



GAS COMPONENTS



ELECTRIC COMPONENTS



WATER TECHNOLOGY



MECHANICAL COMPONENTS



TOOLS

Spare parts suitable for

ACP

Find the complete and up-to-date range of products in our GEV Webshop



Manufacturer catalogue

The most important spare parts and accessories arranged clearly for every manufacturer

- ✓ Complete product range and all appliance data always up to date in the GEV Webshop
- ✓ Alphabetical Index at the end of the catalogue

GEV Webshop

www.gev-online.co.uk

www.gev-online.com





- 🔍 Add to Favourites
- 🔍 Sign In with email address and usual password
- 🔍 Easy-order – place several items in your basket at the same time
- 🔍 Quick Item search – no login needed



heating elements

heating elements for microwaves

			
1			
GEV No.	419193	Ref. No.	59002125
description	heating element 2000W 208V heating circuits 1 L 330mm W 25mm flange length 82mm flange width 45mm hole distance 67mm connection male faston 6.3mm		
For models:	AXP20-P1333601M, AXP20-P1333602M, AXP5201-P1333603M, AXP5203-P1333608M, MXP5201-P1333604M, MXP5203-P1333609M, MXP5221BO-P2001617M, MXP5221-P2001606M, MXP5223-P2001607M, MXP5223TL-P2001620M		

			
1			
GEV No.	420488	Ref. No.	59134374
description	heating element 2700W 230V heating circuits 2 L 265mm W 247mm flange length 80mm flange width 25mm hole distance 70mm tube ø 7.5mm hole ø 3mm		
For models:	JET5192-P2002710M, JET519V2-P2002711M		

			
1			
GEV No.	419199	Ref. No.	12002874
description	heating element 3000W 208V heating circuits 1 L 415mm W 320mm flange lengthmm flange widthmm hole distancemm connection male faston 6.3mm tube ø 10.8mm thread 5/8" mounting pos. lower for microwave		
For models:	AXP20-P1333601M, AXP20-P1333602M, AXP5201-P1333603M, AXP5203-P1333608M, MXP5201-P1333604M, MXP5203-P1333609M, MXP5221BO-P2001617M, MXP5221-P2001606M, MXP5223-P2001607M, MXP5223TL-P2001620M		

heating elements for convection

			
1			
GEV No.	419198	Ref. No.	12000102 12000107
description	heating element 2200W 230V heating circuits 2 L 260mm W 245mm H 28mm flange length 83mm flange width 28mm hole distance 35/35mm connection male faston 6.3mm tube ø 6.5mm for micro-wave		
For models:	UCA2000NT3-P1332921M, UCA2000NT3-P2000406M		

			
1			
GEV No.	419192	Ref. No.	59002082 59004076
description	heating element 2700W 208V heating circuits 2 L 260mm W 245mm H 28mm flange length 83mm flange width 28mm hole distance 35/35mm connection male faston 6.3mm tube ø 6.5mm for micro-wave		
For models:	ACE14-P1333201M, ACE14-P1333206M, ACE14-P2000401M, ACE14-P2001901M, ACE14-P2001909M, ACE5140-P1333203M, ACE5140-P1333207M, ACE5140-P2000403M, DS1400E-P1333204M, DS1400E-P2000404M, DS1400E-P2001904M, DS1400E-P2001912M, MCE14-P2000407M, MCE14-P2001902M, MCE14-P2001910M, UCA1400-P1333205M, UCA1400-P2000405M, UCA1400-P2001906M, UCA1400-P2001913M		

thermostats

bi-metal thermostats

safety bi-metal thermostats

			
1			
GEV No.	698920	Ref. No.	14159097
description	service kit hole distancemm switch-off temp.°C 1NC 1-pole 10A 220V connection adhesive tape starting temperature°C starting temperature°F probe Lmm probe ømm for microwaves Qty 1 pcs JET514/JET5192/JET5193/JET519V2+V3/PCJET514C		

bi-metal thermostats



GEV No.	390950	Ref. No.	54127037
description	temperature limiter hole distance 23.5mm switch-off temp. 100°C 1NC 10A 240V connection F6.3 2 hole fixing cavity Qty 1 pcs KSD1XT2		
For models:	MCS10DSE-P2002404M, MCS10TS-P2002403M, RCS10TS-P2002401M, RCS511DSE-P2002406M, RCS511TS-P2002405M		



GEV No.	390948	Ref. No.	58101029 58101030
description	temperature limiter hole distance 23.5mm switch-off temp. 110°C 1NC 10A 240V connection F6.3 2 hole fixing cavity Qty 1 pcs GKSD201110		
For models:	MMS10TS-P2001217M, RMS10TS-P2001203M, RMS10TS-P2001209M, RMS510D-P2001204M, RMS510D-P2001210M, RMS510T-P2001205M, RMS510T-P2001211M		



GEV No.	390947	Ref. No.	53001817 R9900321
description	temperature limiter hole distance 23.5mm switch-off temp. 110°C 1NC 10A 240V connection F6.3 2 hole fixing cavity Qty 1 pcs KSD-1W03110		
For models:	DFS11EA-P1330220M, MFS18TS-P2001008M, RCS511A-P1330214M, RFS12MPSB-P1330235M, RFS12TSW-P2001001M, RFS18MPS-P1330209M, RFS18MPS-P2000703M, RFS18TS-P2001003M, RFS511SW2A-P1330223M, RFS511TSW13-P2001010M, RFS511TSW13-P2001012M, RFS511TSW-P2001005M, RFS511T-SW-P2001011M, RFS518TS-P2001004M, UCS11MA-P1330228M, URC511A-P1330226M		



GEV No.	390945	Ref. No.	53001561
description	temperature limiter hole distance 23.5mm switch-off temp. 110°C 1NC 10A 240V connection F6.3 2 hole fixing Qty 1 pcs PW-3N 8051 11070		
For models:	DFS18E-P1330222M, RCS10DA-P1330201M, RCS10DA-P2000702M, RCS10MPA-P1330202M, RCS10MPA-P2000704M, RFS12MP-SA-P1330206M, RFS518S-P1330216M, URF5518S-P1330227M		



GEV No.	390937	Ref. No.	B5684119
description	temperature limiter hole distance 23.5mm switch-off temp. 113°C 1NC 10A 240V connection F6.3 2 hole fixing starting temperature 66°C starting temperature 150°F Qty 1 pcs 36TX21-10729 235°F		
For models:	ACE5302-P1331307M, ACE5302-P1332907M, ACE5302-P1332912M, ACE5302-P1332914M, DS30E2-P1331309M, DS30E2-P1332909M, DS30E2-P1332916M, UCA2000NT3-P1332921M, UCA2000NT3-P2000406M		





GEV No.	390938	Ref. No.	B5684121
description	temperature limiter hole distance 23.5mm switch-off temp. 138°C 1NC 10A 240V connection F6.3 2 hole fixing starting temperature 82°C starting temperature 180°F Qty 1 pcs 36TX21-10970 280°F		
For models:	ACE14-P1333201M, ACE14-P1333206M, ACE14-P2000401M, ACE14-P2001901M, ACE14-P2001909M, ACE5140-P1333203M, ACE5140-P1333207M, ACE5140-P2000403M, DEC11E2-P1331213M, DEC14E2-P1331217M, DEC18E2-P1331221M, DEC21E2-P1331226M, DS1400E-P1333204M, DS1400E-P2000404M, DS1400E-P2001904M, DS1400E-P2001912M, HDC12A2-P1331203M, HDC12A2-P1333101M, HDC12A2-P2001401M, HDC12A2-P2001501M, HDC12A2-P2002201M, HDC12A-P1323002M, HDC12A-P1323012M, HDC12A-P1330503M, HDC12P2-P1331223M, HDC182-P1331204M, HDC182-P1333102M, HDC182-P2001403M, HDC182-P2001503M, HDC182-P2002203M, HDC18SD2-P1331205M, HDC18SD2-P1333103M, HDC-18SD2-P2001405M, HDC18SD2-P2001505M, HDC18SD2-P2002205M, HDC212-P1331207M, HDC212-P1333105M, HDC212-P2001407M, HDC212-P2001507M, HDC212-P2002207M, HDC5112-P1331211M, HDC5142-P1331215M, HDC5182-P1331219M, HDC518-P1325209M, HDC518-P1330518M, HDC5212-P1331224M, MCE14-P2000407M, MCE14-P2001902M, MCE14-P2001910M, MCHDC21-P1333130M... (Other models you can see in the webshop)		





GEV No.	390939	Ref. No.	B5684129
description	temperature limiter hole distance 23.5mm switch-off temp. 138°C 1NC 10A 240V connection F6.3 2 hole fixing starting temperature 82°C starting temperature 180°F Qty 1 pcs 36TXVE21-21171 280°F		
For models:	DEC11E2-P1331235M, DEC11E2-P1333111M, DEC11E2-P2001412M, DEC11E2-P2001514M, DEC11E2-P2002223M, DEC14E2-P1331239M, DEC14E2-P1333115M, DEC14E2-P2001413M, DEC14E2-P2001515M, DEC14E2-P2002214M, DEC18E2-P1331243M, DEC18E2-P1333119M, DEC18E2-P2001414M, DEC18E2-P2001516M, DEC18E2-P2002215M, DEC21E2-P1331247M, DEC21E2-P1333123M, DEC21E2-P2001415M, DEC21E2-P2001517M, DEC21E2-P2002216M, HDC5112-P1331233M, HDC5112-P1333109M, HDC5142-P1331237M, HDC5142-P1333113M, HDC5182-P1331241M, HDC5182-P1333117M, HDC5212-P1331245M, HDC5212-P1333121M, UC11E2-P1331236M, UC11E2-P1333112M, UC14E2-P1331240M, UC14E2-P1333116M, UC18E2-P1331244M, UC18E2-P1333120M, UHDC5112-P1331234M, UHDC5112-P1333110M, UHDC5142-P1331238M, UHDC5142-P1333114M, UHDC5182-P1331242M, UHDC5182-P1333118M		





			
GEV No.	390944	Ref. No.	B5684124 B5684130
description	temperature limiter hole distance 23.5mm switch-off temp. 148.9°C 1NC 10A 250V connection F6.3 2 hole fixing starting temperature 43°F Qty 1 pcs 36TX21-13152 300°F		
For models:	AXP20-P1333601M, AXP20-P1333602M, AXP20-P1333605M, AXP5201-P1333603M, AXP5203-P1333608M, JET5192-P2002710M, JET519V2-P2002711M, MOC5241-P2000303M, MRC1752-P1333417M, MRC1752-P2001802M, MRC1752-P2001814M, MRC1752-P2001824M, MRC2252-P1333418M, MRC2252-P2001817M, MRC3052-P2001812M, MRC524TS2-P1331432M, MRC524TS2-P1333415M, MXP5201-P1333604M, MXP5203-P1333609M, MXP5221BO-P2001617M, MXP5221-P2001606M, MXP5223-P2001607M, MXP5223TL-P2001620M, OC5241BK-P2000304M, RC1752-P1331401M, RC1752-P1332801M, RC1752-P1333401M, RC1752-P2001801M, RC1752-P2001813M, RC1752-P2001823M, RC2252-P1331403M, RC2252-P1332804M, RC2252-P1333404M, RC2252-P2001804M, RC2252-P2001816M, RC225-P1326303M, RC225-P1329103M, RC225-P1329610M, RC225-P1330104M, RC3052-P1331415M, RC3052-P1332816M, RC3052-P1333410M, RC3052-P2001811M, RC524TS2-P1331430M, RC524TS2-P1333414M		

			
GEV No.	390946	Ref. No.	R9900542
description	temperature limiter hole distance 23.5mm switch-off temp. 62.8°C 1NC 10A 240V connection F6.3 2 hole fixing starting temperature 60°F Qty 1 pcs KS-2N Z158 145°F		
For models:	DFS11EA-P1330220M, RCS511A-P1330214M, RFS511S-W2A-P1330223M, UCS11MA-P1330228M, URCS511A-P1330226M		

			
GEV No.	390935	Ref. No.	31866P01
description	temperature limiter hole distance 23.5mm switch-off temp. 149°C 1NC 10A 240V connection F6.3 2 hole fixing starting temperature 143°C starting temperature 257°F Qty 1 pcs 300°F		
For models:	ACE14-P1333201M, ACE14-P1333206M, ACE14-P2000401M, ACE14-P2001901M, ACE14-P2001909M, ACE5140-P1333203M, ACE5140-P1333207M, ACE5140-P2000403M, ACE5302-P1332912M, ACE5302-P1332914M, DS1400E-P1333204M, DS1400E-P2000404M, DS1400E-P2001904M, DS1400E-P2001912M, DS30E2-P1332916M, JET5192-P2002710M, JET519V2-P2002711M, MCE14-P2000407M, MCE14-P2001902M, MCE14-P2001910M, UCA1400-P1333205M, UCA1400-P2000405M, UCA1400-P2001906M, UCA1400-P2001913M, UCA2000NT3-P1332921M, UCA2000NT3-P2000406M		

			
GEV No.	390942	Ref. No.	54116023 56001432
description	temperature limiter hole distance 23.5mm switch-off temp. 66°C 1NC 10A 240V connection F4.8 2 hole fixing Qty 1 pcs KSD1 WR3 150°F		
For models:	ALD10D-P1331011M, ALD10D-P1331019M, ALD10T-P1331002M, ALD10T-P1331018M, ALD510D-P1331003M, ALD510-P1331005M, ALD510SE-P1331012M, MCS10DS-P2001104M, MCS-10DS-P2001110M, MCS10TS-P2001103M, MCS10TS-P2001109M, MFS18TS-P2001008M, MLD510D-P1331007M, MLD510-P1331009M, MLD510SE-P1331014M, RCS10DS-P2001102M, RCS10DS-P2001108M, RCS10TS-P2001101M, RCS10TS-P2001107M, RCS511DS-P2001106M, RCS511DS-P2001112M, RCS511TS-P2001105M, RCS511TS-P2001111M, RFS12TSW-P2001001M, RFS18TS-P2001003M, RFS518TS-P2001004M, UALD510-P1331006M, UALD510SE-P1331013M, UMLD510D-P1331008M, UMLD510-P1331010M, UMLD-510SE-P1331015M		

			
GEV No.	390949	Ref. No.	54127038
description	temperature limiter hole distance 23.5mm switch-off temp. 150°C 1NC 10A 240V connection F6.3 2 hole fixing magnetron Qty 1 pcs KSD1WT3150/		
For models:	MCS10DSE-P2002404M, MCS10TS-P2002403M, RCS10TS-P2002401M, RCS511DSE-P2002406M, RCS511TS-P2002405M		

			
GEV No.	390936	Ref. No.	B5684102
description	temperature limiter hole distance 23.5mm switch-off temp. 71°C 1NO 10A 240V connection F6.3 2 hole fixing starting temperature 69°C starting temperature 125°F Qty 1 pcs 36TX22-3476 160°F		
For models:	ACE5302-P1331307M, ACE5302-P1332907M, ACE5302-P1332912M, ACE5302-P1332914M, DS30E2-P1331309M, DS30E2-P1332909M, DS30E2-P1332916M, UCA2000NT3-P1332921M, UCA2000NT3-P2000406M		

			
GEV No.	390951	Ref. No.	53002034 R9900097
description	temperature limiter hole distance 23.5mm switch-off temp. 62.8°C 1NC 10A 240V connection F6.3 2 hole fixing starting temperature 60°C magnetron Qty 1 pcs KSD1UQ3 145°F		
For models:	DEL10D-P1329706M, DEL10E-P1329707M, LD10D2-P1329702M, LD10MP-P1329703M, LD10MP-P2000701M, LD510D-P1329704M, LD510P-P1329705M, RFS12MPSB-P1330235M		

			
GEV No.	390940	Ref. No.	B5684123
description	temperature limiter hole distance 23.5mm switch-off temp. 81°C 1NC 10A 240V connection F6.3 2 hole fixing Qty 1 pcs 1NT01L-3827 177°F		
For models:	ACE5140-P1333203M, ACE5140-P1333207M, ACE5140-P2000403M, ACE5302-P1331307M, ACE5302-P1332912M, ACE5302-P1332914M, DS1400E-P1333204M, DS1400E-P2000404M, DS1400E-P2001904M, DS1400E-P2001912M, DS30E2-P1331309M, DS30E2-P1332916M, JET5192-P2002710M, JET519V2-P2002711M, UCA1400-P1333205M, UCA1400-P2000405M, UCA1400-P2001906M, UCA1400-P2001913M, UCA2000NT3-P1332921M, UCA2000NT3-P2000406M		



			
1			
GEV No.	390941	Ref. No.	56001426
description	temperature limiter hole distance 23.5mm switch-off temp. 85°C 1NC 10A 240V connection F4.8 2 hole fixing Qty 1 pcs KSD 185°F		
For models:	ALD10D-P1331011M, ALD10D-P1331019M, ALD10T-P1331002M, ALD10T-P1331018M, ALD510D-P1331003M, ALD510-P1331005M, ALD510SE-P1331012M, MCS10DS-P2001104M, MCS10DS-P2001110M, MCS10TS-P2001103M, MCS10TS-P2001109M, MLD510D-P1331007M, MLD510-P1331009M, MLD-510SE-P1331014M, RCS10DS-P2001102M, RCS10DS-P2001108M, RCS10TS-P2001101M, RCS10TS-P2001107M, RCS511DS-P2001106M, RCS511DS-P2001112M, RCS511TS-P2001105M, RCS511TS-P2001111M, UALD510-P1331006M, UALD510SE-P1331013M, UMLD510D-P1331008M, UMLD510-P1331010M, UMLD-510SE-P1331015M		

switches and momentary switches

microswitches

pin-plunger actuated

			
1			
GEV No.	348015	Ref. No.	56001036
description	microswitch with plunger 250V 16A 1NO connection male faston 4.8mm ambient temperature max. 120°C mounting distance 22mm type A2730R FD-63 actuating force: 120g black		
For models:	MMS10TS-P2001217M, RMS10TS-P2001203M, RMS10TS-P2001209M, RMS510D-P2001204M, RMS510D-P2001210M, RMS510T-P2001205M, RMS510T-P2001211M		

M12

			
1			
GEV No.	348014	Ref. No.	59002121
description	microswitch rectangular mounting distance 24mm thread M12 thread L 12mm 240V 1A 1CO connection male faston 6.3mm stroke 7mm L 49mm ambient temperature max. 125°C type BZ-2RQ17223528-06 actuating force: 200g		
For models:	AXP20-P1333601M, AXP20-P1333602M, AXP20-P1333605M, AXP5201-P1333603M, AXP5203-P1333608M, MXP5201-P1333604M, MXP5203-P1333609M, MXP5221BO-P2001617M, MXP5221-P2001606M, MXP5223-P2001607M, MXP5223TL-P2001620M		

door lock switches

			
1			
GEV No.	347991	Ref. No.	53001600 53002030 54116036
description	switch kit for microwave		
For models:	DFS18E-P1330222M, RFS18MPS-P1330209M, RFS18MPS-P2000703M, RFS511TSW13-P2001010M, RFS511TSW13-P2001012M, RFS511T-SW-P2001005M, RFS511TSW-P2001011M, RFS518S-P1330216M, RFS518TS-P2001004M, URF5518S-P1330227M		

			
1			
GEV No.	347992	Ref. No.	54127052
description	switch kit for microwave		
For models:	RCS511DSE-P2002406M, RCS511TS-P2002405M		

			
1			
GEV No.	347999	Ref. No.	12002517 14090023 53001601 53002001
description	switch kit for microwave		
For models:	DFS11EA-P1330220M, RCS10DA-P1330201M, RCS-10DA-P2000702M, RCS10MPA-P1330202M, RCS10MPA-P2000704M, RCS511A-P1330214M, RFS12MPSA-P1330206M, RFS511S-W2A-P1330223M, UCS11MA-P1330228M, URF5511A-P1330226M		





			
1			
GEV No.	348001	Ref. No.	12538901Q 59002018 59002060 59114167
description	switch kit for microwave		
For models:	DEC11E2-P1331213M, DEC11E2-P1331235M, DEC11E2-P1333111M, DEC11E2-P2001412M, DEC11E2-P2001514M, DEC11E2-P2002223M, DEC14E2-P1331217M, DEC14E2-P1331239M, DEC14E2-P1333115M, DEC14E2-P2001413M, DEC14E2-P2001515M, DEC14E2-P2002214M, DEC18E2-P1331221M, DEC18E2-P1331243M, DEC18E2-P1333119M, DEC18E2-P2001414M, DEC18E2-P2001516M, DEC18E2-P2002215M, DEC21E2-P1331226M, DEC21E2-P1331247M, DEC21E2-P1333123M, DEC21E2-P2001415M, DEC21E2-P2001517M, DEC21E2-P2002216M, HDC12A2-P1331203M, HDC12A2-P1333101M, HDC12A2-P2001401M, HDC12A2-P2001501M, HDC12A2-P2002201M, HDC12A-P1323012M, HDC12A-P1330503M, HDC12P2-P1331223M, HDC182-P1331204M, HDC182-P1333102M, HDC182-P2001403M, HDC182-P2001503M, HDC182-P2002203M, HDC18SD2-P1331205M, HDC-18SD2-P1333103M, HDC18SD2-P2001405M, HDC18SD2-P2001505M, HDC18SD2-P2002205M, HDC212-P1331207M, HDC212-P1333105M, HDC212-P2001407M, HDC212-P2001507M, HDC212-P2002207M, HDC5112-P1331211M, HDC5112-P1331233M, HDC5112-P1333109M...(Other models you can see in the webshop)		

			
2			
GEV No.	348002	Ref. No.	56002011 56002052
description	switch kit for microwave		
For models:	ALD510D-P1331003M, ALD510-P1331005M, ALD510SE-P1331012M, MLD510D-P1331007M, MLD510-P1331009M, MLD510SE-P1331014M, RCS511DS-P2001106M, RCS511DS-P2001112M, RCS511TS-P2001105M, RCS511TS-P2001111M, UALD510-P1331006M, UALD-510SE-P1331013M, UMLD510D-P1331008M, UMLD510-P1331010M, UMLD510SE-P1331015M		

			
1			
GEV No.	348003	Ref. No.	12028008 59002097 R0000277 R0150154
description	switch kit for microwave		
For models:	HDC12A-P1323002M		

			
1			
GEV No.	348009	Ref. No.	12002647 12360503 59001154
description	switch kit for microwave		
For models:	ACE5302-P1331307M, ACE5302-P1332907M, ACE5302-P1332912M, ACE5302-P1332914M, DS30E2-P1331309M, DS30E2-P1332909M, DS30E2-P1332916M, MRC518SU2-P1332832M, MRC524TS2-P1331432M, MRC524TS2-P1333415M, RC524TS2-P1331430M, RC524TS2-P1333414M, RCS511-P1325802M, RCS511-P1327809M		

			
1			
GEV No.	348010	Ref. No.	12002636 12028001 12028002 12028003 12028201Q 12077501 12360504 12360506 59001114 R0000196
description	switch kit for microwave		
For models:	ACE14-P1333201M, ACE14-P1333206M, ACE14-P2000401M, MCE14-P2000407M, MRC17S2-P1333417M, MRC22S2-P1333418M, MRC518SU2-P1332818M, RC17S2-P1331401M, RC17S2-P1332801M, RC17S2-P1333401M, RC22S2-P1331403M, RC22S2-P1332804M, RC22S2-P1333404M, RC22S-P1326303M, RC22S-P1329103M, RC22S-P1329610M, RC22S-P1330104M, RC30S2-P1331415M, RC30S2-P1332816M, RC30S2-P1333410M, RC518SU-P1327602M, RC520S-P1327601M		

			
1			
GEV No.	348011	Ref. No.	10985002 12002862 R0150155
description	switch kit for microwave		
For models:	RC22S-P1198605M		



			
1			
GEV No.	348012	Ref. No.	59114157
description	switch kit for microwave		
For models:	ACE14-P2001901M, ACE14-P2001909M, DS1400E-P2001904M, DS1400E-P2001912M, MCE14-P2001902M, MCE14-P2001910M, MRC17S2-P2001802M, MRC17S2-P2001814M, MRC17S2-P2001824M, MRC22S2-P2001817M, MRC30S2-P2001812M, RC17S2-P2001801M, RC17S2-P2001813M, RC17S2-P2001823M, RC22S2-P2001804M, RC22S2-P2001816M, RC30S2-P2001811M, UCA1400-P2001906M, UCA1400-P2001913M		

			
1			
GEV No.	347998	Ref. No.	14090030 14119060
description	switch kit with relay and fuse F1 for microwave		
For models:	AXP20-P1333601M, AXP20-P1333602M, AXP20-P1333605M, AXP5201-P1333603M, AXP5203-P1333608M, MXP5221BO-P2001617M, MXP5221-P2001606M, MXP5223-P2001607M, MXP5223TL-P2001620M		

lamps

LED

LED lamps

			
1			
GEV No.	357236	Ref. No.	59154464
description	LED lamp socket E14 240V 3W L 53mm light colour 4000K		

screw-on/push-on fit

light bulbs

for lighting

			
1			
GEV No.	357219	Ref. No.	59002101 67002552
description	light bulb t.max. 300°C socket E27 250V 40W ø 47mm L 88mm lens L 62mm matt finish Qty 1 pcs		
For models:	ACE5302-P1331307M, ACE5302-P1332907M, ACE5302-P1332912M, ACE5302-P1332914M, DS30E2-P1331309M, DS30E2-P1332909M, DS30E2-P1332916M, MRC17S2-P2001802M, MRC518SU2-P1332818M, MRC518SU2-P1332832M, MRC524TS2-P1331432M, MRC524TS2-P1333415M, RC17S2-P2001801M, RC22S2-P2001804M, RC518SU-P1327602M, RC520S-P1327601M, RC524TS2-P1331430M, RC524TS2-P1333414M		

microwave lamps

LED lamps

			
1			
GEV No.	357236	Ref. No.	59154464
description	LED lamp socket E14 240V 3W L 53mm light colour 4000K		

lamps (complete)

			
1			
GEV No.	358149	Ref. No.	53001591 53001832 54116027
description	lamp socket E14 250V 75W ø 25mm L 125mm Qty 1 pcs		
For models:	DFS11EA-P1330220M, DFS18E-P1330222M, MFS18TS-P2001008M, RCS511A-P1330214M, RFS18MPS-P1330209M, RFS18MPS-P2000703M, RFS18TS-P2001003M, RFS511SW2A-P1330223M, RFS511TSW13-P2001010M, RFS511TSW13-P2001012M, RFS511TSW-P2001005M, RFS511TSW-P2001011M, RFS518S-P1330216M, RFS518TS-P2001004M, UCS11MA-P1330228M, URC5511A-P1330226M, URF5518S-P1330227M		

			
1			
GEV No.	357221	Ref. No.	56001463 56002007 58101024 R9900548
description	light bulb socket flange 52x27mm 240V 25W ø 25mm L 62mm Qty 1 pcs		
For models:	ALD510D-P1331003M, ALD510-P1331005M, ALD510SE-P1331012M, DEL10D-P1329706M, DEL10E-P1329707M, LD510D-P1329704M, LD510P-P1329705M, MLD510D-P1331007M, MLD510-P1331009M, MLD510SE-P1331014M, RCS511DSE-P2002406M, RCS511DS-P2001106M, RCS511DS-P2001112M, RCS511TS-P2001105M, RCS511TS-P2001111M, RCS511TS-P2002405M, RMS510D-P2001204M, RMS510D-P2001210M, RMS510T-P2001205M, RMS510T-P2001211M, UALD510-P1331006M, UALD510SE-P1331013M, UMLD510D-P1331008M, UMLD510-P1331010M, UMLD510SE-P1331015M		

sockets			
 <p>1</p>			
GEV No.	360597	Ref. No.	12163801 12163802
description	lamp socket socket E14 250V ø 27mm L 44mm H 35mm connection male faston 6.3mm mounting distance 8mm for microwave 22 cable length 300mm Qty 1 pcs 75W		
For models:	DEC11E2-P1331213M, DEC11E2-P1331235M, DEC11E2-P1333111M, DEC11E2-P2001412M, DEC11E2-P2001514M, DEC11E2-P2002223M, DEC14E2-P1331217M, DEC14E2-P1331239M, DEC14E2-P1333115M, DEC14E2-P2001413M, DEC14E2-P2001515M, DEC14E2-P2002214M, DEC18E2-P1331221M, DEC18E2-P1331243M, DEC18E2-P1333119M, DEC18E2-P2001414M, DEC18E2-P2001516M, DEC18E2-P2002215M, DEC21E2-P1331226M, DEC21E2-P1331247M, DEC21E2-P1333123M, DEC21E2-P2001415M, DEC21E2-P2001517M, DEC21E2-P2002216M, HDC12P2-P1331223M, HDC5112-P1331211M, HDC5112-P1331233M, HDC5112-P1333109M, HDC5142-P1331215M, HDC5142-P1331237M, HDC5142-P1333113M, HDC5182-P1331219M, HDC5182-P1331241M, HDC5182-P1333117M, HDC518-P1325209M, HDC518-P1330518M, HDC5212-P1331224M, HDC5212-P1331245M, HDC5212-P1333121M, UC11E2-P1331214M, UC11E2-P1331236M, UC11E2-P1333112M, UC14E2-P1331218M, UC14E2-P1331240M, UC14E2-P1333116M, UC18E2-P1331222M, UC18E2-P1331244M, UC18E2-P1333120M, UHDC5112-P1331212M, UHDC5112-P1331234M...(Other models you can see in the webshop)		

light bulbs			
 <p>1</p>			
GEV No.	357238	Ref. No.	59002146
description	light bulb socket E14 130V 25W ø 25mm L 65mm Qty 1 pcs		
For models:	HDC12A2-P2001401M, HDC12A2-P2001501M, HDC12A2-P2002201M, MCHDC21-P1333130M, MDC12A2-P1333127M, MD-C12A2-P2001402M, MDC12A2-P2001502M, MDC12A2-P2002202M, MDC182-P1333128M		

 <p>1</p>			
GEV No.	357220	Ref. No.	53001590 54116028
description	light bulb socket E14 240V 20W ø 25mm L 40mm Qty 1 pcs		
For models:	DFS11EA-P1330220M, DFS18E-P1330222M, MFS18TS-P2001008M, RCS511A-P1330214M, RFS18MPS-P1330209M, RFS18MPS-P2000703M, RFS18TS-P2001003M, RFS511SW2A-P1330223M, RFS511TSW13-P2001010M, RFS511TSW13-P2001012M, RFS511TSW-P2001005M, RFS511TSW-P2001011M, RFS518S-P1330216M, RFS518TS-P2001004M, UCS11MA-P1330228M, URC-S511A-P1330226M, URF5518S-P1330227M		

 <p>1</p>			
GEV No.	357222	Ref. No.	46536P01 59002071 M0360402
description	light bulb socket E14 240V 25W ø 24.8mm L 81.5mm Qty 1 pcs		
For models:	DEC11E2-P1331213M, DEC11E2-P1331235M, DEC11E2-P1333111M, DEC11E2-P2001412M, DEC11E2-P2001514M, DEC11E2-P2002223M, DEC14E2-P1331217M, DEC14E2-P1331239M, DEC14E2-P1333115M, DEC14E2-P2001413M, DEC14E2-P2001515M, DEC14E2-P2002214M, DEC18E2-P1331221M, DEC18E2-P1331243M, DEC18E2-P1333119M, DEC18E2-P2001414M, DEC18E2-P2001516M, DEC18E2-P2002215M, DEC21E2-P1331226M, DEC21E2-P1331247M, DEC21E2-P1333123M, DEC21E2-P2001415M, DEC21E2-P2001517M, DEC21E2-P2002216M, HDC12P2-P1331223M, HDC5112-P1331211M, HDC5112-P1331233M, HDC5112-P1333109M, HDC5142-P1331215M, HDC5142-P1331237M, HDC5142-P1333113M, HDC5182-P1331219M, HDC5182-P1331241M, HDC5182-P1333117M, HDC518-P1325209M, HDC518-P1330518M, HDC5212-P1331224M, HDC5212-P1331245M, HDC5212-P1333121M, UC11E2-P1331214M, UC11E2-P1331236M, UC11E2-P1333112M, UC14E2-P1331218M, UC14E2-P1331240M, UC14E2-P1333116M, UC18E2-P1331222M, UC18E2-P1331244M, UC18E2-P1333120M, UHDC5112-P1331212M, UHDC5112-P1331234M...(Other models you can see in the webshop)		

timers

electric timers

 <p>1</p>			
GEV No.	350212	Ref. No.	56001458
description	timer NT10MKD01E-P with bell operation time 10min time spread-min 1NC permanent position no shaft ø 6x4.6mm shaft 6x4.6mm shaft L 24mm for microwave 2-pole		
For models:	ALD510D-P1331003M, MLD510D-P1331007M, RCS-511DS-P2001106M, RCS511DS-P2001112M, UMLD510D-P1331008M		



contactors

miscellaneous

RC circuits



GEV No.	403433	Ref. No.	10172901 10172901Q 10172902 10172902Q 10172903Q 59002017 B8329402 B8329403
description	RC circuit type CRD 600V 50/60Hz conductor 2 connection male faston 6.3mm plastic Qty 1 pcs		
For models:	ACE14-P2001901M, ACE14-P2001909M, ACE5302-P1331307M, ACE5302-P1332907M, ACE5302-P1332912M, ACE5302-P1332914M, AXP20-P1333601M, AXP20-P1333602M, AXP20-P1333605M, AXP5201-P1333603M, AXP5203-P1333608M, DEC11E2-P1331213M, DEC11E2-P1331235M, DEC11E2-P1333111M, DEC14E2-P1331217M, DEC14E2-P1331239M, DEC14E2-P1333115M, DEC18E2-P1331221M, DEC18E2-P1331243M, DEC18E2-P1333119M, DEC21E2-P1331226M, DEC21E2-P1331247M, DEC21E2-P1333123M, DS1400E-P2001904M, DS1400E-P2001912M, DS30E2-P1331309M, DS30E2-P1332909M, DS30E2-P1332916M, HDC12A2-P1331203M, HDC12A2-P1333101M, HDC12A-P1330503M, HDC12P2-P1331223M, HDC182-P1331204M, HDC182-P1333102M, HDC18SD2-P1331205M, HDC18SD2-P1333103M, HDC212-P1331207M, HDC212-P1333105M, HDC5112-P1331211M, HDC5112-P1331233M, HDC5112-P1333109M, HDC5142-P1331215M, HDC5142-P1331237M, HDC5142-P1333113M, HDC5182-P1331219M, HDC5182-P1331241M, HDC5182-P1333117M, HDC518-P1332509M, HDC518-P1330518M, HDC5212-P1331224M... (Other models you can see in the webshop)		

solid state relays

accessories

diodes

high voltage diodes



GEV No.	358163	Ref. No.	12173701 12372701 R9800022
description	hv diode type 2x HV05-12 F25 connection F6.3mm / lug M4 cable length 500mm for microwave with holder Qty 1 pcs		
For models:	ACE14-P1333201M, ACE14-P1333206M, ACE14-P2000401M, ACE14-P2001901M, ACE14-P2001909M, ACE5140-P1333203M, ACE5140-P1333207M, ACE5140-P2000403M, DEC14E2-P1331217M, DEC14E2-P1331239M, DEC14E2-P1333115M, DEC18E2-P1331221M, DEC18E2-P1331243M, DEC18E2-P1333119M, DEC21E2-P1331226M, DEC21E2-P1331247M, DEC21E2-P1333123M, DS1400E-P1333204M, DS1400E-P2000404M, DS1400E-P2001904M, DS1400E-P2001912M, HDC12A2-P1331203M, HDC12A2-P1333101M, HDC12A-P1323002M, HDC12A-P1323012M, HDC12A-P1330503M, HDC12P2-P1331223M, HDC182-P1331204M, HDC182-P1333102M, HDC18SD2-P1331205M, HDC18SD2-P1333103M, HDC212-P1331207M, HDC212-P1333105M, HDC5142-P1331215M, HDC5142-P1331237M, HDC5142-P1333113M, HDC5182-P1331219M, HDC5182-P1331241M, HDC5182-P1333117M, HDC518-P1332509M, HDC518-P1330518M, HDC5212-P1331224M, HDC5212-P1331245M, HDC5212-P1333121M, MCE14-P2000407M, MCE14-P2001902M, MCE14-P2001910M, MCHDC21-P1333130M, MDC12A2-P1333127M, MDC182-P1333128M... (Other models you can see in the webshop)		



GEV No.	358161	Ref. No.	10649001 53001210
description	hv diode type 2X062+HVR-1X connection F6.3mm / lug M4 cable lengthmm for microwave		
For models:	DEL10D-P1329706M, DEL10E-P1329707M, DFS11EA-P1330220M, LD510D-P1329704M, LD510P-P1329705M, RCS511A-P1330214M, RCS511-P1325802M, RCS511-P1327809M, RFS511SW2A-P1330223M, URC511A-P1330226M		





GEV No.	358158	Ref. No.	20036801 53001583 R9800486
description	hv diode type HV03-12 F26 connection F6.3mm / lug M4 cable lengthmm for microwave Qty 1 pcs		
For models:	DFS11EA-P1330220M, DFS18E-P1330222M, LD10D2-P1329702M, LD10MP-P1329703M, LD10MP-P2000701M, MCS10DSE-P2002404M, MCS10TS-P2002403M, RCS10DA-P1330201M, RCS10DA-P2000702M, RCS10MPA-P1330202M, RCS10MPA-P2000704M, RCS10TS-P2002401M, RCS511A-P1330214M, RCS511DSE-P2002406M, RCS511TS-P2002405M, RFS12MPSA-P1330206M, RFS12MPSB-P1330235M, RFS12TSW-P2001001M, RFS18MPS-P1330209M, RFS18MPS-P2000703M, RFS511SW2A-P1330223M, RFS511T-SW13-P2001010M, RFS511TSW13-P2001012M, RFS511T-SW-P2001005M, RFS511TSW-P2001011M, RFS518S-P1330216M, RFS518TS-P2001004M, UCS11MA-P1330228M, URC-S511A-P1330226M, URF518S-P1330227M		



GEV No.	358159	Ref. No.	56001436
description	hv diode type HV03-12 F27 connection F4.8mm / lug M4 cable lengthmm for microwave		
For models:	ALD10D-P1331011M, ALD10D-P1331019M, ALD10T-P1331002M, ALD10T-P1331018M, ALD510D-P1331003M, ALD510-P1331005M, ALD510SE-P1331012M, MCS10DS-P2001104M, MCS-10DS-P2001110M, MCS10TS-P2001103M, MCS10TS-P2001109M, MLD510D-P1331007M, MLD510-P1331009M, MLD510SE-P1331014M, MMS10TS-P2001217M, RCS10DS-P2001102M, RCS10DS-P2001108M, RCS10TS-P2001101M, RCS10TS-P2001107M, RCS511DS-P2001106M, RCS511DS-P2001112M, RCS511TS-P2001105M, RCS511TS-P2001111M, RMS10TS-P2001203M, RMS10TS-P2001209M, UALD510-P1331006M, UALD510SE-P1331013M, UMLD510-P1331008M, UMLD510-P1331010M, UMLD510SE-P1331015M		

			
1			
GEV No.	358160	Ref. No.	13091701 1330000101 59002123 B8383102
description	hv diode type HV05-12 connection F6.3mm / lug M4 cable length-mm for microwave		
For models:	ACE5302-P1331307M, ACE5302-P1332907M, ACE5302-P1332912M, ACE5302-P1332914M, AXP20-P1333601M, AXP20-P1333602M, AXP20-P1333605M, AXP5201-P1333603M, AXP5203-P1333608M, DEC11E2-P1331213M, DEC11E2-P1331235M, DEC11E2-P1333111M, DEC14E2-P1331239M, DEC14E2-P1333115M, DEC18E2-P1331243M, DEC18E2-P1333119M, DEC21E2-P1331247M, DEC21E2-P1333123M, DS30E2-P1331309M, DS30E2-P1332909M, DS30E2-P1332916M, HDC12A2-P1331203M, HDC12A2-P1333101M, HDC182-P1331204M, HDC182-P1333102M, HDC18SD2-P1331205M, HDC18SD2-P1333103M, HDC212-P1331207M, HDC212-P1333105M, HDC5112-P1331211M, HDC5112-P1331233M, HDC5112-P1333109M, HDC5142-P1331237M, HDC5142-P1333113M, HDC5182-P1331241M, HDC5182-P1333117M, HDC5212-P1331245M, HDC5212-P1333121M, JET5192-P2002710M, JET519V2-P2002711M, MCHDC21-P1333130M, MDC12A2-P1333127M, MDC182-P1333128M, MOC5241-P2000303M, MRC17S2-P1333417M, MRC17S2-P2001802M, MRC17S2-P2001814M, MRC17S2-P2001824M, MRC22S2-P1333418M, MRC22S2-P2001817M...(Other models you can see in the webshop)		

			
1			
GEV No.	358167	Ref. No.	58101020
description	hv diode type RG304 suitable for for microwave Qty 1 pcs		
For models:	RMS510D-P2001204M, RMS510D-P2001210M, RMS510T-P2001205M, RMS510T-P2001211M		

			
1			
GEV No.	358162	Ref. No.	20037701 20076101
description	hv diode type TV-20 connection F6.3mm / lug M4 cable length 96mm for microwave		
For models:	DEC11E2-P2001412M, DEC11E2-P2001514M, DEC11E2-P2002223M, DEC14E2-P2001413M, DEC14E2-P2001515M, DEC14E2-P2002214M, DEC18E2-P2001414M, DEC18E2-P2001516M, DEC18E2-P2002215M, DEC21E2-P2001415M, DEC21E2-P2001517M, DEC21E2-P2002216M, HDC12A2-P2001401M, HDC12A2-P2001501M, HDC12A2-P2002201M, HDC182-P2001403M, HDC182-P2001503M, HDC182-P2002203M, HDC18SD2-P2001405M, HDC18SD2-P2001505M, HDC18SD2-P2002205M, HDC212-P2001407M, HDC212-P2001507M, HDC212-P2002207M, MCHDC21-P2001512M, MCHDC21-P2002212M, MDC12A2-P2001402M, MDC12A2-P2001502M, MDC12A2-P2002202M, MDC182-P2001404M, MDC182-P2001504M, MDC182-P2002204M		

relays

power relays

with bracket mounting

			
1			
GEV No.	381252	Ref. No.	12492202 59001981
description	relay OMRON 230VAC 25A 2NO connection male faston 6.3mm bracket mounting at 250V 25A manuf. no. G7L-2A-TUB 230VAC		
For models:	ACE14-P1333201M, ACE14-P1333206M, ACE14-P2000401M, ACE14-P2001901M, ACE14-P2001909M, ACE5140-P1333203M, ACE5140-P1333207M, ACE5140-P2000403M, ACE5302-P1331307M, ACE5302-P1332907M, ACE5302-P1332912M, ACE5302-P1332914M, AXP20-P1333601M, AXP20-P1333602M, AXP20-P1333605M, AXP5201-P1333603M, AXP5203-P1333608M, DS1400E-P1333204M, DS1400E-P2000404M, DS1400E-P2001904M, DS1400E-P2001912M, DS30E2-P1331309M, DS30E2-P1332909M, DS30E2-P1332916M, JET5192-P2002710M, JET519V2-P2002711M, MCE14-P2000407M, MCE14-P2001902M, MCE14-P2001910M, MRC17S2-P1333417M, MRC17S2-P2001802M, MRC17S2-P2001814M, MRC17S2-P2001824M, MRC22S2-P1333418M, MRC22S2-P2001817M, MRC30S2-P2001812M, MRC518SU2-P1332818M, MRC518SU2-P1332832M, MRC524TS2-P1331432M, MRC524TS2-P1333415M, MXP5201-P1333604M, MXP5203-P1333609M, MXP5221BO-P2001617M, MXP5221-P2001606M, MXP5223-P2001607M, MXP5223TL-P2001620M, RC17S2-P1331401M, RC17S2-P1332801M, RC17S2-P1333401M, RC17S2-P2001801M...(Other models you can see in the webshop)		

miscellaneous

			
1			
GEV No.	381251	Ref. No.	14119057
description	relay shroud 250V voltage AC 10A		
For models:	ACE5140-P2000403M, DS1400E-P2000404M, DS1400E-P2001904M, DS1400E-P2001912M, UCA1400-P2000405M, UCA1400-P2001906M, UCA1400-P2001913M		



magnetrons



1

GEV No.	403363	Ref. No.	53001594 53002025
description	Magnetron LG type 2M246-35GKH		
For models:	DFS18E-P1330222M, MFS18TS-P2001008M, RFS12MPSB-P1330235M, RFS12TSW-P2001001M, RFS18MPS-P1330209M, RFS18MPS-P2000703M, RFS18TS-P2001003M, RFS518S-P1330216M, RFS518TS-P2001004M, URFS518S-P1330227M		



1

GEV No.	403362	Ref. No.	59002081
description	Magnetron PANASONIC type 2M262A-01BA		
For models:	ACE14-P1333201M, ACE14-P1333206M, ACE14-P2000401M, ACE14-P2001901M, ACE14-P2001909M, ACE5140-P1333203M, ACE5140-P1333207M, ACE5140-P2000403M, DS1400E-P1333204M, DS1400E-P2000404M, DS1400E-P2001904M, DS1400E-P2001912M, MCE14-P2000407M, MCE14-P2001902M, MCE14-P2001910M, UCA1400-P1333205M, UCA1400-P2000405M, UCA1400-P2001906M, UCA1400-P2001913M		



1

GEV No.	403361	Ref. No.	10489402 59001484 59004010
description	Magnetron TOSHIBA type 2M248H(A)-B 940W		
For models:	ACE5302-P1331307M, ACE5302-P1332907M, ACE5302-P1332912M, ACE5302-P1332914M, AXP20-P1333601M, AXP20-P1333602M, AXP20-P1333605M, AXP5201-P1333603M, AXP5203-P1333608M, DS30E2-P1331309M, DS30E2-P1332909M, DS30E2-P1332916M, JET5192-P2002710M, JET519V2-P2002711M, MRC17S2-P1333417M, MRC17S2-P2001802M, MRC17S2-P2001814M, MRC17S2-P2001824M, MRC22S2-P1333418M, MRC22S2-P2001817M, MRC30S2-P2001812M, MRC524TS2-P1331432M, MRC524TS2-P1333415M, MXP5201-P1333604M, MXP5203-P1333609M, MXP5221BO-P2001617M, MXP5221-P2001606M, MXP5223-P2001607M, MXP5223TL-P2001620M, RC17S2-P1331401M, RC17S2-P1332801M, RC17S2-P1333401M, RC17S2-P2001801M, RC17S2-P2001813M, RC17S2-P2001823M, RC22S2-P1331403M, RC22S2-P1332804M, RC22S2-P1333404M, RC22S2-P2001804M, RC22S2-P2001816M, RC22S-P1326303M, RC22S-P1329103M, RC22S-P1329610M, RC22S-P1330104M, RC30S2-P1331415M, RC30S2-P1332816M, RC30S2-P1333410M, RC30S2-P2001811M, RC518SU-P1327602M, RC520S-P1327601M...(Other models you can see in the webshop)		





1

GEV No.	403371	Ref. No.	2M248H(A) 56001462 56002014
description	Magnetron TOSHIBA type 2M248H(A)-LT 1040W with bolt		
For models:	ALD510D-P1331003M, ALD510-P1331005M, ALD510SE-P1331012M, MLD510D-P1331007M, MLD510-P1331009M, MLD510SE-P1331014M, RCS511DSE-P2002406M, RCS511DS-P2001106M, RCS511DS-P2001112M, RCS511TS-P2001105M, RCS511TS-P2001111M, RCS511TS-P2002405M, UALD510-P1331006M, UALD510SE-P1331013M, UMLD510D-P1331008M, UMLD510-P1331010M, UMLD510SE-P1331015M		



			
1			
GEV No.	403364	Ref. No.	53001193 53002004 R0131296 R9900082
description	Magnetron TOSHIBA type 2M248J		
For models:	DEL10D-P1329706M, DEL10E-P1329707M, LD10D2-P1329702M, LD10MP-P1329703M, LD10MP-P2000701M, LD510D-P1329704M, LD510P-P1329705M, MMS10TS-P2001217M, RCS10DA-P1330201M, RCS10DA-P2000702M, RCS10MPA-P1330202M, RCS10M-PA-P2000704M, RMS10TS-P2001203M, RMS10TS-P2001209M, RMS510D-P2001204M, RMS510D-P2001210M, RMS510T-P2001205M, RMS510T-P2001211M		

			
1			
GEV No.	403359	Ref. No.	10489404 59001997 59004009 59004013 D7831007
description	Magnetron TOSHIBA type 2M248K(A)		
For models:	DEC11E2-P1331213M, DEC11E2-P1331235M, DEC11E2-P1333111M, DEC11E2-P2001412M, DEC11E2-P2001514M, DEC11E2-P2002223M, DEC14E2-P1331217M, DEC14E2-P1331239M, DEC14E2-P1333115M, DEC14E2-P2001413M, DEC14E2-P2001515M, DEC14E2-P2002214M, DEC18E2-P1331221M, DEC18E2-P1331243M, DEC18E2-P1333119M, DEC18E2-P2001414M, DEC18E2-P2001516M, DEC18E2-P2002215M, DEC21E2-P1331226M, DEC21E2-P1331247M, DEC21E2-P1333123M, DEC21E2-P2001415M, DEC21E2-P2001517M, DEC21E2-P2002216M, HDC12A2-P1331203M, HDC12A2-P1333101M, HDC12A2-P2001401M, HDC12A2-P2001501M, HDC12A2-P2002201M, HDC12A-P1323002M, HDC12A-P1323012M, HDC12A-P1330503M, HDC12P2-P1331223M, HDC182-P1331204M, HDC182-P1333102M, HDC182-P2001403M, HDC182-P2001503M, HDC182-P2002203M, HDC18SD2-P1331205M, HDC18SD2-P1333103M, HDC18SD2-P2001405M, HDC18SD2-P2001505M, HDC18SD2-P2002205M, HDC212-P1331207M, HDC212-P1333105M, HDC212-P2001407M, HDC212-P2001507M, HDC212-P2002207M, HDC5112-P1331211M, HDC5112-P1331233M... (Other models you can see in the webshop)		

			
1			
GEV No.	403546	Ref. No.	54137088
description	Magnetron TOSHIBA type 2M303H(YL)		
For models:	RFS511TSW13-P2001012M, RFS511TSW-P2001011M		

			
1			
GEV No.	403360	Ref. No.	53001581 53002002 59002166 59004083
description	Magnetron TOSHIBA type 2M355J(A)		
For models:	DFS11EA-P1330220M, RCS511A-P1330214M, RFS12MP-SA-P1330206M, RFS511SW2A-P1330223M, UCS11MA-P1330228M, URC5511A-P1330226M		

transformers

open transformers

with plug connection

			
1			
GEV No.	403348	Ref. No.	59004091 59004119
description	transformer primary 230VAC secondary 26VAC 56VA secondary 2.15A connection soldering connection 50/60Hz type 241-7-3092A		
For models:	MOC5241-P2000303M, OC5241BK-P2000304M		



HV transformers

1



GEV No.	403378	Ref. No.	59004041
description	HV transformer primary 200/230V 50Hz type DPC10788629 for microwave		
For models:	AXP5201-P1333603M, AXP5203-P1333608M, MXP5201-P1333604M, MXP5203-P1333609M, MXP5221BO-P2001617M, MXP5221-P2001606M, MXP5223-P2001607M, MXP5223TL-P2001620M		

1



GEV No.	403380	Ref. No.	10788603 10788606 10788607 10788609 10788620 59001863 59004054
description	HV transformer primary 220/230V 50Hz type DPC10788620 class 220 for microwave		
For models:	ACE5302-P1331307M, ACE5302-P1332907M, ACE5302-P1332912M, ACE5302-P1332914M, DS30E2-P1331309M, DS30E2-P1332909M, DS30E2-P1332916M, MRC518SU2-P1332818M, MRC518SU2-P1332832M, MRC524TS2-P1331432M, MRC524TS2-P1333415M, RC518SU-P1327602M, RC520S-P1327601M, RC524TS2-P1331430M, RC524TS2-P1333414M, UCA2000NT3-P1332921M, UCA2000NT3-P2000406M		

1



GEV No.	403374	Ref. No.	10788610 10788623 59002011 59004024
description	HV transformer primary 220/230V 50Hz type DPC10788621 for microwave		
For models:	DEC11E2-P1331213M, DEC11E2-P1331235M, DEC11E2-P1333111M, HDC5112-P1331211M, HDC5112-P1331233M, HDC5112-P1333109M, UC11E2-P1331214M, UC11E2-P1331236M, UC11E2-P1333112M, UHDC5112-P1331212M, UHDC5112-P1331234M, UHDC5112-P1333110M		

1



GEV No.	403372	Ref. No.	53001669 53001819 53002024
description	HV transformer primary 230V 50Hz type 6170W1D089H for microwave		
For models:	DFS11EA-P1330220M, RCS511A-P1330214M, RFS511S-W2A-P1330223M, RFS511TSW13-P2001010M, RFS511T-SW-P2001005M, UCS11MA-P1330228M, URC5511A-P1330226M		

1



GEV No.	403547	Ref. No.	54137090
description	HV transformer primary 230V 50Hz type DCP-MDI02ID3		
For models:	RFS511TSW13-P2001012M, RFS511TSW-P2001011M		

1





GEV No.	403376	Ref. No.	59002087
description	HV transformer primary 230V 50Hz type DPC10788625 for microwave		
For models:	ACE5140-P1333203M, ACE5140-P1333207M, ACE5140-P2000403M, DS1400E-P1333204M, DS1400E-P2000404M, DS1400E-P2001904M, DS1400E-P2001912M, UCA1400-P1333205M, UCA1400-P2000405M, UCA1400-P2001906M, UCA1400-P2001913M		





 <p>1</p>			
GEV No.	403373	Ref. No.	12136105 59001554 59001993
description	HV transformer primary 230V 50Hz type DPC12136114TA for microwave		
For models:	DEC14E2-P1331217M, DEC14E2-P1331239M, DEC14E2-P1333115M, DEC18E2-P1331221M, DEC18E2-P1331243M, DEC18E2-P1333119M, DEC21E2-P1331226M, DEC21E2-P1331247M, DEC21E2-P1333123M, HDC5142-P1331215M, HDC5142-P1331237M, HDC5142-P1333113M, HDC5182-P1331219M, HDC5182-P1331241M, HDC5182-P1333117M, HDC518-P1325209M, HDC518-P1330518M, HDC5212-P1331224M, HDC5212-P1331245M, HDC5212-P1333121M, UC14E2-P1331218M, UC14E2-P1331240M, UC14E2-P1333116M, UC18E2-P1331222M, UC18E2-P1331244M, UC18E2-P1333120M, UHDC5142-P1331216M, UHDC5142-P1331238M, UHDC5142-P1333114M, UHDC5182-P1331220M, UHDC5182-P1331242M, UHDC5182-P1333118M		

 <p>2</p>			
GEV No.	403411	Ref. No.	59114146
description	HV transformer primary 230V 50Hz type DPC20039207 class 250 for microwave		
For models:	DEC14E2-P2001413M, DEC14E2-P2001515M, DEC14E2-P2002214M, DEC18E2-P2001414M, DEC18E2-P2001516M, DEC18E2-P2002215M, DEC21E2-P2001415M, DEC21E2-P2001517M, DEC21E2-P2002216M		

 <p>1</p>			
GEV No.	403379	Ref. No.	58101017
description	HV transformer primary 230V 50Hz type MD-101EMR-1 class 220 for microwave		
For models:	RMS510D-P2001204M, RMS510D-P2001210M, RMS510T-P2001205M, RMS510T-P2001211M		

 <p>1</p>			
GEV No.	403375	Ref. No.	56001465
description	HV transformer primary 230V 50Hz type R9S59A for microwave		
For models:	ALD510D-P1331003M, ALD510-P1331005M, ALD510SE-P1331012M, MLD510D-P1331007M, MLD510-P1331009M, MLD-510SE-P1331014M, UALD510-P1331006M, UALD510SE-P1331013M, UMLD510D-P1331008M, UMLD510-P1331010M, UMLD-510SE-P1331015M		

 <p>1</p>			
GEV No.	403370	Ref. No.	56002027
description	HV transformer primary 230V 50Hz type R9S5BA for microwave		
For models:	RCS511DS-P2001106M, RCS511DS-P2001112M, RCS511TS-P2001105M, RCS511TS-P2001111M		

 <p>1</p>			
GEV No.	403377	Ref. No.	54127013
description	HV transformer primary 230V 50Hz type YR-E1100A for microwave		
For models:	RCS511DSE-P2002406M, RCS511TS-P2002405M		

 <p>1</p>			
GEV No.	403369	Ref. No.	53001748 53001749 54116058 54127071
description	HV transformer primary 230V connection cable 50Hz type DPC20057603 for microwave		
For models:	DFS18E-P1330222M, RFS518S-P1330216M, RFS518TS-P2001004M		



1

GEV No.	698817	Ref. No.	59134368
description	transformer primary 230V 50Hz		
For models:	JET5192-P2002710M, JET519V2-P2002711M		

probes

producer-specific probes

probes



1

GEV No.	378368	Ref. No.	12000201 12000202
description	temperature probe Pt100 cable glass fibre probe -100 up to 450°C cable -50 up to +350°C connection coded plug thread probe ø4.8x-24mm cable length 0.1m		
For models:	ACE14-P1333201M, ACE14-P1333206M, ACE14-P2000401M, ACE14-P2001901M, ACE14-P2001909M, ACE5140-P1333203M, ACE5140-P1333207M, ACE5140-P2000403M, ACE5302-P1331307M, ACE5302-P1332907M, ACE5302-P1332912M, ACE5302-P1332914M, DS1400E-P1333204M, DS1400E-P2000404M, DS1400E-P2001904M, DS1400E-P2001912M, DS30E2-P1331309M, DS30E2-P1332909M, DS30E2-P1332916M, JET5192-P2002710M, JET519V2-P2002711M, MCE14-P2000407M, MCE14-P2001902M, MCE14-P2001910M, UCA1400-P1333205M, UCA1400-P2000405M, UCA1400-P2001906M, UCA1400-P2001913M, UCA2000NT3-P1332921M, UCA2000NT3-P2000406M		



1

GEV No.	378369	Ref. No.	59001709
description	temperature probe Pt1000 cable PTFE probe -100 up to 450°C cable -40 up to +250°C connection coded plug thread probe ø4.8x160mm cable length 0.17m		
For models:	AXP20-P1333601M, AXP20-P1333602M, AXP20-P1333605M, AXP5201-P1333603M, AXP5203-P1333608M, MXP5201-P1333604M, MXP5203-P1333609M, MXP5221BO-P2001617M, MXP5221-P2001606M, MXP5223-P2001607M, MXP5223TL-P2001620M		

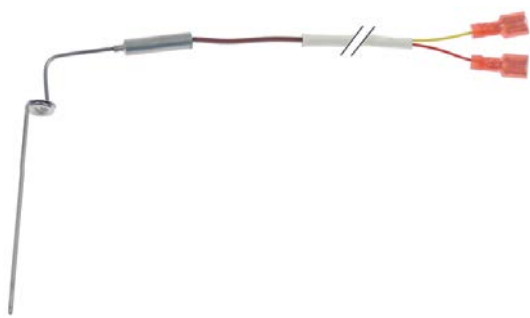

1

GEV No.	107580	Ref. No.	59002131
description	thermocouple thermocouple K (NiCr-Ni) cable PTFE probe -50 up to 1150°C cable -40 up to +250°C connection male faston 6.3mm thread probe ø1.6x75mm cable length 0.55m		
For models:	AXP20-P1333601M, AXP20-P1333602M, AXP20-P1333605M, MXP5221-P2001606M, MXP5223-P2001607M, MXP5223TL-P2001620M		

electronics

PCBs



1

GEV No.	403339	Ref. No.	59002133
description	control PCB microwave AXP20/5201/5203 connection male faston 6.3mm 50/60Hz primary 230V secondaryV		
For models:	AXP20-P1333601M, AXP20-P1333602M, AXP20-P1333605M, AXP5201-P1333603M, AXP5203-P1333608M, MXP5201-P1333604M, MXP5203-P1333609M, MXP5221BO-P2001617M, MXP5221-P2001606M, MXP5223-P2001607M, MXP5223TL-P2001620M		



1

GEV No.	403342	Ref. No.	12002876 59004082
description	control PCB microwave AXP5201/5203		
For models:	AXP5201-P1333603M, AXP5203-P1333608M, MXP5201-P1333604M, MXP5203-P1333609M		



1

GEV No.	403343	Ref. No.	12002877
description	display microwave AXP20/5201/5203		
For models:	AXP20-P1333601M, AXP20-P1333602M, AXP20-P1333605M, AXP5201-P1333603M, AXP5203-P1333608M, MXP5201-P1333604M, MXP5203-P1333609M		





1

GEV No.	403344	Ref. No.	59004085
description	display microwave MOC5241/OC524BK		
For models:	MOC5241-P2000303M, OC5241BK-P2000304M		





			
1			
GEV No.	403347	Ref. No.	59114156
description	display microwave MXP5221-P2001606M		
For models:	MXP5221BO-P2001617M, MXP5221-P2001606M, MXP5223-P2001607M, MXP5223TL-P2001620M		

			
1			
GEV No.	403409	Ref. No.	59002084 59104126
description	display PCB microwave ACE14-P1333201M		
For models:	ACE14-P1333201M, ACE14-P1333206M, ACE14-P2000401M, ACE14-P2001901M, ACE14-P2001909M, ACE5140-P1333203M, ACE5140-P1333207M, ACE5140-P2000403M, DS1400E-P1333204M, DS1400E-P2000404M, DS1400E-P2001904M, DS1400E-P2001912M, JET5192-P2002710M, JET519V2-P2002711M, MCE14-P2000407M, MCE14-P2001902M, MCE14-P2001910M, MRC17S2-P1333417M, MRC17S2-P2001802M, MRC17S2-P2001814M, MRC17S2-P2001824M, MRC22S2-P1333418M, MRC22S2-P2001817M, MRC30S2-P2001812M, MRC524TS2-P1333415M, RC17S2-P1333401M, RC17S2-P2001801M, RC17S2-P2001813M, RC17S2-P2001823M, RC22S2-P1333404M, RC22S2-P2001804M, RC22S2-P2001816M, RC30S2-P1333410M, RC30S2-P2001811M, RC524TS2-P1333414M, UCA1400-P1333205M, UCA1400-P2000405M, UCA1400-P2001906M, UCA1400-P2001913M, UCA2000NT3-P1332921M, UCA2000NT3-P2000406M		

			
1			
GEV No.	403335	Ref. No.	59004108
description	main PCB microwave AXP5201/P-1333603M		
For models:	AXP5201-P1333603M, MXP5201-P1333604M, MXP5221-P2001606M		

			
1			
GEV No.	403337	Ref. No.	20002603 59004107
description	main PCB microwave AXP5203/P-1333608M		
For models:	AXP5203-P1333608M, MXP5203-P1333609M, MXP5223-P2001607M, MXP5223TL-P2001620M		

			
1			
GEV No.	403331	Ref. No.	14139085
description	main PCB microwave MXP5203/P-1333608M incl. display PCB and USB PCB monophasic, Hz		

			
1			
GEV No.	403368	Ref. No.	14139086
description	main PCB microwave MXP5221-P2001606M incl. display PCB and USB PCB three-phase, 50Hz		

			
1			
GEV No.	403341	Ref. No.	59004110
description	main PCB microwave OC541		
For models:	OC5241BK-P2000304M		

			
1			
GEV No.	403652	Ref. No.	59134306
description	PCB for microwave L 50mm W 45mm		
For models:	JET5192-P2002710M, JET519V2-P2002711M		

			
1			
GEV No.	403650	Ref. No.	59134363
description	PCB HV L 228mm W 126mm		

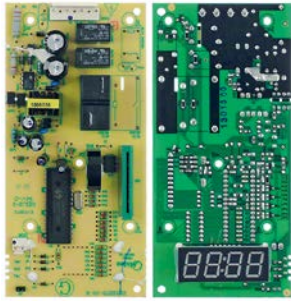

1			
GEV No.	403666	Ref. No.	58101011
description	PCB L 165mm W 80mm		
For models:	RMS510T-P2001205M, RMS510T-P2001211M		



1			
GEV No.	403424	Ref. No.	59134218
description	PCB microwave ACE14 USB interface		



1			
GEV No.	403399	Ref. No.	59004051 59004067 59124182
description	PCB microwave ACE5140-P1333203M HV		
For models:	ACE5140-P1333203M, ACE5140-P1333207M, ACE5140-P2000403M, DS1400E-P1333204M, DS1400E-P2000404M, DS1400E-P2001904M, DS1400E-P2001912M		



1			
GEV No.	403405	Ref. No.	56001472
description	PCB microwave ALD510-P1331005M HV/LV		
For models:	ALD510-P1331005M, MLD510-P1331009M, UALD510-P1331006M, UMLD510-P1331010M		



1			
GEV No.	403401	Ref. No.	12470106 59001698 59002070
description	PCB microwave DEC11E2-P1331213M HV/LV		
For models:	DEC11E2-P1331213M, DEC11E2-P1331235M, DEC14E2-P1331217M, DEC14E2-P1331239M, DEC18E2-P1331221M, DEC18E2-P1331243M, DEC21E2-P1331226M, DEC21E2-P1331247M, HDC12P2-P1331223M, HDC5112-P1331211M, HDC5112-P1331233M, HDC5142-P1331215M, HDC5142-P1331237M, HDC5182-P1331219M, HDC5182-P1331241M, HDC518-P1325209M, HDC518-P1330518M, HDC5212-P1331224M, HDC5212-P1331245M, UC11E2-P1331214M, UC11E2-P1331236M, UC14E2-P1331218M, UC14E2-P1331240M, UC18E2-P1331222M, UC18E2-P1331244M, UHDC5112-P1331212M, UHDC5112-P1331234M, UHDC5142-P1331216M, UHDC5142-P1331238M, UHDC5182-P1331220M, UHDC5182-P1331242M		



1			
GEV No.	403402	Ref. No.	59004111
description	PCB microwave DEC11E2-P133311M HV/LV		
For models:	DEC11E2-P1333111M, DEC11E2-P2001412M, DEC11E2-P2001514M, DEC11E2-P2002223M, DEC14E2-P1333115M, DEC14E2-P2001413M, DEC14E2-P2001515M, DEC14E2-P2002214M, DEC18E2-P1333119M, DEC18E2-P2001414M, DEC18E2-P2001516M, DEC18E2-P2002215M, DEC21E2-P1333123M, DEC21E2-P2001415M, DEC21E2-P2001517M, DEC21E2-P2002216M, HDC12A2-P1333101M, HDC12A2-P2001401M, HDC12A2-P2001501M, HDC12A2-P2002201M, HDC5112-P1333109M, HDC5142-P1333113M, HDC5182-P1333117M, HDC5212-P1333121M, MDC12A2-P1333127M, MDC12A2-P2001402M, MDC12A2-P2001502M, MDC12A2-P2002202M, UC11E2-P1333112M, UC14E2-P1333116M, UC18E2-P1333120M, UHDC5112-P1333110M, UHDC5142-P1333114M, UHDC5182-P1333118M		



1			
GEV No.	403404	Ref. No.	53001659
description	PCB microwave DFS11EA-P1330220M HV/LV		
For models:	DFS11EA-P1330220M, RCSS11A-P1330214M, RFS511S-W2A-P1330223M, URCS511A-P1330226M		



1

GEV No.	403408	Ref. No.	53001738 59002143
description	PCB microwave DFS18E-P133022M HV/LV		
For models:	DFS18E-P133022M, RFS518S-P1330216M, URF5518S-P1330227M		



1

GEV No.	403391	Ref. No.	59134213
description	PCB microwave for display		



1

GEV No.	403389	Ref. No.	54116068
description	PCB microwave HV/LV		
For models:	RFS511TSW13-P2001010M, RFS511TSW13-P2001012M, RFS511TSW-P2001005M, RFS511TSW-P2001011M		



1

GEV No.	403611	Ref. No.	14159091
description	PCB microwave L 185mm W 105mm		



1

GEV No.	403392	Ref. No.	54127054
description	PCB microwave MCS10DSE-P2002404M with green LEDs		
For models:	MCS10DSE-P2002404M, RCS511DSE-P2002406M		



1

GEV No.	403386	Ref. No.	54127034
description	PCB microwave RCS511DSE-P2002406 HV/LV		
For models:	RCS511DSE-P2002406M		



1

GEV No.	403406	Ref. No.	56002036 56132076
description	PCB microwave RCS511TS-P2001105M HV/LV		
For models:	RCS511TS-P2001105M, RCS511TS-P2001111M		



1

GEV No.	403387	Ref. No.	54127035
description	PCB microwave RCS511TS-P2002405M HV/LV		
For models:	RCS511TS-P2002405M		



1

GEV No.	403365	Ref. No.	54116043
description	PCB microwave RFS518TS-P2001004M HV/LV		
For models:	RFS518TS-P2001004M		

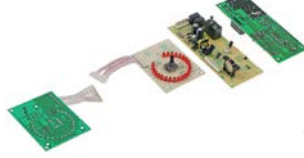

1

GEV No.	403407	Ref. No.	58101010
description	PCB microwave RME510D-P2001204M HV/LV		
For models:	RMS510D-P2001204M, RMS510D-P2001210M		



1

GEV No.	403400	Ref. No.	59004053 59004068 59124183
description	PCB microwave UCA1400P1333205 HV		
For models:	UCA1400-P1333205M, UCA1400-P2000405M, UCA1400-P2001906M, UCA1400-P2001913M		



1

GEV No.	403345	Ref. No.	59002118
description	power PCB for microwave AXP5201/P-1333603M		
For models:	AXP20-P1333601M, AXP20-P1333602M, AXP20-P1333605M, AXP5201-P1333603M, AXP5203-P1333608M, MXP5201-P1333604M, MXP5203-P1333609M, MXP5221BO-P2001617M, MXP5221-P2001606M, MXP5223-P2001607M, MXP5223TL-P2001620M		

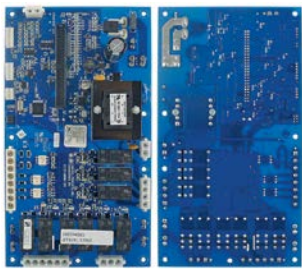

1

GEV No.	403639	Ref. No.	59134364
description	power PCB microwave Jet5192,519V2 L 229mm W 127mm 20097406Q HV		
For models:	JET5192-P2002710M, JET519V2-P2002711M		



1

GEV No.	403431	Ref. No.	56001480
description	relay PCB microwave ALD510-P1331005M L 66mm W 35mm H 35mm Qty 1 pcs		
For models:	ALD510D-P1331003M, ALD510-P1331005M, ALD510SE-P1331012M, MLD510D-P1331007M, MLD510-P1331009M, MLD510SE-P1331014M, RCS511DS-P2001106M, RCS511DS-P2001112M, UALD510-P1331006M, UALD510SE-P1331013M, UMLD510D-P1331008M, UMLD510-P1331010M, UMLD510SE-P1331015M		



1

GEV No.	403346	Ref. No.	59002117
description	relay PCB microwave AXP5201/P-1333603M		
For models:	ACE14-P2001901M, ACE14-P2001909M, AXP20-P1333601M, AXP20-P1333602M, AXP20-P1333605M, AXP5201-P1333603M, AXP5203-P1333608M, DS1400E-P2001904M, DS1400E-P2001912M, JET5192-P2002710M, JET519V2-P2002711M, MCE14-P2001902M, MCE14-P2001910M, MRC1752-P2001802M, MRC1752-P2001814M, MRC1752-P2001824M, MRC2252-P2001817M, MRC3052-P2001812M, MXP5201-P1333604M, MXP5203-P1333609M, MXP5221BO-P2001617M, MXP5221-P2001606M, MXP5223-P2001607M, MXP5223TL-P2001620M, RC1752-P2001801M, RC1752-P2001813M, RC1752-P2001823M, RC2252-P2001804M, RC2252-P2001816M, RC3052-P2001811M, UCA1400-P2001906M, UCA1400-P2001913M		

Triacs



1

GEV No.	403420	Ref. No.	D7681501
description	Triac 25A 600W type TG25E60		
For models:	MRC518SU2-P1332832M, RC225-P1198605M, RC225-P1326303M, RC225-P1329103M, RC225-P1329610M, RC3052-P1331415M, RC518SU-P1327602M, RC520S-P1327601M		



1			
GEV No.	403421	Ref. No.	R0000341 R0157373
description	Triac 25A 600W type TG25E60 heat-conducting paste included		
For models:	ACE5302-P1331307M, ACE5302-P1332907M, ACE5302-P1332912M, ACE5302-P1332914M, DEC11E2-P1331213M, DEC11E2-P1331235M, DEC11E2-P1333111M, DEC11E2-P2001412M, DEC11E2-P2001514M, DEC11E2-P2002223M, DEC14E2-P1331217M, DEC14E2-P1331239M, DEC14E2-P1333115M, DEC14E2-P2001413M, DEC14E2-P2001515M, DEC14E2-P2002214M, DEC18E2-P1331221M, DEC18E2-P1331243M, DEC18E2-P1333119M, DEC18E2-P2001414M, DEC18E2-P2001516M, DEC18E2-P2002215M, DEC21E2-P1331226M, DEC21E2-P1331247M, DEC21E2-P1333123M, DEC21E2-P2001415M, DEC21E2-P2001517M, DEC21E2-P2002216M, DS30E2-P1331309M, DS30E2-P1332909M, DS30E2-P1332916M, HDC12A2-P1331203M, HDC12A2-P1333101M, HDC12A2-P2001401M, HDC12A2-P2001501M, HDC12A2-P2002201M, HDC12A-P1330503M, HDC12P2-P1331223M, HDC182-P1331204M, HDC182-P1333102M, HDC182-P2001403M, HDC182-P2001503M, HDC182-P2002203M, HDC18SD2-P1331205M, HDC-18SD2-P1333103M, HDC18SD2-P2001405M, HDC18SD2-P2001505M, HDC18SD2-P2002205M, HDC212-P1331207M, HDC212-P1333105M... (Other models you can see in the webshop)		

2			
GEV No.	403742	Ref. No.	59174520
description	Triac 25A 600W type TG25E60 heat-conducting paste included with diode		



1			
GEV No.	403422	Ref. No.	59002026
description	Triac 40A 600W type TG40E60		
For models:	ACE14-P1333201M, ACE14-P1333206M, ACE14-P2000401M, ACE14-P2001901M, ACE14-P2001909M, ACE5140-P1333203M, ACE5140-P1333207M, ACE5140-P2000403M, AXP20-P1333601M, AXP20-P1333602M, AXP20-P1333605M, AXP5201-P1333603M, AXP5203-P1333608M, DS1400E-P1333204M, DS1400E-P2000404M, DS1400E-P2001904M, DS1400E-P2001912M, JET5192-P2002710M, JET5192V2-P2002711M, MCE14-P2000407M, MCE14-P2001902M, MCE14-P2001910M, MOC5241-P2000303M, MRC524TS2-P1331432M, MRC524TS2-P1333415M, MXP5201-P1333604M, MXP5203-P1333609M, MXP5221BO-P2001617M, MXP5221-P2001606M, MXP5223-P2001607M, MXP5223TL-P2001620M, OC5241BK-P2000304M, RC524TS2-P1331430M, RC524TS2-P1333414M, UCA1400-P1333205M, UCA1400-P2000405M, UCA1400-P2001906M, UCA1400-P2001913M, UCA2000NT3-P1332921M, UCA2000NT3-P2000406M		

keypads

keypad units



1			
GEV No.	403366	Ref. No.	53001574 53001575 53001578 53001598 53001604 53001606 53001658 53001736 53001821 53001822 53001825 53001864 53002010 53002026 53002063 53002070 54116008 54116009
description	keypad PCB microwave RCS10MPA-P133020M AM		
For models:	RCS10MPA-P1330202M, RCS10MPA-P2000704M, RC-S511A-P1330214M, RFS12MPSA-P1330206M, RFS12MPSB-P1330235M, RFS18MPS-P1330209M, RFS18MPS-P2000703M, RFS18TS-P2001003M, RFS518S-P1330216M, URCS511A-P1330226M, URF5518S-P1330227M		



1

GEV No.	403367	Ref. No.	53001807 53001808 53001823 53001874 53002019 53002041 53002043 53002065 53002069 54116006 54116007
description	keypad PCB microwave RFS511SW-P200100M SW		
For models:	RFS12TSW-P2001001M, RFS511SW2A-P1330223M, RFS511T-SW13-P2001010M, RFS511TSW13-P2001012M, RFS511T-SW-P2001005M, RFS511TSW-P2001011M		



2

GEV No.	403651	Ref. No.	59134369
description	keypad unit microwave		
For models:	JET5192-P2002710M, JET519V2-P2002711M		



1

GEV No.	403416	Ref. No.	59002099 59104132 R0000280
description	keypad unit microwave ACE14/ACE5140/ACE5302/UCA1400/UCA2000		
For models:	ACE14-P1333201M, ACE14-P1333206M, ACE14-P2000401M, ACE14-P2001901M, ACE14-P2001909M, ACE5140-P1333203M, ACE5140-P1333207M, ACE5140-P2000403M, ACE5302-P1331307M, ACE5302-P1332907M, ACE5302-P1332912M, ACE5302-P1332914M, UCA1400-P1333205M, UCA1400-P2000405M, UCA1400-P2001906M, UCA2000NT3-P1332921M, UCA2000NT3-P2000406M		



1

GEV No.	403398	Ref. No.	59002093 59104131
description	keypad unit microwave ACE14/ACES140/UCA1400		
For models:	ACE14-P1333201M, ACE14-P1333206M, ACE14-P2000401M, ACE14-P2001901M, ACE14-P2001909M, ACE5140-P1333203M, ACE5140-P1333207M, ACE5140-P2000403M, UCA1400-P1333205M, UCA1400-P2000405M, UCA1400-P2001906M, UCA2000NT3-P1332921M, UCA2000NT3-P2000406M		





1



GEV No.	403403	Ref. No.	R0000279 R0130109
description	keypad unit microwave ACE5302/RC17S2/RC22S		
For models:	ACE5302-P1331307M, ACE5302-P1332907M, ACE5302-P1332912M, ACE5302-P1332914M, RC17S2-P1331401M, RC17S2-P1332801M, RC17S2-P1333401M, RC22S2-P1331403M, RC22S2-P1332804M, RC22S2-P1333404M, RC22S-P1326303M, RC22S-P1329103M, RC22S-P1329610M, RC22S-P1330104M, RC30S2-P1331415M, RC30S2-P1332816M, RC30S2-P1333410M, RC518SU-P1327602M, RC520S-P1327601M, RC524TS2-P1331430M, RC524TS2-P1333414M		

			
1			
GEV No.	403394	Ref. No.	56001455 56001471
description	keypad unit microwave ALD10T/ALD510/UALD510/UMD510		
For models:	ALD10T-P1331002M, ALD10T-P1331018M, ALD510-P1331005M, MLD510-P1331009M, UALD510-P1331006M, UMLD510-P1331010M		

			
1			
GEV No.	403388	Ref. No.	53001735 53001824 53001830 53001863 53001865 53002015 53002061 53002071 53002072 54116010 54116011
description	keypad unit microwave DFS11EA/DFS18E/MFS18TS/RF5518 MENUMASTER		
For models:	DFS11EA-P1330220M, DFS18E-P1330222M, MFS18TS-P2001008M, RF5518TS-P2001004M		

			
1			
GEV No.	403330	Ref. No.	59002100
description	keypad unit microwave buttons 6 L 480mm W 50mm MENUMASTER Jetwave III		
For models:	DS1400E-P1333204M, DS1400E-P2000404M, MCE14-P2000407M		

			
1			
GEV No.	403417	Ref. No.	59104134
description	keypad unit microwave DS1400/MCE14/UCA1400		
For models:	DS1400E-P2001904M, DS1400E-P2001912M, MCE14-P2001902M, MCE14-P2001910M, UCA1400-P2001913M		

			
1			
GEV No.	403418	Ref. No.	59004062 59104138 59174529 R0000244
description	keypad unit microwave DEC11E/DEC14E		
For models:	DEC11E2-P1331213M, DEC11E2-P1331235M, DEC11E2-P1333111M, DEC11E2-P2001412M, DEC11E2-P2001514M, DEC11E2-P2002223M, DEC14E2-P1331217M, DEC14E2-P1331239M, DEC14E2-P1333115M, DEC14E2-P2001413M, DEC14E2-P2001515M, DEC14E2-P2002214M, DEC18E2-P1331221M, DEC18E2-P1331243M, DEC18E2-P1333119M, DEC18E2-P2001414M, DEC18E2-P2001516M, DEC18E2-P2002215M, DEC21E2-P1331226M, DEC21E2-P1331247M, DEC21E2-P1333123M, DEC21E2-P2001415M, DEC21E2-P2001517M, DEC21E2-P2002216M, MDC12A2-P1333127M, MDC12A2-P2001402M, MDC12A2-P2001502M, MDC12A2-P2002202M, MDC182-P1333128M, MDC182-P2001404M, MDC182-P2001504M, MDC182-P2002204M, UC11E2-P1331214M, UC11E2-P1331236M, UC11E2-P1333112M, UC14E2-P1331218M, UC14E2-P1331240M, UC14E2-P1333116M, UC18E2-P1331222M, UC18E2-P1331244M, UC18E2-P1333120M		
accessories for	403418		
	GEV No.	701331	Ref. No. 12131002
	end cap mounting pos. left		
	GEV No.	701356	Ref. No. 12131001
	bezel L 57.5mm W 31.6mm plastic silver Qty 1 pcs		

			
1			
GEV No.	403338	Ref. No.	59002098 59104133
description	keypad unit microwave DS1400E/MCE14/UCA1400 L 342mm W 74mm		
For models:	DS1400E-P1333204M, DS1400E-P2000404M, DS1400E-P2001904M, DS1400E-P2001912M, MCE14-P2000407M, MCE14-P2001902M, MCE14-P2001910M, UCA1400-P2001913M		



1 			
GEV No.	403415	Ref. No.	59004020 59104136 59174527 R9900111
description	keypad unit microwave HDC12/HDC182		
For models:	HDC12A2-P1331203M, HDC12A2-P1333101M, HDC12A2-P2001401M, HDC12A2-P2001501M, HDC12A2-P2002201M, HDC12A-P1323002M, HDC12A-P1323012M, HDC12A-P1330503M, HDC12P2-P1331223M, HDC182-P1331204M, HDC182-P1333102M, HDC182-P2001403M, HDC182-P2001503M, HDC182-P2002203M, HDC18SD2-P1331205M, HDC18SD2-P1333103M, HDC18SD2-P2001405M, HDC18SD2-P2001505M, HDC18SD2-P2002205M, HDC212-P1331207M, HDC212-P1333105M, HDC212-P2001407M, HDC212-P2001507M, HDC5112-P1331211M, HDC5112-P1331233M, HDC5112-P1333109M, HDC5142-P1331215M, HDC5142-P1331237M, HDC5142-P1333113M, HDC5182-P1331219M, HDC5182-P1331241M, HDC5182-P1333117M, HDC518-P1332509M, HDC518-P1330518M, HDC5212-P1331224M, HDC5212-P1331245M, HDC5212-P1333121M, MCHDC21-P1333130M, MCHDC21-P2001512M, MCHDC21-P2002212M, UHDC5112-P1331212M, UHDC5112-P1331234M, UHDC5112-P1333110M, UHDC5142-P1331216M, UHDC5142-P1331238M, UHDC5142-P1333114M, UHDC5182-P1331220M, UHDC5182-P1331242M, UHDC5182-P1333118M		

1 			
GEV No.	403395	Ref. No.	56002046
description	keypad unit microwave MCS10TS/RCS511TS		
For models:	MCS10TS-P2001103M, MCS10TS-P2001109M, RCS511TS-P2001105M, RCS511TS-P2001111M		

1 			
GEV No.	403649	Ref. No.	59134370
description	keypad unit microwave L 373mm W 70mm		
For models:	JET5192-P2002710M, JET519V2-P2002711M		

1 			
GEV No.	403385	Ref. No.	54127005
description	keypad unit microwave MCS10TS-P2001004M		
For models:	MCS10TS-P2002403M, RCS511TS-P2002405M		

1 			
GEV No.	403384	Ref. No.	54127004
description	keypad unit microwave MCS10DSE-P2002403M		
For models:	MCS10DSE-P2002404M, RCS511DSE-P2002406M		

1 			
GEV No.	403396	Ref. No.	58101006
description	keypad unit microwave MMS10TS/RMS10TS		
For models:	MMS10TS-P2001217M, RMS10TS-P2001203M, RMS10TS-P2001209M		



GEV No.	403332	Ref. No.	59114151 59114152
description	keypad unit microwave MXP5221-P2001606M L 350mm W 94mm		
For models:	MXP5221BO-P2001617M, MXP5221-P2001606M, MXP5223-P2001607M, MXP5223TL-P2001620M		



GEV No.	403334	Ref. No.	59004114
description	keypad unit microwave OC524BK-P2000304M L 340mm W 58mm		
For models:	OC5241BK-P2000304M		



GEV No.	403397	Ref. No.	58101070
description	keypad unit microwave RMS510T		
For models:	RMS510T-P2001205M, RMS510T-P2001211M		

fans

axial fans

ebm-papst

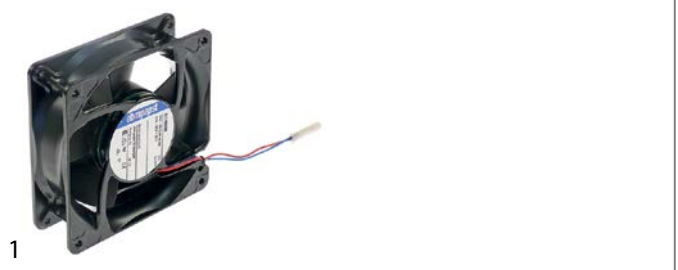

GEV No.	601915 ¹	Ref. No.	14149088 59002132
description	axial fan L 119mm W 119mm H 38mm 24VDC 19.5W bearing ball bearing manuf. no. 4114NH3R cable length 100mm connection cable ebm-papst		
For models:	AXP20-P1333601M, AXP20-P1333602M, AXP20-P1333605M, AXP5201-P1333603M, AXP5203-P1333608M, MOC5241-P2000303M, MXP5201-P1333604M, MXP5203-P1333609M, MXP5221BO-P2001617M, MXP5221-P2001606M, MXP5223-P2001607M, MXP5223TL-P2001620M, OC5241BK-P2000304M		

¹with ball bearings

cooling fans

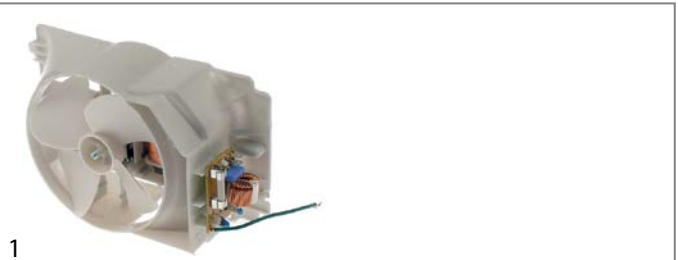

GEV No.	601927	Ref. No.	56002037
description	cooling fan 230V 50Hz 4.8W W 250mm H 90mm D 140mm shaft L 30mm shaft ø 3mm type OEM-15DWC2-C03 cable lengthmm 2600rpm for microwave		
For models:	RCS511DS-P2001106M, RCS511DS-P2001112M, RCS511TS-P2001105M, RCS511TS-P2001111M		

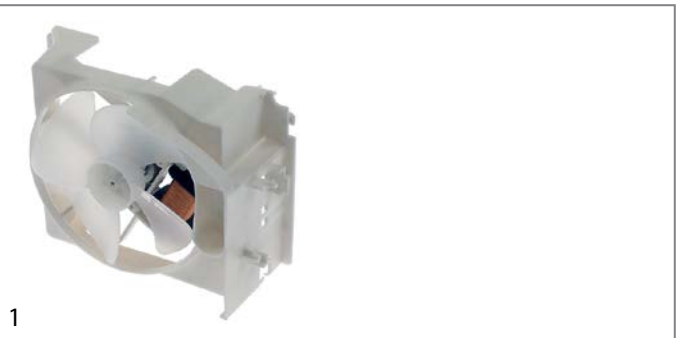

GEV No.	601920	Ref. No.	58101056
description	fan 220-240V 50Hz 18W shaft L 23mm shaft ø 3mm type MDT-10CEF cable lengthmm		
For models:	RMS510D-P2001204M, RMS510D-P2001210M, RMS510T-P2001205M, RMS510T-P2001211M		



1

GEV No.	601926	Ref. No.	53001744
description	fan 230-240V 50Hz 100W for microwave		
For models:	DFS18E-P1330222M, RFS518S-P1330216M, RFS518TS-P2001004M, URF5518S-P1330227M		



1

GEV No.	601924	Ref. No.	53001670
description	fan 230-240V 50Hz 22W shaft L 28mm shaft ø 4mm type OEB-2003C2 cable lengthmm		
For models:	DFS11EA-P1330220M, RCS511A-P1330214M, RFS511S-W2A-P1330223M, RFS511TSW13-P2001010M, RFS511T-SW13-P2001012M, RFS511TSW-P2001005M, RFS511TSW-P2001011M, UCS11MA-P1330228M, URC5511A-P1330226M		



1

GEV No.	602161	Ref. No.	59174525
description	fan 230V 50/60Hz W 160mm H 170mm D 185mm shaft L 28mm shaft ø 6.3x4.7mm cable lengthmm		



1

GEV No.	601923	Ref. No.	54127058
description	fan 230V 50Hz 22W shaft L 30mm shaft ø 3mm fan wheel ø 132mm		
For models:	RCS511DSE-P2002406M, RCS511TS-P2002405M		



1

GEV No.	601925	Ref. No.	56001459
description	fan 230V 50Hz W 250mm H 90mm D 140mm shaft L 30mm shaft ø 3mm type OEM-15DWC2-C03 cable lengthmm for microwave		
For models:	ALD510D-P1331003M, ALD510-P1331005M, ALD510SE-P1331012M, MLD510D-P1331007M, MLD510-P1331009M, MLD-510SE-P1331014M, UALD510-P1331006M, UALD510SE-P1331013M, UMLD510D-P1331008M, UMLD510-P1331010M, UMLD-510SE-P1331015M		



1

GEV No.	601983	Ref. No.	14090018 59002088
description	fan motor 208V 60Hz 0.67W W 110mm H 110mm shaft L 28mm shaft ø 6mm		
For models:	ACE14-P1333201M, ACE14-P1333206M, ACE14-P2000401M, ACE14-P2001901M, ACE14-P2001909M, MCE14-P2000407M, MCE14-P2001902M, MCE14-P2001910M		



1

GEV No.	601916	Ref. No.	12138105 59004019
description	fan motor 230V 50/60Hz shaft L 28mm shaft ø 6.3x4.7mm		
For models:	DEC11E2-P1331213M, DEC11E2-P1331235M, DEC11E2-P1333111M, DEC11E2-P2001412M, DEC11E2-P2001514M, DEC11E2-P2002223M, DEC14E2-P1331239M, DEC14E2-P1333115M, DEC14E2-P2001413M, DEC14E2-P2001515M, DEC14E2-P2002214M, DEC18E2-P1331221M, DEC18E2-P1331243M, DEC18E2-P1333119M, DEC18E2-P2001414M, DEC18E2-P2001516M, DEC18E2-P2002215M, DEC21E2-P1331226M, DEC21E2-P1331247M, DEC21E2-P1333123M, DEC21E2-P2001415M, DEC21E2-P2001517M, DEC21E2-P2002216M, HDC12P2-P1331223M, HDC182-P1331204M, HDC182-P1333102M, HDC185D2-P1331205M, HDC185D2-P1333103M, HDC212-P1331207M, HDC212-P1333105M, HDC5112-P1331211M, HDC5112-P1331233M, HDC5112-P1333109M, HDC5142-P1331237M, HDC5142-P1333113M, HDC5182-P1331219M, HDC5182-P1331241M, HDC5182-P1333117M, HDC518-P1325209M, HDC518-P1330518M, HDC5212-P1331224M, HDC5212-P1331245M, HDC5212-P1333121M, MCHDC21-P1333130M, MDC182-P1333128M, UC11E2-P1331214M, UC11E2-P1331236M, UC11E2-P1333112M, UC14E2-P1331240M, UC14E2-P1333116M...(Other models you can see in the webshop)		



1

GEV No.	601917	Ref. No.	10773301 10773303 12002065 12138106 59001482
description	fan motor 230V 50/60Hz shaft L 33mm shaft ø 6.4mm		
For models:	MRC17S2-P1333417M, MRC22S2-P1333418M, MRC-518SU2-P1332818M, MRC518SU2-P1332832M, MRC524TS2-P1331432M, MRC524TS2-P1333415M, RC17S2-P1331401M, RC17S2-P1332801M, RC17S2-P1333401M, RC22S2-P1331403M, RC22S2-P1332804M, RC22S2-P1333404M, RC22S-P1198605M, RC22S-P1326303M, RC22S-P1329103M, RC22S-P1329610M, RC22S-P1330104M, RC30S2-P1331415M, RC30S2-P1332816M, RC30S2-P1333410M, RC518SU-P1327602M, RC520S-P1327601M, RC524TS2-P1331430M, RC524TS2-P1333414M		



1

GEV No.	601921	Ref. No.	10773308 14179132 59004029
description	fan motor 230V 50/60Hz shaft L 36mm shaft ø 6.4mm		
For models:	ACE5140-P1333203M, ACE5140-P1333207M, ACE5140-P2000403M, ACE5302-P1331307M, ACE5302-P1332912M, ACE5302-P1332914M, DS1400E-P1333204M, DS1400E-P2000404M, DS1400E-P2001904M, DS1400E-P2001912M, DS30E2-P1331309M, DS30E2-P1332916M, JET5192-P2002710M, JET519V2-P2002711M, UCA1400-P1333205M, UCA1400-P2000405M, UCA1400-P2001906M, UCA1400-P2001913M, UCA2000NT3-P1332921M, UCA2000NT3-P2000406M		

hot air motors



1

GEV No.	514445	Ref. No.	C3670802 C3670808 C3670809
description	fan wheel blades 24 D1 ø 108mm D2 ø 6mm D3 ø 6mm H1 62mm H2 12mm H3 54mm		
For models:	ACE14-P1333201M, ACE14-P1333206M, ACE14-P2000401M, ACE14-P2001901M, ACE14-P2001909M, ACE5140-P1333203M, ACE5140-P1333207M, ACE5140-P2000403M, ACE5302-P1331307M, ACE5302-P1332912M, ACE5302-P1332914M, DS1400E-P1333204M, DS1400E-P2000404M, DS1400E-P2001904M, DS1400E-P2001912M, DS30E2-P1331309M, DS30E2-P1332916M, JET5192-P2002710M, JET519V2-P2002711M, MCE14-P2000407M, MCE14-P2001902M, MCE14-P2001910M, MRC17S2-P1333417M, MRC17S2-P2001802M, MRC17S2-P2001814M, MRC17S2-P2001824M, MRC22S2-P1333418M, MRC22S2-P2001817M, MRC30S2-P2001812M, MRC518SU2-P1332818M, MRC518SU2-P1332832M, MRC524TS2-P1331432M, MRC524TS2-P1333415M, RC17S2-P1331401M, RC17S2-P1332801M, RC17S2-P1333401M, RC17S2-P2001801M, RC17S2-P2001813M, RC17S2-P2001823M, RC22S2-P1331403M, RC22S2-P1332804M, RC22S2-P1333404M, RC22S2-P2001804M, RC22S2-P2001816M, RC22S-P1198605M, RC22S-P1326303M, RC22S-P1329103M, RC22S-P1329610M, RC22S-P1330104M, RC30S2-P1331415M...(Other models you can see in the webshop)		



1

GEV No.	514444	Ref. No.	12138201
description	fan wheel blades 32 D1 ø 110mm D2 ø 6mm D3 ø 6mm H1 51mm H2 15mm H3 50mm		
For models:	DEC11E2-P1331213M, DEC11E2-P1331235M, DEC11E2-P1333111M, DEC11E2-P2001412M, DEC11E2-P2001514M, DEC11E2-P2002223M, DEC14E2-P1331239M, DEC14E2-P1333115M, DEC14E2-P2001413M, DEC14E2-P2001515M, DEC14E2-P2002214M, DEC18E2-P1331221M, DEC18E2-P1331243M, DEC18E2-P1333119M, DEC18E2-P2001414M, DEC18E2-P2001516M, DEC18E2-P2002215M, DEC21E2-P1331226M, DEC21E2-P1331247M, DEC21E2-P1333123M, DEC21E2-P2001415M, DEC21E2-P2001517M, DEC21E2-P2002216M, HDC12A2-P1331203M, HDC12A2-P1333101M, HDC12A-P1330503M, HDC12P2-P1331223M, HDC182-P1331204M, HDC182-P1333102M, HDC182-P2001403M, HDC182-P2001503M, HDC182-P2002203M, HDC18SD2-P1331205M, HDC18SD2-P1333103M, HDC18SD2-P2001405M, HDC-18SD2-P2001505M, HDC18SD2-P2002205M, HDC212-P1331207M, HDC212-P1333105M, HDC212-P2001407M, HDC212-P2001507M, HDC212-P2002207M, HDC5112-P1331211M, HDC5112-P1331233M, HDC5112-P1333109M, HDC5142-P1331237M, HDC5142-P1333113M, HDC5182-P1331219M, HDC5182-P1331241M, HDC5182-P1333117M...(Other models you can see in the webshop)		



hot air fans

miscellaneous



1

GEV No.	601922	Ref. No.	14090019 59002089
description	hot air fan 230V 0.43A L1 75mm L2mm L3mm L4 87mm fan wheel ø 110mm		
For models:	ACE5140-P1333203M, ACE5140-P1333207M, ACE5140-P2000403M, DS1400E-P1333204M, DS1400E-P2000404M, DS1400E-P2001904M, DS1400E-P2001912M, UCA1400-P1333205M, UCA1400-P2000405M, UCA1400-P2001906M, UCA1400-P2001913M		

group 6



1

GEV No.	602071	Ref. No.	59134309
description	hot air fan 230VAC 0.43A L1 60mm L3 6.5mm fan wheel ø 85mm		
For models:	JET5192-P2002710M, JET519V2-P2002711M		



1

GEV No.	601918	Ref. No.	59002076
description	cooling fan 230V 410W 6530rpm L1 110mm L2 5mm L3 55mm L4mm fan wheel ø 165mm for microwave		
For models:	AXP20-P1333601M, AXP20-P1333602M, AXP20-P1333605M, AXP5201-P1333603M, AXP5203-P1333608M, MXP5201-P1333604M, MXP5203-P1333609M, MXP5221BO-P2001617M, MXP5221-P2001606M, MXP5223-P2001607M, MXP5223TL-P2001620M		

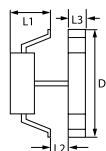

1

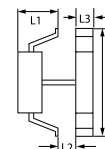

GEV No.	601938	Ref. No.	10999701 12537803 59004038
description	fan motor 230V 0.43A L1 80mm L2 10mm L3 10mm L4 87mm without fan wheel		
For models:	ACE5302-P1331307M, ACE5302-P1332912M, ACE5302-P1332914M, DS30E2-P1331309M, DS30E2-P1332916M, UCA2000NT3-P1332921M, UCA2000NT3-P2000406M		

accessories

fan wheels for hot air fans



1

GEV No.	523038	Ref. No.	59002159 B5706706 B5706707
description	fan wheel ø 100mm W 35mm shaft intake ø 6mm plastic blades 5 Qty 1 pcs		
For models:	ACE14-P1333201M, ACE14-P1333206M, ACE14-P2000401M, ACE14-P2001901M, ACE14-P2001909M, ACE5140-P1333203M, ACE5140-P1333207M, ACE5140-P2000403M, DS1400E-P1333204M, DS1400E-P2000404M, DS1400E-P2001904M, DS1400E-P2001912M, MCE14-P2000407M, MCE14-P2001902M, MCE14-P2001910M, UCA1400-P1333205M, UCA1400-P2000405M, UCA1400-P2001906M, UCA1400-P2001913M		



1

GEV No.	601148	Ref. No.	12537901
description	fan wheel ø 152mm W 20mm shaft intake ø 6x5mm stainless steel blades 6		
For models:	ACE14-P1333201M, ACE14-P1333206M, ACE14-P2000401M, ACE14-P2001901M, ACE14-P2001909M, ACE5140-P1333203M, ACE5140-P1333207M, ACE5140-P2000403M, ACE5302-P1331307M, ACE5302-P1332912M, ACE5302-P1332914M, DS1400E-P1333204M, DS1400E-P2000404M, DS1400E-P2001904M, DS1400E-P2001912M, DS30E2-P1331309M, DS30E2-P1332916M, JET5192-P2002710M, JET519V2-P2002711M, MCE14-P2000407M, MCE14-P2001902M, MCE14-P2001910M, UCA1400-P1333205M, UCA1400-P2000405M, UCA1400-P2001906M, UCA1400-P2001913M, UCA2000NT3-P1332921M, UCA2000NT3-P2000406M		

accessories universal



1

GEV No.	801797	Ref. No.	B5706703 B5706704
description	fan blade ø 74mm H 13.75mm		
For models:	ACE14-P1333201M, ACE14-P1333206M, ACE14-P2000401M, ACE14-P2001901M, ACE14-P2001909M, ACE5140-P1333203M, ACE5140-P1333207M, ACE5140-P2000403M, ACE5302-P1331307M, ACE5302-P1332912M, ACE5302-P1332914M, DEC11E2-P1331213M, DEC11E2-P1331235M, DEC11E2-P1333111M, DEC11E2-P2001412M, DEC11E2-P2001514M, DEC11E2-P2002223M, DEC14E2-P1331239M, DEC14E2-P1333115M, DEC14E2-P2001413M, DEC14E2-P2001515M, DEC14E2-P2002214M, DEC18E2-P1331221M, DEC18E2-P1331243M, DEC18E2-P1333119M, DEC18E2-P2001414M, DEC18E2-P2001516M, DEC18E2-P2002215M, DEC21E2-P1331226M, DEC21E2-P1331247M, DEC21E2-P1333123M, DEC21E2-P2001415M, DEC21E2-P2001517M, DEC21E2-P2002216M, DS1400E-P2000404M, DS1400E-P2001904M, DS1400E-P2001912M, DS30E2-P1331309M, DS30E2-P1332916M, HDC12A2-P1331203M, HDC12A2-P1333101M, HDC12A2-P2001401M, HDC12A2-P2001501M, HDC12A2-P2002201M, HDC12A-P1330503M, HDC12P2-P1331223M, HDC182-P1331204M, HDC182-P1333102M, HDC182-P2001403M, HDC182-P2001503M...(Other models you can see in the webshop)		



1

GEV No.	601946	Ref. No.	12138301 12138302
description	fanwheel cover L 190mm W 155mm H 80mm		
For models:	DEC11E2-P1331213M, DEC11E2-P1331235M, DEC11E2-P1333111M, DEC11E2-P2001412M, DEC11E2-P2001514M, DEC11E2-P2002223M, DEC14E2-P1331239M, DEC14E2-P1333115M, DEC14E2-P2001413M, DEC14E2-P2001515M, DEC14E2-P2002214M, DEC18E2-P1331221M, DEC18E2-P1331243M, DEC18E2-P1333119M, DEC18E2-P2001414M, DEC18E2-P2001516M, DEC18E2-P2002215M, DEC21E2-P1331226M, DEC21E2-P1331247M, DEC21E2-P1333123M, DEC21E2-P2001415M, DEC21E2-P2001517M, DEC21E2-P2002216M, HDC12A2-P1331203M, HDC12A2-P1333101M, HDC12A2-P2001401M, HDC12A2-P2001501M, HDC12A2-P2002201M, HDC12A-P1330503M, HDC12P2-P1331223M, HDC182-P1331204M, HDC182-P1333102M, HDC182-P2001403M, HDC182-P2001503M, HDC182-P2002203M, HDC18SD2-P1331205M, HDC18SD2-P1333103M, HDC18SD2-P2001405M, HDC18SD2-P2001505M, HDC18SD2-P2002205M, HDC212-P1331207M, HDC212-P1333105M, HDC212-P2001407M, HDC212-P2001507M, HDC212-P2002207M, HDC5112-P1331211M, HDC5112-P1331233M, HDC5112-P1333109M, HDC5142-P1331237M, HDC5142-P1333113M...(Other models you can see in the webshop)		

motors

gear motors

for microwaves



1

GEV No.	601941	Ref. No.	12002873
description	gear motor type 7E K24FUN02 2.3/1.9W 230V voltage AC 50/60Hz 25.3/30.3rpm shaft ø 6.5x6mm for microwave		
For models:	AXP20-P1333601M, AXP20-P1333602M, AXP20-P1333605M, AXP5201-P1333603M, AXP5203-P1333608M, MXP5201-P1333604M, MXP5203-P1333609M, MXP5221BO-P2001617M, MXP5221-P2001606M, MXP5223-P2001607M, MXP5223TL-P2001620M		



1

GEV No.	602110	Ref. No.	14169104
description	gear motor type 7E K24FUN02 2.3/1.9W 230V voltage AC 50/60Hz 25.3/30.3rpm shaft ø 6.5x6mm for microwave kit		





1

GEV No.	601943	Ref. No.	59004093
description	gear motor type 7E P24FUN03 2.3/1.9W 230V voltage AC 50/60Hz 25.3/30.3rpm shaft ø 6x4.6mm for microwave		
For models:	MOC5241-P2000303M, OC5241BK-P2000304M		

			
1			
GEV No.	601944	Ref. No.	54126033 56001460 59001625
description	gear motor type SSM-16H 3W 220-240V voltage AC 50/60Hz 29.1/34.9rpm shaft ø 5.5x5.5mm for microwave		
For models:	ALD510D-P1331003M, ALD510-P1331005M, ALD510SE-P1331012M, DEL10D-P1329706M, DEL10E-P1329707M, DFS11EA-P1330220M, LD510D-P1329704M, LD510P-P1329705M, MFS18TS-P2001008M, MLD510D-P1331007M, MLD510-P1331009M, MLD-510SE-P1331014M, RCS511A-P1330214M, RCS511DSE-P2002406M, RCS511DS-P2001106M, RCS511DS-P2001112M, RCS511TS-P2001105M, RCS511TS-P2001111M, RCS511TS-P2002405M, RFS18MPS-P1330209M, RFS18MPS-P2000703M, RFS18TS-P2001003M, RFS511SW2A-P1330223M, RFS511TSW13-P2001010M, RFS511TSW13-P2001012M, RFS511TSW-P2001005M, RFS511TSW-P2001011M, RFS518TS-P2001004M, UALD510-P1331006M, UALD-510SE-P1331013M, UCS11MA-P1330228M, UMLD510D-P1331008M, UMLD510-P1331010M, UMLD510SE-P1331015M, URC-5511A-P1330226M		

			
1			
GEV No.	601942	Ref. No.	58101053
description	gear motor type TYJ50-8A7F 4W 220/240V voltage AC 50/60Hz 29.7/35.6rpm shaft ø 5.5x5.5mm for microwave		
For models:	RMS510D-P2001204M, RMS510D-P2001210M, RMS510T-P2001205M, RMS510T-P2001211M		

			
1			
GEV No.	698819	Ref. No.	RO130263
description	stirrer motor 230V 50/60Hz 25.3/30.3rpm type 7EK24FUN02		

			
1			
GEV No.	699538	Ref. No.	12133601 R0150197
description	stirrer motor incl. antenna 230V 50/60Hz 25.3/30.3rpm type 7E P24FUN01		
For models:	DEC11E2-P1331213M, DEC11E2-P1331235M, DEC11E2-P1333111M, DEC11E2-P2001412M, DEC11E2-P2001514M, DEC14E2-P1331239M, DEC14E2-P1333115M, DEC14E2-P2001413M, DEC14E2-P2001515M, DEC18E2-P1331221M, DEC18E2-P1331243M, DEC18E2-P1333119M, DEC18E2-P2001414M, DEC18E2-P2001516M, DEC21E2-P1331226M, DEC21E2-P1331247M, DEC21E2-P1333123M, DEC21E2-P2001415M, DEC21E2-P2001517M, HDC12P2-P1331223M, HDC182-P1331204M, HDC182-P1333102M, HDC182-P2001403M, HDC182-P2001503M, HDC18SD2-P1331205M, HDC18SD2-P1333103M, HDC-18SD2-P2001405M, HDC18SD2-P2001505M, HDC212-P1331207M, HDC212-P1333105M, HDC212-P2001407M, HDC212-P2001507M, HDC5112-P1331211M, HDC5112-P1331233M, HDC5112-P1333109M, HDC5142-P1331237M, HDC5142-P1333113M, HDC5182-P1331219M, HDC5182-P1331241M, HDC5182-P1333117M, HDC518-P1325209M, HDC518-P1330518M, HDC5212-P1331224M, HDC5212-P1331245M, HDC5212-P1333121M, MCHDC21-P1333130M, MCHDC21-P2001512M, MDC182-P1333128M, MDC182-P2001404M, MDC182-P2001504M...(Other models you can see in the webshop)		

motors

for microwaves

			
1			
GEV No.	601911	Ref. No.	14179118 59124180
description	stirrer motor 230V 50/60Hz 25.3/30.3rpm type 7E P24FUN04		
For models:	DEC11E2-P2002223M, DEC14E2-P2002214M, DEC18E2-P2002215M, DEC21E2-P2002216M, HDC182-P2002203M, HDC18SD2-P2002205M, HDC212-P2002207M, MCHDC21-P2002212M, MDC182-P2002204M		

condensators & interference suppression filters

filters

line filters



with housing



			
1			
GEV No.	403349	Ref. No.	12930001 20070301
description	line filter type 3054-1B1052251531 115/250V 50/60Hz conductor 3 cable connection male faston 6.3mm L 90mm ømm H 50mm W 50mm screw mounting metal Qty 1 pcs for microwave 30A		
For models:	AXP5201-P1333603M, AXP5203-P1333608M, MXP5201-P1333604M, MXP5203-P1333609M, MXP5221BO-P2001617M, MXP5221-P2001606M, MXP5223-P2001607M, MXP5223TL-P2001620M		





			
GEV No.	403350	Ref. No.	12130001 12173001 59001893
description	line filter type 5500.2318 FMBB-3FPC-2020 250V 50/60Hz conductor 2 with E connection male faston 6.3mm L 115mm ømm H 45mm W 53mm flange with thread metal Qty 1 pcs		
For models:	ACE5140-P1333203M, ACE5140-P1333207M, ACE5140-P2000403M, ACE5302-P1331307M, ACE5302-P1332912M, ACE5302-P1332914M, DEC11E2-P1331213M, DEC11E2-P1331235M, DEC11E2-P1333111M, DEC11E2-P2001412M, DEC11E2-P2001514M, DEC11E2-P2002223M, DEC14E2-P1331239M, DEC14E2-P1333115M, DEC14E2-P2001413M, DEC14E2-P2001515M, DEC14E2-P2002214M, DEC18E2-P1331221M, DEC18E2-P1331243M, DEC18E2-P1333119M, DEC18E2-P2001414M, DEC18E2-P2001516M, DEC18E2-P2002215M, DEC21E2-P1331226M, DEC21E2-P1331247M, DEC21E2-P1333123M, DEC21E2-P2001415M, DEC21E2-P2001517M, DEC21E2-P2002216M, DS1400E-P1333204M, DS1400E-P2000404M, DS1400E-P2001904M, DS1400E-P2001912M, DS30E2-P1331309M, DS30E2-P1332916M, HDC5112-P1331211M, HDC5112-P1331233M, HDC5112-P1333109M, HDC5142-P1331237M, HDC5142-P1333113M, HDC5182-P1331219M, HDC5182-P1331241M, HDC5182-P1333117M, HDC518-P1325209M, HDC518-P1330518M, HDC5212-P1331224M, HDC5212-P1331245M, HDC5212-P1333121M, JET5192-P2002710M, JET519V2-P2002711M...(Other models you can see in the webshop)		

without housing			
			
GEV No.	403430	Ref. No.	53001667 54116070
description	line filter for microwave type 6201W1A009D 250V 50/60Hz conductor 2 with fuse connection male faston 4.8mm L 80mm H 32mm W 52mm snap-on connection PCB Qty 1 pcs MDA T12A suitable for ACP		
For models:	DFS11EA-P1330220M, RCS511A-P1330214M, RFS511S-W2A-P1330223M, RFS511TSW13-P2001010M, RFS511T-SW13-P2001012M, RFS511TSW-P2001005M, RFS511TSW-P2001011M, UCS11MA-P1330228M, URCSS511A-P1330226M		

			
GEV No.	403428	Ref. No.	56002030
description	line filter type DWLF - M05 SS 250V 50/60Hz conductor 2 with fuse connection male faston 4.8mm L 60mm H 28mm W 40mm snap-on connection PCB Qty 1 pcs MDA 15A suitable for ACP		
For models:	RCS511DS-P2001106M, RCS511DS-P2001112M, RCS511TS-P2001105M, RCS511TS-P2001111M		
accessories for	403428		
	GEV No.	Ref. No.	20034001
	 fuse size ø6.3x32mm 15A slow-acting rated 250V Qty 1 pcs		

			
GEV No.	403429	Ref. No.	58101022
description	line filter type MDFLT25A 250V 50/60Hz conductor 2 without fuse connection male faston 4.8mm L 58mm H 23mm W 40mm snap-on connection PCB Qty 1 pcs T10A/T8A suitable for ACP		
For models:	RMS510D-P2001204M, RMS510D-P2001210M, RMS510T-P2001205M, RMS510T-P2001211M		
accessories for	403429		
	GEV No.	Ref. No.	—
	 fine fuse size ø5x20mm 10A slow-acting rated 250V Qty 10 pcs		
	GEV No.	Ref. No.	—
	 fine fuse size ø5x20mm 8A slow-acting rated 250V Qty 10 pcs		

RC circuits			
			
GEV No.	403433	Ref. No.	10172901 10172901Q 10172902 10172902Q 10172903Q 59002017 B8329402 B8329403
description	RC circuit type CRD 600V 50/60Hz conductor 2 connection male faston 6.3mm plastic Qty 1 pcs		
For models:	ACE14-P2001901M, ACE14-P2001909M, ACE5302-P1331307M, ACE5302-P1332907M, ACE5302-P1332912M, ACE5302-P1332914M, AXP20-P1333601M, AXP20-P1333602M, AXP20-P1333605M, AXP5201-P1333603M, AXP5203-P1333608M, DEC11E2-P1331213M, DEC11E2-P1331235M, DEC11E2-P1333111M, DEC14E2-P1331217M, DEC14E2-P1331239M, DEC14E2-P1333115M, DEC18E2-P1331221M, DEC18E2-P1331243M, DEC18E2-P1333119M, DEC21E2-P1331226M, DEC21E2-P1331247M, DEC21E2-P1333123M, DS1400E-P2001904M, DS1400E-P2001912M, DS30E2-P1331309M, DS30E2-P1332909M, DS30E2-P1332916M, HDC12A2-P1331203M, HDC12A2-P1333101M, HDC12A-P1330503M, HDC12P2-P1331223M, HDC182-P1331204M, HDC182-P1333102M, HDC18SD2-P1331205M, HDC18SD2-P1333103M, HDC212-P1331207M, HDC212-P1333105M, HDC5112-P1331211M, HDC5112-P1331233M, HDC5112-P1333109M, HDC5142-P1331215M, HDC5142-P1331237M, HDC5142-P1333113M, HDC5182-P1331219M, HDC5182-P1331241M, HDC5182-P1333117M, HDC518-P1325209M, HDC518-P1330518M, HDC5212-P1331224M...(Other models you can see in the webshop)		

HV capacitors			
			
GEV No.	365210	Ref. No.	59134372
description	capacitor 0.82µF 50/60Hz connection F6.3 L 112mm H 32mm W 52mm		





			
1			
GEV No.	365186	Ref. No.	10366919 12548804 43267P01 59001161 59001162 59001196 59002153 59174535
description	HV capacitor for microwave 0.74µF type N50H2374G21A3 2300V 50/60Hz triple connection male faston 6.3mm L 112mm H 32mm W 52mm dependent on equipment aluminium Qty 1 pcs		
For models:	ACE5140-P1333203M, ACE5140-P1333207M, ACE5140-P2000403M, DEC11E2-P2001412M, DEC11E2-P2001514M, DS1400E-P1333204M, DS1400E-P2000404M, DS1400E-P2001904M, DS1400E-P2001912M, HDC182-P1331204M, HDC182-P1333102M, HDC182-P2001403M, HDC182-P2001503M, HDC182-P2002203M, HDC18SD2-P1331205M, HDC18SD2-P1333103M, HDC18SD2-P2001405M, HDC-18SD2-P2001505M, HDC18SD2-P2002205M, MDC182-P1333128M, MDC182-P2001404M, MDC182-P2001504M, MDC182-P2002204M, MRC1752-P2001824M, MRC3052-P2001812M, RC1752-P2001823M, RC3052-P1331415M, RC3052-P1332816M, RC3052-P2001811M, UCA1400-P1333205M, UCA1400-P2000405M, UCA1400-P2001906M, UCA1400-P2001913M		

			
1			
GEV No.	365179	Ref. No.	10366912 12548805 59001163 59001649 D8547902 D8547920 D8547929
description	HV capacitor for microwave 0.8µF type N50H2180G25A3 2100V 50/60Hz triple connection male faston 6.3mm L 113mm H 32mm W 52mm dependent on equipment aluminium Qty 1 pcs		
For models:	MRC3052-P2001812M, RC3052-P1331415M, RC3052-P1332816M, RC3052-P2001811M		

			
1			
GEV No.	365180	Ref. No.	10366914 12548807 45230P01 59001651 59174539 C8790512 D8547922
description	HV capacitor for microwave 0.85µF type N50H2185G30A3 2100V 50/60Hz triple connection male faston 6.3mm L 112mm H 32mm W 52mm dependent on equipment aluminium Qty 1 pcs		
For models:	DEC18E2-P1331221M, DEC18E2-P1331243M, DEC18E2-P1333119M, DEC18E2-P2002215M, HDC5182-P1331219M, HDC5182-P1331241M, HDC5182-P1333117M, HDC518-P1325209M, HDC518-P1330518M, UC18E2-P1331222M, UC18E2-P1331244M, UC18E2-P1333120M, UHDC5182-P1331220M, UHDC5182-P1331242M, UHDC5182-P1333118M		

			
1			
GEV No.	365175	Ref. No.	10366908 10366920 12548808 59001024 59001166
description	HV capacitor for microwave 0.88µF type N50H2188G34A3 2100V 50/60Hz triple connection male faston 6.3mm L 125mm H 32mm W 52mm dependent on equipment aluminium Qty 1 pcs		

			
1			
GEV No.	365176	Ref. No.	59001167 59174541 D8547904
description	HV capacitor for microwave 0.9µF type N50H2190G37A3 2100V 50/60Hz triple connection male faston 6.3mm L 125mm H 32mm W 51mm dependent on equipment aluminium Qty 1 pcs		
For models:	DEC21E2-P1331226M, DEC21E2-P1331247M, DEC21E2-P1333123M, DEC21E2-P2002216M, HDC5212-P1331224M, HDC5212-P1331245M, HDC5212-P1333121M		

			
1			
GEV No.	403453	Ref. No.	53001903 54116053 54116074
description	HV capacitor for microwave 0.91µF type HCHP-212091A 2100V 50/60Hz double connection male faston 6.3mm L 109mm H 33mm W 52mm dependent on equipment aluminium Qty 1 pcs		
For models:	MFS18TS-P2001008M, RFS18MPS-P1330209M, RFS18MPS-P2000703M, RFS18TS-P2001003M		

			
1			
GEV No.	365182	Ref. No.	53001566 53001747 53002017 54116054
description	HV capacitor for microwave 0.95µF type CH85-21095 2100V 50/60Hz triple connection male faston 6.3mm L 114mm H 33mm W 52mm dependent on equipment aluminium Qty 1 pcs		
For models:	DFS18E-P1330222M, RCS10DA-P1330201M, RCS10DA-P2000702M, RCS10MPA-P1330202M, RCS10MPA-P2000704M, RFS518S-P1330216M, RFS518TS-P2001004M, URF5518S-P1330227M		





			
1			
GEV No.	365192	Ref. No.	10366907 1241524333 12730013 59001037 59001169 59134373
description	HV capacitor for microwave 1.05µF type N50H2110GA5A3 2100V 50/60Hz triple connection male faston 6.3mm L 138mm H 32mm W 51mm dependent on equipment aluminium Qty 1 pcs		
For models:	MOC5241-P2000303M, MRC518SU2-P1332818M, MRC-518SU2-P1332832M, OC5241BK-P2000304M		

			
1			
GEV No.	365185	Ref. No.	54127016
description	HV capacitor for microwave 1.2µF type CH85-21120 2100V 50/60Hz double connection male faston 6.3mm L 100mm H 33mm W 52mm dependent on equipment aluminium Qty 1 pcs		
For models:	RCS511DSE-P2002406M, RCS511TS-P2002405M		

			
1			
GEV No.	365184	Ref. No.	58101019
description	HV capacitor for microwave 1.1µF type CH85-21110 2100V 50/60Hz double connection male faston 4.8mm L 90mm H 33mm W 52mm dependent on equipment aluminium Qty 1 pcs		
For models:	RMS510D-P2001204M, RMS510D-P2001210M, RMS510T-P2001205M, RMS510T-P2001211M		

			
1			
GEV No.	365183	Ref. No.	53002066
description	HV capacitor for microwave 1.2µF type CH85-23120 2300V 50/60Hz double connection male faston 6.3mm L 108mm H 38mm W 66mm dependent on equipment aluminium Qty 1 pcs		
For models:	DFS11EA-P1330220M, RCS511A-P1330214M, RFS511S-W2A-P1330223M, RFS511TSW13-P2001010M, RFS511T-SW13-P2001012M, RFS511TSW-P2001005M, RFS511TSW-P2001011M, URC511A-P1330226M		

			
1			
GEV No.	365181	Ref. No.	56002042
description	HV capacitor for microwave 1.15µF type CH85-23115 2300V 50/60Hz double connection male faston 4.8mm L 100mm H 39mm W 66mm dependent on equipment aluminium Qty 1 pcs		
For models:	RCS511DS-P2001106M, RCS511DS-P2001112M, RCS511TS-P2001105M, RCS511TS-P2001111M		

			
1			
GEV No.	365187	Ref. No.	10366902 12548812 53001664 59001171 59004046
description	HV capacitor for microwave 1.2µF type N50H2112G41A3 2100V 50/60Hz triple connection male faston 6.3mm L 137mm H 32mm W 51mm dependent on equipment aluminium Qty 1 pcs		
For models:	DFS11EA-P1330220M, RCS511A-P1330214M, RFS511S-W2A-P1330223M, UCS11MA-P1330228M, URC511A-P1330226M		

			
1			
GEV No.	365188	Ref. No.	59001170 59004052
description	HV capacitor for microwave 1.15µF type N50H2111G64A3 2100V 50/60Hz triple connection male faston 6.3mm L 138mm H 32mm W 51mm dependent on equipment aluminium Qty 1 pcs		
For models:	AXP5201-P1333603M, AXP5203-P1333608M, DEC11E2-P1331213M, DEC11E2-P1331235M, DEC11E2-P1333111M, DEC11E2-P2002223M, HDC5112-P1331211M, HDC5112-P1331233M, HDC5112-P1333109M, MXP5201-P1333604M, MXP5203-P1333609M, MXP5221BO-P2001617M, RC520S-P1327601M, UC11E2-P1331214M, UC11E2-P1331236M, UC11E2-P1333112M, UHDC5112-P1331212M, UHDC5112-P1331234M, UHDC5112-P1333110M		

			
1			
GEV No.	365178	Ref. No.	10366909 12548813 59001011 59001172
description	HV capacitor for microwave 1.3µF type N50H2113G25A3 2100V 50/60Hz triple connection male faston 6.3mm L 138mm H 32mm W 51mm dependent on equipment aluminium Qty 1 pcs		
For models:	ACE5302-P1331307M, ACE5302-P1332907M, ACE5302-P1332912M, ACE5302-P1332914M, DS30E2-P1331309M, DS30E2-P1332909M, DS30E2-P1332916M, RCS511-P1325802M, RCS511-P1327809M, UCA2000NT3-P1332921M, UCA2000NT3-P2000406M		





			
1			
GEV No.	365177	Ref. No.	10366904 10366906 10804104 10804108 12548810 59001010 59001168 D8547908 D8547923 D8547926
description	HV capacitor for microwave 1µF type N50H2110GA7A3 2100V 50/60Hz triple connection male faston 6.3mm L 124mm H 32mm W 52mm dependent on equipment aluminium Qty 1 pcs		
For models:	AXP20-P1333601M, AXP20-P1333602M, AXP20-P1333605M, HDC12P2-P1331223M, JET5192-P2002710M, JET519V2-P2002711M, MRC524TS2-P1331432M, MRC524TS2-P1333415M, MXP5221-P2001606M, MXP5223-P2001607M, MXP5223TL-P2001620M, RC524TS2-P1331430M, RC524TS2-P1333414M		

			
1			
GEV No.	365174	Ref. No.	10366915 12548802 59001009 59001159 59174533 D8547930
description	HV capacitor kit for microwave 0.65µF type N50H2365G21A3 2300V 50/60Hz triple connection male faston 6.3mm L 112mm H 32mm W 51mm dependent on equipment aluminium Qty 1 pcs		
For models:	ACE14-P1333201M, ACE14-P1333206M, ACE14-P2000401M, ACE14-P2001901M, ACE14-P2001909M, DEC14E2-P1331217M, DEC14E2-P1331239M, DEC14E2-P1333115M, DEC14E2-P2001413M, DEC14E2-P2001515M, DEC14E2-P2002214M, DEC18E2-P2001414M, DEC18E2-P2001516M, DEC21E2-P2001415M, DEC21E2-P2001517M, HDC5142-P1331215M, HDC5142-P1331237M, HDC5142-P1333113M, MCE14-P2000407M, MCE14-P2001902M, MCE14-P2001910M, UC14E2-P1331218M, UC14E2-P1331240M, UC14E2-P1333116M, UHDC5142-P1331216M, UHDC5142-P1331238M, UHDC5142-P1333114M		

fuses

fine fuses

			
1			
GEV No.	358168	Ref. No.	20034004
description	fine fuse size ø5x20mm 10A medium lag rated 250V Qty 1 pcs size 5x20mm		
For models:	RMS510D-P2001204M, RMS510D-P2001210M, RMS510T-P2001205M, RMS510T-P2001211M		

			
1			
GEV No.	358154	Ref. No.	M0805103 M0805106 R9900522
description	fine fuse size ø6.3x32mm 10A fast-acting rated 250V Qty 1 pcs		
For models:	DEL10D-P1329706M, DEL10E-P1329707M, LD510D-P1329704M, LD510P-P1329705M, RCS10DA-P1330201M, RCS10DA-P2000702M		

			
1			
GEV No.	358156	Ref. No.	53001666 56001475 M0805105
description	fine fuse size ø6.3x32mm 12A fast-acting rated 250V Qty 1 pcs		
For models:	ALD510D-P1331003M, ALD510-P1331005M, ALD510SE-P1331012M, AXP20-P1333601M, AXP20-P1333602M, AXP20-P1333605M, AXP5201-P1333603M, AXP5203-P1333608M, DFS11EA-P1330220M, DFS18E-P1330222M, MFS18TS-P2001008M, MLD510D-P1331007M, MLD510-P1331009M, MLD510SE-P1331014M, MXP5201-P1333604M, MXP5203-P1333609M, MXP5221BO-P2001617M, MXP5221-P2001606M, MXP5223-P2001607M, MXP5223TL-P2001620M, RC510MPA-P1330202M, RCS10MPA-P2000704M, RCS511A-P1330214M, RCS511-P1325802M, RCS511-P1327809M, RFS12MPSA-P1330206M, RFS18MPS-P1330209M, RFS18MPS-P2000703M, RFS18TS-P2001003M, RFS511SW2A-P1330223M, RFS511TSW13-P2001010M, RFS511TSW13-P2001012M, RFS511TSW-P2001005M, RFS511T-SW-P2001011M, RFS518S-P1330216M, RFS518TS-P2001004M, UALD510-P1331006M, UALD510SE-P1331013M, UCS-11MA-P1330228M, UMLD510D-P1331008M, UMLD510-P1331010M, UMLD510SE-P1331015M, URCS511A-P1330226M, UR-FS518S-P1330227M		

			
1			
GEV No.	358157	Ref. No.	1760000301 M0805102
description	fine fuse size ø6.3x32mm 15A fast-acting rated 250V Qty 1 pcs		
For models:	ACE5140-P1333203M, ACE5140-P1333207M, ACE5140-P2000403M, ACE5302-P1331307M, ACE5302-P1332912M, ACE5302-P1332914M, DS1400E-P1333204M, DS1400E-P2000404M, DS1400E-P2001904M, DS1400E-P2001912M, DS30E2-P1331309M, DS30E2-P1332916M, MRC17S2-P1333417M, MRC17S2-P2001802M, MRC22S2-P1333418M, MRC30S2-P2001812M, MRC518SU2-P1332818M, MRC518SU2-P1332832M, MRC524TS2-P1331432M, MRC524TS2-P1333415M, RC17S2-P1331401M, RC17S2-P1332801M, RC17S2-P1333401M, RC17S2-P2001801M, RC22S2-P1331403M, RC22S2-P1332804M, RC22S2-P1333404M, RC22S2-P2001804M, RC22S-P1326303M, RC22S-P1329103M, RC22S-P1329610M, RC22S-P1330104M, RC30S2-P1332816M, RC30S2-P1333410M, RC30S2-P2001811M, RC518SU-P1327602M, RC520S-P1327601M, RC524TS2-P1331430M, RC524TS2-P1333414M, UCA1400-P1333205M, UCA1400-P2000405M, UCA1400-P2001906M, UCA1400-P2001913M, UCA2000NT3-P1332921M, UCA2000NT3-P2000406M		





			
1			
GEV No.	358155	Ref. No.	56001353 M0805101 R0131110 Y0057191
description	fine fuse size ϕ 6.3x32mm 20A fast-acting rated 250V Qty 1 pcs		
For models:	ALD10D-P1331011M, ALD10D-P1331019M, ALD10T-P1331002M, ALD10T-P1331018M, LD10D2-P1329702M, LD10MP-P1329703M, LD10MP-P2000701M		

			
1			
GEV No.	358851	Ref. No.	20034001
description	fuse size ϕ 6.3x32mm 15A slow-acting rated 250V Qty 1 pcs		
For models:	RCS511DSE-P2002406M, RCS511DS-P2001106M, RCS-511DS-P2001112M, RCS511TS-P2001105M, RCS511TS-P2001111M, RCS511TS-P2002405M, RFS12MPSB-P1330235M, RFS12T-SW-P2001001M		

			
1			
GEV No.	358153	Ref. No.	M0805202
description	fine fuse size ϕ 10.4x38mm 15A fast-acting rated 250V type BLN Qty 1 pcs		
For models:	DEC11E2-P1331213M, DEC11E2-P1331235M, DEC11E2-P1333111M, DEC11E2-P2001412M, DEC11E2-P2001514M, DEC11E2-P200223M, HDC12P2-P1331223M, HDC5112-P1331211M, HDC5112-P1331233M, HDC5112-P1333109M, UC11E2-P1331214M, UC11E2-P1331236M, UC11E2-P1333112M, UCA2000NT3-P1332921M, UCA2000NT3-P2000406M, UHDC5112-P1331212M, UHDC5112-P1331234M, UHDC5112-P1333110M		

			
1			
GEV No.	358150	Ref. No.	M0805203
description	fine fuse size ϕ 10.4x38mm 20A fast-acting rated 250V type BLN Qty 1 pcs		
For models:	ACE5140-P1333203M, ACE5140-P1333207M, ACE5302-P1331307M, ACE5302-P1332912M, ACE5302-P1332914M, DEC14E2-P1331239M, DEC14E2-P1333115M, DEC14E2-P2001413M, DEC14E2-P2001515M, DEC14E2-P2002214M, DEC18E2-P1331221M, DEC18E2-P1331243M, DEC18E2-P1333119M, DEC18E2-P2001414M, DEC18E2-P2001516M, DEC18E2-P2002215M, DEC21E2-P1331226M, DEC21E2-P1331247M, DEC21E2-P1333123M, DEC21E2-P2001415M, DEC21E2-P2001517M, DEC21E2-P2002216M, DS1400E-P1333204M, DS30E2-P1331309M, DS30E2-P1332916M, HDC5142-P1331237M, HDC5142-P1333113M, HDC5182-P1331219M, HDC5182-P1331241M, HDC5182-P1333117M, HDC518-P1325209M, HDC518-P1330518M, HDC5212-P1331224M, HDC5212-P1331245M, HDC5212-P1333121M, MOC5241-P2000303M, OCS241BK-P2000304M, UC14E2-P1331240M, UC14E2-P1333116M, UC18E2-P1331222M, UC18E2-P1331244M, UC18E2-P1333120M, UCA1400-P1333205M, UHDC5142-P1331238M, UHDC5142-P1333114M, UHDC5182-P1331220M, UHDC5182-P1331242M, UHDC5182-P1333118M		

			
1			
GEV No.	358151	Ref. No.	M0805201
description	fine fuse size ϕ 10.4x38mm 25A fast-acting rated 250V type BLN Qty 1 pcs		
For models:	AXP20-P1333601M, AXP20-P1333602M, AXP20-P1333605M, AXP5201-P1333603M, AXP5203-P1333608M, HDC12A2-P1331203M, HDC12A2-P1333101M, HDC12A2-P2001401M, HDC12A2-P2001501M, HDC12A2-P2002201M, HDC12A-P1323002M, HDC12A-P1323012M, HDC12A-P1330503M, MDC12A2-P1333127M, MDC12A2-P2001402M, MDC12A2-P2001502M, MDC12A2-P2002202M, MXP5201-P1333604M, MXP5203-P1333609M, MXP5221BO-P2001617M, MXP5221-P2001606M, MXP5223-P2001607M, MXP5223TL-P2001620M, RC22S-P1198605M		

			
1			
GEV No.	358152	Ref. No.	M0805205
description	fine fuse size ϕ 10.4x38mm 30A fast-acting rated 250V type BLN Qty 1 pcs		
For models:	ACE14-P1333201M, ACE14-P1333206M, ACE14-P2000401M, ACE14-P2001901M, ACE14-P2001909M, JET5192-P2002710M, JET519V2-P2002711M, MCE14-P2000407M, MCE14-P2001902M, MCE14-P2001910M, MRC17S2-P1333417M, MRC17S2-P2001802M, MRC17S2-P2001814M, MRC17S2-P2001824M, MRC22S2-P1333418M, MRC22S2-P2001817M, MRC30S2-P2001812M, MRC518SU2-P1332818M, MRC518SU2-P1332832M, MRC524TS2-P1331432M, MRC524TS2-P1333415M, RC17S2-P1331401M, RC17S2-P1332801M, RC17S2-P1333401M, RC17S2-P2001801M, RC17S2-P2001813M, RC17S2-P2001823M, RC22S2-P1331403M, RC22S2-P1332804M, RC22S2-P1333404M, RC22S2-P2001804M, RC22S2-P2001816M, RC22S-P1326303M, RC22S-P1329103M, RC22S-P1329610M, RC22S-P1330104M, RC30S2-P1331415M, RC30S2-P1332816M, RC30S2-P1333410M, RC30S2-P2001811M, RC518SU-P1327602M, RC520S-P1327601M, RC524TS2-P1331430M, RC524TS2-P1333414M		

fine fuse holders

			
1			
GEV No.	504479	Ref. No.	12136503 30928P01 B8351101
description	fuse holder suitable fuse ϕ 5x30mm ϕ mm 25A rated 300V L 35mm W 12.9mm H 13.5mm connection F6.3 single		
For models:	ACE5140-P1333203M, ACE5140-P1333207M, ACE5140-P2000403M, ACE5302-P1331307M, ACE5302-P1332912M, ACE5302-P1332914M, DS1400E-P1333204M, DS1400E-P2000404M, DS1400E-P2001904M, DS1400E-P2001912M, DS30E2-P1331309M, DS30E2-P1332916M, RCSS11-P1325802M, RCSS11-P1327809M, UCA1400-P1333205M, UCA1400-P2000405M, UCA1400-P2001906M, UCA1400-P2001913M, UCA2000NT3-P1332921M, UCA2000NT3-P2000406M		



1

GEV No.	551268	Ref. No.	10091101 10091102 1783050531
description	fuse holder suitable fuse ø5x30mm ømm 30A rated 600V L 76mm W 20mm H 33mm connection F6.3x0.8		
For models:	ACE14-P1333201M, ACE14-P1333206M, ACE14-P2000401M, ACE14-P2001901M, ACE14-P2001909M, ACE5140-P1333203M, ACE5140-P1333207M, ACE5140-P2000403M, ACE5302-P1331307M, ACE5302-P1332912M, ACE5302-P1332914M, AXP20-P1333601M, AXP20-P1333602M, AXP20-P1333605M, AXP5201-P1333603M, AXP5203-P1333608M, DEC11E2-P1331213M, DEC11E2-P1331235M, DEC11E2-P1333111M, DEC11E2-P2001412M, DEC11E2-P2001514M, DEC11E2-P2002223M, DEC14E2-P1331239M, DEC14E2-P1333115M, DEC14E2-P2001413M, DEC14E2-P2001515M, DEC14E2-P2002214M, DEC18E2-P1331221M, DEC18E2-P1331243M, DEC18E2-P1333119M, DEC18E2-P2001414M, DEC18E2-P2001516M, DEC18E2-P2002215M, DEC21E2-P1331226M, DEC21E2-P1331247M, DEC21E2-P1333123M, DEC21E2-P2001415M, DEC21E2-P2001517M, DEC21E2-P2002216M, DS1400E-P1333204M, DS1400E-P2000404M, DS1400E-P2001904M, DS1400E-P2001912M, DS30E2-P1331309M, DS30E2-P1332916M, HDC12A2-P1331203M, HDC12A2-P1333101M, HDC12A2-P2001401M, HDC12A2-P2001501M, HDC12A2-P2002201M...(Other models you can see in the webshop)		



1

GEV No.	504475	Ref. No.	12136502 59001682
description	fuse holder triple suitable fuse ø6.3x32mm ømm 16A rated 300V L 44mm W 36mm H 13mm connection F6.3		
For models:	AXP20-P1333601M, AXP20-P1333602M, AXP20-P1333605M, AXP5201-P1333603M, AXP5203-P1333608M, MRC17S2-P1333417M, MRC17S2-P2001802M, MRC22S2-P1333418M, MRC30S2-P2001812M, MRC518SU2-P1332818M, MRC518SU2-P1332832M, MRC524TS2-P1331432M, MRC524TS2-P1333415M, MXP5201-P1333604M, MXP5203-P1333609M, MXP5221BO-P2001617M, MXP5221-P2001606M, MXP5223-P2001607M, MXP5223TL-P2001620M, RC17S2-P1331401M, RC17S2-P1332801M, RC17S2-P1333401M, RC17S2-P2001801M, RC22S2-P1331403M, RC22S2-P1332804M, RC22S2-P1333404M, RC22S2-P2001804M, RC22S-P1326303M, RC22S-P1329103M, RC22S-P1329610M, RC22S-P1330104M, RC30S2-P1332816M, RC30S2-P1333410M, RC30S2-P2001811M, RC518SU-P1327602M, RC520S-P1327601M, RC524TS2-P1331430M, RC524TS2-P1333414M		

thermal fuses

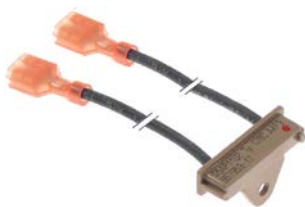

1

GEV No.	358164	Ref. No.	59001211 59001992 B5795317
description	temperature limiter switch-off temp. 128°C type G5AP1102 Qty 1 pcs		
For models:	AXP5201-P1333603M, AXP5203-P1333608M, MRC-518SU2-P1332832M, MRC524TS2-P1331432M, MRC524TS2-P1333415M, MXP5201-P1333604M, MXP5203-P1333609M, MXP-5221BO-P2001617M, MXP5221-P2001606M, MXP5223-P2001607M, MXP5223TL-P2001620M, RC524TS2-P1331430M, RC524TS2-P1333414M		

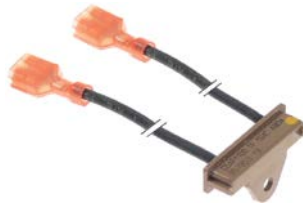

1

GEV No.	358165	Ref. No.	59001667 59001874 B5795302 B5795319
description	thermal fuse switch-off temp. 104°C type G5AP1100 Qty 1 pcs		
For models:	DEC11E2-P1331213M, DEC11E2-P1331235M, DEC11E2-P1333111M, DEC11E2-P2001412M, DEC11E2-P2001514M, DEC11E2-P2002223M, DEC14E2-P1331217M, DEC14E2-P1331239M, DEC14E2-P1333115M, DEC14E2-P2001413M, DEC14E2-P2001515M, DEC14E2-P2002214M, DEC18E2-P1331221M, DEC18E2-P1331243M, DEC18E2-P1333119M, DEC18E2-P2001414M, DEC18E2-P2001516M, DEC18E2-P2002215M, DEC21E2-P1331226M, DEC21E2-P1331247M, DEC21E2-P1333123M, DEC21E2-P2001415M, DEC21E2-P2001517M, DEC21E2-P2002216M, HDC12A2-P1331203M, HDC12A2-P1333101M, HDC12A2-P2001401M, HDC12A2-P2001501M, HDC12A2-P2002201M, HDC12A2-P1323002M, HDC12A2-P1323012M, HDC12A2-P1330503M, HDC12P2-P1331223M, HDC18E2-P1331204M, HDC18E2-P1333102M, HDC18E2-P2001403M, HDC18E2-P2001503M, HDC18E2-P2002203M, HDC18SD2-P1331205M, HDC18SD2-P1333103M, HDC18SD2-P2001405M, HDC-18SD2-P2001505M, HDC18SD2-P2002205M, HDC21E2-P1331207M, HDC21E2-P1333105M, HDC21E2-P2001407M, HDC21E2-P2001507M, HDC21E2-P2002207M, HDC511E2-P1331211M, HDC511E2-P1331233M...(Other models you can see in the webshop)		



1

GEV No.	358166	Ref. No.	59004115
description	thermal fuse switch-off temp. 104°C type G5AP1101 Qty 1 pcs with cable gland		
For models:	MOC5241-P2000303M, OC5241BK-P2000304M		

HV fuses



1

GEV No.	358169	Ref. No.	54116050
description	HV fuse 0.8A slow-acting rated 5000V Qty 1 pcs		
For models:	MFS18TS-P2001008M, RFS18TS-P2001003M, RFS518TS-P2001004M		





1

GEV No.	358171	Ref. No.	58101028
description	HV fuse 0.9A slow-acting rated 5000V Qty 1 pcs		
For models:	RMS510D-P2001204M, RMS510D-P2001210M, RMS510T-P2001205M, RMS510T-P2001211M		



			
1			
GEV No.	358170	Ref. No.	54116072
description	HV fuse 1A slow-acting rated 5000V Qty 1 pcs		
For models:	RFS511TSW13-P2001010M, RFS511TSW-P2001005M		

			
1			
GEV No.	358172	Ref. No.	56001474
description	HV fuse 1A slow-acting rated 5000V Qty 1 pcs		
For models:	ALD10D-P1331011M, ALD10D-P1331019M, ALD10T-P1331002M, ALD10T-P1331018M, ALD510D-P1331003M, ALD510-P1331005M, ALD510SE-P1331012M, MLD510D-P1331007M, MLD510-P1331009M, MLD510SE-P1331014M, RCS511DS-P2001106M, RCS511DS-P2001112M, RCS511TS-P2001105M, RCS511TS-P2001111M, UALD510-P1331006M, UALD510SE-P1331013M, UMLD510D-P1331008M, UMLD510-P1331010M, UMLD510SE-P1331015M		

			
1			
GEV No.	551271	Ref. No.	58101027
description	connecting cable CEE7/7 type E+F 3-pole contacts P+N+E 1mm ² 1.5m with strain relief countries A/B/D/F/I		
For models:	RMS510D-P2001204M, RMS510D-P2001210M, RMS510T-P2001205M, RMS510T-P2001211M		

cable harnesses

			
1			
GEV No.	701373	Ref. No.	20039702 20039704
description	cable harness for HV wiring grey plug type male faston Qty 1 pcs		
For models:	DEC11E2-P2002223M, DEC14E2-P2001413M, DEC14E2-P2001515M, DEC14E2-P2002214M, DEC18E2-P2001414M, DEC18E2-P2001516M, DEC18E2-P2002215M, DEC21E2-P2001415M, DEC21E2-P2001517M, DEC21E2-P2002216M, HDC182-P2001403M, HDC18SD2-P2001405M, HDC212-P2001407M, MDC12A2-P2001402M, MDC182-P2001404M		

electric accessories

cables

power supply cables

			
1			
GEV No.	551270	Ref. No.	53001742 53001818
description	connecting cable CEE7/7 type E+F 3-pole contacts P+N+E 1.5mm ² 1.5m with strain relief countries A/B/D/F/I		
For models:	DFS11EA-P1330220M, DFS18E-P1330222M, RCS511A-P1330214M, RFS511SW2A-P1330223M, RFS511TSW-P2001005M, RFS511TSW-P2001011M, RFS518S-P1330216M, RFS518TS-P2001004M, URCS511A-P1330226M		

			
1			
GEV No.	551269	Ref. No.	59002001 B5669025
description	connecting cable CEE7/7 type E+F 3-pole contacts P+N+E 1.5mm ² 1.8m with strain relief countries A/B/D/F/I		
For models:	ACE5302-P1331307M, ACE5302-P1332914M, DEC11E2-P1331213M, DEC11E2-P1331235M, DEC11E2-P1333111M, DEC11E2-P2001412M, DEC11E2-P2001514M, DEC11E2-P2002223M, DEC14E2-P1331217M, DEC14E2-P1331239M, DEC14E2-P1333115M, DEC14E2-P2001413M, DEC14E2-P2001515M, DEC14E2-P2002214M, DEC18E2-P1331221M, DEC18E2-P1331243M, DEC18E2-P1333119M, DEC18E2-P2001414M, DEC18E2-P2001516M, DEC18E2-P2002215M, DEC21E2-P1331226M, DEC21E2-P2001415M, DEC21E2-P2001517M, DEC21E2-P2002216M, DS30E2-P1331309M, DS30E2-P1332916M, HDC5112-P1331211M, HDC5112-P1331233M, HDC5112-P1333109M, HDC5142-P1331215M, HDC5142-P1331237M, HDC5142-P1333113M, HDC5182-P1331219M, HDC5182-P1331241M, HDC5182-P1333117M, HDC518-P1325209M, HDC518-P1330518M, HDC5212-P1331224M, MOC5241-P2000303M, MRC518SU2-P1332832M, OCS5241BK-P2000304M, RCS511-P1325802M, RCS511-P1327809M		

connection cables

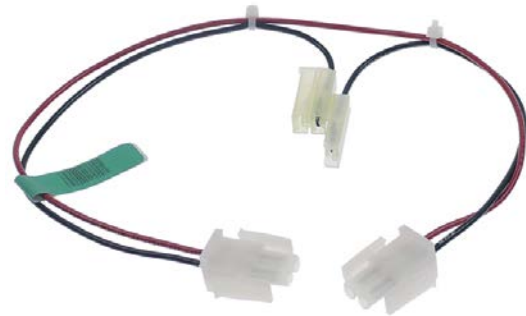
			
1			
GEV No.	698825	Ref. No.	20094101
description	cable L 450mm		
For models:	JET5192-P2002710M, JET519V2-P2002711M		

electronic components

varistors

			
1			
GEV No.	308000	Ref. No.	53001725
description	line protection		
For models:	DFS11EA-P1330220M, DFS18E-P1330222M, RCS511A-P1330214M, RFS18MPS-P1330209M, RFS18MPS-P2000703M, RFS511S-W2A-P1330223M, RFS518S-P1330216M, UCS11MA-P1330228M, URCS511A-P1330226M, URF518S-P1330227M		



chip cards

EZ cards



1

GEV No.	403432	Ref. No.	59002095
description	chip card reader L 45mm W 55mm H 18mm		
For models:	ACE14-P1333201M, ACE14-P1333206M, ACE14-P2000401M, ACE14-P2001901M, ACE14-P2001909M, ACE5140-P1333203M, ACE5140-P1333207M, ACE5140-P2000403M, AXP20-P1333601M, AXP20-P1333602M, AXP20-P1333605M, AXP5201-P1333603M, AXP5203-P1333608M, DS1400E-P1333204M, DS1400E-P2000404M, DS1400E-P2001904M, DS1400E-P2001912M, MCE14-P2000407M, MCE14-P2001902M, MCE14-P2001910M, MXP5201-P1333604M, MXP5203-P1333609M, UCA1400-P1333205M, UCA1400-P2000405M		
accessories for	403432		
	GEV No.	403425	Ref. No. 13044901 EZ10
EZ-Chip edition black			
	GEV No.	403426	Ref. No. 13044902 14080009
EZ-Chip edition red			



1

GEV No.	403425	Ref. No.	13044901 EZ10
description	EZ-Chip edition black		
For models:	ACE14-P2001901M, ACE14-P2001909M, DS1400E-P2001904M, DS1400E-P2001912M, MCE14-P2001910M, UCA1400-P2001906M, UCA1400-P2001913M		
accessories for	403425		
	GEV No.	403432	Ref. No. 59002095
chip card reader L 45mm W 55mm H 18mm			



1

GEV No.	403426	Ref. No.	13044902 14080009
description	EZ-Chip edition red		
accessories for	403426		
	GEV No.	403432	Ref. No. 59002095
chip card reader L 45mm W 55mm H 18mm			

USB flash drives



1

GEV No.	403427	Ref. No.	59134222
description	USB stick capacity 1GB		

equipment-specific units

for microwaves

antennas

covers



1

GEV No.	699550	Ref. No.	59004097
description	stirrer glass L 295mm W 220mm for microwave plastic		
For models:	MOC5241-P2000303M, OC5241BK-P2000304M		



1

GEV No.	699545	Ref. No.	12126601 59004011 59124202
description	stirrer glass L 295mm W 325mm for microwave plastic Qty 1 pcs		
For models:	DEC11E2-P1331213M, DEC11E2-P1331235M, DEC11E2-P1333111M, DEC11E2-P2001412M, DEC11E2-P2001514M, DEC11E2-P2002223M, DEC14E2-P1331217M, DEC14E2-P1331239M, DEC14E2-P1333115M, DEC14E2-P2001413M, DEC14E2-P2001515M, DEC14E2-P2002214M, DEC18E2-P1331221M, DEC18E2-P1331243M, DEC18E2-P1333119M, DEC18E2-P2001414M, DEC18E2-P2001516M, DEC18E2-P2002215M, DEC21E2-P1331226M, DEC21E2-P1331247M, DEC21E2-P1333123M, DEC21E2-P2001415M, DEC21E2-P2001517M, DEC21E2-P2002216M, HDC12A2-P1331203M, HDC12A2-P1333101M, HDC12A2-P2001401M, HDC12A2-P2001501M, HDC12A2-P2002201M, HDC12A-P1330503M, HDC12P2-P1331223M, HDC182-P1331204M, HDC182-P1333102M, HDC182-P2001403M, HDC182-P2001503M, HDC182-P2002203M, HDC18SD2-P1331205M, HDC18SD2-P1333103M, HDC-18SD2-P2001405M, HDC18SD2-P2001505M, HDC18SD2-P2002205M, HDC212-P1331207M, HDC212-P1333105M, HDC212-P2001407M, HDC212-P2001507M, HDC212-P2002207M, HDC5112-P1331211M, HDC5112-P1331233M, HDC5112-P1333109M, HDC5142-P1331215M...(Other models you can see in the webshop)		

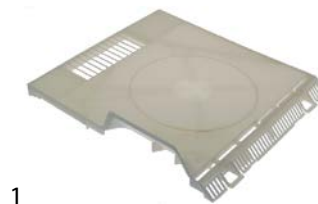



1

GEV No.	699500	Ref. No.	53001556 53001588 53002003
description	stirrer glass L 357mm W 390mm plastic Qty 1 pcs		
For models:	DFS11EA-P1330220M, DFS18E-P1330222M, MFS18TS-P2001008M, RCS10DA-P1330201M, RCS10DA-P2000702M, RCS10M-PA-P1330202M, RCS10MPA-P2000704M, RFS12MPSA-P1330206M, RFS12MPSB-P1330235M, RFS12TSW-P2001001M, RFS18MPS-P1330209M, RFS18MPS-P2000703M, RFS18TS-P2001003M, RFS511SW2A-P1330223M, RFS511TSW13-P2001010M, RFS511T-SW13-P2001012M, RFS511TSW-P2001005M, RFS511TSW-P2001011M, RFS518S-P1330216M, RFS518TS-P2001004M, UCS11MA-P1330228M, URCS511A-P1330226M, URFS518S-P1330227M		



			
1			
GEV No.	699555	Ref. No.	10766601 59004008
description	stirrer glass L 365mm W 330mm for microwave plastic Qty 1 pcs		
For models:	MRC17S2-P1333417M, MRC17S2-P2001802M, MRC17S2-P2001814M, MRC17S2-P2001824M, MRC22S2-P1333418M, MRC22S2-P2001817M, MRC30S2-P2001812M, MRC518SU2-P1331419M, MRC518SU2-P1332818M, MRC518SU2-P1332832M, MRC518SU-P1327613M, MRC520S-P1327614M, MRC524TS2-P1331432M, MRC524TS2-P1333415M, RC17S2-P1331401M, RC17S2-P1332801M, RC17S2-P1333401M, RC17S2-P2001801M, RC17S2-P2001813M, RC17S2-P2001823M, RC22S2-P1331403M, RC22S2-P1332804M, RC22S2-P1333404M, RC22S2-P2001804M, RC22S2-P2001816M, RC22S-P1198605M, RC22S-P1326303M, RC22S-P1329103M, RC22S-P1329610M, RC22S-P1330104M, RC30S2-P1331415M, RC30S2-P1332816M, RC30S2-P1333410M, RC30S2-P2001811M, RC518SU-P1327602M, RC520S-P1327601M, RC524TS2-P1331430M, RC524TS2-P1333414M		

antennas			
			
1			
GEV No.	699535	Ref. No.	R0130737 R0150114
description	stirrer for microwave		
For models:	ACE14-P1333201M, ACE14-P1333206M, ACE14-P2000401M, ACE14-P2001901M, ACE14-P2001909M, ACE5140-P1333203M, ACE5140-P1333207M, ACE5140-P2000403M, ACE5302-P1331307M, ACE5302-P1332912M, ACE5302-P1332914M, DS1400E-P1333204M, DS1400E-P2000404M, DS1400E-P2001904M, DS1400E-P2001912M, DS30E2-P1331309M, DS30E2-P1332916M, MCE14-P2000407M, MCE14-P2001902M, MCE14-P2001910M, UCA1400-P1333205M, UCA1400-P2000405M, UCA1400-P2001906M, UCA1400-P2001913M, UCA2000NT3-P1332921M, UCA2000NT3-P2000406M		

			
1			
GEV No.	701376	Ref. No.	58101058
description	stirrer H 28mm ø 218mm for microwaves aluminium Qty 1 pcs		
For models:	MMS10TS-P2001217M, RMS10TS-P2001203M, RMS10TS-P2001209M, RMS510D-P2001204M, RMS510D-P2001210M, RMS510T-P2001205M, RMS510T-P2001211M		

			
1			
GEV No.	701372	Ref. No.	10825904Q
description	stirrer ø 215mm thickness 0.6mm suitable for ACP aluminium round		
For models:	ACE14-P1333201M, ACE14-P1333206M, ACE14-P2000401M, ACE14-P2001901M, ACE14-P2001909M, ACE5140-P1333203M, ACE5140-P1333207M, ACE5140-P2000403M, ACE5302-P1331307M, ACE5302-P1332912M, ACE5302-P1332914M, DS1400E-P1333204M, DS1400E-P2000404M, DS1400E-P2001904M, DS1400E-P2001912M, DS30E2-P1331309M, DS30E2-P1332916M, MCE14-P2000407M, MCE14-P2001902M, MCE14-P2001910M, UCA1400-P1333205M, UCA1400-P2000405M, UCA1400-P2001906M, UCA1400-P2001913M, UCA2000NT3-P1332921M, UCA2000NT3-P2000406M		

accessories			
			
1			
GEV No.	701361	Ref. No.	12002867
description	drive for microwave suitable for ACP nylon Qty 1 pcs gear wheels, transmission and add-on parts		
For models:	AXP20-P1333601M, AXP20-P1333602M, AXP20-P1333605M, AXP5201-P1333603M, AXP5203-P1333608M, MXP5201-P1333604M, MXP5203-P1333609M, MXP5221BO-P2001617M, MXP5221-P2001606M, MXP5223-P2001607M, MXP5223TL-P2001620M		

			
1			
GEV No.	701346	Ref. No.	12004401
description	pin L 39mm ø 18.8mm brown		
For models:	ACE14-P1333201M, ACE14-P1333206M, ACE14-P2000401M, ACE14-P2001901M, ACE14-P2001909M, ACE5140-P1333203M, ACE5140-P1333207M, ACE5140-P2000403M, ACE5302-P1331307M, ACE5302-P1332912M, ACE5302-P1332914M, DS1400E-P1333204M, DS1400E-P2000404M, DS1400E-P2001904M, DS1400E-P2001912M, DS30E2-P1331309M, DS30E2-P1332916M, MCE14-P2000407M, MCE14-P2001902M, MCE14-P2001910M, UCA1400-P1333205M, UCA1400-P2000405M, UCA1400-P2001906M, UCA1400-P2001913M, UCA2000NT3-P1332921M, UCA2000NT3-P2000406M		

			
1			
GEV No.	701487	Ref. No.	12002512
description	service kit for antenna		
For models:	JET5192-P2002710M, JET519V2-P2002711M		

			
1			
GEV No.	699539	Ref. No.	12487701Q 59001948 R9900585
description	stirrer incl. adhesive mounting pos. lower for microwave		
For models:	DEC14E2-P1331239M, DEC14E2-P1333115M, DEC14E2-P2001413M, DEC14E2-P2001515M, DEC18E2-P1331221M, DEC18E2-P1331243M, DEC18E2-P1333119M, DEC18E2-P2001414M, DEC18E2-P2001516M, DEC21E2-P1331226M, DEC21E2-P1331247M, DEC21E2-P1333123M, DEC21E2-P2001415M, DEC21E2-P2001517M, HDC12A2-P1331203M, HDC12A2-P1333101M, HDC12A2-P2001401M, HDC12A2-P2001501M, HDC12A-P1323002M, HDC12A-P1323012M, HDC12A-P1330503M, HDC182-P1331204M, HDC182-P1333102M, HDC182-P2001403M, HDC182-P2001503M, HDC18SD2-P1331205M, HDC18SD2-P1333103M, HDC18SD2-P2001405M, HDC18SD2-P2001505M, HDC212-P1331207M, HDC212-P1333105M, HDC212-P2001407M, HDC212-P2001507M, HDC5142-P1331237M, HDC5142-P1333113M, HDC5182-P1331219M, HDC5182-P1331241M, HDC5182-P1333117M, HDC518-P1325209M, HDC518-P1330518M, HDC5212-P1331224M, HDC5212-P1331245M, HDC5212-P1333121M, MCHDC21-P1333130M, MCHDC21-P2001512M, MDC12A2-P1333127M, MDC12A2-P2001402M, MDC12A2-P2001502M, MDC182-P1333128M, MDC182-P2001404M...(Other models you can see in the webshop)		

			
1			
GEV No.	699540	Ref. No.	59004095
description	stirrer kit for microwave		
For models:	MOC5241-P2000303M, OC5241BK-P2000304M		

			
1			
GEV No.	699516	Ref. No.	12002451 53001553
description	stirrer kit mounting pos. lateral for microwave		
For models:	DFS11EA-P1330220M, RCS10DA-P1330201M, RCS10DA-P2000702M, RCS10MPA-P1330202M, RCS10MPA-P2000704M, RCS511A-P1330214M, RFS12MPSA-P1330206M, RFS511SW2A-P1330223M, RFS511TSW13-P2001010M, RFS511TSW13-P2001012M, RFS511TSW-P2001005M, RFS511TSW-P2001011M, UCS11MA-P1330228M, URCS511A-P1330226M		

			
1			
GEV No.	699513	Ref. No.	14129065 14179122
description	stirrer kit mounting pos. lower for microwave		
For models:	DEC14E2-P2002214M, DEC18E2-P2002215M, DEC21E2-P2002216M, HDC12A2-P2002201M, HDC182-P2002203M, HDC18SD2-P2002205M, HDC212-P2002207M, MCHDC21-P2002212M, MDC12A2-P2002202M, MDC182-P2002204M		

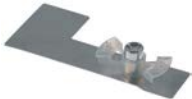
			
1			
GEV No.	699515	Ref. No.	12002593 53001587
description	stirrer kit mounting pos. lower for microwave		
For models:	DFS18E-P1330222M, MFS18TS-P2001008M, RFS12MPSB-P1330235M, RFS12TSW-P2001001M, RFS18MPS-P1330209M, RFS18MPS-P2000703M, RFS18TS-P2001003M, RFS518S-P1330216M, RFS518TS-P2001004M, URF5518S-P1330227M		

			
1			
GEV No.	699514	Ref. No.	12002592 53001586
description	stirrer kit mounting pos. upper for microwave		
For models:	DFS18E-P1330222M, MFS18TS-P2001008M, RFS12MPSB-P1330235M, RFS12TSW-P2001001M, RFS18MPS-P1330209M, RFS18MPS-P2000703M, RFS18TS-P2001003M, RFS518S-P1330216M, RFS518TS-P2001004M, URF5518S-P1330227M		

			
1			
GEV No.	701359	Ref. No.	58101054
description	stirrer shaft H 37mm ø 35mm white shaft square suitable for ACP Qty 1 pcs		
For models:	MMS10TS-P2001217M, RMS10TS-P2001203M, RMS10TS-P2001209M, RMS510D-P2001204M, RMS510D-P2001210M, RMS510T-P2001205M, RMS510T-P2001211M		

electric

displays

			
1			
GEV No.	696771	Ref. No.	14114050
description	front panel for AXP22 / MXP22 / MXP5221 / MXP5223 L 30mm W 97mm H 352mm		

microswitches

holders

			
1			
GEV No.	692494	Ref. No.	58101034
description	bracket L 190mm W 30mm H 60mm plastic for microswitch suitable for ACP Qty 1 pcs		
For models:	MMS10TS-P2001217M, RMS10TS-P2001203M, RMS10TS-P2001209M, RMS510D-P2001204M, RMS510D-P2001210M, RMS510T-P2001205M, RMS510T-P2001211M		



accessories



1

GEV No.	701352	Ref. No.	B5677203 B5677212
description	connecting block L 61mm W 18mm H 22mm		
For models:	ACE5302-P1331307M, ACE5302-P1332912M, ACE5302-P1332914M, DEC11E2-P1331213M, DEC11E2-P1331235M, DEC11E2-P1333111M, DEC11E2-P2001412M, DEC11E2-P2001514M, DEC11E2-P2002223M, DEC14E2-P1331217M, DEC14E2-P1331239M, DEC14E2-P1333115M, DEC14E2-P2001413M, DEC14E2-P2001515M, DEC14E2-P2002214M, DEC18E2-P1331221M, DEC18E2-P1331243M, DEC18E2-P1333119M, DEC18E2-P2001414M, DEC18E2-P2001516M, DEC18E2-P2002215M, DEC21E2-P1331226M, DEC21E2-P1331247M, DEC21E2-P1333123M, DEC21E2-P2001415M, DEC21E2-P2001517M, DEC21E2-P2002216M, DS30E2-P1331309M, DS30E2-P1332916M, HDC5112-P1331211M, HDC5112-P1331233M, HDC5112-P1333109M, HDC5142-P1331215M, HDC5142-P1331237M, HDC5142-P1333113M, HDC5182-P1331219M, HDC5182-P1331241M, HDC5182-P1333117M, HDC518-P1325209M, HDC518-P1330518M, HDC5212-P1331224M, HDC5212-P1331245M, HDC5212-P1333121M, MOC5241-P2000303M, MRC1752-P1333417M, MRC1752-P2001814M, MRC1752-P2001824M, MRC2252-P1333418M, MRC2252-P2001817M, MRC518SU2-P1332818M...(Other models you can see in the webshop)		



2

GEV No.	698920	Ref. No.	14159097
description	service kit hole distance mm switch-off temp.°C 1NC 1-pole 10A 220V connection adhesive tape starting temperature°C starting temperature°F probe Lmm probe Ømm for microwaves Qty 1 pcs JET514/JET5192/JET5193/JET519V2+V3/PCJET514C		



1

GEV No.	701349	Ref. No.	R9900668
description	stirrer motor kit mounting pos. lower Qty 1 pcs		
For models:	DEC14E2-P1331239M, DEC14E2-P1333115M, DEC14E2-P2001413M, DEC14E2-P2001515M, DEC14E2-P2002214M, DEC18E2-P1331221M, DEC18E2-P1331243M, DEC18E2-P1333119M, DEC18E2-P2001414M, DEC18E2-P2001516M, DEC18E2-P2002215M, DEC21E2-P1331226M, DEC21E2-P1331247M, DEC21E2-P1333123M, DEC21E2-P2001415M, DEC21E2-P2001517M, DEC21E2-P2002216M, HDC182-P1331204M, HDC182-P1333102M, HDC182-P2001403M, HDC182-P2001503M, HDC182-P2002203M, HDC18SD2-P1331205M, HDC18SD2-P1333103M, HDC18SD2-P2001405M, HDC18SD2-P2001505M, HDC18SD2-P2002205M, HDC212-P1331207M, HDC212-P1333105M, HDC212-P2001407M, HDC212-P2001507M, HDC212-P2002207M, HDC5142-P1331237M, HDC5142-P1333113M, HDC5182-P1331219M, HDC5182-P1331241M, HDC5182-P1333117M, HDC518-P1325209M, HDC518-P1330518M, HDC5212-P1331224M, HDC5212-P1331245M, HDC5212-P1333121M, MCHDC21-P1333130M, MCHDC21-P2001512M, MCHDC21-P2002212M, MDC182-P1333128M, MDC182-P2001404M, MDC182-P2001504M, MDC182-P2002204M, UC14E2-P1331240M...(Other models you can see in the webshop)		



1

GEV No.	692495	Ref. No.	B8367703 B8367704 R9900114
description	window set for lighting incl. screws, nuts and film L 93.5mm W 65.5mm thickness 1.5mm PTFE hole distance 40x75mm white		
For models:	DEC11E2-P1331213M, DEC11E2-P1331235M, DEC11E2-P1333111M, DEC11E2-P2001412M, DEC11E2-P2001514M, DEC11E2-P2002223M, DEC14E2-P1331217M, DEC14E2-P1331239M, DEC14E2-P1333115M, DEC14E2-P2001413M, DEC14E2-P2001515M, DEC14E2-P2002214M, DEC18E2-P1331221M, DEC18E2-P1331243M, DEC18E2-P1333119M, DEC18E2-P2001414M, DEC18E2-P2001516M, DEC18E2-P2002215M, DEC21E2-P1331226M, DEC21E2-P1331247M, DEC21E2-P1333123M, DEC21E2-P2001415M, DEC21E2-P2001517M, DEC21E2-P2002216M, HDC12A2-P1331203M, HDC12A2-P1333101M, HDC12A2-P2001401M, HDC12A2-P2001501M, HDC12A2-P2002201M, HDC12A-P1330503M, HDC12P2-P1331223M, HDC182-P1331204M, HDC182-P1333102M, HDC182-P2001403M, HDC182-P2001503M, HDC182-P2002203M, HDC18SD2-P1331205M, HDC18SD2-P1333103M, HDC18SD2-P2001405M, HDC18SD2-P2001505M, HDC18SD2-P2002205M, HDC212-P1331207M, HDC212-P1333105M, HDC212-P2001407M, HDC212-P2001507M, HDC212-P2002207M, HDC5112-P1331211M, HDC5112-P1331233M, HDC5112-P1333109M, HDC5142-P1331215M...(Other models you can see in the webshop)		

feet



1

GEV No.	701365	Ref. No.	58101003
description	equipment foot for microwave Ø 30mm H 30mm bore Ø 4mm suitable for ACP plastic Qty 1 pcs		
For models:	MMS10TS-P2001217M, RMS10TS-P2001203M, RMS10TS-P2001209M, RMS510D-P2001204M, RMS510D-P2001210M, RMS510T-P2001205M, RMS510T-P2001211M		



1

GEV No.	701333	Ref. No.	58101004
description	foot Ø 21mm H 3mm mounting Ø 13mm overall height 10mm for microwave rubber Qty 1 pcs		
For models:	MMS10TS-P2001217M, RMS10TS-P2001203M, RMS10TS-P2001209M, RMS510D-P2001204M, RMS510D-P2001210M, RMS510T-P2001205M, RMS510T-P2001211M		

housings

outer parts



1

GEV No.	701331	Ref. No.	12131002
description	end cap mounting pos. left		
For models:	DEC11E2-P1331213M, DEC11E2-P1331235M, DEC11E2-P1333111M, DEC11E2-P2001412M, DEC11E2-P2001514M, DEC11E2-P2002223M, DEC14E2-P1331217M, DEC14E2-P1331239M, DEC14E2-P1333115M, DEC14E2-P2001413M, DEC14E2-P2001515M, DEC14E2-P2002214M, DEC18E2-P1331221M, DEC18E2-P1331243M, DEC18E2-P1333119M, DEC18E2-P2001414M, DEC18E2-P2001516M, DEC18E2-P2002215M, DEC21E2-P1331226M, DEC21E2-P1331247M, DEC21E2-P1333123M, DEC21E2-P2001415M, DEC21E2-P2001517M, DEC21E2-P2002216M, HDC12A2-P1331203M, HDC12A2-P1333101M, HDC12A2-P2001401M, HDC12A2-P2002201M, HDC12A-P1323002M, HDC12A-P1323012M, HDC12A-P1330503M, HDC12P2-P1331223M, HDC182-P1331204M, HDC182-P1333102M, HDC182-P2001403M, HDC182-P2001503M, HDC182-P2002203M, HDC18SD2-P1331205M, HDC-18SD2-P1333103M, HDC18SD2-P2001405M, HDC18SD2-P2001505M, HDC18SD2-P2002205M, HDC212-P1331207M, HDC212-P1333105M, HDC212-P2001407M, HDC212-P2001507M, HDC212-P2002207M, HDC5112-P1331211M, HDC5112-P1331233M, HDC5112-P1333109M...(Other models you can see in the webshop)		



2

GEV No.	699543	Ref. No.	56002060
description	front panel for microwave		
For models:	RCS511DS-P2001106M, RCS511DS-P2001112M		

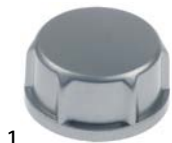

1

GEV No.	701350	Ref. No.	54127053 56001484
description	knob H 33mm ø 50mm mounting pos. for time setting silver Qty 1 pcs		
For models:	ALD10D-P1331011M, ALD10D-P1331019M, ALD510SE-P1331012M, MCS10DSE-P2002404M, MCS10DS-P2001104M, MCS-10DS-P2001110M, MLD510SE-P1331014M, RCS10DS-P2001102M, RCS10DS-P2001108M, RCS511DSE-P2002406M, UALD-510SE-P1331013M, UMLD510SE-P1331015M		



1

GEV No.	701347	Ref. No.	56001417
description	knob H 34mm ø 56mm mounting pos. for time setting silver Qty 1 pcs		
For models:	ALD510D-P1331003M, MLD510D-P1331007M, RCS-511DS-P2001106M, RCS511DS-P2001112M, UMLD510D-P1331008M		

inner parts



1

GEV No.	699561	Ref. No.	59002074 R0000036 R0150146 R9800597
description	bottom plate L 443mm W 415mm H 45mm		
For models:	DEC11E2-P1331213M, DEC11E2-P1331235M, DEC11E2-P1333111M, DEC11E2-P2001412M, DEC11E2-P2001514M, DEC11E2-P2002223M, DEC14E2-P1331217M, DEC14E2-P1331239M, DEC14E2-P1333115M, DEC14E2-P2001413M, DEC14E2-P2001515M, DEC14E2-P2002214M, DEC18E2-P1331221M, DEC18E2-P1331243M, DEC18E2-P1333119M, DEC18E2-P2001414M, DEC18E2-P2001516M, DEC18E2-P2002215M, DEC21E2-P1331226M, DEC21E2-P1331247M, DEC21E2-P1333123M, DEC21E2-P2001415M, DEC21E2-P2001517M, DEC21E2-P2002216M, HDC12A2-P1331203M, HDC12A2-P1333101M, HDC12A2-P2001401M, HDC12A2-P2002201M, HDC12A-P1323002M, HDC12A-P1323012M, HDC12A-P1330503M, HDC12P2-P1331223M, HDC182-P1331204M, HDC182-P1333102M, HDC182-P2001403M, HDC182-P2001503M, HDC182-P2002203M, HDC18SD2-P1331205M, HDC18SD2-P1333103M, HDC18SD2-P2001405M, HDC-18SD2-P2001505M, HDC18SD2-P2002205M, HDC212-P1331207M, HDC212-P1333105M, HDC212-P2001407M, HDC212-P2001507M, HDC212-P2002207M, HDC5112-P1331211M, HDC5112-P1331233M...(Other models you can see in the webshop)		





1

GEV No.	701370	Ref. No.	14080012 14090020
description	button H 12.2mm ø 22mm silver Qty 1 pcs		
For models:	ACE14-P1333201M, ACE14-P1333206M, ACE14-P2000401M, ACE14-P2001901M, ACE14-P2001909M, ACE5140-P1333203M, ACE5140-P1333207M, ACE5140-P2000403M, DS1400E-P1333204M, DS1400E-P2000404M, DS1400E-P2001904M, DS1400E-P2001912M, MCE14-P2000407M, MCE14-P2001902M, MCE14-P2001910M, UCA1400-P1333205M, UCA1400-P2000405M, UCA1400-P2001906M, UCA1400-P2001913M		





			
GEV No.	701345	Ref. No.	12019002 12083001 12083101
description	gasket L 240mm W 7mm H 2.5mm red silicone Qty 1 pcs		
For models:	ACE14-P1333201M, ACE14-P1333206M, ACE14-P2000401M, ACE14-P2001901M, ACE14-P2001909M, ACE5140-P1333203M, ACE5140-P1333207M, ACE5140-P2000403M, ACE5302-P1331307M, ACE5302-P1332912M, ACE5302-P1332914M, DS1400E-P1333204M, DS1400E-P2000404M, DS1400E-P2001904M, DS1400E-P2001912M, DS30E2-P1331309M, DS30E2-P1332916M, MCE14-P2000407M, MCE14-P2001902M, MCE14-P2001910M, UCA1400-P1333205M, UCA1400-P2000405M, UCA1400-P2001906M, UCA1400-P2001913M, UCA2000NT3-P1332921M, UCA2000NT3-P2000406M		

			
GEV No.	701348	Ref. No.	58101035
description	lever L 28mm W 33mm H 15mm Qty 1 pcs		
For models:	MMS10TS-P2001217M, RMS10TS-P2001203M, RMS10TS-P2001209M, RMS510D-P2001204M, RMS510D-P2001210M, RMS510T-P2001205M, RMS510T-P2001211M		

			
GEV No.	699501	Ref. No.	TL10
description	PTFE foil 5-piece for microwave		
For models:	MXP5221BO-P2001617M, MXP5223TL-P2001620M		

			
GEV No.	699524	Ref. No.	12002678 14129066 59001994
description	repair kit cavity 18 + 19 for microwave		
For models:	DEC14E2-P1331217M, DEC14E2-P1331239M, DEC14E2-P1333115M, DEC14E2-P2001413M, DEC14E2-P2001515M, DEC14E2-P2002214M, DEC18E2-P1331221M, DEC18E2-P1331243M, DEC18E2-P1333119M, DEC18E2-P2001414M, DEC18E2-P2001516M, DEC18E2-P2002215M, DEC21E2-P2001415M, DEC21E2-P2001517M, DEC21E2-P2002216M, HDC12P2-P1331223M, HDC182-P1331204M, HDC182-P1333102M, HDC182-P2001403M, HDC182-P2001503M, HDC182-P2002203M, HDC18SD2-P1331205M, HDC18SD2-P1333103M, HDC18SD2-P2001405M, HDC18SD2-P2001505M, HDC18SD2-P2002205M, HDC212-P1331207M, HDC212-P1333105M, HDC212-P2001407M, HDC212-P2001507M, HDC212-P2002207M, HDC5142-P1331215M, HDC5142-P1331237M, HDC5142-P1333113M, HDC5182-P1331219M, HDC5182-P1331241M, HDC5182-P1333117M, HDC518-P1325209M, HDC518-P1330518M, MCHDC21-P1333130M, MCHDC21-P2001512M, MCHDC21-P2002212M, MDC182-P1333128M, MDC182-P2001404M, MDC182-P2001504M, MDC182-P2002204M, UC14E2-P1331218M, UC14E2-P1331240M, UC14E2-P1333116M, UC18E2-P1331222M... (Other models you can see in the webshop)		

			
GEV No.	699542	Ref. No.	12002625 56001415 56001442
description	repair kit cover and stirrer for microwave		
For models:	ALD10D-P1331011M, ALD10D-P1331019M, ALD10T-P1331002M, ALD10T-P1331018M, ALD510D-P1331003M, ALD510-P1331005M, ALD510SE-P1331012M, MCS10DSE-P2002404M, MCS10DS-P2001104M, MCS10DS-P2001110M, MCS10TS-P2001103M, MCS10TS-P2001109M, MCS10TS-P2002403M, MLD510D-P1331007M, MLD510-P1331009M, MLD510SE-P1331014M, RCS10DS-P2001102M, RCS10DS-P2001108M, RCS10TS-P2001101M, RCS10TS-P2001107M, RCS10TS-P2002401M, RCS511DSE-P2002406M, RCS511DS-P2001106M, RCS511DS-P2001112M, RCS511TS-P2001105M, RCS511TS-P2001111M, RCS511TS-P2002405M, UALD510-P1331006M, UALD510SE-P1331013M, UMLD510D-P1331008M, UMLD510-P1331010M, UMLD510SE-P1331015M		

<h3>housing and bezels</h3>			
			
GEV No.	694690	Ref. No.	10785602 10785608
description	flap for lighting without screws L 98mm W 91mm mounting distance 51mm SS		
For models:	ACE14-P1333201M, ACE14-P1333206M, ACE14-P2000401M, ACE14-P2001901M, ACE14-P2001909M, ACE5140-P1333203M, ACE5140-P1333207M, ACE5140-P2000403M, ACE5302-P1331307M, ACE5302-P1332912M, ACE5302-P1332914M, DEC11E2-P1331213M, DEC11E2-P1331235M, DEC11E2-P1333111M, DEC11E2-P2001412M, DEC11E2-P2001514M, DEC11E2-P2002223M, DEC14E2-P1331217M, DEC14E2-P1331239M, DEC14E2-P1333115M, DEC14E2-P2001413M, DEC14E2-P2001515M, DEC14E2-P2002214M, DEC18E2-P1331221M, DEC18E2-P1331243M, DEC18E2-P1333119M, DEC18E2-P2001414M, DEC18E2-P2001516M, DEC18E2-P2002215M, DEC21E2-P1331226M, DEC21E2-P1331247M, DEC21E2-P1333123M, DEC21E2-P2001415M, DEC21E2-P2001517M, DEC21E2-P2002216M, DS1400E-P1333204M, DS1400E-P2000404M, DS1400E-P2001904M, DS1400E-P2001912M, DS30E2-P1331309M, DS30E2-P1332916M, HDC12A2-P1331203M, HDC12A2-P1333101M, HDC12A2-P2001401M, HDC12A2-P2001501M, HDC12A2-P2002201M, HDC12A-P1323002M, HDC12A-P1323012M, HDC12A-P1330503M, HDC12P2-P1331223M... (Other models you can see in the webshop)		

			
GEV No.	701340	Ref. No.	12114401
description	mounting plate for microwaves cavity catch L 190mm W 30mm H 30mm zinc-plated		
For models:	DEC11E2-P1331213M, DEC11E2-P1331235M, DEC11E2-P1333111M, DEC11E2-P2001412M, DEC14E2-P1331239M, DEC14E2-P1333115M, DEC14E2-P2001413M, DEC18E2-P1331221M, DEC18E2-P1331243M, DEC18E2-P1333119M, DEC18E2-P2001414M, DEC21E2-P1331226M, DEC21E2-P1331247M, DEC21E2-P1333123M, DEC21E2-P2001415M, HDC12A2-P1331203M, HDC12A2-P1333101M, HDC12A2-P2001401M, HDC12A-P1323002M, HDC12A-P1323012M, HDC12A-P1330503M, HDC12P2-P1331223M, HDC182-P1331204M, HDC182-P1333102M, HDC182-P2001403M, HDC18SD2-P1331205M, HDC18SD2-P1333103M, HDC18SD2-P2001405M, HDC212-P1331207M, HDC212-P1333105M, HDC212-P2001407M, HDC5112-P1331211M, HDC5112-P1331233M, HDC5112-P1333109M, HDC5142-P1331237M, HDC5142-P1333113M, HDC5182-P1331219M, HDC5182-P1331241M, HDC5182-P1333117M, HDC518-P1325209M, HDC518-P1330518M, HDC5212-P1331224M, HDC5212-P1331245M, HDC5212-P1333121M, MCHDC21-P1333130M, MDC12A2-P1333127M, MDC12A2-P2001402M, MDC182-P1333128M, MDC182-P2001404M, UC11E2-P1331214M...(Other models you can see in the webshop)		

ceramic plates

			
GEV No.	699546	Ref. No.	R0150115
description	ceramic plate L 240mm W 240mm H 3mm ømm for microwave		
For models:	ACE14-P1333201M, ACE14-P1333206M, ACE14-P2000401M, ACE14-P2001901M, ACE14-P2001909M, ACE5140-P1333203M, ACE5140-P1333207M, ACE5140-P2000403M, ACE5302-P1331307M, ACE5302-P1332912M, ACE5302-P1332914M, DS1400E-P1333204M, DS1400E-P2000404M, DS1400E-P2001904M, DS1400E-P2001912M, DS30E2-P1331309M, DS30E2-P1332916M, MCE14-P2000407M, MCE14-P2001902M, MCE14-P2001910M, UCA1400-P1333205M, UCA1400-P2000405M, UCA1400-P2001906M, UCA1400-P2001913M, UCA2000NT3-P1332921M, UCA2000NT3-P2000406M		

			
GEV No.	699549	Ref. No.	58101001
description	ceramic plate L 300mm W 300mm ømm for microwave		
For models:	MMS10TS-P2001217M, RMS10TS-P2001203M, RMS10TS-P2001209M, RMS510D-P2001204M, RMS510D-P2001210M, RMS510T-P2001205M, RMS510T-P2001211M		

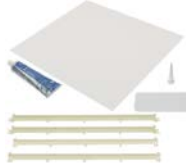
			
GEV No.	699560	Ref. No.	14109040 14159092
description	ceramic plate L 327mm W 297mm thickness 3mm suitable for ACP incl. accessories		
For models:	DEC11E2-P2001412M, DEC11E2-P2001514M, DEC11E2-P2002223M, DEC14E2-P2001413M, DEC14E2-P2001515M, DEC14E2-P2002214M, DEC18E2-P2001414M, DEC18E2-P2001516M, DEC18E2-P2002215M, DEC21E2-P2001415M, DEC21E2-P2001517M, DEC21E2-P2002216M, HDC12A2-P2001401M, HDC12A2-P2001501M, HDC12A2-P2002201M, HDC182-P2001403M, HDC182-P2001503M, HDC182-P2002203M, HDC18SD2-P2001405M, HDC18SD2-P2001505M, HDC18SD2-P2002205M, HDC212-P2001407M, HDC212-P2001507M, HDC212-P2002207M, MCHDC21-P1333130M, MCHDC21-P2001512M, MCHDC21-P2002212M, MDC12A2-P2001402M, MDC12A2-P2001502M, MDC12A2-P2002202M, MDC182-P2001404M, MDC182-P2001504M, MDC182-P2002204M		

			
GEV No.	698814	Ref. No.	59134300
description	ceramic plate L 354mm W 120mm H 4mm		
For models:	JETS192-P2002710M, JETS19V2-P2002711M		

			
GEV No.	699510	Ref. No.	54127018 56001441 56002041
description	ceramic plate L 36.7mm W 37.5mm ømm for microwave		
For models:	ALD10D-P1331011M, ALD10D-P1331019M, ALD10T-P1331002M, ALD10T-P1331018M, ALD510D-P1331003M, ALD510-P1331005M, ALD510SE-P1331012M, MCS10DSE-P2002404M, MCS10DS-P2001104M, MCS10DS-P2001110M, MCS10TS-P2001103M, MCS10TS-P2001109M, MCS10TS-P2002403M, MLD510D-P1331007M, MLD510-P1331009M, MLD510SE-P1331014M, RCS10DS-P2001102M, RCS10DS-P2001108M, RCS10TS-P2001101M, RCS10TS-P2001107M, RCS10TS-P2002401M, RCS511DSE-P2002406M, RCS511DS-P2001106M, RCS511DS-P2001112M, RCS511TS-P2001105M, RCS511TS-P2001111M, RCS511TS-P2002405M, UALD510-P1331006M, UALD510SE-P1331013M, UMLD510D-P1331008M, UMLD510-P1331010M, UMLD510SE-P1331015M		

			
GEV No.	699503	Ref. No.	53001555 53002009
description	ceramic plate L 405mm W 355mm H 7mm ømm for microwave		
For models:	DFS11EA-P1330220M, DFS18E-P1330222M, MFS18TS-P2001008M, RCS10DA-P1330201M, RCS10DA-P2000702M, RCS10M-PA-P1330202M, RCS10MPA-P2000704M, RCS511A-P1330214M, RFS12MPSA-P1330206M, RFS12MPSB-P1330235M, RFS12T-SW-P2001001M, RFS18MPS-P1330209M, RFS18MPS-P2000703M, RFS18TS-P2001003M, RFS511SW2A-P1330223M, RFS511T-SW13-P2001010M, RFS511TSW13-P2001012M, RFS511T-SW-P2001005M, RFS511TSW-P2001011M, RFS518S-P1330216M, RFS518TS-P2001004M, UCS11MA-P1330228M, URC-S511A-P1330226M, URF5518S-P1330227M		



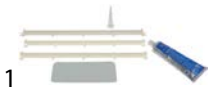

			
GEV No.	699523	Ref. No.	12496801 14109044
description	repair kit ceramic plate and support for microwave		
For models:	DEC11E2-P1331213M, DEC11E2-P1331235M, DEC11E2-P1333111M, DEC11E2-P2001412M, DEC11E2-P2001514M, DEC11E2-P2002223M, DEC14E2-P1331217M, DEC14E2-P1331239M, DEC14E2-P1333115M, DEC14E2-P2001413M, DEC14E2-P2001515M, DEC14E2-P2002214M, DEC18E2-P1331221M, DEC18E2-P1331243M, DEC18E2-P1333119M, DEC18E2-P2001414M, DEC18E2-P2001516M, DEC18E2-P2002215M, DEC21E2-P1331226M, DEC21E2-P1331247M, DEC21E2-P1333123M, DEC21E2-P2001415M, DEC21E2-P2001517M, DEC21E2-P2002216M, HDC12A2-P1331203M, HDC12A2-P1333101M, HDC12A2-P2001401M, HDC12A2-P2001501M, HDC12A2-P2002201M, HDC12A-P1323002M, HDC12A-P1323012M, HDC12A-P1330503M, HDC12P2-P1331223M, HDC182-P1331204M, HDC182-P1333102M, HDC182-P2001403M, HDC182-P2001503M, HDC182-P2002203M, HDC18SD2-P1331205M, HDC18SD2-P1333103M, HDC18SD2-P2001405M, HDC18SD2-P2001505M, HDC18SD2-P2002205M, HDC212-P1331207M, HDC212-P1333105M, HDC212-P2001407M, HDC212-P2001507M, HDC212-P2002207M, HDC5112-P1331211M, HDC5112-P1331233M... (Other models you can see in the webshop)		

			
GEV No.	699548	Ref. No.	10772501 10772503 R0156942
description	repair kit L 370mm W 330mm H 2mm ømm ceramic plate for microwave		
For models:	MRC17S2-P1333417M, MRC17S2-P2001802M, MRC17S2-P2001814M, MRC17S2-P2001824M, MRC22S2-P1333418M, MRC22S2-P2001817M, MRC30S2-P2001812M, MRC518SU2-P1331419M, MRC518SU2-P1332818M, MRC518SU2-P1332832M, MRC518SU-P1327613M, MRC520S-P1327614M, MRC524TS2-P1331432M, MRC524TS2-P1333415M, RC17S2-P1331401M, RC17S2-P1332801M, RC17S2-P1333401M, RC17S2-P2001801M, RC17S2-P2001813M, RC17S2-P2001823M, RC22S2-P1331403M, RC22S2-P1332804M, RC22S2-P1333404M, RC22S2-P2001804M, RC22S2-P2001816M, RC22S-P1198605M, RC22S-P1326303M, RC22S-P1329103M, RC22S-P1329610M, RC22S-P1330104M, RC30S2-P1331415M, RC30S2-P1332816M, RC30S2-P1333410M, RC30S2-P2001811M, RC518SU-P1327602M, RC520S-P1327601M, RC524TS2-P1331430M, RC524TS2-P1333414M		

			
GEV No.	699536	Ref. No.	14080002 59002152
description	repair kit L 185mm W 133mm H 2mm ømm ceramic plate and stirrer for microwave		
For models:	AXP20-P1333601M, AXP20-P1333602M, AXP20-P1333605M, AXP5201-P1333603M, AXP5203-P1333608M, MXP5201-P1333604M, MXP5203-P1333609M		

<h3 style="background-color: #cccccc; padding: 5px;">fans</h3>			
			
GEV No.	701332	Ref. No.	12296601
description	air duct for air inlet L 97mm W 103mm H 45mm plastic		
For models:	DEC14E2-P1331217M, DEC14E2-P1331239M, DEC14E2-P1333115M, DEC18E2-P1331221M, DEC18E2-P1331243M, DEC18E2-P1333119M, DEC21E2-P1331226M, DEC21E2-P1331247M, DEC21E2-P1333123M, HDC182-P1331204M, HDC182-P1333102M, HDC18SD2-P1331205M, HDC18SD2-P1333103M, HDC212-P1331207M, HDC212-P1333105M, HDC5142-P1331215M, HDC5142-P1331237M, HDC5142-P1333113M, HDC5182-P1331219M, HDC5182-P1331241M, HDC5182-P1333117M, HDC518-P1325209M, HDC518-P1330518M, HDC5212-P1331224M, HDC5212-P1331245M, HDC5212-P1333121M, MCHDC21-P1333130M, MDC182-P1333128M, UC14E2-P1331218M, UC14E2-P1331240M, UC14E2-P1333116M, UC18E2-P1331222M, UC18E2-P1331244M, UC18E2-P1333120M, UHDC5142-P1331216M, UHDC5142-P1331238M, UHDC5142-P1333114M, UHDC5182-P1331220M, UHDC5182-P1331242M, UHDC5182-P1333118M		

			
GEV No.	699521	Ref. No.	14080004
description	repair kit L 186mm W 133mm H 2mm ømm ceramic plate for microwave		
For models:	AXP20-P1333601M, AXP20-P1333602M, AXP20-P1333605M, AXP5201-P1333603M, AXP5203-P1333608M, MXP5201-P1333604M, MXP5203-P1333609M		

			
GEV No.	701371	Ref. No.	56001440
description	air duct L 109mm W 89.6mm H 23mm white Qty 1 pcs		
For models:	ALD10D-P1331011M, ALD10D-P1331019M, ALD10T-P1331002M, ALD10T-P1331018M, ALD510D-P1331003M, ALD510-P1331005M, ALD510SE-P1331012M, MCS10DS-P2001104M, MCS10DS-P2001110M, MCS10TS-P2001103M, MCS10TS-P2001109M, MLD510D-P1331007M, MLD510-P1331009M, MLD510SE-P1331014M, RCS10DS-P2001102M, RCS10DS-P2001108M, RCS10TS-P2001101M, RCS10TS-P2001107M, RCS511DS-P2001106M, RCS511DS-P2001112M, RCS511TS-P2001105M, RCS511TS-P2001111M, UALD510-P1331006M, UALD510SE-P1331013M, UMLD510D-P1331008M, UMLD510-P1331010M, UMLD510SE-P1331015M		

			
GEV No.	699520	Ref. No.	14114053
description	repair kit L 200mm W 146mm H 2mm ømm ceramic plate and stirrer for microwave		
For models:	MXP5221BO-P2001617M, MXP5221-P2001606M, MXP5223-P2001607M, MXP5223TL-P2001620M		



1

GEV No.	699541	Ref. No.	54127039
description	deflector for microwave plastic		
For models:	MCS10DSE-P2002404M, MCS10TS-P2002403M, RCS10TS-P2002401M, RCS511DSE-P2002406M, RCS511TS-P2002405M		



1

GEV No.	701488	Ref. No.	20093001
description	fan Lmm Wmm H 23mm ø 150mm		
For models:	JET5192-P2002710M, JET519V2-P2002711M		

air filters



1

GEV No.	698822	Ref. No.	59134366
description	air filter L 210mm W 40mm H 6mm suitable for microwave suitable for ACP		
For models:	JET5192-P2002710M, JET519V2-P2002711M		



1

GEV No.	699141	Ref. No.	12135803 12135804 59001659
description	air filter L 382mm W 25mm Hmm ømm for microwave		
For models:	DEC11E2-P1331213M, DEC11E2-P1331235M, DEC11E2-P1333111M, DEC11E2-P2001412M, DEC11E2-P2001514M, DEC11E2-P2002223M, DEC14E2-P1331217M, DEC14E2-P1331239M, DEC14E2-P1333115M, DEC14E2-P2001413M, DEC14E2-P2001515M, DEC14E2-P2002214M, DEC18E2-P1331221M, DEC18E2-P1331243M, DEC18E2-P1333119M, DEC18E2-P2001414M, DEC18E2-P2001516M, DEC18E2-P2002215M, DEC21E2-P1331226M, DEC21E2-P1331247M, DEC21E2-P1333123M, DEC21E2-P2001415M, DEC21E2-P2001517M, DEC21E2-P2002216M, HDC12A2-P1331203M, HDC12A2-P1333101M, HDC12A2-P2001401M, HDC12A2-P2001501M, HDC12A2-P2002201M, HDC12A2-P1330503M, HDC12P2-P1331223M, HDC182-P1331204M, HDC182-P1333102M, HDC182-P2001403M, HDC182-P2001503M, HDC182-P2002203M, HDC18SD2-P1331205M, HDC18SD2-P1333103M, HDC-18SD2-P2001405M, HDC18SD2-P2001505M, HDC18SD2-P2002205M, HDC212-P1331207M, HDC212-P1333105M, HDC212-P2001407M, HDC212-P2001507M, HDC212-P2002207M, HDC5112-P1331211M, HDC5112-P1331233M, HDC5112-P1333109M, HDC5142-P1331215M...(Other models you can see in the webshop)		



1

GEV No.	699142	Ref. No.	10853101 10853102 21028602
description	air filter L 445mm W 50mm Hmm ømm for microwave thickness 2mm		
For models:	ACE14-P1333201M, ACE14-P1333206M, ACE14-P2000401M, ACE14-P2001901M, ACE14-P2001909M, ACE5140-P1333203M, ACE5140-P1333207M, ACE5140-P2000403M, ACE5302-P1331307M, ACE5302-P1332912M, ACE5302-P1332914M, DS1400E-P1333204M, DS1400E-P2000404M, DS1400E-P2001904M, DS1400E-P2001912M, DS30E2-P1331309M, DS30E2-P1332916M, MCE14-P2000407M, MCE14-P2001902M, MCE14-P2001910M, MRC17S2-P1333417M, MRC17S2-P2001802M, MRC17S2-P2001814M, MRC17S2-P2001824M, MRC22S2-P1333418M, MRC22S2-P2001817M, MRC30S2-P2001812M, MRC518SU2-P1331419M, MRC518SU2-P1332818M, MRC518SU2-P1332832M, MRC518SU-P1327613M, MRC520S-P1327614M, MRC524TS2-P1331432M, MRC524TS2-P1333415M, RC17S2-P1331401M, RC17S2-P1332801M, RC17S2-P1333401M, RC17S2-P2001801M, RC17S2-P2001813M, RC17S2-P2001823M, RC22S2-P1331403M, RC22S2-P1332804M, RC22S2-P1333404M, RC22S2-P2001804M, RC22S2-P2001816M, RC22S-P1198605M, RC22S-P1326303M, RC22S-P1329103M, RC22S-P1329610M, RC22S-P1330104M...(Other models you can see in the webshop)		



1

GEV No.	699511	Ref. No.	59002139
description	air filter L 500mm W 50mm Hmm ømm for microwave		
For models:	AXP20-P1333601M, AXP20-P1333602M, AXP20-P1333605M, AXP5201-P1333603M, AXP5203-P1333608M, MXP5201-P1333604M, MXP5203-P1333609M, MXP5221BO-P2001617M, MXP5221-P2001606M, MXP5223-P2001607M, MXP5223TL-P2001620M		





1

GEV No.	699143	Ref. No.	53001571 54116015
description	air filter L 530mm W 24mm Hmm ømm for microwave thickness 1.5mm with screw		
For models:	DFS11EA-P1330220M, DFS18E-P1330222M, MFS18TS-P2001008M, RCS10DA-P1330201M, RCS10DA-P2000702M, RCS10M-PA-P1330202M, RCS10MPA-P2000704M, RCS511A-P1330214M, RFS12MPSA-P1330206M, RFS12MPSB-P1330235M, RFS12T-SW-P2001001M, RFS18MPS-P1330209M, RFS18MPS-P2000703M, RFS18TS-P2001003M, RFS511SW2A-P1330223M, RFS518S-P1330216M, RFS518TS-P2001004M, UCS11MA-P1330228M, URC-SS11A-P1330226M, URFS518S-P1330227M		



miscellaneous

			
GEV No.	701358	Ref. No.	59001660 M0295501 M0295503
description	cover H 5.6mm ø 18mm for screws Qty 1 pcs		
For models:	ACE14-P1333201M, ACE14-P1333206M, ACE14-P2000401M, ACE14-P2001901M, ACE14-P2001909M, ACE5140-P1333203M, ACE5140-P1333207M, ACE5140-P2000403M, ACE5302-P1331307M, ACE5302-P1332912M, ACE5302-P1332914M, DS1400E-P1333204M, DS1400E-P2000404M, DS1400E-P2001904M, DS1400E-P2001912M, DS30E2-P1331309M, DS30E2-P1332916M, MCE14-P2000407M, MCE14-P2001902M, MCE14-P2001910M, UCA1400-P1333205M, UCA1400-P2000405M, UCA1400-P2001906M, UCA1400-P2001913M, UCA2000NT3-P1332921M, UCA2000NT3-P2000406M		

			
GEV No.	701344	Ref. No.	59001007 59002165 M0310305
description	cover cap for screw Qty 1 pcs white ø 14mm		
For models:	ACE14-P1333201M, ACE14-P1333206M, ACE14-P2000401M, ACE14-P2001901M, ACE14-P2001909M, ACE5140-P1333203M, ACE5140-P1333207M, ACE5140-P2000403M, ACE5302-P1331307M, ACE5302-P1332912M, ACE5302-P1332914M, DS1400E-P1333204M, DS1400E-P2000404M, DS1400E-P2001904M, DS1400E-P2001912M, DS30E2-P1331309M, DS30E2-P1332916M, MCE14-P2000407M, MCE14-P2001902M, MCE14-P2001910M, MRC17S2-P1333417M, MRC17S2-P2001802M, MRC17S2-P2001814M, MRC17S2-P2001824M, MRC22S2-P1333418M, MRC22S2-P2001817M, MRC30S2-P2001812M, MRC518SU2-P1331419M, MRC518SU2-P1332818M, MRC518SU2-P1332832M, MRC518SU-P1327613M, MRC520S-P1327614M, MRC524TS2-P1331432M, MRC524TS2-P1333415M, RC17S2-P1331401M, RC17S2-P1332801M, RC17S2-P1333401M, RC17S2-P2001801M, RC17S2-P2001813M, RC17S2-P2001823M, RC22S2-P1331403M, RC22S2-P1332804M, RC22S2-P1333404M, RC22S2-P2001804M, RC22S2-P2001816M, RC22S-P1326303M, RC22S-P1329103M, RC22S-P1329610M, RC22S-P1330104M, RC30S2-P1331415M...(Other models you can see in the webshop)		

			
GEV No.	698821	Ref. No.	59134311
description	drip tray L 350mm W 150mm H 19mm		
For models:	JET5192-P2002710M, JET519V2-P2002711M		

			
GEV No.	698826	Ref. No.	20090902
description	hole cover Lmm Wmm ø 9mm		
For models:	JET5192-P2002710M, JET519V2-P2002711M		

doors

outer doors

			
GEV No.	699370	Ref. No.	14119064
description	door L 415mm H 255mm MENUMASTER for microwave		

			
GEV No.	699531	Ref. No.	12224002Q R9800043 R9800043 Old Style
description	door MENUMASTER for microwave		

			
GEV No.	698816	Ref. No.	59134315
description	outer door L 340mm W 410mm H 35mm mounting pos. front		
For models:	JET5192-P2002710M, JET519V2-P2002711M		

			
GEV No.	699527	Ref. No.	58101013
description	outer door L 410mm W 260mm H 37mm ømm MENUMASTER for microwave		
For models:	MMS10TS-P2001217M, RMS510D-P2001204M, RMS510D-P2001210M, RMS510T-P2001205M, RMS510T-P2001211M		



1

GEV No.	699556	Ref. No.	59114174
description	outer door L 415mm W 245mm H 23mm ømm for microwave		
For models:	DEC11E2-P2001514M, DEC11E2-P2002223M, DEC14E2-P2001515M, DEC14E2-P2002214M, DEC18E2-P2001516M, DEC18E2-P2002215M, DEC21E2-P2001517M, DEC21E2-P2002216M, MDC12A2-P2001502M, MDC12A2-P2002202M, MDC182-P2001504M, MDC182-P2002204M		



1

GEV No.	699528	Ref. No.	12092502 12224001Q R0150151 R9800008 R9900413
description	outer door L 415mm W 245mm H 35mm ømm MENU MASTER for microwave		
For models:	DEC21E2-P1331247M, DEC21E2-P1333123M		



1

GEV No.	699504	Ref. No.	53001811 53001826 54116003
description	outer door L 440mm W 335mm H 30mm ømm MENU MASTER for microwave		
For models:	DFS11EA-P1330220M, DFS18E-P1330222M, MFS18TS-P2001008M, RFS12TSW-P2001001M, RFS511TSW13-P2001010M, RFS511T-SW13-P2001012M, RFS511TSW-P2001005M, RFS511TSW-P2001011M, RFS518TS-P2001004M, UCS11MA-P1330228M		



1

GEV No.	699559	Ref. No.	53001573 53001820 54116002
description	outer door L 445mm W 325mm H 30mm ømm for microwave		
For models:	RCS511A-P1330214M, RFS12MPSA-P1330206M, RFS12MPSB-P1330235M, RFS12TSW-P2001001M, RFS18MPS-P1330209M, RFS18MPS-P2000703M, RFS18TS-P2001003M, RFS511S-W2A-P1330223M, RFS518S-P1330216M, URCS511A-P1330226M, URF5518S-P1330227M		



1

GEV No.	699525	Ref. No.	56002048
description	outer door L 450mm W 315mm H 40mm ømm MENU MASTER for microwave		
For models:	MCS10DS-P2001104M, MCS10DS-P2001110M, MCS10TS-P2001103M, MCS10TS-P2001109M, RCS511DS-P2001106M, RCS511DS-P2001112M, RCS511TS-P2001105M, RCS511TS-P2001111M		





1

GEV No.	699526	Ref. No.	54127022
description	outer door MENU MASTER for microwave		
For models:	MCS10DSE-P2002404M, MCS10TS-P2002403M, RCS511DSE-P2002406M, RCS511TS-P2002405M		





			
1			
GEV No.	699530	Ref. No.	14080015
description	repair kit L 540mm W 350mm H 22mm ømm outer door for microwave		
For models:	AXP20-P1333601M, AXP20-P1333602M, AXP20-P1333605M, AXP5201-P1333603M, AXP5203-P1333608M, MXP5201-P1333604M, MXP5203-P1333609M, MXP5221BO-P2001617M, MXP5221-P2001606M, MXP5223-P2001607M, MXP5223TL-P2001620M		

films			
			
1			
GEV No.	343003	Ref. No.	20044801 20181801
description	disc L 310mm W 152mm mounting pos. inner		
For models:	DEC11E2-P2001514M, DEC11E2-P2002223M, DEC14E2-P2001515M, DEC14E2-P2002214M, DEC18E2-P2001516M, DEC18E2-P2002215M, DEC21E2-P2001517M, DEC21E2-P2002216M, HDC12A2-P2001501M, HDC12A2-P2002201M, HDC182-P2001503M, HDC182-P2002203M, HDC18SD2-P2001505M, HDC18SD2-P2002205M, HDC212-P2001507M, HDC212-P2002207M, MCHDC21-P2001512M, MCHDC21-P2002212M, MDC12A2-P2001502M, MDC12A2-P2002202M, MDC182-P2001504M, MDC182-P2002204M		

			
1			
GEV No.	343002	Ref. No.	13066801
description	protective film L 315mm W 208mm		
For models:	DFS11EA-P1330220M, DFS18E-P1330222M, MFS18TS-P2001008M, RCS10DA-P1330201M, RCS10DA-P2000702M, RCS10M-PA-P1330202M, RCS10MPA-P2000704M, RCS511A-P1330214M, RFS12MPSA-P1330206M, RFS12MPSB-P1330235M, RFS12T-SW-P2001001M, RFS18MPS-P1330209M, RFS18MPS-P2000703M, RFS18TS-P2001003M, RFS511SW2A-P1330223M, RFS511T-SW13-P2001010M, RFS511TSW13-P2001012M, RFS511T-SW-P2001005M, RFS511TSW-P2001011M, RFS518S-P1330216M, RFS518TS-P2001004M, UCS11MA-P1330228M, URC-S511A-P1330226M, URF5518S-P1330227M		

			
1			
GEV No.	343000	Ref. No.	54127026
description	protective film L 320mm W 194mm		
For models:	MCS10DSE-P2002404M, MCS10TS-P2002403M, RCS10TS-P2002401M, RCS511DSE-P2002406M, RCS511TS-P2002405M		

			
1			
GEV No.	343001	Ref. No.	56001406
description	protective film L 322mm W 192mm		
For models:	ALD10D-P1331011M, ALD10D-P1331019M, ALD10T-P1331002M, ALD10T-P1331018M, ALD510D-P1331003M, ALD510-P1331005M, ALD510SE-P1331012M, MCS10DS-P2001104M, MCS10DS-P2001110M, MCS10TS-P2001103M, MCS10TS-P2001109M, MLD510SE-P1331014M, RCS10DS-P2001102M, RCS10DS-P2001108M, RCS10TS-P2001101M, RCS10TS-P2001107M, RCS511DS-P2001106M, RCS511DS-P2001112M, RCS511TS-P2001105M, RCS511TS-P2001111M, UALD510-P1331006M, UALD510SE-P1331013M, UMLD510D-P1331008M, UMLD510-P1331010M, UMLD510SE-P1331015M		

inner doors			
			
1			
GEV No.	694713	Ref. No.	59004026
description	door frame inner W 335mm L 405mm H 2mm ACP		

			
1			
GEV No.	699506	Ref. No.	12472202 13098101
description	inner door for microwave		
For models:	DEC11E2-P1331213M, DEC11E2-P1331235M, DEC11E2-P1333111M, DEC11E2-P2001412M, DEC14E2-P1331239M, DEC14E2-P1333115M, DEC14E2-P2001413M, DEC18E2-P1331221M, DEC18E2-P1331243M, DEC18E2-P1333119M, DEC18E2-P2001414M, DEC21E2-P1331226M, DEC21E2-P1331247M, DEC21E2-P1333123M, DEC21E2-P2001415M, HDC12A2-P1331203M, HDC12A2-P1333101M, HDC12A2-P2001401M, HDC12A-P1323002M, HDC12A-P1323012M, HDC12A-P1330503M, HDC182-P1331204M, HDC182-P1333102M, HDC182-P2001403M, HDC18SD2-P2001405M, HDC212-P1331207M, HDC212-P1333105M, HDC212-P2001407M, HDC5112-P1331211M, HDC5112-P1331233M, HDC5112-P1333109M, HDC5142-P1331237M, HDC5142-P1333113M, HDC5182-P1331219M, HDC5182-P1331241M, HDC5182-P1333117M, HDC518-P1325209M, HDC518-P1330518M, HDC5212-P1331224M, HDC5212-P1331245M, HDC5212-P1333121M, MCHDC21-P1333130M, MDC12A2-P1333127M, MDC12A2-P2001402M, MDC182-P1333128M, MDC182-P2001404M, UC11E2-P1331214M, UC11E2-P1331236M, UC11E2-P1333112M, UC14E2-P1331240M... (Other models you can see in the webshop)		

			
2			
GEV No.	699552	Ref. No.	12002103 12697301 59002015 D7731201 D7731202 D7784901Q
description	inner door L 405mm W 332mm H 1mm ømm for microwave		
For models:	MRC1752-P1333417M, MRC1752-P2001802M, MRC1752-P2001814M, MRC1752-P2001824M, MRC2252-P1333418M, MRC2252-P2001817M, MRC3052-P2001812M, MRC518SU2-P1331419M, MRC518SU2-P1332818M, MRC518SU2-P1332832M, MRC518SU-P1327613M, MRC5205-P1327614M, RC1752-P1331401M, RC1752-P1332801M, RC1752-P1333401M, RC1752-P2001801M, RC1752-P2001813M, RC1752-P2001823M, RC2252-P1331403M, RC2252-P1332804M, RC2252-P1333404M, RC2252-P2001804M, RC2252-P2001816M, RC225-P1330104M, RC3052-P1331415M, RC3052-P1332816M, RC3052-P1333410M, RC3052-P2001811M		

			
1			
GEV No.	699553	Ref. No.	59114170
description	inner door L 410mm W 235mm H 20mm ømm for microwave		
For models:	DEC11E2-P2001514M, DEC11E2-P2002223M, DEC14E2-P2001515M, DEC14E2-P2002214M, DEC18E2-P2001516M, DEC18E2-P2002215M, DEC21E2-P2001517M, DEC21E2-P2002216M, HDC12A2-P2001501M, HDC12A2-P2002201M, HDC182-P2001503M, HDC182-P2002203M, HDC212-P2001507M, HDC212-P2002207M, MCHDC21-P2001512M, MCHDC21-P2002212M, MDC12A2-P2001502M, MDC12A2-P2002202M, MDC182-P2001504M, MDC182-P2002204M		

			
1			
GEV No.	698815	Ref. No.	59134317
description	inner door L 410mm W 340mm thickness 20mm		
For models:	JET5192-P2002710M, JET519V2-P2002711M		

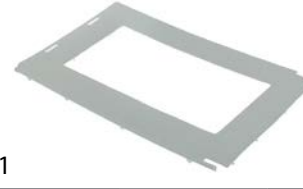
			
1			
GEV No.	699551	Ref. No.	59114168
description	inner door L 415mm W 250mm H 100mm ømm for microwave		
For models:	DEC11E2-P2001514M, DEC11E2-P2002223M, DEC14E2-P2001515M, DEC14E2-P2002214M, DEC18E2-P2001516M, DEC18E2-P2002215M, DEC21E2-P2001517M, DEC21E2-P2002216M, HDC12A2-P2001501M, HDC12A2-P2002201M, HDC182-P2001503M, HDC182-P2002203M, HDC18SD2-P2001505M, HDC18SD2-P2002205M, HDC212-P2001507M, HDC212-P2002207M, MCHDC21-P2001512M, MCHDC21-P2002212M, MDC12A2-P2001502M, MDC12A2-P2002202M, MDC182-P2001504M, MDC182-P2002204M		

			
1			
GEV No.	699554	Ref. No.	53001778 53002018 54116004
description	inner door L 415mm W 325mm H 28mm ømm for microwave		
For models:	DFS11EA-P1330220M, DFS18E-P1330222M, MFS18TS-P2001008M, RCS10DA-P1330201M, RCS10DA-P2000702M, RCS10M-PA-P1330202M, RCS10MPA-P2000704M, RCS511A-P1330214M, RFS12MPSA-P1330206M, RFS12MPSB-P1330235M, RFS12T-SW-P2001001M, RFS18MPS-P1330209M, RFS18MPS-P2000703M, RFS18TS-P2001003M, RFS511SW2A-P1330223M, RFS511T-SW13-P2001010M, RFS511TSW13-P2001012M, RFS511T-SW-P2001005M, RFS511TSW-P2001011M, RFS518S-P1330216M, RFS518TS-P2001004M, UCS11MA-P1330228M, URC-S511A-P1330226M, URF5518S-P1330227M		





			
1			
GEV No.	699508	Ref. No.	13067001 59004007 R0150148
description	inner door L 420mm W 250mm H 15mm for microwave		
For models:	DEC11E2-P1331213M, DEC11E2-P1331235M, DEC11E2-P1333111M, DEC11E2-P2001412M, DEC14E2-P1331239M, DEC14E2-P1333115M, DEC14E2-P2001413M, DEC18E2-P1331221M, DEC18E2-P1331243M, DEC18E2-P1333119M, DEC18E2-P2001414M, DEC21E2-P1331226M, DEC21E2-P1331247M, DEC21E2-P1333123M, DEC21E2-P2001415M, HDC12A2-P1331203M, HDC12A2-P1333101M, HDC12A2-P2001401M, HDC12A-P1323002M, HDC12A-P1323012M, HDC12A-P1330503M, HDC12P2-P1331223M, HDC182-P1331204M, HDC182-P1333102M, HDC182-P2001403M, HDC18SD2-P1331205M, HDC18SD2-P1333103M, HDC18SD2-P2001405M, HDC212-P1331207M, HDC212-P1333105M, HDC212-P2001407M, HDC5112-P1331211M, HDC5112-P1331233M, HDC5112-P1333109M, HDC5142-P1331237M, HDC5142-P1333113M, HDC5182-P1331219M, HDC5182-P1331241M, HDC5182-P1333117M, HDC518-P1325209M, HDC518-P1330518M, HDC5212-P1331224M, HDC5212-P1331245M, HDC5212-P1333121M, MCHDC21-P1333130M, MDC12A2-P1333127M, MDC12A2-P2001402M, MDC182-P1333128M, MDC182-P2001404M, UC11E2-P1331214M...(Other models you can see in the webshop)		

			
2			
GEV No.	699532	Ref. No.	12002760 59002021 R0000498
description	repair kit L 405mm W 335mm H 33mm ømm inner door for microwave		
For models:	ACE14-P1333201M, ACE14-P1333206M, ACE14-P2000401M, ACE14-P2001901M, ACE14-P2001909M, ACE5140-P1333203M, ACE5140-P1333207M, ACE5140-P2000403M, ACE5302-P1331307M, ACE5302-P1332912M, ACE5302-P1332914M, DS1400E-P1333204M, DS1400E-P2000404M, DS1400E-P2001904M, DS1400E-P2001912M, DS30E2-P1331309M, DS30E2-P1332916M, MCE14-P2000407M, MCE14-P2001902M, MCE14-P2001910M, MRC524TS2-P1331432M, MRC524TS2-P1333415M, RC524TS2-P1331430M, RC524TS2-P1333414M, UCA1400-P1333205M, UCA1400-P2000405M, UCA1400-P2001906M, UCA1400-P2001913M, UCA2000NT3-P1332921M, UCA2000NT3-P2000406M		

			
1			
GEV No.	699529	Ref. No.	14080014
description	repair kit L 531mm W 350mm H 60mm ømm inner door for microwave		
For models:	AXP20-P1333601M, AXP20-P1333602M, AXP20-P1333605M, AXP5201-P1333603M, AXP5203-P1333608M, MXP5201-P1333604M, MXP5203-P1333609M, MXP5221BO-P2001617M, MXP5221-P2001606M, MXP5223-P2001607M, MXP5223TL-P2001620M		

			
1			
GEV No.	701368	Ref. No.	12490902
description	door handle L 103mm W 18mm H 35mm silver		
For models:	ACE14-P1333201M, ACE14-P1333206M, ACE14-P2000401M, ACE14-P2001901M, ACE14-P2001909M, ACE5140-P1333203M, ACE5140-P1333207M, ACE5140-P2000403M, ACE5302-P1331307M, ACE5302-P1332912M, ACE5302-P1332914M, DS1400E-P1333204M, DS1400E-P2000404M, DS1400E-P2001904M, DS1400E-P2001912M, DS30E2-P1331309M, DS30E2-P1332916M, MCE14-P2000407M, MCE14-P2001902M, MCE14-P2001910M, UCA1400-P1333205M, UCA1400-P2000405M, UCA1400-P2001906M, UCA1400-P2001913M, UCA2000NT3-P1332921M, UCA2000NT3-P2000406M		

			
1			
GEV No.	701367	Ref. No.	12002453
description	door handle L 106mm W 18mm H 37mm silver metal Qty 1 pcs		
For models:	DFS11EA-P1330220M, DFS18E-P1330222M, MFS18TS-P2001008M, RCS10DA-P1330201M, RCS10DA-P2000702M, RCS10M-PA-P1330202M, RCS10MPA-P2000704M, RCS511A-P1330214M, RFS12MPSA-P1330206M, RFS12MPSB-P1330235M, RFS12T-SW-P2001001M, RFS18MPS-P1330209M, RFS18MPS-P2000703M, RFS18TS-P2001003M, RFS511SW2A-P1330223M, RFS511T-SW13-P2001010M, RFS511TSW13-P2001012M, RFS511T-SW-P2001005M, RFS511TSW-P2001011M, RFS518S-P1330216M, RFS518TS-P2001004M, UCS11MA-P1330228M, URC-5511A-P1330226M, URF5518S-P1330227M		

			
1			
GEV No.	701369	Ref. No.	12133901 20175601
description	door handle L 155mm W 25.7mm H 40mm silver metal Qty 1 pcs U-shape		
For models:	DEC11E2-P1331213M, DEC11E2-P1331235M, DEC11E2-P1333111M, DEC11E2-P2001412M, DEC11E2-P2001514M, DEC11E2-P2002223M, DEC14E2-P1331239M, DEC14E2-P1333115M, DEC14E2-P2001413M, DEC14E2-P2001515M, DEC14E2-P2002214M, DEC18E2-P1331221M, DEC18E2-P1331243M, DEC18E2-P1333119M, DEC18E2-P2001414M, DEC18E2-P2001516M, DEC18E2-P2002215M, DEC21E2-P1331226M, DEC21E2-P1331247M, DEC21E2-P1333123M, DEC21E2-P2001415M, DEC21E2-P2001517M, DEC21E2-P2002216M, HDC12A2-P1331203M, HDC12A2-P1333101M, HDC12A2-P2001401M, HDC12A2-P2001501M, HDC12A2-P2002201M, HDC12A-P1323002M, HDC12A-P1323012M, HDC12A-P1330503M, HDC12P2-P1331223M, HDC182-P1331204M, HDC182-P1333102M, HDC182-P2001403M, HDC182-P2001503M, HDC182-P2002203M, HDC18SD2-P1331205M, HDC18SD2-P1333103M, HDC18SD2-P2001405M, HDC18SD2-P2001505M, HDC18SD2-P2002205M, HDC212-P1331207M, HDC212-P1333105M, HDC212-P2001407M, HDC212-P2001507M, HDC212-P2002207M, HDC5112-P1331211M, HDC5112-P1331233M, HDC5112-P1333109M...(Other models you can see in the webshop)		

			
2			
GEV No.	701374	Ref. No.	699145
description	inner part L 18.9mm W 11mm H 18.6mm mounting pos. door handle suitable for ACP white nylon Qty 1 pcs		

door hinges

			
1			
GEV No.	698823	Ref. No.	20090602 20090603
description	bracket L 330mm W 15mm H 27mm		
For models:	JET5192-P2002710M, JET519V2-P2002711M		

			
1			
GEV No.	530436	Ref. No.	5210001001
description	bush H 4.2mm ø 6.2mm white D1 ø 7.9mm D2 ø 11.3mm nylon Qty 1 pcs		
For models:	DEC11E2-P1331213M, DEC11E2-P1331235M, DEC11E2-P1333111M, DEC11E2-P2001412M, DEC14E2-P1331239M, DEC14E2-P1333115M, DEC14E2-P2001413M, DEC18E2-P1331221M, DEC18E2-P1331243M, DEC18E2-P1333119M, DEC18E2-P2001414M, DEC21E2-P1331226M, DEC21E2-P1331247M, DEC21E2-P1333123M, DEC21E2-P2001415M, HDC12A2-P1331203M, HDC12A2-P1333101M, HDC12A2-P2001401M, HDC12A-P1323002M, HDC12A-P1323012M, HDC12A-P1330503M, HDC12P2-P1331223M, HDC182-P1331204M, HDC182-P1333102M, HDC182-P2001403M, HDC182-P2001503M, HDC182-P2002203M, HDC18SD2-P1331205M, HDC18SD2-P1333103M, HDC18SD2-P2001405M, HDC18SD2-P2001505M, HDC18SD2-P2002205M, HDC212-P1331207M, HDC212-P1333105M, HDC212-P2001407M, HDC212-P2001507M, HDC212-P2002207M, HDC5112-P1331211M, HDC5112-P1331233M, HDC5112-P1333109M, HDC5142-P1331237M, HDC5142-P1333113M, HDC5182-P1331219M, HDC5182-P1331241M, HDC5182-P1333117M, HDC518-P1325209M, HDC518-P1330518M, HDC5212-P1331224M, HDC5212-P1331245M, HDC5212-P1333121M, MCHDC21-P1333130M, MDC12A2-P1333127M, MDC12A2-P2001402M, MDC182-P1333128M, MDC182-P2001404M, UC11E2-P1331214M...(Other models you can see in the webshop)		

			
1			
GEV No.	701354	Ref. No.	56002029
description	hinge L 93mm W 28mm H 35mm mounting pos. upper thickness 2.6mm suitable for ACP Qty 1 pcs		
For models:	MCS10DS-P2001104M, MCS10DS-P2001110M, MCS10TS-P2001103M, MCS10TS-P2001109M, RCS10DS-P2001102M, RCS10DS-P2001108M, RCS10TS-P2001101M, RCS10TS-P2001107M, RCS511DS-P2001106M, RCS511DS-P2001112M, RCS511TS-P2001105M, RCS511TS-P2001111M		

			
1			
GEV No.	701342	Ref. No.	12126804 12126806 12126806Q 14119059 14179128
description	joint mounting pos. lower for microwaves Qty 1 pcs complete auxiliary equipment door		
For models:	DEC11E2-P1331213M, DEC11E2-P1331235M, DEC11E2-P1333111M, DEC11E2-P2001412M, DEC11E2-P2001514M, DEC11E2-P2002223M, DEC14E2-P1331239M, DEC14E2-P1333115M, DEC14E2-P2001413M, DEC14E2-P2001515M, DEC14E2-P2002214M, DEC18E2-P1331221M, DEC18E2-P1331243M, DEC18E2-P1333119M, DEC18E2-P2001414M, DEC18E2-P2001516M, DEC18E2-P2002215M, DEC21E2-P1331226M, DEC21E2-P1331247M, DEC21E2-P1333123M, DEC21E2-P2001415M, DEC21E2-P2001517M, DEC21E2-P2002216M, HDC12A2-P1331203M, HDC12A2-P1333101M, HDC12A2-P2001401M, HDC12A2-P2001501M, HDC12A2-P2002201M, HDC12A-P1323002M, HDC12A-P1323012M, HDC12A-P1330503M, HDC12P2-P1331223M, HDC182-P1331204M, HDC182-P1333102M, HDC182-P2001403M, HDC182-P2001503M, HDC182-P2002203M, HDC18SD2-P1331205M, HDC18SD2-P1333103M, HDC18SD2-P2001405M, HDC18SD2-P2001505M, HDC18SD2-P2002205M, HDC212-P1331207M, HDC212-P1333105M, HDC212-P2001407M, HDC212-P2001507M, HDC212-P2002207M, HDC5112-P1331211M, HDC5112-P1331233M, HDC5112-P1333109M...(Other models you can see in the webshop)		

			
1			
GEV No.	701341	Ref. No.	12126803 12126805 12126805Q 14119058
description	joint mounting pos. upper for microwaves Qty 1 pcs complete auxiliary equipment door		
For models:	DEC11E2-P1331213M, DEC11E2-P1331235M, DEC11E2-P1333111M, DEC11E2-P2001412M, DEC11E2-P2001514M, DEC11E2-P2002223M, DEC14E2-P1331239M, DEC14E2-P1333115M, DEC14E2-P2001413M, DEC14E2-P2001515M, DEC14E2-P2002214M, DEC18E2-P1331221M, DEC18E2-P1331243M, DEC18E2-P1333119M, DEC18E2-P2001414M, DEC18E2-P2001516M, DEC18E2-P2002215M, DEC21E2-P1331226M, DEC21E2-P1331247M, DEC21E2-P1333123M, DEC21E2-P2001415M, DEC21E2-P2001517M, DEC21E2-P2002216M, HDC12A2-P1331203M, HDC12A2-P1333101M, HDC12A2-P2001401M, HDC12A2-P2001501M, HDC12A2-P2002201M, HDC12A2-P1323002M, HDC12A2-P1323012M, HDC12A2-P1330503M, HDC12P2-P1331223M, HDC182-P1331204M, HDC182-P1333102M, HDC182-P2001403M, HDC182-P2001503M, HDC182-P2002203M, HDC18SD2-P1331205M, HDC-18SD2-P1333103M, HDC18SD2-P2001405M, HDC18SD2-P2001505M, HDC18SD2-P2002205M, HDC212-P1331207M, HDC212-P1333105M, HDC212-P2001407M, HDC212-P2001507M, HDC212-P2002207M, HDC5112-P1331211M, HDC5112-P1331233M, HDC5112-P1333109M...(Other models you can see in the webshop)		

			
1			
GEV No.	701355	Ref. No.	12126901
description	catch L 47.5mm W 15mm H 9.5mm mounting pos. door suitable for ACP Qty 1 pcs		
For models:	DEC11E2-P1331213M, DEC11E2-P1331235M, DEC11E2-P1333111M, DEC11E2-P2001412M, DEC14E2-P1331239M, DEC14E2-P1333115M, DEC14E2-P2001413M, DEC18E2-P1331221M, DEC18E2-P1331243M, DEC18E2-P1333119M, DEC18E2-P2001414M, DEC21E2-P1331226M, DEC21E2-P1331247M, DEC21E2-P1333123M, DEC21E2-P2001415M, HDC12A2-P1331203M, HDC12A2-P1333101M, HDC12A2-P2001401M, HDC12A2-P1323002M, HDC12A2-P1323012M, HDC12A2-P1330503M, HDC12P2-P1331223M, HDC182-P1331204M, HDC182-P1333102M, HDC182-P2001403M, HDC18SD2-P1331205M, HDC-18SD2-P1333103M, HDC18SD2-P2001405M, HDC212-P1331207M, HDC212-P1333105M, HDC212-P2001407M, HDC5112-P1331211M, HDC5112-P1331233M, HDC5112-P1333109M, HDC5142-P1331237M, HDC5142-P1333113M, HDC5182-P1331219M, HDC5182-P1331241M, HDC5182-P1333117M, HDC518-P1325209M, HDC518-P1330518M, HDC5212-P1331224M, HDC5212-P1331245M, HDC5212-P1333121M, MCHDC21-P1333130M, MDC12A2-P1333127M, MDC12A2-P2001402M, MDC182-P1333128M, MDC182-P2001404M, UC11E2-P1331214M...(Other models you can see in the webshop)		

door catches

			
1			
GEV No.	699145	Ref. No.	59114175
description	catch L 145mm W 9.93mm H 43.8mm plastic black suitable for ACP Qty 1 pcs		
For models:	DEC11E2-P2001514M, DEC11E2-P2002223M, DEC14E2-P2001515M, DEC14E2-P2002214M, DEC18E2-P2001516M, DEC18E2-P2002215M, DEC21E2-P2001517M, DEC21E2-P2002216M, HDC12A2-P2001501M, HDC12A2-P2002201M, HDC182-P2001503M, HDC182-P2002203M, HDC18SD2-P2001505M, HDC18SD2-P2002205M, HDC212-P2001507M, HDC212-P2002207M, MCHDC21-P2001512M, MCHDC21-P2002212M, MDC12A2-P2001502M, MDC12A2-P2002202M, MDC182-P2001504M, MDC182-P2002204M		

			
1			
GEV No.	699371	Ref. No.	14179126 54127009
description	door catch for microwave with switch kit		
For models:	MCS10DSE-P2002404M, MCS10TS-P2002403M, RCS10TS-P2002401M		

			
1			
GEV No.	698824	Ref. No.	14124068
description	door catch kit		
For models:	MCS10DSE-P2002404M, MCS10TS-P2002403M, RCS10TS-P2002401M, RCS511DSE-P2002406M, RCS511TS-P2002405M		

			
1			
GEV No.	701363	Ref. No.	R0000281 R0000282
description	door catch L 115mm W 36mm H 57mm suitable for microwave suitable for ACP Qty 1 pcs incl. rivet		
For models:	MRC518SU2-P1331419M, MRC518SU-P1327613M, MRC520S-P1327614M, RC1752-P1331401M, RC2252-P1331403M, RC225-P1326303M, RC225-P1329103M, RC225-P1329610M, RC225-P1330104M, RC3052-P1331415M, RC518SU-P1327602M, RC520S-P1327601M, RCS511-P1327809M		

			
1			
GEV No.	698818	Ref. No.	59134308
description	door catch with switch W 120mm H 17mm L 165mm		
For models:	JET5192-P2002710M, JET519V2-P2002711M		

			
1			
GEV No.	701353	Ref. No.	53001779 54116005
description	latch L 100mm W 29mm H 78mm for microwave		
For models:	DFS11EA-P1330220M, DFS18E-P1330222M, MFS18TS-P2001008M, RCS10DA-P1330201M, RCS10DA-P2000702M, RCS10M-PA-P1330202M, RCS10MPA-P2000704M, RCS511A-P1330214M, RFS12MPSA-P1330206M, RFS12MP5B-P1330235M, RFS12T-SW-P2001001M, RFS18MPS-P1330209M, RFS18MPS-P2000703M, RFS18TS-P2001003M, RFS511SW2A-P1330223M, RFS511T-SW13-P2001010M, RFS511TSW13-P2001012M, RFS511T-SW-P2001005M, RFS511TSW-P2001011M, RFS518S-P1330216M, RFS518TS-P2001004M, UCS11MA-P1330228M, URC-S511A-P1330226M, URFS518S-P1330227M		

			
1			
GEV No.	701489	Ref. No.	59134314
description	snap lock L 207mm W 32mm H2 32mm H 9mm spring thickness 0.7mm for microwave W2 61mm		
For models:	JET5192-P2002710M, JET519V2-P2002711M		
spare parts for	701489		
	GEV No.	701492	Ref. No. 20045103
tension spring ø 6.4mm total length 48mm wire gauge ø 0.7mm for microwave			

tension springs			
			
1			
GEV No.	701493	Ref. No.	20096602
description	tension spring ø 11mm total length 90mm wire gauge ø 1.5mm		
For models:	JET5192-P2002710M, JET519V2-P2002711M		

			
1			
GEV No.	701492	Ref. No.	20045103
description	tension spring ø 6.4mm total length 48mm wire gauge ø 0.7mm for microwave		
For models:	JET5192-P2002710M, JET519V2-P2002711M		

handles and hand wheels

door handles

door handles			
			
1			
GEV No.	699144	Ref. No.	59001230
description	door handle for microwave L 305mm W 30mm grey mounting distance 127mm		
For models:	ACE14-P1333201M, ACE14-P1333206M, ACE14-P2000401M, ACE14-P2001901M, ACE14-P2001909M, ACE5140-P1333203M, ACE5140-P1333207M, ACE5140-P2000403M, ACE5302-P1331307M, ACE5302-P1332912M, ACE5302-P1332914M, DS1400E-P1333204M, DS1400E-P2000404M, DS1400E-P2001904M, DS1400E-P2001912M, DS30E2-P1331309M, DS30E2-P1332916M, MCE14-P2000407M, MCE14-P2001902M, MCE14-P2001910M, UCA1400-P1333205M, UCA1400-P2000405M, UCA1400-P2001906M, UCA1400-P2001913M, UCA2000NT3-P1332921M, UCA2000NT3-P2000406M		



			
1			
GEV No.	699512	Ref. No.	59002142
description	door handle for microwave L 530mm		
For models:	AXP20-P1333601M, AXP20-P1333602M, AXP20-P1333605M, AXP5201-P1333603M, AXP5203-P1333608M, MXP5201-P1333604M, MXP5203-P1333609M, MXP5221BO-P2001617M, MXP5221-P2001606M, MXP5223-P2001607M, MXP5223TL-P2001620M		

locks



snap locks

producer-specific

ACP

			
1			
GEV No.	701363	Ref. No.	R0000281 R0000282
description	door catch L 115mm W 36mm H 57mm suitable for microwave suitable for ACP Qty 1 pcs incl. rivet		
For models:	MRC518SU2-P1331419M, MRC518SU-P1327613M, MRC520S-P1327614M, RC17S2-P1331401M, RC22S2-P1331403M, RC22S-P1326303M, RC22S-P1329103M, RC22S-P1329610M, RC22S-P1330104M, RC30S2-P1331415M, RC518SU-P1327602M, RC520S-P1327601M, RCS511-P1327809M		

			
1			
GEV No.	701353	Ref. No.	53001779 54116005
description	latch L 100mm W 29mm H 78mm for microwave		
For models:	DFS11EA-P1330220M, DFS18E-P1330222M, MFS18TS-P2001008M, RCS10DA-P1330201M, RCS10DA-P2000702M, RCS10M-PA-P1330202M, RCS10MPA-P2000704M, RCS511A-P1330214M, RFS12MPSA-P1330206M, RFS12MPSB-P1330235M, RFS12T-SW-P2001001M, RFS18MPS-P1330209M, RFS18MPS-P2000703M, RFS18TS-P2001003M, RFS511SW2A-P1330223M, RFS511T-SW13-P2001010M, RFS511TSW13-P2001012M, RFS511T-SW-P2001005M, RFS511TSW-P2001011M, RFS518S-P1330216M, RFS518TS-P2001004M, UCS11MA-P1330228M, URC-S511A-P1330226M, URF5518S-P1330227M		

			
1			
GEV No.	701489	Ref. No.	59134314
description	snap lock L 207mm W 32mm H2 32mm H 9mm spring thickness 0.7mm for microwave W2 61mm		
For models:	JETS192-P2002710M, JETS19V2-P2002711M		
spare parts for	701489		
	GEV No.	Ref. No.	20045103
	 tension spring ø 6.4mm total length 48mm wire gauge ø 0.7mm for microwave		

			
1			
GEV No.	701492	Ref. No.	20045103
description	tension spring ø 6.4mm total length 48mm wire gauge ø 0.7mm for microwave		
For models:	JETS192-P2002710M, JETS19V2-P2002711M		

hinges

piano hinges

producer-specific

ACP

			
1			
GEV No.	701339	Ref. No.	59004034 C8936201 C8936205 C8936206 C8936208 C8961811
description	hinge L 305mm W 65mm mounting distance 82mm mounting distance 1 67mm hole ø 4.5mm thickness 1.9mm zinc-plated for microwaves		
For models:	MRC17S2-P1333417M, MRC17S2-P2001802M, MRC17S2-P2001814M, MRC17S2-P2001824M, MRC22S2-P1333418M, MRC22S2-P2001817M, MRC30S2-P2001812M, MRC518SU2-P1331419M, MRC518SU2-P1332818M, MRC518SU2-P1332832M, MRC-518SU-P1327613M, MRC520S-P1327614M, MRC524TS2-P1331432M, MRC524TS2-P1333415M, RC17S2-P1331401M, RC17S2-P1332801M, RC17S2-P1333401M, RC17S2-P2001801M, RC17S2-P2001813M, RC17S2-P2001823M, RC22S2-P1331403M, RC22S2-P1332804M, RC22S2-P1333404M, RC22S2-P2001804M, RC22S2-P2001816M, RC22S-P1198605M, RC22S-P1326303M, RC22S-P1329103M, RC22S-P1329610M, RC22S-P1330104M, RC30S2-P1331415M, RC30S2-P1332816M, RC30S2-P1333410M, RC30S2-P2001811M, RC518SU-P1327602M, RC520S-P1327601M, RC524TS2-P1331430M, RC524TS2-P1333414M, RCS511-P1327809M, UCA1400-P1333205M		

			
1			
GEV No.	701351	Ref. No.	59001869
description	hinge L 305mm W 72mm H 9mm mounting distance 127mm mounting distance 1 67mm mounting distance 2 76mm mounting distance 3 82mm hole ø 6/4mm thickness 1.9mm zinc-plated for microwaves		
For models:	ACE14-P1333201M, ACE14-P1333206M, ACE14-P2000401M, ACE14-P2001901M, ACE14-P2001909M, ACE5140-P1333203M, ACE5140-P1333207M, ACE5140-P2000403M, ACE5302-P1332912M, ACE5302-P1332914M, DS1400E-P1333204M, DS1400E-P2000404M, DS1400E-P2001904M, DS1400E-P2001912M, DS30E2-P1332916M, MCE14-P2000407M, MCE14-P2001902M, MCE14-P2001910M, UCA1400-P1333205M, UCA1400-P2000405M, UCA1400-P2001906M, UCA1400-P2001913M, UCA2000NT3-P1332921M, UCA2000NT3-P2000406M		

oven hinges



GEV No.	699544	Ref. No.	59002141 59004080
description	door hinge lever length 139mm spring thickness 2.6mm spring length 100mm L 157mm W 22mm for microwave		
For models:	AXP20-P1333601M, AXP20-P1333602M, AXP20-P1333605M, AXP5201-P1333603M, AXP5203-P1333608M, MXP5201-P1333604M, MXP5203-P1333609M, MXP5221BO-P2001617M, MXP5221-P2001606M, MXP5223-P2001607M, MXP5223TL-P2001620M		

door bearing



GEV No.	701490	Ref. No.	59134313
description	hinge bearing L 89mm W 37mm mounting pos. lower		
For models:	JET5192-P2002710M, JET519V2-P2002711M		



GEV No.	701491	Ref. No.	59134312
description	hinge bearing L 89mm W 37mm mounting pos. upper		
For models:	JET5192-P2002710M, JET519V2-P2002711M		

equipment feet with stem



GEV No.	701333	Ref. No.	58101004
description	foot ø 21mm H 3mm mounting ø 13mm overall height 10mm for microwave rubber Qty 1 pcs		
For models:	MMS10TS-P2001217M, RMS10TS-P2001203M, RMS10TS-P2001209M, RMS510D-P2001204M, RMS510D-P2001210M, RMS510T-P2001205M, RMS510T-P2001211M		

shelves and shelf rails

grates

universal

with upstand



GEV No.	970843	Ref. No.	20030801 RA14
description	grate W 328mm D 375mm chrome-plated steel with hinge camp		
For models:	ACE14-P2000401M, ACE14-P2001901M, ACE14-P2001909M, ACE5140-P2000403M, DS1400E-P2000404M, DS1400E-P2001904M, DS1400E-P2001912M, JET5192-P2002710M, JET519V2-P2002711M, MCE14-P2000407M, MCE14-P2001902M, MCE14-P2001910M, UCA1400-P2000405M, UCA1400-P2001906M, UCA1400-P2001913M, UCA2000NT3-P2000406M		



GEV No.	970842	Ref. No.	59002140
description	grate W 397mm D 370mm chrome-plated steel with hinge camp		
For models:	AXP20-P1333601M, AXP20-P1333602M, AXP20-P1333605M, AXP5201-P1333603M, AXP5203-P1333608M, MXP5201-P1333604M, MXP5203-P1333609M, MXP5221BO-P2001617M, MXP5221-P2001606M, MXP5223-P2001607M, MXP5223TL-P2001620M		

equipment feet and end caps

bolting feet



GEV No.	701365	Ref. No.	58101003
description	equipment foot for microwave ø 30mm H 30mm bore ø 4mm suitable for ACP plastic Qty 1 pcs		
For models:	MMS10TS-P2001217M, RMS10TS-P2001203M, RMS10TS-P2001209M, RMS510D-P2001204M, RMS510D-P2001210M, RMS510T-P2001205M, RMS510T-P2001211M		



gaskets

gaskets for heated units

miscellaneous

			
1			
GEV No.	701375	Ref. No.	10732508Q 10732509Q 10732512Q 10732514Q 53001626 53001627 59001642 59001643 R0000413
description	gasket for microwave L 2130mm W 11.5mm H 7mm		
For models:	AXP20-P1333601M, AXP20-P1333602M, AXP20-P1333605M, AXP5201-P1333603M, AXP5203-P1333608M, DEC11E2-P1331213M, DEC11E2-P1331235M, DEC11E2-P1333111M, DEC11E2-P2001412M, DEC11E2-P2001514M, DEC11E2-P2002223M, DEC14E2-P1331217M, DEC14E2-P1331239M, DEC14E2-P1333115M, DEC14E2-P2001413M, DEC14E2-P2001515M, DEC14E2-P2002214M, DEC18E2-P1331221M, DEC18E2-P1331243M, DEC18E2-P1333119M, DEC18E2-P2001414M, DEC18E2-P2001516M, DEC18E2-P2002215M, DEC21E2-P1331226M, DEC21E2-P1331247M, DEC21E2-P1333123M, DEC21E2-P2001415M, DEC21E2-P2001517M, DEC21E2-P2002216M, DFS11EA-P1330220M, DFS18E-P1330222M, HDC12A2-P1331203M, HDC12A2-P1333101M, HDC12A2-P2001401M, HDC12A2-P2001501M, HDC12A2-P2002201M, HDC12A-P1323002M, HDC12A-P1323012M, HDC12A-P1330503M, HDC12P2-P1331223M, HDC182-P1331204M, HDC182-P1333102M, HDC182-P2001403M, HDC182-P2001503M, HDC182-P2002203M, HDC18SD2-P1331205M, HDC18SD2-P1333103M, HDC18SD2-P2001405M, HDC18SD2-P2001505M, HDC-18SD2-P2002205M...(Other models you can see in the webshop)		

			
1			
GEV No.	694696	Ref. No.	59002107 59004077 A3030302 A3030330 A3263905
description	gasket W 14mm thickness 5mm self-adhesive Qty supplied by meter		
For models:	ACE14-P1333201M, ACE14-P1333206M, ACE14-P2000401M, ACE14-P2001901M, ACE14-P2001909M, ACE5140-P1333203M, ACE5140-P1333207M, ACE5140-P2000403M, ACE5302-P1332912M, ACE5302-P1332914M, AXP20-P1333601M, AXP20-P1333602M, AXP20-P1333605M, AXP5201-P1333603M, AXP5203-P1333608M, DEC11E2-P1331213M, DEC11E2-P1331235M, DEC11E2-P1333111M, DEC11E2-P2001412M, DEC11E2-P2001514M, DEC11E2-P2002223M, DEC14E2-P1331239M, DEC14E2-P1333115M, DEC14E2-P2001413M, DEC14E2-P2001515M, DEC14E2-P2002214M, DEC18E2-P1331221M, DEC18E2-P1331243M, DEC18E2-P1333119M, DEC18E2-P2001414M, DEC18E2-P2001516M, DEC18E2-P2002215M, DEC21E2-P1331226M, DEC21E2-P1331247M, DEC21E2-P1333123M, DEC21E2-P2001415M, DEC21E2-P2001517M, DEC21E2-P2002216M, DS1400E-P1333204M, DS1400E-P2000404M, DS1400E-P2001904M, DS1400E-P2001912M, DS30E2-P1332916M, HDC12A2-P1331203M, HDC12A2-P1333101M, HDC12A2-P2001401M, HDC12A2-P2001501M, HDC12A2-P2002201M, HDC12A-P1323002M, HDC12A-P1323012M...(Other models you can see in the webshop)		

foam rubber gaskets

			
1			
GEV No.	694695	Ref. No.	10966607 59002162 A3263907
description	gasket W 12.6mm thickness 16mm self-adhesive Qty supplied by meter		
For models:	ACE5302-P1332907M, DEC11E2-P1331213M, DEC11E2-P2001412M, DEC11E2-P2001514M, DEC11E2-P2002223M, DEC14E2-P2001413M, DEC14E2-P2001515M, DEC14E2-P2002214M, DEC18E2-P2001414M, DEC18E2-P2001516M, DEC18E2-P2002215M, DEC21E2-P1331226M, DEC21E2-P2001415M, DEC21E2-P2001517M, DEC21E2-P2002216M, DS30E2-P1332909M, HDC12A2-P1331203M, HDC12A2-P1333101M, HDC12A2-P2001401M, HDC12A2-P2001501M, HDC12A2-P2002201M, HDC12A-P1323002M, HDC12A-P1323012M, HDC12A-P1330503M, HDC12P2-P1331223M, HDC182-P1331204M, HDC182-P1333102M, HDC182-P2001403M, HDC182-P2001503M, HDC182-P2002203M, HDC18SD2-P1331205M, HDC18SD2-P1333103M, HDC-18SD2-P2001405M, HDC18SD2-P2001505M, HDC18SD2-P2002205M, HDC212-P1331207M, HDC212-P1333105M, HDC212-P2001407M, HDC212-P2001507M, HDC212-P2002207M, HDC5112-P1331211M, HDC518-P1330518M, HDC5212-P1331224M, MCHDC21-P1333130M, MCHDC21-P2001512M, MCHDC21-P2002212M, MDC12A2-P1333127M, MDC12A2-P2001402M, MDC12A2-P2001502M, MDC12A2-P2002202M...(Other models you can see in the webshop)		

special gaskets

for microwaves

			
1			
GEV No.	343004	Ref. No.	13077801 13077802
description	gasket L 283mm W 350mm Qty 1 pcs		
For models:	MXP5221BO-P2001617M, MXP5221-P2001606M, MXP5223-P2001607M, MXP5223TL-P2001620M		

springs

tension springs

			
1			
GEV No.	701335	Ref. No.	59001721 C8893505
description	tension spring for door latch ø 5mm total length 42mm wire gauge ø 0.5mm for microwave Qty 1 pcs		
For models:	ACE14-P1333201M, ACE14-P1333206M, ACE14-P2000401M, ACE5140-P1333203M, ACE5140-P1333207M, ACE5140-P2000403M, ACE5302-P1331307M, ACE5302-P1332912M, ACE5302-P1332914M, DS1400E-P1333204M, DS1400E-P2000404M, DS30E2-P1331309M, DS30E2-P1332916M, MCE14-P2000407M, UCA1400-P1333205M, UCA1400-P2000405M, UCA2000NT3-P1332921M, UCA2000NT3-P2000406M		



GEV No.	701336	Ref. No.	C8893506
description	tension spring for door latch ø 5mm total length 42mm wire gauge ø 0.6mm for microwave Qty 1 pcs		
For models:	ACE14-P2001901M, ACE14-P2001909M, DS1400E-P2001904M, DS1400E-P2001912M, MCE14-P2001902M, MCE14-P2001910M, MRC17S2-P2001802M, MRC17S2-P2001814M, MRC17S2-P2001824M, MRC22S2-P2001817M, MRC30S2-P2001812M, RC17S2-P2001801M, RC17S2-P2001813M, RC17S2-P2001823M, RC22S2-P2001804M, RC22S2-P2001816M, RC30S2-P2001811M, UCA1400-P2001906M, UCA1400-P2001913M		



GEV No.	701337	Ref. No.	C8893502 C8893504
description	tension spring for door latch ø 5mm total length 42mm wire gauge ø 0.6mm for microwave Qty 1 pcs		
For models:	DEC11E2-P1331213M, DEC11E2-P1331235M, DEC11E2-P1333111M, DEC11E2-P2001412M, DEC14E2-P1331239M, DEC14E2-P1333115M, DEC14E2-P2001413M, DEC18E2-P1331221M, DEC18E2-P1331243M, DEC18E2-P1333119M, DEC18E2-P2001414M, DEC21E2-P1331226M, DEC21E2-P1331247M, DEC21E2-P1333123M, DEC21E2-P2001415M, HDC12A2-P1331203M, HDC12A2-P1333101M, HDC12A2-P2001401M, HDC12A-P1323002M, HDC12A-P1323012M, HDC12A-P1330503M, HDC12P2-P1331223M, HDC182-P1331204M, HDC182-P1333102M, HDC182-P2001403M, HDC18SD2-P1331205M, HDC18SD2-P1333103M, HDC18SD2-P2001405M, HDC212-P1331207M, HDC212-P1333105M, HDC212-P2001407M, HDC5112-P1331211M, HDC5112-P1331233M, HDC5112-P1333109M, HDC5142-P1331237M, HDC5142-P1333113M, HDC5182-P1331219M, HDC5182-P1331241M, HDC5182-P1333117M, HDC518-P1325209M, HDC518-P1330518M, HDC5212-P1331224M, HDC5212-P1331245M, HDC5212-P1333121M, MCHDC21-P1333130M, MDC12A2-P1333127M, MDC12A2-P2001402M, MDC182-P1333128M, MDC182-P2001404M, MRC17S2-P1333417M...(Other models you can see in the webshop)		



GEV No.	701338	Ref. No.	53001780
description	tension spring for door latch ø 6mm total length 44mm wire gauge ø 0.8mm for microwave Qty 1 pcs		
For models:	DFS11EA-P1330220M, DFS18E-P1330222M, MFS18TS-P2001008M, RCS10DA-P1330201M, RCS10DA-P2000702M, RCS10M-PA-P1330202M, RCS10MPA-P2000704M, RCS511A-P1330214M, RFS12MPSA-P1330206M, RFS12MPSB-P1330235M, RFS12T-SW-P2001001M, RFS18MPS-P1330209M, RFS18MPS-P2000703M, RFS18TS-P2001003M, RFS511SW2A-P1330223M, RFS511T-SW13-P2001010M, RFS511TSW13-P2001012M, RFS511T-SW-P2001005M, RFS511TSW-P2001011M, RFS518S-P1330216M, RFS518TS-P2001004M, UCS11MA-P1330228M, URC-S511A-P1330226M, URFS518S-P1330227M		



GEV No.	701334	Ref. No.	20045102
description	tension spring for door latch ø 6mm total length 50mm wire gauge ø 0.5mm for microwave Qty 1 pcs		
For models:	DEC11E2-P2001514M, DEC11E2-P2002223M, DEC14E2-P2001515M, DEC14E2-P2002214M, DEC18E2-P2001516M, DEC18E2-P2002215M, DEC21E2-P2001517M, DEC21E2-P2002216M, HDC12A2-P2001501M, HDC12A2-P2002201M, HDC182-P2001503M, HDC182-P2002203M, HDC18SD2-P2001505M, HDC18SD2-P2002205M, HDC212-P2001507M, HDC212-P2002207M, MCHDC21-P2001512M, MCHDC21-P2002212M, MDC12A2-P2001502M, MDC12A2-P2002202M, MDC182-P2001504M, MDC182-P2002204M		



GEV No.	701493	Ref. No.	20096602
description	tension spring ø 11mm total length 90mm wire gauge ø 1.5mm		
For models:	JET5192-P2002710M, JET519V2-P2002711M		



GEV No.	701492	Ref. No.	20045103
description	tension spring ø 6.4mm total length 48mm wire gauge ø 0.7mm for microwave		
For models:	JET5192-P2002710M, JET519V2-P2002711M		

tools

hand tools

screwdrivers

bits



GEV No.	801808	Ref. No.	92113P01
description	bit insert not magnetic size 10 L 31.5mm Qty 1 pcs		
For models:	ACE14-P2001901M, ACE5302-P1331307M, ACE5302-P1332912M, ACE5302-P1332914M, DS1400E-P2001904M, DS30E2-P1331309M, DS30E2-P1332916M, MCE14-P2001902M, UCA1400-P2001906M		



GEV No.	801807	Ref. No.	20001136
description	bit insert not magnetic size 6 L 33mm suitable for 560557 Qty 1 pcs		
For models:	MRC17S2-P1333417M, MRC17S2-P2001802M, MRC17S2-P2001814M, MRC17S2-P2001824M, MRC22S2-P2001817M, MRC30S2-P2001812M, RC17S2-P1332801M, RC17S2-P1333401M, RC17S2-P2001801M, RC17S2-P2001813M, RC17S2-P2001823M, RC22S2-P2001804M, RC22S2-P2001816M, RC30S2-P2001811M		



accessories for	801807	GEV No.	560557	Ref. No.	13042701 5145-E
screw ø 4.2mm L 15mm zinc-coated steel Qty 1 pcs for housing					



fastening material

rivets/rivet nuts

plastic rivets



GEV No.	560560	Ref. No.	56001450
description	rivet ø 4mm thread M4 PVC Qty 1 pcs		
For models:	ALD10D-P1331011M, ALD10D-P1331019M, ALD10T-P1331002M, ALD10T-P1331018M, ALD510D-P1331003M, ALD510-P1331005M, ALD510SE-P1331012M, MCS10DS-P2001104M, MCS10DS-P2001110M, MCS10TS-P2001103M, MCS10TS-P2001109M, MLD510D-P1331007M, MLD510-P1331009M, MLD510SE-P1331014M, RCS10DS-P2001102M, RCS10DS-P2001108M, RCS10TS-P2001101M, RCS10TS-P2001107M, RCS511DS-P2001106M, RCS511DS-P2001112M, RCS511TS-P2001105M, RCS511TS-P2001111M, UALD510-P1331006M, UALD510SE-P1331013M, UMLD510D-P1331008M, UMLD510-P1331010M, UMLD510SE-P1331015M		



GEV No.	560559	Ref. No.	53001554 54116064
description	rivet ø 5.5mm L 6mm PVC Qty 1 pcs		
For models:	DFS11EA-P1330220M, DFS18E-P1330222M, MCS10DSE-P2002404M, MCS10TS-P2002403M, MFS18TS-P2001008M, RCS10DA-P1330201M, RCS10DA-P2000702M, RCS10MPA-P1330202M, RCS10MPA-P2000704M, RCS10TS-P2002401M, RCS511A-P1330214M, RCS511DSE-P2002406M, RCS511TS-P2002405M, RFS12MP-SA-P1330206M, RFS12MP-SB-P1330235M, RFS12TSW-P2001001M, RFS18MPS-P1330209M, RFS18MPS-P2000703M, RFS18TS-P2001003M, RFS511SW2A-P1330223M, RFS511TSW13-P2001010M, RFS511TSW13-P2001012M, RFS511TSW-P2001005M, RFS511TSW-P2001011M, RFS518S-P1330216M, RFS518TS-P2001004M, UCS-11MA-P1330228M, URCS511A-P1330226M, URF5518S-P1330227M		

screws

sheet metal screws



GEV No.	560557	Ref. No.	13042701 5145-E
description	screw ø 4.2mm L 15mm zinc-coated steel Qty 1 pcs for housing		
For models:	ACE14-P1333201M, ACE14-P1333206M, ACE14-P2000401M, ACE14-P2001901M, ACE14-P2001909M, ACE5140-P1333203M, ACE5140-P1333207M, ACE5140-P2000403M, ACE5302-P1331307M, ACE5302-P1332912M, ACE5302-P1332914M, DS1400E-P1333204M, DS1400E-P2000404M, DS1400E-P2001904M, DS1400E-P2001912M, DS30E2-P1331309M, DS30E2-P1332916M, MCE14-P2000407M, MCE14-P2001902M, MCE14-P2001910M, UCA1400-P1333205M, UCA1400-P2000405M, UCA1400-P2001906M, UCA1400-P2001913M, UCA2000NT3-P1332921M, UCA2000NT3-P2000406M		
accessories for	560557		
	GEV No.	801807	Ref. No. 20001136
	bit insert not magnetic size 6 L 33mm suitable for 560557 Qty 1 pcs		



GEV No.	560558	Ref. No.	12990525 M0200316 M0216703
description	sheet-metal screw ø 3.3mm L 11mm WS 6 zinc-coated steel Qty 1 pcs		
For models:	ACE14-P1333201M, ACE14-P1333206M, ACE14-P2000401M, ACE14-P2001901M, ACE14-P2001909M, ACE5140-P1333203M, ACE5140-P1333207M, ACE5140-P2000403M, ACE5302-P1331307M, ACE5302-P1332907M, ACE5302-P1332912M, ACE5302-P1332914M, DEC11E2-P1331213M, DEC11E2-P1331235M, DEC11E2-P1333111M, DEC11E2-P2001412M, DEC11E2-P2001514M, DEC11E2-P2002223M, DEC14E2-P1331217M, DEC14E2-P1331239M, DEC14E2-P1333115M, DEC14E2-P2001413M, DEC14E2-P2001515M, DEC14E2-P2002214M, DEC18E2-P1331221M, DEC18E2-P1331243M, DEC18E2-P1333119M, DEC18E2-P2001414M, DEC18E2-P2001516M, DEC18E2-P2002215M, DEC21E2-P1331226M, DEC21E2-P1331247M, DEC21E2-P1333123M, DEC21E2-P2001415M, DEC21E2-P2001517M, DEC21E2-P2002216M, DS1400E-P1333204M, DS1400E-P2000404M, DS1400E-P2001904M, DS1400E-P2001912M, DS30E2-P1331309M, DS30E2-P1332909M, DS30E2-P1332916M, HDC12A2-P1331203M, HDC12A2-P1333101M, HDC12A2-P2001401M, HDC12A2-P2001501M, HDC12A2-P2002201M, HDC12A-P1323002M, HDC12A-P1323012M...(Other models you can see in the webshop)		

grub screws

DIN 914/ISO 4027



GEV No.	504477	Ref. No.	13046901 M0208943
description	grub screw thread 10-32 UNF L 7.8mm SS intake internal hexagon WS 3/32 inch conical Qty 1 pcs		
For models:	ACE5302-P1331307M, DS30E2-P1331309M, MRC1752-P1333417M, MRC1752-P2001802M, MRC1752-P2001814M, MRC1752-P2001824M, MRC2252-P1333418M, MRC2252-P2001817M, MRC3052-P2001812M, MRC518SU2-P1332832M, MRC524TS2-P1331432M, MRC524TS2-P1333415M, RC1752-P1331401M, RC1752-P1332801M, RC1752-P1333401M, RC1752-P2001801M, RC1752-P2001813M, RC1752-P2001823M, RC2252-P1331403M, RC2252-P1332804M, RC2252-P1333404M, RC2252-P2001804M, RC2252-P2001816M, RC225-P1330104M, RC3052-P1332816M, RC3052-P1333410M, RC3052-P2001811M, RC518SU-P1327602M, RCS520S-P1327601M, RCS524TS2-P1331430M, RCS524TS2-P1333414M		



GEV No.	504478	Ref. No.	13046902 59002036
description	grub screw thread 10-32 UNF L 9.3mm SS intake internal hexagon WS 3/32 inch conical Qty 1 pcs		
For models:	ACE14-P1333201M, ACE14-P1333206M, ACE14-P2000401M, ACE14-P2001901M, ACE14-P2001909M, ACE5140-P1333203M, ACE5140-P1333207M, ACE5140-P2000403M, ACE5302-P1332912M, ACE5302-P1332914M, DS1400E-P1333204M, DS1400E-P2000404M, DS1400E-P2001904M, DS1400E-P2001912M, DS30E2-P1331309M, DS30E2-P1332916M, MCE14-P2000407M, MCE14-P2001902M, MCE14-P2001910M, UCA1400-P1333205M, UCA1400-P2000405M, UCA1400-P2001906M, UCA1400-P2001913M, UCA2000NT3-P1332921M, UCA2000NT3-P2000406M		

miscellaneous



GEV No.	504476	Ref. No.	13047001 M0206943 M0208342
description	grub screw thread M5 L 7.8mm SS intake internal hexagon WS 2.4 warding Qty 1 pcs		
For models:	ACE14-P1333201M, ACE14-P1333206M, ACE14-P2000401M, ACE14-P2001901M, ACE14-P2001909M, ACE5140-P1333203M, ACE5140-P1333207M, ACE5140-P2000403M, ACE5302-P1331307M, ACE5302-P1332912M, ACE5302-P1332914M, DS1400E-P1333204M, DS1400E-P2000404M, DS1400E-P2001904M, DS1400E-P2001912M, DS30E2-P1331309M, DS30E2-P1332916M, MCE14-P2000407M, MCE14-P2001902M, MCE14-P2001910M, MRC17S2-P1333417M, MRC17S2-P2001802M, MRC17S2-P2001814M, MRC17S2-P2001824M, MRC22S2-P1333418M, MRC22S2-P2001817M, MRC30S2-P2001812M, MRC518SU2-P1331419M, MRC518SU2-P1332818M, MRC518SU2-P1332832M, MRC518SU-P1327613M, MRC520S-P1327614M, MRC524TS2-P1331432M, MRC524TS2-P1333415M, RC17S2-P1331401M, RC17S2-P1332801M, RC17S2-P1333401M, RC17S2-P2001801M, RC17S2-P2001813M, RC17S2-P2001823M, RC22S2-P1331403M, RC22S2-P1332804M, RC22S2-P1333404M, RC22S2-P2001804M, RC22S2-P2001816M, RC22S-P1198605M, RC22S-P1326303M, RC22S-P1329103M, RC22S-P1329610M, RC22S-P1330104M...(Other models you can see in the webshop)		

knurled screws



GEV No.	701366	Ref. No.	13042901 M0209701
description	Thumb screw thread M4 thread L 6mm ø 9.5mm H 13mm SS Qty 1 pcs		
For models:	ACE14-P1333201M, ACE14-P1333206M, ACE14-P2000401M, ACE14-P2001901M, ACE14-P2001909M, ACE5140-P1333203M, ACE5140-P1333207M, ACE5140-P2000403M, ACE5302-P1331307M, DS1400E-P1333204M, DS1400E-P2000404M, DS1400E-P2001904M, DS1400E-P2001912M, DS30E2-P1331309M, MCE14-P2000407M, MCE14-P2001902M, MCE14-P2001910M, MRC17S2-P1333417M, MRC17S2-P2001802M, MRC17S2-P2001814M, MRC17S2-P2001824M, MRC22S2-P1333418M, MRC22S2-P2001817M, MRC30S2-P2001812M, MRC518SU2-P1331419M, MRC518SU2-P1332818M, MRC518SU2-P1332832M, MRC518SU-P1327613M, MRC520S-P1327614M, MRC524TS2-P1331432M, MRC524TS2-P1333415M, RC17S2-P1331401M, RC17S2-P1332801M, RC17S2-P1333401M, RC17S2-P2001801M, RC17S2-P2001813M, RC17S2-P2001823M, RC22S2-P1331403M, RC22S2-P1332804M, RC22S2-P1333404M, RC22S2-P2001804M, RC22S2-P2001816M, RC22S-P1198605M, RC22S-P1326303M, RC22S-P1329103M, RC22S-P1329610M, RC22S-P1330104M, RC30S2-P1332816M, RC30S2-P1333410M, RC30S2-P2001811M...(Other models you can see in the webshop)		

nuts

plate nuts



GEV No.	103198	Ref. No.	20020502 M0118901
description	plate nut hole ø 6mm Lmm Wmm ø 13.5mm suitable for 1/4"		
For models:	DEC11E2-P1331213M, DEC11E2-P1331235M, DEC11E2-P1333111M, DEC11E2-P2001412M, DEC11E2-P2001514M, DEC11E2-P2002223M, DEC14E2-P1331239M, DEC14E2-P1333115M, DEC14E2-P2001413M, DEC14E2-P2001515M, DEC14E2-P2002214M, DEC18E2-P1331221M, DEC18E2-P1331243M, DEC18E2-P1333119M, DEC18E2-P2001414M, DEC18E2-P2001516M, DEC18E2-P2002215M, DEC21E2-P1331226M, DEC21E2-P1331247M, DEC21E2-P1333123M, DEC21E2-P2001415M, DEC21E2-P2001517M, DEC21E2-P2002216M, HDC12A2-P1331203M, HDC12A2-P1333101M, HDC12A2-P2001401M, HDC12A2-P2001501M, HDC12A2-P2002201M, HDC12A-P1330503M, HDC12P2-P1331223M, HDC182-P1331204M, HDC182-P1333102M, HDC182-P2001403M, HDC182-P2001503M, HDC182-P2002203M, HDC18SD2-P1331205M, HDC18SD2-P1333103M, HDC18SD2-P2001405M, HDC-18SD2-P2001505M, HDC18SD2-P2002205M, HDC212-P1331207M, HDC212-P1333105M, HDC212-P2001407M, HDC212-P2001507M, HDC212-P2002207M, HDC5112-P1331211M, HDC5112-P1331233M, HDC5112-P1333109M, HDC5142-P1331237M, HDC5142-P1333113M...(Other models you can see in the webshop)		

washers

washers

nylon



GEV No.	560561	Ref. No.	M0274066
description	plain washer ID ø 2.9mm ED ø 9.5mm thickness 0.38mm plastic Qty 1 pcs		
For models:	ACE5302-P1331307M, ACE5302-P1332912M, ACE5302-P1332914M, DEC11E2-P1331213M, DEC11E2-P1331235M, DEC11E2-P1333111M, DEC11E2-P2001412M, DEC14E2-P1331239M, DEC14E2-P1333115M, DEC14E2-P2001413M, DEC18E2-P1331221M, DEC18E2-P1331243M, DEC18E2-P1333119M, DEC18E2-P2001414M, DEC21E2-P1331226M, DEC21E2-P1331247M, DEC21E2-P1333123M, DEC21E2-P2001415M, DS30E2-P1331309M, DS30E2-P1332916M, HDC12A2-P1331203M, HDC12A2-P1333101M, HDC12A2-P2001401M, HDC12A-P1323002M, HDC12A-P1323012M, HDC12A-P1330503M, HDC12P2-P1331223M, HDC182-P1331204M, HDC182-P1333102M, HDC182-P2001403M, HDC18SD2-P1331205M, HDC18SD2-P1333103M, HDC-18SD2-P2001405M, HDC212-P1331207M, HDC212-P1333105M, HDC212-P2001407M, HDC5112-P1331211M, HDC5112-P1331233M, HDC5112-P1333109M, HDC5142-P1331237M, HDC5142-P1333113M, HDC5182-P1331219M, HDC5182-P1331241M, HDC5182-P1333117M, HDC518-P1325209M, HDC518-P1330518M, HDC5212-P1331224M, HDC5212-P1331245M, HDC5212-P1333121M, MCHDC21-P1333130M...(Other models you can see in the webshop)		





miscellaneous			
			
1			
GEV No.	701364	Ref. No.	M0295502
description	plain washer ID ø 5.2mm ED ø 16.1mm thickness 1mm zinc-coated steel Qty 1 pcs for thread M5 zinc-plated		
For models:	ACE14-P1333201M, ACE14-P1333206M, ACE14-P2000401M, ACE14-P2001901M, ACE14-P2001909M, ACE5140-P1333203M, ACE5140-P1333207M, ACE5140-P2000403M, ACE5302-P1331307M, ACE5302-P1332912M, ACE5302-P1332914M, DS1400E-P1333204M, DS1400E-P2000404M, DS1400E-P2001904M, DS1400E-P2001912M, DS30E2-P1331309M, DS30E2-P1332916M, MCE14-P2000407M, MCE14-P2001902M, MCE14-P2001910M, UCA1400-P1333205M, UCA1400-P2000405M, UCA1400-P2001906M, UCA1400-P2001913M, UCA2000NT3-P1332921M, UCA2000NT3-P2000406M		

consumables

sealants and adhesives

high temperature silicone			
			
1			
GEV No.	890037	Ref. No.	59001950 59004004 M0275408
description	high temperature silicone MOMENTIVE RTV106 -60 up to +260°C red tube 83ml		
description	<p>Momentive RTV106 - tube 83ml - red</p> <p>Used for sealing heating elements, gasketing, electrical insulation, and other critical bonding and sealing applications where parts must perform at high temperatures. Can be applied to vertical or overhead surfaces.</p> <p>Capability to cure at room temperature and ambient humidity, low temperature flexibility, excellent weatherability and ozone and chemical resistance, excellent electrical insulation properties.</p> <p>Temperature range -60°C to +260°C</p> <p>NSF approved</p>		
For models:	ACE5302-P1331307M, ACE5302-P1332912M, ACE5302-P1332914M, DS30E2-P1331309M, DS30E2-P1332916M		

			
1			
GEV No.	890035	Ref. No.	59004022 M0275501
description	high temperature silicone SIL-BOND RTV4500 -52 up to +204°C white cartridge 305ml		
description	<p>Sil-Bond RTV 4500 - cartridge 305ml - white</p> <p>One component room temperature vulcanizing RTV acetoxy cure silicone sealant and adhesive that has been chemically formulated for high strength adhesion. When fully cured, this unique VOC compliant formula offers UV stability and excellent adhesion to form waterproof and airtight bonds to metal, steel, tile, fiberglass, ceramic, glass, aluminum, painted surfaces, wood, plywood, marble, plus many other common substrates. This product is specifically formulated to offer all weather performance.</p> <p>Temperature range: -52°C to +204°C</p> <p>NTF approved</p>		

			
1			
GEV No.	890036	Ref. No.	59002167 M0275598
description	high temperature silicone SIL-BOND RTV4500 -52 up to +204°C white tube 83ml		
description	<p>Sil-Bond RTV 4500 - tube 83ml - white</p> <p>One component room temperature vulcanizing RTV acetoxy cure silicone sealant and adhesive that has been chemically formulated for high strength adhesion. When fully cured, this unique VOC compliant formula offers UV stability and excellent adhesion to form waterproof and airtight bonds to metal, steel, tile, fiberglass, ceramic, glass, aluminum, painted surfaces, wood, plywood, marble, plus many other common substrates. This product is specifically formulated to offer all weather performance.</p> <p>Temperature range: -52°C to +204°C</p> <p>NTF approved</p>		
For models:	DEC11E2-P1331213M, DEC11E2-P1331235M, DEC11E2-P1333111M, DEC11E2-P2001412M, DEC11E2-P2001514M, DEC11E2-P2002223M, DEC14E2-P1331217M, DEC14E2-P1331239M, DEC14E2-P1333115M, DEC14E2-P2001413M, DEC14E2-P2001515M, DEC14E2-P2002214M, DEC18E2-P1331221M, DEC18E2-P1331243M, DEC18E2-P1333119M, DEC18E2-P2001414M, DEC18E2-P2001516M, DEC18E2-P2002215M, DEC21E2-P1331226M, DEC21E2-P1331247M, DEC21E2-P1333123M, DEC21E2-P2001415M, DEC21E2-P2001517M, DEC21E2-P2002216M, HDC12A2-P1331203M, HDC12A2-P1333101M, HDC12A2-P2001401M, HDC12A2-P2001501M, HDC12A2-P2002201M, HDC12A-P1323002M, HDC12A-P1323012M, HDC12A-P1330503M, HDC12P2-P1331223M, HDC182-P1331204M, HDC182-P1333102M, HDC182-P2001403M, HDC182-P2001503M, HDC182-P2002203M, HDC18SD2-P1331205M, HDC18SD2-P1333103M, HDC18SD2-P2001405M, HDC18SD2-P2001505M, HDC18SD2-P2002205M, HDC212-P1331207M, HDC212-P1333105M, HDC212-P2001407M, HDC212-P2001507M, HDC212-P2002207M, HDC5112-P1331211M, HDC5112-P1331233M... (Other models you can see in the webshop)		

containers

measuring cups



GEV No.	961000	Ref. No.	12018801 M95D26 R0181105
description	measuring cup 1l ø 170mm H 112mm plastic Power Output Test		

fuses

fine fuses



GEV No.	358168	Ref. No.	20034004
description	fine fuse size ø5x20mm 10A medium lag rated 250V Qty 1 pcs size 5x20mm		
For models:	RMS510D-P2001204M, RMS510D-P2001210M, RMS510T-P2001205M, RMS510T-P2001211M		

ø6.3x32mm 250V



GEV No.	358154	Ref. No.	M0805103 M0805106 R9900522
description	fine fuse size ø6.3x32mm 10A fast-acting rated 250V Qty 1 pcs		
For models:	DEL10D-P1329706M, DEL10E-P1329707M, LD510D-P1329704M, LD510P-P1329705M, RCS10DA-P1330201M, RCS10DA-P2000702M		



GEV No.	358156	Ref. No.	53001666 56001475 M0805105
description	fine fuse size ø6.3x32mm 12A fast-acting rated 250V Qty 1 pcs		
For models:	ALD510D-P1331003M, ALD510-P1331005M, ALD510SE-P1331012M, AXP20-P1333601M, AXP20-P1333602M, AXP20-P1333605M, AXP5201-P1333603M, AXP5203-P1333608M, DFS11EA-P1330220M, DFS18E-P1330222M, MFS18TS-P2001008M, MLD510D-P1331007M, MLD510-P1331009M, MLD510SE-P1331014M, MXP5201-P1333604M, MXP5203-P1333609M, MXP5221BO-P2001617M, MXP5221-P2001606M, MXP5223-P2001607M, MXP5223TL-P2001620M, RCS10MPA-P1330202M, RCS10MPA-P2000704M, RCS511A-P1330214M, RCS511-P1325802M, RCS511-P1327809M, RFS12MPSA-P1330206M, RFS18MPS-P1330209M, RFS18MPS-P2000703M, RFS18TS-P2001003M, RFS511SW2A-P1330223M, RFS511TSW13-P2001010M, RFS511TSW13-P2001012M, RFS511TSW-P2001005M, RFS511TSW-P2001011M, RFS518S-P1330216M, RFS518TS-P2001004M, UALD510-P1331006M, UALD510SE-P1331013M, UCS11MA-P1330228M, UMLD510D-P1331008M, UMLD510-P1331010M, UMLD510SE-P1331015M, URCS511A-P1330226M, URFS518S-P1330227M		



GEV No.	358157	Ref. No.	1760000301 M0805102
description	fine fuse size ø6.3x32mm 15A fast-acting rated 250V Qty 1 pcs		
For models:	ACE5140-P1333203M, ACE5140-P1333207M, ACE5140-P2000403M, ACE5302-P1331307M, ACE5302-P1332912M, ACE5302-P1332914M, DS1400E-P1333204M, DS1400E-P2000404M, DS1400E-P2001904M, DS1400E-P2001912M, DS30E2-P1331309M, DS30E2-P1332916M, MRC17S2-P1333417M, MRC17S2-P2001802M, MRC22S2-P1333418M, MRC30S2-P2001812M, MRC518SU2-P1332818M, MRC518SU2-P1332832M, MRC524TS2-P1331432M, MRC524TS2-P1333415M, RC17S2-P1331401M, RC17S2-P1332801M, RC17S2-P1333401M, RC17S2-P2001801M, RC22S2-P1331403M, RC22S2-P1332804M, RC22S2-P1333404M, RC22S2-P2001804M, RC22S-P1326303M, RC22S-P1329103M, RC22S-P1329610M, RC22S-P1330104M, RC30S2-P1332816M, RC30S2-P1333410M, RC30S2-P2001811M, RC518SU-P1327602M, RC520S-P1327601M, RC524TS2-P1331430M, RC524TS2-P1333414M, UCA1400-P133205M, UCA1400-P2000405M, UCA1400-P2001906M, UCA1400-P2001913M, UCA2000NT3-P1332921M, UCA2000NT3-P2000406M		



GEV No.	358155	Ref. No.	56001353 M0805101 R0131110 Y0057191
description	fine fuse size ø6.3x32mm 20A fast-acting rated 250V Qty 1 pcs		
For models:	ALD10D-P1331011M, ALD10D-P1331019M, ALD10T-P1331002M, ALD10T-P1331018M, LD10D2-P1329702M, LD10MP-P1329703M, LD10MP-P2000701M		





GEV No.	358851	Ref. No.	20034001
description	fuse size ø6.3x32mm 15A slow-acting rated 250V Qty 1 pcs		
For models:	RCS511DSE-P2002406M, RCS511DS-P2001106M, RCS511DS-P2001112M, RCS511TS-P2001105M, RCS511TS-P2001111M, RCS511TS-P2002405M, RFS12MPSB-P1330235M, RFS12TSW-P2001001M		





GEV No.	358153	Ref. No.	M0805202
description	fine fuse size ø10.4x38mm 15A fast-acting rated 250V type BLN Qty 1 pcs		
For models:	DEC11E2-P1331213M, DEC11E2-P1331235M, DEC11E2-P1333111M, DEC11E2-P2001412M, DEC11E2-P2001514M, DEC11E2-P2002223M, HDC12P2-P1331223M, HDC5112-P1331211M, HDC5112-P1331233M, HDC5112-P133109M, UC11E2-P1331214M, UC11E2-P1331236M, UC11E2-P1333112M, UCA2000NT3-P1332921M, UCA2000NT3-P2000406M, UHDC5112-P1331212M, UHDC5112-P1331234M, UHDC5112-P1333110M		





			
GEV No.	358150	Ref. No.	M0805203
description	fine fuse size ø10.4x38mm 20A fast-acting rated 250V type BLN Qty 1 pcs		
For models:	ACE5140-P1333203M, ACE5140-P1333207M, ACE5302-P1331307M, ACE5302-P1332912M, ACE5302-P1332914M, DEC14E2-P1331239M, DEC14E2-P1333115M, DEC14E2-P2001413M, DEC14E2-P2001515M, DEC14E2-P2002214M, DEC18E2-P1331221M, DEC18E2-P1331243M, DEC18E2-P1333119M, DEC18E2-P2001414M, DEC18E2-P2001516M, DEC18E2-P2002215M, DEC21E2-P1331226M, DEC21E2-P1331247M, DEC21E2-P1333123M, DEC21E2-P2001415M, DEC21E2-P2001517M, DEC21E2-P2002216M, DS1400E-P1333204M, DS30E2-P1331309M, DS30E2-P1332916M, HDC5142-P1331237M, HDC5142-P1333113M, HDC5182-P1331219M, HDC5182-P1331241M, HDC5182-P1333117M, HDC518-P1325209M, HDC518-P1330518M, HDC5212-P1331224M, HDC5212-P1331245M, HDC5212-P1333121M, MOC5241-P2000303M, OC5241BK-P2000304M, UC14E2-P1331240M, UC14E2-P1333116M, UC18E2-P1331222M, UC18E2-P1331244M, UC18E2-P1333120M, UCA1400-P1333205M, UHDC5142-P1331238M, UHDC5142-P1333114M, UHDC5182-P1331220M, UHDC5182-P1331242M, UHDC5182-P1333118M		

			
GEV No.	358151	Ref. No.	M0805201
description	fine fuse size ø10.4x38mm 25A fast-acting rated 250V type BLN Qty 1 pcs		
For models:	AXP20-P1333601M, AXP20-P1333602M, AXP20-P1333605M, AXP5201-P1333603M, AXP5203-P1333608M, HDC12A2-P1331203M, HDC12A2-P1333101M, HDC12A2-P2001401M, HDC12A2-P2001501M, HDC12A2-P2002201M, HDC12A-P1323002M, HDC12A-P1323012M, HDC12A-P1330503M, MDC12A2-P1333127M, MDC12A2-P2001402M, MDC12A2-P2001502M, MDC12A2-P2002202M, MXP5201-P1333604M, MXP5203-P1333609M, MXP5221BO-P2001617M, MXP5221-P2001606M, MXP5223-P2001607M, MXP5223TL-P2001620M, RC225-P1198605M		

			
GEV No.	358152	Ref. No.	M0805205
description	fine fuse size ø10.4x38mm 30A fast-acting rated 250V type BLN Qty 1 pcs		
For models:	ACE14-P1333201M, ACE14-P1333206M, ACE14-P2000401M, ACE14-P2001901M, ACE14-P2001909M, JET5192-P2002710M, JET519V2-P2002711M, MCE14-P2000407M, MCE14-P2001902M, MCE14-P2001910M, MRC17S2-P1333417M, MRC17S2-P2001802M, MRC17S2-P2001814M, MRC17S2-P2001824M, MRC22S2-P1333418M, MRC22S2-P2001817M, MRC30S2-P2001812M, MRC518SU2-P1332818M, MRC518SU2-P1332832M, MRC524TS2-P1331432M, MRC524TS2-P1333415M, RC17S2-P1331401M, RC17S2-P1332801M, RC17S2-P1333401M, RC17S2-P2001801M, RC17S2-P2001813M, RC17S2-P2001823M, RC22S2-P1331403M, RC22S2-P1332804M, RC22S2-P1333404M, RC22S2-P2001804M, RC22S2-P2001816M, RC22S-P1326303M, RC22S-P1329103M, RC22S-P1329610M, RC22S-P1330104M, RC30S2-P1331415M, RC30S2-P1332816M, RC30S2-P1333410M, RC30S2-P2001811M, RC518SU-P1327602M, RC520S-P1327601M, RC524TS2-P1331430M, RC524TS2-P1333414M		

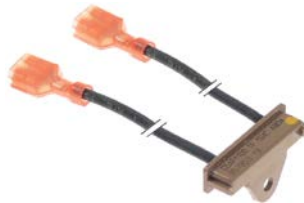
<p>thermal fuses</p> 			
GEV No.	358164	Ref. No.	59001211 59001992 B5795317
description	temperature limiter switch-off temp. 128°C type G5AP1102 Qty 1 pcs		
For models:	AXP5201-P1333603M, AXP5203-P1333608M, MRC-518SU2-P1332832M, MRC524TS2-P1331432M, MRC524TS2-P1333415M, MXP5201-P1333604M, MXP5203-P1333609M, MXP-5221BO-P2001617M, MXP5221-P2001606M, MXP5223-P2001607M, MXP5223TL-P2001620M, RC524TS2-P1331430M, RC524TS2-P1333414M		

			
GEV No.	358165	Ref. No.	59001667 59001874 B5795302 B5795319
description	thermal fuse switch-off temp. 104°C type G5AP1100 Qty 1 pcs		
For models:	DEC11E2-P1331213M, DEC11E2-P1331235M, DEC11E2-P1333111M, DEC11E2-P2001412M, DEC11E2-P2001514M, DEC11E2-P2002223M, DEC14E2-P1331217M, DEC14E2-P1331239M, DEC14E2-P1333115M, DEC14E2-P2001413M, DEC14E2-P2001515M, DEC14E2-P2002214M, DEC18E2-P1331221M, DEC18E2-P1331243M, DEC18E2-P1333119M, DEC18E2-P2001414M, DEC18E2-P2001516M, DEC18E2-P2002215M, DEC21E2-P1331226M, DEC21E2-P1331247M, DEC21E2-P1333123M, DEC21E2-P2001415M, DEC21E2-P2001517M, DEC21E2-P2002216M, HDC12A2-P1331203M, HDC12A2-P1333101M, HDC12A2-P2001401M, HDC12A2-P2001501M, HDC12A2-P2002201M, HDC12A-P1323002M, HDC12A-P1323012M, HDC12A-P1330503M, HDC12P2-P1331223M, HDC182-P1331204M, HDC182-P1333102M, HDC182-P2001403M, HDC182-P2001503M, HDC182-P2002203M, HDC18SD2-P1331205M, HDC18SD2-P1333103M, HDC18SD2-P2001405M, HDC-18SD2-P2001505M, HDC18SD2-P2002205M, HDC212-P1331207M, HDC212-P1333105M, HDC212-P2001407M, HDC212-P2001507M, HDC212-P2002207M, HDC5112-P1331211M, HDC5112-P1331233M... (Other models you can see in the webshop)		

			
GEV No.	358166	Ref. No.	59004115
description	thermal fuse switch-off temp. 104°C type G5AP1101 Qty 1 pcs with cable gland		
For models:	MOC5241-P2000303M, OC5241BK-P2000304M		

HV fuses



1

GEV No.	358169	Ref. No.	54116050
description	HV fuse 0.8A slow-acting rated 5000V Qty 1 pcs		
For models:	MFS18TS-P2001008M, RFS18TS-P2001003M, RFS518TS-P2001004M		



1

GEV No.	358171	Ref. No.	58101028
description	HV fuse 0.9A slow-acting rated 5000V Qty 1 pcs		
For models:	RMS510D-P2001204M, RMS510D-P2001210M, RMS510T-P2001205M, RMS510T-P2001211M		



1

GEV No.	358170	Ref. No.	54116072
description	HV fuse 1A slow-acting rated 5000V Qty 1 pcs		
For models:	RFS511TSW13-P2001010M, RFS511TSW-P2001005M		



1

GEV No.	358172	Ref. No.	56001474
description	HV fuse 1A slow-acting rated 5000V Qty 1 pcs		
For models:	ALD10D-P1331011M, ALD10D-P1331019M, ALD10T-P1331002M, ALD10T-P1331018M, ALD510D-P1331003M, ALD510-P1331005M, ALD510SE-P1331012M, MLD510D-P1331007M, MLD510-P1331009M, MLD510SE-P1331014M, RCS511DS-P2001106M, RCS511DS-P2001112M, RCS511TS-P2001105M, RCS511TS-P2001111M, UALD510-P1331006M, UALD510SE-P1331013M, UMLD510D-P1331008M, UMLD510-P1331010M, UMLD-510SE-P1331015M		

A		
axial fans	25	
B		
bi-metal thermostats	3, 4	
bits	58	
C		
cables	37	
condensators & interference suppression filters	30	
connection cables	37	
consumables	61	
contactors	10	
containers	62	
cooling fans	25	
D		
door lock switches	6	
E		
electric accessories	37	
electric timers	9	
F		
fans	25	
fastening material	59	
filters	30	
fine fuses	62	
foam rubber gaskets	57	
fuses	34, 62	
G		
gaskets for heated units	57	
grates	56	
grub screws	59	
H		
hand tools	58	
heating elements	3	
heating elements for convection	3	
heating elements for microwaves	3	
high temperature silicone	61	
hot air fans	28	
hot air motors	27	
HV capacitors	31	
HV fuses	64	
K		
knurled screws	60	
L		
lamps	8	
LED	8	
light bulbs	8	
M		
magnetrons	12	
measuring cups	62	
microswitches	6	
microwave lamps	8	
motors	29	
N		
nuts	60	
O		
oven hinges	56	
P		
piano hinges	55	
plate nuts	60	
power supply cables	37	
probes	16	
R		
relays	11	
rivets/rivet nuts	59	
S		
safety bi-metal thermostats	3	
screwdrivers	58	
screws	59	
sealants and adhesives	61	
sheet metal screws	59	
shelves and shelf rails	56	
silicone	61	
snap locks	55	
solid state relays	10	
switches and momentary switches	6	
T		
thermal fuses	63	
thermostats	3	
timers	9	
tools	58	
transformers	13	
W		
washers	60	