



GAS COMPONENTS



ELECTRIC COMPONENTS



WATER TECHNOLOGY



MECHANICAL COMPONENTS



TOOLS

Spare parts suitable for

ALLPAX

Find the complete and up-to-date range of products in our GEV Webshop



Manufacturer catalogue

The most important spare parts and accessories arranged clearly for every manufacturer

- ✓ Complete product range and all appliance data always up to date in the GEV Webshop
- ✓ Alphabetical Index at the end of the catalogue

GEV Webshop

www.gev-online.co.uk

www.gev-online.com



- 🔍 Add to Favourites
- 🔍 Sign In with email address and usual password
- 🔍 Easy-order – place several items in your basket at the same time
- 🔍 Quick Item search – no login needed



switches and momentary switches

rocker/momentary rocker switches

28x13.5mm



1

GEV No.	347039	Ref. No.	0220010
description	rocker switch mounting measurements 27.4x12.4mm black/orange 2NO 250V 16A illuminated O connection male faston 6.3mm ambient temperature max. 100/55°C protection IP40		

microswitches

lever actuated



1

GEV No.	347034	Ref. No.	0900465
description	microswitch with lever 30V 1A 1NO connection with cable L 18mm ambient temperature max. 85°C type D2FW-G 271M actuating force: 100g lever length 25mm		

rotary switches

producer-specific rotary switches

DIHR / KROMO



1

GEV No.	345896	Ref. No.	0065736 0065788
description	O-ring EPDM thickness 1.5mm ID ø 37mm Qty 1 pcs		

miscellaneous



1

GEV No.	347040	Ref. No.	0220060
description	rotary switch sets of contacts 3 2 0-1 momentary type 400V 32A shaft ø 5x5mm shaft Lmm connection screw		

accessories

levers



1

GEV No.	347041	Ref. No.	0220065
description	knob 2 0-1 typeVA shaft ømm shaft Lmm connection for rotary switch		

control equipment

miscellaneous



1

GEV No.	347037	Ref. No.	0220005
description	push switch mounting measurements ø22mm black 2NO 10A		

contactors

LOVATO

power contactors



1

GEV No.	381102	Ref. No.	0221005
description	power contactor resistive load 20A 24VAC (AC3/400V) 9A/4kW main contacts 4NO auxiliary contacts connection screw connection type 11BG09T4A24		



1

GEV No.	381103	Ref. No.	0221106
description	power contactor resistive load 25A 24VAC (AC3/400V) 9A/4.2kW main contacts 4NO auxiliary contacts connection screw connection type BF09T4A024		



transformers

open transformers

with clamp terminal



1

GEV No.	402081	Ref. No.	0223032
description	transformer primary 220/380VAC secondary 0-21.4VAC 900VA connection screw connection 50/60Hz		

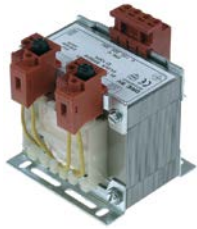

1

GEV No.	402086	Ref. No.	0223011
description	transformer primary 230/400VAC secondary 0-9/0-24VAC 64.5VA connection screw 50/60Hz		

encapsulated transformers

multiple connections



1

GEV No.	402085	Ref. No.	0223004
description	transformer primary 230VAC secondary 24VAC 30VA secondary 1.25A connection male faston 6.3mm 50/60Hz type 65.16.230.323.224.05		

electronics

PCBs



1

GEV No.	402093	Ref. No.	0230040
description	PCB vacuum packing machine B35 / B-M 42/42XL H_HD4		
spare parts for	402093		
GEV No.	358596	Ref. No.	—
description	fine fuse size ø5x20mm 0.25A slow-acting rated 250V Qty 10 pcs		



1

GEV No.	402095	Ref. No.	0230042
description	PCB vacuum packing machine B35 / B-M 42/42XL H_HD4 with sensor		



1

GEV No.	402092	Ref. No.	0230036
description	PCB vacuum packing machine JUMBO		

keypads

membrane keypads



1

GEV No.	402098	Ref. No.	0900102
description	membrane keypad vacuum packing machine B35-16 with frame		



1

GEV No.	402096	Ref. No.	0900100
description	membrane keypad with frame		

control panel



1

GEV No.	692068	Ref. No.	0600020
description	switch panel vacuum packing machine JUMBO Combivac L 258mm W 55mm thickness 2.3mm		



			
1			
GEV No.	692069	Ref. No.	0600011
description	switch panel vacuum packing machine JUMBO L 288mm L 88mm thickness 20mm digital		

solenoid valves

solenoid valves (water)

metal

ASCO

2-way

			
1			
GEV No.	370509	Ref. No.	0280042
description	solenoid valve 2-ways 24VAC inlet 1/2" outlet 1/2" connection 1/2" L 52mm DN 12.5mm slide-on receptacle DIN -20° up to 85°C membranes NBR (water) p max 7bar 1/2" brass		

Solenoid valve - accessories

			
1			
GEV No.	370516	Ref. No.	0280072
description	nut thread M8x0.75 for solenoid coil		

			
1			
GEV No.	370515	Ref. No.	0280071
description	solenoid coil 24V voltage AC seat ø 9mm		

			
1			
GEV No.	370508	Ref. No.	0280024
description	solenoid coil 3-way 24V 6mm		

			
1			
GEV No.	370517	Ref. No.	0280075
description	solenoid valve body nominal dimension 2.8mm		

			
1			
GEV No.	370519	Ref. No.	0280080
description	solenoid valve body nominal dimension 2.8mm		

			
1			
GEV No.	370518	Ref. No.	0280078
description	solenoid valve body nominal dimension 6mm		

solenoid valves for vacuum machines

			
1			
GEV No.	370520	Ref. No.	0900858
description	solenoid valve 2-way 24VACV inlet 1/4" outlet ø4 vacuum packing machine		

			
1			
GEV No.	370507	Ref. No.	0280021
description	solenoid valve 2-ways 24VAC inlet 1/8" outlet 1/8" mm L 31mm DN 3.3mm 1/8" brass		

			
1			
GEV No.	370506	Ref. No.	0280010
description	solenoid valve 3-ways 24VAC inlet 1/8" outlet 1/8"mm L 35mm body inner cone DN 2.8mm 1/8" 24V brass		

			
1			
GEV No.	370787	Ref. No.	0280039
description	solenoid valve assembly 24VAC inlet 1/2" outlet 7.5mm 2 coils coil type VA12 thread 1/2" MJ		

			
1			
GEV No.	370513	Ref. No.	0280027
description	solenoid valve assembly 24VAC inlet 1/2" outlet 10.5mm 2 coils coil type VA12 thread 1/2" JP		

			
1			
GEV No.	370505	Ref. No.	0900836
description	solenoid valve assembly 3 coils 24V thread 1/2" hose ø 21mm coil type VA12 B42(XL)+SA		

			
1			
GEV No.	370800	Ref. No.	0280035
description	solenoid valve assembly 24VAC inlet 1/2" outlet 10.5mm 2 coils coil type VA12 thread 1/2" JP		

			
1			
GEV No.	370501	Ref. No.	0900831
description	solenoid valve assembly thread 1/2" hose ø 10mm 24V coil type VA12 JP		

			
1			
GEV No.	370816	Ref. No.	0280026
description	solenoid valve assembly 24VAC inlet 1/2" outlet 21mm 2 coils coil type VA12 24V thread 1/2" hose ø 21mm J35/J42/B35		

			
1			
GEV No.	370502	Ref. No.	0900832
description	solenoid valve assembly thread 1/2" hose ø 21mm 24V coil type VA12 J35		

			
1			
GEV No.	370511	Ref. No.	0280025
description	solenoid valve assembly 24VAC inlet 1/2" outlet 7.5mm 2 coils coil type VA12 thread 1/2" MJ		

			
1			
GEV No.	370503	Ref. No.	0900833
description	solenoid valve assembly thread 1/2" hose ø 21mm 24V coil type VA12 J42		





			
1			
GEV No.	692064	Ref. No.	0280032
description	solenoid valve assembly thread 1/2" hose ø 6mm 24V H200		

			
1			
GEV No.	370500	Ref. No.	0900830
description	solenoid valve assembly thread 1/2" hose ø 7.5mm 24V coil type VA12 MJ		

pumps

vacuum pumps

vacuum pumps			
			
1			
GEV No.	500987	Ref. No.	0430130
description	vacuum pump 4m ³ /h 230V 0.1kW 50Hz type PB 0004 B 000		
spare parts for	500987		
	GEV No.	500988	Ref. No. —
	level glass thread 1/2" plastic		

			
1			
GEV No.	499006	Ref. No.	0431300
description	vacuum pump 8m ³ /h 220/240V 0.35kW 50/60Hz type PB0008		

rotor vanes			
			
1			
GEV No.	691585	Ref. No.	0939065
description	rotor vane L 100mm W 40mm H 4mm		

			
1			
GEV No.	692070	Ref. No.	0939054
description	rotor vane L 28mm W 14mm H 3mm		

			
1			
GEV No.	691584	Ref. No.	0939060
description	rotor vane L 70mm W 18mm H 4mm		

level glasses			
			
1			
GEV No.	691561	Ref. No.	0438000
description	level glass thread 1/2"		

			
1			
GEV No.	691562	Ref. No.	0438005
description	level glass thread 3/4"		

equipment-specific units

for vacuum packers

air valves			
			
1			
GEV No.	691551	Ref. No.	0281005
description	air valve connection 1" 24VAC		



1

GEV No.	691555	Ref. No.	0900852
description	air valve connection 1¼"		

lids



1

GEV No.	692062	Ref. No.	0620010 0620011
description	lid with gasket L 475mm W 460mm H 75mm B42/J42/H-200		

air cylinders

air cylinders



1

GEV No.	691547	Ref. No.	0286015
description	air cylinder ø 110mm H 47mm shaft length 29mm		



1

GEV No.	691548	Ref. No.	N/A
description	air cylinder ø 110mm H 47mm shaft length 29mm		



1

GEV No.	691544	Ref. No.	0286000
description	air cylinder ø 50mm H 25mm		



1

GEV No.	691545	Ref. No.	0286005
description	air cylinder ø 80mm H 30mm		



1

GEV No.	691546	Ref. No.	0286010
description	air cylinder ø 80mm H 48mm		
spare parts for	691546		



GEV No.	691581	Ref. No.	0931405
description	membrane ø 80mm H 24mm		

insert plates



1

GEV No.	692063	Ref. No.	0307050
description	insert plate L 740mm W 490mm thickness 20mm F80 KL		



oil separator filters

with thread

1 

GEV No.	691534	Ref. No.	0939000 0939160
description	oil separator filter flow rate 4m ³ /h ø 35mm L 52mm thread 3/8"		

1 

GEV No.	691536	Ref. No.	0939001 0939161
description	oil separator filter flow rate 8m ³ /h ø 40mm L 70mm thread 1/2"		

without thread

1 

GEV No.	691540	Ref. No.	0939010 0939170
description	oil separator filter flow rate 100m ³ /h ø 72mm L 248mm		

1 

GEV No.	691537	Ref. No.	0939003 0939163
description	oil separator filter flow rate 16m ³ /h ø 52mm L 120mm		

1 

GEV No.	691538	Ref. No.	0939005 0939165
description	oil separator filter flow rate 21m ³ /h ø 72mm L 128mm		

1 

GEV No.	691539	Ref. No.	0939011 0939171
description	oil separator filter flow rate 63m ³ /h ø 72mm L 206mm		

membranes

1 

GEV No.	691582	Ref. No.	0931410
description	membrane ø 110mm H 34mm		

1 

GEV No.	691579	Ref. No.	0931226
description	membrane ø 48mm H 5mm		

1 

GEV No.	691580	Ref. No.	0931400
description	membrane ø 50mm H 19mm		

1 

GEV No.	691581	Ref. No.	0931405
description	membrane ø 80mm H 24mm		

oils

1 

GEV No.	890296	Ref. No.	0439510
description	oil type V32 1l for vacuum packing machine		



1

GEV No.	890253	Ref. No.	0439520
description	oil type VM100 1l for vacuum packing machine		



1

GEV No.	890247	Ref. No.	0439500
description	oil type VM22 0.05l for vacuum packing machine		



1

GEV No.	890248	Ref. No.	0439501
description	oil type VM22 1l for vacuum packing machine		



1

GEV No.	890200	Ref. No.	0439502
description	oil type VM32 0.25l for vacuum packing machine		



1

GEV No.	890250	Ref. No.	0439503
description	oil type VM32 0.3l for vacuum packing machine		



1

GEV No.	890251	Ref. No.	0439505
description	oil type VM32 0.5l for vacuum packing machine		

1

GEV No.	890252	Ref. No.	0439510 old version
description	oil type VM32 11 for vacuum packing machine		

oil filter



1

GEV No.	691542	Ref. No.	0939090
description	oil filter size 63-100 ø 78mm L 78mm		

PTFE tapes



1

GEV No.	691526	Ref. No.	0305505
description	PTFE tape W 15mm thickness 0.25mm Qty supplied by meter		



1

GEV No.	693842	Ref. No.	0305515
description	PTFE tape W 46mm thickness 0.1mm Qty supplied by meter		

sealing bars



1

GEV No.	691632	Ref. No.	0300010 0300011
description	sealing bar L 277mm W 15mm H 31mm		



1

GEV No.	691997	Ref. No.	0300041
description	sealing bar L 280mm W 16mm H 34mm double		



1

GEV No.	692469	Ref. No.	0300116
description	sealing bar L 355mm W 15mm H 31mm double welding		



1

GEV No.	691998	Ref. No.	0300215
description	sealing bar L 425mm W 16mm H 34mm cut-off seal		



1

GEV No.	691816	Ref. No.	0300337
description	sealing bar L 500mm W 16mm H 34mm double		



1

GEV No.	692468	Ref. No.	0300320
description	sealing bar L 520mm W 15.5mm H 31mm		



1

GEV No.	691999	Ref. No.	0300332
description	sealing bar L 525mm W 16mm H 35mm double		

heating wires

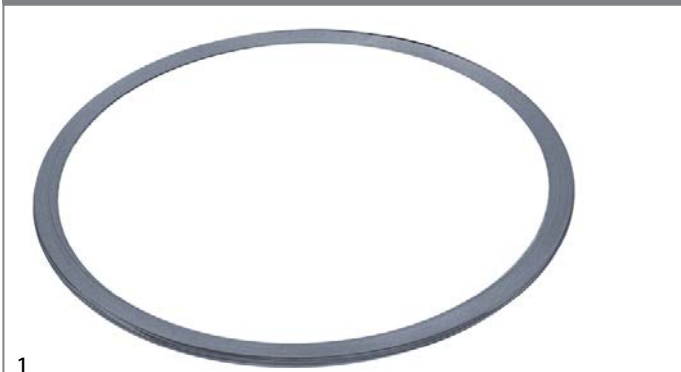

1

GEV No.	572020	Ref. No.	0305000 (3 meters)
description	heating wire W 3.5mm thickness 0.3mm Qty 3m		

service kits



1

GEV No.	890254	Ref. No.	0940100
description	service kit container capacity 0.05l for vacuum packing machine type MJ		



1

GEV No.	890255	Ref. No.	0940110
description	service kit container capacity 0.2l for vacuum packing machine type JP		



1

GEV No.	890262	Ref. No.	0940120
description	service kit for vacuum packing machine type B35 / B-M 42/42XL		



1

GEV No.	890261	Ref. No.	0940125
description	service kit for vacuum packing machine type B42 XL BA/Toucan BA		



1

GEV No.	890263	Ref. No.	0940140
description	service kit for vacuum packing machine type F80/P80 LL		



1

GEV No.	890256	Ref. No.	0940115
description	service kit for vacuum packing machine type J35/J42/B35		



1

GEV No.	890264	Ref. No.	0940130
description	service kit for vacuum packing machine type M46-M/F/P 52		



1

GEV No.	890265	Ref. No.	0940160
description	service kit for vacuum packing machine type P2-40/50/75		

cut off wires



1

GEV No.	572018	Ref. No.	0305009
description	cut off wire \varnothing 1.1mm Qty 3m		



1

GEV No.	572051	Ref. No.	0305010
description	cut off wire \varnothing 1.1mm Qty supplied by meter		

vacuum valves

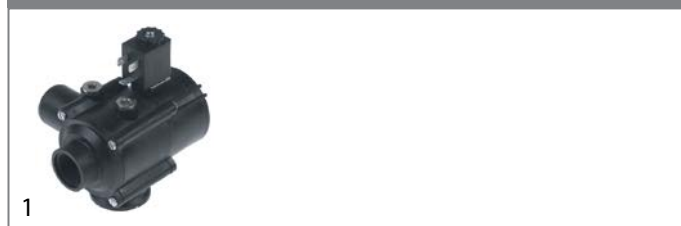

1

GEV No.	691550	Ref. No.	0281000
description	vacuum valve connection 1"		

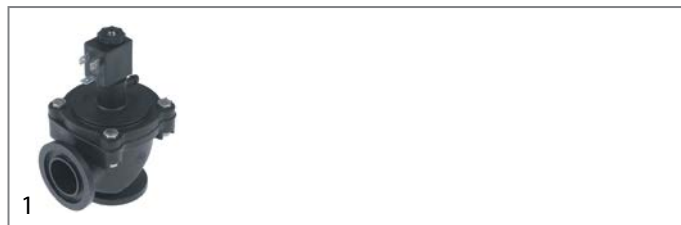

1

GEV No.	691554	Ref. No.	0900850
description	vacuum valve connection 1 1/4"		

locking screws



1

GEV No.	691566	Ref. No.	0939110
description	locking screw thread 1/2" plastic		



1

GEV No.	691565	Ref. No.	0939105
description	locking screw thread 1/4" SS		



1

GEV No.	691564	Ref. No.	0939102
description	locking screw thread 1/8" SS		



1

GEV No.	691567	Ref. No.	0939113
description	locking screw thread 3/4" plastic		

maintenance sets



1

GEV No.	691577	Ref. No.	0931225
description	maintenance set for air valve size 1"		



1

GEV No.	691575	Ref. No.	0900872
description	maintenance set for air valve size 1/4"		



1

GEV No.	691576	Ref. No.	0931220
description	maintenance set for vacuum valve size 1"		



1

GEV No.	691574	Ref. No.	N/A
description	maintenance set for vacuum valve size 1/4"		

miscellaneous



1

GEV No.	691955	Ref. No.	0400735
description	flange ID ø 54mm L 80mm W 40mm H 14mm		



1

GEV No.	692470	Ref. No.	0380710
description	guide bar L 425mm W 25mm H 25mm for vacuum packing machine		

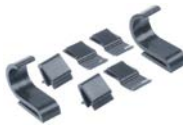

1

GEV No.	697921	Ref. No.	0330116
description	mounting clip set plastic for front panel		



1

GEV No.	692471	Ref. No.	0810112
description	non-return valve ID ø 8mm ED ø 10mm L 39.5mm for vacuum packing machine		



1

GEV No.	690977	Ref. No.	0380702
description	rail for gasket L 280mm aluminium		





			
1			
GEV No.	692065	Ref. No.	0065250
description	retaining ring for vacuum packing machine shaft ϕ 6mm thickness 0.7mm SS DIN 471		

			
1			
GEV No.	692066	Ref. No.	0390500
description	spindle ED ϕ 6mm L 127mm		

gaskets

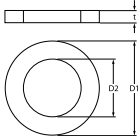
O-rings

 			
1			
GEV No.	345896	Ref. No.	0065736 0065788
description	O-ring EPDM thickness 1.5mm ID ϕ 37mm Qty 1 pcs		

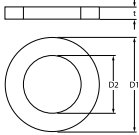
 			
1			
GEV No.	532672	Ref. No.	0065741
description	O-ring EPDM thickness 2mm ID ϕ 25mm Qty 1 pcs		

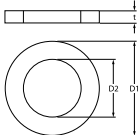
 			
1			
GEV No.	532671	Ref. No.	0065732
description	O-ring EPDM thickness 3mm ID ϕ 34mm Qty 1 pcs		

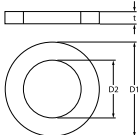
 			
1			
GEV No.	532670	Ref. No.	0065729
description	O-ring EPDM thickness 3mm ID ϕ 40mm Qty 1 pcs		

NBR

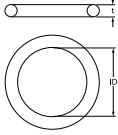
 			
1			
GEV No.	532692	Ref. No.	0065786
description	O-ring NBR thickness 1.5mm ID ϕ 52mm		

foam rubber gaskets

			
1			
GEV No.	693787	Ref. No.	0320100
description	foam rubber gasket ϕ 6mm Qty supplied by meter		

shaft gaskets

v-rings

			
1			
GEV No.	696559	Ref. No.	0065063
description	V-ring for shaft ϕ 32mm ID ϕ 31mm ED ϕ 39mm thickness 7mm		

			
1			
GEV No.	692067	Ref. No.	0065068
description	V-ring ID ϕ 45mm ED ϕ 55mm thickness 9mm		

special gaskets

for vacuum packers

			
1			
GEV No.	693787	Ref. No.	0320100
description	foam rubber gasket ϕ 6mm Qty supplied by meter		

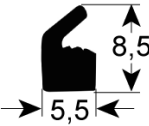
			
1			
GEV No.	900809	Ref. No.	0320215
description	lid gasket W 5.5mm H 9mm silicone Qty supplied by meter for vacuum packing machine		

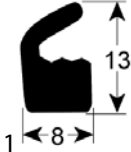
			
GEV No.	900807	Ref. No.	0320210
description	lid gasket W 8mm H 13mm silicone Qty supplied by meter for vacuum packing machine		

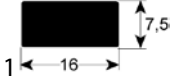
			
GEV No.	900806	Ref. No.	0320200
description	gasket W 16mm H 7.5mm silicone Qty supplied by meter for vacuum packing machine		

springs

gas tension springs

gas tension springs

			
GEV No.	701302	Ref. No.	0955003
description	gas tension spring 450N hub 90mm D1 ø 6mm D2 ø 15mm hole distance 230mm hole ø 6mm L 240mm		

			
GEV No.	691528	Ref. No.	0810200
description	gas tension spring for vacuum packing machine 370N hub 40mm D1 ø 18mm D2 ø 8mm hole distance 145mm hole ø 6.2mm L 155mm		

			
GEV No.	691529	Ref. No.	0810215
description	gas tension spring for vacuum packing machine 500N hub 65mm D1 ø 18mm D2 ø 8mm hole distance 225mm hole ø 6.3mm L 235mm		

tension springs

			
GEV No.	504449	Ref. No.	0080107
description	tension spring ø 70mm total length 340mm wire gauge ø 8mm for vacuum packing machine Qty 1 pcs		

manometers

			
GEV No.	541528	Ref. No.	0810101
description	manometer ø 40mm pressure range 0 up to 1bar connection angled connection ø 5mm		

hoses

industrial hoses

extraction and pressure hoses

			
GEV No.	570202 ¹	Ref. No.	0322052
description	pressure hose ID ø 7mm ED ø 13mm Lm operating p. 10bar burst p. 30bar temp.-resist. -30 up to +80°C		

¹by the meter

measuring equipment

meters

pressure measurement

digital manometers

absolute-pressure measurement

			
GEV No.	800002	Ref. No.	0930300
description	pressure meter 0 up to 1300mbar type GMH 3161-12 vacuum + barometric pressure probe type absolute pressure sensor measurement unit mbar,bar,kPa,MPa,PSI,mmHg,mH2O connections 1 min/max value, tare, hold resolution 1mbar hose ø 4mm accuracy (temperature) ±0.4%FS accuracy (hysteresis) ±0.2%FS overload max. 4 bar interface serial (adapter not included) sensor piezoresistant gauge pressure sensor, int. dimensions 142x71x26mm incl. battery		

fastening material

fasteners

retaining rings

DIN 471

			
GEV No.	692065	Ref. No.	0065250
description	retaining ring for vacuum packing machine shaft ø 6mm thickness 0.7mm SS DIN 471		



			
1			
GEV No.	560302	Ref. No.	0065251
description	retaining ring shaft ø 8mm thickness 0.8mm SS DIN 471		

			
1			
GEV No.	890200	Ref. No.	0439502
description	oil type VM32 0.25l for vacuum packing machine		

consumables

lubricants

oils

for vacuum pumps

			
1			
GEV No.	890296	Ref. No.	0439510
description	oil type V32 1l for vacuum packing machine		

			
1			
GEV No.	890250	Ref. No.	0439503
description	oil type VM32 0.3l for vacuum packing machine		

			
1			
GEV No.	890253	Ref. No.	0439520
description	oil type VM100 1l for vacuum packing machine		

			
1			
GEV No.	890251	Ref. No.	0439505
description	oil type VM32 0.5l for vacuum packing machine		

			
1			
GEV No.	890252	Ref. No.	0439510 old version
description	oil type VM32 1l for vacuum packing machine		

			
1			
GEV No.	890247	Ref. No.	0439500
description	oil type VM22 0.05l for vacuum packing machine		

			
1			
GEV No.	890248	Ref. No.	0439501
description	oil type VM22 1l for vacuum packing machine		

C

consumables	17
contactors	3
control equipment	3

E

extraction and pressure hoses	16
-------------------------------	----

F

fasteners	16
fastening material	16
foam rubber gaskets	15

H

hoses	16
-------	----

I

industrial hoses	16
------------------	----

L

lubricants	17
------------	----

M

measuring equipment	16
meters	16
microswitches	3

O

oils	17
O-rings	15

P

pressure measurement	16
pumps	7

R

retaining rings	16
rocker/momentary rocker switches	3
rotary switches	3

S

shaft gaskets	15
solenoid valves	5
switches and momentary switches	3

T

transformers	4
--------------	---

V

vacuum pumps	7
--------------	---