



GAS COMPONENTS



ELECTRIC COMPONENTS



WATER TECHNOLOGY



MECHANICAL COMPONENTS



TOOLS

Spare parts suitable for

ALPENINOX

Find the complete and up-to-date range of products in our GEV Webshop



Manufacturer catalogue

The most important spare parts and accessories arranged clearly for every manufacturer

- ✓ Complete product range and all appliance data always up to date in the GEV Webshop
- ✓ Alphabetical Index at the end of the catalogue

GEV Webshop

www.gev-online.co.uk

www.gev-online.com





- 🔍 Add to Favourites
- 🔍 Sign In with email address and usual password
- 🔍 Easy-order – place several items in your basket at the same time
- 🔍 Quick Item search – no login needed



heating elements

heating elements for bain maries

			
1			
GEV No.	415096	Ref. No.	0A2197
description	heating element 550W 230V heating circuits 1 L 438mm W 44mm flange length 60mm flange width 40mm connection length 38mm connection male faston 6.3mm tube ø 6.3mm rectangular flange hole ø 6mm dry heating element		

			
1			
GEV No.	415097	Ref. No.	0A2137
description	heating element 800W 230V heating circuits 1 L 630mm W 44mm flange length 60mm flange width 40mm connection length 32mm connection male faston 6.3mm tube ø 6.3mm rectangular flange hole ø 6mm dry heating element		

heating elements for fryers

			
1			
GEV No.	417631	Ref. No.	0C2616
description	heating element 2900W 230V heating circuits 1 L 270mm W 50mm H 235mm rectangular flange connection male faston 6.3mm immersion heater L1 10mm L2 260mm H1 27mm H2 170mm H3 38mm windings 4 hole distance 53mm hole ø 6mm flange length 67mm flange width 32mm tube ø 8.5mm		

heating elements for griddles

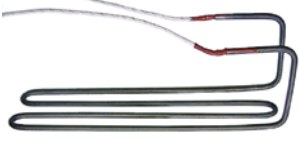
			
1			
GEV No.	415099	Ref. No.	0A2208
description	heating element 1500W 220V heating circuits 1 L 380mm W 90mm H 124mm tube ø 8.5mm L1 80mm L2 300mm cable length 1000mm connection distance 68mm dry heating element		

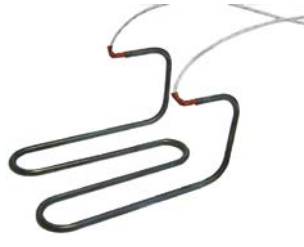
			
1			
GEV No.	415100	Ref. No.	0A2070
description	heating element 1500W 230V heating circuits 1 L 242mm W 155mm H 120mm tube ø 6.5mm L1 50mm L2 192mm cable length 1000mm dry heating element		

			
1			
GEV No.	415098	Ref. No.	0A2068 0A2247
description	heating element 2250W 220V heating circuits 1 L 533mm W 75mm H 123mm tube ø 14mm L1 78mm L2 456mm connection cable cable length 2000mm dry heating element		

heating elements for tilting bratt pan

			
1			
GEV No.	415098	Ref. No.	0A2068 0A2247
description	heating element 2250W 220V heating circuits 1 L 533mm W 75mm H 123mm tube ø 14mm L1 78mm L2 456mm connection cable cable length 2000mm dry heating element		

immersion heating elements

with round flange ø47.5mm







			
1			
GEV No.	415598	Ref. No.	046622 046623
description	heating element 4500W 230V heating circuits 3 mounting ø 47.5mm L 350mm W 28mm H 34mm round flange connection male faston 6.3mm immersion heater tube ø 6.5mm thermostat sleeves ø 6.5mm number of thermostat sleeves 1 length thermostat sleeves 305mm thermostat sleeve centre not clinging		
spare parts for	415598		
		GEV No.	510408 Ref. No. —
			O-ring EPDM thickness 5.34mm ID ø 47mm Qty 1 pcs
accessories for	415598		
		GEV No.	510562 Ref. No. —
			O-ring silicone thickness 5.34mm ID ø 47mm Qty 1 pcs
		GEV No.	520235 Ref. No. —
			3 hole flange hole distance 70.5mm perforation ø 6.5mm ID ø 53.5mm
		GEV No.	520236 Ref. No. —
			flange for heating element ID ø 50mm ED ø 90mm hole ø 6.5mm 3 holes
		GEV No.	550002 Ref. No. —
			tension strap H 10mm L 21mm W 10mm hole ø 6.5mm for heating element

Table continues overleaf

accessories for	415598		
	GEV No.	550362	Ref. No.
			—
	blind flange ø 64mm mounting ø 47.5mm		

hot plates

square & rectangular

with radiused edge

	1		
GEV No.	490065	Ref. No.	0A2198
description	hot plate dimensions 220x220mm 2000W 230V with spill ring connection 4 screw clamps protector no square		

	1		
GEV No.	490066 ¹	Ref. No.	0A2199
description	hot plate dimensions 220x220mm 2600W 230V with spill ring connection 4 screw clamps protector yes square		

¹incl. protector

	1		
GEV No.	490054 ¹	Ref. No.	0A2020
description	hot plate dimensions 300x300mm 2500W 230V with spill ring connection 4 screw clamps protector yes		

¹incl. protector

	1		
GEV No.	490071 ¹	Ref. No.	052199
description	hot plate dimensions 300x300mm 4000W 230V with spill ring connection 4 screw clamps protector yes square		

¹incl. protector

energy regulators

EGO

1-circuit

	1		
GEV No.	380015	Ref. No.	0A2482
description	energy regulator 230V 13A single-circuit turn direction right shaft ø 6x4.6mm shaft L 23mm mounting thread M4 power release 6-100% no. 50.57021.010		

thermostats

bi-metal thermostats

safety bi-metal thermostats

	1		
GEV No.	390590	Ref. No.	0KK203
description	bi-metal safety thermostat hole distance 24mm switch-off temp.°C 1NC 1-poleAV connection plug 2 hole fixing		

control and safety thermostats

EGO

control thermostats

55.10/19_ series

	1		
GEV No.	375055	Ref. No.	0A2018
description	thermostat t.max. 110°C temperature range 30-110°C 1-pole 1CO 16A probe ø 6mm probe L 130mm capillary pipe 1500mm capillary pipe isolatedmm gland nut shaft L 23mm shaft position upper rotation 318° 250V		



E-G-O



1

GEV No.	375661	Ref. No.	056701
description	thermostat t.max. 500°C temperature range 75-500°C 1-pole 1NO 16A probe ø 3.9mm probe L 228mm capillary pipe 1470mm capillary pipe isolated 960mm gland nut shaft ø 6x4.6mm shaft L 23mm shaft position upper rotation 270°		

55.34_ series

E-G-O



1

GEV No.	375143	Ref. No.	0A2237
description	thermostat t.max. 110°C temperature range 32-110°C 3-pole 3NO 16A probe ø 6mm probe L 138mm capillary pipe 1480mm capillary pipe isolated 1100mm gland nut M9x1 shaft ø 6x4.6mm shaft L 23mm shaft position upper rotation 270°		

E-G-O



1

GEV No.	375412	Ref. No.	0A2206
description	thermostat t.max. 320°C temperature range 50-320°C 3-pole 3NO 16A probe ø 3.1mm probe L 226mm capillary pipe 1480mm capillary pipe isolated 1400mm gland nut shaft ø 6x4.6mm shaft L 23mm shaft position upper rotation 318°		

safety thermostats

55.10/19_ series

E-G-O



1

GEV No.	390062	Ref. No.	0A2011	
description	safety thermostat switch-off temp. 235°C 1-pole 0.5A probe ø 6mm probe L 130mm capillary pipe 1800mm capillary pipe isolated 1500mm gland nut M9x1 probe SS			
accessories for	390062			
	GEV No.	551083	Ref. No.	—
	cap for safety thermostat thread M8x1			

55.32_ series

E-G-O



1

GEV No.	390064	Ref. No.	0A2204
description	safety thermostat switch-off temp. 220°C 3-pole 3NC 20A probe ø 6mm probe L 133mm capillary pipe 1890mm capillary pipe isolated 700mm gland nut probe SS		

switches and momentary switches

microswitches

lever actuated



1

GEV No.	346362	Ref. No.	0A2145
description	microswitch with lever connection cable		



cam switches

on/off



1

GEV No.	300074	Ref. No.	0A2162 0A2227
description	cam switch 4 operating positions 2NO sequence 0-1-0-1 16A shaft ø 6x4.6mm shaft L 23mm connection male faston 6.3mm ceramic		



1

GEV No.	300017	Ref. No.	0A2241
description	cam switch 4 operating positions 4NO sequence 0-1-0-1 16A shaft ø 6x4.6mm shaft L 23mm connection male faston 6.3mm ceramic		

7-position



1

GEV No.	300025	Ref. No.	0A2021
description	cam switch 7 operating positions 1NO/2CO sequence 0-1-2-3-4-5-6 16A shaft ø 6x4.6mm shaft L 23mm connection screw 7-position ceramic		

accessories for 300025

GEV No.	112172	Ref. No.	—
knob universal ø 70mm black without adaptor/dial plate			



GEV No.	112213	Ref. No.	—
knob dial plate silver switch 7-position t.max.°C ED ø 63mm ID ø 45.5mm			



GEV No.	112311	Ref. No.	—
knob adapter shaft ø 6x4.6mm L 0mm with spring			



1

GEV No.	300106	Ref. No.	0A2022
description	cam switch 7 operating positions 1NO/2CO sequence 0-1-2-3-4-5-6 32A shaft ø 6x4.6mm shaft L 23mm connection screw 7-position shaft flat upper		

4 operating positions



1

GEV No.	347483	Ref. No.	053866 0C7965
description	cam switch 4 operating positions 8NO sequence 0-1-2-3 16A shaft ø 6x4.6mm shaft L 17mm connection male faston 6.3mm plastic		

operation switches



1

GEV No.	300002	Ref. No.	0A2134
description	cam switch 2 operating positions 4NO 16A sequence 0-1 shaft ø 6x4.6mm shaft L 23mm connection male faston 6.3mm ceramic		



1

GEV No.	300200	Ref. No.	0A2036
description	operation switch 2 operating positions 2NO 16A sequence 0-1 shaft ø 6x4.6mm shaft L 23mm connection male faston 6.3mm operation switch ceramic		



miscellaneous

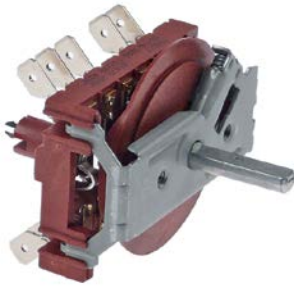

GEV No.	301299	Ref. No.	0C6245
description	cam switch 8 operating positions 5NO sequence 0-1-2-3-4-5-6-7 16A shaft ø 6x4.6mm shaft L 23mm connection male faston 6.3mm plastic		

lamps

indicator lights

indicator lights (complete)

ø10mm

with screw socket



GEV No.	359378	Ref. No.	0A2224
description	indicator light ø 10mm 230V green connection male faston 6.3mm socket screw base		

control equipment

MOELLER/EATON

switches (complete)

push/momentary push switches



GEV No.	346367	Ref. No.	0A2234
description	momentary push switch mounting measurements ø22mm black 1NO water momentary		



GEV No.	346366	Ref. No.	0A2232
description	momentary push switch mounting measurements ø22mm black 1NO/1CO arrow momentary		



GEV No.	346340	Ref. No.	0A2196
description	switch mounting measurements ø22mm red complete EMERGENCY SHUT-DOWN		



GEV No.	359380	Ref. No.	0A2408
description	indicator light ø 10mm 230V red connection male faston 6.3mm socket screw base		



GEV No.	359379	Ref. No.	0A2225
description	indicator light ø 10mm 230V yellow connection male faston 6.3mm socket screw base		

oven lamps

universal oven lamps

mounting diameter 47.8mm



GEV No.	357187	Ref. No.	056708
description	oven lamp mounting ø 47.8mm 230V 15W socket E14 temp.-resist. 300°C connection male faston 6.3mm hard glas		

spare parts for	357187		
GEV No.	359610	Ref. No.	—
description	light bulb t.max. 300°C socket E14 15W 230V ø 22mm L 47mm lens L 20mm for oven lamp type Philips		

GEV No.	359725	Ref. No.	—
description	oven lamp glass thread ø 44mm H 43mm ø 54mm hard glas temp.-resist. 350°C		



timers

programme timers



1

GEV No.	360525	Ref. No.	088285
description	timer CDC 11904 engines 1 chambers 4 operation time 10min 230V shaft ømm shaft Lmm manif. no. 11904F1 / BCR000.0000 motor type M48R ATS		
spare parts for	360525		
	GEV No.	360118	Ref. No. —
description	motor CDC pinion ø 4.9mm teeth 10 230V voltage AC 50/60Hz turn direction right motor ø 47mm H 19.3mm motor type M48R ATS for timer cable length 260mm 1.9/2.5W		

defrost timers

miscellaneous



1

GEV No.	360187	Ref. No.	084986
description	defrost timer type RZ-2001-21 defrosting interval 4H defrosting time 15min fan delay 5min 230V 50Hz defr. funct. 4x per 24h		

relays

power relays

with bracket mounting



1

GEV No.	380052	Ref. No.	088267
description	power relays 230VAC 25A 2NO connection male faston 6.3mm flange support		

transformers

miscellaneous



1

GEV No.	403448	Ref. No.	083389
description	transformer for blast chiller suitable for ZANUSSI		

probes

producer-specific probes



1

GEV No.	379628	Ref. No.	086560
description	temperature probe 2x NTC 10K cable PVC probe -40 up to +110°C cable -10 up to 100°C connection coded plug thread probe ø6.5x45mm cable length 0.4/0.55m		

electronics

PCBs



1

GEV No.	402137	Ref. No.	086520
description	PCB for float switch		

solenoïd valves

solenoïd valves (water)



1

GEV No.	370453	Ref. No.	0H9328
description	solenoid valve single angled 230VAC inlet 11.5mm outlet 11.5mm RPE		



solenoid valves (refrigeration)

PARKER

valve bodies



GEV No.	370536	Ref. No.	OKM756
description	solenoid valve body p max 35bar connection 3/8" US PARKER for ice maker tube ø 10mm hot gas		
accessories for	370536		
	GEV No.	371098	Ref. No. —
	solenoid coil 220-230VAC 50/60Hz seat ø 14mm cable length 1000mm 14W		

pressure switches

for warewashing

ø 58mm with male faston 6.3mm

with connection horizontal



GEV No.	543030	Ref. No.	OKZ785
description	pressure control pressure range 40/15mbar connection 6mm ø 58mm pressure connection horizontal warewashing		

for steam control



GEV No.	541350	Ref. No.	0A2480
description	pressure control pressure range adjustable 0.3-0.8bar connection 1/4" CO 250V 10A ambient temperature max. 60°C pressure connection 1/4"		

compressors

EMBRACO / ASPERA

R134A

HBP monophasé

High evaporation temperature above -15°C



GEV No.	605189	Ref. No.	093207
description	compressor coolant R134a type EMT6160Z 220-240V 50Hz HBP 7.8kg 1/4HP cylinder capacity 6.76cm ³ CSIR H 166mmWWW 325W 412W 513W 630W 762W 910W ambient temperature max. 45°C		



GEV No.	605208	Ref. No.	093297
description	compressor coolant R134a type NEK6210Z-A 220-240V 50Hz HBP 11kg 1/3HP cylinder capacity 12.1cm ³ CSIR H 200mmWWW 364W 485W 636W 818W 1030W 1273W test method EN 12900 ambient temperature max. 55°C		



GEV No.	605210	Ref. No.	093205
description	compressor coolant R134a type NEK6212Z-A 220-240V 50Hz HBP 11.2kg 1/2HP cylinder capacity 14.28cm ³ CSIR H 206mmWWW 413W 561W 739W 945W 1181W 1295W test method EN 12900 ambient temperature max. 55°C		



1

GEV No.	605079	Ref. No.	092312
description	compressor coolant R134a type NT6215Z 220-240V 50Hz HBP fully hermetic 17kg 1/2HP cylinder capacity 17.4cm ³ CSIR H 207mmWWW 484W 646W 843W 1071W 1326W 1606W test method EN 12900		

R404a/R507

LBP monophase

Lower evaporation temperature below -20°C



1

GEV No.	605174	Ref. No.	084076
description	compressor coolant R404a/R507 type NJ2192GK 220-240V 50Hz LBP 20.4kg 1 1/4HP cylinder capacity 26.2cm ³ CSR H 265mm 685W 989W 1342W 1745W 2196W 2196WWWWWW		

HMBP monophase

High/Medium evaporation temperature above -20/-15 °C



1

GEV No.	605139	Ref. No.	093208
description	compressor coolant R404a/R507 type EMT6165GK 220-240V 50Hz HMBP 7.92kg 1/4HP cylinder capacity 5.19cm ³ CSIR H 180mmWW 315W 384W 477W 570W 689W 808W test method ASHRAE		



1

GEV No.	605162	Ref. No.	093373
description	compressor coolant R404a/R507 type NEK6181GK 220-240V 50Hz HMBP 10.4kg 1/4HP cylinder capacity 7.28cm ³ CSIR H 190mmWW 454W 533W 677W 826W 1000W 1198W 1422W		



1

GEV No.	605161	Ref. No.	093377
description	compressor coolant R404a/R507 type NEK6210GK 220-240V 50Hz HMBP fully hermetic 8.5kg 3/8HP cylinder capacity 8.78cm ³ CSIR H 200mmW 566W 674W 815W 988W 1195W 1435W 1707W		



1

GEV No.	605178	Ref. No.	092239
description	compressor coolant R404a/R507 type NEK6217GK 220-240V 50Hz HMBP 11.6kg 5/8HP cylinder capacity 14.3cm ³ CSIR H 206mmW 777W 954W 955W 1171W 1386W 1651W 1916W		



1

GEV No.	605190	Ref. No.	092906
description	compressor coolant R404a/R507 type NJ9232GK 220-240V 50Hz HMBP 22.1kg 1 1/4HP cylinder capacity 26.2cm ³ CSR H 277mmWW 1093W 1470W 1911W 2413W 2973W 3588W 4255W ambient temperature max. 45°C		

fans

refrigeration fans

cold air circulating fans (complete)

miscellaneous



1

GEV No.	601119	Ref. No.	600051
description	fan 230V 50/60Hz 2W ø 100mm type C09R1731 fan wheel ø 100mm connection male faston 6.3mm shaft L 23mm		

cross flow fans

COPREL

with standard coil



1

GEV No.	601452	Ref. No.	300778
description	cross flow fan TFL 180 roller ø 60mm roller length 180mm laminated core thickness 20mm motor position left 230V/50Hz 19W universal bearing silicone connection male faston 6.3mm airflow 100m ³ /h -30 up to +100°C 230V 50Hz		

pumps





wash and rinse pumps

FIR

pumps



1

GEV No.	500115	Ref. No.	048216	
description	pump inlet ø 70mm outlet ø 60mm type 2254.2561 230/400V 50Hz 3 phase 1.5kW 2HP L 325mm rotation direction right FIR			
spare parts for	500115			
	GEV No.	504313	Ref. No.	—
	hose connector thread M12x1.75 grommet ø 11.3mm grommet length 23mm WS 17 total length 43mm thread L 15mm stainless steel IT M8x1.25			
	GEV No.	510693	Ref. No.	—
	mechanical shaft seal for shaft ø 12mm slide ring ext. ø 24mm slide ring H 15.5mm slide ring int. ø 11mm counter ring mounting ø 24mm height counter ring 8mm counter ring int. ø 13.5mm			
	GEV No.	521014	Ref. No.	—
	impellor ø 110mm H 32mm rotation direction right thread M8L shaft ø 28mm shaft length 3mm seat ø 12.2mm blades 6			
	GEV No.	521515	Ref. No.	—
	pump cover inlet ø 70mm outlet ø 60mm			
	GEV No.	524416	Ref. No.	—
	pump cover gasket thickness 4x4mm Qty 1 pcs			

pumps for ice machines



1

GEV No.	601413	Ref. No.	OKK248
description	fixing plate suitable for fanwheel ED ø 32mm shaft ø 7 mounting distance 26mm		



gas taps

PEL

20S series

















1

GEV No.	101094	Ref. No.	0A2163
description	gas tap PEL type 20S gas inlet M16x1.5 (tube ø 10mm) bypass nozzle ø 0.35mm gas outlet M16x1.5 (tube ø 10/8mm) thermocouple connection M8x1 pilot connection shaft ø 8x6.5mm shaft L 22/15mm shaft flat lower		
spare parts for	101094		
	GEV No.	100408	Ref. No. —
	bypass nozzle type PEL20/21 bore ø 0.35mm thread M5x0.5		
	GEV No.	101060	Ref. No. —
	magnet unit standard L 39mm D1 ø 15.4mm D2 ø 11mm suitable for PEL20-21/JUNKERS/EGA		
	GEV No.	101205	Ref. No. —
	gas tap front part shaft ø 8x6.5mm shaft L 22/15mm shaft flat upper/lower suitable for PEL20		
	GEV No.	101230	Ref. No. —
	thermocouple nut T1: M8x1 T2: M18x1 aluminium		
accessories for	101094		
	GEV No.	101278	Ref. No. —
	olive for pipe ø 10mm Qty 1 pcs		
	GEV No.	101300	Ref. No. —
	union nut thread M16x1.5 tube ø 10mm		
	GEV No.	101450	Ref. No. —
	olive for pipe ø 8mm L 12.7mm Qty 1 pcs ED ø 10mm		
	GEV No.	101451	Ref. No. —
	union nut thread M16x1.5 tube ø 8mm		
	GEV No.	110081	Ref. No. —
	knob ø 70mm shaft ø 8x6.5mm shaft flat universal		
	GEV No.	110083	Ref. No. —
	knob dial plate gas tap without ignition flame silver		

21S series





1

GEV No.	101397	Ref. No.	0A2169
description	gas tap PEL type 21S gas inlet M16x1.5 (tube ø 10mm) bypass nozzle ø 0.35mm gas outlet M16x1.5 (tube ø 10/8mm) thermocouple connection M9x1 pilot connection M10x1 shaft ø 8x6.5mm shaft L 22/15mm shaft flat lower		
spare parts for	101397		
	GEV No.	100408	Ref. No. —
	bypass nozzle type PEL20/21 bore ø 0.35mm thread M5x0.5		
	GEV No.	101060	Ref. No. —
	magnet unit standard L 39mm D1 ø 15.4mm D2 ø 11mm suitable for PEL20-21/JUNKERS/EGA		
	GEV No.	101206	Ref. No. —
	gas tap front part shaft ø 8x6.5mm shaft L 22/15mm shaft flat upper/lower suitable for PEL21		
	GEV No.	101231	Ref. No. —
	thermocouple nut T1: M9x1 T2: M18x1		
accessories for	101397		
	GEV No.	100908	Ref. No. —
	union screw thread M10x1 for pipe ø 4mm Qty 1 pcs		
	GEV No.	100909	Ref. No. —
	union screw thread M10x1 for pipe ø 6mm Qty 1 pcs		
	GEV No.	101246	Ref. No. —
	olive for pipe ø 4mm Qty 1 pcs		
	GEV No.	101278	Ref. No. —
	olive for pipe ø 10mm Qty 1 pcs		
	GEV No.	101286	Ref. No. —
	olive ID ø 6mm Qty 1 pcs		
	GEV No.	101300	Ref. No. —
	union nut thread M16x1.5 tube ø 10mm		
	GEV No.	101450	Ref. No. —
	olive for pipe ø 8mm L 12.7mm Qty 1 pcs ED ø 10mm		
	GEV No.	101451	Ref. No. —
	union nut thread M16x1.5 tube ø 8mm		
	GEV No.	110081	Ref. No. —
	knob ø 70mm shaft ø 8x6.5mm shaft flat universal		
	GEV No.	112206	Ref. No. —
	knob dial plate silver gas tap PEL21/22/23 t.max.°C ED ø 63mm ID ø 45.5mm		



22S/O series			
			
1			
GEV No.	101089	Ref. No.	300026
description	gas tap PEL type 22S/O gas inlet M20x1.5 (tube ø 12mm) bypass nozzle ø 0.35mm gas outlet M20x1.5 (tube ø 12/10mm) thermocouple connection M8x1 pilot connection M10x1 shaft ø 10x8mm shaft L 25/17mm shaft flat upper		
spare parts for	101089		
	GEV No.	100259	Ref. No. —
	bypass nozzle type PEL22 bore ø 0.35mm thread M6x0.5		
	GEV No.	101058	Ref. No. —
	magnet unit L 39mm D1 ø 15.4mm D2 ø 13.5mm suitable for PEL22/EGA24197 standard		
	GEV No.	101201	Ref. No. —
	gas tap front part shaft ø 10x8mm shaft L 25/17mm shaft flat upper/lower suitable for PEL22		
	GEV No.	101230	Ref. No. —
	thermocouple nut T1: M8x1 T2: M18x1 aluminium		
	GEV No.	101240	Ref. No. —
	gas connection thread M20x1.5 tube ø 12/10mm for PEL gas taps with gasket and screws horizontal		
	GEV No.	101460	Ref. No. —
	O-ring ø 12.37mm D1 ø 2.62mm suitable for PEL22		
	GEV No.	101461	Ref. No. —
	screw kit suitable for PEL22 Qty 4 pcs		
accessories for	101089		
	GEV No.	100908	Ref. No. —
	union screw thread M10x1 for pipe ø 4mm Qty 1 pcs		
	GEV No.	100909	Ref. No. —
	union screw thread M10x1 for pipe ø 6mm Qty 1 pcs		
	GEV No.	101241	Ref. No. —
	gas connection thread M20x1.5 tube ø 12/10mm for PEL gas taps vertical		
	GEV No.	101246	Ref. No. —
	olive for pipe ø 4mm Qty 1 pcs		
	GEV No.	101248	Ref. No. —
	olive for pipe ø 12mm Qty 1 pcs suitable for PEL		
	GEV No.	101249	Ref. No. —
	olive for pipe ø 10mm Qty 1 pcs		
	GEV No.	101250	Ref. No. —
	union nut thread M20x1.5 for pipe ø 10mm		
	GEV No.	101251	Ref. No. —
	union nut thread M20x1.5 for pipe ø 12mm		

accessories for	101089		
	GEV No.	101286	Ref. No. —
	olive ID ø 6mm Qty 1 pcs		
	GEV No.	110080	Ref. No. —
	knob ø 70mm shaft ø 10x8mm shaft flat universal		
	GEV No.	112206	Ref. No. —
	knob dial plate silver gas tap PEL21/22/23 t.max.°C ED ø 63mm ID ø 45.5mm		

			
1			
GEV No.	101086	Ref. No.	300028
description	gas tap PEL type 22S/O gas inlet M20x1.5 (tube ø 12mm) bypass nozzle ø 0.35mm gas outlet M20x1.5 (tube ø 12/10mm) thermocouple connection M9x1 pilot connection M10x1 shaft ø 10x8mm shaft L 25/17mm shaft flat lower		
spare parts for	101086		
	GEV No.	100259	Ref. No. —
	bypass nozzle type PEL22 bore ø 0.35mm thread M6x0.5		
	GEV No.	101058	Ref. No. —
	magnet unit L 39mm D1 ø 15.4mm D2 ø 13.5mm suitable for PEL22/EGA24197 standard		
	GEV No.	101201	Ref. No. —
	gas tap front part shaft ø 10x8mm shaft L 25/17mm shaft flat upper/lower suitable for PEL22		
	GEV No.	101231	Ref. No. —
	thermocouple nut T1: M9x1 T2: M18x1		
	GEV No.	101240	Ref. No. —
	gas connection thread M20x1.5 tube ø 12/10mm for PEL gas taps with gasket and screws horizontal		
	GEV No.	101460	Ref. No. —
	O-ring ø 12.37mm D1 ø 2.62mm suitable for PEL22		
	GEV No.	101461	Ref. No. —
	screw kit suitable for PEL22 Qty 4 pcs		
accessories for	101086		
	GEV No.	100908	Ref. No. —
	union screw thread M10x1 for pipe ø 4mm Qty 1 pcs		
	GEV No.	100909	Ref. No. —
	union screw thread M10x1 for pipe ø 6mm Qty 1 pcs		
	GEV No.	101241	Ref. No. —
	gas connection thread M20x1.5 tube ø 12/10mm for PEL gas taps vertical		
	GEV No.	101246	Ref. No. —
	olive for pipe ø 4mm Qty 1 pcs		
	GEV No.	101248	Ref. No. —
	olive for pipe ø 12mm Qty 1 pcs suitable for PEL		

Table continues overleaf







accessories for		101086		
GEV No.		101249	Ref. No.	—
	olive for pipe ø 10mm Qty 1 pcs			
	union nut thread M20x1.5 for pipe ø 10mm	101250	Ref. No.	—
	union nut thread M20x1.5 for pipe ø 12mm	101251	Ref. No.	—
	olive ID ø 6mm Qty 1 pcs	101286	Ref. No.	—
	knob ø 70mm shaft ø 10x8mm shaft flat universal	110080	Ref. No.	—
	knob dial plate silver gas tap PEL21/22/23 t.max.°C ED ø 63mm ID ø 45.5mm	112206	Ref. No.	—



accessories for		101092		
GEV No.		101246	Ref. No.	—
	olive for pipe ø 4mm Qty 1 pcs			
	union nut thread M24x1.5 for pipe ø 12mm	101252	Ref. No.	—
	union nut thread M24x1.5 PEL for pipe ø 16mm	101253	Ref. No.	—
	union nut thread M28x1.5 tube ø 20mm	101254	Ref. No.	—
	olive for pipe ø 12mm Qty 1 pcs	101255	Ref. No.	—
	olive for pipe ø 16mm Qty 1 pcs	101256	Ref. No.	—
	olive for pipe ø 20mm Qty 1 pcs	101257	Ref. No.	—
	olive ID ø 6mm Qty 1 pcs	101286	Ref. No.	—
	knob ø 70mm shaft ø 10x8mm shaft flat universal	110080	Ref. No.	—
	knob dial plate silver gas tap PEL21/22/23 t.max.°C ED ø 63mm ID ø 45.5mm	112206	Ref. No.	—

23S/O series



GEV No.	101092	Ref. No.	0A2146
description	gas tap PEL type 23S/O gas inlet M28x1.5 (tube ø 20mm) bypass nozzle ø 0.35mm gas outlet M24x1.5 (tube ø 16mm) thermocouple connection M10x1 pilot connection M10x1 shaft ø 10x8mm shaft L 25/17mm shaft flat upper		

spare parts for		101092		
GEV No.		100455	Ref. No.	—
	bypass nozzle type PEL23/24 bore ø 0.35mm thread M8x0.5			
	magnet unit T1: M10x1 T2: M22x1 L 46mm ø 18mm suitable for PEL23S M10x1	101059	Ref. No.	—
	gas tap front part shaft ø 10x8mm shaft L 25/17mm shaft flat upper/lower suitable for PEL23S	101204	Ref. No.	—
	gas connection thread M24x1.5 tube ø 12/16mm horizontal for PEL gas taps	101244	Ref. No.	—
	screw suitable for PEL23S Qty 4 pcs	101463	Ref. No.	—
	O-ring Viton thickness 2.62mm ID ø 18.72mm Qty 1 pcs	528455	Ref. No.	—

accessories for		101092		
GEV No.		100908	Ref. No.	—
	union screw thread M10x1 for pipe ø 4mm Qty 1 pcs			
	union screw thread M10x1 for pipe ø 6mm Qty 1 pcs	100909	Ref. No.	—

gas thermostats

SIT

710 Minisit series

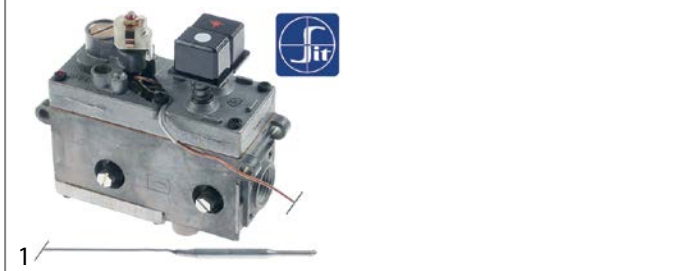



GEV No.	101132	Ref. No.	056833	
description	gas thermostat SIT type MINISIT 710 t.max. 340°C 100-340°C gas inlet 1/2" gas outlet 3/8" thermocouple connection M9x1 pilot connection M10x1 probe ø 5mm probe L 68mm capillary pipe 1050mm probe type type B1 pressure controller no pressure regulator bar gland nut ignition gas no			
spare parts for	101132			
	GEV No.	101053	Ref. No.	—
	GEV No.	102102	Ref. No.	—
	probe 100-340°C probe ø 5mm probe L 68mm capillary pipe 1750mm t.max. 340°C oven/grill probe type type B1 suitable for MINISIT 710			

Table continues overleaf



accessories for		101132		
	GEV No.	100809	Ref. No.	—
	O-ring EPDM thickness 2mm ID ø 21mm Qty 1 pcs			
	GEV No.	100904	Ref. No.	—
	locking screw M10x1 for pipe ø 4mm Qty 1 pcs			
	GEV No.	100905	Ref. No.	—
	locking screw M10x1 for pipe ø 6mm Qty 1 pcs			
	GEV No.	101054	Ref. No.	—
	magnet unit T1: M10x1 T2: M24x1 L 45mm ø 17mm suitable for Minisit			
	GEV No.	101136	Ref. No.	051567
	piezoelectric igniter suitable for Minisit with cover cap ømm connection F6.3x0.8			
	GEV No.	101137	Ref. No.	—
	cover cap without piezoelectric igniter			
	GEV No.	101267	Ref. No.	—
	reducer IT 3/8" ET 1/2" L 21mm			
	GEV No.	101268	Ref. No.	—
	gas connection thread 3/8" angled with O-ring MINISIT 710			
	GEV No.	101269	Ref. No.	—
	gas connection thread 1/2" angled with O-ring MINISIT 710			
	GEV No.	101270	Ref. No.	—
	screw connection IT 3/8" ET 3/8" L 28mm			
	GEV No.	101272	Ref. No.	—
	screw connection IT 1/2" ET 3/8" L 57mm			
	GEV No.	101273	Ref. No.	—
	olive for pipe ø 12mm L 9.5mm brass Qty 1 pcs suitable for universal			
	GEV No.	101274	Ref. No.	—
	olive for pipe ø 16mm Qty 1 pcs			
	GEV No.	101275	Ref. No.	—
	union screw thread 1/2" for pipe ø 16mm Qty 1 pcs			
	GEV No.	101276	Ref. No.	—
	union screw thread 3/8" tube ø 12mm Qty 1 pcs			
	GEV No.	110068	Ref. No.	054268 0A2172
	knob suitable for Minisit ø 37mm			

gas valves and ignition boxes

gas control valves

SIT

ELETTROSIT



1

GEV No.	101123	Ref. No.	0A2035	
description	gas valve SIT type ELETTROSIT 230V gas inlet 3/4" gas outlet 3/4" thermocouple connection M9x1 pilot connection M10x1 bottom equiv. no. 0.810.138			
spare parts for	101123			
	GEV No.	101312	Ref. No.	054539
	microswitch			
	GEV No.	101352	Ref. No.	—
	solenoid coil 230V 50Hz suitable for ELETTROSIT			
accessories for	101123			
	GEV No.	100006	Ref. No.	—
	piezoelectric igniter suitable for ELETTROSIT body plastic blowing connection ø2.4mm ø 14mm			
	GEV No.	100904	Ref. No.	—
	locking screw M10x1 for pipe ø 4mm Qty 1 pcs			
	GEV No.	100905	Ref. No.	—
	locking screw M10x1 for pipe ø 6mm Qty 1 pcs			
	GEV No.	101301	Ref. No.	—
	gas connection thread 1/2" straight ELETTROSIT screw with O-ring			
	GEV No.	101303	Ref. No.	—
	gas connection straight thread 3/4" ELETTROSIT			
	GEV No.	101309	Ref. No.	—
	extension			

NOVASIT

accessories



1

GEV No.	101312	Ref. No.	054539
description	microswitch		









ignition boxes

SIT



GEV No.	102346	Ref. No.	OC1059
description	ignition box SIT type 577DBC electrodes 2 waiting time 1.5s safety time 6s 220/240V 20VA 50/60Hz protection IP40		

accessories for 106904			
	GEV No.	100246	Ref. No. —
	pilot burner nozzle natural gas bore \varnothing 0.35mm Qty 1 pcs thread M8x0.75		
	GEV No.	100904	Ref. No. —
	locking screw M10x1 for pipe \varnothing 4mm Qty 1 pcs		
	GEV No.	100905	Ref. No. —
	locking screw M10x1 for pipe \varnothing 6mm Qty 1 pcs		
	GEV No.	102110	Ref. No. —
	pilot tube copper pipe \varnothing 4mm thickness 1mm L 3000mm		
	GEV No.	102111	Ref. No. —
	pilot tube copper pipe \varnothing 6mm thickness 1mm L 3000mm		
	GEV No.	107171	Ref. No. —
	pilot burner nozzle SIT natural/liquid gas bore \varnothing 0.25mm Qty 1 pcs		
	GEV No.	107700	Ref. No. —
	pilot burner bottom part SIT 100 series nozzle \varnothing 0.25mm		
	GEV No.	107702	Ref. No. —
	pilot burner bottom part SIT 100 series nozzle \varnothing 0.35mm		

ignition parts

pilot burners

SIT

100 series



GEV No.	106904	Ref. No.	300436 300437
description	pilot burner SIT type 100 series 1 flame nozzle \varnothing 0.2mm gas connection 6mm		





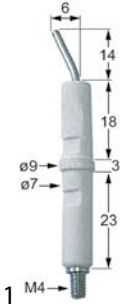









spare parts for 106904			
	GEV No.	100245	Ref. No. —
	pilot burner nozzle LPG code 20 bore \varnothing 0.2mm Qty 1 pcs thread M8x0.75		
	GEV No.	100855	Ref. No. —
	pilot burner bracket triple		
	GEV No.	100885	Ref. No. —
	air mixing sleeve for pilot burner Qty 1 pcs		
	GEV No.	100916	Ref. No. —
	compression spring for pilot burner Qty 1 pcs		
	GEV No.	100917	Ref. No. —
	gasket for pilot burner Qty 1 pcs aluminium		
	GEV No.	100918	Ref. No. —
	screw for pilot burner		
	GEV No.	107160	Ref. No. —
	pilot burner cap SIT 1 flame Hmm Lmm Qty 1 pcs		
	GEV No.	107166	Ref. No. —
	pilot burner head SIT 1 flame Hmm Lmm Qty 1 pcs		
	GEV No.	107701	Ref. No. —
	pilot burner bottom part SIT 100 series nozzle \varnothing 0.2mm		

accessories
ignition electrodes



	GEV No.	100706	Ref. No.	300035
	description	ignition electrode connection M4 Qty 1 pcs		

	GEV No.	100707	Ref. No.	054336 056754
	description	ignition electrode D1 \varnothing 7mm D2 \varnothing 9mm connection \varnothing 2.4mm L1 14mm L2 6mm BL1 18mm BL2 3mm BL3 23mm to clip Qty 1 pcs		



160 series			
			
GEV No.	100109	Ref. No.	0A2472
description	pilot burner SIT type 160 series 1 flame nozzle ømm gas connectionmm		
spare parts for	100109		
	GEV No.	100907	Ref. No. —
	screw connection thread M10x1 Qty 1 pcs type SEF 1 ømm for thermocouple		
accessories for	100109		
	GEV No.	100202	Ref. No. —
	pilot burner nozzle natural gas code 41 Qty 1 pcs nozzle ø 0.41mm		
	GEV No.	100203	Ref. No. —
	pilot burner nozzle LPG code 25 Qty 1 pcs nozzle ø 0.25mm		
	GEV No.	100701	Ref. No. 0A2473
	ignition electrode connection M4 Qty 1 pcs		
	GEV No.	100801	Ref. No. —
	gasket for pilot burner Qty 1 pcs		
	GEV No.	100869	Ref. No. —
	pilot burner nozzle natural gas code 51 Qty 1 pcs suitable for 160 series nozzle ø 0.51mm		
	GEV No.	100906	Ref. No. —
	screw connection thread M10x1 for ignition electrode brass Qty 1 pcs WS 10		
	GEV No.	100908	Ref. No. —
	union screw thread M10x1 for pipe ø 4mm Qty 1 pcs		
	GEV No.	100909	Ref. No. —
	union screw thread M10x1 for pipe ø 6mm Qty 1 pcs		
	GEV No.	101282	Ref. No. —
	olive for pipe ø 4mm L 7.4mm Qty 1 pcs		
	GEV No.	101287	Ref. No. —
	olive for pipe ø 6mm Qty 1 pcs		
	GEV No.	102110	Ref. No. —
	pilot tube copper pipe ø 4mm thickness 1mm L 3000mm		
	GEV No.	102111	Ref. No. —
	pilot tube copper pipe ø 6mm thickness 1mm L 3000mm		
	GEV No.	107650	Ref. No. —
	pilot burner nozzle SIT LPG code 30 Qty 1 pcs		

electrodes

			
GEV No.	100701	Ref. No.	0A2473
description	ignition electrode connection M4 Qty 1 pcs		
accessories for	100701		
	GEV No.	100906	Ref. No. —
	screw connection thread M10x1 for ignition electrode brass Qty 1 pcs WS 10		

			
GEV No.	100706	Ref. No.	300035
description	ignition electrode connection M4 Qty 1 pcs		

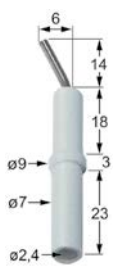
			
GEV No.	100707	Ref. No.	054336 056754
description	ignition electrode D1 ø 7mm D2 ø 9mm connection ø2.4mm L1 14mm L2 6mm BL1 18mm BL2 3mm BL3 23mm to clip Qty 1 pcs		

ignition cables

pre-assembled cables

			
GEV No.	100026	Ref. No.	054273
description	ignition cable cable length 1000mm connection ø4mm / F6.3mm		



piezoelectric igniters

miscellaneous



1			
GEV No.	nla ¹	Ref. No.	051567
description	piezoelectric igniter suitable for Minisit with cover cap ømm connection F6.3x0.8		
spare parts for	101136		
	GEV No.	100001	Ref. No. —
	piezoelectric igniter suitable for Minisit connection F6.3x0.8 ømm		

¹no longer available

ignition units



1			
GEV No.	102485	Ref. No.	300484
description	ignition unit outputs 2 220-240VAC 0.6VA 50-60Hz		



1			
GEV No.	101015	Ref. No.	300486
description	ignition unit outputs 4 230VAC 0.6VA 50Hz		



1			
GEV No.	102388	Ref. No.	300486
description	ignition unit outputs 4 230VAC dimensions 111x23x34mm mounting distance 100mm inlet F6.3x0.8 outlet F2.8x0.8 type WAC-T4 0.6VA 50/60Hz		

thermocouples

plug-in thermocouples

plug-in thermocouples standard

with barrel socket ø6(6.5)mm

thermocouples SIT

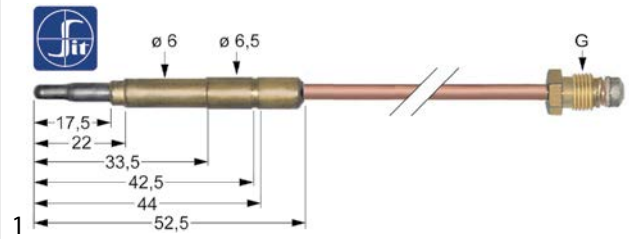

GEV No.	107619	Ref. No.	0A2161
description	thermocouple SIT M10x1 L 1000mm plug connection ø6.0(6.5)mm		

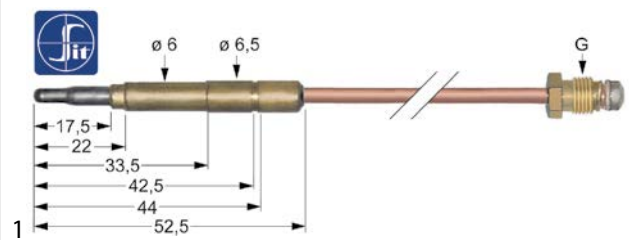

GEV No.	107614	Ref. No.	300034
description	thermocouple SIT M9x1 L 1500mm plug connection ø6.0(6.5)mm		

plug-in thermocouples with interruption

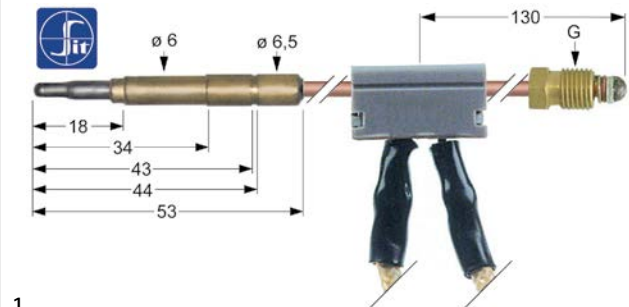

GEV No.	107863	Ref. No.	051932 056914
description	thermocouple SIT with interrupter M9x1 L 1000mm plug connection ø6.0(6.5)mm cable 820mm		



threaded thermocouples

threaded thermocouples standard

threaded thermocouples (miscellaneous)

GEV No.	107646	Ref. No.	052163
description	thermocouple M9x1 L 1000mm M8x1		

gas burners

hob burners

producer-specific hob burners

ALPENINOX

700, 900 series

GEV No.	103052	Ref. No.	300489
description	burner cap ø 125mm		
accessories for	103052		
	GEV No.	Ref. No.	0A2165 0A2168 300488
	burner head for burner cap ø 125mm		
	GEV No.	Ref. No.	300487
	burner lower part for burner cap ø 125mm		

GEV No.	103051	Ref. No.	300475
description	burner cap ø 80mm		
accessories for	103051		
	GEV No.	Ref. No.	0A2093
	burner head for burner cap ø 80mm		
	GEV No.	Ref. No.	300473
	burner lower part for burner cap ø 80mm		

GEV No.	104083	Ref. No.	0A2165 0A2168 300488
description	burner head for burner cap ø 125mm		

GEV No.	104082	Ref. No.	300474
description	burner head for burner cap ø 80mm		
accessories for	104082		
	GEV No.	Ref. No.	300475
	burner cap ø 80mm		
	GEV No.	Ref. No.	300473
	burner lower part for burner cap ø 80mm		

GEV No.	104087	Ref. No.	300487
description	burner lower part for burner cap ø 125mm		

GEV No.	104086	Ref. No.	300473
description	burner lower part for burner cap ø 80mm		
accessories for	104086		
	GEV No.	Ref. No.	300475
	burner cap ø 80mm		
	GEV No.	Ref. No.	0A2093
	burner head for burner cap ø 80mm		



900 series



GEV No.	103052	Ref. No.	300489
----------------	--------	-----------------	--------

description burner cap ø 125mm

accessories for 103052



GEV No.	104083	Ref. No.	0A2165 0A2168 300488
----------------	--------	-----------------	----------------------------

burner head for burner cap ø 125mm



GEV No.	104087	Ref. No.	300487
----------------	--------	-----------------	--------

burner lower part for burner cap ø 125mm



GEV No.	104083	Ref. No.	0A2165 0A2168 300488
----------------	--------	-----------------	----------------------------

description burner head for burner cap ø 125mm



GEV No.	104085	Ref. No.	0A2099
----------------	--------	-----------------	--------

description burner head for burner cap ø 125mm



GEV No.	104084	Ref. No.	0A2093
----------------	--------	-----------------	--------

description burner head for burner cap ø 80mm

accessories for 104084



GEV No.	103051	Ref. No.	300475
----------------	--------	-----------------	--------

burner cap ø 80mm



GEV No.	104086	Ref. No.	300473
----------------	--------	-----------------	--------

burner lower part for burner cap ø 80mm



GEV No.	104087	Ref. No.	300487
----------------	--------	-----------------	--------

description burner lower part for burner cap ø 125mm

reducers for pan supports



GEV No.	210001	Ref. No.	301044
----------------	--------	-----------------	--------

description reducer for pan support L 265mm W 265mm SS suitable for universal

accessories

reducers for pan supports



GEV No.	210001	Ref. No.	301044
----------------	--------	-----------------	--------

description reducer for pan support L 265mm W 265mm SS suitable for universal

bar burners

bar burners



GEV No.	105773	Ref. No.	0A2474
----------------	--------	-----------------	--------

description bar burner angled L 660mm W 205mm ømm Hmm oven

gas nozzles

main nozzles

gas nozzles (other)



GEV No.	103180	Ref. No.	026623
----------------	--------	-----------------	--------

description nozzle bore ø 2.85mm

auxiliary gas parts

gas pressure regulators

Standard pressure according to country:

Germany 50mbar

France 37mbar

Italy 30mbar

Spain 37/50mbar

UK 20mbar



GEV No.	250124	Ref. No.	0S0027
----------------	--------	-----------------	--------

description gas pressure regulator BP2205 connection 1/4" - 1/2" 30mbar/7kg/h countries IT input pressure max. 4bar NOVACOMET LPG

equipment-specific units

for ice-cube maker

drain systems

filters



1

GEV No.	695769	Ref. No.	086023
description	drain filter thread 7/8" ø 32mm H 10mm		

doors

door guides



1

GEV No.	695447	Ref. No.	OKM684
description	door guides mounting pos. right L 215/240mm W 14mm		

mechanics for evaporators

holders



1

GEV No.	694437	Ref. No.	OKM705
description	bearing block for evaporator kit with holder mounting pos. lower		

miscellaneous



1

GEV No.	695630	Ref. No.	086445 OKM780
description	coupling set ø 37mm		



1

GEV No.	695744	Ref. No.	086584
description	insulation L 150mm W 100mm H 140mm ID ø 55mm		

for convection ovens/combi-steamers

spare parts and accessories



1

GEV No.	545179	Ref. No.	003701
description	spring for hose reel thickness 1mm for hose 6x12mm spring steel combi-steamer		

knobs

producer-specific knobs

ALPENINOX



1

GEV No.	110084	Ref. No.	0A2260
description	knob gas tap with ignition flame ø 57mm shaft ø 10x8mm shaft flat -135° black		





1

GEV No.	111731	Ref. No.	0A2468
description	knob gas tap without ignition flame shaft ø 8x6.5mm shaft flat left black		

			
1			
GEV No.	111732	Ref. No.	0A2461
description	knob thermostat 1-8 shaft ø 6x4.6mm shaft flat right black		

			
1			
GEV No.	700006	Ref. No.	0A2005
description	oven hinge mounting distance 173mm mounting distance 2 105mm lug mounting 14mm lever length 120mm groove distance 11mm spring thickness 3.5mm mounting ear position left spring length 112mm W 25mm		

accessories for	700006			
	GEV No.	700001	Ref. No.	053096
	opposite support L 118mm W 17mm mounting distance 94mm			

	GEV No.	700007	Ref. No.	0A2004
	oven hinge mounting distance 173mm mounting distance 2 105mm lug mounting 14mm lever length 120mm groove distance 11mm spring thickness 3.5mm mounting ear position right spring length 112mm W 25mm			

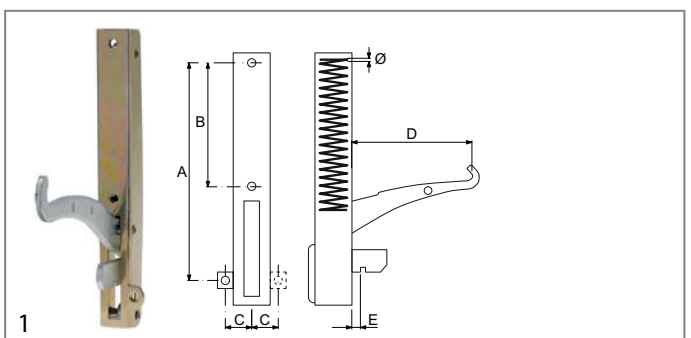

GEV No.	700007	Ref. No.	0A2004
description	oven hinge mounting distance 173mm mounting distance 2 105mm lug mounting 14mm lever length 120mm groove distance 11mm spring thickness 3.5mm mounting ear position right spring length 112mm W 25mm		

accessories for	700007			
	GEV No.	700001	Ref. No.	053096
	opposite support L 118mm W 17mm mounting distance 94mm			

			
1			
GEV No.	701561	Ref. No.	050766
description	oven hinge mounting distance 173mm mounting distance 2mm lug mounting 14mm lever length 112mm groove distance 10mm spring thickness 3mm mounting ear position left/right spring length 111mm L 205mm W 25mm with opposite support		

description	oven hinge mounting distance 173mm mounting distance 2mm lug mounting 14mm lever length 112mm groove distance 10mm spring thickness 3mm mounting ear position left/right spring length 111mm L 205mm W 25mm with opposite support		
--------------------	---	--	--

hinges

spring assisted hinges

producer-specific

ELECTROLUX/ZANUSSI

			
1			
GEV No.	690620	Ref. No.	2209/R
description	spring assisted hinge		

			
1			
GEV No.	690621	Ref. No.	2257/R
description	spring assisted hinge left		

oven hinges

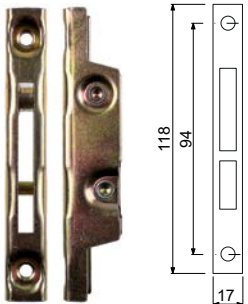
			
1			
GEV No.	700001	Ref. No.	053096
description	opposite support L 118mm W 17mm mounting distance 94mm		



pullouts

rollers

rollers

GEV No.	690680	Ref. No.	600889
description	roller rollerø 24mm B1 6mm overall width 9mm A 24mm B 6mm C 9mm D 6mm E 10mm ceramic bearing ball bearing		

fittings for catering equipment

drain taps

brass

drain taps

GEV No.	540296	Ref. No.	0S0112	
description	drain tap ET M60x2mm chrome-plated brass			
spare parts for	540296			
	GEV No.	505092	Ref. No.	—
	O-ring EPDM thickness 5.34mm ID ø 43.82mm Qty 1 pcs			
	GEV No.	540213	Ref. No.	—
	handle ID ø 5mm L 117mm			

baskets

fryer baskets

ALPENINOX

GEV No.	970419	Ref. No.	0A2603
description	fryer basket L1 290mm W1 285mm H1 125mm chrome-plated steel		

gaskets

refrigeration gaskets

plug-in gaskets

profile 9048

We offer custom-made gaskets for this profile

GEV No.	900019	Ref. No.	082759
description	refrigeration gasket profile 9048 W 262mm L 372mm plug size drawer size 1/2		

GEV No.	900018	Ref. No.	082725
description	refrigeration gasket profile 9048 W 372mm L 572mm plug size door size 1/1		

profile 9773

We offer custom-made gaskets for this profile

GEV No.	900984	Ref. No.	600748
description	refrigeration gasket profile 9773 W 664mm L 762mm external size W1 651mm L1 749mm plug size suitable for ELECTROLUX, ZANUSSI		

GEV No.	900983	Ref. No.	600743
description	refrigeration gasket profile 9773 W 665mm L 1570mm external size W1 652mm L1 1557mm plug size suitable for ELECTROLUX, ZANUSSI		

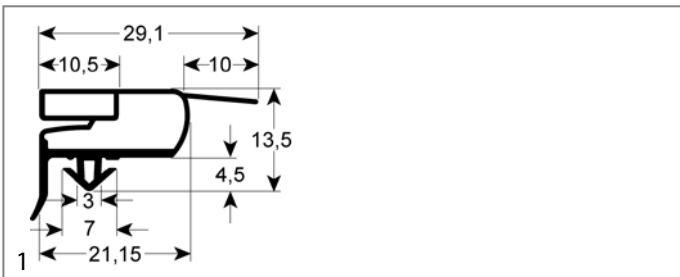

GEV No.	900254	Ref. No.	0780085719
description	refrigeration gasket profile 9773 W 682mm L 1531mm external size W1 669mm L1 1518mm plug size suitable for ELECTROLUX, ZANUSSI		

profile 9794

We offer custom-made gaskets for this profile

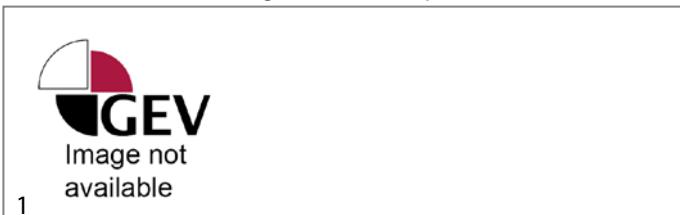

GEV No.	902546	Ref. No.	091143 092689
description	refrigeration gasket profile 9794 W 561mm L 685mm plug size		

screw-in gaskets

profile 9030

We offer custom-made gaskets for this profile

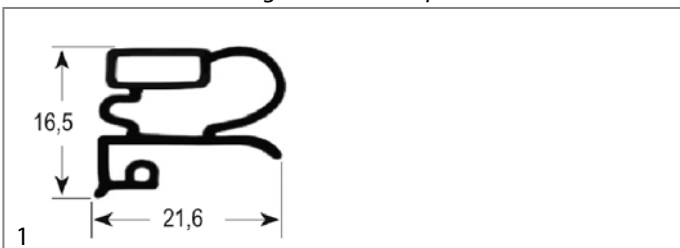

GEV No.	900002	Ref. No.	0A8079
description	refrigeration gasket profile 9030 W 310mm L 390mm external size drawer for refrigerated counter refrigeration size 1/2		

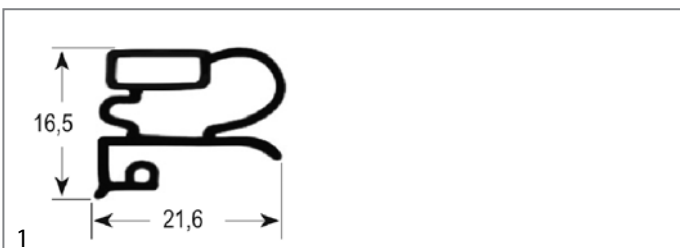

GEV No.	900004	Ref. No.	600213
description	refrigeration gasket profile 9030 W 391mm L 640mm external size door for refrigerated counter refrigeration size 1/1		

foam rubber gaskets



GEV No.	901292	Ref. No.	086670
description	foam rubber gasket W 15mm thickness 8mm self-adhesive Qty supplied by meter		

shaft gaskets



GEV No.	511533	Ref. No.	0KM798
description	shaft seal ID ø 25mm ED ø 34mm thickness 5mm for ice maker		

refrigeration cycle components

valves

spare parts and accessories



GEV No.	371310	Ref. No.	089614
description	insulating cover		

evaporation and condensing trays

unheated condensing trays



GEV No.	750316	Ref. No.	089615
description	condensing tray L 160mm W 80mm H 85mm		



transmission technology and ball bearings

drive belts

toothed belts



1			
GEV No.	698653	Ref. No.	OKJ039
description	toothed belt profile V L 1000mm CODE 4668 W 31.5mm		

springs

torsion springs



1			
GEV No.	690683	Ref. No.	600091
description	torsion spring ϕ 14.5mm wire gauge ϕ 2.5mm L1 86mm L2 30mm L3 16mm refrigerator		



1			
GEV No.	700087	Ref. No.	600092
description	torsion spring ϕ 14.5mm wire gauge ϕ 2.7mm L1 86mm L2 30mm L3 16mm refrigerator		

gas tension springs

gas tension springs



1			
GEV No.	692685	Ref. No.	033241
description	gas tension spring 150N hub 100mm D1 ϕ 6mm D2 ϕ 15mm hole distance 260mm hole ϕ 6mm L 275mm		

hose reels and spray guns

hose reels

spare parts and accessories

miscellaneous



1			
GEV No.	545179	Ref. No.	003701
description	spring for hose reel thickness 1mm for hose 6x12mm spring steel combi-steamer		

consumables

lubricants

machine lubricants



1			
GEV No.	890029	Ref. No.	OKL180
description	machine lubricant Mobilux EP004 can 500g for gearbox -25 up to +120°C		
description	<p>Mobilux EP004 - can 500g</p> <p>Suitable for lubricating enclosed gears and bearings in poorly sealed gear cases with the exception of electric motor bearings. Can also be used for many other industrial applications, e.g. gear cases and chains, in which conventional gear oils would escape due to leaks caused by worn or missing seals. Meets requirements of SEW 1008 hour gear test, DR.EM.2003 mod.</p> <p>Temperature resistance: -25°C to +120°C</p>		

B		M	
bar burners	20	machine lubricants	25
bi-metal thermostats	4	microswitches	5
C		O	
cam switches	6	oven hinges	22
cold air circulating fans (complete)	11	oven lamps	7
compressors	9	P	
consumables	25	piezoelectric igniters	18
control equipment	7	pilot burners	16
control thermostats	4	plug-in gaskets	23
cross flow fans	11	pressure switches	9
D		probes	8
defrost timers	8	programme timers	8
E		pumps	11
energy regulators	4	pumps for ice machines	11
F		R	
fans	11	refrigeration cycle components	24
foam rubber gaskets	24	refrigeration fans	11
G		refrigeration gaskets	23
gas burners	19	relays	8
gas control valves	15	S	
gas nozzles	20	safety bi-metal thermostats	4
gas pressure regulators	20	safety thermostats	5
gas taps	12	screw-in gaskets	24
gas thermostats	14	shaft gaskets	24
H		solenoid valves	8
heating elements	3	spring assisted hinges	22
heating elements for bain maries	3	switches and momentary switches	5
heating elements for fryers	3	T	
heating elements for griddles	3	thermocouples	18
heating elements for tilting bratt pan	3	thermostats	4
hob burners	19	timers	8
hose reels	25	transformers	8
hot plates	4	W	
I		wash and rinse pumps	11
ignition boxes	16		
ignition cables	17		
ignition units	18		
immersion heating elements	3		
indicator lights	7		
indicator lights (complete)	7		
L			
lamps	7		
lubricants	25		