



GAS COMPONENTS



ELECTRIC COMPONENTS



WATER TECHNOLOGY



MECHANICAL COMPONENTS



TOOLS

Spare parts suitable for

AMBASSADE

Find the complete and up-to-date range of products in our GEV Webshop



Manufacturer catalogue

The most important spare parts and accessories arranged clearly for every manufacturer

- ✓ Complete product range and all appliance data always up to date in the GEV Webshop
- ✓ Alphabetical Index at the end of the catalogue

GEV Webshop

www.gev-online.co.uk

www.gev-online.com



- 🔍 Add to Favourites
- 🔍 Sign In with email address and usual password
- 🔍 Easy-order – place several items in your basket at the same time
- 🔍 Quick Item search – no login needed



heating elements

heating elements for ovens



GEV No.	418478	Ref. No.	65211001 65211007
description	heating element 1000W 230V heating circuits 1 L 420mm W 200mm connection male faston 6.3mm connection distance 194mm connection length 15mm tube \varnothing 6.3mm dry heating element oven/bain marie H 47mm		
For models:	CME410GL, CME410GR, CME410M, CME410MCA, CME410SLK, CME410SLR, CME610SLK, CME610SLR, CME610SRK, CME810M, CME810MCA		

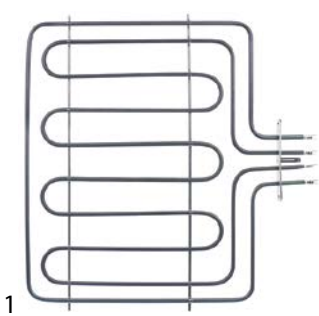

GEV No.	418961	Ref. No.	65211030 6535970
description	heating element 1200/2850W 230V heating circuits 2 L 400mm W 467mm L1 40mm L2 360mm W1 70mm W2 78mm flange length 127mm flange width 22mm hole distance 114mm bridge length 35mm hole \varnothing 6mm tube \varnothing 6.3mm connection male faston 6.3mm vertical connection length 17mm windings 4		
For models:	CG1051CTA, CG1051CTAE, CG1051EA, CG1051EAE, CG731CFCT, CG731CFE, CG731CT, CG731E, CG741CT, CG741E, CG831CFCT, CG831CFE, CG831CT, CG831E		

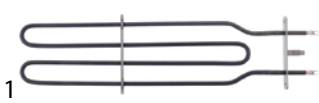

GEV No.	417627	Ref. No.	6532343 6532415
description	heating element 1200W 230V heating circuits 1 L 405mm W 95mm L1 80mm L2 325mm W1 66mm W2 20mm flange length 110mm flange width 22mm hole distance 95mm hole \varnothing 5mm tube \varnothing 6.5mm connection male faston 6.3mm connection length 50mm windings 2 mounting pos. upper for oven		
For models:	CG831CFE, CG831E		

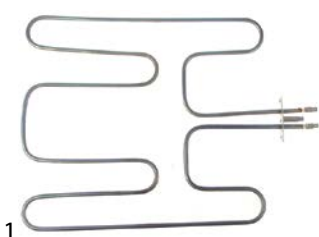

GEV No.	418546	Ref. No.	6536147
description	heating element 1800W 230V heating circuits 1 L 405mm W 324mm L1 30mm L2 375mm W2 30mm flange length 72mm flange width 22mm hole distance 57mm hole \varnothing 5mm tube \varnothing 6.3mm connection male faston 6.3mm connection length 55mm mounting pos. lower rectangular flange dry heating element oven		
For models:	CG1051EB, CG1052GE, CG641E, GC1052CFGE		

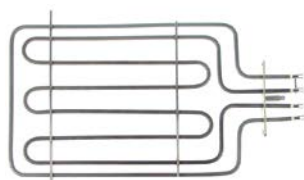

GEV No.	418545	Ref. No.	6530051
description	heating element 3100W 230V heating circuits 2 L 415mm W 258mm L1 38mm L2 377mm W1 89mm W2 80mm flange length 128mm flange width 22mm hole distance 114mm bridge length 300mm hole \varnothing 4.5mm tube \varnothing 6.5mm connection male faston 6.3mm connection length 65mm mounting pos. upper rectangular flange dry heating element oven		
For models:	CG1051EB, CG1052GCT, CG1052GE, CG641CT, CG641E, GC1052CF-GCT, GC1052CFGE		



GEV No.	418479	Ref. No.	6530624
description	heating element 950W 230V heating circuits 1 L 405mm W 96mm L1 75mm L2 330mm W1 15mm W2 66mm flange length 110mm flange width 22mm hole distance 95mm connection male faston 6.3mm connection length 18mm tube \varnothing 6.3mm rectangular flange hole \varnothing 5mm dry heating element heated cabinet		
For models:	CG1051CTA, CG1051CTAE, CG1051EA, CG1051EAE, CG1051GA, CG1051GAE, CG731CFE, CG731E, CG741E, CME401CA, CME410MCA, CME801CA, CME810MCA		

heating elements for bain maries



GEV No.	418478	Ref. No.	65211001 65211007
description	heating element 1000W 230V heating circuits 1 L 420mm W 200mm connection male faston 6.3mm connection distance 194mm connection length 15mm tube \varnothing 6.3mm dry heating element oven/bain marie H 47mm		
For models:	CME410GL, CME410GR, CME410M, CME410MCA, CME410SLK, CME410SLR, CME610SLK, CME610SLR, CME610SRK, CME810M, CME810MCA		

heating elements for fryers

off-center connection

with retaining rings

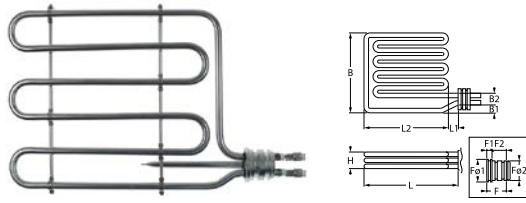

GEV No.	417663	Ref. No.	65211013
description	heating element 3500W 230V heating circuits 1 mounting pos. right L 260mm W 215mm H 8.5mm flange length 31mm flange length 1 14mm flange length 2 12.5mm flange \varnothing 1 38mm flange \varnothing 2 30mm thermostat sleeves \varnothing 7mm length thermostat sleeves 115mm number of thermostat sleeves 1 thermostat sleeve centre windings 3 L1 20mm L2 240mm W1 15mm W2 25mm for retaining ring \varnothing 28mm for o-ring \varnothing 28.5mm tube \varnothing 8.5mm cable lengthmm connection screw		



2 hole fixing

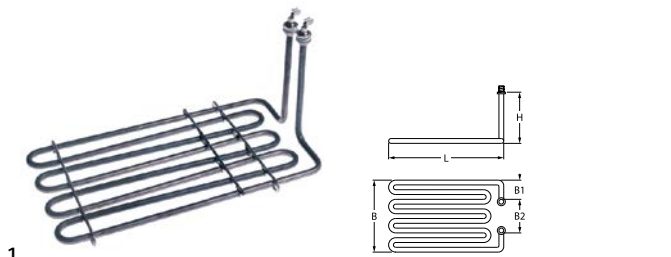

GEV No.	418488	Ref. No.	6537366
----------------	--------	-----------------	---------

description heating element 2800W 230V heating circuits 1 L 343mm W 180mm H 152mm 2 hole fixing connection male faston 6.3mm W1 66mm W2 44mm thread M12x1 tube ø 8.5mm windings 4 fryer

For models: CME413FR

accessories for 418488

	GEV No.	520229	Ref. No.	—
	nut thread M12x1 H 4mm WS 16 zinc-coated steel Qty 1 pcs			
	GEV No.	521110	Ref. No.	—
	flat gasket fibre ED ø 20mm ID ø 13mm thickness 2mm Qty 1 pcs			
	GEV No.	521131	Ref. No.	—
	nut thread M12x1 H 3.5mm WS 17 SS Qty 1 pcs			
	GEV No.	528110	Ref. No.	—
	O-ring EPDM thickness 2.62mm ID ø 12.37mm Qty 1 pcs			

6 hole fixing

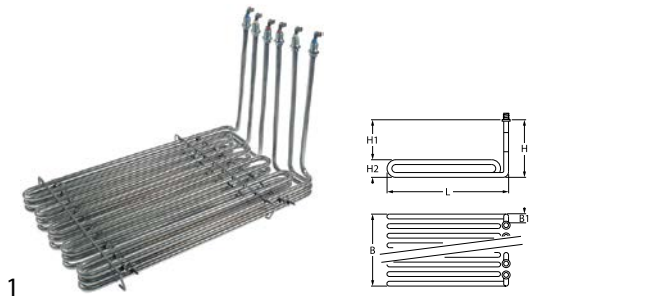

GEV No.	417620	Ref. No.	6536631
----------------	--------	-----------------	---------

description heating element 1200W 400V heating circuits 3 L 390mm W 270mm H 233mm W1 30mm H1 200mm H2 35mm thread M11 tube ø 7.8mm connection male faston 6.3mm immersion heater screw mounting fryer incl. gasket

For models: CME434FR

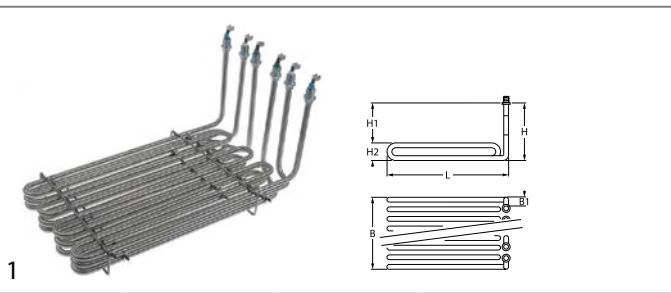

GEV No.	417619	Ref. No.	6532917
----------------	--------	-----------------	---------

description heating element 6000W 230V heating circuits 3 L 345mm W 200mm H 160mm W1 15mm H1 125mm H2 35mm thread M11 tube ø 7.8mm connection male faston 6.3mm immersion heater screw mounting fryer incl. gasket

For models: CME416FR, CME626FR

heating elements for griddles



GEV No.	418934	Ref. No.	021786 652208 653864222
----------------	--------	-----------------	-------------------------------

description heating element 1100W 230V heating circuits 1 L 327mm W 96.5mm H 52mm tube ø 6.3mm connection male faston 6.3mm griddle connection distance 76mm dry heating element

For models: CME410G, CME410SKS, CME410SR, CME610SKS, CME610SR



GEV No.	418489	Ref. No.	65211011
----------------	--------	-----------------	----------

description heating element 1100W 230V heating circuits 1 L 467mm W 95mm H 52mm tube ø 6.3mm connection M4 griddle dry heating element

heating elements for pasta cookers



GEV No.	417663	Ref. No.	65211013
----------------	--------	-----------------	----------

description heating element 3500W 230V heating circuits 1 mounting pos. right L 260mm W 215mm H 8.5mm flange length 31mm flange length 1 14mm flange length 2 12.5mm flange ø1 38mm flange ø2 30mm thermostat sleeves ø 7mm length thermostat sleeves 115mm number of thermostat sleeves 1 thermostat sleeve centre windings 3 L1 20mm L2 240mm W1 15mm W2 25mm for retaining ring ø 28mm for o-ring ø 28.5mm tube ø 8.5mm cable lengthmm connection screw

immersion heating elements

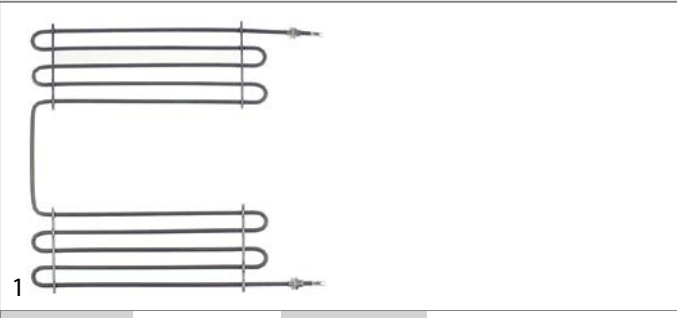

GEV No.	420465	Ref. No.	6539052
----------------	--------	-----------------	---------

description heating element 2000W 230V heating circuits 1 L 403mm W 420mm thread M12 connection male faston 6.3mm



heating elements for convection

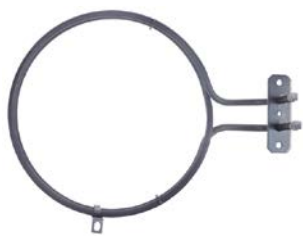

1

GEV No.	418936	Ref. No.	6539168
description	heating element 1700W 240V heating circuits 1 ID ø 176mm ED ø 190mm L 248mm H 34mm L1 58mm W1 31mm H1 12mm H2 22mm flange length 70mm flange width 22mm hole distance 56mm connection male faston 6.3mm connection length 55mm tube ø 6.3mm convection heating element hole ø 5mm rectangular flange		
For models:	CG1051CTA, CG1051CTAE, CG731CFCT, CG731CT, CG741CT, CG831CFCT, CG831CT		



1

GEV No.	418935	Ref. No.	6527752
description	heating element 2650W 240V heating circuits 1 ID ø 201mm ED ø 218mm L 252mm H 36mm L1 28mm W1 31mm H1 9mm H2 27mm flange length 70mm flange width 23mm hole distance 56mm connection male faston 6.3mm connection length 38mm tube ø 6.3mm convection heating element hole ø 5mm rectangular flange		
For models:	CG1052GCT, CG641CT, GC1052CFGCT		



1

GEV No.	417628	Ref. No.	65211012
description	heating element 7000W 230V heating circuits 3 ID ø 216mm ED ø 229mm L 263mm H 78mm L1 23mm W1 112mm H1 11mm H2 68mm flange length 142mm flange width 25mm hole distance 6.3mm connection M4 connection length 66mm tube ø 6.5mm hole ø 6mm with gasket		

radiation heaters

square



1

GEV No.	490159	Ref. No.	6535283	
description	radiation heater L 300mm W 300mm 3500W 230V connections 3 square without pan detection EGO			
For models:	CE1051VTR, CE1052VTR, CE841VTR, CME423VTR			
spare parts for	490159			
	GEV No.	499157	Ref. No.	—
	protection pipe for temperature probe ceramic L 297mm ED ø 7mm ID ø 5mm			

1-circuit



1

GEV No.	490045	Ref. No.	6535286
description	radiation heater ø 165mm 1200W 230V heating circuits 1 7-position control with temperature signalization connections 4+2 connection type male faston 6.3mm EGO		
For models:	CE841VTR, CME423VTR		



1

GEV No.	490047	Ref. No.	6532987
description	radiation heater ø 230mm 2100W 230V heating circuits 1 7-position control with temperature signalization connections 4+2 connection type male faston 6.3mm EGO		
For models:	CE1051VTR, CE1052VTR, CE741VTR, CE841VTR, CME420VTR, CME423VTR		

2-circuit



1

GEV No.	490134	Ref. No.	6535285
description	radiation heater ø 230mm 2200W 230V heating circuits 2		
For models:	CE1051VTR, CE1052VTR, CE741VTR, CE841VTR, CME420VTR, CME423VTR		



hot plates

square & rectangular

with radiused edge



1

GEV No.	490056 ¹	Ref. No.	7111002
description	hot plate dimensions 300x300mm 3000W 230V with spill ring connection 4 screw clamps protector yes square		

¹incl. protector

round

with radiused edge

for domestic and commercial kitchens



1

GEV No.	490012	Ref. No.	6517745
description	hot plate ø 145mm 1500W 230V connection 4 screw clamps with 8mm spill ring		
For models:	CE1051B, CE1051CTA, CE1051EA, CE1052E, CE641E, CE741E, CE841E		



1

GEV No.	490014	Ref. No.	6550951
description	hot plate ø 180mm 1500W 230V connection 4 screw clamps with 8mm spill ring		
For models:	CE1051B, CE1051CTA, CE1051EA, CE1052E		



1

GEV No.	490016	Ref. No.	6550952
description	hot plate ø 180mm 2000W 230V connection 4 screw clamps with 8mm spill ring		
For models:	CE1051B, CE1051CTA, CE1051EA, CE1052E, CE641E, CE741E, CE841E, CME410G, CME410SKS, CME410SR, CME420E, CME610SKS, CME610SR, CMG410G, CMG410SKS, CMG410SR, CMG610SKS, CMG610SR		



1

GEV No.	490018	Ref. No.	6550953
description	hot plate ø 220mm 2000W 230V connection 4 screw clamps with 8mm spill ring		
For models:	CE1051B, CE1051CTA, CE1051EA, CE1052E		



1

GEV No.	490020	Ref. No.	6527688
description	hot plate ø 220mm 2600W 230V connection 4 screw clamps with 8mm spill ring		
For models:	CE1051B, CE1051CTA, CE1051EA, CE1052E, CE841E		
accessories for	490020		
	GEV No.	550796	Ref. No.
			—
	fixing plate for hot plate ø220mm		

energy regulators

EGO

1-circuit



1

GEV No.	380016	Ref. No.	6535287
description	energy regulator 230V 12A dual circuit turn direction right with operation switch 1-pole		
For models:	CE1051VTR, CE1052VTR, CE741VTR, CE841VTR, CME420VTR, CME423VTR		



1

GEV No.	380031	Ref. No.	65225003
description	energy regulator 240V no. 50.31071.570		



2-circuit



1

GEV No.	376048 ¹	Ref. No.	65225007
description	energy regulator EGO 230V 13A turn direction right shaft ø 6.4x4.8mm shaft L 23mm mounting thread M4		

¹with cable

miscellaneous



1

GEV No.	381406	Ref. No.	65225001
description	energy regulator 230V 13A no.50.67021.461 turn direction right EGO shaft ø 6x4.6mm shaft L 23mm mounting thread M4 power release 6-70%		

thermostats

control and safety thermostats



EGO

control thermostats

55.13_series



1

GEV No.	375007	Ref. No.	6528195
description	thermostat t.max. 110°C temperature range 30-110°C 1-pole 1NO 16A probe ø 6mm probe L 113mm capillary pipe 870mm capillary pipe isolatedmm gland nut M9x1 shaft L 25mm shaft position upper rotation 270°		
For models:	CE1051VTR, CG1051CTA, CG1051CTAE, CG1051EA, CG1051EAE, CG1051GA, CG1051GAE, CME401CA, CME410M, CME410MCA, CME-801CA, CME810M, CME810MCA		
accessories for	375007		
	GEV No.	110119	Ref. No. —
	knob thermostat t.max. 110°C ø 50mm shaft ø 6x4.6mm shaft flat upper black temperature range 30-110°C rotation 270°		
	GEV No.	110241	Ref. No. —
	knob thermostat t.max. 110°C ø 50mm shaft ø 6x4.6mm shaft flat upper black temperature range 30-110°C		



1

GEV No.	375705	Ref. No.	6528193
description	thermostat t.max. 110°C temperature range 30-110°C 1-pole 1NO 16A probe ø 6mm probe L 115mm capillary pipe 1430mm capillary pipe isolatedmm gland nut M9x1 shaft ø 6x4.6mm shaft L 23mm shaft position upper rotation 270°		



1

GEV No.	375788	Ref. No.	6528980
description	thermostat t.max. 175°C temperature range 101-175°C 1-pole 1NO 16A probe ø 6mm probe L 98mm capillary pipe 870mm capillary pipe isolated 800mm gland nut shaft ø 6x4.6mm shaft L 23mm shaft position upper rotation 270°		
For models:	CME413FR, CME415FR, CME416FR, CME419FR, CME434FR, CME-625FR, CME626FR		



1

GEV No.	375460	Ref. No.	65224008 6538102
description	thermostat t.max. 255°C temperature range 55-255°C 1-pole 1NO 16A probe ø 3.1mm probe L 201mm capillary pipe 1170mm capillary pipe isolated 1100mm gland nut shaft ø 6x4.6mm shaft L 23mm shaft position upper		



GEV No.	375087	Ref. No.	6553670
description	thermostat t.max. 300°C temperature range 50-300°C 1-pole 1CO 16A probe ø 3.03mm probe L 160mm capillary pipe 1130mm capillary pipe isolated 1103mm gland nut shaft L 23mm shaft position upper rotation 270°		
For models:	CE1051B, CE1051CTA, CE1051EA, CE1051VTR, CE1052E, CE1052VTR, CE641E, CE741E, CE741VTR, CE841E, CE841VTR, CG1051CTA, CG1051CTAE, CG1051EA, CG1051EAE, CG1051EB, CG1052GCT, CG1052GE, CG641CT, CG641E, CG731CFE, CG731E, CG741E, CG831CFE, CG831E, CME410G, GC1052CFGCT, GC1052CFGE		

55.32_ series

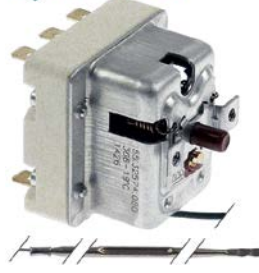

GEV No.	376047	Ref. No.	6539942
description	safety rod thermostat switch-off temp. 368°C 3-pole 3NO 16A probe ø 3mm probe L 160mm capillary pipe 1490mm capillary pipe isolated 76mm		
For models:	CE1051CTA, CE1051EA, CE1051VTR, CE741E, CE741VTR, CE841E, CE841VTR, CFE505RT, CFE605RT, CFE705RT, CFE714RT, CG1051CTA, CG1051CTAE, CG1051EA, CG1051EAE, CG731CFE, CG731E, CG741E, CG831CFE, CG831E		

55.34_ series



GEV No.	376051	Ref. No.	65224002
description	thermostat t.max. 200°C temperature range 70-145-200°C 3-pole 3NC probe ø 3.1mm probe L 263mm capillary pipe 880mm capillary pipe isolated 400mm		
For models:	CFE505RT, CFE605RT, CFE705RT, CFE714RT		

55.33_ series



GEV No.	375796	Ref. No.	6537879
description	safety thermostat switch-off temp. 220°C 3-pole 3NC 20A probe ø 6mm probe L 107mm capillary pipe 870mm capillary pipe isolated 800mm gland nut probe		
For models:	CME413FR, CME415FR, CME416FR, CME419FR, CME434FR, CME625FR, CME626FR		

safety thermostats

55.13_ series



GEV No.	375830	Ref. No.	6538562
description	safety thermostat switch-off temp. 365°C 1-pole 1NC 16A probe ø 3mm probe L 160mm capillary pipe 1730mm capillary pipe isolated 1710mm gland nut probe		
For models:	CE1051B, CE1052E, CE1052VTR, CE641E, CG1051EB, CG1052GCT, CG1052GE, CG641CT, CG641E, GC1052CFGCT, GC1052CFGE		

control thermostats with operation switch

55.34_ series

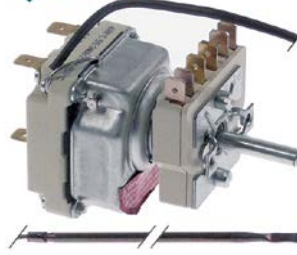

GEV No.	376050	Ref. No.	6535284
description	thermostat t.max. 650°C temperature range 100-650°C 1-pole 1NO probe ø 3.9mm probe L 228mm capillary pipe 1110mm capillary pipe isolated 800mm gland nut shaft ø 6x4.6mm shaft L 24mm shaft position lower rotation 270° outer switch 2NO		
For models:	CE1051VTR, CE1052VTR, CE841VTR, CME420VTR, CME423VTR		



accessories

probe clips

spring clips

for safety thermostat



1			
GEV No.	551289	Ref. No.	6535288
description	probe clip for probe ø 4mm metal Qty 1 pcs		
For models:	CE1051VTR, CE1052VTR, CE841VTR, CME423VTR		



1			
GEV No.	551290	Ref. No.	6551465
description	probe clip for probe ø 4mm metal Qty 1 pcs		

switches and momentary switches

rocker/momentary rocker switches

30x22mm



1			
GEV No.	301062	Ref. No.	6540129
description	rocker switch mounting measurements 30x22mm green 2NO 250V 16A illuminated connection male faston 6.3mm ambient temperature max. 100/55°C protection IP40		
For models:	CME401CA, CME410G, CME410GE, CME410GL, CME410GR, CME410M, CME410MCA, CME410RF, CME410SKS, CME410SLK, CME410SLR, CME410SR, CME413FR, CME415FR, CME416FR, CME419FR, CME434FR, CME610SKS, CME610SLK, CME610SLR, CME610SR, CME610SRK, CME625FR, CME626FR, CME801CA, CME810M, CME810MCA		
accessories for	301062		



GEV No.	301036	Ref. No.	—
description	protective cover internal size 30x22mm for rocker switch mounting measurementsmm		

push/momentary push switches

27.2x22.2mm



1			
GEV No.	345033 ¹	Ref. No.	65222009 6532192
description	push switch mounting measurements 27.2x22.2mm red 2NO 250V 16A illuminated connection male faston 6.3mm ambient temperature max. 85°C protection IP40		
For models:	CFE505RT, CFE605RT, CFE705RT, CFE714RT		

¹illuminated

microswitches

lever actuated



1			
GEV No.	530480	Ref. No.	65222001
description	microswitch with plunger 250V 16A 1CO connection male faston 6.3mm L 42mm ambient temperature max. 125°C mounting distance 22mm type EF83161.3 actuating force: 20g		
For models:	CFE505RT, CFE605RT, CFE705RT, CFE714RT		

cam switches

7-position



1			
GEV No.	300031	Ref. No.	6553435
description	cam switch 7 operating positions 1NO/2CO sequence 0-1-2-3-4-5-6 16A shaft ø 6x4.6mm shaft L 23mm connection male faston 6.3mm 7-position plastic		
For models:	CE1051B, CE1051CTA, CE1051EA, CE1051VTR, CE1052E, CE1052VTR, CE641E, CE741E, CE741VTR, CE841E, CE841VTR, CME420E, CME420VTR, CME423VTR		

5 operating positions



1			
GEV No.	300258	Ref. No.	65221002
description	cam switch 5 operating positions shaft ø 6x4.6mm shaft L 23mm connection male faston 6.3mm		



operation switches

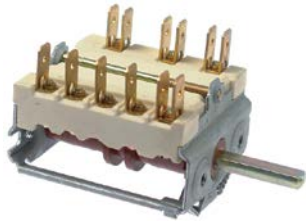

GEV No.	300209	Ref. No.	6552194
description	cam switch 5 operating positions operation switch 16A sequence 0-1-2-3-4 shaft \varnothing 6x4.6mm shaft L 23mm connection male faston ceramic 3-pole ambient temperature max. 330°C		
For models:	CE1051B, CE1051CTA, CE1051EA, CE1051VTR, CE1052E, CE1052VTR, CE641E, CE741E, CE741VTR, CE841E, CE841VTR, CG1051CTA, CG1051CTAE, CG1051EA, CG1051EAE, CG1051EB, CG1052GCT, CG1052GE, CG641CT, CG641E, CG731CFE, CG731E, CG741E, CG831CFE, CG831E, GC1052CFGCT, GC1052CFGE		



GEV No.	300200	Ref. No.	6528979
description	operation switch 2 operating positions 2NO 16A sequence 0-1 shaft \varnothing 6x4.6mm shaft L 23mm connection male faston 6.3mm operation switch ceramic		
For models:	CE1051VTR, CG1051CTA, CG1051CTAE, CG1051EA, CG1051EAE, CG1051GA, CG1051GAE		

control equipment

miscellaneous



GEV No.	347717	Ref. No.	—
description	signal element mounting measurements \varnothing 22mm yellow		

lamps

indicator lights

indicator lights (complete)

 \varnothing 9mm

GEV No.	359135	Ref. No.	6537606
description	indicator light \varnothing 9mm 230V red connection male faston 6.3mm temp.-resist. 120°C with lens		
For models:	CE1051B, CE1051CTA, CE1051EA, CE1051VTR, CE1052E, CE1052VTR, CE841E, CE841VTR, CG1051EB, CG1052GCT, CG1052GE, CG641CT, CG641E, CG731CFCT, CG731CFE, CG731CT, CG731E, CG741CT, CG741E, CG831CFCT, CG831CFE, CG831CT, CG831E, CME401CA, CME410G, CME410GE, CME410GL, CME410GR, CME410M, CME410MCA, CME410RF, CME410SKS, CME410SLK, CME410SLR, CME410SR, CME413FR, CME415FR, CME416FR, CME419FR, CME420E, CME420VTR, CME423VTR, CME434FR, CME610SKS, CME610SLK, CME610SLR, CME610SR, CME610SRK, CME625FR, CME626FR... (Other models you can see in the webshop)		



GEV No.	359137	Ref. No.	6537607
description	indicator light \varnothing 9mm 230V yellow connection male faston 6.3mm temp.-resist. 120°C with lens		
For models:	CE1051B, CE1051CTA, CE1051EA, CE1051VTR, CE1052E, CE1052VTR, CE741E, CE741VTR, CE841E, CE841VTR, CG1051EB, CG1051GA, CG1051GAE, CG1052GCT, CG1052GE, CG641CT, CG641E, CG731CFCT, CG731CFE, CG731CT, CG731E, CG741CT, CG741E, CG831CFCT, CG831CFE, CG831CT, CG831E, GC1052CFGCT, GC1052CFGE		



GEV No.	360662	Ref. No.	90000125
description	indicator light \varnothing 9mm yellow 230V connection cable 200mm		



 \varnothing 12mm

with plug-in socket





GEV No.	360661	Ref. No.	5322000487 6540107
description	indicator light \varnothing 12mm yellow 400V connection cable 700mm		
For models:	CME413FR, CME415FR, CME416FR, CME419FR, CME434FR, CME625FR, CME626FR		







ø13mm			
with screw socket			
			
1			
GEV No.	359146	Ref. No.	6540106
description	indicator light ø 13mm 230V yellow		
For models:	CME413FR, CME415FR, CME416FR, CME419FR, CME434FR, CME-625FR, CME626FR		
accessories for	359146		
	GEV No.	510302	Ref. No. —
	O-ring EPDM ID ø 12.42mm thickness 1.78mm Qty 1 pcs		
	GEV No.	511505	Ref. No. —
	O-ring EPDM thickness 1.78mm ID ø 12.42mm Qty 10 pcs		

27.2x22.2mm			
			
1			
GEV No.	359631	Ref. No.	6532193
description	indicator light mounting measurements 27.2x22.2mm 230V yellow connection male faston 6.3mm 1-pole		
For models:	CFE505RT, CFE605RT, CFE705RT, CFE714RT		

			
1			
GEV No.	360660	Ref. No.	6532194 6533194
description	indicator light mounting measurements 27.2x22.2mm green 220V connection male faston 6.3mm		
For models:	CFE505RT, CFE605RT, CFE705RT, CFE714RT		

			
1			
GEV No.	360659	Ref. No.	65231002
description	indicator light mounting measurements 27.2x22.2mm white 220V connection male faston 6.3mm		
For models:	CFE705RT, CFE714RT		

oven lamps			
universal oven lamps			
55x70mm			
			
1			
GEV No.	360608	Ref. No.	65232002
description	lamp 230-240V 25W socket E14 complete temp.-resist. 300°C connection F6.3 L 95mm W 80mm		

timers			
electric timers			
			
1			
GEV No.	350197	Ref. No.	65270002
description	timer MI1 operation time 120min time spreadmin 1CO/1NO at 250V 16A permanent position yes impulse electric shaft ø 6x4.6mm shaft L 23mm mounting distance 28mm connection lateral 2-pole		
			
1			
GEV No.	350015	Ref. No.	65270002
description	timer MS65 without bell operation time 120min time spreadmin 1CO/1NO at 250V 16A permanent position yes impulse electric shaft ø 6x4.6mm shaft L 23mm mounting distance 28mm connection lateral 2-pole		
accessories for	350015		
	GEV No.	110366	Ref. No. —
	knob switch zero mark t.max.°C ø 44mm shaft ø 6x4.6mm shaft flat upper black		
	GEV No.	111206	Ref. No. —
	dial plate graduation 120min permanent position no rotation 10-300° ø 60mm timers knob ø 45mm		





mechanical timers

			
1			
GEV No.	360632	Ref. No.	6532959
description	timer C10 2-pole operation time 135min impulse mechanical 1NO/1NC at 250V 16A shaft 6x4.6mm shaft L 23mm mounting distance 28.8mm connection male faston 6.3mm 250V		

			
1			
GEV No.	350168	Ref. No.	6528965
description	timer C53 2-pole operation time 120min impulse mechanical 1NO/1NC at 250V 16A permanent position no shaft 6x4.6mm shaft L 23mm mounting distance 28mm connection lateral		
For models:	CFE505RT, CFE605RT, CFE705RT, CFE714RT		

audible timers

			
1			
GEV No.	350000	Ref. No.	6527739
description	audible timer operation time 30min ø 57mm shaft ø 6x4.6mm shaft L 24mm mounting distance 28mm		

			
1			
GEV No.	360630	Ref. No.	6527739
description	timer operation time 15min ø 57.6mm shaft ø 6.4x4.8mm shaft L 22.4mm mounting distance 28.5mm		
For models:	CME413FR, CME415FR, CME416FR, CME419FR, CME434FR, CME625FR, CME626FR		

alarm devices

buzzers

			
1			
GEV No.	350215	Ref. No.	65290012
description	buzzer 220VAC/DC connection male faston 6.3mm moulded built-in version thread M28x1 83dB mounting ø 42.5/32.5mm		

contactors

GENERAL ELECTRIC (AEG)

power contactors

			
1			
GEV No.	381345	Ref. No.	65223002
description	power contactor resistive load 13A 400VAC (AC3/400V) 4A/2.2kW main contacts 4NO auxiliary contacts connection screw connection type 100275 type AEG type GE MCOA400ATU		
For models:	CME410GL, CME410GR, CME410SLK, CME410SLR, CME415FR, CME416FR, CME419FR, CME434FR, CME610SLK, CME610SLR, CME610SRK, CME625FR, CME626FR		

miscellaneous

power contactors

			
1			
GEV No.	381346	Ref. No.	65223009
description	power contactor resistive load 25A 380-400VAC (AC3/400V) 14A/5.5kW main contacts 3NC auxiliary contacts 1NC connection screw connection type MC14N-S-10		



relays

level relays

miscellaneous



1

GEV No.	380961	Ref. No.	02681A
description	level controller 1-pole 230V voltage AC type CNRVA1 FLT		

time relays

time relays



1

GEV No.	360631	Ref. No.	6537884
description	time relay CROUZET MLS2-88826054 time range 0.1s-100h 24-240VAC 0.7A mounting measurements DIN railmm 1NO connection screw		
For models:	CFE705RT, CFE714RT		

solenoid valves

solenoid valves (water)

ELBI



1

GEV No.	370357	Ref. No.	65042005
description	solenoid valve double straight 230VAC inlet 3/4" outlet 11.5mm plastic flow regulating valve outlet A 0.25		





TP

















1

GEV No.	370021	Ref. No.	65042005	
description	solenoid valve double straight 230VAC inlet 3/4" outlet 11.5mm DN10 TP flow regulating valve inlet white			
spare parts for	370021			
	GEV No.	371013	Ref. No.	—
	solenoid coil TP 230VAC 50/60Hz			
accessories for	370021			
	GEV No.	371220	Ref. No.	—
	reducer TP flow rate 3l/min red tolerance ±15%			
	GEV No.	371221	Ref. No.	—
	reducer TP flow rate 5.5l/min yellow tolerance ±15%			
	GEV No.	371222	Ref. No.	—
	reducer TP flow rate 6l/min grey tolerance ±15%			
	GEV No.	371223	Ref. No.	—
	reducer TP flow rate 10l/min white tolerance ±15%			
	GEV No.	371224	Ref. No.	—
	reducer TP flow rate 12l/min bronze tolerance ±15%			
	GEV No.	371225	Ref. No.	—
	reducer TP flow rate 16l/min light brown tolerance ±15%			
	GEV No.	371226	Ref. No.	—
	reducer TP flow rate 20l/min red tolerance ±15%			
	GEV No.	371230	Ref. No.	—
	reducer TP flow rate 0.25l/min red tolerance ±25%			
	GEV No.	371231	Ref. No.	—
	reducer TP flow rate 0.35l/min violet tolerance ±25%			
	GEV No.	371232	Ref. No.	—
	reducer TP flow rate 0.5l/min orange tolerance ±25%			
	GEV No.	371233	Ref. No.	—
	reducer TP flow rate 0.8l/min white tolerance ±25%			
	GEV No.	371234	Ref. No.	—
	reducer TP flow rate 1l/min light blue tolerance ±25%			
	GEV No.	371235	Ref. No.	—
	reducer TP flow rate 1.2l/min brown tolerance ±25%			
	GEV No.	371236	Ref. No.	—
	reducer TP flow rate 1.5l/min light brown tolerance ±25%			

Table continues overleaf

accessories for		370021		
GEV No.	371237	Ref. No.	—	
	reducer TP flow rate 2.5l/min yellow tolerance ±25%			
	reducer TP flow rate 3.4l/min dark green tolerance ±25%			
	reducer TP flow rate 5l/min black tolerance ±25%			
	reducer TP flow rate 8l/min blue tolerance ±20%			

  1				
GEV No.	370025	Ref. No.	65109013	
description	solenoid valve triple straight 230VAC inlet 3/4" outlet 11.5mm DN10 TP			
spare parts for	370025			
	GEV No.	371013	Ref. No.	—
	solenoid coil TP 230VAC 50/60Hz			
accessories for	370025			
	GEV No.	371220	Ref. No.	—
	reducer TP flow rate 3l/min red tolerance ±15%			
	GEV No.	371221	Ref. No.	—
	reducer TP flow rate 5.5l/min yellow tolerance ±15%			
	GEV No.	371222	Ref. No.	—
	reducer TP flow rate 6l/min grey tolerance ±15%			
	GEV No.	371223	Ref. No.	—
	reducer TP flow rate 10l/min white tolerance ±15%			
	GEV No.	371224	Ref. No.	—
	reducer TP flow rate 12l/min bronze tolerance ±15%			
	GEV No.	371225	Ref. No.	—
	reducer TP flow rate 16l/min light brown tolerance ±15%			
	GEV No.	371226	Ref. No.	—
	reducer TP flow rate 20l/min red tolerance ±15%			
	GEV No.	371230	Ref. No.	—
	reducer TP flow rate 0.25l/min red tolerance ±25%			
	GEV No.	371231	Ref. No.	—
	reducer TP flow rate 0.35l/min violet tolerance ±25%			
	GEV No.	371232	Ref. No.	—
	reducer TP flow rate 0.5l/min orange tolerance ±25%			
	GEV No.	371233	Ref. No.	—
	reducer TP flow rate 0.8l/min white tolerance ±25%			

accessories for		370025		
GEV No.	371234	Ref. No.	—	
	reducer TP flow rate 1l/min light blue tolerance ±25%			
	reducer TP flow rate 1.2l/min brown tolerance ±25%			
	reducer TP flow rate 1.5l/min light brown tolerance ±25%			
	reducer TP flow rate 2.5l/min yellow tolerance ±25%			
	reducer TP flow rate 3.4l/min dark green tolerance ±25%			
	reducer TP flow rate 5l/min black tolerance ±25%			
	reducer TP flow rate 8l/min blue tolerance ±20%			

metal

ODE

solenoid valves steam (water)

4991K series



GEV No.	370801	Ref. No.	6532053	
description	solenoid valve brass 2-ways 220-230V/50-60Hz inlet 1/4" outlet 1/4" L 35mm DN 2.5mm ODE coil type BDA p max 14bar			
For models:	CFE705RT, CFE714RT			

fans

hot air motors



GEV No.	601221	Ref. No.	65260003	
description	fan wheel D1 ø 180mm H1 60mm blades 12 D2 ø 9mm D3 ø 12.5mm H2 35mm			
For models:	CFE707RT, CFE714RT			

hot air fans

ebm-papst

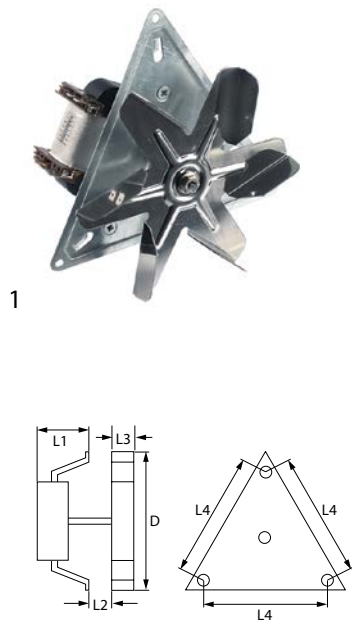

GEV No.	601249	Ref. No.	6539352
description	hot air fan 230V 32W 0.27A L1 60mm L2 20mm L3 20mm L4 157mm fan wheel ø 150mm ebm-papst type R2K150-AC01-15		
For models:	CE1051CTA, CE1051EA, CG1051CTA, CG1051CTAE, CG1052GCT, CG641CT, CG731CFCT, CG731CT, CG741CT, CG831CFCT, CG831CT, GC1052CFGCT		

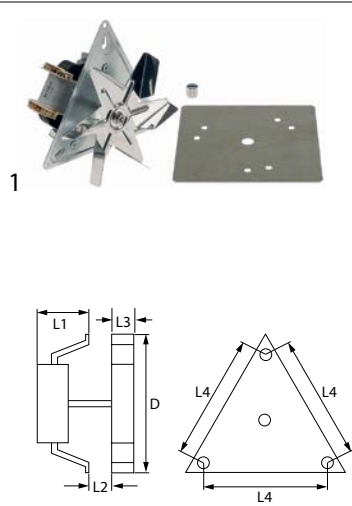

GEV No.	602035	Ref. No.	6539815
description	hot air fan 230V 32W 0.27A L1 60mm L2 20mm L3 20mm L4 157mm fan wheel ø 150mm ebm-papst type R2K150-AC01-15		

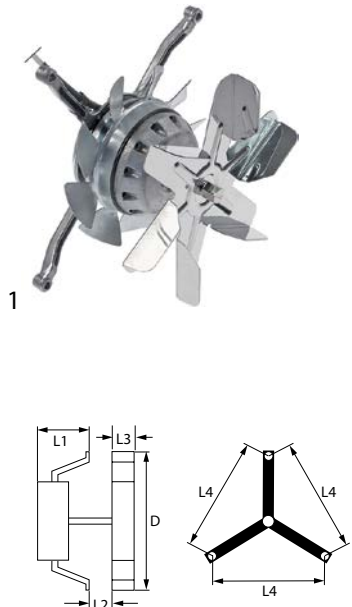

GEV No.	602033	Ref. No.	6527753
description	hot air fan 220V 46W 4 hole fixing L1 15mm L2 65mm L3 20mm L4 134/147mm fan wheel ø 150mm type R2S150-AD08-09 ebm-papst		

HANNING



GEV No.	602034	Ref. No.	65260006
description	hot air fan 200-240V L1 1mm L2 2mm L3 25mm L4 4mm fan wheel ø 180mm HANNING type EMC		
For models:	CFE505RT		

motors

motors

for combi-steamers



GEV No.	602028	Ref. No.	65260008
description	motor 75W 220-240V 50Hz 1 phase 0.55A shaft ø 11.5mm shaft length 75mm flange ø 90mm 2800rpm type 1074.1922 ø 130mm H 200mm mounting distance 64.5mm FIR 0.075kW		

electric accessories

terminals

connection terminals with screw/faston connections



GEV No.	550411	Ref. No.	6551785
description	power terminal block 6-pole max. 40A max 450V connection $\phi 6\text{mm}^2$ / F6.3 temp.-resist. 150°C cross section 6mm ²		
For models:	CE1051B, CE1051CTA, CE1051EA, CE1051VTR, CE1052E, CE1052VTR, CE741E, CE841E, CE841VTR, CFE505RT, CFE605RT, CFE705RT, CFE714RT, CG1051CTA, CG1051CTAE, CG1051EA, CG1051EAE, CG1052GCT, CG641CT, CG731CFCT, CG731CT, CG741CT, CG831CFCT, CG831CT, CME410G, CME410GE, CME410GL, CME410GR, CME410M, CME410MCA, CME410SKS, CME410SLK, CME410SLR, CME410SR, CME415FR, CME416FR, CME419FR, CME420E, CME420VTR, CME423VTR, CME434FR, CME610SKS, CME610SLK, CME610SLR, CME610SR, CME610SRK, CME625FR, CME626FR, CME801CA, CME810M...(Other models you can see in the webshop)		

gas taps

COPRECI

CAL-5200



GEV No.	106036	Ref. No.	6539140 6551114
description	gas tap COPRECI type CAL-5200 gas inlet pipe flange $\phi 21\text{mm}$ bypass nozzle $\phi 0.35\text{mm}$ gas outlet M14x1.5 (tube $\phi 6\text{mm}$) thermocouple connection M8x1 pilot connection shaft $\phi 6 \times 4.6\text{mm}$ shaft L 25/16mm shaft flat lower with pipe outlet		
For models:	CG1051B, CG1052G, CG641G, CG831G, CMG410CF, CMG410G, CMG410GL, CMG410GR, CMG410SKS, CMG410SLK, CMG410SLR, CMG410SR, CMG410UR, CMG420R, CMG610SKS, CMG610SLK, CMG610SLR, CMG610SR, CMG610SRK, CMG840		
spare parts for	106036		
	GEV No.	101060	Ref. No. 6551089
		magnet unit standard L 39mm D1 $\phi 15.4\text{mm}$ D2 $\phi 11\text{mm}$ suitable for PEL20-21/JUNKERS/EGA	

gas thermostats

COPRECI



GEV No.	109089	Ref. No.	65103026 6551110
description	gas thermostat E.C.A/COPRECI 100-300°C gas inlet pipe flange $\phi 21\text{mm}$ bypass nozzle $\phi 0.45\text{mm}$ gas outlet M14x1.5 pilot connection thermocouple connection M8x1 capillary pipe 840mm probe $\phi 4.5\text{mm}$ probe L 92mm shaft $\phi 6 \times 4.6\text{mm}$ shaft L 27/14mm shaft flat lower		
For models:	CG1051B, CG1052G, CG641G, CG731G, CG741G, CG831G		
spare parts for	109089		
	GEV No.	101060	Ref. No. 6551089
		magnet unit standard L 39mm D1 $\phi 15.4\text{mm}$ D2 $\phi 11\text{mm}$ suitable for PEL20-21/JUNKERS/EGA	
	GEV No.	101537	Ref. No. —
		gasket ID $\phi 8\text{mm}$ ED $\phi 11.5\text{mm}$ H 3mm Qty 1 pcs	
accessories for	109089		
	GEV No.	101538	Ref. No. —
		clamp	

ignition parts

piezoelectric igniters

mounting diameter 22mm



GEV No.	100013	Ref. No.	6535997
description	piezoelectric igniter body plastic blowing mounting $\phi 22\text{mm}$ connection $\phi 2.4\text{mm}$ cable lengthmm		
For models:	CMG410G, CMG410SKS, CMG410SR, CMG610SKS, CMG610SR		
accessories for	100013		
	GEV No.	100023	Ref. No. —
		female bullet size 2.3mm 0.5-1.5mm ² CuZn t.max. 125°C Qty 20 pcs	



			
1			
GEV No.	100005	Ref. No.	6535997
description	piezoelectric igniter body plastic blowing mounting ø 22mm connection ø2.4mm cable lengthmm SIT		

ignition units

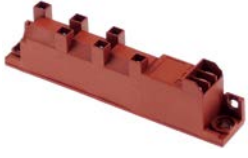
			
1			
GEV No.	102389	Ref. No.	65226007
description	ignition unit outputs 6 230VAC dimensions 135x23x34mm mounting distance 123mm inlet F6.3x0.8 outlet F2.8x0.8 0.6VA 50/60Hz		
For models:	CMG410GL, CMG410GR, CMG410SLK, CMG410SLR, CMG610SLK, CMG610SLR, CMG610SRK		

thermocouples

threaded thermocouples

threaded thermocouples standard

with socket with thread M8x1

SIT

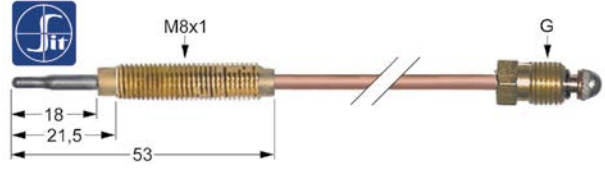
			
1			
GEV No.	107633	Ref. No.	6539896
description	thermocouple SIT M8x1 L 1200mm M8x1		
For models:	CG1051B, CG1051GA, CG1051GAE, CG1052CF, CG1052G, CG641G, CG731CF, CG731G, CG741G, CG831CF, CG831G		
accessories for	107633		
	GEV No.	Ref. No.	—
	102067		
	nut thread M8x1 H 3mm brass Qty 1 pcs type SEF 1		

type Junkers with aluminised tip

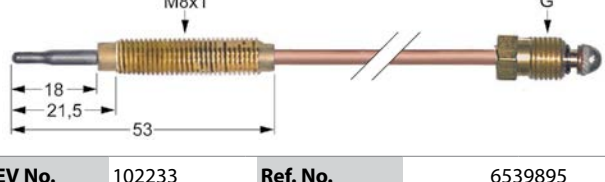
			
1			
GEV No.	102233	Ref. No.	6539895
description	thermocouple M8x1 L 750mm M8x1		
For models:	CG1051B, CG1052G, CG641G, CG731G, CG741G, CG831G, CMG410CF, CMG410UR, CMG420R, CMG840		
accessories for	102233		
	GEV No.	Ref. No.	—
	102067		
	nut thread M8x1 H 3mm brass Qty 1 pcs type SEF 1		

gas burners

hob burners

producer-specific hob burners

AMBASSADE

650 (1) series

			
1			
GEV No.	104722	Ref. No.	6516862
description	air mixer large		
For models:	CG1051B, CG1052G, CG731G, CG831G, CMG410CF, CMG410UR		

			
1			
GEV No.	104795	Ref. No.	6517160
description	air mixer large H 12mm ED ø 38mm ID ø 36mm thickness 1mm		
For models:	CG1051B, CG1052G, CG731G, CG831G, CMG410CF, CMG410UR		

			
1			
GEV No.	104721	Ref. No.	5014741
description	air mixer small		
For models:	CG1051B, CG1052G, CG641G, CG731G, CG741G, CG831G, CMG420R, CMG840		

			
1			
GEV No.	104723	Ref. No.	6550821
description	air mixing sleeve small H 12mm ED ø 26mm ID ø 24mm thickness 1mm		
For models:	CG1051B, CG1052G, CG641G, CG731G, CG741G, CG831G, CMG420R, CMG840		

			
1			
GEV No.	104719	Ref. No.	6528204
description	burner cap ø 100mm suitable for burner 5kW		
For models:	CG1051B, CG1051BCF, CG1052CF, CG1052G, CG731CF, CG731G, CG831G, CMG410CF, CMG410UR		



			
1			
GEV No.	104715	Ref. No.	6528203
description	burner cap ø 65mm suitable for burner 3kW		
For models:	CG1051B, CG1051BCF, CG1052CF, CG1052G, CG641G, CG731CF, CG731G, CG741G, CG831G, CMG840		



			
1			
GEV No.	104717	Ref. No.	6517430
description	burner cap ø 78mm suitable for burner 4kW		
For models:	CG1051B, CG1051BCF, CG1052CF, CG1052G, CG741G, CMG420R, CMG840		

			
1			
GEV No.	104713	Ref. No.	6528202
description	burner cap suitable for burner 1.5kW		
For models:	CG1051B, CG1051BCF, CG1052CF, CG1052G		

			
1			
GEV No.	104716	Ref. No.	5039142
description	burner head for burner cap ø 61mm suitable for burner 3kW		
For models:	CG1051B, CG1051BCF, CG1052CF, CG1052G, CG641G, CG731CF, CG731G, CG741G, CG831G, CMG840		

			
1			
GEV No.	104718	Ref. No.	5039143
description	burner head for burner cap ø 78mm suitable for burner 4kW		
For models:	CG1051B, CG1051BCF, CG1052CF, CG1052G, CG741G, CMG420R, CMG840		
accessories for	104718		
	GEV No.	104717	Ref. No. 6517430
burner cap ø 78mm suitable for burner 4kW			

			
1			
GEV No.	104714	Ref. No.	5039141
description	burner head suitable for burner 1.5kW		
For models:	CG1051B, CG1051BCF, CG1052CF, CG1052G		

			
1			
GEV No.	104720	Ref. No.	5039144
description	burner head suitable for burner 5kW		
For models:	CG1051B, CG1051BCF, CG1052CF, CG1052G, CG731CF, CG731G, CG831G, CMG410CF, CMG410UR		
accessories for	104720		
	GEV No.	104719	Ref. No. 6528204
burner cap ø 100mm suitable for burner 5kW			
	GEV No.	104722	Ref. No. 6516862
air mixer large			
	GEV No.	104724	Ref. No. 6530915
nozzle holder			
	GEV No.	104795	Ref. No. 6517160
air mixer large H 12mm ED ø 38mm ID ø 36mm thickness 1mm			

			
1			
GEV No.	104724	Ref. No.	6530915
description	nozzle holder		
For models:	CG1051B, CG1052G, CG641G, CG731G, CG741G, CG831G, CMG410CF, CMG410UR, CMG420R, CMG840		



650 (2) series			
			
1			
GEV No.	104467	Ref. No.	65330004 65330008 65350008
description	burner cap ø 106.5mm suitable for burner 5kW		



			
1			
GEV No.	104461	Ref. No.	65330005
description	burner cap ø 55mm suitable for burner 1.5kW		



			
1			
GEV No.	104463	Ref. No.	65330006
description	burner cap ø 72mm suitable for burner 3kW		



 <p>1</p>			
GEV No.	104465	Ref. No.	65330007
description	burner cap ø 90mm suitable for burner 4kW		

 <p>1</p>			
GEV No.	104462	Ref. No.	65640003
description	burner head ø 45mm suitable for burner 1.5kW		
accessories for	104462		
 <p>burner cap ø 55mm suitable for burner 1.5kW</p>			
GEV No.	104461	Ref. No.	65330005

 <p>1</p>			
GEV No.	104464	Ref. No.	65640004
description	burner head ø 63mm suitable for burner 3kW		
accessories for	104464		
 <p>burner cap ø 72mm suitable for burner 3kW</p>			
GEV No.	104463	Ref. No.	65330006

 <p>1</p>			
GEV No.	104466	Ref. No.	65640005
description	burner head ø 81mm suitable for burner 4kW		
accessories for	104466		
 <p>burner cap ø 90mm suitable for burner 4kW</p>			
GEV No.	104465	Ref. No.	65330007

 <p>1</p>			
GEV No.	104468	Ref. No.	64640006 65640006
description	burner head ø 98mm suitable for burner 5kW		
accessories for	104468		
 <p>burner cap ø 106.5mm suitable for burner 5kW</p>			
GEV No.	104467	Ref. No.	65330004 65330008 65350008

accessories			
pan supports			
 <p>1</p>			
GEV No.	210052	Ref. No.	88.37024
description	pan support W 263mm L 515mm H 44mm mounting pos. lateral		
For models:	CG1051B, CG1051BCF, CG1052CF, CG1052G, CG641G, CG731CF, CG731G, CG831CF, CG831G		

ring burners			
 <p>1</p>			
GEV No.	107742	Ref. No.	8832998
description	ring burner L 357mm W 172mm		
For models:	CG1051B, CG1052CF, CG1052G, CG641G, CG731CF, CG731G, CG741G, CG831CF, CG831G		

accessories			
nozzle holders			
 <p>1</p>			
GEV No.	104724	Ref. No.	6530915
description	nozzle holder		
For models:	CG1051B, CG1052G, CG641G, CG731G, CG741G, CG831G, CMG410CF, CMG410UR, CMG420R, CMG840		

 <p>1</p>			
GEV No.	103255	Ref. No.	6551764
description	nozzle holder L 29mm without nozzle ET M14x1.5 IT M9x1 WS 16		
For models:	CG1051B, CG1052CF, CG1052G, CG641G, CG731CF, CG731G, CG741G, CG831CF, CG831G, CME410G, CME410SKS, CME410SR, CME610SKS, CME610SR, CMG410G, CMG410SKS, CMG410SR, CMG610SKS, CMG610SR		

gas nozzles

main nozzles

gas nozzles M9x1



GEV No. 103273 **Ref. No.** 65INJ065

description gas injector thread M9x1 WS 12 bore ø 0.65mm conical



GEV No. 103271 **Ref. No.** 65INJ080

description gas injector thread M9x1 WS 12 bore ø 0.8mm conical



GEV No. 103248 **Ref. No.** 65INJ095

description gas injector thread M9x1 WS 12 bore ø 0.95mm conical



GEV No. 103275 **Ref. No.** 65INJ090

description gas injector thread M9x1 WS 12 bore ø 0.9mm conical



GEV No. 103249 **Ref. No.** 65INJ135

description gas injector thread M9x1 WS 12 bore ø 1.35mm conical



GEV No. 103272 **Ref. No.** 65INJ130

description gas injector thread M9x1 WS 12 bore ø 1.3mm conical



GEV No. 103274 **Ref. No.** 65INJ100

description gas injector thread M9x1 WS 12 bore ø 1mm conical

gas nozzles M10x1



GEV No. 100067 **Ref. No.** INJECTEUR170

description gas injector thread M10x1 WS 12 bore ø 1.1mm G30 gas pressure 30mbar

equipment-specific units

for espresso machines

screw connections

double nipples



GEV No. 520682 **Ref. No.** —

description double nipple brass thread 1/4" - 3/8" Qty 1 pcs

for convection ovens/combi-steamers

miscellaneous



GEV No. 692595 **Ref. No.** 50309500

description bracket for motor gasket SS L 79.5mm W 70mm



GEV No. 698635 **Ref. No.** 50325200

description reducer bore ø 6mm D1 ø 50mm D2 ø 59mm SS H 35mm Qty 1 pcs



GEV No. 698636 **Ref. No.** 5038147



description spacer piece SS thread 3/4" thickness 5mm H 70mm Qty 1 pcs

For models: CME410M, CME413FR, CME415FR, CME416FR, CME419FR, CME434FR, CME625FR, CME626FR



knobs

universal knobs

			
1			
GEV No.	110121	Ref. No.	6527735
description	knob thermostat t.max. 200°C ø 50mm shaft ø 6x4.6mm shaft flat upper black temperature range 60-200°C rotation 270°		
For models:	CME413FR, CME415FR, CME416FR, CME419FR, CME434FR, CME-625FR, CME626FR		
accessories for	110121		
		GEV No.	110135
		Ref. No.	—
	rosette knob up to ø 52mm		

			
1			
GEV No.	112739	Ref. No.	88044006
description	knob MIN / STOP / MAX t.max.°C ø 49mm shaft ø 6x4.6mm shaft flat upper black		
For models:	CG1051B, CG1051GA, CG1051GAE, CG1052G, CG641E, CG641G, CG731CFCT, CG731CFE, CG731CT, CG731E, CG731G, CG741CT, CG741E, CG741G, CG831CF, CG831CFCT, CG831CFE, CG831CT, CG831E, CG831G, CMG410CF, CMG410G, CMG410GL, CMG410GR, CMG410SKS, CMG410SLK, CMG410SLR, CMG410SR, CMG410UR, CMG420R, CMG610SKS, CMG610SLK, CMG610SLR, CMG610SR, CMG610SRK, CMG840		

producer-specific knobs

AMBASSADE

			
1			
GEV No.	111898	Ref. No.	8804406
description	knob gas tap without ignition flame t.max.°C ø 49mm shaft ø 6x4.6mm shaft flat upper black		

			
1			
GEV No.	112786	Ref. No.	88044001
description	knob switch 4-position t.max.°C ø 49mm shaft ø 6x4.6mm shaft flat upper black		
For models:	CE1051VTR, CE1052VTR, CE741VTR, CE841VTR, CME420VTR, CME423VTR		

			
1			
GEV No.	112741	Ref. No.	88044009
description	knob gas thermostat 1-10 t.max.°C ø 49mm shaft ø 6x4.6mm shaft flat upper black		
For models:	CG1051B, CG1051GA, CG1051GAE, CG1052G, CG641G, CG731G, CG741G, CG831CF, CG831G		

			
1			
GEV No.	112740	Ref. No.	65044000 88044000
description	knob switch zero mark t.max.°C ø 49mm shaft ø 6x4.6mm shaft flat upper black		
For models:	CFE705RT, CFE714RT		

			
1			
GEV No.	112062	Ref. No.	88044007
description	knob graduated Min/Max t.max.°C ø 49mm shaft ø 6x4.6mm shaft flat lower black		
For models:	CME410GL, CME410GR, CME410SKS, CME410SLK, CME410SLR, CME410SR, CME610SKS, CME610SLK, CME610SLR, CME610SR, CME610SRK		

			
1			
GEV No.	112787	Ref. No.	8828178
description	knob switch zero mark t.max.°C ø 55mm shaft ø 6x4.6mm shaft flat universal		

			
1			
GEV No.	111975	Ref. No.	88044008
description	knob t.max.°C ø 49mm shaft ø 5.8x4.5mm black		
For models:	CME413FR, CME415FR, CME416FR, CME419FR, CME434FR, CME-625FR, CME626FR		

			
1			
GEV No.	112056	Ref. No.	65044004 88044004
description	knob thermostat t.max. 110°C 30-110°C ø 49mm shaft ø 6x4.6mm shaft flat upper black temperature range 30-110°C		
For models:	CE1051CTA, CE1051EA, CG1051GA, CG1051GAE, CME401CA, CME410G, CME410M, CME410MCA, CME801CA, CME810M, CME810MCA		

			
1			
GEV No.	112166	Ref. No.	65044002
description	knob thermostat t.max. 240°C 50-240°C ø 49mm shaft ø 6x4.6mm shaft flat upper black		

			
1			
GEV No.	112063	Ref. No.	011564
description	knob spring ø 24mm L 28mm wire gauge ø 0.9mm		

			
1			
GEV No.	111897	Ref. No.	65043001
description	rosette knob		
For models:	CG1051B, CG1051GA, CG1051GAE, CG1052G, CG641E, CG641G, CG731CFCT, CG731CFE, CG731CT, CG731E, CG731G, CG741CT, CG741E, CG741G, CG831CF, CG831CFCT, CG831CFE, CG831CT, CG831E, CG831G, CMG410CF, CMG410G, CMG410SKS, CMG410SR, CMG410UR, CMG420R, CMG610SKS, CMG610SLK, CMG610SLR, CMG610SR, CMG610SRK, CMG840		

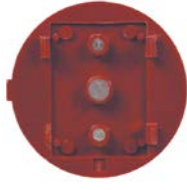
			
1			
GEV No.	112049	Ref. No.	65043002
description	rosette knob		
For models:	CE1051B, CE1051CTA, CE1051EA, CE1051VTR, CE1052E, CE1052VTR, CE641E, CE741E, CE741VTR, CE841E, CE841VTR, CG1051EB, CG-1051GA, CG1051GAE, CG1052GCT, CG1052GE, CG641CT, CG641E, CG731CFCT, CG731CFE, CG731CT, CG731E, CG741CT, CG741E, CG831CFCT, CG831CFE, CG831CT, CG831E, CME401CA, CME410G, CME410M, CME410MCA, CME410SKS, CME410SR, CME413FR, CME-415FR, CME416FR, CME419FR, CME420E, CME420VTR, CME423VTR, CME434FR, CME610SKS, CME610SR, CME625FR, CME626FR, CME-801CA, CME810M, CME810MCA, GC1052CFGCT...(Other models you can see in the webshop)		

accessories

rosettes

			
1			
GEV No.	111897	Ref. No.	65043001
description	rosette knob		
For models:	CG1051B, CG1051GA, CG1051GAE, CG1052G, CG641E, CG641G, CG731CFCT, CG731CFE, CG731CT, CG731E, CG731G, CG741CT, CG741E, CG741G, CG831CF, CG831CFCT, CG831CFE, CG831CT, CG831E, CG831G, CMG410CF, CMG410G, CMG410SKS, CMG410SR, CMG410UR, CMG420R, CMG610SKS, CMG610SLK, CMG610SLR, CMG610SR, CMG610SRK, CMG840		

			
1			
GEV No.	112049	Ref. No.	65043002
description	rosette knob		
For models:	CE1051B, CE1051CTA, CE1051EA, CE1051VTR, CE1052E, CE1052VTR, CE641E, CE741E, CE741VTR, CE841E, CE841VTR, CG1051EB, CG-1051GA, CG1051GAE, CG1052GCT, CG1052GE, CG641CT, CG641E, CG731CFCT, CG731CFE, CG731CT, CG731E, CG741CT, CG741E, CG831CFCT, CG831CFE, CG831CT, CG831E, CME401CA, CME410G, CME410M, CME410MCA, CME410SKS, CME410SR, CME413FR, CME-415FR, CME416FR, CME419FR, CME420E, CME420VTR, CME423VTR, CME434FR, CME610SKS, CME610SR, CME625FR, CME626FR, CME-801CA, CME810M, CME810MCA, GC1052CFGCT...(Other models you can see in the webshop)		



locks

edgmount latches

handle latches

CAFF/FERMOD



1

GEV No.	701453	Ref. No.	6532023
description	handle latch L 150mm mounting distance 133mm metal heated units W 29.7mm type 790 / 791 total length 250mm handle length 100mm overall height 67mm		
For models:	CFE705RT, CFE707RT, CFE710RT, CFE714RT		

snap locks

universal



1

GEV No.	700803	Ref. No.	6532934
description	snap lock L 69mm W 12.5mm H 20mm mounting distance 57mm complete with door catch brass		



1

GEV No.	692609	Ref. No.	6532934
description	snap lock L 70mm W 13mm H 21mm mounting distance 60/30mm complete with door catch zamak		

producer-specific

AMBASSADE



1

GEV No.	692671	Ref. No.	65132002
description	snap lock L 59mm W 10mm H 15mm mounting distance 50mm complete with door catch thickness 2.4mm		



1

GEV No.	692670	Ref. No.	65139012
description	snap lock L 60mm W 19mm H 20mm mounting distance 50.5mm complete with door catch thickness 1.2mm		

hinges

edgmount hinges

CAFF/FERMOD



1

GEV No.	692669	Ref. No.	6532022
description	edgmount hinge L 96mm W 15/17mm mounting distance 64/32mm hinging left/right without lift centre of rotation 14/23mm		
For models:	CFE705RT, CFE707RT, CFE710RT		

oven hinges

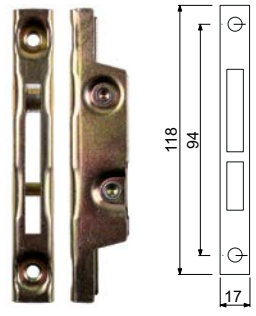

1

GEV No.	700001	Ref. No.	90001982
description	opposite support L 118mm W 17mm mounting distance 94mm		

			
1			
GEV No.	694789	Ref. No.	50129052 65131010 6532729 65573700
description	opposite support mounting distance 94mm L 118mm W 17mm cut-out 8x59mm		
For models:	CG1051B, CG1051CTA, CG1051CTAE, CG1051EA, CG1051EAE, CG1051GA, CG1051GAE, CG1052CF, CG1052G, CG731CF, CG731CFE, CG731E, CG731G, CG741E, CG741G, CG831CF, CG831CFCT, CG831CFE, CG831CT, CG831E, CG831G		

			
1			
GEV No.	701404	Ref. No.	6532728
description	oven hinge mounting distance 118mm mounting distance 2mm lug mounting 14mm lever length 117mm groove distance 11mm spring thickness 4mm mounting ear position left/right spring length 55mm L 155mm mounting pos. W 22mm		
For models:	CG1051B, CG1052CF, CG1052G, CG731CF, CG731CFCT, CG731CFE, CG731CT, CG731E, CG731G, CG741CT, CG741E, CG741G, CG831CF, CG831G		

miscellaneous

			
1			
GEV No.	701454	Ref. No.	65131015
description	oven hinge mounting distance 118mm lug mounting 13mm lever length 117mm groove distance 11mm spring thickness 4mm mounting ear position left spring length 55mm L 155mm W 22mm		

			
1			
GEV No.	692610	Ref. No.	7332993
description	hinge kit		

equipment feet and end caps

end caps and plugs

for circular pipes

			
1			
GEV No.	701455	Ref. No.	65131014
description	oven hinge mounting distance 118mm lug mounting 13mm lever length 117mm groove distance 11mm spring thickness 4mm mounting ear position right spring length 55mm L 155mm W 22mm		

			
1			
GEV No.	696659	Ref. No.	65149005
description	plug mounting ø 7mm ø 9.9mm H 8mm rubber Qty 4 pcs		

baskets

fryer baskets

AMBASSADE

			
1			
GEV No.	970878	Ref. No.	6536432
description	fryer basket W1 220mm L1 290mm H1 90mm L2 480mm H2 135mm H3 180mm metal hinged handle		
For models:	CME415FR, CME416FR, CME625FR, CME626FR		



			
1			
GEV No.	970879	Ref. No.	6537401
description	fryer basket W1 270mm L1 360mm H1 125mm L2 550mm H2 220mm H3 250mm metal hinged handle		
For models:	CME434FR		

gaskets

gaskets for heated units

door seals

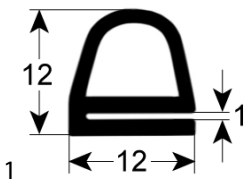
			
1			
GEV No.	902157	Ref. No.	65111018
description	door seal profile 2211 W 470mm L 590mm external size		

door seals with fixing hook

			
1			
GEV No.	901966	Ref. No.	6530952
description	door seal L 380mm W 220mm 4-sided with 4 mounting clips		

			
1			
GEV No.	901851	Ref. No.	6532911
description	door seal L 385mm W 360mm 4-sided with hook		

			
1			
GEV No.	902005 ¹	Ref. No.	65111022
description	door seal L 400mm W 290mm 3-sided long side open with mounting clip		

¹3-sided, long side open

			
1			
GEV No.	902003 ¹	Ref. No.	65111002
description	door seal L 410mm W 230mm 3-sided long side open with 4 mounting clips		
For models:	CG1052CF, CG1052G, CG1052GCT, CG641CT, CG641E, GC1052CFGCT		

¹3-sided, long side open

			
1			
GEV No.	901850	Ref. No.	65111034 6531833
description	door seal L 420mm W 315mm 4-sided with hook		

			
1			
GEV No.	902008	Ref. No.	65111016
description	door seal L 460mm W 405mm 4-sided with mounting clip		
For models:	CFE605RT		

			
1			
GEV No.	902009	Ref. No.	6532199
description	door seal L 460mm W 405mm 4-sided with mounting clip		

			
1			
GEV No.	902007	Ref. No.	65111003
description	door seal L 505mm W 405mm 4-sided with mounting clip		

			
1			
GEV No.	902004 ¹	Ref. No.	65111021
description	door seal L 515mm W 290mm 3-sided long side open with mounting clip		

¹3-sided, long side open



GEV No.	902002 ¹	Ref. No.	65111001
description	door seal L 545mm W 245mm 3-sided long side open with mounting clip		
For models:	CG1051CTA, CG1051CTAE, CG1051EA, CG1051EAE, CG1051GA, CG1051GAE, CG731CF, CG731CFCT, CG731CFE, CG731CT, CG731E, CG731G, CG741CT, CG741E, CG741G		

¹3-sided, long side open

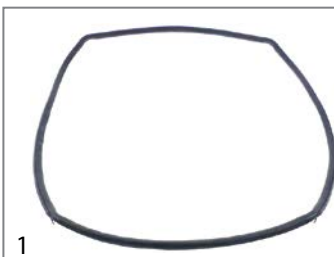

GEV No.	901965	Ref. No.	65111012
description	door seal L 580mm W 390mm 4-sided with mounting clip		
For models:	CFE705RT		



GEV No.	901963 ¹	Ref. No.	65111011
description	door seal L 590mm W 230mm 3-sided long side open with mounting clip		
For models:	CG831CF, CG831CFCT, CG831CFE, CG831CT, CG831E, CG831G		

¹3-sided, long side open



GEV No.	902006 ¹	Ref. No.	65111023
description	door seal L 600mm W 290mm 3-sided long side open with mounting clip		

¹3-sided, long side open

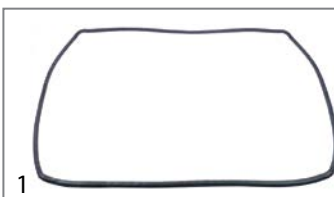

GEV No.	901964	Ref. No.	65111004
description	door seal L 680mm W 580mm 4-sided with 4 mounting clips		



GEV No.	901967	Ref. No.	65111013 65111027
description	door seal L 930mm W 565mm 4-sided with 5 mounting clips		
For models:	CFE714RT		



GEV No.	901961	Ref. No.	65111008
description	oven gasket L 220mm Wmm with 2 mounting clips		
For models:	CG1051B		



GEV No.	901962	Ref. No.	65111010
description	oven gasket L 875mm Wmm with 2 mounting clips		
For models:	CG1051B		

O-rings

EPDM

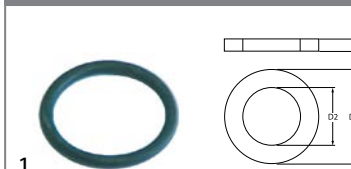

GEV No.	511521	Ref. No.	65119014
description	O-ring EPDM thickness 3.53mm ID ø 28.17mm Qty 10 pcs		

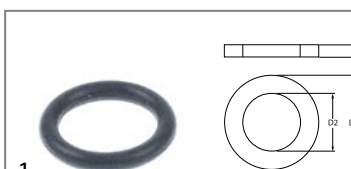

GEV No.	501413	Ref. No.	04087A
description	O-ring EPDM thickness 3mm ID ø 14mm Qty 1 pcs		



sealing washers

rubber gaskets



1

GEV No.	696658	Ref. No.	6552845
description	rubber gasket rubber ED \varnothing 11.5mm ID \varnothing 8mm thickness 1.9mm Qty 1 pcs		
For models:	CG1051B, CG1052G, CG641G, CG731G, CG831G		



1

GEV No.	696660	Ref. No.	65119021
description	rubber gasket silicone ED \varnothing 21mm ID \varnothing 12mm thickness 2mm Qty 1 pcs		

springs

compression springs



1

GEV No.	112063	Ref. No.	011564
description	knob spring \varnothing 24mm L 28mm wire gauge \varnothing 0.9mm		

tension springs



1

GEV No.	701452	Ref. No.	6551380
description	tension spring \varnothing 14.3mm total length 344mm wire gauge \varnothing 1.8mm thread L 72mm Qty 1 pcs		

hoses

industrial hoses

silicone hoses

without fabric



1

GEV No.	570042	Ref. No.	0228530
description	silicone hose ID \varnothing 8mm ED \varnothing 12mm L 5m		

fittings, hose and pipe connectors

fittings

double nipples



1

GEV No.	520662	Ref. No.	—
description	double nipple brass thread 1/4" - 1/4" Qty 1 pcs		



1

GEV No.	520682	Ref. No.	—
description	double nipple brass thread 1/4" - 3/8" Qty 1 pcs		

valves and tank inlets

ball valves

universal

ball valves with butterfly handle



1

GEV No.	540982	Ref. No.	65101004
description	ball valve connection 3/4" IT - 3/4" ET DN20 total length 69mm shaft \varnothing 8x5mm		

measuring equipment

thermometers

built-in thermometers

\varnothing 60mm



1

GEV No.	542180	Ref. No.	65224012
description	thermometer mounting \varnothing 60mm t.max. 400°C 0-400°C probe \varnothing 8mm probe L 150mm capillary pipe 1500mm		

fastening material

fasteners

retaining rings

DIN 471



1

GEV No.	698591	Ref. No.	65490005
description	retaining ring shaft ø 28mm thickness 1.5mm SS DIN 471		

A			
alarm devices	12		
audible timers	12		
B			
ball valves	27		
C			
cam switches	9		
contactors	12		
control equipment	10		
control thermostats	7		
D			
door seals	25		
door seals with fixing hook	25		
double nipples	27		
E			
edgemount hinges	23		
edgemount latches	23		
electric accessories	16		
electric timers	11		
end caps and plugs	24		
energy regulators	6		
F			
fans	14		
fasteners	28		
fastening material	28		
fittings	27		
G			
gas burners	17		
gas nozzles	20		
gas taps	16		
gas thermostats	16		
gaskets for heated units	25		
H			
handle latches	23		
heating elements	3		
heating elements for bain maries	3		
heating elements for convection	5		
heating elements for fryers	3		
heating elements for griddles	4		
heating elements for ovens	3		
heating elements for pasta cookers	4		
hob burners	17		
hoses	27		
hot air fans	15		
hot air motors	14		
hot plates		6	
I			
ignition units		17	
immersion heating elements		4	
indicator lights		10	
indicator lights (complete)		10	
industrial hoses		27	
L			
lamps		10	
M			
measuring equipment		27	
mechanical timers		12	
microswitches		9	
motors		15	
O			
O-rings		26	
oven hinges		23	
oven lamps		11	
P			
piezoelectric igniters		16	
probe clips		9	
push/momentary push switches		9	
R			
radiation heaters		5	
relays		13	
retaining rings		28	
ring burners		19	
rocker/momentary rocker switches		9	
S			
safety thermostats		8	
sealing washers		27	
silicone hoses		27	
snap locks		23	
solenoid valves		13	
spring clips		9	
switches and momentary switches		9	
T			
terminals		16	
thermocouples		17	
thermostats		7	
time relays		13	
timers		11	
V			
valves and tank inlets		27	