



GAS COMPONENTS



ELECTRIC COMPONENTS



WATER TECHNOLOGY



MECHANICAL COMPONENTS



TOOLS

Spare parts suitable for

ARISTARCO

Find the complete and up-to-date range of products in our GEV Webshop



Manufacturer catalogue

The most important spare parts and accessories arranged clearly for every manufacturer

- ✓ Complete product range and all appliance data always up to date in the GEV Webshop
- ✓ Alphabetical Index at the end of the catalogue

GEV Webshop

www.gev-online.co.uk

www.gev-online.com







- 🔍 Add to Favourites
- 🔍 Sign In with email address and usual password
- 🔍 Easy-order – place several items in your basket at the same time
- 🔍 Quick Item search – no login needed



heating elements

heating elements for bain maries

 <p>1</p>			
GEV No.	416244	Ref. No.	00000386
description	heating element 1000W 230V heating circuits 1 L 258mm W 34mm connection male faston 6.3mm tube ø 6.3mm 2 hole fixing thread 1/8" immersion heater H 35mm mounting distance 26mm		
For models:	GL4.32E, GL4.32EM, PROJECT28, PROJECT28E, PROJECT28EM		
accessories for	416244		
	GEV No.	361181	Ref. No. —
	nut thread 1/8" H 4.5mm nickel-plated brass WS 14 Qty 1 pcs		
	GEV No.	525780	Ref. No. —
	flat gasket copper ED ø 13mm ID ø 10.2mm thickness 1.5mm for thread 1/8" Qty 1 pcs		
	GEV No.	560192	Ref. No. —
	tooth lock washer ID ø 10.4mm ED ø 18mm SS DIN/ISO DIN 6798A Qty 1 pcs for thread M10		

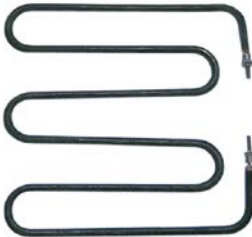
 <p>1</p>			
GEV No.	415726	Ref. No.	00001597
description	heating element 750W 230V L 180mm W 170mm H 18mm W1 45mm W2 80mm connection length 26mm tube ø 6.3mm windings 3 connection M4 dry heating element		
For models:	ORION-1, ORION-2, ORION-G1, ORION-G2, ORION-VTR1, ORION-VTR2		

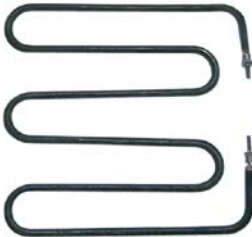
 <p>1</p>			
GEV No.	415727	Ref. No.	00001598
description	heating element 900W 230V L 180mm W 175mm H 15mm W1 42mm W2 91mm connection length 24mm tube ø 6.3mm windings 3 connection M4 dry heating element		
For models:	ORION-1, ORION-2, ORION-G1, ORION-G2, ORION-VTR1, ORION-VTR2		

heating elements for contact grills

 <p>1</p>			
GEV No.	416044	Ref. No.	00002396
description	heating element 1100W 230V L 180mm W 245mm H 23mm W1 65mm W2 115mm connection length 20mm tube ø 6.3mm windings 3 connection M4 dry heating element		
For models:	ORION-1.5, ORION-G1.5, ORION-VTR1.5		

 <p>1</p>			
GEV No.	416116	Ref. No.	00002397
description	heating element 1200W 230V L 183mm W 272mm H 16mm W1 55mm W2 162mm connection length 20mm tube ø 6.3mm windings 3 connection M4 dry heating element		
For models:	ORION-1.5, ORION-G1.5, ORION-VTR1.5		

heating elements for salamanders/toast-

 <p>1</p>			
GEV No.	416037	Ref. No.	00001104 00001104 DX
description	hot plate 400W 120V heating circuits 1 L 145mm W 150mm H 5mm cable length 175mm mounting pos. right for toaster		
For models:	TA-2, TA-3		

 <p>1</p>			
GEV No.	417536	Ref. No.	00001104 SX
description	hot plate 400W 120V L 145mm W 150mm H 5mm cable length 175mm mounting pos. left for toaster		

heating cartridges

			
1			
GEV No.	420320	Ref. No.	00003370
description	heating cartridge 150W 230V ø 12.6mm L 104mm thread 1/4" cable length 550mm connection female faston 6.3mm		
For models:	ALISEO40.28E, ALISEO45.32E, AW4028, AW45.32		

quartz heating elements

			
1			
GEV No.	416036	Ref. No.	00002524
description	heating coil 1000W 230V for quartz tube connection eye		
For models:	FORNO-EXPO-2P		

			
1			
GEV No.	416034	Ref. No.	00000603
description	heating coil 1000W 230V for quartz tube L1 245mm L2 180mm W 120mm ø 6.5mm connection eye		
For models:	FORNO-EXPO-3P, FORNO-EXPO-6P		

			
1			
GEV No.	417664	Ref. No.	00006989
description	quartz heating element 500W 110V L 370mm ø 15mm connection male faston 6.3mm		
For models:	FORNO3P, FORNO6P		

			
1			
GEV No.	416035	Ref. No.	00002523
description	quartz tube L 285mm ID ø 9mm ED ø 11mm		
For models:	FORNO-EXPO-2P		



			
1			
GEV No.	416020	Ref. No.	00000615
description	quartz tube WV L 390mm ID ø 9mm ED ø 11mm		
For models:	FORNO-EXPO-3P, FORNO-EXPO-6P		

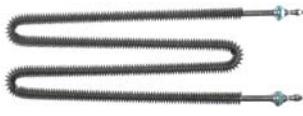

coil heating elements



			
1			
GEV No.	420319	Ref. No.	00005616
description	heating element 2300W 230V L 405mm W 135mm ø 18.5mm thread 1/4" connection M6 for dishwasher heating circuits 1 2 hole fixing		
For models:	TR1200, TR1650, TR1650N, TR2000, TR2500, TR3000, TR3500, TR4000, TR5000, TRC250, TRR2500		

immersion heating elements

3 hole flange ø60.0mm			
connection straight			
group 1			

			
1			
GEV No.	415166	Ref. No.	00001324
description	heating element 2000W 230V mounting ø 60mm heating circuits 1 L 180mm W 42mm H 65mm number of thermostat sleeves 1 thermostat sleeves ø 7mm length thermostat sleeves 170mm tube ø 6.3mm hole distance 83mm hole ø 10mm connection male faston 6.3mm 3 hole flange immersion heater		
For models:	AE35.21, AE38.25, AE40.29, AP35.21, AP35.21DA, AP38.25, AP38.25DA, AP40.28, AP40.28DA, AP40.29, AP40.29DA, COMPACT20, EURO350, EURO380, EURO400, GEMINICF, GEMINI-CF, GEMINI-CR, MINIBAR, MINIBAR-CF, MINIBAR-CR, PROGRAM25CF, PROGRAM25CR		
accessories for	415166		
	GEV No.	521121	Ref. No. 00000057 57
O-ring EPDM thickness 8mm ID ø 62mm Qty 1 pcs			



			
1			
GEV No.	420269	Ref. No.	00001323 1324
description	heating element 2500W 230V heating circuits 1 mounting ø 60mm L 185mm W 45mm H 45mm 3 hole flange connection male faston 6.3mm immersion heater tube ø 6.3mm thermostat sleeves ø 7.7mm number of thermostat sleeves 1 length thermostat sleeves 175mm thermostat sleeve centre not clinging		
For models:	AC20, AC25, AC26, AE35.21, AE38.25, AE40.29, AE40.30, AL40.28, AL40.28E, AL40.28EM, AP35.21, AP35.21DA, AP38.25, AP38.25DA, AP40.29, AP40.29DA, AP40.31, AP40.31DA, AS40.31, AS40.31DA, AS40.31DGT, AS40.31DGT-DA, COMPACT20, EURO400, GEMINICF, MINIBAR, MINIBAR-CF, MINIBAR-CR, PROGRAM25CF, PROJECT28, PROJECT28E, PROJECT28EM		
accessories for	420269		
	GEV No.	521121	Ref. No. 00000057 57
O-ring EPDM thickness 8mm ID ø 62mm Qty 1 pcs			

			
1			
GEV No.	418711	Ref. No.	00001294
description	heating element 3000W 230V mounting ø 60mm heating circuits 1 L 285mm W 42mm H 36mm number of thermostat sleeves 1 thermostat sleeves ø 7mm length thermostat sleeves 185mm tube ø 6.5mm hole distance 84mm hole ø 10mm connection male faston 6.3mm 3 hole flange immersion heater		
For models:	AE45.30, AL45.32, AL45.32E, AL45.32EM, AP45.30, AP45.30DA, GL4.32E, GL4.32EM, PASSPORT45.30, PASSPORT50.32, SELF4.32, SELF400		
accessories for	418711		
	GEV No.	521121	Ref. No. 00000057 57
O-ring EPDM thickness 8mm ID ø 62mm Qty 1 pcs			





with round flange ø60.0mm





GEV No.	415147	Ref. No.	00002126
description	heating element 6000W 230V heating circuits 3 mounting ø 60mm L 348mm W 34mm H 39mm round flange connection male faston 6.3mm immersion heater thermostat sleeves ø 7mm number of thermostat sleeves 1 length thermostat sleeves 175mm		
For models:	AL1200E, AL1500E, AL55.45E, AL55.45EM, AL55.45EM-P, AL55.45E-P, AP1000, AP55.40, AP55.40DA, GL1040, GL1240, GL5.34, GL5.34E, GL7.38, GL7.40E, GL8.50E, GL8.50EM, LP55-65, LP55-80, LP65-65, PASSPORT50.40		
accessories for	415147		
	GEV No.	529460	Ref. No. 2713
	O-ring EPDM thickness 5.34mm ID ø 59.69mm Qty 1 pcs		
	GEV No.	550002	Ref. No. 00001209 1209
	tension strap H 10mm L 21mm W 10mm hole ø 6.5mm for heating element		





GEV No.	416244	Ref. No.	00000386
description	heating element 1000W 230V heating circuits 1 L 258mm W 34mm connection male faston 6.3mm tube ø 6.3mm 2 hole fixing thread 1/8" immersion heater H 35mm mounting distance 26mm		
For models:	GL4.32E, GL4.32EM, PROJECT28, PROJECT28E, PROJECT28EM		
accessories for	416244		
	GEV No.	361181	Ref. No. —
	nut thread 1/8" H 4.5mm nickel-plated brass WS 14 Qty 1 pcs		
	GEV No.	525780	Ref. No. —
	flat gasket copper ED ø 13mm ID ø 10.2mm thickness 1.5mm for thread 1/8" Qty 1 pcs		
	GEV No.	560192	Ref. No. —
	tooth lock washer ID ø 10.4mm ED ø 18mm SS DIN/ISO DIN 6798A Qty 1 pcs for thread M10		







GEV No.	416246	Ref. No.	00001595
description	heating element 1090W 230V heating circuits 1 L 174mm W 34mm H 20mm L1 54mm L2 120mm thread M10x1 mounting distance 28mm tube ø 6.3mm 2 hole fixing connection male faston 6.3mm immersion heater		
For models:	GL4.32E, GL4.32EM, PROJECT28, PROJECT28E, PROJECT28EM, SELF4.32		
accessories for	416246		
	GEV No.	510416	Ref. No. —
	flat gasket fibre ED ø 19mm ID ø 10.5mm thickness 1.5mm for thread M10 Qty 1 pcs		
	GEV No.	510893	Ref. No. 00000697 697
	O-ring EPDM thickness 2.62mm ID ø 9.92mm Qty 1 pcs		
	GEV No.	520231	Ref. No. 00000267 267
	nut thread M10x1 H 6mm WS 14 zinc-coated steel Qty 1 pcs		





accessories for 416246

	GEV No.	521129	Ref. No.	—
nut thread M10 H 6mm SS WS 17 Qty 1 pcs DIN/ISO DIN 439				









GEV No.	415671	Ref. No.	00000200
description	heating element 1500W 230V heating circuits 1 L 245mm W 35mm Hmm thread M10x1 mounting distance 34mm tube ø 6.5mm connection length 20mm 2 hole fixing immersion heater connection male faston 6.3mm		
For models:	AL1200E, AL1500E, AL50.34E, AL50.34EM, AL50.40E, AL50.40EM		
accessories for	415671		
	GEV No.	510416	Ref. No. —
	flat gasket fibre ED ø 19mm ID ø 10.5mm thickness 1.5mm for thread M10 Qty 1 pcs		
	GEV No.	510893	Ref. No. 00000697 697
	O-ring EPDM thickness 2.62mm ID ø 9.92mm Qty 1 pcs		
	GEV No.	520231	Ref. No. 00000267 267
	nut thread M10x1 H 6mm WS 14 zinc-coated steel Qty 1 pcs		
	GEV No.	521129	Ref. No. —
	nut thread M10 H 6mm SS WS 17 Qty 1 pcs DIN/ISO DIN 439		







GEV No.	415145	Ref. No.	00001350
description	heating element 1500W 230V heating circuits 1 L 254mm W 36mm H 28mm thread M10x1 mounting distance 26mm tube ø 6.6mm connection male faston 6.3mm 2 hole fixing connection length 22mm immersion heater		
For models:	AE1000, AE1200, AE50.32, AE50.35, AH1000, AH1000Easy, AH1100, AH1100DGT, AH1200, AH1200DGT, AL50.34, AL50.34E, AL50.40, AL50.40E, AP1000, AP1200, AP50.32, AP50.32DA, AP50.35, AP50.35DA, AS50.35, AS50.35DA, AS50.35DGT, AS50.35DGT-DA, EURO500, GL1040, GL1240, GL5.34, GL5.34E, GL500CF, GL500CR, GL7.38, GL7.40E, GL7.40EM, GL700CF, GL700CR, GL8.50E, GL8.50EM, PASSPORT50.32		
accessories for	415145		
	GEV No.	510416	Ref. No. —
	flat gasket fibre ED ø 19mm ID ø 10.5mm thickness 1.5mm for thread M10 Qty 1 pcs		
	GEV No.	510893	Ref. No. 00000697 697
	O-ring EPDM thickness 2.62mm ID ø 9.92mm Qty 1 pcs		
	GEV No.	520231	Ref. No. 00000267 267
	nut thread M10x1 H 6mm WS 14 zinc-coated steel Qty 1 pcs		
	GEV No.	521129	Ref. No. —
	nut thread M10 H 6mm SS WS 17 Qty 1 pcs DIN/ISO DIN 439		

			
GEV No.	415144	Ref. No.	00000312
description	heating element 2000W 230V heating circuits 1 L 162mm W 30mm H 46mm thread M10x1 mounting distance 24mm tube ø 6.3mm connection male faston 6.3mm 2 hole fixing immersion heater		
For models:	AC25, AC26, GEMINICF, GEMINI-CF, GEMINI-CR, PROGRAM25CF, PROGRAM25CR		
accessories for	415144		
	GEV No.	510416	Ref. No. —
	GEV No.	510893	Ref. No. 00000697 697
	GEV No.	520231	Ref. No. 00000267 267
	GEV No.	521129	Ref. No. —

			
GEV No.	416247	Ref. No.	00002114
description	heating element 2000W 230V heating circuits 1 L 264mm W 38mm H 19mm thread M10x1 mounting distance 32mm tube ø 6.3mm connection male faston 6.3mm 2 hole fixing immersion heater		
For models:	AE35.21, AE38.25, AE40.29, AE40.30, AE45.30, AH1400, AL1400, AL40.28, AL40.28E, AL40.28EM, AL45.32, AL45.32E, AL45.32EM, AL50.45, AP1000, AP35.21, AP35.21DA, AP38.25, AP38.25DA, AP40.28, AP40.28DA, AP40.29, AP40.29DA, AP40.31, AP45.30, AP45.30DA, AP55.40, AP55.40DA, AS40.31, AS40.31DGT, AS50.40, AS50.40DA, AS50.40DGT, AS50.40DGT-DA, AU-H1400, AU-L55.45, AU-P55.40, AU-S55.40, AU-S55.40DGT, GL4.32E, GL4.32EM, GL8.50EM, LPC1500, PASSPORT45.30, PASSPORT50.40, PROJECT28, PROJECT28E, PROJECT28EM, SELF4.32, SELF400		
spare parts for	416247		
	GEV No.	510416	Ref. No. —
	GEV No.	510893	Ref. No. 00000697 697
	GEV No.	520231	Ref. No. 00000267 267
	GEV No.	521129	Ref. No. —

			
GEV No.	418911	Ref. No.	0002114P
description	heating element 2000W 230V heating circuits 1 L 264mm W 38mm H 21mm thread M10x1 mounting distance 32mm tube ø 6.3mm connection male faston 6.3mm		
For models:	EURO350, EURO380, EURO400		

			
GEV No.	416248	Ref. No.	00006445 6445T
description	heating element 2000W 230V heating circuits 1 L 335mm W 40mm Hmm thread M10x1 mounting distance 33mm tube ø 6.5mm connection length 21mm 2 hole fixing immersion heater connection male faston 6.3mm		
For models:	AL1400, AL55.45E, AL55.45EM, AL55.45EM-P, AL55.45E-P, LPC1500		
accessories for	416248		
	GEV No.	510416	Ref. No. —
	GEV No.	510893	Ref. No. 00000697 697
	GEV No.	520231	Ref. No. 00000267 267
	GEV No.	521129	Ref. No. —

foil heating elements



			
GEV No.	416249	Ref. No.	00004761
description	foil heating element L 120mm W 120mm 100W 230V t.max.°C without temperature limiter silicone cable length 200mm thickness 1mm		
For models:	ALISEO422, ALISEO428		





thermostats

bi-metal thermostats

safety bi-metal thermostats

 <p>1</p>			
GEV No.	390461	Ref. No.	00004066
description	bi-metal safety thermostat hole distance 23.8mm switch-off temp. 95°C 1NC 1-pole 16A connection F6.3 2 hole fixing		
For models:	AH1400, AL1200E, AL1400, AL1500E, AL40.28, AL40.28E, AL40.28EM, AL45.32, AL45.32E, AL45.32EM, AL50.34, AL50.34E, AL50.34EM, AL50.40, AL50.40E, AL50.40EM, AL50.45, AL55.45E, AL55.45EM, AL55.45EM-P, AL55.45E-P, ALISEO40.28E, ALISEO45.32E, AS40.31, AS40.31DA, AS40.31DGT, AS40.31DGT-DA, AS50.35, AS50.35DA, AS50.35DGT, AS50.35DGT-DA, AU-H1400, AU-L55.45, GL4.32E, GL4.32EM, GL5.34E, GL7.40E, GL7.40EM, GL8.50E, GL8.50EM, LP55-65, LP55-80, LP65-65, LPC1500, PASSPORT50.32, PROJECT28E, PROJECT28EM		
accessories for	390461		
 <p>GEV No. 550388 Ref. No. —</p> <p>bracket for contact thermostat mounting distance 24.5mm mounting ø 3.8</p>			

 <p>1</p>			
GEV No.	390462	Ref. No.	00004913
description	bi-metal safety thermostat hole distance 23.8mm switch-off temp. 105°C 1NC 1-pole 10A connection F6.3 1 hole fixing		
For models:	AE1000, AE1200, AE35.21, AE38.25, AE40.29, AE40.30, AE45.30, AE50.32, AE50.35, AH1000, AH1000Easy, AH1100, AH1100DGT, AH1200, AH1200DGT, AH1400, AL1200E, AL1400, AL1500E, AL40.28, AL40.28E, AL40.28EM, AL45.32, AL45.32E, AL45.32EM, AL50.34, AL50.34E, AL50.34EM, AL50.40, AL50.40E, AL50.40EM, AL50.45, AL55.45E, AL55.45EM, AL55.45EM-P, AL55.45E-P, ALISEO40.28E, ALISEO42, ALISEO428, ALISEO45.32E, AP1000, AP1200, AP35.21, AP35.21DA, AP38.25, AP38.25DA, AP40.28, AP40.28DA, AP40.29, AP40.29DA... (Other models you can see in the webshop)		
accessories for	390462		
 <p>GEV No. 550388 Ref. No. —</p> <p>bracket for contact thermostat mounting distance 24.5mm mounting ø 3.8</p>			

 <p>1</p>			
GEV No.	390318	Ref. No.	4066
description	bi-metal safety thermostat switch-off temp. 95°C 1-pole 2 hole fixing		

bi-metal thermostats



 <p>1</p>			
GEV No.	390906	Ref. No.	00006299
description	bi-metal thermostat hole distance 23.5mm switch-off temp. 60°C 1NC 1-pole AV connection F6.3 2 hole fixing Qty 1 pcs		
For models:	EURO350, EURO380, EURO400		

control and safety thermostats

IMIT / TEMPOMATIC / ARTERMO

control thermostats

 <p>1</p>			
GEV No.	390421	Ref. No.	00000359
description	thermostat t.max. 85°C temperature range 0-90°C 1-pole 1CO 16A probe ø 6.5mm probe L 95mm capillary pipe 1500mm capillary pipe isolated 1450mm gland nut shaft ø 6mm shaft Lmm shaft position rotation 270° probe material copper		
For models:	AC20, AC25, AC26, AE1000, AE1200, AE35.21, AE38.25, AE40.29, AE40.30, AE45.30, AE50.32, AE50.35, AH1000, AH1000Easy, AH1100, AH1200, AL1200E, AL1500E, AL40.28E, AL40.28EM, AL45.32E, AL45.32EM, AL50.34E, AL50.34EM, AL50.40E, AL50.40EM, AL55.45E, AL55.45EM, AL55.45EM-P, AL55.45E-P, ALISEO40.28E, ALISEO42, ALISEO428, ALISEO45.32E, AP1000, AP1200, AP35.21, AP35.21DA, AP38.25, AP38.25DA, AP40.28, AP40.28DA, AP40.29, AP40.29DA, AP40.31, AP40.31DA, AP45.30, AP45.30DA, AP50.32, AP50.32DA... (Other models you can see in the webshop)		

 <p>1</p>			
GEV No.	390006	Ref. No.	359
description	thermostat t.max. 86°C temperature range 0-86°C 1-pole 1CO 16A probe ø 6.5mm probe L 95mm capillary pipe 1500mm capillary pipe isolatedmm gland nut shaft ø 6x4.6mm shaft L 19mm rotation 270°		
accessories for	390006		
 <p>GEV No. 110100 Ref. No. —</p> <p>knob thermostat t.max. 90°C 0-90°C ø 42mm shaft ø 6x4.6mm shaft flat -135° black</p>			
 <p>GEV No. 110105 Ref. No. —</p> <p>rosette knob ø 42mm ø 56mm zero mark</p>			

electric components



control thermostats with operation switch

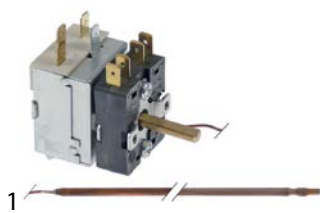

GEV No.	390904	Ref. No.	00003350
description	thermostat t.max. 300°C temperature range 67-300°C 1-pole 1CO 16A probe ø 3.5mm probe L 197mm capillary pipe 900mm capillary pipe isolated gland nut shaft ø 6x4.6mm shaft L 26mm shaft position upper rotation 270° probe material 2NO		
For models:	ORION-G1, ORION-G1.5, ORION-G2, ORION-VTR1, ORION-VTR1.5, ORION-VTR2		

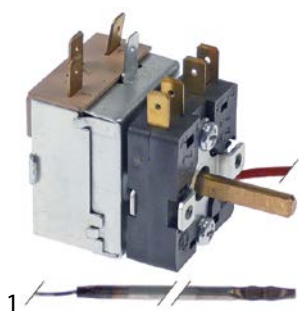

GEV No.	390905	Ref. No.	00003470
description	thermostat t.max. 300°C temperature range 76-300°C 1-pole 1CO 16A probe ø 3mm probe L 195mm capillary pipe 1030mm capillary pipe isolated 250mm gland nut shaft ø 6x4.6mm shaft L 26mm shaft position upper rotation 270° outer switch 2NO		
For models:	ORION-G1, ORION-G1.5, ORION-G2, ORION-VTR1, ORION-VTR1.5, ORION-VTR2		

safety thermostats



GEV No.	375972	Ref. No.	00002527
description	safety thermostat switch-off temp. 125°C 1-pole 1CO 16/0.5A probe ø 6.5mm probe L 78mm capillary pipe 1500mm capillary pipe isolated 1400mm gland nut probe material copper		
For models:	AU125-80, AU55-65, AU55-80, AU65-65, LP125-80, LP55-65, LP55-80, LP65-65, TR1650, TR1650N, TR2000, TR2500, TR3000, TR3500, TR4000, TRC250, TRR2500		

switches and momentary switches

rocker/momentary rocker switches

30x22mm



GEV No.	301188	Ref. No.	2383
description	rocker switch mounting measurements 30x22mm black 2NO/2NO 250V 16A I O II connection male faston 6.3mm ambient temperature max. 125/55°C protection IP40		
accessories for	301188		
	GEV No.	301036	Ref. No. —
	protective cover internal size 30x22mm for rocker switch mounting measurementsmm		

blank







GEV No.	301165	Ref. No.	00000001
description	rocker switch mounting measurements 30x22mm black 2CO 250V 16A connection male faston 6.3mm ambient temperature max. 125/55°C protection IP65 with cover cap		
For models:	GEMINI-CF, GEMINI-CR, GL1040, GL1240, GL5.34, GL500CF, GL500CR, GL7.38, GL700CF, GL700CR, PROGRAM25CF, PROGRAM25CR, PROJECT28, SELF4.32, SELF400		
accessories for	301165		
	GEV No.	301036	Ref. No. —
	protective cover internal size 30x22mm for rocker switch mounting measurementsmm		







GEV No.	346297	Ref. No.	1146
description	rocker switch mounting measurements 30x22mm orange 2NO 230V 16A illuminated connection male faston 6.3mm ambient temperature max. 125/55°C protection IP65		
accessories for	346297		
	GEV No.	301036	Ref. No. —
	protective cover internal size 30x22mm for rocker switch mounting measurementsmm		



labelled			
			
1			
GEV No.	301162	Ref. No.	00001146
description	momentary rocker switch mounting measurements 30x22mm orange 2NO 250V 16A illuminated connection male faston 6.3mm ambient temperature max. 100/55°C protection IP65 with cover cap		
For models:	COMPACT20, GEMINI-CF, GEMINI-CR, GL1040, GL1240, GL5.34, GL500CF, GL500CR, GL7.38, GL700CF, GL700CR, MASTER21, MINIBAR, MINIBAR-CF, MINIBAR-CR, PROGRAM25CF, PROGRAM25CR, PROJECT28, SELF4.32, SELF400		
accessories for	301162		
	GEV No.	301036	Ref. No. —
	protective cover internal size 30x22mm for rocker switch mounting measurementsmm		

			
1			
GEV No.	301163	Ref. No.	00002496
description	momentary rocker switch mounting measurements 30x22mm white 2NO 250V 16A illuminated connection male faston 6.3mm ambient temperature max. 100/55°C protection IP65 with cover cap		
For models:	COMPACT20, GEMINI-CF, GEMINI-CR, MASTER21, MINIBAR, MINIBAR-CF, MINIBAR-CR, PROGRAM25CF, PROGRAM25CR		
accessories for	301163		
	GEV No.	301036	Ref. No. —
	protective cover internal size 30x22mm for rocker switch mounting measurementsmm		

			
1			
GEV No.	301164	Ref. No.	00000364 2496
description	rocker switch mounting measurements 30x22mm green 2NO 250V 16A illuminated connection male faston 6.3mm ambient temperature max. 85°C protection IP65 with cover cap		
For models:	COMPACT20, EMA75, EMA80, EMALUX, GEMINI-CF, GEMINI-CR, GL1040, GL1240, GL5.34, GL500CF, GL500CR, GL7.38, GL700CF, GL700CR, GSN, MASTER21, MINIBAR, MINIBAR-CF, MINIBAR-CR, ORION-1, ORION-1.5, ORION-2, PROGRAM25CF, PROGRAM25CR, PROJECT28, SELF4.32, SELF400, SENT, SPF, SPN, TG, TGSP		
accessories for	301164		
	GEV No.	301036	Ref. No. —
	protective cover internal size 30x22mm for rocker switch mounting measurementsmm		

with symbol			
			
1			
GEV No.	301228	Ref. No.	1
description	rocker switch mounting measurements 30x22mm black 2CO 250V 16A I-II connection male faston 6.3mm ambient temperature max. 125/55°C protection IP65 with cover cap		
accessories for	301228		
	GEV No.	301036	Ref. No. —
	protective cover internal size 30x22mm for rocker switch mounting measurementsmm		

push/momentary push switches

ø16mm			
			
1			
GEV No.	301172	Ref. No.	00004043
description	momentary push switch mounting ø 16mm black 1NO 250V 16A connection male faston 6.3mm protection IP40 ambient temperature max. 150°C		
For models:	AC20, AC25, AC26, AE1000, AE1200, AE35.21, AE38.25, AE40.29, AE45.30, AE50.32, AL40.28EM, AL45.32EM, AL50.34EM, AL50.40EM, AL55.45EM, AL55.45EM-P, ALISEO422, ALISEO428, AP1000, AP1200, AP35.21, AP35.21DA, AP38.25, AP38.25DA, AP40.28, AP40.28DA, AP40.29, AP40.29DA, AP45.30, AP45.30DA, AP50.32, AP50.32DA, AP50.35, AP50.35DA, AP55.40, AP55.40DA, COMPACT20, EURO350, EURO380, EURO400, EURO500, GEMINICF, GEMINI-CF, GL1040, GL1240, GL4.32EM, GL7.40EM, GL8.50E, GL8.50EM, PASSPORT45.30... (Other models you can see in the webshop)		

			
1			
GEV No.	301173	Ref. No.	00004702
description	momentary push switch mounting ø 16mm black 2CO 250V 16A connection male faston 6.3mm protection IP40 ambient temperature max. 150°C		
For models:	ALISEO422, ALISEO428		

			
1			
GEV No.	301175	Ref. No.	00004373
description	push switch mounting ø 16mm black 2CO 250V 16A connection male faston 6.3mm protection IP40 ambient temperature max. 150°C		
For models:	AC25, AP50.35, AP50.35DA, GEMINICF, GL4.32EM, GL7.40EM, LP65-65, PROGRAM25CF, PROGRAM25CR, PROJECT28EM		

			
1			
GEV No.	301174	Ref. No.	00004042
description	push switch mounting ø 16mm black 2NO 250V 16A connection male faston 6.3mm protection IP40 ambient temperature max. 150°C		
For models:	AC20, AC25, AC26, AE1000, AE1200, AE35.21, AE38.25, AE40.29, AE45.30, AE50.32, AL1200E, AL1500E, AL40.28E, AL40.28EM, AL45.32E, AL45.32EM, AL50.34E, AL50.34EM, AL50.40E, AL50.40EM, AL55.45E, AL55.45EM, AL55.45EM-P, AL55.45E-P, ALISEO40.28E, ALISEO422, ALISEO428, ALISEO45.32E, AP1000, AP1200, AP35.21, AP35.21DA, AP38.25, AP38.25DA, AP40.28, AP40.28DA, AP40.29, AP40.29DA, AP45.30, AP45.30DA, AP50.32, AP50.32DA, AP50.35, AP50.35DA, AP55.40, AP55.40DA, AW4028, AW45.32, COMPACT20, EURO350...(Other models you can see in the webshop)		



ø25mm



1

GEV No.	300256	Ref. No.	K02508 K04133
description	push switch mounting ø 25mm white 2NO 250V 16A illuminated connection male faston 6.3mm ambient temperature max. 85°C protection IP65		

toggle switches

M12x0.75



1

GEV No.	345637	Ref. No.	00000632
description	toggle switch		
For models:	FORNO-EXPO-2P, FORNO-EXPO-3P, FORNO-EXPO-6P		

microswitches

lever actuated



1

GEV No.	345254	Ref. No.	00002384
description	microswitch with lever 250V 16A 1CO connection male faston 6.3mm ambient temperature max. 120°C mounting distance 22mm actuating force: 60g lever length 58mm		
For models:	AH1100, AH1100DGT, AH1200, AH1200DGT, AH1400, AL1200E, AL1400, AL1500E, AP1000, AP1200, AU125-80, AU55-65, AU55-80, AU65-65, AU-H1400, GL1040, GL1240, GL500CF, GL500CR, GL700CF, GL700CR, LP125-80, LP55-65, LP55-80, LP65-65, LPC1500, SELF400		



1

GEV No.	345812	Ref. No.	00006476
description	microswitch with lever 250V 10A 2CO connection male faston 6.3mm ambient temperature max. 85°C		
For models:	AL50.34E, AL50.34EM, AL50.40EM, AL55.45EM, AL55.45EM-P, AL55.45E-P		

roller-lever actuated

microswitches

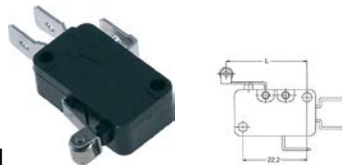

1

GEV No.	345041	Ref. No.	00000925
description	microswitch with handle with a switch 250V 16A 1CO connection male faston 6.3mm ambient temperature max. 85°C black lever length 20.5mm		
For models:	AC20, AC25, COMPACT20, EMA75, EMA80, GEMINICF, GEMINI-CF, GEMINI-CR, GSN, MIXER1, MIXER2, SENT, SPN, TG		

pin-plunger actuated





1

GEV No.	345105	Ref. No.	00001689 833
description	microswitch with plunger 250V 16A 1CO connection male faston 6.3mm L 28mm ambient temperature max. 125°C mounting distance 22mm type SM-51 actuating force: 280g black		
For models:	COMPACT20, EMA80, EMALUX, GEMINI-CF, GEMINI-CR, GL5.34, GL7.38, MASTER21, MINIBAR, MINIBAR-CF, MINIBAR-CR, MIXER1, MIXER2, PROGRAM25CF, PROGRAM25CR, PROJECT28, SELF4.32		

M10





1

GEV No.	347862	Ref. No.	00003528 00012271 + 2 x 00010273	
description	microswitch with plunger thread M10x0.75 thread L 18mm 230V 10A 1CO connection F6.3 stroke 4mm mounting distance 22mm ambient temperature max. 125°C type U83161.1 actuating force: 240g			
For models:	AE1000, AE35.21, AE38.25, AE40.29, AE45.30, AE50.32, AP35.21, AP35.21DA, AP38.25, AP38.25DA, AP40.29, AP40.29DA, AP45.30, AP45.30DA, AP50.32, AP50.32DA, AP50.35, AP50.35DA, AP55.40, AP55.40DA			
spare parts for	347862			
	GEV No.	347847	Ref. No.	—
	microswitch with plunger 250V 4A 1CO connection male faston 6.3mm ambient temperature max. 125°C mounting distance 22.2mm type U83161.1 actuating force: 240g white			
	GEV No.	519546	Ref. No.	00010273 10273
	nut thread M10x0.75 H 3.45mm WS 14 brass Qty 1 pcs			





			
1			
GEV No.	347864	Ref. No.	00012271 3528
description	microswitch with plunger thread M10x0.75 thread L 18mm 230V 10A 1CO connection male faston 6.3mm stroke 4mm mounting distancemm ambient temperature max. 125°C actuating force: 240g		
For models:	AE38.25, AE40.30, AE45.30, AE50.32, AE50.35, AP35.21, AP35.21DA		

M12			
			
1			
GEV No.	347865	Ref. No.	00009454
description	microswitch with plunger mounting distancemm thread M12 thread L 14mm 250V 12A 1CO connection male faston 6.3mm stroke 2mm ambient temperature max. 125°C type actuating force: 500g		
For models:	EURO350, EURO380, EURO400		

			
1			
GEV No.	345810	Ref. No.	00002651 00004088
description	microswitch with plunger thread M12 thread L 14mm 230V 12A 1CO connection male faston 6.3mm stroke 2mm ambient temperature max. 125°C type U83161.3 actuating force: 2000g		
For models:	AC26, AP35.21, AP35.21DA, AP38.25, AP38.25DA, AP40.28, AP40.28DA, AP55.40, AP55.40DA, EURO350, EURO380, EURO400, GL5.34, GL7.38, MASTER21, PASSPORT50.32, PROGRAM25CF, PROGRAM25CFR, PROJECT28, SELF4.32		

miscellaneous			
			
1			
GEV No.	345811	Ref. No.	00004159 2651
description	microswitch with plunger thread M12 thread L 14mm 250V 12A 2CO connection male faston 6.3mm stroke 3mm ambient temperature max. 125°C type U83161.1 actuating force: 1800g		
For models:	ALISEO422, ALISEO428, AP35.21, AP35.21DA, AP38.25, AP38.25DA, AP40.28, AP40.28DA, AP45.30, AP45.30DA, AP50.32, AP50.32DA, AP50.35, AP50.35DA, AP55.40, AP55.40DA, EURO500, GL4.32E, GL4.32EM, GL5.34E, GL7.40E, GL7.40EM, GL8.50E, GL8.50EM, PASSPORT45.30, PASSPORT50.32, PASSPORT50.40, PROGRAM25CF, PROGRAM25CFR, PROJECT28E, PROJECT28EM		

accessories			
			
Image not available			
1			
GEV No.	508189	Ref. No.	00002832
description	lever for microswitch		

system switches (ROLD)			
			
1			
GEV No.	345536	Ref. No.	00004046
description	element holder mounting ø 16mm flat black		
For models:	AP1000, AP35.21, AP35.21DA, AP38.25, AP38.25DA, AP40.28, AP40.28DA, AP45.30, AP45.30DA, AP50.32, AP50.32DA, AP50.35, AP50.35DA, AP55.40, AP55.40DA, EURO350, EURO380, EURO400, EURO500, FORNO2P, FORNO3P, FORNO4P, FORNO6P, LP55-65, TR1200		

			
1			
GEV No.	345601	Ref. No.	00004045
description	indicator lamp holder V ø 11mm		
For models:	AU125-80, AU55-65, AU55-80, AU65-65, LP125-80, LP55-65, LP55-80, LP65-65, TR1200		

			
1			
GEV No.	346228	Ref. No.	00004049
description	indicator light lens ø 12.2mm clear		
For models:	TR1200		

			
1			
GEV No.	359247	Ref. No.	00004047
description	indicator light lens ø 12.2mm green		

			
1			
GEV No.	359246	Ref. No.	00004048
description	indicator light lens ø 12.2mm yellow		



1

GEV No.	346244	Ref. No.	00006648
description	indicator light lens ø 23.3mm blue		
For models:	LP125-80, LP55-65, LP55-80, LP65-65		



1

GEV No.	346240	Ref. No.	00006647
description	indicator light lens ø 23.3mm green		
For models:	LP125-80, LP55-65, LP55-80, LP65-65		



1

GEV No.	346241	Ref. No.	00006639
description	indicator light lens ø 23.3mm yellow		
For models:	LP125-80, LP55-65, LP55-80, LP65-65		



1

GEV No.	345130	Ref. No.	00004322
description	momentary switch unit 1NO 250V 16A connection male faston 6.3mm		
For models:	AP1000, AP35.21, AP35.21DA, AP38.25, AP38.25DA, AP40.28, AP40.28DA, AP45.30, AP45.30DA, AP50.32, AP50.32DA, AP50.35, AP50.35DA, AP55.40, AP55.40DA, AU125-80, AU55-65, AU55-80, AU65-65, EURO350, EURO380, EURO400, EURO500, LP125-80, LP55-65, LP55-80, LP65-65, TR1200		



1

GEV No.	347193	Ref. No.	4322
description	momentary switch unit 1NO 250V 16A connection male faston 6.3mm		



1

GEV No.	345538	Ref. No.	00004044
description	push button ø 11.9mm black		
For models:	AP1000, AP35.21, AP35.21DA, AP38.25, AP38.25DA, AP40.28, AP40.28DA, AP45.30, AP45.30DA, AP50.32, AP50.32DA, AP50.35, AP50.35DA, AP55.40, AP55.40DA, EURO350, EURO380, EURO400, EURO500, FORNO2P, FORNO3P, FORNO4P, FORNO6P		



1

GEV No.	346816	Ref. No.	00006649
description	push button ø 23mm black		
For models:	LP125-80, LP55-65, LP55-80, LP65-65		



1

GEV No.	345720	Ref. No.	00004323
description	switch 2NO 250V 16A connection male faston 6.3mm		
For models:	AP1000, AP35.21, AP35.21DA, AP38.25, AP38.25DA, AP40.28, AP40.28DA, AP45.30, AP45.30DA, AP50.32, AP50.32DA, AP50.35, AP50.35DA, AP55.40, AP55.40DA, AU125-80, AU55-65, AU55-80, AU65-65, EURO350, EURO380, EURO400, EURO500, LP125-80, LP55-65, LP55-80, LP65-65, TR1200		

magnetic switches

accessories

magnets



1

GEV No.	347702	Ref. No.	00005678
description	magnet H 10mm ED ø 12mm		
For models:	TR1200, TR1650, TR1650N, TR2000, TR2500, TR3000, TR3500, TR4000, TRC250, TRR2500		

magnetic holders



1

GEV No.	523042	Ref. No.	00015198
description	magnet holder H 65mm thread M6 ø 16mm		



control equipment

LOVATO

			
1			
GEV No.	301171	Ref. No.	00004456 (old version)
description	contact block LAVATO 8 LM2T-C10 1NC max 690V 10A		

			
1			
GEV No.	301170	Ref. No.	00004450 (old version)
description	contact block LAVATO 8 LM2T-C10 1NO max 690V 10A		

plastic series

switch block brackets

			
1			
GEV No.	301169	Ref. No.	00004449
description	contact block holder		
For models:	AU125-80, AU55-65, AU55-80, AU65-65, LP125-80, LP55-65, LP55-80, LP65-65, PASSPORT50.40		

rotary switches

			
1			
GEV No.	301300	Ref. No.	00004452
description	rotary selector mounting measurements ø22mm 2NC/1NO complete		
For models:	AE1000, AE1200, AL55.45EM, AL55.45EM-P, AP1000, AP1200, AP55.40, AP55.40DA, GL1040, GL1240, GL8.50EM, LP55-65		

			
1			
GEV No.	301167	Ref. No.	00004452 (1NC/2NO)
description	rotary selector mounting measurements ø22mm black 1NC/2NO complete		

			
1			
GEV No.	301168	Ref. No.	00004453
description	rotary selector mounting measurements ø22mm black latching sequence 1-0-2		
For models:	AE1200, AP1000, AP1200, AP55.40, AP55.40DA, AU125-80, AU55-65, AU55-80, AU65-65, GL8.50E, GL8.50EM, LP125-80, LP55-65, LP55-80, LP65-65, PASSPORT50.40		

			
1			
GEV No.	346790	Ref. No.	00004453 old
description	rotary selector mounting measurements ø22mm black latching sequence 1-0-2		

lamps

indicator lights

indicator lights 2-piece (lens and indicator lamp)

indicator lamps for socket type SRZ / SDK / SDY / SFK

			
1			
GEV No.	359130	Ref. No.	00004051
description	indicator lamp 230V clear connection male faston 6.3mm ø 8mm		
For models:	AU125-80, AU55-65, AU55-80, AU65-65, LP125-80, LP55-65, LP55-80, LP65-65		

			
1			
GEV No.	359132	Ref. No.	00004050
description	indicator lamp green 250V connection male faston 6.3mm protection IP54 ambient temperature max. 85°C		
For models:	AU125-80, AU55-65, AU55-80, AU65-65, LP125-80, LP55-65, LP55-80, LP65-65		

indicator lights (complete)

ø 9mm

			
1			
GEV No.	359134	Ref. No.	00006204
description	indicator light ø 9mm 230V clear connection male faston 6.3mm temp.-resist. 120°C		
For models:	AP1000, AP35.21, AP35.21DA, AP38.25, AP38.25DA, AP40.28, AP40.28DA, AP45.30, AP45.30DA, AP50.32, AP50.32DA, AP50.35, AP50.35DA, AP55.40, AP55.40DA, EURO350, EURO380, EURO400, EURO500, PASSPORT50.32, PASSPORT50.40		





			
1			
GEV No.	359136	Ref. No.	00006207
description	indicator light ø 9mm 230V green connection male faston 6.3mm temp.-resist. 120°C		
For models:	AP1000, AP35.21, AP35.21DA, AP38.25, AP38.25DA, AP40.28, AP40.28DA, AP45.30, AP45.30DA, AP50.32, AP50.32DA, AP50.35, AP50.35DA, AP55.40, AP55.40DA, EURO350, EURO380, EURO400, EURO500, FORNO2P, FORNO3P, FORNO4P, FORNO6P, PASSPORT50.32, PASSPORT50.40		

			
1			
GEV No.	359137	Ref. No.	00006206
description	indicator light ø 9mm 230V yellow connection male faston 6.3mm temp.-resist. 120°C with lens		
For models:	AP1000, AP35.21, AP35.21DA, AP38.25, AP38.25DA, AP40.28, AP40.28DA, AP45.30, AP45.30DA, AP50.32, AP50.32DA, AP50.35, AP50.35DA, AP55.40, AP55.40DA, EURO350, EURO380, EURO400, EURO500, PASSPORT50.32, PASSPORT50.40		

ø10mm

with screw socket

			
1			
GEV No.	359791	Ref. No.	00001083
description	indicator light ø 10mm 230V green cable length 250mm		
For models:	COMPACT20, GEMINI-CF, GEMINI-CR, PROGRAM25CF, PROGRAM25CR, TA-2, TA-3		

			
1			
GEV No.	359105	Ref. No.	00000624
description	indicator light ø 10mm 230V green		
For models:	FORNO-EXPO-2P, FORNO-EXPO-3P, FORNO-EXPO-6P		

ø16mm



with plug-in socket

			
1			
GEV No.	359790	Ref. No.	00004092
description	indicator light ø 16mm 230V clear connection male faston 6.3mm		
For models:	AC20, AC25, AC26, AE1000, AE1200, AE35.21, AE38.25, AE40.29, AE45.30, AE50.32, AL40.28EM, AL45.32EM, AL50.34EM, AL50.40EM, AL55.45EM, AL55.45EM-P, ALISEO422, ALISEO428, AP1000, AP1200, AP35.21, AP35.21DA, AP38.25, AP38.25DA, AP40.29, AP40.29DA, AP45.30, AP45.30DA, AP50.32, AP50.32DA, AP50.35, AP50.35DA, AP55.40, AP55.40DA, COMPACT20, EURO350, EURO380, EURO400, GEMINICF, GEMINI-CF, GL1040, GL1240, GL4.32EM, GL7.40EM, GL8.50E, GL8.50EM, PASSPORT45.30, PASSPORT50.32, PROGRAM25CF, PROGRAM25CR...(Other models you can see in the webshop)		

			
1			
GEV No.	359788	Ref. No.	00004091
description	indicator light ø 16mm 230V green connection male faston 6.3mm		
For models:	AC20, AC25, AC26, AE1000, AE1200, AE35.21, AE38.25, AE40.29, AE45.30, AE50.32, AL40.28EM, AL45.32EM, AL50.34EM, AL50.40EM, AL55.45EM, AL55.45EM-P, ALISEO422, ALISEO428, AP1000, AP1200, AP35.21, AP35.21DA, AP38.25, AP38.25DA, AP40.29, AP40.29DA, AP45.30, AP45.30DA, AP50.32, AP50.32DA, AP50.35, AP50.35DA, AP55.40, AP55.40DA, COMPACT20, EURO350, EURO380, EURO400, GEMINICF, GEMINI-CF, GL1040, GL1240, GL4.32EM, GL7.40EM, GL8.50E, GL8.50EM, ORION-G1, ORION-G1.5, ORION-G2, ORION-VTR1...(Other models you can see in the webshop)		

			
1			
GEV No.	359789	Ref. No.	00004090
description	indicator light ø 16mm 230V yellow connection male faston 6.3mm		
For models:	AC20, AC25, AC26, AE1000, AE1200, AE35.21, AE38.25, AE40.29, AE45.30, AE50.32, AL40.28EM, AL45.32EM, AL50.34EM, AL50.40EM, AL55.45EM, AL55.45EM-P, ALISEO422, ALISEO428, AP1000, AP1200, AP35.21, AP35.21DA, AP38.25, AP38.25DA, AP40.29, AP40.29DA, AP45.30, AP45.30DA, AP50.32, AP50.32DA, AP50.35, AP50.35DA, AP55.40, AP55.40DA, COMPACT20, EURO350, EURO380, EURO400, GEMINICF, GEMINI-CF, GL1040, GL1240, GL4.32EM, GL7.40EM, GL8.50E, GL8.50EM, ORION-G1, ORION-G1.5, ORION-G2, ORION-VTR1...(Other models you can see in the webshop)		

30x22mm

			
1			
GEV No.	301166	Ref. No.	00000071
description	indicator light mounting measurements 30x22mm 230V blue		
For models:	COMPACT20, GEMINI-CF, GEMINI-CR, GL1040, GL1240, GL500CF, GL500CR, GL700CF, GL700CR, MASTER21, MINIBAR, MINIBAR-CF, MINIBAR-CR, PROGRAM25CF, PROGRAM25CR, PROJECT28, SELF4.32, SELF400		
accessories for	301166		
	GEV No.	301036	Ref. No. —
	protective cover internal size 30x22mm for rocker switch mounting measurementsmm		

			
1			
GEV No.	359156	Ref. No.	00001271
description	indicator light mounting measurements 30x22mm 230V yellow connection male faston 6.3mm temp.-resist. 125/55°C type RL2		
For models:	ORION-1, ORION-1.5, ORION-2		

timers

programme timers



Image not available

1

GEV No.	402907	Ref. No.	00010723
description	electronic timer L 80mm W 80mm model SYEN suitable for Aristarco		
For models:	AE1000, AE35.21, AE38.25, AE40.29, AE45.30, AE50.32, AP35.21, AP35.21DA, AP38.25, AP38.25DA, AP40.29, AP40.29DA, AP45.30, AP45.30DA, AP50.32, AP50.32DA, AP50.35, AP50.35DA		



2

GEV No.	360212	Ref. No.	00004190
description	timer CDC 11803 engines 1 chambers 3 operation time 120s 230V manif. no. 13190f motor type M48L ATS		
spare parts for	360212		
	GEV No.	360083	Ref. No.
			—
	motor CDC pinion ø 4.9mm teeth 10 230V turn direction left motor ø 47mm H 19.3mm motor type M48L ATS for timer		



1

GEV No.	360401	Ref. No.	00006615
description	timer CDC 11804F engines 1 chambers 4 operation time 18min 230V manif. no. 11804F1 / 6615 motor type M48R ATS		
For models:	AP35.21, AP35.21DA, AP38.25, AP38.25DA, AP40.28, AP40.28DA, AP40.29DA, AP45.30, AP45.30DA, AP50.32, AP50.32DA, AP50.35, AP50.35DA, AP55.40, AP55.40DA		
spare parts for	360401		
	GEV No.	360118	Ref. No.
			—
	motor CDC pinion ø 4.9mm teeth 10 230V voltage AC 50/60Hz turn direction right motor ø 47mm H 19.3mm motor type M48R ATS for timer cable length 260mm 1.9/2.5W		





1

GEV No.	360634	Ref. No.	K01387
description	timer CDC 11904 engines 1 chambers 4 operation time 18min 230V 50/60Hz manif. no. 11904F1BFE000.0000 motor type M48R ATS		



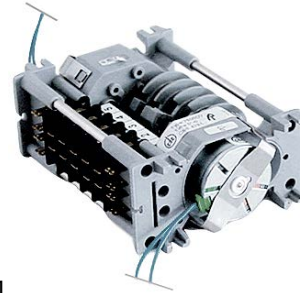

1

GEV No.	360270	Ref. No.	00005047
description	timer CDC 7805DV engines 2 chambers 5 operation time 6s / 3min 230V shaft ømm shaft Lmm manif. no. 7805DV / 5047 motor type M37RN/M37LN		
For models:	GL1040, GL1240		
spare parts for	360270		
	GEV No.	360119	Ref. No.
			—
	motor CDC pinion ø 5.4mm teeth 12 230V turn direction right motor ø 37mm motor type M37RN for timer		
	GEV No.	360131	Ref. No.
			—
	motor CDC pinion ø 5.4mm teeth 12 230V turn direction left motor ø 37mm motor type M37LN for timer		



1

GEV No.	360269	Ref. No.	00004781
description	timer CDC 7805DV engines 2 chambers 5 operation time 6s / 6min 230V shaft ømm shaft Lmm manif. no. 7805DV / 4781 motor type M37RN/M37LN		
For models:	AL55.45EM, AL55.45EM-P, AP55.40, AP55.40DA, GL8.50E, GL8.50EM, PASSPORT50.40		
spare parts for	360269		
	GEV No.	360119	Ref. No.
			—
	motor CDC pinion ø 5.4mm teeth 12 230V turn direction right motor ø 37mm motor type M37RN for timer		
	GEV No.	360131	Ref. No.
			—
	motor CDC pinion ø 5.4mm teeth 12 230V turn direction left motor ø 37mm motor type M37LN for timer		

mechanical timers



1

GEV No.	360707	Ref. No.	00004608
description	timer CDC 7805DV engines 2 chambers 5 operation time 6s / 9min 230V manif. no. 7805DV0CTE000.0000		
For models:	AU125-80, AU55-65, AU55-80, AU65-65, LP125-80, LP55-65, LP55-80, LP65-65		



1

GEV No.	360077	Ref. No.	00001623
description	timer CROUZET engines 1 chambers 2 operation time 120s 230V shaft ømm shaft Lmm manif. no. 627/5261 motor type 82340		
For models:	AC20, AC25, AE35.21, AE38.25, AE40.29, AE45.30, AE50.32, AL40.28EM, AL45.32EM, AL50.34EM, AL50.40EM, ALISEO422, ALISEO428, AP1000, AP35.21, AP35.21DA, AP38.25, AP38.25DA, AP40.28, AP40.28DA, AP40.29, AP40.29DA, AP45.30, AP45.30DA, AP50.32, AP50.32DA, AP50.35, AP50.35DA, COMPACT20, EURO350, EURO380, EURO400, EURO500, GEMINICF, GEMINI-CF, GEMINI-CR, GL1040, GL1240, GL4.32EM, GL5.34, GL500CF, GL500CR, GL7.38, GL7.40EM, GL700CF, GL700CR, MASTER21, MINIBAR, MINIBAR-CF, MINIBAR-CR... (Other models you can see in the webshop)		





1

GEV No.	360268	Ref. No.	00001144
description	timer CROUZET engines 1 chambers 4 operation time 18min 230V manif. no. 642/4966 motor type 82340		
For models:	MINIBAR-CF, MINIBAR-CR		





1

GEV No.	350176	Ref. No.	00001089	
description	timer C20 2-pole operation time 5min 2NO at 250V 16A permanent position no shaft ø 6x4.6mm shaft 6x4.6mm shaft L 20mm mounting distance 28mm			
For models:	TA-2, TA-3			
accessories for	350176			
	GEV No.	110366	Ref. No.	—
	knob switch zero mark t.max. °C ø 44mm shaft ø 6x4.6mm shaft flat upper black			
	GEV No.	112138	Ref. No.	—
	dial plate graduation 5min permanent position no rotation 0-290° ø 60mm			



1

GEV No.	350028	Ref. No.	00000629	
description	timer G 2-pole operation time 15min impulse mechanical 2NO at 250V 16A permanent position no shaft ø 3.5 x 3.5mm shaft 3.5x3.5mm shaft L 17mm mounting distance 28mm mounting thread M8 connection lateral			
For models:	FORNO-EXPO-2P, FORNO-EXPO-3P, FORNO-EXPO-6P			
accessories for	350028			
	GEV No.	110365	Ref. No.	—
	knob switch zero mark t.max. °C ø 44mm shaft ø 3.5x3.5mm shaft flat black			
	GEV No.	110371	Ref. No.	—
	dial plate graduation 15min permanent position no rotation 30-330° ø 60mm timers knob ø 45mm			



contactors

GENERAL ELECTRIC (AEG)

power contactors



1			
GEV No.	380238	Ref. No.	00000355
description	power contactor resistive load 20A 230VAC (AC3/400V) 8.4A/4kW main contacts 3NO auxiliary contacts 1NO connection screw connection type LS0510A type AEG LS0510A type GE MC1A 310A		
For models:	AE45.30, AL40.28E, AL40.28EM, AL45.32E, AL45.32EM, ALISEO40.28E, ALISEO422, ALISEO428, ALISEO45.32E, AP35.21, AP35.21DA, AP38.25, AP38.25DA, AP40.28, AP40.28DA, AP45.30, AP45.30DA, GL1040, GL1240, GL4.32E, GL4.32EM, GL5.34, GL500CF, GL500CR, GL7.38, GL7.40E, GL700CF, GL700CR, LP125-80, LP55-65, LP55-80, LP65-65, PASSPORT45.30, PROJECT28, PROJECT28E, PROJECT28EM, SELF4.32, SELF400		

ISKRA (FANAL)

power contactors



1			
GEV No.	380213	Ref. No.	00005140
description	power contactor resistive load 20A 230VAC (AC3/400V) 8.5A/5.5kW main contacts 3NO auxiliary contacts 1NO connection screw connection type Fanal DSL7 10 type ISKRA K07M 10		
For models:	AE1000, AE1200, AE45.30, AE50.32, AE50.35, AH1000, AH1000Easy, AH1100, AH1100DGT, AH1200, AH1200DGT, AL40.28, AL40.28E, AL45.32, AL45.32E, AL50.34, AL50.34E, AL50.34EM, AL50.40, AL50.40E, AL50.40EM, ALISEO40.28E, ALISEO45.32E, AP1000, AP1200, AP45.30, AP45.30DA, AP50.32, AP50.32DA, AP50.35, AP50.35DA, AP55.40, AP55.40DA, AS50.35, AS50.35DA, AS50.35DGT, AS50.35DGT-DA, AS50.40, AS50.40DA, AS50.40DGT, AS50.40DGT-DA, AU125-80, AU-P55.40, AU-S55.40, AU-S55.40DGT, AW4028, AW45.32, EMA75, EMA80, EURO500...(Other models you can see in the webshop)		



1			
GEV No.	380204	Ref. No.	00004375
description	power contactor resistive load 25A 230VAC (AC3/400V) 9A/4kW main contacts 3NO auxiliary contacts 1NO connection screw connection type Fanal DSL9 10 type ISKRA KNL9 10		
For models:	AH1100, AH1100DGT, AH1200, AH1200DGT, AH1400, AL1200E, AL1400, AL1500E, AL50.34E, AL50.45, AL55.45E, AL55.45EM, AL55.45EM-P, AL55.45E-P, AP1000, AP1200, AP55.40, AP55.40DA, AS50.40, AS50.40DA, AS50.40DGT, AS50.40DGT-DA, AU-H1400, AU-L55.45, AU-P55.40, AU-S55.40, AU-S55.40DGT, GL1040, GL1240, GL8.50E, GL8.50EM, LPC1500, PASSPORT50.40		

LOVATO

power contactors



1			
GEV No.	380708	Ref. No.	00001608
description	power contactor resistive load 20A 24VAC (AC3/400V) 9A/4kW main contacts 3NO auxiliary contacts 1NO connection screw connection type 11BG0910A24		
For models:	TR1200, TR1650, TR2000, TR2500, TR3000, TR3500, TR4000, TRC250, TRR2500		



1			
GEV No.	380718	Ref. No.	00005469
description	power contactor resistive load 32A 230VAC (AC3/400V) 18A/7.5kW main contacts 3NO auxiliary contacts 1NO connection screw connection type BF1810A230		

relays

power relays

with bracket mounting



1			
GEV No.	380312	Ref. No.	00002300
description	power relays FINDER 230VAC 10A 3CO connection male faston 4.8mm bracket mounting dimensions 52x32.2x36.5mm manuf. no. 60.63.8.230.0000		
For models:	GL1040, GL1240		

1

GEV No.	380368	Ref. No.	00004867
description	power relays ZETTLER ELECTRONICS 230VAC 30A 1NO/1NC connection male faston 6.3mm bracket mounting manuf. no. AZ 2280-1A-240AF AZ2280-1C-240AF		
For models:	ALISEO422, ALISEO428		





with male contacts
female contact 2.0mm

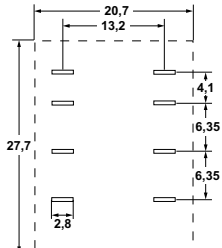

1



GEV No.	380129	Ref. No.	00005474
description	power relays 24VAC 12A 2CO connection F2 plug-in connection 94.92.3 250V connection 2mm		
For models:	TR1650, TR2000, TR2500, TR3000, TR3500, TR4000, TRC250, TRR2500		

accessories for	380129			
	GEV No.	380341	Ref. No.	—
	relay socket 4-pole contacts 12 300V voltage AC 6A Italiana Relè manuf. no. ZMD4			
	GEV No.	380378	Ref. No.	—
	relay socket 2-pole 55/85 dimensions 70.5x30x27mm 250V voltage AC 10A FINDER manuf. no. 94.72			
	GEV No.	380384	Ref. No.	—
	relay socket 2-pole contacts male faston 2.8mm 250V voltage AC 10A W 23mm for			
	GEV No.	380399	Ref. No.	—
	relay socket 4-pole dimensions 76.2x27x86.1mm 250V voltage AC 1A FINDER manuf. no. 94.94.3			

time relays



1

GEV No.	380075	Ref. No.	00005470 00005471
description	time relay LOVATO TM P time range 0.1s-240h 24-240VAC/24-48VDC 8A 1CO connection screw clamp		
For models:	AU125-80, LP125-80, TR1650, TR2000, TR2500, TR3000, TR3500, TR4000, TRC250, TRR2500		

probes
universal probes

temperature probes



1

GEV No.	379630	Ref. No.	00006902
description	temperature probe NTC 10kOhm cable thermoplastic probe -40 up to +110°C cable -40 up to +110°C probe ø6x14mm cable length 2.5m without screw connection 2-wire resistor 10kOhm		
For models:	AH1100DGT, AH1200DGT, AH1400, AL1200E, AL1400, AL1500E, AL40.28, AL40.28E, AL45.32, AL45.32E, AL50.34, AL50.34E, AL50.40, AL50.40E, AL50.45, AL55.45E, AL55.45E-P, ALISEO40.28E, ALISEO45.32E, AS40.31DGT, AS40.31DGT-DA, AS50.35DGT, AS50.35DGT-DA, AS50.40DGT, AS50.40DGT-DA, AU-H1400, AU-L55.45, AU-S55.40DGT, AW4028, AW45.32, LPC1500		

producer-specific probes

probes



1

GEV No.	379551	Ref. No.	00004122 00004213 00004214
description	temperature probe NTC 2.2kOhm cable PVC probe -40 up to +110°C cable -10 up to 100°C connection 2-wire thread probe ø6x17mm cable length 3m		
For models:	AL50.34E, AL55.45E-P, GL4.32E, GL5.34E, GL7.40E, PROJECT28E		

electronics
electronics accessories





1

GEV No.	696548	Ref. No.	00004107
description	handle for PCB L 30mm plastic thread M3 ø 8.3mm		
For models:	AL1200E, AL1500E, AL40.28E, AL45.32E, AL50.34E, AL50.40E, AL55.45E, AL55.45E-P, ALISEO40.28E, ALISEO45.32E, AW4028, AW45.32, GL4.32E, GL5.34E, GL7.40E, PROJECT28E		



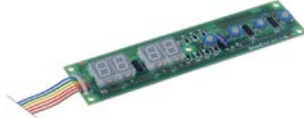

			
1			
GEV No.	520504	Ref. No.	00004350
description	mounting clip for PCB nominal-ø 5mm plastic L 16.5mm W 10mm mounting distancemm		
For models:	AC26, AE1000, AE1200, AE35.21, AE38.25, AE40.29, AE40.30, AE45.30, AE50.32, AE50.35, AH1000, AH1000Easy, AH1100, AH1100D-GT, AH1200, AH1200DGT, AH1400, AL1400, AL40.28, AL40.28E, AL40.28EM, AL45.32, AL45.32E, AL45.32EM, AL50.34, AL50.34E, AL50.34EM, AL50.40, AL50.40E, AL50.40EM, AL50.45, AL55.45E, AL55.45EM, AL55.45EM-P, AL55.45E-P, AP1000, AP1200, AP35.21, AP35.21DA, AP38.25, AP38.25DA, AP40.29, AP40.29DA, AP40.31, AP40.31DA, AP45.30, AP45.30DA, AP50.32, AP50.32DA, AP50.35... (Other models you can see in the webshop)		

			
1			
GEV No.	402948	Ref. No.	00006916 00006916+4x00013770
description	keypad PCB dishwasher AL40.28/AL1200 L 165mm W 38mm with digital display buttons 4		
For models:	AL1200E, AL1500E, AL40.28E, AL45.32E, AL50.34E, AL50.40E, AL55.45E, AL55.45E-P, ALISEO40.28E, ALISEO45.32E, AW4028, AW45.32		
accessories for	402948		
			
GEV No.	696548	Ref. No.	00004107 4107
description	handle for PCB L 30mm plastic thread M3 ø 8.3mm		

PCBs

			
1			
GEV No.	403329	Ref. No.	00015482
description	electronic timer dishwasher NOALIA/AE1000/AE1200 L 80mm W 122mm Qty 1 pcs		

			
1			
GEV No.	403233	Ref. No.	00009498
description	PCB dishwasher AL 45/55 L 110mm W 104mm		
For models:	AL55.45E, AL55.45E-P		

			
1			
GEV No.	403612	Ref. No.	00010940 00015804 10940+4350 15482
description	electronic timer dishwasher NOALIA/AE1000/AE1200 L 82mm W 133mm		
For models:	AC26, AE1000, AE38.25, AE40.29, AE40.30, AE45.30, AE50.32, AE50.35, AH1000Easy, AP35.21, AP35.21DA, AP38.25, AP38.25DA, AP40.29, AP40.29DA, AP40.31, AP45.30, AP45.30DA, AP50.32, AP50.32DA, AP50.35, AP50.35DA, AS40.31, PROGRAM25CF		

			
1			
GEV No.	403232	Ref. No.	00003303
description	PCB dishwasher ALISEO 40/45 L 107mm W 104mm		
For models:	ALISEO40.28E, ALISEO45.32E, AW4028, AW45.32		

			
1			
GEV No.	403224	Ref. No.	00010846
description	electronic timer L 80mm suitable for 122		
For models:	AE1000, AE1200, AE50.32, AE50.35, AH1000, AH1100, AH1200, AP1000, AP1200, AP35.21DA, AP38.25DA, AP40.29DA, AP40.31DA, AP45.30DA, AP50.32DA, AP50.35, AP50.35DA, AP55.40, AP55.40DA, AS40.31DA, AS50.35, AS50.35DA, AS50.40, AS50.40DA, AU-P55.40, AU-S55.40		

			
1			
GEV No.	403235	Ref. No.	00004105
description	PCB dishwasher L 70mm W 61mm for drain pump H 42mm Qty 1 pcs		

keypads

front foils



1

GEV No.	403096	Ref. No.	00009444
description	PCB for dishwasher L 109mm W 104mm		
For models:	AL1200E, AL1500E		



1

GEV No.	402883	Ref. No.	00006478
description	PCB for dishwasher L 110mm W 103mm		
For models:	AL40.28E, AL45.32E, AL50.34E, AL50.40E		

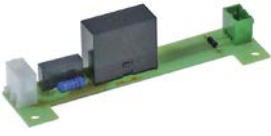

1

GEV No.	401875	Ref. No.	00006917
description	PCB for dishwasher L 110mm W 27mm 12V 16A voltage DC		
For models:	ALISEO40.28E, ALISEO45.32E, AW4028, AW45.32		

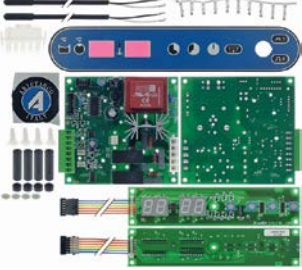

1

GEV No.	403871	Ref. No.	00017606
description	PCB kit conversion kit		
accessories for	403871		
	GEV No.	Ref. No.	
	694974	00011425	
	front panel L 555mm W 40mm H 75mm for AL50.34E/50.40E		



1

GEV No.	508348	Ref. No.	00004776
description	front foil		
For models:	GL4.32EM		

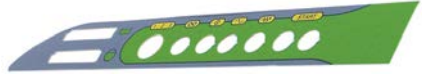

1

GEV No.	508352	Ref. No.	00005042
description	front foil		
For models:	GL1040, GL1240		



1

GEV No.	508000	Ref. No.	00010467
description	front foil dishwasher AP1000 L 370mm W 60mm		
For models:	AP1000, AP45.30, AP45.30DA, AP50.32, AP50.32DA, AP50.35, AP50.35DA, AP55.40, AP55.40DA		



1

GEV No.	508039	Ref. No.	00010468
description	front foil dishwasher AP35.21 L 370mm W 60mm		
For models:	AP35.21, AP35.21DA, AP38.25, AP38.25DA, AP40.29, AP40.29DA		



1

GEV No.	508342	Ref. No.	00003293
description	front foil dishwasher GL 1040-1240 L 385mm W 48mm		
For models:	GL1040, GL1240		



1

GEV No.	508186	Ref. No.	00006161
description	front foil ø 46mm		
For models:	AE1000		



1

GEV No.	403234	Ref. No.	00004305
description	keypad foil dishwasher AE50.35 L 396mm W 55mm buttons 5		



			
GEV No.	402947	Ref. No.	00006424
description	keypad foil dishwasher AL120/AL40/AL45 suitable for Aristarco L 253mm W 45mm		
For models:	AL1200E, AL1500E, AL40.28E, AL40.28EM, AL45.32E, AL50.34E, AL50.40E, AL55.45E, AL55.45E-P		

control panel

			
GEV No.	508346	Ref. No.	00002805
description	switch panel		
For models:	COMPACT20		

			
GEV No.	508347	Ref. No.	00002464
description	switch panel		
For models:	COMPACT20		

			
GEV No.	508351	Ref. No.	00006203
description	switch panel		
For models:	AP55.40, AP55.40DA, PASSPORT50.40		

			
GEV No.	508363	Ref. No.	00001688
description	switch panel		
For models:	GEMINI-CF, GEMINI-CR		

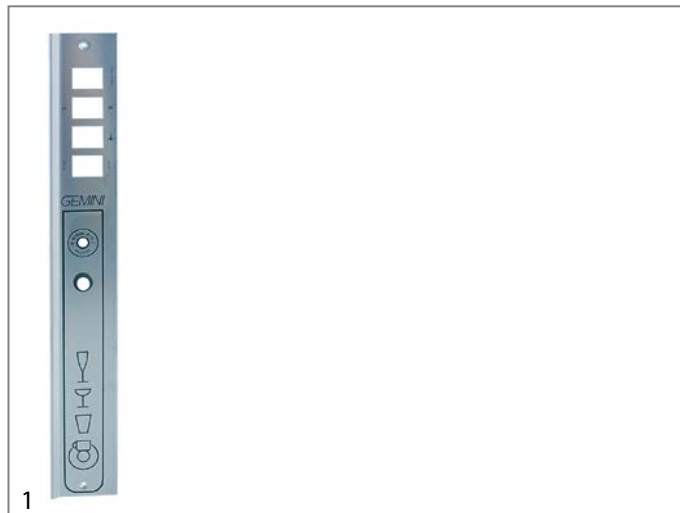



GEV No.	508364	Ref. No.	00001369
description	switch panel		
For models:	GEMINI-CF, GEMINI-CR		



			
GEV No.	508365	Ref. No.	00004776/00003183 4776/3183
description	switch panel		

			
GEV No.	508367	Ref. No.	00004244
description	switch panel		
For models:	GL4.32E		

 <p>Image not available</p>			
GEV No.	508368	Ref. No.	00006351
description	switch panel		
For models:	AL55.45E-P		

			
GEV No.	508350	Ref. No.	00006202
description	switch panel L 370mm H 65mm		
For models:	AP1000, AP45.30, AP45.30DA, AP50.32, AP50.32DA, AP50.35, AP50.35DA, PASSPORT50.32		
accessories for	508350		
	GEV No.	508358	Ref. No.
			00006224 6224
blank plastic H 10.3mm mounting ø 17.5mm ID ø 13.4mm			



			
1			
GEV No.	508349	Ref. No.	00006201
description	switch panel L 370mm W 65mm		
For models:	AP35.21, AP35.21DA, AP38.25, AP38.25DA, AP40.28, AP40.28DA		
accessories for	508349		
	GEV No.	508358	Ref. No. 00006224 6224
	blank plastic H 10.3mm mounting ø 17.5mm ID ø 13.4mm		

			
1			
GEV No.	508384	Ref. No.	00010543
description	switch panel suitable for AP1000		
For models:	AP1000		

			
1			
GEV No.	508385	Ref. No.	00010629
description	switch panel suitable for AP1000 1,2,3		

 Image not available			
1			
GEV No.	508393	Ref. No.	N/A
description	switch panel suitable for AP1000 1,2,3 complete		

 Image not available			
1			
GEV No.	508392	Ref. No.	N/A
description	switch panel suitable for AP1000 complete		

			
1			
GEV No.	508378	Ref. No.	00010537
description	switch panel suitable for AP35.21		
For models:	AP35.21, AP35.21DA		

 Image not available			
1			
GEV No.	508386	Ref. No.	N/A
description	switch panel suitable for AP35.21 complete		

 Image not available			
1			
GEV No.	508379	Ref. No.	00010538
description	switch panel suitable for AP38.25		
For models:	AP38.25, AP38.25DA		

 Image not available			
1			
GEV No.	508387	Ref. No.	N/A
description	switch panel suitable for AP38.25 complete		

			
1			
GEV No.	508380	Ref. No.	00010539
description	switch panel suitable for AP40.28		
For models:	AP40.29, AP40.29DA		

 Image not available			
1			
GEV No.	508388	Ref. No.	N/A
description	switch panel suitable for AP40.28 complete		

			
1			
GEV No.	508381	Ref. No.	00010540
description	switch panel suitable for AP45.30		
For models:	AP45.30, AP45.30DA		



 <p>Image not available</p>			
1			
GEV No.	508389	Ref. No.	N/A
description	switch panel suitable for AP45.30 complete		

			
2			
GEV No.	508382	Ref. No.	00010541
description	switch panel suitable for AP50.32		
For models:	AP50.32, AP50.32DA, AP50.35, AP50.35DA		

			
1			
GEV No.	508390	Ref. No.	N/A
description	switch panel suitable for AP50.32 complete		

			
1			
GEV No.	508383	Ref. No.	00010542
description	switch panel suitable for AP55.40		
For models:	AP55.40, AP55.40DA		

 <p>Image not available</p>			
1			
GEV No.	508391	Ref. No.	N/A
description	switch panel suitable for AP55.40 complete		

solenoid valves

solenoid valves (water)

RPE			
			
1			
GEV No.	374015	Ref. No.	N/A
description	solenoid valve single angled 230VAC inlet 3/4" outlet 10mm input 10-12l/min DN10 RPE flow regulating valve inlet white		

























TP			
			
1			
GEV No.	370021	Ref. No.	3269
description	solenoid valve double straight 230VAC inlet 3/4" outlet 11.5mm DN10 TP flow regulating valve inlet white		
spare parts for	370021		
			
GEV No.	371013	Ref. No.	—
description	solenoid coil TP 230VAC 50/60Hz		
accessories for	370021		
			
GEV No.	371220	Ref. No.	—
description	reducer TP flow rate 3l/min red tolerance ±15%		
			
GEV No.	371221	Ref. No.	—
description	reducer TP flow rate 5.5l/min yellow tolerance ±15%		
			
GEV No.	371222	Ref. No.	—
description	reducer TP flow rate 6l/min grey tolerance ±15%		
			
GEV No.	371223	Ref. No.	—
description	reducer TP flow rate 10l/min white tolerance ±15%		
			
GEV No.	371224	Ref. No.	—
description	reducer TP flow rate 12l/min bronze tolerance ±15%		
			
GEV No.	371225	Ref. No.	—
description	reducer TP flow rate 16l/min light brown tolerance ±15%		
			
GEV No.	371226	Ref. No.	—
description	reducer TP flow rate 20l/min red tolerance ±15%		
			
GEV No.	371230	Ref. No.	—
description	reducer TP flow rate 0.25l/min red tolerance ±25%		
			
GEV No.	371231	Ref. No.	—
description	reducer TP flow rate 0.35l/min violet tolerance ±25%		
			
GEV No.	371232	Ref. No.	—
description	reducer TP flow rate 0.5l/min orange tolerance ±25%		
			
GEV No.	371233	Ref. No.	—
description	reducer TP flow rate 0.8l/min white tolerance ±25%		
			
GEV No.	371234	Ref. No.	—
description	reducer TP flow rate 1l/min light blue tolerance ±25%		
			
GEV No.	371235	Ref. No.	—
description	reducer TP flow rate 1.2l/min brown tolerance ±25%		
			
GEV No.	371236	Ref. No.	—
description	reducer TP flow rate 1.5l/min light brown tolerance ±25%		

Table continues overleaf

accessories for 370021				
	GEV No.	371237	Ref. No.	—
reducer TP flow rate 2.5l/min yellow tolerance ±25%				
	GEV No.	371238	Ref. No.	—
reducer TP flow rate 3.4l/min dark green tolerance ±25%				
	GEV No.	371239	Ref. No.	—
reducer TP flow rate 5l/min black tolerance ±25%				
	GEV No.	371240	Ref. No.	—
reducer TP flow rate 8l/min blue tolerance ±20%				

 <p>1</p>				
GEV No.	370019	Ref. No.	148	
description	solenoid valve double angled 230VAC inlet 3/4" outlet 11.5mm DN10 TP plastic			
spare parts for	370019			
	GEV No.	371013	Ref. No.	—
solenoid coil TP 230VAC 50/60Hz				
accessories for	370019			
	GEV No.	371220	Ref. No.	—
reducer TP flow rate 3l/min red tolerance ±15%				
	GEV No.	371221	Ref. No.	—
reducer TP flow rate 5.5l/min yellow tolerance ±15%				
	GEV No.	371222	Ref. No.	—
reducer TP flow rate 6l/min grey tolerance ±15%				
	GEV No.	371223	Ref. No.	—
reducer TP flow rate 10l/min white tolerance ±15%				
	GEV No.	371224	Ref. No.	—
reducer TP flow rate 12l/min bronze tolerance ±15%				
	GEV No.	371225	Ref. No.	—
reducer TP flow rate 16l/min light brown tolerance ±15%				
	GEV No.	371226	Ref. No.	—
reducer TP flow rate 20l/min red tolerance ±15%				
	GEV No.	371230	Ref. No.	—
reducer TP flow rate 0.25l/min red tolerance ±25%				
	GEV No.	371231	Ref. No.	—
reducer TP flow rate 0.35l/min violet tolerance ±25%				
	GEV No.	371232	Ref. No.	—
reducer TP flow rate 0.5l/min orange tolerance ±25%				

accessories for 370019				
	GEV No.	371233	Ref. No.	—
reducer TP flow rate 0.8l/min white tolerance ±25%				
	GEV No.	371234	Ref. No.	—
reducer TP flow rate 1l/min light blue tolerance ±25%				
	GEV No.	371235	Ref. No.	—
reducer TP flow rate 1.2l/min brown tolerance ±25%				
	GEV No.	371236	Ref. No.	—
reducer TP flow rate 1.5l/min light brown tolerance ±25%				
	GEV No.	371237	Ref. No.	—
reducer TP flow rate 2.5l/min yellow tolerance ±25%				
	GEV No.	371238	Ref. No.	—
reducer TP flow rate 3.4l/min dark green tolerance ±25%				
	GEV No.	371239	Ref. No.	—
reducer TP flow rate 5l/min black tolerance ±25%				
	GEV No.	371240	Ref. No.	—
reducer TP flow rate 8l/min blue tolerance ±20%				









































 <p>1</p>				
GEV No.	370020	Ref. No.	00000148	
description	solenoid valve double angled 230VAC inlet 3/4" outlet 14mm DN10 TP			
For models:	AU55-65, AU55-80, AU65-65, GL4.32E, GL4.32EM, LP55-65, LP55-80, LP65-65, MASTER21, PROJECT28, PROJECT28E, PROJECT28EM, SELF4.32, SELF400			
spare parts for	370020			
	GEV No.	371013	Ref. No.	—
solenoid coil TP 230VAC 50/60Hz				
accessories for	370020			
	GEV No.	371220	Ref. No.	—
reducer TP flow rate 3l/min red tolerance ±15%				
	GEV No.	371221	Ref. No.	—
reducer TP flow rate 5.5l/min yellow tolerance ±15%				
	GEV No.	371222	Ref. No.	—
reducer TP flow rate 6l/min grey tolerance ±15%				
	GEV No.	371223	Ref. No.	—
reducer TP flow rate 10l/min white tolerance ±15%				
	GEV No.	371224	Ref. No.	—
reducer TP flow rate 12l/min bronze tolerance ±15%				

Table continues overleaf



accessories for		370020		
	GEV No.	371225	Ref. No.	—
reducer TP flow rate 16l/min light brown tolerance ±15%				
	GEV No.	371226	Ref. No.	—
reducer TP flow rate 20l/min red tolerance ±15%				
	GEV No.	371230	Ref. No.	—
reducer TP flow rate 0.25l/min red tolerance ±25%				
	GEV No.	371231	Ref. No.	—
reducer TP flow rate 0.35l/min violet tolerance ±25%				
	GEV No.	371232	Ref. No.	—
reducer TP flow rate 0.5l/min orange tolerance ±25%				
	GEV No.	371233	Ref. No.	—
reducer TP flow rate 0.8l/min white tolerance ±25%				
	GEV No.	371234	Ref. No.	—
reducer TP flow rate 1l/min light blue tolerance ±25%				
	GEV No.	371235	Ref. No.	—
reducer TP flow rate 1.2l/min brown tolerance ±25%				
	GEV No.	371236	Ref. No.	—
reducer TP flow rate 1.5l/min light brown tolerance ±25%				
	GEV No.	371237	Ref. No.	—
reducer TP flow rate 2.5l/min yellow tolerance ±25%				
	GEV No.	371238	Ref. No.	—
reducer TP flow rate 3.4l/min dark green tolerance ±25%				
	GEV No.	371239	Ref. No.	—
reducer TP flow rate 5l/min black tolerance ±25%				
	GEV No.	371240	Ref. No.	—
reducer TP flow rate 8l/min blue tolerance ±20%				

accessories for		370015		
	GEV No.	371223	Ref. No.	—
reducer TP flow rate 10l/min white tolerance ±15%				
	GEV No.	371224	Ref. No.	—
reducer TP flow rate 12l/min bronze tolerance ±15%				
	GEV No.	371225	Ref. No.	—
reducer TP flow rate 16l/min light brown tolerance ±15%				
	GEV No.	371226	Ref. No.	—
reducer TP flow rate 20l/min red tolerance ±15%				
	GEV No.	371230	Ref. No.	—
reducer TP flow rate 0.25l/min red tolerance ±25%				
	GEV No.	371231	Ref. No.	—
reducer TP flow rate 0.35l/min violet tolerance ±25%				
	GEV No.	371232	Ref. No.	—
reducer TP flow rate 0.5l/min orange tolerance ±25%				
	GEV No.	371233	Ref. No.	—
reducer TP flow rate 0.8l/min white tolerance ±25%				
	GEV No.	371234	Ref. No.	—
reducer TP flow rate 1l/min light blue tolerance ±25%				
	GEV No.	371235	Ref. No.	—
reducer TP flow rate 1.2l/min brown tolerance ±25%				
	GEV No.	371236	Ref. No.	—
reducer TP flow rate 1.5l/min light brown tolerance ±25%				
	GEV No.	371237	Ref. No.	—
reducer TP flow rate 2.5l/min yellow tolerance ±25%				
	GEV No.	371238	Ref. No.	—
reducer TP flow rate 3.4l/min dark green tolerance ±25%				
	GEV No.	371239	Ref. No.	—
reducer TP flow rate 5l/min black tolerance ±25%				
	GEV No.	371240	Ref. No.	—
reducer TP flow rate 8l/min blue tolerance ±20%				

 				
1				
GEV No.	370015	Ref. No.	394	
description	solenoid valve single angled 230VAC inlet 3/4" outlet 11.5mm DN10 TP			
accessories for	370015			
	GEV No.	371220	Ref. No.	—
reducer TP flow rate 3l/min red tolerance ±15%				
	GEV No.	371221	Ref. No.	—
reducer TP flow rate 5.5l/min yellow tolerance ±15%				
	GEV No.	371222	Ref. No.	—
reducer TP flow rate 6l/min grey tolerance ±15%				



1

GEV No.	370248	Ref. No.	00000394
description	solenoid valve single angled 230VAC inlet 3/4" outlet 14.5mm		
For models:	AC20, AC25, AC26, AE1000, AE1200, AE35.21, AE38.25, AE40.29, AE40.30, AE45.30, AE50.32, AE50.35, AH1000, AH1000Easy, AH1100, AH1100DGT, AH1200, AH1200DGT, AH1400, AL1200E, AL1400, AL1500E, AL40.28, AL40.28E, AL40.28EM, AL45.32, AL45.32E, AL45.32EM, AL50.34, AL50.34E, AL50.34EM, AL50.40, AL50.40E, AL50.40EM, AL50.45, AL55.45E, AL55.45EM, AL55.45EM-P, AL55.45E-P, ALISEO40.28E, ALISEO422, ALISEO428, ALISEO45.32E, AP1000, AP1200, AP35.21, AP35.21DA, AP38.25, AP38.25DA, AP40.28...(Other models you can see in the webshop)		

metal



SIRAI

2-way

L180-B series



1

GEV No.	370329	Ref. No.	3446	
description	solenoid valve 2-ways 24VAC inlet 1/2" outlet 1/2" connection 1/2" L 66mm DN 13.5mm slide-on receptacle compact -10 up to +90°C SIRAI type series L180-B coil type Z610A membranes NBR (water) p max 12bar p min 0.35bar			
spare parts for	370329			
	GEV No.	371070	Ref. No.	—
	solenoid coil 24VAC 10VA SIRAI coil type Z610A seat ø 10mm			
	GEV No.	371171	Ref. No.	—
	membrane series L180-B membrane type NBR (water)			
accessories for	370329			
	GEV No.	371091	Ref. No.	—
	power socket plug type DIN 43650B cable lengthmm small			

pressure switches

for warewashing

ø 58mm with male faston 6.3mm

with connection horizontal



1

GEV No.	541142	Ref. No.	00000351
description	pressure control pressure range 123/75mbar connection 6mm ø 58mm pressure connection horizontal warewashing		
For models:	AE1000, AH1400, AL1200E, AL1400, AL1500E, ALISEO422, ALISEO428, AP1000, AU-H1400, GL1040, GL1240, LP55-65, LP65-65, LPC1500		



1

GEV No.	541913	Ref. No.	00005594
description	pressure control pressure range 260/90mbar connection 6mm ø 58mm pressure connection horizontal warewashing pressure connection ø 6mm		
For models:	AU55-65, AU55-80, AU65-65, LP125-80, LP55-65, LP55-80, LP65-65, TR1200, TR1650, TR1650N, TR2000, TR2500, TR3000, TR3500, TR4000, TR5000, TRC250, TRR2500		



1

GEV No.	541140	Ref. No.	00035110
description	pressure control pressure range 55/30mbar connection 6mm ø 58mm pressure connection horizontal warewashing		
For models:	AC20, AC25, AC26, AE1000, AE1200, AE35.21, AE38.25, AE40.29, AE40.30, AE45.30, AE50.32, AE50.35, AH1000, AH1000Easy, AH1100, AH1100DGT, AH1200, AH1200DGT, AL40.28, AL40.28E, AL40.28EM, AL45.32, AL45.32E, AL45.32EM, AL50.34, AL50.34E, AL50.34EM, AL50.40, AL50.40E, AL50.40EM, AL50.45, AL55.45E, AL55.45EM, AL55.45EM-P, AL55.45E-P, AP1000, AP1200, AP35.21, AP35.21DA, AP38.25, AP38.25DA, AP40.28, AP40.28DA, AP40.29, AP40.29DA, AP40.31, AP40.31DA, AP45.30, AP45.30DA, AP50.32...(Other models you can see in the webshop)		



miscellaneous



1			
GEV No.	541914	Ref. No.	00005609
description	pressure control pressure range 300mbar connection 1/4" ø 34.5mm for dishwasher		
For models:	TR1200, TR1650, TR1650N, TR2000, TR2500, TR3000, TR5000		

for refrigeration

RANCO

DWFK series



1			
GEV No.	541853	Ref. No.	K00077+K01106+K00489
description	pressure control RANCO type HR10811A4R001 switching diff.bar pressure range 17.5bar		

electrodes



1			
GEV No.	403236	Ref. No.	00006984
description	level electrode M10x1.5 total length 54mm probe L 15mm insulated probe lengthmm connection M4 ø 20mm probe ø 5mm		
For models:	AL1200E, AL1500E, AL40.28E, AL45.32E, AL50.34E, AL50.40E, AL55.45E, AL55.45E-P		

compressors

ACC/ZEL

R404a/R507

HMBP monophase

High/Medium evaporation temperature above -20/-15 °C



1			
GEV No.	605028	Ref. No.	K04323
description	compressor coolant R404a/R507 type ML90TB 220-240V 50Hz HMBP fully hermetic 11.6kg 3/8HP cylinder capacity 8.85cm ³ CSIR H 175.5mmW 323W 418W 532W 666W 819W 990W 1181W 1391W test method ASHRAE ambient temperature max. 43°C		

pumps

wash and rinse pumps

ALBA (C&A)

pumps













1			
GEV No.	500366	Ref. No.	00001629 00004980
description	pump inlet ø 30mm outlet ø 30mm type C1629 230V 50Hz 1 phase 0.19kW 0.25HP L 180mm rotation direction right capacitor 10µF ALBA PUMPS (C&A)		
For models:	AC25, AC26, ALISEO422, ALISEO428, AP38.25, AP38.25DA, AP40.28, AP40.28DA, AP40.29, AP40.29DA, AP40.31, AP40.31DA, AS40.31, AS40.31DA, AS40.31DGT, AS40.31DGT-DA, GEMINICF, GEMINI-CF, GEMINI-CR, PROGRAM25CF, PROGRAM25CR, TR3500, TR4000, TR5000, TRC250, TRR2500		
spare parts for	500366		
	GEV No.	365015	Ref. No. 166
	operating capacitor capacity 10µF 400V tolerance 5%Hz ambient temperature max. -25 to +85°C ø 35.5mm L 59mm M8 plastic connection male faston 6.3mm protection		
	GEV No.	509018	Ref. No. 00004382 4382
	O-ring EPDM thickness 3.53mm ID ø 107.5mm Qty 1 pcs		

Table continues overleaf

spare parts for 500366			
	GEV No.	510693	Ref. No. 00004388 4388
mechanical shaft seal for shaft \varnothing 12mm slide ring ext. \varnothing 24mm slide ring H 15.5mm slide ring int. \varnothing 11mm counter ring mounting \varnothing 24mm height counter ring 8mm counter ring int. \varnothing 13.5mm			
	GEV No.	521045	Ref. No. —
pump cover ALBA PUMPS (C&A) inlet \varnothing 30mm outlet \varnothing 30mm rotation direction right			
	GEV No.	521233	Ref. No. 00004385 4385
impeller \varnothing 87mm H 21mm rotation direction right thread M7L shaft \varnothing 12mm shaft length 31mm blades 6			



1			
GEV No.	500372	Ref. No.	00010511
description	pump inlet \varnothing 45mm outlet \varnothing 40mm type C10511 230V 50Hz 1 phase 0.37kW 0.5HP L 200mm rotation direction right capacitor 12.5 μ F ALBA PUMPS (C&A)		
For models:	AE45.30, AP45.30, AP45.30DA, AP50.35, AP50.35DA, AS50.35, AS50.35DA, AS50.35DGT, AS50.35DGT-DA, GL4.32E, GL4.32EM, PAS-SPORT45.30, PROJECT28E, PROJECT28EM, SELF4.32, SELF400		
spare parts for 500372			
	GEV No.	365014	Ref. No. 00000234 234
operating capacitor capacity 12.5 μ F 450V tolerance 5%Hz ambient temperature max. -25 to +85°C \varnothing 35mm L 70mm M8 plastic connection male faston 6.3mm 45S.C3DS.12.5 protection			
	GEV No.	509021	Ref. No. 00004406 4406
impeller \varnothing 102mm H 32mm shaft intake \varnothing 9/8mm rotation direction right			
	GEV No.	510692	Ref. No. 00004387 4387
mechanical shaft seal for shaft \varnothing 11mm slide ring ext. \varnothing 24mm slide ring H 13mm counter ring mounting \varnothing 26mm height counter ring 8mm counter ring int. \varnothing 14mm			
	GEV No.	521531	Ref. No. 00004391 4391
pump cover ALBA PUMPS (C&A) inlet \varnothing 45mm outlet \varnothing 40mm turn direction right \varnothing 153mm ID \varnothing 127mm inner height 24mm			
	GEV No.	521709	Ref. No. 00004383 4383
O-ring EPDM thickness 3mm ID \varnothing 126mm Qty 1 pcs			



1			
GEV No.	500368	Ref. No.	00002868
description	pump inlet \varnothing 45mm outlet \varnothing 40mm type C2868 230V 50Hz 1 phase 0.74kW 1HP L 230mm rotation direction right capacitor 12.5 μ F ALBA PUMPS (C&A)		
For models:	AE1000, AE1200, AE50.32, AE50.35, AH1000, AH1000Easy, AL50.34, AL50.34E, AL50.34EM, AP50.32, AP50.32DA, AP50.35, AP50.35DA, AP55.40, AP55.40DA, EURO500, GL5.34, GL5.34E, GL7.38, PAS-SPORT50.32		
spare parts for 500368			
	GEV No.	365014	Ref. No. 00000234 234
operating capacitor capacity 12.5 μ F 450V tolerance 5%Hz ambient temperature max. -25 to +85°C \varnothing 35mm L 70mm M8 plastic connection male faston 6.3mm 45S.C3DS.12.5 protection			
	GEV No.	509021	Ref. No. 00004406 4406
impeller \varnothing 102mm H 32mm shaft intake \varnothing 9/8mm rotation direction right			
	GEV No.	510692	Ref. No. 00004387 4387
mechanical shaft seal for shaft \varnothing 11mm slide ring ext. \varnothing 24mm slide ring H 13mm counter ring mounting \varnothing 26mm height counter ring 8mm counter ring int. \varnothing 14mm			
	GEV No.	521044	Ref. No. —
fanwheel cover suitable for ALBA PUMPS (C&A) ID \varnothing 132mm ED \varnothing 138mm H 70mm for wash pump plastic			
	GEV No.	521531	Ref. No. 00004391 4391
pump cover ALBA PUMPS (C&A) inlet \varnothing 45mm outlet \varnothing 40mm turn direction right \varnothing 153mm ID \varnothing 127mm inner height 24mm			
	GEV No.	521709	Ref. No. 00004383 4383
O-ring EPDM thickness 3mm ID \varnothing 126mm Qty 1 pcs			



1

GEV No.	500367	Ref. No.	00005688
description	pump inlet ø 45mm outlet ø 40mm type C5688 230/400V 50Hz 3 phase 0.74kW 1HP L 250mm rotation direction right ALBA PUMPS (C&A)		
For models:	AP55.40, AP55.40DA, PASSPORT50.40		
spare parts for	500367		
	GEV No.	510692	Ref. No. 00004387 4387
	mechanical shaft seal for shaft ø 11mm slide ringext. ø 24mm slide ring H 13mm counter ring mounting ø 26mm height counter ring 8mm counter ring int. ø 14mm		
	GEV No.	521235	Ref. No. 00006645 6645
	impellor ø 102mm H 32mm		
	GEV No.	521531	Ref. No. 00004391 4391
	pump cover ALBA PUMPS (C&A) inlet ø 45mm outlet ø 40mm turn direction right ø 153mm ID ø 127mm inner height 24mm		
	GEV No.	521709	Ref. No. 00004383 4383
	O-ring EPDM thickness 3mm ID ø 126mm Qty 1 pcs		

spare parts for	500373		
	GEV No.	509030	Ref. No. —
	impellor ø 111mm H 40mm thread M8R blades 6		
	GEV No.	510693	Ref. No. 00004388 4388
	mechanical shaft seal for shaft ø 12mm slide ringext. ø 24mm slide ring H 15.5mm slide ring int. ø 11mm counter ring mounting ø 24mm height counter ring 8mm counter ring int. ø 13.5mm		



1

GEV No.	500371	Ref. No.	2532
description	pump inlet ø 62mm outlet ø 52mm type C2532 230/400V 50Hz 3 phase 0.88kW 1.2HP L 315mm rotation direction left ALBA PUMPS (C&A)		
spare parts for	500371		
	GEV No.	508395	Ref. No. 00004397 4397
	pump cover ALBA PUMPS (C&A) inlet ø 62mm outlet ø 52mm turn direction left ø 180mm ID ø 150mm inner height 38mm		
	GEV No.	510693	Ref. No. 00004388 4388
	mechanical shaft seal for shaft ø 12mm slide ringext. ø 24mm slide ring H 15.5mm slide ring int. ø 11mm counter ring mounting ø 24mm height counter ring 8mm counter ring int. ø 13.5mm		



1





GEV No.	500373	Ref. No.	00000424
description	pump inlet ø 62mm outlet ø 52mm type C2012 230/400V 50Hz 3 phase 1.12kW 1.5HP L 315mm rotation direction left ALBA PUMPS (C&A)		
For models:	GL1040, GL1240		
spare parts for	500373		
	GEV No.	508395	Ref. No. 00004397 4397
	pump cover ALBA PUMPS (C&A) inlet ø 62mm outlet ø 52mm turn direction left ø 180mm ID ø 150mm inner height 38mm		

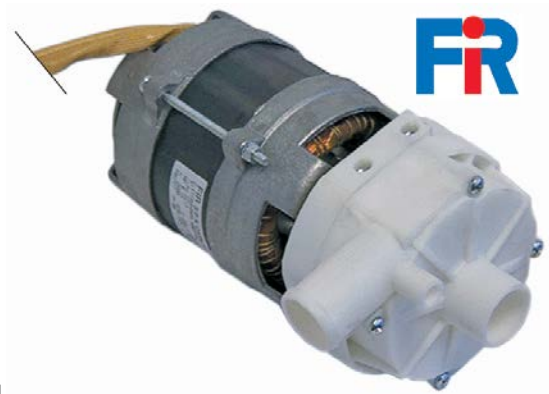

FIR





pumps





1			
GEV No.	500037	Ref. No.	00000397
description	pump inlet \varnothing 28mm outlet \varnothing 26mm type 2211.1410 230V 50Hz 1 phase 0.074kW 0.1HP L 190mm rotation direction left capacitor 5 μ F FIR		
For models:	AC20, AE35.21, AE38.25, AE40.29, AP35.21, AP35.21DA, AP38.25, AP38.25DA, COMPACT20, EURO350, EURO380, EURO400, MASTER21, MINIBAR, MINIBAR-CF, MINIBAR-CR		
spare parts for	500037		
	GEV No.	365017	Ref. No. —
	operating capacitor capacity 5 μ F 450V tolerance 5% 50/60Hz ambient temperature max. -25 to +85°C \varnothing 28mm L 54mm M8 plastic connection male faston 6.3mm 16.10.08 protection		
	GEV No.	510384	Ref. No. —
	pump cover inlet \varnothing 28mm outlet \varnothing 26mm \varnothing 100mm ID \varnothing 76mm		
	GEV No.	510695	Ref. No. —
	mechanical shaft seal height counter ring 5.5mm ID \varnothing 11mm		
	GEV No.	521203	Ref. No. —
	impeller \varnothing 72mm H 18mm thread M7 shaft \varnothing 11mm shaft length 32mm blades 3		
	GEV No.	521703	Ref. No. —
	pump cover gasket EPDM thickness 2.5mm ID \varnothing 75mm Qty 1 pcs		



1			
GEV No.	500027	Ref. No.	00000045
description	pump inlet \varnothing 45mm outlet \varnothing 40mm type 1292.1400 230V 50Hz 1 phase 0.56kW 0.75HP L 200mm rotation direction right capacitor 12.5 μ F FIR		
spare parts for	500027		
	GEV No.	365014	Ref. No. 00000234 234
	operating capacitor capacity 12.5 μ F 450V tolerance 5%Hz ambient temperature max. -25 to +85°C \varnothing 35mm L 70mm M8 plastic connection male faston 6.3mm 45S.C3DS.12.5 protection		

spare parts for	500027		
	GEV No.	510600	Ref. No. —
	impeller \varnothing 102mm H 29mm shaft intake \varnothing 9/8mm rotation direction right blades 6		
	GEV No.	510692	Ref. No. 00004387 4387
	mechanical shaft seal for shaft \varnothing 11mm slide ring ext. \varnothing 24mm slide ring H 13mm counter ring mounting \varnothing 26mm height counter ring 8mm counter ring int. \varnothing 14mm		
	GEV No.	521506	Ref. No. —
	pump cover FIR inlet \varnothing 45mm outlet \varnothing 40mm turn direction right \varnothing 160mm ID \varnothing 125mm inner height 25mm		
	GEV No.	521702	Ref. No. —
	pump cover gasket thickness 3.5x4.5mm Qty 1 pcs		



1			
GEV No.	500117	Ref. No.	00006581
description	pump inlet \varnothing 63mm outlet \varnothing 47mm type 4225.22725 230/400V 50Hz 3 phase 1.4kW 2HP L 280mm rotation direction right FIR		
For models:	AU55-65, AU55-80, LP55-65, LP55-80		
spare parts for	500117		
	GEV No.	510602	Ref. No. —
	impeller \varnothing 110mm H 34mm rotation direction right thread M8L shaft \varnothing 28mm seat \varnothing 12.2mm blades 6		
	GEV No.	510693	Ref. No. 00004388 4388
	mechanical shaft seal for shaft \varnothing 12mm slide ring ext. \varnothing 24mm slide ring H 15.5mm slide ring int. \varnothing 11mm counter ring mounting \varnothing 24mm height counter ring 8mm counter ring int. \varnothing 13.5mm		
	GEV No.	521513	Ref. No. —
	pump cover FIR inlet \varnothing 63mm outlet \varnothing 47mm turn direction right ID \varnothing 150mm inner height 32mm		
	GEV No.	524416	Ref. No. —
	pump cover gasket thickness 4x4mm Qty 1 pcs		



1

GEV No.	499237	Ref. No.	00006730
description	pump inlet ø 63mm outlet ø 53mm type 1241.2503 230/400V 50Hz 3 phase 1.1kW 1.5HP L 330mm rotation direction left FIR		
For models:	AL1200E, AL1500E		



1

GEV No.	499096	Ref. No.	00003259
description	pump inlet ø 45mm outlet ø 40mm type ZF220SX 230V 50Hz 1 phase 0.69kW L 188mm rotation direction right capacitor 12.5µF LGB		
For models:	AL40.28, AL40.28E, AL40.28EM, AL45.32, AL45.32E, AL45.32EM		

LGB



1

GEV No.	499074	Ref. No.	00004053
description	pump inlet ø 45mm outlet ø 38mm type ZF340SX 230V 50Hz 1 phase 0.7kW 0.95HP L 215mm rotation direction right capacitor 16µF auxiliary pressure connection 13mm LGB		
spare parts for	499074		

	GEV No.	365021	Ref. No.	00002036 2036
		operating capacitor capacity 16µF 425V tolerance 5% 50/60Hz ambient temperature max. -25 to +85°C ø 35mm L 73mm single M8 plastic connection male faston 6.3mm 416.10.99 protection		
	GEV No.	510702	Ref. No.	—
		mechanical shaft seal height counter ring 5.5mm ID ø 12mm		
	GEV No.	521246	Ref. No.	—
		impellor ø 103mm H 26mm thread M8L shaft ø 20mm shaft length 7mm seat ø 8.2mm blades 6		
	GEV No.	521542	Ref. No.	—
		pump cover LGB inlet ø 45mm outlet ø 40mm auxiliary pressure connection 13mm supporting pressure open ø 150mm ID ø 120mm inner high 25mm		
	GEV No.	521714	Ref. No.	—
		pump cover gasket thickness 4x4mm Qty 1 pcs		







1

GEV No.	499135	Ref. No.	00004054
description	pump inlet ø 45mm outlet ø 40mm type ZF350SX 230/400V 50Hz 3 phase 0.61kW L 220mm rotation direction right LGB		
For models:	AH1100, AH1100DGT, AP1000, AP55.40, AP55.40DA, GL8.50E, GL8.50EM		

spare parts for	499135			
	GEV No.	510702	Ref. No.	—
		mechanical shaft seal height counter ring 5.5mm ID ø 12mm		
	GEV No.	521278	Ref. No.	—
		impellor ø 93mm H 32mm pump type ZF350SX thread M8L		
	GEV No.	521542	Ref. No.	—
		pump cover LGB inlet ø 45mm outlet ø 40mm auxiliary pressure connection 13mm supporting pressure open ø 150mm ID ø 120mm inner high 25mm		
	GEV No.	521714	Ref. No.	—
		pump cover gasket thickness 4x4mm Qty 1 pcs		







1

GEV No.	499241	Ref. No.	00005697
description	pump inlet ø 62mm outlet ø 48mm type ZF650SX 230/400V 50Hz 3 phase 1.33kW L 340mm rotation direction right LGB		
For models:	TR3000, TR3500, TR4000, TR5000		
spare parts for	499241		
	GEV No.	510551	Ref. No. —
	pump cover gasket ID ø 158.3mm pump type 1214/1293/1225/2243/1226/1204/3473/1241 thickness 3.53mm EPDM Qty 1 pcs		
	GEV No.	510694	Ref. No. —
	mechanical shaft seal for shaft ø 13mm height counter ring 8mm ID ø 11.5mm H 16mm mounting ø 24/26mm int. ø 1 14mm		
	GEV No.	521240	Ref. No. —
	impellor ø 110mm H 32mm rotation direction left thread M8L shaft ø 20mm shaft length 10mm seat ø 8.2mm blades 6		
	GEV No.	521536	Ref. No. —
	pump cover ALBA / LGB inlet ø 62mm outlet ø 50mm auxiliary pressure connection 12mm supporting pressure closed turn direction right ø 180mm ID ø 150mm inner height 38mm		







1

GEV No.	499238	Ref. No.	00005696
description	pump inlet ø 62mm outlet ø 50mm type ZF650SX 230/400V 50Hz 3 phase 1.7kW L 340mm rotation direction right LGB		
For models:	TR3000, TR3500, TR4000, TR5000		
spare parts for	499238		
	GEV No.	510551	Ref. No. —
	pump cover gasket ID ø 158.3mm pump type 1214/1293/1225/2243/1226/1204/3473/1241 thickness 3.53mm EPDM Qty 1 pcs		
	GEV No.	510694	Ref. No. —
	mechanical shaft seal for shaft ø 13mm height counter ring 8mm ID ø 11.5mm H 16mm mounting ø 24/26mm int. ø 1 14mm		

spare parts for	499238		
	GEV No.	521094	Ref. No. —
	impellor ø 105mm H 34mm thread M8L shaft ø 27mm shaft length 7mm		
	GEV No.	521536	Ref. No. —
	pump cover ALBA / LGB inlet ø 62mm outlet ø 50mm auxiliary pressure connection 12mm supporting pressure closed turn direction right ø 180mm ID ø 150mm inner height 38mm		



1

GEV No.	500122	Ref. No.	00002532
description	pump inlet ø 62mm outlet ø 52mm type AM5225DX 230/400V 50Hz 3 phase 1.2kW 1.6HP L 300mm rotation direction left LGB		
For models:	GL1040, GL1240		
spare parts for	500122		
	GEV No.	501495	Ref. No. —
	cover plastic for terminal box for pump LGB		
	GEV No.	510551	Ref. No. —
	pump cover gasket ID ø 158.3mm pump type 1214/1293/1225/2243/1226/1204/3473/1241 thickness 3.53mm EPDM Qty 1 pcs		
	GEV No.	510694	Ref. No. —
	mechanical shaft seal for shaft ø 13mm height counter ring 8mm ID ø 11.5mm H 16mm mounting ø 24/26mm int. ø 1 14mm		
	GEV No.	521236	Ref. No. —
	impellor ø 105mm H 32mm M8R		
	GEV No.	521516	Ref. No. —
	pump cover LGB inlet ø 62mm outlet ø 52mm auxiliary pressure connection 12mm supporting pressure closed turn direction left ø 190mm ID ø 150mm inner height 40mm		



1

GEV No.	499242	Ref. No.	00004395
description	pump inlet ø 62mm outlet ø 52mm type ZF650DX 230V 50Hz 1 phase 1.47kW L 335mm rotation direction left capacitor 20µF LGB		
For models:	GL1040, GL1240		
spare parts for	499242		
	GEV No.	365019	Ref. No. —
	operating capacitor capacity 20µF 400V tolerance 5% 50/60Hz ambient temperature max. -25 to +85°C ø 39.5mm L 70mm M8 plastic connection male faston 6.3mm 16.10.25. protection		
	GEV No.	510551	Ref. No. —
	pump cover gasket ID ø 158.3mm pump type 1214/1293/1225/2243/1226/1204/3473/1241 thickness 3.53mm EPDM Qty 1 pcs		
	GEV No.	510694	Ref. No. —
	mechanical shaft seal for shaft ø 13mm height counter ring 8mm ID ø 11.5mm H 16mm mounting ø 24/26mm int. ø 1 14mm		
	GEV No.	521217	Ref. No. —
	impellor ø 110mm H 32mm thread M8R shaft ø 20mm shaft length 10mm seat ø 8.2mm blades 6 for ZF522DX		
	GEV No.	521516	Ref. No. —
	pump cover LGB inlet ø 62mm outlet ø 52mm auxiliary pressure connection 12mm supporting pressure closed turn direction left ø 190mm ID ø 150mm inner height 40mm		



1



GEV No.	499243	Ref. No.	00005695
description	pump inlet ø 63mm outlet ø 50mm type ZF900SX 230/400V 50Hz 3 phase 2.41kW L 380mm rotation direction right LGB		
For models:	TR1650, TR1650N, TR2000, TR2500, TR3000, TR3500, TR4000, TR5000, TRC250, TRR2500		

OLYMPIA

pumps



1







GEV No.	499208	Ref. No.	00004053
description	pump inlet ø 45mm outlet ø 40mm type L80.T100 230V 50Hz 1 phase 0.75kW 1HP L 210mm rotation direction right capacitor 12.5µF OLYMPIA		
For models:	AE1000, AL50.40, AL50.40E, AL50.40EM, AL50.45, AL55.45E, AL55.45EM, AL55.45EM-P, AL55.45E-P, AP1000, AP55.40, AP55.40DA, AS50.40, AS50.40DA, AS50.40DGT, AS50.40DGT-DA, AU-L55.45, AU-P55.40, AU-S55.40, AU-S55.40DGT, GL7.40E, GL7.40EM, GL8.50EM		
spare parts for	499208		
	GEV No.	365014	Ref. No. 00000234 234
	operating capacitor capacity 12.5µF 450V tolerance 5%Hz ambient temperature max. -25 to +85°C ø 35mm L 70mm M8 plastic connection male faston 6.3mm 45S.C3DS.12.5 protection		
	GEV No.	510693	Ref. No. 00004388 4388
	mechanical shaft seal for shaft ø 12mm slide ring ext. ø 24mm slide ring H 15.5mm slide ring int. ø 11mm counter ring mounting ø 24mm height counter ring 8mm counter ring int. ø 13.5mm		



booster pumps I







1

GEV No.	499240	Ref. No.	00003208
description	pump inlet ø 1" IT outlet ø 1" IT type PBC50 230V 50Hz 1 phase 0.57kW L 260mm rotation direction left capacitor 12µF OSIP		
For models:	AU55-65, AU55-80, AU65-65, LP55-65, LP55-80, LP65-65		

			
1			
GEV No.	500193	Ref. No.	00000380 00001510
description	pump inlet \varnothing 3/8" IT outlet \varnothing 3/8" IT type C.1510 230V 50Hz 0.43kW \varnothing 100mm L 170mm rotation direction left capacitor 10 μ F ALBA PUMPS (C&A)		
For models:	AC20, AC25, AC26, AE1000, AE1200, AE35.21, AE38.25, AE40.29, AE40.30, AE45.30, AE50.32, AE50.35, AH1000, AH1000Easy, AH1100, AH1100DGT, AH1200, AH1200DGT, AH1400, AL1200E, AL1400, AL1500E, AL40.28, AL40.28E, AL40.28EM, AL45.32, AL45.32E, AL45.32EM, AL50.34, AL50.34E, AL50.34EM, AL50.40, AL50.40E, AL50.40EM, AL50.45, AL55.45E, AL55.45EM, AL55.45EM-P, AL55.45E-P, ALISEO40.28E, ALISEO422, ALISEO428, ALISEO45.32E, AP1000, AP1200, AP35.21, AP35.21DA, AP38.25, AP38.25DA, AP40.28...(Other models you can see in the webshop)		
spare parts for	500193		
	GEV No.	550331	Ref. No. —
	protective covering 1-pole size 6.3mm straight nylon t.max. 120°C Qty 20 pcs		
accessories for	500193		
	GEV No.	365015	Ref. No. 166
	operating capacitor capacity 10 μ F 400V tolerance 5%Hz ambient temperature max. -25 to +85°C \varnothing 35.5mm L 59mm M8 plastic connection male faston 6.3mm protection		
	GEV No.	511279	Ref. No. —
	hose connector brass straight thread 3/8" hose \varnothing 12mm Qty 1 pcs		
	GEV No.	520202	Ref. No. —
	hose connector nickel-plated brass straight thread 3/8" hose \varnothing 12mm Qty 1 pcs		
	GEV No.	520204	Ref. No. —
	hose connector nickel-plated brass straight thread 3/8" hose \varnothing 17mm Qty 1 pcs		

			
1			
GEV No.	500358	Ref. No.	380
description	pump inlet \varnothing 3/8" outlet \varnothing 3/8" type PS46 230V 50Hz 0.45kW \varnothing 100mm L 200mm capacitor 10 μ F LGB		
spare parts for	500358		
	GEV No.	510713	Ref. No. —
	slide ring for shaft \varnothing 12mm ED \varnothing 24mm H 16mm		
	GEV No.	510723	Ref. No. —
	counter ring H 8mm ED \varnothing 26mm ID \varnothing 13.5mm for mechanical shaft seal		
	GEV No.	698400	Ref. No. —
	pump cover gasket pump type PS46 thickness 2mm ID \varnothing 66mm Qty 1 pcs		

accessories for	500358		
	GEV No.	365015	Ref. No. 166
	operating capacitor capacity 10 μ F 400V tolerance 5%Hz ambient temperature max. -25 to +85°C \varnothing 35.5mm L 59mm M8 plastic connection male faston 6.3mm protection		
	GEV No.	511279	Ref. No. —
	hose connector brass straight thread 3/8" hose \varnothing 12mm Qty 1 pcs		
	GEV No.	520202	Ref. No. —
	hose connector nickel-plated brass straight thread 3/8" hose \varnothing 12mm Qty 1 pcs		
	GEV No.	520677	Ref. No. —
	hose connector brass straight thread 3/8" hose \varnothing 13mm Qty 1 pcs		

			
1			
GEV No.	499239	Ref. No.	00005103
description	pump inlet \varnothing 3/8" outlet \varnothing 3/8" type VIB45/42 230/450V 50Hz 1 phase 0.37kW L 225mm rotation direction left capacitor 8 μ F OSIP		
For models:	LP55-65		
spare parts for	499239		
	GEV No.	499240	Ref. No. 00003208 3208
	pump inlet \varnothing 1" IT outlet \varnothing 1" IT type PBC50 230V 50Hz 1 phase 0.57kW L 260mm rotation direction left capacitor 12 μ F OSIP		
	GEV No.	520183	Ref. No. 00003206 3206
	reducer thread 1" ET - 3/4" IT brass		
	GEV No.	521192	Ref. No. 00003207 3207
	double nipple brass thread 1"-3/4" Qty 1 pcs		

drain pumps

GRE			
			
1			
GEV No.	499222	Ref. No.	00000379
description	drain pump inlet \varnothing 30mm outlet \varnothing 22mm 34W 230V 50Hz GRE		
For models:	AC20, AC25, AC26, AE1000, AE1200, AE35.21, AE38.25, AE40.29, AE40.30, AE45.30, AE50.32, AE50.35, AH1000, AH1000Easy, AH1100, AH1100DGT, AH1200, AH1200DGT, AH1400, AL1200E, AL1400, AL1500E, AL40.28, AL40.28E, AL40.28EM, AL45.32, AL45.32E, AL45.32EM, AL50.34, AL50.34E, AL50.34EM, AL50.40, AL50.40E, AL50.40EM, AL50.45, AL55.45E, AL55.45EM, AL55.45EM-P, AL55.45E-P, ALISEO40.28E, ALISEO422, ALISEO428, ALISEO45.32E, AP1000, AP1200, AP35.21, AP35.21DA, AP38.25, AP38.25DA, AP40.28...(Other models you can see in the webshop)		



booster pumps II

accessories



1

GEV No.	365015	Ref. No.	166
description	operating capacitor capacity 10µF 400V tolerance 5%Hz ambient temperature max. -25 to +85°C ø 35.5mm L 59mm M8 plastic connection male faston 6.3mm protection		



1

GEV No.	365012	Ref. No.	00000402
description	operating capacitor capacity 6.3µF 450V tolerance 5% 50Hz ambient temperature max. -25 to +85°C ø 30mm L 61mm M8 plastic connection male faston 6.3mm protection		
For models:	AE35.21, AE38.25, AE40.29, AP35.21, AP35.21DA, AP38.25, AP38.25DA, COMPACT20, EURO350, EURO380, EURO400, MASTER21, MINIBAR, MINIBAR-CF, MINIBAR-CR		

pumps for ice machines



1

GEV No.	501493	Ref. No.	K02939
description	pump GRE 100W 230V 50Hz inlet ø 21mm outlet ø 19mm L 127mm for ice maker		

condensators & interference suppression filters

operating capacitors

plastic



1

GEV No.	365015	Ref. No.	166
description	operating capacitor capacity 10µF 400V tolerance 5%Hz ambient temperature max. -25 to +85°C ø 35.5mm L 59mm M8 plastic connection male faston 6.3mm protection		



1

GEV No.	365014	Ref. No.	00000234
description	operating capacitor capacity 12.5µF 450V tolerance 5%Hz ambient temperature max. -25 to +85°C ø 35mm L 70mm M8 plastic connection male faston 6.3mm 45S.C3DS.12.5 protection		
For models:	AE45.30, AH1200, AH1200DGT, AL40.28, AL40.28E, AL40.28EM, AL45.32, AL45.32E, AL45.32EM, AL50.34E, AL50.34EM, AP45.30, AP45.30DA, GL4.32E, GL4.32EM, PASSPORT45.30, PROJECT28, PROJECT28E, PROJECT28EM, SELF4.32, SELF400		



1

GEV No.	365021	Ref. No.	00002036
description	operating capacitor capacity 16µF 425V tolerance 5% 50/60Hz ambient temperature max. -25 to +85°C ø 35mm L 73mm single M8 plastic connection male faston 6.3mm 416.10.99 protection		
For models:	AE1000, AE50.32, AE50.35, AL50.34, AL50.34E, AL50.34EM, AL50.40, AL50.40E, AL50.40EM, AL55.45E, AL55.45E-P, AP50.32, AP50.32DA, AP50.35, AP50.35DA, EURO500, GL5.34, GL5.34E, GL500CR, GL7.38, GL7.40E, GL7.40EM, GL700CR, PASSPORT50.32		



1

GEV No.	365012	Ref. No.	00000402
description	operating capacitor capacity 6.3µF 450V tolerance 5% 50Hz ambient temperature max. -25 to +85°C ø 30mm L 61mm M8 plastic connection male faston 6.3mm protection		
For models:	AE35.21, AE38.25, AE40.29, AP35.21, AP35.21DA, AP38.25, AP38.25DA, COMPACT20, EURO350, EURO380, EURO400, MASTER21, MINIBAR, MINIBAR-CF, MINIBAR-CR		

filters

interference suppression filters





1

GEV No.	365049	Ref. No.	00005606
description	interference suppression filter capacity 0.33µF(X2)+2x0.015µF 1MΩhm		
For models:	AL1200E, AL1500E, AL55.45E, AL55.45EM, AL55.45EM-P, AL55.45E-P, AP1000, AP55.40, AP55.40DA, AU125-80, GL1040, GL1240, LP125-80, LP55-65, LP55-80, LP65-65, PASSPORT50.40		





			
1			
GEV No.	365045	Ref. No.	00002779
description	interference suppression filter type FC701Y2F 250V 50-60Hz conductor 2 with E connection cable 200mm L 40mm ø 30mm Hmm Wmm plastic Qty 1 pcs		
For models:	AC26, AE1000, AE1200, AE35.21, AE38.25, AE40.29, AE40.30, AE45.30, AE50.32, AE50.35, AH1000, AH1000Easy, AH1100, AH1200, AH1400, AL1400, AL40.28, AL40.28E, AL40.28EM, AL45.32, AL45.32E, AL45.32EM, AL50.34, AL50.34E, AL50.34EM, AL50.40, AL50.40E, AL50.40EM, AL50.45, AL55.45E, AL55.45E-P, ALISEO40.28E, ALISEO422, ALISEO428, ALISEO45.32E, AP1000, AP1200, AP35.21, AP35.21DA, AP38.25, AP38.25DA, AP40.28, AP40.28DA, AP40.29, AP40.29DA, AP40.31, AP40.31DA, AP45.30, AP45.30DA, AP50.32... (Other models you can see in the webshop)		

			
1			
GEV No.	365044	Ref. No.	2779
description	interference suppression filter type FC701Y2F 250V 50-60Hz conductor 2 with E connection cable 200mm L 42mm ø 23mm Hmm Wmm plastic Qty 1 pcs		

			
1			
GEV No.	550838	Ref. No.	00000891 00004251
description	lustre terminal 12-pole cross section 6mm ² max. 41A max 750V temp.-resist. 150°C		
For models:	AE1000, AE1200, AE35.21, AE38.25, AE40.29, AE40.30, AE45.30, AE50.32, AE50.35, AH1000, AH1000Easy, AH1100, AH1100DGT, AH1200, AH1200DGT, AH1400, AL1200E, AL1400, AL1500E, AL40.28, AL40.28E, AL40.28EM, AL45.32, AL45.32E, AL45.32EM, AL50.34, AL50.34E, AL50.34EM, AL50.40, AL50.40E, AL50.40EM, AL50.45, AL55.45E, AL55.45EM, AL55.45EM-P, AL55.45E-P, ALISEO40.28E, ALISEO422, ALISEO428, ALISEO45.32E, AP1000, AP1200, AP35.21, AP35.21DA, AP38.25, AP38.25DA, AP40.29, AP40.29DA, AP40.31, AP40.31DA...(Other models you can see in the webshop)		

			
1			
GEV No.	508353	Ref. No.	00000921
description	lustre terminal 3-pole cross section 4mm ² max. 32A max 750V temp.-resist. 150°C		
For models:	AC20, AC25, AC26, AP35.21, AP35.21DA, AP38.25, AP38.25DA, AP40.28, AP40.28DA, COMPACT20, GEMINICF, GEMINI-CF, MINIBAR, PROGRAM25CF		

			
1			
GEV No.	508356	Ref. No.	00000120
description	connection terminal 3-pole max 400V cross section 4mm ²		
For models:	COMPACT20, FORNO2P, FORNO3P, FORNO4P, FORNO6P, GEMINI-CF, GEMINI-CR, MASTER21, MINIBAR-CF, MINIBAR-CR, ORION-1, ORION-1.5, ORION-2, ORION-G1, ORION-G1.5, ORION-G2, ORION-VTR1, ORION-VTR1.5, ORION-VTR2, PROGRAM25CF, PROGRAM25CR, PROJECT28, SELF4.32, SELF400, TA-2, TA-3		

			
1			
GEV No.	508218	Ref. No.	00003125
description	signboard		
For models:	ALISEO422, ALISEO428, AP35.21, AP35.21DA, AP38.25, AP38.25DA, AP40.28, AP40.28DA, AP45.30, AP45.30DA, AP50.32, AP50.32DA, AP50.35, AP50.35DA, AP55.40, AP55.40DA, EURO350, EURO380, EURO400, EURO500, GL4.32E, GL4.32EM, GL5.34E, GL7.40E, GL7.40EM, GL8.50E, GL8.50EM, PASSPORT45.30, PASSPORT50.32, PASSPORT50.40, PROJECT28E, PROJECT28EM		

electric accessories

terminals

porcelain clamps

			
1			
GEV No.	550116	Ref. No.	120
description	porcelain terminal block 3-pole 10mm ² hole distance 16mm max. 30A max 450V L 52mm W 30mm H 23mm mounting distance 16mm Qty 1 pcs		

terminal blocks

			
1			
GEV No.	550232	Ref. No.	00001488
description	lustre terminal 12-pole cross section 2.5mm ² max. 32A max 450V temp.-resist. 150°C		
For models:	AL55.45E, AL55.45EM, AL55.45EM-P, AL55.45E-P, GL8.50E, GL8.50EM		

accessories

miscellaneous



equipment-specific units

for bar blender

blenders

jar components

blades

miscellaneous



1

GEV No.	696552	Ref. No.	00001011
description	disc ID ø 5mm ED ø 13mm H 3mm SS Qty 1 pcs thickness 3mm		
For models:	GSN, SPF, STAR-1, STAR-2, STAR-4, STAR-6		

miscellaneous



1

GEV No.	560512	Ref. No.	00007213
description	disc ID ø 7mm ED ø 16mm thickness 0.85mm FIBER Qty 1 pcs		
For models:	GSN, SPF, STAR-1, STAR-2, STAR-4, STAR-6		

for citrus juicers

miscellaneous



1

GEV No.	694343	Ref. No.	00001403
description	coupling for juice extractor ø 55.5mm H 26.6mm		
For models:	GSN, SPF, SPN, TGSP		

for espresso machines

steam/water taps

steam/water pipes

accessories

gaskets



1

GEV No.	510893	Ref. No.	00000697
description	O-ring EPDM thickness 2.62mm ID ø 9.92mm Qty 1 pcs		
For models:	AC25, AC26, AE1000, AE1200, AE35.21, AE38.25, AE40.29, AE40.30, AE45.30, AE50.32, AE50.35, AH1000, AH1000Easy, AH1100, AH1100DGT, AH1200, AH1200DGT, AH1400, AL1200E, AL1400, AL1500E, AL40.28, AL40.28E, AL40.28EM, AL45.32, AL45.32E, AL45.32EM, AL50.34, AL50.34E, AL50.34EM, AL50.40, AL50.40E, AL50.40EM, AL50.45, AL55.45E, AL55.45EM, AL55.45EM-P, AL55.45E-P, AP1000, AP1200, AP35.21, AP35.21DA, AP38.25, AP38.25DA, AP40.28, AP40.28DA, AP40.29, AP40.29DA, AP40.31, AP40.31DA...(Other models you can see in the webshop)		

for griddles

spare parts and accessories



1

GEV No.	506236	Ref. No.	00001671
description	bush H 9mm ET M18x1 IT M16x1.5 Qty 1 pcs WS 21		
For models:	ORION-1, ORION-1.5, ORION-2		

for dishwashers

drain and intake components

ARISTARCO

drain /intake bodies



1

GEV No.	508010	Ref. No.	00000108
description	drain connection thread 3/4" hose ø 23mm		
For models:	AC20, AC25, AC26, AE35.21, AE38.25, AE40.29, ALISEO40.28E, ALISEO422, ALISEO428, ALISEO45.32E, AW4028, AW45.32, COMPACT20, EURO350, EURO380, EURO400, GEMINICF, GEMINI-CF, GEMINI-CR, MASTER21, MINIBAR, MINIBAR-CF, MINIBAR-CR, PROGRAM25CF, PROGRAM25CR, TR5000		





1

GEV No.	508117	Ref. No.	00002478
description	drain fitting		
For models:	AC20, COMPACT20, GEMINI-CF, PROGRAM25CF, PROGRAM25CR		





1

GEV No.	517362	Ref. No.	00005027
description	drain fitting angled thread 1½"		
For models:	AE1000, AE1200, AH1000, AH1000Easy, AH1100, AH1100DGT, AH1200, AH1200DGT, AH1400, AL1400, AL40.28E, AL45.32, AL45.32E, AL50.34, AL50.34E, AL50.40, AL50.40E, AL50.45, AL55.45E, AL55.45E-P, AP1000, AP1200, AP55.40, AP55.40DA, AS50.40, AS50.40DA, AS50.40DGT, AS50.40DGT-DA, AU125-80, AU55-65, AU55-80, AU65-65, AU-H1400, AU-L55.45, AU-P55.40, AU-S55.40, AU-S55.40DGT, LP125-80, LP55-65, LP55-80, LP65-65, LPC1500, TR1200, TR1650, TR1650N, TR2000, TR2500, TR3500, TR5000, TRR2500		

			
1			
GEV No.	508002	Ref. No.	00000032
description	drain fitting thread 1½" hose ø 33mm		
For models:	AE1000, AE35.21, AE38.25, AE40.29, AE40.30, AE45.30, AE50.32, AE50.35, AL1200E, AL1500E, AL40.28E, AL40.28EM, AL45.32E, AL45.32EM, AL50.34E, AL50.34EM, AL50.40E, AL50.40EM, AL55.45E, AL55.45EM, AL55.45EM-P, AL55.45E-P, AP1000, AP35.21, AP35.21DA, AP38.25, AP38.25DA, AP40.28, AP40.28DA, AP40.29, AP40.29DA, AP40.31, AP40.31DA, AP45.30, AP45.30DA, AP50.32, AP50.32DA, AP50.35, AP50.35DA, AP55.40, AP55.40DA, AS40.31, AS40.31DA, AS40.31DGT, AS40.31DGT-DA, AS50.35, AS50.35DA, AS50.35DGT, AS50.35DGT-DA, GL1040...(Other models you can see in the webshop)		
accessories for	508002		
	GEV No.	508028	Ref. No. 00000203 203
	nut thread 1½"		
	GEV No.	508029	Ref. No. 00000204 204
	flat gasket rubber D1 ø 59mm D2 ø 45mm thickness 2.5mm Qty 1 pcs for model AE/AL/AP/AS/GL/F		

			
1			
GEV No.	508012	Ref. No.	00000110
description	drain fitting thread 3/4"		
For models:	AC20, AC25, AC26, AE35.21, AE38.25, AE40.29, ALISEO40.28E, ALISEO422, ALISEO428, ALISEO45.32E, AW4028, AW45.32, COMPACT20, EURO350, EURO380, EURO400, GEMINICF, GEMINI-CF, GEMINI-CR, MASTER21, MINIBAR, MINIBAR-CF, MINIBAR-CR, PROGRAM25CF, PROGRAM25CR, TR5000		

			
1			
GEV No.	508126	Ref. No.	00002541
description	flange		
For models:	GL1040, GL1240, LP55-65, LP65-65		



			
1			
GEV No.	508329	Ref. No.	00007990
description	flange ED ø 51mm ID ø 12mm		
For models:	ALISEO40.28E, ALISEO422, ALISEO428, ALISEO45.32E, AW4028		

			
1			
GEV No.	508011	Ref. No.	00000109
description	flat gasket rubber D1 ø 45mm D2 ø 26mm thickness 2mm equiv. no. for model Aliseo/Master/Minibar/Gemini/Program		
For models:	AC20, AC25, AC26, AE35.21, AE38.25, AE40.29, ALISEO40.28E, ALISEO422, ALISEO428, ALISEO45.32E, AW4028, AW45.32, COMPACT20, EURO350, EURO380, EURO400, GEMINICF, GEMINI-CF, GEMINI-CR, MASTER21, MINIBAR, MINIBAR-CF, MINIBAR-CR, PROGRAM25CF, PROGRAM25CR, TR5000		

			
1			
GEV No.	508029	Ref. No.	00000204
description	flat gasket rubber D1 ø 59mm D2 ø 45mm thickness 2.5mm Qty 1 pcs for model AE/AL/AP/AS/GL/F		
For models:	AE1000, AE1200, AE35.21, AE38.25, AE40.29, AE40.30, AE45.30, AE50.32, AE50.35, AH1000, AH1000Easy, AH1100, AH1100DGT, AH1200, AH1200DGT, AH1400, AL1200E, AL1400, AL1500E, AL40.28E, AL40.28EM, AL45.32, AL45.32E, AL45.32EM, AL50.34, AL50.34E, AL50.34EM, AL50.40, AL50.40E, AL50.40EM, AL50.45, AL55.45E, AL55.45EM, AL55.45EM-P, AL55.45E-P, AP1000, AP1200, AP35.21, AP35.21DA, AP38.25, AP38.25DA, AP40.28, AP40.28DA, AP40.29, AP40.29DA, AP40.31, AP40.31DA, AP45.30, AP45.30DA, AP50.32...(Other models you can see in the webshop)		

			
1			
Image not available			
GEV No.	508328	Ref. No.	00007956
description	hexagonal nut		
For models:	ALISEO422, ALISEO428		

			
1			
GEV No.	508081	Ref. No.	1933 und 2900
description	intake body		

			
1			
GEV No.	508108	Ref. No.	00002373
description	intake body thread 2"		
For models:	AE1000, AE45.30, AE50.32, AE50.35, AL40.28, AL40.28E, AL40.28EM, AL45.32, AL45.32E, AL45.32EM, AP1000, AP45.30, AP45.30DA, AP50.32, AP50.32DA, AP50.35, AP50.35DA, AP55.40, AP55.40DA, AS50.35, AS50.35DA, AS50.35DGT, AS50.35DGT-DA, AS50.40, AS50.40DA, AS50.40DGT, AS50.40DGT-DA, AU-P55.40, AU-S55.40, AU-S55.40DGT, EURO500, GL4.32E, GL4.32EM, GL5.34, GL5.34E, GL500CF, GL500CR, GL7.38, GL7.40E, GL7.40EM, GL700CF, GL700CR, GL8.50E, GL8.50EM, PASSPORT45.30, PASSPORT50.32, PASSPORT50.40, PROJECT28, PROJECT28E, PROJECT28EM...(Other models you can see in the webshop)		
accessories for	508108		
	GEV No.	508109	Ref. No. 00002374 2374
	O-ring EPDM thickness 5.34mm ID ø 69.22mm Qty 1 pcs		





			
GEV No.	508028	Ref. No.	00000203
description	nut thread 1 1/2"		
For models:	AE1000, AE1200, AE35.21, AE38.25, AE40.29, AE40.30, AE45.30, AE50.32, AE50.35, AH1000, AH1000Easy, AH1100, AH1100DGT, AH1200, AH1200DGT, AH1400, AL1200E, AL1400, AL1500E, AL40.28, AL40.28E, AL40.28EM, AL45.32, AL45.32E, AL45.32EM, AL50.34, AL50.34E, AL50.34EM, AL50.40, AL50.40E, AL50.40EM, AL50.45, AL55.45E, AL55.45EM, AL55.45EM-P, AL55.45E-P, AP1000, AP1200, AP35.21, AP35.21DA, AP38.25, AP38.25DA, AP40.28, AP40.28DA, AP40.29, AP40.29DA, AP40.31, AP40.31DA, AP45.30, AP45.30DA... (Other models you can see in the webshop)		

			
GEV No.	508107	Ref. No.	00002362
description	nut thread 2"		
For models:	AE1000, AE45.30, AE50.32, AE50.35, AL40.28, AL40.28E, AL40.28EM, AL45.32, AL45.32E, AL45.32EM, AP1000, AP45.30, AP45.30DA, AP50.32, AP50.32DA, AP50.35, AP50.35DA, AP55.40, AP55.40DA, AS50.35, AS50.35DA, AS50.35DGT, AS50.35DGT-DA, AS50.40, AS50.40DA, AS50.40DGT, AS50.40DGT-DA, AU-P55.40, AU-S55.40, AU-S55.40DGT, EURO500, GL4.32E, GL4.32EM, GL5.34, GL5.34E, GL500CF, GL500CR, GL7.38, GL7.40E, GL7.40EM, GL700CF, GL700CR, GL8.50E, GL8.50EM, PASSPORT45.30, PASSPORT50.32, PASSPORT50.40, PROJECT28, PROJECT28E, PROJECT28EM... (Other models you can see in the webshop)		

			
GEV No.	508061	Ref. No.	00001633
description	O-ring EPDM thickness 3.53mm ID ø 42.86mm Qty 1 pcs		
For models:	AC20, AC25, AC26, AE1000, AE1200, AE35.21, AE38.25, AE40.29, AE40.30, AE45.30, AE50.32, AE50.35, AH1000, AH1000Easy, AH1100, AH1100DGT, AL40.28, AL40.28E, AL40.28EM, AL45.32, AL45.32E, AL45.32EM, AL50.34, AL50.34E, AL50.34EM, AL50.40, AL50.40E, AL50.40EM, AL50.45, AL55.45E, AL55.45EM, AL55.45EM-P, AL55.45E-P, ALISEO40.28E, ALISEO422, ALISEO428, ALISEO45.32E, AP1000, AP35.21, AP35.21DA, AP38.25, AP38.25DA, AP40.28, AP40.28DA, AP40.29, AP40.29DA, AP40.31, AP40.31DA, AP45.30, AP45.30DA... (Other models you can see in the webshop)		

			
GEV No.	508129	Ref. No.	00002564
description	O-ring EPDM thickness 5.34mm ID ø 139.7mm Qty 1 pcs		
For models:	GL1040, GL1240, LP55-65, LP65-65		

			
GEV No.	508109	Ref. No.	00002374
description	O-ring EPDM thickness 5.34mm ID ø 69.22mm Qty 1 pcs		
For models:	AE1000, AE45.30, AE50.32, AE50.35, AL40.28, AL40.28E, AL40.28EM, AL45.32, AL45.32E, AL45.32EM, AP1000, AP45.30, AP45.30DA, AP50.32, AP50.32DA, AP50.35, AP50.35DA, AP55.40, AP55.40DA, AS50.35, AS50.35DA, AS50.35DGT, AS50.35DGT-DA, AS50.40, AS50.40DA, AS50.40DGT, AS50.40DGT-DA, AU-P55.40, AU-S55.40, AU-S55.40DGT, EURO500, GL1040, GL1240, GL4.32E, GL4.32EM, GL5.34, GL5.34E, GL500CF, GL500CR, GL7.38, GL7.40E, GL7.40EM, GL700CF, GL700CR, GL8.50E, GL8.50EM, LP55-65, LP65-65, PASSPORT45.30, PASSPORT50.32... (Other models you can see in the webshop)		

			
GEV No.	508291	Ref. No.	00004948
description	screw		
For models:	ALISEO40.28E, ALISEO422, ALISEO428, ALISEO45.32E, AW4028		

<p>filters</p> 			
GEV No.	508408	Ref. No.	00011630+00000032+00000204
description	drain filter ø 66mm H 83mm		

			
GEV No.	508416	Ref. No.	00011632
description	filter ø 77mm H 115mm		

			
GEV No.	508163	Ref. No.	00002722
description	filter support		
For models:	AE1000, AP1000, GL1040, GL1240		

			
GEV No.	508150	Ref. No.	00002701
description	flat filter		
For models:	AE1000, AP1000, GL1040, GL1240, GL7.40E, GL7.40EM, GL8.50E, GL8.50EM		

			
GEV No.	508297	Ref. No.	00004995
description	flat filter		
For models:	ALISEO422, ALISEO428		



GEV No.	508311	Ref. No.	00006341
description	flat filter		
For models:	AL50.34, AL50.34E, AL50.34EM, AL50.40, AL50.40E, AL50.40EM		



GEV No.	508335	Ref. No.	00009105
description	flat filter for model AL55.45		
For models:	AL50.45, AL55.45E, AL55.45EM, AL55.45EM-P, AL55.45E-P, AU-L55.45		

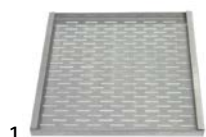

GEV No.	508331	Ref. No.	00008857
description	flat filter for model AP55.40		
For models:	AP55.40, AP55.40DA, PASSPORT50.40		



GEV No.	508312	Ref. No.	00006342
description	flat filter mounting pos. centre		
For models:	AL50.34, AL50.34E, AL50.34EM, AL50.40, AL50.40E, AL50.40EM		



GEV No.	508332	Ref. No.	00008858
description	flat filter mounting pos. centre		
For models:	AP55.40, AP55.40DA, PASSPORT50.40		



GEV No.	508334	Ref. No.	00009104
description	flat filter mounting pos. centre		
For models:	AL50.45, AL55.45E, AL55.45EM, AL55.45EM-P, AL55.45E-P, AU-L55.45		



GEV No.	508194	Ref. No.	00002901
description	knurled nut thread M5 ED ø 22mm H 15mm		
For models:	AE1000, AE45.30, AE50.32, AE50.35, ALISEO40.28E, ALISEO422, ALISEO428, ALISEO45.32E, AP1000, AP45.30, AP45.30DA, AP50.32, AP50.32DA, AP50.35, AP50.35DA, AP55.40, AP55.40DA, AS50.35, AS50.35DA, AS50.35DGT, AS50.35DGT-DA, AS50.40, AS50.40DA, AS50.40DGT, AS50.40DGT-DA, AU125-80, AU55-65, AU55-80, AU65-65, AU-P55.40, AU-S55.40, AU-S55.40DGT, AW4028, EURO500, GL1040, GL1240, GL4.32E, GL4.32EM, GL5.34, GL5.34E, GL7.38, GL7.40E, GL7.40EM, GL8.50E, GL8.50EM, LP125-80, LP55-65, LP55-80, LP65-65, PASSPORT45.30...(Other models you can see in the webshop)		



GEV No.	508293	Ref. No.	00004954
description	rectangular filter suction		
For models:	ALISEO40.28E, ALISEO422, ALISEO428, ALISEO45.32E, AW4028		



GEV No.	508226	Ref. No.	00003169
description	ring ED ø 42mm H 23mm		
For models:	AE35.21, AE38.25, AE40.29, AE40.30, AP35.21, AP35.21DA, AP38.25, AP38.25DA, AP40.28, AP40.28DA, AP40.29, AP40.29DA, AP40.31, AP40.31DA, AS40.31, AS40.31DA, AS40.31DGT, AS40.31DGT-DA, EURO350, EURO380, EURO400		



GEV No.	508264	Ref. No.	00004722
description	round filters ø 144mm H 70mm		
For models:	AE45.30, AE50.32, AP45.30, AP45.30DA, AP50.32, AP50.32DA, EURO500, GL8.50EM, PASSPORT50.32, PROJECT28E, PROJECT28EM		





			
1			
GEV No.	508263	Ref. No.	00004721 43
description	round filters ø 144mm H 73mm		
For models:	AE1000, AE45.30, AE50.32, AE50.35, AP1000, AP45.30, AP45.30DA, AP50.32, AP50.32DA, AP50.35, AP50.35DA, AP55.40, AP55.40DA, AS50.35, AS50.35DA, AS50.35DGT, AS50.35DGT-DA, AS50.40, AS50.40DA, AS50.40DGT, AS50.40DGT-DA, AU-P55.40, AU-S55.40, AU-S55.40DGT, EURO500, GL1040, GL1240, GL8.50EM, PASSPORT45.30, PASSPORT50.32, PASSPORT50.40, PROJECT28E, PROJECT28EM		

			
1			
GEV No.	524974	Ref. No.	00006798
description	round filters ø 185mm H 190mm		
For models:	AH1400, AL1200E, AL1400, AL1500E, AU-H1400, LPC1500		

			
1			
GEV No.	508005	Ref. No.	00000043
description	round filters outflow		
For models:	AE1000, AE45.30, AE50.32, AE50.35, AP1000, AP45.30, AP45.30DA, AP50.32, AP50.32DA, AP50.35, AP50.35DA, AP55.40, AP55.40DA, AS50.35, AS50.35DA, AS50.35DGT, AS50.35DGT-DA, AS50.40, AS50.40DA, AS50.40DGT, AS50.40DGT-DA, AU-P55.40, AU-S55.40, AU-S55.40DGT, EURO500, GL1040, GL1240, GL4.32E, GL4.32EM, GL5.34, GL500CF, GL500CR, GL7.38, GL700CF, GL700CR, GL8.50E, GL8.50EM, LP55-65, LP65-65, PASSPORT45.30, PASSPORT50.32, PASSPORT50.40, PROJECT28, PROJECT28E, PROJECT28EM, SELF4.32		

			
1			
GEV No.	508308	Ref. No.	00006278
description	round filters outflow		
For models:	AP50.32, AP50.32DA, AP50.35, AP50.35DA, AP55.40, AP55.40DA, PASSPORT50.32		

			
1			
GEV No.	508319	Ref. No.	00006434
description	round filters outflow ø 185mm H 150mm		
For models:	AL50.45, AL55.45E, AL55.45EM, AL55.45EM-P, AL55.45E-P, AU-L55.45		

			
1			
GEV No.	508318	Ref. No.	00006398
description	round filters outflow ø 185mm H 90mm		
For models:	AL50.34, AL50.34E, AL50.34EM, AL50.40, AL50.40E, AL50.40EM		

			
1			
GEV No.	508309	Ref. No.	00006279
description	round filters outflow ø 90mm H 85mm		
For models:	PASSPORT45.30		

			
1			
GEV No.	508310	Ref. No.	00006280
description	round filters outflow ø 96mm		
For models:	AE45.30, AP40.28, AP40.28DA, AP45.30, AP45.30DA, AP55.40, AP55.40DA, PASSPORT50.40		

			
1			
GEV No.	508015	Ref. No.	00000114
description	round filters suction		
For models:	AE45.30, AE50.32, AL40.28E, AP45.30, AP45.30DA, AP50.32, AP50.32DA, EURO500, GL4.32E, GL4.32EM, GL5.34, GL5.34E, GL7.38, GL7.40E, GL7.40EM, GL8.50E, GL8.50EM, PROJECT28, PROJECT28E, PROJECT28EM, SELF4.32, SELF400		

			
1			
GEV No.	508050	Ref. No.	00001177
description	round filters suction		
For models:	GEMINICF, GEMINI-CF, GEMINI-CR, PROGRAM25CF, PROGRAM25CR		

overflow pipes			
			
1			
GEV No.	508336	Ref. No.	00009113
description	overflow pipe		
For models:	AL50.45, AL55.45E, AL55.45EM, AL55.45EM-P, AL55.45E-P, AU-L55.45		

			
1			
GEV No.	508217	Ref. No.	00003113
description	round filters suction ø 60mm H 60mm		
For models:	AE35.21, AE38.25, AE40.29, AE40.30, AP35.21, AP35.21DA, AP38.25, AP38.25DA, AP40.28, AP40.28DA, AP40.29, AP40.29DA, AP40.31, AP40.31DA, AS40.31, AS40.31DA, AS40.31DGT, AS40.31DGT-DA, EURO350, EURO380, EURO400		

			
1			
GEV No.	508249	Ref. No.	00004183
description	overflow pipe L 108mm ø 35mm		
For models:	AE35.21, AE38.25, AE40.29, AE40.30, AE45.30, AP35.21, AP35.21DA, AP38.25, AP38.25DA, AP40.28, AP40.28DA, AP40.29, AP40.29DA, AP40.31, AP40.31DA, AP45.30, AP45.30DA, AS40.31, AS40.31DA, AS40.31DGT, AS40.31DGT-DA, PASSPORT45.30, PROJECT28E, PROJECT28EM		

			
1			
GEV No.	508018	Ref. No.	00000137
description	round filters suction ø 69mm H 70mm		
For models:	AC20, AC25, AC26, COMPACT20, GEMINICF, MASTER21, MINIBAR, MINIBAR-CF, MINIBAR-CR, PROGRAM25CF		

			
1			
GEV No.	508232	Ref. No.	00003157 00004185
description	overflow pipe L 109mm ø 22mm		
For models:	AE35.21, AE38.25, AE40.29, EURO350, EURO380, EURO400		

			
1			
GEV No.	508292	Ref. No.	00004953
description	tie bar		
For models:	ALISEO40.28E, ALISEO422, ALISEO428, ALISEO45.32E, AW4028		

			
1			
GEV No.	508105	Ref. No.	00002274
description	overflow pipe L 111mm ø 35mm		
For models:	GL4.32E, GL4.32EM, PASSPORT45.30, PROJECT28, SELF4.32, SELF400		

			
1			
GEV No.	508193	Ref. No.	00002900
description	tie bar L 85mm thread M5 ED ø 8mm		
For models:	AE1000, AE45.30, AE50.32, AE50.35, AP1000, AP45.30, AP45.30DA, AP50.32, AP50.32DA, AP50.35, AP50.35DA, AP55.40, AP55.40DA, AS50.35, AS50.35DA, AS50.35DGT, AS50.35DGT-DA, AS50.40, AS50.40DA, AS50.40DGT, AS50.40DGT-DA, AU-P55.40, AU-S55.40, AU-S55.40DGT, EURO500, GL1040, GL1240, GL4.32E, GL4.32EM, GL5.34, GL5.34E, GL7.38, GL7.40E, GL7.40EM, GL8.50E, GL8.50EM, LP55-65, LP65-65, PASSPORT45.30, PASSPORT50.32, PASSPORT50.40, PROJECT28, PROJECT28E, PROJECT28EM, SELF4.32		

			
1			
GEV No.	508305	Ref. No.	00005669
description	overflow pipe L 120mm ø 35mm		
For models:	AP55.40, AP55.40DA, AS50.40, AS50.40DA, AS50.40DGT, AS50.40DGT-DA, AU-P55.40, AU-S55.40, AU-S55.40DGT, PASSPORT50.40		



			
1			
GEV No.	508103	Ref. No.	00002199
description	overflow pipe L 135mm ø 22mm		
For models:	AC20, AC25, AC26, COMPACT20, GEMINICF, GEMINI-CF, GEMINI-CR, MASTER21, MINIBAR, MINIBAR-CF, MINIBAR-CR, PROGRAM25CF, PROGRAM25CR		

			
1			
GEV No.	508207	Ref. No.	00002992
description	overflow pipe L 140mm ø 35mm		
For models:	GL5.34, GL7.38, GL7.40E, GL7.40EM, GL8.50EM, PASSPORT50.32		

			
1			
GEV No.	508250	Ref. No.	00004184
description	overflow pipe L 140mm ø 35mm		
For models:	AE50.32, AE50.35, AP50.32, AP50.32DA, AP50.35, AP50.35DA, AS50.35, AS50.35DA, AS50.35DGT, AS50.35DGT-DA, EURO500, GL5.34E, GL7.40E, GL8.50E, GL8.50EM, PASSPORT50.32		

			
1			
GEV No.	508152	Ref. No.	00002704
description	overflow pipe L 198mm ø 35mm		
For models:	AE1000, AP1000, GL1040, GL1240		

			
1			
GEV No.	508333	Ref. No.	00009070
description	overflow pipe L 210mm ø 35mm		
For models:	AL50.34, AL50.34E, AL50.34EM, AL50.40, AL50.40E, AL50.40EM		

			
1			
GEV No.	508409	Ref. No.	00006592
description	overflow pipe L 445mm ø 35mm		
For models:	AU125-80, AU55-65, AU55-80, AU65-65, LP125-80, LP55-65, LP55-80, LP65-65		

containers

accessories

			
1			
GEV No.	510071	Ref. No.	00001153 6152
description	flat gasket rubber ED ø 81mm ID ø 68mm thickness 3mm for salt tank Qty 1 pcs		
For models:	AP35.21DA, AP38.25DA, AP40.28DA, AP40.29DA, AP45.30DA, AP50.32DA, AP50.35DA, AP55.40DA		

boilers

boilers for dishwashers

 <p>Image not available</p>			
1			
GEV No.	508006	Ref. No.	00000084
description	boiler		
For models:	GL500CF, GL500CR, GL700CF, GL700CR		

			
1			
GEV No.	508067	Ref. No.	00001699
description	boiler		
For models:	AC25, AC26, GEMINICF, GEMINI-CF, GEMINI-CR, PROGRAM25CF, PROGRAM25CR		

			
1			
GEV No.	508121	Ref. No.	00002486
description	boiler		
For models:	AP38.25, AP38.25DA, AP40.28, AP40.28DA, AP40.29, AP40.29DA, EURO380, EURO400, PROJECT28, PROJECT28E, PROJECT28EM		

			
1			
GEV No.	508169	Ref. No.	00002745
description	boiler		
For models:	MASTER21		

			
1			
GEV No.	508209	Ref. No.	00002995
description	boiler		
For models:	AE45.30, AE50.32, AE50.35, AL50.34, AL50.34E, AL50.34EM, AL50.40, AL50.40E, AL50.40EM, AP45.30, AP45.30DA, AP50.32, AP50.32DA, AP50.35, AP50.35DA, AP55.40DA, AS50.35, AS50.35DA, AS50.35DGT, AS50.35DGT-DA, EURO500, GL1040, GL1240, GL4.32E, GL4.32EM, GL5.34, GL5.34E, GL7.38, GL7.40E, GL7.40EM, GL8.50E, GL8.50EM, PASSPORT45.30, PASSPORT50.32, SELF4.32		

			
1			
GEV No.	508261	Ref. No.	00004686
description	boiler		
For models:	ALISEO40.28E, ALISEO422, ALISEO428, ALISEO45.32E, AW4028, SPF		

			
1			
GEV No.	508281	Ref. No.	00004839
description	boiler		
For models:	AL50.45, AL55.45E, AL55.45EM, AL55.45EM-P, AL55.45E-P, AP55.40, AP55.40DA, AS50.40, AS50.40DA, AS50.40DGT, AS50.40DGT-DA, AU-L55.45, AU-P55.40, AU-S55.40, AU-S55.40DGT, GL8.50EM, PASSPORT50.40		

			
1			
GEV No.	508283	Ref. No.	00004889
description	boiler		
For models:	AE1000, AE1200, AH1000, AH1000Easy, AH1100, AH1100DGT, AH1200, AH1200DGT, AH1400, AL1400, AP1000, AP1200, AU-H1400, GL1040, GL1240, LPC1500		

			
Image not available			
1			
GEV No.	508330	Ref. No.	00008410
description	boiler		
For models:	SELF400		

			
1			
GEV No.	508221	Ref. No.	00003161
description	boiler ø 120mm L 210mm		
For models:	AE35.21, AE38.25, AE40.29, AP35.21, AP35.21DA, AP38.25, AP38.25DA, EURO350		

			
1			
GEV No.	508419	Ref. No.	00011725
description	boiler ø 122mm L 210mm hose ø 12mm		
For models:	AE38.25, AE40.30, AP35.21, AP35.21DA		

			
1			
GEV No.	517426	Ref. No.	00004412
description	boiler ø 194mm L 470mm inlet ø 12		
For models:	AL1200E, AL1500E, AU55-65, AU55-80, AU65-65, LP55-65, LP55-80, LP65-65		



accessories



GEV No.	508038	Ref. No.	00000265
description	flange		
For models:	GL4.32E, GL4.32EM, PROJECT28, PROJECT28E, PROJECT28EM, SELF4.32		

rotation plates

rotation plates



GEV No.	508021	Ref. No.	00000159
description	rotation plate		
For models:	GL500CR		



GEV No.	508042	Ref. No.	00000631
description	rotation plate		
For models:	AP38.25, AP38.25DA, GEMINI-CF, GEMINI-CR, MINIBAR, PROGRAM-25CF, PROGRAM25CR		



GEV No.	508341	Ref. No.	00179011
description	rotation plate		
For models:	GEMINI-CF, GEMINI-CR, MINIBAR, MINIBAR-CF, MINIBAR-CR, PROGRAM25CF, PROGRAM25CR		

accessories



GEV No.	508020	Ref. No.	00000157
description	thread bolt		
For models:	GEMINI-CF, GEMINI-CR, MINIBAR, MINIBAR-CF, MINIBAR-CR, PROGRAM25CF, PROGRAM25CR		

housing and bezels

fascias



GEV No.	502202	Ref. No.	00006367
description	control panel sheet L 250mm H 46mm		



GEV No.	694974	Ref. No.	00011425
description	front panel L 555mm W 40mm H 75mm for AL50.34E/50.40E		

accessories for	694974		
	GEV No.	403871	Ref. No.
			00017606 17606
	PCB kit conversion kit		

miscellaneous



GEV No.	508210	Ref. No.	00002997
description	mounting ring for lid		
For models:	ALISEO422, ALISEO428, AS40.31, AS40.31DA, AS40.31DGT, AS40.31DGT-DA, AS50.35, AS50.35DA, AS50.35DGT, AS50.35DGT-DA, AS50.40, AS50.40DA, AS50.40DGT, AS50.40DGT-DA, AU-S55.40, AU-S55.40DGT, GL4.32E, GL4.32EM, GL5.34E, GL7.40E, GL7.40EM, GL8.50E, GL8.50EM, PROJECT28E, PROJECT28EM		



GEV No.	508170	Ref. No.	00002748
description	side panel mounting pos. lower		
For models:	AE1000, AP1000, GL1040, GL1240		

hood mechanics for dishwashers

bushes



GEV No.	508134	Ref. No.	00002579
description	cylinder liner hood guide		
For models:	AE1000, AE1200, AH1000, AH1000Easy, AH1100, AH1100DGT, AH1200, AH1200DGT, AH1400, AL1400, AP1000, AP1200, AU-H1400, GL1040, GL1240, LPC1500		



GEV No.	508139	Ref. No.	00002585
description	cylinder liner hood mechanics		
For models:	AH1100, AH1100DGT, AH1200, AH1200DGT, AH1400, AL1200E, AL1400, AL1500E, AP1000, AP1200, AU-H1400, GL1040, GL1240, LPC1500		



GEV No.	508130	Ref. No.	00002574
description	spacer bush for spindle hood mechanics		
For models:	AH1100, AH1100DGT, AH1200, AH1200DGT, AH1400, AL1400, AP1000, AP1200, AU-H1400, GL1040, GL1240, LPC1500		



GEV No.	517427	Ref. No.	00006833
description	threaded bush ED ø 8mm L 5mm thread M5 for door spring WS 12		
For models:	AL40.28E, AL45.32E, AL45.32EM, AL50.34E, AL50.34EM, AL50.40E, AL50.40EM, AL55.45E, AL55.45EM, AL55.45EM-P, AL55.45E-P, ALI-SEO45.32E, AW45.32		

spring holders



GEV No.	508131	Ref. No.	00002576
description	bush for spring holder hood mechanics		
For models:	AH1100, AH1100DGT, AH1200, AH1200DGT, AH1400, AL1400, AP1000, AP1200, AU-H1400, GL1040, GL1240, LPC1500		

springs



GEV No.	511972	Ref. No.	00006451
description	spring for hood mechanics wire gauge ø 4.8mm ø 25mm total length 680mm		
For models:	AH1400, AL1200E, AL1400, AL1500E, AU-H1400, LPC1500		

guide bars



GEV No.	508190	Ref. No.	00002862
description	guide bar hood mechanics		
For models:	AP1000, GL1040, GL1240		

linkage



GEV No.	508154	Ref. No.	00002706
description	spindle for hood handle		
For models:	AP1000, GL1040, GL1240		

hood handles



GEV No.	508153	Ref. No.	00002705
description	hood handle		
For models:	AH1100, AH1100DGT, AH1200, AH1200DGT, AP1000, AP1200, GL1040, GL1240		

rollers



GEV No.	508133	Ref. No.	00002578
description	roller hood mechanics		
For models:	AL1200E, AL1500E, AP1000, GL1040, GL1240		

miscellaneous





GEV No.	508137	Ref. No.	00002582
description	actuator for microswitch hood mechanics		
For models:	GL1040, GL1240		





GEV No.	508132	Ref. No.	00002577
description	bearing bolt hood mechanics		
For models:	AH1100, AH1100DGT, AH1200, AH1200DGT, AH1400, AL1200E, AL1400, AL1500E, AP1000, AP1200, AU-H1400, GL1040, GL1240, LPC1500		



			
1			
GEV No.	508140	Ref. No.	00002586
description	bush for spindle with thread hood mechanics		
For models:	AP1000, GL1040, GL1240		

 <p>Image not available</p>			
1			
GEV No.	508160	Ref. No.	00002712
description	con rod for door shaft		
For models:	AP1000, GL1040, GL1240		

			
1			
GEV No.	508136	Ref. No.	00002581
description	nut hood mechanics thread M32x1.5		
For models:	AP1000, GL1040, GL1240		

			
1			
GEV No.	508041	Ref. No.	00000626
description	rubber pad hood mechanics		
For models:	AE1000, AE1200, AH1000, AH1000Easy, AH1100, AH1100DGT, AH1200, AH1200DGT, AH1400, AL1400, AP1000, AP1200, AU-H1400, GL1040, GL1240, LPC1500, MIXER1, MIXER2, ORION-1, ORION-1.5, ORION-2, ORION-G1, ORION-G1.5, ORION-G2, ORION-VTR1, ORION-VTR1.5, ORION-VTR2, STAR-1, STAR-2, STAR-4, STAR-6		

			
1			
GEV No.	508135	Ref. No.	00002580
description	spacer piece hood mechanics		
For models:	AP1000, GL1040, GL1240		



			
1			
GEV No.	508168	Ref. No.	00002738
description	spring holder		
For models:	AH1100, AH1100DGT, AH1200, AH1200DGT, AP1000, AP1200, GL1040, GL1240		





			
1			
GEV No.	508159	Ref. No.	00002711
description	spring holder hood mechanics		
For models:	AP1000, GL1040, GL1240		



			
1			
GEV No.	508138	Ref. No.	00002583
description	stop bolt hood mechanics		
For models:	AP1000, GL1040, GL1240		

air traps

air traps

			
1			
GEV No.	508030	Ref. No.	00000206 1349
description	air trap		
For models:	AC26, COMPACT20, GEMINI-CF, GEMINI-CR, MINIBAR, MINIBAR-CF, MINIBAR-CR, PROGRAM25CF, PROGRAM25CR		
accessories for	508030		
		GEV No.	508031
		Ref. No.	00000207 207
	flat gasket FIBER ED ø 19mm ID ø 10.5mm thickness 2mm Qty 1 pcs		
		GEV No.	520231
		Ref. No.	00000267 267
	nut thread M10x1 H 6mm WS 14 zinc-coated steel Qty 1 pcs		

			
1			
GEV No.	508202	Ref. No.	00002932
description	air trap		
For models:	AL40.28EM, AL45.32EM, AL50.34E, AL50.34EM, AL50.40EM, AL55.45EM, AL55.45EM-P, AL55.45E-P, ALISEO422, ALISEO428, AP1000, AP35.21, AP35.21DA, AP38.25, AP38.25DA, AP40.28, AP40.28DA, AP45.30, AP45.30DA, AP50.32, AP50.32DA, AP50.35, AP50.35DA, AP55.40, AP55.40DA, COMPACT20, EURO350, EURO380, EURO400, EURO500, GEMINI-CF, GEMINI-CR, GL1040, GL1240, GL4.32E, GL4.32EM, GL5.34, GL5.34E, GL7.38, GL7.40E, GL7.40EM, GL8.50E, GL8.50EM, LP125-80, LP55-65, LP55-80, LP65-65, PASSPORT45.30, PASSPORT50.32, PASSPORT50.40...(Other models you can see in the webshop)		
spare parts for	508202		
			
GEV No.	508377	Ref. No.	00003536 3536
description	hose connector		
accessories for	508202		
			
GEV No.	508201	Ref. No.	00002927 2927
description	formed hose warewashing L-shape equiv. no. 2927		
			
GEV No.	508203	Ref. No.	00002933 2933
description	pipe		
			
GEV No.	511322	Ref. No.	—
description	O-ring EPDM thickness 3.53mm ID ø 20.22mm Qty 1 pcs		

			
1			
GEV No.	508376	Ref. No.	00003535
description	air trap		
For models:	AC20, AC25, AE1000, AE1200, AE35.21, AE38.25, AE40.29, AE40.30, AE45.30, AE50.32, AE50.35, AH1000, AH1000Easy, AH1100, AH1100D-GT, AH1200, AH1200DGT, AH1400, AL1200E, AL1400, AL1500E, AL40.28, AL40.28E, AL40.28EM, AL45.32, AL45.32E, AL45.32EM, AL50.34, AL50.34E, AL50.34EM, AL50.40, AL50.40E, AL50.40EM, AL50.45, AL55.45E, AL55.45EM, AL55.45EM-P, AL55.45E-P, AP1000, AP1200, AP35.21, AP35.21DA, AP38.25, AP38.25DA, AP40.28, AP40.28DA, AP40.29, AP40.29DA, AP40.31, AP40.31DA...(Other models you can see in the webshop)		
accessories for	508376		
			
GEV No.	508377	Ref. No.	00003536 3536
description	hose connector		
			
GEV No.	511322	Ref. No.	—
description	O-ring EPDM thickness 3.53mm ID ø 20.22mm Qty 1 pcs		

air trap accessories			
			
1			
GEV No.	508377	Ref. No.	00003536
description	hose connector		
For models:	AC20, AC25, AE1000, AE1200, AE35.21, AE38.25, AE40.29, AE40.30, AE45.30, AE50.32, AE50.35, AH1000, AH1000Easy, AH1100, AH1100D-GT, AH1200, AH1200DGT, AH1400, AL1200E, AL1400, AL1500E, AL40.28, AL40.28E, AL40.28EM, AL45.32, AL45.32E, AL45.32EM, AL50.34, AL50.34E, AL50.34EM, AL50.40, AL50.40E, AL50.40EM, AL50.45, AL55.45E, AL55.45EM, AL55.45EM-P, AL55.45E-P, AP1000, AP1200, AP35.21, AP35.21DA, AP38.25, AP38.25DA, AP40.28, AP40.28DA, AP40.29, AP40.29DA, AP40.31, AP40.31DA...(Other models you can see in the webshop)		

mechanics for flight type dishwashers			
			
1			
GEV No.	524979	Ref. No.	00005249
description	flange for gear motor H 56mm ø 100mm ID ø 42mm		
For models:	TR1200, TR1650, TR1650N, TR2000, TR2500, TR3000, TR3500, TR4000, TR5000, TRC250, TRR2500		

			
1			
GEV No.	560517	Ref. No.	00005259
description	plain washer ID ø 6.6mm ED ø 33mm thickness 2mm SS Qty 1 pcs		
For models:	TR1200, TR1650, TR1650N, TR2000, TR2500, TR3000, TR3500, TR4000, TR5000, TRC250, TRR2500		

pipes			
			
1			
GEV No.	508203	Ref. No.	00002933
description	pipe		
For models:	AC20, AC25, AE1000, AE1200, AE35.21, AE38.25, AE40.29, AE40.30, AE45.30, AE50.32, AE50.35, AH1000, AH1000Easy, AH1100, AH1100D-GT, AH1200, AH1200DGT, AH1400, AL1200E, AL1400, AL1500E, AL40.28, AL40.28E, AL40.28EM, AL45.32, AL45.32E, AL45.32EM, AL50.34, AL50.34E, AL50.34EM, AL50.40, AL50.40E, AL50.40EM, AL50.45, AL55.45E, AL55.45EM, AL55.45EM-P, AL55.45E-P, ALISEO422, ALISEO428, AP1000, AP1200, AP35.21, AP35.21DA, AP38.25, AP38.25DA, AP40.28, AP40.28DA, AP40.29, AP40.29DA...(Other models you can see in the webshop)		



backflow preventers

backflow preventers



1

GEV No.	504140	Ref. No.	2802
description	backflow preventer		



Image not available

1

GEV No.	508267	Ref. No.	00004728
description	backflow preventer		
For models:	AP35.21, AP35.21DA, AP38.25, AP38.25DA		





Image not available

1

GEV No.	508268	Ref. No.	00004729
description	backflow preventer		
For models:	AP38.25, AP38.25DA, EURO350, EURO380, EURO400		



1

GEV No.	508269	Ref. No.	00004730 00013114
description	backflow preventer		
For models:	AP38.25, AP38.25DA, AP40.28, AP40.28DA, AP40.29, AP40.29DA		



Image not available

1

GEV No.	508271	Ref. No.	00004732
description	backflow preventer		
For models:	AL50.34E, AP45.30, AP45.30DA, AP50.32, AP50.32DA, EURO500, PASSPORT50.32		



Image not available

1

GEV No.	508272	Ref. No.	00004733
description	backflow preventer		
For models:	GL4.32EM		



Image not available

1

GEV No.	508273	Ref. No.	00004734
description	backflow preventer		
For models:	ALISEO45.32E, GL4.32E, GL4.32EM		



Image not available

1

GEV No.	508279	Ref. No.	00004803
description	backflow preventer		
For models:	PROGRAM25CF		



Image not available

1

GEV No.	508280	Ref. No.	00004804
description	backflow preventer		
For models:	AL40.28E, AL40.28EM, ALISEO40.28E, ALISEO428, ALISEO45.32E, EURO400, PROJECT28E, PROJECT28EM		





Image not available

1

GEV No.	508298	Ref. No.	00004999
description	backflow preventer complete with hose		
For models:	GEMINICF, GEMINI-CF		

 <p>Image not available</p>			
1			
GEV No.	508110	Ref. No.	00002376
description	backflow preventer dishwasher		
For models:	GL4.32E, GL4.32EM, MASTER21, PROJECT28, PROJECT28E, PROJECT28EM, SELF4.32, SELF400		

			
2			
GEV No.	516101	Ref. No.	00002802 00004070 00004731 00004735
description	backflow preventer dishwasher hose ø 12mm		
For models:	AC20, AC25, AC26, AE1000, AE1200, AH1000, AH1000Easy, AH1100, AH1100DGT, AH1200, AH1200DGT, AH1400, AL1200E, AL1400, AL1500E, AL40.28, AL40.28E, AL45.32, AL45.32E, AL50.34, AL50.34E, AL50.40, AL50.40E, AL50.40EM, AL50.45, AL55.45E, AL55.45EM, AL55.45EM-P, AL55.45E-P, ALISEO40.28E, ALISEO422, ALISEO45.32E, AP1000, AP1200, AP35.21, AP35.21DA, AP38.25, AP38.25DA, AP40.28DA, AP40.29, AP40.29DA, AP40.31, AP40.31DA, AP45.30, AP45.30DA, AP50.32, AP50.32DA, AP50.35, AP50.35DA, AP55.40... (Other models you can see in the webshop)		
spare parts for	516101		
	GEV No.	506367	Ref. No. —
	 <p>flat gasket rubber ED ø 40mm ID ø 28mm thickness 1.8mm Qty 1 pcs</p>		

miscellaneous

			
1			
GEV No.	508358	Ref. No.	00006224
description	blank plastic H 10.3mm mounting ø 17.5mm ID ø 13.4mm		
For models:	AP1000, AP35.21, AP35.21DA, AP38.25, AP38.25DA, AP40.28, AP40.28DA, AP45.30, AP45.30DA, AP50.32, AP50.32DA, AP50.35, AP50.35DA, AP55.40, AP55.40DA, PASSPORT50.32, PASSPORT50.40		

 <p>Image not available</p>			
1			
GEV No.	508025	Ref. No.	00000186
description	bracket for plate		
For models:	COMPACT20, GEMINI-CF, GEMINI-CR, MASTER21, MINIBAR, MINIBAR-CF, MINIBAR-CR, PROGRAM25CF, PROGRAM25CR, PROJECT28, PROJECT28E, PROJECT28EM, TR1650, TR2000		

			
1			
GEV No.	508087	Ref. No.	00002098
description	bush PTFE		
For models:	GL500CF, GL700CF		

 <p>Image not available</p>			
1			
GEV No.	508091	Ref. No.	00002137
description	cone for dishwasher		
For models:	GL500CF, GL700CF		

 <p>Image not available</p>			
1			
GEV No.	508035	Ref. No.	00000225
description	counterpart lower		
For models:	GL500CF, GL500CR, GL700CF, GL700CR		

 <p>Image not available</p>			
1			
GEV No.	508090	Ref. No.	00002135
description	elbow		
For models:	GL500CF, GL700CF		

 <p>Image not available</p>			
1			
GEV No.	508065	Ref. No.	00001696
description	flange conical		
For models:	SELF400		





 <p>Image not available</p>			
1			
GEV No.	508007	Ref. No.	00000092
description	pin hollow		
For models:	GL500CR, GL700CR		

 <p>Image not available</p>			
2			
GEV No.	508359	Ref. No.	00002151
description	pipe		
For models:	SELF400		

 <p>Image not available</p>			
1			
GEV No.	508100	Ref. No.	00002180
description	pipe SS		
For models:	GL500CF, GL700CF		

 <p>Image not available</p>			
1			
GEV No.	508024	Ref. No.	00000173
description	spindle		
For models:	GL500CF, GL500CR, GL700CF, GL700CR		

door mechanics			
bolts			
			
1			
GEV No.	508070	Ref. No.	00001715
description	bolt		
For models:	AC20, AC25, COMPACT20, GEMINICF, GEMINI-CF, GEMINI-CR, MINIBAR, MINIBAR-CF, MINIBAR-CR		

			
1			
GEV No.	508313	Ref. No.	6371 old
description	door bolt left		

			
1			
GEV No.	508372	Ref. No.	00006371
description	door bolt left ø 4.7mm L 58mm thread M10 SS		
For models:	AL45.32E, AL45.32EM, AL50.34E, AL50.34EM, AL50.40E, AL50.40EM, AL55.45E, AL55.45EM, AL55.45EM-P, AL55.45E-P, ALISEO45.32E, AW45.32		

			
1			
GEV No.	508371	Ref. No.	00006370 6370 R5
description	door bolt right		
For models:	AL40.28E, AL40.28EM, AL50.34E, AL55.45E-P, ALISEO40.28E, AW4028		

			
1			
GEV No.	508414	Ref. No.	00003232 3232 R5
description	door bolt right ø 4.7mm L 58mm thread M10 SS		
For models:	AL45.32E, AL45.32EM, AL50.34E, AL50.34EM, AL50.40E, AL50.40EM, AL55.45E, AL55.45EM, AL55.45EM-P, AL55.45E-P, ALISEO45.32E, AW45.32		

			
1			
GEV No.	508069	Ref. No.	00001714
description	door bolt short		
For models:	AC20, AC25, AC26, COMPACT20, GEMINICF, GEMINI-CF, GEMINI-CR, MASTER21, MINIBAR, MINIBAR-CF, MINIBAR-CR, PROGRAM25CF, PROGRAM25CR, PROJECT28, SELF4.32, SELF400		

springs

roller springs



1			
GEV No.	519500	Ref. No.	00009653
description	roller spring complete incl. holder		
For models:	TR1650, TR1650N, TR2000, TR2500, TR3000, TR3500, TR4000, TR5000, TRC250, TRR2500		



1			
GEV No.	517429	Ref. No.	00009649
description	roller spring W 51mm ID 8mm lug length 50mm mounting distance 35/80mm		
For models:	TR1200, TR3500, TR4000, TR5000, TRR2500		

linkage



1			
GEV No.	508275	Ref. No.	00004744
description	door pin door pin		
For models:	AE35.21, AE38.25, AE40.29, AE40.30, AE45.30, AE50.32, AE50.35, ALISEO422, ALISEO428, AP35.21, AP35.21DA, AP38.25, AP38.25DA, AP40.28, AP40.28DA, AP40.29, AP40.29DA, AP40.31, AP40.31DA, AP45.30, AP45.30DA, AP50.32, AP50.32DA, AP50.35, AP50.35DA, EURO350, EURO380, EURO400, EURO500, GL4.32E, GL4.32EM, GL5.34E, GL7.40EM, PASSPORT45.30, PASSPORT50.32, PROJECT28E, PROJECT28EM		



1			
GEV No.	508276	Ref. No.	00004745
description	door pin door pin		
For models:	AP55.40, AP55.40DA, GL8.50E, GL8.50EM, PASSPORT50.40		

sliding plates



1			
GEV No.	508198	Ref. No.	00002919
description	sliding plate sliding plate		
For models:	AE35.21, AE38.25, AE40.29, AE40.30, AE45.30, AE50.32, AE50.35, ALISEO422, ALISEO428, AP35.21, AP35.21DA, AP38.25, AP38.25DA, AP40.28, AP40.28DA, AP40.29, AP40.29DA, AP40.31, AP40.31DA, AP45.30, AP45.30DA, AP50.32, AP50.32DA, AP50.35, AP50.35DA, AP55.40, AP55.40DA, AU-P55.40, EURO350, EURO380, EURO400, EURO500, GL4.32E, GL4.32EM, GL5.34, GL5.34E, GL7.38, GL7.40E, GL7.40EM, GL8.50E, GL8.50EM, PASSPORT45.30, PASSPORT50.32, PASSPORT50.40, PROJECT28E, PROJECT28EM		

hinges



1			
GEV No.	508324	Ref. No.	00006473
description	deflector drop collecting tank door		
For models:	AL40.28, AL40.28E, AL40.28EM, AL45.32, AL45.32E, AL45.32EM, AL50.34, AL50.34E, AL50.34EM, AL50.40, AL50.40E, AL50.40EM, AL50.45, AL55.45E, AL55.45EM, AL55.45EM-P, AL55.45E-P, ALISEO40.28E, ALISEO45.32E, AU-L55.45, AW4028, AW45.32		

hinge pins



1			
GEV No.	508225	Ref. No.	00003167
description	hinge pin hinge pin		
For models:	ALISEO422, ALISEO428, AP35.21, AP35.21DA, AP38.25, AP38.25DA, AP40.28, AP40.28DA, AP45.30, AP45.30DA, AP50.32, AP50.32DA, AP50.35, AP50.35DA, AP55.40, AP55.40DA, EURO350, EURO380, EURO400, EURO500, GL4.32E, GL4.32EM, GL5.34E, GL7.40E, GL7.40EM, GL8.50E, GL8.50EM, PASSPORT45.30, PASSPORT50.32, PASSPORT50.40, PROJECT28E, PROJECT28EM		

door bumpers





1			
GEV No.	508256	Ref. No.	00004609
description	door bumper guide washer SS		
For models:	ALISEO428, AP35.21, AP35.21DA, AP38.25, AP38.25DA, AP40.28, AP40.28DA, AP45.30, AP45.30DA, AP50.32, AP50.32DA, AP50.35, AP50.35DA, EURO500, GL4.32E, GL4.32EM, GL5.34E, GL7.40E, GL7.40EM, GL8.50E, GL8.50EM, LP125-80, PASSPORT45.30, PASSPORT50.32, PROJECT28E, PROJECT28EM		





locks			
 <p>1</p>			
GEV No.	508102	Ref. No.	00002194
description	door catch complete catch		
For models:	AC26, AE35.21, AE38.25, AE40.29, AE40.30, AE45.30, AE50.32, AE50.35, ALISEO422, ALISEO428, AP35.21, AP35.21DA, AP38.25, AP38.25DA, AP40.28, AP40.28DA, AP40.29, AP40.29DA, AP40.31, AP40.31DA, AP45.30, AP45.30DA, AP50.32, AP50.32DA, AP50.35, AP50.35DA, AP55.40, AP55.40DA, AU-P55.40, EURO350, EURO380, EURO400, EURO500, GL4.32E, GL4.32EM, GL5.34, GL7.38, MASTER21, PASSPORT45.30, PASSPORT50.32, PASSPORT50.40, PROGRAM25CF, PROGRAM25CR, PROJECT28, PROJECT28E, PROJECT28EM, SELF4.32, SELF400		

miscellaneous			
 <p>1</p>			
GEV No.	508057	Ref. No.	00001272
description	bumper impact cap		
For models:	ALISEO422, ALISEO428, GL4.32E, GL4.32EM, GL5.34E, GL7.40E, GL7.40EM, GL8.50E, GL8.50EM, PROJECT28E, PROJECT28EM		

 <p>1</p>			
GEV No.	508223	Ref. No.	00003165
description	bush bush		
For models:	AE35.21, AE38.25, AE40.29, AE40.30, AE45.30, AE50.32, AE50.35, ALISEO422, ALISEO428, AP35.21, AP35.21DA, AP38.25, AP38.25DA, AP40.28, AP40.28DA, AP40.29, AP40.29DA, AP40.31, AP40.31DA, AP45.30, AP45.30DA, AP50.32, AP50.32DA, AP50.35, AP50.35DA, AP55.40, AP55.40DA, AU-P55.40, EURO350, EURO380, EURO400, EURO500, GL4.32E, GL4.32EM, GL5.34E, GL7.40E, GL7.40EM, GL8.50E, GL8.50EM, PASSPORT45.30, PASSPORT50.32, PASSPORT50.40, PROJECT28E, PROJECT28EM		

 <p>1</p>			
GEV No.	508362	Ref. No.	00004438
description	deflector drop collecting tank		
For models:	ALISEO422, ALISEO428, AP35.21, AP35.21DA, AP38.25, AP38.25DA, AP40.28, AP40.28DA, AP45.30, AP45.30DA, AP50.32, AP50.32DA, AP50.35, AP50.35DA, AP55.40, AP55.40DA, EURO350, EURO380, EURO400, EURO500, GL4.32E, GL4.32EM, GL5.34E, GL7.40E, GL7.40EM, GL8.50E, GL8.50EM, PASSPORT45.30, PASSPORT50.32, PASSPORT50.40, PROJECT28E, PROJECT28EM		

 <p>1</p>			
GEV No.	524982	Ref. No.	00002604
description	disc for door mechanism SS ED ø 26mm ID ø 5mm H 5mm		
For models:	GL1040, GL1240		

 <p>1</p>			
GEV No.	508360	Ref. No.	00000897
description	nut microswitch nut		
For models:	AE35.21, AE38.25, AE40.29, AE40.30, AE45.30, AE50.32, AE50.35, ALISEO422, ALISEO428, AP35.21, AP35.21DA, AP38.25, AP38.25DA, AP40.28, AP40.28DA, AP40.29, AP40.29DA, AP40.31, AP40.31DA, AP45.30, AP45.30DA, AP50.32, AP50.32DA, AP50.35, AP50.35DA, AP55.40, AP55.40DA, AU-P55.40, EURO350, EURO380, EURO400, EURO500, GL4.32E, GL4.32EM, GL5.34E, GL7.40EM, GL8.50E, GL8.50EM, PASSPORT45.30, PASSPORT50.32, PASSPORT50.40, PROGRAM25CF, PROGRAM25CR, PROJECT28E, PROJECT28EM		

 <p>1</p>			
GEV No.	508222	Ref. No.	00003164
description	nut nut		
For models:	AE35.21, AE38.25, AE40.29, AE40.30, AE45.30, AE50.32, AE50.35, ALISEO422, ALISEO428, AP35.21, AP35.21DA, AP38.25, AP38.25DA, AP40.28, AP40.28DA, AP40.29, AP40.29DA, AP40.31, AP40.31DA, AP45.30, AP45.30DA, AP50.32, AP50.32DA, AP50.35, AP50.35DA, AP55.40, AP55.40DA, AU-P55.40, EURO350, EURO380, EURO400, EURO500, GL4.32E, GL4.32EM, GL5.34E, GL7.40E, GL7.40EM, GL8.50E, GL8.50EM, PASSPORT45.30, PASSPORT50.32, PASSPORT50.40, PROJECT28E, PROJECT28EM		

 <p>1</p>			
GEV No.	508124	Ref. No.	00002508
description	spring holder spring holder		
For models:	AC20, COMPACT20, GEMINI-CF		

 <p>1</p>			
GEV No.	508072	Ref. No.	00001723
description	spring rod spring holder		
For models:	AC20, AC25, COMPACT20, GEMINICF, GEMINI-CF, GEMINI-CR, MINIBAR, MINIBAR-CF, MINIBAR-CR		

screw connections			
 <p>1</p>			
GEV No.	508074	Ref. No.	00001765
description	screw connection brass		
For models:	GL500CF, GL700CF		



GEV No.	508116	Ref. No.	00002450
description	union nut thread M10x1 H 16mm WS 16 plastic Qty 1 pcs		
For models:	AC20, AC25, AC26, AE1000, AE1200, AE35.21, AE38.25, AE40.29, AE40.30, AE45.30, AE50.32, AE50.35, AH1000, AH1000Easy, AH1100, AH1100DGT, AH1200, AH1200DGT, AH1400, AL1200E, AL1400, AL1500E, AL40.28, AL40.28E, AL40.28EM, AL45.32, AL45.32E, AL45.32EM, AL50.34, AL50.34E, AL50.34EM, AL50.40, AL50.40E, AL50.40EM, AL50.45, AL55.45E, AL55.45EM, AL55.45EM-P, AL55.45E-P, ALISEO40.28E, ALISEO422, ALISEO428, ALISEO45.32E, AP1000, AP1200, AP35.21, AP35.21DA, AP38.25, AP38.25DA, AP40.28...(Other models you can see in the webshop)		

washing and rinsing systems



GEV No.	508241	Ref. No.	00002793 00002911 00004120 00004807 00004808 00004810 00004938 00004941 00004942 00004943
description	manifold 3-way hose ø 12-12-12mm plastic		
For models:	AE1000, AE1200, AE35.21, AE38.25, AE40.29, AE40.30, AE45.30, AE50.32, AE50.35, AH1000, AH1000Easy, AH1100, AH1100DGT, AH1200, AH1200DGT, AH1400, AL1200E, AL1400, AL1500E, AL40.28E, AL45.32E, AL50.34, AL50.34E, AL50.34EM, AL50.40, AL50.40E, AL50.40EM, AL50.45, AL55.45E, AL55.45EM, AL55.45EM-P, AL55.45E-P, ALISEO40.28E, ALISEO422, ALISEO428, ALISEO45.32E, AP1000, AP1200, AP35.21, AP35.21DA, AP38.25, AP38.25DA, AP40.28, AP40.28DA, AP40.29, AP40.29DA, AP40.31, AP40.31DA, AP45.30, AP45.30DA...(Other models you can see in the webshop)		



GEV No.	508344	Ref. No.	00214711
description	manifold brass		
For models:	PROGRAM25CF		



GEV No.	560516	Ref. No.	00007998
description	plain washer ID ø 22mm ED ø 33mm thickness 0.6mm SS Qty 1 pcs		
For models:	AU125-80, AU55-65, AU55-80, AU65-65, LP125-80, LP55-65, LP55-80, LP65-65		



GEV No.	508185	Ref. No.	00009249
description	ring		
For models:	AH1200, AH1200DGT, AH1400, AL1200E, AL1400, AL1500E, AP1200, AU125-80, AU55-65, AU55-80, AU65-65, AU-H1400, GL1040, GL1240, LP125-80, LP55-65, LP55-80, LP65-65, LPC1500		



GEV No.	508151	Ref. No.	00002702
description	rinse pipe		
For models:	GL1040, GL1240		



GEV No.	508144	Ref. No.	00002624
description	rinse pipe mounting pos. lower brass		
For models:	COMPACT20		



GEV No.	508195	Ref. No.	00002904
description	throttle disc		
For models:	AE1000, AE45.30, AE50.32, AE50.35, ALISEO40.28E, ALISEO422, ALISEO428, ALISEO45.32E, AP1000, AP45.30, AP45.30DA, AP50.32, AP50.32DA, AP50.35, AP50.35DA, AP55.40, AP55.40DA, AS50.35, AS50.35DA, AS50.35DGT, AS50.35DGT-DA, AS50.40, AS50.40DA, AS50.40DGT, AS50.40DGT-DA, AU125-80, AU55-65, AU55-80, AU65-65, AU-P55.40, AU-S55.40, AU-S55.40DGT, AW4028, EURO500, GL1040, GL1240, GL4.32E, GL4.32EM, GL5.34, GL5.34E, GL7.38, GL7.40E, GL7.40EM, GL8.50E, GL8.50EM, LP125-80, LP55-65, LP55-80, LP65-65, PASSPORT45.30...(Other models you can see in the webshop)		



washing and rinsing systems (sorted by producer)

ARISTARCO



GEV No.	508068	Ref. No.	00001712
description	rinse arm		
For models:	COMPACT20, GEMINI-CF, MASTER21, MINIBAR-CF, PROGRAM25CF		



GEV No.	508176	Ref. No.	00002761
description	rinse arm complete		
For models:	AH1200, AH1200DGT, AH1400, AL1200E, AL1400, AL1500E, AP1200, AU-H1400, GL1040, GL1240, LP55-65, LPC1500		

spare parts for	508176			
	GEV No.	508112	Ref. No.	00002416 2416
	union nut SS			
	GEV No.	508113	Ref. No.	00002417 2417
	rinse arm shaft			
	GEV No.	508114	Ref. No.	00002419 2419
	bush PTFE			
	GEV No.	508122	Ref. No.	00002502 2502
	end cap			
	GEV No.	510303	Ref. No.	00002531 2531
	O-ring EPDM thickness 1.78mm ID ø 6.75mm Qty 1 pcs			



GEV No.	508243	Ref. No.	00004133
description	rinse arm L 323mm nozzles 5 mounting ø 10mm mounting pos. upper		
For models:	AC20, AE35.21, AP35.21, AP35.21DA, AP38.25, AP38.25DA, COMPACT20, EURO350		

spare parts for	508243			
	GEV No.	508062	Ref. No.	00004359 00005308 00017155 1669 4359
	rinse jet			

spare parts for	508243			
	GEV No.	508083	Ref. No.	00001955 1955
	rinse arm boss			
	GEV No.	508122	Ref. No.	00002502 2502
	end cap			
	GEV No.	508228	Ref. No.	00003196 3196
	rinse arm L 170mm nozzles 2			
	GEV No.	508229	Ref. No.	00003197 3197
	rinse arm L 150mm nozzles 3			
	GEV No.	510303	Ref. No.	00002531 2531
	O-ring EPDM thickness 1.78mm ID ø 6.75mm Qty 1 pcs			



GEV No.	508255	Ref. No.	00004376 1712
description	rinse arm L 360mm nozzles 5 mounting ø 10mm mounting pos. upper		
For models:	AC25, AC26, AE38.25, AE40.29, AE40.30, EURO400, GEMINICF, GEMINI-CF, PROGRAM25CF		



GEV No.	508340	Ref. No.	0002761C
description	rinse arm L 565mm nozzles 6 mounting ø 18mm mounting pos. upper and bottom		
For models:	AH1200, AH1200DGT, AH1400, AL1200E, AL1400, AL1500E, AP1200, AU-H1400, GL1040, GL1240, LPC1500		

spare parts for	508340			
	GEV No.	508112	Ref. No.	00002416 2416
	union nut SS			
	GEV No.	508113	Ref. No.	00002417 2417
	rinse arm shaft			
	GEV No.	508114	Ref. No.	00002419 2419
	bush PTFE			
	GEV No.	508122	Ref. No.	00002502 2502
	end cap			
	GEV No.	508176	Ref. No.	00002761 2761
	rinse arm complete			

Table continues overleaf

spare parts for 508340			
	GEV No.	510303	Ref. No. 00002531 2531
O-ring EPDM thickness 1.78mm ID ø 6.75mm Qty 1 pcs			





GEV No.	517430	Ref. No.	0004510C
description	rinse arm mounting pos. upper/lower L 605mm nozzles 8 complete		
For models:	AU125-80, AU55-65, AU55-80, LP125-80, LP55-65, LP55-80		

spare parts for 517430			
	GEV No.	508062	Ref. No. 00004359 00005308 00017155 1669 4359
rinse jet			

	GEV No.	508112	Ref. No. 00002416 2416
union nut SS			

	GEV No.	508113	Ref. No. 00002417 2417
rinse arm shaft			

	GEV No.	508114	Ref. No. 00002419 2419
bush PTFE			

	GEV No.	508122	Ref. No. 00002502 2502
end cap			

	GEV No.	510303	Ref. No. 00002531 2531
O-ring EPDM thickness 1.78mm ID ø 6.75mm Qty 1 pcs			





GEV No.	508322	Ref. No.	00006471
description	wash and rinse arm		
For models:	AL55.45E, AL55.45EM, AL55.45EM-P, AL55.45E-P		



GEV No.	508266	Ref. No.	00004725 00013326
description	wash and rinse arm 2 wash arms/ 2 rinse arms		
For models:	AL45.32, AL45.32E, AL45.32EM, GL4.32E, GL4.32EM		

spare parts for 508266			
	GEV No.	508008	Ref. No. 00000093 93
O-ring EPDM thickness 2.62mm ID ø 15.88mm Qty 1 pcs			

	GEV No.	508062	Ref. No. 00004359 00005308 00017155 1669 4359
rinse jet			

	GEV No.	508104	Ref. No. 00002265 2265
bush wash arm			

	GEV No.	508145	Ref. No. 00002650 2650
end cap for wash arm			

	GEV No.	508146	Ref. No. 00002654 2654
spring			

	GEV No.	508191	Ref. No. 00002866 2866
wash and rinse arm complete			

	GEV No.	510303	Ref. No. 00002531 2531
O-ring EPDM thickness 1.78mm ID ø 6.75mm Qty 1 pcs			















GEV No.	508300	Ref. No.	00003021
description	wash and rinse arm 2 wash arms/ 2 rinse arms		
For models:	AL50.34E, AL50.34EM, AL50.40E, AL50.40EM, GL5.34, GL5.34E, GL7.38, GL7.40E, GL7.40EM		











GEV No.	508191	Ref. No.	00002866
description	wash and rinse arm complete		
For models:	GL4.32E, GL4.32EM, SELF4.32		









 <p>Image not available</p>			
GEV No.	508262	Ref. No.	00003048
description	wash and rinse arm complete with rinse arm		
For models:	AL50.34E, AL50.34EM, AL50.40E, AL50.40EM, GL5.34, GL5.34E, GL7.38, GL7.40E, GL7.40EM		





			
GEV No.	508242	Ref. No.	00004132 00016116
description	wash and rinse arm L 320mm w. jets 8 r. jets 5 mounting ø 10/42mm mounting pos. lower 2 wash arms/ 2 rinse arms		
For models:	AE35.21, AP35.21, AP35.21DA, AP38.25, AP38.25DA, EURO350		
spare parts for	508242		
	GEV No.	508008	Ref. No. 00000093 93
	O-ring EPDM thickness 2.62mm ID ø 15.88mm Qty 1 pcs		
	GEV No.	508062	Ref. No. 00004359 00005308 00017155 1669 4359
	rinse jet		
	GEV No.	508082	Ref. No. 00001954 1954
	wash arm boss		
	GEV No.	508122	Ref. No. 00002502 2502
	end cap		
	GEV No.	508145	Ref. No. 00002650 2650
	end cap for wash arm		
	GEV No.	508146	Ref. No. 00002654 2654
	spring		
	GEV No.	508227	Ref. No. 00003195 3195
	wash arm L 137mm nozzles 4		
	GEV No.	508228	Ref. No. 00003196 3196
	rinse arm L 170mm nozzles 2		
	GEV No.	508229	Ref. No. 00003197 3197
	rinse arm L 150mm nozzles 3		
	GEV No.	510303	Ref. No. 00002531 2531
	O-ring EPDM thickness 1.78mm ID ø 6.75mm Qty 1 pcs		



			
GEV No.	508299	Ref. No.	00005010
description	wash and rinse arm L 360mm w. jets 8 r. jets 5 mounting ø 10/41.5mm mounting pos. upper		
For models:	ALISEO40.28E, ALISEO422, ALISEO428, ALISEO45.32E, AW4028		
spare parts for	508299		
	GEV No.	508008	Ref. No. 00000093 93
	O-ring EPDM thickness 2.62mm ID ø 15.88mm Qty 1 pcs		
	GEV No.	508062	Ref. No. 00004359 00005308 00017155 1669 4359
	rinse jet		
	GEV No.	508082	Ref. No. 00001954 1954
	wash arm boss		
	GEV No.	508122	Ref. No. 00002502 2502
	end cap		
	GEV No.	508145	Ref. No. 00002650 2650
	end cap for wash arm		
	GEV No.	508146	Ref. No. 00002654 2654
	spring		
	GEV No.	510303	Ref. No. 00002531 2531
	O-ring EPDM thickness 1.78mm ID ø 6.75mm Qty 1 pcs		











			
GEV No.	508244	Ref. No.	00004160 00015771
description	wash and rinse arm L 360mm w. jets 8 r. jets 5 mounting ø 10/41.5mm mounting pos. upper/lower		
For models:	AC20, AC25, AE38.25, AE40.29, AE40.30, AP38.25, AP38.25DA, AP40.28, AP40.28DA, AP40.29, AP40.29DA, AP40.31, AP40.31DA, AS40.31, AS40.31DA, AS40.31DGT, AS40.31DGT-DA, COMPACT20, EURO380, EURO400		
spare parts for	508244		
	GEV No.	508008	Ref. No. 00000093 93
	O-ring EPDM thickness 2.62mm ID ø 15.88mm Qty 1 pcs		

Table continues overleaf

spare parts for		508244	
	GEV No.	508062	Ref. No.
			00004359 00005308 00017155 1669 4359
	rinse jet		
	GEV No.	508082	Ref. No.
			00001954 1954
	wash arm boss		
	GEV No.	508122	Ref. No.
			00002502 2502
	end cap		
	GEV No.	508145	Ref. No.
			00002650 2650
	end cap for wash arm		
	GEV No.	508146	Ref. No.
			00002654 2654
	spring		
	GEV No.	508230	Ref. No.
			00003198 00015233 3198
	wash arm L 157mm nozzles 4		
	GEV No.	508231	Ref. No.
			00003199 3199
	rinse arm L 170mm nozzles 2		
	GEV No.	508233	Ref. No.
			00004000 4000
	rinse arm L 170mm nozzles 3		
	GEV No.	510303	Ref. No.
			00002531 2531
	O-ring EPDM thickness 1.78mm ID ø 6.75mm Qty 1 pcs		









			
1			
GEV No.	508296	Ref. No.	00004986
description	wash and rinse arm L 360mm w. jets 8 r. jets 6 mounting ø 10/41.5mm mounting pos. lower		
For models:	ALISEO40.28E, ALISEO422, ALISEO428, ALISEO45.32E, AW4028		
spare parts for	508296		
	GEV No.	508008	Ref. No.
			00000093 93
	O-ring EPDM thickness 2.62mm ID ø 15.88mm Qty 1 pcs		
	GEV No.	508062	Ref. No.
			00004359 00005308 00017155 1669 4359
	rinse jet		
	GEV No.	508082	Ref. No.
			00001954 1954
	wash arm boss		
	GEV No.	508122	Ref. No.
			00002502 2502
	end cap		

spare parts for		508296	
	GEV No.	508145	Ref. No.
			00002650 2650
	end cap for wash arm		
	GEV No.	508146	Ref. No.
			00002654 2654
	spring		
	GEV No.	510303	Ref. No.
			00002531 2531
	O-ring EPDM thickness 1.78mm ID ø 6.75mm Qty 1 pcs		

			
1			
GEV No.	508245	Ref. No.	00004162 00016117
description	wash and rinse arm L 430mm w. jets 10 r. jets 6 mounting ø 10/41.5mm mounting pos. upper/lower		
For models:	AE45.30, ALISEO45.32E, AP45.30, AP45.30DA, PASSPORT45.30		
spare parts for	508245		
	GEV No.	508008	Ref. No.
			00000093 93
	O-ring EPDM thickness 2.62mm ID ø 15.88mm Qty 1 pcs		
	GEV No.	508062	Ref. No.
			00004359 00005308 00017155 1669 4359
	rinse jet		
	GEV No.	508082	Ref. No.
			00001954 1954
	wash arm boss		
	GEV No.	508122	Ref. No.
			00002502 2502
	end cap		
	GEV No.	508145	Ref. No.
			00002650 2650
	end cap for wash arm		
	GEV No.	508146	Ref. No.
			00002654 2654
	spring		
	GEV No.	508234	Ref. No.
			00004001 4001
	wash arm L 190mm nozzles 5		
	GEV No.	508235	Ref. No.
			00004002 4002
	rinse arm L 205mm nozzles 3		
	GEV No.	508236	Ref. No.
			00004003 4003
	rinse arm L 205mm nozzles 3		
	GEV No.	510303	Ref. No.
			00002531 2531
	O-ring EPDM thickness 1.78mm ID ø 6.75mm Qty 1 pcs		



				
1				
GEV No.	508247	Ref. No.	00004164	
description	wash and rinse arm L 480mm w. jets 10 r. jets 6 mounting ø 10/41.5mm mounting pos. upper/lower for glasses			
For models:	AE50.32, AP50.32, AP50.32DA, EURO500, PASSPORT50.32			
spare parts for	508247			
	GEV No.	508008	Ref. No.	00000093 93
O-ring EPDM thickness 2.62mm ID ø 15.88mm Qty 1 pcs				
	GEV No.	508062	Ref. No.	00004359 00005308 00017155 1669 4359
rinse jet				
	GEV No.	508082	Ref. No.	00001954 1954
wash arm boss				
	GEV No.	508122	Ref. No.	00002502 2502
end cap				
	GEV No.	508145	Ref. No.	00002650 2650
end cap for wash arm				
	GEV No.	508146	Ref. No.	00002654 2654
spring				
	GEV No.	508238	Ref. No.	00004005 4005
wash arm L 217mm nozzles 5 for plate				
	GEV No.	508239	Ref. No.	00004006 4006
rinse arm L 232mm nozzles 3				
	GEV No.	508240	Ref. No.	00004007 4007
rinse arm L 232mm nozzles 3				
	GEV No.	510303	Ref. No.	00002531 2531
O-ring EPDM thickness 1.78mm ID ø 6.75mm Qty 1 pcs				

				
1				
GEV No.	508246	Ref. No.	00004163 00015517	
description	wash and rinse arm L 480mm w. jets 10 r. jets 6 mounting ø 10/42mm mounting pos. upper/lower 2 wash arms/ 2 rinse arms gasses/dishes			
For models:	AE1000, AE1200, AE50.32, AE50.35, AH1000, AH1000Easy, AP50.32, AP50.32DA, AP50.35, AP50.35DA, AS50.35, AS50.35DA, AS50.35DGT, AS50.35DGT-DA, EURO500, PASSPORT50.32			
spare parts for	508246			
	GEV No.	508008	Ref. No.	00000093 93
O-ring EPDM thickness 2.62mm ID ø 15.88mm Qty 1 pcs				
	GEV No.	508062	Ref. No.	00004359 00005308 00017155 1669 4359
rinse jet				
	GEV No.	508082	Ref. No.	00001954 1954
wash arm boss				
	GEV No.	508145	Ref. No.	00002650 2650
end cap for wash arm				
	GEV No.	508146	Ref. No.	00002654 2654
spring				
	GEV No.	508237	Ref. No.	00004004 00012361 12361 4004
wash arm L 217mm nozzles 5 for glasses				
	GEV No.	508239	Ref. No.	00004006 4006
rinse arm L 232mm nozzles 3				
	GEV No.	508240	Ref. No.	00004007 4007
rinse arm L 232mm nozzles 3				













				
1				
GEV No.	508265	Ref. No.	00004724	
description	wash and rinse arm wash arm L 360mm rinse arm L 360mm w. jets 8 r. jets 5 mounting ø 10/42mm mounting pos. lower			
For models:	AC25, GEMINICF, GEMINI-CF, PROGRAM25CF, PROJECT28E, PROJECT28EM			
spare parts for	508265			
	GEV No.	508008	Ref. No.	00000093 93
O-ring EPDM thickness 2.62mm ID ø 15.88mm Qty 1 pcs				

Table continues overleaf

spare parts for		508265	
	GEV No.	508062	Ref. No.
			00004359 00005308 00017155 1669 4359
	rinse jet		
	GEV No.	508104	Ref. No.
			00002265 2265
	bush wash arm		
	GEV No.	508122	Ref. No.
			00002502 2502
	end cap		
	GEV No.	508145	Ref. No.
			00002650 2650
	end cap for wash arm		
	GEV No.	508146	Ref. No.
			00002654 2654
	spring		
	GEV No.	508177	Ref. No.
			00002762 2762
	wash arm		
	GEV No.	510303	Ref. No.
			00002531 2531
	O-ring EPDM thickness 1.78mm ID ø 6.75mm Qty 1 pcs		

	GEV No.	508407	Ref. No.	00013331
	description	wash and rinse arm wash arm L 380mm rinse arm L 375mm w. jets 8 r. jets 5 mounting ø 18mm		
	For models:	AC26, AL40.28		

	GEV No.	508211	Ref. No.	00005051
	description	wash and rinse arm wash arm L 485mm rinse arm L 485mm w. jets 10 r. jets 6 mounting ø 10/42mm mounting pos. upper/lower for glasses		
	For models:	AL50.34E, AL50.34EM, AL50.40E, AL50.40EM, GL7.40E, GL7.40EM		
spare parts for 508211				
	GEV No.	508008	Ref. No.	00000093 93
	O-ring EPDM thickness 2.62mm ID ø 15.88mm Qty 1 pcs			
	GEV No.	508062	Ref. No.	00004359 00005308 00017155 1669 4359
	rinse jet			
	GEV No.	508104	Ref. No.	00002265 2265
	bush wash arm			
	GEV No.	508122	Ref. No.	00002502 2502
	end cap			

spare parts for		508211	
	GEV No.	508145	Ref. No.
			00002650 2650
	end cap for wash arm		
	GEV No.	508146	Ref. No.
			00002654 2654
	spring		
	GEV No.	508262	Ref. No.
			00003048 3048
	wash and rinse arm complete with rinse arm		
	GEV No.	510303	Ref. No.
			00002531 2531
	O-ring EPDM thickness 1.78mm ID ø 6.75mm Qty 1 pcs		









GEV No.	508212	Ref. No.	00004720 00013317
description	wash and rinse arm wash arm L 485mm rinse arm L 485mm w. jets 10 r. jets 6 mounting ø 10/42mm mounting pos. upper/lower for plate		
For models:	AL50.34, AL50.34E, AL50.34EM, AL50.40, AL50.40E, AL50.40EM, GL7.40E, GL7.40EM		





spare parts for		508212	
	GEV No.	508008	Ref. No.
			00000093 93
	O-ring EPDM thickness 2.62mm ID ø 15.88mm Qty 1 pcs		
	GEV No.	508062	Ref. No.
			00004359 00005308 00017155 1669 4359
	rinse jet		
	GEV No.	508104	Ref. No.
			00002265 2265
	bush wash arm		
	GEV No.	508122	Ref. No.
			00002502 2502
	end cap		
	GEV No.	508145	Ref. No.
			00002650 2650
	end cap for wash arm		
	GEV No.	508146	Ref. No.
			00002654 2654
	spring		
	GEV No.	508300	Ref. No.
			00003021 3021
	wash and rinse arm 2 wash arms / 2 rinse arms		
	GEV No.	510303	Ref. No.
			00002531 2531
	O-ring EPDM thickness 1.78mm ID ø 6.75mm Qty 1 pcs		



			
GEV No.	508403	Ref. No.	00006472 00013232
description	wash and rinse arm wash arm L 570mm rinse arm L 565mm w. jets 12 r. jets 7 mounting ø 10/42mm mounting pos. upper/lower		
For models:	AH1100, AH1100DGT, AL50.45, AL55.45E, AL55.45EM, AL55.45EM-P, AL55.45E-P, AP55.40, AP55.40DA, AS50.40, AS50.40DA, AS50.40DGT, AS50.40DGT-DA, AU-L55.45, AU-P55.40, AU-S55.40, AU-S55.40DGT		

			
GEV No.	508216	Ref. No.	00003087 00004841
description	wash and rinse arm wash arm L 575mm rinse arm L 570mm w. jets 12 r. jets 7 mounting ø 10/43mm mounting pos. upper/lower 2 wash arms/ 2 rinse arms edition since 2006		
For models:	AE1000, AP1000, AP55.40, AP55.40DA, GL8.50E, GL8.50EM, PAS-SPORT50.40		
spare parts for	508216		
	GEV No.	508008	Ref. No.
			00000093 93
	O-ring EPDM thickness 2.62mm ID ø 15.88mm Qty 1 pcs		
	GEV No.	508062	Ref. No.
			00004359 00005308 00017155 1669 4359
	rinse jet		
	GEV No.	508104	Ref. No.
			00002265 2265
	bush wash arm		
	GEV No.	508122	Ref. No.
			00002502 2502
	end cap		
	GEV No.	508145	Ref. No.
			00002650 2650
	end cap for wash arm		
	GEV No.	508146	Ref. No.
			00002654 2654
	spring		
	GEV No.	508282	Ref. No.
			—
	wash and rinse arm 2 wash arms/ 2 rinse arms		
	GEV No.	510303	Ref. No.
			00002531 2531
	O-ring EPDM thickness 1.78mm ID ø 6.75mm Qty 1 pcs		

			
GEV No.	508177	Ref. No.	00002762
description	wash arm		
For models:	AC25, AL45.32E, AL45.32EM, AL50.34E, AL50.34EM, COMPACT20, GEMINICF, GEMINI-CF, MASTER21, MINIBAR-CF, PROGRAM25CF, PROJECT28, PROJECT28E, PROJECT28EM		
spare parts for	508177		
	GEV No.	508062	Ref. No.
			00004359 00005308 00017155 1669 4359
	rinse jet		
	GEV No.	508083	Ref. No.
			00001955 1955
	rinse arm boss		
	GEV No.	508122	Ref. No.
			00002502 2502
	end cap		
	GEV No.	508231	Ref. No.
			00003199 3199
	rinse arm L 170mm nozzles 2		
	GEV No.	508233	Ref. No.
			00004000 4000
	rinse arm L 170mm nozzles 3		
	GEV No.	510303	Ref. No.
			00002531 2531
	O-ring EPDM thickness 1.78mm ID ø 6.75mm Qty 1 pcs		

			
GEV No.	508175	Ref. No.	00002760 0002760C
description	wash arm L 280mm nozzles 15 mounting ø 22/57mm mounting pos. upper/lower for glasses		
For models:	AL1200E, AL1400, AL1500E, GL1240, LPC1500		
spare parts for	508175		
	GEV No.	508008	Ref. No.
			00000093 93
	O-ring EPDM thickness 2.62mm ID ø 15.88mm Qty 1 pcs		
	GEV No.	508115	Ref. No.
			00002445 2445
	bush wash arm PTFE		
	GEV No.	508145	Ref. No.
			00002650 2650
	end cap for wash arm		
	GEV No.	508146	Ref. No.
			00002654 2654
	spring		

			
GEV No.	508173	Ref. No.	00002758 0002758C
description	wash arm L 280mm nozzles 18 mounting ø 22/57mm mounting pos. upper/lower for plate		
For models:	AH1400, AL1200E, AL1400, AL1500E, AU-H1400, GL1240, LP55-65, LPC1500		
spare parts for	508173		
	GEV No.	508008	Ref. No.
			00000093 93
	O-ring EPDM thickness 2.62mm ID ø 15.88mm Qty 1 pcs		
	GEV No.	508115	Ref. No.
			00002445 2445
	bush wash arm PTFE		
	GEV No.	508145	Ref. No.
			00002650 2650
	end cap for wash arm		
	GEV No.	508146	Ref. No.
			00002654 2654
	spring		

			
GEV No.	508426	Ref. No.	00015521
description	wash arm L 500mm mounting ø 22/57mm mounting pos. upper/lower nozzles 15		

			
GEV No.	508174	Ref. No.	00002759
description	wash arm L 560mm nozzles 10 mounting ø 22/57mm mounting pos. upper/lower for glasses		
For models:	GL1040		
spare parts for	508174		
	GEV No.	508008	Ref. No.
			00000093 93
	O-ring EPDM thickness 2.62mm ID ø 15.88mm Qty 1 pcs		
	GEV No.	508115	Ref. No.
			00002445 2445
	bush wash arm PTFE		
	GEV No.	508145	Ref. No.
			00002650 2650
	end cap for wash arm		
	GEV No.	508146	Ref. No.
			00002654 2654
	spring		

			
GEV No.	508172	Ref. No.	00002757 00013461
description	wash arm L 560mm nozzles 12 mounting ø 22/57mm mounting pos. upper/lower for plate		
For models:	AH1200, AH1200DGT, AP1200, GL1040		
spare parts for	508172		
	GEV No.	508008	Ref. No.
			00000093 93
	O-ring EPDM thickness 2.62mm ID ø 15.88mm Qty 1 pcs		
	GEV No.	508115	Ref. No.
			00002445 2445
	bush wash arm PTFE		
	GEV No.	508145	Ref. No.
			00002650 2650
	end cap for wash arm		
	GEV No.	508146	Ref. No.
			00002654 2654
	spring		

			
GEV No.	508188	Ref. No.	00002808
description	bush for rinse arm		
For models:	AC20, AC25, AC26, AE1000, AE1200, AE35.21, AE38.25, AE40.29, AE40.30, AE45.30, AE50.32, AE50.35, AH1000, AH1000Easy, AL40.28, AL45.32, AL50.34, AL50.40, AL50.45, ALISEO40.28E, ALISEO422, ALISEO428, ALISEO45.32E, AP35.21, AP35.21DA, AP38.25, AP38.25DA, AP40.28, AP40.28DA, AP40.29, AP40.29DA, AP40.31, AP40.31DA, AP45.30, AP45.30DA, AP50.32, AP50.32DA, AP50.35, AP50.35DA, AP55.40, AP55.40DA, AS40.31, AS40.31DA, AS40.31DGT, AS40.31DGT-DA, AS50.35, AS50.35DA, AS50.35DGT, AS50.35DGT-DA, AS50.40... (Other models you can see in the webshop)		

			
GEV No.	508114	Ref. No.	00002419
description	bush PTFE		
For models:	AH1200, AH1200DGT, AH1400, AL1200E, AL1400, AL1500E, AP1200, AU125-80, AU55-65, AU55-80, AU65-65, AU-H1400, GL1040, GL1240, LP125-80, LP55-65, LP55-80, LP65-65, LPC1500		

			
GEV No.	508104	Ref. No.	00002265
description	bush wash arm		
For models:	AC25, AE1000, AH1100, AH1100DGT, AL40.28E, AL40.28EM, AL45.32E, AL45.32EM, AL50.34E, AL50.34EM, AL50.40E, AL50.40EM, AL55.45E, AL55.45EM, AL55.45EM-P, AL55.45E-P, AP1000, AP55.40, AP55.40DA, COMPACT20, GEMINICF, GEMINI-CF, GL4.32E, GL4.32EM, GL5.34, GL5.34E, GL7.38, GL7.40E, GL7.40EM, GL8.50E, GL8.50EM, MASTER21, MINIBAR-CF, PASSPORT50.40, PROGRAM25CF, PROJECT28, PROJECT28E, PROJECT28EM, SELF4.32, SELF400		





			
GEV No.	508115	Ref. No.	00002445
description	bush wash arm PTFE		
For models:	AH1200, AH1200DGT, AH1400, AL1200E, AL1400, AL1500E, AP1200, AU125-80, AU55-65, AU55-80, AU65-65, AU-H1400, GL1040, GL1240, GL500CF, GL700CF, LP125-80, LP55-65, LP55-80, LP65-65, LPC1500		

			
GEV No.	508122	Ref. No.	00002502
description	end cap		
For models:	AC20, AC25, AC26, AE1000, AE1200, AE35.21, AE38.25, AE40.29, AE40.30, AE45.30, AE50.32, AE50.35, AH1000, AH1000Easy, AH1100, AH1100DGT, AH1200, AH1200DGT, AH1400, AL1200E, AL1400, AL1500E, AL40.28, AL40.28E, AL40.28EM, AL45.32, AL45.32E, AL45.32EM, AL50.34, AL50.34E, AL50.34EM, AL50.40, AL50.40E, AL50.40EM, AL50.45, AL55.45E, AL55.45EM, AL55.45EM-P, AL55.45E-P, ALISEO40.28E, ALISEO422, ALISEO428, ALISEO45.32E, AP1000, AP1200, AP35.21, AP35.21DA, AP38.25, AP38.25DA, AP40.28...(Other models you can see in the webshop)		

			
GEV No.	508145	Ref. No.	00002650
description	end cap for wash arm		
For models:	AC20, AC25, AC26, AE1000, AE1200, AE35.21, AE38.25, AE40.29, AE40.30, AE45.30, AE50.32, AE50.35, AH1000, AH1000Easy, AH1100, AH1100DGT, AH1200, AH1200DGT, AH1400, AL1200E, AL1400, AL1500E, AL40.28, AL40.28E, AL40.28EM, AL45.32, AL45.32E, AL45.32EM, AL50.34, AL50.34E, AL50.34EM, AL50.40, AL50.40E, AL50.40EM, AL50.45, AL55.45E, AL55.45EM, AL55.45EM-P, AL55.45E-P, ALISEO40.28E, ALISEO422, ALISEO428, ALISEO45.32E, AP1000, AP1200, AP35.21, AP35.21DA, AP38.25, AP38.25DA, AP40.28...(Other models you can see in the webshop)		

			
GEV No.	510303	Ref. No.	00002531
description	O-ring EPDM thickness 1.78mm ID ø 6.75mm Qty 1 pcs		
For models:	AC20, AC25, AC26, AE1000, AE35.21, AE38.25, AE40.29, AE40.30, AE45.30, AE50.32, AE50.35, AH1000, AH1000Easy, AH1100, AH1100DGT, AH1200, AH1200DGT, AH1400, AL1200E, AL1400, AL1500E, AL40.28, AL40.28E, AL40.28EM, AL45.32, AL45.32E, AL45.32EM, AL50.34, AL50.34E, AL50.34EM, AL50.40, AL50.40E, AL50.40EM, AL50.45, AL55.45E, AL55.45EM, AL55.45EM-P, AL55.45E-P, ALISEO40.28E, ALISEO422, ALISEO428, ALISEO45.32E, AP1000, AP1200, AP35.21, AP35.21DA, AP38.25, AP38.25DA, AP40.28, AP40.28DA...(Other models you can see in the webshop)		

			
GEV No.	508008	Ref. No.	00000093
description	O-ring EPDM thickness 2.62mm ID ø 15.88mm Qty 1 pcs		
For models:	AC20, AC25, AC26, AE1000, AE1200, AE35.21, AE38.25, AE40.29, AE40.30, AE45.30, AE50.32, AE50.35, AH1000, AH1000Easy, AH1100, AH1100DGT, AH1200, AH1200DGT, AH1400, AL1200E, AL1400, AL1500E, AL40.28, AL40.28E, AL40.28EM, AL45.32, AL45.32E, AL45.32EM, AL50.34, AL50.34E, AL50.34EM, AL50.40, AL50.40E, AL50.40EM, AL50.45, AL55.45E, AL55.45EM, AL55.45EM-P, AL55.45E-P, ALISEO40.28E, ALISEO422, ALISEO428, ALISEO45.32E, AP1000, AP1200, AP35.21, AP35.21DA, AP38.25, AP38.25DA, AP40.28...(Other models you can see in the webshop)		

			
GEV No.	508229	Ref. No.	00003197
description	rinse arm L 150mm nozzles 3		
For models:	AE35.21, AP35.21DA, AP38.25, AP38.25DA, EURO350, EURO380		

			
GEV No.	508228	Ref. No.	00003196
description	rinse arm L 170mm nozzles 2		
For models:	AE35.21, AP35.21, AP35.21DA, AP38.25, AP38.25DA, EURO350, EURO380, EURO400		

			
GEV No.	508231	Ref. No.	00003199
description	rinse arm L 170mm nozzles 2		
For models:	AC20, AC25, AC26, AE38.25, AE40.29, AE40.30, ALISEO40.28E, ALISEO45.32E, AP38.25, AP38.25DA, AP40.28, AP40.28DA, AP40.29, AP40.29DA, AP40.31, AP40.31DA, AS40.31, AS40.31DA, AS40.31DGT, AS40.31DGT-DA, AW4028, EURO400, GEMINICF, GEMINI-CF, PROGRAM25CF		

			
GEV No.	508233	Ref. No.	00004000
description	rinse arm L 170mm nozzles 3		
For models:	AC20, AC25, AC26, AE38.25, AE40.29, AE40.30, ALISEO40.28E, ALISEO45.32E, AP38.25, AP38.25DA, AP40.28, AP40.28DA, AP40.29, AP40.29DA, AP40.31, AP40.31DA, AS40.31, AS40.31DA, AS40.31DGT, AS40.31DGT-DA, AW4028, EURO400, GEMINICF, GEMINI-CF, PROGRAM25CF		

			
GEV No.	508235	Ref. No.	00004002
description	rinse arm L 205mm nozzles 3		
For models:	AE45.30, ALISEO45.32E, AP45.30, AP45.30DA, PASSPORT45.30		

			
GEV No.	508236	Ref. No.	00004003
description	rinse arm L 205mm nozzles 3		
For models:	AE45.30, ALISEO45.32E, AP45.30, AP45.30DA, PASSPORT45.30		

			
1			
GEV No.	508239	Ref. No.	00004006
description	rinse arm L 232mm nozzles 3		
For models:	AE1000, AE1200, AE50.32, AE50.35, AH1000, AH1000Easy, AP50.32, AP50.32DA, AP50.35, AP50.35DA, AS50.35, AS50.35DA, AS50.35DGT, AS50.35DGT-DA, EURO500, PASSPORT50.32		

			
1			
GEV No.	508240	Ref. No.	00004007
description	rinse arm L 232mm nozzles 3		
For models:	AE1000, AE1200, AE50.32, AE50.35, AH1000, AH1000Easy, AP50.32, AP50.32DA, AP50.35, AP50.35DA, AS50.35, AS50.35DA, AS50.35DGT, AS50.35DGT-DA, EURO500, PASSPORT50.32		

			
1			
GEV No.	508083	Ref. No.	00001955
description	rinse arm boss		
For models:	AC20, AC25, AC26, AE35.21, AE38.25, AE40.29, AE40.30, AP35.21, AP35.21DA, AP38.25, AP38.25DA, COMPACT20, EURO350, EURO380, EURO400, GEMINICF, GEMINI-CF, PROGRAM25CF		

			
1			
GEV No.	508062	Ref. No.	00004359 00005308 00017155 1669
description	rinse jet		
For models:	AC20, AC25, AC26, AE1000, AE1200, AE35.21, AE38.25, AE40.29, AE40.30, AE45.30, AE50.32, AE50.35, AH1000, AH1000Easy, AH1100, AH1100DGT, AH1200, AH1200DGT, AH1400, AL1200E, AL1400, AL1500E, AL40.28, AL40.28E, AL40.28EM, AL45.32, AL45.32E, AL45.32EM, AL50.34, AL50.34E, AL50.34EM, AL50.40, AL50.40E, AL50.40EM, AL50.45, AL55.45E, AL55.45EM, AL55.45EM-P, AL55.45E-P, ALISEO40.28E, ALISEO422, ALISEO428, ALISEO45.32E, AP1000, AP1200, AP35.21, AP35.21DA, AP38.25, AP38.25DA, AP40.28...(Other models you can see in the webshop)		

			
1			
GEV No.	508146	Ref. No.	00002654
description	spring		
For models:	AC20, AC25, AC26, AE1000, AE1200, AE35.21, AE38.25, AE40.29, AE40.30, AE45.30, AE50.32, AE50.35, AH1000, AH1000Easy, AH1100, AH1100DGT, AH1200, AH1200DGT, AH1400, AL1200E, AL1400, AL1500E, AL40.28, AL40.28E, AL40.28EM, AL45.32, AL45.32E, AL45.32EM, AL50.34, AL50.34E, AL50.34EM, AL50.40, AL50.40E, AL50.40EM, AL50.45, AL55.45E, AL55.45EM, AL55.45EM-P, AL55.45E-P, ALISEO40.28E, ALISEO422, ALISEO428, ALISEO45.32E, AP1000, AP1200, AP35.21, AP35.21DA, AP38.25, AP38.25DA, AP40.28...(Other models you can see in the webshop)		

			
1			
GEV No.	524981	Ref. No.	00006919
description	spring for wash arm L 37mm W 13mm wire gauge ø 1.2mm		
For models:	AC25, AE1000, AH1100, AH1100DGT, AL40.28E, AL40.28EM, AL45.32E, AL45.32EM, AL50.34E, AL50.34EM, AL50.40E, AL50.40EM, AL55.45E, AL55.45EM, AL55.45EM-P, AL55.45E-P, ALISEO40.28E, ALISEO45.32E, AP1000, AP55.40, AP55.40DA, GEMINICF, GEMINI-CF, PROGRAM25CF		

			
1			
GEV No.	508047	Ref. No.	00001133 4374
description	Thumb screw ø 22mm thread M6 thread L 6mm		
For models:	AL40.28E, AL40.28EM, AL45.32E, AL45.32EM, AL50.34E, AL50.34EM, AL50.40E, AL50.40EM, AL55.45E, AL55.45EM, AL55.45EM-P, AL55.45E-P, ALISEO40.28E, ALISEO422, ALISEO428, ALISEO45.32E, AP1000, AP50.35, AP50.35DA, AP55.40, AP55.40DA, COMPACT20, GEMINI-CF, GL4.32E, GL4.32EM, GL5.34, GL5.34E, GL500CF, GL7.38, GL7.40E, GL7.40EM, GL700CF, GL8.50E, GL8.50EM, MASTER21, MINIBAR-CF, PASSPORT50.40, PROGRAM25CF, PROJECT28, PROJECT28E, PROJECT28EM, SELF4.32, SELF400		

			
1			
GEV No.	508254	Ref. No.	00004374
description	Thumb screw thread M6 thread L 4mm ø 22mm H 9mm SS Qty 1 pcs		
For models:	AC20, AC25, AC26, AE1000, AE1200, AE35.21, AE38.25, AE40.29, AE40.30, AE45.30, AE50.32, AE50.35, AH1000, AH1000Easy, AH1100, AH1100DGT, AL40.28, AL40.28E, AL45.32, AL45.32E, AL50.34, AL50.34E, AL50.40, AL50.40E, AL50.45, AL55.45E, AL55.45E-P, ALISEO40.28E, ALISEO45.32E, AP1000, AP35.21, AP35.21DA, AP38.25, AP38.25DA, AP40.28, AP40.28DA, AP40.29, AP40.29DA, AP40.31, AP40.31DA, AP45.30, AP45.30DA, AP50.32, AP50.32DA, AP50.35, AP50.35DA, AP55.40, AP55.40DA, AS40.31, AS40.31DA...(Other models you can see in the webshop)		

			
1			
GEV No.	508112	Ref. No.	00002416
description	union nut SS		
For models:	AH1200, AH1200DGT, AH1400, AL1200E, AL1400, AL1500E, AP1200, AU125-80, AU55-65, AU55-80, AU65-65, AU-H1400, GL1040, GL1240, LP125-80, LP55-65, LP55-80, LP65-65, LPC1500		

			
1			
GEV No.	508227	Ref. No.	00003195
description	wash arm L 137mm nozzles 4		
For models:	AE35.21, AP35.21, AP35.21DA, AP38.25, AP38.25DA, EURO350, EURO380, EURO400		

			
1			
GEV No.	508230	Ref. No.	00003198 00015233
description	wash arm L 157mm nozzles 4		
For models:	AE38.25, AE40.29, AP38.25, AP38.25DA, AP40.28, AP40.28DA, AP40.29, AP40.29DA, EURO400		









			
1			
GEV No.	508234	Ref. No.	00004001
description	wash arm L 190mm nozzles 5		
For models:	AE45.30, AP45.30, AP45.30DA, PASSPORT45.30		

			
1			
GEV No.	508237	Ref. No.	00004004 00012361
description	wash arm L 217mm nozzles 5 for glasses		
For models:	AE50.32, AE50.35, AH1000, AH1000Easy, AP50.32, AP50.32DA, AP50.35, AP50.35DA, AS50.35, AS50.35DA, AS50.35DGT, AS50.35DGT-DA, EURO500, PASSPORT50.32		



			
1			
GEV No.	508238	Ref. No.	00004005
description	wash arm L 217mm nozzles 5 for plate		
For models:	AE1000, AE1200, AE50.32, AP50.32, AP50.32DA, AP50.35, AP50.35DA, EURO500, PASSPORT50.32		

			
1			
GEV No.	508401	Ref. No.	00012360 00015234
description	wash arm mounting pos. left/right L 193mm nozzles 5 ø 25mm		
For models:	AE45.30		

			
1			
GEV No.	508082	Ref. No.	00001954
description	wash arm boss		
For models:	AC20, AC25, AE1000, AE1200, AE35.21, AE38.25, AE40.29, AE40.30, AE45.30, AE50.32, AE50.35, AH1000, AH1000Easy, ALISEO40.28E, ALISEO422, ALISEO428, ALISEO45.32E, AP35.21, AP35.21DA, AP38.25, AP38.25DA, AP40.28, AP40.28DA, AP40.29, AP40.29DA, AP40.31, AP40.31DA, AP45.30, AP45.30DA, AP50.32, AP50.32DA, AP50.35, AP50.35DA, AS40.31, AS40.31DA, AS40.31DGT, AS40.31DGT-DA, AS50.35, AS50.35DA, AS50.35DGT, AS50.35DGT-DA, AW4028, COMPACT20, EURO350, EURO380, EURO400, EURO500, PASSPORT45.30, PASSPORT50.32		

			
1			
GEV No.	508075	Ref. No.	00001795
description	rinse arm H 380mm L 225mm nozzles 9 ø 16mm		
For models:	GEMINI-CR, MINIBAR-CR, PROGRAM25CR		
spare parts for	508075		
	GEV No.	508051	Ref. No.
			00001183 1183
	sealing ring		
	GEV No.	508052	Ref. No.
			00001184 1184
	union nut		
	GEV No.	508056	Ref. No.
			00001223 1223
	end cap for rinse arm		
	GEV No.	508062	Ref. No.
			00004359 00005308 00017155 1669 4359
	rinse jet		
	GEV No.	530293	Ref. No.
			00001826 1826
	O-ring EPDM thickness 1.78mm ID ø 8.73mm Qty 1 pcs		

			
1			
GEV No.	508086	Ref. No.	00002092
description	rinse arm L 480mm nozzles 6 mounting ø 12mm mounting pos. upper/lower		
For models:	GL500CF, GL700CF		

			
1			
GEV No.	508111	Ref. No.	00002402
description	wash arm H 360mm L 340mm nozzles 6		
For models:	GEMINI-CR, PROGRAM25CR		
spare parts for	508111		
	GEV No.	508079	Ref. No. 00001832 1832
	description	wash jet	
	GEV No.	508098	Ref. No. —
	description	O-ring EPDM thickness 1.78mm ID ø 20.35mm Qty 1 pcs	

			
1			
GEV No.	508056	Ref. No.	00001223
description	end cap for rinse arm		
For models:	GEMINI-CR, GL500CF, GL500CR, GL700CF, GL700CR, MINIBAR, MINIBAR-CR, PROGRAM25CR		

			
1			
GEV No.	508063	Ref. No.	00001692
description	end cap for wash arm		
For models:	GEMINI-CR, MINIBAR, MINIBAR-CR, PROGRAM25CR, SELF400		

			
1			
GEV No.	508361	Ref. No.	00000125
description	nut for rinse arm		
For models:	AC20, AC25, COMPACT20, GEMINICF, GEMINI-CF, GEMINI-CR, MINIBAR, MINIBAR-CF, MINIBAR-CR, PROGRAM25CF, PROGRAM25CR		

			
1			
GEV No.	530293	Ref. No.	00001826
description	O-ring EPDM thickness 1.78mm ID ø 8.73mm Qty 1 pcs		
For models:	GEMINI-CR, GL500CF, GL500CR, GL700CF, GL700CR, MINIBAR, MINIBAR-CR, PROGRAM25CR		

			
1			
GEV No.	508062	Ref. No.	00004359 00005308 00017155 1669
description	rinse jet		
For models:	AC20, AC25, AC26, AE1000, AE1200, AE35.21, AE38.25, AE40.29, AE40.30, AE45.30, AE50.32, AE50.35, AH1000, AH1000Easy, AH1100, AH1100DGT, AH1200, AH1200DGT, AH1400, AL1200E, AL1400, AL1500E, AL40.28, AL40.28E, AL40.28EM, AL45.32, AL45.32E, AL45.32EM, AL50.34, AL50.34E, AL50.34EM, AL50.40, AL50.40E, AL50.40EM, AL50.45, AL55.45E, AL55.45EM, AL55.45EM-P, AL55.45E-P, ALISEO40.28E, ALISEO422, ALISEO428, ALISEO45.32E, AP1000, AP1200, AP35.21, AP35.21DA, AP38.25, AP38.25DA, AP40.28...(Other models you can see in the webshop)		

			
1			
GEV No.	508051	Ref. No.	00001183
description	sealing ring		
For models:	AC20, AC25, AC26, AL50.45, AL55.45E, AL55.45E-P, AP55.40, AP55.40DA, AS50.40, AS50.40DA, AS50.40DGT, AS50.40DGT-DA, AU55-65, AU55-80, AU65-65, AU-L55.45, AU-P55.40, AU-S55.40, AU-S55.40DGT, COMPACT20, GEMINICF, GEMINI-CF, GEMINI-CR, GL1040, GL1240, GL500CF, GL500CR, GL700CF, GL700CR, LP55-65, LP55-80, LP65-65, MINIBAR, MINIBAR-CF, MINIBAR-CR, PASSPORT50.40, PROGRAM25CF, PROGRAM25CR, SELF400		

			
1			
GEV No.	508052	Ref. No.	00001184
description	union nut		
For models:	AC20, AC25, AC26, AL50.45, AL55.45E, AL55.45E-P, AP55.40, AP55.40DA, AS50.40, AS50.40DA, AS50.40DGT, AS50.40DGT-DA, AU55-65, AU55-80, AU65-65, AU-L55.45, AU-P55.40, AU-S55.40, AU-S55.40DGT, COMPACT20, GEMINICF, GEMINI-CF, GEMINI-CR, GL1040, GL1240, GL500CF, GL500CR, GL700CF, GL700CR, LP55-65, LP55-80, LP65-65, MINIBAR, MINIBAR-CF, MINIBAR-CR, PASSPORT50.40, PROGRAM25CF, PROGRAM25CR, SELF400		

			
1			
GEV No.	508079	Ref. No.	00001832
description	wash jet		
For models:	GEMINI-CR, MINIBAR, MINIBAR-CR, PROGRAM25CR		

			
Image not available			
1			
GEV No.	508085	Ref. No.	00002084
description	wash arm		
For models:	GL500CF, GL700CF		





 Image not available 1			
GEV No.	508343	Ref. No.	00208410
description	wash arm		
For models:	GL500CF, GL700CF		

 1			
GEV No.	508013	Ref. No.	00000111
description	swirl hole \varnothing 2.5mm H 4.5mm \varnothing 14mm 4mm		
For models:	GL500CF, GL700CF		

 1			
GEV No.	508033	Ref. No.	00000213
description	swirl hole \varnothing 3.5mm H 7mm \varnothing 22mm 6.5mm		
For models:	GL500CF, GL500CR, GL700CF, GL700CR		

 1			
GEV No.	508053	Ref. No.	00001186
description	union nut		

miscellaneous			
 1			
GEV No.	524980	Ref. No.	00008691
description	end cap for wash arm \varnothing 47mm H 29mm		
For models:	AU125-80, LP125-80, TR1200, TR1650, TR2000, TR2500, TR3000, TR3500, TRC250, TRR2500		

 1			
GEV No.	508036	Ref. No.	00000241
description	rinse jet		
For models:	GL500CF, GL500CR, GL700CF, GL700CR, LP125-80		

 1			
GEV No.	508037	Ref. No.	00000242
description	swirl H 20mm \varnothing 9mm H1 1.5mm		
For models:	GL500CF, GL500CR, GL700CF, GL700CR		

wash arm supports			
 1			
GEV No.	508157	Ref. No.	00002709
description	pillar for wash arm support		
For models:	GL1040, GL1240		

 1			
GEV No.	508158	Ref. No.	00002710
description	pillar for wash arm support		
For models:	AU125-80, AU55-65, AU55-80, AU65-65, GL1040, GL1240, LP125-80, LP55-65, LP55-80, LP65-65		

 1			
GEV No.	508184	Ref. No.	00010236
description	pillar for wash arm support		
For models:	GL1040, GL1240		

 1			
GEV No.	508251	Ref. No.	00004217 00009938
description	pillar for wash arm support mounting pos. lower		
For models:	AE1000, AE1200, AH1000, AH1000Easy, AH1100, AH1100DGT, AL50.45, AL55.45E, AL55.45EM, AL55.45EM-P, AL55.45E-P, AP1000, AU-L55.45, GL7.40E, GL7.40EM, GL8.50E, GL8.50EM		

 1			
GEV No.	508258	Ref. No.	00004672 3170
description	pillar for wash arm support mounting pos. lower		
For models:	AE35.21, AE38.25, AE40.29, AE40.30, AP35.21, AP35.21DA, AP38.25, AP38.25DA, AP40.28, AP40.28DA, AP40.29, AP40.29DA, EURO350, EURO380, EURO400		

			
1			
GEV No.	508259	Ref. No.	00004673
description	pillar for wash arm support mounting pos. lower		
For models:	AE45.30, AP45.30, AP45.30DA, PASSPORT45.30		

			
1			
GEV No.	508260	Ref. No.	00004674
description	pillar for wash arm support mounting pos. lower		
For models:	AE50.32, AE50.35, AP50.32, AP50.32DA, AP50.35, AP50.35DA, AS50.35, AS50.35DA, AS50.35DGT, AS50.35DGT-DA, EURO500, PASSPORT50.32		

			
1			
GEV No.	508317	Ref. No.	00006392 00009936
description	pillar for wash arm support mounting pos. lower		
For models:	AL50.34, AL50.34E, AL50.34EM, AL50.40, AL50.40E, AL50.40EM		

			
1			
GEV No.	508208	Ref. No.	00002993 00009937
description	pillar for wash arm support mounting pos. lower edition since 2006		
For models:	AP55.40, AP55.40DA, AS50.40, AS50.40DA, AS50.40DGT, AS50.40DGT-DA, AU-P55.40, AU-S55.40, AU-S55.40DGT, GL5.34, GL7.38, PASSPORT50.32, PASSPORT50.40		

			
1			
GEV No.	508285	Ref. No.	00004920 00009939
description	pillar for wash arm support mounting pos. lower edition since 2006		
For models:	AE1000, AP1000		

			
1			
GEV No.	508287	Ref. No.	00004925 00009940 00011301
description	pillar for wash arm support mounting pos. upper		
For models:	AE1000, AE1200, AH1000, AH1000Easy, AH1100, AH1100DGT, AP1000		

			
1			
GEV No.	508048	Ref. No.	00001171
description	rinse arm support mounting pos. upper		
For models:	AC20, AC25, COMPACT20, GEMINICF, GEMINI-CF, MINIBAR-CF, PROGRAM25CF		

			
1			
GEV No.	508120	Ref. No.	00002482
description	rinse arm support mounting pos. upper		
For models:	AL40.28E, AL40.28EM, AL45.32E, AL45.32EM, AL50.34E, AL50.34EM, AL50.40E, AL50.40EM, AL55.45E, AL55.45EM, AL55.45EM-P, AL55.45E-P, ALISEO40.28E, ALISEO422, ALISEO428, ALISEO45.32E, AP38.25, AP38.25DA, AP40.28, AP40.28DA, AP45.30, AP45.30DA, AP50.32, AP50.32DA, AP50.35, AP50.35DA, AP55.40, AP55.40DA, AW4028, EURO500, GL1040, GL1240, GL4.32E, GL4.32EM, GL5.34, GL5.34E, GL7.38, GL7.40E, GL7.40EM, GL8.50E, GL8.50EM, PASSPORT45.30, PASSPORT50.32, PASSPORT50.40, PROJECT28, PROJECT28E, PROJECT28EM, SELF4.32, SELF400		



			
1			
GEV No.	508183	Ref. No.	00002797
description	rinse arm support mounting pos. upper		
For models:	AE35.21, AE38.25, AE40.29, AP35.21, AP35.21DA, EURO350, EURO380, EURO400, LP125-80, LP55-65, LP55-80, LP65-65, MASTER21, PROGRAM25CF, TR1200		

			
1			
GEV No.	508055	Ref. No.	00001193
description	wash arm support		
For models:	GL500CF, GL700CF		





			
1			
GEV No.	508076	Ref. No.	00001796
description	wash arm support		
For models:	GEMINI-CR, MINIBAR, PROGRAM25CR		

			
1			
GEV No.	508064	Ref. No.	00001695
description	wash arm support ID ø 40mm hose ø 30mm		
For models:	AC20, AC25, AC26, ALISEO422, ALISEO428, AP35.21, AP35.21DA, COMPACT20, EURO350, EURO380, EURO400, GEMINICF, GEMINI-CF, GEMINI-CR, MASTER21, MINIBAR, MINIBAR-CF, MINIBAR-CR, PROGRAM25CF, PROGRAM25CR		

			
1			
GEV No.	508094	Ref. No.	00002149
description	wash arm support mounting pos. lower		
For models:	AE1000, AE1200, AE45.30, AE50.32, AE50.35, AH1000, AH1000Easy, AH1100, AH1100DGT, AL40.28, AL40.28E, AL40.28EM, AL45.32, AL45.32E, AL45.32EM, AL50.34, AL50.34E, AL50.34EM, AL50.40, AL50.40E, AL50.40EM, AL50.45, AL55.45E, AL55.45EM, AL55.45EM-P, AL55.45E-P, ALISEO40.28E, ALISEO422, ALISEO428, ALISEO45.32E, AP1000, AP38.25, AP38.25DA, AP40.28, AP40.28DA, AP40.29, AP40.29DA, AP40.31, AP40.31DA, AP45.30, AP45.30DA, AP50.32, AP50.32DA, AP50.35, AP50.35DA, AP55.40, AP55.40DA, AS40.31, AS40.31DA, AS40.31DGT...(Other models you can see in the webshop)		
accessories for	508094		
		GEV No.	508061
		Ref. No.	00001633
	O-ring EPDM thickness 3.53mm ID ø 42.86mm Qty 1 pcs		

			
1			
GEV No.	508428	Ref. No.	00010786
description	wash arm support mounting pos. lower		
For models:	AE35.21, AE38.25, AE40.29, AE40.30, AP35.21, AP35.21DA, AP38.25, AP38.25DA		

			
1			
GEV No.	508095	Ref. No.	00002150
description	wash arm support mounting pos. upper		
For models:	AL40.28E, AL40.28EM, AL45.32E, AL45.32EM, AL50.34E, AL50.34EM, AL50.40E, AL50.40EM, AL55.45E, AL55.45EM, AL55.45EM-P, AL55.45E-P, ALISEO40.28E, ALISEO422, ALISEO428, ALISEO45.32E, AP1000, AP38.25, AP38.25DA, AP40.28, AP40.28DA, AP45.30, AP45.30DA, AP50.32, AP50.32DA, AP50.35, AP50.35DA, AP55.40, AP55.40DA, AW4028, EURO500, GL4.32E, GL4.32EM, GL5.34, GL5.34E, GL7.38, GL7.40E, GL7.40EM, GL8.50E, GL8.50EM, PASSPORT45.30, PASSPORT50.32, PASSPORT50.40, PROJECT28, PROJECT28E, PROJECT28EM, SELF4.32, SELF400		

			
1			
GEV No.	508410	Ref. No.	00003515
description	wash arm support mounting pos. upper		
For models:	AE35.21, AE38.25, AE40.29, AE45.30, AE50.32, AE50.35, AL40.28, AL40.28E, AL40.28EM, AL45.32, AL45.32E, AL45.32EM, AL50.34, AL50.34E, AL50.34EM, AL50.40, AL50.40E, AL50.40EM, AL50.45, AL55.45E, AL55.45EM, AL55.45EM-P, AL55.45E-P, ALISEO40.28E, ALISEO45.32E, AP1000, AP38.25, AP38.25DA, AP40.28, AP40.28DA, AP40.29, AP40.29DA, AP40.31, AP40.31DA, AP45.30, AP45.30DA, AP50.32, AP50.32DA, AP50.35, AP50.35DA, AP55.40, AP55.40DA, AS40.31, AS40.31DA, AS40.31DGT, AS40.31DGT-DA, AS50.35, AS50.35DA, AS50.35DGT, AS50.35DGT-DA...(Other models you can see in the webshop)		

			
1			
GEV No.	505073	Ref. No.	00000025
description	O-ring EPDM thickness 2.62mm ID ø 20.63mm Qty 1 pcs		
For models:	AC26, AE1000, AE1200, AE35.21, AE38.25, AE40.29, AE40.30, AE45.30, AE50.32, AE50.35, AH1000, AH1000Easy, AH1100, AH1100DGT, AH1200, AH1200DGT, AH1400, AL1200E, AL1400, AL1500E, AL40.28, AL40.28E, AL40.28EM, AL45.32, AL45.32E, AL45.32EM, AL50.34, AL50.34E, AL50.34EM, AL50.40, AL50.40E, AL50.40EM, AL50.45, AL55.45E, AL55.45EM, AL55.45EM-P, AL55.45E-P, ALISEO40.28E, ALISEO422, ALISEO428, ALISEO45.32E, AP1000, AP1200, AP35.21, AP35.21DA, AP38.25, AP38.25DA, AP40.28, AP40.28DA, AP40.29...(Other models you can see in the webshop)		

			
1			
GEV No.	508061	Ref. No.	00001633
description	O-ring EPDM thickness 3.53mm ID ø 42.86mm Qty 1 pcs		
For models:	AC20, AC25, AC26, AE1000, AE1200, AE35.21, AE38.25, AE40.29, AE40.30, AE45.30, AE50.32, AE50.35, AH1000, AH1000Easy, AH1100, AH1100DGT, AL40.28, AL40.28E, AL40.28EM, AL45.32, AL45.32E, AL45.32EM, AL50.34, AL50.34E, AL50.34EM, AL50.40, AL50.40E, AL50.40EM, AL50.45, AL55.45E, AL55.45EM, AL55.45EM-P, AL55.45E-P, ALISEO40.28E, ALISEO422, ALISEO428, ALISEO45.32E, AP1000, AP35.21, AP35.21DA, AP38.25, AP38.25DA, AP40.28, AP40.28DA, AP40.29, AP40.29DA, AP40.31, AP40.31DA, AP45.30, AP45.30DA...(Other models you can see in the webshop)		



GEV No.	510408	Ref. No.	00002662
description	O-ring EPDM thickness 5.34mm ID ø 47mm Qty 1 pcs		
For models:	GL1040, GL1240		



GEV No.	529460	Ref. No.	2713
description	O-ring EPDM thickness 5.34mm ID ø 59.69mm Qty 1 pcs		



GEV No.	508109	Ref. No.	00002374
description	O-ring EPDM thickness 5.34mm ID ø 69.22mm Qty 1 pcs		
For models:	AE1000, AE45.30, AE50.32, AE50.35, AL40.28, AL40.28E, AL40.28EM, AL45.32, AL45.32E, AL45.32EM, AP1000, AP45.30, AP45.30DA, AP50.32, AP50.32DA, AP50.35, AP50.35DA, AP55.40, AP55.40DA, AS50.35, AS50.35DA, AS50.35DGT, AS50.35DGT-DA, AS50.40, AS50.40DA, AS50.40DGT, AS50.40DGT-DA, AU-P55.40, AU-S55.40, AU-S55.40DGT, EURO500, GL1040, GL1240, GL4.32E, GL4.32EM, GL5.34, GL5.34E, GL500CF, GL500CR, GL7.38, GL7.40E, GL7.40EM, GL700CF, GL700CR, GL8.50E, GL8.50EM, LP55-65, LP65-65, PASSPORT45.30, PASSPORT50.32...(Other models you can see in the webshop)		



GEV No.	508089	Ref. No.	00002130
description	sealing ring PTFE ED ø 68mm ID ø 55mm thickness 2mm Qty 1 pcs		
For models:	AH1200, AH1200DGT, AH1400, AL1200E, AL1400, AL1500E, AP1200, AU125-80, AU55-65, AU55-80, AU65-65, AU-H1400, GL1040, GL1240, GL500CF, GL700CF, LP125-80, LP55-65, LP55-80, LP65-65, LPC1500		



GEV No.	508178	Ref. No.	00002763 00012208+00004671 12208+4671
description	wash arm bearing		
For models:	AE45.30, AE50.32, AL40.28E, AL40.28EM, AL45.32E, AL45.32EM, AL50.34E, AL50.34EM, AL50.40E, AL50.40EM, AL55.45E, AL55.45EM, AL55.45EM-P, AL55.45E-P, AP38.25, AP38.25DA, AP40.28, AP40.28DA, AP40.29, AP40.29DA, AP45.30, AP45.30DA, AP50.32, AP50.32DA, AP50.35, AP50.35DA, AP55.40, AP55.40DA, COMPACT20, EURO500, GEMINICF, GEMINI-CF, GL4.32E, GL4.32EM, GL5.34, GL5.34E, GL7.38, GL7.40E, GL7.40EM, GL8.50E, GL8.50EM, MASTER21, MINIBAR-CF, PASSPORT45.30, PASSPORT50.32, PASSPORT50.40, PROGRAM25CF, PROJECT28, PROJECT28E, PROJECT28EM...(Other models you can see in the webshop)		



GEV No.	508303	Ref. No.	00005113
description	wash arm bearing		
For models:	ALISEO40.28E, ALISEO422, ALISEO428, ALISEO45.32E, AW4028		



GEV No.	508304	Ref. No.	00005114
description	wash arm bearing		
For models:	ALISEO422, ALISEO428		



GEV No.	508162	Ref. No.	00002718
description	disc		
For models:	AL40.28E, AL40.28EM, AL45.32E, AL45.32EM, AL50.34E, AL55.45E-P, GL4.32E, GL4.32EM, GL5.34, GL5.34E, GL7.38, GL7.40E, GL7.40EM, GL8.50E, GL8.50EM, PASSPORT50.32, PASSPORT50.40, PROJECT28, PROJECT28E, PROJECT28EM, SELF4.32		





GEV No.	508257	Ref. No.	00004671
description	disc		
For models:	AC20, AC25, AC26, AE1000, AE1200, AE35.21, AE38.25, AE40.29, AE40.30, AE45.30, AE50.32, AE50.35, AH1000, AH1000Easy, AH1100, AH1100DGT, AL40.28, AL45.32, AL50.34, AL50.34E, AL50.34EM, AL50.40, AL50.40E, AL50.40EM, AL50.45, AL55.45E, AL55.45EM, AL55.45EM-P, AL55.45E-P, ALISEO422, ALISEO428, AP1000, AP35.21, AP35.21DA, AP38.25, AP38.25DA, AP40.28, AP40.28DA, AP40.29, AP40.29DA, AP40.31, AP40.31DA, AP45.30, AP45.30DA, AP50.32, AP50.32DA, AP50.35, AP50.35DA, AP55.40, AP55.40DA...(Other models you can see in the webshop)		





GEV No.	508142	Ref. No.	00002593
description	flange		
For models:	GL1040, GL1240, LP55-65, LP65-65		



			
1			
GEV No.	508049	Ref. No.	00001173
description	flat gasket PTFE ED ø 16mm ID ø 10mm thickness 2mm Qty 1 pcs		
For models:	AC20, AC26, AE1000, AE1200, AE35.21, AE38.25, AE40.29, AE40.30, AE45.30, AE50.32, AE50.35, AH1000, AH1000Easy, AH1100, AH1100DGT, AL40.28, ALISEO40.28E, ALISEO422, ALISEO428, ALISEO45.32E, AP1000, AP35.21, AP35.21DA, AP38.25, AP38.25DA, AP40.28, AP40.28DA, AP40.29, AP40.29DA, AP40.31, AP40.31DA, AP45.30, AP45.30DA, AP50.32, AP50.32DA, AP50.35, AP50.35DA, AP55.40, AP55.40DA, AS40.31, AS40.31DA, AS40.31DGT, AS40.31DGT-DA, AS50.35, AS50.35DA, AS50.35DGT, AS50.35DGT-DA, AS50.40, AS50.40DA, AS50.40DGT...(Other models you can see in the webshop)		

			
2			
GEV No.	508118	Ref. No.	00002480
description	formed hose dishwasher straight		
For models:	AE35.21, AE38.25, AE40.29, AE40.30, AE45.30, AL40.28, AL40.28E, AL40.28EM, AL45.32, AL45.32E, AL45.32EM, ALISEO40.28E, ALISEO422, ALISEO428, ALISEO45.32E, AP35.21, AP35.21DA, AP38.25, AP38.25DA, AP40.28, AP40.28DA, AP40.29, AP40.29DA, AP40.31DA, AP45.30, AP45.30DA, AS40.31DA, AS40.31DGT-DA, AW4028, GL4.32E, GL4.32EM, PASSPORT45.30, PROJECT28, PROJECT28E, PROJECT28EM, SELF4.32, SELF400		

			
1			
GEV No.	508179	Ref. No.	00002788
description	hose connector		
For models:	AC26, AH1400, AL1400, AP35.21, AP35.21DA, AU55-65, AU55-80, AU65-65, AU-H1400, EURO350, EURO380, EURO400, MASTER21, PROGRAM25CF		

			
1			
GEV No.	508180	Ref. No.	00002789
description	hose connector		
For models:	AE45.30, AE50.32, AL40.28E, AL40.28EM, AL45.32E, AL45.32EM, AL50.34E, AL50.34EM, AL50.40E, AL50.40EM, AL55.45E, AL55.45EM, AL55.45EM-P, AL55.45E-P, ALISEO40.28E, ALISEO422, ALISEO428, ALISEO45.32E, AP1000, AP38.25, AP38.25DA, AP40.28, AP40.28DA, AP45.30, AP45.30DA, AP50.32, AP50.32DA, AP50.35, AP50.35DA, AP55.40, AP55.40DA, EURO500, GL4.32E, GL4.32EM, GL5.34, GL5.34E, GL7.38, GL7.40E, GL7.40EM, GL8.50E, GL8.50EM, PASSPORT45.30, PASSPORT50.32, PASSPORT50.40, PROJECT28, PROJECT28E, PROJECT28EM, SELF4.32		

			
1			
GEV No.	508199	Ref. No.	00002921
description	hose connector		
For models:	AH1200, AH1200DGT, AH1400, AL1200E, AL1400, AL1500E, AP1200, AU-H1400, GL1040, GL1240, LP55-65, LP65-65, LPC1500		

						
1						
GEV No.	508394	Ref. No.	00010620			
description	hose connector ø 12mm					
For models:	AE1000, AE1200, AE45.30, AE50.32, AL40.28E, AL45.32E, AL50.34E, AL50.40E, AL55.45E, AL55.45E-P, ALISEO40.28E, ALISEO45.32E, AP1000, AP38.25, AP38.25DA, AP40.29, AP40.29DA, AP45.30, AP45.30DA, AP50.32, AP50.32DA, AP50.35, AP50.35DA, AP55.40, AP55.40DA					
accessories for	508394					
		<table border="1"> <tr> <td>GEV No.</td> <td>505073</td> <td>Ref. No.</td> <td>0000002525</td> </tr> </table>	GEV No.	505073	Ref. No.	0000002525
GEV No.	505073	Ref. No.	0000002525			
	O-ring EPDM thickness 2.62mm ID ø 20.63mm Qty 1 pcs					

			
1			
GEV No.	508405	Ref. No.	00010750
description	hose connector thread M12x1		
For models:	AC20, AC25, AC26, AE35.21, AE38.25, AE40.29, AE40.30, AP35.21, AP35.21DA, AP38.25, AP38.25DA, AU125-80, AU55-65, AU55-80, AU65-65, LP125-80, LP55-65, LP55-80, LP65-65, PROGRAM25CF		

			
1			
GEV No.	528223	Ref. No.	00000123
description	O-ring EPDM thickness 2.62mm ID ø 11.91mm Qty 1 pcs		
For models:	AC20, AC25, AC26, AE1000, AE1200, AH1000, AH1000Easy, AH1100, AH1100DGT, AH1200, AH1200DGT, AH1400, AL1200E, AL1400, AL1500E, AL40.28, AL40.28E, AL40.28EM, AL45.32, AL45.32E, AL45.32EM, AL50.34, AL50.34E, AL50.34EM, AL50.40, AL50.40E, AL50.40EM, AL50.45, AL55.45E, AL55.45EM, AL55.45EM-P, AL55.45E-P, ALISEO40.28E, ALISEO422, ALISEO428, ALISEO45.32E, AP1000, AP1200, AP35.21, AP35.21DA, AP38.25, AP38.25DA, AP40.28, AP40.28DA, AP40.29, AP40.29DA, AP40.31, AP40.31DA, AP45.30, AP45.30DA...(Other models you can see in the webshop)		

			
1			
GEV No.	508008	Ref. No.	00000093
description	O-ring EPDM thickness 2.62mm ID ø 15.88mm Qty 1 pcs		
For models:	AC20, AC25, AC26, AE1000, AE1200, AE35.21, AE38.25, AE40.29, AE40.30, AE45.30, AE50.32, AE50.35, AH1000, AH1000Easy, AH1100, AH1100DGT, AH1200, AH1200DGT, AH1400, AL1200E, AL1400, AL1500E, AL40.28, AL40.28E, AL40.28EM, AL45.32, AL45.32E, AL45.32EM, AL50.34, AL50.34E, AL50.34EM, AL50.40, AL50.40E, AL50.40EM, AL50.45, AL55.45E, AL55.45EM, AL55.45EM-P, AL55.45E-P, ALISEO40.28E, ALISEO422, ALISEO428, ALISEO45.32E, AP1000, AP1200, AP35.21, AP35.21DA, AP38.25, AP38.25DA, AP40.28...(Other models you can see in the webshop)		

			
2			
GEV No.	508164	Ref. No.	00002730
description	pipe SS		
For models:	GL1040, GL1240, LP55-65, LP65-65		

			
1			
GEV No.	508278	Ref. No.	00004760
description	reducer D1 ø 18mm D2 ø 30mm		
For models:	ALISEO422, ALISEO428		

			
1			
GEV No.	508077	Ref. No.	00001797
description	screw for wash arm support SS		
For models:	GEMINI-CR, MINIBAR, MINIBAR-CR, PROGRAM25CR		

			
1			
GEV No.	508106	Ref. No.	00002294
description	screw connection for rinse arm shaft		
For models:	COMPACT20, GEMINICF, GEMINI-CF, MINIBAR-CF, PROGRAM25CF		

			
1			
GEV No.	508143	Ref. No.	00002594
description	shim		
For models:	AL1200E, AL1500E, GL1040, GL1240		

			
1			
GEV No.	508167	Ref. No.	00002733
description	spacer piece		
For models:	AE45.30, AE50.32, AL40.28E, AL40.28EM, AL45.32E, AL45.32EM, AL50.34E, AL50.34EM, AL50.40E, AL50.40EM, AL55.45E, AL55.45EM, AL55.45EM-P, AL55.45E-P, ALISEO40.28E, ALISEO45.32E, AP38.25, AP38.25DA, AP40.28, AP40.28DA, AP40.29, AP40.29DA, AP45.30, AP45.30DA, AP50.32, AP50.32DA, AP50.35, AP50.35DA, AP55.40, AP55.40DA, AW4028, COMPACT20, EURO500, GEMINICF, GEMINI-CF, GL4.32E, GL4.32EM, GL5.34, GL5.34E, GL7.38, GL7.40E, GL7.40EM, GL8.50E, GL8.50EM, MASTER21, MINIBAR-CF, PASSPORT45.30, PASSPORT50.32, PASSPORT50.40, PROGRAM25CF...(Other models you can see in the webshop)		

			
1			
GEV No.	508197	Ref. No.	00002914
description	throttle disc		
For models:	AH1200, AH1200DGT, AH1400, AL1200E, AL1400, AL1500E, AP1200, AU125-80, AU55-65, AU55-80, AU65-65, AU-H1400, GL1040, GL1240, LP125-80, LP55-65, LP55-80, LP65-65, LPC1500		

rinse arm shafts

			
1			
GEV No.	508097	Ref. No.	00002154
description	extension for rinse arm shaft		
For models:	AE45.30, AP45.30, AP45.30DA, GL4.32E, GL4.32EM, PASSPORT45.30, PROJECT28, PROJECT28E, PROJECT28EM, SELF4.32, SELF400		

			
1			
GEV No.	508156	Ref. No.	00002708
description	extension for rinse arm shaft		
For models:	GL1040, GL1240		

			
1			
GEV No.	508206	Ref. No.	00002991
description	extension for rinse arm shaft		
For models:	AE50.32, AP50.32, AP50.32DA, AP50.35, AP50.35DA, AP55.40, AP55.40DA, EURO500, GL5.34, GL7.38, PASSPORT50.32, PASSPORT50.40		

			
1			
GEV No.	508219	Ref. No.	00003155
description	extension for rinse arm shaft		
For models:	AP35.21, AP35.21DA, EURO350, EURO380, EURO400		





			
1			
GEV No.	508220	Ref. No.	00003156
description	extension for rinse arm shaft		
For models:	AP38.25, AP38.25DA, AP40.28, AP40.28DA, AP40.29, AP40.29DA		

			
1			
GEV No.	508252	Ref. No.	00004218
description	extension for rinse arm shaft		
For models:	AE1000, AE1200, AL55.45E, AL55.45EM, AL55.45EM-P, AL55.45E-P, AP1000, GL7.40E, GL7.40EM, GL8.50E, GL8.50EM		

			
1			
GEV No.	508277	Ref. No.	00004756
description	extension for rinse arm shaft		
For models:	ALISEO40.28E, ALISEO422, ALISEO428, ALISEO45.32E		

			
1			
GEV No.	508316	Ref. No.	00006391
description	extension for rinse arm shaft		
For models:	AL50.34E, AL50.34EM, AL50.40E, AL50.40EM		

			
1			
GEV No.	508155	Ref. No.	00002707
description	extension for rinse arm shaft mounting pos. lower		
For models:	GL1040, GL1240		

			
1			
GEV No.	508288	Ref. No.	00004926
description	extension mounting pos. lower for rinse arm shaft		
For models:	AE1000, AP1000		

			
1			
GEV No.	508289	Ref. No.	00004927
description	extension mounting pos. upper for rinse arm shaft		
For models:	AE1000, AE1200, AH1000, AH1000Easy, AH1100, AH1100DGT, AP1000		

			
1			
GEV No.	508066	Ref. No.	00001697
description	rinse arm shaft		
For models:	AC20, AC25, AC26, COMPACT20, GEMINICF, GEMINI-CF, MASTER21, MINIBAR-CF, PROGRAM25CF		

			
1			
GEV No.	508113	Ref. No.	00002417
description	rinse arm shaft		
For models:	AH1200, AH1200DGT, AH1400, AL1200E, AL1400, AL1500E, AP1200, AU125-80, AU55-65, AU55-80, AU65-65, AU-H1400, GL1040, GL1240, LP125-80, LP55-65, LP55-80, LP65-65, LPC1500		

			
1			
GEV No.	508141	Ref. No.	00002587
description	rinse arm shaft		
For models:	AH1200, AH1200DGT, AH1400, AL1200E, AL1400, AL1500E, AP1200, AU125-80, AU55-65, AU55-80, AU65-65, AU-H1400, GL1040, GL1240, LP125-80, LP55-65, LP55-80, LP65-65, LPC1500		

			
1			
GEV No.	508302	Ref. No.	00005110
description	rinse arm shaft		
For models:	ALISEO40.28E, ALISEO422, ALISEO428, ALISEO45.32E, AW4028		

			
1			
GEV No.	508096	Ref. No.	00002153
description	rinse arm shaft for wash arm mounting pos. upper/lower		
For models:	AE1000, AE1200, AE35.21, AE38.25, AE40.29, AE40.30, AE45.30, AE50.32, AE50.35, AH1000, AH1000Easy, AH1100, AH1100DGT, AL40.28, AL40.28E, AL40.28EM, AL45.32, AL45.32E, AL45.32EM, AL50.34, AL50.34E, AL50.34EM, AL50.40, AL50.40E, AL50.40EM, AL50.45, AL55.45E, AL55.45EM, AL55.45EM-P, AL55.45E-P, ALISEO40.28E, ALISEO45.32E, AP1000, AP35.21, AP35.21DA, AP38.25, AP38.25DA, AP40.28, AP40.28DA, AP40.29, AP40.29DA, AP40.31, AP40.31DA, AP45.30, AP45.30DA, AP50.32, AP50.32DA, AP50.35, AP50.35DA, AP55.40...(Other models you can see in the webshop)		

			
1			
GEV No.	508181	Ref. No.	00002790
description	rinse arm shaft mounting pos. upper shaft ø 10mm ø 26mm H 35.5mm thread M12x1 thread L 8mm		
For models:	AE35.21, AE38.25, AE40.29, AP35.21, AP35.21DA, EURO350, EURO380, EURO400, MASTER21, PROGRAM25CF		

			
1			
GEV No.	508404	Ref. No.	00010749
description	rinse arm shaft mounting pos. upper shaft ø 10mm ø 26mm H 43.5mm thread M12x1 thread L 16mm		
For models:	AC26, AE35.21, AE38.25, AE40.29, AE40.30, AP35.21, AP35.21DA, AP38.25, AP38.25DA, PROGRAM25CF		

wash pipes

			
1			
GEV No.	503173	Ref. No.	00015106 00171010
description	repair kit		
For models:	GEMINICF, GEMINI-CF		

knobs

producer-specific knobs

ARISTARCO

			
1			
GEV No.	110004	Ref. No.	00002686
description	knob switch zero mark ø 38mm shaft ø 4x4mm black		
For models:	TA-2, TA-3		

			
1			
GEV No.	110285	Ref. No.	00000621 00003345
description	knob switch zero mark t.max.°C ø 40mm shaft ø 6x4.6mm shaft flat upper black		
For models:	FORNO2P, FORNO3P, FORNO4P, FORNO6P, ORION-1, ORION-1.5, ORION-2, ORION-G1, ORION-G1.5, ORION-G2, ORION-VTR1, ORION-VTR1.5, ORION-VTR2, TA-2, TA-3		

			
1			
GEV No.	110906	Ref. No.	00000374
description	knob without symbol t.max.°C ø 22mm shaft ø 6x4.6mm shaft flat universal black		
For models:	EMA80, EMALUX, GL500CF, GL500CR, GL700CF, GL700CR, SELF400		

handles and hand wheels

handle rails

end caps

			
1			
GEV No.	508338	Ref. No.	00126010
description	end cap mounting pos. left		
For models:	AC20, AC25, AC26, ALISEO422, ALISEO428, COMPACT20, GEMINICF, GEMINI-CF, GEMINI-CR, GL4.32E, GL4.32EM, GL5.34, GL5.34E, GL500CF, GL500CR, GL7.38, GL7.40E, GL7.40EM, GL700CF, GL700CR, GL8.50E, GL8.50EM, MASTER21, MINIBAR, MINIBAR-CF, MINIBAR-CR, PASSPORT45.30, PASSPORT50.32, PROGRAM25CF, PROGRAM25CR, PROJECT28, PROJECT28E, PROJECT28EM, SELF4.32, SELF400		



			
1			
GEV No.	508339	Ref. No.	00126011
description	end cap mounting pos. right		
For models:	AC20, AC25, AC26, ALISEO422, ALISEO428, COMPACT20, GEMINICF, GEMINI-CF, GEMINI-CR, GL4.32E, GL4.32EM, GL5.34, GL5.34E, GL500CF, GL500CR, GL7.38, GL7.40E, GL7.40EM, GL700CF, GL700CR, GL8.50E, GL8.50EM, MASTER21, MINIBAR, MINIBAR-CF, MINIBAR-CR, PASSPORT45.30, PASSPORT50.32, PROGRAM25CF, PROGRAM25CR, PROJECT28, PROJECT28E, PROJECT28EM, SELF4.32, SELF400		



hinges

door bearing

 <p>1</p>			
GEV No.	701297	Ref. No.	00011499 00011499 + 00010294 10247 11499 + 10294
description	hinge L 103mm W 33mm H 15mm mounting pos. left with base plate for dishwasher Qty 1 pcs		
For models:	AE35.21, AE38.25, AE40.30, AE45.30, AE50.32, AE50.35, AP35.21, AP35.21DA, AP38.25, AP38.25DA, AP40.29, AP40.29DA, AP40.31, AP40.31DA, AP45.30, AP45.30DA, AP50.32, AP50.32DA, AP50.35, AP50.35DA, AP55.40, AP55.40DA, AU-P55.40		
accessories for	701297		
 <p>GEV No. 701298 Ref. No. 00010294 10294</p> <p>base plate plastic L 113mm W 33mm thickness 1.5mm for hinge mounting pos. left/right Qty 1 pcs</p>			

 <p>1</p>			
GEV No.	701296	Ref. No.	00011498 00011498 + 00010294 10246 11498 + 10294
description	hinge L 103mm W 33mm H 15mm mounting pos. right with base plate for dishwasher		
For models:	AE35.21, AE38.25, AE40.30, AE45.30, AE50.32, AE50.35, AP35.21, AP35.21DA, AP38.25, AP38.25DA, AP40.29, AP40.29DA, AP40.31, AP40.31DA, AP45.30, AP45.30DA, AP50.32, AP50.32DA, AP50.35, AP50.35DA, AP55.40, AP55.40DA, AU-P55.40		
spare parts for	701296		
 <p>GEV No. 701298 Ref. No. 00010294 10294</p> <p>base plate plastic L 113mm W 33mm thickness 1.5mm for hinge mounting pos. left/right Qty 1 pcs</p>			
accessories for	701296		
 <p>GEV No. 701298 Ref. No. 00010294 10294</p> <p>base plate plastic L 113mm W 33mm thickness 1.5mm for hinge mounting pos. left/right Qty 1 pcs</p>			

accessories

base plate

 <p>1</p>			
GEV No.	519414	Ref. No.	00003159 00010040 3160
description	base plate L 37mm W 15mm for hinge		
For models:	ALISEO422, AP35.21, AP35.21DA, AP38.25, AP38.25DA, AP40.28, AP40.28DA, AP45.30, AP45.30DA, AP50.32, AP50.32DA, AP50.35, AP50.35DA, AP55.40, AP55.40DA, EURO350, EURO380, EURO400, EURO500, GL4.32E, GL4.32EM, GL5.34E, GL7.40E, GL7.40EM, GL8.50E, GL8.50EM, PASSPORT45.30, PASSPORT50.32, PASSPORT50.40, PROJECT28E, PROJECT28EM		

 <p>1</p>			
GEV No.	701298	Ref. No.	00010294
description	base plate plastic L 113mm W 33mm thickness 1.5mm for hinge mounting pos. left/right Qty 1 pcs		
For models:	AE35.21, AE38.25, AE40.29, AE45.30, AE50.32, AP35.21, AP35.21DA, AP38.25, AP38.25DA, AP40.29, AP40.29DA, AP45.30, AP45.30DA, AP50.32, AP50.32DA, AP50.35, AP50.35DA, AP55.40, AP55.40DA		

baskets

warewashing baskets

steel wire baskets square

glass basket

 <p>1</p>			
GEV No.	971012	Ref. No.	00063010
description	glass basket L 380mm W 380mm H 175mm number of rows 3 rows spacing 115mm		
For models:	AE38.25, AP38.25, AP38.25DA, GEMINICF, GEMINI-CF, GEMINI-CR, MINIBAR, MINIBAR-CF, MINIBAR-CR, PROGRAM25CF		

mix baskets

 <p>1</p>			
GEV No.	971011 ¹	Ref. No.	00063011
description	mix basket L 375mm W 375mm H 170mm		
For models:	AE38.25, AP38.25, AP38.25DA, GEMINI-CF, MINIBAR, MINIBAR-CF, MINIBAR-CR, PROGRAM25CF, PROGRAM25CR		

¹wide-meshed

plate baskets

 <p>1</p>			
GEV No.	971027	Ref. No.	00000232
description	plate basket L 420mm W 420mm H 105mm plates 12 plate ø 270mm		



1

GEV No.	971026	Ref. No.	00002171
description	plate basket L 420mm W 420mm H 120mm plates 8 plate ø 250mm		

plastic baskets square

mix baskets



1

GEV No.	971058	Ref. No.	2461 2461S
description	mix basket L 350mm W 350mm H 150mm		



1

GEV No.	971097	Ref. No.	00006305
description	mix basket L 380mm W 380mm H 150mm		
For models:	AC25, AC26, AE38.25, AP38.25, AP38.25DA, EURO380, GEMINICF, GEMINI-CF, PROGRAM25CF, PROGRAM25CR		

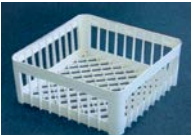

1

GEV No.	971078	Ref. No.	00002145 00004824 0002145S
description	mix basket L 400mm W 400mm H 150mm		
For models:	AE40.29, AE40.30, AL40.28, AL40.28E, AL40.28EM, ALISEO40.28E, ALISEO422, ALISEO428, AP40.28, AP40.28DA, AP40.29, AP40.29DA, AP40.31, AP40.31DA, AS40.31, AS40.31DA, AS40.31DGT, AS40.31DGT-DA, AW4028, EURO350, EURO400, PROJECT28, PROJECT28E, PROJECT28EM		



1

GEV No.	970695	Ref. No.	00003513
description	mix basket L 450mm W 450mm H 106mm		
For models:	AE45.30, AL45.32, AL45.32E, AL45.32EM, ALISEO45.32E, AP45.30, AP45.30DA, AW45.32		



1

GEV No.	970696	Ref. No.	00002491
description	mix basket L 450mm W 450mm H 165mm		
For models:	AE45.30, AL45.32, AL45.32E, AL45.32EM, ALISEO45.32E, AP45.30, AP45.30DA, GL4.32E, GL4.32EM, PASSPORT45.30, SELF4.32		

plate baskets



1

GEV No.	970694	Ref. No.	00002492
description	plate basket L 450mm W 450mm H 106mm plates 14		
For models:	AE45.30, AL45.32, AL45.32E, AL45.32EM, ALISEO45.32E, AP45.30, AP45.30DA, GL4.32E, GL4.32EM, PASSPORT45.30, SELF4.32		

accessories

cutlery inserts



1

GEV No.	976011	Ref. No.	00000189
description	cutlery insert Lmm Wmm ø 110mm H 130mm		
For models:	AL40.28E, AL50.34E, AL55.45E-P, ALISEO422, ALISEO428, COMPACT20, EURO350, EURO400, EURO500, GEMINI-CF, GEMINI-CR, GL1040, GL1240, GL4.32E, GL4.32EM, GL5.34, GL5.34E, GL500CF, GL500CR, GL7.38, GL7.40E, GL7.40EM, GL700CF, GL700CR, GL8.50E, GL8.50EM, LP55-65, LP65-65, MASTER21, MINIBAR, MINIBAR-CF, MINIBAR-CR, PASSPORT45.30, PASSPORT50.32, PASSPORT50.40, PROGRAM25CF, PROGRAM25CR, PROJECT28, PROJECT28E, PROJECT28EM, SELF4.32, SELF400, TR1650, TR2000, TR2500		

plate inserts



1

GEV No.	508026	Ref. No.	00000187
description	plate insert		
For models:	AE35.21, AE38.25, AE40.29, AE45.30, AE50.32, AL40.28E, AL40.28EM, AL45.32E, AL45.32EM, AL50.34E, AL50.34EM, AL50.40E, AL50.40EM, AL55.45E, AL55.45EM, ALISEO40.28E, ALISEO422, ALISEO428, ALISEO45.32E, AP35.21, AP35.21DA, AP38.25, AP38.25DA, AP40.28, AP40.28DA, AP45.30, AP45.30DA, AP50.32, AP50.32DA, AP50.35, AP50.35DA, AP55.40, AP55.40DA, COMPACT20, EURO350, EURO380, EURO400, EURO500, GEMINICF, GEMINI-CF, GL4.32E, GL4.32EM, GL5.34, GL5.34E, GL7.38, GL7.40E, GL7.40EM, GL8.50E, GL8.50EM, PASSPORT45.30...(Other models you can see in the webshop)		



			
1			
GEV No.	972036	Ref. No.	00001875
description	plate insert L 290mm W 90mm H 75mm plates 12		
For models:	AC20, AC25, AC26, AE35.21, AE38.25, AE40.29, AE40.30, AE45.30, AE50.32, AE50.35, AL40.28, AL40.28E, AL45.32, AL45.32E, AL50.34, AL50.34E, AL50.40, AL50.40E, AL55.45E, ALISEO40.28E, ALISEO45.32E, AP35.21, AP35.21DA, AP38.25, AP38.25DA, AP40.29, AP40.29DA, AP40.31, AP40.31DA, AP45.30, AP45.30DA, AP50.32, AP50.32DA, AP50.35, AP50.35DA, AP55.40, AP55.40DA, AS40.31, AS40.31DA, AS40.31DGT, AS40.31DGT-DA, AS50.35, AS50.35DA, AS50.35DGT, AS50.35DGT-DA, AW4028, AW45.32, COMPACT20, GEMINICF, PROGRAM25CF		

			
1			
GEV No.	510303	Ref. No.	00002531
description	O-ring EPDM thickness 1.78mm ID ø 6.75mm Qty 1 pcs		
For models:	AC20, AC25, AC26, AE1000, AE35.21, AE38.25, AE40.29, AE40.30, AE45.30, AE50.32, AE50.35, AH1000, AH1000Easy, AH1100, AH1100DGT, AH1200, AH1200DGT, AH1400, AL1200E, AL1400, AL1500E, AL40.28, AL40.28E, AL40.28EM, AL45.32, AL45.32E, AL45.32EM, AL50.34, AL50.34E, AL50.34EM, AL50.40, AL50.40E, AL50.40EM, AL50.45, AL55.45E, AL55.45EM, AL55.45EM-P, AL55.45E-P, ALISEO40.28E, ALISEO422, ALISEO428, ALISEO45.32E, AP1000, AP1200, AP35.21, AP35.21DA, AP38.25, AP38.25DA, AP40.28, AP40.28DA... (Other models you can see in the webshop)		

gaskets

O-rings

EPDM

			
1			
GEV No.	504512	Ref. No.	00006456
description	O-ring EPDM thickness 1.78mm ID ø 14mm Qty 1 pcs		
For models:	AL40.28E, AL40.28EM, AL45.32E, AL45.32EM, AL50.34E, AL50.34EM, AL50.40E, AL50.40EM, AL55.45E, AL55.45EM, AL55.45EM-P, AL55.45E-P, ALISEO40.28E, ALISEO45.32E, AW4028, AW45.32		

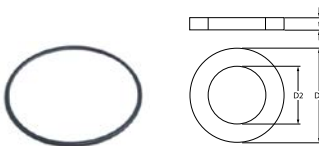
			
1			
GEV No.	532656	Ref. No.	00003454
description	O-ring EPDM thickness 1.78mm ID ø 60.05mm Qty 1 pcs		
For models:	TR1200, TR1650, TR1650N		

			
1			
GEV No.	510824	Ref. No.	00002155
description	O-ring EPDM thickness 1.78mm ID ø 20.35mm Qty 1 pcs		
For models:	GEMINI-CR, LP125-80, LP65-65, MINIBAR, MINIBAR-CR, PROGRAM-25CR		

			
1			
GEV No.	521724	Ref. No.	00006290
description	O-ring EPDM thickness 1.78mm ID ø 72.75mm Qty 1 pcs		
For models:	TR1650, TR1650N, TR2000, TR2500, TR3000, TR3500, TR4000, TR5000, TRC250, TRR2500		

			
1			
GEV No.	508084	Ref. No.	00002038
description	O-ring EPDM thickness 1.78mm ID ø 25.12mm Qty 1 pcs		
For models:	AU125-80, AU55-65, AU55-80, AU65-65, GL500CF, GL700CF, LP125-80, LP55-65, LP55-80, LP65-65		

			
1			
GEV No.	530293	Ref. No.	00001826
description	O-ring EPDM thickness 1.78mm ID ø 8.73mm Qty 1 pcs		
For models:	GEMINI-CR, GL500CF, GL500CR, GL700CF, GL700CR, MINIBAR, MINIBAR-CR, PROGRAM25CR		

			
1			
GEV No.	528223	Ref. No.	00000123
description	O-ring EPDM thickness 2.62mm ID ø 11.91mm Qty 1 pcs		
For models:	AC20, AC25, AC26, AE1000, AE1200, AH1000, AH1000Easy, AH1100, AH1100DGT, AH1200, AH1200DGT, AH1400, AL1200E, AL1400, AL1500E, AL40.28, AL40.28E, AL40.28EM, AL45.32, AL45.32E, AL45.32EM, AL50.34, AL50.34E, AL50.34EM, AL50.40, AL50.40E, AL50.40EM, AL50.45, AL55.45E, AL55.45EM, AL55.45EM-P, AL55.45E-P, ALISEO40.28E, ALISEO422, ALISEO428, ALISEO45.32E, AP1000, AP1200, AP35.21, AP35.21DA, AP38.25, AP38.25DA, AP40.28, AP40.28DA, AP40.29, AP40.29DA, AP40.31, AP40.31DA, AP45.30, AP45.30DA... (Other models you can see in the webshop)		



GEV No.	508008	Ref. No.	00000093
description	O-ring EPDM thickness 2.62mm ID ø 15.88mm Qty 1 pcs		
For models:	AC20, AC25, AC26, AE1000, AE1200, AE35.21, AE38.25, AE40.29, AE40.30, AE45.30, AE50.32, AE50.35, AH1000, AH1000Easy, AH1100, AH1100DGT, AH1200, AH1200DGT, AH1400, AL1200E, AL1400, AL1500E, AL40.28, AL40.28E, AL40.28EM, AL45.32, AL45.32E, AL45.32EM, AL50.34, AL50.34E, AL50.34EM, AL50.40, AL50.40E, AL50.40EM, AL50.45, AL55.45E, AL55.45EM, AL55.45EM-P, AL55.45E-P, ALISEO40.28E, ALISEO422, ALISEO428, ALISEO45.32E, AP1000, AP1200, AP35.21, AP35.21DA, AP38.25, AP38.25DA, AP40.28...(Other models you can see in the webshop)		



GEV No.	510893	Ref. No.	00000697
description	O-ring EPDM thickness 2.62mm ID ø 9.92mm Qty 1 pcs		
For models:	AC25, AC26, AE1000, AE1200, AE35.21, AE38.25, AE40.29, AE40.30, AE45.30, AE50.32, AE50.35, AH1000, AH1000Easy, AH1100, AH1100DGT, AH1200, AH1200DGT, AH1400, AL1200E, AL1400, AL1500E, AL40.28, AL40.28E, AL40.28EM, AL45.32, AL45.32E, AL45.32EM, AL50.34, AL50.34E, AL50.34EM, AL50.40, AL50.40E, AL50.40EM, AL50.45, AL55.45E, AL55.45EM, AL55.45EM-P, AL55.45E-P, AP1000, AP1200, AP35.21, AP35.21DA, AP38.25, AP38.25DA, AP40.28, AP40.28DA, AP40.29, AP40.29DA, AP40.31, AP40.31DA...(Other models you can see in the webshop)		



GEV No.	505073	Ref. No.	00000025
description	O-ring EPDM thickness 2.62mm ID ø 20.63mm Qty 1 pcs		
For models:	AC26, AE1000, AE1200, AE35.21, AE38.25, AE40.29, AE40.30, AE45.30, AE50.32, AE50.35, AH1000, AH1000Easy, AH1100, AH1100DGT, AH1200, AH1200DGT, AH1400, AL1200E, AL1400, AL1500E, AL40.28, AL40.28E, AL40.28EM, AL45.32, AL45.32E, AL45.32EM, AL50.34, AL50.34E, AL50.34EM, AL50.40, AL50.40E, AL50.40EM, AL50.45, AL55.45E, AL55.45EM, AL55.45EM-P, AL55.45E-P, ALISEO40.28E, ALISEO422, ALISEO428, ALISEO45.32E, AP1000, AP1200, AP35.21, AP35.21DA, AP38.25, AP38.25DA, AP40.28, AP40.28DA, AP40.29...(Other models you can see in the webshop)		



GEV No.	509018	Ref. No.	00004382
description	O-ring EPDM thickness 3.53mm ID ø 107.5mm Qty 1 pcs		



GEV No.	508061	Ref. No.	00001633
description	O-ring EPDM thickness 3.53mm ID ø 42.86mm Qty 1 pcs		
For models:	AC20, AC25, AC26, AE1000, AE1200, AE35.21, AE38.25, AE40.29, AE40.30, AE45.30, AE50.32, AE50.35, AH1000, AH1000Easy, AH1100, AH1100DGT, AL40.28, AL40.28E, AL40.28EM, AL45.32, AL45.32E, AL45.32EM, AL50.34, AL50.34E, AL50.34EM, AL50.40, AL50.40E, AL50.40EM, AL50.45, AL55.45E, AL55.45EM, AL55.45EM-P, AL55.45E-P, ALISEO40.28E, ALISEO422, ALISEO428, ALISEO45.32E, AP1000, AP35.21, AP35.21DA, AP38.25, AP38.25DA, AP40.28, AP40.28DA, AP40.29, AP40.29DA, AP40.31, AP40.31DA, AP45.30, AP45.30DA...(Other models you can see in the webshop)		



GEV No.	532546	Ref. No.	00006291
description	O-ring EPDM thickness 2.62mm ID ø 52.07mm Qty 1 pcs		
For models:	TR1200, TR1650, TR1650N, TR2000, TR2500, TR3000, TR3500, TR4000, TR5000, TRC250, TRR2500		



GEV No.	532451	Ref. No.	00006546
description	O-ring EPDM thickness 3.53mm ID ø 53.98mm Qty 1 pcs		
For models:	AE1000, AE1200, AE38.25, AE40.29, AH1000, AH1000Easy, AH1100, AH1100DGT, AH1200, AH1200DGT, AH1400, AL1200E, AL1400, AL1500E, AP1000, AP1200, AU125-80, AU55-65, AU55-80, AU65-65, AU-H1400, GL1040, GL1240, LP125-80, LP55-65, LP55-80, LP65-65, LPC1500		



GEV No.	532490	Ref. No.	00004381
description	O-ring EPDM thickness 2.62mm ID ø 72.69mm Qty 1 pcs		

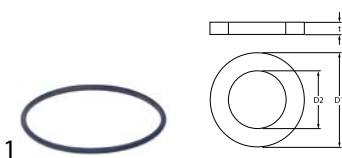

GEV No.	528487	Ref. No.	00000201
description	O-ring EPDM thickness 2.62mm ID ø 9.19mm Qty 1 pcs		
For models:	GL500CF, GL500CR, GL700CF, GL700CR, SELF400		

GEV No.	532534	Ref. No.	00005206
description	O-ring EPDM thickness 3.53mm ID ø 82.14mm Qty 1 pcs		
For models:	GSN, SPF, STAR-1, STAR-2, STAR-4, STAR-6, TR1200, TR1650, TR1650N, TR2000, TR2500, TR3000, TR3500, TR4000, TR5000, TRC250, TRR2500		

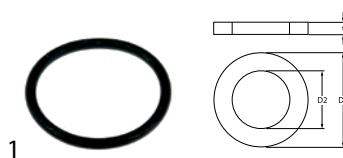

GEV No.	529460	Ref. No.	2713
description	O-ring EPDM thickness 5.34mm ID ø 59.69mm Qty 1 pcs		

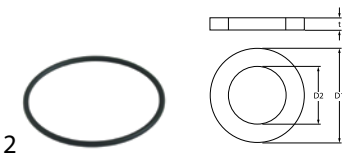

GEV No.	532457	Ref. No.	00002556
description	O-ring EPDM thickness 3.53mm ID ø 85.32mm Qty 1 pcs		
For models:	GSN, SPF, STAR-1, STAR-2, STAR-4, STAR-6		

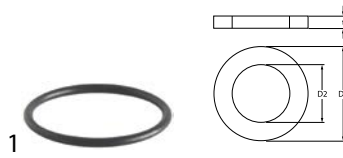

GEV No.	508109	Ref. No.	00002374
description	O-ring EPDM thickness 5.34mm ID ø 69.22mm Qty 1 pcs		
For models:	AE1000, AE45.30, AE50.32, AE50.35, AL40.28, AL40.28E, AL40.28EM, AL45.32, AL45.32E, AL45.32EM, AP1000, AP45.30, AP45.30DA, AP50.32, AP50.32DA, AP50.35, AP50.35DA, AP55.40, AP55.40DA, AS50.35, AS50.35DA, AS50.35DGT, AS50.35DGT-DA, AS50.40, AS50.40DA, AS50.40DGT, AS50.40DGT-DA, AU-P55.40, AU-S55.40, AU-S55.40DGT, EURO500, GL1040, GL1240, GL4.32E, GL4.32EM, GL5.34, GL5.34E, GL500CF, GL500CR, GL7.38, GL7.40E, GL7.40EM, GL700CF, GL700CR, GL8.50E, GL8.50EM, LP55-65, LP65-65, PASSPORT45.30, PASSPORT50.32...(Other models you can see in the webshop)		



GEV No.	521709	Ref. No.	00004383
description	O-ring EPDM thickness 3mm ID ø 126mm Qty 1 pcs		

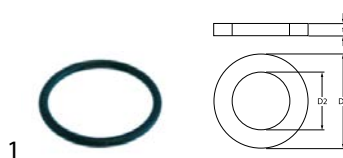

GEV No.	521121	Ref. No.	00000057
description	O-ring EPDM thickness 8mm ID ø 62mm Qty 1 pcs		
For models:	AC20, AC25, AC26, AE1000, AE1200, AE35.21, AE38.25, AE40.29, AE40.30, AE45.30, AE50.32, AE50.35, AH1000, AH1000Easy, AH1100, AH1100DGT, AH1200, AH1200DGT, AH1400, AL1200E, AL1400, AL1500E, AL40.28, AL40.28E, AL40.28EM, AL45.32, AL45.32E, AL45.32EM, AL50.34, AL50.34E, AL50.34EM, AL50.40, AL50.40E, AL50.40EM, AL50.45, AL55.45E, AL55.45EM, AL55.45EM-P, AL55.45E-P, ALISEO40.28E, ALISEO422, ALISEO428, ALISEO45.32E, AP1000, AP1200, AP35.21, AP35.21DA, AP38.25, AP38.25DA, AP40.28...(Other models you can see in the webshop)		

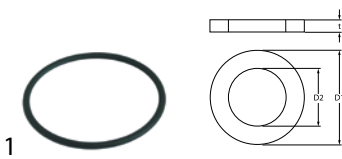

GEV No.	508032	Ref. No.	00000212
description	O-ring EPDM thickness 5.34mm ID ø 110.5mm Qty 1 pcs		
For models:	GL500CF, GL500CR, GL700CF, GL700CR		

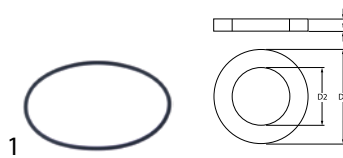

GEV No.	521062	Ref. No.	00004401
description	O-ring ID ø 80mm thickness 2.62mm EPDM Qty 1 pcs		



GEV No.	508129	Ref. No.	00002564
description	O-ring EPDM thickness 5.34mm ID ø 139.7mm Qty 1 pcs		
For models:	GL1040, GL1240, LP55-65, LP65-65		



GEV No.	510408	Ref. No.	00002662
description	O-ring EPDM thickness 5.34mm ID ø 47mm Qty 1 pcs		
For models:	GL1040, GL1240		

silicone



GEV No.	532586	Ref. No.	K02940
description	O-ring silicone thickness 2.62mm ID ø 40.95mm Qty 1 pcs		

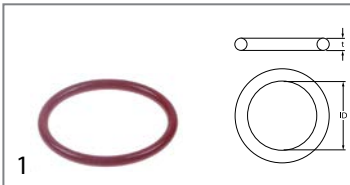

GEV No.	532606	Ref. No.	00004698
description	O-ring silicone thickness 3.53mm ID ø 37.69mm Qty 1 pcs		
For models:	AU125-80, LP125-80, TR1200, TR1650, TR2000, TR2500, TR3000, TR3500, TRC250, TRR2500		

sealing washers

fibre gaskets



GEV No.	508031	Ref. No.	00000207
description	flat gasket FIBER ED ø 19mm ID ø 10.5mm thickness 2mm Qty 1 pcs		
For models:	AC26, COMPACT20, GEMINI-CF, GEMINI-CR, GL500CF, GL500CR, GL700CF, GL700CR, MASTER21, MINIBAR, MINIBAR-CF, MINIBAR-CR, PROGRAM25CF, PROGRAM25CR, SELF400		



GEV No.	508017	Ref. No.	00000124
description	flat gasket FIBER ED ø 24mm ID ø 17mm thickness 2mm Qty 1 pcs		
For models:	AC20, AC25, COMPACT20, GEMINICF, GEMINI-CF, GEMINI-CR, MINIBAR, MINIBAR-CF, MINIBAR-CR, PROGRAM25CF, PROGRAM25CR		

rubber gaskets



GEV No.	508011	Ref. No.	00000109
description	flat gasket rubber D1 ø 45mm D2 ø 26mm thickness 2mm equiv. no. for model Aliseo/Master/Minibar/Gemini/Program		
For models:	AC20, AC25, AC26, AE35.21, AE38.25, AE40.29, ALISEO40.28E, ALISEO422, ALISEO428, ALISEO45.32E, AW4028, AW45.32, COMPACT20, EURO350, EURO380, EURO400, GEMINICF, GEMINI-CF, GEMINI-CR, MASTER21, MINIBAR, MINIBAR-CF, MINIBAR-CR, PROGRAM25CF, PROGRAM25CR, TR5000		



GEV No.	508029	Ref. No.	00000204
description	flat gasket rubber D1 ø 59mm D2 ø 45mm thickness 2.5mm Qty 1 pcs for model AE/AL/AP/AS/GL/F		
For models:	AE1000, AE1200, AE35.21, AE38.25, AE40.29, AE40.30, AE45.30, AE50.32, AE50.35, AH1000, AH1000Easy, AH1100, AH1100DGT, AH1200, AH1200DGT, AH1400, AL1200E, AL1400, AL1500E, AL40.28E, AL40.28EM, AL45.32, AL45.32E, AL45.32EM, AL50.34, AL50.34E, AL50.34EM, AL50.40, AL50.40E, AL50.40EM, AL50.45, AL55.45E, AL55.45EM, AL55.45EM-P, AL55.45E-P, AP1000, AP1200, AP35.21, AP35.21DA, AP38.25, AP38.25DA, AP40.28, AP40.28DA, AP40.29, AP40.29DA, AP40.31, AP40.31DA, AP45.30, AP45.30DA, AP50.32... (Other models you can see in the webshop)		



GEV No.	508215	Ref. No.	00003086
description	flat gasket rubber ED ø 40mm ID ø 27mm thickness 1.4mm Qty 1 pcs		
For models:	AC20, AC25, AC26, AE1000, AE1200, AH1000, AH1000Easy, AH1100, AH1100DGT, AH1200, AH1200DGT, AH1400, AL1200E, AL1400, AL1500E, AL40.28, AL40.28E, AL40.28EM, AL45.32, AL45.32E, AL45.32EM, AL50.34, AL50.34E, AL50.34EM, AL50.40, AL50.40E, AL50.40EM, AL50.45, AL55.45E, AL55.45EM, AL55.45EM-P, AL55.45E-P, ALISEO40.28E, ALISEO422, ALISEO428, ALISEO45.32E, AP1000, AP1200, AP35.21, AP35.21DA, AP38.25, AP38.25DA, AP40.28, AP40.28DA, AP40.29, AP40.29DA, AP40.31, AP40.31DA, AP45.30, AP45.30DA... (Other models you can see in the webshop)		



GEV No.	511582	Ref. No.	00009343
description	flat gasket rubber ED ø 69mm ID ø 47.5mm thickness 5mm Qty 1 pcs		
For models:	LP125-80, LP55-65, LP55-80, LP65-65		



GEV No.	510071	Ref. No.	00001153 6152
description	flat gasket rubber ED ø 81mm ID ø 68mm thickness 3mm for salt tank Qty 1 pcs		
For models:	AP35.21DA, AP38.25DA, AP40.28DA, AP40.29DA, AP45.30DA, AP50.32DA, AP50.35DA, AP55.40DA		

PTFE gaskets



GEV No.	508049	Ref. No.	00001173
description	flat gasket PTFE ED ø 16mm ID ø 10mm thickness 2mm Qty 1 pcs		
For models:	AC20, AC26, AE1000, AE1200, AE35.21, AE38.25, AE40.29, AE40.30, AE45.30, AE50.32, AE50.35, AH1000, AH1000Easy, AH1100, AH1100DGT, AL40.28, ALISEO40.28E, ALISEO422, ALISEO428, ALISEO45.32E, AP1000, AP35.21, AP35.21DA, AP38.25, AP38.25DA, AP40.28, AP40.28DA, AP40.29, AP40.29DA, AP40.31, AP40.31DA, AP45.30, AP45.30DA, AP50.32, AP50.32DA, AP50.35, AP50.35DA, AP55.40, AP55.40DA, AS40.31, AS40.31DA, AS40.31DGT, AS40.31DGT-DA, AS50.35, AS50.35DA, AS50.35DGT, AS50.35DGT-DA, AS50.40, AS50.40DA, AS50.40DGT... (Other models you can see in the webshop)		



GEV No.	508089	Ref. No.	00002130
description	sealing ring PTFE ED ø 68mm ID ø 55mm thickness 2mm Qty 1 pcs		
For models:	AH1200, AH1200DGT, AH1400, AL1200E, AL1400, AL1500E, AP1200, AU125-80, AU55-65, AU55-80, AU65-65, AU-H1400, GL1040, GL1240, GL500CF, GL700CF, LP125-80, LP55-65, LP55-80, LP65-65, LPC1500		

foam rubber gaskets



1

GEV No.	508307	Ref. No.	00006143
description	foam rubber gasket W 15mm thickness 4mm self-adhesive Qty supplied by meter		
For models:	AE35.21, AE38.25, AE40.29, AE40.30, AE45.30, AE50.32, AE50.35, AL40.28, AL40.28E, AL40.28EM, AL45.32, AL45.32E, AL45.32EM, AL50.34, AL50.34E, AL50.34EM, AL50.40, AL50.40E, AL50.40EM, AL50.45, AL55.45E, AL55.45EM, AL55.45EM-P, AL55.45E-P, ALI-SEO40.28E, ALISEO45.32E, AP35.21, AP35.21DA, AP38.25, AP38.25DA, AP40.29, AP40.29DA, AP40.31, AP40.31DA, AP45.30, AP45.30DA, AP50.32, AP50.32DA, AP50.35, AP50.35DA, AP55.40, AP55.40DA, AS40.31, AS40.31DA, AS40.31DGT, AS40.31DGT-DA, AS50.35, AS50.35DA, AS50.35DGT, AS50.35DGT-DA...(Other models you can see in the webshop)		



1

GEV No.	508406	Ref. No.	00006233
description	foam rubber gasket W 9mm thickness 3mm self-adhesive Qty supplied by meter		
For models:	AE35.21, AE38.25, AE40.29, AE45.30, AE50.32, AP35.21, AP35.21DA, AP38.25, AP38.25DA, AP40.28, AP40.28DA, AP45.30, AP45.30DA, AP50.32, AP50.32DA, AP50.35, AP50.35DA, AP55.40, AP55.40DA		

shaft gaskets

shaft gaskets



1

GEV No.	698303	Ref. No.	00005711
description	shaft sealing ID ø 28mm ED ø 50mm thickness 10mm		
For models:	TR1200, TR1650, TR1650N, TR2000, TR2500, TR3000, TR3500, TR4000, TR5000, TRC250, TRR2500		

special gaskets

door seals for dishwashers

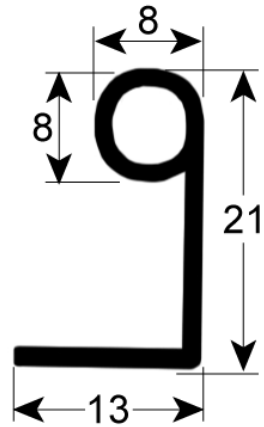

1

GEV No.	508284	Ref. No.	00004897
description	door seal L 1230mm		
For models:	GL4.32E, GL4.32EM, GL5.34E, GL8.50E, GL8.50EM, LP55-65, LP65-65		

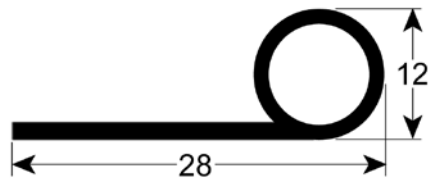

1

GEV No.	518630	Ref. No.	4623
description	door seal W 28mm mounting pos. for door H 12mm Qty supplied by meter rubber		



1

GEV No.	508307	Ref. No.	00006143
description	foam rubber gasket W 15mm thickness 4mm self-adhesive Qty supplied by meter		
For models:	AE35.21, AE38.25, AE40.29, AE40.30, AE45.30, AE50.32, AE50.35, AL40.28, AL40.28E, AL40.28EM, AL45.32, AL45.32E, AL45.32EM, AL50.34, AL50.34E, AL50.34EM, AL50.40, AL50.40E, AL50.40EM, AL50.45, AL55.45E, AL55.45EM, AL55.45EM-P, AL55.45E-P, ALI-SEO40.28E, ALISEO45.32E, AP35.21, AP35.21DA, AP38.25, AP38.25DA, AP40.29, AP40.29DA, AP40.31, AP40.31DA, AP45.30, AP45.30DA, AP50.32, AP50.32DA, AP50.35, AP50.35DA, AP55.40, AP55.40DA, AS40.31, AS40.31DA, AS40.31DGT, AS40.31DGT-DA, AS50.35, AS50.35DA, AS50.35DGT, AS50.35DGT-DA...(Other models you can see in the webshop)		

refrigeration cycle components

valves

Schrader valves

Schrader valves (complete)



1

GEV No.	750340	Ref. No.	K00489
description	Schrader valve complete connection soldering connection ø 6mm pipe length 100mm		
accessories for	750340		
	GEV No.	750479	Ref. No. —
	screw cap CASTEL 8392/A size 1/4" SAE for Schrader valve connection 1/4" Qty 1		

springs

torsion springs



1

GEV No.	690081	Ref. No.	00000670
description	torsion spring ø 19.4mm L2 36mm wire gauge ø 3.3mm mounting pos. left L1 42mm L3 36mm Qty 1 pcs		
For models:	ORION-1, ORION-1.5, ORION-2		
accessories for	690081		
	GEV No.	690080	Ref. No. 00000669 669
	torsion spring ø 19.4mm L2 37mm wire gauge ø 3.4mm mounting pos. right L1 42mm L3 37mm Qty 1 pcs		



1

GEV No.	690080	Ref. No.	00000669
description	torsion spring ø 19.4mm L2 37mm wire gauge ø 3.4mm mounting pos. right L1 42mm L3 37mm Qty 1 pcs		
For models:	ORION-1, ORION-1.5, ORION-2		
accessories for	690080		
	GEV No.	690081	Ref. No. 00000670 670
	torsion spring ø 19.4mm L2 36mm wire gauge ø 3.3mm mounting pos. left L1 42mm L3 36mm Qty 1 pcs		

gas tension springs

gas tension springs



1

GEV No.	701294	Ref. No.	00011013 00011014
description	gas tension spring N hub 350mm D1 ø 18.9mm D2 ø 8mm hole distance 720mm hole ø 10mm L 740mm		
For models:	AE1000, AE1200, AH1000, AH1000Easy		

roller springs

roller springs



1

GEV No.	519500	Ref. No.	00009653
description	roller spring complete incl. holder		
For models:	TR1650, TR1650N, TR2000, TR2500, TR3000, TR3500, TR4000, TR5000, TRC250, TRR2500		



1

GEV No.	517429	Ref. No.	00009649
description	roller spring W 51mm ID ømm lug length 50mm mounting distance 35/80mm		
For models:	TR1200, TR3500, TR4000, TR5000, TRR2500		

tension springs



1

GEV No.	511972	Ref. No.	00006451
description	spring for hood mechanics wire gauge ø 4.8mm ø 25mm total length 680mm		
For models:	AH1400, AL1200E, AL1400, AL1500E, AU-H1400, LPC1500		



1

GEV No.	508127	Ref. No.	00002543
description	tension spring		
For models:	AH1100, AH1100DGT, AH1200, AH1200DGT, AP1000, AP1200, GL1040, GL1240		



1

GEV No.	508071	Ref. No.	00001722
description	tension spring D1 ø 20mm D2 ø 2mm for door L 110mm		
For models:	AC20, AC25, COMPACT20, GEMINICF, GEMINI-CF, GEMINI-CR, MINIBAR, MINIBAR-CF, MINIBAR-CR		



1			
GEV No.	508315	Ref. No.	00006377
description	tension spring \varnothing 13.7mm total length 257mm wire gauge \varnothing 2.2mm for door		
For models:	AL50.34, AL50.34E, AL50.34EM, AL50.40, AL50.40E, AL50.40EM, AL50.45, AL55.45E, AL55.45EM, AL55.45EM-P, AL55.45E-P, AU-L55.45		

dosing pumps





peristaltic dosing pumps

GIADOS

built-in version





with frequency control



1					
GEV No.	361524	Ref. No.	6223		
description	dosing pump GIADOS frequency control 3l/h 230VAC detergent hose \varnothing 4x6mm hose type Santoprene type 6223 dimensions 69x75x116mm				
spare parts for	361524				
		GEV No.	361526	Ref. No.	—
	pump hose detergent hose type Santoprene hose \varnothing 4x6mm				
accessories for	361524				
		GEV No.	520090	Ref. No.	—
	PVC hose ID \varnothing 4mm ED \varnothing 6mm L 2m thickness 1mm t.max. 60°C transparent				
		GEV No.	520091	Ref. No.	00000135 135
	nylon hose ID \varnothing 4mm ED \varnothing 6mm L 2m thickness 1mm operating p. 10bar burst p. 50bar t.max. 100°C transparent				

without control



1					
GEV No.	361369	Ref. No.	00004880		
description	dosing pump GIADOS without control 3l/h 230VAC detergent hose \varnothing 4x6mm hose type Santoprene type 4880 dimensions 69x58x95mm				
For models:	AC20, AC25, AC26, AE1000, AE1200, AE35.21, AE38.25, AE40.29, AE40.30, AE45.30, AE50.32, AE50.35, AH1000, AH1000Easy, AH1100, AH1100DGT, AH1200, AH1200DGT, AH1400, AL1200E, AL1400, AL1500E, AL40.28, AL40.28E, AL40.28EM, AL45.32, AL45.32E, AL45.32EM, AL50.34, AL50.34E, AL50.34EM, AL50.40, AL50.40E, AL50.40EM, AL50.45, AL55.45E, AL55.45EM, AL55.45EM-P, AL55.45E-P, ALISEO40.28E, ALISEO45.32E, AP1000, AP1200, AP35.21, AP35.21DA, AP38.25, AP38.25DA, AP40.28, AP40.28DA, AP40.29...(Other models you can see in the webshop)				
spare parts for	361369				
		GEV No.	361526	Ref. No.	—
	pump hose detergent hose type Santoprene hose \varnothing 4x6mm				
accessories for	361369				
		GEV No.	520090	Ref. No.	—
	PVC hose ID \varnothing 4mm ED \varnothing 6mm L 2m thickness 1mm t.max. 60°C transparent				
		GEV No.	520091	Ref. No.	00000135 135
	nylon hose ID \varnothing 4mm ED \varnothing 6mm L 2m thickness 1mm operating p. 10bar burst p. 50bar t.max. 100°C transparent				

membrane dosing pumps

self-priming

various





1					
GEV No.	361370	Ref. No.	00000060		
description	dosing pump type model 2 rinse aid inlet 4x6mm outlet 4x6mm pressure connection \varnothing 4x6mm suction connection \varnothing 4x6mm				
For models:	AC20, AC25, AC26, AE1000, AE1200, AE35.21, AE38.25, AE40.29, AE40.30, AE45.30, AE50.32, AE50.35, AH1000, AH1000Easy, AH1100, AH1100DGT, AH1200, AH1200DGT, AH1400, AL1200E, AL1400, AL1500E, AL40.28, AL40.28E, AL40.28EM, AL45.32, AL45.32E, AL45.32EM, AL50.34, AL50.34E, AL50.34EM, AL50.40, AL50.40E, AL50.40EM, AL50.45, AL55.45E, AL55.45EM, AL55.45EM-P, AL55.45E-P, ALISEO40.28E, ALISEO42, ALISEO428, ALISEO45.32E, AP1000, AP1200, AP35.21, AP35.21DA, AP38.25, AP38.25DA, AP40.28...(Other models you can see in the webshop)				
spare parts for	361370				
		GEV No.	361307	Ref. No.	—
	membrane dosing pump \varnothing 68mm hole \varnothing 6mm for type DIB3P/DIB5P				

Table continues overleaf



spare parts for 361370			
	GEV No.	361459	Ref. No. —
hose connector ø 6mm for dosing pump			



GEV No.	361741	Ref. No.	60
description	dosing pump type model 2 rinse aid inlet 4x6mm outlet 4x6mm pressure connection ø 4x6mm suction connection ø 4x6mm		
spare parts for 361741			
	GEV No.	361307	Ref. No. —
membrane dosing pump ø 68mm hole ø 6mm for type DIB3P/DIB5P			
	GEV No.	361459	Ref. No. —
hose connector ø 6mm for dosing pump			
	GEV No.	361462	Ref. No. —
container filter with weight SS hose ø 4x6mm			
	GEV No.	508116	Ref. No. 00002450 2450
union nut thread M10x1 H 16mm WS 16 plastic Qty 1 pcs			
	GEV No.	508123	Ref. No. 00002503 2503
T-piece 3-way hose ø 13-5-13mm plastic			
	GEV No.	520090	Ref. No. —
PVC hose ID ø 4mm ED ø 6mm L 2m thickness 1mm t.max. 60°C transparent			

accessories

non-return valves

	GEV No.	508326	Ref. No.	00006535
description non-return valve inlet 4x6mm outlet M10x1 IT L 56mm mounting pos. for dosing pump outlet				
For models: AL55.45E-P				

T-pieces

without non-return valve

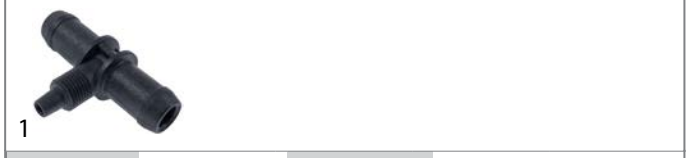

GEV No.	508123	Ref. No.	00002503
description	T-piece 3-way hose ø 13-5-13mm plastic		
For models:	AC20, AC25, AC26, AE1000, AE1200, AE35.21, AE38.25, AE40.29, AE40.30, AE45.30, AE50.32, AE50.35, AH1000, AH1000Easy, AH1100, AH1100DGT, AH1200, AH1200DGT, AH1400, AL1200E, AL1400, AL1500E, AL40.28, AL40.28E, AL40.28EM, AL45.32, AL45.32E, AL45.32EM, AL50.34, AL50.34E, AL50.34EM, AL50.40, AL50.40E, AL50.40EM, AL50.45, AL55.45E, AL55.45EM, AL55.45EM-P, AL55.45E-P, ALISEO40.28E, ALISEO422, ALISEO428, ALISEO45.32E, AP1000, AP1200, AP35.21, AP35.21DA, AP38.25, AP38.25DA, AP40.28...(Other models you can see in the webshop)		
accessories for	508123		
	GEV No.	508116	Ref. No. 00002450 2450
union nut thread M10x1 H 16mm WS 16 plastic Qty 1 pcs			

tank inlets



GEV No.	508301	Ref. No.	00005073
description	tank inlet plastic M9x1.5 hose ø 4mm		
For models:	AL50.34E, ALISEO40.28E, ALISEO45.32E, GL1040, GL1240, GL8.50E, GL8.50EM, LP55-65, LP65-65, PASSPORT45.30, PASSPORT50.32, PASSPORT50.40		

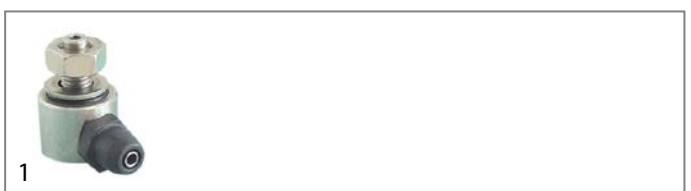

GEV No.	508306	Ref. No.	00009528
description	tank inlet SS		
For models:	AL1200E, AL1500E, AL40.28E, AL40.28EM, AL45.32E, AL45.32EM, AL50.34E, AL50.34EM, AL50.40E, AL50.40EM, AL55.45E, AL55.45EM, AL55.45EM-P, AL55.45E-P, ALISEO40.28E, ALISEO45.32E, AP1000, AP35.21, AP35.21DA, AP38.25, AP38.25DA, AP40.28, AP40.28DA, AP45.30, AP45.30DA, AP50.32, AP50.32DA, AP50.35, AP50.35DA, AP55.40, AP55.40DA, AU125-80, AU55-65, AU55-80, AU65-65, AW4028, AW45.32, COMPACT20, EURO500, GEMINICF, GEMINI-CF, GL1040, GL1240, LP125-80, LP55-65, LP55-80, LP65-65, LPC1500, PROGRAM25CF, PROGRAM25CR		



hoses

drain hoses

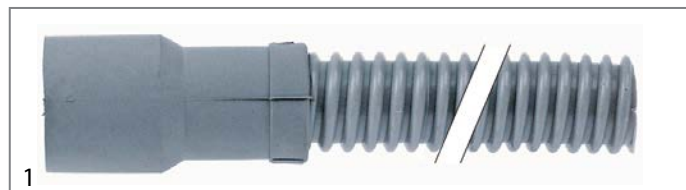

GEV No.	508043	Ref. No.	00000638
description	drain hose DN19 L 2000mm straight ϕ inside 19/30mm straight ext. ϕ 26/34mm outer hose ϕ 25mm		
For models:	AC20, AC25, AC26, AE35.21, AE38.25, AE40.29, AE40.30, AL45.32E, AL45.32EM, ALISEO40.28E, ALISEO422, ALISEO428, ALISEO45.32E, AP35.21, AP35.21DA, AP38.25, AP38.25DA, AP40.28, AP40.28DA, AP40.29, AP40.29DA, AP40.31, AP40.31DA, AS40.31, AS40.31DA, AS40.31DGT, AS40.31DGT-DA, AW4028, COMPACT20, EURO350, EURO380, EURO400, GEMINICF, GEMINI-CF, GEMINI-CR, MASTER21, MINIBAR, MINIBAR-CF, MINIBAR-CR, PROGRAM25CF, PROGRAM25CR		

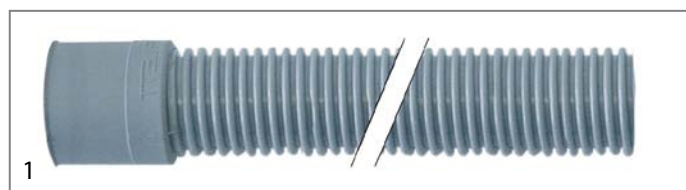

GEV No.	530587	Ref. No.	00002188
description	drain hose DN28 L 2000mm straight ϕ inside 32mm straight ext. ϕ 40mm outer hose ϕ 35mm		
For models:	AE1000, AE1200, AE45.30, AE50.32, AE50.35, AH1000, AH1000Easy, AH1100, AH1100DGT, AH1200, AH1200DGT, AH1400, AL1200E, AL1400, AL1500E, AL40.28, AL40.28E, AL40.28EM, AL45.32, AL45.32E, AL45.32EM, AL50.34, AL50.34E, AL50.34EM, AL50.40, AL50.40E, AL50.40EM, AL50.45, AL55.45E, AL55.45EM, AL55.45EM-P, AL55.45E-P, AP1000, AP1200, AP45.30, AP45.30DA, AP50.32, AP50.32DA, AP50.35, AP50.35DA, AP55.40, AP55.40DA, AS50.35, AS50.35DA, AS50.35DGT, AS50.35DGT-DA, AS50.40, AS50.40DA, AS50.40DGT, AS50.40DGT-DA... (Other models you can see in the webshop)		

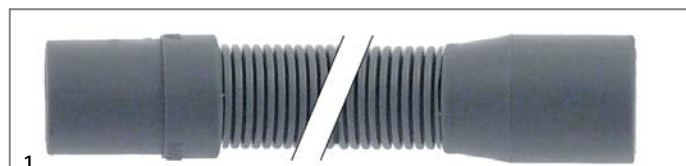

GEV No.	530489	Ref. No.	K01085
description	drain hose DN19 L 2000mm A int. ϕ 22mm A ext. ϕ 27mm B int. ϕ 19mm B ext. ϕ 24mm outer hose ϕ 22mm		

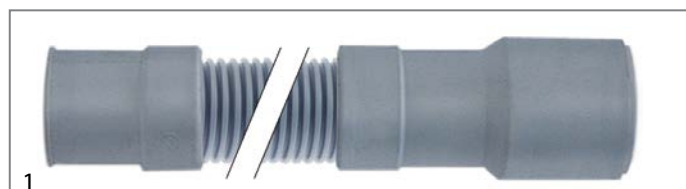

GEV No.	530570	Ref. No.	638
description	drain hose DN21 L 2000mm A int. ϕ 21mm A ext. ϕ 25mm B int. ϕ 20/29mm B ext. ϕ 27/35mm outer hose ϕ 25mm		

industrial hoses

nylon hoses



GEV No.	520091	Ref. No.	00000135
description	nylon hose ID ϕ 4mm ED ϕ 6mm L 2m thickness 1mm operating p. 10bar burst p. 50bar t.max. 100°C transparent		
For models:	AC20, AC25, AC26, AE1000, AE1200, AE35.21, AE38.25, AE40.29, AE40.30, AE45.30, AE50.32, AE50.35, AH1000, AH1000Easy, AH1100, AH1100DGT, AH1200, AH1200DGT, AH1400, AL1400, AL40.28, AL40.28E, AL40.28EM, AL45.32, AL45.32E, AL45.32EM, AL50.34, AL50.34E, AL50.34EM, AL50.40, AL50.40E, AL50.40EM, AL50.45, AL55.45E, AL55.45EM, AL55.45EM-P, AL55.45E-P, ALISEO40.28E, ALISEO422, ALISEO428, ALISEO45.32E, AP1000, AP1200, AP35.21, AP35.21DA, AP38.25, AP38.25DA, AP40.28, AP40.28DA, AP40.29... (Other models you can see in the webshop)		

pressure control hoses



GEV No.	530560	Ref. No.	00002329
description	pressure control hose ID ϕ 5mm ED ϕ 9mm L 5m operating p. 30bar burst p. 90bar temp.-resist. 60°C		
For models:	AC20, AC25, AC26, AE1000, AE1200, AE35.21, AE38.25, AE40.29, AE40.30, AE45.30, AE50.32, AE50.35, AH1000, AH1000Easy, AH1100, AH1100DGT, AH1200, AH1200DGT, AH1400, AL1200E, AL1400, AL1500E, AL40.28, AL40.28E, AL40.28EM, AL45.32, AL45.32E, AL45.32EM, AL50.34, AL50.34E, AL50.34EM, AL50.40, AL50.40E, AL50.40EM, AL50.45, AL55.45E, AL55.45EM, AL55.45EM-P, AL55.45E-P, AP1000, AP1200, AP35.21, AP35.21DA, AP38.25, AP38.25DA, AP40.28, AP40.28DA, AP40.29, AP40.29DA, AP40.31... (Other models you can see in the webshop)		

formed hoses

straight



GEV No.	508045	Ref. No.	00000700
description	formed hose dishwasher straight		
For models:	AC25, AC26, GEMINICF, GEMINI-CF, GEMINI-CR, PROGRAM25CF, PROGRAM25CR		



1

GEV No.	508092	Ref. No.	00002139
description	formed hose dishwasher straight		
For models:	AC20, AE35.21, AP35.21, AP35.21DA, COMPACT20, EURO350, EURO380, EURO400, MASTER21, MINIBAR, MINIBAR-CF, MINIBAR-CR, TR3500, TR4000, TR5000, TRC250, TRR2500		



1

GEV No.	508118	Ref. No.	00002480
description	formed hose dishwasher straight		
For models:	AE35.21, AE38.25, AE40.29, AE40.30, AE45.30, AL40.28, AL40.28E, AL40.28EM, AL45.32, AL45.32E, AL45.32EM, ALISEO40.28E, ALISEO422, ALISEO428, ALISEO45.32E, AP35.21, AP35.21DA, AP38.25, AP38.25DA, AP40.28, AP40.28DA, AP40.29, AP40.29DA, AP40.31DA, AP45.30, AP45.30DA, AS40.31DA, AS40.31DGT-DA, AW4028, GL4.32E, GL4.32EM, PASSPORT45.30, PROJECT28, PROJECT28E, PROJECT28EM, SELF4.32, SELF400		



1

GEV No.	508166	Ref. No.	00002732
description	formed hose dishwasher straight equiv. no. 2732		
For models:	AH1400, AL1200E, AL1400, AL1500E, AU-H1400, GL1040, GL1240, LP55-65, LP65-65, LPC1500		



1

GEV No.	508248	Ref. No.	00004171
description	formed hose dishwasher straight equiv. no. 4171		
For models:	AP38.25, AP38.25DA, AP40.28, AP40.28DA, AP40.29, AP40.29DA, AP40.31, AP40.31DA, AS40.31, AS40.31DA, AS40.31DGT, AS40.31DGT-DA		



1

GEV No.	508290	Ref. No.	00004935
description	formed hose dishwasher straight equiv. no. 4935		
For models:	AE1000, AP1000, GL1040, GL1240		



1

GEV No.	508325	Ref. No.	00006534
description	formed hose dishwasher straight equiv. no. 6534		
For models:	AL50.45, AL55.45E, AL55.45EM, AL55.45EM-P, AL55.45E-P, AU55-65, AU55-80, AU65-65, AU-L55.45		



1

GEV No.	508327	Ref. No.	00006544
description	formed hose dishwasher straight equiv. no. 6544		
For models:	AL50.34, AL50.34E, AL50.34EM, AL50.40, AL50.40E, AL50.40EM		



1

GEV No.	508165	Ref. No.	00002731
description	formed hose dishwasher straight mounting pos. upper		
For models:	AH1200, AH1200DGT, AH1400, AL1400, AP1200, AU-H1400, GL1040, GL1240, LP55-65, LP65-65, LPC1500		





			
1			
GEV No.	508213	Ref. No.	00003072
description	formed hose dishwasher straight mounting pos. upper equiv. no. 3072		
For models:	AE1000, AE1200, AE50.32, AE50.35, AH1000, AH1000Easy, AH1100, AH1100DGT, AL50.34, AL50.34E, AL50.34EM, AL50.40, AL50.40E, AL50.40EM, AL50.45, AL55.45E, AL55.45EM, AL55.45EM-P, AL55.45E-P, AP1000, AP50.32, AP50.32DA, AP50.35, AP50.35DA, AP55.40, AP55.40DA, AS50.35, AS50.35DA, AS50.35DGT, AS50.35DGT-DA, AS50.40, AS50.40DA, AS50.40DGT, AS50.40DGT-DA, AU-L55.45, AU-P55.40, AU-S55.40, AU-S55.40DGT, EURO500, GL5.34, GL5.34E, GL7.38, GL7.40E, GL7.40EM, GL8.50E, GL8.50EM, PASSPORT50.32, PASSPORT50.40		

form L			
			
1			
GEV No.	508128	Ref. No.	00002549
description	formed hose end piece A ext. ø 75.5mm end piece A int. ø 63.5mm AD2 ø 100mm ø end piece B 88mm warewashing L-shape extraction hose equiv. no. 2549		
For models:	GL1040, GL1240, LP55-65, LP65-65		

			
1			
GEV No.	508099	Ref. No.	00002157
description	formed hose warewashing L-shape equiv. no. 2157		
For models:	GL500CF, GL500CR, GL700CF, GL700CR, PROJECT28, PROJECT28E, PROJECT28EM		

			
1			
GEV No.	508147	Ref. No.	00002655
description	formed hose warewashing L-shape equiv. no. 2655		
For models:	AE1000, AE45.30, AE50.32, AE50.35, AP1000, AP45.30, AP45.30DA, AP50.32, AP50.32DA, AP50.35, AP50.35DA, AP55.40, AP55.40DA, AS50.35, AS50.35DA, AS50.35DGT, AS50.35DGT-DA, AS50.40, AS50.40DA, AS50.40DGT, AS50.40DGT-DA, AU-P55.40, AU-S55.40, AU-S55.40DGT, EURO500, GL4.32E, GL4.32EM, GL5.34, GL500CF, GL500CR, GL7.38, GL7.40E, GL7.40EM, GL700CF, GL700CR, GL8.50E, GL8.50EM, PASSPORT45.30, PASSPORT50.32, PASSPORT50.40, PROJECT28, PROJECT28E, PROJECT28EM, SELF4.32, SELF400		

			
1			
GEV No.	508201	Ref. No.	00002927
description	formed hose warewashing L-shape equiv. no. 2927		
For models:	AC20, AC25, AE1000, AE1200, AE35.21, AE38.25, AE40.29, AE40.30, AE45.30, AE50.32, AE50.35, AH1000, AH1000Easy, AH1100, AH1100DGT, AH1200, AH1200DGT, AH1400, AL1200E, AL1400, AL1500E, AL40.28, AL40.28E, AL40.28EM, AL45.32, AL45.32E, AL45.32EM, AL50.34, AL50.34E, AL50.34EM, AL50.40, AL50.40E, AL50.40EM, AL50.45, AL55.45E, AL55.45EM, AL55.45EM-P, AL55.45E-P, ALISEO422, ALISEO428, AP1000, AP1200, AP35.21, AP35.21DA, AP38.25, AP38.25DA, AP40.28, AP40.28DA, AP40.29, AP40.29DA...(Other models you can see in the webshop)		

			
1			
GEV No.	508205	Ref. No.	00002962
description	formed hose warewashing L-shape equiv. no. 2962		
For models:	AE45.30, AE50.32, AE50.35, AL50.34, AL50.34E, AL50.34EM, AL50.40, AL50.40E, AL50.40EM, AL50.45, AL55.45E, AL55.45EM, AL55.45EM-P, AL55.45E-P, ALISEO40.28E, ALISEO45.32E, AP45.30, AP45.30DA, AP50.32, AP50.32DA, AP50.35, AP50.35DA, AP55.40, AP55.40DA, AS50.35, AS50.35DA, AS50.35DGT, AS50.35DGT-DA, AS50.40, AS50.40DA, AS50.40DGT, AS50.40DGT-DA, AU-L55.45, AU-P55.40, AU-S55.40, AU-S55.40DGT, AW4028, EURO500, GL4.32E, GL4.32EM, GL5.34, GL5.34E, GL7.38, GL7.40E, GL7.40EM, GL8.50E, GL8.50EM, PASSPORT45.30, PASSPORT50.32, PASSPORT50.40...(Other models you can see in the webshop)		

			
1			
GEV No.	508214	Ref. No.	00003080
description	formed hose warewashing L-shape equiv. no. 3080		
For models:	AE35.21, AE38.25, AE40.29, AE40.30, AP35.21, AP35.21DA, AP38.25, AP38.25DA, AP40.28, AP40.28DA, AP40.29, AP40.29DA, EURO350, EURO380, EURO400, GL4.32E		

			
1			
GEV No.	508294	Ref. No.	00004984
description	formed hose warewashing L-shape equiv. no. 4984		



1

GEV No.	508295	Ref. No.	00004985
description	formed hose warewashing L-shape equiv. no. 4985		
For models:	ALISEO422, ALISEO428		



1

GEV No.	508373	Ref. No.	00000161
description	hose end piece A ext. ø 27mm end piece A int. ø 23mm L2 60mm L1 195mm		
For models:	ACC20, ALISEO40.28E, ALISEO45.32E, AW4028, AW45.32, COMPACT20, GEMINI-CF, PROGRAM25CF, PROGRAM25CR		

miscellaneous



1

GEV No.	508345	Ref. No.	00215710
description	formed hose		
For models:	SELF400		

fittings, hose and pipe connectors

fittings

double nipples



1

GEV No.	521192	Ref. No.	00003207
description	double nipple brass thread 1"-3/4" Qty 1 pcs		
For models:	AU125-80, AU55-65, AU55-80, AU65-65, LP125-80, LP55-65, LP55-80, LP65-65		

reducers



1

GEV No.	520183	Ref. No.	00003206
description	reducer thread 1" ET - 3/4" IT brass		
For models:	LP55-65, LP55-80, LP65-65		

hose connectors

producer-specific



1

GEV No.	508060	Ref. No.	00001387
description	hose connector		
For models:	AL55.45E, AL55.45E-P, AP55.40, AP55.40DA, AU-H1400, AU-L55.45, AU-P55.40, AU-S55.40, AU-S55.40DGT, LP55-65, LP65-65, LPC1500, PASSPORT50.40		



1



GEV No.	508149	Ref. No.	00002674
description	hose connector for boiler		
For models:	MASTER21, TR1650, TR1650N, TR2000, TR2500		



1

GEV No.	508278	Ref. No.	00004760
description	reducer D1 ø 18mm D2 ø 30mm		
For models:	ALISEO422, ALISEO428		



			
1			
GEV No.	508123	Ref. No.	00002503
description	T-piece 3-way hose ø 13-5-13mm plastic		
For models:	AC20, AC25, AC26, AE1000, AE1200, AE35.21, AE38.25, AE40.29, AE40.30, AE45.30, AE50.32, AE50.35, AH1000, AH1000Easy, AH1100, AH1100DGT, AH1200, AH1200DGT, AH1400, AL1200E, AL1400, AL1500E, AL40.28, AL40.28E, AL40.28EM, AL45.32, AL45.32E, AL45.32EM, AL50.34, AL50.34E, AL50.34EM, AL50.40, AL50.40E, AL50.40EM, AL50.45, AL55.45E, AL55.45EM, AL55.45EM-P, AL55.45E-P, ALISEO40.28E, ALISEO422, ALISEO428, ALISEO45.32E, AP1000, AP1200, AP35.21, AP35.21DA, AP38.25, AP38.25DA, AP40.28...(Other models you can see in the webshop)		
accessories for	508123		
			
GEV No.	508116	Ref. No.	00002450 2450
description	union nut thread M10x1 H 16mm WS 16 plastic Qty 1 pcs		

			
1			
GEV No.	541306	Ref. No.	00005576 00005693
description	thermometer mounting measurements 62x11mm 0 up to +120°C capillary pipe 3000mm probe ø 6mm probe L 27mm		
For models:	AH1000, AH1000Easy, AH1100, AH1200, AL40.28EM, AL45.32EM, AL50.34EM, AL50.40EM, AL55.45EM, AL55.45EM-P, AP1000, AP1200, AP45.30, AP45.30DA, AP50.32, AP50.32DA, AP50.35, AP50.35DA, AP55.40, AP55.40DA, AS50.35, AS50.35DA, AS50.40, AS50.40DA, AU-P55.40, AU-S55.40, GL1040, GL1240, PASSPORT45.30, PASSPORT50.32, PASSPORT50.40		

ancillary products

clamps

double wire clamps

			
1			
GEV No.	505351	Ref. No.	388
description	wire clamp ø 11.6-12.2mm wire gauge ø 1.5mm zinc-coated steel Qty 100 pcs		

ø38mm			
			
1			
GEV No.	541912	Ref. No.	00005421
description	thermometer mounting ø 38mm t.max. 120°C 0-120°C probe ø 6.5mm probe L 25mm capillary pipe 3000mm		
For models:	TR1650, TR1650N, TR2000, TR2500, TRC250		

measuring equipment

thermometers

built-in thermometers

			
1			
GEV No.	541086	Ref. No.	6460
description	thermometer mounting measurements 58x25.5mm 0 up to +120°C capillary pipe 2000mm probe ø 6mm probe L 23mm		

ø40mm			
			
1			
GEV No.	541037	Ref. No.	00002620
description	thermometer mounting ø 40mm t.max. 120°C 0 up to +120°C probe ø 6.5mm probe L 25mm capillary pipe 2000mm		
For models:	LP55-65, LP65-65		

fastening material

screws

sheet metal screws



1

GEV No.	560000	Ref. No.	00001976
description	sheet-metal screw ø 4.8mm L 16mm SS Qty 1 pcs head ø 13mm		

hexagonal screws



1

GEV No.	560079	Ref. No.	00000052
description	hexagonal screw thread M6 thread L 12mm SS WS 10 Qty 20 pcs DIN 933 / ISO 4017		
For models:	PASSPORT50.32		

knurled screws



1

GEV No.	508047	Ref. No.	00001133 4374
description	Thumb screw ø 22mm thread M6 thread L 6mm		
For models:	AL40.28E, AL40.28EM, AL45.32E, AL45.32EM, AL50.34E, AL50.34EM, AL50.40E, AL50.40EM, AL55.45E, AL55.45EM, AL55.45EM-P, AL55.45E-P, ALISEO40.28E, ALISEO422, ALISEO428, ALISEO45.32E, AP1000, AP50.35, AP50.35DA, AP55.40, AP55.40DA, COMPACT20, GEMINI-CF, GL4.32E, GL4.32EM, GL5.34, GL5.34E, GL500CF, GL7.38, GL7.40E, GL7.40EM, GL700CF, GL8.50E, GL8.50EM, MASTER21, MINI-BAR-CF, PASSPORT50.40, PROGRAM25CF, PROJECT28, PROJECT28E, PROJECT28EM, SELF4.32, SELF400		



1

GEV No.	508254	Ref. No.	00004374
description	Thumb screw thread M6 thread L 4mm ø 22mm H 9mm SS Qty 1 pcs		
For models:	AC20, AC25, AC26, AE1000, AE1200, AE35.21, AE38.25, AE40.29, AE40.30, AE45.30, AE50.32, AE50.35, AH1000, AH1000Easy, AH1100, AH1100DGT, AL40.28, AL40.28E, AL45.32, AL45.32E, AL50.34, AL50.34E, AL50.40, AL50.40E, AL50.45, AL55.45E, AL55.45E-P, ALISEO40.28E, ALISEO45.32E, AP1000, AP35.21, AP35.21DA, AP38.25, AP38.25DA, AP40.28, AP40.28DA, AP40.29, AP40.29DA, AP40.31, AP40.31DA, AP45.30, AP45.30DA, AP50.32, AP50.32DA, AP50.35, AP50.35DA, AP55.40, AP55.40DA, AS40.31, AS40.31DA...(Other models you can see in the webshop)		

nuts

plate nuts



1

GEV No.	560004	Ref. No.	00000064
description	plate nut hole ø 2.9mm L 17mm W 12mm		

cap nuts



1

GEV No.	560136	Ref. No.	00001013
description	cap nuts thread M5 WS 8 SS Qty 20 pcs DIN/ISO DIN 1587		
For models:	GSN, SPF, STAR-1, STAR-2, STAR-4, STAR-6		

hexagonal nuts

DIN 439 / ISO 4035/8675



1

GEV No.	560511	Ref. No.	00003289
description	nut thread M8 H 4mm SS WS 13 Qty 1 pcs DIN/ISO DIN 439		
For models:	TR1200, TR1650, TR1650N, TR2000, TR2500, TR3000, TR3500, TR4000, TR5000, TRC250, TRR2500		

hexagonal nuts metric (without norm)



1

GEV No.	519546	Ref. No.	00010273
description	nut thread M10x0.75 H 3.45mm WS 14 brass Qty 1 pcs		
For models:	AE1000, AE35.21, AE38.25, AE40.29, AE40.30, AE45.30, AE50.32, AE50.35, AP35.21, AP35.21DA, AP38.25, AP38.25DA, AP40.29, AP40.29DA, AP45.30, AP45.30DA, AP50.32, AP50.32DA, AP50.35, AP50.35DA, AP55.40, AP55.40DA		



1

GEV No.	520231	Ref. No.	00000267
description	nut thread M10x1 H 6mm WS 14 zinc-coated steel Qty 1 pcs		
For models:	AC25, AC26, AE1000, AE1200, AE35.21, AE38.25, AE40.29, AE40.30, AE45.30, AE50.32, AE50.35, AH1000, AH1000Easy, AH1100, AH1100DGT, AH1200, AH1200DGT, AH1400, AL1200E, AL1400, AL1500E, AL40.28, AL40.28E, AL40.28EM, AL45.32, AL45.32E, AL45.32EM, AL50.34, AL50.34E, AL50.34EM, AL50.40, AL50.40E, AL50.40EM, AL50.45, AL55.45E, AL55.45EM, AL55.45EM-P, AL55.45E-P, AP1000, AP1200, AP35.21, AP35.21DA, AP38.25, AP38.25DA, AP40.28, AP40.28DA, AP40.29, AP40.29DA, AP40.31, AP40.31DA...(Other models you can see in the webshop)		



washers

washers

DIN 9021



GEV No.	560398	Ref. No.	00008005
description	plain washer ID ø 6.5mm ED ø 22mm thickness 1.5mm SS Qty 1 pcs		
For models:	PASSPORT50.32, TRC250		

miscellaneous



GEV No.	696552	Ref. No.	00001011
description	disc ID ø 5mm ED ø 13mm H 3mm SS Qty 1 pcs thickness 3mm		
For models:	GSN, SPF, STAR-1, STAR-2, STAR-4, STAR-6		



GEV No.	560512	Ref. No.	00007213
description	disc ID ø 7mm ED ø 16mm thickness 0.85mm FIBER Qty 1 pcs		
For models:	GSN, SPF, STAR-1, STAR-2, STAR-4, STAR-6		



GEV No.	560516	Ref. No.	00007998
description	plain washer ID ø 22mm ED ø 33mm thickness 0.6mm SS Qty 1 pcs		
For models:	AU125-80, AU55-65, AU55-80, AU65-65, LP125-80, LP55-65, LP55-80, LP65-65		



GEV No.	560517	Ref. No.	00005259
description	plain washer ID ø 6.6mm ED ø 33mm thickness 2mm SS Qty 1 pcs		
For models:	TR1200, TR1650, TR1650N, TR2000, TR2500, TR3000, TR3500, TR4000, TR5000, TRC250, TRR2500		



GEV No.	696551	Ref. No.	00008888
description	plain washer ID ø 8mm ED ø 22.4mm thickness 1.5mm SS Qty 1 pcs		
For models:	TR1200, TR1650, TR1650N, TR2000, TR2500, TR3000, TR3500, TR4000, TR5000, TRC250, TRR2500		

fasteners

slot nuts



GEV No.	560515	Ref. No.	00006511
description	slot nut W 6mm H 6mm L 70mm		
For models:	TR1200, TR1650, TR1650N, TR2000, TR2500, TR3000, TR3500, TR4000, TR5000, TRC250, TRR2500		

clamps

double wire clamps



GEV No.	505351	Ref. No.	388
description	wire clamp ø 11.6-12.2mm wire gauge ø 1.5mm zinc-coated steel Qty 100 pcs		

retaining rings

DIN 471



GEV No.	508014	Ref. No.	00000113
description	retaining ring shaft ø 9mm DIN 471		
For models:	AE1000, AE45.30, AE50.32, AE50.35, ALISEO40.28E, ALISEO422, ALISEO428, ALISEO45.32E, AP1000, AP45.30, AP45.30DA, AP50.32, AP50.32DA, AP50.35, AP50.35DA, AP55.40, AP55.40DA, AS50.35, AS50.35DA, AS50.35DGT, AS50.35DGT-DA, AS50.40, AS50.40DA, AS50.40DGT, AS50.40DGT-DA, AU125-80, AU55-65, AU55-80, AU65-65, AU-P55.40, AU-S55.40, AU-S55.40DGT, AW4028, EURO500, GL1040, GL1240, GL4.32E, GL4.32EM, GL5.34, GL5.34E, GL7.38, GL7.40E, GL7.40EM, GL8.50E, GL8.50EM, LP125-80, LP55-65, LP55-80, LP65-65, PASSPORT45.30...(Other models you can see in the webshop)		

B			
bi-metal thermostats		7, 7	
booster pumps I		33	
booster pumps II		35	
C			
cap nuts		90	
clamps		89, 91	
coil heating elements		4	
compressors		27	
condensators & interference suppression filters		35	
contactors		17	
control equipment		13	
control thermostats		7	
D			
door seals for dishwashers		81	
dosing pumps		83	
double nipples		88	
double wire clamps		89, 91	
drain hoses		85	
drain pumps		34	
E			
electric accessories		36	
electrodes		27	
F			
fasteners		91	
fastening material		90	
filters		35	
fittings		88	
foam rubber gaskets		81	
foil heating elements		6	
formed hoses		85	
H			
heating cartridges		4	
heating elements		3	
heating elements for bain maries		3	
heating elements for contact grills		3	
heating elements for salamanders/toasters		3	
hexagonal nuts		90	
hexagonal screws		90	
hose connectors		88	
hoses		85	
I			
immersion heating elements		4	
indicator lights		13	
indicator lights (complete)		13	
industrial hoses		85	
K			
knurled screws		90	
L			
lamps		13	
M			
magnetic switches		12	
measuring equipment		89	
mechanical timers		16	
microswitches		10	
N			
non-return valves		84	
nuts		90	
nylon hoses		85	
O			
operating capacitors		35	
O-rings		77	
P			
plate nuts		90	
pressure control hoses		85	
pressure switches		26	
probes		18	
programme timers		15	
pumps		27	
pumps for ice machines		35	
push/momentary push switches		9	
Q			
quartz heating elements		4	
R			
reducers		88	
refrigeration cycle components		82	
relays		17	
retaining rings		91	
rocker/momentary rocker switches		8	
S			
safety bi-metal thermostats		7	
safety thermostats		8	
Schrader valves		82	
screws		90	
sealing washers		80	
shaft gaskets		81	
sheet metal screws		90	
slot nuts		91	
solenoid valves		23	
switches and momentary switches		8	

system switches (ROLD) 11

T

tank inlets 84

temperature probes 18

terminals 36

thermostats 7

time relays 18

timers 15

toggle switches 10

U

universal probes 18

W

wash and rinse pumps 27

washers 91