



GAS COMPONENTS



ELECTRIC COMPONENTS



WATER TECHNOLOGY



MECHANICAL COMPONENTS



TOOLS

Spare parts suitable for

ASCOBLOC

Find the complete and up-to-date range of products in our GEV Webshop



Manufacturer catalogue

The most important spare parts and accessories arranged clearly for every manufacturer

- ✓ Complete product range and all appliance data always up to date in the GEV Webshop
- ✓ Alphabetical Index at the end of the catalogue

GEV Webshop

www.gev-online.co.uk

www.gev-online.com



- 🔍 Add to Favourites
- 🔍 Sign In with email address and usual password
- 🔍 Easy-order – place several items in your basket at the same time
- 🔍 Quick Item search – no login needed



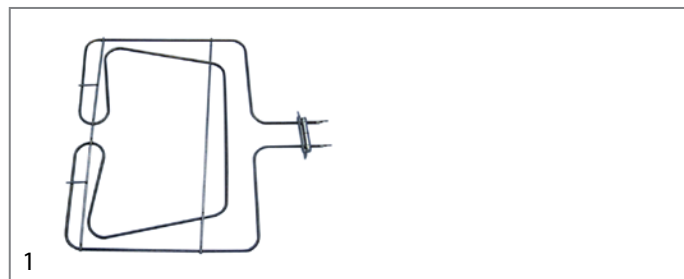

heating elements

heating elements for ovens

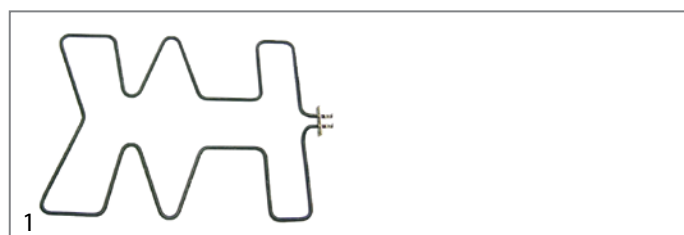

GEV No.	415995	Ref. No.	9294281
description	heating element 1500W 400V heating circuits 1 L 460mm W 484mm L1 107mm L2 360mm W1 211mm W2 62mm flange length 104mm flange width 32mm hole distance 96/39mm hole ø 4mm tube ø 6.4mm connection male faston 6.3mm connection length 51mm tilt flange dry heating element		
For models:	AEH413, AEH503, AEH613, AEH703		



GEV No.	415861	Ref. No.	09/3347
description	heating element 3000W 400V heating circuits 1 L 607mm W 447mm L1 25mm L2 580mm W1 200mm W2 32mm flange length 70mm flange width 22mm hole distance 28mm hole ø 3.5mm tube ø 8.5mm connection M5 rectangular flange dry heating element		
accessories for	415861		
	GEV No.	510368	Ref. No. —
	gasket L 70mm W 23.5mm hole ø 5mm hole distance 56mm FIBER thickness 2mm for heating element		
	GEV No.	699566	Ref. No. —
	connection terminal for heating element		

heating elements for bain maries



GEV No.	416912	Ref. No.	09 1343 9174025
description	heating element 750W 230V heating circuits 1 L 375mm W 200mm connection male faston 6.3mm connection distance 193mm tube ø 6.25mm dry heating element bain marie		
For models:	AEW250, AEW400, AEW408, AEW450, AEW452		

heating elements for fryers

2 hole fixing

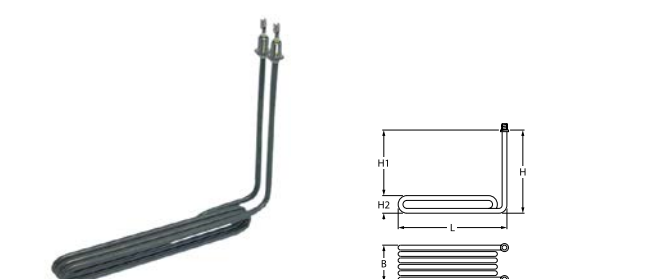

GEV No.	415591	Ref. No.	9294087
description	heating element 2000W 230V heating circuits 1 L 285mm W 40mm H 240mm H1 200mm H2 40mm mounting pos. 20 thread M14x1.5 tube ø 8.5mm mounting distance 20mm windings 3 2 hole fixing connection male faston 6.3mm immersion heater		
For models:	AEF124, AEF128, AEF224		

spare parts for	415591		
	GEV No.	510417	Ref. No. —
	flat gasket fibre ED ø 20mm ID ø 14mm thickness 2mm Qty 1 pcs		
accessories for	415591		
	GEV No.	520228	Ref. No. —
	tooth lock washer ID ø 15.3mm ED ø 24mm steel Qty 1 pcs for thread M14		
	GEV No.	520230	Ref. No. —
	nut thread M14x1.5 H 5mm WS 19 zinc-coated steel Qty 1 pcs		
	GEV No.	521101	Ref. No. —
	nut thread M14x1.5 H 5mm WS 19 SS Qty 1 pcs		
	GEV No.	550262	Ref. No. —
	flat gasket copper ED ø 20mm ID ø 14mm thickness 2mm		





heating elements for transport containers



GEV No.	415706	Ref. No.	09/3407
description	heating element 275W 230V L 399mm W 31mm dry heating element rectangular flange tube ø 6.5mm heating circuits 1 cable length 950mm flange length 40mm flange width 22mm hole ø 5mm connection length 40mm		









pilot heating elements

			
1			
GEV No.	415607	Ref. No.	8181729
description	heating element 500W 230V heating circuits 1 thread 3/4" L 295mm W 20mm H 19mm length thermostat sleeves 235mm thermostat sleeves ø 6mm number of thermostat sleeves 1 thermostat sleeve clinging tube ø 6.5mm immersion heater flange with thread connection length 50mm pilot heating element		
For models:	AES060, AES080		
spare parts for	415607		
	GEV No.	510403	Ref. No. —
	flat gasket fibre ED ø 36.5mm ID ø 27mm thickness 2mm Qty 1 pcs		
accessories for	415607		
	GEV No.	510421	Ref. No. —
	gasket copper ED ø 31.8mm ID ø 26.4mm thickness 2.2mm for thread 3/4"		
	GEV No.	520234	Ref. No. —
	nut thread 3/4" H 5mm brass WS 30 Qty 1 pcs		



immersion heating elements

with round flange ø47.5mm

			
1			
GEV No.	418147	Ref. No.	9294496
description	heating element 6000W 230V heating circuits 3 immersion heater round flange mounting ø 47.5mm		
For models:	AES060, AES080		
accessories for	418147		
	GEV No.	510408	Ref. No. 9298045
	O-ring EPDM thickness 5.34mm ID ø 47mm Qty 1 pcs		
	GEV No.	510562	Ref. No. 08 1008 8060842
	O-ring silicone thickness 5.34mm ID ø 47mm Qty 1 pcs		
	GEV No.	520235	Ref. No. —
	3 hole flange hole distance 70.5mm perforation ø 6.5mm ID ø 53.5mm		
	GEV No.	520236	Ref. No. —
	flange for heating element ID ø 50mm ED ø 90mm hole ø 6.5mm 3 holes		
	GEV No.	550002	Ref. No. 9294008
	tension strap H 10mm L 21mm W 10mm hole ø 6.5mm for heating element		
	GEV No.	550362	Ref. No. —
	blind flange ø 64mm mounting ø 47.5mm		

			
1			
GEV No.	415405	Ref. No.	09 1942 9294203 9294496
description	heating element 6000W 230V heating circuits 3 L 465mm W 38mm H 24mm tube ø 6.3mm connection male faston 6.3mm immersion heater round flange mounting ø 47.5mm		
For models:	AES060, AES080		
spare parts for	415405		
	GEV No.	504148	Ref. No. —
	boiler		
accessories for	415405		
	GEV No.	520235	Ref. No. —
	3 hole flange hole distance 70.5mm perforation ø 6.5mm ID ø 53.5mm		
	GEV No.	520236	Ref. No. —
	flange for heating element ID ø 50mm ED ø 90mm hole ø 6.5mm 3 holes		
	GEV No.	521012	Ref. No. —
	gasket graphite ED ø 15mm ID ø 5mm thickness 1.2mm Qty 1 pcs		
	GEV No.	550002	Ref. No. 9294008
	tension strap H 10mm L 21mm W 10mm hole ø 6.5mm for heating element		
	GEV No.	550362	Ref. No. —
	blind flange ø 64mm mounting ø 47.5mm		

heating elements for convection

			
1			
GEV No.	415841	Ref. No.	09/3388
description	heating element 3000W 230V heating circuits 1 ID ø 192mm ED ø 205mm L 220mm H 36mm L1 17mm W1 30mm H1 12mm H2 24mm flange length 70mm flange width 22mm hole distance 28mm connection male faston 6.3mm tube ø 6.3mm convection heating element hole ø 4.5mm rectangular flange		
accessories for	415841		
	GEV No.	510368	Ref. No. —
	gasket L 70mm W 23.5mm hole ø 5mm hole distance 56mm FIBER thickness 2mm for heating element		

1

GEV No.	415845	Ref. No.	99/186
description	heating element 3150W 230V heating circuits 3 ID ø 201mm ED ø 215mm L 272mm H 35mm L1 57mm W1 60mm H1 8mm H2 27mm flange length 95mm flange width 22mm hole distance 77mm connection male faston 6.3mm connection length 20mm tube ø 6.5mm convection heating element hole ø 6mm rectangular flange		



1

GEV No.	490220	Ref. No.	09/3332 09-3332 HKK
description	radiation heater rectangular 7750W 400V L 500mm W 460mm H 52mm heating circuits 3 connections screw		

radiation heaters

square



1

GEV No.	490207	Ref. No.	093303
description	radiation heater L 300mm W 300mm 2350/1150W 400V heating circuits 2 connections 2 square connection type grip connection without pan detection		

1-circuit



1

GEV No.	490047	Ref. No.	09/1356
description	radiation heater ø 230mm 2100W 230V heating circuits 1 7-position control with temperature signalization connections 4+2 connection type male faston 6.3mm EGO		



1

GEV No.	416907	Ref. No.	09 1020 09 1021 8160350 8160351
description	radiation heater rectangular 3500W 400V L 415mm W 275mm H 46mm heating circuits 2 connections 2		
For models:	AEB230, AEB238, AEB430, AEB438, AEP500, AEP508		



1

GEV No.	490132	Ref. No.	9174100
description	radiation heater ø 230mm 2100W 230V heating circuits 1 7-position control without temperature signalization 7-position control connection type male faston 6.3mm EGO		
For models:	AEH300, AEH308, AEH500, AEH503, AEH508, AEH700, AEH703, AEH708		



1

GEV No.	416895	Ref. No.	09 - 1357 9174101
description	radiation heater rectangular 5200W 230V L 530mm W 300mm heating circuits 2		

2-circuit



1

GEV No.	490028	Ref. No.	8181713
description	radiation heater ø 230mm 2100W 230V heating circuits 2 energy regulation with temperature signalization partial power 650W with heating coil connections 3+2 connection type male faston 6.3mm EGO		
For models:	AEH300, AEH308, AEH500, AEH503, AEH508, AEH700, AEH703, AEH708		



accessories

sealing washers

O-rings

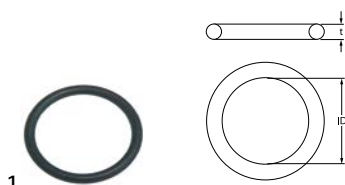

GEV No.	510408	Ref. No.	9298045
description	O-ring EPDM thickness 5.34mm ID ø 47mm Qty 1 pcs		

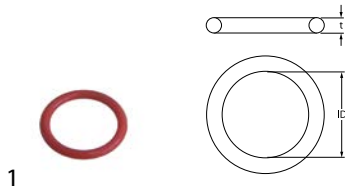

GEV No.	510562	Ref. No.	08 1008 8060842
description	O-ring silicone thickness 5.34mm ID ø 47mm Qty 1 pcs		
For models:	AES060, AES080		

flange gaskets

counterflanges



GEV No.	550002	Ref. No.	9294008
description	tension strap H 10mm L 21mm W 10mm hole ø 6.5mm for heating element		



GEV No.	550002	Ref. No.	9294008
description	tension strap H 10mm L 21mm W 10mm hole ø 6.5mm for heating element		

energy regulators

EGO

1-circuit



GEV No.	380016	Ref. No.	8183237
description	energy regulator 230V 12A dual circuit turn direction right with operation switch 1-pole		
For models:	AEH300, AEH308, AEH500, AEH503, AEH508, AEH700, AEH703, AEH708		



GEV No.	380015	Ref. No.	8183150
description	energy regulator 230V 13A single-circuit turn direction right shaft ø 6x4.6mm shaft L 23mm mounting thread M4 power release 6-100% no. 50.57021.010		
For models:	AES060, AES080		

accessories

knobs



GEV No.	110235	Ref. No.	18/604
description	knob energy regulator 1-3 t.max.°C ø 50mm shaft ø 6x4.6mm shaft flat upper black		

thermostats

bi-metal thermostats

bi-metal thermostats



GEV No.	390609	Ref. No.	9186200
description	bi-metal thermostat 1NC		



GEV No.	390483	Ref. No.	09/1933 09/9294101
description	bi-metal thermostat hole distancemm switch-off temp. 65°C 1NO 1-pole 16A connection F6.3 M4		
For models:	AEH413, AEH503, AEH613, AEH703		



control and safety thermostats

EGO

control thermostats

55.13_ series



GEV No.	375505	Ref. No.	1687 8174681
description	thermostat t.max. 320°C temperature range 50-320°C 1-pole 1NO 16A probe ø 3mm probe L 160mm capillary pipe 870mm capillary pipe isolated gland nut shaft ø 6x4.6mm shaft L 23mm shaft position upper rotation 270°		
For models:	AEB230, AEB238, AEB430, AEB438, AEP500, AEP508, AEW250, AEW400, AEW408, AEW450, AEW452		

55.18_ series



GEV No.	375483	Ref. No.	09/1687
description	thermostat t.max. 320°C temperature range 50-320°C 1-pole NO 16A probe ø 3mm probe L 158mm capillary pipe 870mm capillary pipe isolated gland nut shaft ø 6x4.6mm shaft L 23mm shaft position upper rotation 270°		

55.34_ series

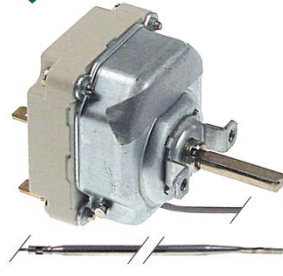

GEV No.	375422	Ref. No.	09-1012 8152105
description	thermostat t.max. 210°C temperature range 95-210°C 3-pole 3NO 16A probe ø 3.1mm probe L 226mm capillary pipe 1780mm capillary pipe isolated 1600mm gland nut shaft ø 6x4.6mm shaft L 23mm shaft position upper rotation 270°		
For models:	AEF124, AEF128, AEF224		



GEV No.	375038	Ref. No.	09/3458
description	thermostat t.max. 300°C temperature range 50-300°C 3-pole 3NO 16A probe ø 6mm probe L 79mm capillary pipe 1740mm capillary pipe isolated 800mm gland nut shaft ø 6x4.6mm shaft L 23mm shaft position upper rotation 270°		
accessories for	375038		
	GEV No.	110123	Ref. No.
			—
	knob thermostat t.max. 300°C ø 50mm shaft ø 6x4.6mm shaft flat upper black temperature range 50-300°C rotation 270°		

55.40_ series



GEV No.	375096	Ref. No.	093305
description	thermostat t.max. 450°C temperature range 100-450°C 4-pole 4NO 16A probe ø 3.9mm probe L 163mm capillary pipe 1180mm capillary pipe isolated 850mm gland nut shaft ø 6x4.6mm shaft L 23mm shaft position upper rotation 270°		

safety thermostats

55.33_ series

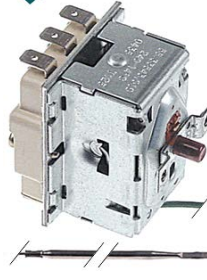

GEV No.	375421	Ref. No.	09-1011 8152102
description	safety thermostat switch-off temp. 240°C 3-pole 20A probe ø 3.1mm probe L 226mm capillary pipe 1170mm capillary pipe isolated 960mm gland nut probe SS		
For models:	AEF124, AEF128, AEF224		

56._ series



GEV No.	375447	Ref. No.	09-3689
description	safety thermostat switch-off temp. 150°C 1-pole 1CO 16A probe ø 6mm probe L 77mm capillary pipe 1460mm capillary pipe isolated 1100mm gland nut M9x1 starting temperature 139°C probe		

control thermostats with operation switch

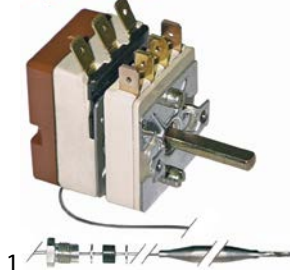

55.13_ series



GEV No.	375406	Ref. No.	9295433
description	thermostat t.max. 110°C temperature range 30-110°C 1-pole 1CO 16A probe ø 6mm probe L 113mm capillary pipe 2380mm capillary pipe isolated 1700mm gland nut M9x1 shaft ø 6x4.6mm shaft L 18mm shaft position upper rotation 270° outer switch 2NO		

For models: AEW250, AEW400, AEW408, AEW450, AEW452

accessories for 375406

	GEV No.	110545	Ref. No.	9297019
	knob dial plate silver thermostat t.max. 110°C 30-110°C rotation 310° ED ø 59mm ID ø 45.5mm			
	GEV No.	112173	Ref. No.	—
	knob universal ø 62mm black without adaptor/dial plate			
	GEV No.	112311	Ref. No.	—
	knob adapter shaft ø 6x4.6mm L 0mm with spring			

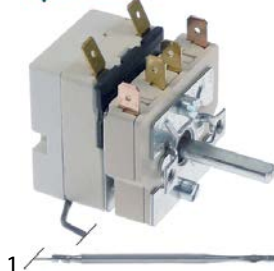

GEV No.	390902	Ref. No.	09/2085 3397
description	thermostat t.max. 320°C temperature range 50-320°C 1-pole 1CO 16A probe ø 3.03mm probe L 160mm capillary pipe 1300mm capillary pipe isolated 1230mm gland nut shaft ø 6x4.6mm shaft L 23mm shaft position upper rotation 270° outer switch 2NO		

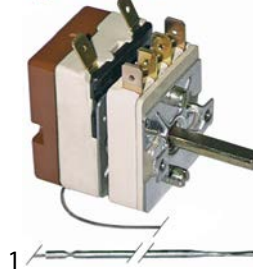

GEV No.	375408	Ref. No.	9295400
description	thermostat t.max. 320°C temperature range 50-320°C 1-pole 1NO 16A probe ø 3.03mm probe L 160mm capillary pipe 1150mm capillary pipe isolatedmm gland nut shaft ø 6x4.6mm shaft L 23mm shaft position upper rotation 270° outer switch 2NO		
For models:	AEB230, AEB238, AEB430, AEB438, AEH413, AEH503, AEH613, AEH703, AEP500, AEP508		

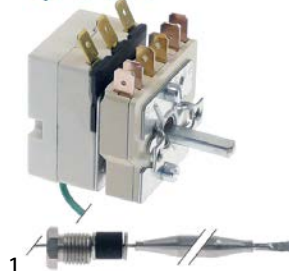

GEV No.	375405	Ref. No.	09/3501
description	thermostat t.max. 90°C temperature range 30-90°C 1-pole 1CO 16A probe ø 6mm probe L 98mm capillary pipe 2380mm capillary pipe isolated 1700mm gland nut M9x1 shaft ø 6x4.6mm shaft L 18mm shaft position upper rotation 270° outer switch 2NO		

CAEM

safety thermostats



GEV No.	390594	Ref. No.	09/3585
description	safety thermostat switch-off temp. 95°C 1-pole 16A probe ø 6mm probe L 80mm capillary pipe 1550mm capillary pipe isolatedmm gland nut probe SS 250V		

various

safety thermostats



GEV No.	390137	Ref. No.	99/186
description	safety thermostat switch-off temp. 95°C 1-pole 16A probe ø 6mm probe L 80mm capillary pipe 1550mm		



accessories

gland nut accessories

ducts



GEV No.	100820	Ref. No.	10/1375
description	gland duct ET M14x1.5 IT M10x0.75 probe ø max. 6.5mm WS 22		

connecting bows



GEV No.	550028	Ref. No.	09/3459
description	connecting bow long for thermostat Qty 10 pcs		

switches and momentary switches

microswitches

pin-plunger actuated



GEV No.	345062	Ref. No.	8177168
description	microswitch with plunger 250V 16A 1NO/1NC connection male faston 6.3mm ambient temperature max. 85°C mounting distance 22mm type BS1012 actuating force: 350g red stroke 8mm		
For models:	AEF124, AEF128, AEF224, AEF494		

M16



GEV No.	345046	Ref. No.	09/3486
description	microswitch with plunger thread M16x1 thread L 25mm 250V 5A 1NC/1NO connection male faston 6.3mm stroke 6mm ambient temperature max. 85°C actuating force: 400g		

position switches

OMRON



GEV No.	346299	Ref. No.	8486038
description	position switch		
For models:	AEP500, AEP508		

cam switches

on/off



GEV No.	300129	Ref. No.	09/1324
description	cam switch 2 operating positions 2NO sequence 0-1 16A shaft ø 6x4.6mm shaft L 23mm connection male faston 6.3mm ceramic		



GEV No.	300102	Ref. No.	09/3306
description	cam switch 4 operating positions 4NO sequence 0-1-0-1 32A shaft ø 6x4.6mm shaft L 23mm connection screw ceramic		

5-position

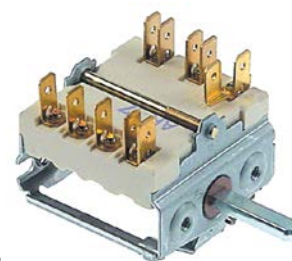

GEV No.	300172	Ref. No.	9173302
description	cam switch 5 operating positions 1NO/2CO sequence 0-1-2-3-4 16A shaft ø 6x4.6mm shaft L 23mm connection male faston 6.3mm 5-position		
For models:	AEH210, AEH218, AEH300, AEH308, AEH410, AEH413, AEH418, AEH500, AEH503, AEH508, AEH610, AEH613, AEH700, AEH703, AEH708		



7-position



1

GEV No.	300004	Ref. No.	9295403
description	cam switch 7 operating positions 1NO/2CO sequence 0-1-2-3-4-5-6 16A shaft ø 6x4.6mm shaft L 23mm connection male faston 6.3mm 7-position ceramic		
For models:	AEH300, AEH308, AEH500, AEH503, AEH508, AEH700, AEH703, AEH708		

4 operating positions



1

GEV No.	300113	Ref. No.	9296002
description	cam switch 4 operating positions 4NO sequence 0-1-0-2 32A shaft ø 6x4.6mm shaft L 23mm connection screw ceramic		
For models:	AES060, AES080		



1

GEV No.	300179	Ref. No.	9295405
description	cam switch 4 operating positions 4NO/1CO sequence 0-1-0-2 32A shaft ø 6x4.6mm shaft L 23mm connection screw 0-1-0-2 ceramic		
For models:	AEF124, AEF128, AEF224		

operation switches



1

GEV No.	300200	Ref. No.	09/3460
description	operation switch 2 operating positions 2NO 16A sequence 0-1 shaft ø 6x4.6mm shaft L 23mm connection male faston 6.3mm operation switch ceramic		

magnetic switches

miscellaneous



1

GEV No.	347812	Ref. No.	091273
description	magnetic switch 100VDC 0.1A P max. 5W cable length 2000mm 1NC connection cable L 48mm 5W L1 12mm L2 11mm white mounting distance 16-18mm nominal 0.2A		

control equipment

MOELLER/EATON

push buttons - signal lamps



1

GEV No.	346272	Ref. No.	8486105
description	push button mounting measurements ø22mm green		
For models:	AEP500, AEP508		



1

GEV No.	346271	Ref. No.	8486102
description	push button mounting measurements ø22mm silver without button plate momentary		
For models:	AEP500, AEP508		

switch blocks



1

GEV No.	346270	Ref. No.	8486101
description	contact block screw 1NC		
For models:	AEP500, AEP508		

switches (complete)

push/momentary push switches



1

GEV No.	347920 ¹	Ref. No.	09/1257
description	momentary push switch mounting measurements ø22mm green illuminated, 80-264V 2NO protection cap momentary		

¹with rubber cap



lamps

indicator lights

indicator lights (complete)

ø16mm

with screw socket



1

GEV No.	359835	Ref. No.	09/2092 9295408
description	indicator light ø 16mm 230V green connection male faston 6.3mm		
For models:	AEB230, AEB238, AEB430, AEB438, AEF124, AEF128, AEF224, AEH210, AEH218, AEH300, AEH308, AEH410, AEH413, AEH418, AEH500, AEH503, AEH508, AEH610, AEH613, AEH700, AEH703, AEH708, AEP500, AEP508, AES060, AES080, AEW250, AEW400, AEW408, AEW450, AEW452		
accessories for	359835		
	GEV No.	550559	Ref. No. —
	nut thread M16x1 H 5.5mm WS 19		



1

GEV No.	359834	Ref. No.	09/2091
description	indicator light ø 16mm 230V yellow connection male faston 6.3mm temp.-resist. 120°C		
accessories for	359834		
	GEV No.	550559	Ref. No. —
	nut thread M16x1 H 5.5mm WS 19		

with plug-in socket



1

GEV No.	359166	Ref. No.	9295407
description	indicator light ø 16mm 230V white		
For models:	AEF124, AEF128, AEF224, AES060, AES080, AEW250, AEW400, AEW408, AEW450, AEW452		



1

GEV No.	359198	Ref. No.	9295409
description	indicator light ø 16mm 400V white		
For models:	AEB230, AEB238, AEB430, AEB438, AEH413, AEH503, AEH613, AEH703, AEP500, AEP508		

contactors

ABB

power contactors



1

GEV No.	380092	Ref. No.	09-1035
description	power contactor resistive load 20A 230VAC (AC3/400V) 12A/5.5kW main contacts 4NO auxiliary contacts connection screw connection type B6-40-00 / B7-40-00		

ISKRA (FANAL)

power contactors



1



GEV No.	380418	Ref. No.	8486100
description	power contactor resistive load 20A 24VDC (AC3/400V) 8.5A/5.5kW main contacts 3NO auxiliary contacts 1NO connection screw connection type Fanal DSL7 10 type ISKRA K07MG 10		
For models:	AEP500, AEP508		

relays

plug-in/print relays



1

GEV No.	380500	Ref. No.	091274
description	print relay 12VDC 2CO at 250V 8A connection pins raster size 5mm REIPOL		
accessories for	380500		
	GEV No.	380340	Ref. No. —
	relay socket dimensions 62x36x15mm 250V voltage AC 10A Italiana Relè manuf. no. ZMEM/5		
	GEV No.	380505	Ref. No. —
	relay socket 2CO 40.52 dimensions 81.9x15.5x75mm 250V voltage AC 10A FINDER manuf. no. 95.95.3		
	GEV No.	381181	Ref. No. —
	relay socket 2-pole 40.51/40.52/40.61 connection screw clamp dimensions 15.8x78.6mm 250V voltage AC 10A FINDER manuf. no. 95.75		



level relays

miscellaneous



1

GEV No.	380346	Ref. No.	9177191
description	level relay 1CO 230V voltage AC		



1

GEV No.	380486	Ref. No.	9177191
description	level relay 1CO type CM-ENS		
For models:	AEW400, AEW408		

electronics

PCBs



1

GEV No.	401393	Ref. No.	09/3020
description	PCB 230V		

pressure switches

for steam control



1

GEV No.	541016	Ref. No.	09/2126 9296000
description	pressure control ø 45mm pressure range 480/430mbar pressure connection vertical steam control pressure range 0.48/0.43bar connection 1/4" pressure connection 1/4"		
For models:	AES060, AES080		

electrodes



1

GEV No.	400697	Ref. No.	04/10257 915000648	
description	level electrode PG16 total length 26mm probe L 20mm insulated probe length 5mm connection M5 ø 29mm			
For models:	AEW400, AEW408			
spare parts for	400697			
	GEV No.	550577	Ref. No.	—
	nut thread PG16 H 3mm WS 26 nickel-plated brass Qty 1 pcs mounting ømm cable ømm			

fans

cross flow fans

COPREL

with moulded coils



1

GEV No.	601456	Ref. No.	8178463
description	cross flow fan roller ø 45mm roller length 180mm laminated core thickness 15mm motor position right 230V/50Hz 26W universal bearing silicone connection male faston 6.3mm -30 up to +100°C 230V 50/60Hz		
For models:	AEH413, AEH503, AEH613, AEH703, AGH417, AGH617		

electric accessories

terminals

connection terminals with screw/faston connections



1

GEV No.	550110	Ref. No.	09/3447
description	power terminal block 5-pole max. 40A max 250V connection M6/ male faston 6.3mm temp.-resist. 130°C		



gas taps

PEL

21S series

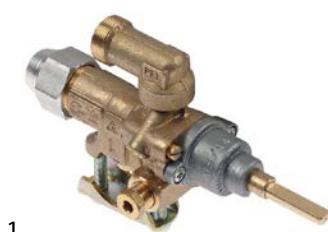

1

GEV No.	101671	Ref. No.	9146369 9146372
description	gas tap PEL type 21S gas inlet pipe flange ø21mm bypass nozzle ø 0.35mm gas outlet M17x1 (tube ø 10mm) thermocouple connection M8x1 pilot connection M10x1 shaft ø 6x4.6mm shaft L 30/23mm shaft flat upper		
For models:	AGH210, AGH218, AGH410, AGH413, AGH417, AGH418, AGH610, AGH613, AGH617, AGH618		
spare parts for	101671		
	GEV No.	100408	Ref. No. —
	bypass nozzle type PEL20/21 bore ø 0.35mm thread M5x0.5		
	GEV No.	100908	Ref. No. —
	union screw thread M10x1 for pipe ø 4mm Qty 1 pcs		
	GEV No.	101060	Ref. No. —
	magnet unit standard L 39mm D1 ø 15.4mm D2 ø 11mm suitable for PEL20-21/JUNKERS/EGA		
	GEV No.	101230	Ref. No. —
	thermocouple nut T1: M8x1 T2: M18x1 aluminium		
	GEV No.	101246	Ref. No. —
	olive for pipe ø 4mm Qty 1 pcs		
	GEV No.	101803	Ref. No. —
	gas tap front part shaft ø 6x4.6mm shaft L 30/23mm shaft flat upper/lower suitable for PEL21		
accessories for	101671		
	GEV No.	100909	Ref. No. —
	union screw thread M10x1 for pipe ø 6mm Qty 1 pcs		
	GEV No.	101278	Ref. No. —
	olive for pipe ø 10mm Qty 1 pcs		
	GEV No.	101286	Ref. No. —
	olive ID ø 6mm Qty 1 pcs		
	GEV No.	101300	Ref. No. —
	union nut thread M16x1.5 tube ø 10mm		
	GEV No.	101450	Ref. No. —
	olive for pipe ø 8mm L 12.7mm Qty 1 pcs ED ø 10mm		
	GEV No.	101451	Ref. No. —
	union nut thread M16x1.5 tube ø 8mm		
	GEV No.	110078	Ref. No. 99/198
	knob without symbol ø 70mm shaft ø 6x4.6mm shaft flat universal		

accessories for	101671		
	GEV No.	112206	Ref. No. —
	knob dial plate silver gas tap PEL21/22/23 t.max.°C ED ø 63mm ID ø 45.5mm		

22S/O series



1

GEV No.	101626	Ref. No.	10/1440
description	gas tap PEL type 22S/O gas inlet pipe flange ø27mm bypass nozzle ø 0.35mm gas outlet M20x1.5 (tube ø 12/10mm) thermocouple connection M8x1 pilot connection M10x1 shaft ø 6x4.6mm shaft L 35/21mm shaft flat upper		
spare parts for	101626		
	GEV No.	100259	Ref. No. 10/1416
	bypass nozzle type PEL22 bore ø 0.35mm thread M6x0.5		
	GEV No.	101058	Ref. No. —
	magnet unit L 39mm D1 ø 15.4mm D2 ø 13.5mm suitable for PEL22/EGA24197 standard		
	GEV No.	101230	Ref. No. —
	thermocouple nut T1: M8x1 T2: M18x1 aluminium		
	GEV No.	101240	Ref. No. —
	gas connection thread M20x1.5 tube ø 12/10mm for PEL gas taps with gasket and screws horizontal		
	GEV No.	101353	Ref. No. —
	flange thread M20x1.5 tube ø 27mm suitable for PEL22		
	GEV No.	101460	Ref. No. —
	O-ring ø 12.37mm D1 ø 2.62mm suitable for PEL22		
	GEV No.	101461	Ref. No. —
	screw kit suitable for PEL22 Qty 4 pcs		
	GEV No.	101823	Ref. No. —
	gas tap front part shaft ø 6x4.6mm shaft L 35/21mm shaft flat upper/lower suitable for PEL22		
	GEV No.	106165	Ref. No. —
	gasket ø 27mm		
accessories for	101626		
	GEV No.	100908	Ref. No. —
	union screw thread M10x1 for pipe ø 4mm Qty 1 pcs		
	GEV No.	100909	Ref. No. —
	union screw thread M10x1 for pipe ø 6mm Qty 1 pcs		
	GEV No.	101246	Ref. No. —
	olive for pipe ø 4mm Qty 1 pcs		
	GEV No.	101248	Ref. No. 10/1000
	olive for pipe ø 12mm Qty 1 pcs suitable for PEL		

Table continues overleaf



accessories for		101626		
GEV No.		101249	Ref. No.	—
	olive for pipe ø 10mm Qty 1 pcs			
	union nut thread M20x1.5 for pipe ø 10mm			
	union nut thread M20x1.5 for pipe ø 12mm			10/1449
	olive ID ø 6mm Qty 1 pcs			
	knob without symbol ø 70mm shaft ø 6x4.6mm shaft flat universal			99/198
	knob dial plate silver gas tap PEL21/22/23 t.max.°C ED ø 63mm ID ø 45.5mm			

alternatives to EGA

GPEL21 series

with nozzle outlet



1

GEV No.	101606	Ref. No.	10/1378
description	gas tap alternatives to EGA type GPEL21D with nozzle outlet (without nozzle) gas inlet M15x1 (tube ø 10mm) external nozzle ømm internal nozzle ømm bypass nozzle ø 0.35mm mixing pipe connection M17x1 thermocouple connection M8x1 pilot connection M10x1 shaft ø 6x4.6mm shaft L 31/23mm shaft flat upper		
spare parts for	101606		
	GEV No. 100408	Ref. No.	—
	bypass nozzle type PEL20/21 bore ø 0.35mm thread M5x0.5		
	GEV No. 100927	Ref. No.	—
	torsion spring L 2.8-8.0mm for internal nozzle ø 3mm bore ømm		
	GEV No. 101060	Ref. No.	—
	magnet unit standard L 39mm D1 ø 15.4mm D2 ø 11mm suitable for PEL20-21/JUNKERS/EGA		
	GEV No. 101230	Ref. No.	—
	thermocouple nut T1: M8x1 T2: M18x1 aluminium		
	GEV No. 101526	Ref. No.	—
	O-ring Viton thickness 1.78mm ID ø 4.48mm Qty 1 pcs		
	GEV No. 101593	Ref. No.	—
	adjusting screw for internal nozzle thread M8x0.75		
	GEV No. 101803	Ref. No.	—
	gas tap front part shaft ø 6x4.6mm shaft L 30/23mm shaft flat upper/lower suitable for PEL21		

accessories for		101606		
GEV No.		100908	Ref. No.	—
	union screw thread M10x1 for pipe ø 4mm Qty 1 pcs			
	union screw thread M10x1 for pipe ø 6mm Qty 1 pcs			
	centring piece thread M17x1			
	torsion spring L 2.8-8.0mm for internal nozzle ø 3mm bore ømm			
	union nut thread M15x1 for pipe ø 10mm			
	union nut thread M17x1 tube ø 10mm			
	olive for pipe ø 4mm Qty 1 pcs			
	olive for pipe ø 10mm Qty 1 pcs			
	olive ID ø 6mm Qty 1 pcs			
	knob without symbol ø 70mm shaft ø 6x4.6mm shaft flat universal			99/198
	knob dial plate silver gas tap PEL21/22/23 t.max.°C ED ø 63mm ID ø 45.5mm			

EGA

26440 series

gas taps











1

GEV No.	104260	Ref. No.	151001
description	gas tap EGA type 26440 series		
spare parts for	104260		
	GEV No. 100346	Ref. No.	—
	bypass nozzle EGA type 31248 series bore ø 0.85mm		
	GEV No. 100395	Ref. No.	—
	internal nozzle bore ø 1.4mm suitable for EGA26400/26440		
	GEV No. 101060	Ref. No.	—
	magnet unit standard L 39mm D1 ø 15.4mm D2 ø 11mm suitable for PEL20-21/JUNKERS/EGA		
	GEV No. 101230	Ref. No.	—
	thermocouple nut T1: M8x1 T2: M18x1 aluminium		

Table continues overleaf







accessories for		104260		
	GEV No.	100942	Ref. No.	—
union nut thread M15x1 for pipe ø 10mm				
	GEV No.	101278	Ref. No.	—
olive for pipe ø 10mm Qty 1 pcs				
	GEV No.	101284	Ref. No.	—
olive for pipe ø 4mm Qty 1 pcs				
	GEV No.	101285	Ref. No.	—
union screw thread M8x1 for pipe ø 4mm Qty 1 pcs JUNKERS				
	GEV No.	110078	Ref. No.	99/198
knob without symbol ø 70mm shaft ø 6x4.6mm shaft flat universal				
	GEV No.	112206	Ref. No.	—
knob dial plate silver gas tap PEL21/22/23 t.max.°C ED ø 63mm ID ø 45.5mm				

accessories for		101905		
	GEV No.	101286	Ref. No.	—
olive ID ø 6mm Qty 1 pcs				
	GEV No.	101300	Ref. No.	—
union nut thread M16x1.5 tube ø 10mm				
	GEV No.	101450	Ref. No.	—
olive for pipe ø 8mm L 12.7mm Qty 1 pcs ED ø 10mm				
	GEV No.	101451	Ref. No.	—
union nut thread M16x1.5 tube ø 8mm				
	GEV No.	110079	Ref. No.	—
knob dial plate gas thermostat 1-8 silver				
	GEV No.	110081	Ref. No.	—
knob ø 70mm shaft ø 8x6.5mm shaft flat universal				

gas thermostats

PEL





25ST series

	1			
GEV No.	101905	Ref. No.	10-1352	
description	gas thermostat PEL type 25ST 100-200°C gas inlet pipe flange ø21mm bypass nozzle ø 0.35mm gas outlet M16x1.5 (tube ø 10/8mm) thermocouple connection M9x1 pilot connection M10x1 capillary pipe 1200mm probe ø 6mm probe L 120mm shaft ø 8x6.5mm shaft L 21/15mm shaft flat upper			
spare parts for	101905			
	GEV No.	100259	Ref. No.	10/1416
bypass nozzle type PEL22 bore ø 0.35mm thread M6x0.5				
	GEV No.	101060	Ref. No.	—
magnet unit standard L 39mm D1 ø 15.4mm D2 ø 11mm suitable for PEL20-21/JUNKERS/EGA				
	GEV No.	106200	Ref. No.	—
nut thread M9x1 suitable for PEL 24/25S				
accessories for	101905			
	GEV No.	100908	Ref. No.	—
union screw thread M10x1 for pipe ø 4mm Qty 1 pcs				
	GEV No.	100909	Ref. No.	—
union screw thread M10x1 for pipe ø 6mm Qty 1 pcs				
	GEV No.	101246	Ref. No.	—
olive for pipe ø 4mm Qty 1 pcs				
	GEV No.	101278	Ref. No.	—
olive for pipe ø 10mm Qty 1 pcs				

	1			
GEV No.	101901	Ref. No.	10/1351	
description	gas thermostat PEL type 25ST 50-300°C gas inlet pipe flange ø21mm bypass nozzle ø 0.35mm gas outlet M16x1.5 (tube ø 10/8mm) thermocouple connection M9x1 pilot connection M10x1 capillary pipe 1200mm probe ø 6mm probe L 100mm shaft ø 8x6.5mm shaft L 21/15mm shaft flat upper			
spare parts for	101901			
	GEV No.	100259	Ref. No.	10/1416
bypass nozzle type PEL22 bore ø 0.35mm thread M6x0.5				
	GEV No.	101060	Ref. No.	—
magnet unit standard L 39mm D1 ø 15.4mm D2 ø 11mm suitable for PEL20-21/JUNKERS/EGA				
	GEV No.	106200	Ref. No.	—
nut thread M9x1 suitable for PEL 24/25S				
accessories for	101901			
	GEV No.	100908	Ref. No.	—
union screw thread M10x1 for pipe ø 4mm Qty 1 pcs				
	GEV No.	100909	Ref. No.	—
union screw thread M10x1 for pipe ø 6mm Qty 1 pcs				
	GEV No.	101246	Ref. No.	—
olive for pipe ø 4mm Qty 1 pcs				
	GEV No.	101278	Ref. No.	—
olive for pipe ø 10mm Qty 1 pcs				
	GEV No.	101286	Ref. No.	—
olive ID ø 6mm Qty 1 pcs				
	GEV No.	101300	Ref. No.	—
union nut thread M16x1.5 tube ø 10mm				

Table continues overleaf



accessories for		101901		
GEV No.	101450	Ref. No.	—	
	olive for pipe ø 8mm L 12.7mm Qty 1 pcs ED ø 10mm			
GEV No.	101451	Ref. No.	—	
	union nut thread M16x1.5 tube ø 8mm			
GEV No.	110079	Ref. No.	—	
	knob dial plate gas thermostat 1-8 silver			
GEV No.	110081	Ref. No.	—	
	knob ø 70mm shaft ø 8x6.5mm shaft flat universal			

ignition parts

pilot burners

SIT

100 series

accessories

pilot burner bottom parts

			
1			
GEV No.	100880	Ref. No.	08/8032
description	pilot burner bottom part SIT 100 series nozzle ø 0.4mm		



pilot burner nozzles













			
1			
GEV No.	102545	Ref. No.	10/1350
description	pilot burner nozzle LPG code 20 bore ø 0.2mm Qty 5 pcs		

JUNKERS

CB 502 series

pilot burners

				
1				
GEV No.	100125	Ref. No.	9294282	
description	pilot burner JUNKERS type CB502024			
spare parts for	100125			
	GEV No.	100228	Ref. No.	—
pilot burner nozzle town gas gas pressure 8mbar code 4 Qty 1 pcs suitable for JUNKERS CB50203_				
	GEV No.	100719	Ref. No.	—
ignition electrode D1 ø 7mm D2 ø 9mm connection M4 L1 12mm L2 17mm BL1 18mm BL2 3mm BL3 23mm				
	GEV No.	100906	Ref. No.	—
screw connection thread M10x1 for ignition electrode brass Qty 1 pcs WS 10				

spare parts for		100125		
GEV No.	100907	Ref. No.	—	
	screw connection thread M10x1 Qty 1 pcs type SEF 1 ømm for thermocouple			
GEV No.	101281	Ref. No.	—	
	olive for pipe ø 4mm L 8.7mm Qty 1 pcs suitable for CB 502/503			
GEV No.	101283	Ref. No.	—	
	union screw thread M10x1 for pipe ø 4mm Qty 1 pcs			
accessories for		100125		
GEV No.	100220	Ref. No.	—	
	pilot burner nozzle LPG gas pressure 50mbar code 2 Qty 1 pcs suitable for JUNKERS CB503_			
GEV No.	100221	Ref. No.	—	
	pilot burner nozzle LPG gas pressure 30mbar code 29 Qty 1 pcs suitable for JUNKERS CB50203_			
GEV No.	100222	Ref. No.	—	
	pilot burner nozzle LPG gas pressure 50mbar code 5 Qty 1 pcs suitable for JUNKERS CB50203_			
GEV No.	100223	Ref. No.	—	
	pilot burner nozzle natural gas gas pressure 20mbar code 3 Qty 1 pcs suitable for JUNKERS CB503_			
GEV No.	100224	Ref. No.	—	
	pilot burner nozzle natural gas gas pressure 25mbar code 26 Qty 1 pcs suitable for JUNKERS CB503_			
GEV No.	100225	Ref. No.	—	
	pilot burner nozzle LPG gas pressure 30mbar code 39 Qty 1 pcs suitable for JUNKERS CB503_			
GEV No.	100226	Ref. No.	—	
	pilot burner nozzle LPG gas pressure 50mbar code 15 suitable for JUNKERS			
GEV No.	100227	Ref. No.	—	
	pilot burner nozzle natural gas gas pressure 25mbar code 6 Qty 1 pcs suitable for JUNKERS CB50203_			
GEV No.	100909	Ref. No.	—	
	union screw thread M10x1 for pipe ø 6mm Qty 1 pcs			
GEV No.	101287	Ref. No.	—	
	olive for pipe ø 6mm Qty 1 pcs			























				
1				
GEV No.	100085	Ref. No.	9264282	
description	pilot burner JUNKERS type CB502031 natural gas nozzle no.6 gas connection 6mm with primary air			
For models:	AGB230, AGB238, AGB430, AGB438, AGF124, AGF128, AGF224, AGF228			
spare parts for	100085			
	GEV No.	100227	Ref. No.	—
pilot burner nozzle natural gas gas pressure 25mbar code 6 Qty 1 pcs suitable for JUNKERS CB50203_				

Table continues overleaf



spare parts for		100085	
	GEV No.	100704	Ref. No. —
	ignition electrode D1 ø 9mm connection M4 D2 ø 11mm L1 17mm L2 17mm BL1 13mm BL2 4mm BL3 22mm		
	GEV No.	100909	Ref. No. —
	union screw thread M10x1 for pipe ø 6mm Qty 1 pcs		
	GEV No.	101287	Ref. No. —
	olive for pipe ø 6mm Qty 1 pcs		
	GEV No.	101292	Ref. No. —
	union screw for igniter suitable for CB 502/505 Qty 1 pcs		
	GEV No.	101295	Ref. No. —
	clamping collet for thermocouple suitable for CB 502/505 Qty 1 pcs		
accessories for		100085	
	GEV No.	100220	Ref. No. —
	pilot burner nozzle LPG gas pressure 50mbar code 2 Qty 1 pcs suitable for JUNKERS CB503_		
	GEV No.	100221	Ref. No. —
	pilot burner nozzle LPG gas pressure 30mbar code 29 Qty 1 pcs suitable for JUNKERS CB50203_		
	GEV No.	100222	Ref. No. —
	pilot burner nozzle LPG gas pressure 50mbar code 5 Qty 1 pcs suitable for JUNKERS CB50203_		
	GEV No.	100223	Ref. No. —
	pilot burner nozzle natural gas gas pressure 20mbar code 3 Qty 1 pcs suitable for JUNKERS CB503_		
	GEV No.	100224	Ref. No. —
	pilot burner nozzle natural gas gas pressure 25mbar code 26 Qty 1 pcs suitable for JUNKERS CB503_		
	GEV No.	100225	Ref. No. —
	pilot burner nozzle LPG gas pressure 30mbar code 39 Qty 1 pcs suitable for JUNKERS CB503_		
	GEV No.	100226	Ref. No. —
	pilot burner nozzle LPG gas pressure 50mbar code 15 suitable for JUNKERS		
	GEV No.	100228	Ref. No. —
	pilot burner nozzle town gas gas pressure 8mbar code 4 Qty 1 pcs suitable for JUNKERS CB50203_		
	GEV No.	101281	Ref. No. —
	olive for pipe ø 4mm L 8.7mm Qty 1 pcs suitable for CB 502/503		
	GEV No.	101283	Ref. No. —
	union screw thread M10x1 for pipe ø 4mm Qty 1 pcs		

CB 503 series			
pilot burners			
			
1			
GEV No.	100058	Ref. No.	9290540
description	pilot burner JUNKERS type CB503006 natural gas nozzle no.26 gas connection 4mm		
For models:	AGH417, AGH617		
spare parts for		100058	
	GEV No.	100224	Ref. No. —
	pilot burner nozzle natural gas gas pressure 25mbar code 26 Qty 1 pcs suitable for JUNKERS CB503_		
	GEV No.	101281	Ref. No. —
	olive for pipe ø 4mm L 8.7mm Qty 1 pcs suitable for CB 502/503		
	GEV No.	101283	Ref. No. —
	union screw thread M10x1 for pipe ø 4mm Qty 1 pcs		
accessories for		100058	
	GEV No.	100220	Ref. No. —
	pilot burner nozzle LPG gas pressure 50mbar code 2 Qty 1 pcs suitable for JUNKERS CB503_		
	GEV No.	100221	Ref. No. —
	pilot burner nozzle LPG gas pressure 30mbar code 29 Qty 1 pcs suitable for JUNKERS CB50203_		
	GEV No.	100222	Ref. No. —
	pilot burner nozzle LPG gas pressure 50mbar code 5 Qty 1 pcs suitable for JUNKERS CB50203_		
	GEV No.	100223	Ref. No. —
	pilot burner nozzle natural gas gas pressure 20mbar code 3 Qty 1 pcs suitable for JUNKERS CB503_		
	GEV No.	100226	Ref. No. —
	pilot burner nozzle LPG gas pressure 50mbar code 15 suitable for JUNKERS		
	GEV No.	100227	Ref. No. —
	pilot burner nozzle natural gas gas pressure 25mbar code 6 Qty 1 pcs suitable for JUNKERS CB50203_		
	GEV No.	100228	Ref. No. —
	pilot burner nozzle town gas gas pressure 8mbar code 4 Qty 1 pcs suitable for JUNKERS CB50203_		
	GEV No.	100909	Ref. No. —
	union screw thread M10x1 for pipe ø 6mm Qty 1 pcs		
	GEV No.	101287	Ref. No. —
	olive for pipe ø 6mm Qty 1 pcs		
	GEV No.	102110	Ref. No. —
	pilot tube copper pipe ø 4mm thickness 1mm L 3000mm		
	GEV No.	102111	Ref. No. —
	pilot tube copper pipe ø 6mm thickness 1mm L 3000mm		



producer-specific pilot burners

ASCOBLOC

AGH_ series (version 1)



GEV No.	102956	Ref. No.	-
description	pilot burner type C without nozzle		





GEV No.	102957	Ref. No.	-
description	pilot burner type D without nozzle		









GEV No.	102958	Ref. No.	-
description	pilot burner type E without nozzle		

AGH_ series (version 2)



GEV No.	101529	Ref. No.	10 1355 109146500
description	pilot burner type E incl. nozzles 0.18mm / 0.20mm / 0.32mm / 0.35mm		
spare parts for	101529		
	GEV No.	100235	Ref. No. 10/1366
	pilot burner nozzle LPG bore \varnothing 0.2mm code 20 gas pressure 50mbar thread M5x0.8		
	GEV No.	100236	Ref. No. -
	pilot burner nozzle natural gas bore \varnothing 0.35mm code 35 gas pressure 20mbar thread M5x0.8 WS 5.5		

spare parts for	101529		
	GEV No.	100900	Ref. No. -
	air mixing sleeve for pilot burner Qty 1 pcs		
	GEV No.	101583	Ref. No. 10/1107
	pilot burner head slit width 0.8mm bore \varnothing 3mm \varnothing 6mm M7x0.75mm total length 22mm WS 8 nickel-plated brass		
	GEV No.	101587	Ref. No. 9146402
	gasket for pilot burner without ignition electrode		
	GEV No.	101588	Ref. No. 10/1131
	pilot burner nozzle natural gas bore \varnothing 0.32mm code 32 gas pressure 20mbar thread M5x0.8		
	GEV No.	101589	Ref. No. -
	pilot burner nozzle LPG bore \varnothing 0.18mm code 18 gas pressure 50mbar thread M5x0.8 WS 5.5		
	GEV No.	101848	Ref. No. 135690
	cover for pilot burner		

piezoelectric igniters

miscellaneous



GEV No.	nla ¹	Ref. No.	9296035
description	piezoelectric igniter body metal connection F6.3x0.8 2 hole fixing \varnothing 22mm		
For models:	AGB230, AGB238, AGB430, AGB438, AGF124, AGF128, AGF224, AGF228		

¹no longer available

thermocouples

plug-in thermocouples

plug-in thermocouples standard

with barrel socket \varnothing 5mm - type Junkers with aluminised tip



GEV No.	102251	Ref. No.	09/3587
description	thermocouple M9x1 L 750mm plug connection \varnothing 5.0mm		



with barrel socket $\varnothing 6\text{mm}$

type Junkers with aluminised tip

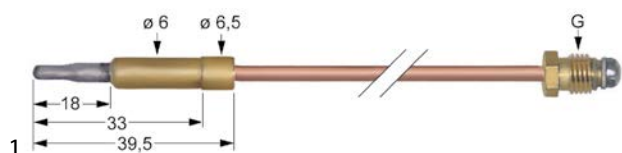

GEV No.	102218	Ref. No.	9296024
description	thermocouple M8x1 L 320mm plug connection $\varnothing 6.0\text{mm}$		
For models:	AGB230, AGB238, AGB430, AGB438, AGH210, AGH218, AGH410, AGH413, AGH417, AGH418, AGH610, AGH613, AGH617, AGH618		

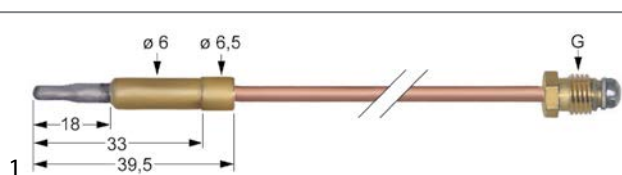

GEV No.	102220	Ref. No.	9296025
description	thermocouple M8x1 L 600mm plug connection $\varnothing 6.0\text{mm}$		
For models:	AGH210, AGH218, AGH410, AGH413, AGH417, AGH418, AGH610, AGH613, AGH617, AGH618		

with barrel socket $\varnothing 6(6.5)\text{mm}$

thermocouples SIT

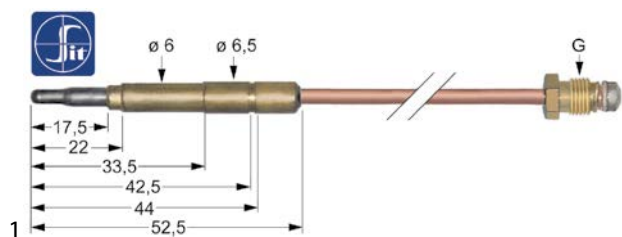

GEV No.	107614	Ref. No.	09 3361 099181121
description	thermocouple SIT M9x1 L 1500mm plug connection $\varnothing 6.0(6.5)\text{mm}$		

thermocouples with aluminised tip

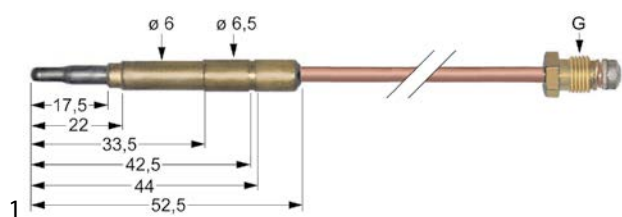

GEV No.	102045	Ref. No.	09/3361
description	thermocouple M9x1 L 1500mm plug connection $\varnothing 6.0(6.5)\text{mm}$		

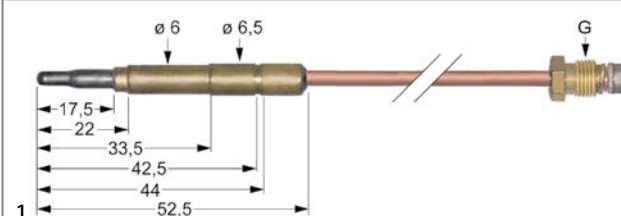

GEV No.	102040	Ref. No.	09/3362
description	thermocouple M9x1 L 500mm plug connection $\varnothing 6.0(6.5)\text{mm}$		

plug-in thermocouples with cable link



GEV No.	102131	Ref. No.	09/3556
description	thermocouple with two-conductors L 1000mm plug connection $\varnothing 5.0\text{mm}$ M8x1		



GEV No.	102089	Ref. No.	9296034
description	thermocouple with two-conductors L 600mm plug connection $\varnothing 5.0\text{mm}$ M8x1		
For models:	AGF124, AGF128, AGF224, AGF228		

plug-in thermocouples with interruption

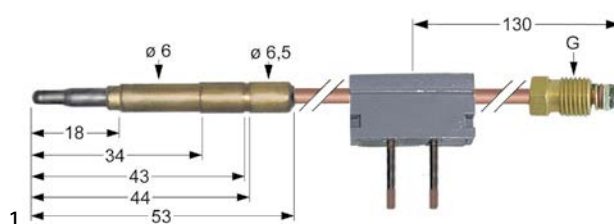

GEV No.	102069	Ref. No.	09/3446
description	thermocouple with interrupter M9x1 L 600mm plug connection $\varnothing 6.0\text{mm}$ soldering connection		

gas burners

hob burners

producer-specific hob burners

ASCOBLOC

Ascoline 700, 850 series





GEV No.	104520	Ref. No.	N/A
description	air mixing tube C $\varnothing 16\text{mm}$		

1			
GEV No.	104521	Ref. No.	N/A
description	air mixing tube D ø 18mm		

 <p>Image not available</p>			
1			
GEV No.	104531	Ref. No.	10/1091
description	burner cap		

1			
GEV No.	104501	Ref. No.	9146383
description	burner cap C/2.3mm ø 83mm		
For models:	AGB230, AGB238, AGB430, AGB438, AGH210, AGH218, AGH410, AGH413, AGH417, AGH418, AGH610, AGH613, AGH617, AGH618		

1			
GEV No.	104460	Ref. No.	9146389
description	burner cap D ø 94mm 5kW with central hole		
For models:	AGH210, AGH218, AGH410, AGH413, AGH417, AGH418, AGH610, AGH613, AGH617, AGH618		

1			
GEV No.	104500	Ref. No.	9146387
description	burner head C for burner cap ø 85mm		
For models:	AGB230, AGB238, AGB430, AGB438, AGH210, AGH218, AGH410, AGH413, AGH417, AGH418, AGH610, AGH613, AGH617, AGH618		

1			
GEV No.	104505	Ref. No.	9146388
description	burner head D for burner cap ø 95mm		
For models:	AGH210, AGH218, AGH410, AGH413, AGH417, AGH418, AGH610, AGH613, AGH617, AGH618		

1			
GEV No.	104507	Ref. No.	10/1377
description	burner head E for burner cap ø 115mm		

1			
GEV No.	104502	Ref. No.	9146385
description	burner lower part C for burner cap ø 85mm hole ø 16.5mm		
For models:	AGB230, AGB238, AGB430, AGB438, AGH210, AGH218, AGH410, AGH413, AGH417, AGH418, AGH610, AGH613, AGH617, AGH618		

1			
GEV No.	104544	Ref. No.	10/1349
description	burner lower part C for burner cap ø 85mm hole ø 16mm		

1			
GEV No.	104545	Ref. No.	10/1350
description	burner lower part D for burner cap ø 100mm hole ø 16.5mm		

1			
GEV No.	104504	Ref. No.	9146391
description	burner lower part D for burner cap ø 100mm hole ø 16mm		
For models:	AGH210, AGH218, AGH410, AGH413, AGH417, AGH418, AGH610, AGH613, AGH617, AGH618		

1			
GEV No.	104712	Ref. No.	10/1379
description	burner lower part E ID ø 18mm complete without mixing pipe		





			
1			
GEV No.	104511	Ref. No.	9146393
description	gasket ø 72mm ID ø 45mm for burner head H 1.2mm perforation ø 5mm		
For models:	AGB230, AGB238, AGB430, AGB438, AGH210, AGH218, AGH410, AGH413, AGH417, AGH418, AGH610, AGH613, AGH617, AGH618		

accessories			
air mixers			
			
1			
GEV No.	101400	Ref. No.	10/1353
description	air mixing tube thread M17x1 suitable for L350, L700		

bar burners

bar burners			
			
1			
GEV No.	104156	Ref. No.	10/1409
description	bar burner 2 row L 445mm W 200mm ømm H 50mm chargrill stainless steel		

			
1			
GEV No.	105260	Ref. No.	10/1427
description	bar burner 2 row L 445mm W 300mm ømm H 50mm 8.5kW griddle		

			
1			
GEV No.	104163	Ref. No.	99/186
description	bar burner 2 row L 600mm W 300mm ømm griddle		

			
1			
GEV No.	104380	Ref. No.	12767805
description	bar burner ømm W 41mm H 56mm L 216mm fryer		
For models:	AGF124, AGF128, AGF224, AGF228		

ring burners

			
1			
GEV No.	104189	Ref. No.	10/1373
description	ring burner L 460mm W 245mm for oven		

accessories

nozzle holders			
			
1			
GEV No.	101852	Ref. No.	10/1158
description	nozzle holder		

			
1			
GEV No.	104522	Ref. No.	10/1318
description	nozzle holder ID ø 10mm ET M17x1		

gas nozzles

main nozzles

gas nozzles M12x1			
			
1			
GEV No.	100279	Ref. No.	10/1116
description	gas injector thread M12x1 WS 14 bore ø 0.82mm		

			
1			
GEV No.	100249	Ref. No.	10/1420
description	gas injector thread M12x1 WS 14 bore ø 0.85mm		



1

GEV No.	100283	Ref. No.	10/1381
description	gas injector thread M12x1 WS 14 bore ø 0.90mm		



1

GEV No.	100282	Ref. No.	10/1119
description	gas injector thread M12x1 WS 14 bore ø 0.95mm		



1

GEV No.	100284	Ref. No.	10/1456
description	gas injector thread M12x1 WS 14 bore ø 1.00mm		



1

GEV No.	100662	Ref. No.	10/1424
description	gas injector thread M12x1 WS 14 bore ø 1.05mm		



1

GEV No.	100877	Ref. No.	10/1120
description	gas injector thread M12x1 WS 14 bore ø 1.07mm		



1

GEV No.	100663	Ref. No.	10/1395
description	gas injector thread M12x1 WS 14 bore ø 1.15mm		



1

GEV No.	100306	Ref. No.	10/1396
description	gas injector thread M12x1 WS 14 bore ø 1.20mm		



1

GEV No.	100975	Ref. No.	10/1421
description	gas injector thread M12x1 WS 14 bore ø 1.25mm		



1

GEV No.	100286	Ref. No.	10/1397
description	gas injector thread M12x1 WS 14 bore ø 1.30mm		



1

GEV No.	100300	Ref. No.	10/1384
description	gas injector thread M12x1 WS 14 bore ø 1.35mm		



1

GEV No.	100669	Ref. No.	10/1093
description	gas injector thread M12x1 WS 14 bore ø 1.37mm		



1

GEV No.	100287	Ref. No.	10/1422
description	gas injector thread M12x1 WS 14 bore ø 1.45mm		



1

GEV No.	100700	Ref. No.	10/1121
description	gas injector thread M12x1 WS 14 bore ø 1.50mm		





1

GEV No.	100301	Ref. No.	10/1386
description	gas injector thread M12x1 WS 14 bore ø 1.55mm		





			
1			
GEV No.	100239	Ref. No.	10/1387
description	gas injector thread M12x1 WS 14 bore ø 1.65mm		

			
1			
GEV No.	100292	Ref. No.	10/1398
description	gas injector thread M12x1 WS 14 bore ø 2.10mm		

			
1			
GEV No.	100288	Ref. No.	10/1348
description	gas injector thread M12x1 WS 14 bore ø 1.70mm		

			
1			
GEV No.	100309	Ref. No.	10/1399
description	gas injector thread M12x1 WS 14 bore ø 2.30mm		

			
1			
GEV No.	100878	Ref. No.	10/1388
description	gas injector thread M12x1 WS 14 bore ø 1.75mm		

			
1			
GEV No.	100668	Ref. No.	10/1432
description	gas injector thread M12x1 WS 14 bore ø 2.35mm		

			
1			
GEV No.	100289	Ref. No.	10/1389
description	gas injector thread M12x1 WS 14 bore ø 1.80mm		

			
1			
GEV No.	100749	Ref. No.	10/1400
description	gas injector thread M12x1 WS 14 bore ø 2.45mm		

			
1			
GEV No.	100302	Ref. No.	10/1425
description	gas injector thread M12x1 WS 14 bore ø 1.85mm		

			
1			
GEV No.	100326	Ref. No.	10/1433
description	gas injector thread M12x1 WS 14 bore ø 2.50mm		

			
1			
GEV No.	100290	Ref. No.	10/1426
description	gas injector thread M12x1 WS 14 bore ø 1.90mm		

			
1			
GEV No.	100304	Ref. No.	10/1434
description	gas injector thread M12x1 WS 14 bore ø 2.60mm		

			
1			
GEV No.	100303	Ref. No.	10/1457
description	gas injector thread M12x1 WS 14 bore ø 2.05mm		

			
1			
GEV No.	100295	Ref. No.	10/1435
description	gas injector thread M12x1 WS 14 bore ø 2.70mm		

			
1			
GEV No.	106329	Ref. No.	10/1452
description	gas injector thread M12x1 WS 14 bore ø 2.80mm		

			
1			
GEV No.	106308	Ref. No.	10/1450
description	gas injector thread M12x1 WS 14 bore ø 2.90mm		

			
1			
GEV No.	100305	Ref. No.	10/1446
description	gas injector thread M12x1 WS 14 bore ø 3.00mm		

			
1			
GEV No.	106281	Ref. No.	10/1061
description	gas injector thread M12x1 WS 14 bore ø 3.10mm		

			
1			
GEV No.	100752	Ref. No.	10/1447
description	gas injector thread M12x1 WS 14 bore ø 3.20mm		

			
1			
GEV No.	100296	Ref. No.	10/1448
description	gas injector thread M12x1 WS 14 bore ø 3.30mm		

pilot burner nozzles

pilot burner nozzles EGA

			
1			
GEV No.	100235	Ref. No.	10/1366
description	pilot burner nozzle LPG bore ø 0.2mm code 20 gas pressure 50mbar thread M5x0.8		

			
1			
GEV No.	100215	Ref. No.	10/1367
description	pilot burner nozzle natural gas bore ø 0.28mm Qty 1 pcs		

			
1			
GEV No.	101588	Ref. No.	10/1131
description	pilot burner nozzle natural gas bore ø 0.32mm code 32 gas pressure 20mbar thread M5x0.8		

pilot burner nozzles SIT

100 series

			
1			
GEV No.	102545	Ref. No.	10/1350
description	pilot burner nozzle LPG code 20 bore ø 0.2mm Qty 5 pcs		

pilot burner nozzles (other)

MKN

			
1			
GEV No.	100271	Ref. No.	10/1368
description	pilot burner nozzle natural gas bore ø 0.3mm		

bypass nozzles

bypass nozzles PEL20/21

			
1			
GEV No.	100554	Ref. No.	10/1342
description	bypass nozzle type PEL20/21 bore ø 0.45mm thread M5x0.5		

			
1			
GEV No.	100526	Ref. No.	10/1343
description	bypass nozzle type PEL20/21 bore ø 0.5mm thread M5x0.5		

			
1			
GEV No.	100551	Ref. No.	10/1344
description	bypass nozzle type PEL20/21 bore ø 0.6mm thread M5x0.5		





			
1			
GEV No.	100552	Ref. No.	10/1390
description	bypass nozzle type PEL20/21 bore ø 0.7mm thread M5x0.5		

			
1			
GEV No.	100527	Ref. No.	10/1360
description	bypass nozzle type PEL20/21 bore ø 0.85mm thread M5x0.5		

			
1			
GEV No.	100555	Ref. No.	10/1340
description	bypass nozzle type PEL20/21 bore ø 0.8mm thread M5x0.5		

			
1			
GEV No.	100556	Ref. No.	10/1341
description	bypass nozzle type PEL20/21 bore ø 0.95mm thread M5x0.5		

			
1			
GEV No.	100528	Ref. No.	10/1430
description	bypass nozzle type PEL20/21 bore ø 0.9mm thread M5x0.5		

			
1			
GEV No.	100557	Ref. No.	10/1393
description	bypass nozzle type PEL20/21 bore ø 1.05mm thread M5x0.5		

			
1			
GEV No.	100531	Ref. No.	10/1394
description	bypass nozzle type PEL20/21 bore ø 1.15mm thread M5x0.5		

			
1			
GEV No.	100547	Ref. No.	10/1428
description	bypass nozzle type PEL20/21 bore ø 1.75mm thread M5x0.5		

bypass nozzles PEL22			
			
1			
GEV No.	100259	Ref. No.	10/1416
description	bypass nozzle type PEL22 bore ø 0.35mm thread M6x0.5		

			
1			
GEV No.	100391	Ref. No.	10/1402
description	bypass nozzle type PEL22 bore ø 0.55mm thread M6x0.5		

			
1			
GEV No.	100390	Ref. No.	10/1401
description	bypass nozzle type PEL22 bore ø 0.5mm thread M6x0.5		

			
1			
GEV No.	100428	Ref. No.	10/1403
description	bypass nozzle type PEL22 bore ø 0.65mm thread M6x0.5		

			
1			
GEV No.	100392	Ref. No.	10/1391
description	bypass nozzle type PEL22 bore ø 0.6mm thread M6x0.5		

			
1			
GEV No.	100432	Ref. No.	10/1454
description	bypass nozzle type PEL22 bore ø 0.75mm thread M6x0.5		

			
1			
GEV No.	100429	Ref. No.	10/1354
description	bypass nozzle type PEL22 bore ø 0.7mm thread M6x0.5		

			
1			
GEV No.	100410	Ref. No.	10/1363
description	bypass nozzle type PEL22 bore ø 0.85mm thread M6x0.5		

			
1			
GEV No.	100409	Ref. No.	10/1404
description	bypass nozzle type PEL22 bore ø 0.8mm thread M6x0.5		

			
1			
GEV No.	100434	Ref. No.	10/1406
description	bypass nozzle type PEL22 bore ø 0.95mm thread M6x0.5		

1			
GEV No.	100433	Ref. No.	10/1405
description	bypass nozzle type PEL22 bore ø 0.9mm thread M6x0.5		

1			
GEV No.	100437	Ref. No.	10/1408
description	bypass nozzle type PEL22 bore ø 1.15mm thread M6x0.5		

1			
GEV No.	100436	Ref. No.	10/1444
description	bypass nozzle type PEL22 bore ø 1.1mm thread M6x0.5		

1			
GEV No.	100438	Ref. No.	10/1445
description	bypass nozzle type PEL22 bore ø 1.2mm thread M6x0.5		

1			
GEV No.	100407	Ref. No.	10/1407
description	bypass nozzle type PEL22 bore ø 1mm thread M6x0.5		

bypass nozzles PEL23/24

1			
GEV No.	100493	Ref. No.	10/1441
description	bypass nozzle type PEL23/24 bore ø 0.7mm thread M8x0.5		



1			
GEV No.	100649	Ref. No.	10/1442
description	bypass nozzle type PEL23/24 bore ø 1.1mm thread M8x0.5		

1			
GEV No.	100664	Ref. No.	10/1443
description	bypass nozzle type PEL23/24 bore ø 1.25mm thread M8x0.5		



auxiliary gas parts

screw connections

olives

1				
GEV No.	101248	Ref. No.	10/1000	
description	olive for pipe ø 12mm Qty 1 pcs suitable for PEL			
accessories for	101248			
	GEV No.	101251	Ref. No.	10/1449
union nut thread M20x1.5 for pipe ø 12mm				

union nuts

1				
GEV No.	101251	Ref. No.	10/1449	
description	union nut thread M20x1.5 for pipe ø 12mm			
accessories for	101251			
	GEV No.	101248	Ref. No.	10/1000
olive for pipe ø 12mm Qty 1 pcs suitable for PEL				

equipment-specific units

for deep fryers

glass panels

1			
GEV No.	691322	Ref. No.	082484
description	glass panel ø 40mm thickness 4mm		

for tilting bratt pans

glass panels

1			
GEV No.	691322	Ref. No.	082484
description	glass panel ø 40mm thickness 4mm		



miscellaneous



1

GEV No.	691321	Ref. No.	082484
description	frame		



1

GEV No.	110234	Ref. No.	18/603
description	knob switch 7-position t.max.°C ø 50mm shaft ø 6x4.6mm shaft flat upper black		

for boiling pans

glass panels



1

GEV No.	691322	Ref. No.	082484
description	glass panel ø 40mm thickness 4mm		



1

GEV No.	110127	Ref. No.	09/3502	
description	knob graduated t.max.°C ø 50mm shaft ø 6x4.6mm shaft flat upper black			
accessories for	110127			
	GEV No.	110135	Ref. No.	—
	rosette knob up to ø 52mm			

for ovens

miscellaneous



1

GEV No.	691321	Ref. No.	082484
description	frame		

producer-specific knobs

ASCOBLOC



1

GEV No.	112670	Ref. No.	09/2662
description	knob without symbol ø 65mm shaft ø 6x4.6mm shaft flat upper		

knobs

universal knobs



1

GEV No.	110235	Ref. No.	18/604
description	knob energy regulator 1-3 t.max.°C ø 50mm shaft ø 6x4.6mm shaft flat upper black		



fittings for catering equipment

drain taps

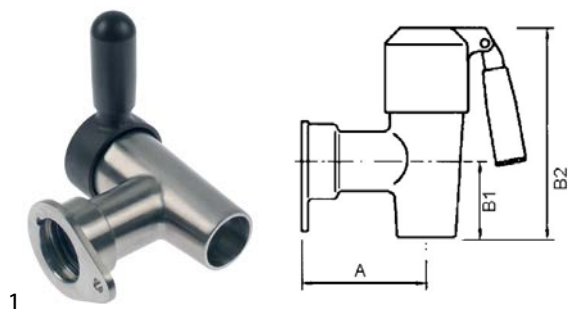

stainless steel

drain taps

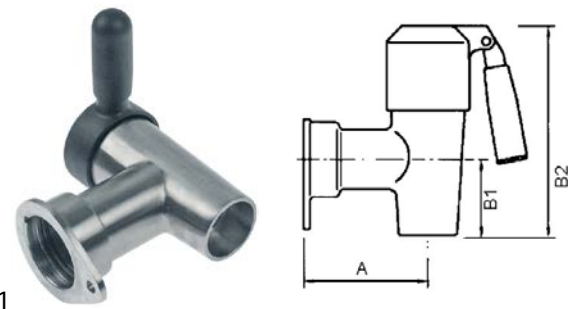

GEV No.	541997	Ref. No.	08/1172 08/8511
description	drain tap connection push-in for pipe ϕ 47mm A 98mm B1 64mm B2 145mm stainless steel O-ring seal		
spare parts for	541997		
	GEV No.	542174	Ref. No. —
	O-ring set for drain tap 1½" gaskets and grease ECHTERMANN 6726.60/6726.61/6726.62/6726.63		
accessories for	541997		
	GEV No.	890116	Ref. No. —
	fitting grease FERMIT GLISSA tube 60g -20 up to +140°C approval complies with KTW recommendation		



GEV No.	542110	Ref. No.	08/8512
description	drain tap connection push-in for pipe ϕ 59mm A 120mm B1 65mm B2 158mm stainless steel O-ring seal		
spare parts for	542110		
	GEV No.	542185	Ref. No. —
	O-ring set EPDM for drain tap 2" gaskets and grease		
accessories for	542110		
	GEV No.	890116	Ref. No. —
	fitting grease FERMIT GLISSA tube 60g -20 up to +140°C approval complies with KTW recommendation		
	GEV No.	890118	Ref. No. —
	fitting grease FERMIT GLISSA can 1000g -20 up to +140°C approval complies with KTW recommendation		

steam traps

steam traps

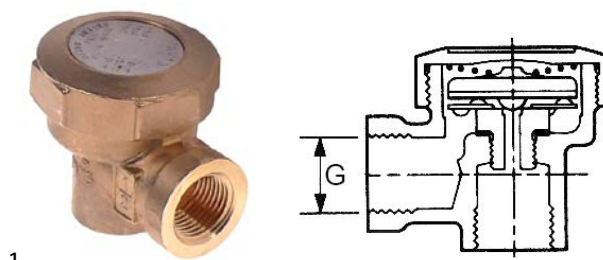

GEV No.	514272	Ref. No.	8150901
description	thermostatic steam trap thread 1/2" type AV13 brass		
For models:	AES060, AES080		

safety valves



GEV No.	514273	Ref. No.	8151701
description	safety valve T1: 1/2" T2: 1/2" triggering pressure 0.65bar		
For models:	AES060, AES080		

baskets

fryer baskets

ASCOBLOC



GEV No.	970159	Ref. No.	9292205
description	fryer basket L1 305mm W1 175mm H1 125mm L2 515mm H2 195mm		
For models:	AEF124, AEF128, AEF224, AEF494		

gaskets

refrigeration gaskets

plug-in gaskets

profile 9162

universal

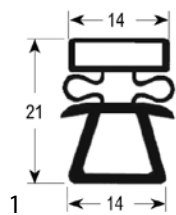

GEV No.	901696	Ref. No.	08/2042
description	refrigeration gasket profile 9162 W 385mm L 595mm external size		

gaskets for heated units

door seals with fixing hook

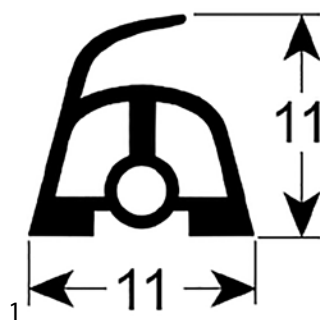

GEV No.	900390	Ref. No.	04/12775005 04/1782
description	door seal L 380mm Wmm with 5 mounting clips		
For models:	AEH413, AEH503, AEH613, AEH703, AGH417, AGH617		

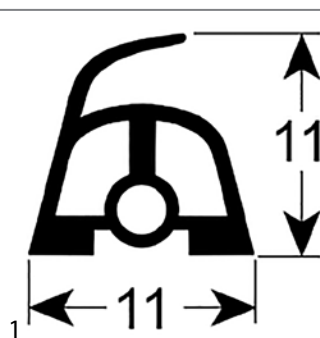

GEV No.	900391	Ref. No.	04/12775105 04/1783
description	door seal L 585mm Wmm with 9 mounting clips		
For models:	AEH413, AEH503, AEH613, AEH703, AGH417, AGH617		

O-rings

EPDM

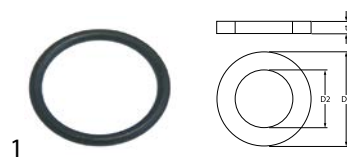

GEV No.	510408	Ref. No.	9298045
description	O-ring EPDM thickness 5.34mm ID ø 47mm Qty 1 pcs		

silicone

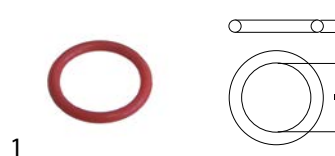

GEV No.	510562	Ref. No.	08 1008 8060842
description	O-ring silicone thickness 5.34mm ID ø 47mm Qty 1 pcs		
For models:	AES060, AES080		

sealing washers

Viton gaskets



GEV No.	106250	Ref. No.	08/7300
description	gasket Viton ED ø 14mm ID ø 9mm thickness 3.3mm Qty 1 pcs		



GEV No.	101880	Ref. No.	08/8032
description	gasket Viton ED ø 14mm ID ø 9mm thickness 7.7mm Qty 1 pcs		

sealing cords

round



GEV No.	691326	Ref. No.	08/9127800 081505
description	sealing cord round ø 8mm braided Qty supplied by meter		

springs

miscellaneous

1 

GEV No.	700187	Ref. No.	9294387
description	spring for door		
For models:	AEH413, AEH503, AEH613, AEH703, AGH417, AGH617		

kitchen accessories

waste chute rings

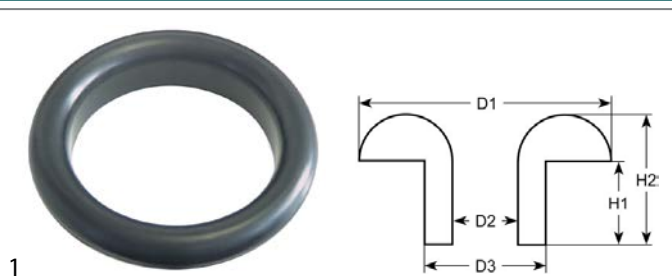

GEV No.	690333	Ref. No.	08/6836
description	waste chute ring D1 \varnothing 234mm D2 \varnothing 166mm D3 \varnothing 200mm D4 \varnothing 218mm H1 24mm H2 47mm		

manometers



GEV No.	541343	Ref. No.	8151500
description	manometer \varnothing 63mm pressure range 0 up to 1.6bar thread 1/4" marking 0.5-1 kettle connection on the backside		
For models:	AES060, AES080		

valves and tank inlets

inlet taps



GEV No.	540887	Ref. No.	8178419
description	inlet tap connection 3/4" ET tube \varnothing 20mm projection 100mm overall height 110mm spout height 40mm rotation 90°		
For models:	AES060, AES080		

B			
bar burners		21	
bi-metal thermostats		6, 6	
C			
cam switches		9	
contactors		11	
control equipment		10	
control thermostats		7	
cross flow fans		12	
D			
door seals with fixing hook		29	
E			
electric accessories		12	
electrodes		12	
energy regulators		6	
F			
fans		12	
G			
gas burners		19	
gas nozzles		21	
gas taps		13	
gas thermostats		15	
gaskets for heated units		29	
H			
heating elements		3	
heating elements for bain maries		3	
heating elements for convection		4	
heating elements for fryers		3	
heating elements for ovens		3	
heating elements for transport containers		3	
hob burners		19	
I			
immersion heating elements		4	
indicator lights		11	
indicator lights (complete)		11	
inlet spouts		30	
inlet taps		30	
L			
lamps		11	
M			
magnetic switches		10	
microswitches		9	
O			
O-rings		29	
P			
piezoelectric igniters		18	
pilot burners		16	
pilot heating elements		4	
plug-in gaskets		29	
position switches		9	
pressure switches		12	
R			
radiation heaters		5	
refrigeration gaskets		29	
relays		11	
ring burners		21	
S			
safety thermostats		7	
sealing cords		29	
sealing washers		29	
switches and momentary switches		9	
T			
terminals		12	
thermocouples		18	
thermostats		6	
V			
valves and tank inlets		30	