



GAS COMPONENTS



ELECTRIC COMPONENTS



WATER TECHNOLOGY



MECHANICAL COMPONENTS



TOOLS

Spare parts suitable for

BARTSCHER

Find the complete and up-to-date range of products in our GEV Webshop



Manufacturer catalogue

The most important spare parts and accessories arranged clearly for every manufacturer

- ✓ Complete product range and all appliance data always up to date in the GEV Webshop
- ✓ Alphabetical Index at the end of the catalogue

GEV Webshop

www.gev-online.co.uk

www.gev-online.com



- 🔍 Add to Favourites
- 🔍 Sign In with email address and usual password
- 🔍 Easy-order – place several items in your basket at the same time
- 🔍 Quick Item search – no login needed



induction

induction coils



1

GEV No.	404000	Ref. No.	01058352
description	induction coils 3500W 230V 50Hz L 220mm W 217mm H 12mm suitable for BARTSCHER for induction device		

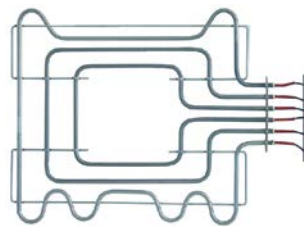

1

GEV No.	416785	Ref. No.	016727
description	heating element 1800W 230/400V heating circuits 3 L 515mm W 452mm L1 57mm L2 458mm W1 162mm W2 128mm flange length 160mm flange width 22mm hole distance 144mm hole ø M5mm tube ø 8.5mm rectangular flange dry heating element oven cable length 570mm		

heating elements

heating elements for ovens



1

GEV No.	418478	Ref. No.	065211001 065211007
description	heating element 1000W 230V heating circuits 1 L 420mm W 200mm connection male faston 6.3mm connection distance 194mm connection length 15mm tube ø 6.3mm dry heating element oven/bain marie H 47mm		

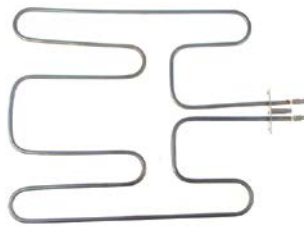

1

GEV No.	418546	Ref. No.	021061
description	heating element 1800W 230V heating circuits 1 L 405mm W 324mm L1 30mm L2 375mm W2 30mm flange length 72mm flange width 22mm hole distance 57mm hole ø 5mm tube ø 6.3mm connection male faston 6.3mm connection length 55mm mounting pos. lower rectangular flange dry heating element oven		

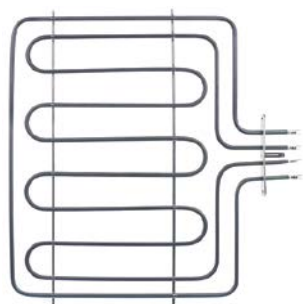

1

GEV No.	418961	Ref. No.	023319
description	heating element 1200/2850W 230V heating circuits 2 L 400mm W 467mm L1 40mm L2 360mm W1 70mm W2 78mm flange length 127mm flange width 22mm hole distance 114mm bridge length 35mm hole ø 6mm tube ø 6.3mm connection male faston 6.3mm vertical connection length 17mm windings 4		

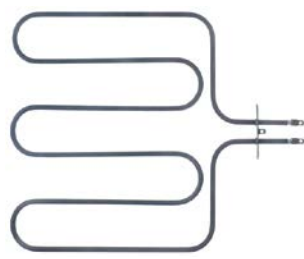

1

GEV No.	420040	Ref. No.	A0YXD4A40
description	heating element 2000W 230V heating circuits 1 L 330mm W 315mm L1 55mm L2 275mm W1 142mm W2 31mm flange length 70mm flange width 22mm hole distance 56mm hole ø 6mm tube ø 6.6mm connection male faston 6.3mm		
For models:	A120788		

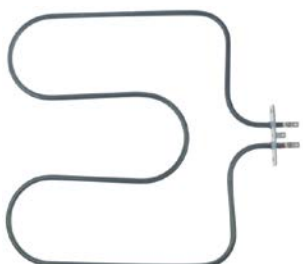

1

GEV No.	420276	Ref. No.	ORES009
description	heating element 1500W 230V heating circuits 1 L 313mm W 300mm L1 48mm L2 305mm W1 135mm W2 30mm flange length 70mm flange width 22mm hole distance 56mm hole ø 5mm tube ø 6.5mm connection male faston 6.3mm windings 2 oven heating element		

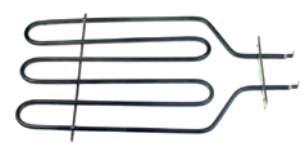

1

GEV No.	416855	Ref. No.	030008373
description	heating element 2300W 230V heating circuits 1 L 345mm W 213mm L1 33mm L2 42mm W1 70mm W2 68mm flange length 130mm flange width 16mm hole distance 104mm hole ø 3mm tube ø 6.3mm connection male faston 6.3mm connection length 48mm rectangular flange dry heating element L3 270mm		

heating elements for bain maries

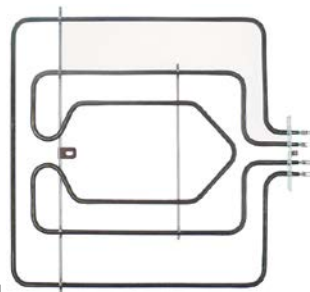

1

GEV No.	420275	Ref. No.	ORES039
description	heating element 2400W 230V heating circuits 2 L 335mm W 350mm L1 30mm L2 305mm W1 145mm W2 60mm flange length 100mm flange width 22mm hole distance 86mm hole ø 5mm tube ø 6.5mm connection male faston 6.3mm oven heating element		

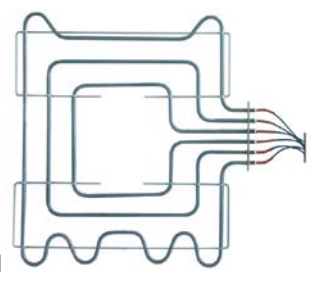

1

GEV No.	416786	Ref. No.	010848
description	heating element 2750W 230/400V heating circuits 3 L 515mm W 580mm L1 55mm L2 460mm W1 130mm W2 225mm flange length 160mm flange width 22mm hole distance 139mm hole ø 4mm tube ø 8.5mm connection cable rectangular flange dry heating element oven cable length 590mm		

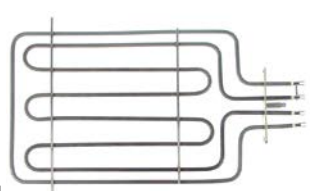

1

GEV No.	418545	Ref. No.	021060
description	heating element 3100W 230V heating circuits 2 L 415mm W 258mm L1 38mm L2 377mm W1 89mm W2 80mm flange length 128mm flange width 22mm hole distance 114mm bridge length 300mm hole ø 4.5mm tube ø 6.5mm connection male faston 6.3mm connection length 65mm mounting pos. upper rectangular flange dry heating element oven		



1

GEV No.	418479	Ref. No.	06530624
description	heating element 950W 230V heating circuits 1 L 405mm W 96mm L1 75mm L2 330mm W1 15mm W2 66mm flange length 110mm flange width 22mm hole distance 95mm connection male faston 6.3mm connection length 18mm tube ø 6.3mm rectangular flange hole ø 5mm dry heating element heated cabinet		



1

GEV No.	418478	Ref. No.	065211001 065211007
description	heating element 1000W 230V heating circuits 1 L 420mm W 200mm connection male faston 6.3mm connection distance 194mm connection length 15mm tube ø 6.3mm dry heating element oven/bain marie H 47mm		

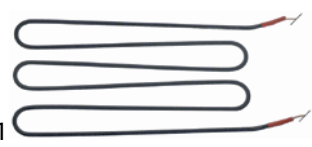

1

GEV No.	417748	Ref. No.	00SL0006
description	heating element 1200W 230V heating circuits 1 L 365mm W 190mm connection cable 500mm tube ø 6.3mm		

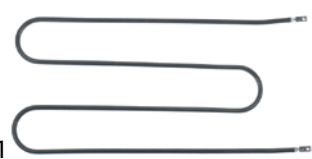

1

GEV No.	420542	Ref. No.	OKG1652
description	heating element 1200W 230V heating circuits 1 L 370mm W 185mm connection M4 connection distance 180mm tube ø 6.5mm mounting pos. lower bain marie		



1

GEV No.	417707	Ref. No.	02002301
description	heating element 1300W 230V heating circuits 1 L 405mm W 150mm tube ø 6.8mm		





1

GEV No.	416067	Ref. No.	06001024	
description	heating element 1380W 230V heating circuits 1 L 346mm W 190mm connection M5 tube ø 8.5mm 2 hole fixing thread 1/4" immersion heater W1 70mm W2 105mm H 27mm mounting distance 67mm			
spare parts for	416067			
	GEV No.	510417	Ref. No.	—
	flat gasket fibre ED ø 20mm ID ø 14mm thickness 2mm Qty 1 pcs			
accessories for	416067			
	GEV No.	361182	Ref. No.	—
	nut thread 1/4" H 5mm nickel-plated brass WS 17 Qty 1 pcs			
	GEV No.	520228	Ref. No.	—
	tooth lock washer ID ø 15.3mm ED ø 24mm steel Qty 1 pcs for thread M14			
	GEV No.	550262	Ref. No.	—
	flat gasket copper ED ø 20mm ID ø 14mm thickness 2mm			





Table continues overleaf

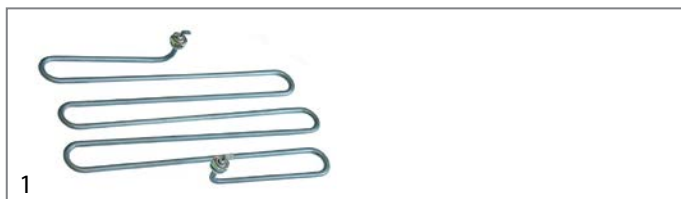

accessories for	416067			
	GEV No.	560112	Ref. No.	—
	plain washer ID ø 5.3mm ED ø 10mm thickness 1mm SS Qty 20 pcs DIN 125A for thread M5			
	GEV No.	560132	Ref. No.	—
	hexagonal nut thread M5 H 4mm WS 8 SS DIN/ISO DIN 934 / ISO 4032/8673 Qty 20 pcs			



GEV No.	416796	Ref. No.	018160
description	heating element 1500W 240V heating circuits 1 L 325mm W 180mm connection male faston 6.3mm tube ø 6.3mm 2 hole fixing thread 1/4" dry heating element bain marie L1 155mm L2 170mm H 34mm mounting distance 174mm		

accessories for	416796			
	GEV No.	361182	Ref. No.	—
	nut thread 1/4" H 5mm nickel-plated brass WS 17 Qty 1 pcs			
	GEV No.	510417	Ref. No.	—
	flat gasket fibre ED ø 20mm ID ø 14mm thickness 2mm Qty 1 pcs			
	GEV No.	520228	Ref. No.	—
	tooth lock washer ID ø 15.3mm ED ø 24mm steel Qty 1 pcs for thread M14			
	GEV No.	550262	Ref. No.	—
	flat gasket copper ED ø 20mm ID ø 14mm thickness 2mm			

heating elements for chip scuttles





GEV No.	416067	Ref. No.	06001024
description	heating element 1380W 230V heating circuits 1 L 346mm W 190mm connection M5 tube ø 8.5mm 2 hole fixing thread 1/4" immersion heater W1 70mm W2 105mm H 27mm mounting distance 67mm		

accessories for	416067			
	GEV No.	510417	Ref. No.	—
	flat gasket fibre ED ø 20mm ID ø 14mm thickness 2mm Qty 1 pcs			

accessories for	416067			
	GEV No.	361182	Ref. No.	—
	nut thread 1/4" H 5mm nickel-plated brass WS 17 Qty 1 pcs			

	GEV No.	520228	Ref. No.	—
	tooth lock washer ID ø 15.3mm ED ø 24mm steel Qty 1 pcs for thread M14			

	GEV No.	550262	Ref. No.	—
	flat gasket copper ED ø 20mm ID ø 14mm thickness 2mm			

	GEV No.	560112	Ref. No.	—
	plain washer ID ø 5.3mm ED ø 10mm thickness 1mm SS Qty 20 pcs DIN 125A for thread M5			

	GEV No.	560132	Ref. No.	—
	hexagonal nut thread M5 H 4mm WS 8 SS DIN/ISO DIN 934 / ISO 4032/8673 Qty 20 pcs			

heating elements for crepes makers

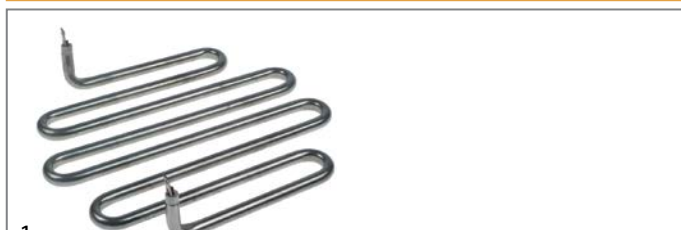

GEV No.	419011	Ref. No.	010444611
description	heating element 3000W 230V L 307mm W 272mm H 50mm connec- tion distance 260mm dry heating element heating circuits 1 for crepes maker		
For models:	104447		



GEV No.	419203	Ref. No.	0301040775
description	heating element kit 3000W 230V H 50mm tube ø 8.5mm connec- tion screw connection distance 30mm dry heating element heating circuits 1 ø 325mm for crepes maker		

heating elements for fryers

center connection

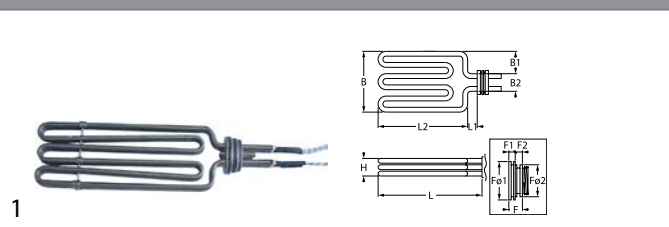

GEV No.	415297	Ref. No.	0211441
description	heating element 6800W 230/400V heating circuits 3 L 299mm W 107mm H 35mm flange length 19.5mm flange length 1 9.5mm flange length 2 9.8mm flange ø1 62mm flange ø2 57mm thermostat sleeves ø 8.5mm sensor screw connection 2x M10x1 thermostat sleeve up- per/lower L1 16mm L2 283mm W1 30mm W2 77mm thread M54x1.5 tube ø 8.5mm cable length 450mm rotation flange immersion heater		

accessories for	415297			
	GEV No.	510243	Ref. No.	—
	O-ring Viton thickness 3.53mm ID ø 55.56mm Qty 1 pcs			

	GEV No.	510245	Ref. No.	—
	O-ring Viton thickness 3.53mm ID ø 50.8mm Qty 1 pcs			

	GEV No.	550447	Ref. No.	—
	ring nut thread M54x1.5			



2 hole fixing

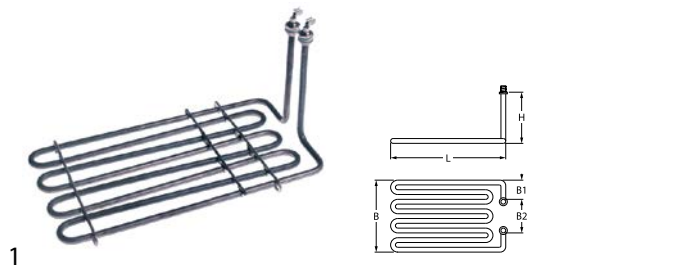

GEV No.	418488	Ref. No.	06537366
----------------	--------	-----------------	----------

description heating element 2800W 230V heating circuits 1 L 343mm W 180mm H 152mm 2 hole fixing connection male faston 6.3mm W1 66mm W2 44mm thread M12x1 tube ø 8.5mm windings 4 fryer

accessories for 418488

	GEV No.	520229	Ref. No.	—
	nut thread M12x1 H 4mm WS 16 zinc-coated steel Qty 1 pcs			
	GEV No.	521110	Ref. No.	—
	flat gasket fibre ED ø 20mm ID ø 13mm thickness 2mm Qty 1 pcs			
	GEV No.	521131	Ref. No.	—
	nut thread M12x1 H 3.5mm WS 17 SS Qty 1 pcs			
	GEV No.	528110	Ref. No.	—
	O-ring EPDM thickness 2.62mm ID ø 12.37mm Qty 1 pcs			

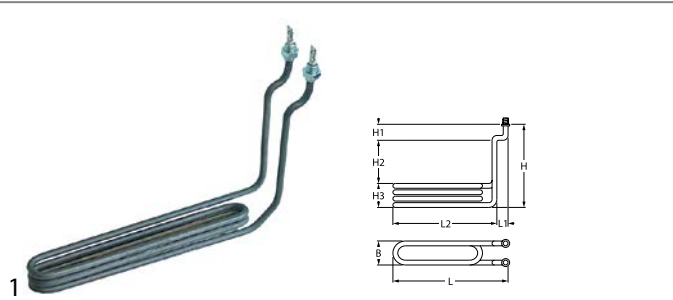

GEV No.	416800	Ref. No.	08208200
----------------	--------	-----------------	----------

description heating element 2300W 230V heating circuits 1 L 340mm W 42mm H 210mm L1 24mm L2 316mm H1 46mm H2 130mm H3 34mm mounting distance 32mm thread M14x1.5 tube ø 8.5mm connection length 20mm connection M5 2 hole fixing fryer

spare parts for 416800

	GEV No.	521101	Ref. No.	—
	nut thread M14x1.5 H 5mm WS 19 SS Qty 1 pcs			
accessories for	416800			
	GEV No.	560112	Ref. No.	—
	plain washer ID ø 5.3mm ED ø 10mm thickness 1mm SS Qty 20 pcs DIN 125A for thread M5			
	GEV No.	560132	Ref. No.	—
	hexagonal nut thread M5 H 4mm WS 8 SS DIN/ISO DIN 934 / ISO 4032/8673 Qty 20 pcs			

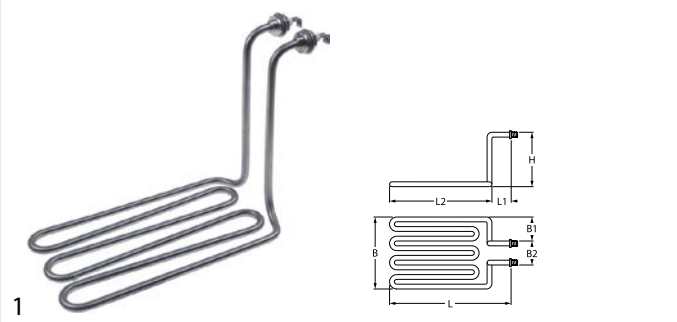

GEV No.	420145	Ref. No.	016240419 A039885
----------------	--------	-----------------	----------------------

description heating element 2500W 230V heating circuits 1 L 267mm W 127mm H 187mm 2 hole fixing connection M4 immersion heater L1 32mm L2 235mm W1 38mm W2 50mm tube ø 8mm thread M12x1.25 mounting distance 42mm connection length 15mm windings 3

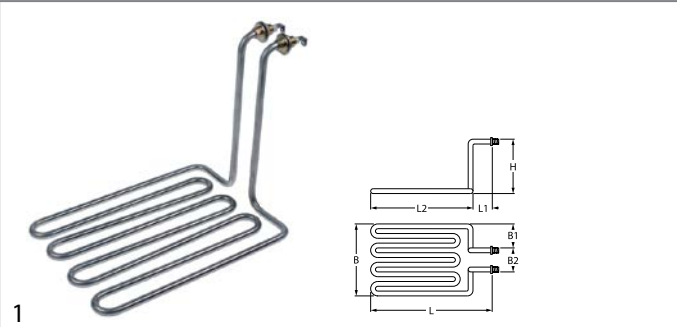

GEV No.	420018	Ref. No.	016210818 A040579
----------------	--------	-----------------	----------------------

description heating element 3250W 230V heating circuits 1 L 265mm W 185mm H 200mm 2 hole fixing connection M4 immersion heater L1 25mm L2 240mm W1 71mm W2 42mm tube ø 8.1mm thread M12x1 mounting distance 34mm windings 4

For models: A150107, A150207

spare parts for 420018

	GEV No.	521131	Ref. No.	—
	nut thread M12x1 H 3.5mm WS 17 SS Qty 1 pcs			

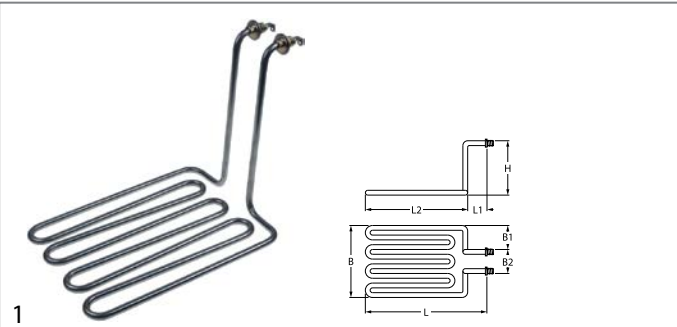





GEV No.	420066	Ref. No.	A039886
----------------	--------	-----------------	---------

description heating element 3250W 230V heating circuits 1 L 280mm W 180mm H 210mm 2 hole fixing connection M4 immersion heater L1 35mm L2 245mm W1 61mm W2 58mm tube ø 8.1mm thread M12x1.25 mounting distance 50mm windings 4

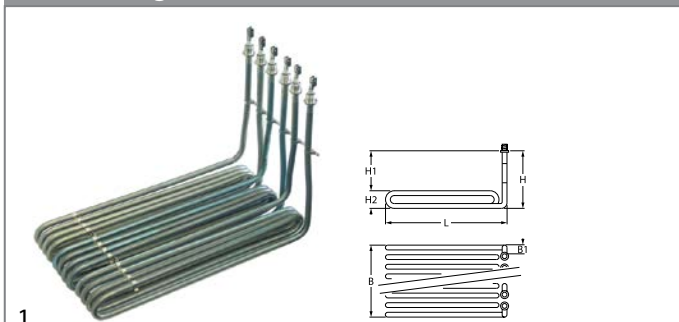

6 hole fixing



GEV No.	416811	Ref. No.	01037317200
description	heating element 9000W 230V heating circuits 3 L 320mm W 175mm H 205mm W1 5mm H1 165mm H2 40mm thread M12x1 tube ø 8.5mm connection male faston 6.3mm immersion heater 6 hole fixing		
spare parts for	416811		
	GEV No.	521110	Ref. No. —
	flat gasket fibre ED ø 20mm ID ø 13mm thickness 2mm Qty 1 pcs		
accessories for	416811		
	GEV No.	520229	Ref. No. —
	nut thread M12x1 H 4mm WS 16 zinc-coated steel Qty 1 pcs		
	GEV No.	521131	Ref. No. —
	nut thread M12x1 H 3.5mm WS 17 SS Qty 1 pcs		
	GEV No.	528110	Ref. No. —
	O-ring EPDM thickness 2.62mm ID ø 12.37mm Qty 1 pcs		

heating elements for hot counters



GEV No.	420065	Ref. No.	03060533
description	heating element 1840W 230V heating circuits 1 L 550mm W 180mm W2 38mm tube ø 8mm connection M4 for hot counter L1 65mm L2 410mm hole distance 187mm flange length 200mm flange width 50mm hole ø 5mm		

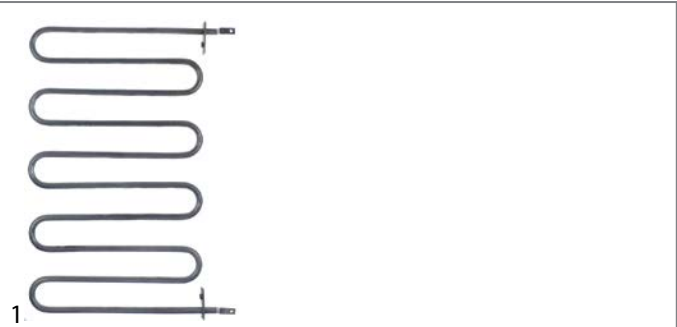

GEV No.	420039	Ref. No.	A02030937
description	heating element 260W 230V heating circuits 1 L 221mm W 363mm tube ø 8mm connection male faston 6.3mm screw lug length 40mm lug width 15mm		
For models:	A203093, A203094		

heating elements for griddles



GEV No.	418934	Ref. No.	021786
description	heating element 1100W 230V heating circuits 1 L 327mm W 96.5mm H 52mm tube ø 6.3mm connection male faston 6.3mm griddle connection distance 76mm dry heating element		



GEV No.	418489	Ref. No.	065211011
description	heating element 1100W 230V heating circuits 1 L 467mm W 95mm H 52mm tube ø 6.3mm connection M4 griddle dry heating element		

heating elements for chicken rotisseries



GEV No.	418869	Ref. No.	007032324
description	heating element 1900W 230V thread M14x1.5 L 690mm W 40mm dry heating element tube ø 8.5mm mounting distance 61mm chicken rotisserie		

heating elements for hot dog machines



GEV No.	418661	Ref. No.	A0401022500
description	heating element 1000W 230V L 180mm W 187mm H 18mm tube ø 6.2mm L1 30mm L2 150mm connection 6.3 connection distance 181mm heating circuits 1 hot dog machine		

heating elements for coffee machine



GEV No.	420147	Ref. No.	A0ND010
description	heating element 1200W 230V heating circuits 1 D1 ø 65mm H 42mm D2 ø 54mm windings 3 connection male faston 6.3mm immersion heater tube ø 6.5mm for coffee machine		
For models:	A190141, A190161		

accessories for	420147		
	GEV No.	511646	Ref. No. A0ND011
	gasket silicone ED ø 63mm ID ø 55mm thickness 2.3mm Qty 1 pcs for heating element		



heating elements for contact grills



1

GEV No.	420146	Ref. No.	A0ND012
description	heating element 130W 230V ø 130mm L 130mm H 54mm connection male faston 6.3mm W 130mm heating circuits 1		
For models:	A190141, A190161		



1

GEV No.	417218	Ref. No.	A040640
description	heating element D1 ø 65mm H 42mm tube ø 6.5mm coffee machine		







1

GEV No.	420143	Ref. No.	A0ND037
description	heating element heating circuits 1 D1 ø 65mm H 42mm D2 ø 54mm windings 4 connection male faston 6.3mm immersion heater tube ø 6.5mm for coffee machine		
accessories for	420143		
	GEV No.	511646	Ref. No. A0ND011
	gasket silicone ED ø 63mm ID ø 55mm thickness 2.3mm Qty 1 pcs for heating element		

heating elements for tilting bratt pan



1

GEV No.	416693	Ref. No.	040400084
description	heating element 1650W 230V L 490mm W 45mm H 45mm 2 hole fixing connection M4 thread 1/4" tube ø 8.5mm mounting distance 32mm dry heating element		
accessories for	416693		
	GEV No.	361182	Ref. No. —
	nut thread 1/4" H 5mm nickel-plated brass WS 17 Qty 1 pcs		
	GEV No.	510417	Ref. No. —
	flat gasket fibre ED ø 20mm ID ø 14mm thickness 2mm Qty 1 pcs		
	GEV No.	520228	Ref. No. —
	tooth lock washer ID ø 15.3mm ED ø 24mm steel Qty 1 pcs for thread M14		
	GEV No.	550262	Ref. No. —
	flat gasket copper ED ø 20mm ID ø 14mm thickness 2mm		

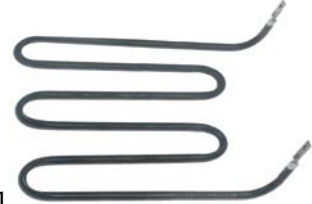

1

GEV No.	419013	Ref. No.	A039855
description	heating element 1000W 230V L 178mm W 180mm H 40mm tube ø 6.25mm connection M4 connection length 22mm dry heating element windings 3 for contact grill		
For models:	A150671		



1

GEV No.	416845	Ref. No.	A017607
description	heating element 1100W 230V L 208mm W 220mm H 25mm tube ø 6.5mm connection distance 65mm cable length 500mm dry heating element heating circuits 1		



1

GEV No.	416853	Ref. No.	A010416
description	heating element 1100W 230V L 210mm W 250mm W1 70mm W2 110mm tube ø 6.3mm cable length 200mm dry heating element windings 3 H 6.3mm		



1

GEV No.	419002	Ref. No.	A041537
description	heating element 1400W 230V heating circuits 1 L 175mm W 305mm H 20mm W1 40mm W2 325mm tube ø 6.3mm windings 5		
For models:	A150674		

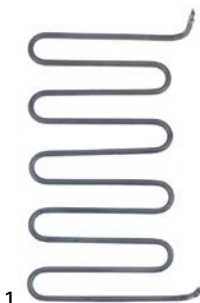
1

GEV No.	419003	Ref. No.	A041538
description	heating element 1550W 240V L 175mm W 305mm H 40mm tube ø 6.3mm connection M4 windings 5		
For models:	A150674		



1

GEV No.	416844	Ref. No.	A010415
description	heating element 900W 230V L 185mm W 247mm W1 80mm W2 100mm tube ø 6.3mm connection cable connection length 18mm cable length 600mm windings 3 H 6.3mm		



1

GEV No.	416843	Ref. No.	A010414
description	heating element 650W 230V L 172mm W 162mm W1 70mm W2 40mm tube ø 6.5mm connection cable cable length 550mm dry heating element windings 3		



1

GEV No.	416854	Ref. No.	030008014
description	heating element 900W 230V L 210mm W 170mm H 20mm W1 55mm W2 60mm tube ø 6.3mm windings 3 cable length 250mm dry heating element		



1

GEV No.	419012	Ref. No.	A039854
description	heating element 800W 230V heating circuits 1 L 175mm W 183mm H 15mm W1 40mm W2 102mm tube ø 6.6mm windings 3 connection M4 mounting pos. upper dry heating element for contact grill		
For models:	A150671		

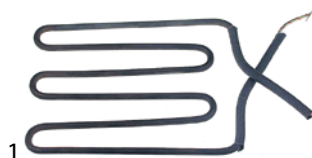

1

GEV No.	416859	Ref. No.	A010418
description	heating element 900W 230V L 210mm W 180mm W1 33mm W2 100mm tube ø 6.3mm connection cable connection length 20mm cable length 240mm windings 3 H 6.3mm		

heating elements for pizza ovens



1

GEV No.	416849	Ref. No.	030008013
description	heating element 800W 230V L 170mm W 167mm H 33mm W1 26mm W2 115mm connection length 30mm tube ø 6.3mm windings 3 cable length 260mm dry heating element		

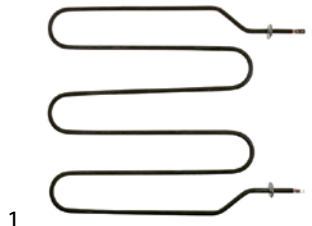

1





GEV No.	418672	Ref. No.	0401031000
description	heating element 1000W 230V heating circuits 1 L 330mm W 300mm L1 30mm L2 60mm L3 240mm W1 35mm W2 230mm lug length 27mm lug width 22mm connection length 55mm connection male faston 6.3mm tube ø 6.3mm 2 hole fixing hole ø 3mm dry heating element pizza oven		



1

GEV No.	416847	Ref. No.	030008049
description	heating element 1000W 230V dry heating element 2 hole fixing pizza oven		





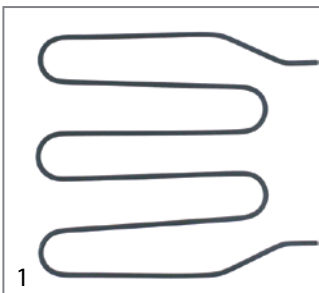



GEV No.	416848	Ref. No.	030008062
description	heating element 800W 230V L 445mm W 195mm thread 1/4" mounting distance 186mm connection length 15mm connection M4 tube ø 8.5mm heating circuits 1 dry heating element 2 hole fixing		
For models:	ROMA/II		
accessories for	416848		
	GEV No.	361182	Ref. No.
			—
	nut thread 1/4" H 5mm nickel-plated brass WS 17 Qty 1 pcs		
	GEV No.	510417	Ref. No.
			—
	flat gasket fibre ED ø 20mm ID ø 14mm thickness 2mm Qty 1 pcs		
	GEV No.	520228	Ref. No.
			—
	tooth lock washer ID ø 15.3mm ED ø 24mm steel Qty 1 pcs for thread M14		
	GEV No.	550262	Ref. No.
			—
	flat gasket copper ED ø 20mm ID ø 14mm thickness 2mm		



GEV No.	418781	Ref. No.	A02011008
description	heating element 900W 230V L 350mm W 300mm connection distance 220mm L1 40mm L2 90mm L3 220mm W1 40mm W2 220mm tube ø 6.3mm heating circuits 1 pizza oven		

heating elements for chargrills



GEV No.	415965	Ref. No.	01037311315
description	heating element 1800W 230V L 486mm W 83mm H 30mm 2 hole fixing mounting distance 72mm connection M4 L1 38mm L2 448mm heating circuits 1 tube ø 6.3mm dry heating element thread M12x1 for sausage warmer		
accessories for	415965		
	GEV No.	520229	Ref. No.
			—
	nut thread M12x1 H 4mm WS 16 zinc-coated steel Qty 1 pcs		
	GEV No.	521110	Ref. No.
			—
	flat gasket fibre ED ø 20mm ID ø 13mm thickness 2mm Qty 1 pcs		
	GEV No.	521131	Ref. No.
			—
	nut thread M12x1 H 3.5mm WS 17 SS Qty 1 pcs		
	GEV No.	528110	Ref. No.
			—
	O-ring EPDM thickness 2.62mm ID ø 12.37mm Qty 1 pcs		

heating elements for salamanders/toast-

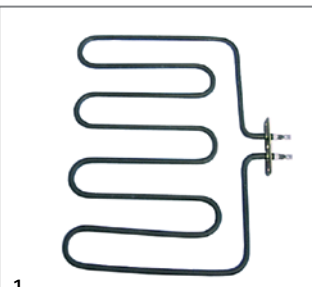

GEV No.	415659	Ref. No.	011029
description	heating element 2000W 230V heating circuits 1 L 230mm W 303mm L1 35mm L2 195mm W1 135mm W2 33mm flange length 70mm flange width 22mm hole distance 56mm tube ø 8.5mm dry heating element connection M5 rectangular flange hole ø 5mm H 8.5mm		



GEV No.	418740	Ref. No.	OAT93607 A0AT93607
description	heating element 2000W 230V heating circuits 1 L 400mm W 200mm L1 27mm L2 373mm W1 85mm W2 30mm flange length 70mm flange width 22mm hole distance 56mm tube ø 6.5mm rectangular flange hole ø 5mm H 6.5mm		
For models:	A1515001		

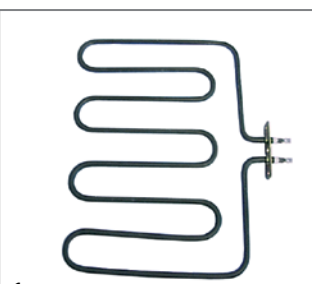



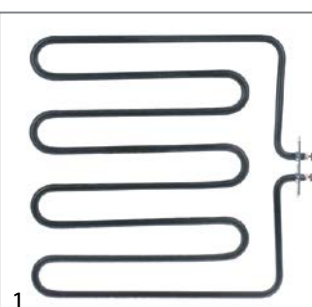

GEV No.	415660	Ref. No.	011003
description	heating element 2800W 230V heating circuits 1 L 230mm W 298mm L1 20mm L2 210mm W1 133mm W2 32mm flange length 70mm flange width 22mm hole distance 56mm tube ø 8.5mm dry heating element connection M5 rectangular flange hole ø 5mm H 8.5mm		





GEV No.	418790	Ref. No.	011008
description	heating element 2800W 400V heating circuits 1 L 305mm W 300mm L1 18mm L2 287mm W1 130mm W2 25mm flange length 70mm flange width 22mm hole distance 65mm tube ø 8.5mm connection M5 rectangular flange hole ø 5mm salamander grill H 8.5mm		





			
GEV No.	418862	Ref. No.	0V036700 A039857 EB-600-15
description	heating element 2000W 230V heating circuits 1 L 235mm W 215mm H 35mm thread M12x1 mounting distance 209mm connection length 48mm tube ø 6.3mm salamander grill		
For models:	EB600		

			
GEV No.	418653	Ref. No.	0401024000
description	heating element 2200W 230V L 350mm W 260mm thread M12 mounting distance 245mm connection 6.3 air tube ø 8.5mm heating circuits 1 H 8.5mm		
spare parts for	418653		
		GEV No. 521110	Ref. No. —
	flat gasket fibre ED ø 20mm ID ø 13mm thickness 2mm Qty 1 pcs		
accessories for	418653		
		GEV No. 520229	Ref. No. —
	nut thread M12x1 H 4mm WS 16 zinc-coated steel Qty 1 pcs		
		GEV No. 521131	Ref. No. —
	nut thread M12x1 H 3.5mm WS 17 SS Qty 1 pcs		
		GEV No. 528110	Ref. No. —
	O-ring EPDM thickness 2.62mm ID ø 12.37mm Qty 1 pcs		

			
GEV No.	420046	Ref. No.	A039856
description	heating element 2800W 230V heating circuits 1 L 240mm W 350mm H 25mm thread M12x1 mounting distance 342mm tube ø 8.5mm connection M4		
For models:	151510		

			
GEV No.	416820	Ref. No.	6001071
description	heating element 930W 230V L 260mm W 55mm thread M15x1 mounting distance 45mm connection length 26mm connection M4 tube ø 10mm heating circuits 1 dry heating element 2 hole fixing H 10mm		

			
GEV No.	416001	Ref. No.	027676
description	radiation heater rectangular 1500W 230/240V L 265mm W 165mm H 32mm heating circuits 1 connections 2 connection type cable cable length 700mm EGO salamander grill		
accessories for	416001		
		GEV No. 390880	Ref. No. 027677
	safety rod thermostat switch-off temp. 780°C temperature range°C 2-pole 1NC/1NOA probe ø 4mm probe L 170mm capillary pipemm capillary pipe isolatedmm gland nut shaft ømm		
		GEV No. 403523	Ref. No. —
	solid state relay ANLY 1 phase 40A 24-280V 4-32VDC L 47.5mm W 43mm screw type ASR-40DA		

heating elements for heating bridges

			
GEV No.	420019	Ref. No.	A01140015
description	heating element 900W 230V heating circuits 1 L 335mm W 110mm connection M4 tube ø 9.7mm connection distance 100mm		
For models:	A114001		

heating elements for heated cabinets

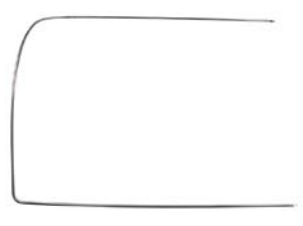
			
GEV No.	418743	Ref. No.	040576
description	heating element 1200W 230V L 220mm W 680mm H 700mm heated cabinet		
For models:	103.122		



GEV No.	418741	Ref. No.	040827
description	heating element 400W 230V L 220mm W 350mm H 440mm heated cabinet		

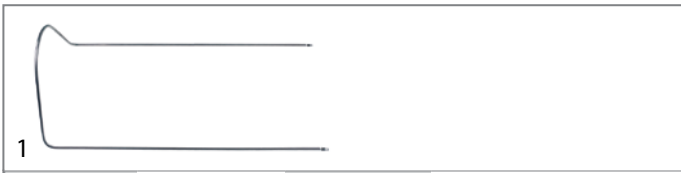

GEV No.	418742	Ref. No.	040577
description	heating element 750W 230V L 220mm W 360mm H 690mm heated cabinet		
For models:	103063		

heating plates



GEV No.	419094	Ref. No.	A01204068
description	hot plate 1000W 230V ø 150mm with mounting thread for hot dog machine connection male faston 6.3mm		



GEV No.	419093	Ref. No.	020051028 020051028+0LY20051028+A01204066 A012040618
description	hot plate 800W 230V ø 125mm with thermostat t.max. 95°C for hot dog machine connection male faston 6.3mm		

quartz heating elements



GEV No.	420048	Ref. No.	A015160016
description	quartz heating element 340W 76V L 385mm ø 11mm connection eye for model A151.600		
For models:	A151600		



GEV No.	416858	Ref. No.	A030008462
description	quartz heating element 420W 115V L 380mm ø 10mm connection male faston 6.3mm		



GEV No.	420047	Ref. No.	A041032
description	quartz heating element 425W 120V L 385mm ø 11mm connection eye for model A151.300		
For models:	A151300		

immersion heating elements

2 hole flange 74mm

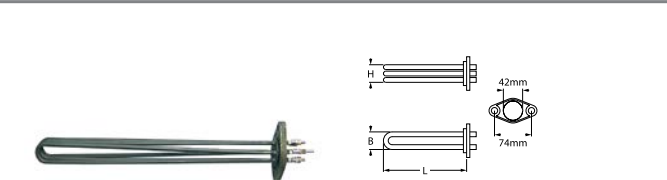

GEV No.	415190	Ref. No.	0481925928596
description	heating element 6000W 230V mounting ø 42mm heating circuits 3 L 340mm W 34mm H 30mm hole distance 75mm hole ø 9mm connection M4 immersion heater 2 hole flange flange length 93mm flange width 57mm		
accessories for	415190		

GEV No.	521103	Ref. No.	—
description	nut thread M4 H 3mm WS 7 brass Qty 20 pcs		
GEV No.	521104	Ref. No.	—
description	washer ID ø 4.3mm ED ø 8mm thickness 0.5mm brass Qty 20 pcs for thread M4		
GEV No.	521124	Ref. No.	0481946669609
description	flat gasket rubber ED ø 52mm ID ø 42mm thickness 6mm Qty 1 pcs		
GEV No.	550444	Ref. No.	—
description	protection cap ø 47mm H 40mm		
GEV No.	560111	Ref. No.	—
description	plain washer ID ø 4.3mm ED ø 9mm thickness 0.8mm SS Qty 20 pcs DIN 125A for thread M4		
GEV No.	560131	Ref. No.	—
description	hexagonal nut thread M4 H 3.2mm WS 7 SS DIN/ISO DIN 934 / ISO 4032/8673 Qty 20 pcs		



3 hole flange ø47.5mm

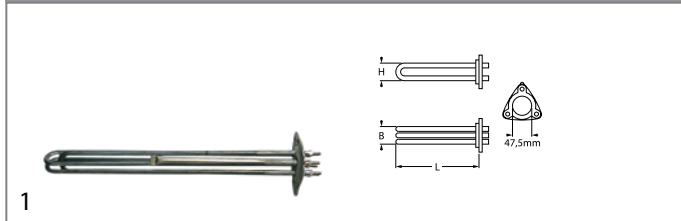

GEV No.	415001	Ref. No.	0230081
description	heating element 4500W 230V mounting ø 47.5mm heating circuits 3 L 316mm W 35mm H 34mm number of thermostat sleeves 1 thermostat sleeves ø 7mm length thermostat sleeves 180mm thermostat sleeve eccentric, non clinging tube ø 6.3mm hole distance 62mm hole ø 8mm connection M4 3 hole flange immersion heater		
spare parts for	415001		
	GEV No.	510408	Ref. No. 011510 011620
	O-ring EPDM thickness 5.34mm ID ø 47mm Qty 1 pcs		
accessories for	415001		
	GEV No.	510562	Ref. No. —
	O-ring silicone thickness 5.34mm ID ø 47mm Qty 1 pcs		
	GEV No.	521103	Ref. No. —
	nut thread M4 H 3mm WS 7 brass Qty 20 pcs		
	GEV No.	521104	Ref. No. —
	washer ID ø 4.3mm ED ø 8mm thickness 0.5mm brass Qty 20 pcs for thread M4		
	GEV No.	560111	Ref. No. —
	plain washer ID ø 4.3mm ED ø 9mm thickness 0.8mm SS Qty 20 pcs DIN 125A for thread M4		
	GEV No.	560131	Ref. No. —
	hexagonal nut thread M4 H 3.2mm WS 7 SS DIN/ISO DIN 934 / ISO 4032/8673 Qty 20 pcs		

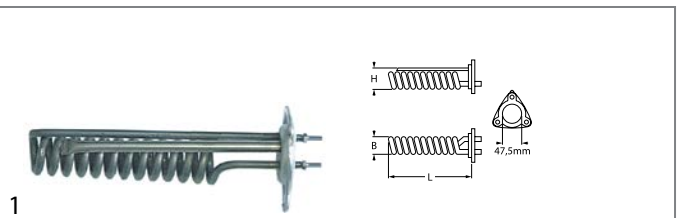

GEV No.	415668	Ref. No.	0230090
description	heating element 2625W 230V mounting ø 47.5mm heating circuits 1 L 190mm W 41mm H 54mm number of thermostat sleeves 1 thermostat sleeves ø 7mm length thermostat sleeves 170mm thermostat sleeve eccentric, non clinging tube ø 6.3mm hole distance 62mm hole ø 8mm connection M4 3 hole flange immersion heater		
spare parts for	415668		
	GEV No.	510408	Ref. No. 011510 011620
	O-ring EPDM thickness 5.34mm ID ø 47mm Qty 1 pcs		
accessories for	415668		
	GEV No.	510562	Ref. No. —
	O-ring silicone thickness 5.34mm ID ø 47mm Qty 1 pcs		

with compression flange 50 x 26mm

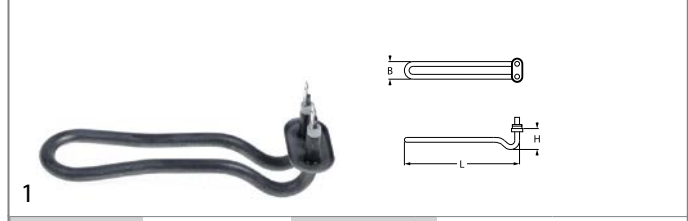







GEV No.	416234	Ref. No.	0230098
description	heating element 600W 230V heating circuits 1 flange 50x26mm L 160mm W 45mm H 27mm tube ø 8.8mm connection male faston 6.3mm connection length 40mm immersion heater compression flange		
accessories for	416234		
	GEV No.	510387	Ref. No. —
	gasket L 46mm W 22mm ømm EPDM for heating element for flange 50x26mm		
	GEV No.	510388	Ref. No. —
	counterflange ømm hole distance mm perforation ømm L 43mm W 21mm SS for heating element for flange 50x26mm		









1 1/4"









GEV No.	415005	Ref. No.	012290
description	heating element 2000W 230V heating circuits 1 thread 1 1/4" L 170mm W 32mm H 22mm tube ø 6.2mm connection M4		
accessories for	415005		
	GEV No.	510405	Ref. No. 012291
	flat gasket fibre ED ø 56mm ID ø 42mm thickness 2mm for thread 1 1/4" Qty 1 pcs		
	GEV No.	520232	Ref. No. —
	nut thread 1 1/4" H 5mm nickel-plated brass WS 47 Qty 1 pcs		
	GEV No.	521103	Ref. No. —
	nut thread M4 H 3mm WS 7 brass Qty 20 pcs		
	GEV No.	521104	Ref. No. —
	washer ID ø 4.3mm ED ø 8mm thickness 0.5mm brass Qty 20 pcs for thread M4		
	GEV No.	528021	Ref. No. —
	flat gasket PTFE ED ø 53mm ID ø 42.5mm thickness 3mm Qty 1 pcs equiv. no. 12001/02286 suitable for Astoria/Aurora/Brasilia/Wega		
	GEV No.	560111	Ref. No. —
	plain washer ID ø 4.3mm ED ø 9mm thickness 0.8mm SS Qty 20 pcs DIN 125A for thread M4		
	GEV No.	560131	Ref. No. —
	hexagonal nut thread M4 H 3.2mm WS 7 SS DIN/ISO DIN 934 / ISO 4032/8673 Qty 20 pcs		



			
1			
GEV No.	415664	Ref. No.	011598
description	heating element 2250W 230V heating circuits 1 L 300mm W 90mm H 25mm thread 1/8" mounting distance 64mm tube ø 6.3mm connection M4 immersion heater 2 hole fixing		
accessories for	415664		
	GEV No.	510893	Ref. No. —
	O-ring EPDM thickness 2.62mm ID ø 9.92mm Qty 1 pcs		
	GEV No.	521103	Ref. No. —
	nut thread M4 H 3mm WS 7 brass Qty 20 pcs		
	GEV No.	521104	Ref. No. —
	washer ID ø 4.3mm ED ø 8mm thickness 0.5mm brass Qty 20 pcs for thread M4		
	GEV No.	521129	Ref. No. —
	nut thread M10 H 6mm SS WS 17 Qty 1 pcs DIN/ISO DIN 439		
	GEV No.	560111	Ref. No. —
	plain washer ID ø 4.3mm ED ø 9mm thickness 0.8mm SS Qty 20 pcs DIN 125A for thread M4		
	GEV No.	560131	Ref. No. —
	hexagonal nut thread M4 H 3.2mm WS 7 SS DIN/ISO DIN 934 / ISO 4032/8673 Qty 20 pcs		

			
1			
GEV No.	415665	Ref. No.	017677 0230060
description	heating element 2750/3250W 220/240V heating circuits 1 L 380mm W 110mm H 30mm thread M10x1 mounting distance 75mm tube ø 6.5mm connection M4 immersion heater 2 hole fixing		
spare parts for	415665		
	GEV No.	510893	Ref. No. —
	O-ring EPDM thickness 2.62mm ID ø 9.92mm Qty 1 pcs		
accessories for	415665		
	GEV No.	510416	Ref. No. —
	flat gasket fibre ED ø 19mm ID ø 10.5mm thickness 1.5mm for thread M10 Qty 1 pcs		
	GEV No.	520231	Ref. No. —
	nut thread M10x1 H 6mm WS 14 zinc-coated steel Qty 1 pcs		
	GEV No.	521103	Ref. No. —
	nut thread M4 H 3mm WS 7 brass Qty 20 pcs		
	GEV No.	521104	Ref. No. —
	washer ID ø 4.3mm ED ø 8mm thickness 0.5mm brass Qty 20 pcs for thread M4		
	GEV No.	521129	Ref. No. —
	nut thread M10 H 6mm SS WS 17 Qty 1 pcs DIN/ISO DIN 439		
	GEV No.	560111	Ref. No. —
	plain washer ID ø 4.3mm ED ø 9mm thickness 0.8mm SS Qty 20 pcs DIN 125A for thread M4		

accessories for	415665		
	GEV No.	560131	Ref. No. —
	hexagonal nut thread M4 H 3.2mm WS 7 SS DIN/ISO DIN 934 / ISO 4032/8673 Qty 20 pcs		

			
1			
GEV No.	416235	Ref. No.	080360
description	heating element 3000W 230V heating circuits 1 L 320mm W 50mm H 40mm thread M10x1 mounting distance 44mm tube ø 6.3mm connection male faston 6.3mm 2 hole fixing L1 32mm L2 288mm		
spare parts for	416235		
	GEV No.	510893	Ref. No. —
	O-ring EPDM thickness 2.62mm ID ø 9.92mm Qty 1 pcs		
accessories for	416235		
	GEV No.	510416	Ref. No. —
	flat gasket fibre ED ø 19mm ID ø 10.5mm thickness 1.5mm for thread M10 Qty 1 pcs		
	GEV No.	510893	Ref. No. —
	O-ring EPDM thickness 2.62mm ID ø 9.92mm Qty 1 pcs		
	GEV No.	521129	Ref. No. —
	nut thread M10 H 6mm SS WS 17 Qty 1 pcs DIN/ISO DIN 439		
	GEV No.	560192	Ref. No. —
	tooth lock washer ID ø 10.4mm ED ø 18mm SS DIN/ISO DIN 6798A Qty 1 pcs for thread M10		

heating elements for convection

			
1			
GEV No.	420038	Ref. No.	A0YXD1A4A16
description	heating element 1260W 230V heating circuits 1 ID ø 181mm ED ø 193mm L 240mm H 29mm L1 39mm W1 30mm H1 12mm H2 17mm flange length 70mm flange width 22mm hole distance 56mm connection male faston 6.3mm tube ø 6.6mm hole ø 6mm		
For models:	A120788		





1

GEV No.	416850	Ref. No.	030008381
description	heating element 1260W 230V heating circuits 1 ID ø 182mm ED ø 194mm L 252mm H 30mm L1 48mm W1 30mm H1 10mm H2 20mm flange length 70mm flange width 22mm hole distance 56mm connection male faston 6.3mm tube ø 6.3mm convection heating element hole ø 5mm rectangular flange		
accessories for	416850		
	GEV No.	510368	Ref. No. 02005174
	gasket L 70mm W 23.5mm hole ø 5mm hole distance 56mm FIBER thickness 2mm for heating element		





1

GEV No.	416852	Ref. No.	030008461
description	heating element 2500W 220V heating circuits 1 ID ø 183mm ED ø 195mm L 240mm H 26mm L1 45mm W1 31mm H1 6mm H2 20mm flange length 70mm flange width 22mm hole distance 56mm connection male faston 6.3mm tube ø 6.5mm convection heating element hole ø 5mm rectangular flange		
spare parts for	416852		
	GEV No.	510368	Ref. No. 02005174
	gasket L 70mm W 23.5mm hole ø 5mm hole distance 56mm FIBER thickness 2mm for heating element		





1

GEV No.	416851	Ref. No.	A030008458
description	heating element 1600W 230V heating circuits 1 ID ø 183mm ED ø 195mm L 250mm H 51mm L1 47mm W1 32mm H1 15mm H2 36mm flange length 70mm flange width 22mm hole distance 56mm connection male faston 6.3mm tube ø 6.3mm convection heating element hole ø 5mm rectangular flange		
accessories for	416851		
	GEV No.	510368	Ref. No. 02005174
	gasket L 70mm W 23.5mm hole ø 5mm hole distance 56mm FIBER thickness 2mm for heating element		



1

GEV No.	415966	Ref. No.	ORES006
description	heating element 2500W 230V heating circuits 1 ID ø 176mm ED ø 188mm L 210mm H 28mm L1 22mm W1 30mm H1 3mm H2 25mm flange length 70mm flange width 22mm hole distance 56mm connection male faston 6.3mm tube ø 6.3mm convection heating element hole ø 5mm rectangular flange		
spare parts for	415966		
	GEV No.	510368	Ref. No. 02005174
	gasket L 70mm W 23.5mm hole ø 5mm hole distance 56mm FIBER thickness 2mm for heating element		
accessories for	415966		
	GEV No.	510368	Ref. No. 02005174
	gasket L 70mm W 23.5mm hole ø 5mm hole distance 56mm FIBER thickness 2mm for heating element		



1

GEV No.	418936	Ref. No.	06539168
description	heating element 1700W 240V heating circuits 1 ID ø 176mm ED ø 190mm L 248mm H 34mm L1 58mm W1 31mm H1 12mm H2 22mm flange length 70mm flange width 22mm hole distance 56mm connection male faston 6.3mm connection length 55mm tube ø 6.3mm convection heating element hole ø 5mm rectangular flange		



1

GEV No.	418935	Ref. No.	06527752
description	heating element 2650W 240V heating circuits 1 ID ø 201mm ED ø 218mm L 252mm H 36mm L1 28mm W1 31mm H1 9mm H2 27mm flange length 70mm flange width 23mm hole distance 56mm connection male faston 6.3mm connection length 38mm tube ø 6.3mm convection heating element hole ø 5mm rectangular flange		



1

GEV No.	420534	Ref. No.	ORES015
description	heating element 2000W 240V heating circuits 2 ID ø 220mm ED ø 233mm L 270mm H 44mm L1 16mm W1 58mm H1 14mm H2 30mm flange length 100mm flange width 22mm connection F6.3 tube ø 6.5mm threaded		



1

GEV No.	417607	Ref. No.	ORES000
description	heating element 2x2000W 230V heating circuits 2 ID ø 185mm ED ø 200mm L 240mm H 50mm L1 40mm W1 63mm H1 15mm H2 35mm flange length 100mm flange width 22mm hole distance 85mm connection male faston 6.3mm tube ø 6.4mm hot air hole ø 4.9mm		
accessories for	417607		
	GEV No.	550986	Ref. No. —
	gasket L 100mm W 22mm 7 holes graphite thickness 1mm for heating element		

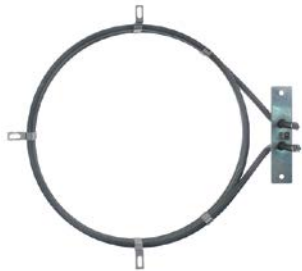

1

GEV No.	419004	Ref. No.	010578052
description	heating element 3100W 230V heating circuits 1 ID ø 223mm ED ø 239mm L 260mm H 60mm L1 20mm W1 23mm H1 20mm H2 40mm flange length 100mm flange width 22mm hole distance 86mm connection M4 tube ø 6.3mm hole ø 5.2mm		
For models:	105780		





1

GEV No.	417606	Ref. No.	ORES026
description	heating element 4500W 230V heating circuits 3 ID ø 220mm ED ø 240mm L 280mm H 50mm L1mm W1 96mm H1 15mm H2 35mm flange length 140mm flange width 25mm hole distance 63mm connection male faston 6.3mm connection length 41.5mm tube ø 8.4mm hot air hole ø 7mm		

radiation heaters



1

GEV No.	416001	Ref. No.	027676
description	radiation heater rectangular 1500W 230/240V L 265mm W 165mm H 32mm heating circuits 1 connections 2 connection type cable cable length 700mm EGO salamander grill		
accessories for	416001		
	GEV No.	390880	Ref. No. 027677
	safety rod thermostat switch-off temp. 780°C temperature range°C 2-pole 1NC/1NOA probe ø 4mm probe L 170mm capillary pipemm capillary pipe isolatedmm gland nut shaft ømm		
	GEV No.	403523	Ref. No. —
	solid state relay ANLY 1 phase 40A 24-280V 4-32VDC L 47.5mm W 43mm screw type ASR-40DA		

hot plates

square & rectangular

with radiused edge



1

GEV No.	490068 ¹	Ref. No.	01122454238
description	hot plate dimensions 220x220mm 2600W 400V with spill ring connection 4 screw clamps protector yes square		

¹incl. protector



1

GEV No.	490057 ¹	Ref. No.	016726
description	hot plate dimensions 300x300mm 3000W 400V with spill ring connection 4 screw clamps protector yes square		

¹incl. protector



round

with radiused edge

for domestic and commercial kitchens



1

GEV No.	490014	Ref. No.	017797
description	hot plate ø 180mm 1500W 230V connection 4 screw clamps with 8mm spill ring		



1

GEV No.	490020	Ref. No.	028010
description	hot plate ø 220mm 2600W 230V connection 4 screw clamps with 8mm spill ring		
accessories for	490020		
	GEV No.	550796	Ref. No.
			—
	fixing plate for hot plate ø220mm		

energy regulators

EGO

1-circuit



1

GEV No.	380009	Ref. No.	A0106041
description	energy regulator 230V 13A single-circuit turn direction left shaft ø 6x4.6mm mounting thread M4 no. 50.57020.010		



1

GEV No.	380015	Ref. No.	05057021010
description	energy regulator 230V 13A single-circuit turn direction right shaft ø 6x4.6mm shaft L 23mm mounting thread M4 power release 6-100% no. 50.57021.010		
For models:	151510		

DIAMOND



1

GEV No.	380032	Ref. No.	EB-600-08
description	energy regulator 230V 13.5A turn direction right shaft ø 6x4.6mm shaft L 23mm mounting thread M4 equiv. no. 45ER104C1		

thermostats

bi-metal thermostats

safety bi-metal thermostats



1

GEV No.	390100	Ref. No.	A017405
description	bi-metal safety thermostat hole distance 23.5mm switch-off temp. 110°C 1NC 1-pole 16A connection F6.3 mounting ø 16mm		



1

GEV No.	390708	Ref. No.	A039889
description	bi-metal safety thermostat hole distance 23.5mm switch-off temp. 180°C 1NC 1-pole 16A connection M3 mounting ø 15mm		
For models:	A150671, A150674		



1

GEV No.	390379	Ref. No.	A040625
description	bi-metal safety thermostat hole distance 23.5mm switch-off temp. 150°C 1NC 1-pole 16A connection F6.3		
For models:	A190141, A190161, REGINA90 A190192		
accessories for	390379		
	GEV No.	550389	Ref. No.
			—
	bracket for contact thermostat		

bi-metal thermostats



GEV No.	390319	Ref. No.	236048
description	bi-metal thermostat hole distance 23.8mm switch-off temp. 80°C 1NC 1-pole 16A connection F6.3 2 hole fixing		



GEV No.	390753	Ref. No.	A0ND013
description	bi-metal thermostat hole distance 24mm switch-off temp. 83°C 1NC 1-pole 16A 250V connection F6.3 2 hole fixing for coffee machine		
For models:	A190141, A190161		



GEV No.	390955	Ref. No.	A037165
description	thermostat hole distance 23.5mm switch-off temp. 73°C 1NC 1-pole 10A connection F6.3		
For models:	REGINA90 A190192		

control and safety thermostats

EGO

control thermostats

51._ series



GEV No.	375261	Ref. No.	0104231
description	thermostat t.max. 190°C temperature range 94-190°C 1-pole 1NO 15A probe ø 6mm probe L 133mm capillary pipe 890mm capillary pipe isolated 700mm gland nut M10x1 shaft L 23mm shaft position upper rotation 318°		



GEV No.	390306	Ref. No.	0236027
description	thermostat t.max. 85°C temperature range fixed 85°C 1-pole gland nut		

55.10/19_ series



GEV No.	375002	Ref. No.	A010401
description	thermostat t.max. 320°C temperature range 55-320°C 1-pole 1NO 16A probe ø 3.1mm probe L 226mm capillary pipe 870mm capillary pipe isolated 850mm gland nut shaft L 23mm shaft position upper rotation 270°		



GEV No.	390416	Ref. No.	0481927128594
description	thermostat t.max. 85°C temperature range fixed 85°C 1-pole 1CO 16A probe ø 6mm probe L 129mm capillary pipe 1470mm capillary pipe isolated 1430mm gland nut shaft Lmm shaft position		



55.13_series



GEV No.	390719	Ref. No.	A02030935
description	thermostat t.max. 110°C temperature range 30-110°C 1-pole 1NO 16A probe ø 6mm probe L 115mm capillary pipe 830mm capillary pipe isolatedmm gland nut shaft ø 6x4.6mm shaft L 23mm shaft position left rotation 270°		
For models:	A203093		



GEV No.	375705	Ref. No.	06528193
description	thermostat t.max. 110°C temperature range 30-110°C 1-pole 1NO 16A probe ø 6mm probe L 115mm capillary pipe 1430mm capillary pipe isolatedmm gland nut M9x1 shaft ø 6x4.6mm shaft L 23mm shaft position upper rotation 270°		



GEV No.	375788	Ref. No.	021899
description	thermostat t.max. 175°C temperature range 101-175°C 1-pole 1NO 16A probe ø 6mm probe L 98mm capillary pipe 870mm capillary pipe isolated 800mm gland nut shaft ø 6x4.6mm shaft L 23mm shaft position upper rotation 270°		



GEV No.	375517	Ref. No.	A039882
description	thermostat t.max. 190°C temperature range 60-190°C 1-pole 1NO 16A probe ø 6mm probe L 77mm capillary pipe 870mm capillary pipe isolatedmm gland nut shaft ø 6/4.6mm shaft L 23mm shaft position left° rotation 270°		
For models:	A150107, A150207		
accessories for	375517		
	GEV No.	Ref. No.	016240433
	 gasket for temperature probe ED ø 15mm plastic Qty 1 pcs		

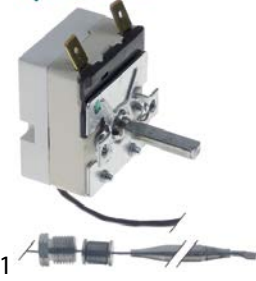

GEV No.	375492	Ref. No.	014231
description	thermostat t.max. 190°C temperature range 94-190°C 1-pole 1NO 16A probe ø 6mm probe L 94mm capillary pipe 1090mm capillary pipe isolated 960mm gland nut M10x1 shaft ø 6x4.6mm shaft L 23mm shaft position upper rotation 310° probe material SS		



GEV No.	375615	Ref. No.	0KG20509
description	thermostat t.max. 200°C temperature range 68-200°C 1-pole 1NO 16A probe ø 6mm probe L 78mm capillary pipe 870mm capillary pipe isolatedmm gland nut shaft ø 6x4.6mm shaft L 25mm shaft position left° rotation 270° probe material SS		
For models:	A203094		



GEV No.	375087	Ref. No.	06553670
description	thermostat t.max. 300°C temperature range 50-300°C 1-pole 1CO 16A probe ø 3.03mm probe L 160mm capillary pipe 1130mm capillary pipe isolated 1103mm gland nut shaft L 23mm shaft position upper rotation 270°		



GEV No.	375505	Ref. No.	01044465 030008099 A039884
description	thermostat t.max. 320°C temperature range 50-320°C 1-pole 1NO 16A probe ø 3mm probe L 160mm capillary pipe 870mm capillary pipe isolatedmm gland nut shaft ø 6x4.6mm shaft L 23mm shaft position upper rotation 270°		
For models:	104447, A150671, A150674		



GEV No.	375530	Ref. No.	029154
description	thermostat t.max. 400°C temperature range 100-400°C 1-pole 1NO 16A probe ø 3.9mm probe L 163mm capillary pipe 830mm capillary pipe isolatedmm gland nut shaft ø 6x4.6mm shaft L 23mm shaft position upper rotation 270°		



GEV No.	375006	Ref. No.	040575
description	thermostat t.max. 85°C temperature range 30-85°C 1-pole 1CO 16A probe ø 6mm probe L 92mm capillary pipe 3150mm capillary pipe isolated 300mm gland nut shaft L 23mm shaft position upper rotation 270° probe material SS		
For models:	103.122, 103063		

55.14_ series



GEV No.	390001	Ref. No.	022823 0236023
description	thermostat t.max. 58°C temperature range fixed 58°C 1-pole 1NC 16A probe ø 11mm probe L 35mm capillary pipe 580mm capillary pipe isolated 580mm gland nut shaft Lmm shaft position° shaft position screw-in probe probe thread M14x1		

accessories for	390001			
	GEV No.	510417	Ref. No.	—
	flat gasket fibre ED ø 20mm ID ø 14mm thickness 2mm Qty 1 pcs			
	GEV No.	550261	Ref. No.	—
	nut thread M14x1 H 4mm WS 19 SS Qty 1 pcs			

55.18_ series



GEV No.	375110	Ref. No.	A010502
description	thermostat t.max. 190°C temperature range 121-190°C 1-pole 1NC 16A probe ø 6mm probe L 117mm capillary pipe 390mm capillary pipe isolatedmm gland nut shaft ø 6x4.6mm shaft L 15mm shaft position left rotation 270° probe material SS		



55.34_series



GEV No.	375385	Ref. No.	023964
description	thermostat t.max. 180°C temperature range 100-180°C 3-pole 3NO 16A probe ø 6mm probe L 131mm capillary pipe 2000mm capillary pipe isolated 1800mm gland nut shaft ø 6x4.6mm shaft L 23mm shaft position upper rotation 270°		

55.13_series



GEV No.	375830	Ref. No.	020411
description	safety thermostat switch-off temp. 365°C 1-pole 1NC 16A probe ø 3mm probe L 160mm capillary pipe 1730mm capillary pipe isolated 1710mm gland nut probe		



GEV No.	375412	Ref. No.	016728
description	thermostat t.max. 320°C temperature range 50-320°C 3-pole 3NO 16A probe ø 3.1mm probe L 226mm capillary pipe 1480mm capillary pipe isolated 1400mm gland nut shaft ø 6x4.6mm shaft L 23mm shaft position upper rotation 318°		

55.32_series



GEV No.	390813	Ref. No.	049050
description	safety thermostat switch-off temp. 245°C 3-pole 20A probe ø 6mm probe L 78mm capillary pipe 1500mm capillary pipe isolated 1050mm gland nut M9x1 probe		

safety thermostats

55.11_series



GEV No.	375109	Ref. No.	A010501
description	safety thermostat switch-off temp. 240°C 1-pole 16A probe ø 4mm probe L 91mm capillary pipe 530mm capillary pipe isolated 350mm gland nut probe SS		



GEV No.	375312	Ref. No.	023965
description	safety thermostat switch-off temp. 245°C 3-pole 3NC 20A probe ø 4mm probe L 120mm capillary pipe 1800mm capillary pipe isolated 1800mm gland nut probe SS		
accessories for	375312		
	GEV No.	550981	Ref. No. —
	probe clip for pipe ø 8.5mm for probe ø 6mm for heating elements spacing 0.4mm Qty 1 pcs		



55.33_ series



GEV No.	375796	Ref. No.	06537879
description	safety thermostat switch-off temp. 220°C 3-pole 3NC 20A probe ø 6mm probe L 107mm capillary pipe 870mm capillary pipe isolated 800mm gland nut probe		

control thermostats with operation switch

55.10/19_ series



GEV No.	390052	Ref. No.	049672
description	thermostat t.max. 185°C temperature range 90-185°C 1-pole 1NO 15A probe ø 4mm probe L 229mm capillary pipe 2500mm capillary pipe isolated 1200/200mm gland nut shaft ø 6x4.6mm shaft L 23mm shaft position upper° rotation 270° outer switch 2NO		

IMIT / TEMPOMATIC / ARTHERMO

control thermostats



GEV No.	390421	Ref. No.	0236043
description	thermostat t.max. 85°C temperature range 0-90°C 1-pole 1CO 16A probe ø 6.5mm probe L 95mm capillary pipe 1500mm capillary pipe isolated 1450mm gland nut shaft ømm shaft Lmm shaft position rotation 270° probe material copper		

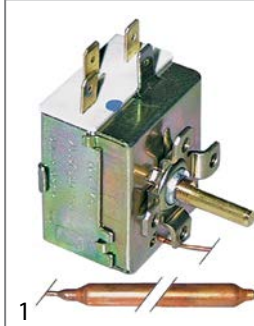

GEV No.	390006	Ref. No.	0929044
description	thermostat t.max. 86°C temperature range 0-86°C 1-pole 1CO 16A probe ø 6.5mm probe L 95mm capillary pipe 1500mm capillary pipe isolatedmm gland nut shaft ø 6x4.6mm shaft L 19mm rotation 270°		
accessories for	390006		



GEV No.	110100	Ref. No.	—
description	knob thermostat t.max. 90°C 0-90°C ø 42mm shaft ø 6x4.6mm shaft flat -135° black		



GEV No.	110105	Ref. No.	—
description	rosette knob ø 42mm ø 56mm zero mark		

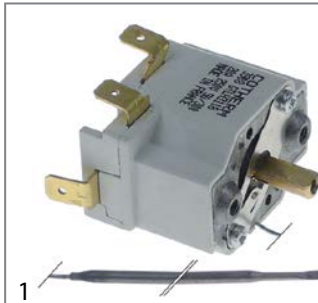

GEV No.	390718	Ref. No.	A0YXD1A4A11
description	thermostat temperature range 50-300°C 1-pole 1NO 20A probe ø 3mm probe L 190mm capillary pipe 900mm shaft ø 6x4.6mm shaft L 12.5mm shaft position upper rotation 270° 250V		
For models:	105780, A120788		

CAEM

control thermostats



GEV No.	390602	Ref. No.	A0402503000
description	thermostat t.max. 300°C temperature range 50-300°C 1-pole 1NO 16A probe ø 5mm probe L 70mm capillary pipe 900mm capillary pipe isolated 700mm gland nut shaft L 18mm rotation 270°		



 <p>1</p>			
GEV No.	375419	Ref. No.	A030008288
description	thermostat t.max. 300°C temperature range 50-300°C 1-pole 1NO 16A probe ø 5mm probe L 90mm capillary pipe 890mm rotation 270°		

safety thermostats

 <p>1</p>			
GEV No.	376029	Ref. No.	TER008
description	safety thermostat switch-off temp. 320°C temperature range °C 1-pole 1NC 20A probe ø 3mm probe L 165mm capillary pipe 1280mm capillary pipe isolated 1080mm gland nut shaft ømm probe SS 250V		

 <p>1</p>			
GEV No.	375990	Ref. No.	OTER035 OTER325 TER002 TER008 old
description	safety thermostat switch-off temp. 335°C 1-pole 16A probe ø 3mm probe L 180mm capillary pipe 1400mm capillary pipe isolated dmm gland nut M10x1 probe SS		

PRODIGY / FIRT

safety thermostats

 <p>1</p>			
GEV No.	375478	Ref. No.	0927106
description	safety thermostat switch-off temp. 200°C temperature range °C 1-pole 1CO 20A probe ø 3.3mm probe L 190mm capillary pipe 2150mm capillary pipe isolated dmm gland nut probe SS		

various

control thermostats

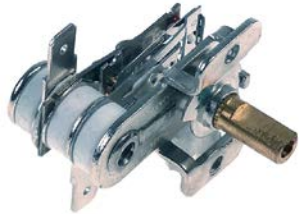
 <p>1</p>			
GEV No.	390623	Ref. No.	A02011002
description	thermostat for pizza oven		

 <p>1</p>			
GEV No.	376082	Ref. No.	020006332
description	thermostat t.max. 100°C 16A probe ø 6mm probe L 88mm capillary pipe 510mm capillary pipe isolated 160mm shaft ø 6x4.6mm shaft L 20mm rotation 270°		

 <p>1</p>			
GEV No.	390622	Ref. No.	01143566
description	thermostat t.max. °C temperature range °C 1-pole 1NC 10A probe ømm probe Lmm capillary pipemm capillary pipe isolated dmm gland nut shaft ø 6x4.6mm shaft L 30mm shaft position upper rotation 315° for heated cabinet		

safety thermostats

 <p>1</p>			
GEV No.	375523	Ref. No.	016240438 A039891
description	safety thermostat switch-off temp. 230°C 1-pole 1NC 16A probe ø 4mm probe L 100mm capillary pipe 900mm capillary pipe isolated 410mm gland nut probe		
For models:	A150107, A150207		



1

GEV No.	390720	Ref. No.	A0YXD4A26
description	thermostat switch-off temp. 320°C 1-pole 1NC 16A probe ø 5mm probe L 57mm capillary pipe 870mm capillary pipe isolated 45mm screw connection M10x1		
For models:	105780, A120788		

rod thermostats

safety rod thermostats



1

GEV No.	390880	Ref. No.	027677
description	safety rod thermostat switch-off temp. 780°C temperature range°C 2-pole 1NC/1NOA probe ø 4mm probe L 170mm capillary pipemm capillary pipe isolatedmm gland nut shaft ømm		

refrigeration thermostats

miscellaneous producers



1

GEV No.	390481	Ref. No.	030008404
description	thermostat		

accessories

probe clips

clamps

for thermostat



1

GEV No.	692185	Ref. No.	016210821
description	probe clip for probe ø 6mm SS Qty 1 pcs L 40mm W 14mm		



1

GEV No.	692184	Ref. No.	016240410
description	probe clip for probe ø 6mm SS Qty 1 pcs L 57mm W 20mm		

switches and momentary switches
rocker/momentary rocker switches

30x11 mm



1

GEV No.	301010	Ref. No.	A0ND021	
description	rocker switch mounting measurements 30x11mm red 1NO/indicator light 250V 16A 0-I connection male faston 6.3mm ambient temperature max. 85/125°C protection IP40			
For models:	A190141, A190161			
accessories for	301010			
	GEV No.	301035	Ref. No.	—
	protective cover mounting measurements 30x11mm			



1

GEV No.	301038	Ref. No.	01143568
description	rocker switch mounting measurements 30x11mm green 1NO/indicator light 250V 16A connection male faston 6.3mm		



1

GEV No.	346890	Ref. No.	SL0758	
description	rocker switch mounting measurements 30x11mm black 1CO 250V 16A I-II connection male faston 6.3mm ambient temperature max. 85°C/145°C protection IP65 with cover cap			
accessories for	346890			
	GEV No.	301035	Ref. No.	—
	protective cover mounting measurements 30x11mm			

30x22mm





1



GEV No.	347791	Ref. No.	A040573
description	rocker switch mounting measurements 30x22mm green 2NO 230V 20A illuminated 0-I connection male faston 6.3mm ambient temperature max. 125/55°C protection IP65 with rubber collar		



			
1			
GEV No.	347531	Ref. No.	016210836
description	rocker switch mounting measurements 30x22mm green 2NO 250V 20A illuminated 0-I connection male faston 6.3mm ambient temperature max. 125/55°C protection IP65 with rubber collar		

			
1			
GEV No.	301062	Ref. No.	06540129
description	rocker switch mounting measurements 30x22mm green 2NO 250V 16A illuminated connection male faston 6.3mm ambient temperature max. 100/55°C protection IP40		
accessories for	301062		
	GEV No.	301036	Ref. No.
			—
	 protective cover internal size 30x22mm for rocker switch mounting measurementsmm		

			
1			
GEV No.	301101	Ref. No.	030008385
description	rocker switch mounting measurements 30x22mm white 2CO 250V 16A connection male faston 6.3mm ambient temperature max. 100/55°C protection IP40		

blank			
			
1			
GEV No.	301005	Ref. No.	A017615
description	rocker switch mounting measurements 30x22mm red 2NO 250V 16A illuminated connection male faston 6.3mm ambient temperature max. 125/55°C protection IP65 with protecting cover		
accessories for	301005		
	GEV No.	301036	Ref. No.
			—
	 protective cover internal size 30x22mm for rocker switch mounting measurementsmm		

push/momentary push switches

ø16mm			
			
1			
GEV No.	347363	Ref. No.	A038978
description	momentary push switch mounting ø 16mm black 1NO 250V 3A connection male faston 4.8mm ambient temperature max. 85°C protection IP40		
For models:	105780, A120788		

ø25mm			
			
1			
GEV No.	348211	Ref. No.	016148
description	push switch mounting ø 25mm red 1NO/indicator light 250V 16A illuminated connection male faston 6.3mm ambient temperature max. 85°C protection IP65 with cover		

overload switches			
			
1			
GEV No.	348137	Ref. No.	017319526
description	push switch KLD-28A mounting measurements 45x22mm green/red 2NO/A1 250V 16A I O connection male faston 2.8mm/6.3mm ambient temperature max. 85°C protection IP55 with cover cap		

toggle switches			
M12x1			
			
1			
GEV No.	347340	Ref. No.	A01140013
description	toggle switch thread M12x1 1NO 250V 15A ON-OFF screw		
For models:	A114001		

microswitches			
lever actuated			
			
1			
GEV No.	345049	Ref. No.	011505 011644 012273
description	microswitch with lever CO connection male faston		

pin-plunger actuated			
			
1			
GEV No.	345060	Ref. No.	A0800045
description	microswitch with plunger 250V 16A 1NO connection male faston 6.3mm ambient temperature max. 85°C mounting distance 22mm type BS1010 actuating force: 350g red stroke 9mm		



M10



1

GEV No.	347341	Ref. No.	016240435 A040031
description	microswitch with plunger thread M10x1 thread L 16mm 250V 10A 1NO connection male faston 6.3mm stroke 5mm mounting distance L 41mm ambient temperature max. 85°C type X3L502K6DD actuating force: 130g		
For models:	A150107, A150207		

M12



1

GEV No.	345138	Ref. No.	010578032
description	microswitch with plunger mounting distance 25mm thread M12x1 thread L 12mm 250V 20A 1CO connection screw stroke 7mm L1 13mm ambient temperature max. 85°C type Z15G1307 actuating force: 250g		
For models:	105780		

system switches (ROLD)



1

GEV No.	345606	Ref. No.	0226071
description	momentary switch unit 2CO 250V 16A connection male faston 6.3mm		



1

GEV No.	345538	Ref. No.	0227050
description	push button ø 11.9mm black		

cam switches

4-position



1

GEV No.	300094	Ref. No.	A010708
description	cam switch 4 operating positions 1NO/2CO sequence 0-1-2-3 16A shaft ø 6x4.6mm shaft L 15mm connection screw 4-position ceramic		

7-position



1

GEV No.	300031	Ref. No.	06553435 A030008088
description	cam switch 7 operating positions 1NO/2CO sequence 0-1-2-3-4-5-6 16A shaft ø 6x4.6mm shaft L 23mm connection male faston 6.3mm 7-position plastic		

4 operating positions



1

GEV No.	347366	Ref. No.	A040081
description	rotary switch 4 operating positions 2NO sequence 0-1-2-3 16A shaft ø 6x4.6mm shaft L 23mm connection male faston 6.3mm 250V A040081 sets of contacts 2 plastic for oven		
For models:	A151600		



operation switches

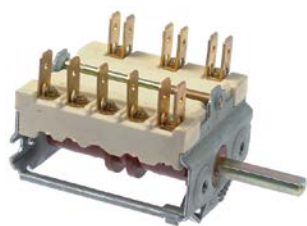

1			
GEV No.	300209	Ref. No.	06552194
description	cam switch 5 operating positions operation switch 16A sequence 0-1-2-3-4 shaft \varnothing 6x4.6mm shaft L 23mm connection male faston ceramic 3-pole ambient temperature max. 330°C		

rotary switches

miscellaneous



1			
GEV No.	347367	Ref. No.	A040080
description	rotary switch sets of contacts 2 4 0-1-2-3 type A040080 250V 16A shaft \varnothing 6x4.6mm shaft L 22.5mm with knob connection male faston 6.3mm for oven		
For models:	A151300		
accessories for	347367		
	GEV No.	112626	Ref. No. A040082
	knob oven t.max.°C \varnothing 41mm shaft \varnothing 6x4.6mm shaft flat lower black		

magnetic switches

accessories

magnets

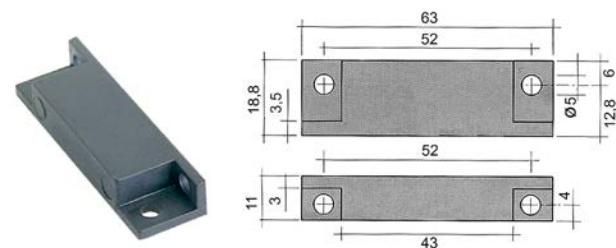

1			
GEV No.	345336	Ref. No.	0926014
description	magnet \varnothing 4.8mm L 63mm H 11mm W 18.8mm hole distance 51mm M4		

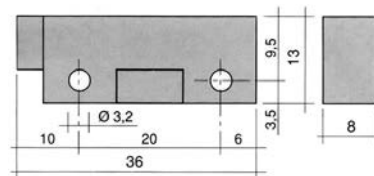

1			
GEV No.	345398	Ref. No.	0217003
description	magnet \varnothing mm L 36mm H 8mm W 13mm hole distance 20mm M3 hole \varnothing 3mm		

lamps

indicator lights

indicator lights 2-piece (lens and indicator lamp)

indicator lamps for socket type SRZ / SDK / SDY / SFK



1			
GEV No.	359130	Ref. No.	010426 0216006
description	indicator lamp 230V clear connection male faston 6.3mm \varnothing 8mm		

indicator lights (complete)

\varnothing 6mm



1			
GEV No.	359031	Ref. No.	0216022
description	indicator light \varnothing 6mm 230V green		

\varnothing 9mm



1			
GEV No.	359137	Ref. No.	021784
description	indicator light \varnothing 9mm 230V yellow connection male faston 6.3mm temp.-resist. 120°C with lens		

\varnothing 10mm

with screw socket



1			
GEV No.	359870	Ref. No.	A0ND022
description	indicator light \varnothing 10mm 230V green connection male faston 4.8mm socket screw base		
For models:	A190141, A190161		





1			
GEV No.	359872	Ref. No.	01143569
description	indicator light \varnothing 10mm 230V red connection male faston 4.8mm socket screw base		

			
1			
GEV No.	359871	Ref. No.	A040380
description	indicator light ø 10mm 230V yellow connection male faston 4.8mm socket screw base		

with plug-in socket

			
1			
GEV No.	359139	Ref. No.	0216019
description	indicator light ø 10mm green 230V connection male faston 6.3mm Qty 1 pcs		

			
1			
GEV No.	359140	Ref. No.	0216018
description	indicator light ø 10mm yellow 230V connection male faston 6.3mm Qty 1 pcs		

			
1			
GEV No.	359315	Ref. No.	A010403
description	indicator light ø 10mm 230V green cable length 250mm		

ø12mm

with plug-in socket

			
1			
GEV No.	359846	Ref. No.	01044466 A039883 EB-600-09
description	indicator light ø 12mm green 230V connection male faston 6.3mm Sinus		
For models:	104447, 151510, A120788, A150107, A150207, A150671, A150674, A203094, EB600		

			
1			
GEV No.	360509	Ref. No.	016240441 A039887 EB-600-06
description	indicator light ø 12mm yellow 230V connection male faston 6.3mm thermometer		
For models:	151510, A150107, A150207, A150671, A150674, EB600		



			
1			
GEV No.	359571	Ref. No.	010578014
description	indicator light ø 13mm green 230V connection male faston 6.3mm steaming		
For models:	105780		

			
1			
GEV No.	359570	Ref. No.	010578012
description	indicator light ø 13mm green 230V connection male faston 6.3mm temperature		
For models:	105780		

			
1			
GEV No.	359572	Ref. No.	010578015
description	indicator light ø 13mm green 230V connection male faston 6.3mm timer		
For models:	105780		

ø13mm

with screw socket

			
1			
GEV No.	359146	Ref. No.	06540106
description	indicator light ø 13mm 230V yellow		
accessories for	359146		
	GEV No.	510302	Ref. No. —
	O-ring EPDM ID ø 12.42mm thickness 1.78mm Qty 1 pcs		
	GEV No.	511505	Ref. No. —
	O-ring EPDM thickness 1.78mm ID ø 12.42mm Qty 10 pcs		

with plug-in socket

			
1			
GEV No.	357010	Ref. No.	OAT93615 A0AT93615
description	indicator light ø 13mm green clock		
For models:	A1515001		



screw-on/push-on fit

light bulbs

for ovens



1

GEV No.	359610	Ref. No.	014034 A0YXD1A4A10
description	light bulb t.max. 300°C socket E14 15W 230V ø 22mm L 47mm lens L 20mm for oven lamp type Philips		
For models:	105780, A120788		

halogen lamp

for socket G4 / G6.35 / G9



1

GEV No.	359946	Ref. No.	A01140014
description	halogen lamp socket G9 230V 40W temp.-resist. 300°C		
For models:	A114001		

fluorescent lamps

accessories

sockets



1

GEV No.	359662	Ref. No.	030008413
description	lamp socket for fluorescent lamps		

oven lamps

universal oven lamps

mounting diameter 35.5mm



1

GEV No.	359718	Ref. No.	030003005+030008380 A0YXD1A4A12
description	oven lamp mounting ø 35.5mm 230V 15W socket E14 temp.-resist. 300°C connection male faston 6.3mm hard glas		
For models:	105780, A120788		
spare parts for	359718		
	GEV No.	359701	Ref. No. —
	lamp socket socket E14 220-230V mounting ø 35.5mm connection male faston 6.3mm 15W		

spare parts for	359718		
	GEV No.	359740	Ref. No. —
	light bulb t.max. 300°C socket E14 15W 230V ø 22mm L 48mm lens L 20mm for oven lamp IMPORT		

lamps

light bulbs



1

GEV No.	359610	Ref. No.	014034 A0YXD1A4A10
description	light bulb t.max. 300°C socket E14 15W 230V ø 22mm L 47mm lens L 20mm for oven lamp type Philips		
For models:	105780, A120788		

halogen lamps

for socket G4 / G6.35 / G9



1

GEV No.	359946	Ref. No.	A01140014
description	halogen lamp socket G9 230V 40W temp.-resist. 300°C		
For models:	A114001		

sockets

G9



1

GEV No.	359742	Ref. No.	0200201013
description	lamp socket L 36mm mounting distance 28mm		
For models:	A114001		



timers

programme timers



1

GEV No.	360726	Ref. No.	OINV013 OINVER230
description	programme timer Guaitani R3/3 engines 1 chambers 3 operation time 6min 220/240V 50/60Hz shaft \varnothing 6x6mm shaft L 44mm manuf. no. R3/3 motor type UDS40NE1RNZ165		
spare parts for	360726		
	GEV No.	360673	Ref. No. —
	motor kit pinion \varnothing 6.8mm teeth 15 230V voltage AC 50/60Hz turn direction clockwise motor \varnothing 48mm H 18.5mm motor type UDS-40NE1RNZ165 cable length 150mm with holder		



1

GEV No.	400740	Ref. No.	A017610
description	timer		



1

GEV No.	360005	Ref. No.	012268 0238052
description	timer BIGATTI D94 engines 1 chambers 1 operation time 20min 230V shaft \varnothing mm shaft Lmm manuf. no. WE006 motor type 82354021L		



1

GEV No.	360349	Ref. No.	018202 0238053
description	timer CDC 11803 engines 1 chambers 3 operation time 150s 230V shaft \varnothing mm shaft Lmm manuf. no. 11803F1BEE000.0010 motor type M48R ATS type 11803F1 / 238046		
spare parts for	360349		
	GEV No.	360673	Ref. No. —
	motor kit pinion \varnothing 6.8mm teeth 15 230V voltage AC 50/60Hz turn direction clockwise motor \varnothing 48mm H 18.5mm motor type UDS-40NE1RNZ165 cable length 150mm with holder		



1

GEV No.	360413	Ref. No.	010578024
description	timer FIBER P19 engines 1 chambers 2 operation time 4min 230V 50Hz shaft \varnothing mm shaft Lmm		
For models:	105780		



1

GEV No.	360152	Ref. No.	A010701
description	timer with permanent position 2-pole NO for B1 operation time 120min		

electric timers





1

GEV No.	350194	Ref. No.	OTIM000 OTIM060
description	timer MS65 with bell operation time 60min time spreadmin 2NO at 250V 16A permanent position yes impulse electric shaft \varnothing 6x4.6mm shaft L 23mm mounting distance 29mm mounting thread M4 connection male faston 6.3mm Invensys 230V voltage AC 2-pole		



mechanical timers

			
1			
GEV No.	360470	Ref. No.	010578022
description	timer C53 2-pole operation time 120min impulse mechanical 1NO/1NC at 250V 16A permanent position yes shaft ø 6x4.6mm shaft 6x4.6mm shaft L 23mm mounting distance 28mm		
For models:	105780		

			
1			
GEV No.	360475	Ref. No.	A0YXD1A4A06
description	timer M11 with bell 1-pole operation time 120min impulse mechanical 1NO at 250V 16A permanent position no shaft ø 6x4.6mm shaft 6x4.6mm shaft L 21mm mounting distance 28mm		
For models:	A120788		



			
1			
GEV No.	360545 ¹	Ref. No.	A040900
description	timer M11 with bell 1-pole operation time 15min 1NO at 250V 16A permanent position no shaft ø 6mm shaft 6mm shaft L 15mm mounting distance 28mm connection male faston 6.3mm with knob		
accessories for	360545		
	GEV No.	112624	Ref. No. A040898
	knob time 15min t.max.°C ø 41mm shaft ø 6mm shaft flat black rosette ø 58mm		

¹incl. knob

			
1			
GEV No.	360544	Ref. No.	A040897
description	timer M11 with bell 1-pole operation time 15min impulse mechanical 1NO at 250V 16A permanent position no shaft ø 6mm shaft 6x4.6mm shaft L 15mm mounting distance 24mm mounting thread M3 connection male faston 6.3mm		
For models:	A151300, A151600		

			
1			
GEV No.	350182	Ref. No.	0AT93623 A0AT93623
description	timer M11 with bell 1-pole operation time 15min impulse mechanical 1NO at 250V 16A permanent position no shaft ø 6x4.6mm shaft 6x4.6mm shaft L 15mm mounting distance 28mm		
For models:	A151300, A1515001, A151600		

			
1			
GEV No.	360476	Ref. No.	01207908 A040897 (old version)
description	timer M11 with bell 2-pole operation time 15min 2NO at 250V 16A shaft ø 6mm shaft L 15mm connection male faston 6.3mm		

			
1			
GEV No.	360510 ¹	Ref. No.	A040895
description	timer M11 with bell 2-pole operation time 15min 2NO at 250V 16A shaft ø 6mm shaft L 15mm connection male faston 6.3mm with knob		
spare parts for	360510		
	GEV No.	112624	Ref. No. A040898
	knob time 15min t.max.°C ø 41mm shaft ø 6mm shaft flat black rosette ø 58mm		
	GEV No.	360476	Ref. No. 01207908 A040897 (old version)
	timer M11 with bell 2-pole operation time 15min 2NO at 250V 16A shaft ø 6mm shaft L 15mm connection male faston 6.3mm		

¹incl. knob



contactors

GENERAL ELECTRIC (AEG)

power contactors



1

GEV No.	380244	Ref. No.	040100023
description	power contactor resistive load 25A 230VAC (AC3/400V) 9A/4kW main contacts 3NO auxiliary contacts 1NO connection screw connection type AEG LS4K 10A type GE CL00A 310		



1

GEV No.	380264	Ref. No.	017594
description	power contactor resistive load 45A 230VAC (AC3/400V) 25A/11kW main contacts 3NO auxiliary contacts connection screw connection type AEG LS11K 00A type GE CL25A 300		

SIEMENS

power contactors



1

GEV No.	380389	Ref. No.	0229037
description	power contactor resistive load 22A 230VAC (AC3/400V) 9A/4kW main contacts 3NO auxiliary contacts 1NO connection screw connection type 3RT10-16-1AP01		



1

GEV No.	380957	Ref. No.	0927051
description	power contactor resistive load 22A 24VAC (AC3/400V) 12A/5.5kW main contacts 3NO auxiliary contacts 1NO connection screw connection type 3RT10-17-1AB01 50/60Hz		

miscellaneous

power contactors



1

GEV No.	380915	Ref. No.	010578021
description	power contactor 230V resistive load 32A main contacts 3NO auxiliary contacts 1NO connection screw type CJX2-1810 SHAPU		
For models:	105780		

relays

power relays

with bracket mounting



1

GEV No.	380312	Ref. No.	0229023 0229024
description	power relays FINDER 230VAC 10A 3CO connection male faston 4.8mm bracket mounting dimensions 52x32.2x36.5mm manuf. no. 60.63.8.230.0000		

1

GEV No.	380139	Ref. No.	0926021
description	power relays FINDER 230VAC 16A 2CO connection F6.3 bracket mounting dimensions 68x38.2x35.8mm manuf. no. 62.82.8.230.0000		



1

GEV No.	380403	Ref. No.	0229036
description	power relays FINDER 230VAC 16A 3CO connection F6.3 bracket mounting manuf. no. 62.83.8.230.0500		



1

GEV No.	380185	Ref. No.	020473
description	power relays Italiana Relè 230VAC 30A 1NO connection F6.3 bracket mounting dimensions 36.5x32.2x51.8mm manuf. no. A10-230AC-FA		

magnetrons



1

GEV No.	403173	Ref. No.	0610181C08
description	Magnetron type 2M248(JT)		

probes

producer-specific probes

probes



1

GEV No.	379887	Ref. No.	0SON006
description	temperature probe Pt100 cable high temperature film probe -50 up to +200°C cable -50 up to +200°C connection 2-wire thread M10x1.5 probe ø5x42mm cable length 1.9m		

core probes



1

GEV No.	379886	Ref. No.	0SON000
description	core temperature probe Pt100 cable PTFE probe -40 up to +250°C cable -40 up to +250°C connection 2-wire probe ø4x100mm thread M10x1.5 cable length 3m handle ø 15mm handle length 90mm		

electronics

PCBs



1

GEV No.	402961	Ref. No.	01059331M
description	control PCB for induction device GIC2030 L 242mm W 69mm with digital display buttons 6		



1

GEV No.	403324	Ref. No.	01059353M
description	control PCB for induction device GIC2035 L 257mm W 75mm edition until 06/2010 buttons 6		

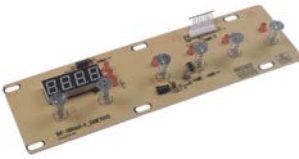

1

GEV No.	402962	Ref. No.	01059353M2
description	control PCB induction device GIC2035 L 257mm W 75mm edition since 06/2010 buttons 6		

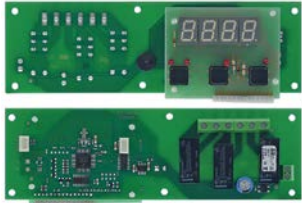

1

GEV No.	400736	Ref. No.	06010083
description	control PCB salamander grill SH50SR		



1

GEV No.	402960	Ref. No.	01059332M
description	main PCB for induction device GIC2030 L 237mm W 231mm		

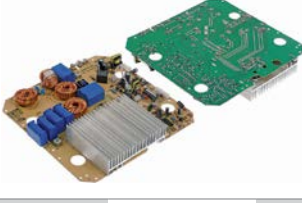

1

GEV No.	403325	Ref. No.	010583510M
description	main PCB for induction device GIC2035 L 236mm W 230mm until 06/2010		



1

GEV No.	402959	Ref. No.	010583510M2
description	main PCB induction device GIC2035 L 236mm W 230mm since 06/2010		







1

GEV No.	402045	Ref. No.	SA3600
description	PCB hand blenders FM3 with potentiometer 230V		



1

GEV No.	400899	Ref. No.	0215018	
description	power PCB dishwasher LP10/20/30 without EPROM			
accessories for	400899			
	GEV No.	400761	Ref. No.	—
	plug connector 5-pole			
	GEV No.	400900	Ref. No.	—
	EPROM CODE 225029-3			
	GEV No.	401558	Ref. No.	—
	EPROM CODE 81000-1			
	GEV No.	403241	Ref. No.	—
	EPROM type U61E for dishwasher CODE 81001-3			
	GEV No.	550048	Ref. No.	—
	female bullet			

keypads

front foils



1

GEV No.	400689	Ref. No.	A016769
description	keypad foil		



1





GEV No.	403791	Ref. No.	02012427 02016790
description	keypad foil for salamander grill model suitable for BARTSCHER 0mm for mounting pos. suitable for for model L 547mm W 67mm		



solenoid valves

solenoid valves (water)

TP			
			
1			
GEV No.	370111	Ref. No.	0927001
description	solenoid valve double straight 24VAC inlet 3/4" outlet 11.5mm DN10 TP		
spare parts for	370111		
	GEV No.	371035	Ref. No. —
	solenoid coil 24VAC		
accessories for	370111		
	GEV No.	371220	Ref. No. —
	reducer TP flow rate 3l/min red tolerance ±15%		
	GEV No.	371221	Ref. No. —
	reducer TP flow rate 5.5l/min yellow tolerance ±15%		
	GEV No.	371222	Ref. No. —
	reducer TP flow rate 6l/min grey tolerance ±15%		
	GEV No.	371223	Ref. No. —
	reducer TP flow rate 10l/min white tolerance ±15%		
	GEV No.	371224	Ref. No. —
	reducer TP flow rate 12l/min bronze tolerance ±15%		
	GEV No.	371225	Ref. No. —
	reducer TP flow rate 16l/min light brown tolerance ±15%		
	GEV No.	371226	Ref. No. —
	reducer TP flow rate 20l/min red tolerance ±15%		
	GEV No.	371230	Ref. No. —
	reducer TP flow rate 0.25l/min red tolerance ±25%		
	GEV No.	371231	Ref. No. —
	reducer TP flow rate 0.35l/min violet tolerance ±25%		
	GEV No.	371232	Ref. No. —
	reducer TP flow rate 0.5l/min orange tolerance ±25%		
	GEV No.	371233	Ref. No. —
	reducer TP flow rate 0.8l/min white tolerance ±25%		
	GEV No.	371234	Ref. No. —
	reducer TP flow rate 1l/min light blue tolerance ±25%		
	GEV No.	371235	Ref. No. —
	reducer TP flow rate 1.2l/min brown tolerance ±25%		

accessories for 370111			
	GEV No.	371236	Ref. No. —
	reducer TP flow rate 1.5l/min light brown tolerance ±25%		
	GEV No.	371237	Ref. No. —
	reducer TP flow rate 2.5l/min yellow tolerance ±25%		
	GEV No.	371238	Ref. No. —
	reducer TP flow rate 3.4l/min dark green tolerance ±25%		
	GEV No.	371239	Ref. No. —
	reducer TP flow rate 5l/min black tolerance ±25%		
	GEV No.	371240	Ref. No. —
	reducer TP flow rate 8l/min blue tolerance ±20%		















TP			
			
1			
GEV No.	370017	Ref. No.	0240011
description	solenoid valve single straight 230VAC inlet 3/4" outlet 11.5mm DN10 TP p max 10bar		
spare parts for	370017		
	GEV No.	371013	Ref. No. —
	solenoid coil TP 230VAC 50/60Hz		
accessories for	370017		
	GEV No.	371220	Ref. No. —
	reducer TP flow rate 3l/min red tolerance ±15%		
	GEV No.	371221	Ref. No. —
	reducer TP flow rate 5.5l/min yellow tolerance ±15%		
	GEV No.	371222	Ref. No. —
	reducer TP flow rate 6l/min grey tolerance ±15%		
	GEV No.	371223	Ref. No. —
	reducer TP flow rate 10l/min white tolerance ±15%		
	GEV No.	371224	Ref. No. —
	reducer TP flow rate 12l/min bronze tolerance ±15%		
	GEV No.	371225	Ref. No. —
	reducer TP flow rate 16l/min light brown tolerance ±15%		
	GEV No.	371226	Ref. No. —
	reducer TP flow rate 20l/min red tolerance ±15%		
	GEV No.	371230	Ref. No. —
	reducer TP flow rate 0.25l/min red tolerance ±25%		
	GEV No.	371231	Ref. No. —
	reducer TP flow rate 0.35l/min violet tolerance ±25%		

Table continues overleaf



accessories for		370017	
	GEV No.	371232	Ref. No. —
reducer TP flow rate 0.5l/min orange tolerance ±25%			
	GEV No.	371233	Ref. No. —
reducer TP flow rate 0.8l/min white tolerance ±25%			
	GEV No.	371234	Ref. No. —
reducer TP flow rate 1l/min light blue tolerance ±25%			
	GEV No.	371235	Ref. No. —
reducer TP flow rate 1.2l/min brown tolerance ±25%			
	GEV No.	371236	Ref. No. —
reducer TP flow rate 1.5l/min light brown tolerance ±25%			
	GEV No.	371237	Ref. No. —
reducer TP flow rate 2.5l/min yellow tolerance ±25%			
	GEV No.	371238	Ref. No. —
reducer TP flow rate 3.4l/min dark green tolerance ±25%			
	GEV No.	371239	Ref. No. —
reducer TP flow rate 5l/min black tolerance ±25%			
	GEV No.	371240	Ref. No. —
reducer TP flow rate 8l/min blue tolerance ±20%			

solenoid valves with reducers



1

GEV No.	370628	Ref. No.	017696
description	solenoid valve double straight 230VAC inlet 3/4" input 16l/min DN10 TP plastic outlet 11.5mm		

various



1

GEV No.	370589	Ref. No.	A0YXD4A39
description	solenoid valve single straight inlet 3/4" ET outlet 11.5mm male faston 6.3mm		
For models:	105780, A120788		

pressure switches

for warewashing

ø 58mm with male faston 6.3mm

with connection horizontal



1

GEV No.	541002	Ref. No.	0224002
description	pressure control pressure range 110/60mbar connection 6mm ø 58mm pressure connection horizontal warewashing pressure connection ø 6mm		



1

GEV No.	541105	Ref. No.	0926049
description	pressure control pressure range 180/70mbar connection 6mm ø 58mm pressure connection horizontal warewashing		



1

GEV No.	541013	Ref. No.	0929039
description	pressure control pressure range 55/25mbar connection 6mm ø 58mm pressure connection horizontal warewashing		



1

GEV No.	541003	Ref. No.	011515 011595 0224003
description	pressure control pressure range 55/35mbar connection 6mm ø 58mm pressure connection horizontal warewashing pressure connection ø 6mm		



compressors

ACC/ZEL

R600A

LBP monophase

Lower evaporation temperature below -20°C



1

GEV No.	605150	Ref. No.	038281
description	compressor coolant R600a type HVM10AA 220-240V 50Hz LBP 8.7kg 1/6HP cylinder capacity 10cm ³ RSIR H 180mmWWWWWWWWW		

fans

axial fans

import



1

GEV No.	601743	Ref. No.	01058355
description	axial fan L 80mm W 80mm H 25mm 18VDC 1.8W connection coded plug cable length 300mm		

refrigeration fans

cooling motors (complete)



1

GEV No.	601145	Ref. No.	030609
description	fan 230V 10W		

cold air circulating fans (other)



1

GEV No.	602132	Ref. No.	038169
description	fan motor 220-240V 50Hz IN 22W / OUT 5W shaft ø 4mm shaft L 20/48mm L 65mm W 66mm H 73mm fan wheel ø 150mm Qty 1 pcs		
For models:	700158G-McDonalds		

cross flow fans

COPREL

with standard coil



1

GEV No.	601453	Ref. No.	030008386
description	cross flow fan TFR 180 roller ø 60mm roller length 180mm laminated core thickness 16mm motor position right 230V/50-60Hz 17W universal bearing silicone connection male faston 6.3mm airflow 100m ³ /h -30 up to +100°C 230V 50Hz		

accessories for	601453			
	GEV No.	415114	Ref. No.	—
	heater battery mounting distance 185mm W 40mm H 35mm 2000W 230V temperature restriction 105°C heating circuits 2 connection cable cable length 150mm L 192mm for cross flow fan			



hot air motors



GEV No.	601993	Ref. No.	0MOT001
description	fan motor 230V 1 phase 50Hz 0.18/0.12kW 2800rpm speeds 1 L1 85mm L2 65mm L3 23mm D1 ø 8mm D2 ø 6mm M5x0.8 0.8A suitable capacitor 5µF/450V		
accessories for	601993		
	GEV No.	365017	Ref. No. —
description	operating capacitor capacity 5µF 450V tolerance 5% 50/60Hz ambient temperature max. -25 to +85°C ø 28mm L 54mm M8 plastic connection male faston 6.3mm 16.10.08 protection		



GEV No.	601690	Ref. No.	010578043
description	fan motor 230V 50Hz 0.09kW 2450rpm L1 80mm L2 20mm L3 35mm L4 20mm D1 ø 12mm D2 ø 8x6mm M5		
For models:	105780		



GEV No.	601688	Ref. No.	010578050
description	fan wheel D1 ø 200mm H1 43mm blades 39 D2 ø 8x6mm D3 ø 8mm H2 29mm		
For models:	105780		

hot air fans

miscellaneous

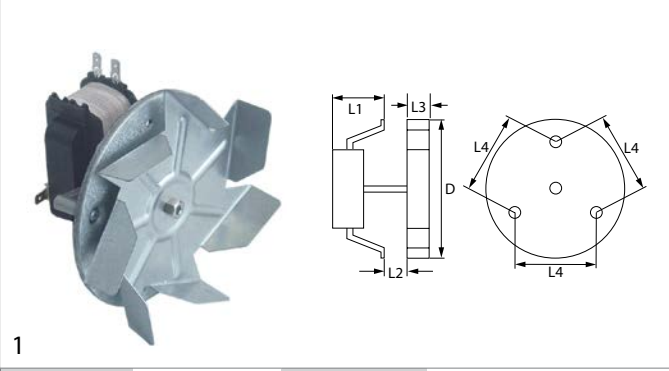

GEV No.	601124	Ref. No.	009G623
description	hot air fan 220-240V 30W L1 60mm L2 12mm L3 25mm L4 84mm fan wheel ø 150mm IMS type VRB150H2028		

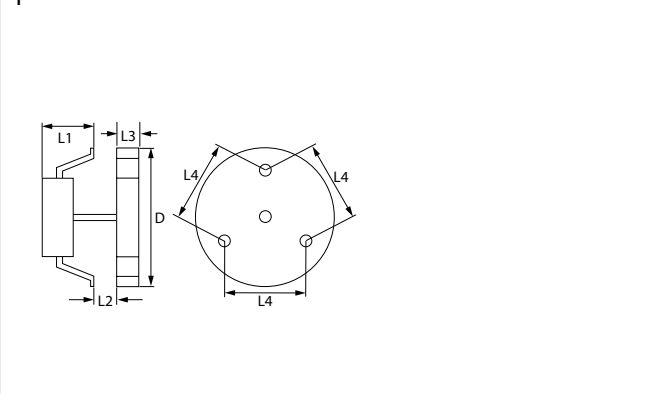
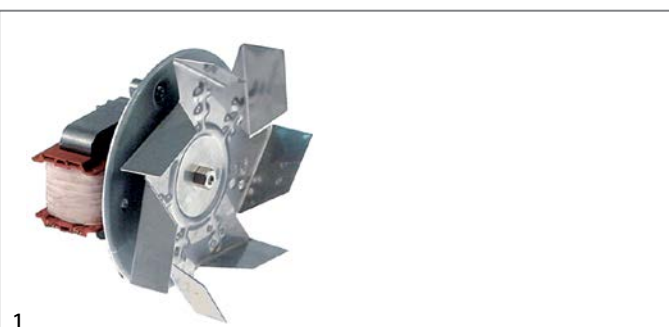

GEV No.	601054	Ref. No.	023117700
description	hot air fan 220-240V 32W 50/60Hz L1 60mm L2 10mm L3 25mm L4 87mm fan wheel ø 150mm FIME type C20X0E01/46		

spare parts for	601054		
	GEV No.	601441	Ref. No. —
description	fan wheel ø 150mm W 25mm shaft intake ø 6x5mm stainless steel blades 7		

accessories for	601054		
	GEV No.	550879	Ref. No. —
description	insulation ø 130mm thickness 3mm hole ø 20mm for hot air fan		

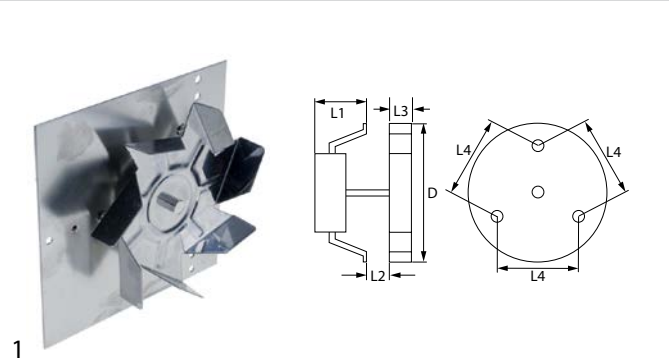

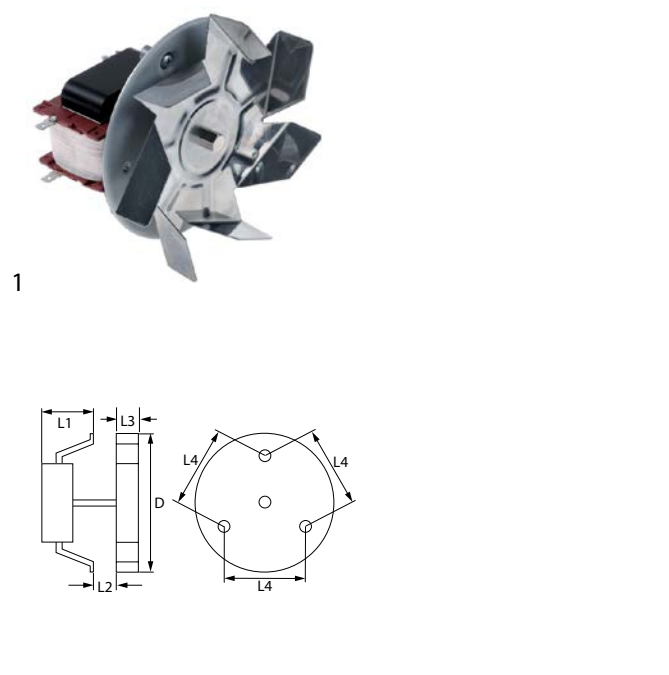

1

GEV No.	601548	Ref. No.	A0000103006
description	hot air fan 220-240V 40W 50/60Hz L1 65mm L2 11mm L3 25mm L4 87mm fan wheel ø 150mm FIME type C25R8023CLH		
accessories for	601548		
	GEV No.	601441	Ref. No. —
	fan wheel ø 150mm W 25mm shaft intake ø 6x5mm stainless steel blades 7		



1

GEV No.	601125	Ref. No.	0A036410
description	hot air fan 220-240V 45W 50/60Hz L1 70mm L2 11mm L3 25mm L4 87mm fan wheel ø 150mm FIME type C30R0479CLF		
For models:	A120788		
accessories for	601125		
	GEV No.	550879	Ref. No. —
	insulation ø 130mm thickness 3mm hole ø 20mm for hot air fan		

motors

gear motors

for conveyor toaster

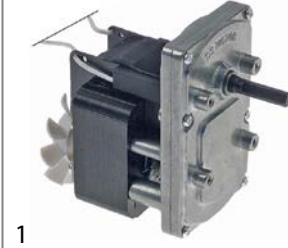

1

GEV No.	602131	Ref. No.	A01002057 QXYH6030M23G
description	gear motor W 230V voltage AC 50Hz 1 phaserpm shaft ø 7mm L 92mm W 60mm H 96mm		

for ice-cube maker

for paddles



1

GEV No.	501535	Ref. No.	010402530
description	gear motor type 50KTYZ 6W 220-240V 50/60Hz 33/40rpm shaft ø 7mm		



pumps

wash and rinse pumps

LGB



1			
GEV No.	500156	Ref. No.	0130109
description	pump inlet ø 50mm outlet ø 50mm type ZF400SX 230V 50Hz 1 phase 0.6kW 0.8HP L 210mm rotation direction right capacitor 16µF LGB		
spare parts for	500156		
	GEV No.	509020	Ref. No. —
	impellor ø 104mm H 25mm M8L		
	GEV No.	510703	Ref. No. —
	mechanical shaft seal for shaft ø 13mm slide ring H 13mm height counter ring 5.5mm ED ø 26mm		
	GEV No.	521548	Ref. No. —
	pump cover LGB inlet ø 50mm outlet ø 50mm		
	GEV No.	521734	Ref. No. —
	pump cover bottom part		
	GEV No.	523509	Ref. No. —
	deep-groove ball bearing type 6201-2RS shaft ø 12mm ED ø 32mm W 10mm with sealing discs deep-groove ball bearing DIN 625-1		
	GEV No.	532623	Ref. No. —
	O-ring EPDM thickness 2.62mm ID ø 120.32mm Qty 1 pcs		
accessories for	500156		
	GEV No.	365021	Ref. No. 0206004
	operating capacitor capacity 16µF 425V tolerance 5% 50/60Hz ambient temperature max. -25 to +85°C ø 35mm L 73mm single M8 plastic connection male faston 6.3mm 416.10.99 protection		

OLYMPIA

pumps



1			
GEV No.	500003	Ref. No.	020727
description	pump inlet ø 45mm outlet ø 32mm type T30 230V 50Hz 1 phase 0.29kW 0.39HP L 190mm rotation direction right capacitor 8µF OLYMPIA		
spare parts for	500003		
	GEV No.	365013	Ref. No. —
	operating capacitor capacity 8µF 400V tolerance 5%Hz ambient temperature max. -25 to +85°C ø 31.5mm L 55mm M8 plastic connection male faston 6.3mm protection		
	GEV No.	510512	Ref. No. 023317
	pump cover OLYMPIA inlet ø 45mm outlet ø 31mm outlet 2 ø 24 turn direction right ø 130mm ID ø 124mm inner height 20mm		
	GEV No.	510554	Ref. No. —
	O-ring EPDM thickness 2mm ID ø 120mm Qty 1 pcs		
	GEV No.	510615	Ref. No. 012263
	impellor ø 90mm H 22mm rotation direction right thread M10L blades 4		
	GEV No.	510693	Ref. No. 0141002 021188
	mechanical shaft seal for shaft ø 12mm slide ring ext. ø 24mm slide ring H 15.5mm slide ring int. ø 11mm counter ring mounting ø 24mm height counter ring 8mm counter ring int. ø 13.5mm		



1

GEV No.	500525	Ref. No.	0150914
description	pump inlet ø 50mm outlet ø 30mm type T7 230V 50Hz 1 phase 0.52kW 0.71HP L 230mm rotation direction right capacitor 12.5µF OLYMPIA		
spare parts for	500525		
	GEV No.	365014	Ref. No. —
	operating capacitor capacity 12.5µF 450V tolerance 5%Hz ambient temperature max. -25 to +85°C ø 35mm L 70mm M8 plastic connection male faston 6.3mm 45S.C3DS.12.5 protection		
	GEV No.	510554	Ref. No. —
	O-ring EPDM thickness 2mm ID ø 120mm Qty 1 pcs		
	GEV No.	510693	Ref. No. 0141002 021188
	mechanical shaft seal for shaft ø 12mm slide ring ext. ø 24mm slide ring H 15.5mm slide ring int. ø 11mm counter ring mounting ø 24mm height counter ring 8mm counter ring int. ø 13.5mm		
	GEV No.	517368	Ref. No. —
	impellor ø 102mm H 21mm rotation direction right thread M10L suitable for Dühr blades 8		
	GEV No.	521556	Ref. No. —
	pump cover OLYMPIA inlet ø 50mm outlet ø 30mm outlet 2 ø 30 auxiliary pressure connection 10mm supporting pressure open turn direction right ø 130mm ID ø 124mm inner height 20mm		

drain pumps

ASKOLL



1

GEV No.	500214	Ref. No.	0130105 0130146
description	drain pump inlet ø 30mm outlet ø 22mm 230/240V 30W 50Hz ASKOLL type R113		

condensators & interference suppression filters

operating capacitors

plastic



1

GEV No.	365021	Ref. No.	0206004
description	operating capacitor capacity 16µF 425V tolerance 5% 50/60Hz ambient temperature max. -25 to +85°C ø 35mm L 73mm single M8 plastic connection male faston 6.3mm 416.10.99 protection		



1

GEV No.	365019	Ref. No.	0206005
description	operating capacitor capacity 20µF 400V tolerance 5% 50/60Hz ambient temperature max. -25 to +85°C ø 39.5mm L 70mm M8 plastic connection male faston 6.3mm 16.10.25. protection		



1

GEV No.	365028	Ref. No.	010578025
description	operating capacitor capacity 3µF 450V tolerance 5% 50/60Hz ambient temperature max. -25 to +85°C ø 35.5mm L 75mm M8 plastic connection male faston 6.3mm protection		
For models:	105780		

filters

interference suppression filters



1

GEV No.	365044	Ref. No.	0926144
description	interference suppression filter type FC701Y2F 250V 50-60Hz conductor 2 with E connection cable 200mm L 42mm ø 23mm Hmm Wmm plastic Qty 1 pcs		



fuses

fine fuses

			
1			
GEV No.	358533	Ref. No.	01143561
description	fine fuse size ø5x20mm 6.3A fast-acting rated 250V Qty 10 pcs		

electric accessories

terminals

terminal blocks

			
1			
GEV No.	693220	Ref. No.	030008125
description	lustre terminal 12-pole cross section 4mm ² max. 32A max 750V temp.-resist. 150°C		

connection terminals with screw/faston connections

			
1			
GEV No.	550411	Ref. No.	0220011
description	power terminal block 6-pole max. 40A max 450V connection ø6mm ² / F6.3 temp.-resist. 150°C cross section 6mm ²		

connection terminals with screw connection

			
1			
GEV No.	551109	Ref. No.	A01506752
description	connecting cable 4-pole max. 15A max 500V connection screw temp.-resist. 150°C		
For models:	A150671, A150674		

			
1			
GEV No.	551021	Ref. No.	OAT93621 A0AT93621
description	porcelain terminal block 3-pole max. 15A max 500V connection screw temp.-resist. 150°C with fastening angle t.max. 150°C Qty 1 pcs		
For models:	151510, A151300, A1515001, A151600		

gas taps

PEL

22S/O series









				
1				
GEV No.	101086	Ref. No.	010909	
description	gas tap PEL type 22S/O gas inlet M20x1.5 (tube ø 12mm) bypass nozzle ø 0.35mm gas outlet M20x1.5 (tube ø 12/10mm) thermocouple connection M9x1 pilot connection M10x1 shaft ø 10x8mm shaft L 25/17mm shaft flat lower			
spare parts for	101086			
	GEV No.	100259	Ref. No.	—
	bypass nozzle type PEL22 bore ø 0.35mm thread M6x0.5			
	GEV No.	101058	Ref. No.	—
	magnet unit L 39mm D1 ø 15.4mm D2 ø 13.5mm suitable for PEL22/EGA24197 standard			
	GEV No.	101201	Ref. No.	—
	gas tap front part shaft ø 10x8mm shaft L 25/17mm shaft flat upper/lower suitable for PEL22			
	GEV No.	101231	Ref. No.	—
	thermocouple nut T1: M9x1 T2: M18x1			
	GEV No.	101240	Ref. No.	—
	gas connection thread M20x1.5 tube ø 12/10mm for PEL gas taps with gasket and screws horizontal			
	GEV No.	101460	Ref. No.	—
	O-ring ø 12.37mm D1 ø 2.62mm suitable for PEL22			
	GEV No.	101461	Ref. No.	—
	screw kit suitable for PEL22 Qty 4 pcs			
accessories for	101086			
	GEV No.	100908	Ref. No.	—
	union screw thread M10x1 for pipe ø 4mm Qty 1 pcs			
	GEV No.	100909	Ref. No.	—
	union screw thread M10x1 for pipe ø 6mm Qty 1 pcs			
	GEV No.	101241	Ref. No.	—
	gas connection thread M20x1.5 tube ø 12/10mm for PEL gas taps vertical			

Table continues overleaf



accessories for		101086		
GEV No.	Ref. No.	Ref. No.	Ref. No.	—
	101246			
olive for pipe ø 4mm Qty 1 pcs				
	101248			
olive for pipe ø 12mm Qty 1 pcs suitable for PEL				
	101249			
olive for pipe ø 10mm Qty 1 pcs				
	101250			
union nut thread M20x1.5 for pipe ø 10mm				
	101251			
union nut thread M20x1.5 for pipe ø 12mm				
	101286			
olive ID ø 6mm Qty 1 pcs				
	110080			
knob ø 70mm shaft ø 10x8mm shaft flat universal				
	112206			
knob dial plate silver gas tap PEL21/22/23 t.max.°C ED ø 63mm ID ø 45.5mm				

COPRECI

CAL-5200



1

GEV No.	Ref. No.	Ref. No.	Ref. No.	010038
description				
gas tap COPRECI type CAL-5200 gas inlet pipe flange ø21mm bypass nozzle ø 0.35mm gas outlet M14x1.5 (tube ø 6mm) thermocouple connection M8x1 pilot connection shaft ø 6x4.6mm shaft L 25/16mm shaft flat lower with pipe outlet				
spare parts for				
106036				
	101060			
magnet unit standard L 39mm D1 ø 15.4mm D2 ø 11mm suitable for PEL20-21/JUNKERS/EGA				

SABAF



1

GEV No.	Ref. No.	Ref. No.	Ref. No.	001G463
description				
gas tap SABAF type 10 gas inlet pipe flange ø16mm bypass nozzle ø 0.25mm gas outlet M13x1 IT (tube ø 8mm) front fixing thermocouple connection plug-in connection shaft ø 8x6.5mm shaft L 45/12mm shaft flat lower				
spare parts for				
106062				
	106723			
magnet unit L 29mm D1 ø 12.5mm D2 ø 8.5mm suitable for SABAF				
accessories for				
106062				
	101277			
olive ID ø 8mm Qty 1 pcs				
	101376			
gasket ID ø 8mm ED ø 12mm H 3/5mm				
	101477			
union screw thread M13x1 tube ø 8mm Qty 1 pcs				
	101751			
bracket				
	560082			
hexagonal screw thread M4 thread L 16mm SS WS 7 Qty 20 pcs DIN 933 / ISO 4017				

gas thermostats

SIT





630 Eurosit series







1

GEV No.	Ref. No.	Ref. No.	Ref. No.	035271800
description				
gas thermostat type 630 Eurosit series t.max. 190°C 110-190°C gas inlet 3/8" gas outlet 3/8" thermocouple connection M9x1 pilot connection M10x1 probe ø 4mm probe L 202mm capillary pipe 1050mm SIT				
accessories for				
101992				
	100904			
locking screw M10x1 for pipe ø 4mm Qty 1 pcs				
	100905			
locking screw M10x1 for pipe ø 6mm Qty 1 pcs				

Table continues overleaf

accessories for	101992			
	GEV No.	101273	Ref. No.	—
	olive for pipe ø 12mm L 9.5mm brass Qty 1 pcs suitable for universal			
	GEV No.	101276	Ref. No.	—
	union screw thread 3/8" tube ø 12mm Qty 1 pcs			
	GEV No.	101333	Ref. No.	—
	plug thread 3/8" with O-ring			
	GEV No.	510655	Ref. No.	—
	gasket silicone ø 7.8mm L 5mm blue Shore 55° Qty 10 pcs			



GEV No.	101125	Ref. No.	023035	
description	gas thermostat type 630 Eurosit series t.max. 340°C 100-340°C gas inlet 3/8" gas outlet 3/8" thermocouple connection M9x1 pilot connection M10x1 probe ø 4mm probe L 72mm capillary pipe 1050mm SIT			
accessories for	101125			
	GEV No.	100825	Ref. No.	—
	gas tap spindle shaft ø 8x6.5mm shaft L 22/14mm suitable for EUROSIT			
	GEV No.	100904	Ref. No.	—
	locking screw M10x1 for pipe ø 4mm Qty 1 pcs			
	GEV No.	100905	Ref. No.	—
	locking screw M10x1 for pipe ø 6mm Qty 1 pcs			
	GEV No.	100949	Ref. No.	—
	gasket suitable for 630 Eurosit series			
	GEV No.	101273	Ref. No.	—
	olive for pipe ø 12mm L 9.5mm brass Qty 1 pcs suitable for universal			
	GEV No.	101276	Ref. No.	—
	union screw thread 3/8" tube ø 12mm Qty 1 pcs			
	GEV No.	101333	Ref. No.	—
	plug thread 3/8" with O-ring			
	GEV No.	101390	Ref. No.	—
	gas tap spindle shaft ø 6x4.6mm shaft L 32/15mm gas tap with ignition flame suitable for ZANUSSI, MARENO for gas thermostat EUROSIT			
	GEV No.	101392	Ref. No.	—
	adapter suitable for 630 Eurosit series			
	GEV No.	110357	Ref. No.	—
	gas tap spindle shaft ø 8x6.5mm shaft L 36/12mm suitable for 630 Eurosit series			
	GEV No.	110358	Ref. No.	—
	adapter shaft ø 10x8mm shaft L 29/18mm suitable for 630 Eurosit series			

710 Minisit series

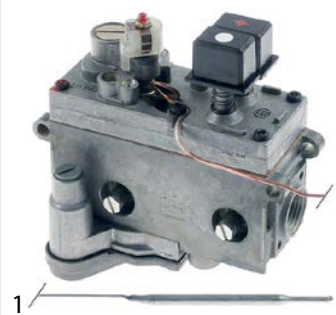











GEV No.	101437	Ref. No.	010425	
description	gas thermostat SIT type MINISIT 710 t.max. 190°C 110-190°C gas inlet 1/2" gas outlet 3/8" thermocouple connection M9x1 pilot connection M10x1 probe ø 6mm probe L 102mm capillary pipe 1050mm probe type type A3 pressure controller yes pressure regulator 3-18mbar gland nut			
spare parts for	101437			
	GEV No.	101053	Ref. No.	—
	magnet unit T1: M9x1 T2: M24x1 L 45mm ø 17mm suitable for Minisit			
	GEV No.	102118	Ref. No.	—
	probe 110-190°C probe ø 6mm probe L 102mm capillary pipe 1050mm t.max. 190°C fryer probe type type A3 suitable for MINISIT 710			
accessories for	101437			
	GEV No.	100809	Ref. No.	—
	O-ring EPDM thickness 2mm ID ø 21mm Qty 1 pcs			
	GEV No.	100820	Ref. No.	—
	gland duct ET M14x1.5 IT M10x0.75 probe ø max. 6.5mm WS 22			
	GEV No.	100904	Ref. No.	—
	locking screw M10x1 for pipe ø 4mm Qty 1 pcs			
	GEV No.	100905	Ref. No.	—
	locking screw M10x1 for pipe ø 6mm Qty 1 pcs			
	GEV No.	101054	Ref. No.	—
	magnet unit T1: M10x1 T2: M24x1 L 45mm ø 17mm suitable for Minisit			
	GEV No.	101136	Ref. No.	—
	piezoelectric igniter suitable for Minisit with cover cap ømm connection F6.3x0.8			
	GEV No.	101137	Ref. No.	—
	cover cap without piezoelectric igniter			
	GEV No.	101267	Ref. No.	—
	reducer IT 3/8" ET 1/2" L 21mm			
	GEV No.	101268	Ref. No.	—
	gas connection thread 3/8" angled with O-ring MINISIT 710			
	GEV No.	101269	Ref. No.	—
	gas connection thread 1/2" angled with O-ring MINISIT 710			
	GEV No.	101270	Ref. No.	—
	screw connection IT 3/8" ET 3/8" L 28mm			

Table continues overleaf



accessories for		101437		
Image	GEV No.	Ref. No.	Qty	Notes
	101272		—	
screw connection IT 1/2" ET 3/8" L 57mm				
	101273		—	
olive for pipe ø 12mm L 9.5mm brass Qty 1 pcs suitable for universal				
	101274		—	
olive for pipe ø 16mm Qty 1 pcs				
	101275		—	
union screw thread 1/2" for pipe ø 16mm Qty 1 pcs				
	101276		—	
union screw thread 3/8" tube ø 12mm Qty 1 pcs				
	110068		—	
knob suitable for Minisit ø 37mm				



GEV No.	101438	Ref. No.	010829
description	gas thermostat SIT type MINISIT 710 t.max. 340°C 100-340°C gas inlet 1/2" gas outlet 3/8" thermocouple connection M9x1 pilot connection M10x1 probe ø 5mm probe L 68mm capillary pipe 1050mm probe type type B1 pressure controller yes pressure regulator 3-18mbar gland nut		

spare parts for		101438		
Image	GEV No.	Ref. No.	Qty	Notes
	101053		—	magnet unit T1: M9x1 T2: M24x1 L 45mm ø 17mm suitable for Minisit
	102102		—	probe 100-340°C probe ø 5mm probe L 68mm capillary pipe 1750mm t.max. 340°C oven/grill probe type type B1 suitable for MINISIT 710

accessories for		101438		
Image	GEV No.	Ref. No.	Qty	Notes
	100809		—	O-ring EPDM thickness 2mm ID ø 21mm Qty 1 pcs
	100904		—	locking screw M10x1 for pipe ø 4mm Qty 1 pcs
	100905		—	locking screw M10x1 for pipe ø 6mm Qty 1 pcs
	101054		—	magnet unit T1: M10x1 T2: M24x1 L 45mm ø 17mm suitable for Minisit
	101136		—	piezoelectric igniter suitable for Minisit with cover cap ømm connection F6.3x0.8
	101137		—	cover cap without piezoelectric igniter

accessories for		101438		
Image	GEV No.	Ref. No.	Qty	Notes
	101267		—	reducer IT 3/8" ET 1/2" L 21mm
	101268		—	gas connection thread 3/8" angled with O-ring MINISIT 710
	101269		—	gas connection thread 1/2" angled with O-ring MINISIT 710
	101270		—	screw connection IT 3/8" ET 3/8" L 28mm
	101272		—	screw connection IT 1/2" ET 3/8" L 57mm
	101273		—	olive for pipe ø 12mm L 9.5mm brass Qty 1 pcs suitable for universal
	101274		—	olive for pipe ø 16mm Qty 1 pcs
	101275		—	union screw thread 1/2" for pipe ø 16mm Qty 1 pcs
	101276		—	union screw thread 3/8" tube ø 12mm Qty 1 pcs
	110068		—	knob suitable for Minisit ø 37mm

PEL

24ST series



GEV No.	101076	Ref. No.	016880
description	gas thermostat PEL type 24ST 120-320°C gas inlet M20x1.5 (tube ø 12mm) bypass nozzle ø 0.35mm gas outlet M20x1.5 (tube ø 12/10mm) thermocouple connection M9x1 pilot connection M10x1 capillary pipe 1200mm probe ø 6mm probe L 100mm shaft ø 10x8mm shaft L 27/17mm shaft flat upper		

spare parts for		101076		
Image	GEV No.	Ref. No.	Qty	Notes
	100455		—	bypass nozzle type PEL23/24 bore ø 0.35mm thread M8x0.5
	101058		—	magnet unit L 39mm D1 ø 15.4mm D2 ø 13.5mm suitable for PEL22/EGA24197 standard
	106200		—	nut thread M9x1 suitable for PEL 24/25S

Table continues overleaf

accessories for 101076				
	GEV No.	100908	Ref. No.	—
	union screw thread M10x1 for pipe ø 4mm Qty 1 pcs			
	GEV No.	100909	Ref. No.	—
	union screw thread M10x1 for pipe ø 6mm Qty 1 pcs			
	GEV No.	101246	Ref. No.	—
	olive for pipe ø 4mm Qty 1 pcs			
	GEV No.	101248	Ref. No.	—
	olive for pipe ø 12mm Qty 1 pcs suitable for PEL			
	GEV No.	101249	Ref. No.	—
	olive for pipe ø 10mm Qty 1 pcs			
	GEV No.	101250	Ref. No.	—
	union nut thread M20x1.5 for pipe ø 10mm			
	GEV No.	101251	Ref. No.	—
	union nut thread M20x1.5 for pipe ø 12mm			
	GEV No.	101286	Ref. No.	—
	olive ID ø 6mm Qty 1 pcs			
	GEV No.	110079	Ref. No.	—
	knob dial plate gas thermostat 1-8 silver			
	GEV No.	110080	Ref. No.	—
	knob ø 70mm shaft ø 10x8mm shaft flat universal			

gas valves and ignition boxes



gas control valves



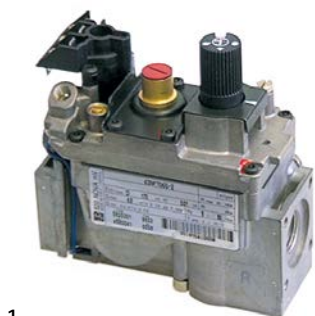

SIT

NOVASIT



1

GEV No.	101187	Ref. No.	030100014
description	gas valve SIT series Novasit 820 0.17VHz gas inlet 1/2" gas outlet 1/2" thermocouple connection M9x1 pilot connection M10x1 ignition pressurebar pressure range 5-50mbar pressure regulator connection blind equiv. no. 0.820.301 supply Operator millivolt		
spare parts for	101187		
	GEV No.	101065	Ref. No.
	magnet unit with cable L 44mm D1 ø 30mm D2 ø 20mm suitable for NOVASIT		
accessories for	101187		
	GEV No.	100110	Ref. No.
	pilot burner SIT type 190 series 3 flames nozzle ømm gas connectionmm		

accessories for 101187				
	GEV No.	101305	Ref. No.	—
	gas connection straight 1/2" flange 45x45mm ELETTROSIT/V4400/4600/4605 suitable for SIT/HONEYWELL hole distance 36x36mm			
	GEV No.	101306	Ref. No.	—
	gas connection angled flange 45x45mm hole distance 36x36mm 1/2" ELETTROSIT/V4400/4600/4605 screw with O-ring suitable for SIT/HONEYWELL			
	GEV No.	101307	Ref. No.	—
	gas connection straight flange 45x45mm hole distance 36x36mm 3/4" ELETTROSIT/V4400/4600/4605 screw with O-ring suitable for SIT/HONEYWELL			
	GEV No.	101308	Ref. No.	—
	gas connection angled flange 45x45mm hole distance 36x36mm 3/4" ELETTROSIT/V4400/4600/4605 screw with O-ring suitable for SIT/HONEYWELL			
	GEV No.	102116	Ref. No.	040400130
	thermopile ROBERTSHAW L 900mm probe ø 9mm probe L 57mm 250-750mV screw connection 7/16"			

ignition boxes

HONEYWELL



1

GEV No.	102367	Ref. No.	OCEN000
description	ignition box HONEYWELL type S4565A 2092 1 electrodes 3 waiting times safety time 10s 220-240V 4VA 50/60Hz		

ignition parts

pilot burners

SIT

100 series

accessories

pilot burner bottom parts



1









GEV No.	107701	Ref. No.	020484
description	pilot burner bottom part SIT 100 series nozzle ø 0.2mm		
spare parts for	107701		
	GEV No.	100245	Ref. No.
	pilot burner nozzle LPG code 20 bore ø 0.2mm Qty 1 pcs thread M8x0.75		

Table continues overleaf







spare parts for		107701	
	GEV No.	100916	Ref. No. —
	compression spring for pilot burner Qty 1 pcs		
	GEV No.	100917	Ref. No. —
	gasket for pilot burner Qty 1 pcs aluminium		
	GEV No.	100918	Ref. No. —
	screw for pilot burner		
accessories for		107701	
	GEV No.	100246	Ref. No. —
	pilot burner nozzle natural gas bore \varnothing 0.35mm Qty 1 pcs thread M8x0.75		
	GEV No.	100904	Ref. No. —
	locking screw M10x1 for pipe \varnothing 4mm Qty 1 pcs		
	GEV No.	100905	Ref. No. —
	locking screw M10x1 for pipe \varnothing 6mm Qty 1 pcs		
	GEV No.	102110	Ref. No. —
	pilot tube copper pipe \varnothing 4mm thickness 1mm L 3000mm		
	GEV No.	102111	Ref. No. —
	pilot tube copper pipe \varnothing 6mm thickness 1mm L 3000mm		
	GEV No.	102742	Ref. No. —
	pilot burner nozzle LPG code 25 bore \varnothing 0.25mm Qty 1 pcs		

pilot burner nozzles

	1		
GEV No.	100245	Ref. No.	016106
description	pilot burner nozzle LPG code 20 bore \varnothing 0.2mm Qty 1 pcs thread M8x0.75		
For models:	105014		

190 series

	1		
GEV No.	100110	Ref. No.	030100000
description	pilot burner SIT type 190 series 3 flames nozzle \varnothing mm gas connectionmm		
accessories for		100110	
	GEV No.	100202	Ref. No. —
	pilot burner nozzle natural gas code 41 Qty 1 pcs nozzle \varnothing 0.41mm		
	GEV No.	100203	Ref. No. —
	pilot burner nozzle LPG code 25 Qty 1 pcs nozzle \varnothing 0.25mm		
	GEV No.	100701	Ref. No. —
	ignition electrode connection M4 Qty 1 pcs		
	GEV No.	100906	Ref. No. —
	screw connection thread M10x1 for ignition electrode brass Qty 1 pcs WS 10		

accessories for		100110	
	GEV No.	100907	Ref. No. —
	screw connection thread M10x1 Qty 1 pcs type SEF 1 \varnothing mm for thermocouple		
	GEV No.	100908	Ref. No. —
	union screw thread M10x1 for pipe \varnothing 4mm Qty 1 pcs		
	GEV No.	100909	Ref. No. —
	union screw thread M10x1 for pipe \varnothing 6mm Qty 1 pcs		
	GEV No.	101282	Ref. No. —
	olive for pipe \varnothing 4mm L 7.4mm Qty 1 pcs		
	GEV No.	101287	Ref. No. —
	olive for pipe \varnothing 6mm Qty 1 pcs		
	GEV No.	102110	Ref. No. —
	pilot tube copper pipe \varnothing 4mm thickness 1mm L 3000mm		
	GEV No.	102111	Ref. No. —
	pilot tube copper pipe \varnothing 6mm thickness 1mm L 3000mm		
	GEV No.	107650	Ref. No. —
	pilot burner nozzle SIT LPG code 30 Qty 1 pcs		

POLIDORO

pilot burners















	1		
GEV No.	102295	Ref. No.	016081
description	pilot burner POLIDORO 3 flames code gas connection 4mm		
spare parts for		102295	
	GEV No.	100907	Ref. No. —
	screw connection thread M10x1 Qty 1 pcs type SEF 1 \varnothing mm for thermocouple		
accessories for		102295	
	GEV No.	100208	Ref. No. —
	pilot burner nozzle POLIDORO LPG code 20 bore \varnothing 0.2mm Qty 1 pcs		
	GEV No.	100209	Ref. No. —
	pilot burner nozzle POLIDORO natural gas code 40 bore \varnothing 0.4mm Qty 1 pcs		
	GEV No.	100701	Ref. No. —
	ignition electrode connection M4 Qty 1 pcs		
	GEV No.	100906	Ref. No. —
	screw connection thread M10x1 for ignition electrode brass Qty 1 pcs WS 10		
	GEV No.	100908	Ref. No. —
	union screw thread M10x1 for pipe \varnothing 4mm Qty 1 pcs		
	GEV No.	100909	Ref. No. —
	union screw thread M10x1 for pipe \varnothing 6mm Qty 1 pcs		

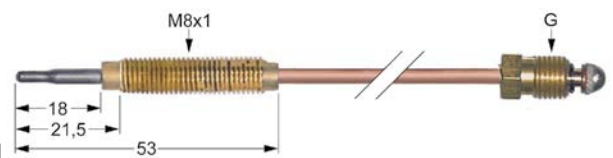

Table continues overleaf



accessories for	102295		
	GEV No.	101280	Ref. No. —
	olive for pipe ø 4mm Qty 1 pcs		
	GEV No.	101287	Ref. No. —
	olive for pipe ø 6mm Qty 1 pcs		
	GEV No.	102110	Ref. No. —
	pilot tube copper pipe ø 4mm thickness 1mm L 3000mm		
	GEV No.	102111	Ref. No. —
	pilot tube copper pipe ø 6mm thickness 1mm L 3000mm		



electrodes

			
GEV No.	100724	Ref. No.	010288
description	ignition electrode D1 ø 8mm BL1 13mm BL2 28mm BL3 8mm connection F 2.8x0.8mm M10x0.75		
accessories for	100724		
	GEV No.	519546	Ref. No. —
	nut thread M10x0.75 H 3.45mm WS 14 brass Qty 1 pcs		

thermocouples

threaded thermocouples			
threaded thermocouples standard			
with socket with thread M8x1			
type Junkers with aluminised tip			
			
GEV No.	102233	Ref. No.	016991 019991
description	thermocouple M8x1 L 750mm M8x1		
accessories for	102233		
	GEV No.	102067	Ref. No. —
	nut thread M8x1 H 3mm brass Qty 1 pcs type SEF 1		

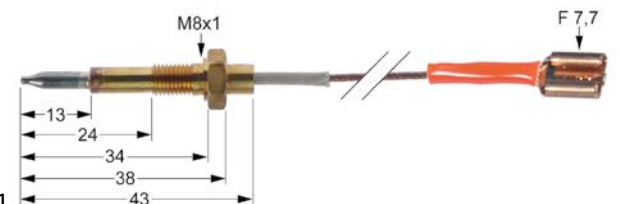
threaded thermocouples with cable link			
			
GEV No.	102274	Ref. No.	001Q855
description	thermocouple with 1 conductor L 450mm connection F 7.7mm M6x0.75		
accessories for	102274		
	GEV No.	102680	Ref. No. —
	nut thread M6x0.75 H 2.6mm WS 8 brass Qty 1 pcs type SEF 2		

			
GEV No.	102275	Ref. No.	001Q876
description	thermocouple with 1 conductor L 450mm connection F 7.7mm M6x0.75		
accessories for	102275		
	GEV No.	102680	Ref. No. —
	nut thread M6x0.75 H 2.6mm WS 8 brass Qty 1 pcs type SEF 2		



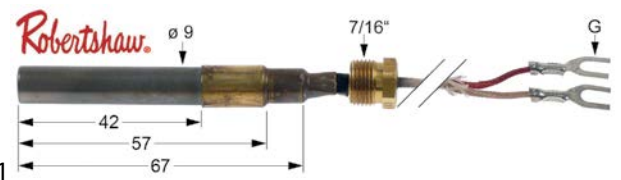

thermopiles





			
GEV No.	102116	Ref. No.	040400130
description	thermopile ROBERTSHAW L 900mm probe ø 9mm probe L 57mm 250-750mV screw connection 7/16"		

gas burners





hob burners			
universal hob burners			
GEV			
			
GEV No.	106379	Ref. No.	N/A
description	air mixing tube for burner cap ø 80mm L 23mm D1 ø 20mm D2 ø 15.6mm D3 ø 14mm		











			
1			
GEV No.	103068	Ref. No.	A042200
description	burner cap ø 100mm		
accessories for	103068		
	GEV No.	103067	Ref. No. A042000
	burner ring for burner cap ø 100mm		
	GEV No.	104102	Ref. No. A041800
	burner head for burner cap ø 100mm ext. ø 130		
	GEV No.	104103	Ref. No. A041600
	burner holder suitable for burner ø100mm with nozzle holder		





			
1			
GEV No.	103066	Ref. No.	A042100
description	burner cap ø 80mm		
accessories for	103066		
	GEV No.	103065	Ref. No. A041900
	burner ring for burner cap ø 80mm		
	GEV No.	104100	Ref. No. A041700
	burner head for burner cap ø 80mm		
	GEV No.	104101	Ref. No. A041500
	burner holder for burner cap ø 80mm with nozzle holder with mixing sleeve		

			
1			
GEV No.	104102	Ref. No.	A041800
description	burner head for burner cap ø 100mm ext. ø 130		





			
1			
GEV No.	104100	Ref. No.	A041700
description	burner head for burner cap ø 80mm		
accessories for	104100		
	GEV No.	103065	Ref. No. A041900
	burner ring for burner cap ø 80mm		
	GEV No.	103066	Ref. No. A042100
	burner cap ø 80mm		
	GEV No.	104103	Ref. No. A041600
	burner holder suitable for burner ø100mm with nozzle holder		

			
1			
GEV No.	104101	Ref. No.	A041500
description	burner holder for burner cap ø 80mm with nozzle holder with mixing sleeve		
accessories for	104101		
	GEV No.	103065	Ref. No. A041900
	burner ring for burner cap ø 80mm		
	GEV No.	103066	Ref. No. A042100
	burner cap ø 80mm		
	GEV No.	104100	Ref. No. A041700
	burner head for burner cap ø 80mm		

			
1			
GEV No.	104103	Ref. No.	A041600
description	burner holder suitable for burner ø100mm with nozzle holder		
accessories for	104103		
	GEV No.	103067	Ref. No. A042000
	burner ring for burner cap ø 100mm		
	GEV No.	103068	Ref. No. A042200
	burner cap ø 100mm		
	GEV No.	104102	Ref. No. A041800
	burner head for burner cap ø 100mm ext. ø 130		

			
1			
GEV No.	103067	Ref. No.	A042000
description	burner ring for burner cap ø 100mm		
accessories for	103067		
	GEV No.	103068	Ref. No. A042200
	burner cap ø 100mm		
	GEV No.	104102	Ref. No. A041800
	burner head for burner cap ø 100mm ext. ø 130		
	GEV No.	104103	Ref. No. A041600
	burner holder suitable for burner ø100mm with nozzle holder		





			
1			
GEV No.	103065	Ref. No.	A041900
description	burner ring for burner cap ø 80mm		
accessories for	103065		
	GEV No.	103066	Ref. No. A042100
burner cap ø 80mm			
	GEV No.	104100	Ref. No. A041700
burner head for burner cap ø 80mm			
	GEV No.	104101	Ref. No. A041500
burner holder for burner cap ø 80mm with nozzle holder with mixing sleeve			

SABAF

2 series - standard



			
1			
GEV No.	105993	Ref. No.	001U588
description	burner cap 1.8kW ø 75mm bright finish		

			
1			
GEV No.	105054	Ref. No.	001U589
description	burner cap 3kW ø 100mm H 3.5mm bright finish		
accessories for	105054		
	GEV No.	105058	Ref. No. —
burner head 3kW for igniter ø 6mm for burner cap ø 100mm			
	GEV No.	105059	Ref. No. —
burner lower part 3kW for igniter ø 6mm for thermocouple ø 6mm without nozzle for burner cap ø 100mm			

2 series - flat skirt version

			
1			
GEV No.	105993	Ref. No.	001U588
description	burner cap 1.8kW ø 75mm bright finish		

			
1			
GEV No.	105994	Ref. No.	001U587 0210003003
description	burner cap 1kW ø 55mm bright finish		





			
1			
GEV No.	105054	Ref. No.	001U589
description	burner cap 3kW ø 100mm H 3.5mm bright finish		
accessories for	105054		
	GEV No.	105058	Ref. No. —
burner head 3kW for igniter ø 6mm for burner cap ø 100mm			
	GEV No.	105059	Ref. No. —
burner lower part 3kW for igniter ø 6mm for thermocouple ø 6mm without nozzle for burner cap ø 100mm			

			
1			
GEV No.	105995	Ref. No.	001Q808
description	burner head 1.8kW for burner cap ø 75mm		





			
1			
GEV No.	105996	Ref. No.	001Q805
description	burner head 1kW for burner cap ø 55mm		

			
1			
GEV No.	105992	Ref. No.	001Q811
description	burner head 3kW for burner cap ø 100mm		





triple ring burner series - standard version





			
1			
GEV No.	105063	Ref. No.	001U591
description	burner cap 3.6kW ø 131mm H 4mm mounting pos. outer		
accessories for	105063		
	GEV No.	105064	Ref. No. 001U590
burner cap 3.6kW ø 61mm H 6.5mm mounting pos. inner bright finish			
	GEV No.	105065	Ref. No. —
burner head 3.6kW for burner cap ø 61/131mm			
	GEV No.	105717	Ref. No. —
burner lower part 3.6kW for igniter ø 6mm for thermocouple ø 6mm with nozzle ø1.35mm ID ø 64mm for burner cap ø 61/131mm			
	GEV No.	105922	Ref. No. —
burner lower part 3.6kW for igniter ø 6mm for thermocouple ø 6mm with nozzle ø1.35mm ID ø 75mm for burner cap ø 61/131mm			



 <p>1</p>			
GEV No.	105064	Ref. No.	001U590
description	burner cap 3.6kW ø 61mm H 6.5mm mounting pos. inner bright finish		
accessories for	105064		
 <p>burner cap 3.6kW ø 131mm H 4mm mounting pos. outer</p>			
 <p>burner head 3.6kW for burner cap ø 61/131mm</p>			
 <p>burner lower part 3.6kW for igniter ø 6mm for thermocouple ø 6mm with nozzle ø1.35mm ID ø 64mm for burner cap ø 61/131mm</p>			
 <p>burner lower part 3.6kW for igniter ø 6mm for thermocouple ø 6mm with nozzle ø1.35mm ID ø 75mm for burner cap ø 61/131mm</p>			







triple ring burner series - flat skirt version

 <p>1</p>			
GEV No.	105063	Ref. No.	001U591
description	burner cap 3.6kW ø 131mm H 4mm mounting pos. outer		
accessories for	105063		
 <p>burner cap 3.6kW ø 61mm H 6.5mm mounting pos. inner bright finish</p>			
 <p>burner head 3.6kW for burner cap ø 61/131mm</p>			
 <p>burner lower part 3.6kW for igniter ø 6mm for thermocouple ø 6mm with nozzle ø1.35mm ID ø 64mm for burner cap ø 61/131mm</p>			
 <p>burner lower part 3.6kW for igniter ø 6mm for thermocouple ø 6mm with nozzle ø1.35mm ID ø 75mm for burner cap ø 61/131mm</p>			

 <p>1</p>			
GEV No.	105064	Ref. No.	001U590
description	burner cap 3.6kW ø 61mm H 6.5mm mounting pos. inner bright finish		
accessories for	105064		
 <p>burner cap 3.6kW ø 131mm H 4mm mounting pos. outer</p>			
 <p>burner head 3.6kW for burner cap ø 61/131mm</p>			
 <p>burner lower part 3.6kW for igniter ø 6mm for thermocouple ø 6mm with nozzle ø1.35mm ID ø 64mm for burner cap ø 61/131mm</p>			
 <p>burner lower part 3.6kW for igniter ø 6mm for thermocouple ø 6mm with nozzle ø1.35mm ID ø 75mm for burner cap ø 61/131mm</p>			

 <p>1</p>			
GEV No.	105991	Ref. No.	001Q815 E0L01A192G
description	burner head for burner cap ø 131mm		

producer-specific hob burners
BARTSCHER
70, 85 (old) series

 <p>1</p>			
GEV No.	104056	Ref. No.	2510140
description	air mixing sleeve		
accessories for	104056		
 <p>burner head for burner cap ø 70mm 3.5kW</p>			
 <p>burner cap ø 70mm 3.5kW</p>			
 <p>venturi</p>			
 <p>burner holder with nozzle holder</p>			
 <p>cover for pilot burner suitable for 700 series Qty 1 pcs</p>			

 <p>1</p>			
GEV No.	104053	Ref. No.	2510134
description	burner head for burner cap ø 125mm		

 <p>1</p>			
GEV No.	104052	Ref. No.	2510136
description	burner head for burner cap ø 80mm		

 <p>1</p>			
GEV No.	105198	Ref. No.	2530085
description	fastening angle		

70. 90 (TopLine) series



GEV No.	105289	Ref. No.	2519002
----------------	--------	-----------------	---------

description air mixing sleeve L 50mm ED ø 45mm ID ø 42mm aluminium

accessories for 105289

GEV No.	105280	Ref. No.	2510351
----------------	--------	-----------------	---------

burner head C for burner cap ø 80mm 3.5kW

GEV No.	105281	Ref. No.	2510352
----------------	--------	-----------------	---------

burner cap C ø 80mm 3.5kW with central hole ID ø 32mm

GEV No.	105282	Ref. No.	—
----------------	--------	-----------------	---

venturi C for burner cap ø 80mm 3.5kW

GEV No.	105283	Ref. No.	2510354
----------------	--------	-----------------	---------

burner head D for burner cap ø 105mm 5.6kW

GEV No.	105284	Ref. No.	2510355
----------------	--------	-----------------	---------

burner cap ID ø 54mm D ø 105mm 5.6kW with central hole

GEV No.	105285	Ref. No.	2510353
----------------	--------	-----------------	---------

venturi D for burner cap ø 105mm 5.6kW

GEV No.	105286	Ref. No.	2510357
----------------	--------	-----------------	---------

burner head E for burner cap ø 125mm 7kW

GEV No.	105287	Ref. No.	2510341 2510358
----------------	--------	-----------------	--------------------

burner cap E ø 125mm 7kW with central hole

GEV No.	105288	Ref. No.	2510340 2510356
----------------	--------	-----------------	--------------------

venturi E for burner cap ø 125mm 7kW

GEV No.	105290	Ref. No.	021647
----------------	--------	-----------------	--------

nozzle holder nozzle mounting M11x1



GEV No.	105281	Ref. No.	2510352
----------------	--------	-----------------	---------

description burner cap C ø 80mm 3.5kW with central hole ID ø 32mm

accessories for 105281

GEV No.	105280	Ref. No.	2510351
----------------	--------	-----------------	---------

burner head C for burner cap ø 80mm 3.5kW

GEV No.	105282	Ref. No.	—
----------------	--------	-----------------	---

venturi C for burner cap ø 80mm 3.5kW

GEV No.	105289	Ref. No.	2519002
----------------	--------	-----------------	---------

air mixing sleeve L 50mm ED ø 45mm ID ø 42mm aluminium

GEV No.	105290	Ref. No.	021647
----------------	--------	-----------------	--------

nozzle holder nozzle mounting M11x1



GEV No.	105287	Ref. No.	2510341 2510358
----------------	--------	-----------------	--------------------

description burner cap E ø 125mm 7kW with central hole

accessories for 105287

GEV No.	105286	Ref. No.	2510357
----------------	--------	-----------------	---------

burner head E for burner cap ø 125mm 7kW

GEV No.	105288	Ref. No.	2510340 2510356
----------------	--------	-----------------	--------------------

venturi E for burner cap ø 125mm 7kW

GEV No.	105289	Ref. No.	2519002
----------------	--------	-----------------	---------

air mixing sleeve L 50mm ED ø 45mm ID ø 42mm aluminium

GEV No.	105290	Ref. No.	021647
----------------	--------	-----------------	--------

nozzle holder nozzle mounting M11x1



GEV No.	105284	Ref. No.	2510355
----------------	--------	-----------------	---------

description burner cap ID ø 54mm D ø 105mm 5.6kW with central hole

accessories for 105284

GEV No.	105283	Ref. No.	2510354
----------------	--------	-----------------	---------

burner head D for burner cap ø 105mm 5.6kW

GEV No.	105285	Ref. No.	2510353
----------------	--------	-----------------	---------

venturi D for burner cap ø 105mm 5.6kW

GEV No.	105289	Ref. No.	2519002
----------------	--------	-----------------	---------

air mixing sleeve L 50mm ED ø 45mm ID ø 42mm aluminium

GEV No.	105290	Ref. No.	021647
----------------	--------	-----------------	--------

nozzle holder nozzle mounting M11x1



GEV No.	105280	Ref. No.	2510351
----------------	--------	-----------------	---------

description burner head C for burner cap ø 80mm 3.5kW

accessories for 105280

GEV No.	105281	Ref. No.	2510352
----------------	--------	-----------------	---------

burner cap C ø 80mm 3.5kW with central hole ID ø 32mm

GEV No.	105282	Ref. No.	—
----------------	--------	-----------------	---

venturi C for burner cap ø 80mm 3.5kW





GEV No.	105289	Ref. No.	2519002
----------------	--------	-----------------	---------

air mixing sleeve L 50mm ED ø 45mm ID ø 42mm aluminium





Table continues overleaf



accessories for	105280		
	GEV No.	105290	Ref. No. 021647
	nozzle holder nozzle mounting M11x1		





 <p>1</p>			
GEV No.	105283	Ref. No.	2510354
description	burner head D for burner cap ø 105mm 5.6kW		
accessories for	105283		
	GEV No.	105284	Ref. No. 2510355
	burner cap ID ø 54mm D ø 105mm 5.6kW with central hole		
	GEV No.	105285	Ref. No. 2510353
	venturi D for burner cap ø 105mm 5.6kW		
	GEV No.	105289	Ref. No. 2519002
	air mixing sleeve L 50mm ED ø 45mm ID ø 42mm aluminium		
	GEV No.	105290	Ref. No. 021647
	nozzle holder nozzle mounting M11x1		

 <p>1</p>			
GEV No.	105286	Ref. No.	2510357
description	burner head E for burner cap ø 125mm 7kW		
accessories for	105286		
	GEV No.	105287	Ref. No. 2510341 2510358
	burner cap E ø 125mm 7kW with central hole		
	GEV No.	105288	Ref. No. 2510340 2510356
	venturi E for burner cap ø 125mm 7kW		
	GEV No.	105289	Ref. No. 2519002
	air mixing sleeve L 50mm ED ø 45mm ID ø 42mm aluminium		
	GEV No.	105290	Ref. No. 021647
	nozzle holder nozzle mounting M11x1		

 <p>1</p>			
GEV No.	105290	Ref. No.	021647
description	nozzle holder nozzle mounting M11x1		
accessories for	105290		
	GEV No.	105280	Ref. No. 2510351
	burner head C for burner cap ø 80mm 3.5kW		
	GEV No.	105281	Ref. No. 2510352
	burner cap C ø 80mm 3.5kW with central hole ID ø 32mm		
	GEV No.	105282	Ref. No. —
	venturi C for burner cap ø 80mm 3.5kW		

accessories for	105290		
	GEV No.	105283	Ref. No. 2510354
	burner head D for burner cap ø 105mm 5.6kW		
	GEV No.	105284	Ref. No. 2510355
	burner cap ID ø 54mm D ø 105mm 5.6kW with central hole		
	GEV No.	105285	Ref. No. 2510353
	venturi D for burner cap ø 105mm 5.6kW		
	GEV No.	105286	Ref. No. 2510357
	burner head E for burner cap ø 125mm 7kW		
	GEV No.	105287	Ref. No. 2510341 2510358
	burner cap E ø 125mm 7kW with central hole		
	GEV No.	105288	Ref. No. 2510340 2510356
	venturi E for burner cap ø 125mm 7kW		
	GEV No.	105289	Ref. No. 2519002
	air mixing sleeve L 50mm ED ø 45mm ID ø 42mm aluminium		



 <p>1</p>			
GEV No.	104452	Ref. No.	2510350
description	venturi C for burner cap ø 80mm 3.5kW		



 <p>1</p>			
GEV No.	105285	Ref. No.	2510353
description	venturi D for burner cap ø 105mm 5.6kW		
accessories for	105285		
	GEV No.	105283	Ref. No. 2510354
	burner head D for burner cap ø 105mm 5.6kW		
	GEV No.	105284	Ref. No. 2510355
	burner cap ID ø 54mm D ø 105mm 5.6kW with central hole		
	GEV No.	105289	Ref. No. 2519002
	air mixing sleeve L 50mm ED ø 45mm ID ø 42mm aluminium		
	GEV No.	105290	Ref. No. 021647
	nozzle holder nozzle mounting M11x1		

			
GEV No.	105288	Ref. No.	2510340 2510356
description	venturi E for burner cap ø 125mm 7kW		
accessories for	105288		
	GEV No.	105286	Ref. No. 2510357
	burner head E for burner cap ø 125mm 7kW		
	GEV No.	105287	Ref. No. 2510341 2510358
	burner cap E ø 125mm 7kW with central hole		
	GEV No.	105289	Ref. No. 2519002
	air mixing sleeve L 50mm ED ø 45mm ID ø 42mm aluminium		
	GEV No.	105290	Ref. No. 021647
	nozzle holder nozzle mounting M11x1		

70N series

			
GEV No.	104056	Ref. No.	2510140
description	air mixing sleeve		
accessories for	104056		
	GEV No.	105291	Ref. No. N/A
	burner head for burner cap ø 70mm 3.5kW		
	GEV No.	105292	Ref. No. 2510601
	burner cap ø 70mm 3.5kW		
	GEV No.	105293	Ref. No. 2510602
	venturi		
	GEV No.	105294	Ref. No. 2510603
	burner holder with nozzle holder		
	GEV No.	105296	Ref. No. —
	cover for pilot burner suitable for 700 series Qty 1 pcs		

			
GEV No.	105292	Ref. No.	2510601
description	burner cap ø 70mm 3.5kW		
accessories for	105292		
	GEV No.	104056	Ref. No. 2510140
	air mixing sleeve		
	GEV No.	105291	Ref. No. N/A
	burner head for burner cap ø 70mm 3.5kW		





accessories for	105292		
	GEV No.	105293	Ref. No. 2510602
	venturi		
	GEV No.	105294	Ref. No. 2510603
	burner holder with nozzle holder		
	GEV No.	105296	Ref. No. —
	cover for pilot burner suitable for 700 series Qty 1 pcs		

			
GEV No.	105291	Ref. No.	N/A
description	burner head for burner cap ø 70mm 3.5kW		
accessories for	105291		
	GEV No.	104056	Ref. No. 2510140
	air mixing sleeve		
	GEV No.	105292	Ref. No. 2510601
	burner cap ø 70mm 3.5kW		
	GEV No.	105293	Ref. No. 2510602
	venturi		
	GEV No.	105294	Ref. No. 2510603
	burner holder with nozzle holder		
	GEV No.	105296	Ref. No. —
	cover for pilot burner suitable for 700 series Qty 1 pcs		











			
GEV No.	105294	Ref. No.	2510603
description	burner holder with nozzle holder		
accessories for	105294		
	GEV No.	104056	Ref. No. 2510140
	air mixing sleeve		
	GEV No.	105291	Ref. No. N/A
	burner head for burner cap ø 70mm 3.5kW		
	GEV No.	105292	Ref. No. 2510601
	burner cap ø 70mm 3.5kW		
	GEV No.	105293	Ref. No. 2510602
	venturi		
	GEV No.	105296	Ref. No. —
	cover for pilot burner suitable for 700 series Qty 1 pcs		











	1		
GEV No.	105293	Ref. No.	2510602
description	venturi		
accessories for	105293		
	GEV No.	104056	Ref. No. 2510140
air mixing sleeve			
	GEV No.	105291	Ref. No. N/A
burner head for burner cap ø 70mm 3.5kW			
	GEV No.	105292	Ref. No. 2510601
burner cap ø 70mm 3.5kW			
	GEV No.	105294	Ref. No. 2510603
burner holder with nozzle holder			
	GEV No.	105296	Ref. No. —
cover for pilot burner suitable for 700 series Qty 1 pcs			

	1		
GEV No.	103030	Ref. No.	2510190
description	burner cap C ø 85mm 3.5kW		
accessories for	103030		
	GEV No.	104045	Ref. No. 2510189
burner head C for burner cap ø 85mm 3.5kW			
	GEV No.	104048	Ref. No. 2510195
venturi C for burner cap ø 85mm 3.5kW			
	GEV No.	104051	Ref. No. 2510197
air mixing sleeve			

90 (old) series

	1		
GEV No.	104051	Ref. No.	2510197
description	air mixing sleeve		
accessories for	104051		
	GEV No.	103030	Ref. No. 2510190
burner cap C ø 85mm 3.5kW			
	GEV No.	103031	Ref. No. 2510193
burner cap D ø 115mm 5.5kW			
	GEV No.	103032	Ref. No. —
burner cap E ø 125mm 7kW with central hole			
	GEV No.	104045	Ref. No. 2510189
burner head C for burner cap ø 85mm 3.5kW			
	GEV No.	104046	Ref. No. 2510192
burner head D for burner cap ø 115mm 5.5kW			
	GEV No.	104047	Ref. No. 2510194
burner head E for burner cap ø 125mm 7kW			
	GEV No.	104048	Ref. No. 2510195
venturi C for burner cap ø 85mm 3.5kW			
	GEV No.	104049	Ref. No. 2510201
venturi D for burner cap ø 115mm 5.5kW			
	GEV No.	104050	Ref. No. 2510202
venturi E for burner cap ø 125mm 7kW			





	1		
GEV No.	103031	Ref. No.	2510193
description	burner cap D ø 115mm 5.5kW		
accessories for	103031		
	GEV No.	104046	Ref. No. 2510192
burner head D for burner cap ø 115mm 5.5kW			
	GEV No.	104049	Ref. No. 2510201
venturi D for burner cap ø 115mm 5.5kW			
	GEV No.	104051	Ref. No. 2510197
air mixing sleeve			





	1		
GEV No.	104045	Ref. No.	2510189
description	burner head C for burner cap ø 85mm 3.5kW		
accessories for	104045		
	GEV No.	103030	Ref. No. 2510190
burner cap C ø 85mm 3.5kW			
	GEV No.	104048	Ref. No. 2510195
venturi C for burner cap ø 85mm 3.5kW			
	GEV No.	104051	Ref. No. 2510197
air mixing sleeve			







			
1			
GEV No.	104046	Ref. No.	2510192
description	burner head D for burner cap ø 115mm 5.5kW		
accessories for	104046		
	GEV No.	103031	Ref. No. 2510193
	burner cap D ø 115mm 5.5kW		
	GEV No.	104049	Ref. No. 2510201
	venturi D for burner cap ø 115mm 5.5kW		
	GEV No.	104051	Ref. No. 2510197
	air mixing sleeve		

			
1			
GEV No.	104047	Ref. No.	2510194
description	burner head E for burner cap ø 125mm 7kW		
accessories for	104047		
	GEV No.	103032	Ref. No. —
	burner cap E ø 125mm 7kW with central hole		
	GEV No.	104050	Ref. No. 2510202
	venturi E for burner cap ø 125mm 7kW		
	GEV No.	104051	Ref. No. 2510197
	air mixing sleeve		

			
1			
GEV No.	104048	Ref. No.	2510195
description	venturi C for burner cap ø 85mm 3.5kW		
accessories for	104048		
	GEV No.	103030	Ref. No. 2510190
	burner cap C ø 85mm 3.5kW		
	GEV No.	104045	Ref. No. 2510189
	burner head C for burner cap ø 85mm 3.5kW		
	GEV No.	104051	Ref. No. 2510197
	air mixing sleeve		

			
1			
GEV No.	104049	Ref. No.	2510201
description	venturi D for burner cap ø 115mm 5.5kW		
accessories for	104049		
	GEV No.	103031	Ref. No. 2510193
	burner cap D ø 115mm 5.5kW		
	GEV No.	104046	Ref. No. 2510192
	burner head D for burner cap ø 115mm 5.5kW		
	GEV No.	104051	Ref. No. 2510197
	air mixing sleeve		

			
1			
GEV No.	104050	Ref. No.	2510202
description	venturi E for burner cap ø 125mm 7kW		
accessories for	104050		
	GEV No.	103032	Ref. No. —
	burner cap E ø 125mm 7kW with central hole		
	GEV No.	104047	Ref. No. 2510194
	burner head E for burner cap ø 125mm 7kW		
	GEV No.	104051	Ref. No. 2510197
	air mixing sleeve		

Snack series

			
1			
GEV No.	106379	Ref. No.	N/A
description	air mixing tube for burner cap ø 80mm L 23mm D1 ø 20mm D2 ø 15.6mm D3 ø 14mm		









			
1			
GEV No.	103068	Ref. No.	A042200
description	burner cap ø 100mm		
accessories for	103068		
	GEV No.	103067	Ref. No. A042000
	burner ring for burner cap ø 100mm		
	GEV No.	104102	Ref. No. A041800
	burner head for burner cap ø 100mm ext. ø 130		





Table continues overleaf







accessories for	103068		
	GEV No.	104103	Ref. No. A041600
	burner holder suitable for burner ø100mm with nozzle holder		





accessories for	104101		
	GEV No.	104100	Ref. No. A041700
	burner head for burner cap ø 80mm		





1			
GEV No.	103066	Ref. No.	A042100
description	burner cap ø 80mm		
accessories for	103066		
	GEV No.	103065	Ref. No. A041900
	burner ring for burner cap ø 80mm		
	GEV No.	104100	Ref. No. A041700
	burner head for burner cap ø 80mm		
	GEV No.	104101	Ref. No. A041500
	burner holder for burner cap ø 80mm with nozzle holder with mixing sleeve		



1			
GEV No.	104103	Ref. No.	A041600
description	burner holder suitable for burner ø100mm with nozzle holder		
accessories for	104103		
	GEV No.	103067	Ref. No. A042000
	burner ring for burner cap ø 100mm		
	GEV No.	103068	Ref. No. A042200
	burner cap ø 100mm		
	GEV No.	104102	Ref. No. A041800
	burner head for burner cap ø 100mm ext. ø 130		

1			
GEV No.	104102	Ref. No.	A041800
description	burner head for burner cap ø 100mm ext. ø 130		

1			
GEV No.	103067	Ref. No.	A042000
description	burner ring for burner cap ø 100mm		
accessories for	103067		
	GEV No.	103068	Ref. No. A042200
	burner cap ø 100mm		
	GEV No.	104102	Ref. No. A041800
	burner head for burner cap ø 100mm ext. ø 130		
	GEV No.	104103	Ref. No. A041600
	burner holder suitable for burner ø100mm with nozzle holder		

1			
GEV No.	104100	Ref. No.	A041700
description	burner head for burner cap ø 80mm		
accessories for	104100		
	GEV No.	103065	Ref. No. A041900
	burner ring for burner cap ø 80mm		
	GEV No.	103066	Ref. No. A042100
	burner cap ø 80mm		
	GEV No.	104103	Ref. No. A041600
	burner holder suitable for burner ø100mm with nozzle holder		

1			
GEV No.	103065	Ref. No.	A041900
description	burner ring for burner cap ø 80mm		
accessories for	103065		
	GEV No.	103066	Ref. No. A042100
	burner cap ø 80mm		
	GEV No.	104100	Ref. No. A041700
	burner head for burner cap ø 80mm		
	GEV No.	104101	Ref. No. A041500
	burner holder for burner cap ø 80mm with nozzle holder with mixing sleeve		

1			
GEV No.	104101	Ref. No.	A041500
description	burner holder for burner cap ø 80mm with nozzle holder with mixing sleeve		
accessories for	104101		
	GEV No.	103065	Ref. No. A041900
	burner ring for burner cap ø 80mm		
	GEV No.	103066	Ref. No. A042100
	burner cap ø 80mm		

accessories

pan supports



1			
GEV No.	210245	Ref. No.	N/A
description	pan support W 370mm L 580mm		

bar burners

bar burners



1			
GEV No.	105443	Ref. No.	024075
description	bar burner ø 40mm Wmm Hmm L 490mm flange width 43mm flange length 43mm pasta cooker		

solid top burners



1			
GEV No.	105251	Ref. No.	02510069
description	solid top burner ø 120mm H 102mm L 340mm		

accessories

nozzle holders



1			
GEV No.	104724	Ref. No.	010037
description	nozzle holder		



1			
GEV No.	105290	Ref. No.	021647
description	nozzle holder nozzle mounting M11x1		
accessories for	105290		
	GEV No.	105280	Ref. No. 2510351
	burner head C for burner cap ø 80mm 3.5kW		
	GEV No.	105281	Ref. No. 2510352
	burner cap C ø 80mm 3.5kW with central hole ID ø 32mm		
	GEV No.	105283	Ref. No. 2510354
	burner head D for burner cap ø 105mm 5.6kW		
	GEV No.	105284	Ref. No. 2510355
	burner cap ID ø 54mm D ø 105mm 5.6kW with central hole		
	GEV No.	105285	Ref. No. 2510353
	venturi D for burner cap ø 105mm 5.6kW		
	GEV No.	105286	Ref. No. 2510357
	burner head E for burner cap ø 125mm 7kW		
	GEV No.	105287	Ref. No. 2510341 2510358
	burner cap E ø 125mm 7kW with central hole		
	GEV No.	105288	Ref. No. 2510340 2510356
	venturi E for burner cap ø 125mm 7kW		
	GEV No.	105289	Ref. No. 2519002
	air mixing sleeve L 50mm ED ø 45mm ID ø 42mm aluminium		

miscellaneous

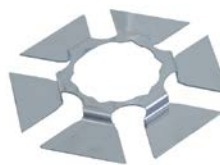

1			
GEV No.	105501	Ref. No.	136069110
description	flame spreader		



gas nozzles

main nozzles

gas nozzles M6x0.75



1

GEV No.	104778	Ref. No.	003090429
description	gas injector thread M6x0.75 WS 7 bore ø 1.45mm		

gas nozzles M9x1



1

GEV No.	100957	Ref. No.	016118
description	gas injector thread M9x1 WS 10 bore ø 0.8mm		
For models:	105.014, 105014		



1

GEV No.	100956	Ref. No.	016123
description	gas injector thread M9x1 WS 10 bore ø 1.3mm		
For models:	105014		

gas nozzles (other)



1

GEV No.	101942	Ref. No.	051123010
description	gas injector thread M6x1 natural gas WS 10 bore ø 1.25mm		

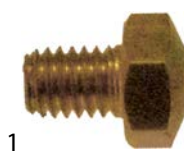

1

GEV No.	100999	Ref. No.	051123009
description	gas injector LPG		

pilot burner nozzles

pilot burner nozzles SIT

100 series



1

GEV No.	100245	Ref. No.	016106
description	pilot burner nozzle LPG code 20 bore ø 0.2mm Qty 1 pcs thread M8x0.75		
For models:	105014		

auxiliary gas parts

screw connections

union screws



1

GEV No.	102506	Ref. No.	021295
description	screw connection thread M10x1 Qty 5 pcs for igniter		

equipment-specific units

for meat mincers

gearboxes



1

GEV No.	699296	Ref. No.	240309-2 A062101
description	gearbox ø 36mm H 60mm model K5		

for dough mixers

gearboxes



1

GEV No.	699296	Ref. No.	240309-2 A062101
description	gearbox ø 36mm H 60mm model K5		

for planetary mixers

gearboxes



1

GEV No.	699296	Ref. No.	240309-2 A062101
description	gearbox ø 36mm H 60mm model K5		

beaters



1

GEV No.	699393	Ref. No.	A150017
description	whisk shaft intake ø 12.7mm H 185mm suitable for KitchenAid		

for hand blenders

couplings



1

GEV No.	699008	Ref. No.	SL1496
description	coupling D1 ø 20mm D2 ø 23mm int. ø 1 8mm int. ø 2 8mm L 33.5mm FM3		
accessories for	699008		
	GEV No.	697417	Ref. No. —
description	grub screw thread M5 L 10mm stainless steel DIN 914/ISO 4027 WS 2.5 with spike Qty 1 pcs		

for ice-cube maker

cutting grid



1

GEV No.	480100	Ref. No.	0481925998215
description	cutting grid for ice-cube maker L 350mm W 285mm H 40mm		

for espresso machines

brewing units

filter holder gaskets

O-rings



1

GEV No.	510409	Ref. No.	0929046
description	O-ring EPDM thickness 5.34mm ID ø 56.52mm Qty 1 pcs		

for pour machines

coffee pots



1

GEV No.	960004	Ref. No.	A210.142
description	coffee pot 1.8l plastic/steel		

coffee filters

paper filters

basket filters



1

GEV No.	960100	Ref. No.	190013
description	paper filter for coffee makers D1 ø 90mm D2 ø 250mm Qty 1000 pcs		



filter pans

filter pans

BARTSCHER



1

GEV No.	950000	Ref. No.	A038004 A0ND003+A040583
description	filter pan aluminium with percolator tube edition since year of construction 10/2007 ø 205mm H 50mm suitable for PRO 40T		
For models:	A190141		

drain taps

drain taps



1

GEV No.	531128	Ref. No.	A0ND029	
description	outlet tap complete tube ø 19mm pipe length 22mm thread M15x1 black			
For models:	A190141, A190161			
spare parts for	531128			
	GEV No.	531129	Ref. No.	A0ND032
	gasket for outlet tap H 29mm ø 14.5mm suitable for BARTSCHER			



1

GEV No.	531151	Ref. No.	A040580
description	outlet tap tube ø 22.5mm pipe length 52mm thread M16 black		

components



1

GEV No.	531129	Ref. No.	A0ND032
description	gasket for outlet tap H 29mm ø 14.5mm suitable for BARTSCHER		
For models:	A190141, A190161		

liquid level pipes

liquid level pipes



1

GEV No.	531131	Ref. No.	A0ND043	
description	water level tube ED ø 12mm ID ø 10mm H 202mm for coffee machine			
For models:	A190141			
accessories for	531131			
	GEV No.	504297	Ref. No.	A0ND036
	gasket for water level tube ED ø 13mm ID ø 6mm silicone			



1

GEV No.	531130	Ref. No.	A039690	
description	water level tube ED ø 12mm ID ø 10mm H 262mm for coffee machine			
For models:	A190161			
accessories for	531130			
	GEV No.	504297	Ref. No.	A0ND036
	gasket for water level tube ED ø 13mm ID ø 6mm silicone			

accessories

gaskets



1

GEV No.	504297	Ref. No.	A0ND036
description	gasket for water level tube ED ø 13mm ID ø 6mm silicone		
For models:	A190141, A190161		



miscellaneous



1

GEV No.	531308	Ref. No.	A039688 A040627
description	pipe L 335mm W 43mm tube ø 9mm		
For models:	A190161		



1

GEV No.	531208	Ref. No.	A0ND038
description	reset pin L 107mm W 33mm suitable for BARTSCHER		
For models:	A190141, A190161		

for crepes makers

accessories



1

GEV No.	697850	Ref. No.	010444614
description	batter spreader for crepes maker L 320mm W 275mm wood		
For models:	104447		



1

GEV No.	694339	Ref. No.	010444615
description	crêpe spatula L 430mm W 57mm thickness 4mm wood		
For models:	104447		

for deep fryers

lids



1

GEV No.	970745	Ref. No.	016240415
description	lid for fryer SS L 295mm W 215mm H 7mm		

basket holders



1

GEV No.	970744	Ref. No.	016240426
description	basket support for fryer L 139mm W 44mm H 8mm suitable for BARTSCHER		

miscellaneous



1

GEV No.	692498	Ref. No.	A040572
description	mounting set fryer		
For models:	A150107, A150207, A150671		

for grills

sumps



1

GEV No.	693206	Ref. No.	A016490
description	grease collecting tray		

			
1			
GEV No.	692237	Ref. No.	A041541
description	grease collecting tray L 357mm W 37mm H 29mm		
For models:	A150674		

for hot dog machines

water containers

			
1			
GEV No.	693169	Ref. No.	A042233034
description	water container for hot dog machine ø 205mm H 65mm		

for panini grill

guiding pieces

			
1			
GEV No.	699289	Ref. No.	A042575
description	support bracket mounting pos. rear L 35mm W 14mm H 12.5mm		
For models:	A150671, A150674		

for contact grills

miscellaneous

			
1			
GEV No.	701381	Ref. No.	A041543
description	handle L 350mm W 406mm H 20mm Panini		
For models:	A150674		

			
1			
GEV No.	692239	Ref. No.	A040548
description	spindle for contact grill L 404mm ø 12mm		
For models:	A150674		

for pizza ovens

firebricks

			
1			
GEV No.	850015	Ref. No.	0300180131
description	firebrick L 620mm W 305mm H 25mm delivery freight forwarding company only		

			
1			
GEV No.	850113	Ref. No.	022552
description	firebrick L 620mm W 610mm H 25mm delivery freight forwarding company only		

for rechauds

warming plates

warming plates

			
1			
GEV No.	693132	Ref. No.	A000800
description	warming plate plate size 280x155x8mm with handle suitable for PLA5/PLA12		

for rice cookers



1

GEV No.	694342	Ref. No.	A01505131
description	silicon insert for rice cooker ø 293mm thickness 1.3mm		

for saladettes

guide bars

1

GEV No.	693176	Ref. No.	048234001
description	guide bar for saladette		

for salamander grills



1

GEV No.	692729	Ref. No.	02013882
description	belt for salamander grill L 385mm W 13mm Hmm ED ømm ID ømm		



1

GEV No.	697836	Ref. No.	A039868
description	gear wheel teeth 16 shaft intake ø 8mm ø 35mm tooth width 3mm W 18mm for toaster		
For models:	151510		



1

GEV No.	692728	Ref. No.	02013873
description	spindle for salamander grill L 493mm Wmm Hmm ED ø 5mm ID ømm		

for sliding doors

door guides



1

GEV No.	693219	Ref. No.	041615
description	guide for sliding door aluminium		

for dishwashers

containers

dosing containers



1

GEV No.	361255	Ref. No.	0481241867008
description	rinse aid container		

salt tanks





1

GEV No.	510929	Ref. No.	011628 012247
description	salt tank ø 120mm H 117mm hose ø 10mm mounting ø 70mm overall height 157mm		





spare parts for	510929			
	GEV No.	506015	Ref. No.	—
	O-ring EPDM thickness 3.53mm ID ø 39.69mm Qty 1 pcs			
	GEV No.	510018	Ref. No.	—
	nut ø 92mm H 10.5mm for salt tank ID ø 64mm			
	GEV No.	524177	Ref. No.	—
	lid ø 69mm H 20mm for salt tank ID ø 50mm			

Table continues overleaf



accessories for		510929	
	GEV No.	510071	Ref. No. —
flat gasket rubber ED ø 81mm ID ø 68mm thickness 3mm for salt tank Qty 1 pcs			
	GEV No.	510654	Ref. No. —
gasket H 6mm D1 ø 82mm D2 ø 68mm			
	GEV No.	510883	Ref. No. —
gasket rubber ED ø 86mm ID ø 66mm thickness 2mm for salt tank Qty 1 pcs			



GEV No.	510032	Ref. No.	0406998
description salt tank without gasket new model			
spare parts for 510032			
	GEV No.	506015	Ref. No. —
O-ring EPDM thickness 3.53mm ID ø 39.69mm Qty 1 pcs			
	GEV No.	510018	Ref. No. —
nut ø 92mm H 10.5mm for salt tank ID ø 64mm			
	GEV No.	510071	Ref. No. —
flat gasket rubber ED ø 81mm ID ø 68mm thickness 3mm for salt tank Qty 1 pcs			
	GEV No.	524177	Ref. No. —
lid ø 69mm H 20mm for salt tank ID ø 50mm			

boilers

boilers for dishwashers

	1		
GEV No.	518379	Ref. No.	0982017
description boiler			





hood mechanics for dishwashers

guide bars

	1		
GEV No.	693174	Ref. No.	058233013
description guide bar			



air traps

air traps

	1		
GEV No.	510103	Ref. No.	011500 011672
description air trap L 85mm W 20mm H 80mm hose ø 6mm plastic			
spare parts for 510103			
	GEV No.	505045	Ref. No. —
O-ring EPDM thickness 1.78mm ID ø 5.28mm Qty 1 pcs			
	GEV No.	505094	Ref. No. —
air trap			
	GEV No.	510016	Ref. No. 011498 011675 020696
eye bolt for rinse aid container connection			
	GEV No.	510105	Ref. No. 011674
hose connector for air trap			

	1		
GEV No.	518200	Ref. No.	0984005
description air trap ø 34mm H 78mm hose ø 6mm plastic			
spare parts for 518200			
	GEV No.	504618	Ref. No. —
O-ring EPDM thickness 2.62mm ID ø 15.54mm Qty 1 pcs			
	GEV No.	510075	Ref. No. —
flat gasket rubber ED ø 22mm ID ø 13mm thickness 1.5mm Qty 1 pcs			
	GEV No.	510106	Ref. No. —
hose connector for air trap			

air trap accessories

	1		
GEV No.	510105	Ref. No.	011674
description hose connector for air trap			
spare parts for 510105			
	GEV No.	510017	Ref. No. 0468007
union screw			

washing and rinsing systems



1

GEV No.	524406	Ref. No.	011909
description	bush for wash arm		



1

GEV No.	510016	Ref. No.	011498 011675 020696
description	eye bolt for rinse aid container connection		



1

GEV No.	510112	Ref. No.	011601
description	Thumb screw thread M10 thread L 10mm ø 22mm H 4.5mm SS		

for toasters

pliers

pliers



1

GEV No.	690010	Ref. No.	A040894
description	plier for toaster H 180mm total length 100mm		
For models:	A151300, A151600		

knobs

producer-specific knobs

BARTSCHER



1

GEV No.	112626 ¹	Ref. No.	A040082
description	knob oven t.max.°C° ø 41mm shaft ø 6x4.6mm shaft flat lower black		
For models:	A151300, A151600		

¹with rosette 58mm

1

GEV No.	112622 ¹	Ref. No.	0KG20526
description	knob thermostat 1-10 t.max.°C° ø 41mm shaft ø 6x4.6mm shaft flat lower black		
For models:	A203093, A203094		

¹with rosette 58mm

1

GEV No.	112618 ¹	Ref. No.	A040078
description	knob thermostat t.max. 190°C 50-190°C ø 41mm shaft ø 6x4.6mm shaft flat lower black		
For models:	A150107, A150207		

¹with rosette 58mm

1

GEV No.	112617 ¹	Ref. No.	01044465A A039853
description	knob thermostat t.max. 300°C 50-300°C ø 41mm shaft ø 6x4.6mm shaft flat lower black		
For models:	104447, A150671, A150674		

¹with rosette 58mm

1

GEV No.	112619 ¹	Ref. No.	040574
description	knob thermostat t.max. 80°C 30-80°C ø 41mm shaft ø 6x4.6mm shaft flat lower black		
For models:	103.122, 103063		

¹with rosette 58mm



1

GEV No.	112620 ¹	Ref. No.	A0YXD1A4A09
description	knob thermostat t.max. 300°C 50-300°C ø 48mm shaft ø 6x4.6mm shaft flat upper black		
For models:	105780, A120788		

¹with rosette 70mm



1

GEV No.	112616 ¹	Ref. No.	010578016
description	knob time 120min + ON t.max.°C°C ø 41mm shaft ø 6x4.6mm shaft flat lower black		
For models:	105780		

¹with rosette 58mm



1

GEV No.	112621 ¹	Ref. No.	A0YXD1A4A08
description	knob time 120min t.max.°C°C ø 48mm shaft ø 6x4.6mm shaft flat upper black		
For models:	A120788		

¹with rosette 70mm



1

GEV No.	112624 ¹	Ref. No.	A040898
description	knob time 15min t.max.°C°C ø 41mm shaft ø 6mm shaft flat black rosette ø 58mm		
For models:	A151300, A151600		

¹with rosette 58mm

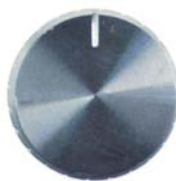

1

GEV No.	112535	Ref. No.	01143562
description	knob switch zero mark t.max.°C°C ø 23mm shaft ø 6x4.6mm shaft flat upper silver		



1

GEV No.	112625 ¹	Ref. No.	A040899
description	knob time 15min t.max.°C°C ø 41mm shaft ø 6x4.6mm shaft flat lower black		
For models:	A151300, A151600		

¹with rosette 58mm



1

GEV No.	112537	Ref. No.	A02011006
description	knob switch zero mark t.max.°C°C ø 41mm shaft ø 6x4.6mm shaft flat left black		



1

GEV No.	112533 ¹	Ref. No.	OAT93617 A0AT93617 EB-600-00
description	knob energy regulator t.max.°C°C ø 48mm shaft ø 6x4.6mm shaft flat upper black		
For models:	151510, A1515001		

¹with rosette 70mm



1

GEV No.	112649 ¹	Ref. No.	016240421
description	knob switch zero mark t.max.°C°C ø 50mm shaft ø 6x4.6mm shaft flat upper black		
accessories for	112649		
	GEV No.	Ref. No.	016240423
	slide ring ø 50mm black plastic for knob		

¹with rosette 55mm



1

GEV No.	112653	Ref. No.	016240423
description	slide ring ø 50mm black plastic for knob		
accessories for	112653		
	GEV No.	112649	Ref. No. 016240421
description	knob switch zero mark t.max.°C°C ø 50mm shaft ø 6x4.6mm shaft flat upper black		

accessories

rosettes



1

GEV No.	112058	Ref. No.	003Q677
description	rosette gas tap with ignition flame knob		



1

GEV No.	111897	Ref. No.	065043001
description	rosette knob		



1

GEV No.	112049	Ref. No.	065043002
description	rosette knob		

handles and hand wheels

cylindrical handles

fixed



1

GEV No.	693170	Ref. No.	A030012157
description	cylindrical handle for lid		

cone handles



1

GEV No.	697834	Ref. No.	A040576
description	cone handle thread M6x1 ø 13mm plastic L 53mm black thread L 6mm		
For models:	A150107, A150207		

mushroom cap handles



1

GEV No.	111441	Ref. No.	016240439
description	mushroom cap handle with screw thread M4 handle ø 28mm L 24mm black for lid		

handle bars

handle bars



1

GEV No.	692128	Ref. No.	010578060
description	handle rod tube ø 19mm L 690mm stainless steel		
For models:	105780		
accessories for	692128		
	GEV No.	694306	Ref. No. A0308983
description	console for handle rod tube ø 17mm plastic mounting pos. left/right Qty 1 pcs		



1

GEV No.	694307	Ref. No.	A0YXD1A34
description	handle rod tube ø 19mm thickness 1mm L 453mm SS		
For models:	A120788		



consoles



GEV No.	694306	Ref. No.	A0308983
description	console for handle rod tube ø 17mm plastic mounting pos. left/right Qty 1 pcs		
For models:	105780, A120788		
accessories for	694306		
	GEV No.	692128	Ref. No.
			010578060
	handle rod tube ø 19mm L 690mm stainless steel		

bracket handles



GEV No.	697997	Ref. No.	A0ND006
description	handle L 107mm H 20mm mounting distance 60mm for container ø 20mm W 46mm black		
For models:	A190141, A190161		



GEV No.	698580	Ref. No.	A0ND001
description	pull handle L 114mm H 33mm mounting distance 106mm thread M3 W 30mm		
For models:	A190141, A190161		



GEV No.	691510	Ref. No.	016210828 A040575
description	pull handle L 130mm H 44mm mounting distance 112mm		
For models:	103.122, 103063, A150107, A150207		



GEV No.	698563	Ref. No.	A0ND024
description	pull handle L 144mm H 42mm mounting distance 136mm thread M3 W 32mm		



GEV No.	700965	Ref. No.	A039859 EB-600-18
description	pull handle L 275mm H 60mm mounting distance 197mm thread M8x1.25		
For models:	151510, EB600		

folding grill handles



GEV No.	693178	Ref. No.	040212006
description	folding grill handle		



GEV No.	693253	Ref. No.	0A040212002
description	folding grill handle		



GEV No.	692149	Ref. No.	A0GH81334
description	handle L 155mm ø 30mm seat ø 10mm for contact grill		
For models:	A150671, A150674		

recessed handles



GEV No.	697995	Ref. No.	016240427
description	recessed handle L 90mm W 60mm H 23.5mm mounting distance 75mm plastic for fryer		

miscellaneous

			
1			
GEV No.	691511	Ref. No.	A02011007
description	door handle L 160mm W 36mm hole distance 116mm		

			
1			
GEV No.	701455	Ref. No.	65131014
description	oven hinge mounting distance 118mm lug mounting 13mm lever length 117mm groove distance 11mm spring thickness 4mm mounting ear position right spring length 55mm L 155mm W 22mm		

hinges

oven hinges



			
1			
GEV No.	701380	Ref. No.	0A0YXD4A42
description	hinge mounting distance 142mm lever length 116mm groove distance 7mm spring thickness 3.5mm mounting ear position L 155mm W 19mm		
For models:	A120788		

			
1			
GEV No.	701404	Ref. No.	06532728
description	oven hinge mounting distance 118mm mounting distance 2mm lug mounting 14mm lever length 117mm groove distance 11mm spring thickness 4mm mounting ear position left/right spring length 55mm L 155mm mounting pos. W 22mm		

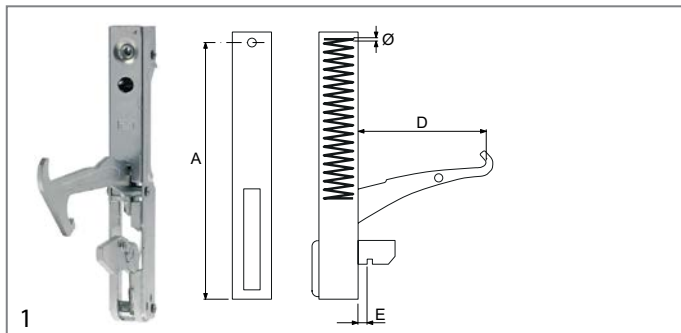

			
1			
GEV No.	701454	Ref. No.	65131015
description	oven hinge mounting distance 118mm lug mounting 13mm lever length 117mm groove distance 11mm spring thickness 4mm mounting ear position left spring length 55mm L 155mm W 22mm		

			
1			
GEV No.	701217	Ref. No.	0CER001
description	oven hinge mounting distance 142mm lever length 118mm groove distance 10mm spring thickness 3.5mm spring length 57mm L 155mm mounting pos. left/right W 21mm		



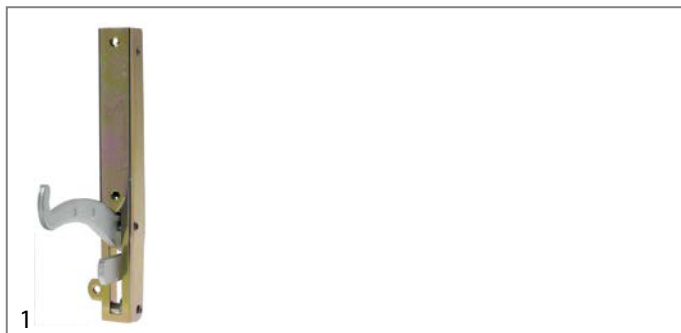

GEV No.	700000	Ref. No.	01057803
description	oven hinge mounting distance 142mm mounting distance 2mm lug mountingmm lever length 127mm groove distance 10mm spring thickness 3.7mm mounting ear position L 155mm mounting pos. left/right		
For models:	105780		
accessories for	700000		
	GEV No.	693045	Ref. No. —
	opposite support L 110mm W 12mm mounting distance 94mm		
	GEV No.	700707	Ref. No. —
	opposite support mounting distance 94mm L 140mm mounting pos. left W 13mm with welded metal sheet H 110mm for hinge		

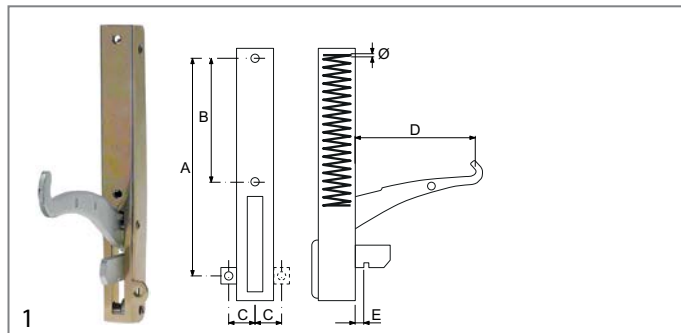

GEV No.	700006	Ref. No.	022752
description	oven hinge mounting distance 173mm mounting distance 2 105mm lug mounting 14mm lever length 120mm groove distance 11mm spring thickness 3.5mm mounting ear position left spring length 112mm W 25mm		
accessories for	700006		
	GEV No.	700001	Ref. No. —
	opposite support L 118mm W 17mm mounting distance 94mm		
	GEV No.	700007	Ref. No. 022751
	oven hinge mounting distance 173mm mounting distance 2 105mm lug mounting 14mm lever length 120mm groove distance 11mm spring thickness 3.5mm mounting ear position right spring length 112mm W 25mm		



GEV No.	700007	Ref. No.	022751
description	oven hinge mounting distance 173mm mounting distance 2 105mm lug mounting 14mm lever length 120mm groove distance 11mm spring thickness 3.5mm mounting ear position right spring length 112mm W 25mm		
accessories for	700007		
	GEV No.	700001	Ref. No. —
	opposite support L 118mm W 17mm mounting distance 94mm		

miscellaneous



GEV No.	700926	Ref. No.	040607
description	door hinge L 75mm W 60mm mounting distance 48mm		
For models:	103.122, 103063		

fittings for catering equipment

outlet taps

universal



GEV No.	697834	Ref. No.	A040576
description	cone handle thread M6x1 ø 13mm plastic L 53mm black thread L 6mm		
For models:	A150107, A150207		

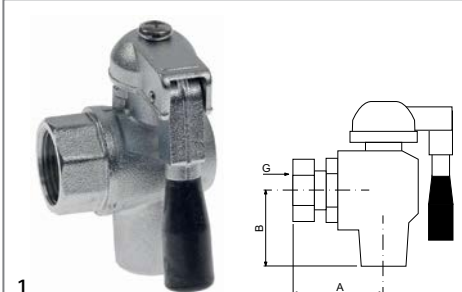

1

GEV No.	541540	Ref. No.	016210829 A040578
description	outlet tap stainless steel W 38mm H 40mm thread 3/4" IT		
For models:	A150107, A150207		
spare parts for	541540		
	GEV No.	Ref. No.	A040576
	cone handle thread M6x1 ø 13mm plastic L 53mm black thread L 6mm		



1

GEV No.	692499	Ref. No.	016210831 A041308
description	reducer L 46mm thread 1/2" ET / 3/4" ET ø 26mm		
For models:	A150107, A150207		



1

GEV No.	541749	Ref. No.	016210830
description	rosette for outlet tap thread D1 ø 63mm D2 ø 25mm		
For models:	A150207		

dispenser tap

complete



1

GEV No.	527165	Ref. No.	A040375
description	outlet tap complete ø 40mm inlet 3/8" plastic black		

equipment feet and end caps

equipment feet

with screw mounting



1

GEV No.	513287	Ref. No.	0926117
description	equipment foot tube ø 60mm thread M12 thread L 33mm H 155-235mm SS size 2" Qty 1 pcs		

screw-in feet



1

GEV No.	693204	Ref. No.	047122001
description	equipment foot hot bar		



1

GEV No.	700966	Ref. No.	A038973
description	equipment foot thread L 20mm ø 37mm H 20mm Qty 1 pcs		
For models:	105780, A120788		



1

GEV No.	693133	Ref. No.	030012167
description	equipment foot thread M10 saladette		





1

GEV No.	693139	Ref. No.	031136
description	equipment foot thread M8 BETA I/II		



bolting feet

 <p>1</p>			
GEV No.	697849	Ref. No.	01044461
description	equipment foot H 28mm thread M8 D1 ø 50mm D2 ø 38mm thread L 10mm		
For models:	104447		

 <p>1</p>			
GEV No.	697996	Ref. No.	016240431
description	equipment foot ø 23mm H 23.5mm bore ø 5mm Qty 1 pcs		

 <p>1</p>			
GEV No.	697998	Ref. No.	01058356
description	equipment foot ø 24/36mm H 25mm bore ø 19mm Qty 1 pcs thread M8x1.25		

 <p>1</p>			
GEV No.	691509	Ref. No.	0AT93602 A042567 A0AT93602 EB-600-04
description	equipment foot ø 28mm H 17.5mm rubber bore ø 6mm Qty 1 pcs		
For models:	151510, A114001, A150107, A150207, A150671, A150674, A151300, A1515001, A151600, A203093, A203094, EB600		

baskets

fryer baskets

BARTSCHER

 <p>1</p>			
GEV No.	970741	Ref. No.	016240416 165513 165519 165522
description	fryer basket W1 140mm L1 210mm H1 125mm chrome-plated steel		

 <p>1</p>			
GEV No.	970811	Ref. No.	165514 165520 165523
description	fryer basket W1 190mm L1 240mm H1 145mm L2 445mm H2 170mm H3 280mm chrome-plated steel plastic		

 <p>1</p>			
GEV No.	970716	Ref. No.	016210815 165516 A040571
description	fryer basket W1 192mm L1 230mm H1 140mm L2 470mm H2 200mm H3 220mm		
For models:	A150107, A150207		

 <p>1</p>			
GEV No.	970825	Ref. No.	165518
description	fryer basket W1 192mm L1 230mm H1 142mm L2 460mm H2 195mm H3 230mm stainless steel		

 <p>1</p>			
GEV No.	697833	Ref. No.	A041303
description	handle for fryer basket L 142mm H 21mm W 39mm		
For models:	A150107, A150207		

crumb screens

 <p>1</p>			
GEV No.	970743	Ref. No.	016210816 A041310
description	crumb screen L 245mm W 205mm H 5mm chrome-plated steel for fryer		
For models:	A150107, A150207		



1

GEV No.	970742	Ref. No.	016240418
description	crumb screen L 216mm W 149mm H 37mm chrome-plated steel for fryer		

miscellaneous

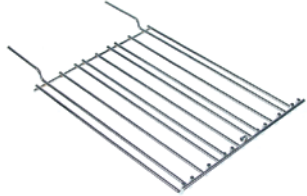

Image not available

1

GEV No.	693209	Ref. No.	A030048022V
description	basket without bottom		



1

GEV No.	210200	Ref. No.	030048019
description	chargrill grid W 250mm D 315mm		

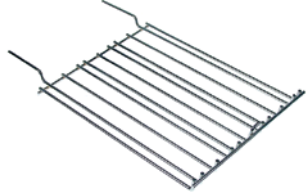

1

GEV No.	210201	Ref. No.	030048021
description	chargrill grid W 250mm D 315mm		



1

GEV No.	210260	Ref. No.	0AT93606 A0AT93606
description	chargrill grid W 250mm D 450mm chrome-plated steel with handle suitable for salamander grill		
For models:	A1515001		

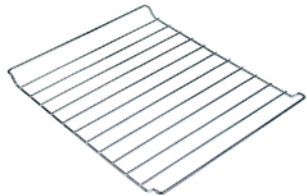

1

GEV No.	210197	Ref. No.	A030048042
description	chargrill grid W 290mm D 357mm chrome-plated steel		

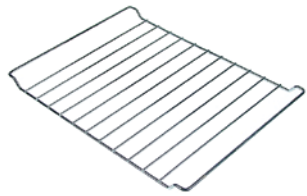

1

GEV No.	210199	Ref. No.	A030048043
description	chargrill grid W 290mm D 397mm chrome-plated steel		

shelves and shelf rails

grates

producer-specific

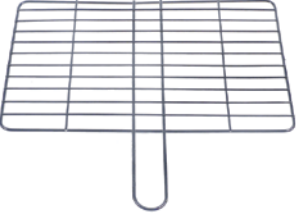

1

GEV No.	970715	Ref. No.	A040581
description	chargrill grid W 223mm D 352mm H 9mm chrome-plated steel with handle for toaster wire gauge frame 4mm lengthwise wires gauge 2.5mm crossing wires 4 BARTSCHER		
For models:	A151300, A151600		

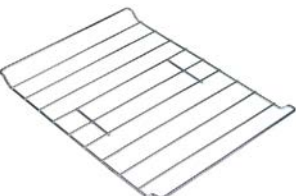

1

GEV No.	210198	Ref. No.	A030048044
description	chargrill grid W 245mm D 346mm chrome-plated steel		

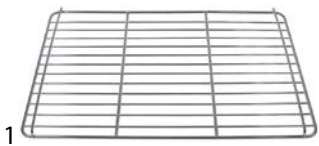
1

GEV No.	970813	Ref. No.	786002 786005
description	chargrill grid W 315mm D 435mm H 15mm chrome-plated steel L 315mm crossing wires 2		

gaskets

refrigeration gaskets

plug-in gaskets

profile 9399

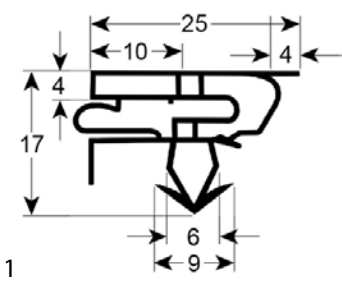

1

GEV No.	902156	Ref. No.	0700075
description	refrigeration gasket profile 9399 W 415mm L 430mm plug size		

screw-in gaskets

profile 9031

We offer custom-made gaskets for this profile

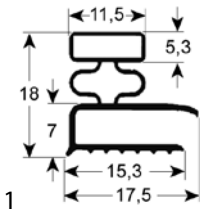

1

GEV No.	900266	Ref. No.	030012200
description	refrigeration gasket profile 9031 W 440mm L 600mm external size		

profile 9970

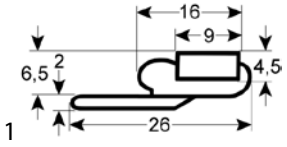

1

GEV No.	902470	Ref. No.	038275
description	refrigeration gasket profile 9970 W 420mm L 505mm external size		
For models:	700158G-McDonalds		

gaskets for heated units

door seals with fixing hook



1

GEV No.	901178	Ref. No.	010578049
description	door seal L 330mm W 680mm with 12 holes type series until 03/2013		
For models:	105780		



1

GEV No.	901946	Ref. No.	012078919
description	door seal W 320mm with 8 mounting clips H 260mm		



1

GEV No.	900264	Ref. No.	A030044013
description	door seal W 360mm with mounting clip H 225mm		



1

GEV No.	900265	Ref. No.	030044015
description	door seal W 405mm long side open with mounting clip H 245mm		



1

GEV No.	901842	Ref. No.	0105780491
description	door seal W 680mm H 330mm type series since 03/2013 16 holes		

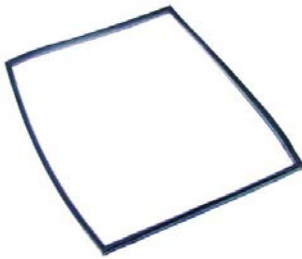

1

GEV No.	900393	Ref. No.	030004007
description	oven gasket L 330mm W 420mm external size		



1

GEV No.	901354	Ref. No.	A038980
description	oven gasket L 430mm W 330mm with 8 mounting clips		
For models:	A120788		

O-rings

EPDM

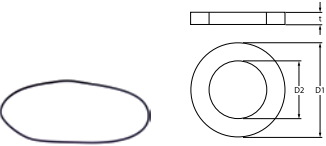

1

GEV No.	521717	Ref. No.	019380 021858
description	O-ring EPDM thickness 1.78mm ID ø 120.37mm Qty 1 pcs		

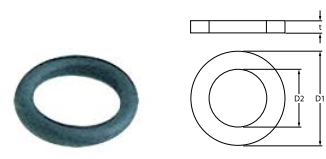

1

GEV No.	529412	Ref. No.	011499 011676 011677 0456048
description	O-ring EPDM thickness 2.62mm ID ø 10.78mm Qty 1 pcs		

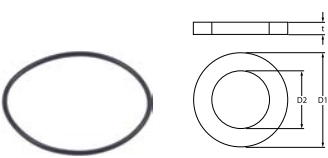

1

GEV No.	532618	Ref. No.	016240424
description	O-ring EPDM thickness 2mm ID ø 48.5mm Qty 1 pcs		

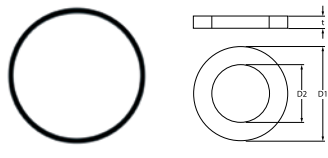

1

GEV No.	510009	Ref. No.	011691
description	O-ring EPDM thickness 3.53mm ID ø 101.2mm Qty 1 pcs		

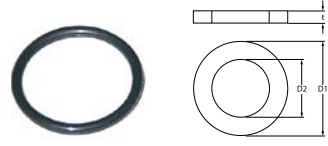

1

GEV No.	510072	Ref. No.	011630 012249 0456016
description	O-ring EPDM thickness 3.53mm ID ø 32.93mm Qty 1 pcs		



1

GEV No.	532118	Ref. No.	021145 214289
description	O-ring EPDM thickness 3.53mm ID ø 55.56mm Qty 10 pcs		

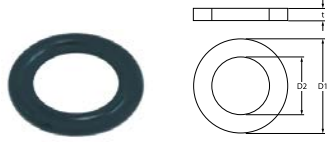

1

GEV No.	532498	Ref. No.	0456047
description	O-ring EPDM thickness 3.53mm ID ø 9.12mm Qty 1 pcs		



1

GEV No.	510408	Ref. No.	011510 011620
description	O-ring EPDM thickness 5.34mm ID ø 47mm Qty 1 pcs		

1

GEV No.	510409	Ref. No.	0929046
description	O-ring EPDM thickness 5.34mm ID ø 56.52mm Qty 1 pcs		

Viton

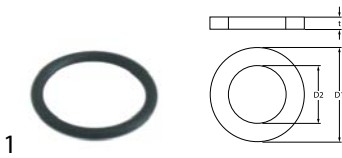

1

GEV No.	532504	Ref. No.	030010104
description	O-ring Viton thickness 2.62mm ID ø 20.24mm Qty 1 pcs		



1

GEV No.	550496	Ref. No.	049671
description	O-ring Viton thickness 3.53mm ID ø 50.39mm Qty 1 pcs		

sealing washers

fibre gaskets



1

GEV No.	529160	Ref. No.	004652632
description	flat gasket fibre ED ø 32mm ID ø 26mm thickness 1.5mm for drain tap suitable for 541540 Qty 1 pcs		
For models:	A150107, A150207		



1

GEV No.	510405	Ref. No.	012291
description	flat gasket fibre ED ø 56mm ID ø 42mm thickness 2mm for thread 1¼" Qty 1 pcs		

rubber gaskets



1

GEV No.	513059	Ref. No.	0437063
description	flat gasket rubber ED ø 52mm ID ø 40mm thickness 3mm Qty 1 pcs		



1

GEV No.	521124	Ref. No.	0481946669609
description	flat gasket rubber ED ø 52mm ID ø 42mm thickness 6mm Qty 1 pcs		



1

GEV No.	518060	Ref. No.	0456040
description	gasket rubber ED ø 132mm ID ø 122mm thickness 5mm		

PTFE gaskets



1

GEV No.	510012	Ref. No.	011662
description	flat gasket PTFE ED ø 16.5mm ID ø 12.5mm thickness 1.5mm Qty 1 pcs equiv. no. 437008		

silicone gaskets



1

GEV No.	504296	Ref. No.	A040382
description	flat gasket silicone ED ø 29mm ID ø 12mm thickness 1.6mm Qty 1 pcs for coffee machine		
For models:	A190141, A190161		



1

GEV No.	511646	Ref. No.	A0ND011
description	gasket silicone ED ø 63mm ID ø 55mm thickness 2.3mm Qty 1 pcs for heating element		
For models:	A190141, A190161		

special gaskets

miscellaneous



1

GEV No.	504297	Ref. No.	A0ND036
description	gasket for water level tube ED ø 13mm ID ø 6mm silicone		
For models:	A190141, A190161		



thermostat gaskets



GEV No.	512205	Ref. No.	016240433
description	gasket for temperature probe ED ø 15mm plastic Qty 1 pcs		

transmission technology and ball bearings

chains

roller chains 04B-1 single



GEV No.	697844	Ref. No.	A039870
description	chain DIN/ISO 04 B-1 splitting 6mm links 58 L 365mm internal width 2.8mm rollerø 4mm single		
For models:	151510		

springs

torsion springs



GEV No.	700569	Ref. No.	A0GH81313
description	torsion spring ø 21.5mm L2 40mm wire gauge ø 3.3mm L1 100mm L3 45mm		
For models:	A150671, A150674		

compression springs



GEV No.	112063	Ref. No.	0011564
description	knob spring ø 24mm L 28mm wire gauge ø 0.9mm		

tension springs



GEV No.	693175	Ref. No.	030014013
description	tension spring total length 330mm		

kitchen accessories

gastronorm

bridges



GEV No.	693210	Ref. No.	047233076
description	bridge for Gastronorm container		



GEV No.	693218	Ref. No.	047233173
description	bridge for Gastronorm container		

baking sheets



GEV No.	693167	Ref. No.	031165
description	baking sheet suitable for BETA I/II		



GEV No.	694532	Ref. No.	100 403 100.303
description	baking sheet W 325mm L 530mm perforated		







dosing pumps

piston pumps

with solenoid coil



1

GEV No.	361013	Ref. No.	010799
description	dosing pump inlet 4x6mm outlet 5mm 230V rinse aid duty cycle 25% type EKP-M 50Hz impulse 3imp/s		
spare parts for	361013		
	GEV No.	361482	Ref. No. —
	solenoid coil 230VAC for type EKP-M		
	GEV No.	361811	Ref. No. —
	hose connector for dosing pump hose ø 6.3mm T1: M12x1.5 chrome-plated brass		
	GEV No.	371090	Ref. No. —
	power socket plug type DIN 43650A screw		
accessories for	361013		
	GEV No.	361366	Ref. No. —
	PCB dishwasher 11F suitable for DB2 type DB2/EV1/EKP-M		
	GEV No.	361505	Ref. No. —
	screw pipe fitting straight nickel-plated brass thread 3/8" IT hose ø 6x8mm		

spare parts

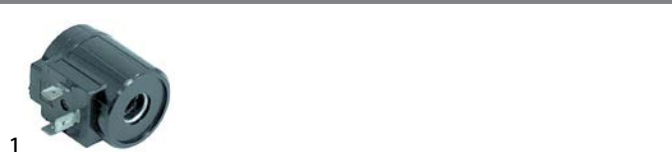

1

GEV No.	361113	Ref. No.	011525 011639
description	solenoid coil 230VAC for type DB2		

membrane dosing pumps

self-priming

SEKO



1

GEV No.	361364 ¹	Ref. No.	0209025
description	dosing pump type DIB5E self-sucking rinse aid pump rate 0-5cm ³ per stroke pressure connection ø 4x6mm suction connection ø 4x6mm SEKO supporting pressure closed		
spare parts for	361364		
	GEV No.	361301	Ref. No. —
	hose connector for type DIB3E/DIB5E		
	GEV No.	361302	Ref. No. —
	valve bush for type DIB3E/DIB5E		
	GEV No.	361304	Ref. No. —
	O-ring EPDM ID ø 11.11mm thickness 1.78mm Qty 1 pcs for type DIB3E/DIB5E		
	GEV No.	361305	Ref. No. —
	valve disc for type DIB3E/DIB5E DIB3P/DIB5P		
	GEV No.	361306	Ref. No. —
	membrane for type DIB3E/DIB5E ø 49mm hole ø 5mm		
	GEV No.	361307	Ref. No. —
	membrane dosing pump ø 68mm hole ø 6mm for type DIB3P/DIB5P		
	GEV No.	361459	Ref. No. —
	hose connector ø 6mm for dosing pump		
	GEV No.	361481	Ref. No. —
	lip valve for type DIB3P/DIB5P DIB3E/DIB5E		
accessories for	361364		
	GEV No.	361240	Ref. No. —
	hose connector 1-way hose ø 6mm plastic connection M10x1		
	GEV No.	361241	Ref. No. —
	hose connector 1-way hose ø 9mm plastic connection M10x1		

¹auxiliary pressure connection closed



hoses

drain hoses



1

GEV No.	518068	Ref. No.	020453
description	drain hose DN34 L 2000mm elbow ø inside 50mm elbow ext. ø 59mm inner hose ø 35mm outer hose ø 42mm PVC		

industrial hoses

Niplaflex hoses



1

GEV No.	570561	Ref. No.	011637
description	pressure hose ID ø 10mm ED ø 17mm L 40m thickness 3.5mm operating p. 10bar burst p. 30bar t.max. 110°C		



1

GEV No.	530561	Ref. No.	011503
description	pressure hose ID ø 10mm ED ø 17mm L 5m thickness 3.5mm operating p. 10bar burst p. 30bar t.max. 110°C		

ancillary products

clamps

hose clamps

DIN 3017 - W2



1

GEV No.	520110	Ref. No.	0423010 neu 21.05.96
description	hose clamp ø 8-12mm width 9mm Qty 10 pcs DIN 3017		

measuring equipment

thermometers

thermometers with core sensor



1

GEV No.	541096	Ref. No.	A293043
description	penetration thermometer L 139mm -50 up to +300°C display digital ø 35mm NTC probe L 120mm		



1

GEV No.	541097	Ref. No.	A292044
description	penetration thermometer L 143mm -10 up to 100°C t.max. 100°C display analogue ø 27mm probe L 120mm		

miscellaneous



1

GEV No.	541093	Ref. No.	A292048
description	thermometer -30 up to +30°C size ø60mm display analogue		

1

GEV No.	541098	Ref. No.	A292049
description	thermometer -30 up to +50°C size ø52mm display analogue		



1

GEV No.	541094	Ref. No.	A292043
description	thermometer -40 up to +25°C size 124x30mm display analogue		

fastening material

screws

knurled screws



1

GEV No.	510112	Ref. No.	011601
description	Thumb screw thread M10 thread L 10mm ø 22mm H 4.5mm SS		

nuts

hexagonal nuts

hexagonal nuts inch thread



1

GEV No.	501318	Ref. No.	152-2
description	nut thread 1/4" H 6.5mm SS WS 22 Qty 1 pcs		

fasteners

clamps

hose clamps

DIN 3017 - W2



1

GEV No.	520110	Ref. No.	0423010 neu 21.05.96
description	hose clamp ø 8-12mm width 9mm Qty 10 pcs DIN 3017		

roll pins



1

GEV No.	692236	Ref. No.	A0GH81316
description	roll pin ø 4mm L 40mm		
For models:	A150671, A150674		

consumables

coffee filters

basket filters

paper filters



1

GEV No.	960100	Ref. No.	190013
description	paper filter for coffee makers D1 ø 90mm D2 ø 250mm Qty 1000 pcs		

fuses

fine fuses



1

GEV No.	358533	Ref. No.	01143561
description	fine fuse size ø5x20mm 6.3A fast-acting rated 250V Qty 10 pcs		

A			
axial fans		37	
B			
bar burners		58	
bi-metal thermostats		17, 18	
C			
cam switches		26	
clamps		24, 80, 81	
coffee filters		81	
compressors		37	
condensators & interference suppression filters		41	
consumables		81	
contactors		32	
control thermostats		18, 22	
cross flow fans		37	
D			
door seals with fixing hook		75	
dosing pumps		79	
drain hoses		80	
drain pumps		41	
E			
electric accessories		42	
electric timers		30	
energy regulators		17	
F			
fans		37	
fasteners		81	
fastening material		81	
filters		41	
fine fuses		81	
fluorescent lamps		29	
fuses		42, 81	
G			
gas burners		48	
gas control valves		46	
gas nozzles		59	
gas taps		42	
gas thermostats		43	
gaskets for heated units		75	
gastronorm		78	
grates		74	
H			
halogen lamp		29	
heating elements		3	
heating elements for bain maries		4	
heating elements for charrills		10	
heating elements for chip scuttles		5	
heating elements for coffee machine		7	
heating elements for contact grills		8	
heating elements for convection		14	
heating elements for fryers		5	
heating elements for griddles		7	
heating elements for heated cabinets		11	
heating elements for heating bridges		11	
heating elements for ovens		3	
heating elements for pizza ovens		9	
heating elements for salamanders/toasters		10	
heating elements for tilting bratt pan		8	
heating plates		12	
hexagonal nuts		81	
hob burners		48	
hose clamps		80, 81	
hoses		80	
hot air fans		38	
hot air motors		38	
hot plates		16	
I			
ignition boxes		46	
immersion heating elements		12	
indicator lights		27	
indicator lights (complete)		27	
induction coils		3	
industrial hoses		80	
K			
knurled screws		81	
L			
lamps		27	
light bulbs		29	
M			
magnetic switches		27	
magnetrons		33	
measuring equipment		80	
mechanical timers		31	
microswitches		25	
motors		39	
N			
Niplaflex hoses		80	
nuts		81	
O			
operating capacitors		41	
O-rings		76	
oven hinges		70	

oven lamps	29
P	
pilot burners	46
plug-in gaskets	75
pressure switches	36
probe clips	24
probes	33
programme timers	30
pumps	40
push/momentary push switches	25
Q	
quartz heating elements	12
R	
radiation heaters	16
refrigeration fans	37
refrigeration gaskets	75
refrigeration thermostats	24
relays	32
rocker/momentary rocker switches	24
rod thermostats	24
roll pins	81
rotary switches	27
S	
safety bi-metal thermostats	17
safety rod thermostats	24
safety thermostats	21
screw-in gaskets	75
screws	81
sealing washers	77
shelves and shelf rails	74
solenoid valves	35
solid top burners	58
switches and momentary switches	24
system switches (ROLD)	26
T	
terminals	42
thermocouples	48
thermostat gaskets	78
thermostats	17
timers	30
toggle switches	25
W	
wash and rinse pumps	40