



GAS COMPONENTS



ELECTRIC COMPONENTS



WATER TECHNOLOGY



MECHANICAL COMPONENTS



TOOLS

Spare parts suitable for

BERTOS

Find the complete and up-to-date range of products in our GEV Webshop



Manufacturer catalogue

The most important spare parts and accessories arranged clearly for every manufacturer

- ✓ Complete product range and all appliance data always up to date in the GEV Webshop
- ✓ Alphabetical Index at the end of the catalogue

GEV Webshop

www.gev-online.co.uk

www.gev-online.com



- 🔍 Add to Favourites
- 🔍 Sign In with email address and usual password
- 🔍 Easy-order – place several items in your basket at the same time
- 🔍 Quick Item search – no login needed



heating elements

heating elements for ovens

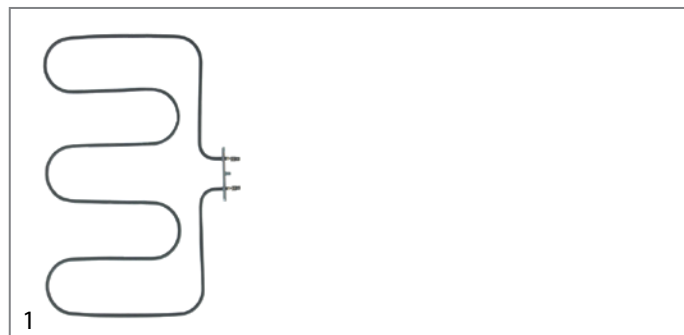

GEV No.	416042	Ref. No.	22016700
description	heating element 1500W 230V heating circuits 1 L 365mm W 500mm L1 45mm L2 315mm W1 240mm W2 30mm flange length 100mm flange width 22mm hole distance 86mm hole \varnothing 5mm tube \varnothing 6.3mm connection male faston 6.3mm mounting pos. lower rectangular flange dry heating element oven		
For models:	G4S+FCGN, G6S+FCGN		

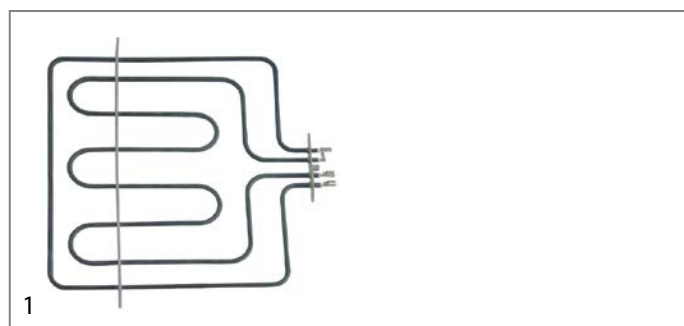



GEV No.	416041	Ref. No.	22016900
description	heating element 2600W 230V heating circuits 2 L 350mm W 355mm L1 36mm L2 314mm W1 147mm W2 60mm flange length 100mm flange width 22mm hole distance 80mm bridge length 480mm hole \varnothing 5mm tube \varnothing 6.3mm connection male faston 6.3mm mounting pos. upper rectangular flange dry heating element oven		
For models:	G4S+FCGN, G6S+FCGN		

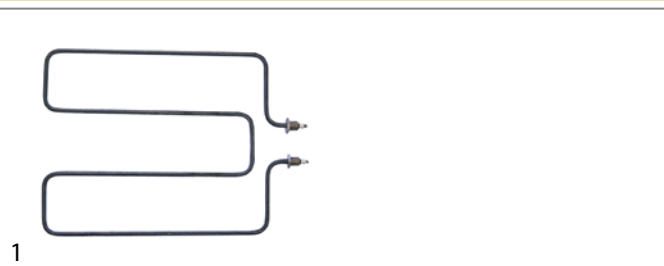

GEV No.	415294	Ref. No.	31320000
description	heating element 900W 230V L 468mm W 112mm H 23mm lug length 60mm lug width 20mm hole distance 153mm hole \varnothing 6mm tube \varnothing 6.3mm heating circuits 1 dry heating element windings 1 rectangular flange oven		
For models:	E7P4+FE, E7P4+FES, E7P4-VTR+FE, E7P6+FE, E7P6+FES, E7PQ4+FE, E7PQ4+FE+T, E7PQ4+FES, E7PQ6+FE, E7PQ6+FE+T, E7PQ6+FES, E7TP+FE, E9P4+FE, E9P4+FES, E9P4P-VTR+FE, E9P4-VTR+FE, E9P4-VTR+FES, E9P6+FE, E9P6+FES, E9PQ4+FE, E9PQ4+FE+T, E9PQ4+FES, E9PQ6+FE, E9PQ6+FE+T, E9PQ6+FES, G7F4+FE, G7F4+FES, G7F4E+FE, G7F4E+FE+A4, G7F4PW+FE, G7F4PW+FE+AE, G7F6+FE, G7F6+FES, G7F6E+FE, G7F6E+FE+A6, G7F6PW+FE, G7F6PW+FE+AE, G9F4+FE, G9F4PW+FE, G9F4PW+FE+AE, G9F6+FE, G9F6PW+FE, G9F6PW+FE+AE, G9F8+2FE, SE9P4P-VTR+FE, SE9PQ4+FE, SE9PQ6+FE, SG9F4+FE, SG9F6+FE, SG9F8+2FE		

heating elements for bain maries



GEV No.	415844	Ref. No.	22015800
description	heating element 2600W 230V heating circuits 1 L 410mm W 300mm connection length 10mm connection M4 tube \varnothing 8.5mm 2 hole fixing thread 3/8" immersion heater L1 27mm L2 383mm W1 120mm W2 60mm mounting distance 50mm		
For models:	EBMM6		
spare parts for	415844		
	GEV No.	Ref. No.	—
	521137	—	flat gasket fibre ED \varnothing 20mm ID \varnothing 18mm thickness 1.5mm for thread 3/8" Qty 1 pcs
accessories for	415844		
	GEV No.	Ref. No.	—
	361183	—	nut thread 3/8" H 6mm nickel-plated brass WS 20 Qty 1 pcs

heating elements for chip scuttles

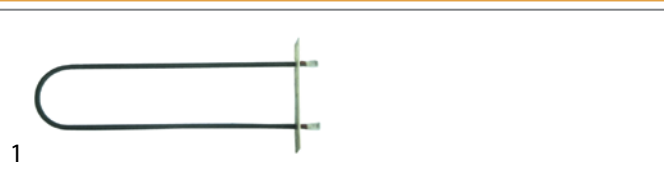



GEV No.	416082	Ref. No.	22016400
description	heating element 350W 230V heating circuits 8.5 L 172mm W 74mm flange length 110mm flange width 22mm hole distance 94mm connection length 20mm connection male faston 6.3mm tube \varnothing 8.5mm rectangular flange hole \varnothing 6mm dry heating element		
For models:	ESPS4		

heating elements for fryers

off-center connection

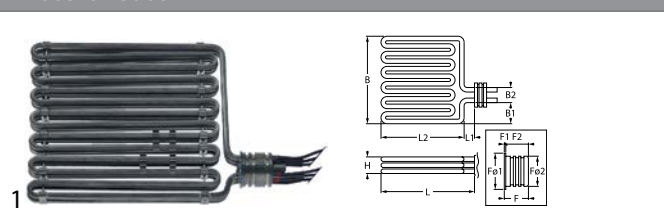
miscellaneous



GEV No.	417764	Ref. No.	38927800
description	heating element 18000W 230V heating circuits 3 L 332mm W 265mm H 33mm flange length 48mm flange \varnothing 1 58mm flange \varnothing 2 54mm thermostat sleeves \varnothing 6.5mm sensor screw connection 2x M10x1 thermostat sleeve upper/lower L1 17mm L2 315mm W1 33mm W2 35mm tube \varnothing 8.5mm cable length 550mm rotation flange fryer		
accessories for	417764		
	GEV No.	Ref. No.	45354800 45854800
	529186	—	O-ring Viton thickness 3.53mm ID \varnothing 47.63mm Qty 1 pcs

1 electric components



GEV No.	416008	Ref. No.	33026600
description	heating element 5000W 230/400V heating circuits 3 L 245mm W 200mm H 170mm H1 143mm H2 27mm rectangular flange connection male faston 6.3mm fryer heaters hole distance 60mm hole ø 5mm flange length 270mm flange width 25mm tube ø 8.5mm		
For models:	ELT10+10B-E, ELT10B-E, ELT12+12B-E, ELT12B-E, ELT15+15B, ELT15+15B-E, ELT15B, ELT15B-E, ELT18+18B, ELT18+18BE, ELT18B, ELT18BE		

GEV No.	418104	Ref. No.	33026700
description	heating element 6000W 230/400V heating circuits 3 L 280mm W 205mm H 175mm H1 150mm H2 25mm rectangular flange connection male faston 6.3mm immersion heater hole distance 60.5mm hole ø 5mm flange length 270mm flange width 24mm tube ø 8.5mm		
For models:	ELT10+10B-E, ELT10B-E, ELT12+12B-E, ELT12+12M-E, ELT12B-E, ELT12M-E, ELT15+15B, ELT15+15B-E, ELT15+15M, ELT15+15M-E, ELT15B, ELT15B-E, ELT15M, ELT15M-E, ELT18+18B, ELT18+18BE, ELT18+18M, ELT18+18M-E, ELT18+18M-E224, ELT18B, ELT18BE, ELT18M, ELT18M-E		

GEV No.	418106	Ref. No.	33026900
description	heating element 9000W 230/400V heating circuits 3 L 300mm W 240mm H 200mm H1 175mm H2 25mm rectangular flange connection male faston 6.3mm fryer heaters hole distance 85mm hole ø 5mm flange length 325mm flange width 25mm tube ø 8.5mm		
For models:	ELT10+10B-E, ELT10B-E, ELT12+12B-E, ELT12+12M-E, ELT12B-E, ELT12M-E, ELT15+15B, ELT15+15B-E, ELT15+15M, ELT15+15M-E, ELT15B, ELT15B-E, ELT15M, ELT15M-E, ELT18+18B, ELT18+18BE, ELT18+18B-E, ELT18+18M, ELT18+18M-E, ELT18+18M-E224, ELT18B, ELT18BE, ELT18B-E, ELT18M, ELT18M-E		

GEV No.	417765	Ref. No.	31016600
description	heating element 13050W 230V heating circuits 3 L 370mm W 230mm H 250mm L1 65mm L2 305mm W1 55mm W2 135mm H1 215mm H2 32mm flange ø 40mm rotation flange cable length 400mm fryer heaters mounting ø 25mm		
For models:	E7F18-4M, E7F18-8M		

GEV No.	415257	Ref. No.	22016200
description	heating element 6000W 230/400V heating circuits 3 L 300mm W 182mm H 252mm L1 65mm L2 235mm W1 59mm W2 134mm W3 250mm H1 220mm H2 32mm windings 12 flange ø 40mm rotation flange cable length 380mm fryer heaters mounting ø 25mm		
For models:	E10+10MB6, E10B4, E6F10-3B, E6F10-3M, E6F10-6B, E6F10-6M, E7F10-4B, E7F10-4BS, E7F10-4M, E7F10-4MS, E7F10-8B, E7F10-8BS, E7F10-8M, E7F10-8MS, E7F30-8B, E7F30-8M		

2 hole fixing

GEV No.	416004	Ref. No.	33024700
description	heating element 2700W 230V heating circuits 1 L 240mm W 208mm H 125mm thread 1/4" tube ø 8.5mm windings 4 mounting distance 200mm connection male faston 6.3mm 2 hole fixing immersion heater		
For models:	8+8LB-LD, 8LB-LD, ELT8+8B, ELT8+8B-E, ELT8B, ELT8B-E		
accessories for	416004		
	GEV No.	361182	Ref. No. —
	nut thread 1/4" H 5mm nickel-plated brass WS 17 Qty 1 pcs		
	GEV No.	510417	Ref. No. —
	flat gasket fibre ED ø 20mm ID ø 14mm thickness 2mm Qty 1 pcs		
	GEV No.	520228	Ref. No. —
	tooth lock washer ID ø 15.3mm ED ø 24mm steel Qty 1 pcs for thread M14		
	GEV No.	550262	Ref. No. —
	flat gasket copper ED ø 20mm ID ø 14mm thickness 2mm		



GEV No.	416006	Ref. No.	33024800
description	heating element 3100W 230V heating circuits 1 L 270mm W 215mm H 131mm thread 1/4" tube ø 8.5mm windings 4 mounting distance 203mm connection male faston 6.3mm 2 hole fixing immersion heater		
For models:	10+10LB-LD, 10LB-LD, ELT10+10B, ELT10B, ELT12+12B, ELT12B		
accessories for	416006		
	GEV No.	361182	Ref. No. —
	nut thread 1/4" H 5mm nickel-plated brass WS 17 Qty 1 pcs		
	GEV No.	510417	Ref. No. —
	flat gasket fibre ED ø 20mm ID ø 14mm thickness 2mm Qty 1 pcs		
	GEV No.	520228	Ref. No. —
	tooth lock washer ID ø 15.3mm ED ø 24mm steel Qty 1 pcs for thread M14		
	GEV No.	550262	Ref. No. —
	flat gasket copper ED ø 20mm ID ø 14mm thickness 2mm		

GEV No.	416007	Ref. No.	33025600
description	heating element 3500W 230V heating circuits 1 L 290mm W 190mm H 153mm thread 1/4" tube ø 8.5mm windings 4 mounting distance 84mm connection male faston 6.3mm 2 hole fixing connection length 20mm immersion heater		
For models:	12+12LB-LD, 12+12LM-LD, 12LB-LD, 12LM-LD, 15LBZ-LD, 15LMZ-LD, ELT10+10B, ELT10B, ELT12+12B, ELT12+12M, ELT12B, ELT12M		
accessories for	416007		
	GEV No.	361182	Ref. No. —
	nut thread 1/4" H 5mm nickel-plated brass WS 17 Qty 1 pcs		
	GEV No.	510417	Ref. No. —
	flat gasket fibre ED ø 20mm ID ø 14mm thickness 2mm Qty 1 pcs		
	GEV No.	520228	Ref. No. —
	tooth lock washer ID ø 15.3mm ED ø 24mm steel Qty 1 pcs for thread M14		
	GEV No.	550262	Ref. No. —
	flat gasket copper ED ø 20mm ID ø 14mm thickness 2mm		

GEV No.	416005	Ref. No.	33024900
description	heating element 3450W 230V heating circuits 1 L 260mm W 200mm H 167mm thread 1/4" tube ø 8.5mm windings 4 mounting distance 192mm connection male faston 6.3mm 2 hole fixing connection length 20mm immersion heater fryer		
For models:	ELT8+8B, ELT8+8B-E, ELT8B, ELT8B-E		

GEV No.	416003	Ref. No.	33024600
description	heating element 1800W 230V heating circuits 1 L 270mm W 137mm H 150mm L1 25mm L2 245mm thread M14x1.5 mounting distance 128mm tube ø 8.5mm windings 3 1/4" connection male faston 6.3mm dry heating element		
For models:	ELT4+4B, ELT4B		

GEV No.	420068	Ref. No.	33025900
description	heating element 3450W 400V heating circuits 1 L 290mm W 180mm H 153mm thread 1/4" tube ø 8.5mm windings 4 mounting distance 172mm connection male faston 6.3mm 2 hole fixing immersion heater/dry heating element fryer		
For models:	12+12LB-LD, 12+12LM-LD, 12LB-LD, 12LM-LD, 15LBZ-LD, 15LMZ-LD, ELT16B, ELT30B		

heating elements for griddles

GEV No.	415651	Ref. No.	22039300
description	heating element 1500W 230V heating circuits 1 L 425mm W 72mm H 53mm tube ø 8.5mm L1 22mm connection male faston 6.3mm connection distance 52mm dry heating element		
For models:	E6BR6B, E6BR6M, E7BR4B, E7BR4M, E7FL4B, E7FL4B-CR, E7FL4B-SX, E7FL4M, E7FL4M-CR, E7FL4M-SX, E7FL8B-2, E7FL8B-2-CR, E7FL8B-2-SX, E7FL8M-2, E7FL8M-2-CR, E7FL8M-2-SX, E7FM8B-2, E7FM8M-2, E7FR4B, E7FR4M, E7FR8B-2, E7FR8M-2, EFLD8, EFLD8-CR, EFLM6, EFLM6-2, EFLM6-2-CR, EFLM6-CR, EFLS4, EFLS4-CR, EFM6-2, EFM6-2-CR, EFRS4		

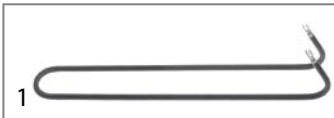

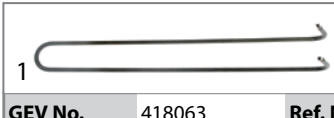

GEV No.	420521	Ref. No.	22039400 35039500
description	heating element 1600W 230V heating circuits 1 L 428mm W 65mm H 88mm tube ø 8.5mm		
For models:	E7FL4BP, E7FL4BP-CR, E7FL4BP-SX, E7FL4MP, E7FL4MP-CR, E7FL4MP-SX, E7FL8BP-2, E7FL8BP-2-CR, E7FL8BP-2-SX, E7FL8MP-2, E7FL8MP-2-CR, E7FL8MP-2-SX, E7FM8BP-2, E7FM8MP-2, E7FR4BP, E7FR4MP, E7FR8BP-2, E7FR8MP-2, E9BR8, E9BR8-I, LXE9BR8-I, SE9BR8, SE9BR8-I		



GEV No.	418063	Ref. No.	35039300
description	heating element 1900W 240V heating circuits 1 L 600mm W 65mm H 75mm tube ø 9mm L1 30mm dry heating element		
For models:	E9FL4M, E9FL4M-CPD, E9FL4M-CR, E9FL4M-SX, E9FL8M-2, E9FL8M-2-CPD, E9FL8M-2-CR, E9FL8M-2-SX, E9FM8M-2, E9FR4M, E9FR8M-2		

heating elements for tilting bratt pan



GEV No.	416002	Ref. No.	31927000
description	heating element 3000W 240V L 390mm W 120mm H 68mm connection M4 dry heating element heating circuits 1 tube ø 10mm L1 30mm L2 360mm connection distance 103mm		
For models:	E7BR8, E7BR8-I		

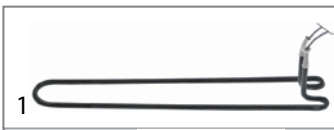

GEV No.	420593	Ref. No.	38416100
description	heating element for tilting bratt pan 1600W 230V L 460mm W 78mm H 95mm connection cable 2000mm heating circuits 1 tube ø 8.5mm		



GEV No.	415077	Ref. No.	22039800
description	heating element stock pot 1300W 230V L 280mm W 150mm H 40mm connection male faston 6.3mm tilting bratt pan heating circuits 1 tube ø 8.5mm bracket mounting hole distance 142mm hole ø 5mm lug length 25mm lug width 15mm		
For models:	EBRS4		



GEV No.	420067	Ref. No.	36039300
description	heating element tilting bratt pan 1350W 240V L 360mm W 66mm H 70mm connection male faston 6.3mm dry heating element heating circuits 1 tube ø 8.5mm L1 30mm connection distance 58mm		
For models:	E6BR6B, E6BR6M, E6FL3B, E6FL3BP, E6FL3B-P, E6FL3BP-CR, E6FL3BP-SX, E6FL3B-SX, E6FL3M, E6FL3MP, E6FL3M-P, E6FL3MP-CR, E6FL3MP-SX, E6FL3M-SX, E6FL6B-2, E6FL6B-2-SX, E6FL6BP-2, E6FL6BP-2-CR, E6FL6BP-2-SX, E6FL6M-2, E6FL6M-2-SX, E6FL6MP-2, E6FL6MP-2-CR, E6FL6MP-2-SX, E6FM6B-2, E6FM6BP-2, E6FM6M-2, E6FM6MP-2, E6FR3B, E6FR3BP, E6FR3M, E6FR3MP, E6FR6B-2, E6FR6BP-2, E6FR6M-2, E6FR6MP-2, E7BR4B, E7BR4M		

heating elements for contact grills

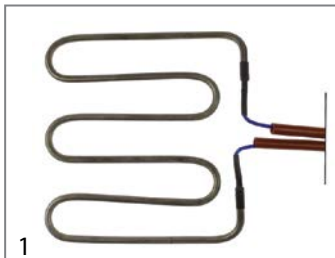

GEV No.	416011	Ref. No.	30023500
description	heating element 1000W 230V L 182mm W 195mm H 12mm W1 42mm W2 111mm connection length 25mm tube ø 6.3mm windings 3 cable length 400mm dry heating element		
For models:	PDL-LD, PDL-ST, PDL-SX, PDM-LD, PDM-ST, PDR-LD, PDR-ST, PDR-VTR, PDT-L, PDT-LD, PDT-LS, PDT-M, PDT-R, PDT-SX, PDT-VTR, PD-VTR, PSL-LD, PSL-ST, PSL-SX, PSM-ST, PSR-LD, PSR-ST, PST-L, PST-LD, PST-R		

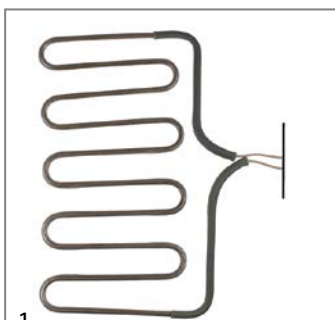

GEV No.	416013	Ref. No.	30024100
description	heating element 1000W 230V L 185mm W 310mm H 28mm W1 115mm W2 80mm connection length 35mm tube ø 6.9mm windings 5 cable length 690mm dry heating element		
For models:	PM+VTR, PML-LD, PML-ST, PMR-LD, PMR-ST, PMR-VTR, PM-VTR		

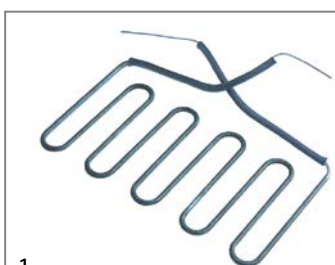

GEV No.	416014	Ref. No.	30024300
description	heating element 1500W 230V L 180mm W 325mm H 42mm W1 108mm W2 109mm connection length 75mm tube ø 6.3mm windings 5 cable length 330mm dry heating element		
For models:	PM+VTR, PML-LD, PML-ST, PMR-LD, PMR-ST, PMR-VTR, PMT-VTR, PM-VTR		



1

GEV No.	416012	Ref. No.	30022500
description	heating element 700W 230V L 185mm W 187mm H 11mm W1 42mm W2 102mm tube ø 6.3mm windings 3 cable length 750mm dry heating element		
For models:	PDL-LD, PDL-ST, PDL-SX, PDM-LD, PDM-ST, PDR-LD, PDR-ST, PDR-VTR, PD-VTR, PSL-LD, PSL-ST, PSL-SX, PSM-ST, PSR-LD, PSR-ST		

heating elements for pasta cookers





1

GEV No.	415902	Ref. No.	22015900
description	heating element 2510W 230V L 295mm W 115mm Hmm 2 hole fixing connection male faston 6.3mm thread M14x1 tube ø 8.5mm		
For models:	E6CP6B, E6CP6M, E6CPM, ECRM6		
accessories for	415902		
	GEV No.	510417	Ref. No. —
	flat gasket fibre ED ø 20mm ID ø 14mm thickness 2mm Qty 1 pcs		
	GEV No.	520228	Ref. No. —
	tooth lock washer ID ø 15.3mm ED ø 24mm steel Qty 1 pcs for thread M14		
	GEV No.	521133	Ref. No. —
	nut thread M14x1.5 H 6mm WS 19 zinc-coated steel Qty 1 pcs		
	GEV No.	550261	Ref. No. —
	nut thread M14x1 H 4mm WS 19 SS Qty 1 pcs		
	GEV No.	550262	Ref. No. —
	flat gasket copper ED ø 20mm ID ø 14mm thickness 2mm		

heating elements for chargrills



1

GEV No.	416000	Ref. No.	22039100
description	heating element 1500W 230V L 438mm W 80mm H 62mm thread 1/4" mounting distance 19mm tube ø 8.5mm connection male faston 6.3mm windings 2 heating circuits 1 connection length 23mm 2 hole fixing dry heating element		
For models:	EGRM4, EGRS4		
spare parts for	416000		
	GEV No.	510417	Ref. No. —
	flat gasket fibre ED ø 20mm ID ø 14mm thickness 2mm Qty 1 pcs		
accessories for	416000		
	GEV No.	361182	Ref. No. —
	nut thread 1/4" H 5mm nickel-plated brass WS 17 Qty 1 pcs		
	GEV No.	520228	Ref. No. —
	tooth lock washer ID ø 15.3mm ED ø 24mm steel Qty 1 pcs for thread M14		

accessories for	416000		
	GEV No.	550262	Ref. No. —
	flat gasket copper ED ø 20mm ID ø 14mm thickness 2mm		

heating elements for salamanders/toast-

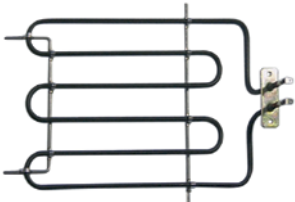

1

GEV No.	415347	Ref. No.	27022200 27022300
description	heating element 1600W 230V heating circuits 1 L 295mm W 205mm H 45mm flange length 70mm flange width 22mm hole distance 56mm connection male faston 6.3mm tube ø 6.3mm mounting thread M5 rectangular flange dry heating element		
For models:	SA-E60, SA-E60-E, SA-E68, SA-E68M, SA-E68M-E		

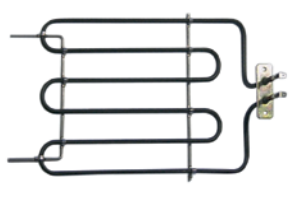

1

GEV No.	416009	Ref. No.	27023000
description	heating element 2300W 230V heating circuits 1 L 300mm W 205mm H 40mm W1 88mm W2 30mm flange length 70mm flange width 22mm hole distance 56mm connection M4 tube ø 6.5mm connection length 8mm mounting thread M4 rectangular flange dry heating element		
For models:	SA-E60, SA-E60-E, SA-E68M, SA-E68M-E		

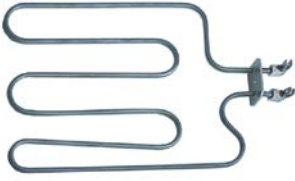

1

GEV No.	416010	Ref. No.	30031600
description	heating element 800W 230V heating circuits 1 L 255mm W 169mm L1 40mm L2 185mm W1 70mm W2 29mm flange length 40mm flange width 22mm tube ø 4.2mm connection length 30mm dry heating element connection male faston 6.3mm rectangular flange mounting thread M4		
For models:	4TO		

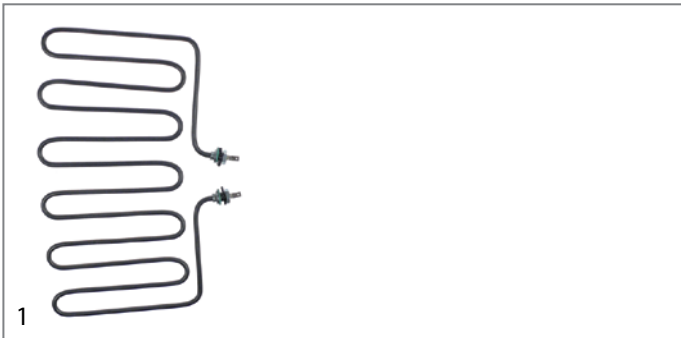



GEV No.	416833	Ref. No.	27022100
description	heating element 2800W 230V L 206mm W 398mm W1 149mm W2 100mm thread 1/4" mounting distance 94mm tube ø 6.3mm connection male faston 6.3mm heating circuits 1 dry heating element 2 hole fixing H 6.3mm		
For models:	SA-E48		
accessories for	416833		
	GEV No.	361182	Ref. No. —
	nut thread 1/4" H 5mm nickel-plated brass WS 17 Qty 1 pcs		
	GEV No.	510417	Ref. No. —
	flat gasket fibre ED ø 20mm ID ø 14mm thickness 2mm Qty 1 pcs		
	GEV No.	520228	Ref. No. —
	tooth lock washer ID ø 15.3mm ED ø 24mm steel Qty 1 pcs for thread M14		
	GEV No.	550262	Ref. No. —
	flat gasket copper ED ø 20mm ID ø 14mm thickness 2mm		

ceramic heaters

245x60mm



GEV No.	415103	Ref. No.	22016100
description	ceramic emitter 650W 230V cable beaded cord L 245mm W 60mm H 35mm		
For models:	E6SP6B, E6SP6M, E7SP-4B, E7SP-4M, ESPS4		
spare parts for	415103		
	GEV No.	415109	Ref. No. —
	spring clip		
accessories for	415103		
	GEV No.	415110	Ref. No. —
	reflector L 245mm W 95mm H 31mm thickness 0.75mm hole ø 15x40mm		

quartz heating elements

GEV No.	416021	Ref. No.	30040800
description	heating coil 500W 110V for quartz tube L1 390mm L2 325mm ø 5mm connection eye		
For models:	12T, 6T		



GEV No.	415311	Ref. No.	30014100
description	quartz heating element L 410mm ø 11mm 1000W 230V W 130mm connection eye double inner length 390mm		
For models:	12T, 6T		

GEV No.	416020	Ref. No.	30043100
description	quartz tube WV L 390mm ID ø 9mm ED ø 11mm		
For models:	12T, 6T		

immersion heating elements

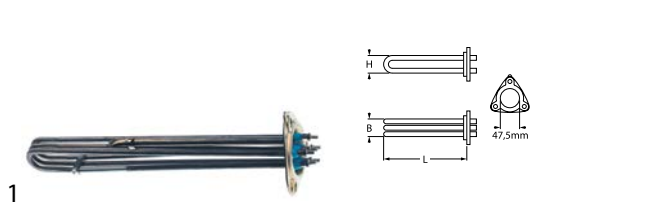
3 hole flange ø47.5mm



GEV No.	418136	Ref. No.	25021600
description	heating element 4360W 240V mounting ø 47.5mm heating circuits 3 L 310mm W 31mm H 35mm number of thermostat sleeves 1 thermostat sleeves ø 7mm length thermostat sleeves 200mm thermostat sleeve clinging tube ø 6.3mm hole distance 62mm hole ø 8mm connection M4 3 hole flange immersion heater		
For models:	FME06M, FME10, FME10EP, FME10M, FME20, FME20M, FME6		
spare parts for	418136		
	GEV No.	510408	Ref. No. 35859500
	O-ring EPDM thickness 5.34mm ID ø 47mm Qty 1 pcs		
accessories for	418136		
	GEV No.	510408	Ref. No. 35859500
	O-ring EPDM thickness 5.34mm ID ø 47mm Qty 1 pcs		
	GEV No.	510562	Ref. No. —
	O-ring silicone thickness 5.34mm ID ø 47mm Qty 1 pcs		



1

GEV No.	418064	Ref. No.	35039900
description	heating element 8000W 230V mounting \varnothing 47.5mm heating circuits 3 L 497mm W 30mm H 36mm number of thermostat sleeves 1 thermostat sleeves \varnothing 7mm length thermostat sleeves 260mm thermostat sleeve clinging tube \varnothing 8.5mm hole distance 63mm hole \varnothing 8mm connection length 16mm connection M4 3 hole flange immersion heater		
For models:	E9P10I, E9P10IA, E9P15I, SE9P10I, SE9P10IA, SE9P15I		
accessories for	418064		
	GEV No.	Ref. No.	35859500
	510408		
	O-ring EPDM thickness 5.34mm ID \varnothing 47mm Qty 1 pcs		
	GEV No.	Ref. No.	—
	510562		
	O-ring silicone thickness 5.34mm ID \varnothing 47mm Qty 1 pcs		

with expansion flange 70 x 18mm

1

GEV No.	418137	Ref. No.	10622
description	heating element 3000W 230V heating circuits 1 flange 70x18mm L 220mm W 65mm Hmm connection male faston 6.3mm tube \varnothing 8.5mm immersion heater expansion flange connection length 34mm		

1

GEV No.	418138	Ref. No.	10620
description	heating element 6000W 230V heating circuits 1 flange 70x18mm L 445mm W 68mm connection male faston 6.3mm tube \varnothing 8.5mm immersion heater expansion flange connection length 34mm		

1

GEV No.	418065	Ref. No.	35040100
description	heating element 9000W 230V mounting \varnothing 47.5mm heating circuits 1 L 415mm W 36mm H 43mm number of thermostat sleeves 1 thermostat sleeves \varnothing 6mm length thermostat sleeves 267mm thermostat sleeve clinging tube \varnothing 9mm hole distance 62mm hole \varnothing 8mm connection M4 3 hole flange immersion heater		
For models:	E9P15I, E9P15IA, LXE9P15I, SE9P15I, SE9P15IA		
accessories for	418065		
	GEV No.	Ref. No.	35859500
	510408		
	O-ring EPDM thickness 5.34mm ID \varnothing 47mm Qty 1 pcs		
	GEV No.	Ref. No.	—
	510562		
	O-ring silicone thickness 5.34mm ID \varnothing 47mm Qty 1 pcs		

2"

1

GEV No.	416073	Ref. No.	31320200
description	heating element 6000W 220V heating circuits 3 L 315mm W 43mm H 39mm tube \varnothing 8.5mm thermostat sleeves \varnothing 5mm length thermostat sleeves 280mm number of thermostat sleeves 1 thermostat sleeve eccentric, clinging connection M4 immersion heater flange with thread thread 2"		
For models:	E7PI		
accessories for	416073		
	GEV No.	Ref. No.	—
	510407		
	flat gasket fibre ED \varnothing 78mm ID \varnothing 60mm thickness 2mm for heating element for thread 2" Qty 1 pcs		

heating elements for convection

1

GEV No.	418129	Ref. No.	10638
description	heating element 16000W 230V heating circuits 3 ID \varnothing 337mm ED \varnothing 358mm L 450mm H 100mm L1 84mm W1 108mm H1 15mm H2 85mm flange length 142mm flange width 25mm hole distance 64mm connection M4 tube \varnothing 8.5mm convection heating element hole \varnothing 6mm rectangular flange		

3 hole flange \varnothing 57.5mm

1

GEV No.	417739	Ref. No.	31015900
description	heating element 4000W 230V mounting \varnothing 57.5mm heating circuits 3 L 300mm W 42mm H 44mm number of thermostat sleeves 1 thermostat sleeves \varnothing 7.5mm length thermostat sleeves 230mm tube \varnothing 6.3mm hole \varnothing 8x10mm connection M4 3 hole flange immersion heater		
For models:	CPE40		



1

GEV No.	418127	Ref. No.	10641
description	heating element 16000W 230V heating circuits 3 ID ø 390mm ED ø 410mm L 430mm H 99mm L1 15mm W1 100mm H1 15mm H2 84mm flange length 142mm flange width 25mm hole distance 63mm connection M4 tube ø 8.5mm convection heating element hole ø 6mm rectangular flange		





1

GEV No.	418133	Ref. No.	23019200
description	heating element 2000W 220V heating circuits 1 ID ø 187mm ED ø 200mm L 215mm H 25mm L1 15mm W1 60mm H1 5mm H2 20mm flange length 100mm flange width 22mm hole distance 86mm connection male faston 6.3mm connection length 37mm tube ø 6.5mm convection heating element hole ø 5mm rectangular flange		
For models:	LAU-10, WAV-E1-2, WAV-E2-3		



1

GEV No.	416040	Ref. No.	22015500
description	heating element 2500W 230V heating circuits 1 ID ø 185mm ED ø 198mm L 212mm H 30mm L1 17mm W1 32mm H1 6mm H2 24mm flange length 70mm flange width 22mm hole distance 56mm connection male faston 6.3mm connection length 33mm tube ø 6.5mm dry heating element hole ø 5mm rectangular flange		
For models:	E4F+FCD8, E4F+FCDQ8, E7P4+FE1, E7P4-VTR+FE1, E7P6+FE1, E7PQ4+FE1, E7PQ6+FE1, E9P4+FE1, E9P4-VTR+FE1, E9P6+FE1, E9PQ4+FE1, E9PQ6+FE1, G4F+FCD8, G4S+FCGN, G6S+FCGN, G7F4+FE1, G7F4E+FE1, G7F4E+FE1+A4, G7F4E+FG1, G7F4E+FG1+A4, G7F6+FE1, G7F6E+FE1, G7F6E+FE1+A6, G7F6E+FG1, G7F6E+FG1+A6, G9F4+FE1, G9F4E+FE1, G9F4E+FE1+A4, G9F6+FE1, G9F6E+FE1, G9F6E+FE1+A6, G9F8+2FE1		
accessories for	416040		
	GEV No.	510368	Ref. No. —
	gasket L 70mm W 23.5mm hole ø 5mm hole distance 56mm FIBER thickness 2mm for heating element		



1

GEV No.	420520	Ref. No.	23930000
description	heating element 3000W 440V heating circuits 1 ID ø 180mm ED ø 193mm L 204mm H 25mm L1 2mm W1 60mm H1 15mm H2 34mm flange length 100mm flange width 22mm hole distance 86mm connection F6.3 tube ø 6.5mm		



1

GEV No.	418134	Ref. No.	23020500
description	heating element 3300W 240V heating circuits 1 ID ø 185mm ED ø 200mm L 215mm H 30mm W1 60mm H1 5mm H2 25mm flange length 100mm flange width 22mm hole distance 85mm connection male faston 6.3mm connection length 22mm tube ø 6.5mm convection heating element hole ø 5mm rectangular flange		
For models:	E6P4+FE1, E6P6+FE1, E6PQ2H6+FE1, E6PQ2H6+FE1+T, E6PQ2P9+FE1, E7P4+FE1, E7P4-VTR+FE1, E7P6+FE1, E7PQ4+FE1, E7PQ4+FE1+T, E7PQ6+FE1, E7PQ6+FE1+T, E9P4+FE1, E9P4P-VTR+FE1, E9P4-VTR+FE1, E9P6+FE1, E9PQ4+FE1, E9PQ4+FE1+T, E9PQ6+FE1, E9PQ6+FE1+T, G6F2H6+FE1, G6F2H9+FE1, G6F2P6+FE1, G6F2P9+FE1, G6F3H12+FE1, G6F4+FE1, G6F4+FE1+A4, G6F4PW+FE1, G6F4PW+FE1+AE, G6F6+FE1, G6F6+FE1+A6, G6F6PW+FE1, G6F6PW+FE1+AE, G7F4+FE1, G7F4E+FE1, G7F4E+FE1+A4, G7F4PW+FE1, G7F4PW+FE1+AE, G7F6+FE1, G7F6E+FE1, G7F6E+FE1+A6, G7F6PW+FE1, G7F6PW+FE1+AE, G9F4+FE1, G9F4E+FE1, G9F4E+FE1+A4, G9F4PW+FE1, G9F4PW+FE1+AE, G9F6+FE1, G9F6E+FE1...(Other models you can see in the webshop)		





1





GEV No.	418130	Ref. No.	25020800
description	heating element 3900W 230V heating circuits 3 ID ø 175mm ED ø 245mm L 285mm H 32mm L1 60mm W1 62mm H1 10mm H2 26mm flange length 93mm flange width 22mm hole distance 77mm connection male faston 6.3mm connection length 61mm tube ø 6.5mm convection heating element hole ø 5mm rectangular flange		
For models:	MM2-3EA, MM2-3EB, PASTRY-VIP-EMU		



			
1			
GEV No.	418131	Ref. No.	23021300
description	heating element 6000W 230V heating circuits 3 ID ø 217mm ED ø 231mm L 271mm H 90mm L1 41mm W1 103mm H1 24mm H2 66mm flange length 140mm flange width 22mm hole distance 63mm tube ø 6.3mm convection heating element hole ø 5mm rectangular flange		
For models:	WAV-ESU		

			
1			
GEV No.	418132	Ref. No.	24020800 25021400
description	heating element 7350W 230V heating circuits 3 ID ø 250mm ED ø 265mm L 277mm H 75mm L1 17mm W1 102mm H1 12mm H2 67mm flange length 143mm flange width 25mm hole distance 7mm connection M4 tube ø 6.5mm convection heating element hole ø 63mm rectangular flange		
For models:	FME06M, FME6, FPE5A, FPE5B, FPE5C, FPE5D, FPE6TURBO, MM06EA, MM06EB, WAV-E6T, WAV-E6TURBO		

			
1			
GEV No.	418128	Ref. No.	10633
description	heating element 9000W 230V heating circuits 3 ID ø 500mm ED ø 515mm L 535mm H 95mm L1 13mm W1 105mm H1 15mm H2 80mm flange length 142mm flange width 25mm hole distance 64mm connection M4 tube ø 8.5mm convection heating element hole ø 6mm rectangular flange		

			
1			
GEV No.	418135	Ref. No.	23016600
description	heating element 920W 230V heating circuits 1 ID ø 200mm ED ø 215mm L 255mm H 40mm thread 1/4" connection male faston 6.3mm 2 hole fixing mounting distance 24mm tube ø 8.5mm convection heating element		
For models:	WAV-E12, WAV-E6		
accessories for	418135		
	GEV No.	361182	Ref. No. —
	nut thread 1/4" H 5mm nickel-plated brass WS 17 Qty 1 pcs		
	GEV No.	510417	Ref. No. —
	flat gasket fibre ED ø 20mm ID ø 14mm thickness 2mm Qty 1 pcs		
	GEV No.	520228	Ref. No. —
	tooth lock washer ID ø 15.3mm ED ø 24mm steel Qty 1 pcs for thread M14		
	GEV No.	550262	Ref. No. —
	flat gasket copper ED ø 20mm ID ø 14mm thickness 2mm		

			
1			
GEV No.	418139	Ref. No.	25040600
description	heating element 3500W 240V heating circuits 1 L 620mm W 120mm L1 33mm L2 587mm W2 90mm flange length 70mm flange width 22mm hole distance 56mm connection length 100mm connection M4 tube ø 8.5mm hole ø 6mm W1 30mm rectangular flange convection heating element windings 2		
For models:	FME10, FME10EP, FME10M, FME20, FME20M, FPE12TURBO, MM10EA, MM10EB, WAV-E12T, WAV-E12TURBO, WAV-E20		

radiation heaters

			
1			
GEV No.	490152	Ref. No.	31927100
description	radiation heater octagonal 2500W 230V L 250mm W 250mm heating circuits 2 with heating coil energy regulation with temperature signalization connections 3+2 connection type cable AD		
For models:	E6P2M-VTR, E6P4M-VTR, E7P2B-VTR, E7P2M-VTR, E7P4B-VTR, E7P4M-VTR, E7P4-VTR+FE, E7P4-VTR+FE1		



hot plates

square & rectangular

with radiused edge



1

GEV No.	490066 ¹	Ref. No.	22037400
description	hot plate dimensions 220x220mm 2600W 230V with spill ring connection 4 screw clamps protector yes square		
For models:	E2FQS4, E4F+FCDQ8, E4FDQ8, E6PQ2BH6, E6PQ2BH6+T, E6PQ2H6+FE1, E6PQ2H6+FE1+T, E6PQ2MH6, E6PQ2MH6+T, E7PQ2B, E7PQ2B+T, E7PQ2M, E7PQ2M+T, E7PQ4+FE, E7PQ4+FE+T, E7PQ4+FE1, E7PQ4+FE1+T, E7PQ4+FES, E7PQ4B, E7PQ4B+T, E7PQ4M, E7PQ4M+T, E7PQ6+FE, E7PQ6+FE+T, E7PQ6+FE1, E7PQ6+FE1+T, E7PQ6+FES, E7PQ6B, E7PQ6B+T, E7PQ6M, E7PQ6M+T		

¹incl. protector

1

GEV No.	490071 ¹	Ref. No.	35037400
description	hot plate dimensions 300x300mm 4000W 230V with spill ring connection 4 screw clamps protector yes square		
For models:	E9PQ2M, E9PQ2M+T, E9PQ4+FE, E9PQ4+FE+T, E9PQ4+FE1, E9PQ4+FE1+T, E9PQ4+FES, E9PQ4M, E9PQ4M+T, E9PQ6+FE, E9PQ6+FE+T, E9PQ6+FE1, E9PQ6+FE1+T, E9PQ6+FES, E9PQ6M, E9PQ6M+T		

¹incl. protector

round

with radiused edge

for domestic and commercial kitchens



1

GEV No.	490020	Ref. No.	22037800
description	hot plate ø 220mm 2600W 230V connection 4 screw clamps with 8mm spill ring		
For models:	E2FS4, E4F+FCD8, E4FD8, E7P2B, E7P2M, E7P4+FE, E7P4+FE1, E7P4+FES, E7P4B, E7P4M, E7P6+FE, E7P6+FE1, E7P6+FES, E7P6B, E7P6M		
accessories for	490020		
	GEV No.	550796	Ref. No.
			—
	fixing plate for hot plate ø220mm		



1

GEV No.	490062	Ref. No.	35037800
description	hot plate ø 300mm 3500W 220V connection 4 screw clamps with 8mm spill ring		
For models:	E9P2M, E9P4+FE, E9P4+FE1, E9P4+FES, E9P4M, E9P6+FE, E9P6+FE1, E9P6+FES, E9P6M		

energy regulators

EGO

1-circuit



1

GEV No.	380015	Ref. No.	24114800 27114900 27115100
description	energy regulator 230V 13A single-circuit turn direction right shaft ø 6x4.6mm shaft L 23mm mounting thread M4 power release 6-100% no. 50.57021.010		
For models:	E6BM3B, E6BM3M, E6BM6B, E6BM6M, E6PL60B, E6PL60M, E9BM4M, E9BM8M, E9P2MP-VTR, E9P4MP-VTR, E9P4P-VTR+FE, E9P4P-VTR+FE1, E9PL40M, E9PL80M, EGRM4, EGRS4, FME06M, FME10M, FME20M, FMG10M, FMG20M, FMG6, FMG6M, FPE12TURBO, FPE6TURBO, FPG12, FPG5A, FPG5B, FPG6, LXE9P2P-VTR, LXE9P4P-VTR, PLE40BE, PLE40ME, PLE80BE, PLE80ME, SA-E48, SA-E60, SA-E60-E, SA-E68, SA-E68M, SA-E68M-E, SE9BM4M, SE9BM8M, SE9P2MP-VTR, SE9P4MP-VTR, SE9P4P-VTR+FE, SE9PL40M, SE9PL80M, WAV-E12, WAV-E12T...(Other models you can see in the webshop)		

thermostats

control and safety thermostats

EGO

control thermostats

55.10/19_ series



1

GEV No.	375647	Ref. No.	25070800
description	thermostat t.max. 110°C temperature range 31-110°C 1-pole 1NO 16A probe ø 6mm probe L 133mm capillary pipe 870mm capillary pipe isolatedmm gland nut shaft ø 6x4.6mm shaft L 23mm shaft position upper rotation 318°		
For models:	MM2-3EB		



GEV No.	375341	Ref. No.	31290000
description	thermostat t.max. 150°C temperature range 60-150°C 1-pole 1NO 16A probe ø 3mm probe L 219mm capillary pipe 900mm capillary pipe isolated 900mm gland nut shaft ø 6x4.6mm shaft L 23mm shaft position upper rotation 270°		
For models:	G7PI		



GEV No.	375363	Ref. No.	35301000
description	thermostat t.max. 161°C temperature range 73-161°C 1-pole 1NO 16A probe ø 3mm probe L 144mm capillary pipe 1600mm capillary pipe isolated 1600mm gland nut shaft ø 6x4.6mm shaft L 23mm shaft position upper rotation 270°		
For models:	E9P10I, E9P10IA, E9P15I, E9P15IA, LXE9P15I, SE9P10I, SE9P10IA, SE9P15I, SE9P15IA		



GEV No.	375063	Ref. No.	22056700 22064932
description	thermostat t.max. 170°C temperature range 70-170°C 1-pole 1NO 16A probe ø 11mm probe L 28mm capillary pipe 900mm capillary pipe isolated 900mm gland nut shaft L 23mm shaft position upper rotation 270° screw-in probe probe thread M14x1		
accessories for	375063		
	GEV No.	510417	Ref. No. —
	flat gasket fibre ED ø 20mm ID ø 14mm thickness 2mm Qty 1 pcs		
	GEV No.	510420	Ref. No. —
	gasket copper ED ø 19.9mm ID ø 14.3mm thickness 2mm Qty 1 pcs		
	GEV No.	521133	Ref. No. —
	nut thread M14x1.5 H 6mm WS 19 zinc-coated steel Qty 1 pcs		



GEV No.	375856	Ref. No.	32065700
description	thermostat t.max. 187°C temperature range 101-187°C 1-pole 1NO 16A probe ø 6mm probe L 130mm capillary pipe 900mm capillary pipe isolated 700mm gland nut M10x1 shaft ø 6x4.6mm shaft L 23mm shaft position upper rotation 270°		
For models:	GL18+18MI, GL18MI		



GEV No.	376096	Ref. No.	32065800
description	thermostat t.max. 192°C temperature range 101-192°C 1-pole 1NO probe ø 6mm probe L 133mm capillary pipe 1770mm capillary pipe isolated 1450mm gland nut M10x1 shaft ø 6x4.6mm shaft L 25mm rotation 270°		



GEV No.	390068	Ref. No.	23063300 23900600
description	thermostat t.max. 269°C temperature range 55-269°C 1-pole 1CO 16A probe ø 3.1mm probe L 219mm capillary pipe 1280mm capillary pipe isolated 1270mm gland nut shaft ø 6x4.6mm shaft L 23mm shaft position upper rotation 318°		
For models:	FC100EM, FC100GM, FC200EB, FC200GB, FC60EM, FC60GM, FME06M, FME10M, FME20M, FMG10M, FMG20M, FMG6, FMG6M, FPE12TURBO, FPE6TURBO, FPG12, FPG6, MM06EB, MM06GB, MM10EB, MM10GB, MM2-3EB, PASTRY-EM, PASTRY-VIP-EMU, WAV1-GAS, WAV2-1K-GAS, WAV3-GAS, WAV-E12, WAV-E12T, WAV-E12TURBO, WAV-E20, WAV-E5U, WAV-E6, WAV-E6T, WAV-E6TURBO, WAV-G12, WAV-G20, WAV-G5U, WAV-G6		



GEV No.	375216	Ref. No.	22061900
description	thermostat t.max. 280°C temperature range 50-280°C 1-pole 1NO 16A probe ø 3mm probe L 228mm capillary pipe 1300mm capillary pipe isolated 1150mm gland nut shaft L 23mm shaft position upper rotation 318°		
For models:	E4F+FCD8, E4F+FCDQ8, G4F+FCD8		



GEV No.	375327	Ref. No.	23063600
description	thermostat t.max. 297°C temperature range 58-297°C 1-pole 1NO 16A probe ø 3.03mm probe L 219mm capillary pipe 870mm capillary pipe isolated 870mm gland nut shaft L 23mm shaft position upper rotation 270°		
For models:	E7P4-VTR+FE1, E9BR8, E9BR8-I, E9P4+FE1, E9P4P-VTR+FE1, E9P6+FE1, G4S+FCGN, G6F3H12+FE1, G6F4PW+FE1, G6F4PW+FE1+AE, G6F6PW+FE1, G6F6PW+FE1+AE, G6S+FCGN, G7F4PW+FE1, G7F4PW+FE1+AE, G7F6PW+FE1, G7F6PW+FE1+AE, G9F4PW+FE1, G9F4PW+FE1+AE, G9F6PW+FE1, G9F6PW+FE1+AE, G9F8+2FE1, SE9BR8, SE9BR8-I, SNACK-E, WAV-1, WAV1-2, WAV1-GAS, WAV2-3, WAV2-GAS, WAV3-GAS, WAV-E1-2, WAV-E2-3		



GEV No.	375002	Ref. No.	22063600 22063623
description	thermostat t.max. 320°C temperature range 55-320°C 1-pole 1NO 16A probe ø 3.1mm probe L 226mm capillary pipe 870mm capillary pipe isolated 850mm gland nut shaft L 23mm shaft position upper rotation 270°		

55.13_series



GEV No.	375401	Ref. No.	33065600
description	thermostat t.max. 185°C temperature range 97-185°C 1-pole 1NO 16A probe ø 6mm probe L 87mm capillary pipe 1430mm capillary pipe isolated 1100mm gland nut M9x1 shaft ø 6x4.6mm shaft L 23mm shaft position upper rotation 270°		
For models:	4+4LB-LD, 4LB-LD, 8+8LB-LD, 8LB-LD, ELT10+10B, ELT10B, ELT12+12B, ELT12+12M, ELT12B, ELT12M, ELT4+4B, ELT4B, ELT8+8B, ELT8+8B-E, ELT8B, ELT8B-E		



GEV No.	391032	Ref. No.	35301200
description	thermostat t.max. 291°C temperature range 30-291°C 1-pole 1NO 16A probe ø 3mm probe L 160mm capillary pipe 1500mm capillary pipe isolated 770mm gland nut shaft ø 6x4.6mm shaft L 23mm shaft position upper		
For models:	E9BR8-I, LXE9BR8-I, SE9BR8-I		

55.34_ series



GEV No.	375385	Ref. No.	22062900 33066000 33066200
description	thermostat t.max. 180°C temperature range 100-180°C 3-pole 3NO 16A probe ø 6mm probe L 131mm capillary pipe 2000mm capillary pipe isolated 1800mm gland nut shaft ø 6x4.6mm shaft L 23mm shaft position upper rotation 270°		
For models:	E10+10MB6, E10B4, E6F10-3B, E6F10-3BS, E6F10-3M, E6F10-3MS, E6F10-6B, E6F10-6BS, E6F10-6M, E6F10-6MS, E7F10-4B, E7F10-4BS, E7F10-4M, E7F10-4MS, E7F10-8B, E7F10-8BS, E7F10-8M, E7F10-8MS, E7F18-4M, E7F18-4MS, E7F18-8M, E7F18-8MS, E7F30-8B, E7F30-8BP, E7F30-8M, E7F30-8MP, ELT10+10B-E, ELT10B-E, ELT12+12B-E, ELT12+12M, ELT12+12M-E, ELT12B-E, ELT12M, ELT12M-E, ELT15+15B, ELT15+15B-E, ELT15+15M, ELT15+15M-E, ELT15B, ELT15B-E, ELT15M, ELT15M-E, ELT16B, ELT18+18B, ELT18+18BE, ELT18+18B-E, ELT18+18M, ELT18+18M-E, ELT18+18M-E224, ELT18B...(Other models you can see in the webshop)		



GEV No.	375097	Ref. No.	22062900
description	thermostat t.max. 195°C temperature range 95-195°C 3-pole 3NO 16A probe ø 6mm probe L 117mm capillary pipe 1780mm capillary pipe isolated 1400mm gland nut M9x1 shaft ø 6x4.6mm shaft L 23mm shaft position upper rotation 270°		



GEV No.	375470	Ref. No.	30064900
description	thermostat t.max. 278°C temperature range 71-278°C 3-pole 3NO 16A probe ø 6mm probe L 75mm capillary pipe 1180mm capillary pipe isolated 1100mm gland nut shaft ø 6x4.6mm shaft L 23mm rotation 270° probe material SS		
For models:	E6BR6B, E6BR6M, E6FL3B, E6FL3BP, E6FL3B-P, E6FL3BP-CR, E6FL3BP-SX, E6FL3B-SX, E6FL3M, E6FL3MP, E6FL3M-P, E6FL3MP-CR, E6FL3MP-SX, E6FL3M-SX, E6FL6B-2, E6FL6B-2-SX, E6FL6BP-2, E6FL6BP-2-CR, E6FL6BP-2-SX, E6FL6M-2, E6FL6M-2-SX, E6FL6MP-2, E6FL6MP-2-CR, E6FL6MP-2-SX, E6FM6B-2, E6FM6BP-2, E6FM6M-2, E6FM6MP-2, E6FR3B, E6FR3BP, E6FR3M, E6FR3MP, E6FR6B-2, E6FR6BP-2, E6FR6M-2, E6FR6MP-2, E6P6+TE, E6PQ2P9+TE, E7BR4B, E7BR4M, E7BR8, E7BR8-L, E7FL4B, E7FL4B-CR, E7FL4BP, E7FL4BP-CR, E7FL4BP-SX, E7FL4B-SX, E7FL4M, E7FL4M-CR...(Other models you can see in the webshop)		



GEV No.	375038	Ref. No.	22062600
description	thermostat t.max. 300°C temperature range 50-300°C 3-pole 3NO 16A probe ø 6mm probe L 79mm capillary pipe 1740mm capillary pipe isolated 800mm gland nut shaft ø 6x4.6mm shaft L 23mm shaft position upper rotation 270°		
For models:	E6FL3B, E6FL3B-P, E6FL3BP-SX, E6FL3B-SX, E6FL3M, E6FL3M-P, E6FL3MP-SX, E6FL3M-SX, E6FL6B-2, E6FL6B-2-SX, E6FL6BP-2, E6FL6BP-2-SX, E6FL6M-2, E6FL6M-2-SX, E6FL6MP-2, E6FL6MP-2-SX, E6FM6B-2, E6FM6BP-2, E6FM6M-2, E6FM6MP-2, E6FR3B, E6FR3BP, E6FR3M, E6FR3MP, E6FR6B-2, E6FR6BP-2, E6FR6M-2, E6FR6MP-2, E6P-Q2P9+TE, E7BR8, E7FL4B, E7FL4B-CR, E7FL4B-SX, E7FL4M, E7FL4M-CR, E7FL4M-SX, E7FL8B-2, E7FL8B-2-CR, E7FL8B-2-SX, E7FL8M-2, E7FL8M-2-CR, E7FL8M-2-SX, E7FM8B-2, E7FM8M-2, E7FR4B, E7FR4M, E7FR8B-2, E7FR8M-2, E7P4+FE, E7P4-VTR+FE...(Other models you can see in the webshop)		
accessories for	375038		
		GEV No.	110123
		Ref. No.	—
	knob thermostat t.max. 300°C ø 50mm shaft ø 6x4.6mm shaft flat upper black temperature range 50-300°C rotation 270°		

56_ series





GEV No.	391034	Ref. No.	35300200 35300800
description	safety thermostat t.max. 182°C temperature range 13-182°C 1-pole 1NC 16A probe ø 4mm probe L 93mm capillary pipe 2445mm capillary pipe isolated 1210mm gland nut shaft ømm shaft Lmm shaft position° probe material SS		
For models:	E9P10I, E9P10IA, E9P15I, E9P15IA, LXE9P15I, SE9P10I, SE9P10IA, SE9P15I, SE9P15IA		





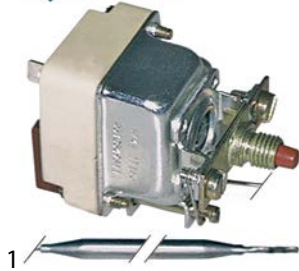

safety thermostats

55.10/19_ series

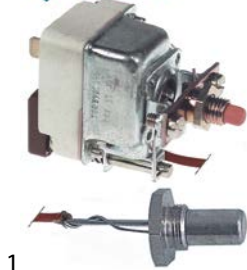

GEV No.	375250	Ref. No.	25070000
description	safety thermostat capillary pipe 870mm probe ø 6mm 1-pole probe L 129mm 16A capillary pipe isolatedmm gland nut switch-off temp. 130°C probe SS		
For models:	FME10, FME10EP, FME20, FME6, FMG10M, FMG20M, FMG6, FMG6M		
spare parts for	375250		
	GEV No.	551083	Ref. No. —
	cap for safety thermostat thread M8x1		



GEV No.	375282	Ref. No.	22070432
description	safety thermostat switch-off temp. 230°C 1-pole 16A probe ø 11mm probe L 28mm capillary pipe 850mm capillary pipe isolated 830mm gland nut probe screw-in probe probe thread M14x1		
accessories for	375282		
	GEV No.	507313	Ref. No. —
	O-ring EPDM thickness 2.62mm ID ø 13.95mm Qty 1 pcs		
	GEV No.	510420	Ref. No. —
	gasket copper ED ø 19.9mm ID ø 14.3mm thickness 2mm Qty 1 pcs		
	GEV No.	521133	Ref. No. —
	nut thread M14x1.5 H 6mm WS 19 zinc-coated steel Qty 1 pcs		

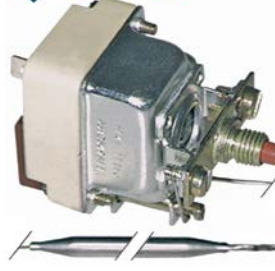

GEV No.	390062	Ref. No.	22069400 32070200
description	safety thermostat switch-off temp. 235°C 1-pole 0.5A probe ø 6mm probe L 130mm capillary pipe 1800mm capillary pipe isolated 1500mm gland nut M9x1 probe SS		
For models:	6GL18M, 9GL15+15M, 9GL15M, 9GL20+20M, 9GL20M, E10+10MB6, E10B4, GL10+10B, GL10+10M, GL10B, GL10M, GL15+15M, GL15M, GL20+20M, GL20M, GL30B, GL30M, GL8+8B, GL8+8M, GL8B, GL8M		
accessories for	390062		
	GEV No.	551083	Ref. No. —
	cap for safety thermostat thread M8x1		



GEV No.	391031	Ref. No.	32070300
description	safety thermostat switch-off temp. 235°C 1-pole 1CO 16A probe ø 6mm probe L 133mm capillary pipe 870mm shaft ømm probe SS		
For models:	6GL18B, 9GL15+15M, 9GL15M, 9GL20+20M, 9GL20M, GL10+10B, GL10+10M, GL10B, GL10M, GL15+15M, GL15M, GL20+20M, GL20M, GL30B, GL30M, GL7+7M, GL8+8B, GL8+8M, GL8B, GL8M, S9GL20+20M, S9GL20M, S9GL22M		



GEV No.	375352	Ref. No.	22069400
description	safety thermostat switch-off temp. 245°C 1-pole 1NC 16A probe ø 6mm probe L 130mm capillary pipe 1200mm capillary pipe isolated 1200mm gland nut probe		



55.32_series



GEV No.	375281	Ref. No.	31290200
description	safety thermostat switch-off temp. 150°C 3-pole 0.5A probe ø 3mm probe L 188mm capillary pipe 1100mm capillary pipe isolated gland nut probe SS		
For models:	E7PI, G7PI		





GEV No.	375649	Ref. No.	25070100
description	safety thermostat switch-off temp. 160°C 3-pole 20A probe ø 6mm probe L 87mm capillary pipe 890mm capillary pipe isolated gland nut probe SS		
For models:	FME06M, FME10M, FME20M, FMG10, FMG10EP, FMG10M, FMG20, FMG6, FMG6EP		



GEV No.	375364	Ref. No.	35300000
description	safety thermostat switch-off temp. 190°C 3-pole 20A probe ø 4mm probe L 120mm capillary pipe 3000mm capillary pipe isolated gland nut probe		
For models:	E9P10I, E9P10IA, E9P15I, E9P15IA, G9P10I, G9P10IA, G9P15I, G9P15IA, LXG9P15I, SE9P10I, SE9P10IA, SE9P15I, SE9P15IA, SG9P10I, SG9P10IA, SG9P15I		



GEV No.	375320	Ref. No.	33070800
description	safety thermostat switch-off temp. 230°C 3-pole 3NC 20A probe ø 6mm probe L 79mm capillary pipe 1700mm capillary pipe isolated 1100mm gland nut probe SS		
For models:	E6F10-3B, E6F10-3BS, E6F10-3M, E6F10-3MS, E6F10-6B, E6F10-6BS, E6F10-6M, E6F10-6MS, E7F10-4B, E7F10-4BS, E7F10-4M, E7F10-4MS, E7F10-8B, E7F10-8BS, E7F10-8M, E7F10-8MS, E7F18-4M, E7F18-4MS, E7F18-8M, E7F18-8MS, E7F30-8B, E7F30-8BP, E7F30-8M, E7F30-8MP, E9F15-4M, E9F15-8M, E9F18-4M, E9F18-8M, ELT10+10B-E, ELT10B-E, ELT12+12B-E, ELT12+12M, ELT12+12M-E, ELT12B-E, ELT12M, ELT12M-E, ELT15+15B, ELT15+15B-E, ELT15+15M, ELT15+15M-E, ELT15B, ELT15B-E, ELT15M, ELT15M-E, ELT16B, ELT18+18B, ELT18+18BE, ELT18+18B-E, ELT18+18M, ELT18+18M-E...(Other models you can see in the webshop)		
accessories for	375320		
	GEV No.	100779	Ref. No.
			—
	nut thread M10x0.75 H 3mm WS 14 SS Qty 2 pcs		
	GEV No.	551272	Ref. No.
			—
	cap for safety thermostat thread M10x0.75		



GEV No.	391033	Ref. No.	32070800
description	safety thermostat switch-off temp. 240°C temperature range 19-240°C 3-pole 3NC 16A probe ø 6mm probe L 80mm capillary pipe 1680mm capillary pipe isolated 660mm gland nut M10x1 shaft ømm probe SS		



GEV No.	375469	Ref. No.	22069700
description	safety thermostat switch-off temp. 358°C 3-pole probe ø 6mm probe L 85mm capillary pipe 3000mm capillary pipe isolated 2980mm SS		
For models:	E6BR6B, E6BR6M, E6FL3B, E6FL3BP, E6FL3B-P, E6FL3BP-CR, E6FL3BP-SX, E6FL3B-SX, E6FL3M, E6FL3MP, E6FL3M-P, E6FL3MP-CR, E6FL3MP-SX, E6FL3M-SX, E6FL6B-2, E6FL6B-2-SX, E6FL6BP-2, E6FL6BP-2-CR, E6FL6BP-2-SX, E6FL6M-2, E6FL6M-2-SX, E6FL6MP-2, E6FL6MP-2-CR, E6FL6MP-2-SX, E6FM6B-2, E6FM6BP-2, E6FM6M-2, E6FM6MP-2, E6FR3B, E6FR3BP, E6FR3M, E6FR3MP, E6FR6B-2, E6FR6BP-2, E6FR6M-2, E6FR6MP-2, E6P6+TE, E7BR4B, E7BR4M, E7BR8, E7BR8-I, E7FL4B, E7FL4B-CR, E7FL4BP, E7FL4BP-CR, E7FL4BP-SX, E7FL4B-SX, E7FL4M, E7FL4M-CR, E7FL4MP...(Other models you can see in the webshop)		

IMIT / TEMPOMATIC / ARTHERMO

control thermostats



GEV No.	375404	Ref. No.	22062400 24064000
description	thermostat t.max. 110°C temperature range 0-90°C 1-pole 1CO 15A probe ø 6mm probe L 104mm capillary pipe 1400mm capillary pipe isolated 1350mm gland nut shaft ø 6x4.6mm shaft L 18mm shaft position upper rotation 270° probe material copper 400V		
For models:	EBMD8, EBMM6, EBMS4		

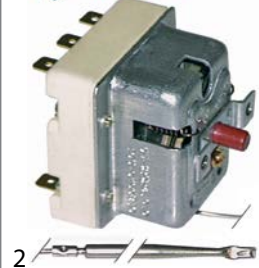

GEV No.	375350	Ref. No.	35301400
description	safety thermostat switch-off temp. 360°C 3-pole 20A probe ø 4mm probe L 120mm capillary pipe 1800mm capillary pipe isolated 1800mm gland nut probe SS		
For models:	E9BR8-I, LXE9BR8-I, SE9BR8-I		



GEV No.	390007	Ref. No.	24064000
description	thermostat t.max. 120°C temperature range 0-120°C 1-pole 1CO 16A probe ø 6.5mm probe L 95mm capillary pipe 1000mm capillary pipe isolatedmm gland nut shaft L 19mm shaft position +135° rotation 270°		
For models:	E6PL60B, E6PL60M, E7BM4B, E7BM4M, E7BM8B, E7BM8M, E9BM4M, E9BM8M, E9PL40M, E9PL80M, LAU-10, PLE40ME, PLE80ME, SE-9PL40M, SE9PL80M		

56._ series



GEV No.	376095	Ref. No.	32070600 32070700
description	thermostat switch-off temp. 240°C 1-pole 1NC probe ø 6mm probe L 80mm capillary pipe 850mm capillary pipe isolated 450mm gland nut M10x1		
For models:	GL18+18MI, GL18+18MI-E, GL18MI, GL18MI-E		



GEV No.	375280	Ref. No.	34068300
description	thermostat t.max. 86°C temperature range 0-86°C 1-pole 1CO 16A probe ø 6.5mm probe L 98mm capillary pipe 920mm capillary pipe isolatedmm gland nut shaft ø 6x4.6mm shaft L 20mm shaft position +135° rotation 270° probe material copper		
For models:	SPT120, SPT30, SPT60		

control thermostats with operation switch

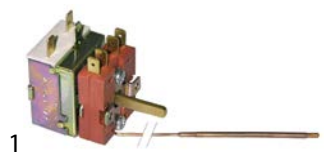
			
GEV No.	390139	Ref. No.	30064600
description	thermostat t.max. 270°C temperature range 63-270°C 1-pole 1CO 15A probe ø 3.5mm probe L 195mm capillary pipe 1000mm capillary pipe isolatedmm gland nut shaft ø 6x4.6mm shaft L 17mm shaft position upper rotation 270°		
For models:	E6P4+FE1, E6P6+FE1, E6PQ2H6+FE1, E6PQ2H6+FE1+T, E6PQ2P9+FE1, E7P4+FE1, E7P4+FES, E7P4-VTR+FE1, E7P6+FE1, E7P6+FES, E7PQ4+FE1, E7PQ4+FE1+T, E7PQ4+FES, E7PQ6+FE1, E7PQ6+FE1+T, E7PQ6+FES, E9P4+FE1, E9P4+FES, E9P4P-VTR+FE1, E9P4-VTR+FE1, E9P4-VTR+FES, E9P6+FE1, E9P6+FES, E9PQ4+FE1, E9PQ4+FE1+T, E9PQ4+FES, E9PQ6+FE1, E9PQ6+FE1+T, E9PQ6+FES, G6F2H6+FE1, G6F2H9+FE1, G6F2P6+FE1, G6F2P9+FE1, G6F4+FE1, G6F4+FE1+A4, G6F6+FE1, G6F6+FE1+A6, G7F4+FE1, G7F4+FES, G7F4E+FE1, G7F4E+FE1+A4, G7F4E+FG1, G7F4E+FG1+A4, G7F6+FE1, G7F6+FES, G7F6E+FE1, G7F6E+FE1+A6, G7F6E+FG1, G7F6E+FG1+A6, G9F4E+FE1...(Other models you can see in the webshop)		

CAEM

control thermostats

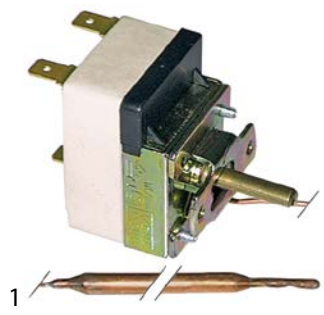
			
GEV No.	375094	Ref. No.	31290500
description	thermostat t.max. 110°C temperature range 30-110°C 1-pole 1CO 16A probe ø 6mm probe L 75mm capillary pipe 1600mm capillary pipe isolatedmm gland nut shaft ø 6x4.6mm shaft L 22mm shaft position upper rotation 270° probe material copper		
For models:	E7PI		

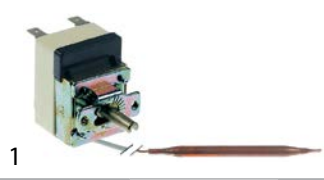
			
GEV No.	375645	Ref. No.	25064500
description	thermostat t.max. 120°C temperature range 30-120°C 1-pole 1CO 16A probe ø 6mm probe L 110mm capillary pipe 1600mm capillary pipe isolated 1550mm gland nut shaft ø 6x4.6mm shaft L 22mm shaft position upper rotation 270° probe material copper 250V		
For models:	FC200EA, FC200EB, FC200GA, FC200GB, MM06EA, MM06EB, MM06GA, MM06GB, MM10EA, MM10EB, MM10GB, MM2-3EB		

TECASA

safety thermostats

			
GEV No.	390028	Ref. No.	33070300
description	safety thermostat switch-off temp. 230°C 1-pole 16A probe ø 3mm probe L 155mm capillary pipe 890mm capillary pipe isolated 600mm gland nut probe SS		
For models:	10+10LB-LD, 10LB-LD, 12+12LB-LD, 12+12LM-LD, 12LB-LD, 12LM-LD, 4+4LB-LD, 4LB-LD, 8+8LB-LD, 8LB-LD, ELT10+10B, ELT10B, ELT12+12B, ELT12+12M, ELT12B, ELT12M, ELT4+4B, ELT4B, ELT8+8B, ELT8+8B-E, ELT8B, ELT8B-E		

accessories

probe clips

spring clips

for thermostat

			
GEV No.	550390	Ref. No.	33612900
description	probe clip for pipe ø 8mm for probe ø 4mm		
For models:	E6F10-3B, E6F10-3BS, E6F10-3M, E6F10-3MS, E6F10-6B, E6F10-6BS, E6F10-6M, E6F10-6MS, E6F8-3B, E6F8-3M, E6F8-6B, E6F8-6M, E7F10-4B, E7F10-4BS, E7F10-4M, E7F10-4MS, E7F10-8B, E7F10-8BS, E7F10-8M, E7F10-8MS, E7F18-4M, E7F18-4MS, E7F18-8M, E7F18-8MS, E7F30-8B, E7F30-8BP, E7F30-8M, E7F30-8MP, ELT10+10B, ELT10+10B-E, ELT10B, ELT10B-E, ELT12+12B, ELT12+12B-E, ELT12+12M, ELT12+12M-E, ELT12B, ELT12B-E, ELT12M, ELT12M-E, ELT15+15B, ELT15+15B-E, ELT15+15M, ELT15+15M-E, ELT15B, ELT15B-E, ELT15M, ELT15M-E, ELT16B, ELT18+18B...(Other models you can see in the webshop)		

			
GEV No.	550258	Ref. No.	22884200
description	probe clip for pipe ø 8mm for probe ø 6mm		
For models:	E10+10MB6, E10B4		

connecting bows

			
GEV No.	550060	Ref. No.	22699200
description	connecting bow long for thermostat Qty 1 pcs		
For models:	E10+10MB6, E10B4, E4F+FCD8, E4F+FCDQ8, E7BR8, E7BR8-I, EBRS4, EFLD8, EFLD8-CR, EFLM6, EFLM6-2, EFLM6-2-CR, EFLM6-CR, EFLS4, EFLS4-CR, EFM6-2, EFM6-2, EFRM6, EFRM6, EFRS4, G4F+FCD8		



switches and momentary switches

rocker/momentary rocker switches

30x22mm

labelled



GEV No.	300125	Ref. No.	22056600
----------------	--------	-----------------	----------

description rocker switch mounting measurements 30x22mm green 2NO 230V 16A 0-I connection male faston 6.3mm ambient temperature max. 125/55°C protection IP65 with cover cap

For models: E6SP6B, E6SP6M, E7BM4B, E7BM4M, E7BM8B, E7BM8M, E7SP-4B, E7SP-4M, E9BM4M, E9BM8M, EBMD8, EBMM6, EBMS4, ESPS4, G4F+FSD8

accessories for 300125



GEV No.	301036	Ref. No.	—
----------------	--------	-----------------	---

protective cover internal size 30x22mm for rocker switch mounting measurementsmm

push/momentary push switches

28.5x77.5mm



GEV No.	346365	Ref. No.	25057800
----------------	--------	-----------------	----------

description switch combination momentary/latching mounting measurements 28.5x77.5mm black 2CO/2CO 250V 16A with indicator connection male faston 6.3mm ambient temperature max. 85°C protection IP40

For models: MM06EB, MM06GB, MM10EB, MM10GB



GEV No.	346363	Ref. No.	10043
----------------	--------	-----------------	-------

description switch combination with indicator mounting measurements 28.5x77.5mm black 2CO/2CO 250V 16A connection male faston 6.3mm ambient temperature max. 85°C protection IP40

ø11mm



GEV No.	300126	Ref. No.	33059200
----------------	--------	-----------------	----------

description push button mounting ø M11x1mm black 2NO 250V 16A connection male faston 6.3mm ambient temperature max. 150°C with plunger actuating force: 500g type CM thread L 14mm

For models: E7F10-4B, E7F10-4BS, E7F10-4M, E7F10-4MS, E7F10-8B, E7F10-8BS, E7F10-8M, E7F10-8MS, E7F18-4M, E7F18-8M, E9F15-4M, E9F15-8M, E9F18-4M, E9F18-8M, ELT10+10B, ELT10+10B-E, ELT10B, ELT10B-E, ELT12+12B, ELT12+12B-E, ELT12+12M, ELT12+12M-E, ELT12B, ELT12B-E, ELT12M, ELT12M-E, ELT15+15B, ELT15+15B-E, ELT15+15M, ELT15+15M-E, ELT15B, ELT15B-E, ELT15M, ELT15M-E, ELT16B, ELT18+18B, ELT18+18BE, ELT18+18B-E, ELT18+18M, ELT18+18M-E, ELT18+18M-E224, ELT18B, ELT18BE, ELT18B-E, ELT18M, ELT18M-E, ELT30B, ELT30M, ELT4+4B, ELT4B...(Other models you can see in the webshop)

ø22mm



GEV No.	348235	Ref. No.	35080000
----------------	--------	-----------------	----------

description momentary push switch mounting ø 22mm silver 1NC/1NO 250V 5A SS connection soldering connection ambient temperature max. 85°C protection IP40

microswitches

pin-plunger actuated

M10







GEV No.	347216	Ref. No.	23060600
----------------	--------	-----------------	----------

description microswitch with plunger thread M10x0.75 thread L 14mm 250V 10A 1CO connection male faston 6.3mm stroke 7.5mm mounting distance 22mm L 28mm ambient temperature max. 125°C type NR6K5 actuating force: 260g

For models: FC100EM, FC100EP, FC100GEP, FC100GM, FC200EA, FC200EB, FC200GA, FC200GB, FC60EM, FC60EP, FC60GEP, FC60GM, FME06M, FME10, FME10EP, FME10M, FME20, FME20M, FME6, FMG10, FMG10EP, FMG10M, FMG20, FMG20M, FMG6, FMG6EP, FMG6M, FPE12TURBO, FPE6TURBO, FPG12, FPG6, G7F4P+FG+AF2, G7F6P+FG+AF2, G7F6P+T+AF2, G9BR8-I, G9F4P+FG+AF2, G9F6P+T+AF2, LXG9BR8-I, MM06EA, MM06EB, MM06GA, MM06GB, MM10EA, MM10EB, MM10GA, MM10GB, MM2-3EA, MM2-3EB, SG9BR8-I, SG9P10I...(Other models you can see in the webshop)



			
1			
GEV No.	347762	Ref. No.	33059400
description	microswitch with plunger thread M10x0.75 thread L 14mm 250V 16A 2NO connection male faston 6.3mm stroke 4mm mounting distance 22mm ambient temperature max. 85°C actuating force: 650g		
For models:	E6F10-3B, E6F10-3BS, E6F10-3M, E6F10-3MS, E6F10-6B, E6F10-6BS, E6F10-6M, E6F10-6MS, E6F8-3B, E6F8-3M, E6F8-6B, E6F8-6M, E6PL60B, E6PL60M, E7F10-4B, E7F10-4BS, E7F10-4M, E7F10-4MS, E7F10-8B, E7F10-8BS, E7F10-8M, E7F10-8MS, E7F18-4M, E7F18-4MS, E7F18-8M, E7F18-8MS, E7F30-8B, E7F30-8BP, E7F30-8M, E7F30-8MP, E9F15-4M, E9F15-8M, E9F18-4M, E9F18-8M, E9PL40M, E9PL80M, ELT10+10B, ELT10+10B-E, ELT10B, ELT10B-E, ELT12+12B, ELT12+12B-E, ELT12+12M, ELT12+12M-E, ELT12B, ELT12B-E, ELT12M, ELT12M-E, ELT15+15B, ELT15+15B-E...(Other models you can see in the webshop)		
accessories for	347762		
		GEV No.	100779
		Ref. No.	—
	nut thread M10x0.75 H 3mm WS 14 SS Qty 2 pcs		

M12			
			
1			
GEV No.	345350	Ref. No.	22060200 22060300
description	microswitch with plunger mounting distance 22mm thread M12x0.75 thread L 16mm 250V 16A 1CO connection male faston 6.3mm stroke 4mm ambient temperature max. 125°C type EF83161.3 actuating force: 66g		
For models:	E10+10MB6, E10B4, EGRM4, EGRS4		
accessories for	345350		
		GEV No.	345351
		Ref. No.	—
	nut thread M12x0.75 H 1.6mm WS 14 chrome-plated brass Qty 1 pcs		

position switches

PIZZATO			
FB series			
			
1			
GEV No.	346175	Ref. No.	35837000
description	position switch cast aluminum 1NO/1NC 400V 3A L 52mm W 39mm H 16mm protection IP67 actuating force: 1000g screw connection mounting distance 25mm cable length 1800mm		
For models:	E9BR8		

system switches (ROLD)

			
1			
GEV No.	345537	Ref. No.	10313
description	element holder mounting measurements 20.6x16.4mm grey arched for push buttons 13x17mm		
For models:	FC200GB, WAV-G5U		

			
1			
GEV No.	345606	Ref. No.	25061800 3474
description	momentary switch unit 2CO 250V 16A connection male faston 6.3mm		
For models:	FC100EM, FC100GM, FC200EB, FC200GB, FC60EM, FC60GM, PASTRY-EM, PASTRY-VIP-EMU, WAV-G5U		

			
1			
GEV No.	345539	Ref. No.	10312
description	push button size 17x13mm grey		
For models:	FC200GB, WAV-G5U		

			
1			
GEV No.	345605	Ref. No.	25058400
description	switch 2CO 250V 16A connection male faston 6.3mm		
For models:	FME06M, FME10M, FME20M, FMG10M, FMG20M, FMG6, FMG6M, MM06EB, MM06GB, MM10EB, MM10GB, MM2-3EB		

cam switches

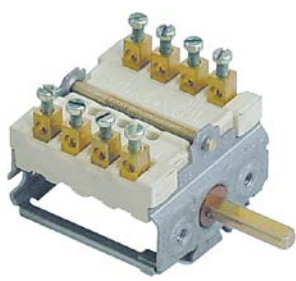
on/off			
			
1			
GEV No.	345665	Ref. No.	22051600
description	cam switch 2 operating positions 4NO sequence 0-1 16A shaft ø 6x4.6mm shaft L 23mm connection screw		

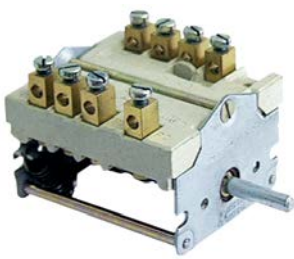

1

GEV No.	300095	Ref. No.	22050800
description	cam switch ON-OFF connection screw clamp		
For models:	EGRM4		

4-position

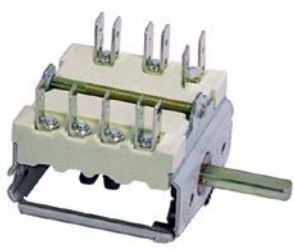

1

GEV No.	300007	Ref. No.	22050100
description	cam switch 4 operating positions 1NO/2CO sequence 0-1-2-3 16A shaft ø 6x4.6mm shaft L 23mm connection male faston 6.3mm 4-position ceramic		
For models:	E6CP6B, E6CP6M, E6CPM, ECRM6		

7-position



1

GEV No.	300004	Ref. No.	22049900
description	cam switch 7 operating positions 1NO/2CO sequence 0-1-2-3-4-5-6 16A shaft ø 6x4.6mm shaft L 23mm connection male faston 6.3mm 7-position ceramic		
For models:	E2FQS4, E2FS4, E4F+FCD8, E4F+FCDQ8, E4FD8, E4FDQ8, E6P2B, E6P2M, E6P4+FE1, E6P4B, E6P4M, E6P6+FE1, E6P6+TE, E6P6B, E6P6M, E6PQ2BH6, E6PQ2BH6+T, E6PQ2H6+FE1, E6PQ2H6+FE1+T, E6PQ2MH6, E6PQ2MH6+T, E7P2B, E7P2M, E7P4+FE, E7P4+FE1, E7P4+FES, E7P4B, E7P4M, E7P6+FE, E7P6+FE1, E7P6+FES, E7P6B, E7P6M, E7PQ2B, E7PQ2B+T, E7PQ2M, E7PQ2M+T, E7PQ4+FE, E7PQ4+FE+T, E7PQ4+FE1, E7PQ4+FE1+T, E7PQ4+FES, E7PQ4B, E7PQ4B+T, E7PQ4M, E7PQ4M+T, E7PQ6+FE, E7PQ6+FE+T, E7PQ6+FE1, E7PQ6+FE1+T...(Other models you can see in the webshop)		

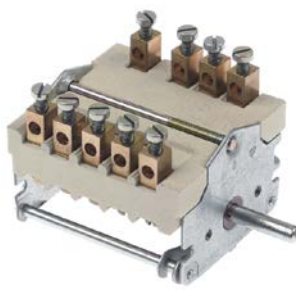

1

GEV No.	300264	Ref. No.	35049900
description	cam switch 7 operating positions 1NO/2CO sequence 0-1-2-3-4-5-6 32A shaft ø 6x4.6mm shaft L 23mm connection screw 7-position shaft flat lower		
For models:	E6PQ2BP9, E6PQ2MP9, E6PQ2P9+FE1, E6PQ2P9+TE, SE9PQ2M, SE9PQ4+FE, SE9PQ4M, SE9PQ6+FE, SE9PQ6M		

3 operating positions



1

GEV No.	345670	Ref. No.	30051600
description	cam switch 3 operating positions 1CO sequence 1-0-2 16A shaft ø 6x4.6mm shaft L 23mm connection male faston 6.3mm		
For models:	12T, E9P10I, E9P10IA, E9P15I, E9P15IA, LXE9P15I, SE9P10I, SE9P10IA, SE9P15I, SE9P15IA		



1

GEV No.	300167	Ref. No.	35050100
description	cam switch 3 operating positions 2NO/1CO sequence 0-1-2 16A shaft ø 6x4.6mm shaft L 23mm connection screw		
For models:	E6PQ2P9+FE1, E9P10I, E9P10IA, E9P15I, E9P15IA, SE9P10I, SE9P10IA, SE9P15I, SE9P15IA		



4 operating positions

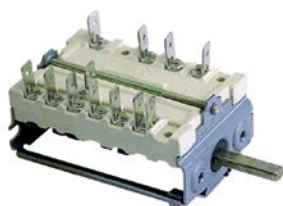

1			
GEV No.	300010	Ref. No.	23050900
description	cam switch 4 operating positions 2NO/2CO sequence 0-1-2-3 16A shaft ø 6x4.6mm shaft L 23mm connection male faston 6.3mm ceramic		
For models:	FC100EM, FC100GM, FC200EB, FC200GB, FC60EM, FC60GM, FPE12TURBO, FPE6TURBO, FPG12, FPG6, WAV1-GAS, WAV2-1K-GAS, WAV3-GAS, WAV-E12, WAV-E12T, WAV-E12TURBO, WAV-E20, WAV-E5U, WAV-E6, WAV-E6T, WAV-E6TURBO, WAV-G12, WAV-G20, WAV-G5U, WAV-G6		



1			
GEV No.	300081	Ref. No.	22049800
description	cam switch 4 operating positions 3NO/2CO sequence 0-1-2-3 16A shaft ø 6x4.6mm shaft L 23mm connection screw		
For models:	CPE40, E7P4+FE, E7P4-VTR+FE, E7P6+FE, E7PQ4+FE, E7PQ4+FE+T, E7PQ6+FE, E7PQ6+FE+T, E7TP+FE, E9CP40, E9P4+FE, E9P4P-VTR+FE, E9P4-VTR+FE, E9P6+FE, E9PQ4+FE, E9PQ4+FE+T, E9PQ6+FE, E9PQ6+FE+T, G7F4PW+FE, G7F4PW+FE+AE, G7F6PW+FE, G7F6PW+FE+AE, G9F4+FE, G9F4PW+FE, G9F4PW+FE+AE, G9F6+FE, G9F6PW+FE, G9F6PW+FE+AE, G9F8+2FE, SE9CP40, SE9P4P-VTR+FE, SE9PQ4+FE, SE9PQ6+FE, SG9F4+FE, SG9F6+FE, SG9F8+2FE		

10 operating positions



1			
GEV No.	345666	Ref. No.	22049700
description	cam switch 10 operating positions 6NO/1CO sequence 0-1-2-3-4-5-6-7-8-9 8A shaft ø 6x4.6mm shaft L 23mm connection male faston 6.3mm plastic		
For models:	G4S+FCGN, G6S+FCGN		

with potentiometer



1			
GEV No.	347599	Ref. No.	38151000 38151200
description	cam switch 2 operating positions 4NO sequence 0-1 16A shaft ø 6x4.6mm shaft L 23mm connection coded plug 0.1-10KOhm 2-pole with potentiometer		
For models:	E9P2M-IND, E9P2M-IND-230V3~, E9P4M-IND, E9P4M-IND-230V3~, E9WOK-IND, LXE9P2-IND, LXE9P2-IND-230V3~, LXE9P4-IND, LXE9P4-IND-230V3~, LXE9WOK-IND, SE9P2M-IND, SE9P2M-IND-230V3~, SE9P4M-IND, SE9P4M-IND-230V3~, SE9WOK-IND		

operation switches



1			
GEV No.	300002	Ref. No.	22050300
description	cam switch 2 operating positions 4NO 16A sequence 0-1 shaft ø 6x4.6mm shaft L 23mm connection male faston 6.3mm ceramic		
For models:	E6BR6B, E6BR6M, E6FL3B, E6FL3BP, E6FL3B-P, E6FL3BP-CR, E6FL3BP-SX, E6FL3B-SX, E6FL3M, E6FL3MP, E6FL3M-P, E6FL3MP-CR, E6FL3MP-SX, E6FL3M-SX, E6FL6B-2, E6FL6B-2-SX, E6FL6BP-2, E6FL6BP-2-CR, E6FL6BP-2-SX, E6FL6M-2, E6FL6M-2-SX, E6FL6MP-2, E6FL6MP-2-CR, E6FL6MP-2-SX, E6FM6B-2, E6FM6BP-2, E6FM6M-2, E6FM6MP-2, E6FR3B, E6FR3BP, E6FR3M, E6FR3MP, E6FR6B-2, E6FR6BP-2, E6FR6M-2, E6FR6MP-2, E6P6+TE, E7BR4B, E7BR4M, E7BR8, E7BR8-I, E7FL4B, E7FL4B-CR, E7FL4BP, E7FL4BP-CR, E7FL4BP-SX, E7FL4B-SX, E7FL4M, E7FL4M-CR, E7FL4MP...(Other models you can see in the webshop)		



1			
GEV No.	300153	Ref. No.	23050600
description	cam switch 3 operating positions operation switch 16A sequence 0-1-2 shaft ø 6x4.6mm shaft L 23mm connection male faston 6.3mm plastic ambient temperature max. 240°C		
For models:	WAV1-2, WAV2-3, WAV-E1-2, WAV-E2-3		

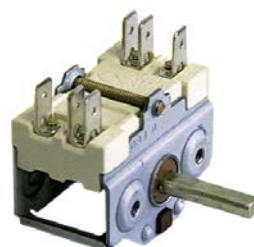

1			
GEV No.	300001	Ref. No.	22051000
description	cam switch operation switch 16A sequence 0-1 shaft ø 6x4.6mm connection male faston 6.3mm 2-pole		
For models:	E7F30-8B, E7F30-8BP, E7F30-8M, E7F30-8MP, E9BR8-I, E9P10I, E9P10IA, E9P15I, E9P15IA, E9P4+FE1, E9P6+FE1, G6F3H12+FE1, G6F4PW+FE1, G6F4PW+FE1+AE, G6F6PW+FE1, G6F6PW+FE1+AE, G7F4PW+FE1, G7F4PW+FE1+AE, G7F6PW+FE1, G7F6PW+FE1+AE, G9F4PW+FE1, G9F4PW+FE1+AE, G9F6PW+FE1, G9F6PW+FE1+AE, G9F8+2FE1, GL18+18MI, GL18MI, LXE9BR8-I, LXE9P15I, SE9BR8-I, SE9F18-4M, SE9F18-8M, SE9P10I, SE9P10IA, SE9P15I, SE9P15IA		
accessories for	300001		
		GEV No.	551456
		Ref. No.	—
	gasket for switch ED ø 14mm ID ø 2.5mm thickness 3.5mm white		

E-G-O



1

GEV No.	300091	Ref. No.	22050400
description	operation switch EGO 2 operating positions 2NO 16A sequence 0-1 shaft ø 6x4.6mm shaft L 23mm connection screw ceramic		
For models:	E10+10MB6, E10B4		

control equipment

MOELLER/EATON

switches (complete)

rotary switches



1

GEV No.	300132	Ref. No.	31205000
description	rotary switch mounting measurements ø22mm green complete		
For models:	E7PI, G7PI		

push/momentary push switches



1

GEV No.	300131	Ref. No.	31923000
description	momentary push switch mounting measurements ø22mm red illuminated, 80-264V 1NO momentary		
For models:	G7PI		

encoders and potentiometers



1

GEV No.	347599	Ref. No.	38151000 38151200
description	cam switch 2 operating positions 4NO sequence 0-1 16A shaft ø 6x4.6mm shaft L 23mm connection coded plug 0.1-10KOhm 2-pole with potentiometer		
For models:	E9P2M-IND, E9P2M-IND-230V3~, E9P4M-IND, E9P4M-IND-230V3~, E9WOK-IND, LXE9P2-IND, LXE9P2-IND-230V3~, LXE9P4-IND, LXE9P4-IND-230V3~, LXE9WOK-IND, SE9P2M-IND, SE9P2M-IND-230V3~, SE9P4M-IND, SE9P4M-IND-230V3~, SE9WOK-IND		

lamps

indicator lights

indicator lights (complete)

ø10mm

with plug-in socket



1

GEV No.	359139	Ref. No.	30168800 30866700
description	indicator light ø 10mm green 230V connection male faston 6.3mm Qty 1 pcs		
For models:	E6BR6B, E6BR6M, E6CP3B, E6CP6B, E6CP6M, E6CPM, E6F8-3B, E6F8-3M, E6F8-6B, E6F8-6M, E6FL3B, E6FL3BP, E6FL3B-P, E6FL3BP-CR, E6FL3BP-SX, E6FL3B-SX, E6FL3M, E6FL3MP, E6FL3M-P, E6FL3MP-CR, E6FL3MP-SX, E6FL3M-SX, E6FL6B-2, E6FL6B-2-SX, E6FL6BP-2, E6FL6BP-2-CR, E6FL6BP-2-SX, E6FL6M-2, E6FL6M-2-SX, E6FL6MP-2, E6FL6MP-2-CR, E6FL6MP-2-SX, E6FM6B-2, E6FM6BP-2, E6FM6M-2, E6FM6MP-2, E6FR3B, E6FR3BP, E6FR3M, E6FR3MP, E6FR6B-2, E6FR6BP-2, E6FR6M-2, E6FR6MP-2, E6P2B, E6P2M, E6P4+FE1, E6P4B, E6P4M, E6P6+FE1...(Other models you can see in the webshop)		



1

GEV No.	359019	Ref. No.	33171000
description	indicator light ø 10mm green 400V connection male faston 6.3mm Qty 1 pcs		
For models:	CPE40, E6F10-3B, E6F10-3BS, E6F10-3M, E6F10-3MS, E6F10-6B, E6F10-6BS, E6F10-6M, E6F10-6MS, E7F10-4B, E7F10-4BS, E7F10-4M, E7F10-4MS, E7F10-8B, E7F10-8BS, E7F10-8M, E7F10-8MS, E9CP40, ELT10+10B-E, ELT10B-E, ELT12+12B-E, ELT12+12M, ELT12+12M-E, ELT12B-E, ELT12M, ELT12M-E, ELT15+15B, ELT15+15B-E, ELT15+15M, ELT15+15M-E, ELT15B, ELT15B-E, ELT15M, ELT15M-E, ELT16B, ELT18+18B, ELT18+18BE, ELT18+18B-E, ELT18+18M, ELT18+18M-E, ELT18+18M-E224, ELT18B, ELT18BE, ELT18B-E, ELT18M, ELT18M-E, ELT30B, ELT30M, SE9CP40		





1

GEV No.	359140	Ref. No.	30168500
description	indicator light ø 10mm yellow 230V connection male faston 6.3mm Qty 1 pcs		
For models:	E6BR6B, E6BR6M, E6F8-3B, E6F8-3M, E6F8-6B, E6F8-6M, E6FL3B, E6FL3BP, E6FL3B-P, E6FL3BP-CR, E6FL3BP-SX, E6FL3B-SX, E6FL3M, E6FL3MP, E6FL3M-P, E6FL3MP-CR, E6FL3MP-SX, E6FL3M-SX, E6FL6B-2, E6FL6B-2-SX, E6FL6BP-2, E6FL6BP-2-CR, E6FL6BP-2-SX, E6FL6M-2, E6FL6M-2-SX, E6FL6MP-2, E6FL6MP-2-CR, E6FL6MP-2-SX, E6FM6B-2, E6FM6BP-2, E6FM6M-2, E6FM6MP-2, E6FR3B, E6FR3BP, E6FR3M, E6FR3MP, E6FR6B-2, E6FR6BP-2, E6FR6M-2, E6FR6MP-2, E6P4+FE1, E6P6+FE1, E6P6+TE, E6PQ2H6+FE1, E6PQ2H6+FE1+T, E6PQ2P9+FE1, E6PQ2P9+TE, E7BM4B, E7BM4M, E7BM8B...(Other models you can see in the webshop)		





			
1			
GEV No.	359034	Ref. No.	33171100
description	indicator light ø 10mm yellow 400V connection male faston 6.3mm Qty 1 pcs		
For models:	E6F10-3B, E6F10-3BS, E6F10-3M, E6F10-3MS, E6F10-6B, E6F10-6BS, E6F10-6M, E6F10-6MS, E7F10-4B, E7F10-4BS, E7F10-4M, E7F10-4MS, E7F10-8B, E7F10-8BS, E7F10-8M, E7F10-8MS, ELT10+10B-E, ELT10B-E, ELT12+12B-E, ELT12+12M, ELT12+12M-E, ELT12B-E, ELT12M, ELT12M-E, ELT15+15B, ELT15+15B-E, ELT15+15M, ELT15+15M-E, ELT15B, ELT15B-E, ELT15M, ELT15M-E, ELT16B, ELT18+18B, ELT18+18B-E, ELT18+18M, ELT18+18M-E, ELT18+18M-E224, ELT18B, ELT18BE, ELT18B-E, ELT18M, ELT18M-E, ELT30B, ELT30M		

ø12mm			
with screw socket			
			
1			
GEV No.	359023	Ref. No.	22170532
description	indicator light ø 12mm 24V green connection male faston 6.3mm		

			
1			
GEV No.	359291	Ref. No.	33170700
description	indicator light ø 12mm 400V green connection male faston 6.3mm		
For models:	E7PI, G7PI		

with plug-in socket			
			
1			
GEV No.	359041	Ref. No.	22167900
description	indicator light ø 12mm green 230V connection male faston 6.3mm temp.-resist. 120°C Qty 1 pcs		
For models:	E10+10MB6, E10B4, E2FQS4, E2FS4, E4F+FCD8, E4F+FCDQ8, E4FD8, E4FDQ8, EBMD8, EBMM6, EBMS4, EBR54, ECRM6, EFLD8, EFLD8-CR, EFLM6, EFLM6-2, EFLM6-2-CR, EFLM6-CR, EFLS4, EFLS4-CR, EFM6-2, EFMD8, EFRM6, EFRS4, EGRM4, EGRS4, G4F+FCD8, G4S+FCGN, G6S+FCGN		

			
1			
GEV No.	359042	Ref. No.	22167800
description	indicator light ø 12mm yellow 230V connection male faston 6.3mm temp.-resist. 120°C Qty 1 pcs		
For models:	E10+10MB6, E10B4, E4F+FCD8, E4F+FCDQ8, EBR54, EFLD8, EFLD8-CR, EFLM6, EFLM6-2, EFLM6-2-CR, EFLM6-CR, EFLS4, EFLS4-CR, EFM6-2, EFMD8, EFRM6, EFRS4, EGRM4, EGRS4, G4F+FCD8, G4S+FCGN, G6S+FCGN		

ø13mm			
with screw socket			
			
1			
GEV No.	359049	Ref. No.	33170800
description	indicator light ø 13mm 400V green		
For models:	10+10LB-LD, 10LB-LD, 12+12LB-LD, 12+12LM-LD, 12LB-LD, 12LM-LD, 15+15LB-LD, 15+15LM-LD, 15LB-LD, 15LBZ-LD, 15LM-LD, 15LMZ-LD, 18+18LB-LD, 18+18LM-LD, 18LB-LD, 18LM-LD, 8+8LB-LD, 8LB-LD, E9BR8, E9BR8-I, E9P10I, E9P10IA, E9P15I, E9P15IA, SE9BR8, SE9BR8-I, SE9P10I, SE9P10IA, SE9P15I, SE9P15IA		
accessories for	359049		
	GEV No.	510302	Ref. No. —
	O-ring EPDM ID ø 12.42mm thickness 1.78mm Qty 1 pcs		
	GEV No.	511505	Ref. No. —
	O-ring EPDM thickness 1.78mm ID ø 12.42mm Qty 10 pcs		

			
1			
GEV No.	359050	Ref. No.	33170900
description	indicator light ø 13mm 400V yellow		
For models:	10+10LB-LD, 10LB-LD, 12+12LB-LD, 12+12LM-LD, 12LB-LD, 12LM-LD, 15+15LB-LD, 15+15LM-LD, 15LB-LD, 15LBZ-LD, 15LM-LD, 15LMZ-LD, 18+18LB-LD, 18+18LM-LD, 18LB-LD, 18LM-LD, 8+8LB-LD, 8LB-LD, E9BR8, E9BR8-I, E9P10I, E9P10IA, E9P15I, E9P15IA, SE9BR8, SE9BR8-I, SE9P10I, SE9P10IA, SE9P15I, SE9P15IA		
accessories for	359050		
	GEV No.	510302	Ref. No. —
	O-ring EPDM ID ø 12.42mm thickness 1.78mm Qty 1 pcs		
	GEV No.	511505	Ref. No. —
	O-ring EPDM thickness 1.78mm ID ø 12.42mm Qty 10 pcs		

screw-on/push-on fit			
light bulbs			
for ovens			
			
1			
GEV No.	359610	Ref. No.	23155100
description	light bulb t.max. 300°C socket E14 15W 230V ø 22mm L 47mm lens L 20mm for oven lamp type Philips		
For models:	E4F+FCD8, E4F+FCDQ8, FPE12TURBO, FPE6TURBO, FPG12, FPG6, G4F+FCD8, G4F+FSD8, PASTRY-EM, PASTRY-VIP-EMU, SNACK-E, SNACK-E-LS, WAV1-2, WAV2-3, WAV2-GAS, WAV3-GAS, WAV-E12, WAV-E1-2, WAV-E12T, WAV-E12TURBO, WAV-E20, WAV-E2-3, WAV-ESU, WAV-E6, WAV-E6T, WAV-E6TURBO, WAV-G12, WAV-G20, WAV-GSU, WAV-G6		



1

GEV No.	359612	Ref. No.	23155300
description	light bulb t.max. 300°C socket E14 25W 230V ø 25mm L 56mm lens L 30mm for oven lamp type Philips		
For models:	FME06M, FME10, FME10EP, FME10M, FME20, FME20M, FME6, FMG10, FMG10EP, FMG10M, FMG20, FMG20M, FMG6, FMG6EP, FMG6M, MM06EA, MM06EB, MM06GA, MM06GB, MM10EA, MM10EB, MM10GA, MM10GB, MM2-3EA, MM2-3EB		

halogen lamp

for socket G4 / G6.35 / G9



1

GEV No.	359599	Ref. No.	10307
description	halogen lamp socket G4 12V 20W temp.-resist. 500°C		
For models:	FC200GB		

oven lamps

universal oven lamps

mounting diameter 35.5mm



1

GEV No.	359701	Ref. No.	23158600	
description	lamp socket socket E14 220-230V mounting ø 35.5mm connection male faston 6.3mm 15W			
For models:	E4F+FCD8, E4F+FCDQ8, FPE12TURBO, FPE6TURBO, FPG12, FPG6, G4F+FCD8, G4F+FSD8, WAV1-2, WAV2-3, WAV2-GAS, WAV3-GAS, WAV-E12, WAV-E1-2, WAV-E12T, WAV-E12TURBO, WAV-E20, WAV-E2-3, WAV-E5U, WAV-E6, WAV-E6T, WAV-E6TURBO, WAV-G12, WAV-G20, WAV-G5U, WAV-G6			
accessories for	359701			
	GEV No.	359705	Ref. No.	—
	oven lamp glass thr.ø 33.5mm ø 52mm hard glas temp.-resist. 350°C			
	GEV No.	359709	Ref. No.	23160700
	oven lamp glass thr.ø 33.5mm ø 42mm hard glas temp.-resist. 350°C			
	GEV No.	359721	Ref. No.	23602800
	gasket silicone ED ø 48mm ID ø 39.5mm thickness 5mm Qty 1 pcs			
	GEV No.	359942	Ref. No.	—
	oven lamp glass thr.ø 33.5mm ø 41mm hard glas temp.-resist. 350°C			



1

GEV No.	359709	Ref. No.	23160700
description	oven lamp glass thr.ø 33.5mm ø 42mm hard glas temp.-resist. 350°C		
For models:	FPE12TURBO, FPE6TURBO, FPG12, FPG6, G4F+FCD8, G4F+FSD8, WAV1-2, WAV2-3, WAV2-GAS, WAV3-GAS, WAV-E12, WAV-E1-2, WAV-E12T, WAV-E12TURBO, WAV-E2-3, WAV-E5U, WAV-E6, WAV-E6T, WAV-E6TURBO, WAV-G12, WAV-G5U, WAV-G6		



1

GEV No.	359721	Ref. No.	23602800
description	gasket silicone ED ø 48mm ID ø 39.5mm thickness 5mm Qty 1 pcs		
For models:	FC100EM, FC100EP, FC100GEP, FC100GM, FC200EA, FC200EB, FC200GA, FC200GB, FC60EM, FC60EP, FC60GEP, FC60GM, FPE12TURBO, FPE6TURBO, FPG12, FPG6, WAV-E12, WAV-E12T, WAV-E12TURBO, WAV-E5U, WAV-E6, WAV-E6T, WAV-E6TURBO, WAV-G12, WAV-G5U, WAV-G6		

55x70mm



1

GEV No.	359297	Ref. No.	10306 24289500	
description	frame L 95mm W 81mm mounting distance 68/83mm thickness 6mm			
For models:	FC100EM, FC100EP, FC100GEP, FC100GM, FC200EA, FC200EB, FC200GA, FC200GB, FC60EM, FC60EP, FC60GEP, FC60GM, PASTRY-EM, PASTRY-VIP-EMU, WAV-G5U			
accessories for	359297			
	GEV No.	359299	Ref. No.	10304
	gasket L 91mm W 77mm hole ø 3mm for oven lamp			



1

GEV No.	359299	Ref. No.	10304
description	gasket L 91mm W 77mm hole ø 3mm for oven lamp		
For models:	WAV-G5U		

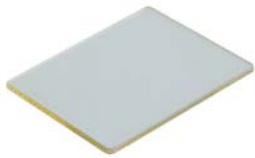

			
1			
GEV No.	359296	Ref. No.	10305
description	lamp glass L 74mm W 58mm thickness 3mm		
For models:	WAV-G5U		

			
1			
GEV No.	359716	Ref. No.	25806900
description	frame for bulb socket		
For models:	FME06M, FME10, FME10EP, FME10M, FME20, FME20M, FME6, FMG10, FMG10EP, FMG10M, FMG20, FMG20M, FMG6, FMG6EP, FMG6M, MM06EA, MM06EB, MM06GA, MM06GB, MM10EA, MM10EB, MM10GA, MM10GB, MM2-3EA, MM2-3EB, WAV-E20, WAV-G20		

55x100mm

			
1			
GEV No.	359698	Ref. No.	25159500
description	lamp socket L 100mm W 55mm socket E14 connection male faston 6.3mm		
For models:	FME06M, FME10, FME10EP, FME10M, FME20, FME20M, FME6, FMG10, FMG10EP, FMG10M, FMG20, FMG20M, FMG6, FMG6EP, FMG6M, MM06EA, MM06EB, MM06GA, MM06GB, MM10EA, MM10EB, MM10GA, MM10GB, MM2-3EA, MM2-3EB		
spare parts for	359698		
	GEV No.	358119	Ref. No.
			—
	frame L 118mm W 72mm mounting distance 143mm for bulb socket		
	GEV No.	358122	Ref. No.
			—
	gasket L 112mm W 68mm silicone thickness 3mm for bulb socket		
	GEV No.	358123	Ref. No.
			—
	lamp glass L 112mm W 68mm		
	GEV No.	359612	Ref. No.
			23155300
	light bulb t.max. 300°C socket E14 25W 230V ø 25mm L 56mm lens L 30mm for oven lamp type Philips		
	GEV No.	359714	Ref. No.
			25597400
	gasket for bulb socket		
	GEV No.	359715	Ref. No.
			25589200
	lamp glass L 110mm W 65mm thickness 5mm		
	GEV No.	359716	Ref. No.
			25806900
	frame for bulb socket		
accessories for	359698		
	GEV No.	359612	Ref. No.
			23155300
	light bulb t.max. 300°C socket E14 25W 230V ø 25mm L 56mm lens L 30mm for oven lamp type Philips		
	GEV No.	359938	Ref. No.
			—
	borosilicate glass L 115mm W 69mm		

			
1			
GEV No.	359714	Ref. No.	25597400
description	gasket for bulb socket		
For models:	FME06M, FME10, FME10EP, FME10M, FME20, FME20M, FME6, FMG10, FMG10EP, FMG10M, FMG20, FMG20M, FMG6, FMG6EP, FMG6M, MM06EA, MM06EB, MM06GA, MM06GB, MM10EA, MM10EB, MM10GA, MM10GB, MM2-3EA, MM2-3EB, WAV-E20, WAV-G20		

			
1			
GEV No.	359715	Ref. No.	25589200
description	lamp glass L 110mm W 65mm thickness 5mm		
For models:	FME06M, FME10, FME10EP, FME10M, FME20, FME20M, FME6, FMG10, FMG10EP, FMG10M, FMG20, FMG20M, FMG6, FMG6EP, FMG6M, MM06EA, MM06EB, MM06GA, MM06GB, MM10EA, MM10EB, MM10GA, MM10GB, MM2-3EA, MM2-3EB, WAV-E20, WAV-G20		











			
1			
GEV No.	359698	Ref. No.	25159500
description	lamp socket L 100mm W 55mm socket E14 connection male faston 6.3mm		
For models:	FME06M, FME10, FME10EP, FME10M, FME20, FME20M, FME6, FMG10, FMG10EP, FMG10M, FMG20, FMG20M, FMG6, FMG6EP, FMG6M, MM06EA, MM06EB, MM06GA, MM06GB, MM10EA, MM10EB, MM10GA, MM10GB, MM2-3EA, MM2-3EB		
spare parts for	359698		
	GEV No.	358119	Ref. No.
			—
	frame L 118mm W 72mm mounting distance 143mm for bulb socket		
	GEV No.	358122	Ref. No.
			—
	gasket L 112mm W 68mm silicone thickness 3mm for bulb socket		
	GEV No.	358123	Ref. No.
			—
	lamp glass L 112mm W 68mm		



Table continues overleaf

spare parts for 359698					
	<table border="1"> <tr> <th>GEV No.</th> <th>359612</th> <th>Ref. No.</th> <th>23155300</th> </tr> </table> <p>light bulb t.max. 300°C socket E14 25W 230V ø 25mm L 56mm lens L 30mm for oven lamp type Philips</p>	GEV No.	359612	Ref. No.	23155300
GEV No.	359612	Ref. No.	23155300		
	<table border="1"> <tr> <th>GEV No.</th> <th>359714</th> <th>Ref. No.</th> <th>25597400</th> </tr> </table> <p>gasket for bulb socket</p>	GEV No.	359714	Ref. No.	25597400
GEV No.	359714	Ref. No.	25597400		
	<table border="1"> <tr> <th>GEV No.</th> <th>359715</th> <th>Ref. No.</th> <th>25589200</th> </tr> </table> <p>lamp glass L 110mm W 65mm thickness 5mm</p>	GEV No.	359715	Ref. No.	25589200
GEV No.	359715	Ref. No.	25589200		
	<table border="1"> <tr> <th>GEV No.</th> <th>359716</th> <th>Ref. No.</th> <th>25806900</th> </tr> </table> <p>frame for bulb socket</p>	GEV No.	359716	Ref. No.	25806900
GEV No.	359716	Ref. No.	25806900		
accessories for 359698					
	<table border="1"> <tr> <th>GEV No.</th> <th>359612</th> <th>Ref. No.</th> <th>23155300</th> </tr> </table> <p>light bulb t.max. 300°C socket E14 25W 230V ø 25mm L 56mm lens L 30mm for oven lamp type Philips</p>	GEV No.	359612	Ref. No.	23155300
GEV No.	359612	Ref. No.	23155300		
	<table border="1"> <tr> <th>GEV No.</th> <th>359938</th> <th>Ref. No.</th> <th>—</th> </tr> </table> <p>borosilicate glass L 115mm W 69mm</p>	GEV No.	359938	Ref. No.	—
GEV No.	359938	Ref. No.	—		

producer-specific oven lamps

BERTO'S

	1
GEV No. 359840	Ref. No. 40863
description frame for oven lamp	

	1				
GEV No. 359297	Ref. No. 10306 24289500				
description frame L 95mm W 81mm mounting distance 68/83mm thickness 6mm					
For models: FC100EM, FC100EP, FC100GEP, FC100GM, FC200EA, FC200EB, FC200GA, FC200GB, FC60EM, FC60EP, FC60GEP, FC60GM, PASTRY-EM, PASTRY-VIP-EMU, WAV-G5U					
accessories for 359297					
	<table border="1"> <tr> <th>GEV No.</th> <th>359299</th> <th>Ref. No.</th> <th>10304</th> </tr> </table> <p>gasket L 91mm W 77mm hole ø 3mm for oven lamp</p>	GEV No.	359299	Ref. No.	10304
GEV No.	359299	Ref. No.	10304		

	1
GEV No. 359299	Ref. No. 10304
description gasket L 91mm W 77mm hole ø 3mm for oven lamp	
For models: WAV-G5U	

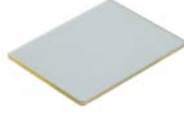
	1
GEV No. 359296	Ref. No. 10305
description lamp glass L 74mm W 58mm thickness 3mm	
For models: WAV-G5U	

	1
GEV No. 359839	Ref. No. 10867
description lamp socket socket G4 for halogen lamp	

lamps

light bulbs

	1
GEV No. 359610	Ref. No. 23155100
description light bulb t.max. 300°C socket E14 15W 230V ø 22mm L 47mm lens L 20mm for oven lamp type Philips	
For models: E4F+FCD8, E4F+FCDQ8, FPE12TURBO, FPE6TURBO, FPG12, FPG6, G4F+FCD8, G4F+FSD8, PASTRY-EM, PASTRY-VIP-EMU, SNACK-E, SNACK-E-LS, WAV1-2, WAV2-3, WAV2-GAS, WAV3-GAS, WAV-E12, WAV-E1-2, WAV-E12T, WAV-E12TURBO, WAV-E20, WAV-E2-3, WAV-E5U, WAV-E6, WAV-E6T, WAV-E6TURBO, WAV-G12, WAV-G20, WAV-G5U, WAV-G6	

	1
GEV No. 359612	Ref. No. 23155300
description light bulb t.max. 300°C socket E14 25W 230V ø 25mm L 56mm lens L 30mm for oven lamp type Philips	
For models: FME06M, FME10, FME10EP, FME10M, FME20, FME20M, FME6, FMG10, FMG10EP, FMG10M, FMG20, FMG20M, FMG6, FMG6EP, FMG6M, MM06EA, MM06EB, MM06GA, MM06GB, MM10EA, MM10EB, MM10GA, MM10GB, MM2-3EA, MM2-3EB	

halogen lamps

for socket G4 / G6.35 / G9

	1
GEV No. 359599	Ref. No. 10307
description halogen lamp socket G4 12V 20W temp.-resist. 500°C	
For models: FC200GB	



sockets

G4 / G5,3 / G6,35



GEV No.	359646	Ref. No.	10308
description	lamp socket socket G4/G5.3/G6.35 24V ø 17mm H 15mm connection cable 130mm mounting distance 26mm for halogen lamp holder length 31mm cable length 130mm		

timers



programme timers





GEV No.	360339	Ref. No.	10042
description	timer FIBER P25 engines 1 chambers 1 operation time 20s 230V shaft ø 6x4.6mm shaft L 20mm manuf. no. P255J01C1N4 motor type M51BJ0R6400		
spare parts for	360339		
	GEV No.	360673	Ref. No. —
	motor kit pinion ø 6.8mm teeth 15 230V voltage AC 50/60Hz turn direction clockwise motor ø 48mm H 18.5mm motor type UDS-40NE1RNZ165 cable length 150mm with holder		

mechanical timers



GEV No.	350028	Ref. No.	30082100
description	timer G 2-pole operation time 15min impulse mechanical 2NO at 250V 16A permanent position no shaft ø 3.5 x 3.5mm shaft 3.5x3.5mm shaft L 17mm mounting distance 28mm mounting thread M8 connection lateral		
For models:	12T, 4TO, 6T		
accessories for	350028		
	GEV No.	110365	Ref. No. —
	knob switch zero mark t.max.°C ø 44mm shaft ø 3.5x3.5mm shaft flat black		
	GEV No.	110371	Ref. No. —
	dial plate graduation 15min permanent position no rotation 30-330° ø 60mm timers knob ø 45mm		



GEV No.	350003	Ref. No.	23078700
description	timer M2 with bell 2-pole operation time 120min impulse mechanical 2NO at 250V 16A permanent position no shaft ø 6x4.6mm shaft 6x4.6mm shaft L 23mm mounting distance 28mm connection lateral		
For models:	FPE12TURBO, FPE6TURBO, FPG12, FPG6, WAV1-2, WAV2-3, WAV2-GAS, WAV3-GAS, WAV-E12, WAV-E12T, WAV-E12TURBO, WAV-E20, WAV-ESU, WAV-E6, WAV-E6T, WAV-E6TURBO, WAV-G12, WAV-G20, WAV-G5U, WAV-G6		
accessories for	350003		
	GEV No.	110366	Ref. No. —
	knob switch zero mark t.max.°C ø 44mm shaft ø 6x4.6mm shaft flat upper black		
	GEV No.	111199	Ref. No. —
	dial plate graduation 120min permanent position no rotation 0-330° ø 60mm timers knob ø 45mm		



GEV No.	350008	Ref. No.	25078600
description	timer M2 with bell 2-pole operation time 120min impulse mechanical 2NO at 250V 16A permanent position yes shaft ø 6x4.6mm shaft 6x4.6mm shaft L 24mm mounting distance 28mm connection lateral		
For models:	FC100EM, FC100GM, FC200EB, FC200GB, FC60EM, FC60GM, FME06M, FME10M, FME20M, FMG10M, FMG20M, FMG6, FMG6M, MM06EB, MM06GB, MM10EB, MM10GB		

alarm devices

alarm units



GEV No.	350081	Ref. No.	25078900
description	alarm device 9-15VDC H 14.5mm wall-mounted version 75dB protection IPx0		
For models:	FME10, FME15, FME20, FME5, FMG10, FMG15, FMG20, FMG5, FPE12TURBO, FPE6TURBO, FPG12, FPG6, FVE, WAV-E12, WAV-E12T, WAV-E12TURBO, WAV-E20, WAV-E6, WAV-E6T, WAV-E6TURBO, WAV-G12, WAV-G6		



buzzers



1

GEV No.	350050	Ref. No.	25079300
description	buzzer 230VAC connection male faston 6.3mm screw mounting thread M4 60dB		
For models:	FC100EM, FC100GEP, FC100GM, FC200EB, FC200GA, FC200GB, FC60EM, FC60GEP, FC60GM, FME06M, FME10M, FME20M, FMG10M, FMG20M, FMG6, FMG6M, FPE12TURBO, FPE6TURBO, FPG12, FPG6, MM06EA, MM06EB, MM06GA, MM06GB, MM10EA, MM10EB, MM10GA, MM10GB, WAV-E12, WAV-E12T, WAV-E12TURBO, WAV-E20, WAV-E6, WAV-E6T, WAV-E6TURBO, WAV-G12, WAV-G6		

contactors

GENERAL ELECTRIC (AEG)

power contactors



1

GEV No.	380238	Ref. No.	22105200
description	power contactor resistive load 20A 230VAC (AC3/400V) 8.4A/4kW main contacts 3NO auxiliary contacts 1NO connection screw connection type LS0510A type AEG LS0510A type GE MC1A 310A		
For models:	EGRM4, EGRS4		



1

GEV No.	380244	Ref. No.	22105100 23105900
description	power contactor resistive load 25A 230VAC (AC3/400V) 9A/4kW main contacts 3NO auxiliary contacts 1NO connection screw connection type AEG LS4K 10A type GE CL00A 310		
For models:	E10+10MB6, E10B4, E6PL60B, E6PL60M, E7F30-8B, E7F30-8BP, E7F30-8M, E7F30-8MP, E9BR8, E9BR8-I, E9P10D, E9P10I, E9P10IA, E9P15D, E9P15I, E9P15IA, E9PL40M, E9PL80M, SE9BR8, SE9BR8-I, SE9F18-4M, SE9F18-8M, SE9P10I, SE9P10IA, SE9P15I, SE9P15IA, SE9PL40M, SE9PL80M		

relays

power relays

with bracket mounting



1

GEV No.	380702	Ref. No.	31060300 31060400 31081810
description	power relays FINDER 230VAC 16A 3NO connection male faston 6.3mm flange dimensions 36x38x68mm manuf. no. 62.83.8.230.0300 230V		
For models:	E9P2MP-VTR, E9P4MP-VTR, E9P4P-VTR+FE, E9P4P-VTR+FE1, LXE9P2P-VTR, LXE9P4P-VTR, SE9P2MP-VTR, SE9P4MP-VTR, SE9P4P-VTR+FE		



1



GEV No.	380900	Ref. No.	31081000
description	power relays FINDER 230VAC 20A 1NO/1NC connection F6.3 bracket mounting dimensions 36.5x32.2x51.8mm manuf. no. 65.31.8.230.0000 2-pole		

with male contacts

female contact 2.0mm



1

GEV No.	380642	Ref. No.	25080600
description	power relays 230VAC connection 2.0 plug-in connection		
For models:	MM06EB, MM06GB, MM10EB, MM10GB, MM2-3EB		
accessories for	380642		
	GEV No.	380378	Ref. No. 10509
	relay socket 2-pole 55/85 dimensions 70.5x30x27mm 250V voltage AC 10A FINDER manuf. no. 94.72		
	GEV No.	380384	Ref. No. —
	relay socket 2-pole contacts male faston 2.8mm 250V voltage AC 10A W 23mm for		
	GEV No.	380399	Ref. No. —
	relay socket 4-pole dimensions 76.2x27x86.1mm 250V voltage AC 1A FINDER manuf. no. 94.94.3		



GEV No.	380377	Ref. No.	10507	
description	power relays FINDER 220-240VAC 10A 2CO connection F2 plug-in connection manuf. no. 55.32.8.230.0000 94.92.3 250V			
accessories for	380377			
	GEV No.	380341	Ref. No.	—
	relay socket 4-pole contacts 12 300V voltage AC 6A Italiana Relè manuf. no. ZMD4			
	GEV No.	380378	Ref. No.	10509
	relay socket 2-pole 55/85 dimensions 70.5x30x27mm 250V voltage AC 10A FINDER manuf. no. 94.72			
	GEV No.	380384	Ref. No.	—
	relay socket 2-pole contacts male faston 2.8mm 250V voltage AC 10A W 23mm for			
	GEV No.	380399	Ref. No.	—
	relay socket 4-pole dimensions 76.2x27x86.1mm 250V voltage AC 1A FINDER manuf. no. 94.94.3			

GEV No.	380638	Ref. No.	25998400
description	relay socket 8-pole dimensions 51x41x23mm 250V 10A FINDER manuf. no. 90.26		
For models:	MM2-3EB		

relay sockets

GEV No.	380641	Ref. No.	25998000
description	relay socket		
For models:	MM06EB, MM06GB, MM10EB, MM10GB, MM2-3EB		

GEV No.	380378	Ref. No.	10509	
description	relay socket 2-pole 55/85 dimensions 70.5x30x27mm 250V voltage AC 10A FINDER manuf. no. 94.72			
accessories for	380378			
	GEV No.	380804	Ref. No.	—
	support bracket			

level relays

GICAR

GEV No.	401224	Ref. No.	10532
description	level relay 230V connection F6.3 type RL30/3ES/F/G		

time relays

time relays

GEV No.	380329	Ref. No.	10508	
description	time relay FIBER 85.02.8.240 time range 0.05s - 100h 230-240VAC 10A mounting measurements 20.6x27.7mm 2CO connection 2.0			
accessories for	380329			
	GEV No.	380378	Ref. No.	10509
	relay socket 2-pole 55/85 dimensions 70.5x30x27mm 250V voltage AC 10A FINDER manuf. no. 94.72			
	GEV No.	380803	Ref. No.	—
	relay socket 2-pole dimensions 76.2x27x86.1mm 250V voltage AC 10A FINDER manuf. no. 94.92.3			



GEV No.	380639	Ref. No.	25081400
description	time relay TECNOLOGIC RTR12DS06S time range 6s 230VAC 5A mounting measurements 34x34mm 1CO connection plug-in connection round 8-pole		
For models:	MM06EB, MM06GB, MM10EB, MM10GB		
accessories for	380639		
	GEV No.	380638	Ref. No. 25998400
	relay socket 8-pole dimensions 51x41x23mm 250V 10A FINDER manuf. no. 90.26		



GEV No.	380640	Ref. No.	25081600
description	time relay TECNOLOGIC RTR12DS60S time range 60s 230VAC 5A 1CO connection plug-in connection round 8-pole		
For models:	MM06EB, MM06GB, MM10EB, MM10GB		
accessories for	380640		
	GEV No.	380638	Ref. No. 25998400
	relay socket 8-pole dimensions 51x41x23mm 250V 10A FINDER manuf. no. 90.26		

encapsulated transformers

PMA



GEV No.	379196	Ref. No.	24164600
description	transformer primary 230VAC secondary 12VAC 10VA secondary 0.8A connection screw 50Hz		
For models:	FPE10C, FPE10D, FPE12TURBO, FPE15C, FPE15D, FPE5C, FPE5D, FPE6TURBO, FPG10C, FPG10D, FPG12, FPG15C, FPG15D, FPG5C, FPG5D, FPG6, WAV-E12, WAV-E12T, WAV-E12TURBO, WAV-E20, WAV-E6, WAV-E6T, WAV-E6TURBO, WAV-G12, WAV-G6		



GEV No.	379054	Ref. No.	25164500
description	transformer primary 230VAC secondary 12VAC 3VA secondary 0.25A H 40mm L 45mm W 50mm connection screw 50/60Hz type 153/M		
For models:	FC100EM, FC200EB, FC200GB, FME06M, FME10M, FME20M, FMG10M, FMG20M, FMG6, FMG6M, FPE12TURBO, FPE6TURBO, FPG12, FPG6, MM06EA, MM06EB, MM10EA, MM10EB, WAV-E12, WAV-E12T, WAV-E12TURBO, WAV-E20, WAV-E6, WAV-E6T, WAV-E6TURBO, WAV-G12, WAV-G6		

transformers

open transformers

with clamp terminal



GEV No.	401229	Ref. No.	10324
description	transformer primary 230V secondary 12V 63VA		
For models:	FC200GB		

electronic controllers

EVCO - EVERY CONTROL

universal controllers

built-in version





GEV No.	379589	Ref. No.	25982800
description	electronic controller EVERY CONTROL mounting measurements 71x29mm built-in depth 64mm 12V voltage AC Pt100/TC (J,K,S) protection IP54 for oven type FK401A front measurements 33x75mm		
For models:	FME06M, FME10M, FME20M, FMG10M, FMG20M, FMG6, FMG6M, FPE12TURBO, FPE6TURBO, FPG12, FPG6, MM06EB, MM10EB, WAV-E12, WAV-E12T, WAV-E12TURBO, WAV-E20, WAV-E6, WAV-E6T, WAV-E6TURBO, WAV-G12, WAV-G6		
accessories for	379589		
	GEV No.	378009	Ref. No. —
	temperature probe thermocouple K (NiCr-Ni) cable silicone probe -50 up to 1150°C cable -50 up to +180°C connection 2-wire thread 1/8" probe ø3x200mm cable length 1m		

Table continues overleaf



accessories for 379589			
	GEV No.	379000	Ref. No. —
	temperature probe thermocouple J (Fe-CuNi) cable red/blue cable length 0.7m probe ø 2mm probe L 2000mm		
	GEV No.	379050	Ref. No. 24076500
	temperature probe Pt100 cable Vetrotex probe -200 up to +600°C cable -50 up to +350°C probe ø6x100mm cable length 2.7m without screw connection 3-wire		

SHANGFANG

accessories

			
1	GEV No.	379054	Ref. No. 25164500
	description transformer primary 230VAC secondary 12VAC 3VA secondary 0.25A H 40mm L 45mm W 50mm connection screw 50/60Hz type 153/M		
	For models: FC100EM, FC200EB, FC200GB, FME06M, FME10M, FME20M, FMG10M, FMG20M, FMG6, FMG6M, FPE12TURBO, FPE6TURBO, FPG12, FPG6, MM06EA, MM06EB, MM10EA, MM10EB, WAV-E12, WAV-E12T, WAV-E12TURBO, WAV-E20, WAV-E6, WAV-E6T, WAV-E6TURBO, WAV-G12, WAV-G6		

probes

universal probes

temperature probes

			
1	GEV No.	379050 ¹	Ref. No. 24076500
	description temperature probe Pt100 cable Vetrotex probe -200 up to +600°C cable -50 up to +350°C probe ø6x100mm cable length 2.7m without screw connection 3-wire		
	For models: FPE12TURBO, FPE6TURBO, FPG12, FPG6, WAV-E12, WAV-E12T, WAV-E12TURBO, WAV-E20, WAV-E6, WAV-E6T, WAV-E6TURBO, WAV-G12, WAV-G6		

¹3-wire

producer-specific probes

probes

			
1	GEV No.	402154	Ref. No. N/A
	description temperature probe Pt100 cable silicone probe -100 up to 450°C cable -50 up to +180°C connection 3-wire thread 1/8" probe ø6x35mm cable length 1.5m		

core probes

			
1	GEV No.	379945	Ref. No. 25919300
	description core temperature probe Pt100 cable PTFE probe -40 up to +250°C cable -40 up to +250°C connection plug probe ø3.5x100mm thread cable length 0.5m handle ø 10mm handle length 80mm		
	For models: FME10M, FME20M, FMG10M, FMG20M, FPE12TURBO, FPG12, MM10EA, MM10EB, MM10GA, WAV-E12, WAV-E12T, WAV-E12TURBO, WAV-E20, WAV-G12		

			
1	GEV No.	379946	Ref. No. 25919100
	description core temperature probe Pt100 cable PTFE probe -40 up to +250°C cable -40 up to +250°C connection plug probe ø3.5x100mm thread cable length 0.7m handle ø 10mm handle length 80mm		

			
1	GEV No.	379947	Ref. No. 10405
	description core temperature probe Pt100 cable PTFE probe -40 up to +250°C cable -40 up to +250°C connection plug probe ø3.5x100mm thread cable length 1.2m handle ø 10mm handle length 80mm		
	For models: FC200GB		

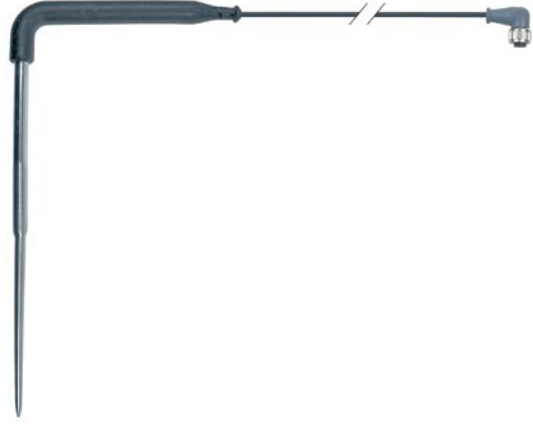
			
1	GEV No.	379350 ¹	Ref. No. 70404
	description core temperature probe PTC 1kOhm cable silicone probe -40 up to +120°C cable -50 up to +180°C connection plug probe ø4x100mm thread cable length 1.7m handle ø 8mm handle length 120/35mm L1 120mm L2 130mm		

¹multipoint probe



GEV No.	379662 ¹	Ref. No.	70402A
description	core temperature probe PTC 1kOhm cable silicone probe -40 up to +120°C cable -50 up to +180°C connection plug probe ø4x70mm thread cable length 1.3m handle ø 16mm handle length 120mm L1 120mm L2 130mm		

¹multipoint probe

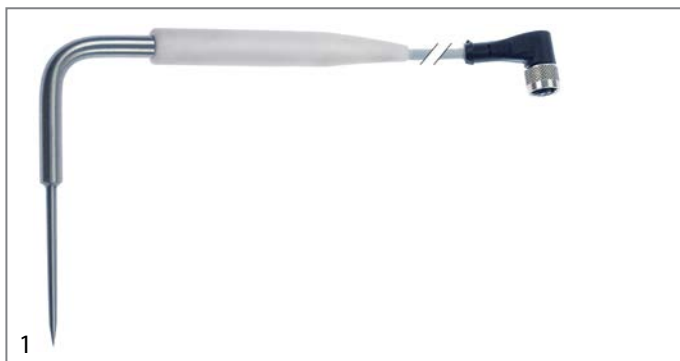

GEV No.	379806 ¹	Ref. No.	70405A
description	core temperature probe PTC 1kOhm cable silicone probe -40 up to +120°C cable -50 up to +180°C connection plug probe ø5x70mm thread cable length 1.2m handle ø 16mm handle length 125mm L1 170mm L2 65mm		

¹multipoint probe



GEV No.	379948	Ref. No.	25918900
description	core temperature probe thermocouple J (Fe-CuNi) cable SS corrugated hose probe -40 up to +250°C cable -40 up to +250°C connection 1/8" probe ø3.5x100mm thread 1/8" cable length 1.8m handle ø 10mm handle length 80mm		
For models:	FME6, FMG10M, FMG6, FMG6EP		



GEV No.	379951	Ref. No.	25919500
description	temperature probe thermocouple J (Fe-CuNi) cable SS corrugated hose probe -40 up to +250°C cable -40 up to +250°C connection 2-wire probe ø3.5x100mm thread 1/8" cable length 2.1m handle ø 10mm handle length 80mm		
For models:	FME10, FME10EP, FME20, FMG10, FMG10EP, FMG20		

electronics

PCBs

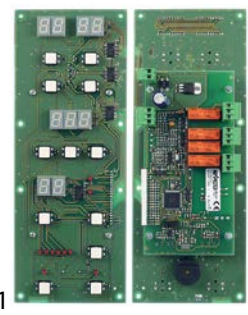

GEV No.	401219	Ref. No.	24047900
description	keypad PCB convection oven FC06/12/20		
For models:	FPE12TURBO, FPE6TURBO, FPG12, FPG6, WAV-E12, WAV-E12T, WAV-E12TURBO, WAV-E20, WAV-E6, WAV-E6T, WAV-E6TURBO, WAV-G12, WAV-G6		

solenoid valves

solenoid valves (water)

RPE





GEV No.	374021	Ref. No.	23116900
description	solenoid valve double straight 230VAC inlet 3/4" outlet 10mm DN10 RPE		
For models:	FME06M, FME10, FME10EP, FME10M, FME20, FME20M, FME6, FMG10, FMG10EP, FMG10M, FMG20, FMG20M, FMG6, FMG6EP, FMG6M, WAV-E20, WAV-G20		



GEV No.	374017	Ref. No.	23116200
description	solenoid valve single straight 230VAC inlet 3/4" outlet 10mm input 6l/min DN10 RPE polyamide flow regulating valve inlet white membranes NBR pressure range 0.2-10bar		
For models:	FC100EM, FC100EP, FC100GEP, FC100GM, FC200EA, FC200EB, FC200GA, FC200GB, FC60EM, FC60EP, FC60GEP, FC60GM, FPE12TURBO, FPE6TURBO, FPG12, FPG6, MM06EA, MM06EB, MM06GA, MM06GB, MM10EA, MM10EB, MM10GA, MM10GB, MM2-3EA, MM2-3EB, PASTRY-EM, PASTRY-VIP-EMU, WAV-E12, WAV-E12T, WAV-E12TURBO, WAV-E5U, WAV-E6, WAV-E6T, WAV-E6TURBO, WAV-G12, WAV-G5U, WAV-G6		



reducers			
outlet side			
			
1			
GEV No.	371269	Ref. No.	25932200
description	reducer flow rate 0.07-0.14l/min brown		
For models:	MM06EA, MM06GA, MM06GB, MM10EA, MM10GA, MM10GB, PASTRY-EM, PASTRY-VIP-EMU		

			
1			
GEV No.	371266	Ref. No.	25932400
description	reducer flow rate 0.2l/min red		
For models:	FC100EM, FC100EP, FC100GEP, FC100GM, FC200EA, FC200EB, FC200GA, FC200GB, FC60EM, FC60EP, FC60GEP, FC60GM, FME06M, FME10, FME10EP, FME10M, FME20, FME20M, FME6, FMG10, FMG10EP, FMG10M, FMG20, FMG20M, FMG6, FMG6EP, FMG6M, WAV-E20, WAV-G20		

			
1			
GEV No.	371268	Ref. No.	25932800
description	reducer flow rate 0.32-0.42l/min green		
For models:	FME10, FME10EP, FME10M, FME20, FME20M, FMG10, FMG10EP, FMG10M, FMG20, FMG20M, FMG6, FMG6EP, FMG6M		

ball valves electric

			
1			
GEV No.	401233	Ref. No.	10036
description	ball valve inlet 1/2" IT outlet 1/2" IT 230V 50/60Hz mode of operation electric W 60mm H 99mm cable 4-pole 2.5W 4-pole duty cycle 50%		

pressure switches

for steam control

			
1			
GEV No.	541025	Ref. No.	31917000
description	pressure control pressure connection vertical steam control pressure range adjustable 0.2-0.9bar connection male faston 6.3mm pressure connection ø 1/4"mm		
For models:	E7PI, G7PI		

electrodes

			
1			
GEV No.	401225	Ref. No.	3680
description	level electrode M12 ET - 1/8" ET total length 124/127/139mm probe L 91/95/104mm insulated probe length 42mm set 3-piece connection male faston 6.3mm ø 2.5mm		

			
1			
GEV No.	401226	Ref. No.	3681
description	level electrode M12x1 total length 150/160/171mm probe L 117/127/138mm insulated probe length 20mm set 3-piece connection male faston 6.3mm ø 2.5mm		



			
1			
GEV No.	401227	Ref. No.	3683
description	level electrode M12x1 total length 80/86/98mm probe L 48/53/65mm insulated probe length 20mm set 3-piece connection male faston 6.3mm ø 2.5mm		

			
1			
GEV No.	401228	Ref. No.	3572
description	level electrode total length 175mm connection male faston 6.3mm ø 2.5mm		

fans

axial fans

import

			
1			
GEV No.	601080 ¹	Ref. No.	10724
description	axial fan L 119mm W 119mm H 38mm 230VAC 50/60Hz 23/20W bearing ball bearing connection male faston 2.8mm metal ADDA fan wheel ø 110mm temp.-resist. 70°C		
For models:	FC200GB		
accessories for	601080		
	GEV No.	550898	Ref. No. —
	connecting cable cable length 2000mm connection F 2.8 connection distance 7.9mm for axial flow fan		
	GEV No.	692519	Ref. No. —
	guard L 120mm W 120mm plastic		

¹with ball bearings



hot air motors

1

GEV No.	550854	Ref. No.	0691
description	counterflange for fan motor ED ϕ 60mm int. ϕ 1 34.5mm int. ϕ 2 24.6mm thickness 5.1mm brass		
For models:	FC200GB		



1

GEV No.	601046	Ref. No.	24119100
description	fan motor 220/380V 3 phase 50/60Hz 0.75kW 1350/1650rpm speeds 1 L1 185mm L2 42mm L3 47mm D1 ϕ 24mm D2 ϕ 20mm M12L IT 1.9/3.3A Cos(fi) 0.83 at 50Hz 200-240/346-415V at 60Hz 200-277/346-480V at 50Hz 1350rpm at 60Hz 1650rpm type ST80/4 no. 661512		
For models:	FC100EM, FC100EP, FC100GEP, FC100GM, FC200EA, FC200EB, FC200GA, FC200GB, FME10M, FME20M, FMG10M, FMG20M, FPE10A, FPE10B, FPE10C, FPE10D, FPE12TURBO, FPE15A, FPE15B, FPE15C, FPE15D, FPG10A, FPG10B, FPG10C, FPG10D, FPG12, FPG15A, FPG15B, FPG15C, FPG15D, MM10EA, MM10EB, MM10GA, MM10GB, WAV-E12T, WAV-E12TURBO, WAV-E20, WAV-G12		

1

GEV No.	601043	Ref. No.	23118300	
description	fan motor 220-240V 1 phase 50Hz 0.37/0.07kW 0.1/0.5HP 1400/2700rpm speeds 2 L1 123mm L2 107mm L3 15mm D1 ϕ 15mm D2 ϕ 12mm M10L ET 2/0.7A suitable capacitor 20 μ F/250V at 50Hz 1400/2700rpm type 1057			
For models:	WAV-E5U, WAV-G5U			
accessories for	601043			
	GEV No.	365019	Ref. No.	—
	operating capacitor capacity 20 μ F 400V tolerance 5% 50/60Hz ambient temperature max. -25 to +85°C ϕ 39.5mm L 70mm M8 plastic connection male faston 6.3mm 16.10.25. protection			

1

GEV No.	601166	Ref. No.	24118500	
description	fan motor 220-240V 1 phase 50Hz 0.37kW 2700rpm speeds 1 L1 123mm L2 77mm L3 30mm D1 ϕ 15mm D2 ϕ 12mm M10L ET 2A suitable capacitor 12.5 μ F/450V at 50Hz 2700rpm type 1057.2157			
For models:	FC60EM, FC60EP, FC60GEP, FC60GM, FPE6TURBO, WAV-E6TURBO			
spare parts for	601166			
	GEV No.	365014	Ref. No.	—
	operating capacitor capacity 12.5 μ F 450V tolerance 5%Hz ambient temperature max. -25 to +85°C ϕ 35mm L 70mm M8 plastic connection male faston 6.3mm 45S.C3DS.12.5 protection			
accessories for	601166			
	GEV No.	601165	Ref. No.	—
	fan wheel D1 ϕ 160mm H1 60mm blades 15 D2 ϕ 16mm D3 ϕ 16mm H2 29mm			

1

GEV No.	500652	Ref. No.	0841
description	fan motor 380-415V 3 phase 50Hz 0.13/0.55kW 700/1350rpm speeds 2 L1 188mm L2 44mm L3 48mm D1 ϕ 24mm D2 ϕ 20mm M12L ITA Cos(fi) 0.13/0.55 at 50Hz 700/1350rpm 4P/8P type FB80 4/8 no. 390133		

1

GEV No.	601067	Ref. No.	25647200
description	fan wheel D1 ϕ 150mm H1 38mm blades 36 D2 ϕ 6mm D3 ϕ 6mm H2 14mm		
For models:	MM2-3EA, MM2-3EB, PASTRY-VIP-EMU		

electric components



			
1			
GEV No.	601060	Ref. No.	24646500
description	fan wheel D1 ø 180mm H1 60mm blades 16 D2 ø 11mm D3 ø 16mm H2 30mm		
For models:	FME06M, FME6, FMG10M, FMG6, FMG6EP, FMG6M, FPE5A, FPE5B, FPE5C, FPE5D, FPE6TURBO, FPG5A, FPG5B, FPG5C, FPG5D, FPG6, MM06EA, MM06EB, MM06GA, MM06GB, WAV-E6T, WAV-E6TURBO, WAV-G6		

			
1			
GEV No.	601224	Ref. No.	24646900
description	fan wheel D1 ø 300mm H1 100mm blades 24 D2 ø 19.5mm D3 ø 23mm H2 46mm		
For models:	FC200EA, FC200EB, FC200GA, FC200GB		

			
1			
GEV No.	601063	Ref. No.	0759
description	fan wheel D1 ø 350mm H1 100mm blades 24 D2 ø 19.5mm D3 ø 23mm H2 46mm		
For models:	FC200GB		

			
1			
GEV No.	550852	Ref. No.	0690
description	flange for fan motor ED ø 60mm int. ø 1 28.5mm int. ø 2 24.5mm thickness 3.5mm brass		
For models:	FC200GB		

			
1			
GEV No.	550853	Ref. No.	0688
description	gasket for fan motor ID ø 24mm ED ø 29mm thickness 3mm		
For models:	FC200GB		

hot air fans

miscellaneous

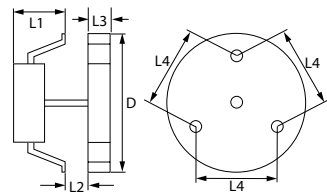
			
1			
			
GEV No.	601054	Ref. No.	23117700
description	hot air fan 220-240V 32W 50/60Hz L1 60mm L2 10mm L3 25mm L4 87mm fan wheel ø 150mm FIME type C20X0E01/46		
For models:	E4F+FCD8, E4F+FCDQ8, E6P4+FE1, E6P6+FE1, E6P6+TE, E6PQ2H6+FE1, E6PQ2H6+FE1+T, E6PQ2P9+FE1, E6PQ2P9+TE, E7P4+FE1, E7P4-VTR+FE1, E7P6+FE1, E7PQ4+FE1, E7PQ4+FE1+T, E7PQ6+FE1, E7PQ6+FE1+T, E9P4+FE1, E9P4P-VTR+FE1, E9P4-VTR+FE1, E9P6+FE1, E9PQ4+FE1, E9PQ4+FE1+T, E9PQ6+FE1, E9PQ6+FE1+T, G4F+FCD8, G4S+FCGN, G6F2H6+FE1, G6F2H9+FE1, G6F2H9+TE, G6F2P6+FE1, G6F2P9+FE1, G6F2P9+TE, G6F3H12+FE1, G6F3H12+TE, G6F4+FE1, G6F4+FE1+A4, G6F4PW+FE1, G6F4PW+FE1+AE, G6F6+FE1, G6F6+FE1+A6, G6F6+TE, G6F6+TE+A6, G6F6PW+FE1, G6F6PW+FE1+AE, G6F6PW+TE, G6F6PW+TE+AE, G6S+FCGN, G7F4+FE1, G7F4E+FE1, G7F4E+FE1+A4...(Other models you can see in the webshop)		
spare parts for	601054		
	GEV No.	601441	Ref. No.
			—
	fan wheel ø 150mm W 25mm shaft intake ø 6x5mm stainless steel blades 7		
accessories for	601054		
	GEV No.	550879	Ref. No.
			—
	insulation ø 130mm thickness 3mm hole ø 20mm for hot air fan		



1

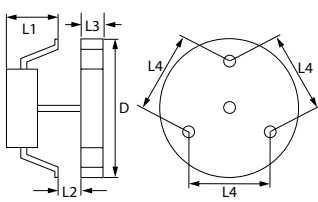

GEV No.	601125	Ref. No.	23118000
description	hot air fan 220-240V 45W 50/60Hz L1 70mm L2 11mm L3 25mm L4 87mm fan wheel ø 150mm FIME type C30R0479CLF		
For models:	PASTRY-EM, WAV-E2-3		
accessories for	601125		
	GEV No.	550879	Ref. No. —
	insulation ø 130mm thickness 3mm hole ø 20mm for hot air fan		

pumps

drain pumps

ASKOLL



1

GEV No.	500565	Ref. No.	25115600
description	drain pump 30W		
For models:	FME06M, FME10, FME10EP, FME10M, FME20, FME20M, FME6, FMG10, FMG10EP, FMG10M, FMG20, FMG20M, FMG6, FMG6EP, FMG6M		

electric accessories

terminals

connection terminals with screw/faston connections



1

GEV No.	550411	Ref. No.	30184200
description	power terminal block 6-pole max. 40A max 450V connection ø6mm ² / F6.3 temp.-resist. 150°C cross section 6mm ²		
For models:	CPE40, E2FQS4, E2FS4, E4F+FCD8, E4F+FCDQ8, E4FD8, E4FDQ8, E6CP6B, E6CP6M, E6CPM, E6F10-3B, E6F10-3BS, E6F10-3M, E6F10-3MS, E6F10-6B, E6F10-6BS, E6F10-6M, E6F10-6MS, E6F8-3B, E6F8-3M, E6F8-6B, E6F8-6M, E6FL3B, E6FL3BP, E6FL3B-P, E6FL3BP-CR, E6FL3BP-SX, E6FL3B-SX, E6FL3M, E6FL3MP, E6FL3M-P, E6FL3MP-CR, E6FL3MP-SX, E6FL3M-SX, E6FL6B-2, E6FL6B-2-SX, E6FL6BP-2, E6FL6BP-2-CR, E6FL6BP-2-SX, E6FL6M-2, E6FL6M-2-SX, E6FL6MP-2, E6FL6MP-2-CR, E6FL6MP-2-SX, E6FM6B-2, E6FM6BP-2, E6FM6M-2, E6FM6MP-2, E6FR3B, E6FR3BP...(Other models you can see in the webshop)		

gas taps

PEL

20S series



1

GEV No.	101094	Ref. No.	22272900
description	gas tap PEL type 20S gas inlet M16x1.5 (tube ø 10mm) bypass nozzle ø 0.35mm gas outlet M16x1.5 (tube ø 10/8mm) thermocouple connection M8x1 pilot connection shaft ø 8x6.5mm shaft L 22/15mm shaft flat lower		
spare parts for	101094		
	GEV No.	100408	Ref. No. —
	bypass nozzle type PEL20/21 bore ø 0.35mm thread M5x0.5		
	GEV No.	101060	Ref. No. —
	magnet unit standard L 39mm D1 ø 15.4mm D2 ø 11mm suitable for PEL20-21/JUNKERS/EGA		
	GEV No.	101205	Ref. No. —
	gas tap front part shaft ø 8x6.5mm shaft L 22/15mm shaft flat upper/lower suitable for PEL20		
	GEV No.	101230	Ref. No. —
	thermocouple nut T1: M8x1 T2: M18x1 aluminium		
accessories for	101094		
	GEV No.	101278	Ref. No. 32777300
	olive for pipe ø 10mm Qty 1 pcs		
	GEV No.	101300	Ref. No. —
	union nut thread M16x1.5 tube ø 10mm		

Table continues overleaf



accessories for		101094		
GEV No.		101450	Ref. No.	—
	olive for pipe ø 8mm L 12.7mm Qty 1 pcs ED ø 10mm			
GEV No.		101451	Ref. No.	—
	union nut thread M16x1.5 tube ø 8mm			
GEV No.		110081	Ref. No.	31875900
	knob ø 70mm shaft ø 8x6.5mm shaft flat universal			
GEV No.		110083	Ref. No.	—
	knob dial plate gas tap without ignition flame silver			

accessories for		101095		
GEV No.		101286	Ref. No.	—
	olive ID ø 6mm Qty 1 pcs			
GEV No.		101300	Ref. No.	—
	union nut thread M16x1.5 tube ø 10mm			
GEV No.		101450	Ref. No.	—
	olive for pipe ø 8mm L 12.7mm Qty 1 pcs ED ø 10mm			
GEV No.		101451	Ref. No.	—
	union nut thread M16x1.5 tube ø 8mm			
GEV No.		110081	Ref. No.	31875900
	knob ø 70mm shaft ø 8x6.5mm shaft flat universal			
GEV No.		112206	Ref. No.	—
	knob dial plate silver gas tap PEL21/22/23 t.max.°C ED ø 63mm ID ø 45.5mm			

21S series



GEV No.	101095	Ref. No.	22783600
description	gas tap PEL type 21S gas inlet M16x1.5 (tube ø 10mm) bypass nozzle ø 0.35mm gas outlet M16x1.5 (tube ø 10/8mm) thermocouple connection M8x1 pilot connection M10x1 shaft ø 8x6.5mm shaft L 22/15mm shaft flat lower		
For models:	G6F2BH6, G6F2BP6, G6F2BPW, G6F2H6+FE1, G6F2H6+FG1, G6F2H9+FE1, G6F2H9+FG1, G6F2H9+T, G6F2H9+TE, G6F2MH6, G6F2MP6, G6F2MPW, G6F2P6+FE1, G6F2P6+FG1, G6F2P9+FE1, G6F2P9+FG1, G6F2P9+T, G6F2P9+TE, G6F4BPW, G6F4MPW, G6F4PW+FE1, G6F4PW+FG1, G6F6+T, G6F6+T+A6, G6F6BPW, G6F6MPW, G6F6PW+FE1, G6F6PW+FG1, G6F6PW+T, G6F6PW+T+AE, G6F6PW+TE, G6F6PW+TE+AE, G7F2B, G7F2BPW, G7F2M, G7F2MPW, G7F4+FE, G7F4+FE1, G7F4+FES, G7F4+FG, G7F4+FG1, G7F4B, G7F4BPW, G7F4M, G7F4MPW, G7F4PW+FE, G7F4PW+FE1, G7F4PW+FG, G7F4PW+FG1, G7F6+FE...(Other models you can see in the webshop)		

GEV No.	101397	Ref. No.	22273500 31273700
description	gas tap PEL type 21S gas inlet M16x1.5 (tube ø 10mm) bypass nozzle ø 0.35mm gas outlet M16x1.5 (tube ø 10/8mm) thermocouple connection M9x1 pilot connection M10x1 shaft ø 8x6.5mm shaft L 22/15mm shaft flat lower		
For models:	CPG40, CPG40E, CPG80, CPG80E, E9F15-4M, E9F15-8M, E9F18-4M, E9F18-8M, G6CP6, G6F2BH6, G6F2BP6, G6F2BPW, G6F2MH6, G6F2MP6, G6F2MPW, G6F4BPW, G6F4MPW, G6F4PW+FE1, G6F4PW+FG1, G6F6BPW, G6F6MPW, G6F6PW+FE1, G6F6PW+FG1, G6F6PW+T, G6F6PW+T+AE, G6F6PW+TE, G6F6PW+TE+AE, G6FL3B, G6FL3B-CR, G6FL3B-SX, G6FL3M, G6FL3M-CR, G6FL3M-SX, G6FL6B, G6FL6B-CR, G6FL6B-SX, G6FL6M, G6FL6M-CR, G6FL6M-SX, G6FM6B, G6FM6M, G6FR3B, G6FR3M, G6FR6B, G6FR6M, G6PL60B, G6PL60M, G7F2B, G7F2BPW, G7F2M, G7F2MPW, G7F4+FE...(Other models you can see in the webshop)		

spare parts for		101095		
GEV No.		100408	Ref. No.	—
	bypass nozzle type PEL20/21 bore ø 0.35mm thread M5x0.5			
GEV No.		101060	Ref. No.	—
	magnet unit standard L 39mm D1 ø 15.4mm D2 ø 11mm suitable for PEL20-21/JUNKERS/EGA			
GEV No.		101206	Ref. No.	—
	gas tap front part shaft ø 8x6.5mm shaft L 22/15mm shaft flat upper/lower suitable for PEL21			
GEV No.		101230	Ref. No.	—
	thermocouple nut T1: M8x1 T2: M18x1 aluminium			
accessories for		101095		
GEV No.		100908	Ref. No.	—
	union screw thread M10x1 for pipe ø 4mm Qty 1 pcs			
GEV No.		100909	Ref. No.	—
	union screw thread M10x1 for pipe ø 6mm Qty 1 pcs			
GEV No.		101246	Ref. No.	31777500 31777700
	olive for pipe ø 4mm Qty 1 pcs			
GEV No.		101278	Ref. No.	32777300
	olive for pipe ø 10mm Qty 1 pcs			

spare parts for		101397		
GEV No.		100408	Ref. No.	—
	bypass nozzle type PEL20/21 bore ø 0.35mm thread M5x0.5			
GEV No.		101060	Ref. No.	—
	magnet unit standard L 39mm D1 ø 15.4mm D2 ø 11mm suitable for PEL20-21/JUNKERS/EGA			
GEV No.		101206	Ref. No.	—
	gas tap front part shaft ø 8x6.5mm shaft L 22/15mm shaft flat upper/lower suitable for PEL21			
GEV No.		101231	Ref. No.	—
	thermocouple nut T1: M9x1 T2: M18x1			
accessories for		101397		
GEV No.		100908	Ref. No.	—
	union screw thread M10x1 for pipe ø 4mm Qty 1 pcs			
GEV No.		100909	Ref. No.	—
	union screw thread M10x1 for pipe ø 6mm Qty 1 pcs			

Table continues overleaf

accessories for 101397				
	GEV No.	101246	Ref. No.	31777500 31777700
olive for pipe ø 4mm Qty 1 pcs				
	GEV No.	101278	Ref. No.	32777300
olive for pipe ø 10mm Qty 1 pcs				
	GEV No.	101286	Ref. No.	—
olive ID ø 6mm Qty 1 pcs				
	GEV No.	101300	Ref. No.	—
union nut thread M16x1.5 tube ø 10mm				
	GEV No.	101450	Ref. No.	—
olive for pipe ø 8mm L 12.7mm Qty 1 pcs ED ø 10mm				
	GEV No.	101451	Ref. No.	—
union nut thread M16x1.5 tube ø 8mm				
	GEV No.	110081	Ref. No.	31875900
knob ø 70mm shaft ø 8x6.5mm shaft flat universal				
	GEV No.	112206	Ref. No.	—
knob dial plate silver gas tap PEL21/22/23 t.max.°C ED ø 63mm ID ø 45.5mm				

				
1				
GEV No.	107582	Ref. No.	31273500	
description	gas tap PEL type 21S gas inlet M16x1.5 (tube ø 10mm) bypass nozzle ø 0.45mm gas outlet M16x1.5 (tube ø 10/8mm) thermocouple connection M9x1 pilot connection M10x1 shaft ø 8x6.5mm shaft L 22/15mm shaft flat upper			
For models:	G12F4H9+FGP, G12F4H9M, G6F2B, G6F2B+A2, G6F2BH9, G6F2BP9, G6F2H6+FE1, G6F2H6+FG1, G6F2H9+FE1, G6F2H9+FG1, G6F2H9+T, G6F2H9+TE, G6F2MH9, G6F2MP9, G6F2P6+FE1, G6F2P6+FG1, G6F2P9+FE1, G6F2P9+FG1, G6F2P9+T, G6F2P9+TE, G6F4B, G6F4B+A4, G6F6B, G6F6B+A6, G7F2M, G7F4+FE1, G7F4+FG, G7F4+FG1, G7F4M, G7F6+FE1, G7F6+FG, G7F6+FG1, G7F6M, G7T4P2F+FG1, G7T4P2FB, G7T4P2FM, G7T4P4F+FG, G7T4P4F+FG1, G7T4P4FB, G7T4P4FM, G9F2M, G9F4+FG, G9F4+FG1, G9F4M, G9F6+FG, G9F6+FG1, G9F6M, SG9F4+FG, SG9F4M, SG9F6+FG...(Other models you can see in the webshop)			

				
1				
GEV No.	107581	Ref. No.	31273600	
description	gas tap PEL type 21S gas inlet M16x1.5 (tube ø 10mm) bypass nozzle ø 0.55mm gas outlet M16x1.5 (tube ø 10/8mm) thermocouple connection M9x1 pilot connection M10x1 shaft ø 8x6.5mm shaft L 22/15mm shaft flat upper			
For models:	G12F4H9+FGP, G12F4H9M, G12F4P9+FGP, G12F4P9M, G6F2B, G6F2B+A2, G6F2BH9, G6F2BP9, G6F2H6+FE1, G6F2H6+FG1, G6F2H9+FE1, G6F2H9+FG1, G6F2H9+T, G6F2H9+TE, G6F2MH9, G6F2MP9, G6F2P6+FE1, G6F2P6+FG1, G6F2P9+FE1, G6F2P9+FG1, G6F2P9+T, G6F2P9+TE, G6F3BH12, G6F3BH9, G6F3H12+FE1, G6F3H12+FG1, G6F3H12+T, G6F3H12+TE, G6F3H9+T, G6F3MH12, G6F4B, G6F4B+A4, G6F6B, G6F6B+A6, G6FL3B, G6FL6B, G6FM6B, G6FR3B, G6FR6B, G7F2BP, G7F2M, G7F2MP, G7F4+FE1, G7F4+FG, G7F4+FG1, G7F4BP, G7F4M, G7F4MP, G7F4P+FG, G7F4P+FG+AF2...(Other models you can see in the webshop)			













23S/O series				
				
1				
GEV No.	101092	Ref. No.	31274100 35273800	
description	gas tap PEL type 23S/O gas inlet M28x1.5 (tube ø 20mm) bypass nozzle ø 0.35mm gas outlet M24x1.5 (tube ø 16mm) thermocouple connection M10x1 pilot connection M10x1 shaft ø 10x8mm shaft L 25/17mm shaft flat upper			
For models:	G7PD, G9P10D, G9P10DA, G9P10I, G9P10IA, G9P15D, G9P15DA, G9P15I, G9P15IA, G9P20D, G9P20DA, LXG9P15I, SG9P10D, SG9P10DA, SG9P10I, SG9P10IA, SG9P15D, SG9P15DA, SG9P15I			
spare parts for	101092			
	GEV No.	100455	Ref. No.	—
bypass nozzle type PEL23/24 bore ø 0.35mm thread M8x0.5				
	GEV No.	101059	Ref. No.	—
magnet unit T1: M10x1 T2: M22x1 L 46mm ø 18mm suitable for PEL23S M10x1				
	GEV No.	101204	Ref. No.	—
gas tap front part shaft ø 10x8mm shaft L 25/17mm shaft flat upper/lower suitable for PEL23S				
	GEV No.	101244	Ref. No.	—
gas connection thread M24x1.5 tube ø 12/16mm horizontal for PEL gas taps				
	GEV No.	101463	Ref. No.	—
screw suitable for PEL23S Qty 4 pcs				
	GEV No.	528455	Ref. No.	—
O-ring Viton thickness 2.62mm ID ø 18.72mm Qty 1 pcs				
accessories for	101092			
	GEV No.	100908	Ref. No.	—
union screw thread M10x1 for pipe ø 4mm Qty 1 pcs				

Table continues overleaf







accessories for		101092		
	GEV No.	100909	Ref. No.	—
union screw thread M10x1 for pipe ø 6mm Qty 1 pcs				
	GEV No.	101246	Ref. No.	31777500 31777700
olive for pipe ø 4mm Qty 1 pcs				
	GEV No.	101252	Ref. No.	—
union nut thread M24x1.5 for pipe ø 12mm				
	GEV No.	101253	Ref. No.	—
union nut thread M24x1.5 PEL for pipe ø 16mm				
	GEV No.	101254	Ref. No.	—
union nut thread M28x1.5 tube ø 20mm				
	GEV No.	101255	Ref. No.	—
olive for pipe ø 12mm Qty 1 pcs				
	GEV No.	101256	Ref. No.	—
olive for pipe ø 16mm Qty 1 pcs				
	GEV No.	101257	Ref. No.	—
olive for pipe ø 20mm Qty 1 pcs				
	GEV No.	101286	Ref. No.	—
olive ID ø 6mm Qty 1 pcs				
	GEV No.	110080	Ref. No.	—
knob ø 70mm shaft ø 10x8mm shaft flat universal				
	GEV No.	112206	Ref. No.	—
knob dial plate silver gas tap PEL21/22/23 t.max.°C ED ø 63mm ID ø 45.5mm				

spare parts for		101357		
	GEV No.	106723	Ref. No.	—
magnet unit L 29mm D1 ø 12.5mm D2 ø 8.5mm suitable for SABAF				
accessories for		101357		
	GEV No.	101277	Ref. No.	—
olive ID ø 8mm Qty 1 pcs				
	GEV No.	101751	Ref. No.	22966200
bracket				
	GEV No.	520656	Ref. No.	—
union nut thread 1/4" tube ø 6/8mm				
	GEV No.	560082	Ref. No.	—
hexagonal screw thread M4 thread L 16mm SS WS 7 Qty 20 pcs DIN 933 / ISO 4017				



gas thermostats

SIT







630 Eurosit series





				
1				
GEV No.	101992	Ref. No.	35271800 35271809	
description	gas thermostat type 630 Eurosit series t.max. 190°C 110-190°C gas inlet 3/8" gas outlet 3/8" thermocouple connection M9x1 pilot connection M10x1 probe ø 4mm probe L 202mm capillary pipe 1050mm SIT			
For models:	6GL18B, 6GL18M, 9GL15+15M, 9GL15M, 9GL20+20M, 9GL20M, GL15+15M, GL15M, GL20+20M, GL20M, GL30B, GL30M, GL7+7M, S9GL20+20M, S9GL20M, S9GL22M			
accessories for		101992		
	GEV No.	100904	Ref. No.	—
locking screw M10x1 for pipe ø 4mm Qty 1 pcs				
	GEV No.	100905	Ref. No.	—
locking screw M10x1 for pipe ø 6mm Qty 1 pcs				
	GEV No.	101273	Ref. No.	—
olive for pipe ø 12mm L 9.5mm brass Qty 1 pcs suitable for universal				
	GEV No.	101276	Ref. No.	—
union screw thread 3/8" tube ø 12mm Qty 1 pcs				
	GEV No.	101333	Ref. No.	—
plug thread 3/8" with O-ring				
	GEV No.	510655	Ref. No.	—
gasket silicone ø 7.8mm L 5mm blue Shore 55° Qty 10 pcs				







SABAF

				
1				
GEV No.	101357	Ref. No.	31274500 31275000	
description	gas tap SABAF type 10 gas inlet pipe flange ø16mm bypass nozzle ø 0.52mm gas outlet 1/4" (tube ø 8mm) front fixing thermocouple connection plug-in connection shaft ø 8x6.5mm shaft L 26/12mm shaft flat lower			
For models:	G6F2B, G6F2B+A2, G6F2BPW+AE, G6F2M, G6F2M+A2, G6F2MPW+AE, G6F4+FE1, G6F4+FE1+A4, G6F4+FG1, G6F4+FG1+A4, G6F4B, G6F4B+A4, G6F4BPW+AE, G6F4M, G6F4M+A4, G6F4MPW+AE, G6F4PW+FE1+AE, G6F4PW+FG1+AE, G6F6+FE1, G6F6+FE1+A6, G6F6+FG1, G6F6+FG1+A6, G6F6+T, G6F6+T+A6, G6F6+TE, G6F6+TE+A6, G6F6B, G6F6B+A6, G6F6BPW+AE, G6F6M, G6F6M+A6, G6F6MPW+AE, G6F6PW+FE1+AE, G6F6PW+FG1+AE, G7F2BE, G7F2BE+A2, G7F2B-PW+AE, G7F2BPW-F, G7F2ME, G7F2ME+A2, G7F2MPW+AE, G7F4BE, G7F4BE+A4, G7F4BPW+AE, G7F4E+FE, G7F4E+FE+A4, G7F4E+FE1, G7F4E+FE1+A4, G7F4E+FG, G7F4E+FG+A4...(Other models you can see in the webshop)			
spare parts for		101357		
	GEV No.	101376	Ref. No.	22594900
gasket ID ø 8mm ED ø 12mm H 3/5mm				



			
GEV No.	101696	Ref. No.	35274500
description	gas thermostat type 630 Eurosit series t.max. 300°C 60-300°C gas inlet 3/8" gas outlet 3/8" thermocouple connection M9x1 pilot connection M10x1 probe ø 4mm probe L 72mm capillary pipe 1050mm SIT		
For models:	G12F4H9+FGP, G12F4P9+FGP, G9FL4M, G9FL4M-CR, G9FL4M-SX, G9FL8M-2, G9FL8M-2-CR, G9FL8M-2-SX, G9FM8M-2, G9FR4M, G9FR8M-2, SG9FL4M-CR, SG9FL8M-2-CR, SG9FM8M-2-CR, SG-9FR4M-CR, SG9FR8M-2-CR		
spare parts for	101696		
	GEV No.	101333	Ref. No. —
plug thread 3/8" with O-ring			
accessories for	101696		
	GEV No.	100904	Ref. No. —
locking screw M10x1 for pipe ø 4mm Qty 1 pcs			
	GEV No.	100905	Ref. No. —
locking screw M10x1 for pipe ø 6mm Qty 1 pcs			
	GEV No.	101273	Ref. No. —
olive for pipe ø 12mm L 9.5mm brass Qty 1 pcs suitable for universal			
	GEV No.	101276	Ref. No. —
union screw thread 3/8" tube ø 12mm Qty 1 pcs			

			
GEV No.	101125	Ref. No.	35271600
description	gas thermostat type 630 Eurosit series t.max. 340°C 100-340°C gas inlet 3/8" gas outlet 3/8" thermocouple connection M9x1 pilot connection M10x1 probe ø 4mm probe L 72mm capillary pipe 1050mm SIT		
For models:	G9BR8, G9BR8-I, LXG9BR8-I, SG9BR8, SG9BR8-I		
accessories for	101125		
	GEV No.	100825	Ref. No. —
gas tap spindle shaft ø 8x6.5mm shaft L 22/14mm suitable for EUROSIT			
	GEV No.	100904	Ref. No. —
locking screw M10x1 for pipe ø 4mm Qty 1 pcs			
	GEV No.	100905	Ref. No. —
locking screw M10x1 for pipe ø 6mm Qty 1 pcs			
	GEV No.	100949	Ref. No. —
gasket suitable for 630 Eurosit series			

accessories for	101125		
	GEV No.	101273	Ref. No. —
olive for pipe ø 12mm L 9.5mm brass Qty 1 pcs suitable for universal			
	GEV No.	101276	Ref. No. —
union screw thread 3/8" tube ø 12mm Qty 1 pcs			
	GEV No.	101333	Ref. No. —
plug thread 3/8" with O-ring			
	GEV No.	101390	Ref. No. —
gas tap spindle shaft ø 6x4.6mm shaft L 32/15mm gas tap with ignition flame suitable for ZANUSSI, MARENO for gas thermostat EUROSIT			
	GEV No.	101392	Ref. No. —
adapter suitable for 630 Eurosit series			
	GEV No.	110357	Ref. No. —
gas tap spindle shaft ø 8x6.5mm shaft L 36/12mm suitable for 630 Eurosit series			
	GEV No.	110358	Ref. No. —
adapter shaft ø 10x8mm shaft L 29/18mm suitable for 630 Eurosit series			

710 Minisit series







			
GEV No.	101131	Ref. No.	32271600
description	gas thermostat without cap, button and angle SIT type MINISIT 710 t.max. 190°C 50-190°C gas inlet 1/2" gas outlet 3/8" thermocouple connection M9x1 pilot connection M10x1 probe ø 5mm probe L 98mm capillary pipe 1200mm probe type type A2 pressure controller no pressure regulator mbar gland nut		
For models:	GL10+10B, GL10+10M, GL10B, GL10M, GL15+15M, GL15M, GL20+20M, GL20M, GL30M, GL8+8B, GL8+8M, GL8B, GL8M		
spare parts for	101131		
	GEV No.	101053	Ref. No. —
magnet unit T1: M9x1 T2: M24x1 L 45mm ø 17mm suitable for Minisit			
	GEV No.	102103	Ref. No. —
probe 60-200°C probe ø 5mm probe L 98mm capillary pipe 1050mm t.max. 200°C fryer probe type type A2 suitable for MINISIT 710			
accessories for	101131		
	GEV No.	100809	Ref. No. —
O-ring EPDM thickness 2mm ID ø 21mm Qty 1 pcs			
	GEV No.	100820	Ref. No. —
gland duct ET M14x1.5 IT M10x0.75 probe ø max. 6.5mm WS 22			
	GEV No.	100904	Ref. No. —
locking screw M10x1 for pipe ø 4mm Qty 1 pcs			
	GEV No.	100905	Ref. No. —
locking screw M10x1 for pipe ø 6mm Qty 1 pcs			

Table continues overleaf



accessories for		101131		
	GEV No.	101054	Ref. No.	—
	magnet unit T1: M10x1 T2: M24x1 L 45mm ø 17mm suitable for Minisit			
	GEV No.	101136	Ref. No.	—
	piezoelectric igniter suitable for Minisit with cover cap ømm connection F6.3x0.8			
	GEV No.	101137	Ref. No.	—
	cover cap without piezoelectric igniter			
	GEV No.	101267	Ref. No.	32924100
	reducer IT 3/8" ET 1/2" L 21mm			
	GEV No.	101268	Ref. No.	—
	gas connection thread 3/8" angled with O-ring MINISIT 710			
	GEV No.	101269	Ref. No.	—
	gas connection thread 1/2" angled with O-ring MINISIT 710			
	GEV No.	101270	Ref. No.	—
	screw connection IT 3/8" ET 3/8" L 28mm			
	GEV No.	101272	Ref. No.	—
	screw connection IT 1/2" ET 3/8" L 57mm			
	GEV No.	101273	Ref. No.	—
	olive for pipe ø 12mm L 9.5mm brass Qty 1 pcs suitable for universal			
	GEV No.	101274	Ref. No.	—
	olive for pipe ø 16mm Qty 1 pcs			
	GEV No.	101275	Ref. No.	—
	union screw thread 1/2" for pipe ø 16mm Qty 1 pcs			
	GEV No.	101276	Ref. No.	—
	union screw thread 3/8" tube ø 12mm Qty 1 pcs			
	GEV No.	110068	Ref. No.	32652600
	knob suitable for Minisit ø 37mm			

PEL

25ST series



GEV No.	107933	Ref. No.	22274700
description	gas thermostat PEL type 25ST 100-260°C gas inlet M16x1.5 (tube ø 10mm) gas outlet M16x1.5 (tube ø 10mm) thermocouple connection M9x1 pilot connection M10x1 capillary pipe 1200mm probe ø 6mm probe L 90mm shaft ø 8x6.5mm shaft L 21/15mm shaft flat upper		
For models:	G6F3H12+T, G6F3H9+T, G6F6+T, G6F6+T+A6, G6F6PW+T, G6F6PW+T+AE, G7F4+FG, G7F4E+FG, G7F4E+FG+A4, G7F4P+FG, G7F4P+FG+AF2, G7F4PW+FG, G7F4PW+FG+AE, G7F6+FG, G7F6+T, G7F6E+FG, G7F6E+FG+A6, G7F6E+T, G7F6P+FG, G7F6P+FG+AF2, G7F6P+T, G7F6P+T+AF2, G7F6PW+FG, G7F6PW+FG+AE, G7F6PW+T, G7F6PW+T+AE, G7T4P4F+FG, G7TP+FG, G7TP2F+FG, G7TP2F+T, G9F4+FE1, G9F4+FG, G9F4P+FG, G9F4P+FG+AF2, G9F4PW+FG, G9F4PW+FG+AE, G9F6+FE1, G9F6+FG, G9F6+T, G9F6P+FG, G9F6P+T+AE, G9F6P+T+AF2, G9F6PW+FG, G9F6PW+FG+AE, G9F6PW+T, G9F6PW+T+AE, G9F8+2FG, G9F8P+2FG, G9F8P+2FG+AF2... (Other models you can see in the webshop)		











GEV No.	101172	Ref. No.	22274500 22274600
description	gas thermostat PEL type 25ST 100-300°C gas inlet M16x1.5 (tube ø 10mm) bypass nozzle ø 0.35mm gas outlet M16x1.5 (tube ø 10/8mm) thermocouple connection M9x1 pilot connection M10x1 capillary pipe 1200mm probe ø 6mm probe L 100mm shaft ø 8x6.5mm shaft L 21/15mm shaft flat upper		
For models:	G6F2B, G6F2B+A2, G6F3H12+T, G6F3H9+T, G6F4B, G6F4B+A4, G6F6+T, G6F6+T+A6, G6F6B, G6F6B+A6, G6F6PW+T, G6F6PW+T+AE, G6FL3B-SX, G6FL6B-CR, G6FL6B-SX, G6FR6B, G7BR8, G7BR8-I, G7F4+FG, G7F4E+FG, G7F4E+FG+A4, G7F4P+FG, G7F4P+FG+AF2, G7F4PW+FG, G7F4PW+FG+AE, G7F6+FG, G7F6+T, G7F6E+FG, G7F6E+FG+A4, G7F6E+FG+A6, G7F6E+T, G7F6P+FG, G7F6P+FG+AF2, G7F6P+T, G7F6P+T+AF2, G7F6PW+FG, G7F6PW+FG+AE, G7F6PW+T, G7F6PW+T+AE, G7FL4B, G7FL4B-CR, G7FL4B-SX, G7FL4M, G7FL4M-CR, G7FL4M-SX, G7FL8B-2, G7FL8B-2-CR, G7FL8B-2-SX, G7FL8M-2, G7FL8M-2-CR... (Other models you can see in the webshop)		





spare parts for		101172		
	GEV No.	100259	Ref. No.	—
	bypass nozzle type PEL22 bore ø 0.35mm thread M6x0.5			
	GEV No.	101060	Ref. No.	—
	magnet unit standard L 39mm D1 ø 15.4mm D2 ø 11mm suitable for PEL20-21/JUNKERS/EGA			
	GEV No.	106200	Ref. No.	—
	nut thread M9x1 suitable for PEL 24/25S			
accessories for		101172		
	GEV No.	100908	Ref. No.	—
	union screw thread M10x1 for pipe ø 4mm Qty 1 pcs			
	GEV No.	100909	Ref. No.	—
	union screw thread M10x1 for pipe ø 6mm Qty 1 pcs			
	GEV No.	101246	Ref. No.	31777500 31777700
	olive for pipe ø 4mm Qty 1 pcs			

Table continues overleaf

accessories for 101172	
	GEV No. 101278 Ref. No. 32777300 olive for pipe ø 10mm Qty 1 pcs
	GEV No. 101286 Ref. No. — olive ID ø 6mm Qty 1 pcs
	GEV No. 101300 Ref. No. — union nut thread M16x1.5 tube ø 10mm
	GEV No. 101450 Ref. No. — olive for pipe ø 8mm L 12.7mm Qty 1 pcs ED ø 10mm
	GEV No. 101451 Ref. No. — union nut thread M16x1.5 tube ø 8mm
	GEV No. 110079 Ref. No. — knob dial plate gas thermostat 1-8 silver
	GEV No. 110081 Ref. No. 31875900 knob ø 70mm shaft ø 8x6.5mm shaft flat universal

SABAF

	
1 	
GEV No. 101181	Ref. No. 22273900
description	gas thermostat SABAF t.max. 300°C gas inlet pipe flange ø16mm bypass nozzle ø 0.46mm gas outlet M13x1 IT (tube ø 8mm) gas outlet 2 thermocouple connection M8x1 pilot connection capillary pipe 850mm probe ø 4mm probe L 150mm shaft ø 6x4.6mm shaft L 45/27mm shaft flat upper
For models:	G4F+FSD8
spare parts for 101181	
	GEV No. 101060 Ref. No. — magnet unit standard L 39mm D1 ø 15.4mm D2 ø 11mm suitable for PEL20-21/JUNKERS/EGA
accessories for 101181	
	GEV No. 101277 Ref. No. — olive ID ø 8mm Qty 1 pcs
	GEV No. 101376 Ref. No. 22594900 gasket ID ø 8mm ED ø 12mm H 3/5mm
	GEV No. 101477 Ref. No. — union screw thread M13x1 tube ø 8mm Qty 1 pcs
	GEV No. 101751 Ref. No. 22966200 bracket
	GEV No. 110360 Ref. No. — knob without symbol ø 65mm shaft ø 6x4.6mm shaft flat upper black
	GEV No. 110603 Ref. No. — knob dial plate gas thermostat t.max. 300°C 90-300°C

	
1 	
GEV No. 106742	Ref. No. 22274000
description	gas thermostat SABAF t.max. 300°C gas inlet pipe flange ø16mm bypass nozzle ø 0.52mm gas outlet M13x1 IT (tube ø 8mm) gas outlet 2 thermocouple connection M8x1 pilot connection capillary pipe 850mm probe ø 4mm probe L 150mm shaft ø 6x4.6mm shaft L 45/27mm shaft flat upper
For models:	G4S+FSGN, G6F2H6+FG1, G6F2H9+FG1, G6F2P6+FG1, G6F-2P9+FG1, G6F3H12+FG1, G6F4+FG1, G6F4+FG1+A4, G6F4PW+FG1, G6F6+FG1, G6F6+FG1+A6, G6F6PW+FG1, G6S+FSGN, G7F4+FG1, G7F4E+FG1, G7F4E+FG1+A4, G7F4P+FG1, G7F4PW+FG1, G7F4PW+FG1+AE, G7F6+FG1, G7F6E+FG1, G7F6E+FG1+A4, G7F6E+FG1+A6, G7F6P+FG1, G7F6PW+FG1, G7F6PW+FG1+AE, G7T4P2F+FG1, G7T4P4F+FG1, G7TP+FG1, G7TP2F+FG1, G9F4+FG1, G9F4E+FG1, G9F4E+FG1+A4, G9F4P+FG1, G9F4P+FG1+AF1, G9F4PW+FG1, G9F4PW+FG1+AE, G9F6+FG1, G9F6E+FG1, G9F6E+FG1+A6, G9F6P+FG1, G9F6PW+FG1, G9F6PW+FG1+AE, G9F8+2FG1, G9F8P+2FG1, G9TP+FG1, G9TP2F+FG1
spare parts for 106742	
	GEV No. 101376 Ref. No. 22594900 gasket ID ø 8mm ED ø 12mm H 3/5mm
accessories for 106742	
	GEV No. 101277 Ref. No. — olive ID ø 8mm Qty 1 pcs
	GEV No. 101477 Ref. No. — union screw thread M13x1 tube ø 8mm Qty 1 pcs

gas valves and ignition boxes

gas control valves

HONEYWELL	
	
1 	
GEV No. 106004	Ref. No. 11017
description	gas valve type VK4105C 220-240V 50/60Hz gas inlet flange 32x32mm gas outlet flange 32x32mm thermocouple connection pilot connection pressure range 15-60mbar max 60mbar operator type pressure controller type V5306E 1234 1 suitable for HONEYWELL flange 32x32mm
For models:	WAV-G5U
accessories for 106004	
	GEV No. 102845 Ref. No. — gas connection angled 1/2" flange 32x32mm hole distance 24x24mm Tandem
	GEV No. 102846 Ref. No. — gas connection straight 1/2" flange 32x32mm hole distance 24x24mm suitable for Tandem



SIT











ELETTROSIT



GEV No.	101127	Ref. No.	23270900
description	gas valve SIT type ELETTROSIT 230V gas inlet 3/4" gas outlet 3/4" thermocouple connection M9x1 pilot connection M10x1 lateral equiv. no. 0.810.175		
For models:	FPG12, FPG6, WAV2-GAS, WAV-G12, WAV-G20, WAV-G5U, WAV-G6		
spare parts for	101127		
	GEV No.	101312	Ref. No. 22194632
	microswitch		
	GEV No.	101352	Ref. No. —
	solenoid coil 230V 50Hz suitable for ELETTROSIT		
accessories for	101127		
	GEV No.	100006	Ref. No. —
	piezoelectric igniter suitable for ELETTROSIT body plastic blowing connection ø2.4mm ø 14mm		
	GEV No.	100904	Ref. No. —
	locking screw M10x1 for pipe ø 4mm Qty 1 pcs		
	GEV No.	100905	Ref. No. —
	locking screw M10x1 for pipe ø 6mm Qty 1 pcs		
	GEV No.	101301	Ref. No. —
	gas connection thread 1/2" straight ELETTROSIT screw with O-ring		
	GEV No.	101303	Ref. No. —
	gas connection straight thread 3/4" ELETTROSIT		
	GEV No.	101309	Ref. No. —
	extension		









NOVASIT



GEV No.	101162	Ref. No.	22271332 32271300
description	gas valve SIT series Novasit 820 230V 50Hz gas inlet 1/2" gas outlet 1/2" thermocouple connection M9x1 pilot connection M10x1 ignition pressure 3-5mbar pressure range 3-30mbar pressure regulator connection blind equiv. no. 0.820.010		
For models:	FMG10, FMG10EP, FMG10M, FMG20, FMG20M, FMG6, FMG6EP, FMG6M, GL10+10B8, GL10+10M8, GL10B4, GL10M4, GL15+15M8, GL15M4, GL20+20M8, GL20M4		
spare parts for	101162		
	GEV No.	101065	Ref. No. —
	magnet unit with cable L 44mm D1 ø 30mm D2 ø 20mm suitable for NOVASIT		
	GEV No.	101313	Ref. No. 22161832
	solenoid coil 230V 50Hz		
accessories for	101162		
	GEV No.	100006	Ref. No. —
	piezoelectric igniter suitable for ELETTROSIT body plastic blowing connection ø2.4mm ø 14mm		
	GEV No.	101305	Ref. No. —
	gas connection straight 1/2" flange 45x45mm ELETTROSIT/V4400/4600/4605 suitable for SIT/HONEYWELL hole distance 36x36mm		
	GEV No.	101306	Ref. No. —
	gas connection angled flange 45x45mm hole distance 36x36mm 1/2" ELETTROSIT/V4400/4600/4605 screw with O-ring suitable for SIT/HONEYWELL		
	GEV No.	101307	Ref. No. —
	gas connection straight flange 45x45mm hole distance 36x36mm 3/4" ELETTROSIT/V4400/4600/4605 screw with O-ring suitable for SIT/HONEYWELL		
	GEV No.	101308	Ref. No. —
	gas connection angled flange 45x45mm hole distance 36x36mm 3/4" ELETTROSIT/V4400/4600/4605 screw with O-ring suitable for SIT/HONEYWELL		
	GEV No.	101312	Ref. No. 22194632
	microswitch		
	GEV No.	101314	Ref. No. 22162232
	solenoid coil 24V 50Hz		
	GEV No.	101317	Ref. No. —
	plug with cable L 1000mm suitable for NOVASIT		
	GEV No.	101318	Ref. No. —
	cover cap for solenoid coil suitable for NOVASIT		



1

GEV No.	101914	Ref. No.	31990700
description	gas valve SIT series Novasit 822 230V 50Hz gas inlet 1/2" gas outlet 1/2" thermocouple connection pilot connection closed ignition pressure range 3-30mbar pressure regulator connection blind equiv. no. 0.822.144		
For models:	E9P10I, E9P10IA, E9P15I, E9P15IA, G7PI, G9P10I, G9P10IA, G9P15I, G9P15IA, SE9P10I, SE9P10IA, SE9P15I, SE9P15IA, SG9P10I, SG9P10IA, SG9P15I		
spare parts for	101914		
	GEV No.	101313	Ref. No. 22161832
	solenoid coil 230V 50Hz		
	GEV No.	101542	Ref. No. —
	solenoid coil 50Hz NOVA 822/826/827 suitable for NOVASIT 230V		
accessories for	101914		
	GEV No.	101305	Ref. No. —
	gas connection straight 1/2" flange 45x45mm ELETTROSIT/V4400/4600/4605 suitable for SIT/HONEYWELL hole distance 36x36mm		
	GEV No.	101306	Ref. No. —
	gas connection angled flange 45x45mm hole distance 36x36mm 1/2" ELETTROSIT/V4400/4600/4605 screw with O-ring suitable for SIT/HONEYWELL		
	GEV No.	101307	Ref. No. —
	gas connection straight flange 45x45mm hole distance 36x36mm 3/4" ELETTROSIT/V4400/4600/4605 screw with O-ring suitable for SIT/HONEYWELL		
	GEV No.	101308	Ref. No. —
	gas connection angled flange 45x45mm hole distance 36x36mm 3/4" ELETTROSIT/V4400/4600/4605 screw with O-ring suitable for SIT/HONEYWELL		
	GEV No.	101503	Ref. No. —
	O-ring EPDM thickness 2mm ID ø 32mm Qty 1 pcs		
	GEV No.	101924	Ref. No. —
	plug with cable L 1090mm suitable for NOVA 822/826/827		

TANDEM



1

GEV No.	101984	Ref. No.	25271500
description	gas valve 230V 50Hz gas inlet 1/2" gas outlet 1/2" pilot connection level slow ignition ignition times pressure range 2-50mbar power supply for modulator 230VAC rectified Tandem equiv. no. 0.836.010		
For models:	FMG10, FMG10M, FMG6, FMG6M, MM06GA, MM06GB, MM10GA, MM10GB		
spare parts for	101984		
	GEV No.	101379	Ref. No. —
	solenoid coil 230V 50Hz suitable for Tandem		
accessories for	101984		
	GEV No.	101274	Ref. No. —
	olive for pipe ø 16mm Qty 1 pcs		
	GEV No.	101275	Ref. No. —
	union screw thread 1/2" for pipe ø 16mm Qty 1 pcs		
	GEV No.	101925	Ref. No. —
	plug with O-ring thread M10x1 for pilot burner suitable for NOVASIT		
	GEV No.	102845	Ref. No. —
	gas connection angled 1/2" flange 32x32mm hole distance 24x24mm Tandem		
	GEV No.	102846	Ref. No. —
	gas connection straight 1/2" flange 32x32mm hole distance 24x24mm suitable for Tandem		
	GEV No.	102847	Ref. No. —
	O-ring		

ignition boxes

HONEYWELL



1







GEV No.	101165	Ref. No.	25271700
description	ignition box HONEYWELL type S4560A 1008 equiv. no. S4560A 1008 electrodes 1 waiting time 0s safety time 10s 220-240V 10VA 50Hz		
For models:	FC100GEP, FC100GM, FC200GA, FC200GB, FC60GEP, FC60GM		
spare parts for	101165		
	GEV No.	358696	Ref. No. —
	fine fuse size ø5x20mm 4A medium lag rated 250V Qty 10 pcs		



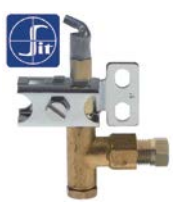

			
GEV No.	102367	Ref. No.	25271400
description	ignition box HONEYWELL type S4565A 2092 1 electrodes 3 waiting times safety time 10s 220-240V 4VA 50/60Hz		
For models:	FMG10, FMG10M, FMG6, FMG6M, MM06GA, MM06GB, MM10GA, MM10GB		

ignition parts

pilot burners

<p>SIT</p> <p>100 series</p> 			
GEV No.	106901	Ref. No.	31291300
description	pilot burner SIT type 100 series 1 flame nozzle ø 0.2mm gas connection 6mm		
For models:	G12F4H9+FGP, G12F4H9M, G12F4P9+FGP, G12F4P9M, G6F2B, G6F2B+A2, G6F2BH6, G6F2BH9, G6F2BP6, G6F2BP9, G6F2H6+FE1, G6F2H6+FG1, G6F2H9+FE1, G6F2H9+FG1, G6F2H9+T, G6F2H9+TE, G6F2MH6, G6F2MH9, G6F2MP6, G6F2MP9, G6F2P6+FE1, G6F2P6+FG1, G6F2P9+FE1, G6F2P9+FG1, G6F2P9+T, G6F2P9+TE, G6F3BH12, G6F3BH9, G6F3H12+FE1, G6F3H12+FG1, G6F3H12+T, G6F3H12+TE, G6F3H9+T, G6F3MH12, G6F4B, G6F4B+A4, G6F6B, G6F6B+A6, G7F2B, G7F2M, G7F2MP, G7F4+FE, G7F4+FE1, G7F4+FES, G7F4+FG, G7F4+FG1, G7F4B, G7F4BP, G7F4M...(Other models you can see in the webshop)		
spare parts for	106901		
	GEV No.	100854	Ref. No. —
	pilot burner bracket double		
	GEV No.	100916	Ref. No. —
	compression spring for pilot burner Qty 1 pcs		
	GEV No.	100917	Ref. No. —
	gasket for pilot burner Qty 1 pcs aluminium		
	GEV No.	100918	Ref. No. —
	screw for pilot burner		
accessories for	106901		
	GEV No.	100904	Ref. No. —
	locking screw M10x1 for pipe ø 4mm Qty 1 pcs		
	GEV No.	100905	Ref. No. —
	locking screw M10x1 for pipe ø 6mm Qty 1 pcs		

accessories for	106901		
	GEV No.	102110	Ref. No. —
	pilot tube copper pipe ø 4mm thickness 1mm L 3000mm		
	GEV No.	102111	Ref. No. —
	pilot tube copper pipe ø 6mm thickness 1mm L 3000mm		
	GEV No.	102742	Ref. No. —
	pilot burner nozzle LPG code 25 bore ø 0.25mm Qty 1 pcs		





















			
GEV No.	106904	Ref. No.	31291400
description	pilot burner SIT type 100 series 1 flame nozzle ø 0.2mm gas connection 6mm		
For models:	G12F4H9+FGP, G12F4P9+FGP, G6F6+T, G6F6+T+A6, G6F6PW+T, G6F6PW+T+AE, G7F4E+FG, G7F4E+FG+A4, G7F4P+FG, G7F4PW+FG, G7F4PW+FG+AE, G7F6+T, G7F6E+FG, G7F6E+FG+A6, G7F6E+T, G7F6P+FG, G7F6P+T, G7F6PW+FG, G7F6PW+FG+AE, G7F6PW+T, G7F6PW+T+AE, G7T4P4F+FG, G7TP+FG, G7TP2F+T, G9F4+FG, G9F4P+FG, G9F4P+FG+AF2, G9F4PW+FG, G9F4PW+FG+AE, G9F6+FG, G9F6+T, G9F6P+FG, G9F6P+FG+AF2, G9F6P+T, G9F6PW+FG, G9F6PW+FG+AE, G9F6PW+T, G9F6PW+T+AE, G9F8+2FG, G9F8P+2FG, G9F8P+2F+G+AF2, G9TP2F+FG, G9TP2F+T, G9TP4F+FG, GL18+18MI, GL18+18MI-E, GL18MI, GL18MI-E, SG9F6+T, SG9F6P+FG...(Other models you can see in the webshop)		
spare parts for	106904		
	GEV No.	100245	Ref. No. —
	pilot burner nozzle LPG code 20 bore ø 0.2mm Qty 1 pcs thread M8x0.75		
	GEV No.	100855	Ref. No. —
	pilot burner bracket triple		
	GEV No.	100885	Ref. No. —
	air mixing sleeve for pilot burner Qty 1 pcs		
	GEV No.	100916	Ref. No. —
	compression spring for pilot burner Qty 1 pcs		
	GEV No.	100917	Ref. No. —
	gasket for pilot burner Qty 1 pcs aluminium		
	GEV No.	100918	Ref. No. —
	screw for pilot burner		
accessories for	106904		
	GEV No.	107160	Ref. No. —
	pilot burner cap SIT 1 flame Hmm Lmm Qty 1 pcs		
	GEV No.	107166	Ref. No. —
	pilot burner head SIT 1 flame Hmm Lmm Qty 1 pcs		
	GEV No.	107701	Ref. No. —
	pilot burner bottom part SIT 100 series nozzle ø 0.2mm		
accessories for	106904		
	GEV No.	100246	Ref. No. —
	pilot burner nozzle natural gas bore ø 0.35mm Qty 1 pcs thread M8x0.75		

Table continues overleaf







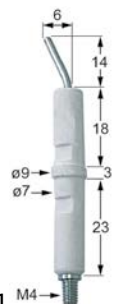







accessories for		106904		
GEV No.		100904	Ref. No.	—
	locking screw M10x1 for pipe ø 4mm Qty 1 pcs			
	locking screw M10x1 for pipe ø 6mm Qty 1 pcs			
	pilot tube copper pipe ø 4mm thickness 1mm L 3000mm			
	pilot tube copper pipe ø 6mm thickness 1mm L 3000mm			
	pilot burner nozzle SIT natural/liquid gas bore ø 0.25mm Qty 1 pcs			
	pilot burner bottom part SIT 100 series nozzle ø 0.25mm			
	pilot burner bottom part SIT 100 series nozzle ø 0.35mm			

			
1			
GEV No.	106906	Ref. No.	22291632 25291400
description	pilot burner SIT type 100 series 3 flames nozzle ø 0.2mm gas connection 6mm		
For models:	FMG10, FMG10EP, FMG10M, FMG20, FMG20M, FMG6, FMG6EP, FMG6M, FPG12, FPG6, G9BR8, G9BR8-I, G9P10D, G9P10DA, G9P10I, G9P10IA, G9P15D, G9P15DA, G9P15I, G9P15IA, SG9BR8, SG9BR8-I, SG9P10D, SG9P10DA, SG9P10I, SG9P10IA, SG9P15D, SG9P15DA, SG9P15I, WAV-G12, WAV-G20, WAV-G5U, WAV-G6		
spare parts for	106906		
	GEV No.	100245	Ref. No. —
	pilot burner nozzle LPG code 20 bore ø 0.2mm Qty 1 pcs thread M8x0.75		
	GEV No.	100855	Ref. No. —
	pilot burner bracket triple		
	GEV No.	100885	Ref. No. —
	air mixing sleeve for pilot burner Qty 1 pcs		
	GEV No.	100916	Ref. No. —
	compression spring for pilot burner Qty 1 pcs		
	GEV No.	100917	Ref. No. —
	gasket for pilot burner Qty 1 pcs aluminium		
	GEV No.	100918	Ref. No. —
	screw for pilot burner		
	GEV No.	107162	Ref. No. —
	pilot burner cap SIT 3 flames Hmm Lmm Qty 1 pcs		
	GEV No.	107701	Ref. No. —
	pilot burner bottom part SIT 100 series nozzle ø 0.2mm		















accessories for		106906		
GEV No.		100245	Ref. No.	—
	pilot burner nozzle LPG code 20 bore ø 0.2mm Qty 1 pcs thread M8x0.75			
	pilot burner nozzle natural gas bore ø 0.35mm Qty 1 pcs thread M8x0.75			
	locking screw M10x1 for pipe ø 4mm Qty 1 pcs			
	locking screw M10x1 for pipe ø 6mm Qty 1 pcs			
	pilot tube copper pipe ø 4mm thickness 1mm L 3000mm			
	pilot tube copper pipe ø 6mm thickness 1mm L 3000mm			
	pilot burner nozzle SIT natural/liquid gas bore ø 0.25mm Qty 1 pcs			
	pilot burner bottom part SIT 100 series nozzle ø 0.25mm			
	pilot burner bottom part SIT 100 series nozzle ø 0.35mm			

accessories			
ignition electrodes			
			
GEV No.	100706	Ref. No.	22298332 23297400
description	ignition electrode connection M4 Qty 1 pcs		
For models:	FMG10, FMG10EP, FMG10M, FMG20, FMG20M, FMG6, FMG6EP, FMG6M, FPG12, FPG6, G9BR8, G9BR8-I, GL18+18MI, GL18+18MI-E, GL18MI, GL18MI-E, SG9BR8, SG9BR8-I, WAV2-GAS, WAV-G12, WAV-G20, WAV-G5U, WAV-G6		























140 - 145 -150 series			
			
GEV No.	107114 ¹	Ref. No.	22291200 31780400
description	pilot burner SIT type 140 series 2 flames nozzle ømm gas connecti- onmm		
For models:	G7PD, GFLD8, GFLD8-CR, GFLM6, GFLM6-CR, GFLS4, GFLS4-CR, GFRD8, GFRM6, GFRS4		
spare parts for	107114		
	GEV No.	100907	Ref. No. —
	screw connection thread M10x1 Qty 1 pcs type SEF 1 ømm for thermocouple		
accessories for	107114		
	GEV No.	100204	Ref. No. —
	pilot burner nozzle SIT LPG code 14 bore ø 0.18/0.20mm Qty 1 pcs suitable for 140 series		
	GEV No.	100205	Ref. No. —
	pilot burner nozzle SIT LPG code 19 bore ø 0.23/0.26mm Qty 1 pcs suitable for SIT 150 series		
	GEV No.	100206	Ref. No. —
	pilot burner nozzle SIT natural gas code 36 bore ø 0.60/0.55mm Qty 1 pcs suitable for SIT 150 series		
	GEV No.	100207	Ref. No. —
	pilot burner nozzle SIT natural gas code 27 bore ø 0.40/0.38mm suitable for SIT 140 series		
	GEV No.	100216	Ref. No. —
	pilot burner nozzle SIT natural gas code 38 bore ø 0.45mm Qty 1 pcs suitable for SIT 150 series		
	GEV No.	100701	Ref. No. 22296900
	ignition electrode connection M4 Qty 1 pcs		
	GEV No.	100801	Ref. No. —
	gasket for pilot burner Qty 1 pcs		
	GEV No.	100897	Ref. No. —
	olive for pipe ø 4mm Qty 1 pcs for pilot burner		
	GEV No.	100898	Ref. No. —
	olive for pipe ø 6mm Qty 1 pcs for pilot burner		
	GEV No.	100906	Ref. No. —
	screw connection thread M10x1 for ignition electrode brass Qty 1 pcs WS 10		
	GEV No.	100908	Ref. No. —
	union screw thread M10x1 for pipe ø 4mm Qty 1 pcs		
	GEV No.	100909	Ref. No. —
	union screw thread M10x1 for pipe ø 6mm Qty 1 pcs		
	GEV No.	102110	Ref. No. —
	pilot tube copper pipe ø 4mm thickness 1mm L 3000mm		
	GEV No.	102111	Ref. No. —
	pilot tube copper pipe ø 6mm thickness 1mm L 3000mm		

¹incl. thermocouple fitting

160 series			
			
GEV No.	100056	Ref. No.	27291100
description	pilot burner SIT type 160 series 3 flames nozzle ømm gas connecti- onmm		
For models:	6GL18B, 6GL18M, 9GL15+15M, 9GL15M, 9GL20+20M, 9GL20M, CPG40, CPG40E, CPG80, CPG80E, E9F15-4M, E9F15-8M, E9F18- 4M, E9F18-8M, G6CP6, G6FL3B, G6FL3B-CR, G6FL3B-SX, G6FL3M, G6FL3M-CR, G6FL3M-SX, G6FL6B, G6FL6B-CR, G6FL6B-SX, G6FL6M, G6FL6M-SX, G6FM6B, G6FM6M, G6FR3B, G6FR3M, G6FR6B, G6FR6M, G6PL60B, G6PL60M, G7BM4M, G7BR8, G7BR8-I, G7FL4B, G7FL4B-CR, G7FL4B-SX, G7FL4M, G7FL4M-CR, G7FL4M-SX, G7FL8B-2, G7FL8B- 2-CR, G7FL8B-2-SX, G7FL8M-2, G7FL8M-2-CR, G7FL8M-2-SX, G7F- M8B-2...(Other models you can see in the webshop)		
spare parts for	100056		
	GEV No.	100907	Ref. No. —
	screw connection thread M10x1 Qty 1 pcs type SEF 1 ømm for thermocouple		
accessories for	100056		
	GEV No.	100202	Ref. No. —
	pilot burner nozzle natural gas code 41 Qty 1 pcs nozzle ø 0.41mm		
	GEV No.	100203	Ref. No. —
	pilot burner nozzle LPG code 25 Qty 1 pcs nozzle ø 0.25mm		
	GEV No.	100701	Ref. No. 22296900
	ignition electrode connection M4 Qty 1 pcs		
	GEV No.	100801	Ref. No. —
	gasket for pilot burner Qty 1 pcs		
	GEV No.	100869	Ref. No. —
	pilot burner nozzle natural gas code 51 Qty 1 pcs suitable for 160 series nozzle ø 0.51mm		
	GEV No.	100870	Ref. No. —
	olive for pipe ø 4mm Qty 1 pcs suitable for 160 series for pilot burner		
	GEV No.	100906	Ref. No. —
	screw connection thread M10x1 for ignition electrode brass Qty 1 pcs WS 10		
	GEV No.	100908	Ref. No. —
	union screw thread M10x1 for pipe ø 4mm Qty 1 pcs		
	GEV No.	100909	Ref. No. —
	union screw thread M10x1 for pipe ø 6mm Qty 1 pcs		
	GEV No.	101287	Ref. No. —
	olive for pipe ø 6mm Qty 1 pcs		
	GEV No.	102110	Ref. No. —
	pilot tube copper pipe ø 4mm thickness 1mm L 3000mm		
	GEV No.	102111	Ref. No. —
	pilot tube copper pipe ø 6mm thickness 1mm L 3000mm		
	GEV No.	107650	Ref. No. 32366500
	pilot burner nozzle SIT LPG code 30 Qty 1 pcs		



POLIDORO			
pilot burners			
 1			
GEV No.	100162	Ref. No.	31291500
description	pilot burner POLIDORO 3 flames code gas connectionmm		
For models:	G6F2B, G6F2B+A2, G6F4B, G6F4B+A4, G6F6B, G6F6B+A6, G7T-4P2F+FG1, G7T4P2FB, G7T4P2FM, G7T4P4F+FG, G7T4P4F+FG1, G7T-4P4FB, G7T4P4FM, G7TP+FG, G7TP+FG1, G7TP2F+FG, G7TP2F+FG1, G7TP2F+T, G7TP2FM, G7TPM, G9BR8-I, G9P10D, G9P10DA, G9P10I, G9P10IA, G9P15D, G9P15DA, G9P15I, G9P15IA, G9P20D, G9P20DA, G9TP+FG, G9TP+FG1, G9TP2F+FG, G9TP2F+FG1, G9TP2F+T, G9TP2FM, G9TP4F+FG, G9TP4FM, G9TPM, LXG9BR8-I, LXG9P15I, SG9BR8-I, SG9P10D, SG9P10DA, SG9P10I, SG9P10IA, SG9P15D, SG9P-15DA, SG9P15I...(Other models you can see in the webshop)		
spare parts for	100162		
	GEV No.	100907	Ref. No. —
	screw connection thread M10x1 Qty 1 pcs type SEF 1 ømm for thermocouple		
accessories for	100162		
	GEV No.	100000	Ref. No. 40902200
	pilot burner nozzle POLIDORO LPG code 22 bore ø 0.22mm Qty 1 pcs		
	GEV No.	100208	Ref. No. —
	pilot burner nozzle POLIDORO LPG code 20 bore ø 0.2mm Qty 1 pcs		
	GEV No.	100209	Ref. No. —
	pilot burner nozzle POLIDORO natural gas code 40 bore ø 0.4mm Qty 1 pcs		
	GEV No.	100701	Ref. No. 22296900
	ignition electrode connection M4 Qty 1 pcs		
	GEV No.	100906	Ref. No. —
	screw connection thread M10x1 for ignition electrode brass Qty 1 pcs WS 10		
	GEV No.	100907	Ref. No. —
	screw connection thread M10x1 Qty 1 pcs type SEF 1 ømm for thermocouple		
	GEV No.	100908	Ref. No. —
	union screw thread M10x1 for pipe ø 4mm Qty 1 pcs		
	GEV No.	100909	Ref. No. —
	union screw thread M10x1 for pipe ø 6mm Qty 1 pcs		
	GEV No.	102110	Ref. No. —
	pilot tube copper pipe ø 4mm thickness 1mm L 3000mm		
	GEV No.	102111	Ref. No. —
	pilot tube copper pipe ø 6mm thickness 1mm L 3000mm		
	GEV No.	102508	Ref. No. —
	union screw thread M10x1 for pipe ø 4mm Qty 5 pcs		
	GEV No.	102509	Ref. No. —
	union screw thread M10x1 for pipe ø 6mm Qty 5 pcs		

accessories for 100162			
	GEV No.	102699	Ref. No. —
	pilot burner nozzle POLIDORO natural gas code 25.2 bore ø 2x0.25mm Qty 1 pcs 2 bores		
	GEV No.	102795	Ref. No. —
	olive for pipe ø 4mm Qty 1 pcs		
	GEV No.	102797	Ref. No. —
	olive for pipe ø 6mm Qty 1 pcs		
	GEV No.	106703	Ref. No. —
	pilot burner nozzle POLIDORO natural gas code 27.2 bore ø 2x0.27mm Qty 1 pcs		
	GEV No.	106704	Ref. No. —
	pilot burner nozzle POLIDORO LPG code 16.2 bore ø 2x0.16mm Qty 1 pcs		
	GEV No.	106763	Ref. No. —
	pilot burner nozzle POLIDORO natural gas code 27.2A bore ø 2x 0.27mm Qty 1 pcs		
	GEV No.	106859	Ref. No. —
	pilot burner nozzle POLIDORO LPG code 24 bore ø 0.24mm Qty 1 pcs		

accessories universal			
pilot burner brackets			
 1			
GEV No.	105724	Ref. No.	35974400
description	pilot burner bracket		
For models:	G6F2BH9, G6F2BP9, G6F2MH9, G6F2MP9, G9F2M, G9F2MP, G9F4M, G9F4MP, G9F4P+FG, G9F4P+FG+AF2, G9F4P+FG1, G9F4P+FG1+AF1, G9F6M, G9F6MP, G9F6P+FG, G9F6P+FG1, G9F6P+T, G9F6P+T+AF2, G9F8P+2FG, G9F8P+2FG1, G9TP4FM, SG9F2M, SG9F2MP, SG9F4M, SG9F4MP, SG9F6M, SG9F6MP, SG9F6P+T		
accessories for	105724		
	GEV No.	105097	Ref. No. 32327600
	nozzle holder nozzle mounting M10x1 tube ø 10mm gas inlet M16x1.5 gas outlet M14x1		
	GEV No.	105725	Ref. No. 35807000
	burner head 9kW for burner cap ø 130mm		
	GEV No.	105726	Ref. No. 35954300
	burner cap with central hole ø 130mm 9kW		

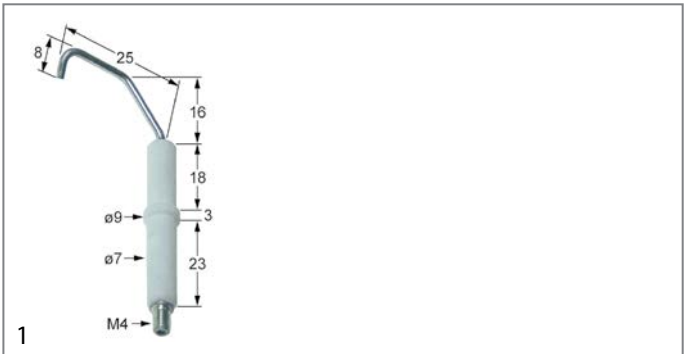

GEV No.	100822	Ref. No.	31187000
description	ignition electrode D1 ø 7mm D2 ø 9mm connection M4 L1 16mm L2 25mm L3 8mm BL1 18mm BL2 3mm BL3 23mm to clip		
For models:	G12F4H9+FGP, G12F4P9+FGP, G6F6+T, G6F6+T+A6, G6F6PW+T+AE, G7F4+FG, G7F4E+FG, G7F4E+FG+A4, G7F4P+FG+AF2, G7F4PW+FG, G7F4PW+FG+AE, G7F6+FG, G7F6+T, G7F6E+FG, G7F6E+FG+A6, G7F6E+T, G7F6P+FG, G7F6P+FG+AF2, G7F6P+T, G7F6P+T+AF2, G7F6PW+FG, G7F6PW+FG+AE, G7F6PW+T, G7F6PW+T+AE, G7T4P4F+FG, G7TP+FG, G7TP2F+FG, G7TP2F+T, G9F4+FG, G9F4P+FG, G9F4P+FG+AF2, G9F4PW+FG, G9F4PW+FG+AE, G9F6+FG, G9F6+T, G9F6P+FG, G9F6P+T, G9F6P+T+AF2, G9F6PW+FG, G9F6PW+FG+AE, G9F6PW+T, G9F6PW+T+AE, G9F8+2FG, G9F8P+2FG, G9TP+FG, G9TP2F+FG, G9TP2F+T, G9TP4F+FG, SG9F4+FG, SG9F4P+FG...(Other models you can see in the webshop)		

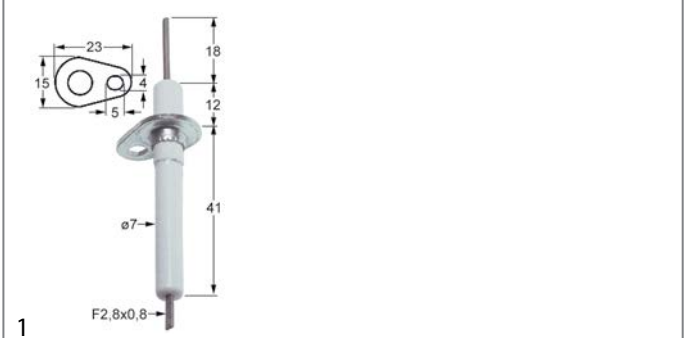

GEV No.	100818	Ref. No.	22296500
description	ignition electrode flange length 23mm flange width 15mm D1 ø 7mm L1 18mm BL1 12mm BL2 41mm connection F 2.8x0.8mm fixing dimensions ø5x4mm with flange		
For models:	G4F+FSD8, G4S+FSGN, G6F4PW+FG1+AE, G6F6PW+FG1+AE, G6S+FSGN, G7F4P+FG1+AF1, G7F4PW+FG1, G7F4PW+FG1+AE, G7F6P+FG1+AF1, G7F6PW+FG1, G7F6PW+FG1+AE, G9F4P+FG1+AF1, G9F4PW+FG1, G9F4PW+FG1+AE, G9F6PW+FG1, G9F6PW+FG1+AE, G9F8P+2FG1		

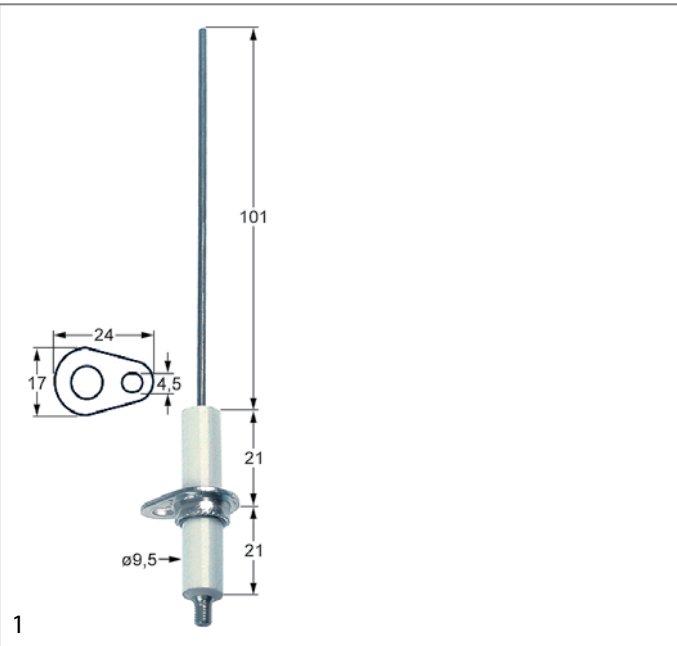

GEV No.	102323	Ref. No.	31187600
description	ignition electrode flange length 24mm flange width 17mm D1 ø 9.5mm L1 101mm BL2 21mm BL3 21mm connection M4 fixing dimensions ø4.5mm with flange		
For models:	G7PI		

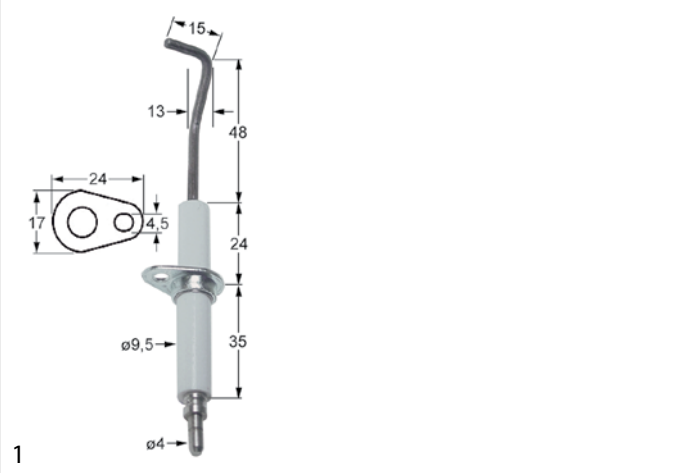

GEV No.	102342	Ref. No.	25297600
description	ignition electrode flange length 24mm flange width 17mm D1 ø 9.5mm L1 48mm L2 13mm L3 15mm BL1 24mm BL2 35mm fixing dimensions ø4.5mm with flange connection ø 4mm		
For models:	FC100GEP, FC100GM, FC200GA, FC200GB, FC60GEP, FC60GM, FMG10, FMG10M, FMG6, FMG6M, MM06GA, MM06GB, MM10GA, MM10GB		

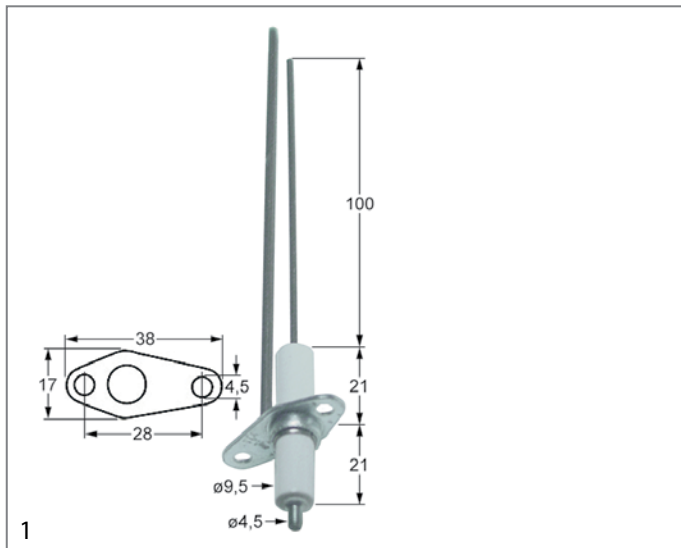

GEV No.	102322	Ref. No.	31187400
description	ignition electrode flange length 38mm flange width 17mm D1 ø 9.5mm L1 100mm BL1 21mm BL2 21mm connection M4 fixing dimensions ø4.5mm mounting distance 28mm with flange with earthing contact		
For models:	G7PI		



GEV No.	100729	Ref. No.	22296100
description	ignition electrode L1 5mm D1 ø 8mm D2 ø 10mm BL1 41mm BL2 14mm connection F 2.8x0.8mm to clip with spring		
For models:	G2FS4, G4F+FCDB, G4F+FSD8, G4FD8		

ignition cables

pre-assembled cables

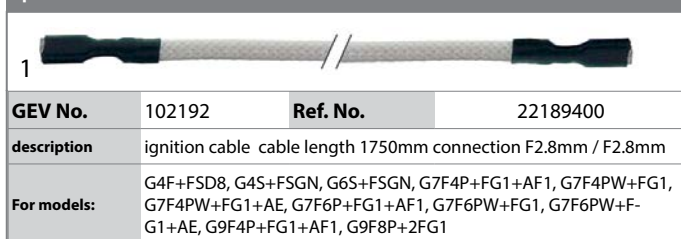

GEV No.	102192	Ref. No.	22189400
description	ignition cable cable length 1750mm connection F2.8mm / F2.8mm		
For models:	G4F+FSD8, G4S+FSGN, G6S+FSGN, G7F4P+FG1+AF1, G7F4PW+FG1, G7F4PW+FG1+AE, G7F6P+FG1+AF1, G7F6PW+FG1, G7F6PW+F-G1+AE, G9F4P+FG1+AF1, G9F8P+2FG1		

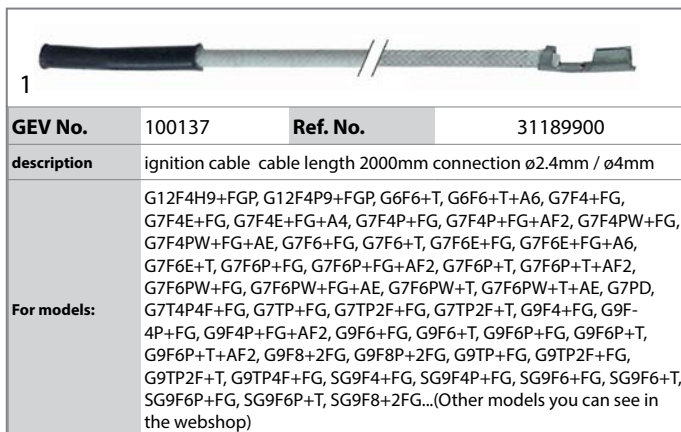

GEV No.	100137	Ref. No.	31189900
description	ignition cable cable length 2000mm connection ø2.4mm / ø4mm		
For models:	G12F4H9+FGP, G12F4P9+FGP, G6F6+T, G6F6+T+A6, G7F4+FG, G7F4E+FG, G7F4E+FG+A4, G7F4P+FG, G7F4P+FG+AF2, G7F4PW+FG, G7F4PW+FG+AE, G7F6+FG, G7F6+T, G7F6E+FG, G7F6E+FG+A6, G7F6E+T, G7F6P+FG, G7F6P+FG+AF2, G7F6P+T, G7F6P+T+AF2, G7F6PW+FG, G7F6PW+FG+AE, G7F6PW+T, G7F6PW+T+AE, G7PD, G7T4P4F+FG, G7TP+FG, G7TP2F+FG, G7TP2F+T, G9F4+FG, G9F-4P+FG, G9F4P+FG+AF2, G9F6+FG, G9F6+T, G9F6P+FG, G9F6P+T, G9F6P+T+AF2, G9F8+2FG, G9F8P+2FG, G9TP+FG, G9TP2F+FG, G9TP2F+T, G9TP4F+FG, SG9F4+FG, SG9F4P+FG, SG9F6+FG, SG9F6+T, SG9F6P+FG, SG9F6P+T, SG9F8+2FG...(Other models you can see in the webshop)		

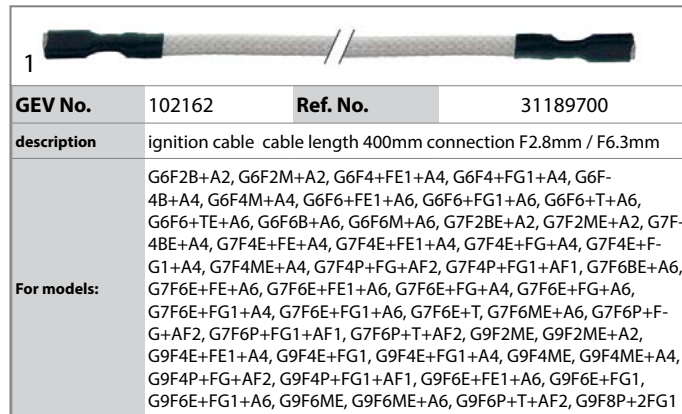

GEV No.	102162	Ref. No.	31189700
description	ignition cable cable length 400mm connection F2.8mm / F6.3mm		
For models:	G6F2B+A2, G6F2M+A2, G6F4+FE1+A4, G6F4+FG1+A4, G6F-4B+A4, G6F4M+A4, G6F6+FE1+A6, G6F6+FG1+A6, G6F6+T+A6, G6F6+TE+A6, G6F6B+A6, G6F6M+A6, G7F2BE+A2, G7F2ME+A2, G7F-4BE+A4, G7F4E+FE+A4, G7F4E+FE1+A4, G7F4E+FG+A4, G7F4E+F-G1+A4, G7F4ME+A4, G7F4P+FG+AF2, G7F4P+FG1+AF1, G7F6BE+A6, G7F6E+FE+A6, G7F6E+FE1+A6, G7F6E+FG+A4, G7F6E+FG+A6, G7F6E+FG1+A4, G7F6E+FG1+A6, G7F6E+T, G7F6ME+A6, G7F6P+F-G+AF2, G7F6P+FG1+AF1, G7F6P+T+AF2, G9F2ME, G9F2ME+A2, G9F4E+FE1+A4, G9F4E+FG1, G9F4E+FG1+A4, G9F4ME, G9F4ME+A4, G9F4P+FG+AF2, G9F4P+FG1+AF1, G9F6E+FE1+A6, G9F6E+FG1, G9F6E+FG1+A6, G9F6ME, G9F6ME+A6, G9F6P+T+AF2, G9F8P+2FG1		

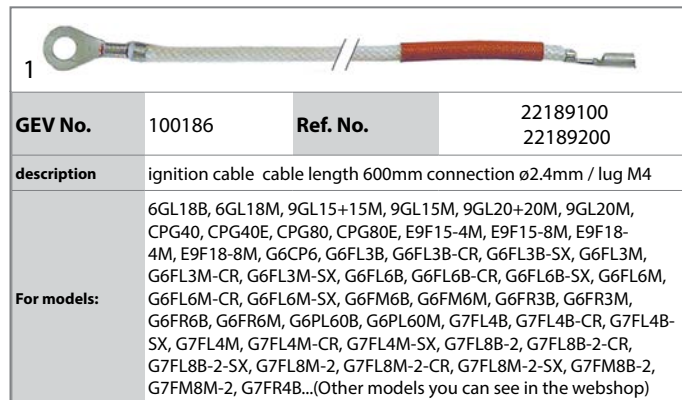

GEV No.	100186	Ref. No.	22189100 22189200
description	ignition cable cable length 600mm connection ø2.4mm / lug M4		
For models:	6GL18B, 6GL18M, 9GL15+15M, 9GL15M, 9GL20+20M, 9GL20M, CPG40, CPG40E, CPG80, CPG80E, E9F15-4M, E9F15-8M, E9F18-4M, E9F18-8M, G6CP6, G6FL3B, G6FL3B-CR, G6FL3B-SX, G6FL3M, G6FL3M-CR, G6FL3M-SX, G6FL6B, G6FL6B-CR, G6FL6B-SX, G6FL6M, G6FL6M-CR, G6FL6M-SX, G6FM6B, G6FM6M, G6FR3B, G6FR3M, G6FR6B, G6FR6M, G6PL60B, G6PL60M, G7FL4B, G7FL4B-CR, G7FL4B-SX, G7FL4M, G7FL4M-CR, G7FL4M-SX, G7FL8B-2, G7FL8B-2-CR, G7FL8B-2-SX, G7FL8M-2, G7FL8M-2-CR, G7FL8M-2-SX, G7FM8B-2, G7FM8M-2, G7FR4B...(Other models you can see in the webshop)		

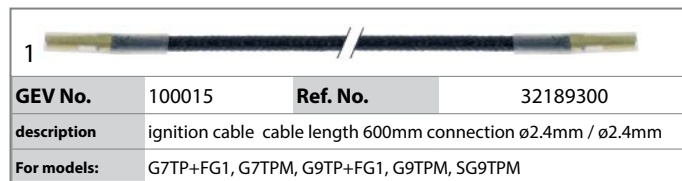

GEV No.	100015	Ref. No.	32189300
description	ignition cable cable length 600mm connection ø2.4mm / ø2.4mm		
For models:	G7TP+FG1, G7TPM, G9TP+FG1, G9TPM, SG9TPM		

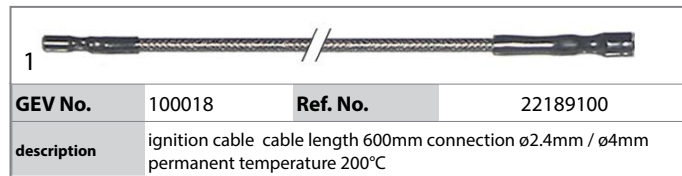

GEV No.	100018	Ref. No.	22189100
description	ignition cable cable length 600mm connection ø2.4mm / ø4mm permanent temperature 200°C		

piezoelectric igniters

mounting diameter 18mm

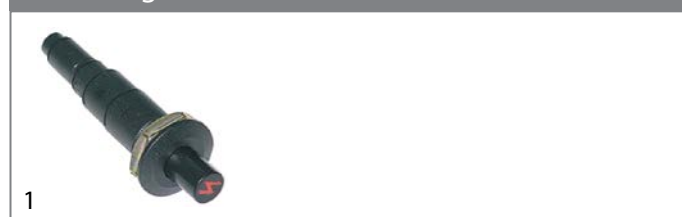

GEV No.	100009	Ref. No.	31001000 32188200
description	piezoelectric igniter body plastic blowing mounting ø 18mm connection ø2.4mm front measurements 26mm M18x1.5		
accessories for	100009		

GEV No.	101339	Ref. No.	—
description	cover cap for piezoelectric igniter		
GEV No.	106869	Ref. No.	—
description	cover cap for piezoelectric igniter ID ø 22mm ED ø 35mm H 25mm		

Table continues overleaf

accessories for	100009		
	GEV No.	107931	Ref. No. 32188400
	cover cap for piezoelectric igniter ID ø 21mm ED ø 36mm		

	1		
GEV No.	103361	Ref. No.	32188300
description	piezoelectric igniter body plastic blowing mounting ø 18mm connection ø2.4mm front measurements 26mm M18x1.5		

mounting diameter 22mm

	1		
GEV No.	100005	Ref. No.	22188300
description	piezoelectric igniter body plastic blowing mounting ø 22mm connection ø2.4mm cable lengthmm SIT		
For models:	G2FS4, G2FS4-S, G4F+FCD8, G4F+FSD8, G4FD8, G4FD8-S, G4S+FCGN, G4S+FSGN, G6F12-S, G6S+FCGN, G6S+FSGN, G9BR8, G9BR8-I, G9P10D, G9P10DA, G9P10I, G9P10IA, G9P15D, G9P15DA, G9P15I, G9P15IA, GFLD8, GFLD8-CR, GFLM6, GFLM6-CR, GFLS4, GFLS4-CR, GFRD8, GFRM6, GFRS4, SG9BR8, SG9BR8-I, SG9P10D, SG9P10DA, SG9P10I, SG9P10IA, SG9P15D, SG9P15DA, SG9P15I		

accessories

	1		
GEV No.	107931	Ref. No.	32188400
description	cover cap for piezoelectric igniter ID ø 21mm ED ø 36mm		
For models:	G12F4H9+FGP, G12F4P9+FGP, G6F6+T, G6F6+T+A6, G7F4+FG, G7F4E+FG, G7F4E+FG+A4, G7F4P+FG, G7F4PW+FG, G7F4PW+FG1, G7F6+FG, G7F6+T, G7F6E+FG, G7F6E+FG+A6, G7F6E+T, G7F6P+FG, G7F6P+T, G7F6PW+FG, G7F6PW+FG1, G7F6PW+T, G7T4P4F+FG, G7TP+FG, G7TP2F+FG, G7TP2F+T, G9BM4M, G9BR8-I, G9F4+FG, G9F4P+FG, G9F4PW+FG, G9F4PW+FG1, G9F6+FG, G9F6+T, G9F6P+FG, G9F6P+T, G9F6PW+FG, G9F6PW+FG1, G9F6PW+T, G9F8+2FG, G9F8P+2FG, G9P10D, G9P10DA, G9P10I, G9P10IA, G9P15D, G9P15DA, G9P15I, G9P15IA, G9P20D, G9P20DA, G9TP+FG...(Other models you can see in the webshop)		

ignition units

	1		
GEV No.	101030	Ref. No.	31003000
description	ignition unit outputs 2 1.5 V/DC		
For models:	G6F4PW+FG1+AE, G6F6BPW+AE, G6F6MPW+AE, G6F6PW+FE1+AE, G6F6PW+FG1+AE, G6F6PW+T+AE, G6F6PW+TE+AE, G7F4PW+F-G+AE, G7F4PW+FG1+AE, G7F6BPW+AE, G7F6MPW+AE, G7F6PW+FE+AE, G7F6PW+FE1+AE, G7F6PW+FG+AE, G7F6PW+FG1+AE, G7F6PW+T+AE, G9F4PW+FG+AE, G9F4PW+FG1+AE, G9F6MPW+AE, G9F6PW+FE+AE, G9F6PW+FG+AE, G9F6PW+FG1+AE, G9F6PW+T+AE		

	1		
GEV No.	102485	Ref. No.	32164200
description	ignition unit outputs 2 220-240VAC 0.6VA 50-60Hz		
For models:	FMG10, FMG10EP, FMG10M, FMG20, FMG20M, FMG6, FMG6EP, FMG6M, FPG12, FPG6, GL10+10B8, GL10+10M8, GL10B4, GL10M4, GL15+15M8, GL15M4, GL20+20M8, GL20M4, WAV-G12, WAV-G20, WAV-G5U, WAV-G6		

	1		
GEV No.	101002	Ref. No.	22164232
description	ignition unit outputs 2 230VAC dimensions 88x23x34mm mounting distance 73mm inlet F6.3x0.8 outlet F2.8x0.8 0.6VA 50/60Hz		

	1		
GEV No.	101031	Ref. No.	31002200
description	ignition unit outputs 4 1.5 V/DC dimensions 111x23x34mm mounting distance 100mm inlet F6.3x0.8 outlet F2.8x0.8 mounting ø 100mm		
For models:	G6F4+FE1+A4, G6F4+FG1+A4, G6F4B+A4, G6F4M+A4, G7F4BE+A4, G7F4E+FE+A4, G7F4E+FE1+A4, G7F4E+FG+A4, G7F4E+FG1+A4, G7F4ME+A4, G9F4E+FE1+A4, G9F4E+FG1+A4, G9F4ME, G9F4ME+A4		

	1		
GEV No.	101032	Ref. No.	31002400
description	ignition unit outputs 6 1.5 V/DC dimensions 135x23x34mm mounting distance 123mm inlet F6.3x0.8 outlet F2.8x0.8 mounting ø 122mm		
For models:	G6F6+FE1+A6, G6F6+FG1+A6, G6F6+T+A6, G6F6+TE+A6, G6F6B+A6, G6F6M+A6, G7F6BE+A6, G7F6E+FE+A6, G7F6E+FE1+A6, G7F6E+F-G+A4, G7F6E+FG+A6, G7F6E+FG1+A4, G7F6E+FG1+A6, G7F6E+T, G7F6ME+A6, G9F4E+FE1+A4, G9F4E+FG1+A4, G9F6E+FE1+A6, G9F6E+FG1+A6, G9F6ME, G9F6ME+A6		

ignition switches

	1		
GEV No.	106646	Ref. No.	31877300
description	ignition switch double		
For models:	G6F2B+A2, G6F2BPW+AE, G6F2M+A2, G6F2MPW+AE, G7F2BE+A2, G7F2BPW+AE, G7F2ME+A2, G7F2MPW+AE, G9F2ME, G9F2ME+A2, G9F2MPW+AE		



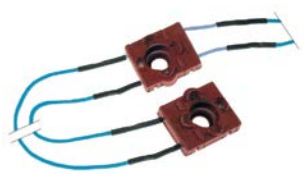

			
1			
GEV No.	101033	Ref. No.	31877400
description	ignition switch double for gas taps Sabaf		
For models:	G7F2BE+A2, G7F2ME+A2, G9F2ME, G9F2ME+A2		

			
1			
GEV No.	101039	Ref. No.	31877600
description	ignition switch 4-fold		
For models:	G6F4+FE1+A4, G6F4+FG1+A4, G6F4B+A4, G6F4BPW+AE, G6F4M+A4, G6F4MPW+AE, G6F4PW+FE1+AE, G6F4PW+FG1+AE, G6F6+FE1+A6, G6F6+TE+A6, G6F6B+A6, G6F6M+A6, G6F6MPW+AE, G6F6PW+FE1+AE, G6F6PW+FG1+AE, G7F4BE+A4, G7F4BPW+AE, G7F4E+FE+A4, G7F4E+FE1+A4, G7F4E+FG+A4, G7F4E+FG1, G7F4E+FG1+A4, G7F4MPW+AE, G7F4PW+FE+AE, G7F4PW+FE1+AE, G7F4PW+FG+AE, G7F4PW+FG1+AE, G7F6E+-FE1+A6, G9F4E+FE1+A4, G9F4E+FG1+A4, G9F4ME, G9F4ME+A4, G9F4MPW+AE, G9F4PW+FE+AE, G9F4PW+FE1+AE, G9F4PW+FG+AE, G9F4PW+FG1+AE		

			
1			
GEV No.	101034	Ref. No.	31877500
description	ignition switch 4-fold for gas taps Sabaf		
For models:	G7F4BE+A4, G7F4E+FE+A4, G7F4E+FE1, G7F4E+FE1+A4, G7F4E+FG+A4, G7F4E+FG1, G7F4E+FG1+A4, G7F4ME+A4, G9F4E+FE1+A4, G9F4E+FG1+A4, G9F4ME, G9F4ME+A4		

			
1			
GEV No.	101035	Ref. No.	31877700 31877800
description	ignition switch 6-fold for gas taps Sabaf		
For models:	G6F4+FG1+A4, G6F6+FE1+A6, G6F6+T+A6, G6F6+TE+A6, G6F6B+A6, G6F6BPW+AE, G6F6M+A6, G6F6MPW+AE, G6F6PW+FE1+AE, G6F6PW+FG1+AE, G6F6PW+T+AE, G6F6PW+TE+AE, G7F4E+FE1+A4, G7F6BE+A6, G7F6BPW+AE, G7F6E+FE+A6, G7F6E+FE1+A6, G7F6E+FG+A4, G7F6E+FG+A6, G7F6E+FG1, G7F6E+FG1+A4, G7F6E+FG1+A6, G7F6E+T, G7F6MPW+AE, G7F6PW+FE+AE, G7F6PW+FE1+AE, G7F6PW+FG+AE, G7F6PW+FG1+AE, G7F6PW+T+AE, G9F6E+FE1+A6, G9F6E+FG1+A6, G9F6ME, G9F6ME+A6, G9F6MPW+AE, G9F6PW+-FE+AE, G9F6PW+FG+AE, G9F6PW+FG1+AE, G9F6PW+T+AE		

			
1			
GEV No.	101036	Ref. No.	31915000
description	battery holder for battery type AA 1.5V mounting ø 22mm connection male faston 2.8mm/6.3mm		
For models:	G6F2B+A2, G6F2M+A2, G6F4+FE1+A4, G6F4+FG1+A4, G6F-4B+A4, G6F4M+A4, G6F6+FE1+A6, G6F6+FG1+A6, G6F6+T+A6, G6F6+TE+A6, G6F6B+A6, G6F6M+A6, G7F2BE+A2, G7F2ME+A2, G7F-4BE+A4, G7F4E+FE+A4, G7F4E+FE1, G7F4E+FE1+A4, G7F4E+FG+A4, G7F4E+FG1+A4, G7F4ME+A4, G7F4P+FG+AF2, G7F4P+FG1+AF1, G7F6BE+A6, G7F6E+FE+A6, G7F6E+FE1, G7F6E+FE1+A6, G7F6E+FG+A4, G7F6E+FG+A6, G7F6E+FG1+A4, G7F6E+FG1+A6, G7F6E+T, G7F6ME+A6, G7F6P+FG+AF2, G7F6P+FG1+AF1, G7F6P+T+AF2, G9F2ME, G9F2ME+A2, G9F4E+FE1+A4, G9F4E+FG1+A4, G9F4ME, G9F4ME+A4, G9F4P+FG+AF2, G9F4P+FG1+AF1, G9F6E+FE1+A6, G9F6E+FG1+A6, G9F6ME, G9F6ME+A6, G9F6P+T, G9F6P+T+AF2... (Other models you can see in the webshop)		

			
1			
GEV No.	101445	Ref. No.	31938400
description	disc for ignition switch ID ø 8.8mm ED ø 12.5mm		
For models:	G7F2BE+A2, G7F2ME+A2, G7F4BE+A4, G7F4E+FE+A4, G7F4E+-FE1+A4, G7F4E+FG+A4, G7F4E+FG1+A4, G7F4ME+A4, G7F6BE+A6, G7F6E+FE+A6, G7F6E+FE1+A6, G7F6E+FG+A4, G7F6E+FG1+A4, G7F6E+FG1+A6, G7F6E+T, G7F6ME+A6, G9F2ME, G9F2ME+A2, G9F4E+FE1+A4, G9F4E+FG1+A4, G9F4ME, G9F4ME+A4, G9F6ME, G9F6ME+A6		

thermocouples

plug-in thermocouples

plug-in thermocouples standard

with barrel socket ø6(6.5)mm

thermocouples SIT

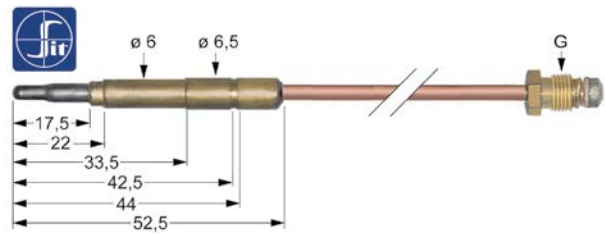
			
1			
GEV No.	107619	Ref. No.	31288000
description	thermocouple SIT M10x1 L 1000mm plug connection ø6.0(6.5)mm		

GEV No.	107621	Ref. No.	31288000
description	thermocouple SIT M10x1 L 1500mm plug connection ø6.0(6.5)mm		
For models:	G7PD		

GEV No.	107609	Ref. No.	22289200
description	thermocouple SIT M9x1 L 600mm plug connection ø6.0(6.5)mm		
For models:	CPG40, CPG40E, CPG80, CPG80E, E9F15-4M, E9F15-8M, E9F18-4M, E9F18-8M, G12F4H9+FGP, G12F4H9M, G12F4P9+FGP, G12F4P9M, G2FS4-S, G4FD8-S, G4S+FCGN, G4S+FSGN, G6CP6, G6F12-S, G6F2B, G6F2B+A2, G6F2BH6, G6F2BH9, G6F2BP6, G6F2BP9, G6F2H6+FE1, G6F2H6+FG1, G6F2H9+FE1, G6F2H9+FG1, G6F2H9+T, G6F2H9+TE, G6F2MH6, G6F2MH9, G6F2MP6, G6F2MP9, G6F2P6+FE1, G6F2P6+FG1, G6F2P9+FE1, G6F2P9+FG1, G6F2P9+T, G6F2P9+TE, G6F3BH12, G6F3BH9, G6F3H12+FE1, G6F3H12+FG1, G6F3H12+T, G6F3H12+TE, G6F3H9+T, G6F3MH12, G6F4B, G6F4B+A4...(Other models you can see in the webshop)		

GEV No.	107612	Ref. No.	23288900
description	thermocouple SIT M9x1 L 1000mm plug connection ø6.0(6.5)mm		
For models:	FMG10M, FMG6M, FPG12, FPG6, WAV-G12, WAV-G20, WAV-G5U, WAV-G6		

GEV No.	107614	Ref. No.	31289000
description	thermocouple SIT M9x1 L 1500mm plug connection ø6.0(6.5)mm		
For models:	G12F4H9+FGP, G12F4P9+FGP, G6F2B, G6F2B+A2, G6F2H9+T, G6F2P9+T, G6F3H12+T, G6F3H9+T, G6F4B, G6F4B+A4, G6F6+T, G6F6+T+A6, G6F6B, G6F6B+A6, G6F6PW+T+AE, G6F6PW+T+AE, G7F4+FG, G7F4E+FG, G7F4E+FG+A4, G7F4P+FG, G7F4P+FG+AF2, G7F4PW+FG, G7F4PW+FG+AE, G7F6+FG, G7F6E+FG, G7F6E+FG+A4, G7F6E+FG+A6, G7F6E+T, G7F6P+FG, G7F6P+FG+AF2, G7F6P+T, G7F6P+T+AF2, G7F6PW+FG, G7F6PW+FG+AE, G7F6PW+T, G7F6PW+T+AE, G7T4P4F+FG, G7TP+FG, G7TP2F+FG, G7TP2F+T, G9F4+FG, G9F4P+FG, G9F4P+FG+AF2, G9F4PW+FG, G9F4PW+FG+AE, G9F6+FG, G9F6P+FG, G9F6P+FG+AF2, G9F6P+T, G9F6P+T+AF2...(Other models you can see in the webshop)		

GEV No.	107608	Ref. No.	31288600
description	thermocouple SIT M9x1 L 500mm plug connection ø6.0(6.5)mm		
For models:	G6FL3B, G6FL3B-CR, G6FL3B-SX, G6FL3M, G6FL3M-CR, G6FL3M-SX, G6FL6B, G6FL6B-CR, G6FL6B-SX, G6FL6M, G6FL6M-CR, G6FL6M-SX, G6FM6B, G6FM6M, G6FR3B, G6FR3M, G6FR6B, G6FR6M, G7FL4B, G7FL4B-CR, G7FL4B-SX, G7FL4M, G7FL4M-CR, G7FL4M-SX, G7FL8B-2, G7FL8B-2-CR, G7FL8B-2-SX, G7FL8M-2, G7FL8M-2-CR, G7FL8M-2-SX, G7FM8B-2, G7FM8M-2, G7FR4B, G7FR4M, G7FR8B-2, G7FR8M, G7FR8M-2, G9BR8, G9BR8-1, G9FL4M, G9FL4M-CPD, G9FL4M-CR, G9FL4M-SX, G9FL8M-2, G9FL8M-2-CPD, G9FL8M-2-CR, G9FL8M-2-SX, G9FM8M-2, G9FR4M, G9FR8M-2...(Other models you can see in the webshop)		

plug-in thermocouples with interruption

GEV No.	107932	Ref. No.	31290100
description	thermocouple SIT with interrupter M9x1 L 1500mm plug connection ø6.0(6.5)mm cable 500mm		

GEV No.	102247	Ref. No.	32290100
description	thermocouple with interrupter M9x1 L 600mm plug connection ø6.0mm cable 700mm		
For models:	6GL18B, 6GL18M, 9GL15+15M, 9GL15M, 9GL20+20M, 9GL20M, GL10+10B, GL10+10M, GL10B, GL10M, GL15+15M, GL15M, GL18+18MI, GL18+18MI-E, GL18MI, GL18MI-E, GL20+20M, GL20M, GL30B, GL30M, GL7+7M, GL8+8B, GL8+8M, GL8B, GL8M, S9GL20+20M, S9GL20M, S9GL22M		



threaded thermocouples

threaded thermocouples standard

with socket with thread M8x1

SIT

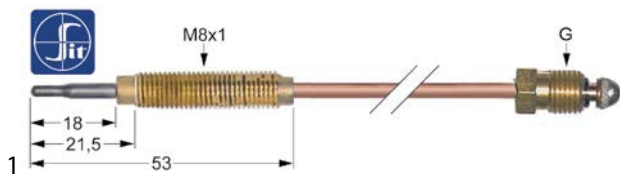

GEV No. 107634 **Ref. No.** 22287400

description thermocouple SIT M8x1 L 1500mm M8x1

accessories for 107634

GEV No. 102067 **Ref. No.** 22290900

nut thread M8x1 H 3mm brass Qty 1 pcs type SEF 1

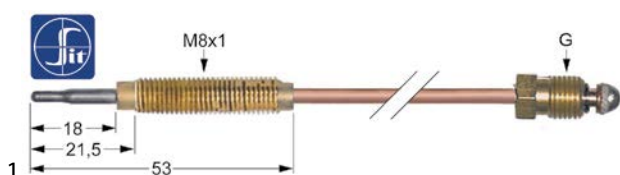

GEV No. 107636 **Ref. No.** 22286900

description thermocouple SIT M9x1 L 600mm M8x1

For models: G2F54, G4F+FCD8, G4FD8

accessories for 107636

GEV No. 102067 **Ref. No.** 22290900

nut thread M8x1 H 3mm brass Qty 1 pcs type SEF 1

type Junkers with aluminised tip

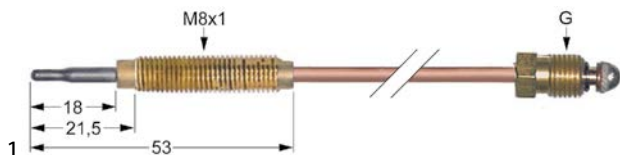

GEV No. 102059 **Ref. No.** 22287500

description thermocouple M8x1 L 1200mm M8x1

For models: G6F2H6+FG1, G6F2H9+FG1, G6F2P6+FG1, G6F2P9+FG1, G6F-3H12+FG1, G6F4+FG1, G6F4+FG1+A4, G6F4PW+FG1, G6F4PW+F-G1+AE, G6F6+FG1, G6F6+FG1+A6, G6F6PW+FG1, G6F6PW+FG1+AE, G7F4+FG1, G7F4E+FG1, G7F4E+FG1+A4, G7F4P+FG1, G7F4P+F-G1+AF1, G7F4PW+FG1, G7F4PW+FG1+AE, G7F6+FG1, G7F6E+FG1, G7F6E+FG1+A4, G7F6E+FG1+A6, G7F6P+FG1, G7F6P+FG1+AF1, G7F6PW+FG1, G7F6PW+FG1+AE, G7T4P2F+FG1, G7T4P4F+FG1, G9F4+FG1, G9F4E+FG1, G9F4E+FG1+A4, G9F4P+FG1, G9F4P+F-G1+AF1, G9F4PW+FG1, G9F4PW+FG1+AE, G9F6+FG1, G9F6E+FG1, G9F6E+FG1+A6, G9F6P+FG1, G9F6PW+FG1, G9F6PW+FG1+AE, G9F8+2FG1, G9F8P+2FG1, G9TP2F+FG1

accessories for 102059

GEV No. 102067 **Ref. No.** 22290900

nut thread M8x1 H 3mm brass Qty 1 pcs type SEF 1

threaded thermocouples (miscellaneous)

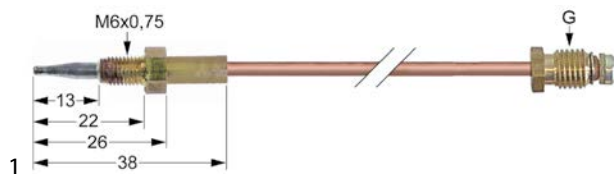

GEV No. 107185 **Ref. No.** 31288300

description thermocouple M9x1 L 600mm M6x0.75

accessories for 107185



GEV No. 103173 **Ref. No.** —

nut thread M6x0.75 H 4mm WS 10 brass Qty 1 pcs

threaded thermocouples with cable link

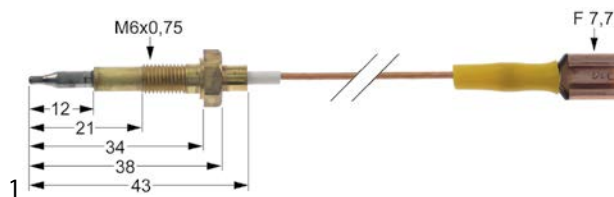

GEV No. 102242 **Ref. No.** 35289200

description thermocouple with cable link L 750mm connection F 7.7mm M6x0.75

For models: G9F2ME, G9F2ME+A2, G9F4E+FE1, G9F4E+FE1+A4, G9F4E+FG1, G9F4E+FG1+A4, G9F4ME, G9F4ME+A4, G9F6E+FE1, G9F6E+FE1+A6, G9F6E+FG1, G9F6E+FG1+A6, G9F6ME, G9F6ME+A6

accessories for 102242



GEV No. 102680 **Ref. No.** 31807600

nut thread M6x0.75 H 2.6mm WS 8 brass Qty 1 pcs type SEF 2

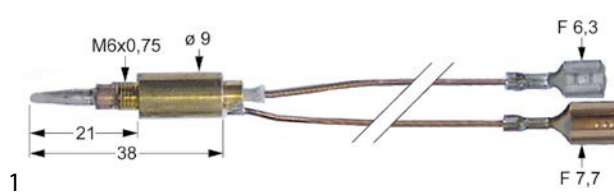

GEV No. 102120 **Ref. No.** 31289200

description thermocouple with two-conductors L 750mm M6x0.75 F 7.7mm F 6.3mm

For models: G6F2B, G6F2B+A2, G6F2BPW+AE, G6F2M, G6F2M+A2, G6F2MPW+AE, G6F4+FE1, G6F4+FE1+A4, G6F4+FG1, G6F4+FG1+A4, G6F4B, G6F-4B+A4, G6F4BPW+AE, G6F4M, G6F4M+A4, G6F4MPW+AE, G6F4PW+FE1+AE, G6F4PW+FG1+AE, G6F6+FE1, G6F6+FE1+A6, G6F6+FG1, G6F6+FG1+A6, G6F6+T, G6F6+T+A6, G6F6+TE, G6F6+TE+A6, G6F6B, G6F6B+A6, G6F6BPW+AE, G6F6M, G6F6M+A6, G6F6MPW+AE, G6F6PW+FE1+AE, G6F6PW+FG1+AE, G7F2BE, G7F2BE+A2, G7F2B-PW+AE, G7F2BPW-F, G7F2ME, G7F2ME+A2, G7F4BE, G7F4BE+A4, G7F4BPW+AE, G7F4E+FE, G7F4E+FE+A4, G7F4E+FE1, G7F4E+FE1+A4, G7F4E+FG, G7F4E+FG+A4, G7F4E+FG1... (Other models you can see in the webshop)

accessories for 102120



GEV No. 102680 **Ref. No.** 31807600

nut thread M6x0.75 H 2.6mm WS 8 brass Qty 1 pcs type SEF 2



accessories

nuts



1

GEV No.	102067	Ref. No.	22290900
description	nut thread M8x1 H 3mm brass Qty 1 pcs type SEF 1		
For models:	G2FS4, G4F+FCD8, G4F+FSD8, G4FD8, G6F2H6+FG1, G6F2P6+FG1, G6F4+FG1, G6F4+FG1+A4, G6F4PW+FG1, G6F4PW+FG1+AE, G6F6+FG1, G6F6+FG1+A6, G6F6PW+FG1, G6F6PW+FG1+AE, G7F4+FG1, G7F4E+FG1, G7F4E+FG1+A4, G7F4P+FG1, G7F4P+FG1+AF1, G7F4PW+FG1, G7F4PW+FG1+AE, G7F6+FG1, G7F6E+FG1, G7F6E+FG1+A4, G7F6E+FG1+A6, G7F6P+FG1, G7F6P+FG1+AF1, G7F6PW+FG1, G7F6PW+FG1+AE, G7T4P2F+FG1, G7T4P4F+FG1, G7TP+FG1, G7TP2F+FG1, G9F4+FG1, G9F4E+FG1, G9F4E+FG1+A4, G9F4P+FG1, G9F4P+FG1+AF1, G9F4PW+FG1, G9F4PW+FG1+AE, G9F6+FG1, G9F6E+FG1, G9F6E+FG1+A6, G9F6P+FG1, G9F6PW+FG1, G9F6PW+FG1+AE, G9F8+2FG1, G9F8P+2FG1, G9TP+FG1, G9TP2F+FG1		

gas burners

hob burners

universal hob burners

GEV



1

GEV No.	103068	Ref. No.	22294500	
description	burner cap ø 100mm			
For models:	G2FS4, G4F+FCD8, G4F+FSD8, G4FD8			
accessories for	103068			
	GEV No.	103067	Ref. No.	22285300
	burner ring for burner cap ø 100mm			
	GEV No.	104102	Ref. No.	22283200
	burner head for burner cap ø 100mm ext. ø 130			
	GEV No.	104103	Ref. No.	22993100
	burner holder suitable for burner ø100mm with nozzle holder			



1

GEV No.	103066	Ref. No.	22294100	
description	burner cap ø 80mm			
For models:	G2FS4, G4F+FCD8, G4F+FSD8, G4FD8			
accessories for	103066			
	GEV No.	103065	Ref. No.	22284800
	burner ring for burner cap ø 80mm			
	GEV No.	104100	Ref. No.	22282700
	burner head for burner cap ø 80mm			
	GEV No.	104101	Ref. No.	22992900
	burner holder for burner cap ø 80mm with nozzle holder with mixing sleeve			



1

GEV No.	104102	Ref. No.	22283200
description	burner head for burner cap ø 100mm ext. ø 130		
For models:	G2FS4, G4F+FCD8, G4F+FSD8, G4FD8		



1

GEV No.	104100	Ref. No.	22282700	
description	burner head for burner cap ø 80mm			
For models:	G2FS4, G4F+FCD8, G4F+FSD8, G4FD8			
accessories for	104100			
	GEV No.	103065	Ref. No.	22284800
	burner ring for burner cap ø 80mm			
	GEV No.	103066	Ref. No.	22294100
	burner cap ø 80mm			
	GEV No.	104103	Ref. No.	22993100
	burner holder suitable for burner ø100mm with nozzle holder			



1

GEV No.	104101	Ref. No.	22992900	
description	burner holder for burner cap ø 80mm with nozzle holder with mixing sleeve			
For models:	G4F+FCD8, G4F+FSD8			
accessories for	104101			
	GEV No.	103065	Ref. No.	22284800
	burner ring for burner cap ø 80mm			
	GEV No.	103066	Ref. No.	22294100
	burner cap ø 80mm			
	GEV No.	104100	Ref. No.	22282700
	burner head for burner cap ø 80mm			







1





GEV No.	104103	Ref. No.	22993100	
description	burner holder suitable for burner ø100mm with nozzle holder			
For models:	G4F+FCD8, G4F+FSD8			
accessories for	104103			
	GEV No.	103067	Ref. No.	22285300
	burner ring for burner cap ø 100mm			
	GEV No.	103068	Ref. No.	22294500
	burner cap ø 100mm			

Table continues overleaf



accessories for	104103		
	GEV No.	104102	Ref. No. 22283200
	burner head for burner cap ø 100mm ext. ø 130		

	GEV No.	103067	Ref. No. 22285300
description	burner ring for burner cap ø 100mm		
For models:	G2FS4, G4F+FCD8, G4F+FSD8, G4FD8		
accessories for	103067		
	GEV No.	103068	Ref. No. 22294500
	burner cap ø 100mm		
	GEV No.	104102	Ref. No. 22283200
	burner head for burner cap ø 100mm ext. ø 130		
	GEV No.	104103	Ref. No. 22993100
	burner holder suitable for burner ø100mm with nozzle holder		

	GEV No.	103065	Ref. No. 22284800
description	burner ring for burner cap ø 80mm		
For models:	G2FS4, G4F+FCD8, G4F+FSD8, G4FD8		
accessories for	103065		
	GEV No.	103066	Ref. No. 22294100
	burner cap ø 80mm		
	GEV No.	104100	Ref. No. 22282700
	burner head for burner cap ø 80mm		
	GEV No.	104101	Ref. No. 22992900
	burner holder for burner cap ø 80mm with nozzle holder with mixing sleeve		

ARC			
O4 series			
	GEV No.	103166	Ref. No. 31283300
description	burner cap C ø 92mm mounting ø 85mm 3.5kW		
For models:	G6F2BPW, G6F2BPW+AE, G6F2MPW, G6F2MPW+AE, G6F4BPW, G6F4BPW+AE, G6F4MPW, G6F4MPW+AE, G6F4PW+FE1, G6F4PW+FE1+AE, G6F4PW+FG1, G6F4PW+FG1+AE, G6F6BPW, G6F6BPW+AE, G6F6MPW, G6F6MPW+AE, G6F6PW+FE1, G6F6PW+FE1+AE, G6F6PW+FG1, G6F6PW+FG1+AE, G6F6PW+T, G6F6PW+T+AE, G6F6PW+TE, G6F6PW+TE+AE, G7F2BPW, G7F2BPW+AE, G7F2BPW-F, G7F2MPW, G7F2MPW+AE, G7F4BPW, G7F4BPW+AE, G7F4MPW, G7F4MPW+AE, G7F4PW+FE, G7F4PW+FE+AE, G7F4PW+FE1, G7F4PW+FE1+AE, G7F4PW+FG, G7F4PW+FG+AE, G7F4PW+FG1, G7F4PW+FG1+AE, G7F6BPW, G7F6BPW+AE, G7F6MPW, G7F6MPW+AE, G7F6PW+FE, G7F6PW+FE+AE, G7F6PW+FE1, G7F6PW+FE1+AE, G7F6PW+FG...(Other models you can see in the webshop)		

	GEV No.	103170	Ref. No. 31283600
description	burner cap D ø 121mm mounting ø 113mm 6kW		
For models:	G6F2BPW, G6F2BPW+AE, G6F2MPW, G6F2MPW+AE, G6F4BPW, G6F4BPW+AE, G6F4MPW, G6F4MPW+AE, G6F4PW+FE1, G6F4PW+FE1+AE, G6F4PW+FG1, G6F4PW+FG1+AE, G6F6BPW, G6F6BPW+AE, G6F6MPW, G6F6MPW+AE, G6F6PW+FE1, G6F6PW+FE1+AE, G6F6PW+FG1, G6F6PW+FG1+AE, G6F6PW+T, G6F6PW+T+AE, G6F6PW+TE, G6F6PW+TE+AE, G7F2BPW, G7F2BPW+AE, G7F2BPW-F, G7F2MPW, G7F2MPW+AE, G7F4BPW, G7F4BPW+AE, G7F4MPW, G7F4MPW+AE, G7F4PW+FE, G7F4PW+FE+AE, G7F4PW+FE1, G7F4PW+FE1+AE, G7F4PW+FG, G7F4PW+FG+AE, G7F4PW+FG1, G7F4PW+FG1+AE, G7F6BPW, G7F6BPW+AE, G7F6MPW, G7F6MPW+AE, G7F6PW+FE, G7F6PW+FE+AE, G7F6PW+FE1, G7F6PW+FE1+AE, G7F6PW+FG...(Other models you can see in the webshop)		



	GEV No.	103167	Ref. No. 31283200
description	burner head C 3.5kW for burner cap ø 92mm ED ø 94mm mounting thread M4x0.75		
For models:	G6F2BPW, G6F2MPW, G6F4BPW, G6F4MPW, G6F4PW+FE1, G6F4PW+FG1, G6F6BPW, G6F6MPW, G6F6PW+FE1, G6F6PW+FG1, G6F6PW+T, G6F6PW+TE, G7F2BPW, G7F2MPW, G7F4BPW, G7F4MPW, G7F4PW+FE, G7F4PW+FE1, G7F4PW+FG, G7F4PW+FG1, G7F6BPW, G7F6MPW, G7F6PW+FE, G7F6PW+FE1, G7F6PW+FG, G7F6PW+FG1, G7F6PW+T		
accessories for	103167		
	GEV No.	103168	Ref. No. —
	venturi L 52mm total length 60mm ED ø 21mm ID ø 13.5mm M20x1 WS 27		

	GEV No.	103171	Ref. No. 31283500
description	burner head D 6kW for burner cap ø 121mm ED ø 123mm mounting thread M4x0.75		
For models:	G6F2BPW, G6F2MPW, G6F4BPW, G6F4MPW, G6F4PW+FE1, G6F4PW+FG1, G6F6BPW, G6F6MPW, G6F6PW+FE1, G6F6PW+FG1, G6F6PW+T, G6F6PW+TE, G7F2BPW, G7F2MPW, G7F4BPW, G7F4MPW, G7F4PW+FE, G7F4PW+FE1, G7F4PW+FG, G7F4PW+FG1, G7F6BPW, G7F6MPW, G7F6PW+FE, G7F6PW+FE1, G7F6PW+FG, G7F6PW+FG1, G7F6PW+T, G9F2MPW, G9F4MPW, G9F4PW+FE, G9F4PW+FE1, G9F4PW+FG, G9F4PW+FG1, G9F6MPW, G9F6PW+FE, G9F6PW+FE1, G9F6PW+FG, G9F6PW+FG1, G9F6PW+T		
accessories for	103171		
	GEV No.	103172	Ref. No. —
	venturi L 79mm total length 90mm D1 ø 26mm D2 ø 21mm ID ø 15mm M25x1 WS 27		



			
1			
GEV No.	103169	Ref. No.	32328000
description	nozzle holder gas connection M14x1mm tube ø 10mm nozzle connection M8x0.75		
For models:	G6F2BPW, G6F2BPW+AE, G6F2MPW, G6F2MPW+AE, G6F4BPW, G6F4BPW+AE, G6F4MPW, G6F4MPW+AE, G6F4PW+FE1, G6F4PW+FE1+AE, G6F4PW+FG1, G6F4PW+FG1+AE, G6F6BPW, G6F6BPW+AE, G6F6MPW, G6F6MPW+AE, G6F6PW+FE1, G6F6PW+FE1+AE, G6F6PW+FG1, G6F6PW+FG1+AE, G6F6PW+T, G6F6PW+T+AE, G6F6PW+TE, G6F6PW+TE+AE, G7F2BPW, G7F2BPW+AE, G7F2BPW-F, G7F2MPW, G7F2MPW+AE, G7F4BPW, G7F4BPW+AE, G7F4MPW, G7F4MPW+AE, G7F4PW+FE, G7F4PW+FE+AE, G7F4PW+FE1, G7F4PW+FE1+AE, G7F4PW+FG, G7F4PW+FG+AE, G7F4PW+FG1, G7F4PW+FG1+AE, G7F6BPW, G7F6BPW+AE, G7F6MPW, G7F6MPW+AE, G7F6PW+FE, G7F6PW+FE+AE, G7F6PW+FE1, G7F6PW+FE1+AE, G7F6PW+FG...(Other models you can see in the webshop)		
accessories for	103169		
	GEV No.	104808	Ref. No. 40312000
	gas injector thread M8x0.75 WS 10 bore ø 1.2mm		
	GEV No.	107506	Ref. No. 32811600
	union nut thread M14x1 tube ø 10mm WS 17		
	GEV No.	107507	Ref. No. 32777200
	olive for pipe ø 10mm L 7mm Qty 1 pcs		



SABAF			
1 series			
			
1			
GEV No.	104288	Ref. No.	31280700 31281300
description	burner cap 3.6kW ø 120mm		
For models:	G6F2B, G6F2B+A2, G6F2M, G6F2M+A2, G6F4+FE1, G6F4+FE1+A4, G6F4+FG1, G6F4+FG1+A4, G6F4B, G6F4B+A4, G6F4M, G6F4M+A4, G6F6+FE1, G6F6+FE1+A6, G6F6+FG1, G6F6+FG1+A6, G6F6+T, G6F6+T+A6, G6F6+TE, G6F6+TE+A6, G6F6B, G6F6B+A6, G6F6M, G6F6M+A6, G7F2BE, G7F2BE+A2, G7F2ME, G7F2ME+A2, G7F4BE, G7F4BE+A4, G7F4E+FE, G7F4E+FE+A4, G7F4E+FE1, G7F4E+FE1+A4, G7F4E+FG, G7F4E+FG+A4, G7F4E+FG1, G7F4E+FG1+A4, G7F4ME, G7F4ME+A4, G7F6BE, G7F6BE+A6, G7F6E+FE, G7F6E+FE+A6, G7F6E+FE1, G7F6E+FE1+A6, G7F6E+FG, G7F6E+FG+A4, G7F6E+FG+A6, G7F6E+FG1...(Other models you can see in the webshop)		
accessories for	104288		
	GEV No.	104289	Ref. No. 31280100
	burner lower part 3/3.6kW for burner cap ø 90/120mm		
	GEV No.	105086	Ref. No. 31280600
	burner ring 3.6kW for burner cap ø 120mm		
	GEV No.	105087	Ref. No. 31280500
	burner head 3.6kW for burner cap ø 120mm		

			
1			
GEV No.	104286	Ref. No.	31280400 31281000
description	burner cap 3kW ø 90mm		
For models:	G6F2B, G6F2B+A2, G6F2M, G6F2M+A2, G6F4+FE1, G6F4+FE1+A4, G6F4+FG1, G6F4+FG1+A4, G6F4B, G6F4B+A4, G6F4M, G6F4M+A4, G6F6+FE1, G6F6+FE1+A6, G6F6+FG1, G6F6+FG1+A6, G6F6+T, G6F6+T+A6, G6F6+TE, G6F6+TE+A6, G6F6B, G6F6B+A6, G6F6M, G6F6M+A6, G7F2BE, G7F2BE+A2, G7F2ME, G7F2ME+A2, G7F4BE, G7F4BE+A4, G7F4E+FE, G7F4E+FE+A4, G7F4E+FE1, G7F4E+FE1+A4, G7F4E+FG, G7F4E+FG+A4, G7F4E+FG1, G7F4E+FG1+A4, G7F4ME, G7F4ME+A4, G7F6BE, G7F6BE+A6, G7F6E+FE, G7F6E+FE+A6, G7F6E+FE1, G7F6E+FE1+A6, G7F6E+FG, G7F6E+FG+A4, G7F6E+FG+A6, G7F6E+FG1...(Other models you can see in the webshop)		
accessories for	104286		
	GEV No.	104289	Ref. No. 31280100
	burner lower part 3/3.6kW for burner cap ø 90/120mm		
	GEV No.	105089	Ref. No. 31280300
	burner ring 3kW for burner cap ø 90mm		
	GEV No.	105090	Ref. No. 31280200
	burner head 3kW for burner cap ø 90mm		

			
1			
GEV No.	105087	Ref. No.	31280500
description	burner head 3.6kW for burner cap ø 120mm		
For models:	G6F2B, G6F2B+A2, G6F2M, G6F2M+A2, G6F4+FE1, G6F4+FE1+A4, G6F4+FG1, G6F4+FG1+A4, G6F4B, G6F4B+A4, G6F4M, G6F4M+A4, G6F6+FE1, G6F6+FE1+A6, G6F6+FG1, G6F6+FG1+A6, G6F6+T, G6F6+T+A6, G6F6+TE, G6F6+TE+A6, G6F6B, G6F6B+A6, G6F6M, G6F6M+A6, G7F2BE, G7F2BE+A2, G7F2ME, G7F2ME+A2, G7F4BE, G7F4BE+A4, G7F4E+FE, G7F4E+FE+A4, G7F4E+FE1, G7F4E+FE1+A4, G7F4E+FG, G7F4E+FG+A4, G7F4E+FG1, G7F4E+FG1+A4, G7F4ME, G7F4ME+A4, G7F6BE, G7F6BE+A6, G7F6E+FE, G7F6E+FE+A6, G7F6E+FE1, G7F6E+FE1+A6, G7F6E+FG, G7F6E+FG+A4, G7F6E+FG+A6, G7F6E+FG1...(Other models you can see in the webshop)		
accessories for	105087		
	GEV No.	104288	Ref. No. 31280700 31281300
	burner cap 3.6kW ø 120mm		
	GEV No.	105085	Ref. No. —
	burner cap ø 120mm		
	GEV No.	105086	Ref. No. 31280600
	burner ring 3.6kW for burner cap ø 120mm		
	GEV No.	105088	Ref. No. —
	burner cap A ø 110mm with central hole		
	GEV No.	105089	Ref. No. 31280300
	burner ring 3kW for burner cap ø 90mm		









			
GEV No.	105090	Ref. No.	31280200
description	burner head 3kW for burner cap ø 90mm		
For models:	G6F2B, G6F2B+A2, G6F2M, G6F2M+A2, G6F4+FE1, G6F4+FE1+A4, G6F4+FG1, G6F4+FG1+A4, G6F4B, G6F4B+A4, G6F4M, G6F4M+A4, G6F6+FE1, G6F6+FE1+A6, G6F6+FG1, G6F6+FG1+A6, G6F6+T, G6F6+T+A6, G6F6+TE, G6F6+TE+A6, G6F6B, G6F6B+A6, G6F6M, G6F6M+A6, G7F2BE, G7F2BE+A2, G7F2ME, G7F2ME+A2, G7F4BE, G7F4BE+A4, G7F4E+FE, G7F4E+FE+A4, G7F4E+FE1, G7F4E+FE1+A4, G7F4E+FG, G7F4E+FG+A4, G7F4E+FG1, G7F4E+FG1+A4, G7F4ME, G7F4ME+A4, G7F6BE, G7F6BE+A6, G7F6E+FE, G7F6E+FE+A6, G7F6E+FE1, G7F6E+FE1+A6, G7F6E+FG, G7F6E+FG+A4, G7F6E+FG+A6, G7F6E+FG1...(Other models you can see in the webshop)		
accessories for	105090		
		GEV No.	104286
		Ref. No.	31280400 31281000
	burner cap 3kW ø 90mm		
		GEV No.	104289
		Ref. No.	31280100
	burner lower part 3/3.6kW for burner cap ø 90/120mm		
		GEV No.	105089
		Ref. No.	31280300
	burner ring 3kW for burner cap ø 90mm		

			
GEV No.	104289	Ref. No.	31280100
description	burner lower part 3/3.6kW for burner cap ø 90/120mm		
For models:	G6F2B, G6F2B+A2, G6F2M, G6F2M+A2, G6F4+FE1, G6F4+FE1+A4, G6F4+FG1, G6F4+FG1+A4, G6F4B, G6F4B+A4, G6F4M, G6F4M+A4, G6F6+FE1, G6F6+FE1+A6, G6F6+FG1, G6F6+FG1+A6, G6F6+T, G6F6+T+A6, G6F6+TE, G6F6+TE+A6, G6F6B, G6F6B+A6, G6F6M, G6F6M+A6, G7F2BE, G7F2BE+A2, G7F2ME, G7F2ME+A2, G7F4BE, G7F4BE+A4, G7F4E+FE, G7F4E+FE+A4, G7F4E+FE1, G7F4E+FE1+A4, G7F4E+FG, G7F4E+FG+A4, G7F4E+FG1, G7F4E+FG1+A4, G7F4ME, G7F4ME+A4, G7F6BE, G7F6BE+A6, G7F6E+FE, G7F6E+FE+A6, G7F6E+FE1, G7F6E+FE1+A6, G7F6E+FG, G7F6E+FG+A4, G7F6E+FG+A6, G7F6E+FG1...(Other models you can see in the webshop)		
accessories for	104289		
		GEV No.	104286
		Ref. No.	31280400 31281000
	burner cap 3kW ø 90mm		
		GEV No.	104288
		Ref. No.	31280700 31281300
	burner cap 3.6kW ø 120mm		
		GEV No.	105086
		Ref. No.	31280600
	burner ring 3.6kW for burner cap ø 120mm		
		GEV No.	105087
		Ref. No.	31280500
	burner head 3.6kW for burner cap ø 120mm		
		GEV No.	105089
		Ref. No.	31280300
	burner ring 3kW for burner cap ø 90mm		
		GEV No.	105090
		Ref. No.	31280200
	burner head 3kW for burner cap ø 90mm		
		GEV No.	106482
		Ref. No.	—
	gas injector thread M6x0.75 WS 7 bore ø 1.1mm		

accessories for	104289		
		GEV No.	106485
		Ref. No.	—
	gas injector thread M6x0.75 WS 7 bore ø 1.6mm		

			
GEV No.	105086	Ref. No.	31280600
description	burner ring 3.6kW for burner cap ø 120mm		
For models:	G6F2B, G6F2B+A2, G6F2M, G6F2M+A2, G6F4+FE1, G6F4+FE1+A4, G6F4+FG1, G6F4+FG1+A4, G6F4B, G6F4B+A4, G6F4M, G6F4M+A4, G6F6+FE1, G6F6+FE1+A6, G6F6+FG1, G6F6+FG1+A6, G6F6+T, G6F6+T+A6, G6F6+TE, G6F6+TE+A6, G6F6B, G6F6B+A6, G6F6M, G6F6M+A6, G7F2BE, G7F2BE+A2, G7F2ME, G7F2ME+A2, G7F4BE, G7F4BE+A4, G7F4E+FE, G7F4E+FE+A4, G7F4E+FE1, G7F4E+FE1+A4, G7F4E+FG, G7F4E+FG+A4, G7F4E+FG1, G7F4E+FG1+A4, G7F4ME, G7F4ME+A4, G7F6BE, G7F6BE+A6, G7F6E+FE, G7F6E+FE+A6, G7F6E+FE1, G7F6E+FE1+A6, G7F6E+FG, G7F6E+FG+A4, G7F6E+FG+A6, G7F6E+FG1...(Other models you can see in the webshop)		

accessories for	105086		
		GEV No.	105085
		Ref. No.	—
	burner cap ø 120mm		
		GEV No.	105087
		Ref. No.	31280500
	burner head 3.6kW for burner cap ø 120mm		
		GEV No.	105088
		Ref. No.	—
	burner cap A ø 110mm with central hole		
		GEV No.	105089
		Ref. No.	31280300
	burner ring 3kW for burner cap ø 90mm		

			
GEV No.	105089	Ref. No.	31280300
description	burner ring 3kW for burner cap ø 90mm		
For models:	G6F2B, G6F2B+A2, G6F2M, G6F2M+A2, G6F4+FE1, G6F4+FE1+A4, G6F4+FG1, G6F4+FG1+A4, G6F4B, G6F4B+A4, G6F4M, G6F4M+A4, G6F6+FE1, G6F6+FE1+A6, G6F6+FG1, G6F6+FG1+A6, G6F6+T, G6F6+T+A6, G6F6+TE, G6F6+TE+A6, G6F6B, G6F6B+A6, G6F6M, G6F6M+A6, G7F2BE, G7F2BE+A2, G7F2ME, G7F2ME+A2, G7F4BE, G7F4BE+A4, G7F4E+FE, G7F4E+FE+A4, G7F4E+FE1, G7F4E+FE1+A4, G7F4E+FG, G7F4E+FG+A4, G7F4E+FG1, G7F4E+FG1+A4, G7F4ME, G7F4ME+A4, G7F6BE, G7F6BE+A6, G7F6E+FE, G7F6E+FE+A6, G7F6E+FE1, G7F6E+FE1+A6, G7F6E+FG, G7F6E+FG+A4, G7F6E+FG+A6, G7F6E+FG1...(Other models you can see in the webshop)		
accessories for	105089		
		GEV No.	104286
		Ref. No.	31280400 31281000
	burner cap 3kW ø 90mm		
		GEV No.	104289
		Ref. No.	31280100
	burner lower part 3/3.6kW for burner cap ø 90/120mm		
		GEV No.	105090
		Ref. No.	31280200
	burner head 3kW for burner cap ø 90mm		



2 series - flat skirt version



GEV No.	105700	Ref. No.	35281300
description	burner cap		
For models:	G9F2ME, G9F2ME+A2, G9F4E+FE1, G9F4E+FE1+A4, G9F4E+FG1, G9F4E+FG1+A4, G9F4ME, G9F4ME+A4, G9F6E+FE1, G9F6E+FE1+A6, G9F6E+FG1, G9F6E+FG1+A6, G9F6ME, G9F6ME+A6		

triple ring burner series - standard version





GEV No.	105700	Ref. No.	35281300
description	burner cap		
For models:	G9F2ME, G9F2ME+A2, G9F4E+FE1, G9F4E+FE1+A4, G9F4E+FG1, G9F4E+FG1+A4, G9F4ME, G9F4ME+A4, G9F6E+FE1, G9F6E+FE1+A6, G9F6E+FG1, G9F6E+FG1+A6, G9F6ME, G9F6ME+A6		



GEV No.	105721	Ref. No.	35280500 35280600
description	burner head 3.6kW for burner cap ø 131mm		
For models:	G9F2ME, G9F2ME+A2, G9F4E+FE1, G9F4E+FE1+A4, G9F4E+FG1, G9F4E+FG1+A4, G9F4ME, G9F4ME+A4, G9F6E+FE1, G9F6E+FE1+A6, G9F6E+FG1, G9F6E+FG1+A6, G9F6ME, G9F6ME+A6		





GEV No.	105717	Ref. No.	35280100
description	burner lower part 3.6kW for igniter ø 6mm for thermocouple ø 6mm with nozzle ø 1.35mm ID ø 64mm for burner cap ø 61/131mm		
For models:	G9F2ME, G9F2ME+A2, G9F4E+FE1, G9F4E+FE1+A4, G9F4E+FG1, G9F4E+FG1+A4, G9F4ME, G9F4ME+A4, G9F6E+FE1, G9F6E+FE1+A6, G9F6E+FG1, G9F6E+FG1+A6, G9F6ME, G9F6ME+A6		

accessories for	105717			
	GEV No.	101277	Ref. No.	—
	olive ID ø 8mm Qty 1 pcs			
	GEV No.	101477	Ref. No.	—
	union screw thread M13x1 tube ø 8mm Qty 1 pcs			

triple ring burner series - flat skirt version



GEV No.	105717	Ref. No.	35280100
description	burner lower part 3.6kW for igniter ø 6mm for thermocouple ø 6mm with nozzle ø 1.35mm ID ø 64mm for burner cap ø 61/131mm		
For models:	G9F2ME, G9F2ME+A2, G9F4E+FE1, G9F4E+FE1+A4, G9F4E+FG1, G9F4E+FG1+A4, G9F4ME, G9F4ME+A4, G9F6E+FE1, G9F6E+FE1+A6, G9F6E+FG1, G9F6E+FG1+A6, G9F6ME, G9F6ME+A6		

accessories for	105717			
	GEV No.	101277	Ref. No.	—
	olive ID ø 8mm Qty 1 pcs			
	GEV No.	101477	Ref. No.	—
	union screw thread M13x1 tube ø 8mm Qty 1 pcs			

producer-specific hob burners

BERTO'S

700 Macros, 900 Maxima (1) series



GEV No.	105699	Ref. No.	35281400
description	burner cap		
For models:	G9F2ME, G9F2ME+A2, G9F4E+FE1, G9F4E+FE1+A4, G9F4E+FG1, G9F4E+FG1+A4, G9F4ME, G9F4ME+A4, G9F6E+FE1, G9F6E+FE1+A6, G9F6E+FG1, G9F6E+FG1+A6, G9F6ME, G9F6ME+A6		



GEV No.	105700	Ref. No.	35281300
description	burner cap		
For models:	G9F2ME, G9F2ME+A2, G9F4E+FE1, G9F4E+FE1+A4, G9F4E+FG1, G9F4E+FG1+A4, G9F4ME, G9F4ME+A4, G9F6E+FE1, G9F6E+FE1+A6, G9F6E+FG1, G9F6E+FG1+A6, G9F6ME, G9F6ME+A6		



GEV No.	104288	Ref. No.	31280700 31281300
description	burner cap 3.6kW ø 120mm		
For models:	G6F2B, G6F2B+A2, G6F2M, G6F2M+A2, G6F4+FE1, G6F4+FE1+A4, G6F4+FG1, G6F4+FG1+A4, G6F4B, G6F4B+A4, G6F4M, G6F4M+A4, G6F6+FE1, G6F6+FE1+A6, G6F6+FG1, G6F6+FG1+A6, G6F6+T, G6F6+T+A6, G6F6+TE, G6F6+TE+A6, G6F6B, G6F6B+A6, G6F6M, G6F6M+A6, G7F2BE, G7F2BE+A2, G7F2ME, G7F2ME+A2, G7F4BE, G7F4BE+A4, G7F4E+FE, G7F4E+FE+A4, G7F4E+FE1, G7F4E+FE1+A4, G7F4E+FG, G7F4E+FG+A4, G7F4E+FG1, G7F4E+FG1+A4, G7F4ME, G7F4ME+A4, G7F6BE, G7F6BE+A6, G7F6E+FE, G7F6E+FE+A6, G7F6E+FE1, G7F6E+FE1+A6, G7F6E+FG, G7F6E+FG+A4, G7F6E+FG+A6, G7F6E+FG1...(Other models you can see in the webshop)		







accessories for	104288			
	GEV No.	104289	Ref. No.	31280100
	burner lower part 3/3.6kW for burner cap ø 90/120mm			

Table continues overleaf



accessories for	104288		
	GEV No.	105086	Ref. No. 31280600
	burner ring 3.6kW for burner cap ø 120mm		
	GEV No.	105087	Ref. No. 31280500
	burner head 3.6kW for burner cap ø 120mm		

	1		
GEV No.	104286	Ref. No.	31280400 31281000
description	burner cap 3kW ø 90mm		
For models:	G6F2B, G6F2B+A2, G6F2M, G6F2M+A2, G6F4+FE1, G6F4+FE1+A4, G6F4+FG1, G6F4+FG1+A4, G6F4B, G6F4B+A4, G6F4M, G6F4M+A4, G6F6+FE1, G6F6+FE1+A6, G6F6+FG1, G6F6+FG1+A6, G6F6+T, G6F6+T+A6, G6F6+TE, G6F6+TE+A6, G6F6B, G6F6B+A6, G6F6M, G6F6M+A6, G7F2BE, G7F2BE+A2, G7F2ME, G7F2ME+A2, G7F4BE, G7F4BE+A4, G7F4E+FE, G7F4E+FE+A4, G7F4E+FE1, G7F4E+FE1+A4, G7F4E+FG, G7F4E+FG+A4, G7F4E+FG1, G7F4E+FG1+A4, G7F4ME, G7F4ME+A4, G7F6BE, G7F6BE+A6, G7F6E+FE, G7F6E+FE+A6, G7F6E+FE1, G7F6E+FE1+A6, G7F6E+FG, G7F6E+FG+A4, G7F6E+F-G+A6, G7F6E+FG1...(Other models you can see in the webshop)		
accessories for	104286		
	GEV No.	104289	Ref. No. 31280100
	burner lower part 3/3.6kW for burner cap ø 90/120mm		
	GEV No.	105089	Ref. No. 31280300
	burner ring 3kW for burner cap ø 90mm		
	GEV No.	105090	Ref. No. 31280200
	burner head 3kW for burner cap ø 90mm		



	1		
GEV No.	105087	Ref. No.	31280500
description	burner head 3.6kW for burner cap ø 120mm		
For models:	G6F2B, G6F2B+A2, G6F2M, G6F2M+A2, G6F4+FE1, G6F4+FE1+A4, G6F4+FG1, G6F4+FG1+A4, G6F4B, G6F4B+A4, G6F4M, G6F4M+A4, G6F6+FE1, G6F6+FE1+A6, G6F6+FG1, G6F6+FG1+A6, G6F6+T, G6F6+T+A6, G6F6+TE, G6F6+TE+A6, G6F6B, G6F6B+A6, G6F6M, G6F6M+A6, G7F2BE, G7F2BE+A2, G7F2ME, G7F2ME+A2, G7F4BE, G7F4BE+A4, G7F4E+FE, G7F4E+FE+A4, G7F4E+FE1, G7F4E+FE1+A4, G7F4E+FG, G7F4E+FG+A4, G7F4E+FG1, G7F4E+FG1+A4, G7F4ME, G7F4ME+A4, G7F6BE, G7F6BE+A6, G7F6E+FE, G7F6E+FE+A6, G7F6E+FE1, G7F6E+FE1+A6, G7F6E+FG, G7F6E+FG+A4, G7F6E+F-G+A6, G7F6E+FG1...(Other models you can see in the webshop)		
accessories for	105087		
	GEV No.	104288	Ref. No. 31280700 31281300
	burner cap 3.6kW ø 120mm		
	GEV No.	105085	Ref. No. —
	burner cap ø 120mm		
	GEV No.	105086	Ref. No. 31280600
	burner ring 3.6kW for burner cap ø 120mm		
	GEV No.	105088	Ref. No. —
	burner cap A ø 110mm with central hole		
	GEV No.	105089	Ref. No. 31280300
	burner ring 3kW for burner cap ø 90mm		



	1		
GEV No.	105721	Ref. No.	35280500 35280600
description	burner head 3.6kW for burner cap ø 131mm		
For models:	G9F2ME, G9F2ME+A2, G9F4E+FE1, G9F4E+FE1+A4, G9F4E+FG1, G9F4E+FG1+A4, G9F4ME, G9F4ME+A4, G9F6E+FE1, G9F6E+FE1+A6, G9F6E+FG1, G9F6E+FG1+A6, G9F6ME, G9F6ME+A6		

	1		
GEV No.	105090	Ref. No.	31280200
description	burner head 3kW for burner cap ø 90mm		
For models:	G6F2B, G6F2B+A2, G6F2M, G6F2M+A2, G6F4+FE1, G6F4+FE1+A4, G6F4+FG1, G6F4+FG1+A4, G6F4B, G6F4B+A4, G6F4M, G6F4M+A4, G6F6+FE1, G6F6+FE1+A6, G6F6+FG1, G6F6+FG1+A6, G6F6+T, G6F6+T+A6, G6F6+TE, G6F6+TE+A6, G6F6B, G6F6B+A6, G6F6M, G6F6M+A6, G7F2BE, G7F2BE+A2, G7F2ME, G7F2ME+A2, G7F4BE, G7F4BE+A4, G7F4E+FE, G7F4E+FE+A4, G7F4E+FE1, G7F4E+FE1+A4, G7F4E+FG, G7F4E+FG+A4, G7F4E+FG1, G7F4E+FG1+A4, G7F4ME, G7F4ME+A4, G7F6BE, G7F6BE+A6, G7F6E+FE, G7F6E+FE+A6, G7F6E+FE1, G7F6E+FE1+A6, G7F6E+FG, G7F6E+FG+A4, G7F6E+F-G+A6, G7F6E+FG1...(Other models you can see in the webshop)		
accessories for	105090		
	GEV No.	104286	Ref. No. 31280400 31281000
	burner cap 3kW ø 90mm		
	GEV No.	104289	Ref. No. 31280100
	burner lower part 3/3.6kW for burner cap ø 90/120mm		
	GEV No.	105089	Ref. No. 31280300
	burner ring 3kW for burner cap ø 90mm		

	1		
GEV No.	105717	Ref. No.	35280100
description	burner lower part 3.6kW for igniter ø 6mm for thermocouple ø 6mm with nozzle ø 1.35mm ID ø 64mm for burner cap ø 61/131mm		
For models:	G9F2ME, G9F2ME+A2, G9F4E+FE1, G9F4E+FE1+A4, G9F4E+FG1, G9F4E+FG1+A4, G9F4ME, G9F4ME+A4, G9F6E+FE1, G9F6E+FE1+A6, G9F6E+FG1, G9F6E+FG1+A6, G9F6ME, G9F6ME+A6		
accessories for	105717		
	GEV No.	101277	Ref. No. —
	olive ID ø 8mm Qty 1 pcs		
	GEV No.	101477	Ref. No. —
	union screw thread M13x1 tube ø 8mm Qty 1 pcs		

 <p>1</p>			
GEV No.	104289	Ref. No.	31280100
description	burner lower part 3/3.6kW for burner cap ø 90/120mm		
For models:	G6F2B, G6F2B+A2, G6F2M, G6F2M+A2, G6F4+FE1, G6F4+FE1+A4, G6F4+FG1, G6F4+FG1+A4, G6F4B, G6F4B+A4, G6F4M, G6F4M+A4, G6F6+FE1, G6F6+FE1+A6, G6F6+FG1, G6F6+FG1+A6, G6F6+T, G6F6+T+A6, G6F6+TE, G6F6+TE+A6, G6F6B, G6F6B+A6, G6F6M, G6F6M+A6, G7F2BE, G7F2BE+A2, G7F2ME, G7F2ME+A2, G7F4BE, G7F4BE+A4, G7F4E+FE, G7F4E+FE+A4, G7F4E+FE1, G7F4E+FE1+A4, G7F4E+FG, G7F4E+FG+A4, G7F4E+FG1, G7F4E+FG1+A4, G7F4ME, G7F4ME+A4, G7F6BE, G7F6BE+A6, G7F6E+FE, G7F6E+FE+A6, G7F6E+FE1, G7F6E+FE1+A6, G7F6E+FG, G7F6E+FG+A4, G7F6E+FG+A6, G7F6E+FG1...(Other models you can see in the webshop)		
accessories for	104289		
	GEV No.	104286	Ref. No. 31280400 31281000
burner cap 3kW ø 90mm			
	GEV No.	104288	Ref. No. 31280700 31281300
burner cap 3.6kW ø 120mm			
	GEV No.	105086	Ref. No. 31280600
burner ring 3.6kW for burner cap ø 120mm			
	GEV No.	105087	Ref. No. 31280500
burner head 3.6kW for burner cap ø 120mm			
	GEV No.	105089	Ref. No. 31280300
burner ring 3kW for burner cap ø 90mm			
	GEV No.	105090	Ref. No. 31280200
burner head 3kW for burner cap ø 90mm			
	GEV No.	106482	Ref. No. —
gas injector thread M6x0.75 WS 7 bore ø 1.1mm			
	GEV No.	106485	Ref. No. —
gas injector thread M6x0.75 WS 7 bore ø 1.6mm			

 <p>1</p>			
GEV No.	105086	Ref. No.	31280600
description	burner ring 3.6kW for burner cap ø 120mm		
For models:	G6F2B, G6F2B+A2, G6F2M, G6F2M+A2, G6F4+FE1, G6F4+FE1+A4, G6F4+FG1, G6F4+FG1+A4, G6F4B, G6F4B+A4, G6F4M, G6F4M+A4, G6F6+FE1, G6F6+FE1+A6, G6F6+FG1, G6F6+FG1+A6, G6F6+T, G6F6+T+A6, G6F6+TE, G6F6+TE+A6, G6F6B, G6F6B+A6, G6F6M, G6F6M+A6, G7F2BE, G7F2BE+A2, G7F2ME, G7F2ME+A2, G7F4BE, G7F4BE+A4, G7F4E+FE, G7F4E+FE+A4, G7F4E+FE1, G7F4E+FE1+A4, G7F4E+FG, G7F4E+FG+A4, G7F4E+FG1, G7F4E+FG1+A4, G7F4ME, G7F4ME+A4, G7F6BE, G7F6BE+A6, G7F6E+FE, G7F6E+FE+A6, G7F6E+FE1, G7F6E+FE1+A6, G7F6E+FG, G7F6E+FG+A4, G7F6E+FG+A6, G7F6E+FG1...(Other models you can see in the webshop)		
accessories for	105086		
	GEV No.	105085	Ref. No. —
burner cap ø 120mm			
	GEV No.	105087	Ref. No. 31280500
burner head 3.6kW for burner cap ø 120mm			

accessories for	105086		
	GEV No.	105088	Ref. No. —
burner cap A ø 110mm with central hole			
	GEV No.	105089	Ref. No. 31280300
burner ring 3kW for burner cap ø 90mm			

 <p>1</p>			
GEV No.	105089	Ref. No.	31280300
description	burner ring 3kW for burner cap ø 90mm		
For models:	G6F2B, G6F2B+A2, G6F2M, G6F2M+A2, G6F4+FE1, G6F4+FE1+A4, G6F4+FG1, G6F4+FG1+A4, G6F4B, G6F4B+A4, G6F4M, G6F4M+A4, G6F6+FE1, G6F6+FE1+A6, G6F6+FG1, G6F6+FG1+A6, G6F6+T, G6F6+T+A6, G6F6+TE, G6F6+TE+A6, G6F6B, G6F6B+A6, G6F6M, G6F6M+A6, G7F2BE, G7F2BE+A2, G7F2ME, G7F2ME+A2, G7F4BE, G7F4BE+A4, G7F4E+FE, G7F4E+FE+A4, G7F4E+FE1, G7F4E+FE1+A4, G7F4E+FG, G7F4E+FG+A4, G7F4E+FG1, G7F4E+FG1+A4, G7F4ME, G7F4ME+A4, G7F6BE, G7F6BE+A6, G7F6E+FE, G7F6E+FE+A6, G7F6E+FE1, G7F6E+FE1+A6, G7F6E+FG, G7F6E+FG+A4, G7F6E+FG+A6, G7F6E+FG1...(Other models you can see in the webshop)		
accessories for	105089		
	GEV No.	104286	Ref. No. 31280400 31281000
burner cap 3kW ø 90mm			
	GEV No.	104289	Ref. No. 31280100
burner lower part 3/3.6kW for burner cap ø 90/120mm			
	GEV No.	105090	Ref. No. 31280200
burner head 3kW for burner cap ø 90mm			

700 Macros, 900 Maxima (2) series

 <p>1</p>			
GEV No.	106934	Ref. No.	31834100
description	air mixing sleeve ID ø 42mm H 40mm		



 <p>1</p>			
GEV No.	105095	Ref. No.	31954400
description	burner cap ø 80mm 3.5kW		
For models:	G12F4H9+FGP, G12F4H9M, G6F2B, G6F2B+A2, G6F2BH6, G6F2BH9, G6F2H6+FE1, G6F2H6+FG1, G6F2H9+FE1, G6F2H9+FG1, G6F2H9+T, G6F2H9+TE, G6F2MH6, G6F2MH9, G6F2P9+TE, G6F3BH9, G6F3H9+T, G6F4B, G6F4B+A4, G6F6B, G6F6B+A6, G7F2B, G7F2M, G7F4+FE, G7F4+FE1, G7F4+FES, G7F4+FG, G7F4+FG1, G7F4B, G7F4M, G7F6+FE, G7F6+FE1, G7F6+FES, G7F6+FG, G7F6+FG1, G7F6+T, G7F6B, G7F6M, G7T4P2F+FG1, G7T4P2FB, G7T4P2FM, G7T4P4F+FG, G7T4P4F+FG1, G7T4P4FB, G7T4P4FM, G7TP2F+FG, G7TP2F+FG1, G7TP2F+T, G7TP2FM, G9F2M...(Other models you can see in the webshop)		
accessories for	105095		
	GEV No.	105094	Ref. No. 31913600
burner holder 3.5/6kW for burner cap ø 80/110mm			
	GEV No.	105096	Ref. No. 31807200
burner head 3.5kW for burner cap ø 80mm			

Table continues overleaf





accessories for	105095		
	GEV No.	105097	Ref. No. 32327600
	nozzle holder nozzle mounting M10x1 tube ø 10mm gas inlet M16x1.5 gas outlet M14x1		



GEV No.	105092	Ref. No.	31954300
description	burner cap with central hole ø 110mm 6kW		
For models:	G12F4H9+FGP, G12F4H9M, G6F2B, G6F2B+A2, G6F2BH6, G6F2BP6, G6F2H6+FE1, G6F2H6+FG1, G6F2MH6, G6F2MP6, G6F2P6+FE1, G6F2P6+FG1, G6F3BH12, G6F3BH9, G6F3H12+FE1, G6F3H12+FG1, G6F3H12+T, G6F3H12+TE, G6F3H9+T, G6F3MH12, G6F4B, G6F4B+A4, G6F6B, G6F6B+A6, G7F2B, G7F2BP, G7F2M, G7F2MP, G7F4+FE, G7F4+FE1, G7F4+FES, G7F4+FG, G7F4+FG1, G7F4B, G7F4BP, G7F4M, G7F4MP, G7F4P+FG, G7F4P+FG+AF2, G7F4P+FG1, G7F4P+FG1+AF1, G7F6+FE, G7F6+FE1, G7F6+FES, G7F6+FG, G7F6+FG1, G7F6+T, G7F6B, G7F6BP, G7F6M...(Other models you can see in the webshop)		

accessories for	105092		
	GEV No.	105093	Ref. No. 31807000
	burner head 6kW for burner cap ø 110mm		

	GEV No.	105097	Ref. No. 32327600
	nozzle holder nozzle mounting M10x1 tube ø 10mm gas inlet M16x1.5 gas outlet M14x1		

	GEV No.	107691	Ref. No. 35912600
	burner holder D/E ø 33mm for burner cap ø 130/140mm		



GEV No.	105726	Ref. No.	35954300
description	burner cap with central hole ø 130mm 9kW		
For models:	G12F4H9M, G12F4P9+FGP, G12F4P9M, G6F2BH9, G6F2BP9, G6F2H9+FE1, G6F2H9+FG1, G6F2H9+T, G6F2H9+TE, G6F2MH9, G6F2MP9, G6F2P9+FE1, G6F2P9+FG1, G6F2P9+T, G6F2P9+TE, G6F3BH12, G6F3BH9, G6F3H12+FE1, G6F3H12+FG1, G6F3H12+T, G6F3H12+TE, G6F3H9+T, G6F3MH12, G9F2M, G9F2MP, G9F4+FE, G9F4+FE1, G9F4+FG, G9F4+FG1, G9F4M, G9F4MP, G9F4P+FG, G9F4P+FG+AF2, G9F4P+FG1, G9F4P+FG1+AF1, G9F6+FE, G9F6+FE1, G9F6+FG, G9F6+FG1, G9F6+T, G9F6M, G9F6MP, G9F6P+FG, G9F6P+FG+AF2, G9F6P+FG1, G9F6P+T, G9F6P+T+AF2, G9F8+2FE, G9F8+2FE1, G9F8+2FG...(Other models you can see in the webshop)		

accessories for	105726		
	GEV No.	105097	Ref. No. 32327600
	nozzle holder nozzle mounting M10x1 tube ø 10mm gas inlet M16x1.5 gas outlet M14x1		

	GEV No.	105725	Ref. No. 35807000
	burner head 9kW for burner cap ø 130mm		

	GEV No.	105727	Ref. No. 31781300 31782500
	bar burner angled ømm W 240mm Hmm L 560mm oven		

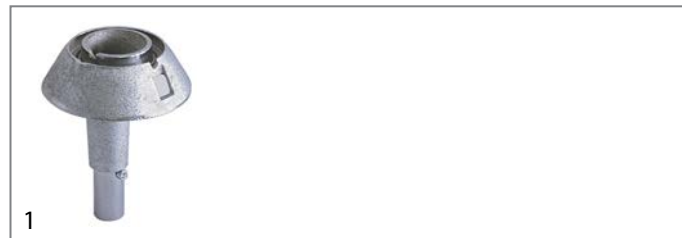

GEV No.	105096	Ref. No.	31807200
description	burner head 3.5kW for burner cap ø 80mm		
For models:	G12F4H9+FGP, G12F4H9M, G6F2B, G6F2B+A2, G6F2BH6, G6F2BH9, G6F2H6+FE1, G6F2H6+FG1, G6F2H9+FE1, G6F2H9+FG1, G6F2H9+T, G6F2H9+TE, G6F2MH6, G6F2MH9, G6F2P9+TE, G6F3BH9, G6F3H9+T, G6F4B, G6F4B+A4, G6F6B, G6F6B+A6, G7F2B, G7F2M, G7F4+FE, G7F4+FE1, G7F4+FES, G7F4+FG, G7F4+FG1, G7F4B, G7F4M, G7F6+FE, G7F6+FE1, G7F6+FES, G7F6+FG, G7F6+FG1, G7F6+T, G7F6B, G7F6M, G7T4P2F+FG1, G7T4P2FB, G7T4P2FM, G7T4P4F+FG, G7T4P4F+FG1, G7T4P4FB, G7T4P4FM, G7TP2F+FG, G7TP2F+FG1, G7TP2F+T, G7TP2FM, G9F2M...(Other models you can see in the webshop)		

accessories for	105096		
	GEV No.	105094	Ref. No. 31913600
	burner holder 3.5/6kW for burner cap ø 80/110mm		

	GEV No.	105096	Ref. No. 31807200
	burner head 3.5kW for burner cap ø 80mm		

	GEV No.	105097	Ref. No. 32327600
	nozzle holder nozzle mounting M10x1 tube ø 10mm gas inlet M16x1.5 gas outlet M14x1		







GEV No.	105093	Ref. No.	31807000
description	burner head 6kW for burner cap ø 110mm		
For models:	G12F4H9+FGP, G12F4H9M, G6F2B, G6F2B+A2, G6F2BH6, G6F2BP6, G6F2H6+FE1, G6F2H6+FG1, G6F2MH6, G6F2MP6, G6F2P6+FE1, G6F2P6+FG1, G6F3BH12, G6F3BH9, G6F3H12+FE1, G6F3H12+FG1, G6F3H12+T, G6F3H12+TE, G6F3H9+T, G6F3MH12, G6F4B, G6F4B+A4, G6F6B, G6F6B+A6, G7F2B, G7F2BP, G7F2M, G7F2MP, G7F4+FE, G7F4+FE1, G7F4+FES, G7F4+FG, G7F4+FG1, G7F4B, G7F4BP, G7F4M, G7F4MP, G7F4P+FG, G7F4P+FG+AF2, G7F4P+FG1, G7F4P+FG1+AF1, G7F6+FE, G7F6+FE1, G7F6+FES, G7F6+FG, G7F6+FG1, G7F6+T, G7F6B, G7F6BP, G7F6M...(Other models you can see in the webshop)		





accessories for	105093		
	GEV No.	105092	Ref. No. 31954300
	burner cap with central hole ø 110mm 6kW		

	GEV No.	105093	Ref. No. 31807000
	burner head 6kW for burner cap ø 110mm		

	GEV No.	105097	Ref. No. 32327600
	nozzle holder nozzle mounting M10x1 tube ø 10mm gas inlet M16x1.5 gas outlet M14x1		

			
GEV No.	105725	Ref. No.	35807000
description	burner head 9kW for burner cap ø 130mm		
For models:	G12F4H9+FGP, G12F4H9M, G12F4P9+FGP, G12F4P9M, G6F2BH9, G6F2BP9, G6F2H9+FE1, G6F2H9+FG1, G6F2H9+T, G6F2H9+TE, G6F2MH9, G6F2MP9, G6F2P9+FE1, G6F2P9+FG1, G6F2P9+T, G6F2P9+TE, G6F3BH12, G6F3BH9, G6F3H12+FE1, G6F3H12+FG1, G6F3H12+T, G6F3H12+TE, G6F3H9+T, G6F3MH12, G9F2M, G9F2MP, G9F4+FE, G9F4+FE1, G9F4+FG, G9F4+FG1, G9F4M, G9F4MP, G9F4P+FG, G9F4P+FG+AF2, G9F4P+FG1, G9F4P+FG1+AF1, G9F6+FE, G9F6+FE1, G9F6+FG, G9F6+FG1, G9F6+T, G9F6M, G9F6MP, G9F6P+FG, G9F6P+FG+AF2, G9F6P+FG1, G9F6P+T, G9F6P+T+AF2, G9F8+2FE, G9F8+2FE1...(Other models you can see in the webshop)		
accessories for	105725		
	GEV No.	105097	Ref. No. 32327600
	nozzle holder nozzle mounting M10x1 tube ø 10mm gas inlet M16x1.5 gas outlet M14x1		
	GEV No.	105724	Ref. No. 35974400
	pilot burner bracket		
	GEV No.	105726	Ref. No. 35954300
	burner cap with central hole ø 130mm 9kW		

			
GEV No.	105094	Ref. No.	31913600
description	burner holder 3.5/6kW for burner cap ø 80/110mm		
For models:	G12F4H9+FGP, G12F4H9M, G6F2B, G6F2B+A2, G6F2BH6, G6F2BH9, G6F2BP6, G6F2H6+FE1, G6F2H6+FG1, G6F2H9+FE1, G6F2H9+FG1, G6F2H9+T, G6F2H9+TE, G6F2MH6, G6F2MH9, G6F2MP6, G6F2P6+FE1, G6F2P6+FG1, G6F2P9+FG1, G6F2P9+T, G6F2P9+TE, G6F3BH12, G6F3BH9, G6F3H12+FE1, G6F3H12+FG1, G6F3H12+T, G6F3H12+TE, G6F3H9+T, G6F3MH12, G6F4B, G6F4B+A4, G6F6B, G6F6B+A6, G7F2B, G7F2BP, G7F2M, G7F2MP, G7F4+FE, G7F4+FE1, G7F4+FG, G7F4+FG1, G7F4B, G7F4BP, G7F4E+FG, G7F4E+FG+A4, G7F4M, G7F4MP, G7F4P+FG, G7F4P+FG+AF2...(Other models you can see in the webshop)		
accessories for	105094		
	GEV No.	105095	Ref. No. 31954400
	burner cap ø 80mm 3.5kW		
	GEV No.	105096	Ref. No. 31807200
	burner head 3.5kW for burner cap ø 80mm		
	GEV No.	105097	Ref. No. 32327600
	nozzle holder nozzle mounting M10x1 tube ø 10mm gas inlet M16x1.5 gas outlet M14x1		

			
GEV No.	105716	Ref. No.	35913600
description	burner holder 9kW for burner cap ø 130mm		
For models:	G12F4H9+FGP, G12F4H9M, G12F4P9+FGP, G12F4P9M, G6F2H9+FE1, G6F2H9+FG1, G6F2H9+T, G6F2H9+TE, G6F2P9+FE1, G6F2P9+FG1, G6F2P9+T, G6F2P9+TE, G6F3BH12, G6F3BH9, G6F3H12+FE1, G6F3H12+FG1, G6F3H12+T, G6F3H12+TE, G6F3H9+T, G6F3MH12, G9F2M, G9F2MP, G9F4+FE, G9F4+FE1, G9F4+FG, G9F4+FG1, G9F4M, G9F4MP, G9F4P+FG, G9F4P+FG+AF2, G9F4P+FG1, G9F4P+FG1+AF1, G9F6+FE, G9F6+FE1, G9F6+FG, G9F6+FG1, G9F6+T, G9F6M, G9F6MP, G9F6P+FG, G9F6P+FG+AF2, G9F6P+FG1, G9F6P+T, G9F6P+T+AF2, G9F8+2FE, G9F8+2FE1, G9F8+2FG, G9F8+2FG1, G9F8P+2FG, G9F8P+2FG+AF2...(Other models you can see in the webshop)		
accessories for	105716		
	GEV No.	105092	Ref. No. 31954300
	burner cap with central hole ø 110mm 6kW		
	GEV No.	105093	Ref. No. 31807000
	burner head 6kW for burner cap ø 110mm		
	GEV No.	105097	Ref. No. 32327600
	nozzle holder nozzle mounting M10x1 tube ø 10mm gas inlet M16x1.5 gas outlet M14x1		
	GEV No.	105725	Ref. No. 35807000
	burner head 9kW for burner cap ø 130mm		













			
GEV No.	106918	Ref. No.	31912400
description	burner holder ø 30mm D for burner cap ø 110mm		
For models:	CPG40, CPG40E, CPG80, CPG80E, E9F15-4M, E9F15-8M, E9F18-4M, E9F18-8M, G6CP6, G6F2B, G6F2B+A2, G6F2BH6, G6F2BH9, G6F2BP6, G6F2BP9, G6F2H6+FE1, G6F2H6+FG1, G6F2H9+FE1, G6F2H9+FG1, G6F2H9+T, G6F2H9+TE, G6F2MH6, G6F2MH9, G6F2MP6, G6F2P6+FE1, G6F2P6+FG1, G6F2P9+FE1, G6F2P9+FG1, G6F2P9+T, G6F2P9+TE, G6F3BH12, G6F3BH9, G6F3H12+FE1, G6F3H12+FG1, G6F3H12+T, G6F3H12+TE, G6F3MH12, G6F4B, G6F4B+A4, G6F6B, G6F6B+A6, G6FL3B, G6FL3B-CR, G6FL3B-SX, G6FL3M, G6FL3M-CR, G6FL3M-SX, G6FL6B, G6FL6B-CR, G6FL6B-SX...(Other models you can see in the webshop)		
accessories for	105097		
	GEV No.	105094	Ref. No. 31913600
	burner holder 3.5/6kW for burner cap ø 80/110mm		
	GEV No.	105724	Ref. No. 35974400
	pilot burner bracket		

Table continues overleaf











accessories for	105097		
	GEV No.	107691	Ref. No. 35912600
	burner holder D/E ø 33mm for burner cap ø 130/140mm		
	GEV No.	107934	Ref. No. 32811500
	nut H 5mm thread M14x1 WS 17		





Modulare Systeme (1) series			
	1		
GEV No.	103068	Ref. No.	22294500
description	burner cap ø 100mm		
For models:	G2FS4, G4F+FCD8, G4F+FSD8, G4FD8		
accessories for	103068		
	GEV No.	103067	Ref. No. 22285300
	burner ring for burner cap ø 100mm		
	GEV No.	104102	Ref. No. 22283200
	burner head for burner cap ø 100mm ext. ø 130		
	GEV No.	104103	Ref. No. 22993100
	burner holder suitable for burner ø 100mm with nozzle holder		





	1		
GEV No.	103066	Ref. No.	22294100
description	burner cap ø 80mm		
For models:	G2FS4, G4F+FCD8, G4F+FSD8, G4FD8		
accessories for	103066		
	GEV No.	103065	Ref. No. 22284800
	burner ring for burner cap ø 80mm		
	GEV No.	104100	Ref. No. 22282700
	burner head for burner cap ø 80mm		
	GEV No.	104101	Ref. No. 22992900
	burner holder for burner cap ø 80mm with nozzle holder with mixing sleeve		





	1		
GEV No.	104102	Ref. No.	22283200
description	burner head for burner cap ø 100mm ext. ø 130		
For models:	G2FS4, G4F+FCD8, G4F+FSD8, G4FD8		

	1		
GEV No.	104100	Ref. No.	22282700
description	burner head for burner cap ø 80mm		
For models:	G2FS4, G4F+FCD8, G4F+FSD8, G4FD8		
accessories for	104100		
	GEV No.	103065	Ref. No. 22284800
	burner ring for burner cap ø 80mm		
	GEV No.	103066	Ref. No. 22294100
	burner cap ø 80mm		
	GEV No.	104103	Ref. No. 22993100
	burner holder suitable for burner ø 100mm with nozzle holder		



	1		
GEV No.	104101	Ref. No.	22992900
description	burner holder for burner cap ø 80mm with nozzle holder with mixing sleeve		
For models:	G4F+FCD8, G4F+FSD8		
accessories for	104101		
	GEV No.	103065	Ref. No. 22284800
	burner ring for burner cap ø 80mm		
	GEV No.	103066	Ref. No. 22294100
	burner cap ø 80mm		
	GEV No.	104100	Ref. No. 22282700
	burner head for burner cap ø 80mm		









	1		
GEV No.	104103	Ref. No.	22993100
description	burner holder suitable for burner ø 100mm with nozzle holder		
For models:	G4F+FCD8, G4F+FSD8		
accessories for	104103		
	GEV No.	103067	Ref. No. 22285300
	burner ring for burner cap ø 100mm		
	GEV No.	103068	Ref. No. 22294500
	burner cap ø 100mm		
	GEV No.	104102	Ref. No. 22283200
	burner head for burner cap ø 100mm ext. ø 130		

			
1			
GEV No.	103067	Ref. No.	22285300
description	burner ring for burner cap ø 100mm		
For models:	G2FS4, G4F+FCD8, G4F+FSD8, G4FD8		
accessories for	103067		
	GEV No.	103068	Ref. No. 22294500
	burner cap ø 100mm		
	GEV No.	104102	Ref. No. 22283200
	burner head for burner cap ø 100mm ext. ø 130		
	GEV No.	104103	Ref. No. 22993100
	burner holder suitable for burner ø100mm with nozzle holder		

			
1			
GEV No.	103065	Ref. No.	22284800
description	burner ring for burner cap ø 80mm		
For models:	G2FS4, G4F+FCD8, G4F+FSD8, G4FD8		
accessories for	103065		
	GEV No.	103066	Ref. No. 22294100
	burner cap ø 80mm		
	GEV No.	104100	Ref. No. 22282700
	burner head for burner cap ø 80mm		
	GEV No.	104101	Ref. No. 22992900
	burner holder for burner cap ø 80mm with nozzle holder with mixing sleeve		

Modulare Systeme (2) series			
			
1			
GEV No.	103069	Ref. No.	22293700
description	burner cap ø 80mm 4.3kW with central hole		
For models:	G2FS4-S, G4FD8-S, G4S+FCGN, G4S+FSGN, G6F12-S, G6S+FCGN, G6S+FSGN		
accessories for	103069		
	GEV No.	100907	Ref. No. —
	screw connection thread M10x1 Qty 1 pcs type SEF 1 ømm for thermocouple		
	GEV No.	101452	Ref. No. —
	ignition electrode support for burner type C/D suitable for 900 series		
	GEV No.	101453	Ref. No. —
	bracket for thermocouple gas range for burner type C/D suitable for 900 series		
	GEV No.	101454	Ref. No. —
	union screw for igniter thread M10x1 ID ø 7mm L 15mm		
	GEV No.	104104	Ref. No. 22280300
	burner head for burner cap ø 80mm 3.5kW code 100212		

accessories for	103069		
	GEV No.	104105	Ref. No. 22993300
	burner lower part for burner cap ø 80mm 3.5kW		
	GEV No.	104108	Ref. No. 22913400
	nozzle holder nozzle mounting M10x1 tube ø 10mm gas inlet M16x1.5 gas outlet M14x1		
	GEV No.	105297	Ref. No. —
	burner head for burner cap ø 80mm 4.3kW for pilot burner		

			
1			
GEV No.	103070	Ref. No.	22293900
description	burner cap ø 95mm 6.4kW with central hole		
For models:	G2FS4-S, G4FD8-S, G4S+FCGN, G4S+FSGN, G6F12-S, G6S+FCGN, G6S+FSGN		
accessories for	103070		
	GEV No.	100907	Ref. No. —
	screw connection thread M10x1 Qty 1 pcs type SEF 1 ømm for thermocouple		
	GEV No.	101452	Ref. No. —
	ignition electrode support for burner type C/D suitable for 900 series		
	GEV No.	101453	Ref. No. —
	bracket for thermocouple gas range for burner type C/D suitable for 900 series		
	GEV No.	101454	Ref. No. —
	union screw for igniter thread M10x1 ID ø 7mm L 15mm		
	GEV No.	104106	Ref. No. 22280400
	burner head for burner cap ø 100mm 5.5kW for igniter		
	GEV No.	104107	Ref. No. 22993400
	burner lower part for burner cap ø 100mm 6.4kW		
	GEV No.	104108	Ref. No. 22913400
	nozzle holder nozzle mounting M10x1 tube ø 10mm gas inlet M16x1.5 gas outlet M14x1		











			
1			
GEV No.	104106	Ref. No.	22280400
description	burner head for burner cap ø 100mm 5.5kW for igniter		
For models:	G2FS4-S, G4FD8-S, G4S+FCGN, G4S+FSGN, G6F12-S, G6S+FCGN, G6S+FSGN		
accessories for	104106		
	GEV No.	100907	Ref. No. —
	screw connection thread M10x1 Qty 1 pcs type SEF 1 ømm for thermocouple		
	GEV No.	101452	Ref. No. —
	ignition electrode support for burner type C/D suitable for 900 series		
	GEV No.	101453	Ref. No. —
	bracket for thermocouple gas range for burner type C/D suitable for 900 series		





Table continues overleaf



accessories for		104106		
	GEV No.	101454	Ref. No.	—
union screw for igniter thread M10x1 ID ø 7mm L 15mm				
	GEV No.	103070	Ref. No.	22293900
burner cap ø 95mm 6.4kW with central hole				
	GEV No.	104107	Ref. No.	22993400
burner lower part for burner cap ø 100mm 6.4kW				
	GEV No.	104108	Ref. No.	22913400
nozzle holder nozzle mounting M10x1 tube ø 10mm gas inlet M16x1.5 gas outlet M14x1				





				
1				
GEV No.	104104	Ref. No.	22280300	
description	burner head for burner cap ø 80mm 3.5kW code 100212			
For models:	G2FS4-S, G4FD8-S, G4S+FCGN, G4S+FSGN, G6F12-S, G6S+FCGN, G6S+FSGN			
accessories for		104104		
	GEV No.	100907	Ref. No.	—
screw connection thread M10x1 Qty 1 pcs type SEF 1 ømm for thermocouple				
	GEV No.	101452	Ref. No.	—
ignition electrode support for burner type C/D suitable for 900 series				
	GEV No.	101453	Ref. No.	—
bracket for thermocouple gas range for burner type C/D suitable for 900 series				
	GEV No.	101454	Ref. No.	—
union screw for igniter thread M10x1 ID ø 7mm L 15mm				
	GEV No.	103069	Ref. No.	22293700
burner cap ø 80mm 4.3kW with central hole				
	GEV No.	104105	Ref. No.	22993300
burner lower part for burner cap ø 80mm 3.5kW				
	GEV No.	104108	Ref. No.	22913400
nozzle holder nozzle mounting M10x1 tube ø 10mm gas inlet M16x1.5 gas outlet M14x1				

				
1				
GEV No.	104107	Ref. No.	22993400	
description	burner lower part for burner cap ø 100mm 6.4kW			
For models:	G2FS4-S, G4FD8-S, G4S+FCGN, G4S+FSGN, G6F12-S, G6S+FCGN, G6S+FSGN			
accessories for		104107		
	GEV No.	100907	Ref. No.	—
screw connection thread M10x1 Qty 1 pcs type SEF 1 ømm for thermocouple				
	GEV No.	101452	Ref. No.	—
ignition electrode support for burner type C/D suitable for 900 series				

accessories for		104107		
	GEV No.	101453	Ref. No.	—
bracket for thermocouple gas range for burner type C/D suitable for 900 series				
	GEV No.	101454	Ref. No.	—
union screw for igniter thread M10x1 ID ø 7mm L 15mm				
	GEV No.	103070	Ref. No.	22293900
burner cap ø 95mm 6.4kW with central hole				
	GEV No.	104106	Ref. No.	22280400
burner head for burner cap ø 100mm 5.5kW for igniter				
	GEV No.	104108	Ref. No.	22913400
nozzle holder nozzle mounting M10x1 tube ø 10mm gas inlet M16x1.5 gas outlet M14x1				



				
1				
GEV No.	104105	Ref. No.	22993300	
description	burner lower part for burner cap ø 80mm 3.5kW			
For models:	G2FS4-S, G4FD8-S, G4S+FCGN, G4S+FSGN, G6F12-S, G6S+FCGN, G6S+FSGN			
accessories for		104105		
	GEV No.	100907	Ref. No.	—
screw connection thread M10x1 Qty 1 pcs type SEF 1 ømm for thermocouple				
	GEV No.	101452	Ref. No.	—
ignition electrode support for burner type C/D suitable for 900 series				
	GEV No.	101453	Ref. No.	—
bracket for thermocouple gas range for burner type C/D suitable for 900 series				
	GEV No.	101454	Ref. No.	—
union screw for igniter thread M10x1 ID ø 7mm L 15mm				
	GEV No.	103069	Ref. No.	22293700
burner cap ø 80mm 4.3kW with central hole				
	GEV No.	104104	Ref. No.	22280300
burner head for burner cap ø 80mm 3.5kW code 100212				
	GEV No.	104108	Ref. No.	22913400
nozzle holder nozzle mounting M10x1 tube ø 10mm gas inlet M16x1.5 gas outlet M14x1				
	GEV No.	105297	Ref. No.	—
burner head for burner cap ø 80mm 4.3kW for pilot burner				





	1			
GEV No.	104108	Ref. No.	22913400	
description	nozzle holder nozzle mounting M10x1 tube ø 10mm gas inlet M16x1.5 gas outlet M14x1			
For models:	G2F54-S, G4FD8-S, G4S+FCGN, G4S+FSGN, G6F12-S, G6S+FCGN, G6S+FSGN			
accessories for	104108			
	GEV No.	102382	Ref. No.	—
	nut thread M14x1 H 3.5mm WS 18 brass Qty 1 pcs			
	GEV No.	104105	Ref. No.	22993300
	burner lower part for burner cap ø 80mm 3.5kW			
	GEV No.	104107	Ref. No.	22993400
	burner lower part for burner cap ø 100mm 6.4kW			

S900 series



	1			
GEV No.	105826	Ref. No.	31954800	
description	burner cap C ø 82mm 3.5kW			





	1			
GEV No.	106713	Ref. No.	35954200	
description	burner cap E ø 140mm 12kW			
accessories for	106713			
	GEV No.	106714	Ref. No.	35806800
	burner head E ø 130mm for burner cap ø 140mm 12kW			

	1			
GEV No.	106933	Ref. No.	31954700	
description	burner cap ø 110mm 7kW			

	1			
GEV No.	106827	Ref. No.	31808200	
description	burner head C for burner cap ø 82mm 3.5kW			

	1			
GEV No.	106917	Ref. No.	31807100	
description	burner head D ø 140mm for burner cap ø 110mm 7kW			

	1			
GEV No.	106714	Ref. No.	35806800	
description	burner head E ø 130mm for burner cap ø 140mm 12kW			
accessories for	106714			
	GEV No.	106713	Ref. No.	35954200
	burner cap E ø 140mm 12kW			

	1			
GEV No.	105094	Ref. No.	31913600	
description	burner holder 3.5/6kW for burner cap ø 80/110mm			
For models:	G12F4H9+FGP, G12F4H9M, G6F2B, G6F2B+A2, G6F2BH6, G6F2BH9, G6F2BP6, G6F2H6+FE1, G6F2H6+FG1, G6F2H9+FE1, G6F2H9+FG1, G6F2H9+T, G6F2H9+TE, G6F2MH6, G6F2MH9, G6F2MP6, G6F2P6+FE1, G6F2P6+FG1, G6F2P9+FG1, G6F2P9+T, G6F2P9+TE, G6F3BH12, G6F3BH9, G6F3H12+FE1, G6F3H12+FG1, G6F3H12+T, G6F3H12+TE, G6F3H9+T, G6F3MH12, G6F4B, G6F4B+A4, G6F6B, G6F6B+A6, G7F2B, G7F2BP, G7F2M, G7F2MP, G7F4+FE, G7F4+FE1, G7F4+FES, G7F4+FG, G7F4+FG1, G7F4B, G7F4BP, G7F4E+FG, G7F4E+FG+A4, G7F4M, G7F4MP, G7F4P+FG, G7F4P+FG+AF2...(Other models you can see in the webshop)			
accessories for	105094			
	GEV No.	105095	Ref. No.	31954400
	burner cap ø 80mm 3.5kW			
	GEV No.	105096	Ref. No.	31807200
	burner head 3.5kW for burner cap ø 80mm			
	GEV No.	105097	Ref. No.	32327600
	nozzle holder nozzle mounting M10x1 tube ø 10mm gas inlet M16x1.5 gas outlet M14x1			





			
1			
GEV No.	107691	Ref. No.	35912600
description	burner holder D/E ø 33mm for burner cap ø 130/140mm		

			
1			
GEV No.	106918	Ref. No.	31912400
description	burner holder ø 30mm D for burner cap ø 110mm		

pan supports

			
1			
GEV No.	210142	Ref. No.	31856500
description	pan support		
For models:	G6F2B, G6F2B+A2, G6F4B, G6F4B+A4, G6F6B, G6F6B+A6, G7F2B, G7F2M, G7F4+FE, G7F4+FE1, G7F4+FES, G7F4+FG, G7F4+FG1, G7F4B, G7F4M, G7F6+FE, G7F6+FE1, G7F6+FES, G7F6+FG, G7F6+FG1, G7F6B, G7F6M, G7T4P2F+FG1, G7T4P2FB, G7T4P2FM, G7T4P4F+FG, G7T4P4F+FG1, G7T4P4FB, G7T4P4FM, G7TP2F+FG, G7TP2F+FG1, G7TP2F+T, G7TP2FM		

			
1			
GEV No.	210061	Ref. No.	35856700 35858700
description	pan support L 380mm W 380mm 1 flame		
For models:	G9F2ME, G9F2ME+A2, G9F2MPW, G9F2MPW+AE, G9F4E+FE1, G9F4E+FE1+A4, G9F4E+FG1, G9F4E+FG1+A4, G9F4ME, G9F4ME+A4, G9F4MPW, G9F4MPW+AE, G9F4PW+FE, G9F4PW+FE+AE, G9F4PW+FE1, G9F4PW+FE1+AE, G9F4PW+FG, G9F4PW+FG+AE, G9F4PW+FG1, G9F4PW+FG1+AE, G9F6E+FE1, G9F6E+FE1+A6, G9F6E+FG1, G9F6E+FG1+A6, G9F6ME, G9F6ME+A6, G9F6MPW, G9F6MPW+AE, G9F6PW+FE, G9F6PW+FE+AE, G9F6PW+FE1, G9F6PW+FE1+AE, G9F6PW+FG, G9F6PW+FG+AE, G9F6PW+FG1, G9F6PW+FG1+AE, G9F6PW+T, G9F6PW+T+AE		

			
1			
GEV No.	210136	Ref. No.	31856600
description	pan support W 340mm L 560mm		
For models:	G7F2BE, G7F2BE+A2, G7F2ME, G7F2ME+A2, G7F4BE, G7F4BE+A4, G7F4E+FE, G7F4E+FE+A4, G7F4E+FE1, G7F4E+FE1+A4, G7F4E+FG, G7F4E+FG+A4, G7F4E+FG1, G7F4E+FG1+A4, G7F4ME, G7F4ME+A4, G7F6BE, G7F6BE+A6, G7F6E+FE, G7F6E+FE+A6, G7F6E+FE1, G7F6E+FE1+A6, G7F6E+FG, G7F6E+FG+A4, G7F6E+FG1, G7F6E+FG1+A4, G7F6E+FG1+A6, G7F6E+T		

			
1			
GEV No.	210253	Ref. No.	31856700
description	pan support W 345mm L 560mm		
For models:	G7F2BE, G7F2BE+A2, G7F2BPW, G7F2BPW+AE, G7F2BPW-F, G7F2ME, G7F2ME+A2, G7F2MPW, G7F2MPW+AE, G7F4BE, G7F4BE+A4, G7F4BPW, G7F4BPW+AE, G7F4E+FE, G7F4E+FE+A4, G7F4E+FE1, G7F4E+FE1+A4, G7F4E+FG, G7F4E+FG+A4, G7F4E+FG1, G7F4E+FG1+A4, G7F4ME, G7F4ME+A4, G7F4MPW, G7F4MPW+AE, G7F4PW+FE, G7F4PW+FE+AE, G7F4PW+FE1, G7F4PW+FE1+AE, G7F4PW+FG, G7F4PW+FG+AE, G7F4PW+FG1, G7F4PW+FG1+AE, G7F6BE, G7F6BE+A6, G7F6BPW, G7F6BPW+AE, G7F6E+FE, G7F6E+FE+A6, G7F6E+FE1, G7F6E+FE1+A6, G7F6E+FG, G7F6E+FG+A6, G7F6E+FG1, G7F6E+FG1+A6, G7F6ME, G7F6ME+A6, G7F6MPW, G7F6MPW+AE, G7F6PW+FE...(Other models you can see in the webshop)		

			
1			
GEV No.	210252	Ref. No.	31856200
description	pan support W 365mm L 580mm		
For models:	G6F2BH6, G6F2BP6, G6F2H6+FE1, G6F2H6+FG1, G6F2MH6, G6F2MP6, G6F2P6+FE1, G6F2P6+FG1, G7F2BP, G7F2MP, G7F4+FE1, G7F4+FG, G7F4+FG1, G7F4BP, G7F4MP, G7F4P+FG, G7F4P+FG+AF2, G7F4P+FG1, G7F4P+FG1+AF1, G7F6+FE1, G7F6+FG, G7F6+FG1, G7F6+T, G7F6BP, G7F6MP, G7F6P+FG, G7F6P+FG+AF2, G7F6P+FG1, G7F6P+FG1+AF1, G7F6P+T, G7F6P+T+AF2		



1

GEV No.	210161	Ref. No.	22642300
description	pan support W 385mm L 580mm		
For models:	G2FS4-S, G4FD8-S, G4S+FCGN, G4S+FSGN, G6F12-S, G6S+FCGN, G6S+FSGN		



1

GEV No.	210215	Ref. No.	35856500 35856600 38856700
description	pan support W 390mm L 390mm		
For models:	G12F4H9+FGP, G12F4H9M, G12F4P9+FGP, G12F4P9M, G6F2BH9, G6F2BP9, G6F2H9+FE1, G6F2H9+FG1, G6F2H9+T, G6F2H9+TE, G6F2MH9, G6F2MP9, G6F2P9+FE1, G6F2P9+FG1, G6F2P9+T, G6F2P9+TE, G6F3BH12, G6F3H12+FE1, G6F3H12+FG1, G6F3H12+T, G6F3H12+TE, G6F3MH12, G9F2M, G9F2MP, G9F4+FE, G9F4+FE1, G9F4+FG, G9F4+FG1, G9F4M, G9F4MP, G9F4P+FG, G9F4P+FG+AF2, G9F4P+FG1, G9F4P+FG1+AF1, G9F6+FE, G9F6+FE1, G9F6+FG, G9F6+FG1, G9F6+T, G9F6M, G9F6MP, G9F6P+FG, G9F6P+FG+AF2, G9F6P+FG1, G9F6P+T, G9F6P+T+AF2, G9F8+2FE, G9F8+2FE1, G9F8+2FG, G9F8+2FG1...(Other models you can see in the webshop)		

accessories

pan supports



1

GEV No.	210142	Ref. No.	31856500
description	pan support		
For models:	G6F2B, G6F2B+A2, G6F4B, G6F4B+A4, G6F6B, G6F6B+A6, G7F2B, G7F2M, G7F4+FE, G7F4+FE1, G7F4+FES, G7F4+FG, G7F4+FG1, G7F4B, G7F4M, G7F6+FE, G7F6+FE1, G7F6+FES, G7F6+FG, G7F6+FG1, G7F6B, G7F6M, G7T4P2F+FG1, G7T4P2FB, G7T4P2FM, G7T4P4F+FG, G7T4P4F+FG1, G7T4P4FB, G7T4P4FM, G7TP2F+FG, G7TP2F+FG1, G7TP2F+T, G7TP2FM		



1

GEV No.	210136	Ref. No.	31856600
description	pan support W 340mm L 560mm		
For models:	G7F2BE, G7F2BE+A2, G7F2ME, G7F2ME+A2, G7F4BE, G7F4BE+A4, G7F4E+FE, G7F4E+FE+A4, G7F4E+FE1, G7F4E+FE1+A4, G7F4E+FG, G7F4E+FG+A4, G7F4E+FG1, G7F4E+FG1+A4, G7F4ME, G7F4ME+A4, G7F6BE, G7F6BE+A6, G7F6E+FE, G7F6E+FE+A6, G7F6E+FE1, G7F6E+FE1+A6, G7F6E+FG, G7F6E+FG+A4, G7F6E+FG1, G7F6E+FG1+A4, G7F6E+FG1+A6, G7F6E+T		



1

GEV No.	210253	Ref. No.	31856700
description	pan support W 345mm L 560mm		
For models:	G7F2BE, G7F2BE+A2, G7F2BPW, G7F2BPW+AE, G7F2BPW-F, G7F2ME, G7F2ME+A2, G7F2MPW, G7F2MPW+AE, G7F4BE, G7F4BE+A4, G7F4BPW, G7F4BPW+AE, G7F4E+FE, G7F4E+FE+A4, G7F4E+FE1, G7F4E+FE1+A4, G7F4E+FG, G7F4E+FG+A4, G7F4E+FG1, G7F4E+FG1+A4, G7F4ME, G7F4ME+A4, G7F4MPW, G7F4MPW+AE, G7F4PW+FE, G7F4PW+FE+AE, G7F4PW+FE1, G7F4PW+FE1+AE, G7F4PW+FG, G7F4PW+FG+AE, G7F4PW+FG1, G7F4PW+FG1+AE, G7F6BE, G7F6BE+A6, G7F6BPW, G7F6BPW+AE, G7F6E+FE, G7F6E+FE+A6, G7F6E+FE1, G7F6E+FE1+A6, G7F6E+FG, G7F6E+FG+A6, G7F6E+FG1, G7F6E+FG1+A6, G7F6ME, G7F6ME+A6, G7F6MPW, G7F6MPW+AE, G7F6PW+FE...(Other models you can see in the webshop)		



1

GEV No.	210263	Ref. No.	31858100
description	pan support W 360mm L 578mm		

1

GEV No.	210252	Ref. No.	31856200
description	pan support W 365mm L 580mm		
For models:	G6F2BH6, G6F2BP6, G6F2H6+FE1, G6F2H6+FG1, G6F2MH6, G6F2MP6, G6F2P6+FE1, G6F2P6+FG1, G7F2BP, G7F2MP, G7F4+FE1, G7F4+FG, G7F4+FG1, G7F4BP, G7F4MP, G7F4P+FG, G7F4P+FG+AF2, G7F4P+FG1, G7F4P+FG1+AF1, G7F6+FE1, G7F6+FG, G7F6+FG1, G7F6+T, G7F6BP, G7F6MP, G7F6P+FG, G7F6P+FG+AF2, G7F6P+FG1, G7F6P+FG1+AF1, G7F6P+T, G7F6P+T+AF2		



1

GEV No.	210161	Ref. No.	22642300
description	pan support W 385mm L 580mm		
For models:	G2FS4-S, G4FD8-S, G4S+FCGN, G4S+FSGN, G6F12-S, G6S+FCGN, G6S+FSGN		



1

GEV No.	210215	Ref. No.	35856500 35856600 38856700
description	pan support W 390mm L 390mm		
For models:	G12F4H9+FGP, G12F4H9M, G12F4P9+FGP, G12F4P9M, G6F2BH9, G6F2BP9, G6F2H9+FE1, G6F2H9+FG1, G6F2H9+T, G6F2H9+TE, G6F2MH9, G6F2MP9, G6F2P9+FE1, G6F2P9+FG1, G6F2P9+T, G6F2P9+TE, G6F3BH12, G6F3H12+FE1, G6F3H12+FG1, G6F3H12+T, G6F3H12+TE, G6F3MH12, G9F2M, G9F2MP, G9F4+FE, G9F4+FE1, G9F4+FG, G9F4+FG1, G9F4M, G9F4MP, G9F4P+FG, G9F4P+FG+AF2, G9F4P+FG1, G9F4P+FG1+AF1, G9F6+FE, G9F6+FE1, G9F6+FG, G9F6+FG1, G9F6+T, G9F6M, G9F6MP, G9F6P+FG, G9F6P+FG+AF2, G9F6P+FG1, G9F6P+T, G9F6P+T+AF2, G9F8+2FE, G9F8+2FE1, G9F8+2FG, G9F8+2FG1...(Other models you can see in the webshop)		

bar burners

bar burners



1

GEV No.	105102	Ref. No.	22275300
description	bar burner 1-row ø 27mm Wmm Hmm L 418mm oven		
For models:	G4F+FSD8		
spare parts for	105102		
	GEV No.	104651	Ref. No.
			—
	mounting flange for igniter and thermocouple		



1

GEV No.	105788	Ref. No.	25277500
description	bar burner 1-row ø 50mm Wmm Hmm L 483mm flange width 71mm convection oven flange ø 75mm		
For models:	FMG10, FMG10EP, FMG10M, FPG12, MM10GA, MM10GB, WAV-G12, WAV-G20		



1

GEV No.	105202	Ref. No.	31278400
description	bar burner 2 row L 430mm W 200mm ømm H 45mm chargrill		
For models:	PLG40B, PLG40BE, PLG40M, PLG40ME, PLG80B, PLG80BE, PLG80M, PLG80ME		





1

GEV No.	105260	Ref. No.	22276300
description	bar burner 2 row L 450mm W 300mm ømm H 50mm 8.5kW griddle		
For models:	GFLM6, GFLM6-CR, GFRM6		



			
GEV No.	105719	Ref. No.	35278400
description	bar burner 2 row L 600mm W 200mm ømm chargrill		
For models:	G9PL40B, G9PL40M, G9PL80B, G9PL80M, SG9PL40M, SG9PL80M		

			
GEV No.	105727	Ref. No.	31781300 31782500
description	bar burner angled ømm W 240mm Hmm L 560mm oven		
For models:	G6F2B, G6F2B+A2, G6F4B, G6F4B+A4, G6F6B, G6F6B+A6, G7F4+FG, G7F4P+FG, G7F4P+FG+AF2, G7F4PW+FG, G7F4PW+FG+AE, G7F6+FG, G7F6P+FG, G7F6P+FG+AF2, G7F6PW+FG, G7F6PW+F-G+AE, G7T4P4F+FG, G7TP+FG, G7TP2F+FG, G9F4+FG, G9F4P+FG, G9F4P+FG+AF2, G9F4PW+FG, G9F4PW+FG+AE, G9F6+FG, G9F6P+FG, G9F6P+FG+AF2, G9F6PW+FG, G9F6PW+FG+AE, G9F8+2FG, G9F8P+2FG, G9F8P+2FG+AF2, G9TP+FG, G9TP2F+FG, G9TP4F+FG, SG9F4+FG, SG9F6+FG, SG9F6P+FG, SG9F8+2FG, SG9F8P+2FG, SG9TP+FG, SG9TP2F+FG, SG9TP4F+FG		

			
GEV No.	105103	Ref. No.	22275500
description	bar burner ø 27mm Wmm Hmm L 638mm oven		
For models:	G4S+FSGN, G6S+FSGN, G7F4+FG1, G7F4E+FG1, G7F4E+FG1+A4, G7F4P+FG1, G7F4P+FG1+AF1, G7F4PW+FG1, G7F4PW+FG1+AE, G7F6+FG1, G7F6E+FG1, G7F6E+FG1+A4, G7F6E+FG1+A6, G7F6P+FG1, G7F6P+FG1+AF1, G7F6PW+FG1, G7F6PW+FG1+AE, G7T4P2F+FG1, G7T4P4F+FG1, G7TP+FG1, G7TP2F+FG1, G9F4+FG1, G9F4E+FG1, G9F4E+FG1+A4, G9F4P+FG1, G9F4P+FG1+AF1, G9F4PW+FG1, G9F4PW+FG1+AE, G9F6+FG1, G9F6E+FG1, G9F6E+F-G1+A6, G9F6P+FG1, G9F6PW+FG1, G9F6PW+FG1+AE, G9F8+2FG1, G9F8P+2FG1, G9TP+FG1, G9TP2F+FG1		
spare parts for	105103		
	GEV No.	104651	Ref. No. —
mounting flange for igniter and thermocouple			
accessories for	105103		
	GEV No.	104651	Ref. No. —
mounting flange for igniter and thermocouple			

			
GEV No.	105718	Ref. No.	35277500
description	bar burner ø 40mm Wmm Hmm L 395mm flange ø 61mm tilting bratt pan		
For models:	G9BR8, G9BR8-I, G9P10D, G9P10DA, G9P10I, G9P10IA, G9P15D, G9P15DA, G9P15I, G9P15IA, SG9BR8, SG9BR8-I, SG9P10D, SG9P10DA, SG9P10I, SG9P10IA, SG9P15D, SG9P15DA, SG9P15I		

			
GEV No.	105787	Ref. No.	23277000
description	bar burner ø 40mm Wmm Hmm L 415mm flange width 43mm flange length 43mm convection oven		

			
GEV No.	105790	Ref. No.	25278700
description	bar burner ø 50mm Wmm Hmm L 322mm flange width 57mm flange length 57mm convection oven		
For models:	FMG10, FMG10EP, FMG10M, FMG20, FMG20M, FMG6, FMG6EP, FMG6M, MM06GA, MM06GB		

			
GEV No.	105203	Ref. No.	31279600
description	bar burner ø 50mm Wmm Hmm L 344mm flange width 65mm flange length 71mm tilting bratt pan		
For models:	G7BR8, G7BR8-I		

			
GEV No.	105791	Ref. No.	11031
description	bar burner ø 50mm Wmm Hmm L 375mm flange width 57mm flange length 57mm convection oven		





			
1			
GEV No.	105681	Ref. No.	35782000
description	bar burner ø 50mm Wmm Hmm L 607mm flange ø 75mm flange width 71mm oven		
For models:	G9FL4M, G9FL4M-CPD, G9FL4M-CR, G9FL4M-SX, G9FL8M-2, G9FL8M-2-CPD, G9FL8M-2-CR, G9FL8M-2-SX, G9FM8M-2, G9FR4M, G9FR8M-2, SG9FL4M, SG9FL4M-CPD, SG9FL4M-CR, SG9FL8M-2, SG9FL8M-2-CPD, SG9FL8M-2-CR, SG9FM8M-2, SG9FM8M-2-CR, SG9FR4M, SG9FR4M-CR, SG9FR8M-2, SG9FR8M-2-CR		

			
1			
GEV No.	105789	Ref. No.	1361
description	bar burner ø 50mm Wmm Hmm L 618mm flange width 71mm convection oven flange ø 75mm		

			
1			
GEV No.	105204	Ref. No.	31278800
description	bar burner ø 60mm Wmm Hmm L 350mm flange width 67mm flange length 67mm pasta cooker		
For models:	CPG40, CPG40E, CPG80, CPG80E, G6CP6		

			
1			
GEV No.	105255	Ref. No.	22275800
description	bar burner ømm W 41mm H 34mm L 490mm flange width 70mm 5.5kW griddle		
For models:	GFLD8, GFLD8-CR, GFLS4, GFLS4-CR, GFRD8, GFRS4		

			
1			
GEV No.	107568	Ref. No.	31772000 31782000
description	burner ømm W 45mm H 55mm L 500mm 5kW friddle		
For models:	G7FL4B, G7FL4B-CR, G7FL4B-SX, G7FL4M, G7FL4M-CR, G7FL4M-SX, G7FL8B-2, G7FL8B-2-CR, G7FL8B-2-SX, G7FL8M-2, G7FL8M-2-CR, G7FL8M-2-SX, G7FM8B-2, G7FM8M-2, G7FR4B, G7FR4M, G7FR8B-2, G7FR8M, G7FR8M-2		

			
1			
GEV No.	211004	Ref. No.	31972500
description	lava rock grid L 465mm W 325mm		
For models:	PLG40B, PLG40BE, PLG40M, PLG40ME		

			
1			
GEV No.	211042	Ref. No.	35972500
description	lava rock grid L 670mm W 330mm		
For models:	G9PL40B, G9PL40M, G9PL80B, G9PL80M, SG9PL40M		

			
1			
GEV No.	211005	Ref. No.	31972700
description	lava rock grid L 685mm W 465mm H 37mm		
For models:	PLG80B, PLG80BE, PLG80M, PLG80ME		

			
1			
GEV No.	211043	Ref. No.	35972700
description	lava rock grid L 685mm W 670mm		
For models:	G9PL40B, G9PL40M, G9PL80B, G9PL80M, SG9PL80M		

lava rock grids

			
1			
GEV No.	211004	Ref. No.	31972500
description	lava rock grid L 465mm W 325mm		
For models:	PLG40B, PLG40BE, PLG40M, PLG40ME		

			
1			
GEV No.	211042	Ref. No.	35972500
description	lava rock grid L 670mm W 330mm		
For models:	G9PL40B, G9PL40M, G9PL80B, G9PL80M, SG9PL40M		



			
1			
GEV No.	211005	Ref. No.	31972700
description	lava rock grid L 685mm W 465mm H 37mm		
For models:	PLG80B, PLG80BE, PLG80M, PLG80ME		

			
1			
GEV No.	211043	Ref. No.	35972700
description	lava rock grid L 685mm W 670mm		
For models:	G9PL40B, G9PL40M, G9PL80B, G9PL80M, SG9PL80M		

tube burners

			
1			
GEV No.	105720	Ref. No.	32279600
description	tubular burner L 275mm W 53mm H 66mm for fryer oval		
For models:	9GL15+15M, 9GL15M, 9GL20+20M, 9GL20M, GL15+15M, GL15M, GL20+20M, GL20M, GL7+7M, S9GL20+20M, S9GL20M, S9GL22M		





			
1			
GEV No.	105118	Ref. No.	32279300
description	tubular burner ø 74mm L 180mm H 60mm mounting pos. left round for fryer		
For models:	GL10+10B, GL10+10M, GL10B, GL10M, GL8+8B, GL8+8M, GL8B, GL8M		
accessories for	105118		
	GEV No.	100420	Ref. No. 40109500
	gas injector thread M10x1 WS 11 bore ø 0.95mm		
	GEV No.	101997	Ref. No. 40114000
	gas injector thread M10x1 WS 11 bore ø 1.4mm		

			
1			
GEV No.	105117	Ref. No.	32279200
description	tubular burner ø 74mm L 180mm H 60mm mounting pos. right round for fryer		
For models:	GL10+10B, GL10+10M, GL10B, GL10M, GL30B, GL30M, GL8+8B, GL8+8M, GL8B, GL8M		
accessories for	105117		
	GEV No.	100420	Ref. No. 40109500
	gas injector thread M10x1 WS 11 bore ø 0.95mm		
	GEV No.	101997	Ref. No. 40114000
	gas injector thread M10x1 WS 11 bore ø 1.4mm		





			
1			
GEV No.	105261	Ref. No.	22278932
description	tubular burner ø 74mm L 180mm W 75mm H 60mm for fryer round		

accessories

nozzle holders

			
1			
GEV No.	104108	Ref. No.	22913400
description	nozzle holder nozzle mounting M10x1 tube ø 10mm gas inlet M16x1.5 gas outlet M14x1		
For models:	G2FS4-S, G4FD8-S, G4S+FCGN, G4S+FSGN, G6F12-S, G6S+FCGN, G6S+FSGN		
accessories for	104108		
	GEV No.	102382	Ref. No. —
	nut thread M14x1 H 3.5mm WS 18 brass Qty 1 pcs		
	GEV No.	104105	Ref. No. 22993300
	burner lower part for burner cap ø 80mm 3.5kW		
	GEV No.	104107	Ref. No. 22993400
	burner lower part for burner cap ø 100mm 6.4kW		



			
1			
GEV No.	105097	Ref. No.	32327600
description	nozzle holder nozzle mounting M10x1 tube ø 10mm gas inlet M16x1.5 gas outlet M14x1		
For models:	CPG40, CPG40E, CPG80, CPG80E, E9F15-4M, E9F15-8M, E9F18-4M, E9F18-8M, G6CP6, G6F2B, G6F2B+A2, G6F2BH6, G6F2BH9, G6F2BP6, G6F2BP9, G6F2H6+FE1, G6F2H6+FG1, G6F2H9+FE1, G6F2H9+FG1, G6F2H9+T, G6F2H9+TE, G6F2MH6, G6F2MH9, G6F2MP6, G6F2MP9, G6F2P6+FE1, G6F2P6+FG1, G6F2P9+FE1, G6F2P9+FG1, G6F2P9+T, G6F2P9+TE, G6F3BH12, G6F3H12+FE1, G6F3H12+FG1, G6F3H12+T, G6F3H12+TE, G6F3MH12, G6F4B, G6F4B+A4, G6F6B, G6F6B+A6, G6FL3B, G6FL3B-CR, G6FL3B-SX, G6FL3M, G6FL3M-CR, G6FL3M-SX, G6FL6B, G6FL6B-CR, G6FL6B-SX...(Other models you can see in the webshop)		
accessories for	105097		
		GEV No.	105094
		Ref. No.	31913600
	burner holder 3.5/6kW for burner cap ø 80/110mm		
		GEV No.	105724
		Ref. No.	35974400
	pilot burner bracket		
		GEV No.	107691
		Ref. No.	35912600
	burner holder D/E ø 33mm for burner cap ø 130/140mm		
		GEV No.	107934
		Ref. No.	32811500
	nut H 5mm thread M14x1 WS 17		

			
1			
GEV No.	107521	Ref. No.	31327600
description	nozzle holder thread M10x1 screw pipe fitting 1/4" M6x0.75 tube ø 8mm		
For models:	G6F2H6+FG1, G6F2H9+FG1, G6F2P6+FG1, G6F2P9+FG1, G6F3H9+T, G6F4+FG1, G6F4+FG1+A4, G6F4PW+FG1, G6F4PW+FG1+AE, G6F6+FG1, G6F6+FG1+A6, G6F6PW+FG1, G6F6PW+T, G6F6PW+T+AE, G7F4+FG1, G7F4E+FG1, G7F4E+FG1+A4, G7F4P+FG1, G7F4P+FG1+AF1, G7F4PW+FG1, G7F4PW+FG1+AE, G7F6+FG1, G7F6E+FG1, G7F6E+FG1+A4, G7F6E+FG1+A6, G7F6P+FG1, G7F6P+FG1+AF1, G7F6PW+FG1, G7F6PW+FG1+AE, G7T4P2F+FG1, G7T4P4F+FG1, G7TP+FG1, G7TP2F+FG1, G9F4E+FG1, G9F4E+FG1+A4, G9F4P+FG1, G9F4P+FG1+AF1, G9F4PW+FG1, G9F4PW+FG1+AE, G9F6E+FG1, G9F6E+FG1+A6, G9F6P+FG1, G9F6PW+FG1, G9F6PW+FG1+AE, G9F8P+2FG1, G9TP+FG1, G9TP2F+FG1		

<p>miscellaneous</p>			
			
1			
GEV No.	107934	Ref. No.	32811500
description	nut H 5mm thread M14x1 WS 17		
For models:	G6F2B, G6F2B+A2, G6F2H6+FE1, G6F2H6+FG1, G6F2P6+FE1, G6F2P6+FG1, G6F4B, G6F4B+A4, G6F6B, G6F6B+A6, G7F2BP, G7F2MP, G7F4BP, G7F4MP, G7F4P+FG, G7F4P+FG+AF2, G7F4P+FG1, G7F4P+FG1+AF1, G7F6BP, G7F6MP, G7F6P+FG, G7F6P+FG+AF2, G7F6P+FG1, G7F6P+FG1+AF1, G7F6P+T, G7F6P+T+AF2, G7T4P2F+FG1, G7T4P2FB, G7T4P2FM, G7T4P4F+FG, G7T4P4F+FG1, G7T4P4FB, G7T4P4FM, G7TP+FG, G7TP2F+FG, G7TP2F+FG1, G7TP2F+T, G7TP2FM, G9F2MP, G9F4MP, G9F4P+FG, G9F4P+FG+AF2, G9F4P+FG1, G9F4P+FG1+AF1, G9F4PW+FG+AE, G9F6MP, G9F6P+FG, G9F6P+FG1, G9F6P+T, G9F6P+T+AF2...(Other models you can see in the webshop)		

gas nozzles

main nozzles

gas nozzles M6x0.75

			
1			
GEV No.	104343	Ref. No.	40407400
description	gas injector thread M6x0.75 WS 7 bore ø 0.74mm		

			
1			
GEV No.	106694	Ref. No.	40407500
description	gas injector thread M6x0.75 WS 7 bore ø 0.75mm		

			
1			
GEV No.	100415	Ref. No.	40408500
description	gas injector thread M6x0.75 WS 7 bore ø 0.85mm		
For models:	G6F2H9+FG1, G6F2H9+T, G6F2M, G6F2P9+FG1, G6F2P9+T, G6F4+FE1, G6F4+FE1+A4, G6F4+FG1, G6F4+FG1+A4, G6F4M, G6F6+FE1, G6F6+FE1+A6, G6F6+FG1, G6F6+FG1+A6, G6F6M, G7F2BE, G7F2BE+A2, G7F2ME, G7F2ME+A2, G7F4+FG1, G7F4BE, G7F4BE+A4, G7F4E+FE, G7F4E+FE+A4, G7F4E+FE1, G7F4E+FE1+A4, G7F4E+FG, G7F4E+FG+A4, G7F4E+FG1, G7F4E+FG1+A4, G7F4ME, G7F4ME+A4, G7F4P+FG1, G7F4P+FG1+AF1, G7F6+FG1, G7F6BE, G7F6BE+A6, G7F6E+FE, G7F6E+FE+A6, G7F6E+FE1, G7F6E+FE1+A6, G7F6E+FG, G7F6E+FG+A4, G7F6E+FG+A6, G7F6E+FG1, G7F6E+FG1+A4, G7F6E+FG1+A6, G7F6E+T, G7F6ME, G7F6P+FG1...(Other models you can see in the webshop)		

			
1			
GEV No.	107823	Ref. No.	40409300
description	gas injector thread M6x0.75 WS 7 bore ø 0.93mm		
For models:	G6F2H6+FG1, G6F2H9+FG1, G6F2M, G6F2P6+FG1, G6F2P9+FG1, G6F4+FE1, G6F4+FE1+A4, G6F4+FG1, G6F4+FG1+A4, G6F4M, G6F6+FE1, G6F6+FE1+A6, G6F6+FG1, G6F6+FG1+A6, G6F6M, G7F2BE, G7F2BE+A2, G7F2ME, G7F4BE, G7F4BE+A4, G7F4E+FE, G7F4E+FE+A4, G7F4E+FE1, G7F4E+FE1+A4, G7F4E+FG, G7F4E+FG+A4, G7F4E+FG1, G7F4E+FG1+A4, G7F4ME, G7F6BE, G7F6BE+A6, G7F6E+FE, G7F6E+FE+A6, G7F6E+FE1, G7F6E+FE1+A6, G7F6E+FG, G7F6E+FG+A4, G7F6E+FG+A6, G7F6E+FG1, G7F6E+FG1+A4, G7F6E+FG1+A6, G7F6E+T, G7F6ME, G9F2ME, G9F2ME+A2, G9F4E+FE1, G9F4E+FE1+A4, G9F4E+FG1, G9F4E+FG1+A4, G9F4ME...(Other models you can see in the webshop)		



			
1			
GEV No.	102553	Ref. No.	40413500
description	gas injector thread M6x0.75 WS 7 bore ø 1.35mm sunk bore		
For models:	G6F4+FG1, G6F4+FG1+A4, G7F4E+FG, G7F4E+FG+A4, G7F4E+FG1, G7F4E+FG1+A4, G7F6E+FG, G7F6E+FG+A4, G7F6E+FG+A6, G7F6E+T		

			
1			
GEV No.	106683	Ref. No.	40109300
description	gas injector thread M10x1 WS 11 bore ø 0.93mm		
For models:	GL10+10B, GL10+10M, GL10B, GL10M		

			
1			
GEV No.	104781	Ref. No.	40413000
description	gas injector thread M6x0.75 WS 7 bore ø 1.3mm		
For models:	G6F2H9+FG1, G6F2H9+T, G6F2M, G6F2P9+FG1, G6F2P9+T, G6F4+FE1, G6F4+FE1+A4, G6F4+FG1, G6F4+FG1+A4, G6F4M, G6F6+FE1, G6F6+FE1+A6, G6F6+FG1, G6F6+FG1+A6, G6F6M, G7F2BE, G7F2BE+A2, G7F2ME, G7F4+FG1, G7F4BE, G7F4BE+A4, G7F4E+FE, G7F4E+FE+A4, G7F4E+FE1, G7F4E+FE1+A4, G7F4E+FG, G7F4E+FG+A4, G7F4E+FG1, G7F4E+FG1+A4, G7F4ME, G7F4P+FG1, G7F4P+FG1+AF1, G7F6+FG1, G7F6BE, G7F6BE+A6, G7F6E+FE, G7F6E+FE+A6, G7F6E+FE1, G7F6E+FE1+A6, G7F6E+FG, G7F6E+FG+A4, G7F6E+FG+A6, G7F6E+FG1, G7F6E+FG1+A4, G7F6E+FG1+A6, G7F6E+T, G7F6ME, G7F6P+FG1, G7F6P+FG1+AF1, G7T4P2F+FG1... (Other models you can see in the webshop)		

			
1			
GEV No.	100420	Ref. No.	40109500
description	gas injector thread M10x1 WS 11 bore ø 0.95mm		
For models:	G6F2B, G6F2B+A2, G6F2BH6, G6F2BH9, G6F2BP9, G6F2H6+FE1, G6F2H6+FG1, G6F2H9+FE1, G6F2MH6, G6F2MH9, G6F4B, G6F4B+A4, G6F6B, G6F6B+A6, G7F2B, G7F2M, G7F4+FE, G7F4+FE1, G7F4+FES, G7F4+FG, G7F4+FG1, G7F4B, G7F4M, G7F6+FE, G7F6+FE1, G7F6+FES, G7F6+FG, G7F6+FG1, G7F6+T, G7F6B, G7F6M, G7T4P2F+FG1, G7T4P2FB, G7T4P2FM, G7T4P4F+FG, G7T4P4F+FG1, G7T4P4FB, G7T4P4FM, G7TP2F+FG, G7TP2F+FG1, G7TP2F+T, G7TP2FM, G9F2M, G9F4+FE, G9F4+FE1, G9F4+FG, G9F4+FG1, G9F4M, G9F4P+FG, G9F6+FE...(Other models you can see in the webshop)		

			
1			
GEV No.	104778	Ref. No.	40414500
description	gas injector thread M6x0.75 WS 7 bore ø 1.45mm		
For models:	G6F2H6+FG1, G6F2M, G6F2P6+FG1, G6F4+FE1, G6F4+FE1+A4, G6F4+FG1, G6F4+FG1+A4, G6F4M, G6F6+FE1, G6F6+FE1+A6, G6F6+FG1, G6F6+FG1+A6, G6F6M, G7F2BE, G7F2BE+A2, G7F2ME, G7F4BE, G7F4BE+A4, G7F4E+FE, G7F4E+FE+A4, G7F4E+FE1, G7F4E+FE1+A4, G7F4E+FG, G7F4E+FG+A4, G7F4E+FG1, G7F4E+FG1+A4, G7F4ME, G7F6BE, G7F6BE+A6, G7F6E+FE, G7F6E+FE+A6, G7F6E+FE1, G7F6E+FE1+A6, G7F6E+FG, G7F6E+FG+A4, G7F6E+FG+A6, G7F6E+FG1, G7F6E+FG1+A4, G7F6E+FG1+A6, G7F6E+T, G7F6ME, G9F2ME, G9F2ME+A2, G9F4E+FE1, G9F4E+FE1+A4, G9F4E+FG1, G9F4E+FG1+A4, G9F4ME, G9F4ME+A4, G9F6E+FE1...(Other models you can see in the webshop)		

			
1			
GEV No.	106295	Ref. No.	40109000
description	gas injector thread M10x1 WS 11 bore ø 0.9mm code 90		
For models:	GL8+8B, GL8+8M, GL8B, GL8M		

			
1			
GEV No.	106494	Ref. No.	40110500
description	gas injector thread M10x1 WS 11 bore ø 1.05mm		
For models:	GL30B, GL30M		

gas nozzles M10x1

			
1			
GEV No.	100646	Ref. No.	40512000
description	gas injector thread M10x1 WS 11 bore ø 1.2mm inner peaked		

			
1			
GEV No.	107825	Ref. No.	40111500
description	gas injector thread M10x1 WS 11 bore ø 1.15mm code 115		

			
1			
GEV No.	102705	Ref. No.	40108000
description	gas injector thread M10x1 WS 11 bore ø 0.8mm		





			
1			
GEV No.	106490	Ref. No.	40112500
description	gas injector thread M10x1 WS 11 bore ø 1.25mm		
For models:	G6F2B, G6F2B+A2, G6F2BH6, G6F2BP6, G6F2H6+FE1, G6F2H6+FG1, G6F2MH6, G6F2MP6, G6F2P6+FE1, G6F2P6+FG1, G6F4B, G6F4B+A4, G6F6B, G6F6B+A6, G7F2B, G7F2BP, G7F2M, G7F2MP, G7F4+FE, G7F4+FE1, G7F4+FES, G7F4+FG, G7F4+FG1, G7F4B, G7F4BP, G7F4M, G7F4MP, G7F4P+FG, G7F4P+FG+AF2, G7F4P+FG1, G7F4P+FG1+AF1, G7F6+FE, G7F6+FE1, G7F6+FES, G7F6+FG, G7F6+FG1, G7F6+T, G7F6B, G7F6BP, G7F6M, G7F6MP, G7F6P+FG, G7F6P+FG+AF2, G7F6P+FG1, G7F6P+FG1+AF1, G7F6P+T, G7F6P+T+AF2, G7T4P2F+FG1, G7T4P2FB, G7T4P2FM...(Other models you can see in the webshop)		

			
1			
GEV No.	106440	Ref. No.	40118500
description	gas injector thread M10x1 WS 11 bore ø 1.85mm		
For models:	9GL15+15M, 9GL15M, 9GL20+20M, 9GL20M, G6F2B, G6F2B+A2, G6F2BH6, G6F2BP6, G6F2H6+FE1, G6F2H6+FG1, G6F2MH6, G6F2MP6, G6F2P6+FE1, G6F2P6+FG1, G6F4B, G6F4B+A4, G6F6B, G6F6B+A6, G6FL3B, G6FL3B-SX, G6FL3M, G6FL3M-SX, G6FL6B, G6FL6B-SX, G6FL6M, G6FL6M-SX, G6FM6B, G6FM6M, G6FR3B, G6FR3M, G6FR6B, G6FR6M, G6FR8B, G6FR8M, G6FR8M-2, G7F2B, G7F2BP, G7F2M, G7F2MP, G7F4+FE, G7F4+FE1, G7F4+FES, G7F4+FG, G7F4+FG1, G7F4B, G7F4BP, G7F4M, G7F4MP, G7F4P+FG, G7F4P+FG+AF2, G7F4P+FG1, G7F4P+FG1+AF1, G7F6+FE...(Other models you can see in the webshop)		

			
2			
GEV No.	102704	Ref. No.	40112000
description	gas injector thread M10x1 WS 11 bore ø 1.2mm		
For models:	9GL15+15M, 9GL15M, 9GL20+20M, 9GL20M, G6FL3B, G6FL3B-SX, G6FL3M, G6FL3M-SX, G6FL6B, G6FL6B-SX, G6FL6M, G6FL6M-SX, G6FM6B, G6FM6M, G6FR3B, G6FR3M, G6FR6B, G6FR6M, G7FL4B, G7FL4B-CR, G7FL4B-SX, G7FL4M, G7FL4M-CR, G7FL4M-SX, G7FL8B-2, G7FL8B-2-CR, G7FL8B-2-SX, G7FL8M-2, G7FL8M-2-CR, G7FL8M-2-SX, G7FM8B-2, G7FM8M-2, G7FR4B, G7FR4M, G7FR8B-2, G7FR8M, G7FR8M-2, G7TP2F+FG, G7TP2F+FG1, G7TP2F+T, G7TP2FM, G9F4+FE, G9F4+FE1, G9F4+FG, G9F4+FG1, G9F4P+FG, G9F6+FE, G9F6+FE1, G9F6+FG, G9F6+FG1...(Other models you can see in the webshop)		

			
1			
GEV No.	106498	Ref. No.	40119500
description	gas injector thread M10x1 WS 11 bore ø 1.95mm		

			
1			
GEV No.	109116	Ref. No.	40110000
description	gas injector thread M10x1 WS 11 bore ø 1mm code 100		

			
1			
GEV No.	106296	Ref. No.	40113000
description	gas injector thread M10x1 WS 11 bore ø 1.3mm code 130		
For models:	G9PL40B, G9PL40M, G9PL80B, G9PL80M, PLG40B, PLG40BE, PLG40M, PLG40ME, PLG80B, PLG80BE, PLG80M, PLG80ME		

			
1			
GEV No.	106684	Ref. No.	40120500
description	gas injector thread M10x1 WS 11 bore ø 2.05mm		
For models:	G9PL40B, G9PL40M, G9PL80B, G9PL80M, PLG40B, PLG40BE, PLG40M, PLG40ME, PLG80B, PLG80BE, PLG80M, PLG80ME		

			
1			
GEV No.	101997	Ref. No.	40114000
description	gas injector thread M10x1 WS 11 bore ø 1.4mm		
For models:	G6F2B, G6F2B+A2, G6F2BH6, G6F2BH9, G6F2BP9, G6F2H6+FE1, G6F2H6+FG1, G6F2H9+FE1, G6F2MH6, G6F2MH9, G6F4B, G6F4B+A4, G6F6B, G6F6B+A6, G7F2B, G7F2M, G7F4+FE, G7F4+FE1, G7F4+FES, G7F4+FG, G7F4+FG1, G7F4B, G7F4E+FG, G7F4E+FG+A4, G7F4M, G7F4P+FG, G7F4P+FG+AF2, G7F6+FE, G7F6+FE1, G7F6+FES, G7F6+FG, G7F6+FG1, G7F6+T, G7F6B, G7F6E+FG, G7F6E+FG+A4, G7F6E+F-G+A6, G7F6M, G7F6P+FG, G7F6P+FG+AF2, G7T4P2F+FG1, G7T4P2FB, G7T4P2FM, G7T4P4F+FG, G7T4P4F+FG1, G7T4P4FB, G7T4P4FM, G7TP+FG, G7TP2F+FG, G7TP2F+FG1...(Other models you can see in the webshop)		

			
1			
GEV No.	104069	Ref. No.	40123000
description	gas injector thread M10x1 WS 11 bore ø 2.3mm		
For models:	G6F2BH9, G6F2BP9, G6F2H9+FE1, G6F2H9+FG1, G6F2H9+T, G6F2MH9, G6F2MP9, G6F2P9+FE1, G6F2P9+FG1, G6F2P9+T, G9F2M, G9F2MP, G9F4M, G9F4MP, G9F4P+FG, G9F4P+FG+AF2, G9F4P+FG1, G9F4P+FG1+AF1, G9F6M, G9F6MP, G9F6P+FG, G9F6P+FG1, G9F6P+T, G9F6P+T+AF2, G9F8P+2FG, G9F8P+2FG1		



pilot burner nozzles

pilot burner nozzles POLIDORO



1

GEV No.	100000	Ref. No.	40902200
description	pilot burner nozzle POLIDORO LPG code 22 bore \varnothing 0.22mm Qty 1 pcs		
For models:	G6F2B, G6F2B+A2, G6F4B, G6F4B+A4, G6F6B, G6F6B+A6, G7T-4P2F+FG1, G7T4P2FB, G7T4P2FM, G7T4P4F+FG, G7T4P4F+FG1, G7T-4P4FB, G7T4P4FM, G7TP+FG, G7TP+FG1, G7TP2F+FG, G7TP2F+FG1, G7TP2F+T, G7TP2FM, G7TPM, G9TP+FG, G9TP+FG1, G9TP2F+FG, G9TP2F+FG1, G9TP2F+T, G9TP2FM, G9TPM		

pilot burner nozzles SIT

160 series



1

GEV No.	107172	Ref. No.	32365300 32366300
description	pilot burner nozzle SIT LPG code 25 Qty 1 pcs		
For models:	9GL15+15M, 9GL15M, 9GL20+20M, 9GL20M, CPG40, CPG40E, CPG80, CPG80E, E9F15-4M, E9F15-8M, E9F18-4M, E9F18-8M, G6CP6, G6FL3B, G6FL3B-SX, G6FL3M, G6FL3M-SX, G6FL6B, G6FL6B-SX, G6FL6M, G6FL6M-SX, G6FM6B, G6FM6M, G6FR3B, G6FR3M, G6FR6B, G6FR6M, G6PL60B, G6PL60M, G7FL4B, G7FL4B-CR, G7FL4B-SX, G7FL4M, G7FL4M-CR, G7FL4M-SX, G7FL8B-2, G7FL8B-2-CR, G7FL8B-2-SX, G7FL8M-2, G7FL8M-2-CR, G7FL8M-2-SX, G7FM8B-2, G7FM8M-2, G7FR4B, G7FR4M, G7FR8B-2, G7FR8M, G7FR8M-2, G9CP40, G9CP40-2...(Other models you can see in the webshop)		



1

GEV No.	107650	Ref. No.	32366500
description	pilot burner nozzle SIT LPG code 30 Qty 1 pcs		



1

GEV No.	107174	Ref. No.	32363600 32367100
description	pilot burner nozzle SIT natural gas code 41 Qty 1 pcs		
For models:	CPG40, CPG40E, CPG80, CPG80E, G6CP6, G6FL3B, G6FL3B-SX, G6FL6B, G6FL6B-CR, G6FL6B-SX, G6FL6M, G6FL6M-SX, G6FM6B, G6FM6M, G6FR3B, G6FR3M, G6FR6B, G6FR6M, G6PL60B, G6PL60M, G7FL4B, G7FL4B-CR, G7FL4B-SX, G7FL4M, G7FL4M-CR, G7FL4M-SX, G7FL8B-2, G7FL8B-2-CR, G7FL8B-2-SX, G7FL8M-2, G7FL8M-2-CR, G7FL8M-2-SX, G7FM8B-2, G7FM8M-2, G7FR4B, G7FR4M, G7FR8B-2, G7FR8M, G7FR8M-2, G9FL4M, G9FL4M-SX, G9FL8M-2, G9FL8M-2-SX, G9FM8M-2, G9FR4M, G9FR8M-2, G9PL40B, G9PL40M, G9PL80B...(Other models you can see in the webshop)		



1

GEV No.	107175	Ref. No.	32366900
description	pilot burner nozzle SIT natural gas code 51 Qty 1 pcs suitable for 160 series		
For models:	9GL15+15M, 9GL15M, 9GL20+20M, 9GL20M, E9F15-4M, E9F15-8M, E9F18-4M, E9F18-8M, G9CP40, G9CP40-2, G9CP80, G9CP80-2, GL10+10M, GL10M, GL30B, GL30M, GL8+8B, GL8+8M, GL8B, GL8M		

bypass nozzles

bypass nozzles PEL20/21



1

GEV No.	100554	Ref. No.	22783500
description	bypass nozzle type PEL20/21 bore \varnothing 0.45mm thread M5x0.5		
For models:	G6F2BH6, G6F2BPW, G6F2H6+FE1, G6F2H6+FG1, G6F2H9+FE1, G6F2H9+FG1, G6F2H9+T, G6F2H9+TE, G6F2MH6, G6F2MPW, G6F-2P9+FG1, G6F2P9+T, G6F2P9+TE, G6F4BPW, G6F4MPW, G6F4PW+FE1, G6F4PW+FG1, G6F6BPW, G6F6MPW, G6F6PW+FE1, G6F-6PW+FG1, G6F6PW+T, G6F6PW+T+AE, G6F6PW+TE, G6F6PW+TE+AE, G7F2B, G7F2BPW, G7F2M, G7F2MPW, G7F4+FE, G7F4+FE1, G7F4+FES, G7F4+FG, G7F4+FG1, G7F4B, G7F4BPW, G7F4M, G7F4MPW, G7F4PW+FE, G7F4PW+FE1, G7F4PW+FG, G7F4PW+FG1, G7F6+FE, G7F6+FE1, G7F6+FES, G7F6+FG, G7F6+FG1, G7F6+T, G7F6B, G7F6B-PW...(Other models you can see in the webshop)		



1

GEV No.	100550	Ref. No.	22783600
description	bypass nozzle type PEL20/21 bore \varnothing 0.55mm thread M5x0.5		

bypass nozzles PEL22



1

GEV No.	100392	Ref. No.	31782800
description	bypass nozzle type PEL22 bore \varnothing 0.6mm thread M6x0.5		
For models:	G6FL3B, G6FL3B-CR, G6FL3B-SX, G6FL3M, G6FL3M-CR, G6FL3M-SX, G6FL6B, G6FL6B-CR, G6FL6B-SX, G6FL6M, G6FL6M-CR, G6FL6M-SX, G6FM6B, G6FM6M, G6FR3B, G6FR3M, G6FR6B, G6FR6M, G7FL4B, G7FL4B-CR, G7FL4B-SX, G7FL4M, G7FL4M-CR, G7FL4M-SX, G7FL8B-2, G7FL8B-2-CR, G7FL8B-2-SX, G7FL8M-2, G7FL8M-2-CR, G7FL8M-2-SX, G7FM8B-2, G7FM8M-2, G7FR4B, G7FR4M, G7FR8B-2, G7FR8M, G7FR8M-2		









auxiliary gas parts

screw connections

olives

			
1			
GEV No.	107507	Ref. No.	32777200
description	olive for pipe ø 10mm L 7mm Qty 1 pcs		
For models:	G6F2BPW, G6F2BPW+AE, G6F2MPW, G6F2MPW+AE, G6F4BPW, G6F4BPW+AE, G6F4MPW, G6F4MPW+AE, G6F4PW+FE1, G6F4PW+FE1+AE, G6F4PW+FG1, G6F4PW+FG1+AE, G6F6BPW, G6F6BPW+AE, G6F6MPW, G6F6MPW+AE, G6F6PW+FE1, G6F6PW+FE1+AE, G6F6PW+FG1, G6F6PW+FG1+AE, G6F6PW+T, G6F6PW+T+AE, G6F6PW+TE, G6F6PW+TE+AE, G7F2BPW, G7F2BPW+AE, G7F2BPW-F, G7F2MPW, G7F2MPW+AE, G7F4BPW, G7F4BPW+AE, G7F4MPW, G7F4MPW+AE, G7F4PW+FE, G7F4PW+FE+AE, G7F4PW+FE1, G7F4PW+FE1+AE, G7F4PW+FG, G7F4PW+FG+AE, G7F4PW+FG1, G7F4PW+FG1+AE, G7F6BPW, G7F6BPW+AE, G7F6MPW, G7F6MPW+AE, G7F6PW+FE, G7F6PW+FE+AE, G7F6PW+FE1, G7F6PW+FE1+AE, G7F6PW+FG...(Other models you can see in the webshop)		

			
1			
GEV No.	101278	Ref. No.	32777300
description	olive for pipe ø 10mm Qty 1 pcs		
For models:	G6F2B, G6F2B+A2, G6F2BPW, G6F2MPW, G6F4B, G6F4B+A4, G6F4BPW, G6F4MPW, G6F4PW+FE1, G6F4PW+FG1, G6F6B, G6F6B+A6, G6F6BPW, G6F6MPW, G6F6PW+FE1, G6F6PW+FG1, G6F6PW+T, G6F6PW+T+AE, G6F6PW+TE, G7F2BP, G7F2BPW, G7F2MP, G7F2MPW, G7F4BP, G7F4BPW, G7F4MP, G7F4MPW, G7F4P+FG, G7F4P+F-G+AF2, G7F4P+FG1, G7F4P+FG1+AF1, G7F4PW+FE, G7F4PW+FE1, G7F4PW+FG, G7F4PW+FG+AE, G7F4PW+FG1, G7F6BP, G7F6BPW, G7F6MP, G7F6MPW, G7F6P+FG, G7F6P+FG+AF2, G7F6P+FG1, G7F6P+FG1+AF1, G7F6P+T, G7F6P+T+AF2, G7F6PW+FE, G7F6PW+FE1, G7F6PW+FG, G7F6PW+FG+AE...(Other models you can see in the webshop)		
accessories for	101278		
	GEV No.	100943	Ref. No.
			—
	union nut thread M17x1 tube ø 10mm		
	GEV No.	101300	Ref. No.
			—
	union nut thread M16x1.5 tube ø 10mm		
	GEV No.	101478	Ref. No.
			—
	union nut thread 3/8" for pipe ø 10mm		

			
1			
GEV No.	101246	Ref. No.	31777500 31777700
description	olive for pipe ø 4mm Qty 1 pcs		
For models:	G6F2B, G6F2B+A2, G6F2BPW, G6F2MPW, G6F4B, G6F4B+A4, G6F4BPW, G6F4MPW, G6F4PW+FE1, G6F4PW+FG1, G6F6B, G6F6B+A6, G6F6BPW, G6F6MPW, G6F6PW+FE1, G6F6PW+FG1, G6F6PW+T, G6F6PW+TE, G7F2BP, G7F2BPW, G7F2MP, G7F2MPW, G7F4BP, G7F4BPW, G7F4MP, G7F4MPW, G7F4P+FG, G7F4P+FG+AF2, G7F4P+FG1, G7F4P+FG1+AF1, G7F4PW+FE, G7F4PW+FE1, G7F4PW+FG, G7F4PW+FG1, G7F6BP, G7F6BPW, G7F6MP, G7F6MPW, G7F6P+FG, G7F6P+FG+AF2, G7F6P+FG1, G7F6P+FG1+AF1, G7F6P+T, G7F6P+T+AF2, G7F6PW+FE, G7F6PW+FE1, G7F6PW+FG, G7F6PW+FG1, G7F6PW+T, G7T4P2F+FG1...(Other models you can see in the webshop)		
accessories for	101246		
	GEV No.	100908	Ref. No.
			—
	union screw thread M10x1 for pipe ø 4mm Qty 1 pcs		

union nuts

			
1			
GEV No.	107506	Ref. No.	32811600
description	union nut thread M14x1 tube ø 10mm WS 17		
For models:	G6F2BPW, G6F2BPW+AE, G6F2MPW, G6F2MPW+AE, G6F4BPW, G6F4BPW+AE, G6F4MPW, G6F4MPW+AE, G6F4PW+FE1, G6F4PW+FE1+AE, G6F4PW+FG1, G6F4PW+FG1+AE, G6F6BPW, G6F6BPW+AE, G6F6MPW, G6F6MPW+AE, G6F6PW+FE1, G6F6PW+FE1+AE, G6F6PW+FG1, G6F6PW+FG1+AE, G6F6PW+T, G6F6PW+T+AE, G6F6PW+TE, G6F6PW+TE+AE, G7F2BPW, G7F2BPW+AE, G7F2BPW-F, G7F2MPW, G7F2MPW+AE, G7F4BPW, G7F4BPW+AE, G7F4MPW, G7F4MPW+AE, G7F4PW+FE, G7F4PW+FE+AE, G7F4PW+FE1, G7F4PW+FE1+AE, G7F4PW+FG, G7F4PW+FG+AE, G7F4PW+FG1, G7F4PW+FG1+AE, G7F6BPW, G7F6BPW+AE, G7F6MPW, G7F6MPW+AE, G7F6PW+FE, G7F6PW+FE+AE, G7F6PW+FE1, G7F6PW+FE1+AE, G7F6PW+FG...(Other models you can see in the webshop)		

equipment-specific units

for deep fryers

lids



1

GEV No.	696534	Ref. No.	33807700
description	lid with handle for fryer L 356mm W 283mm		
For models:	ELT15+15B, ELT15+15B-E, ELT15+15M, ELT15+15M-E, ELT15B, ELT15M, ELT15M-E, GL8+8B, GL8+8M, GL8B, GL8M		
spare parts for	696534		
	GEV No.	692125	Ref. No. 33606100 336061000
	pull handle L 110mm H 36mm mounting distance 88mm hole ø 4mm		

for tilting bratt pans

spindles



1

GEV No.	693345	Ref. No.	35993600
description	spindle ø 20mm total length 360mm		
For models:	E9BR8, E9BR8-I, G9BR8, G9BR8-I, SE9BR8, SE9BR8-I, SG9BR8, SG9BR8-I		

miscellaneous



1

GEV No.	693344	Ref. No.	35872000
description	threaded bush for tilting bratt pan		
For models:	E9BR8, E9BR8-I, G9BR8, G9BR8-I, SE9BR8, SE9BR8-I, SG9BR8, SG9BR8-I		

for boiling pans

level glasses

complete



1

GEV No.	540706	Ref. No.	31240000
description	level glass hole distance 76mm mounting thread M10 L 107mm W 28mm plastic/SS for kettle model ELESA HCX-76-BW-SST		
For models:	E7PI, G7PI		

for contact grills

miscellaneous



1

GEV No.	699207	Ref. No.	30779100
description	coupling L 45mm W 25mm H 20mm		
For models:	PDL-ST, PDL-SX, PDM-ST, PDR-ST, PDR-VTR, PD-VTR, PM+VTR, PML-ST, PMR-ST, PMR-VTR, PM-VTR, PSL-ST, PSL-SX, PSM-ST, PSR-ST		

for toasters

pliers

pliers



1

GEV No.	690010	Ref. No.	30611300
description	plier for toaster H 180mm total length 100mm		
For models:	12T, 4TO, 6T		



knobs

producer-specific knobs

BERTO'S



1

GEV No.	110073	Ref. No.	31875800
description	knob ø 72mm		
For models:	CPG40, CPG40E, CPG80, CPG80E, G6CP6, G6F2B, G6F2B+A2, G6F2BH6, G6F2BP6, G6F2MH6, G6F2MP6, G6F4B, G6F4B+A4, G6F6B, G6F6B+A6, G6FL3B, G6FL3B-CR, G6FL3B-SX, G6FL3M, G6FL3M-CR, G6FL3M-SX, G6FL6B, G6FL6B-CR, G6FL6B-SX, G6FL6M, G6FL6M-CR, G6FL6M-SX, G6FM6B, G6FM6M, G6FR3B, G6FR3M, G6FR6B, G6FR6M, G6PL60B, G6PL60M, G7F2B, G7F2BE, G7F2BE+A2, G7F2M, G7F2ME, G7F2ME+A2, G7F4+FE, G7F4+FE1, G7F4+FES, G7F4+FG, G7F4+FG1, G7F4B, G7F4BE, G7F4BE+A4, G7F4E+FE1...(Other models you can see in the webshop)		



1

GEV No.	112692	Ref. No.	35878100 35878300
description	knob universal ø 72mm shaft ø 6x4.6mm shaft flat upper/lower silver		



1

GEV No.	113026	Ref. No.	35875900
description	knob universal ø 72mm shaft ø 8x6.5mm shaft flat upper/lower black		



1

GEV No.	111719	Ref. No.	35876300
description	knob without symbol ø 72mm BERTOS		
For models:	CPE40, E6BM3B, E6BM3M, E6BM6B, E6BM6M, E6CP6B, E6CP6M, E6CPM, E6P2M, E6P4M, E6P6+TE, E6P6M, E6PL60B, E6PL60M, E6PQ2P9+FE1, E6PQ2P9+TE, E7BR4B, E7BR4M, E7P2B-VTR, E7P2M, E7P2M-VTR, E7P4B-VTR, E7P4M, E7P4M-VTR, E7P4-VTR+FE, E7P4-VTR+FE1, E7P6M, E7PQ2B+T, E7PQ2M, E7PQ2M+T, E7PQ4+FE+T, E7PQ4+FE1+T, E7PQ4B+T, E7PQ4M, E7PQ4M+T, E7PQ6+FE+T, E7PQ6+FE1+T, E7PQ6B+T, E7PQ6M, E7PQ6M+T, E9BM4M, E9BM8M, E9CP40, E9F15-4M, E9F15-8M, E9F18-4M, E9F18-8M, E9P2M-VTR, E9P4+FE, E9P4+FE1...(Other models you can see in the webshop)		



1

GEV No.	111556	Ref. No.	35876200
description	knob without symbol ø 72mm BERTOS shaft ø 6x4.6mm shaft flat lower		
For models:	E6F8-3B, E6F8-3M, E6F8-6B, E6F8-6M, E6FL3B, E6FL3BP, E6FL3B-P, E6FL3BP-CR, E6FL3BP-SX, E6FL3B-SX, E6FL3M, E6FL3MP, E6FL3M-P, E6FL3MP-CR, E6FL3MP-SX, E6FL3M-SX, E6FL6B-2, E6FL6B-2-SX, E6FL6BP-2, E6FL6BP-2-CR, E6FL6BP-2-SX, E6FL6M-2, E6FL6M-2-SX, E6FL6MP-2, E6FL6MP-2-CR, E6FL6MP-2-SX, E6FM6B-2, E6FM6BP-2, E6FM6M-2, E6FM6MP-2, E6FR3B, E6FR3BP, E6FR3M, E6FR3MP, E6FR6B-2, E6FR6BP-2, E6FR6M-2, E6FR6MP-2, E7F18-4M, E7F18-4MS, E7F18-8M, E7F18-8MS, E7PI, E9BR8, E9BR8-I, E9FL4M, E9FL4M-CPD, E9FL4M-CR, E9FL4MP, E9FL4MP-CPD...(Other models you can see in the webshop)		



1

GEV No.	113024	Ref. No.	31876000 35876000
description	knob without symbol ø 72mm BERTOS shaft ø 6x4.6mm shaft flat upper		
For models:	E6P4+FE1, E6P6+FE1, E7BR8, E7P4+FE, E7P4+FE1, E7P4+FES, E7P6+FE, E7P6+FE1, E7P6+FES, E7PQ4+FE, E7PQ4+FE+T, E7PQ4+FE1, E7PQ4+FE1+T, E7PQ4+FES, E7PQ6+FE, E7PQ6+FE+T, E7PQ6+FE1, E7PQ6+FE1+T, E7PQ6+FES, ELT10+10B, ELT10B, ELT12+12B, ELT12B, ELT4+4B, ELT4B, G7F4+FE, G7F4+FE1, G7F4+FES, G7F4+FG, G7F4E+FE1, G7F4E+FE1+A4, G7F4E+FG1, G7F4E+FG1+A4, G7F6+FE, G7F6+FE1, G7F6+FES, G7F6+FG, G7F6E+FE1, G7F6E+FE1+A6, G7F6E+FG1, G7F6E+FG1+A6		



1

GEV No.	112875	Ref. No.	38951000
description	bezel gas tap with ignition flame ø 90mm		
For models:	G9P10D, G9P10DA, G9P10I, G9P10IA, G9P15D, G9P15DA, G9P15I, G9P15IA, G9P20D, G9P20DA, LXG9P15I, SG9P10D, SG9P10DA, SG9P10I, SG9P10IA, SG9P15D, SG9P15DA, SG9P15I		



1

GEV No.	112874	Ref. No.	38951200
description	bezel gas thermostat t.max. 300°C 170-300°C for gas oven ø 90mm		

mechanical components, equipment accessories



GEV No.	110593	Ref. No.	31952200
description	knob dial plate gas tap with ignition flame t.max.°C°C PEL21 ED ø 63mm ID ø 45.5mm silver/red		
For models:	E9F15-4M, E9F15-8M, E9F18-4M, E9F18-8M, G12F4H9+FGP, G12F-4H9M, G12F4P9+FGP, G12F4P9M, G6F2B, G6F2B+A2, G6F2BH6, G6F2BH9, G6F2BP6, G6F2BP9, G6F2BPW, G6F2BPW+AE, G6F2H6+FE1, G6F2H6+FG1, G6F2H9+FG1, G6F2H9+T, G6F2H9+TE, G6F2MH6, G6F2MH9, G6F2MP6, G6F2MP9, G6F2MPW, G6F2MPW+AE, G6F2P6+FE1, G6F2P6+FG1, G6F2P9+FG1, G6F2P9+T, G6F2P9+TE, G6F3BH12, G6F3BH9, G6F3H12+FE1, G6F3H12+FG1, G6F3H12+T, G6F3H12+TE, G6F3H9+T, G6F3MH12, G6F4B, G6F4B+A4, G6F4BPW, G6F4B-PW+AE, G6F4MPW, G6F4MPW+AE, G6F4PW+FE1, G6F4PW+FG1+AE, G6F4PW+FG1, G6F4PW+FG1+AE...(Other models you can see in the webshop)		



GEV No.	110594	Ref. No.	31952400
description	knob dial plate gas thermostat 1-8 t.max.°C°C SABAF ED ø 63mm ID ø 45.5mm silver/red		
For models:	G6F2H6+FG1, G6F2H9+FG1, G6F2P6+FG1, G6F2P9+FG1, G6F-3H12+FG1, G6F4PW+FG1, G6F4PW+FG1+AE, G6F6PW+FG1, G6F6PW+FG1+AE, G7F4+FG1, G7F4P+FG1, G7F4P+FG1+AF1, G7F4PW+FG1, G7F4PW+FG1+AE, G7F6+FG1, G7F6P+FG1, G7F-6P+FG1+AF1, G7F6PW+FG1, G7F6PW+FG1+AE, G7T4P2F+FG1, G7T4P4F+FG1, G7TP+FG, G7TP+FG1, G7TP2F+FG1, G9F4+FG1, G9F4E+FG1, G9F4E+FG1+A4, G9F4P+FG1, G9F4P+FG1+AF1, G9F-4PW+FG1, G9F4PW+FG1+AE, G9F6+FG1, G9F6E+FG1, G9F6E+F-G1+A6, G9F6P+FG1, G9F6PW+FG1, G9F6PW+FG1+AE, G9F8+2FG1, G9F8P+2FG1, G9TP+FG, G9TP+FG1, G9TP2F+FG1		

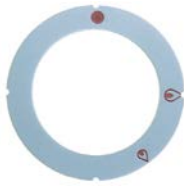

GEV No.	110590	Ref. No.	31952000
description	knob dial plate gas tap without ignition flame t.max.°C°C ED ø 63mm ID ø 45.5mm silver/red		
For models:	E7P2B-VTR, E7P2M-VTR, E7P4B-VTR, E7P4M-VTR, E7P4-VTR+FE, E7P4-VTR+FE1, G6F2B, G6F2B+A2, G6F2M, G6F2M+A2, G6F4+FE1, G6F4+FE1+A4, G6F4+FG1, G6F4+FG1+A4, G6F4B, G6F4B+A4, G6F4M, G6F4M+A4, G6F6+FE1, G6F6+FE1+A6, G6F6+FG1, G6F6+FG1+A6, G6F6+T, G6F6+T+A6, G6F6+TE, G6F6+TE+A6, G6F6B, G6F6B+A6, G6F6M, G6F6M+A6, G7F2BE, G7F2BE+A2, G7F2ME, G7F2ME+A2, G7F4BE, G7F4BE+A4, G7F4E+FE, G7F4E+FE+A4, G7F4E+FE1, G7F4E+-FE1+A4, G7F4E+FG, G7F4E+FG+A4, G7F4E+FG1, G7F4E+FG1+A4, G7F4ME, G7F4ME+A4, G7F6BE, G7F6BE+A6, G7F6E+FE, G7F6E+-FE+A6...(Other models you can see in the webshop)		



GEV No.	110596	Ref. No.	31952600
description	knob dial plate oven TH/BH/TH+BH t.max.°C°C turn direction right ED ø 63mm ID ø 45.5mm silver/red		
For models:	E7P4+FE, E7P6+FE, E7PQ4+FE, E7PQ4+FE+T, E7PQ6+FE, E7P-Q6+FE+T, E7TP+FE, E9P4+FE, E9P4P-VTR+FE, E9P4P-VTR+FE1, E9P4-VTR+FE, E9P4-VTR+FE1, E9P6+FE, E9PQ4+FE, E9PQ4+FE+T, E9PQ6+FE, E9PQ6+FE+T, G7F4PW+FE, G7F4PW+FE+AE, G7F6PW+FE, G7F6PW+FE+AE, G9F4+FE, G9F4PW+FE, G9F4PW+FE+AE, G9F6+FE, G9F6PW+FE, G9F6PW+FE+AE, G9F8+2FE, SE9P4P-VTR+FE, SE9PQ4+-FE, SE9PQ6+FE, SG9F4+FE, SG9F6+FE, SG9F8+2FE		



GEV No.	110595	Ref. No.	31952300
description	knob dial plate gas thermostat 1-8 t.max.°C°C PEL ED ø 63mm ID ø 45.5mm silver/red		
For models:	E9FL4M, E9FL4M-CPD, E9FL4M-CR, E9FL4MP, E9FL4MP-CPD, E9FL4MP-CR, E9FL4MP-SX, E9FL4M-SX, E9FL8M-2, E9FL8M-2-CPD, E9FL8M-2-CR, E9FL8M-2-SX, E9FL8MP-2, E9FL8MP-2-CPD, E9FL8MP-2-CR, E9FL8MP-2-SX, E9FM8M-2, E9FM8MP-2, E9FR4M, E9FR4MP, E9FR8M-2, E9FR8MP-2, G6F2B, G6F2B+A2, G6F2H9+FE1, G6F2P9+FE1, G6F3H12+T, G6F3H9+T, G6F4+FG1, G6F4+FG1+A4, G6F4B, G6F4B+A4, G6F6+FG1, G6F6+FG1+A6, G6F6+T, G6F6+T+A6, G6F6B, G6F6B+A6, G6F6PW+T, G6F6PW+T+AE, G6FL3B, G6FL3B-CR, G6FL3B-SX, G6FL3M, G6FL3M-CR, G6FL3M-SX, G6FL6B, G6FL6B-CR, G6FL6B-SX, G6FL6M...(Other models you can see in the webshop)		



GEV No.	111721	Ref. No.	35954000
description	knob dial plate switch 0-1-2 t.max.°C°C silver/red		
For models:	E9P10I, E9P10IA, E9P15I, E9P15IA, SE9P10I, SE9P10IA, SE9P15I, SE9P15IA		



GEV No.	113025	Ref. No.	30949300
description	knob dial plate switch 2-0-1 t.max.°C°C silver/red		

1

GEV No.	110592	Ref. No.	31952500
description	knob dial plate switch 7-position t.max.°C°C ED ø 63mm ID ø 45.5mm silver/red		
For models:	E6P2B, E6P2M, E6P4+FE1, E6P4B, E6P4M, E6P6+FE1, E6P6+TE, E6P6B, E6P6M, E6PQ2BH6, E6PQ2BH6+T, E6PQ2BP9, E6PQ2H6+FE1, E6P-Q2H6+FE1+T, E6PQ2MH6, E6PQ2MH6+T, E6PQ2MP9, E6PQ2P9+FE1, E6PQ2P9+TE, E7P2B, E7P2M, E7P4+FE, E7P4+FE1, E7P4+FES, E7P4B, E7P4M, E7P6+FE, E7P6+FE1, E7P6+FES, E7P6B, E7P6M, E7PQ2B, E7P-Q2B+T, E7PQ2M, E7PQ2M+T, E7PQ4+FE, E7PQ4+FE+T, E7PQ4+FE1, E7PQ4+FE1+T, E7PQ4+FES, E7PQ4B, E7PQ4B+T, E7PQ4M, E7PQ4M+T, E7PQ6+FE, E7PQ6+FE+T, E7PQ6+FE1, E7PQ6+FE1+T, E7PQ6+FES, E7PQ6B...(Other models you can see in the webshop)		

1

GEV No.	110598	Ref. No.	31953900
description	knob dial plate thermostat t.max. 195°C 100-195°C ED ø 63mm ID ø 45.5mm silver/red		
For models:	E6F10-3B, E6F10-3BS, E6F10-3M, E6F10-3MS, E6F10-6B, E6F10-6BS, E6F10-6M, E6F10-6MS, E6F8-3B, E6F8-3M, E6F8-6B, E6F8-6M, E7F10-4B, E7F10-4BS, E7F10-4M, E7F10-4MS, E7F10-8B, E7F10-8BS, E7F10-8M, E7F10-8MS, E7F18-4M, E7F18-4MS, E7F18-8M, E7F18-8MS, E7F30-8B, E7F30-8BP, E7F30-8M, E7F30-8MP, E9F15-4M, E9F15-8M, E9F18-4M, E9F18-8M, SE9F18-4M, SE9F18-8M		

1

GEV No.	110597	Ref. No.	31952700
description	knob dial plate thermostat t.max. 110°C 30-110°C rotation 270° ED ø 63mm ID ø 45.5mm silver/red		
For models:	E7BM4B, E7BM4M, E7BM8B, E7BM8M, E9BM4M, E9BM8M		

1

GEV No.	110591	Ref. No.	31953500
description	knob dial plate thermostat t.max. 300°C 50-300°C ED ø 63mm ID ø 45.5mm silver/red		
For models:	E6BR6B, E6BR6M, E6FL3B, E6FL3BP, E6FL3B-P, E6FL3BP-CR, E6FL3BP-SX, E6FL3B-SX, E6FL3M, E6FL3MP, E6FL3M-P, E6FL3MP-CR, E6FL3MP-SX, E6FL3M-SX, E6FL6B-2, E6FL6B-2-SX, E6FL6BP-2, E6FL6BP-2-CR, E6FL6BP-2-SX, E6FL6M-2, E6FL6M-2-SX, E6FL6MP-2, E6FL6MP-2-CR, E6FL6MP-2-SX, E6FM6B-2, E6FM6BP-2, E6FM6M-2, E6FM6MP-2, E6FR3B, E6FR3BP, E6FR3M, E6FR3MP, E6FR6B-2, E6FR6BP-2, E6FR6M-2, E6FR6MP-2, E6P4+FE1, E6P6+FE1, E6P6+TE, E6PQ2H6+FE1, E6P-Q2H6+FE1+T, E6PQ2P9+FE1, E6PQ2P9+TE, E7BR4B, E7BR4M, E7BR8, E7BR8-I, E7FL4B, E7FL4B-CR, E7FL4BP...(Other models you can see in the webshop)		

1

GEV No.	110599	Ref. No.	31954100
description	knob dial plate thermostat t.max. 110°C ED ø 63mm ID ø 45.5mm silver/red		
For models:	E7PI, G7PI		

1

GEV No.	111722	Ref. No.	22874700
description	knob without symbol ø 60mm shaft ø 6x4.6mm shaft flat upper		

1

GEV No.	111790	Ref. No.	35954100
description	knob dial plate thermostat t.max. 150°C ED ø 45.5mm ID ø 63mm silver/red		
For models:	E9P10I, E9P10IA, E9P15I, E9P15IA, SE9P10I, SE9P10IA, SE9P15I, SE9P15IA		

1

GEV No.	111723	Ref. No.	22953400
description	knob dial plate gas thermostat 1-8		

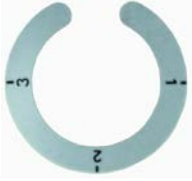

1

GEV No.	112055	Ref. No.	22953800
description	knob dial plate switch 4-position		



1

GEV No.	110771	Ref. No.	22651800
description	knob gas tap with ignition flame ø 60mm shaft ø 8x6.5mm shaft flat upper black		
For models:	GFLD8, GFLD8-CR, GFLM6, GFLM6-CR, GFLS4, GFLS4-CR, GFRD8, GFRM6, GFRS4		



1

GEV No.	110049	Ref. No.	22650900
description	knob gas tap without ignition flame ø 60mm shaft ø 8x6.5mm shaft flat upper		
For models:	G2FS4, G2FS4-S, G4F+FCD8, G4F+FSD8, G4FD8, G4FD8-S, G4S+FCGN, G4S+FSGN, G6F12-S, G6S+FCGN, G6S+FSGN		



1

GEV No.	110352	Ref. No.	22651400
description	knob gas thermostat 1-8 ø 60mm shaft ø 8x6.5mm shaft flat upper black		
For models:	G4S+FSGN, G6S+FSGN		



1

GEV No.	110774	Ref. No.	22652400
description	knob oven ø 60mm shaft ø 6x4.6mm shaft flat lower black		



1

GEV No.	110773	Ref. No.	22653100
description	knob switch 0-1 ø 60mm shaft ø 6x4.6mm shaft flat upper black		
For models:	EGRM4, EGRS4		



1

GEV No.	110770	Ref. No.	22652300
description	knob switch 4-position ø 60mm shaft ø 6x4.6mm shaft flat upper		
For models:	ECRM6		



1

GEV No.	110451	Ref. No.	22560700
description	knob switch 7-position ø 60mm shaft ø 6x4.6mm shaft flat upper black		



1

GEV No.	110453	Ref. No.	22652100
description	knob thermostat t.max. 110°C 30-110°C ø 60mm shaft ø 6x4.6mm shaft flat upper black temperature range 30-110°C		
For models:	EBMD8, EBMM6, EBMS4		



1

GEV No.	110455	Ref. No.	22652500
description	knob thermostat t.max. 195°C ø 60mm shaft ø 6x4.6mm shaft flat upper temperature range 100-195°C		
For models:	E10+10MB6, E10B4		



1			
GEV No.	110454	Ref. No.	22651600
description	knob thermostat t.max. 300°C 50-300°C ø 60mm shaft ø 6x4.6mm shaft flat upper		
For models:	EBRS4, EFLD8, EFLD8-CR, EFLM6, EFLM6-2, EFLM6-2-CR, EFLM6-CR, EFLS4, EFLS4-CR, EFM6-2, EFMD8, EFRM6, EFRS4, G4S+FCGN, G6S+FCGN		

1			
GEV No.	110452	Ref. No.	22651200
description	knob thermostat t.max. 300°C ø 60mm shaft ø 6x4.6mm shaft flat upper temperature range 50-300°C		
For models:	E4F+FCD8, E4F+FCDQ8, G4F+FCD8, G4F+FSD8		

1			
GEV No.	110764	Ref. No.	23653400
description	knob		
For models:	12T, SNACK-E, SNACK-E-LS, WAV-1, WAV1-GAS		

1			
GEV No.	110760	Ref. No.	27653300
description	knob graduated ø 52mm shaft ø 6x4.6mm shaft flat upper silver		
For models:	SA-E48, SA-E60, SA-E60-E, SA-E68M, SA-E68M-E		

1			
GEV No.	111753	Ref. No.	23652900
description	knob switch zero mark ø 37mm shaft ø 6x4.6mm shaft flat upper black		
For models:	WAV1-2, WAV2-3, WAV-E1-2, WAV-E2-3		

1			
GEV No.	110761	Ref. No.	30654500
description	knob switch zero mark ø 40mm shaft ø 6x4.6mm shaft flat right black		
For models:	ELT10+10B, ELT10B, ELT12+12B, ELT12+12M, ELT12B, ELT12M, ELT4+4B, ELT4B, PDL-LD, PDM-LD, PDR-LD, PDT-LD, PSL-LD, PSR-LD, PST-LD		

1			
GEV No.	110763	Ref. No.	30654700
description	knob switch zero mark ø 40mm shaft ø 6x4.6mm shaft flat right black		

1			
GEV No.	112876	Ref. No.	38877600
description	knob zero mark ø 69mm shaft ø 6x4.6mm shaft flat upper grey		
For models:	E6F10-3B, E6F10-3BS, E6F10-3M, E6F10-3MS, E6F10-6B, E6F10-6BS, E6F10-6M, E6F10-6MS, E6P2B, E6P2B-VTR, E6P2M-VTR, E6P4+FE1, E6P4B, E6P4B-VTR, E6P4M-VTR, E6P6+FE1, E6P6B, E7BM4B, E7BM4M, E7BM8B, E7BM8M, E7F10-4B, E7F10-4BS, E7F10-4M, E7F10-4MS, E7F10-8B, E7F10-8BS, E7F10-8M, E7F10-8MS, E7FL4B, E7FL4B-CR, E7FL4BP, E7FL4BP-CR, E7FL4BP-SX, E7FL4B-SX, E7FL4M, E7FL4M-CR, E7FL4MP, E7FL4MP-CR, E7FL4MP-SX, E7FL4M-SX, E7FL8B-2, E7FL8B-2-CR, E7FL8B-2-SX, E7FL8B-2-VTR, E7FL8BP-2, E7FL8BP-2-CR, E7FL8BP-2-SX, E7FL8M-2, E7FL8M-2-CR...(Other models you can see in the webshop)		

1			
GEV No.	112686	Ref. No.	38877100
description	knob zero mark ø 69mm shaft ø 8x6.5mm shaft flat upper grey edition since 11/2011		
For models:	E9P2M, E9P4M, E9P6M, E9PQ2M, E9PQ2M+T, E9PQ4M, E9PQ4M+T, E9PQ6M, E9PQ6M+T, G12F4H9+FGP, G12F4H9M, G12F4P9+FGP, G12F4P9M, G6F2BH9, G6F2BP9, G6F2BPW, G6F2BPW+AE, G6F-2H6+FE1, G6F2H6+FG1, G6F2H9+FE1, G6F2H9+FG1, G6F2H9+T, G6F2H9+TE, G6F2MH9, G6F2MP9, G6F2MPW, G6F2MPW+AE, G6F2P6+FE1, G6F2P6+FG1, G6F2P9+FE1, G6F2P9+FG1, G6F2P9+T, G6F2P9+TE, G6F3BH12, G6F3BH9, G6F3H12+FE1, G6F3H12+FG1, G6F3H12+T, G6F3H12+TE, G6F3H9+T, G6F3MH12, G6F4+FG1, G6F4+FG1+A4, G6F4BPW, G6F4BPW+AE, G6F4MPW, G6F4MPW+AE, G6F4PW+FE1, G6F4PW+FE1+AE, G6F4PW+FG1...(Other models you can see in the webshop)		



accessories

fascias



GEV No.	112875	Ref. No.	38951000
description	bezel gas tap with ignition flame ø 90mm		
For models:	G9P10D, G9P10DA, G9P10I, G9P10IA, G9P15D, G9P15DA, G9P15I, G9P15IA, G9P20D, G9P20DA, LXG9P15I, SG9P10D, SG9P10DA, SG9P10I, SG9P10IA, SG9P15D, SG9P15DA, SG9P15I		



GEV No.	112874	Ref. No.	38951200
description	bezel gas thermostat t.max. 300°C 170-300°C for gas oven ø 90mm		

handles and hand wheels

hand wheels

hand wheels



GEV No.	514398	Ref. No.	31995000
description	hand wheel ø 200mm D1 ø 40mm bore ø 15mm depth of bore 20mm thread M6 hole distance 6mm groove widthmm L1 35mm L2 70mm handle length 90mm with folding handle		
For models:	E7BR8, E7BR8-I, G7BR8, G7BR8-I		



GEV No.	692430	Ref. No.	35995000
description	hand wheel ø 200mm D1 ø 50mm bore ø 20mm thread groove width 6mm groove depth 13mm mounting distance 30mm L1 47mm L2 50mm handle length 90mm with folding handle		
For models:	E9BR8, E9BR8-I, G9BR8, G9BR8-I, SE9BR8, SE9BR8-I, SG9BR8, SG9BR8-I		

cylindrical handles

fixed



GEV No.	540235	Ref. No.	30661400
description	cylindrical handle thread M6 ø 17mm L 40mm		
For models:	E6CP3B, E7F30-8B, E7F30-8BP, PDL-LD, PDM-LD, PDR-LD, PDT-LD, PSL-LD, PSR-LD, PST-LD, SE9BM4M, SE9BM8M		

ball handles



GEV No.	540323	Ref. No.	35604000
description	ball handle thread M10 ø 40mm with metal bush black		
For models:	E9P10D, E9P10I, E9P10IA, E9P15D, E9P15I, E9P15IA, G9P10D, G9P10DA, G9P10I, G9P10IA, G9P15D, G9P15DA, G9P15I, G9P15IA, G9P20D, G9P20DA, LXE9P15I, LXG9P15I, SE9P10I, SE9P10IA, SE9P15I, SE9P15IA, SG9P10D, SG9P10DA, SG9P10I, SG9P10IA, SG9P15D, SG9P15DA, SG9P15I		

handle bars

consoles



GEV No.	111243	Ref. No.	31978400
description	console		



bracket handles

			
1			
GEV No.	692125	Ref. No.	33606100 336061000
description	pull handle L 110mm H 36mm mounting distance 88mm hole ø 4mm		
For models:	9GL15+15M, 9GL15M, 9GL20+20M, 9GL20M, E6CP6B, E6CP6M, E6CPM, E6F10-3B, E6F10-3BS, E6F10-3M, E6F10-3MS, E6F10-6B, E6F10-6BS, E6F10-6M, E6F10-6MS, E6F8-3B, E6F8-3M, E6F8-6B, E6F8-6M, E7F10-4B, E7F10-4BS, E7F10-4M, E7F10-4MS, E7F10-8B, E7F10-8BS, E7F10-8M, E7F10-8MS, E7F18-4M, E7F18-4MS, E7F18-8M, E7F18-8MS, E9F15-4M, E9F15-8M, E9F18-4M, E9F18-8M, ELT10+10B, ELT10+10B-E, ELT10B, ELT10B-E, ELT12+12B, ELT12+12B-E, ELT12+12M, ELT12+12M-E, ELT12B, ELT12B-E, ELT12M, ELT12M-E, ELT15+15B, ELT15+15B-E, ELT15+15M...(Other models you can see in the webshop)		

			
2			
GEV No.	699206	Ref. No.	27604500
description	pull handle L 205mm H 49mm mounting distance 180mm thread M8 W 28mm		
For models:	E6CP6B, E6CP6M, E7F30-8B, E7F30-8BP, E7F30-8M, E7F30-8MP, GL15+15M, GL15M, GL18+18MI, GL18+18MI-E, GL18MI, GL18MI-E, GL20+20M, GL20M, S9GL20+20M, S9GL20M, SA-E60, SA-E60-E, SE9F18-4M, SE9F18-8M		



locks



handle latches

universal

outside fixing





locks

				
1				
GEV No.	694065	Ref. No.	25884400	
description	door handle for headed units L 145mm W 40mm H 62mm spring length 33mm outer black			
spare parts for	694065			
	GEV No.	514390	Ref. No.	—
spring for door handle ø 6mm L 54mm W 27.5mm				
	GEV No.	694734	Ref. No.	—
door handle L 165mm W 40mm H 25mm black				

spare parts for	694065			
	GEV No.	694735	Ref. No.	—
cap ø 32mm black				
accessories for	694065			
	GEV No.	694066	Ref. No.	—
door catch with spigot 2-stage L 28mm W 14mm H 15mm H1 16mm total length 51mm thread M8 thread L 23mm stainless steel				
	GEV No.	694067	Ref. No.	—
door catch with spigot 1-stage L 26mm total length 51mm thread M8				

producer-specific

BERTO'S

				
1				
GEV No.	694065	Ref. No.	25884400	
description	door handle for headed units L 145mm W 40mm H 62mm spring length 33mm outer black			
spare parts for	694065			
	GEV No.	514390	Ref. No.	—
spring for door handle ø 6mm L 54mm W 27.5mm				
	GEV No.	694734	Ref. No.	—
door handle L 165mm W 40mm H 25mm black				
	GEV No.	694735	Ref. No.	—
cap ø 32mm black				
accessories for	694065			
	GEV No.	694066	Ref. No.	—
door catch with spigot 2-stage L 28mm W 14mm H 15mm H1 16mm total length 51mm thread M8 thread L 23mm stainless steel				
	GEV No.	694067	Ref. No.	—
door catch with spigot 1-stage L 26mm total length 51mm thread M8				

edgmount latches

handle latches

CAFF/FERMOD

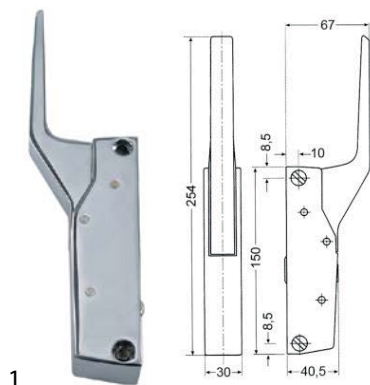

GEV No.	700060	Ref. No.	23604400
----------------	--------	-----------------	----------

description handle latch L 150mm mounting distance 133mm non lockable heated units G 791

For models: FME06M, FME10, FME10EP, FME10M, FME20, FME20M, FME6, FMG10, FMG10EP, FMG10M, FMG20, FMG20M, FMG6, FMG6EP, FMG6M, FPE12TURBO, FPE6TURBO, FPG12, FPG6, WAV-E12, WAV-E12T, WAV-E12TURBO, WAV-E20, WAV-E6, WAV-E6T, WAV-E6TURBO, WAV-G12, WAV-G20, WAV-G6

accessories for 700060

	GEV No.	700061	Ref. No.	23579700
door catch L 58mm W 20mm H 35mm mounting distance 42mm chrome-plated brass for headed units				

	GEV No.	700062	Ref. No.	—
handle protection heated units				

door catches



GEV No.	700061	Ref. No.	23579700
----------------	--------	-----------------	----------

description door catch L 58mm W 20mm H 35mm mounting distance 42mm chrome-plated brass for headed units

For models: FME06M, FME10, FME10EP, FME10M, FME20, FME20M, FME6, FMG10, FMG10EP, FMG10M, FMG20, FMG20M, FMG6, FMG6EP, FMG6M, FPE12TURBO, FPE6TURBO, FPG12, FPG6, WAV-E12, WAV-E12T, WAV-E12TURBO, WAV-E20, WAV-E6, WAV-E6T, WAV-E6TURBO, WAV-G12, WAV-G20, WAV-G6

accessories for 700061

	GEV No.	690414	Ref. No.	—
handle latch L 150mm mounting distance 133mm non lockable refrigeration units G 791				

snap locks

universal



GEV No.	690864	Ref. No.	24579500
----------------	--------	-----------------	----------

description door catch L 38mm W 13mm H 21mm mounting distance 28mm zamak with spigot

For models: FPE10A, FPE10B, FPE10C, FPE10D, FPE5A, FPE5B, FPE5C, FPE5D, FPG10A, FPG10B, FPG5A, FPG5B, FPG5C, FPG5D, WAV-ESU, WAV-G5U



GEV No.	690596	Ref. No.	24577700 + 24579500
----------------	--------	-----------------	---------------------

description snap lock L 60mm W 15mm H 36mm mounting distance 48/28mm spring thickness 1.5mm complete with door catch zamak



GEV No.	690863	Ref. No.	24577700
----------------	--------	-----------------	----------

description snap lock L 60mm W 16mm mounting distance 48mm spring thickness 1.5mm without door catch zamak

For models: FPE10A, FPE10B, FPE10C, FPE10D, FPE5A, FPE5B, FPE5C, FPE5D, FPG10A, FPG10B, FPG10C, FPG10D, FPG5A, FPG5B, FPG5C, FPG5D, WAV-ESU, WAV-G5U



GEV No.	700803	Ref. No.	23577300
----------------	--------	-----------------	----------

description snap lock L 69mm W 12.5mm H 20mm mounting distance 57mm complete with door catch brass

For models: WAV-E1-2, WAV-E2-3



GEV No.	690903	Ref. No.	23578800
----------------	--------	-----------------	----------

description snap lock L 69mm W 13mm H 20mm mounting distance 57mm complete with door catch nickel-plated brass

For models: WAV-E1-2, WAV-E2-3



espagnolette locks

producer-specific

BERTO'S



GEV No.	690829	Ref. No.	N/A
description	bush H 8mm ID ø 8mm ED ø 26mm		



GEV No.	690828	Ref. No.	N/A
description	bush L 20mm brass ID ø 10mm ED ø 15mm		



GEV No.	514317	Ref. No.	25938600
description	disc ID ø 11mm ED ø 17mm H 3mm brass		
For models:	FC60EM, FC60EP, FC60GEP, FC60GM, FMG6, FMG6EP, FMG6M, FPE6TURBO, FPG6, MM06EA, MM06EB, MM06GA, MM06GB, MM10EA, MM10EB, MM10GA, MM10GB, MM2-3EA, MM2-3EB, WAV-E6, WAV-E6TURBO, WAV-G6		



GEV No.	514321	Ref. No.	25760000
description	door catch with roller L 35mm W 26mm H 32mm mounting distance 20mm rollerø 10mm		
For models:	FC100EM, FC100EP, FC100GEP, FC100GM, FC200EA, FC200EB, FC200GA, FC200GB, FC60EM, FC60EP, FC60GEP, FC60GM, FMG6, FMG6EP, FMG6M, FPE6TURBO, FPG6, MM06EA, MM06EB, MM06GA, MM06GB, MM10EA, MM10EB, MM10GA, MM10GB, WAV-E6, WAV-E6TURBO, WAV-G6		



GEV No.	514316	Ref. No.	25605100
description	door handle black		
For models:	FME06M, FME10, FME10EP, FME10M, FME20, FME20M, FME6, FMG10, FMG10EP, FMG10M, FMG20, FMG20M, FMG6, FMG6EP, FMG6M, FPE12TURBO, FPE6TURBO, FPG12, FPG6, MM06EA, MM06EB, MM06GA, MM06GB, MM10EA, MM10EB, MM10GA, MM10GB, MM2-3EA, MM2-3EB, WAV-E12, WAV-E12T, WAV-E12TURBO, WAV-E20, WAV-E6, WAV-E6T, WAV-E6TURBO, WAV-G12, WAV-G20, WAV-G6		



GEV No.	514321	Ref. No.	25760000
description	door catch with roller L 35mm W 26mm H 32mm mounting distance 20mm rollerø 10mm		



GEV No.	690826	Ref. No.	N/A
description	striker bolt L1 60mm L2 64mm D1 ø 20mm D2 ø 10mm		

accessories for	514316			
	GEV No.	690862	Ref. No.	25878100
	latch gear opening to the right shaft intake ø 8x8mm L 170mm W 40mm H 29mm			
	GEV No.	691655	Ref. No.	N/A
	striker bolt L1 60mm L2 95mm D1 ø 20mm D2 ø 10mm			



GEV No.	690827	Ref. No.	N/A
description	latch block L 40mm brass hole ø 20mm dimensions 30x30mm		



GEV No.	690862	Ref. No.	25878100
description	latch gear opening to the right shaft intake ø 8x8mm L 170mm W 40mm H 29mm		
For models:	FC100EM, FC100EP, FC100GEP, FC100GM, FC200EA, FC200EB, FC200GA, FC200GB, FC60EM, FC60EP, FC60GEP, FC60GM, FME06M, FME10, FME10EP, FME10M, FME20, FME20M, FME6, FMG10, FMG10EP, FMG10M, FMG20, FMG20M, FMG6, FMG6EP, FMG6M, FPE12TURBO, FPE6TURBO, FPG12, FPG6, MM06EA, MM06EB, MM06GA, MM06GB, MM10EA, MM10EB, MM10GA, MM10GB, WAV-E12, WAV-E12T, WAV-E12TURBO, WAV-E20, WAV-E6, WAV-E6T, WAV-E6TURBO, WAV-G12, WAV-G20, WAV-G6		

accessories for	690862			
	GEV No.	514317	Ref. No.	25938600
	disc ID ø 11mm ED ø 17mm H 3mm brass			

	GEV No.	514321	Ref. No.	25760000
	door catch with roller L 35mm W 26mm H 32mm mounting distance 20mm rollerø 10mm			

	GEV No.	690826	Ref. No.	N/A
	striker bolt L1 60mm L2 64mm D1 ø 20mm D2 ø 10mm			

	GEV No.	690827	Ref. No.	N/A
	latch block L 40mm brass hole ø 20mm dimensions 30x30mm			

	GEV No.	690828	Ref. No.	N/A
	bush L 20mm brass ID ø 10mm ED ø 15mm			

	GEV No.	690829	Ref. No.	N/A
	bush H 8mm ID ø 8mm ED ø 26mm			

	GEV No.	691637	Ref. No.	—
	roll pin ø 3mm L 20mm			

	GEV No.	691653	Ref. No.	N/A
	striker bolt L1 60mm L2 240mm D1 ø 20mm D2 ø 10mm			

	GEV No.	691654	Ref. No.	N/A
	striker bolt L1 60mm L2 113mm D1 ø 20mm D2 ø 10mm			

	GEV No.	691655	Ref. No.	N/A
	striker bolt L1 60mm L2 95mm D1 ø 20mm D2 ø 10mm			

	GEV No.	691637	Ref. No.	—
	roll pin ø 3mm L 20mm			

	GEV No.	691653	Ref. No.	N/A
	striker bolt L1 60mm L2 240mm D1 ø 20mm D2 ø 10mm			



	GEV No.	691654	Ref. No.	N/A
	striker bolt L1 60mm L2 113mm D1 ø 20mm D2 ø 10mm			

	GEV No.	691655	Ref. No.	N/A
	striker bolt L1 60mm L2 95mm D1 ø 20mm D2 ø 10mm			

	GEV No.	691655	Ref. No.	N/A
	striker bolt L1 60mm L2 95mm D1 ø 20mm D2 ø 10mm			

	GEV No.	691655	Ref. No.	N/A
	striker bolt L1 60mm L2 95mm D1 ø 20mm D2 ø 10mm			

Table continues overleaf

accessories for	690862		
GEV No.	691656	Ref. No.	N/A
	striker bolt L1 60mm L2 315mm D1 ø 20mm D2 ø 10mm		
GEV No.	691657	Ref. No.	N/A
	striker bolt L1 60mm L2 283mm D1 ø 20mm D2 ø 10mm		
GEV No.	691658	Ref. No.	N/A
	striker bolt L1 60mm L2 570mm D1 ø 20mm D2 ø 10mm		

	GEV No.	691654	Ref. No.	N/A
description	striker bolt L1 60mm L2 113mm D1 ø 20mm D2 ø 10mm			

	GEV No.	691653	Ref. No.	N/A
description	striker bolt L1 60mm L2 240mm D1 ø 20mm D2 ø 10mm			

	GEV No.	691657	Ref. No.	N/A
description	striker bolt L1 60mm L2 283mm D1 ø 20mm D2 ø 10mm			

	GEV No.	691656	Ref. No.	N/A
description	striker bolt L1 60mm L2 315mm D1 ø 20mm D2 ø 10mm			

	GEV No.	691658	Ref. No.	N/A
description	striker bolt L1 60mm L2 570mm D1 ø 20mm D2 ø 10mm			

	GEV No.	690826	Ref. No.	N/A
description	striker bolt L1 60mm L2 64mm D1 ø 20mm D2 ø 10mm			

	GEV No.	691655	Ref. No.	N/A
description	striker bolt L1 60mm L2 95mm D1 ø 20mm D2 ø 10mm			

hinges

oven hinges

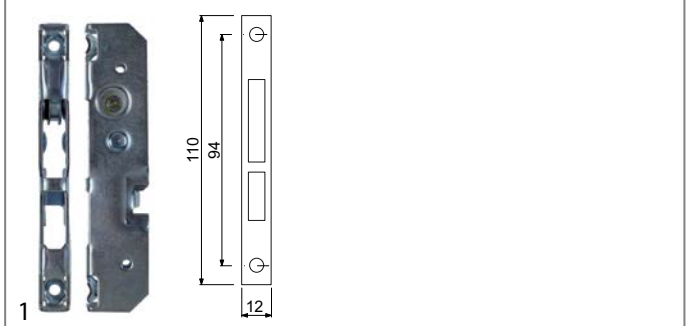



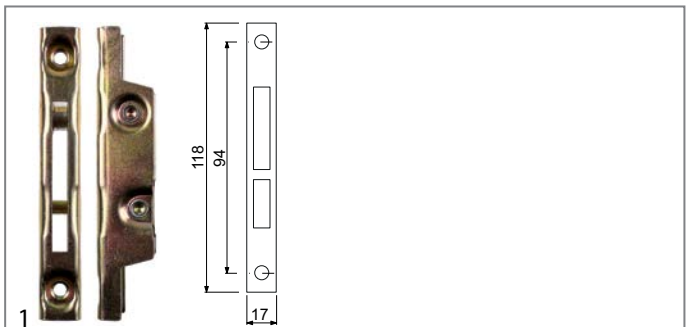

GEV No.	700003	Ref. No.	22608200
description	opposite support L 110mm W 12mm mounting distance 94mm		
For models:	E4F+FCD8, E4F+FCDQ8, E6P4+FE1, E6P6+FE1, E6P6+TE, E6PQ2H6+FE1, E6PQ2H6+FE1+T, E6PQ2P9+FE1, E6PQ2P9+TE, E7P4+FE1, E7P4-VTR+FE1, E7P6+FE1, E7PQ4+FE1, E7PQ4+FE1+T, E7PQ6+FE1, E7PQ6+FE1+T, E9P4+FE1, E9P4P-VTR+FE1, E9P4-VTR+FE1, E9P6+FE1, E9PQ4+FE1, E9PQ4+FE1+T, E9PQ6+FE1, E9PQ6+FE1+T, G4F+FCD8, G4F+FSD8, G4S+FCGN, G4S+FSGN, G6F2H6+FE1, G6F2H6+FG1, G6F2H9+FE1, G6F2H9+FG1, G6F2H9+TE, G6F2P6+FE1, G6F2P6+FG1, G6F2P9+FE1, G6F2P9+FG1, G6F2P9+T, G6F2P9+TE, G6F3H12+FE1, G6F3H12+FG1, G6F3H12+T, G6F3H12+TE, G6F3H9+T, G6F4+FE1, G6F4+FE1+A4, G6F4+FG1, G6F4+FG1+A4, G6F4PW+FE1, G6F4PW+FE1+AE...(Other models you can see in the webshop)		









GEV No.	700001	Ref. No.	31802500
description	opposite support L 118mm W 17mm mounting distance 94mm		
For models:	E6PQ2P9+FE1, E7P4+FE, E7P4+FE1, E7P4+FES, E7P4-VTR+FE, E7P4-VTR+FE1, E7P6+FE, E7P6+FE1, E7P6+FES, E7PQ4+FE, E7PQ4+FE+T, E7PQ6+FE1, E7PQ6+FE1+T, E7PQ6+FES, E7PQ6+FE, E7PQ6+FE+T, E7PQ6+FE1, E7PQ6+FE1+T, E7PQ6+FES, E7TP+FE, E9P4+FE, E9P4+FE1, E9P4+FES, E9P4P-VTR+FE, E9P4P-VTR+FE1, E9P4-VTR+FE, E9P4-VTR+FE1, E9P4-VTR+FES, E9P6+FE, E9P6+FE1, E9P6+FES, E9PQ4+FE, E9PQ4+FE+T, E9PQ4+FE1, E9PQ4+FE1+T, E9PQ4+FES, E9PQ6+FE, E9PQ6+FE+T, E9PQ6+FE1, E9PQ6+FE1+T, E9PQ6+FES, G12F4P9+FGP, G6F2B, G6F2B+A2, G6F2H9+FE1, G6F2H9+FG1, G6F2P9+FE1, G6F2P9+FG1, G6F4B, G6F4B+A4...(Other models you can see in the webshop)		



							
GEV No.	690499	Ref. No.	22608100				
description	oven hinge mounting distance 118mm lug mounting 13mm lever length 119mm groove distance 12mm spring thickness 4mm mounting ear position left spring length 59mm L 155mm W 21mm						
For models:	E4F+FCD8, E4F+FCDQ8, E6P4+FE1, E6P6+FE1, E6P6+TE, E6PQ2H6+FE1, E6PQ2H6+FE1+T, E6PQ2P9+FE1, E6PQ2P9+TE, E7P4+FE1, E7P4-VTR+FE1, E7P6+FE1, E7PQ4+FE1, E7PQ4+FE1+T, E7PQ6+FE1, E7PQ6+FE1+T, E9P4+FE1, E9P4P-VTR+FE1, E9P4-VTR+FE1, E9P6+FE1, E9PQ4+FE1, E9PQ4+FE1+T, E9PQ6+FE1, E9PQ6+FE1+T, G4F+FCD8, G4F+FSD8, G4S+FCGN, G4S+FSGN, G6F2H6+FE1, G6F2H6+FG1, G6F2H9+FE1, G6F2H9+FG1, G6F2H9+T, G6F2H9+TE, G6F2P6+FE1, G6F2P6+FG1, G6F2P9+FE1, G6F2P9+FG1, G6F2P9+T, G6F2P9+TE, G6F3H12+FE1, G6F3H12+FG1, G6F3H12+T, G6F3H12+TE, G6F3H9+T, G6F4+FE1, G6F4+FE1+A4, G6F4+FG1, G6F4+FG1+A4, G6F4PW+FE1... (Other models you can see in the webshop)						
accessories for	690499						
 <table border="1"> <tr> <td>GEV No.</td> <td>700003</td> <td>Ref. No.</td> <td>22608200</td> </tr> </table> <p>opposite support L 110mm W 12mm mounting distance 94mm</p>				GEV No.	700003	Ref. No.	22608200
GEV No.	700003	Ref. No.	22608200				

							
GEV No.	690498	Ref. No.	22607800				
description	oven hinge mounting distance 118mm lug mounting 13mm lever length 119mm groove distance 12mm spring thickness 4mm mounting ear position right spring length 59mm L 155mm W 21mm						
For models:	E4F+FCD8, E4F+FCDQ8, E6P4+FE1, E6P6+FE1, E6P6+TE, E6PQ2H6+FE1, E6PQ2H6+FE1+T, E6PQ2P9+FE1, E6PQ2P9+TE, E7P4+FE1, E7P4-VTR+FE1, E7P6+FE1, E7PQ4+FE1, E7PQ4+FE1+T, E7PQ6+FE1, E7PQ6+FE1+T, E9P4+FE1, E9P4P-VTR+FE1, E9P6+FE1, E9PQ4+FE1, E9PQ4+FE1+T, E9PQ6+FE1, E9PQ6+FE1+T, G4F+FCD8, G4F+FSD8, G4S+FCGN, G4S+FSGN, G6F2H6+FE1, G6F2H6+FG1, G6F2H9+FE1, G6F2H9+FG1, G6F2H9+T, G6F2H9+TE, G6F2P6+FE1, G6F2P6+FG1, G6F2P9+FE1, G6F2P9+FG1, G6F2P9+T, G6F2P9+TE, G6F3H12+FE1, G6F3H12+FG1, G6F3H12+T, G6F3H12+TE, G6F3H9+T, G6F4+FE1, G6F4+FE1+A4, G6F4+FG1, G6F4+FG1+A4, G6F4PW+FE1, G6F4PW+FE1+AE... (Other models you can see in the webshop)						
accessories for	690498						
 <table border="1"> <tr> <td>GEV No.</td> <td>700003</td> <td>Ref. No.</td> <td>22608200</td> </tr> </table> <p>opposite support L 110mm W 12mm mounting distance 94mm</p>				GEV No.	700003	Ref. No.	22608200
GEV No.	700003	Ref. No.	22608200				

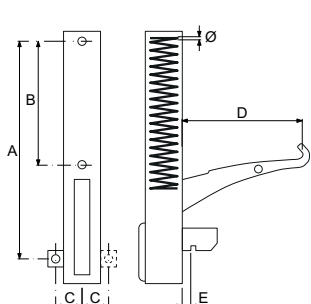
							
GEV No.	700006	Ref. No.	31802100				
description	oven hinge mounting distance 173mm mounting distance 2 105mm lug mounting 14mm lever length 120mm groove distance 11mm spring thickness 3.5mm mounting ear position left spring length 112mm W 25mm						
For models:	E6PQ2P9+FE1, E7P4+FE, E7P4+FE1, E7P4+FES, E7P4-VTR+FE, E7P4-VTR+FE1, E7P6+FE, E7P6+FE1, E7P6+FES, E7PQ4+FE, E7PQ4+FE+T, E7PQ4+FE1, E7PQ4+FE1+T, E7PQ4+FES, E7PQ6+FE, E7PQ6+FE+T, E7PQ6+FE1, E7PQ6+FE1+T, E7PQ6+FES, E7TP+FE, E9P4+FE, E9P4+FE1, E9P4+FES, E9P4P-VTR+FE, E9P4P-VTR+FE1, E9P4-VTR+FE, E9P4-VTR+FE1, E9P4-VTR+FES, E9P6+FE, E9P6+FE1, E9P6+FES, E9PQ4+FE, E9PQ4+FE+T, E9PQ4+FE1, E9PQ4+FE1+T, E9PQ4+FES, E9PQ6+FE, E9PQ6+FE+T, E9PQ6+FE1, E9PQ6+FE1+T, E9PQ6+FES, G12F4H9+FGP, G12F4P9+FGP, G6F2B, G6F2B+A2, G6F2H9+FE1, G6F2H9+FG1, G6F2P9+FE1, G6F2P9+FG1, G6F4B... (Other models you can see in the webshop)						
accessories for	700006						
 <table border="1"> <tr> <td>GEV No.</td> <td>700001</td> <td>Ref. No.</td> <td>31802500</td> </tr> </table> <p>opposite support L 118mm W 17mm mounting distance 94mm</p>				GEV No.	700001	Ref. No.	31802500
GEV No.	700001	Ref. No.	31802500				
 <table border="1"> <tr> <td>GEV No.</td> <td>700007</td> <td>Ref. No.</td> <td>31802000</td> </tr> </table> <p>oven hinge mounting distance 173mm mounting distance 2 105mm lug mounting 14mm lever length 120mm groove distance 11mm spring thickness 3.5mm mounting ear position right spring length 112mm W 25mm</p>				GEV No.	700007	Ref. No.	31802000
GEV No.	700007	Ref. No.	31802000				

 							
GEV No.	700007	Ref. No.	31802000				
description	oven hinge mounting distance 173mm mounting distance 2 105mm lug mounting 14mm lever length 120mm groove distance 11mm spring thickness 3.5mm mounting ear position right spring length 112mm W 25mm						
For models:	E6PQ2P9+FE1, E7P4+FE, E7P4+FE1, E7P4+FES, E7P4-VTR+FE, E7P4-VTR+FE1, E7P6+FE, E7P6+FE1, E7P6+FES, E7PQ4+FE, E7PQ4+FE+T, E7PQ4+FE1, E7PQ4+FE1+T, E7PQ4+FES, E7PQ6+FE, E7PQ6+FE+T, E7PQ6+FE1, E7PQ6+FE1+T, E7PQ6+FES, E7TP+FE, E9P4+FE, E9P4+FE1, E9P4+FES, E9P4P-VTR+FE, E9P4P-VTR+FE1, E9P4-VTR+FE, E9P4-VTR+FE1, E9P4-VTR+FES, E9P6+FE, E9P6+FE1, E9P6+FES, E9PQ4+FE, E9PQ4+FE+T, E9PQ4+FE1, E9PQ4+FE1+T, E9PQ4+FES, E9PQ6+FE, E9PQ6+FE+T, E9PQ6+FE1, E9PQ6+FE1+T, E9PQ6+FES, G12F4H9+FGP, G12F4P9+FGP, G6F2B, G6F2B+A2, G6F2H9+FE1, G6F2H9+FG1, G6F2P9+FE1, G6F2P9+FG1, G6F4B... (Other models you can see in the webshop)						
accessories for	700007						
 <table border="1"> <tr> <td>GEV No.</td> <td>700001</td> <td>Ref. No.</td> <td>31802500</td> </tr> </table> <p>opposite support L 118mm W 17mm mounting distance 94mm</p>				GEV No.	700001	Ref. No.	31802500
GEV No.	700001	Ref. No.	31802500				

door bearing

			
1			
GEV No.	514306	Ref. No.	0045D
description	hinge bearing mounting pos. bottom left without bolt		

			
1			
GEV No.	514308	Ref. No.	1004A
description	hinge bearing mounting pos. bottom left without bolt		

			
1			
GEV No.	514310	Ref. No.	0321.05
description	hinge bearing mounting pos. bottom left without bolt		

			
1			
GEV No.	514313	Ref. No.	12025
description	hinge bearing mounting pos. lower without bolt		
For models:	FC200GB		

			
1			
GEV No.	514315	Ref. No.	30082
description	hinge bearing mounting pos. lower without bolt		
For models:	MM2-3EA, MM2-3EB		

			
1			
GEV No.	514305	Ref. No.	0046B
description	hinge bearing mounting pos. upper left without bolt		

			
1			
GEV No.	514307	Ref. No.	1003A
description	hinge bearing mounting pos. upper left without bolt		
For models:	WAV-G5U		

			
1			
GEV No.	514309	Ref. No.	0322C
description	hinge bearing mounting pos. upper left without bolt		
For models:	MM-10-EB		

			
1			
GEV No.	514311	Ref. No.	15.0007.01
description	hinge bearing mounting pos. upper left without bolt		

			
1			
GEV No.	514312	Ref. No.	12024
description	hinge bearing mounting pos. upper left without bolt		
For models:	FC200GB		

			
1			
GEV No.	514314	Ref. No.	30083
description	hinge bearing mounting pos. upper left without bolt		
For models:	MM2-3EA, MM2-3EB		



fittings for catering equipment

outlet taps

producer-specific

BERTO'S



1

GEV No.	540658	Ref. No.	32686300 32686900
description	ball valve connection 3/4" IT - 3/4" IT DN20 total length 69mm		
For models:	9GL15+15M, 9GL15M, 9GL20+20M, 9GL20M, CPE40, CPG40, CPG40E, CPG80, CPG80E, E6F8-3M, E6F8-6M, E7F10-4B, E7F10-4BS, E7F10-4M, E7F10-4MS, E7F10-8B, E7F10-8BS, E7F10-8M, E7F10-8MS, E7F18-4M, E7F18-4MS, E7F18-8M, E7F18-8MS, E7F30-8M, E7F30-8MP, E9F15-4M, E9F15-8M, E9F18-4M, E9F18-8M, ELT12+12M, ELT12+12M-E, ELT12M, ELT12M-E, ELT15+15M, ELT15+15M-E, ELT15M, ELT15M-E, ELT18+18M, ELT18+18M-E, ELT18+18M-E224, ELT18M, ELT18M-E, ELT30M, G6CP6, G9BM4M, G9CP40, G9CP40-2, G9CP80, G9CP80-2, GL10+10M...(Other models you can see in the webshop)		



1

GEV No.	514120	Ref. No.	32685400
description	outlet tap L 84mm spout ø 22mm thread 3/4" IT		
For models:	6GL18B, 6GL18M, E6BM3B, E6BM3M, E6BM6B, E6BM6M, E6CP3B, E6CP6B, E6CP6M, E6CPM, E6F10-3B, E6F10-3BS, E6F10-3M, E6F10-3MS, E6F10-6B, E6F10-6BS, E6F10-6M, E6F10-6MS, E6F8-3B, E6F8-6B, E6PL60B, E6PL60M, E7BM4B, E7BM4M, E7BM8B, E7BM8M, E7F30-8B, E7F30-8BP, E9BM4M, E9BM8M, E9PL40M, E9PL80M, ELT10+10B, ELT10+10B-E, ELT10B, ELT10B-E, ELT12+12B, ELT12+12B-E, ELT12B, ELT12B-E, ELT15+15B, ELT15+15B-E, ELT15B, ELT15B-E, ELT16B, ELT18+18B, ELT18+18BE, ELT18+18B-E, ELT18B, ELT18BE...(Other models you can see in the webshop)		

aerators and air bleeders



1

GEV No.	540824	Ref. No.	31990600
description	pressure compensation valve thread 1/4" ET WS 19 chrome-plated L 18mm		
For models:	E7PI, G7PI		

lid hinges

ELECTROLUX

spare parts



1

GEV No.	693299	Ref. No.	31878200
description	torsion spring ø 28.6mm L2 103mm wire gauge ø 3.6mm L1 45mm		
For models:	E7PI, G7PD, G7PI		

inlet taps



1

GEV No.	514210	Ref. No.	22686400
description	shut-off valve		
For models:	ECRM6		



1

GEV No.	514205	Ref. No.	31686800 (old version)
description	shut-off valve thread 1/2"		

1





drain taps

brass

drain taps





1

GEV No.	540132	Ref. No.	3127440
description	drain tap 1 1/2" IT conical seal kettle A 90mm B 137mm B1 70mm chrome-plated brass		
spare parts for	540132		
	GEV No.	540213	Ref. No. —
	handle ID ø 5mm L 117mm		
	GEV No.	540461	Ref. No. —
	shim for drain tap		
	GEV No.	540464	Ref. No. —
	nut for drain tap thread 1 1/2"		
accessories for	540132		
	GEV No.	510404	Ref. No. —
	flat gasket fibre ED ø 44mm ID ø 34mm thickness 2mm Qty 1 pcs		



1

GEV No.	540131	Ref. No.	31274300
description	drain tap 1 1/4" IT chrome-plated brass		
For models:	E7PI, G7PD, G7PI		
spare parts for	540131		
	GEV No.	540213	Ref. No. —
	handle ID ø 5mm L 117mm		
	GEV No.	540461	Ref. No. —
	shim for drain tap		
	GEV No.	540464	Ref. No. —
	nut for drain tap thread 1 1/2"		

FITTINGS FOR CATERING EQUIPMENT BERTOS



1

GEV No.	540275	Ref. No.	35274800
description	drain tap 2" IT with union nut A 90mm B 151mm B1 80mm chrome-plated brass		
For models:	E9P10I, E9P10IA, E9P15I, E9P15IA, G9P10D, G9P10DA, G9P10I, G9P10IA, G9P15D, G9P15DA, G9P15I, G9P15IA, G9P20D, G9P20DA, LXE9P15I, LXG9P15I, SE9P10I, SE9P10IA, SE9P15I, SE9P15IA, SG9P10D, SG9P10DA, SG9P10I, SG9P10IA, SG9P15D, SG9P15DA, SG9P15I		
spare parts for	540275		
	GEV No.	540214	Ref. No. —
	handle ID ø 6mm L 145mm		
accessories for	540275		
	GEV No.	529484	Ref. No. —
	flat gasket fibre ED ø 58mm ID ø 50mm thickness 2mm Qty 1 pcs		
	GEV No.	542448	Ref. No. 35859800
	gasket silicone 60x49x2 for drain tap 2"		

accessories



1

GEV No.	542448	Ref. No.	35859800
description	gasket silicone 60x49x2 for drain tap 2"		
For models:	E9P10D, E9P10I, E9P10IA, E9P15D, E9P15I, E9P15IA, G9P10D, G9P10DA, G9P10I, G9P10IA, G9P15D, G9P15DA, G9P15I, G9P15IA, LXE9P15I, SE9P10I, SE9P10IA, SE9P15I, SE9P15IA, SG9P10D, SG9P10DA, SG9P10I, SG9P10IA, SG9P15D, SG9P15DA, SG9P15I		

steam traps

steam traps



1

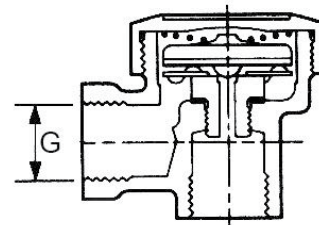

GEV No.	540784	Ref. No.	31954600
description	thermostatic steam trap thread 1/2" type BPT13A brass		
For models:	E7PI, G7PI		



safety fittings

safety fittings



1

GEV No.	514501	Ref. No.	31857400
description	safety fitting thread 3/4" 0.5bar with manometer chrome-plated brass H 235mm		
For models:	E7PI, E9P10I, E9P10IA, E9P15I, E9P15IA, G7PI, G9P10I, G9P10IA, G9P15I, G9P15IA, SE9P10I, SE9P10IA, SE9P15I, SE9P15IA, SG9P10I, SG9P10IA, SG9P15I		
spare parts for	514501		
	GEV No.	514122	Ref. No. —
	safety valve triggering pressure 0.5bar with CE approval thread 3/4"		
	GEV No.	540822	Ref. No. —
	fitting support thread 3/4"		
	GEV No.	540827	Ref. No. —
	aerator and air bleeder thread 3/4" ET chrome-plated L 45mm ø 36mm		
	GEV No.	540828	Ref. No. 31954900
	manometer siphon thread 3/8"		
	GEV No.	541062	Ref. No. 31875700
	manometer ø 63mm pressure range 0 up to 1bar connection marking adjustable kettle thread 1/4"		

accessories





1

GEV No.	540836	Ref. No.	31273900
description	funnel thread 1/2" with shut-off valve		
For models:	E7PI, G7PI		



1

GEV No.	540835	Ref. No.	31287500
description	screw cap thread 3/4"		
For models:	E7PI, E9P10I, E9P10IA, E9P15I, E9P15IA, G7PI, G9P10I, G9P10IA, G9P15I, G9P15IA, SE9P10I, SE9P10IA, SE9P15I, SE9P15IA, SG9P10I, SG9P10IA, SG9P15I		
spare parts for	540835		
	GEV No.	513016	Ref. No. —
	O-ring EPDM thickness 3.53mm ID ø 26.58mm Qty 1 pcs		

accessories for	540835		
	GEV No.	513016	Ref. No. —
	O-ring EPDM thickness 3.53mm ID ø 26.58mm Qty 1 pcs		



1

GEV No.	540828	Ref. No.	31954900
description	manometer siphon thread 3/8"		
For models:	E7PI, E9P10I, E9P10IA, E9P15I, E9P15IA, G7PI, G9P10I, G9P10IA, G9P15I, G9P15IA, SE9P10I, SE9P10IA, SE9P15I, SE9P15IA, SG9P10I, SG9P10IA, SG9P15I		

baskets

fryer baskets

BERTO'S



1

GEV No.	970230	Ref. No.	33614400
description	fryer basket L1 235mm W1 200mm H1 100mm L2 395mm H2 210mm chrome-plated steel		
For models:	ELT10+10B, ELT10+10B-E, ELT10B, ELT10B-E, ELT12+12B, ELT12+12B-E, ELT12B, ELT12B-E, ELT15+15B, ELT15+15B-E, ELT15B, ELT15B-E, ELT18+18B, ELT18+18BE, ELT18B, ELT18BE, ELT8+8B, ELT8+8B-E, ELT8B, ELT8B-E, GL8+8B, GL8+8M, GL8B, GL8M		



1

GEV No.	970225	Ref. No.	33502000
description	fryer basket L1 255mm W1 95mm H1 110mm L2 440mm H2 170mm H3 230mm chrome-plated steel		
For models:	E6F10-3B, E6F10-3BS, E6F10-3M, E6F10-3MS, E6F10-6B, E6F10-6BS, E6F10-6M, E6F10-6MS, E6F8-3B, E6F8-3M, E6F8-6B, E6F8-6M, E7F10-4B, E7F10-4BS, E7F10-4M, E7F10-4MS, E7F10-8B, E7F10-8BS, E7F10-8M, E7F10-8MS		



1

GEV No.	970231	Ref. No.	33614600
description	fryer basket L1 275mm W1 210mm H1 110mm H2 155mm H3 205mm		
For models:	6GL18B, 6GL18M, E6F10-3B, E6F10-3BS, E6F10-3M, E6F10-3MS, E6F10-6B, E6F10-6BS, E6F10-6M, E6F10-6MS, E6F8-3B, E6F8-3M, E6F8-6B, E6F8-6M, E7F10-4B, E7F10-4BS, E7F10-4M, E7F10-4MS, E7F10-8B, E7F10-8BS, E7F10-8M, E7F10-8MS, ELT10+10B, ELT10+10B-E, ELT10B, ELT10B-E, ELT12+12B, ELT12+12B-E, ELT12+12M, ELT12+12M-E, ELT12B, ELT12B-E, ELT12M, ELT12M-E, ELT15+15B, ELT15+15B-E, ELT15+15M, ELT15+15M-E, ELT15B, ELT15B-E, ELT15M, ELT15M-E, ELT18+18B, ELT18+18BE, ELT18+18M, ELT18+18M-E, ELT18+18M-E224, ELT18B, ELT18BE, ELT18M...(Other models you can see in the webshop)		



2

GEV No.	970451	Ref. No.	2250200
description	fryer basket L1 280mm W1 100mm H1 100mm chrome-plated steel		



1

GEV No.	970215	Ref. No.	22617400
description	fryer basket L1 280mm W1 200mm H1 100mm chrome-plated steel		
For models:	E10+10MB6, E10B4		



1

GEV No.	970217	Ref. No.	22617132
description	fryer basket L1 300mm W1 230mm H1 105mm		



1

GEV No.	970226	Ref. No.	32617100
description	fryer basket L1 300mm W1 245mm H1 110mm		
For models:	ELT10+10B-E, ELT10B-E, ELT12+12B-E, ELT12+12M-E, ELT12B-E, ELT12M-E, ELT15+15B, ELT15+15B-E, ELT15+15M, ELT15+15M-E, ELT15B, ELT15B-E, ELT15M, ELT15M-E, ELT18+18B, ELT18+18BE, ELT18+18B-E, ELT18+18M, ELT18+18M-E, ELT18+18M-E224, ELT18B, ELT18BE, ELT18B-E, ELT18M, ELT18M-E, GL10+10B, GL10+10B8, GL10+10M, GL10B, GL10B4, GL10M, GL15+15M, GL15M, GL20+20M, GL20M		

pasta baskets

BERTO'S (1)



1

GEV No.	970717	Ref. No.	31613900
description	pasta basket H1 200mm W1 140mm L1 105mm for 700		
For models:	CPG40, CPG40E, CPG80, CPG80E, G6CP6		



1

GEV No.	970719	Ref. No.	35614900
description	pasta basket H1 200mm W1 140mm L1 140mm for 900		



1

GEV No.	970729	Ref. No.	31613800
description	pasta basket H1 200mm W1 290mm L1 105mm H3 400mm SS		
For models:	CPE40, CPG40, CPG40E, CPG80, CPG80E, E9CP40, G9CP40, G9CP40-2, G9CP80, G9CP80-2, SE9CP40, SG9CP40, SG9CP80		



 <p>1</p>			
GEV No.	970232	Ref. No.	31614900
description	pasta basket L1 105mm W1 120mm H1 240mm H3 445mm stainless steel for 700 (old)		
For models:	CPE40, CPG40, CPG40E, CPG80, CPG80E, E9CP40, E9F15-4M, E9F15-8M, E9F18-4M, E9F18-8M, G9CP40, G9CP40-2, G9CP80, G9CP80-2, SE9CP40, SG9CP40, SG9CP80		

 <p>1</p>			
GEV No.	970216	Ref. No.	22617700
description	pasta basket L1 295mm W1 135mm H1 160mm H3 290mm stainless steel		
For models:	E6CP6B, E6CP6M, E6CPM, ECRM6		

 <p>1</p>			
GEV No.	970222	Ref. No.	22930100
description	crumb screen L 303mm W 212mm suitable for fryer		
For models:	E10+10MB6, E10B4		

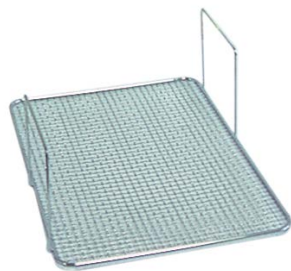
 <p>1</p>			
GEV No.	970219	Ref. No.	22714900
description	crumb screen L 337mm W 237mm fryer		

crumb screens

 <p>1</p>			
GEV No.	970227	Ref. No.	32714400
description	crumb screen L 215mm W 275mm suitable for fryer		
For models:	E6F10-3B, E6F10-3BS, E6F10-3M, E6F10-3MS, E6F10-6B, E6F10-6BS, E6F10-6M, E6F10-6MS, E6F8-3B, E6F8-3M, E6F8-6B, E6F8-6M, E7F10-4B, E7F10-4BS, E7F10-4M, E7F10-4MS, E7F10-8B, E7F10-8BS, E7F10-8M, E7F10-8MS, ELT10+10B, ELT10+10B-E, ELT10B, ELT10B-E, ELT12+12B, ELT12+12B-E, ELT12B, ELT12B-E, ELT15+15B, ELT15+15B-E, ELT15B, ELT15B-E, ELT18+18B, ELT18+18BE, ELT18B, ELT18BE, GL8+8B, GL8+8M, GL8B, GL8M		

 <p>1</p>			
GEV No.	970228	Ref. No.	32714500
description	crumb screen L 336mm W 250mm suitable for fryer		
For models:	9GL15+15M, 9GL15M, ELT10+10B-E, ELT10B-E, ELT12+12B-E, ELT12+12M-E, ELT12B-E, ELT12M-E, ELT15+15B, ELT15+15B-E, ELT15+15M, ELT15+15M-E, ELT15B, ELT15B-E, ELT15M, ELT15M-E, ELT18+18B, ELT18+18BE, ELT18+18B-E, ELT18+18M, ELT18+18M-E, ELT18+18M-E224, ELT18B, ELT18BE, ELT18B-E, ELT18M, ELT18M-E, GL10+10B, GL10+10M, GL10B, GL10M, GL15+15M, GL15M		

shelves and shelf rails

chargrill grids

 <p>1</p>			
GEV No.	211097	Ref. No.	31643500
description	chargrill grid L 525mm W 350mm H 11mm		
For models:	PLG40B, PLG40BE, PLG40M, PLG40ME, PLG80B, PLG80BE, PLG80M, PLG80ME		

grates

producer-specific



GEV No.	970990	Ref. No.	24848700
description	grate W 600mm D 400mm H 36mm chrome-plated steel for oven wire gauge frame 7mm lengthwise wires gauge 4mm crossing wires 1		
For models:	E7P4+FE1, E7P4-VTR+FE1, E7P6+FE1, E7PQ4+FE1, E7PQ4+FE1+T, E7PQ6+FE1, E7PQ6+FE1+T, E9P4+FE1, E9P4P-VTR+FE1, E9P4-VTR+FE1, E9P6+FE1, E9PQ4+FE1, E9PQ4+FE1+T, E9PQ6+FE1, E9PQ6+FE1+T, G7F4+FE1, G7F4+FG1, G7F4E+FE1, G7F4E+FE1+A4, G7F4E+FG1, G7F4E+FG1+A4, G7F4P+FG1, G7F4P+FG1+AF1, G7F4PW+FE1, G7F4PW+FE1+AE, G7F4PW+FG1, G7F4PW+FG1+AE, G7F6+FE1, G7F6+FG1, G7F6E+FE1, G7F6E+FE1+A6, G7F6E+FG1, G7F6E+FG1+A4, G7F6E+FG1+A6, G7F6P+FG1, G7F6P+FG1+AF1, G7F6PW+FE1, G7F6PW+FE1+AE, G7F6PW+FG1, G7F6PW+FG1+AE, G7T4P2F+FG1, G7T4P4F+FG1, G7TP+FG1, G7TP2F+FG1, G9F4+FG1, G9F4E+FE1, G9F4E+FE1+A4, G9F4E+FG1, G9F4E+FG1+A4, G9F4P+FG1...(Other models you can see in the webshop)		

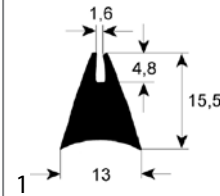

GEV No.	900473	Ref. No.	23602100
description	window gasket profile 1650 L 2250mm Qty 1		
For models:	FME10, FME10EP, FME10M, FME20, FME20M, FMG10, FMG10EP, FMG10M, FMG20, FMG20M, FPE12TURBO, FPG12, MM10EA, MM10EB, MM10GA, MM10GB, WAV-E12, WAV-E12T, WAV-E12TURBO, WAV-E20, WAV-G12, WAV-G20		

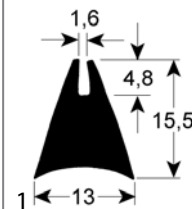

GEV No.	900881	Ref. No.	N/A
description	window gasket profile 1650 Qty supplied by meter		

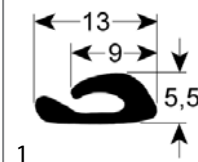

GEV No.	900469	Ref. No.	14017
description	window gasket profile 1880 L 1385mm Qty 1		
For models:	FC200GB		

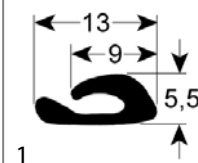

GEV No.	900470	Ref. No.	14018
description	window gasket profile 1880 L 520mm Qty 1		
For models:	FC200GB		

accessories for	900470			
	GEV No.	900471	Ref. No.	14019
	window gasket profile 1880 L 680mm Qty 1			

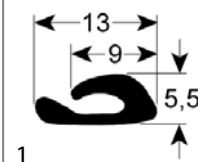

GEV No.	900471	Ref. No.	14019
description	window gasket profile 1880 L 680mm Qty 1		
accessories for	900471		

	GEV No.	900470	Ref. No.	14018
	window gasket profile 1880 L 520mm Qty 1			

gaskets

gaskets for heated units

window seals

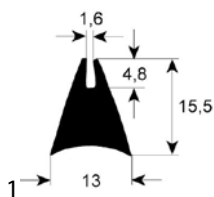

GEV No.	900463	Ref. No.	25594000
description	window gasket profile 1650 L 1110mm Qty 1		
For models:	MM2-3EA, MM2-3EB		

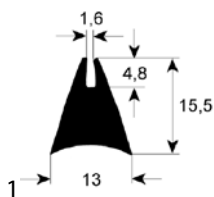

GEV No.	900472	Ref. No.	23601400
description	window gasket profile 1650 L 1700mm Qty 1		
For models:	FME06M, FME6, FMG10M, FMG6, FMG6EP, FMG6M, FPE6TURBO, FPG6, MM06EA, MM06EB, MM06GA, MM06GB, WAV-E12, WAV-E5U, WAV-E6, WAV-E6T, WAV-E6TURBO, WAV-G5U, WAV-G6		

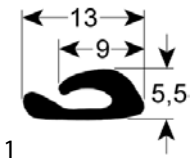

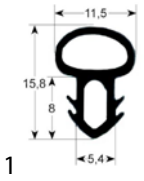

GEV No.	900882	Ref. No.	14002
description	window gasket profile 1880 Qty supplied by meter		

door seals

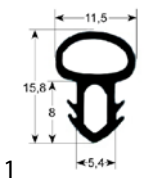

GEV No.	900112	Ref. No.	31859000
description	door seal profile 2040 L 1800mm Qty 1		
For models:	E7P4+FE1, E7P4-VTR+FE, E7P4-VTR+FE1, E7P6+FE1, E7PQ4+FE+T, E7PQ4+FE1, E7PQ4+FE1+T, E7PQ6+FE+T, E7PQ6+FE1, E7PQ6+FE1+T, E9P4+FE1, E9P4+FES, E9P4P-VTR+FE1, E9P4-VTR+FE, E9P4-VTR+FE1, E9P4-VTR+FES, E9P6+FE1, E9P6+FES, E9PQ4+FE1, E9PQ4+FE1+T, E9PQ4+FES, E9PQ6+FE1, E9PQ6+FE1+T, E9PQ6+FES, G12F4H9+FGP, G12F4P9+FGP, G6F2B, G6F2B+A2, G6F4B, G6F4B+A4, G6F6B, G6F6B+A6, G7F4+FE, G7F4+FE1, G7F4+FES, G7F4+FG, G7F4+FG1, G7F4E+FE, G7F4E+FE+A4, G7F4E+FE1, G7F4E+FE1+A4, G7F4E+FG, G7F4E+FG+A4, G7F4E+FG1, G7F4E+FG1+A4, G7F4P+FG, G7F4P+FG+AF2, G7F4P+FG1, G7F4P+FG1+AF1, G7F4PW+FG1...(Other models you can see in the webshop)		



GEV No.	900625	Ref. No.	N/A
description	door seal profile 2040 Qty supplied by meter		

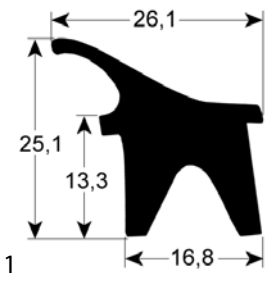

GEV No.	900464	Ref. No.	23595800
description	door seal profile 2400 W 420mm L 645mm external size Qty 1		
For models:	WAV-ESU, WAV-G5U		

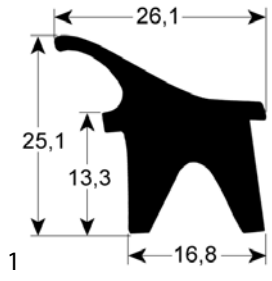

GEV No.	900467	Ref. No.	23596700
description	door seal profile 2400 W 480mm L 650mm external size Qty 1		
For models:	SNACK-E, SNACK-E-LS		

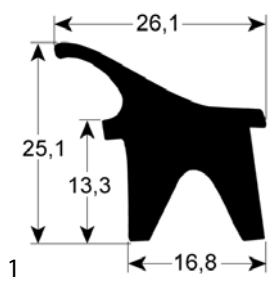

GEV No.	900465	Ref. No.	23595200
description	door seal profile 2400 W 480mm L 700mm external size Qty 1		
For models:	FPE6TURBO, FPG6, WAV-E6, WAV-E6T, WAV-E6TURBO, WAV-G6		

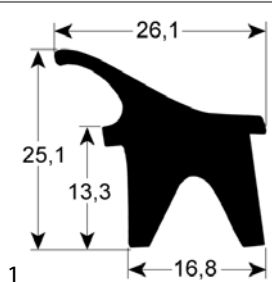

GEV No.	900468	Ref. No.	23595600 25595623
description	door seal profile 2400 W 640mm L 800mm external size Qty 1		
For models:	FME10, FME10EP, FME10M, FME20, FME20M, FMG10, FMG10EP, FMG10M, FMG20, FMG20M, MM10EA, MM10EB, MM10GA, WAV-E20, WAV-G20		

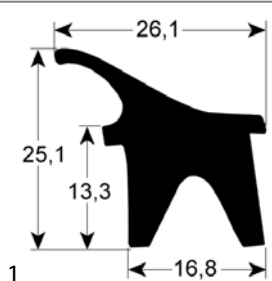

GEV No.	900475	Ref. No.	14013
description	door seal profile 2400 W 685mm L 1465mm external size Qty 1		

GEV No.	900474	Ref. No.	14014
description	door seal profile 2400 W 685mm L 805mm external size Qty 1		
For models:	FC200GB		

GEV No.	900059	Ref. No.	23595400
description	door seal profile 2410 Qty supplied by meter		

GEV No.	900230	Ref. No.	22594400
description	door seal profile 2920 L 1400mm Qty 1		
For models:	E4F+FCD8, E4F+FCDQ8, G4F+FCD8, G4F+FSD8		

door seals with fixing hook

GEV No.	900401	Ref. No.	22594200
description	door seal L 600mm W 300mm 3-sided long side open with 5 mounting clips		
For models:	E7P4+FE1, E7P4-VTR+FE1, E7P6+FE1, E7PQ4+FE1, E7PQ4+FE1+T, E7PQ6+FE1, E7PQ6+FE1+T, E9P4+FE1, E9P4P-VTR+FE1, E9P4-VTR+FE1, E9P6+FE1, E9PQ4+FE1, E9PQ4+FE1+T, E9PQ6+FE1, E9PQ6+FE1+T, G4S+FCGN, G4S+FSGN, G6F2B, G6F2B+A2, G6F4+FE1, G6F4+FE1+A4, G6F4+FG1, G6F4+FG1+A4, G6F4B, G6F4B+A4, G6F6+FE1, G6F6+FE1+A6, G6F6+FG1, G6F6+FG1+A6, G6F6B, G6F6B+A6, G6S+FCGN, G6S+FSGN, G7F4+FE1, G7F4+FG1, G7F4E+FE1, G7F4E+FE1+A4, G7F4E+FG1, G7F4E+FG1+A4, G7F4P+FG1, G7F4P+FG1+AF1, G7F4PW+FE, G7F4PW+FE+AE, G7F4PW+FE1, G7F4PW+FE1+AE, G7F4PW+FG, G7F4PW+FG+AE, G7F6+FE1, G7F6+FG1, G7F6E+FE1... (Other models you can see in the webshop)		

GEV No.	901301	Ref. No.	22594300
description	door seal W 540mm long side open H 270mm		
For models:	E6P4+FE1, E6P6+FE1, E6PQ2H6+FE1, E6PQ2H6+FE1+T, E6PQ2P9+FE1, G6F2H6+FE1, G6F2H6+FG1, G6F2H9+FE1, G6F2H9+FG1, G6F2P6+FE1, G6F2P6+FG1, G6F2P9+FE1, G6F2P9+FG1, G6F3H12+FE1, G6F3H12+FG1, G6F4+FE1, G6F4+FE1+A4, G6F4+FG1, G6F4+FG1+A4, G6F4PW+FE1, G6F4PW+FE1+AE, G6F4PW+FG1, G6F4PW+FG1+AE, G6F6+FE1, G6F6+FE1+A6, G6F6+FG1, G6F6+FG1+A6, G6F6PW+FE1, G6F6PW+FE1+AE, G6F6PW+FG1, G6F6PW+FG1+AE		

GEV No.	901142	Ref. No.	36594100
description	door seal W 800mm with 6 mounting clips H 240mm		
For models:	E6P6+TE, E6PQ2P9+TE, G6F2H9+T, G6F2H9+TE, G6F2P9+T, G6F2P9+TE, G6F3H12+T, G6F3H12+TE, G6F3H9+T, G6F6+T, G6F6+T+A6, G6F6+TE, G6F6+TE+A6, G6F6PW+T, G6F6PW+T+AE, G6F6PW+TE, G6F6PW+TE+AE		

O-rings

EPDM

GEV No.	510408	Ref. No.	35859500
description	O-ring EPDM thickness 5.34mm ID ø 47mm Qty 1 pcs		
For models:	E9P10I, E9P10IA, E9P15I, E9P15IA, SE9P10I, SE9P10IA, SE9P15I, SE9P15IA		

Viton

GEV No.	529186	Ref. No.	45354800 45854800
description	O-ring Viton thickness 3.53mm ID ø 47.63mm Qty 1 pcs		
For models:	E9F15-4M, E9F15-8M, E9F18-4M, E9F18-8M		

GEV No.	510245	Ref. No.	22014800
description	O-ring Viton thickness 3.53mm ID ø 50.8mm Qty 1 pcs		

GEV No.	510243	Ref. No.	22015000
description	O-ring Viton thickness 3.53mm ID ø 55.56mm Qty 1 pcs		

miscellaneous

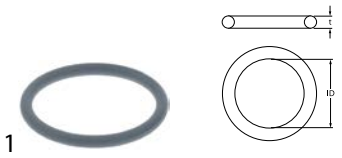

GEV No.	519639	Ref. No.	35859400
description	O-ring thickness 5.5mm ID ø 53mm Qty 1 pcs grey		
For models:	E9P10D, E9P15D		

sealing washers

silicone gaskets



GEV No.	542448	Ref. No.	35859800
description	gasket silicone 60x49x2 for drain tap 2"		
For models:	E9P10D, E9P10I, E9P10IA, E9P15D, E9P15I, E9P15IA, G9P10D, G9P10DA, G9P10I, G9P10IA, G9P15D, G9P15DA, G9P15I, G9P15IA, LXE9P15I, SE9P10I, SE9P10IA, SE9P15I, SE9P15IA, SG9P10D, SG9P10DA, SG9P10I, SG9P10IA, SG9P15D, SG9P15DA, SG9P15I		



GEV No.	359721	Ref. No.	23602800
description	gasket silicone ED ø 48mm ID ø 39.5mm thickness 5mm Qty 1 pcs		
For models:	FC100EM, FC100EP, FC100GEP, FC100GM, FC200EA, FC200EB, FC200GA, FC200GB, FC60EM, FC60EP, FC60GEP, FC60GM, FPE12TURBO, FPE6TURBO, FPG12, FPG6, WAV-E12, WAV-E12T, WAV-E12TURBO, WAV-E5U, WAV-E6, WAV-E6T, WAV-E6TURBO, WAV-G12, WAV-G5U, WAV-G6		

sealing cords

flat



GEV No.	699208	Ref. No.	31858600
description	sealing cord glass fibre size 5x26mm L 1325m		
For models:	E7P4+FE, E7P4-VTR+FE, E7P6+FE, E7PQ4+FE, E7TP+FE, E9P4+FE, E9P4-VTR+FE, E9P6+FE, E9PQ4+FE, G7F4+FE, G7F4+FG, G7F4E+FE, G7F4E+FG, G7F4P+FG, G7F6+T, G7T4P4F+FG, G7TP+FG, G7TP2F+FG, G9F4+FE, G9F4+FG, G9F4P+FG, G9F4P+FG+AF2, G9F4PW+FG, G9F4PW+FG+AE, G9F6+FG, G9F6P+FG, G9F6P+FG+AF2, G9F6PW+FG, G9F6PW+FG+AE, G9F8+2FE, G9F8+2FG, G9F8P+2FG, G9F8P+2FG+AF2, G9TP+FG, G9TP2F+FG, SE9PQ4+FE, SG9TP2F+FG		

springs

torsion springs



GEV No.	693299	Ref. No.	31878200
description	torsion spring ø 28.6mm L2 103mm wire gauge ø 3.6mm L1 45mm		
For models:	E7PI, G7PD, G7PI		

compression springs



GEV No.	101446	Ref. No.	31878600
description	compression spring ø 11mm L 6mm wire gauge ø 1.2mm		
For models:	G7F2BE+A2, G7F2ME+A2, G7F4BE+A4, G7F4E+FE+A4, G7F4E+FE1+A4, G7F4E+FG+A4, G7F4E+FG1+A4, G7F4ME+A4, G7F6BE+A6, G7F6E+FE+A6, G7F6E+FE1+A6, G7F6E+FG+A4, G7F6E+FG1+A4, G7F6E+FG1+A6, G7F6E+T, G7F6ME+A6, G9F2ME, G9F2ME+A2, G9F4ME, G9F4ME+A4, G9F6E+FE1+A6, G9F6E+FG1+A6, G9F6ME, G9F6ME+A6		

manometers



GEV No.	541062	Ref. No.	31875700
description	manometer ø 63mm pressure range 0 up to 1bar connection marking adjustable kettle thread 1/4"		
For models:	E7PI, E9P10I, E9P10IA, E9P15I, E9P15IA, G7PI, G9P10I, G9P10IA, G9P15I, G9P15IA, LXG9P15I, SE9P10I, SE9P10IA, SE9P15I, SE9P15IA, SG9P10I, SG9P10IA, SG9P15I		
spare parts for	541062		
GEV No.	541130	Ref. No.	—
description	glass panel ø 58mm thickness 2mm		



valves and tank inlets

ball valves

universal

ball valves with butterfly handle



GEV No.	540658	Ref. No.	32686300 32686900
description	ball valve connection 3/4" IT - 3/4" IT DN20 total length 69mm		
For models:	9GL15+15M, 9GL15M, 9GL20+20M, 9GL20M, CPE40, CPG40, CPG40E, CPG80, CPG80E, E6F8-3M, E6F8-6M, E7F10-4B, E7F10-4BS, E7F10-4M, E7F10-4MS, E7F10-8B, E7F10-8BS, E7F10-8M, E7F10-8MS, E7F18-4M, E7F18-4MS, E7F18-8M, E7F18-8MS, E7F30-8M, E7F30-8MP, E9F15-4M, E9F15-8M, E9F18-4M, E9F18-8M, ELT12+12M, ELT12+12M-E, ELT12M, ELT12M-E, ELT15+15M, ELT15+15M-E, ELT15M, ELT15M-E, ELT18+18M, ELT18+18M-E, ELT18+18M-E224, ELT18M, ELT18M-E, ELT30M, G6CP6, G9BM4M, G9CP40, G9CP40-2, G9CP80, G9CP80-2, GL10+10M...(Other models you can see in the webshop)		

producer-specific

BERTO'S



GEV No.	540658	Ref. No.	32686300 32686900
description	ball valve connection 3/4" IT - 3/4" IT DN20 total length 69mm		
For models:	9GL15+15M, 9GL15M, 9GL20+20M, 9GL20M, CPE40, CPG40, CPG40E, CPG80, CPG80E, E6F8-3M, E6F8-6M, E7F10-4B, E7F10-4BS, E7F10-4M, E7F10-4MS, E7F10-8B, E7F10-8BS, E7F10-8M, E7F10-8MS, E7F18-4M, E7F18-4MS, E7F18-8M, E7F18-8MS, E7F30-8M, E7F30-8MP, E9F15-4M, E9F15-8M, E9F18-4M, E9F18-8M, ELT12+12M, ELT12+12M-E, ELT12M, ELT12M-E, ELT15+15M, ELT15+15M-E, ELT15M, ELT15M-E, ELT18+18M, ELT18+18M-E, ELT18+18M-E224, ELT18M, ELT18M-E, ELT30M, G6CP6, G9BM4M, G9CP40, G9CP40-2, G9CP80, G9CP80-2, GL10+10M...(Other models you can see in the webshop)		



GEV No.	514280	Ref. No.	32696300
description	extension ball valve		
For models:	GL15+15M, GL15M, GL20+20M, GL20M		

ball valves electric



GEV No.	401233	Ref. No.	10036
description	ball valve inlet 1/2" IT outlet 1/2" IT 230V 50/60Hz mode of operation electric W 60mm H 99mm cable 4-pole 2.5W 4-pole duty cycle 50%		

shut-off valves

universal



GEV No.	514374	Ref. No.	31686800 31686800+31924800
description	shut-off valve connection 1/2" 1/2" cold		
For models:	CPE40, CPG40, CPG40E, CPG80, CPG80E, E6CP3B, E6CP6B, E6CP6M, E6CPM, E6PL60B, E6PL60M, E9BR8, E9BR8-I, E9CP40, E9F15-4M, E9F15-8M, E9F18-4M, E9F18-8M, E9PL40M, E9PL80M, G6CP6, G9BM4M, G9BR8, G9BR8-I, G9CP40, G9CP40-2, G9CP80, G9CP80-2, LXE9BR8-I, LXG9BR8-I, PLE40BE, PLE40ME, PLE80BE, PLE80ME, SE9BM4M, SE9BM8M, SE9BR8, SE9BR8-I, SE9CP40, SE9PL40M, SE9PL80M, SG9BM4M, SG9BR8, SG9BR8-I, SG9CP40, SG9CP80		

fastening material

nuts

hexagonal nuts

hexagonal nuts metric (without norm)



GEV No.	107934	Ref. No.	32811500
description	nut H 5mm thread M14x1 WS 17		
For models:	G6F2B, G6F2B+A2, G6F2H6+FE1, G6F2H6+FG1, G6F2P6+FE1, G6F-2P6+FG1, G6F4B, G6F4B+A4, G6F6B, G6F6B+A6, G7F2BP, G7F2MP, G7F4BP, G7F4MP, G7F4P+FG, G7F4P+FG+AF2, G7F4P+FG1, G7F4P+FG1+AF1, G7F6BP, G7F6MP, G7F6P+FG, G7F6P+FG+AF2, G7F6P+FG1, G7F6P+FG1+AF1, G7F6P+T, G7F6P+T+AF2, G7T4P2F+FG1, G7T4P2FM, G7T4P2FM, G7T4P4F+FG, G7T4P4F+FG1, G7T4P4FB, G7T4P4FM, G7TP+FG, G7TP2F+FG, G7TP2F+FG1, G7TP2F+T, G7TP2FM, G9F2MP, G9F4MP, G9F4P+FG, G9F4P+FG+AF2, G9F4P+FG1, G9F4P+FG1+AF1, G9F4PW+FG+AE, G9F6MP, G9F6P+FG, G9F6P+FG1, G9F6P+T, G9F-6P+T+AF2...(Other models you can see in the webshop)		



1			
GEV No.	102680	Ref. No.	31807600
description	nut thread M6x0.75 H 2.6mm WS 8 brass Qty 1 pcs type SEF 2		
For models:	G6F2B, G6F2B+A2, G6F2M, G6F2M+A2, G6F4+FE1, G6F4+FE1+A4, G6F4+FG1, G6F4+FG1+A4, G6F4B, G6F4B+A4, G6F4M, G6F4M+A4, G6F6+FE1, G6F6+FE1+A6, G6F6+FG1, G6F6+FG1+A6, G6F6+T, G6F6+T+A6, G6F6+TE, G6F6+TE+A6, G6F6B, G6F6B+A6, G6F6M, G6F6M+A6, G7F2BE, G7F2BE+A2, G7F2ME, G7F2ME+A2, G7F4BE, G7F4BE+A4, G7F4E+FE, G7F4E+FE+A4, G7F4E+FE1, G7F4E+FE1+A4, G7F4E+FG, G7F4E+FG+A4, G7F4E+FG1, G7F4E+FG1+A4, G7F4ME, G7F4ME+A4, G7F6BE, G7F6BE+A6, G7F6E+FE, G7F6E+FE+A6, G7F6E+FE1, G7F6E+FE1+A6, G7F6E+FG, G7F6E+FG+A4, G7F6E+FG+A6, G7F6E+FG1...(Other models you can see in the webshop)		

1			
GEV No.	102067	Ref. No.	22290900
description	nut thread M8x1 H 3mm brass Qty 1 pcs type SEF 1		
For models:	G2F54, G4F+FCD8, G4F+FSD8, G4FD8, G6F2H6+FG1, G6F2P6+FG1, G6F4+FG1, G6F4+FG1+A4, G6F4PW+FG1, G6F4PW+FG1+AE, G6F6+FG1, G6F6+FG1+A6, G6F6PW+FG1, G6F6PW+FG1+AE, G7F4+FG1, G7F4E+FG1, G7F4E+FG1+A4, G7F4P+FG1, G7F4P+FG1+AF1, G7F4PW+FG1, G7F4PW+FG1+AE, G7F6+FG1, G7F6E+FG1, G7F6E+FG1+A4, G7F6E+FG1+A6, G7F6P+FG1, G7F6P+FG1+AF1, G7F6PW+FG1, G7F6PW+FG1+AE, G7T4P2F+FG1, G7T4P4F+FG1, G7TP+FG1, G7TP2F+FG1, G9F4+FG1, G9F4E+FG1, G9F4E+FG1+A4, G9F4P+FG1, G9F4P+FG1+AF1, G9F4PW+FG1, G9F4PW+FG1+AE, G9F6+FG1, G9F6E+FG1, G9F6E+FG1+A6, G9F6P+FG1, G9F6PW+FG1, G9F6PW+FG1+AE, G9F8+2FG1, G9F8P+2FG1, G9TP+FG1, G9TP2F+FG1		

consumables

sealants and adhesives

high temperature silicone

1			
GEV No.	890050	Ref. No.	30951000
description	high temperature silicone NOVASIL S76 acetoxy-curing -40 up to +265°C t.max. 280°C anthracite cartridge 310ml		
description	Novasil S56 - cartridge 310ml - anthracite - Developed for applications in the home appliance industry: - Gluing of oven door seals - Gluing of mounting brackets for cooker fascias, oven door seals and handles - Attachment of elastic seals, e.g. to oven doors Temperature resistance: -40°C to +265°C		

A			
alarm devices	29	heating elements for convection	9
axial fans	35	heating elements for fryers	3
B		heating elements for griddles	5
ball valves	104	heating elements for ovens	3
ball valves electric	35, 104	heating elements for pasta cookers	7
bar burners	73	heating elements for salamanders/toasters	7
C		heating elements for tilting bratt pan	6
cam switches	21	hexagonal nuts	104
ceramic heaters	8	high temperature silicone	105
consumables	105	hob burners	58
contactors	30	hot air fans	37
control equipment	24	hot air motors	36
control thermostats	12, 18	hot plates	12
D		I	
door catches	90	ignition boxes	46
door seals	101	ignition cables	53
door seals with fixing hook	102	ignition switches	54
drain pumps	38	ignition units	54
E		immersion heating elements	8
edgemount latches	90	indicator lights	24
electric accessories	38	indicator lights (complete)	24
electrodes	35	L	
electronic controllers	32	lamps	24
energy regulators	12	light bulbs	25
espagnolette locks	91	M	
F		mechanical timers	29
fans	35	microswitches	20
fastening material	104	N	
G		nuts	104
gas burners	58	O	
gas control valves	44	O-rings	102
gas nozzles	77	oven hinges	92
gas taps	38	oven lamps	26
gas thermostats	41	P	
gaskets for heated units	100	piezoelectric igniters	53
grates	100	pilot burners	47
H		position switches	21
halogen lamp	26	pressure switches	35
handle latches	90	probe clips	19
heating elements	3	probes	33
heating elements for bain maries	3	programme timers	29
heating elements for charginills	7	pumps	38
heating elements for chip scuttles	3	push/momentary push switches	20
heating elements for contact grills	6	Q	
		quartz heating elements	8

R

radiation heaters	11
relays	30
rocker/momentary rocker switches	20

S

safety thermostats	16
sealants and adhesives	105
sealing cords	103
sealing washers	103
shelves and shelf rails	99
shut-off valves	104
silicone	105
snap locks	90
solenoid valves	34
spring clips	19
switches and momentary switches	20
system switches (ROLD)	21

T

temperature probes	33
terminals	38
thermocouples	55
thermostats	12
time relays	31
timers	29
transformers	32
tube burners	76

U

universal probes	33
------------------	----

V

valves and tank inlets	104
------------------------	-----

W

window seals	100
--------------	-----