



GAS COMPONENTS



ELECTRIC COMPONENTS



WATER TECHNOLOGY



MECHANICAL COMPONENTS



TOOLS

Spare parts suitable for

BLUMAUER

Find the complete and up-to-date range of products in our GEV Webshop



Manufacturer catalogue

The most important spare parts and accessories arranged clearly for every manufacturer

- ✓ Complete product range and all appliance data always up to date in the GEV Webshop
- ✓ Alphabetical Index at the end of the catalogue

GEV Webshop

www.gev-online.co.uk

www.gev-online.com



- 🔍 Add to Favourites
- 🔍 Sign In with email address and usual password
- 🔍 Easy-order – place several items in your basket at the same time
- 🔍 Quick Item search – no login needed



heating elements

heating elements for ovens

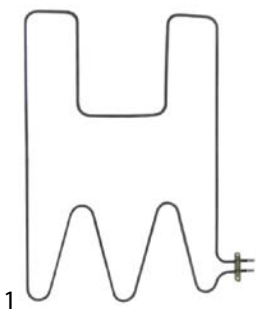

1

GEV No.	415585	Ref. No.	180352
description	heating element 2000W 400V L 493mm W 640mm L1 48mm L2 445mm W1 560mm W2 31mm flange length 70mm flange width 22mm hole distance 47mm hole ø 5mm tube ø 6.4mm connection length 40mm connection male faston 6.3mm heating circuits 1 rectangular flange dry heating element oven		
accessories for	415585		
	GEV No.	510368	Ref. No. —
	gasket L 70mm W 23.5mm hole ø 5mm hole distance 56mm FIBER thickness 2mm for heating element		

heating elements for bain maries



1

GEV No.	415583	Ref. No.	180355
description	heating element 1100W 380V heating circuits 1 L 435mm W 202mm H 33mm lug length 43mm lug width 10mm tube ø 6.3mm dry heating element connection plug-in connection bracket mounting bain marie		

heating elements for tilting bratt pan



1







GEV No.	415584	Ref. No.	180373
description	heating element 5000W 400V L 460mm W 295mm H 75mm connection 4mm bolt dry heating element heating circuits 3 tube ø 6.5mm W1 36mm connection distance 108mm		
accessories for	415584		
	GEV No.	550354	Ref. No. —
	terminal bore ø 4.1mm Qty 10 pcs		

immersion heating elements

with round flange ø47.5mm





1

GEV No.	415581	Ref. No.	00180361
description	heating element 3000W 230V heating circuits 3 L 268mm W 36mm H 28mm tube ø 6.3mm connection cable cable length 300mm immersion heater mounting ø 47.5mm		
accessories for	415581		
	GEV No.	510562	Ref. No. —
	O-ring silicone thickness 5.34mm ID ø 47mm Qty 1 pcs		
	GEV No.	520235	Ref. No. —
	3 hole flange hole distance 70.5mm perforation ø 6.5mm ID ø 53.5mm		
	GEV No.	520236	Ref. No. —
	flange for heating element ID ø 50mm ED ø 90mm hole ø 6.5mm 3 holes		
	GEV No.	521012	Ref. No. —
	gasket graphite ED ø 15mm ID ø 5mm thickness 1.2mm Qty 1 pcs		
	GEV No.	550002	Ref. No. —
	tension strap H 10mm L 21mm W 10mm hole ø 6.5mm for heating element		
	GEV No.	550362	Ref. No. —
	blind flange ø 64mm mounting ø 47.5mm		

1½"



1

GEV No.	415582	Ref. No.	00180362
description	heating element 5000W 230V heating circuits 3 thread 1½" L 345mm W 36mm H 23mm tube ø 6.3mm cable length 350mm connection cable immersion heater flange with thread		
accessories for	415582		
	GEV No.	510406	Ref. No. —
	flat gasket fibre ED ø 60mm ID ø 48mm thickness 3mm for thread 1½" Qty 1 pcs		
	GEV No.	510424	Ref. No. —
	gasket copper ED ø 55mm ID ø 48mm thickness 2.2mm Centellen for thread 1½"		
	GEV No.	520211	Ref. No. —
	reducer thread 2" ET - 1½" IT brass		
	GEV No.	520212	Ref. No. —
	hexagonal nut thread 1½" brass WS 60 H 8mm		
	GEV No.	550361	Ref. No. —
	blind flange ø 58mm thread 1½"		



hot plates

square & rectangular

with cast edge

with screw connection



GEV No.	490078	Ref. No.	180131
description	hot plate dimensions 300x300mm 3000W 400V with cast edge connection 4 screw clamps square		

round

with radiused edge

for domestic and commercial kitchens



GEV No.	490017	Ref. No.	180110
description	hot plate ø 180mm 2000W 400V connection 4 screw clamps with 8mm spill ring		



GEV No.	490021	Ref. No.	180120
description	hot plate ø 220mm 2600W 400V connection 4 screw clamps with 8mm spill ring		

with cast brim

with screw connection

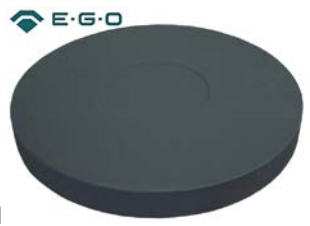

GEV No.	490106	Ref. No.	180411
description	hot plate ø 400mm 5000W 400V connection 2x 3 screw clamps with cast edge screw bolt H 42mm		

thermostats

control and safety thermostats

EGO

control thermostats

55.34_ series



GEV No.	375143	Ref. No.	180705
description	thermostat t.max. 110°C temperature range 32-110°C 3-pole 3NO 16A probe ø 6mm probe L 138mm capillary pipe 1480mm capillary pipe isolated 1100mm gland nut M9x1 shaft ø 6x4.6mm shaft L 23mm shaft position upper rotation 270°		



GEV No.	375038	Ref. No.	180706 183305
description	thermostat t.max. 300°C temperature range 50-300°C 3-pole 3NO 16A probe ø 6mm probe L 79mm capillary pipe 1740mm capillary pipe isolated 800mm gland nut shaft ø 6x4.6mm shaft L 23mm shaft position upper rotation 270°		

accessories for	375038			
	GEV No.	110123	Ref. No.	—
	knob thermostat t.max. 300°C ø 50mm shaft ø 6x4.6mm shaft flat upper black temperature range 50-300°C rotation 270°			



safety thermostats

55.13_series



1

GEV No.	375157	Ref. No.	180710
description	safety thermostat switch-off temp. 140°C 1-pole 16A probe ø 5mm probe L 96mm capillary pipe 1470mm capillary pipe isolatedmm gland nut probe		

switches and momentary switches

cam switches

4-position



1

GEV No.	300023	Ref. No.	180510
description	cam switch 4 operating positions 1NO/2CO sequence 0-1-2-3 16A shaft ø 6x4.6mm shaft L 23mm connection screw 4-position ceramic		

7-position



1

GEV No.	300025	Ref. No.	180511
description	cam switch 7 operating positions 1NO/2CO sequence 0-1-2-3-4-5-6 16A shaft ø 6x4.6mm shaft L 23mm connection screw 7-position ceramic		

accessories for 300025

	GEV No.	112172	Ref. No.	—
	knob universal ø 70mm black without adaptor/dial plate			
	GEV No.	112213	Ref. No.	—
	knob dial plate silver switch 7-position t.max.°C ED ø 63mm ID ø 45.5mm			
	GEV No.	112311	Ref. No.	—
	knob adapter shaft ø 6x4.6mm L 0mm with spring			

control equipment

MOELLER/EATON

switches (complete)

push/momentary push switches



1

GEV No.	346439	Ref. No.	180656 180666
description	momentary push switch mounting measurements ø22mm white complete II		



1

GEV No.	346438	Ref. No.	180665
description	momentary push switch mounting measurements ø22mm white complete on		

pressure switches

for steam control



1

GEV No.	541377	Ref. No.	185070
description	pressure control pressure connection vertical steam control pressure range adjustable 0.1-0.6bar pressure connection 1/4" IT		



gas taps











alternatives to EGA







GPEL21 series

with nozzle outlet



1

GEV No.	101606	Ref. No.	183050 183051 183052 183053 183054 183055
description	gas tap alternatives to EGA type GPEL21D with nozzle outlet (without nozzle) gas inlet M15x1 (tube \varnothing 10mm) external nozzle \varnothing mm internal nozzle \varnothing mm bypass nozzle \varnothing 0.35mm mixing pipe connection M17x1 thermocouple connection M8x1 pilot connection M10x1 shaft \varnothing 6x4.6mm shaft L 31/23mm shaft flat upper		
spare parts for	101606		
	GEV No.	100408	Ref. No. —
	bypass nozzle type PEL20/21 bore \varnothing 0.35mm thread M5x0.5		
	GEV No.	100927	Ref. No. —
	torsion spring L 2.8-8.0mm for internal nozzle \varnothing 3mm bore \varnothing mm		
	GEV No.	101060	Ref. No. —
	magnet unit standard L 39mm D1 \varnothing 15.4mm D2 \varnothing 11mm suitable for PEL20-21/JUNKERS/EGA		
	GEV No.	101230	Ref. No. —
	thermocouple nut T1: M8x1 T2: M18x1 aluminium		
	GEV No.	101526	Ref. No. —
	O-ring Viton thickness 1.78mm ID \varnothing 4.48mm Qty 1 pcs		
	GEV No.	101593	Ref. No. —
	adjusting screw for internal nozzle thread M8x0.75		
accessories for	101606		
	GEV No.	100908	Ref. No. 183050 183051 183052 183053 183054 183055
	union screw thread M10x1 for pipe \varnothing 4mm Qty 1 pcs		
	GEV No.	100909	Ref. No. —
	union screw thread M10x1 for pipe \varnothing 6mm Qty 1 pcs		
	GEV No.	100926	Ref. No. —
	centring piece thread M17x1		
	GEV No.	100927	Ref. No. —
	torsion spring L 2.8-8.0mm for internal nozzle \varnothing 3mm bore \varnothing mm		
	GEV No.	100942	Ref. No. —
	union nut thread M15x1 for pipe \varnothing 10mm		

accessories for	101606		
	GEV No.	100943	Ref. No. —
	union nut thread M17x1 tube \varnothing 10mm		
	GEV No.	101246	Ref. No. 183050 183051 183052 183053 183054 183055
	olive for pipe \varnothing 4mm Qty 1 pcs		
	GEV No.	101278	Ref. No. —
	olive for pipe \varnothing 10mm Qty 1 pcs		
	GEV No.	101286	Ref. No. —
	olive ID \varnothing 6mm Qty 1 pcs		
	GEV No.	110078	Ref. No. —
	knob without symbol \varnothing 70mm shaft \varnothing 6x4.6mm shaft flat universal		
	GEV No.	112206	Ref. No. —
	knob dial plate silver gas tap PEL21/22/23 t.max.°C ED \varnothing 63mm ID \varnothing 45.5mm		

GPEL22 series

with nozzle outlet



1





















GEV No.	101622	Ref. No.	183011
description	gas tap alternatives to EGA type PEL22S with nozzle outlet (without nozzle) gas inlet M18x1.5 (tube \varnothing 12mm) external nozzle \varnothing mm internal nozzle \varnothing mm bypass nozzle \varnothing 0.35mm mixing pipe connection M22x1 thermocouple connection M8x1 pilot connection M10x1 shaft \varnothing 6x4.6mm shaft L 35/21mm shaft flat upper		
spare parts for	101622		
	GEV No.	100259	Ref. No. —
	bypass nozzle type PEL22 bore \varnothing 0.35mm thread M6x0.5		
	GEV No.	100927	Ref. No. —
	torsion spring L 2.8-8.0mm for internal nozzle \varnothing 3mm bore \varnothing mm		
	GEV No.	101058	Ref. No. —
	magnet unit L 39mm D1 \varnothing 15.4mm D2 \varnothing 13.5mm suitable for PEL22/EGA24197 standard		
	GEV No.	101230	Ref. No. —
	thermocouple nut T1: M8x1 T2: M18x1 aluminium		
	GEV No.	101460	Ref. No. —
	O-ring \varnothing 12.37mm D1 \varnothing 2.62mm suitable for PEL22		
	GEV No.	101527	Ref. No. —
	O-ring Viton thickness 1.78mm ID \varnothing 6.75mm Qty 1 pcs		
	GEV No.	101594	Ref. No. —
	adjusting screw for internal nozzle thread M10x0.75		

Table continues overleaf



spare parts for 101622				
	GEV No.	101823	Ref. No.	—
gas tap front part shaft ø 6x4.6mm shaft L 35/21mm shaft flat upper/lower suitable for PEL22				
accessories for 101622				
	GEV No.	100908	Ref. No.	183050 183051 183052 183053 183054 183055
union screw thread M10x1 for pipe ø 4mm Qty 1 pcs				
	GEV No.	100909	Ref. No.	—
union screw thread M10x1 for pipe ø 6mm Qty 1 pcs				
	GEV No.	100944	Ref. No.	—
union nut thread M18x1.5 for pipe ø 12mm				
	GEV No.	101246	Ref. No.	183050 183051 183052 183053 183054 183055
olive for pipe ø 4mm Qty 1 pcs				
	GEV No.	101273	Ref. No.	—
olive for pipe ø 12mm L 9.5mm brass Qty 1 pcs suitable for universal				
	GEV No.	101286	Ref. No.	—
olive ID ø 6mm Qty 1 pcs				
	GEV No.	110078	Ref. No.	—
knob without symbol ø 70mm shaft ø 6x4.6mm shaft flat universal				
	GEV No.	112206	Ref. No.	—
knob dial plate silver gas tap PEL21/22/23 t.max.°C ED ø 63mm ID ø 45.5mm				

with pipe outlet

 <p>1</p>				
GEV No.	101620	Ref. No.	183012	
description	gas tap alternatives to EGA type GPEL22R with pipe outlet gas inlet M18x1.5 (tube ø 12mm) bypass nozzle ø 0.35mm gas outlet M18x1.5 (tube ø 12mm) thermocouple connection M8x1 pilot connection M10x1 shaft ø 6x4.6mm shaft L 35/21mm shaft flat upper			
spare parts for 101620				
	GEV No.	100259	Ref. No.	—
bypass nozzle type PEL22 bore ø 0.35mm thread M6x0.5				
	GEV No.	101058	Ref. No.	—
magnet unit L 39mm D1 ø 15.4mm D2 ø 13.5mm suitable for PEL22/EGA24197 standard				
	GEV No.	101230	Ref. No.	—
thermocouple nut T1: M8x1 T2: M18x1 aluminium				

spare parts for 101620				
	GEV No.	101460	Ref. No.	—
O-ring ø 12.37mm D1 ø 2.62mm suitable for PEL22				
	GEV No.	101823	Ref. No.	—
gas tap front part shaft ø 6x4.6mm shaft L 35/21mm shaft flat upper/lower suitable for PEL22				
accessories for 101620				
	GEV No.	100908	Ref. No.	183050 183051 183052 183053 183054 183055
union screw thread M10x1 for pipe ø 4mm Qty 1 pcs				
	GEV No.	100909	Ref. No.	—
union screw thread M10x1 for pipe ø 6mm Qty 1 pcs				
	GEV No.	100944	Ref. No.	—
union nut thread M18x1.5 for pipe ø 12mm				
	GEV No.	101246	Ref. No.	183050 183051 183052 183053 183054 183055
olive for pipe ø 4mm Qty 1 pcs				
	GEV No.	101273	Ref. No.	—
olive for pipe ø 12mm L 9.5mm brass Qty 1 pcs suitable for universal				
	GEV No.	101286	Ref. No.	—
olive ID ø 6mm Qty 1 pcs				
	GEV No.	110078	Ref. No.	—
knob without symbol ø 70mm shaft ø 6x4.6mm shaft flat universal				
	GEV No.	112206	Ref. No.	—
knob dial plate silver gas tap PEL21/22/23 t.max.°C ED ø 63mm ID ø 45.5mm				

ignition parts

pilot burners

JUNKERS

CB 505 series

pilot burners

















 <p>1</p>				
GEV No.	100059	Ref. No.	183305	
description	pilot burner JUNKERS type CB505004 1 flame natural gas nozzle no.4 gas connection 4mm with primary air			
spare parts for 100059				
	GEV No.	100231	Ref. No.	—
pilot burner nozzle natural gas gas pressure 25mbar code 4 Qty 1 pcs suitable for JUNKERS CB5050_				

Table continues overleaf

spare parts for		100059	
	GEV No.	100703	Ref. No. —
ignition electrode D1 ø 9mm connection M4 D2 ø 11mm L1 8mm BL1 13mm BL2 4mm BL3 22mm to clip			
	GEV No.	100805	Ref. No. —
gasket for pilot burner fibre			
	GEV No.	101282	Ref. No. —
olive for pipe ø 4mm L 7.4mm Qty 1 pcs			
	GEV No.	101283	Ref. No. —
union screw thread M10x1 for pipe ø 4mm Qty 1 pcs			
	GEV No.	101292	Ref. No. —
union screw for igniter suitable for CB 502/505 Qty 1 pcs			
accessories for		100059	
	GEV No.	100217	Ref. No. —
pilot burner nozzle LPG gas pressure 30mbar code 3 Qty 1 pcs suitable for JUNKERS CB5050_			
	GEV No.	100230	Ref. No. —
pilot burner nozzle LPG gas pressure 50mbar code 2 Qty 1 pcs suitable for JUNKERS CB5050_			
	GEV No.	100232	Ref. No. —
pilot burner nozzle natural gas gas pressure 25mbar code 9 Qty 1 pcs suitable for JUNKERS CB5050_			
	GEV No.	100233	Ref. No. —
pilot burner nozzle LPG gas pressure 50mbar code 8 Qty 1 pcs suitable for JUNKERS CB5050_			
	GEV No.	100234	Ref. No. —
pilot burner nozzle natural gas gas pressure 20mbar code 14 Qty 1 pcs suitable for JUNKERS CB5050_			
	GEV No.	100907	Ref. No. —
screw connection thread M10x1 Qty 1 pcs type SEF 1 ømm for thermocouple			
	GEV No.	100909	Ref. No. —
union screw thread M10x1 for pipe ø 6mm Qty 1 pcs			
	GEV No.	101288	Ref. No. —
olive for pipe ø 6mm L 6mm aluminium Qty 1 pcs ED ø 8.5mm			

ignition cables

pre-assembled cables

	1		
GEV No.	100191	Ref. No.	00190210
description ignition cable cable length 2000mm connection F2.8mm / ø2.4mm			

piezoelectric igniters

miscellaneous



1			
GEV No.	nla ¹	Ref. No.	183306
description piezoelectric igniter body metal connection F6.3x0.8 2 hole fixing ø 22mm			

¹no longer available

thermocouples

plug-in thermocouples

plug-in thermocouples standard

with barrel socket ø6mm

type Junkers with aluminised tip

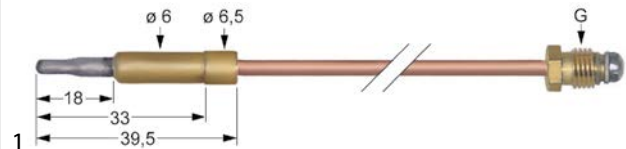

1			
GEV No.	102223	Ref. No.	183102
description thermocouple M8x1 L 1200mm plug connection ø6.0mm			

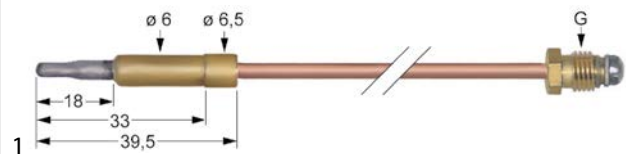

1			
GEV No.	102219	Ref. No.	183113
description thermocouple M8x1 L 450mm plug connection ø6.0mm			

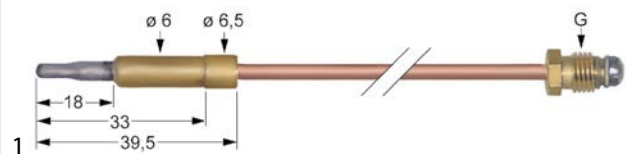

1			
GEV No.	102221	Ref. No.	183114
description thermocouple M8x1 L 750mm plug connection ø6.0mm			



gas burners

hob burners

producer-specific hob burners

BLUMAUER

900, 1200 series

 <p>1</p>			
GEV No.	103082	Ref. No.	183723
description	burner cap ø 100mm with central hole		

 <p>1</p>			
GEV No.	103080	Ref. No.	183725
description	burner cap ø 80mm		

 <p>1</p>			
GEV No.	103081	Ref. No.	183727
description	burner cap ø 97mm		

auxiliary gas parts





screw connections

olives

 <p>1</p>			
GEV No.	101246	Ref. No.	183050 183051 183052 183053 183054 183055
description	olive for pipe ø 4mm Qty 1 pcs		
accessories for	101246		

			
GEV No.	100908	Ref. No.	183050 183051 183052 183053 183054 183055
description	union screw thread M10x1 for pipe ø 4mm Qty 1 pcs		

union screws

 <p>1</p>			
GEV No.	100908	Ref. No.	183050 183051 183052 183053 183054 183055
description	union screw thread M10x1 for pipe ø 4mm Qty 1 pcs		
accessories for	100908		
			
GEV No.	100897	Ref. No.	—
description	olive for pipe ø 4mm Qty 1 pcs for pilot burner		
			
GEV No.	101246	Ref. No.	183050 183051 183052 183053 183054 183055
description	olive for pipe ø 4mm Qty 1 pcs		
			
GEV No.	101280	Ref. No.	—
description	olive for pipe ø 4mm Qty 1 pcs		
			
GEV No.	101282	Ref. No.	—
description	olive for pipe ø 4mm L 7.4mm Qty 1 pcs		

fittings for catering equipment

aerators and air bleeders

 <p>1</p>			
GEV No.	541407	Ref. No.	185021 185053
description	aerator and air bleeder thread 1/2" IT chrome-plated		

test taps

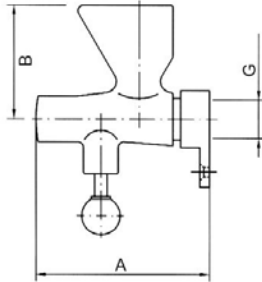
			
			
<p>1</p>			
GEV No.	540079	Ref. No.	185060
description	funnel thread 1/2" IT W 90mm W1 60mm		

safety valves

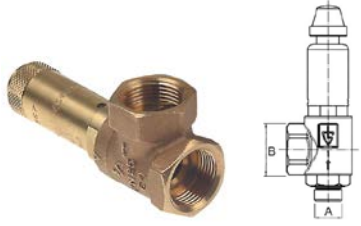

1

GEV No.	101977	Ref. No.	185021 185053
description	safety valve T1: 3/4" T2: 3/4" triggering pressure 0.65bar		

C

cam switches	5
control equipment	5
control thermostats	4

G

gas burners	9
gas taps	6

H

heating elements	3
heating elements for bain maries	3
heating elements for ovens	3
heating elements for tilting bratt pan	3
hob burners	9
hot plates	4

I

ignition cables	8
immersion heating elements	3

P

piezoelectric igniters	8
pilot burners	7
pressure switches	5

S

safety thermostats	5
switches and momentary switches	5

T

thermocouples	8
thermostats	4