



**GAS COMPONENTS**



**ELECTRIC COMPONENTS**



**WATER TECHNOLOGY**



**MECHANICAL COMPONENTS**



**TOOLS**

Spare parts suitable for

**BONAMAT**

Find the complete and up-to-date range of products in our GEV Webshop



# Manufacturer catalogue

The most important spare parts and accessories arranged clearly for every manufacturer

- ✓ Complete product range and all appliance data always up to date in the GEV Webshop
- ✓ Alphabetical Index at the end of the catalogue

## GEV Webshop

[www.gev-online.co.uk](http://www.gev-online.co.uk)

[www.gev-online.com](http://www.gev-online.com)





- 🔍 Add to Favourites
- 🔍 Sign In with email address and usual password
- 🔍 Easy-order – place several items in your basket at the same time
- 🔍 Quick Item search – no login needed







# heating elements



## heating elements for coffee machine



			
1			
<b>GEV No.</b>	417432	<b>Ref. No.</b>	6.243.042.000
<b>description</b>	band heater for water container L 1000mm W 60mm cable length 300mm		
<b>For models:</b>	B20, B20HW, B20HW-5, B40, VHGT20T, VHGT40T		

			
1			
<b>GEV No.</b>	417329	<b>Ref. No.</b>	6.236.098.000
<b>description</b>	heating element 1250W 240V heating circuits 1 ø 120mm H 36mm flange 50x26mm connection male faston 6.3mm compression flange tube ø 6.3mm immersion heater		
<b>For models:</b>	RL101, RL101-1N, RL111, RL111-1N, RL118, RL121-1N, RL211, RL211-1N, RL212-1N, RL221-1N, RL222-1N, RL413-1N		
<b>accessories for</b>	417329		
	<b>GEV No.</b>	<b>Ref. No.</b>	<b>6.011.031.000</b>
		510387	
	gasket L 46mm W 22mm ømm EPDM for heating element for flange 50x26mm		

			
1			
<b>GEV No.</b>	417481	<b>Ref. No.</b>	6.284.028.000
<b>description</b>	heating element 1590W 240V heating circuits 1 L 125mm W 125mm H 55mm flange length 74mm flange width 43mm rectangular flange connection male faston 6.3mm immersion heater tube ø 6.4mm		
<b>For models:</b>	AM112, AM112AT, HWA50		

			
1			
<b>GEV No.</b>	417327	<b>Ref. No.</b>	6.000.256.083
<b>description</b>	heating element 1710W 240V heating circuits 1 ø 108mm H 255mm W1 126mm H1 187mm H2 68mm mounting distance 120mm thread M14x1.5 stainless steel windings 6 tube ø 6.3mm immersion heater 2 hole fixing connection male faston 6.3mm		
<b>For models:</b>	RL102, RL102-1N, RL112-1N, RL212		
<b>accessories for</b>	417327		
	<b>GEV No.</b>	<b>Ref. No.</b>	<b>6.011.001.63</b>
		510417	
	flat gasket fibre ED ø 20mm ID ø 14mm thickness 2mm Qty 1 pcs		
	<b>GEV No.</b>	<b>Ref. No.</b>	—
		520228	
	tooth lock washer ID ø 15.3mm ED ø 24mm steel Qty 1 pcs for thread M14		

<b>accessories for</b>	417327		
	<b>GEV No.</b>	<b>Ref. No.</b>	—
		520230	
	nut thread M14x1.5 H 5mm WS 19 zinc-coated steel Qty 1 pcs		
	<b>GEV No.</b>	<b>Ref. No.</b>	—
		521101	
	nut thread M14x1.5 H 5mm WS 19 SS Qty 1 pcs		
	<b>GEV No.</b>	<b>Ref. No.</b>	—
		550262	
	flat gasket copper ED ø 20mm ID ø 14mm thickness 2mm		

			
1			
<b>GEV No.</b>	417326	<b>Ref. No.</b>	6.236.011.000
<b>description</b>	heating element 2160W 230V heating circuits 1 ø 125mm H 35mm flange 50x26mm connection male faston 6.3mm compression flange tube ø 6.5mm immersion heater		
<b>For models:</b>	HW+505, HW+505-v.3.0, HW+505-v.4.0, HW10, HW505, HW505-v.3.0, HW505-v.4.0, HW505-v.5.0, HWA20, RL101-1N, RL101-3N, RL111-1N, RL111-3N, RL118, RL121-1N, RL121-3N, RL211-1N, RL211-3N, RL212-1N, RL212-3N, RL221, RL221-1N, RL221-3N, RL222-1N, RL222-3N, RL411-1N, RL411-3N, RL413-1N, RL413-3N		
<b>accessories for</b>	417326		
	<b>GEV No.</b>	<b>Ref. No.</b>	<b>6.011.031.000</b>
		510387	
	gasket L 46mm W 22mm ømm EPDM for heating element for flange 50x26mm		
	<b>GEV No.</b>	<b>Ref. No.</b>	<b>6.006.015.001</b>
		510388	
	counterflange ømm hole distancemm perforation ømm L 43mm W 21mm SS for heating element for flange 50x26mm		

			
1			
<b>GEV No.</b>	417478	<b>Ref. No.</b>	6.000.262.014
<b>description</b>	heating element 2270W 240V heating circuits 1 L 155mm W 122mm H 24mm flange 46x22mm connection male faston 6.3mm compression flange tube ø 6.4mm immersion heater suitable for BONAMAT		
<b>For models:</b>	CB3, CB6, HM505, HM505-v.2.0, HM505-v.3.0, HM510-v.2.0, HM510-v.3.0, HM520-v.2.0, HM520-v.3.0, HW+510, HW+510-v.3.0, HW+510-v.4.0, HW+510-v.5.0, HW+520, HW+520-v.3.0, HW+520-v.4.0, HW+520-v.5.0, HW505, HW510, HW510-v.3.0, HW510-v.4.0, HW510-v.5.0, HW520, HW520-v.3.0, HW520-v.4.0, HW520-v.5.0, HWA505		

electric components

			
<b>GEV No.</b>	417433	<b>Ref. No.</b>	6.000.256.055
<b>description</b>	heating element 3000W 240V heating circuits 1 ø 10mm H 256mm W1 138mm H1 190mm H2 70mm mounting distance 132mm thread M14x1.5 stainless steel windings 5 tube ø 6.5mm immersion heater 2 hole fixing connection male faston 6.3mm countries GB/IRL		
<b>For models:</b>	HWD30, RL102-1N, RL102-3N, RL112-1N, RL112-3N		

			
<b>GEV No.</b>	417479	<b>Ref. No.</b>	6.000.261.016
<b>description</b>	heating element 3100W 240V heating circuits 1 L 155mm W 122mm H 25mm flange 46x22mm connection male faston 6.3mm compression flange tube ø 6.4mm immersion heater suitable for BONAMAT		
<b>For models:</b>	HCM510, HCM510-v.4.0, HCM510-v.5.0, HCM520, HCM520-v.4.0, HCM520-v.5.0, HM510, HM510-v.2.0, HM510-v.3.0, HM520, HM520-v.2.0, HM520-v.3.0, HW+510, HW+510-v.3.0, HW+510-v.4.0, HW+510-v.5.0, HW+520, HW+520-v.3.0, HW+520-v.4.0, HW+520-v.5.0, HW510, HW510-v.3.0, HW510-v.4.0, HW510-v.5.0, HW520, HW520-v.3.0, HW520-v.4.0, HW520-v.5.0, HWA510, HWA520		

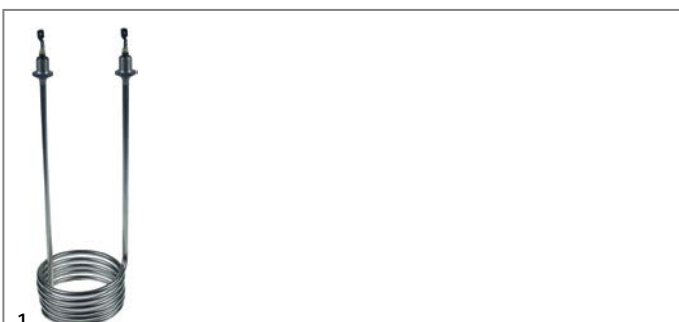
			
<b>GEV No.</b>	417485	<b>Ref. No.</b>	6.214.242.000
<b>description</b>	heating element 3100W 240V heating circuits 1 ø 98mm H 295mm W1 98mm H1 240mm H2 55mm mounting distance 92mm thread M14x1.5 windings 5 tube ø 6.5mm immersion heater 2 hole fixing connection male faston 6.3mm suitable for BONAMAT		
<b>For models:</b>	BFT322, RLX141, RLX241, RLX4, RLX41, RLX585, RLX8, RLX85, RLX86		

			
<b>GEV No.</b>	417477	<b>Ref. No.</b>	6.236.202.000
<b>description</b>	heating element stainless steel 1020W 240V heating circuits 1 flange 46x22mm L 115mm W 31mm H 36mm compression flange connection male faston 6.3mm tube ø 6.3mm immersion heater		
<b>For models:</b>	HWA30-D, HWA60-D, RLX131, RLX231, RLX3, RLX31, RLX575, RLX676, RLX75, RLX76		

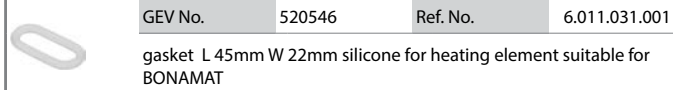
			
<b>GEV No.</b>	417408	<b>Ref. No.</b>	6.236.158.000
<b>description</b>	heating element stainless steel 1200W 240V heating circuits 1 flange 50x26mm L 115mm W 28mm H 35mm compression flange connection male faston 6.3mm tube ø 6.4mm		
<b>For models:</b>	B10HW, B10HW-5, B20HW, B20HW-5, B5HW, B5HW-5, BFT321, BFT321AT, BFT322		
<b>accessories for</b>	417408		
	<b>GEV No.</b>	520546	<b>Ref. No.</b> 6.011.031.001
			

			
<b>GEV No.</b>	417413	<b>Ref. No.</b>	6.101.072.000
<b>description</b>	hot plate 100-240V heating circuits 1 ø 125mm connection plug-in connection cable length 500mm		
<b>For models:</b>	HP2, Matic, MaticTwin, Mondo, MondoTwin, Novo		

			
<b>GEV No.</b>	417434	<b>Ref. No.</b>	6.213.203.000
<b>description</b>	hot plate 100-240V ø 95mm H 8mm hole ø 5.3mm connection male faston 4.8mm countries GB/IRL		
<b>For models:</b>	RL211-1N, RL211-3N, RL212-1N, RL212-3N, RL214-1N, RL221-1N, RL221-3N, RL222-1N, RL222-3N, RL224-1N, RL224-3N		

			
<b>GEV No.</b>	417476	<b>Ref. No.</b>	6.214.240.000
<b>description</b>	hot plate 165W 240V heating circuits 1 L 146mm W 90mm H 13mm connection male faston 6.3mm suitable for BONAMAT for Mika for model BFT321-011		
<b>For models:</b>	BFT321AT		

			
<b>GEV No.</b>	417428	<b>Ref. No.</b>	6.243.033.000
<b>description</b>	hot plate 195W 240V ø 100mm connection Faston 6.3mm cable length 280mm for water container		
<b>For models:</b>	B20, B20HW, VHG20, VHG20T, VHG-DOS-20L		



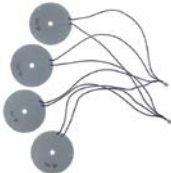

			
1			
<b>GEV No.</b>	417411	<b>Ref. No.</b>	6.301.134.000
<b>description</b>	hot plate 240V heating circuits 1 ø 150mm connection male faston 4.8mm countries GB/IRL		
<b>For models:</b>	Matic2, Matic2WB, Matic3, MaticTwin-1N, MaticTwin-3N, Mondo1, Mondo2, Mondo3WB, MondoTwin-1N, MondoTwin-3N, Novo2, RL101-1N, RL101-3N, RL102-1N, RL102-3N, RL111-1N, RL111-3N, RL112-1N, RL112-3N, RL121-3N, RL211-1N, RL211-3N, RL212-1N, RL212-3N, RL214-1N, RL221-1N, RL221-3N, RL222-1N, RL222-3N, RL224-1N, RL224-3N		

			
1			
<b>GEV No.</b>	417319	<b>Ref. No.</b>	6.401.001.000
<b>description</b>	hot plate L 150mm W 150mm H 20mm without heating element		
<b>For models:</b>	Matic2, Matic2-KTS, Matic2WB, Matic3, Matic3-KTS, Matic3WB, MaticTwin-1N, MaticTwin-3N, MaticTwin-KTS-230V3N, MaticTwin-KTS-400V3N, Mondo1, Mondo2, Mondo2-KTS, Mondo3WB, MondoTwin-1N, MondoTwin-3N, MondoTwin-KTS-230V3N, MondoTwin-KTS-400V3N, RLX131, RLX141, RLX231, RLX241, RLX31, RLX41, RLX6, RLX676, RLX76, RLX86		

			
1			
<b>GEV No.</b>	417429	<b>Ref. No.</b>	6.248.030.000
<b>description</b>	hot plate 260W 240V ø 100mm connection Faston 6.3mm cable length 320mm for water container		
<b>For models:</b>	B40, VH40, VH40T, VH-DOS-40L		

			
1			
<b>GEV No.</b>	417412	<b>Ref. No.</b>	6.301.554.000
<b>description</b>	PTC element 100-240V heating circuits 1 L 75mm W 48mm H 11mm cable length 380mm hole distance 42mm hole ø 4mm connection male faston 2.8mm suitable for BONAMAT		
<b>For models:</b>	Novo		

			
1			
<b>GEV No.</b>	417427	<b>Ref. No.</b>	6.240.029.000
<b>description</b>	hot plate 60W 230V ø 100mm Lmm Wmm connection Faston 6.3mm cable length 100mm for water container H 1mm		
<b>For models:</b>	B5, B5HW, VH5, VH5T		

			
1			
<b>GEV No.</b>	417475	<b>Ref. No.</b>	6.214.249.000
<b>description</b>	PTC element 100-240V L 75mm W 48mm H 11mm cable length 60mm hole distance 42mm hole ø 4mm connection male faston 2.8mm suitable for BONAMAT BFT/WHK HP08 1/13		
<b>For models:</b>	BFT321, BFT321AT, BFT322		

			
1			
<b>GEV No.</b>	417325	<b>Ref. No.</b>	6.301.023.000
<b>description</b>	hot plate 90W 230V heating circuits 1 ø 150mm suitable for BONAMAT		
<b>For models:</b>	Matic2, Matic2WB, Matic3, MaticTwin-1N, MaticTwin-3N, Mondo1, Mondo2, Mondo3WB, MondoTwin-1N, MondoTwin-3N, Novo2, RL101-1N, RL101-3N, RL102-1N, RL102-3N, RL111-1N, RL111-3N, RL112-1N, RL112-3N, RL121-3N, RL211-1N, RL211-3N, RL212-1N, RL212-3N, RL214-1N, RL221-1N, RL221-3N, RL222-1N, RL222-3N, RL224-1N, RL224-3N, RL226		

			
1			
<b>GEV No.</b>	417435	<b>Ref. No.</b>	6.301.555.000
<b>description</b>	PTC element 100-240V L 75mm W 49mm H 11mm cable length 380mm hole distance 42mm hole ø 4mm connection male faston 2.8mm countries GB/IRL suitable for BONAMAT		
<b>For models:</b>	Novo		

			
1			
<b>GEV No.</b>	417482	<b>Ref. No.</b>	6.214.124.000
<b>description</b>	hot plate 90W 240V heating circuits 1 L 147mm W 90mm connection male faston 6.3mm dry heating element for Mika for model BFT321-001, BFT322-001		
<b>For models:</b>	BFT321, BFT322		





			
1			
<b>GEV No.</b>	417436	<b>Ref. No.</b>	6.401.077.000
<b>description</b>	PTC element 100-240V L 75mm W 49mm H 11mm cable length 80mm hole distance 42mm hole ø 4mm connection male faston 2.8mm countries GB/IRL suitable for BONAMAT		
<b>For models:</b>	Matic2, Matic2WB, Matic3, Matic3WB, MaticTwin-1N, MaticTwin-3N, Mondo1, Mondo2, Mondo3WB, MondoTwin-1N, MondoTwin-3N, RL101-1N, RL101-3N, RL102-1N, RL102-3N, RL111-1N, RL111-3N, RL112-1N, RL112-3N, RL121-3N, RL211-1N, RL211-3N, RL212-1N, RL212-3N, RL214-1N, RL221-1N, RL221-3N, RL222-1N, RL222-3N, RL224-1N, RL224-3N, RLX131, RLX141, RLX231, RLX241, RLX31, RLX41		

			
2			
<b>GEV No.</b>	417324	<b>Ref. No.</b>	6.401.076.000
<b>description</b>	PTC element 100-240V L 75mm W 50mm H 11mm cable length 60mm hole distance 42mm hole ø 4mm connection male faston 2.8mm suitable for BONAMAT		
<b>For models:</b>	Matic2, Matic2-KTS, Matic2WB, Matic3, Matic3-KTS, Matic3WB, MaticTwin-1N, MaticTwin-3N, MaticTwin-KTS-230V3N, MaticTwin-KTS-400V3N, Mondo1, Mondo2, Mondo2-KTS, Mondo3WB, MondoTwin-1N, MondoTwin-3N, MondoTwin-KTS-230V3N, MondoTwin-KTS-400V3N, RL101-1N, RL101-3N, RL102-1N, RL102-3N, RL111-1N, RL111-3N, RL112-1N, RL112-3N, RL118, RL121-3N, RL211-1N, RL211-3N, RL212-1N, RL212-3N, RL214-1N, RL221-1N, RL221-3N, RL222-1N, RL222-3N, RL224-1N, RL224-3N, RLX131, RLX141, RLX231, RLX241, RLX31, RLX41		

			
1			
<b>GEV No.</b>	417486	<b>Ref. No.</b>	6.284.129.000
<b>description</b>	PTC element 100-240V ø 95mm H 8mm hole ø 5.5mm suitable for BONAMAT RLX		
<b>For models:</b>	AM112, AM112AT, RLX5, RLX55, RLX575, RLX585, RLX75, RLX85		

			
1			
<b>GEV No.</b>	417425	<b>Ref. No.</b>	6.243.243.000
<b>description</b>	PTC element 60+60W 100-240V heating circuits 2 L 75mm W 48mm H 11mm cable length 280mm hole distance 42mm hole ø 4mm connection male faston 6.3mm suitable for BONAMAT		
<b>For models:</b>	B20, B20HW, B20HW-5, VH20, VH20T		

			
1			
<b>GEV No.</b>	417424	<b>Ref. No.</b>	6.240.147.000
<b>description</b>	PTC element 65W 100-240V heating circuits 1 L 75mm W 48mm H 11mm cable length 200mm hole distance 42mm hole ø 4mm connection male faston 6.3mm suitable for BONAMAT		
<b>For models:</b>	B5, B5HW, B5HW-5, VH5, VH5T		

			
1			
<b>GEV No.</b>	417426	<b>Ref. No.</b>	6.248.139.000
<b>description</b>	PTC element 80+80W 100-240V heating circuits 2 L 75mm W 48mm H 11mm cable length 300mm hole distance 42mm hole ø 4mm connection male faston 6.3mm suitable for BONAMAT		
<b>For models:</b>	B40, VH40, VH40T		

			
1			
<b>GEV No.</b>	417423	<b>Ref. No.</b>	6.242.206.000
<b>description</b>	PTC element 90W 100-240V heating circuits 1 L 75mm W 48mm H 11mm cable length 250mm hole distance 42mm hole ø 4mm connection male faston 6.3mm suitable for BONAMAT		
<b>For models:</b>	B10, B10HW, B10HW-5, VH10, VH10T		

flow heaters

			
1			
<b>GEV No.</b>	417404	<b>Ref. No.</b>	6.000.201.676
<b>description</b>	flow heater 1300W 240V ø 82mm L 123mm		
<b>For models:</b>	MaticTwin-1N, MondoTwin-1N		

			
1			
<b>GEV No.</b>	417210	<b>Ref. No.</b>	6.247.090.000
<b>description</b>	flow heater 13065W 240V ø 125mm L 245mm suitable for BONAMAT B40		
<b>For models:</b>	B40, VH40		





1

<b>GEV No.</b>	417419	<b>Ref. No.</b>	6.101.137.000
<b>description</b>	flow heater 1400W 240V ø 58mm H 120mm		
<b>For models:</b>	Matic, MaticTwin, MondoTwin, TH, THA		



1

<b>GEV No.</b>	417420	<b>Ref. No.</b>	6.101.061.000
<b>description</b>	flow heater 2000W 230V ø 58mm H 120mm connection male faston 6.3mm		
<b>For models:</b>	Iso, Matic, MaticTwin, Mondo, MondoTwin, Novo, TH		





1

<b>GEV No.</b>	417414	<b>Ref. No.</b>	6.101.133.000
<b>description</b>	flow heater 1600W 230V ø 58mm H 120mm		
<b>For models:</b>	Matic, MaticTwin, MondoTwin, TH, THA		



1

<b>GEV No.</b>	417203	<b>Ref. No.</b>	6.000.201.499 6.000.201.652
<b>description</b>	flow heater 2160W 240V ø 82mm L 122mm W 87mm connection male faston 6.3mm suitable for Mondo, Matik,...		
<b>For models:</b>	Iso, Matic2, Matic2WB, Matic3, Matic3WB, MaticTwin, MaticTwin-1N, MaticTwin-3N, Mondo1, Mondo2, Mondo3WB, MondoTwin-3N, Novo, Novo2, RL101, RL101-1N, RL101-3N, RL102-1N, RL102-3N, RL111, RL111-1N, RL111-3N, RL112-1N, RL112-3N, RL118, RL121-3N, RL211, RL211-1N, RL211-3N, RL212-3N, RL214-1N, RL221-1N, RL221-3N, RL222-3N, RL411-1N, RL411-3N, RL413-1N, RL413-3N, RLX131, RLX141, RLX231, RLX241, RLX31, RLX41, RLX5, RLX55, RLX575, RLX585, RLX6, RLX676...(Other models you can see in the webshop)		
<b>spare parts for</b>	417203		
	<b>GEV No.</b>	417205	<b>Ref. No.</b> 6.011.001.082
	O-ring silicone thickness 3mm ID ø 74mm Qty 1 pcs		
	<b>GEV No.</b>	417330	<b>Ref. No.</b> 6.301.045.001
	tension strap L 32.5mm W 10mm H 14mm		





1

<b>GEV No.</b>	417409	<b>Ref. No.</b>	6.000.247.296
<b>description</b>	flow heater 16132W 240V ø 125mm L 280mm with thread bolt edition since 11/2000		
<b>For models:</b>	B40		



1

<b>GEV No.</b>	417204	<b>Ref. No.</b>	6.000.201.536 6.000.201.675
<b>description</b>	flow heater 1710W 240V ø 82mm L 123mm W 87mm suitable for Mondo Twin/Matik Twin		
<b>For models:</b>	MaticTwin-1N, MondoTwin, MondoTwin-1N, RL102, RL102-1N, RL112-1N, RL212, RL212-1N, RL222-1N, RL224, RL224-1N, RL226		
<b>spare parts for</b>	417204		
	<b>GEV No.</b>	417205	<b>Ref. No.</b> 6.011.001.082
	O-ring silicone thickness 3mm ID ø 74mm Qty 1 pcs		
	<b>GEV No.</b>	417330	<b>Ref. No.</b> 6.301.045.001
	tension strap L 32.5mm W 10mm H 14mm		





1

<b>GEV No.</b>	417421	<b>Ref. No.</b>	6.101.079.000
<b>description</b>	flow heater 2300W 230V ø 58mm H 140mm connection male faston 6.3mm		
<b>For models:</b>	TH, THA		



1

<b>GEV No.</b>	417206	<b>Ref. No.</b>	6.000.201.656
<b>description</b>	flow heater 2750W 240V ø 82mm L 158mm suitable for BONAMAT TH20		
<b>For models:</b>	RL211-1N, RL211-3N, RL212-1N, RL212-3N, RL214-1N, RL221-1N, RL221-3N, RL222-1N, RL222-3N, RL224-1N, RL224-3N, TH20, THA20		
<b>spare parts for</b>	417206		
	<b>GEV No.</b>	<b>Ref. No.</b>	<b>6.011.001.082</b>
	O-ring silicone thickness 3mm ID ø 74mm Qty 1 pcs		
	<b>GEV No.</b>	<b>Ref. No.</b>	<b>6.301.045.001</b>
	tension strap L 32.5mm W 10mm H 14mm		



1

<b>GEV No.</b>	417484	<b>Ref. No.</b>	6.000.214.007
<b>description</b>	flow heater 3270W 240V ø 82mm L 200mm with 3x safety thermostat suitable for BFT		
<b>For models:</b>	BFT321, BFT321AT, BFT322		





1

<b>GEV No.</b>	417405	<b>Ref. No.</b>	6.000.211.595
<b>description</b>	flow heater 3270W 240V ø 82mm L 200mm with thread bolt edition since 11/2000		
<b>For models:</b>	B5, B5HW, B5HW-5		



1

<b>GEV No.</b>	417407	<b>Ref. No.</b>	6.000.205.582
<b>description</b>	flow heater 6540W 240V ø 100mm L 220mm W 105mm with thread bolt edition since 11/2000		
<b>For models:</b>	B10, B10HW, B10HW-5		
<b>spare parts for</b>	417407		
	<b>GEV No.</b>	<b>Ref. No.</b>	<b>6.236.158.000</b>
	heating element stainless steel 1200W 240V heating circuits 1 flange 50x26mm L 115mm W 28mm H 35mm compression flange connection male faston 6.3mm tube ø 6.4mm		



1

<b>GEV No.</b>	417406	<b>Ref. No.</b>	6.000.206.414
<b>description</b>	flow heater 9810W 240V ø 125mm L 220mm with thread bolt edition since 11/2000		
<b>For models:</b>	B20, B20HW, B20HW-5		





1

<b>GEV No.</b>	417437	<b>Ref. No.</b>	6.301.338.000
<b>description</b>	heating element 1300W 240V ø 80mm L 105mm immersion heater connection male faston 6.3mm for flow heaters		
<b>For models:</b>	MaticTwin-1N, MondoTwin-1N		









1

<b>GEV No.</b>	417321	<b>Ref. No.</b>	6.301.201.000
<b>description</b>	heating element 1710W 240V ø 82mm L 105mm immersion heater connection male faston 6.3mm for flow heaters suitable for Mondo Twin/Matik Twin		
<b>For models:</b>	MaticTwin-1N, MondoTwin, MondoTwin-1N, RL102, RL102-1N, RL112-1N, RL212, RL212-1N, RL212-3N, RL214-1N, RL222-1N, RL224, RL224-1N, RL226		
<b>accessories for</b>	417321		
	<b>GEV No.</b>	<b>Ref. No.</b>	<b>6.011.001.082</b>
	O-ring silicone thickness 3mm ID ø 74mm Qty 1 pcs		
	<b>GEV No.</b>	<b>Ref. No.</b>	<b>6.301.045.001</b>
	tension strap L 32.5mm W 10mm H 14mm		







			
1			
<b>GEV No.</b>	417320	<b>Ref. No.</b>	6.301.002.000
<b>description</b>	heating element 2160W 240V ø 82mm L 105mm Wmm immersion heater for flow heaters suitable for Mondo, Matik,...		
<b>For models:</b>	Iso, Matic2, Matic2WB, Matic3, Matic3WB, MaticTwin, MaticTwin-3N, Mondo1, Mondo2, Mondo3WB, MondoTwin-3N, Novo, Novo2, RL101, RL101-1N, RL101-3N, RL102-1N, RL102-3N, RL111, RL111-1N, RL111-3N, RL112-1N, RL112-3N, RL118, RL121-3N, RL211, RL211-1N, RL211-3N, RL221, RL221-1N, RL221-3N, RL222, RL222-1N, RL222-3N, RL413-1N, RL413-3N, RLX131, RLX141, RLX231, RLX241, RLX31, RLX41, RLX5, RLX55, RLX575, RLX585, RLX6, RLX676, RLX75, RLX76...(Other models you can see in the webshop)		
<b>accessories for</b>	417320		
	<b>GEV No.</b>	417205	<b>Ref. No.</b> 6.011.001.082
	O-ring silicone thickness 3mm ID ø 74mm Qty 1 pcs		
	<b>GEV No.</b>	417330	<b>Ref. No.</b> 6.301.045.001
	tension strap L 32.5mm W 10mm H 14mm		

			
1			
<b>GEV No.</b>	417322	<b>Ref. No.</b>	6.301.079.000
<b>description</b>	heating element 2750W 240V ø 82mm L 140mm immersion heater connection male faston 6.3mm for flow heaters suitable for BONAMAT TH20		
<b>For models:</b>	RL211-1N, RL211-3N, RL212-1N, RL212-3N, RL214, RL214-1N, RL216, RL221-1N, RL221-3N, RL222-1N, RL222-3N, RL224-1N, RL224-3N, TH20, THA20		
<b>accessories for</b>	417322		
	<b>GEV No.</b>	417205	<b>Ref. No.</b> 6.011.001.082
	O-ring silicone thickness 3mm ID ø 74mm Qty 1 pcs		
	<b>GEV No.</b>	417330	<b>Ref. No.</b> 6.301.045.001
	tension strap L 32.5mm W 10mm H 14mm		

## energy regulators

### miscellaneous

			
1			
<b>GEV No.</b>	380925	<b>Ref. No.</b>	6.004.005.003
<b>description</b>	energy regulator 230V 16A turn direction right shaft ø 6x4.6mm shaft L 23mm mounting thread M4		
<b>For models:</b>	B10, B10HW, B10HW-5, B20, B20HW, B20HW-5, B40, B5, B5HW, B5HW-5, VH10, VH10T, VH20, VH20T, VH40, VH40T, VH5, VH5T		
<b>accessories for</b>	380925		
	<b>GEV No.</b>	111383	<b>Ref. No.</b> 6.014.002.024
	knob zero mark ø 42mm shaft ø 6x4.6mm shaft flat right black		

<b>accessories for</b>	380925		
	<b>GEV No.</b>	111384	<b>Ref. No.</b> 6.014.002.088
	knob zero mark ø 40mm shaft ø 6x4.6mm shaft flat upper dark grey		

## thermostats

### bi-metal thermostats

#### safety bi-metal thermostats

			
1			
<b>GEV No.</b>	390394	<b>Ref. No.</b>	6.016.008.052
<b>description</b>	bi-metal safety thermostat hole distance 24mm switch-off temp. 130°C 1NC 1-pole 16A connection F6.3 2 hole fixing		
<b>For models:</b>	AM112, AM112AT, B10, B10HW, B10HW-5, B20, B20HW, B20HW-5, B40, B5, B5HW, B5HW-5, BFT321, BFT321AT, BFT322, GFA70, RLX141, RLX241, RLX4, RLX41, RLX585, RLX8, RLX85, RLX86, VH10, VH10G, VH40		

			
1			
<b>GEV No.</b>	390115	<b>Ref. No.</b>	6.016.008.064
<b>description</b>	bi-metal safety thermostat hole distance 30mm switch-off temp. 115°C NC 1-pole 16A connection F6.3 2 hole flange		
<b>For models:</b>	B10, B10HW, B10HW-5, B20, B20HW, B20HW-5, B40, B5, B5HW, B5HW-5, BFT321, BFT321AT, BFT322, Bolero10, Bolero101, Bolero10-BS, Bolero10-F, Bolero10-MT, Bolero10-PA, Bolero11, Bolero111, Bolero11-BS, Bolero11-F, Bolero11-MT, Bolero11-PA, Bolero20, Bolero20-Maggi, Bolero21, Bolero211, Bolero22, BoleroTurbo, BoleroTurboXL, BoleroTurboXL-302-10L, BoleroTurboXL-303, BoleroTurboXL-322-10L, BoleroTurboXL-403, BoleroTurboXL-4L, BoleroXL-313, BoleroXL32, BoleroXL-323, BoleroXL32F, BoleroXL33, BoleroXL-333, BoleroXL42, BoleroXL-423, BoleroXL43, BoleroXL-433, Combino, FreshGround-220, FreshGround-221...(Other models you can see in the webshop)		

			
1			
<b>GEV No.</b>	390392	<b>Ref. No.</b>	6.016.008.054
<b>description</b>	bi-metal safety thermostat hole distance 24mm switch-off temp. 115°C 1NC 1-pole 16A connection F6.3 M4		
<b>For models:</b>	B10HW, B20HW, B5HW		

bi-metal thermostats



<b>GEV No.</b>	390390	<b>Ref. No.</b>	6.016.008.057
<b>description</b>	bi-metal thermostat hole distance mm switch-off temp. 200°C 2NC 2-pole 16A 250V connection F6.3		
<b>For models:</b>	AM112, AM112AT, Bolero1, Bolero2, HWA50, Iso, Matic2, Matic2-KTS, Matic2WB, Matic3, Matic3-KTS, Matic3WB, MaticTwin, MaticTwin-1N, MaticTwin-3N, MaticTwin-KTS-230V3N, MaticTwin-KTS-400V3N, Mondo1, Mondo2, Mondo2-KTS, Mondo3WB, MondoTwin, MondoTwin-1N, MondoTwin-3N, MondoTwin-KTS-230V3N, MondoTwin-KTS-400V3N, Novo, Novo2, Quinto-322, Quinto-422, RL101, RL101-1N, RL101-3N, RL102, RL102-1N, RL102-3N, RL111, RL111-1N, RL111-3N, RL112-1N, RL112-3N, RL118, RL121-1N, RL121-3N, RL211, RL211-1N, RL211-3N, RL212, RL212-1N, RL212-3N...(Other models you can see in the webshop)		

control and safety thermostats

EGO

control thermostats

55.10/19\_series



<b>GEV No.</b>	375908	<b>Ref. No.</b>	6.016.005.035 6.016.005.102
<b>description</b>	thermostat t.max. 150°C 1-pole probe ø 6mm probe L 135mm capillary pipe 710mm		
<b>For models:</b>	HCM510, HCM510-v.4.0, HCM510-v.5.0, HCM520, HCM520-v.4.0, HCM520-v.5.0, HM505, HM505-v.2.0, HM505-v.3.0, HM510, HM510-v.2.0, HM510-v.3.0, HM520, HM520-v.2.0, HM520-v.3.0		



<b>GEV No.</b>	375906	<b>Ref. No.</b>	6.016.005.034
<b>description</b>	thermostat temperature range 32-96°C 1-pole probe ø 6mm probe L 136mm capillary pipe 750mm contacts male faston 6.3mm		
<b>For models:</b>	HW+505-v.3.0, HW+505-v.4.0, HW+510-v.3.0, HW+510-v.4.0, HW+510-v.5.0, HW+520-v.3.0, HW+520-v.4.0, HW+520-v.5.0, HW505-v.3.0, HW505-v.4.0, HW505-v.5.0, HW510-v.3.0, HW510-v.4.0, HW510-v.5.0, HW520-v.3.0, HW520-v.4.0, HW520-v.5.0		

55.13\_series



<b>GEV No.</b>	390395	<b>Ref. No.</b>	6.016.005.018 6.016.005.101
<b>description</b>	thermostat t.max. 110°C temperature range 27-110°C 1-pole 1NO 16A probe ø 6mm probe L 113mm capillary pipe 520mm capillary pipe isolated 350mm gland nut shaft Lmm shaft position* rotation 310°		
<b>For models:</b>	CB3, CB6, HW10, RL118, RL411-1N, RL411-3N		

safety thermostats

55.13\_series



<b>GEV No.</b>	375907	<b>Ref. No.</b>	6.016.008.200
<b>description</b>	safety thermostat switch-off temp. 132°C 1-pole NC probe ø 3mm probe L 245mm capillary pipe 900mm		
<b>For models:</b>	CB3, CB6, HCM510, HCM510-v.4.0, HCM510-v.5.0, HCM520, HCM520-v.4.0, HCM520-v.5.0, HM505, HM505-v.2.0, HM505-v.3.0, HM510, HM510-v.2.0, HM510-v.3.0, HM520, HM520-v.2.0, HM520-v.3.0, HW+505, HW+505-v.3.0, HW+505-v.4.0, HW+510, HW+510-v.3.0, HW+510-v.4.0, HW+510-v.5.0, HW+520, HW+520-v.3.0, HW+520-v.4.0, HW+520-v.5.0, HW505, HW505-v.3.0, HW505-v.4.0, HW505-v.5.0, HW510, HW510-v.3.0, HW510-v.4.0, HW510-v.5.0, HW520, HW520-v.3.0, HW520-v.4.0, HW520-v.5.0		

STIEBEL-ELTRON





<b>GEV No.</b>	390391	<b>Ref. No.</b>	6.016.008.005
<b>description</b>	safety thermostat switch-off temp. 165°C 2-pole 20A probe ø 3mm capillary pipe 210mm with capillary probe		
<b>For models:</b>	HW10, HWA20, RL101, RL101-1N, RL101-3N, RL111, RL111-1N, RL111-3N, RL118, RL121-1N, RL121-3N, RL211, RL211-1N, RL211-3N, RL212-1N, RL212-3N, RL221, RL221-1N, RL221-3N, RL222-1N, RL222-3N, RL411-1N, RL411-3N, RL413-1N, RL413-3N		





## switches and momentary switches

### rocker/momentary rocker switches

30x11mm			
			
<b>GEV No.</b>	301260	<b>Ref. No.</b>	6.004.001.080
<b>description</b>	rocker switch mounting measurements 30x11mm orange 1NO/indicator light 250V 16A connection male faston 6.3mm ambient temperature max. 105°C protection IP40 with cover cap		
<b>For models:</b>	B10, B10HW, B10HW-5, B20, B20HW, B20HW-5, B40, B5, B5HW, B5HW-5, HCM510-v.4.0, HCM520-v.4.0, VHG10, VHG10T, VHG20, VHG20T, VHG40, VHG40T, VHGS, VHGS5T		
<b>accessories for</b>	301260		
			
<b>GEV No.</b>	301035	<b>Ref. No.</b>	—
<b>description</b>	protective cover mounting measurements 30x11mm		

30x22mm			
			
<b>GEV No.</b>	347394	<b>Ref. No.</b>	6.004.001.081
<b>description</b>	rocker switch mounting measurements 30x22mm white 2NO 250V 16A illuminated 0-1 connection male faston 6.3mm ambient temperature max. 125/55°C protection IP65 with rubber collar		
<b>For models:</b>	B10, B10HW, B10HW-5, B20, B20HW, B20HW-5, B40, B5, B5HW, B5HW-5, HCM510-v.5.0, HCM520-v.5.0, VHG10, VHG10T, VHG20, VHG20T, VHG40, VHG40T, VHGS, VHGS5T		

34x15mm			
			
<b>GEV No.</b>	347414	<b>Ref. No.</b>	6.004.001.058 6.004.001.077
<b>description</b>	momentary rocker switch mounting measurements 30x15mm black 1NO 250V 6A with frame connection male faston 6.3mm ambient temperature max. 85°C protection IP40		
<b>For models:</b>	Chiller-v.1.0, HW+505, HW+505-v.3.0, HW+505-v.4.0, HW+510, HW+510-v.3.0, HW+510-v.4.0, HW+520, HW+520-v.3.0, HW+520-v.4.0, HWA30-D, HWA60-D		

			
<b>GEV No.</b>	345284	<b>Ref. No.</b>	6.004.001.069
<b>description</b>	rocker switch mounting measurements 34x15mm clear 11NO 230V 16A illuminated connection male faston 4.8mm		
<b>For models:</b>	B10, B10HW, B10HW-5, B20, B20HW, B20HW-5, B40, B5, B5HW, B5HW-5, BFT321, BFT321AT, BFT322, Chiller-v.2.0, HWA30-D, HWA60-D, KMD, Matic2, Matic2-KTS, Matic2WB, Matic3, Matic3-KTS, Matic3WB, MaticTwin-1N, MaticTwin-3N, MaticTwin-KTS-230V3N, MaticTwin-KTS-400V3N, Mondo1, Mondo2, Mondo2-KTS, Mondo3WB, MondoTwin-1N, MondoTwin-3N, MondoTwin-KTS-230V3N, MondoTwin-KTS-400V3N, RLX131, RLX141, RLX231, RLX241, RLX3, RLX31, RLX4, RLX41, RLX5, RLX55, RLX575, RLX585, RLX6, RLX676, RLX75... (Other models you can see in the webshop)		

			
<b>GEV No.</b>	345283	<b>Ref. No.</b>	6.004.001.045 6.004.001.051
<b>description</b>	rocker switch mounting measurements 34x15mm orange 1NO/indicator light 250V 10A illuminated connection male faston 6.3mm ambient temperature max. 85°C protection IP40		
<b>For models:</b>	AM112, AM112AT, B10HW, B20HW, B5HW, CB3, CB6, GFA70, HP1, HP2, HW10, HWA20, HWA50, HWD30, Matic2, Matic2WB, Matic3, MaticTwin, MaticTwin-1N, MaticTwin-3N, Mondo1, Mondo2, Mondo3WB, MondoTwin, MondoTwin-1N, MondoTwin-3N, Novo2, RL101-1N, RL101-3N, RL102-1N, RL102-3N, RL111-1N, RL111-3N, RL112-1N, RL112-3N, RL118, RL121-3N, RL211-1N, RL211-3N, RL212-1N, RL212-3N, RL214-1N, RL221-1N, RL221-3N, RL222-1N, RL222-3N, RL224-1N, RL224-3N, RL411-1N, RL411-3N...(Other models you can see in the webshop)		

### accessories

frame			
			
<b>GEV No.</b>	347416	<b>Ref. No.</b>	6.401.217.001
<b>description</b>	frame external size 15x35mm internal size 12.7x28mm suitable for BONAMAT black		
<b>For models:</b>	Matic2, Matic2-KTS, Matic2WB, Matic3, Matic3-KTS, Matic3WB, MaticTwin-1N, MaticTwin-3N, MaticTwin-KTS-230V3N, MaticTwin-KTS-400V3N, Mondo1, Mondo2, Mondo2-KTS, Mondo3WB, MondoTwin-1N, MondoTwin-3N, MondoTwin-KTS-230V3N, MondoTwin-KTS-400V3N, RLX131, RLX141, RLX231, RLX241, RLX3, RLX31, RLX4, RLX41, RLX5, RLX55, RLX575, RLX585, RLX6, RLX676, RLX75, RLX76, RLX8, RLX85, RLX86		

			
<b>GEV No.</b>	345289	<b>Ref. No.</b>	6.004.001.070
<b>description</b>	frame suitable for BONAMAT grey		
<b>For models:</b>	BFT321, BFT321AT, BFT322, Chiller-v.2.0, HWA30-D, HWA60-D, KMD, Matic2WB, Matic3WB, Mondo3WB, TH10, TH10-KTS, TH20, THA10, THA10-KTS, THA20		

### float switches

			
<b>GEV No.</b>	347382	<b>Ref. No.</b>	6.301.552.000
<b>description</b>	float switch thread 1/8" 1NO ø 20mm L 40mm mounting ø 10mm 240V 0.5A male faston 2.8mm cable length 150mm		
<b>For models:</b>	Chiller-v.1.0, Iso, Novo		



			
1			
<b>GEV No.</b>	347381	<b>Ref. No.</b>	6.401.018.000
<b>description</b>	float switch thread 10.8 1NO $\phi$ 20mm L 40mm mounting $\phi$ 10.8mm 250V 0.5A cable cable length 170mm		
<b>For models:</b>	Mondo1, Mondo2, Mondo2-KTS, Mondo3WB, MondoTwin-1N, MondoTwin-3N, MondoTwin-KTS-230V3N, MondoTwin-KTS-400V3N, TH10, TH10-KTS, TH20		

			
1			
<b>GEV No.</b>	347391	<b>Ref. No.</b>	6.000.101.003
<b>description</b>	float switch $\phi$ 41mm L 230mm mounting $\phi$ 45mm 6-pole		
<b>For models:</b>	Matic, MaticTwin, THA		

## floats

			
1			
<b>GEV No.</b>	525283	<b>Ref. No.</b>	6.101.093.001
<b>description</b>	float $\phi$ 25mm H 26mm plastic		
<b>For models:</b>	Iso, Mondo, MondoTwin, Novo, TH		

## magnetic switches

 $\phi$  6mm

			
1			
<b>GEV No.</b>	347388	<b>Ref. No.</b>	6.101.071.000
<b>description</b>	magnetic switch NO connection plug-in connection cable length 160mm L 45mm mounting $\phi$ 6mm		
<b>For models:</b>	Iso, Novo		

			
1			
<b>GEV No.</b>	347387	<b>Ref. No.</b>	6.101.113.000
<b>description</b>	magnetic switch NO connection plug-in connection cable length 200mm L 45mm mounting $\phi$ 6mm		
<b>For models:</b>	Mondo, MondoTwin, TH		

 $\phi$ 10mm

			
1			
<b>GEV No.</b>	347409	<b>Ref. No.</b>	6.000.205.429 6.000.247.257
<b>description</b>	magnetic switch 165V 0.75A P max. 120W probe L 39mm 1NO connection plug cable length 800mm		
<b>For models:</b>	B10, B10HW, B20, B20HW, B40, B5, B5HW, GFA70		

## lamps

## indicator lights

## indicator lights (complete)

 $\phi$ 12mm

with plug-in socket

			
1			
<b>GEV No.</b>	359053	<b>Ref. No.</b>	6.005.001.035
<b>description</b>	indicator light $\phi$ 12mm 230V red		
<b>For models:</b>	CB3, CB6, HCM510, HCM510-v.4.0, HCM520, HCM520-v.4.0, HM505, HM505-v.2.0, HM510, HM510-v.2.0, HM520, HM520-v.2.0, HW+505, HW+505-v.3.0, HW+510, HW+510-v.3.0, HW+520, HW+520-v.3.0, HW505, HW505-v.3.0, HW510, HW510-v.3.0, HW520, HW520-v.3.0, Mondo1, Mondo2, Mondo3WB, MondoTwin-1N, MondoTwin-3N, Novo2, Percolator45, Percolator75, RL118, RL411-1N, RL411-3N, TH10, TH20		



			
1			
<b>GEV No.</b>	359052	<b>Ref. No.</b>	6.005.001.034
<b>description</b>	indicator light ø 12mm 230V yellow		
<b>For models:</b>	HCM510-v.4.0, HCM510-v.5.0, HCM520-v.4.0, HCM520-v.5.0, HM505, HM505-v.2.0, HM505-v.3.0, HM510, HM510-v.2.0, HM510-v.3.0, HM520, HM520-v.2.0, HM520-v.3.0, HW+505, HW+505-v.3.0, HW+505-v.4.0, HW+510, HW+510-v.3.0, HW+510-v.4.0, HW+510-v.5.0, HW+520, HW+520-v.3.0, HW+520-v.4.0, HW+520-v.5.0, HW505, HW505-v.3.0, HW505-v.4.0, HW505-v.5.0, HW510, HW510-v.3.0, HW510-v.4.0, HW510-v.5.0, HW520, HW520-v.3.0, HW520-v.4.0, HW520-v.5.0, HWA50, HWA505, HWA510, HWA520, Mondo1, Mondo2, Mondo3WB, MondoTwin, MondoTwin-1N, MondoTwin-3N, Novo2, RL118, RL216, RL226...(Other models you can see in the webshop)		

			
2			
<b>GEV No.</b>	359057	<b>Ref. No.</b>	6.005.001.032
<b>description</b>	indicator light ø 12mm 24V red connection male faston 2.8mm		
<b>For models:</b>	AM112, AM112AT, HWA50, Mondo1, Mondo2, Mondo3WB, MondoTwin, MondoTwin-1N, MondoTwin-3N, RL118, RL216, RL226, RL411-1N, RL411-3N, TH10, TH20		

## contactors

### TELEMECANIQUE (Schneider Electric)

#### power contactors

			
1			
<b>GEV No.</b>	380969	<b>Ref. No.</b>	6.004.008.025
<b>description</b>	power contactor resistive load 20A 230VAC (AC3/400V) 9A/4kW main contacts 2NO/2NC connection screw connection type LC1K09008P7		
<b>For models:</b>	RL101-1N, RL102-1N, RL111-1N, RL112-1N, RL211-1N, RL221-1N, RL411-1N		

			
1			
<b>GEV No.</b>	380479	<b>Ref. No.</b>	6.004.008.014
<b>description</b>	power contactor resistive load 25A 230VAC (AC3/400V) 9A/4kW main contacts 3NO auxiliary contacts 1NO/1NC connection screw connection type LC1D09P7		
<b>For models:</b>	AM112, AM112AT, B20, B20HW, B20HW-5, HWA50, HWD30, RL102, RL102-1N, RL102-3N, RL112-1N, RL112-3N, RL212, VH10, VH20		

			
1			
<b>GEV No.</b>	380976	<b>Ref. No.</b>	6.004.008.015
<b>description</b>	power contactor resistive load 32A 230VAC (AC3/400V) 18A/7.5kW main contacts 3NO auxiliary contacts 1NO/1NC connection screw connection		
<b>For models:</b>	B40, VH40		

### TRIPUS (Eichhoff)

#### small relay switches

			
1			
<b>GEV No.</b>	380121	<b>Ref. No.</b>	6.004.002.068
<b>description</b>	small relay switch 230V main contacts 3NO/1NC auxiliary contacts knob ø70mm (227-piece) connection Faston 6.3mm type E3250 resistive load 16A		
<b>For models:</b>	B10, B10HW, B10HW-5, B20HW, B20HW-5, B5, B5HW, B5HW-5, BFT321, BFT321AT, BFT322, GFA70, HWA60-D		

## solid state relays

### CRYDOM

			
1			
<b>GEV No.</b>	402644	<b>Ref. No.</b>	6.004.024.003
<b>description</b>	solid state relay CRYDOM 1 phase 25A 240V 3-32VDC L 58mm W 45mm male faston 6.3mm type CSW2425FGH-6997 3-32VDC		
<b>For models:</b>	BFT322, Bolero10, Bolero101, Bolero10-BS, Bolero10-F, Bolero10-MT, Bolero10-PA, Bolero10-v.1.0, Bolero10-v.2.0, Bolero11, Bolero111, Bolero11-BS, Bolero11-F, Bolero11-MT, Bolero11-PA, Bolero11-v.1.0, Bolero11-v.2.0, Bolero20, Bolero20-Maggi, Bolero21, Bolero211, Bolero22, BoleroXL-313, BoleroXL32, BoleroXL-323, BoleroXL32F, BoleroXL33, BoleroXL-333, BoleroXL42, BoleroXL-423, BoleroXL43, BoleroXL-433, FreshOne, FreshOne-Grinder		





## relays

### power relays

#### with bracket mounting



<b>1</b>			
<b>GEV No.</b>	380815	<b>Ref. No.</b>	6.004.002.055
<b>description</b>	power relays 230VAC 16A 2NO connection male faston 6.3mm flange dimensions 36x38x68mm		
<b>For models:</b>	RL101, RL101-1N, RL101-3N, RL111, RL111-1N, RL111-3N, RL121-3N, RL211, RL211-1N, RL211-3N, RL212, RL212-1N, RL212-3N, RL214, RL214-1N, RL216, RL221, RL221-1N, RL221-3N, RL222-1N, RL222-3N, RL224-1N, RL224-3N		

#### with special fixing



<b>1</b>			
<b>GEV No.</b>	380053	<b>Ref. No.</b>	6.004.002.064
<b>description</b>	power relays 230VAC 16A with adapter 2-pole		
<b>For models:</b>	HWA20, HWA30-D, RL413-1N, RL413-3N, TH20, THA20		
<b>spare parts for</b>	380053		
	<b>GEV No.</b>	380318	<b>Ref. No.</b> —
	power relays SCHRACK 230VAC 16A 2NO connection coded plug manuf. no. 0419 120301 00 2-pole		

#### miscellaneous



<b>1</b>			
<b>GEV No.</b>	380929	<b>Ref. No.</b>	6.004.002.088
<b>description</b>	power relays 240V connection male faston 6.3mm 1NO 25A voltage DC 12V		
<b>For models:</b>	RLX141, RLX241, RLX4, RLX41, RLX585, RLX8, RLX85, RLX86		

## transformers

### encapsulated transformers

#### multiple connections



<b>1</b>			
<b>GEV No.</b>	402638	<b>Ref. No.</b>	6.004.011.070
<b>description</b>	transformer primary 240V secondary 8-10V 40VA secondary 0.8-40A connection male faston 50/60Hz		
<b>For models:</b>	BFT321, BFT321AT, BFT322		

## probes

### producer-specific probes

#### probes



<b>1</b>			
<b>GEV No.</b>	378508	<b>Ref. No.</b>	6203674000
<b>description</b>	temperature probe cable length 0.5m		
<b>For models:</b>	AM112, AM112AT, HWA50		



<b>1</b>			
<b>GEV No.</b>	379500	<b>Ref. No.</b>	6.236.188.000
<b>description</b>	temperature probe NTC 1kOhm cable PVC probe -40 up to +110°C cable -10 up to 100°C connection male faston 2.8mm thread probe eye M3 cable length 0.3m		
<b>For models:</b>	B10, B10HW, B10HW-5, B20, B20HW, B20HW-5, B40, B5, B5HW, B5HW-5, Bolero10, Bolero101, Bolero10-BS, Bolero10-F, Bolero10-MT, Bolero10-PA, Bolero11, Bolero111, Bolero11-BS, Bolero11-F, Bolero11-MT, Bolero11-PA, Bolero20, Bolero20-Maggi, Bolero21, Bolero211, Bolero22, BoleroTurboXL-4L, BoleroXL-313, BoleroXL32, BoleroXL-323, BoleroXL32F, BoleroXL33, BoleroXL-333, BoleroXL42, BoleroXL-423, BoleroXL43, BoleroXL-433, Combino, DOS10, DOS20, DOS40, FreshMore-220, FreshMore-221, FreshMore-310, FreshMore-311, FreshOne, FreshOne-Grinder, HWA30-D, HWA40-1phase...(Other models you can see in the webshop)		



<b>1</b>			
<b>GEV No.</b>	379241	<b>Ref. No.</b>	6.214.211.000
<b>description</b>	temperature probe NTC 900kOhm cable PVC probe -40 up to +110°C cable -10 up to 100°C connection coded plug thread probe eye M3 cable length 0.5m		
<b>For models:</b>	BFT321, BFT321AT, BFT322		



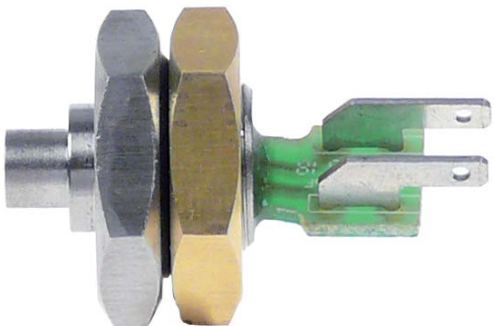

			
1			
<b>GEV No.</b>	379697	<b>Ref. No.</b>	6.000.236.017
<b>description</b>	temperature probe PTC cable probe -50 up to +150°C cable°C connection male faston 2.8mm thread 1/4" probe ø6.2x7mm cable lengthm		
<b>For models:</b>	B10HW, B20HW, B5HW, HWA20, RL101, RL101-1N, RL101-3N, RL111, RL111-1N, RL111-3N, RL121-1N, RL121-3N, RL211, RL211-1N, RL211-3N, RL212-1N, RL212-3N, RL221, RL221-1N, RL221-3N, RL222-1N, RL222-3N, RL413-1N, RL413-3N		

## electronics

### PCBs



			
1			
<b>GEV No.</b>	400615	<b>Ref. No.</b>	6.202.966.000
<b>description</b>	control PCB coffee machine Matic 2/3		
<b>For models:</b>	Chiller-v.2.0, Chiller-v.3.0, Chiller-v.4.0, Matic2, Matic2-KTS, Matic2WB, Matic3, Matic3-KTS, Matic3WB, MaticTwin-1N, MaticTwin-3N, MaticTwin-KTS-230V3N, MaticTwin-KTS-400V3N, THA10, THA10-KTS, THA20		

			
1			
<b>GEV No.</b>	400611	<b>Ref. No.</b>	6.301.714.000
<b>description</b>	display PCB with display		
<b>For models:</b>	Mondo1, Mondo2, Mondo2-KTS, Mondo3WB, MondoTwin-1N, MondoTwin-3N, MondoTwin-KTS-230V3N, MondoTwin-KTS-400V3N, TH10, TH10-KTS, TH20		

			
1			
<b>GEV No.</b>	400617	<b>Ref. No.</b>	6.202.998.000
<b>description</b>	keypad PCB		
<b>For models:</b>	RL121-3N, RL413-1N, RL413-3N		

			
1			
<b>GEV No.</b>	400625	<b>Ref. No.</b>	6.211.900.000
<b>description</b>	keypad PCB		
<b>For models:</b>	B10HW, B20HW, B5HW		

			
1			
<b>GEV No.</b>	402737	<b>Ref. No.</b>	6.214.112.000
<b>description</b>	keypad PCB BFT suitable for BONAMAT buttons 4		
<b>For models:</b>	BFT321, BFT321AT, BFT322		

			
1			
<b>GEV No.</b>	402642	<b>Ref. No.</b>	6.205.861.000
<b>description</b>	keypad PCB coffee machine B10 HW L 135mm W 110mm with display buttons 8		
<b>For models:</b>	B10, B10HW, B10HW-5, B20, B20HW, B20HW-5, B40, B5, B5HW, B5HW-5		
<b>accessories for</b>	402642		
		<b>GEV No.</b>	402646
		<b>Ref. No.</b>	6.205.862.001
	buttons strip W 107mm L 112mm buttons 8 edition since 2000		

			
1			
<b>GEV No.</b>	402648	<b>Ref. No.</b>	6.000.201.630
<b>description</b>	keypad PCB L 160mm W 100mm countries GB/IRL with housing buttons 1		
<b>For models:</b>	Iso		

			
1			
<b>GEV No.</b>	402641	<b>Ref. No.</b>	6.000.201.620
<b>description</b>	keypad PCB L 160mm W 100mm suitable for BONAMAT with housing buttons 2		
<b>For models:</b>	Iso, Novo		



1

<b>GEV No.</b>	402651	<b>Ref. No.</b>	6.101.161.000
<b>description</b>	keypad PCB L 165mm W 40mm with display buttons 5		
<b>For models:</b>	Matic, MaticTwin		



1

<b>GEV No.</b>	402653	<b>Ref. No.</b>	6.101.048.000
<b>description</b>	keypad PCB L 80mm W 65mm buttons 2		
<b>For models:</b>	Novo		



1

<b>GEV No.</b>	402650	<b>Ref. No.</b>	6.101.153.000
<b>description</b>	keypad PCB L 82mm W 65mm countries GB/IRL buttons 2		
<b>For models:</b>	Novo		



1

<b>GEV No.</b>	402688	<b>Ref. No.</b>	6.101.160.000
<b>description</b>	keypad PCB L 84mm W 39mm buttons 2		
<b>For models:</b>	Mondo, MondoTwin, TH		



1

<b>GEV No.</b>	400613	<b>Ref. No.</b>	6.202.623.000
<b>description</b>	keypad PCB MATIC		
<b>For models:</b>	AM112, AM112AT, Matic2, Matic2WB, Matic3, MaticTwin, MaticTwin-1N, MaticTwin-3N, RL101, RL101-1N, RL101-3N, RL102, RL102-1N, RL102-3N, RL111, RL111-1N, RL111-3N, RL112-1N, RL112-3N, RL211, RL211-1N, RL211-3N, RL212, RL212-1N, RL212-3N, RL214, RL214-1N, THA10, THA20		



1

<b>GEV No.</b>	402741	<b>Ref. No.</b>	6.213.501.000
<b>description</b>	keypad PCB RLX suitable for BONAMAT buttons 2		
<b>For models:</b>	RLX131, RLX141, RLX231, RLX241, RLX3, RLX31, RLX4, RLX41, RLX5, RLX55, RLX575, RLX585, RLX6, RLX676, RLX75, RLX76, RLX8, RLX85, RLX86		



1

<b>GEV No.</b>	402686	<b>Ref. No.</b>	6.101.162.000
<b>description</b>	keypad PCB THA L 165mm W 38mm with display buttons 5		
<b>For models:</b>	THA		



1

<b>GEV No.</b>	402735	<b>Ref. No.</b>	6.211.990.000
<b>description</b>	keypad unit black/yellow/red buttons 5 type B5-B40 Computronic		
<b>For models:</b>	B10, B20, B40, B5		



1

<b>GEV No.</b>	400610	<b>Ref. No.</b>	6.301.106.000 6.301.713.000
<b>description</b>	net board coffee machine Mondo 1/2/3 model MONDO TH10 since year of construction 1996		
<b>For models:</b>	Mondo1, Mondo2, Mondo2-KTS, Mondo3WB, MondoTwin, MondoTwin-1N, MondoTwin-3N, MondoTwin-KTS-230V3N, MondoTwin-KTS-400V3N, RL118, RL216, RL226, RL411-1N, RL411-3N, TH10, TH10-KTS, TH20		



1

<b>GEV No.</b>	400614	<b>Ref. No.</b>	6.202.970.000
<b>description</b>	PCB		
<b>For models:</b>	Matic2, Matic2WB, Matic3, Matic3WB, MaticTwin-1N, MaticTwin-3N, RL121-3N		

1

<b>GEV No.</b>	400621	<b>Ref. No.</b>	6.256.184.000
<b>description</b>	PCB		
<b>For models:</b>	HWD30, RL102, RL102-3N, RL112-1N, RL112-3N, RL212, RL222		



1

<b>GEV No.</b>	402798	<b>Ref. No.</b>	6.214.190.000
<b>description</b>	PCB for BONAMAT for BFT321-011		
<b>For models:</b>	BFT321AT		



1

<b>GEV No.</b>	401830	<b>Ref. No.</b>	6.236.232.000
<b>description</b>	PCB		
<b>For models:</b>	B10HW, B20HW, B5HW, HWA20, RL101-1N, RL101-3N, RL111-1N, RL111-3N, RL121-1N, RL121-3N, RL211-1N, RL211-3N, RL212-1N, RL212-3N, RL221-1N, RL221-3N, RL222-1N, RL222-3N, RL413-1N, RL413-3N		

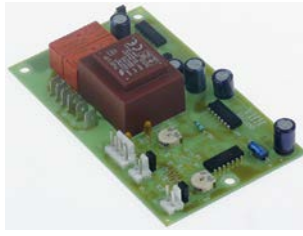

1

<b>GEV No.</b>	402742	<b>Ref. No.</b>	6.284.133.000
<b>description</b>	PCB for BONAMAT for HWA		
<b>For models:</b>	AM112, AM112AT, HWA50		



1

<b>GEV No.</b>	402740	<b>Ref. No.</b>	6.213.495.000
<b>description</b>	PCB		
<b>For models:</b>	RLX131, RLX141, RLX231, RLX241, RLX31, RLX41		



1

<b>GEV No.</b>	402758	<b>Ref. No.</b>	6.256.207.000
<b>description</b>	PCB for BONAMAT for RLX		
<b>For models:</b>	RLX141, RLX241, RLX4, RLX41, RLX585, RLX8, RLX85, RLX86		



1

<b>GEV No.</b>	402760	<b>Ref. No.</b>	6.214.236.000
<b>description</b>	PCB for BONAMAT for BFT321-001		
<b>For models:</b>	BFT321		



1

<b>GEV No.</b>	402759	<b>Ref. No.</b>	6.213.504.000
<b>description</b>	PCB for BONAMAT for RLX		
<b>For models:</b>	RLX5, RLX55, RLX575, RLX585, RLX6, RLX676, RLX75, RLX76, RLX85, RLX86		





1

<b>GEV No.</b>	402697	<b>Ref. No.</b>	6.301.719.000
<b>description</b>	PCB L 110mm W 60mm countries GB/IRL 240V		
<b>For models:</b>	Mondo1, Mondo2, Mondo3WB, MondoTwin-1N, MondoTwin-3N, TH10, TH20		



1

<b>GEV No.</b>	402830	<b>Ref. No.</b>	6.236.264.000
<b>description</b>	PCB L 140mm W 70mm 240V		
<b>For models:</b>	RLX131, RLX231, RLX3, RLX31, RLX575, RLX676, RLX75, RLX76		



1

<b>GEV No.</b>	402652	<b>Ref. No.</b>	6.101.047.000
<b>description</b>	PCB L 120mm W 65mm 230V		
<b>For models:</b>	Matic, MaticTwin, Mondo, MondoTwin, TH, THA		



1

<b>GEV No.</b>	402639	<b>Ref. No.</b>	6.205.774.000
<b>description</b>	PCB L 155mm W 100mm 240V for B 10 HW		
<b>For models:</b>	B10HW		

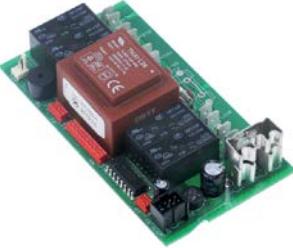

1

<b>GEV No.</b>	402689	<b>Ref. No.</b>	6.101.151.000
<b>description</b>	PCB L 120mm W 65mm countries UK 230V		
<b>For models:</b>	Matic, MaticTwin, Mondo, MondoTwin, TH, THA		



1

<b>GEV No.</b>	402649	<b>Ref. No.</b>	6.206.542.000
<b>description</b>	PCB L 155mm W 100mm 240V for B 20 HW		
<b>For models:</b>	B20HW		



1

<b>GEV No.</b>	402640	<b>Ref. No.</b>	6.205.873.000
<b>description</b>	PCB L 130mm W 125mm edition since 11/2000 240V for BONAMAT		
<b>For models:</b>	B10, B20, B40, B5		



1

<b>GEV No.</b>	402743	<b>Ref. No.</b>	6.236.191.000
<b>description</b>	PCB L 155mm W 100mm for BONAMAT for HWA for model 30-D/60-D		
<b>For models:</b>	HWA30-D, HWA60-D		





1

<b>GEV No.</b>	402696	<b>Ref. No.</b>	6.000.201.671
<b>description</b>	PCB L 160mm W 100mm countries GB/IRL 60V with housing		
<b>For models:</b>	Novo		



1

<b>GEV No.</b>	402643	<b>Ref. No.</b>	6.205.874.000
<b>description</b>	PCB L 160mm W 125mm edition since 11/2000 240V for BONAMAT		
<b>For models:</b>	B10HW, B20HW, B5HW		



1

<b>GEV No.</b>	402799	<b>Ref. No.</b>	6.214.237.000
<b>description</b>	PCB L 160mm W 130mm for BONAMAT for BFT322-001		
<b>For models:</b>	BFT322		



1

<b>GEV No.</b>	400616	<b>Ref. No.</b>	6.402.061.000
<b>description</b>	PCB suitable for BONAMAT		
<b>For models:</b>	RL413-1N, RL413-3N, THA10, THA20		



1

<b>GEV No.</b>	402744	<b>Ref. No.</b>	6.228.019.000
<b>description</b>	PCB suitable for BONAMAT buttons 2 for HWA		
<b>For models:</b>	HWA30-D, HWA60-D, KMD		

programming device



1

<b>GEV No.</b>	402736	<b>Ref. No.</b>	6.000.214.014
<b>description</b>	programmer for coffee machine suitable for BONAMAT BFT321-001		
<b>For models:</b>	BFT321		



1

<b>GEV No.</b>	402796	<b>Ref. No.</b>	6.000.214.028
<b>description</b>	programmer for coffee machine suitable for BONAMAT BFT321-011		
<b>For models:</b>	BFT321AT		



1

<b>GEV No.</b>	402797	<b>Ref. No.</b>	6.000.214.027
<b>description</b>	programmer for coffee machine suitable for BONAMAT BFT322-001		
<b>For models:</b>	BFT322		

keypads

front foils



1

<b>GEV No.</b>	402746	<b>Ref. No.</b>	6.200.113.202
<b>description</b>	front foil suitable for BONAMAT for RLX for model 2 L 73mm W 55mm		

<b>GEV No.</b>	402747	<b>Ref. No.</b>	6.200.113.203
<b>description</b>	keypad foil suitable for BONAMAT L 74mm W 55mm buttons 2 for model 3		
<b>For models:</b>	RLX131, RLX231, RLX3, RLX31		



<b>GEV No.</b>	531116	<b>Ref. No.</b>	6.200.113.204
<b>description</b>	keypad foil suitable for BONAMAT L 74mm W 55mm buttons 2 for model 4		
<b>For models:</b>	RLX141, RLX241, RLX4, RLX41		



<b>GEV No.</b>	531058	<b>Ref. No.</b>	6.200.113.205
<b>description</b>	keypad foil suitable for BONAMAT L 74mm W 55mm buttons 2 for model 5		
<b>For models:</b>	RLX5, RLX55, RLX575, RLX585, RLX75, RLX85		



<b>GEV No.</b>	531059	<b>Ref. No.</b>	6.200.113.206
<b>description</b>	keypad foil suitable for BONAMAT L 74mm W 55mm buttons 2 for model 6		
<b>For models:</b>	RLX6, RLX676, RLX76, RLX86		



<b>GEV No.</b>	531115	<b>Ref. No.</b>	6.200.113.207
<b>description</b>	keypad foil suitable for BONAMAT L 74mm W 55mm buttons 2 for model 7		
<b>For models:</b>	RLX575, RLX676, RLX75, RLX76		



<b>GEV No.</b>	531117	<b>Ref. No.</b>	6.200.113.208
<b>description</b>	keypad foil suitable for BONAMAT L 74mm W 55mm buttons 2 for model 8		
<b>For models:</b>	RLX585, RLX8, RLX85, RLX86		



<b>GEV No.</b>	402745	<b>Ref. No.</b>	6.200.113.201
<b>description</b>	keypad foil suitable for BONAMAT L 74mm W 55mm for model 1		
<b>For models:</b>	RLX131, RLX141, RLX231, RLX241, RLX31, RLX41		

keypad units



<b>GEV No.</b>	400622	<b>Ref. No.</b>	6.211.471.000 6.211.916.000
<b>description</b>	keypad unit		
<b>For models:</b>	B10, B20, B40, B5, VHG10, VHG20, VHG40		

accessories

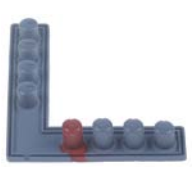

<b>GEV No.</b>	402646	<b>Ref. No.</b>	6.205.862.001
<b>description</b>	buttons strip W 107mm L 112mm buttons 8 edition since 2000		
<b>For models:</b>	B10, B10HW, B10HW-5, B20, B20HW, B20HW-5, B40, B5, B5HW, B5HW-5		

solenoid valves

solenoid valves (water)

ELBI





<b>GEV No.</b>	373004	<b>Ref. No.</b>	6.016.001.019
<b>description</b>	solenoid valve single straight 230VAC inlet 3/4" outlet 11.5mm output 0.5l/min ELBI flow regulating valve outlet red		
<b>For models:</b>	HWA30-D, HWD30, RLX3, RLX4		





			
1			
<b>GEV No.</b>	373002	<b>Ref. No.</b>	6.016.001.045
<b>description</b>	solenoid valve single straight 230VAC inlet 3/4" outlet 11.5mm output 1.2l/min duty cycle 100% ELBI 329 flow regulating valve outlet white		
<b>For models:</b>	HWA60-D		

			
1			
<b>GEV No.</b>	370597	<b>Ref. No.</b>	6.016.001.077
<b>description</b>	solenoid valve double straight 230VAC inlet 3/4" outlet 11.5mm ELBI plastic output A 2l/min output B 2.5l/min flow regulating valve outlet A white flow regulating valve outlet B orange		
<b>For models:</b>	B10HW-5, B20HW-5, B5HW-5		

			
1			
<b>GEV No.</b>	370184	<b>Ref. No.</b>	6.016.001.033
<b>description</b>	solenoid valve double straight 230VAC inlet 3/4" outlet 11.5mm t. max. 90°C ELBI plastic flow regulating valve inlet white output A 2.5l/min output B 0.5l/min flow regulating valve outlet A orange		
<b>For models:</b>	B10HW, B20HW, B5HW		

			
1			
<b>GEV No.</b>	370181	<b>Ref. No.</b>	6.016.001.022 6.016.001.036
<b>description</b>	solenoid valve double straight 230VAC inlet 3/4" outlet 11.5mm t.max. 90°C ELBI plastic output A 2.5l/min output B 2.5l/min flow regulating valve outlet A orange flow regulating valve outlet B orange		
<b>For models:</b>	AM112, AM112AT, Matic, MaticTwin, MaticTwin-1N, MaticTwin-3N, MaticTwin-KTS-230V3N, MaticTwin-KTS-400V3N, RL101, RL101-1N, RL101-3N, RL111, RL111-1N, RL111-3N, RL211-1N, RL211-3N, RL224, RL224-1N, RL224-3N, RL413-1N, RL413-3N, RLX55		

			
1			
<b>GEV No.</b>	370182	<b>Ref. No.</b>	6.016.001.028
<b>description</b>	solenoid valve triple straight 230VAC inlet 3/4" outlet 11.5mm t.max. 90°C ELBI plastic flow regulating valve inlet white output A 2.5l/min output B 2.5l/min output C 2.5l/min flow regulating valve outlet A orange flow regulating valve outlet B orange flow regulating valve outlet C orange		
<b>For models:</b>	RL121-3N, RL211, RL221, RL221-1N, RL221-3N		

			
1			
<b>GEV No.</b>	370185	<b>Ref. No.</b>	6.016.001.027
<b>description</b>	solenoid valve triple straight 230VAC inlet 3/4" outlet 11.5mm t.max. 90°C ELBI plastic output A 2.5l/min output B 0.5l/min output C 2.5l/min flow regulating valve outlet A orange flow regulating valve outlet B red flow regulating valve outlet C orange		
<b>For models:</b>	BFT321, BFT321AT, BFT322, RL222, RL222-1N, RL222-3N, RLX131, RLX575, RLX585, RLX676		

ROBERTSHAW/INVENSYS

medium temperature: 90°C 90°C 60°C  
 ambient temperature: 60°C 25°C 60°C  
 duty cycle: 40% 100% 100%

solenoid valves with reducers







single













			
1			
<b>GEV No.</b>	373003	<b>Ref. No.</b>	6.016.001.017
<b>description</b>	solenoid valve single straight 230VAC inlet 3/4" outlet 11.5mm EATON (INVENSYS) flow regulating valve inlet dark brown		
<b>For models:</b>	B10, B20, B5, HWA50, RL214, RL214-1N, RLX5, THA10, VHG3		

			
1			
<b>GEV No.</b>	371140	<b>Ref. No.</b>	6.016.001.078
<b>description</b>	solenoid valve single straight 230VAC inlet 3/4" outlet 11.5mm input 9l/min EATON (INVENSYS)		
<b>For models:</b>	B40		

			
1			
<b>GEV No.</b>	370180	<b>Ref. No.</b>	6.016.001.035
<b>description</b>	solenoid valve single straight 230VAC inlet 3/4" outlet 11.5mm output 2.5l/min plastic		
<b>For models:</b>	HWA20, Matic2, Matic2-KTS, Matic2WB, Matic3, Matic3-KTS, Matic3WB, THA, THA10, THA10-KTS, THA20		

<b>2-fold</b>			
			
1			
<b>GEV No.</b>	370183	<b>Ref. No.</b>	6.016.001.026
<b>description</b>	solenoid valve double straight 230VAC inlet 3/4" outlet 11.5mm t.max. 90°C EATON (INVENSYS) plastic output A 0.5l/min output B 2.5l/min flow regulating valve outlet A yellow flow regulating valve outlet B dark brown		
<b>For models:</b>	B10HW, B20HW, B5HW, RL102, RL102-1N, RL102-3N, RL112-1N, RL112-3N, RL212, RL212-1N, RL212-3N, RLX231, RLX241, RLX31, RLX41, RLX75, RLX76, RLX85		

<b>TP</b>			
			
1			
<b>GEV No.</b>	370017	<b>Ref. No.</b>	6.016.001.001
<b>description</b>	solenoid valve single straight 230VAC inlet 3/4" outlet 11.5mm DN10 TP p max 10bar		
<b>For models:</b>	B10, B20, B40, B5, Chiller-v.1.0, GFA70, HW+505, HW+505-v.3.0, HW+505-v.4.0, HW+510, HW+510-v.3.0, HW+510-v.4.0, HW+510-v.5.0, HW+520, HW+520-v.3.0, HW+520-v.4.0, HW+520-v.5.0, VHG10, VHG20, VHG40		
<b>spare parts for</b>	370017		
	<b>GEV No.</b>	371013	<b>Ref. No.</b> —
solenoid coil TP 230VAC 50/60Hz			
<b>accessories for</b>	370017		
	<b>GEV No.</b>	371220	<b>Ref. No.</b> —
reducer TP flow rate 3l/min red tolerance ±15%			
	<b>GEV No.</b>	371221	<b>Ref. No.</b> —
reducer TP flow rate 5.5l/min yellow tolerance ±15%			
	<b>GEV No.</b>	371222	<b>Ref. No.</b> —
reducer TP flow rate 6l/min grey tolerance ±15%			
	<b>GEV No.</b>	371223	<b>Ref. No.</b> —
reducer TP flow rate 10l/min white tolerance ±15%			
	<b>GEV No.</b>	371224	<b>Ref. No.</b> —
reducer TP flow rate 12l/min bronze tolerance ±15%			

<b>accessories for</b>	370017		
	<b>GEV No.</b>	371225	<b>Ref. No.</b> —
reducer TP flow rate 16l/min light brown tolerance ±15%			
	<b>GEV No.</b>	371226	<b>Ref. No.</b> —
reducer TP flow rate 20l/min red tolerance ±15%			
	<b>GEV No.</b>	371230	<b>Ref. No.</b> —
reducer TP flow rate 0.25l/min red tolerance ±25%			
	<b>GEV No.</b>	371231	<b>Ref. No.</b> —
reducer TP flow rate 0.35l/min violet tolerance ±25%			
	<b>GEV No.</b>	371232	<b>Ref. No.</b> —
reducer TP flow rate 0.5l/min orange tolerance ±25%			
	<b>GEV No.</b>	371233	<b>Ref. No.</b> —
reducer TP flow rate 0.8l/min white tolerance ±25%			
	<b>GEV No.</b>	371234	<b>Ref. No.</b> —
reducer TP flow rate 1l/min light blue tolerance ±25%			
	<b>GEV No.</b>	371235	<b>Ref. No.</b> —
reducer TP flow rate 1.2l/min brown tolerance ±25%			
	<b>GEV No.</b>	371236	<b>Ref. No.</b> —
reducer TP flow rate 1.5l/min light brown tolerance ±25%			
	<b>GEV No.</b>	371237	<b>Ref. No.</b> —
reducer TP flow rate 2.5l/min yellow tolerance ±25%			
	<b>GEV No.</b>	371238	<b>Ref. No.</b> —
reducer TP flow rate 3.4l/min dark green tolerance ±25%			
	<b>GEV No.</b>	371239	<b>Ref. No.</b> —
reducer TP flow rate 5l/min black tolerance ±25%			
	<b>GEV No.</b>	371240	<b>Ref. No.</b> —
reducer TP flow rate 8l/min blue tolerance ±20%			

<b>metal</b>			
<b>M&amp;M</b>			
<b>2-way</b>			
<b>miscellaneous</b>			
			
1			
<b>GEV No.</b>	370610	<b>Ref. No.</b>	6.016.001.047
<b>description</b>	solenoid valve brass 230VAC inlet 1/4" M&M coil type 2700 p max 0.2bar p min 0bar 230V outlet 10/6mm		
<b>For models:</b>	AM112AT, BFT321AT, DOS10, DOS20, DOS40, HWA30-D, HWA60-D		



solenoid valves (various)



<b>GEV No.</b>	370607	<b>Ref. No.</b>	6.016.001.073
<b>description</b>	solenoid valve inlet 4mm outlet 4mm 3-way M&M coil type 2700 p max 10bar 230V brass NC inlet 4mm		
<b>For models:</b>	BFT321, BFT321AT, BFT322		

pressure switches

for coffee machines

ø 45mm



<b>GEV No.</b>	541100	<b>Ref. No.</b>	6.016.015.005
<b>description</b>	pressure control ø 45mm triggering pressure 0.5bar reset pressure 0.3bar pressure range 0.3/0.5bar pressure connection vertical coffee machine parts connection 6mm suitable for BONAMAT pressure connection 6mm		
<b>For models:</b>	HWD30, RL102, RL102-1N, RL102-3N, RL112-1N, RL112-3N, RL212, RL222		

electrodes



<b>GEV No.</b>	402754	<b>Ref. No.</b>	6.205.610.000
<b>description</b>	level electrode probe L 107mm suitable for BONAMAT for B10 HW edition before 2000		
<b>For models:</b>	B10HW		



<b>GEV No.</b>	402756	<b>Ref. No.</b>	6.205.856.000
<b>description</b>	level electrode probe L 120mm suitable for BONAMAT for B5 HW, B10 HW, B20 HW edition since 2000		
<b>For models:</b>	B10, B10HW, B10HW-5, B20, B20HW, B20HW-5, B40, B5, B5HW, B5HW-5		

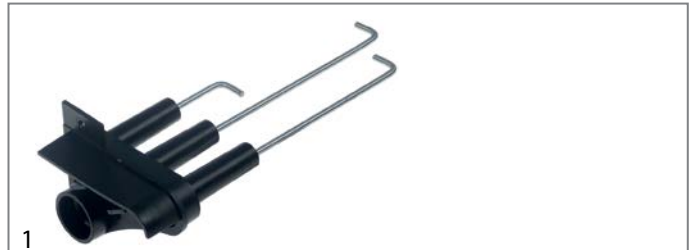

<b>GEV No.</b>	402757	<b>Ref. No.</b>	6.205.855.000
<b>description</b>	level electrode probe L 120mm suitable for BONAMAT for B5, B10, B20, B40 +HW edition since 2000		
<b>For models:</b>	B10, B10HW, B10HW-5, B20, B20HW, B20HW-5, B40, B5, B5HW, B5HW-5		



<b>GEV No.</b>	402738	<b>Ref. No.</b>	6.206.453.000
<b>description</b>	level electrode probe L 125mm suitable for BONAMAT for BFT		
<b>For models:</b>	B20HW		



<b>GEV No.</b>	402876	<b>Ref. No.</b>	6.000.210.130
<b>description</b>	level electrode probe L 130mm ø 3mm suitable for BONAMAT for B20/B40		
<b>For models:</b>	B20, B40		







			
1			
<b>GEV No.</b>	402752	<b>Ref. No.</b>	6.205.611.000
<b>description</b>	level electrode probe L 50mm suitable for BONAMAT for B HW edition before 2000		
<b>For models:</b>	B10HW, B20HW, B5HW		

			
1			
<b>GEV No.</b>	402751	<b>Ref. No.</b>	6.000.211.363
<b>description</b>	level electrode probe L 70mm suitable for BONAMAT for B5 edition before 2000		
<b>For models:</b>	B5		

			
1			
<b>GEV No.</b>	402753	<b>Ref. No.</b>	6.211.953.000
<b>description</b>	level electrode probe L 96mm suitable for BONAMAT for B5 HW edition before 2000		
<b>For models:</b>	B5HW		

			
1			
<b>GEV No.</b>	525854	<b>Ref. No.</b>	6.000.214.022
<b>description</b>	level electrode suitable for BONAMAT for BFT		
<b>For models:</b>	BFT321AT, DOS10, DOS20, DOS40		

			
1			
<b>GEV No.</b>	525855	<b>Ref. No.</b>	6.000.214.001
<b>description</b>	level electrode suitable for BONAMAT for BFT		
<b>For models:</b>	BFT321, BFT322		

			
1			
<b>GEV No.</b>	402645	<b>Ref. No.</b>	6.214.096.000
<b>description</b>	level electrode total length 130mm probe L 92mm insulated probe length 22mm connection ø 2.5x11mm ø 2.5mm		
<b>For models:</b>	BFT322, RLX141, RLX241, RLX4, RLX41, RLX585, RLX8, RLX85, RLX86		

			
1			
<b>GEV No.</b>	402755	<b>Ref. No.</b>	6.000.236.018 6.000.236.060 6.236.009.001
<b>description</b>	level electrode total length 67mm probe L 40mm insulated probe length 23mm		
<b>For models:</b>	B10HW, B20HW, B5HW, HWA20, RL101, RL101-1N, RL101-3N, RL111, RL111-1N, RL111-3N, RL121-1N, RL121-3N, RL211, RL211-1N, RL211-3N, RL212-1N, RL212-3N, RL221, RL221-1N, RL221-3N, RL222-1N, RL222-3N, RL413-1N, RL413-3N		

			
1			
<b>GEV No.</b>	402647	<b>Ref. No.</b>	6.000.201.496
<b>description</b>	level electrode with holder total length 85mm		
<b>For models:</b>	HWA30-D, HWA60-D, Mondo1, Mondo2, Mondo3WB, MondoTwin, MondoTwin-1N, MondoTwin-3N, Novo2, RL118, RL216, RL226, RL411-1N, RL411-3N, TH10, TH20		

## flow meters and flow sensors

### flow meters

#### miscellaneous

			
1			
<b>GEV No.</b>	402739	<b>Ref. No.</b>	6.016.024.001
<b>description</b>	flow meter hose ø 10.5mm plastic approval NSF nominal-ø 2.5mm flow rate 5l/min		
<b>For models:</b>	BFT321, BFT321AT, BFT322		



## motors

### motors

			
1			
<b>GEV No.</b>	501382	<b>Ref. No.</b>	6.000.242.026
<b>description</b>	agitator motor magnetic 220/240V 50Hz CROUZET 16.7W suitable for BONAMAT for HCM		
<b>For models:</b>	HCM510, HCM510-v.4.0, HCM510-v.5.0, HCM520, HCM520-v.4.0, HCM520-v.5.0		

## pumps

### miscellaneous

### pumps

			
1			
<b>GEV No.</b>	501381	<b>Ref. No.</b>	6.023.004.014
<b>description</b>	pump 33W 230V 60Hz inlet ø 14mm outlet ø 14mm L 130mm		
<b>For models:</b>	BFT321AT, DOS10, DOS20, DOS40		

## fuses

### fine fuses

### fine fuse holders

			
1			
<b>GEV No.</b>	358852	<b>Ref. No.</b>	6.005.012.008
<b>description</b>	fuse holder suitable fuse ø6.3x32mm ø 16mm 1-pole 16A rated 250V L 52mm connection male faston 4.8mm/6.3mm		
<b>For models:</b>	B10, B10HW, B10HW-5, B20, B20HW, B20HW-5, B40, B5, B5HW, B5HW-5, GFA70, VHG20, VHG40		

## electric accessories

### plugs - couplings - power sockets

#### protective contact power sockets

#### producer-specific power sockets

#### BONAMAT

			
1			
<b>GEV No.</b>	551053	<b>Ref. No.</b>	6.205.865.000
<b>description</b>	frame with lid for power socket mounting pos. left anthracite		
<b>For models:</b>	B10, B10HW, B10HW-5, B20, B20HW, B20HW-5, B40, B5, B5HW, B5HW-5		

			
1			
<b>GEV No.</b>	551052	<b>Ref. No.</b>	6.205.864.000
<b>description</b>	frame with lid for power socket mounting pos. right anthracite		
<b>For models:</b>	B10, B10HW, B10HW-5, B20, B20HW, B20HW-5, B40, B5, B5HW, B5HW-5		

 <p>Image not available</p>			
1			
<b>GEV No.</b>	551055	<b>Ref. No.</b>	6.006.005.053
<b>description</b>	power socket max. 10A with screw clamps countries CH 240V 1 phase L/N/PE		
<b>For models:</b>	B10, B10HW, B20, B20HW, B40, B5, B5HW		

			
1			
<b>GEV No.</b>	551042	<b>Ref. No.</b>	N/A
<b>description</b>	power socket max. 13A countries GB 240V 1 phase L/N/PE		

 <p>Image not available</p>			
1			
<b>GEV No.</b>	551056	<b>Ref. No.</b>	6.006.005.054
<b>description</b>	power socket max. 13A countries GB 240V 1 phase L/N/PE		
<b>For models:</b>	B10, B10HW, B20, B20HW, B40, B5, B5HW		



<b>GEV No.</b>	551054	<b>Ref. No.</b>	6.006.005.051
<b>description</b>	power socket max. 16A with screw clamps countries F/B 240V 1 phase L/N/PE		
<b>For models:</b>	B10, B10HW, B20, B20HW, B40, B5, B5HW, GFA70		



<b>GEV No.</b>	551044	<b>Ref. No.</b>	6.006.005.100
<b>description</b>	power socket protective contact socket max. 16A countries DE 240V mounting ø 45mm 1 phase L/N/PE		
<b>For models:</b>	B10, B10HW, B10HW-5, B20, B20HW, B20HW-5, B40, B5, B5HW, B5HW-5		



<b>GEV No.</b>	551035	<b>Ref. No.</b>	6.006.005.050
<b>description</b>	power socket with lid max. 16A countries DE 240V H 60mm mounting ø 45mm W 60mm 1 phase L/N/PE		
<b>For models:</b>	B10, B10HW, B20, B20HW, B40, B5, B5HW, GFA70, VHG10, VHG20, VHG3, VHG40		

**terminals**

connection terminals with screw/faston connections



<b>GEV No.</b>	551026	<b>Ref. No.</b>	6.002.019.150
<b>description</b>	connection terminal 5-pole max. 16A max 400V connection ø2.5mm <sup>2</sup> / F6.3 temp.-resist. 150°C cross section 2.5mm <sup>2</sup>		
<b>For models:</b>	Matic, MaticTwin, MondoTwin, RL101-1N, RL101-3N, RL102-1N, RL102-3N, RL111, RL111-1N, RL111-3N, RL112-1N, RL112-3N, RL121-3N, RL211, RL211-1N, RL211-3N, RL212, RL212-1N, RL212-3N, RL221-1N, RL221-3N, RL222-1N, RL222-3N, RL226		



<b>GEV No.</b>	550110	<b>Ref. No.</b>	6.002.019.160
<b>description</b>	power terminal block 5-pole max. 40A max 250V connection M6/ male faston 6.3mm temp.-resist. 130°C		
<b>For models:</b>	B10, B10HW, B10HW-5, B20, B20HW, B20HW-5, B40, B5, B5HW, B5HW-5, BFT321, BFT321AT, BFT322, HWA50, HWA60-D, HWA70-3phases, MaticTwin-KTS-230V3N, MaticTwin-KTS-400V3N, MondoTwin-3N, MondoTwin-KTS-400V3N, RL101-1N, RL102-1N, RL102-3N, RL111-1N, RL111-3N, RL112-1N, RL112-3N, RL121-3N, RL211-1N, RL211-3N, RL212-1N, RL212-3N, RL221-1N, RL221-3N, RL222-1N, RL222-3N, RLX131, RLX231, RLX241, RLX3, RLX31, RLX4, RLX41, RLX5, RLX55, RLX575, RLX585, RLX676, RLX75, RLX76...(Other models you can see in the webshop)		

connection terminals with strain relief



<b>GEV No.</b>	551029	<b>Ref. No.</b>	6.006.001.101
<b>description</b>	power terminal block 3-pole max 400V max. 16A cable ø 10.5mm cross section 2.5mm <sup>2</sup> 1 phase connection male faston 6.3mm/screw connection with strain relief		
<b>For models:</b>	B10, B10HW, B10HW-5, B20, B20HW, B20HW-5, B40, B5, B5HW, B5HW-5, Bolero10, Bolero101, Bolero10-BS, Bolero10-F, Bolero10-MT, Bolero10-PA, Bolero11, Bolero111, Bolero11-BS, Bolero11-F, Bolero11-MT, Bolero11-PA, Bolero20, Bolero20-Maggi, Bolero21, Bolero211, Bolero22, BoleroTurboXL-302-10L, BoleroTurboXL-303, BoleroTurboXL-322-10L, BoleroTurboXL-403, BoleroTurboXL-4L, BoleroXL-313, BoleroXL32, BoleroXL-323, BoleroXL32F, BoleroXL33, BoleroXL-333, BoleroXL42, BoleroXL-423, BoleroXL43, BoleroXL-433, CB3, CB6, Chiller-v.2.0, Chiller-v.3.0, Chiller-v.4.0, Combino, DOS10, DOS20...(Other models you can see in the webshop)		



<b>GEV No.</b>	551037	<b>Ref. No.</b>	6.006.001.105 6.006.001.108
<b>description</b>	power terminal block 3-pole max 400V max. 16A cable ø 8.5mm cross section 2.5mm <sup>2</sup> 1 phase connection male faston 6.3mm		
<b>For models:</b>	HCM510, HCM510-v.4.0, HCM510-v.5.0, HCM520, HCM520-v.4.0, HCM520-v.5.0, HM505, HM505-v.2.0, HM505-v.3.0, HM510, HM510-v.2.0, HM510-v.3.0, HM520, HM520-v.2.0, HM520-v.3.0, HW505, HW510, HW520, HWA505, HWA510, HWA520, KMD, TH10, TH10-KTS, TH20, THA10, THA10-KTS, THA20		



			
1			
<b>GEV No.</b>	551036	<b>Ref. No.</b>	6.006.001.102
<b>description</b>	power terminal block 5-pole max 400V max. 16A cable ø 12.5mm 3 phase connection male faston 6.3mm		
<b>For models:</b>	BoleroTurbo, BoleroTurboXL, MaticTwin, MaticTwin-3N, MondoTwin-3N, MondoTwin-KTS-230V3N		

## equipment-specific units

### for espresso machines

#### boilers

#### gaskets

#### unperforated

			
1			
<b>GEV No.</b>	417331	<b>Ref. No.</b>	6.011.001.118
<b>description</b>	boiler gasket D1 ø 180mm D2 ø 175mm thickness 5mm Viton suitable for BONAMAT		
<b>For models:</b>	HWD30, RL102-1N, RL102-3N, RL112-1N, RL112-3N		

#### level glasses

#### adapters

			
1			
<b>GEV No.</b>	527075	<b>Ref. No.</b>	6.015.001.204
<b>description</b>	screw muff mounting pos. lower equiv. no. 6015001204		
<b>For models:</b>	HCM510, HCM510-v.4.0, HCM510-v.5.0, HCM520, HCM520-v.4.0, HCM520-v.5.0, HM505, HM505-v.2.0, HM505-v.3.0, HM510, HM510-v.2.0, HM510-v.3.0, HM520, HM520-v.2.0, HM520-v.3.0, HW+505, HW+505-v.3.0, HW+505-v.4.0, HW+510, HW+510-v.3.0, HW+510-v.4.0, HW+520, HW+520-v.3.0, HW+520-v.4.0, HW505, HW505-v.3.0, HW505-v.4.0, HW510, HW510-v.3.0, HW510-v.4.0, HW520, HW520-v.3.0, HW520-v.4.0, HWA505, HWA510, HWA520, RL211, RL211-1N, RL211-3N, RL212, RL212-1N, RL212-3N, RL214, RL214-1N, RL216, RL221, RL221-1N, RL221-3N, RL222, RL222-1N... (Other models you can see in the webshop)		

#### level glasses

#### gaskets

			
1			
<b>GEV No.</b>	527078	<b>Ref. No.</b>	6.015.001.012
<b>description</b>	gasket rubber equiv. no. 6015001012 mounting pos. lower		
<b>For models:</b>	AM112, GFA70, HWA50, HWD30, RL101, RL101-1N, RL101-3N, RL102, RL102-1N, RL102-3N, RL111, RL111-1N, RL111-3N, RL112-1N, RL112-3N, RL118, RL121-1N, RL121-3N, RL211, RL211-1N, RL211-3N, RL212, RL212-1N, RL212-3N, RL221, RL221-1N, RL221-3N, RL222, RL222-1N, RL222-3N, RL411-1N, RL411-3N, RL413-1N, RL413-3N, RLX141, RLX241, RLX4, RLX41, RLX585, RLX8, RLX85, RLX86, VH10, VH20, VH3, VH4, VH40, VH40-DOS-20L, VH40-DOS-40L		

			
1			
<b>GEV No.</b>	527074	<b>Ref. No.</b>	6.015.001.205
<b>description</b>	gasket rubber equiv. no. 6015001205 mounting pos. lower		
<b>For models:</b>	HCM510, HCM510-v.4.0, HCM510-v.5.0, HCM520, HCM520-v.4.0, HCM520-v.5.0, HM505, HM505-v.2.0, HM505-v.3.0, HM510, HM510-v.2.0, HM510-v.3.0, HM520, HM520-v.2.0, HM520-v.3.0, HW+505, HW+505-v.3.0, HW+505-v.4.0, HW+510, HW+510-v.3.0, HW+510-v.4.0, HW+520, HW+520-v.3.0, HW+520-v.4.0, HW505, HW505-v.3.0, HW505-v.4.0, HW510, HW510-v.3.0, HW510-v.4.0, HW520, HW520-v.3.0, HW520-v.4.0, HWA505, HWA510, HWA520, RL211, RL211-1N, RL211-3N, RL212, RL212-1N, RL212-3N, RL214, RL214-1N, RL216, RL221, RL221-1N, RL221-3N, RL222, RL222-1N... (Other models you can see in the webshop)		

			
1			
<b>GEV No.</b>	527073	<b>Ref. No.</b>	6.015.001.209
<b>description</b>	gasket rubber equiv. no. 6015001209 mounting pos. upper		
<b>For models:</b>	HCM510, HCM510-v.4.0, HCM510-v.5.0, HCM520, HCM520-v.4.0, HCM520-v.5.0, HM505, HM505-v.2.0, HM505-v.3.0, HM510, HM510-v.2.0, HM510-v.3.0, HM520, HM520-v.2.0, HM520-v.3.0, HW+505, HW+505-v.3.0, HW+505-v.4.0, HW+510, HW+510-v.3.0, HW+510-v.4.0, HW+520, HW+520-v.3.0, HW+520-v.4.0, HW505, HW505-v.3.0, HW505-v.4.0, HW510, HW510-v.3.0, HW510-v.4.0, HW520, HW520-v.3.0, HW520-v.4.0, HWA505, HWA510, HWA520, RL211, RL211-1N, RL211-3N, RL212, RL212-1N, RL212-3N, RL214, RL214-1N, RL216, RL221, RL221-1N, RL221-3N, RL222, RL222-1N... (Other models you can see in the webshop)		

#### level glass pipes

			
1			
<b>GEV No.</b>	527381	<b>Ref. No.</b>	6.242.193.001
<b>description</b>	water level tube ø 12/9mm H 257mm since year of construction 2000 VH10		
<b>For models:</b>	B10, B10HW, B10HW-5, HW+510-v.5.0, HW510-v.5.0, VH10, VH10T		

#### screw caps

			
1			
<b>GEV No.</b>	527072	<b>Ref. No.</b>	6.015.001.210
<b>description</b>	screw cap		
<b>For models:</b>	HCM510, HCM510-v.4.0, HCM510-v.5.0, HCM520, HCM520-v.4.0, HCM520-v.5.0, HM505, HM505-v.2.0, HM505-v.3.0, HM510, HM510-v.2.0, HM510-v.3.0, HM520, HM520-v.2.0, HM520-v.3.0, HW+505, HW+505-v.3.0, HW+505-v.4.0, HW+510, HW+510-v.3.0, HW+510-v.4.0, HW+520, HW+520-v.3.0, HW+520-v.4.0, HW505, HW505-v.3.0, HW505-v.4.0, HW510, HW510-v.3.0, HW510-v.4.0, HW520, HW520-v.3.0, HW520-v.4.0, HWA505, HWA510, HWA520, RL211, RL211-1N, RL211-3N, RL212, RL212-1N, RL212-3N, RL214, RL214-1N, RL216, RL221, RL221-1N, RL221-3N, RL222, RL222-1N... (Other models you can see in the webshop)		

			
1			
<b>GEV No.</b>	527076	<b>Ref. No.</b>	6.015.001.010
<b>description</b>	screw cap		
<b>For models:</b>	AM112, AM112AT, B10, B10HW, B20, B20HW, B40, B5, B5HW, VHG10, VHG10T, VHG20, VHG20T, VHG3, VHG40, VHG40T, VHG5, VHG5T, VHGDOS-20L, VHGDOS-40L		

for pour machines  
coffee pots

			
1			
<b>GEV No.</b>	960070	<b>Ref. No.</b>	7.170.400.101 7.170.401.101 7.170.602.101
<b>description</b>	coffee pot 1.7l glas suitable for BONAMAT		

coffee filters  
paper filters  
basket filters

			
1			
<b>GEV No.</b>	960101	<b>Ref. No.</b>	7.150.111.301
<b>description</b>	paper filter for coffee makers D1 ø 100mm D2 ø 320mm Qty 500 pcs		

			
1			
<b>GEV No.</b>	960105	<b>Ref. No.</b>	7.150.102.301
<b>description</b>	paper filter for coffee makers D1 ø 110mm D2 ø 360mm Qty 500 pcs		

			
1			
<b>GEV No.</b>	960102	<b>Ref. No.</b>	7.150.103.301
<b>description</b>	paper filter for coffee makers D1 ø 150mm D2 ø 435mm Qty 500 pcs		

			
1			
<b>GEV No.</b>	960103	<b>Ref. No.</b>	7.150.104.301
<b>description</b>	paper filter for coffee makers D1 ø 175mm D2 ø 525mm Qty 500 pcs		

			
1			
<b>GEV No.</b>	960104	<b>Ref. No.</b>	7.150.105.301
<b>description</b>	paper filter for coffee makers D1 ø 280mm D2 ø 635mm Qty 500 pcs		

			
1			
<b>GEV No.</b>	960100	<b>Ref. No.</b>	7.150.101.101 7.150.101.103
<b>description</b>	paper filter for coffee makers D1 ø 90mm D2 ø 250mm Qty 1000 pcs		

<p>round filters</p> 			
1			
<b>GEV No.</b>	960022	<b>Ref. No.</b>	7.150.502.301
<b>description</b>	paper filter ø 144mm Qty 250 pcs for B3 suitable for BONAMAT		





			
1			
<b>GEV No.</b>	960023	<b>Ref. No.</b>	7.150.503.301
<b>description</b>	paper filter ø 172mm Qty 250 pcs for B5 suitable for BONAMAT		

			
1			
<b>GEV No.</b>	960024	<b>Ref. No.</b>	7.150.507.301
<b>description</b>	paper filter ø 244mm Qty 250 pcs for B 10 suitable for BONAMAT		

			
1			
<b>GEV No.</b>	960025	<b>Ref. No.</b>	7.150.505.301
<b>description</b>	paper filter ø 330mm Qty 250 pcs for B 20 suitable for BONAMAT		

			
1			
<b>GEV No.</b>	960026	<b>Ref. No.</b>	7.150.508.301
<b>description</b>	paper filter ø 400mm Qty 250 pcs for B 40 suitable for BONAMAT		

filter pans

filter pans

BONAMAT

			
1			
<b>GEV No.</b>	960082	<b>Ref. No.</b>	7.090.802.201
<b>description</b>	filter pan plastic ED ø 174mm int. ø 1 156mm int. ø 2 90mm H 100mm filter no. 960100 suitable for BONAMAT		

			
1			
<b>GEV No.</b>	960072	<b>Ref. No.</b>	7.090.101.101
<b>description</b>	filter pan stainless steel W 175mm D 175mm H 95mm filter no. 960100 suitable for BONAMAT		

<b>accessories for</b>	960072		
------------------------	--------	--	--

			
1			
<b>GEV No.</b>	960071	<b>Ref. No.</b>	7.091.600.101
<b>description</b>	spring		

			
1			
<b>GEV No.</b>	960100	<b>Ref. No.</b>	7.150.101.101 7.150.101.103
<b>description</b>	paper filter for coffee makers D1 ø 90mm D2 ø 250mm Qty 1000 pcs		

accessories

			
1			
<b>GEV No.</b>	960071	<b>Ref. No.</b>	7.091.600.101
<b>description</b>	spring		

<b>GEV No.</b>	960071	<b>Ref. No.</b>	7.091.600.101
<b>description</b>	spring		

drain taps

drain taps

			
1			
<b>GEV No.</b>	527053	<b>Ref. No.</b>	6.015.001.230
<b>description</b>	outlet tap complete tube ø 18mm pipe length 45mm thread M16x0.75		

<b>For models:</b>	HW10, HWA20, RL101, RL101-1N, RL101-3N, RL111-1N, RL111-3N, RL118, RL121-1N, RL121-3N, RL211-1N, RL211-3N, RL212-1N, RL212-3N, RL221, RL221-1N, RL221-3N, RL222-1N, RL222-3N, RL411-1N, RL411-3N, RL413-1N, RL413-3N		
--------------------	--	--	--

			
1			
<b>GEV No.</b>	525871	<b>Ref. No.</b>	6.015.001.133
<b>description</b>	outlet tap tube ømm pipe lengthmm thread M18x1 suitable for BONAMAT		

<b>For models:</b>	HWA50, VHG10, VHG20, VHG40		
--------------------	----------------------------	--	--

## components



<b>GEV No.</b>	525427	<b>Ref. No.</b>	6.015.001.281
<b>description</b>	bolt for tap H 41mm ø 9mm		
<b>For models:</b>	B10, B10HW, B10HW-5, B20, B20HW, B20HW-5, B40, HCM510, HCM510-v.4.0, HCM510-v.5.0, HCM520, HCM520-v.4.0, HCM520-v.5.0, HM505, HM505-v.2.0, HM505-v.3.0, HM510, HM510-v.2.0, HM510-v.3.0, HM520, HM520-v.2.0, HM520-v.3.0, HW+510-v.5.0, HW+520-v.5.0, HW510-v.5.0, HW520-v.5.0, HWA50, VHG10, VHG10T, VHG20, VHG20T, VHG40, VHG40T		



<b>GEV No.</b>	527086	<b>Ref. No.</b>	6.015.001.214
<b>description</b>	guide for drain tap total length 35mm ø 8mm		
<b>For models:</b>	B10, B10HW, B10HW-5, B20, B20HW, B20HW-5, B40, B5, B5HW, B5HW-5, BFT321, BFT321AT, BFT322, CB6, HW+505, HW+505-v.3.0, HW+505-v.4.0, HW+510, HW+510-v.3.0, HW+510-v.4.0, HW+520, HW+520-v.3.0, HW+520-v.4.0, HW10, HW505, HW505-v.3.0, HW505-v.4.0, HW505-v.5.0, HW510, HW510-v.3.0, HW510-v.4.0, HW520, HW520-v.3.0, HW520-v.4.0, HWA20, HWA505, HWA510, HWA520, HWD30, RL101, RL101-1N, RL101-3N, RL102, RL102-1N, RL102-3N, RL111, RL111-1N, RL111-3N, RL112-1N, RL112-3N...(Other models you can see in the webshop)		



<b>GEV No.</b>	525885	<b>Ref. No.</b>	6.015.001.280
<b>description</b>	lever for drain tap suitable for BONAMAT		
<b>For models:</b>	HCM510, HCM510-v.4.0, HCM520, HCM520-v.4.0, HM505, HM505-v.2.0, HM510, HM510-v.2.0, HM520, HM520-v.2.0, HWA50		



<b>GEV No.</b>	525424	<b>Ref. No.</b>	6.214.056.001
<b>description</b>	lever for tap D 20mm W 32mm H 50mm		
<b>For models:</b>	B10, B10HW, B10HW-5, B20, B20HW, B20HW-5, B40, B5, B5HW, B5HW-5, BFT321, BFT321AT, BFT322, HW+505-v.4.0, HW+510-v.4.0, HW+520-v.4.0, HW505-v.4.0, HW505-v.5.0, HW510-v.4.0, HW520-v.4.0, RLX131, RLX231, RLX3, RLX31, RLX5, RLX55, RLX575, RLX585, RLX676, RLX75, RLX76, RLX85, VHGS, VHGS5T		



<b>GEV No.</b>	525423	<b>Ref. No.</b>	6.242.191.001
<b>description</b>	lever for tap D 23mm W 32mm H 50mm		
<b>For models:</b>	B10, B10HW, B10HW-5, B20, B20HW, B20HW-5, B40, HCM510-v.5.0, HCM520-v.5.0, HM505-v.3.0, HM510-v.3.0, HM520-v.3.0, HW+510-v.5.0, HW+520-v.5.0, HW510-v.5.0, HW520-v.5.0, VHG10, VHG10T, VHG20, VHG20T, VHG40, VHG40T		



<b>GEV No.</b>	525877	<b>Ref. No.</b>	6.242.215.001
<b>description</b>	screw cap for drain tap H 11.5mm ø 39mm suitable for BONAMAT for HM, HCM		
<b>For models:</b>	HCM510-v.4.0, HCM520-v.4.0, HM505-v.2.0, HM510-v.2.0, HM520-v.2.0, HWA50		



<b>GEV No.</b>	525425	<b>Ref. No.</b>	6.214.058.001
<b>description</b>	screw cap for tap H 10mm ø 32mm thread M28x1.5		
<b>For models:</b>	B10, B10HW, B10HW-5, B20, B20HW, B20HW-5, B40, B5, B5HW, B5HW-5, BFT321, BFT321AT, BFT322, Chiller-v.4.0, HW+505-v.4.0, HW+510-v.4.0, HW+520-v.4.0, HW505-v.4.0, HW505-v.5.0, HW510-v.4.0, HW520-v.4.0, RLX131, RLX231, RLX3, RLX31, RLX5, RLX55, RLX575, RLX585, RLX676, RLX75, RLX76, RLX85, VHGS, VHGS5T		



<b>GEV No.</b>	525426	<b>Ref. No.</b>	6.242.183.001
<b>description</b>	screw cap for tap H 12mm ø 39mm thread M35x1.5		
<b>For models:</b>	B10, B10HW, B10HW-5, B20, B20HW, B20HW-5, B40, HCM510-v.5.0, HCM520-v.5.0, HM505-v.3.0, HM510-v.3.0, HM520-v.3.0, HW+510-v.5.0, HW+520-v.5.0, HW510-v.5.0, HW520-v.5.0, VHG10, VHG10T, VHG20, VHG20T, VHG40, VHG40T		

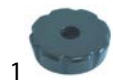

<b>GEV No.</b>	527084	<b>Ref. No.</b>	6.015.001.216
<b>description</b>	screw cap thread M28x1.5		
<b>For models:</b>	CB6, HW+505, HW+505-v.3.0, HW+510, HW+510-v.3.0, HW+520, HW+520-v.3.0, HW10, HW505, HW505-v.3.0, HW510-v.3.0, HW520-v.3.0, HWA20, HWA505, HWA510, HWA520, RL101, RL101-1N, RL101-3N, RL111, RL111-1N, RL111-3N, RL118, RL121-1N, RL121-3N, RL211, RL211-1N, RL211-3N, RL212, RL212-1N, RL212-3N, RL214, RL214-1N, RL216, RL221, RL221-1N, RL221-3N, RL222, RL222-1N, RL222-3N, RL224, RL224-1N, RL224-3N, RL226, RL411-1N, RL411-3N, RL413-1N, RL413-3N		



<b>GEV No.</b>	525430	<b>Ref. No.</b>	6.000.313.016 6.015.001.365
<b>description</b>	tap tap head ø 32mm thread M28x1.5 grey		
<b>For models:</b>	B10, B10HW, B10HW-5, B20, B20HW, B20HW-5, B40, B5, B5HW, B5HW-5, BFT321, BFT321AT, BFT322, HW+505-v.4.0, HW+510-v.4.0, HW+520-v.4.0, HW505-v.4.0, HW505-v.5.0, HW510-v.4.0, HW520-v.4.0, RLX131, RLX231, RLX3, RLX31, RLX5, RLX55, RLX575, RLX585, RLX676, RLX75, RLX76, RLX85, VHGS, VHGS5T		

**spare parts for** 525430



<b>GEV No.</b>	525424	<b>Ref. No.</b>	6.214.056.001
----------------	--------	-----------------	---------------

lever for tap D 20mm W 32mm H 50mm



<b>GEV No.</b>	525425	<b>Ref. No.</b>	6.214.058.001
----------------	--------	-----------------	---------------

screw cap for tap H 10mm ø 32mm thread M28x1.5





			
1			
<b>GEV No.</b>	525422	<b>Ref. No.</b>	6.015.001.366
<b>description</b>	tap tap head ø 39.5mm thread M35x1.5 suitable for BONAMAT grey		
<b>For models:</b>	B10, B10HW, B10HW-5, B20, B20HW, B20HW-5, B40, HCM510-v.5.0, HCM520-v.5.0, HM505-v.3.0, HM510-v.3.0, HM520-v.3.0, HW+510-v.5.0, HW+520-v.5.0, HW510-v.5.0, HW520-v.5.0, VHG10, VHG10T, VHG20, VHG20T, VHG40, VHG40T		
<b>spare parts for</b>	525422		
	<b>GEV No.</b>	525423	<b>Ref. No.</b> 6.242.191.001
	lever for tap D 23mm W 32mm H 50mm		
	<b>GEV No.</b>	525426	<b>Ref. No.</b> 6.242.183.001
	screw cap for tap H 12mm ø 39mm thread M35x1.5		
	<b>GEV No.</b>	525427	<b>Ref. No.</b> 6.015.001.281
	bolt for tap H 41mm ø 9mm		

			
1			
<b>GEV No.</b>	525872	<b>Ref. No.</b>	6.015.001.274
<b>description</b>	tap body thread M18x1 suitable for BONAMAT		
<b>For models:</b>	HCM510, HCM510-v.4.0, HCM510-v.5.0, HCM520, HCM520-v.4.0, HCM520-v.5.0, HM505, HM505-v.2.0, HM505-v.3.0, HM510, HM510-v.2.0, HM510-v.3.0, HM520, HM520-v.2.0, HM520-v.3.0		

brew units

gaskets

			
1			
<b>GEV No.</b>	527051	<b>Ref. No.</b>	6.201.902.001
<b>description</b>	gasket for spray head		
<b>For models:</b>	BFT321, BFT321AT, BFT322, Iso, Matic2, Matic2-KTS, Matic2WB, Matic3, Matic3-KTS, Matic3WB, MaticTwin, MaticTwin-1N, MaticTwin-3N, MaticTwin-KTS-230V3N, MaticTwin-KTS-400V3N, Mondo1, Mondo2, Mondo2-KTS, Mondo3WB, MondoTwin, MondoTwin-1N, MondoTwin-3N, MondoTwin-KTS-230V3N, MondoTwin-KTS-400V3N, Novo, Novo2, RL101, RL101-1N, RL101-3N, RL102, RL102-1N, RL102-3N, RL111, RL111-1N, RL111-3N, RL112-1N, RL112-3N, RL118, RL121-1N, RL121-3N, RL211, RL211-1N, RL211-3N, RL212, RL212-1N, RL212-3N, RL214, RL214-1N, RL216, RL221...(Other models you can see in the webshop)		

			
1			
<b>GEV No.</b>	525225	<b>Ref. No.</b>	6.011.001.157
<b>description</b>	gasket for spray head ID ø 75mm thickness 3mm silicone		
<b>For models:</b>	Matic, MaticTwin, Mondo, MondoTwin, TH, THA		

spray heads

			
1			
<b>GEV No.</b>	525853	<b>Ref. No.</b>	6.214.295.001
<b>description</b>	spray head ø 57mm suitable for BONAMAT BFT		
<b>For models:</b>	BFT321, BFT321AT, BFT322		

			
1			
<b>GEV No.</b>	525222	<b>Ref. No.</b>	6.301.378.001
<b>description</b>	spray head tap head ø 82mm hose ø 14.5mm plastic suitable for BONAMAT		
<b>For models:</b>	BFT321, BFT321AT, BFT322, Iso, Novo, Novo2		

			
1			
<b>GEV No.</b>	527050	<b>Ref. No.</b>	6.201.900.000
<b>description</b>	spray head tap head ø 82mm suitable for BONAMAT		
<b>For models:</b>	Matic2, Matic2-KTS, Matic2WB, Matic3, Matic3-KTS, Matic3WB, MaticTwin, MaticTwin-1N, MaticTwin-3N, MaticTwin-KTS-230V3N, MaticTwin-KTS-400V3N, Mondo1, Mondo2, Mondo2-KTS, Mondo3WB, MondoTwin, MondoTwin-1N, MondoTwin-3N, MondoTwin-KTS-230V3N, MondoTwin-KTS-400V3N, RL101, RL101-1N, RL101-3N, RL102, RL102-1N, RL102-3N, RL111, RL111-1N, RL111-3N, RL112-1N, RL112-3N, RL118, RL121-1N, RL121-3N, RL211, RL211-1N, RL211-3N, RL212, RL212-1N, RL212-3N, RL214, RL214-1N, RL216, RL221, RL221-1N, RL221-3N, RL222, RL222-1N, RL222-3N, RL224...(Other models you can see in the webshop)		



1

<b>GEV No.</b>	525282	<b>Ref. No.</b>	6.101.008.001
<b>description</b>	spray head tap head ø 86mm hose ø 14.5mm suitable for BONAMAT		
<b>For models:</b>	Matic, MaticTwin, Mondo, MondoTwin, TH, THA		



1

<b>GEV No.</b>	525227	<b>Ref. No.</b>	6.101.087.001
<b>description</b>	manifold for spray head ø 50mm		
<b>For models:</b>	Iso, Novo		

manifolds



1

<b>GEV No.</b>	527052	<b>Ref. No.</b>	6.201.901.001 6.301.008.001
<b>description</b>	manifold bottom part ø 49mm MONDO		
<b>For models:</b>	Matic2, Matic2WB, Matic3, Matic3WB, MaticTwin, MaticTwin-1N, MaticTwin-3N, Mondo1, Mondo2, Mondo3WB, MondoTwin, MondoTwin-1N, MondoTwin-3N, Novo2, RL101, RL101-1N, RL101-3N, RL102, RL102-1N, RL102-3N, RL111, RL111-1N, RL111-3N, RL112-1N, RL112-3N, RL118, RL121-1N, RL121-3N, RL211, RL211-1N, RL211-3N, RL212, RL212-1N, RL212-3N, RL214, RL214-1N, RL216, RL221, RL221-1N, RL221-3N, RL222-1N, RL222-3N, RL224, RL224-1N, RL224-3N, RL226, RL411-1N, RL411-3N, RL413-1N, RL413-3N...(Other models you can see in the webshop)		



1

<b>GEV No.</b>	525226	<b>Ref. No.</b>	6.101.062.001
<b>description</b>	manifold for spray head ø 65mm		
<b>For models:</b>	Matic, MaticTwin, Mondo, MondoTwin, TH, THA		



1

<b>GEV No.</b>	525224	<b>Ref. No.</b>	6.301.598.001
<b>description</b>	manifold bottom part ø 49mm NOVO		
<b>For models:</b>	Iso, Novo		



1

<b>GEV No.</b>	525852	<b>Ref. No.</b>	6.214.245.001
<b>description</b>	water distributor ø 89mm suitable for BONAMAT BFT		
<b>For models:</b>	BFT321, BFT321AT, BFT322		

steam/water taps

steam taps



1

<b>GEV No.</b>	527054	<b>Ref. No.</b>	6.015.001.229
<b>description</b>	steam tap complete		
<b>For models:</b>	HWD30, RL102, RL102-1N, RL102-3N, RL112-1N, RL112-3N, RL212, RL222		





1

<b>GEV No.</b>	525849	<b>Ref. No.</b>	6.214.159.000
<b>description</b>	steam tap inlet M12x1 chrome-plated brass suitable for BONAMAT series BFT		
<b>For models:</b>	BFT322		



1

<b>GEV No.</b>	525869	<b>Ref. No.</b>	6.000.313.003
<b>description</b>	steam/water tap inlet 8.5 suitable for BONAMAT series RLX 4		
<b>For models:</b>	RLX141, RLX241, RLX4, RLX41		



1

<b>GEV No.</b>	525996	<b>Ref. No.</b>	6.000.313.011
<b>description</b>	steam/water tap inlet 8.5 suitable for BONAMAT series RLX 8		
<b>For models:</b>	RLX585, RLX8, RLX85, RLX86		

components

nozzles for steam pipes



1

<b>GEV No.</b>	525851	<b>Ref. No.</b>	6.214.071.001
<b>description</b>	nozzle thread M10x0.75 ø 13mm L 35mm 4 holes bore ø 1.5mm stainless steel		
<b>For models:</b>	BFT322		

valve bodies



1

<b>GEV No.</b>	525878	<b>Ref. No.</b>	6.013.016.001
<b>description</b>	valve body for steam-/water-tap suitable for BFT/RLX		
<b>For models:</b>	BFT322, RLX141, RLX241, RLX4, RLX41, RLX585, RLX8, RLX85, RLX86		

screw connections



1

<b>GEV No.</b>	525220	<b>Ref. No.</b>	6.015.001.226
<b>description</b>	screw connection for steam-/water-tap T1: M30x1.5 L 19mm ID ø 8mm WS 33 chrome-plated brass		
<b>For models:</b>	HWD30, RL102, RL102-1N, RL102-3N, RL112-1N, RL112-3N, RL212, RL222		

water taps



1

<b>GEV No.</b>	527055	<b>Ref. No.</b>	6.015.001.232
<b>description</b>	water tap complete		
<b>For models:</b>	HWD30, RL102, RL102-1N, RL102-3N, RL112-1N, RL112-3N, RL212, RL222		



1

<b>GEV No.</b>	525870	<b>Ref. No.</b>	6.000.313.002
<b>description</b>	water tap inlet 8.5 suitable for BONAMAT series RLX 4		
<b>For models:</b>	RLX141, RLX241, RLX4, RLX41		





1

<b>GEV No.</b>	525995	<b>Ref. No.</b>	6.000.313.010
<b>description</b>	water tap inlet 8.5 suitable for BONAMAT series RLX 8		
<b>For models:</b>	RLX585, RLX8, RLX85, RLX86		



1

<b>GEV No.</b>	525850	<b>Ref. No.</b>	6.214.160.000
<b>description</b>	water tap inlet M12x1 chrome-plated brass suitable for BONAMAT series BFT		
<b>For models:</b>	BFT322		

liquid level pipes

angle valves



1

<b>GEV No.</b>	525873	<b>Ref. No.</b>	6.214.057.001
<b>description</b>	angle valve for level glass		
<b>For models:</b>	BFT321, BFT321AT, BFT322		



1

<b>GEV No.</b>	525874	<b>Ref. No.</b>	6.214.066.001
<b>description</b>	outlet tap for level glass		
<b>For models:</b>	BFT321, BFT321AT		

liquid level pipes



1

<b>GEV No.</b>	525861	<b>Ref. No.</b>	6.015.001.292
<b>description</b>	level glass pipe ED ø 12mm ID ø 9mm H 181mm marking 1-4 HW, HWA for BONAMAT		
<b>For models:</b>	HW+505, HW+505-v.3.0, HW+505-v.4.0, HW505, HW505-v.3.0, HW505-v.4.0		



1

<b>GEV No.</b>	525862	<b>Ref. No.</b>	6.015.001.289
<b>description</b>	level glass pipe ED ø 12mm ID ø 9mm H 181mm marking 1-8 HW, HWA for BONAMAT		
<b>For models:</b>	HW+510, HW+510-v.3.0, HW+510-v.4.0, HW510, HW510-v.3.0, HW510-v.4.0		



1

<b>GEV No.</b>	525863	<b>Ref. No.</b>	6.015.001.293
<b>description</b>	level glass pipe ED ø 12mm ID ø 9mm H 205mm marking 2-16 for BONAMAT		
<b>For models:</b>	HW+520, HW+520-v.3.0, HW+520-v.4.0, HW520, HW520-v.3.0, HW520-v.4.0		



1

<b>GEV No.</b>	525865	<b>Ref. No.</b>	6.015.001.275
<b>description</b>	level glass pipe ED ø 12mm ID ø 9mm H 207mm marking Min/Max HM, HCM for BONAMAT		
<b>For models:</b>	HCM510, HCM510-v.4.0, HCM510-v.5.0, HM505, HM505-v.2.0, HM505-v.3.0, HM510, HM510-v.2.0, HM510-v.3.0, HM520		



1

<b>GEV No.</b>	525864	<b>Ref. No.</b>	6.015.001.276
<b>description</b>	level glass pipe ED ø 12mm ID ø 9mm H 234mm marking Min/Max HM, HW(A) for BONAMAT		
<b>For models:</b>	HCM520, HCM520-v.4.0, HCM520-v.5.0, HM520, HM520-v.2.0, HM520-v.3.0		





1



<b>GEV No.</b>	525867	<b>Ref. No.</b>	6.015.001.256
<b>description</b>	protection pipe ED ø 16mm ID ø 13mm H 207mm HM, HW(A) for BONAMAT		
<b>For models:</b>	HCM510, HCM510-v.4.0, HCM510-v.5.0, HM505, HM505-v.2.0, HM505-v.3.0, HM510, HM510-v.2.0, HM510-v.3.0, HM520, HW+520, HW+520-v.3.0, HW+520-v.4.0, HW505, HW510, HW520, HW520-v.3.0, HW520-v.4.0, HWA505, HWA510, HWA520		





			
1			
<b>GEV No.</b>	525875	<b>Ref. No.</b>	6.313.246.001
<b>description</b>	water level tube ED ø 12mm ID ø 9mm H 143mm RLX for BONAMAT		
<b>For models:</b>	RLX5, RLX55, RLX575, RLX585, RLX75, RLX85		

			
1			
<b>GEV No.</b>	525876	<b>Ref. No.</b>	6.015.001.345
<b>description</b>	water level tube ED ø 12mm ID ø 9mm H 187mm BFT for BONAMAT		
<b>For models:</b>	BFT321, BFT321AT, BFT322		

			
1			
<b>GEV No.</b>	525418	<b>Ref. No.</b>	6.240.124.001
<b>description</b>	water level tube ED ø 12mm ID ø 9mm H 244mm		
<b>For models:</b>	B5, B5HW, B5HW-5, HW505-v.5.0, VHG5, VHG5T		
<b>accessories for</b>	525418		
	<b>GEV No.</b>	<b>Ref. No.</b>	
	525269	6.240.134.001	
	 end cap for water level tube ø 9mm H 15mm		

			
1			
<b>GEV No.</b>	525417	<b>Ref. No.</b>	6.243.232.001
<b>description</b>	water level tube ED ø 12mm ID ø 9mm H 282mm for BONAMAT		
<b>For models:</b>	B20, B20HW, B20HW-5, HW+520-v.5.0, HW520-v.5.0, VHG20, VHG20T		
<b>accessories for</b>	525417		
	<b>GEV No.</b>	<b>Ref. No.</b>	
	532584	6.011.001.112	
	 O-ring silicone thickness 3mm ID ø 12mm Qty 1 pcs		

			
1			
<b>GEV No.</b>	525419	<b>Ref. No.</b>	6.248.132.001
<b>description</b>	water level tube ED ø 12mm ID ø 9mm H 398mm for BONAMAT		
<b>For models:</b>	B40, VHG40, VHG40T		

			
1			
<b>GEV No.</b>	527070	<b>Ref. No.</b>	6.015.001.207
<b>description</b>	water level tube for BONAMAT		
<b>For models:</b>	RL211, RL211-1N, RL211-3N, RL212, RL212-1N, RL212-3N, RL214, RL214-1N, RL216, RL221, RL221-1N, RL221-3N, RL222, RL222-1N, RL222-3N, RL224, RL224-1N, RL224-3N, RL226		

protective tube

metal

			
1			
<b>GEV No.</b>	527066	<b>Ref. No.</b>	6.015.001.018
<b>description</b>	protection pipe for level glass		
<b>For models:</b>	B5, B5HW, VHG5, VHG5T		

			
1			
<b>GEV No.</b>	527069	<b>Ref. No.</b>	6.015.001.136
<b>description</b>	protection pipe for level glass		
<b>For models:</b>	B40, VHG40, VHG40T, VHG-DOS-40L		

			
1			
<b>GEV No.</b>	525868	<b>Ref. No.</b>	6.015.001.291
<b>description</b>	protection pipe ø 16mm ID ø 13mm L 181mm M16x0.75 aluminium		
<b>For models:</b>	HW+505, HW+505-v.3.0, HW+505-v.4.0, HW+510, HW+510-v.3.0, HW+510-v.4.0, HW505, HW505-v.3.0, HW505-v.4.0, HW510, HW510-v.3.0, HW510-v.4.0		

			
1			
<b>GEV No.</b>	525866	<b>Ref. No.</b>	6.015.001.262
<b>description</b>	protection pipe ø 16mm ID ø 13mm L 234mm M16x0.75 aluminium		
<b>For models:</b>	HCM520, HCM520-v.4.0, HCM520-v.5.0, HM520, HM520-v.2.0, HM520-v.3.0		

accessories

end caps

			
1			
<b>GEV No.</b>	525269	<b>Ref. No.</b>	6.240.134.001
<b>description</b>	end cap for water level tube ø 9mm H 15mm		
<b>For models:</b>	B10, B10HW, B10HW-5, B20, B20HW, B20HW-5, B40, B5, B5HW, B5HW-5, HW+510-v.5.0, HW+520-v.5.0, HW505-v.5.0, HW510-v.5.0, HW520-v.5.0, VHG10, VHG10T, VHG20, VHG20T, VHG40, VHG40T, VHG5, VHG5T		

## housing and bezels

### control panel



1

<b>GEV No.</b>	525228	<b>Ref. No.</b>	6.101.089.000
<b>description</b>	actuator L 65mm W 28mm buttons 2		
<b>For models:</b>	Novo		



1

<b>GEV No.</b>	525278	<b>Ref. No.</b>	6.101.143.001
<b>description</b>	control panel with botton strips L 194mm W 30mm H 80mm buttons 1 TH		
<b>For models:</b>	TH		



1

<b>GEV No.</b>	525276	<b>Ref. No.</b>	6.101.139.001
<b>description</b>	control panel with botton strips L 194mm W 30mm H 80mm buttons 2 MONDO		
<b>For models:</b>	Mondo, MondoTwin		



1

<b>GEV No.</b>	525277	<b>Ref. No.</b>	6.101.140.001
<b>description</b>	control panel with botton strips L 194mm W 30mm H 80mm buttons 2 TWIN		
<b>For models:</b>	MondoTwin		

## EQUIPMENT-SPECIFIC UNITS BONAMAT



1

<b>GEV No.</b>	525280	<b>Ref. No.</b>	6.101.144.001
<b>description</b>	control panel with botton strips L 194mm W 30mm H 80mm buttons 4 THA		
<b>For models:</b>	THA		



1

<b>GEV No.</b>	525223	<b>Ref. No.</b>	6.101.141.001
<b>description</b>	control panel with botton strips L 194mm W 30mm H 80mm buttons 5 MATIC		
<b>For models:</b>	Matic, MaticTwin		



1

<b>GEV No.</b>	525279	<b>Ref. No.</b>	6.101.142.001
<b>description</b>	control panel with botton strips L 194mm W 30mm H 80mm buttons 5 TWIN		
<b>For models:</b>	Matic, MaticTwin		



1

<b>GEV No.</b>	525221	<b>Ref. No.</b>	6.205.860.001
<b>description</b>	protector for display L 74mm W 74mm		
<b>For models:</b>	B10, B10HW, B10HW-5, B20, B20HW, B20HW-5, B40, B5, B5HW, B5HW-5		

### hoses



1

<b>GEV No.</b>	525229	<b>Ref. No.</b>	6.101.100.000
<b>description</b>	hose for spray head ø 18mm thickness 3mm L 300mm silicone		
<b>For models:</b>	Novo		



floats

float switches



1

<b>GEV No.</b>	347391	<b>Ref. No.</b>	6.000.101.003
<b>description</b>	float switch ø 41mm L 230mm mounting ø 45mm 6-pole		
<b>For models:</b>	Matic, MaticTwin, THA		

safety valves



1

<b>GEV No.</b>	527100	<b>Ref. No.</b>	6.000.256.054
<b>description</b>	safety valve		



1

<b>GEV No.</b>	525879	<b>Ref. No.</b>	6.000.214.030
<b>description</b>	safety valve suitable for BONAMAT for BFT/RLX		
<b>For models:</b>	BFT322, RLX141, RLX241, RLX4, RLX41, RLX585, RLX8, RLX85, RLX86		

water containers



1

<b>GEV No.</b>	525859	<b>Ref. No.</b>	6.000.214.020
<b>description</b>	water container plastic H 170mm for BONAMAT for RLX		
<b>For models:</b>	BFT321, BFT321AT, BFT322, RLX131, RLX231, RLX3, RLX31, RLX575, RLX676, RLX75, RLX76		

for cup coffee machines

gaskets



1

<b>GEV No.</b>	520547	<b>Ref. No.</b>	6.030.071.020
<b>description</b>	gasket for mixer ø 17mm H 6mm ID ø 5mm silicone		
<b>For models:</b>	Bolero1, Bolero10, Bolero10-BS, Bolero10-F, Bolero10-MT, Bolero11, Bolero11-BS, Bolero11-F, Bolero11-MT, Bolero2, Bolero20, Bolero20-Maggi, Bolero21, Bolero22, BoleroTurboXL-302-10L, BoleroTurboXL-303, BoleroTurboXL-403, BoleroXL32, BoleroXL-323, BoleroXL32F, BoleroXL33, BoleroXL-333, BoleroXL42, BoleroXL-423, BoleroXL43, BoleroXL-433, Quinto-322, Quinto-422		

for drink dispensers

miscellaneous



1

<b>GEV No.</b>	696696	<b>Ref. No.</b>	6.000.288.006
<b>description</b>	rubber protection L 29mm W 13mm H 25mm white		
<b>For models:</b>	Airpot-Furento-1.9, Airpot-Furento-2.2		

knobs

universal knobs



<b>GEV No.</b>	111383	<b>Ref. No.</b>	6.014.002.024
<b>description</b>	knob zero mark ø 42mm shaft ø 6x4.6mm shaft flat right black		
<b>For models:</b>	B10, B10HW, B20, B20HW, B40, B5, B5HW, HCM510, HCM510-v.4.0, HCM520, HCM520-v.4.0, HM505, HM505-v.2.0, HM510, HM510-v.2.0, HM520, HM520-v.2.0, HW+505, HW+505-v.3.0, HW+510, HW+510-v.3.0, HW+520, HW+520-v.3.0, HW505, HW505-v.3.0, HW510, HW510-v.3.0, HW520, HW520-v.3.0, HWA505, HWA510, HWA520, VHG10, VHG10T, VHG20, VHG20T, VHG40, VHG40T, VHGS, VHGS5T		

producer-specific knobs

BONAMAT



<b>GEV No.</b>	111391	<b>Ref. No.</b>	6.214.068.001
<b>description</b>	knob ø 45mm L 40mm anthracite		
<b>For models:</b>	BFT322, RLX141, RLX241, RLX4, RLX41, RLX585, RLX8, RLX85, RLX86		



<b>GEV No.</b>	111384	<b>Ref. No.</b>	6.014.002.088
<b>description</b>	knob zero mark ø 40mm shaft ø 6x4.6mm shaft flat upper dark grey		
<b>For models:</b>	B10, B10HW, B10HW-5, B20, B20HW, B20HW-5, B40, B5, B5HW, B5HW-5, HCM510-v.5.0, HCM520-v.5.0, HM505-v.3.0, HM510-v.3.0, HM520-v.3.0, HW+505-v.4.0, HW+510-v.4.0, HW+510-v.5.0, HW+520-v.4.0, HW+520-v.5.0, HW505-v.4.0, HW505-v.5.0, HW510-v.4.0, HW510-v.5.0, HW520-v.4.0, HW520-v.5.0, VHG10, VH-G10T, VHGS20, VHGS20T, VHGS40, VHGS40T, VHGS5, VHGS5T		



<b>GEV No.</b>	111383	<b>Ref. No.</b>	6.014.002.024
<b>description</b>	knob zero mark ø 42mm shaft ø 6x4.6mm shaft flat right black		
<b>For models:</b>	B10, B10HW, B20, B20HW, B40, B5, B5HW, HCM510, HCM510-v.4.0, HCM520, HCM520-v.4.0, HM505, HM505-v.2.0, HM510, HM510-v.2.0, HM520, HM520-v.2.0, HW+505, HW+505-v.3.0, HW+510, HW+510-v.3.0, HW+520, HW+520-v.3.0, HW505, HW505-v.3.0, HW510, HW510-v.3.0, HW520, HW520-v.3.0, HWA505, HWA510, HWA520, VHG10, VHG10T, VHG20, VHG20T, VHG40, VHG40T, VHGS, VHGS5T		

handles and hand wheels

lever handles



<b>GEV No.</b>	527083	<b>Ref. No.</b>	6.015.001.217
<b>description</b>	lever handle plastic black		
<b>For models:</b>	HW+505, HW+505-v.3.0, HW+510, HW+510-v.3.0, HW+520, HW+520-v.3.0, HW10, HW505, HW505-v.3.0, HW510, HW510-v.3.0, HW520, HW520-v.3.0, HWA20, HWA505, HWA510, HWA520, HWD30, RL101, RL101-1N, RL101-3N, RL102, RL102-1N, RL102-3N, RL111, RL111-1N, RL111-3N, RL112-1N, RL112-3N, RL118, RL121-1N, RL121-3N, RL211, RL211-1N, RL211-3N, RL212, RL212-1N, RL212-3N, RL214, RL214-1N, RL216, RL221, RL221-1N, RL221-3N, RL222, RL222-1N, RL222-3N, RL224, RL224-1N, RL224-3N...(Other models you can see in the webshop)		

miscellaneous



<b>GEV No.</b>	111388	<b>Ref. No.</b>	6.311.094.001
<b>description</b>	handle L 100mm W 55mm hole distance 30mm mounting pos. left/right Qty 1 pcs		
<b>For models:</b>	B5, B5HW, B5HW-5, VHGS, VHGS5T		



<b>GEV No.</b>	111385	<b>Ref. No.</b>	6.242.198.001
<b>description</b>	handle L 110mm W 50mm hole distance 50mm mounting pos. left/right Qty 1 pcs Mod.10		
<b>For models:</b>	B10, B10HW, B10HW-5, HCM510-v.4.0, HCM510-v.5.0, HM510-v.2.0, HM510-v.3.0, HW+510-v.3.0, HW+510-v.4.0, HW+510-v.5.0, HW510-v.3.0, HW510-v.4.0, HW510-v.5.0, VHGS10, VHGS10T		





1

<b>GEV No.</b>	111386	<b>Ref. No.</b>	6.243.233.001
<b>description</b>	handle L 123mm W 54mm hole distance 50mm mounting pos. left/right Qty 1 pcs Mod.20		
<b>For models:</b>	B20, B20HW, B20HW-5, HCM520-v.4.0, HCM520-v.5.0, HM520-v.2.0, HM520-v.3.0, HW+520-v.3.0, HW+520-v.4.0, HW+520-v.5.0, HW520-v.3.0, HW520-v.4.0, HW520-v.5.0, VHG20, VHG20T		



1

<b>GEV No.</b>	111387	<b>Ref. No.</b>	6.248.133.001
<b>description</b>	handle L 124mm W 54mm hole distance 50mm mounting pos. left/right Qty 1 pcs Mod.40		
<b>For models:</b>	B40, VHG40, VHG40T		



1

<b>GEV No.</b>	527056	<b>Ref. No.</b>	6.015.001.144
<b>description</b>	tap head thread M35x1.5		
<b>For models:</b>	AM112, AM112AT, B10, B10HW, B20, B20HW, B40, B5, B5HW, HCM510, HCM510-v.4.0, HCM520, HCM520-v.4.0, HM505, HM505-v.2.0, HM510, HM510-v.2.0, HM520, HM520-v.2.0, HWA50, VHG10, VHG10T, VHG20, VHG20T, VHG40, VHG40T, VHGS, VHGS5		

tap bodies



1

<b>GEV No.</b>	527090	<b>Ref. No.</b>	6.015.001.218
<b>description</b>	tap body chrome-plated ET M28x1.5 / M16x0.75		
<b>For models:</b>	B10HW, B20HW, B5HW, HW10, HWA20, RL101, RL101-1N, RL101-3N, RL111, RL111-1N, RL111-3N, RL118, RL121-1N, RL121-3N, RL211, RL211-1N, RL211-3N, RL212-1N, RL212-3N, RL221, RL221-1N, RL221-3N, RL222-1N, RL222-3N, RL411-1N, RL411-3N, RL413-1N, RL413-3N		
<b>spare parts for</b>	527090		
		<b>GEV No.</b>	527089
		<b>Ref. No.</b>	6.015.001.227
	tap head complete thread M28x1.5		

## fittings for catering equipment

### dispenser tap

#### tap heads



1

<b>GEV No.</b>	527089	<b>Ref. No.</b>	6.015.001.227
<b>description</b>	tap head complete thread M28x1.5		
<b>For models:</b>	B10HW, B20HW, B5HW, HW+505, HW+505-v.3.0, HW+510, HW+510-v.3.0, HW+510-v.4.0, HW+520, HW+520-v.3.0, HW10, HW505, HW505-v.3.0, HW510, HW510-v.3.0, HW520, HW520-v.3.0, HWA20, HWA505, HWA510, HWA520, RL101, RL101-1N, RL101-3N, RL111, RL111-1N, RL111-3N, RL118, RL121-1N, RL121-3N, RL211, RL211-1N, RL211-3N, RL212, RL212-1N, RL212-3N, RL214, RL214-1N, RL216, RL221, RL221-1N, RL221-3N, RL222, RL222-1N, RL222-3N, RL224, RL224-1N, RL224-3N, RL226, RL411-1N, RL411-3N...(Other models you can see in the webshop)		



1

<b>GEV No.</b>	527082	<b>Ref. No.</b>	6.015.001.212
<b>description</b>	tap body chrome-plated ET M28x1.5 / M16x0.75 IT M10x1		
<b>For models:</b>	HW+505, HW+505-v.3.0, HW+505-v.4.0, HW+510, HW+510-v.3.0, HW+510-v.4.0, HW+520, HW+520-v.3.0, HW+520-v.4.0, HW505, HW505-v.3.0, HW505-v.4.0, HW510, HW510-v.3.0, HW510-v.4.0, HW520, HW520-v.3.0, HW520-v.4.0, HWA505, HWA510, HWA520, RL211, RL211-1N, RL211-3N, RL212, RL212-1N, RL212-3N, RL214, RL214-1N, RL216, RL221, RL221-1N, RL221-3N, RL222-1N, RL222-3N, RL224, RL224-1N, RL224-3N, RL226		





<b>GEV No.</b>	417205	<b>Ref. No.</b>	6.011.001.082
<b>description</b>	O-ring silicone thickness 3mm ID ø 74mm Qty 1 pcs		
<b>For models:</b>	Iso, Matic2, Matic2-KTS, Matic2WB, Matic3, Matic3-KTS, Matic3WB, MaticTwin, MaticTwin-1N, MaticTwin-3N, MaticTwin-KTS-230V3N, MaticTwin-KTS-400V3N, Mondo1, Mondo2, Mondo2-KTS, Mondo3WB, MondoTwin, MondoTwin-1N, MondoTwin-3N, MondoTwin-KTS-230V3N, MondoTwin-KTS-400V3N, Novo, Novo2, RL101, RL101-1N, RL101-3N, RL102, RL102-1N, RL102-3N, RL111, RL111-1N, RL111-3N, RL112-1N, RL112-3N, RL118, RL121-1N, RL121-3N, RL211, RL211-1N, RL211-3N, RL212, RL212-1N, RL212-3N, RL214, RL214-1N, RL216, RL221, RL221-1N, RL221-3N, RL222...(Other models you can see in the webshop)		

### sealing washers

#### fibre gaskets

<b>GEV No.</b>	510417	<b>Ref. No.</b>	6.011.001.63
<b>description</b>	flat gasket fibre ED ø 20mm ID ø 14mm thickness 2mm Qty 1 pcs		

### miscellaneous

<b>GEV No.</b>	520547	<b>Ref. No.</b>	6.030.071.020
<b>description</b>	gasket for mixer ø 17mm H 6mm ID ø 5mm silicone		
<b>For models:</b>	Bolero1, Bolero10, Bolero10-BS, Bolero10-F, Bolero10-MT, Bolero11, Bolero11-BS, Bolero11-F, Bolero11-MT, Bolero20, Bolero20-Maggi, Bolero21, Bolero22, BoleroTurboXL-302-10L, BoleroTurboXL-303, BoleroTurboXL-403, BoleroXL32, BoleroXL-323, BoleroXL32F, BoleroXL33, BoleroXL-333, BoleroXL42, BoleroXL-423, BoleroXL43, BoleroXL-433, Quinto-322, Quinto-422		

### springs

#### compression springs

<b>GEV No.</b>	527085	<b>Ref. No.</b>	6.015.001.215
<b>description</b>	compression spring ø 14.7/10.6mm L 28mm wire gauge ø 1.4mm cone-shaped		
<b>For models:</b>	B10, B10HW, B10HW-5, B20, B20HW, B20HW-5, B40, B5, B5HW, B5HW-5, BFT321, BFT321AT, BFT322, Bolero1, Bolero10, Bolero101, Bolero10-BS, Bolero10-F, Bolero10-MT, Bolero10-PA, Bolero10-v.1.0, Bolero10-v.2.0, Bolero11, Bolero111, Bolero11-BS, Bolero11-F, Bolero11-MT, Bolero11-PA, Bolero11-v.1.0, Bolero11-v.2.0, Bolero2, Bolero20, Bolero20-Maggi, Bolero21, Bolero211, Bolero22, CB6, Chiller-v.2.0, Chiller-v.3.0, Chiller-v.4.0, HW+505, HW+505-v.3.0, HW+505-v.4.0, HW+510, HW+510-v.3.0, HW+510-v.4.0, HW+520, HW+520-v.3.0, HW+520-v.4.0, HW10...(Other models you can see in the webshop)		

<b>GEV No.</b>	527080	<b>Ref. No.</b>	6.015.001.027
<b>description</b>	compression spring ø 17.7/13.9mm L 32mm wire gauge ø 1.8mm cone-shaped		
<b>For models:</b>	AM112, AM112AT, B10, B10HW, B10HW-5, B20, B20HW, B20HW-5, B40, B5, B5HW, HCM510, HCM510-v.4.0, HCM510-v.5.0, HCM520, HCM520-v.4.0, HCM520-v.5.0, HM505, HM505-v.2.0, HM505-v.3.0, HM510, HM510-v.2.0, HM510-v.3.0, HM520, HM520-v.2.0, HM520-v.3.0, HW+510-v.5.0, HW+520-v.5.0, HW510-v.5.0, HW520-v.5.0, HWA50, VHG10, VHG10T, VHG20, VHG20T, VHG3, VHG40, VHG40T, VHGS, VHGST		

### coffee accessories

#### measuring spoons

<b>GEV No.</b>	960084	<b>Ref. No.</b>	7.094.100.101
<b>description</b>	coffee spoon amount of coffee 40g plastic		

measuring cups



1			
<b>GEV No.</b>	960078	<b>Ref. No.</b>	7.094.301.101
<b>description</b>	measuring cup 2.2l plastic		

pipe brushes

nylon

1			
<b>GEV No.</b>	960080	<b>Ref. No.</b>	7.110.605.101
<b>description</b>	brush nylon ø 15mm total length 450mm brush length 100mm level glass		

fastening material

screws

sheet metal screws



1			
<b>GEV No.</b>	560108	<b>Ref. No.</b>	6.001.028.006
<b>description</b>	sheet metal screws ø 4.2mm L 13mm SS Qty 20 pcs DIN 7981/ISO 7049 head ø 8.2mm oval head		
<b>For models:</b>	VHG20, VHG3, VHG40		

tools

cleaning tools

brushes

cleaning brushes

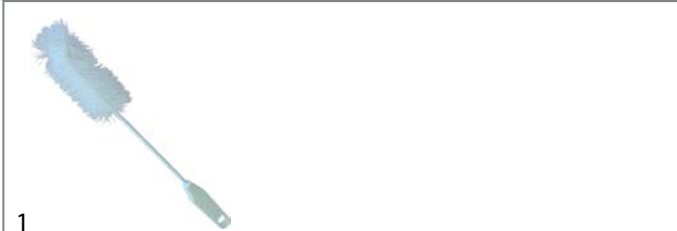

1			
<b>GEV No.</b>	960081	<b>Ref. No.</b>	7.270.102.101
<b>description</b>	brush container equiv. no. 7270102101 nylon ø 50mm total length 370mm brush length 100mm		

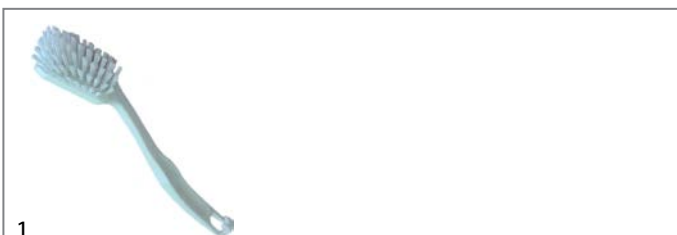

1			
<b>GEV No.</b>	960079	<b>Ref. No.</b>	7.110.606.101
<b>description</b>	brush equiv. no. 7110606101 plastic total length 380mm setting height 34mm brush length 100mm		

consumables

cleaning agents

detergents for coffee machines

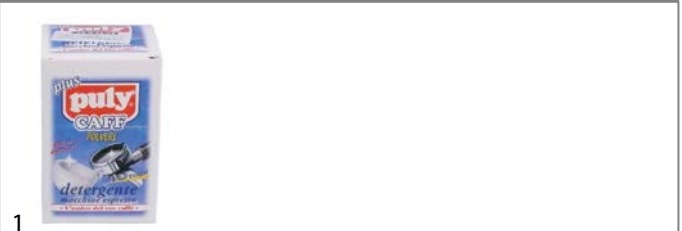

1			
<b>GEV No.</b>	802106	<b>Ref. No.</b>	7.190.102.101
<b>description</b>	detergent puly CAFF plus approval NSF 200g 10 pouch of 20g		

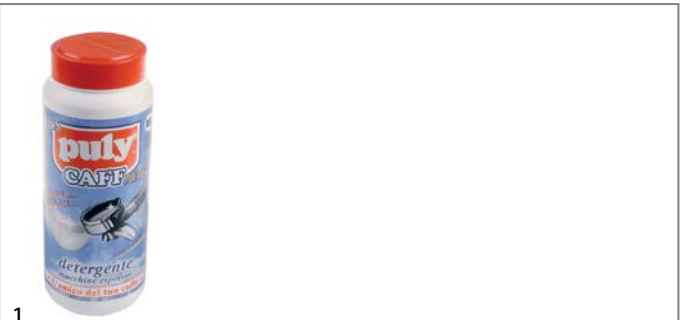

1			
<b>GEV No.</b>	950010	<b>Ref. No.</b>	7.190.101.103
<b>description</b>	detergents for coffee machines puly CAFF plus approval NSF 900g can		



containers

measuring cups



1			
<b>GEV No.</b>	960078	<b>Ref. No.</b>	7.094.301.101
<b>description</b>	measuring cup 2.2l plastic		

coffee filters

round filters



1			
<b>GEV No.</b>	960022	<b>Ref. No.</b>	7.150.502.301
<b>description</b>	paper filter ø 144mm Qty 250 pcs for B3 suitable for BONAMAT		



1			
<b>GEV No.</b>	960023	<b>Ref. No.</b>	7.150.503.301
<b>description</b>	paper filter ø 172mm Qty 250 pcs for B5 suitable for BONAMAT		



1			
<b>GEV No.</b>	960024	<b>Ref. No.</b>	7.150.507.301
<b>description</b>	paper filter ø 244mm Qty 250 pcs for B 10 suitable for BONAMAT		



1			
<b>GEV No.</b>	960025	<b>Ref. No.</b>	7.150.505.301
<b>description</b>	paper filter ø 330mm Qty 250 pcs for B 20 suitable for BONAMAT		



1			
<b>GEV No.</b>	960026	<b>Ref. No.</b>	7.150.508.301
<b>description</b>	paper filter ø 400mm Qty 250 pcs for B 40 suitable for BONAMAT		

basket filters

paper filters



1			
<b>GEV No.</b>	960101	<b>Ref. No.</b>	7.150.111.301
<b>description</b>	paper filter for coffee makers D1 ø 100mm D2 ø 320mm Qty 500 pcs		



1			
<b>GEV No.</b>	960105	<b>Ref. No.</b>	7.150.102.301
<b>description</b>	paper filter for coffee makers D1 ø 110mm D2 ø 360mm Qty 500 pcs		



1			
<b>GEV No.</b>	960102	<b>Ref. No.</b>	7.150.103.301
<b>description</b>	paper filter for coffee makers D1 ø 150mm D2 ø 435mm Qty 500 pcs		



1			
<b>GEV No.</b>	960103	<b>Ref. No.</b>	7.150.104.301
<b>description</b>	paper filter for coffee makers D1 ø 175mm D2 ø 525mm Qty 500 pcs		



1			
<b>GEV No.</b>	960104	<b>Ref. No.</b>	7.150.105.301
<b>description</b>	paper filter for coffee makers D1 ø 280mm D2 ø 635mm Qty 500 pcs		





1

<b>GEV No.</b>	960100	<b>Ref. No.</b>	7.150.101.101 7.150.101.103
<b>description</b>	paper filter for coffee makers D1 ø 90mm D2 ø 250mm Qty 1000 pcs		

<b>B</b>				
bi-metal thermostats		9, 10		
brushes		42		
<b>C</b>				
cleaning agents		42		
cleaning brushes		42		
cleaning tools		42		
coffee filters		43		
consumables		42		
contactors		13		
containers		43		
control thermostats		10		
<b>D</b>				
detergents for coffee machines		42		
<b>E</b>				
electric accessories		25		
electrodes		23		
energy regulators		9		
<b>F</b>				
fastening material		42		
float switches		11		
flow heaters		6		
flow meters		24		
fuses		25		
<b>H</b>				
heating elements		3		
heating elements for coffee machine		3		
<b>I</b>				
indicator lights		12		
indicator lights (complete)		12		
<b>L</b>				
lamps		12		
<b>M</b>				
magnetic switches		12		
measuring cups		42, 43		
measuring spoons		41		
motors		25		
<b>O</b>				
O-rings		40		
<b>P</b>				
pipe brushes		42		
plugs - couplings - power sockets		25		
			pressure switches	23
			probes	14
			protective contact power sockets	25
			pumps	25
<b>R</b>				
			relays	14
			rocker/momentary rocker switches	11
<b>S</b>				
			safety bi-metal thermostats	9
			safety thermostats	10
			screws	42
			sealing washers	41
			sheet metal screws	42
			solenoid valves	20
			solid state relays	13
			switches and momentary switches	11
<b>T</b>				
			terminals	26
			thermostats	9
			tools	42
			transformers	14