



GAS COMPONENTS



ELECTRIC COMPONENTS



WATER TECHNOLOGY



MECHANICAL COMPONENTS



TOOLS

Spare parts suitable for

BONNET

Find the complete and up-to-date range of products in our GEV Webshop



Manufacturer catalogue

The most important spare parts and accessories arranged clearly for every manufacturer

- ✓ Complete product range and all appliance data always up to date in the GEV Webshop
- ✓ Alphabetical Index at the end of the catalogue

GEV Webshop

www.gev-online.co.uk

www.gev-online.com



- 🔍 Add to Favourites
- 🔍 Sign In with email address and usual password
- 🔍 Easy-order – place several items in your basket at the same time
- 🔍 Quick Item search – no login needed



heating elements

heating elements for ovens

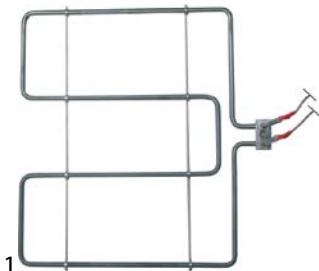

1

GEV No.	418524	Ref. No.	302189 BAAN169356 BAAN304579
description	heating element 1800W 400V heating circuits 1 L 416mm W 438mm L1 48mm L2 438mm W1 200mm W2 38mm flange length 50mm flange width 25mm hole ø 6.3mm tube ø 8.5mm connection length 115mm rectangular flange dry heating element oven H1 8mm cable length 880mm		

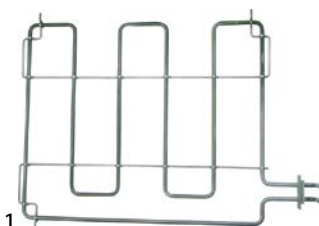

1

GEV No.	418525	Ref. No.	302191 BAAN169358 BAAN304581
description	heating element 3300W 400V L 610mm W 450mm L1 75mm L2 535mm W1 40mm W2 55mm flange length 72mm flange width 53mm hole distance 62mm hole ø 5mm tube ø 8.5mm connection M5 heating circuits 1 rectangular flange dry heating element oven		

heating elements for bain maries



1

GEV No.	418913	Ref. No.	311739 BAAN1210213 BAAN305131
description	heating element 1800W 230V heating circuits 1 L 508mm L1 455mm W 70mm connection M4 connection distance 43mm tube ø 8.5mm dry heating element L2 50mm H 92mm		

heating elements for frying pans



1

GEV No.	420432	Ref. No.	302197 302256 BAAN304588
description	heating element 1800W 230V heating circuits 1 L 90mm W 556mm hole distance 55mm tube ø 8mm H 134mm		

heating elements for fryers

2 hole fixing

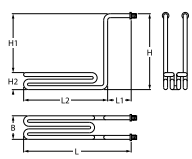
1

GEV No.	418914	Ref. No.	322523 BAAN305394
description	heating element 4000W 230V heating circuits 1 L 500mm W 64mm H 290mm L1 120mm L2 380mm W1 12mm W2 40mm H1 245mm H2 55mm connection M5 immersion heater thread 1/4" tube ø 8.5mm fryer		

heating elements for griddles



1

GEV No.	418922	Ref. No.	310128 BAAN304890
description	heating element 1800W 220V heating circuits 1 L 523mm W 57mm H 81mm tube ø 10mm connection M4 grill connection distance 480mm dry heating element		

heating elements for salamanders/toast-



1

GEV No.	420497	Ref. No.	D02149
description	heating element 2000W 230V L 230mm W 215mm L1 22mm L2 208mm W1 74mm W2 70mm thread M16 mounting distance 55mm tube ø 8mm connection M4		



1

GEV No.	418215	Ref. No.	402077 BAAN774888
description	heating element 700W 245V L 410mm thread M14x1.25 connection length 19mm tube ø 10mm connection M4 heating circuits 1 dry heating element salamander grill W 10mm H 10mm		



immersion heating elements

3 hole flange ø38.5mm

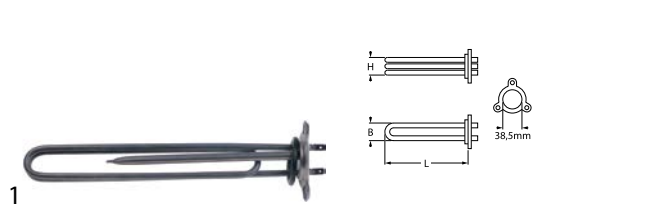

GEV No.	418642	Ref. No.	2001621H
----------------	--------	-----------------	----------

description heating element 2600W 230V mounting ø 38.5mm heating circuits 1 L 260mm W 33mm H 24mm number of thermostat sleeves 1 thermostat sleeves ø 7mm length thermostat sleeves 175mm thermostat sleeve eccentric, non clinging tube ø 6.5mm hole distance 57mm 3 hole flange connection male faston 6.3mm immersion heater

accessories for	418642		
------------------------	--------	--	--

	GEV No.	532577	Ref. No.	—
		O-ring EPDM thickness 5.34mm ID ø 40.65mm Qty 1 pcs		

3 hole flange ø47.5mm

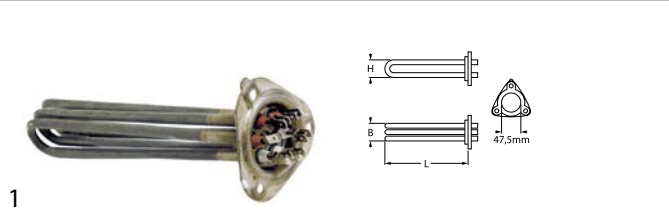

GEV No.	416128	Ref. No.	5079E
----------------	--------	-----------------	-------

description heating element 4500W 230V mounting ø 47.5mm heating circuits 3 L 265mm W 30mm H 35mm tube ø 8.5mm hole distance 60mm hole ø 10mm connection male faston 6.3mm 3 hole flange immersion heater

accessories for	416128		
------------------------	--------	--	--

	GEV No.	510408	Ref. No.	2001827H
		O-ring EPDM thickness 5.34mm ID ø 47mm Qty 1 pcs		

	GEV No.	510562	Ref. No.	—
		O-ring silicone thickness 5.34mm ID ø 47mm Qty 1 pcs		

3 hole flange ø47.5mm

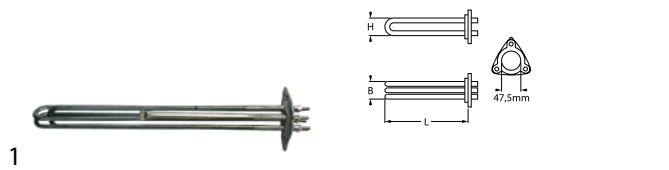

GEV No.	415001	Ref. No.	5845E
----------------	--------	-----------------	-------

description heating element 4500W 230V mounting ø 47.5mm heating circuits 3 L 316mm W 35mm H 34mm number of thermostat sleeves 1 thermostat sleeves ø 7mm length thermostat sleeves 180mm thermostat sleeve eccentric, non clinging tube ø 6.3mm hole distance 62mm hole ø 8mm connection M4 3 hole flange immersion heater

spare parts for	415001		
------------------------	--------	--	--

	GEV No.	510408	Ref. No.	2001827H
		O-ring EPDM thickness 5.34mm ID ø 47mm Qty 1 pcs		

accessories for	415001		
------------------------	--------	--	--

	GEV No.	510562	Ref. No.	—
		O-ring silicone thickness 5.34mm ID ø 47mm Qty 1 pcs		

accessories for	415001			
	GEV No.	521103	Ref. No.	—
		nut thread M4 H 3mm WS 7 brass Qty 20 pcs		
	GEV No.	521104	Ref. No.	—
		washer ID ø 4.3mm ED ø 8mm thickness 0.5mm brass Qty 20 pcs for thread M4		
	GEV No.	560111	Ref. No.	—
		plain washer ID ø 4.3mm ED ø 9mm thickness 0.8mm SS Qty 20 pcs DIN 125A for thread M4		
	GEV No.	560131	Ref. No.	—
		hexagonal nut thread M4 H 3.2mm WS 7 SS DIN/ISO DIN 934 / ISO 4032/8673 Qty 20 pcs		

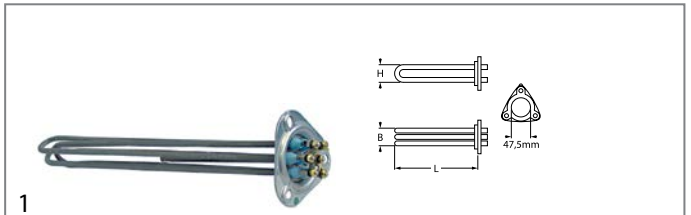

GEV No.	416240	Ref. No.	2001858H
----------------	--------	-----------------	----------

description heating element 6545W 230/400V mounting ø 48mm heating circuits 3 L 355mm W 31mm H 37mm number of thermostat sleeves 1 thermostat sleeves ø 7mm length thermostat sleeves 175mm thermostat sleeve upper centre not clinging tube ø 6.5mm hole distance 63mm hole ø 10mm connection M4 3 hole flange immersion heater

accessories for	416240		
------------------------	--------	--	--

	GEV No.	510408	Ref. No.	2001827H
		O-ring EPDM thickness 5.34mm ID ø 47mm Qty 1 pcs		

	GEV No.	510562	Ref. No.	—
		O-ring silicone thickness 5.34mm ID ø 47mm Qty 1 pcs		

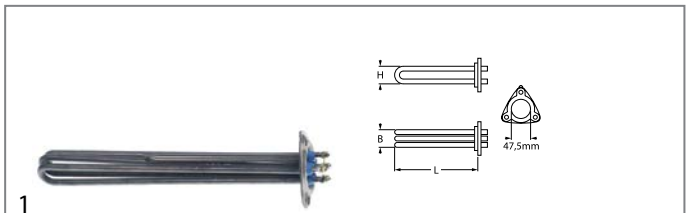

GEV No.	416242	Ref. No.	2001941H BAAN1049665 BAAN1321560
----------------	--------	-----------------	--



description heating element 9500W 230V mounting ø 47.5mm heating circuits 3 L 330mm W 35mm H 35mm number of thermostat sleeves 1 thermostat sleeves ø 7mm length thermostat sleeves 175mm thermostat sleeve eccentric, non clinging tube ø 8.5mm hole distance 72mm hole ø 8/10mm connection M4 3 hole flange immersion heater

spare parts for	416242		
------------------------	--------	--	--

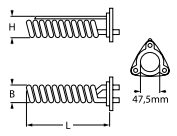
	GEV No.	510408	Ref. No.	2001827H
		O-ring EPDM thickness 5.34mm ID ø 47mm Qty 1 pcs		

1

GEV No.	418709	Ref. No.	5535E 5536E BAAN307533
description	heating element 2400W 230V mounting \varnothing 47.5mm heating circuits 1 L 190mm W 32mm H 40mm number of thermostat sleeves 1 thermostat sleeves \varnothing 7mm length thermostat sleeves 170mm thermostat sleeve eccentric, non clinging tube \varnothing 6.5mm hole distance 72mm hole \varnothing 8x10mm connection M4 3 hole flange immersion heater		
spare parts for	418709		
	GEV No.	510408	Ref. No. 2001827H
accessories for	418709		
	GEV No.	510562	Ref. No. —
	O-ring silicone thickness 5.34mm ID \varnothing 47mm Qty 1 pcs		

with expansion flange 70 x 18mm



1

GEV No.	420171	Ref. No.	903121 BAAN1323213 BAAN311688
description	heating element 1500W 220V heating circuits 1 flange 70x18mm L 255mm W 65mm H 32mm connection male faston 6.3mm immersion heater tube \varnothing 8.5mm		



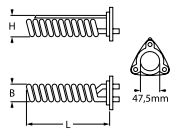

1

GEV No.	415016	Ref. No.	903101 BAAN1323208 BAAN782792
description	heating element 3000W 230V heating circuits 3 flange 70x18mm L 398mm W 60mm H 24mm connection male faston 6.3mm immersion heater expansion flange tube \varnothing 6.3mm		

1

GEV No.	415668	Ref. No.	5535E 5536E BAAN307533
description	heating element 2625W 230V mounting \varnothing 47.5mm heating circuits 1 L 190mm W 41mm H 54mm number of thermostat sleeves 1 thermostat sleeves \varnothing 7mm length thermostat sleeves 170mm thermostat sleeve eccentric, non clinging tube \varnothing 6.3mm hole distance 62mm hole \varnothing 8mm connection M4 3 hole flange immersion heater		
spare parts for	415668		
	GEV No.	510408	Ref. No. 2001827H
accessories for	415668		
	GEV No.	510562	Ref. No. —
	O-ring silicone thickness 5.34mm ID \varnothing 47mm Qty 1 pcs		



1

GEV No.	416243	Ref. No.	2001624H BAAN1121241 BAAN1321308
description	heating element 7600W 230V heating circuits 3 flange 70x18mm L 390mm W 60mm H 13mm connection male faston 6.3mm tube \varnothing 6.3mm immersion heater expansion flange INCOLOY-800		

with round flange \varnothing 47.5mm



1

GEV No.	418923	Ref. No.	1030210 103210 BAAN1209264 BAAN301064
description	heating element 6000W 230V heating circuits 3 mounting \varnothing 47.5mm L 493mm W 36mm H 31mm round flange connection male faston 6.3mm thermostat sleeves \varnothing 7mm number of thermostat sleeves 1 length thermostat sleeves 145mm thermostat sleeve eccentric, clinging		

with compression flange 50 x 26mm

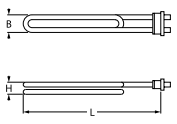
1

GEV No.	418932	Ref. No.	71244E
description	heating element 2000W 240V heating circuits 1 flange 50x26mm L 350mm W 30mm Hmm compression flange connection male faston 6.3mm tube \varnothing 6.3mm immersion heater		

miscellaneous



1

GEV No.	418924	Ref. No.	71892E BAAN309670
description	heating element 8000W 230V heating circuits 3 L 305mm W 37mm H 36mm thermostat sleeve eccentric, non clinging tube \varnothing 8mm hole distance 45mm hole \varnothing 10mm connection length 30mm connection M4 immersion heater flange width 64mm flange length 64mm		



1 1/4"



1

GEV No.	415005	Ref. No.	3696E
description	heating element 2000W 230V heating circuits 1 thread 1 1/4" L 170mm W 32mm H 22mm tube ø 6.2mm connection M4		
accessories for	415005		
	GEV No.	510405	Ref. No. —
	GEV No.	520232	Ref. No. —
	GEV No.	521103	Ref. No. —
	GEV No.	521104	Ref. No. —
	GEV No.	528021	Ref. No. —
	GEV No.	560111	Ref. No. —
	GEV No.	560131	Ref. No. —



1

GEV No.	415010	Ref. No.	5514E BAAN1322910 BAAN307475
description	heating element 2000W 230V heating circuits 1 L 260mm W 125mm H 20mm L1 110mm L2 150mm W1 42mm W2 83mm thread M10x1 mounting distance 70mm tube ø 6.5mm connection M4 immersion heater 2 hole fixing		
spare parts for	415010		
	GEV No.	510416	Ref. No. —
accessories for	415010		
	GEV No.	504306	Ref. No. —
	GEV No.	510893	Ref. No. —
	GEV No.	520231	Ref. No. —
	GEV No.	521103	Ref. No. —
	GEV No.	521104	Ref. No. —

accessories for	415010		
	GEV No.	521129	Ref. No. —
	GEV No.	560111	Ref. No. —
	GEV No.	560131	Ref. No. —



1

GEV No.	415072	Ref. No.	5065E
description	heating element 2200W 230V heating circuits 1 L 325mm W 83mm H 25mm thread M14x1 mounting distance 75mm tube ø 8.5mm connection male faston 6.3mm 2 hole fixing immersion heater		
accessories for	415072		
	GEV No.	510417	Ref. No. —
	GEV No.	520228	Ref. No. —
	GEV No.	521133	Ref. No. —
	GEV No.	550261	Ref. No. —
	GEV No.	550262	Ref. No. —













1

GEV No.	415665	Ref. No.	5856E
description	heating element 2750/3250W 220/240V heating circuits 1 L 380mm W 110mm H 30mm thread M10x1 mounting distance 75mm tube ø 6.5mm connection M4 immersion heater 2 hole fixing		
spare parts for	415665		
	GEV No.	510893	Ref. No. —
accessories for	415665		
	GEV No.	510416	Ref. No. —
	GEV No.	520231	Ref. No. —
	GEV No.	521103	Ref. No. —



Table continues overleaf







accessories for 415665	
	GEV No. 521104 Ref. No. — washer ID ø 4.3mm ED ø 8mm thickness 0.5mm brass Qty 20 pcs for thread M4
	GEV No. 521129 Ref. No. — nut thread M10 H 6mm SS WS 17 Qty 1 pcs DIN/ISO DIN 439
	GEV No. 560111 Ref. No. — plain washer ID ø 4.3mm ED ø 9mm thickness 0.8mm SS Qty 20 pcs DIN 125A for thread M4
	GEV No. 560131 Ref. No. — hexagonal nut thread M4 H 3.2mm WS 7 SS DIN/ISO DIN 934 / ISO 4032/8673 Qty 20 pcs



 <p>1</p>			
GEV No.	416235	Ref. No.	2001933H
description	heating element 3000W 230V heating circuits 1 L 320mm W 50mm H 40mm thread M10x1 mounting distance 44mm tube ø 6.3mm connection male faston 6.3mm 2 hole fixing L1 32mm L2 288mm		
spare parts for	416235		
	GEV No. 510893 Ref. No. —	O-ring EPDM thickness 2.62mm ID ø 9.92mm Qty 1 pcs	
accessories for	416235		
	GEV No. 510416 Ref. No. —	flat gasket fibre ED ø 19mm ID ø 10.5mm thickness 1.5mm for thread M10 Qty 1 pcs	
	GEV No. 510893 Ref. No. —	O-ring EPDM thickness 2.62mm ID ø 9.92mm Qty 1 pcs	
	GEV No. 521129 Ref. No. —	nut thread M10 H 6mm SS WS 17 Qty 1 pcs DIN/ISO DIN 439	
	GEV No. 560192 Ref. No. —	tooth lock washer ID ø 10.4mm ED ø 18mm SS DIN/ISO DIN 6798A Qty 1 pcs for thread M10	

heating elements for convection

 <p>1</p>			
GEV No.	418916	Ref. No.	72104E BAAN309867
description	heating element 12000W 240V heating circuits 3 ID ø 390mm ED ø 410mm L 410mm H 100mm H1 25mm H2 75mm thread M12x1 6 hole fixing connection male faston 6.3mm tube ø 8.5mm convection heating element		
accessories for	418916		
	GEV No. 101566 Ref. No. —	nut thread M12x1 H 10mm WS 19 SS Qty 1 pcs	

accessories for 418916	
	GEV No. 506046 Ref. No. — flat gasket FIBER ED ø 19.5mm ID ø 13mm thickness 2mm Qty 1 pcs
	GEV No. 528622 Ref. No. — spring ø 15.3mm L 25mm wire gauge ø 1.25mm for water filling

 <p>1</p>			
GEV No.	415134	Ref. No.	302241 BAAN1005875 BAAN1057721
description	heating element 2500W 230V heating circuits 1 ID ø 180mm ED ø 193mm L 245mm H 28mm L1 54mm W1 32mm H1 18mm H2 10mm flange length 70mm flange width 22mm hole distance 55mm connection male faston 6.3mm 2 hole fixing L1 32mm L2 288mm convection heating element hole ø 5mm rectangular flange		
accessories for	415134		
	GEV No. 510368 Ref. No. —	gasket L 70mm W 23.5mm hole ø 5mm hole distance 56mm FIBER thickness 2mm for heating element	

 <p>1</p>			
GEV No.	418925	Ref. No.	71844E BAAN309621
description	heating element 1500W 230V heating circuits 1 L 293mm W 106mm L1 32mm L2 261mm W2 83mm flange length 50mm flange width 26mm connection length 63mm connection male faston 6.3mm tube ø 8.5mm hole ø 6.2mm W1 23mm convection heating element convection oven INCOLOY windings 2		
accessories for	418925		
	GEV No. 520588 Ref. No. —	gasket L 46mm W 22mm hole distance 24.5mm silicone for heating element	

 <p>1</p>			
GEV No.	418933	Ref. No.	71240E
description	heating element 2000W 240V heating circuits 1 L 390mm W 134mm W2 100mm flange length 50mm flange width 20mm connection length 50mm connection M4 tube ø 10mm thread M4 W1 34mm rectangular flange convection heating element convection oven		

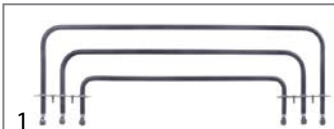

GEV No.	418917	Ref. No.	309252 71241E BAAN71241E
description	heating element 3000W 240V heating circuits 3 L 570mm W 140mm W2 110mm flange length 110mm flange width 20mm hole distance 40mm connection length 55mm connection M4 tube ø 10mm thread M4 W1 30mm rectangular flange convection heating element convection oven		

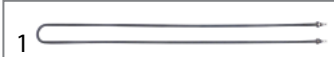

GEV No.	418931	Ref. No.	71243E
description	heating element 4000W 230V heating circuits 1 L 1130mm W 80mm connection M4 tube ø 10mm thread M14x1.25 2 hole fixing convection heating element convection oven mounting distance 70mm		



GEV No.	418918	Ref. No.	71242E BAAN309253
description	heating element 4000W 240V heating circuits 3 L 570mm W 140mm W2 110mm flange length 110mm flange width 20mm hole distance 40mm connection length 55mm connection M4 tube ø 10mm thread M4 W1 30mm rectangular flange convection heating element convection oven		

radiation heaters



GEV No.	417638	Ref. No.	303055 BAAN836485 BAAN847614
description	radiation heater rectangular 8000W 400V L 300mm W 570mm H 40mm heating circuits 2 EGO		

hot plates
square & rectangular

with radiused edge



GEV No.	490056 ¹	Ref. No.	904877
description	hot plate dimensions 300x300mm 3000W 230V with spill ring connection 4 screw clamps protector yes square		

¹incl. protector



GEV No.	490073	Ref. No.	303561 BAAN304723
description	hot plate dimensions 300x300mm 3000W 400V with spill ring connection 4 screw clamps protector no square		



GEV No.	490057 ¹	Ref. No.	303561 BAAN304723
description	hot plate dimensions 300x300mm 3000W 400V with spill ring connection 4 screw clamps protector yes square		

¹incl. protector



GEV No.	490071 ¹	Ref. No.	904879
description	hot plate dimensions 300x300mm 4000W 230V with spill ring connection 4 screw clamps protector yes square		

¹incl. protector



GEV No.	490074 ¹	Ref. No.	303562 BAAN304725
description	hot plate dimensions 300x300mm 4000W 400V with spill ring connection 4 screw clamps protector yes square		

¹incl. protector

round

with radiused edge

for domestic and commercial kitchens

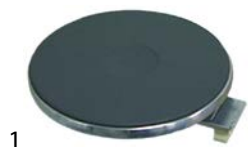

GEV No.	490019	Ref. No.	905303 BAAN311946
description	hot plate ø 220mm 2000W 400V connection 4 screw clamps with 8mm spill ring		



GEV No.	490020	Ref. No.	7450384
description	hot plate ø 220mm 2600W 230V connection 4 screw clamps with 8mm spill ring		
accessories for	490020		
	GEV No.	550796	Ref. No.
	fixing plate for hot plate ø220mm		



GEV No.	490021	Ref. No.	7450385 BAAN310419
description	hot plate ø 220mm 2600W 400V connection 4 screw clamps with 8mm spill ring		



GEV No.	490063	Ref. No.	7450387
description	hot plate ø 300mm 2500W 400V connection 4 screw clamps with 8mm spill ring		



GEV No.	490064	Ref. No.	303008 BAAN167143 BAAN304666
description	hot plate ø 300mm 3500W 400V with 8mm spill ring		

energy regulators

EGO

1-circuit



GEV No.	380015	Ref. No.	1800602 301200 70486E 72113E BAAN167036 BAAN304497
description	energy regulator 230V 13A single-circuit turn direction right shaft ø 6x4.6mm shaft L 23mm mounting thread M4 power release 6-100% no. 50.57021.010		

DIAMOND



GEV No.	380037	Ref. No.	904982 BAAN1209964 BAAN311867
description	energy regulator 240V 13.5A turn direction right shaft ø 6x4.6mm shaft L 13mm mounting thread 3/8"-24UNF equiv. no. 35ERE101230V		



GEV No.	380039	Ref. No.	7492053 BAAN310695
description	energy regulator 400V 13.5A turn direction right shaft ø 6x4.6mm mounting thread 3/8"-24UNF equiv. no. 35ERE104400V		
accessories for	380039		
	GEV No.	361181	Ref. No.
	nut thread 1/8" H 4.5mm nickel-plated brass WS 14 Qty 1 pcs		





thermostats

bi-metal thermostats

safety bi-metal thermostats





1

GEV No.	390233	Ref. No.	2001681H 2001855H BAAN1121247 BAAN1321364 BAAN1321486 BAAN307863
description	bi-metal safety thermostat hole distance 24mm switch-off temp. 110°C 1NC 1-pole 16A connection F6.3 2 hole fixing without holder		
accessories for	390233		
	GEV No.	504736	Ref. No. —
bracket for contact thermostat			
	GEV No.	550388	Ref. No. —
bracket for contact thermostat mounting distance 24.5mm mounting ø 3.8			



1

GEV No.	390138	Ref. No.	2001685H BAAN1121246 BAAN1321368
description	bi-metal safety thermostat hole distance 24mm switch-off temp. 112°C 1NC 1-pole 16A connection F6.3		
accessories for	390138		
	GEV No.	504736	Ref. No. —
bracket for contact thermostat			
	GEV No.	550388	Ref. No. —
bracket for contact thermostat mounting distance 24.5mm mounting ø 3.8			

bi-metal thermostats



1

GEV No.	375927	Ref. No.	301045
description	bi-metal thermostat hole distance 23.5mm switch-off temp. 50°C 1NO 10A connection F6.3		



1

GEV No.	390301	Ref. No.	2001680H BAAN1121245 BAAN1321363
description	bi-metal thermostat hole distance 23.8mm switch-off temp. 60°C 1NC 1-pole 16A connection F6.3 2 hole fixing		



1

GEV No.	390101	Ref. No.	5011E
description	bi-metal thermostat hole distance 38mm switch-off temp. 53°C 1CO 1-pole 16A connection F6.3 2 hole fixing		

control and safety thermostats

EGO

control thermostats

55.10/19_ series



1

GEV No.	375001	Ref. No.	24650 BAAN1322435 BAAN303907
description	thermostat t.max. 112°C temperature range 30-110°C 1-pole 1NO 16A probe ø 6mm probe L 130mm capillary pipe 900mm capillary pipe isolated gland nut M9x1 shaft L 23mm shaft position upper rotation 270°		



1



GEV No.	375063	Ref. No.	70707E BAAN308981
description	thermostat t.max. 170°C temperature range 70-170°C 1-pole 1NO 16A probe ø 11mm probe L 28mm capillary pipe 900mm capillary pipe isolated 900mm gland nut shaft L 23mm shaft position upper rotation 270° screw-in probe probe thread M14x1		
accessories for	375063		
	GEV No.	510417	Ref. No. —
flat gasket fibre ED ø 20mm ID ø 14mm thickness 2mm Qty 1 pcs			

Table continues overleaf



accessories for 375063	
	GEV No. 510420 Ref. No. — gasket copper ED ø 19.9mm ID ø 14.3mm thickness 2mm Qty 1 pcs
	GEV No. 521133 Ref. No. — nut thread M14x1.5 H 6mm WS 19 zinc-coated steel Qty 1 pcs

	
	
GEV No. 375468	Ref. No. 7471024 BAAN1209938 BAAN310614
description	thermostat t.max. 180°C temperature range 80-180°C 1-pole 1NO 16A probe ø 6mm probe L 135mm capillary pipe 900mm capillary pipe isolatedmm gland nut M9x1 shaft ø 6x4.6mm shaft L 23mm shaft position upper rotation 270°

	
	
GEV No. 376054	Ref. No. 2020062
description	thermostat t.max. 200°C temperature range 65-200°C 1CO 6.3A probe ø 6mm probe L 78mm capillary pipe 900mm capillary pipe isolatedmm gland nut M12 shaft ø 6x4.6mm shaft L 23mm rotation 270° probe material SS screw connection M9x1 disc ø 7.7mm
accessories for 376054	
	GEV No. 110121 Ref. No. — knob thermostat t.max. 200°C ø 50mm shaft ø 6x4.6mm shaft flat upper black temperature range 60-200°C rotation 270°
	GEV No. 110135 Ref. No. — rosette knob up to ø 52mm

	
	
GEV No. 375664	Ref. No. 301031 BAAN167028 BAAN936229
description	thermostat t.max. 287°C temperature range 60-287°C 1-pole 1NO 16A probe ø 3.1mm probe L 226mm capillary pipe 1470mm capillary pipe isolated 350mm gland nut shaft ø 6x4.6mm shaft L 23mm shaft position upper rotation 270°

	
	
GEV No. 375314	Ref. No. 2050031 BAAN303428
description	thermostat t.max. 320°C temperature range 50-320°C 1-pole 1NO 16A probe ø 3mm probe L 120mm capillary pipe 1200mm capillary pipe isolatedmm gland nut shaft ø 6x4.6mm shaft L 23mm shaft position upper rotation 270° with 2 probes

	
	
GEV No. 375002	Ref. No. 7471032 BAAN1209939 BAAN310615
description	thermostat t.max. 320°C temperature range 55-320°C 1-pole 1NO 16A probe ø 3.1mm probe L 226mm capillary pipe 870mm capillary pipe isolated 850mm gland nut shaft L 23mm shaft position upper rotation 270°



GEV No.	390003	Ref. No.	3650E BAAN305570
description	thermostat t.max. 90°C temperature range 30-90°C 1-pole 1CO 16A probe ø 15mm probe L 22.5mm capillary pipe 1700mm capillary pipe isolatedmm gland nut shaft ø 6x4.6mm shaft L 16mm shaft position upper° shaft position rotation 270° with knob probe		
accessories for	390003		
	GEV No.	510165	Ref. No. —
gasket for thermostat ED ø 27mm ID ø 11mm thickness 8.5mm			



GEV No.	375482	Ref. No.	1244788 905838
description	thermostat t.max. 95°C temperature range 30-90°C 1-pole 1CO 16A probe ø 6mm probe L 138mm capillary pipe 860mm capillary pipe isolatedmm gland nut M9x1 shaft ø 6x4.6mm shaft L 23mm shaft position lower rotation 270°		
accessories for	375482		
	GEV No.	111934	Ref. No. —
knob thermostat t.max. 90°C ø 50mm shaft ø 6x4.6mm shaft flat upper black temperature range 30-90°C rotation 270°			

55.34_series



GEV No.	375143	Ref. No.	301003 7492058 BAAN1300894
description	thermostat t.max. 110°C temperature range 32-110°C 3-pole 3NO 16A probe ø 6mm probe L 138mm capillary pipe 1480mm capillary pipe isolated 1100mm gland nut M9x1 shaft ø 6x4.6mm shaft L 23mm shaft position upper rotation 270°		



GEV No.	375020	Ref. No.	301003 BAAN167016 BAAN878818
description	thermostat t.max. 110°C temperature range 32-110°C 3-pole capillary pipe isolatedmm gland nut		



GEV No.	375022	Ref. No.	301062 BAAN171096 BAAN304481
description	thermostat t.max. 180°C temperature range 95-180°C 3-pole 3NO 16A probe ø 6mm probe L 133mm capillary pipe 1780mm capillary pipe isolated 1400mm gland nut M9x1 shaft ø 6x4.6mm shaft L 23mm rotation 270°		



GEV No.	375417	Ref. No.	301004
description	thermostat t.max. 200°C temperature range 65-200°C 3-pole 3NO 16A probe ø 6mm probe L 79mm capillary pipe 840mm capillary pipe isolatedmm gland nut M9x1 shaft ø 6x4.6mm shaft L 23mm rotation 270°		



GEV No.	375038	Ref. No.	301005 310824 BAAN1300997 BAAN167017 BAAN304466 BAAN304978
description	thermostat t.max. 300°C temperature range 50-300°C 3-pole 3NO 16A probe ø 6mm probe L 79mm capillary pipe 1740mm capillary pipe isolated 800mm gland nut shaft ø 6x4.6mm shaft L 23mm shaft position upper rotation 270°		
accessories for	375038		
	GEV No.	110123	Ref. No. —
	knob thermostat t.max. 300°C ø 50mm shaft ø 6x4.6mm shaft flat upper black temperature range 50-300°C rotation 270°		



GEV No.	375026	Ref. No.	301006 7471044 BAAN1209940 BAAN310624
description	thermostat t.max. 350°C temperature range 100-350°C 3-pole 3NO 16A probe ø 6mm probe L 77mm capillary pipe 2430mm capillary pipe isolated 1100mm gland nut shaft ø 6x4.6mm shaft L 23mm shaft position upper rotation 270°		



GEV No.	390038	Ref. No.	5004E
description	thermostat t.max. 90°C temperature range 30-90°C 3-pole 3CO 16A probe ø 6mm probe L 215mm capillary pipe 900mm capillary pipe isolatedmm gland nut shaft Lmm		

safety thermostats

55.10/19_ series



GEV No.	375233	Ref. No.	5519542090
description	safety thermostat switch-off temp. 235°C 1-pole 16A probe ø 6mm probe L 133mm capillary pipe 870mm capillary pipe isolated 830mm gland nut probe SS		
accessories for	375233		
	GEV No.	102067	Ref. No. —
	nut thread M8x1 H 3mm brass Qty 1 pcs type SEF 1		
	GEV No.	551083	Ref. No. —
	cap for safety thermostat thread M8x1		

55.13_ series



GEV No.	375830	Ref. No.	905866 905886
description	safety thermostat switch-off temp. 365°C 1-pole 1NC 16A probe ø 3mm probe L 160mm capillary pipe 1730mm capillary pipe isolated 1710mm gland nut probe		



GEV No.	390801	Ref. No.	71280E
description	thermostat switch-off temp. 140°C 1-pole 16A probe ø 6mm probe L 78mm capillary pipe 1500mm capillary pipe isolatedmm gland nut probe connection male faston 6.3mm		

55.32_ series

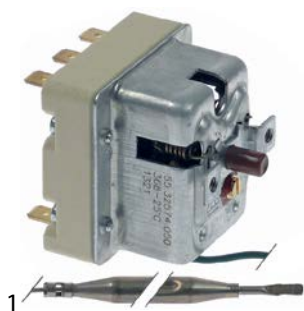

GEV No.	376062	Ref. No.	1040069
description	safety rod thermostat switch-off temp. 370°C 3-pole probe ø 6mm probe L 77mm capillary pipe 1500mm		



GEV No.	375984	Ref. No.	301061 BAAN171095 BAAN304480
description	safety thermostat switch-off temp. 225°C 3-pole 3NC 20A probe ø 6mm probe L 94mm capillary pipe 900mm capillary pipe isolated 670mm gland nut M10x1 probe SS		

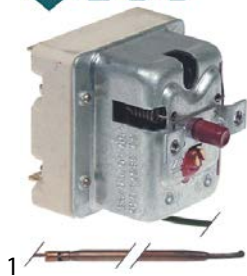

GEV No.	375706	Ref. No.	301049 BAAN169338 BAAN304476
description	safety thermostat switch-off temp. 400°C 3-pole 3NC 20A probe ø 3.9mm probe L 228mm capillary pipe 1190mm capillary pipe isolatedmm gland nut probe SS		

56_ series



GEV No.	375442	Ref. No.	301039 301066 BAAN172196 BAAN304485
description	safety thermostat capillary pipe 1760mm probe ø 4mm 1-pole probe L 100mm 16A capillary pipe isolated 1600mm gland nut switch-off temp. 320°C probe		

control thermostats with operation switch

55.34_ series

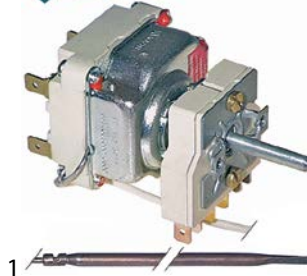

GEV No.	375246	Ref. No.	301034
description	thermostat t.max. 645°C temperature range 100-615/645°C 2-pole 2NO 16A probe ø 4mm probe L 230mm capillary pipe 1100mm capillary pipe isolated 600mm gland nut shaft ø 6x4.6mm shaft L 25mm shaft position lower rotation 270° outer switch 2NO probe material copper		

IMIT / TEMPOMATIC / ARTHERMO

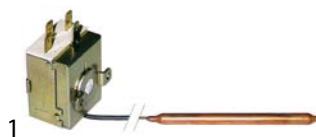

control thermostats





GEV No.	390314	Ref. No.	2001895H BAAN1321520 BAAN782894
description	thermostat t.max. 60°C temperature range fixed 60°C-pole 1CO 15A probe ø 6.5mm probe L 95mm capillary pipe 2000mm capillary pipe isolated 1950mm gland nut shaft ømm shaft Lmm shaft position rotation° probe material copper		





			
GEV No.	390421	Ref. No.	5508E
description	thermostat t.max. 85°C temperature range 0-90°C 1-pole 1CO 16A probe ø 6.5mm probe L 95mm capillary pipe 1500mm capillary pipe isolated 1450mm gland nut shaft ømm shaft Lmm shaft position rotation 270° probe material copper		

			
GEV No.	390425	Ref. No.	5868E BAAN1322991 BAAN307892
description	thermostat t.max. 85°C temperature range fixed 60°C 1-pole 1CO 16A probe ø 9.5mm probe L 37mm capillary pipe 600mm capillary pipe isolated 600mm gland nut shaft ømm shaft Lmm shaft position rotation° screw-in probe probe thread M14x1 probe material SS		
accessories for	390425		
	GEV No.	Ref. No.	—
	510417		
	flat gasket fibre ED ø 20mm ID ø 14mm thickness 2mm Qty 1 pcs		
	GEV No.	Ref. No.	—
	511472		
	nut thread 3/8" H 4mm brass WS 21 Qty 1 pcs		

			
GEV No.	375847	Ref. No.	901017
description	thermostat t.max. 90°C temperature range 0-90°C 1-pole 1CO 15A probe ø 6.5mm probe L 100mm capillary pipe 1500mm capillary pipe isolatedmm gland nut shaft ø 6x4.6mm shaft L 18mm shaft position +135° rotation 270° 250V		

safety thermostats			
			
GEV No.	390770	Ref. No.	2002136H BAAN1137217 BAAN1321720
description	safety thermostat switch-off temp. 90-110°C 1-pole 1CO 16/0.5A probe ø 6.5mm probe L 90mm capillary pipe 2000mm capillary pipe isolated 1950mm gland nut probe		

PRODIGY / FIRT			
safety thermostats			
			
GEV No.	375478	Ref. No.	2001687H
description	safety thermostat switch-off temp. 200°C temperature range°C 1-pole 1CO 20A probe ø 3.3mm probe L 190mm capillary pipe 2150mm capillary pipe isolatedmm gland nut probe SS		

accessories			
gland nut accessories			
ducts			
			
GEV No.	550148	Ref. No.	91373062 BAAN1323396 BAAN312763
description	gland duct ET M12x0.75 IT M9x1 probe ø max. 6.5mm WS 17 silicone		

connecting bows			
			
GEV No.	550060	Ref. No.	300177
description	connecting bow long for thermostat Qty 1 pcs		



switches and momentary switches

rocker/momentary rocker switches

30x22mm



1

GEV No.	301202 ¹	Ref. No.	905913
description	rocker switch mounting measurements 30x22mm black 2NO 230V 20A 0-1 connection male faston 6.3mm ambient temperature max. 125/55°C protection IP65 with rubber collar		

¹non-illuminated

1

GEV No.	346068	Ref. No.	905022 905913 BAAN1323284 BAAN1323317 BAAN312059 BAAN876393
description	momentary rocker switch mounting measurements 30x22mm black 2NO 250V 16A 0-1 connection male faston 6.3mm ambient temperature max. 85/125°C protection IP40		
accessories for	346068		
	GEV No.	301036	Ref. No. —
	protective cover internal size 30x22mm for rocker switch mounting measurementsmm		



1

GEV No.	346377	Ref. No.	905914 BAAN1323318 BAAN312060
description	rocker switch mounting measurements 30x22mm black 2CO 230V 16A 0-1 connection male faston 6.3mm ambient temperature max. 125/55°C protection IP40		
accessories for	346377		
	GEV No.	301036	Ref. No. —
	protective cover internal size 30x22mm for rocker switch mounting measurementsmm		

push/momentary push switches

28.5x77.5mm



1

GEV No.	347611	Ref. No.	5865E BAAN1322989 BAAN307889
description	switch combination latching mounting measurements 28.5x77.5mm black 2CO/2NO/2NO 250V 16A with indicator connection male faston 6.3mm ambient temperature max. 85°C protection IP40		

ø12mm



1

GEV No.	347745	Ref. No.	300157 302556 BAAN166958 BAAN304361 BAAN304630
description	momentary switch with plunger thread M12x0.75 thread L 10mm 250V 2A 1NO connection male faston 6.3mm stroke 4mm ambient temperature max. 125°C type 1233A actuating force: 500g		

microswitches

lever actuated



1

GEV No.	345257	Ref. No.	300688 3755E BAAN305693
description	microswitch with lever 250V 16A 1CO connection male faston 6.3mm L 29mm L1 33mm ambient temperature max. 120°C mounting distance 22mm actuating force: 130g lever length 31.5mm		



1

GEV No.	345049	Ref. No.	3755E BAAN305693
description	microswitch with lever CO connection male faston		

pin-plunger actuated

M10



1



GEV No.	347216	Ref. No.	303621 BAAN1210182 BAAN304729
description	microswitch with plunger thread M10x0.75 thread L 14mm 250V 10A 1CO connection male faston 6.3mm stroke 7.5mm mounting distance 22mm L 28mm ambient temperature max. 125°C type NR6K5 actuating force: 260g		



1

GEV No.	345032	Ref. No.	303621
description	microswitch with plunger thread M10x1 thread L 12mm 250V 16A 1CO connection male faston 6.3mm stroke 7mm mounting distance 22mm L 28mm ambient temperature max. 125°C type SP9603 actuating force: 180g		





M12			
 <p>1</p>			
GEV No.	345350	Ref. No.	1700340 BAAN1320656 BAAN302929
description	microswitch with plunger mounting distance 22mm thread M12x0.75 thread L 16mm 250V 16A 1CO connection male faston 6.3mm stroke 4mm ambient temperature max. 125°C type EF83161.3 actuating force: 66g		
accessories for	345350		
		GEV No.	345351 Ref. No. —
	nut thread M12x0.75 H 1.6mm WS 14 chrome-plated brass Qty 1 pcs		

with push button			
switches with snap-fit			
 <p>1</p>			
GEV No.	348008	Ref. No.	645128 825662 S128P15
description	microswitch with push button 250V 2.5A 1NO/1NC connection male faston 2.8mm/6.3mm L 27mm L1 22mm ambient temperature max. 104°C actuating force: 180g		

system switches (ROLD)

 <p>1</p>			
GEV No.	345537	Ref. No.	2001160H
description	element holder mounting measurements 20.6x16.4mm grey arched for push buttons 13x17mm		

 <p>1</p>			
GEV No.	346498	Ref. No.	900055 BAAN1323150 BAAN311605
description	element holder mounting measurements 28.5x28.5mm black single element holder		

 <p>1</p>			
GEV No.	345536	Ref. No.	900162
description	element holder mounting ø 16mm flat black		

 <p>1</p>			
GEV No.	345606	Ref. No.	2001544H
description	momentary switch unit 2CO 250V 16A connection male faston 6.3mm		

 <p>1</p>			
GEV No.	345538	Ref. No.	900163
description	push button ø 11.9mm black		

 <p>1</p>			
GEV No.	346816	Ref. No.	900056 BAAN1323151 BAAN311606
description	push button ø 23mm black		

 <p>1</p>			
GEV No.	346035	Ref. No.	2001695H
description	push button size 17x13mm silver		

 <p>1</p>			
GEV No.	345651	Ref. No.	900053 BAAN1323148 BAAN311603
description	switch 2CO 250V 16A connection male faston 6.3mm		



			
1			
GEV No.	346851	Ref. No.	2001327H
description	switch 2CO 250V 16A connection male faston 6.3mm		

cam switches

7-position

			
1			
GEV No.	300106	Ref. No.	300010 BAAN166926 BAAN304345
description	cam switch 7 operating positions 1NO/2CO sequence 0-1-2-3-4-5-6 32A shaft \varnothing 6x4.6mm shaft L 23mm connection screw 7-position shaft flat upper		

4 operating positions

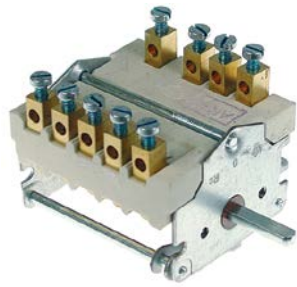
			
1			
GEV No.	300360	Ref. No.	300051 BAAN166932 BAAN304354
description	cam switch 4 operating positions 3NO/1CO sequence 0-1-2-3 32A shaft \varnothing 6x4.6mm shaft L 23mm connection screw ceramic		

operation switches

			
1			
GEV No.	300200	Ref. No.	905108 BAAN1218907 BAAN311907
description	operation switch 2 operating positions 2NO 16A sequence 0-1 shaft \varnothing 6x4.6mm shaft L 23mm connection male faston 6.3mm operation switch ceramic		

			
1			
GEV No.	300091	Ref. No.	300175 BAAN169296 BAAN304364
description	operation switch EGO 2 operating positions 2NO 16A sequence 0-1 shaft \varnothing 6x4.6mm shaft L 23mm connection screw ceramic		



rotary switches

ENTRELEC

			
1			
GEV No.	305001	Ref. No.	311243 BAAN305071
description	rotary switch 4 0-1-2-3 sets of contacts 10 type 400V 18A shaft \varnothing 6x6mm shaft L 23mm shaft square connection screw		

magnetic switches

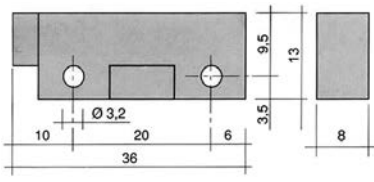
36x13mm

			
1			
			
GEV No.	345118 ¹	Ref. No.	2001136H 2001844H 2002431H
description	magnetic switch L 36mm W 13mm 1NO 250V 1A P max. 50W connection cable length 980mm		
accessories for	345118		
	GEV No.	345399	Ref. No.
			2001884H 2002082H 2002096H
	magnet \varnothing 3.3mm L 40mm H 8mm W 13mm hole distance 30mm M3		

¹with coded connector



accessories

magnets

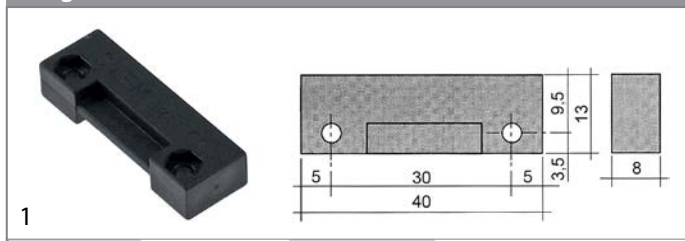

GEV No.	345399	Ref. No.	2001884H 2002082H 2002096H
description	magnet ø 3.3mm L 40mm H 8mm W 13mm hole distance 30mm M3		

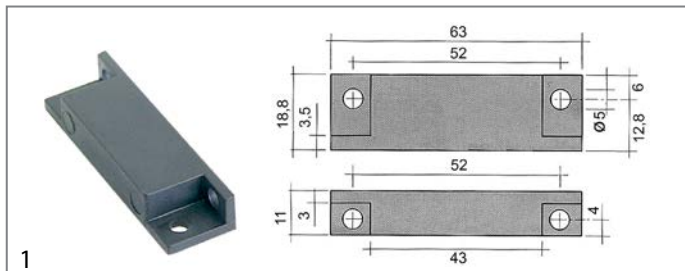

GEV No.	345336	Ref. No.	2001868H BAAN1321497 BAAN307903
description	magnet ø 4.8mm L 63mm H 11mm W 18.8mm hole distance 51mm M4		

encoders and potentiometers



GEV No.	300265	Ref. No.	309411 BAAN172230 BAAN701367
description	potentiometer		

lamps

indicator lights

indicator lights 2-piece (lens and indicator lamp)

indicator light lenses

ø12mm (type SDY-3)



GEV No.	359261	Ref. No.	904359
description	indicator light housings mounting measurements ø12mm red round Qty 1 pcs		

indicator lights 3-piece (housing, lens and bulb)

lamps

neon light bulbs

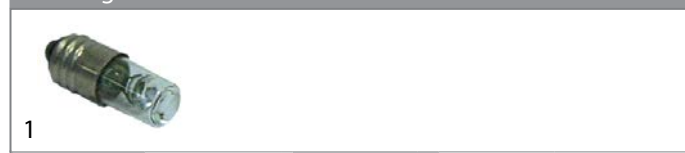

GEV No.	359585	Ref. No.	74540008
description	neon light bulb socket E10 230V green ø 10mm L 28mm		

accessories for	359585		
GEV No.	359060	Ref. No.	—

description	lamp socket mounting measurements ø16.2mm socket E10 connection screw		
--------------------	---	--	--



GEV No.	359601	Ref. No.	74540009
description	neon light bulb socket E10 380V clear ø 10mm L 28mm glas		

accessories for	359601		
GEV No.	359060	Ref. No.	—

description	lamp socket mounting measurements ø16.2mm socket E10 connection screw		
--------------------	---	--	--

GEV No.	359063	Ref. No.	—
description	lamp socket mounting measurements ø19.2mm socket E14 connection screw		

GEV No.	359064	Ref. No.	—
description	lamp socket mounting measurements ø22.3mm socket E14 connection screw 250/380V ambient temperature at 1W 100°C ambient temperature at 2W 85°C		

GEV No.	359685	Ref. No.	—
description	lamp socket mounting measurements ø16.2mm socket E10		

GEV No.	359832	Ref. No.	—
description	lamp socket mounting measurements ø16.2mm socket Ba9s connection male faston 6.3mm		

GEV No.	359853	Ref. No.	—
description	lamp socket mounting measurements ø18.2mm socket Ba9s connection male faston 6.3mm		

GEV No.	359988	Ref. No.	—
description	lamp socket mounting measurements ø30.5mm 250V connection F6.3 temp.-resist. 55°C E14		

indicator lights (complete)

ø 6mm

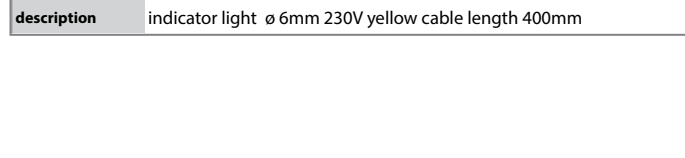

GEV No.	359005	Ref. No.	2002147H
description	indicator light ø 6mm 230V yellow cable length 400mm		

ø12mm

with screw socket



GEV No.	359892	Ref. No.	N/A
description	indicator light ø 12mm 24V yellow connection cable 200mm		



GEV No.	359893	Ref. No.	N/A
description	indicator light ø 12mm 400V green connection cable 200mm		



GEV No.	359895	Ref. No.	N/A
description	indicator light ø 12mm 400V yellow connection cable 200mm		



GEV No.	359894	Ref. No.	N/A
description	indicator light ø 12mm 400V red connection cable 200mm		

with plug-in socket



GEV No.	359925	Ref. No.	308334 BAAN167305 BAAN304818
description	indicator light ø 12mm 400V green connection 2-wire cable length 700mm temp.-resist. 150°C		

ø13mm

with plug-in socket



GEV No.	359141	Ref. No.	904359
description	indicator light ø 13mm red 230V connection male faston 6.3mm temp.-resist. 120°C Qty 1 pcs		



GEV No.	359143	Ref. No.	904300 904360 BAAN1323249 BAAN311747
description	indicator light ø 13mm yellow 230V connection male faston 6.3mm temp.-resist. 120°C Qty 1 pcs		

30x22mm



GEV No.	359156	Ref. No.	S175P15
description	indicator light mounting measurements 30x22mm 230V yellow connection male faston 6.3mm temp.-resist. 125/55°C type RL2		

LED

indicator lamps

mounting diameter 6mm



GEV No.	359404	Ref. No.	2001678H
description	indicator light LED mounting ø 6mm 5VDC green connection cable 200mm 2mA		



GEV No.	358098	Ref. No.	2001677H BAAN1121222 BAAN1321360
description	indicator light LED mounting ø 6mm 5VDC yellow connection cable 200mm 2mA		

screw-on/push-on fit

neon light bulbs



GEV No.	359585	Ref. No.	74540008
description	neon light bulb socket E10 230V green ø 10mm L 28mm		

accessories for	359585		
GEV No.	359060	Ref. No.	—
description	lamp socket mounting measurements ø16.2mm socket E10 connection screw		

GEV No.	359685	Ref. No.	—
description	lamp socket mounting measurements ø16.2mm socket E10		









GEV No.	359601	Ref. No.	74540009
description	neon light bulb socket E10 380V clear ø 10mm L 28mm glas		

accessories for	359601		
GEV No.	359060	Ref. No.	—
description	lamp socket mounting measurements ø16.2mm socket E10 connection screw		

Table continues overleaf



accessories for		359601	
	GEV No.	359063	Ref. No. —
	GEV No.	359064	Ref. No. —
	GEV No.	359685	Ref. No. —
	GEV No.	359832	Ref. No. —
	GEV No.	359853	Ref. No. —
	GEV No.	359988	Ref. No. —

light bulbs

for ovens

	PHILIPS		
1			
GEV No.	359610	Ref. No.	70597E
description	light bulb t.max. 300°C socket E14 15W 230V ø 22mm L 47mm lens L 20mm for oven lamp type Philips		

			
1			
GEV No.	357153	Ref. No.	70598E
description	light bulb t.max. 300°C socket E14 25W 230V ø 25mm L 55mm lens L 30mm for oven type		

			
1			
GEV No.	359614	Ref. No.	308463
description	light bulb t.max. 300°C socket E27 230V 40W ø 45mm L 71mm lens L 44mm Qty 1 pcs		

halogen lamp

for socket G4 / G6.35 / G9

	1 500°C		
GEV No.	359599	Ref. No.	308477 BAAN172222 BAAN304831
description	halogen lamp socket G4 12V 20W temp.-resist. 500°C		

fluorescent lamps

fluorescent lamps

G23

	1		
GEV No.	359933	Ref. No.	71819E
description	fluorescent lamp socket G23 L 237mm 11W 230V		

oven lamps

lamps

light bulbs

	PHILIPS		
1			
GEV No.	359610	Ref. No.	70597E
description	light bulb t.max. 300°C socket E14 15W 230V ø 22mm L 47mm lens L 20mm for oven lamp type Philips		

			
1			
GEV No.	357153	Ref. No.	70598E
description	light bulb t.max. 300°C socket E14 25W 230V ø 25mm L 55mm lens L 30mm for oven type		

			
1			
GEV No.	359614	Ref. No.	308463
description	light bulb t.max. 300°C socket E27 230V 40W ø 45mm L 71mm lens L 44mm Qty 1 pcs		



halogen lamps

for socket G4 / G6.35 / G9



GEV No.	359599	Ref. No.	308477 BAAN172222 BAAN304831
description	halogen lamp socket G4 12V 20W temp.-resist. 500°C		

sockets

G4 / G5,3 / G6,35



GEV No.	359646	Ref. No.	147328
description	lamp socket socket G4/G5.3/G6.35 24V ø 17mm H 15mm connection cable 130mm mounting distance 26mm for halogen lamp holder length 31mm cable length 130mm		

timers

programme timers

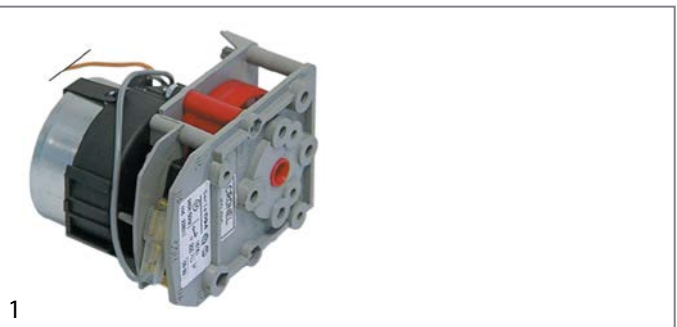

GEV No.	360005	Ref. No.	5507E
description	timer BIGATTI D94 engines 1 chambers 1 operation time 20min 230V shaft ømm shaft Lmm manuf. no. WE006 motor type 82354021L		



GEV No.	360349	Ref. No.	5506E	
description	timer CDC 11803 engines 1 chambers 3 operation time 150s 230V shaft ømm shaft Lmm manuf. no. 11803F1BEE000.0010 motor type M48R ATS type 11803F1 / 238046			
spare parts for	360349			
	GEV No.	360673	Ref. No.	—
description	motor kit pinion ø 6.8mm teeth 15 230V voltage AC 50/60Hz turn direction clockwise motor ø 48mm H 18.5mm motor type UDS-40NE1RNZ165 cable length 150mm with holder			



GEV No.	360025	Ref. No.	905026 BAAN1323285 BAAN311882	
description	timer CDC 7003F engines 1 chambers 3 operation time 360s 230V 50Hz shaft ø 6x7mm shaft L 26mm manuf. no. 7003F3 / 360025 motor type M37LN			
spare parts for	360025			
	GEV No.	360131	Ref. No.	—
description	motor CDC pinion ø 5.4mm teeth 12 230V turn direction left motor ø 37mm motor type M37LN for timer			
accessories for	360025			
	GEV No.	110085	Ref. No.	—
description	push button t.max.°C°C ø 36mm shaft ømm shaft flat grey for knob			
	GEV No.	110086	Ref. No.	N/A
description	knob switch zero mark t.max.°C°C ø 45mm shaft ømm shaft flat special black			
	GEV No.	110087	Ref. No.	—
description	retaining ring shaft ø 8mm DIN 471			

mechanical timers

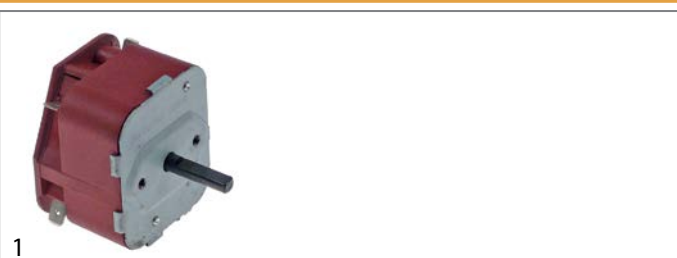

GEV No.	360470	Ref. No.	645086
description	timer C53 2-pole operation time 120min impulse mechanical 1NO/1NC at 250V 16A permanent position yes shaft ø 6x4.6mm shaft 6x4.6mm shaft L 23mm mounting distance 28mm		

alarm devices

buzzers

	GEV No.	350050	Ref. No.	305106
description	buzzer 230VAC connection male faston 6.3mm screw mounting thread M4 60dB			



contactors

LS Industrial Systems

power contactors



1

GEV No.	381167	Ref. No.	2001137H
description	power contactor resistive load 20A 230VAC (AC3/400V) 9A/4kW main contacts 4NO auxiliary contacts connection screw connection type GMC-9M/4		

SIEMENS

power contactors



1

GEV No.	380389	Ref. No.	2001923H
description	power contactor resistive load 22A 230VAC (AC3/400V) 9A/4kW main contacts 3NO auxiliary contacts 1NO connection screw connection type 3RT10-16-1AP01		



1

GEV No.	380957	Ref. No.	2001138H
description	power contactor resistive load 22A 24VAC (AC3/400V) 12A/5.5kW main contacts 3NO auxiliary contacts 1NO connection screw connection type 3RT10-17-1AB01 50/60Hz		

TELEMECANIQUE (Schneider Electric)

power contactors



1

GEV No.	380617	Ref. No.	1700468
description	power contactor resistive load 25A 24VAC (AC3/400V) 9A/4kW main contacts 3NO auxiliary contacts 1NO/1NC connection screw connection type LC1D09B7		



1

GEV No.	380976	Ref. No.	1700732 300698
description	power contactor resistive load 32A 230VAC (AC3/400V) 18A/7.5kW main contacts 3NO auxiliary contacts 1NO/1NC connection screw connection		



1

GEV No.	380979	Ref. No.	300697 300699 300760 5875E 900130 905239 905241 905686 906759 910566 BAAN1322995 BAAN169330 BAAN304436 BAANS084P20
description	power contactor resistive load 40A 230VAC (AC3/400V) 25A/11kW main contacts 3NO auxiliary contacts 1NO/1NC connection screw connection type LC1D25P7		



1			
GEV No.	380980	Ref. No.	300700
description	power contactor resistive load 50A 230VAC (AC3/400V) 32A/15kW main contacts 3NO auxiliary contacts 1NO/1NC connection screw connection type LC1D32P7		



1			
GEV No.	380702	Ref. No.	2002044H
description	power relays FINDER 230VAC 16A 3NO connection male faston 6.3mm flange dimensions 36x38x68mm manuf. no. 62.83.8.230.0300 230V		

relays

power relays

with bracket mounting



1			
GEV No.	380312	Ref. No.	2001867H 2001887H
description	power relays FINDER 230VAC 10A 3CO connection male faston 4.8mm bracket mounting dimensions 52x32.2x36.5mm manuf. no. 60.63.8.230.0000		



1			
GEV No.	380139	Ref. No.	2001873H
description	power relays FINDER 230VAC 16A 2CO connection F6.3 bracket mounting dimensions 68x38.2x35.8mm manuf. no. 62.82.8.230.0000		



1			
GEV No.	380403	Ref. No.	2001258H 2001873H 900073 BAAN1323154 BAAN311608
description	power relays FINDER 230VAC 16A 3CO connection F6.3 bracket mounting manuf. no. 62.83.8.230.0500		



1			
GEV No.	380185	Ref. No.	2001929h 300283 BAAN1027526 BAAN171090 BAAN304383
description	power relays Italiana Relè 230VAC 30A 1NO connection F6.3 bracket mounting dimensions 36.5x32.2x51.8mm manuf. no. A10-230AC-FA		

relay sockets



1			
GEV No.	380137	Ref. No.	5937E
description	relay socket 8-pole connection plug-in connection round 8-pole dimensions 65x28x40mm 380V voltage AC 10A Italiana Relè manuf. no. ZVE8		
accessories for	380137		
	GEV No.	380805	Ref. No.
			—
	support bracket		



transformers

open transformers

with plug connection

			
1			
GEV No.	400956	Ref. No.	308479
description	transformer primary 230VAC secondary 12VAC 20VA connection male faston 6.3mm 50/60Hz type T602012/E temperature restriction 150°C ambient temperature max. 80°C		

electronic controllers

EVCO - EVERY CONTROL



universal controllers

built-in version

			
1			
GEV No.	378131	Ref. No.	651225 S225P20
description	electronic controller EVERY CONTROL EVK411M mounting measurements 71x29mm 12V voltage AC/DC NTC/PTC/Pt100/Pt1000 relay outputs 1 CO-16A(8) NTC/PTC/Pt100/Pt1000/TC(J,K)/mV/mA yes protection IP65 dependent on probe°C display 3½ digits		
accessories for	378131		
	GEV No.	379050	Ref. No. —
	temperature probe Pt100 cable Vetrotex probe -200 up to +600°C cable -50 up to +350°C probe ø6x100mm cable length 2.7m without screw connection 3-wire		
	GEV No.	379160	Ref. No. —
	temperature probe NTC 10kOhm cable thermoplastic probe -40 up to +110°C cable -40 up to +110°C probe ø6x14mm cable length 1.5m without screw connection 2-wire		
	GEV No.	379781	Ref. No. —
	temperature probe PTC 1kOhm cable thermoplastic probe -50 up to +150°C cable -40 up to +110°C probe ø6x14mm cable length 1.5m without screw connection 2-wire		
	GEV No.	379944	Ref. No. —
	temperature probe Pt1000 cable Vetrotex probe -70 up to +500°C cable -50 up to +350°C connection 2-wire thread probe ø6x180mm cable length 1.7m		

refrigeration controllers

built-in version

			
1			
GEV No.	378147	Ref. No.	651093
description	electronic controller EVERY CONTROL type EVK211N3VXBS mounting measurements 71x29mm 12/24V voltage AC/DC NTC/PTC relay outputs 1 CO-16A(5) PTC/NTC front measurementsmm built-in depth 59mm protection IP65 yes -50 up to +150°C display 3½ digits		
accessories for	378147		
	GEV No.	379053	Ref. No. —
	temperature probe PTC 1kOhm cable PVC probe -50 up to +150°C cable -10 up to 100°C probe ø6x30mm cable length 3m without screw connection 2-wire		
	GEV No.	379064	Ref. No. —
	temperature probe PTC 1kOhm cable silicone probe -50 up to +150°C cable -50 up to +180°C probe ø6x40mm cable length 3m without screw connection 2-wire		
	GEV No.	379161	Ref. No. —
	temperature probe NTC 10kOhm cable thermoplastic probe -40 up to +110°C cable -40 up to +110°C probe ø6x14mm cable length 3m without screw connection 2-wire		
	GEV No.	379782	Ref. No. —
	temperature probe PTC 1kOhm cable thermoplastic probe -50 up to +150°C cable -40 up to +110°C probe ø6x14mm cable length 3m 2-wire resistor 1kOhm		
			
1			
GEV No.	378153	Ref. No.	651094 BAAN171256 S094P20
description	electronic controller EVERY CONTROL type EVK213N3VXBS mounting measurements 71x29mm 12/24V voltage AC/DC NTC/PTC relay outputs 3 NO-16A(5) CO-8A(4) NO-8A(4) NTC/PTC NTC/PTC DI front measurementsmm built-in depth 59mm protection IP65 yes -50 up to +150°C display 3½ digits		
accessories for	378153		
	GEV No.	379053	Ref. No. —
	temperature probe PTC 1kOhm cable PVC probe -50 up to +150°C cable -10 up to 100°C probe ø6x30mm cable length 3m without screw connection 2-wire		
	GEV No.	379064	Ref. No. —
	temperature probe PTC 1kOhm cable silicone probe -50 up to +150°C cable -50 up to +180°C probe ø6x40mm cable length 3m without screw connection 2-wire		
	GEV No.	379161	Ref. No. —
	temperature probe NTC 10kOhm cable thermoplastic probe -40 up to +110°C cable -40 up to +110°C probe ø6x14mm cable length 3m without screw connection 2-wire		
	GEV No.	379782	Ref. No. —
	temperature probe PTC 1kOhm cable thermoplastic probe -50 up to +150°C cable -40 up to +110°C probe ø6x14mm cable length 3m 2-wire resistor 1kOhm		

1 electric components



Image not available

1

GEV No.	379503	Ref. No.	1051059 BAANS094PB70
description	electronic controller kit		

LOREME

analogue



1

GEV No.	379745	Ref. No.	72098E BAAN309861
description	electronic controller kit LOREME type Dsl 94 mounting measurements 66x32mm 230V voltage AC TC/J 0-250°C display without display relay outputs 2 front measurements 70x34mm built-in depth 95mm cable length 2530mm probe L 20mm probe ø 4mm with probe and fastening material		
spare parts for	379745		
	GEV No.	379744	Ref. No. —
	electronic controller LOREME type Dsl 94 mounting measurements 66x32mm 230V voltage AC TC/J 0-250°C display without display relay outputs 2 front measurements 70x34mm built-in depth 95mm		

probes

universal probes

temperature probes



1

GEV No.	379142	Ref. No.	651184
description	temperature probe PTC 1kOhm cable PVC probe -50 up to +150°C cable -10 up to 100°C probe ø6x30mm cable length 1.5m without screw connection 2-wire		



1

GEV No.	378070	Ref. No.	751775 BAANS194P20
description	temperature probe PTC 1kOhm cable silicone probe -50 up to +150°C cable -50 up to +180°C probe ø6x40mm cable length 30m without screw connection 2-wire		

producer-specific probes

probes



1

GEV No.	400910	Ref. No.	2001913H 2002264H 6046E
description	temperature probe NTC 10kOhm cable silicone probe -40 up to +110°C cable -50 up to +180°C connection coded plug thread probe ø4.5x30mm cable length 0.35m		

electronics

PCBs



1

GEV No.	400898	Ref. No.	2002432H
description	keypad PCB dishwasher LP10/20/30 with display		
accessories for	400898		
	GEV No.	402970	Ref. No. 2001927H BAAN1027510 BAAN1321548
	ribbon cable 10-pole L 1200mm plug type 2 row coded Qty 1m		



1







GEV No.	403093	Ref. No.	2002140H BAAN1158403 BAAN1321724
description	PCB dishwasher L 135mm W 82mm		

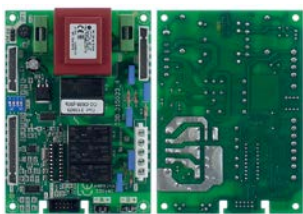

1

GEV No.	403572	Ref. No.	2002141H 2002541H
description	PCB dishwasher Protech 1113/611 TR10 L 178mm W 125mm		



			
GEV No.	400899	Ref. No.	2001914H
description	power PCB dishwasher LP10/20/30 without EPROM		
accessories for	400899		
	GEV No.	400761	Ref. No. —
	plug connector 5-pole		
	GEV No.	400900	Ref. No. —
	EPROM CODE 225029-3		
	GEV No.	401558	Ref. No. —
	EPROM CODE 81000-1		
	GEV No.	403241	Ref. No. —
	EPROM type U61E for dishwasher CODE 81001-3		
	GEV No.	550048	Ref. No. —
	female bullet		

solenoid valves

solenoid valves (water)

			
GEV No.	373020	Ref. No.	241447
description	solenoid valve double angled 230VAC inlet 3/4" outlet 14mm input 10l/min DN10 t.max. 90°C duty cycle 100% ELBI flow regulating valve inlet white		

			
GEV No.	370357	Ref. No.	3697E
description	solenoid valve double straight 230VAC inlet 3/4" outlet 11.5mm plastic flow regulating valve outlet A 0.25		

ROBERTSHAW/INVENSYS

medium temperature: 90°C 90°C 60°C
 ambient temperature: 60°C 25°C 60°C
 duty cycle: 40% 100% 100%

			
GEV No.	372017	Ref. No.	144937 BAAN171061 BAAN302233
description	solenoid valve single straight 230VAC inlet 3/4" outlet 11.5mm DN10 EATON (INVENSYS)		



















			
GEV No.	370021	Ref. No.	1700434 3697E BAAN1320666 BAAN302969
description	solenoid valve double straight 230VAC inlet 3/4" outlet 11.5mm DN10 TP flow regulating valve inlet white		
spare parts for	370021		
	GEV No.	371013	Ref. No. —
	solenoid coil TP 230VAC 50/60Hz		
accessories for	370021		
	GEV No.	371220	Ref. No. —
	reducer TP flow rate 3l/min red tolerance ±15%		
	GEV No.	371221	Ref. No. —
	reducer TP flow rate 5.5l/min yellow tolerance ±15%		
	GEV No.	371222	Ref. No. —
	reducer TP flow rate 6l/min grey tolerance ±15%		
	GEV No.	371223	Ref. No. —
	reducer TP flow rate 10l/min white tolerance ±15%		
	GEV No.	371224	Ref. No. —
	reducer TP flow rate 12l/min bronze tolerance ±15%		
	GEV No.	371225	Ref. No. —
	reducer TP flow rate 16l/min light brown tolerance ±15%		
	GEV No.	371226	Ref. No. —
	reducer TP flow rate 20l/min red tolerance ±15%		
	GEV No.	371230	Ref. No. —
	reducer TP flow rate 0.25l/min red tolerance ±25%		

Table continues overleaf

accessories for		370021		
	GEV No.	371231	Ref. No.	—
reducer TP flow rate 0.35l/min violet tolerance ±25%				
	GEV No.	371232	Ref. No.	—
reducer TP flow rate 0.5l/min orange tolerance ±25%				
	GEV No.	371233	Ref. No.	—
reducer TP flow rate 0.8l/min white tolerance ±25%				
	GEV No.	371234	Ref. No.	—
reducer TP flow rate 1l/min light blue tolerance ±25%				
	GEV No.	371235	Ref. No.	—
reducer TP flow rate 1.2l/min brown tolerance ±25%				
	GEV No.	371236	Ref. No.	—
reducer TP flow rate 1.5l/min light brown tolerance ±25%				
	GEV No.	371237	Ref. No.	—
reducer TP flow rate 2.5l/min yellow tolerance ±25%				
	GEV No.	371238	Ref. No.	—
reducer TP flow rate 3.4l/min dark green tolerance ±25%				
	GEV No.	371239	Ref. No.	—
reducer TP flow rate 5l/min black tolerance ±25%				
	GEV No.	371240	Ref. No.	—
reducer TP flow rate 8l/min blue tolerance ±20%				

 				
GEV No.	370017	Ref. No.	634084	
description	solenoid valve single straight 230VAC inlet 3/4" outlet 11.5mm DN10 TP p max 10bar			
spare parts for	370017			
	GEV No.	371013	Ref. No.	—
solenoid coil TP 230VAC 50/60Hz				
accessories for	370017			
	GEV No.	371220	Ref. No.	—
reducer TP flow rate 3l/min red tolerance ±15%				
	GEV No.	371221	Ref. No.	—
reducer TP flow rate 5.5l/min yellow tolerance ±15%				
	GEV No.	371222	Ref. No.	—
reducer TP flow rate 6l/min grey tolerance ±15%				
	GEV No.	371223	Ref. No.	—
reducer TP flow rate 10l/min white tolerance ±15%				
	GEV No.	371224	Ref. No.	—
reducer TP flow rate 12l/min bronze tolerance ±15%				

accessories for		370017		
	GEV No.	371225	Ref. No.	—
reducer TP flow rate 16l/min light brown tolerance ±15%				
	GEV No.	371226	Ref. No.	—
reducer TP flow rate 20l/min red tolerance ±15%				
	GEV No.	371230	Ref. No.	—
reducer TP flow rate 0.25l/min red tolerance ±25%				
	GEV No.	371231	Ref. No.	—
reducer TP flow rate 0.35l/min violet tolerance ±25%				
	GEV No.	371232	Ref. No.	—
reducer TP flow rate 0.5l/min orange tolerance ±25%				
	GEV No.	371233	Ref. No.	—
reducer TP flow rate 0.8l/min white tolerance ±25%				
	GEV No.	371234	Ref. No.	—
reducer TP flow rate 1l/min light blue tolerance ±25%				
	GEV No.	371235	Ref. No.	—
reducer TP flow rate 1.2l/min brown tolerance ±25%				
	GEV No.	371236	Ref. No.	—
reducer TP flow rate 1.5l/min light brown tolerance ±25%				
	GEV No.	371237	Ref. No.	—
reducer TP flow rate 2.5l/min yellow tolerance ±25%				
	GEV No.	371238	Ref. No.	—
reducer TP flow rate 3.4l/min dark green tolerance ±25%				
	GEV No.	371239	Ref. No.	—
reducer TP flow rate 5l/min black tolerance ±25%				
	GEV No.	371240	Ref. No.	—
reducer TP flow rate 8l/min blue tolerance ±20%				





















 				
GEV No.	370018	Ref. No.	904693	
description	solenoid valve single straight 230VAC inlet 3/4" outlet 14mm DN10 TP			
spare parts for	370018			
	GEV No.	371013	Ref. No.	—
solenoid coil TP 230VAC 50/60Hz				
accessories for	370018			
	GEV No.	371220	Ref. No.	—
reducer TP flow rate 3l/min red tolerance ±15%				





Table continues overleaf



accessories for		370018	
	GEV No.	371221	Ref. No. —
reducer TP flow rate 5.5l/min yellow tolerance ±15%			
	GEV No.	371222	Ref. No. —
reducer TP flow rate 6l/min grey tolerance ±15%			
	GEV No.	371223	Ref. No. —
reducer TP flow rate 10l/min white tolerance ±15%			
	GEV No.	371224	Ref. No. —
reducer TP flow rate 12l/min bronze tolerance ±15%			
	GEV No.	371225	Ref. No. —
reducer TP flow rate 16l/min light brown tolerance ±15%			
	GEV No.	371226	Ref. No. —
reducer TP flow rate 20l/min red tolerance ±15%			
	GEV No.	371230	Ref. No. —
reducer TP flow rate 0.25l/min red tolerance ±25%			
	GEV No.	371231	Ref. No. —
reducer TP flow rate 0.35l/min violet tolerance ±25%			
	GEV No.	371232	Ref. No. —
reducer TP flow rate 0.5l/min orange tolerance ±25%			
	GEV No.	371233	Ref. No. —
reducer TP flow rate 0.8l/min white tolerance ±25%			
	GEV No.	371234	Ref. No. —
reducer TP flow rate 1l/min light blue tolerance ±25%			
	GEV No.	371235	Ref. No. —
reducer TP flow rate 1.2l/min brown tolerance ±25%			
	GEV No.	371236	Ref. No. —
reducer TP flow rate 1.5l/min light brown tolerance ±25%			
	GEV No.	371237	Ref. No. —
reducer TP flow rate 2.5l/min yellow tolerance ±25%			
	GEV No.	371238	Ref. No. —
reducer TP flow rate 3.4l/min dark green tolerance ±25%			
	GEV No.	371239	Ref. No. —
reducer TP flow rate 5l/min black tolerance ±25%			
	GEV No.	371240	Ref. No. —
reducer TP flow rate 8l/min blue tolerance ±20%			

  1			
GEV No.	370025	Ref. No.	314345 3664E BAAN305607
description	solenoid valve triple straight 230VAC inlet 3/4" outlet 11.5mm DN10 TP		
spare parts for	370025		
	GEV No.	371013	Ref. No. —
solenoid coil TP 230VAC 50/60Hz			
accessories for	370025		
	GEV No.	371220	Ref. No. —
reducer TP flow rate 3l/min red tolerance ±15%			
	GEV No.	371221	Ref. No. —
reducer TP flow rate 5.5l/min yellow tolerance ±15%			
	GEV No.	371222	Ref. No. —
reducer TP flow rate 6l/min grey tolerance ±15%			
	GEV No.	371223	Ref. No. —
reducer TP flow rate 10l/min white tolerance ±15%			
	GEV No.	371224	Ref. No. —
reducer TP flow rate 12l/min bronze tolerance ±15%			
	GEV No.	371225	Ref. No. —
reducer TP flow rate 16l/min light brown tolerance ±15%			
	GEV No.	371226	Ref. No. —
reducer TP flow rate 20l/min red tolerance ±15%			
	GEV No.	371230	Ref. No. —
reducer TP flow rate 0.25l/min red tolerance ±25%			
	GEV No.	371231	Ref. No. —
reducer TP flow rate 0.35l/min violet tolerance ±25%			
	GEV No.	371232	Ref. No. —
reducer TP flow rate 0.5l/min orange tolerance ±25%			
	GEV No.	371233	Ref. No. —
reducer TP flow rate 0.8l/min white tolerance ±25%			
	GEV No.	371234	Ref. No. —
reducer TP flow rate 1l/min light blue tolerance ±25%			
	GEV No.	371235	Ref. No. —
reducer TP flow rate 1.2l/min brown tolerance ±25%			
	GEV No.	371236	Ref. No. —
reducer TP flow rate 1.5l/min light brown tolerance ±25%			

Table continues overleaf

accessories for 370025				
	GEV No.	371237	Ref. No.	—
reducer TP flow rate 2.5l/min yellow tolerance ±25%				
	GEV No.	371238	Ref. No.	—
reducer TP flow rate 3.4l/min dark green tolerance ±25%				
	GEV No.	371239	Ref. No.	—
reducer TP flow rate 5l/min black tolerance ±25%				
	GEV No.	371240	Ref. No.	—
reducer TP flow rate 8l/min blue tolerance ±20%				

 				
1				
GEV No.	370020	Ref. No.	914123	
description	solenoid valve double angled 230VAC inlet 3/4" outlet 14mm DN10 TP			
spare parts for	370020			
	GEV No.	371013	Ref. No.	—
solenoid coil TP 230VAC 50/60Hz				
accessories for 370020				
	GEV No.	371220	Ref. No.	—
reducer TP flow rate 3l/min red tolerance ±15%				
	GEV No.	371221	Ref. No.	—
reducer TP flow rate 5.5l/min yellow tolerance ±15%				
	GEV No.	371222	Ref. No.	—
reducer TP flow rate 6l/min grey tolerance ±15%				
	GEV No.	371223	Ref. No.	—
reducer TP flow rate 10l/min white tolerance ±15%				
	GEV No.	371224	Ref. No.	—
reducer TP flow rate 12l/min bronze tolerance ±15%				
	GEV No.	371225	Ref. No.	—
reducer TP flow rate 16l/min light brown tolerance ±15%				
	GEV No.	371226	Ref. No.	—
reducer TP flow rate 20l/min red tolerance ±15%				
	GEV No.	371230	Ref. No.	—
reducer TP flow rate 0.25l/min red tolerance ±25%				
	GEV No.	371231	Ref. No.	—
reducer TP flow rate 0.35l/min violet tolerance ±25%				
	GEV No.	371232	Ref. No.	—
reducer TP flow rate 0.5l/min orange tolerance ±25%				

accessories for 370020				
	GEV No.	371233	Ref. No.	—
reducer TP flow rate 0.8l/min white tolerance ±25%				
	GEV No.	371234	Ref. No.	—
reducer TP flow rate 1l/min light blue tolerance ±25%				
	GEV No.	371235	Ref. No.	—
reducer TP flow rate 1.2l/min brown tolerance ±25%				
	GEV No.	371236	Ref. No.	—
reducer TP flow rate 1.5l/min light brown tolerance ±25%				
	GEV No.	371237	Ref. No.	—
reducer TP flow rate 2.5l/min yellow tolerance ±25%				
	GEV No.	371238	Ref. No.	—
reducer TP flow rate 3.4l/min dark green tolerance ±25%				
	GEV No.	371239	Ref. No.	—
reducer TP flow rate 5l/min black tolerance ±25%				
	GEV No.	371240	Ref. No.	—
reducer TP flow rate 8l/min blue tolerance ±20%				









































 				
1				
GEV No.	370015	Ref. No.	634085	
description	solenoid valve single angled 230VAC inlet 3/4" outlet 11.5mm DN10 TP			
accessories for 370015				
	GEV No.	371220	Ref. No.	—
reducer TP flow rate 3l/min red tolerance ±15%				
	GEV No.	371221	Ref. No.	—
reducer TP flow rate 5.5l/min yellow tolerance ±15%				
	GEV No.	371222	Ref. No.	—
reducer TP flow rate 6l/min grey tolerance ±15%				
	GEV No.	371223	Ref. No.	—
reducer TP flow rate 10l/min white tolerance ±15%				
	GEV No.	371224	Ref. No.	—
reducer TP flow rate 12l/min bronze tolerance ±15%				
	GEV No.	371225	Ref. No.	—
reducer TP flow rate 16l/min light brown tolerance ±15%				
	GEV No.	371226	Ref. No.	—
reducer TP flow rate 20l/min red tolerance ±15%				
	GEV No.	371230	Ref. No.	—
reducer TP flow rate 0.25l/min red tolerance ±25%				

Table continues overleaf



accessories for		370015		
	GEV No.	371231	Ref. No.	—
reducer TP flow rate 0.35l/min violet tolerance ±25%				
	GEV No.	371232	Ref. No.	—
reducer TP flow rate 0.5l/min orange tolerance ±25%				
	GEV No.	371233	Ref. No.	—
reducer TP flow rate 0.8l/min white tolerance ±25%				
	GEV No.	371234	Ref. No.	—
reducer TP flow rate 1l/min light blue tolerance ±25%				
	GEV No.	371235	Ref. No.	—
reducer TP flow rate 1.2l/min brown tolerance ±25%				
	GEV No.	371236	Ref. No.	—
reducer TP flow rate 1.5l/min light brown tolerance ±25%				
	GEV No.	371237	Ref. No.	—
reducer TP flow rate 2.5l/min yellow tolerance ±25%				
	GEV No.	371238	Ref. No.	—
reducer TP flow rate 3.4l/min dark green tolerance ±25%				
	GEV No.	371239	Ref. No.	—
reducer TP flow rate 5l/min black tolerance ±25%				
	GEV No.	371240	Ref. No.	—
reducer TP flow rate 8l/min blue tolerance ±20%				

  <p>1</p>				
GEV No.	370016	Ref. No.	23458	
description	solenoid valve single angled 230VAC inlet 3/4" outlet 14mm DN10 TP			
spare parts for	370016			
	GEV No.	371013	Ref. No.	—
solenoid coil TP 230VAC 50/60Hz				
accessories for	370016			
	GEV No.	371220	Ref. No.	—
reducer TP flow rate 3l/min red tolerance ±15%				
	GEV No.	371221	Ref. No.	—
reducer TP flow rate 5.5l/min yellow tolerance ±15%				
	GEV No.	371222	Ref. No.	—
reducer TP flow rate 6l/min grey tolerance ±15%				
	GEV No.	371223	Ref. No.	—
reducer TP flow rate 10l/min white tolerance ±15%				
	GEV No.	371224	Ref. No.	—
reducer TP flow rate 12l/min bronze tolerance ±15%				

accessories for		370016		
	GEV No.	371225	Ref. No.	—
reducer TP flow rate 16l/min light brown tolerance ±15%				
	GEV No.	371226	Ref. No.	—
reducer TP flow rate 20l/min red tolerance ±15%				
	GEV No.	371230	Ref. No.	—
reducer TP flow rate 0.25l/min red tolerance ±25%				
	GEV No.	371231	Ref. No.	—
reducer TP flow rate 0.35l/min violet tolerance ±25%				
	GEV No.	371232	Ref. No.	—
reducer TP flow rate 0.5l/min orange tolerance ±25%				
	GEV No.	371233	Ref. No.	—
reducer TP flow rate 0.8l/min white tolerance ±25%				
	GEV No.	371234	Ref. No.	—
reducer TP flow rate 1l/min light blue tolerance ±25%				
	GEV No.	371235	Ref. No.	—
reducer TP flow rate 1.2l/min brown tolerance ±25%				
	GEV No.	371236	Ref. No.	—
reducer TP flow rate 1.5l/min light brown tolerance ±25%				
	GEV No.	371237	Ref. No.	—
reducer TP flow rate 2.5l/min yellow tolerance ±25%				
	GEV No.	371238	Ref. No.	—
reducer TP flow rate 3.4l/min dark green tolerance ±25%				
	GEV No.	371239	Ref. No.	—
reducer TP flow rate 5l/min black tolerance ±25%				
	GEV No.	371240	Ref. No.	—
reducer TP flow rate 8l/min blue tolerance ±20%				
	GEV No.	503139	Ref. No.	—
solenoid valve filter ø 19.5mm H 16mm				



  <p>1</p>				
GEV No.	370024	Ref. No.	634089	
description	solenoid valve triple angled 230VAC inlet 3/4" outlet 14mm DN10 TP			
spare parts for	370024			
	GEV No.	371013	Ref. No.	—
solenoid coil TP 230VAC 50/60Hz				

Table continues overleaf

accessories for		370024		
	GEV No.	371220	Ref. No.	—
reducer TP flow rate 3l/min red tolerance ±15%				
	GEV No.	371221	Ref. No.	—
reducer TP flow rate 5.5l/min yellow tolerance ±15%				
	GEV No.	371222	Ref. No.	—
reducer TP flow rate 6l/min grey tolerance ±15%				
	GEV No.	371223	Ref. No.	—
reducer TP flow rate 10l/min white tolerance ±15%				
	GEV No.	371224	Ref. No.	—
reducer TP flow rate 12l/min bronze tolerance ±15%				
	GEV No.	371225	Ref. No.	—
reducer TP flow rate 16l/min light brown tolerance ±15%				
	GEV No.	371226	Ref. No.	—
reducer TP flow rate 20l/min red tolerance ±15%				
	GEV No.	371230	Ref. No.	—
reducer TP flow rate 0.25l/min red tolerance ±25%				
	GEV No.	371231	Ref. No.	—
reducer TP flow rate 0.35l/min violet tolerance ±25%				
	GEV No.	371232	Ref. No.	—
reducer TP flow rate 0.5l/min orange tolerance ±25%				
	GEV No.	371233	Ref. No.	—
reducer TP flow rate 0.8l/min white tolerance ±25%				
	GEV No.	371234	Ref. No.	—
reducer TP flow rate 1l/min light blue tolerance ±25%				
	GEV No.	371235	Ref. No.	—
reducer TP flow rate 1.2l/min brown tolerance ±25%				
	GEV No.	371236	Ref. No.	—
reducer TP flow rate 1.5l/min light brown tolerance ±25%				
	GEV No.	371237	Ref. No.	—
reducer TP flow rate 2.5l/min yellow tolerance ±25%				
	GEV No.	371238	Ref. No.	—
reducer TP flow rate 3.4l/min dark green tolerance ±25%				
	GEV No.	371239	Ref. No.	—
reducer TP flow rate 5l/min black tolerance ±25%				
	GEV No.	371240	Ref. No.	—
reducer TP flow rate 8l/min blue tolerance ±20%				

solenoid valves with reducers



GEV No.	370255	Ref. No.	914135
description	solenoid valve triple angled 230VAC inlet 3/4" outlet 11.5mm plastic		



GEV No.	370250	Ref. No.	147723
description	solenoid valve triple straight 230VAC inlet 3/4" outlet 11.5mm t.max. 90°C TP plastic output B 0.25l/min flow regulating valve outlet B red		

various



GEV No.	370726	Ref. No.	2002183H BAAN1191877 BAAN1321764
description	solenoid valve double straight 220-240VAC inlet 11mm outlet 11mm MILANO plastic output B red		

metal

ASCO

spare parts and accessories

O-rings



GEV No.	371095	Ref. No.	2001374H BAAN1121434 BAAN1321069
description	O-ring Viton thickness 1.78mm ID ø 6.07mm Qty 1 pcs		



solenoid valves (various)



1			
GEV No.	370665	Ref. No.	1049474 BAANSB10018
description	solenoid valve 2-ways 24VAC inlet 1/8" outlet 1/8" connection male faston 6.3mm L 31mm Olab type series 6000-9000 coil type 6000BH/B1-FN 50/60Hz brass		

drain valves



1			
GEV No.	371107	Ref. No.	2000039
description	drain valve 24V 50/60Hz single inlet 50mm outlet 50mm		

Solenoid valve - accessories



1			
GEV No.	371095	Ref. No.	2001374H BAAN1121434 BAAN1321069
description	O-ring Viton thickness 1.78mm ID ø 6.07mm Qty 1 pcs		

ball valves electric



1			
GEV No.	401190	Ref. No.	314359
description	ball valve inlet 3/4" IT outlet 3/4" IT IP42 230V L 68mm 50/60Hz closed off-current mode of operation electric connection cable 300mm 3.5W duty cycle 50%		

pressure switches

for warewashing

ø 58mm with male faston 6.3mm

with connection horizontal



1			
GEV No.	541002	Ref. No.	2001959H 3682E BAAN1321578 BAAN305626
description	pressure control pressure range 110/60mbar connection 6mm ø 58mm pressure connection horizontal warewashing pressure connection ø 6mm		



1			
GEV No.	541105	Ref. No.	2001546H 5915E
description	pressure control pressure range 180/70mbar connection 6mm ø 58mm pressure connection horizontal warewashing		

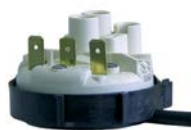



1			
GEV No.	541039	Ref. No.	2002189h
description	pressure control pressure range 45/25mbar connection 6mm ø 58mm pressure connection horizontal warewashing		



1			
GEV No.	541013	Ref. No.	5849E BAAN1322979 BAAN307872
description	pressure control pressure range 55/25mbar connection 6mm ø 58mm pressure connection horizontal warewashing		



			
1			
GEV No.	541003	Ref. No.	5627E
description	pressure control pressure range 55/35mbar connection 6mm ø 58mm pressure connection horizontal warewashing pressure connection ø 6mm		

			
1			
GEV No.	541165	Ref. No.	901300
description	pressure control pressure range 60/30mbar connection 6mm ø 58mm pressure connection horizontal warewashing pressure connection ø 6mm		

			
1			
GEV No.	541017	Ref. No.	901300 BAAN1323202 BAAN311635
description	pressure control with mounting strap pressure range 40/20mbar connection 6mm ø 58mm pressure connection horizontal warewashing		

compressors

CUBIGEL

R404a/R507

HMBP monophase

High/Medium evaporation temperature above -20/-15 °C

			
1			
GEV No.	605029	Ref. No.	653185
description	compressor coolant R404a/R507 type MP12RB 220-240V 50Hz HMBP fully hermetic 13.5kg 1/2HP cylinder capacity 12cm³ CSR H 203.6mmW 561W 734W 933W 1157W 1407W 1681W 1982WW test method ASHRAE ambient temperature max. 43°C		

fans



axial fans

ebm-papst

				
1				
GEV No.	601030 ¹	Ref. No.	780002656	
description	axial fan L 119mm W 119mm H 38mm 230VAC 50Hz 18W bearing ball bearing manuf. no. 4656Z metal connection male faston 2.8mm ebm-papst fan wheel ø 110mm temp.-resist. 75°C			
accessories for	601030			
	GEV No.	550898	Ref. No.	—
	connecting cable cable length 2000mm connection F 2.8 connection distance 7.9mm for axial flow fan			
	GEV No.	692497	Ref. No.	—
	guard ø 105mm mounting distance 150mm for axial fan ebm-papst-mm			

¹with ball bearings

import

				
1				
GEV No.	601080 ¹	Ref. No.	304194 780002656 906107 BAAN167195 BAAN312100	
description	axial fan L 119mm W 119mm H 38mm 230VAC 50/60Hz 23/20W bearing ball bearing connection male faston 2.8mm metal ADDA fan wheel ø 110mm temp.-resist. 70°C			
accessories for	601080			
	GEV No.	550898	Ref. No.	—
	connecting cable cable length 2000mm connection F 2.8 connection distance 7.9mm for axial flow fan			
	GEV No.	692519	Ref. No.	—
	guard L 120mm W 120mm plastic			

¹with ball bearings

refrigeration fans





refrigeration motors universal

ELCO

N series - multi fit





1

GEV No.	601430	Ref. No.	2010063 BAAN1054982 S158P15
description	fan motor ELCO 5W 230V 50/60Hz bearing slide bearing L1 48mm L2 52mm L3 79.5mm W 83mm connection cable 500mm 1300/1550rpm 5 mounting options VNT5-13/027		
spare parts for	601430		
	GEV No.	560140	Ref. No. —
	hexagonal nut thread M4 H 4.8mm SS WS 7 Qty 20 pcs DIN/ISO DIN 985 self-locking		
	GEV No.	560332	Ref. No. —
	plain washer ID ø 4.3mm ED ø 9mm thickness 0.8mm SS Qty 1 pcs		
	GEV No.	560340	Ref. No. —
	hexagonal nut thread M4 H 3.2mm WS 7 SS DIN/ISO DIN 934 / ISO 4032/8673 Qty 1 pcs		
	GEV No.	601413	Ref. No. —
	fixing plate suitable for fanwheel ED ø 32mm shaft ø 7 mounting distance 26mm		

cooling motors (complete)



1

GEV No.	601280	Ref. No.	N/A
description	fan 230V 5W 50/60Hz fan wheel ø 172mm		
spare parts for	601280		
	GEV No.	601020	Ref. No. —
	fan motor 5W 230V 50-60Hz L1 44mm L2 48mm L3 79mm W 84mm cable length 500mm 1300rpm YZF5-13-18/26 5 mounting options bearing slide bearing		
	GEV No.	601069	Ref. No. —
	fan wheel sucking ø 172mm turn direction left fan wheel mounting 25.4mm blade angle 25° W 32mm aluminium		

cross flow fans

COPREL

with standard coil



1



GEV No.	602060	Ref. No.	304229
description	cross flow fan COPREL FFR roller ø 60mm roller length 240mm laminated core thickness 20mm motor position right 230V/50-60Hz 33W universal bearing silicone connection male faston 6.3mm airflow 149m³/h -10 up to +60°C		

cross flow fan with heater battery

roller diameter ø60mm



1

GEV No.	601027	Ref. No.	135557 304237 BAAN171121 BAAN304749
description	cross flow fan roller length 180mm roller ø 60mm motor position right 230V 50Hz 17W heat output 2000W bearing silicone cable length 200mm with temperature limiter 125°C		
spare parts for	601027		
	GEV No.	375095	Ref. No. —
	bi-metal thermostat hole distance 18mm switch-off temp. 105°C 1NC 1-pole 16A connection F6.3 2 hole fixing		
	GEV No.	375911	Ref. No. —
	bi-metal thermostat switch-off temp. 125°C 1NC 1-pole for cross flow fan		

hot air motors



1

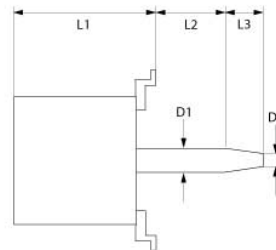

GEV No.	500812	Ref. No.	71251E
description	fan motor 220-240/380-415V 3 phase 50Hz 0.26kW 1440rpm speeds 1 D1 ø 17mm D2 ø 13.5mm		

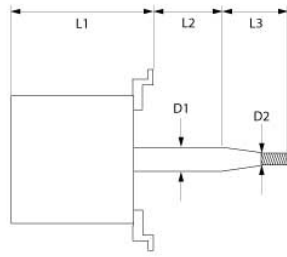

1

GEV No.	499206	Ref. No.	304267 BAAN1050261 BAAN1051644
description	fan motor 230/400V 3 phase 50/60Hz 0.12kW 1400/1700rpm speeds 2 L1 145mm L2 30mm L3 25mm D1 ø 17mm D2 ø 14mm M6 1.2/0.7A suitable capacitor 16µF/450V Cos(fi) 0.53 type 1079TH		

hot air fans

ebm-papst



1

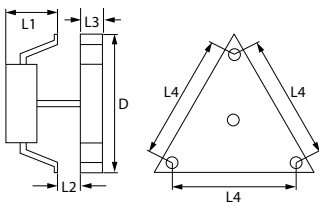

GEV No.	601267	Ref. No.	645457
description	hot air fan 230V 32W 0.27A L1 60mm L2 50mm L3 20mm L4 157mm fan wheel ø 150mm ebm-papst type R2K150-0020A9		

motors

gear motors

for dishwashers



1

GEV No.	601861	Ref. No.	2001419H BAAN1121764 BAAN1321110
description	gear motor FIR type 71-B5 180W 400V voltage AC 50/60Hz 3 phase 900/1100rpm shaft ø 14mm L 227mm for transport system without gearbox		

pumps

wash and rinse pumps

FIR

pumps



1







GEV No.	499079	Ref. No.	5519E	
description	pump inlet ø 28mm outlet ø 26mm type 2211.1610 220-240V 50Hz 1 phase 0.07kW 0.1HP rotation direction left capacitor 5µF FIR			
spare parts for	499079			
	GEV No.	365017	Ref. No.	2000001 304269
	operating capacitor capacity 5µF 450V tolerance 5% 50/60Hz ambient temperature max. -25 to +85°C ø 28mm L 54mm M8 plastic connection male faston 6.3mm 16.10.08 protection			
	GEV No.	510384	Ref. No.	—
	pump cover inlet ø 28mm outlet ø 26mm ø 100mm ID ø 76mm			
	GEV No.	510695	Ref. No.	—
	mechanical shaft seal height counter ring 5.5mm ID ø 11mm			
	GEV No.	521203	Ref. No.	—
	impellor ø 72mm H 18mm thread M7 shaft ø 11mm shaft length 32mm blades 3			

Table continues overleaf









spare parts for 499079				
	GEV No.	521703	Ref. No.	—
pump cover gasket EPDM thickness 2.5mm ID ø 75mm Qty 1 pcs				









1	GEV No.	502287	Ref. No.	2001420H 904562
description	pump inlet ø 30mm outlet ø 26mm type 5213.4050 230/400V 50Hz 3 phase 0.11kW 0.15HP L 200mm rotation direction left			
spare parts for 502287				
	GEV No.	699372	Ref. No.	—
flange for pump with cover type 5213 L 103mm W 103mm H 69mm				







1	GEV No.	500598	Ref. No.	904135 904156 BAAN1020463 BAAN1323244
description	pump inlet ø 30mm outlet ø 26mm type 5213E2450 230V 50Hz 1 phase 0.22kW 0.1HP L 190mm rotation direction left capacitor 5µF FIR			
spare parts for 500598				
	GEV No.	365017	Ref. No.	2000001 304269
operating capacitor capacity 5µF 450V tolerance 5% 50/60Hz ambient temperature max. -25 to +85°C ø 28mm L 54mm M8 plastic connection male faston 6.3mm 16.10.08 protection				
	GEV No.	502265	Ref. No.	—
pump cover inlet ø 30mm outlet ø 26mm ID ø 89mm inner height 35mm				
	GEV No.	510695	Ref. No.	—
mechanical shaft seal height counter ring 5.5mm ID ø 11mm				

spare parts for 500598				
	GEV No.	521203	Ref. No.	—
impellor ø 72mm H 18mm thread M7 shaft ø 11mm shaft length 32mm blades 3				
	GEV No.	532718	Ref. No.	—
O-ring EPDM thickness 4mm ID ø 80mm Qty 1 pcs				
	GEV No.	699372	Ref. No.	—
flange for pump with cover type 5213 L 103mm W 103mm H 69mm				







1	GEV No.	500038	Ref. No.	54103
description	pump inlet ø 45mm outlet ø 40mm type 3911.1425 230V 50Hz 1 phase 0.55kW 0.75HP L 205mm rotation direction right capacitor 10µF FIR			
spare parts for 500038				
	GEV No.	365015	Ref. No.	—
operating capacitor capacity 10µF 400V tolerance 5%Hz ambient temperature max. -25 to +85°C ø 35.5mm L 59mm M8 plastic connection male faston 6.3mm protection				
	GEV No.	510508	Ref. No.	—
pump cover FIR inlet ø 45mm outlet ø 40mm pump type PU 0.5/3911 turn direction right ø 160mm ID ø 125mm inner height 25mm				
	GEV No.	510610	Ref. No.	3203E
impellor ø 95.5mm H 23mm shaft intake ø 9/8mm rotation direction right seat ø 16mm blades 6				
	GEV No.	510692	Ref. No.	3291E
mechanical shaft seal for shaft ø 11mm slide ring ext. ø 24mm slide ring H 13mm counter ring mounting ø 26mm height counter ring 8mm counter ring int. ø 14mm				
	GEV No.	521702	Ref. No.	—
pump cover gasket thickness 3.5x4.5mm Qty 1 pcs				
accessories for 500038				
	GEV No.	551286	Ref. No.	—
adapter L 120mm 4-pole for Meiko pump suitable for 500038 plug type dependent on equipment				





GEV No.	499281	Ref. No.	2002416H
description	pump inlet \varnothing 60mm outlet \varnothing 50mm type 4298.1404 230V 50Hz 1 phase 1.1kW L 210mm rotation direction right capacitor 12.5 μ F FIR		
spare parts for	499281		
	GEV No.	365014	Ref. No. —
	operating capacitor capacity 12.5 μ F 450V tolerance 5%Hz ambient temperature max. -25 to +85°C \varnothing 35mm L 70mm M8 plastic connection male faston 6.3mm 45S.C3DS.12.5 protection		
	GEV No.	510600	Ref. No. —
	impellor \varnothing 102mm H 29mm shaft intake \varnothing 9/8mm rotation direction right blades 6		
	GEV No.	510692	Ref. No. 3291E
	mechanical shaft seal for shaft \varnothing 11mm slide ring ext. \varnothing 24mm slide ring H 13mm counter ring mounting \varnothing 26mm height counter ring 8mm counter ring int. \varnothing 14mm		
	GEV No.	521702	Ref. No. —
	pump cover gasket thickness 3.5x4.5mm Qty 1 pcs		



GEV No.	499334	Ref. No.	2001896H BAAN1321521
description	pump inlet \varnothing 62mm outlet \varnothing 62mm type 2250.2731 230/400V 50Hz 1 phase 3kW FIR		
spare parts for	499334		
	GEV No.	510687	Ref. No. 1443E 2001952H
	mechanical shaft seal for shaft \varnothing 18mm height counter ring 8mm ID \varnothing 17mm ED \varnothing 39mm H 15mm mounting \varnothing 42mm int. \varnothing 1 21mm		
	GEV No.	512455	Ref. No. —
	fan wheel \varnothing 155mm H 18mm shaft intake \varnothing 18mm plastic blades 12		
	GEV No.	521026	Ref. No. N/A
	pump cover gasket ID \varnothing 182.5mm thickness 5x4.5mm		





spare parts for	499334		
	GEV No.	521028	Ref. No. —
	pump cover FIR inlet \varnothing 62mm outlet \varnothing 62mm turn direction right \varnothing 215mm ID \varnothing 175mm inner height 40mm		
	GEV No.	521277	Ref. No. —
	impellor \varnothing 135mm H 39mm pump type Fir 2275 - 3.6HP thread M14L		



GEV No.	499139	Ref. No.	1244732 30827 BAAN1322558 BAAN304815
description	pump inlet \varnothing 62mm outlet \varnothing 62mm type 2275.2722 230/400V 50Hz 3 phase 2.6kW L 400mm rotation direction right FIR		
spare parts for	499139		
	GEV No.	510687	Ref. No. 1443E 2001952H
	mechanical shaft seal for shaft \varnothing 18mm height counter ring 8mm ID \varnothing 17mm ED \varnothing 39mm H 15mm mounting \varnothing 42mm int. \varnothing 1 21mm		
	GEV No.	521026	Ref. No. N/A
	pump cover gasket ID \varnothing 182.5mm thickness 5x4.5mm		
	GEV No.	521028	Ref. No. —
	pump cover FIR inlet \varnothing 62mm outlet \varnothing 62mm turn direction right \varnothing 215mm ID \varnothing 175mm inner height 40mm		
	GEV No.	521277	Ref. No. —
	impellor \varnothing 135mm H 39mm pump type Fir 2275 - 3.6HP thread M14L		
	GEV No.	524676	Ref. No. —
	fan wheel \varnothing 160mm shaft intake \varnothing 24mm plastic blades 12 W 30mm		







1

GEV No.	500323	Ref. No.	904034 BAAN1029470 BAAN1323230
description	pump inlet ø 63mm outlet ø 47mm type 1227.2721 230/400V 50Hz 3 phase 2kW 2.7HP L 335mm rotation direction right FIR		
spare parts for	500323		
	GEV No.	510599	Ref. No. —
	impellor ø 123mm H 34mm M8L		
	GEV No.	510693	Ref. No. 1475E
	mechanical shaft seal for shaft ø 12mm slide ringext. ø 24mm slide ring H 15.5mm slide ring int. ø 11mm counter ring mounting ø 24mm height counter ring 8mm counter ring int. ø 13.5mm		
	GEV No.	521513	Ref. No. —
	pump cover FIR inlet ø 63mm outlet ø 47mm turn direction right ID ø 150mm inner high 32mm		
	GEV No.	524416	Ref. No. —
	pump cover gasket thickness 4x4mm Qty 1 pcs		







1

GEV No.	500117	Ref. No.	2001980H BAAN1321601 BAAN307942
description	pump inlet ø 63mm outlet ø 47mm type 4225.22725 230/400V 50Hz 3 phase 1.4kW 2HP L 280mm rotation direction right FIR		
spare parts for	500117		
	GEV No.	510602	Ref. No. —
	impellor ø 110mm H 34mm rotation direction right thread M8L shaft ø 28mm seat ø 12.2mm blades 6		

spare parts for	500117		
	GEV No.	510693	Ref. No. 1475E
	mechanical shaft seal for shaft ø 12mm slide ringext. ø 24mm slide ring H 15.5mm slide ring int. ø 11mm counter ring mounting ø 24mm height counter ring 8mm counter ring int. ø 13.5mm		
	GEV No.	521513	Ref. No. —
	pump cover FIR inlet ø 63mm outlet ø 47mm turn direction right ID ø 150mm inner high 32mm		
	GEV No.	524416	Ref. No. —
	pump cover gasket thickness 4x4mm Qty 1 pcs		







1

GEV No.	500570	Ref. No.	2001423H 5901E
description	pump inlet ø 63mm outlet ø 47mm type 422512725 230/400V 50Hz 3 phase 1.1kW 1.5HP L 285mm rotation direction right FIR		
spare parts for	500570		
	GEV No.	510693	Ref. No. 1475E
	mechanical shaft seal for shaft ø 12mm slide ringext. ø 24mm slide ring H 15.5mm slide ring int. ø 11mm counter ring mounting ø 24mm height counter ring 8mm counter ring int. ø 13.5mm		
	GEV No.	521082	Ref. No. —
	impellor ø 96mm H 32mm rotation direction right thread M8L		
	GEV No.	521513	Ref. No. —
	pump cover FIR inlet ø 63mm outlet ø 47mm turn direction right ID ø 150mm inner high 32mm		
	GEV No.	524416	Ref. No. —
	pump cover gasket thickness 4x4mm Qty 1 pcs		



1



GEV No.	500258	Ref. No.	91369308
description	pump inlet ø 63mm outlet ø 53mm type 1204.2725 230/400V 50Hz 3 phase 1.5kW 2.01HP L 320mm rotation direction left FIR		
spare parts for	500258		
	GEV No.	510531	Ref. No. 1474E BAAN1320522 BAAN302263
	pump cover FIR inlet ø 63mm outlet ø 53mm auxiliary pressure connection M16x1.5mm supporting pressure open turn direction left ø 185mm ID ø 150mm inner height 37mm		
	GEV No.	510604	Ref. No. —
	impeller ø 118mm H 34mm M8R rotation direction left		
	GEV No.	510693	Ref. No. 1475E
	mechanical shaft seal for shaft ø 12mm slide ring ext. ø 24mm slide ring H 15.5mm slide ring int. ø 11mm counter ring mounting ø 24mm height counter ring 8mm counter ring int. ø 13.5mm		
	GEV No.	511667	Ref. No. —
	fan wheel ø 123mm H 17mm shaft intake ø 15mm		
	GEV No.	524416	Ref. No. —
	pump cover gasket thickness 4x4mm Qty 1 pcs		

HANNING

pumps



1

GEV No.	499284	Ref. No.	314361
description	pump inlet ø 28mm outlet ø 26mm type UP60-321 Ru. 220-240V 50Hz 1 phase 0.27kW L 190mm rotation direction right capacitor 5µF HANNING		
spare parts for	499284		
	GEV No.	365017	Ref. No. 2000001 304269
	operating capacitor capacity 5µF 450V tolerance 5% 50/60Hz ambient temperature max. -25 to +85°C ø 28mm L 54mm M8 plastic connection male faston 6.3mm 16.10.08 protection		
	GEV No.	507558	Ref. No. —
	mechanical shaft seal for shaft ø 7mm height counter ring 5mm ID ø 6.75mm ED ø 20mm mounting ø counter ring 18.5/slide ring 20mm		
	GEV No.	532644	Ref. No. —
	O-ring EPDM thickness 3mm ID ø 78mm Qty 1 pcs		

LGB



1





GEV No.	499099	Ref. No.	2002220H
description	pump inlet ø 28mm outlet ø 26mm type CRC-R DX 230V 50Hz 1 phase 0.2kW L 175mm rotation direction left capacitor 4µF LGB		
spare parts for	499099		
	GEV No.	365031	Ref. No. —
	operating capacitor capacity 4µF 450V tolerance 5% 50/60Hz ambient temperature max. -25 to +85°C ø 31mm L 58mm M8 plastic connection male faston 6.3mm protection		
	GEV No.	509002	Ref. No. —
	O-ring EPDM thickness 2.62mm ID ø 82.22mm Qty 1 pcs		
	GEV No.	510703	Ref. No. —
	mechanical shaft seal for shaft ø 13mm slide ring H 13mm height counter ring 5.5mm ED ø 26mm		
	GEV No.	521091	Ref. No. —
	pump cover LGB inlet ø 28mm outlet ø 26mm pump type CRC-R DX		

Table continues overleaf







spare parts for 499099			
	GEV No.	521092	Ref. No. —
impellor ø 80mm H 25mm pump type CRC-R DX thread M6R shaft ø 13mm shaft length 20mm			



1	GEV No.	500156	Ref. No.	2001513H
	description	pump inlet ø 50mm outlet ø 50mm type ZF400SX 230V 50Hz 1 phase 0.6kW 0.8HP L 210mm rotation direction right capacitor 16µF LGB		
	spare parts for	500156		
	GEV No.	509020	Ref. No.	—
impellor ø 104mm H 25mm M8L				
	GEV No.	510703	Ref. No.	—
mechanical shaft seal for shaft ø 13mm slide ring H 13mm height counter ring 5.5mm ED ø 26mm				
	GEV No.	521548	Ref. No.	—
pump cover LGB inlet ø 50mm outlet ø 50mm				
	GEV No.	521734	Ref. No.	—
pump cover bottom part				
	GEV No.	523509	Ref. No.	—
deep-groove ball bearing type 6201-2RS shaft ø 12mm ED ø 32mm W 10mm with sealing discs deep-groove ball bearing DIN 625-1				
	GEV No.	532623	Ref. No.	—
O-ring EPDM thickness 2.62mm ID ø 120.32mm Qty 1 pcs				
accessories for 500156				
	GEV No.	365021	Ref. No.	2001118H 304259
operating capacitor capacity 16µF 425V tolerance 5% 50/60Hz ambient temperature max. -25 to +85°C ø 35mm L 73mm single M8 plastic connection male faston 6.3mm 416.10.99 protection				









1	GEV No.	500361	Ref. No.	2001517H
	description	pump inlet ø 60mm outlet ø 49mm type ZF400SX 230V 50Hz 1 phase 0.8kW 1HP L 210mm rotation direction right capacitor 16µF LGB		
	spare parts for	500361		
	GEV No.	365021	Ref. No.	2001118H 304259
operating capacitor capacity 16µF 425V tolerance 5% 50/60Hz ambient temperature max. -25 to +85°C ø 35mm L 73mm single M8 plastic connection male faston 6.3mm 416.10.99 protection				
	GEV No.	509020	Ref. No.	—
impellor ø 104mm H 25mm M8L				
	GEV No.	510703	Ref. No.	—
mechanical shaft seal for shaft ø 13mm slide ring H 13mm height counter ring 5.5mm ED ø 26mm				
	GEV No.	521547	Ref. No.	—
pump cover LGB inlet ø 60mm outlet ø 50mm supporting pressure M8 turn direction right ø 160mm ID ø 127mm inner hight 36mm				
	GEV No.	532623	Ref. No.	—
O-ring EPDM thickness 2.62mm ID ø 120.32mm Qty 1 pcs				



1			
GEV No.	500733	Ref. No.	2001424H
description	pump inlet ø 63mm outlet ø 48mm type AM5225SX 230/400V 50Hz 3 phase 0.9kW 1.2HP L 300mm rotation direction right LGB		







1			
GEV No.	499119	Ref. No.	2001302H
description	pump inlet ø outlet ø 38mm type RV54 230V 50Hz 1 phase 0.8kW L 380mm rotation direction right capacitor 16µF LGB with holder		
spare parts for	499119		
	GEV No.	365021	Ref. No. 2001118H 304259
	operating capacitor capacity 16µF 425V tolerance 5% 50/60Hz ambient temperature max. -25 to +85°C ø 35mm L 73mm single M8 plastic connection male faston 6.3mm 416.10.99 protection		
	GEV No.	502280	Ref. No. —
	pump sump LGB auxiliary pressure connection 7mm supporting pressure closed pump type RV54		
	GEV No.	510703	Ref. No. —
	mechanical shaft seal for shaft ø 13mm slide ring H 13mm height counter ring 5.5mm ED ø 26mm		
	GEV No.	521234	Ref. No. —
	impellor thread M8L ED ø 93mm W 16mm		
	GEV No.	523509	Ref. No. —
	deep-groove ball bearing type 6201-2RS shaft ø 12mm ED ø 32mm W 10mm with sealing discs deep-groove ball bearing DIN 625-1		

spare parts for	499119		
	GEV No.	532537	Ref. No. —
	O-ring EPDM thickness 3.53mm ID ø 113.9mm Qty 1 pcs		

OLYMPIA
pumps



1			
GEV No.	500003	Ref. No.	5591E BAAN307645
description	pump inlet ø 45mm outlet ø 32mm type T30 230V 50Hz 1 phase 0.29kW 0.39HP L 190mm rotation direction right capacitor 8µF OLYMPIA		
spare parts for	500003		
	GEV No.	365013	Ref. No. 3709E
	operating capacitor capacity 8µF 400V tolerance 5%Hz ambient temperature max. -25 to +85°C ø 31.5mm L 55mm M8 plastic connection male faston 6.3mm protection		
	GEV No.	510512	Ref. No. 5618E
	pump cover OLYMPIA inlet ø 45mm outlet ø 31mm outlet 2 ø 24 turn direction right ø 130mm ID ø 124mm inner height 20mm		
	GEV No.	510554	Ref. No. 1255E 3710E 5620E BAAN301931
	O-ring EPDM thickness 2mm ID ø 120mm Qty 1 pcs		
	GEV No.	510615	Ref. No. 5617E 5619E BAAN307734
	impellor ø 90mm H 22mm rotation direction right thread M10L blades 4		
	GEV No.	510693	Ref. No. 1475E
	mechanical shaft seal for shaft ø 12mm slide ring ext. ø 24mm slide ring H 15.5mm slide ring int. ø 11mm counter ring mounting ø 24mm height counter ring 8mm counter ring int. ø 13.5mm		



drain pumps

ASKOLL



GEV No.	500210	Ref. No.	2001519H BAAN1121142 BAAN1321210
description	drain pump 230V 40W		



GEV No.	500214	Ref. No.	2001518H
description	drain pump inlet ø 30mm outlet ø 22mm 230/240V 30W 50Hz ASKOLL type R113		



GEV No.	500346	Ref. No.	2001518H
description	drain pump inlet ø 30mm outlet ø 22mm 230V 40W 50Hz ASKOLL type M231 XP with holder		

HANNING



GEV No.	500573	Ref. No.	2001523H BAAN1121677 BAAN1321214
description	drain pump 30W 4-piece 230V inlet ø 24/30mm outlet ø 24mm 50Hz HANNING type DPS25-032 1x pump, 3x pump cover		

service kits



GEV No.	500573	Ref. No.	2001523H BAAN1121677 BAAN1321214
description	drain pump 30W 4-piece 230V inlet ø 24/30mm outlet ø 24mm 50Hz HANNING type DPS25-032 1x pump, 3x pump cover		

booster pumps II

accessories



GEV No.	365017	Ref. No.	2000001 304269
description	operating capacitor capacity 5µF 450V tolerance 5% 50/60Hz ambient temperature max. -25 to +85°C ø 28mm L 54mm M8 plastic connection male faston 6.3mm 16.10.08 protection		



GEV No.	365012	Ref. No.	2000059
description	operating capacitor capacity 6.3µF 450V tolerance 5% 50Hz ambient temperature max. -25 to +85°C ø 30mm L 61mm M8 plastic connection male faston 6.3mm protection		

condensators & interference suppression filters

operating capacitors

plastic



1

GEV No.	365021	Ref. No.	2001118H 304259
description	operating capacitor capacity 16µF 425V tolerance 5% 50/60Hz ambient temperature max. -25 to +85°C ø 35mm L 73mm single M8 plastic connection male faston 6.3mm 416.10.99 protection		



1

GEV No.	365019	Ref. No.	2001119H
description	operating capacitor capacity 20µF 400V tolerance 5% 50/60Hz ambient temperature max. -25 to +85°C ø 39.5mm L 70mm M8 plastic connection male faston 6.3mm 16.10.25. protection		



1

GEV No.	365017	Ref. No.	2000001 304269
description	operating capacitor capacity 5µF 450V tolerance 5% 50/60Hz ambient temperature max. -25 to +85°C ø 28mm L 54mm M8 plastic connection male faston 6.3mm 16.10.08 protection		



1

GEV No.	365012	Ref. No.	2000059
description	operating capacitor capacity 6.3µF 450V tolerance 5% 50Hz ambient temperature max. -25 to +85°C ø 30mm L 61mm M8 plastic connection male faston 6.3mm protection		



1

GEV No.	365013	Ref. No.	3709E
description	operating capacitor capacity 8µF 400V tolerance 5%Hz ambient temperature max. -25 to +85°C ø 31.5mm L 55mm M8 plastic connection male faston 6.3mm protection		

metal



1

GEV No.	365139	Ref. No.	5843E
description	operating capacitor capacity 10µF 450V tolerance 5% 60Hz ambient temperature max. -25 up to +70°C ø 40mm L 83mm M8 aluminium connection male faston 6.3mm C.87.8BF2 MKP protection		



1

GEV No.	365142	Ref. No.	304259
description	operating capacitor capacity 15µF 450V with metal case tolerance 5% 50/60Hz ø 40mm L 110mm M8x1.25		

fuses

fine fuses



1

GEV No.	358666	Ref. No.	309316
description	fine fuse size ø5x20mm 0.315A fast-acting rated 250V Qty 10 pcs		



1

GEV No.	358530	Ref. No.	2001921H
description	fine fuse size ø5x20mm 0.8A fast-acting rated 250V Qty 10 pcs		



1

GEV No.	358677	Ref. No.	2001981H 2002146H
description	fine fuse size ø5x20mm 4A fast-acting rated 250V Qty 10 pcs		





			
1			
GEV No.	358752	Ref. No.	3090506
description	fine fuse size ø6.3x32mm 10A fast-acting rated 500V Qty 10 pcs		



electric accessories

cables

copper wire			
up to 280°C			
			
1			
GEV No.	550588	Ref. No.	306437
description	copper wire 6mm ² permanent temperature -60 up to +280°C conductor nickel-plated copper wire insulation glass fibre braiding/silicone rubber Qty 10m brown t.max. 350°C rated 300/500V test voltage 2000V		

nickel wire			
up to 350°C			
			
1			
GEV No.	550089	Ref. No.	306435
description	nickel wire 4mm ² brown Qty 10m permanent temperature -60 up to +350°C t.max. 400°C rated 300/500V test voltage 2000V conductor nickel wire insulation glass fibre braiding/silicone rubber		

			
1			
GEV No.	550590	Ref. No.	306437
description	nickel wire 6mm ² brown Qty 10m permanent temperature -60 up to +350°C t.max. 400°C rated 300/500V test voltage 2000V conductor nickel wire insulation glass fibre braiding/silicone rubber		

ribbon cables			
group 1			
			
1			
GEV No.	402970	Ref. No.	2001927H BAAN1027510 BAAN1321548
description	ribbon cable 10-pole L 1200mm plug type 2 row coded Qty 1m		
			
1			
GEV No.	400902	Ref. No.	2001087H
description	ribbon cable 10-pole L 750mm plug type FC-10P raster size 2.54mm		

terminals

connection terminals with screw/faston connections

			
1			
GEV No.	550411	Ref. No.	2001039H 306090 306157 5876E 906154
description	power terminal block 6-pole max. 40A max 450V connection ø6mm ² / F6.3 temp.-resist. 150°C cross section 6mm ²		

gas taps

PEL

21S series















			
1			
GEV No.	101397	Ref. No.	310139 BAAN169423 BAAN304894
description	gas tap PEL type 21S gas inlet M16x1.5 (tube ø 10mm) bypass nozzle ø 0.35mm gas outlet M16x1.5 (tube ø 10/8mm) thermocouple connection M9x1 pilot connection M10x1 shaft ø 8x6.5mm shaft L 22/15mm shaft flat lower		
spare parts for	101397		
	GEV No.	Ref. No.	—
	100408		
	bypass nozzle type PEL20/21 bore ø 0.35mm thread M5x0.5		
	GEV No.	Ref. No.	7473048 BAAN310651
	101060		
	magnet unit standard L 39mm D1 ø 15.4mm D2 ø 11mm suitable for PEL20-21/JUNKERS/EGA		
	GEV No.	Ref. No.	—
	101206		
	gas tap front part shaft ø 8x6.5mm shaft L 22/15mm shaft flat upper/lower suitable for PEL21		
	GEV No.	Ref. No.	—
	101231		
	thermocouple nut T1: M9x1 T2: M18x1		
accessories for	101397		
	GEV No.	Ref. No.	—
	100908		
	union screw thread M10x1 for pipe ø 4mm Qty 1 pcs		
	GEV No.	Ref. No.	—
	100909		
	union screw thread M10x1 for pipe ø 6mm Qty 1 pcs		
	GEV No.	Ref. No.	—
	101246		
	olive for pipe ø 4mm Qty 1 pcs		

Table continues overleaf

accessories for 101397				
	GEV No.	101278	Ref. No.	—
olive for pipe ø 10mm Qty 1 pcs				
	GEV No.	101286	Ref. No.	—
olive ID ø 6mm Qty 1 pcs				
	GEV No.	101300	Ref. No.	—
union nut thread M16x1.5 tube ø 10mm				
	GEV No.	101450	Ref. No.	—
olive for pipe ø 8mm L 12.7mm Qty 1 pcs ED ø 10mm				
	GEV No.	101451	Ref. No.	—
union nut thread M16x1.5 tube ø 8mm				
	GEV No.	110081	Ref. No.	171475
knob ø 70mm shaft ø 8x6.5mm shaft flat universal				
	GEV No.	112206	Ref. No.	—
knob dial plate silver gas tap PEL21/22/23 t.max.°C ED ø 63mm ID ø 45.5mm				

				
1				
GEV No.	106815	Ref. No.	N/A	
description	gas tap PEL type 21S gas inlet M16x1.5 (tube ø 10mm) bypass nozzle ø 0mm gas outlet 2x M10x1 thermocouple connection M9x1 pilot connection M10x1 shaft ø 8x6.5mm shaft L 22/15mm shaft flat upper			
spare parts for	106815			
	GEV No.	101060	Ref. No.	7473048 BAAN310651
magnet unit standard L 39mm D1 ø 15.4mm D2 ø 11mm suitable for PEL20-21/JUNKERS/EGA				
	GEV No.	101206	Ref. No.	—
gas tap front part shaft ø 8x6.5mm shaft L 22/15mm shaft flat upper/lower suitable for PEL21				
	GEV No.	101231	Ref. No.	—
thermocouple nut T1: M9x1 T2: M18x1				
	GEV No.	106202	Ref. No.	—
bypass nozzle type PEL20/21 bore ø 0mm thread M5x0.5				
	GEV No.	106823	Ref. No.	—
gas connection gas inlet M16x1.5 gas outlet 2x M10x1				



























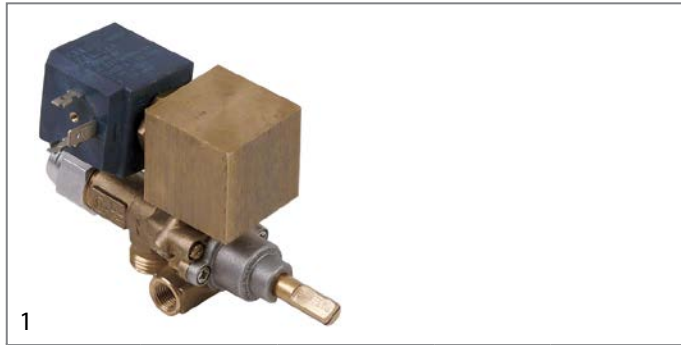

				
1				
GEV No.	106817	Ref. No.	165961 165961SEM BAAN1071350 BAAN1147970	
description	gas tap PEL type 21S gas inlet M16x1.5 (tube ø 10mm) bypass nozzle ø 0mm gas outlet 2x M10x1 thermocouple connection M9x1 pilot connection M10x1 shaft ø 8x6.5mm shaft L 22/15mm shaft flat upper			
spare parts for	106817			
	GEV No.	101060	Ref. No.	7473048 BAAN310651
magnet unit standard L 39mm D1 ø 15.4mm D2 ø 11mm suitable for PEL20-21/JUNKERS/EGA				
	GEV No.	101206	Ref. No.	—
gas tap front part shaft ø 8x6.5mm shaft L 22/15mm shaft flat upper/lower suitable for PEL21				
	GEV No.	101231	Ref. No.	—
thermocouple nut T1: M9x1 T2: M18x1				
	GEV No.	106202	Ref. No.	—
bypass nozzle type PEL20/21 bore ø 0mm thread M5x0.5				
	GEV No.	106819	Ref. No.	—
solenoid valve body				
	GEV No.	106820	Ref. No.	—
solenoid valve connection gas inlet M16x1.5 gas outlet 2x M10x1 thread size valve body M20x1				
	GEV No.	371157	Ref. No.	—
solenoid coil t.max. 125°C 230V seat ø 13mm 17VA				
accessories for	106817			
	GEV No.	100908	Ref. No.	—
union screw thread M10x1 for pipe ø 4mm Qty 1 pcs				
	GEV No.	100909	Ref. No.	—
union screw thread M10x1 for pipe ø 6mm Qty 1 pcs				
	GEV No.	101246	Ref. No.	—
olive for pipe ø 4mm Qty 1 pcs				
	GEV No.	101278	Ref. No.	—
olive for pipe ø 10mm Qty 1 pcs				
	GEV No.	101286	Ref. No.	—
olive ID ø 6mm Qty 1 pcs				
	GEV No.	101300	Ref. No.	—
union nut thread M16x1.5 tube ø 10mm				
	GEV No.	101450	Ref. No.	—
olive for pipe ø 8mm L 12.7mm Qty 1 pcs ED ø 10mm				







Table continues overleaf



accessories for 106817				
	GEV No.	101451	Ref. No.	—
union nut thread M16x1.5 tube ø 8mm				
	GEV No.	110081	Ref. No.	171475
knob ø 70mm shaft ø 8x6.5mm shaft flat universal				
	GEV No.	112206	Ref. No.	—
knob dial plate silver gas tap PEL21/22/23 t.max.°C ED ø 63mm ID ø 45.5mm				



GEV No.	106816	Ref. No.	165962	
description	gas tap PEL type 21S gas inlet M16x1.5 (tube ø 10mm) bypass nozzle ø 0mm gas outlet M10x1 thermocouple connection M9x1 pilot connection M10x1 shaft ø 8x6.5mm shaft L 22/15mm shaft flat upper with solenoid valve with ignition safety device			
spare parts for 106816				
	GEV No.	101060	Ref. No.	7473048 BAAN310651
magnet unit standard L 39mm D1 ø 15.4mm D2 ø 11mm suitable for PEL20-21/JUNKERS/EGA				
	GEV No.	101206	Ref. No.	—
gas tap front part shaft ø 8x6.5mm shaft L 22/15mm shaft flat upper/lower suitable for PEL21				
	GEV No.	101231	Ref. No.	—
thermocouple nut T1: M9x1 T2: M18x1				
	GEV No.	106202	Ref. No.	—
bypass nozzle type PEL20/21 bore ø 0mm thread M5x0.5				
	GEV No.	106819	Ref. No.	—
solenoid valve body				
	GEV No.	106821	Ref. No.	—
solenoid valve connection gas inlet M16x1.5 gas outlet 3/8" thread size valve body M20x1				
	GEV No.	371157	Ref. No.	—
solenoid coil t.max. 125°C 230V seat ø 13mm 17VA				
accessories for 106816				
	GEV No.	100908	Ref. No.	—
union screw thread M10x1 for pipe ø 4mm Qty 1 pcs				
	GEV No.	100909	Ref. No.	—
union screw thread M10x1 for pipe ø 6mm Qty 1 pcs				
	GEV No.	101246	Ref. No.	—
olive for pipe ø 4mm Qty 1 pcs				
	GEV No.	101278	Ref. No.	—
olive for pipe ø 10mm Qty 1 pcs				

accessories for 106816				
	GEV No.	101286	Ref. No.	—
olive ID ø 6mm Qty 1 pcs				
	GEV No.	101300	Ref. No.	—
union nut thread M16x1.5 tube ø 10mm				
	GEV No.	101450	Ref. No.	—
olive for pipe ø 8mm L 12.7mm Qty 1 pcs ED ø 10mm				
	GEV No.	101451	Ref. No.	—
union nut thread M16x1.5 tube ø 8mm				
	GEV No.	110081	Ref. No.	171475
knob ø 70mm shaft ø 8x6.5mm shaft flat universal				
	GEV No.	112206	Ref. No.	—
knob dial plate silver gas tap PEL21/22/23 t.max.°C ED ø 63mm ID ø 45.5mm				









22N/O series				
1				
	GEV No.	101443	Ref. No.	904883
description	gas tap PEL type 22N/O gas inlet M20x1.5 (tube ø 12mm) bypass nozzle ø 0.35mm gas outlet M20x1.5 (tube ø 12/10mm) thermocouple connection pilot connection M10x1 shaft ø 10x8mm shaft L 25/17mm shaft flat lower			
spare parts for 101443				
	GEV No.	100259	Ref. No.	—
bypass nozzle type PEL22 bore ø 0.35mm thread M6x0.5				
	GEV No.	101201	Ref. No.	—
gas tap front part shaft ø 10x8mm shaft L 25/17mm shaft flat upper/lower suitable for PEL22				
	GEV No.	101240	Ref. No.	—
gas connection thread M20x1.5 tube ø 12/10mm for PEL gas taps with gasket and screws horizontal				
	GEV No.	101460	Ref. No.	—
O-ring ø 12.37mm D1 ø 2.62mm suitable for PEL22				
	GEV No.	101461	Ref. No.	—
screw kit suitable for PEL22 Qty 4 pcs				
accessories for 101443				
	GEV No.	100908	Ref. No.	—
union screw thread M10x1 for pipe ø 4mm Qty 1 pcs				
	GEV No.	100909	Ref. No.	—
union screw thread M10x1 for pipe ø 6mm Qty 1 pcs				
	GEV No.	101246	Ref. No.	—
olive for pipe ø 4mm Qty 1 pcs				

Table continues overleaf

accessories for		101443		
GEV No.	101248	Ref. No.	—	
	olive for pipe ø 12mm Qty 1 pcs suitable for PEL			
GEV No.	101249	Ref. No.	—	
	olive for pipe ø 10mm Qty 1 pcs			
GEV No.	101250	Ref. No.	—	
	union nut thread M20x1.5 for pipe ø 10mm			
GEV No.	101251	Ref. No.	—	
	union nut thread M20x1.5 for pipe ø 12mm			
GEV No.	101286	Ref. No.	—	
	olive ID ø 6mm Qty 1 pcs			

22S/O series

<p>1</p>				
GEV No.	101086	Ref. No.	310140 904882 BAAN1209962 BAAN169424 BAAN311840	
description	gas tap PEL type 22S/O gas inlet M20x1.5 (tube ø 12mm) bypass nozzle ø 0.35mm gas outlet M20x1.5 (tube ø 12/10mm) thermocouple connection M9x1 pilot connection M10x1 shaft ø 10x8mm shaft L 25/17mm shaft flat lower			
spare parts for	101086			
GEV No.	100259	Ref. No.	—	
	bypass nozzle type PEL22 bore ø 0.35mm thread M6x0.5			
GEV No.	101058	Ref. No.	309132 BAAN71001E	
	magnet unit L 39mm D1 ø 15.4mm D2 ø 13.5mm suitable for PEL22/ EGA24197 standard			
GEV No.	101201	Ref. No.	—	
	gas tap front part shaft ø 10x8mm shaft L 25/17mm shaft flat upper/ lower suitable for PEL22			
GEV No.	101231	Ref. No.	—	
	thermocouple nut T1: M9x1 T2: M18x1			
GEV No.	101240	Ref. No.	—	
	gas connection thread M20x1.5 tube ø 12/10mm for PEL gas taps with gasket and screws horizontal			
GEV No.	101460	Ref. No.	—	
	O-ring ø 12.37mm D1 ø 2.62mm suitable for PEL22			
GEV No.	101461	Ref. No.	—	
	screw kit suitable for PEL22 Qty 4 pcs			
accessories for		101086		
GEV No.	100908	Ref. No.	—	
	union screw thread M10x1 for pipe ø 4mm Qty 1 pcs			
GEV No.	100909	Ref. No.	—	
	union screw thread M10x1 for pipe ø 6mm Qty 1 pcs			

accessories for		101086		
GEV No.	101241	Ref. No.	—	
	gas connection thread M20x1.5 tube ø 12/10mm for PEL gas taps vertical			
GEV No.	101246	Ref. No.	—	
	olive for pipe ø 4mm Qty 1 pcs			
GEV No.	101248	Ref. No.	—	
	olive for pipe ø 12mm Qty 1 pcs suitable for PEL			
GEV No.	101249	Ref. No.	—	
	olive for pipe ø 10mm Qty 1 pcs			
GEV No.	101250	Ref. No.	—	
	union nut thread M20x1.5 for pipe ø 10mm			
GEV No.	101251	Ref. No.	—	
	union nut thread M20x1.5 for pipe ø 12mm			
GEV No.	101286	Ref. No.	—	
	olive ID ø 6mm Qty 1 pcs			
GEV No.	110080	Ref. No.	—	
	knob ø 70mm shaft ø 10x8mm shaft flat universal			
GEV No.	112206	Ref. No.	—	
	knob dial plate silver gas tap PEL21/22/23 t.max.°C ED ø 63mm ID ø 45.5mm			

<p>1</p>				
GEV No.	106818	Ref. No.	156033	
description	gas tap PEL type 22S/O gas inlet M20x1.5 (tube ø 12mm) bypass nozzle ø 0mm gas outlet 3/8" thermocouple connection M9x1 pilot connection M10x1 shaft ø 10x8mm shaft L 25/17mm shaft flat lower with solenoid valve			
spare parts for	106818			
GEV No.	101058	Ref. No.	309132 BAAN71001E	
	magnet unit L 39mm D1 ø 15.4mm D2 ø 13.5mm suitable for PEL22/ EGA24197 standard			
GEV No.	101231	Ref. No.	—	
	thermocouple nut T1: M9x1 T2: M18x1			
GEV No.	101365	Ref. No.	—	
	gas connection thread M20x1.5 tube ø 12mm for PEL gas taps horizontal			
GEV No.	106191	Ref. No.	—	
	bypass nozzle type PEL22 bore ø 0mm thread M6x0.5			
GEV No.	106819	Ref. No.	—	
	solenoid valve body			

Table continues overleaf



spare parts for 106818	
	GEV No. 106822 Ref. No. — solenoid valve connection gas inlet M20x1.5 gas outlet 3/8" thread size valve body M20x1
	GEV No. 371157 Ref. No. — solenoid coil t.max. 125°C 230V seat ø 13mm 17VA
accessories for 106818	
	GEV No. 101248 Ref. No. — olive for pipe ø 12mm Qty 1 pcs suitable for PEL
	GEV No. 101249 Ref. No. — olive for pipe ø 10mm Qty 1 pcs
	GEV No. 101250 Ref. No. — union nut thread M20x1.5 for pipe ø 10mm
	GEV No. 101251 Ref. No. — union nut thread M20x1.5 for pipe ø 12mm

			
1			
GEV No.	109510	Ref. No.	904882 BAAN1209962 BAAN311840
description	gas tap PEL type 22S/O gas inlet M20x1.5 (tube ø 12mm) bypass nozzle ø 1.3mm gas outlet M20x1.5 (tube ø 12/10mm) thermocouple connection M8x1 pilot connection M10x1 shaft ø 10x8mm shaft L 25/17mm shaft flat right		
spare parts for 109510			
	GEV No. 100438	Ref. No.	— bypass nozzle type PEL22 bore ø 1.2mm thread M6x0.5
	GEV No. 101058	Ref. No.	309132 BAAN71001E magnet unit L 39mm D1 ø 15.4mm D2 ø 13.5mm suitable for PEL22/ EGA24197 standard
	GEV No. 101202	Ref. No.	— gas tap front part shaft ø 8x10mm shaft L 25/17mm shaft flat right/ left suitable for PEL22
	GEV No. 101230	Ref. No.	— thermocouple nut T1: M8x1 T2: M18x1 aluminium
	GEV No. 101240	Ref. No.	— gas connection thread M20x1.5 tube ø 12/10mm for PEL gas taps with gasket and screws horizontal
	GEV No. 101460	Ref. No.	— O-ring ø 12.37mm D1 ø 2.62mm suitable for PEL22
	GEV No. 101461	Ref. No.	— screw kit suitable for PEL22 Qty 4 pcs
accessories for 109510			
	GEV No. 100908	Ref. No.	— union screw thread M10x1 for pipe ø 4mm Qty 1 pcs
	GEV No. 100909	Ref. No.	— union screw thread M10x1 for pipe ø 6mm Qty 1 pcs

accessories for 109510	
	GEV No. 101241 Ref. No. — gas connection thread M20x1.5 tube ø 12/10mm for PEL gas taps vertical
	GEV No. 101246 Ref. No. — olive for pipe ø 4mm Qty 1 pcs
	GEV No. 101248 Ref. No. — olive for pipe ø 12mm Qty 1 pcs suitable for PEL
	GEV No. 101249 Ref. No. — olive for pipe ø 10mm Qty 1 pcs
	GEV No. 101250 Ref. No. — union nut thread M20x1.5 for pipe ø 10mm
	GEV No. 101251 Ref. No. — union nut thread M20x1.5 for pipe ø 12mm
	GEV No. 101286 Ref. No. — olive ID ø 6mm Qty 1 pcs

22S/V series

			
1			
GEV No.	101457	Ref. No.	7462033
description	gas tap alternatives to JUNKERS type CH110 gas inlet M20x1.5 (tube ø 12mm) bypass nozzle ø 0.35mm gas outlet M20x1.5 (tube ø 12/10mm) thermocouple connection M8x1 pilot connection M10x1 shaft ø 10mm shaft L 25mm shaft flat with pipe outlet		
spare parts for 101457			
	GEV No. 100259	Ref. No.	— bypass nozzle type PEL22 bore ø 0.35mm thread M6x0.5
	GEV No. 100908	Ref. No.	— union screw thread M10x1 for pipe ø 4mm Qty 1 pcs
	GEV No. 101058	Ref. No.	309132 BAAN71001E magnet unit L 39mm D1 ø 15.4mm D2 ø 13.5mm suitable for PEL22/ EGA24197 standard
	GEV No. 101200	Ref. No.	— gas tap front part shaft ø 10mm shaft L 25mm shaft flat suitable for 22S/O
	GEV No. 101230	Ref. No.	— thermocouple nut T1: M8x1 T2: M18x1 aluminium
	GEV No. 101241	Ref. No.	— gas connection thread M20x1.5 tube ø 12/10mm for PEL gas taps vertical
	GEV No. 101246	Ref. No.	— olive for pipe ø 4mm Qty 1 pcs

Table continues overleaf





spare parts for		101457	
	GEV No.	101460	Ref. No. —
	O-ring ø 12.37mm D1 ø 2.62mm suitable for PEL22		
	GEV No.	101461	Ref. No. —
	screw kit suitable for PEL22 Qty 4 pcs		
accessories for		101457	
	GEV No.	100945	Ref. No. —
	roll pin ø 3.2mm L 10mm		
	GEV No.	101218	Ref. No. —
	shaft extension JUNKERS		
	GEV No.	101219	Ref. No. —
	shaft extension L 25mm JUNKERS		
	GEV No.	101231	Ref. No. —
	thermocouple nut T1: M9x1 T2: M18x1		
	GEV No.	101248	Ref. No. —
	olive for pipe ø 12mm Qty 1 pcs suitable for PEL		
	GEV No.	101249	Ref. No. —
	olive for pipe ø 10mm Qty 1 pcs		
	GEV No.	101250	Ref. No. —
	union nut thread M20x1.5 for pipe ø 10mm		
	GEV No.	101251	Ref. No. —
	union nut thread M20x1.5 for pipe ø 12mm		
	GEV No.	101290	Ref. No. —
	thermocouple nut T1: M10x1 T2: M18x1 suitable for PEL20/21		
	GEV No.	110064	Ref. No. —
	knob		
	GEV No.	110066	Ref. No. —
	knob screw		
	GEV No.	550396	Ref. No. —
	shaft extension L 25mm JUNKERS		

23S/V series			
1			
GEV No.	101093	Ref. No.	905992 BAAN312065
description	gas tap PEL type 23S/V gas inlet M28x1.5 (tube ø 20mm) bypass nozzle ø 0.35mm thermocouple connection M10x1 pilot connection M10x1 shaft ø 10x8mm shaft L 25/17mm shaft flat lower		
spare parts for		101093	
	GEV No.	100455	Ref. No. —
	bypass nozzle type PEL23/24 bore ø 0.35mm thread M8x0.5		
	GEV No.	101059	Ref. No. —
	magnet unit T1: M10x1 T2: M22x1 L 46mm ø 18mm suitable for PEL23S M10x1		
	GEV No.	101204	Ref. No. —
	gas tap front part shaft ø 10x8mm shaft L 25/17mm shaft flat upper/lower suitable for PEL23S		
	GEV No.	101245	Ref. No. —
	gas connection thread M24x1.5 tube ø 12/16mm vertical for PEL gas taps		
	GEV No.	101463	Ref. No. —
	screw suitable for PEL23S Qty 4 pcs		
	GEV No.	528455	Ref. No. —
	O-ring Viton thickness 2.62mm ID ø 18.72mm Qty 1 pcs		
accessories for		101093	
	GEV No.	100908	Ref. No. —
	union screw thread M10x1 for pipe ø 4mm Qty 1 pcs		
	GEV No.	100909	Ref. No. —
	union screw thread M10x1 for pipe ø 6mm Qty 1 pcs		
	GEV No.	101246	Ref. No. —
	olive for pipe ø 4mm Qty 1 pcs		
	GEV No.	101252	Ref. No. —
	union nut thread M24x1.5 for pipe ø 12mm		
	GEV No.	101253	Ref. No. —
	union nut thread M24x1.5 PEL for pipe ø 16mm		
	GEV No.	101254	Ref. No. —
	union nut thread M28x1.5 tube ø 20mm		
	GEV No.	101255	Ref. No. —
	olive for pipe ø 12mm Qty 1 pcs		
	GEV No.	101256	Ref. No. —
	olive for pipe ø 16mm Qty 1 pcs		
	GEV No.	101257	Ref. No. —
	olive for pipe ø 20mm Qty 1 pcs		

Table continues overleaf





accessories for		101093	
	GEV No.	101286	Ref. No. —
olive ID ø 6mm Qty 1 pcs			
	GEV No.	110080	Ref. No. —
knob ø 70mm shaft ø 10x8mm shaft flat universal			
	GEV No.	112206	Ref. No. —
knob dial plate silver gas tap PEL21/22/23 t.max.°C ED ø 63mm ID ø 45.5mm			

alternatives to JUNKERS

			
1			
GEV No.	101457	Ref. No.	7462033
description	gas tap alternatives to JUNKERS type CH110 gas inlet M20x1.5 (tube ø 12mm) bypass nozzle ø 0.35mm gas outlet M20x1.5 (tube ø 12/10mm) thermocouple connection M8x1 pilot connection M10x1 shaft ø 10mm shaft L 25mm shaft flat with pipe outlet		
spare parts for		101457	
	GEV No.	100259	Ref. No. —
bypass nozzle type PEL22 bore ø 0.35mm thread M6x0.5			
	GEV No.	100908	Ref. No. —
union screw thread M10x1 for pipe ø 4mm Qty 1 pcs			
	GEV No.	101058	Ref. No. 309132 BAAN71001E
magnet unit L 39mm D1 ø 15.4mm D2 ø 13.5mm suitable for PEL22/EGA24197 standard			
	GEV No.	101200	Ref. No. —
gas tap front part shaft ø 10mm shaft L 25mm shaft flat suitable for 22S/O			
	GEV No.	101230	Ref. No. —
thermocouple nut T1: M8x1 T2: M18x1 aluminium			
	GEV No.	101241	Ref. No. —
gas connection thread M20x1.5 tube ø 12/10mm for PEL gas taps vertical			
	GEV No.	101246	Ref. No. —
olive for pipe ø 4mm Qty 1 pcs			
	GEV No.	101460	Ref. No. —
O-ring ø 12.37mm D1 ø 2.62mm suitable for PEL22			
	GEV No.	101461	Ref. No. —
screw kit suitable for PEL22 Qty 4 pcs			
accessories for		101457	
	GEV No.	100945	Ref. No. —
roll pin ø 3.2mm L 10mm			
	GEV No.	101218	Ref. No. —
shaft extension JUNKERS			

accessories for		101457	
	GEV No.	101219	Ref. No. —
shaft extension L 25mm JUNKERS			
	GEV No.	101231	Ref. No. —
thermocouple nut T1: M9x1 T2: M18x1			
	GEV No.	101248	Ref. No. —
olive for pipe ø 12mm Qty 1 pcs suitable for PEL			
	GEV No.	101249	Ref. No. —
olive for pipe ø 10mm Qty 1 pcs			
	GEV No.	101250	Ref. No. —
union nut thread M20x1.5 for pipe ø 10mm			
	GEV No.	101251	Ref. No. —
union nut thread M20x1.5 for pipe ø 12mm			
	GEV No.	101290	Ref. No. —
thermocouple nut T1: M10x1 T2: M18x1 suitable for PEL20/21			
	GEV No.	110064	Ref. No. —
knob			
	GEV No.	110066	Ref. No. —
knob screw			
	GEV No.	550396	Ref. No. —
shaft extension L 25mm JUNKERS			

STN3R

			
1			
GEV No.	106186	Ref. No.	7462038 BAAN310577
description	gas tap STN3R gas inlet pipe flange ø27mm bypass nozzle ø 0mm gas outlet 1/2" thermocouple connection M9x1 pilot connection M10x1 shaft ø 7x7mm shaft L 21/12mm shaft flat diagonal suitable for CHARVET		
spare parts for		106186	
	GEV No.	101964	Ref. No. —
clamping bracket			

SIRAL



1			
GEV No.	107387	Ref. No.	303028 BAAN70879E
description	gas tap SIRAL type 06-1464 gas inlet pipe flange ø20mm bypass nozzle ø 0.42mm gas outlet 1/4" (tube ø 8mm) front fixing thermocouple connection M8x1 shaft ø 6x4.6mm shaft L 19/15mm shaft flat upper mounting thread M5x0.8		





accessories for	101689		
	GEV No.	101136	Ref. No. —
	piezoelectric igniter suitable for Minisit with cover cap ømm connection F6.3x0.8		
	GEV No.	101137	Ref. No. 7472037 BAAN310636
	cover cap without piezoelectric igniter		
	GEV No.	101267	Ref. No. —
	reducer IT 3/8" ET 1/2" L 21mm		
	GEV No.	101268	Ref. No. —
	gas connection thread 3/8" angled with O-ring MINISIT 710		
	GEV No.	101269	Ref. No. —
	gas connection thread 1/2" angled with O-ring MINISIT 710		
	GEV No.	101270	Ref. No. —
	screw connection IT 3/8" ET 3/8" L 28mm		
	GEV No.	101272	Ref. No. —
	screw connection IT 1/2" ET 3/8" L 57mm		
	GEV No.	101273	Ref. No. —
	olive for pipe ø 12mm L 9.5mm brass Qty 1 pcs suitable for universal		
	GEV No.	101274	Ref. No. —
	olive for pipe ø 16mm Qty 1 pcs		
	GEV No.	101275	Ref. No. —
	union screw thread 1/2" for pipe ø 16mm Qty 1 pcs		
	GEV No.	101276	Ref. No. —
	union screw thread 3/8" tube ø 12mm Qty 1 pcs		
	GEV No.	110068	Ref. No. 7479041
	knob suitable for Minisit ø 37mm		



gas thermostats

SIT

710 Minisit series





1			
GEV No.	101689	Ref. No.	7472022
description	gas thermostat SIT type MINISIT 710 t.max. 110°C 40-110°C gas inlet 1/2" gas outlet 3/8" thermocouple connection M9x1 pilot connection M10x1 probe ø 5mm probe L 125mm capillary pipe 1050mm probe type type A1 pressure controller no pressure regulator mbar gland nut		
spare parts for	101689		
	GEV No.	101053	Ref. No. 7473051 BAAN310654
	magnet unit T1: M9x1 T2: M24x1 L 45mm ø 17mm suitable for Minisit		
	GEV No.	102100	Ref. No. —
	probe 30-100°C probe ø 5mm probe L 122mm capillary pipe 1050mm t.max. 100°C bain marie probe type type A1 suitable for MINISIT 710		
accessories for	101689		
	GEV No.	100809	Ref. No. —
	O-ring EPDM thickness 2mm ID ø 21mm Qty 1 pcs		
	GEV No.	100820	Ref. No. —
	gland duct ET M14x1.5 IT M10x0.75 probe ø max. 6.5mm WS 22		
	GEV No.	100904	Ref. No. —
	locking screw M10x1 for pipe ø 4mm Qty 1 pcs		
	GEV No.	100905	Ref. No. —
	locking screw M10x1 for pipe ø 6mm Qty 1 pcs		
	GEV No.	101054	Ref. No. —
	magnet unit T1: M10x1 T2: M24x1 L 45mm ø 17mm suitable for Minisit		

1			
GEV No.	106931	Ref. No.	7472031
description	gas thermostat SIT type MINISIT 710 t.max. 310°C 70-310°C gas inlet 1/2" gas outlet 3/8" thermocouple connection M9x1 pilot connection M10x1 probe ø 4mm probe L 72mm capillary pipe 1300mm pressure controller no pressure regulator mbar gland nut 0710647 ignition gas 6mm probe material stainless steel		
accessories for	106931		
	GEV No.	101137	Ref. No. 7472037 BAAN310636
	cover cap without piezoelectric igniter		
	GEV No.	110068	Ref. No. 7479041
	knob suitable for Minisit ø 37mm		



			
GEV No.	101132	Ref. No.	7472031
description	gas thermostat SIT type MINISIT 710 t.max. 340°C 100-340°C gas inlet 1/2" gas outlet 3/8" thermocouple connection M9x1 pilot connection M10x1 probe ø 5mm probe L 68mm capillary pipe 1050mm probe type type B1 pressure controller no pressure regulator mbar gland nut ignition gas no		
spare parts for	101132		
	GEV No.	101053	Ref. No. 7473051 BAAN310654
	magnet unit T1: M9x1 T2: M24x1 L 45mm ø 17mm suitable for Minisit		
	GEV No.	102102	Ref. No. —
	probe 100-340°C probe ø 5mm probe L 68mm capillary pipe 1750mm t.max. 340°C oven/grill probe type type B1 suitable for MINISIT 710		
accessories for	101132		
	GEV No.	100809	Ref. No. —
	O-ring EPDM thickness 2mm ID ø 21mm Qty 1 pcs		
	GEV No.	100904	Ref. No. —
	locking screw M10x1 for pipe ø 4mm Qty 1 pcs		
	GEV No.	100905	Ref. No. —
	locking screw M10x1 for pipe ø 6mm Qty 1 pcs		
	GEV No.	101054	Ref. No. —
	magnet unit T1: M10x1 T2: M24x1 L 45mm ø 17mm suitable for Minisit		
	GEV No.	101136	Ref. No. —
	piezoelectric igniter suitable for Minisit with cover cap ømm connection F6.3x0.8		
	GEV No.	101137	Ref. No. 7472037 BAAN310636
	cover cap without piezoelectric igniter		
	GEV No.	101267	Ref. No. —
	reducer IT 3/8" ET 1/2" L 21mm		
	GEV No.	101268	Ref. No. —
	gas connection thread 3/8" angled with O-ring MINISIT 710		
	GEV No.	101269	Ref. No. —
	gas connection thread 1/2" angled with O-ring MINISIT 710		
	GEV No.	101270	Ref. No. —
	screw connection IT 3/8" ET 3/8" L 28mm		
	GEV No.	101272	Ref. No. —
	screw connection IT 1/2" ET 3/8" L 57mm		
	GEV No.	101273	Ref. No. —
	olive for pipe ø 12mm L 9.5mm brass Qty 1 pcs suitable for universal		
	GEV No.	101274	Ref. No. —
	olive for pipe ø 16mm Qty 1 pcs		

accessories for	101132		
	GEV No.	101275	Ref. No. —
	union screw thread 1/2" for pipe ø 16mm Qty 1 pcs		
	GEV No.	101276	Ref. No. —
	union screw thread 3/8" tube ø 12mm Qty 1 pcs		
	GEV No.	110068	Ref. No. 7479041
	knob suitable for Minisit ø 37mm		













			
GEV No.	101130	Ref. No.	7472022 BAAN310629
description	gas thermostat without cap, button and angle SIT type MINISIT 710 t.max. 100°C 30-100°C gas inlet 1/2" gas outlet 3/8" thermocouple connection M9x1 pilot connection M10x1 probe ø 5mm probe L 122mm capillary pipe 1050mm probe type type A1 pressure controller no pressure regulator mbar gland nut		
spare parts for	101130		
	GEV No.	101053	Ref. No. 7473051 BAAN310654
	magnet unit T1: M9x1 T2: M24x1 L 45mm ø 17mm suitable for Minisit		
	GEV No.	102100	Ref. No. —
	probe 30-100°C probe ø 5mm probe L 122mm capillary pipe 1050mm t.max. 100°C bain marie probe type type A1 suitable for MINISIT 710		
accessories for	101130		
	GEV No.	100809	Ref. No. —
	O-ring EPDM thickness 2mm ID ø 21mm Qty 1 pcs		
	GEV No.	100820	Ref. No. —
	gland duct ET M14x1.5 IT M10x0.75 probe ø max. 6.5mm WS 22		
	GEV No.	100904	Ref. No. —
	locking screw M10x1 for pipe ø 4mm Qty 1 pcs		
	GEV No.	100905	Ref. No. —
	locking screw M10x1 for pipe ø 6mm Qty 1 pcs		
	GEV No.	101054	Ref. No. —
	magnet unit T1: M10x1 T2: M24x1 L 45mm ø 17mm suitable for Minisit		
	GEV No.	101136	Ref. No. —
	piezoelectric igniter suitable for Minisit with cover cap ømm connection F6.3x0.8		
	GEV No.	101137	Ref. No. 7472037 BAAN310636
	cover cap without piezoelectric igniter		
	GEV No.	101267	Ref. No. —
	reducer IT 3/8" ET 1/2" L 21mm		



Table continues overleaf

accessories for		101130	
	GEV No.	101268	Ref. No. —
gas connection thread 3/8" angled with O-ring MINISIT 710			
	GEV No.	101269	Ref. No. —
gas connection thread 1/2" angled with O-ring MINISIT 710			
	GEV No.	101270	Ref. No. —
screw connection IT 3/8" ET 3/8" L 28mm			
	GEV No.	101272	Ref. No. —
screw connection IT 1/2" ET 3/8" L 57mm			
	GEV No.	101273	Ref. No. —
olive for pipe ø 12mm L 9.5mm brass Qty 1 pcs suitable for universal			
	GEV No.	101274	Ref. No. —
olive for pipe ø 16mm Qty 1 pcs			
	GEV No.	101275	Ref. No. —
union screw thread 1/2" for pipe ø 16mm Qty 1 pcs			
	GEV No.	101276	Ref. No. —
union screw thread 3/8" tube ø 12mm Qty 1 pcs			
	GEV No.	110068	Ref. No. 7479041
knob suitable for Minisit ø 37mm			

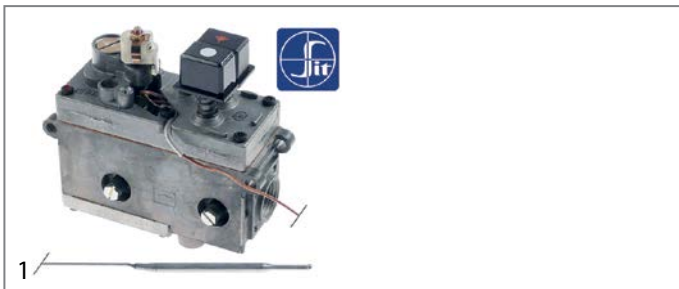





GEV No.	101131	Ref. No.	7472030 BAAN1209943 BAAN310633
description	gas thermostat without cap, button and angle SIT type MINISIT 710 t.max. 190°C 50-190°C gas inlet 1/2" gas outlet 3/8" thermocouple connection M9x1 pilot connection M10x1 probe ø 5mm probe L 98mm capillary pipe 1200mm probe type type A2 pressure controller no pressure regulator mbar gland nut		

spare parts for		101131	
	GEV No.	101053	Ref. No. 7473051 BAAN310654
magnet unit T1: M9x1 T2: M24x1 L 45mm ø 17mm suitable for Minisit			
	GEV No.	102103	Ref. No. —
probe 60-200°C probe ø 5mm probe L 98mm capillary pipe 1050mm t.max. 200°C fryer probe type type A2 suitable for MINISIT 710			

accessories for		101131	
	GEV No.	100809	Ref. No. —
O-ring EPDM thickness 2mm ID ø 21mm Qty 1 pcs			
	GEV No.	100820	Ref. No. —
gland duct ET M14x1.5 IT M10x0.75 probe ø max. 6.5mm WS 22			
	GEV No.	100904	Ref. No. —
locking screw M10x1 for pipe ø 4mm Qty 1 pcs			

accessories for		101131	
	GEV No.	100905	Ref. No. —
locking screw M10x1 for pipe ø 6mm Qty 1 pcs			
	GEV No.	101054	Ref. No. —
magnet unit T1: M10x1 T2: M24x1 L 45mm ø 17mm suitable for Minisit			
	GEV No.	101136	Ref. No. —
piezoelectric igniter suitable for Minisit with cover cap ømm connection F6.3x0.8			
	GEV No.	101137	Ref. No. 7472037 BAAN310636
cover cap without piezoelectric igniter			
	GEV No.	101267	Ref. No. —
reducer IT 3/8" ET 1/2" L 21mm			
	GEV No.	101268	Ref. No. —
gas connection thread 3/8" angled with O-ring MINISIT 710			
	GEV No.	101269	Ref. No. —
gas connection thread 1/2" angled with O-ring MINISIT 710			
	GEV No.	101270	Ref. No. —
screw connection IT 3/8" ET 3/8" L 28mm			
	GEV No.	101272	Ref. No. —
screw connection IT 1/2" ET 3/8" L 57mm			
	GEV No.	101273	Ref. No. —
olive for pipe ø 12mm L 9.5mm brass Qty 1 pcs suitable for universal			
	GEV No.	101274	Ref. No. —
olive for pipe ø 16mm Qty 1 pcs			
	GEV No.	101275	Ref. No. —
union screw thread 1/2" for pipe ø 16mm Qty 1 pcs			
	GEV No.	101276	Ref. No. —
union screw thread 3/8" tube ø 12mm Qty 1 pcs			
	GEV No.	110068	Ref. No. 7479041
knob suitable for Minisit ø 37mm			



			
1			
GEV No.	107237	Ref. No.	7472030 BAAN1209943 BAAN310633
description	gas thermostat without cap, button and angle SIT type MINISIT 710 t.max. 210°C 70-210°C gas inlet 1/2" gas outlet 3/8" thermocouple connection M9x1 pilot connection M10x1 probe ø 4mm probe L 122mm capillary pipe 1300mm probe type pressure controller no pressure regulator bar gland nut		
accessories for	107237		
	GEV No.	101137	Ref. No. 7472037 BAAN310636
	cover cap without piezoelectric igniter		
	GEV No.	101267	Ref. No. —
	reducer IT 3/8" ET 1/2" L 21mm		
	GEV No.	101268	Ref. No. —
	gas connection thread 3/8" angled with O-ring MINISIT 710		
	GEV No.	110068	Ref. No. 7479041
	knob suitable for Minisit ø 37mm		

accessories for	101172		
	GEV No.	101246	Ref. No. —
	olive for pipe ø 4mm Qty 1 pcs		
	GEV No.	101278	Ref. No. —
	olive for pipe ø 10mm Qty 1 pcs		
	GEV No.	101286	Ref. No. —
	olive ID ø 6mm Qty 1 pcs		
	GEV No.	101300	Ref. No. —
	union nut thread M16x1.5 tube ø 10mm		
	GEV No.	101450	Ref. No. —
	olive for pipe ø 8mm L 12.7mm Qty 1 pcs ED ø 10mm		
	GEV No.	101451	Ref. No. —
	union nut thread M16x1.5 tube ø 8mm		
	GEV No.	110079	Ref. No. —
	knob dial plate gas thermostat 1-8 silver		
	GEV No.	110081	Ref. No. 171475
	knob ø 70mm shaft ø 8x6.5mm shaft flat universal		

gas valves and ignition boxes





gas control valves

ROBERTSHAW

electric controlled valves

PEL

25ST series

			
1			
GEV No.	101172	Ref. No.	310137
description	gas thermostat PEL type 25ST 100-300°C gas inlet M16x1.5 (tube ø 10mm) bypass nozzle ø 0.35mm gas outlet M16x1.5 (tube ø 10/8mm) thermocouple connection M9x1 pilot connection M10x1 capillary pipe 1200mm probe ø 6mm probe L 100mm shaft ø 8x6.5mm shaft L 21/15mm shaft flat upper		
spare parts for	101172		
	GEV No.	100259	Ref. No. —
	bypass nozzle type PEL22 bore ø 0.35mm thread M6x0.5		
	GEV No.	101060	Ref. No. 7473048 BAAN310651
	magnet unit standard L 39mm D1 ø 15.4mm D2 ø 11mm suitable for PEL20-21/JUNKERS/EGA		
	GEV No.	106200	Ref. No. —
	nut thread M9x1 suitable for PEL 24/25S		
accessories for	101172		
	GEV No.	100908	Ref. No. —
	union screw thread M10x1 for pipe ø 4mm Qty 1 pcs		
	GEV No.	100909	Ref. No. —
	union screw thread M10x1 for pipe ø 6mm Qty 1 pcs		





			
1			
GEV No.	101388	Ref. No.	7473017
description	gas valve supply 220-240VAC supply VDC 50/60Hz gas inlet 3/4" NPT gas outlet 3/4" NPT thermocouple connection 11/32" pilot connection 1/4" CCT type U7000ER-240--S7CL/s pressure controller natural gas 6.7" W.C. suitable for ROBERTSHAW		
spare parts for	101388		
	GEV No.	101047	Ref. No. —
	magnet unit T1: ASA 11/32 T2: M24x1 L 59mm ø 4mm suitable for ROBERTSHAW		
	GEV No.	580033	Ref. No. —
	knob suitable for ROBERTSHAW		
accessories for	101388		
	GEV No.	102122	Ref. No. —
	thermocouple ROBERTSHAW ASA 11/32 L 18" - 455mm 7/16"		

Table continues overleaf



accessories for	101388		
GEV No.	102277	Ref. No.	—
	thermocouple ROBERTSHAW ASA 11/32 L 36" - 915mm 7/16"		

SIT

ELETTROSIT







1

GEV No.	101127	Ref. No.	7472025 BAAN1209942 BAAN310630
description	gas valve SIT type ELETTROSIT 230V gas inlet 3/4" gas outlet 3/4" thermocouple connection M9x1 pilot connection M10x1 lateral equiv. no. 0.810.175		
spare parts for	101127		
	GEV No.	101312	Ref. No. —
	microswitch		
	GEV No.	101352	Ref. No. —
	solenoid coil 230V 50Hz suitable for ELETTROSIT		
accessories for	101127		
	GEV No.	100006	Ref. No. —
	piezoelectric igniter suitable for ELETTROSIT body plastic blowing connection ø2.4mm ø 14mm		
	GEV No.	100904	Ref. No. —
	locking screw M10x1 for pipe ø 4mm Qty 1 pcs		
	GEV No.	100905	Ref. No. —
	locking screw M10x1 for pipe ø 6mm Qty 1 pcs		
	GEV No.	101301	Ref. No. —
	gas connection thread 1/2" straight ELETTROSIT screw with O-ring		
	GEV No.	101303	Ref. No. —
	gas connection straight thread 3/4" ELETTROSIT		
	GEV No.	101309	Ref. No. —
	extension		

TANDEM











1

GEV No.	101189	Ref. No.	310305 BAAN829205 BAAN847641
description	gas valve 230V 50Hz gas inlet 1/2" gas outlet 1/2" pilot connection M10x1 level slow ignition ignition times pressure range 3-50mbar power supply for modulator equiv. no. 0.830.040 suitable for Tandem		
spare parts for	101189		
	GEV No.	101379	Ref. No. —
	solenoid coil 230V 50Hz suitable for Tandem		
accessories for	101189		
	GEV No.	100904	Ref. No. —
	locking screw M10x1 for pipe ø 4mm Qty 1 pcs		
	GEV No.	100905	Ref. No. —
	locking screw M10x1 for pipe ø 6mm Qty 1 pcs		
	GEV No.	101274	Ref. No. —
	olive for pipe ø 16mm Qty 1 pcs		
	GEV No.	101275	Ref. No. —
	union screw thread 1/2" for pipe ø 16mm Qty 1 pcs		
	GEV No.	101925	Ref. No. —
	plug with O-ring thread M10x1 for pilot burner suitable for NOVASIT		
	GEV No.	102845	Ref. No. —
	gas connection angled 1/2" flange 32x32mm hole distance 24x24mm Tandem		
	GEV No.	102846	Ref. No. —
	gas connection straight 1/2" flange 32x32mm hole distance 24x24mm suitable for Tandem		
	GEV No.	102847	Ref. No. —
	O-ring		



1

GEV No.	107831	Ref. No.	310196
description	gas valve 230V 50Hz gas inlet 1/2" gas outlet 1/2" pilot connection M10x1 pressure range 3-50mbar type Tandem 830 SIT equiv. no. 0.830.030		
spare parts for	107831		
	GEV No.	101379	Ref. No. —
	solenoid coil 230V 50Hz suitable for Tandem		
accessories for	107831		
	GEV No.	100904	Ref. No. —
	locking screw M10x1 for pipe ø 4mm Qty 1 pcs		
	GEV No.	100905	Ref. No. —
	locking screw M10x1 for pipe ø 6mm Qty 1 pcs		
	GEV No.	101274	Ref. No. —
	olive for pipe ø 16mm Qty 1 pcs		
	GEV No.	101275	Ref. No. —
	union screw thread 1/2" for pipe ø 16mm Qty 1 pcs		
	GEV No.	101925	Ref. No. —
	plug with O-ring thread M10x1 for pilot burner suitable for NOVASIT		
	GEV No.	102845	Ref. No. —
	gas connection angled 1/2" flange 32x32mm hole distance 24x24mm Tandem		
	GEV No.	102846	Ref. No. —
	gas connection straight 1/2" flange 32x32mm hole distance 24x24mm suitable for Tandem		
	GEV No.	102847	Ref. No. —
	O-ring		

ignition boxes

SIT



1

GEV No.	102387	Ref. No.	310197 BAAN172267 BAAN304937
description	ignition box SIT type 503EFD electrodes 1 waiting time 1.5s safety time 60s 220/240V 12VA 50-60Hz protection IP20		



1

GEV No.	107519	Ref. No.	310324 BAAN1064197 BAAN1067290
description	ignition box SIT type 579DBC electrodes 2 waiting time 3s safety time 5s 220/240V 12VA 50/60Hz		



safety valves

SIT

440 series



1

GEV No.	101101	Ref. No.	7473027
description	gas valve pressure range 50mbar gas inlet 3/4" gas outlet 3/4" pilot connection M10x1 (tube ø 6mm) thermocouple connection M9x1 type SIT D3		
accessories for	101101		
	GEV No.	100904	Ref. No. —
	locking screw M10x1 for pipe ø 4mm Qty 1 pcs		
	GEV No.	100905	Ref. No. —
	locking screw M10x1 for pipe ø 6mm Qty 1 pcs		



ignition parts

pilot burners

SIT

100 series



















1

GEV No.	107337	Ref. No.	2020122 905107 BAAN1074407 BAAN1210152 V2020122
description	pilot burner SIT type 100 series 1 flame nozzle \varnothing 0.2/0.4mm gas connection 4/6mm set		



1

GEV No.	106906	Ref. No.	2020124 7434003
description	pilot burner SIT type 100 series 3 flames nozzle \varnothing 0.2mm gas connection 6mm		
spare parts for	106906		
	GEV No.	100245	Ref. No. —
	pilot burner nozzle LPG code 20 bore \varnothing 0.2mm Qty 1 pcs thread M8x0.75		
	GEV No.	100855	Ref. No. —
	pilot burner bracket triple		
	GEV No.	100885	Ref. No. —
	air mixing sleeve for pilot burner Qty 1 pcs		
	GEV No.	100916	Ref. No. —
	compression spring for pilot burner Qty 1 pcs		
	GEV No.	100917	Ref. No. —
	gasket for pilot burner Qty 1 pcs aluminium		
	GEV No.	100918	Ref. No. —
	screw for pilot burner		
	GEV No.	107162	Ref. No. —
	pilot burner cap SIT 3 flames Hmm Lmm Qty 1 pcs		
	GEV No.	107701	Ref. No. —
	pilot burner bottom part SIT 100 series nozzle \varnothing 0.2mm		
accessories for	106906		
	GEV No.	100245	Ref. No. —
	pilot burner nozzle LPG code 20 bore \varnothing 0.2mm Qty 1 pcs thread M8x0.75		

accessories for	106906		
	GEV No.	100246	Ref. No. —
	pilot burner nozzle natural gas bore \varnothing 0.35mm Qty 1 pcs thread M8x0.75		
	GEV No.	100904	Ref. No. —
	locking screw M10x1 for pipe \varnothing 4mm Qty 1 pcs		
	GEV No.	100905	Ref. No. —
	locking screw M10x1 for pipe \varnothing 6mm Qty 1 pcs		
	GEV No.	102110	Ref. No. —
	pilot tube copper pipe \varnothing 4mm thickness 1mm L 3000mm		
	GEV No.	102111	Ref. No. —
	pilot tube copper pipe \varnothing 6mm thickness 1mm L 3000mm		
	GEV No.	107171	Ref. No. —
	pilot burner nozzle SIT natural/liquid gas bore \varnothing 0.25mm Qty 1 pcs		
	GEV No.	107700	Ref. No. —
	pilot burner bottom part SIT 100 series nozzle \varnothing 0.25mm		
	GEV No.	107702	Ref. No. —
	pilot burner bottom part SIT 100 series nozzle \varnothing 0.35mm		

accessories

ignition electrodes

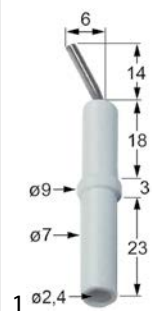

GEV No.	100707	Ref. No.	7455048
description	ignition electrode D1 \varnothing 7mm D2 \varnothing 9mm connection \varnothing 2.4mm L1 14mm L2 6mm BL1 18mm BL2 3mm BL3 23mm to clip Qty 1 pcs		

160 series



1













GEV No.	102946	Ref. No.	310272 BAAN827901 BAAN838024
description	pilot burner SIT type 160 series 3 flames nozzle \varnothing mm gas connectionmm		
spare parts for	102946		
	GEV No.	100202	Ref. No. —
	pilot burner nozzle natural gas code 41 Qty 1 pcs nozzle \varnothing 0.41mm		



Table continues overleaf



spare parts for 102946				
	GEV No.	100701	Ref. No.	308480 BAAN824045 BAAN838031
ignition electrode connection M4 Qty 1 pcs				
	GEV No.	100906	Ref. No.	317980 BAAN829766 BAAN838033
screw connection thread M10x1 for ignition electrode brass Qty 1 pcs WS 10				
	GEV No.	100907	Ref. No.	317979 BAAN829767 BAAN838027
screw connection thread M10x1 Qty 1 pcs type SEF 1 ømm for thermocouple				
	GEV No.	100909	Ref. No.	—
union screw thread M10x1 for pipe ø 6mm Qty 1 pcs				
	GEV No.	101287	Ref. No.	310275 BAAN825615 BAAN838028
olive for pipe ø 6mm Qty 1 pcs				
accessories for 102946				
	GEV No.	100203	Ref. No.	—
pilot burner nozzle LPG code 25 Qty 1 pcs nozzle ø 0.25mm				
	GEV No.	100869	Ref. No.	—
pilot burner nozzle natural gas code 51 Qty 1 pcs suitable for 160 series nozzle ø 0.51mm				
	GEV No.	100908	Ref. No.	—
union screw thread M10x1 for pipe ø 4mm Qty 1 pcs				
	GEV No.	101282	Ref. No.	—
olive for pipe ø 4mm L 7.4mm Qty 1 pcs				
	GEV No.	107650	Ref. No.	311171
pilot burner nozzle SIT LPG code 30 Qty 1 pcs				

accessories for 102886				
	GEV No.	102892	Ref. No.	308468 310215 BAAN169391 BAAN304828
ignition electrode D1 ø 6mm L1 22mm BL1 25mm BL2 19mm connection F 2.8x0.8mm M8x10				



GEV No.	102887	Ref. No.	310092 BAAN167363 BAAN304882	
description	pilot burner HONEYWELL type Q327 3 flames			
accessories for 102887				
	GEV No.	102891	Ref. No.	310091 BAAN167362 BAAN304881
pilot burner nozzle HONEYWELL LPG code KR14 model Q3480, Q3481, Q348, Q179, Q327				
	GEV No.	107496	Ref. No.	—
pilot burner nozzle HONEYWELL natural gas code NE22 model Q3480, Q3481, Q348, Q179, Q327				



GEV No.	107495	Ref. No.	132885 BAAN172129 BAAN860936
description	pilot burner HONEYWELL type Q327 3 flames natural gas nozzle NE22 with ignition electrode		

HONEYWELL				
pilot burners				
	1			
GEV No.	102886	Ref. No.	310148 BAAN169431 BAAN304903	
description	pilot burner 1 flame			
accessories for 102886				
	GEV No.	102888	Ref. No.	—
pilot burner nozzle HONEYWELL natural gas bore ø 0.51mm model Q349				
	GEV No.	102889	Ref. No.	310150 BAAN169433 BAAN304905
pilot burner nozzle HONEYWELL LPG bore ø 0.25mm model Q349				

spare parts for 107495				
	GEV No.	102887	Ref. No.	310092 BAAN167363 BAAN304882
pilot burner HONEYWELL type Q327 3 flames				
	GEV No.	102892	Ref. No.	308468 310215 BAAN169391 BAAN304828
ignition electrode D1 ø 6mm L1 22mm BL1 25mm BL2 19mm connection F 2.8x0.8mm M8x10				
	GEV No.	102905	Ref. No.	—
locking screw thread M11x1 ø 6mm				
	GEV No.	102981	Ref. No.	308469 BAAN169392 BAAN304829
ignition electrode D1 ø 7mm L1 30mm BL1 24mm BL2 21.5mm connection F2.8x0.8 cable length 1300mm 1/8"				
	GEV No.	107496	Ref. No.	—
pilot burner nozzle HONEYWELL natural gas code NE22 model Q3480, Q3481, Q348, Q179, Q327				



producer-specific pilot burners

BONNET



1

GEV No.	101293	Ref. No.	014073M BAAN1027483 BAAN825612
description	flat gasket aluminium ED ø 14mm ID ø 10.3mm for pilot burner Qty 1 pcs		



1

GEV No.	102949	Ref. No.	368146 BAAN820515 BAAN834387
description	pilot burner gas connection M10x1mm		



1

GEV No.	102948	Ref. No.	140309 BAAN943443 BAAN963043
description	pilot burner bottom part		



1

GEV No.	102947	Ref. No.	368147 BAAN834245 BAAN834385
description	pilot burner head thread M10x1		



1

GEV No.	101293	Ref. No.	014073M BAAN1027483 BAAN825612
description	flat gasket aluminium ED ø 14mm ID ø 10.3mm for pilot burner Qty 1 pcs		



1

GEV No.	102949	Ref. No.	368146 BAAN820515 BAAN834387
description	pilot burner gas connection M10x1mm		



1

GEV No.	104632	Ref. No.	165527 BAAN1071743 BAAN1120945
description	pilot burner bottom part thread 1/8"		



1

GEV No.	104634	Ref. No.	140869 BAAN1027486 BAAN829845
description	pilot burner bracket		



1

GEV No.	104631	Ref. No.	368234 BAAN1027487 BAAN820513
description	pilot burner head 2 thread M10x1		
accessories for	104631		



GEV No.	107172	Ref. No.	310274 BAAN834138 BAAN838035
description	pilot burner nozzle SIT LPG code 25 Qty 1 pcs		



GEV No.	107173	Ref. No.	—
description	pilot burner nozzle SIT natural gas code 35 Qty 1 pcs suitable for 160 series nozzle ø 0.35mm		



GEV No.	107174	Ref. No.	310273 BAAN829765 BAAN838038
description	pilot burner nozzle SIT natural gas code 41 Qty 1 pcs		





GEV No.	107649	Ref. No.	311170 BAAN71621E BAAN825618 BAAN860092
description	pilot burner nozzle SIT LPG code 20 Qty 1 pcs		



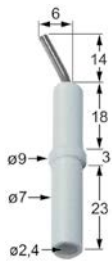

			
GEV No.	107337	Ref. No.	2020122 905107 BAAN1074407 BAAN1210152 V2020122
description	pilot burner SIT type 100 series 1 flame nozzle \varnothing 0.2/0.4mm gas connection 4/6mm set		

			
GEV No.	100707	Ref. No.	7455048
description	ignition electrode D1 \varnothing 7mm D2 \varnothing 9mm connection \varnothing 2.4mm L1 14mm L2 6mm BL1 18mm BL2 3mm BL3 23mm to clip Qty 1 pcs		

electrodes

			
GEV No.	100701	Ref. No.	308480 BAAN824045 BAAN838031
description	ignition electrode connection M4 Qty 1 pcs		
accessories for	100701		
			
GEV No.	100906	Ref. No.	317980 BAAN829766 BAAN838033
description	screw connection thread M10x1 for ignition electrode brass Qty 1 pcs WS 10		

			
GEV No.	102981	Ref. No.	308469 BAAN169392 BAAN304829
description	ignition electrode D1 \varnothing 7mm L1 30mm BL1 24mm BL2 21.5mm connection F2.8x0.8 cable length 1300mm 1/8"		

			
GEV No.	100906	Ref. No.	317980 BAAN829766 BAAN838033
description	screw connection thread M10x1 for ignition electrode brass Qty 1 pcs WS 10		

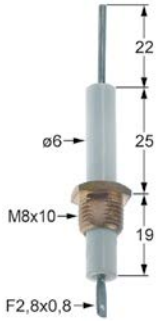
			
GEV No.	102892	Ref. No.	308468 310215 BAAN169391 BAAN304828
description	ignition electrode D1 \varnothing 6mm L1 22mm BL1 25mm BL2 19mm connection F 2.8x0.8mm M8x10		

ignition cables

pre-assembled cables

			
GEV No.	100176	Ref. No.	307997
description	ignition cable cable length 1000mm connection \varnothing 2.4mm / \varnothing 4mm permanent temperature 200°C		

			
GEV No.	102155	Ref. No.	140379 307997 BAAN1005882 BAAN1207836 BAAN829847 BAAN975565
description	ignition cable cable length 900mm connection \varnothing 4mm / F2.8mm		

**ignition units**

GEV No.	102485	Ref. No.	308465
description	ignition unit outputs 2 220-240VAC 0.6VA 50-60Hz		



GEV No.	101002	Ref. No.	308465
description	ignition unit outputs 2 230VAC dimensions 88x23x34mm mounting distance 73mm inlet F6.3x0.8 outlet F2.8x0.8 0.6VA 50/60Hz		



GEV No.	102388	Ref. No.	308466 680782 BAAN308466
description	ignition unit outputs 4 230VAC dimensions 111x23x34mm mounting distance 100mm inlet F6.3x0.8 outlet F2.8x0.8 type WAC-T4 0.6VA 50/60Hz		

thermocouples**thermocouple sets universal**

GEV No.	107648	Ref. No.	7473055
description	thermocouple set SIT 11-piece L 1200mm		

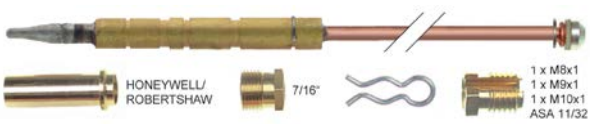

GEV No.	102284	Ref. No.	310144 BAAN169427
description	thermocouple set 8-piece L 900mm		

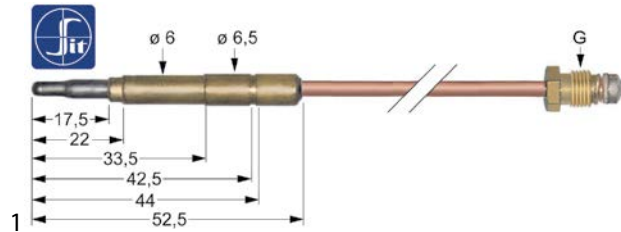

GEV No.	102286	Ref. No.	634321
description	thermocouple set 8-piece L 900mm flexible		

plug-in thermocouples**plug-in thermocouples standard****with barrel socket ø6(6.5)mm****thermocouples SIT**

GEV No.	102682	Ref. No.	310276 7473056 BAAN310657 BAAN840079
description	thermocouple SIT aluminized tip M9x1 L 850mm plug connection ø6.0(6.5)mm		

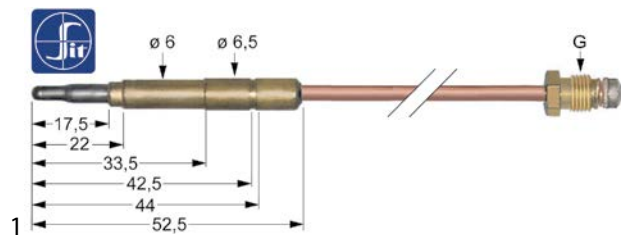

GEV No.	107613	Ref. No.	310277 7473029 BAAN310646
description	thermocouple SIT M9x1 L 1200mm plug connection ø6.0(6.5)mm		

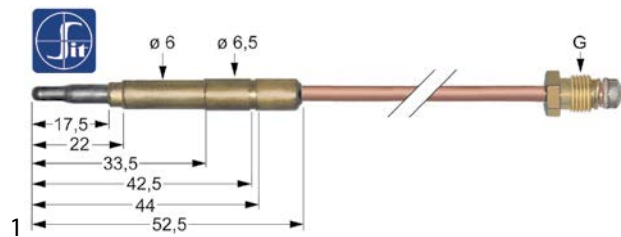

GEV No.	107614	Ref. No.	7473034
description	thermocouple SIT M9x1 L 1500mm plug connection ø6.0(6.5)mm		



GEV No.	107611	Ref. No.	7473056
description	thermocouple SIT M9x1 L 850mm plug connection ø6.0(6.5)mm		

thermocouples with aluminised tip

GEV No.	102077	Ref. No.	172265 310193 7473055
description	thermocouple M10x1 L 1500mm plug connection ø6.0(6.5)mm		

threaded thermocouples
threaded thermocouples standard
with socket with thread M8x1

SIT

GEV No.	107634	Ref. No.	310193
description	thermocouple SIT M8x1 L 1500mm M8x1		
accessories for	107634		
	GEV No.	Ref. No.	—
	nut thread M8x1 H 3mm brass Qty 1 pcs type SEF 1		

extensions

GEV No.	102811	Ref. No.	7492000
description	thermocouple extension thread M9x1 - M9x1 L 600mm		

accessories

interrupters

GEV No.	580046	Ref. No.	N/A
description	extension for interruptor L 18" - 455mm		

GEV No.	101265	Ref. No.	605680 905680
description	interrupter thread M9x1		

gas burners
hob burners

producer-specific hob burners

BONNET

universal

GEV No.	108140	Ref. No.	1256950 BAAN1320490 BAAN301946
description	air mixing sleeve		



GEV No.	107030	Ref. No.	N/A
description	burner ø 130mm complete		

GEV No.	108026	Ref. No.	7505097 BAAN311057
description	burner cap ø 100mm mounting ø 84mm		





			
1			
GEV No.	108027	Ref. No.	7505098 BAAN311058
description	burner cap ø 130mm		



			
1			
GEV No.	108119	Ref. No.	322389 BAAN305375
description	burner head for burner cap ø 100mm		
accessories for	108119		
	GEV No.	108026	Ref. No.
			7505097 BAAN311057
	burner cap ø 100mm mounting ø 84mm		



			
1			
GEV No.	108120	Ref. No.	322390 BAAN305376
description	burner head for burner cap ø 130mm		
accessories for	108120		
	GEV No.	108027	Ref. No.
			7505098 BAAN311058
	burner cap ø 130mm		



			
1			
GEV No.	108136	Ref. No.	368150 BAAN847689 BAAN970844
description	venturi L 110mm ø 21.5mm		

miscellaneous			
			
1			
GEV No.	108007	Ref. No.	130625 141952 381211 BAAN1207695 BAAN172134 BAAN302027
description	burner cap ø 110mm mounting ø 106mm		
accessories for	108007		
	GEV No.	104636	Ref. No.
			381221 BAAN169576 BAAN305780
	burner holder for burner cap ø 110mm with nozzle holder		



accessories for	108007		
	GEV No.	108094	Ref. No.
			381212 BAAN169570
	burner head for burner cap ø 110mm brass		



			
1			
GEV No.	108134	Ref. No.	165013 BAAN1208099 BAAN835234
description	burner cap ø 110mm with central hole		
accessories for	108134		
	GEV No.	104636	Ref. No.
			381221 BAAN169576 BAAN305780
	burner holder for burner cap ø 110mm with nozzle holder		
	GEV No.	108095	Ref. No.
			130627 BAAN1207697 BAAN302029
	burner head for burner cap ø 110mm black		

			
1			
GEV No.	108009	Ref. No.	130624 BAAN1207694 BAAN302026
description	burner cap ø 85mm mounting ø 81mm		
accessories for	108009		
	GEV No.	104635	Ref. No.
			381220 BAAN169575 BAAN305779
	burner holder for burner cap ø 85mm with nozzle holder		
	GEV No.	108093	Ref. No.
			130626 BAAN1207696 BAAN302028
	burner head for burner cap ø 85mm black		





			
1			
GEV No.	108148	Ref. No.	141951 980462724 BAAN1178944 BAAN172133
description	burner cap ø 85mm mounting ø 81mm		
accessories for	108148		
	GEV No.	104635	Ref. No.
			381220 BAAN169575 BAAN305779
	burner holder for burner cap ø 85mm with nozzle holder		
	GEV No.	108132	Ref. No.
			381210 BAAN169568
	burner head for burner cap ø 85mm brass		





			
1			
GEV No.	108095	Ref. No.	130627 BAAN1207697 BAAN302029
description	burner head for burner cap ø 110mm black		
accessories for	108095		
	GEV No.	104636	Ref. No. 381221 BAAN169576 BAAN305780
burner holder for burner cap ø 110mm with nozzle holder			
	GEV No.	108134	Ref. No. 165013 BAAN1208099 BAAN835234
burner cap ø 110mm with central hole			

			
1			
GEV No.	108132	Ref. No.	381210 BAAN169568
description	burner head for burner cap ø 85mm brass		
accessories for	108132		
	GEV No.	104635	Ref. No. 381220 BAAN169575 BAAN305779
burner holder for burner cap ø 85mm with nozzle holder			
	GEV No.	108148	Ref. No. 141951 980462724 BAAN1178944 BAAN172133
burner cap ø 85mm mounting ø 81mm			

			
1			
GEV No.	108094	Ref. No.	381212 BAAN169570
description	burner head for burner cap ø 110mm brass		
accessories for	108094		
	GEV No.	104636	Ref. No. 381221 BAAN169576 BAAN305780
burner holder for burner cap ø 110mm with nozzle holder			
	GEV No.	108007	Ref. No. 130625 141952 381211 BAAN1207695 BAAN172134 BAAN302027
burner cap ø 110mm mounting ø 106mm			

			
1			
GEV No.	104636	Ref. No.	381221 BAAN169576 BAAN305780
description	burner holder for burner cap ø 110mm with nozzle holder		
accessories for	104636		
	GEV No.	108007	Ref. No. 130625 141952 381211 BAAN1207695 BAAN172134 BAAN302027
burner cap ø 110mm mounting ø 106mm			
	GEV No.	108094	Ref. No. 381212 BAAN169570
burner head for burner cap ø 110mm brass			
	GEV No.	108095	Ref. No. 130627 BAAN1207697 BAAN302029
burner head for burner cap ø 110mm black			
	GEV No.	108134	Ref. No. 165013 BAAN1208099 BAAN835234
burner cap ø 110mm with central hole			

			
1			
GEV No.	108093	Ref. No.	130626 BAAN1207696 BAAN302028
description	burner head for burner cap ø 85mm black		
accessories for	108093		
	GEV No.	104635	Ref. No. 381220 BAAN169575 BAAN305779
burner holder for burner cap ø 85mm with nozzle holder			
	GEV No.	108009	Ref. No. 130624 BAAN1207694 BAAN302026
burner cap ø 85mm mounting ø 81mm			







			
1			
GEV No.	104635	Ref. No.	381220 BAAN169575 BAAN305779
description	burner holder for burner cap ø 85mm with nozzle holder		
accessories for	104635		
	GEV No.	108009	Ref. No. 130624 BAAN1207694 BAAN302026
burner cap ø 85mm mounting ø 81mm			
	GEV No.	108093	Ref. No. 130626 BAAN1207696 BAAN302028
burner head for burner cap ø 85mm black			

Table continues overleaf



accessories for 104635			
	GEV No.	108132	Ref. No. 381210 BAAN169568
burner head for burner cap ø 85mm brass			
	GEV No.	108148	Ref. No. 141951 980462724 BAAN1178944 BAAN172133
burner cap ø 85mm mounting ø 81mm			

	GEV No.	108135	Ref. No. 140823 BAAN971176
description burner pipe			

bar burners

bar burners			
	GEV No.	104732	Ref. No. 141610 BAAN169184 BAAN302137
description bar burner ø 50mm Wmm Hmm L 350mm			

	GEV No.	104733	Ref. No. 141613 BAAN169187 BAAN302140
description bar burner ø 50mm Wmm Hmm L 490mm			

accessories



nozzle holders			
	GEV No.	108137	Ref. No. 381301 BAAN835208 BAAN847699
description nozzle holder			

gas nozzles

main nozzles

gas nozzles M10x1			
	GEV No.	106440	Ref. No. 7433039 BAAN1209916 V7433039
description gas injector thread M10x1 WS 11 bore ø 1.85mm			

pilot burner nozzles

pilot burner nozzles HONEYWELL			
for series Q3480, Q3481, Q348, Q179, Q327			
	GEV No.	102891	Ref. No. 310091 BAAN167362 BAAN304881
description pilot burner nozzle HONEYWELL LPG code KR14 model Q3480, Q3481, Q348, Q179, Q327			
accessories for 102891			
	GEV No.	102905	Ref. No. —
locking screw thread M11x1 ø 6mm			

for series Q349

	GEV No.	102889	Ref. No. 310150 BAAN169433 BAAN304905
description pilot burner nozzle HONEYWELL LPG bore ø 0.25mm model Q349			

	GEV No.	106938	Ref. No. 310152 BAAN169434 BAAN304906
description pilot burner nozzle HONEYWELL natural gas code 0.51 model Q349			

pilot burner nozzles SIT

100 series			
	GEV No.	102973	Ref. No. 7433158
description pilot burner nozzle natural gas bore ø 0.45mm Qty 1 pcs			





160 series

			
1			
GEV No.	102686	Ref. No.	311172 BAAN305063 BAAN825617 BAAN831373
description	pilot burner nozzle natural gas code 45 Qty 1 pcs nozzle ø 8.6mm		

			
1			
GEV No.	107649	Ref. No.	311170 BAAN71621E BAAN825618 BAAN860092
description	pilot burner nozzle SIT LPG code 20 Qty 1 pcs		

			
1			
GEV No.	107172	Ref. No.	310274 BAAN834138 BAAN838035
description	pilot burner nozzle SIT LPG code 25 Qty 1 pcs		

			
1			
GEV No.	107650	Ref. No.	311171
description	pilot burner nozzle SIT LPG code 30 Qty 1 pcs		

			
1			
GEV No.	107174	Ref. No.	310273 BAAN829765 BAAN838038
description	pilot burner nozzle SIT natural gas code 41 Qty 1 pcs		

bypass nozzles

bypass nozzles PEL20/21

			
1			
GEV No.	100551	Ref. No.	310173
description	bypass nozzle type PEL20/21 bore ø 0.6mm thread M5x0.5		

bypass nozzles PEL22

			
1			
GEV No.	100428	Ref. No.	310165
description	bypass nozzle type PEL22 bore ø 0.65mm thread M6x0.5		

			
1			
GEV No.	100407	Ref. No.	310166
description	bypass nozzle type PEL22 bore ø 1mm thread M6x0.5		

auxiliary gas parts

screw connections

olives

			
1			
GEV No.	101857	Ref. No.	310275
description	olive for pipe ø 6mm Qty 1 pcs suitable for 160 series for pilot burner		

union screws

			
1			
GEV No.	100906	Ref. No.	317980 BAAN829766 BAAN838033
description	screw connection thread M10x1 for ignition electrode brass Qty 1 pcs WS 10		

			
1			
GEV No.	100907	Ref. No.	317979 BAAN829767 BAAN838027
description	screw connection thread M10x1 Qty 1 pcs type SEF 1 ømm for thermocouple		

equipment-specific units

for ice-cube maker

hoses

formed hoses

straight

silicone hoses



GEV No.	530063	Ref. No.	71289E
description	silicone hose ID ø 18mm ED ø 25mm L 1m t.max. 200°C transparent		

for espresso machines

brewing units

filter holder gaskets

O-rings





GEV No.	510409	Ref. No.	318044 905588 966001 BAAN1323306 BAAN311999
description	O-ring EPDM thickness 5.34mm ID ø 56.52mm Qty 1 pcs		





for dishwashers

containers

salt tanks



GEV No.	510929	Ref. No.	315728 915405	
description	salt tank ø 120mm H 117mm hose ø 10mm mounting ø 70mm overall height 157mm			
spare parts for	510929			
	GEV No.	506015	Ref. No.	—
	O-ring EPDM thickness 3.53mm ID ø 39.69mm Qty 1 pcs			
	GEV No.	510018	Ref. No.	—
	nut ø 92mm H 10.5mm for salt tank ID ø 64mm			

spare parts for	510929			
	GEV No.	524177	Ref. No.	—
	lid ø 69mm H 20mm for salt tank ID ø 50mm			
accessories for	510929			
	GEV No.	510071	Ref. No.	—
	flat gasket rubber ED ø 81mm ID ø 68mm thickness 3mm for salt tank Qty 1 pcs			
	GEV No.	510654	Ref. No.	—
	gasket H 6mm D1 ø 82mm D2 ø 68mm			
	GEV No.	510883	Ref. No.	—
	gasket rubber ED ø 86mm ID ø 66mm thickness 2mm for salt tank Qty 1 pcs			

boilers

boilers for dishwashers



GEV No.	513243	Ref. No.	2001602H
description	boiler		





GEV No.	518235	Ref. No.	2002149H
description	boiler ø 145mm L 405mm flange 3 hole flange		





air traps





air traps



GEV No.	519499	Ref. No.	2001106H	
description	air trap L 46mm W 35mm H 72mm thread 3/4" hose ø 5.5mm plastic			
accessories for	519499			
	GEV No.	516261	Ref. No.	2001359H
	flat gasket rubber ED ø 33mm ID ø 25mm thickness 2.5mm for air trap Qty 1 pcs			
	GEV No.	519498	Ref. No.	2001201H
	nut thread 3/4" H 10mm WS 30 plastic Qty 1 pcs			



 <p>1</p>			
GEV No.	510103	Ref. No.	5567E BAAN1322919 BAAN307590
description	air trap L 85mm W 20mm H 80mm hose ø 6mm plastic		
spare parts for	510103		
	GEV No.	505045	Ref. No. —
	O-ring EPDM thickness 1.78mm ID ø 5.28mm Qty 1 pcs		
	GEV No.	505094	Ref. No. —
	air trap		
	GEV No.	510016	Ref. No. —
	eye bolt for rinse aid container connection		
	GEV No.	510105	Ref. No. —
	hose connector for air trap		

 <p>1</p>			
GEV No.	518200	Ref. No.	2001861H 5848E BAAN1321491 BAAN307871
description	air trap ø 34mm H 78mm hose ø 6mm plastic		
spare parts for	518200		
	GEV No.	504618	Ref. No. —
	O-ring EPDM thickness 2.62mm ID ø 15.54mm Qty 1 pcs		
	GEV No.	510075	Ref. No. —
	flat gasket rubber ED ø 22mm ID ø 13mm thickness 1.5mm Qty 1 pcs		
	GEV No.	510106	Ref. No. —
	hose connector for air trap		

backflow preventers			
backflow preventers			
 <p>1</p>			
GEV No.	514502	Ref. No.	2002476H
description	backflow preventer plastic hose ø 11mm		

door mechanics			
hinges			
 <p>1</p>			
GEV No.	518547	Ref. No.	5565E
description	door hinge hinge mounting pos. left		

hinge camps			
 <p>1</p>			
GEV No.	518257	Ref. No.	5566E
description	hinge camp mounting pos. left		

screw connections			
 <p>1</p>			
GEV No.	519498	Ref. No.	2001201H
description	nut thread 3/4" H 10mm WS 30 plastic Qty 1 pcs		

washing and rinsing systems			
 <p>1</p>			
GEV No.	504550	Ref. No.	5042E
description	bush		







 <p>1</p>			
GEV No.	517568	Ref. No.	2001143H BAAN1121321 BAAN1320857
description	counterflange for wash arm support ø 69mm ID ø 63mm H 35mm mounting distance 64mm hole ø 7mm		
accessories for	517568		
	GEV No.	531605	Ref. No.
	2001907H BAAN1321530 BAAN924677		
	extension for rinsing shaft ø 16mm H 122mm thread L 12mm WS 19		

Table continues overleaf

accessories for	517568		
	GEV No.	532603	Ref. No. —
	O-ring EPDM thickness 3.53mm ID ø 69.85mm Qty 1 pcs		
	GEV No.	698750	Ref. No. —
	throttle disc ø 71.5mm hole ø 17/22mm		

	GEV No.	507541	Ref. No.	2002510H
description	flat gasket rubber ED ø 74mm ID ø 57mm thickness 2mm Qty 1 pcs			

	GEV No.	518071	Ref. No.	2001332H BAAN1121689 BAAN1321032
description	gasket for wash arm support L 109mm W 68mm			

	GEV No.	504516	Ref. No.	5109E
description	knurled nut thread M8x1 ø 25mm H 6mm SS			

	GEV No.	504547	Ref. No.	5013E
description	knurled nut thread M8x1 ø 25mm H 6mm SS			

	GEV No.	518637	Ref. No.	2002506H
description	nut for wash arm support thread M56x2			

	GEV No.	518086	Ref. No.	2001580H
description	opposite support			

	GEV No.	518471	Ref. No.	5820E BAAN1322963 BAAN307842
description	rinse pipe			

	GEV No.	518003	Ref. No.	5523E
description	screw cap			

	GEV No.	513286	Ref. No.	2001024H
description	screw connection			

	GEV No.	510058	Ref. No.	199018
description	throttle disc			

	GEV No.	513270	Ref. No.	2001604H
description	throttle disc			

	GEV No.	510112	Ref. No.	5517E
description	Thumb screw thread M10 thread L 10mm ø 22mm H 4.5mm SS			

	GEV No.	504560	Ref. No.	5062E
description	wash pipe			



			
1			
GEV No.	518633	Ref. No.	2001127H
description	wash pipe		



washing and rinsing systems (sorted by producer)

BONNET

rinse arms

rotary

complete

				
1				
GEV No.	510118	Ref. No.	5556E	
description	wash arm L 245mm nozzles 4 mounting ø 12mm mounting pos. upper			
spare parts for	510118			
	GEV No.	510011	Ref. No.	—
	screw connection plastic			
	GEV No.	510012	Ref. No.	—
	flat gasket PTFE ED ø 16.5mm ID ø 12.5mm thickness 1.5mm Qty 1 pcs equiv. no. 437008			
	GEV No.	510013	Ref. No.	—
	rinse arm shaft			
	GEV No.	510130	Ref. No.	5531K
	union nut for rinse jet			
	GEV No.	510139	Ref. No.	5532K
	rinse jet			
	GEV No.	518326	Ref. No.	—
	rinse arm boss			
	GEV No.	518328	Ref. No.	5559K
	rinse arm mounting pos. right L 110mm mounting ø 13mm nozzles 2			
	GEV No.	518329	Ref. No.	5559K
	rinse arm mounting pos. left L 110mm mounting ø 13mm nozzles 2			

knobs

producer-specific knobs

BONNET

			
1			
GEV No.	112123	Ref. No.	138341 BAAN1207825
description	knob ø 50mm shaft ø 8x6.5mm shaft flat upper special		
			
1			
GEV No.	110197	Ref. No.	908117 BAAN1323372 BAAN313287
description	knob switch zero mark ø 42mm shaft ø 6x4.6mm shaft flat adjustable black		
			
1			
GEV No.	112168	Ref. No.	310997 BAAN1210197 BAAN304989
description	knob switch zero mark ø 50mm shaft ø 10x8mm shaft flat upper black		
			
1			
GEV No.	112122	Ref. No.	138340 BAAN1207824 BAAN835242
description	knob t.max.°C ø 50mm shaft ø 6x4.6mm shaft flat upper special		
			
1			
GEV No.	112125	Ref. No.	381286 BAAN856673 BAAN890769
description	knob adapter shaft ø 8x6.5mm shaft flat universal		

			
1			
GEV No.	112124	Ref. No.	381285 BAAN856672 BAAN870196
description	knob adapter t.max.°C shaft ø 6x4.6mm shaft flat universal		

accessories

gaskets

			
1			
GEV No.	112128	Ref. No.	366369 BAAN169545 BAAN305593
description	gasket knob D1 ø 40mm D2 ø 13.5mm		

			
1			
GEV No.	112126	Ref. No.	366370 BAAN169546 BAAN305594
description	gasket knob D1 ø 42mm D2 ø 23.5mm equiv. no. 56500 suitable for ZANUSSI		

knob adaptors

			
1			
GEV No.	112125	Ref. No.	381286 BAAN856673 BAAN890769
description	knob adaptor shaft ø 8x6.5mm shaft flat universal		

			
1			
GEV No.	112124	Ref. No.	381285 BAAN856672 BAAN870196
description	knob adapter t.max.°C shaft ø 6x4.6mm shaft flat universal		

locks

edgemount latches

handle latches

CAFF/FERMOD

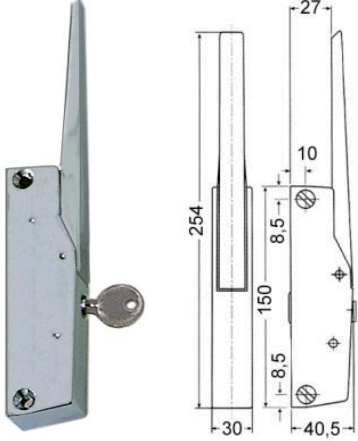
			
1			
GEV No.	690413	Ref. No.	74441 BAAN1323109 BAAN310371
description	handle latch L 150mm mounting distance 133mm lockable refrigeration units G 795		
accessories for	690413		

GEV No.	690418	Ref. No.	—
description	door catch L 36mm W 19mm H 29mm mounting distance 12mm zinc-coated steel for refrigeration units		

GEV No.	690419	Ref. No.	—
description	door catch L 52mm W 20mm H 30mm mounting distance 26-37mm zamak for refrigeration units		

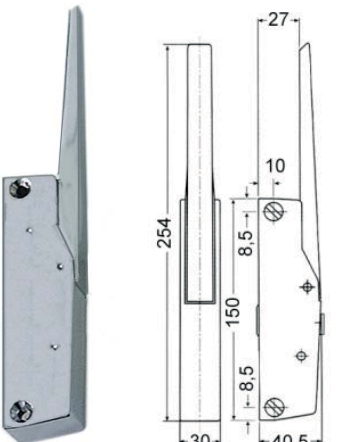

GEV No.	700435	Ref. No.	—
description	door catch L 58mm W 20mm H 35mm mounting distance 42mm zamak for refrigeration units		

			
1			
GEV No.	690412	Ref. No.	21433E 384634 BAAN1322230 BAAN303576
description	handle latch L 150mm mounting distance 133mm non lockable G 790 total length 254mm handle length 105mm		
accessories for	690412		



GEV No.	690418	Ref. No.	—
description	door catch L 36mm W 19mm H 29mm mounting distance 12mm zinc-coated steel for refrigeration units		

Table continues overleaf

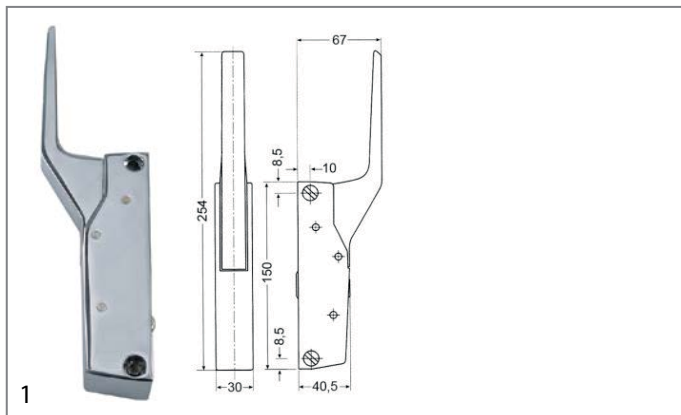

accessories for 690412	
	GEV No. 690419 Ref. No. — door catch L 52mm W 20mm H 30mm mounting distance 26-37mm zamak for refrigeration units
	GEV No. 700061 Ref. No. — door catch L 58mm W 20mm H 35mm mounting distance 42mm chrome-plated brass for headed units
	GEV No. 700435 Ref. No. — door catch L 58mm W 20mm H 35mm mounting distance 42mm zamak for refrigeration units



GEV No. 700060	Ref. No. 384634 71261E BAAN309273 BAAN953821 BAAN974840
description	handle latch L 150mm mounting distance 133mm non lockable heated units G 791
accessories for 700060	
	GEV No. 700061 Ref. No. — door catch L 58mm W 20mm H 35mm mounting distance 42mm chrome-plated brass for headed units
	GEV No. 700062 Ref. No. — handle protection heated units

door catches

	GEV No. 700082	Ref. No. 679486 S486P51
description	door catch L 38mm W 18mm mounting distance 26mm	

walk-in fridge catches

CAFF/FERMOD

620/621 series



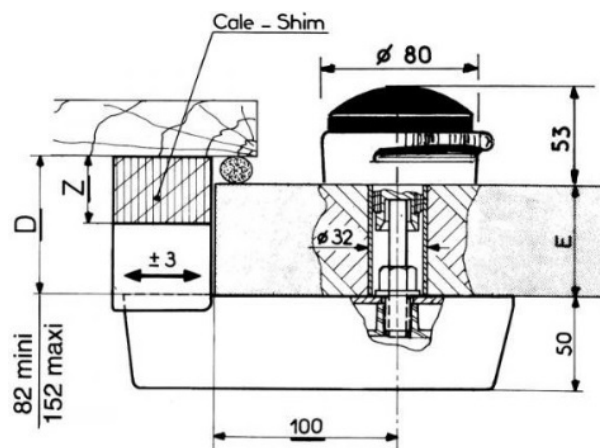

1



GEV No. 700575	Ref. No. 21273E
description	walk-in fridge catch door thickness 30-120mm lockable type 621 L 213mm W 104mm H 50mm
spare parts for 700575	
	GEV No. 692532 Ref. No. — key cylinder rotation 90°
	GEV No. 700618 Ref. No. — door opener type 520/521/620/621/920/921 for door thickness 30-120mm
	GEV No. 700619 Ref. No. — door catch for off-set 27-42mm W 54mm L 117mm H 47mm type 620/621
accessories for 700575	
	GEV No. 700795 Ref. No. — base plate door thickness 42-57mm H 15mm type 620/621
	GEV No. 700796 Ref. No. — base plate H 30mm type 620/621 for door thickness 57/72mm
	GEV No. 700797 Ref. No. — base plate H 50mm type 620/621

Table continues overleaf

accessories for 700575			
	GEV No.	700798	Ref. No. —
base plate H 80mm type 620/621			

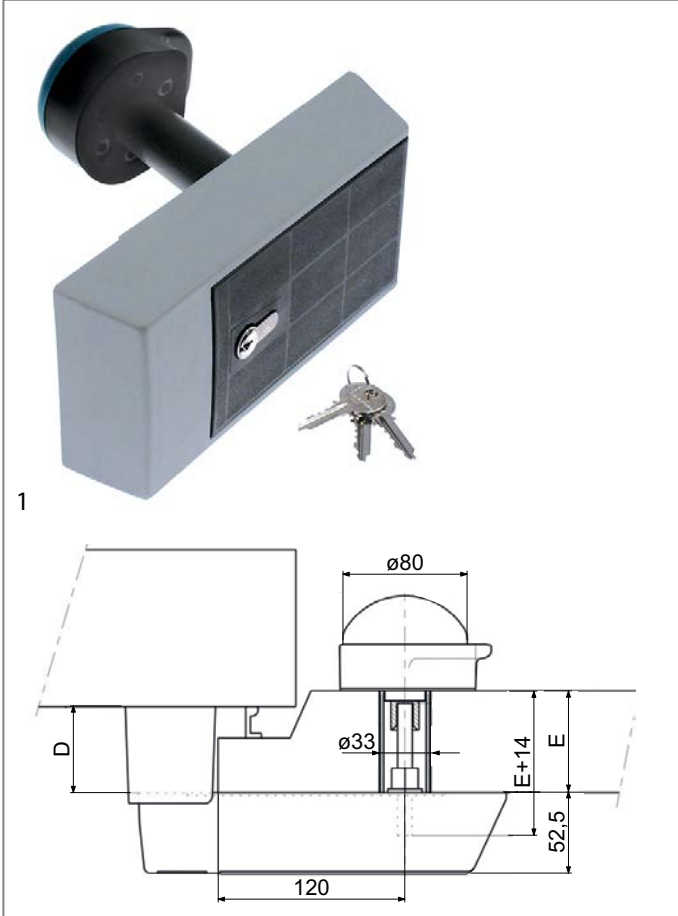

accessories for 700574			
	GEV No.	700794	Ref. No. —
door catch for off-set 137-157mm W 54mm H 167mm L 135mm type 920/921/920HP/921HP			

920/921 series



GEV No.	700574	Ref. No.	621092
description	walk-in fridge catch door thickness 100mm type 921HP L 245mm W 108mm H 52.5mm lockable H1 220mm		
accessories for 700574			
	GEV No.	700577	Ref. No. —
door catch for off-set 27-42mm W 54mm H 47mm L 135mm type 920/921/920HP/921HP			
	GEV No.	700578	Ref. No. —
door catch for off-set 42-57mm W 54mm H 62mm L 135mm type 920/921/920HP/921HP			
	GEV No.	700579	Ref. No. —
door catch for off-set 52-72mm W 54mm H 82mm L 135mm type 920/921/920HP/921HP			
	GEV No.	700580	Ref. No. —
door catch for off-set 65-85mm W 54mm H 99mm L 135mm type 920/921/920HP/921HP			
	GEV No.	700791	Ref. No. —
door catch for off-set 86-106mm W 54mm H 82mm L 135mm type 920/921/920HP/921HP			
	GEV No.	700792	Ref. No. —
door catch for off-set 103-123mm W 54mm H 133mm L 135mm type 920/921/920HP/921HP			
	GEV No.	700793	Ref. No. —
door catch for off-set 120-140mm W 54mm H 82mm L 135mm type 920/921/920HP/921HP			

miscellaneous

1			
	GEV No.	696420	Ref. No. 72308E
description	door catch with microswitch L 80mm W 46mm mounting distance 60mm		
spare parts for 696420			
	GEV No.	347567	Ref. No. —
momentary push switch mounting \varnothing 12mm white 1NO 250V 4A connection male faston 6.3mm ambient temperature max. 85°C protection IP40			

hinges edgmount hinges

CAFF/FERMOD

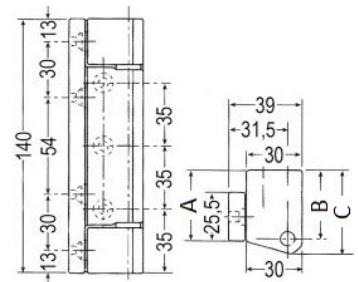
1			
		GEV No.	700562
		Ref. No.	71258E BAAN309271
description	edgmount hinge L 140mm W 31/24mm mounting distance 30/35mm hinging left/right without lift L1 37mm L2 36mm L3 45.5mm series G 361		

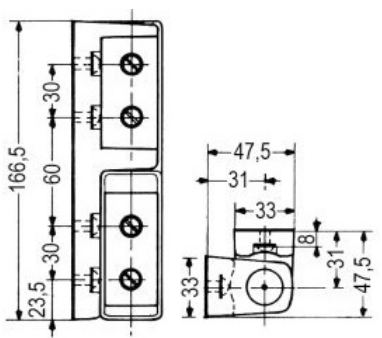
1			
		GEV No.	700566
		Ref. No.	621090 BAAN159291 BAAN300702 S090P01
description	edgmount hinge L 166.5mm W 33mm mounting distance 30/60mm hinging left/right with gradient series G 481		



CHG

GEV No.	690298	Ref. No.	621096 BAAN172066 S096P01
description	edgmount hinge L 146mm W 31mm mounting distance 27/27mm hinging left/right with gradient L1 38mm series R50		
accessories for	690298		
	GEV No.	345323	Ref. No. —
	microswitch with lever 250V 10A 1CO connection male faston ambient temperature max. 105°C		

GEV No.	690574	Ref. No.	621083 85873 BAAN311508 S083P01
description	spring assisted hinge series 176 mounting pos. left/right L 75mm W 25.6mm A 11mm B 15mm mounting measurements 22x22mm intake 7.5x7.5		

spring assisted hinges

universal

CAFF/FERMOD

group 2

GEV No.	690494	Ref. No.	621083
description	spring assisted hinge series 175 mounting pos. left/right torx L 75mm W 25.6mm H 100mm A 4mm B 11mm mounting measurements 22x22mm intake torx refrigeration units mounting distance 25mm		

fittings for catering equipment

drain taps

brass

drain taps

GEV No.	541941	Ref. No.	313048 BAAN169473 BAAN305156
description	drain tap 1 1/2" IT L 124mm conical seal thread 1 1/2"		
accessories for	541941		
	GEV No.	510404	Ref. No. —
	flat gasket fibre ED ø 44mm ID ø 34mm thickness 2mm Qty 1 pcs		

equipment feet and end caps

equipment feet

with screw mounting

GEV No.	513287	Ref. No.	2001489H
description	equipment foot tube ø 60mm thread M12 thread L 33mm H 155-235mm SS size 2" Qty 1 pcs		







shelves and shelf rails

grates

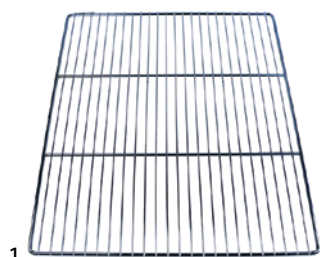
universal

without upstand



GEV No.	970123	Ref. No.	635022
description	grate W 650mm D 530mm GN 2/1 stainless steel wire gauge frame 7.8mm lengthwise wires gauge 3.8mm crossing wires 2 suitable for refrigerator		
accessories for	970123		
	GEV No.	Ref. No.	—
	690330		
	rack L 1000mm W 22mm H 4mm aperture 3x8mm hole distance 12.5mm stainless steel		
	GEV No.	Ref. No.	—
	694700		
	shelf support L 31/28mm W 22mm H 18mm SS Qty 12 pcs		
	GEV No.	Ref. No.	—
	694701		
	shelf support L 31/28mm W 22mm H 17mm SS with hook Qty 12 pcs		

gaskets

refrigeration gaskets

plug-in gaskets

profile 9153

We offer custom-made gaskets for this profile

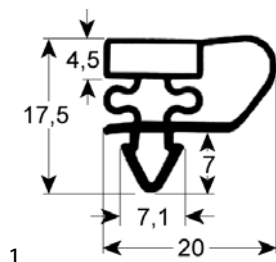

GEV No.	900723	Ref. No.	922155 BAANS359P11
description	refrigeration gasket profile 9153 W 670mm L 1280mm plug size		

profile 9794

We offer custom-made gaskets for this profile

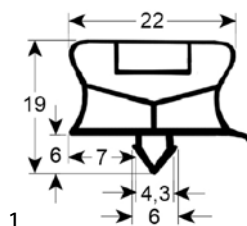

GEV No.	901941	Ref. No.	638268 S268P11
description	refrigeration gasket profile 9794 W 371mm L 592mm plug size		

profile 9195

We offer custom-made gaskets for this profile

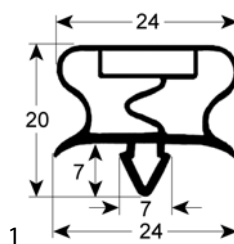

GEV No.	901916	Ref. No.	638256 S256P11
description	refrigeration gasket profile 9195 W 158mm L 387mm plug size		

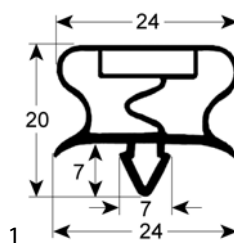

GEV No.	901913	Ref. No.	638247 S247P11
description	refrigeration gasket profile 9195 W 174mm L 387mm plug size		

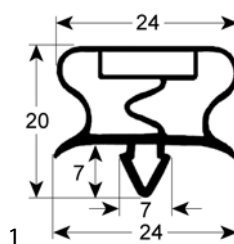

GEV No.	901921	Ref. No.	638217 BAAN849162 S217P11
description	refrigeration gasket profile 9195 W 364mm L 689mm plug size		



GEV No.	901914	Ref. No.	638249 S249P11
description	refrigeration gasket profile 9195 W 373mm L 387mm plug size		

GEV No.	901911	Ref. No.	638209 S209P11 S210P11
description	refrigeration gasket profile 9195 W 624mm L 1842mm plug size		

GEV No.	901906	Ref. No.	638201 S201P11
description	refrigeration gasket profile 9195 W 374mm L 689mm plug size		

GEV No.	901905	Ref. No.	15398881 638138 906002019 BAAN159207 S138P11
description	refrigeration gasket profile 9195 W 627mm L 1500mm plug size		

GEV No.	901915	Ref. No.	638255
description	refrigeration gasket profile 9195 W 387mm L 572mm plug size		

GEV No.	901945	Ref. No.	S443P11
description	refrigeration gasket profile 9195 W 654mm L 1524mm plug size		

GEV No.	901942	Ref. No.	638396 BAAN987475 S396P11
description	refrigeration gasket profile 9195 W 420mm L 585mm plug size		

GEV No.	901943	Ref. No.	1325364 638400
description	refrigeration gasket profile 9195 W 667mm L 1545mm plug size		

GEV No.	901920	Ref. No.	S259P11
description	refrigeration gasket profile 9195 W 462mm L 572mm plug size		

GEV No.	901904	Ref. No.	638136 BAAN168741 S136P11
description	refrigeration gasket profile 9195 W 668mm L 1523mm plug size		

GEV No.	901907	Ref. No.	300799 BAAN300799 BAANS202P11
description	refrigeration gasket profile 9195 W 689mm L 774mm plug size		

GEV No.	901944	Ref. No.	S402P11
description	refrigeration gasket profile 9195 W 675mm L 760mm plug size		

GEV No.	901910	Ref. No.	300802 638208 824542 BAAN300802 BAANS208P11
description	refrigeration gasket profile 9195 W 702mm L 1843mm plug size		

GEV No.	901939	Ref. No.	638219 BAAN849165 S219P11
description	refrigeration gasket profile 9195 W 689mm L 1109mm plug size		

GEV No.	901912	Ref. No.	638211 S211P11
description	refrigeration gasket profile 9195 W 702mm L 1863mm plug size		

GEV No.	901908	Ref. No.	S203P11
description	refrigeration gasket profile 9195 W 689mm L 1119mm plug size		

GEV No.	901940	Ref. No.	S220P11
description	refrigeration gasket profile 9195 W 820mm L 1860mm plug size		

GEV No.	901938	Ref. No.	638218 888695 BAAN888695 BAANS218P11
description	refrigeration gasket profile 9195 W 689mm L 764mm plug size		



profile 9793

We offer custom-made gaskets for this profile

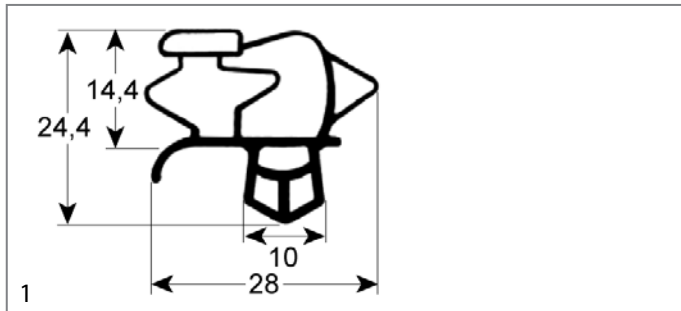

GEV No.	900936	Ref. No.	74306 BAAN1323106 BAAN310202
description	refrigeration gasket profile 9793 W 637mm L 1512mm plug size		

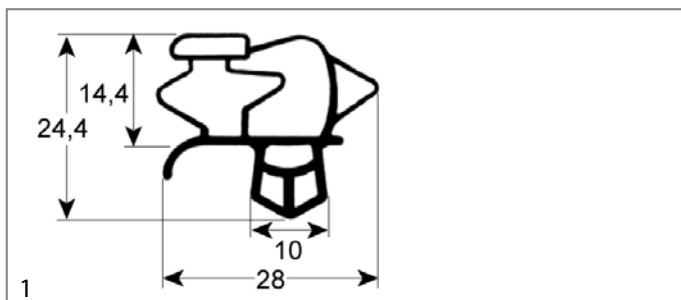

GEV No.	902307	Ref. No.	N/A
description	refrigeration gasket profile 9793 Wmm L 2500mm		

gaskets for heated units

window seals

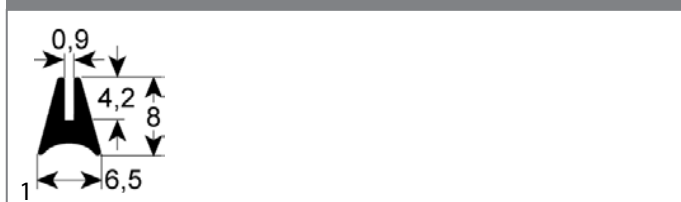

GEV No.	901306	Ref. No.	366122
description	window gasket profile 1515 Qty supplied by meter		

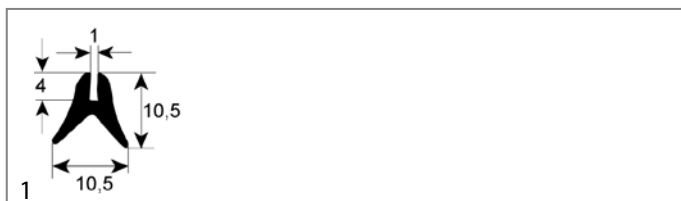

GEV No.	901513	Ref. No.	71209E
description	window gasket profile 1615 suitable for BOURGEOIS Qty supplied by meter		

door seals

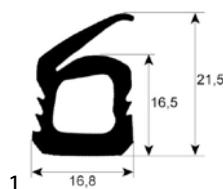

GEV No.	900610	Ref. No.	366371 BAAN169547 BAAN305595
description	door seal profile 2275 W 290mm L 690mm external size Qty 1 3-sided		

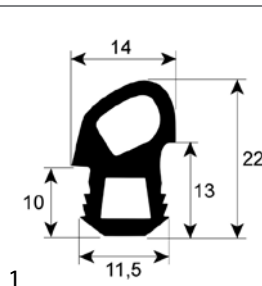

GEV No.	901362	Ref. No.	366386 BAAN171176 BAAN305603
description	door seal profile 2707 Qty supplied by meter		

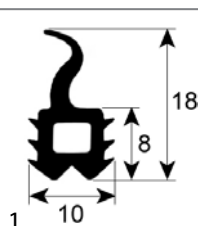

GEV No.	901424	Ref. No.	71204E 71206E BAAN309220 BAAN309222
description	door seal profile 2711 L 2600mm Qty 1		

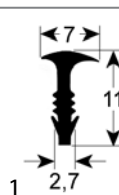

GEV No.	518126	Ref. No.	71876E
description	door seal profile 2980 L 2820mm		

O-rings

EPDM

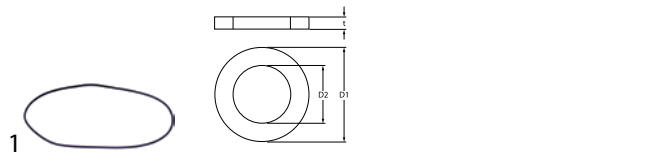

GEV No.	521717	Ref. No.	1255E 3710E 5620E BAAN301931
description	O-ring EPDM thickness 1.78mm ID ø 120.37mm Qty 1 pcs		

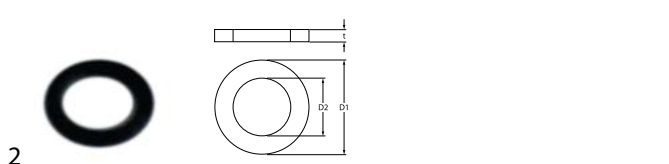

GEV No.	528485	Ref. No.	5091E
description	O-ring EPDM thickness 1.78mm ID ø 6.07mm Qty 1 pcs		

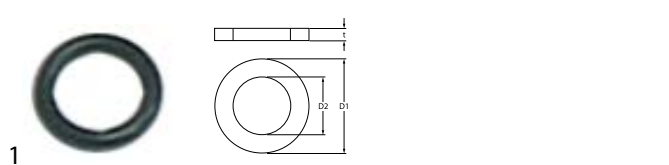

GEV No.	510303	Ref. No.	5814E
description	O-ring EPDM thickness 1.78mm ID ø 6.75mm Qty 1 pcs		

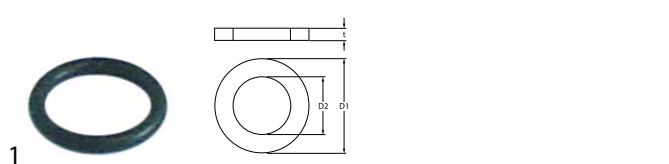

GEV No.	504574	Ref. No.	2001375H 5090E
description	O-ring EPDM thickness 1.78mm ID ø 9.25mm Qty 1 pcs		

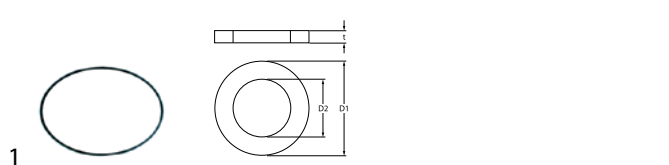

GEV No.	510554	Ref. No.	1255E 3710E 5620E BAAN301931
description	O-ring EPDM thickness 2mm ID ø 120mm Qty 1 pcs		

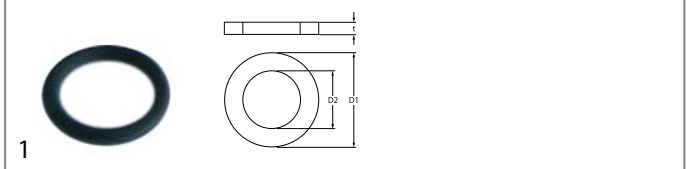

GEV No.	510902	Ref. No.	5090E BAAN307058
description	O-ring EPDM thickness 2mm ID ø 9.5mm Qty 1 pcs		

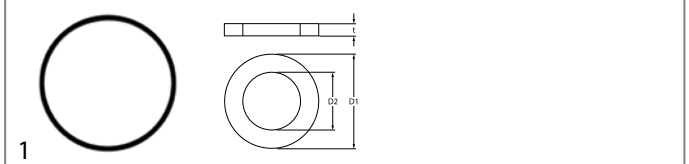

GEV No.	510009	Ref. No.	5584E BAAN1322923 BAAN307631
description	O-ring EPDM thickness 3.53mm ID ø 101.2mm Qty 1 pcs		

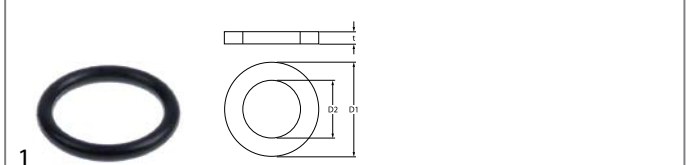

GEV No.	511322	Ref. No.	15173K 966085
description	O-ring EPDM thickness 3.53mm ID ø 20.22mm Qty 1 pcs		

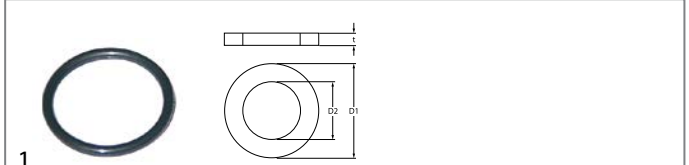

GEV No.	510072	Ref. No.	2001917H BAAN1321539 BAAN953969
description	O-ring EPDM thickness 3.53mm ID ø 32.93mm Qty 1 pcs		

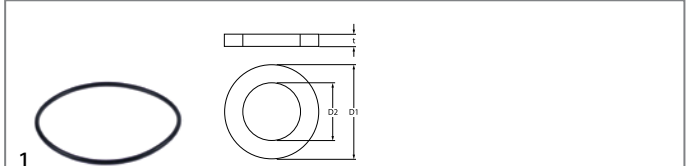

GEV No.	532543	Ref. No.	2002516H
description	O-ring EPDM thickness 5.34mm ID ø 136.5mm Qty 1 pcs		

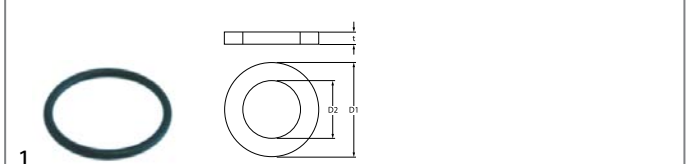

GEV No.	521120	Ref. No.	2001370H
description	O-ring EPDM thickness 5.34mm ID ø 37.47mm Qty 1 pcs		

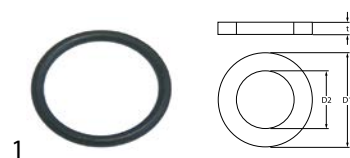

			
1			
GEV No.	510408	Ref. No.	2001827H
description	O-ring EPDM thickness 5.34mm ID ø 47mm Qty 1 pcs		

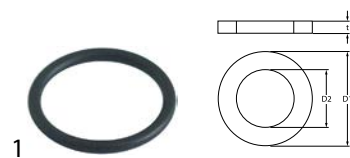
			
1			
GEV No.	505175	Ref. No.	966084
description	O-ring EPDM thickness 5.34mm ID ø 50.16mm Qty 1 pcs		

			
1			
GEV No.	510409	Ref. No.	318044 905588 966001 BAAN1323306 BAAN311999
description	O-ring EPDM thickness 5.34mm ID ø 56.52mm Qty 1 pcs		

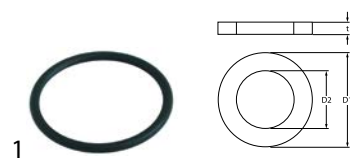
			
1			
GEV No.	691033	Ref. No.	15118K BAAN1320551 BAAN302432
description	O-ring EPDM thickness 5.34mm ID ø 62.87mm Qty 1 pcs		

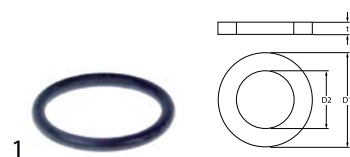
			
1			
GEV No.	532000	Ref. No.	366185
description	O-ring EPDM thickness 7mm ID ø 57mm Qty 1 pcs		

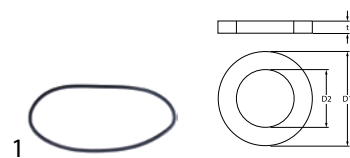
			
1			
GEV No.	510551	Ref. No.	91369308
description	pump cover gasket ID ø 158.3mm pump type 1214/1293/1225/2243/1226/1204/3473/1241 thickness 3.53mm EPDM Qty 1 pcs		

silicone			
			
1			
GEV No.	532316	Ref. No.	15138K BAAN302448
description	O-ring silicone thickness 3.53mm ID ø 32.93mm Qty 10 pcs		

Viton			
			
1			
GEV No.	371095	Ref. No.	2001374H BAAN1121434 BAAN1321069
description	O-ring Viton thickness 1.78mm ID ø 6.07mm Qty 1 pcs		

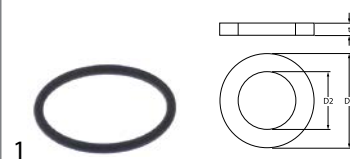
			
1			
GEV No.	532625	Ref. No.	2002519H
description	O-ring Viton thickness 2.62mm ID ø 28.25mm Qty 1 pcs		

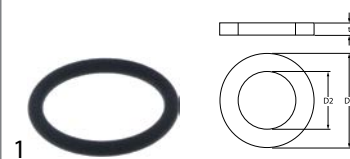
			
1			
GEV No.	524478	Ref. No.	15118K 966003 966017 BAAN1320551 BAAN302432 BAAN942897
description	O-ring Viton thickness 5.7mm ID ø 44.2mm Qty 1 pcs		

sealing washers

aluminium gaskets

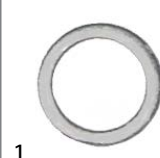
			
1			
GEV No.	101293	Ref. No.	014073M BAAN1027483 BAAN825612
description	flat gasket aluminium ED ø 14mm ID ø 10.3mm for pilot burner Qty 1 pcs		

rubber gaskets



1

GEV No.	519547	Ref. No.	2001335H
description	flat gasket rubber ED \varnothing 14.4mm ID \varnothing 15.5mm thickness 2mm Qty 1 pcs size 3/4"		



1

GEV No.	505397	Ref. No.	2001340H
description	flat gasket rubber ED \varnothing 32mm ID \varnothing 19.5mm thickness 1.5mm Qty 1 pcs		



1

GEV No.	516261	Ref. No.	2001359H
description	flat gasket rubber ED \varnothing 33mm ID \varnothing 25mm thickness 2.5mm for air trap Qty 1 pcs		



1

GEV No.	513059	Ref. No.	5914E
description	flat gasket rubber ED \varnothing 52mm ID \varnothing 40mm thickness 3mm Qty 1 pcs		



1

GEV No.	518205	Ref. No.	2001343H 2001368H
description	flat gasket rubber ED \varnothing 61mm ID \varnothing 47mm thickness 2mm Qty 1 pcs		



1

GEV No.	507541	Ref. No.	2002510H
description	flat gasket rubber ED \varnothing 74mm ID \varnothing 57mm thickness 2mm Qty 1 pcs		



1

GEV No.	518060	Ref. No.	2001851H 5830E BAAN1321482 BAAN307852
description	gasket rubber ED \varnothing 132mm ID \varnothing 122mm thickness 5mm		

special gaskets

miscellaneous



1

GEV No.	511600	Ref. No.	71860E
description	gasket ED \varnothing 80mm		

gaskets for wash arm support



1

GEV No.	510054	Ref. No.	437046
description	gasket D1 \varnothing 65mm D2 \varnothing 35.5mm thickness 2.5mm with 5 holes wash arm support		



1

GEV No.	518402	Ref. No.	2001344H BAAN1321043
description	gasket with 3 screw holes wash arm support hole distance 61mm D2 \varnothing 34mm thickness 2.5mm hole \varnothing 34mm		

springs

roller springs

roller springs



1

GEV No.	517450	Ref. No.	2001228H
description	roller spring W 51mm ID \varnothing 31mm lug length 90mm		



tension springs

			
1			
GEV No.	693881	Ref. No.	385053 BAAN169610 BAAN305842
description	tension spring ø 23mm total length 90mm wire gauge ø 3mm thread M8		

			
1			
GEV No.	513206	Ref. No.	2001879H
description	tension spring ø 29.8mm total length 513mm wire gauge ø 5.8mm		

dosing pumps







peristaltic dosing pumps

SEKO



built-in version

with frequency control

			
1			

GEV No.	361215	Ref. No.	2001180H	
description	dosing pump SEKO frequency control 0.3-3.0l/h 230VAC detergent hose ø 4x6mm hose type K hose Santoprene suction level 1.5m type PBR protection IP55 dimensions 100x67x68mm power input 3.5W			
spare parts for	361215			
	GEV No.	361136	Ref. No.	—
	roller assembly for dosing pump hole ø 4.8x4mm			
	GEV No.	361226	Ref. No.	—
	PCB L 59mm W 26mm electronic control			
	GEV No.	361815	Ref. No.	—
	pump hose detergent hose ø 6x10mm hose ø 4x6mm hose type K hose Santoprene type SEKO			
accessories for	361215			
	GEV No.	361142	Ref. No.	—
	mounting set detergent hose type 4x6mm hose length 2m PVC 2x hose/container filter/tank intake transparent			
	GEV No.	520090	Ref. No.	—
	PVC hose ID ø 4mm ED ø 6mm L 2m thickness 1mm t.max. 60°C transparent			
	GEV No.	520091	Ref. No.	—
	nylon hose ID ø 4mm ED ø 6mm L 2m thickness 1mm operating p. 10bar burst p. 50bar t.max. 100°C transparent			

without control

				
1				
GEV No.	361929 ¹	Ref. No.	2002480H	
description	dosing pump SEKO without control 0.4l/h 230VAC rinse aid hose ø 4x6mm hose type E hose Sekobril suction level 1.5m type NPG 0.4 8W cable length 45mm built-in version with backflow preventer			
spare parts for	361929			
	GEV No.	361925	Ref. No.	2002474H
	pump hose SEKO rinse aid hose ø 3x8mm with backflow preventer hose ø 6mm hose type E hose Sekobril			

¹with accessories



spare parts

			
1			
GEV No.	361925 ¹	Ref. No.	2002474H
description	pump hose SEKO rinse aid hose ø 3x8mm with backflow preventer hose ø 6mm hose type E hose Sekobril		

¹with backflow preventer

piston pumps

dosing pumps

				
1				
GEV No.	361895	Ref. No.	378630	
description	dosing pump type TTE service kit 200-240V detergent inlet 5.5mm outlet 5.5mm			
spare parts for	361895			
	GEV No.	361838	Ref. No.	—
	dosing pump type TTE 200-240V detergent inlet 5.5mm outlet 5.5mm HOBART			













membrane dosing pumps

self-priming

SEKO



1

GEV No.	361364 ¹	Ref. No.	2001520H
description	dosing pump type DIB5E self-sucking rinse aid pump rate 0-5cm ³ per stroke pressure connection ø 4x6mm suction connection ø 4x6mm SEKO supporting pressure closed		
spare parts for	361364		
	GEV No.	361301	Ref. No. —
	hose connector for type DIB3E/DIB5E		
	GEV No.	361302	Ref. No. —
	valve bush for type DIB3E/DIB5E		
	GEV No.	361304	Ref. No. —
	O-ring EPDM ID ø 11.11mm thickness 1.78mm Qty 1 pcs for type DIB3E/DIB5E		
	GEV No.	361305	Ref. No. —
	valve disc for type DIB3E/DIB5E DIB3P/DIB5P		
	GEV No.	361306	Ref. No. —
	membrane for type DIB3E/DIB5E ø 49mm hole ø 5mm		
	GEV No.	361307	Ref. No. —
	membrane dosing pump ø 68mm hole ø 6mm for type DIB3P/DIB5P		
	GEV No.	361459	Ref. No. —
	hose connector ø 6mm for dosing pump		
	GEV No.	361481	Ref. No. —
	lip valve for type DIB3P/DIB5P DIB3E/DIB5E		
accessories for	361364		
	GEV No.	361240	Ref. No. —
	hose connector 1-way hose ø 6mm plastic connection M10x1		
	GEV No.	361241	Ref. No. —
	hose connector 1-way hose ø 9mm plastic connection M10x1		

¹auxiliary pressure connection closed

various



GEV No.	361741	Ref. No.	914207 BAAN1323415 BAAN312790
description	dosing pump type model 2 rinse aid inlet 4x6mm outlet 4x6mm pressure connection ø 4x6mm suction connection ø 4x6mm		
spare parts for	361741		
	GEV No.	361307	Ref. No. —
	membrane dosing pump ø 68mm hole ø 6mm for type DIB3P/DIB5P		
	GEV No.	361459	Ref. No. —
	hose connector ø 6mm for dosing pump		
	GEV No.	361462	Ref. No. —
	container filter with weight SS hose ø 4x6mm		
	GEV No.	508116	Ref. No. —
	union nut thread M10x1 H 16mm WS 16 plastic Qty 1 pcs		
	GEV No.	508123	Ref. No. —
	T-piece 3-way hose ø 13-5-13mm plastic		
	GEV No.	520090	Ref. No. —
	PVC hose ID ø 4mm ED ø 6mm L 2m thickness 1mm t.max. 60°C transparent		

accessories

container filters with non-return valve



1

GEV No.	361058	Ref. No.	2000034
description	container filter with non-return valve SS hose ø 4x6mm ø 20mm L 56mm		





hoses

supply hoses

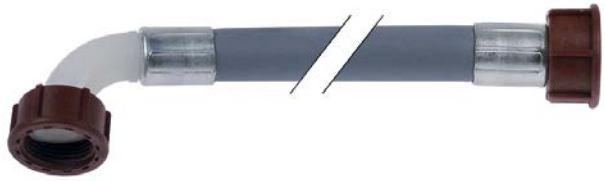
PVC supply hoses



1

GEV No.	520010	Ref. No.	2001753H 42551
description	supply hose PVC straight-curved DN13 connections 3/4" L 1500mm operating p. 10bar burst p. 32bar t.max. 90°C blue approval VDE flat seal		
accessories for	520010		
	GEV No.	520053	Ref. No. —
	screen connection 3/4" D1 ø 26mm D2 ø 15mm Qty 10 pcs rubber thickness 8mm		
	GEV No.	520054	Ref. No. —
	flat gasket rubber ED ø 23.5mm ID ø 14mm thickness 2.3mm Qty 10 pcs		



1

GEV No.	520011	Ref. No.	2001738H
description	supply hose PVC straight-curved DN13 connections 3/4" L 2000mm operating p. 10bar burst p. 32bar t.max. 90°C approval VDE flat seal		

drain hoses



1

GEV No.	518068	Ref. No.	2001854H 5834E
description	drain hose DN34 L 2000mm elbow ø inside 50mm elbow ext. ø 59mm inner hose ø 35mm outer hose ø 42mm PVC		

industrial hoses

Niplaflex hoses



1

GEV No.	530561	Ref. No.	2001726H
description	pressure hose ID ø 10mm ED ø 17mm L 5m thickness 3.5mm operating p. 10bar burst p. 30bar t.max. 110°C		

pressure control hoses



1







GEV No.	530560	Ref. No.	2001744H 2002194H
description	pressure control hose ID ø 5mm ED ø 9mm L 5m operating p. 30bar burst p. 90bar temp.-resist. 60°C		

PVC hoses

PVC hoses without fabric



1

GEV No.	520383	Ref. No.	2001722H
description	PVC hose ID ø 4mm ED ø 6mm L 2m thickness 1mm t.max. 60°C blue		
accessories for	520383		
	GEV No.	361058	Ref. No. 2000034
	container filter with non-return valve SS hose ø 4x6mm ø 20mm L 56mm		
	GEV No.	361066	Ref. No. —
	container filter straight SS hose ø 4x6mm L 37mm non return valve ball valve		
	GEV No.	361106	Ref. No. —
	container filter with weight and non-return valve SS hose ø 4x6mm ø 21mm L 51mm non return valve lip valve		
	GEV No.	361141	Ref. No. —
	container filter with weight ceramic hose ø 4mm		
	GEV No.	361230	Ref. No. —
	container filter with weight stainless steel hose ø 4x6mm		
	GEV No.	361462	Ref. No. —
	container filter with weight SS hose ø 4x6mm		
	GEV No.	361728	Ref. No. —
	container filter with 4m 4x6 hose SS hose ø 4x6mm hose length 4000mm		

1

GEV No.	520029	Ref. No.	2001747H
description	PVC hose ID ø 6mm ED ø 9mm L 10m thickness 1.5mm t.max. 60°C transparent		

extraction and pressure hoses



1

GEV No.	530444	Ref. No.	N/A
description	universal hose ID ø 38mm ED ø 50mm L 1m operating p. 10bar burst p. 30bar temp.-resist. -30 up to +80°C		

silicone hoses

without fabric



1

GEV No.	530063	Ref. No.	71289E
description	silicone hose ID ø 18mm ED ø 25mm L 1m t.max. 200°C transparent		

with fabric

with monofilament braid



1

GEV No.	530542	Ref. No.	71265E
description	silicone hose with monofilament braid ID ø 10mm ED ø 17mm L 5m thickness 3.5mm operating p. 4bar burst pressure at 95°C non definedbar burst pressure 130°C non definedbar t.max. 200°C Qty 5m		

formed hoses

form U



1

GEV No.	518517	Ref. No.	2001408H BAAN1121125 BAAN1321100
description	formed hose for drain pump D1 ø 28mm D2 ø 21mm warewashing U-shape		

miscellaneous



1

GEV No.	513306	Ref. No.	2002452H
description	formed hose ext. ø 43 ID ø 34mm ED ø 23mm D1 ø 32mm L 140mm		



1

GEV No.	513307	Ref. No.	2002450H
description	formed hose ext. ø 47 ID ø 39mm ED ø 47mm D1 ø 39mm L 82mm		

fittings, hose and pipe connectors

hose connectors

without screw connection



1

GEV No.	504302	Ref. No.	904364 917001 BAAN1323251 BAAN311749
description	T-piece plastic hose ø 10-6-10mm ID ø 5/7.5mm L 62mm W 34mm		



hose connectors

brass



1

GEV No.	513253	Ref. No.	2001857H BAAN1321487 BAAN307867
description	hose connector brass angled thread 1/4" hose ø 12mm Qty 1 pcs		

valves and tank inlets

ball valves

ball valves electric



1

GEV No.	401190	Ref. No.	314359
description	ball valve inlet 3/4" IT outlet 3/4" IT IP42 230V L 68mm 50/60Hz closed off-current mode of operation electric connection cable 300mm 3.5W duty cycle 50%		

water cycle components

supply filters



1

GEV No.	520261	Ref. No.	91297387
description	supply filter thread 1/2" IT - 1/2" IT total length 58mm red brass mesh opening 0.4mm		

ancillary products

clamps

hose clamps

DIN 3017 - W2



1

GEV No.	520114	Ref. No.	917110
description	hose clamp ø 20-32mm width 9mm Qty 10 pcs DIN 3017		

DIN 3017 - W4



1

GEV No.	520120	Ref. No.	15181K 917109
description	hose clamp SS W4 ø 12-20mm width 9mm Qty 1 pcs DIN 3017		

measuring equipment

thermometers

built-in thermometers



1

GEV No.	541086	Ref. No.	901018 BAAN1323190 BAAN869118
description	thermometer mounting measurements 58x25.5mm 0 up to +120°C capillary pipe 2000mm probe ø 6mm probe L 23mm		

fastening material

screws

hexagonal screws



1

GEV No.	560083	Ref. No.	388105 BAAN1080078
description	hexagonal screw thread M5 thread L 10mm SS WS 8 Qty 20 pcs DIN 933 / ISO 4017		

cylinder head bolts

DIN 912/ISO 4762



1

GEV No.	560335	Ref. No.	388107 BAAN781719
description	cylinder head bolt thread M5 thread L 20mm WS 4 SS Qty 1 pcs DIN 912/ISO 4762		

knurled screws



1

GEV No.	510112	Ref. No.	5517E
description	Thumb screw thread M10 thread L 10mm ø 22mm H 4.5mm SS		

nuts

knurled nuts



1

GEV No.	504516	Ref. No.	5109E
description	knurled nut thread M8x1 ø 25mm H 6mm SS		



1

GEV No.	504547	Ref. No.	5013E
description	knurled nut thread M8x1 ø 25mm H 6mm SS		

hexagonal nuts

DIN 934 / ISO 4032/8673



1

GEV No.	560129	Ref. No.	989100
description	hexagonal nut thread M5 H 4mm WS 8 SS DIN/ISO DIN 934 / ISO 4032/8673 Qty 1 pcs		



1

GEV No.	560197	Ref. No.	388146
description	nut thread M10 H 8mm WS 17 SS DIN/ISO DIN 934 / ISO 4032/8673 Qty 1 pcs		

DIN 985



1

GEV No.	560141	Ref. No.	389540 BAAN1050326
description	hexagonal nut thread M5 H 5.4mm SS WS 8 Qty 20 pcs DIN/ISO DIN 985 self-locking		

fasteners

clamps

hose clamps

DIN 3017 - W2



1

GEV No.	520114	Ref. No.	917110
description	hose clamp ø 20-32mm width 9mm Qty 10 pcs DIN 3017		

DIN 3017 - W4



1

GEV No.	520120	Ref. No.	15181K 917109
description	hose clamp SS W4 ø 12-20mm width 9mm Qty 1 pcs DIN 3017		

consumables

fuses

fine fuses



1

GEV No.	358666	Ref. No.	309316
description	fine fuse size ø5x20mm 0.315A fast-acting rated 250V Qty 10 pcs		



1

GEV No.	358530	Ref. No.	2001921H
description	fine fuse size ø5x20mm 0.8A fast-acting rated 250V Qty 10 pcs		



			
1			
GEV No.	358677	Ref. No.	2001981H 2002146H
description	fine fuse size ø5x20mm 4A fast-acting rated 250V Qty 10 pcs		

ø6.3x32mm 500V			
			
1			
GEV No.	358752	Ref. No.	3090506
description	fine fuse size ø6.3x32mm 10A fast-acting rated 500V Qty 10 pcs		

A			
alarm devices	22		
axial fans	34		
B			
ball valves	87		
ball valves electric	33, 87		
bar burners	66		
bi-metal thermostats	10, 10		
booster pumps II	43		
C			
cables	45		
cam switches	18		
clamps	87, 88		
compressors	34		
condensators & interference suppression filters	44		
consumables	88		
contactors	23		
container filters	84		
control thermostats	10, 14		
copper wire	45		
cross flow fans	35		
cylinder head bolts	88		
D			
door catches	73		
door seals	79		
dosing pumps	83		
drain hoses	85		
drain pumps	43		
E			
edgemount hinges	74		
edgemount latches	72		
electric accessories	45		
electronic controllers	25		
energy regulators	9		
extraction and pressure hoses	86		
F			
fans	34		
fasteners	88		
fastening material	87		
fine fuses	88		
fluorescent lamps	21, 21		
formed hoses	86		
fuses	44, 88		
G			
gas burners	63		
gas control valves	55		
		gas nozzles	66
		gas taps	45
		gas thermostats	52
		gaskets for heated units	79
		gaskets for wash arm support	82
		grates	76
H			
		halogen lamp	21
		handle latches	72
		heating elements	3
		heating elements for bain maries	3
		heating elements for convection	7
		heating elements for fryers	3
		heating elements for frying pans	3
		heating elements for griddles	3
		heating elements for ovens	3
		heating elements for salamanders/toasters	3
		hexagonal nuts	88
		hexagonal screws	87
		hob burners	63
		hose clamps	87, 88
		hose connectors	86, 87
		hoses	85
		hot air fans	36
		hot air motors	35
		hot plates	8
I			
		ignition boxes	57
		ignition cables	61
		ignition units	62
		immersion heating elements	4
		indicator lights	19
		indicator lights (complete)	19
		industrial hoses	85
K			
		knurled nuts	88
		knurled screws	88
L			
		lamps	19
		LED	20
		light bulbs	21
M			
		magnetic switches	18
		measuring equipment	87
		mechanical timers	22
		microswitches	16
		motors	36

N

neon light bulbs	19, 20
nickel wire	45
Niplaflex hoses	85
nuts	88

O

operating capacitors	44
O-rings	80
oven lamps	21

P

pilot burners	58
plug-in gaskets	76
pressure control hoses	85
pressure switches	33
probes	26
programme timers	22
pumps	36
push/momentary push switches	16
PVC hoses	85
PVC supply hoses	85

R

radiation heaters	8
refrigeration fans	35
refrigeration gaskets	76
refrigeration motors universal	35
relays	24
ribbon cables	45
rocker/momentary rocker switches	16
rotary switches	18

S

safety bi-metal thermostats	10
safety thermostats	13, 15
safety valves	57
screws	87
sealing washers	81
shelves and shelf rails	76
silicone hoses	86
solenoid valves	27
spring assisted hinges	75
supply filters	87, 87
supply hoses	85
switches and momentary switches	16
system switches (ROLD)	17

T

temperature probes	26
terminals	45
thermocouples	62

thermostats	10
timers	22
transformers	25

U

universal probes	26
------------------	----

V

valves and tank inlets	87
------------------------	----

W

walk-in fridge catches	73
wash and rinse pumps	36
water cycle components	87
window seals	79