



GAS COMPONENTS



ELECTRIC COMPONENTS



WATER TECHNOLOGY



MECHANICAL COMPONENTS



TOOLS

Spare parts suitable for

BRASILIA

Find the complete and up-to-date range of products in our GEV Webshop



Manufacturer catalogue

The most important spare parts and accessories arranged clearly for every manufacturer

- ✓ Complete product range and all appliance data always up to date in the GEV Webshop
- ✓ Alphabetical Index at the end of the catalogue

GEV Webshop

www.gev-online.co.uk

www.gev-online.com









- 🔍 Add to Favourites
- 🔍 Sign In with email address and usual password
- 🔍 Easy-order – place several items in your basket at the same time
- 🔍 Quick Item search – no login needed

heating elements







heating elements for coffee machine

			
1			
GEV No.	417280	Ref. No.	10432.2.00.08
description	heating element 1000W 220V heating circuits 1 \varnothing 50mm H 60mm W1 45mm H1 20mm H2 40mm mounting distance 35mm thread M10x1 windings 4 tube \varnothing 6.3mm immersion heater 2 hole fixing connection male faston 6.3mm		
For models:	205-Exclusive, Bolero, Excelsior-OR, Excelsior-Standard, Gradisca-Res-tyling, Opus, Opus-B03-OR, Opus-OR		

			
1			
GEV No.	417035	Ref. No.	00625.2.00.08
description	heating element 1200W 230V heating circuits 1 \varnothing 55mm H 66mm W1 55mm H1 30mm H2 36mm mounting distance 42mm thread 1/4" copper windings 3 tube \varnothing 8.5mm immersion heater 2 hole fixing connection male faston 6.3mm		
For models:	BELLE EPOQUE JUNIOR, CLUB, LADY, MBM GOLF, OFFICE RB2		
accessories for	417035		
	GEV No.	Ref. No.	00839.0.00.02
	528231		
	O-ring Viton thickness 2.62mm ID \varnothing 12.37mm Qty 1 pcs		
	GEV No.	Ref. No.	—
	550932		
	nut thread 1/2" H 6mm WS 27 SS Qty 1 pcs		

			
1			
GEV No.	417081	Ref. No.	01911.2.00.08
description	heating element 1350W 230V heating circuits 1 thread 1" L 140mm W 22mm H 23mm tube \varnothing 8.5mm connection 6.3 immersion heater flange with thread		
For models:	Roma-Cappuccino		
accessories for	417081		
	GEV No.	Ref. No.	—
	510404		
	flat gasket fibre ED \varnothing 44mm ID \varnothing 34mm thickness 2mm Qty 1 pcs		
	GEV No.	Ref. No.	18661.0.00.02 18661.2.00.02
	528018		
	flat gasket PTFE ED \varnothing 41mm ID \varnothing 33mm thickness 3mm size 1" Qty 1 pcs		

			
1			
GEV No.	417034	Ref. No.	05430.0.00.04 05430.2.00.08
description	heating element 1400W 230V heating circuits 1 L 228mm W 45mm hole distance 68mm hole \varnothing 6.5mm tube \varnothing 8.5mm connection M3x0.6 immersion heater 2 hole flange		
For models:	CAPPUCCINO		

			
1			
GEV No.	417173	Ref. No.	02286.2.00.08
description	heating element 1700W 230V heating circuits 3 thread 1 1/4" L 135mm W 26mm H 29mm tube \varnothing 8.5mm connection M3 immersion heater flange with thread		
For models:	Belle-Epoque		
accessories for	417173		
	GEV No.	Ref. No.	—
	510405		
	flat gasket fibre ED \varnothing 56mm ID \varnothing 42mm thickness 2mm for thread 1 1/4" Qty 1 pcs		
	GEV No.	Ref. No.	01263.0.00.03
	527169		
	hexagonal nut thread M3 H 2.8mm WS 5.5 brass Qty 1 pcs		
	GEV No.	Ref. No.	00826.0.00.02 02286
	528021		
	flat gasket PTFE ED \varnothing 53mm ID \varnothing 42.5mm thickness 3mm Qty 1 pcs equiv. no. 12001/02286 suitable for Astoria/Aurora/Brasilia/Wega		
	GEV No.	Ref. No.	—
	560110		
	plain washer ID \varnothing 3.2mm ED \varnothing 7mm thickness 0.5mm SS Qty 20 pcs DIN 125A for thread M3		
	GEV No.	Ref. No.	—
	560130		
	hexagonal nut thread M3 H 2.4mm WS 5.5 SS DIN/ISO DIN 934 / ISO 4032/8673 Qty 20 pcs		

			
1			
GEV No.	417030	Ref. No.	00614.2.00.02 00614.2.00.08
description	heating element 1800W 230V heating circuits 2 mounting \varnothing 40mm hole distance 57mm L 177mm W 26mm H 53mm L1 35mm L2 60mm L3 74mm H1 24mm H2 29mm hole \varnothing 10mm tube \varnothing 8.5mm connection M6 immersion heater 3 hole flange suitable for BRASILIA, VIBIEMME		
For models:	100, 105, 105SL, 205, Century, Firenze, Firenze-SL, Firenze-SL-Raised, PORTOFINO		











			
1			
GEV No.	415006	Ref. No.	00613.2.00.08
description	heating element 1880W 230V heating circuits 1 thread 1 1/4" L 147mm W 35mm H 26mm connection M4 immersion heater flange with thread copper		
spare parts for	415006		
	GEV No.	Ref. No.	—
	510405		
	flat gasket fibre ED \varnothing 56mm ID \varnothing 42mm thickness 2mm for thread 1 1/4" Qty 1 pcs		



Table continues overleaf

accessories for 415006			
	GEV No.	520232	Ref. No. —
nut thread 1¼" H 5mm nickel-plated brass WS 47 Qty 1 pcs			
	GEV No.	521103	Ref. No. —
nut thread M4 H 3mm WS 7 brass Qty 20 pcs			
	GEV No.	521104	Ref. No. —
washer ID ø 4.3mm ED ø 8mm thickness 0.5mm brass Qty 20 pcs for thread M4			
	GEV No.	528021	Ref. No. 00826.0.00.02 02286
flat gasket PTFE ED ø 53mm ID ø 42.5mm thickness 3mm Qty 1 pcs equiv. no. 12001/02286 suitable for Astoria/Aurora/Brasilia/Wega			
	GEV No.	560111	Ref. No. —
plain washer ID ø 4.3mm ED ø 9mm thickness 0.8mm SS Qty 20 pcs DIN 125A for thread M4			
	GEV No.	560131	Ref. No. —
hexagonal nut thread M4 H 3.2mm WS 7 SS DIN/ISO DIN 934 / ISO 4032/8673 Qty 20 pcs			



			
1			
GEV No.	417032	Ref. No.	00613.2.00.08
description	heating element 2000W 230V heating circuits 1 thread 1¼" L 170mm W 35mm H 33mm tube ø 8.5mm connection M6x1 immersion heater flange with thread		
For models:	MILLENNIO, PORTOFINO AMERICA		
accessories for 417032			
	GEV No.	510405	Ref. No. —
flat gasket fibre ED ø 56mm ID ø 42mm thickness 2mm for thread 1¼" Qty 1 pcs			
	GEV No.	528021	Ref. No. 00826.0.00.02 02286
flat gasket PTFE ED ø 53mm ID ø 42.5mm thickness 3mm Qty 1 pcs equiv. no. 12001/02286 suitable for Astoria/Aurora/Brasilia/Wega			

			
1			
GEV No.	417196	Ref. No.	00627.2.00.08
description	heating element 2400W 220V heating circuits 2 thread 1¼" L 230mm W 33mm H 23mm connection M4 immersion heater flange with thread		
For models:	Belle-Epoque		
accessories for 417196			
	GEV No.	510405	Ref. No. —
flat gasket fibre ED ø 56mm ID ø 42mm thickness 2mm for thread 1¼" Qty 1 pcs			
	GEV No.	528021	Ref. No. 00826.0.00.02 02286
flat gasket PTFE ED ø 53mm ID ø 42.5mm thickness 3mm Qty 1 pcs equiv. no. 12001/02286 suitable for Astoria/Aurora/Brasilia/Wega			



			
1			
GEV No.	417080	Ref. No.	01378
description	heating element 2400W 230V heating circuits 2 thread 1¼" L 225mm W 24mm H 38mm tube ø 8mm connection male faston 6.3mm immersion heater connection length 18mm flange with thread		
accessories for 417080			
	GEV No.	510405	Ref. No. —
flat gasket fibre ED ø 56mm ID ø 42mm thickness 2mm for thread 1¼" Qty 1 pcs			
	GEV No.	528021	Ref. No. 00826.0.00.02 02286
flat gasket PTFE ED ø 53mm ID ø 42.5mm thickness 3mm Qty 1 pcs equiv. no. 12001/02286 suitable for Astoria/Aurora/Brasilia/Wega			

			
1			
GEV No.	417031	Ref. No.	00615.2.00.08
description	heating element 3000W 230V heating circuits 2 mounting ø 40mm hole distance 59mm L 327mm W 28mm H 52mm L1 31mm L2 59mm L3 240mm H1 24mm H2 28mm windings 2 hole ø 10mm tube ø 8.5mm connection M6x1 immersion heater 3 hole flange suitable for BRASILIA		
For models:	100, 105, 105SL, 205, 205-Exclusive, Century, Century-Restyling, DeCurtis-CAMME, DeCurtis-DIG, DeCurtis-LEVA, Firenze, Firenze-SL, Firenze-SL-Raised, PORTOFINO, Portofino-Restyling		
accessories for 417031			
	GEV No.	528013	Ref. No. —
gasket ID ø 40mm fibre thickness 4mm hole ø 11mm hole distance 57mm for heating element coffee machine parts			

			
1			
GEV No.	417033	Ref. No.	04995.2.00.08
description	heating element 3200W 230V heating circuits 2 L 415mm W 44mm H 25mm hole distance 68mm hole ø 6.5mm tube ø 8.5mm L1 35mm L2 50mm L3 330mm connection M3x0.6 2 hole fixing immersion heater		

			
1			
GEV No.	417095	Ref. No.	01834.2.00.08
description	heating element 3500W 230V heating circuits 2 mounting ø 39mm hole distance 57mm L 330mm W 34mm H 53mm L1 30mm L2 70mm L3 225mm H1 24mm H2 29mm windings 2 hole ø 11mm tube ø 8.3mm connection M6 immersion heater 3 hole flange		
accessories for 417095			
	GEV No.	528013	Ref. No. —
gasket ID ø 40mm fibre thickness 4mm hole ø 11mm hole distance 57mm for heating element coffee machine parts			
	GEV No.	528740	Ref. No. 00819.0.00.02
gasket ID ø 44mm PTFE thickness 3.5mm hole ø 9.5mm hole distance 58mm suitable for ITALCREM, VISACREM for heating element coffee machine parts			







			
GEV No.	417446	Ref. No.	00616.2.00.08
description	heating element 4000W 230V heating circuits 2 mounting ø 38.5mm hole distance 57mm L 342mm W 26mm H 51mm L1 35mm L2 50mm L3 257mm H1 25mm H2 26mm windings 2 hole ø 10mm tube ø 8mm connection M6 immersion heater 3 hole flange		
For models:	100, 105, 105SL, 205, 205-Exclusive, Century, Century-Restyling, DeCurtis-CAMME, DeCurtis-DIG, DeCurtis-LEVA, Firenze, Firenze-SL, Firenze-SL-Raised, PORTOFINO, Portofino-Restyling		
accessories for	417446		
	GEV No.	Ref. No.	Qty
	528740	00819.0.00.02	—
	gasket ID ø 44mm PTFE thickness 3.5mm hole ø 9.5mm hole distance 58mm suitable for ITALCREM, VISACREM for heating element coffee machine parts		

			
GEV No.	417213	Ref. No.	00617.2.00.08
description	heating element 4000W 230V heating circuits 2 mounting ø 40mm hole distance 57mm L 485mm W 25mm H 53mm L1 30mm L2 60mm L3 385mm H1 24mm H2 29mm windings 2 hole ø 10mm tube ø 8mm connection M6 immersion heater 3 hole flange suitable for BRASILIA, VIBIEMME		
For models:	105, 105SL, 205, Century, Firenze		

			
GEV No.	417086	Ref. No.	04996.2.00.08
description	heating element 4200W 230V heating circuits 2 L 535mm W 44mm H 23mm hole distance 69mm hole ø 6.5mm tube ø 8.5mm L1 30mm L2 40mm L3 465mm connection 1/8" 2 hole fixing immersion heater H1 13mm H2 10mm		

			
GEV No.	417282	Ref. No.	01835.2.00.08
description	heating element 5000W 230V heating circuits 2 mounting ø 40mm hole distance 58mm L 460mm W 25mm H 54mm L1 40mm L2 70mm L3 350mm H1 24mm H2 30mm windings 2 hole ø 1mm tube ø 8.3mm connection M6 immersion heater 3 hole flange		
For models:	205, 205-Exclusive, Agile, Cadetta, Century, Century-Restyling, DeCurtis-CAMME, DeCurtis-DIG, DeCurtis-LEVA, Excelsior-OR, Excelsior-Standard, Executive, Gradisca, Gradisca-Restyling, Gradisca-Take-Away, Maior, Maior-OR, Maior-Plus, Opus, Opus-B03-OR, Opus-OR, Opus-Sublima, Portofino-Restyling, Roma, Roma-OR, Roma-OR-170		

			
GEV No.	417172	Ref. No.	05391.2.00.08
description	heating element 5500W 230/400V heating circuits 3 mounting ø 40mm hole distance 57mm L 460mm W 39mm H 58mm L1 35mm L2 65mm L3 360mm H1 28mm H2 30mm windings 3 hole ø 10mm tube ø 8.5mm connection M3 immersion heater 3 hole flange suitable for BRASILIA		
For models:	205, Century-Restyling, Executive, Gradisca, Gradisca-Restyling, Gradisca-Take-Away, Maior, Maior-OR, Maior-Plus, Portofino-Restyling, Roma, Roma-OR, Roma-OR-170		
accessories for	417172		
	GEV No.	Ref. No.	Qty
	527169	01263.0.00.03	—
	hexagonal nut thread M3 H 2.8mm WS 5.5 brass Qty 1 pcs		
	GEV No.	Ref. No.	Qty
	560110	—	—
	plain washer ID ø 3.2mm ED ø 7mm thickness 0.5mm SS Qty 20 pcs DIN 125A for thread M3		

accessories for	417172		
	GEV No.	Ref. No.	Qty
	560130	—	—
	hexagonal nut thread M3 H 2.4mm WS 5.5 SS DIN/ISO DIN 934 / ISO 4032/8673 Qty 20 pcs		

thermostats

bi-metal thermostats

safety bi-metal thermostats

			
GEV No.	390370	Ref. No.	12571.2.00.08
description	bi-metal safety thermostat hole distancemm switch-off temp. 145°C 1NC 1-pole 16A connection F6.3 M4		
For models:	205-Exclusive, Bolero, Excelsior-OR, Excelsior-Standard, Gradisca-Restyling, Opus, Opus-B03-OR, Opus-OR		

			
GEV No.	390372	Ref. No.	08703.2.00.08
description	bi-metal safety thermostat hole distancemm switch-off temp. 165°C 1NC 1-pole 16A connection F6.3 M4		
For models:	CAPPUCCINO, CLUB, CP1, CP2, LADY, MBM GOLF, MINIPODS, OFFICE RB2, Opus-Sublima, RB1, RB2, SECS, TOP CLASS		

bi-metal thermostats

			
GEV No.	390322	Ref. No.	09415.2.00.08
description	bi-metal thermostat hole distancemm switch-off temp. 100°C 1NC 1-pole 16A connection F6.3 M4		
For models:	CLUB, LADY, MBM GOLF		

			
GEV No.	390152	Ref. No.	08701.2.00.08
description	bi-metal thermostat hole distancemm switch-off temp. 107°C 1NC 1-pole 16A connection F6.3 M4		
For models:	CLUB, LADY, MBM GOLF, SECS, TOP CLASS		

			
GEV No.	375160	Ref. No.	10157.2.00.08
description	bi-metal thermostat hole distancemm switch-off temp. 110°C 1NC 1-pole 16A connection F6.3 M4		
For models:	Bolero, CLUB, LADY, MBM GOLF		



			
1			
GEV No.	390129	Ref. No.	06525.2.00.08
description	bi-metal thermostat hole distancemm switch-off temp. 125°C 1NC 1-pole 16A connection F6.3 M4		
For models:	MINIPODS		

			
1			
GEV No.	390323	Ref. No.	08702.2.00.08
description	bi-metal thermostat hole distancemm switch-off temp. 145°C 1NC 1-pole 16A connection F6.3 M4		
For models:	CLUB, LADY, MBM GOLF		

			
1			
GEV No.	390128	Ref. No.	06524.2.00.08
description	bi-metal thermostat hole distancemm switch-off temp. 95°C 1NC 1-pole 16A connection F6.3 M4		
For models:	MINIPODS, TOP CLASS		

control and safety thermostats

various



control thermostats

			
1			
GEV No.	390114	Ref. No.	00651.4.00.08
description	thermostat t.max. 110°C temperature range fixed 110°C 1-pole		
For models:	CLUB, LADY, TOP CLASS		

switches and momentary switches

rocker/momentary rocker switches

19x13mm

			
1			
GEV No.	301068 ¹	Ref. No.	20050.2.00.08
description	rocker switch mounting measurements 19x13mm yellow 2NO 250V 13A illuminated 0-I connection male faston 4.8mm protection IP40		
For models:	Excelsior-OR, Excelsior-Standard		
accessories for	301068		
	GEV No.	301064	Ref. No. —
	protective cover for pressure switch external size 23.4x17.4mm internal size 19x13mm H 7.5mm clear mounting measurementsmm		

¹illuminated

28x13.5mm			
			
1			
GEV No.	346143	Ref. No.	01919.0.00.08
description	rocker switch mounting measurements 27.4x12.4mm white 1NO 250V 10A 0-I connection male faston 6.3mm ambient temperature max. 85°C protection IP40		
For models:	BFD		

30x22mm			
			
1			
GEV No.	301060	Ref. No.	08474.2.00.08
description	rocker switch mounting measurements 30x22mm red 2NO 250V 16A illuminated connection male faston 6.3mm ambient temperature max. 125/55°C protection IP40		
For models:	Bolero, Maior, Maior-OR, Maior-Plus, Roma, Roma-OR, Roma-OR-170		



			
1			
GEV No.	301076	Ref. No.	07545
description	momentary rocker switch mounting measurements 30x22mm red 2NO 250V 16A illuminated START connection male faston 6.3mm ambient temperature max. 125/55°C protection IP40 mounting ømm male faston 6.3mm		

			
1			
GEV No.	346049	Ref. No.	06534.2.00.08
description	rocker switch mounting measurements 30x22mm red 2NO 250V 16A illuminated cup connection male faston 6.3mm ambient temperature max. 125/55°C protection IP40		
For models:	MINIPODS		

			
1			
GEV No.	346047	Ref. No.	07545.2.00.08
description	rocker switch mounting measurements 30x22mm red 2NO 250V 16A illuminated flash connection male faston 6.3mm ambient temperature max. 125/55°C protection IP40		
For models:	MINIPODS		

			
1			
GEV No.	346046	Ref. No.	07547.2.00.08
description	rocker switch mounting measurements 30x22mm red 2NO 250V 16A illuminated steam connection male faston 6.3mm ambient temperature max. 85°C protection IP40		
For models:	MINIPODS		





labelled			
			
1			
GEV No.	346142	Ref. No.	03632.2.00.08
description	rocker switch mounting measurements 30x22mm orange 2NO 250V 16A illuminated 0-I connection male faston 6.3mm ambient temperature max. 85°C protection IP65 with cover cap		
For models:	MAC64, MAC64-On-Demand, MC, RR45-A, RR45-DEL, RR45-On-Demand, RR45-PST, RR45-S, RR45-SILENT, RR55-AE, RR55-On-Demand, RR65-AE, RR65-SE		
accessories for	346142		
			
GEV No.	301036	Ref. No.	—
description	protective cover internal size 30x22mm for rocker switch mounting measurementsmm		

			
1			
GEV No.	345151 ¹	Ref. No.	01975.2.00.08
description	push switch mounting ø 25mm orange 2NO 250V 16A illuminated connection male faston 6.3mm ambient temperature max. 85°C protection IP40		
For models:	100, 105, 105SL, 205, 205-Exclusive, Cadetta, CAPPUCCINO, Century, Century-Restyling, Executive, Firenze, Firenze-SL, Firenze-SL-Raised, Gradisca, Gradisca-Restyling, Gradisca-Take-Away, Maior, Maior-OR, Maior-Plus, MILLENNIO, PORTOFINO, PORTOFINO AMERICA, Portofino-Restyling, Roma, Roma-Cappuccino, Roma-OR, Roma-OR-170, SECS, TOP CLASS		

¹illuminated

push/momentary push switches

ø25mm			
			
1			
GEV No.	346002	Ref. No.	00661.2.00.08
description	momentary push switch mounting ø 25mm red 2NO 250V 16A connection male faston 6.3mm ambient temperature max. 85°C protection IP40		
For models:	BELLE EPOQUE JUNIOR, Belle-Epoque, CLUB, MBM GOLF		

			
1			
GEV No.	345155	Ref. No.	00745.2.00.08
description	push switch mounting ø 25mm red 2NO 250V 16A illuminated connection male faston 6.3mm ambient temperature max. 85°C protection IP40		
For models:	LADY		

			
1			
GEV No.	345152 ¹	Ref. No.	01976.2.00.08
description	momentary push switch mounting ø 25mm orange 2NO 250V 16A illuminated connection male faston 6.3mm ambient temperature max. 85°C protection IP40		
For models:	Belle-Epoque, CAPPUCCINO		

			
1			
GEV No.	345160 ¹	Ref. No.	00663.2.00.08
description	push switch mounting ø 25mm red 2NO 250V 16A illuminated connection male faston 6.3mm ambient temperature max. 85°C protection IP40		
For models:	BELLE EPOQUE JUNIOR, CLUB, MBM GOLF		

¹illuminated

¹illuminated

			
1			
GEV No.	346003	Ref. No.	00660.2.00.08
description	momentary push switch mounting ø 25mm red 1NO/indicator light 250V 16A illuminated connection male faston 6.3mm ambient temperature max. 85°C protection IP65		
For models:	BELLE EPOQUE JUNIOR, CLUB, MBM GOLF		

			
1			
GEV No.	345153	Ref. No.	00664.2.00.08
description	push switch mounting ø 25mm red 2NO/indicator light 250V 16A connection male faston 6.3mm ambient temperature max. 85°C protection IP40		
For models:	LADY		

microswitches

roller-lever actuated

microswitches

			
1			
GEV No.	346137	Ref. No.	10275.2.00.08
description	microswitch with handle with a switch 250V 5A 1CO connection soldering connection L 14mm L1 16.5mm ambient temperature max. 125°C mounting distance 9mm type SS-5GL2 actuating force: 20g black lever length 18mm		
For models:	CP1, CP2, OFFICE RB2		



pin-plunger actuated



1

GEV No.	345105	Ref. No.	00751.2.00.08
description	microswitch with plunger 250V 16A 1CO connection male faston 6.3mm L 28mm ambient temperature max. 125°C mounting distance 22mm type SM-51 actuating force: 280g black		
For models:	MC, RR45-A, RR45-DEL, RR45-S, RR45-SILENT, RR55-AE, RR65-AE		

with push button

switches with snap-fit



1

GEV No.	346139	Ref. No.	10151.2.00.08
description	microswitch with plunger connection male faston		

system switches (ROLD)



1

GEV No.	347192	Ref. No.	18535.2.00.08	
description	switch 2NO 250V 16A connection male faston 6.3mm			
For models:	Agile, Cadetta, Opus, Opus-B03-OR, Opus-OR, Opus-Sublima			
accessories for	347192			
	GEV No.	347183	Ref. No.	—
	push button mounting ø 14.3mm chrome-plated			

rotary switches

BREMAS

A1700 series



1

GEV No.	346397	Ref. No.	17213.2.00.08	
description	rotary switch 3 0-1-2 sets of contacts 6 type CA020V200 400V 20A shaft ø 5x5mm shaft L 23mm shaft square connection screw			
For models:	Roma, Roma-OR, Roma-OR-170			
accessories for	346397			
	GEV No.	110619	Ref. No.	—
	knob switch zero mark t.max.°C ø 48mm shaft ø 5x5mm shaft flat black			

accessories



1

GEV No.	346399	Ref. No.	17234.2.00.08
description	rubber protection ø 50mm shaft ømm transparent Hmm Lmm		
For models:	Executive, Maior, Maior-OR, Maior-Plus, Roma, Roma-OR, Roma-OR-170		

BRETER

rotary switches



1

GEV No.	345112	Ref. No.	04991.2.00.08
description	rotary switch 20A shaft L 38mm shaft 5x5mm		
For models:	100, 105, 105SL, 205, 205-Exclusive, CAPPUCCINO, Century-Restyling, DeCurtis-CAMME, DeCurtis-DIG, DeCurtis-LEVA, Firenze, Gradisca, Gradisca-Restyling, Gradisca-Take-Away, MILLENNIO, Opus, Opus-B03-OR, Opus-OR, Opus-Sublima, PORTOFINO, PORTOFINO AMERICA, Portofino-Restyling		

accessories



1

GEV No.	111294	Ref. No.	18053.0.00.02
description	knob shaft 5x5 black		
For models:	Opus, Opus-B03-OR, Opus-OR, Opus-Sublima		

VM



1

GEV No.	346090	Ref. No.	00675.2.00.08
description	rotary switch		
For models:	Belle-Epoque, Firenze-SL, Firenze-SL-Raised, Roma, Roma-OR, Roma-OR-170		



1

GEV No.	345111	Ref. No.	00674.2.00.08
description	rotary switch 16A connection screw clamp 6-pole shaft 5x5mm		
For models:	Belle-Epoque, Firenze-SL, Firenze-SL-Raised, Roma, Roma-OR, Roma-OR-170		



miscellaneous



1			
GEV No.	400034	Ref. No.	01814.2.00.08
description	rotary switch 6 operating positions connection male faston		
For models:	Belle-Epoque		

lamps

indicator lights

indicator lights 2-piece (lens and indicator lamp)

indicator light lenses

ø10mm (type SR-3)



1			
GEV No.	359414	Ref. No.	02627.0.00.02
description	indicator light housings mounting measurements ø10mm yellow Qty 1 pcs		
For models:	105, 105SL, 205-Exclusive, Agile, Belle-Epoque, Bolero, Cadetta, CAPPUCCINO, Century-Restyling, DeCurtis-CAMME, DeCurtis-DIG, DeCurtis-LEVA, Excelsior-OR, Excelsior-Standard, Executive, Firenze-SL, Firenze-SL-Raised, Gradisca-Restyling, Gradisca-Take-Away, LADY, Maior, Maior-OR, Maior-Plus, Opus, Opus-B03-OR, Opus-OR, Opus-Sublima, PORTOFINO, PORTOFINO AM. SUPER, PORTOFINO AMERICA, Portofino-Restyling, Roma, Roma-Cappuccino, Roma-OR, Roma-OR-170, TOP CLASS		



1			
GEV No.	359412	Ref. No.	02628.0.00.02
description	indicator light lens yellow		
For models:	105, 105SL, Belle-Epoque, Cadetta, CAPPUCCINO, Century-Restyling, DeCurtis-CAMME, DeCurtis-DIG, DeCurtis-LEVA, Excelsior-OR, Excelsior-Standard, Executive, Firenze-SL, Firenze-SL-Raised, Gradisca-Restyling, Gradisca-Take-Away, Maior, Maior-OR, Maior-Plus, Portofino-Restyling, Roma, Roma-Cappuccino, Roma-OR, Roma-OR-170		

indicator lamps for socket type SA / SC / SD / SF / SR



1			
GEV No.	359814	Ref. No.	00668.2.00.08
description	indicator lamp 230V clear connection cable 400mm cable material silicone Qty 1 pcs		
For models:	105, 105SL, 205-Exclusive, Agile, Belle-Epoque, Bolero, Cadetta, CAPPUCCINO, Century-Restyling, DeCurtis-CAMME, DeCurtis-DIG, DeCurtis-LEVA, Excelsior-OR, Excelsior-Standard, Executive, Firenze-SL, Firenze-SL-Raised, Gradisca-Restyling, Maior, Maior-OR, Maior-Plus, MILLENNIO, Opus, Opus-B03-OR, Opus-OR, Opus-Sublima, PORTOFINO, Portofino-Restyling, Roma, Roma-Cappuccino, Roma-OR, Roma-OR-170		

solid state relays

CROUZET



1			
GEV No.	402294	Ref. No.	19258.2.00.08
description	solid state relay CROUZET 1 phase 25A 48-660V 90-280 L 58mm W 45mm screw type 84137111		
For models:	Excelsior-OR, Excelsior-Standard, Opus, Opus-B03-OR, Opus-OR		

relays

power relays

with male contacts

female contact 2.0mm

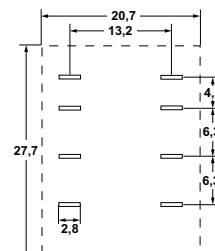

1			
GEV No.	380377	Ref. No.	01955.2.00.08
description	power relays FINDER 220-240VAC 10A 2CO connection F2 plug-in connection manuf. no. 55.32.8.230.0000 94.92.3 250V		
For models:	MAC64, MC		
accessories for	380377		
	GEV No.	Ref. No.	—
	380341		
	relay socket 4-pole contacts 12 300V voltage AC 6A Italiana Relè manuf. no. ZMD4		
	GEV No.	Ref. No.	—
	380378		
	relay socket 2-pole 55/85 dimensions 70.5x30x27mm 250V voltage AC 10A FINDER manuf. no. 94.72		
	GEV No.	Ref. No.	—
	380384		
	relay socket 2-pole contacts male faston 2.8mm 250V voltage AC 10A W 23mm for		
	GEV No.	Ref. No.	—
	380399		
	relay socket 4-pole dimensions 76.2x27x86.1mm 250V voltage AC 1A FINDER manuf. no. 94.94.3		

relay sockets



1			
GEV No.	380136	Ref. No.	01920
description	relay socket 11-pole connection plug-in connection round 11-pole dimensions 65x28x40mm 250V voltage AC 10A Italiana Relè manuf. no. ZVE11		
accessories for	380136		
	GEV No.	380805	Ref. No. —
	 support bracket		



1			
GEV No.	380137	Ref. No.	01810.2.00.08
description	relay socket 8-pole connection plug-in connection round 8-pole dimensions 65x28x40mm 380V voltage AC 10A Italiana Relè manuf. no. ZVE8		
For models:	100, CAPPUCCINO, Century, Firenze, Gradisca, Gradisca-Take-Away, MILLENNIO, PORTOFINO, PORTOFINO AMERICA		
accessories for	380137		
	GEV No.	380805	Ref. No. —
	 support bracket		

level relays

GICAR



1			
GEV No.	400029	Ref. No.	02259 05441.2.00.08
description	level relay 230V voltage AC 11-pole connection plug-in connection round 11-pole		



1			
GEV No.	400028	Ref. No.	01871.2.00.08
description	level relay 230V voltage AC 2NO 8-pole connection plug-in connection round 8-pole type NRL30/1E-2C/8		
For models:	100, CAPPUCCINO, Century, Firenze, Gradisca, Gradisca-Take-Away, MILLENNIO, PORTOFINO, PORTOFINO AMERICA		

miscellaneous



1			
GEV No.	400264	Ref. No.	09522.2.00.08
description	level relay 230V		
For models:	100, 105, 105SL, 205, 205-Exclusive, Cadetta, CAPPUCCINO, Century, Century-Restyling, DeCurtis-CAMME, DeCurtis-DIG, DeCurtis-LEVA, Executive, Firenze, Firenze-SL, Firenze-SL-Raised, Gradisca, Gradisca-Take-Away, Maior, Maior-OR, Maior-Plus, MILLENNIO, PORTOFINO, Portofino-Restyling, Roma, Roma-OR, Roma-OR-170		



1			
GEV No.	400265	Ref. No.	09948.2.00.08
description	level relay 230V voltage AC 3A type FE-MBC1G		
For models:	Century, Gradisca, Gradisca-Restyling, Gradisca-Take-Away, PORTOFINO		



1			
GEV No.	400310	Ref. No.	01878.2.00.08
description	level relay 230V voltage AC connection male faston 6.3mm type SMA		
For models:	BELLE EPOQUE JUNIOR, CLUB, LADY, Opus-Sublima		

probes

producer-specific probes

probes

1



GEV No.	379452	Ref. No.	20553.2.00.08
description	temperature probe NTC cable glass fibre probe -40 up to +125°C cable -50 up to +350°C connection plug thread 1/4" probe ø3.5x20mm cable length 0.24m		
For models:	Opus-Sublima		

electronics

PCBs

1



GEV No.	400561	Ref. No.	10168.2.00.08
description	keypad PCB		
For models:	CP1, CP2, OFFICE RB2, RB1, RB2		

1



GEV No.	402977	Ref. No.	13420.2.00.08
description	PCB for coffee machine L 113mm W 97mm 230V 2-group H 38mm		
For models:	105, 105SL, 205, 205-Exclusive, Century, Century-Restyling, DeCurtis-CAMME, DeCurtis-DIG, DeCurtis-LEVA, Firenze, Firenze-SL, Firenze-SL-Raised, Gradisca, Gradisca-Restyling, Gradisca-Take-Away, Portofino-Restyling		

1



GEV No.	400566	Ref. No.	11242.2.00.08 17034.2.00.08
description	power PCB for dosing pump 230V		
For models:	RR45-A, RR45-DEL		

1



GEV No.	400268	Ref. No.	10438.2.00.08
description	relay PCB		
For models:	Century, Gradisca, Gradisca-Take-Away, PORTOFINO		

1



GEV No.	400269	Ref. No.	11738.2.00.08
description	relay PCB		
For models:	Century, Gradisca, Gradisca-Take-Away, PORTOFINO		

central units

1



GEV No.	400037	Ref. No.	01805.2.00.08
description	control box 1-group for coffee machine 230V type Cubik		
For models:	Belle-Epoque, Century, PORTOFINO		

1



GEV No.	400266	Ref. No.	09950.2.00.08
description	control box 2-group for coffee machine		
For models:	100, 105, 105SL, 205, Century, Gradisca, Gradisca-Take-Away, MILLENNIO, PORTOFINO		



1

GEV No.	400036	Ref. No.	01806.2.00.08
description	control box 2-group for coffee machine 230V		
For models:	Belle-Epoque		



1

GEV No.	400283	Ref. No.	01807
description	control box 3-group for coffee machine		



1

GEV No.	402275	Ref. No.	13420.2.00.08 + Stückliste
description	control box 2-group for coffee machine 230V		



1

GEV No.	400267	Ref. No.	09952.2.00.08
description	control box 3-group for coffee machine 230V type FE-MBC		
For models:	100, 105, 105SL, 205, Century, Gradisca, Gradisca-Take-Away, MILLENNIO, PORTOFINO		



1

GEV No.	402843	Ref. No.	13376.6.00.09
description	control box 2-group for coffee machine 230V		
For models:	205-Exclusive		



1

GEV No.	400284	Ref. No.	04965.2.00.08
description	control box 3-group for coffee machine 230V type MBAR 3SFF		
For models:	100, Century, Firenze, Firenze-SL, Firenze-SL-Raised, PORTOFINO		



1

GEV No.	402844	Ref. No.	13377.6.00.09
description	control box 3-4 group for coffee machine 230V		
For models:	205-Exclusive		



1

GEV No.	402996	Ref. No.	12743.0.00.02
description	control box empty L 125mm W 50mm H 106mm		
For models:	Opus, Opus-B03-OR, Opus-OR		





1

GEV No.	402995	Ref. No.	12744.0.00.02
description	lid L 138mm W 54mm		
For models:	205-Exclusive, Gradisca-Restyling, Opus, Opus-B03-OR, Opus-OR		



1

GEV No.	402276	Ref. No.	13421.2.00.08
description	PCB 3-group for coffee machine 230V		
For models:	105, 105SL, 205, 205-Exclusive, Century, Century-Restyling, De-Curtis-CAMME, DeCurtis-DIG, DeCurtis-LEVA, Firenze, Firenze-SL, Firenze-SL-Raised, Gradisca, Gradisca-Restyling, Gradisca-Take-Away, Portofino-Restyling		



1

GEV No.	402269	Ref. No.	21217.2.00.08
description	control box 2-group 230V 50/60Hz type 3d5 2GRCT XLC		
For models:	Cadetta		



1

GEV No.	402270	Ref. No.	21218.2.00.08
description	control box 3-group 230/240V 50/60Hz type 3d5 3GRCT XLC (SC)		
For models:	Cadetta		

dosing electronics

GICAR



1

GEV No.	402266	Ref. No.	16035.2.00.08
description	control box 2-group 230V 50/60Hz type 3d5 2GRCT XLC		
For models:	Executive, Maior, Maior-OR, Maior-Plus, Roma, Roma-OR, Roma-OR-170		



1

GEV No.	402267	Ref. No.	16036.2.00.08
description	control box 3-group 230V 50/60Hz type 3d5 3GRCT XLC		
For models:	Executive, Maior, Maior-OR, Maior-Plus, Roma, Roma-OR, Roma-OR-170		

keypads

front foils



1

GEV No.	400562	Ref. No.	10501.0.00.02
description	keypad foil		
For models:	CP1, CP2, OFFICE RB2, RB1, RB2		



1

GEV No.	403066	Ref. No.	N/A
description	keypad foil suitable for BRASILIA L 82.5mm W 55mm buttons 6		



keypad units



1

GEV No.	400039	Ref. No.	04962.2.00.08
description	keypad unit		
For models:	Century		



1

GEV No.	400271	Ref. No.	10138.2.00.08
description	keypad unit		
For models:	105, 105SL, 205		



1

GEV No.	400286	Ref. No.	05475.2.00.08
description	keypad unit		



1

GEV No.	400287	Ref. No.	06556.2.00.08
description	keypad unit		
For models:	PORTOFINO, PORTOFINO AMERICA		



1

GEV No.	400288	Ref. No.	10135.2.00.08
description	keypad unit		



1

GEV No.	400289	Ref. No.	09954.2.00.08
description	keypad unit		
For models:	PORTOFINO		



1



GEV No.	400291	Ref. No.	10136.2.00.08	
description	keypad unit			
For models:	Gradisca, Gradisca-Take-Away			
spare parts for	400291			
	GEV No.	403066	Ref. No.	N/A
	keypad foil suitable for BRASILIA L 82.5mm W 55mm buttons 6			





1

GEV No.	400346	Ref. No.	08494.2.00.08
description	keypad unit		
For models:	PORTOFINO		





			
1			
GEV No.	400347	Ref. No.	01812.2.00.08
description	keypad unit		
accessories for	400347		
			
	GEV No.	400348	Ref. No. 01494
	bezel for keypad		

			
1			
GEV No.	402295	Ref. No.	19424.2.00.08
description	keypad unit buttons 1 chrome-plated L 35mm W 25mm		
For models:	Agile		

			
1			
GEV No.	402287	Ref. No.	19427.2.00.08
description	keypad unit buttons 5 chrome-plated L 117mm W 45mm		
For models:	Agile, Cadetta		

			
1			
GEV No.	402292	Ref. No.	21493.2.00.08
description	keypad unit buttons 5 L 88mm W 60mm		
For models:	Maior, Maior-OR, Maior-Plus		

			
1			
GEV No.	402280	Ref. No.	13123.4.00.08 13123.4.00.09
description	keypad unit buttons 6 L 100mm W 90mm		
For models:	205-Exclusive, DeCurtis-CAMME, DeCurtis-DIG, DeCurtis-LEVA, Gradisca-Restyling, Portofino-Restyling		

			
1			
GEV No.	400038	Ref. No.	04961.2.00.08
description	keypad unit buttons 6 L 85mm W 57mm		
For models:	Century		

			
1			
GEV No.	402288	Ref. No.	21494.2.00.08
description	keypad unit coffee machine Executive buttons 5 chrome-plated L 117mm W 45mm		
For models:	Executive		

			
1			
GEV No.	402286	Ref. No.	17578.2.00.08
description	keypad unit coffee machine ROMA buttons 5 L 87mm W 59mm		
For models:	Roma, Roma-OR, Roma-OR-170		

			
1			
GEV No.	400227	Ref. No.	12583.2.00.08
description	keypad unit coffee machine ROMA buttons 6 L 88mm W 60mm		
For models:	Roma, Roma-OR, Roma-OR-170		

accessories

			
1			
GEV No.	400348	Ref. No.	01494
description	bezel for keypad		



solenoid valves

solenoid valves (water)

metal

ASCO

spare parts and accessories

O-rings



1

GEV No.	371095	Ref. No.	00833.0.00.02
description	O-ring Viton thickness 1.78mm ID ø 6.07mm Qty 1 pcs		
For models:	100, 105, 105SL, 205, 205-Exclusive, BELLE EPOQUE JUNIOR, Belle-Epoque, Cadetta, CAPPUCCINO, Century, Century-Restyling, CLUB, DeCurtis-CAMME, DeCurtis-DIG, DeCurtis-LEVA, Excelsior-OR, Excelsior-Standard, Executive, Firenze, Firenze-SL, Firenze-SL-Raised, Gradisca, Gradisca-Restyling, Gradisca-Take-Away, LADY, Maior, Maior-OR, Maior-Plus, MBM GOLF, MILLENNIO, MINIPODS, Opus, Opus-B03-OR, Opus-OR, Opus-Sublima, PORTOFINO, PORTOFINO AM. SUPER, PORTOFINO AMERICA, Portofino-Restyling, Roma-Cappuccino, SECS, TOP CLASS		

LUCIFER

spare parts and accessories

valve bodies



1

GEV No.	370061	Ref. No.	BF0201
description	solenoid valve body LUCIFER-PARKER 3-ways outer cone		



M&M

2-way

B-297 series



1

GEV No.	370096	Ref. No.	02269.4.00.08	
description	solenoid valve 2-ways 230VAC connection 1/8" L 30mm DN 2.5mm slide-on receptacle compact -10 up to 130°C M&M type series B-297 coil type 2700 membranes FKM (water) p max 5bar p min 0bar			
For models:	Agile, CAPPUCCINO			
spare parts for	370096			
	GEV No.	371022	Ref. No.	—
	solenoid coil M&M 230VAC 10VA 50Hz coil type 2700 seat ø 10mm			
accessories for	370096			
	GEV No.	371091	Ref. No.	—
	power socket plug type DIN 43650B cable lengthmm small			



1

GEV No.	370167	Ref. No.	10446.4.00.08	
description	solenoid valve 2-ways 24VDC connection 1/8" L 30mm DN 1.5mm slide-on receptacle compact -10 up to 130°C M&M type series B-297 coil type 2250 membranes FKM (water) p max 22bar p min 0bar			
For models:	CP2, OFFICE RB2, RB2			
accessories for	370167			
	GEV No.	371091	Ref. No.	—
	power socket plug type DIN 43650B cable lengthmm small			

OLAB

solenoid valves

2-way



1

GEV No.	370095	Ref. No.	09436.4.00.08
description	solenoid valve brass 2-ways 230VAC L 230mm Olab flange 20x27mm		
For models:	100, 105, 105SL, 205, 205-Exclusive, Belle-Epoque, Cadetta, CAPPUCCINO, Century, Century-Restyling, DeCurtis-CAMME, DeCurtis-DIG, DeCurtis-LEVA, Excelsior-OR, Excelsior-Standard, Executive, Firenze, Firenze-SL, Firenze-SL-Raised, Gradisca, Gradisca-Restyling, Gradisca-Take-Away, Maior, Maior-OR, Maior-Plus, MILLENNIO, Opus, Opus-B03-OR, Opus-OR, Opus-Sublima, PORTOFINO, PORTOFINO AM. SUPER, PORTOFINO AMERICA, Portofino-Restyling, Roma-Cappuccino		

PARKER

3-way

VE-128 series



1





GEV No.	370057	Ref. No.	01947.2.00.08 01947.4.00.08	
description	solenoid valve 3-ways 230VAC body outer cone DN 1.2mm slide-on receptacle DIN -20° up to 140°C PARKER type series VE-128 coil type ZB09 membranes ruby p max 10bar brass flange 32x32mm			
For models:	105, 105SL, 205, 205-Exclusive, Agile, Belle-Epoque, CAPPUCCINO, Century, Century-Restyling, Excelsior-OR, Excelsior-Standard, Executive, Firenze, Firenze-SL, Firenze-SL-Raised, Maior, Maior-OR, Maior-Plus, MILLENNIO, Opus, Opus-B03-OR, Opus-OR, PORTOFINO, PORTOFINO AM. SUPER, PORTOFINO AMERICA, Portofino-Restyling, Roma, Roma-Cappuccino, Roma-OR, Roma-OR-170, SECS, TOP CLASS			
spare parts for	370057			
	GEV No.	370062	Ref. No.	BF0201 BF0401 BF0501
	solenoid valve body PARKER 3-ways outer cone			



Table continues overleaf



spare parts for 370057	
	GEV No. 371029 Ref. No. — solenoid coil PARKER 230VAC 9VA coil type ZB09 seat ø 14mm H 33mm W 34mm D 43mm
accessories for 370057	
	GEV No. 371090 Ref. No. — power socket plug type DIN 43650A screw
	GEV No. 371095 Ref. No. 00833.0.00.02 O-ring Viton thickness 1.78mm ID ø 6.07mm Qty 1 pcs
	GEV No. 371100 Ref. No. — O-ring silicone thickness 1.78mm ID ø 6.07mm Qty 1 pcs

spare parts and accessories

valve bodies

	1		
GEV No. 370062	Ref. No.	BF0201 BF0401 BF0501	
description	solenoid valve body PARKER 3-ways outer cone		
accessories for 370062			
	GEV No. 371029	Ref. No.	—
solenoid coil PARKER 230VAC 9VA coil type ZB09 seat ø 14mm H 33mm W 34mm D 43mm			
	GEV No. 371030	Ref. No.	—
solenoid coil 24VDC 12VA coil type ZB12 seat ø 14mm			
	GEV No. 371033	Ref. No.	—
solenoid coil PARKER 230VAC 9VA coil type YB09 with cable seat ø 14mm			
	GEV No. 371036	Ref. No.	—
solenoid coil 24VAC 9VA coil type ZB09 seat ø 14mm			
	GEV No. 371095	Ref. No.	00833.0.00.02
O-ring Viton thickness 1.78mm ID ø 6.07mm Qty 1 pcs			
	GEV No. 371100	Ref. No.	—
O-ring silicone thickness 1.78mm ID ø 6.07mm Qty 1 pcs			

SIRAI

2-way

L256N series

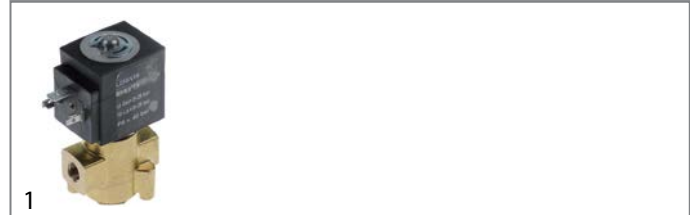

GEV No. 370565	Ref. No.	19895.4.00.08 22988.4.00.08
-----------------------	-----------------	--------------------------------

description solenoid valve brass 2-ways 230VAC inlet 1/8" outlet 1/8" connection 1/8" L 42mm DN 1.6mm -10 up to +90°C SIRAI coil type ZA30A membranes NBR p max 25bar p min 0bar

For models: Opus-Sublima

spare parts for 370565

	GEV No. 371047	Ref. No.	—
solenoid coil 230VAC 14VA SIRAI coil type ZA30A seat ø 14mm			

3-way

L334-R series

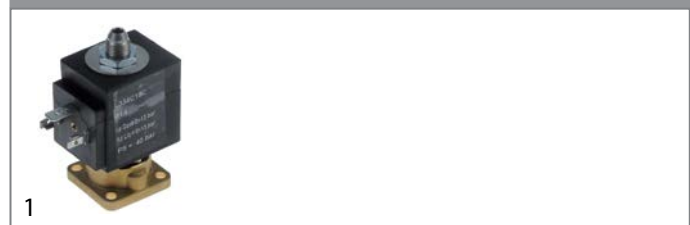

GEV No. 370563	Ref. No.	16194.4.00.08
-----------------------	-----------------	---------------

description solenoid valve 3-ways DN 1.6mm -10° up to +170°C p max 13bar 230V voltage AC flange 32x32mm

For models: 105, 105SL, Cadetta, Firenze-SL, Firenze-SL-Raised, Opus-Sublima

Solenoid valve - accessories



GEV No. 371095	Ref. No.	00833.0.00.02
-----------------------	-----------------	---------------

description O-ring Viton thickness 1.78mm ID ø 6.07mm Qty 1 pcs

For models: 100, 105, 105SL, 205, 205-Exclusive, BELLE EPOQUE JUNIOR, Belle-Epoque, Cadetta, CAPPUCCINO, Century, Century-Restyling, CLUB, DeCurtis-CAMME, DeCurtis-DIG, DeCurtis-LEVA, Excelsior-OR, Excelsior-Standard, Executive, Firenze, Firenze-SL, Firenze-SL-Raised, Gradisca, Gradisca-Restyling, Gradisca-Take-Away, LADY, Maior, Maior-OR, Maior-Plus, MBM GOLF, MILLENNIO, MINIPODS, Opus, Opus-B03-OR, Opus-OR, Opus-Sublima, PORTOFINO, PORTOFINO AM. SUPER, PORTOFINO AMERICA, Portofino-Restyling, Roma-Cappuccino, SECS, TOP CLASS

pressure switches

for coffee machines

ø 38mm



GEV No.	541155	Ref. No.	09935.2.00.08
description	pressure control ø 38mm pressure range 1-2.5bar pressure connection vertical 16A 250V coffee machine parts connection 1/8" pressure connection 1/8"		
For models:	CAPPUCCINO		



GEV No.	541154	Ref. No.	10598.2.00.08
description	pressure control ø 38mm pressure range 2-4bar pressure connection vertical preset at 2bar 16A 250V coffee machine parts connection 1/8" pressure connection 1/8"		
For models:	CP1, CP2, OFFICE RB2, RB1, RB2		

miscellaneous



GEV No.	541021	Ref. No.	00630.4.00.08
description	pressure control pressure range adjustable 0.5-1.4bar connection 1/4" 30A 3-pole type P302 coffee machine parts SIRAI		
For models:	100, 105, 105SL, 205, 205-Exclusive, Agile, Belle-Epoque, CAPPUCINO, Century, Century-Restyling, DeCurtis-CAMME, DeCurtis-DIG, DeCurtis-LEVA, Executive, Firenze, Firenze-SL, Firenze-SL-Raised, Gradisca, Gradisca-Restyling, Gradisca-Take-Away, Maior, Maior-OR, Maior-Plus, MILLENNIO, Opus, Opus-B03-OR, Opus-OR, Opus-Sublima, PORTOFINO, PORTOFINO AMERICA, Portofino-Restyling, Roma, Roma-Cappuccino, Roma-OR, Roma-OR-170		

accessories for 541021

GEV No.	550262	Ref. No.	—
----------------	--------	-----------------	---

 flat gasket copper ED ø 20mm ID ø 14mm thickness 2mm

GEV No.	890100	Ref. No.	—
----------------	--------	-----------------	---

 PTFE tape reel L 12m W 12mm -200 up to +260°C approval DIN-DVGW, KTW temperature-resistant, elastic for fine thread thickness 0.1mm

electrodes



GEV No.	401254	Ref. No.	18749.4.00.08 18749.8.00.08
description	level electrode 1/4" total length 74mm probe L 47mm insulated probe length 41mm PTFE insulated connection angled, male faston 6.3mm stainless steel ø 2.5mm marking S		
For models:	Roma-Cappuccino		

flow meters and flow sensors

flow meters

GICAR



GEV No.	400255	Ref. No.	08729.2.00.08
description	flow meter thread 1/8" stainless steel with LED plug-in connection approval NSF		
For models:	100, 105, 105SL, 205, 205-Exclusive, CAPPUCINO, Century, Century-Restyling, Firenze, Firenze-SL, Firenze-SL-Raised, Gradisca, Gradisca-Restyling, Gradisca-Take-Away, MILLENNIO, Opus, Opus-B03-OR, Opus-OR, Opus-Sublima, PORTOFINO, PORTOFINO AMERICA, Roma-Cappuccino, TOP CLASS		

accessories for 400255

GEV No.	400256	Ref. No.	09013.0.00.08
----------------	--------	-----------------	---------------

 plug GICAR for flow meter

accessories



GEV No.	400256	Ref. No.	09013.0.00.08
description	plug GICAR for flow meter		
For models:	100, 105, 105SL, 205, CAPPUCINO, MILLENNIO, PORTOFINO, PORTOFINO AMERICA		



VENDING



1

GEV No.	400565	Ref. No.	10264.2.00.08
description	flow meter hose ø 6mm plastic plug-in connection approval NSF DIGMESA		
For models:	CP1, CP2, OFFICE RB2, RB1, RB2		



1

GEV No.	500064	Ref. No.	04321.4.00.08 04321.4.00.09 15382.4.00.08
description	pump head PO204 FLUID-O-TECH L 82mm 200l/h connection 3/8" GAS with bypass brass clip connection for coffee machine shaft ø 4.8x11mm		
For models:	105, 105SL, 205, 205-Exclusive, Agile, Belle-Epoque, Century, Century-Restyling, Firenze, Firenze-SL, Firenze-SL-Raised, Gradisca, Gradisca-Restyling, Gradisca-Take-Away, Opus, Opus-B03-OR, Opus-OR, Portofino-Restyling, Roma, Roma-OR, Roma-OR-170		
accessories for	500064		
	GEV No.	520126	Ref. No. —
	clamp for pump/motor		

pumps

booster pumps II

pump motors

clip connection



1

GEV No.	500442	Ref. No.	00600.4.00.08
description	motor RPM type 11002708 165W 230V 50/60Hz connection clip capacitor 10µF shaft ø 13mm		
For models:	105, 105SL, 205, 205-Exclusive, Agile, Cadetta, Century, Century-Restyling, DeCurtis-CAMME, DeCurtis-DIG, DeCurtis-LEVA, Excelsior-OR, Excelsior-Standard, Executive, Firenze, Gradisca, Gradisca-Restyling, Gradisca-Take-Away, Maior, Maior-OR, Maior-Plus, Opus, Opus-B03-OR, Opus-OR, Opus-Sublima, Portofino-Restyling, Roma, Roma-OR, Roma-OR-170		

ROSSI



1

GEV No.	504238	Ref. No.	00604.4.00.08 21212.4.00.08
description	pump RF140SO9E ROSSI L 82mm 100l/h connection 3/8" NPT with bypass brass clip connection for coffee machine shaft ø 4.8x11mm		
For models:	100, 105, 105SL, 205, 205-Exclusive, Belle-Epoque, Century, Century-Restyling, DeCurtis-CAMME, DeCurtis-DIG, DeCurtis-LEVA, Excelsior-OR, Excelsior-Standard, Executive, Firenze, Firenze-SL, Firenze-SL-Raised, Gradisca, Gradisca-Restyling, Gradisca-Take-Away, Maior, Maior-OR, Maior-Plus, MILLENNIO, Opus, Opus-B03-OR, Opus-OR, PORTOFINO, Portofino-Restyling		

pump heads

FLUID-O-TECH



1

GEV No.	499088	Ref. No.	05399.4.00.08
description	pump head PA074 FLUID-O-TECH L 82mm 70l/h connection 3/8" GAS with bypass brass clip connection shaft ø 10.8x4.8mm approval NSF		
For models:	105, 105SL, 205, 205-Exclusive, Belle-Epoque, Century, Century-Restyling, Firenze, Firenze-SL, Firenze-SL-Raised, Gradisca, Gradisca-Restyling, Gradisca-Take-Away, Opus, Opus-B03-OR, Opus-OR, Portofino-Restyling		

vibration pumps



1

GEV No.	501515	Ref. No.	11723.4.00.08
description	vibration pump type EP8 230/240V 26W 50Hz inlet ø 6 outlet ø 1/8" ULKA		



condensators & interference suppression filters

operating capacitors

plastic



1

GEV No.	365014	Ref. No.	01897.2.00.08
description	operating capacitor capacity 12.5µF 450V tolerance 5%Hz ambient temperature max. -25 to +85°C ø 35mm L 70mm M8 plastic connection male faston 6.3mm 45S.C3DS.12.5 protection		
For models:	105, 105SL, 205, 205-Exclusive, Agile, Cadetta, Century, Century-Restyling, DeCurtis-CAMME, DeCurtis-DIG, DeCurtis-LEVA, Excelsior-OR, Excelsior-Standard, Executive, Firenze, Firenze-SL, Firenze-SL-Raised, Gradisca, Gradisca-Restyling, Gradisca-Take-Away, Maior, Maior-OR, Maior-Plus, MC, Opus, Opus-B03-OR, Opus-OR, Opus-Sublima, Portofino-Restyling, Roma, Roma-OR, Roma-OR-170, RR45-A, RR45-DEL, RR45-PST, RR45-S, RR45-SILENT, RR55-AE, RR55-On-Demand, RR65-AE, RR65-SE		



1

GEV No.	365021	Ref. No.	05444.2.00.08 09406.2.00.08
description	operating capacitor capacity 16µF 425V tolerance 5% 50/60Hz ambient temperature max. -25 to +85°C ø 35mm L 73mm single M8 plastic connection male faston 6.3mm 416.10.99 protection		
For models:	MAC64, MAC64-On-Demand, RR45-A, RR45-DEL, RR45-On-Demand, RR45-SILENT, RR55-On-Demand		



1

GEV No.	365022	Ref. No.	01962.2.00.08
description	operating capacitor capacity 40µF 400V tolerance 5%Hz ambient temperature max. -25 to +85°C ø 45mm L 95mm M8 plastic connection male faston 6.3mm protection		
For models:	105, 105SL, 205, 205-Exclusive, Agile, Cadetta, Century, Century-Restyling, DeCurtis-CAMME, DeCurtis-DIG, DeCurtis-LEVA, Excelsior-OR, Excelsior-Standard, Executive, Firenze, Firenze-SL, Firenze-SL-Raised, Gradisca, Gradisca-Restyling, Gradisca-Take-Away, Maior, Maior-OR, Maior-Plus, MC, Opus, Opus-B03-OR, Opus-OR, Opus-Sublima, Portofino-Restyling, Roma, Roma-OR, Roma-OR-170, RR55-On-Demand		

electronic magnets



1

GEV No.	370170	Ref. No.	11065.2.00.08
description	electronic magnet 24V voltage AC 50Hz		
For models:	CP1, CP2, OFFICE RB2, RB1, RB2		

ignition parts

ignition switches



1

GEV No.	301076	Ref. No.	07545
description	momentary rocker switch mounting measurements 30x22mm red 2NO 250V 16A illuminated START connection male faston 6.3mm ambient temperature max. 125/55°C protection IP40 mounting ømm male faston 6.3mm		

equipment-specific units

for espresso machines

filter holders

filter holders standard

filter holder without spout



1

GEV No.	525984	Ref. No.	N/A
description	filter holder suitable for AURORA/BRASILIA/FAEMA without outlet mounting ø 82.5mm outlet 3/8" ID ø 62mm wedge height 10.5mm wedge position horizontal number of wedges 2 lever straight		



1

GEV No.	525985	Ref. No.	N/A
description	filter holder suitable for BRASILIA without outlet mounting ø 80mm outlet 3/8" ID ø 62mm wedge height 8.8mm wedge position diagonal number of wedges 2 lever straight		





filter holders short			
 <p>1</p>			
GEV No.	529935	Ref. No.	N/A
description	filter holder mounting ø 80mm outlet 3/8" ID ø 62mm handle M12x1.75 wedge height 8.8mm wedge position diagonal number of wedges 2 lever straight chrome-plated brass		

 <p>1</p>			
GEV No.	529041	Ref. No.	02151.0.00.04 04106.0.00.04
description	filter holder mounting ø 82.5mm outlet 3/8" ID ø 62mm handle M12x1.75 wedge height 10.5mm wedge position horizontal number of wedges 2 lever straight chrome-plated brass		
For models:	100, 105, 105SL, 205, Cadetta, Century-Restyling, DeCurtis-CAMME, DeCurtis-DIG, DeCurtis-LEVA, Excelsior-OR, Excelsior-Standard, Firenze, Gradisca, Gradisca-Restyling, Gradisca-Take-Away, MILLENNIO, Portofino-Restyling		

handles			
with external thread			
 <p>1</p>			
GEV No.	529044	Ref. No.	06355.0.00.02
description	handle ø 35mm thread M12x1.75 thread L 15mm L 120mm black		
For models:	105, 105SL, Century-Restyling, Firenze		
accessories for	529044		
	GEV No.	531161	Ref. No.
	end cap ø 24.6mm mounting ø 22.1mm H 14mm chrome-plated		

end caps			
 <p>1</p>			
GEV No.	112022	Ref. No.	06364.0.00.02
description	end cap		
For models:	105, 105SL, 205, Agile, Firenze, Firenze-SL, Firenze-SL-Raised, Gradisca-Restyling, Roma, Roma-Cappuccino, Roma-OR, Roma-OR-170		

screws			
 <p>1</p>			
GEV No.	112021	Ref. No.	02680.0.00.03
description	cylinder head bolt thread M8 L 45mm thread L 30mm WS 6 zinc-coated steel Qty 1 pcs DIN 912/ISO 4762		
For models:	205-Exclusive, Agile, Cadetta, DeCurtis-CAMME, DeCurtis-DIG, DeCurtis-LEVA, Gradisca, Gradisca-Restyling, Opus, Opus-B03-OR, Opus-OR, Opus-Sublima, Portofino-Restyling, Roma, Roma-Cappuccino, Roma-OR, Roma-OR-170		

spouts			
with thread 3/8"			
 <p>1</p>			
GEV No.	529003	Ref. No.	00056.0.10.04
description	filter holder spout thread 3/8" 1-way curved/long outlet distance mm thread L 5mm		
For models:	205-Exclusive, CLUB, Gradisca-Restyling, Gradisca-Take-Away, LADY		

 <p>1</p>			
GEV No.	529005	Ref. No.	08275.0.00.04
description	filter holder spout thread 3/8" 1-way curved/short outlet distance mm		

 <p>1</p>			
GEV No.	529002	Ref. No.	00032.0.10.04
description	filter holder spout thread 3/8" 1-way straight/short outlet distance mm		
For models:	100, 105, 105SL, 205, Belle-Epoque, Century, Century-Restyling, Firenze, Gradisca, MILLENNIO, PORTOFINO, PORTOFINO AM. SUPER, PORTOFINO AMERICA		

 <p>1</p>			
GEV No.	529008	Ref. No.	00036.4.00.04
description	filter holder spout thread 3/8" 2-way curved outlet distance 33mm		
For models:	105, 105SL, Agile, BELLE EPOQUE JUNIOR, CAPPUCCINO, CLUB, Firenze-SL, Firenze-SL-Raised, LADY, MBM GOLF, Roma, Roma-OR, Roma-OR-170		

 <p>1</p>			
GEV No.	529007	Ref. No.	00031.4.00.04
description	filter holder spout thread 3/8" 2-way curved/short outlet distance 45mm		
For models:	100, 105, 105SL, 205, 205-Exclusive, Belle-Epoque, Century, Century-Restyling, Firenze, Gradisca, Gradisca-Restyling, Gradisca-Take-Away, MILLENNIO, PORTOFINO, PORTOFINO AM. SUPER, PORTOFINO AMERICA		

filters

for 1 cup



1

GEV No.	527631	Ref. No.	N/A
description	coffee filter ø 70mm mounting ø 60.7mm H 17mm cups 1 amount of coffee 8g		



1

GEV No.	529012	Ref. No.	01702.0.40.01
description	coffee filter ø 70mm mounting ø 60.8mm H 19.5mm cups 1 amount of coffee 6g		
For models:	100, 105, 105SL, 205, 205-Exclusive, Agile, Belle-Epoque, Cadetta, CAPPUCCINO, Century, Century-Restyling, Excelsior-OR, Excelsior-Standard, Executive, Firenze, Firenze-SL, Firenze-SL-Raised, Gradisca, Gradisca-Restyling, Gradisca-Take-Away, Maior, Maior-OR, Maior-Plus, MILLENNIO, Opus, Opus-B03-OR, Opus-OR, PORTOFINO, PORTOFINO AM. SUPER, PORTOFINO AMERICA, Portofino-Restyling, Roma, Roma-Cappuccino, Roma-OR, Roma-OR-170		



1

GEV No.	529011	Ref. No.	00560.0.40.01
description	coffee filter ø 70mm mounting ø 60mm H 24.5mm cups 1 amount of coffee 7g perforation ø 0.4mm		
For models:	105, 105SL, 205-Exclusive, Agile, Belle-Epoque, Cadetta, Century, Excelsior-OR, Excelsior-Standard, Gradisca, Gradisca-Restyling, Maior, Maior-OR, Maior-Plus, Opus, Opus-B03-OR, Opus-OR, PORTOFINO, PORTOFINO AM. SUPER, PORTOFINO AMERICA, Portofino-Restyling, Roma, Roma-Cappuccino, Roma-OR, Roma-OR-170		

for 2 cups



1

GEV No.	529013	Ref. No.	00561.0.40.01
description	coffee filter ø 70mm mounting ø 60.5mm H 25.5mm cups 2 amount of coffee 14g perforation ø 0.3x0.3mm square		
For models:	105, 105SL, 205-Exclusive, Agile, BELLE EPOQUE JUNIOR, Belle-Epoque, Cadetta, Century, CLUB, Excelsior-OR, Excelsior-Standard, Gradisca, Gradisca-Restyling, LADY, Maior, Maior-OR, Maior-Plus, MBM GOLF, Opus, Opus-B03-OR, Opus-OR, Opus-Sublima, PORTOFINO, PORTOFINO AM. SUPER, PORTOFINO AMERICA, Roma, Roma-Cappuccino, Roma-OR, Roma-OR-170		



1

GEV No.	529014	Ref. No.	01703.0.40.01
description	coffee filter ø 70mm mounting ø 60mm H 21mm cups 2 amount of coffee 12g perforation ø 0.3mm round		
For models:	100, 105, 105SL, 205, 205-Exclusive, Agile, Belle-Epoque, Cadetta, CAPPUCCINO, Century, Century-Restyling, Excelsior-OR, Excelsior-Standard, Executive, Firenze, Firenze-SL, Firenze-SL-Raised, Gradisca, Gradisca-Restyling, Gradisca-Take-Away, Maior, Maior-OR, Maior-Plus, MILLENNIO, Opus, Opus-B03-OR, Opus-OR, Opus-Sublima, PORTOFINO, PORTOFINO AM. SUPER, PORTOFINO AMERICA, Portofino-Restyling, Roma, Roma-Cappuccino, Roma-OR, Roma-OR-170		

blind filters



1

GEV No.	529023	Ref. No.	00564.0.40.01
description	blind filter ø 70mm mounting ø 60mm H 18mm		
For models:	105, 105SL, 205, 205-Exclusive, Agile, Belle-Epoque, Cadetta, Century, Century-Restyling, Excelsior-OR, Excelsior-Standard, Executive, Firenze, Firenze-SL, Firenze-SL-Raised, Gradisca, Gradisca-Restyling, Gradisca-Take-Away, Maior, Maior-OR, Maior-Plus, MILLENNIO, Opus, Opus-B03-OR, Opus-OR, Opus-Sublima, PORTOFINO, PORTOFINO AM. SUPER, PORTOFINO AMERICA, Portofino-Restyling, Roma, Roma-Cappuccino, Roma-OR, Roma-OR-170		

filter holder springs



1

GEV No.	531240	Ref. No.	0086200003 0223300003
description	filter holder spring L 62mm W 56.5mm wire gauge ø 1mm for espresso filter holder Qty 20 pcs		



1

GEV No.	531243	Ref. No.	N/A
description	filter holder spring L 70mm W 60mm wire gauge ø 1.3mm for espresso filter holder Qty 20 pcs		

brewing units

shower screens

with upstand



1

GEV No.	528417	Ref. No.	04214.0.40.01
description	shower screen ø 58mm H 19mm		
For models:	100, 105, 105SL, 205, 205-Exclusive, Cadetta, Century-Restyling, DeCurtis-CAMME, DeCurtis-DIG, DeCurtis-LEVA, Excelsior-OR, Excelsior-Standard, Executive, Firenze, Gradisca, Gradisca-Restyling, Gradisca-Take-Away, Maior, Maior-OR, Maior-Plus, MILLENNIO, Opus, Opus-B03-OR, Opus-OR, Opus-Sublima, Portofino-Restyling		

filter holder gaskets

flat

with external notch



1

GEV No.	528040	Ref. No.	01393.0.00.02 04408.0.00.02
description	filter holder gasket D1 ø 71mm D2 ø 56.5mm H 8mm with outside notch Qty 1 pcs		
For models:	105, 105SL, Agile, Belle-Epoque, CAPPUCCINO, Century, Firenze-SL, Firenze-SL-Raised, PORTOFINO, PORTOFINO AM. SUPER, PORTOFINO AMERICA, Roma, Roma-Cappuccino, Roma-OR, Roma-OR-170		

standard



1

GEV No.	526551	Ref. No.	04367.0.00.02
description	filter holder gasket D1 ø 72.5mm D2 ø 57mm H 8mm Qty 1 pcs		
For models:	105, 105SL, 205, 205-Exclusive, Cadetta, Century-Restyling, DeCurtis-CAMME, DeCurtis-DIG, DeCurtis-LEVA, Excelsior-OR, Excelsior-Standard, Executive, Firenze, Gradisca, Gradisca-Restyling, Gradisca-Take-Away, Maior, Maior-OR, Maior-Plus, Opus, Opus-B03-OR, Opus-OR, Opus-Sublima, Portofino-Restyling		



1

GEV No.	526255	Ref. No.	05820.0.00.02
description	filter holder gasket D1 ø 73.6mm D2 ø 58mm H 8.5mm Qty 1 pcs		
For models:	Belle-Epoque, Century, Firenze-SL, Firenze-SL-Raised		

with cone



1

GEV No.	528067	Ref. No.	N/A
description	filter holder gasket with cone D1 ø 67mm D2 ø 56.5mm H1 6.4mm H2 4mm Qty 1 pcs		

shim gaskets



1

GEV No.	531251	Ref. No.	—
description	shim gasket D1 ø 66mm D2 ø 58mm thickness 0.8mm paper Qty 20 pcs		



1

GEV No.	528033	Ref. No.	04371.0.00.02
description	shim gasket D1 ø 71mm D2 ø 58mm thickness 0.8mm paper Qty 1 pcs		
For models:	Belle-Epoque, Century, Firenze-SL, Firenze-SL-Raised, PORTOFINO, PORTOFINO AM. SUPER, PORTOFINO AMERICA		



1

GEV No.	528050	Ref. No.	04368.0.00.02
description	shim gasket D1 ø 73mm D2 ø 59mm thickness 0.5mm paper Qty 1 pcs		
For models:	Belle-Epoque, Century, Firenze-SL, Firenze-SL-Raised, PORTOFINO, PORTOFINO AM. SUPER, PORTOFINO AMERICA		

			
1			
GEV No.	531250	Ref. No.	—
description	shim gasket D1 ø 73mm D2 ø 59mm thickness 0.5mm paper Qty 20 pcs		

brewing units with solenoid valve

nozzles

			
1			
GEV No.	528410	Ref. No.	00046.0.00.04
description	nozzle hole ø 0.7mm L 8.5mm thread M5x0.75 thread L 4.5mm head thickness 4mm brass		
For models:	100, 105, 105SL, 205, Belle-Epoque, Cadetta, CAPPUCCINO, Century, Firenze, Firenze-SL, Firenze-SL-Raised, Gradisca, Gradisca-Restyling, Gradisca-Take-Away, Maior, Maior-OR, Maior-Plus, MILLENNIO, PORTOFINO, PORTOFINO AM. SUPER, PORTOFINO AMERICA, Roma, Roma-Cappuccino, Roma-OR, Roma-OR-170		

			
1			
GEV No.	526595	Ref. No.	19702.0.00.04
description	nozzle hole ø 1mm L 8.5mm thread M5x0.8 thread L 4.5mm head thickness 4mm brass		
For models:	Agile		

components

			
1			
GEV No.	526566	Ref. No.	12860.4.10.09
description	drain pipe 1/8" L 35mm WS 22		
For models:	Excelsior-OR, Excelsior-Standard, Portofino-Restyling		

pipes

			
1			
GEV No.	526569	Ref. No.	09562.2.10.04
description	drain pipe ø 6mm ID ø 4mm T1: 1/8" chrome-plated		
For models:	DeCurtis-CAMME, DeCurtis-DIG, DeCurtis-LEVA, Gradisca, Gradisca-Restyling, Gradisca-Take-Away		

screw connections

			
1			
GEV No.	526708	Ref. No.	03460.0.10.04
description	plug thread 1/8" L 8.5mm chrome-plated brass		
For models:	105, 105SL, Agile, Cadetta, Century, Firenze-SL, Firenze-SL-Raised, Maior, Maior-OR, Maior-Plus, Roma, Roma-OR, Roma-OR-170		

brewing units manual

components

drain units

drain valves

			
1			
GEV No.	526002	Ref. No.	09451.4.00.09
description	valve support ø 16mm L 27mm brass shaft triangular D1 ø 10mm D2 ø 7mm		
For models:	DeCurtis-CAMME, DeCurtis-DIG, DeCurtis-LEVA, Gradisca		



nozzle holders

			
1			
GEV No.	526783	Ref. No.	12790.0.10.04
description	nozzle holder thread M30x1.5 IT M16x1.5 IT 1 M8 ø 26mm int. ø 1 15mm int. ø 2 17.5mm L 66.5mm total length 82mm WS 36 chrome-plated brass		
For models:	205-Exclusive, Century-Restyling, DeCurtis-CAMME, DeCurtis-DIG, DeCurtis-LEVA, Excelsior-OR, Excelsior-Standard, Executive, Gradisca, Maior, Maior-OR, Maior-Plus, Opus, Opus-B03-OR, Opus-OR, Portofino-Restyling		

camshafts

			
1			
GEV No.	527940	Ref. No.	09320.0.00.04
description	camshaft shaft ø 8mm shaft intake ø 6.2mm L 86.5mm W 20mm H 17mm thread M6 brass		
For models:	DeCurtis-CAMME, DeCurtis-DIG, DeCurtis-LEVA, Gradisca		



valves			
			
1			
GEV No.	526008	Ref. No.	09453.4.00.09
description	valve group outflow L 54.3mm ED ø 16mm shaft ø 4.5mm brass		
For models:	DeCurtis-CAMME, DeCurtis-DIG, DeCurtis-LEVA, Gradisca		
accessories for	526008		
	GEV No.	526003	Ref. No. —
	compression spring ø 13.8mm L 54.5mm wire gauge ø 1.5mm windings 10 drain valve		
	GEV No.	532550	Ref. No. —
	O-ring NBR 787/70 thickness 2.62mm ID ø 9.13mm Qty 10 pcs		

			
1			
GEV No.	526007	Ref. No.	09452.4.00.09
description	valve group supply L 52.8mm ED ø 16mm shaft triangular		
For models:	DeCurtis-CAMME, DeCurtis-DIG, DeCurtis-LEVA, Gradisca		

components			
nozzles			
with thread			
			
1			
GEV No.	528486	Ref. No.	12792.0.00.04
description	nozzle bore ø 0.7mm thread M6x0.75 L 9mm WS 7		
For models:	205-Exclusive, Century-Restyling, DeCurtis-CAMME, DeCurtis-DIG, DeCurtis-LEVA, Excelsior-OR, Excelsior-Standard, Executive, Gradisca, Maior, Maior-OR, Maior-Plus, Opus, Opus-B03-OR, Opus-OR, Portofino-Restyling		

springs			
			
1			
GEV No.	526561	Ref. No.	12941.0.00.03
description	compression spring ø 14.3mm L 21mm wire gauge ø 1.8mm		
For models:	DeCurtis-CAMME, DeCurtis-DIG, DeCurtis-LEVA, Gradisca		

screw connections			
			
1			
GEV No.	528407	Ref. No.	02106.0.00.04 02106.0.11.04
description	screw cap		
For models:	100, 105, 105SL, 205, 205-Exclusive, Agile, Cadetta, CAPPUCCINO, Century, Excelsior-OR, Excelsior-Standard, Firenze, Firenze-SL, Firenze-SL-Raised, Gradisca, Gradisca-Restyling, Gradisca-Take-Away, Maior, Maior-OR, Maior-Plus, MILLENNIO, Opus, Opus-B03-OR, Opus-OR, Opus-Sublima, PORTOFINO, PORTOFINO AM. SUPER, PORTOFINO AMERICA, Roma, Roma-Cappuccino, Roma-OR, Roma-OR-170		

water dispersions			
water dispersions			
group 2			
			
1			
GEV No.	529081	Ref. No.	04089.0.00.04
description	water distributor ø 30mm hole ø 1.5mm H 15mm ET M10x1 grooves 6 2.5mm brass		
For models:	100, 105, 105SL, 205, 205-Exclusive, Cadetta, Century-Restyling, DeCurtis-CAMME, DeCurtis-DIG, DeCurtis-LEVA, Excelsior-OR, Excelsior-Standard, Executive, Firenze, Gradisca, Gradisca-Restyling, Gradisca-Take-Away, Maior, Maior-OR, Maior-Plus, MILLENNIO, Opus, Opus-B03-OR, Opus-OR, Opus-Sublima, Portofino-Restyling		

group 3			
			
1			
GEV No.	528411	Ref. No.	04087.0.00.04
description	water distributor ø 55mm H 7mm 6 holes hole ø 1.2mm mounting ø 5.1mm brass		
For models:	105, 105SL, Belle-Epoque, CAPPUCCINO, Century, Firenze-SL, Firenze-SL-Raised, PORTOFINO, PORTOFINO AM. SUPER, PORTOFINO AMERICA, Roma, Roma-Cappuccino, Roma-OR, Roma-OR-170		

			
1			
GEV No.	528414	Ref. No.	00021.0.00.04
description	water distributor ø 58mm H 7mm 6 holes hole ø 1.15mm mounting ø 5mm brass		
For models:	BELLE EPOQUE JUNIOR, CLUB, LADY, MBM GOLF		

safety valves			
safety valves			
3/8"			
			
1			
GEV No.	529879	Ref. No.	12611.4.00.09
description	safety valve connection 3/8" triggering pressure 1.6bar approval CE 0036 sealed		
For models:	105, 105SL, 205, 205-Exclusive, Agile, Belle-Epoque, Cadetta, Century, Century-Restyling, DeCurtis-CAMME, DeCurtis-DIG, DeCurtis-LEVA, Excelsior-OR, Excelsior-Standard, Executive, Firenze, Firenze-SL, Firenze-SL-Raised, Gradisca, Gradisca-Restyling, Gradisca-Take-Away, Maior, Maior-OR, Maior-Plus, Opus, Opus-B03-OR, Opus-OR, Portofino-Restyling, Roma, Roma-Cappuccino, Roma-OR, Roma-OR-170		

			
1			
GEV No.	529312	Ref. No.	01120.4.00.09
description	safety valve connection 3/8" triggering pressure 1.8bar		
For models:	100, 105, 105SL, 205, Belle-Epoque, CAPPUCCINO, Century, Firenze, Gradisca, Gradisca-Take-Away, PORTOFINO, PORTOFINO AM. SUPER, PORTOFINO AMERICA, SECS		

			
1			
GEV No.	529338	Ref. No.	01181.4.00.09
description	safety valve connection 3/8" triggering pressure 1.8bar approval TÜV suitable for BRASILIA		
For models:	MILLENNIO, PORTOFINO, PORTOFINO AM. SUPER, PORTOFINO AMERICA, TOP CLASS		

expansion valves

			
1			
GEV No.	529337	Ref. No.	12845.4.00.09
description	expansion valve T1: 3/8" ET T2: 1/4" ET L 48mm		
For models:	DeCurtis-CAMME, DeCurtis-DIG, DeCurtis-LEVA, Firenze-SL, Firenze-SL-Raised, Opus-B03-OR, Opus-Sublima, Roma, Roma-OR, Roma-OR-170		

with hose connection

			
1			
GEV No.	529593	Ref. No.	01182.4.00.09
description	expansion valve T1: 1/4" ET hose ø 8mm L 51mm		
For models:	Belle-Epoque, SECS, TOP CLASS		

			
1			
GEV No.	526587	Ref. No.	13533.4.00.09
description	expansion valve T1: 1/4" ET hose ø 9.5mm L 42mm		
For models:	Agile, Firenze-SL, Firenze-SL-Raised, Roma, Roma-OR, Roma-OR-170		

gasket supports

			
1			
GEV No.	528245	Ref. No.	00153.0.00.04 18406.0.00.04
description	gasket support D1 ø 7.5mm ID ø 10.5mm L 14mm brass		
For models:	100, 105, 105SL, 205, 205-Exclusive, Agile, Belle-Epoque, Cadetta, CAPPUCCINO, Century, Century-Restyling, DeCurtis-CAMME, DeCurtis-DIG, DeCurtis-LEVA, Excelsior-OR, Excelsior-Standard, Executive, Firenze, Firenze-SL, Firenze-SL-Raised, Gradisca, Gradisca-Restyling, Gradisca-Take-Away, Maior, Maior-OR, Maior-Plus, MILLENNIO, Opus, Opus-B03-OR, Opus-OR, Opus-Sublima, PORTOFINO, PORTOFINO AMERICA, Portofino-Restyling		



drain pans

drain pans

			
1			
GEV No.	526563	Ref. No.	05933.2.06.01
description	drain pan ø 60mm H 30mm hose ø 10mm		
For models:	Roma-Cappuccino		

			
1			
GEV No.	526564	Ref. No.	08229.0.00.02
description	drain pan ø 60mm H 46mm hole ø 20mm hose ø 10mm		
For models:	105, 105SL, 205, 205-Exclusive, Agile, Belle-Epoque, Cadetta, Century, Century-Restyling, DeCurtis-CAMME, DeCurtis-DIG, DeCurtis-LEVA, Excelsior-OR, Excelsior-Standard, Firenze, Firenze-SL, Firenze-SL-Raised, Gradisca, Gradisca-Restyling, Gradisca-Take-Away, Opus, Opus-B03-OR, Opus-OR, Opus-Sublima, Portofino-Restyling, Roma, Roma-OR, Roma-OR-170		

aerators and air bleeders

			
1			
GEV No.	529303	Ref. No.	05062.4.00.09
description	aerator and air bleeder connection 1/4" only steam		
For models:	100		
spare parts for	529303		
	GEV No.	528687	Ref. No. —
	O-ring Viton thickness 1.78mm ID ø 3.69mm Qty 1 pcs		

			
1			
GEV No.	529304	Ref. No.	01571.2.00.04
description	aerator and air bleeder screw connection 1/4"		
For models:	PORTOFINO AM. SUPER		

boilers			
gaskets			
unperforated			
			
1			
GEV No.	528139	Ref. No.	00821.0.00.02
description	boiler gasket D1 ø 143mm D2 ø 128mm thickness 3mm graphite suitable for BRASILIA equiv. no. 00821		
For models:	Century		

accessories			
			
1			
GEV No.	526707	Ref. No.	01246.0.00.03
description	thread bolt for heating element thread M8 L 31mm		
For models:	105, 105SL, 205, 205-Exclusive, Cadetta, Century, Century-Restyling, DeCurtis-CAMME, DeCurtis-DIG, DeCurtis-LEVA, Excelsior-OR, Excelsior-Standard, Executive, Firenze, Firenze-SL, Firenze-SL-Raised, Gradisca, Gradisca-Restyling, Gradisca-Take-Away, Maior, Maior-OR, Maior-Plus, Opus, Opus-B03-OR, Opus-OR, Portofino-Restyling		

steam/water taps			
steam/water taps			
steam/water taps			
			
1			
GEV No.	529594	Ref. No.	01169.4.00.09
description	steam/water tap		
For models:	PORTOFINO		

			
1			
GEV No.	529595	Ref. No.	01153.4.00.09
description	steam/water tap inlet 1/4" outlet 1/8" suitable for AMERICA series		
For models:	105, 105SL, CAPPUCCINO, Firenze-SL, Firenze-SL-Raised		

			
1			
GEV No.	529616	Ref. No.	11927.4.00.09
description	steam/water tap rubber inlet 1/4" outlet 1/8"		
For models:	105, 105SL, 205, 205-Exclusive, Century, Century-Restyling, Executive, Firenze, Gradisca, Gradisca-Restyling, Gradisca-Take-Away, PORTOFINO, PORTOFINO AM. SUPER, PORTOFINO AMERICA, Portofino-Restyling		

components			
shafts			
			
1			
GEV No.	526568	Ref. No.	05384.0.00.04
description	shaft for ceramic washer ø 9mm D2 ø 16mm L 91mm brass		
For models:	105, 105SL, 205, Century, Firenze, Gradisca, Gradisca-Take-Away		

			
1			
GEV No.	526570	Ref. No.	12046.4.00.09
description	shaft ø 7.8mm D2 ø 17.5mm L 98mm		
For models:	105, 105SL, 205, 205-Exclusive, Century, Century-Restyling, Executive, Firenze, Firenze-SL, Firenze-SL-Raised, Gradisca, Gradisca-Restyling, Gradisca-Take-Away, Portofino-Restyling		

bushes			
			
1			
GEV No.	529804	Ref. No.	06508.0.00.04
description	bush		
For models:	205, 205-Exclusive, Agile, Bolero, Cadetta, Excelsior-OR, Excelsior-Standard, Executive, Firenze-SL, Firenze-SL-Raised, Maior, Maior-OR, Maior-Plus, MILLENNIO, OFFICE RB2, Opus, Opus-B03-OR, Opus-OR, Opus-Sublima, PORTOFINO AMERICA, Portofino-Restyling, Roma, Roma-Cappuccino, Roma-OR, Roma-OR-170		

gaskets			
			
1			
GEV No.	528244	Ref. No.	00818.0.00.02 18513.0.00.02
description	gasket D1 ø 11mm ID ø 4mm thickness 4mm		
For models:	100, 105, 105SL, 205, 205-Exclusive, Agile, Belle-Epoque, Cadetta, CAPPUCCINO, Century, Century-Restyling, DeCurtis-CAMME, DeCurtis-DIG, DeCurtis-LEVA, Excelsior-OR, Excelsior-Standard, Executive, Firenze, Firenze-SL, Firenze-SL-Raised, Gradisca, Gradisca-Restyling, Gradisca-Take-Away, Maior, Maior-OR, Maior-Plus, MILLENNIO, Opus, Opus-B03-OR, Opus-OR, Opus-Sublima, PORTOFINO, PORTOFINO AMERICA, Portofino-Restyling		

			
1			
GEV No.	528280	Ref. No.	01365.0.00.02 16886.0.00.02
description	gasket D1 ø 11mm thickness 4mm Viton		
For models:	100, 105, 105SL, 205, Belle-Epoque, CAPPUCCINO, Century, Century-Restyling, DeCurtis-CAMME, DeCurtis-DIG, DeCurtis-LEVA, Firenze, Firenze-SL, Firenze-SL-Raised, Gradisca, Gradisca-Take-Away, MILLENNIO, PORTOFINO, PORTOFINO AM. SUPER, PORTOFINO AMERICA, Portofino-Restyling, Roma-Cappuccino		



1

GEV No.	528283	Ref. No.	12005.0.00.02
description	gasket D1 ø 13mm ID ø 4mm thickness 4mm rubber		
For models:	105, 105SL, 205, 205-Exclusive, Century, Century-Restyling, Executive, Firenze, Firenze-SL, Firenze-SL-Raised, Gradisca, Gradisca-Restyling, Gradisca-Take-Away, PORTOFINO, PORTOFINO AM. SUPER, PORTOFINO AMERICA, Portofino-Restyling		



1

GEV No.	526555	Ref. No.	08570.0.00.02
description	gasket D1 ø 16mm ID ø 8mm thickness 4mm		
For models:	DeCurtis-CAMME, DeCurtis-DIG, DeCurtis-LEVA, Gradisca		



1

GEV No.	528281	Ref. No.	00825.0.00.02
description	gasket D1 ø 6mm thickness 3mm PTFE		
For models:	BELLE EPOQUE JUNIOR, CLUB, LADY, MBM GOLF		

springs



1

GEV No.	529946	Ref. No.	08953.0.00.03
description	compression spring ø 14.7mm L 34mm wire gauge ø 2mm		
For models:	DeCurtis-CAMME, DeCurtis-DIG, DeCurtis-LEVA, Gradisca		

tap bodies



1

GEV No.	526585	Ref. No.	12010.0.00.04
description	tap body T1: 1/8" T2: 1/4" T3: M20x1.5 L 72mm		
For models:	105, 105SL, 205, 205-Exclusive, Century, Century-Restyling, Executive, Firenze, Firenze-SL, Firenze-SL-Raised, Gradisca, Gradisca-Restyling, Gradisca-Take-Away, Portofino-Restyling		

ceramic washers



1

GEV No.	528274	Ref. No.	05810.0.00.02
description	ceramic washer		
For models:	100, 105, 105SL, 205, Century, Firenze, Gradisca, Gradisca-Take-Away, MILLENNIO, PORTOFINO, PORTOFINO AM. SUPER, PORTOFINO AMERICA		

union nuts



1

GEV No.	528279	Ref. No.	00131.0.12.04
description	union nut		
For models:	100, 105, 105SL, 205, 205-Exclusive, Century, Century-Restyling, Excelsior-OR, Excelsior-Standard, Executive, Firenze, Firenze-SL, Firenze-SL-Raised, Gradisca, Gradisca-Restyling, Gradisca-Take-Away, MILLENNIO, Opus, Opus-B03-OR, Opus-OR, PORTOFINO, PORTOFINO AM. SUPER, PORTOFINO AMERICA, Portofino-Restyling		



1

GEV No.	528263	Ref. No.	00145.0.00.04 00145.0.14.04
description	union nut thread 3/8" ID ø 12.5mm L 21mm WS 22 anthracite		
For models:	105, 105SL, Belle-Epoque, CAPPUCINO		

1

GEV No.	528264	Ref. No.	05363.0.14.04
description	union nut thread 3/8" L 22.5mm WS 29 anthracite		
For models:	Firenze-SL, Firenze-SL-Raised		



1

GEV No.	526584	Ref. No.	05383.0.00.04
description	screw connection T1: 1/2" T2: M25 L 65mm		
For models:	105, 105SL, 205, Century, Firenze, Gradisca, Gradisca-Take-Away		

washers



1

GEV No.	528185	Ref. No.	12153.0.00.03
description	disc D1 ø 12mm D2 ø 8.2mm thickness 2mm brass		
For models:	105, 105SL, 205, 205-Exclusive, Century, Executive, Firenze, Firenze-SL, Firenze-SL-Raised, Gradisca, Gradisca-Restyling, Gradisca-Take-Away, PORTOFINO, PORTOFINO AM. SUPER, PORTOFINO AMERICA, Portofino-Restyling		

miscellaneous



1

GEV No.	528271	Ref. No.	05808.0.00.02
description	bush		
For models:	100, 105, 105SL, 205, Century, Firenze, Gradisca, Gradisca-Take-Away, MILLENNIO, PORTOFINO, PORTOFINO AM. SUPER, PORTOFINO AMERICA		

screw connections



1

GEV No.	528295	Ref. No.	07202.0.00.04
description	screw connection		
For models:	205, 205-Exclusive, Agile, Bolero, Executive, Firenze-SL, Firenze-SL-Raised, MILLENNIO, OFFICE RB2, Opus-Sublima, PORTOFINO AMERICA, Portofino-Restyling, SECS, TOP CLASS		



1

GEV No.	528275	Ref. No.	05807.0.00.02
description	bush		
For models:	100, 105, 105SL, 205, Century, Firenze, Gradisca, Gradisca-Take-Away, MILLENNIO, PORTOFINO, PORTOFINO AM. SUPER, PORTOFINO AMERICA		



1

GEV No.	526572	Ref. No.	12013.0.00.04
description	screw connection for steam-/water-tap L 46mm ø 18mm ID ø 8.5mm WS 24 thread 1/2"		
For models:	105, 105SL, 205, 205-Exclusive, Century, Century-Restyling, Executive, Firenze, Firenze-SL, Firenze-SL-Raised, Gradisca, Gradisca-Restyling, Gradisca-Take-Away, Portofino-Restyling		



1

GEV No.	528272	Ref. No.	05811.0.00.02
description	disc		
For models:	100, 105, 105SL, 205, Century, Firenze, Gradisca, Gradisca-Take-Away, MILLENNIO, PORTOFINO, PORTOFINO AM. SUPER, PORTOFINO AMERICA		

steam/water pipes

steam pipes



1

GEV No.	529754	Ref. No.	01599.2.10.04
description	steam pipe		
For models:	Belle-Epoque		



1

GEV No.	529873	Ref. No.	06512.2.10.04
description	steam pipe		
For models:	PORTOFINO AMERICA		

			
1			
GEV No.	529888	Ref. No.	04676.2.10.04
description	steam pipe H 170mm tube ø 10mm chrome-plated brass AMERICA		
For models:	105, 105SL		

			
1			
GEV No.	529740	Ref. No.	04676
description	steam pipe H 180mm tube ø 10mm chrome-plated brass		

			
1			
GEV No.	529752	Ref. No.	12062.4.00.09
description	steam pipe H 200mm		
For models:	105, 105SL, Century-Restyling		

			
1			
GEV No.	529741	Ref. No.	12058.4.00.09
description	steam pipe H 23.5mm tube ø 10mm chrome-plated brass CENTURY		
For models:	Century		

			
1			
GEV No.	529749	Ref. No.	12060.4.00.09
description	steam pipe thread 3/8" L 220mm tube ø 10mm GRADISCA		
For models:	Gradisca, Gradisca-Restyling, Gradisca-Take-Away		

			
1			
GEV No.	529758	Ref. No.	11767.2.10.04
description	steam pipe with ball joint/ without nozzle		
For models:	205, Firenze-SL, Firenze-SL-Raised, MILLENNIO		

			
1			
GEV No.	529867	Ref. No.	10767.2.10.04
description	steam pipe without nozzle		
For models:	Gradisca, Gradisca-Take-Away		

			
1			
GEV No.	529881	Ref. No.	04657.2.10.04
description	steam pipe without nozzle		
For models:	Century		

nozzles for water pipes

nozzles for water pipes

			
1			
GEV No.	525095	Ref. No.	04661.0.10.04
description	nozzle D1 ø 24mm H 30mm thread M10x1 int. ø 1 9mm		
For models:	100, 105, 105SL, 205, Cadetta, CAPPUCCINO, Century, Century-Restyling, Firenze, Firenze-SL, Firenze-SL-Raised, Gradisca, Gradisca-Restyling, Gradisca-Take-Away, Maior, Maior-OR, Maior-Plus, MILLENNIO, OFFICE RB2, Opus, Opus-B03-OR, Opus-OR, Opus-Sublima, PORTOFINO, PORTOFINO AM. SUPER, PORTOFINO AMERICA, SECS, TOP CLASS		

components

			
1			
GEV No.	529604	Ref. No.	00054.0.00.04
description	end piece for flow regulator		

tap aerators

			
1			
GEV No.	529608	Ref. No.	05004.4.00.09
description	tap aerator D1 ø 23mm H 15mm thread M22x1		
For models:	100, 105, 105SL, 205, Cadetta, CAPPUCCINO, Century, Century-Restyling, Firenze, Firenze-SL, Firenze-SL-Raised, Gradisca, Gradisca-Restyling, Gradisca-Take-Away, Maior, Maior-OR, Maior-Plus, MILLENNIO, OFFICE RB2, Opus, Opus-B03-OR, Opus-OR, Opus-Sublima, PORTOFINO, PORTOFINO AM. SUPER, PORTOFINO AMERICA, Roma, Roma-Cappuccino, Roma-OR, Roma-OR-170, SECS, TOP CLASS		



water pipes			
			
1			
GEV No.	529597	Ref. No.	00259.2.10.04
description	water pipe		
For models:	CAPPUCCINO, Firenze, PORTOFINO, PORTOFINO AM. SUPER		

			
1			
GEV No.	529600	Ref. No.	01630.2.10.04
description	water pipe		

			
1			
GEV No.	529755	Ref. No.	02533.2.10.04 12061.4.00.09
description	water pipe		
For models:	100, 105, 105SL, PORTOFINO		

			
1			
GEV No.	529874	Ref. No.	02509.2.10.04
description	water pipe		

			
1			
GEV No.	529599	Ref. No.	00251 02550 12055.4.00.09
description	water pipe L 120mm chrome-plated brass		
For models:	CAPPUCCINO, Century-Restyling, Firenze, PORTOFINO, PORTOFINO AM. SUPER		

			
1			
GEV No.	529757	Ref. No.	12059.4.00.09
description	water pipe ø 10mm L 185mm suitable for GRADISCA		
For models:	Gradisca, Gradisca-Restyling, Gradisca-Take-Away		

			
1			
GEV No.	529817	Ref. No.	06511.2.10.04
description	water pipe ø 10mm L 50mm		
For models:	205, Firenze-SL, Firenze-SL-Raised, MILLENNIO, PORTOFINO AMERICA		

			
1			
GEV No.	529748	Ref. No.	12057.4.00.09
description	water pipe ø 23.5mm L 135mm chrome-plated brass CENTURY		
For models:	Century		

			
1			
GEV No.	526614	Ref. No.	13519.4.00.09
description	water pipe thread 3/8" L 75mm WS 22		
For models:	205-Exclusive, Agile, Executive, Portofino-Restyling		

			
1			
GEV No.	529759	Ref. No.	06511.2.10.04
description	water pipe with ball joint		

accessories

bushes

			
1			
GEV No.	528297	Ref. No.	11029.0.00.04
description	bush		
For models:	Gradisca, Gradisca-Restyling, Gradisca-Take-Away, SECS, TOP CLASS		

gaskets



GEV No.	528259	Ref. No.	01286.0.00.03
description	flat gasket ID ø 10mm thickness 1mm		
For models:	100, 105, 105SL, 205, Agile, Belle-Epoque, CAPPUCCINO, Century, Century-Restyling, Excelsior-OR, Excelsior-Standard, Firenze, Firenze-SL, Firenze-SL-Raised, Gradisca, Gradisca-Restyling, Gradisca-Take-Away, MILLENNIO, PORTOFINO, PORTOFINO AM. SUPER, Roma, Roma-Cappuccino, Roma-OR, Roma-OR-170		



GEV No.	528258	Ref. No.	00810.0.00.02
description	gasket ID ø 10 no to be sold in Francem thickness 1/2.4mm outer cone		
For models:	100, 105, 105SL, 205, Belle-Epoque, CAPPUCCINO, Century-Restyling, Excelsior-OR, Excelsior-Standard, Firenze, Firenze-SL, Firenze-SL-Raised, Gradisca, Gradisca-Restyling, Gradisca-Take-Away, MILLENNIO, PORTOFINO, PORTOFINO AM. SUPER, Roma-Cappuccino		



GEV No.	528231	Ref. No.	00839.0.00.02
description	O-ring Viton thickness 2.62mm ID ø 12.37mm Qty 1 pcs		
For models:	100, 105, 105SL, 205, 205-Exclusive, BELLE EPOQUE JUNIOR, CLUB, DeCurtis-CAMME, DeCurtis-DIG, DeCurtis-LEVA, Excelsior-OR, Excelsior-Standard, Gradisca, Gradisca-Restyling, Gradisca-Take-Away, LADY, MBM GOLF, MILLENNIO, Opus, Opus-B03-OR, Opus-OR, Portofino-Restyling		

springs



GEV No.	529704	Ref. No.	07060.0.00.03
description	compression spring ø 11.8mm L 16mm wire gauge ø 1.6mm steel		
For models:	205, 205-Exclusive, Agile, Bolero, Cadetta, Excelsior-OR, Excelsior-Standard, Executive, Firenze-SL, Firenze-SL-Raised, Gradisca, Gradisca-Restyling, Gradisca-Take-Away, Maior, Maior-OR, Maior-Plus, MILLENNIO, OFFICE RB2, Opus, Opus-OR, Opus-Sublima, PORTOFINO AMERICA, Portofino-Restyling, Roma, Roma-Cappuccino, Roma-OR, Roma-OR-170, SECS, TOP CLASS		

tube handles



GEV No.	529626	Ref. No.	11972.0.00.02 11972.0.00.04
description	tube handle		
For models:	205-Exclusive, Cadetta, Gradisca-Restyling, Portofino-Restyling		



GEV No.	528625	Ref. No.	15692.0.00.02
description	tube handle L 35mm rubber ID ø 8mm		
For models:	205-Exclusive, Agile, Cadetta, DeCurtis-CAMME, DeCurtis-DIG, DeCurtis-LEVA, Excelsior-OR, Excelsior-Standard, Executive, Maior, Maior-OR, Maior-Plus, Opus, Opus-B03-OR, Opus-OR, Opus-Sublima, Portofino-Restyling		

washers



GEV No.	528268	Ref. No.	00166.0.00.04
description	disc ID ø 5.4mm ED ø 10mm thickness 2mm		
For models:	100, 105, 105SL, 205, 205-Exclusive, Agile, Cadetta, CAPPUCCINO, Century, Century-Restyling, DeCurtis-CAMME, DeCurtis-DIG, DeCurtis-LEVA, Excelsior-OR, Excelsior-Standard, Executive, Firenze, Firenze-SL, Firenze-SL-Raised, Gradisca, Gradisca-Restyling, Gradisca-Take-Away, Maior, Maior-OR, Maior-Plus, MILLENNIO, Opus, Opus-B03-OR, Opus-OR, Opus-Sublima, PORTOFINO, PORTOFINO AMERICA, Portofino-Restyling		

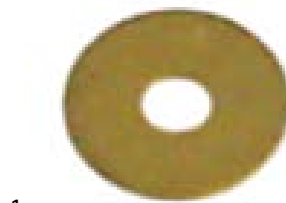

GEV No.	529603	Ref. No.	01301.0.00.03
description	plain washer ID ø 17mm ED ø 29.8mm thickness 3mm		
For models:	100, Belle-Epoque		

union nuts



GEV No.	528300	Ref. No.	06509.0.00.04
description	union nut		
For models:	205, 205-Exclusive, Agile, Bolero, Executive, Firenze-SL, Firenze-SL-Raised, Gradisca, Gradisca-Restyling, Gradisca-Take-Away, Maior, Maior-OR, Maior-Plus, MILLENNIO, OFFICE RB2, Opus-Sublima, PORTOFINO AMERICA, Portofino-Restyling		

fine filters

fine filters

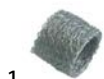

1

GEV No.	528409	Ref. No.	00086.0.00.04
----------------	--------	-----------------	---------------

description fine filter fabric pipe \varnothing 14mm H 11.5mm

For models: 100, 105, 105SL, 205, 205-Exclusive, Agile, Belle-Epoque, Cadetta, CAPPUCCINO, Century, Excelsior-OR, Excelsior-Standard, Firenze, Firenze-SL, Firenze-SL-Raised, Gradisca, Gradisca-Restyling, Gradisca-Take-Away, Maior, Maior-OR, Maior-Plus, MILLENNIO, Opus, Opus-B03-OR, Opus-OR, Opus-Sublima, PORTOFINO, PORTOFINO AM. SUPER, PORTOFINO AMERICA, Roma, Roma-Cappuccino, Roma-OR, Roma-OR-170



1

GEV No.	528562	Ref. No.	09756.0.00.04
----------------	--------	-----------------	---------------

description fine filter flat \varnothing 9mm

For models: 205-Exclusive, Cadetta, Century, Excelsior-OR, Excelsior-Standard, Executive, Gradisca-Restyling, Maior, Maior-OR, Maior-Plus, Opus, Opus-B03-OR, Opus-OR, Opus-Sublima



1

GEV No.	529979	Ref. No.	12897.0.40.01
----------------	--------	-----------------	---------------

description fine filter \varnothing 8.8mm H 22mm

For models: 205-Exclusive, Century-Restyling, DeCurtis-CAMME, DeCurtis-DIG, DeCurtis-LEVA, Excelsior-OR, Excelsior-Standard, Executive, Gradisca, Maior, Maior-OR, Maior-Plus, Opus, Opus-B03-OR, Opus-OR, Portofino-Restyling

intake valves

intake valves



1

GEV No.	529590	Ref. No.	02954.6.00.09
----------------	--------	-----------------	---------------

description intake valve water equiv. no. 02954 with solenoid valve

For models: 100, 105, 105SL, 205, Century, Century-Restyling, DeCurtis-CAMME, DeCurtis-DIG, DeCurtis-LEVA, Firenze, Firenze-SL, Firenze-SL-Raised, Gradisca, Gradisca-Take-Away, MILLENNIO, PORTOFINO, PORTOFINO AMERICA, Portofino-Restyling



1

GEV No.	529615	Ref. No.	06267.6.00.09
----------------	--------	-----------------	---------------

description intake valve water equiv. no. 06267 complete voltage AC

For models: 105, 105SL, Belle-Epoque, CAPPUCCINO, MILLENNIO, PORTOFINO AM. SUPER, PORTOFINO AMERICA

accessories

gaskets



1

GEV No.	527995	Ref. No.	18508.0.00.08 18508.2.00.08
----------------	--------	-----------------	--------------------------------

description gasket ED \varnothing 15mm seat \varnothing 6mm H 5mm overall height 10mm

springs



1

GEV No.	526560	Ref. No.	08952.0.00.03
----------------	--------	-----------------	---------------

description compression spring \varnothing 14.3mm L 46mm wire gauge \varnothing 1.5mm

For models: DeCurtis-CAMME, DeCurtis-DIG, DeCurtis-LEVA, Gradisca

miscellaneous



1

GEV No.	528422	Ref. No.	02227.0.00.03
----------------	--------	-----------------	---------------

description ball \varnothing 8mm SS

valves



1

GEV No.	528247	Ref. No.	00078.0.00.04
----------------	--------	-----------------	---------------

description valve L 16mm W 6mm H 6mm ED \varnothing 12mm brass

For models: 100, 105, 105SL, 205, Belle-Epoque, CAPPUCCINO, Century, Century-Restyling, DeCurtis-CAMME, DeCurtis-DIG, DeCurtis-LEVA, Firenze, Firenze-SL, Firenze-SL-Raised, Gradisca, Gradisca-Take-Away, MILLENNIO, PORTOFINO, PORTOFINO AM. SUPER, PORTOFINO AMERICA, Portofino-Restyling, Roma-Cappuccino



1

GEV No.	528252	Ref. No.	05595.0.00.04
----------------	--------	-----------------	---------------

description valve L 20mm W 6x6mm ED \varnothing 12mm brass

For models: 100, 105, 105SL, 205, Belle-Epoque, CAPPUCCINO, Century, Century-Restyling, DeCurtis-CAMME, DeCurtis-DIG, DeCurtis-LEVA, Firenze, Firenze-SL, Firenze-SL-Raised, Gradisca, Gradisca-Take-Away, MILLENNIO, PORTOFINO, PORTOFINO AM. SUPER, PORTOFINO AMERICA, Portofino-Restyling, Roma-Cappuccino

level glasses

level glasses

pressure rings



GEV No.	529396	Ref. No.	00088.0.00.04
description	press ring D1 ø 11.3mm D2 ø 14.6mm thickness 3mm		
For models:	100, 105, 105SL, 205, 205-Exclusive, Agile, Belle-Epoque, Century, Century-Restyling, DeCurtis-CAMME, DeCurtis-DIG, DeCurtis-LEVA, Excelsior-OR, Excelsior-Standard, Firenze, Firenze-SL, Firenze-SL-Raised, Gradisca, Gradisca-Restyling, Gradisca-Take-Away, MILLENNIO, Opus, Opus-B03-OR, Opus-OR, PORTOFINO, PORTOFINO AM. SUPER, PORTOFINO AMERICA, Portofino-Restyling, Roma, Roma-OR, Roma-OR-170		

level glasses (complete)



GEV No.	526603	Ref. No.	21161.6.00.09 21161.8.00.09
description	water level tube with breathers H 200mm		
For models:	205, 205-Exclusive, Agile, Century, Century-Restyling, Excelsior-OR, Excelsior-Standard, Executive, Firenze, Firenze-SL, Firenze-SL-Raised, Gradisca, Gradisca-Restyling, Gradisca-Take-Away, Maior, Maior-OR, Maior-Plus, Opus, Opus-B03-OR, Opus-OR, Opus-Sublima, Portofino-Restyling, Roma, Roma-OR, Roma-OR-170		

level glass pipes



GEV No.	529398	Ref. No.	00787.0.00.02
description	water level tube ø 11mm H 135mm		
For models:	100, 105, 105SL, 205, 205-Exclusive, Agile, Belle-Epoque, Century, Century-Restyling, DeCurtis-CAMME, DeCurtis-DIG, DeCurtis-LEVA, Excelsior-OR, Excelsior-Standard, Executive, Firenze, Firenze-SL, Firenze-SL-Raised, Gradisca, Gradisca-Restyling, Gradisca-Take-Away, Maior, Maior-OR, Maior-Plus, MILLENNIO, Opus, Opus-B03-OR, Opus-OR, Opus-Sublima, PORTOFINO, PORTOFINO AM. SUPER, PORTOFINO AMERICA, Portofino-Restyling, Roma, Roma-OR, Roma-OR-170		

screw connections

double nipples



GEV No.	528294	Ref. No.	10766.0.00.04
description	double nipple T1: 1/8" T2: 3/8" int. ø 1 5mm int. ø 2 12mm L 27mm brass for steam pipe		
For models:	Gradisca, Gradisca-Take-Away		

for coffee grinders

grinding burrs

grinding burrs straight

standard



GEV No.	527213	Ref. No.	00059.3.00.04
description	grinding burrs pair turn direction left D1 ø 50mm ID ø 30mm H 8mm tooth spacing 2.5mm hole ø 4.5mm bore ø 7.5mm mounting ø 40 straight suitable for BRASILIA		
For models:	BFD		



GEV No.	526518	Ref. No.	19164.3.00.04
description	grinding burrs pair turn direction left D1 ø 63.3mm ID ø 38mm H 9mm tooth spacing 2.5mm hole ø 5mm bore ø 8.5mm mounting ø 50 suitable for BRASILIA, ROSSI teeth 12/60		
For models:	MAC64, MAC64-On-Demand, RR55-On-Demand		



GEV No.	531206	Ref. No.	N/A
description	grinding burrs pair turn direction left D1 ø 63.3mm ID ø 38mm H 9mm tooth spacing 2.5mm hole ø 5mm bore ø 8.5mm mounting ø 50 suitable for BRASILIA, ROSSI teeth 16/60		



GEV No.	527202	Ref. No.	00058.2.00.04 00058.3.00.04
description	grinding burrs pair turn direction left D1 ø 63.3mm ID ø 38mm H 9mm tooth spacing 3mm hole ø 5.5mm bore ø 8.5mm mounting ø 50 straight suitable for BRASILIA, ROSSI equiv. no. 00058/BRASILIA, 4433/ROSSI		
For models:	RR45-A, RR45-DEL, RR45-PST, RR45-S, RR45-SILENT, RR55-AE, RR65-AE, RR65-SE		



1

GEV No.	527215	Ref. No.	N/A
description	grinding burrs pair turn direction left D1 ø 83mm ID ø 45mm H 10mm tooth spacing 3.5mm hole ø 6.5mm bore ø 10.5mm mounting ø 65 straight suitable for BRASILIA, ROSSI		

grinding burrs conical



1

GEV No.	527200	Ref. No.	11779.3.00.04 11799.3.00.04 17084.3.40.04
description	grinding burrs pair turn direction right D1 ø 47mm D2 ø 31.5mm H 20mm shaft ø 10mm equiv. no. 11799		
For models:	CP1, CP2, RB1, RB2		



1

GEV No.	527237	Ref. No.	03603.3.00.04
description	grinding burrs pair turn direction right D1 ø 68mm D2 ø 49mm H 25mm shaft ø 13mm with flute suitable for ROSSI		
For models:	MC		

grinding burrs holders



1

GEV No.	527268	Ref. No.	02077.0.00.04
description	grinding burr holder type RR45, CC45 suitable for ROSSI equiv. no. 4984		
For models:	MAC64, RR45-A, RR45-DEL, RR45-On-Demand, RR45-PST, RR45-S, RR45-SILENT, RR55-AE, RR55-On-Demand, RR65-AE, RR65-SE		

screws



1

GEV No.	560365	Ref. No.	07079.0.00.03 20096.0.00.03
description	flat-headed bolt thread M4 thread L 8mm SS DIN 7985/ISO 7045 Qty 1 pcs intake Phillips head ø 8mm head thickness 3mm		
For models:	MAC64, MAC64-On-Demand, RR45-A, RR45-DEL, RR45-On-Demand, RR45-PST, RR45-S, RR45-SILENT, RR55-AE, RR55-On-Demand, RR65-AE, RR65-SE		

dosing containers

dosing container lids



1

GEV No.	527301	Ref. No.	03191.0.00.02
description	lid		
For models:	BFD		



1

GEV No.	527306	Ref. No.	01430.0.00.02
description	lid for dosing container ø 118mm		
For models:	MC, RR45-A, RR45-DEL, RR45-S, RR45-SILENT, RR55-AE, RR65-AE, RR65-SE		

adjusting screws



1

GEV No.	527551	Ref. No.	09610.0.00.02
description	adjusting screw for dosing container thread M8 L 40mm plastic		
For models:	MC, RR45-A, RR45-DEL, RR45-S, RR45-SILENT, RR55-AE, RR65-AE, RR65-SE		

springs

group 1



1

GEV No.	526509	Ref. No.	00897.0.00.03
description	compression spring ø 8.5mm L 95mm wire gauge ø 0.8mm right		
For models:	MAC64, MC, RR45-A, RR45-S, RR45-SILENT, RR55-AE, RR65-AE, RR65-SE		



1

GEV No.	526513	Ref. No.	17684.0.00.03
description	tension spring ø 11mm total length 44mm wire gauge ø 0.9mm L1 35mm for lever		
For models:	MAC64, MC, RR45-A, RR45-S, RR45-SILENT		

glass cylinders



1

GEV No.	527305	Ref. No.	01429.0.00.02
description	glass cylinder for dosing container ø 125mm H 60mm plexiglas		
For models:	MC, RR45-A, RR45-DEL, RR45-S, RR45-SILENT, RR55-AE, RR65-AE, RR65-SE		

coffee presses

coffee presses



1

GEV No.	527549	Ref. No.	00797.0.00.02
description	coffee press ø 57mm H 98mm plastic		
For models:	MAC64, MAC64-On-Demand, RR45-On-Demand, RR55-On-Demand		

sector plates



1

GEV No.	527553	Ref. No.	01772.0.00.01 01772.0.40.01
description	sector plates SS		
For models:	MC, RR45-A, RR45-DEL, RR45-S, RR45-SILENT, RR55-AE, RR65-AE, RR65-SE		

miscellaneous



1

GEV No.	526541	Ref. No.	12472.0.00.01
description	frame for lid L 73.5mm W 44mm H 8mm mounting pos. lower plastic		
For models:	RR45-A, RR45-DEL		

stars

upper



1

GEV No.	527552	Ref. No.	01485.0.00.02
description	star mounting pos. upper ø 112mm H 19mm		
For models:	MC, RR45-A, RR45-DEL, RR45-S, RR45-SILENT, RR55-AE, RR65-AE, RR65-SE		

adjustment mechanism

lockable adjustment



1

GEV No.	526536	Ref. No.	01470.0.00.02
description	pressure pin for setting ring L 20mm W 17mm shaft ø 5mm shaft length 26mm		
For models:	RR45-PST, RR45-S, RR55-AE, RR65-AE, RR65-SE		

setting rings



1

GEV No.	527400	Ref. No.	10200.0.00.02 20722.0.00.02
description	setting ring mounting ø 76mm ø 99mm ID ø 51mm H 34mm suitable for ROSSI for RR45A equiv. no. 28371		
For models:	RR45-A, RR45-DEL, RR45-On-Demand, RR45-S, RR45-SILENT, RR55-On-Demand		



1

GEV No.	527402	Ref. No.	11593.0.00.02
description	setting ring suitable for BRASILIA for Office equiv. no. 11593		
For models:	CP1, CP2, OFFICE RB2, RB1, RB2		

coffee beans containers

container lids



1

GEV No.	527327	Ref. No.	N/A
description	lid for coffee beans container ø 210mm		

coffee beans containers



1

GEV No.	527309	Ref. No.	10513.0.00.02
description	coffee beans container		
For models:	CP1, CP2, OFFICE RB2, RB1, RB2		



1

GEV No.	531179	Ref. No.	N/A	
description	coffee beans container without lid ø 207mm H 245mm universal			
accessories for	531179			
	GEV No.	527327	Ref. No.	N/A
	lid for coffee beans container ø 210mm			



1

GEV No.	527355	Ref. No.	13808.4.00.09
description	container complete ø 210mm H 290mm seat ø 51mm		
For models:	MC, RR65-SE		

support for filter holder



1

GEV No.	527891	Ref. No.	00798.0.00.02
description	filter holder support for dosing unit L 71mm W 98mm H 25mm plastic		
For models:	RR45-A, RR45-DEL, RR45-On-Demand, RR45-PST, RR45-S, RR45-SILENT		

for cup coffee machines

water containers



1

GEV No.	527308	Ref. No.	10192.0.00.02
description	lid for water container		
For models:	CP1, CP2, OFFICE RB2, RB1, RB2		



1

GEV No.	527307	Ref. No.	10193.0.00.02
description	water container suitable for BRASILIA		
For models:	CP1, CP2, OFFICE RB2, RB1, RB2		

knobs

producer-specific knobs

BRASILIA



1			
GEV No.	111294	Ref. No.	18053.0.00.02
description	knob shaft 5x5 black		
For models:	Opus, Opus-B03-OR, Opus-OR, Opus-Sublima		



1			
GEV No.	111100	Ref. No.	00772.0.00.02
description	knob switch zero mark ø 28mm shaft ø 7mm black		
For models:	100, 105, 105SL, 205, Belle-Epoque, CLUB, Firenze, MILLENNIO		



1			
GEV No.	111774	Ref. No.	17196.0.00.02
description	knob zero mark ø 40mm shaft ø 5x5mm black		

steam/water taps

knob dial plates



1			
GEV No.	111300	Ref. No.	19104.0.00.02
description	symbol ø 32mm L 28mm		
For models:	Roma, Roma-OR, Roma-OR-170		



1			
GEV No.	111275	Ref. No.	16884.0.00.02
description	symbol steam ø 32mm L 28mm		
For models:	Cadetta, Maior, Maior-OR, Maior-Plus, Roma, Roma-Cappuccino, Roma-OR, Roma-OR-170		



1			
GEV No.	111276	Ref. No.	16885.0.00.02
description	symbol water ø 32mm L 28mm		
For models:	Cadetta, Maior, Maior-OR, Maior-Plus, Roma, Roma-Cappuccino, Roma-OR, Roma-OR-170		

accessories



1			
GEV No.	528762	Ref. No.	12185.0.00.03
description	cotter pin ø 1.8mm L 17mm		
For models:	Maior, Maior-OR, Maior-Plus, MC, Roma, Roma-Cappuccino, Roma-OR, Roma-OR-170, RR45-A, RR45-S, RR45-SILENT, RR55-AE, RR65-AE, RR65-SE		

accessories

knob adaptors



1			
GEV No.	528261	Ref. No.	02088.0.00.04 02088.0.10.04
description	knob adaptor		
For models:	105, 105SL, Belle-Epoque, CAPPUCCINO		

handles and hand wheels

mushroom cap handles



1			
GEV No.	111782	Ref. No.	00781.0.00.02
description	mushroom cap handle thread M6 handle ø 25mm L 17mm plastic black		

equipment feet and end caps

equipment feet with stem



1			
GEV No.	526537	Ref. No.	18673.0.00.02
description	equipment foot ø 29mm H 24mm bore ø 5.5mm		
For models:	RR45-A, RR45-DEL, RR45-On-Demand, RR45-S, RR45-SILENT, RR55-On-Demand		



gaskets

O-rings

EPDM

GEV No.	504512	Ref. No.	01389.0.00.02 18511.0.00.02
description	O-ring EPDM thickness 1.78mm ID ø 14mm Qty 1 pcs		
For models:	100, 105, 105SL, 205, 205-Exclusive, Cadetta, Century, Century-Restyling, DeCurtis-CAMME, DeCurtis-DIG, DeCurtis-LEVA, Excelsior-OR, Excelsior-Standard, Executive, Firenze, Firenze-SL, Firenze-SL-Raised, Gradisca, Gradisca-Restyling, Gradisca-Take-Away, Maior, Maior-OR, Maior-Plus, MILLENNIO, Opus, Opus-B03-OR, Opus-OR, Opus-Sublima, PORTOFINO, PORTOFINO AMERICA, Portofino-Restyling		

GEV No.	528243	Ref. No.	01390.0.00.02 02107.0.00.04 18512.0.00.02
description	O-ring EPDM thickness 1.78mm ID ø 15.6mm Qty 1 pcs		
For models:	100, 105, 105SL, 205, 205-Exclusive, Cadetta, Century, Century-Restyling, DeCurtis-CAMME, DeCurtis-DIG, DeCurtis-LEVA, Excelsior-OR, Excelsior-Standard, Executive, Firenze, Firenze-SL, Firenze-SL-Raised, Gradisca, Gradisca-Restyling, Gradisca-Take-Away, Maior, Maior-OR, Maior-Plus, MILLENNIO, Opus, Opus-B03-OR, Opus-OR, Opus-Sublima, PORTOFINO, PORTOFINO AMERICA, Portofino-Restyling		

GEV No.	504574	Ref. No.	00851.0.00.02
description	O-ring EPDM thickness 1.78mm ID ø 9.25mm Qty 1 pcs		
For models:	105, 105SL, Agile, Century, Roma, Roma-Cappuccino, Roma-OR, Roma-OR-170		

GEV No.	529412	Ref. No.	00838.0.00.02
description	O-ring EPDM thickness 2.62mm ID ø 10.78mm Qty 1 pcs		
For models:	100, 105, 105SL, 205, 205-Exclusive, Agile, Belle-Epoque, Century, Century-Restyling, DeCurtis-CAMME, DeCurtis-DIG, DeCurtis-LEVA, Excelsior-OR, Excelsior-Standard, Executive, Firenze, Firenze-SL, Firenze-SL-Raised, Gradisca, Gradisca-Restyling, Gradisca-Take-Away, Maior, Maior-OR, Maior-Plus, MILLENNIO, Opus, Opus-B03-OR, Opus-OR, Opus-Sublima, PORTOFINO, PORTOFINO AM. SUPER, PORTOFINO AMERICA, Portofino-Restyling, Roma, Roma-OR, Roma-OR-170		

GEV No.	511512	Ref. No.	00800.0.00.02
description	O-ring EPDM thickness 2.62mm ID ø 18.72mm Qty 10 pcs		
For models:	105, 105SL, 205, 205-Exclusive, Century-Restyling, Excelsior-OR, Excelsior-Standard, Executive, Firenze, Gradisca, Gradisca-Restyling, Gradisca-Take-Away, Maior, Maior-OR, Maior-Plus, Opus, Opus-B03-OR, Opus-OR		

GEV No.	511395	Ref. No.	00843.0.00.02
description	O-ring EPDM thickness 2.62mm ID ø 71.12mm Qty 1 pcs		
For models:	BELLE EPOQUE JUNIOR, Bolero, CLUB, LADY, MBM GOLF, OFFICE RB2, Opus-Sublima		

GEV No.	528487	Ref. No.	00837.0.00.02
description	O-ring EPDM thickness 2.62mm ID ø 9.19mm Qty 1 pcs		
For models:	105, 105SL, 205, 205-Exclusive, Belle-Epoque, Century, Century-Restyling, DeCurtis-CAMME, DeCurtis-DIG, DeCurtis-LEVA, Firenze, Gradisca, Gradisca-Take-Away, Portofino-Restyling		

GEV No.	506015	Ref. No.	01368.0.00.02
description	O-ring EPDM thickness 3.53mm ID ø 39.69mm Qty 1 pcs		
For models:	CAPPUCCINO		

GEV No.	511711	Ref. No.	10179.0.00.02 14117.0.00.02 18330.0.00.02
description	O-ring EPDM thickness 3.53mm ID ø 78.97mm Qty 1 pcs		
For models:	205-Exclusive		

silicone

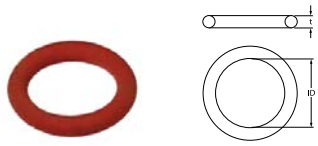

GEV No.	532190	Ref. No.	11970.0.00.02
description	O-ring silicone thickness 1.78mm ID ø 4.48mm Qty 10 pcs		
For models:	Gradisca-Take-Away		

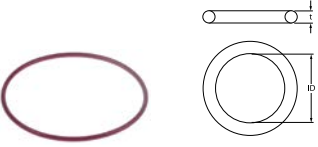

GEV No.	532561	Ref. No.	11428.0.00.02
description	O-ring silicone thickness 2.62mm ID ø 71.12mm Qty 1 pcs		
For models:	205-Exclusive, Excelsior-OR, Excelsior-Standard, Gradisca-Restyling, Opus, Opus-B03-OR, Opus-OR		

Viton



GEV No.	528489	Ref. No.	01370.0.00.02
description	O-ring Viton thickness 1.78mm ID ø 12.42mm Qty 1 pcs		
For models:	100, 105, 105SL, 205, 205-Exclusive, Agile, Belle-Epoque, Cadetta, Century-Restyling, DeCurtis-CAMME, DeCurtis-DIG, DeCurtis-LEVA, Excelsior-OR, Excelsior-Standard, Executive, Firenze, Firenze-SL, Firenze-SL-Raised, Gradisca, Gradisca-Restyling, Gradisca-Take-Away, Maior, Maior-OR, Maior-Plus, MILLENNIO, OFFICE RB2, Opus-B03-OR, Opus-Sublima, PORTOFINO, PORTOFINO AM. SUPER, PORTOFINO AMERICA, Roma, Roma-OR, Roma-OR-170		

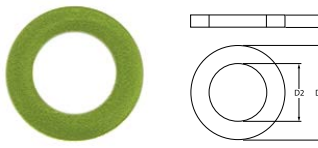

GEV No.	101526	Ref. No.	18509.0.00.02
description	O-ring Viton thickness 1.78mm ID ø 4.48mm Qty 1 pcs		
For models:	205-Exclusive, Cadetta, Century, Excelsior-OR, Excelsior-Standard, Executive, Gradisca-Restyling, Maior, Maior-OR, Maior-Plus, Opus, Opus-B03-OR, Opus-OR, Opus-Sublima		

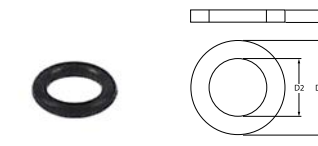

GEV No.	371095	Ref. No.	00833.0.00.02
description	O-ring Viton thickness 1.78mm ID ø 6.07mm Qty 1 pcs		
For models:	100, 105, 105SL, 205, 205-Exclusive, BELLE EPOQUE JUNIOR, Belle-Epoque, Cadetta, CAPPUCINO, Century, Century-Restyling, CLUB, DeCurtis-CAMME, DeCurtis-DIG, DeCurtis-LEVA, Excelsior-OR, Excelsior-Standard, Executive, Firenze, Firenze-SL, Firenze-SL-Raised, Gradisca, Gradisca-Restyling, Gradisca-Take-Away, LADY, Maior, Maior-OR, Maior-Plus, MBM GOLF, MILLENNIO, MINIPODS, Opus, Opus-B03-OR, Opus-OR, Opus-Sublima, PORTOFINO, PORTOFINO AM. SUPER, PORTOFINO AMERICA, Portofino-Restyling, Roma-Cappuccino, SECS, TOP CLASS		

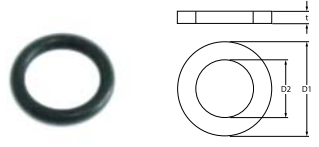

GEV No.	528282	Ref. No.	00835.0.00.02
description	O-ring Viton thickness 1.78mm ID ø 7.66mm Qty 1 pcs		
For models:	100, 105, 105SL, 205, BELLE EPOQUE JUNIOR, Century, Century-Restyling, CLUB, DeCurtis-CAMME, DeCurtis-DIG, DeCurtis-LEVA, Firenze-SL, Firenze-SL-Raised, LADY, MBM GOLF, Opus-Sublima, PORTOFINO, Portofino-Restyling		

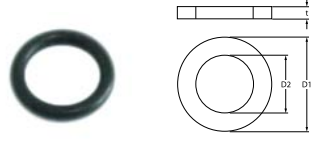

GEV No.	528246	Ref. No.	00836.0.00.02 18510.0.00.02
description	O-ring Viton thickness 1.78mm ID ø 8.73mm Qty 1 pcs		
For models:	100, 105, 105SL, 205, 205-Exclusive, Cadetta, Century, Century-Restyling, DeCurtis-CAMME, DeCurtis-DIG, DeCurtis-LEVA, Excelsior-OR, Excelsior-Standard, Executive, Firenze, Firenze-SL, Firenze-SL-Raised, Gradisca, Gradisca-Restyling, Gradisca-Take-Away, Maior, Maior-OR, Maior-Plus, MILLENNIO, Opus, Opus-B03-OR, Opus-OR, Opus-Sublima, PORTOFINO, PORTOFINO AMERICA, Portofino-Restyling		

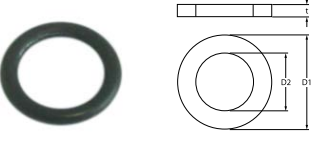

GEV No.	528291	Ref. No.	07001.0.00.02
description	O-ring Viton thickness 2.62mm ID ø 11.91mm Qty 1 pcs		
For models:	205, 205-Exclusive, Agile, Bolero, Cadetta, Excelsior-OR, Excelsior-Standard, Executive, Firenze-SL, Firenze-SL-Raised, Gradisca, Gradisca-Restyling, Gradisca-Take-Away, Maior, Maior-OR, Maior-Plus, MILLENNIO, OFFICE RB2, Opus, Opus-B03-OR, Opus-OR, Opus-Sublima, PORTOFINO AMERICA, Portofino-Restyling, Roma, Roma-Cappuccino, Roma-OR, Roma-OR-170, SECS, TOP CLASS		

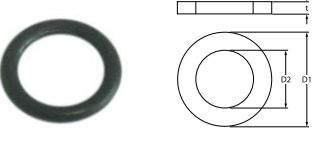

GEV No.	528231	Ref. No.	00839.0.00.02
description	O-ring Viton thickness 2.62mm ID ø 12.37mm Qty 1 pcs		
For models:	100, 105, 105SL, 205, 205-Exclusive, BELLE EPOQUE JUNIOR, CLUB, DeCurtis-CAMME, DeCurtis-DIG, DeCurtis-LEVA, Excelsior-OR, Excelsior-Standard, Gradisca, Gradisca-Restyling, Gradisca-Take-Away, LADY, MBM GOLF, MILLENNIO, Opus, Opus-B03-OR, Opus-OR, Portofino-Restyling		



1

GEV No.	528647	Ref. No.	00840.0.00.02
description	O-ring Viton thickness 2.62mm ID ø 15.08mm Qty 1 pcs		
For models:	105, 105SL, Belle-Epoque, CAPPUCCINO, MILLENNIO, PORTOFINO AM. SUPER, PORTOFINO AMERICA, Roma-Cappuccino		

1

GEV No.	528240	Ref. No.	01428.0.00.02
description	O-ring Viton thickness 2mm ID ø 4mm Qty 1 pcs		
For models:	100, 105, 105SL, 205, Century, Century-Restyling, DeCurtis-CAMME, DeCurtis-DIG, DeCurtis-LEVA, Firenze, Firenze-SL, Firenze-SL-Raised, Gradisca, Gradisca-Take-Away, MILLENNIO, PORTOFINO, PORTOFINO AMERICA, Portofino-Restyling		

2

GEV No.	528293	Ref. No.	06370.0.00.02
description	O-ring Viton thickness 2.62mm ID ø 15.88mm Qty 1 pcs		
For models:	205, 205-Exclusive, Gradisca, Gradisca-Take-Away, Maior, Maior-OR, Maior-Plus, MILLENNIO, PORTOFINO AMERICA, Roma, Roma-Cappuccino, Roma-OR, Roma-OR-170, SECS, TOP CLASS		

1

GEV No.	528250	Ref. No.	00847.0.00.02
description	O-ring Viton thickness 2mm ID ø 8mm Qty 1 pcs		
For models:	105, 105SL, Belle-Epoque, CAPPUCCINO, MILLENNIO, PORTOFINO AM. SUPER, PORTOFINO AMERICA, Roma-Cappuccino		

1

GEV No.	532560	Ref. No.	12953.0.00.02
description	O-ring Viton thickness 2.62mm ID ø 20.63mm Qty 1 pcs		
For models:	DeCurtis-CAMME, DeCurtis-DIG, DeCurtis-LEVA, Gradisca		

1

GEV No.	528155	Ref. No.	00842.0.00.02
description	O-ring Viton thickness 3.53mm ID ø 32.93mm Qty 1 pcs		
For models:	Belle-Epoque		

1

GEV No.	528413	Ref. No.	03182.0.00.02
description	O-ring Viton thickness 2.62mm ID ø 47.3mm Qty 1 pcs		
For models:	105, 105SL, Agile, BELLE EPOQUE JUNIOR, Belle-Epoque, Bolero, CAPPUCCINO, Century, CLUB, LADY, MBM GOLF, PORTOFINO, PORTOFINO AM. SUPER, PORTOFINO AMERICA, Roma, Roma-Cappuccino, Roma-OR, Roma-OR-170		

1

GEV No.	532456	Ref. No.	18682.0.00.02 18682.0.00.03
description	O-ring Viton thickness 2mm ID ø 16mm Qty 1 pcs		
For models:	Agile, Cadetta, Opus-B03-OR		

sealing washers

rubber gaskets

1

GEV No.	528254	Ref. No.	00109.0.00.04
description	flat gasket ED ø 26mm ID ø 21mm thickness 3mm Qty 1 pcs		
For models:	PORTOFINO		

copper gaskets

DIN-7603-A

1

GEV No.	528233	Ref. No.	01404.0.00.02 21559.0.00.03
description	flat gasket copper ED ø 12mm ID ø 8.3mm thickness 1.5mm		
For models:	Agile		

			
1			
GEV No.	528698	Ref. No.	12152.0.00.03
description	flat gasket copper ED ø 24mm ID ø 20mm thickness 1mm		
For models:	105, 105SL, 205, 205-Exclusive, Century, Century-Restyling, Executive, Firenze, Firenze-SL, Firenze-SL-Raised, Gradisca, Gradisca-Restyling, Gradisca-Take-Away, PORTOFINO, PORTOFINO AM. SUPER, PORTOFINO AMERICA, Portofino-Restyling, TOP CLASS		

DIN-7603-C			
			
1			
GEV No.	527164	Ref. No.	01386.0.00.02
description	gasket copper ED ø 23mm ID ø 17mm thickness 3mm for thread 3/8"		
For models:	100, 105, 105SL, 205, 205-Exclusive, Agile, Belle-Epoque, Cadetta, Century, Century-Restyling, DeCurtis-CAMME, DeCurtis-DIG, DeCurtis-LEVA, Excelsior-OR, Excelsior-Standard, Executive, Firenze, Firenze-SL, Firenze-SL-Raised, Gradisca, Gradisca-Restyling, Gradisca-Take-Away, MILLENNIO, OFFICE RB2, Opus, Opus-B03-OR, Opus-OR, Opus-Sublima, PORTOFINO, PORTOFINO AMERICA, Portofino-Restyling, Roma, Roma-Cappuccino, Roma-OR, Roma-OR-170, SECS, TOP CLASS		

PTFE gaskets			
			
1			
GEV No.	526554	Ref. No.	08576.0.00.02
description	flat gasket PTFE ED ø 10mm ID ø 6mm thickness 1mm Qty 1 pcs		
For models:	DeCurtis-CAMME, DeCurtis-DIG, DeCurtis-LEVA, Gradisca		

			
1			
GEV No.	526661	Ref. No.	00813.0.00.02
description	flat gasket PTFE ED ø 17mm ID ø 13mm thickness 2mm Qty 1 pcs		
For models:	100, 105, 105SL, 205, 205-Exclusive, Agile, Belle-Epoque, Century, Century-Restyling, DeCurtis-CAMME, DeCurtis-DIG, DeCurtis-LEVA, Excelsior-OR, Excelsior-Standard, Executive, Firenze, Firenze-SL, Firenze-SL-Raised, Gradisca, Gradisca-Restyling, Gradisca-Take-Away, Maior, Maior-OR, Maior-Plus, MILLENNIO, Opus-B03-OR, Opus-Sublima, PORTOFINO, PORTOFINO AM. SUPER, PORTOFINO AMERICA, Portofino-Restyling, Roma, Roma-OR, Roma-OR-170		

			
1			
GEV No.	526679	Ref. No.	N/A
description	flat gasket PTFE ED ø 18mm ID ø 13mm thickness 2mm Qty 1 pcs		

			
1			
GEV No.	527993	Ref. No.	N/A
description	flat gasket PTFE ED ø 18mm ID ø 13mm thickness 2mm Qty 1 pcs		

			
1			
GEV No.	528314	Ref. No.	00820.0.00.02
description	flat gasket PTFE ED ø 20mm ID ø 17mm thickness 2mm Qty 1 pcs suitable for Astoria/Azkoyen/Espresa/Wega		
For models:	205-Exclusive, Cadetta, Century, Excelsior-OR, Excelsior-Standard, Executive, Gradisca-Restyling, Maior, Maior-OR, Maior-Plus, Opus, Opus-B03-OR, Opus-OR, Opus-Sublima, Roma-Cappuccino		

			
1			
GEV No.	527154	Ref. No.	08575.0.00.02
description	flat gasket PTFE ED ø 22mm ID ø 16.8mm thickness 2mm Qty 1 pcs		
For models:	205-Exclusive, Century-Restyling, DeCurtis-CAMME, DeCurtis-DIG, DeCurtis-LEVA, Excelsior-OR, Excelsior-Standard, Executive, Gradisca, Gradisca-Restyling, Maior, Maior-OR, Maior-Plus, Opus, Opus-B03-OR, Opus-OR, Portofino-Restyling		

			
1			
GEV No.	528683	Ref. No.	00812.0.00.02
description	flat gasket PTFE ED ø 26mm ID ø 21mm thickness 2mm Qty 1 pcs suitable for GAGGIA, SPAZIALE		
For models:	DeCurtis-CAMME, DeCurtis-DIG, DeCurtis-LEVA, Gradisca		

			
1			
GEV No.	526014	Ref. No.	04360.0.00.02
description	flat gasket PTFE ED ø 35mm ID ø 30mm thickness 2mm Qty 1 pcs		
For models:	105, 105SL, 205, 205-Exclusive, Century-Restyling, DeCurtis-CAMME, DeCurtis-DIG, DeCurtis-LEVA, Excelsior-OR, Excelsior-Standard, Executive, Firenze, Gradisca, Gradisca-Restyling, Gradisca-Take-Away, Maior, Maior-OR, Maior-Plus, Opus, Opus-B03-OR, Opus-OR, Portofino-Restyling		

			
1			
GEV No.	528018	Ref. No.	18661.0.00.02 18661.2.00.02
description	flat gasket PTFE ED ø 41mm ID ø 33mm thickness 3mm size 1" Qty 1 pcs		
For models:	Roma-Cappuccino		

			
1			
GEV No.	528021	Ref. No.	00826.0.00.02 02286
description	flat gasket PTFE ED ø 53mm ID ø 42.5mm thickness 3mm Qty 1 pcs equiv. no. 12001/02286 suitable for Astoria/Aurora/Brasilia/Wega		
For models:	Belle-Epoque, DeCurtis-CAMME, DeCurtis-DIG, DeCurtis-LEVA, MILLENNIO, PORTOFINO AM. SUPER, PORTOFINO AMERICA, SECS, TOP CLASS		

			
1			
GEV No.	528277	Ref. No.	05809.0.00.02
description	gasket PTFE ED ø 15mm ID ø 12.4mm thickness 0.6mm Qty 1 pcs		
For models:	100, 105, 105SL, 205, Century, Firenze, Gradisca, Gradisca-Take-Away, MILLENNIO, PORTOFINO, PORTOFINO AM. SUPER, PORTOFINO AMERICA		

special gaskets

group gaskets

			
1			
GEV No.	528406	Ref. No.	04394.0.00.02
description	group gasket L 79mm W 73mm thickness 2mm hole distance 55mm suitable for BRASILIA equiv. no. 04394 fibre		
For models:	100, 105, 105SL, 205, 205-Exclusive, Cadetta, Century-Restyling, DeCurtis-CAMME, DeCurtis-DIG, DeCurtis-LEVA, Excelsior-OR, Excelsior-Standard, Executive, Firenze, Gradisca, Gradisca-Restyling, Gradisca-Take-Away, Maior, Maior-OR, Maior-Plus, MILLENNIO, Opus, Opus-B03-OR, Opus-OR, Portofino-Restyling		

			
1			
GEV No.	528142	Ref. No.	00814.0.00.02
description	group gasket L 76mm W 50mm thickness 3mm hole distance 60mm suitable for BEZZERA		
For models:	105, 105SL, Agile, Belle-Epoque, Century, Firenze-SL, Firenze-SL-Raised, PORTOFINO, PORTOFINO AM. SUPER, PORTOFINO AMERICA, Roma, Roma-Cappuccino, Roma-OR, Roma-OR-170		

			
1			
GEV No.	528355	Ref. No.	N/A
description	group gasket L 74mm W 74mm thickness 3.5mm suitable for AZKOYEN		

springs

compression springs

			
1			
GEV No.	528237	Ref. No.	00884.0.00.03
description	compression spring ø 10.8mm L 29mm wire gauge ø 1.6mm		
For models:	100, 105, 105SL, 205, Belle-Epoque, CAPPUCCINO, Century, Century-Restyling, DeCurtis-CAMME, DeCurtis-DIG, DeCurtis-LEVA, Firenze, Firenze-SL, Firenze-SL-Raised, Gradisca, Gradisca-Take-Away, MILLENNIO, PORTOFINO, PORTOFINO AM. SUPER, PORTOFINO AMERICA, Portofino-Restyling, Roma-Cappuccino		

			
1			
GEV No.	529704	Ref. No.	07060.0.00.03
description	compression spring ø 11.8mm L 16mm wire gauge ø 1.6mm steel		
For models:	205, 205-Exclusive, Agile, Bolero, Cadetta, Excelsior-OR, Excelsior-Standard, Executive, Firenze-SL, Firenze-SL-Raised, Gradisca, Gradisca-Restyling, Gradisca-Take-Away, Maior, Maior-OR, Maior-Plus, MILLENNIO, OFFICE RB2, Opus, Opus-OR, Opus-Sublima, PORTOFINO AMERICA, Portofino-Restyling, Roma, Roma-Cappuccino, Roma-OR, Roma-OR-170, SECS, TOP CLASS		

			
1			
GEV No.	528284	Ref. No.	10962.0.00.03
description	compression spring ø 11mm L 26mm wire gauge ø 1.3mm		
For models:	105, 105SL, 205, 205-Exclusive, Century, Century-Restyling, Executive, Firenze, Firenze-SL, Firenze-SL-Raised, Gradisca, Gradisca-Restyling, Gradisca-Take-Away, PORTOFINO, PORTOFINO AM. SUPER, PORTOFINO AMERICA, Portofino-Restyling		

			
1			
GEV No.	528253	Ref. No.	00866.0.00.03
description	compression spring ø 12.5mm L 28mm wire gauge ø 1.6mm		
For models:	PORTOFINO		

			
1			
GEV No.	528493	Ref. No.	17695.0.00.03
description	compression spring ø 12.6mm L 30mm wire gauge ø 1.9mm		
For models:	205-Exclusive, Cadetta, Century, Excelsior-OR, Excelsior-Standard, Executive, Gradisca-Restyling, Maior, Maior-OR, Maior-Plus, Opus, Opus-B03-OR, Opus-OR, Opus-Sublima		

			
1			
GEV No.	526561	Ref. No.	12941.0.00.03
description	compression spring ø 14.3mm L 21mm wire gauge ø 1.8mm		
For models:	DeCurtis-CAMME, DeCurtis-DIG, DeCurtis-LEVA, Gradisca		

			
1			
GEV No.	526560	Ref. No.	08952.0.00.03
description	compression spring ø 14.3mm L 46mm wire gauge ø 1.5mm		
For models:	DeCurtis-CAMME, DeCurtis-DIG, DeCurtis-LEVA, Gradisca		

			
1			
GEV No.	529946	Ref. No.	08953.0.00.03
description	compression spring ø 14.7mm L 34mm wire gauge ø 2mm		
For models:	DeCurtis-CAMME, DeCurtis-DIG, DeCurtis-LEVA, Gradisca		

			
1			
GEV No.	528235	Ref. No.	00863.0.00.03
description	compression spring ø 5.5mm L 15mm wire gauge ø 0.05mm		

			
1			
GEV No.	528269	Ref. No.	00871.0.00.03
description	compression spring ø 7.5mm L 18mm wire gauge ø 1.1mm		
For models:	105, 105SL, Agile, Belle-Epoque, CAPPUCINO, DeCurtis-CAMME, DeCurtis-DIG, DeCurtis-LEVA, Firenze-SL, Firenze-SL-Raised, Opus-Sublima, SECS, TOP CLASS		

			
1			
GEV No.	528248	Ref. No.	00870.0.00.03
description	compression spring ø 7.8mm L 40mm wire gauge ø 0.5mm		
For models:	100, 105, 105SL, 205, 205-Exclusive, Belle-Epoque, Cadetta, CAPPUCINO, Century, Century-Restyling, DeCurtis-CAMME, DeCurtis-DIG, DeCurtis-LEVA, Excelsior-OR, Excelsior-Standard, Executive, Firenze, Firenze-SL, Firenze-SL-Raised, Gradisca, Gradisca-Restyling, Gradisca-Take-Away, Maior, Maior-OR, Maior-Plus, MILLENNIO, Opus, Opus-B03-OR, Opus-OR, Opus-Sublima, PORTOFINO, PORTOFINO AM. SUPER, PORTOFINO AMERICA, Portofino-Restyling, Roma-Cappuccino		

			
1			
GEV No.	528249	Ref. No.	05538.0.00.03
description	compression spring ø 7.8mm L 40mm wire gauge ø 0.5mm		
For models:	105, 105SL, Belle-Epoque, CAPPUCINO, MILLENNIO, PORTOFINO AM. SUPER, PORTOFINO AMERICA, Roma-Cappuccino		

			
1			
GEV No.	526509	Ref. No.	00897.0.00.03
description	compression spring ø 8.5mm L 95mm wire gauge ø 0.8mm right		
For models:	MAC64, MC, RR45-A, RR45-S, RR45-SILENT, RR55-AE, RR65-AE, RR65-SE		

			
1			
GEV No.	527555	Ref. No.	00898.0.00.03
description	compression spring ø 9.9mm L 80mm wire gauge ø 0.8mm		
For models:	MC, RR45-A, RR45-DEL, RR45-PST, RR45-S, RR45-SILENT, RR55-AE, RR65-AE, RR65-SE		



tension springs

			
1			
GEV No.	526513	Ref. No.	17684.0.00.03
description	tension spring ø 11mm total length 44mm wire gauge ø 0.9mm L1 35mm for lever		
For models:	MAC64, MC, RR45-A, RR45-S, RR45-SILENT		

coffee accessories

milk foamers

milk foamers

			
1			
GEV No.	525933	Ref. No.	10075.4.00.09
description	milk foamer connection 6mm angle 90° plastic		
For models:	Agile, Firenze-SL, Firenze-SL-Raised, Gradisca, Roma, Roma-OR, Roma-OR-170		
accessories for	525933		
		GEV No.	531255
	adapter thread 3/8" L 40mm	Ref. No.	—



manometers

			
1			
GEV No.	541257	Ref. No.	06555.2.00.08
description	manometer double scale ø 58mm pressure range 0-2.5 / 0-15bar connection on the backside coffee machine thread 1/8"		
For models:	Agile, PORTOFINO, PORTOFINO AMERICA		

			
1			
GEV No.	541256	Ref. No.	00737.2.00.08 04971.2.00.08 05465.2.00.08 05466.2.00.08
description	manometer double scale ø 58mm pressure range 0-3 / 0-15bar connection on the backside coffee machine thread 1/8"		
For models:	100, 105, 105SL, 205, 205-Exclusive, Century, Century-Restyling, Gradisca, Gradisca-Restyling, Gradisca-Take-Away, MILLENNIO, Portofino-Restyling		

dosing pumps

accessories

hose couplings

metal

			
1			
GEV No.	361182	Ref. No.	00177.0.00.04
description	nut thread 1/4" H 5mm nickel-plated brass WS 17 Qty 1 pcs		
For models:	Agile, Cadetta, Century-Restyling, DeCurtis-CAMME, DeCurtis-DIG, DeCurtis-LEVA, Excelsior-OR, Excelsior-Standard, Executive, Firenze-SL, Firenze-SL-Raised, Gradisca-Restyling, Maior, Maior-OR, Maior-Plus, Opus, Opus-B03-OR, Opus-OR, Opus-Sublima, Roma, Roma-OR, Roma-OR-170		

fittings, hose and pipe connectors

fittings

double nipples

			
1			
GEV No.	520160	Ref. No.	00236.0.00.04
description	double nipple nickel-plated brass thread 1/8" - 1/8" Qty 1 pcs		
For models:	105, 105SL, 205, 205-Exclusive, Agile, Belle-Epoque, Bolero, Cadetta, Century, Century-Restyling, DeCurtis-CAMME, DeCurtis-DIG, DeCurtis-LEVA, Excelsior-OR, Excelsior-Standard, Executive, Firenze, Firenze-SL, Firenze-SL-Raised, Gradisca, Gradisca-Restyling, Gradisca-Take-Away, Maior, Maior-OR, Maior-Plus, Opus, Opus-B03-OR, Opus-OR, Opus-Sublima, Portofino-Restyling, Roma, Roma-Cappuccino, Roma-OR, Roma-OR-170		

angle pieces

			
1			
GEV No.	520816	Ref. No.	00217.0.00.04
description	angle piece thread 1/8" ET - 1/8" ET nickel-plated brass		
For models:	105, 105SL, 205-Exclusive, Belle-Epoque, Century, Century-Restyling, DeCurtis-CAMME, DeCurtis-DIG, DeCurtis-LEVA, Excelsior-OR, Excelsior-Standard, Firenze, Firenze-SL, Firenze-SL-Raised, Gradisca-Restyling, Gradisca-Take-Away, Opus, Opus-B03-OR, Opus-OR, Opus-Sublima, Roma-Cappuccino		

fastening material

screws

sheet metal screws

			
1			
GEV No.	560105	Ref. No.	01254.0.00.03
description	sheet metal screws ø 3.9mm L 25mm SS Qty 20 pcs DIN 7981/ISO 7049 head ø 7.5mm oval head		

countersunk screws



1

GEV No.	560215	Ref. No.	01242.0.00.03
description	countersunk screw thread M5 L 14mm SS DIN 963/ISO 2009 Qty 20 pcs intake slotted head ø 9.2mm		
For models:	105, 105SL, Agile, Belle-Epoque, Century, Firenze-SL, Firenze-SL-Raised, Roma, Roma-Cappuccino, Roma-OR, Roma-OR-170		

flat-headed bolts



1

GEV No.	560365	Ref. No.	07079.0.00.03 20096.0.00.03
description	flat-headed bolt thread M4 thread L 8mm SS DIN 7985/ISO 7045 Qty 1 pcs intake Phillips head ø 8mm head thickness 3mm		
For models:	MAC64, MAC64-On-Demand, RR45-A, RR45-DEL, RR45-On-Demand, RR45-PST, RR45-S, RR45-SILENT, RR55-AE, RR55-On-Demand, RR65-AE, RR65-SE		

hexagonal screws



1

GEV No.	560204	Ref. No.	01231.0.00.03
description	hexagonal screw thread M8 thread L 25mm SS WS 13 Qty 1 pcs DIN 933 / ISO 4017		
For models:	105, 105SL, Agile, Belle-Epoque, Century, Firenze-SL, Firenze-SL-Raised, Roma, Roma-Cappuccino, Roma-OR, Roma-OR-170		

cylinder head bolts

DIN 912/ISO 4762



1

GEV No.	560025	Ref. No.	02688.0.00.03
description	cylinder head bolt thread M4 thread L 10mm WS 3 SS Qty 20 pcs DIN 912/ISO 4762		
For models:	105, 105SL, 205, 205-Exclusive, Belle-Epoque, Cadetta, Century, Century-Restyling, DeCurtis-CAMME, DeCurtis-DIG, DeCurtis-LEVA, Excelsior-OR, Excelsior-Standard, Executive, Firenze, Firenze-SL, Firenze-SL-Raised, Gradisca, Gradisca-Restyling, Gradisca-Take-Away, Maior, Maior-OR, Maior-Plus, Opus, Opus-B03-OR, Opus-OR, Opus-Sublima, Portofino-Restyling		



1

GEV No.	560402	Ref. No.	01247.0.00.03
description	cylinder head bolt thread M5 thread L 10mm L 15.5mm WS 4 SS Qty 1 pcs intake hexagonal DIN 912/ISO 4762		
For models:	Belle-Epoque, MC, RR45-A, RR45-S, RR45-SILENT, RR55-AE, RR65-AE, RR65-SE		



1

GEV No.	560031	Ref. No.	05545.0.00.03
description	cylinder head bolt thread M6 thread L 10mm WS 5 SS Qty 20 pcs DIN 912/ISO 4762		
For models:	105, 105SL, 205, 205-Exclusive, Cadetta, Century-Restyling, DeCurtis-CAMME, DeCurtis-DIG, DeCurtis-LEVA, Excelsior-OR, Excelsior-Standard, Executive, Firenze, Gradisca, Gradisca-Restyling, Gradisca-Take-Away, Maior, Maior-OR, Maior-Plus, Opus, Opus-B03-OR, Opus-OR, Portofino-Restyling		



1

GEV No.	112021	Ref. No.	02680.0.00.03
description	cylinder head bolt thread M8 L 45mm thread L 30mm WS 6 zinc-coated steel Qty 1 pcs DIN 912/ISO 4762		
For models:	205-Exclusive, Agile, Cadetta, DeCurtis-CAMME, DeCurtis-DIG, DeCurtis-LEVA, Gradisca, Gradisca-Restyling, Opus, Opus-B03-OR, Opus-OR, Opus-Sublima, Portofino-Restyling, Roma, Roma-Cappuccino, Roma-OR, Roma-OR-170		

grub screws

DIN 913/ISO 4026



1

GEV No.	560346	Ref. No.	16518.0.40.04
description	grub screw thread M5 L 6mm SS DIN 913/ISO 4026 intake internal hexagon WS 2.5 Qty 20 pcs		
For models:	Opus-Sublima		

nuts

hexagonal nuts

DIN 985



1

GEV No.	560142	Ref. No.	12188.0.00.03
description	hexagonal nut thread M6 H 6mm SS WS 10 Qty 20 pcs DIN/ISO DIN 985 self-locking		
For models:	MC, RR45-A, RR45-S, RR45-SILENT, RR55-AE, RR65-AE, RR65-SE		



hexagonal nuts metric (without norm)			
			
1			
GEV No.	527169	Ref. No.	01263.0.00.03
description	hexagonal nut thread M3 H 2.8mm WS 5.5 brass Qty 1 pcs		
For models:	105, 105SL, 205, 205-Exclusive, Century, Century-Restyling, Executive, Firenze, Firenze-SL, Firenze-SL-Raised, Gradisca, Gradisca-Restyling, Gradisca-Take-Away, Portofino-Restyling		

hexagonal nuts inch thread			
			
1			
GEV No.	361182	Ref. No.	00177.0.00.04
description	nut thread 1/4" H 5mm nickel-plated brass WS 17 Qty 1 pcs		
For models:	Agile, Cadetta, Century-Restyling, DeCurtis-CAMME, DeCurtis-DIG, DeCurtis-LEVA, Excelsior-OR, Excelsior-Standard, Executive, Firenze-SL, Firenze-SL-Raised, Gradisca-Restyling, Maior, Maior-OR, Maior-Plus, Opus, Opus-B03-OR, Opus-OR, Opus-Sublima, Roma, Roma-OR, Roma-OR-170		

washers

washers			
DIN 9021			
			
1			
GEV No.	560117	Ref. No.	12187.0.00.03
description	plain washer ID ø 6.4mm ED ø 18mm thickness 1.5mm SS Qty 20 pcs DIN 9021 for thread M6		
For models:	MAC64, MC, RR45-A, RR45-S, RR45-SILENT, RR55-AE, RR65-AE, RR65-SE		

miscellaneous

			
1			
GEV No.	528268	Ref. No.	00166.0.00.04
description	disc ID ø 5.4mm ED ø 10mm thickness 2mm		
For models:	100, 105, 105SL, 205, 205-Exclusive, Agile, Cadetta, CAPPUCCINO, Century, Century-Restyling, DeCurtis-CAMME, DeCurtis-DIG, DeCurtis-LEVA, Excelsior-OR, Excelsior-Standard, Executive, Firenze, Firenze-SL, Firenze-SL-Raised, Gradisca, Gradisca-Restyling, Gradisca-Take-Away, Maior, Maior-OR, Maior-Plus, MILLENNIO, Opus, Opus-B03-OR, Opus-OR, Opus-Sublima, PORTOFINO, PORTOFINO AMERICA, Portofino-Restyling		

tooth lock washers			
miscellaneous			
			
1			
GEV No.	112020	Ref. No.	01291.0.00.03
description	tooth lock washer ID ø 8.5mm		
For models:	105, 105SL, 205, 205-Exclusive, Agile, Belle-Epoque, Cadetta, DeCurtis-CAMME, DeCurtis-DIG, DeCurtis-LEVA, Firenze, Firenze-SL, Firenze-SL-Raised, Gradisca, Gradisca-Restyling, Opus, Opus-B03-OR, Opus-OR, Opus-Sublima, Portofino-Restyling, Roma, Roma-Cappuccino, Roma-OR, Roma-OR-170		

fasteners

cable ties			
			
1			
GEV No.	550253	Ref. No.	01468.0.00.02
description	cable tie W 3.6mm L 290mm white Qty 100 pcs nylon		
For models:	BFD		

retaining rings

DIN 6799			
			
1			
GEV No.	516198	Ref. No.	08949.0.00.03
description	retaining ring E D1 ø 6mm D2 ø 12mm SS DIN 6799 thickness 0.7mm for shaft ø 7-9mm		
For models:	MC, RR45-A, RR45-DEL, RR45-S, RR45-SILENT, RR55-AE, RR65-AE, RR65-SE		

cotter pins

			
1			
GEV No.	528762	Ref. No.	12185.0.00.03
description	cotter pin ø 1.8mm L 17mm		
For models:	Maior, Maior-OR, Maior-Plus, MC, Roma, Roma-Cappuccino, Roma-OR, Roma-OR-170, RR45-A, RR45-S, RR45-SILENT, RR55-AE, RR65-AE, RR65-SE		

B			
bi-metal thermostats	5, 5		
booster pumps II	19		
C			
cable ties	47		
condensators & interference suppression filters	20		
cotter pins	47		
countersunk screws	46		
cylinder head bolts	46		
D			
dosing pumps	45		
double nipples	45		
E			
electrodes	18		
electronic magnets	20		
F			
fasteners	47		
fastening material	45		
fittings	45		
flat-headed bolts	46		
flow meters	18		
G			
grub screws	46		
H			
heating elements	3		
heating elements for coffee machine	3		
hexagonal nuts	46		
hexagonal screws	46		
hose couplings	45		
I			
ignition switches	20		
indicator lights	9		
L			
lamps	9		
M			
microswitches	7		
milk foamers	44		
N			
nuts	46		
O			
operating capacitors	20		
		O-rings	39
P			
		pressure switches	18
		probes	11
		pumps	19
		push/momentary push switches	7
R			
		relays	9
		retaining rings	47
		rocker/momentary rocker switches	6
		rotary switches	8
S			
		safety bi-metal thermostats	5
		screws	45
		sealing washers	41
		sheet metal screws	45
		solenoid valves	16
		solid state relays	9
		switches and momentary switches	6
		system switches (ROLD)	8
T			
		thermostats	5
		tooth lock washers	47
V			
		vibration pumps	19
W			
		washers	47