



GAS COMPONENTS



ELECTRIC COMPONENTS



WATER TECHNOLOGY



MECHANICAL COMPONENTS



TOOLS

Spare parts suitable for

CAB

Find the complete and up-to-date range of products in our GEV Webshop



Manufacturer catalogue

The most important spare parts and accessories arranged clearly for every manufacturer

- ✓ Complete product range and all appliance data always up to date in the GEV Webshop
- ✓ Alphabetical Index at the end of the catalogue

GEV Webshop

www.gev-online.co.uk

www.gev-online.com



- 🔍 Add to Favourites
- 🔍 Sign In with email address and usual password
- 🔍 Easy-order – place several items in your basket at the same time
- 🔍 Quick Item search – no login needed



thermostats

refrigeration thermostats

ATEA



GEV No.	390522	Ref. No.	1025 F025
description	thermostat ATEA type A01 0716 probe ø 2mm probe Lmm capillary pipe 1200mm		

switches and momentary switches

rocker/momentary rocker switches

30x11mm



GEV No.	301013	Ref. No.	F132
description	rocker switch mounting measurements 30x11mm black 1CO 250V 16A connection male faston 6.3mm ambient temperature max. 85/125°C protection IP40		



GEV No.	345575	Ref. No.	F133
description	rocker switch mounting measurements 30x11mm black 1CO 250V 16A I O II connection male faston 6.3mm ambient temperature max. 90°C protection IP40 with neutral position		

30x22mm



GEV No.	301004	Ref. No.	F131
description	rocker switch mounting measurements 30x22mm black 2CO 250V 16A connection male faston 6.3mm ambient temperature max. 125/55°C protection IP40		

accessories for	301004			
	GEV No.	301036	Ref. No.	—
	protective cover internal size 30x22mm for rocker switch mounting measurementsmm			



GEV No.	301188	Ref. No.	1350	
description	rocker switch mounting measurements 30x22mm black 2NO/2NO 250V 16A I O II connection male faston 6.3mm ambient temperature max. 125/55°C protection IP40			
accessories for	301188			
	GEV No.	301036	Ref. No.	—
	protective cover internal size 30x22mm for rocker switch mounting measurementsmm			

microswitches

lever actuated



GEV No.	346865	Ref. No.	1061/UL F448
description	microswitch with lever 250V 5A connection male faston 6.3mm ambient temperature max. 125°C type 831540		

lamps

screw-on/push-on fit

halogen lamp

for socket G4 / G6.35 / G9



GEV No.	359599	Ref. No.	1236 P236
description	halogen lamp socket G4 12V 20W temp.-resist. 500°C		

oven lamps

lamps

halogen lamps

for socket G4 / G6.35 / G9



GEV No.	359599	Ref. No.	1236 P236
description	halogen lamp socket G4 12V 20W temp.-resist. 500°C		

sockets

G4 / G5,3 / G6,35



GEV No.	359939	Ref. No.	F089
description	lamp socket socket G4 L 20mm with 2 hole fixing cable length 150mm		

timers

programme timers

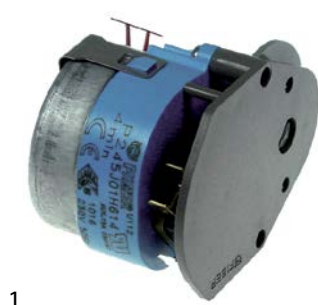

GEV No.	360364	Ref. No.	1016 (old version)
description	timer FIBER P24 engines 1 chambers 1 operation time 4min 230V shaft ømm shaft Lmm manuf. no. P245J01H614 motor type M51B-J0R6400		
spare parts for	360364		
	GEV No.	360673	Ref. No. —
	motor kit pinion ø 6.8mm teeth 15 230V voltage AC 50/60Hz turn direction clockwise motor ø 48mm H 18.5mm motor type UDS-40NE1RNZ165 cable length 150mm with holder		



GEV No.	360694	Ref. No.	1016 F429
description	timer MECHTEX MTR5/1 engines 1 chambers 1 operation time 4min 220-240V 50/60Hz shaft Lmm motor type DS40NE1RNZ165		

transformers

open transformers

with cable connection



GEV No.	401593	Ref. No.	F049/4 (old)
description	transformer primary 230V secondary 11.5V 60VA secondary 5A connection screw 50-60Hz		

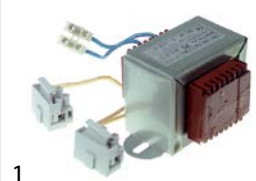

GEV No.	401594	Ref. No.	F279
description	transformer primary 230V secondary 24/11.5V 75VA		

encapsulated transformers

multiple connections



GEV No.	403550	Ref. No.	F049/4
description	transformer primary 230VAC secondary 11VAC 60VA secondary 5.4A H 60mm L 70mm W 95mm connection male faston 6.3mm 50-60Hz type TM001-781 moulded		



solenoid valves

solenoid valves (water)

metal

CEME

accessories



1

GEV No. 371189 **Ref. No.** 1285

description solenoid coil 240V seat ø 13mm



1

GEV No. 371188 **Ref. No.** 1298

description solenoid coil 50Hz 230V H 35mm seat ø 13mm type H 17VA series 688

solenoid valves (refrigeration)

PARKER

spare parts and accessories

solenoid coils



1

GEV No. 370685 **Ref. No.** F601

description solenoid coil 230V 50/60Hz type RT14

valve bodies



1

GEV No. 370684 **Ref. No.** F600

description solenoid valve connection 6mm soldering connection PARKER refrigeration straight



1

GEV No. 370392 **Ref. No.** 1183

description solenoid valve body connection 6mm soldering connection refrigeration straight

accessories for 370392



GEV No. 371189 **Ref. No.** 1285

solenoid coil 240V seat ø 13mm

compressors

ACC/ZEL

R134A

HMBP monophase

High/Medium evaporation temperature above -20/-15 °C



1

GEV No. 605006 **Ref. No.** FB018

description compressor coolant R134a type GD40MB 220-240V 50Hz HMBP fully hermetic 6.7kg 1/8HP power input 200W cylinder capacity 4.1cm³ CSIR H 162.5mm 64W 87W 117W 153W 196W 245W 301W 363W test method ASHRAE

CUBIGEL

accessories



1

GEV No. 380068 **Ref. No.** F061/6

description start relay MTRP0029 120/240V voltage AC 8A 1NO



1

GEV No.	380067	Ref. No.	F081/3
description	start relay MTRP5708 120/240V voltage AC 8A 1NO		



1

GEV No.	380069	Ref. No.	F081/4
description	start relay MTRP5736 120/240V voltage AC 8A 1NO		

EMBRACO / ASPERA

R134A

LBP monophase

Lower evaporation temperature below -20°C



1

GEV No.	605017	Ref. No.	L8113/3
description	compressor coolant R134a type EMT36HLP 220-240V 50Hz LBP fully hermetic 7.52kg 1/10HP power input 108W cylinder capacity 3.97cm ³ RSIR 71W 94W 123W 160W 203W 253W test method ASHRAE		

HMBP monophase

High/Medium evaporation temperature above -20/-15 °C



1

GEV No.	605016	Ref. No.	L8116/2
description	compressor coolant R134a type EM65HHR 220-240V 50Hz HBP fully hermetic 7.62kg 1/6HP cylinder capacity 5.54cm ³ CSIRWWW 287W 389W 499W 617W 742W test method ASHRAE 842W		

R404a/R507

LBP monophase

Lower evaporation temperature below -20°C



1

GEV No.	605019	Ref. No.	F214
description	compressor coolant R404A type T2168GK 230V 50Hz LBP fully hermetic 17kg cylinder capacity 17.39cm ³ CSIR 326W 492W 683W 906W 1167W 1473W test method ASHRAE		



1

GEV No.	605018	Ref. No.	F241
description	compressor coolant R404a/R507 type NE2125GK 220-240V 50Hz LBP fully hermetic 10.45kg 1/3HP cylinder capacity 8.78cm ³ CSIR 160W 213W 278W 354W 439W 534W test method ASHRAE		



1

GEV No.	605005	Ref. No.	F213
description	compressor coolant R404a/R507 type T2155GK 230V 50Hz LBP fully hermetic 16.3kg power input 458W cylinder capacity 14.5cm ³ CSR H 221mm 368W 524W 717W 948W 1215W test method ASHRAE		



accessories



1			
GEV No.	380070	Ref. No.	L51
description	start relay 11F13 220-240V		

L'UNITE HERMETIQUE / TECUMSEH

accessories



1			
GEV No.	380072	Ref. No.	FB019
description	start relay		

accessories

overload protector (klixon)



1			
GEV No.	390575	Ref. No.	L 39
description	overload protector for engine protective curcuit breaker T0221/26 150°C reset automatic suitable for Luke 2		



1			
GEV No.	390576	Ref. No.	F082/3
description	overload protector for engine protective curcuit breaker T0573/17 with cable t.max. 150°C reset automatic suitable for Faby 2		



1			
GEV No.	390574	Ref. No.	F082/4
description	overload protector for engine protective curcuit breaker T0573/17 with cable t.max. 150°C reset automatic suitable for Faby 3		



1			
GEV No.	390572	Ref. No.	FB020
description	overload protector for engine protective curcuit breaker 232NFBYY 120°C/61°C reset automatic suitable for Fast Cold 1		



1			
GEV No.	390573	Ref. No.	L52
description	overload protector for engine protective curcuit breaker 734LFBYY 110°C/61°C reset automatic suitable for Luke 3-4/Fast Cold 2		



1			
GEV No.	390571	Ref. No.	F061/5
description	overload protector for engine protective curcuit breaker 757NFBYY with cable 120°C/61°C reset automatic suitable for Faby 1/Fast Cold 3		

fans

axial fans

import

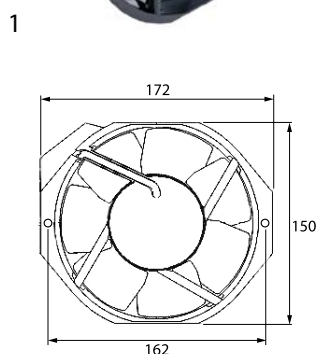

1			
GEV No.	601388 ¹	Ref. No.	F067/4
description	axial fan L 172mm W 150mm H 38mm 230VAC 50/60Hz 38/35W bearing ball bearing connection male faston 2.8mm metal ADDA fan wheel ø 145mm mounting distance 162mm		

¹with ball bearings



1

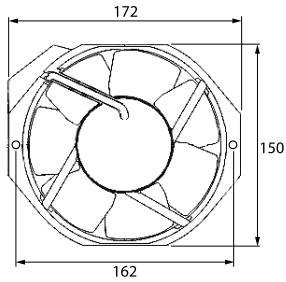

GEV No.	601133 ¹	Ref. No.	F067
description	axial fan L 172mm W 150mm H 51mm 230VAC 50/60Hz 42/37W bearing ball bearing connection male faston 2.8mm metal COMMON-WEALTH fan wheel ø 155mm temp.-resist. 70°C mounting distance 162mm		

¹with ball bearings

refrigeration fans

refrigeration motors universal

ELCO

N series - multi fit



1

GEV No.	601427	Ref. No.	5010
description	fan motor ELCO 10W 230V 50/60Hz bearing slide bearing L1 49mm L2 59mm L3 86.5mm W 83mm connection cable 500mm 1300/1550rpm 5 mounting options VNT10-20/028		

spare parts for 601427			
	GEV No.	560140	Ref. No. —
	hexagonal nut thread M4 H 4.8mm SS WS 7 Qty 20 pcs DIN/ISO DIN 985 self-locking		
	GEV No.	560332	Ref. No. —
	plain washer ID ø 4.3mm ED ø 9mm thickness 0.8mm SS Qty 1 pcs		
	GEV No.	560340	Ref. No. —
	hexagonal nut thread M4 H 3.2mm WS 7 SS DIN/ISO DIN 934 / ISO 4032/8673 Qty 1 pcs		
	GEV No.	601413	Ref. No. —
	fixing plate suitable for fanwheel ED ø 32mm shaft ø 7 mounting distance 26mm		



1

GEV No.	601430	Ref. No.	5045
description	fan motor ELCO 5W 230V 50/60Hz bearing slide bearing L1 48mm L2 52mm L3 79.5mm W 83mm connection cable 500mm 1300/1550rpm 5 mounting options VNT5-13/027		
spare parts for 601430			
	GEV No.	560140	Ref. No. —
	hexagonal nut thread M4 H 4.8mm SS WS 7 Qty 20 pcs DIN/ISO DIN 985 self-locking		
	GEV No.	560332	Ref. No. —
	plain washer ID ø 4.3mm ED ø 9mm thickness 0.8mm SS Qty 1 pcs		
	GEV No.	560340	Ref. No. —
	hexagonal nut thread M4 H 3.2mm WS 7 SS DIN/ISO DIN 934 / ISO 4032/8673 Qty 1 pcs		
	GEV No.	601413	Ref. No. —
	fixing plate suitable for fanwheel ED ø 32mm shaft ø 7 mounting distance 26mm		

accessories

fan wheels

aluminium

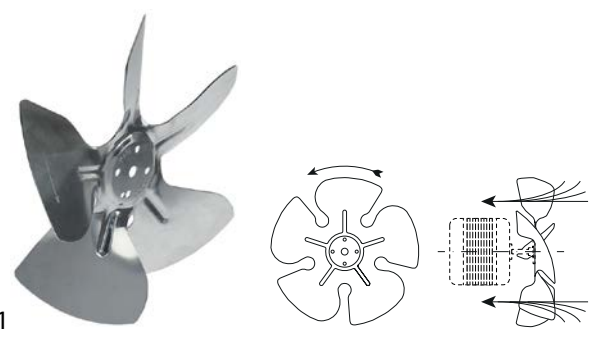

1

GEV No.	601385	Ref. No.	L8022
description	fan wheel sucking ø 172mm fan wheel mounting 25.4mm blade angle 34° W 42mm aluminium		

1

GEV No.	601070	Ref. No.	L8055
description	fan wheel sucking \varnothing 200mm fan wheel mounting 25.4mm blade angle 28° W 38mm aluminium		

1

GEV No.	601071	Ref. No.	1244
description	fan wheel sucking \varnothing 230mm fan wheel mounting 25.4mm blade angle 25° W 37mm aluminium		

1

GEV No.	601284	Ref. No.	1100
description	fan wheel sucking \varnothing 254mm fan wheel mounting 25.4mm blade angle 28° W 42mm aluminium		

1

GEV No.	601387	Ref. No.	1112
description	fan wheel sucking \varnothing 254mm fan wheel mounting 25.4mm blade angle 34° W 50mm aluminium		

aluminium

1

GEV No.	601571	Ref. No.	L8092
description	fan wheel blowing \varnothing 230mm fan wheel mounting 25.4mm blade angle 28° W 43mm aluminium		

cooling motors (various)

refrigeration motors with foot

1

GEV No.	601433	Ref. No.	1099
description	fan motor 16W 230V 50Hz L1 42mm L3 95mm W 83mm feet depth 84mm cable length 500mm connection with plug		

1

GEV No.	601380	Ref. No.	1113
description	fan motor 25W 230V 50Hz L1 53mm L3 111.5mm W 83mm feet depth 84mm cable length 500mm connection with plug		



motors

gear motors

for drink dispensers

electric components

1



GEV No.	501505	Ref. No.	P201+L6102
description	gear motor 230V 50/60Hz 40rpm shaft ø 6mm L 66mm W 51mm H 34mm for drink dispenser for 6 litres with drive shaft kit shaft length 16mm		

1





Image not available

GEV No.	501506	Ref. No.	P201+L6124
description	gear motor 230V 50/60Hz 40rpm shaft ø 6mm L 66mm W 51mm H 34mm for drink dispenser for 9 litres with drive shaft kit shaft length 16mm		

1



GEV No.	500907	Ref. No.	P201 (old version)
description	gear motor FIBER type G025J0BAFHA 230V 50/60Hz 40rpm shaft ø 6mm L 66mm W 51mm H 34mm for drink dispenser motor type M51BJ0R0000 shaft length 16mm		

1



GEV No.	500911	Ref. No.	L8102
description	gear motor FIBER type G025J0BAFSR 230V 50/60Hz 40rpm shaft ø 4mm L 66mm W 50mm H 34mm for drink dispenser motor type M51BJ0R0000 shaft length 19mm		
spare parts for	500911		
	GEV No.	360673	Ref. No. —
	motor kit pinion ø 6.8mm teeth 15 230V voltage AC 50/60Hz turn direction clockwise motor ø 48mm H 18.5mm motor type UDS-40NE1RNZ165 cable length 150mm with holder		

1



GEV No.	500908	Ref. No.	F023/3
description	gear motor FIBER type G03520AASC3 24V 50Hz 20rpm shaft ø 6mm L 66mm W 51mm H 48mm for drink dispenser motor type M52B20B6500		

1



GEV No.	501539	Ref. No.	FB209
description	gear motor MECHTEX 12V 50Hz shaft ø 6mm L 66mm W 53mm H 37mm for drink dispenser		

1



GEV No.	501508	Ref. No.	P201
description	gear motor MECHTEX 230V 50/60Hz shaft ø 6mm L 66mm W 48mm H 36mm for drink dispenser		

1



GEV No.	500909	Ref. No.	F033 F033/1
description	gear motor KENTA type CD79F 60/68W 115/230V 50/60Hz 33/40rpm shaft ø 6x12mm L 220mm W 70mm H 105mm for drink dispenser		



condensators & interference suppression filters

starting capacitors

starting capacitors



1

GEV No. 365057 **Ref. No.** F083/3

description starting capacitor 330V capacity 53-64µF



1

GEV No. 365055 **Ref. No.** F061/7

description starting capacitor 330V duty cycle 1.7% capacity 59µF



1

GEV No. 365056 **Ref. No.** F083/4

description starting capacitor 330V duty cycle 1.7% capacity 59µF

fuses

fine fuses



1

GEV No. 358027 **Ref. No.** 1027

description fine fuse size ø10x38mm 16A rated 500V type Gg fast-acting Qty 1 pcs



1

GEV No. 358032 **Ref. No.** 1237

description fine fuse size ø10x38mm 25A rated 500V type Gg fast-acting Qty 1 pcs



1

GEV No. 358022 **Ref. No.** F147

description fine fuse size ø10x38mm 4A rated 500V type Gg fast-acting Qty 1 pcs

fine fuse holders



1

GEV No. 358535 **Ref. No.** 1240

description fuse holder suitable fuse ø5x20mm ø 25.2mm 30A rated 600V connection F6.3 hole distance 34mm

equipment-specific units

for drink dispensers

drain taps

control parts



1

GEV No. 650042 **Ref. No.** F 012/GMB

description lever



1

GEV No. 650090 **Ref. No.** F012/N

description lever



1

GEV No. 650041 **Ref. No.** F012 F012BM

description lever for drink dispenser



1

GEV No. 650088 **Ref. No.** F012/NL

description lever for drink dispenser black



1

GEV No.	650059	Ref. No.	L8017BLU
description	lever for drink dispenser blue		



1

GEV No.	650087	Ref. No.	F012/BB
description	lever for drink dispenser white		



1

GEV No.	650086	Ref. No.	F012/GB
description	lever for drink dispenser yellow		



1

GEV No.	650089	Ref. No.	F012/Y
description	lever for drink dispenser yellow		

pistons



1

GEV No.	650036	Ref. No.	FB213
description	piston D1 ø 22.4mm L 73mm for outlet tap		



1

GEV No.	650035	Ref. No.	F015
description	piston D1 ø 22.4mm L 76mm for outlet tap		

miscellaneous



1

GEV No.	650046	Ref. No.	7510
description	bush for lever		



1

GEV No.	650049	Ref. No.	L8011
description	drain pipe L 102.5mm ø 14.5mm		



1

GEV No.	650040	Ref. No.	F013
description	pin for lever		

transmission technology and ball bearings

drive shafts



1

GEV No.	650033	Ref. No.	L6102
description	drive shaft		



1

GEV No.	650034	Ref. No.	303/1 F303 F303/1
description	drive shaft for drink dispenser ø 12mm L 330mm		



1

GEV No.	650029	Ref. No.	L6124
description	drive shaft for paddle L 335mm suitable for 9 litres		



1

GEV No.	696695	Ref. No.	L6102
description	drive shaft for paddle ø 10mm L 245mm suitable for 6 litres		

gear wheels



1

GEV No.	697829	Ref. No.	F033.6T.N.
description	gear wheel ø 42.4mm teeth 80 tooth width 6.6mm shaft L 29mm		



containers

group 1



1

GEV No.	650097	Ref. No.	F410
description	container		



1

GEV No.	650101	Ref. No.	F009
description	container for drink dispenser		



1







GEV No.	650098	Ref. No.	F302 F302/N
description	container with lever blue		
spare parts for	650098		
	GEV No.	532513	Ref. No. F016
	O-ring silicone thickness 2.62mm ID ø 15.88mm Qty 1 pcs food-safe white		
	GEV No.	650035	Ref. No. F015
	piston D1 ø 22.4mm L 76mm for outlet tap		
	GEV No.	650040	Ref. No. F013
	pin for lever		
	GEV No.	650041	Ref. No. F012 F012BM
	lever for drink dispenser		
	GEV No.	650051	Ref. No. F017
	gasket for outlet tap mounting pos. lower		
	GEV No.	650097	Ref. No. F410
	container		

spare parts for 650098

GEV No.	691113	Ref. No.	F014
	compression spring ø 21.5mm L 80mm wire gauge ø 1.5mm		





1

GEV No.	650099	Ref. No.	F302/N/GM F302/N/N F302/N/W
description	container with lever siver		
spare parts for	650099		
	GEV No.	532513	Ref. No. F016
	O-ring silicone thickness 2.62mm ID ø 15.88mm Qty 1 pcs food-safe white		
	GEV No.	650035	Ref. No. F015
	piston D1 ø 22.4mm L 76mm for outlet tap		
	GEV No.	650040	Ref. No. F013
	pin for lever		
	GEV No.	650042	Ref. No. F 012/GMB
	lever		
	GEV No.	650051	Ref. No. F017
	gasket for outlet tap mounting pos. lower		
	GEV No.	650097	Ref. No. F410
	container		
	GEV No.	691113	Ref. No. F014
	compression spring ø 21.5mm L 80mm wire gauge ø 1.5mm		

group 2





1

GEV No.	650018	Ref. No.	L8007
description	container 6l		
accessories for	650018		
	GEV No.	532515	Ref. No. L8008
	O-ring silicone thickness 5.34mm ID ø 109.5mm Qty 1 pcs		
	GEV No.	650049	Ref. No. L8011
	drain pipe L 102.5mm ø 14.5mm		

			
1			
GEV No.	650017	Ref. No.	L8098
description	container 9l		

bushes

			
1			
GEV No.	650044	Ref. No.	F315/3
description	bush for container ø 35mm L 16mm		

			
1			
GEV No.	650043	Ref. No.	F317
description	bush for drive shaft ø 16mm L 30mm		

			
1			
GEV No.	650045	Ref. No.	F226
description	bush for evaporator ø 19mm L 11mm		

			
1			
GEV No.	650032	Ref. No.	1041
description	bush for paddle		

			
1			
GEV No.	650047	Ref. No.	FB011
description	bush ø 36mm L 16mm		

lids

			
1			
GEV No.	650053	Ref. No.	L8006B
description	container lid grey		

			
1			
GEV No.	650073	Ref. No.	F001/NL
description	lid black mounting pos. front		

			
1			
GEV No.	650077	Ref. No.	F001,1/NL
description	lid black mounting pos. rear		

			
1			
GEV No.	650062	Ref. No.	F001/N
description	lid black suitable for drink dispenser mounting pos. front		





			
1			
GEV No.	650065	Ref. No.	F001/N/CF
description	lid black suitable for drink dispenser mounting pos. rear		

			
1			
GEV No.	650096	Ref. No.	F300
description	lid blue suitable for drink dispenser with lamp complete with gear motor		

			
1			
GEV No.	650060	Ref. No.	F001/BM/SF F001BM
description	lid blue mounting pos. front		

			
1			
GEV No.	650066	Ref. No.	F005
description	lid bottom part mounting pos. front		

			
1			
GEV No.	650094	Ref. No.	F301 F301BM
description	lid blue suitable for drink dispenser complete		

			
1			
GEV No.	650067	Ref. No.	F095
description	lid bottom part mounting pos. rear		

			
1			
GEV No.	650063	Ref. No.	F001/BM/CF F001BMCONFORO
description	lid blue suitable for drink dispenser mounting pos. rear		

			
1			
GEV No.	650080	Ref. No.	F095,1
description	lid bottom part mounting pos. rear		

			
1			
GEV No.	650095	Ref. No.	F300/C
description	lid blue suitable for drink dispenser with lamp complete		

			
1			
GEV No.	650084	Ref. No.	F030/N
description	lid for evaporator black		



1

GEV No.	650082	Ref. No.	F030BM
description	lid for evaporator blue		



1

GEV No.	650083	Ref. No.	F030GM
description	lid for evaporator grey		



1

GEV No.	650085	Ref. No.	F030/Y
description	lid for evaporator thread yellow		



1

GEV No.	650074	Ref. No.	F001/GMB
description	lid grey mounting pos. front		



1

GEV No.	650078	Ref. No.	F001,1/GMB
description	lid grey mounting pos. rear		



1

GEV No.	650079	Ref. No.	F005,1
description	lid suitable for drink dispenser bottom part mounting pos. front		



1

GEV No.	650091	Ref. No.	F301/N/W
description	lid white complete		



1

GEV No.	650075	Ref. No.	F001,1/BB
description	lid white mounting pos. front		



1

GEV No.	650071	Ref. No.	F001/BB
description	lid white suitable for drink dispenser mounting pos. front		



1

GEV No.	650093	Ref. No.	F300/N/DA/W
description	lid white suitable for drink dispenser with lamp complete with gear motor		



1

GEV No.	650092	Ref. No.	F300/N/SA/W
description	lid white with lamp complete		

			
1			
GEV No.	650072	Ref. No.	F001/GB
description	lid yellow mounting pos. front		

			
1			
GEV No.	650076	Ref. No.	F001,1/GB
description	lid yellow mounting pos. rear		

			
1			
GEV No.	650061	Ref. No.	F001/Y/SF
description	lid yellow suitable for drink dispenser mounting pos. front		

			
1			
GEV No.	650064	Ref. No.	F001/Y/CF
description	lid yellow suitable for drink dispenser mounting pos. rear		

accessories			
			
1			
GEV No.	650081	Ref. No.	F238
description	hinge pin for lid ø 4mm L 50mm		

gaskets			
			
1			
GEV No.	650039	Ref. No.	F026/2
description	bottom gasket for auger D1 ø 31mm D2 ø 24mm ID ø 12mm H 21mm rubber		

			
1			
GEV No.	650026	Ref. No.	F019
description	gasket for evaporator H 14mm silicone		

			
1			
GEV No.	650051	Ref. No.	F017
description	gasket for outlet tap mounting pos. lower		

			
1			
GEV No.	650052	Ref. No.	F022/1
description	shaft sealing for drink dispenser D1 ø 12mm D2 ø 19mm		

adjusting screws			
			
1			
GEV No.	650050	Ref. No.	F034
description	adjusting screw thread M6		

holders			
			
1			
GEV No.	650070	Ref. No.	F002/N
description	bracket for drink dispenser black		

			
1			
GEV No.	650069	Ref. No.	F002/BM
description	bracket for drink dispenser blue		

			
1			
GEV No.	650068	Ref. No.	F002
description	bracket for drink dispenser white		

paddles

			
1			
GEV No.	650019	Ref. No.	FB016
description	paddle for drink dispenser		

			
1			
GEV No.	650022	Ref. No.	F003
description	paddle for drink dispenser		

			
1			
GEV No.	650024	Ref. No.	L8099
description	paddle for drink dispenser		

			
1			
GEV No.	650025	Ref. No.	L8001
description	paddle for drink dispenser		

accessories

			
1			
GEV No.	650037	Ref. No.	F007
description	connecting fitting for paddle ø 19mm L 37mm		

augers

			
1			
GEV No.	650054	Ref. No.	F304/1
description	auger for drink dispenser		

drip grids

			
1			
GEV No.	650028	Ref. No.	L8034BLU
description	drip grid for drink dispenser		

			
1			
GEV No.	650031	Ref. No.	F060BM
description	drip grid for drink dispenser		

			
1			
GEV No.	650056	Ref. No.	F060/N/B
description	drip grid for drink dispenser		

			
1			
GEV No.	650021	Ref. No.	F060GM04
description	drip grid for drink dispenser grey		

			
1			
GEV No.	650108	Ref. No.	F060 F060B04
description	drip grid for drink dispenser L 165mm W 78mm H 15mm		

drip water trays



1

GEV No.	650027	Ref. No.	L8033BLU
description	drip tray blue		



1

GEV No.	650109	Ref. No.	L6126
description	drip tray complete L 148mm W 74mm H 60mm blue		



1

GEV No.	650020	Ref. No.	F059GM04 GV2MODG
description	drip tray grey		



1

GEV No.	650106	Ref. No.	F059/60/N F059/N+F060/N F059GM+F060GM GV1N
description	drip tray L 167mm W 115mm H 72mm black		



1

GEV No.	650030	Ref. No.	F059+F060BM F059BM GV1B
description	drip tray with drip grid blue		



1

GEV No.	650157	Ref. No.	GV2MODG
description	drip tray with drip grid grey		

miscellaneous



1

GEV No.	650102	Ref. No.	F010
description	cross rail for drink dispenser		



1

GEV No.	650048	Ref. No.	F035
description	guide for spring		

gaskets

O-rings

silicone

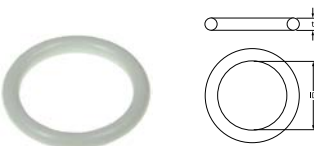

1

GEV No.	532513	Ref. No.	F016
description	O-ring silicone thickness 2.62mm ID ø 15.88mm Qty 1 pcs food-safe white		

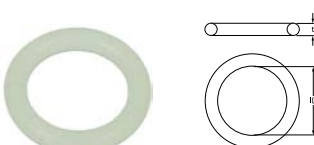

1

GEV No.	532514	Ref. No.	5034
description	O-ring silicone thickness 3mm ID ø 13mm Qty 1 pcs		

shaft gaskets

shaft gaskets



1			
GEV No.	650052	Ref. No.	F022/1
description	shaft sealing for drink dispenser D1 ø 12mm D2 ø 19mm		

special gaskets

miscellaneous



1			
GEV No.	650039	Ref. No.	F026/2
description	bottom gasket for auger D1 ø 31mm D2 ø 24mm ID ø 12mm H 21mm rubber		



1			
GEV No.	650026	Ref. No.	F019
description	gasket for evaporator H 14mm silicone		



1			
GEV No.	650051	Ref. No.	F017
description	gasket for outlet tap mounting pos. lower		

refrigeration cycle components

filter driers

miscellaneous



1			
GEV No.	750229	Ref. No.	1184 F1184
description	dryer size 20g ø 19mm L 138mm connection 6,2/6,2mm		

1			
GEV No.	750228	Ref. No.	F062
description	dryer size 20g ø 24mm L 109mm connection 2,6/6,2mm		

evaporators

for drink dispensers

1			
GEV No.	750187	Ref. No.	FB208
description	evaporator for drink dispenser Fast Cold 1-3 L 200mm W 178mm H 330mm		

1			
GEV No.	750185	Ref. No.	LEV6LT
description	evaporator for drink dispenser Luke 1-4 L 134mm W 134mm H 214mm for 6 litre devices		

1			
GEV No.	750186	Ref. No.	LEV9LT
description	evaporator for drink dispenser Luke 1-4 L 134mm W 134mm H 308mm for 9 litre devices		

1			
GEV No.	750184	Ref. No.	FEV3WT FEV4W FEV4WT L6118
description	evaporator for drink dispenser NEW Faby 1-3 L 200mm W 180mm H 330mm		

accessories

miscellaneous

1			
GEV No.	750252	Ref. No.	L8009BLU
description	bracket for evaporator		



springs

compression springs

1			
GEV No.	691111	Ref. No.	F036
description	compression spring ø 10mm L 70mm wire gauge ø 1mm		

1			
GEV No.	691113	Ref. No.	F014
description	compression spring ø 21.5mm L 80mm wire gauge ø 1.5mm		

1			
GEV No.	691112	Ref. No.	L8014
description	compression spring ø 22.5mm L 50mm wire gauge ø 1.4mm		

fastening material

fasteners

retaining rings

DIN 471

1			
GEV No.	516222	Ref. No.	F021
description	retaining ring shaft ø 12mm thickness 1mm SS DIN 471		

consumables

lubricants

silicone fats

1			
GEV No.	890101	Ref. No.	F139
description	silicone grease FERMIT GLISSA tube 60g -40 to +200°C approval		
description	<p>Fermit GLISSA - tube 60g</p> <p>Non-drip lubricating grease for drinking water valves and fittings</p> <p>Glissa silicone grease is suitable as a lubricant and sealant for drinking water valves and fittings (e.g. cartridges of single-lever mixers, switching valves and swivel spouts). Water-repellent, physiologically safe, sealing and has a high temperature resistance up to 200°C.</p> <p>Complies with the guidelines of the UBA for sanitary lubricants, tested by TZW for suitability for drinking water and approved in accordance with DIN ISO 21469.</p> <p>Temperature range: -40°C to +200°C</p>		

fuses

fine fuses

ø10x38mm 500V

1			
GEV No.	358027	Ref. No.	1027
description	fine fuse size ø10x38mm 16A rated 500V type Gg fast-acting Qty 1 pcs		

1			
GEV No.	358032	Ref. No.	1237
description	fine fuse size ø10x38mm 25A rated 500V type Gg fast-acting Qty 1 pcs		

1			
GEV No.	358022	Ref. No.	F147
description	fine fuse size ø10x38mm 4A rated 500V type Gg fast-acting Qty 1 pcs		

A

axial fans 7

C

compressors 5

condensators & interference suppression filters 11

consumables 21

E

evaporators 20

F

fans 7

fasteners 21

fastening material 21

filter driers 20

fine fuses 21

fuses 11, 21

H

halogen lamp 3

L

lamps 3

lubricants 21

M

microswitches 3

motors 10

O

O-rings 19

oven lamps 3

P

programme timers 4

R

refrigeration cycle components 20

refrigeration fans 8

refrigeration motors universal 8

refrigeration thermostats 3

retaining rings 21

rocker/momentary rocker switches 3

S

shaft gaskets 20

silicone fats 21

solenoid valves 5

starting capacitors 11

switches and momentary switches 3

T

thermostats 3

timers 4

transformers 4