



GAS COMPONENTS



ELECTRIC COMPONENTS



WATER TECHNOLOGY



MECHANICAL COMPONENTS



TOOLS

Spare parts suitable for

CB

Find the complete and up-to-date range of products in our GEV Webshop



Manufacturer catalogue

The most important spare parts and accessories arranged clearly for every manufacturer

- ✓ Complete product range and all appliance data always up to date in the GEV Webshop
- ✓ Alphabetical Index at the end of the catalogue

GEV Webshop

www.gev-online.co.uk

www.gev-online.com





- 🔍 Add to Favourites
- 🔍 Sign In with email address and usual password
- 🔍 Easy-order – place several items in your basket at the same time
- 🔍 Quick Item search – no login needed

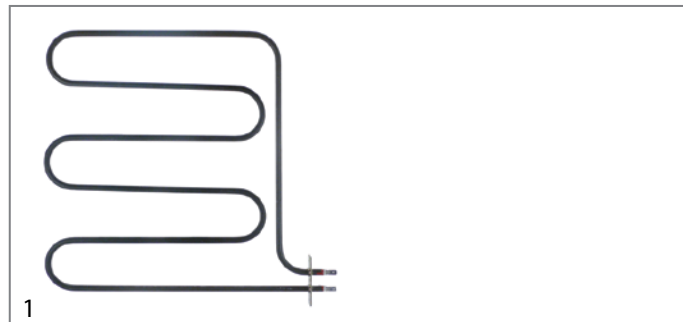

heating elements

heating elements for ovens



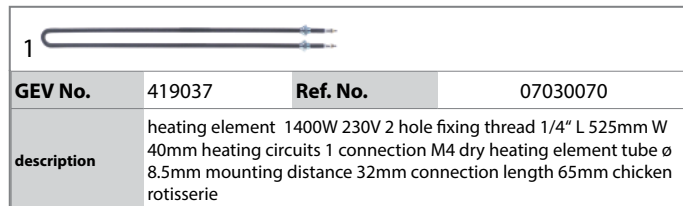

GEV No.	418418	Ref. No.	07030066
description	heating element 2500W 230V L 358mm W 360mm L1 35mm L2 320mm W1 325mm W2 34mm flange length 70mm flange width 22mm hole distance 56/28mm hole ø M4mm tube ø 8.5mm connection male faston 6.3mm heating circuits 1 rectangular flange grill setting oven		
accessories for	418418		
	GEV No.	510368	Ref. No. —
	gasket L 70mm W 23.5mm hole ø 5mm hole distance 56mm FIBER thickness 2mm for heating element		

heating elements for chicken rotisseries



GEV No.	419037	Ref. No.	07030070
description	heating element 1400W 230V 2 hole fixing thread 1/4" L 525mm W 40mm heating circuits 1 connection M4 dry heating element tube ø 8.5mm mounting distance 32mm connection length 65mm chicken rotisserie		





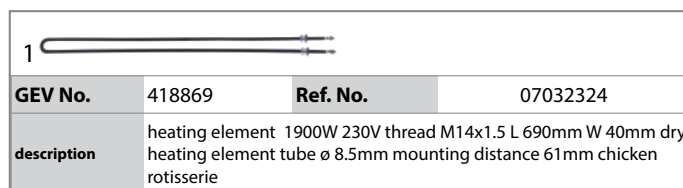

GEV No.	418423	Ref. No.	07030563
description	heating element 1450W 230V 2 hole fixing thread 1/4" L 675mm W 37mm heating circuits 1 connection M4 dry heating element tube ø 6.3mm mounting distance 31mm chicken rotisserie		
accessories for	418423		
	GEV No.	361182	Ref. No. —
	nut thread 1/4" H 5mm nickel-plated brass WS 17 Qty 1 pcs		
	GEV No.	510420	Ref. No. —
	gasket copper ED ø 19.9mm ID ø 14.3mm thickness 2mm Qty 1 pcs		
	GEV No.	560131	Ref. No. —
	hexagonal nut thread M4 H 3.2mm WS 7 SS DIN/ISO DIN 934 / ISO 4032/8673 Qty 20 pcs		

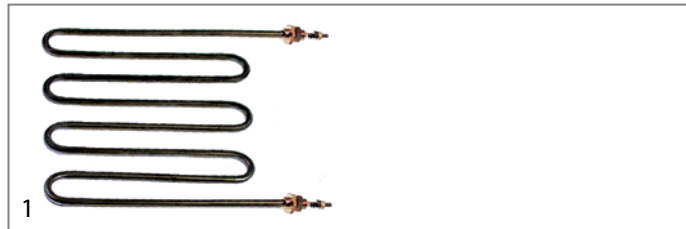

GEV No.	418869	Ref. No.	07032324
description	heating element 1900W 230V thread M14x1.5 L 690mm W 40mm dry heating element tube ø 8.5mm mounting distance 61mm chicken rotisserie		

heating elements for hot counters



GEV No.	418414	Ref. No.	07030021
description	heating element 1600W 230V heating circuits 1 L 220mm W 220mm tube ø 6.3mm connection M4 dry heating element hot bar 2 hole fixing thread M10x1 mounting distance 214mm		
spare parts for	418414		
	GEV No.	510416	Ref. No. —
	flat gasket fibre ED ø 19mm ID ø 10.5mm thickness 1.5mm for thread M10 Qty 1 pcs		
accessories for	418414		
	GEV No.	510893	Ref. No. —
	O-ring EPDM thickness 2.62mm ID ø 9.92mm Qty 1 pcs		
	GEV No.	520231	Ref. No. —
	nut thread M10x1 H 6mm WS 14 zinc-coated steel Qty 1 pcs		
	GEV No.	521129	Ref. No. —
	nut thread M10 H 6mm SS WS 17 Qty 1 pcs DIN/ISO DIN 439		

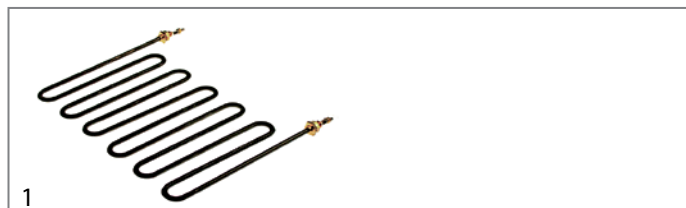

GEV No.	418416	Ref. No.	07030023
description	heating element 1700W 230V heating circuits 1 L 221mm W 326mm tube ø 6.3mm connection M4 dry heating element hot bar 2 hole fixing thread M10x1 mounting distance 320mm		







GEV No.	418415	Ref. No.	07030022
description	heating element 2000W 230V L 213mm W 362mm tube ø 6.3mm connection M4 dry heating element hot bar 2 hole fixing mounting distance 356mm		

heating elements for pizza ovens

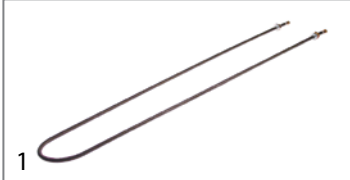





GEV No.	419028	Ref. No.	07030071
description	heating element 1200W 230V L 600mm W 232mm thread M14x1.5 mounting distance 224mm connection length 67mm connection M6 tube ø 8.5mm heating circuits 1 dry heating element pizza oven		

GEV No.	418412	Ref. No.	07030080
description	heating element 1200W 230V L 994mm W 121mm thread M14x1.5 mounting distance 113mm connection length 55mm connection M6 tube ø 8.5mm heating circuits 1 dry heating element 2 hole fixing		
accessories for	418412		
	GEV No.	510417	Ref. No. —
	flat gasket fibre ED ø 20mm ID ø 14mm thickness 2mm Qty 1 pcs		
	GEV No.	520228	Ref. No. —
	tooth lock washer ID ø 15.3mm ED ø 24mm steel Qty 1 pcs for thread M14		
	GEV No.	520230	Ref. No. —
	nut thread M14x1.5 H 5mm WS 19 zinc-coated steel Qty 1 pcs		
	GEV No.	521101	Ref. No. —
	nut thread M14x1.5 H 5mm WS 19 SS Qty 1 pcs		
	GEV No.	550262	Ref. No. —
	flat gasket copper ED ø 20mm ID ø 14mm thickness 2mm		







GEV No.	418413	Ref. No.	07030069
description	heating element 1900W 230V L 900mm W 230mm thread M14x1.5 mounting distance 222mm connection length 66mm connection M6 tube ø 8.5mm heating circuits 1 dry heating element 2 hole fixing		
accessories for	418413		
	GEV No.	510417	Ref. No. —
	flat gasket fibre ED ø 20mm ID ø 14mm thickness 2mm Qty 1 pcs		
	GEV No.	520228	Ref. No. —
	tooth lock washer ID ø 15.3mm ED ø 24mm steel Qty 1 pcs for thread M14		
	GEV No.	520230	Ref. No. —
	nut thread M14x1.5 H 5mm WS 19 zinc-coated steel Qty 1 pcs		
	GEV No.	521101	Ref. No. —
	nut thread M14x1.5 H 5mm WS 19 SS Qty 1 pcs		
	GEV No.	550262	Ref. No. —
	flat gasket copper ED ø 20mm ID ø 14mm thickness 2mm		

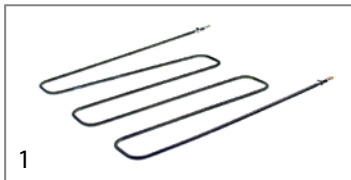

GEV No.	418410	Ref. No.	07030060
description	heating element 1450W 230V L 440mm W 390mm thread M14x1.5 mounting distance 391.5mm connection length 47mm connection M6 tube ø 8.5mm heating circuits 1 dry heating element 2 hole fixing		
accessories for	418410		
	GEV No.	510417	Ref. No. —
	flat gasket fibre ED ø 20mm ID ø 14mm thickness 2mm Qty 1 pcs		
	GEV No.	520228	Ref. No. —
	tooth lock washer ID ø 15.3mm ED ø 24mm steel Qty 1 pcs for thread M14		
	GEV No.	520230	Ref. No. —
	nut thread M14x1.5 H 5mm WS 19 zinc-coated steel Qty 1 pcs		
	GEV No.	521101	Ref. No. —
	nut thread M14x1.5 H 5mm WS 19 SS Qty 1 pcs		
	GEV No.	550262	Ref. No. —
	flat gasket copper ED ø 20mm ID ø 14mm thickness 2mm		



GEV No.	418411	Ref. No.	07030058
description	heating element 2000W 230V L 560mm W 520mm thread M14x1.5 mounting distance 513mm connection length 46mm connection M6 tube ø 8.5mm heating circuits 1 dry heating element 2 hole fixing		
accessories for	418411		
	GEV No.	510417	Ref. No. —
	flat gasket fibre ED ø 20mm ID ø 14mm thickness 2mm Qty 1 pcs		
	GEV No.	520228	Ref. No. —
	tooth lock washer ID ø 15.3mm ED ø 24mm steel Qty 1 pcs for thread M14		
	GEV No.	520230	Ref. No. —
	nut thread M14x1.5 H 5mm WS 19 zinc-coated steel Qty 1 pcs		
	GEV No.	521101	Ref. No. —
	nut thread M14x1.5 H 5mm WS 19 SS Qty 1 pcs		
	GEV No.	550262	Ref. No. —
	flat gasket copper ED ø 20mm ID ø 14mm thickness 2mm		









heating elements for rolling grills

			
1			
GEV No.	418419	Ref. No.	07030053
description	heating element 200W 230V heating circuits 1 L 472mm connection male faston 7.3mm tube ø 8.5mm connection length 23mm dry heating element roller grill		

			
1			
GEV No.	416189	Ref. No.	07030052
description	heating element 220W 240V heating circuits 1 L 359mm connection distance 359mm tube ø 8.5mm dry heating element roller grill		

heating elements for heating bridges

			
1			
GEV No.	418426	Ref. No.	07030900
description	heating element 3280W 230V heating circuits 1 L 970mm W 42mm connection length 20mm connection M6 tube ø 10mm 2 hole fixing thread M14x1.5 dry heating element heated bridge mounting distance 32mm		
accessories for	418426		
	GEV No.	510417	Ref. No. —
	flat gasket fibre ED ø 20mm ID ø 14mm thickness 2mm Qty 1 pcs		
	GEV No.	520228	Ref. No. —
	tooth lock washer ID ø 15.3mm ED ø 24mm steel Qty 1 pcs for thread M14		
	GEV No.	520230	Ref. No. —
	nut thread M14x1.5 H 5mm WS 19 zinc-coated steel Qty 1 pcs		
	GEV No.	521101	Ref. No. —
	nut thread M14x1.5 H 5mm WS 19 SS Qty 1 pcs		
	GEV No.	550262	Ref. No. —
	flat gasket copper ED ø 20mm ID ø 14mm thickness 2mm		

heating cartridges

			
1			
GEV No.	416190	Ref. No.	07031500
description	heating cartridge 80W 230V ø 24mm L 102mm cable length 345mm dry heating element		



heater battery

			
1			
GEV No.	415122	Ref. No.	07032361
description	heater battery mounting distance 185mm W 40mm H 35mm 2000W 230V temperature restriction 105°C heating circuits 2 connection cable cable length 340mm L 197mm for cross flow fan		

ceramic heaters

245x60mm

			
1			
GEV No.	415104	Ref. No.	07030064
description	ceramic emitter 1000W 230V cable beaded cord L 245mm W 60mm H 35mm		
spare parts for	415104		
	GEV No.	415109	Ref. No. —
	spring clip		
accessories for	415104		
	GEV No.	415110	Ref. No. —
	reflector L 245mm W 95mm H 31mm thickness 0.75mm hole ø 15x40mm		

			
1			
GEV No.	415103	Ref. No.	07030063
description	ceramic emitter 650W 230V cable beaded cord L 245mm W 60mm H 35mm		
spare parts for	415103		
	GEV No.	415109	Ref. No. —
	spring clip		
accessories for	415103		
	GEV No.	415110	Ref. No. —
	reflector L 245mm W 95mm H 31mm thickness 0.75mm hole ø 15x40mm		



quartz heating elements



1

GEV No.	693722	Ref. No.	05010005
description	insulator female L 7mm ø 13mm bore ø 5.5mm		



1

GEV No.	693721	Ref. No.	05010004
description	insulator male L 10mm ø 13mm bore ø 5.5mm		

heating elements for convection



1

GEV No.	418417	Ref. No.	07030065
description	heating element 2580W 230V heating circuits 1 ID ø 178mm ED ø 190mm H 70mm flange length 100mm flange width 22mm		









1

GEV No.	418408	Ref. No.	07030017
description	heating element 1500W 230V heating circuits 1 L 527mm W 42mm connection length 53mm connection M6 tube ø 10mm thread M14x1.5 2 hole fixing dry heating element mounting distance 34mm		



1

GEV No.	418409	Ref. No.	07030564	
description	heating element 2480W 230V heating circuits 1 L 690mm W 43mm connection length 80mm connection M6 tube ø 10mm thread M14x1.25 2 hole fixing dry heating element mounting distance 30mm			
accessories for	418409			
	GEV No.	510417	Ref. No.	—
	flat gasket fibre ED ø 20mm ID ø 14mm thickness 2mm Qty 1 pcs			
	GEV No.	520228	Ref. No.	—
	tooth lock washer ID ø 15.3mm ED ø 24mm steel Qty 1 pcs for thread M14			
	GEV No.	520230	Ref. No.	—
	nut thread M14x1.5 H 5mm WS 19 zinc-coated steel Qty 1 pcs			
	GEV No.	521101	Ref. No.	—
	nut thread M14x1.5 H 5mm WS 19 SS Qty 1 pcs			
	GEV No.	550262	Ref. No.	—
	flat gasket copper ED ø 20mm ID ø 14mm thickness 2mm			
	GEV No.	560133	Ref. No.	—
	hexagonal nut thread M6 H 5mm WS 10 SS DIN/ISO DIN 934 / ISO 4032/8673 Qty 20 pcs			

accessories



1

GEV No.	693722	Ref. No.	05010005
description	insulator female L 7mm ø 13mm bore ø 5.5mm		



1

GEV No.	693721	Ref. No.	05010004
description	insulator male L 10mm ø 13mm bore ø 5.5mm		

hot plates

round

with radiused edge

for domestic and commercial kitchens



1

GEV No.	416191	Ref. No.	07031260
description	hot plate ø 90mm 450W 230V connection 3 screw clamps with 8mm spill ring		

energy regulators

EGO

1-circuit



1

GEV No.	380015	Ref. No.	09020004
description	energy regulator 230V 13A single-circuit turn direction right shaft ø 6x4.6mm shaft L 23mm mounting thread M4 power release 6-100% no. 50.57021.010		

thermostats

control and safety thermostats

EGO

control thermostats

55.10/19_series



1

GEV No.	375001	Ref. No.	09010015
description	thermostat t.max. 112°C temperature range 30-110°C 1-pole 1NO 16A probe ø 6mm probe L 130mm capillary pipe 900mm capillary pipe isolatedmm gland nut M9x1 shaft L 23mm shaft position upper rotation 270°		

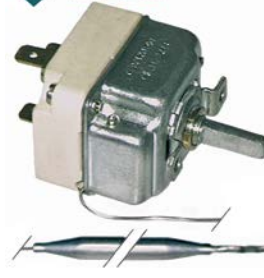

1

GEV No.	375336	Ref. No.	09010014
description	thermostat t.max. 255°C temperature range 45-255°C 1-pole 1CO 16A probe ø 6mm probe L 74mm capillary pipe 900mm capillary pipe isolated 900mm gland nut shaft ø 6x4.6mm shaft L 23mm shaft position upper rotation 270°		



1

GEV No.	375002	Ref. No.	09010021
description	thermostat t.max. 320°C temperature range 55-320°C 1-pole 1NO 16A probe ø 3.1mm probe L 226mm capillary pipe 870mm capillary pipe isolated 850mm gland nut shaft L 23mm shaft position upper rotation 270°		



1

GEV No.	375253	Ref. No.	09010027
description	thermostat t.max. 455°C temperature range 85-455°C 1-pole 1NO 16A probe ø 3.9mm probe L 228mm capillary pipe 870mm capillary pipe isolated 660mm gland nut shaft ø 6x4.6mm shaft L 23mm shaft position upper rotation 270°		



safety thermostats

55.32_ series



1

GEV No.	375220	Ref. No.	09010019
description	safety thermostat switch-off temp. 330°C 3-pole 20A probe ø 11mm probe L 18.5mm capillary pipe 900mm capillary pipe isolated 900mm gland nut probe screw-in probe probe thread M14x1		

JUMO

safety thermostats



1

GEV No.	390163	Ref. No.	09010020
description	safety thermostat switch-off temp. 20-500°C 1-pole 1NC 16A probe ø 8mm probe L 155mm capillary pipe 1000mm capillary pipe isolated-mm gland nut shaft ømm probe material steel 230V		

RANCO

safety thermostats



1

GEV No.	375779	Ref. No.	09010025
description	safety thermostat 2-pole 16A probe ø 2mm capillary pipe 1050mm capillary pipe isolatedmm gland nut with capillary probe switch-off temp. 108°C		

switches and momentary switches

rocker/momentary rocker switches

30x22mm



1

GEV No.	347103	Ref. No.	07040068
description	rocker switch mounting measurements 30x22mm black 2NO 250V 16A 0-motor connection male faston 6.3mm ambient temperature max. 125/55°C protection IP40		

blank



1

GEV No.	346564	Ref. No.	07040011
description	rocker switch mounting measurements 30x22mm black 2CO 230V 16A connection male faston 6.3mm ambient temperature max. 85°C protection IP65 with cover cap		

labelled



1

GEV No.	346566	Ref. No.	07040033	
description	momentary rocker switch mounting measurements 30x22mm black 2NO 230V 10A 0-I connection male faston 6.3mm ambient temperature max. 100/55°C protection IP65 with cover cap			
accessories for	346566			
	GEV No.	301036	Ref. No.	—
	protective cover internal size 30x22mm for rocker switch mounting measurementsmm			

cam switches

operation switches



1

GEV No.	345321	Ref. No.	07040014
description	operation switch 4 operating positions 5NO 16A sequence 0-1-2-3 shaft ø 6x4.6mm shaft L 23mm connection male faston 6.3mm plastic 3-pole ambient temperature max. 300°C		

rotary switches

BREMAS

accessories



1

GEV No.	111012	Ref. No.	07110149 10010017
description	knob switch zero mark t.max. °C°C ø 34/60mm shaft ø 5x5mm shaft flat black H 22mm L 50mm		

GIOVENZANA

rotary switches



1

GEV No. 346565¹ **Ref. No.** 07040031

description rotary switch 2 0-1-2 sets of contacts 4 type PO16 600V 16A shaft ø 5x5mm shaft L 15mm shaft square connection screw

¹incl. knob and dial plate



1

GEV No. 347427 **Ref. No.** 07040976
07CC0084

description rotary switch 3 0-1-2 sets of contacts 6 type CX25 690V 25A shaft ø 6x6mm shaft L 15mm shaft square connection male faston

lamps

indicator lights

indicator lights (complete)

ø10mm

with plug-in socket



1

GEV No. 359138 **Ref. No.** 07050994

description indicator light ø 10mm red 230V connection male faston 6.3mm Qty 1 pcs



1

GEV No. 359140 **Ref. No.** 07051486

description indicator light ø 10mm yellow 230V connection male faston 6.3mm Qty 1 pcs

screw-on/push-on fit

light bulbs

for ovens



1

GEV No. 359611 **Ref. No.** 07020966

description light bulb t.max. 300°C socket E14 40W 230V ø 45mm L 75mm lens L 50mm for oven lamp IMPORT

halogen lamp

for socket G4 / G6.35 / G9



1

GEV No. 359946 **Ref. No.** 07020042

description halogen lamp socket G9 230V 40W temp.-resist. 300°C

linear lamps

infrared lamps

with base type X lug



1

GEV No. 359617 **Ref. No.** 07020001

description infrared lamp 1000W 220V L 365mm lens L 340mm total length 480mm with mounting strap

sockets for linear lamps

X lug



1

GEV No. 359710 **Ref. No.** 07CC0021

description lamp socket L 70mm W 70mm H 49mm mounting distance 50mm bracket mounting

fluorescent lamps

fluorescent lamps

G13



1

GEV No. 359386 **Ref. No.** 07020013

description fluorescent lamp socket G13 L 1198mm 36W 230V Qty 1 pcs



1

GEV No. 359383 **Ref. No.** 07020010

description fluorescent lamp socket G13 L 438mm 15W 230V Qty 1 pcs light colour 640



1

GEV No. 359371 **Ref. No.** 07020011

description fluorescent lamp socket G13 L 590mm 18W 230V Qty 1 pcs

For models: EVF2



1			
GEV No.	359738	Ref. No.	07020012
description	fluorescent lamp socket G13 L 970mm 23W 230V Qty 1 pcs		
For models:	EVF3		

accessories

sockets

1			
GEV No.	359395	Ref. No.	07020014
description	lamp socket socket G13 for fluorescent lamps		
For models:	EVF2, EVF3		

starter holders

1			
GEV No.	359394	Ref. No.	07110003
description	starter holder for fluorescent lamps socket G13		
For models:	EVF2, EVF3		

starter

1			
GEV No.	380464	Ref. No.	07110002
description	starter 4-65W		
For models:	EVF2, EVF3		

ballasts

1			
GEV No.	401504	Ref. No.	07110004
description	electrical ballast 18W 230V Qty 1 pcs		
For models:	EVF2		

1			
GEV No.	401505	Ref. No.	07110005
description	electrical ballast 36W 230V Qty 1 pcs		
For models:	EVF2, EVF3		

oven lamps

universal oven lamps

mounting diameter 65.5mm



1				
GEV No.	359712	Ref. No.	07020018	
description	oven lamp mounting ø 65.5mm 230V 40W socket E14 temp.-resist. 300°C connection male faston 6.3mm hard glas			
spare parts for	359712			
	GEV No.	359022	Ref. No.	—
	lamp socket socket E14 mounting ø 65.5mm connection male faston 6.3mm			
	GEV No.	359611	Ref. No.	07020966
	light bulb t.max. 300°C socket E14 40W 230V ø 45mm L 75mm lens L 50mm for oven lamp IMPORT			
	GEV No.	359722	Ref. No.	—
	gasket silicone ID ø 57.5mm ED ø 68mm thickness 2mm			
	GEV No.	359724	Ref. No.	—
	oven lamp glass thread ø 62mm H 46mm ø 74mm hard glas temp.-resist. 350°C			

55x70mm

1			
GEV No.	359659	Ref. No.	07020028
description	oven lamp complete 230V 25W socket E14 L 70mm W 55mm mounting measurements 55x70mm temp.-resist. 300°C connection male faston 6.3mm		

lamps

light bulbs



1			
GEV No.	359611	Ref. No.	07020966
description	light bulb t.max. 300°C socket E14 40W 230V ø 45mm L 75mm lens L 50mm for oven lamp IMPORT		



halogen lamps			
for socket G4 / G6.35 / G9			
			
1			
GEV No.	359946	Ref. No.	07020042
description	halogen lamp socket G9 230V 40W temp.-resist. 300°C		

timers

programme timers			
			
1			
GEV No.	360719	Ref. No.	09030002
description	timer CDC 11902F3 engines 1 chambers 2 operation time 144min 230V shaft ø 6x4.6mm shaft L 20mm manuf. no. 11902F3DFE000.0010		

			
1			
GEV No.	360351	Ref. No.	09030002 (old version)
description	timer FIBER P20 engines 1 chambers 2 operation time 144min 230V shaft ø 6x4.6mm shaft L 20mm manuf. no. P205J02N734 motor type M51BJ0L6400 for chicken rotisserie		
spare parts for	360351		
	GEV No.	360674	Ref. No.
			—
	 motor kit pinion ø 6.8mm teeth 15 230V voltage AC 50/60Hz turn direction counterclockwise motor ø 48mm H 18.5mm motor type UDS40NE1RNZ165 cable length 150mm with holder		

digital timers			
			
1			
GEV No.	401503	Ref. No.	09030001
description	timer electronic		

mechanical timers			
			
1			
GEV No.	350008	Ref. No.	09030065
description	timer M2 with bell 2-pole operation time 120min impulse mechanical 2NO at 250V 16A permanent position yes shaft ø 6x4.6mm shaft 6x4.6mm shaft L 24mm mounting distance 28mm connection lateral		

contactors			
SIEMENS			
power contactors			
			
1			
GEV No.	380389	Ref. No.	07070001
description	power contactor resistive load 22A 230VAC (AC3/400V) 9A/4kW main contacts 3NO auxiliary contacts 1NO connection screw connection type 3RT10-16-1AP01		

overload switches			
			
1			
GEV No.	380659	Ref. No.	07070002
description	overload switch setting range 0.7-1A connection screw type 3RU1116-0JB0 (AC3/400V) 0.25kW		



relays

power relays

with male contacts

bullet connectors, 11 contacts



1

GEV No.	380132	Ref. No.	07072134
----------------	--------	-----------------	----------

description power relays Italiana Relè 230VAC 10A 3CO connection plug-in connection round 11-pole manuf. no. C43-230AC ZVE11 250V 11-pole

accessories for 380132

GEV No.	380136	Ref. No.	07072135
----------------	--------	-----------------	----------



relay socket 11-pole connection plug-in connection round 11-pole dimensions 65x28x40mm 250V voltage AC 10A Italiana Relè manuf. no. ZVE11

relay sockets



1

GEV No.	380136	Ref. No.	07072135
----------------	--------	-----------------	----------

description relay socket 11-pole connection plug-in connection round 11-pole dimensions 65x28x40mm 250V voltage AC 10A Italiana Relè manuf. no. ZVE11

accessories for 380136

GEV No.	380805	Ref. No.	—
----------------	--------	-----------------	---



support bracket

transformers

encapsulated transformers

PMA



1

GEV No.	379054	Ref. No.	07062363
----------------	--------	-----------------	----------

description transformer primary 230VAC secondary 12VAC 3VA secondary 0.25A H 40mm L 45mm W 50mm connection screw 50/60Hz type 153/M

electronic controllers

ELIWELL

universal controllers

built-in version



1

GEV No.	379690	Ref. No.	09010029
----------------	--------	-----------------	----------

description electronic controller ELIWELL type ICPlus902 model ICP16D0750000 mounting measurements 71x29mm 230V voltage AC NTC/PTC relay outputs 1 CO-15A(8) NTC/PTC built-in depth 60mm defr. funct. -50 up to +150°C display 3½ digits

accessories for 379690

GEV No.	378194	Ref. No.	—
----------------	--------	-----------------	---

temperature probe NTC 10kOhm cable PVC probe -20 up to +80°C cable -10 up to 100°C probe ø7x24.5mm cable length 1.5m without screw connection 2-wire

GEV No.	379052	Ref. No.	—
----------------	--------	-----------------	---

temperature probe PTC 1kOhm cable silicone probe -50 up to +150°C cable -50 up to +180°C probe ø6x40mm cable length 1.5m without screw connection 2-wire

GEV No.	379053	Ref. No.	09040008
----------------	--------	-----------------	----------

temperature probe PTC 1kOhm cable PVC probe -50 up to +150°C cable -10 up to 100°C probe ø6x30mm cable length 3m without screw connection 2-wire

GEV No.	379057	Ref. No.	—
----------------	--------	-----------------	---

temperature probe NTC 10kOhm cable PVC probe -20 up to +80°C cable -10 up to 100°C probe ø6x25mm cable length 3m 2-wire

GEV No.	379064	Ref. No.	—
----------------	--------	-----------------	---

temperature probe PTC 1kOhm cable silicone probe -50 up to +150°C cable -50 up to +180°C probe ø6x40mm cable length 3m without screw connection 2-wire

GEV No.	379142	Ref. No.	—
----------------	--------	-----------------	---

temperature probe PTC 1kOhm cable PVC probe -50 up to +150°C cable -10 up to 100°C probe ø6x30mm cable length 1.5m without screw connection 2-wire

GEV No.	379160	Ref. No.	—
----------------	--------	-----------------	---

temperature probe NTC 10kOhm cable thermoplastic probe -40 up to +110°C cable -40 up to +110°C probe ø6x14mm cable length 1.5m without screw connection 2-wire

GEV No.	379161	Ref. No.	—
----------------	--------	-----------------	---

temperature probe NTC 10kOhm cable thermoplastic probe -40 up to +110°C cable -40 up to +110°C probe ø6x14mm cable length 3m without screw connection 2-wire

GEV No.	379343	Ref. No.	—
----------------	--------	-----------------	---

temperature probe NTC 10kOhm cable silicone probe -40 up to +110°C cable -50 up to +180°C probe ø6x40mm cable length 3m 2-wire

GEV No.	379458	Ref. No.	—
----------------	--------	-----------------	---

temperature probe NTC 10kOhm cable silicone probe -40 up to +110°C cable -50 up to +180°C probe ø6x40mm cable length 1.5m without screw connection 2-wire

GEV No.	379781	Ref. No.	—
----------------	--------	-----------------	---

temperature probe PTC 1kOhm cable thermoplastic probe -50 up to +150°C cable -40 up to +110°C probe ø6x14mm cable length 1.5m without screw connection 2-wire

Table continues overleaf



accessories for	379690			
	GEV No.	379782	Ref. No.	—
	temperature probe PTC 1kOhm cable thermoplastic probe -50 up to +150°C cable -40 up to +110°C probe ø6x14mm cable length 3m 2-wire resistor 1kOhm			



GEV No.	379568	Ref. No.	09010030
description	electronic controller ELIWELL type ICP22JI750000 mounting measurements 71x29mm 230V voltage AC Pt100/TC (J,K) relay outputs 2 CO-8A(4) CO-8A(4) Pt100/TC (J,K,S) DI front measurements 78x37mm built-in depth 60mm mode of operation cooking protection IPx0 accuracy 1% built-in version defr. funct. no -150 to 1350°C display 3½ digits		

accessories for	379568			
	GEV No.	378065	Ref. No.	—
	alarm device AKO type AKO-520641 mounting measurements 214x214mm 230V voltage AC relay outputs 1 CO-8A(4) up to 4 front measurements 222x222mm yes yes			

	GEV No.	378074	Ref. No.	—
	temperature probe thermocouple J (Fe-CuNi) cable Vetrotex probe -50 up to +750°C cable -50 up to +350°C probe ø3x100mm cable length 3m without screw connection 2-wire			

	GEV No.	378075	Ref. No.	—
	temperature probe thermocouple K (NiCr-Ni) cable Vetrotex probe -50 up to 1150°C cable -50 up to +350°C probe ø4.5x150mm cable length 3m without screw connection 2-wire			

	GEV No.	379050	Ref. No.	—
	temperature probe Pt100 cable Vetrotex probe -200 up to +600°C cable -50 up to +350°C probe ø6x100mm cable length 2.7m without screw connection 3-wire			

	GEV No.	379062	Ref. No.	—
	temperature probe thermocouple J (Fe-CuNi) cable Vetrotex probe -50 up to +750°C cable -50 up to +350°C probe ø6x50mm cable length 3m without screw connection 2-wire			

SHANGFANG

accessories



GEV No.	379054	Ref. No.	07062363
description	transformer primary 230VAC secondary 12VAC 3VA secondary 0.25A H 40mm L 45mm W 50mm connection screw 50/60Hz type 153/M		

probes

universal probes

temperature probes

1			
GEV No.	379053	Ref. No.	09040008
description	temperature probe PTC 1kOhm cable PVC probe -50 up to +150°C cable -10 up to 100°C probe ø6x30mm cable length 3m without screw connection 2-wire		

1				
GEV No.	379051	Ref. No.	09040001	
description	temperature probe thermocouple J (Fe-CuNi) cable Vetrotex probe -50 up to +750°C cable -50 up to +350°C probe ø6x100mm cable length 3m without screw connection cable colours red/blue 2-wire			
accessories for	379051			
	GEV No.	379877	Ref. No.	—
	electronic controller HONEYWELL type DC10N-400 mounting measurements 92x92mm 24/230V voltage AC TC (J) relay outputs 1 CO-10A(6) TC (J) universal built-in depth 55mm protection IP54 accuracy 1% built-in version defr. funct. no 0 up to +400°C display 3 digits			

electronics

PCBs

1			
GEV No.	401508	Ref. No.	09030059
description	keypad PCB pizza oven with keypad		

1			
GEV No.	401509	Ref. No.	09030005
description	PCB		



keypads

front foils



1

GEV No.	401506	Ref. No.	11030014
description	front foil		



1

GEV No.	401507	Ref. No.	11030018
description	keypad foil		

solenoid valves

solenoid valves (water)

RPE



1

GEV No.	374015	Ref. No.	18010005
description	solenoid valve single angled 230VAC inlet 3/4" outlet 10mm input 10-12l/min DN10 RPE flow regulating valve inlet white		

TP

solenoid valves with reducers



1

GEV No.	374034	Ref. No.	18CC0001
description	solenoid valve single angled 230VAC inlet 3/4" outlet 11.5mm input 10l/min output 0.25l/min t.max. 90°C RPE plastic flow regulating valve outlet red flow regulating valve inlet white		

fans

cross flow fans



COPREL

with moulded coils



1

GEV No.	601340	Ref. No.	07012360
description	cross flow fan roller ø 60mm roller length 180mm laminated core thickness 30mm motor position right 230V/50Hz 19W universal bearing silicone connection male faston 6.3mm -30 up to +100°C 230V 50Hz		

accessories for	601340			
	GEV No.	415122	Ref. No.	07032361
	description	heater battery mounting distance 185mm W 40mm H 35mm 2000W 230V temperature restriction 105°C heating circuits 2 connection cable cable length 340mm L 197mm for cross flow fan		
	GEV No.	420267	Ref. No.	—
	description	heater battery mounting distance 185mm W 40mm H 35mm 2000W 230V temperature restriction 105°C heating circuits 2 connection cable cable length 340mm L 197mm for cross flow fan		

accessories for cross flow fans

heater battery



1

GEV No.	415122	Ref. No.	07032361
description	heater battery mounting distance 185mm W 40mm H 35mm 2000W 230V temperature restriction 105°C heating circuits 2 connection cable cable length 340mm L 197mm for cross flow fan		

hot air fans

ebm-papst



1

GEV No.	601103	Ref. No.	07010007
description	radial fan 230V 47W L1 60mm L2 26mm L3 20mm L4 157mm fan wheel ø 150mm type G2S150-AB08-44		

miscellaneous

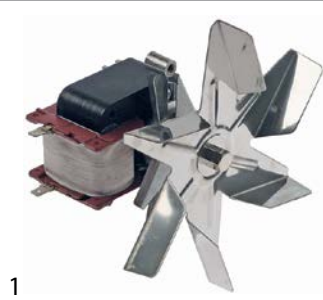

1

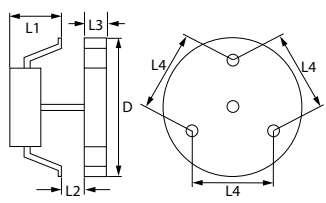

GEV No.	601751	Ref. No.	07010013 07010078
description	hot air fan 230V 25W L1 65mm L2 16mm L3 20mm L4 80/80/97mm fan wheel ø 150mm FIME type C30R0404CLH		
spare parts for	601751		
	GEV No.	601148	Ref. No. —
	fan wheel ø 152mm W 20mm shaft intake ø 6x5mm stainless steel blades 6		

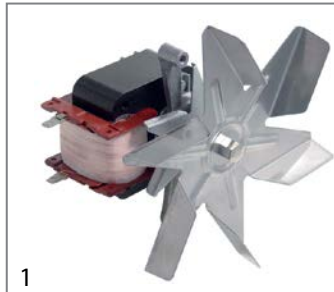

1

GEV No.	601012	Ref. No.	07010013
description	hot air fan 230V 25W L1 65mm L2 16mm L3 20mm L4 80/80/97mm fan wheel ø 150mm FIME type C30R0404CLH		
spare parts for	601012		
	GEV No.	601148	Ref. No. —
	fan wheel ø 152mm W 20mm shaft intake ø 6x5mm stainless steel blades 6		

motors

gear motors

for grills



1

GEV No.	500768	Ref. No.	07010116 07010155
description	gear motor 12W 230V 50Hz 2rpm shaft ø 16mm L 111mm W 60mm H 45mm type 981 METEOR		

for gyros grills



1

GEV No.	500877	Ref. No.	14080053
description	gear motor 14W 230V 1.8rpm shaft ø 18mm L 190mm W 130mm H 105mm for gyro grill		
spare parts for	500877		
	GEV No.	300125	Ref. No. —
	rocker switch mounting measurements 30x22mm green 2NO 230V 16A 0-I connection male faston 6.3mm ambient temperature max. 125/55°C protection IP65 with cover cap		



1

GEV No.	500878	Ref. No.	07010076
description	gear motor 1.8rpm for gyro grill		

miscellaneous



1

GEV No.	500488	Ref. No.	07012401
description			

1

GEV No.	501468	Ref. No.	07010118
description	gear motor FIBER type G085J0BDA36 230V 50Hz 2rpm shaft ø 8x6mm L 59mm W 36mm H 83.5mm for roller grill		

motors

universal



1

GEV No.	500875	Ref. No.	07011238
description	motor 90W 230/400V 50Hz 3 phase shaft ø 9mm flange ø 120mm 1400rpm type M56B4 ø 110mm H 160mm L 170mm CARPANELLI 0.09kW		



1

GEV No.	500874	Ref. No.	07010635
description	motor 90W 230V 50Hz 1 phase shaft ø 9mm flange ø 120mm 1300rpm type MM56 ø 110mm H 160mm L 170mm 0.09kW		

electric accessories

plugs - couplings - power sockets

protective contact power sockets

producer-specific power sockets

miscellaneous



1

GEV No.	550915	Ref. No.	07110080
description	power socket CEE7/4 type F built-in version 3-pole contacts P+N+E max. 16A max 230V with lid countries D/I mounting ø 40mm		

gas taps

PEL

22S/O series







1







GEV No.	101086	Ref. No.	08020023	
description	gas tap PEL type 22S/O gas inlet M20x1.5 (tube ø 12mm) bypass nozzle ø 0.35mm gas outlet M20x1.5 (tube ø 12/10mm) thermocouple connection M9x1 pilot connection M10x1 shaft ø 10x8mm shaft L 25/17mm shaft flat lower			
spare parts for	101086			
	GEV No.	100259	Ref. No.	—
	bypass nozzle type PEL22 bore ø 0.35mm thread M6x0.5			
	GEV No.	101058	Ref. No.	—
	magnet unit L 39mm D1 ø 15.4mm D2 ø 13.5mm suitable for PEL22/EGA24197 standard			
	GEV No.	101201	Ref. No.	—
	gas tap front part shaft ø 10x8mm shaft L 25/17mm shaft flat upper/lower suitable for PEL22			
	GEV No.	101231	Ref. No.	—
	thermocouple nut T1: M9x1 T2: M18x1			
	GEV No.	101240	Ref. No.	—
	gas connection thread M20x1.5 tube ø 12/10mm for PEL gas taps with gasket and screws horizontal			
	GEV No.	101460	Ref. No.	—
	O-ring ø 12.37mm D1 ø 2.62mm suitable for PEL22			
	GEV No.	101461	Ref. No.	—
	screw kit suitable for PEL22 Qty 4 pcs			
accessories for	101086			
	GEV No.	100908	Ref. No.	—
	union screw thread M10x1 for pipe ø 4mm Qty 1 pcs			
	GEV No.	100909	Ref. No.	—
	union screw thread M10x1 for pipe ø 6mm Qty 1 pcs			
	GEV No.	101241	Ref. No.	—
	gas connection thread M20x1.5 tube ø 12/10mm for PEL gas taps vertical			
	GEV No.	101246	Ref. No.	—
	olive for pipe ø 4mm Qty 1 pcs			
	GEV No.	101248	Ref. No.	—
	olive for pipe ø 12mm Qty 1 pcs suitable for PEL			
	GEV No.	101249	Ref. No.	—
	olive for pipe ø 10mm Qty 1 pcs			
	GEV No.	101250	Ref. No.	—
	union nut thread M20x1.5 for pipe ø 10mm			

Table continues overleaf



accessories for	101086		
	GEV No.	101251	Ref. No. —
	union nut thread M20x1.5 for pipe ø 12mm		
	GEV No.	101286	Ref. No. —
	olive ID ø 6mm Qty 1 pcs		
	GEV No.	110080	Ref. No. —
	knob ø 70mm shaft ø 10x8mm shaft flat universal		
	GEV No.	112206	Ref. No. —
	knob dial plate silver gas tap PEL21/22/23 t.max.°C ED ø 63mm ID ø 45.5mm		

SABAF

	1		
GEV No.	101994	Ref. No.	08020001
description	gas tap SABAF type 10 gas inlet pipe flange ø16mm bypass nozzle ø 0.65mm gas outlet 1/4" (tube ø 8mm) front fixing thermocouple connection plug-in connection shaft ø 8x6.5mm shaft L 26/12mm shaft flat lower		
spare parts for	101994		
	GEV No.	101376	Ref. No. —
	gasket ID ø 8mm ED ø 12mm H 3/5mm		
	GEV No.	106725	Ref. No. —
	magnet unit L 35mm D1 ø 12.5mm D2 ø 8.5mm suitable for SABAF		
accessories for	101994		
	GEV No.	101277	Ref. No. —
	olive ID ø 8mm Qty 1 pcs		
	GEV No.	101751	Ref. No. —
	bracket		
	GEV No.	520656	Ref. No. —
	union nut thread 1/4" tube ø 6/8mm		
	GEV No.	560082	Ref. No. —
	hexagonal screw thread M4 thread L 16mm SS WS 7 Qty 20 pcs DIN 933 / ISO 4017		

ignition parts

pilot burners

SIT

100 series



1

















GEV No.	106906	Ref. No.	08100602
description	pilot burner SIT type 100 series 3 flames nozzle ø 0.2mm gas connection 6mm		
spare parts for	106906		
	GEV No.	100245	Ref. No. —
	pilot burner nozzle LPG code 20 bore ø 0.2mm Qty 1 pcs thread M8x0.75		
	GEV No.	100855	Ref. No. —
	pilot burner bracket triple		
	GEV No.	100885	Ref. No. —
	air mixing sleeve for pilot burner Qty 1 pcs		
	GEV No.	100916	Ref. No. —
	compression spring for pilot burner Qty 1 pcs		
	GEV No.	100917	Ref. No. —
	gasket for pilot burner Qty 1 pcs aluminium		
	GEV No.	100918	Ref. No. —
	screw for pilot burner		
	GEV No.	107162	Ref. No. —
	pilot burner cap SIT 3 flames Hmm Lmm Qty 1 pcs		
	GEV No.	107701	Ref. No. —
	pilot burner bottom part SIT 100 series nozzle ø 0.2mm		
accessories for	106906		
	GEV No.	100245	Ref. No. —
	pilot burner nozzle LPG code 20 bore ø 0.2mm Qty 1 pcs thread M8x0.75		
	GEV No.	100246	Ref. No. —
	pilot burner nozzle natural gas bore ø 0.35mm Qty 1 pcs thread M8x0.75		
	GEV No.	100904	Ref. No. —
	locking screw M10x1 for pipe ø 4mm Qty 1 pcs		
	GEV No.	100905	Ref. No. —
	locking screw M10x1 for pipe ø 6mm Qty 1 pcs		
	GEV No.	102110	Ref. No. —
	pilot tube copper pipe ø 4mm thickness 1mm L 3000mm		
	GEV No.	102111	Ref. No. —
	pilot tube copper pipe ø 6mm thickness 1mm L 3000mm		

Table continues overleaf



accessories for	106906		
	GEV No.	107171	Ref. No. 08120048
	pilot burner nozzle SIT natural/liquid gas bore ø 0.25mm Qty 1 pcs		
	GEV No.	107700	Ref. No. —
	pilot burner bottom part SIT 100 series nozzle ø 0.25mm		
	GEV No.	107702	Ref. No. —
	pilot burner bottom part SIT 100 series nozzle ø 0.35mm		





producer-specific pilot burners

CB



GEV No.	102850	Ref. No.	08070002
description	pilot burner		



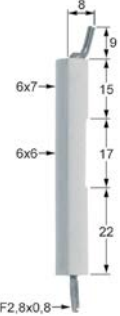

GEV No.	100064	Ref. No.	N/A
description	pilot burner for left fixing		
spare parts for	100064		
	GEV No.	100705	Ref. No. 08080003
	ignition electrode D1 ø 7mm L1 15mm L2 25mm BL1 18mm BL2 17mm BL3 10mm fixing dimensions M11x1mm connection ø 4mm		
	GEV No.	100905	Ref. No. —
	locking screw M10x1 for pipe ø 6mm Qty 1 pcs		
	GEV No.	102849	Ref. No. —
	pilot burner SIT type 160 series 2 flames nozzle ømm gas connectionmm		
	GEV No.	102850	Ref. No. 08070002
	pilot burner		
	GEV No.	102851	Ref. No. —
	thermocouple extension thread M9x1 L 1000mm		

electrodes

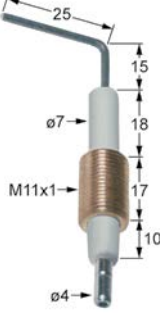

GEV No.	102903	Ref. No.	08082327
description	ignition electrode D1 ø 6x7mm connection F 2.8x0.8mm D2 ø 6x6mm L1 9mm L2 8mm BL1 15mm BL2 17mm BL3 22mm to clip		



GEV No.	100705	Ref. No.	08080003
description	ignition electrode D1 ø 7mm L1 15mm L2 25mm BL1 18mm BL2 17mm BL3 10mm fixing dimensions M11x1mm connection ø 4mm		
accessories for	100705		
	GEV No.	520597	Ref. No. —
	hexagonal nut thread M11x1 H 4mm WS 17 brass Qty 1 pcs		

ignition cables

pre-assembled cables



GEV No.	100037	Ref. No.	08060601
description	ignition cable cable length 900mm connection F2.8mm / F2.8mm		



GEV No.	100019	Ref. No.	08061352
description	ignition cable cable length 900mm connection ø2.4mm / ø4mm		

piezoelectric igniters

mounting diameter 22mm



GEV No.	100013	Ref. No.	08061351
description	piezoelectric igniter body plastic blowing mounting ø 22mm connection ø2.4mm cable lengthmm		
accessories for	100013		
	GEV No.	100023	Ref. No. —
	female bullet size 2.3mm 0.5-1.5mm ² CuZn t.max. 125°C Qty 20 pcs		

thermocouples

plug-in thermocouples

plug-in thermocouples standard

with barrel socket ø6(6.5)mm

thermocouples SIT

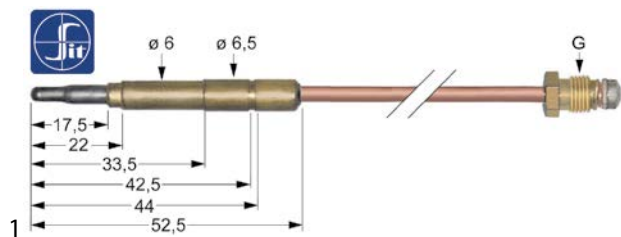

GEV No.	107611	Ref. No.	08090604
description	thermocouple SIT M9x1 L 850mm plug connection ø6.0(6.5)mm		

threaded thermocouples

threaded thermocouples standard

with socket with thread M8x1

SIT

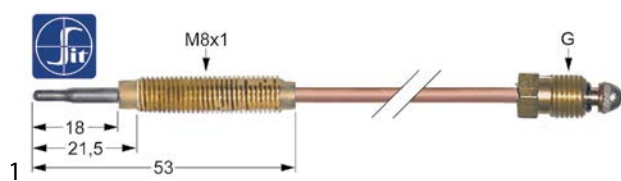

GEV No.	107630	Ref. No.	08090003
description	thermocouple SIT M8x1 L 600mm M8x1		
accessories for	107630		
	GEV No.	102067	Ref. No. —
	nut thread M8x1 H 3mm brass Qty 1 pcs type SEF 1		

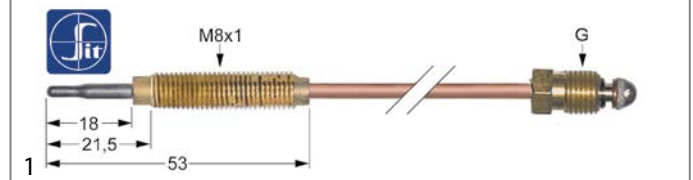

GEV No.	107637	Ref. No.	08090001
description	thermocouple SIT M9x1 L 850mm M8x1		
accessories for	107637		
	GEV No.	102067	Ref. No. —
	nut thread M8x1 H 3mm brass Qty 1 pcs type SEF 1		

ignition bridges



GEV No.	105960	Ref. No.	04030010 04360001
description	ignition bridge L 130mm		

gas burners

bar burners

bar burners



GEV No.	105958	Ref. No.	08CC0056
description	bar burner 2 row L 458mm W 200mm ømm H 60mm chargrill		





GEV No.	105956	Ref. No.	08CC0044
description	bar burner 3 row L 460mm W 285mm ømm H 60mm chargrill		





GEV No.	104182	Ref. No.	08111685
description	bar burner 3 row L 490mm W 270mm ømm H 150mm chargrill		





			
1			
GEV No.	105953	Ref. No.	08111361 08CC0005
description	bar burner 4 row L 400mm W 270mm ømm H 60mm chargrill		

			
1			
GEV No.	105957	Ref. No.	08CC0046
description	bar burner 4 row L 460mm W 460mm ømm chargrill		

			
1			
GEV No.	105954	Ref. No.	08111343 08CC0026
description	bar burner 5 row L 400mm W 370mm ømm H 60mm 22.5kW chargrill		

			
1			
GEV No.	105955	Ref. No.	08111328 08CC0013
description	bar burner 6 row L 500mm W 435mm ømm H 90mm chargrill		

			
1			
GEV No.	105964	Ref. No.	08CC0029
description	bar burner ømm W 40mm H 53mm L 1000mm chicken rotisserie		

			
1			
GEV No.	105963	Ref. No.	08CC0016
description	bar burner ømm W 40mm H 53mm L 700mm flange width 53mm flange length 70mm chicken rotisserie		

			
1			
GEV No.	211073	Ref. No.	14080036
description	chargrill grid L 530mm W 370mm fish		

			
1			
GEV No.	211072	Ref. No.	14080035
description	chargrill grid L 530mm W 370mm meat		

			
1			
GEV No.	211074	Ref. No.	14080054
description	chargrill grid L 530mm W 370mm universal		

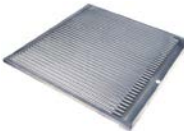
			
1			
GEV No.	211076	Ref. No.	14080025
description	chargrill grid L 550mm W 533mm fish		

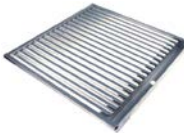
			
1			
GEV No.	211075	Ref. No.	14080022
description	chargrill grid L 550mm W 533mm meat		

			
1			
GEV No.	211077	Ref. No.	14080055
description	chargrill grid L 550mm W 533mm universal		

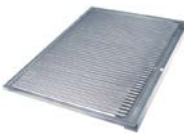
			
1			
GEV No.	211079	Ref. No.	14080032
description	chargrill grid L 700mm W 533mm fish		



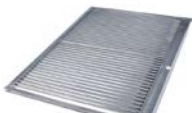

			
1			
GEV No.	211081	Ref. No.	14080033
description	chargrill grid L 700mm W 533mm fish/meat		

			
1			
GEV No.	211072	Ref. No.	14080035
description	chargrill grid L 530mm W 370mm meat		

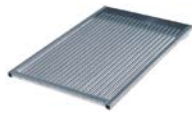
			
1			
GEV No.	211082	Ref. No.	14080070
description	chargrill grid L 700mm W 533mm fish/meat		

			
1			
GEV No.	211074	Ref. No.	14080054
description	chargrill grid L 530mm W 370mm universal		

			
1			
GEV No.	211078	Ref. No.	14080031
description	chargrill grid L 700mm W 533mm meat		

			
1			
GEV No.	211076	Ref. No.	14080025
description	chargrill grid L 550mm W 533mm fish		

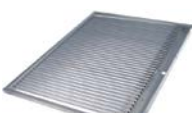
			
1			
GEV No.	211080	Ref. No.	14080056
description	chargrill grid L 700mm W 533mm universal		

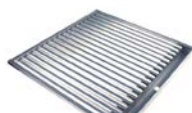
			
1			
GEV No.	211075	Ref. No.	14080022
description	chargrill grid L 550mm W 533mm meat		

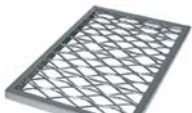
			
1			
GEV No.	211021	Ref. No.	14081897
description	lava rock grid L 425mm W 250mm		

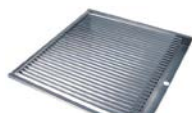
			
1			
GEV No.	211077	Ref. No.	14080055
description	chargrill grid L 550mm W 533mm universal		

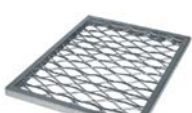
			
1			
GEV No.	211061	Ref. No.	14081834
description	lava rock grid L 426mm W 323mm		

			
1			
GEV No.	211079	Ref. No.	14080032
description	chargrill grid L 700mm W 533mm fish		

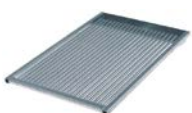
chargrill grids			
			
1			
GEV No.	211073	Ref. No.	14080036
description	chargrill grid L 530mm W 370mm fish		

			
1			
GEV No.	211081	Ref. No.	14080033
description	chargrill grid L 700mm W 533mm fish/meat		



			
1			
GEV No.	211082	Ref. No.	14080070
description	chargrill grid L 700mm W 533mm fish/meat		

			
1			
GEV No.	211078	Ref. No.	14080031
description	chargrill grid L 700mm W 533mm meat		

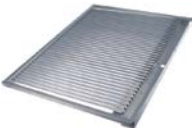
			
1			
GEV No.	211080	Ref. No.	14080056
description	chargrill grid L 700mm W 533mm universal		

lava rock grids			
			
1			
GEV No.	211021	Ref. No.	14081897
description	lava rock grid L 425mm W 250mm		

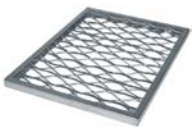
			
1			
GEV No.	211061	Ref. No.	14081834
description	lava rock grid L 426mm W 323mm		

ceramic burners

			
1			
GEV No.	105965	Ref. No.	08110012 08110016
description	ceramic burner L 220mm W 162mm firing range 182x133mm		

accessories

burner grids

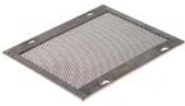
			
1			
GEV No.	850034	Ref. No.	04010089
description	burner grid L 239mm W 200mm		

			
1			
GEV No.	850035	Ref. No.	04010090
description	burner grid L 465mm W 200mm		

			
1			
GEV No.	850036	Ref. No.	04010091
description	burner grid L 520mm W 250mm		

			
1			
GEV No.	850037	Ref. No.	04010092
description	burner grid L 690mm W 250mm		

accessories

nozzle holders

			
1			
GEV No.	104183	Ref. No.	08100003
description	nozzle holder nozzle mounting M9x1 tube ø 12mm gas inlet M20x1.5 gas outlet M14x1		



			
1			
GEV No.	105959	Ref. No.	08100001
description	nozzle holder nozzle mounting M9x1 tube ø 12mm gas inlet M20x1.5 gas outlet M14x1		
accessories for	105959		
	GEV No.	100508	Ref. No. —
gas injector thread M9x1 WS 10 bore ø 1.45mm			

Table continues overleaf





accessories for	105959			
	GEV No.	100514	Ref. No.	—
	gas injector thread M9x1 WS 10 bore ø 2.35mm			

gas nozzles

main nozzles

gas nozzles M9x1

	1		
GEV No.	100511	Ref. No.	08050030
description	gas injector thread M9x1 WS 10 bore ø 1.9mm		

	1		
GEV No.	106881	Ref. No.	08051811
description	gas injector thread M9x1 WS 10 bore ø 2.1mm		

	1		
GEV No.	100512	Ref. No.	08052140
description	gas injector thread M9x1 WS 10 bore ø 2mm		

pilot burner nozzles

pilot burner nozzles SIT

100 series

	1		
GEV No.	107171	Ref. No.	08120048
description	pilot burner nozzle SIT natural/liquid gas bore ø 0.25mm Qty 1 pcs		

equipment-specific units

for gyros grills

brakes

	1		
GEV No.	693613	Ref. No.	04040362
description	locking lever for gyros grill motor		

	1		
GEV No.	693614	Ref. No.	04040365
description	set screw for gyro grill		

	1		
GEV No.	693612	Ref. No.	04040366
description	slide for gyro grill mounting pos. upper		

skewers

	1		
GEV No.	693620	Ref. No.	04450003
description	skewer for gyro grill size 12x12mm L 380mm		

	1		
GEV No.	693615	Ref. No.	04010061
description	skewer for gyro grill size 12x12mm L 450mm		

	1		
GEV No.	693622	Ref. No.	04450002
description	skewer for gyro grill size 12x12mm L 635mm		

	1		
GEV No.	693616	Ref. No.	04010062
description	skewer for gyro grill size 12x12mm L 645mm		

	1		
GEV No.	693617	Ref. No.	04010063
description	skewer for gyro grill size 12x12mm L 700mm		

	1		
GEV No.	693618	Ref. No.	04010065
description	skewer for gyro grill size 12x12mm L 880mm		

	1		
GEV No.	693709	Ref. No.	04450001
description	skewer for gyro grills L 890mm		

skewer plates



1

GEV No.	693621	Ref. No.	04040421
description	skewer plate ø 140mm intake for skewer 12x12mm for gyro grill		



1

GEV No.	693619	Ref. No.	04040363
description	skewer plate ø 200mm intake for skewer 12x12mm for gyro grill		

cotter pins



1

GEV No.	693457	Ref. No.	03071912
description	retainer clip L 73mm wire gauge ø 3mm zinc-coated steel Qty 1 pcs		

miscellaneous



1

GEV No.	693844	Ref. No.	04040668
description	skewer intake counterpart		

for chicken rotisserie

motors



1

GEV No.	693608	Ref. No.	13010003 (old version)
description	gearbox transmission 1/784 type CRMI 28/40		



1

GEV No.	694828	Ref. No.	13010003
description	gearbox transmission 1/800 type BSK 30/40		



1

GEV No.	500875	Ref. No.	07011238
description	motor 90W 230/400V 50Hz 3 phase shaft ø 9mm flange ø 120mm 1400rpm type M56B4 ø 110mm H 160mm L 170mm CARPANELLI 0.09kW		

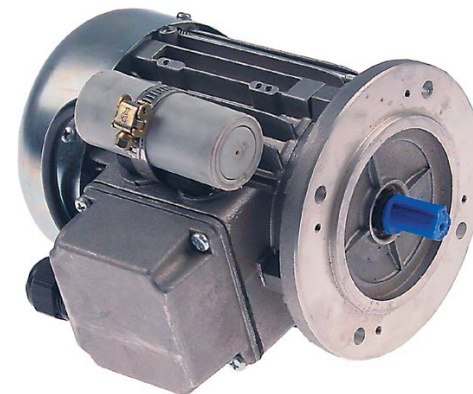

1

GEV No.	500874	Ref. No.	07010635
description	motor 90W 230V 50Hz 1 phase shaft ø 9mm flange ø 120mm 1300rpm type MM56 ø 110mm H 160mm L 170mm 0.09kW		



firebricks



1			
GEV No.	850099	Ref. No.	05050693
description	firebrick L 380mm W 100mm curved delivery freight forwarding company only		



1			
GEV No.	850098	Ref. No.	05050581
description	firebrick L 385mm W 100mm straight delivery freight forwarding company only		

skewer intakes



1			
GEV No.	693600	Ref. No.	04CC0012
description	skewer intake		



1			
GEV No.	693601	Ref. No.	04010647
description	skewer intake mounting pos. engine side		

skewers



1			
GEV No.	693603	Ref. No.	04040659
description	skewer for chicken rotisserie L 695mm thickness 10x10mm shaft intake ø 9x35mm stainless steel		

1			
GEV No.	693602	Ref. No.	04040535
description	skewer for chicken rotisserie L 715mm		
accessories for	693602		
	GEV No.	693605	Ref. No. 01080017
	skewer clamp double inner		
	GEV No.	693606	Ref. No. 01080018
	skewer clamp single end connector with screw connection		
	GEV No.	693607	Ref. No. 03010062
	thumbscrew thread M6 thread L 20mm		

1			
GEV No.	693604	Ref. No.	04040903
description	skewer for chicken rotisserie L 985mm size 10x10		

spit clamp



1			
GEV No.	693605	Ref. No.	01080017
description	skewer clamp double inner		



1			
GEV No.	693606	Ref. No.	01080018
description	skewer clamp single end connector with screw connection		
accessories for	693606		
	GEV No.	693607	Ref. No. 03010062
	thumbscrew thread M6 thread L 20mm		

doors



1

GEV No.	697895	Ref. No.	02010558
description	door for chicken rotisserie L 740mm W 270mm thickness 5mm		

miscellaneous



1

GEV No.	697893	Ref. No.	02030001
description	protector for quartz lamp L 290mm W 30mm H 14.5mm		

for hot dog machines

lids



1

GEV No.	693719	Ref. No.	10041259
description	lid		

glass cylinders



1

GEV No.	693067	Ref. No.	02031257
description	glass cylinder ø 200mm H 204mm		

skewers



1

GEV No.	693065	Ref. No.	04040164
description	bun spikes hot dog grill		

water containers



1

GEV No.	693068	Ref. No.	10041256
description	water container for hot dog machine		

for rolling grills

pipes

pipes



1

GEV No.	693713	Ref. No.	14081043
description	pipe with gear wheel L 370mm for roller grill		



1

GEV No.	693714	Ref. No.	14081073
description	pipe with gear wheel L 477mm for roller grill		

gear wheels



1

GEV No.	693718	Ref. No.	04010500
description	sprocket-wheel DIN/ISO 05 B-1 splitting 8mm teeth 16 shaft intake ø 8mm H 14mm		

knobs

universal knobs



1

GEV No.	111533	Ref. No.	10010030
description	knob thermostat t.max. 500°C ø 50mm shaft ø 6x4.6mm shaft flat upper black temperature range 0-500°C rotation 270°		
accessories for	111533		
	GEV No.	110135	Ref. No. —
	rosette knob up to ø 52mm		

producer-specific knobs

CB



1

GEV No.	112028	Ref. No.	10010016
description	knob gas tap without ignition flame ø 42mm shaft ø 8x6.5mm shaft flat lower black		



1

GEV No.	112725	Ref. No.	10010016
description	knob gas tap without ignition flame t.max.°C°C ø 42mm shaft ø 8x6.5mm shaft flat lower black		



1

GEV No.	111012	Ref. No.	07110149 10010017
description	knob switch zero mark t.max.°C°C ø 34/60mm shaft ø 5x5mm shaft flat black H 22mm L 50mm		



1

GEV No.	112027	Ref. No.	10010012
description	knob switch zero mark t.max.°C°C ø 39mm shaft ø 6x4.6mm shaft flat upper black		



1

GEV No.	111533	Ref. No.	10010030
description	knob thermostat t.max. 500°C ø 50mm shaft ø 6x4.6mm shaft flat upper black temperature range 0-500°C rotation 270°		
accessories for	111533		
	GEV No.	110135	Ref. No. —
	rosette knob up to ø 52mm		



1

GEV No.	112029	Ref. No.	10011049
description	knob zero mark ø 40mm shaft ø 6x4.6mm shaft flat lower black		



1

GEV No.	112713	Ref. No.	10010042
description	knob zero mark t.max.°C°C ø 40mm shaft ø 6x4.6mm shaft flat lower red		

handles and hand wheels

handle bars

handle bars



1	GEV No.	690972	Ref. No.	04290001
	description	handle rod thickness 1mm L 382mm SS ø 20mm		



1	GEV No.	690973	Ref. No.	04290002
	description	handle rod tube ø 20mm thickness 1mm L 631mm SS		

consoles



1	GEV No.	693611	Ref. No.	05010006
	description	console for handle rod tube ø 20mm		
	For models:	EVF2, EVF3		

bracket handles



1	GEV No.	693609	Ref. No.	10010009 10CC0001
	description	pull handle L 149mm H 55mm mounting distance 129mm		

miscellaneous



1	GEV No.	693712	Ref. No.	01220104
	description	handle L 298mm		

locks

snap locks

universal



1	GEV No.	700602	Ref. No.	10060009
	description	snap lock L 61mm W 16mm		

miscellaneous



1	GEV No.	700603	Ref. No.	04040597
	description	support bracket for snap lock		

hinges

door bearing



1	GEV No.	693711	Ref. No.	04040596
	description	hinge mounting pos. lower		

1

GEV No.	693710	Ref. No.	04040595
description	hinge mounting pos. upper		



1

GEV No.	693610	Ref. No.	04040008
description	hinge universal		

baskets

wire baskets for hot dog machines



1

GEV No.	693720	Ref. No.	10041258
description	grid basket for hot dog grill ϕ 180mm H 95mm		

gaskets

gaskets for heated units

window seals

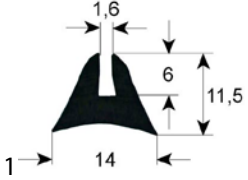

1

GEV No.	900576	Ref. No.	05020017
description	window gasket profile 1655 L 1310mm Qty 1		

door seals with fixing hook



1

GEV No.	901317	Ref. No.	05020025
description	door seal L 620mm W 380mm with 6 mounting clips		



1

GEV No.	900604	Ref. No.	05020016
description	oven gasket L 420mm W 330mm with 4 mounting clips external size		

transmission technology and ball bearings

ball bearings

deep-groove ball bearings 2Z



1

GEV No.	523539	Ref. No.	03050662
description	deep-groove ball bearing shaft ϕ 20mm ED ϕ 47mm W 14mm type 6204-2Z DIN 625-1		



1

GEV No.	523540	Ref. No.	03050661
description	deep-groove ball bearing shaft ϕ 25mm ED ϕ 52mm W 15mm type 6205-2Z DIN 625-1		

deep-groove ball bearings Z



GEV No.	523020	Ref. No.	03050626
description	deep-groove ball bearing type 6001-Z shaft ø 12mm ED ø 28mm W 8mm with special grease DIN 625-1		

chains

roller chains 05B-1 single



GEV No.	693715	Ref. No.	13031045
description	chain DIN/ISO 05 B-1 splitting 8mm links 32 internal width 3mm rollerø 5mm single		



GEV No.	693716	Ref. No.	13031068
description	chain DIN/ISO 05 B-1 splitting 8mm links 41 internal width 3mm rollerø 5mm single		



GEV No.	693717	Ref. No.	13031085
description	chain DIN/ISO 05 B-1 splitting 8mm links 50 internal width 3mm rollerø 5mm single		

springs

compression springs



GEV No.	693723	Ref. No.	03071255
description	compression spring ø 25mm L 45mm wire gauge ø 1.2mm		

gas tension springs

gas tension springs



GEV No.	700586	Ref. No.	10080005
description	gas tension spring N hub 122mm D1 ø 15.1mm D2 ø 6mm hole distance 318mm hole ømm L 325mm		

fastening material

screws

thumbscrews



GEV No.	693607	Ref. No.	03010062
description	thumbscrew thread M6 thread L 20mm		
For models:	EVF2, EVF3		

fasteners

retainer clips



GEV No.	693457	Ref. No.	03071912
description	retainer clip L 73mm wire gauge ø 3mm zinc-coated steel Qty 1 pcs		

retaining rings

DIN 471



GEV No.	693061	Ref. No.	03041051
description	retaining ring shaft ø 25mm thickness 1.2mm steel DIN 471		

DIN 472



GEV No.	523106	Ref. No.	03040625
description	retaining ring bore ø 28mm thickness 1.3mm steel DIN 472		

B			
ballasts	10		
bar burners	19		
C			
cam switches	8		
ceramic burners	22		
ceramic heaters	5		
contactors	11		
control thermostats	7		
cross flow fans	14		
D			
digital timers	11		
door seals with fixing hook	29		
E			
electric accessories	16		
electronic controllers	12		
energy regulators	7		
F			
fans	14		
fasteners	30		
fastening material	30		
fluorescent lamps	9, 9		
G			
gas burners	19		
gas nozzles	23		
gas taps	16		
gaskets for heated units	29		
H			
halogen lamp	9		
heater battery	5		
heating cartridges	5		
heating elements	3		
heating elements for convection	6		
heating elements for heating bridges	5		
heating elements for ovens	3		
heating elements for pizza ovens	3		
hot air fans	14		
hot plates	7		
I			
ignition bridges	19		
ignition cables	18		
indicator lights	9		
indicator lights (complete)	9		
infrared lamps	9		
L			
lamps	9		
light bulbs	9		
linear lamps	9		
M			
mechanical timers	11		
motors	15		
O			
oven lamps	10		
P			
piezoelectric igniters	19		
pilot burners	17		
plugs - couplings - power sockets	16		
probes	13		
programme timers	11		
protective contact power sockets	16		
Q			
quartz heating elements	6		
R			
relays	12		
retainer clips	30		
retaining rings	30		
rocker/momentary rocker switches	8		
rotary switches	8		
S			
safety thermostats	8, 8		
screws	30		
snap locks	28		
solenoid valves	14		
starter	10		
switches and momentary switches	8		
T			
temperature probes	13		
thermocouples	19		
thermostats	7		
thumbscrews	30		
timers	11		
transformers	12		
U			
universal probes	13		
W			
window seals	29		