



**GAS COMPONENTS**



**ELECTRIC COMPONENTS**



**WATER TECHNOLOGY**



**MECHANICAL COMPONENTS**



**TOOLS**

Spare parts suitable for

**CF-CENEDESE**

Find the complete and up-to-date range of products in our GEV Webshop



# Manufacturer catalogue

The most important spare parts and accessories arranged clearly for every manufacturer

- ✓ Complete product range and all appliance data always up to date in the GEV Webshop
- ✓ Alphabetical Index at the end of the catalogue

## GEV Webshop

[www.gev-online.co.uk](http://www.gev-online.co.uk)

[www.gev-online.com](http://www.gev-online.com)



- 🔍 Add to Favourites
- 🔍 Sign In with email address and usual password
- 🔍 Easy-order – place several items in your basket at the same time
- 🔍 Quick Item search – no login needed





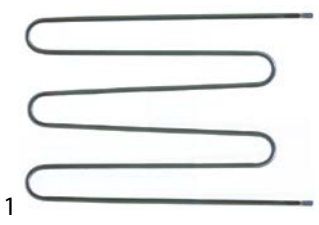

## heating elements

### heating elements for bain maries

			
<b>GEV No.</b>	416194	<b>Ref. No.</b>	63.7.1052
<b>description</b>	heating element 1189W 230V heating circuits 1 L 278mm W 150mm connection male faston 6.3mm tube ø 6.3mm 2 hole fixing thread 1/8" immersion heater/dry heating element L1 135mm L2 143mm H 22mm mounting distance 144mm		
<b>For models:</b>	BM23		







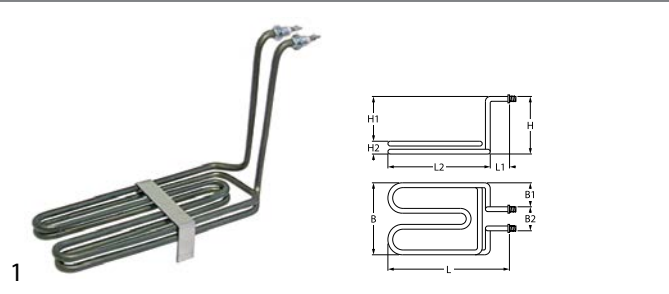

			
<b>GEV No.</b>	416195	<b>Ref. No.</b>	63.7.1023
<b>description</b>	heating element 1500W 230V heating circuits 1 L 368mm L1 23mm W 268mm connection male faston 6.3mm connection distance 263mm tube ø 6.3mm dry heating element bain marie L2 345mm H 19mm		

			
<b>GEV No.</b>	416193	<b>Ref. No.</b>	63.7.1051
<b>description</b>	heating element 823W 230V heating circuits 1 L 280mm W 106mm connection male faston 6.3mm tube ø 6.3mm 2 hole fixing thread M10x1 dry heating element bain marie L1 135mm L2 145mm W1 27mm W2 105mm H 18mm mounting distance 100mm		
<b>For models:</b>	BM11, BM12, BM13		
<b>accessories for</b>	416193		
	<b>GEV No.</b>	510416	<b>Ref. No.</b> —
	flat gasket fibre ED ø 19mm ID ø 10.5mm thickness 1.5mm for thread M10 Qty 1 pcs		
	<b>GEV No.</b>	510893	<b>Ref. No.</b> —
	O-ring EPDM thickness 2.62mm ID ø 9.92mm Qty 1 pcs		
	<b>GEV No.</b>	520231	<b>Ref. No.</b> —
	nut thread M10x1 H 6mm WS 14 zinc-coated steel Qty 1 pcs		
	<b>GEV No.</b>	521129	<b>Ref. No.</b> —
	nut thread M10 H 6mm SS WS 17 Qty 1 pcs DIN/ISO DIN 439		

### heating elements for fryers

#### 2 hole fixing



			
<b>GEV No.</b>	415721	<b>Ref. No.</b>	63.7.1064
<b>description</b>	heating element 2100W 230V heating circuits 1 L 292mm W 107mm H 200mm 2 hole fixing connection M4 fryer heaters L1 25mm L2 267mm W1 21mm W2 65mm H1 162mm H2 38mm tube ø 8.5mm thread 1/4" mounting distance 99mm connection length 23mm		
<b>For models:</b>	FE04, FE44		
<b>accessories for</b>	415721		
	<b>GEV No.</b>	361182	<b>Ref. No.</b> —
	nut thread 1/4" H 5mm nickel-plated brass WS 17 Qty 1 pcs		
	<b>GEV No.</b>	510417	<b>Ref. No.</b> —
	flat gasket fibre ED ø 20mm ID ø 14mm thickness 2mm Qty 1 pcs		
	<b>GEV No.</b>	520228	<b>Ref. No.</b> —
	tooth lock washer ID ø 15.3mm ED ø 24mm steel Qty 1 pcs for thread M14		
	<b>GEV No.</b>	521103	<b>Ref. No.</b> —
	nut thread M4 H 3mm WS 7 brass Qty 20 pcs		
	<b>GEV No.</b>	521104	<b>Ref. No.</b> —
	washer ID ø 4.3mm ED ø 8mm thickness 0.5mm brass Qty 20 pcs for thread M4		
	<b>GEV No.</b>	550262	<b>Ref. No.</b> —
	flat gasket copper ED ø 20mm ID ø 14mm thickness 2mm		
	<b>GEV No.</b>	560111	<b>Ref. No.</b> —
	plain washer ID ø 4.3mm ED ø 9mm thickness 0.8mm SS Qty 20 pcs DIN 125A for thread M4		
	<b>GEV No.</b>	560131	<b>Ref. No.</b> —
	hexagonal nut thread M4 H 3.2mm WS 7 SS DIN/ISO DIN 934 / ISO 4032/8673 Qty 20 pcs		

1 electric components

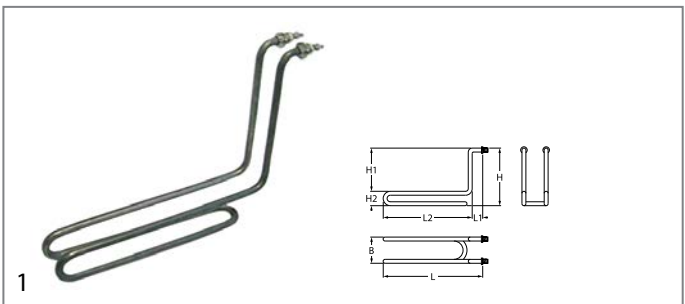

<b>GEV No.</b>	415720	<b>Ref. No.</b>	63.7.1068
<b>description</b>	heating element 1400W 230V heating circuits 1 L 275mm W 40mm H 210mm L1 15mm L2 260mm H1 165mm H2 45mm thread 1/4" mounting distance 32mm tube ø 8.5mm 2 hole fixing connection M4 fryer heaters windings 2		
<b>For models:</b>	FE07T, FE77T		
<b>accessories for</b>	415720		
	<b>GEV No.</b>	361182	<b>Ref. No.</b> —
	nut thread 1/4" H 5mm nickel-plated brass WS 17 Qty 1 pcs		
	<b>GEV No.</b>	510417	<b>Ref. No.</b> —
	flat gasket fibre ED ø 20mm ID ø 14mm thickness 2mm Qty 1 pcs		
	<b>GEV No.</b>	520228	<b>Ref. No.</b> —
	tooth lock washer ID ø 15.3mm ED ø 24mm steel Qty 1 pcs for thread M14		
	<b>GEV No.</b>	521103	<b>Ref. No.</b> —
	nut thread M4 H 3mm WS 7 brass Qty 20 pcs		
	<b>GEV No.</b>	521104	<b>Ref. No.</b> —
	washer ID ø 4.3mm ED ø 8mm thickness 0.5mm brass Qty 20 pcs for thread M4		
	<b>GEV No.</b>	550262	<b>Ref. No.</b> —
	flat gasket copper ED ø 20mm ID ø 14mm thickness 2mm		
	<b>GEV No.</b>	560111	<b>Ref. No.</b> —
	plain washer ID ø 4.3mm ED ø 9mm thickness 0.8mm SS Qty 20 pcs DIN 125A for thread M4		
	<b>GEV No.</b>	560131	<b>Ref. No.</b> —
	hexagonal nut thread M4 H 3.2mm WS 7 SS DIN/ISO DIN 934 / ISO 4032/8673 Qty 20 pcs		

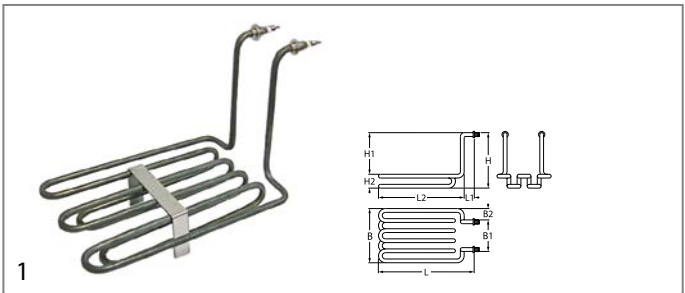

<b>GEV No.</b>	415722	<b>Ref. No.</b>	63.7.1067
<b>description</b>	heating element 3000W 230V heating circuits 1 L 280mm W 180mm H 200mm L1 25mm L2 255mm H1 160mm H2 40mm thread 1/4" mounting distance 76mm tube ø 8.5mm 2 hole fixing connection M4 connection length 28mm fryer heaters windings 6 W1 45mm W2 85mm		
<b>For models:</b>	FE07, FE77		
<b>spare parts for</b>	415722		
	<b>GEV No.</b>	510417	<b>Ref. No.</b> —
	flat gasket fibre ED ø 20mm ID ø 14mm thickness 2mm Qty 1 pcs		

<b>accessories for</b>	415722		
	<b>GEV No.</b>	521103	<b>Ref. No.</b> —
	nut thread M4 H 3mm WS 7 brass Qty 20 pcs		
	<b>GEV No.</b>	521104	<b>Ref. No.</b> —
	washer ID ø 4.3mm ED ø 8mm thickness 0.5mm brass Qty 20 pcs for thread M4		
	<b>GEV No.</b>	560111	<b>Ref. No.</b> —
	plain washer ID ø 4.3mm ED ø 9mm thickness 0.8mm SS Qty 20 pcs DIN 125A for thread M4		
	<b>GEV No.</b>	560131	<b>Ref. No.</b> —
	hexagonal nut thread M4 H 3.2mm WS 7 SS DIN/ISO DIN 934 / ISO 4032/8673 Qty 20 pcs		

heating elements for hot counters

	<b>GEV No.</b>	415699	<b>Ref. No.</b>	63.7.1090
<b>description</b>	heating element 400W 230V heating circuits 1 L 298mm W 138mm tube ø 6.3mm connection male faston 6.3mm dry heating element for vitrine 2 hole fixing thread M12x1.25 mounting distance 132mm			
<b>For models:</b>	VEC 10, VEC 20, VEC 510, VEC 520			

	<b>GEV No.</b>	417667	<b>Ref. No.</b>	63.7.1026
<b>description</b>	heating element 450W 230V heating circuits 1 L 188mm W 280mm tube ø 6.5mm			



heating elements for refrigeration

condensing trays heated



	<b>GEV No.</b>	750003	<b>Ref. No.</b>	750003
<b>description</b>	condensing tray heated L 240mm W 240mm H 75mm 230V 650W connect with power contactor			
<b>spare parts for</b>	750003			
	<b>GEV No.</b>	348139	<b>Ref. No.</b>	—
	float switch 250V 1A 1NO or 1NC thread M16x1.5 ø 17.4mm L 100.5mm mounting ø 28mm cable length 1500mm temp.-resist. -20 up to +90°C			

Table continues overleaf



<b>spare parts for</b> 750003	
	GEV No. 418732 Ref. No. — heating element 650W 230V L 280mm W 95mm H 87mm L1 65mm L2 215mm cable length 1500mm connection distance 86mm tube ø 8.5mm heating circuits 1 immersion heater
<b>accessories for</b> 750003	
	GEV No. 380185 Ref. No. — power relays Italiana Relè 230VAC 30A 1NO connection F6.3 bracket mounting dimensions 36.5x32.2x51.8mm manuf. no. A10-230AC-FA



<b>GEV No.</b> 750004	<b>Ref. No.</b> 750004
<b>description</b>	condensing tray heated L 380mm W 240mm H 75mm 230V 750W with float switch
<b>spare parts for</b> 750004	
	GEV No. 348139 Ref. No. — float switch 250V 1A 1NO or 1NC thread M16x1.5 ø 17.4mm L 100.5mm mounting ø 28mm cable cable length 1500mm temp.-resist. -20 up to +90°C
	GEV No. 418733 Ref. No. — heating element 750W 230V L 430mm W 95mm H 98mm L1 85mm L2 345mm cable length 1500mm connection cable connection distance 86mm tube ø 8.5mm heating circuits 1 immersion heater
<b>accessories for</b> 750004	
	GEV No. 380185 Ref. No. — power relays Italiana Relè 230VAC 30A 1NO connection F6.3 bracket mounting dimensions 36.5x32.2x51.8mm manuf. no. A10-230AC-FA



<b>GEV No.</b> 415726	<b>Ref. No.</b> 63.7.1012
<b>description</b>	heating element 750W 230V L 180mm W 170mm H 18mm W1 45mm W2 80mm connection length 26mm tube ø 6.3mm windings 3 connection M4 dry heating element
<b>For models:</b>	PD 1020 L, PD 1020 M, PD 1020 R, PD 2020 L, PD 2020 M, PD 2020 R, PS 1010 L, PS 1010 R, PS 2010 L, PS 2010 LB, PS 2010 R, PS 2010 RB



<b>GEV No.</b> 415727	<b>Ref. No.</b> 63.7.1011
<b>description</b>	heating element 900W 230V L 180mm W 175mm H 15mm W1 42mm W2 91mm connection length 24mm tube ø 6.3mm windings 3 connection M4 dry heating element
<b>For models:</b>	PD 1020 L, PD 1020 LB, PD 1020 M, PD 1020 MB, PD 1020 R, PD 1020 RB, PD 2020 L, PD 2020 LB, PD 2020 M, PD 2020 MB, PD 2020 R, PD 2020 RB, PS 1010 L, PS 1010 LB, PS 1010 R, PS 1010 RB, PS 2010 L, PS 2010 LB, PS 2010 R, PS 2010 RB

heating elements for contact grills

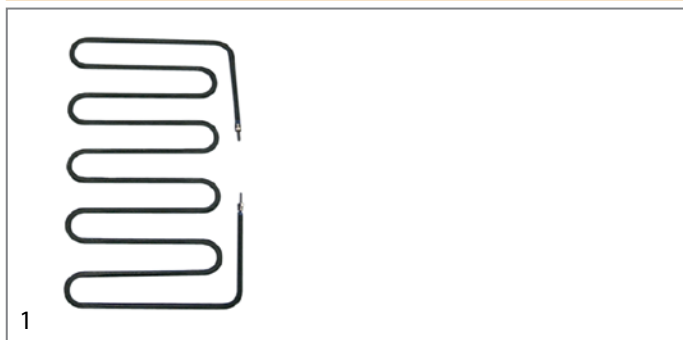

<b>GEV No.</b> 415724	<b>Ref. No.</b> 63.7.1015
<b>description</b>	heating element 1200W 230V L 192mm W 305mm H 10mm W1 102mm W2 100mm tube ø 6mm windings 5 connection M4 dry heating element
<b>For models:</b>	B800E, PM 1015 L, PM 1015 LB, PM 1015 R, PM 1015 RB, PM 2015 L, PM 2015 LB, PM 2015 R, PM 2015 RB

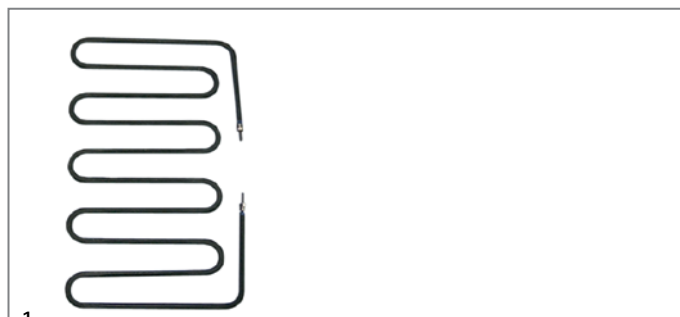

<b>GEV No.</b> 415725	<b>Ref. No.</b> 63.7.1016
<b>description</b>	heating element 900W 230V L 194mm W 300mm H 17mm W1 100mm W2 100mm connection length 25mm tube ø 6.3mm windings 5 connection M4 dry heating element
<b>For models:</b>	PM 1015 L, PM 1015 R, PM 2015 L, PM 2015 R



## heating elements for pizza ovens

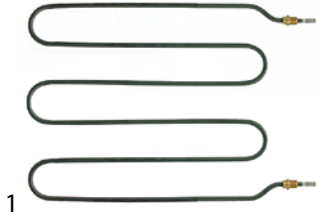

<b>GEV No.</b>	416188	<b>Ref. No.</b>	63.7.1088
<b>description</b>	heating element 800W 230V L 365mm W 290mm L1 30mm L2 40mm L3 295mm W1 18mm W2 254mm thread 1/4" mounting distance 246mm connection length 33mm connection male faston 6.3mm windings 3 tube ø 6.3mm heating circuits 1 dry heating element 2 hole fixing		
<b>For models:</b>	FP36, FP36R, FP66R		
<b>spare parts for</b>	416188		
	<b>GEV No.</b>	361182	<b>Ref. No.</b> —
	nut thread 1/4" H 5mm nickel-plated brass WS 17 Qty 1 pcs		

## heating elements for rolling grills



<b>GEV No.</b>	416189	<b>Ref. No.</b>	63.7.1081 63.7.1098
<b>description</b>	heating element 220W 240V heating circuits 1 L 359mm connection distance 359mm tube ø 8.5mm dry heating element roller grill		
<b>For models:</b>	CW6, CW8		

## heating elements for salamanders/toast-

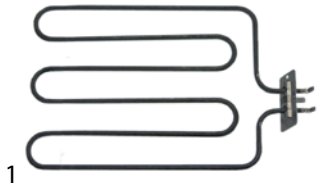

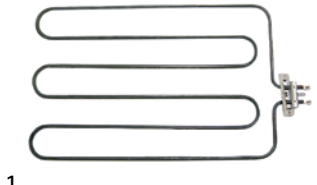

<b>GEV No.</b>	415723	<b>Ref. No.</b>	63.7.1022
<b>description</b>	heating element 1900W 230V L 305mm W 260mm L1 25mm L2 280mm W1 90mm W2 30mm hole distance 60mm connection male faston 6.3mm tube ø 6.3mm flange length 70mm flange width 36mm heating circuits 1 hole ø 4.9mm tilt flange dry heating element H 6.3mm		
<b>For models:</b>	SE2, SE2M		



<b>GEV No.</b>	415757	<b>Ref. No.</b>	63.7.1021
<b>description</b>	heating element 2400W 230V L 425mm W 260mm L1 25mm L2 400mm W1 90mm W2 30mm hole distance 60mm connection male faston 6.3mm tube ø 6.3mm flange length 70mm flange width 36mm heating circuits 1 hole ø 5mm tilt flange dry heating element		
<b>For models:</b>	SE1, SE1M		



<b>GEV No.</b>	415698	<b>Ref. No.</b>	63.7.1093
<b>description</b>	heating element 1000W 230V L 330mm W 140mm 2 hole fixing thread M12x1.25 mounting distance 133mm connection male faston 6.3mm dry heating element tube ø 6.3mm heating circuits 1 connection length 33mm H 6.3mm		
<b>For models:</b>	SEPC, T930, T960		
<b>spare parts for</b>	415698		
	<b>GEV No.</b>	521110	<b>Ref. No.</b> —
	flat gasket fibre ED ø 20mm ID ø 13mm thickness 2mm Qty 1 pcs		
<b>accessories for</b>	415698		
	<b>GEV No.</b>	550681	<b>Ref. No.</b> —
	nut thread M12x1.25 H 5mm WS 17 brass Qty 1 pcs		

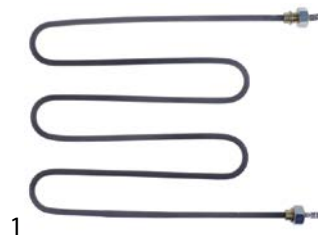

<b>GEV No.</b>	416199	<b>Ref. No.</b>	63.7.1083
<b>description</b>	heating element 1600W 230V L 270mm W 210mm 2 hole fixing thread M12x1.5 mounting distance 204mm connection male faston 6.3mm dry heating element tube ø 6.3mm heating circuits 1		
<b>For models:</b>	B830, B840, B860, B870		

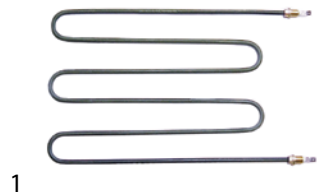

<b>GEV No.</b>	415694	<b>Ref. No.</b>	63.7.1084
<b>description</b>	heating element 2000W 230V L 350mm W 205mm 2 hole fixing thread M12x1.25 mounting distance 198mm connection male faston dry heating element tube ø 6.3mm heating circuits 1 connection length 33mm H 6.3mm		
<b>For models:</b>	B800E, B840, SEP, SEPC		

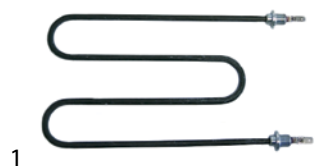

<b>GEV No.</b>	415697	<b>Ref. No.</b>	63.7.1092
<b>description</b>	heating element 800W 230V L 225mm W 135mm 2 hole fixing thread M12x1 mounting distance 128mm connection male faston 6.3mm dry heating element tube ø 6.3mm heating circuits 1 H 6.3mm		
<b>For models:</b>	T920, T940		





heating cartridges

			
1			
<b>GEV No.</b>	416190	<b>Ref. No.</b>	63.7.1040
<b>description</b>	heating cartridge 80W 230V ø 24mm L 102mm cable length 345mm dry heating element		
<b>For models:</b>	HD20, HD40, PT40, PT60		

quartz heating elements

			
1			
<b>GEV No.</b>	693058	<b>Ref. No.</b>	63.7.0002
<b>description</b>	insulator female L 7mm hole ø 5.5mm ø 13mm		

			
1			
<b>GEV No.</b>	419205	<b>Ref. No.</b>	63.7.1097
<b>description</b>	quartz heating element 300W 115V L 360mm ø 11.5mm connection male faston 6.3mm		

			
1			
<b>GEV No.</b>	416187	<b>Ref. No.</b>	63.7.1094
<b>description</b>	quartz heating element 400W 115V L 260mm ø 12mm connection male faston 6.3mm mounting distance 24.8mm		
<b>For models:</b>	SEPC, T920, T940		

			
1			
<b>GEV No.</b>	419204	<b>Ref. No.</b>	63.7.1095
<b>description</b>	quartz heating element 500W 115V L 360mm ø 11.5mm connection male faston 6.3mm		
<b>For models:</b>	T930, T960		

			
1			
<b>GEV No.</b>	415312	<b>Ref. No.</b>	63.7.1094 old version
<b>description</b>	quartz heating element L 285mm ø 11.5mm 800W 230V W 130mm connection eye double		

radiation heaters

square

			
1			
<b>GEV No.</b>	416192	<b>Ref. No.</b>	63.7.1100
<b>description</b>	radiation heater L 225mm W 225mm 750W 230V heating circuits 1 connections 2 square		
<b>For models:</b>	PDV 3020 L, PDV 3020 R, PDV-3020-McDonalds, PSV 3010 L, PSV 3010 R		

accessories

			
1			
<b>GEV No.</b>	693058	<b>Ref. No.</b>	63.7.0002
<b>description</b>	insulator female L 7mm hole ø 5.5mm ø 13mm		

			
1			
<b>GEV No.</b>	693057	<b>Ref. No.</b>	63.7.0001
<b>description</b>	insulator male L 10mm hole ø 8.4mm ø 13mm		

hot plates

round

with radiused edge

for domestic and commercial kitchens

			
1			
<b>GEV No.</b>	416191	<b>Ref. No.</b>	63.7.1030
<b>description</b>	hot plate ø 90mm 450W 230V connection 3 screw clamps with 8mm spill ring		
<b>For models:</b>	HD20, HD40		



## energy regulators

## EGO

## 1-circuit



<b>GEV No.</b>	380015	<b>Ref. No.</b>	63.7.0601
<b>description</b>	energy regulator 230V 13A single-circuit turn direction right shaft ø 6x4.6mm shaft L 23mm mounting thread M4 power release 6-100% no. 50.57021.010		
<b>For models:</b>	CW6, CW8, HD20, HD40, SE1, SE1M, SEP, SEPC, TN30 PLUS		

## accessories

## knobs



<b>GEV No.</b>	110075	<b>Ref. No.</b>	63.7.0280
<b>description</b>	knob energy regulator 1-3 t.max.°C ø 50mm shaft ø 6x4.6mm shaft flat upper black		
<b>For models:</b>	SE1, SE1M		

accessories for 110075



<b>GEV No.</b>	110135	<b>Ref. No.</b>	—
<b>description</b>	rosette knob up to ø 52mm		

## thermostats

## bi-metal thermostats

## safety bi-metal thermostats



<b>GEV No.</b>	390026	<b>Ref. No.</b>	63.7.0670
<b>description</b>	bi-metal safety thermostat hole distancemm switch-off temp. 70°C 1NC 1-pole 16A connection F6.3 M4		

## bi-metal thermostats



<b>GEV No.</b>	390850	<b>Ref. No.</b>	63.7.0680
<b>description</b>	bi-metal thermostat hole distancemm switch-off temp. 250°C 1NC 1-pole 10A 250V connection F6.3 1 hole fixing for contact grill		
<b>For models:</b>	PDV-3020-McDonalds		

## control and safety thermostats

## EGO

## control thermostats

## 55.10/19\_ series



<b>GEV No.</b>	375232	<b>Ref. No.</b>	63.7.0635
<b>description</b>	thermostat t.max. 320°C temperature range 55-320°C 1-pole capillary pipe isolatedmm gland nut		
<b>For models:</b>	FP36, FP36R, FP66R		

## safety thermostats

## 56.\_ series



<b>GEV No.</b>	390610	<b>Ref. No.</b>	63.7.0632
<b>description</b>	safety thermostat switch-off temp. 235°C 1-pole 16A probe ø 3mm probe L 190mm capillary pipe 1000mm capillary pipe isolated 640mm gland nut probe SS		
<b>For models:</b>	FE04, FE07, FE07T, FE77, FE77T		







IMIT / TEMPOMATIC / ARTERMO

control thermostats



<b>GEV No.</b>	390006	<b>Ref. No.</b>	63.7.0658
<b>description</b>	thermostat t.max. 86°C temperature range 0-86°C 1-pole 1CO 16A probe ø 6.5mm probe L 95mm capillary pipe 1500mm capillary pipe isolatedmm gland nut shaft ø 6x4.6mm shaft L 19mm rotation 270°		
<b>For models:</b>	VEC 510, VEC 520		
<b>accessories for</b>	390006		
	<b>GEV No.</b>	110100	<b>Ref. No.</b> —
	knob thermostat t.max. 90°C 0-90°C ø 42mm shaft ø 6x4.6mm shaft flat -135° black		
	<b>GEV No.</b>	110105	<b>Ref. No.</b> —
	rosette knob ø 42mm ø 56mm zero mark		

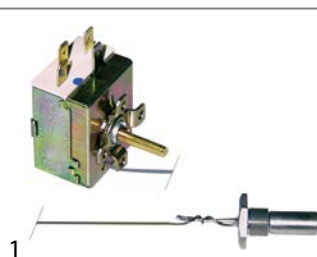

<b>GEV No.</b>	375318	<b>Ref. No.</b>	63.7.0655
<b>description</b>	thermostat t.max. 90°C temperature range 0-90°C 1-pole 1CO 15A probe ø 11mm probe L 36mm capillary pipe 600mm capillary pipe isolated 550mm gland nut shaft ø 6x4.6mm shaft L 19mm shaft position upper rotation 270° screw-in probe probe thread M14x1		
<b>For models:</b>	B830, B850, BM11, BM12, BM13, BM23, VEC 10, VEC 20		

TECASA

control thermostats



<b>GEV No.</b>	390027	<b>Ref. No.</b>	63.7.0640
<b>description</b>	thermostat t.max. 190°C temperature range 50-190°C 1-pole 1NO 16A probe ø 3mm probe L 145mm capillary pipe 880mm capillary pipe isolated 680mm gland nut shaft ø 6x4.6mm rotation 270° probe material SS		
<b>For models:</b>	F620, F640, FE04, FE07, FE07T, FE44, FE77, FE77T		

safety thermostats



<b>GEV No.</b>	390028	<b>Ref. No.</b>	63.7.0630
<b>description</b>	safety thermostat switch-off temp. 230°C 1-pole 16A probe ø 3mm probe L 155mm capillary pipe 890mm capillary pipe isolated 600mm gland nut probe SS		
<b>For models:</b>	F620, F640, TN30 PLUS		

PRODIGY / FIRT

control thermostats with operation switch

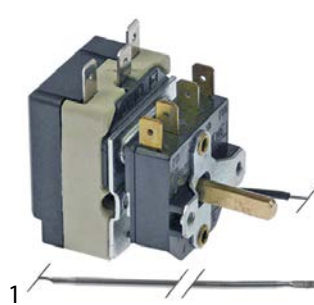

<b>GEV No.</b>	390791	<b>Ref. No.</b>	63.7.0651
<b>description</b>	thermostat t.max. 270°C temperature range 63-270°C 1-pole 1CO 16A probe ø 3mm probe L 185mm capillary pipe 950mm capillary pipe isolated 55mm gland nut shaft ø 6x4.6mm shaft L 16.5mm shaft position upper rotation 270° outer switch 2NO		
<b>For models:</b>	PD 1020 L, PD 1020 LB, PD 1020 M, PD 1020 MB, PD 1020 R, PD 1020 RB, PD 2020 L, PD 2020 LB, PD 2020 M, PD 2020 MB, PD 2020 R, PD 2020 RB, PDV 3020 L, PDV 3020 R, PDV-3020-McDonalds, PM 1015 L, PM 1015 LB, PM 1015 R, PM 1015 RB, PM 2015 L, PM 2015 LB, PM 2015 R, PM 2015 RB, PS 2010 L, PS 2010 LB, PS 2010 R, PS 2010 RB, PS 2010 L, PS 2010 LB, PS 2010 R, PS 2010 RB, PSV 3010 L, PSV 3010 R		

switches and momentary switches

rocker/momentary rocker switches

30x22mm



<b>GEV No.</b>	301061	<b>Ref. No.</b>	63.7.0861
<b>description</b>	rocker switch mounting measurements 30x22mm orange 2NO 250V 16A illuminated connection male faston 6.3mm ambient temperature max. 125/55°C protection IP40		
<b>For models:</b>	B800E, B830, B840, PT40, PT60, SEPC		



<b>GEV No.</b>	345599	<b>Ref. No.</b>	63.7.0862
<b>description</b>	rocker switch mounting measurements 30x22mm orange/orange 1NO/1NO/indicator light 250V 16A illuminated connection male faston 6.3mm ambient temperature max. 85/125°C protection IP40		
<b>For models:</b>	B860, HD20, HD40, T920, T930		



			
1			
<b>GEV No.</b>	301077	<b>Ref. No.</b>	63.7.0863
<b>description</b>	rocker switch mounting measurements 30x22mm orange/orange 1NO/indicator light 250V 16A illuminated connection male faston 6.3mm ambient temperature max. 100/55°C protection IP40		
<b>For models:</b>	VEC 510, VEC 520		

### push/momentary push switches

#### 30x22mm

			
1			
<b>GEV No.</b>	301086	<b>Ref. No.</b>	63.7.0860
<b>description</b>	push switch mounting measurements 30x22mm black 2NO 250V 12A 0-1 connection male faston 6.3mm ambient temperature max. 85/55°C protection IP54 with protective collar		
<b>For models:</b>	BM11, BM12, BM13, BM23, CW6, CW8, FE04, FE07, FE07T, FE77, FE77T		

### microswitches

#### pin-plunger actuated

#### M10

			
1			
<b>GEV No.</b>	347216	<b>Ref. No.</b>	63.7.0880
<b>description</b>	microswitch with plunger thread M10x0.75 thread L 14mm 250V 10A 1CO connection male faston 6.3mm stroke 7.5mm mounting distance 22mm L 28mm ambient temperature max. 125°C type NR6K5 actuating force: 260g		
<b>For models:</b>	F620, F640, FE04, FE07, FE07T, FE77, FE77T		

### rotary switches

#### BRETER

#### rotary switches

			
1			
<b>GEV No.</b>	347618	<b>Ref. No.</b>	63.7.0852
<b>description</b>	rotary switch 2 0-1 sets of contacts 2 type LE2-20-1752 600V 20A shaft ø 8x9mm shaft L 20mm shaft star-shaped connection screw		
<b>For models:</b>	B850, T920, T930		

			
1			
<b>GEV No.</b>	345572	<b>Ref. No.</b>	63.7.0850
<b>description</b>	rotary switch 2 0-1 sets of contacts 2 type LE2-20-1752 690V 16A shaft ø 7x8mm shaft L 20mm shaft star-shaped connection screw clamp		
<b>For models:</b>	TN30, TN30 PLUS		

### accessories

			
1			
<b>GEV No.</b>	347619	<b>Ref. No.</b>	63.6.0281
<b>description</b>	knob with bezel 0-1		

### encoders and potentiometers

			
1			
<b>GEV No.</b>	300138	<b>Ref. No.</b>	63.7.0628
<b>description</b>	potentiometer		

### lamps

#### indicator lights

#### indicator lights 2-piece (lens and indicator lamp)

#### indicator light lenses

#### ø10mm (type SRZ-3)

			
1			
<b>GEV No.</b>	359125	<b>Ref. No.</b>	57.2.9.9.0.01
<b>description</b>	indicator light housings mounting measurements ø10mm red round Qty 1 pcs		

#### ø12mm (type SDK-3)

			
1			
<b>GEV No.</b>	359275	<b>Ref. No.</b>	51.2.9.99.00.0T
<b>description</b>	indicator light housings mounting measurements ø12mm clear Qty 1 pcs		





			
1			
<b>GEV No.</b>	359277	<b>Ref. No.</b>	51.2.9.99.03.0T
<b>description</b>	indicator light housings mounting measurements ø12mm green Qty 1 pcs		

			
1			
<b>GEV No.</b>	359276	<b>Ref. No.</b>	51.2.9.99.01.0T
<b>description</b>	indicator light housings mounting measurements ø12mm red Qty 1 pcs		

			
1			
<b>GEV No.</b>	359278	<b>Ref. No.</b>	51.2.9.99.04.0T
<b>description</b>	indicator light housings mounting measurements ø12mm yellow Qty 1 pcs		

ø12mm (type SDY-3)			
			
1			
<b>GEV No.</b>	359280	<b>Ref. No.</b>	41.2.0.0.0.00.0.0
<b>description</b>	indicator light housings mounting measurements ø12mm clear round Qty 1 pcs		

			
1			
<b>GEV No.</b>	359262	<b>Ref. No.</b>	41.2.0.00.03.00
<b>description</b>	indicator light housings mounting measurements ø12mm green round Qty 1 pcs		

			
1			
<b>GEV No.</b>	359261	<b>Ref. No.</b>	41.2.0.00.01.00
<b>description</b>	indicator light housings mounting measurements ø12mm red round Qty 1 pcs		

			
1			
<b>GEV No.</b>	359260	<b>Ref. No.</b>	41.2.9.00.04.00
<b>description</b>	indicator light housings mounting measurements ø12mm yellow round Qty 1 pcs		

indicator lamps for socket type SRZ / SDK / SDY / SFK			
			
1			
<b>GEV No.</b>	359130	<b>Ref. No.</b>	21.3.2.40.00.0T
<b>description</b>	indicator lamp 230V clear connection male faston 6.3mm ø 8mm		

indicator lights (complete)			
ø10mm			
with plug-in socket			
			
1			
<b>GEV No.</b>	359139	<b>Ref. No.</b>	63.7.0811
<b>description</b>	indicator light ø 10mm green 230V connection male faston 6.3mm Qty 1 pcs		
<b>For models:</b>	F620, F640, TN30 PLUS		

			
1			
<b>GEV No.</b>	359140	<b>Ref. No.</b>	63.7.0810
<b>description</b>	indicator light ø 10mm yellow 230V connection male faston 6.3mm Qty 1 pcs		
<b>For models:</b>	F620, F640		

ø12mm			
with screw socket			
			
1			
<b>GEV No.</b>	359994	<b>Ref. No.</b>	51.F.2.H.0.00
<b>description</b>	indicator light ø 12mm 400V clear connection male faston 6.3mm		

			
1			
<b>GEV No.</b>	359291	<b>Ref. No.</b>	51.F.2.H.7.03
<b>description</b>	indicator light ø 12mm 400V green connection male faston 6.3mm		

			
1			
<b>GEV No.</b>	359292	<b>Ref. No.</b>	51.F.2.H.0.01
<b>description</b>	indicator light ø 12mm 400V red connection male faston 6.3mm		

			
1			
<b>GEV No.</b>	359290	<b>Ref. No.</b>	51.F.2.H.0.04
<b>description</b>	indicator light ø 12mm 400V yellow connection male faston 6.3mm		





ø13mm

with plug-in socket



			
1			
<b>GEV No.</b>	359530	<b>Ref. No.</b>	53.2.0.0.0.00.0.0
<b>description</b>	indicator light housings mounting measurements ø13mm clear round		

			
1			
<b>GEV No.</b>	359282	<b>Ref. No.</b>	53.2.0.0.0.03.0.0
<b>description</b>	indicator light housings mounting measurements ø13mm green round		

			
1			
<b>GEV No.</b>	359281	<b>Ref. No.</b>	53.2.0.0.0.04.0.0
<b>description</b>	indicator light housings mounting measurements ø13mm orange round		

			
1			
<b>GEV No.</b>	359283	<b>Ref. No.</b>	53.2.0.0.0.01.0.0
<b>description</b>	indicator light housings mounting measurements ø13mm red round		

30x22mm

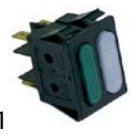

			
1			
<b>GEV No.</b>	359157	<b>Ref. No.</b>	63.7.0820
<b>description</b>	indicator light mounting measurements 30x22mm 230V green connection male faston 6.3mm temp.-resist. 125/55°C type RL2		
<b>For models:</b>	HD20, HD40, SE1, SE1M, SE2, SE2M, SEP, SEPC, SUV 66, T940, T960, TN30		
<b>accessories for</b>	359157		
			
	<b>GEV No.</b>	301036	<b>Ref. No.</b> —
	protective cover internal size 30x22mm for rocker switch mounting measurementsmm		

			
1			
<b>GEV No.</b>	359156	<b>Ref. No.</b>	63.7.0805
<b>description</b>	indicator light mounting measurements 30x22mm 230V yellow connection male faston 6.3mm temp.-resist. 125/55°C type RL2		
<b>For models:</b>	SE1, SE1M, SE2, SE2M, SEP, SEPC, T940, T960		

			
1			
<b>GEV No.</b>	359164	<b>Ref. No.</b>	63.7.0821
<b>description</b>	indicator light mounting measurements 30x22mm 230V green/white connection male faston 6.3mm temp.-resist. 125°C		
<b>For models:</b>	BM11, BM12, BM13, BM23, CW6, CW8, FE04, FE07, FE07T, FE77, FE77T, PD 1020 L, PD 1020 LB, PD 1020 M, PD 1020 MB, PD 1020 R, PD 1020 RB, PD 2020 L, PD 2020 LB, PD 2020 M, PD 2020 MB, PD 2020 R, PD 2020 RB, PDV 3020 L, PDV 3020 R, PDV-3020-McDonalds, PM 1015 L, PM 1015 LB, PM 1015 R, PM 1015 RB, PM 2015 L, PM 2015 LB, PM 2015 R, PM 2015 RB, PS 1010 L, PS 1010 LB, PS 1010 R, PS 1010 RB, PS 2010 L, PS 2010 LB, PS 2010 R, PS 2010 RB, PSV 3010 L, PSV 3010 R		

timers

mechanical timers

			
1			
<b>GEV No.</b>	350044	<b>Ref. No.</b>	63.7.0665 63.7.0666
<b>description</b>	timer C20 2-pole operation time 15min impulse mechanical 2NO at 250V 16A permanent position no shaft ø 6x4.6mm shaft 6x4.6mm shaft L 20mm mounting distance 28mm connection lateral for toaster		
<b>For models:</b>	FP36, FP36R, FP66R, T920, T930, T940, T960		
<b>accessories for</b>	350044		
			
	<b>GEV No.</b>	110285	<b>Ref. No.</b> —
	knob switch zero mark t.max.°C ø 40mm shaft ø 6x4.6mm shaft flat upper black		

contactors

ISKRA (FANAL)

power contactors

			
1			
<b>GEV No.</b>	380213	<b>Ref. No.</b>	63.7.0890
<b>description</b>	power contactor resistive load 20A 230VAC (AC3/400V) 8.5A/5.5kW main contacts 3NO auxiliary contacts 1NO connection screw connection type Fanal DSL7 10 type ISKRA K07M 10		
<b>For models:</b>	FE07T, FE77T		



## transformers

### encapsulated transformers

#### PMA



1

<b>GEV No.</b>	400583	<b>Ref. No.</b>	63.7.0701
<b>description</b>	transformer primary 230VAC secondary 24VAC 10VA secondary 0.4A connection screw 50Hz		
<b>For models:</b>	BM11, BM12, BM13, BM23, FE04, FE07, FE07T, FE44, FE77, FE77T, TN30 PLUS		

## electronics

### PCBs



1

<b>GEV No.</b>	400579	<b>Ref. No.</b>	63.7.0627
<b>description</b>	PCB		
<b>For models:</b>	TN30 PLUS		



## evaporation and condensing trays

### condensing trays heated

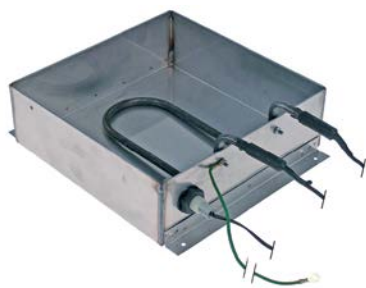
#### producer-specific





1

<b>GEV No.</b>	750003	<b>Ref. No.</b>	750003	
<b>description</b>	condensing tray heated L 240mm W 240mm H 75mm 230V 650W connect with power contactor			
<b>spare parts for</b>	750003			
	<b>GEV No.</b>	348139	<b>Ref. No.</b>	—
	float switch 250V 1A 1NO or 1NC thread M16x1.5 ø 17.4mm L 100.5mm mounting ø 28mm cable cable length 1500mm temp.-resist. -20 up to +90°C			
	<b>GEV No.</b>	418732	<b>Ref. No.</b>	—
	heating element 650W 230V L 280mm W 95mm H 87mm L1 65mm L2 215mm cable length 1500mm connection distance 86mm tube ø 8.5mm heating circuits 1 immersion heater			

<b>accessories for</b>	750003			
	<b>GEV No.</b>	380185	<b>Ref. No.</b>	—
	power relays Italiana Relè 230VAC 30A 1NO connection F6.3 bracket mounting dimensions 36.5x32.2x51.8mm manuf. no. A10-230AC-FA			



1

<b>GEV No.</b>	750004	<b>Ref. No.</b>	750004	
<b>description</b>	condensing tray heated L 380mm W 240mm H 75mm 230V 750W with float switch			
<b>spare parts for</b>	750004			
	<b>GEV No.</b>	348139	<b>Ref. No.</b>	—
	float switch 250V 1A 1NO or 1NC thread M16x1.5 ø 17.4mm L 100.5mm mounting ø 28mm cable cable length 1500mm temp.-resist. -20 up to +90°C			
	<b>GEV No.</b>	418733	<b>Ref. No.</b>	—
	heating element 750W 230V L 430mm W 95mm H 98mm L1 85mm L2 345mm cable length 1500mm connection cable connection distance 86mm tube ø 8.5mm heating circuits 1 immersion heater			
<b>accessories for</b>	750004			
	<b>GEV No.</b>	380185	<b>Ref. No.</b>	—
	power relays Italiana Relè 230VAC 30A 1NO connection F6.3 bracket mounting dimensions 36.5x32.2x51.8mm manuf. no. A10-230AC-FA			

## motors

### gear motors

#### for conveyor toaster



1

<b>GEV No.</b>	499246	<b>Ref. No.</b>	63.7.0752
<b>description</b>	gear motor 24V H 85mm L 137mm W 65mm type K9119052 KENTA voltage DC shaft ø 6x8mm		
<b>For models:</b>	TN30 PLUS		



for grills



1

<b>GEV No.</b>	499209	<b>Ref. No.</b>	63.7.0751 old
<b>description</b>	gear motor KENTA type K9113069 23W 230V 50Hz 2.5rpm shaft ø 6x8mm L 108mm W 58mm H 66mm		

miscellaneous



1

<b>GEV No.</b>	500496	<b>Ref. No.</b>	63.7.0752 old
<b>description</b>	gear motor TRIAL type R5/G4.5 24V voltage DC shaft ø 5x8mm L 100mm W 70mm H 120mm for toaster		

electric accessories

terminals

connection terminals with strain relief



1

<b>GEV No.</b>	550356	<b>Ref. No.</b>	63.7.0543
<b>description</b>	power terminal block 2-pole max 450V max. 16A cable ø 15mm cross section 1.5mm <sup>2</sup>		
<b>For models:</b>	CW6, CW8, HD20, HD40, PT40, PT60, VEC 510, VEC 520		

equipment-specific units

for convection ovens/combi-steamers

door mechanics

accessories



1

<b>GEV No.</b>	694840	<b>Ref. No.</b>	694840
<b>description</b>	guide bar SS L 725mm		

for hot dog machines

lids



1

<b>GEV No.</b>	693066	<b>Ref. No.</b>	63.4.0401
<b>description</b>	lid for hot dog machine		
<b>For models:</b>	HD20, HD40		

glass cylinders



1

<b>GEV No.</b>	693067	<b>Ref. No.</b>	63.6.7010
<b>description</b>	glass cylinder ø 200mm H 204mm		
<b>For models:</b>	HD20, HD40		

miscellaneous



1

<b>GEV No.</b>	691359	<b>Ref. No.</b>	63.0.0113
<b>description</b>	mounting angle		





			
1			
<b>GEV No.</b>	691358	<b>Ref. No.</b>	63.0.0112
<b>description</b>	mounting angle L 207mm		

water containers			
			
1			
<b>GEV No.</b>	693068	<b>Ref. No.</b>	63.4.0441
<b>description</b>	water container for hot dog machine		
<b>For models:</b>	HD20, HD40		

gear wheels			
			
1			
<b>GEV No.</b>	693062	<b>Ref. No.</b>	63.3.1003
<b>description</b>	gear wheel teeth 11 shaft intake ø 8mm ø 31mm hub ø 18mm stainless steel		
<b>For models:</b>	CW6, CW8		

for pizza ovens			
firebricks			
			
1			
<b>GEV No.</b>	850014	<b>Ref. No.</b>	63.6.7401
<b>description</b>	firebrick L 410mm W 362mm H 15mm grooved delivery freight forwarding company only		

for rolling grills			
pipes			
bushes			
			
1			
<b>GEV No.</b>	693060	<b>Ref. No.</b>	63.3.0801
<b>description</b>	bushing PTFE		
<b>For models:</b>	CW6, CW8		

pipes			
			
1			
<b>GEV No.</b>	693059	<b>Ref. No.</b>	63.3.2101
<b>description</b>	pipe with gear wheel for roller grill		
<b>For models:</b>	CW6, CW8		

gear wheels			
			
1			
<b>GEV No.</b>	693062	<b>Ref. No.</b>	63.3.1003
<b>description</b>	gear wheel teeth 11 shaft intake ø 8mm ø 31mm hub ø 18mm stainless steel		
<b>For models:</b>	CW6, CW8		

for toasters			
pliers			
			
1			
<b>GEV No.</b>	690010	<b>Ref. No.</b>	63.3.3095
<b>description</b>	plier for toaster H 180mm total length 100mm		
<b>For models:</b>	T920, T930, T940, T960		

knobs			
universal knobs			
			
1			
<b>GEV No.</b>	110075	<b>Ref. No.</b>	63.7.0280
<b>description</b>	knob energy regulator 1-3 t.max.°C ø 50mm shaft ø 6x4.6mm shaft flat upper black		
<b>For models:</b>	SE1, SE1M		
<b>accessories for</b>	110075		
	<b>GEV No.</b>	110135	<b>Ref. No.</b> —
	rosette knob up to ø 52mm		

## handles and hand wheels

### cylindrical handles

fixed



1

<b>GEV No.</b>	540237	<b>Ref. No.</b>	63.6.0102
<b>description</b>	cylindrical handle thread M8 ø 23mm L 65mm		
<b>For models:</b>	SE1, SE1M, SE2, SE2M		

## hinges

### oven hinges



1

<b>GEV No.</b>	690029	<b>Ref. No.</b>	35.249.70
<b>description</b>	torsion spring ø 25.8mm L2 71mm wire gauge ø 3.7mm L1 79mm L3 13mm		

## equipment feet and end caps

### screw-in feet



1

<b>GEV No.</b>	691344	<b>Ref. No.</b>	63.6.0021
<b>description</b>	equipment foot thread M8 thread L 20mm ø 23mm H 12mm Qty 1 pcs		
<b>For models:</b>	BM11, BM12, BM13, BM23, CW6, CW8, HD20, HD40, PD 1020 L, PD 1020 LB, PD 1020 M, PD 1020 MB, PD 1020 R, PD 1020 RB, PD 2020 L, PD 2020 LB, PD 2020 M, PD 2020 MB, PD 2020 R, PD 2020 RB, PDV 3020 L, PDV 3020 R, PDV-3020-McDonalds, PM 1015 L, PM 1015 LB, PM 1015 R, PM 1015 RB, PM 2015 L, PM 2015 LB, PM 2015 R, PM 2015 RB, PS 1010 L, PS 1010 LB, PS 1010 R, PS 1010 RB, PS 2010 L, PS 2010 LB, PS 2010 R, PS 2010 RB, PSV 3010 L, PSV 3010 R, PT40, PT60, TN30, TN30 PLUS, VEC 510, VEC 520		

## shelves and shelf rails

### grates

producer-specific



1

<b>GEV No.</b>	970301	<b>Ref. No.</b>	63.3.3002
<b>description</b>	grate		
<b>For models:</b>	SE2		



1

<b>GEV No.</b>	970305	<b>Ref. No.</b>	63.3.0003
<b>description</b>	grate W 370mm D 230mm chrome-plated steel		

## transmission technology and ball bearings

### chains

#### roller chains 05B-1 single



1

<b>GEV No.</b>	693063	<b>Ref. No.</b>	63.3.1100
<b>description</b>	chain DIN/ISO 05 B-1 splitting 8mm links 35 internal width 3mm rollerø 5mm single closed		
<b>For models:</b>	CW6		



1

<b>GEV No.</b>	693064	<b>Ref. No.</b>	63.3.1101
<b>description</b>	chain DIN/ISO 05 B-1 splitting 8mm links 52 internal width 3mm rollerø 5mm single		
<b>For models:</b>	CW8		







## springs

### torsion springs



<b>GEV No.</b>	690081	<b>Ref. No.</b>	63.3.0853
<b>description</b>	torsion spring ø 19.4mm L2 36mm wire gauge ø 3.3mm mounting pos. left L1 42mm L3 36mm Qty 1 pcs		
<b>For models:</b>	PD 1020 L, PD 1020 M, PD 1020 R, PM 1015 L, PM 1015 R, PS 1010 L, PS 1010 R		
<b>accessories for</b>	690081		
	<b>GEV No.</b>	690080	<b>Ref. No.</b> 63.3.0852
	torsion spring ø 19.4mm L2 37mm wire gauge ø 3.4mm mounting pos. right L1 42mm L3 37mm Qty 1 pcs		



<b>GEV No.</b>	690080	<b>Ref. No.</b>	63.3.0852
<b>description</b>	torsion spring ø 19.4mm L2 37mm wire gauge ø 3.4mm mounting pos. right L1 42mm L3 37mm Qty 1 pcs		
<b>For models:</b>	PD 1020 L, PD 1020 M, PD 1020 R, PM 1015 L, PM 1015 R, PS 1010 L, PS 1010 R		
<b>accessories for</b>	690080		
	<b>GEV No.</b>	690081	<b>Ref. No.</b> 63.3.0853
	torsion spring ø 19.4mm L2 36mm wire gauge ø 3.3mm mounting pos. left L1 42mm L3 36mm Qty 1 pcs		

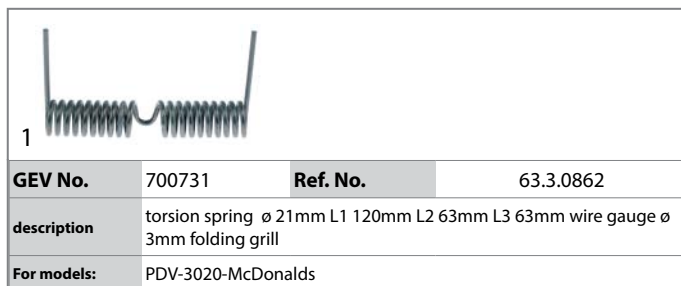

<b>GEV No.</b>	700731	<b>Ref. No.</b>	63.3.0862
<b>description</b>	torsion spring ø 21mm L1 120mm L2 63mm L3 63mm wire gauge ø 3mm folding grill		
<b>For models:</b>	PDV-3020-McDonalds		

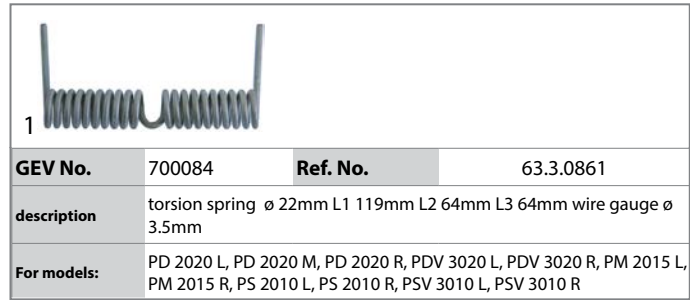

<b>GEV No.</b>	700084	<b>Ref. No.</b>	63.3.0861
<b>description</b>	torsion spring ø 22mm L1 119mm L2 64mm L3 64mm wire gauge ø 3.5mm		
<b>For models:</b>	PD 2020 L, PD 2020 M, PD 2020 R, PDV 3020 L, PDV 3020 R, PM 2015 L, PM 2015 R, PS 2010 L, PS 2010 R, PSV 3010 L, PSV 3010 R		

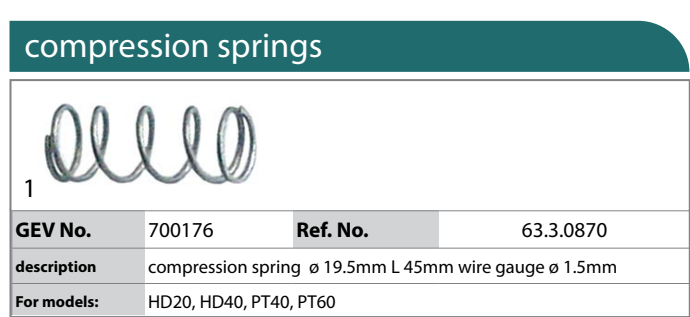

<b>GEV No.</b>	690029	<b>Ref. No.</b>	35.249.70
<b>description</b>	torsion spring ø 25.8mm L2 71mm wire gauge ø 3.7mm L1 79mm L3 13mm		

### compression springs



<b>GEV No.</b>	700176	<b>Ref. No.</b>	63.3.0870
<b>description</b>	compression spring ø 19.5mm L 45mm wire gauge ø 1.5mm		
<b>For models:</b>	HD20, HD40, PT40, PT60		

## fastening material

### fasteners

#### retaining rings



<b>GEV No.</b>	693061	<b>Ref. No.</b>	63.3.0505
<b>description</b>	retaining ring shaft ø 25mm thickness 1.2mm steel DIN 471		
<b>For models:</b>	CW6, CW8		



<b>B</b>		
bi-metal thermostats	8, 8	
<b>C</b>		
condensing trays heated	13	
contactors	12	
control thermostats	8, 9	
<b>E</b>		
electric accessories	14	
energy regulators	8	
<b>F</b>		
fasteners	17	
fastening material	17	
<b>G</b>		
grates	16	
<b>H</b>		
heating cartridges	7	
heating elements	3	
heating elements for bain maries	3	
heating elements for contact grills	5	
heating elements for fryers	3	
heating elements for pizza ovens	6	
heating elements for refrigeration	4	
heating elements for salamanders/toasters	6	
hot plates	7	
<b>I</b>		
indicator lights	10	
indicator lights (complete)	11	
<b>L</b>		
lamps	10	
<b>M</b>		
mechanical timers	12	
microswitches	10	
motors	13	
<b>O</b>		
oven hinges	16	
<b>P</b>		
push/momentary push switches	10	
<b>Q</b>		
quartz heating elements	7	
<b>R</b>		
radiation heaters		7
retaining rings		17
rocker/momentary rocker switches		9
rotary switches		10
<b>S</b>		
safety bi-metal thermostats		8
safety thermostats		8
shelves and shelf rails		16
switches and momentary switches		9
<b>T</b>		
terminals		14
thermostats		8
timers		12
transformers		13