



**GAS COMPONENTS**



**ELECTRIC COMPONENTS**



**WATER TECHNOLOGY**



**MECHANICAL COMPONENTS**



**TOOLS**

Spare parts suitable for

**CAPIC**

Find the complete and up-to-date range of products in our GEV Webshop



# Manufacturer catalogue

The most important spare parts and accessories arranged clearly for every manufacturer

- ✓ Complete product range and all appliance data always up to date in the GEV Webshop
- ✓ Alphabetical Index at the end of the catalogue

## GEV Webshop

[www.gev-online.co.uk](http://www.gev-online.co.uk)

[www.gev-online.com](http://www.gev-online.com)



- 🔍 Add to Favourites
- 🔍 Sign In with email address and usual password
- 🔍 Easy-order – place several items in your basket at the same time
- 🔍 Quick Item search – no login needed



# heating elements

## heating elements for ovens



<b>GEV No.</b>	418947	<b>Ref. No.</b>	E150596
<b>description</b>	heating element 1000W 230V heating circuits 1 L 400mm W 90mm thread M12x1 mounting distance 82mm tube ø 8mm connection M4 oven 2 hole fixing dry heating element		



<b>GEV No.</b>	418944	<b>Ref. No.</b>	E150572
<b>description</b>	heating element 1000W 230V L 550mm W 110mm H 75mm L1 257mm L2 35mm 2 hole fixing mounting distance 27mm connection M4 tube ø 8mm heating circuits 1 dry heating element thread M12x1 oven		



<b>GEV No.</b>	418847	<b>Ref. No.</b>	E150855
<b>description</b>	heating element 1500W 230V heating circuits 1 L 450mm W 60mm H 60mm connection distance 45mm tube ø 16mm dry heating element connection with screw connection length 28mm		



<b>GEV No.</b>	418949	<b>Ref. No.</b>	E150846
<b>description</b>	heating element 1500W 230V heating circuits 1 L 580mm W 110mm thread M14x1.25 mounting distance 100mm tube ø 10mm connection M4 oven 2 hole fixing dry heating element		



<b>GEV No.</b>	418948	<b>Ref. No.</b>	E150852
<b>description</b>	heating element 1500W 230V heating circuits 1 L 730mm W 110mm thread M12x1 mounting distance 102mm tube ø 8mm connection M4 oven mounting pos. lower 2 hole fixing dry heating element		



<b>GEV No.</b>	418952	<b>Ref. No.</b>	E150866
<b>description</b>	heating element 2000W 230V heating circuits 1 L 1300mm W 65mm thread M14x1 mounting distance 55mm tube ø 10mm connection M5 oven 2 hole fixing dry heating element		

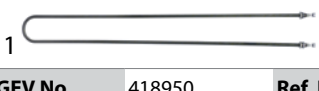

<b>GEV No.</b>	418950	<b>Ref. No.</b>	E150860
<b>description</b>	heating element 2000W 230V heating circuits 1 L 900mm W 115mm thread M14x1.25 mounting distance 105mm tube ø 10mm connection M4 oven 2 hole fixing dry heating element		



<b>GEV No.</b>	418951	<b>Ref. No.</b>	E151107
<b>description</b>	heating element 2250W 230V heating circuits 1 L 700mm W 90mm thread M14x1.25 mounting distance 80mm tube ø 10mm connection M4 oven 2 hole fixing dry heating element		



<b>GEV No.</b>	418953	<b>Ref. No.</b>	E151170
<b>description</b>	heating element 3000W 230V heating circuits 1 L 1295mm W 60mm thread M14x1.25 mounting distance 50mm tube ø 10mm connection M4 oven 2 hole fixing dry heating element		



<b>GEV No.</b>	418954	<b>Ref. No.</b>	E151465
<b>description</b>	heating element 4000W 230V heating circuits 1 L 850mm W 105mm thread M14x1 mounting distance 95mm tube ø 10mm connection M4 oven 2 hole fixing dry heating element		



<b>GEV No.</b>	418943	<b>Ref. No.</b>	E150515
<b>description</b>	heating element 500W 230V heating circuits 1 L 400mm W 110mm L1 45mm L2 355mm W1 31mm W2 40mm flange length 70mm flange width 22mm hole distance 56mm hole ø 6mm tube ø 6.5mm connection M4 connection length 26mm windings 2 rectangular flange dry heating element oven		



<b>GEV No.</b>	418945	<b>Ref. No.</b>	E150514
<b>description</b>	heating element 500W 230V heating circuits 1 L 695mm thread M12x1 tube ø 8mm connection M4 oven 1 hole fixing dry heating element Wmm		



<b>GEV No.</b>	418941	<b>Ref. No.</b>	E150564
<b>description</b>	heating element 850W 220V L 650mm W 148mm L1 100mm L2 545mm W1 55mm W2 38mm bridge length 180mm windings 2 connection plug-in connection heating circuits 1 tube ø 6.5mm flange oven heating element		





<b>GEV No.</b>	418942	<b>Ref. No.</b>	E150556
<b>description</b>	heating element 850W 230V heating circuits 1 L 645mm W 145mm L1 100mm L2 545mm W1 57mm W2 31mm flange length 70mm flange width 22mm hole distance 56mm bridge length 160mm hole ø 6mm tube ø 6.3mm connection M5 connection length 40mm windings 2 rectangular flange dry heating element oven heating element		
<b>For models:</b>	W380151, W380152, W380251, W380351, W380443, W380451, W380541, W380644, W380656, W380741, W380941, W380942, W380944, W380945, W380946, W380947, W380949, W381641, W382551, W382552, W382562, W382651, W382652, W382662, W383041, W383051		

1 electric components



1

<b>GEV No.</b>	550404	<b>Ref. No.</b>	E150565
<b>description</b>	power socket I-II phase 240V max. 16A countries I with screw connection for heating element		
<b>accessories for</b>	550404		
	<b>GEV No.</b>	510408	<b>Ref. No.</b> E153011
	O-ring EPDM thickness 5.34mm ID ø 47mm Qty 1 pcs		
	<b>GEV No.</b>	510562	<b>Ref. No.</b> —
	O-ring silicone thickness 5.34mm ID ø 47mm Qty 1 pcs		

heating elements for bain maries





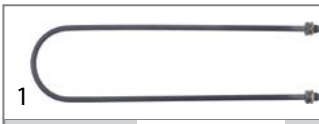

1

<b>GEV No.</b>	420164	<b>Ref. No.</b>	E150570
<b>description</b>	heating element 1000W 230V heating circuits 1 L 483mm W 110mm flange length 160mm flange width 30mm hole distance 139.5mm connection length 38mm connection M5 tube ø 10mm 2 hole flange hole ø 6.5mm dry heating element for bain marie		



1

<b>GEV No.</b>	420165	<b>Ref. No.</b>	E150806
<b>description</b>	heating element 1600W 230V heating circuits 1 L 395mm W 110mm connection length 20mm connection M4 tube ø 8mm 2 hole fixing thread M12x1 immersion heater for bain marie mounting distance 102mm		
<b>For models:</b>	W380811, W380815, W380821, W380825, W380831, W380835		
<b>accessories for</b>	420165		
	<b>GEV No.</b>	520229	<b>Ref. No.</b> —
	nut thread M12x1 H 4mm WS 16 zinc-coated steel Qty 1 pcs		
	<b>GEV No.</b>	521110	<b>Ref. No.</b> —
	flat gasket fibre ED ø 20mm ID ø 13mm thickness 2mm Qty 1 pcs		
	<b>GEV No.</b>	521131	<b>Ref. No.</b> —
	nut thread M12x1 H 3.5mm WS 17 SS Qty 1 pcs		



1

<b>GEV No.</b>	418844	<b>Ref. No.</b>	E150540
<b>description</b>	heating element 700W 230V heating circuits 1 L 395mm W 105mm flange length 70mm flange width 22mm hole distance 56mm connection with screw tube ø 6.25mm rectangular flange hole ø 6mm dry heating element L1 35mm L2 360mm W1 31mm W2 36mm		



1

<b>GEV No.</b>	420163	<b>Ref. No.</b>	E150544
<b>description</b>	heating element 750W 230V heating circuits 1 L 482mm W 110mm flange length 160mm flange width 30mm hole distance 139.5mm connection length 37mm connection M5 tube ø 10mm 2 hole flange hole ø 6.5mm dry heating element for bain marie		

heating elements for frying pans

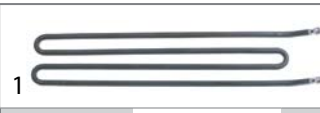

1

<b>GEV No.</b>	418939	<b>Ref. No.</b>	E151112
<b>description</b>	heating element 2500W 230V heating circuits 1 L 575mm W 115mm connection M5 tube ø 12.8mm dry heating element L1 30mm L2 545mm H 30mm connection distance 102mm		



1

<b>GEV No.</b>	418940	<b>Ref. No.</b>	E151455
<b>description</b>	heating element 3500W 230V heating circuits 1 L 515mm W 150mm connection M5 tube ø 13.5mm dry heating element L1 35mm L2 480mm H 36mm connection distance 117mm		

heating elements for chip scuttles



1

<b>GEV No.</b>	420162	<b>Ref. No.</b>	E150510
<b>description</b>	heating element 500W 230V heating circuits 1 L 442mm Wmm connection length 16mm connection male faston 6.3mm tube ø 10mm 1 hole fixing thread M14x1 dry heating element		
<b>For models:</b>	W382211, W382221, W382231		

heating elements for fryers



1

<b>GEV No.</b>	420495	<b>Ref. No.</b>	E152060
<b>description</b>	heating element 10000W 230V heating circuits 1 L 405mm W 142mm H 265mm threaded connection cable hole distance 67mm hole ø 5mm flange length 80mm flange width 40mm cable length 270mm		
<b>For models:</b>	W381031, W382031, W382032		



2 hole fixing

<b>GEV No.</b>	418957	<b>Ref. No.</b>	E152009
<b>description</b>	heating element 4000W 230V heating circuits 1 L 475mm W 80mm H 280mm M11x1 connection male faston fryer heaters L1 60mm L2 55mm L3 360mm H1 40mm H2 200mm H3 40mm tube ø 6.5mm thread M12x1 mounting distance 54mm connection length 30mm windings 4		

<b>GEV No.</b>	418958	<b>Ref. No.</b>	E152050
<b>description</b>	heating element 8000W 220V heating circuits 3 L 490mm W 230mm H 270mm L1 135mm L2 355mm W1 82mm W2 65mm H1 70mm H2 200mm special fixing tube ø 10mm connection M4 fryer heaters		

heating elements for griddles

<b>GEV No.</b>	490196	<b>Ref. No.</b>	E154046
<b>description</b>	griddle 5000W 400V L 620mm W 305mm		
<b>For models:</b>	W380911, W380921, W380931, W380941		

<b>GEV No.</b>	418960	<b>Ref. No.</b>	E150587
<b>description</b>	heating element 1000W 230V heating circuits 1 L 750mm W 110mm Hmm tube ø 8mm connection M4 thread M12x1 mounting distance 102mm dry heating element		

<b>GEV No.</b>	418845	<b>Ref. No.</b>	E150840
<b>description</b>	heating element 1500W 230V heating circuits 1 L 480mm W 70mm Hmm connection length 15mm connection screw tube ø 6.3mm 2 hole fixing thread M10x1 dry heating element mounting distance 64mm		
<b>For models:</b>	W380141, W380142, W380241, W380341, W380441, W380646, W381541, W381545, W383043		

<b>GEV No.</b>	420493	<b>Ref. No.</b>	E1511885
<b>description</b>	heating element 2850W 230V heating circuits 1 L 115mm W 490mm H 85mm tube ø 13.5mm		

<b>GEV No.</b>	418937	<b>Ref. No.</b>	E151138
<b>description</b>	heating element 3000W 230V heating circuits 1 L 430mm W 320mm H 58mm tube ø 13.5mm W1 82mm W2 156mm connection M5 grill connection distance 125mm dry heating element		

heating elements for tilting bratt pan

<b>GEV No.</b>	420494	<b>Ref. No.</b>	E150813
<b>description</b>	heating element 1400W 230V 50Hz L 330mm W 135mm H 85mm suitable for CAPIC heating circuits 1		

<b>GEV No.</b>	418938	<b>Ref. No.</b>	E151125
<b>description</b>	heating element 2500W 230V L 520mm W 110mm H 35mm connection M5 dry heating element heating circuits 1 tube ø 13.5mm L1 40mm L2 480mm connection distance 67mm		

<b>GEV No.</b>	420167	<b>Ref. No.</b>	E151135
<b>description</b>	heating element 3000W 230V L 425mm W 190mm H 30mm connection M5 dry heating element heating circuits 1 tube ø 13mm L1 40mm L2 385mm connection length 13mm connection distance 177mm		

heating elements for heated cabinets

<b>GEV No.</b>	418845	<b>Ref. No.</b>	E150840
<b>description</b>	heating element 1500W 230V heating circuits 1 L 480mm W 70mm Hmm connection length 15mm connection screw tube ø 6.3mm 2 hole fixing thread M10x1 dry heating element mounting distance 64mm		
<b>For models:</b>	W380141, W380142, W380241, W380341, W380441, W380646, W381541, W381545, W383043		



			
<b>GEV No.</b>	418946	<b>Ref. No.</b>	E150532
<b>description</b>	heating element 700W 230V heating circuits 1 L 745mm W 110mm connection length 35mm connection M4 tube ø 8mm 2 hole fixing thread M12x1 dry heating element heated cabinet mounting distance 102mm		
<b>For models:</b>	W380648, W383045		

## heater battery

			
<b>GEV No.</b>	415122	<b>Ref. No.</b>	E254001
<b>description</b>	heater battery mounting distance 185mm W 40mm H 35mm 2000W 230V temperature restriction 105°C heating circuits 2 connection cable cable length 340mm L 197mm for cross flow fan		

## contact heaters



			
<b>GEV No.</b>	416237	<b>Ref. No.</b>	L201017
<b>description</b>	contact heater 1400W 230V heating circuits 1 L 133mm W 120mm H 10mm dishwasher connection soldering connection connection distance 76mm connection length 37mm heat-conducting paste included hole ø 7mm dry heating element		



## quartz heating elements

			
<b>GEV No.</b>	420168	<b>Ref. No.</b>	E302112
<b>description</b>	quartz tube WV L 458mm ID ø 9mm ED ø 11mm		

## immersion heating elements





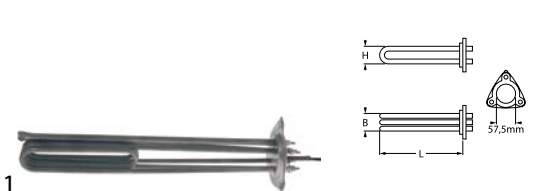

## 3 hole flange ø57.5mm

			
<b>GEV No.</b>	415035	<b>Ref. No.</b>	L201005
<b>description</b>	heating element 3000W 230V mounting ø 57.5mm heating circuits 3 L 207mm W 40mm H 46mm number of thermostat sleeves 1 thermostat sleeves ø 7.5mm length thermostat sleeves 185mm thermostat sleeve eccentric, non clinging tube ø 8.5mm hole distance 73mm hole ø 8mm connection M4 3 hole flange immersion heater		
<b>accessories for</b>	415035		
	<b>GEV No.</b>	521103	<b>Ref. No.</b> —
nut thread M4 H 3mm WS 7 brass Qty 20 pcs			

<b>accessories for</b>	415035		
	<b>GEV No.</b>	521104	<b>Ref. No.</b> —
washer ID ø 4.3mm ED ø 8mm thickness 0.5mm brass Qty 20 pcs for thread M4			
	<b>GEV No.</b>	560111	<b>Ref. No.</b> —
plain washer ID ø 4.3mm ED ø 9mm thickness 0.8mm SS Qty 20 pcs DIN 125A for thread M4			
	<b>GEV No.</b>	560131	<b>Ref. No.</b> —
hexagonal nut thread M4 H 3.2mm WS 7 SS DIN/ISO DIN 934 / ISO 4032/8673 Qty 20 pcs			

			
<b>GEV No.</b>	415846	<b>Ref. No.</b>	L202015
<b>description</b>	heating element 4000W 230V mounting ø 57.5mm heating circuits 3 L 327mm W 36mm H 42mm number of thermostat sleeves 1 thermostat sleeves ø 7mm length thermostat sleeves 320mm thermostat sleeve eccentric, non clinging tube ø 6.3mm hole distance 72mm hole ø 8mm connection M4 3 hole flange immersion heater		

## with compression flange 50 x 26mm

			
<b>GEV No.</b>	415151	<b>Ref. No.</b>	L201035
<b>description</b>	heating element 2500W 230V compression flange flange 50x26mm L 273mm heating circuits 1 H 30mm W 130mm L1 144mm L2 129mm connection M4 immersion heater		
<b>accessories for</b>	415151		
	<b>GEV No.</b>	510387	<b>Ref. No.</b> —
gasket L 46mm W 22mm ømm EPDM for heating element for flange 50x26mm			
	<b>GEV No.</b>	510388	<b>Ref. No.</b> —
counterflange ømm hole distancemm perforation ømm L 43mm W 21mm SS for heating element for flange 50x26mm			
	<b>GEV No.</b>	521103	<b>Ref. No.</b> —
nut thread M4 H 3mm WS 7 brass Qty 20 pcs			
	<b>GEV No.</b>	521104	<b>Ref. No.</b> —
washer ID ø 4.3mm ED ø 8mm thickness 0.5mm brass Qty 20 pcs for thread M4			
	<b>GEV No.</b>	560111	<b>Ref. No.</b> —
plain washer ID ø 4.3mm ED ø 9mm thickness 0.8mm SS Qty 20 pcs DIN 125A for thread M4			
	<b>GEV No.</b>	560131	<b>Ref. No.</b> —
hexagonal nut thread M4 H 3.2mm WS 7 SS DIN/ISO DIN 934 / ISO 4032/8673 Qty 20 pcs			



with expansion flange 40 x 14mm			
1			
<b>GEV No.</b>	415154	<b>Ref. No.</b>	L201030
<b>description</b>	heating element 2500W 230V flange 40x14mm L 455mm W 37mm Hmm tube ø 8.5mm heating circuits 1 connection male faston 6.3mm immersion heater		

with expansion flange 70 x 18mm			
1			
<b>GEV No.</b>	415159	<b>Ref. No.</b>	L201045
<b>description</b>	heating element 2500W 230V heating circuits 2 flange 70x18mm L 285mm W 65mm Hmm connection male faston 6.3mm tube ø 8.5mm immersion heater expansion flange		

with round flange ø47.5mm			
1			
<b>GEV No.</b>	418846	<b>Ref. No.</b>	E153010 E153010+E153011
<b>description</b>	heating element 4500W 230V heating circuits 3 L 395mm W 37mm H 30mm tube ø 6.5mm connection male faston 6.3mm connection length 25mm immersion heater round flange mounting ø 47.5mm		
<b>For models:</b>	W384111, W384112		
<b>accessories for</b>	418846		
		<b>GEV No.</b>	510408 <b>Ref. No.</b> E153011
	O-ring EPDM thickness 5.34mm ID ø 47mm Qty 1 pcs		

with round flange ø57.5mm			
1			
<b>GEV No.</b>	415038	<b>Ref. No.</b>	L202022
<b>description</b>	heating element 5000W 230V heating circuits 3 mounting ø 57.5mm L 373mm W 44mm H 40mm round flange connection M4 immersion heater tube ø 6.3mm connection length 19mm thermostat sleeves ø 7mm number of thermostat sleeves 1 length thermostat sleeves 328mm thermostat sleeve not clinging		
<b>spare parts for</b>	415038		
		<b>GEV No.</b>	510409 <b>Ref. No.</b> L554120
	O-ring EPDM thickness 5.34mm ID ø 56.52mm Qty 1 pcs		
<b>accessories for</b>	415038		
		<b>GEV No.</b>	521103 <b>Ref. No.</b> —
	nut thread M4 H 3mm WS 7 brass Qty 20 pcs		
		<b>GEV No.</b>	521104 <b>Ref. No.</b> —
	washer ID ø 4.3mm ED ø 8mm thickness 0.5mm brass Qty 20 pcs for thread M4		
		<b>GEV No.</b>	550002 <b>Ref. No.</b> —
	tension strap H 10mm L 21mm W 10mm hole ø 6.5mm for heating element		

<b>accessories for</b> 415038			
		<b>GEV No.</b>	560111 <b>Ref. No.</b> —
	plain washer ID ø 4.3mm ED ø 9mm thickness 0.8mm SS Qty 20 pcs DIN 125A for thread M4		
		<b>GEV No.</b>	560131 <b>Ref. No.</b> —
	hexagonal nut thread M4 H 3.2mm WS 7 SS DIN/ISO DIN 934 / ISO 4032/8673 Qty 20 pcs		

1			
<b>GEV No.</b>	420166	<b>Ref. No.</b>	E150818
<b>description</b>	heating element 1500W 230V heating circuits 1 L 480mm W 105mm thread M12x1 mounting distance 97mm tube ø 8mm connection length 16mm 2 hole fixing immersion heater connection M5		

1			
<b>GEV No.</b>	415156	<b>Ref. No.</b>	L201050
<b>description</b>	heating element 2500W 230V heating circuits 1 L 255mm W 42mm H 25mm L1 7mm L2 18mm L3 229mm thread M10x1 mounting distance 36mm tube ø 6.3mm connection male faston 6.3mm 2 hole fixing immersion heater		
<b>spare parts for</b>	415156		
		<b>GEV No.</b>	510893 <b>Ref. No.</b> —
	O-ring EPDM thickness 2.62mm ID ø 9.92mm Qty 1 pcs		
<b>accessories for</b>	415156		
		<b>GEV No.</b>	510416 <b>Ref. No.</b> —
	flat gasket fibre ED ø 19mm ID ø 10.5mm thickness 1.5mm for thread M10 Qty 1 pcs		
		<b>GEV No.</b>	520231 <b>Ref. No.</b> —
	nut thread M10x1 H 6mm WS 14 zinc-coated steel Qty 1 pcs		
		<b>GEV No.</b>	521129 <b>Ref. No.</b> —
	nut thread M10 H 6mm SS WS 17 Qty 1 pcs DIN/ISO DIN 439		

### heating elements for convection

1			
<b>GEV No.</b>	418848	<b>Ref. No.</b>	E150848 E150850
<b>description</b>	heating element 1500W 230V heating circuits 1 L 335mm W 100mm thread M12x1 connection with screw mounting distance 328mm tube ø 8.5mm convection heating element		



			
1			
<b>GEV No.</b>	418956	<b>Ref. No.</b>	E151131
<b>description</b>	heating element 2700W 230V heating circuits 1 L 410mm W 130mm H 102mm H1 42mm H2 60mm thread M20x1.5 connection length 87mm connection M5 2 hole fixing tube ø 13.5mm convection heating element convection oven		

			
1			
<b>GEV No.</b>	418955	<b>Ref. No.</b>	E150824
<b>description</b>	heating element 1500W 230V heating circuits 1 L 393mm W 70mm connection length 28mm connection M4 tube ø 8mm thread M12x1 2 hole fixing convection heating element convection oven mounting distance 62mm		

## hot plates

### square & rectangular

#### with cast edge

#### with screw connection

			
1			
<b>GEV No.</b>	490078	<b>Ref. No.</b>	E154016
<b>description</b>	hot plate dimensions 300x300mm 3000W 400V with cast edge connection 4 screw clamps square		
<b>For models:</b>	W380311, W380321, W380331, W380341, W380351, W380711, W380721, W380731, W380741		

#### tiltable

			
1			
<b>GEV No.</b>	490206	<b>Ref. No.</b>	E154011
<b>description</b>	hot plate dimensions 300x300mm 3000W 400V connection 3 screw clamps foldable		

## round

### with radiused edge

### for domestic and commercial kitchens

			
1			
<b>GEV No.</b>	490061	<b>Ref. No.</b>	E154020
<b>description</b>	hot plate ø 300mm 2500W 230V connection 4 screw clamps with 8mm spill ring		

			
1			
<b>GEV No.</b>	490064	<b>Ref. No.</b>	E154021
<b>description</b>	hot plate ø 300mm 3500W 400V with 8mm spill ring		

## energy regulators

### EGO

#### 1-circuit

			
1			
<b>GEV No.</b>	380019	<b>Ref. No.</b>	E402540
<b>description</b>	energy regulator 240V 13A single-circuit turn direction right shaft ø 6x4.6mm shaft L 23mm mounting thread M4 power release 6-100% no. 50.57071.010		

			
1			
<b>GEV No.</b>	380013	<b>Ref. No.</b>	E402545
<b>description</b>	energy regulator 400V 7A single-circuit turn direction right shaft ø 6x4.6mm mounting thread M4 no. 50.57031.010		
<b>For models:</b>	W384012, W384111, W384112		





DIAMOND



1

<b>GEV No.</b>	380037	<b>Ref. No.</b>	E402516
<b>description</b>	energy regulator 240V 13.5A turn direction right shaft ø 6x4.6mm shaft L 13mm mounting thread 3/8"-24UNF equiv. no. 35ERE101230V		



1

<b>GEV No.</b>	380038	<b>Ref. No.</b>	E402504
<b>description</b>	energy regulator 24V 13.5A turn direction right shaft ø 6x4.6mm mounting thread 3/8"-24UNF equiv. no. 35ERE105024V voltage AC		



1

<b>GEV No.</b>	380039	<b>Ref. No.</b>	E402520
<b>description</b>	energy regulator 400V 13.5A turn direction right shaft ø 6x4.6mm mounting thread 3/8"-24UNF equiv. no. 35ERE104400V		
<b>accessories for</b>	380039		
	<b>GEV No.</b>	361181	<b>Ref. No.</b> —
	nut thread 1/8" H 4.5mm nickel-plated brass WS 14 Qty 1 pcs		

thermostats

control and safety thermostats

EGO

control thermostats

55.10/19\_series



1

<b>GEV No.</b>	375468	<b>Ref. No.</b>	E401075
<b>description</b>	thermostat t.max. 180°C temperature range 80-180°C 1-pole 1NO 16A probe ø 6mm probe L 135mm capillary pipe 900mm capillary pipe isolatedmm gland nut M9x1 shaft ø 6x4.6mm shaft L 23mm shaft position upper rotation 270°		



1

<b>GEV No.</b>	375664	<b>Ref. No.</b>	E401082
<b>description</b>	thermostat t.max. 287°C temperature range 60-287°C 1-pole 1NO 16A probe ø 3.1mm probe L 226mm capillary pipe 1470mm capillary pipe isolated 350mm gland nut shaft ø 6x4.6mm shaft L 23mm shaft position upper rotation 270°		
<b>For models:</b>	W385013, W385015		

55.13\_series



1

<b>GEV No.</b>	390995	<b>Ref. No.</b>	E401077
<b>description</b>	thermostat t.max. 120°C temperature range 30-120°C 1-pole 1NO 16A probe ø 6mm probe L 95mm capillary pipe 900mm capillary pipe isolatedmm gland nut M9x1 shaft ø 6x4.6mm shaft L 23mm shaft position upper rotation 270°		

55.34\_series



1

<b>GEV No.</b>	375143	<b>Ref. No.</b>	E401015
<b>description</b>	thermostat t.max. 110°C temperature range 32-110°C 3-pole 3NO 16A probe ø 6mm probe L 138mm capillary pipe 1480mm capillary pipe isolated 1100mm gland nut M9x1 shaft ø 6x4.6mm shaft L 23mm shaft position upper rotation 270°		
<b>For models:</b>	W380811, W380815, W380821, W380825, W380831, W380835, W381131, W381132		



<b>GEV No.</b>	375043	<b>Ref. No.</b>	E401045
<b>description</b>	thermostat t.max. 200°C temperature range 65-200°C 3-pole 3NO 16A probe ø 6mm probe L 77mm capillary pipe 880mm capillary pipe isolated 800mm gland nut M9x1 shaft ø 6x4.6mm shaft L 23mm shaft position upper rotation 270°		



<b>GEV No.</b>	375417	<b>Ref. No.</b>	N/A
<b>description</b>	thermostat t.max. 200°C temperature range 65-200°C 3-pole 3NO 16A probe ø 6mm probe L 79mm capillary pipe 840mm capillary pipe isolated gland nut M9x1 shaft ø 6x4.6mm shaft L 23mm rotation 270°		



<b>GEV No.</b>	375038	<b>Ref. No.</b>	E401060	
<b>description</b>	thermostat t.max. 300°C temperature range 50-300°C 3-pole 3NO 16A probe ø 6mm probe L 79mm capillary pipe 1740mm capillary pipe isolated 800mm gland nut shaft ø 6x4.6mm shaft L 23mm shaft position upper rotation 270°			
<b>accessories for</b>	375038			
	<b>GEV No.</b>	110123	<b>Ref. No.</b>	E401280
	knob thermostat t.max. 300°C ø 50mm shaft ø 6x4.6mm shaft flat upper black temperature range 50-300°C rotation 270°			



<b>GEV No.</b>	375019	<b>Ref. No.</b>	E401011
<b>description</b>	thermostat t.max. 85°C temperature range 30-85°C 3-pole 3NO 16A probe ø 6mm probe L 131mm capillary pipe 1440mm capillary pipe isolated gland nut M9x1 shaft ø 6x4.6mm shaft L 23mm shaft position upper rotation 270°		
<b>For models:</b>	W380141, W380142, W380241, W380341, W380441, W380443, W380541, W380644, W380646, W380648, W380741, W380941, W380942, W380944, W380945, W380946, W380947, W380949, W381541, W381545, W381641, W382552, W382562, W382652, W382662, W383041, W383043, W383045		

safety thermostats

55.11\_ series



<b>GEV No.</b>	375109	<b>Ref. No.</b>	E401002
<b>description</b>	safety thermostat switch-off temp. 240°C 1-pole 16A probe ø 4mm probe L 91mm capillary pipe 530mm capillary pipe isolated 350mm gland nut probe SS		

55.13\_ series



<b>GEV No.</b>	375981	<b>Ref. No.</b>	E401007
<b>description</b>	safety thermostat switch-off temp. 225°C 1-pole 16A probe ø 6mm probe L 88mm capillary pipe 900mm capillary pipe isolated gland nut probe connection male faston 6.3mm		



<b>GEV No.</b>	375830	<b>Ref. No.</b>	E401003
<b>description</b>	safety thermostat switch-off temp. 365°C 1-pole 1NC 16A probe ø 3mm probe L 160mm capillary pipe 1730mm capillary pipe isolated 1710mm gland nut probe		

55.32\_series



<b>GEV No.</b>	375980	<b>Ref. No.</b>	E401008 E401012
<b>description</b>	safety thermostat switch-off temp. 130°C 3-pole 20A probe ø 6mm probe L 88mm capillary pipe 880mm capillary pipe isolatedmm gland nut probe		
<b>For models:</b>	W384111, W384112, W384121, W384122		



<b>GEV No.</b>	375706	<b>Ref. No.</b>	E401090
<b>description</b>	safety thermostat switch-off temp. 400°C 3-pole 3NC 20A probe ø 3.9mm probe L 228mm capillary pipe 1190mm capillary pipe isolatedmm gland nut probe SS		
<b>For models:</b>	W380151, W380152, W380251, W380351, W380451, W380656, W382551, W382552, W382651, W382652, W383051, W385011, W385012, W385013, W385014, W385015		

55.33\_series



<b>GEV No.</b>	375467	<b>Ref. No.</b>	E401006
<b>description</b>	safety thermostat switch-off temp. 220°C 3-pole 3NC 20A probe ø 6mm probe L 75mm capillary pipe 1500mm capillary pipe isolatedmm gland nut M9x1 probe SS		
<b>For models:</b>	W381031, W381035, W382031, W382032		

control thermostats with operation switch

55.34\_series





<b>GEV No.</b>	375246	<b>Ref. No.</b>	E401084
<b>description</b>	thermostat t.max. 645°C temperature range 100-615/645°C 2-pole 2NO 16A probe ø 4mm probe L 230mm capillary pipe 1100mm capillary pipe isolated 600mm gland nut shaft ø 6x4.6mm shaft L 25mm shaft position lower rotation 270° outer switch 2NO probe material copper		

IMIT / TEMPOMATIC / ARTHERMO

control thermostats



<b>GEV No.</b>	390310	<b>Ref. No.</b>	L455065	
<b>description</b>	thermostat t.max. 85°C temperature range fixed 55°C 1-pole 1CO 16A probe ø 9.5mm probe L 37mm capillary pipe 600mm capillary pipe isolated 540mm gland nut shaft ømm shaft Lmm shaft position rotation° screw-in probe probe thread 3/8" probe material SS			
<b>accessories for</b>	390310			
	<b>GEV No.</b>	506024	<b>Ref. No.</b>	—
	nut thread 3/8" H 6mm SS WS 22 Qty 1 pcs			
	<b>GEV No.</b>	529349	<b>Ref. No.</b>	—
	flat gasket FIBER ED ø 22mm ID ø 16.5mm thickness 2mm for thread 3/8" Qty 1 pcs			



PRODIGY / FIRT

safety thermostats



<b>GEV No.</b>	375478	<b>Ref. No.</b>	L454815
<b>description</b>	safety thermostat switch-off temp. 200°C temperature range°C 1-pole 1CO 20A probe ø 3.3mm probe L 190mm capillary pipe 2150mm capillary pipe isolatedmm gland nut probe SS		

accessories

gland nut accessories

ducts

<b>GEV No.</b>	550148	<b>Ref. No.</b>	E401310
<b>description</b>	gland duct ET M12x0.75 IT M9x1 probe ø max. 6.5mm WS 17 silicone		



<b>GEV No.</b>	100820	<b>Ref. No.</b>	G652208
<b>description</b>	gland duct ET M14x1.5 IT M10x0.75 probe ø max. 6.5mm WS 22		

connecting bows



<b>GEV No.</b>	550060	<b>Ref. No.</b>	E401320
<b>description</b>	connecting bow long for thermostat Qty 1 pcs		

switches and momentary switches

rocker/momentary rocker switches

19x13mm



<b>GEV No.</b>	348167	<b>Ref. No.</b>	E053530
<b>description</b>	rocker switch mounting measurements 19x13mm orange 2NO 250V 13A illuminated connection male faston 4.8mm protection IP40		
<b>For models:</b>	W381131, W381132, W381511, W381521, W381531, W381541, W381711, W381721, W381731		



<b>GEV No.</b>	346541	<b>Ref. No.</b>	E053532
<b>description</b>	protective cover for rocker switch external size 23.4x17.4mm internal size 19x13mm H 9.5mm mounting measurementsmm		
<b>For models:</b>	W381131, W381132, W381511, W381521, W381531, W381541, W381711, W381721, W381731		

push/momentary push switches

ø12mm

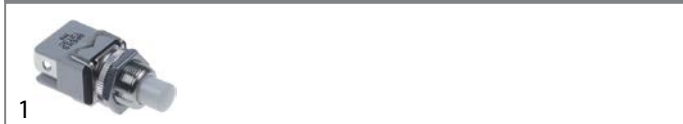

<b>GEV No.</b>	347567	<b>Ref. No.</b>	E053052
<b>description</b>	momentary push switch mounting ø 12mm white 1NO 250V 4A connection male faston 6.3mm ambient temperature max. 85°C protection IP40		
<b>For models:</b>	W381132		

microswitches

universal



<b>GEV No.</b>	348043	<b>Ref. No.</b>	E053005
<b>description</b>	microswitch with plunger 250V 16A 1CO connection male faston 6.3mm Lmm L1 27.8mm ambient temperature max. 125°C mounting distance 22mm with lever set type MS1-16 actuating force: 100g white		

pin-plunger actuated

M12



<b>GEV No.</b>	347586	<b>Ref. No.</b>	E053040
<b>description</b>	position switch with plunger mounting distance 81mm thread M12x1 thread L 66mm 400V 20A 1CO connection screw stroke 8mm L 50mm ambient temperature max. 85°C actuating force: 500g H 75mm W 18mm		



system switches (ROLD)

1 

<b>GEV No.</b>	345606	<b>Ref. No.</b>	L451243
<b>description</b>	momentary switch unit 2CO 250V 16A connection male faston 6.3mm		

1 

<b>GEV No.</b>	345651	<b>Ref. No.</b>	L451247
<b>description</b>	switch 2CO 250V 16A connection male faston 6.3mm		

cam switches

on/off

1 

<b>GEV No.</b>	300021	<b>Ref. No.</b>	E052505
<b>description</b>	cam switch 4 operating positions 4NO sequence 0-1-0-1 16A shaft ø 6x4.6mm shaft L 23mm connection screw ceramic		

1 

<b>GEV No.</b>	300248	<b>Ref. No.</b>	E052510
<b>description</b>	cam switch ON-OFF 16A shaft ø 6x4.6mm connection screw clamp 3-pole		
<b>For models:</b>	W380811, W380815, W380821, W380825, W380831, W380835		

4-position

1 

<b>GEV No.</b>	300103	<b>Ref. No.</b>	E052520
<b>description</b>	cam switch 4 operating positions 1NO/2CO sequence 0-1-2-3 32A shaft ø 6x4.6mm shaft L 23mm connection screw ceramic		
<b>For models:</b>	W380311, W380321, W380331, W380341, W380351, W380711, W380721, W380731, W380741, W380911, W380921, W380931, W380941		

1 

<b>GEV No.</b>	300104	<b>Ref. No.</b>	E052530
<b>description</b>	cam switch 4 operating positions 3NO/1CO sequence 0-1-2-3 32A shaft ø 6x4.6mm shaft L 23mm connection screw ceramic		
<b>For models:</b>	W380914, W380918, W380924, W380928, W380934, W380938, W380944, W381511, W381521, W381531, W381541		

4 operating positions

1 

<b>GEV No.</b>	347756	<b>Ref. No.</b>	E052525
<b>description</b>	cam switch 4 operating positions 2NO/1CO sequence 0-1-2-3 32A shaft ø 6x6mm shaft L 23mm connection screw ceramic		

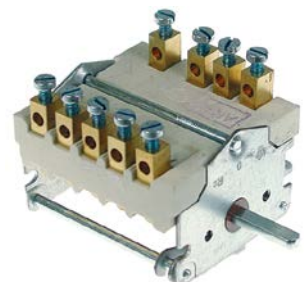
1 

<b>GEV No.</b>	300360	<b>Ref. No.</b>	E052523
<b>description</b>	cam switch 4 operating positions 3NO/1CO sequence 0-1-2-3 32A shaft ø 6x4.6mm shaft L 23mm connection screw ceramic		
<b>For models:</b>	W380151, W380152, W380251, W380351, W380451, W380656, W382551, W382552, W382651, W382652, W383051		



5 operating positions

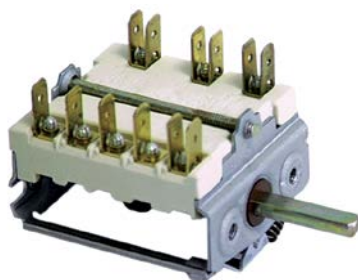

1			
<b>GEV No.</b>	301221	<b>Ref. No.</b>	E052535
<b>description</b>	cam switch 5 operating positions 2NO/1CO sequence 0-4-3-2-1 16A shaft $\phi$ 6x4.6mm shaft L 23mm connection male faston 6.3mm ceramic		

operation switches



1			
<b>GEV No.</b>	300200	<b>Ref. No.</b>	E052584
<b>description</b>	operation switch 2 operating positions 2NO 16A sequence 0-1 shaft $\phi$ 6x4.6mm shaft L 23mm connection male faston 6.3mm operation switch ceramic		

magnetic switches

23x14mm



1			
<b>GEV No.</b>	348169	<b>Ref. No.</b>	E054075
<b>description</b>	magnetic switch L 23mm W 14mm 1NO 100V 0.5A P max. 12W connection cable length 1000mm		
<b>For models:</b>	W385011, W385012, W385013, W385014, W385015, W385021, W385022, W385023, W385024, W385025		

51x16mm



1			
<b>GEV No.</b>	348168	<b>Ref. No.</b>	E054006
<b>description</b>	magnetic switch L 51mm W 16mm 1NO 240V 2A P max. 12W cable length 350mm		
<b>For models:</b>	W381031, W381131, W381132, W382031, W382032		

accessories

magnets

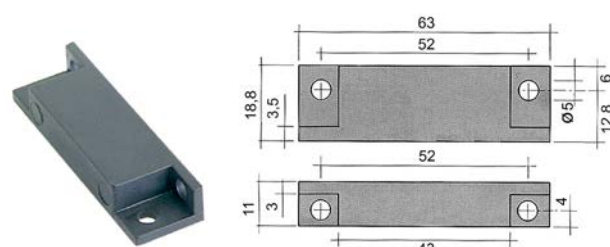

1			
<b>GEV No.</b>	345336	<b>Ref. No.</b>	L453222
<b>description</b>	magnet $\phi$ 4.8mm L 63mm H 11mm W 18.8mm hole distance 51mm M4		

control equipment

SCHNEIDER ELECTRIC





push buttons



1			
<b>GEV No.</b>	347809	<b>Ref. No.</b>	E052710 E052772
<b>description</b>	push button mounting measurements $\phi$ 22mm with protecting cover black		
<b>For models:</b>	W380111, W380112, W380121, W380122, W380131, W380132, W380141, W380142, W380151, W380152, W380161, W380162, W380211, W380221, W380231, W380241, W380251, W380261, W380411, W380413, W380421, W380423, W380431, W380433, W380441, W380443, W380451, W380461, W380511, W380521, W380531, W380541, W380666, W380912, W380915, W380917, W380919, W380922, W380925, W380927, W380929, W380932, W380935, W380937, W380939, W380942, W380945, W380947, W380949, W381515...(Other models you can see in the webshop)		



 <p>1</p>			
<b>GEV No.</b>	347808	<b>Ref. No.</b>	E052613 E052684
<b>description</b>	contact block TELEMECANIQUE ZB4BZ103 2NO max 600V 3A black with holder		
<b>For models:</b>	W380111, W380112, W380121, W380122, W380131, W380132, W380141, W380142, W380151, W380152, W380161, W380162, W380211, W380221, W380231, W380241, W380251, W380261, W380411, W380413, W380421, W380423, W380431, W380433, W380441, W380443, W380451, W380461, W380511, W380521, W380531, W380541, W380666, W380912, W380915, W380917, W380919, W380922, W380925, W380927, W380929, W380932, W380935, W380937, W380939, W380942, W380945, W380947, W380949, W381132...(Other models you can see in the webshop)		

<b>accessories for</b>	359600			
	<b>GEV No.</b>	359064	<b>Ref. No.</b>	—
	lamp socket mounting measurements ø22.3mm socket E14 connection screw 250/380V ambient temperature at 1W 100°C ambient temperature at 2W 85°C			
	<b>GEV No.</b>	359685	<b>Ref. No.</b>	—
	lamp socket mounting measurements ø16.2mm socket E10			
	<b>GEV No.</b>	359832	<b>Ref. No.</b>	—
	lamp socket mounting measurements ø16.2mm socket Ba9s connection male faston 6.3mm			
	<b>GEV No.</b>	359853	<b>Ref. No.</b>	—
	lamp socket mounting measurements ø18.2mm socket Ba9s connection male faston 6.3mm			
	<b>GEV No.</b>	359988	<b>Ref. No.</b>	—
	lamp socket mounting measurements ø30.5mm 250V connection F6.3 temp.-resist. 55°C E14			

<b>TELEMECANIQUE (EFA)</b>			
<b>XB2 series</b>			
signal element			
 <p>1</p>			
<b>GEV No.</b>	345397	<b>Ref. No.</b>	E202042
<b>description</b>	signal element mounting measurements ø22mm red		

 <p>1</p>				
<b>GEV No.</b>	359601	<b>Ref. No.</b>	E201007	
<b>description</b>	neon light bulb socket E10 380V clear ø 10mm L 28mm glas			
<b>accessories for</b>	359601			
	<b>GEV No.</b>	359060	<b>Ref. No.</b>	—
	lamp socket mounting measurements ø16.2mm socket E10 connection screw			
	<b>GEV No.</b>	359063	<b>Ref. No.</b>	—
	lamp socket mounting measurements ø19.2mm socket E14 connection screw			
	<b>GEV No.</b>	359064	<b>Ref. No.</b>	—
	lamp socket mounting measurements ø22.3mm socket E14 connection screw 250/380V ambient temperature at 1W 100°C ambient temperature at 2W 85°C			
	<b>GEV No.</b>	359685	<b>Ref. No.</b>	—
	lamp socket mounting measurements ø16.2mm socket E10			
	<b>GEV No.</b>	359832	<b>Ref. No.</b>	—
	lamp socket mounting measurements ø16.2mm socket Ba9s connection male faston 6.3mm			
	<b>GEV No.</b>	359853	<b>Ref. No.</b>	—
	lamp socket mounting measurements ø18.2mm socket Ba9s connection male faston 6.3mm			
	<b>GEV No.</b>	359988	<b>Ref. No.</b>	—
	lamp socket mounting measurements ø30.5mm 250V connection F6.3 temp.-resist. 55°C E14			

<b>lamps</b>				
indicator lights				
indicator lights 2-piece (lens and indicator lamp)				
indicator lamps for socket type SRZ / SDK / SDY / SFK				
 <p>1</p>				
<b>GEV No.</b>	359130	<b>Ref. No.</b>	L452515	
<b>description</b>	indicator lamp 230V clear connection male faston 6.3mm ø 8mm			
indicator lights 3-piece (housing, lens and bulb)				
lamps				
neon light bulbs				
 <p>1</p>				
<b>GEV No.</b>	359600	<b>Ref. No.</b>	E201005	
<b>description</b>	neon light bulb socket E10 220V 0.35W clear ø 10mm L 28mm			
<b>accessories for</b>	359600			
	<b>GEV No.</b>	359060	<b>Ref. No.</b>	—
	lamp socket mounting measurements ø16.2mm socket E10 connection screw			
	<b>GEV No.</b>	359063	<b>Ref. No.</b>	—
	lamp socket mounting measurements ø19.2mm socket E14 connection screw			

<b>indicator lights (complete)</b>			
ø 6mm			
 <p>1</p>			
<b>GEV No.</b>	359038	<b>Ref. No.</b>	L452522
<b>description</b>	indicator light ø 6mm 230V red		

ø 9mm			
			
1			
GEV No.	360698	Ref. No.	E202092
description	indicator light ø 9mm yellow 380-400V connection 2-wire cable length 200mm temp.-resist.°C		

ø10mm			
with plug-in socket			
			
1			
GEV No.	359139	Ref. No.	E202025
description	indicator light ø 10mm green 230V connection male faston 6.3mm Qty 1 pcs		

			
1			
GEV No.	359019	Ref. No.	E202028
description	indicator light ø 10mm green 400V connection male faston 6.3mm Qty 1 pcs		









			
1			
GEV No.	359140	Ref. No.	E202026
description	indicator light ø 10mm yellow 230V connection male faston 6.3mm Qty 1 pcs		

			
1			
GEV No.	359034	Ref. No.	E202029
description	indicator light ø 10mm yellow 400V connection male faston 6.3mm Qty 1 pcs		

ø12mm			
with screw socket			
			
1			
GEV No.	359893	Ref. No.	E202094
description	indicator light ø 12mm 400V green connection cable 200mm		
For models:	W380141, W380142, W380241, W380341, W380441, W380443, W380541, W380644, W380646, W380648, W380741, W380941, W380942, W380944, W380945, W380946, W380947, W380949, W381131, W381132, W381511, W381521, W381531, W381541, W381545, W381641, W381811, W381821, W381831, W382552, W382562, W382652, W382662, W383041, W383043, W383045, W384111, W384112, W384121, W384122, W385011, W385012, W385013, W385014, W385015, W385021, W385022, W385023, W385024, W385025		

			
1			
GEV No.	357157	Ref. No.	E202098
description	indicator light ø 12mm 380V yellow connection cable cable length 200mm		
For models:	W380311, W380321, W380331, W380341, W380351, W380711, W380721, W380731, W380741, W380815, W380825, W380835, W381611, W381621, W381631, W381641, W381711, W381721, W381731, W384012, W384111, W384112		

screw-on/push-on fit

neon light bulbs				
				
1				
GEV No.	359600	Ref. No.	E201005	
description	neon light bulb socket E10 220V 0.35W clear ø 10mm L 28mm			
accessories for	359600			
	GEV No.	359060	Ref. No.	—
lamp socket mounting measurements ø16.2mm socket E10 connection screw				
	GEV No.	359063	Ref. No.	—
lamp socket mounting measurements ø19.2mm socket E14 connection screw				
	GEV No.	359064	Ref. No.	—
lamp socket mounting measurements ø22.3mm socket E14 connection screw 250/380V ambient temperature at 1W 100°C ambient temperature at 2W 85°C				
	GEV No.	359685	Ref. No.	—
lamp socket mounting measurements ø16.2mm socket E10				
	GEV No.	359832	Ref. No.	—
lamp socket mounting measurements ø16.2mm socket Ba9s connection male faston 6.3mm				
	GEV No.	359853	Ref. No.	—
lamp socket mounting measurements ø18.2mm socket Ba9s connection male faston 6.3mm				
	GEV No.	359988	Ref. No.	—
lamp socket mounting measurements ø30.5mm 250V connection F6.3 temp.-resist. 55°C E14				









				
1				
GEV No.	359601	Ref. No.	E201007	
description	neon light bulb socket E10 380V clear ø 10mm L 28mm glas			
accessories for	359601			
	GEV No.	359060	Ref. No.	—
lamp socket mounting measurements ø16.2mm socket E10 connection screw				
	GEV No.	359063	Ref. No.	—
lamp socket mounting measurements ø19.2mm socket E14 connection screw				
	GEV No.	359064	Ref. No.	—
lamp socket mounting measurements ø22.3mm socket E14 connection screw 250/380V ambient temperature at 1W 100°C ambient temperature at 2W 85°C				

Table continues overleaf



accessories for		359601	
	GEV No.	359685	Ref. No. —
lamp socket mounting measurements ø16.2mm socket E10			
	GEV No.	359832	Ref. No. —
lamp socket mounting measurements ø16.2mm socket Ba9s connection male faston 6.3mm			
	GEV No.	359853	Ref. No. —
lamp socket mounting measurements ø18.2mm socket Ba9s connection male faston 6.3mm			
	GEV No.	359988	Ref. No. —
lamp socket mounting measurements ø30.5mm 250V connection F6.3 temp.-resist. 55°C E14			

light bulbs

for ovens

 <p>1</p>			
GEV No.	359610	Ref. No.	359610
description	light bulb t.max. 300°C socket E14 15W 230V ø 22mm L 47mm lens L 20mm for oven lamp type Philips		



for indicator lights

 <p>1</p>			
GEV No.	360697	Ref. No.	E201001
description	light bulb t.max.°C socket E10 2W 28V ø 10mm L 28mm lens L 12mm Qty 1 pcs		

oven lamps





universal oven lamps



mounting diameter 35.5mm

 <p>1</p>			
GEV No.	359718	Ref. No.	E202055
description	oven lamp mounting ø 35.5mm 230V 15W socket E14 temp.-resist. 300°C connection male faston 6.3mm hard glas		
spare parts for	359718		
	GEV No.	359701	Ref. No. —
lamp socket socket E14 220-230V mounting ø 35.5mm connection male faston 6.3mm 15W			
	GEV No.	359740	Ref. No. —
light bulb t.max. 300°C socket E14 15W 230V ø 22mm L 48mm lens L 20mm for oven lamp IMPORT			

 <p>1</p>			
GEV No.	359709	Ref. No.	E202056
description	oven lamp glass thr.ø 33.5mm ø 42mm hard glas temp.-resist. 350°C		





55x70mm

 <p>1</p>			
GEV No.	357105	Ref. No.	E202046
description	lamp socket socket G9 250V mounting measurements 55x70mm connection male faston 6.3mm H 32mm		
accessories for	357105		
	GEV No.	359297	Ref. No. E202049
frame L 95mm W 81mm mounting distance 68/83mm thickness 6mm			
	GEV No.	359299	Ref. No. E202048
gasket L 91mm W 77mm hole ø 3mm for oven lamp			
	GEV No.	359937	Ref. No. —
lamp glass L 80mm W 65mm mounting measurements 52x67mm			
	GEV No.	359945	Ref. No. —
halogen lamp socket G9 230V 25W temp.-resist. 300°C			

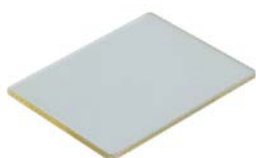
 <p>1</p>			
GEV No.	359297	Ref. No.	E202049
description	frame L 95mm W 81mm mounting distance 68/83mm thickness 6mm		
accessories for	359297		
	GEV No.	359299	Ref. No. E202048
gasket L 91mm W 77mm hole ø 3mm for oven lamp			

 <p>1</p>			
GEV No.	359299	Ref. No.	E202048
description	gasket L 91mm W 77mm hole ø 3mm for oven lamp		

			
1			
<b>GEV No.</b>	359296	<b>Ref. No.</b>	E202047
<b>description</b>	lamp glass L 74mm W 58mm thickness 3mm		

			
1			
<b>GEV No.</b>	357105	<b>Ref. No.</b>	E202046
<b>description</b>	lamp socket socket G9 250V mounting measurements 55x70mm connection male faston 6.3mm H 32mm		
<b>accessories for</b>	357105		
	<b>GEV No.</b>	359297	<b>Ref. No.</b> E202049
	frame L 95mm W 81mm mounting distance 68/83mm thickness 6mm		
	<b>GEV No.</b>	359299	<b>Ref. No.</b> E202048
	gasket L 91mm W 77mm hole ø 3mm for oven lamp		
	<b>GEV No.</b>	359937	<b>Ref. No.</b> —
	lamp glass L 80mm W 65mm mounting measurements 52x67mm		
	<b>GEV No.</b>	359945	<b>Ref. No.</b> —
	halogen lamp socket G9 230V 25W temp.-resist. 300°C		



**lamps**



**light bulbs**



			
1			
<b>GEV No.</b>	359610	<b>Ref. No.</b>	359610
<b>description</b>	light bulb t.max. 300°C socket E14 15W 230V ø 22mm L 47mm lens L 20mm for oven lamp type Philips		

**timers**

**programme timers**



			
1			
<b>GEV No.</b>	360020	<b>Ref. No.</b>	L453520
<b>description</b>	timer CEM HFD4M16 engines 1 chambers 4 operation time 240s 230V shaft ø 6x4.6mm shaft L 17mm manuf. no. HFD4M16 / DTP16 motor type UDS11NE1RH		
<b>spare parts for</b>	360020		
	<b>GEV No.</b>	360112	<b>Ref. No.</b> —
	motor SAIA pinion ø 4mm teeth 12 230V turn direction right motor ø 48mm motor type UDS11NE1RHZ for timer		

			
1			
<b>GEV No.</b>	360028	<b>Ref. No.</b>	L453515
<b>description</b>	timer CEM HFD4M16 engines 1 chambers 4 operation time 270s 230V shaft ø 6x4.6mm shaft L 17mm manuf. no. HFD4M16 / DTP15 motor type UDS11NE1RH		
<b>spare parts for</b>	360028		
	<b>GEV No.</b>	360112	<b>Ref. No.</b> —
	motor SAIA pinion ø 4mm teeth 12 230V turn direction right motor ø 48mm motor type UDS11NE1RHZ for timer		

			
1			
<b>GEV No.</b>	360018	<b>Ref. No.</b>	L453512
<b>description</b>	timer CEM HH4M16 engines 1 chambers 4 operation time 270s 230V manuf. no. HH4M16 / DTP13 motor type UDS11NE1LH		
<b>spare parts for</b>	360018		
	<b>GEV No.</b>	360113	<b>Ref. No.</b> —
	motor SAIA pinion ø 4mm teeth 12 230V turn direction left motor ø 48mm motor type UDS40NE1RNZ165 for timer		





1

<b>GEV No.</b>	360030	<b>Ref. No.</b>	L453528
<b>description</b>	timer CEM HL6M16 engines 2 chambers 6 operation time 60s/120s 230V shaft ømm shaft Lmm manuf. no. HL6M16 / DTP21 motor type UDS11NE1RH / UDS11NE1LH		
<b>spare parts for</b>	360030		
	<b>GEV No.</b>	360112	<b>Ref. No.</b> —
	motor SAIA pinion ø 4mm teeth 12 230V turn direction right motor ø 48mm motor type UDS11NE1RHZ for timer		
	<b>GEV No.</b>	360113	<b>Ref. No.</b> —
	motor SAIA pinion ø 4mm teeth 12 230V turn direction left motor ø 48mm motor type UDS40NE1RNZ165 for timer		

## alarm devices

### buzzers



1

<b>GEV No.</b>	350219	<b>Ref. No.</b>	E204042
<b>description</b>	buzzer 220VAC/DC connection male faston 6.3mm moulded built-in version thread M28x1dB mounting ø 42.5/32.5mm		

## contactors

### TELEMECANIQUE (Schneider Electric)

#### power contactors



1

<b>GEV No.</b>	380479	<b>Ref. No.</b>	E050903
<b>description</b>	power contactor resistive load 25A 230VAC (AC3/400V) 9A/4kW main contacts 3NO auxiliary contacts 1NO/1NC connection screw connection type LC1D09P7		
<b>For models:</b>	W381511, W381521, W381531, W381541, W381611, W381621, W381631, W381641, W381811, W381821, W381831, W385011, W385012		



1

<b>GEV No.</b>	380617	<b>Ref. No.</b>	E050901
<b>description</b>	power contactor resistive load 25A 24VAC (AC3/400V) 9A/4kW main contacts 3NO auxiliary contacts 1NO/1NC connection screw connection type LC1D09B7		



1

<b>GEV No.</b>	381159	<b>Ref. No.</b>	E050904
<b>description</b>	power contactor resistive load 25A 400VAC (AC3/400V) 9A/4kW main contacts 3NO auxiliary contacts 1NO/1NC connection screw connection type LC1D09V7		
<b>For models:</b>	W380916, W380926, W380936, W380946, W381611, W381621, W381631, W381641		



1

<b>GEV No.</b>	380976	<b>Ref. No.</b>	E050932
<b>description</b>	power contactor resistive load 32A 230VAC (AC3/400V) 18A/7.5kW main contacts 3NO auxiliary contacts 1NO/1NC connection screw connection		
<b>For models:</b>	W381031, W381131, W381132, W385013, W385014		



1





<b>GEV No.</b>	380981	<b>Ref. No.</b>	E050869
<b>description</b>	power contactor resistive load 60A 230VAC (AC3/400V) 40A/18.5kW main contacts 3NO auxiliary contacts 1NO/1NC connection screw connection type LC1D40P7		

with male contacts

female contact 2.0mm



1

<b>GEV No.</b>	380377	<b>Ref. No.</b>	E052347
<b>description</b>	power relays FINDER 220-240VAC 10A 2CO connection F2 plug-in connection manuf. no. 55.32.8.230.0000 94.92.3 250V		
<b>accessories for</b>	380377		
	<b>GEV No.</b>	380341	<b>Ref. No.</b> —
	relay socket 4-pole contacts 12 300V voltage AC 6A Italiana Relè manuf. no. ZMD4		
	<b>GEV No.</b>	380378	<b>Ref. No.</b> —
	relay socket 2-pole 55/85 dimensions 70.5x30x27mm 250V voltage AC 10A FINDER manuf. no. 94.72		
	<b>GEV No.</b>	380384	<b>Ref. No.</b> —
	relay socket 2-pole contacts male faston 2.8mm 250V voltage AC 10A W 23mm for		
	<b>GEV No.</b>	380399	<b>Ref. No.</b> —
	relay socket 4-pole dimensions 76.2x27x86.1mm 250V voltage AC 1A FINDER manuf. no. 94.94.3		

## relays

### power relays

#### with bracket mounting



1

<b>GEV No.</b>	380139	<b>Ref. No.</b>	L451712
<b>description</b>	power relays FINDER 230VAC 16A 2CO connection F6.3 bracket mounting dimensions 68x38.2x35.8mm manuf. no. 62.82.8.230.0000		



1

<b>GEV No.</b>	380808	<b>Ref. No.</b>	L451725
<b>description</b>	power relays FINDER 230VAC 16A 3CO connection male faston 6.3mm bracket mounting manuf. no. 62.83.8.230.0000		



1

<b>GEV No.</b>	380185	<b>Ref. No.</b>	L451715
<b>description</b>	power relays Italiana Relè 230VAC 30A 1NO connection F6.3 bracket mounting dimensions 36.5x32.2x51.8mm manuf. no. A10-230AC-FA		

### time relays



1

<b>GEV No.</b>	380878	<b>Ref. No.</b>	E1Z1E10 E452071
<b>description</b>	time relay FINDER 80.11.0.240 time range 0.1s-20h 12-240V AC/DC 16A mounting measurements DIN railmm 1CO connection grip connection		



## electronic controllers

### SERSA



1	<b>GEV No.</b>	378545	<b>Ref. No.</b>	E403036
<b>description</b> electronic controller type SSA 96 J2S D-270-24V mounting measurements 90x90mm 24V voltage AC Pt100 built-in depth 95mm up to +270°C display 3 digits				

## probes

### universal probes

#### temperature probes

1	<b>GEV No.</b>	378546	<b>Ref. No.</b>	E351625
<b>description</b> temperature probe thermocouple J (Fe-CuNi) probe -50 up to +750°C cable probe ø3 cable length 3m				

### producer-specific probes

#### probes

1	<b>GEV No.</b>	381405	<b>Ref. No.</b>	E403525
<b>description</b> temperature probe Pt100 cable PTFE probe -200 up to +600°C connection 3-wire probe ø5x100mm cable length 2m				

1	<b>GEV No.</b>	379635	<b>Ref. No.</b>	E403514
<b>description</b> temperature probe thermocouple J (Fe-CuNi) cable Vetrotex probe -50 up to +750°C cable -50 up to +350°C connection 2-wire thread probe ø5x100mm cable length 2m				
<b>accessories for</b> 379635				
	<b>GEV No.</b>	379636	<b>Ref. No.</b>	G701005
union screw set thread M8x1 probe ø 5mm				

## accessories

### screw connections

1	<b>GEV No.</b>	379636	<b>Ref. No.</b>	G701005 G701005+G701006
<b>description</b> union screw set thread M8x1 probe ø 5mm				

## electronics

### PCBs

1	<b>GEV No.</b>	403140	<b>Ref. No.</b>	E050561
<b>description</b> keypad PCB combi-steamer AC 150- AC 220 L 104mm W 32mm buttons 3				

1	<b>GEV No.</b>	400898	<b>Ref. No.</b>	L453882
<b>description</b> keypad PCB dishwasher LP10/20/30 with display				
<b>accessories for</b> 400898				
	<b>GEV No.</b>	402970	<b>Ref. No.</b>	L454510
ribbon cable 10-pole L 1200mm plug type 2 row coded Qty 1m				

1	<b>GEV No.</b>	403016	<b>Ref. No.</b>	E050555
<b>description</b> keypad PCB fryer JBM L 132mm W 81mm suitable for CAPIC with display buttons 4				

→ electric components



1

<b>GEV No.</b>	403130	<b>Ref. No.</b>	E054059
<b>description</b>	PCB combi-steamer TVTS L 90mm W 70mm level control		
<b>For models:</b>	W384111, W384112, W384121, W384122		



1

<b>GEV No.</b>	403572	<b>Ref. No.</b>	L453812
<b>description</b>	PCB dishwasher Protech 1113/611 TR10 L 178mm W 125mm		



1

<b>GEV No.</b>	403045	<b>Ref. No.</b>	L453812
<b>description</b>	PCB suitable for ELETTOBAR		

## keypads

### front foils



1

<b>GEV No.</b>	505280	<b>Ref. No.</b>	A504232
<b>description</b>	keypad foil tilting bratt pan blue/yellow suitable for CAPIC L 105mm W 57mm buttons 2		

## solenoid valves

### solenoid valves (water)

TP































<b>GEV No.</b>	370021	<b>Ref. No.</b>	L601005	
<b>description</b>	solenoid valve double straight 230VAC inlet 3/4" outlet 11.5mm DN10 TP flow regulating valve inlet white			
<b>For models:</b>	W381131, W381132			
<b>spare parts for</b>	370021			
	<b>GEV No.</b>	371013	<b>Ref. No.</b>	—
	solenoid coil TP 230VAC 50/60Hz			
<b>accessories for</b>	370021			
	<b>GEV No.</b>	371220	<b>Ref. No.</b>	—
	reducer TP flow rate 3l/min red tolerance ±15%			
	<b>GEV No.</b>	371221	<b>Ref. No.</b>	—
	reducer TP flow rate 5.5l/min yellow tolerance ±15%			
	<b>GEV No.</b>	371222	<b>Ref. No.</b>	—
	reducer TP flow rate 6l/min grey tolerance ±15%			
	<b>GEV No.</b>	371223	<b>Ref. No.</b>	—
	reducer TP flow rate 10l/min white tolerance ±15%			
	<b>GEV No.</b>	371224	<b>Ref. No.</b>	—
	reducer TP flow rate 12l/min bronze tolerance ±15%			
	<b>GEV No.</b>	371225	<b>Ref. No.</b>	—
	reducer TP flow rate 16l/min light brown tolerance ±15%			
	<b>GEV No.</b>	371226	<b>Ref. No.</b>	—
	reducer TP flow rate 20l/min red tolerance ±15%			
	<b>GEV No.</b>	371230	<b>Ref. No.</b>	—
	reducer TP flow rate 0.25l/min red tolerance ±25%			
	<b>GEV No.</b>	371231	<b>Ref. No.</b>	—
	reducer TP flow rate 0.35l/min violet tolerance ±25%			
	<b>GEV No.</b>	371232	<b>Ref. No.</b>	—
	reducer TP flow rate 0.5l/min orange tolerance ±25%			
	<b>GEV No.</b>	371233	<b>Ref. No.</b>	—
	reducer TP flow rate 0.8l/min white tolerance ±25%			
	<b>GEV No.</b>	371234	<b>Ref. No.</b>	—
	reducer TP flow rate 1l/min light blue tolerance ±25%			
	<b>GEV No.</b>	371235	<b>Ref. No.</b>	—
	reducer TP flow rate 1.2l/min brown tolerance ±25%			

Table continues overleaf



accessories for 370021				
GEV No.	371236	Ref. No.	—	
			reducer TP flow rate 1.5l/min light brown tolerance ±25%	
			reducer TP flow rate 2.5l/min yellow tolerance ±25%	
			reducer TP flow rate 3.4l/min dark green tolerance ±25%	
			reducer TP flow rate 5l/min black tolerance ±25%	
			reducer TP flow rate 8l/min blue tolerance ±20%	

				
<b>GEV No.</b>	370017	<b>Ref. No.</b>	L600505	
<b>description</b>	solenoid valve single straight 230VAC inlet 3/4" outlet 11.5mm DN10 TP p max 10bar			
<b>spare parts for</b>	370017			
	GEV No.	371013	Ref. No.	—
solenoid coil TP 230VAC 50/60Hz				
<b>accessories for</b>	370017			
	GEV No.	371220	Ref. No.	—
reducer TP flow rate 3l/min red tolerance ±15%				
	GEV No.	371221	Ref. No.	—
reducer TP flow rate 5.5l/min yellow tolerance ±15%				
	GEV No.	371222	Ref. No.	—
reducer TP flow rate 6l/min grey tolerance ±15%				
	GEV No.	371223	Ref. No.	—
reducer TP flow rate 10l/min white tolerance ±15%				
	GEV No.	371224	Ref. No.	—
reducer TP flow rate 12l/min bronze tolerance ±15%				
	GEV No.	371225	Ref. No.	—
reducer TP flow rate 16l/min light brown tolerance ±15%				
	GEV No.	371226	Ref. No.	—
reducer TP flow rate 20l/min red tolerance ±15%				
	GEV No.	371230	Ref. No.	—
reducer TP flow rate 0.25l/min red tolerance ±25%				
	GEV No.	371231	Ref. No.	—
reducer TP flow rate 0.35l/min violet tolerance ±25%				
	GEV No.	371232	Ref. No.	—
reducer TP flow rate 0.5l/min orange tolerance ±25%				

accessories for 370017				
GEV No.	371233	Ref. No.	—	
			reducer TP flow rate 0.8l/min white tolerance ±25%	
			reducer TP flow rate 1l/min light blue tolerance ±25%	
			reducer TP flow rate 1.2l/min brown tolerance ±25%	
			reducer TP flow rate 1.5l/min light brown tolerance ±25%	
			reducer TP flow rate 2.5l/min yellow tolerance ±25%	
			reducer TP flow rate 3.4l/min dark green tolerance ±25%	
			reducer TP flow rate 5l/min black tolerance ±25%	
			reducer TP flow rate 8l/min blue tolerance ±20%	





















				
<b>GEV No.</b>	370025	<b>Ref. No.</b>	L601015	
<b>description</b>	solenoid valve triple straight 230VAC inlet 3/4" outlet 11.5mm DN10 TP			
<b>spare parts for</b>	370025			
	GEV No.	371013	Ref. No.	—
solenoid coil TP 230VAC 50/60Hz				
<b>accessories for</b>	370025			
	GEV No.	371220	Ref. No.	—
reducer TP flow rate 3l/min red tolerance ±15%				
	GEV No.	371221	Ref. No.	—
reducer TP flow rate 5.5l/min yellow tolerance ±15%				
	GEV No.	371222	Ref. No.	—
reducer TP flow rate 6l/min grey tolerance ±15%				
	GEV No.	371223	Ref. No.	—
reducer TP flow rate 10l/min white tolerance ±15%				
	GEV No.	371224	Ref. No.	—
reducer TP flow rate 12l/min bronze tolerance ±15%				
	GEV No.	371225	Ref. No.	—
reducer TP flow rate 16l/min light brown tolerance ±15%				

Table continues overleaf



accessories for		370025		
	GEV No.	371226	Ref. No.	—
reducer TP flow rate 20l/min red tolerance ±15%				
	GEV No.	371230	Ref. No.	—
reducer TP flow rate 0.25l/min red tolerance ±25%				
	GEV No.	371231	Ref. No.	—
reducer TP flow rate 0.35l/min violet tolerance ±25%				
	GEV No.	371232	Ref. No.	—
reducer TP flow rate 0.5l/min orange tolerance ±25%				
	GEV No.	371233	Ref. No.	—
reducer TP flow rate 0.8l/min white tolerance ±25%				
	GEV No.	371234	Ref. No.	—
reducer TP flow rate 1l/min light blue tolerance ±25%				
	GEV No.	371235	Ref. No.	—
reducer TP flow rate 1.2l/min brown tolerance ±25%				
	GEV No.	371236	Ref. No.	—
reducer TP flow rate 1.5l/min light brown tolerance ±25%				
	GEV No.	371237	Ref. No.	—
reducer TP flow rate 2.5l/min yellow tolerance ±25%				
	GEV No.	371238	Ref. No.	—
reducer TP flow rate 3.4l/min dark green tolerance ±25%				
	GEV No.	371239	Ref. No.	—
reducer TP flow rate 5l/min black tolerance ±25%				
	GEV No.	371240	Ref. No.	—
reducer TP flow rate 8l/min blue tolerance ±20%				

metal				
SIRAI				
solenoid valves steam (water)				
2-way				
L145-R series				
	1			
GEV No.	370324	Ref. No.	E131716	
description	solenoid valve 2-ways 24VAC inlet 3/4" outlet 3/4" connection 3/4" L 79mm DN 16mm slide-on receptacle DIN -60 up to +170°C SIRAI type series L145-R coil type Z534A membranes PTFE (steam) p max 6bar p min 0.4bar			
spare parts for	370324			
	GEV No.	371068	Ref. No.	—
solenoid coil 24VAC 14VA SIRAI coil type Z534A seat ø 12mm				

spare parts for		370324		
	GEV No.	371165	Ref. No.	—
membrane connection 3/4" series L145-R membrane type PTFE				
accessories for		370324		
	GEV No.	371090	Ref. No.	—
power socket plug type DIN 43650A screw				

solenoid valves (gas)

ASCO			
	1		
GEV No.	370710	Ref. No.	E131002
description	solenoid valve gas 2-ways 230VAC inlet 1/8" outlet 1/8" t.max. 60°C connection 1/8" L 33mm Asc0 coil type 400127-197 p max 15bar membranes FPM type series 256 overall height 53mm		
For models:	W381035, W384121, W384122		

pressure switches for warewashing

ø 58mm with male faston 6.3mm			
with connection horizontal			
	1		
GEV No.	541013	Ref. No.	L455210
description	pressure control pressure range 55/25mbar connection 6mm ø 58mm pressure connection horizontal warewashing		

	1		
GEV No.	541003	Ref. No.	L455225
description	pressure control pressure range 55/35mbar connection 6mm ø 58mm pressure connection horizontal warewashing pressure connection ø 6mm		





## electrodes

			
1			
<b>GEV No.</b>	403674	<b>Ref. No.</b>	E054062
<b>description</b>	level electrode threaded total length 120mm probe L 61mm insulated probe length 24mm ø 4mm		
<b>For models:</b>	W384111, W384112, W384121, W384122		

## fans

### axial fans

#### import

			
1			
<b>GEV No.</b>	601080 <sup>1</sup>	<b>Ref. No.</b>	E050571
<b>description</b>	axial fan L 119mm W 119mm H 38mm 230VAC 50/60Hz 23/20W bearing ball bearing connection male faston 2.8mm metal ADDA fan wheel ø 110mm temp.-resist. 70°C		
<b>For models:</b>	W381811, W381821, W381831		
<b>accessories for</b>	601080		
	<b>GEV No.</b>	550898	<b>Ref. No.</b> —
	connecting cable cable length 2000mm connection F 2.8 connection distance 7.9mm for axial flow fan		
	<b>GEV No.</b>	692519	<b>Ref. No.</b> —
	guard L 120mm W 120mm plastic		

<sup>1</sup>with ball bearings

### cross flow fans

#### ebm-papst

			
1			
<b>GEV No.</b>	601936	<b>Ref. No.</b>	E254003
<b>description</b>	cross flow fan QLZ06/1800A265-2524 roller ø 60mm roller length 180mm laminated core thickness 28mm motor position right 230V/50Hz 31W refrigeration bearing rubber connection male faston 6.3mm airflow 160m <sup>3</sup> /h 0 up to +60°C 230V 150m <sup>3</sup> /h 50Hz		



## accessories for cross flow fans

### heater battery

			
1			
<b>GEV No.</b>	415122	<b>Ref. No.</b>	E254001
<b>description</b>	heater battery mounting distance 185mm W 40mm H 35mm 2000W 230V temperature restriction 105°C heating circuits 2 connection cable cable length 340mm L 197mm for cross flow fan		

### hot air motors

			
1			
<b>GEV No.</b>	601871	<b>Ref. No.</b>	13390026
<b>description</b>	fan motor 230V 1 phase 50Hz 85kW 2400rpm speeds 1 L1 85mm L2 40mm L3 33mm L4 133.5mm fan wheel ø 180mm at 50Hz 230V at 60Hz 230V at 50Hz 2600rpm at 60Hz 2850rpm type R2E180-AU01-09		

			
1			
<b>GEV No.</b>	500106	<b>Ref. No.</b>	13390026
<b>description</b>	hot air fan 230V 1 phase 50Hz 0.12kW 2600rpm speeds 1 L1 100mm L2 34mm L3 33mm L4 178mm power input 115W 0.51A fan wheel ø 180mm at 50Hz 230V at 60Hz 230V at 50Hz 2600rpm at 60Hz 2850rpm suitable capacitor 3µF400V type R2E180-AH05-06		
<b>accessories for</b>	500106		
	<b>GEV No.</b>	100021	<b>Ref. No.</b> —
	female faston size 2.8x0.8mm 0.5-1.0mm <sup>2</sup> CuZn t.max. 125°C Qty 20 pcs		
	<b>GEV No.</b>	365028	<b>Ref. No.</b> —
	operating capacitor capacity 3µF 450V tolerance 5% 50/60Hz ambient temperature max. -25 to +85°C ø 35.5mm L 75mm M8 plastic connection male faston 6.3mm protection		





### hot air fans

#### LEROY SOMER



1

<b>GEV No.</b>	602081	<b>Ref. No.</b>	E254005
<b>description</b>	hot air fan 230/400V 250W 1.05/0.6A 2770rpm L1 115mm L2 95mm type 400870/003		

<b>spare parts for</b>	500037		
	<b>GEV No.</b>	510695	<b>Ref. No.</b> —
	mechanical shaft seal height counter ring 5.5mm ID ø 11mm		
	<b>GEV No.</b>	521203	<b>Ref. No.</b> —
	impellor ø 72mm H 18mm thread M7 shaft ø 11mm shaft length 32mm blades 3		
	<b>GEV No.</b>	521703	<b>Ref. No.</b> —
	pump cover gasket EPDM thickness 2.5mm ID ø 75mm Qty 1 pcs		



<b>GEV No.</b>	500544	<b>Ref. No.</b>	L350261
<b>description</b>	pump inlet ø 60mm outlet ø 50mm type 4223.1900 230V 50Hz 1 phase 0.73kW 1HP L 225mm rotation direction right capacitor 16µF FIR		

<b>spare parts for</b>	500544		
	<b>GEV No.</b>	365021	<b>Ref. No.</b> —
	operating capacitor capacity 16µF 425V tolerance 5% 50/60Hz ambient temperature max. -25 to +85°C ø 35mm L 73mm single M8 plastic connection male faston 6.3mm 416.10.99 protection		
	<b>GEV No.</b>	510552	<b>Ref. No.</b> —
	pump cover gasket pump type 1292-2/3942/3981/3911/3983		
	<b>GEV No.</b>	510693	<b>Ref. No.</b> L351650
	mechanical shaft seal for shaft ø 12mm slide ring ext. ø 24mm slide ring H 15.5mm slide ring int. ø 11mm counter ring mounting ø 24mm height counter ring 8mm counter ring int. ø 13.5mm		
	<b>GEV No.</b>	518067	<b>Ref. No.</b> —
	impellor ø 103mm H 29mm M7L		
	<b>GEV No.</b>	521512	<b>Ref. No.</b> —
	pump cover FIR inlet ø 60mm outlet ø 50mm		

### motors

#### spindle motors

#### SKF/ATB



1

<b>GEV No.</b>	499136	<b>Ref. No.</b>	E020515
<b>description</b>	spindle motor type MAX30-A200415A25200-000 24V voltage DC L 445mm W 185mm H 120mm SKF/ATB		
<b>For models:</b>	W385011, W385013, W385015, W385021, W385023, W385025		

### pumps



#### wash and rinse pumps

#### FIR

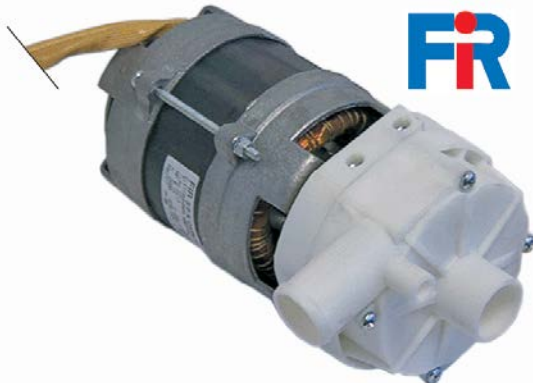



#### pumps





1



<b>GEV No.</b>	500037	<b>Ref. No.</b>	L350210
<b>description</b>	pump inlet ø 28mm outlet ø 26mm type 2211.1410 230V 50Hz 1 phase 0.074kW 0.1HP L 190mm rotation direction left capacitor 5µF FIR		
<b>spare parts for</b>	500037		
	<b>GEV No.</b>	365017	<b>Ref. No.</b> L452005
	operating capacitor capacity 5µF 450V tolerance 5% 50/60Hz ambient temperature max. -25 to +85°C ø 28mm L 54mm M8 plastic connection male faston 6.3mm 16.10.08 protection		
	<b>GEV No.</b>	510384	<b>Ref. No.</b> —
	pump cover inlet ø 28mm outlet ø 26mm ø 100mm ID ø 76mm		



<b>GEV No.</b>	500117	<b>Ref. No.</b>	L350427
<b>description</b>	pump inlet ø 63mm outlet ø 47mm type 4225.22725 230/400V 50Hz 3 phase 1.4kW 2HP L 280mm rotation direction right FIR		
<b>spare parts for</b>	500117		
	<b>GEV No.</b>	510602	<b>Ref. No.</b> —
	impellor ø 110mm H 34mm rotation direction right thread M8L shaft ø 28mm seat ø 12.2mm blades 6		
	<b>GEV No.</b>	510693	<b>Ref. No.</b> L351650
	mechanical shaft seal for shaft ø 12mm slide ringext. ø 24mm slide ring H 15.5mm slide ring int. ø 11mm counter ring mounting ø 24mm height counter ring 8mm counter ring int. ø 13.5mm		
	<b>GEV No.</b>	521513	<b>Ref. No.</b> —
	pump cover FIR inlet ø 63mm outlet ø 47mm turn direction right ID ø 150mm inner hight 32mm		
	<b>GEV No.</b>	524416	<b>Ref. No.</b> L350430
	pump cover gasket thickness 4x4mm Qty 1 pcs		







<b>GEV No.</b>	500258	<b>Ref. No.</b>	L350420
<b>description</b>	pump inlet ø 63mm outlet ø 53mm type 1204.2725 230/400V 50Hz 3 phase 1.5kW 2.01HP L 320mm rotation direction left FIR		
<b>spare parts for</b>	500258		
	<b>GEV No.</b>	510531	<b>Ref. No.</b> L351230
	pump cover FIR inlet ø 63mm outlet ø 53mm auxiliary pressure connection M16x1.5mm supporting pressure open turn direction left ø 185mm ID ø 150mm inner high 37mm		
	<b>GEV No.</b>	510604	<b>Ref. No.</b> —
	impellor ø 118mm H 34mm M8R rotation direction left		

<b>spare parts for</b>	500258		
	<b>GEV No.</b>	510693	<b>Ref. No.</b> L351650
	mechanical shaft seal for shaft ø 12mm slide ringext. ø 24mm slide ring H 15.5mm slide ring int. ø 11mm counter ring mounting ø 24mm height counter ring 8mm counter ring int. ø 13.5mm		
	<b>GEV No.</b>	511667	<b>Ref. No.</b> —
	fan wheel ø 123mm H 17mm shaft intake ø 15mm		
	<b>GEV No.</b>	524416	<b>Ref. No.</b> L350430
	pump cover gasket thickness 4x4mm Qty 1 pcs		

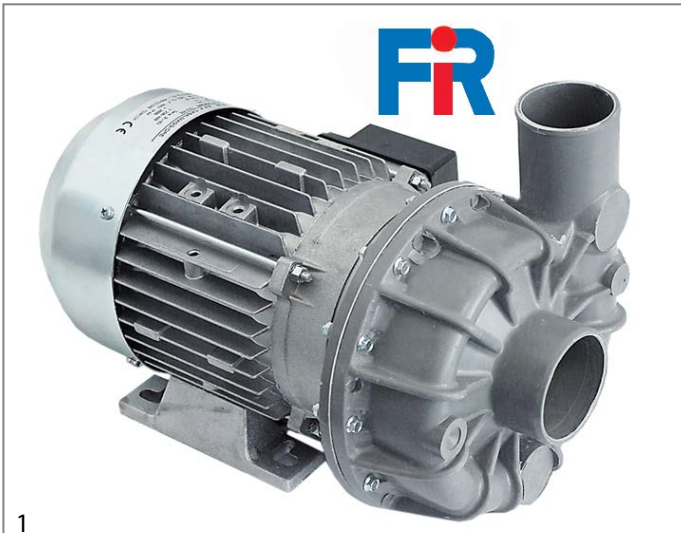





<b>GEV No.</b>	500031	<b>Ref. No.</b>	L350427
<b>description</b>	pump inlet ø 63mm outlet ø 53mm type 1205.2528 230/400V 50Hz 3 phase 2kW 2.7HP L 330mm rotation direction left FIR		
<b>spare parts for</b>	500031		
	<b>GEV No.</b>	510357	<b>Ref. No.</b> L350655
	impellor ø 124mm H 34/16mm thread M8R blades 6		
	<b>GEV No.</b>	510523	<b>Ref. No.</b> —
	fan wheel ø 142mm shaft intake ø 15mm blades 12		
	<b>GEV No.</b>	510531	<b>Ref. No.</b> L351230
	pump cover FIR inlet ø 63mm outlet ø 53mm auxiliary pressure connection M16x1.5mm supporting pressure open turn direction left ø 185mm ID ø 150mm inner high 37mm		
	<b>GEV No.</b>	510693	<b>Ref. No.</b> L351650
	mechanical shaft seal for shaft ø 12mm slide ringext. ø 24mm slide ring H 15.5mm slide ring int. ø 11mm counter ring mounting ø 24mm height counter ring 8mm counter ring int. ø 13.5mm		
	<b>GEV No.</b>	524416	<b>Ref. No.</b> L350430
	pump cover gasket thickness 4x4mm Qty 1 pcs		



<b>GEV No.</b>	500111	<b>Ref. No.</b>	L350410
<b>description</b>	pump inlet ø 63mm outlet ø 53mm type 1241.2500 230/400V 50Hz 3 phase 1.1kW 1.5HP L 330mm rotation direction left FIR		
<b>spare parts for</b>	500111		
	<b>GEV No.</b>	510531	<b>Ref. No.</b> L351230
	pump cover FIR inlet ø 63mm outlet ø 53mm auxiliary pressure connection M16x1.5mm supporting pressure open turn direction left ø 185mm ID ø 150mm inner high 37mm		
	<b>GEV No.</b>	510612	<b>Ref. No.</b> —
	impellor ø 110mm H 34mm M8R		
	<b>GEV No.</b>	510693	<b>Ref. No.</b> L351650
	mechanical shaft seal for shaft ø 12mm slide ring ext. ø 24mm slide ring H 15.5mm slide ring int. ø 11mm counter ring mounting ø 24mm height counter ring 8mm counter ring int. ø 13.5mm		
	<b>GEV No.</b>	524416	<b>Ref. No.</b> L350430
	pump cover gasket thickness 4x4mm Qty 1 pcs		







<b>GEV No.</b>	500324	<b>Ref. No.</b>	L350440
<b>description</b>	pump inlet ø 63mm outlet ø 53mm type 1243.2591 230/400V 50Hz 3 phase 2.35kW 3.2HP L 365mm rotation direction left FIR		
<b>spare parts for</b>	500324		
	<b>GEV No.</b>	510357	<b>Ref. No.</b> L350655
	impellor ø 124mm H 34/16mm thread M8R blades 6		
	<b>GEV No.</b>	510531	<b>Ref. No.</b> L351230
	pump cover FIR inlet ø 63mm outlet ø 53mm auxiliary pressure connection M16x1.5mm supporting pressure open turn direction left ø 185mm ID ø 150mm inner high 37mm		

<b>spare parts for</b>	500324		
	<b>GEV No.</b>	510693	<b>Ref. No.</b> L351650
	mechanical shaft seal for shaft ø 12mm slide ring ext. ø 24mm slide ring H 15.5mm slide ring int. ø 11mm counter ring mounting ø 24mm height counter ring 8mm counter ring int. ø 13.5mm		
	<b>GEV No.</b>	524416	<b>Ref. No.</b> L350430
	pump cover gasket thickness 4x4mm Qty 1 pcs		

LGB



<b>GEV No.</b>	500362	<b>Ref. No.</b>	L350429
<b>description</b>	pump inlet ø 62mm outlet ø 50mm type CE150SX 230/400V 50Hz 3 phase 1.1kW 1.5HP L 280mm rotation direction right LGB		
<b>spare parts for</b>	500362		
	<b>GEV No.</b>	510551	<b>Ref. No.</b> —
	pump cover gasket ID ø 158.3mm pump type 1214/1293/1225/2243/1226/1204/3473/1241 thickness 3.53mm EPDM Qty 1 pcs		
	<b>GEV No.</b>	510693	<b>Ref. No.</b> L351650
	mechanical shaft seal for shaft ø 12mm slide ring ext. ø 24mm slide ring H 15.5mm slide ring int. ø 11mm counter ring mounting ø 24mm height counter ring 8mm counter ring int. ø 13.5mm		
	<b>GEV No.</b>	521240	<b>Ref. No.</b> L350667
	impellor ø 110mm H 32mm rotation direction left thread M8L shaft ø 20mm shaft length 10mm seat ø 8.2mm blades 6		
	<b>GEV No.</b>	521536	<b>Ref. No.</b> —
	pump cover ALBA / LGB inlet ø 62mm outlet ø 50mm auxiliary pressure connection 12mm supporting pressure closed turn direction right ø 180mm ID ø 150mm inner high 38mm		
	<b>GEV No.</b>	602013	<b>Ref. No.</b> —
	fan wheel ø 100mm H 28mm shaft intake ø 17.5mm plastic		



booster pumps II

accessories

			
1			
<b>GEV No.</b>	365017	<b>Ref. No.</b>	L452005
<b>description</b>	operating capacitor capacity 5µF 450V tolerance 5% 50/60Hz ambient temperature max. -25 to +85°C ø 28mm L 54mm M8 plastic connection male faston 6.3mm 16.10.08 protection		

condensators & interference suppression filters

operating capacitors

plastic

			
1			
<b>GEV No.</b>	365019	<b>Ref. No.</b>	L452027
<b>description</b>	operating capacitor capacity 20µF 400V tolerance 5% 50/60Hz ambient temperature max. -25 to +85°C ø 39.5mm L 70mm M8 plastic connection male faston 6.3mm 16.10.25. protection		

			
1			
<b>GEV No.</b>	365017	<b>Ref. No.</b>	L452005
<b>description</b>	operating capacitor capacity 5µF 450V tolerance 5% 50/60Hz ambient temperature max. -25 to +85°C ø 28mm L 54mm M8 plastic connection male faston 6.3mm 16.10.08 protection		

electric accessories

cables



nickel wire

up to 350°C

			
1			
<b>GEV No.</b>	550088	<b>Ref. No.</b>	E351515
<b>description</b>	nickel wire 2.5mm <sup>2</sup> brown Qty 10m permanent temperature -60 up to +350°C t.max. 400°C rated 300/500V test voltage 2000V conductor nickel wire insulation glass fibre braiding/silicone rubber		

accessories

protection hoses

			
1			
<b>GEV No.</b>	550566	<b>Ref. No.</b>	E303030
<b>description</b>	screw connection for protection hose PG21 ID ø 21.7mm ED ømm nickel-plated brass Qty 1 piece		
<b>For models:</b>	W384012, W385011, W385012, W385013, W385014, W385015		
<b>accessories for</b>	550566		
	<b>GEV No.</b>	550578	<b>Ref. No.</b>
			E303045
			
	nut thread PG21 H 4.6mm WS 32 nickel-plated brass Qty 1 pcs mounting ømm cable ømm		

cable glands

threaded cable glands

fastening nuts

			
1			
<b>GEV No.</b>	550578	<b>Ref. No.</b>	E303045
<b>description</b>	nut thread PG21 H 4.6mm WS 32 nickel-plated brass Qty 1 pcs mounting ømm cable ømm		
<b>For models:</b>	W384012, W385011, W385012, W385013, W385014, W385015		

ribbon cables

group 1

			
1			
<b>GEV No.</b>	402970	<b>Ref. No.</b>	L454510
<b>description</b>	ribbon cable 10-pole L 1200mm plug type 2 row coded Qty 1m		

terminals

connection terminals with screw/faston connections

			
1			
<b>GEV No.</b>	550411	<b>Ref. No.</b>	L450310
<b>description</b>	power terminal block 6-pole max. 40A max 450V connection ø6mm <sup>2</sup> / F6.3 temp.-resist. 150°C cross section 6mm <sup>2</sup>		



rail-mounted terminals

miscellaneous



<b>GEV No.</b>	551135	<b>Ref. No.</b>	E352521
<b>description</b>	rail-mounted terminal 6mm <sup>2</sup> grey H 47mm 1-pole		

<b>accessories for</b>	101459			
	<b>GEV No.</b>	101249	<b>Ref. No.</b>	—
	olive for pipe ø 10mm Qty 1 pcs			
	<b>GEV No.</b>	101250	<b>Ref. No.</b>	—
	union nut thread M20x1.5 for pipe ø 10mm			
	<b>GEV No.</b>	101251	<b>Ref. No.</b>	—
	union nut thread M20x1.5 for pipe ø 12mm			
	<b>GEV No.</b>	101286	<b>Ref. No.</b>	G701011
	olive ID ø 6mm Qty 1 pcs			

gas taps

PEL

22N/O series



<b>GEV No.</b>	101459	<b>Ref. No.</b>	G303075
----------------	--------	-----------------	---------

**description**  
gas tap PEL type 22N/O gas inlet pipe flange ø21mm bypass nozzle ø 0.35mm gas outlet M20x1.5 (tube ø 12/10mm) thermocouple connection pilot connection M10x1 shaft ø 8x6.5mm shaft L 39/7mm shaft flat upper

**spare parts for** 101459

	<b>GEV No.</b>	101237	<b>Ref. No.</b>	—
	flange thread M20x1.5 tube ø 21mm suitable for PEL22			
	<b>GEV No.</b>	101365	<b>Ref. No.</b>	—
	gas connection thread M20x1.5 tube ø 12mm for PEL gas taps horizontal			
	<b>GEV No.</b>	101447	<b>Ref. No.</b>	—
	gas tap front part shaft ø 8x6.5mm shaft flat lateral Spezial			
	<b>GEV No.</b>	101460	<b>Ref. No.</b>	—
	O-ring ø 12.37mm D1 ø 2.62mm suitable for PEL22			
	<b>GEV No.</b>	101461	<b>Ref. No.</b>	—
	screw kit suitable for PEL22 Qty 4 pcs			
	<b>GEV No.</b>	101536	<b>Ref. No.</b>	—
	gasket D1 ø 17mm D2 ø 11.5mm thickness 4.7mm			
<b>accessories for</b>	101459			
	<b>GEV No.</b>	100908	<b>Ref. No.</b>	—
	union screw thread M10x1 for pipe ø 4mm Qty 1 pcs			
	<b>GEV No.</b>	100909	<b>Ref. No.</b>	G701010
	union screw thread M10x1 for pipe ø 6mm Qty 1 pcs			
	<b>GEV No.</b>	101246	<b>Ref. No.</b>	—
	olive for pipe ø 4mm Qty 1 pcs			
	<b>GEV No.</b>	101248	<b>Ref. No.</b>	G701026
	olive for pipe ø 12mm Qty 1 pcs suitable for PEL			

22S/O series



<b>GEV No.</b>	101469	<b>Ref. No.</b>	G304040
----------------	--------	-----------------	---------

**description**  
gas tap PEL type 22S/O gas inlet pipe flange ø21mm bypass nozzle ø 0.35mm gas outlet M20x1.5 (tube ø 12/10mm) thermocouple connection M8x1 pilot connection M10x1 shaft ø 8x6.5mm shaft L 39/7mm shaft flat upper

**For models:**  
W380111, W380112, W380121, W380122, W380131, W380132, W380141, W380142, W380151, W380152, W380161, W380162, W380211, W380221, W380231, W380241, W380251, W380261, W380411, W380413, W380421, W380423, W380431, W380433, W380441, W380443, W380451, W380461, W380511, W380521, W380531, W380541, W381515, W381525, W381535, W381545, W382511, W382551, W382552, W382561, W382562, W382611, W382651, W382652, W382661, W382662, W384021, W384022, W385021, W385022

**spare parts for** 101469









	<b>GEV No.</b>	101058	<b>Ref. No.</b>	G402060
	magnet unit L 39mm D1 ø 15.4mm D2 ø 13.5mm suitable for PEL22/EGA24197 standard			
	<b>GEV No.</b>	101231	<b>Ref. No.</b>	—
	thermocouple nut T1: M9x1 T2: M18x1			
	<b>GEV No.</b>	101237	<b>Ref. No.</b>	—
	flange thread M20x1.5 tube ø 21mm suitable for PEL22			
	<b>GEV No.</b>	101365	<b>Ref. No.</b>	—
	gas connection thread M20x1.5 tube ø 12mm for PEL gas taps horizontal			
	<b>GEV No.</b>	101447	<b>Ref. No.</b>	—
	gas tap front part shaft ø 8x6.5mm shaft flat lateral Spezial			
	<b>GEV No.</b>	101460	<b>Ref. No.</b>	—
	O-ring ø 12.37mm D1 ø 2.62mm suitable for PEL22			
	<b>GEV No.</b>	101461	<b>Ref. No.</b>	—
	screw kit suitable for PEL22 Qty 4 pcs			
	<b>GEV No.</b>	101536	<b>Ref. No.</b>	—
	gasket D1 ø 17mm D2 ø 11.5mm thickness 4.7mm			



Table continues overleaf



accessories for		101469		
	GEV No.	100908	Ref. No.	—
	union screw thread M10x1 for pipe ø 4mm Qty 1 pcs			
	GEV No.	100909	Ref. No.	G701010
	union screw thread M10x1 for pipe ø 6mm Qty 1 pcs			
	GEV No.	101246	Ref. No.	—
	olive for pipe ø 4mm Qty 1 pcs			
	GEV No.	101248	Ref. No.	G701026
	olive for pipe ø 12mm Qty 1 pcs suitable for PEL			
	GEV No.	101249	Ref. No.	—
	olive for pipe ø 10mm Qty 1 pcs			
	GEV No.	101250	Ref. No.	—
	union nut thread M20x1.5 for pipe ø 10mm			
	GEV No.	101251	Ref. No.	—
	union nut thread M20x1.5 for pipe ø 12mm			
	GEV No.	101286	Ref. No.	G701011
	olive ID ø 6mm Qty 1 pcs			
	GEV No.	101290	Ref. No.	—
	thermocouple nut T1: M10x1 T2: M18x1 suitable for PEL20/21			

accessories for		101489		
	GEV No.	100908	Ref. No.	—
	union screw thread M10x1 for pipe ø 4mm Qty 1 pcs			
	GEV No.	100909	Ref. No.	G701010
	union screw thread M10x1 for pipe ø 6mm Qty 1 pcs			
	GEV No.	101246	Ref. No.	—
	olive for pipe ø 4mm Qty 1 pcs			
	GEV No.	101248	Ref. No.	G701026
	olive for pipe ø 12mm Qty 1 pcs suitable for PEL			
	GEV No.	101249	Ref. No.	—
	olive for pipe ø 10mm Qty 1 pcs			
	GEV No.	101250	Ref. No.	—
	union nut thread M20x1.5 for pipe ø 10mm			
	GEV No.	101251	Ref. No.	—
	union nut thread M20x1.5 for pipe ø 12mm			
	GEV No.	101286	Ref. No.	G701011
	olive ID ø 6mm Qty 1 pcs			













				
1				
<b>GEV No.</b>	101489	<b>Ref. No.</b>	G304045	
<b>description</b>	gas tap PEL type 22S/O gas inlet pipe flange ø27mm bypass nozzle ø 0.35mm gas outlet M20x1.5 (tube ø 14/10mm) thermocouple connection M8x1 pilot connection M10x1 shaft ø 8x6.5mm shaft L 39/7mm shaft flat left			
<b>spare parts for</b>	101489			
	GEV No.	101058	Ref. No.	G402060
	magnet unit L 39mm D1 ø 15.4mm D2 ø 13.5mm suitable for PEL22/ EGA24197 standard			
	GEV No.	101230	Ref. No.	—
	thermocouple nut T1: M8x1 T2: M18x1 aluminium			
	GEV No.	101353	Ref. No.	—
	flange thread M20x1.5 tube ø 27mm suitable for PEL22			
	GEV No.	101366	Ref. No.	—
	gas connection thread M20x1.5 tube ø 14mm for PEL gas taps horizontal			
	GEV No.	101460	Ref. No.	—
	O-ring ø 12.37mm D1 ø 2.62mm suitable for PEL22			
	GEV No.	101461	Ref. No.	—
	screw kit suitable for PEL22 Qty 4 pcs			
	GEV No.	106165	Ref. No.	—
	gasket ø 27mm			



22S/V series				
				
1				
<b>GEV No.</b>	107322	<b>Ref. No.</b>	G304047	
<b>description</b>	gas tap PEL type 22S/V gas inlet pipe flange ø21mm bypass nozzle ø 0mm gas outlet M20x1.5 (tube ø 12/10mm) thermocouple connection M9x1 pilot connection M10x1 shaft ø 8x6.5mm shaft L 39/7mm shaft flat upper			
<b>For models:</b>	W380912, W380915, W380917, W380919, W380922, W380925, W380927, W380929, W380932, W380935, W380937, W380939, W380942, W380945, W380947, W380949, W381515, W381525, W381535, W381545, W381815, W381825, W381835			
<b>spare parts for</b>	107322			
	GEV No.	101536	Ref. No.	—
	gasket D1 ø 17mm D2 ø 11.5mm thickness 4.7mm			



**23S/O series**



<b>GEV No.</b>	101091	<b>Ref. No.</b>	G304048
<b>description</b>	gas tap PEL type 23S/O gas inlet M28x1.5 (tube ø 20mm) bypass nozzle ø 0.35mm gas outlet M24x1.5 (tube ø 16mm) thermocouple connection M9x1 pilot connection M10x1 shaft ø 10x8mm shaft L 35/19mm shaft flat upper		
<b>For models:</b>	W385023, W385024, W385025		
<b>spare parts for</b>	101091		
	<b>GEV No.</b>	100455	<b>Ref. No.</b> —
	bypass nozzle type PEL23/24 bore ø 0.35mm thread M8x0.5		
	<b>GEV No.</b>	101045	<b>Ref. No.</b> —
	magnet unit T1: M9x1 T2: M22x1 L 46mm ø 18mm suitable for PEL23S M9x1		
	<b>GEV No.</b>	101244	<b>Ref. No.</b> —
	gas connection thread M24x1.5 tube ø 12/16mm horizontal for PEL gas taps		
	<b>GEV No.</b>	101336	<b>Ref. No.</b> —
	gas tap front part shaft ø 10x8mm shaft L 35/17mm shaft flat upper/lower suitable for PEL23S		
	<b>GEV No.</b>	101463	<b>Ref. No.</b> —
	screw suitable for PEL23S Qty 4 pcs		
	<b>GEV No.</b>	528455	<b>Ref. No.</b> —
	O-ring Viton thickness 2.62mm ID ø 18.72mm Qty 1 pcs		
<b>accessories for</b>	101091		
	<b>GEV No.</b>	100908	<b>Ref. No.</b> —
	union screw thread M10x1 for pipe ø 4mm Qty 1 pcs		
	<b>GEV No.</b>	100909	<b>Ref. No.</b> G701010
	union screw thread M10x1 for pipe ø 6mm Qty 1 pcs		
	<b>GEV No.</b>	101246	<b>Ref. No.</b> —
	olive for pipe ø 4mm Qty 1 pcs		
	<b>GEV No.</b>	101252	<b>Ref. No.</b> —
	union nut thread M24x1.5 for pipe ø 12mm		
	<b>GEV No.</b>	101253	<b>Ref. No.</b> —
	union nut thread M24x1.5 PEL for pipe ø 16mm		
	<b>GEV No.</b>	101254	<b>Ref. No.</b> —
	union nut thread M28x1.5 tube ø 20mm		
	<b>GEV No.</b>	101255	<b>Ref. No.</b> —
	olive for pipe ø 12mm Qty 1 pcs		
	<b>GEV No.</b>	101256	<b>Ref. No.</b> —
	olive for pipe ø 16mm Qty 1 pcs		
	<b>GEV No.</b>	101257	<b>Ref. No.</b> —
	olive for pipe ø 20mm Qty 1 pcs		

<b>accessories for</b>	101091		
	<b>GEV No.</b>	101286	<b>Ref. No.</b> G701011
	olive ID ø 6mm Qty 1 pcs		
	<b>GEV No.</b>	110080	<b>Ref. No.</b> —
	knob ø 70mm shaft ø 10x8mm shaft flat universal		
	<b>GEV No.</b>	112206	<b>Ref. No.</b> —
	knob dial plate silver gas tap PEL21/22/23 t.max.°C ED ø 63mm ID ø 45.5mm		

**STN3R**





<b>GEV No.</b>	106184	<b>Ref. No.</b>	G304010
<b>description</b>	gas tap STN3R gas inlet pipe flange ø20mm bypass nozzle ø 0mm gas outlet 3/8" (tube ø 12mm) thermocouple connection M9x1 pilot connection M10x1 shaft ø 10x8mm shaft L 21/12mm shaft flat upper suitable for CAPIC		
<b>spare parts for</b>	106184		
	<b>GEV No.</b>	101964	<b>Ref. No.</b> —
	clamping bracket		

**gas thermostats**

**SIT**

**710 Minisit series**



<b>GEV No.</b>	106931	<b>Ref. No.</b>	G652002
<b>description</b>	gas thermostat SIT type MINISIT 710 t.max. 310°C 70-310°C gas inlet 1/2" gas outlet 3/8" thermocouple connection M9x1 pilot connection M10x1 probe ø 4mm probe L 72mm capillary pipe 1300mm pressure controller no pressure regulator mbar gland nut 0710647 ignition gas 6mm probe material stainless steel		
<b>For models:</b>	W380161, W380162, W380261, W380461, W380666, W382561, W382562, W382661, W382662, W383061		
<b>accessories for</b>	106931		
	<b>GEV No.</b>	101137	<b>Ref. No.</b> G652202
	cover cap without piezoelectric igniter		
	<b>GEV No.</b>	110068	<b>Ref. No.</b> G652225
	knob suitable for Minisit ø 37mm		





<b>GEV No.</b>	101130	<b>Ref. No.</b>	G652006
<b>description</b>	gas thermostat without cap, button and angle SIT type MINISIT 710 t.max. 100°C 30-100°C gas inlet 1/2" gas outlet 3/8" thermocouple connection M9x1 pilot connection M10x1 probe ø 5mm probe L 122mm capillary pipe 1050mm probe type type A1 pressure controller no pressure regulator gland nut		
<b>spare parts for</b>	101130		
	<b>GEV No.</b>	101053	<b>Ref. No.</b> G402010
	magnet unit T1: M9x1 T2: M24x1 L 45mm ø 17mm suitable for Minisit		
	<b>GEV No.</b>	102100	<b>Ref. No.</b> —
	probe 30-100°C probe ø 5mm probe L 122mm capillary pipe 1050mm t.max. 100°C bain marie probe type type A1 suitable for MINISIT 710		
<b>accessories for</b>	101130		
	<b>GEV No.</b>	100809	<b>Ref. No.</b> —
	O-ring EPDM thickness 2mm ID ø 21mm Qty 1 pcs		
	<b>GEV No.</b>	100820	<b>Ref. No.</b> G652208
	gland duct ET M14x1.5 IT M10x0.75 probe ø max. 6.5mm WS 22		
	<b>GEV No.</b>	100904	<b>Ref. No.</b> —
	locking screw M10x1 for pipe ø 4mm Qty 1 pcs		
	<b>GEV No.</b>	100905	<b>Ref. No.</b> —
	locking screw M10x1 for pipe ø 6mm Qty 1 pcs		
	<b>GEV No.</b>	101054	<b>Ref. No.</b> —
	magnet unit T1: M10x1 T2: M24x1 L 45mm ø 17mm suitable for Minisit		
	<b>GEV No.</b>	101136	<b>Ref. No.</b> —
	piezoelectric igniter suitable for Minisit with cover cap ømm connection F6.3x0.8		
	<b>GEV No.</b>	101137	<b>Ref. No.</b> G652202
	cover cap without piezoelectric igniter		
	<b>GEV No.</b>	101267	<b>Ref. No.</b> —
	reducer IT 3/8" ET 1/2" L 21mm		
	<b>GEV No.</b>	101268	<b>Ref. No.</b> —
	gas connection thread 3/8" angled with O-ring MINISIT 710		
	<b>GEV No.</b>	101269	<b>Ref. No.</b> —
	gas connection thread 1/2" angled with O-ring MINISIT 710		
	<b>GEV No.</b>	101270	<b>Ref. No.</b> —
	screw connection IT 3/8" ET 3/8" L 28mm		
	<b>GEV No.</b>	101272	<b>Ref. No.</b> —
	screw connection IT 1/2" ET 3/8" L 57mm		
	<b>GEV No.</b>	101273	<b>Ref. No.</b> —
	olive for pipe ø 12mm L 9.5mm brass Qty 1 pcs suitable for universal		

<b>accessories for</b>	101130		
	<b>GEV No.</b>	101274	<b>Ref. No.</b> —
	olive for pipe ø 16mm Qty 1 pcs		
	<b>GEV No.</b>	101275	<b>Ref. No.</b> —
	union screw thread 1/2" for pipe ø 16mm Qty 1 pcs		
	<b>GEV No.</b>	101276	<b>Ref. No.</b> —
	union screw thread 3/8" tube ø 12mm Qty 1 pcs		
	<b>GEV No.</b>	110068	<b>Ref. No.</b> G652225
	knob suitable for Minisit ø 37mm		

<b>GEV No.</b>	107237	<b>Ref. No.</b>	G652004
<b>description</b>	gas thermostat without cap, button and angle SIT type MINISIT 710 t.max. 210°C 70-210°C gas inlet 1/2" gas outlet 3/8" thermocouple connection M9x1 pilot connection M10x1 probe ø 4mm probe L 122mm capillary pipe 1300mm probe type pressure controller no pressure regulator gland nut		
<b>accessories for</b>	107237		
	<b>GEV No.</b>	101137	<b>Ref. No.</b> G652202
	cover cap without piezoelectric igniter		
	<b>GEV No.</b>	101267	<b>Ref. No.</b> —
	reducer IT 3/8" ET 1/2" L 21mm		
	<b>GEV No.</b>	101268	<b>Ref. No.</b> —
	gas connection thread 3/8" angled with O-ring MINISIT 710		
	<b>GEV No.</b>	110068	<b>Ref. No.</b> G652225
	knob suitable for Minisit ø 37mm		

STN3R



<b>GEV No.</b>	106208	<b>Ref. No.</b>	G652013
<b>description</b>	gas thermostat t.max. 200°C gas inlet 1/2" gas outlet 1/2" probe ø 6mm probe L 120mm capillary pipe 1200mm STN3R		
<b>spare parts for</b>	106208		
	<b>GEV No.</b>	106211	<b>Ref. No.</b> G652220
	knob suitable for STN3R		

Table continues overleaf





<b>spare parts for</b> 106208			
	GEV No.	106212	Ref. No. G652221
knob suitable for STN3R			



<b>GEV No.</b>	106209	<b>Ref. No.</b>	G652012
<b>description</b>	gas thermostat t.max. 300°C gas inlet 1/2" gas outlet 1/2" probe ø 6.5mm probe L 80mm capillary pipe 1200mm STN3R		
<b>spare parts for</b> 106209			
	GEV No.	106211	Ref. No. G652220
knob suitable for STN3R			
	GEV No.	106212	Ref. No. G652221
knob suitable for STN3R			



<b>GEV No.</b>	106210	<b>Ref. No.</b>	G652016
<b>description</b>	gas thermostat t.max. 450°C gas inlet 1/2" gas outlet 1/2" probe ø 6.5mm probe L 250mm capillary pipe 1200mm STN3R		
<b>spare parts for</b> 106210			
	GEV No.	106211	Ref. No. G652220
knob suitable for STN3R			
	GEV No.	106212	Ref. No. G652221
knob suitable for STN3R			







## gas valves and ignition boxes

### gas control valves









#### SIT











#### ELETTROSIT





<b>GEV No.</b>	101124	<b>Ref. No.</b>	G652401
<b>description</b>	gas valve SIT type ELETTROSIT 230V gas inlet 3/4" gas outlet 3/4" thermocouple connection M9x1 pilot connection M10x1 bottom equiv. no. 0.810.122		
<b>spare parts for</b> 101124			
	GEV No.	101312	Ref. No. —
microswitch			
	GEV No.	101352	Ref. No. —
solenoid coil 230V 50Hz suitable for ELETTROSIT			
<b>accessories for</b> 101124			
	GEV No.	100006	Ref. No. —
piezoelectric igniter suitable for ELETTROSIT body plastic blowing connection ø2.4mm ø 14mm			
	GEV No.	100904	Ref. No. —
locking screw M10x1 for pipe ø 4mm Qty 1 pcs			
	GEV No.	100905	Ref. No. —
locking screw M10x1 for pipe ø 6mm Qty 1 pcs			
	GEV No.	101301	Ref. No. —
gas connection thread 1/2" straight ELETTROSIT screw with O-ring			
	GEV No.	101303	Ref. No. —
gas connection straight thread 3/4" ELETTROSIT			
	GEV No.	101309	Ref. No. —
extension			

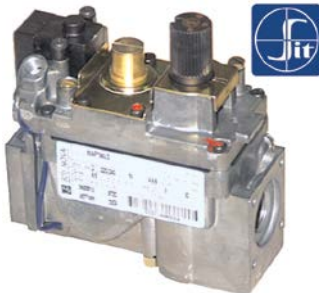

			
1			
<b>GEV No.</b>	101127	<b>Ref. No.</b>	G652405
<b>description</b>	gas valve SIT type ELETTROSIT 230V gas inlet 3/4" gas outlet 3/4" thermocouple connection M9x1 pilot connection M10x1 lateral equiv. no. 0.810.175		
<b>spare parts for</b>	101127		
	<b>GEV No.</b>	101312	<b>Ref. No.</b> —
	microswitch		
	<b>GEV No.</b>	101352	<b>Ref. No.</b> —
	solenoid coil 230V 50Hz suitable for ELETTROSIT		
<b>accessories for</b>	101127		
	<b>GEV No.</b>	100006	<b>Ref. No.</b> —
	piezoelectric igniter suitable for ELETTROSIT body plastic blowing connection ø2.4mm ø 14mm		
	<b>GEV No.</b>	100904	<b>Ref. No.</b> —
	locking screw M10x1 for pipe ø 4mm Qty 1 pcs		
	<b>GEV No.</b>	100905	<b>Ref. No.</b> —
	locking screw M10x1 for pipe ø 6mm Qty 1 pcs		
	<b>GEV No.</b>	101301	<b>Ref. No.</b> —
	gas connection thread 1/2" straight ELETTROSIT screw with O-ring		
	<b>GEV No.</b>	101303	<b>Ref. No.</b> —
	gas connection straight thread 3/4" ELETTROSIT		
	<b>GEV No.</b>	101309	<b>Ref. No.</b> —
	extension		

<b>spare parts for</b>	101162		
	<b>GEV No.</b>	101313	<b>Ref. No.</b> —
	solenoid coil 230V 50Hz		
<b>accessories for</b>	101162		
	<b>GEV No.</b>	100006	<b>Ref. No.</b> —
	piezoelectric igniter suitable for ELETTROSIT body plastic blowing connection ø2.4mm ø 14mm		
	<b>GEV No.</b>	101305	<b>Ref. No.</b> G653033
	gas connection straight 1/2" flange 45x45mm ELETTROSIT/V4400/4600/4605 suitable for SIT/HONEYWELL hole distance 36x36mm		
	<b>GEV No.</b>	101306	<b>Ref. No.</b> G652031
	gas connection angled flange 45x45mm hole distance 36x36mm 1/2" ELETTROSIT/V4400/4600/4605 screw with O-ring suitable for SIT/HONEYWELL		
	<b>GEV No.</b>	101307	<b>Ref. No.</b> —
	gas connection straight flange 45x45mm hole distance 36x36mm 3/4" ELETTROSIT/V4400/4600/4605 screw with O-ring suitable for SIT/HONEYWELL		
	<b>GEV No.</b>	101308	<b>Ref. No.</b> G653032
	gas connection angled flange 45x45mm hole distance 36x36mm 3/4" ELETTROSIT/V4400/4600/4605 screw with O-ring suitable for SIT/HONEYWELL		
	<b>GEV No.</b>	101312	<b>Ref. No.</b> —
	microswitch		
	<b>GEV No.</b>	101314	<b>Ref. No.</b> —
	solenoid coil 24V 50Hz		
	<b>GEV No.</b>	101317	<b>Ref. No.</b> G653035
	plug with cable L 1000mm suitable for NOVASIT		
	<b>GEV No.</b>	101318	<b>Ref. No.</b> —
	cover cap for solenoid coil suitable for NOVASIT		

NOVASIT			
			
1			
<b>GEV No.</b>	101162	<b>Ref. No.</b>	G653030
<b>description</b>	gas valve SIT series Novasit 820 230V 50Hz gas inlet 1/2" gas outlet 1/2" thermocouple connection M9x1 pilot connection M10x1 ignition pressure 3-5mbar pressure range 3-30mbar pressure regulator connection blind equiv. no. 0.820.010		
<b>spare parts for</b>	101162		
	<b>GEV No.</b>	101065	<b>Ref. No.</b> —
	magnet unit with cable L 44mm D1 ø 30mm D2 ø 20mm suitable for NOVASIT		

















			
1			
<b>GEV No.</b>	101908	<b>Ref. No.</b>	G653028
<b>description</b>	gas valve SIT series Novasit 820 230V 50Hz gas inlet 1/2" gas outlet 1/2" thermocouple connection M9x1 pilot connection M10x1 ignition pressure mbar pressure regulator connection blind equiv. no. 0.820.018 output pilot burner M10x1 input pressure max. 60bar setting range 3-30bar		
<b>For models:</b>	W381035, W384121, W384122, W385021, W385022, W385023, W385024, W385025		
<b>spare parts for</b>	101908		
	<b>GEV No.</b>	101065	<b>Ref. No.</b> —
	magnet unit with cable L 44mm D1 ø 30mm D2 ø 20mm suitable for NOVASIT		
	<b>GEV No.</b>	101313	<b>Ref. No.</b> —
	solenoid coil 230V 50Hz		



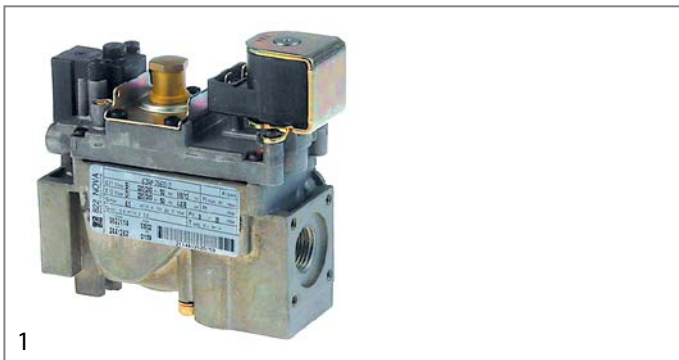
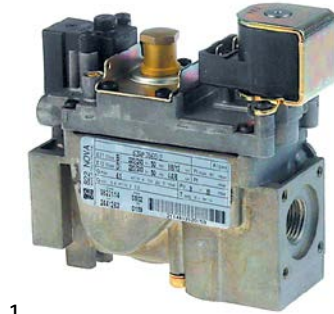

Table continues overleaf





accessories for		101908	
	GEV No.	100006	Ref. No. —
piezoelectric igniter suitable for ELETTROSIT body plastic blowing connection $\varnothing$ 2.4mm $\varnothing$ 14mm			
	GEV No.	101305	Ref. No. G653033
gas connection straight 1/2" flange 45x45mm ELETTROSIT/V4400/4600/4605 suitable for SIT/HONEYWELL hole distance 36x36mm			
	GEV No.	101306	Ref. No. G652031
gas connection angled flange 45x45mm hole distance 36x36mm 1/2" ELETTROSIT/V4400/4600/4605 screw with O-ring suitable for SIT/HONEYWELL			
	GEV No.	101307	Ref. No. —
gas connection straight flange 45x45mm hole distance 36x36mm 3/4" ELETTROSIT/V4400/4600/4605 screw with O-ring suitable for SIT/HONEYWELL			
	GEV No.	101308	Ref. No. G653032
gas connection angled flange 45x45mm hole distance 36x36mm 3/4" ELETTROSIT/V4400/4600/4605 screw with O-ring suitable for SIT/HONEYWELL			
	GEV No.	101312	Ref. No. —
microswitch			
	GEV No.	101314	Ref. No. —
solenoid coil 24V 50Hz			
	GEV No.	101317	Ref. No. G653035
plug with cable L 1000mm suitable for NOVASIT			
	GEV No.	101318	Ref. No. —
cover cap for solenoid coil suitable for NOVASIT			





accessories for		101914	
	GEV No.	101914	Ref. No. G653026
<b>description</b> gas valve SIT series Novasit 822 230V 50Hz gas inlet 1/2" gas outlet 1/2" thermocouple connection pilot connection closed ignition pressure range 3-30mbar pressure regulator connection blind equiv. no. 0.822.144			
<b>spare parts for</b> 101914			
	GEV No.	101313	Ref. No. —
solenoid coil 230V 50Hz			
	GEV No.	101542	Ref. No. —
solenoid coil 50Hz NOVA 822/826/827 suitable for NOVASIT 230V			
<b>accessories for</b> 101914			
	GEV No.	101305	Ref. No. G653033
gas connection straight 1/2" flange 45x45mm ELETTROSIT/V4400/4600/4605 suitable for SIT/HONEYWELL hole distance 36x36mm			
	GEV No.	101306	Ref. No. G652031
gas connection angled flange 45x45mm hole distance 36x36mm 1/2" ELETTROSIT/V4400/4600/4605 screw with O-ring suitable for SIT/HONEYWELL			

accessories for		101914	
	GEV No.	101307	Ref. No. —
gas connection straight flange 45x45mm hole distance 36x36mm 3/4" ELETTROSIT/V4400/4600/4605 screw with O-ring suitable for SIT/HONEYWELL			
	GEV No.	101308	Ref. No. G653032
gas connection angled flange 45x45mm hole distance 36x36mm 3/4" ELETTROSIT/V4400/4600/4605 screw with O-ring suitable for SIT/HONEYWELL			
	GEV No.	101503	Ref. No. —
O-ring EPDM thickness 2mm ID $\varnothing$ 32mm Qty 1 pcs			
	GEV No.	101924	Ref. No. —
plug with cable L 1090mm suitable for NOVA 822/826/827			

accessories			
	1		
<b>GEV No.</b>	101306	<b>Ref. No.</b>	G652031
<b>description</b>	gas connection angled flange 45x45mm hole distance 36x36mm 1/2" ELETTROSIT/V4400/4600/4605 screw with O-ring suitable for SIT/HONEYWELL		
<b>spare parts for</b> 101306			
	GEV No.	517104	Ref. No. —
O-ring EPDM thickness 2.62mm ID $\varnothing$ 31.42mm Qty 1 pcs			

	1		
<b>GEV No.</b>	101308	<b>Ref. No.</b>	G653032
<b>description</b>	gas connection angled flange 45x45mm hole distance 36x36mm 3/4" ELETTROSIT/V4400/4600/4605 screw with O-ring suitable for SIT/HONEYWELL		
<b>For models:</b>	W384121, W384122		

	1		
<b>GEV No.</b>	101305	<b>Ref. No.</b>	G653033
<b>description</b>	gas connection straight 1/2" flange 45x45mm ELETTROSIT/V4400/4600/4605 suitable for SIT/HONEYWELL hole distance 36x36mm		
<b>spare parts for</b> 101305			
	GEV No.	101503	Ref. No. —
O-ring EPDM thickness 2mm ID $\varnothing$ 32mm Qty 1 pcs			

	1		
<b>GEV No.</b>	101674	<b>Ref. No.</b>	G653037
<b>description</b>	knob extension L 57mm NOVA 822/826/827		



			
1			
<b>GEV No.</b>	101317	<b>Ref. No.</b>	G653035
<b>description</b>	plug with cable L 1000mm suitable for NOVASIT		
<b>For models:</b>	W381035, W384121, W384122, W385021, W385022, W385023, W385024, W385025		

			
1			
<b>GEV No.</b>	109128	<b>Ref. No.</b>	G653040
<b>description</b>	pressure controller brass L 25mm ø 11.5mm thread M13x1 for gas valve suitable for gas valves Qty 1 pcs		
<b>For models:</b>	W381035, W384121, W384122, W385021, W385022, W385023, W385024, W385025		

**safety valves**

<b>SIT</b>				
440 series				
				
1				
<b>GEV No.</b>	101101	<b>Ref. No.</b>	G652415	
<b>description</b>	gas valve pressure range 50mbar gas inlet 3/4" gas outlet 3/4" pilot connection M10x1 (tube ø 6mm) thermocouple connection M9x1 type SIT D3			
<b>accessories for</b>	101101			
	<b>GEV No.</b>	100904	<b>Ref. No.</b>	—
locking screw M10x1 for pipe ø 4mm Qty 1 pcs				
	<b>GEV No.</b>	100905	<b>Ref. No.</b>	—
locking screw M10x1 for pipe ø 6mm Qty 1 pcs				

**gas solenoid valves**

<b>ASCO</b>			
			
1			
<b>GEV No.</b>	370710	<b>Ref. No.</b>	E131002
<b>description</b>	solenoid valve gas 2-ways 230VAC inlet 1/8" outlet 1/8" t.max. 60°C connection 1/8" L 33mm Asco coil type 400127-197 p max 15bar membranes FPM type series 256 overall height 53mm		
<b>For models:</b>	W381035, W384121, W384122		

**ignition parts**

**pilot burners**



<b>SIT</b>				
100 series				
				
1				
<b>GEV No.</b>	106906	<b>Ref. No.</b>	G207510	
<b>description</b>	pilot burner SIT type 100 series 3 flames nozzle ø 0.2mm gas connection 6mm			
<b>spare parts for</b>	106906			
	<b>GEV No.</b>	100245	<b>Ref. No.</b>	—
pilot burner nozzle LPG code 20 bore ø 0.2mm Qty 1 pcs thread M8x0.75				
	<b>GEV No.</b>	100855	<b>Ref. No.</b>	—
pilot burner bracket triple				
	<b>GEV No.</b>	100885	<b>Ref. No.</b>	—
air mixing sleeve for pilot burner Qty 1 pcs				
	<b>GEV No.</b>	100916	<b>Ref. No.</b>	—
compression spring for pilot burner Qty 1 pcs				
	<b>GEV No.</b>	100917	<b>Ref. No.</b>	—
gasket for pilot burner Qty 1 pcs aluminium				
	<b>GEV No.</b>	100918	<b>Ref. No.</b>	—
screw for pilot burner				
	<b>GEV No.</b>	107162	<b>Ref. No.</b>	—
pilot burner cap SIT 3 flames Hmm Lmm Qty 1 pcs				
	<b>GEV No.</b>	107701	<b>Ref. No.</b>	—
pilot burner bottom part SIT 100 series nozzle ø 0.2mm				

Table continues overleaf



accessories for 106906				
	GEV No.	100245	Ref. No.	—
	pilot burner nozzle LPG code 20 bore ø 0.2mm Qty 1 pcs thread M8x0.75			
	GEV No.	100246	Ref. No.	—
	pilot burner nozzle natural gas bore ø 0.35mm Qty 1 pcs thread M8x0.75			
	GEV No.	100904	Ref. No.	—
	locking screw M10x1 for pipe ø 4mm Qty 1 pcs			
	GEV No.	100905	Ref. No.	—
	locking screw M10x1 for pipe ø 6mm Qty 1 pcs			
	GEV No.	102110	Ref. No.	—
	pilot tube copper pipe ø 4mm thickness 1mm L 3000mm			
	GEV No.	102111	Ref. No.	B400106
	pilot tube copper pipe ø 6mm thickness 1mm L 3000mm			
	GEV No.	107171	Ref. No.	—
	pilot burner nozzle SIT natural/liquid gas bore ø 0.25mm Qty 1 pcs			
	GEV No.	107700	Ref. No.	—
	pilot burner bottom part SIT 100 series nozzle ø 0.25mm			
	GEV No.	107702	Ref. No.	—
	pilot burner bottom part SIT 100 series nozzle ø 0.35mm			

accessories

ignition electrodes

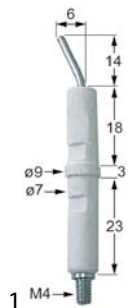



<b>GEV No.</b>	100706	<b>Ref. No.</b>	G207511
<b>description</b>	ignition electrode connection M4 Qty 1 pcs		

**HONEYWELL**



pilot burners

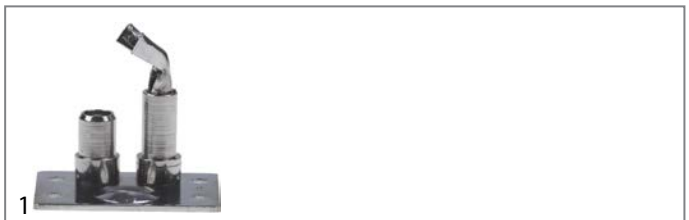

<b>GEV No.</b>	102886	<b>Ref. No.</b>	G207529+G207532
<b>description</b>	pilot burner 1 flame		
<b>accessories for</b>	102886		
	GEV No.	102888	Ref. No. —
	pilot burner nozzle HONEYWELL natural gas bore ø 0.51mm model Q349		

accessories for 102886				
	GEV No.	102889	Ref. No.	G206925
	pilot burner nozzle HONEYWELL LPG bore ø 0.25mm model Q349			
	GEV No.	102892	Ref. No.	G207534
	ignition electrode D1 ø 6mm L1 22mm BL1 25mm BL2 19mm connection F 2.8x0.8mm M8x10			





<b>GEV No.</b>	106939	<b>Ref. No.</b>	G207529
<b>description</b>	pilot burner HONEYWELL type Q349A1124 1 Typ 27		
<b>For models:</b>	W380111, W380112, W380121, W380122, W380131, W380132, W380141, W380142, W380151, W380152, W380161, W380162, W380261, W380411, W380413, W380421, W380423, W380431, W380433, W380441, W380443, W380451, W380461, W380666, W380912, W380915, W380917, W380919, W380922, W380925, W380927, W380929, W380932, W380935, W380937, W380939, W380942, W380945, W380947, W380949, W381035, W381515, W381525, W381535, W381545, W381815, W381825, W381835, W382511, W382551...(Other models you can see in the webshop)		
<b>accessories for</b>	106939		
	GEV No.	102905	Ref. No. G207532
	locking screw thread M11x1 ø 6mm		
	GEV No.	106938	Ref. No. G206932
	pilot burner nozzle HONEYWELL natural gas code 0.51 model Q349		

**AEM**

pilot burners



<b>GEV No.</b>	102480	<b>Ref. No.</b>	G207523
<b>description</b>	pilot burner 1 flame gas connection 6mm mounting thread M4		
<b>accessories for</b>	102480		
	GEV No.	106427	Ref. No. G206942
	pilot burner nozzle natural/liquid gas bore ø 0.3mm code 30 thread 7/32" (28G) WS 6		
	GEV No.	106428	Ref. No. G206944
	pilot burner nozzle LPG bore ø 0.25mm code 25 thread 7/32" (28G) WS 6		





1

<b>GEV No.</b>	102481	<b>Ref. No.</b>	G207522
<b>description</b>	pilot burner 1 flame gas connection 6mm mounting thread M4		
<b>For models:</b>	W380111, W380112, W380121, W380122, W380131, W380132, W380141, W380142, W380151, W380152, W380161, W380162, W380211, W380221, W380231, W380241, W380251, W380261, W380511, W380521, W380531, W380541, W382511, W382551, W382552, W382561, W382562, W382611, W382651, W382652, W382661, W382662		
<b>accessories for</b>	102481		
	<b>GEV No.</b>	106429	<b>Ref. No.</b> G206946
	pilot burner nozzle natural gas bore $\varnothing$ 0.35mm thread M5x0.75 WS 6		
	<b>GEV No.</b>	107244	<b>Ref. No.</b> G206947
	pilot burner nozzle LPG code 20 bore $\varnothing$ 0.2mm thread M5x0.75 Qty 1 pcs brass		



1



<b>GEV No.</b>	102481	<b>Ref. No.</b>	G207522
<b>description</b>	pilot burner 1 flame gas connection 6mm mounting thread M4		
<b>For models:</b>	W380111, W380112, W380121, W380122, W380131, W380132, W380141, W380142, W380151, W380152, W380161, W380162, W380211, W380221, W380231, W380241, W380251, W380261, W380511, W380521, W380531, W380541, W382511, W382551, W382552, W382561, W382562, W382611, W382651, W382652, W382661, W382662		
<b>accessories for</b>	102481		
	<b>GEV No.</b>	106429	<b>Ref. No.</b> G206946
	pilot burner nozzle natural gas bore $\varnothing$ 0.35mm thread M5x0.75 WS 6		
	<b>GEV No.</b>	107244	<b>Ref. No.</b> G206947
	pilot burner nozzle LPG code 20 bore $\varnothing$ 0.2mm thread M5x0.75 Qty 1 pcs brass		

producer-specific pilot burners

CAPIC



1

<b>GEV No.</b>	102480	<b>Ref. No.</b>	G207523
<b>description</b>	pilot burner 1 flame gas connection 6mm mounting thread M4		
<b>accessories for</b>	102480		
	<b>GEV No.</b>	106427	<b>Ref. No.</b> G206942
	pilot burner nozzle natural/liquid gas bore $\varnothing$ 0.3mm code 30 thread 7/32" (28G) WS 6		
	<b>GEV No.</b>	106428	<b>Ref. No.</b> G206944
	pilot burner nozzle LPG bore $\varnothing$ 0.25mm code 25 thread 7/32" (28G) WS 6		

electrodes

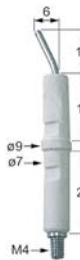

1

<b>GEV No.</b>	100706	<b>Ref. No.</b>	G207511
<b>description</b>	ignition electrode connection M4 Qty 1 pcs		

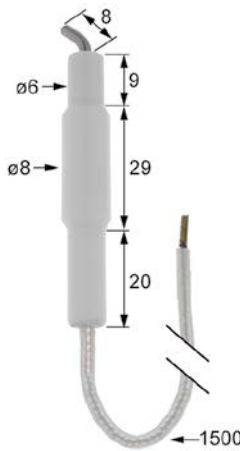

1

<b>GEV No.</b>	107788	<b>Ref. No.</b>	G207554
<b>description</b>	ignition electrode D1 $\varnothing$ 6mm D2 $\varnothing$ 8mm L1 6mm BL1 9mm BL2 29mm BL3 20mm cable length 1500mm connection $\varnothing$ 1.5mm		

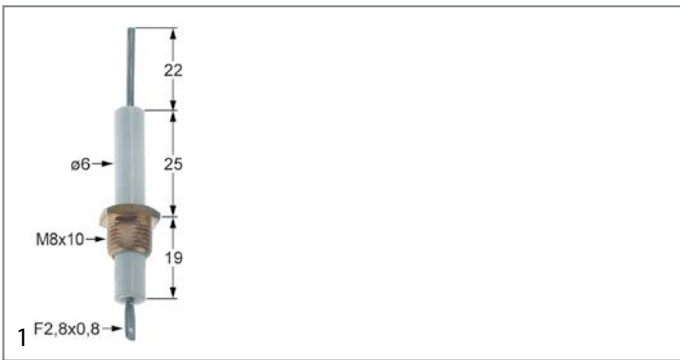

<b>GEV No.</b>	102892	<b>Ref. No.</b>	G207534
<b>description</b>	ignition electrode D1 ø 6mm L1 22mm BL1 25mm BL2 19mm connection F 2.8x0.8mm M8x10		
<b>For models:</b>	W380111, W380112, W380121, W380122, W380131, W380132, W380141, W380142, W380151, W380152, W380161, W380162, W380261, W380411, W380413, W380421, W380423, W380431, W380433, W380441, W380443, W380451, W380461, W380666, W380912, W380915, W380917, W380919, W380922, W380925, W380927, W380929, W380932, W380935, W380937, W380939, W380942, W380945, W380947, W380949, W381035, W381515, W381525, W381535, W381545, W381815, W381825, W381835, W382511, W382511...(Other models you can see in the webshop)		

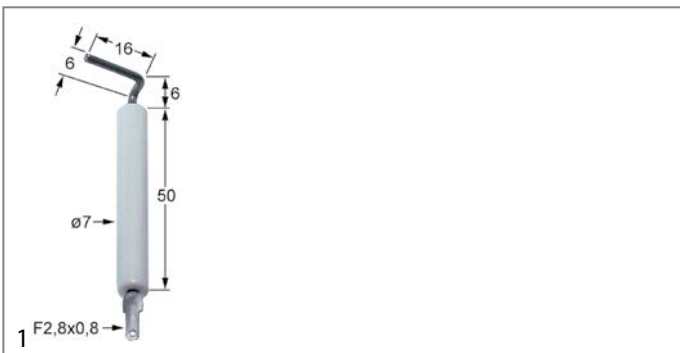

<b>GEV No.</b>	102907	<b>Ref. No.</b>	G101030
<b>description</b>	ignition electrode D1 ø 7mm connection F 2.8x0.8mm L1 6mm L2 6mm L3 16mm BL1 50mm to clip		
<b>For models:</b>	W380111, W380112, W380121, W380122, W380131, W380132, W380141, W380142, W380151, W380152, W380161, W380162, W380211, W380221, W380231, W380241, W380251, W380261, W380511, W380521, W380531, W380541, W382511, W382551, W382552, W382561, W382562, W382611, W382651, W382652, W382661, W382662		

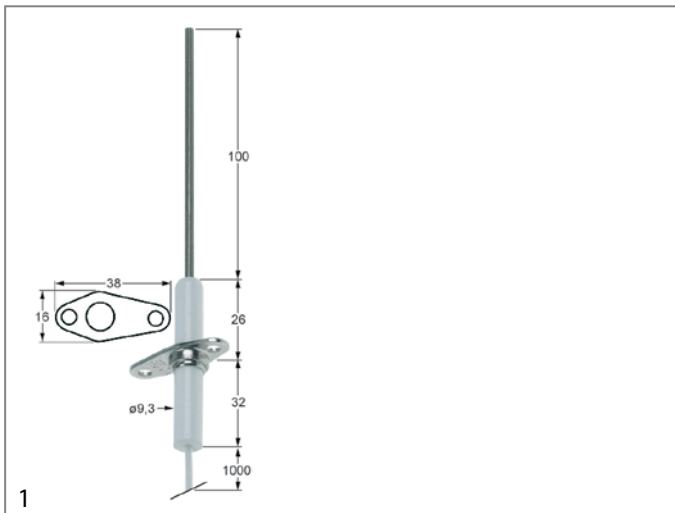

<b>GEV No.</b>	104448	<b>Ref. No.</b>	G207536
<b>description</b>	ignition electrode flange length 38mm flange width 16mm D1 ø 9.3mm L1 100mm BL1 26mm BL2 32mm cable length 1000mm mounting distance 28mm		

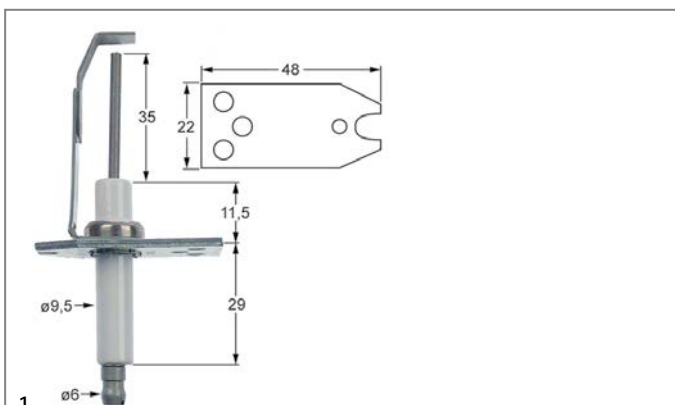





<b>GEV No.</b>	104637	<b>Ref. No.</b>	G101034
<b>description</b>	ignition electrode flange length 48mm flange width 23mm D1 ø 9.5mm L1 35mm BL1 11.5mm BL2 32mm fixing dimensions ø5.5x4.5mm/ø4.5mm flange connection ø 6mm		

## ignition cables

### cables



<b>GEV No.</b>	100027	<b>Ref. No.</b>	E351610
<b>description</b>	ignition cable Qty 5m 0.34mm <sup>2</sup> ED ø 3mm insulation glass fibre t.max. 180°C		
<b>accessories for</b>	100027		
	<b>GEV No.</b>	100021	<b>Ref. No.</b> —
	female faston size 2.8x0.8mm 0.5-1.0mm <sup>2</sup> CuZn t.max. 125°C Qty 20 pcs		
	<b>GEV No.</b>	100022	<b>Ref. No.</b> —
	female faston size 6.3x0.8mm 0.5-1.0mm <sup>2</sup> CuZn t.max. 125°C Qty 20 pcs		
	<b>GEV No.</b>	100023	<b>Ref. No.</b> —
	female bullet size 2.3mm 0.5-1.5mm <sup>2</sup> CuZn t.max. 125°C Qty 20 pcs		
	<b>GEV No.</b>	100024	<b>Ref. No.</b> —
	female bullet size 4mm 0.25-1.5mm <sup>2</sup> CuZn t.max. 125°C Qty 20 pcs		





piezoelectric igniters

miscellaneous



<b>GEV No.</b>	nl <sup>1</sup>	<b>Ref. No.</b>	E050504
<b>description</b>	piezoelectric igniter suitable for Minisit connection F6.3x0.8 ømm		

<sup>1</sup>no longer available

ignition units



<b>GEV No.</b>	102485	<b>Ref. No.</b>	E050505
<b>description</b>	ignition unit outputs 2 220-240VAC 0.6VA 50-60Hz		

**For models:**

W380161, W380162, W380261, W380413, W380423, W380433, W380443, W380461, W380511, W380521, W380531, W380541, W380666, W380912, W380915, W380917, W380919, W380922, W380925, W380927, W380929, W380932, W380935, W380937, W380939, W380942, W380945, W380947, W380949, W381035, W381515, W381525, W381535, W381545, W381815, W381825, W381835, W382561, W382562, W382661, W382662, W383061, W384022, W384121, W384122, W385021, W385022, W385023, W385024, W385025



<b>GEV No.</b>	102389	<b>Ref. No.</b>	E050506
<b>description</b>	ignition unit outputs 6 230VAC dimensions 135x23x34mm mounting distance 123mm inlet F6.3x0.8 outlet F2.8x0.8 0.6VA 50/60Hz		

**For models:**

W380111, W380112, W380121, W380122, W380131, W380132, W380141, W380142, W380151, W380152, W380161, W380162, W380211, W380221, W380231, W380241, W380251, W380261, W380411, W380421, W380431, W380441, W380451, W380461, W382511, W382551, W382552, W382561, W382562, W382611, W382651, W382652, W382661, W382662

thermocouples

thermocouple sets universal



<b>GEV No.</b>	102284	<b>Ref. No.</b>	G401005
<b>description</b>	thermocouple set 8-piece L 900mm		
<b>For models:</b>	W380111, W380112, W380121, W380122, W380131, W380132, W380141, W380142, W380151, W380152, W380161, W380162, W380261, W380411, W380413, W380421, W380423, W380431, W380433, W380441, W380443, W380451, W380461, W380666, W380912, W380915, W380917, W380919, W380922, W380925, W380927, W380929, W380932, W380935, W380937, W380939, W380942, W380945, W380947, W380949, W381035, W381515, W381525, W381535, W381545, W381815, W381825, W381835, W382511, W382551...(Other models you can see in the webshop)		

plug-in thermocouples

plug-in thermocouples standard

with barrel socket ø6(6.5)mm

thermocouples SIT

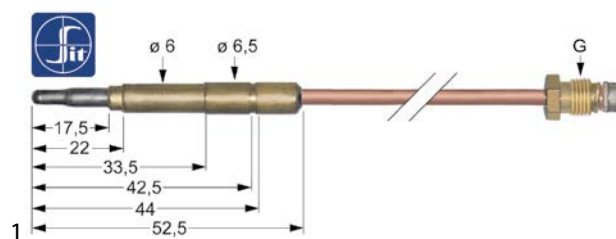

<b>GEV No.</b>	107611	<b>Ref. No.</b>	G401030
<b>description</b>	thermocouple SIT M9x1 L 850mm plug connection ø6.0(6.5)mm		

**For models:**

W380111, W380112, W380121, W380122, W380131, W380132, W380141, W380142, W380151, W380152, W380161, W380162, W380211, W380221, W380231, W380241, W380251, W380261, W380511, W380521, W380531, W380541, W382511, W382551, W382552, W382561, W382562, W382611, W382651, W382652, W382661, W382662

gas burners

hob burners

producer-specific hob burners

CAPIC

1200 series



<b>GEV No.</b>	108099	<b>Ref. No.</b>	G205514
<b>description</b>	venturi L 153mm size 4/5 thread M18x1.5 complete		

**For models:**

W380111, W380121, W380131, W380141, W380151, W380161, W380211, W380221, W380231, W380241, W380251, W380261, W380511, W380521, W380531, W380541, W382511, W382551, W382552, W382561, W382562, W382611, W382651, W382652, W382661, W382662



851 series



<b>GEV No.</b>	107067	<b>Ref. No.</b>	N/A
<b>description</b>	burner type 851 ø 120mm L 120mm complete		



<b>GEV No.</b>	107068	<b>Ref. No.</b>	G200520
<b>description</b>	burner type 851 ø 120mm L 175mm complete		



<b>GEV No.</b>	108043	<b>Ref. No.</b>	N/A
<b>description</b>	burner head ø 120mm seat ø 114mm with central hole		



<b>GEV No.</b>	108017	<b>Ref. No.</b>	G204035
<b>description</b>	burner head ø 120mm seat ø 39mm		



<b>GEV No.</b>	108016	<b>Ref. No.</b>	G204037
<b>description</b>	burner ring ø 115mm		

854 series



<b>GEV No.</b>	108004	<b>Ref. No.</b>	N/A
<b>description</b>	burner cap ø 78mm 5kW mounting ø 72mm		
<b>accessories for</b>	108004		



<b>GEV No.</b>	108003	<b>Ref. No.</b>	G204006
<b>description</b>	burner head for burner cap ø 78mm seat ø 35mm ID ø 30mm ED ø 83mm		



<b>GEV No.</b>	108003	<b>Ref. No.</b>	G204006
<b>description</b>	burner head for burner cap ø 78mm seat ø 35mm ID ø 30mm ED ø 83mm		

**accessories for** 108003



<b>GEV No.</b>	108004	<b>Ref. No.</b>	N/A
<b>description</b>	burner cap ø 78mm 5kW mounting ø 72mm		

860 series



<b>GEV No.</b>	107008	<b>Ref. No.</b>	G200510
<b>description</b>	burner type 860 ø 80mm complete		



<b>GEV No.</b>	107042	<b>Ref. No.</b>	N/A
<b>description</b>	burner type 860 ø 80mm L 175mm complete		



<b>GEV No.</b>	108006	<b>Ref. No.</b>	G204030
<b>description</b>	burner head ø 80mm mounting ø 32mm		



<b>GEV No.</b>	108005	<b>Ref. No.</b>	G204032
<b>description</b>	burner ring ø 72mm		

861 series





<b>GEV No.</b>	107009	<b>Ref. No.</b>	N/A
<b>description</b>	burner type 861 ø 80mm L 185mm complete		





			
1			
<b>GEV No.</b>	108000	<b>Ref. No.</b>	G204007 G204060
<b>description</b>	burner cap ø 78mm		

			
1			
<b>GEV No.</b>	108078	<b>Ref. No.</b>	G204012 G204027
<b>description</b>	burner cap ø 98mm mounting ø 97mm		

			
1			
<b>GEV No.</b>	108010	<b>Ref. No.</b>	G204060
<b>description</b>	burner cap ø 78mm		
<b>For models:</b>	W380111, W380112, W380121, W380122, W380131, W380132, W380141, W380142, W380151, W380152, W380161, W380162, W380211, W380221, W380231, W380241, W380251, W380261, W380511, W380521, W380531, W380541, W382511, W382551, W382552, W382561, W382562, W382611, W382651, W382652, W382661, W382662		
<b>accessories for</b>	108010		
	<b>GEV No.</b>	108003	<b>Ref. No.</b>
			G204006
	burner head for burner cap ø 78mm seat ø 35mm ID ø 30mm ED ø 83mm		

			
1			
<b>GEV No.</b>	108014	<b>Ref. No.</b>	G204011
<b>description</b>	burner head ø 100mm seat ø 97mm		

			
1			
<b>GEV No.</b>	108056	<b>Ref. No.</b>	G205010
<b>description</b>	burner lower part size 6		

			
1			
<b>GEV No.</b>	108003	<b>Ref. No.</b>	G204006
<b>description</b>	burner head for burner cap ø 78mm seat ø 35mm ID ø 30mm ED ø 83mm		
<b>accessories for</b>	108003		
	<b>GEV No.</b>	108004	<b>Ref. No.</b>
			N/A
	burner cap ø 78mm 5kW mounting ø 72mm		

<b>951 series</b>			
			
1			
<b>GEV No.</b>	107019	<b>Ref. No.</b>	G201025
<b>description</b>	burner type 951 ø 120mm L 215mm complete		
<b>For models:</b>	W380111, W380112, W380121, W380122, W380131, W380132, W380141, W380142, W380151, W380152, W380161, W380162, W380411, W380413, W380421, W380423, W380431, W380433, W380441, W380443, W380451, W380461, W382511, W382551, W382552, W382561, W382562		

			
1			
<b>GEV No.</b>	108056	<b>Ref. No.</b>	G205010
<b>description</b>	burner lower part size 6		

			
1			
<b>GEV No.</b>	107194	<b>Ref. No.</b>	G201035
<b>description</b>	burner type 951 ø 120mm L 245mm complete		

<b>862 series</b>			
			
1			
<b>GEV No.</b>	107119	<b>Ref. No.</b>	G205020 G205515
<b>description</b>	burner type 862 ø 100mm L 185mm complete		

			
1			
<b>GEV No.</b>	107020	<b>Ref. No.</b>	N/A
<b>description</b>	burner type 951 ø 120mm L 275mm complete		





			
1			
<b>GEV No.</b>	108018	<b>Ref. No.</b>	G204055
<b>description</b>	burner cap ø 120mm with central hole		

			
1			
<b>GEV No.</b>	108046	<b>Ref. No.</b>	N/A
<b>description</b>	burner head ø 120mm seat ø 114mm with central hole		

956 series			
			
1			
<b>GEV No.</b>	108022	<b>Ref. No.</b>	G204040
<b>description</b>	burner ø 120mm thread 1" IT		

			
1			
<b>GEV No.</b>	107023	<b>Ref. No.</b>	G201010
<b>description</b>	burner type 956 ø 120mm complete		

			
1			
<b>GEV No.</b>	108017	<b>Ref. No.</b>	G204035
<b>description</b>	burner head ø 120mm seat ø 39mm		

			
1			
<b>GEV No.</b>	108025	<b>Ref. No.</b>	N/A
<b>description</b>	burner head ø 120mm thread 1" IT		

			
1			
<b>GEV No.</b>	108016	<b>Ref. No.</b>	G204037
<b>description</b>	burner ring ø 115mm		

1027 series			
			
1			
<b>GEV No.</b>	107013	<b>Ref. No.</b>	G201018
<b>description</b>	burner type 1027 ø 90mm L 125mm complete		

1028 series			
			
1			
<b>GEV No.</b>	107022	<b>Ref. No.</b>	N/A
<b>description</b>	burner type 1028 ø 120mm L 225mm complete		



			
1			
<b>GEV No.</b>	108020	<b>Ref. No.</b>	N/A
<b>description</b>	burner cap ø 120mm with central hole		



1029 series			
			
1			
<b>GEV No.</b>	107088	<b>Ref. No.</b>	N/A
<b>description</b>	burner type 1029 ø 140mm L 295mm complete		



			
1			
<b>GEV No.</b>	108086	<b>Ref. No.</b>	N/A
<b>description</b>	burner cap ø 140mm with central hole		

			
1			
<b>GEV No.</b>	108049	<b>Ref. No.</b>	N/A
<b>description</b>	burner head ø 142mm seat ø 134mm with central hole		



1030 series			
			
1			
<b>GEV No.</b>	107090	<b>Ref. No.</b>	G201032
<b>description</b>	burner type 1030 ø 200mm L 265mm complete		
<b>accessories for</b>	107090		
	<b>GEV No.</b>	106544	<b>Ref. No.</b> G206540
	gas injector thread 3/8" WS 17 bore ø 2.2mm		
	<b>GEV No.</b>	106556	<b>Ref. No.</b> G206558
	gas injector thread 3/8" WS 17 bore ø 3.3mm		

5000 series			
			
1			
<b>GEV No.</b>	108010	<b>Ref. No.</b>	G204060
<b>description</b>	burner cap ø 78mm		
<b>For models:</b>	W380111, W380112, W380121, W380122, W380131, W380132, W380141, W380142, W380151, W380152, W380161, W380162, W380211, W380221, W380231, W380241, W380251, W380261, W380511, W380521, W380531, W380541, W382511, W382551, W382552, W382561, W382562, W382611, W382651, W382652, W382661, W382662		
<b>accessories for</b>	108010		
	<b>GEV No.</b>	108003	<b>Ref. No.</b> G204006
	burner head for burner cap ø 78mm seat ø 35mm ID ø 30mm ED ø 83mm		

			
1			
<b>GEV No.</b>	107324	<b>Ref. No.</b>	G204062
<b>description</b>	burner head ø 119mm for burner cap ø 78mm		
<b>For models:</b>	W380111, W380112, W380121, W380122, W380131, W380132, W380141, W380142, W380151, W380152, W380161, W380162, W380211, W380221, W380231, W380241, W380251, W380261, W380511, W380521, W380531, W380541, W382511, W382551, W382552, W382561, W382562, W382611, W382651, W382652, W382661, W382662		
<b>accessories for</b>	107324		
	<b>GEV No.</b>	108056	<b>Ref. No.</b> G205010
	burner lower part size 6		

pan supports			
			
1			
<b>GEV No.</b>	210044	<b>Ref. No.</b>	A251010
<b>description</b>	pan support L 300mm W 275mm cast iron		

solid tops			
			
1			
<b>GEV No.</b>	211096	<b>Ref. No.</b>	A254020 A254030
<b>description</b>	solid top ø 260mm H 18mm		

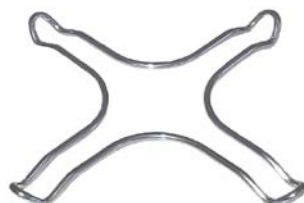
accessories			
reducers for pan supports			
			
1			
<b>GEV No.</b>	210001	<b>Ref. No.</b>	A300503
<b>description</b>	reducer for pan support L 265mm W 265mm SS suitable for universal		



## bar burners

bar burners			
			
1			
<b>GEV No.</b>	109200	<b>Ref. No.</b>	G203010
<b>description</b>	bar burner 1-row L 410mm Wmm ø 50mm Hmm flange width 72mm flange length 75mm fryer		

			
1			
<b>GEV No.</b>	109104	<b>Ref. No.</b>	G203005
<b>description</b>	bar burner 1-row L 495mm Wmm ø 50mm Hmm flange width 72mm flange length 75mm fryer		

			
1			
<b>GEV No.</b>	109103	<b>Ref. No.</b>	G203015
<b>description</b>	bar burner 1-row L 650mm Wmm ø 50mm Hmm flange width 72mm flange length 75mm fryer		

ceramic burners

			
1			
<b>GEV No.</b>	105506	<b>Ref. No.</b>	G201045
<b>description</b>	ceramic burner L 585mm W 67mm firing range 549x38mm for salamander/chicken rotisserie		
<b>accessories for</b>	105506		
	<b>GEV No.</b>	100982	<b>Ref. No.</b> —
	gas injector thread M8x1 WS 12 bore ø 0.85mm		
	<b>GEV No.</b>	102953	<b>Ref. No.</b> —
	gas injector thread M8x1 WS 12 bore ø 1.1mm		

gas nozzles

main nozzles

gas nozzles 3/8"

			
1			
<b>GEV No.</b>	106532	<b>Ref. No.</b>	G206508
<b>description</b>	gas injector thread 3/8" WS 17 bore ø 1.1mm		
<b>For models:</b>	W381035		

			
1			
<b>GEV No.</b>	106534	<b>Ref. No.</b>	G206512
<b>description</b>	gas injector thread 3/8" WS 17 bore ø 1.2mm		
<b>For models:</b>	W380111, W380112, W380121, W380122, W380131, W380132, W380141, W380142, W380151, W380152, W380161, W380162, W380211, W380221, W380231, W380241, W380251, W380261, W380511, W380521, W380531, W380541, W382511, W382551, W382552, W382561, W382562, W382611, W382651, W382652, W382661, W382662		

			
1			
<b>GEV No.</b>	106535	<b>Ref. No.</b>	G206516
<b>description</b>	gas injector thread 3/8" WS 17 bore ø 1.3mm		

			
1			
<b>GEV No.</b>	106536	<b>Ref. No.</b>	G206520
<b>description</b>	gas injector thread 3/8" WS 17 bore ø 1.4mm		
<b>For models:</b>	W380111, W380112, W380121, W380122, W380131, W380132, W380141, W380142, W380151, W380152, W380161, W380162, W380411, W380413, W380421, W380423, W380431, W380433, W380441, W380443, W380451, W380461, W382511, W382551, W382552, W382561, W382562		

			
1			
<b>GEV No.</b>	106537	<b>Ref. No.</b>	G206524
<b>description</b>	gas injector thread 3/8" WS 17 bore ø 1.5mm		

			
1			
<b>GEV No.</b>	106538	<b>Ref. No.</b>	G206526
<b>description</b>	gas injector thread 3/8" WS 17 bore ø 1.6mm		

			
1			
<b>GEV No.</b>	106540	<b>Ref. No.</b>	G206532
<b>description</b>	gas injector thread 3/8" WS 17 bore ø 1.8mm		
<b>For models:</b>	W380111, W380112, W380121, W380122, W380131, W380132, W380141, W380142, W380151, W380152, W380161, W380162, W380211, W380221, W380231, W380241, W380251, W380261, W380511, W380521, W380531, W380541, W382511, W382551, W382552, W382561, W382562, W382611, W382651, W382652, W382661, W382662		

			
1			
<b>GEV No.</b>	106541	<b>Ref. No.</b>	G206534
<b>description</b>	gas injector thread 3/8" WS 17 bore ø 1.9mm		





			
1			
<b>GEV No.</b>	106531	<b>Ref. No.</b>	G206504
<b>description</b>	gas injector thread 3/8" WS 17 bore ø 1mm		

			
1			
<b>GEV No.</b>	106542	<b>Ref. No.</b>	G206536
<b>description</b>	gas injector thread 3/8" WS 17 bore ø 2mm		

			
1			
<b>GEV No.</b>	106543	<b>Ref. No.</b>	G206538
<b>description</b>	gas injector thread 3/8" WS 17 bore ø 2.1mm		
<b>For models:</b>	W380111, W380112, W380121, W380122, W380131, W380132, W380141, W380142, W380151, W380152, W380161, W380162, W380411, W380413, W380421, W380423, W380431, W380433, W380441, W380443, W380451, W380461, W382511, W382551, W382552, W382561, W382562		

			
1			
<b>GEV No.</b>	106556	<b>Ref. No.</b>	G206558
<b>description</b>	gas injector thread 3/8" WS 17 bore ø 3.3mm		

			
1			
<b>GEV No.</b>	106544	<b>Ref. No.</b>	G206540
<b>description</b>	gas injector thread 3/8" WS 17 bore ø 2.2mm		

			
1			
<b>GEV No.</b>	106553	<b>Ref. No.</b>	G206554
<b>description</b>	gas injector thread 3/8" WS 17 bore ø 3mm		

gas nozzles M10x1.5

			
1			
<b>GEV No.</b>	106545	<b>Ref. No.</b>	G206542
<b>description</b>	gas injector thread 3/8" WS 17 bore ø 2.3mm		

			
1			
<b>GEV No.</b>	196000	<b>Ref. No.</b>	G207212
<b>description</b>	gas injector thread M10x1.5 WS 14 bore ø 1.1mm		

			
1			
<b>GEV No.</b>	106547	<b>Ref. No.</b>	G206546
<b>description</b>	gas injector thread 3/8" WS 17 bore ø 2.5mm		

			
1			
<b>GEV No.</b>	106935	<b>Ref. No.</b>	G207240
<b>description</b>	gas injector thread M10x1.5 WS 14 bore ø 1.6mm		

			
1			
<b>GEV No.</b>	106551	<b>Ref. No.</b>	G206552
<b>description</b>	gas injector thread 3/8" WS 17 bore ø 2.8mm		

			
1			
<b>GEV No.</b>	106936	<b>Ref. No.</b>	G207248
<b>description</b>	gas injector thread M10x1.5 WS 14 bore ø 1.7mm		

			
1			
<b>GEV No.</b>	106937	<b>Ref. No.</b>	G207256
<b>description</b>	gas injector thread M10x1.5 WS 14 bore ø 1.8mm		

pilot burner nozzles

pilot burner nozzles AEM



<b>GEV No.</b>	106428	<b>Ref. No.</b>	G206944
<b>description</b>	pilot burner nozzle LPG bore ø 0.25mm code 25 thread 7/32" (28G) WS 6		



<b>GEV No.</b>	107767	<b>Ref. No.</b>	N/A
<b>description</b>	pilot burner nozzle LPG bore ø 0.2mm code 20 thread 7/32" (28G) WS 6		



<b>GEV No.</b>	106429	<b>Ref. No.</b>	G206946
<b>description</b>	pilot burner nozzle natural gas bore ø 0.35mm thread M5x0.75 WS 6		
<b>For models:</b>	W380111, W380112, W380121, W380122, W380131, W380132, W380141, W380142, W380151, W380152, W380161, W380162, W380211, W380221, W380231, W380241, W380251, W380261, W380461, W380511, W380521, W380531, W380541, W380666, W381035, W382511, W382551, W382552, W382561, W382562, W382611, W382651, W382652, W382661, W382662, W383061, W385023, W385024, W385025		



<b>GEV No.</b>	106427	<b>Ref. No.</b>	G206942
<b>description</b>	pilot burner nozzle natural/liquid gas bore ø 0.3mm code 30 thread 7/32" (28G) WS 6		

pilot burner nozzles HONEYWELL

for series Q349



<b>GEV No.</b>	102889	<b>Ref. No.</b>	G206925
<b>description</b>	pilot burner nozzle HONEYWELL LPG bore ø 0.25mm model Q349		
<b>For models:</b>	W380111, W380112, W380121, W380122, W380131, W380132, W380141, W380142, W380151, W380152, W380161, W380162, W380261, W380411, W380413, W380421, W380423, W380431, W380433, W380441, W380443, W380451, W380461, W380666, W380912, W380915, W380917, W380919, W380922, W380925, W380927, W380929, W380932, W380935, W380937, W380939, W380942, W380945, W380947, W380949, W381035, W381815, W381825, W381835, W382511, W382551, W382552, W382561, W382562, W382661...(Other models you can see in the webshop)		



<b>GEV No.</b>	106938	<b>Ref. No.</b>	G206932
<b>description</b>	pilot burner nozzle HONEYWELL natural gas code 0.51 model Q349		
<b>For models:</b>	W380111, W380112, W380121, W380122, W380131, W380132, W380141, W380142, W380151, W380152, W380161, W380162, W380261, W380411, W380413, W380421, W380423, W380431, W380433, W380441, W380443, W380451, W380461, W380666, W380912, W380915, W380917, W380919, W380922, W380925, W380927, W380929, W380932, W380935, W380937, W380939, W380942, W380945, W380947, W380949, W381035, W381815, W381825, W381835, W382511, W382551, W382552, W382561, W382562, W382661...(Other models you can see in the webshop)		

pilot burner nozzles (other)

SOLYMAC/CAPIC



<b>GEV No.</b>	107244	<b>Ref. No.</b>	G206947
<b>description</b>	pilot burner nozzle LPG code 20 bore ø 0.2mm thread M5x0.75 Qty 1 pcs brass		



<b>GEV No.</b>	106429	<b>Ref. No.</b>	G206946
<b>description</b>	pilot burner nozzle natural gas bore ø 0.35mm thread M5x0.75 WS 6		
<b>For models:</b>	W380111, W380112, W380121, W380122, W380131, W380132, W380141, W380142, W380151, W380152, W380161, W380162, W380211, W380221, W380231, W380241, W380251, W380261, W380461, W380511, W380521, W380531, W380541, W380666, W381035, W382511, W382551, W382552, W382561, W382562, W382611, W382651, W382652, W382661, W382662, W383061, W385023, W385024, W385025		

burner nozzles



<b>GEV No.</b>	102897	<b>Ref. No.</b>	G202010
<b>description</b>	burner nozzle LPG		



<b>GEV No.</b>	102896	<b>Ref. No.</b>	G202030
<b>description</b>	burner nozzle natural gas		





## auxiliary gas parts

### screw connections

#### olives



<b>GEV No.</b>	101248	<b>Ref. No.</b>	G701026
----------------	--------	-----------------	---------

**description** olive for pipe ø 12mm Qty 1 pcs suitable for PEL

**accessories for** 101248



<b>GEV No.</b>	101251	<b>Ref. No.</b>	—
----------------	--------	-----------------	---

union nut thread M20x1.5 for pipe ø 12mm



<b>GEV No.</b>	101286	<b>Ref. No.</b>	G701011
----------------	--------	-----------------	---------

**description** olive ID ø 6mm Qty 1 pcs

**accessories for** 101286



<b>GEV No.</b>	100909	<b>Ref. No.</b>	G701010
----------------	--------	-----------------	---------

union screw thread M10x1 for pipe ø 6mm Qty 1 pcs



<b>GEV No.</b>	101464	<b>Ref. No.</b>	—
----------------	--------	-----------------	---

union nut thread M12x1 for pipe ø 6mm

#### union screws



<b>GEV No.</b>	100909	<b>Ref. No.</b>	G701010
----------------	--------	-----------------	---------

**description** union screw thread M10x1 for pipe ø 6mm Qty 1 pcs

**accessories for** 100909



<b>GEV No.</b>	100898	<b>Ref. No.</b>	—
----------------	--------	-----------------	---

olive for pipe ø 6mm Qty 1 pcs for pilot burner



<b>GEV No.</b>	101286	<b>Ref. No.</b>	G701011
----------------	--------	-----------------	---------

olive ID ø 6mm Qty 1 pcs



<b>GEV No.</b>	101287	<b>Ref. No.</b>	—
----------------	--------	-----------------	---

olive for pipe ø 6mm Qty 1 pcs



<b>GEV No.</b>	101288	<b>Ref. No.</b>	—
----------------	--------	-----------------	---

olive for pipe ø 6mm L 6mm aluminium Qty 1 pcs ED ø 8.5mm

#### angle pieces



<b>GEV No.</b>	107323	<b>Ref. No.</b>	G700511
----------------	--------	-----------------	---------

**description** elbow screw joint T1: 1/8" ET T2: 1/8" ET tube ø 6mm WS 13 brass

**For models:** W380111, W380112, W380121, W380122, W380131, W380132, W380141, W380142, W380151, W380152, W380161, W380162, W380211, W380221, W380231, W380241, W380251, W380261, W380461, W380511, W380521, W380531, W380541, W380666, W380912, W380915, W380917, W380919, W380922, W380925, W380927, W380929, W380932, W380935, W380937, W380939, W380942, W380945, W380947, W380949, W381511, W381515, W381521, W381525, W381531, W381535, W381541, W381545, W382511, W382551...(Other models you can see in the webshop)



<b>GEV No.</b>	106940	<b>Ref. No.</b>	K781816
----------------	--------	-----------------	---------

**description** elbow screw joint T1: 3/8" T2: 1/2" tube ø 11/12/14mm

**For models:** W384121, W384122

#### accessories



<b>GEV No.</b>	107779	<b>Ref. No.</b>	SE120180
----------------	--------	-----------------	----------

**description** torch L 500mm ø 10mm

#### gas lines

##### pilot tubes

##### universal



<b>GEV No.</b>	102111	<b>Ref. No.</b>	B400106
----------------	--------	-----------------	---------

**description** pilot tube copper pipe ø 6mm thickness 1mm L 3000mm

## equipment-specific units

### for espresso machines

#### brewing units

#### filter holder gaskets

#### O-rings



<b>GEV No.</b>	510409	<b>Ref. No.</b>	L554120
----------------	--------	-----------------	---------

**description** O-ring EPDM thickness 5.34mm ID ø 56.52mm Qty 1 pcs

for deep fryers

miscellaneous



1	<b>GEV No.</b>	694775	<b>Ref. No.</b>	Q451006
	<b>description</b>	ball valve for oil drain steel L 102mm W 36.5mm H 83mm thread M24 mounting pos. lower WS 33		



1	<b>GEV No.</b>	694776	<b>Ref. No.</b>	T106488
	<b>description</b>	indicator SS L 35mm W 16mm H 3mm mounting pos. valve WS 7		

for dishwashers

boilers

boilers for dishwashers



1	<b>GEV No.</b>	513243	<b>Ref. No.</b>	L100570
	<b>description</b>	boiler		

air traps

air traps



1	<b>GEV No.</b>	510757	<b>Ref. No.</b>	L054517
	<b>description</b>	air trap		



1	<b>GEV No.</b>	510343	<b>Ref. No.</b>	L054520
	<b>description</b>	air trap L 140mm ø 33mm plastic		

knobs

universal knobs



1	<b>GEV No.</b>	110253	<b>Ref. No.</b>	E401205
	<b>description</b>	knob switch zero mark t.max. °C ø 50mm shaft ø 6x4.6mm shaft flat upper black		
	<b>For models:</b>	W380151, W380152, W380251, W380351, W380451, W380656, W382551, W382552, W382651, W382652, W383051		



1	<b>GEV No.</b>	110119	<b>Ref. No.</b>	E401220
	<b>description</b>	knob thermostat t.max. 110°C ø 50mm shaft ø 6x4.6mm shaft flat upper black temperature range 30-110°C rotation 270°		
	<b>accessories for</b>	110119		

	<b>GEV No.</b>	110135	<b>Ref. No.</b>	—
	rosette knob up to ø 52mm			



1	<b>GEV No.</b>	110121	<b>Ref. No.</b>	E401265
	<b>description</b>	knob thermostat t.max. 200°C ø 50mm shaft ø 6x4.6mm shaft flat upper black temperature range 60-200°C rotation 270°		
	<b>accessories for</b>	110121		

	<b>GEV No.</b>	110135	<b>Ref. No.</b>	—
	rosette knob up to ø 52mm			



1	<b>GEV No.</b>	110123	<b>Ref. No.</b>	E401280
	<b>description</b>	knob thermostat t.max. 300°C ø 50mm shaft ø 6x4.6mm shaft flat upper black temperature range 50-300°C rotation 270°		
	<b>accessories for</b>	110123		

	<b>GEV No.</b>	110135	<b>Ref. No.</b>	—
	rosette knob up to ø 52mm			

producer-specific knobs

CAPIC





1

<b>GEV No.</b>	110253	<b>Ref. No.</b>	E401205
<b>description</b>	knob switch zero mark t.max.°C°C ø 50mm shaft ø 6x4.6mm shaft flat upper black		
<b>For models:</b>	W380151, W380152, W380251, W380351, W380451, W380656, W382551, W382552, W382651, W382652, W383051		



1

<b>GEV No.</b>	111488	<b>Ref. No.</b>	Q104202
<b>description</b>	knob switch zero mark t.max.°C°C ø 53mm shaft ø 10x8mm shaft flat upper black		
<b>For models:</b>	W380111, W380112, W380121, W380122, W380131, W380132, W380141, W380142, W380151, W380152, W380161, W380162, W380211, W380221, W380231, W380241, W380251, W380261, W380411, W380413, W380421, W380423, W380431, W380433, W380441, W380443, W380451, W380461, W380511, W380521, W380531, W380541, W380912, W380915, W380917, W380919, W380922, W380925, W380927, W380929, W380932, W380935, W380937, W380939, W380942, W380945, W380947, W380949, W381515, W381525...(Other models you can see in the webshop)		
<b>accessories for</b>	111488		
	<b>GEV No.</b>	111489	<b>Ref. No.</b> Q104224
	knob dial plate gas tap with ignition flame t.max.°C°C ø 70mm shaft ømm shaft flat silver		
	<b>GEV No.</b>	111490	<b>Ref. No.</b> I101007
	gasket for knob ED ø 51mm Qty 1 pcs plastic		



1

<b>GEV No.</b>	111244	<b>Ref. No.</b>	Q104071
<b>description</b>	knob switch zero mark t.max.°C°C ø 53mm shaft ø 10x8mm shaft flat upper blue gas		
<b>accessories for</b>	111244		
	<b>GEV No.</b>	550798	<b>Ref. No.</b> K102060
	pin ø 4mm L 45mm SS		



1

<b>GEV No.</b>	111451	<b>Ref. No.</b>	Q104072 Q104072+K100503
<b>description</b>	knob switch zero mark t.max.°C°C ø 53mm shaft ø 6x4.6mm shaft flat upper with spring blue electric		
<b>spare parts for</b>	111451		
	<b>GEV No.</b>	550965	<b>Ref. No.</b> —
	knob spring ø 6x4.6mm Qty 1 pcs		



1

<b>GEV No.</b>	110119	<b>Ref. No.</b>	E401220
<b>description</b>	knob thermostat t.max. 110°C ø 50mm shaft ø 6x4.6mm shaft flat upper black temperature range 30-110°C rotation 270°		
<b>accessories for</b>	110119		
	<b>GEV No.</b>	110135	<b>Ref. No.</b> —
	rosette knob up to ø 52mm		







1

<b>GEV No.</b>	110121	<b>Ref. No.</b>	E401265
<b>description</b>	knob thermostat t.max. 200°C ø 50mm shaft ø 6x4.6mm shaft flat upper black temperature range 60-200°C rotation 270°		
<b>accessories for</b>	110121		
	<b>GEV No.</b>	110135	<b>Ref. No.</b> —
	rosette knob up to ø 52mm		





1

<b>GEV No.</b>	110123	<b>Ref. No.</b>	E401280
<b>description</b>	knob thermostat t.max. 300°C ø 50mm shaft ø 6x4.6mm shaft flat upper black temperature range 50-300°C rotation 270°		
<b>accessories for</b>	110123		
	<b>GEV No.</b>	110135	<b>Ref. No.</b> —
	rosette knob up to ø 52mm		

			
<b>1</b>			
<b>GEV No.</b>	111489	<b>Ref. No.</b>	Q104224
<b>description</b>	knob dial plate gas tap with ignition flame t.max.°C°C ø 70mm shaft ømm shaft flat silver		
<b>For models:</b>	W380111, W380112, W380121, W380122, W380131, W380132, W380141, W380142, W380151, W380152, W380161, W380162, W380211, W380221, W380231, W380241, W380251, W380261, W380411, W380413, W380421, W380423, W380431, W380433, W380441, W380443, W380451, W380461, W380511, W380521, W380531, W380541, W380912, W380915, W380917, W380919, W380922, W380925, W380927, W380929, W380932, W380935, W380937, W380939, W380942, W380945, W380947, W380949, W381515, W381525...(Other models you can see in the webshop)		
<b>accessories for</b>	111489		
	<b>GEV No.</b>	111488	<b>Ref. No.</b> Q104202
	knob switch zero mark t.max.°C°C ø 53mm shaft ø 10x8mm shaft flat upper black		
	<b>GEV No.</b>	111490	<b>Ref. No.</b> I101007
	gasket for knob ED ø 51mm Qty 1 pcs plastic		

<b>accessories</b>			
<b>gaskets</b>			
			
<b>1</b>			
<b>GEV No.</b>	111490	<b>Ref. No.</b>	I101007
<b>description</b>	gasket for knob ED ø 51mm Qty 1 pcs plastic		
<b>For models:</b>	W380111, W380112, W380121, W380122, W380131, W380132, W380141, W380142, W380151, W380152, W380161, W380162, W380211, W380221, W380231, W380241, W380251, W380261, W380411, W380413, W380421, W380423, W380431, W380433, W380441, W380443, W380451, W380461, W380511, W380521, W380531, W380541, W380912, W380915, W380917, W380919, W380922, W380925, W380927, W380929, W380932, W380935, W380937, W380939, W380942, W380945, W380947, W380949, W381515, W381525...(Other models you can see in the webshop)		

<b>handles and hand wheels</b>			
<b>hand wheels</b>			
<b>spare parts and accessories</b>			
			
<b>1</b>			
<b>GEV No.</b>	580019	<b>Ref. No.</b>	Q104096
<b>description</b>	handle ø 28mm total length 110mm seat ø 11/11.5mm shaft ømm thread M6 L 110mm bore ø 28mm for hand crank		
<b>accessories for</b>	580019		
	<b>GEV No.</b>	580018	<b>Ref. No.</b> Q104095
	lever for hand crank		

<b>levers</b>			
<b>without handle</b>			
			
<b>1</b>			
<b>GEV No.</b>	580018	<b>Ref. No.</b>	Q104095
<b>description</b>	lever for hand crank		
<b>accessories for</b>	580018		
	<b>GEV No.</b>	580019	<b>Ref. No.</b> Q104096
	handle ø 28mm total length 110mm seat ø 11/11.5mm shaft ømm thread M6 L 110mm bore ø 28mm for hand crank		

<b>hand cranks</b>			
			
<b>1</b>			
<b>GEV No.</b>	580018	<b>Ref. No.</b>	Q104095
<b>description</b>	lever for hand crank		
<b>accessories for</b>	580018		
	<b>GEV No.</b>	580019	<b>Ref. No.</b> Q104096
	handle ø 28mm total length 110mm seat ø 11/11.5mm shaft ømm thread M6 L 110mm bore ø 28mm for hand crank		







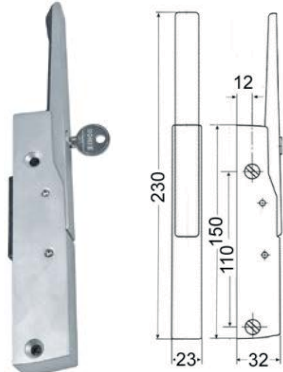

<b>locks</b>			
<b>edgemount latches</b>			
<b>handle latches</b>			
<b>CAFF/FERMOD</b>			
			
<b>1</b>			
<b>GEV No.</b>	690456	<b>Ref. No.</b>	Q105508
<b>description</b>	handle latch L 150mm mounting distance 110mm matt chrome-plated lockable refrigeration units 571 R-L CT 26mm complete with door catch		
<b>spare parts for</b>	690456		
	<b>GEV No.</b>	690429	<b>Ref. No.</b> —
	door catch CT 25.5mm		

Table continues overleaf



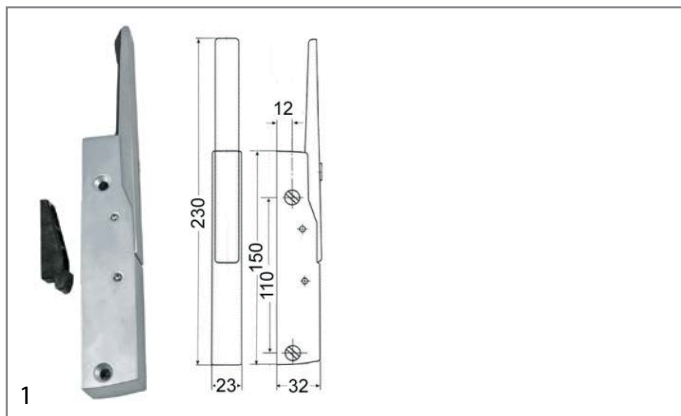



<b>accessories for</b>	690456		
	GEV No.	690428	Ref. No. —
	door catch H 51mm W 13.9mm mounting distance 30mm plastic CT 16.5mm		
	GEV No.	690445	Ref. No. —
	base plate H 2mm		
	GEV No.	690446	Ref. No. —
	base plate H 5mm L 56mm W 18mm		

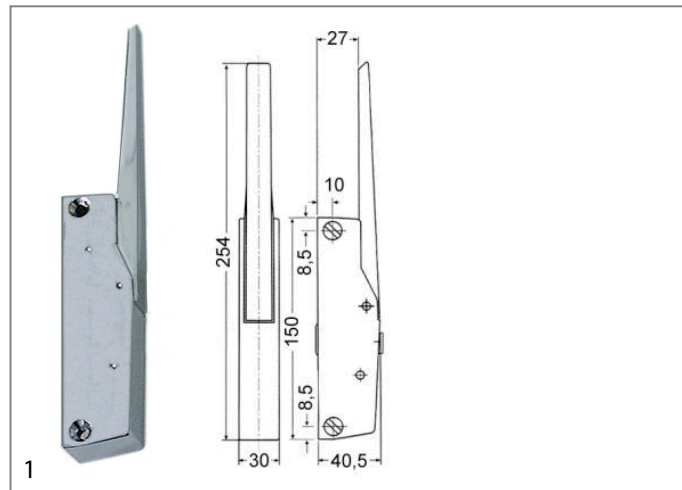



<b>GEV No.</b>	690455	<b>Ref. No.</b>	Q105505
<b>description</b>	handle latch L 150mm mounting distance 110mm matt chrome-plated non lockable refrigeration units 570 R-L complete with door catch		
<b>spare parts for</b>	690455		
	GEV No.	690429	Ref. No. —
	door catch CT 25.5mm		
<b>accessories for</b>	690455		
	GEV No.	690428	Ref. No. —
	door catch H 51mm W 13.9mm mounting distance 30mm plastic CT 16.5mm		
	GEV No.	690445	Ref. No. —
	base plate H 2mm		
	GEV No.	690446	Ref. No. —
	base plate H 5mm L 56mm W 18mm		

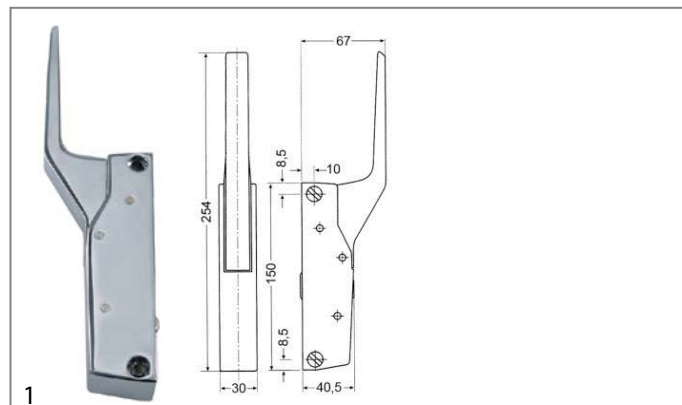

<b>GEV No.</b>	690412	<b>Ref. No.</b>	Q105510
<b>description</b>	handle latch L 150mm mounting distance 133mm non lockable G 790 total length 254mm handle length 105mm		
<b>accessories for</b>	690412		
	GEV No.	690418	Ref. No. —
	door catch L 36mm W 19mm H 29mm mounting distance 12mm zinc-coated steel for refrigeration units		
	GEV No.	690419	Ref. No. —
	door catch L 52mm W 20mm H 30mm mounting distance 26-37mm zamak for refrigeration units		
	GEV No.	700061	Ref. No. —
	door catch L 58mm W 20mm H 35mm mounting distance 42mm chrome-plated brass for headed units		
	GEV No.	700435	Ref. No. —
	door catch L 58mm W 20mm H 35mm mounting distance 42mm zamak for refrigeration units		



<b>GEV No.</b>	700060	<b>Ref. No.</b>	Q105512
<b>description</b>	handle latch L 150mm mounting distance 133mm non lockable heated units G 791		
<b>accessories for</b>	700060		
	GEV No.	700061	Ref. No. —
	door catch L 58mm W 20mm H 35mm mounting distance 42mm chrome-plated brass for headed units		
	GEV No.	700062	Ref. No. —
	handle protection heated units		

## espagnolette locks

### universal



1

<b>GEV No.</b>	690041	<b>Ref. No.</b>	Q101009
<b>description</b>	cam L 148mm mounting distance 32mm		

## hinges

### edgmount hinges

#### CAFF/FERMOD

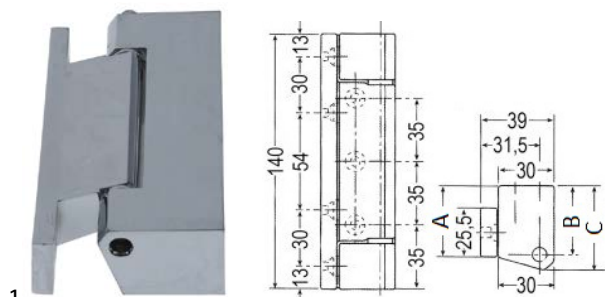

1

<b>GEV No.</b>	700562	<b>Ref. No.</b>	Q104505
<b>description</b>	edgmount hinge L 140mm W 31/24mm mounting distance 30/35mm hinging left/right without lift L1 37mm L2 36mm L3 45.5mm series G 361		



1

<b>GEV No.</b>	692669	<b>Ref. No.</b>	Q104510
<b>description</b>	edgmount hinge L 96mm W 15/17mm mounting distance 64/32mm hinging left/right without lift centre of rotation 14/23mm		

## fittings for catering equipment

### outlet taps

#### universal

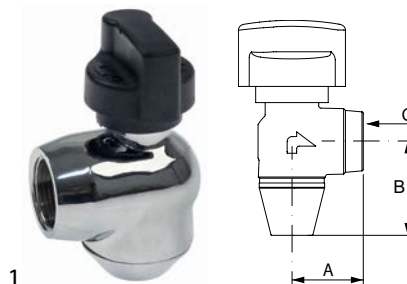

1

<b>GEV No.</b>	540699	<b>Ref. No.</b>	Q451110
<b>description</b>	outlet tap W 35mm H 35mm thread 3/4" IT		

#### producer-specific

##### CAPIC



1

<b>GEV No.</b>	514423	<b>Ref. No.</b>	Q402505
<b>description</b>	ball valve L 59.5mm 3-way W 29mm H 71mm with lever handle thread 3/8" IT - 3/8" IT handle length 78mm		



1

<b>GEV No.</b>	698953	<b>Ref. No.</b>	Q402506
<b>description</b>	outlet tap L 80mm W 32mm H 100mm thread 1/2" IT - 1/2" IT		





drain taps

brass

drain taps



<b>GEV No.</b>	540276	<b>Ref. No.</b>	Q451015
<b>description</b>	drain tap connection with union nut thread 1½"		
<b>spare parts for</b>	540276		
	<b>GEV No.</b>	532374	<b>Ref. No.</b> —
	O-ring silicone thickness 5.34mm ID ø 43.82mm Qty 10 pcs		
<b>accessories for</b>	540276		
	<b>GEV No.</b>	514251	<b>Ref. No.</b> —
	gasket fibre ED ø 46mm ID ø 38mm thickness 2mm Qty 1 pcs		

test taps

test taps

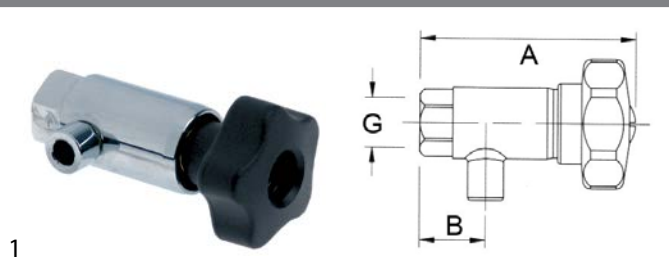

<b>GEV No.</b>	540206	<b>Ref. No.</b>	Q450506
<b>description</b>	test tap thread 3/8" IT W 78mm W1 20mm head ø 37mm head thickness 15mm		
<b>For models:</b>	W384111, W384112, W384122		

equipment feet and end caps

equipment feet

with fixing plate

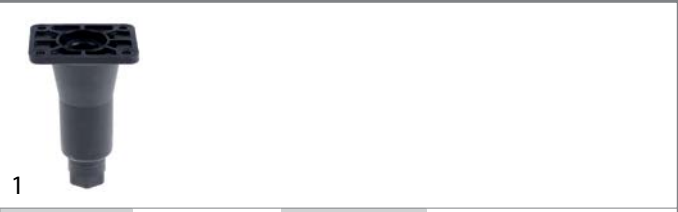

<b>GEV No.</b>	700848	<b>Ref. No.</b>	Q053062
<b>description</b>	equipment foot plate size 80x103mm hole distance 60x80mm H 150-180mm plastic size Qty 1 pcs		
<b>For models:</b>	W380121, W380122, W380131, W380132, W380141, W380142, W380151, W380152, W380161, W380162, W380221, W380231, W380241, W380251, W380261, W380321, W380331, W380341, W380351, W380421, W380423, W380431, W380433, W380441, W380443, W380451, W380461, W380521, W380531, W380541, W380624, W380626, W380628, W380633, W380634, W380636, W380638, W380644, W380646, W380648, W380656, W380666, W380721, W380731, W380741, W380821, W380825, W380831, W380835, W380921...(Other models you can see in the webshop)		

bullet feet

plastic

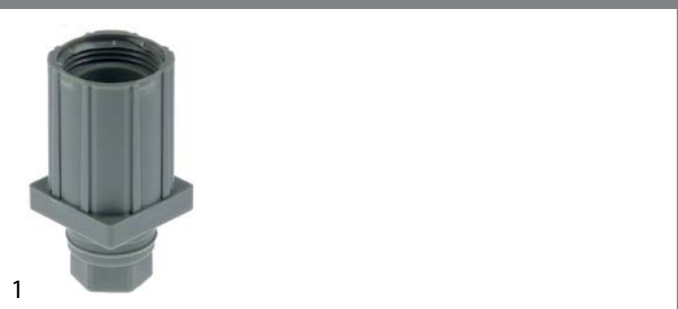

<b>GEV No.</b>	700118	<b>Ref. No.</b>	Q053036
<b>description</b>	equipment foot pipe type 35x35 thickness 1.2-1.5mm H 23-53mm plastic Qty 1 pcs load capacity 90kg		

baskets

fryer baskets

CAPIC



<b>GEV No.</b>	970664	<b>Ref. No.</b>	A401019
<b>description</b>	fryer basket L1 315mm W1 245mm H1 190mm		
<b>accessories for</b>	970664		
	<b>GEV No.</b>	970665	<b>Ref. No.</b> A402050
	handle for fryer basket		



1

<b>GEV No.</b>	970918	<b>Ref. No.</b>	A401023
<b>description</b>	fryer basket W1 160mm L1 320mm H1 130mm		
<b>accessories for</b>	970918		
	<b>GEV No.</b>	970665	<b>Ref. No.</b> A402050
handle for fryer basket			



1

<b>GEV No.</b>	970917	<b>Ref. No.</b>	A401030
<b>description</b>	fryer basket W1 370mm L1 555mm H1 200mm		
<b>accessories for</b>	970917		
	<b>GEV No.</b>	970665	<b>Ref. No.</b> A402050
handle for fryer basket			



1

<b>GEV No.</b>	970665	<b>Ref. No.</b>	A402050
<b>description</b>	handle for fryer basket		
<b>For models:</b>	W381031, W381035, W381131, W381132, W382031, W382032		

## shelves and shelf rails

### chargrill grids



1

<b>GEV No.</b>	210038	<b>Ref. No.</b>	A251512
<b>description</b>	chargrill grid L 333mm W 317mm H 50mm cast iron		



## grates

### universal

#### without upstand







1

<b>GEV No.</b>	970122	<b>Ref. No.</b>	A303005
<b>description</b>	grate W 325mm D 530mm GN 1/1 H 8mm stainless steel wire gauge frame 7mm lengthwise wires gauge 4mm crossing wires 1		
<b>accessories for</b>	970122		
	<b>GEV No.</b>	690330	<b>Ref. No.</b> —
rack L 1000mm W 22mm H 4mm aperture 3x8mm hole distance 12.5mm stainless steel			
	<b>GEV No.</b>	694700	<b>Ref. No.</b> —
shelf support L 31/28mm W 22mm H 18mm SS Qty 12 pcs			
	<b>GEV No.</b>	694701	<b>Ref. No.</b> —
shelf support L 31/28mm W 22mm H 17mm SS with hook Qty 12 pcs			





1

<b>GEV No.</b>	970077	<b>Ref. No.</b>	A303015
<b>description</b>	grate W 400mm D 600mm SS crossing wires 1		
<b>accessories for</b>	970077		
	<b>GEV No.</b>	690330	<b>Ref. No.</b> —
rack L 1000mm W 22mm H 4mm aperture 3x8mm hole distance 12.5mm stainless steel			
	<b>GEV No.</b>	694700	<b>Ref. No.</b> —
shelf support L 31/28mm W 22mm H 18mm SS Qty 12 pcs			
	<b>GEV No.</b>	694701	<b>Ref. No.</b> —
shelf support L 31/28mm W 22mm H 17mm SS with hook Qty 12 pcs			





1

<b>GEV No.</b>	970077	<b>Ref. No.</b>	A303015
<b>description</b>	grate W 400mm D 600mm SS crossing wires 1		
<b>accessories for</b>	970077		
	<b>GEV No.</b>	690330	<b>Ref. No.</b> —
rack L 1000mm W 22mm H 4mm aperture 3x8mm hole distance 12.5mm stainless steel			
	<b>GEV No.</b>	694700	<b>Ref. No.</b> —
shelf support L 31/28mm W 22mm H 18mm SS Qty 12 pcs			
	<b>GEV No.</b>	694701	<b>Ref. No.</b> —
shelf support L 31/28mm W 22mm H 17mm SS with hook Qty 12 pcs			

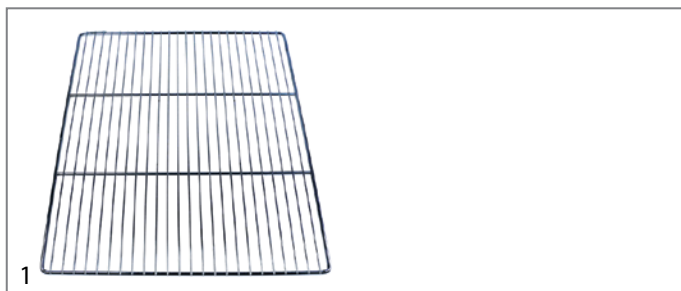



<b>GEV No.</b>	970123	<b>Ref. No.</b>	A303020
<b>description</b>	grate W 650mm D 530mm GN 2/1 stainless steel wire gauge frame 7.8mm lengthwise wires gauge 3.8mm crossing wires 2 suitable for refrigerator		
<b>accessories for</b>	970123		
	<b>GEV No.</b>	690330	<b>Ref. No.</b> —
	rack L 1000mm W 22mm H 4mm aperture 3x8mm hole distance 12.5mm stainless steel		
	<b>GEV No.</b>	694700	<b>Ref. No.</b> —
	shelf support L 31/28mm W 22mm H 18mm SS Qty 12 pcs		
	<b>GEV No.</b>	694701	<b>Ref. No.</b> —
	shelf support L 31/28mm W 22mm H 17mm SS with hook Qty 12 pcs		

**gaskets**

refrigeration gaskets

screw-in gaskets

profile 9207

We offer custom-made gaskets for this profile

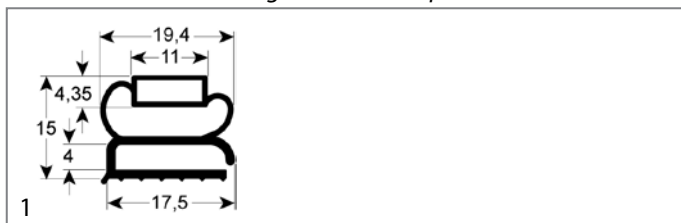

<b>GEV No.</b>	900728	<b>Ref. No.</b>	I302006
<b>description</b>	refrigeration gasket profile 9207 W 387mm L 495mm external size		

gaskets for heated units

window seals

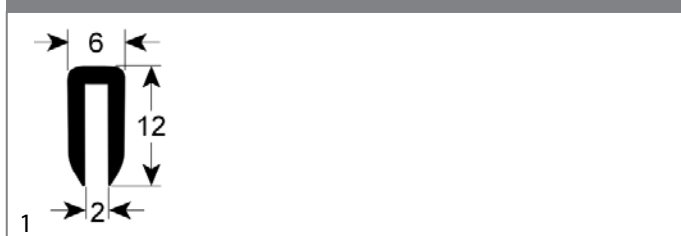

<b>GEV No.</b>	901575	<b>Ref. No.</b>	I304004
<b>description</b>	window gasket profile 1503 suitable for CAPIC Qty supplied by meter		



<b>GEV No.</b>	900937	<b>Ref. No.</b>	I304026
<b>description</b>	window gasket profile 1893 Qty supplied by meter		

door seals

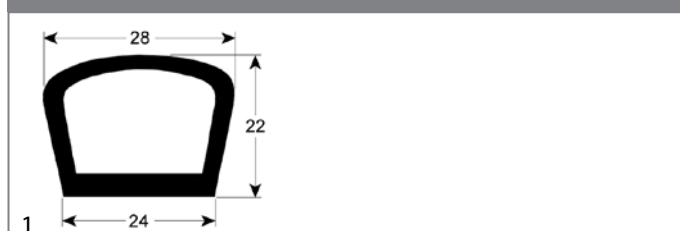

<b>GEV No.</b>	901576	<b>Ref. No.</b>	I304016
<b>description</b>	door seal profile 2202 Qty supplied by meter suitable for CAPIC		

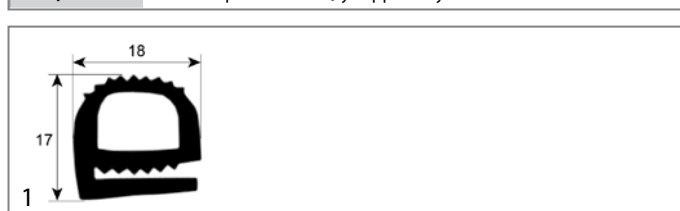

<b>GEV No.</b>	900938	<b>Ref. No.</b>	I304002
<b>description</b>	door seal profile 2257 Qty supplied by meter dark blue silicone Shore 55° temp.-resist. -100 à +220°C		

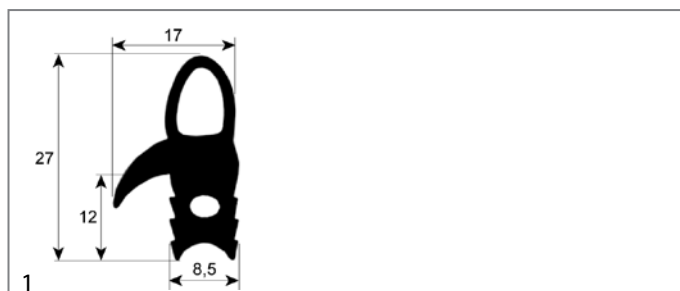

<b>GEV No.</b>	900939	<b>Ref. No.</b>	I304024
<b>description</b>	door seal profile 2700 Qty supplied by meter light blue silicone Shore 55° temp.-resist. -100 à +220°C		

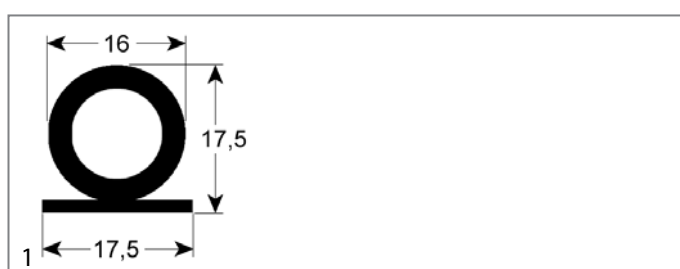

<b>GEV No.</b>	901577	<b>Ref. No.</b>	I304006
<b>description</b>	door seal profile 2952 Qty supplied by meter suitable for CAPIC		



<b>GEV No.</b>	901578	<b>Ref. No.</b>	I304008
<b>description</b>	door seal profile 2957 Qty supplied by meter suitable for CAPIC		

## O-rings

### EPDM



<b>GEV No.</b>	509002	<b>Ref. No.</b>	L351410
<b>description</b>	O-ring EPDM thickness 2.62mm ID ø 82.22mm Qty 1 pcs		

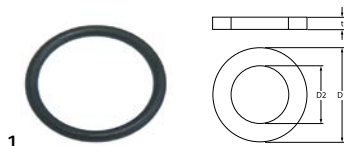

<b>GEV No.</b>	510408	<b>Ref. No.</b>	E153011
<b>description</b>	O-ring EPDM thickness 5.34mm ID ø 47mm Qty 1 pcs		
<b>For models:</b>	W384111, W384112		



<b>GEV No.</b>	510409	<b>Ref. No.</b>	L554120
<b>description</b>	O-ring EPDM thickness 5.34mm ID ø 56.52mm Qty 1 pcs		

## sealing washers

### rubber gaskets



<b>GEV No.</b>	519521	<b>Ref. No.</b>	I101015
<b>description</b>	flat gasket rubber ED ø 41mm ID ø 17.5mm thickness 1mm Qty 1 pcs suitable for CAPIC		

## special gaskets

### miscellaneous



<b>GEV No.</b>	520942	<b>Ref. No.</b>	I101012
<b>description</b>	gasket L 75mm W 58mm silicone thickness 1mm		

### thermostat gaskets



<b>GEV No.</b>	513018	<b>Ref. No.</b>	L455026
<b>description</b>	gasket for thermostat ED ø 41mm ID ø 18mm equiv. no. CGG16 suitable for COLGED		

## transmission technology and ball bearings

### ball bearings

#### flange bearings



<b>GEV No.</b>	694484	<b>Ref. No.</b>	Q201023
<b>description</b>	flange bearing type UCFE205 shaft ø 25mm 4 hole flange hole distance 70mm H 39mm flange length 95mm flange width 95mm hole ø 11.5mm flange FE205 ball bearing UC205G2 FH 30mm		



<b>GEV No.</b>	694483	<b>Ref. No.</b>	Q201010 Q201016
<b>description</b>	flange bearing type RNFTL2806A.5S shaft ø 25mm hole distance 32.5mm flange ø 79mm L 85mm		



## springs

### compression springs



<b>GEV No.</b>	530475	<b>Ref. No.</b>	Q106015
<b>description</b>	spring ø 35mm L 105mm wire gauge ø 4.5mm windings 9 metal		

### gas tension springs

#### gas tension springs



<b>GEV No.</b>	701055	<b>Ref. No.</b>	Q201530
<b>description</b>	gas tension spring 500N hub 200mm D1 ø 18mm D2 ø 8mm hole distance 485mm hole ø 8.1mm L 498mm		



<b>GEV No.</b>	701056	<b>Ref. No.</b>	Q201515
<b>description</b>	gas tension spring 800N hub 60mm D1 ø 19mm D2 ø 8mm hole distance 205.5mm hole ø 8.1mm L 218mm		

### tension springs



<b>GEV No.</b>	698957	<b>Ref. No.</b>	Q106020
<b>description</b>	spring ø 22.5mm total length 116mm wire gauge ø 3mm L1 20mm L2 76mm L3 20mm		

## dosing pumps

### piston pumps

#### spare parts



<b>GEV No.</b>	361113	<b>Ref. No.</b>	L053022
<b>description</b>	solenoid coil 230VAC for type DB2		

## membrane dosing pumps

### self-priming

#### LANG

#### accessories



1

<b>GEV No.</b>	101286	<b>Ref. No.</b>	G701011
----------------	--------	-----------------	---------

<b>description</b>	olive ID ø 6mm Qty 1 pcs		
--------------------	--------------------------	--	--

<b>accessories for</b>	101286		
------------------------	--------	--	--



<b>GEV No.</b>	100909	<b>Ref. No.</b>	G701010
----------------	--------	-----------------	---------

union screw thread M10x1 for pipe ø 6mm Qty 1 pcs



<b>GEV No.</b>	101464	<b>Ref. No.</b>	—
----------------	--------	-----------------	---

union nut thread M12x1 for pipe ø 6mm

## hoses

### supply hoses

#### PVC supply hoses

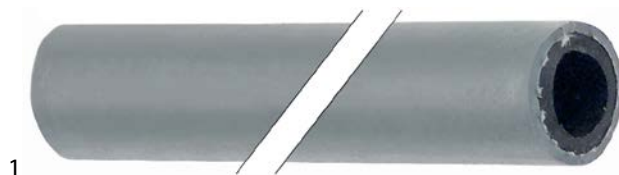

1

<b>GEV No.</b>	520017	<b>Ref. No.</b>	L155025
----------------	--------	-----------------	---------

<b>description</b>	supply hose ID ø 13mm ED ø 20mm L 5m operating p. 20bar burst p. 60bar t.max. 95°C grey Qty 5m		
--------------------	--	--	--

## fittings, hose and pipe connectors

### hose connectors

#### stainless steel



1

<b>GEV No.</b>	542325	<b>Ref. No.</b>	E4403535
----------------	--------	-----------------	----------

<b>description</b>	hose connector thread 1/8" hose ø 6mm stainless steel Qty 1 pcs		
--------------------	---	--	--

## valves and tank inlets

### ball valves

#### universal

#### ball valves with lever handle



<b>GEV No.</b>	520281	<b>Ref. No.</b>	Q401005
<b>description</b>	ball valve connection 3/4" IT - 3/4" IT DN20 total length 56mm with lever handle handle length 87mm		

### mixing valves



<b>GEV No.</b>	514422	<b>Ref. No.</b>	Q452025
<b>description</b>	shut-off valve connection 1/2" 1/2" total length 160mm mounting pos. red/blue rosette thread G2 3/4" shaft ø 7.6mm		

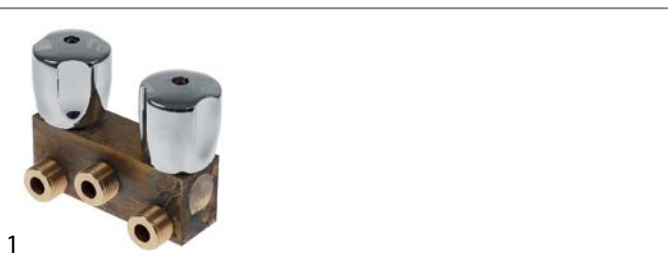

<b>GEV No.</b>	514516	<b>Ref. No.</b>	Q452030
<b>description</b>	shut-off valve thread 1/2"		
<b>For models:</b>	W384012, W384021, W384022, W384111, W384112, W384121, W384122, W385011, W385012, W385013, W385014, W385015, W385021, W385022, W385023, W385024, W385025		

## measuring equipment

### thermometers

#### built-in thermometers



<b>GEV No.</b>	541095	<b>Ref. No.</b>	L057015
<b>description</b>	thermometer mounting measurements 58x25.5mm 0 up to +120°C capillary pipe 3000mm probe ø 6.5mm probe L 20mm		

## fastening material

### nuts

#### hexagonal nuts

#### hexagonal nuts with PG thread



<b>GEV No.</b>	550578	<b>Ref. No.</b>	E303045
<b>description</b>	nut thread PG21 H 4.6mm WS 32 nickel-plated brass Qty 1 pcs mounting ømm cable ømm		
<b>For models:</b>	W384012, W385011, W385012, W385013, W385014, W385015		

### fasteners

#### pins



<b>GEV No.</b>	550798	<b>Ref. No.</b>	K102060
<b>description</b>	pin ø 4mm L 45mm SS		
<b>For models:</b>	W380111, W380112, W380121, W380122, W380131, W380132, W380141, W380142, W380151, W380152, W380161, W380162, W380211, W380221, W380231, W380241, W380251, W380261, W380411, W380413, W380421, W380423, W380431, W380433, W380441, W380443, W380451, W380461, W380511, W380521, W380531, W380541, W380912, W380915, W380917, W380919, W380922, W380925, W380927, W380929, W380932, W380935, W380937, W380939, W380942, W380945, W380947, W380949, W381515, W381525...(Other models you can see in the webshop)		

<b>A</b>			
alarm devices	19	heater battery	6
axial fans	25	heating elements	3
		heating elements for bain maries	4
<b>B</b>		heating elements for chip scuttles	4
ball valves	60	heating elements for convection	7
bar burners	45	heating elements for fryers	4
booster pumps II	29	heating elements for frying pans	4
		heating elements for griddles	5
<b>C</b>		heating elements for heated cabinets	5
cable glands	29	heating elements for ovens	3
cables	29	heating elements for tilting bratt pan	5
cam switches	13	hexagonal nuts	60
ceramic burners	46	hob burners	41
condensators & interference suppression filters	29	hose connectors	59
contact heaters	6	hoses	59
contactors	19	hot air fans	26
control equipment	14	hot air motors	25
control thermostats	9, 11	hot plates	8
cross flow fans	25		
		<b>I</b>	
<b>D</b>		ignition cables	40
door seals	57	ignition units	41
dosing pumps	59	immersion heating elements	6
		indicator lights	15
<b>E</b>		indicator lights (complete)	15
edgemount hinges	54		
edgemount latches	52	<b>L</b>	
electric accessories	29	lamps	15
electrodes	25	light bulbs	17
electronic controllers	21		
energy regulators	8	<b>M</b>	
espagnolette locks	54	magnetic switches	14
		measuring equipment	60
<b>F</b>		microswitches	12
fans	25	mixing valves	60
fasteners	60	motors	26
fastening material	60		
		<b>N</b>	
<b>G</b>		neon light bulbs	15, 16
gas burners	41	nickel wire	29
gas control valves	34	nuts	60
gas lines	49		
gas nozzles	46	<b>O</b>	
gas solenoid valves	37	operating capacitors	29
gas taps	30	O-rings	58
gas thermostats	32	oven lamps	17
gaskets for heated units	57		
grates	56	<b>P</b>	
		piezoelectric igniters	41
<b>H</b>		pilot burners	37
handle latches	52	pins	60
		pressure switches	24
		probes	21

programme timers	18
protection hoses	29
pumps	26
push/momentary push switches	12
PVC supply hoses	59

## Q

quartz heating elements	6
-------------------------	---

## R

refrigeration gaskets	57
relays	20
ribbon cables	29
rocker/momentary rocker switches	12

## S

safety thermostats	10
safety valves	37
screw-in gaskets	57
sealing washers	58
shelves and shelf rails	56
solenoid valves	22
supply hoses	59
switches and momentary switches	12
system switches (ROLD)	13

## T

temperature probes	21
terminals	29
thermocouples	41
thermostat gaskets	58
thermostats	9
threaded cable glands	29
time relays	20
timers	18

## U

universal probes	21
------------------	----

## V

valves and tank inlets	60
------------------------	----

## W

wash and rinse pumps	26
window seals	57