



GAS COMPONENTS



ELECTRIC COMPONENTS



WATER TECHNOLOGY



MECHANICAL COMPONENTS



TOOLS

Spare parts suitable for

CARIMALI

Find the complete and up-to-date range of products in our GEV Webshop



Manufacturer catalogue

The most important spare parts and accessories arranged clearly for every manufacturer

- ✓ Complete product range and all appliance data always up to date in the GEV Webshop
- ✓ Alphabetical Index at the end of the catalogue

GEV Webshop

www.gev-online.co.uk

www.gev-online.com









- 🔍 Add to Favourites
- 🔍 Sign In with email address and usual password
- 🔍 Easy-order – place several items in your basket at the same time
- 🔍 Quick Item search – no login needed







heating elements

heating elements for coffee machine

			
1			
GEV No.	417452	Ref. No.	N/A
description	heating element 1600W 230V heating circuits 1 thread 1¼" L 160mm W 32mm H 23mm tube ø 8mm thermostat sleeves ø 6.6mm length thermostat sleeves 140mm connection M4 immersion heater flange with thread		
accessories for	417452		
	GEV No.	510405	Ref. No. —
	flat gasket fibre ED ø 56mm ID ø 42mm thickness 2mm for thread 1¼" Qty 1 pcs		
	GEV No.	528021	Ref. No. —
	flat gasket PTFE ED ø 53mm ID ø 42.5mm thickness 3mm Qty 1 pcs equiv. no. 12001/02286 suitable for Astoria/Aurora/Brasilia/Wega		

			
1			
GEV No.	417045	Ref. No.	N/A
description	heating element 1800W 230V heating circuits 1 thread 1¼" L 135mm W 36mm H 39mm tube ø 8.5mm connection male faston 6.3mm immersion heater flange with thread		
accessories for	417045		
	GEV No.	510405	Ref. No. —
	flat gasket fibre ED ø 56mm ID ø 42mm thickness 2mm for thread 1¼" Qty 1 pcs		
	GEV No.	528021	Ref. No. —
	flat gasket PTFE ED ø 53mm ID ø 42.5mm thickness 3mm Qty 1 pcs equiv. no. 12001/02286 suitable for Astoria/Aurora/Brasilia/Wega		

			
1			
GEV No.	417046	Ref. No.	95.00985
description	heating element 2000W 230V heating circuits 1 thread 1¼" L 200mm W 32mm H 26mm tube ø 8.5mm thermostat sleeves ø 6.5mm length thermostat sleeves 152mm connection M4 immersion heater connection length 25mm flange with thread		
accessories for	417046		
	GEV No.	510405	Ref. No. —
	flat gasket fibre ED ø 56mm ID ø 42mm thickness 2mm for thread 1¼" Qty 1 pcs		
	GEV No.	528021	Ref. No. —
	flat gasket PTFE ED ø 53mm ID ø 42.5mm thickness 3mm Qty 1 pcs equiv. no. 12001/02286 suitable for Astoria/Aurora/Brasilia/Wega		

			
1			
GEV No.	417048	Ref. No.	N/A
description	heating element 2400W 230V heating circuits 2 thread 1¼" L 235mm W 34mm H 24mm tube ø 8.4mm connection male faston 6.3mm immersion heater connection length 31mm flange with thread WS 37		
accessories for	417048		
	GEV No.	510405	Ref. No. —
	flat gasket fibre ED ø 56mm ID ø 42mm thickness 2mm for thread 1¼" Qty 1 pcs		







accessories for	417048		
	GEV No.	528021	Ref. No. —
	flat gasket PTFE ED ø 53mm ID ø 42.5mm thickness 3mm Qty 1 pcs equiv. no. 12001/02286 suitable for Astoria/Aurora/Brasilia/Wega		

			
1			
GEV No.	417616	Ref. No.	96.00559
description	heating element 2800W 230V heating circuits 3 mounting ø 35mm hole distance 58mm L 153mm W 30mm H 30mm hole ø 10mm thermostat sleeves ø 4mm length thermostat sleeves 140mm number of thermostat sleeves 1 thermostat sleeve centred, adjacent tube ø 6mm connection M3 immersion heater 3 hole flange		
accessories for	417616		
	GEV No.	521077	Ref. No. 87.05003.00.19
	O-ring Viton thickness 5.34mm ID ø 37.47mm Qty 1 pcs		
	GEV No.	527169	Ref. No. 92.00005
	hexagonal nut thread M3 H 2.8mm WS 5.5 brass Qty 1 pcs		
	GEV No.	528529	Ref. No. 93.00007
	plain washer ID ø 3.5mm ED ø 6.6mm thickness 0.5mm brass Qty 1 pcs		
	GEV No.	560036	Ref. No. —
	tooth lock washer ID ø 3.1mm ED ø 5.7mm SS Qty 10 pcs		
	GEV No.	560572	Ref. No. 95.01606
	contact bridge		





			
1			
GEV No.	417250	Ref. No.	96.00482
description	heating element 2800W 230V heating circuits 3 mounting ø 39mm hole distance 58mm L 191mm W 33mm H 32mm hole ø 10mm length thermostat sleeves 153mm thermostat sleeves ø 5mm number of thermostat sleeves 1 thermostat sleeve eccentric, clinging tube ø 8mm connection 3 immersion heater 3 hole flange		
For models:	E9-COF, E9-Espresso, E9-LM, EtaBeta-V2-COF, EtaBeta-V2-COF-Display, EtaBeta-V2-LM, EtaBeta-V2-LM-Display, Kicco-COF, Kicco-Espresso, Kicco-LM, TemaStyle		

			
1			
GEV No.	417036	Ref. No.	N/A
description	heating element 2800W 230V heating circuits 3 mounting ø 51mm hole distance 63mm L 350mm W 36mm H 70mm hole ø 9mm thermostat sleeves ø 7mm length thermostat sleeves 150mm number of thermostat sleeves 1 thermostat sleeve eccentric, non clinging tube ø 8mm connection male faston 6.3mm immersion heater 3 hole flange		







			
GEV No.	417047	Ref. No.	95.01348.10
description	heating element 3000W 230V heating circuits 3 thread 1¼" L 405mm W 29mm H 29mm tube ø 8.5mm thermostat sleeves ø 6.5mm length thermostat sleeves 195mm connection M3 immersion heater flange with thread		
spare parts for	417047		
	GEV No.	510405	Ref. No. —
description	flat gasket fibre ED ø 56mm ID ø 42mm thickness 2mm for thread 1¼" Qty 1 pcs		
accessories for	417047		
	GEV No.	527169	Ref. No. 92.00005
description	hexagonal nut thread M3 H 2.8mm WS 5.5 brass Qty 1 pcs		
	GEV No.	528021	Ref. No. —
description	flat gasket PTFE ED ø 53mm ID ø 42.5mm thickness 3mm Qty 1 pcs equiv. no. 12001/02286 suitable for Astoria/Aurora/Brasilia/Wega		
	GEV No.	560110	Ref. No. —
description	plain washer ID ø 3.2mm ED ø 7mm thickness 0.5mm SS Qty 20 pcs DIN 125A for thread M3		
	GEV No.	560130	Ref. No. —
description	hexagonal nut thread M3 H 2.4mm WS 5.5 SS DIN/ISO DIN 934 / ISO 4032/8673 Qty 20 pcs		

			
GEV No.	417251	Ref. No.	96.00496
description	heating element 3500W 230V heating circuits 3 mounting ø 39mm hole distance 58mm L 380mm W 33mm H 33mm hole ø 10mm length thermostat sleeves 188mm thermostat sleeves ø 5mm number of thermostat sleeves 1 thermostat sleeve eccentric, clinging tube ø 8mm connection M3 immersion heater 3 hole flange		
For models:	E9-COF, E9-Espresso, E9-LM, EtaBeta-V2-COF, EtaBeta-V2-COF-Display, EtaBeta-V2-LM, EtaBeta-V2-LM-Display, Kicco-COF, Kicco-Espresso, Kicco-LM, TemaStyle		

			
GEV No.	417617	Ref. No.	96.00561
description	heating element 4500W 230V heating circuits 3 mounting ø 35mm hole distance 58mm L 265mm W 30mm H 30mm hole ø 10mm thermostat sleeves ø 4mm length thermostat sleeves 140mm number of thermostat sleeves 1 thermostat sleeve centred, adjacent tube ø 6mm connection M3 immersion heater 3 hole flange		
accessories for	417617		
	GEV No.	521077	Ref. No. 87.05003.00.19
description	O-ring Viton thickness 5.34mm ID ø 37.47mm Qty 1 pcs		
	GEV No.	527169	Ref. No. 92.00005
description	hexagonal nut thread M3 H 2.8mm WS 5.5 brass Qty 1 pcs		
	GEV No.	528529	Ref. No. 93.00007
description	plain washer ID ø 3.5mm ED ø 6.6mm thickness 0.5mm brass Qty 1 pcs		
	GEV No.	560036	Ref. No. —
description	tooth lock washer ID ø 3.1mm ED ø 5.7mm SS Qty 10 pcs		
	GEV No.	560572	Ref. No. 95.01606
description	contact bridge		

			
GEV No.	417252	Ref. No.	96.00505
description	heating element 4500W 230V heating circuits 3 mounting ø 39mm hole distance 58mm L 380mm W 33mm H 33mm hole ø 10mm length thermostat sleeves 190mm thermostat sleeves ø 5mm number of thermostat sleeves 1 thermostat sleeve eccentric, clinging tube ø 8mm connection M3 immersion heater 3 hole flange		
For models:	E9-COF, E9-Espresso, E9-LM, EtaBeta-V2-COF, EtaBeta-V2-COF-Display, EtaBeta-V2-LM, EtaBeta-V2-LM-Display, Kicco-COF, Kicco-Espresso, Kicco-LM, TemaStyle		

			
GEV No.	417253	Ref. No.	96.00495
description	heating element 4500W 230V heating circuits 3 mounting ø 39mm hole distance 58mm L 630mm W 33mm H 33mm hole ø 10mm length thermostat sleeves 200mm thermostat sleeves ø 5mm number of thermostat sleeves 1 thermostat sleeve eccentric, clinging tube ø 8mm connection M3 immersion heater 3 hole flange		

			
GEV No.	417345	Ref. No.	95.01202
description	heating element 5000W 230V heating circuits 3 thread 1¼" L 605mm W 34mm H 30mm tube ø 8mm thermostat sleeves ø 6.5mm length thermostat sleeves 200mm number of thermostat sleeves 1 thermostat sleeve not clinging connection M4 immersion heater connection length 28mm flange with thread		
accessories for	417345		
	GEV No.	510405	Ref. No. —
description	flat gasket fibre ED ø 56mm ID ø 42mm thickness 2mm for thread 1¼" Qty 1 pcs		
	GEV No.	528021	Ref. No. —
description	flat gasket PTFE ED ø 53mm ID ø 42.5mm thickness 3mm Qty 1 pcs equiv. no. 12001/02286 suitable for Astoria/Aurora/Brasilia/Wega		

accessories

hexagonal nuts

			
GEV No.	527169	Ref. No.	92.00005
description	hexagonal nut thread M3 H 2.8mm WS 5.5 brass Qty 1 pcs		

tooth lock washers

			
GEV No.	560571	Ref. No.	93.00013
description	tooth lock washer ID ø 3.3mm ED ø 6.2mm zinc-coated steel DIN/ISO Qty 1 pcs for thread M3		



sealing washers

fibre gaskets

GEV No.	528017	Ref. No.	N/A
description	flat gasket fibre ED ø 53mm ID ø 42mm thickness 2mm for thread 1¼" Qty 1 pcs		

PTFE gaskets

GEV No.	528022	Ref. No.	N/A
description	flat gasket PTFE ED ø 52mm ID ø 41mm thickness 2mm size 1¼" Qty 1 pcs suitable for CARIMALI, FAEMA, MARZOCCO, PAVONI		

GEV No.	560572	Ref. No.	95.01606
description	contact bridge		

thermostats

control and safety thermostats

EGO

safety thermostats

55.32_ series

GEV No.	390324	Ref. No.	95.01594
description	safety thermostat switch-off temp. 169°C 3-pole 3NC 20A probe ø 4mm probe L 128mm capillary pipe 890mm capillary pipe isolated 210/210mm gland nut probe SS		
For models:	E9-COF, E9-Espresso, E9-LM, EtaBeta-V2-COF, EtaBeta-V2-COF-Display, EtaBeta-V2-LM, EtaBeta-V2-LM-Display, Kicco-COF, Kicco-Espresso, Kicco-LM, TemaStyle		

switches and momentary switches

push/momentary push switches

30x22mm

GEV No.	301082	Ref. No.	95.01783
description	push switch mounting measurements 30x22mm green 2NO 250V 12A connection male faston 6.3mm ambient temperature max. 85/55°C protection IP54 with protective collar		
For models:	E9-COF, E9-Espresso, E9-LM, Kicco-COF, Kicco-Espresso, Kicco-LM, TemaStyle		

system switches (ROLD)

GEV No.	347181	Ref. No.	95.01735	
description	push button size 13x17mm chrome-plated			
For models:	E9-COF, E9-Espresso, E9-LM, EtaBeta-V2-COF, EtaBeta-V2-COF-Display, EtaBeta-V2-LM, EtaBeta-V2-LM-Display, Kicco-COF, Kicco-Espresso, Kicco-LM, TemaStyle			
accessories for	347181			
	GEV No.	347182	Ref. No.	—
	description	element holder mounting measurements 20.6x16.4mm chrome-plated arched for push buttons 13x17mm		

GEV No.	345720	Ref. No.	96.00786
description	switch 2NO 250V 16A connection male faston 6.3mm		
For models:	TemaStyle		



system switches

CARIMALI

push buttons



1

GEV No.	347181	Ref. No.	95.01735
description	push button size 13x17mmmm chrome-plated		
For models:	E9-COF, E9-Espresso, E9-LM, EtaBeta-V2-COF, EtaBeta-V2-COF-Display, EtaBeta-V2-LM, EtaBeta-V2-LM-Display, Kicco-COF, Kicco-Espresso, Kicco-LM, TemaStyle		
accessories for	347181		
	GEV No.	347182	Ref. No. —
	element holder mounting measurements 20.6x16.4mm chrome-plated arched for push buttons 13x17mm		

element holders



1

GEV No.	526339	Ref. No.	37.00726
description	frame for switch black plastic		
For models:	E9-COF, E9-Espresso, E9-LM, EtaBeta-V2-COF, EtaBeta-V2-COF-Display, EtaBeta-V2-LM, EtaBeta-V2-LM-Display, Kicco-COF, Kicco-Espresso, Kicco-LM, TemaStyle		

switches



1

GEV No.	345720	Ref. No.	96.00786
description	switch 2NO 250V 16A connection male faston 6.3mm		
For models:	TemaStyle		

contactors

MOELLER/EATON

power contactors



1

GEV No.	380497	Ref. No.	96.00807
description	power contactor resistive load 20A 230VAC (AC3/400V) 9A/4kW main contacts 4NO auxiliary contacts connection screw connection type DILEM 4		
For models:	E9-COF, E9-Espresso, E9-LM, EtaBeta-V2-COF-Display, EtaBeta-V2-LM-Display, Kicco-COF, Kicco-Espresso, Kicco-LM, TemaStyle		

relays

power relays

with bracket mounting



1

GEV No.	380808	Ref. No.	96.00032
description	power relays FINDER 230VAC 16A 3CO connection male faston 6.3mm bracket mounting manuf. no. 62.83.8.230.0000		
For models:	E9-COF, E9-Espresso, E9-LM, EtaBeta-V2-COF-Display, EtaBeta-V2-LM-Display, Kicco-COF, Kicco-Espresso, Kicco-LM, TemaStyle		

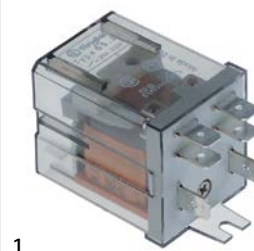

1

GEV No.	380900	Ref. No.	96.00590
description	power relays FINDER 230VAC 20A 1NO/1NC connection F6.3 bracket mounting dimensions 36.5x32.2x51.8mm manuf. no. 65.31.8.230.0000 2-pole		
For models:	E9-COF, E9-Espresso, E9-LM, EtaBeta-V2-COF-Display, EtaBeta-V2-LM-Display, Kicco-COF, Kicco-Espresso, Kicco-LM, TemaStyle		



level relays

GICAR



1

GEV No.	402327	Ref. No.	96.00470
description	level controller 230V voltage AC type RL30/3ES/F/G		
For models:	E9-COF, E9-Espresso, E9-LM, EtaBeta-V2-COF-Display, EtaBeta-V2-LM-Display, Kicco-COF, Kicco-Espresso, Kicco-LM, TemaStyle		
accessories for	402327		
	GEV No.	526322	Ref. No. 03.00999
	cable L 100mm plug type Faston 6.3mm		



1

GEV No.	526316	Ref. No.	96.00753
description	display espresso machine Espresso9 L 135mm W 44mm		
For models:	E9-Espresso		



1

GEV No.	526315	Ref. No.	96.00724
description	display espresso machine KICCO COF-LM L 122mm W 44mm		
For models:	EtaBeta-V2-COF, EtaBeta-V2-COF-Display, EtaBeta-V2-LM, EtaBeta-V2-LM-Display, Kicco-COF, Kicco-Espresso, Kicco-LM		

probes

producer-specific probes

probes



1

GEV No.	526337	Ref. No.	87.00087+96.05151 96.00600
description	probe NTC 47kOhm cable PTFE probe -40 up to +125°C cable -40 up to +250°C connection plug thread 1/4" probe ø6.5x25mm cable length 0.24m		
For models:	E9-COF, E9-Espresso, E9-LM, EtaBeta-V2-COF, EtaBeta-V2-COF-Display, EtaBeta-V2-LM, EtaBeta-V2-LM-Display, Kicco-COF, Kicco-Espresso, Kicco-LM, TemaStyle		



1

GEV No.	403514	Ref. No.	96.00841
description	PCB coffee machine Armonia V2 L 270mm W 134mm		

electronics

PCBs



1

GEV No.	526302	Ref. No.	96.00718.CA
description	display coffee machine TEMA STYLE L 80mm W 36mm		
For models:	TemaStyle		



1

GEV No.	402325	Ref. No.	96.00771
description	central unit 3 relays 230V voltage AC		
For models:	E9-COF, E9-Espresso, E9-LM, EtaBeta-V2-COF, EtaBeta-V2-COF-Display, EtaBeta-V2-LM, EtaBeta-V2-LM-Display, Kicco-COF, Kicco-Espresso, Kicco-LM, TemaStyle		



1			
GEV No.	402326	Ref. No.	96.00750
description	central unit 6 relays 230V voltage AC		
For models:	E9-COF, E9-Espresso, E9-LM, EtaBeta-V2-COF, EtaBeta-V2-COF-Display, EtaBeta-V2-LM, EtaBeta-V2-LM-Display, Kicco-COF, Kicco-Espresso, Kicco-LM, TemaStyle		



1			
GEV No.	526321	Ref. No.	96.00821
description	control box 3-group for coffee machine 230V type 3d5 MAESTRO DELUXE SLAVE 64KB		
For models:	E9-COF, E9-Espresso, E9-LM, Kicco-COF, Kicco-Espresso, Kicco-LM, TemaStyle		



1			
GEV No.	526313	Ref. No.	33.00289
description	front foil L 132mm W 41mm		
For models:	E9-COF, E9-Espresso		



1			
GEV No.	526304	Ref. No.	33.00300
description	front foil L 178mm W 51mm		
For models:	EtaBeta-V2-COF, EtaBeta-V2-COF-Display, EtaBeta-V2-LM, EtaBeta-V2-LM-Display, Kicco-COF, Kicco-Espresso, Kicco-LM		



1			
GEV No.	526305	Ref. No.	33.00303
description	front foil L 178mm W 51mm		
For models:	EtaBeta-V2-COF, EtaBeta-V2-LM, Kicco-COF, Kicco-Espresso, Kicco-LM		



1			
GEV No.	526307	Ref. No.	33.00301
description	front foil L 178mm W 51mm		
For models:	EtaBeta-V2-COF, EtaBeta-V2-LM, Kicco-COF, Kicco-Espresso, Kicco-LM		



1			
GEV No.	526308	Ref. No.	33.00306
description	front foil L 178mm W 51mm		
For models:	EtaBeta-V2-COF, EtaBeta-V2-COF-Display		



1			
GEV No.	526309	Ref. No.	33.00308
description	front foil L 178mm W 51mm		
For models:	EtaBeta-V2-LM, EtaBeta-V2-LM-Display		



1			
GEV No.	526310	Ref. No.	33.00305
description	front foil L 178mm W 51mm		
For models:	EtaBeta-V2-COF, EtaBeta-V2-COF-Display		

keypads

front foils



1			
GEV No.	526303	Ref. No.	33.00287
description	front foil L 132mm W 41mm		
For models:	E9-LM		



1			
GEV No.	526306	Ref. No.	33.00288
description	front foil L 132mm W 41mm		
For models:	E9-COF, E9-Espresso, E9-LM		



1			
GEV No.	526312	Ref. No.	33.00286
description	front foil L 132mm W 41mm		
For models:	E9-COF		





			
1			
GEV No.	526311	Ref. No.	33.00302
description	front foil L 178mm W 51mm		
For models:	EtaBeta-V2-COF, EtaBeta-V2-LM, Kicco-COF, Kicco-Espresso, Kicco-LM		

			
1			
GEV No.	526317	Ref. No.	33.00307
description	front foil L 178mm W 51mm		
For models:	E9-LM, EtaBeta-V2-LM, EtaBeta-V2-LM-Display		

membrane keypads

			
1			
GEV No.	401417	Ref. No.	96.00369
description	membrane keypad buttons 3		

			
1			
GEV No.	526314	Ref. No.	02.02337
description	membrane keypad L 152mm W 32mm		
For models:	TemaStyle		

			
1			
GEV No.	526320	Ref. No.	02.02338
description	membrane keypad L 152mm W 32mm		
For models:	TemaStyle		

keypad units

			
1			
GEV No.	526300	Ref. No.	96.00751
description	keypad unit buttons 6 L 135mm W 44mm		
For models:	E9-COF, E9-Espresso, E9-LM		

			
1			
GEV No.	526301	Ref. No.	96.00725
description	keypad unit buttons 7 L 162mm W 38mm		
For models:	EtaBeta-V2-COF, EtaBeta-V2-COF-Display, EtaBeta-V2-LM, EtaBeta-V2-LM-Display, Kicco-COF, Kicco-Espresso, Kicco-LM		

solenoid valves



solenoid valves (water)

metal			
PARKER			
2-way			
N74.BV series			
			
1			
GEV No.	374061	Ref. No.	96.00621
description	solenoid valve brass 2-ways 230VAC connection 1/8" L 30mm DN 2mm -10 up to 140°C PARKER coil type WB4.5 membranes FKM (water/steam) p max 15bar p min 0bar 50/60Hz		

VE-125 series				
				
1				
GEV No.	370202	Ref. No.	95.01175	
description	solenoid valve 2-ways 230VAC connection DN 2.5mm slide-on receptacle DIN -20° up to 130°C PARKER type series VE-125 coil type ZB09 membranes FKM (water) p max 10bar flange 32x32mm			
spare parts for	370202			
	GEV No.	371029	Ref. No.	—
	solenoid coil PARKER 230VAC 9VA coil type ZB09 seat ø 14mm H 33mm W 34mm D 43mm			
accessories for	370202			
	GEV No.	371090	Ref. No.	—
	power socket plug type DIN 43650A screw			
	GEV No.	532553	Ref. No.	—
	O-ring silicone thickness 1.5mm ID ø 13.15mm Qty 1 pcs			
	GEV No.	532554	Ref. No.	—
	O-ring silicone thickness 1.5mm ID ø 4.1mm Qty 1 pcs			

E-146 series



GEV No.	370206	Ref. No.	95.01176
description	solenoid valve 2-ways 230VAC connection 1/8" L 40mm DN 2.5mm slide-on receptacle DIN -20° up to 130°C PARKER type series VE-146 coil type ZB09 membranes FKM (water) p max 15bar p min 0bar		
For models:	E9-COF, E9-Espresso, E9-LM, EtaBeta-V2-COF, EtaBeta-V2-COF-Display, EtaBeta-V2-LM, EtaBeta-V2-LM-Display, Kicco-COF, Kicco-Espresso, Kicco-LM, TemaStyle		
spare parts for	370206		
	GEV No.	371029	Ref. No. —
	solenoid coil PARKER 230VAC 9VA coil type ZB09 seat ø 14mm H 33mm W 34mm D 43mm		
accessories for	370206		
	GEV No.	371090	Ref. No. —
	power socket plug type DIN 43650A screw		

3-way

N79.6QV series



GEV No.	374062	Ref. No.	96.00620
description	solenoid valve brass 3-ways 230VAC connection 1/8" L 30mm DN 1mm -10 up to 140°C PARKER coil type WB4.5 membranes FKM (water/steam) p max 15bar p min 0bar 50/60Hz		

VE-141 series



GEV No.	370550	Ref. No.	96.00203
description	solenoid valve 3-ways 230VAC connection 1/4" L 40mm DN 3mm slide-on receptacle DIN -20° up to 130°C coil type ZB09 membranes FKM (water) p max 3bar		
For models:	E9-COF, E9-Espresso, E9-LM, EtaBeta-V2-COF, EtaBeta-V2-COF-Display, EtaBeta-V2-LM, EtaBeta-V2-LM-Display, Kicco-COF, Kicco-Espresso, Kicco-LM, TemaStyle		

VE-141R series



GEV No.	370689	Ref. No.	96.00275
description	solenoid valve 3-ways 230VAC connection 1/8" L 40mm DN 1.3mm -40 up to +180°C coil type ZH14 membranes ruby p max 20bar p min 0bar		
accessories for	370689		
	GEV No.	371090	Ref. No. —
	power socket plug type DIN 43650A screw		

solenoid valves (various)



GEV No.	526331	Ref. No.	96.00474
description	solenoid valve 2-ways 230VAC connection 1/8" L 68mm DN 2.5mm -10 up to +70°C coil type WB4.5 membranes FKM (air/water/oil) p max 12bar p min 0bar 50-60Hz brass		
For models:	E9-COF, E9-Espresso, E9-LM, EtaBeta-V2-COF, EtaBeta-V2-COF-Display, EtaBeta-V2-LM, EtaBeta-V2-LM-Display, Kicco-COF, Kicco-Espresso, Kicco-LM, TemaStyle		

pressure switches

for coffee machines

ø 38mm



GEV No.	542179	Ref. No.	96.00210
description	pressure control ø 38mm pressure range 0.5-1.5bar 16A 250V connection 1/4" 1CO		
For models:	Carimalina, E9-COF, E9-Espresso, E9-LM, EtaBeta-V2-COF, EtaBeta-V2-COF-Display, EtaBeta-V2-LM, EtaBeta-V2-LM-Display, Kicco-COF, Kicco-Espresso, Kicco-LM, TemaStyle		



electrodes

 <p>1</p>			
GEV No.	402328	Ref. No.	96.00685
description	level electrode 1/8" total length 110mm probe L 95mm insulated probe length 65mm connection male faston 6.3mm ø 2.5mm		
For models:	E9-COF, E9-Espresso, E9-LM, EtaBeta-V2-COF, EtaBeta-V2-COF-Display, EtaBeta-V2-LM, EtaBeta-V2-LM-Display, Kicco-COF, Kicco-Espresso, Kicco-LM, TemaStyle		

 <p>1</p>			
GEV No.	402329	Ref. No.	96.00686
description	level electrode 1/8" total length 125mm probe L 110mm insulated probe length 88mm connection male faston 6.3mm stainless steel ø 2.5mm		
For models:	E9-COF, E9-Espresso, E9-LM, EtaBeta-V2-COF, EtaBeta-V2-COF-Display, EtaBeta-V2-LM, EtaBeta-V2-LM-Display, Kicco-COF, Kicco-Espresso, Kicco-LM, TemaStyle		

flow meters and flow sensors

flow meters

GICAR

 <p>1</p>			
GEV No.	526324	Ref. No.	95.01205
description	flow meter thread 1/4" stainless steel plug connection approval NSF flow rate 1.15l/min		
For models:	E9-COF, E9-Espresso, E9-LM, EtaBeta-V2-COF, EtaBeta-V2-COF-Display, EtaBeta-V2-LM, EtaBeta-V2-LM-Display, Kicco-COF, Kicco-Espresso, Kicco-LM, TemaStyle		

motors

gear motors

for automatic coffee machines

 <p>1</p>			
GEV No.	501489	Ref. No.	01.01418.CL
description	gear motor 6-24V voltage DC shaft ø 6mm L 200mm W 60mm H 38mm		

 <p>1</p>			
GEV No.	601987	Ref. No.	96.00702.CA
description	gear motor type EL RD-1 24V voltage DC 80rpm shaft ø 7mm L 82.4mm W 36.8mm H 36.8mm		

electric accessories

cables

connection cables

 <p>1</p>			
GEV No.	526322	Ref. No.	03.00999
description	cable L 100mm plug type Faston 6.3mm		

equipment-specific units

for ice-cube maker

miscellaneous

 <p>1</p>			
GEV No.	695832	Ref. No.	97.00102
description	olive for ice maker L 6.5mm ID ø 6.2mm ED ø 8.5mm		
For models:	E9-COF, E9-Espresso, E9-LM, EtaBeta-V2-COF, EtaBeta-V2-COF-Display, EtaBeta-V2-LM, EtaBeta-V2-LM-Display, Kicco-COF, Kicco-Espresso, Kicco-LM, TemaStyle		

for espresso machines

filter holders

filter holders standard







filter holder without spout

 <p>1</p>			
GEV No.	525989	Ref. No.	N/A
description	filter holder suitable for CARIMALI without outlet mounting ø 79.5mm outlet 3/8" ID ø 60mm wedge height 13.5mm number of wedges 3 lever straight		

filter holders short



1

GEV No.	529069	Ref. No.	22.00804.CR
description	filter holder mounting \varnothing 79.5mm outlet 3/8" ID \varnothing 60mm handle M10x1.5 wedge height 13.5mm number of wedges 3 lever straight chrome-plated brass		
For models:	E9-COF, E9-Espresso, E9-LM, EtaBeta-V2-COF, EtaBeta-V2-COF-Display, EtaBeta-V2-LM, EtaBeta-V2-LM-Display, Kicco-COF, Kicco-Espresso, Kicco-LM, TemaStyle		
accessories for	529069		
	GEV No.	Ref. No.	
	525956	14.00767	
	description	filter holder spring L 70mm W 60mm wire gauge \varnothing 1.2mm for espresso filter holder	
	GEV No.	Ref. No.	
	526341	14.02017	
	description	coffee filter \varnothing 68mm mounting \varnothing 60mm H 20mm cups 1 amount of coffee 6g	
	GEV No.	Ref. No.	
	526342	14.00819	
	description	coffee filter \varnothing 68mm mounting \varnothing 60mm H 21mm cups 2 amount of coffee 12g	
	GEV No.	Ref. No.	
	529065	—	
	description	filter holder spring L 70mm W 60mm wire gauge \varnothing 1.1mm for espresso filter holder	
	GEV No.	Ref. No.	
	529079	—	
	description	filter holder spring L 70mm W 60mm wire gauge \varnothing 1.3mm for espresso filter holder	
	GEV No.	Ref. No.	
	529210	14.00768	
	description	coffee filter \varnothing 68mm mounting \varnothing 59.5mm H 22mm cups 1 amount of coffee 7g	
	GEV No.	Ref. No.	
	529211	14.00769	
	description	coffee filter \varnothing 68mm mounting \varnothing 60mm H 23.5mm cups 2 amount of coffee	

handles

with external thread



1

GEV No.	111053	Ref. No.	N/A
description	handle \varnothing 36mm thread M10x1.5 thread L 15mm L 126mm black		

filters

for 1 cup



1

GEV No.	529210	Ref. No.	14.00768
description	coffee filter \varnothing 68mm mounting \varnothing 59.5mm H 22mm cups 1 amount of coffee 7g		
For models:	E9-COF, E9-Espresso, E9-LM, EtaBeta-V2-COF, EtaBeta-V2-COF-Display, EtaBeta-V2-LM, EtaBeta-V2-LM-Display, Kicco-COF, Kicco-Espresso, Kicco-LM, TemaStyle		



1

GEV No.	526341	Ref. No.	14.02017
description	coffee filter \varnothing 68mm mounting \varnothing 60mm H 20mm cups 1 amount of coffee 6g		
For models:	E9-COF, E9-Espresso, E9-LM, EtaBeta-V2-COF, EtaBeta-V2-COF-Display, EtaBeta-V2-LM, EtaBeta-V2-LM-Display, Kicco-COF, Kicco-Espresso, Kicco-LM, TemaStyle		

for 2 cups



1

GEV No.	526342	Ref. No.	14.00819
description	coffee filter \varnothing 68mm mounting \varnothing 60mm H 21mm cups 2 amount of coffee 12g		
For models:	E9-COF, E9-Espresso, E9-LM, EtaBeta-V2-COF, EtaBeta-V2-LM, Kicco-COF, Kicco-Espresso, Kicco-LM, TemaStyle		



1

GEV No.	529211	Ref. No.	14.00769
description	coffee filter \varnothing 68mm mounting \varnothing 60mm H 23.5mm cups 2 amount of coffee		
For models:	E9-COF, E9-Espresso, E9-LM, EtaBeta-V2-COF, EtaBeta-V2-COF-Display, EtaBeta-V2-LM, EtaBeta-V2-LM-Display, Kicco-COF, Kicco-Espresso, Kicco-LM, TemaStyle		

filter holder springs



1

GEV No.	525956	Ref. No.	14.00767
description	filter holder spring L 70mm W 60mm wire gauge \varnothing 1.2mm for espresso filter holder		
For models:	E9-COF, E9-Espresso, E9-LM, EtaBeta-V2-COF, EtaBeta-V2-COF-Display, EtaBeta-V2-LM, EtaBeta-V2-LM-Display, Kicco-COF, Kicco-Espresso, Kicco-LM, TemaStyle		



brewing units

filter holder gaskets

flat

standard



1

GEV No.	528044	Ref. No.	87.00122.00.19
description	filter holder gasket D1 ø 69.5mm D2 ø 57mm H 7.5mm Qty 1 pcs		
For models:	E9-COF, E9-Espresso, E9-LM, EtaBeta-V2-COF, EtaBeta-V2-COF-Display, EtaBeta-V2-LM, EtaBeta-V2-LM-Display, Kicco-COF, Kicco-Espresso, Kicco-LM, TemaStyle		

shim gaskets



1

GEV No.	528068	Ref. No.	74.00009
description	shim gasket D1 ø 69mm D2 ø 57mm thickness 0.8mm paper Qty 1 pcs		
For models:	E9-COF, E9-Espresso, E9-LM, EtaBeta-V2-COF, EtaBeta-V2-COF-Display, EtaBeta-V2-LM, EtaBeta-V2-LM-Display, Kicco-COF, Kicco-Espresso, Kicco-LM, TemaStyle		

brewing units manual

components

miscellaneous



1

GEV No.	528529	Ref. No.	93.00007
description	plain washer ID ø 3.5mm ED ø 6.6mm thickness 0.5mm brass Qty 1 pcs		

components

nozzles

with thread



1

GEV No.	526338	Ref. No.	22.00772
description	nozzle bore ø 0.8mm thread 1/8" L 23mm		
For models:	EtaBeta-V2-COF, EtaBeta-V2-COF-Display, EtaBeta-V2-LM, EtaBeta-V2-LM-Display, Kicco-COF, Kicco-Espresso, Kicco-LM		



1

GEV No.	529490	Ref. No.	22.00806
description	nozzle bore ø 1.2mm		
For models:	E9-COF, E9-Espresso, E9-LM, EtaBeta-V2-COF, EtaBeta-V2-COF-Display, EtaBeta-V2-LM, EtaBeta-V2-LM-Display, Kicco-COF, Kicco-Espresso, Kicco-LM, TemaStyle		

screws



1

GEV No.	560373	Ref. No.	91.00095
description	cylinder head bolt thread M4 thread L 12mm WS 3 SS Qty 1 pcs intake internal hexagon DIN 912/ISO 4762		
For models:	E9-COF, E9-Espresso, E9-LM, EtaBeta-V2-COF, EtaBeta-V2-COF-Display, EtaBeta-V2-LM, EtaBeta-V2-LM-Display, Kicco-COF, Kicco-Espresso, Kicco-LM, TemaStyle		

miscellaneous



1

GEV No.	530477	Ref. No.	37.00533
description	tap aerator		

water dispersions

water dispersions

group 3





1

GEV No.	529495	Ref. No.	22.00896.NP
description	water distributor ø 57.6mm H 14mm 8 holes hole ø 1.5mm thread M5 mounting ø 5.5mm bore ø 13mm stainless steel		

accessories for	529495		
GEV No.	529084	Ref. No.	—
description	shower screen ø 52mm hole ø 6.4mm		

			
1			
GEV No.	526328	Ref. No.	22.01225.NP
description	water distributor ø 57.7mm H 14mm 8 holes hole ø 1.5mm mounting ø 5.2mm stainless steel		
For models:	E9-COF, E9-Espresso, E9-LM, EtaBeta-V2-COF, EtaBeta-V2-COF-Display, EtaBeta-V2-LM, EtaBeta-V2-LM-Display, Kicco-COF, Kicco-Espresso, Kicco-LM, TemaStyle		

accessories			
			
1			
GEV No.	529494	Ref. No.	87.00111 87.00111.00.19
description	gasket water dispersion		
For models:	E9-COF, E9-Espresso, E9-LM, EtaBeta-V2-COF, EtaBeta-V2-COF-Display, EtaBeta-V2-LM, EtaBeta-V2-LM-Display, Kicco-COF, Kicco-Espresso, Kicco-LM, TemaStyle		

safety valves			
safety valves			
3/8"			
			
1			
GEV No.	526330	Ref. No.	95.00980 97.00148
description	safety valve connection 3/8" triggering pressure 1.9bar		
For models:	E9-COF, E9-Espresso, E9-LM, EtaBeta-V2-COF, EtaBeta-V2-COF-Display, EtaBeta-V2-LM, EtaBeta-V2-LM-Display, Kicco-COF, Kicco-Espresso, Kicco-LM, TemaStyle		

metric thread			
			
1			
GEV No.	529308	Ref. No.	N/A
description	safety valve connection M19x1 triggering pressure 1.8bar		

expansion valves			
with hose connection			
			
1			
GEV No.	530481	Ref. No.	97.00125
description	expansion valve 2-way T1: 1/4" ET hose ø 8mm triggering pressure 13bar BL 45mm total length 70mm		



with non-return valve			
			
1			
GEV No.	526340	Ref. No.	01.00473
description	expansion valve with non-return valve		
For models:	E9-COF, E9-Espresso, E9-LM, EtaBeta-V2-COF, EtaBeta-V2-COF-Display, EtaBeta-V2-LM, EtaBeta-V2-LM-Display, Kicco-COF, Kicco-Espresso, Kicco-LM, TemaStyle		

drain pans			
drain pans			
			
1			
GEV No.	526323	Ref. No.	37.00659
description	drain pan L 177mm W 98mm H 55 PT100 probemmm hose ø 1/2"mm		
For models:	E9-COF, E9-Espresso, E9-LM, EtaBeta-V2-COF, EtaBeta-V2-COF-Display, EtaBeta-V2-LM, EtaBeta-V2-LM-Display, Kicco-COF, Kicco-Espresso, Kicco-LM, TemaStyle		

hose couplings			
			
1			
GEV No.	526329	Ref. No.	22.00805
description	hose connector connection 18mm thread 1/2" brass		
For models:	E9-COF, E9-Espresso, E9-LM, EtaBeta-V2-COF, EtaBeta-V2-COF-Display, EtaBeta-V2-LM, EtaBeta-V2-LM-Display, Kicco-COF, Kicco-Espresso, Kicco-LM, TemaStyle		

aerators and air bleeders

 <p>1</p>			
GEV No.	529863	Ref. No.	01.00440
description	aerator and air bleeder		
For models:	E9-COF, E9-Espresso, E9-LM, EtaBeta-V2-COF, EtaBeta-V2-COF-Display, EtaBeta-V2-LM, EtaBeta-V2-LM-Display, Kicco-COF, Kicco-Espresso, Kicco-LM, TemaStyle		

 <p>1</p>			
GEV No.	529303	Ref. No.	01.00504
description	aerator and air bleeder connection 1/4" only steam		
For models:	E9-COF, E9-Espresso, E9-LM, EtaBeta-V2-COF, EtaBeta-V2-COF-Display, EtaBeta-V2-LM, EtaBeta-V2-LM-Display, Kicco-COF, Kicco-Espresso, Kicco-LM, TemaStyle		
spare parts for	529303		
	 <p>GEV No. 528687 Ref. No. —</p> <p>O-ring Viton thickness 1.78mm ID ø 3.69mm Qty 1 pcs</p>		

steam/water taps

steam/water taps

steam taps

steam taps (complete)

 <p>1</p>			
GEV No.	529640	Ref. No.	01.00489
description	steam tap with breathers inlet 3/8" outlet 3/8"		
For models:	E9-COF, E9-Espresso, E9-LM, EtaBeta-V2-COF, EtaBeta-V2-COF-Display, EtaBeta-V2-LM, EtaBeta-V2-LM-Display, Kicco-COF, Kicco-Espresso, Kicco-LM, TemaStyle		

knobs

 <p>1</p>			
GEV No.	526335	Ref. No.	01.01894
description	knob black		
For models:	E9-COF, E9-Espresso, E9-LM, EtaBeta-V2-COF, EtaBeta-V2-COF-Display, EtaBeta-V2-LM, EtaBeta-V2-LM-Display, Kicco-COF, Kicco-Espresso, Kicco-LM, TemaStyle		

components

bushes

 <p>1</p>			
GEV No.	525566	Ref. No.	22.00929
description	bush D1 ø 15mm D2 ø 12mm ID ø 7mm H 10mm brass		
For models:	E9-COF, E9-Espresso, E9-LM, EtaBeta-V2-COF, EtaBeta-V2-COF-Display, EtaBeta-V2-LM, EtaBeta-V2-LM-Display, Kicco-COF, Kicco-Espresso, Kicco-LM, TemaStyle		

gaskets

 <p>1</p>			
GEV No.	529474	Ref. No.	N/A
description	gasket D1 ø 14mm D2 ø 4mm thickness 5mm coffee machine		

water taps

knobs

 <p>1</p>			
GEV No.	526335	Ref. No.	01.01894
description	knob black		
For models:	E9-COF, E9-Espresso, E9-LM, EtaBeta-V2-COF, EtaBeta-V2-COF-Display, EtaBeta-V2-LM, EtaBeta-V2-LM-Display, Kicco-COF, Kicco-Espresso, Kicco-LM, TemaStyle		

water taps

 <p>1</p>			
GEV No.	529641	Ref. No.	01.00490
description	water tap inlet 3/8" outlet 3/8"		
For models:	E9-COF, E9-Espresso, E9-LM, EtaBeta-V2-COF-Display, EtaBeta-V2-LM-Display, Kicco-COF, Kicco-Espresso, Kicco-LM, TemaStyle		

steam/water pipes

steam pipes

 <p>1</p>			
GEV No.	526327	Ref. No.	02.00302.CR
description	steam pipe H 205mm tube ø 8mm		
For models:	E9-Espresso, Kicco-Espresso		

			
1			
GEV No.	526326	Ref. No.	02.01459.CR
description	steam pipe H 230mm tube ø 8mm		
For models:	E9-COF, E9-Espresso, E9-LM, EtaBeta-V2-COF, EtaBeta-V2-COF-Display, EtaBeta-V2-LM, EtaBeta-V2-LM-Display, Kicco-COF, Kicco-LM		

nozzles for steam pipes

			
1			
GEV No.	529673	Ref. No.	22.00189
description	steam nozzle thread M10x1 ø 12mm L 16mm 4 holes bore ø 1.25mm chrome-plated brass		
For models:	E9-Espresso, Kicco-Espresso, TemaStyle		

nozzles for water pipes

tap aerators

			
1			
GEV No.	529608	Ref. No.	95.00746
description	tap aerator D1 ø 23mm H 15mm thread M22x1		
For models:	E9-COF, E9-Espresso, E9-LM, EtaBeta-V2-COF, EtaBeta-V2-COF-Display, EtaBeta-V2-LM, EtaBeta-V2-LM-Display, Kicco-COF, Kicco-Espresso, Kicco-LM, TemaStyle		

accessories

springs

			
1			
GEV No.	529704	Ref. No.	13.00059
description	compression spring ø 11.8mm L 16mm wire gauge ø 1.6mm steel		

tube handles

			
1			
GEV No.	529627	Ref. No.	37.00225
description	tube handle ø 8mm L 30mm plastic		
For models:	E9-COF, E9-Espresso, E9-LM, EtaBeta-V2-COF, EtaBeta-V2-COF-Display, EtaBeta-V2-LM, EtaBeta-V2-LM-Display, Kicco-COF, Kicco-Espresso, Kicco-LM, TemaStyle		

union nuts

			
1			
GEV No.	526334	Ref. No.	22.01186.CR
description	nut thread 3/8" L 21mm hole ø 13mm chrome-plated		
For models:	E9-COF, E9-Espresso, E9-LM, EtaBeta-V2-COF, EtaBeta-V2-COF-Display, EtaBeta-V2-LM, EtaBeta-V2-LM-Display, Kicco-COF, Kicco-Espresso, Kicco-LM, TemaStyle		

non-return valves

complete

			
1			
GEV No.	527978	Ref. No.	95.01280
description	non-return valve inlet 3/8" outlet 3/8" L 38mm		
For models:	E9-COF, E9-Espresso, E9-LM, EtaBeta-V2-COF, EtaBeta-V2-COF-Display, EtaBeta-V2-LM, EtaBeta-V2-LM-Display, Kicco-COF, Kicco-Espresso, Kicco-LM, TemaStyle		

miscellaneous

			
1			
GEV No.	111106	Ref. No.	22.00751
description	mixer coupling		
For models:	E9-COF, E9-Espresso, E9-LM, EtaBeta-V2-COF, EtaBeta-V2-COF-Display, EtaBeta-V2-LM, EtaBeta-V2-LM-Display, Kicco-COF, Kicco-Espresso, Kicco-LM, TemaStyle		

			
1			
GEV No.	530483	Ref. No.	01.01412
description	pressure reduction valve thread M5 ø 10mm L 42mm hose ø 5mm stainless steel		

screw connections

hose connectors

			
1			
GEV No.	530484	Ref. No.	97.00070.00.19
description	hose connector thread M5 L 19mm hose ø 4mm stainless steel		

for coffee grinders

grinding burrs

grinding burrs straight

standard

			
1			
GEV No.	525533	Ref. No.	95.00404
description	grinding burrs pair turn direction left D1 ø 64mm ID ø 37mm H 9mm tooth spacing 3mm hole ø 5.6mm bore ø 8.5mm mounting ø 50		



for cup coffee machines

instant mixer units



1			
GEV No.	530487	Ref. No.	95.01760
description	flange for mixing hopper ø 63mm plastic		

coffee spouts

coffee spouts



1			
GEV No.	530488	Ref. No.	37.00286
description	coffee spout 2-way		

pistons

components



1			
GEV No.	530486	Ref. No.	37.00779
description	piston ø 45mm H 23mm hole ø 8mm plastic		

grinding units

grinding units



1			01.05007
GEV No.	531211	Ref. No.	0105608+0305031+3305033+9505035+96
description	grinding unit complete for CARIMALI		

mechanical components



1			
GEV No.	698548	Ref. No.	86.05000
description	adapter ext. ø 53 ID ø 51mm H 10.5mm		



1			
GEV No.	698660	Ref. No.	37.00531
description	duct plastic ext. ø 18mm hose ø 7mm L 44mm		



1			
GEV No.	698547	Ref. No.	01.01704
description	ejector H 32mm W 50mm L 108mm		

miscellaneous



1			
GEV No.	696661	Ref. No.	97.00097
description	bush L 15mm brass ID ø 3mm D1 ø 5mm D2 ø 4mm		
For models:	E9-COF, E9-Espresso, E9-LM, EtaBeta-V2-COF, EtaBeta-V2-COF-Display, EtaBeta-V2-LM, EtaBeta-V2-LM-Display, Kicco-COF, Kicco-Espresso, Kicco-LM, TemaStyle		



1			
GEV No.	530485	Ref. No.	37.00803
description	cap L 47mm plastic W 37.5mm		



1			
GEV No.	650226	Ref. No.	37.00852
description	drip tray plastic H 60mm W 335mm D 310mm		

			
1			
GEV No.	695832	Ref. No.	97.00102
description	olive for ice maker L 6.5mm ID ø 6.2mm ED ø 8.5mm		
For models:	E9-COF, E9-Espresso, E9-LM, EtaBeta-V2-COF, EtaBeta-V2-COF-Display, EtaBeta-V2-LM, EtaBeta-V2-LM-Display, Kicco-COF, Kicco-Espresso, Kicco-LM, TemaStyle		

knobs

steam/water taps

steam/water taps

			
1			
GEV No.	526335	Ref. No.	01.01894
description	knob black		
For models:	E9-COF, E9-Espresso, E9-LM, EtaBeta-V2-COF, EtaBeta-V2-COF-Display, EtaBeta-V2-LM, EtaBeta-V2-LM-Display, Kicco-COF, Kicco-Espresso, Kicco-LM, TemaStyle		

knob dial plates

			
1			
GEV No.	526318	Ref. No.	33.00266
description	knob dial plate steam		
For models:	E9-COF, E9-Espresso, E9-LM, EtaBeta-V2-COF, EtaBeta-V2-COF-Display, EtaBeta-V2-LM, EtaBeta-V2-LM-Display, Kicco-COF, Kicco-Espresso, Kicco-LM, TemaStyle		

			
1			
GEV No.	526319	Ref. No.	33.00296
description	knob dial plate water		
For models:	E9-COF, E9-Espresso, E9-LM, EtaBeta-V2-COF-Display, EtaBeta-V2-LM-Display, Kicco-COF, Kicco-Espresso, Kicco-LM, TemaStyle		

handles and hand wheels

lever handles

			
1			
GEV No.	526325	Ref. No.	37.00694
description	lever handle ø 48mm shaft ø 6mm		
For models:	E9-COF, E9-Espresso, E9-LM, EtaBeta-V2-COF, EtaBeta-V2-COF-Display, EtaBeta-V2-LM, EtaBeta-V2-LM-Display, Kicco-COF, Kicco-Espresso, Kicco-LM, TemaStyle		

gaskets

refrigeration gaskets

screw-in gaskets

profile 9140

We offer custom-made gaskets for this profile

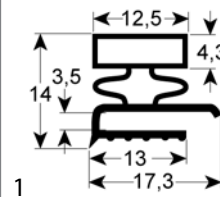

GEV No.	901873	Ref. No.	95.01797
description	refrigeration gasket profile 9140 W 180mm L 295mm external size		

O-rings

EPDM



GEV No.	510302	Ref. No.	87.00032
description	O-ring EPDM ID ø 12.42mm thickness 1.78mm Qty 1 pcs		
For models:	E9-COF, E9-Espresso, E9-LM, EtaBeta-V2-COF, EtaBeta-V2-COF-Display, EtaBeta-V2-LM, EtaBeta-V2-LM-Display, Kicco-COF, Kicco-Espresso, Kicco-LM, TemaStyle		

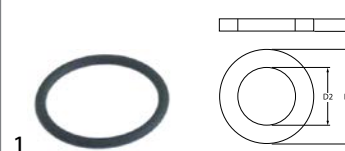

GEV No.	540682	Ref. No.	87.00141
description	O-ring EPDM thickness 1.78mm ID ø 18.77mm Qty 1 pcs		
For models:	E9-COF, E9-Espresso, E9-LM, EtaBeta-V2-COF, EtaBeta-V2-COF-Display, EtaBeta-V2-LM, EtaBeta-V2-LM-Display, Kicco-COF, Kicco-Espresso, Kicco-LM, TemaStyle		

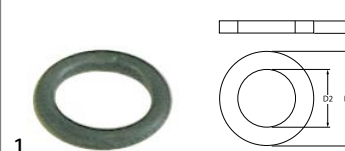

GEV No.	528223	Ref. No.	87.00006.00.19
description	O-ring EPDM thickness 2.62mm ID ø 11.91mm Qty 1 pcs		
For models:	E9-COF, E9-Espresso, E9-LM, EtaBeta-V2-COF, EtaBeta-V2-COF-Display, EtaBeta-V2-LM, EtaBeta-V2-LM-Display, Kicco-COF, Kicco-Espresso, Kicco-LM, TemaStyle		

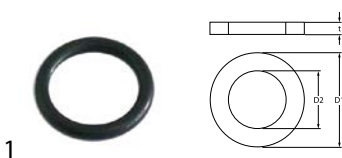
GEV No.	507313	Ref. No.	87.00019
description	O-ring EPDM thickness 2.62mm ID ø 13.95mm Qty 1 pcs		

silicone

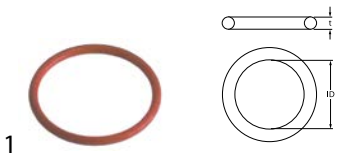

GEV No.	532602	Ref. No.	87.00142
description	O-ring silicone thickness 3.53mm ID ø 36.1mm Qty 1 pcs		

Viton

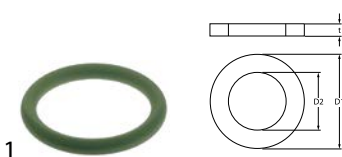

GEV No.	521077	Ref. No.	87.05003.00.19
description	O-ring Viton thickness 5.34mm ID ø 37.47mm Qty 1 pcs		

sealing washers

fibre gaskets



GEV No.	528017	Ref. No.	N/A
description	flat gasket fibre ED ø 53mm ID ø 42mm thickness 2mm for thread 1¼" Qty 1 pcs		

copper gaskets

DIN-7603-A



GEV No.	529480	Ref. No.	95.01166
description	flat gasket copper ED ø 18mm ID ø 14mm thickness 1.5mm		
For models:	E9-COF, E9-Espresso, E9-LM, EtaBeta-V2-COF, EtaBeta-V2-COF-Display, EtaBeta-V2-LM, EtaBeta-V2-LM-Display, Kicco-COF, Kicco-Espresso, Kicco-LM, TemaStyle		

PTFE gaskets



GEV No.	528052	Ref. No.	88.00045
description	flat gasket PTFE ED ø 50mm ID ø 40mm thickness 3mm Qty 1 pcs		
For models:	E9-COF, E9-Espresso, E9-LM, EtaBeta-V2-COF, EtaBeta-V2-COF-Display, EtaBeta-V2-LM, EtaBeta-V2-LM-Display, Kicco-COF, Kicco-Espresso, Kicco-LM, TemaStyle		



GEV No.	528022	Ref. No.	N/A
description	flat gasket PTFE ED ø 52mm ID ø 41mm thickness 2mm size 1¼" Qty 1 pcs suitable for CARIMALI, FAEMA, MARZOCCO, PAVONI		



GEV No.	526332	Ref. No.	88.00015.00.19
description	gasket PTFE ED ø 25mm ID ø 17.5mm thickness 1.5mm Qty 1 pcs suitable for CARIMALI		
For models:	E9-COF, E9-Espresso, E9-LM, EtaBeta-V2-COF, EtaBeta-V2-COF-Display, EtaBeta-V2-LM, EtaBeta-V2-LM-Display, Kicco-COF, Kicco-Espresso, Kicco-LM, TemaStyle		

springs

compression springs



GEV No.	529722	Ref. No.	13.00059
description	compression spring ø 11.6mm L 31mm wire gauge ø 1.4mm		
For models:	E9-COF, E9-Espresso, E9-LM, EtaBeta-V2-COF, EtaBeta-V2-COF-Display, EtaBeta-V2-LM, EtaBeta-V2-LM-Display, Kicco-COF, Kicco-Espresso, Kicco-LM, TemaStyle		

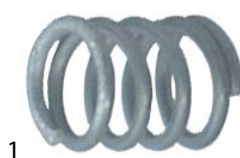

GEV No.	529704	Ref. No.	13.00059
description	compression spring ø 11.8mm L 16mm wire gauge ø 1.6mm steel		



GEV No.	696748	Ref. No.	C0008CPS056
description	spring ø 19mm L 43mm wire gauge ø 2mm windings 10 steel		

coffee accessories

milk foamers

milk foamers



1

GEV No.	802100	Ref. No.	01.01207
description	milk foamer connection 6mm angle 60° plastic		
For models:	E9-COF, E9-Espresso, E9-LM, EtaBeta-V2-COF, EtaBeta-V2-COF-Display, EtaBeta-V2-LM, EtaBeta-V2-LM-Display, Kicco-COF, Kicco-Espresso, Kicco-LM, TemaStyle		



1

GEV No.	525933	Ref. No.	04.00405
description	milk foamer connection 6mm angle 90° plastic		
accessories for	525933		
	GEV No.	531255	Ref. No.
	adapter thread 3/8" L 40mm		

manometers



1

GEV No.	541226	Ref. No.	95.01545
description	manometer double scale ø 60mm pressure range 0-2.5 / 0-16bar connection on the backside thread 1/8"		
For models:	E9-COF, E9-Espresso, E9-LM, EtaBeta-V2-COF, EtaBeta-V2-COF-Display, EtaBeta-V2-LM, EtaBeta-V2-LM-Display, Kicco-COF, Kicco-Espresso, Kicco-LM, TemaStyle		



1

GEV No.	541228	Ref. No.	N/A
description	manometer ø 41mm pressure range 0 up to 15bar thread 1/8" marking 7-8 connection on the backside		



1

GEV No.	541206	Ref. No.	N/A
description	manometer ø 42mm pressure range 0 up to 16bar thread 1/8" marking 12 connection on the backside		



1

GEV No.	541229	Ref. No.	N/A
description	manometer ø 44mm pressure range 0 up to 3bar thread 1/8" marking 2 connection on the backside		



1

GEV No.	541230	Ref. No.	N/A
description	manometer ø 53mm pressure range 0 up to 2bar connection on the backside marking 1.4-2.0 thread 1/8"		

hoses

industrial hoses

silicone hoses

without fabric



1

GEV No.	570156	Ref. No.	84.00028
description	silicone hose ID ø 3mm ED ø 7mm thickness 2mm t.max. 200°C brown		



fittings, hose and pipe connectors

hose connectors

without screw connection



GEV No.	501488	Ref. No.	97.00111 97.05036
description	Y-piece plastic hose ø 5-5-5mm 3-way		

fastening material

screws

countersunk screws



GEV No.	560216	Ref. No.	91.00207
description	countersunk screw thread M5 L 20mm SS DIN 963/ISO 2009 Qty 20 pcs intake slotted head ø 9.2mm		
For models:	E9-COF, E9-Espresso, E9-LM, EtaBeta-V2-COF, EtaBeta-V2-COF-Display, EtaBeta-V2-LM, EtaBeta-V2-LM-Display, Kicco-COF, Kicco-Espresso, Kicco-LM, TemaStyle		

cylinder head bolts

DIN 912/ISO 4762



GEV No.	560373	Ref. No.	91.00095
description	cylinder head bolt thread M4 thread L 12mm WS 3 SS Qty 1 pcs intake internal hexagon DIN 912/ISO 4762		
For models:	E9-COF, E9-Espresso, E9-LM, EtaBeta-V2-COF, EtaBeta-V2-COF-Display, EtaBeta-V2-LM, EtaBeta-V2-LM-Display, Kicco-COF, Kicco-Espresso, Kicco-LM, TemaStyle		

grub screws

DIN 914/ISO 4027



GEV No.	697417	Ref. No.	91.00056
description	grub screw thread M5 L 10mm stainless steel DIN 914/ISO 4027 WS 2.5 with spike Qty 1 pcs		
For models:	E9-COF, E9-Espresso, E9-LM, EtaBeta-V2-COF, EtaBeta-V2-COF-Display, EtaBeta-V2-LM, EtaBeta-V2-LM-Display, Kicco-COF, Kicco-Espresso, Kicco-LM, TemaStyle		

nuts

hexagonal nuts

DIN 934 / ISO 4032/8673

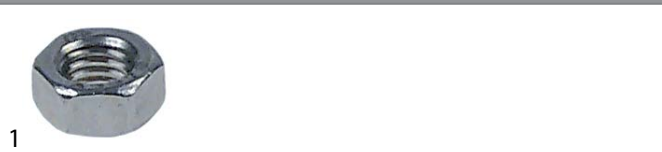

GEV No.	560129	Ref. No.	92.00008
description	hexagonal nut thread M5 H 4mm WS 8 SS DIN/ISO DIN 934 / ISO 4032/8673 Qty 1 pcs		
For models:	E9-COF, E9-Espresso, E9-LM, EtaBeta-V2-COF, EtaBeta-V2-COF-Display, EtaBeta-V2-LM, EtaBeta-V2-LM-Display, Kicco-COF, Kicco-Espresso, Kicco-LM, TemaStyle		

hexagonal nuts metric (without norm)



GEV No.	527169	Ref. No.	92.00005
description	hexagonal nut thread M3 H 2.8mm WS 5.5 brass Qty 1 pcs		

washers

spring washers

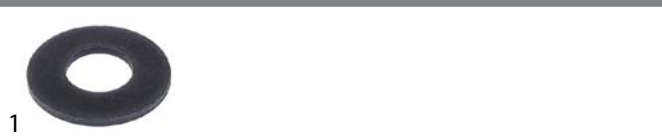

GEV No.	531147	Ref. No.	13.00058
description	spring washer ID ø 6.3mm ED ø 18mm thickness 0.8mm Qty 1 pcs		

washers

miscellaneous

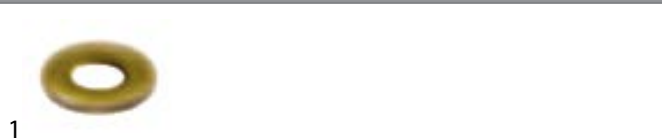

GEV No.	528529	Ref. No.	93.00007
description	plain washer ID ø 3.5mm ED ø 6.6mm thickness 0.5mm brass Qty 1 pcs		

fasteners

retaining rings

DIN 6799



GEV No.	529724	Ref. No.	94.00040
description	retaining ring E D1 \varnothing 4mm D2 \varnothing 9mm SS DIN 6799 thickness 0.7mm for shaft \varnothing 4-5mm		
For models:	E9-COF, E9-Espresso, E9-LM, EtaBeta-V2-COF, EtaBeta-V2-COF-Display, EtaBeta-V2-LM, EtaBeta-V2-LM-Display, Kicco-COF, Kicco-Espresso, Kicco-LM, TemaStyle		

C			
cables	11	screws	21
connection cables	11	sealing washers	19
contactors	6	silicone hoses	20
countersunk screws	21	solenoid valves	9
cylinder head bolts	21	spring washers	21
		switches and momentary switches	5
		system switches	6
		system switches (ROLD)	5
E			
electric accessories	11	T	
electrodes	11	thermostats	5
F			
fasteners	22	W	
fastening material	21	washers	21
flow meters	11		
G			
grub screws	21		
H			
heating elements	3		
heating elements for coffee machine	3		
hexagonal nuts	21		
hose connectors	21		
hoses	20		
I			
industrial hoses	20		
M			
milk foamers	20		
motors	11		
N			
nuts	21		
O			
O-rings	18		
P			
pressure switches	10		
probes	7		
push/momentary push switches	5		
R			
refrigeration gaskets	18		
relays	6		
retaining rings	22		
S			
safety thermostats	5		
screw-in gaskets	18		