



**GAS COMPONENTS**



**ELECTRIC COMPONENTS**



**WATER TECHNOLOGY**



**MECHANICAL COMPONENTS**



**TOOLS**

Spare parts suitable for

**CEADO**

Find the complete and up-to-date range of products in our GEV Webshop



# Manufacturer catalogue

The most important spare parts and accessories arranged clearly for every manufacturer

- ✓ Complete product range and all appliance data always up to date in the GEV Webshop
- ✓ Alphabetical Index at the end of the catalogue

## GEV Webshop

[www.gev-online.co.uk](http://www.gev-online.co.uk)

[www.gev-online.com](http://www.gev-online.com)



- 🔍 Add to Favourites
- 🔍 Sign In with email address and usual password
- 🔍 Easy-order – place several items in your basket at the same time
- 🔍 Quick Item search – no login needed



## heating elements

### quartz heating elements

1 			
<b>GEV No.</b>	420274	<b>Ref. No.</b>	50111
<b>description</b>	quartz heating element 500W 110V L 370mm ø 10mm connection male faston 6.3mm		

## switches and momentary switches



### rocker/momentary rocker switches

19x13mm			
1 			
<b>GEV No.</b>	347978	<b>Ref. No.</b>	50108 M98
<b>description</b>	rocker switch mounting measurements 19x13mm black 2NO 240V 6A connection male faston 4.8mm ambient temperature max. 125°C protection IP40		
<b>For models:</b>	E37, E37-Elettronico		

30x11mm			
1 			
<b>GEV No.</b>	347350	<b>Ref. No.</b>	50113
<b>description</b>	rocker switch mounting measurements 30x11mm black 1CO 250V 16A I O connection male faston 6.3mm ambient temperature max. 90°C protection IP40		

### push/momentary push switches

19x13mm			
1 			
<b>GEV No.</b>	347283	<b>Ref. No.</b>	50171
<b>description</b>	momentary push switch mounting measurements 19x13mm black 1NO 250V 10A connection male faston 2.8mm ambient temperature max. 120°C protection IP40		
<b>For models:</b>	E10ADX-Grigio, E6A-Destro-Grigio, E6TDX-Grigio, E7A-Destro-Grigio, E7T-Destro-Grigio, E8ADX-Grigio, E8TDX-Grigio, E9ADX-Grigio		

ø16mm			
1 			
<b>GEV No.</b>	301310	<b>Ref. No.</b>	50141+50137+50148 90125
<b>description</b>	push switch mounting ø 16mm chrome 1NO 250V 16A connection male faston 6.3mm protection IP40 ambient temperature max. 150°C		
<b>spare parts for</b>	301310		
	<b>GEV No.</b>	347676	<b>Ref. No.</b> 50141
switch 1NO 250V 16A connection male faston 6.3mm			

1 			
<b>GEV No.</b>	301309	<b>Ref. No.</b>	90124
<b>description</b>	push switch mounting ø 16mm chrome 2NO 250V 16A connection male faston 6.3mm protection IP40 ambient temperature max. 150°C		

ø25mm			
1 			
<b>GEV No.</b>	345160 <sup>1</sup>	<b>Ref. No.</b>	50132
<b>description</b>	push switch mounting ø 25mm red 2NO 250V 16A illuminated connection male faston 6.3mm ambient temperature max. 85°C protection IP40		

<sup>1</sup>illuminated

miscellaneous			
1 			
<b>GEV No.</b>	347977	<b>Ref. No.</b>	50175
<b>description</b>	momentary push switch mounting ø 12mm black 1NC 250V 16A connection male faston 6.3mm ambient temperature max. 85°C protection IP40		

1 			
<b>GEV No.</b>	347979	<b>Ref. No.</b>	50174 E2054
<b>description</b>	momentary push switch mounting ø 12mm black 1NO 250V 16A connection male faston 6.3mm ambient temperature max. 85°C protection IP40		

1 			
<b>GEV No.</b>	347980	<b>Ref. No.</b>	50151
<b>description</b>	momentary push switch mounting ø 12mm black 1NO 250V 16A connection male faston 6.3mm ambient temperature max. 85°C protection IP40		



### toggle switches

M12x0.75



<b>GEV No.</b>	346516	<b>Ref. No.</b>	50134
<b>description</b>	toggle switch thread M12x0.75 1NO 250V 15A ON-OFF male faston 6.3mm		



<b>GEV No.</b>	346521	<b>Ref. No.</b>	50133
<b>description</b>	toggle switch thread M12x0.75 2CO 250V 15A ON-OFF-MOM male faston with neutral position		

### accessories



<b>GEV No.</b>	347679	<b>Ref. No.</b>	50143
<b>description</b>	protection cap for toggle switch thread M12x0.75		

### microswitches

#### lever actuated



<b>GEV No.</b>	347285	<b>Ref. No.</b>	50327
<b>description</b>	microswitch with cable 250V 16A 1NO connection with cable ambient temperature max. 85°C lever length 36mm		
<b>For models:</b>	E10ADX-Grigio, E6A-Destro-Grigio, E7A-Destro-Grigio, E8ADX-Grigio, E9ADX-Grigio		



<b>GEV No.</b>	580078	<b>Ref. No.</b>	50123 83261045
<b>description</b>	microswitch with lever 250V 16A 1CO connection male faston 4.8mm L 68mm ambient temperature max. 125°C mounting distance 22.2mm type 83261 actuating force: 30g		
<b>For models:</b>	E37, E37-Elettronico		



<b>GEV No.</b>	347677	<b>Ref. No.</b>	50105
<b>description</b>	microswitch with lever 250V 16A 1CO connection male faston 6.3mm L 33mm ambient temperature max. 85°C mounting distance 22mm type 83263 actuating force: 35g lever length 25mm		

#### pin-plunger actuated

##### non-standard



<b>GEV No.</b>	347284	<b>Ref. No.</b>	50324
<b>description</b>	microswitch with plunger 250V 5A 1NO connection soldering connection ambient temperature max. 85°C with cable cable length 370mm		
<b>For models:</b>	E10ADX-Grigio, E6A-Destro-Grigio, E7A-Destro-Grigio, E8ADX-Grigio, E9ADX-Grigio		

##### non-standard



<b>GEV No.</b>	347606	<b>Ref. No.</b>	90505
<b>description</b>	microswitch 250V 1NO with cable cable length 350mm		
<b>For models:</b>	E10ADX-Grigio, E6A-Destro-Grigio, E7A-Destro-Grigio, E8ADX-Grigio, E9ADX-Grigio		

### system switches (ROLD)





<b>GEV No.</b>	347308	<b>Ref. No.</b>	50137
<b>description</b>	element holder mounting ø 16mm arched black ø 15.9mm ED ø 20mm H 23.5mm		





<b>GEV No.</b>	347282	<b>Ref. No.</b>	50138
<b>description</b>	push button ø 11.9mm chrome-plated 0-1 shaft L 4mm shaft 3.7x3.7mm		
<b>For models:</b>	E10ADX-Grigio, E10SDX-Grigio, E6A-Destro-Grigio, E6S-Destro-Grigio, E6TDX-Grigio, E7A-Destro-Grigio, E7S-Destro-Grigio, E7T-Destro-Grigio, E8ADX-Grigio, E8SDX-Grigio, E8TDX-Grigio, E9ADX-Grigio, E9SDX-Grigio		



			
1			
<b>GEV No.</b>	347680	<b>Ref. No.</b>	50148
<b>description</b>	push button ø 11.9mm chrome-plated 1-2 shaft L 4mm shaft 3.7x3.7mm		

			
1			
<b>GEV No.</b>	345722	<b>Ref. No.</b>	50178
<b>description</b>	switch 1NO 250V 16A connection male faston 6.3mm		
<b>For models:</b>	E6TDX-Grigio, E7T-Destro-Grigio, E8TDX-Grigio		

			
1			
<b>GEV No.</b>	347676	<b>Ref. No.</b>	50141
<b>description</b>	switch 1NO 250V 16A connection male faston 6.3mm		

			
1			
<b>GEV No.</b>	345720	<b>Ref. No.</b>	50170
<b>description</b>	switch 2NO 250V 16A connection male faston 6.3mm		
<b>For models:</b>	E10ADX-Grigio, E10SDX-Grigio, E6A-Destro-Grigio, E6S-Destro-Grigio, E7A-Destro-Grigio, E7S-Destro-Grigio, E8ADX-Grigio, E8SDX-Grigio, E9ADX-Grigio, E9SDX-Grigio		

			
1			
<b>GEV No.</b>	347678	<b>Ref. No.</b>	50140
<b>description</b>	switch 2NO 250V 16A connection male faston 6.3mm black latching triggering pressure 1500mbar ambient temperature max. 150°C series CM		

## timers

### mechanical timers

			
1			
<b>GEV No.</b>	350039	<b>Ref. No.</b>	50112 M215M2C41
<b>description</b>	timer M2 2-pole operation time 15min impulse spring 2NO at 250V 16A shaft ø 3.6mm shaft squaremm shaft L 16.5mm mounting distance 29mm mounting thread M4 connection male faston 6.3mm ambient temperature max. 125°C 250V		

## relays

### power relays

#### with bracket mounting

			
1			
<b>GEV No.</b>	380702	<b>Ref. No.</b>	50153
<b>description</b>	power relays FINDER 230VAC 16A 3NO connection male faston 6.3mm flange dimensions 36x38x68mm manuf. no. 62.83.8.230.0300 230V		

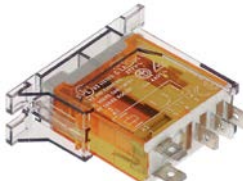
			
1			
<b>GEV No.</b>	381226	<b>Ref. No.</b>	4346.618.230.0040 + 4304605 50155
<b>description</b>	relay FINDER 230VAC 16A 1CO connection male faston 4.8mm flange manuf. no. 46.61.8.230.0040		

## electronics

### PCBs

			
1			
<b>GEV No.</b>	403441	<b>Ref. No.</b>	50130
<b>description</b>	PCB espresso machine V90 L 65mm W 46mm suitable for CEADO 50Hz voltage input 230V vottage output 230V 230V H 22mm type 1220001 voltage AC Qty 1 pcs		



1

<b>GEV No.</b>	403085	<b>Ref. No.</b>	50162
<b>description</b>	PCB for blenders L 65mm W 35.5mm		



1

<b>GEV No.</b>	402430	<b>Ref. No.</b>	50177
<b>description</b>	PCB for coffee grinder 230V 12V		
<b>For models:</b>	E10ADX-Grigio, E6A-Destro-Grigio, E6TDX-Grigio, E7A-Destro-Grigio, E7T-Destro-Grigio, E8ADX-Grigio, E8TDX-Grigio, E9ADX-Grigio		

## fans

### axial fans

#### import



1

<b>GEV No.</b>	601604 <sup>1</sup>	<b>Ref. No.</b>	12032ASTAD 50193
<b>description</b>	axial fan L 119mm W 119mm H 38mm 230VAC 50/60Hz 17/15W bearing slide bearing manuf. no. AA1282HS-AT connection cable 300mm fan wheel ø 110mm temp.-resist. 70°C input current 0.1A airflow 130m <sup>3</sup> /h 2600rpm		
<b>For models:</b>	E10ADX-Grigio, E10SDX-Grigio, E8ADX-Grigio, E8SDX-Grigio, E8TDX-Grigio, E9ADX-Grigio, E9SDX-Grigio		

<sup>1</sup>with slide bearings

## motors

### gear motors

#### for ice crusher



1

<b>GEV No.</b>	499203	<b>Ref. No.</b>	30107 30107+75501+75508
<b>description</b>	gear motor for ice crusher CIARAMELLA type 624017 220/240V voltage AC 50/60Hz shaft ø 8mm shaft length 33mm mounting distance 34mm with fan wheel		

## motors

### for bar blender



1

<b>GEV No.</b>	501455	<b>Ref. No.</b>	30103
<b>description</b>	motor for bar blender 220V 450W 50Hz 800rpm thread M6L shaft ø 8mm mounting distance 36mm H 60mm L 165mm W 80mm mounting thread M4 Dragone CEADO		



1

<b>GEV No.</b>	501456	<b>Ref. No.</b>	30108
<b>description</b>	motor for bar blender 230V 1500W 50Hz 28000rpm 1 phase thread M6L shaft ø 8mm mounting distance 55mm H 100mm L 160mm W 90mm CEADO		



1

<b>GEV No.</b>	499202	<b>Ref. No.</b>	90115
<b>description</b>	motor for mixer 230V 50Hz 1 phase shaft ø 10mm shaft length 125mm H 117mm L 70mm W 62mm		



## pumps

### booster pumps II

#### accessories



1

<b>GEV No.</b>	365015	<b>Ref. No.</b>	50104
<b>description</b>	operating capacitor capacity 10µF 400V tolerance 5%Hz ambient temperature max. -25 to +85°C ø 35.5mm L 59mm M8 plastic connection male faston 6.3mm protection		
<b>For models:</b>	E6A-Destro-Grigio, E6S-Destro-Grigio, E7A-Destro-Grigio, E7S-Destro-Grigio, E7T-Destro-Grigio		

## condensators & interference suppression filters

### operating capacitors

#### plastic



1

<b>GEV No.</b>	365015	<b>Ref. No.</b>	50104
<b>description</b>	operating capacitor capacity 10µF 400V tolerance 5%Hz ambient temperature max. -25 to +85°C ø 35.5mm L 59mm M8 plastic connection male faston 6.3mm protection		
<b>For models:</b>	E6A-Destro-Grigio, E6S-Destro-Grigio, E7A-Destro-Grigio, E7S-Destro-Grigio, E7T-Destro-Grigio		



1

<b>GEV No.</b>	365021	<b>Ref. No.</b>	50173
<b>description</b>	operating capacitor capacity 16µF 425V tolerance 5% 50/60Hz ambient temperature max. -25 to +85°C ø 35mm L 73mm single M8 plastic connection male faston 6.3mm 416.10.99 protection		
<b>For models:</b>	E10ADX-Grigio, E10SDX-Grigio, E8ADX-Grigio, E8SDX-Grigio, E8TDX-Grigio, E9ADX-Grigio, E9SDX-Grigio		

## equipment-specific units

### for bar blender

#### blenders

#### jar components

#### jars

#### complete



1

<b>GEV No.</b>	696347	<b>Ref. No.</b>	90105
<b>description</b>	blender jar plastic 1500ml with blade		



1

<b>GEV No.</b>	696437	<b>Ref. No.</b>	90106
<b>description</b>	blender jar plastic 1500ml with mixer disc		

## gaskets



1

<b>GEV No.</b>	651007	<b>Ref. No.</b>	75503
----------------	--------	-----------------	-------

<b>description</b>	gasket ED ø 75mm ID ø 55mm thickness 3mm Qty 1 pcs		
--------------------	--	--	--

## holders



1

<b>GEV No.</b>	651052	<b>Ref. No.</b>	70101
----------------	--------	-----------------	-------

<b>description</b>	bracket for jar ø 87mm nominal-ø 60mm plastic		
--------------------	---	--	--

## blades

## blades with adaptor (complete)



1

<b>GEV No.</b>	651054	<b>Ref. No.</b>	90134
----------------	--------	-----------------	-------

<b>description</b>	slicing unit complete bar blender ø 70mm SS		
--------------------	---	--	--



1

<b>GEV No.</b>	696501	<b>Ref. No.</b>	90101
----------------	--------	-----------------	-------

<b>description</b>	slicing unit complete for blenders ø 73mm		
--------------------	---	--	--

## mixer discs (complete)



1

<b>GEV No.</b>	696542	<b>Ref. No.</b>	90102
----------------	--------	-----------------	-------

<b>description</b>	mixer disc complete ø 73mm hole ø 6mm		
--------------------	---------------------------------------	--	--

## actuators

## group 1



1

<b>GEV No.</b>	651041	<b>Ref. No.</b>	45107
----------------	--------	-----------------	-------

<b>description</b>	mixer coupling ø 22mm H 13mm IT M6L teeth 4 stainless steel		
--------------------	---	--	--

## group 2



1

<b>GEV No.</b>	651042	<b>Ref. No.</b>	70103
----------------	--------	-----------------	-------

<b>description</b>	mixer coupling ø 32.5mm H 12mm teeth 4 rubber		
--------------------	---	--	--

## mixers

## miscellaneous



1

<b>GEV No.</b>	698344	<b>Ref. No.</b>	70124
----------------	--------	-----------------	-------

<b>description</b>	bumper for mixer L 63mm W 30mm plastic ID ø 25mm		
--------------------	--	--	--



1

<b>GEV No.</b>	698342	<b>Ref. No.</b>	40110
----------------	--------	-----------------	-------

<b>description</b>	distance washers for mixer L 20mm ID ø 8mm ED ø 10mm		
--------------------	--	--	--



1

<b>GEV No.</b>	698343	<b>Ref. No.</b>	75107
----------------	--------	-----------------	-------

<b>description</b>	threaded shaft for mixer L 45mm nylon ED ø 7.5mm		
--------------------	--	--	--





for juicers/centrifuges

centrifuge baskets

grating discs



1

<b>GEV No.</b>	696499	<b>Ref. No.</b>	20188
<b>description</b>	grating disc for juicer ø 120mm seat ø 14x12mm		

plungers



1

<b>GEV No.</b>	650292	<b>Ref. No.</b>	40213
<b>description</b>	plunger ø 76mm L 177mm total length 200mm		

for ice crusher

motors



1

<b>GEV No.</b>	499203	<b>Ref. No.</b>	30107 30107+75501+75508
<b>description</b>	gear motor for ice crusher CIARAMELLA type 624017 220/240V voltage AC 50/60Hz shaft ø 8mm shaft length 33mm mounting distance 34mm with fan wheel		

for coffee grinders

grinding burrs

grinding burrs straight

standard



1

<b>GEV No.</b>	525524	<b>Ref. No.</b>	40185 90302
<b>description</b>	grinding burrs pair turn direction right D1 ø 64mm ID ø 38mm H 9mm tooth spacing 3mm hole ø 5.5mm bore ø 9mm mounting ø 49 straight suitable for CEADO E6		
<b>For models:</b>	E6A-Destro-Grigio, E6S-Destro-Grigio, E6TDX-Grigio		



1

<b>GEV No.</b>	525525	<b>Ref. No.</b>	40168
<b>description</b>	grinding burrs pair turn direction right D1 ø 64mm ID ø 38mm H 9mm tooth spacing 3mm hole ø 5.5mm bore ø 9mm mounting ø 49 straight suitable for CEADO E7		
<b>For models:</b>	E37, E37-Elettronico, E7A-Destro-Grigio, E7S-Destro-Grigio, E7T-Destro-Grigio		



1

<b>GEV No.</b>	525526	<b>Ref. No.</b>	40180
<b>description</b>	grinding burrs pair turn direction right D1 ø 82.5mm ID ø 49.2mm H 9.5mm tooth spacing 3mm hole ø 6mm bore ø 10.2mm mounting ø 65.5 suitable for CEADO E8		
<b>For models:</b>	E10ADX-Grigio, E10SDX-Grigio, E8ADX-Grigio, E8SDX-Grigio, E8TDX-Grigio, E9ADX-Grigio, E9SDX-Grigio		

screws



1

<b>GEV No.</b>	526921	<b>Ref. No.</b>	45315
<b>description</b>	cylinder head bolt thread M4 thread L 10mm head ø 7mm zinc-coated steel Qty 1 pcs intake slotted head thickness 2.5mm		

1 

<b>GEV No.</b>	526922	<b>Ref. No.</b>	45316
<b>description</b>	flat-headed bolt thread M5 thread L 10mm steel Qty 1 pcs intake slotted head ø 8mm head thickness 3mm		

## dosing containers

### dosing container lids



1

<b>GEV No.</b>	525517	<b>Ref. No.</b>	70146
<b>description</b>	lid for coffee beans container ø 200mm		
<b>For models:</b>	E10ADX-Grigio, E10SDX-Grigio, E37, E37-Elettronico, E6A-Destro-Grigio, E6S-Destro-Grigio, E6TDX-Grigio, E7A-Destro-Grigio, E7S-Destro-Grigio, E7T-Destro-Grigio, E8ADX-Grigio, E8SDX-Grigio, E8TDX-Grigio, E9ADX-Grigio, E9SDX-Grigio		



1

<b>GEV No.</b>	525519	<b>Ref. No.</b>	70141
<b>description</b>	lid for dosing container ø 120mm		
<b>For models:</b>	E10ADX-Grigio, E10SDX-Grigio, E6A-Destro-Grigio, E6S-Destro-Grigio, E6TDX-Grigio, E7A-Destro-Grigio, E7S-Destro-Grigio, E7T-Destro-Grigio, E8ADX-Grigio, E8SDX-Grigio, E8TDX-Grigio, E9ADX-Grigio, E9SDX-Grigio		

## springs

### group 1



1

<b>GEV No.</b>	525523	<b>Ref. No.</b>	45507
<b>description</b>	torsion spring ø 28mm wire gauge ø 2mm		
<b>For models:</b>	E10ADX-Grigio, E10SDX-Grigio, E6A-Destro-Grigio, E6S-Destro-Grigio, E6TDX-Grigio, E7A-Destro-Grigio, E7S-Destro-Grigio, E7T-Destro-Grigio, E8ADX-Grigio, E8SDX-Grigio, E8TDX-Grigio, E9ADX-Grigio, E9SDX-Grigio		

## glass cylinders



1

<b>GEV No.</b>	525518	<b>Ref. No.</b>	70142
<b>description</b>	cylinder for dosing unit ø 118mm H 60mm plexiglas		
<b>For models:</b>	E10ADX-Grigio, E10SDX-Grigio, E6A-Destro-Grigio, E6S-Destro-Grigio, E6TDX-Grigio, E7A-Destro-Grigio, E7S-Destro-Grigio, E7T-Destro-Grigio, E8ADX-Grigio, E8SDX-Grigio, E8TDX-Grigio, E9ADX-Grigio, E9SDX-Grigio		
<b>accessories for</b>	525518		
		<b>GEV No.</b>	525519
		<b>Ref. No.</b>	70141
	lid for dosing container ø 120mm		

## coffee presses

### coffee presses



1

<b>GEV No.</b>	525520	<b>Ref. No.</b>	10361
<b>description</b>	coffee press ø 53mm H 16mm aluminium		
<b>For models:</b>	E10ADX-Grigio, E10SDX-Grigio, E6A-Destro-Grigio, E6S-Destro-Grigio, E6TDX-Grigio, E7A-Destro-Grigio, E7S-Destro-Grigio, E7T-Destro-Grigio, E8ADX-Grigio, E8SDX-Grigio, E8TDX-Grigio, E9ADX-Grigio, E9SDX-Grigio		



1

<b>GEV No.</b>	525521	<b>Ref. No.</b>	10362
<b>description</b>	coffee press ø 57mm H 16mm aluminium		
<b>For models:</b>	E10ADX-Grigio, E10SDX-Grigio, E6A-Destro-Grigio, E6S-Destro-Grigio, E6TDX-Grigio, E7A-Destro-Grigio, E7S-Destro-Grigio, E7T-Destro-Grigio, E8ADX-Grigio, E8SDX-Grigio, E8TDX-Grigio, E9ADX-Grigio, E9SDX-Grigio		





coffee beans containers

coffee beans containers



1

<b>GEV No.</b>	525516	<b>Ref. No.</b>	70147
<b>description</b>	coffee beans container ø 200mm H 267mm seat ø 57mm		
<b>For models:</b>	E10ADX-Grigio, E10SDX-Grigio, E37, E37-Elettronico, E6A-Destro-Grigio, E6S-Destro-Grigio, E6TDX-Grigio, E7A-Destro-Grigio, E7S-Destro-Grigio, E7T-Destro-Grigio, E8ADX-Grigio, E8SDX-Grigio, E8TDX-Grigio, E9ADX-Grigio, E9SDX-Grigio		
<b>accessories for</b>	525516		
	<b>GEV No.</b>	525517	<b>Ref. No.</b> 70146
	lid for coffee beans container ø 200mm		
	<b>GEV No.</b>	525522	<b>Ref. No.</b> 70145
	catch for coffee beans container L 122mm W 50mm thickness 6mm plastic		

locks



1

<b>GEV No.</b>	525522	<b>Ref. No.</b>	70145
<b>description</b>	catch for coffee beans container L 122mm W 50mm thickness 6mm plastic		
<b>For models:</b>	E10ADX-Grigio, E10SDX-Grigio, E37, E37-Elettronico, E6A-Destro-Grigio, E6S-Destro-Grigio, E6TDX-Grigio, E7A-Destro-Grigio, E7S-Destro-Grigio, E7T-Destro-Grigio, E8ADX-Grigio, E8SDX-Grigio, E8TDX-Grigio, E9ADX-Grigio, E9SDX-Grigio		

**gaskets**

sealing washers

silicone gaskets



1

<b>GEV No.</b>	651007	<b>Ref. No.</b>	75503
<b>description</b>	gasket ED ø 75mm ID ø 55mm thickness 3mm Qty 1 pcs		

**shaft gaskets**

v-rings



1

<b>GEV No.</b>	698360	<b>Ref. No.</b>	75508
<b>description</b>	V-ring for shaft ø 14mm ID ø 12.5mm ED ø 18.5mm thickness 5.5mm		

shaft gaskets



1

<b>GEV No.</b>	698359	<b>Ref. No.</b>	75501
<b>description</b>	shaft sealing ID ø 15mm ED ø 24mm thickness 7mm		

**springs**

torsion springs



1

<b>GEV No.</b>	525523	<b>Ref. No.</b>	45507
<b>description</b>	torsion spring ø 28mm wire gauge ø 2mm		
<b>For models:</b>	E10ADX-Grigio, E10SDX-Grigio, E6A-Destro-Grigio, E6S-Destro-Grigio, E6TDX-Grigio, E7A-Destro-Grigio, E7S-Destro-Grigio, E7T-Destro-Grigio, E8ADX-Grigio, E8SDX-Grigio, E8TDX-Grigio, E9ADX-Grigio, E9SDX-Grigio		

**fastening material**

screws

flat-headed bolts



1

<b>GEV No.</b>	526922	<b>Ref. No.</b>	45316
<b>description</b>	flat-headed bolt thread M5 thread L 10mm steel Qty 1 pcs intake slotted head ø 8mm head thickness 3mm		

cylinder head bolts

miscellaneous



1

<b>GEV No.</b>	526921	<b>Ref. No.</b>	45315
<b>description</b>	cylinder head bolt thread M4 thread L 10mm head ø 7mm zinc-coated steel Qty 1 pcs intake slotted head thickness 2.5mm		

**A**

axial fans 6

**B**

booster pumps II 7

**C**

condensators & interference suppression filters 7

cylinder head bolts 12

**F**

fans 6

fastening material 11

flat-headed bolts 11

**H**

heating elements 3

**M**

mechanical timers 5

microswitches 4

motors 6

**O**

operating capacitors 7

**P**

pumps 7

push/momentary push switches 3

**Q**

quartz heating elements 3

**R**

relays 5

rocker/momentary rocker switches 3

**S**

screws 11

sealing washers 11

shaft gaskets 11

switches and momentary switches 3

system switches (ROLD) 4

**T**

timers 5

toggle switches 4