



GAS COMPONENTS



ELECTRIC COMPONENTS



WATER TECHNOLOGY



MECHANICAL COMPONENTS



TOOLS

Spare parts suitable for

CELME

Find the complete and up-to-date range of products in our GEV Webshop



Manufacturer catalogue

The most important spare parts and accessories arranged clearly for every manufacturer

- ✓ Complete product range and all appliance data always up to date in the GEV Webshop
- ✓ Alphabetical Index at the end of the catalogue

GEV Webshop

www.gev-online.co.uk

www.gev-online.com



- 🔍 Add to Favourites
- 🔍 Sign In with email address and usual password
- 🔍 Easy-order – place several items in your basket at the same time
- 🔍 Quick Item search – no login needed



switches and momentary switches

push/momentary push switches

overload switches



1

GEV No.	347815	Ref. No.	60169
description	push switch KJD17 mounting measurements 45x22mm red/green 2NO 250V 10A 0-1 connection male faston 6.3mm ambient temperature max. 85°C protection IP54		

magnetic switches

M10x0.75

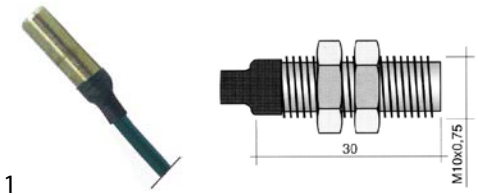

1

GEV No.	345632	Ref. No.	605511
description	magnetic switch thread M10x0.75 1NO 250V 0.5A P max. 50W connection cable cable length 2000mm type 102		
accessories for	345632		
	GEV No.	100779	Ref. No.
			—
	nut thread M10x0.75 H 3mm WS 14 SS Qty 2 pcs		

control equipment

GIOVENZANA

switches (complete)



1

GEV No.	347396	Ref. No.	60523
description	mushroom momentary switch mounting measurements ø22mm red 1NC		

electronics

PCBs



1

GEV No.	403599	Ref. No.	60906A
description	keypad PCB for vegetable slicer L 92.3mm W 82mm		



1

GEV No.	403600	Ref. No.	60905A
description	keypad PCB for vegetable slicer L 92.3mm W 82mm		



1

GEV No.	402489	Ref. No.	60948A
description	PCB for vegetable slicer L 92mm W 82mm 230V/50Hz		
spare parts for	402489		
	GEV No.	381109	Ref. No.
			—
	print relay 24VAC 4NO at 250V 12A connection soldering connection raster size 10mm		



1

GEV No.	402488	Ref. No.	60948
description	PCB for vegetable slicer L 92mm W 82mm cable length 350mm with momentary push switch		



1

GEV No.	402323	Ref. No.	60892 60892MN
description	PCB L 82mm W 65mm		



1

GEV No.	403151	Ref. No.	60906
description	PCB L 93mm W 82mm		

equipment-specific units

for slicers

adjustment knobs



1

GEV No.	698272	Ref. No.	74968
description	bush \varnothing 20mm ID \varnothing 14mm L 33mm brass		

eccentric disc for slice thickness



1

GEV No.	698338	Ref. No.	50322
description	eccentrics for cutting thickness hole \varnothing 12mm groove width 6mm ED \varnothing 56mm thickness 22.7mm plastic		

sharpener units

sharpener units



1

GEV No.	699182	Ref. No.	50126
description	blade sharpener		

grindstones



1

GEV No.	697567	Ref. No.	N/A
description	grindstone \varnothing 40mm thickness 8.2mm bore \varnothing 12mm grained fine with bevel, without hub		

for vegetable slicers

holders



1

GEV No.	697851	Ref. No.	80160
description	bracket for press lever H 83mm L 160mm vegetable slicers		

ejector discs



1

GEV No.	697292	Ref. No.	805556
description	ejector disc flat H 6mm \varnothing 200mm seat \varnothing 20.3mm shaft diameter 52mm hole distance 40mm		



1

GEV No.	697291	Ref. No.	505557
description	ejector disc high H 28mm \varnothing 200mm seat \varnothing 20.3mm hole distance 40mm		

grating discs



1

GEV No.	698404	Ref. No.	Z4
description	grating disc for vegetable slicer type Z4 \varnothing 205mm seat \varnothing 19mm slicing thickness 4mm		





			
1			
GEV No.	697915	Ref. No.	V
description	grating disc ø 205mm seat ø 19mm plastic		

			
1			
GEV No.	697838	Ref. No.	Z3 AK
description	grating disc ø 205mm seat ø 19mm slicing thickness 3mm SS/plastic		

cutting discs

blades smooth



blades

			
1			
GEV No.	697418	Ref. No.	175701
description	spare blades for cutting disc E		
accessories for	697418		
	GEV No.	697301	Ref. No. 970728 E2 AK
	slicing disk type E2 ø 206mm seat ø 19mm slicing thickness 2mm plastic		

cutting discs

			
1			
GEV No.	697389	Ref. No.	E1 AK
description	slicing disk type E1 ø 206mm seat ø 19mm slicing thickness 1mm plastic		

			
1			
GEV No.	698402	Ref. No.	E10 AL
description	slicing disk type E10 ø 205mm seat ø 19mm slicing thickness 10mm aluminium for vegetable slicer		

			
1			
GEV No.	697301	Ref. No.	970728 E2 AK
description	slicing disk type E2 ø 206mm seat ø 19mm slicing thickness 2mm plastic		
spare parts for	697301		
	GEV No.	697418	Ref. No. 175701
	spare blades for cutting disc E		

			
1			
GEV No.	697297	Ref. No.	970729 E3 AK
description	slicing disk type E3 ø 206mm seat ø 19mm slicing thickness 3mm plastic		

blades round

			
1			
GEV No.	697390	Ref. No.	970731 E5 AK
description	slicing disk type E5 ø 206mm seat ø 19mm slicing thickness 5mm plastic		

			
1			
GEV No.	697391	Ref. No.	E1S AK
description	slicing disk type S1 ø 206mm seat ø 19mm slicing thickness 1mm plastic		

cubing grids

			
1			
GEV No.	698403	Ref. No.	D10
description	cubing grid type D10 ø 210mm seat ø 32.5mm slicing thickness 10mm plastic		

for mozzarella slicers



GEV No.	698337	Ref. No.	502114
description	handle kit for lid		

for cup coffee machines

plungers



GEV No.	698337	Ref. No.	502114
description	handle kit for lid		

for tilting bratt pans

miscellaneous



GEV No.	523510	Ref. No.	755620
description	deep-groove ball bearing type 6202-2RS shaft \varnothing 15mm ED \varnothing 35mm W 11mm with sealing discs deep-groove ball bearing DIN 625-1		

transmission technology and ball bearings

ball bearings

deep-groove ball bearings 2RS



GEV No.	523510	Ref. No.	755620
description	deep-groove ball bearing type 6202-2RS shaft \varnothing 15mm ED \varnothing 35mm W 11mm with sealing discs deep-groove ball bearing DIN 625-1		

drive belts

poly-v belts

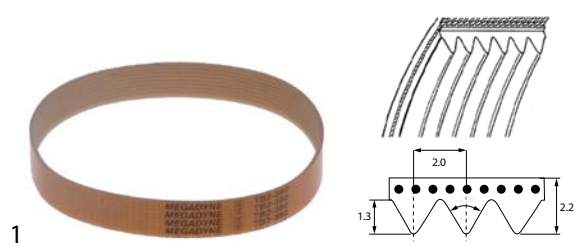

GEV No.	697623	Ref. No.	815554
description	poly-v belt grooves 12 W 24mm L 675mm profile TB2		

C

control equipment 3

M

magnetic switches 3

P

push/momentary push switches 3

S

switches and momentary switches 3