



**GAS COMPONENTS**



**ELECTRIC COMPONENTS**



**WATER TECHNOLOGY**



**MECHANICAL COMPONENTS**



**TOOLS**

Spare parts suitable for

**CHERGUI**

Find the complete and up-to-date range of products in our GEV Webshop



# Manufacturer catalogue

The most important spare parts and accessories arranged clearly for every manufacturer

- ✓ Complete product range and all appliance data always up to date in the GEV Webshop
- ✓ Alphabetical Index at the end of the catalogue

## GEV Webshop

[www.gev-online.co.uk](http://www.gev-online.co.uk)

[www.gev-online.com](http://www.gev-online.com)



- 🔍 Add to Favourites
- 🔍 Sign In with email address and usual password
- 🔍 Easy-order – place several items in your basket at the same time
- 🔍 Quick Item search – no login needed



## heating elements

### heating elements for chicken rotisseries

1	
<b>GEV No.</b>	418348
<b>Ref. No.</b>	03EFBL0030, RBL810R
<b>description</b>	heating element 1500W 230V round flange thread M6x1 L 810mm Wmm heating circuits 1 connection M6x1 L2 890mm flange ø 45mm dry heating element tube ø 16mm hole ø 5mm

1	
<b>GEV No.</b>	418349
<b>Ref. No.</b>	03EFBL0050
<b>description</b>	heating element 1700W 230V round flange L 918mm heating circuits 1 connection M6x1 flange ø 45mm dry heating element tube ø 16mm hole ø 5mm

### quartz heating elements

1	
<b>GEV No.</b>	417652
<b>Ref. No.</b>	03EFBO0070
<b>description</b>	heating coil 435W 250Ohm L1 345mm ø 5.2mm

1	
<b>GEV No.</b>	417651
<b>Ref. No.</b>	03EFBO0530
<b>description</b>	heating coil 435W 90Ohm L1 340mm ø 6.1mm

1	
<b>GEV No.</b>	418475
<b>Ref. No.</b>	03EFBO0300
<b>description</b>	heating coil for quartz tube

1	
<b>GEV No.</b>	418476
<b>Ref. No.</b>	03EFTQ0090
<b>description</b>	quartz tube L 190mm ID ø 7mm ED ø 11mm

1	
<b>GEV No.</b>	417653
<b>Ref. No.</b>	03EFTQ0150
<b>description</b>	quartz tube L 400mm tube ø 11mm

1	
<b>GEV No.</b>	418477
<b>Ref. No.</b>	03EFTQ0020
<b>description</b>	quartz tube WV L 350mm ID ø 7mm ED ø 11mm

## thermostats

### control and safety thermostats

EGO

#### control thermostats

55.13\_ series



<b>GEV No.</b>	375505	<b>Ref. No.</b>	03EDTH0020, EDTH002
<b>description</b>	thermostat t.max. 320°C temperature range 50-320°C 1-pole 1NO 16A probe ø 3mm probe L 160mm capillary pipe 870mm capillary pipe isolated gland nut shaft ø 6x4.6mm shaft L 23mm shaft position upper rotation 270°		

## switches and momentary switches

### push/momentary push switches

30x22mm



<b>GEV No.</b>	301084	<b>Ref. No.</b>	03EDIN0050, INTMB, EDIN005
<b>description</b>	push switch mounting measurements 30x22mm red 2NO 250V 12A connection male faston 6.3mm ambient temperature max. 85/55°C protection IP54 with protective collar		

### toggle switches

M12x0.75



<b>GEV No.</b>	346519	<b>Ref. No.</b>	03EDIN0030	
<b>description</b>	toggle switch thread M12x0.75 2NO 250V 15A ON-OFF male faston 6.3mm			
<b>accessories for</b>	346519			
	<b>GEV No.</b>	346525	<b>Ref. No.</b>	—
	protection cap L 23.5mm W 17.3mm protection cap rubber thread M11			
	<b>GEV No.</b>	347197	<b>Ref. No.</b>	—
	bezel ON-OFF for toggle switch M12			



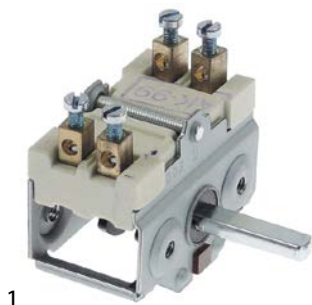

## cam switches

## on/off



1

<b>GEV No.</b>	300020	<b>Ref. No.</b>	03EDCO0010 EDCO001
<b>description</b>	cam switch 4 operating positions 2NO sequence 0-1-0-1 16A shaft $\varnothing$ 6x4.6mm shaft L 23mm connection screw ceramic		
<b>accessories for</b>	300020		
	<b>GEV No.</b>	110135	<b>Ref. No.</b> —
	rosette knob up to $\varnothing$ 52mm		
	<b>GEV No.</b>	110231	<b>Ref. No.</b> —
	knob switch 0-1-0-1 t.max.°C $\varnothing$ 50mm shaft $\varnothing$ 6x4.6mm shaft flat upper black		

## 4-position



1

<b>GEV No.</b>	300023	<b>Ref. No.</b>	03EDCO0020
<b>description</b>	cam switch 4 operating positions 1NO/2CO sequence 0-1-2-3 16A shaft $\varnothing$ 6x4.6mm shaft L 23mm connection screw 4-position ceramic		

## lamps

## indicator lights

## indicator lights 2-piece (lens and indicator lamp)

## indicator light lenses

 $\varnothing$ 12mm (type SDY-3)

1

<b>GEV No.</b>	359261	<b>Ref. No.</b>	EDAM011
<b>description</b>	indicator light housings mounting measurements $\varnothing$ 12mm red round Qty 1 pcs		

## indicator lamps for socket type SRZ / SDK / SDY / SFK



1

<b>GEV No.</b>	359430	<b>Ref. No.</b>	EDAM010
<b>description</b>	indicator lamp 230V clear connection cable 400mm		
<b>accessories for</b>	359430		
	<b>GEV No.</b>	359260	<b>Ref. No.</b> —
	indicator light housings mounting measurements $\varnothing$ 12mm yellow round Qty 1 pcs		

## indicator lights (complete)

 $\varnothing$ 12mm

## with plug-in socket



1

<b>GEV No.</b>	359691	<b>Ref. No.</b>	03EDAM0120
<b>description</b>	indicator light $\varnothing$ 12mm 230V red with cable		

## linear lamps

## halogen lamps



1

<b>GEV No.</b>	357090	<b>Ref. No.</b>	03EEAM0070
<b>description</b>	halogen lamp socket R7s L 117.6mm 230V 120W OSRAM HALOLINE ECO		

## infrared lamps

## with base type X lug



1

<b>GEV No.</b>	359617	<b>Ref. No.</b>	03EEAMA0060, EEAMA006
<b>description</b>	infrared lamp 1000W 220V L 365mm lens L 340mm total length 480mm with mounting strap		

## with base type Z ceramic



1

<b>GEV No.</b>	359699	<b>Ref. No.</b>	03EEAM0080
<b>description</b>	infrared lamp socket Z-ceramic L 122mm 220-240V 300W		



1



<b>GEV No.</b>	359694	<b>Ref. No.</b>	03EEAM0080
<b>description</b>	infrared lamp socket Z-ceramic L 122mm 220-240V 300W cable length 300mm IMPORT		

sockets for linear lamps

R7s

1

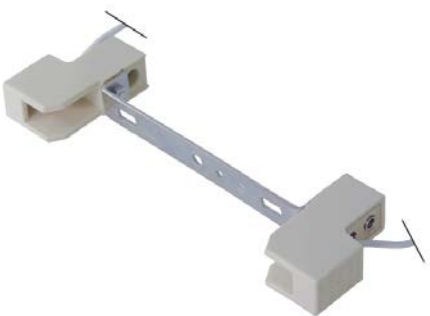

<b>GEV No.</b>	359543	<b>Ref. No.</b>	03EEDO0040
<b>description</b>	lamp socket socket R7s 250V ømm for length of lamp 117.6mm H 43mm connection cable 150mm mounting distance 64mm holder length 140.5mm Qty 1 pcs		

1



<b>GEV No.</b>	360688	<b>Ref. No.</b>	03EE00010
<b>description</b>	reflector for length of lamp 117mm L 163mm W 78mm H 27mm mounting distance 156mm for halogen lamp Qty 1 pcs		

X lug

1



<b>GEV No.</b>	359710	<b>Ref. No.</b>	03EEMA0060, EEMA006
<b>description</b>	lamp socket L 70mm W 70mm H 49mm mounting distance 50mm bracket mounting		

timers

mechanical timers

1



<b>GEV No.</b>	350168	<b>Ref. No.</b>	03EDMI0030
<b>description</b>	timer C53 2-pole operation time 120min impulse mechanical 1NO/1NC at 250V 16A permanent position no shaft 6x4.6mm shaft L 23mm mounting distance 28mm connection lateral		

electronics

PCBs

1



<b>GEV No.</b>	401560	<b>Ref. No.</b>	03EDCE0010
<b>description</b>	PCB		

motors

gear motors

for grills

1



<b>GEV No.</b>	500795	<b>Ref. No.</b>	03KEMO0180
<b>description</b>	gear motor BITRON 2rpm shaft ø 15mm L 116mm W 72mm H 69mm		



1

<b>GEV No.</b>	500800	<b>Ref. No.</b>	03KEMO0060 03KEMP0060 03KEMP0060, MOTRP, MOTOR-RPE
<b>description</b>	gear motor BITRON type 39700022 28W 220V 50Hz 1.9rpm shaft ø 15mm L 106mm W 72mm H 70mm		



1

<b>GEV No.</b>	500799	<b>Ref. No.</b>	03KEMO0120 03KEMO0120, KEMO007
<b>description</b>	gear motor BITRON type 39700023 25W 230V 50Hz 1.9rpm shaft ø 9mm L 135mm W 70mm H 80mm		



1

<b>GEV No.</b>	500796	<b>Ref. No.</b>	03KEMO0080 old
<b>description</b>	gear motor 230V 50Hz 4.5rpm shaft ø 8mm L 96mm W 73mm H 73mm type B4415UI MERKLE		



1

<b>GEV No.</b>	499326	<b>Ref. No.</b>	03KEMO0080
<b>description</b>	gear motor 230V voltage AC 50Hz 4rpm turn direction clockwise shaft ø 8mm L 95mm W 60mm H 76mm hole distance 40mm type TT-YJ61/26L-624K W&W Motors		



1

<b>GEV No.</b>	500704	<b>Ref. No.</b>	03KEMO0120
<b>description</b>	gear motor SPG type K225 230V 50/60Hz 2/2.5rpm shaft ø 11x12mm L 150mm W 130mm H 90mm		



### gas taps

#### PEL

##### 20S series



1

<b>GEV No.</b>	101094	<b>Ref. No.</b>	04ZCCO0110	
<b>description</b>	gas tap PEL type 20S gas inlet M16x1.5 (tube ø 10mm) bypass nozzle ø 0.35mm gas outlet M16x1.5 (tube ø 10/8mm) thermocouple connection M8x1 pilot connection shaft ø 8x6.5mm shaft L 22/15mm shaft flat lower			
<b>spare parts for</b>	101094			
	<b>GEV No.</b>	100408	<b>Ref. No.</b>	—
	bypass nozzle type PEL20/21 bore ø 0.35mm thread M5x0.5			
	<b>GEV No.</b>	101060	<b>Ref. No.</b>	—
	magnet unit standard L 39mm D1 ø 15.4mm D2 ø 11mm suitable for PEL20-21/JUNKERS/EGA			
	<b>GEV No.</b>	101205	<b>Ref. No.</b>	—
	gas tap front part shaft ø 8x6.5mm shaft L 22/15mm shaft flat upper/lower suitable for PEL20			
	<b>GEV No.</b>	101230	<b>Ref. No.</b>	—
	thermocouple nut T1: M8x1 T2: M18x1 aluminium			
<b>accessories for</b>	101094			
	<b>GEV No.</b>	101278	<b>Ref. No.</b>	—
	olive for pipe ø 10mm Qty 1 pcs			
	<b>GEV No.</b>	101300	<b>Ref. No.</b>	—
	union nut thread M16x1.5 tube ø 10mm			
	<b>GEV No.</b>	101450	<b>Ref. No.</b>	—
	olive for pipe ø 8mm L 12.7mm Qty 1 pcs ED ø 10mm			
	<b>GEV No.</b>	101451	<b>Ref. No.</b>	—
	union nut thread M16x1.5 tube ø 8mm			
	<b>GEV No.</b>	110081	<b>Ref. No.</b>	—
	knob ø 70mm shaft ø 8x6.5mm shaft flat universal			
	<b>GEV No.</b>	110083	<b>Ref. No.</b>	—
	knob dial plate gas tap without ignition flame silver			



			
1			
<b>GEV No.</b>	101491	<b>Ref. No.</b>	042CCO0110, ROBGAZ
<b>description</b>	gas tap PEL type 20S gas inlet M16x1.5 (tube ø 10mm) bypass nozzle ø 0.35mm gas outlet M16x1.5 (tube ø 10/8mm) thermocouple connection M9x1 pilot connection shaft ø 8x6.5mm shaft L 22/15mm shaft flat lower		
<b>spare parts for</b>	101491		
	<b>GEV No.</b>	100408	<b>Ref. No.</b> —
	bypass nozzle type PEL20/21 bore ø 0.35mm thread M5x0.5		
	<b>GEV No.</b>	101060	<b>Ref. No.</b> —
	magnet unit standard L 39mm D1 ø 15.4mm D2 ø 11mm suitable for PEL20-21/JUNKERS/EGA		
	<b>GEV No.</b>	101205	<b>Ref. No.</b> —
	gas tap front part shaft ø 8x6.5mm shaft L 22/15mm shaft flat upper/lower suitable for PEL20		
	<b>GEV No.</b>	101231	<b>Ref. No.</b> —
	thermocouple nut T1: M9x1 T2: M18x1		
<b>accessories for</b>	101491		
	<b>GEV No.</b>	101287	<b>Ref. No.</b> —
	olive for pipe ø 6mm Qty 1 pcs		
	<b>GEV No.</b>	101300	<b>Ref. No.</b> —
	union nut thread M16x1.5 tube ø 10mm		
	<b>GEV No.</b>	101450	<b>Ref. No.</b> —
	olive for pipe ø 8mm L 12.7mm Qty 1 pcs ED ø 10mm		
	<b>GEV No.</b>	101451	<b>Ref. No.</b> —
	union nut thread M16x1.5 tube ø 8mm		
	<b>GEV No.</b>	110081	<b>Ref. No.</b> —
	knob ø 70mm shaft ø 8x6.5mm shaft flat universal		
	<b>GEV No.</b>	110083	<b>Ref. No.</b> —
	knob dial plate gas tap without ignition flame silver		

## ignition parts

### thermocouples

#### thermocouple sets universal

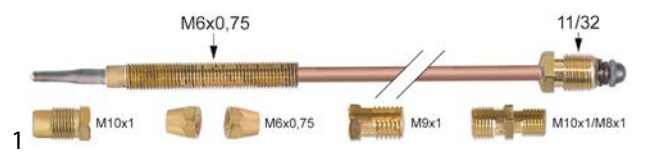
			
1			
<b>GEV No.</b>	102006	<b>Ref. No.</b>	04ZCCO0050
<b>description</b>	thermocouple set 6-piece L 1200mm		

## gas burners

### ceramic burners

			
1			
<b>GEV No.</b>	105934	<b>Ref. No.</b>	04ZCBR0050 04ZCBR0050, RAD785
<b>description</b>	ceramic burner L 785mm W 100mm firing range 745x38mm		

### accessories

#### nozzle holders

			
1			
<b>GEV No.</b>	102951	<b>Ref. No.</b>	04ZCIN0030
<b>description</b>	nozzle holder with nozzle ø1.35mm		

			
1			
<b>GEV No.</b>	102950	<b>Ref. No.</b>	04ZCIN0020
<b>description</b>	nozzle holder with nozzle ø1.95mm		

## gas nozzles

### main nozzles

#### gas nozzles M8x1

			
1			
<b>GEV No.</b>	102953	<b>Ref. No.</b>	04ZCIN0140
<b>description</b>	gas injector thread M8x1 WS 12 bore ø 1.1mm		

			
1			
<b>GEV No.</b>	102952	<b>Ref. No.</b>	04ZCIN0130
<b>description</b>	gas injector thread M8x1 WS 12 bore ø 1.7mm		



## equipment-specific units

### for freezer cabinets

#### glass panels



1	<b>GEV No.</b>	693928	<b>Ref. No.</b>	02GCDI0010
	<b>description</b>	glass panel L 190mm W 60mm thickness 4mm rectangular		

### for chicken rotisserie

#### skewers



1	<b>GEV No.</b>	693492	<b>Ref. No.</b>	45DIV0000
	<b>description</b>	skewer chicken rotisserie L 780mm W 100mm shaft intake ø 11mm		

1	<b>GEV No.</b>	693491	<b>Ref. No.</b>	01FABR0020
	<b>description</b>	skewer for chicken rotisserie L 780mm ø 10/11.5mm		
	<b>accessories for</b>	693491		
	<b>GEV No.</b>	692693	<b>Ref. No.</b>	33FATO0060
	<b>description</b>	skewer clamp single mounting pos. skewermm skewer ø 3.2mm ø 12.5mm		

#### spit clamp



1	<b>GEV No.</b>	692141	<b>Ref. No.</b>	33FATO0040
	<b>description</b>	skewer clamp for chicken rotisserie ID ø 17.5mm L 130mm W 73mm		



1	<b>GEV No.</b>	693489	<b>Ref. No.</b>	33FATO0060 old version
	<b>description</b>	skewer clamp single		



1	<b>GEV No.</b>	692693	<b>Ref. No.</b>	33FATO0060
	<b>description</b>	skewer clamp single mounting pos. skewermm skewer ø 3.2mm ø 12.5mm		

## knobs

### universal knobs



1	<b>GEV No.</b>	112257	<b>Ref. No.</b>	04ZCCO0020
	<b>description</b>	knob gas tap with ignition flame PEL22/23 ø 70mm shaft ø 10x8mm shaft flat universal black		

### producer-specific knobs

#### CHERGUI



1	<b>GEV No.</b>	111937	<b>Ref. No.</b>	04ZCCO0010, MANROBGAZ
	<b>description</b>	knob		



1	<b>GEV No.</b>	110262	<b>Ref. No.</b>	03EDMA0040, EDMA004
	<b>description</b>	knob switch zero mark ø 42mm shaft ø 6x4.6mm shaft flat upper blue		





			
1			
<b>GEV No.</b>	112133	<b>Ref. No.</b>	04ZCCO0220
<b>description</b>	knob switch zero mark ø 53mm shaft ø 10x8mm shaft flat upper black		



**C**

cam switches	4
ceramic burners	7
control thermostats	3

**G**

gas burners	7
gas nozzles	7
gas taps	6

**H**

heating elements	3
------------------	---

**I**

indicator lights	4
indicator lights (complete)	4
infrared lamps	4

**L**

lamps	4
linear lamps	4

**M**

mechanical timers	5
motors	5

**P**

push/momentary push switches	3
------------------------------	---

**Q**

quartz heating elements	3
-------------------------	---

**S**

switches and momentary switches	3
---------------------------------	---

**T**

thermocouples	7
thermostats	3
timers	5
toggle switches	3