



GAS COMPONENTS



ELECTRIC COMPONENTS



WATER TECHNOLOGY



MECHANICAL COMPONENTS



TOOLS

Spare parts suitable for

COMENDA

Find the complete and up-to-date range of products in our GEV Webshop



Manufacturer catalogue

The most important spare parts and accessories arranged clearly for every manufacturer

- ✓ Complete product range and all appliance data always up to date in the GEV Webshop
- ✓ Alphabetical Index at the end of the catalogue

GEV Webshop

www.gev-online.co.uk

www.gev-online.com







- 🔍 Add to Favourites
- 🔍 Sign In with email address and usual password
- 🔍 Easy-order – place several items in your basket at the same time
- 🔍 Quick Item search – no login needed



heating elements

heating elements for pasta cookers

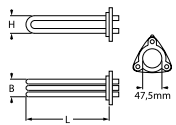

			
GEV No.	415020	Ref. No.	110331
description	heating element 4500W 230V mounting \varnothing 57.5mm heating circuits 3 L 355mm W 35mm H 47mm number of thermostat sleeves 1 thermostat sleeves \varnothing 7mm length thermostat sleeves 295mm thermostat sleeve upper tube \varnothing 8.5mm hole distance 70mm hole \varnothing 10mm connection length 25mm connection male faston 6.3mm 3 hole flange immersion heater		
For models:	AC120, AC150, AC170, AC200, ACR, ACR145, ACR205, ACR225, ACR245, ACR260, ACR265, ACR305, ACR5145, ACR5205, ACR5225, ACR5245, ACR5260, ACR5265, ACR5305, C30, C70, C75, C85, C95, C95E2, F2, F3, F45, F55, F65, F80, G50L, G50LM, G51L, G60L, G61L, G65, G65L, G66, G75, G75L, GE75, GL, GMC, GMC2700, GMC2702, GMC3500, GMC3502, GMC4500, GMC4502...(Other models you can see in the webshop)		

 			
GEV No.	416274	Ref. No.	110398
description	heating element 5000W 230V mounting \varnothing 47.5mm heating circuits 3 L 248mm W 36mm H 34mm number of thermostat sleeves 1 thermostat sleeves \varnothing 7mm length thermostat sleeves 200mm thermostat sleeve eccentric, non clinging tube \varnothing 6.5mm hole distance 64mm hole \varnothing 8mm connection M4 3 hole flange immersion heater		
For models:	BHC30A, BHC30A-2, BHC30HR, BHC30HR380, BHC30HRA, BHC30HRA380, BHC433, BHC433-2, BHC433A, BHC433A-2, BHCHR		
spare parts for	416274		
	GEV No.	510408	Ref. No. 200820
	O-ring EPDM thickness 5.34mm ID \varnothing 47mm Qty 1 pcs		
accessories for	416274		
	GEV No.	510562	Ref. No. —
	O-ring silicone thickness 5.34mm ID \varnothing 47mm Qty 1 pcs		

coil heating elements

			
GEV No.	418823	Ref. No.	110704
description	heating element 1000W 230V L 405mm W 50mm H 25mm tube \varnothing 8.5mm thread M14x1.5 connection M5 heating circuits 1		
For models:	AC100, AC101, AC105, AC120, AC122, AC135, AC150, AC151, AC152, AC170, AC181, AC182, AC200, AC201, AC202, AC241, AC242, AC90, AC91, AC95, ACL100, ACL150, ACR, ACR145, ACR205, ACR225, ACR245, ACR260, ACR265, ACR305, ACR5145, ACR5205, ACR5225, ACR5245, ACR5260, ACR5265, ACR5305, ACS101, ACS101-DIGIT, ACS122, ACS122-DIGIT, ACS151, ACS151-DIGIT, ACS152, ACS152-DIGIT, ACS161-DIGIT, ACS162-DIGIT, ACS181, ACS181-DIGIT, ACS182...(Other models you can see in the webshop)		

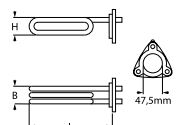
			
GEV No.	418824	Ref. No.	110706
description	heating element 1500W 230V L 428mm W 50mm H 25mm tube \varnothing 8.5mm thread M14x1.5 connection M6 connection length 41mm heating circuits 1 2 hole fixing		
For models:	AC101, AC122, AC151, AC152, AC181, AC182, AC201, AC202, AC241, AC242, AC91, ACR, ACR145, ACR205, ACR225, ACR245, ACR260, ACR265, ACR305, NL302, NL302E, NL402, NL402E, NL502, NL502E, NL552, NL552E		

 			
GEV No.	415014	Ref. No.	110366
description	heating element 3000W 230V mounting \varnothing 47.5mm heating circuits 1 L 240mm W 28mm H 44mm number of thermostat sleeves 1 thermostat sleeves \varnothing 7mm length thermostat sleeves 220mm thermostat sleeve not clinging tube \varnothing 6.3mm hole distance 62mm hole \varnothing 8mm connection male faston 6.3mm 3 hole flange immersion heater		
For models:	B10T, B11T, B12T, B13T, B14T, B15T, B15TM, B16T, B16TM, B18T, B18TM, B19T, B19TM, B31, B32, B41, B42, BC25, BC25A, BC25HR, BC30, BC30A, BC30HR, BC30HRA, BR20, BR20A, BR25, BR25A, F20, FC43, FC43A		
accessories for	415014		
	GEV No.	510408	Ref. No. 200820
	O-ring EPDM thickness 5.34mm ID \varnothing 47mm Qty 1 pcs		
	GEV No.	510562	Ref. No. —
	O-ring silicone thickness 5.34mm ID \varnothing 47mm Qty 1 pcs		

immersion heating elements

3 hole flange \varnothing 47.5mm

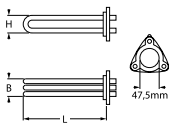
 			
GEV No.	420230	Ref. No.	110395
description	heating element 2000W 230V mounting \varnothing 47.5mm heating circuits 1 L 220mm W 28mm H 35mm number of thermostat sleeves 1 thermostat sleeves \varnothing 8mm length thermostat sleeves 200mm thermostat sleeve eccentric, non clinging tube \varnothing 6.2mm hole distance 62mm hole \varnothing 10mm connection male faston 6.3mm 3 hole flange immersion heater		



GEV No.	415013	Ref. No.	110364 110396
description	heating element 2400W 230V mounting \varnothing 47.5mm heating circuits 1 L 215mm W 40mm H 35mm number of thermostat sleeves 1 thermostat sleeves \varnothing 6.5mm length thermostat sleeves 190mm thermostat sleeve eccentric, non clinging tube \varnothing 6.5mm hole distance 64mm hole \varnothing 8x10mm connection male faston 6.3mm 3 hole flange immersion heater		
For models:	B15, B16, B18, B19, B20, B20D, B23, B24, B25, B26, B27, LB200, LB200-2, LB200A, LB200A-2, LB215, LB215-2, LB215A, LB215A-2, LB260, LB260-2, LB260A, LB260A-2, LB275, LB275-2, LB275A, LB275A-2		
accessories for	415013		
	GEV No.	510408	Ref. No. 200820
	O-ring EPDM thickness 5.34mm ID \varnothing 47mm Qty 1 pcs		
	GEV No.	510562	Ref. No. —
	O-ring silicone thickness 5.34mm ID \varnothing 47mm Qty 1 pcs		

GEV No.	416273	Ref. No.	110397
description	heating element 3200W 230V mounting \varnothing 42mm heating circuits 1 L 237mm W 35mm H 38mm number of thermostat sleeves 1 thermostat sleeves \varnothing 7mm length thermostat sleeves 200mm thermostat sleeve not clinging tube \varnothing 6.3mm hole distance 66mm hole \varnothing 8mm connection length 26mm connection male faston 6.3mm 3 hole flange immersion heater		
For models:	BHC25, BHC25-2, BHC25A, BHC25A-2, BHC25S, BHC30, BHC30-2, BHC30A, BHC30A-2, BHC30E, BHC30E-2, BHC30EA, BHC30EA-2, BHC30HR, BHC30HR-2, BHC30HR380, BHC30HRA, BHC30HRA-2, BHC30HRA380, BHC433, BHC433-2, BHC433A, BHC433A-2, BHCHR		
accessories for	416273		
	GEV No.	510408	Ref. No. 200820
	O-ring EPDM thickness 5.34mm ID \varnothing 47mm Qty 1 pcs		
	GEV No.	510562	Ref. No. —
	O-ring silicone thickness 5.34mm ID \varnothing 47mm Qty 1 pcs		

3 hole flange \varnothing 57.5mm			
GEV No.	418624	Ref. No.	110388
description	heating element 10000W 230/400V mounting \varnothing 57.5mm heating circuits 3 L 480mm W 35mm H 43mm number of thermostat sleeves 1 thermostat sleeves \varnothing 7mm length thermostat sleeves 285mm tube \varnothing 8.5mm hole distance 72mm hole \varnothing 8mm immersion heater		
For models:	AC101, AC120, AC122, AC135, AC150, AC151, AC152, AC170, AC181, AC182, AC200, AC201, AC202, AC241, AC242, AC2A, AC91, ACL100, ACL150, ACR, ACR145, ACR205, ACR225, ACR245, ACR260, ACR265, ACR305, ACRS145, ACRS205, ACRS225, ACRS245, ACRS260, ACRS265, ACRS305, ACS101-DIGIT, ACS122-DIGIT, ACS151, ACS151-DIGIT, ACS152, ACS152-DIGIT, ACS161-DIGIT, ACS162-DIGIT, ACS181, ACS181-DIGIT, ACS182, ACS182-DIGIT, ACS201, ACS201-DIGIT, ACS202, ACS202-DIGIT...(Other models you can see in the webshop)		

GEV No.	418891	Ref. No.	110333
description	heating element 7000W 230V mounting \varnothing 57.5mm heating circuits 3 L 350mm W 25mm H 40mm number of thermostat sleeves 1 thermostat sleeves \varnothing 8mm length thermostat sleeves 285mm thermostat sleeve upper centre not clinging tube \varnothing 8mm hole distance 70mm hole \varnothing 8mm connection length 18mm connection male faston 6.3mm immersion heater		
For models:	FC3E, FC3EA, FC3M, FC3MA, FC3MR, FC44E, FC44EA, FC4E, FC4EA, FC4EHR, FC4M, FC4MA		
accessories for	418891		
	GEV No.	510409	Ref. No. 200815
	O-ring EPDM thickness 5.34mm ID \varnothing 56.52mm Qty 1 pcs		

GEV No.	417403	Ref. No.	110385
description	heating element 12000/14000W 240-415V heating circuits 3 L 620mm W 37mm H 51mm number of thermostat sleeves 1 thermostat sleeves \varnothing 8.8mm length thermostat sleeves 290mm tube \varnothing 10mm hole distance 73mm hole \varnothing 8mm		
For models:	AC101, AC122, AC151, AC152, AC181, AC182, AC201, AC202, AC241, AC242, AC91		



GEV No.	415023	Ref. No.	110367 110379 110382
description	heating element 12500W 230V mounting \varnothing 57.5mm heating circuits 3 L 630mm W 36mm H 48mm number of thermostat sleeves 1 thermostat sleeves \varnothing 7mm length thermostat sleeves 295mm thermostat sleeve eccentric, non clinging tube \varnothing 8.5mm hole distance 76mm hole \varnothing 8x10mm connection M5 3 hole flange immersion heater		
For models:	AC101, AC122, AC151, AC152, AC181, AC182, AC201, AC202, AC241, AC242, AC2A, AC91, AC95, ACL100, ACL150, ACS101, ACS101-DIGIT, ACS122, ACS122-DIGIT, ACS151-DIGIT, ACS152-DIGIT, ACS161-DIGIT, ACS162-DIGIT, ACS181-DIGIT, ACS182-DIGIT, ACS201-DIGIT, ACS202-DIGIT, ACS241-DIGIT, ACS242-DIGIT, ACS91, ACS91-DIGIT, NE00, NG00, NG600, NG600E, NG900, NG900E		

GEV No.	420159	Ref. No.	110392
description	heating element 14000W 230/400V mounting \varnothing 57.5mm heating circuits 3 L 500mm W 36mm H 43mm number of thermostat sleeves 1 thermostat sleeves \varnothing 7.5mm length thermostat sleeves 290mm thermostat sleeve eccentric, non clinging tube \varnothing 8.3mm hole distance 73mm hole \varnothing 10mm connection length 26mm connection M5 3 hole flange		

GEV No.	416275	Ref. No.	110361
description	heating element 2200W 230V mounting \varnothing 57.5mm heating circuits 1 L 235mm W 38mm H 38mm number of thermostat sleeves 1 thermostat sleeves \varnothing 7.5mm length thermostat sleeves 214mm thermostat sleeve not clinging tube \varnothing 6.4mm hole distance 72mm hole \varnothing 8mm connection length 22mm connection male faston 6.3mm 3 hole flange immersion heater		
For models:	FC53CBT, FC53LA, FC53LBT, FC54CBT, FC54LBT, LC1200, LC1200RCD, LC700, LC700RCD, LC900, LC900RCD, LF320CBT, LF320L, LF320LA, LF320LBT		

GEV No.	415060	Ref. No.	110363
description	heating element 3000W 230V mounting \varnothing 57.5mm heating circuits 1 L 330mm W 45mm H 29mm number of thermostat sleeves 1 thermostat sleeves \varnothing 7mm length thermostat sleeves 295mm thermostat sleeve not clinging tube \varnothing 6.25mm hole distance 73mm hole \varnothing 8mm connection male faston 6.3mm 3 hole flange immersion heater		
For models:	F300, F45, F55, F65, F80, FC, FC53, FC533, FC533A, FC53A, FC54, FC543, FC543A, FC544, FC544A, FC54A, FC54E, FC54EA, LF280-lav-line, LF315, LF320, LF320A, LF320LA, LF320-lav-line, LF321, LF321A, LF322, LF322A, LF323, LF323A, LF324, LF324A, LF325E, LF325EA, LF700, LF700A, LS550, R40, R50, R70		



GEV No.	415020	Ref. No.	110331
description	heating element 4500W 230V mounting \varnothing 57.5mm heating circuits 3 L 355mm W 35mm H 47mm number of thermostat sleeves 1 thermostat sleeves \varnothing 7mm length thermostat sleeves 295mm thermostat sleeve upper tube \varnothing 8.5mm hole distance 70mm hole \varnothing 10mm connection length 25mm connection male faston 6.3mm 3 hole flange immersion heater		
For models:	AC120, AC150, AC170, AC200, ACR, ACR145, ACR205, ACR225, ACR245, ACR260, ACR265, ACR305, ACRS145, ACRS205, ACRS225, ACRS245, ACRS260, ACRS265, ACRS305, C30, C70, C75, C85, C95, C95E2, F2, F3, F45, F55, F65, F80, G50L, G50LM, G51L, G60L, G61L, G65, G65L, G66, G75, G75L, GE75, GL, GMC, GMC2700, GMC2702, GMC3500, GMC3502, GMC4500, GMC4502...(Other models you can see in the webshop)		

GEV No.	420091	Ref. No.	110383
description	heating element 5000/6000W 240/415V mounting \varnothing 57.5mm heating circuits 3 L 405mm W 36mm H 41mm number of thermostat sleeves 1 thermostat sleeves \varnothing 7.5mm length thermostat sleeves 280mm tube \varnothing 8.3mm hole distance 73mm hole \varnothing 10mm connection M5 immersion heater		
For models:	AC101, AC120, AC122, AC150, AC151, AC152, AC170, AC181, AC182, AC200, AC201, AC202, AC241, AC242, AC91, ACR, ACR145, ACR205, ACR225, ACR245, ACR260, ACR265, ACR305, GMC, GMC2700, GMC3500, GMC4500, GMC5500, LAV1000, NE3001, NE4001, NE5501, NE7501, NE9001, NG01, NG601, NG601E, NG901, NG901E		



GEV No.	418895	Ref. No.	110332
description	heating element 5000W 230V mounting \varnothing 57.5mm heating circuits 3 L 350mm W 35mm H 40mm number of thermostat sleeves 1 thermostat sleeves \varnothing 7mm length thermostat sleeves 290mm thermostat sleeve eccentric, non clinging tube \varnothing 8.5mm connection male faston 6.3mm		
For models:	LF322MP, LF322MP-A, LF322RCD		
accessories for	418895		
	GEV No.	510409	Ref. No. 200815
	O-ring EPDM thickness 5.34mm ID \varnothing 56.52mm Qty 1 pcs		





GEV No.	415021	Ref. No.	110349
description	heating element 6000W 230V mounting \varnothing 57.5mm heating circuits 3 L 343mm W 37mm H 50mm number of thermostat sleeves 1 thermostat sleeves \varnothing 7mm length thermostat sleeves 294mm thermostat sleeve not clinging tube \varnothing 8.5mm hole distance 72mm hole \varnothing 8mm connection M5 3 hole flange		
For models:	AC100, AC101, AC120, AC122, AC150, AC151, AC152, AC170, AC181, AC182, AC200, AC201, AC202, AC241, AC242, AC2A, AC90, AC91, ACR, ACR145, ACR205, ACR225, ACR245, ACR260, ACR265, ACR305, ACR5145, ACR5205, ACR5225, ACR5245, ACR5260, ACR5265, ACR5305, ACS101-DIGIT, ACS122-DIGIT, ACS151-DIGIT, ACS152-DIGIT, ACS161-DIGIT, ACS162-DIGIT, ACS181-DIGIT, ACS182-DIGIT, ACS201-DIGIT, ACS202-DIGIT, ACS241-DIGIT, ACS242-DIGIT, ACS91-DIGIT, C140, C33, C34, C75BT...(Other models you can see in the webshop)		
spare parts for	415021		
	GEV No.	510409	Ref. No. 200815
	O-ring EPDM thickness 5.34mm ID \varnothing 56.52mm Qty 1 pcs		
accessories for	415021		
	GEV No.	550002	Ref. No. —
	tension strap H 10mm L 21mm W 10mm hole \varnothing 6.5mm for heating element		



GEV No.	420340	Ref. No.	110354
description	heating element 6000W 254/440V mounting \varnothing 57.5mm heating circuits 3 L 410mm W 36mm H 40mm number of thermostat sleeves 1 thermostat sleeves \varnothing 7.4mm length thermostat sleeves 290mm thermostat sleeve eccentric, non clinging tube \varnothing 8.4mm hole distance 72mm hole \varnothing 10mm connection M5 3 hole flange immersion heater		
For models:	AC120, AC150, AC170, AC200, ACR, ACR145, ACR205, ACR225, ACR245, ACR260, ACR265, ACR305, GMC, GMC2700, GMC3500, GMC4500, GMC5500, NE3001, NE4001, NE5501, NE7501, NE9001		



GEV No.	415670	Ref. No.	110343
description	heating element 8000W 230V mounting \varnothing 57.5mm heating circuits 3 L 480mm W 40mm H 50mm number of thermostat sleeves 1 thermostat sleeves \varnothing 7mm length thermostat sleeves 295mm thermostat sleeve not clinging tube \varnothing 10mm hole distance 72mm hole \varnothing 8mm connection M5 3 hole flange immersion heater		
For models:	AC101, AC105, AC120, AC122, AC150, AC151, AC152, AC170, AC181, AC182, AC200, AC201, AC202, AC241, AC242, AC2A, AC91, ACL100, ACL150, ACR, ACR145, ACR205, ACR225, ACR245, ACR260, ACR265, ACR305, ACR5145, ACR5205, ACR5225, ACR5245, ACR5260, ACR5265, ACR5305, ACS101-DIGIT, ACS122-DIGIT, ACS151, ACS151-DIGIT, ACS152, ACS152-DIGIT, ACS161-DIGIT, ACS162-DIGIT, ACS181, ACS181-DIGIT, ACS182, ACS182-DIGIT, ACS201-DIGIT, ACS202-DIGIT, ACS241-DIGIT, ACS242-DIGIT...(Other models you can see in the webshop)		
spare parts for	415670		
	GEV No.	510409	Ref. No. 200815
	O-ring EPDM thickness 5.34mm ID \varnothing 56.52mm Qty 1 pcs		



GEV No.	417633	Ref. No.	110365
description	heating element 8000W 240/415V mounting \varnothing 57.5mm heating circuits 3 L 400mm W 35mm H 46mm number of thermostat sleeves 1 thermostat sleeves \varnothing 7.5mm length thermostat sleeves 290mm thermostat sleeve upper centre not clinging tube \varnothing 10mm hole distance 73mm		
For models:	AC101, AC120, AC122, AC150, AC151, AC152, AC170, AC181, AC182, AC200, AC201, AC202, AC241, AC242, AC91, ACR, ACR145, ACR205, ACR225, ACR245, ACR260, ACR265, ACR305, GMC, GMC2700, GMC3500, GMC4500, GMC5500, LAV1000, NE3001, NE4001, NE5501, NE7501, NE9001, NG01, NG601, NG601E, NG901, NG901E		



GEV No.	415022	Ref. No.	110362
description	heating element 9000W 230/400V mounting ϕ 57.5mm heating circuits 3 L 475mm W 36mm H 43mm number of thermostat sleeves 1 thermostat sleeves ϕ 7mm length thermostat sleeves 300mm thermostat sleeve eccentric, non clinging tube ϕ 10mm hole distance 73mm hole ϕ 10mm connection length 30mm connection M5 3 hole flange immersion heater		
For models:	AC100, AC101, AC105, AC120, AC122, AC135, AC150, AC151, AC152, AC170, AC181, AC182, AC200, AC201, AC202, AC241, AC242, AC2A, AC90, AC91, AC95, ACL100, ACL150, ACR, ACR145, ACR205, ACR225, ACR245, ACR260, ACR265, ACR305, ACRS145, ACRS205, ACRS225, ACRS245, ACRS260, ACRS265, ACRS305, ACS101, ACS101-DIGIT, ACS122, ACS122-DIGIT, ACS151, ACS151-DIGIT, ACS152, ACS152-DIGIT, ACS161-DIGIT, ACS162-DIGIT, ACS181, ACS181-DIGIT...(Other models you can see in the webshop)		
spare parts for	415022		
		GEV No. 510409 Ref. No. 200815	
	O-ring EPDM thickness 5.34mm ID ϕ 56.52mm Qty 1 pcs		

3 hole flange ϕ 60.0mm
 connection straight
 group 2

GEV No.	420342	Ref. No.	110386
description	heating element 14000W 230/400V mounting ϕ 60mm heating circuits 3 L 620mm W 33mm H 49mm number of thermostat sleeves 1 thermostat sleeves ϕ 7.5mm length thermostat sleeves 290mm thermostat sleeve eccentric, non clinging tube ϕ 10mm hole distance 83mm hole ϕ 10mm connection M5 3 hole flange immersion heater		
For models:	AC101, AC122, AC151, AC152, AC181, AC182, AC201, AC202, AC241, AC242, AC2A, AC90, AC91, ACL100, ACL150, ACS101, ACS101-DIGIT, ACS122, ACS122-DIGIT, ACS151-DIGIT, ACS152-DIGIT, ACS161-DIGIT, ACS162-DIGIT, ACS181-DIGIT, ACS182-DIGIT, ACS201-DIGIT, ACS202-DIGIT, ACS241-DIGIT, ACS242-DIGIT, ACS91, ACS91-DIGIT, GMC, GMC2700, GMC3500, GMC4500, GMC5500, SNL		

with expansion flange 70 x 18mm

GEV No.	415015	Ref. No.	110228
description	heating element 1500W 230V heating circuits 1 flange 70x18mm L 212mm W 68mm H 50mm connection male faston 6.3mm immersion heater expansion flange tube ϕ 8.5mm		
For models:	F300		

GEV No.	415061	Ref. No.	110373
description	heating element 2400W 230V heating circuits 1 flange 70x18mm L 383mm W 83mm H 24mm connection male faston 6.3mm immersion heater expansion flange tube ϕ 8.5mm		
For models:	F300, F45, F55, F65, F80, LF280-lav-line, LF320-lav-line, R50		
accessories for	415061		
		GEV No. 510429 Ref. No. —	
	gasket L 76mm W 23mm hole distance 25mm 3 holes for heating element type DB 70 without thermostat sensor hole		



GEV No.	415016	Ref. No.	110227
description	heating element 3000W 230V heating circuits 3 flange 70x18mm L 398mm W 60mm H 24mm connection male faston 6.3mm immersion heater expansion flange tube ϕ 6.3mm		
For models:	C140, C155, C155BT, C155E2, C155RCD, C165, C165E2, C165E2BT, C165E2RCD, C166, C166-2, C30, C70, C75, C75BT, C75M, C75RCD, C85, C95, C95BT, C95E2, C95RCD, F2, F3, F300, GF90, GF90-2004, GF90A, GF90A-2004, LC380, LC380BT, LC380RCD, LC400, LP360, LP360BT, LP360RCD		

GEV No.	420339	Ref. No.	110232
description	heating element 3000W 254V heating circuits 3 flange 70x18mm L 395mm W 61mm H 29mm connection male faston 6.3mm immersion heater expansion flange tube ϕ 6.3mm		

with round flange ϕ 47.5mm

GEV No.	416272	Ref. No.	110262
description	heating element 2400W 230V heating circuits 1 mounting ϕ 47.5mm L 220mm W 35mm H 37mm round flange connection male faston 6.3mm immersion heater tube ϕ 6.5mm thermostat sleeves ϕ 7mm number of thermostat sleeves 1 length thermostat sleeves 195mm		
For models:	C1000ERCD, C1300ERCD, LBC210, LBC215, LBC215A, LBC275, LBC275A, LBR, LBR200, LBR215, LBR215A		
spare parts for	416272		
		GEV No. 510408 Ref. No. 200820	
	O-ring EPDM thickness 5.34mm ID ϕ 47mm Qty 1 pcs		
accessories for	416272		
		GEV No. 510408 Ref. No. 200820	
	O-ring EPDM thickness 5.34mm ID ϕ 47mm Qty 1 pcs		
		GEV No. 510562 Ref. No. —	
	O-ring silicone thickness 5.34mm ID ϕ 47mm Qty 1 pcs		
		GEV No. 520235 Ref. No. —	
	3 hole flange hole distance 70.5mm perforation ϕ 6.5mm ID ϕ 53.5mm		
		GEV No. 520236 Ref. No. —	
	flange for heating element ID ϕ 50mm ED ϕ 90mm hole ϕ 6.5mm 3 holes		

Table continues overleaf









accessories for	416272		
	GEV No.	550002	Ref. No. —
	tension strap H 10mm L 21mm W 10mm hole ø 6.5mm for heating element		
	GEV No.	550362	Ref. No. —
	blind flange ø 64mm mounting ø 47.5mm		

	1		
GEV No.	416271	Ref. No.	110391
description	heating element 5000W heating circuits 3 mounting ø 47.5mm L 252mm W 35mm H 34mm round flange connection male faston 6.3mm immersion heater tube ø 6.2mm thermostat sleeves ø 8mm number of thermostat sleeves 1 length thermostat sleeves 195mm		
For models:	BC25HR, BC30HR380		

accessories for	416271		
	GEV No.	510408	Ref. No. 200820
	O-ring EPDM thickness 5.34mm ID ø 47mm Qty 1 pcs		
	GEV No.	510562	Ref. No. —
	O-ring silicone thickness 5.34mm ID ø 47mm Qty 1 pcs		
	GEV No.	520235	Ref. No. —
	3 hole flange hole distance 70.5mm perforation ø 6.5mm ID ø 53.5mm		
	GEV No.	520236	Ref. No. —
	flange for heating element ID ø 50mm ED ø 90mm hole ø 6.5mm 3 holes		
	GEV No.	550002	Ref. No. —
	tension strap H 10mm L 21mm W 10mm hole ø 6.5mm for heating element		
	GEV No.	550362	Ref. No. —
	blind flange ø 64mm mounting ø 47.5mm		

with round flange ø57.5mm			
	1		
GEV No.	415019	Ref. No.	110226
description	heating element 3000W 230V heating circuits 3 mounting ø 57.5mm L 338mm W 37mm H 41mm round flange connection male faston 6.3mm immersion heater tube ø 8.5mm connection length 27mm thermostat sleeves ø 7mm number of thermostat sleeves 1 length thermostat sleeves 300mm thermostat sleeve not clinging with 3 hole flange & O-ring		
For models:	C1000E, C1000ERCD, C1001M, C1300E, C1300ERCD, C1301M, C33, C34, GE50RCD, LC1200, LC1200RCD, LC412, LC700, LC700RCD, LC900, LC900RCD, SE, XLC		
accessories for	415019		
	GEV No.	550002	Ref. No. —
	tension strap H 10mm L 21mm W 10mm hole ø 6.5mm for heating element		

with round flange (miscellaneous)			
	1		
GEV No.	417554	Ref. No.	110381
description	heating element 12500W 254/440V mounting ø 73mm L 6150mm W 50mm H 40mm heating circuits 3 flange ø 73mm flange connection screw immersion heater tube ø 10mm thermostat sleeves ø 7.3mm number of thermostat sleeves 1 length thermostat sleeves 300mm thermostat sleeve centre/left		
For models:	AC101, AC120, AC122, AC150, AC151, AC152, AC170, AC181, AC182, AC200, AC201, AC202, AC241, AC242, AC91, ACR, ACR145, ACR205, ACR225, ACR245, ACR260, ACR265, ACR305, GMC, GMC2700, GMC3500, GMC4500, GMC5500, NE3001, NE4001, NE5501, NE7501, NE9001, NG01, NG601, NG601E, NG901, NG901E		

1 1/4"			
	1		
GEV No.	415017	Ref. No.	110208
description	heating element 1500W 230V heating circuits 1 thread 1 1/4" L 295mm W 92mm H 27mm L1 45mm L2 45mm L3 205mm W1 34mm W2 26mm H1 20mm H2 7mm connection M4 immersion heater tube ø 6.3mm flange with thread connection length 28mm		
accessories for	415017		
	GEV No.	510405	Ref. No. —
	flat gasket fibre ED ø 56mm ID ø 42mm thickness 2mm for thread 1 1/4" Qty 1 pcs		
	GEV No.	520232	Ref. No. —
	nut thread 1 1/4" H 5mm nickel-plated brass WS 47 Qty 1 pcs		
	GEV No.	521103	Ref. No. —
	nut thread M4 H 3mm WS 7 brass Qty 20 pcs		
	GEV No.	521104	Ref. No. —
	washer ID ø 4.3mm ED ø 8mm thickness 0.5mm brass Qty 20 pcs for thread M4		
	GEV No.	528021	Ref. No. —
	flat gasket PTFE ED ø 53mm ID ø 42.5mm thickness 3mm Qty 1 pcs equiv. no. 12001/02286 suitable for Astoria/Aurora/Brasilia/Wega		
	GEV No.	560111	Ref. No. —
	plain washer ID ø 4.3mm ED ø 9mm thickness 0.8mm SS Qty 20 pcs DIN 125A for thread M4		
	GEV No.	560131	Ref. No. —
	hexagonal nut thread M4 H 3.2mm WS 7 SS DIN/ISO DIN 934 / ISO 4032/8673 Qty 20 pcs		







1

GEV No.	415062	Ref. No.	110260
description	heating element 1275W 230V heating circuits 1 L 147mm W 103mm H 30mm thread M10 mounting distance 32mm tube ϕ 6.5mm connection 6.3 2 hole fixing immersion heater		
For models:	BC25, BC25A, BC25HR, BC30, BC30A, BC30HR, BC30HR380, BC30HRA, BR20, BR20A, BR25, BR25A, FC43, FC43A		
accessories for	415062		
	GEV No.	510416	Ref. No. —
	flat gasket fibre ED ϕ 19mm ID ϕ 10.5mm thickness 1.5mm for thread M10 Qty 1 pcs		
	GEV No.	510893	Ref. No. 200810 200845
	O-ring EPDM thickness 2.62mm ID ϕ 9.92mm Qty 1 pcs		
	GEV No.	520231	Ref. No. —
	nut thread M10x1 H 6mm WS 14 zinc-coated steel Qty 1 pcs		
	GEV No.	521129	Ref. No. —
	nut thread M10 H 6mm SS WS 17 Qty 1 pcs DIN/ISO DIN 439		





1

GEV No.	415012	Ref. No.	110204 110235
description	heating element 1500W 230V heating circuits 1 L 225mm W 120mm H 22mm L1 47mm L2 178mm W1 73mm W2 47mm thread M10x1 mounting distance 41mm tube ϕ 6.3mm 2 hole fixing connection male faston 6.3mm immersion heater		
For models:	B10, B10T, B11, B11T, B12, B12T, B13T, B14T, B15, B15T, B15TM, B16, B16T, B16TM, B18, B18T, B18TM, B19, B19T, B19TM, B20, B20D, B23, B24, B25, B26, B27, B31, B32, B41, B42, F20, LBC215, LBC215A, LBC275, LBC275A		
accessories for	415012		
	GEV No.	510416	Ref. No. —
	flat gasket fibre ED ϕ 19mm ID ϕ 10.5mm thickness 1.5mm for thread M10 Qty 1 pcs		
	GEV No.	510893	Ref. No. 200810 200845
	O-ring EPDM thickness 2.62mm ID ϕ 9.92mm Qty 1 pcs		







1

GEV No.	418702	Ref. No.	110261
description	heating element 1500W 230V heating circuits 1 L 300mm W 120mm H 25mm L1 45mm L2 255mm W1 40mm W2 80mm thread M10x1 mounting distance 38mm tube ϕ 6.2mm		
For models:	LBC210, LBC215, LBC215A, LBC275, LBC275A, LBR, LBR200, LBR215, LBR215A		
accessories for	418702		
	GEV No.	510893	Ref. No. 200810 200845
	O-ring EPDM thickness 2.62mm ID ϕ 9.92mm Qty 1 pcs		
	GEV No.	520231	Ref. No. —
	nut thread M10x1 H 6mm WS 14 zinc-coated steel Qty 1 pcs		



1

GEV No.	415756	Ref. No.	110263
description	heating element 2000W 230V heating circuits 1 L 137mm W 355mm H 25mm thread 1/8" mounting distance 20mm tube ϕ 6.3mm connection male faston 6.3mm connection length 27mm immersion heater 2 hole fixing		
For models:	F90M, F90MA, FC, FC53, FC533, FC533A, FC53A, FC53CBT, FC53LA, FC53LBT, FC54, FC543, FC543A, FC543E, FC543EA, FC544, FC544A, FC54A, FC54CBT, FC54E, FC54EA, FC54LBT, FCHR, FCHRA, FCHRT, FCHRTA, LF315, LF320, LF320A, LF320CBT, LF320L, LF320LA, LF320LBT, LF323, LF323A, LF350, LF350A, LF400A, LF450, LF450A, LS550		
spare parts for	415756		
	GEV No.	532049	Ref. No. —
	O-ring EPDM thickness 2.62mm ID ϕ 9.92mm Qty 10 pcs		
accessories for	415756		
	GEV No.	361181	Ref. No. —
	nut thread 1/8" H 4.5mm nickel-plated brass WS 14 Qty 1 pcs		
	GEV No.	510416	Ref. No. —
	flat gasket fibre ED ϕ 19mm ID ϕ 10.5mm thickness 1.5mm for thread M10 Qty 1 pcs		
	GEV No.	510893	Ref. No. 200810 200845
	O-ring EPDM thickness 2.62mm ID ϕ 9.92mm Qty 1 pcs		



1









GEV No.	416389	Ref. No.	110269 old
description	heating element 2000W 230V heating circuits 1 L 298mm W 151mm H 28mm thread M12x1 mounting distance 75mm tube ϕ 6.3mm connection male faston 6.3mm 2 hole fixing immersion heater L1 22mm L2 98mm L3 45mm W1 11mm W2 265mm		
accessories for	416389		
	GEV No.	361182	Ref. No. —
	nut thread 1/4" H 5mm nickel-plated brass WS 17 Qty 1 pcs		
	GEV No.	510417	Ref. No. —
	flat gasket fibre ED ϕ 20mm ID ϕ 14mm thickness 2mm Qty 1 pcs		

Table continues overleaf





accessories for	416389		
	GEV No.	520228	Ref. No. —
	tooth lock washer ID ø 15.3mm ED ø 24mm steel Qty 1 pcs for thread M14		
	GEV No.	550262	Ref. No. —
	flat gasket copper ED ø 20mm ID ø 14mm thickness 2mm		

	1		
GEV No.	418902	Ref. No.	110269
description	heating element 2000W 230V heating circuits 1 L 300mm W 140mm H 28mm thread M12x1 mounting distance 70mm tube ø 6.3mm connection male faston 6.3mm 2 hole fixing connection length 35mm immersion heater		
For models:	BHC25, BHC25-2, BHC25A, BHC25A-2, BHC25S, BHC30, BHC30-2, BHC30A, BHC30A-2, BHC30E, BHC30E-2, BHC30EA, BHC30EA-2, BHC433, BHC433-2, BHC433A, BHC433A-2, LB200, LB200-2, LB200A, LB200A-2, LB215, LB215-2, LB215A, LB215A-2, LB260, LB260-2, LB260A, LB260A-2, LB275, LB275-2, LB275A, LB275A-2		

	1		
GEV No.	415198	Ref. No.	110273
description	heating element 2000W 230V heating circuits 1 L 318mm W 85mm H 26mm thread M12x1 mounting distance 77mm tube ø 8.3mm connection male faston 6.3mm 2 hole fixing immersion heater		
accessories for	415198		
	GEV No.	520229	Ref. No. —
	nut thread M12x1 H 4mm WS 16 zinc-coated steel Qty 1 pcs		
	GEV No.	521110	Ref. No. 460527
	flat gasket fibre ED ø 20mm ID ø 13mm thickness 2mm Qty 1 pcs		

	1		
GEV No.	418890	Ref. No.	110288
description	heating element 2000W 230V heating circuits 1 L 430mm W 180mm H 60mm L1 60mm L2 370mm W1 105mm W2 23mm thread M10x1 tube ø 6.3mm connection length 35mm 2 hole fixing connection male faston 6.3mm immersion heater tank		
For models:	FC3MR		

	1		
GEV No.	418836	Ref. No.	110265
description	heating element 2000W 440V L 320mm W 170mm H 23mm thread 1/8" mounting distance 50mm tube ø 6mm connection male faston 6.3mm immersion heater 2 hole fixing		

	1		
GEV No.	416270	Ref. No.	110271
description	heating element 500W 230V heating circuits 1 L 225mm W 95mm H 30mm thread M12x1 mounting distance 86mm tube ø 8.5mm connection male faston 6.3mm 2 hole fixing immersion heater		
For models:	BHC30HR, BHC30HR-2, BHC30HR380, BHC30HRA, BHC30HRA-2, BHC30HRA380, BHCHR		



foil heating elements

	1		
GEV No.	419007	Ref. No.	110285
description	foil heating element L 380mm W 73mm 500W 230V t.max. 140°C with temperature limiter 140°C silicone cable length 200mm thickness 1mm connection male faston 6.3mm		
For models:	FC3E, FC3EA, FC3M, FC3MA, FC44E, FC44EA, FC4E, FC4EA, FC4EHR, FC4M, FC4MA		

thermostats

bi-metal thermostats

bi-metal thermostats

	1		
GEV No.	390025	Ref. No.	120524
description	bi-metal thermostat hole distance 40mm switch-off temp. 55/42°C NC/NO 2-pole 16A 250V connection F6.3 2 hole fixing		
For models:	B10T, B11T, B12T, B13T, B14T, B15T, B15TM, B16T, B16TM, B18T, B18TM, B19T, B19TM, BC25, BC25A, BC25HR, BC30, BC30A, BC30HR, BC30HR380, BC30HRA, BHC25, BHC25-2, BHC25A, BHC25A-2, BHC25S, BHC30, BHC30-2, BHC30A, BHC30A-2, BHC30E, BHC30E-2, BHC30EA, BHC30EA-2, BHC433, BHC433-2, BHC433A, BHC433A-2, BR20, BR20A, BR25, BR25A, FC43, FC43A, LB200, LB200-2, LB200A, LB200A-2, LB215, LB215-2...(Other models you can see in the webshop)		
accessories for	390025		
	GEV No.	512154	Ref. No. 200494
	gasket for thermostat ID ø 20mm equiv. no. 200494/H200494 hole distance 41mm suitable for COMENDA, HOONVED		



			
1			
GEV No.	390089	Ref. No.	120509
description	bi-metal thermostat hole distance 40mm switch-off temp. 58°C 1NC 1-pole 16A connection F6.3 2 hole fixing		
For models:	B10, B11, B12, B15, B16, B18, B19, B20, B20D, B23, B24, B25, B26, B27, B31, B32, B41, B42		

			
1			
GEV No.	390014	Ref. No.	120525
description	thermostat t.max. 85°C temperature range 40-78 / 47-85°C 2-pole 2CO 16A probe ø 6.5mm probe L 95mm capillary pipe 1500mm capillary pipe isolated 1450mm gland nut shaft ø 6x4.6mm shaft L 15mm shaft position right rotation 270°		
For models:	BC25HR, BC30HR, BC30HR380, BC30HRA, BHC25-2, BHC25A-2, BHC30-2, BHC30A-2, BHC30E, BHC30E-2, BHC30EA, BHC30EA-2, BHC433-2, BHC433A-2, C155, C155BT, C155RCD, C165, C165E2BT, C165E2RCD, C75BT, C75RCD, C95, C95BT, C95RCD, FC, FC3M, FC3MA, FC3MR, FC4M, FC4MA, FC53, FC533, FC533A, FC53A, FC53CBT, FC53LA, FC53LBT, FC54, FC543, FC543A, FC544, FC544A, FC54A, FC54CBT, FC54E, FC54EA, FC54LBT, GF70, GF70A...(Other models you can see in the webshop)		



control and safety thermostats

EGO

safety thermostats

55.32_series

			
1			
GEV No.	375291	Ref. No.	100780 M100780
description	safety thermostat switch-off temp. 344°C 1-pole 20A probe ø 6mm probe L 79mm capillary pipe 900mm capillary pipe isolated 900mm gland nut probe		

			
1			
GEV No.	390006	Ref. No.	120501
description	thermostat t.max. 86°C temperature range 0-86°C 1-pole 1CO 16A probe ø 6.5mm probe L 95mm capillary pipe 1500mm capillary pipe isolatedmm gland nut shaft ø 6x4.6mm shaft L 19mm rotation 270°		
For models:	AC100, AC101, AC105, AC120, AC122, AC135, AC150, AC151, AC152, AC170, AC181, AC182, AC200, AC201, AC202, AC241, AC242, AC2A, AC90, AC91, AC95, ACL100, ACL150, ACR, ACR145, ACR205, ACR225, ACR245, ACR260, ACR265, ACR305, ACS101, ACS101-DIGIT, ACS122, ACS122-DIGIT, ACS151, ACS151-DIGIT, ACS152, ACS152-DIGIT, ACS161-DIGIT, ACS162-DIGIT, ACS181, ACS181-DIGIT, ACS182, ACS182-DIGIT, ACS201, ACS201-DIGIT, ACS202, ACS202-DIGIT, ACS241...(Other models you can see in the webshop)		
accessories for	390006		
	GEV No.	110100	Ref. No. 450315
	knob thermostat t.max. 90°C 0-90°C ø 42mm shaft ø 6x4.6mm shaft flat -135° black		
	GEV No.	110105	Ref. No. 191040
	rosette knob ø 42mm ø 56mm zero mark		

IMIT / TEMPOMATIC / ARTHERMO

control thermostats

			
1			
GEV No.	390914	Ref. No.	120515
description	bi-metal thermostat t.max. 90°C temperature range 0-90°C 1-pole 1CO 10A probe ø 6.5mm probe L 97mm capillary pipe 1000mm capillary pipe isolated 950mm gland nut shaft ø 6x4.6mm shaft L 12mm shaft position upper rotation 270° with housing 250V		
For models:	AC120, AC150, AC170, AC200, ACR, ACR145, ACR205, ACR225, ACR245, ACR260, ACR265, ACR305, G131, G66, GMC, GMC2700, GMC3500, GMC4500, GMC5500, LV1001, LV1501, LV-LVP, LVP1001, LVP1501, NE00, NE02, NE3001, NE3002, NE4001, NE4002, NE5002, NE5501, NE5502, NE7002, NE7501, NE7502, NE9001, NE9002, NE9502, NG00, NG01, NG02, NG1202, NG1202E, NG600, NG600E, NG601, NG601E, NG602, NG602E...(Other models you can see in the webshop)		

			
1			
GEV No.	390915	Ref. No.	120512
description	thermostat t.max. 87.5°C 1-pole 1CO 16A probe ø 6.5mm probe L 97mm capillary pipe 1000mm capillary pipe isolated 950mm shaft ø 6x4.6mm shaft L 20mm shaft position 45° rotation 270° with housing 250V		
For models:	ACR, ACR145, ACR205, ACR225, ACR245, ACR260, ACR265, ACR305, GMC, GMC2700, GMC3500, GMC4500, GMC5500, NE00, NG00, NG600, NG600E, NG900, NG900E, SE, SNL		



GEV No.	390812	Ref. No.	120530
description	thermostat t.max. 87°C temperature range fixes 87°C 1-pole 1CO 16A probe ø 6.5mm probe L 97mm capillary pipe 1500mm capillary pipe isolatedmm gland nut shaft Lmm rotation 270° 250V contacts male faston 6.3mm		
For models:	C1001M, C1301M, LC1200, LC1200RCD, LC412, LC700, LC700RCD, LC900, LC900RCD		

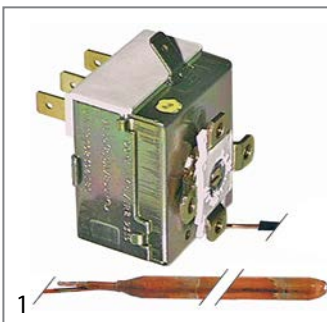

GEV No.	390460	Ref. No.	120530
description	thermostat t.max. 90°C temperature range 30-90°C 1-pole 1CO 16A probe ø 6.5mm probe L 95mm capillary pipe 2000mm capillary pipe isolated 1950mm gland nut shaft ømm shaft Lmm shaft position rotation 270° probe material copper		

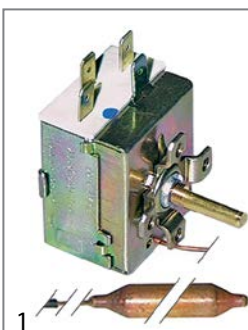

GEV No.	390022	Ref. No.	120522
description	thermostat t.max. 90°C temperature range 30-90°C 1-pole 1CO 16A probe ø 9.5mm probe L 50mm capillary pipe 1000mm capillary pipe isolated 1000mm gland nut shaft L 19mm rotation 270°		
For models:	C155BT, C155RCD, C165E2BT, C165E2RCD, C75, C75BT, C75M, C75RCD, C95BT, C95RCD, F45, F55, F65, F80, F90M, F90MA, FC, FC3E, FC3EA, FC3M, FC3MA, FC3MR, FC44E, FC44EA, FC4E, FC4EA, FC4EHR, FC4M, FC4MA, FC53, FC533, FC533A, FC53A, FC53LA, FC54, FC543, FC543A, FC544, FC544A, FC54A, FC54E, FC54EA, GF70, GF70A, LC380BT, LC380RCD, LF280-lav-line, LF315, LF320, LF320A...(Other models you can see in the webshop)		

safety thermostats



GEV No.	390773	Ref. No.	120519
description	safety thermostat switch-off temp. 135°C temperature range 95-135°C 1-pole 1CO 16A probe ø 5mm probe L 130mm capillary pipe 1000mm capillary pipe isolated 900mm gland nut probe		
For models:	AC100, AC101, AC105, AC120, AC122, AC135, AC150, AC151, AC152, AC170, AC181, AC182, AC200, AC201, AC202, AC241, AC242, AC2A, AC90, AC91, AC95, ACL100, ACL150, ACR, ACR145, ACR205, ACR225, ACR245, ACR260, ACR265, ACR305, ACRS145, ACRS205, ACRS225, ACRS245, ACRS260, ACRS265, ACRS305, ACS101, ACS101-DIGIT, ACS122, ACS122-DIGIT, ACS151, ACS151-DIGIT, ACS152, ACS152-DIGIT, ACS161-DIGIT, ACS162-DIGIT, ACS181, ACS181-DIGIT...(Other models you can see in the webshop)		

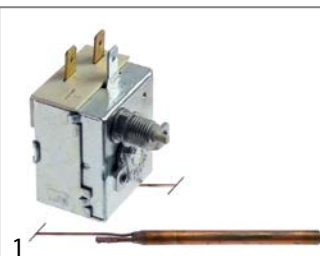

GEV No.	390023	Ref. No.	120519
description	safety thermostat switch-off temp. 90-110°C 1-pole 16A probe ø 6.5mm probe L 90mm capillary pipe 1000mm capillary pipe isolatedmm gland nut probe		

RANCO

safety thermostats

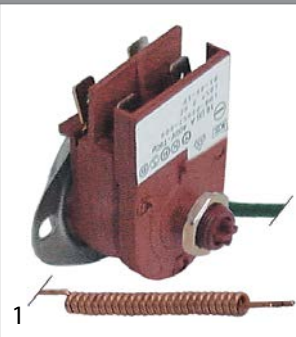

GEV No.	390473	Ref. No.	120536
description	safety thermostat t.max. 105°C temperature range°C 2-pole 2NC 16A probe ø 6mm probe L 50mm capillary pipe 430mm capillary pipe isolated 310mm gland nut shaft ømm shaft Lmm shaft position rotation° probe material copper screw connection M10x0.75		



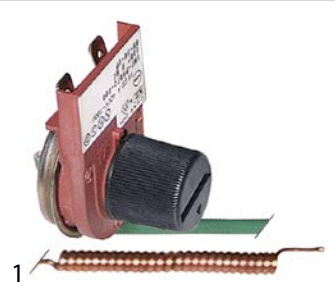

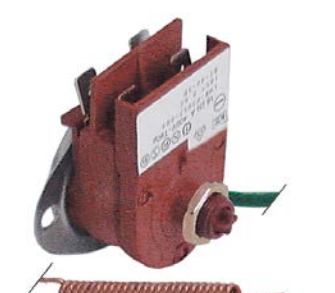
			
1			
GEV No.	390024	Ref. No.	120523
description	safety thermostat t.max. 110°C temperature range°C 1-pole 1NC 16A probe ø 6mm probe L 50mm capillary pipe 1540mm capillary pipe isolated 160mm gland nut shaft ømm shaft Lmm shaft position rotation° probe material copper with coiled probe switch-off temp. 110°C		
For models:	B10T, B11T, B12T, B13T, B14T, B15T, B15TM, B16T, B16TM, B18T, B18TM, B19T, B19TM, BC25, BC25A, BC25HR, BC30, BC30A, BC30HR, BC30HR380, BC30HRA, BR20, BR20A, BR25, BR25A, C155, C155BT, C155E2, C155RCD, C165E2, C165E2BT, C165E2RCD, C166, C166-2, C75, C75BT, C75M, C75RCD, C95, C95BT, C95E2, C95RCD, F20, F45, F55, F65, F80, F90M, F90MA, FC...(Other models you can see in the webshop)		



			
1			
GEV No.	390469	Ref. No.	120526
description	safety thermostat t.max. 110°C temperature range°C 2-pole 2NC 16A probe ø 6mm probe L 50mm capillary pipe 1540mm capillary pipe isolated 160mm gland nut shaft ømm shaft Lmm shaft position rotation° probe material copper screw connection M10x0.75 switch-off temp. 110°C		
For models:	BHC25, BHC25-2, BHC25A, BHC25A-2, BHC25S, BHC30, BHC30-2, BHC30A, BHC30A-2, BHC30E, BHC30E-2, BHC30EA, BHC30EA-2, BHC30HR, BHC30HR-2, BHC30HR380, BHC30HRA, BHC30HRA-2, BHC30HRA380, BHC433, BHC433-2, BHC433A, BHC433A-2, BHCHR, FC53CBT, FC53LBT, FC54CBT, FC54LBT, LB200, LB200-2, LB200A, LB200A-2, LB215, LB215-2, LB215A, LB215A-2, LB260, LB260-2, LB260A, LB260A-2, LB275, LB275-2, LB275A, LB275A-2, LF320CBT, LF320L, LF320LA, LF320LBT, LF321, LF321A...(Other models you can see in the webshop)		



accessories

plunger sockets

			
1			
GEV No.	510812	Ref. No.	450508
description	thermowell		
For models:	C30, C33, C34, F2, F3, F300, LC380, R40, R50, R70		



			
1			
GEV No.	511425	Ref. No.	450520
description	thermowell thread 1/2" L 100mm SS triple ø 6.5mm		
For models:	AC101, AC122, AC151, AC152, AC181, AC182, AC201, AC202, AC241, AC242, AC91, ACS101, ACS101-DIGIT, ACS122, ACS122-DIGIT, ACS151, ACS151-DIGIT, ACS152, ACS152-DIGIT, ACS161-DIGIT, ACS162-DIGIT, ACS181, ACS181-DIGIT, ACS182, ACS182-DIGIT, ACS201, ACS201-DIGIT, ACS202, ACS202-DIGIT, ACS241, ACS241-DIGIT, ACS242, ACS242-DIGIT, ACS91, ACS91-DIGIT		

			
1			
GEV No.	510935	Ref. No.	450515
description	thermowell thread 1/2" L 107mm SS single ø 8mm		
For models:	AC100, AC101, AC105, AC120, AC122, AC135, AC150, AC151, AC152, AC170, AC181, AC182, AC200, AC201, AC202, AC241, AC242, AC90, AC91, AC95, ACL100, ACL150, ACR, ACR145, ACR205, ACR225, ACR245, ACR260, ACR265, ACR305, ACRS145, ACRS205, ACRS225, ACRS245, ACRS260, ACRS265, ACRS305, ACS101, ACS101-DIGIT, ACS122, ACS122-DIGIT, ACS151, ACS151-DIGIT, ACS152, ACS152-DIGIT, ACS161-DIGIT, ACS162-DIGIT, ACS181, ACS181-DIGIT, ACS182...(Other models you can see in the webshop)		
accessories for	510935		
		GEV No.	361184 Ref. No. —
		nut thread 1/2" H 6mm nickel-plated brass WS 24 Qty 1 pcs	
		GEV No.	521122 Ref. No. —
		flat gasket fibre ED ø 31mm ID ø 21.5mm thickness 2mm for thread 1/2" Qty 1 pcs	

			
1			
GEV No.	510986	Ref. No.	415514 450514 450516
description	thermowell thread 1/2" L 120mm SS double ø 6.5mm		
For models:	AC100, AC101, AC105, AC120, AC122, AC135, AC150, AC151, AC152, AC170, AC181, AC182, AC200, AC201, AC202, AC241, AC242, AC2A, AC90, AC91, AC95, ACR, ACR145, ACR205, ACR225, ACR245, ACR260, ACR265, ACR305, ACS101, ACS101-DIGIT, ACS122, ACS122-DIGIT, ACS151, ACS151-DIGIT, ACS152, ACS152-DIGIT, ACS161-DIGIT, ACS162-DIGIT, ACS181, ACS181-DIGIT, ACS182, ACS182-DIGIT, ACS201, ACS201-DIGIT, ACS202, ACS202-DIGIT, ACS241, ACS241-DIGIT, ACS242...(Other models you can see in the webshop)		
accessories for	510986		
		GEV No.	361184 Ref. No. —
		nut thread 1/2" H 6mm nickel-plated brass WS 24 Qty 1 pcs	
		GEV No.	521122 Ref. No. —
		flat gasket fibre ED ø 31mm ID ø 21.5mm thickness 2mm for thread 1/2" Qty 1 pcs	



			
1			
GEV No.	511426	Ref. No.	450521
description	thermowell thread 1/2" L 35mm SS single ø 6.5mm		
For models:	FC, FCHR, FCHRA, FCHRT, FCHRTA		

			
1			
GEV No.	510987	Ref. No.	450519
description	thermowell thread 1/2" L 44mm SS single ø 10mm		
For models:	C75, C75BT, C75M, C75RCD, F45, F55, F65, F80, F90M, F90MA, FC, FC53, FC533, FC533A, FC53A, FC53CBT, FC53LA, FC53LBT, FC54, FC543, FC543A, FC543E, FC543EA, FC544, FC544A, FC54A, FC54CBT, FC54E, FC54EA, FC54LBT, LC380BT, LC380RCD, LF280-lav-line, LF315, LF320, LF320A, LF320CBT, LF320L, LF320LA, LF320-lav-line, LF320LBT, LF321, LF321A, LF322, LF322A, LF322MP, LF322MP-A, LF322RCD, LF323, LF323A...(Other models you can see in the webshop)		
accessories for	510987		
	GEV No.	361184	Ref. No. —
	nut thread 1/2" H 6mm nickel-plated brass WS 24 Qty 1 pcs		
	GEV No.	521122	Ref. No. —
	flat gasket fibre ED ø 31mm ID ø 21.5mm thickness 2mm for thread 1/2" Qty 1 pcs		

			
1			
GEV No.	550914	Ref. No.	450518
description	thermowell thread 1/8" ID ø 7mm L 52mm brass ø 8.3mm		
For models:	AC101, AC122, AC135, AC151, AC152, AC181, AC182, AC201, AC202, AC241, AC242, AC91, ACR, ACR145, ACR205, ACR225, ACR245, ACR260, ACR265, ACR305, GMC, GMC2700, GMC3500, GMC4500, GMC5500, LAV1000		

miscellaneous			
			
1			
GEV No.	551101	Ref. No.	332821
description	bracket for thermostat hole ø 7mm L 99mm W 72mm thickness 1mm		

			
1			
GEV No.	501353	Ref. No.	200491
description	gasket for thermostat hole ø 6.6mm L 98mm W 68mm thickness 2mm		
For models:	AC100, AC101, AC105, AC120, AC122, AC135, AC150, AC151, AC152, AC170, AC181, AC182, AC200, AC201, AC202, AC241, AC242, AC90, AC91, AC95, ACL100, ACL150, ACR, ACR145, ACR205, ACR225, ACR245, ACR260, ACR265, ACR305, ACRS145, ACRS205, ACRS225, ACRS245, ACRS260, ACRS265, ACRS305, ACS101, ACS101-DIGIT, ACS122, ACS122-DIGIT, ACS151, ACS151-DIGIT, ACS152, ACS152-DIGIT, ACS161-DIGIT, ACS162-DIGIT, ACS181, ACS181-DIGIT, ACS182...(Other models you can see in the webshop)		

switches and momentary switches

rocker/momentary rocker switches

27.8x25mm

			
1			
GEV No.	345076	Ref. No.	130444
description	momentary rocker switch mounting measurements 27.8x25mm black 2CO 250V 16A START connection male faston 6.3mm ambient temperature max. 85°C protection IP40		
For models:	C1001M, C1301M, F20, F45, F55, F65, F80, LC1200, LC1200RCD, LC380BT, LC380RCD, LC412, LC700, LC700RCD, LC900, LC900RCD		

			
1			
GEV No.	347714	Ref. No.	130450
description	momentary rocker switch mounting measurements 27.8x25mm black 2NO 250V 16A START connection male faston 6.3mm ambient temperature max. 85°C protection IP40		

			
1			
GEV No.	347695 ¹	Ref. No.	130421
description	momentary rocker switch mounting measurements 27.8x25mm black/green 2CO 250V 16A illuminated cycle connection male faston 6.3mm ambient temperature max. 85°C protection IP40		
For models:	B10, B10T, B11T, B12T, B13T, B14T, B15T, B15TM, B16T, B16TM, B18T, B18TM, B19T, B19TM		

¹illuminated

			
1			
GEV No.	345843 ¹	Ref. No.	130471
description	momentary rocker switch mounting measurements 27.8x25mm green 2CO 24V 16A illuminated outflow connection male faston 6.3mm ambient temperature max. 85°C protection IP40		
For models:	LF320CBT, LF320L, LF320LA, LF320LBT		

¹illuminated

			
1			
GEV No.	345201 ¹	Ref. No.	130464
description	momentary rocker switch mounting measurements 27.8x25mm green 2CO 250V 16A illuminated outflow connection male faston 6.3mm ambient temperature max. 85°C protection IP40		
For models:	F90M, F90MA, LC1200, LC700, LC900, LF315, LF320, LF320LA, LF323, LF323A, LF350, LF350A, LF450, LF450A		

¹illuminated



			
1			
GEV No.	511227 ¹	Ref. No.	130454
description	momentary rocker switch mounting measurements 27.8x25mm green 2CO 250V 16A illuminated regeneration connection male faston 6.3mm ambient temperature max. 85°C protection IP40		

¹illuminated

			
1			
GEV No.	345030 ¹	Ref. No.	130424
description	momentary rocker switch mounting measurements 27.8x25mm orange 2CO 250V 16A illuminated outflow connection male faston 6.3mm ambient temperature max. 85°C protection IP40		

¹illuminated

			
1			
GEV No.	345014 ¹	Ref. No.	130422 130429
description	momentary rocker switch mounting measurements 27.8x25mm orange 2CO 250V 16A illuminated rinsing connection male faston 6.3mm ambient temperature max. 85°C protection IP40		
For models:	B10, B10T, B11T, B12T, B13T, B14T, B15T, B15TM, B16T, B16TM, B18T, B18TM, B19T, B19TM, F20		

¹illuminated

			
1			
GEV No.	345000 ¹	Ref. No.	130421 old version
description	momentary rocker switch mounting measurements 27.8x25mm orange 2CO 250V 16A illuminated START connection male faston 6.3mm ambient temperature max. 85°C protection IP40 2-pole male faston 6.3mm		

¹illuminated

			
1			
GEV No.	347715	Ref. No.	130498
description	momentary rocker switch mounting measurements 27.8x25mm white 2NO 250V 16A START connection male faston 6.3mm ambient temperature max. 85°C protection IP40		

			
1			
GEV No.	347263	Ref. No.	130499
description	rocker switch mounting measurements 25x25mm white 2CO 250V 16A cycle connection male faston 6.3mm protection IP40		

			
1			
GEV No.	345123	Ref. No.	130447
description	rocker switch mounting measurements 27.8x25mm black 2CO 250V 16A auto/manual connection male faston 6.3mm ambient temperature max. 85°C protection IP40		
For models:	C1001M, C1301M, C155, C155BT, C155RCD, C95, C95BT, C95RCD, LC1200, LC1200RCD, LC412, LC700, LC700RCD, LC900, LC900RCD		

			
1			
GEV No.	345844	Ref. No.	130470
description	momentary rocker switch mounting measurements 27.8x25mm orange 1NO/indicator light 230V 16A regeneration connection male faston 6.3mm ambient temperature max. 85°C protection IP40		
For models:	F90M, F90MA, LF320, LF320A, LF320LA, LF323, LF323A, LF350, LF350A, LF450, LF450A		

			
1			
GEV No.	345861 ¹	Ref. No.	130472
description	momentary rocker switch mounting measurements 27.8x25mm orange 1NO/indicator light indicator lamp 24V 230V 16A regeneration connection male faston 6.3mm ambient temperature max. 85°C protection IP40		
For models:	GF90, GF90A, LF320L, LF320LA, LF400A		

¹indicator light 24V

			
1			
GEV No.	510281	Ref. No.	160733
description	blank black mounting measurements 27.8x25mm		
For models:	B10, B10T, B11, B11T, B13T, B15, B15T, B15TM, B16, B16T, B16TM, B18, B18T, B18TM, B19, B19T, B19TM, BHC25, BHC25A, BHC25S, BHC30, BHC30A, BHC433, BHC433A, C1001M, C1301M, C155, C155BT, C155RCD, C95, C95BT, C95RCD, F45, F55, F65, F80, F90M, F90MA, FC, FC53, FC533, FC533A, FC53A, FC53CBT, FC53LA, FC53LBT, FC54, FC543, FC543A, FC544...(Other models you can see in the webshop)		

<h3>30x22mm</h3>			
			
1			
GEV No.	347870	Ref. No.	130468
description	momentary rocker switch mounting measurements 30x22mm green 1NO/indicator light 250V 16A cycle connection male faston 6.3mm ambient temperature max. 100/55°C protection IP40		



1

GEV No.	301304	Ref. No.	130465
description	momentary rocker switch mounting measurements 30x22mm green 2CO 250V 16A illuminated outflow connection male faston 6.3mm ambient temperature max. 100/55°C protection IP40		



1

GEV No.	345124	Ref. No.	130408
description	momentary rocker switch mounting measurements 30x22mm green 2CO 250V 16A illuminated rinsing connection male faston 6.3mm ambient temperature max. 85°C protection IP40		
For models:	B41, B42		

push/momentary push switches

28.5x28.5mm



1

GEV No.	345846	Ref. No.	130459
description	momentary push switch mounting measurements 28.5x28.5mm grey 2CO 250V 16A START connection male faston 6.3mm ambient temperature max. 150°C protection IP40		
For models:	LB200, LB200-2, LB200A, LB215, LB215-2, LB215A, LB215A-2, LB260, LB260-2, LB260A, LB275, LB275-2, LB275A, LB275A-2, LBC210, LBC215, LBC215A, LBC275, LBC275A, LBR, LBR200, LBR215, LBR215A		



1

GEV No.	345845	Ref. No.	130460
description	push switch mounting measurements 28.5x28.5mm green/red 2CO 250V 16A ON-OFF connection male faston 6.3mm ambient temperature max. 150°C protection IP40		
For models:	GF90, GF90A, LB200, LB200-2, LB200A, LB215, LB215-2, LB215A, LB215A-2, LB260, LB260-2, LB260A, LB275, LB275-2, LB275A, LB275A-2, LBC210, LBC215, LBC215A, LBC275, LBC275A, LBR, LBR200, LBR215, LBR215A, LF400A		

28.5x52.6mm



1

GEV No.	347928	Ref. No.	130495
description	switch combination mounting measurements 28.5x52.6mm green 2CO 250V 16A with indicator green/red main switch connection male faston 6.3mm ambient temperature max. 150°C		

accessories

blank elements



1

GEV No.	510458	Ref. No.	160747
description	blank F20		
For models:	F20		

push buttons



1

GEV No.	345078	Ref. No.	130419
description	push button		
For models:	B11, B12, B15, B16, B18, B19		



1

GEV No.	345079	Ref. No.	130420
description	push button		
For models:	B11, B12, B15, B16, B18, B19		



1

GEV No.	347577	Ref. No.	870016
description	push button for PCB grey ED ø 7mm ID ø 3mm H 7.7mm		
For models:	GE100, GE115, GE125, GE60, GE60RCD, GE65, GE65RCD, GE75, GE80		



1

GEV No.	347690	Ref. No.	870017
description	push button for PCB white ED ø 20mm ID ø 5mm H 8mm		
For models:	GE100, GE115, GE125, GE60, GE60RCD, GE65, GE65RCD, GE75, GE80		



toggle switches

M12x0.75



GEV No.	345050	Ref. No.	120771
description	toggle switch thread M12x0.75 2CO 250V 10A male faston 6.3mm		

2 hole fixing



GEV No.	345051	Ref. No.	120704
description	toggle switch 2NO 400V 10A connection screw hole distance 34mm		
For models:	F2, F3		

microswitches

lever actuated



GEV No.	347596	Ref. No.	120323
description	microswitch with lever 250V 12A 1CO connection male faston 6.3mm L 42mm ambient temperature max. 125°C mounting distance 22.2mm type VRSR10DA1 actuating force: 35g lever length 30mm		
For models:	B11, B11T, B12, B12T, B15, B15T, B15TM, B16T, B16TM, B18, B18T, B18TM, B19T, B19TM, B41, B42, LB200, LB200-2, LB215, LB215-2, LB215A, LB215A-2, LB260, LB260-2, LB275, LB275-2, LB275A, LB275A-2, LBC210, LBC215, LBC215A, LBC275, LBC275A, LBR, LBR215, LBR215A, R40, R50, R70		



GEV No.	345074	Ref. No.	120341
description	microswitch with lever 250V 16A 1CO connection male faston 6.3mm ambient temperature max. 85°C mounting distance 25mm type C99ZP3 actuating force: 25g lever length 154mm		
For models:	B13T, B14T		



GEV No.	345125	Ref. No.	120324
description	microswitch with lever 250V 16A 1CO connection male faston 6.3mm ambient temperature max. 85°C mounting distance 25mm type C99ZP3 actuating force: 25g lever length 63.5mm		
For models:	B41, B42		



GEV No.	345044	Ref. No.	120349
description	microswitch with lever 250V 16A 1CO connection male faston 6.3mm ambient temperature max. 85°C mounting distance 25mm type C99ZP3 actuating force: 25g lever length 71mm		
For models:	BC25, BC25A, BC25HR, BC30, BC30A, BC30HR, BC30HR380, BC30HRA, BR20, BR20A, BR25, BR25A, FC43, FC43A		



GEV No.	345121	Ref. No.	120346
description	microswitch with lever 250V 16A 1CO connection screw clamp L 49mm L1 64mm ambient temperature max. 85°C mounting distance 25mm type MV30 actuating force: 30g lever length 80mm		
For models:	BC25, BC25A, BC25HR, BC30, BC30A, BC30HR, BC30HR380, BC30HRA, BHC25, BHC25A, BHC25S, BHC30, BHC30A, BHC30E, BHC30EA, BHC30HR, BHC30HR380, BHC30HRA, BHC30HRA380, BHC433, BHC433A, BHCHR, BR20, BR20A, BR25, BR25A, FC43, FC43A		



GEV No.	345052	Ref. No.	120319
description	microswitch with lever 250V 10A 1CO connection screw clamp L 54mm L1 61mm ambient temperature max. 85°C mounting distance 25mm type AZ71209 actuating force: 180g lever length 76mm		
For models:	C33, C34		



GEV No.	345072	Ref. No.	120329
description	microswitch with lever 250V 15A 2NO connection male faston 6.3mm L 42mm L1 44mm ambient temperature max. 85°C mounting distance 25mm type RM actuating force: 250g		
For models:	B15, B16, B18, B19		

pin-plunger actuated

M10



GEV No.	345032	Ref. No.	120313
description	microswitch with plunger thread M10x1 thread L 12mm 250V 16A 1CO connection male faston 6.3mm stroke 7mm mounting distance 22mm L 28mm ambient temperature max. 125°C type SP9603 actuating force: 180g		
For models:	B31, B32, B41, F2, F20, F3, F300, F45, F55, F65, F80, F90M, F90MA, LF280-lav-line, LF315, LF320, LF320A, LF320CBT, LF320L, LF320LA, LF320-lav-line, LF320LBT, LF323, LF323A, LF350, LF350A, LF400A, LF450, LF450A, LS550		



with push button

gas ignition



1

GEV No.	346209	Ref. No.	120304
description	microswitch with plunger 250V 16A 1CO connection male faston 6.3mm ambient temperature max. 125°C thread M10x0.75 thread L 14mm		
For models:	FC3E, FC3EA, FC3M, FC3MA, FC3MR, FC44E, FC44EA, FC4E, FC4EA, FC4EHRT, FC4M, FC4MA		

accessories



1

GEV No.	510858	Ref. No.	190119
description	bracket for microswitch		
For models:	B11, B12, B15, B16, B18, B19		

position switches

CROUZET



1

GEV No.	347740	Ref. No.	120308
description	position switch cast aluminum 1NO/1NC 380V 10A L 87mm W 30mm H 73mm protection IP66 actuating force: 850g screw connection M19 mounting distance 73.5mm		



1

GEV No.	347741	Ref. No.	120312
description	position switch plastic 1NC/1NO 380V 10A L 69mm W 27mm H 26mm protection IP66 screw connection M19 mounting distance 22mm		
For models:	G131, G66		

PIZZATO

FD series



1

GEV No.	345058	Ref. No.	120322
description	position switch cast aluminum 1NC/1NO 400V 3A L 92mm W 40mm H 35mm protection IP67 actuating force: 900g screw connection PG13.5 mounting distance 30x60mm screw		
For models:	C33, C34, LV1001, LV1501, LV-LVP, LVP1001, LVP1501		



1

GEV No.	345862	Ref. No.	120305 120326
description	position switch cast aluminum 1NO/1NC 400V 3A L 118mm W 40mm H 35mm protection IP67 actuating force: 500g screw connection PG13.5 mounting distance 30x60mm		
For models:	G125, G125L, G75, G75L, GE125, GE75, GL, GMC2702, GMC3502, GMC4502, GMC5502, NE00, NE02, NE3001, NE3002, NE4001, NE4002, NE5002, NE5501, NE5502, NE7002, NE7501, NE7502, NE9001, NE9002, NE9502, NG00, NG01, NG02, NG1202, NG1202E, NG600, NG600E, NG601, NG601E, NG602, NG602E, NG900, NG900E, NG901, NG901E, NG902, NG902E, NL302, NL302E, NL402, NL402E, NL502, NL502E, NL552...(Other models you can see in the webshop)		



1

GEV No.	345075	Ref. No.	120335 120343 120364 870129
description	position switch cast aluminum 1NO/1NC 400V 3A L 141mm W 40mm H 35mm protection IP67 actuating force: 300g screw connection PG13.5 mounting distance 30x60mm type FD503		
For models:	C1001M, C1301M, C140, C155, C155E2, C75, C75BT, C75M, C75RCD, C85, C95, C95E2, LC1200, LC1200RCD, LC380, LC400, LC412, LC700, LC700RCD, LC900, LC900RCD, LP360, LP360BT, LP360RCD		



1

GEV No.	345057	Ref. No.	120320
description	position switch cast aluminum 1NO/1NC 400V 3A L 98mm W 40mm H 35mm protection IP67 actuating force: 450g screw connection PG13.5 mounting distance 30x60mm		
For models:	AC101, AC122, AC151, AC152, AC181, AC182, AC201, AC202, AC241, AC242, AC91, ACS101, ACS101-DIGIT, ACS122, ACS122-DIGIT, ACS151, ACS151-DIGIT, ACS152, ACS152-DIGIT, ACS161-DIGIT, ACS162-DIGIT, ACS181, ACS181-DIGIT, ACS182, ACS182-DIGIT, ACS201, ACS201-DIGIT, ACS202, ACS202-DIGIT, ACS241, ACS241-DIGIT, ACS242, ACS242-DIGIT, ACS91, ACS91-DIGIT, C30, C70		



1

GEV No.	347719	Ref. No.	660862
description	position switch kit 400V L 98mm W 44mm H 40mm protection IP67 mounting distance 60/30mm FD552-S2		
For models:	AC101, AC122, AC151, AC152, AC181, AC182, AC201, AC202, AC241, AC242, AC91		





1

GEV No.	347681	Ref. No.	120321
description	position switch with handle with a switch 2NO/2NC 400V protection IP66 mounting distance 60mm FD230		





system switches (ROLD)

			
1			
GEV No.	347400	Ref. No.	190155
description	element holder dimensions 25x25mm ID ø 21.4mm light blue		
For models:	BHC25-2, BHC25A-2, BHC30-2, BHC30A-2, BHC433-2, BHC433A-2, FC3M, FC3MA, FC3MR, FC4M, FC4MA, GF70, GF70A, GF90-2004, GF90A-2004, LB200, LB200-2, LB200A, LB200A-2, LB215, LB215-2, LB215A, LB215A-2, LB260, LB260-2, LB260A, LB260A-2, LB275, LB275-2, LB275A, LB275A-2, LF321, LF321A, LF322, LF322A, LF322MP, LF322MP-A, LF322RCD, LF324, LF324A, LF700, LF700A, LFD32M, LFD32MA		

			
1			
GEV No.	345131	Ref. No.	190140
description	element holder mounting measurements 28.5x28.5mm grey single element holder		
For models:	BC25, BC25A, BC25HR, BC30, BC30A, BC30HR, BC30HR380, BC30HRA, BHC25, BHC25A, BHC25S, BHC30, BHC30A, BHC30HR, BHC30HR380, BHC30HRA, BHC30HRA380, BHC433, BHC433A, BHCHR, BR20, BR20A, BR25, BR25A, C1000ERCD, C1300ERCD, C155, C155BT, C155RCD, C75BT, C75RCD, C95, C95BT, C95RCD, F90M, F90MA, FC, FC43, FC43A, FC53, FC533, FC533A, FC53A, FC53CBT, FC53LA, FC53LBT, FC54, FC543, FC543A, FC543E...(Other models you can see in the webshop)		

			
1			
GEV No.	345130	Ref. No.	130449
description	momentary switch unit 1NO 250V 16A connection male faston 6.3mm		

			
1			
GEV No.	347193	Ref. No.	130449
description	momentary switch unit 1NO 250V 16A connection male faston 6.3mm		

			
1			
GEV No.	348217	Ref. No.	450341
description	push button ø 21mm blue for ROLD		

			
1			
GEV No.	347469	Ref. No.	450342
description	push button ø 21mm blue regeneration edition 2004 series		
For models:	BHC25-2, BHC25A-2, BHC30-2, BHC30A-2, BHC433-2, BHC433A-2, GF70A, GF90-2004, GF90A-2004, LB200A, LB200A-2, LB215A, LB215A-2, LB260A, LB260A-2, LB275A, LB275A-2, LF321A, LF322A, LF322MP, LF322MP-A, LF324A, LF700A, LFD32M, LFD32MA		

			
1			
GEV No.	347099	Ref. No.	450339
description	push button ø 21mm blue START suitable for ROLD		
For models:	BHC25-2, BHC25A-2, BHC30-2, BHC30A-2, BHC433-2, BHC433A-2, FC3M, FC3MA, FC3MR, FC4M, FC4MA, GF70, GF70A, LB200, LB200-2, LB200A, LB200A-2, LB215, LB215-2, LB215A, LB215A-2, LB260, LB260-2, LB260A, LB260A-2, LB275, LB275-2, LB275A, LB275A-2, LF321, LF321A, LF322, LF322A, LF322MP, LF322MP-A, LF322RCD, LF324, LF324A, LF700, LF700A, LFD32M, LFD32MA		

			
1			
GEV No.	347399	Ref. No.	450340
description	push button ø 21mm shaft 3.5x3.5mm dark blue ON-OFF suitable for ROLD		
For models:	FC3M, FC3MA, FC3MR, FC4M, FC4MA, GF70, GF70A, LB200, LB200-2, LB200A, LB200A-2, LB215, LB215-2, LB215A, LB215A-2, LB260, LB260-2, LB260A, LB260A-2, LB275, LB275-2, LB275A, LB275A-2, LF321, LF321A, LF322, LF322A, LF322MP, LF322MP-A, LF322RCD, LF324, LF324A, LF700, LF700A, LFD32M, LFD32MA		

			
1			
GEV No.	347872	Ref. No.	450352
description	push button ø 23mm black programme		

			
1			
GEV No.	345848	Ref. No.	450332
description	push button ø 23mm blue rinsing		
For models:	BHC25, BHC25A, BHC25S, BHC30, BHC30A, BHC433, BHC433A		





			
1			
GEV No.	345132	Ref. No.	450320
description	push button ø 23mm green		

			
1			
GEV No.	347871	Ref. No.	450353
description	push button ø 23mm green main switch with lens		

			
1			
GEV No.	345847	Ref. No.	450326
description	push button ø 23mm green START		
For models:	BC25, BC25A, BC25HR, BC30, BC30A, BC30HR, BC30HR380, BC30HRA, BHC25, BHC25A, BHC25S, BHC30, BHC30A, BHC30HR, BHC30HR380, BHC30HRA, BHC30HRA380, BHC433, BHC433A, BHCHR, BR20, BR20A, BR25, BR25A, FC, FC43, FC43A, FC53, FC533, FC533A, FC53A, FC53CBT, FC53LA, FC53LBT, FC54, FC543, FC543A, FC544, FC544A, FC54A, FC54CBT, FC54LBT		

			
1			
GEV No.	345133	Ref. No.	450321
description	push button ø 23mm grey		
For models:	BC25, BC25A, BC25HR, BC30, BC30A, BC30HR, BC30HR380, BC30HRA, BR20, BR20A, BR25, BR25A, C155, C155BT, C155RCD, C75BT, C75RCD, C95, C95BT, C95RCD, F90M, F90MA, FC, FC43, FC43A, FC53, FC533, FC533A, FC53A, FC54, FC543, FC543A, FC544, FC544A, FC54A, LF280-lav-line, LF315, LF320CBT, LF320-lav-line, LF320LBT, LF450, LF450A		

			
1			
GEV No.	347686	Ref. No.	450328
description	push button ø 23mm grey outflow		
For models:	BHC25, BHC25A, BHC25S, BHC30, BHC30A, BHC433, BHC433A, FC, FC43, FC53, FC533, FC533A, FC53A, FC53CBT, FC53LA, FC53LBT, FC54, FC543, FC543A, FC543E, FC543EA, FC544, FC544A, FC54A, FC54CBT, FC54LBT		

			
1			
GEV No.	345849	Ref. No.	450327
description	push button ø 23mm grey regeneration		
For models:	BHC25A, BHC30A, BHC30HR, BHC30HRA, BHC30HRA380, BHC433A, BHCHR, FC53LA		

			
1			
GEV No.	345850	Ref. No.	450329
description	push button ø 23mm grey rinsing		
For models:	BHC30HR, BHC30HR380, BHC30HRA, BHC30HRA380, BHCHR, LP360BT, LP360RCD		

			
1			
GEV No.	345851	Ref. No.	450331
description	push button ø 23mm grey START		
For models:	LF320, LF320A, LF320L, LF320LA, LF323, LF323A, LF350, LF350A, LF400A		

			
1			
GEV No.	347475	Ref. No.	450357
description	push button ø 23mm white main switch		

			
1			
GEV No.	347929	Ref. No.	450358
description	push button ø 23mm white programme		

			
1			
GEV No.	347098	Ref. No.	130487
description	switch 2CO 250V 16A connection male faston 6.3mm		
For models:	FC3M, FC3MA, FC3MR, FC4M, FC4MA, GF70, GF70A, LB200, LB200-2, LB200A, LB200A-2, LB215, LB215-2, LB215A, LB215A-2, LB260, LB260-2, LB260A, LB260A-2, LB275, LB275-2, LB275A, LB275A-2, LF321, LF321A, LF322, LF322A, LF322MP, LF322MP-A, LF322RCD, LF324, LF324A, LF700, LF700A, LFD32M, LFD32MA		



float switches

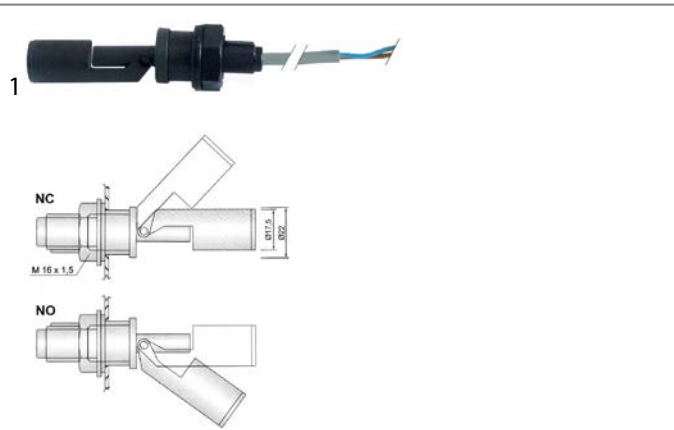

GEV No.	345822	Ref. No.	120358
description	float switch thread M16x1.5 1NO or 1NC ø 17.4mm L 98mm mounting ø 16mm 250V 0.5A cable cable length 2000mm		

rotary switches

BREMAS
A1200 series



GEV No.	345019	Ref. No.	120712
description	rotary switch sets of contacts 2 2 0-1 type CA0120002 380V 12A shaft ø 5x5mm shaft L 23mm shaft square connection screw		
For models:	AC101, AC105, AC2A, AC91, AC95, ACL100, ACL150, ACS101, ACS101-DIGIT, ACS91, ACS91-DIGIT, B10, B10T, B11, B11T, B12, B12T, B13T, B14T, B15, B15T, B15TM, B16, B16T, B16TM, B18, B18T, B18TM, B19, B19T, B19TM, BC25, BC30, BHC25, BHC25-2, BHC25A-2, BHC25S, BHC30, BHC30-2, BHC30A-2, BR20, BR25, C33, C34, F2, F3, F300, F45, G131, G66...(Other models you can see in the webshop)		

A1600 series



GEV No.	345054	Ref. No.	120735
description	rotary switch 0-1-2 16A shaft L 25mm connection screw clamp 3 operating positions 6-pole shaft 5x5mm		
For models:	BHC433, FC43, FC43A		



GEV No.	345677 ¹	Ref. No.	120714
description	rotary switch 2 0-1 sets of contacts 4 type CA0160004V 400V 16A shaft ø 5x5mm shaft L 23mm shaft square connection screw		
For models:	B41, B42, LF280-lav-line, LF320-lav-line		

¹incl. knob and dial plate



GEV No.	300222	Ref. No.	120715
description	rotary switch 3 0-1-2 sets of contacts 4 type CS0167133 400V 16A shaft ø 5x5mm shaft L 24mm shaft square connection screw		
For models:	AC122, AC151, AC152, AC181, AC182, AC201, AC202, AC241, AC242, AC90, ACS122, ACS151, ACS152, ACS181, ACS182, ACS201, ACS202, ACS241, ACS242, SNL		



GEV No.	345840	Ref. No.	120737
description	rotary switch 3 0-1-2 sets of contacts 4 type CS0168308 400V 16A shaft ø 5x5mm shaft L 23mm shaft square connection screw		
For models:	F90M, F90MA, FC, FC53, FC533, FC533A, FC53A, FC54, FC543, FC543A, FC544, FC544A, FC54A, LF320, LF320A, LF320LA, LF323, LF323A, LF350, LF350A, LF400A, LF450, LF450A		



GEV No.	345838	Ref. No.	120744
description	rotary switch 3 0-1-2 sets of contacts 4 type CS0168505 400V 16A shaft ø 5x5mm shaft L 23mm shaft square connection screw		
For models:	BHC30HR, BHC30HR380, BHC30HRA, BHC30HRA380, BHC433-2, BHC433A-2, BHCHR, FC, FC533A, FC53A, FC53CBT, FC53LA, FC53LBT, FC543A, FC544A, FC54A, FC54CBT, FC54LBT, GF90, GF90A, LF320CBT, LF320L, LF320LA, LF320LBT		



GEV No.	345009	Ref. No.	120722
description	rotary switch 3 0-1-2 sets of contacts 6 type CA0168378V 600V 16A shaft ø 5x5mm shaft L 23mm shaft square connection screw		
For models:	AC101, AC105, AC91, AC95, ACL100, ACL150, ACS101, ACS101-DIGIT, ACS122, ACS122-DIGIT, ACS151, ACS151-DIGIT, ACS152, ACS152-DIGIT, ACS161-DIGIT, ACS162-DIGIT, ACS181, ACS181-DIGIT, ACS182, ACS182-DIGIT, ACS201, ACS201-DIGIT, ACS202, ACS202-DIGIT, ACS241, ACS241-DIGIT, ACS242, ACS242-DIGIT, ACS91, ACS91-DIGIT, F20, LAV1001, LAV1501, LF320, LF320A, LF320LA, LF323, LF323A, LF350, LF350A, NL302, NL302E, NL402, NL402E, NL502, NL502E, NL552, NL552E		



GEV No.	300330	Ref. No.	110805
description	rotary switch 3 1-0-2 sets of contacts 2 type CS0168351 400V 16A shaft ø 5x5mm shaft L 25mm shaft square connection screw		
For models:	AC100, AC120, AC122, AC135, AC150, AC151, AC152, AC170, AC181, AC182, AC200, AC201, AC202, AC241, AC242, ACR, ACR145, ACR205, ACR225, ACR245, ACR260, ACR265, ACR305, ACS122, ACS151, ACS152, ACS181, ACS182, ACS201, ACS202, ACS241, ACS242, GMC, GMC2700, GMC3500, GMC4500, GMC5500, NE00, SE, SNL		



1

GEV No.	345315 ¹	Ref. No.	110801
description	rotary switch 3 1-0-2 sets of contacts 6 type CA160007 400V 16A shaft ø 5x5mm shaft L 23mm shaft square with knob connection screw		

¹incl. knob



1

GEV No.	345839	Ref. No.	120740
description	rotary switch 4 1-0-2-3 sets of contacts 6 type CS0168341 400V 16A shaft ø 5x5mm shaft L 23mm shaft square connection screw		
For models:	BHC433A, FC, FC53, FC533, FC53A, FC54, FC543, FC543A, FC544, FC544A, FC54A		



1

GEV No.	347097	Ref. No.	120751
description	rotary switch 5 0-1-2-3-4 sets of contacts 4 type CS0169615V 400V 16A shaft ø 5x5mm shaft L 25mm shaft square connection screw		
For models:	C1001M, C1301M, GF90-2004, GF90A-2004, LC1200, LC1200RCD, LC412, LC700, LC700RCD, LC900, LC900RCD		



1

GEV No.	345842	Ref. No.	120716
description	rotary switch 5 0-1-2-3-4 sets of contacts 6 type CS0168359 400V 16A shaft ø 5x5mm shaft L 23mm shaft square connection screw		
For models:	C1001M, C1301M, C155BT, C155RCD, C95BT, C95RCD, G100L, G101L, G115, G115L, G125, G125L, G131, G50L, G50LM, G51L, G60L, G61L, G65, G65L, G66, G75, G75L, GL, LC1200RCD, LC412, LC700RCD, LC900RCD		



1

GEV No.	345841	Ref. No.	120747
description	rotary switch 5 0-1-2-3-4 sets of contacts 7 type CS0168590 400V 16A shaft ø 5x5mm shaft L 25mm shaft square connection screw		
For models:	C75BT, C75RCD, LC380BT, LC380RCD, LP360BT, LP360RCD		



1

GEV No.	345012	Ref. No.	120728
description	rotary switch 5 0-1-2-3-4 sets of contacts 8 type CS0167898 400V 16A shaft ø 5x5mm shaft L 25mm shaft square connection screw		
For models:	F55, F65, F80		



1

GEV No.	345024	Ref. No.	120729
description	rotary switch 6 0-1-2-3-4-5 sets of contacts 8 type CS0168339 400V 16A shaft ø 5x5mm shaft L 25mm shaft square connection screw		
For models:	C140, C155, C70, C75, C75M, C85, C95, LC1200, LC380, LC400, LC700, LC900, LP360		

A1700 series



1

GEV No.	345007	Ref. No.	120713
description	rotary switch 4 0-1-2-3 sets of contacts 6 type CS0178766 400V 20A shaft ø 5x5mm shaft L 25mm shaft square connection screw		
For models:	C30, R70		

A2500 series



1

GEV No.	347688	Ref. No.	120701
description	rotary switch 2 0-1 sets of contacts 2 type 120701 600V 32A shaft ø 5x5mm shaft L 19mm shaft square connection screw		



1

GEV No.	300325	Ref. No.	120736
description	rotary switch 2 0-1 sets of contacts 4 type CA0250004 600V 25A shaft ø 5x5mm shaft square connection screw		
For models:	AC122, AC151, AC152, AC181, AC182, AC201, AC202, AC241, AC242, ACR, ACR145, ACR205, ACR225, ACR245, ACR260, ACR265, ACR305, ACRS145, ACRS205, ACRS225, ACRS245, ACRS260, ACRS265, ACRS305, GMC, GMC2700, GMC2702, GMC3500, GMC3502, GMC4500, GMC4502, GMC5500, GMC5502, LAV1001, LAV1501, LV1001, LV1501, LV-LVP, LVP1001, LVP1501, NE02, NE3001, NE3002, NE4001, NE4002, NE5002, NE5501, NE5502, NE7002, NE7501...(Other models you can see in the webshop)		



1

GEV No.	345004	Ref. No.	120718
description	rotary switch 3 0-1-2 sets of contacts 4 type CS025704300001 600V 32A shaft ø 5x5mm shaft L 24mm shaft square connection screw		
For models:	AC100, NE00, NG00, NG600, NG600E, NG900, NG900E, SE, SNL		





			
1			
GEV No.	347687	Ref. No.	120733
description	rotary switch 3 0-1-2 sets of contacts 4 type CS0257997 600V 32A shaft \varnothing 5x5mm shaft L 24mm shaft square connection screw		
For models:	AC120, AC135, AC150, AC170, AC200, ACR, ACR145, ACR205, ACR225, ACR245, ACR260, ACR265, ACR305, GMC, GMC2700, GMC3500, GMC4500, GMC5500, LAV1000		

touch sensitive light switches

			
1			
GEV No.	403091	Ref. No.	120907
description	light barrier 24-240V 5A range 100mm L 88mm E3F2-DS10Z1-N		
For models:	LAV1000, LAV1001, LAV1501		

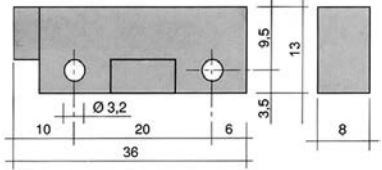
magnetic switches

<p>36x13mm</p> 			
1			
			
GEV No.	345335	Ref. No.	120366 h33188
description	magnetic switch L 36mm W 13mm 1NO 250V 0.04A P max. 10W connection cable cable length 960mm		
For models:	GF90, GF90A		
accessories for	345335		
			
GEV No.	519049	Ref. No.	411010
description	magnet \varnothing mm L 63mm H 10.7mm W 18.8mm hole distance 52mm M2 hole \varnothing 2mm		

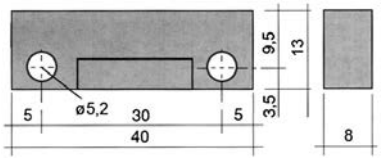
<p>40x13mm</p> 			
1			
			
GEV No.	345358	Ref. No.	120356
description	magnetic switch L 40mm W 13mm 1NO 250V 0.04A P max. 10W connection cable cable length 900mm		
For models:	BHC25-2, BHC25A-2, BHC30-2, BHC30A-2, BHC30E-2, BHC30EA-2, BHC30HR-2, BHC30HRA-2, BHC433-2, BHC433A-2, FC, FC53, FC533, FC533A, FC53A, FC53CBT, FC53LA, FC53LBT, FC54, FC543, FC543A, FC543E, FC543EA, FC544, FC544A, FC54A, FC54CBT, FC54E, FC54EA, FC54LBT, FCHR, FCHRA, FCHRT, FCHRTA, GE100, GE115, GE50RCD, GE60, GE60RCD, GE65, GE65RCD, GE80, GF90-2004, GF90A-2004, LB200, LB200-2, LB200A, LB200A-2, LB215, LB215-2...(Other models you can see in the webshop)		

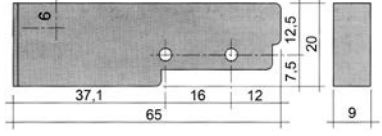
<p>65x20mm</p> 			
1			
			
GEV No.	345122 ¹	Ref. No.	120333 120342
description	magnetic switch L 65mm W 20mm 1NO 24V 8A P max. 192W connection male faston 6.3mm cable length 344mm		
For models:	AC100, AC101, AC105, AC120, AC122, AC135, AC150, AC151, AC152, AC170, AC181, AC182, AC200, AC201, AC202, AC241, AC242, AC2A, AC90, AC91, AC95, ACL100, ACL150, ACR, ACR145, ACR205, ACR225, ACR245, ACR260, ACR265, ACR305, ACS101, ACS101-DIGIT, ACS122, ACS122-DIGIT, ACS151, ACS151-DIGIT, ACS152, ACS152-DIGIT, ACS161-DIGIT, ACS162-DIGIT, ACS181, ACS181-DIGIT, ACS182, ACS182-DIGIT, ACS201, ACS201-DIGIT, ACS202, ACS202-DIGIT, ACS241...(Other models you can see in the webshop)		

¹with coded connector



GEV No.	347720	Ref. No.	620273
description	magnetic switch L 65mm W 20mm 1NO 24V connection coded plug cable length 350mm nominal 8A		
For models:	AC101, AC122, AC151, AC152, AC181, AC182, AC201, AC202, AC241, AC242, AC91		

GEV No.	345116	Ref. No.	120348
description	magnetic switch L 65mm W 20mm 1NO 250V 0.4A P max. 100W connection cable cable length 3000mm		
For models:	ACR, ACR145, ACR205, ACR225, ACR245, ACR260, ACR265, ACR305, ACR5145, ACR5205, ACR5225, ACR5245, ACR5260, ACR5265, ACR5305, C1000E, C1000ERCD, C1300E, C1300ERCD, C155, C155BT, C155E2, C155RCD, C165, C165E2, C165E2BT, C165E2RCD, C166, C166-2, C95, C95BT, C95E2, C95RCD, GMC, GMC2700, GMC2702, GMC3500, GMC3502, GMC4500, GMC4502, GMC5500, GMC5502, LC1200, LC1200RCD, LC380BT, LC380RCD, LC412, LC700, LC700RCD, LC900... (Other models you can see in the webshop)		
accessories for	345116		
	GEV No.	345399	Ref. No. —
	magnet ø 3.3mm L 40mm H 8mm W 13mm hole distance 30mm M3		

M30x1.5

GEV No.	347880	Ref. No.	120345
description	magnetic switch thread M30x1.5 1NO 20-250V 0.3A connection cable cable length 1900mm		
For models:	C166-2		

miscellaneous

GEV No.	511228	Ref. No.	120358
description	magnetic switch		
For models:	ACRS145, ACRS205, ACRS225, ACRS245, ACRS260, ACRS265, ACRS305, ACS101, ACS101-DIGIT, ACS122, ACS122-DIGIT, ACS151, ACS151-DIGIT, ACS152, ACS152-DIGIT, ACS161-DIGIT, ACS162-DIGIT, ACS181, ACS181-DIGIT, ACS182, ACS182-DIGIT, ACS201, ACS201-DIGIT, ACS202, ACS202-DIGIT, ACS241, ACS241-DIGIT, ACS242, ACS242-DIGIT, ACS91, ACS91-DIGIT, C155BT, C155RCD, C165E2BT, C165E2RCD, C75BT, C75RCD, C95BT, C95RCD, FC53CBT, FC53LBT, FC54CBT, FC54LBT, GMC2700, GMC2702, GMC3500, GMC3502, GMC4500, GMC4502, GMC5500... (Other models you can see in the webshop)		

GEV No.	347477	Ref. No.	120317
description	magnetic switch cable length 520mm		
For models:	AC101, AC122, AC151, AC152, AC181, AC182, AC201, AC202, AC241, AC242, AC91, ACL100, ACL150, ACS101, ACS101-DIGIT, ACS122, ACS122-DIGIT, ACS151, ACS151-DIGIT, ACS152, ACS152-DIGIT, ACS161-DIGIT, ACS162-DIGIT, ACS181, ACS181-DIGIT, ACS182, ACS182-DIGIT, ACS201, ACS201-DIGIT, ACS202, ACS202-DIGIT, ACS241, ACS241-DIGIT, ACS242, ACS242-DIGIT, ACS91, ACS91-DIGIT		

accessories

magnets

GEV No.	347882	Ref. No.	411011
description	magnet ø 5mm L 20mm H mm W mm		
For models:	NG02, NG1202, NG1202E, NG602, NG602E, NG902, NG902E		

GEV No.	347881	Ref. No.	411004
description	magnet ø mm L 35mm H 6mm W 11mm		
For models:	BC25, BC25A, BC25HR, BC30, BC30A, BC30HR, BC30HR380, BC30HRA, BR20, BR20A, BR25, BR25A, FC43, FC43A, GF70, GF70A, LF321, LF321A, LF322, LF322A, LF322MP, LF322MP-A, LF322RCD, LF324, LF324A, LF325E, LF325EA, LF700, LF700A		



1

GEV No.	519049	Ref. No.	411010
description	magnet ømm L 63mm H 10.7mm W 18.8mm hole distance 52mm M2 hole ø 2mm		
For models:	BHC25, BHC25-2, BHC25A, BHC25A-2, BHC25S, BHC30, BHC30-2, BHC30A, BHC30A-2, BHC30E, BHC30E-2, BHC30EA, BHC30EA-2, BHC30HR, BHC30HR-2, BHC30HR380, BHC30HRA, BHC30HRA-2, BHC30HRA380, BHC433, BHC433-2, BHC433A, BHC433A-2, BHC433R		
accessories for	519049		
	GEV No.	560095	Ref. No. 260712
	sheet metal screws ø 2.9mm L 9.5mm SS Qty 20 pcs DIN 7981/ISO 7049 head ø 5.6mm oval head		

magnetic holders

1

GEV No.	348234	Ref. No.	331754
description	bracket for magnetic switch		
For models:	AC101, AC105, AC122, AC135, AC151, AC152, AC181, AC182, AC201, AC202, AC241, AC242, AC91, AC95, ACRS145, ACRS205, ACRS225, ACRS245, ACRS260, ACRS265, ACRS305, ACS181, ACS181-DIGIT, ACS182, ACS182-DIGIT, ACS201, ACS201-DIGIT, ACS202, ACS202-DIGIT, ACS241, ACS241-DIGIT, ACS242, ACS242-DIGIT, GMC2702, GMC3502, GMC4502, GMC5502, LAV1000, LAV1001, LAV1501		

1

GEV No.	346075	Ref. No.	190806
description	magnet holder		
For models:	AC100, AC101, AC105, AC120, AC122, AC135, AC150, AC151, AC152, AC170, AC181, AC182, AC200, AC201, AC202, AC241, AC242, AC2A, AC90, AC91, AC95, ACL100, ACL150, ACR, ACR145, ACR205, ACR225, ACR245, ACR260, ACR265, ACR305, ACRS145, ACRS205, ACRS225, ACRS245, ACRS260, ACRS265, ACRS305, ACS101, ACS101-DIGIT, ACS122, ACS122-DIGIT, ACS151, ACS151-DIGIT, ACS152, ACS152-DIGIT, ACS161-DIGIT, ACS162-DIGIT, ACS181, ACS181-DIGIT...(Other models you can see in the webshop)		

control equipment

ABB

1

GEV No.	348089	Ref. No.	130410
description	contact block ABB MCB-01 1NC max 400V 8A black/red		
For models:	AC100, AC101, AC105, AC120, AC122, AC135, AC150, AC151, AC152, AC170, AC181, AC182, AC200, AC201, AC202, AC241, AC242, AC90, AC91, AC95, ACR, ACR145, ACR205, ACR225, ACR245, ACR260, ACR265, ACR305, GMC, GMC2700, GMC3500, GMC4500, GMC5500, LAV1000, LV1001, LV1501, LV-LVP, LVP1001, LVP1501, NE00, NE02, NE3001, NE3002, NE4001, NE4002, NE5002, NE5501, NE5502, NE7002, NE7501...(Other models you can see in the webshop)		

switches (complete)

1

GEV No.	347573	Ref. No.	130453
description	emergency stop switch complete yellow/red		
For models:	AC101, AC122, AC151, AC152, AC181, AC182, AC201, AC202, AC241, AC242, AC91, ACS101, ACS101-DIGIT, ACS122, ACS122-DIGIT, ACS151, ACS151-DIGIT, ACS152, ACS152-DIGIT, ACS161-DIGIT, ACS162-DIGIT, ACS181, ACS181-DIGIT, ACS182, ACS182-DIGIT, ACS201, ACS201-DIGIT, ACS202, ACS202-DIGIT, ACS241, ACS241-DIGIT, ACS242, ACS242-DIGIT, ACS91, ACS91-DIGIT, NL302, NL302E, NL402, NL402E, NL502, NL502E, NL552, NL552E		

BRETER

rotary switches

1

GEV No.	347682	Ref. No.	120721
description	rotary selector mounting measurements ø22mm black latching sequence 0-1		
For models:	ACR, ACR145, ACR205, ACR225, ACR245, ACR260, ACR265, ACR305, GMC, GMC2700, GMC3500, GMC4500, GMC5500, NE00, SE		



GENERAL ELECTRIC (AEG)



1

GEV No.	345780	Ref. No.	130477
description	contact block GENERAL ELECTRIC P9B01VN 1NC max 660V 10A		
For models:	ACRS145, ACRS205, ACRS225, ACRS245, ACRS260, ACRS265, ACRS305, GMC2702, GMC3502, GMC4502, GMC5502, LAV1001, LAV1501, NE02, NE3002, NE4002, NE5002, NE5502, NE7002, NE7502, NE9002, NE9502, NG02, NG1202, NG1202E, NG602, NG602E, NG902, NG902E, NL302, NL302E, NL402, NL402E, NL502, NL502E, NL552, NL552E		



1

GEV No.	345779	Ref. No.	130478
description	contact block GENERAL ELECTRIC P9B10VN 1NO max 400V 10A brown		
For models:	ACRS145, ACRS205, ACRS225, ACRS245, ACRS260, ACRS265, ACRS305, GMC2702, GMC3502, GMC4502, GMC5502, LAV1001, LAV1501, NE02, NE3002, NE4002, NE5002, NE5502, NE7002, NE7502, NE9002, NE9502, NG02, NG1202, NG1202E, NG602, NG602E, NG902, NG902E, NL302, NL302E, NL402, NL402E, NL502, NL502E, NL552, NL552E		

signal element



1

GEV No.	347239	Ref. No.	150106
description	signal element mounting measurements ø22mm with socket element green		
For models:	AC100, AC120, AC122, AC135, AC150, AC151, AC152, AC170, AC181, AC182, AC200, AC201, AC202, AC241, AC242, AC90, ACR, ACR145, ACR205, ACR225, ACR245, ACR260, ACR265, ACR305, GMC, GMC2700, GMC3500, GMC4500, GMC5500, LAV1000, LV1001, LV1501, LV-LVP, LVP1001, LVP1501, NE00, NG00, NG600, NG600E, NG900, NG900E, SE, SNL		



1

GEV No.	346889	Ref. No.	150105
description	signal element mounting measurements ø22mm without socket element red		
For models:	AC100, AC120, AC122, AC135, AC150, AC151, AC152, AC170, AC181, AC182, AC200, AC201, AC202, AC241, AC242, AC90, ACR, ACR145, ACR205, ACR225, ACR245, ACR260, ACR265, ACR305, GMC, GMC2700, GMC3500, GMC4500, GMC5500, LAV1000, LV1001, LV1501, LV-LVP, LVP1001, LVP1501, NG00, NG600, NG600E, NG900, NG900E, SNL		

momentary mushroom switches



1

GEV No.	347575	Ref. No.	130476
description	emergency stop switch mounting measurements ø22mm red latching		
For models:	ACL100, ACL150, ACRS145, ACRS205, ACRS225, ACRS245, ACRS260, ACRS265, ACRS305, ACS101, ACS101-DIGIT, ACS122, ACS122-DIGIT, ACS151, ACS151-DIGIT, ACS152, ACS152-DIGIT, ACS161-DIGIT, ACS162-DIGIT, ACS181, ACS181-DIGIT, ACS182, ACS182-DIGIT, ACS201, ACS201-DIGIT, ACS202, ACS202-DIGIT, ACS241, ACS241-DIGIT, ACS242, ACS242-DIGIT, ACS91-DIGIT, GMC2702, GMC3502, GMC4502, GMC5502, LAV1001, LAV1501, NE02, NE3002, NE4002, NE5002, NE5502, NE7002, NE7502, NE9002, NE9502, NG02, NG1202E...(Other models you can see in the webshop)		
accessories for	347575		
	GEV No.	345780	Ref. No.
			130477
	contact block GENERAL ELECTRIC P9B01VN 1NC max 660V 10A		

lamps

indicator lights

indicator lights 2-piece (lens and indicator lamp)

indicator light lenses

ø 6mm (type SQ-20)



1

GEV No.	359806	Ref. No.	130707
description	indicator light lens clear Qty 1 pcs ø 6mm		
For models:	BHC25-2, BHC25A-2, BHC30-2, BHC30A-2, BHC433-2, BHC433A-2, C1001M, C1301M, C155, C155BT, C155RCD, C75, C75BT, C75M, C75RCD, C95, C95BT, C95RCD, FC3M, FC3MA, FC3MR, FC4M, FC4MA, FC53LA, GF70, GF70A, GF90-2004, GF90A-2004, LB200, LB200-2, LB200A, LB200A-2, LB215, LB215-2, LB215A, LB215A-2, LB260, LB260-2, LB260A, LB260A-2, LB275, LB275-2, LB275A, LB275A-2, LC1200, LC1200RCD, LC412, LC700, LC700RCD, LC900...(Other models you can see in the webshop)		





1

GEV No.	359803	Ref. No.	130704 130708
description	indicator light lens green Qty 1 pcs ø 6mm		
For models:	BC25, BC25A, BC25HR, BC30, BC30A, BC30HR, BC30HR380, BC30HRA, BHC25, BHC25A, BHC255, BHC30, BHC30A, BHC30HR, BHC30HR380, BHC30HRA, BHC30HRA380, BHC433, BHC433A, BHCHR, BR20, BR20A, BR25, BR25A, C1001M, C1301M, C155, C155BT, C155RCD, C75, C75BT, C75M, C75RCD, C95, C95BT, C95RCD, FC, FC43, FC43A, FC53, FC533, FC533A, FC53A, FC53CBT, FC53LA, FC53LBT, FC54, FC543, FC543A, FC543E...(Other models you can see in the webshop)		





			
1			
GEV No.	359805	Ref. No.	130706
description	indicator light lens red Qty 1 pcs ø 6mm		
For models:	C1001M, C1301M, C155, C155BT, C155RCD, C75, C75BT, C75M, C75RCD, C95, C95BT, C95RCD, LC1200, LC1200RCD, LC412, LC700, LC700RCD, LC900, LC900RCD		



ø12mm (type SDY-3)			
			
1			
GEV No.	359262	Ref. No.	130711
description	indicator light housings mounting measurements ø12mm green round Qty 1 pcs		
For models:	AC101, AC91, G100L, G101L, G115L, G125L, G50L, G50LM, G51L, G60L, G61L, G65L, G75L, GL		

			
1			
GEV No.	359261	Ref. No.	130710
description	indicator light housings mounting measurements ø12mm red round Qty 1 pcs		
For models:	AC101, AC91, G100L, G101L, G115L, G125L, G50L, G50LM, G51L, G60L, G61L, G65L, G75L, GL		

indicator lamps for socket type SQ			
			
1			
GEV No.	359801	Ref. No.	130182
description	indicator lamp 12V white connection male faston 6.3mm no lens ø 6mm		
For models:	BHC25-2, BHC25A-2, BHC30-2, BHC30A-2, BHC30HR, BHC30HR380, BHC30HRA, BHC30HRA380, BHC433-2, BHC433A-2, BHCHR, FC3M, FC3MA, FC3MR, FC4M, FC4MA, GF70, GF70A, GF90-2004, GF90A-2004, LB200, LB200-2, LB200A, LB200A-2, LB215, LB215-2, LB215A, LB215A-2, LB260, LB260-2, LB260A, LB260A-2, LB275, LB275-2, LB275A, LB275A-2, LF321, LF321A, LF322, LF322A, LF322MP, LF322MP-A, LF322RCD, LF324, LF324A, LF700, LF700A, LFD32M, LFD32MA		

			
1			
GEV No.	359109	Ref. No.	130188
description	indicator lamp 230V green connection male faston 6.3mm no lens ø 6mm		
For models:	FC3M, FC3MA, FC3MR, FC4M, FC4MA, GF70, GF70A, GF90-2004, GF90A-2004, LB200, LB200-2, LB200A, LB200A-2, LB215, LB215-2, LB215A, LB215A-2, LB260, LB260-2, LB260A, LB260A-2, LB275, LB275-2, LB275A, LB275A-2, LF321, LF321A, LF322, LF322A, LF322MP, LF322MP-A, LF322RCD, LF324, LF324A, LF700, LF700A, LFD32M, LFD32MA		
accessories for	359109		
		GEV No.	359806
		Ref. No.	130707
	indicator light lens clear Qty 1 pcs ø 6mm		

			
1			
GEV No.	359802	Ref. No.	130181
description	indicator lamp 24V white connection male faston 6.3mm no lens temp.-resist. 120°C ø 6mm		
For models:	C155BT, C155RCD, C75BT, C75RCD, C95BT, C95RCD, FC, FC533A, FC53A, FC53CBT, FC53LA, FC53LBT, FC543A, FC544A, FC54A, FC54CBT, FC54LBT, LC1200RCD, LC700RCD, LC900RCD		



			
1			
GEV No.	347476	Ref. No.	130196
description	indicator light 5V green connection cable 170mm		
For models:	C1001M, C1301M, LC1200, LC1200RCD, LC412, LC700, LC700RCD, LC900, LC900RCD		
accessories for	347476		
		GEV No.	359806
		Ref. No.	130707
	indicator light lens clear Qty 1 pcs ø 6mm		

indicator lamps for socket type SRZ / SDK / SDY / SFK			
			
1			
GEV No.	359129	Ref. No.	130170
description	indicator lamp 24V clear connection male faston 6.3mm		
For models:	AC101, AC91, G100L, G101L, G115L, G125L, G50L, G50LM, G51L, G60L, G61L, G65L, G75L, GL		

indicator lights 3-piece (housing, lens and bulb)			
lamps			
neon light bulbs			
			
1			
GEV No.	359000	Ref. No.	130138 870050
description	neon light bulb socket Ba9s 24V 3W clear ø 10mm L 24mm		
For models:	AC100, AC120, AC122, AC135, AC150, AC151, AC152, AC170, AC181, AC182, AC200, AC201, AC202, AC241, AC242, AC90, ACR, ACR145, ACR205, ACR225, ACR245, ACR260, ACR265, ACR305, GMC, GMC2700, GMC3500, GMC4500, GMC5500, LAV1000, LV1001, LV1501, LV-LVP, LVP1001, LVP1501, NE00, NG00, NG600, NG600E, NG900, NG900E, SE, SNL		
accessories for	359000		
		GEV No.	359060
		Ref. No.	—
	lamp socket mounting measurements ø16.2mm socket E10 connection screw		
		GEV No.	359063
		Ref. No.	—
	lamp socket mounting measurements ø19.2mm socket E14 connection screw		
		GEV No.	359064
		Ref. No.	—
	lamp socket mounting measurements ø22.3mm socket E14 connection screw 250/380V ambient temperature at 1W 100°C ambient temperature at 2W 85°C		
		GEV No.	359685
		Ref. No.	—
	lamp socket mounting measurements ø16.2mm socket E10		

Table continues overleaf



accessories for 359000			
	GEV No.	359832	Ref. No. —
lamp socket mounting measurements ø16.2mm socket Ba9s connection male faston 6.3mm			
	GEV No.	359853	Ref. No. —
lamp socket mounting measurements ø18.2mm socket Ba9s connection male faston 6.3mm			
	GEV No.	359988	Ref. No. —
lamp socket mounting measurements ø30.5mm 250V connection F6.3 temp.-resist. 55°C E14			

indicator lights (complete)

ø 6mm



1

GEV No.	359031	Ref. No.	130157
description	indicator light ø 6mm 230V green		
For models:	BC25, BC25A, BC25HR, BC30, BC30A, BC30HR, BC30HR380, BC30HRA, BHC25, BHC25-2, BHC25A, BHC25A-2, BHC25S, BHC30, BHC30-2, BHC30A, BHC30A-2, BHC30HR, BHC30HR380, BHC30HRA, BHC30HRA380, BHC433, BHC433-2, BHC433A, BHC433A-2, BHCHR, BR20, BR20A, BR25, BR25A, C1001M, C1301M, C155, C155BT, C155RCD, C75, C75BT, C75M, C75RCD, C95, C95BT, C95RCD, FC, FC43, FC43A, FC53, FC533, FC533A, FC53A, FC53CBT...(Other models you can see in the webshop)		



1

GEV No.	359032	Ref. No.	130159
description	indicator light ø 6mm 230V yellow		
For models:	C1001M, C1301M, C155, C75, C75M, C95, LC1200, LC1200RCD, LC412, LC700, LC700RCD, LC900, LC900RCD		

ø10mm

with plug-in socket



1

GEV No.	359036	Ref. No.	130123
description	indicator light ø 10mm clear 230V connection male faston 6.3mm Qty 1 pcs		
For models:	R40, R50, R70		



1

GEV No.	359139	Ref. No.	130115
description	indicator light ø 10mm green 230V connection male faston 6.3mm Qty 1 pcs		
For models:	C30, F2, F3, F300, R40, R50, R70		



1

GEV No.	359138	Ref. No.	130103
description	indicator light ø 10mm red 230V connection male faston 6.3mm Qty 1 pcs		
For models:	C30, F2, F3, F300		



1

GEV No.	359140	Ref. No.	130116
description	indicator light ø 10mm yellow 230V connection male faston 6.3mm Qty 1 pcs		
For models:	C30, F300, R40, R50, R70		

ø12mm

with screw socket



1

GEV No.	359021	Ref. No.	130122
description	indicator light ø 12mm 230V clear connection male faston 6.3mm		



1

GEV No.	359026	Ref. No.	130120
description	indicator light ø 12mm 230V red connection male faston 6.3mm model CM/5		
For models:	C33, C34		



1

GEV No.	359047	Ref. No.	130139
description	indicator light ø 12mm 24V clear connection male faston 6.3mm		



1

GEV No.	359023	Ref. No.	130117 130711
description	indicator light ø 12mm 24V green connection male faston 6.3mm		
For models:	AC105, AC95, G115, G125, G131, G65, G66, G75		



1

GEV No.	359024	Ref. No.	130118 130170 130710
description	indicator light ø 12mm 24V red connection male faston 6.3mm		
For models:	AC105, AC95, G115, G125, G131, G65, G66, G75		





			
1			
GEV No.	359025	Ref. No.	130119
description	indicator light ø 12mm 24V yellow connection male faston 6.3mm		
For models:	G131, G66		

			
1			
GEV No.	359027	Ref. No.	130121
description	indicator light ø 12mm 250V green connection male faston 6.3mm		
For models:	C33, C34		

26.5x25.6mm

			
1			
GEV No.	357172	Ref. No.	130151
description	indicator light mounting measurements 27.8x25mm blue 250V connection male faston 6.3mm type MD50		

			
1			
GEV No.	349000	Ref. No.	130140 130153
description	indicator light mounting measurements 27.8x25mm clear 230V connection male faston 6.3mm		

			
1			
GEV No.	345853	Ref. No.	130168
description	indicator light mounting measurements 27.8x25mm green 230V connection male faston 6.3mm		
For models:	F90M, F90MA, LC380, LC400, LF280-lav-line, LF315, LF320, LF320A, LF320CBT, LF320LA, LF320-lav-line, LF320LBT, LF323, LF323A, LF350, LF350A, LF450, LF450A, LP360, LP360BT, LP360RCD		

			
1			
GEV No.	345854	Ref. No.	130169
description	indicator light mounting measurements 27.8x25mm green 230V connection male faston 6.3mm		
For models:	F90M, F90MA, LC380, LC400, LF280-lav-line, LF315, LF320, LF320A, LF320CBT, LF320LA, LF320-lav-line, LF320LBT, LF323, LF323A, LF350, LF350A, LF450, LF450A, LP360, LP360BT, LP360RCD		

			
1			
GEV No.	345855	Ref. No.	130152
description	indicator light mounting measurements 27.8x25mm green 230V connection male faston 6.3mm temp.-resist. 125°C		
For models:	F90M, F90MA, LC380, LC400, LF280-lav-line, LF315, LF320, LF320A, LF320LA, LF320-lav-line, LF323, LF323A, LF350, LF350A, LF450, LF450A, LP360		

			
1			
GEV No.	345857	Ref. No.	130147
description	indicator light mounting measurements 27.8x25mm green 24V connection male faston 6.3mm temp.-resist. 125°C on/ready		
For models:	GF90, GF90A, LC380BT, LC380RCD, LF320L, LF320LA		

			
1			
GEV No.	345856	Ref. No.	130180
description	indicator light mounting measurements 27.8x25mm green 24V connection male faston 6.3mm temp.-resist. 125°C operating		
For models:	GF90, GF90A, LC380BT, LC380RCD, LF320CBT, LF320L, LF320LA, LF320LBT, LP360BT, LP360RCD		

			
1			
GEV No.	345860	Ref. No.	130178
description	indicator light mounting measurements 27.8x25mm white 24V connection male faston 6.3mm temp.-resist. 125°C on/ready		
For models:	LF400A		

			
1			
GEV No.	359010	Ref. No.	130134
description	indicator light mounting measurements 27.8x25mm yellow 230V connection male faston 6.3mm		
For models:	B10, B10T, B11, B11T, B12, B12T, B13T, B14T, B15, B15T, B15TM, B16, B16T, B16TM, B18, B18T, B18TM, B19, B19T, B19TM, C140, C70, C85, F20, F45, F55, F65, F80		





			
1			
GEV No.	359012	Ref. No.	130136
description	indicator light mounting measurements 27.8x25mm yellow 230V connection male faston 6.3mm		
For models:	B11, B12, B15, B16, B18, B19, C140, C70, C85, F20, F45, F55, F65, F80, LBC210, LBC215, LBC215A, LBC275, LBC275A, LBR, LBR200, LBR215, LBR215A		

			
1			
GEV No.	345844	Ref. No.	130470
description	momentary rocker switch mounting measurements 27.8x25mm orange 1NO/indicator light 230V 16A regeneration connection male faston 6.3mm ambient temperature max. 85°C protection IP40		
For models:	F90M, F90MA, LF320, LF320A, LF320LA, LF323, LF323A, LF350, LF350A, LF450, LF450A		

			
1			
GEV No.	345861 ¹	Ref. No.	130472
description	momentary rocker switch mounting measurements 27.8x25mm orange 1NO/indicator light indicator lamp 24V 230V 16A regeneration connection male faston 6.3mm ambient temperature max. 85°C protection IP40		
For models:	GF90, GF90A, LF320L, LF320LA, LF400A		









¹indicator light 24V

30x22mm			
			
1			
GEV No.	359029	Ref. No.	130125
description	indicator light mounting measurements 30x22mm 230V green connection male faston 6.3mm temp.-resist. -100 to +800°C flash		
For models:	B20, B20D, B41, B42		

			
1			
GEV No.	359030	Ref. No.	130126
description	indicator light mounting measurements 30x22mm 230V green connection male faston 6.3mm temp.-resist. -100 to +800°C machine stand-by		
For models:	B20, B20D, B41, B42		

screw-on/push-on fit

neon light bulbs

			
1			
GEV No.	359000	Ref. No.	130138 870050
description	neon light bulb socket Ba9s 24V 3W clear ø 10mm L 24mm		
For models:	AC100, AC120, AC122, AC135, AC150, AC151, AC152, AC170, AC181, AC182, AC200, AC201, AC202, AC241, AC242, AC90, ACR, ACR145, ACR205, ACR225, ACR245, ACR260, ACR265, ACR305, GMC, GMC2700, GMC3500, GMC4500, GMC5500, LAV1000, LV1001, LV1501, LV-LVP, LVP1001, LVP1501, NE00, NG00, NG600, NG600E, NG900, NG900E, SE, SNL		
accessories for	359000		
	GEV No.	359060	Ref. No. —
	lamp socket mounting measurements ø16.2mm socket E10 connection screw		
	GEV No.	359063	Ref. No. —
	lamp socket mounting measurements ø19.2mm socket E14 connection screw		
	GEV No.	359064	Ref. No. —
	lamp socket mounting measurements ø22.3mm socket E14 connection screw 250/380V ambient temperature at 1W 100°C ambient temperature at 2W 85°C		
	GEV No.	359685	Ref. No. —
	lamp socket mounting measurements ø16.2mm socket E10		
	GEV No.	359832	Ref. No. —
	lamp socket mounting measurements ø16.2mm socket Ba9s connection male faston 6.3mm		
	GEV No.	359853	Ref. No. —
	lamp socket mounting measurements ø18.2mm socket Ba9s connection male faston 6.3mm		
	GEV No.	359988	Ref. No. —
	lamp socket mounting measurements ø30.5mm 250V connection F6.3 temp.-resist. 55°C E14		

timers

programme timers

			
1			
GEV No.	400934	Ref. No.	121279
description	electronic timer engines chambers operation timeV		
For models:	BHC30E, BHC30EA, FC54E, FC54EA		





1

GEV No.	360048	Ref. No.	120256 120269 120269A
description	timer CDC 4904DV/4905DV engines 2 chambers 5 operation time 4s / 180s 230V shaft ømm shaft Lmm motor type M48L ATS		
For models:	F55, F65, F80, LF320, LF320A, LF320LA, LF323, LF323A, LF350, LF350A		
spare parts for	360048		
	GEV No.	360083	Ref. No. —
	motor CDC pinion ø 4.9mm teeth 10 230V turn direction left motor ø 47mm H 19.3mm motor type M48L ATS for timer		



1

GEV No.	360047	Ref. No.	120268
description	timer CDC 4905DV engines 2 chambers 5 operation time 4s / 150s 230V shaft ømm shaft Lmm manif. no. 4905DV / 360047 motor type M48L ATS		
For models:	F55, F65, F80, LF320, LF320A, LF320LA, LF323, LF323A, LF350, LF350A		
spare parts for	360047		
	GEV No.	360083	Ref. No. —
	motor CDC pinion ø 4.9mm teeth 10 230V turn direction left motor ø 47mm H 19.3mm motor type M48L ATS for timer		





1

GEV No.	360449	Ref. No.	121231
description	timer CDC 4905DV engines 2 chambers 5 230V 50Hz motor type M48R ATS / M48L ATN voltage AC run-time 4/360s		
For models:	F90M, F90MA		





1

GEV No.	360085	Ref. No.	120256
description	timer CDC 4905DV engines 2 chambers 5 run-time 180s		
For models:	F20		
spare parts for	360085		
	GEV No.	360083	Ref. No. —
	motor CDC pinion ø 4.9mm teeth 10 230V turn direction left motor ø 47mm H 19.3mm motor type M48L ATS for timer		





1

GEV No.	360049	Ref. No.	120270
description	timer CDC 4905DV engines 2 chambers 5 operation time 4s / 120s 230V shaft ømm shaft Lmm manif. no. 4905DV / 360049 motor type M48L ATS		
For models:	F55, F65, F80, LF320, LF320A, LF320LA, LF323, LF323A, LF350, LF350A, LF450, LF450A		
spare parts for	360049		
	GEV No.	360083	Ref. No. —
	motor CDC pinion ø 4.9mm teeth 10 230V turn direction left motor ø 47mm H 19.3mm motor type M48L ATS for timer		





1

GEV No.	360285	Ref. No.	121220
description	timer CDC 7805F engines 1 chambers 5 operation time 18min 230V manif. no. 7805 / 121220C motor type M37RN		
For models:	BC25HR, BC30HRA		
spare parts for	360285		
	GEV No.	360119	Ref. No. —
	motor CDC pinion ø 5.4mm teeth 12 230V turn direction right motor ø 37mm motor type M37RN for timer		



1

GEV No.	360006	Ref. No.	120213
description	timer CEM HFD2M16 engines 1 chambers 2 operation time 120s 230V shaft ø 5x5mm shaft L 24mm manif. no. HFD2M16 / 120213 motor type UDS11NE1LH		
For models:	B20, B20D, B23, B24, B25, B26, B27		
spare parts for	360006		
	GEV No.	360113	Ref. No. —
	motor SAIA pinion ø 4mm teeth 12 230V turn direction left motor ø 48mm motor type UDS11NE1LHZ for timer		



1

GEV No.	360011	Ref. No.	120225
description	timer CEM HH3M16 engines 1 chambers 3 operation time 120s 230V manif. no. HH3M16 / 120225 motor type UDS40NE1RNZ165		
For models:	B10, B11, B12, B15, B16, B18, B19		
spare parts for	360011		
	GEV No.	360112	Ref. No. —
	motor SAIA pinion ø 4mm teeth 12 230V turn direction right motor ø 48mm motor type UDS11NE1RHZ for timer		

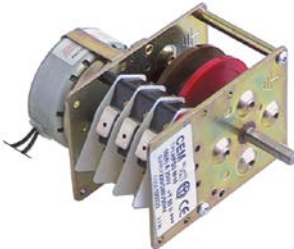

1

GEV No.	360013	Ref. No.	120222
description	timer CEM HFD3M16 engines 1 chambers 3 operation time 360s 230V shaft ø 5x5mm shaft L 22mm manif. no. HFD3M16 / 120222 motor type UDS11NE1LH		
spare parts for	360013		
	GEV No.	360113	Ref. No. —
	motor SAIA pinion ø 4mm teeth 12 230V turn direction left motor ø 48mm motor type UDS11NE1LHZ for timer		

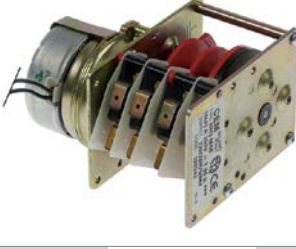



1

GEV No.	360542	Ref. No.	120243
description	timer CEM HH3M16 engines 1 chambers 3 operation time 120s 230V shaft ømm shaft Lmm motor type UDS11NE1RHZ210 type HH3M16 / 120243 voltage AC		





1

GEV No.	360028	Ref. No.	DTB45
description	timer CEM HFD4M16 engines 1 chambers 4 operation time 270s 230V shaft ø 6x4.6mm shaft L 17mm manif. no. HFD4M16 / DTP15 motor type UDS11NE1RH		
spare parts for	360028		
	GEV No.	360112	Ref. No. —
	motor SAIA pinion ø 4mm teeth 12 230V turn direction right motor ø 48mm motor type UDS11NE1RHZ for timer		





1

GEV No.	360012	Ref. No.	120220
description	timer CEM HH3M16 engines 1 chambers 3 operation time 150s 230V shaft ømm shaft Lmm manif. no. HH3M16 / 120220 motor type UDS11NE1RH		
For models:	R40		
spare parts for	360012		
	GEV No.	360112	Ref. No. —
	motor SAIA pinion ø 4mm teeth 12 230V turn direction right motor ø 48mm motor type UDS11NE1RHZ for timer		



1

GEV No.	360008	Ref. No.	120212
description	timer CEM HH3M16 engines 1 chambers 3 operation time 180s 230V manif. no. HH3M16 / 120212 motor type UDS11NE1RH		
For models:	F300		
spare parts for	360008		
	GEV No.	360112	Ref. No. —
	motor SAIA pinion ø 4mm teeth 12 230V turn direction right motor ø 48mm motor type UDS11NE1RHZ for timer		



1

GEV No.	360080	Ref. No.	120277
description	timer CEM HH3M16 engines 1 chambers 3 operation time 20min 230V manif. no. HH3M16 / 120277 motor type UDS11NE1RH		
For models:	LBC210, LBC215, LBC215A, LBC275, LBC275A, LBR, LBR215, LBR215A		
spare parts for	360080		
	GEV No.	360112	Ref. No. —
	motor SAIA pinion ø 4mm teeth 12 230V turn direction right motor ø 48mm motor type UDS11NE1RHZ for timer		





1

GEV No.	360009	Ref. No.	120224
description	timer CEM HH3M16 engines 1 chambers 3 operation time 60s 230V manif. no. HH3M16 / 120224 motor type UDS11NE1RH		
spare parts for	360009		
	GEV No.	360112	Ref. No. —
	motor SAIA pinion ø 4mm teeth 12 230V turn direction right motor ø 48mm motor type UDS11NE1RHZ for timer		





1

GEV No.	360010	Ref. No.	120228
description	timer CEM HH3M16 engines 1 chambers 3 operation time 90s 230V manif. no. HH3M16 / 120228 motor type UDS11NE1RH		
spare parts for	360010		
	GEV No.	360112	Ref. No. —
	motor SAIA pinion ø 4mm teeth 12 230V turn direction right motor ø 48mm motor type UDS11NE1RHZ for timer		



1

GEV No.	360043	Ref. No.	120243 120262
description	timer CEM HH4M16 engines 1 chambers 4 operation time 120s 230V shaft ømm shaft Lmm manif. no. HH4M16 / 120262 motor type UDS11NE1RH		
For models:	B10T, B11T, B12T, B13T, B14T, B15T, B15TM, B16T, B16TM, B18T, B18TM, B19T, B19TM, LBC210, LBC215, LBC215A, LBC275, LBC275A, LBR, LBR200, LBR215, LBR215A		
spare parts for	360043		
	GEV No.	360112	Ref. No. —
	motor SAIA pinion ø 4mm teeth 12 230V turn direction right motor ø 48mm motor type UDS11NE1RHZ for timer		



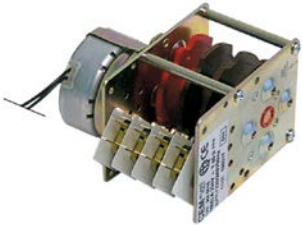

1

GEV No.	360044	Ref. No.	120263 120264
description	timer CEM HH4M16 engines 1 chambers 4 operation time 150s 230V shaft ømm shaft Lmm manif. no. HH4M16 / 120263 motor type UDS11NE1RH		
For models:	F45, LF280-lav-line, LF315, LF320-lav-line		
spare parts for	360044		
	GEV No.	360112	Ref. No. —
	motor SAIA pinion ø 4mm teeth 12 230V turn direction right motor ø 48mm motor type UDS11NE1RHZ for timer		





1

GEV No.	360015	Ref. No.	120217
description	timer CEM HH4M16 engines 1 chambers 4 operation time 180s 230V manuf. no. 120217 motor type UDS11NE1LH		
For models:	C30		
spare parts for	360015		
	GEV No.	360113	Ref. No. —
	motor SAIA pinion \varnothing 4mm teeth 12 230V turn direction left motor \varnothing 48mm motor type UDS11NE1LHZ for timer		



1

GEV No.	360014	Ref. No.	120214
description	timer CEM HH4M16 engines 1 chambers 4 operation time 20min 230V manuf. no. HH4M16 / 120214 motor type UDS11NE1RH		
For models:	B12, B12T, B14T, B15T, B15TM, B16, B16T, B16TM, B18T, B18TM, B19, B19T, B19TM, B25, B27		
spare parts for	360014		
	GEV No.	360112	Ref. No. —
	motor SAIA pinion \varnothing 4mm teeth 12 230V turn direction right motor \varnothing 48mm motor type UDS11NE1RHZ for timer		



1

GEV No.	360668	Ref. No.	121208
description	timer CEM HL5M16 engines 2 chambers 5 operation time 40s / 150s 230V shaft \varnothing mm shaft Lmm		
For models:	FC, FC533, FC533A, FC543, FC543A, FC544, FC544A		





1

GEV No.	360478	Ref. No.	120235
description	timer FIBER P25 engines 1 chambers 3 operation time 100s 230V shaft \varnothing mm shaft Lmm motor type M51BJ0R2200		





1

GEV No.	360046	Ref. No.	120267
description	timer FIBER P25 engines 2 chambers 6 operation time 60s / 85s / 120s 230V shaft \varnothing mm shaft Lmm manuf. no. P255J06JD58 motor type M51BJ0R6400 / M51BJ0L6400		
For models:	C140, C155, LC1200, LC400, LC412, LC700, LC900		
spare parts for	360046		
	GEV No.	360673	Ref. No. —
	motor kit pinion \varnothing 6.8mm teeth 15 230V voltage AC 50/60Hz turn direction clockwise motor \varnothing 48mm H 18.5mm motor type UDS40NE1RNZ165 cable length 150mm with holder		
	GEV No.	360674	Ref. No. —
	motor kit pinion \varnothing 6.8mm teeth 15 230V voltage AC 50/60Hz turn direction counterclockwise motor \varnothing 48mm H 18.5mm motor type UDS40NE1RNZ165 cable length 150mm with holder		





1

GEV No.	360050	Ref. No.	120275
description	timer FIBER P25 engines 2 chambers 6 operation time 6s / 3min 230V 50/60Hz shaft \varnothing mm shaft Lmm manuf. no. P255J06JB61 motor type M51BJ0R6400 / M51BJ0L6400		
For models:	C70, C75M, LC1200, LC700, LC900, LP360		
spare parts for	360050		
	GEV No.	360673	Ref. No. —
	motor kit pinion \varnothing 6.8mm teeth 15 230V voltage AC 50/60Hz turn direction clockwise motor \varnothing 48mm H 18.5mm motor type UDS40NE1RNZ165 cable length 150mm with holder		
	GEV No.	360674	Ref. No. —
	motor kit pinion \varnothing 6.8mm teeth 15 230V voltage AC 50/60Hz turn direction counterclockwise motor \varnothing 48mm H 18.5mm motor type UDS40NE1RNZ165 cable length 150mm with holder		



1

GEV No.	360287	Ref. No.	121218
description	timer FIBER P25 engines 2 chambers 6 operation time 6s / 3min 230V shaft ømm shaft Lmm manuf. no. P255J06JBG6 motor type M51B-J0R6400 / M51BJ0L6400		
For models:	C95, LC380		
spare parts for	360287		
	GEV No.	360673	Ref. No. —
	motor kit pinion ø 6.8mm teeth 15 230V voltage AC 50/60Hz turn direction clockwise motor ø 48mm H 18.5mm motor type UDS-40NE1RNZ165 cable length 150mm with holder		
	GEV No.	360674	Ref. No. —
	motor kit pinion ø 6.8mm teeth 15 230V voltage AC 50/60Hz turn direction counterclockwise motor ø 48mm H 18.5mm motor type UDS40NE1RNZ165 cable length 150mm with holder		



1

GEV No.	360086	Ref. No.	120279
description	timer FIBER P26 engines 1 chambers 4 operation time 120s 230V shaft ømm shaft Lmm manuf. no. P265J04H315 motor type M61B40R6400		
For models:	BC25, BC25A, BC30, BC30A, BHC25, BHC25A, BHC25S, BHC30, BHC30A, BR20, BR20A, BR25, BR25A		



1

GEV No.	360286	Ref. No.	120296
description	timer FIBER P26 engines 1 chambers 4 operation time 120s 230V shaft ømm shaft Lmm manuf. no. P265J04H323 motor type M61B40R6400 / 110V		
For models:	BC25HR, BC30HR, BC30HR380		



1

GEV No.	360041	Ref. No.	120290
description	timer FIBER P26 engines 1 chambers 3 operation time 120s 230V shaft ømm shaft Lmm manuf. no. P265J03H322 motor type M61B40R6400 / M61B40L6400		
For models:	BHC25, BHC25A, BHC25S, BHC30, BHC30A, BHC433, BHC433A, F90M, F90MA, FC, FC43, FC53, FC533, FC533A, FC53A, FC54, FC543, FC543A, FC543E, FC543EA, FC544, FC544A, FC54A, LF315, LF320, LF320A, LF320LA, LF323, LF323A, LF350, LF350A, LF450, LF450A		



1

GEV No.	360288	Ref. No.	121217
description	timer FIBER P26 engines 2 chambers 5 operation time 3min/40s 230V manuf. no. P265J05JK42 motor type M61B40R6400 / M61B40L6400		
For models:	FC, FC53, FC53A, FC54, FC54A		



1

GEV No.	360087	Ref. No.	120291
description	timer FIBER P26 engines 1 chambers 3 operation time 20min 230V shaft ømm shaft Lmm manuf. no. P265J03L130 motor type M61B40R6400		
For models:	BC25A, BC30A, BHC25A, BHC30A, BHC433A, BR20A, BR25A, F90M, F90MA, FC, FC43A, FC53, FC533, FC533A, FC53A, FC54, FC543, FC543A, FC544, FC544A, FC54A, LF320, LF320A, LF320LA, LF323, LF323A, LF350, LF350A, LF450, LF450A		



1

GEV No.	360088	Ref. No.	120292
description	timer FIBER P26 engines 2 chambers 5 operation time 40s / 3min 230V manuf. no. P265J05JK18 motor type M61B40R6400 / M61B40L6400		
For models:	BHC433, BHC433A, FC, FC43, FC43A, FC53, FC53A, FC54, FC54A		



1

GEV No.	360516	Ref. No.	120209 120266/B
description	timer run-time 75/120/180s engines 2 chambers 6 CEM 230V 50/60Hz		

digital timers

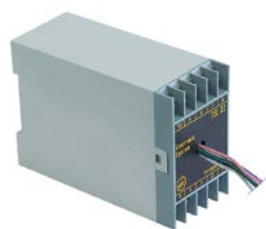

1

GEV No.	400945	Ref. No.	120226
description	timer electronic		
For models:	G131, G66		



1

GEV No.	400946	Ref. No.	120254
description	timer electronic		
For models:	G100L, G101L, G115, G115L, G125, G125L, G50L, G50LM, G51L, G60L, G61L, G65, G65L, G75, G75L, GL		

alarm devices

alarm units



1

GEV No.	350158	Ref. No.	120925
description	alarm device 24VAC ø 105mm H 63.5mm screw mounting mounting ø 114 95dB		
For models:	LAV1000, NE02, NE3001, NE3002, NE4001, NE4002, NE5002, NE5501, NE5502, NE7002, NE7501, NE7502, NE9001, NE9002, NE9502, NG01, NG02, NG1202, NG1202E, NG601, NG601E, NG602, NG602E, NG901, NG901E, NG902, NG902E		

contactors

ABB

power contactors



1

GEV No.	381141	Ref. No.	120474
description	power contactor resistive load 100A 24VAC (AC3/400V) 22kW main contacts 3NO connection screw connection type A50-30-00		
For models:	AC101, AC122, AC151, AC152, AC181, AC182, AC201, AC202, AC241, AC242, AC91, ACS101, ACS101-DIGIT, ACS122, ACS122-DIGIT, ACS151, ACS151-DIGIT, ACS152, ACS152-DIGIT, ACS161-DIGIT, ACS162-DIGIT, ACS181, ACS181-DIGIT, ACS182, ACS182-DIGIT, ACS201, ACS201-DIGIT, ACS202, ACS202-DIGIT, ACS241, ACS241-DIGIT, ACS242, ACS242-DIGIT, ACS91, ACS91-DIGIT, NE02, NE3002, NE4002, NE5002, NE5502, NE7002, NE7502, NE9002, NE9502, NG02, NG1202, NG1202E, NG602, NG602E, NG902...(Other models you can see in the webshop)		



1

GEV No.	380106	Ref. No.	120468
description	power contactor resistive load 25A 24VAC (AC3/400V) 9A/4kW main contacts 3NO auxiliary contacts 1NO connection screw connection type A9-30-10		
For models:	AC101, AC122, AC151, AC152, AC181, AC182, AC201, AC202, AC241, AC242, AC2A, AC91, ACL100, ACL150, ACRS145, ACRS205, ACRS225, ACRS245, ACRS260, ACRS265, ACRS305, ACS101, ACS101-DIGIT, ACS122, ACS122-DIGIT, ACS151, ACS151-DIGIT, ACS152, ACS152-DIGIT, ACS161-DIGIT, ACS162-DIGIT, ACS181, ACS181-DIGIT, ACS182, ACS182-DIGIT, ACS201, ACS201-DIGIT, ACS202, ACS202-DIGIT, ACS241, ACS241-DIGIT, ACS242, ACS242-DIGIT, ACS91, ACS91-DIGIT, GMC2702, GMC3502, GMC4502, GMC5502, LAV1000...(Other models you can see in the webshop)		

auxiliary contacts with time control



1

GEV No.	381179	Ref. No.	130929
description	auxiliary contact contacts 1NO/1NC connection screw connection for contactors A9-A75 run-time 0.1-40s		
For models:	AC122, AC151, AC152, AC181, AC182, AC201, AC202, AC241, AC242, ACR, ACR145, ACR205, ACR225, ACR245, ACR260, ACR265, ACR305, ACS101, ACS101-DIGIT, ACS122, ACS122-DIGIT, ACS151, ACS151-DIGIT, ACS152, ACS152-DIGIT, ACS161-DIGIT, ACS162-DIGIT, ACS181, ACS181-DIGIT, ACS182, ACS182-DIGIT, ACS201, ACS201-DIGIT, ACS202, ACS202-DIGIT, ACS241, ACS241-DIGIT, ACS242, ACS242-DIGIT, ACS91, ACS91-DIGIT, GMC, GMC2700, GMC3500, GMC4500, GMC5500, LAV1001, LAV1501, NL302, NL302E...(Other models you can see in the webshop)		

motor protection circuit breakers



1

GEV No.	381142	Ref. No.	121032
description	motor protection circuit breaker type MS225-4.0 setting range 2.5-4A (AC3/380V) 1.5kW contacts 3NO		
For models:	NE02, NE3002, NE4002, NE5002, NE5502, NE7002, NE7502, NE9002, NE9502, NG02, NG1202, NG1202E, NG602, NG602E, NG902, NG902E		

GENERAL ELECTRIC (AEG)

power contactors



1

GEV No.	380245	Ref. No.	120438
description	power contactor resistive load 25A 230VAC (AC3/400V) 9A/4kW main contacts 3NO auxiliary contacts 1NC connection screw connection type AEG LS4K 01A type GE CL00A 301 H 85mm		



1

GEV No.	380244	Ref. No.	120438
description	power contactor resistive load 25A 230VAC (AC3/400V) 9A/4kW main contacts 3NO auxiliary contacts 1NO connection screw connection type AEG LS4K 10A type GE CL00A 310		



1

GEV No.	380248	Ref. No.	120429
description	power contactor resistive load 25A 24VAC (AC3/400V) 9A/4kW main contacts 3NO auxiliary contacts 1NO connection screw connection type AEG LS4K 10A type GE CL00A 310		
For models:	AC120, AC150, AC170, AC200, ACR, ACR145, ACR205, ACR225, ACR245, ACR260, ACR265, ACR305, ACRS145, ACRS205, ACRS225, ACRS245, ACRS260, ACRS265, ACRS305, G100L, G101L, G115, G115L, G125, G125L, G131, G50L, G50LM, G51L, G60L, G61L, G65, G65L, G66, G75, G75L, GL, GMC, GMC2700, GMC2702, GMC3500, GMC3502, GMC4500, GMC4502, GMC5500, GMC5502, NE00, NE3001, NE4001, NE5501...(Other models you can see in the webshop)		



1

GEV No.	380262	Ref. No.	120435
description	power contactor resistive load 32A 230VAC (AC3/400V) 17A/7.5kW main contacts 3NO auxiliary contacts 1NC connection screw connection type AEG LS7K01A type GE CL02A 301 H 85mm		
For models:	C33, C34		



ISKRA (FANAL)

power contactors



1

GEV No.	380212	Ref. No.	120461
description	power contactor resistive load 20A 230VAC (AC3/400V) 8.5A/5.5kW main contacts 3NO auxiliary contacts 1NC connection screw connection type Fanal K07M 01 type ISKRA DSL7 01		
For models:	BC25HR, BC30HR, BC30HR380, BC30HRA, BHC30E, BHC30E-2, BHC30EA, BHC30EA-2, BHC30HR, BHC30HR-2, BHC30HR380, BHC30HRA, BHC30HRA-2, BHC30HRA380, BHC433, BHC433-2, BHC433A, BHC433A-2, BHCHR, FC, FC3E, FC3EA, FC3M, FC3MA, FC3MR, FC44E, FC44EA, FC4E, FC4EA, FC4EHRT, FC4M, FC4MA, FC533, FC533A, FC53A, FC543, FC543A, FC543E, FC543EA, FC544, FC544A, FC54A, FCHR, FCHRA, FCHRT, FCHRTA, GF70, GF70A, GF90, GF90-2004... (Other models you can see in the webshop)		

LOVATO

power contactors



1

GEV No.	380083	Ref. No.	120444 120481
description	power contactor resistive load 25A 230VAC (AC3/400V) 9A/4.2kW main contacts 3NO auxiliary contacts 1NC connection screw connection type BF0901A230		
For models:	C1000E, C1000ERCD, C1001M, C1300E, C1300ERCD, C1301M, C140, C155, C155BT, C155E2, C155RCD, C165, C165E2, C165E2BT, C165E2RCD, C166, C166-2, C70, C75, C75BT, C75M, C75RCD, C85, C95, C95BT, C95E2, C95RCD, F55, F65, F80, F90M, F90MA, FC54E, FC54EA, GE50RCD, LC1200, LC1200RCD, LC380, LC380BT, LC380RCD, LC400, LC412, LC700, LC700RCD, LC900, LC900RCD, LF320, LF320A, LF320LA, LF323... (Other models you can see in the webshop)		

TELEMECANIQUE (Schneider Electric)

power contactors



1

GEV No.	381144	Ref. No.	120441
description	power contactor resistive load 125A 24VAC (AC3/400V) 80A/45kW main contacts 3NO auxiliary contacts 1NC/1NO connection screw connection type LC1D8011B7		
For models:	AC120, AC150, AC170, AC200, ACR, ACR145, ACR205, ACR225, ACR245, ACR260, ACR265, ACR305, ACRS145, ACRS205, ACRS225, ACRS245, ACRS260, ACRS265, ACRS305, GMC, GMC2700, GMC2702, GMC3500, GMC3502, GMC4500, GMC4502, GMC5500, GMC5502, NE3001, NE4001, NE5501, NE7501, NE9001, NG01, NG601, NG601E, NG901, NG901E		



1

GEV No.	380820	Ref. No.	120434
description	power contactor resistive load 25A 230VAC (AC3/400V) 9A/4kW main contacts 3NO auxiliary contacts 1NO/1NC connection screw connection type LC1D0900M7		
For models:	C155, C155BT, C155E2, C155RCD, C165, C165E2, C165E2BT, C165E2RCD, C166, C166-2, C30, C33, C34, C95, C95BT, C95E2, C95RCD, F2, F3, LC1200, LC380, LC380BT, LC380RCD, LC400, LC700, LC900, R40, R50, R70		



1

GEV No.	380617	Ref. No.	120428
description	power contactor resistive load 25A 24VAC (AC3/400V) 9A/4kW main contacts 3NO auxiliary contacts 1NO/1NC connection screw connection type LC1D09B7		
For models:	AC100, AC105, AC120, AC135, AC150, AC170, AC200, AC2A, AC95, ACL100, ACL150, ACR, ACR145, ACR205, ACR225, ACR245, ACR260, ACR265, ACR305, ACRS145, ACRS205, ACRS225, ACRS245, ACRS260, ACRS265, ACRS305, G100L, G101L, G115, G115L, G125, G125L, G131, G50L, G50LM, G51L, G60L, G61L, G65, G65L, G66, G75, G75L, GL, GMC, GMC2700, GMC2702, GMC3500, GMC3502, GMC4500... (Other models you can see in the webshop)		



auxiliary contacts



1			
GEV No.	381143	Ref. No.	130908
description	auxiliary contact contacts 2NC AC15 10A connection screw type LA1DN02		
For models:	ACRS145, ACRS205, ACRS225, ACRS245, ACRS260, ACRS265, ACRS305, GMC2702, GMC3502, GMC4502, GMC5502, LAV1001, LAV1501, NL302, NL302E, NL402, NL402E, NL502, NL502E, NL552, NL552E		

auxiliary contacts with time control



1			
GEV No.	381145	Ref. No.	130913
description	auxiliary contact contacts 1NC/1NO AC15 10A connection screw type LADT2 time delay 0.1-30s		

relays

power relays

with flange mounting



1			
GEV No.	380131	Ref. No.	120459
description	power relays Italiana Relè 230VAC 16A 3CO connection male faston 6.3mm screw mounting manuf. no. B2-3-230AC		
For models:	BC25HR, BC30HR, BC30HR380, BC30HRA, C1000E, C1000ERCD, C1001M, C1300E, C1300ERCD, C1301M, C155, C155E2, C165E2, C165E2BT, C165E2RCD, C166-2, C75, C75M, C95, C95E2, FC3MA, FC4EHRT, FC4MA, GE100, GE115, GE125, GE50RCD, GE60, GE60RCD, GE65, GE65RCD, GE75, GE80, LC1200, LC1200RCD, LC380, LC380BT, LC380RCD, LC400, LC412, LC700, LC700RCD, LC900, LC900RCD, LF322RCD, LFD32E, LFD32EA, LP360, XLC		

with bracket mounting

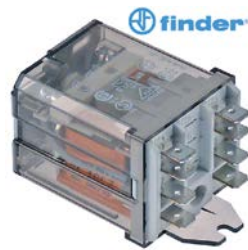

1			
GEV No.	380139	Ref. No.	120460
description	power relays FINDER 230VAC 16A 2CO connection F6.3 bracket mounting dimensions 68x38.2x35.8mm manuf. no. 62.82.8.230.0000		



1			
GEV No.	380403	Ref. No.	120447
description	power relays FINDER 230VAC 16A 3CO connection F6.3 bracket mounting manuf. no. 62.83.8.230.0500		
For models:	C140, C70, C85, GE100, GE115, GE60, GE65, GE80		



1			
GEV No.	380404	Ref. No.	120445
description	power relays FINDER 24VAC 16A 3CO connection male faston 6.3mm bracket mounting manuf. no. 62.83.8.024.0500		
For models:	AC100, AC101, AC105, AC120, AC122, AC135, AC150, AC151, AC152, AC170, AC181, AC182, AC200, AC201, AC202, AC241, AC242, AC2A, AC91, AC95, ACL100, ACL150, ACR, ACR145, ACR205, ACR225, ACR245, ACR260, ACR265, ACR305, ACRS145, ACRS205, ACRS225, ACRS245, ACRS260, ACRS265, ACRS305, ACS101, ACS101-DIGIT, ACS122, ACS122-DIGIT, ACS151, ACS151-DIGIT, ACS152, ACS152-DIGIT, ACS161-DIGIT, ACS162-DIGIT, ACS181, ACS181-DIGIT, ACS182... (Other models you can see in the webshop)		



1



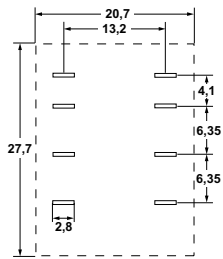

GEV No.	380311	Ref. No.	120460
description	power relays Italiana Relè 230VAC 20A 1NC/1NO connection F6.3 bracket mounting manuf. no. A1B-230AC-FA		
For models:	BHC30E, BHC30EA, BHC30HR, BHC30HR380, BHC30HRA, BH-C30HRA380, BHCHR, C1000E, C1000ERCD, C1001M, C1300E, C1300ERCD, C1301M, FC, FC3EA, FC3MA, FC44EA, FC4EA, FC4MA, FC53, FC533, FC533A, FC53A, FC54, FC543, FC543A, FC544, FC544A, FC54A, FC54E, FC54EA, GE100, GE115, GE125, GE60, GE60RCD, GE65, GE65RCD, GE75, GE80, LC1200, LC1200RCD, LC700, LC700RCD, LC900, LC900RCD, LF322RCD, XLC		

with male contacts

female contact 2.0mm

1

GEV No.	380129	Ref. No.	120449
description	power relays 24VAC 12A 2CO connection F2 plug-in connection 94.92.3 250V connection 2mm		
accessories for	380129		
	GEV No.	380341	Ref. No. —
	relay socket 4-pole contacts 12 300V voltage AC 6A Italiana Relè manuf. no. ZMD4		
	GEV No.	380378	Ref. No. —
	relay socket 2-pole 55/85 dimensions 70.5x30x27mm 250V voltage AC 10A FINDER manuf. no. 94.72		
	GEV No.	380384	Ref. No. —
	relay socket 2-pole contacts male faston 2.8mm 250V voltage AC 10A W 23mm for		
	GEV No.	380399	Ref. No. —
	relay socket 4-pole dimensions 76.2x27x86.1mm 250V voltage AC 1A FINDER manuf. no. 94.94.3		

1

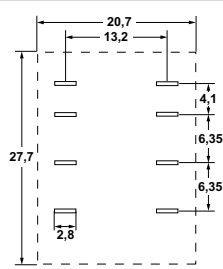
GEV No.	380377	Ref. No.	120479
description	power relays FINDER 220-240VAC 10A 2CO connection F2 plug-in connection manuf. no. 55.32.8.230.0000 94.92.3 250V		
For models:	ACS101, ACS101-DIGIT, ACS122, ACS122-DIGIT, ACS151, ACS151-DIGIT, ACS152, ACS152-DIGIT, ACS161-DIGIT, ACS162-DIGIT, ACS181, ACS181-DIGIT, ACS182, ACS182-DIGIT, ACS201, ACS201-DIGIT, ACS202, ACS202-DIGIT, ACS241, ACS241-DIGIT, ACS242, ACS242-DIGIT, ACS91, ACS91-DIGIT		
accessories for	380377		
	GEV No.	380341	Ref. No. —
	relay socket 4-pole contacts 12 300V voltage AC 6A Italiana Relè manuf. no. ZMD4		
	GEV No.	380378	Ref. No. —
	relay socket 2-pole 55/85 dimensions 70.5x30x27mm 250V voltage AC 10A FINDER manuf. no. 94.72		
	GEV No.	380384	Ref. No. —
	relay socket 2-pole contacts male faston 2.8mm 250V voltage AC 10A W 23mm for		
	GEV No.	380399	Ref. No. —
	relay socket 4-pole dimensions 76.2x27x86.1mm 250V voltage AC 1A FINDER manuf. no. 94.94.3		

plug-in/print relays



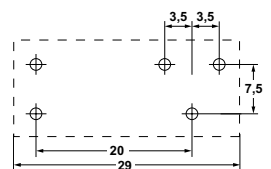



1

GEV No.	380634	Ref. No.	120465
description	print relay 12VDC 1CO at 250V 12A connection pins raster size 3.5mm FINDER manuf. no. 41.31.9.012.0000 95.83.3/95.63		
For models:	FC, FC543E, FC543EA, FCHR, FCHRA, FCHRT, FCHRTA		
accessories for	380634		
	GEV No.	380663	Ref. No. —
	relay socket 250V voltage AC 10A FINDER manuf. no. 95.83.3		

1

GEV No.	380335	Ref. No.	120478
description	print relay 230VAC 1CO at 250V 16A connection pins raster size 5mm Italiana Relè manuf. no. 40.61.8.230.0000 95.65/95.75		
accessories for	380335		
	GEV No.	380340	Ref. No. —
	relay socket dimensions 62x36x15mm 250V voltage AC 10A Italiana Relè manuf. no. ZMEM/5		
	GEV No.	380505	Ref. No. —
	relay socket 2CO 40.52 dimensions 81.9x15.5x75mm 250V voltage AC 10A FINDER manuf. no. 95.95.3		
	GEV No.	381181	Ref. No. —
	relay socket 2-pole 40.51/40.52/40.61 connection screw clamp dimensions 15.8x78.6mm 250V voltage AC 10A FINDER manuf. no. 95.75		





1

GEV No.	380853	Ref. No.	120476
description	print relay 24VAC 1CO at 250V 16A connection pins raster size 5mm FINDER manuf. no. 40.61.8.024.0000 95.65/95.75		
For models:	AC122, AC151, AC152, AC181, AC182, AC201, AC202, AC241, AC242, ACRS145, ACRS205, ACRS225, ACRS245, ACRS260, ACRS265, ACRS305, ACS101, ACS101-DIGIT, ACS122, ACS122-DIGIT, ACS151, ACS151-DIGIT, ACS152, ACS152-DIGIT, ACS161-DIGIT, ACS162-DIGIT, ACS181, ACS181-DIGIT, ACS182, ACS182-DIGIT, ACS201, ACS201-DIGIT, ACS202, ACS202-DIGIT, ACS241, ACS241-DIGIT, ACS242, ACS242-DIGIT, ACS91, ACS91-DIGIT, GMC2702, GMC3502, GMC4502, GMC5502, LAV1000, LAV1001, LAV1501, NG02, NG1202, NG1202E... (Other models you can see in the webshop)		



1

GEV No.	380633	Ref. No.	120480
description	print relay 24VDC 1CO at 250V 16A connection pins raster size 5mm Italiana Relè manuf. no. E61-24DC-S 95.65/95.75		
For models:	FC53LA, GF90, GF90A, LF320L, LF320LA, LF400A		
accessories for	380633		
	GEV No.	380340	Ref. No. —
	relay socket dimensions 62x36x15mm 250V voltage AC 10A Italiana Relè manuf. no. ZMEM/5		
	GEV No.	380505	Ref. No. —
	relay socket 2CO 40.52 dimensions 81.9x15.5x75mm 250V voltage AC 10A FINDER manuf. no. 95.95.3		

accessories for 380633

	GEV No.	381181	Ref. No.	—
	relay socket 2-pole 40.51/40.52/40.61 connection screw clamp dimensions 15.8x78.6mm 250V voltage AC 10A FINDER manuf. no. 95.75			

pulse relays



1

GEV No.	381195	Ref. No.	120493
description	pulse relay voltage AC/DC 1CO 250V 16A connection screw clamp DIN rail		
For models:	AC2A, ACL100, ACL150, ACS101, ACS101-DIGIT, ACS122, ACS122-DIGIT, ACS151, ACS151-DIGIT, ACS152, ACS152-DIGIT, ACS161-DIGIT, ACS162-DIGIT, ACS181, ACS181-DIGIT, ACS182, ACS182-DIGIT, ACS201, ACS201-DIGIT, ACS202, ACS202-DIGIT, ACS241, ACS241-DIGIT, ACS242, ACS242-DIGIT, ACS91, ACS91-DIGIT, LAV1001, LAV1501, NL302, NL302E, NL402, NL402E, NL502, NL502E, NL552, NL552E		

time relays



1

GEV No.	381157	Ref. No.	120227
description	time relay FINDER TF24 time range 0.1-60 s 115-230VAC 2CO connection plug-in connection round 8-pole with socket		
For models:	G131, G66		

transformers

open transformers

with clamp terminal



1

GEV No.	400947	Ref. No.	120608
description	transformer primary 220/230-240-380/400-415V secondary 12-24V 150VA secondary 4.17A 50/60Hz		
For models:	AC100, AC105, AC90, AC95, G100L, G101L, G115, G115L, G125, G125L, G131, G50L, G50LM, G51L, G60L, G61L, G65, G65L, G75, G75L, GL, SNL		



electric components

electronic controllers

ELIWELL

universal controllers

built-in version



GEV No.	379708	Ref. No.	450911
description	electronic controller ELIWELL type IC912/H 12-24AC/12-36DCV Pt100 with probe		
For models:	ACR, ACR145, ACR205, ACR225, ACR245, ACR260, ACR265, ACR305, GMC, GMC2700, GMC3500, GMC4500, GMC5500, NE00, NG00, NG600, NG600E, NG900, NG900E, SE		

accessories for	379708		
GEV No.	379050	Ref. No.	—
description	temperature probe Pt100 cable Vetrotex probe -200 up to +600°C cable -50 up to +350°C probe ø6x100mm cable length 2.7m without screw connection 3-wire		

GEV No.	379054	Ref. No.	—
description	transformer primary 230VAC secondary 12VAC 3VA secondary 0.25A H 40mm L 45mm W 50mm connection screw 50/60Hz type 153/M		

GEV No.	379058	Ref. No.	—
description	temperature probe Pt100 cable silicone probe -100 up to 450°C cable -50 up to +180°C probe ø6x100mm cable length 2.8m without screw connection 3-wire resistance at 0°C 1000hm		

GEV No.	379130	Ref. No.	—
description	temperature probe Pt100 cable Vetrotex probe -200 up to +600°C cable -50 up to +350°C probe ø6x100mm cable length 1.4m without screw connection 3-wire resistance at 0°C 1000hm		

GEV No.	379131	Ref. No.	—
description	temperature probe Pt100 cable Vetrotex probe -200 up to +600°C cable -50 up to +350°C probe ø6x85mm cable length 3m without screw connection 3-wire resistance at 0°C 1000hm		

GEV No.	379284	Ref. No.	—
description	temperature probe Pt100 cable Vetrotex probe -200 up to +600°C cable -50 up to +350°C probe ø6x100mm cable length 2m without screw connection 3-wire resistance at 0°C 1000hm		

GEV No.	400583	Ref. No.	—
description	transformer primary 230VAC secondary 24VAC 10VA secondary 0.4A connection screw 50Hz		



GEV No.	403095	Ref. No.	120613
description	transformer primary 220-240/380-415V secondary 12-24-28V 500VA connection screw clamp 50/60Hz		
For models:	LV1001, LV1501, LV-LVP, LVP1001, LVP1501, NE02, NE3001, NE3002, NE4001, NE4002, NE5002, NE5501, NE5502, NE7002, NE7501, NE7502, NE9001, NE9002, NE9502, NG00, NG01, NG600, NG600E, NG601, NG601E, NG900, NG900E, NG901, NG901E		

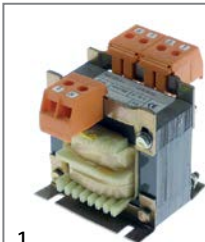

GEV No.	403092	Ref. No.	120641
description	transformer primary 24V secondary 12V 40VA H 77mm L 69mm W 91mm connection screw 50/60Hz		
For models:	NE02, NE3002, NE4002, NE5002, NE5502, NE7002, NE7502, NE9002, NE9502		

with plug connection



GEV No.	400049	Ref. No.	120605
description	transformer primary 115/200/400/440V secondary 230V 110VA connection screw 50/60Hz COMENDA		

power supplies

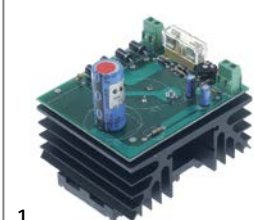

GEV No.	378305	Ref. No.	120647
description	power supply primary 24-30V secondary 24V H 84mm L 88mm W 76mm connection screw 50/60Hz 48W 2A		





probes

producer-specific probes

probes

1 

GEV No.	380938	Ref. No.	120910
description	probe Pt100 cable silicone probe -100 up to 450°C cable -50 up to +180°C connection plug thread 1/2" probe ø6x70mm cable length 6.5m		
For models:	AC122, AC151, AC152, AC181, AC182, AC201, AC202, AC241, AC242, ACR, ACR145, ACR205, ACR225, ACR245, ACR260, ACR265, ACR305, ACRS145, ACRS205, ACRS225, ACRS245, ACRS260, ACRS265, ACRS305, ACS161-DIGIT, ACS162-DIGIT, GMC, GMC2700, GMC2702, GMC3500, GMC3502, GMC4500, GMC4502, GMC5500, GMC5502, LAV1001, LAV1501, NE02, NE3001, NE3002, NE4001, NE4002, NE5002, NE5501, NE5502, NE7002, NE7501, NE7502, NE9001, NE9002...(Other models you can see in the webshop)		
accessories for	380938		
	GEV No.	510355	Ref. No. 460501
	gasket fibre ED ø 24mm ID ø 17mm thickness 2mm Qty 1 pcs		

1 

GEV No.	379904	Ref. No.	120952
description	temperature probe NTC 100kOhm cable silicone probe -40 up to +125°C cable -50 up to +180°C connection 2-wire thread probe ø7x25mm cable length 2.1m		
For models:	BHC30HR, BHC30HR380, BHC30HRA, BHC30HRA380, BHCHR		

1 

GEV No.	378006	Ref. No.	120960
description	temperature probe NTC 40kOhm cable PVC probe -40 up to +110°C cable -10 up to 100°C connection F6.3 thread probe ø4x20mm cable length 0.25m		
For models:	ACL100, ACL150, ACS101, ACS101-DIGIT, ACS122, ACS122-DIGIT, ACS151, ACS151-DIGIT, ACS152, ACS152-DIGIT, ACS161-DIGIT, ACS162-DIGIT, ACS181, ACS181-DIGIT, ACS182, ACS182-DIGIT, ACS201, ACS201-DIGIT, ACS202, ACS202-DIGIT, ACS241, ACS241-DIGIT, ACS242, ACS242-DIGIT, ACS91, ACS91-DIGIT, BHC30-2, BHC30A-2, BHC30E-2, BHC30EA-2, C1000E, C1000ERCD, C1300E, C1300ERCD, FC3E, FC3EA, FC44E, FC44EA, FC4E, FC4EA, FC4EHRT, GE100, GE115, GE125, GE50RCD, GE60, GE60RCD, GE65, GE65RCD, GE75...(Other models you can see in the webshop)		

1 

GEV No.	378341	Ref. No.	120929
description	temperature probe Pt100 cable silicone probe -50 up to +200°C cable -50 up to +180°C connection coded plug thread probe ø6x50mm cable length 6.85m		
For models:	ACRS145, ACRS205, ACRS225, ACRS245, ACRS260, ACRS265, ACRS305, GMC2702, GMC3502, GMC4502, GMC5502, NL302, NL302E, NL402, NL402E, NL502, NL502E, NL552, NL552E		

sensors

1 

GEV No.	403316	Ref. No.	120355
description	sensor for dishwashers ø M12x1mm L 73mm cable lengthmm		
For models:	C166, NE02, NE3002, NE4002, NE5002, NE5502, NE7002, NE7502, NE9002, NE9502		

electronics

PCBs

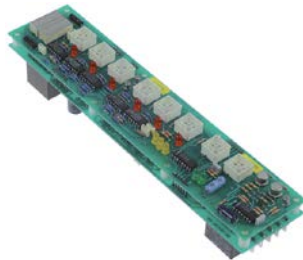
1 

GEV No.	401915	Ref. No.	120274
description	control PCB L 264mm W 57mm		
For models:	F55		

1 

GEV No.	402929	Ref. No.	121306
description	display PCB dishwasher DP45/50 L 85mm W 28mm green 4 digits		

1 

GEV No.	400936	Ref. No.	121211
description	keypad PCB		
For models:	FC, FC543E, FC543EA, FCHR, FCHRA, FCHRT, FCHRTA		

1 

GEV No.	400940	Ref. No.	121267
description	keypad PCB		
For models:	C155E2, C165E2, C95E2		



1

GEV No.	400933	Ref. No.	121277
description	keypad PCB dishwasher BHC 30		
For models:	BHC30E, BHC30EA, FC54E, FC54EA		



1

GEV No.	403119	Ref. No.	121259 121278
description	keypad PCB dishwasher COMENDA L 100mm W 200mm mounting pos. buttons 9		
For models:	ACRS145, ACRS205, ACRS225, ACRS245, ACRS260, ACRS265, ACRS305, GMC2702, GMC3502, GMC4502, GMC5502, LAV1001, LAV1501, NE02, NE3002, NE4002, NE5002, NE5502, NE7002, NE7502, NE9002, NE9502, NG02, NG1202, NG1202E, NG602, NG602E, NG902, NG902E, NL302, NL302E, NL402, NL402E, NL502, NL502E, NL552, NL552E		



1

GEV No.	400935	Ref. No.	121210
description	keypad PCB L 380mm W 60mm buttons 4		
For models:	FC, FC543E, FC543EA, FCHR, FCHRA, FCHRT, FCHRTA		



1

GEV No.	400937	Ref. No.	121216
description	net board L 80mm W 80mm		
For models:	FC, FC543E, FC543EA, FCHR, FCHRA, FCHRT, FCHRTA		



1

GEV No.	400939	Ref. No.	121230
description	PCB		
For models:	C155E2, C165E2, C165E2BT, C165E2RCD, C166, C166-2, C95E2		



1

GEV No.	400942	Ref. No.	121274
description	PCB		
For models:	BHC30HR, BHC30HR380, BHC30HRA, BHC30HRA380, BHCHR		



1

GEV No.	400944	Ref. No.	121237
description	PCB		
For models:	FC, FC533A, FC53A, FC53LA, FC543A, FC544A, FC54A, GF90, GF90A, LF320L, LF320LA, LF400A		



1

GEV No.	698575	Ref. No.	121300
description	PCB dishwasher AP43/48-FW35/40E L 184mm W 34mm		
For models:	FC3E, FC3EA, FC44E, FC44EA, FC4E, FC4EA, FC4EHRT		



1

GEV No.	401902	Ref. No.	121291
description	PCB dishwasher BAC30E		
For models:	BHC30E-2, BHC30EA-2, LF325E, LF325EA		



1

GEV No.	400943	Ref. No.	121239
description	PCB dishwasher C75/C155		
For models:	C155BT, C155RCD, C75BT, C75RCD, C95BT, C95RCD, FC53CBT, FC53LBT, FC54CBT, FC54LBT, LC1200RCD, LC380BT, LC380RCD, LC700RCD, LC900RCD, LF320CBT, LF320LBT, LP360BT, LP360RCD		

1

GEV No.	402881	Ref. No.	121284 121304
description	PCB dishwasher CE-GE L 126mm W 63mm suitable for COMENDA		
For models:	C1000E, C1000ERCD, C1300E, C1300ERCD, GE100, GE115, GE125, GE50RCD, GE60, GE60RCD, GE65, GE65RCD, GE75, GE80, XLC		



1

GEV No.	402715	Ref. No.	121301
description	PCB for dishwashers L 145mm W 105mm		
For models:	FC3E, FC3EA, FC44E, FC44EA, FC4E, FC4EA, FC4EHRT		



1

GEV No.	401846	Ref. No.	121287
description	PCB dishwasher COMENDA, HOONVED		
For models:	BHC25-2, BHC25A-2, BHC30-2, BHC30A-2, BHC433-2, BHC433A-2, C1001M, C1301M, FC3MR, GF70, GF70A, GF90-2004, GF90A-2004, LB200, LB200-2, LB200A, LB200A-2, LB215, LB215-2, LB215A, LB215A-2, LB260, LB260-2, LB260A, LB260A-2, LB275, LB275-2, LB275A, LB275A-2, LC1200, LC1200RCD, LC412, LC700, LC700RCD, LC900, LC900RCD, LF321, LF321A, LF322, LF322A, LF322MP, LF322MP-A, LF322RCD, LF324, LF324A, LF700, LF700A		

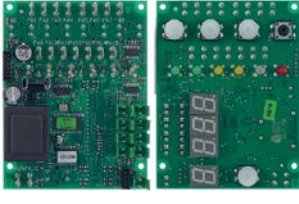

1

GEV No.	361986	Ref. No.	121296
description	PCB for rack conveyor dishwashing machine ACS DIGIT L 115mm W 90mm suitable for COMENDA		
For models:	AC2A, ACL100, ACL150, ACS101, ACS101-DIGIT, ACS122, ACS122-DIGIT, ACS151, ACS151-DIGIT, ACS152, ACS152-DIGIT, ACS161-DIGIT, ACS162-DIGIT, ACS181, ACS181-DIGIT, ACS182, ACS182-DIGIT, ACS201, ACS201-DIGIT, ACS202, ACS202-DIGIT, ACS241, ACS241-DIGIT, ACS242, ACS242-DIGIT, ACS91, ACS91-DIGIT, LAV1001, LAV1501, NL302, NL302E, NL402, NL402E, NL502, NL502E, NL552, NL552E		

keypads

front foils



1

GEV No.	401874	Ref. No.	121302
description	PCB dishwasher FC3M/FC4M L 100mm W 70mm suitable for COMENDA 230V		
For models:	FC3M, FC3MA, FC4M, FC4MA		



1

GEV No.	510726	Ref. No.	460920 460926 490920
description	front foil		
For models:	B10T		



1

GEV No.	403654	Ref. No.	121283
description	PCB dishwasher L 145mm W 105mm		
For models:	C1000E, C1000ERCD, C1300E, C1300ERCD, GE100, GE115, GE125, GE50RCD, GE60, GE60RCD, GE65, GE65RCD, GE75, GE80, XLC		



1

GEV No.	510960	Ref. No.	460912
description	front foil		
For models:	B15T, B16T		



1

GEV No.	511398	Ref. No.	460911
description	front foil		
For models:	B11T, B12T		



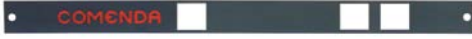

			
1			
GEV No.	511399	Ref. No.	460.917
description	front foil		
For models:	B11T, B12T		

			
1			
GEV No.	511401	Ref. No.	460913
description	front foil		
For models:	B18T, B18TM, B19T, B19TM		

			
1			
GEV No.	511402	Ref. No.	460919
description	front foil		
For models:	B15TM, B16TM, B18T, B18TM, B19T, B19TM		

			
1			
GEV No.	511403	Ref. No.	461051
description	front foil		
For models:	BC25, BC30, BHC25, BHC25S, BHC30, BR20, BR25		

			
1			
GEV No.	511404	Ref. No.	461050
description	front foil		
For models:	BC25A, BC30A, BHC25A, BHC30A, BR20A, BR25A		

			
1			
GEV No.	511405	Ref. No.	461057
description	front foil		
For models:	BC25HR, BC30HR, BC30HR380, BC30HRA, FC43		

			
1			
GEV No.	511406	Ref. No.	461235
description	front foil		
For models:	BHC30HR, BHC30HR380, BHC30HRA, BHCHR		

			
1			
GEV No.	511407	Ref. No.	461232
description	front foil		
For models:	BHC30HR, BHC30HRA, BHC30HRA380, BHCHR		

			
1			
GEV No.	511408	Ref. No.	461108
description	front foil		
For models:	LBR, LBR200		

			
1			
GEV No.	511409	Ref. No.	461073
description	front foil		
For models:	LBC210, LBC215, LBC215A, LBC275, LBC275A, LBR, LBR215, LBR215A		

			
1			
GEV No.	511410	Ref. No.	461063
description	front foil		
For models:	BHC433, FC43		

			
1			
GEV No.	511411	Ref. No.	461074
description	front foil		
For models:	LF280-lav-line, LF315, LF320-lav-line		

			
1			
GEV No.	511412	Ref. No.	461101
description	front foil		
For models:	F90M, F90MA, LF320, LF320A, LF320CBT, LF320L, LF320LA, LF320LBT, LF323, LF323A, LF350, LF350A, LF450, LF450A		

			
1			
GEV No.	511413	Ref. No.	461107
description	front foil		
For models:	FC, FC53, FC533, FC533A, FC53A, FC53CBT, FC53LA, FC53LBT, FC54, FC543, FC543A, FC544, FC544A, FC54A, FC54CBT, FC54LBT		

1

GEV No.	511414	Ref. No.	461138
description	front foil		
For models:	G100L, G101L, G115L, G125L, G50L, G50LM, G51L, G60L, G61L, G65L, G75L, GL		



1

GEV No.	511415	Ref. No.	460921
description	front foil		
For models:	C140, C70, C85		



1

GEV No.	511416	Ref. No.	461075
description	front foil		
For models:	LC380, LC400, LP360		



1

GEV No.	511418	Ref. No.	461192
description	front foil		
For models:	C75BT, C75RCD		



1

GEV No.	510999	Ref. No.	460918
description	front foil COMENDA mounting pos. lower		
For models:	B15T, B16T		

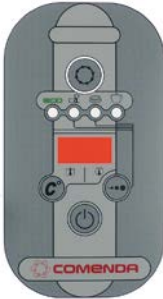

1

GEV No.	403657	Ref. No.	461353
description	front foil dishwasher C1000/1300 GE50/100/125		
For models:	C1000E, C1000ERCD, C1300E, C1300ERCD, GE100, GE115, GE125, GE50RCD, GE60, GE60RCD, GE65, GE65RCD, GE75, GE80, XLC		



1

GEV No.	511420	Ref. No.	461254
description	keypad foil		
For models:	FC54E, FC54EA		



1

GEV No.	511421	Ref. No.	461258
description	keypad foil		
For models:	FC54E, FC54EA		



1

GEV No.	511423	Ref. No.	461170
description	keypad foil		
For models:	C155E2, C165E2, C165E2BT, C165E2RCD, C166, C166-2, C95E2		



1

GEV No.	511424	Ref. No.	461227
description	keypad foil		
For models:	C155E2, C165E2, C95E2		



1			
GEV No.	511422	Ref. No.	461127
description	keypad foil for dishwasher L 572mm W 60mm buttons 4		
For models:	FC, FC543E, FC543EA, FCHR, FCHRA, FCHRT, FCHRTA		

membrane keypads

1			
GEV No.	400052	Ref. No.	461052
description	keypad foil		
For models:	C165		

1			
GEV No.	400053	Ref. No.	461053
description	keypad foil		
For models:	C75, C75M		

control panel

1			
GEV No.	510966	Ref. No.	460991
description	front panel neutral		

1			
GEV No.	510962	Ref. No.	460775 460817
description	switch panel		
For models:	B10, B11, B12, B15, B16, B18, B19, F20, F45, F55, F65, F80		

1			
GEV No.	510253	Ref. No.	460850
description	switch panel dishwasher F45/F55 L 592mm W 75mm white		
For models:	F45, F55, F65, F80		

1			
GEV No.	510963	Ref. No.	460851
description	switch panel L 473mm W 75mm		
For models:	F20		

solenoid valves
solenoid valves (water)

ELBI			
straight			
1			
GEV No.	373017	Ref. No.	120173
description	solenoide valve single straight 230VAC inlet 3/4" outlet 11.5mm DN10 ELBI		
For models:	BHC30-2, BHC30E, BHC30E-2, BHC30EA-2, BHC30HR-2, BHC30HRA-2, GF70, LB200, LB200-2, LB215, LB215-2, LB260, LB260-2, LB275, LB275-2		
spare parts for	373017		
	GEV No.	370467	Ref. No. —

1			
GEV No.	373007	Ref. No.	120196
description	solenoide valve single angled 220-240VAC inlet 3/4" outlet 11.5mm input 6.7l/min t.max. 90°C duty cycle 100% ELBI plastic flow regulating valve inlet green		
For models:	LBC210, LBC215, LBC215A, LBC275, LBC275A, LBR, LBR200, LBR215, LBR215A		

1			
GEV No.	370732	Ref. No.	121104
description	solenoide valve single angled 230VAC inlet 3/4" outlet 11.5mm input 8l/min ELBI 319 plastic flow regulating valve inlet red		
For models:	FC3E, FC3EA, FC3MA, FC44E, FC44EA, FC4E, FC4EA, FC4EHR, FC4MA, GE50RCD		



			
GEV No.	370256	Ref. No.	120175
description	solenoid valve triple straight 230VAC inlet 3/4" outlet 11.5mm t.max. 90°C ELBI plastic flow regulating valve inlet red output B 0.5l/min flow regulating valve outlet B red		
For models:	BHC25A, BHC25A-2, BHC30-2, BHC30A, BHC30A-2, BHC30HR, BHC30HRA, BHC30HRA380, BHC433-2, BHC433A, BHC433A-2, BHCHR		

spare parts and accessories

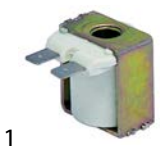

solenoid coils

			
GEV No.	371016	Ref. No.	630969
description	solenoid coil ELBI 230VAC 50/60Hz pressure range 0 up to 10bar coil type EATON (INVENSYS) tolerance ±15%		
For models:	B10T, B11T, B12, B12T, B13T, B14T, B15, B15T, B15TM, B16, B16T, B16TM, B18, B18T, B18TM, B19, B19T, B19TM, B20, B20D, B23, B24, B25, B26, B27, B41, B42, BC25, BC25A, BC25HR, BC30, BC30A, BC30HR, BC30HR380, BC30HRA, BHC25, BHC25-2, BHC25A, BHC25A-2, BHC25S, BHC30, BHC30-2, BHC30A, BHC30A-2, BHC30E, BHC30E-2, BHC30EA, BHC30EA-2, BHC30HR, BHC30HR-2...(Other models you can see in the webshop)		















RPE



			
GEV No.	374019	Ref. No.	120124
description	solenoid valve double angled 230VAC inlet 3/4" outlet 10mm DN10 RPE		
For models:	FC3EA, FC3MA, FC44EA, FC4EA, FC4MA		

TP

			
GEV No.	370021	Ref. No.	120146
description	solenoid valve double straight 230VAC inlet 3/4" outlet 11.5mm DN10 TP flow regulating valve inlet white		
For models:	B10T, B11T, B12T, B13T, B14T, B15, B15T, B15TM, B16T, B16TM, B18, B18T, B18TM, B19T, B19TM, B20, B20D, B24, B25, B26, B27, B41, BHC25, BHC25-2, BHC25S, BHC30, BHC30-2, BHC30A-2, BHC30HR, BHC30HR380, BHC30HRA, BHC433, BHC433-2, BHC433A-2, BHCHR, F20		
spare parts for	370021		
		GEV No.	371013
		Ref. No.	—
	solenoid coil TP 230VAC 50/60Hz		

accessories for	370021			
	GEV No.	371220	Ref. No.	—
	reducer TP flow rate 3l/min red tolerance ±15%			
	GEV No.	371221	Ref. No.	—
	reducer TP flow rate 5.5l/min yellow tolerance ±15%			
	GEV No.	371222	Ref. No.	—
	reducer TP flow rate 6l/min grey tolerance ±15%			
	GEV No.	371223	Ref. No.	—
	reducer TP flow rate 10l/min white tolerance ±15%			
	GEV No.	371224	Ref. No.	—
	reducer TP flow rate 12l/min bronze tolerance ±15%			
	GEV No.	371225	Ref. No.	—
	reducer TP flow rate 16l/min light brown tolerance ±15%			
	GEV No.	371226	Ref. No.	—
	reducer TP flow rate 20l/min red tolerance ±15%			
	GEV No.	371230	Ref. No.	—
	reducer TP flow rate 0.25l/min red tolerance ±25%			
	GEV No.	371231	Ref. No.	—
	reducer TP flow rate 0.35l/min violet tolerance ±25%			
	GEV No.	371232	Ref. No.	—
	reducer TP flow rate 0.5l/min orange tolerance ±25%			
	GEV No.	371233	Ref. No.	—
	reducer TP flow rate 0.8l/min white tolerance ±25%			
	GEV No.	371234	Ref. No.	—
	reducer TP flow rate 1l/min light blue tolerance ±25%			
	GEV No.	371235	Ref. No.	—
	reducer TP flow rate 1.2l/min brown tolerance ±25%			
	GEV No.	371236	Ref. No.	—
	reducer TP flow rate 1.5l/min light brown tolerance ±25%			
	GEV No.	371237	Ref. No.	—
	reducer TP flow rate 2.5l/min yellow tolerance ±25%			
	GEV No.	371238	Ref. No.	—
	reducer TP flow rate 3.4l/min dark green tolerance ±25%			
	GEV No.	371239	Ref. No.	—
	reducer TP flow rate 5l/min black tolerance ±25%			
	GEV No.	371240	Ref. No.	—
	reducer TP flow rate 8l/min blue tolerance ±20%			

 			
GEV No.	370025	Ref. No.	120175
description	solenoid valve triple straight 230VAC inlet 3/4" outlet 11.5mm DN10 TP		
spare parts for	370025		
	GEV No.	371013	Ref. No. —
solenoid coil TP 230VAC 50/60Hz			
accessories for	370025		
	GEV No.	371220	Ref. No. —
reducer TP flow rate 3l/min red tolerance ±15%			
	GEV No.	371221	Ref. No. —
reducer TP flow rate 5.5l/min yellow tolerance ±15%			
	GEV No.	371222	Ref. No. —
reducer TP flow rate 6l/min grey tolerance ±15%			
	GEV No.	371223	Ref. No. —
reducer TP flow rate 10l/min white tolerance ±15%			
	GEV No.	371224	Ref. No. —
reducer TP flow rate 12l/min bronze tolerance ±15%			
	GEV No.	371225	Ref. No. —
reducer TP flow rate 16l/min light brown tolerance ±15%			
	GEV No.	371226	Ref. No. —
reducer TP flow rate 20l/min red tolerance ±15%			
	GEV No.	371230	Ref. No. —
reducer TP flow rate 0.25l/min red tolerance ±25%			
	GEV No.	371231	Ref. No. —
reducer TP flow rate 0.35l/min violet tolerance ±25%			
	GEV No.	371232	Ref. No. —
reducer TP flow rate 0.5l/min orange tolerance ±25%			
	GEV No.	371233	Ref. No. —
reducer TP flow rate 0.8l/min white tolerance ±25%			
	GEV No.	371234	Ref. No. —
reducer TP flow rate 1l/min light blue tolerance ±25%			
	GEV No.	371235	Ref. No. —
reducer TP flow rate 1.2l/min brown tolerance ±25%			
	GEV No.	371236	Ref. No. —
reducer TP flow rate 1.5l/min light brown tolerance ±25%			
	GEV No.	371237	Ref. No. —
reducer TP flow rate 2.5l/min yellow tolerance ±25%			

accessories for	370025		
	GEV No.	371238	Ref. No. —
reducer TP flow rate 3.4l/min dark green tolerance ±25%			
	GEV No.	371239	Ref. No. —
reducer TP flow rate 5l/min black tolerance ±25%			
	GEV No.	371240	Ref. No. —
reducer TP flow rate 8l/min blue tolerance ±20%			













 			
GEV No.	370019	Ref. No.	120142 120197
description	solenoid valve double angled 230VAC inlet 3/4" outlet 11.5mm DN10 TP plastic		
For models:	B12, B12T, B14T, B16, B16T, B16TM, B19, B19T, B19TM, B25, B26, B27, B41, B42, BC25, BC25A, BC25HR, BC30, BC30A, BC30HR, BC30HR380, BR20, BR25, C165, FC43		
spare parts for	370019		
	GEV No.	371013	Ref. No. —
solenoid coil TP 230VAC 50/60Hz			
accessories for	370019		
	GEV No.	371220	Ref. No. —
reducer TP flow rate 3l/min red tolerance ±15%			
	GEV No.	371221	Ref. No. —
reducer TP flow rate 5.5l/min yellow tolerance ±15%			
	GEV No.	371222	Ref. No. —
reducer TP flow rate 6l/min grey tolerance ±15%			
	GEV No.	371223	Ref. No. —
reducer TP flow rate 10l/min white tolerance ±15%			
	GEV No.	371224	Ref. No. —
reducer TP flow rate 12l/min bronze tolerance ±15%			
	GEV No.	371225	Ref. No. —
reducer TP flow rate 16l/min light brown tolerance ±15%			
	GEV No.	371226	Ref. No. —
reducer TP flow rate 20l/min red tolerance ±15%			
	GEV No.	371230	Ref. No. —
reducer TP flow rate 0.25l/min red tolerance ±25%			
	GEV No.	371231	Ref. No. —
reducer TP flow rate 0.35l/min violet tolerance ±25%			
	GEV No.	371232	Ref. No. —
reducer TP flow rate 0.5l/min orange tolerance ±25%			

Table continues overleaf



accessories for		370019		
GEV No.	Ref. No.	Ref. No.	Ref. No.	—
	371233	Ref. No.	—	reducer TP flow rate 0.8l/min white tolerance ±25%
	371234	Ref. No.	—	reducer TP flow rate 1l/min light blue tolerance ±25%
	371235	Ref. No.	—	reducer TP flow rate 1.2l/min brown tolerance ±25%
	371236	Ref. No.	—	reducer TP flow rate 1.5l/min light brown tolerance ±25%
	371237	Ref. No.	—	reducer TP flow rate 2.5l/min yellow tolerance ±25%
	371238	Ref. No.	—	reducer TP flow rate 3.4l/min dark green tolerance ±25%
	371239	Ref. No.	—	reducer TP flow rate 5l/min black tolerance ±25%
	371240	Ref. No.	—	reducer TP flow rate 8l/min blue tolerance ±20%

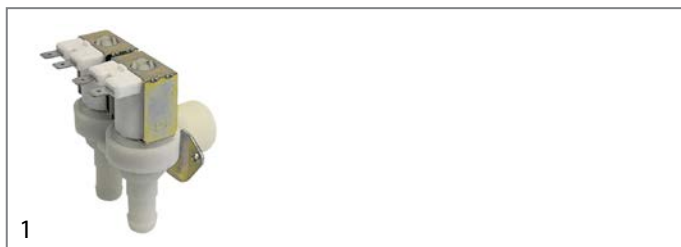

GEV No.	370110	Ref. No.	120168
description	solenoid valve double angled 24VAC inlet 3/4" outlet 14mm DN10 TP		
For models:	AC135, AC90, SNL		

accessories for		370110		
GEV No.	Ref. No.	Ref. No.	Ref. No.	—
	371035	Ref. No.	—	solenoid coil 24VAC

accessories for		370110		
GEV No.	Ref. No.	Ref. No.	Ref. No.	—
	371220	Ref. No.	—	reducer TP flow rate 3l/min red tolerance ±15%
	371221	Ref. No.	—	reducer TP flow rate 5.5l/min yellow tolerance ±15%
	371222	Ref. No.	—	reducer TP flow rate 6l/min grey tolerance ±15%
	371223	Ref. No.	—	reducer TP flow rate 10l/min white tolerance ±15%
	371224	Ref. No.	—	reducer TP flow rate 12l/min bronze tolerance ±15%
	371225	Ref. No.	—	reducer TP flow rate 16l/min light brown tolerance ±15%

accessories for		370110		
GEV No.	Ref. No.	Ref. No.	Ref. No.	—
	371226	Ref. No.	—	reducer TP flow rate 20l/min red tolerance ±15%
	371230	Ref. No.	—	reducer TP flow rate 0.25l/min red tolerance ±25%
	371231	Ref. No.	—	reducer TP flow rate 0.35l/min violet tolerance ±25%
	371232	Ref. No.	—	reducer TP flow rate 0.5l/min orange tolerance ±25%
	371233	Ref. No.	—	reducer TP flow rate 0.8l/min white tolerance ±25%
	371234	Ref. No.	—	reducer TP flow rate 1l/min light blue tolerance ±25%
	371235	Ref. No.	—	reducer TP flow rate 1.2l/min brown tolerance ±25%
	371236	Ref. No.	—	reducer TP flow rate 1.5l/min light brown tolerance ±25%
	371237	Ref. No.	—	reducer TP flow rate 2.5l/min yellow tolerance ±25%
	371238	Ref. No.	—	reducer TP flow rate 3.4l/min dark green tolerance ±25%
	371239	Ref. No.	—	reducer TP flow rate 5l/min black tolerance ±25%
	371240	Ref. No.	—	reducer TP flow rate 8l/min blue tolerance ±20%



GEV No.	370015	Ref. No.	120112 120145
----------------	--------	-----------------	------------------

description	solenoid valve single angled 230VAC inlet 3/4" outlet 11.5mm DN10 TP		
For models:	C1000E, C1000ERCD, C1001M, C1300E, C1300ERCD, C1301M, C140, C155, C155BT, C155E2, C155RCD, C165E2, C165E2BT, C165E2RCD, C166, C166-2, C30, C33, C34, C70, C75, C75BT, C75M, C75RCD, C85, C95, C95BT, C95E2, C95RCD, F2, F3, F300, F45, F55, F65, F80, F90M, F90MA, FC, FC3M, FC3MR, FC4EHRT, FC4M, FC53, FC533, FC53CBT, FC53LBT, FC54, FC543, FC543E...(Other models you can see in the webshop)		

accessories for		370015		
GEV No.	Ref. No.	Ref. No.	Ref. No.	—
	371220	Ref. No.	—	reducer TP flow rate 3l/min red tolerance ±15%
	371221	Ref. No.	—	reducer TP flow rate 5.5l/min yellow tolerance ±15%

Table continues overleaf



accessories for		370015		
	GEV No.	371222	Ref. No.	—
	reducer TP flow rate 6l/min grey tolerance $\pm 15\%$			
	GEV No.	371223	Ref. No.	—
	reducer TP flow rate 10l/min white tolerance $\pm 15\%$			
	GEV No.	371224	Ref. No.	—
	reducer TP flow rate 12l/min bronze tolerance $\pm 15\%$			
	GEV No.	371225	Ref. No.	—
	reducer TP flow rate 16l/min light brown tolerance $\pm 15\%$			
	GEV No.	371226	Ref. No.	—
	reducer TP flow rate 20l/min red tolerance $\pm 15\%$			
	GEV No.	371230	Ref. No.	—
	reducer TP flow rate 0.25l/min red tolerance $\pm 25\%$			
	GEV No.	371231	Ref. No.	—
	reducer TP flow rate 0.35l/min violet tolerance $\pm 25\%$			
	GEV No.	371232	Ref. No.	—
	reducer TP flow rate 0.5l/min orange tolerance $\pm 25\%$			
	GEV No.	371233	Ref. No.	—
	reducer TP flow rate 0.8l/min white tolerance $\pm 25\%$			
	GEV No.	371234	Ref. No.	—
	reducer TP flow rate 1l/min light blue tolerance $\pm 25\%$			
	GEV No.	371235	Ref. No.	—
	reducer TP flow rate 1.2l/min brown tolerance $\pm 25\%$			
	GEV No.	371236	Ref. No.	—
	reducer TP flow rate 1.5l/min light brown tolerance $\pm 25\%$			
	GEV No.	371237	Ref. No.	—
	reducer TP flow rate 2.5l/min yellow tolerance $\pm 25\%$			
	GEV No.	371238	Ref. No.	—
	reducer TP flow rate 3.4l/min dark green tolerance $\pm 25\%$			
	GEV No.	371239	Ref. No.	—
	reducer TP flow rate 5l/min black tolerance $\pm 25\%$			
	GEV No.	371240	Ref. No.	—
	reducer TP flow rate 8l/min blue tolerance $\pm 20\%$			

solenoid valves with reducers



GEV No.	370011	Ref. No.	120144
description	solenoid valve double angled 230VAC inlet 3/4" outlet 11.5mm		
For models:	B12, B12T, B14T, B16, B16T, B16TM, B19, B19T, B19TM, B25, B26, B27, F90M, F90MA, FC, FC533A, FC53A, FC53LA, FC543A, FC543EA, FC544A, FC54A, FC54EA, FCHRA, FCHRTA, LBC210, LBC215, LBC215A, LBC275, LBC275A, LBR, LBR215A, LF320, LF320A, LF320L, LF320LA, LF321, LF321A, LF322, LF322A, LF322MP, LF322MP-A, LF323, LF323A, LF324, LF324A, LF325E, LF325EA, LF350, LF350A...(Other models you can see in the webshop)		



GEV No.	370682	Ref. No.	120188
description	solenoid valve single angled 230VAC inlet 3/4" outlet 11.5mm input 16l/min TP plastic flow regulating valve inlet pink 8VA		
For models:	LF315, LF321, LF321A, LF322, LF322A, LF322MP, LF322MP-A, LF324, LF324A, LF325E, LF325EA, LF700, LF700A, LFD32E, LFD32EA, LFD32M, LFD32MA		



GEV No.	370255	Ref. No.	120179
description	solenoid valve triple angled 230VAC inlet 3/4" outlet 11.5mm plastic		
For models:	BC25, BC25A, BC25HR, BC30, BC30A, BC30HRA, BR20A, BR25A, FC43A		



spare parts and accessories

solenoid coils







GEV No.	371199	Ref. No.	630987
description	solenoid coil TP 230VAC 50/60Hz seat ϕ 9mm connection male faston 6.3mm		
For models:	FC3EA, FC3MA, FC44EA, FC4EA, FC4MA		





metal			
M&M			
2-way			
B204/205/206 series			
			
1			
GEV No.	370076	Ref. No.	120158
description	solenoid valve 2-ways 230VAC connection 3/4" L 82mm DN 25mm slide-on receptacle compact -10 up to +90°C M&M type series B204/205/206 coil type 2700 membranes NBR (water) p max 16bar p min 0.3bar		
For models:	GE100, GE115, GE125, GE60, GE60RCD, GE65, GE65RCD, GE75, GE80		
spare parts for	370076		
	GEV No.	371022	Ref. No. —
	solenoid coil M&M 230VAC 10VA 50Hz coil type 2700 seat ø 10mm		
accessories for	370076		
	GEV No.	371091	Ref. No. 150034
	power socket plug type DIN 43650B cable lengthmm small		

SIRAI			
2-way			
L140-B series			
			
1			
GEV No.	370320	Ref. No.	120141 120191
description	solenoid valve brass 2-ways 24VAC inlet 1/2" outlet 1/2" connection 1/2" L 41mm DN 10mm slide-on receptacle compact -10 up to +90°C SIRAI type series L140-B coil type Z610A membranes NBR (water) p max 12bar p min 0.35bar		
spare parts for	370320		
	GEV No.	371070	Ref. No. 630948
	solenoid coil 24VAC 10VA SIRAI coil type Z610A seat ø 10mm		
	GEV No.	371163	Ref. No. —
	membrane connection 1/2" series L140-B membrane type NBR (water)		
accessories for	370320		
	GEV No.	371091	Ref. No. 150034
	power socket plug type DIN 43650B cable lengthmm small		

L180-B series			
			
1			
GEV No.	370330	Ref. No.	120123
description	solenoid valve 2-ways 24VAC connection 1" L 105mm DN 24mm slide-on receptacle compact -10 up to +90°C SIRAI type series L180-B coil type Z610A membranes NBR (water) p max 12bar p min 0.35bar		
For models:	ACR, ACR145, ACR205, ACR225, ACR245, ACR260, ACR265, ACR305, GMC, GMC2700, GMC3500, GMC4500, GMC5500, NE00, NE3001, NE4001, NE5501, NE7501, NE9001, NG00, NG01, NG02, NG1202, NG1202E, NG600, NG600E, NG601, NG601E, NG602, NG602E, NG900, NG900E, NG901, NG901E, NG902, NG902E, SE		
spare parts for	370330		
	GEV No.	371070	Ref. No. 630948
	solenoid coil 24VAC 10VA SIRAI coil type Z610A seat ø 10mm		
	GEV No.	371173	Ref. No. —
	membrane connection 1" series L180-B membrane type NBR		
accessories for	370330		
	GEV No.	371091	Ref. No. 150034
	power socket plug type DIN 43650B cable lengthmm small		

			
1			
GEV No.	370391	Ref. No.	120122
description	solenoid valve 2-ways 24VAC connection 3/4" L 79mm DN 18mm -10 up to +90°C coil type Z610A membranes NBR (water) p max 12bar p min 0.35bar		
For models:	AC101, AC122, AC151, AC152, AC181, AC182, AC201, AC202, AC241, AC242, AC91, ACR, ACR145, ACR205, ACR225, ACR245, ACR260, ACR265, ACR305, G100L, G101L, G115, G115L, G125, G125L, G131, G50L, G50LM, G51L, G60L, G61L, G65, G65L, G66, G75L, GL, GMC, GMC2700, GMC3500, GMC4500, GMC5500, NE02, NE3002, NE4002, NE5002, NE5502, NE7002, NE7502, NE9002, NE9502		
accessories for	370391		
	GEV No.	371091	Ref. No. 150034
	power socket plug type DIN 43650B cable lengthmm small		

			
1			
GEV No.	370329	Ref. No.	120131 120154
description	solenoid valve 2-ways 24VAC inlet 1/2" outlet 1/2" connection 1/2" L 66mm DN 13.5mm slide-on receptacle compact -10 up to +90°C SIRAI type series L180-B coil type Z610A membranes NBR (water) p max 12bar p min 0.35bar		
For models:	AC101, AC122, AC151, AC152, AC181, AC182, AC201, AC202, AC241, AC242, AC91, ACL100, ACL150, ACR, ACR145, ACR205, ACR225, ACR245, ACR260, ACR265, ACR305, ACRS145, ACRS205, ACRS225, ACRS245, ACRS260, ACRS265, ACRS305, ACS101, ACS101-DIGIT, ACS122, ACS122-DIGIT, ACS151, ACS151-DIGIT, ACS152, ACS152-DIGIT, ACS161-DIGIT, ACS162-DIGIT, ACS181, ACS181-DIGIT, ACS182, ACS182-DIGIT, ACS201, ACS201-DIGIT, ACS202, ACS202-DIGIT, ACS241, ACS241-DIGIT, ACS242, ACS242-DIGIT...(Other models you can see in the webshop)		
spare parts for	370329		
	GEV No.	371070	Ref. No. 630948
accessories for	370329		
	GEV No.	371091	Ref. No. 150034
	power socket plug type DIN 43650B cable lengthmm small		

			
1			
GEV No.	370048	Ref. No.	120158
description	solenoid valve brass 2-ways 230VAC connection 3/4" L 79mm DN 18mm slide-on receptacle compact -10 up to +90°C SIRAI type series L180-B coil type Z610A membranes NBR (water) p max 12bar p min 0.35bar		
spare parts for	370048		
	GEV No.	371085	Ref. No. —
	solenoid coil 230VAC 4VA SIRAI coil type ZB10A seat ø 10mm 50/60Hz		
	GEV No.	371172	Ref. No. —
	membrane connection 3/4" series L180-B membrane type NBR (water)		
accessories for	370048		
	GEV No.	371091	Ref. No. 150034
	power socket plug type DIN 43650B cable lengthmm small		

			
1			
GEV No.	370047	Ref. No.	120174
description	solenoid valve brass 2-ways 230VAC inlet 1/2" outlet 1/2" connection 1/2" L 66mm DN 13.5mm slide-on receptacle compact -10 up to +90°C SIRAI type series L180-B coil type Z610A membranes NBR (water) p max 12bar p min 0.35bar 50/60Hz		
For models:	GE100, GE115, GE125, GE60, GE65, GE75, GE80		
spare parts for	370047		
	GEV No.	371085	Ref. No. —
	solenoid coil 230VAC 4VA SIRAI coil type ZB10A seat ø 10mm 50/60Hz		
	GEV No.	371171	Ref. No. 630631
	membrane series L180-B membrane type NBR (water)		
accessories for	370047		
	GEV No.	371091	Ref. No. 150034
	power socket plug type DIN 43650B cable lengthmm small		

L180-V series

			
1			
GEV No.	370669	Ref. No.	120135
description	solenoid valve brass 2-ways 230VAC inlet 1/2" outlet 1/2" connection 1/2" L 66mm DN 13.5mm 0 up to +130°C SIRAI type series L180-V coil type ZB10A membranes Viton p max 16bar p min 0.35bar 50/60Hz		





solenoid valves steam (water)

2-way

L140-D series

			
1			
GEV No.	370730	Ref. No.	120140 121170
description	solenoid valve brass 2-ways 230VAC inlet 3/4" ET outlet 1/2" IT connection 3/4" L 61mm DN 10mm -10 up to 100°C SIRAI type series L140-D coil type Z610A membranes EPDM p max 10bar p min 0.35bar 50/60Hz		



 <p>1</p>			
GEV No.	370731	Ref. No.	120125
description	solenoid valve brass 2-ways 24VAC inlet 3/4" ET outlet 1/2" IT connection 3/4" L 61mm DN 10mm -10 up to 100°C SIRAI type series L134-D coil type Z610A membranes EPDM p max 10bar p min 0.35bar		
For models:	AC2A		
spare parts for	370731		
	GEV No.	370320	Ref. No. 120141 120191
	solenoid valve brass 2-ways 24VAC inlet 1/2" outlet 1/2" connection 1/2" L 41mm DN 10mm slide-on receptacle compact -10 up to +90°C SIRAI type series L140-B coil type Z610A membranes NBR (water) p max 12bar p min 0.35bar		
	GEV No.	520685	Ref. No. —
	double nipple brass thread 1/2" - 3/4" Qty 1 pcs		
accessories for	370731		
	GEV No.	371091	Ref. No. 150034
	power socket plug type DIN 43650B cable lengthmm small		
	GEV No.	520208	Ref. No. —
	double nipple nickel-plated brass thread 1/2" - 3/4" Qty 1 pcs		

 <p>1</p>			
GEV No.	370705	Ref. No.	120191
description	solenoid valve brass 2-ways 24VAC inlet 3/4" ET outlet 1/2" IT connection 3/4" L 61mm DN 10mm -10 up to 100°C SIRAI type series L140-D coil type Z610A membranes EPDM p max 10bar p min 0.35bar 50/60Hz flow regulating valve inlet black		
For models:	AC101, AC122, AC91, AC95		

 <p>1</p>			
GEV No.	370729	Ref. No.	120192
description	solenoid valve brass 2-ways 24VAC inlet 3/4" ET outlet 1/2" IT connection 3/4" L 61mm DN 10mm -10 up to 100°C SIRAI type series L140-D coil type Z610A membranes EPDM p max 10bar p min 0.35bar 50/60Hz flow regulating valve inlet red		
For models:	AC105		

<p>L145-R series</p>  <p>1</p>			
GEV No.	370311	Ref. No.	120163
description	solenoid valve 2-ways 24VAC connection 1" L 105mm DN 18.5mm slide-on receptacle DIN -60 up to +170°C SIRAI type series L145-R coil type Z534A membranes PTFE (steam) p max 6bar p min 0.4bar		
For models:	AC100, AC101, AC105, AC120, AC122, AC135, AC150, AC151, AC152, AC170, AC181, AC182, AC200, AC201, AC202, AC241, AC242, AC90, AC91, AC95, ACR, ACR145, ACR205, ACR225, ACR245, ACR260, ACR265, ACR305, ACS101, ACS101-DIGIT, ACS122, ACS122-DIGIT, ACS151, ACS151-DIGIT, ACS152, ACS152-DIGIT, ACS161-DIGIT, ACS162-DIGIT, ACS181, ACS181-DIGIT, ACS182, ACS182-DIGIT, ACS201, ACS201-DIGIT, ACS202, ACS202-DIGIT, ACS241, ACS241-DIGIT, ACS242, ACS242-DIGIT...(Other models you can see in the webshop)		
spare parts for	370311		
	GEV No.	371068	Ref. No. 630972
	solenoid coil 24VAC 14VA SIRAI coil type Z534A seat ø 12mm		
	GEV No.	371166	Ref. No. —
	membrane connection 1" series L145-R membrane type PTFE		
accessories for	370311		
	GEV No.	371090	Ref. No. 150033
	power socket plug type DIN 43650A screw		

 <p>1</p>			
GEV No.	370318	Ref. No.	120161
description	solenoid valve 2-ways 24VAC inlet 1/2" outlet 1/2" connection 1/2" L 66mm DN 10mm slide-on receptacle compact -60 up to +170°C SIRAI type series L145-R coil type Z614A membranes PTFE (steam) p max 8bar p min 0.4bar		
For models:	ACS101, ACS101-DIGIT, ACS122, ACS122-DIGIT, ACS151, ACS151-DIGIT, ACS152, ACS152-DIGIT, ACS161-DIGIT, ACS162-DIGIT, ACS181, ACS181-DIGIT, ACS182, ACS182-DIGIT, ACS201, ACS201-DIGIT, ACS202, ACS202-DIGIT, ACS241, ACS241-DIGIT, ACS242, ACS242-DIGIT, ACS91, ACS91-DIGIT, NE02, NE3002, NE4002, NE5002, NE5502, NE7002, NE7502, NE9002, NE9502, NG02, NG1202, NG1202E, NG602, NG602E, NG902, NG902E		
spare parts for	370318		
	GEV No.	371158	Ref. No. 630973
	solenoid coil 24VAC 10VA SIRAI coil type Z614A seat ø 10mm		
	GEV No.	371164	Ref. No. —
	membrane connection 3/8"-1/2" series L145-R membrane type PTFE		
accessories for	370318		
	GEV No.	371091	Ref. No. 150034
	power socket plug type DIN 43650B cable lengthmm small		



1

GEV No.	370324	Ref. No.	120162
description	solenoid valve 2-ways 24VAC inlet 3/4" outlet 3/4" connection 3/4" L 79mm DN 16mm slide-on receptacle DIN -60 up to +170°C SIRAI type series L145-R coil type Z534A membranes PTFE (steam) p max 6bar p min 0.4bar		
For models:	AC100, AC101, AC105, AC120, AC122, AC135, AC150, AC151, AC152, AC170, AC181, AC182, AC200, AC201, AC202, AC241, AC242, AC90, AC91, AC95, ACR, ACR145, ACR205, ACR225, ACR245, ACR260, ACR265, ACR305, ACS101, ACS101-DIGIT, ACS122, ACS122-DIGIT, ACS151, ACS151-DIGIT, ACS152, ACS152-DIGIT, ACS161-DIGIT, ACS162-DIGIT, ACS181, ACS181-DIGIT, ACS182, ACS182-DIGIT, ACS201, ACS201-DIGIT, ACS202, ACS202-DIGIT, ACS241, ACS241-DIGIT, ACS242, ACS242-DIGIT...(Other models you can see in the webshop)		
spare parts for	370324		
	GEV No.	371068	Ref. No. 630972
	solenoid coil 24VAC 14VA SIRAI coil type Z534A seat ø 12mm		
	GEV No.	371165	Ref. No. 630625
	membrane connection 3/4" series L145-R membrane type PTFE		
accessories for	370324		
	GEV No.	371090	Ref. No. 150033
	power socket plug type DIN 43650A screw		

L153-D series



1

GEV No.	370079	Ref. No.	120167
description	solenoid valve 2-ways 230VAC connection 3/4" L 79mm DN 17mm slide-on receptacle DIN -10 up to 140°C SIRAI type series L153-D coil type Z134A membranes EPDM (steam/water) p max 8bar p min 0.1bar 50Hz		
accessories for	370079		
	GEV No.	371077	Ref. No. —
	solenoid coil 230VAC 24VA SIRAI coil type Z110A/Z114A/Z134A seat ø 14mm		



1

GEV No.	370327	Ref. No.	120166
description	solenoid valve 2-ways 24VAC connection 1" L 105mm DN 22mm -10 up to 140°C SIRAI coil type Z923A membranes EPDM (steam/water) p max 8bar p min 0.1bar		
For models:	AC100, AC101, AC105, AC120, AC122, AC135, AC150, AC151, AC152, AC170, AC181, AC182, AC200, AC201, AC202, AC241, AC242, AC90, AC91, AC95, ACR, ACR145, ACR205, ACR225, ACR245, ACR260, ACR265, ACR305, ACS101, ACS101-DIGIT, ACS122, ACS122-DIGIT, ACS151, ACS151-DIGIT, ACS152, ACS152-DIGIT, ACS161-DIGIT, ACS162-DIGIT, ACS181, ACS181-DIGIT, ACS182, ACS182-DIGIT, ACS201, ACS201-DIGIT, ACS202, ACS202-DIGIT, ACS241, ACS241-DIGIT, ACS242, ACS242-DIGIT...(Other models you can see in the webshop)		



1

GEV No.	370325	Ref. No.	120107 120165
description	solenoid valve 2-ways 24VAC inlet 3/4" outlet 3/4" connection 3/4" L 79mm DN 17mm slide-on receptacle DIN -10 up to 140°C SIRAI type series L153-D coil type Z134A membranes EPDM (steam/water) p max 8bar p min 0.1bar 50Hz		
For models:	AC100, AC101, AC105, AC120, AC122, AC135, AC150, AC151, AC152, AC170, AC181, AC182, AC200, AC201, AC202, AC241, AC242, AC90, AC91, AC95, ACR, ACR145, ACR205, ACR225, ACR245, ACR260, ACR265, ACR305, ACS101, ACS101-DIGIT, ACS122, ACS122-DIGIT, ACS151, ACS151-DIGIT, ACS152, ACS152-DIGIT, ACS161-DIGIT, ACS162-DIGIT, ACS181, ACS181-DIGIT, ACS182, ACS182-DIGIT, ACS201, ACS201-DIGIT, ACS202, ACS202-DIGIT, ACS241, ACS241-DIGIT, ACS242, ACS242-DIGIT...(Other models you can see in the webshop)		

spare parts and accessories

solenoid coils





1

GEV No.	371071	Ref. No.	630981
description	solenoid coil 230VAC 10VA SIRAI coil type Z610A seat ø 10mm H 33mm L 33mm W 25mm 50/60Hz		
For models:	GE100, GE115, GE125, GE60, GE60RCD, GE65, GE65RCD, GE75, GE80		
accessories for	371071		
	GEV No.	371091	Ref. No. 150034
	power socket plug type DIN 43650B cable lengthmm small		

1

GEV No.	371070	Ref. No.	630948
description	solenoid coil 24VAC 10VA SIRAI coil type Z610A seat ø 10mm		
For models:	AC101, AC122, AC151, AC152, AC181, AC182, AC201, AC202, AC241, AC242, AC91, ACR, ACR145, ACR205, ACR225, ACR245, ACR260, ACR265, ACR305, ACRS145, ACRS205, ACRS225, ACRS245, ACRS260, ACRS265, ACRS305, G100L, G101L, G115L, G125L, G50L, G50LM, G51L, G60L, G61L, G65L, G75L, GL, GMC, GMC2700, GMC2702, GMC3500, GMC3502, GMC4500, GMC4502, GMC5500, GMC5502, LAV1001, LAV1501, LV1001...(Other models you can see in the webshop)		
accessories for	371070		
	GEV No.	371091	Ref. No. 150034
	power socket plug type DIN 43650B cable lengthmm small		



1

GEV No.	371178	Ref. No.	630976
description	solenoid coil 24VAC 24VA SIRAI coil type Z110A/Z114A/Z134A seat ø 14mm		

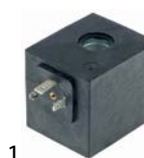

1

GEV No.	371162	Ref. No.	630976
description	solenoid coil 24VAC 27VA SIRAI seat ø 16mm		



1

GEV No.	371158	Ref. No.	630973
description	solenoid coil 24VAC 10VA SIRAI coil type Z614A seat ø 10mm		
For models:	AC100, AC101, AC105, AC120, AC122, AC135, AC150, AC151, AC152, AC170, AC181, AC182, AC200, AC201, AC202, AC241, AC242, AC90, AC91, AC95, ACR, ACR145, ACR205, ACR225, ACR245, ACR260, ACR265, ACR305, ACS101, ACS101-DIGIT, ACS122, ACS122-DIGIT, ACS151, ACS151-DIGIT, ACS152, ACS152-DIGIT, ACS161-DIGIT, ACS162-DIGIT, ACS181, ACS181-DIGIT, ACS182, ACS182-DIGIT, ACS201, ACS201-DIGIT, ACS202, ACS202-DIGIT, ACS241, ACS241-DIGIT, ACS242, ACS242-DIGIT...(Other models you can see in the webshop)		
accessories for	371158		
	GEV No.	371091	Ref. No. 150034
	power socket plug type DIN 43650B cable lengthmm small		

membranes



1

GEV No.	371169	Ref. No.	630629
description	membrane connection 1" series L153-D membrane type EPDM		
For models:	AC100, AC101, AC105, AC120, AC122, AC135, AC150, AC151, AC152, AC170, AC181, AC182, AC200, AC201, AC202, AC241, AC242, AC90, AC91, AC95, ACR, ACR145, ACR205, ACR225, ACR245, ACR260, ACR265, ACR305, ACS101, ACS101-DIGIT, ACS122, ACS122-DIGIT, ACS151, ACS151-DIGIT, ACS152, ACS152-DIGIT, ACS161-DIGIT, ACS162-DIGIT, ACS181, ACS181-DIGIT, ACS182, ACS182-DIGIT, ACS201, ACS201-DIGIT, ACS202, ACS202-DIGIT, ACS241, ACS241-DIGIT, ACS242, ACS242-DIGIT...(Other models you can see in the webshop)		



1

GEV No.	371068	Ref. No.	630972
description	solenoid coil 24VAC 14VA SIRAI coil type Z534A seat ø 12mm		
For models:	AC100, AC101, AC105, AC120, AC122, AC135, AC150, AC151, AC152, AC170, AC181, AC182, AC200, AC201, AC202, AC241, AC242, AC90, AC91, AC95, ACR, ACR145, ACR205, ACR225, ACR245, ACR260, ACR265, ACR305, ACS101, ACS101-DIGIT, ACS122, ACS122-DIGIT, ACS151, ACS151-DIGIT, ACS152, ACS152-DIGIT, ACS161-DIGIT, ACS162-DIGIT, ACS181, ACS181-DIGIT, ACS182, ACS182-DIGIT, ACS201, ACS201-DIGIT, ACS202, ACS202-DIGIT, ACS241, ACS241-DIGIT, ACS242, ACS242-DIGIT...(Other models you can see in the webshop)		





1

GEV No.	371165	Ref. No.	630625
description	membrane connection 3/4" series L145-R membrane type PTFE		
For models:	AC100, AC101, AC105, AC120, AC122, AC135, AC150, AC151, AC152, AC170, AC181, AC182, AC200, AC201, AC202, AC241, AC242, AC90, AC91, AC95, ACR, ACR145, ACR205, ACR225, ACR245, ACR260, ACR265, ACR305, ACS101, ACS101-DIGIT, ACS122, ACS122-DIGIT, ACS151, ACS151-DIGIT, ACS152, ACS152-DIGIT, ACS161-DIGIT, ACS162-DIGIT, ACS181, ACS181-DIGIT, ACS182, ACS182-DIGIT, ACS201, ACS201-DIGIT, ACS202, ACS202-DIGIT, ACS241, ACS241-DIGIT, ACS242, ACS242-DIGIT...(Other models you can see in the webshop)		



			
GEV No.	371168	Ref. No.	630628
description	membrane connection 3/4" series L153-D membrane type EPDM		
For models:	AC100, AC101, AC105, AC120, AC122, AC135, AC150, AC151, AC152, AC170, AC181, AC182, AC200, AC201, AC202, AC241, AC242, AC90, AC91, AC95, ACR, ACR145, ACR205, ACR225, ACR245, ACR260, ACR265, ACR305, ACS101, ACS101-DIGIT, ACS122, ACS122-DIGIT, ACS151, ACS151-DIGIT, ACS152, ACS152-DIGIT, ACS161-DIGIT, ACS162-DIGIT, ACS181, ACS181-DIGIT, ACS182, ACS182-DIGIT, ACS201, ACS201-DIGIT, ACS202, ACS202-DIGIT, ACS241, ACS241-DIGIT, ACS242, ACS242-DIGIT...(Other models you can see in the webshop)		

			
GEV No.	371198	Ref. No.	630901
description	solenoid coil 230V voltage AC H 31mm seat ø 9mm ø 23.5mm		
For models:	B12, B16, B19, B25, B26, B27, B31, B32, F2, F3, F300		

			
GEV No.	371171	Ref. No.	630631
description	membrane series L180-B membrane type NBR (water)		
For models:	NE02, NE3001, NE3002, NE4001, NE4002, NE5002, NE5501, NE5502, NE7002, NE7501, NE7502, NE9001, NE9002, NE9502, NG02, NG1202, NG1202E, NG602, NG602E, NG902, NG902E		

solenoid valves (refrigeration)

CASTEL

spare parts and accessories

			
GEV No.	371090	Ref. No.	150033
description	power socket plug type DIN 43650A screw		

Solenoid valve - accessories

			
GEV No.	371091	Ref. No.	150034
description	power socket plug type DIN 43650B cable lengthmm small		
For models:	AC100, AC101, AC122, AC151, AC152, AC181, AC182, AC201, AC202, AC241, AC242, AC91, ACR, ACR145, ACR205, ACR225, ACR245, ACR260, ACR265, ACR305, ACRS145, ACRS205, ACRS225, ACRS245, ACRS260, ACRS265, ACRS305, ACS101, ACS101-DIGIT, ACS122, ACS122-DIGIT, ACS151, ACS151-DIGIT, ACS152, ACS152-DIGIT, ACS161-DIGIT, ACS162-DIGIT, ACS181, ACS181-DIGIT, ACS182, ACS182-DIGIT, ACS201, ACS201-DIGIT, ACS202, ACS202-DIGIT, ACS241, ACS241-DIGIT, ACS242, ACS242-DIGIT, ACS91...(Other models you can see in the webshop)		

pressure switches

for warewashing

ø 58mm with male faston 6.3mm

with connection horizontal

			
GEV No.	541011	Ref. No.	130609
description	pressure control pressure range 110/70mbar connection 6mm ø 58mm pressure connection horizontal warewashing		
For models:	AC100, AC90, ACR, ACR145, ACR205, ACR225, ACR245, ACR260, ACR265, ACR305, G125, G75, GE100, GE115, GE60, GE60RCD, GE65, GE65RCD, GE80, GMC, GMC2700, GMC3500, GMC4500, GMC5500, NE00, NG00, NG600, NG600E, NG900, NG900E, SE, SNL		

			
GEV No.	541000	Ref. No.	130607
description	pressure control pressure range 110/75mbar connection male faston 6.3mm ø 58mm pressure connection horizontal warewashing pressure connection ø 6mm		
For models:	B13T, B14T, B15, B15T, B15TM, B16, B16T, B16TM, B18, B18T, B18TM, B19, B19T, B19TM, B41, B42, F2, F20, F3, R50		

			
GEV No.	541972	Ref. No.	130635
description	pressure control pressure range 190/40mbar connection male faston 6.3mm ø 58mm pressure connection horizontal warewashing pressure connection ø 5.5mm		
For models:	GE50RCD		



 <p>1</p>			
GEV No.	541023	Ref. No.	130616
description	pressure control pressure range 190/80mbar connection 6mm ø 58mm pressure connection horizontal warewashing		
For models:	C1000E, C1000ERCD, C1001M, C1300E, C1300ERCD, C1301M, C155, C155BT, C155E2, C155RCD, C165, C165E2, C165E2BT, C165E2RCD, C166, C166-2, C95, C95BT, C95E2, C95RCD, GE100, GE115, GE60, GE60RCD, GE65, GE65RCD, GE80, XLC		

 <p>1</p>			
GEV No.	541045	Ref. No.	130629
description	pressure control pressure range 28/12mbar connection 6mm ø 58mm pressure connection horizontal warewashing		

 <p>1</p>			
GEV No.	541307	Ref. No.	130629
description	pressure control pressure range 30/12mbar connection male faston 6.3mm ø 58mm pressure connection horizontal warewashing pressure connection ø 6mm		
For models:	ACL100, ACL150, BHC25, BHC25-2, BHC25A, BHC25A-2, BHC25S, BHC30, BHC30-2, BHC30A, BHC30A-2, BHC30E, BHC30E-2, BHC30EA, BHC30EA-2, BHC433, BHC433-2, BHC433A, BHC433A-2, FC3E, FC3EA, FC3M, FC3MA, FC3MR, FC44E, FC44EA, FC4E, FC4EA, FC4M, FC4MA, GF70, GF70A, LB200, LB200-2, LB200A, LB200A-2, LB215, LB215-2, LB215A, LB215A-2, LB260, LB260-2, LB260A, LB260A-2, LB275, LB275-2, LB275A, LB275A-2, LF321, LF321A...(Other models you can see in the webshop)		

 <p>1</p>			
GEV No.	541039	Ref. No.	130621
description	pressure control pressure range 45/25mbar connection 6mm ø 58mm pressure connection horizontal warewashing		
For models:	BC25HR, BC30HR, BC30HR380, BC30HRA, GF90, GF90-2004, GF90A, GF90A-2004, LF315, LF320, LF320A, LF320CBT, LF320L, LF320LA, LF320LBT, LF323, LF323A, LF350, LF350A, LF450, LF450A, LS550		

 <p>1</p>			
GEV No.	541792	Ref. No.	130605 130622
description	pressure control pressure range 46/30mbar connection male faston 6.3mm ø 58mm pressure connection horizontal warewashing pressure connection ø 6mm		
For models:	AC120, AC122, AC150, AC151, AC152, AC170, AC181, AC182, AC200, AC201, AC202, AC241, AC242, ACR, ACR145, ACR205, ACR225, ACR245, ACR260, ACR265, ACR305, ACRS145, ACRS205, ACRS225, ACRS245, ACRS260, ACRS265, ACRS305, B10, B10T, B11, B11T, B12, B12T, B20, B20D, B23, B24, B25, B26, B27, B31, C140, C155BT, C155RCD, C165E2BT, C165E2RCD, C166-2, C30, C75BT...(Other models you can see in the webshop)		

 <p>1</p>			
GEV No.	541024	Ref. No.	130617
description	pressure control pressure range 60/40mbar connection 6mm ø 58mm pressure connection horizontal warewashing pressure connection ø 6mm		
For models:	BC25, BC25A, BC30, BC30A, BR20, BR20A, BR25, BR25A, FC43, FC43A		

 <p>1</p>			
GEV No.	541012	Ref. No.	130604
description	pressure control pressure range 68/40mbar connection 6mm ø 58mm pressure connection horizontal warewashing pressure connection ø 6mm		
For models:	C30, C33, C34, C70, C75, C75BT, C75M, C75RCD, F2, F3, F300, F45, F55, F65, F80, G115, G131, G65, G66, LP360, LP360BT, LP360RCD, R40, R70		

 <p>1</p>			
GEV No.	541631	Ref. No.	130632
description	pressure control pressure range 75/45mbar connection 6mm ø 55mm pressure connection ø 5.5mm		
For models:	LC1200, LC1200RCD, LC412, LC700, LC700RCD, LC900, LC900RCD		



ø 84mm with coded plug



1			
GEV No.	541308	Ref. No.	130628
description	pressure control 3 pressure ranges pressure range 50/30 50/30 110/70mbar connection 6mm ø 84mm pressure connection horizontal warewashing suitable for COMENDA pressure connection ø 6mm		
For models:	C1000ERCD, C1300ERCD, C155BT, C155RCD, C165E2BT, C165E2RCD, C75BT, C75RCD, C95BT, C95RCD, FC53CBT, FC53LBT, FC54CBT, FC54LBT, GE50RCD, LC1200RCD, LC380BT, LC380RCD, LC700RCD, LC900RCD, LF320CBT, LF320LBT, LP360BT, LP360RCD		



1			
GEV No.	541674	Ref. No.	130620
description	pressure control 3 pressure ranges pressure range 50/30 50/30 160/80mbar connection 6mm ø 84mm pressure connection horizontal warewashing suitable for COMENDA, HOONVED pressure connection ø 6mm		
For models:	AC101, AC105, AC120, AC122, AC135, AC150, AC151, AC152, AC170, AC181, AC182, AC200, AC201, AC202, AC241, AC242, AC2A, AC91, AC95, ACL100, ACL150, ACR, ACR145, ACR205, ACR225, ACR245, ACR260, ACR265, ACR305, ACRS145, ACRS205, ACRS225, ACRS245, ACRS260, ACRS265, ACRS305, ACS101, ACS101-DIGIT, ACS122, ACS122-DIGIT, ACS151, ACS151-DIGIT, ACS152, ACS152-DIGIT, ACS161-DIGIT, ACS162-DIGIT, ACS181, ACS181-DIGIT, ACS182, ACS182-DIGIT...(Other models you can see in the webshop)		

miscellaneous



1			
GEV No.	541310	Ref. No.	130625
description	pressure control pressure range 15mbar		
For models:	C155BT, C155RCD, C165E2BT, C165E2RCD, C166-2, C75BT, C75RCD, C95BT, C95RCD, FC53CBT, FC53LBT, FC54CBT, FC54LBT, LC380BT, LC380RCD, LF320CBT, LF320LBT, LP360BT, LP360RCD		

accessories



1			
GEV No.	541109	Ref. No.	190314
description	Y-piece plastic hose ø 8-6-8mm for pressure switch		
For models:	ACR, ACR145, ACR205, ACR225, ACR245, ACR260, ACR265, ACR305, C166-2, FC3E, FC3EA, FC44E, FC44EA, FC4E, FC4EA, GMC, GMC2700, GMC3500, GMC4500, GMC5500, NE00, NG00, NG600, NG600E, NG900, NG900E		

electrodes



1			
GEV No.	403116	Ref. No.	120951
description	level electrode M10x1.5 probe L 20mm connection M4 ø 4mm		
For models:	BHC30HR, BHC30HR-2, BHC30HR380, BHC30HRA, BHC30HRA-2, BHC30HRA380, BHCHR		



1			
GEV No.	403254	Ref. No.	120954
description	level electrode M10x1.5 total length 55mm probe L 30x40mm insulated probe length 15mm connection M4 ø 4mm Qty 1 pcs		
For models:	BHC30HR, BHC30HR-2, BHC30HR380, BHC30HRA, BHC30HRA-2, BHC30HRA380, BHCHR		



motors

gear motors

for dishwashers



1

GEV No.	601665	Ref. No.	100246
description	gear motor NORD type SK 01-71L/6-4 0.10/0.15W 400V 50Hz 3 phase 12.2/18.8rpm shaft ø 19mm L 363mm speeds 2		
For models:	AC100, AC101, AC105, AC120, AC122, AC135, AC150, AC151, AC152, AC170, AC181, AC182, AC200, AC201, AC202, AC241, AC242, AC90, AC91, AC95, ACS101, ACS101-DIGIT, ACS122, ACS122-DIGIT, ACS151, ACS151-DIGIT, ACS152, ACS152-DIGIT, ACS161-DIGIT, ACS162-DIGIT, ACS181, ACS181-DIGIT, ACS182, ACS182-DIGIT, ACS201, ACS201-DIGIT, ACS202, ACS202-DIGIT, ACS241, ACS241-DIGIT, ACS242, ACS242-DIGIT, ACS91, ACS91-DIGIT, NE02, NE3002, NE4002, NE5002, NE5502, NE7002...(Other models you can see in the webshop)		

pumps



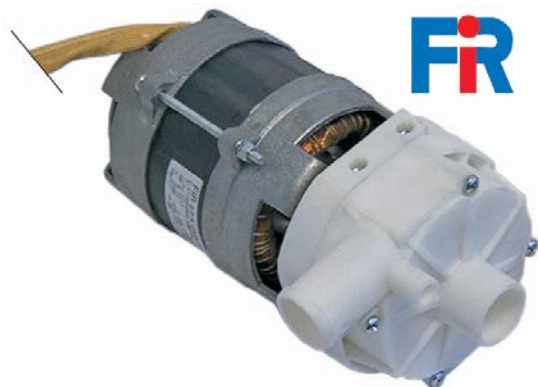

wash and rinse pumps

FIR

pumps



1

GEV No.	500037	Ref. No.	100747
description	pump inlet ø 28mm outlet ø 26mm type 2211.1410 230V 50Hz 1 phase 0.074kW 0.1HP L 190mm rotation direction left capacitor 5µF FIR		
spare parts for	500037		
	GEV No.	365017	Ref. No. 631208
	operating capacitor capacity 5µF 450V tolerance 5% 50/60Hz ambient temperature max. -25 to +85°C ø 28mm L 54mm M8 plastic connection male faston 6.3mm 16.10.08 protection		
	GEV No.	510384	Ref. No. 630131
	pump cover inlet ø 28mm outlet ø 26mm ø 100mm ID ø 76mm		
	GEV No.	510695	Ref. No. —
	mechanical shaft seal height counter ring 5.5mm ID ø 11mm		
	GEV No.	521203	Ref. No. 631660
	impellor ø 72mm H 18mm thread M7 shaft ø 11mm shaft length 32mm blades 3		





spare parts for	500037		
	GEV No.	521703	Ref. No. —
	pump cover gasket EPDM thickness 2.5mm ID ø 75mm Qty 1 pcs		





1

GEV No.	500015	Ref. No.	100303 100701
description	pump inlet ø 28mm outlet ø 26mm type 2228.XXXX 230V 50Hz 1 phase 0.15kW 0.2HP L 190mm rotation direction right capacitor 5µF FIR		
For models:	B10T, B11T, B12T, B15, B16, B18, B19, BR20, BR20A, BR25, BR25A, LBC210, LBC215, LBC215A, LBC275, LBC275A, LBR, LBR200, LBR215, LBR215A		
spare parts for	500015		
	GEV No.	365017	Ref. No. 631208
	operating capacitor capacity 5µF 450V tolerance 5% 50/60Hz ambient temperature max. -25 to +85°C ø 28mm L 54mm M8 plastic connection male faston 6.3mm 16.10.08 protection		
	GEV No.	510510	Ref. No. 630120 630125
	pump cover pump type 2212/2228/2229/2211		
	GEV No.	510532	Ref. No. —
	impellor ø 72mm H 22mm shaft ø 11mm shaft length 32mm blades 3		
	GEV No.	510695	Ref. No. —
	mechanical shaft seal height counter ring 5.5mm ID ø 11mm		
	GEV No.	521703	Ref. No. —
	pump cover gasket EPDM thickness 2.5mm ID ø 75mm Qty 1 pcs		





GEV No.	500399	Ref. No.	100747
description	pump inlet ø 28mm outlet ø 26mm type 4208.1910 230V 50Hz 1 phase 0.075kW 0.1HP L 190mm rotation direction left capacitor 5µF FIR		
For models:	C155BT, C155RCD, C165E2BT, C165E2RCD, C75BT, C75RCD, C95BT, C95RCD, FC53CBT, FC53LBT, FC54CBT, FC54LBT, LC380BT, LC380RCD, LF320CBT, LF320LBT, LP360BT, LP360RCD		
spare parts for	500399		
	GEV No.	365017	Ref. No. 631208
	operating capacitor capacity 5µF 450V tolerance 5% 50/60Hz ambient temperature max. -25 to +85°C ø 28mm L 54mm M8 plastic connection male faston 6.3mm 16.10.08 protection		
	GEV No.	510384	Ref. No. 630131
	pump cover inlet ø 28mm outlet ø 26mm ø 100mm ID ø 76mm		
	GEV No.	510695	Ref. No. —
	mechanical shaft seal height counter ring 5.5mm ID ø 11mm		
	GEV No.	521203	Ref. No. 631660
	impellor ø 72mm H 18mm thread M7 shaft ø 11mm shaft length 32mm blades 3		
	GEV No.	521703	Ref. No. —
	pump cover gasket EPDM thickness 2.5mm ID ø 75mm Qty 1 pcs		



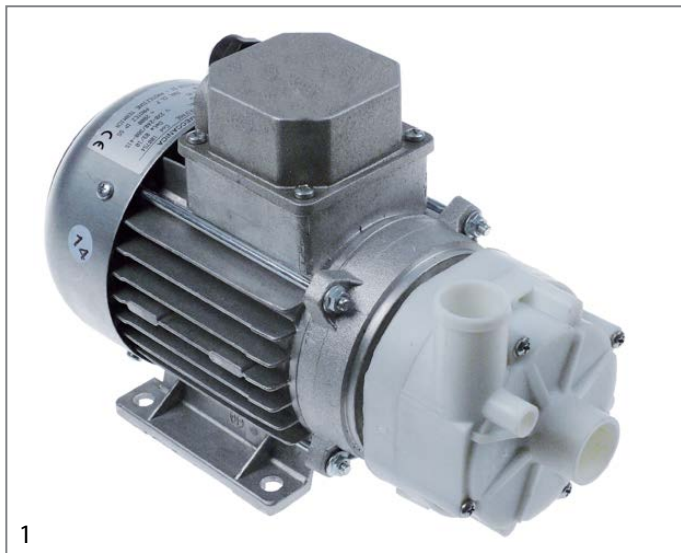



GEV No.	500030	Ref. No.	100647
description	pump inlet ø 28mm outlet ø 26mm type 4226.2540 230/400V 50Hz 3 phase 0.35kW 0.5HP L 260mm rotation direction right FIR		
For models:	AC101, AC120, AC122, AC151, AC152, AC170, AC181, AC182, AC200, AC201, AC202, AC241, AC242, AC2A, AC91, ACL100, ACL150, ACR, ACR145, ACR205, ACR225, ACR245, ACR260, ACR265, ACR305, ACRS145, ACRS205, ACRS225, ACRS245, ACRS260, ACRS265, ACRS305, ACS101, ACS101-DIGIT, ACS122, ACS122-DIGIT, ACS151, ACS151-DIGIT, ACS152, ACS152-DIGIT, ACS161-DIGIT, ACS162-DIGIT, ACS181, ACS181-DIGIT, ACS182, ACS182-DIGIT, ACS201, ACS201-DIGIT, ACS202, ACS202-DIGIT...(Other models you can see in the webshop)		
spare parts for	500030		
	GEV No.	510510	Ref. No. 630120 630125
	pump cover pump type 2212/2228/2229/2211		
	GEV No.	510690	Ref. No. —
	mechanical shaft seal for shaft ø 8mm ED ø 24mm mounting ø 24/26mm		
	GEV No.	521202	Ref. No. 631675
	impellor ø 72mm H 17mm thread M5L		



1



GEV No.	500999	Ref. No.	100754
description	pump inlet ø 28mm outlet ø 26mm type 4226.2541 230/400V 50Hz 3 phase 0.35kW 0.5HP L 260mm rotation direction right FIR		
For models:	AC101, AC122, AC151, AC152, AC181, AC182, AC201, AC202, AC241, AC242, AC91, ACS101, ACS101-DIGIT, ACS122, ACS122-DIGIT, ACS151, ACS151-DIGIT, ACS152, ACS152-DIGIT, ACS161-DIGIT, ACS162-DIGIT, ACS181, ACS181-DIGIT, ACS182, ACS182-DIGIT, ACS201, ACS201-DIGIT, ACS202, ACS202-DIGIT, ACS241, ACS241-DIGIT, ACS242, ACS242-DIGIT, ACS91, ACS91-DIGIT		
spare parts for	500999		
	GEV No.	510510	Ref. No. 630120 630125
	pump cover pump type 2212/2228/2229/2211		
	GEV No.	510690	Ref. No. —
	mechanical shaft seal for shaft ø 8mm ED ø 24mm mounting ø 24/26mm		
	GEV No.	521279	Ref. No. 631687
	impellor ø 64mm H 17mm thread M5L blades 3 metal		

spare parts for 500019

	GEV No.	510510	Ref. No.	630120 630125
	pump cover pump type 2212/2228/2229/2211			
	GEV No.	510532	Ref. No.	—
	impellor ø 72mm H 22mm shaft ø 11mm shaft length 32mm blades 3			
	GEV No.	510695	Ref. No.	—
	mechanical shaft seal height counter ring 5.5mm ID ø 11mm			
	GEV No.	521703	Ref. No.	—
	pump cover gasket EPDM thickness 2.5mm ID ø 75mm Qty 1 pcs			



1

GEV No.	500020	Ref. No.	100376
description	pump inlet ø 32mm outlet ø 32mm type 4134.1402 230V 50Hz 1 phase 0.18kW 0.25HP L 180mm rotation direction right capacitor 10µF FIR		
For models:	B23, B24, B25, B26, B27		
spare parts for	500020		
	GEV No.	510506	Ref. No. —
	pump cover pump type 4333/1265		
accessories for	500020		
	GEV No.	504329	Ref. No. —
	blind plug H 17.5mm thread M16x1.5 plastic WS 22 for pump		







1

GEV No.	500019	Ref. No.	100702
description	pump inlet ø 28mm outlet ø 26mm type B229.1405 230V 50Hz 1 phase 0.22kW 0.3HP L 200mm rotation direction right capacitor 5µF FIR		
For models:	B13T, B14T, B15T, B15TM, B16T, B16TM, B18T, B18TM, B19T, B19TM, BC25, BC25A, BC25HR, BC30, BC30A, BC30HR, BC30HR380, BC30HRA, FC43, FC43A, LBC210, LBC215, LBC215A, LBC275, LBC275A		
spare parts for	500019		
	GEV No.	365017	Ref. No. 631208
	operating capacitor capacity 5µF 450V tolerance 5% 50/60Hz ambient temperature max. -25 to +85°C ø 28mm L 54mm M8 plastic connection male faston 6.3mm 16.10.08 protection		







1

GEV No.	500127	Ref. No.	100375 100399 100740
description	pump inlet \varnothing 37mm outlet \varnothing 41mm type 4247.1900 230V 50Hz 1 phase 0.44kW 0.6HP L 200mm rotation direction right capacitor 10 μ F FIR		
For models:	B31, B32, B41, B42, F2, F20, F3, F300, F45, F55, F65, FC, FC53, FC533, FC533A, FC53A, FC53CBT, FC53LA, FC53LBT, FC54, FC543, FC543A, FC543E, FC543EA, FC544, FC544A, FC54A, FC54CBT, FC54E, FC54EA, FC54LBT, FCHR, FCHRA, FCHRT, FCHRTA, LF315, LF320, LF320A, LF320CBT, LF320L, LF320LA, LF320LBT, LF323, LF323A, LS550, R40, R50, R70		
spare parts for	500127		
	GEV No.	365015	Ref. No. 3068016 631206
	operating capacitor capacity 10 μ F 400V tolerance 5%Hz ambient temperature max. -25 to +85°C \varnothing 35.5mm L 59mm M8 plastic connection male faston 6.3mm protection		
	GEV No.	510608	Ref. No. 631683
	impellor \varnothing 93mm H 32mm shaft intake \varnothing 9/8mm blades 6 inner height 11mm		
	GEV No.	510692	Ref. No. 630510 630514
	mechanical shaft seal for shaft \varnothing 11mm slide ring ext. \varnothing 24mm slide ring H 13mm counter ring mounting \varnothing 26mm height counter ring 8mm counter ring int. \varnothing 14mm		
	GEV No.	521505	Ref. No. 630129
	pump cover FIR inlet \varnothing 37mm outlet \varnothing 40mm turn direction right \varnothing 160mm ID \varnothing 125mm inner height 25mm		
	GEV No.	521702	Ref. No. 630419
	pump cover gasket thickness 3.5x4.5mm Qty 1 pcs		



1

GEV No.	500017	Ref. No.	100384 100672
description	pump inlet \varnothing 45mm outlet \varnothing 40mm type 1219.1405 230V 50Hz 1 phase 0.73kW 1HP L 300mm rotation direction right capacitor 12.5 μ F FIR		
For models:	C30, C70, C75, C75BT, C75M, C75RCD, C85, F80, LF450, LF450A		
spare parts for	500017		
	GEV No.	365014	Ref. No. 631207
	operating capacitor capacity 12.5 μ F 450V tolerance 5%Hz ambient temperature max. -25 to +85°C \varnothing 35mm L 70mm M8 plastic connection male faston 6.3mm 45S.C3DS.12.5 protection		
	GEV No.	510600	Ref. No. 631627 631643
	impellor \varnothing 102mm H 29mm shaft intake \varnothing 9/8mm rotation direction right blades 6		
	GEV No.	510692	Ref. No. 630510 630514
	mechanical shaft seal for shaft \varnothing 11mm slide ring ext. \varnothing 24mm slide ring H 13mm counter ring mounting \varnothing 26mm height counter ring 8mm counter ring int. \varnothing 14mm		
	GEV No.	521539	Ref. No. —
	pump cover FIR inlet \varnothing 45mm outlet \varnothing 40mm auxiliary pressure connection 10mm supporting pressure open turn direction right \varnothing 160mm ID \varnothing 125mm inner height 25mm		
	GEV No.	521702	Ref. No. 630419
	pump cover gasket thickness 3.5x4.5mm Qty 1 pcs		





1

GEV No.	499140	Ref. No.	100386
description	pump inlet ø 45mm outlet ø 40mm type 1219.2504 220/380-240/415V 50Hz 3 phase 1.1kW 1.5HP L 290mm rotation direction right FIR		
For models:	AC101, AC122, AC135, AC150, AC151, AC152, AC170, AC181, AC182, AC200, AC201, AC202, AC241, AC242, AC91, ACS101, ACS101-DIGIT, ACS122, ACS122-DIGIT, ACS151, ACS151-DIGIT, ACS152, ACS152-DIGIT, ACS161-DIGIT, ACS162-DIGIT, ACS181, ACS181-DIGIT, ACS182, ACS182-DIGIT, ACS201, ACS201-DIGIT, ACS202, ACS202-DIGIT, ACS241, ACS241-DIGIT, ACS242, ACS242-DIGIT, ACS91, ACS91-DIGIT, LAV1000, LAV1001, LAV1501, SNL		
spare parts for	499140		
	GEV No.	502007	Ref. No. —
			pump cover gasket
	GEV No.	510529	Ref. No. 631656
			impellor ø 103mm H 30mm shaft intake ø 9/8mm rotation direction right blades 6
	GEV No.	510692	Ref. No. 630510 630514
			mechanical shaft seal for shaft ø 11mm slide ring ext. ø 24mm slide ring H 13mm counter ring mounting ø 26mm height counter ring 8mm counter ring int. ø 14mm
	GEV No.	511187	Ref. No. 630113
			pump cover FIR inlet ø 45mm outlet ø 40mm turn direction right ø 160mm ID ø 122mm inner height 21mm



1

GEV No.	500004	Ref. No.	100707
description	pump inlet ø 45mm outlet ø 40mm type 1219.2521 230/400V 50Hz 3 phase 1.1kW 1.5HP L 300mm rotation direction right capacitor µF FIR		
For models:	C85, F90M, F90MA, LF400A		
spare parts for	500004		
	GEV No.	502007	Ref. No. —
			pump cover gasket
	GEV No.	510529	Ref. No. 631656
			impellor ø 103mm H 30mm shaft intake ø 9/8mm rotation direction right blades 6
	GEV No.	510692	Ref. No. 630510 630514
			mechanical shaft seal for shaft ø 11mm slide ring ext. ø 24mm slide ring H 13mm counter ring mounting ø 26mm height counter ring 8mm counter ring int. ø 14mm
	GEV No.	511187	Ref. No. 630113
			pump cover FIR inlet ø 45mm outlet ø 40mm turn direction right ø 160mm ID ø 122mm inner height 21mm



1











GEV No.	500033	Ref. No.	100346
description	pump inlet ø 45mm outlet ø 40mm type 1221.1400 230V 50Hz 1 phase 0.37kW 0.5HP L 210mm rotation direction right capacitor 12.5µF FIR		
For models:	F300		
spare parts for	500033		
	GEV No.	365014	Ref. No. 631207
			operating capacitor capacity 12.5µF 450V tolerance 5%Hz ambient temperature max. -25 to +85°C ø 35mm L 70mm M8 plastic connection male faston 6.3mm 45S.C3DS.12.5 protection

Table continues overleaf







spare parts for 500033				
	GEV No.	502007	Ref. No.	—
pump cover gasket				
	GEV No.	510607	Ref. No.	—
impellor ø 85mm H 29mm shaft intake ø 9x8mm rotation direction right blades 6				
	GEV No.	510692	Ref. No.	630510 630514
mechanical shaft seal for shaft ø 11mm slide ring ext. ø 24mm slide ring H 13mm counter ring mounting ø 26mm height counter ring 8mm counter ring int. ø 14mm				
	GEV No.	511187	Ref. No.	630113
pump cover FIR inlet ø 45mm outlet ø 40mm turn direction right ø 160mm ID ø 122mm inner height 21mm				



1				
GEV No.	500009	Ref. No.	100363	
description	pump inlet ø 45mm outlet ø 40mm type 1222.1406 230V 50Hz 1 phase 0.37kW 0.5HP L 275mm rotation direction right capacitor 12.5µF FIR			
For models:	F2			
spare parts for 500009				
	GEV No.	365014	Ref. No.	631207
operating capacitor capacity 12.5µF 450V tolerance 5%Hz ambient temperature max. -25 to +85°C ø 35mm L 70mm M8 plastic connection male faston 6.3mm 45S.C3DS.12.5 protection				
	GEV No.	502007	Ref. No.	—
pump cover gasket				
	GEV No.	510607	Ref. No.	—
impellor ø 85mm H 29mm shaft intake ø 9x8mm rotation direction right blades 6				
	GEV No.	510692	Ref. No.	630510 630514
mechanical shaft seal for shaft ø 11mm slide ring ext. ø 24mm slide ring H 13mm counter ring mounting ø 26mm height counter ring 8mm counter ring int. ø 14mm				
	GEV No.	511187	Ref. No.	630113
pump cover FIR inlet ø 45mm outlet ø 40mm turn direction right ø 160mm ID ø 122mm inner height 21mm				



1				
GEV No.	499071	Ref. No.	100336	
description	pump inlet ø 45mm outlet ø 40mm type 1222.2800 440V 60Hz 0.37kW 0.5HP L 275mm rotation direction right FIR			
spare parts for 499071				
	GEV No.	502007	Ref. No.	—
pump cover gasket				
	GEV No.	510528	Ref. No.	630214
flange suitable for pump				
	GEV No.	510692	Ref. No.	630510 630514
mechanical shaft seal for shaft ø 11mm slide ring ext. ø 24mm slide ring H 13mm counter ring mounting ø 26mm height counter ring 8mm counter ring int. ø 14mm				
	GEV No.	511187	Ref. No.	630113
pump cover FIR inlet ø 45mm outlet ø 40mm turn direction right ø 160mm ID ø 122mm inner height 21mm				

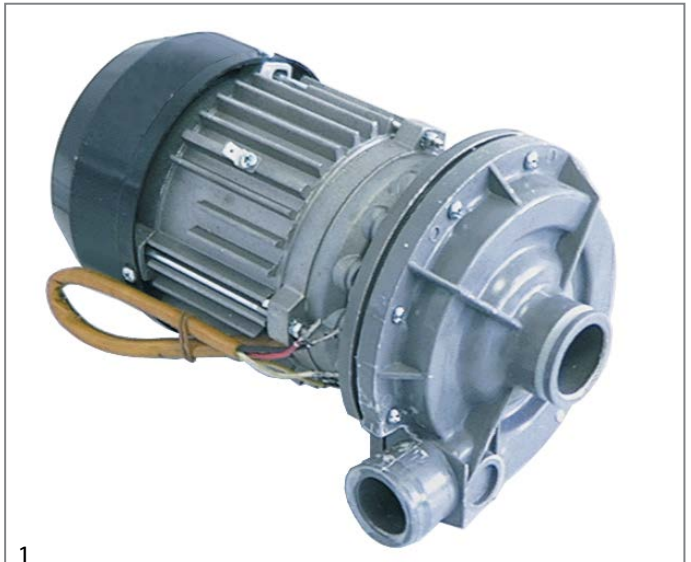







1				
GEV No.	500086	Ref. No.	100365	
description	pump inlet ø 45mm outlet ø 40mm type 1223.1400 230V 50Hz 1 phase 0.55kW 0.75HP L 275mm rotation direction right capacitor 12.5µF FIR			
For models:	F3			
spare parts for 500086				
	GEV No.	365014	Ref. No.	631207
operating capacitor capacity 12.5µF 450V tolerance 5%Hz ambient temperature max. -25 to +85°C ø 35mm L 70mm M8 plastic connection male faston 6.3mm 45S.C3DS.12.5 protection				

Table continues overleaf

spare parts for 500086				
	GEV No.	502007	Ref. No.	—
pump cover gasket				
	GEV No.	510608	Ref. No.	631683
impellor ø 93mm H 32mm shaft intake ø 9/8mm blades 6 inner high 11mm				
	GEV No.	510692	Ref. No.	630510 630514
mechanical shaft seal for shaft ø 11mm slide ring ext. ø 24mm slide ring H 13mm counter ring mounting ø 26mm height counter ring 8mm counter ring int. ø 14mm				
	GEV No.	511187	Ref. No.	630113
pump cover FIR inlet ø 45mm outlet ø 40mm turn direction right ø 160mm ID ø 122mm inner high 21mm				
	GEV No.	521022	Ref. No.	630254
fanwheel cover ID ø 137mm ED ø 142mm H 70mm for wash pump				

 <p>1</p>				
GEV No.	499045	Ref. No.	100896	
description	pump inlet ø 45mm outlet ø 40mm type 4268.2350 230V 50Hz 1 phase 0.45kW 0.6HP L 205mm rotation direction right capacitor 12.5µF FIR			

 <p>1</p>				
GEV No.	499139	Ref. No.	100398 100633	
description	pump inlet ø 62mm outlet ø 62mm type 2275.2722 230/400V 50Hz 3 phase 2.6kW L 400mm rotation direction right FIR			
For models:	NE00, NE02, NE3001, NE3002, NE4001, NE4002, NE5002, NE5501, NE5502, NE7002, NE7501, NE7502, NE9001, NE9002, NE9502			
spare parts for 499139				
	GEV No.	510687	Ref. No.	630516
mechanical shaft seal for shaft ø 18mm height counter ring 8mm ID ø 17mm ED ø 39mm H 15mm mounting ø 42mm int. ø 121mm				
	GEV No.	521026	Ref. No.	630418
pump cover gasket ID ø 182.5mm thickness 5x4.5mm				
	GEV No.	521028	Ref. No.	630122
pump cover FIR inlet ø 62mm outlet ø 62mm turn direction right ø 215mm ID ø 175mm inner high 40mm				
	GEV No.	521277	Ref. No.	631628
impellor ø 135mm H 39mm pump type Fir 2275 - 3.6HP thread M14L				
	GEV No.	524676	Ref. No.	630315
fan wheel ø 160mm shaft intake ø 24mm plastic blades 12 W 30mm				







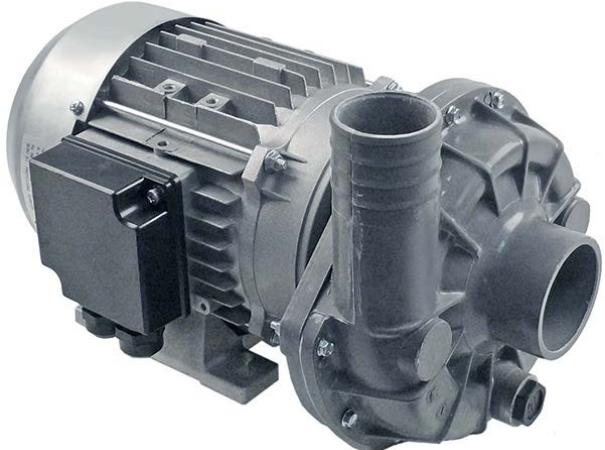

 <p>1</p>				
GEV No.	500023	Ref. No.	100634	
description	pump inlet ø 63mm outlet ø 47mm type 1225.2725 230/400V 50Hz 3 phase 1.1kW 1.5HP L 335mm rotation direction right FIR			
spare parts for 500023				
	GEV No.	510602	Ref. No.	—
impellor ø 110mm H 34mm rotation direction right thread M8L shaft ø 28mm seat ø 12.2mm blades 6				

Table continues overleaf

spare parts for		500023	
	GEV No.	510693	Ref. No. 630501 H35371
mechanical shaft seal for shaft \varnothing 12mm slide ring ext. \varnothing 24mm slide ring H 15.5mm slide ring int. \varnothing 11mm counter ring mounting \varnothing 24mm height counter ring 8mm counter ring int. \varnothing 13.5mm			
	GEV No.	521513	Ref. No. —
pump cover FIR inlet \varnothing 63mm outlet \varnothing 47mm turn direction right ID \varnothing 150mm inner high 32mm			
	GEV No.	524416	Ref. No. 630411
pump cover gasket thickness 4x4mm Qty 1 pcs			



GEV No.		501452		Ref. No.		100366	
description pump inlet \varnothing 63mm outlet \varnothing 53mm type 1204 220-240V 50Hz 1 phase 1.5kW 2HP L 34mm capacitor internal μ F FIR							
For models: LC380BT, LC380RCD							
spare parts for		501452					
	GEV No.	510531	Ref. No.	630114			
pump cover FIR inlet \varnothing 63mm outlet \varnothing 53mm auxiliary pressure connection M16x1.5mm supporting pressure open turn direction left \varnothing 185mm ID \varnothing 150mm inner high 37mm							
	GEV No.	510604	Ref. No.	630500 631618			
impeller \varnothing 118mm H 34mm M8R rotation direction left							
	GEV No.	510693	Ref. No.	630501 H35371			
mechanical shaft seal for shaft \varnothing 12mm slide ring ext. \varnothing 24mm slide ring H 15.5mm slide ring int. \varnothing 11mm counter ring mounting \varnothing 24mm height counter ring 8mm counter ring int. \varnothing 13.5mm							
	GEV No.	524416	Ref. No.	630411			
pump cover gasket thickness 4x4mm Qty 1 pcs							



GEV No.		500018		Ref. No.		100361 100716	
description pump inlet \varnothing 63mm outlet \varnothing 53mm type 1204.2528 230/400V 50Hz 3 phase 1.5kW 2HP L 328mm rotation direction left FIR							
spare parts for		500018					
	GEV No.	510523	Ref. No.	630306			
fan wheel \varnothing 142mm shaft intake \varnothing 15mm blades 12							
	GEV No.	510531	Ref. No.	630114			
pump cover FIR inlet \varnothing 63mm outlet \varnothing 53mm auxiliary pressure connection M16x1.5mm supporting pressure open turn direction left \varnothing 185mm ID \varnothing 150mm inner high 37mm							
	GEV No.	510604	Ref. No.	630500 631618			
impeller \varnothing 118mm H 34mm M8R rotation direction left							
	GEV No.	510693	Ref. No.	630501 H35371			
mechanical shaft seal for shaft \varnothing 12mm slide ring ext. \varnothing 24mm slide ring H 15.5mm slide ring int. \varnothing 11mm counter ring mounting \varnothing 24mm height counter ring 8mm counter ring int. \varnothing 13.5mm							
	GEV No.	524416	Ref. No.	630411			
pump cover gasket thickness 4x4mm Qty 1 pcs							







1

GEV No.	500258	Ref. No.	100361 100716
description	pump inlet ø 63mm outlet ø 53mm type 1204.2725 230/400V 50Hz 3 phase 1.5kW 2.01HP L 320mm rotation direction left FIR		
spare parts for	500258		
	GEV No.	510531	Ref. No. 630114
	pump cover FIR inlet ø 63mm outlet ø 53mm auxiliary pressure connection M16x1.5mm supporting pressure open turn direction left ø 185mm ID ø 150mm inner high 37mm		
	GEV No.	510604	Ref. No. 630500 631618
	impellor ø 118mm H 34mm M8R rotation direction left		
	GEV No.	510693	Ref. No. 630501 H35371
	mechanical shaft seal for shaft ø 12mm slide ring ext. ø 24mm slide ring H 15.5mm slide ring int. ø 11mm counter ring mounting ø 24mm height counter ring 8mm counter ring int. ø 13.5mm		
	GEV No.	511667	Ref. No. 630325
	fan wheel ø 123mm H 17mm shaft intake ø 15mm		
	GEV No.	524416	Ref. No. 630411
	pump cover gasket thickness 4x4mm Qty 1 pcs		





1

GEV No.	500031	Ref. No.	100373
description	pump inlet ø 63mm outlet ø 53mm type 1205.2528 230/400V 50Hz 3 phase 2kW 2.7HP L 330mm rotation direction left FIR		
spare parts for	500031		
	GEV No.	510357	Ref. No. 631620
	impellor ø 124mm H 34/16mm thread M8R blades 6		

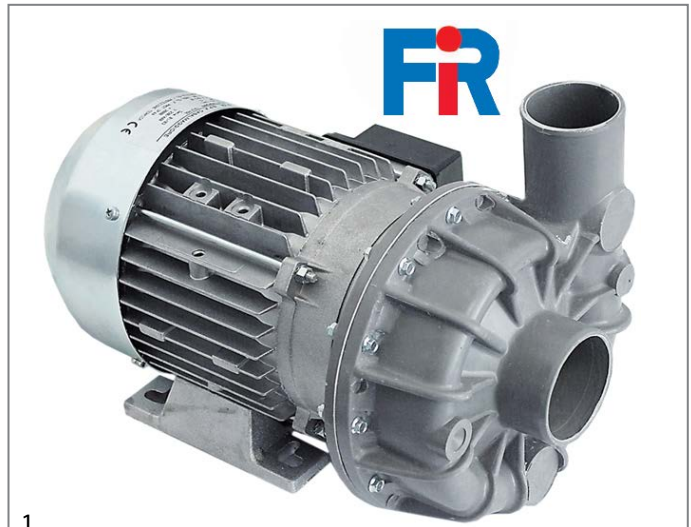
spare parts for	500031		
	GEV No.	510523	Ref. No. 630306
	fan wheel ø 142mm shaft intake ø 15mm blades 12		
	GEV No.	510531	Ref. No. 630114
	pump cover FIR inlet ø 63mm outlet ø 53mm auxiliary pressure connection M16x1.5mm supporting pressure open turn direction left ø 185mm ID ø 150mm inner high 37mm		
	GEV No.	510693	Ref. No. 630501 H35371
	mechanical shaft seal for shaft ø 12mm slide ring ext. ø 24mm slide ring H 15.5mm slide ring int. ø 11mm counter ring mounting ø 24mm height counter ring 8mm counter ring int. ø 13.5mm		
	GEV No.	524416	Ref. No. 630411
	pump cover gasket thickness 4x4mm Qty 1 pcs		





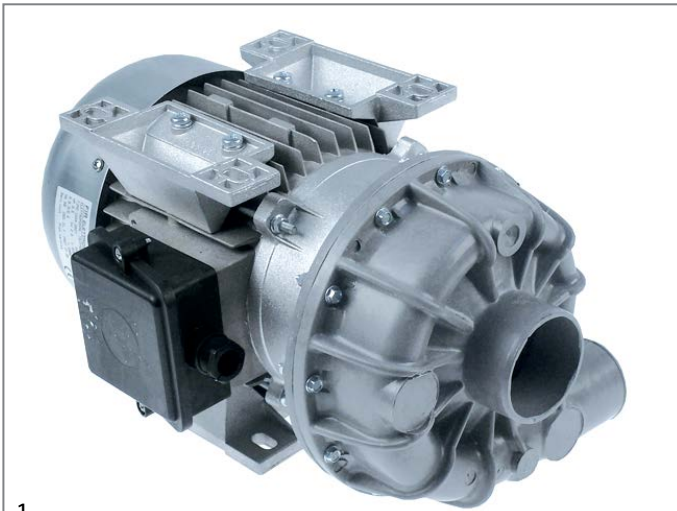

1

GEV No.	500111	Ref. No.	100663
description	pump inlet ø 63mm outlet ø 53mm type 1241.2500 230/400V 50Hz 3 phase 1.1kW 1.5HP L 330mm rotation direction left FIR		
For models:	LC380, LC380BT, LC380RCD, LC400, SE		
spare parts for	500111		
	GEV No.	510531	Ref. No. 630114
	pump cover FIR inlet ø 63mm outlet ø 53mm auxiliary pressure connection M16x1.5mm supporting pressure open turn direction left ø 185mm ID ø 150mm inner high 37mm		
	GEV No.	510612	Ref. No. —
	impellor ø 110mm H 34mm M8R		
	GEV No.	510693	Ref. No. 630501 H35371
	mechanical shaft seal for shaft ø 12mm slide ring ext. ø 24mm slide ring H 15.5mm slide ring int. ø 11mm counter ring mounting ø 24mm height counter ring 8mm counter ring int. ø 13.5mm		
	GEV No.	524416	Ref. No. 630411
	pump cover gasket thickness 4x4mm Qty 1 pcs		



1

GEV No.	500952	Ref. No.	100387 100604 100679 100704 100713
description	pump inlet ø 63mm outlet ø 53mm type 1244.2527 400V 50Hz 3 phase 2.5kW 3.5HP L 360mm rotation direction left FIR		
For models:	ACR, ACR145, ACR205, ACR225, ACR245, ACR260, ACR265, ACR305, ACR5145, ACR5205, ACR5225, ACR5245, ACR5260, ACR5265, ACR5305, GMC, GMC2700, GMC2702, GMC3500, GMC3502, GMC4500, GMC4502, GMC5500, GMC5502, SE		
spare parts for	500952		
	GEV No.	510357	Ref. No. 631620
	impellor ø 124mm H 34/16mm thread M8R blades 6		
	GEV No.	510531	Ref. No. 630114
	pump cover FIR inlet ø 63mm outlet ø 53mm auxiliary pressure connection M16x1.5mm supporting pressure open turn direction left ø 185mm ID ø 150mm inner height 37mm		
	GEV No.	510693	Ref. No. 630501 H35371
	mechanical shaft seal for shaft ø 12mm slide ring ext. ø 24mm slide ring H 15.5mm slide ring int. ø 11mm counter ring mounting ø 24mm height counter ring 8mm counter ring int. ø 13.5mm		
	GEV No.	524416	Ref. No. 630411
	pump cover gasket thickness 4x4mm Qty 1 pcs		



1

GEV No.	501467	Ref. No.	100717
description	pump inlet ø 63mm outlet ø 53mm type 2241.2501 230/400V 50Hz 3 phase 0.89kW 1.5HP L 305mm rotation direction left FIR		
For models:	C95, C95BT, C95E2, C95RCD		

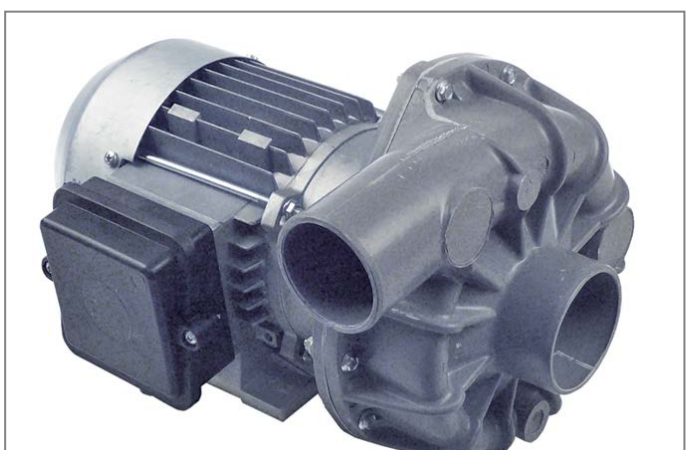





1

GEV No.	499193	Ref. No.	100737
description	pump inlet ø 63mm outlet ø 53mm type 2241.5800 255/440V 60Hz 3 phase 1.1kW L 305mm rotation direction left FIR		



1

GEV No.	499251	Ref. No.	100801
description	pump inlet ø 63mm outlet ø 53mm type 5223.2350 230V 50Hz 1 phase 0.74kW L 314mm rotation direction left capacitor 16µF FIR		
For models:	LC1200, LC1200RCD, LC700, LC700RCD, LC900, LC900RCD		
spare parts for	499251		
	GEV No.	365021	Ref. No. 631202
	operating capacitor capacity 16µF 425V tolerance 5% 50/60Hz ambient temperature max. -25 to +85°C ø 35mm L 73mm single M8 plastic connection male faston 6.3mm 416.10.99 protection		
	GEV No.	502274	Ref. No. 630138
	pump cover FIR inlet ø 63mm outlet ø 53mm		
	GEV No.	502275	Ref. No. 632501
	impellor ø 100mm H 29mm thread M8R blades 6		
	GEV No.	510693	Ref. No. 630501 H35371
	mechanical shaft seal for shaft ø 12mm slide ring ext. ø 24mm slide ring H 15.5mm slide ring int. ø 11mm counter ring mounting ø 24mm height counter ring 8mm counter ring int. ø 13.5mm		
	GEV No.	521022	Ref. No. 630254
	fanwheel cover ID ø 137mm ED ø 142mm H 70mm for wash pump		
	GEV No.	524416	Ref. No. 630411
	pump cover gasket thickness 4x4mm Qty 1 pcs		







1

GEV No.	499300	Ref. No.	100886
description	pump inlet ø 63mm outlet ø 53mm type 5223.4050 230/400V 50Hz 3 phase 1.1kW L 316mm rotation direction left FIR		
For models:	AC2A, ACL100, ACL150		



1

GEV No.	499109	Ref. No.	100797
description	pump inlet ø 63mm outlet ø 53mm type 5233.4051 220-240/380-415V 50Hz 3 phase 1.1kW 1.5HP L 345mm rotation direction left FIR		
For models:	LC1200, LC1200RCD, LC412, LC700, LC700RCD, LC900, LC900RCD		
spare parts for	499109		
	GEV No.	502274	Ref. No. 630138
	pump cover FIR inlet ø 63mm outlet ø 53mm		
	GEV No.	510612	Ref. No. —
	impellor ø 110mm H 34mm M8R		
	GEV No.	510693	Ref. No. 630501 H35371
	mechanical shaft seal for shaft ø 12mm slide ring ext. ø 24mm slide ring H 15.5mm slide ring int. ø 11mm counter ring mounting ø 24mm height counter ring 8mm counter ring int. ø 13.5mm		
	GEV No.	524416	Ref. No. 630411
	pump cover gasket thickness 4x4mm Qty 1 pcs		







1

GEV No.	499113	Ref. No.	H34432
description	pump inlet ø 63mm outlet ø 53mm type 5234.4050 230/400V 50Hz 3 phase 1.62kW 2.2HP L 340mm rotation direction left FIR		
For models:	GF90, GF90-2004, GF90A, GF90A-2004		



1

GEV No.	500741	Ref. No.	100795
description	pump inlet \varnothing 63mm outlet \varnothing 53mm type 5234.4055 230/400V 50Hz 3 phase 1.5kW 2HP L 340mm rotation direction left FIR		
For models:	LC1200, LC1200RCD, LC700, LC700RCD, LC900, LC900RCD		
spare parts for	500741		
	GEV No.	502274	Ref. No. 630138
	pump cover FIR inlet \varnothing 63mm outlet \varnothing 53mm		
	GEV No.	510604	Ref. No. 630500 631618
	impellor \varnothing 118mm H 34mm M8R rotation direction left		
	GEV No.	510693	Ref. No. 630501 H35371
	mechanical shaft seal for shaft \varnothing 12mm slide ring ext. \varnothing 24mm slide ring H 15.5mm slide ring int. \varnothing 11mm counter ring mounting \varnothing 24mm height counter ring 8mm counter ring int. \varnothing 13.5mm		
	GEV No.	524416	Ref. No. 630411
	pump cover gasket thickness 4x4mm Qty 1 pcs		







1

GEV No.	500012	Ref. No.	100387
description	pump type 1243 50Hz rotation direction left FIR		

LGB



1

GEV No.	500510	Ref. No.	100760
description	pump inlet \varnothing 28mm outlet \varnothing 26mm type ZF170SX 230V 50Hz 1 phase 0.3kW 0.41HP L 195mm rotation direction right capacitor 6.3 μ F LGB		
For models:	BHC25, BHC25A, BHC25S, BHC30, BHC30A, BHC30HR, BHC30HR380, BHC30HRA, BHC30HRA380, BHC433, BHC433A, BHCHR		
spare parts for	500510		
	GEV No.	365012	Ref. No. 631216
	operating capacitor capacity 6.3 μ F 450V tolerance 5% 50Hz ambient temperature max. -25 to +85°C \varnothing 30mm L 61mm M8 plastic connection male faston 6.3mm protection		
	GEV No.	510703	Ref. No. 630524 630530 630541
	mechanical shaft seal for shaft \varnothing 13mm slide ring H 13mm height counter ring 5.5mm ED \varnothing 26mm		
	GEV No.	521057	Ref. No. 630133
	pump cover LGB inlet \varnothing 28mm outlet \varnothing 26mm auxiliary pressure connection 12mm supporting pressure open turn direction right \varnothing 102mm ID \varnothing 77mm inner height 31mm		
	GEV No.	521225	Ref. No. 631689
	impellor \varnothing 72mm H 22mm rotation direction right thread M7L shaft \varnothing 13mm shaft length 12mm		
	GEV No.	528800	Ref. No. 630427
	O-ring EPDM thickness 2.62mm ID \varnothing 75.87mm Qty 1 pcs		



1

GEV No.	500480	Ref. No.	100802
description	pump inlet ø 28mm outlet ø 28mm type ZF131DX 230V 50Hz 1 phase 0.29kW 0.4HP L 195mm rotation direction left capacitor 6.3µF LGB		
For models:	C1000ERCD, C1300ERCD, FC3E, FC3EA, FC3M, FC3MA, FC3MR, FC44E, FC44EA, FC4E, FC4EA, FC4EHRT, FC4M, FC4MA, GE50RCD, LC1200RCD, LC700RCD, LC900RCD, LF322RCD, XLC		
spare parts for	500480		
	GEV No.	510690	Ref. No. —
	mechanical shaft seal for shaft ø 8mm ED ø 24mm mounting ø 24/26mm		
	GEV No.	521083	Ref. No. —
	impellor ø 73mm H 13mm thread M7R blades 3 metal		
	GEV No.	521084	Ref. No. —
	pump cover LGB inlet ø 28mm outlet ø 25mm auxiliary pressure connection 13mm pump type ZF131DX ID ø 78mm		
	GEV No.	528800	Ref. No. 630427
	O-ring EPDM thickness 2.62mm ID ø 75.87mm Qty 1 pcs		
accessories for	500480		
	GEV No.	365012	Ref. No. 631216
	operating capacitor capacity 6.3µF 450V tolerance 5% 50Hz ambient temperature max. -25 to +85°C ø 30mm L 61mm M8 plastic connection male faston 6.3mm protection		



1





GEV No.	500966	Ref. No.	100827
description	pump inlet ø 29mm outlet ø 31/38mm type FC2006 230V 50Hz 1 phase 0.7kW 0.95HP L 195mm rotation direction left capacitor 16µF LGB		
For models:	FC3E, FC3EA, FC3M, FC3MA, FC3MR, FC44E, FC44EA, FC4E, FC4EA, FC4EHRT, FC4M, FC4MA		
spare parts for	500966		
	GEV No.	365021	Ref. No. 631202
	operating capacitor capacity 16µF 425V tolerance 5% 50/60Hz ambient temperature max. -25 to +85°C ø 35mm L 73mm single M8 plastic connection male faston 6.3mm 416.10.99 protection		
	GEV No.	510703	Ref. No. 630524 630530 630541
	mechanical shaft seal for shaft ø 13mm slide ring H 13mm height counter ring 5.5mm ED ø 26mm		
	GEV No.	521149	Ref. No. 630144
	pump cover LGB outlet ø 38/31mm		
	GEV No.	521150	Ref. No. 632506
	impellor ø 85mm H 17mm thread M8R shaft ø 13mm shaft length 10mm		
	GEV No.	532537	Ref. No. 630433
	O-ring EPDM thickness 3.53mm ID ø 113.9mm Qty 1 pcs		



GEV No.	499348	Ref. No.	100827/1
description	pump inlet \varnothing 29mm outlet \varnothing 31/38mm type FC2006 400V 50Hz 0.6kW L 195mm rotation direction left LGB		
For models:	FC3E, FC3EA, FC3M, FC3MA, FC3MR, FC44E, FC44EA, FC4E, FC4EA, FC4EHRT, FC4M, FC4MA		







GEV No.	500511	Ref. No.	100785
description	pump inlet \varnothing 30mm outlet \varnothing 29mm type ZF140SX 230V 50Hz 1 phase 0.36kW 0.5HP L 190mm rotation direction right LGB		
For models:	BHC25, BHC25-2, BHC25A, BHC25A-2, BHC30, BHC30-2, BHC30A, BHC30A-2, BHC30E, BHC30E-2, BHC30EA, BHC30EA-2, BHC30HR, BHC30HR-2, BHC30HR380, BHC30HRA, BHC30HRA-2, BHC30HRA380, BHC433, BHC433-2, BHC433A, BHC433A-2, BHCHR, LB200, LB200-2, LB200A, LB200A-2, LB215, LB215-2, LB215A, LB215A-2, LB260, LB260-2, LB260A, LB260A-2, LB275, LB275-2, LB275A, LB275A-2		

spare parts for 500511			
	GEV No.	365017	Ref. No. 631208
	operating capacitor capacity 5 μ F 450V tolerance 5% 50/60Hz ambient temperature max. -25 to +85°C \varnothing 28mm L 54mm M8 plastic connection male faston 6.3mm 16.10.08 protection		
	GEV No.	510703	Ref. No. 630524 630530 630541
	mechanical shaft seal for shaft \varnothing 13mm slide ring H 13mm height counter ring 5.5mm ED \varnothing 26mm		
	GEV No.	521230	Ref. No. 631695
	impellor \varnothing 86mm H 16mm M7L		
	GEV No.	521526	Ref. No. 630135
	pump cover LGB inlet \varnothing 30mm outlet \varnothing 30mm auxiliary pressure connection 12mm supporting pressure open turn direction right \varnothing 117mm ID \varnothing 95mm inner height 19mm		

spare parts for 500511			
	GEV No.	521706	Ref. No. 630424
	pump cover gasket		



GEV No.	500513	Ref. No.	100727
description	pump inlet \varnothing 45mm outlet \varnothing 40mm type FM4023SX 230V 50Hz 1 phase 0.75kW 1HP L 300mm rotation direction right capacitor 16 μ F LGB		
For models:	LP360, LP360BT, LP360RCD		

spare parts for 500513			
	GEV No.	365021	Ref. No. 631202
	operating capacitor capacity 16 μ F 425V tolerance 5% 50/60Hz ambient temperature max. -25 to +85°C \varnothing 35mm L 73mm single M8 plastic connection male faston 6.3mm 416.10.99 protection		
	GEV No.	510703	Ref. No. 630524 630530 630541
	mechanical shaft seal for shaft \varnothing 13mm slide ring H 13mm height counter ring 5.5mm ED \varnothing 26mm		
	GEV No.	521246	Ref. No. 631674
	impellor \varnothing 103mm H 26mm thread M8L shaft \varnothing 20mm shaft length 7mm seat \varnothing 8.2mm blades 6		
	GEV No.	521542	Ref. No. 630130
	pump cover LGB inlet \varnothing 45mm outlet \varnothing 40mm auxiliary pressure connection 13mm supporting pressure open \varnothing 150mm ID \varnothing 120mm inner height 25mm		
	GEV No.	521714	Ref. No. 630420 630431
	pump cover gasket thickness 4x4mm Qty 1 pcs		







1

GEV No.	499248	Ref. No.	H36612
description	pump inlet ø 45mm outlet ø 40mm type ZF220VSX 230V 50Hz 1 phase 0.85kW L 230mm rotation direction right capacitor 12.5µF LGB		
For models:	GF70, GF70A		
spare parts for	499248		
	GEV No.	365014	Ref. No. 631207
	operating capacitor capacity 12.5µF 450V tolerance 5%Hz ambient temperature max. -25 to +85°C ø 35mm L 70mm M8 plastic connection male faston 6.3mm 45S.C3DS.12.5 protection		
	GEV No.	510556	Ref. No. —
	O-ring EPDM thickness 1.78mm ID ø 94.97mm Qty 1 pcs pump type T110		
	GEV No.	510694	Ref. No. 630528 H33839
	mechanical shaft seal for shaft ø 13mm height counter ring 8mm ID ø 11.5mm H 16mm mounting ø 24/26mm int. ø 14mm		
	GEV No.	521112	Ref. No. H36956
	impellor ø 93mm H 21mm pump type ZF220VSX thread M8L shaft ø 13mm shaft length 11mm		
	GEV No.	521113	Ref. No. H36954
	pump cover LGB inlet ø 45mm outlet ø 40mm pump type ZF220VSX		





1



GEV No.	500512	Ref. No.	100777
description	pump inlet ø 45mm outlet ø 40mm type ZF340VSX 230V 50Hz 1 phase 0.75kW 1HP L 245mm rotation direction right capacitor 16µF LGB		
For models:	LF350, LF350A		
spare parts for	500512		
	GEV No.	365021	Ref. No. 631202
	operating capacitor capacity 16µF 425V tolerance 5% 50/60Hz ambient temperature max. -25 to +85°C ø 35mm L 73mm single M8 plastic connection male faston 6.3mm 416.10.99 protection		
	GEV No.	510702	Ref. No. 630526 630536
	mechanical shaft seal height counter ring 5.5mm ID ø 12mm		
	GEV No.	521246	Ref. No. 631674
	impellor ø 103mm H 26mm thread M8L shaft ø 20mm shaft length 7mm seat ø 8.2mm blades 6		
	GEV No.	521542	Ref. No. 630130
	pump cover LGB inlet ø 45mm outlet ø 40mm auxiliary pressure connection 13mm supporting pressure open ø 150mm ID ø 120mm inner hight 25mm		
	GEV No.	521714	Ref. No. 630420 630431
	pump cover gasket thickness 4x4mm Qty 1 pcs		





GEV No.	499011	Ref. No.	100820
description	pump inlet ø 50mm outlet ø 40mm type ZF350SX 230V 50Hz 1 phase 0.63kW L 201mm rotation direction right LGB 2800rpm suitable capacitor 12.5µF		
For models:	LF321, LF321A, LF322, LF322A, LF322MP, LF322MP-A, LF322RCD, LF324, LF324A, LF325E, LF325EA, LF700, LF700A, LFD32E, LFD32EA, LFD32M, LFD32MA		
spare parts for	499011		
	GEV No.	Ref. No.	631207
	operating capacitor capacity 12.5µF 450V tolerance 5%Hz ambient temperature max. -25 to +85°C ø 35mm L 70mm M8 plastic connection male faston 6.3mm 45S.C3DS.12.5 protection		
	GEV No.	Ref. No.	630526 630536
	mechanical shaft seal height counter ring 5.5mm ID ø 12mm		
	GEV No.	Ref. No.	—
	pump cover LGB inlet ø 50mm outlet ø 40mm		
	GEV No.	Ref. No.	631703
	impellor ø 93mm H 32mm pump type ZF350SX thread M8L		



GEV No.	499058	Ref. No.	100819
description	pump inlet ø 50mm outlet ø 40mm type ZF380SX 230V 50Hz 1 phase 0.73kW 0.99HP L 210mm rotation direction right capacitor 16µF LGB		
For models:	LF321, LF321A, LF322, LF322A, LF324, LF324A, LF325E, LF325EA, LF700, LF700A		
spare parts for	499058		
	GEV No.	Ref. No.	631202
	operating capacitor capacity 16µF 425V tolerance 5% 50/60Hz ambient temperature max. -25 to +85°C ø 35mm L 73mm single M8 plastic connection male faston 6.3mm 416.10.99 protection		
	GEV No.	Ref. No.	630526 630536
	mechanical shaft seal height counter ring 5.5mm ID ø 12mm		

spare parts for	499058		
	GEV No.	Ref. No.	—
	pump cover LGB inlet ø 50mm outlet ø 40mm		
	GEV No.	Ref. No.	631702
	impellor ø 100mm H 32mm thread M8L		
	GEV No.	Ref. No.	630420 630431
	pump cover gasket thickness 4x4mm Qty 1 pcs		



GEV No.	499247	Ref. No.	100798
description	pump inlet ø 62mm outlet ø 51mm type ZF650DX 230/400V 50Hz 3 phase 1.1kW L 333mm rotation direction left LGB		
For models:	C1000E, C1000ERCD, C1001M, C1300E, C1300ERCD, C1301M, XLC		
spare parts for	499247		
	GEV No.	Ref. No.	H34484
	impellor H 42mm thread M8R ED ø 90mm		
	GEV No.	Ref. No.	630426 H33855
	pump cover gasket ID ø 158.3mm pump type 1214/1293/1225/2243/1226/1204/3473/1241 thickness 3.53mm EPDM Qty 1 pcs		
	GEV No.	Ref. No.	630528 H33839
	mechanical shaft seal for shaft ø 13mm height counter ring 8mm ID ø 11.5mm H 16mm mounting ø 24/26mm int. ø 1 14mm		
	GEV No.	Ref. No.	—
	impellor ø 110mm H 39mm thread M8R shaft ø 30mm		
	GEV No.	Ref. No.	630137
	pump cover LGB inlet ø 62mm outlet ø 52mm auxiliary pressure connection 12mm supporting pressure closed turn direction left ø 190mm ID ø 150mm inner height 40mm		







1

GEV No.	500537	Ref. No.	100902
description	pump inlet ø 62mm outlet ø 52mm type ZF522VDX 230V 50Hz 1 phase 0.85kW 1.16HP L 255mm rotation direction left capacitor 16µF auxiliary pressure connection 12mm supporting pressure open LGB		
spare parts for	500537		
	GEV No.	365021	Ref. No. 631202
	operating capacitor capacity 16µF 425V tolerance 5% 50/60Hz ambient temperature max. -25 to +85°C ø 35mm L 73mm single M8 plastic connection male faston 6.3mm 416.10.99 protection		
	GEV No.	510551	Ref. No. 630426 H33855
	pump cover gasket ID ø 158.3mm pump type 1214/1293/1225/2243/1226/1204/3473/1241 thickness 3.53mm EPDM Qty 1 pcs		
	GEV No.	510693	Ref. No. 630501 H35371
	mechanical shaft seal for shaft ø 12mm slide ring ext. ø 24mm slide ring H 15.5mm slide ring int. ø 11mm counter ring mounting ø 24mm height counter ring 8mm counter ring int. ø 13.5mm		
	GEV No.	512420	Ref. No. —
	bracket mounting distance 110mm		
	GEV No.	512421	Ref. No. —
	fan wheel shaft intake ø 11mm ø 110mm H 20mm		
	GEV No.	521058	Ref. No. —
	fanwheel cover suitable for LGB ID ø 138mm ED ø 142mm H 59mm plastic		
	GEV No.	521281	Ref. No. —
	impellor ø 90mm H 30mm thread M8R shaft ø 20mm shaft length 10mm seat ø 8.2mm blades 6		
	GEV No.	521516	Ref. No. 630137
	pump cover LGB inlet ø 62mm outlet ø 52mm auxiliary pressure connection 12mm supporting pressure closed turn direction left ø 190mm ID ø 150mm inner height 40mm		



1

GEV No.	500780	Ref. No.	100796
description	pump inlet ø 62mm outlet ø 52mm type ZF800DX 230/400V 50Hz 3 phase 1.5kW 2HP L 340mm rotation direction left LGB		
For models:	C1000E, C1000ERCD, C1001M, C1300E, C1300ERCD, C1301M, GE50RCD, XLC		
spare parts for	500780		
	GEV No.	510551	Ref. No. 630426 H33855
	pump cover gasket ID ø 158.3mm pump type 1214/1293/1225/2243/1226/1204/3473/1241 thickness 3.53mm EPDM Qty 1 pcs		
	GEV No.	510694	Ref. No. 630528 H33839
	mechanical shaft seal for shaft ø 13mm height counter ring 8mm ID ø 11.5mm H 16mm mounting ø 24/26mm int. ø 14mm		
	GEV No.	521276	Ref. No. 631692
	impellor ø 120mm H 39mm pump type ZF800DX shaft intake ø 12mm rotation direction left thread M8R pump for ZF800DX blades 6		
	GEV No.	521516	Ref. No. 630137
	pump cover LGB inlet ø 62mm outlet ø 52mm auxiliary pressure connection 12mm supporting pressure closed turn direction left ø 190mm ID ø 150mm inner height 40mm		

LOWARA

pumps



1

GEV No.	501453	Ref. No.	100729
description	pump inlet ø 44mm outlet ø 35mm type 2MH3TA 220/240V 50Hz 3 phase 0.4kW L 550mm LOWARA		
For models:	ACRS145, ACRS205, ACRS225, ACRS245, ACRS260, ACRS265, ACRS305, ACS101, ACS101-DIGIT, ACS122, ACS122-DIGIT, ACS151, ACS151-DIGIT, ACS152, ACS152-DIGIT, ACS161-DIGIT, ACS162-DIGIT, ACS181, ACS181-DIGIT, ACS182, ACS182-DIGIT, ACS201, ACS201-DIGIT, ACS202, ACS202-DIGIT, ACS241, ACS241-DIGIT, ACS242, ACS242-DIGIT, ACS91, ACS91-DIGIT, GMC2700, GMC2702, GMC3500, GMC3502, GMC4500, GMC4502, GMC5500, GMC5502, NE3002, NE4002, NE5002, NE5502, NE7002, NE7502, NE9002, NE9502, NL302, NL302E, NL402...(Other models you can see in the webshop)		



miscellaneous



1

GEV No.	500006	Ref. No.	100375
description	pump type AL11 230V 50Hz 1 phase 0.29kW 0.4HP IBMEI		



1

GEV No.	500016	Ref. No.	100399
description	pump type AL15 1 phase IBMEI		

booster pumps I



1

GEV No.	499236	Ref. No.	100698 100789
description	pump inlet \varnothing 1 1/4" IT outlet \varnothing 1" IT type CEA120/2/A 220-240/380-415V 50Hz 3 phase 0.64kW rotation direction left LOWARA		
For models:	G100L, G101L, G115, G115L, G125, G125L, G50L, G50LM, G51L, G60L, G61L, G65, G65L, G75, G75L, GE100, GE115, GE125, GE60, GE60RCD, GE65, GE65RCD, GE75, GE80, GL, NG00, NG01, NG02, NG1202, NG1202E, NG600, NG600E, NG601, NG601E, NG602, NG602E, NG900, NG900E, NG901, NG901E, NG902, NG902E		





1

GEV No.	500060	Ref. No.	100302 H25342	
description	pump inlet \varnothing 1" outlet \varnothing 1" type PQM60 230V 50Hz 1 phase 0.37kW PEDRELLO			
For models:	GF90, GF90-2004, GF90A, GF90A-2004			
accessories for	500060			
	GEV No.	365015	Ref. No.	3068016 631206
	operating capacitor capacity 10 μ F 400V tolerance 5%Hz ambient temperature max. -25 to +85°C \varnothing 35.5mm L 59mm M8 plastic connection male faston 6.3mm protection			



1



GEV No.	500395	Ref. No.	100736	
description	pump inlet \varnothing 3/8" IT outlet \varnothing 3/8" IT type PS45DX 230V 50Hz 0.35kW capacitor 8 μ F LGB			
For models:	C166-2			
spare parts for	500395			
	GEV No.	365013	Ref. No.	—
	operating capacitor capacity 8 μ F 400V tolerance 5%Hz ambient temperature max. -25 to +85°C \varnothing 31.5mm L 55mm M8 plastic connection male faston 6.3mm protection			
	GEV No.	698400	Ref. No.	—
	pump cover gasket pump type PS46 thickness 2mm ID \varnothing 66mm Qty 1 pcs			

drain pumps

GRE



1

GEV No.	500967	Ref. No.	100803	
description	drain pump inlet \varnothing 30mm outlet \varnothing 22mm 100W 230V 50Hz GRE			
For models:	BHC25-2, BHC25A-2, BHC30-2, BHC30A-2, BHC30E, BHC30E-2, BHC30EA, BHC30EA-2, BHC30HR, BHC30HR-2, BHC30HR380, BHC30HRA, BHC30HRA-2, BHC30HRA380, BHC433-2, BHC433A-2, BHCHR, C1000E, C1300E, LB200, LB200-2, LB200A, LB200A-2, LB215, LB215-2, LB215A, LB215A-2, LB260, LB260-2, LB260A, LB260A-2, LB275, LB275-2, LB275A, LB275A-2, LC1200, LC700, LC900, LF321, LF321A, LF322, LF322A, LF324, LF324A, LF325E, LF325EA, LF700, LF700A, XLC			
spare parts for	500967			
	GEV No.	500307	Ref. No.	—
	filter			
	GEV No.	500899	Ref. No.	630139
	pump cover inlet \varnothing 30mm outlet \varnothing 22mm pump type 500.213			



1

GEV No.	499359	Ref. No.	100893 (new version)
description	drain pump inlet \varnothing 30mm outlet \varnothing 22mm 34W 230V 50Hz GRE		





1

GEV No.	500961	Ref. No.	100342
description	drain pump inlet ø 30mm outlet ø 23mm 100W 230V 50Hz GRE		
For models:	BC25HR, BC30HR, BC30HR380, BC30HRA, BHC25, BHC25A, BHC25S, BHC30, BHC30A, BHC30HR, BHC30HR380, BHC30HRA, BHC30HRA380, BHC433, BHC433A, BHCHR, F90M, F90MA, FC, FC43, FC53, FC533, FC533A, FC53A, FC53CBT, FC53LA, FC53LBT, FC54, FC543, FC543A, FC543E, FC543EA, FC544, FC544A, FC54A, FC54CBT, FC54E, FC54EA, FC54LBT, GF70, GF70A, GF90-2004, GF90A-2004, LF315, LF320, LF320A, LF320CBT, LF320L, LF320LA, LF320LBT...(Other models you can see in the webshop)		
accessories for	500961		
	GEV No.	524719	Ref. No. —
	formed hose hose ext. ø 40mm hose int. ø 30mm L 65mm warewashing black Qty 1		



1

GEV No.	499059	Ref. No.	100893
description	drain pump inlet ø 30mm outlet ø 24mm 230V 30W 50Hz HANNING type DPS25-131		
For models:	BHC25-2, BHC25A-2, BHC30-2, BHC30A-2, BHC30E-2, BHC30EA-2, BHC30HR-2, BHC30HRA-2, BHC433-2, BHC433A-2, LB200, LB200A, LB215, LB215A, LB260, LB260A, LB275, LB275A, LF315, LF320A, LF320CBT, LF320LA, LF320LBT, LF321, LF321A, LF322, LF322A, LF322MP, LF322MP-A, LF322RCD, LF323, LF323A, LF324, LF324A, LF325E, LF325EA, LF350, LF350A, LF400A, LF450, LF450A, LF700, LF700A, LFD32E, LFD32EA, LFD32M, LFD32MA		



1

GEV No.	499048	Ref. No.	100695
description	pump inlet ø 30mm outlet ø 24mm 190W 230V 50Hz GRE		
For models:	FC, FCHR, FCHRA, FCHRT, FCHRTA		

service kits



1

GEV No.	500573	Ref. No.	100890
description	drain pump 30W 4-piece 230V inlet ø 24/30mm outlet ø 24mm 50Hz HANNING type DPS25-032 1x pump, 3x pump cover		

HANNING



1

GEV No.	500573	Ref. No.	100890
description	drain pump 30W 4-piece 230V inlet ø 24/30mm outlet ø 24mm 50Hz HANNING type DPS25-032 1x pump, 3x pump cover		

booster pumps II

accessories



1

GEV No.	365015	Ref. No.	3068016 631206
description	operating capacitor capacity 10µF 400V tolerance 5%Hz ambient temperature max. -25 to +85°C ø 35.5mm L 59mm M8 plastic connection male faston 6.3mm protection		
For models:	B23, B24, B25, B26, B27, F2, F3, F55, F65, FC, FC53, FC533, FC533A, FC53A, FC53CBT, FC53LA, FC53LBT, FC54, FC543, FC543A, FC543E, FC543EA, FC544, FC544A, FC54A, FC54CBT, FC54E, FC54EA, FC54LBT, FCHR, FCHRA, FCHRT, FCHRTA, GF90, GF90-2004, GF90A, GF90A-2004, LF315, LF320, LF320A, LF320CBT, LF320L, LF320LA, LF320LBT, LF323, LF323A, LS550, R50, R70		



			
1			
GEV No.	365017	Ref. No.	631208
description	operating capacitor capacity 5µF 450V tolerance 5% 50/60Hz ambient temperature max. -25 to +85°C ø 28mm L 54mm M8 plastic connection male faston 6.3mm 16.10.08 protection		
For models:	B10, B10T, B11, B11T, B12, B12T, B13T, B14T, B15, B15T, B15TM, B16, B16T, B16TM, B18, B18T, B18TM, B19, B19T, B19TM, B20, B20D, B23, B24, B25, B26, B27, BC25, BC25A, BC25HR, BC30, BC30A, BC30HR, BC30HR380, BC30HRA, BHC25, BHC25-2, BHC25A, BHC25A-2, BHC30, BHC30-2, BHC30A, BHC30A-2, BHC30E, BHC30E-2, BHC30EA, BHC30EA-2, BHC30HR, BHC30HR-2, BHC30HR380...(Other models you can see in the webshop)		

			
1			
GEV No.	365012	Ref. No.	631216
description	operating capacitor capacity 6.3µF 450V tolerance 5% 50Hz ambient temperature max. -25 to +85°C ø 30mm L 61mm M8 plastic connection male faston 6.3mm protection		
For models:	BHC25, BHC25A, BHC25S, BHC30, BHC30A, BHC30HR, BHC30HR380, BHC30HRA, BHC30HRA380, BHC433, BHC433A, BHCHR, C1000ERCD, C1300ERCD, FC3E, FC3EA, FC3M, FC3MA, FC3MR, FC44E, FC44EA, FC4E, FC4EA, FC4EHRT, FC4M, FC4MA, GE50RCD, LC1200RCD, LC700RCD, LC900RCD, LF322RCD, XLC		

			
1			
GEV No.	365014	Ref. No.	631207
description	operating capacitor capacity 12.5µF 450V tolerance 5%Hz ambient temperature max. -25 to +85°C ø 35mm L 70mm M8 plastic connection male faston 6.3mm 45S.C3DS.12.5 protection		
For models:	C30, C70, C75, C75BT, C75M, C75RCD, C85, F3, F300, F80, LF321, LF321A, LF322, LF322A, LF322MP, LF322MP-A, LF322RCD, LF324, LF324A, LF325E, LF325EA, LF450, LF450A, LF700, LF700A, LFD32E, LFD32EA, LFD32M, LFD32MA		

			
1			
GEV No.	365021	Ref. No.	631202
description	operating capacitor capacity 16µF 425V tolerance 5% 50/60Hz ambient temperature max. -25 to +85°C ø 35mm L 73mm single M8 plastic connection male faston 6.3mm 416.10.99 protection		
For models:	FC3E, FC3EA, FC3M, FC3MA, FC3MR, FC44E, FC44EA, FC4E, FC4EA, FC4EHRT, FC4M, FC4MA, LC1200, LC1200RCD, LC700, LC700RCD, LC900, LC900RCD, LF321, LF321A, LF322, LF322A, LF324, LF324A, LF325E, LF325EA, LF350, LF350A, LF700, LF700A, LP360, LP360BT, LP360RCD		

			
1			
GEV No.	365017	Ref. No.	631208
description	operating capacitor capacity 5µF 450V tolerance 5% 50/60Hz ambient temperature max. -25 to +85°C ø 28mm L 54mm M8 plastic connection male faston 6.3mm 16.10.08 protection		
For models:	B10, B10T, B11, B11T, B12, B12T, B13T, B14T, B15, B15T, B15TM, B16, B16T, B16TM, B18, B18T, B18TM, B19, B19T, B19TM, B20, B20D, B23, B24, B25, B26, B27, BC25, BC25A, BC25HR, BC30, BC30A, BC30HR, BC30HR380, BC30HRA, BHC25, BHC25-2, BHC25A, BHC25A-2, BHC30, BHC30-2, BHC30A, BHC30A-2, BHC30E, BHC30E-2, BHC30EA, BHC30EA-2, BHC30HR, BHC30HR-2, BHC30HR380...(Other models you can see in the webshop)		

			
1			
GEV No.	365012	Ref. No.	631216
description	operating capacitor capacity 6.3µF 450V tolerance 5% 50Hz ambient temperature max. -25 to +85°C ø 30mm L 61mm M8 plastic connection male faston 6.3mm protection		
For models:	BHC25, BHC25A, BHC25S, BHC30, BHC30A, BHC30HR, BHC30HR380, BHC30HRA, BHC30HRA380, BHC433, BHC433A, BHCHR, C1000ERCD, C1300ERCD, FC3E, FC3EA, FC3M, FC3MA, FC3MR, FC44E, FC44EA, FC4E, FC4EA, FC4EHRT, FC4M, FC4MA, GE50RCD, LC1200RCD, LC700RCD, LC900RCD, LF322RCD, XLC		

condensators & interference suppression filters

operating capacitors

plastic

			
1			
GEV No.	365015	Ref. No.	3068016 631206
description	operating capacitor capacity 10µF 400V tolerance 5%Hz ambient temperature max. -25 to +85°C ø 35.5mm L 59mm M8 plastic connection male faston 6.3mm protection		
For models:	B23, B24, B25, B26, B27, F2, F3, F55, F65, FC, FC53, FC533, FC533A, FC53A, FC53CBT, FC53LA, FC53LBT, FC54, FC543, FC543A, FC543E, FC543EA, FC544, FC544A, FC54A, FC54CBT, FC54E, FC54EA, FC54LBT, FCHR, FCHRA, FCHRT, FCHRTA, GF90, GF90-2004, GF90A, GF90A-2004, LF315, LF320, LF320A, LF320CBT, LF320L, LF320LA, LF320LBT, LF323, LF323A, LS550, R50, R70		



filters

interference suppression filters



1			
GEV No.	365046	Ref. No.	631209
description	interference suppression filter type 10S7E-G1474253105-Q 115/250V 50/60Hz conductor 2 with E connection male faston 6.3mm L 40mm ø 40mm Hmm Wmm M8 plastic Qty 1 pcs		



1			
GEV No.	365086	Ref. No.	631209
description	interference suppression filter type 10S7E-G1474253105-Q 115/250V 50/60Hz conductor 2 with E connection male faston 6.3mm L 40mm ø 40mm Hmm Wmm M8 plastic Qty 1 pcs		

fuses

fine fuses



1			
GEV No.	358667	Ref. No.	130263
description	fine fuse size ø5x20mm 0.4A fast-acting rated 250V Qty 10 pcs		



1			
GEV No.	358596	Ref. No.	130273
description	fine fuse size ø5x20mm 0.25A slow-acting rated 250V Qty 10 pcs		
For models:	AC122, AC151, AC152, AC181, AC182, AC201, AC202, AC241, AC242, ACR, ACR145, ACR205, ACR225, ACR245, ACR260, ACR265, ACR305, C155BT, C155RCD, C75BT, C75RCD, C95BT, C95RCD, FC53CBT, FC53LA, FC53LBT, FC54CBT, FC54LBT, GF90, GF90A, GMC, GMC2700, GMC3500, GMC4500, GMC5500, LC1200RCD, LC380BT, LC380RCD, LC700RCD, LC900RCD, LF320CBT, LF320L, LF320LA, LF320LBT, LF400A, LP360BT, LP360RCD		



1			
GEV No.	358702	Ref. No.	130262
description	fine fuse size ø5x20mm 0.315A slow-acting rated 250V Qty 10 pcs		



1			
GEV No.	358602	Ref. No.	130265
description	fine fuse size ø5x20mm 1.6A slow-acting rated 250V Qty 10 pcs		
For models:	AC122, AC151, AC152, AC181, AC182, AC201, AC202, AC241, AC242, ACR, ACR145, ACR205, ACR225, ACR245, ACR260, ACR265, ACR305, GMC, GMC2700, GMC3500, GMC4500, GMC5500, NE3001, NE4001, NE5501, NE7501, NE9001, NG01, NG601, NG601E, NG901, NG901E		

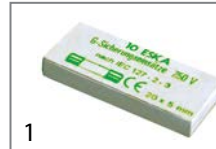

1			
GEV No.	358600	Ref. No.	130264
description	fine fuse size ø5x20mm 1A slow-acting rated 250V Qty 10 pcs		
For models:	AC122, AC151, AC152, AC181, AC182, AC201, AC202, AC241, AC242, ACR, ACR145, ACR205, ACR225, ACR245, ACR260, ACR265, ACR305, BHC30E, BHC30EA, C155BT, C155RCD, C75BT, C75RCD, C95BT, C95RCD, FC53CBT, FC53LA, FC53LBT, FC54CBT, FC54E, FC54EA, FC54LBT, GF90, GF90A, GMC, GMC2700, GMC3500, GMC4500, GMC5500, LC1200RCD, LC380BT, LC380RCD, LC700RCD, LC900RCD, LF320CBT, LF320L, LF320LA, LF320LBT, LF400A, LP360BT...(Other models you can see in the webshop)		



1			
GEV No.	358603	Ref. No.	130270
description	fine fuse size ø5x20mm 2A slow-acting rated 250V Qty 10 pcs		
For models:	C155BT, C155RCD, C75BT, C75RCD, C95BT, C95RCD, FC53CBT, FC53LA, FC53LBT, FC54CBT, FC54LBT, GF90, GF90A, LC1200RCD, LC380BT, LC380RCD, LC700RCD, LC900RCD, LF320CBT, LF320L, LF320LA, LF320LBT, LF400A, LP360BT, LP360RCD		



1			
GEV No.	358606	Ref. No.	130266
description	fine fuse size ø5x20mm 4A slow-acting rated 250V Qty 10 pcs		



1			
GEV No.	358609	Ref. No.	130274
description	fine fuse size ø5x20mm 5A slow-acting rated 250V Qty 10 pcs		
For models:	C155BT, C155RCD, C75BT, C75RCD, C95BT, C95RCD, FC53CBT, FC53LA, FC53LBT, FC54CBT, FC54LBT, GF90, GF90A, LC1200RCD, LC380BT, LC380RCD, LC700RCD, LC900RCD, LF320CBT, LF320L, LF320LA, LF320LBT, LF400A, LP360BT, LP360RCD		

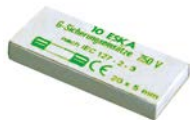

1

GEV No.	358607	Ref. No.	130275
description	fine fuse size ø5x20mm 6.3A slow-acting rated 250V Qty 10 pcs		
For models:	AC122, AC151, AC152, AC181, AC182, AC201, AC202, AC241, AC242, ACR, ACR145, ACR205, ACR225, ACR245, ACR260, ACR265, ACR305, C155BT, C155RCD, C75BT, C75RCD, C95BT, C95RCD, FC53CBT, FC53LA, FC53LBT, FC54CBT, FC54LBT, GF90, GF90A, GMC, GMC2700, GMC3500, GMC4500, GMC5500, LC1200RCD, LC380BT, LC380RCD, LC700RCD, LC900RCD, LF320CBT, LF320L, LF320LA, LF320LBT, LF400A, LP360BT, LP360RCD		



1

GEV No.	358041	Ref. No.	130236
description	fine fuse size ø10x38mm 20A slow-acting rated 400V type aM Qty 1 pcs		
For models:	AC100, AC101, AC120, AC122, AC150, AC151, AC152, AC170, AC181, AC182, AC200, AC201, AC202, AC241, AC242, AC91, ACR, ACR145, ACR205, ACR225, ACR245, ACR260, ACR265, ACR305, ACR5145, ACR5205, ACR5225, ACR5245, ACR5260, ACR5265, ACR5305, ACS101, ACS101-DIGIT, ACS122, ACS122-DIGIT, ACS151, ACS151-DIGIT, ACS152, ACS152-DIGIT, ACS161-DIGIT, ACS162-DIGIT, ACS181, ACS181-DIGIT, ACS182, ACS182-DIGIT, ACS201, ACS201-DIGIT, ACS202, ACS202-DIGIT, ACS241...(Other models you can see in the webshop)		



1

GEV No.	358039	Ref. No.	130234
description	fine fuse size ø10x38mm 12A slow-acting rated 500V type aM Qty 1 pcs		
For models:	AC101, AC120, AC122, AC150, AC151, AC152, AC170, AC181, AC182, AC200, AC201, AC202, AC241, AC242, AC90, AC91, ACR, ACR145, ACR205, ACR225, ACR245, ACR260, ACR265, ACR305, ACS101, ACS101-DIGIT, ACS122, ACS122-DIGIT, ACS151, ACS151-DIGIT, ACS152, ACS152-DIGIT, ACS161-DIGIT, ACS162-DIGIT, ACS181, ACS181-DIGIT, ACS182, ACS182-DIGIT, ACS201, ACS201-DIGIT, ACS202, ACS202-DIGIT, ACS241, ACS241-DIGIT, ACS242, ACS242-DIGIT, ACS242-DIGIT, ACS91, ACS91-DIGIT, G131, G66...(Other models you can see in the webshop)		



1

GEV No.	358040	Ref. No.	130235
description	fine fuse size ø10x38mm 16A slow-acting rated 500V type aM Qty 1 pcs		
For models:	AC120, AC150, AC170, AC200, ACR, ACR145, ACR205, ACR225, ACR245, ACR260, ACR265, ACR305, G66, GMC, GMC2700, GMC3500, GMC4500, GMC5500, LAV1000, NE3001, NE4001, NE5501, NE7501, NE9001		



1

GEV No.	358033	Ref. No.	130259
description	fine fuse size ø10x38mm 1A slow-acting rated 500V type aM Qty 1 pcs		
For models:	AC101, AC105, AC122, AC151, AC152, AC181, AC182, AC201, AC202, AC241, AC242, AC91, AC95, ACS101, ACS101-DIGIT, ACS122, ACS122-DIGIT, ACS151, ACS151-DIGIT, ACS152, ACS152-DIGIT, ACS161-DIGIT, ACS162-DIGIT, ACS181, ACS181-DIGIT, ACS182, ACS182-DIGIT, ACS201, ACS201-DIGIT, ACS202, ACS202-DIGIT, ACS241, ACS241-DIGIT, ACS242, ACS242-DIGIT, ACS91, ACS91-DIGIT, G100L, G101L, G115, G115L, G125L, G50L, G50LM, G51L, G60L, G61L, G65, G65L, G75...(Other models you can see in the webshop)		



1

GEV No.	358034	Ref. No.	130260
description	fine fuse size ø10x38mm 2A slow-acting rated 500V type aM Qty 1 pcs		
For models:	AC101, AC122, AC151, AC152, AC181, AC182, AC201, AC202, AC241, AC242, AC91, ACS101, ACS101-DIGIT, ACS122, ACS122-DIGIT, ACS151, ACS151-DIGIT, ACS152, ACS152-DIGIT, ACS161-DIGIT, ACS162-DIGIT, ACS181, ACS181-DIGIT, ACS182, ACS182-DIGIT, ACS201, ACS201-DIGIT, ACS202, ACS202-DIGIT, ACS241, ACS241-DIGIT, ACS242, ACS242-DIGIT, ACS91, ACS91-DIGIT, G100L, G101L, G115, G115L, G125L, G50L, G50LM, G51L, G60L, G61L, G65, G65L, G75, G75L, GE100...(Other models you can see in the webshop)		



1

GEV No.	358035	Ref. No.	130230
description	fine fuse size ø10x38mm 4A slow-acting rated 500V type aM Qty 1 pcs		
For models:	AC100, AC101, AC105, AC120, AC122, AC150, AC151, AC152, AC170, AC181, AC182, AC200, AC201, AC202, AC241, AC242, AC90, AC91, AC95, ACR, ACR145, ACR205, ACR225, ACR245, ACR260, ACR265, ACR305, ACS101, ACS101-DIGIT, ACS122, ACS122-DIGIT, ACS151, ACS151-DIGIT, ACS152, ACS152-DIGIT, ACS161-DIGIT, ACS162-DIGIT, ACS181, ACS181-DIGIT, ACS182, ACS182-DIGIT, ACS201, ACS201-DIGIT, ACS202, ACS202-DIGIT, ACS241, ACS241-DIGIT, ACS242, ACS242-DIGIT, ACS91...(Other models you can see in the webshop)		





1

GEV No.	358036	Ref. No.	130231
description	fine fuse size ø10x38mm 6A slow-acting rated 500V type aM Qty 1 pcs		
For models:	AC100, AC101, AC120, AC122, AC150, AC151, AC152, AC170, AC181, AC182, AC200, AC201, AC202, AC241, AC242, AC90, AC91, ACR, ACR145, ACR205, ACR225, ACR245, ACR260, ACR265, ACR305, ACS101, ACS101-DIGIT, ACS122, ACS122-DIGIT, ACS151, ACS151-DIGIT, ACS152, ACS152-DIGIT, ACS161-DIGIT, ACS162-DIGIT, ACS181, ACS181-DIGIT, ACS182, ACS182-DIGIT, ACS201, ACS201-DIGIT, ACS202, ACS202-DIGIT, ACS241, ACS241-DIGIT, ACS242, ACS242-DIGIT, ACS91, ACS91-DIGIT, GMC...(Other models you can see in the webshop)		



			
1			
GEV No.	358037	Ref. No.	130232
description	fine fuse size ϕ 10x38mm 8A slow-acting rated 500V type aM Qty 1 pcs		
For models:	AC100, AC101, AC120, AC122, AC150, AC151, AC152, AC170, AC181, AC182, AC200, AC201, AC202, AC241, AC242, AC90, AC91, ACR, ACR145, ACR205, ACR225, ACR245, ACR260, ACR265, ACR305, ACS101, ACS101-DIGIT, ACS122, ACS122-DIGIT, ACS151, ACS151-DIGIT, ACS152, ACS152-DIGIT, ACS161-DIGIT, ACS162-DIGIT, ACS181, ACS181-DIGIT, ACS182, ACS182-DIGIT, ACS201, ACS201-DIGIT, ACS202, ACS202-DIGIT, ACS241, ACS241-DIGIT, ACS242, ACS242-DIGIT, ACS91, ACS91-DIGIT, GMC...(Other models you can see in the webshop)		

			
1			
GEV No.	358021	Ref. No.	130260
description	fine fuse size ϕ 10x38mm 2A rated 500V type gI fast-acting Qty 1 pcs		

			
1			
GEV No.	358024	Ref. No.	130245
description	fine fuse size ϕ 10x38mm 8A rated 500V type gI fast-acting Qty 1 pcs		
For models:	AC120, AC150, AC170, AC200, ACR, ACR145, ACR205, ACR225, ACR245, ACR260, ACR265, ACR305, ACRS145, ACRS205, ACRS225, ACRS245, ACRS260, ACRS265, ACRS305, G100L, G101L, G115L, G125L, G50L, G50LM, G51L, G60L, G61L, G65, G65L, G75, G75L, GL, GMC, GMC2700, GMC2702, GMC3500, GMC3502, GMC4500, GMC4502, GMC5500, GMC5502		

 <p>Image not available</p>			
1			
GEV No.	358196	Ref. No.	130246
description	fine fuse size ϕ 10x38mm 12A rated 500V type Gg fast-acting Qty 1 pcs		

fine fuse holders

			
1			

GEV No.	358075	Ref. No.	150710
description	fuse holder for for fuse ϕ 10x38mm suitable fuse ϕ 10x38mm 1-pole 32A rated 690V for DIN rail 35mm cross section 10mm ² suitable for for fuse ϕ 10x38mm		
For models:	AC100, AC101, AC105, AC120, AC122, AC135, AC150, AC151, AC152, AC170, AC181, AC182, AC200, AC201, AC202, AC241, AC242, AC2A, AC90, AC91, AC95, ACR, ACR145, ACR205, ACR225, ACR245, ACR260, ACR265, ACR305, ACS101, ACS101-DIGIT, ACS122, ACS122-DIGIT, ACS151, ACS151-DIGIT, ACS152, ACS152-DIGIT, ACS161-DIGIT, ACS162-DIGIT, ACS181, ACS181-DIGIT, ACS182, ACS182-DIGIT, ACS201, ACS201-DIGIT, ACS202, ACS202-DIGIT, ACS241, ACS241-DIGIT, ACS242...(Other models you can see in the webshop)		

			
1			
GEV No.	358027	Ref. No.	130247
description	fine fuse size ϕ 10x38mm 16A rated 500V type Gg fast-acting Qty 1 pcs		
For models:	AC100, AC105, AC120, AC150, AC170, AC200, AC90, AC95, ACR, ACR145, ACR205, ACR225, ACR245, ACR260, ACR265, ACR305, ACRS145, ACRS205, ACRS225, ACRS245, ACRS260, ACRS265, ACRS305, G66, GMC, GMC2700, GMC2702, GMC3500, GMC3502, GMC4500, GMC4502, GMC5500, GMC5502, NE00, NE3001, NE4001, NE5501, NE7501, NE9001, SE, SNL		

line circuit breakers

ABL SURSUM

			
1			

GEV No.	358233	Ref. No.	121022
description	line circuit breaker 3-pole 32A tripping type K rated 400V		
For models:	AC101, AC105, AC122, AC151, AC152, AC181, AC182, AC201, AC202, AC241, AC242, AC2A, AC91, AC95, ACL100, ACL150, ACS101, ACS101-DIGIT, ACS122, ACS122-DIGIT, ACS151, ACS151-DIGIT, ACS152, ACS152-DIGIT, ACS161-DIGIT, ACS162-DIGIT, ACS181, ACS181-DIGIT, ACS182, ACS182-DIGIT, ACS201, ACS201-DIGIT, ACS202, ACS202-DIGIT, ACS241, ACS241-DIGIT, ACS242, ACS242-DIGIT, ACS91, ACS91-DIGIT, LAV1000, LV1001, LV1501, LV-LVP, LVP1001, LVP1501, NE02, NE3001, NE3002, NE4001...(Other models you can see in the webshop)		

			
1			
GEV No.	358028	Ref. No.	130248
description	fine fuse size ϕ 10x38mm 20A rated 500V type Gg fast-acting Qty 1 pcs		
For models:	AC101, AC120, AC122, AC150, AC151, AC152, AC170, AC181, AC182, AC200, AC201, AC202, AC241, AC242, AC91, ACR, ACR145, ACR205, ACR225, ACR245, ACR260, ACR265, ACR305, ACRS145, ACRS205, ACRS225, ACRS245, ACRS260, ACRS265, ACRS305, ACS101, ACS101-DIGIT, ACS122, ACS122-DIGIT, ACS151, ACS151-DIGIT, ACS152, ACS152-DIGIT, ACS161-DIGIT, ACS162-DIGIT, ACS181, ACS181-DIGIT, ACS182, ACS182-DIGIT, ACS201, ACS201-DIGIT, ACS202, ACS202-DIGIT, ACS241, ACS241-DIGIT...(Other models you can see in the webshop)		

			
1			
GEV No.	358032	Ref. No.	130253
description	fine fuse size ϕ 10x38mm 25A rated 500V type Gg fast-acting Qty 1 pcs		
For models:	G115		



miscellaneous



GEV No.	358126	Ref. No.	121026
description	line circuit breaker 3-pole 80A tripping type C rated 400V connection screw clamp		
For models:	AC101, AC122, AC151, AC152, AC181, AC182, AC201, AC202, AC241, AC242, AC2A, AC91, ACL100, ACL150, ACS101, ACS101-DIGIT, ACS122, ACS122-DIGIT, ACS151, ACS151-DIGIT, ACS152, ACS152-DIGIT, ACS161-DIGIT, ACS162-DIGIT, ACS181, ACS181-DIGIT, ACS182, ACS182-DIGIT, ACS201, ACS201-DIGIT, ACS202, ACS202-DIGIT, ACS241, ACS241-DIGIT, ACS242, ACS242-DIGIT, ACS91, ACS91-DIGIT, NE02, NE3002, NE4002, NE5002, NE5502, NE7002, NE7502, NE9002, NE9502, NG01, NG02, NG1202...(Other models you can see in the webshop)		

connection terminals with screw connection



GEV No.	551119	Ref. No.	150220
description	rail-mounted terminal 3-pole max 600V connection screw		
For models:	B10T, B11T, B12T, B13T, B14T, F300, F45, R40, R50		

electric accessories

cables

ribbon cables

group 1



GEV No.	402992	Ref. No.	110482
description	ribbon cable 20-pole L 1250mm plug type 2 row coded		
For models:	BHC30HR-2, BHC30HRA-2, C1000E, C1000ERCDC, C1300E, C1300ERCDC, FC3E, FC3EA, FC44E, FC44EA, FC4E, FC4EA, FC4EHR, GE100, GE115, GE125, GE50RCD, GE60, GE60RCD, GE65, GE65RCD, GE75, GE80, XLC		

terminals

connection terminals with screw/faston connections



GEV No.	550534 ¹	Ref. No.	150226
description	power terminal block 3-pole max. 40A max 450V connection ø6mm ² / F6.3 temp.-resist. 150°C cross section 6mm ² mounting distance 67mm with ground lug		
For models:	LB200, LB200-2, LB200A, LB200A-2, LB215, LB215-2, LB215A, LB215A-2, LB260, LB260-2, LB260A, LB260A-2, LB275, LB275-2, LB275A, LB275A-2, LBR, LBR200, LBR215, LBR215A		

¹with ground lug

GEV No.	550411	Ref. No.	130321
description	power terminal block 6-pole max. 40A max 450V connection ø6mm ² / F6.3 temp.-resist. 150°C cross section 6mm ²		
For models:	FC3E, FC3EA, FC3M, FC3MA, FC3MR, FC44E, FC44EA, FC4E, FC4EA, FC4EHR, FC4M, FC4MA, GF70, GF70A, LF322MP, LF322MP-A, LF322RCD, LFD32E, LFD32EA, LFD32M, LFD32MA		

electronic components

condensators

group 1

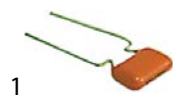

GEV No.	511225	Ref. No.	631213
description	operating capacitor capacity 0.1µF		
For models:	AC100, AC105, AC120, AC135, AC150, AC170, AC200, AC90, AC95, ACR, ACR145, ACR205, ACR225, ACR245, ACR260, ACR265, ACR305, SE, SNL		

equipment-specific units

for dough mixers

chains

connectors



GEV No.	693276	Ref. No.	410903
description	connector single DIN/ISO 08 B-1 splitting 1/2" links 1 L 23mm internal width 11.8mm rollerø 4.3mm metal		
For models:	AC100, AC101, AC105, AC120, AC122, AC135, AC150, AC151, AC152, AC170, AC181, AC182, AC200, AC201, AC202, AC241, AC242, AC90, AC91, AC95, ACR, ACR145, ACR205, ACR225, ACR245, ACR260, ACR265, ACR305, ACR5145, ACR5205, ACR5225, ACR5245, ACR5260, ACR5265, ACR5305, ACS101, ACS101-DIGIT, ACS122, ACS122-DIGIT, ACS151, ACS151-DIGIT, ACS152, ACS152-DIGIT, ACS161-DIGIT, ACS162-DIGIT, ACS181, ACS181-DIGIT, ACS182, ACS182-DIGIT, ACS201...(Other models you can see in the webshop)		



for espresso machines

brewing units

filter holder gaskets

O-rings



GEV No.	510409	Ref. No.	200815
description	O-ring EPDM thickness 5.34mm ID ø 56.52mm Qty 1 pcs		
For models:	AC100, AC101, AC105, AC120, AC122, AC135, AC150, AC151, AC152, AC170, AC181, AC182, AC200, AC201, AC202, AC241, AC242, AC2A, AC90, AC91, AC95, ACR, ACR145, ACR205, ACR225, ACR245, ACR260, ACR265, ACR305, ACS101, ACS101-DIGIT, ACS122, ACS122-DIGIT, ACS151, ACS151-DIGIT, ACS152, ACS152-DIGIT, ACS161-DIGIT, ACS162-DIGIT, ACS181, ACS181-DIGIT, ACS182, ACS182-DIGIT, ACS201, ACS201-DIGIT, ACS202, ACS202-DIGIT, ACS241, ACS241-DIGIT, ACS242...(Other models you can see in the webshop)		

steam/water taps

steam/water pipes

accessories

gaskets



GEV No.	510893	Ref. No.	200810 200845
description	O-ring EPDM thickness 2.62mm ID ø 9.92mm Qty 1 pcs		
For models:	B10, B10T, B11, B11T, B12, B12T, B13T, B14T, B15, B15T, B15TM, B16, B16T, B16TM, B18, B18T, B18TM, B19, B19T, B19TM, B20, B20D, B23, B24, B25, B26, B27, B31, B32, BC25, BC25A, BC25HR, BC30, BC30A, BC30HR, BC30HR380, BC30HRA, BR20, BR20A, BR25, BR25A, F20, F90M, F90MA, FC, FC43, FC43A, FC53, FC533, FC533A...(Other models you can see in the webshop)		

for coffee grinders



GEV No.	345019	Ref. No.	120712
description	rotary switch sets of contacts 2 2 0-1 type CA0120002 380V 12A shaft ø 5x5mm shaft L 23mm shaft square connection screw		
For models:	AC101, AC105, AC2A, AC91, AC95, ACL100, ACL150, ACS101, ACS101-DIGIT, ACS91, ACS91-DIGIT, B10, B10T, B11, B11T, B12, B12T, B13T, B14T, B15, B15T, B15TM, B16, B16T, B16TM, B18, B18T, B18TM, B19, B19T, B19TM, BC25, BC30, BHC25, BHC25-2, BHC25A-2, BHC25S, BHC30, BHC30-2, BHC30A-2, BR20, BR25, C33, C34, F2, F3, F300, F45, G131, G66...(Other models you can see in the webshop)		

for garbage disposal units



GEV No.	694473	Ref. No.	CH313237
description	knife for garbage disposal unit L 25.5mm W 25.5mm H 25.5mm		



GEV No.	694472	Ref. No.	CH312390
description	knife for garbage disposal unit L 95mm W 70mm H 26mm		

for dishwashers

drain and intake components

COMENDA

drain /intake bodies





GEV No.	511567	Ref. No.	190122
description	bearing for drain assembly L 53mm H 20mm		
For models:	NE00, SE		





GEV No.	510803	Ref. No.	160203
description	connection angle ED ø 35mm ID ø 30mm		
For models:	AC100, AC101, AC105, AC120, AC122, AC135, AC150, AC151, AC152, AC170, AC181, AC182, AC200, AC201, AC202, AC241, AC242, AC90, AC91, AC95, ACR, ACR145, ACR205, ACR225, ACR245, ACR260, ACR265, ACR305, ACRS145, ACRS205, ACRS225, ACRS245, ACRS260, ACRS265, ACRS305, ACS101, ACS101-DIGIT, ACS122, ACS122-DIGIT, ACS151, ACS151-DIGIT, ACS152, ACS152-DIGIT, ACS91, ACS91-DIGIT, B13T, B14T, B15, B15T, B15TM...(Other models you can see in the webshop)		



GEV No.	517411	Ref. No.	190326
description	connection angle ED ø 70mm		
For models:	AC120, AC150, AC170, AC200, ACR, ACR145, ACR205, ACR225, ACR245, ACR260, ACR265, ACR305, GMC, GMC2700, GMC3500, GMC4500, GMC5500, LV1001, LV1501, LV-LVP, LVP1001, LVP1501, NE3001, NE4001, NE5501, NE7501, NE9001		



			
GEV No.	510945	Ref. No.	190308
description	connection angle for overflow pipe		
For models:	AC241, AC242, ACL100, ACL150, ACR5145, ACR5205, ACR5225, ACR5245, ACR5260, ACR5265, ACR5305, ACS181, ACS181-DIGIT, ACS182, ACS182-DIGIT, ACS201, ACS201-DIGIT, ACS202, ACS202-DIGIT, ACS241, ACS241-DIGIT, ACS242, ACS242-DIGIT, GMC2702, GMC3502, GMC4502, GMC5502, NG01, NG601E, NG901E, SE, SNL		
accessories for	510945		
	GEV No.	510498	Ref. No. 180109
	nut thread 1 1/2"		
	GEV No.	516254	Ref. No. 200410
	flat gasket rubber ED ø 66mm ID ø 46mm thickness 2.1mm Qty 1 pcs		

			
GEV No.	512110	Ref. No.	190225
description	drain connection thread 1 1/4" hose ø 30mm		
For models:	BHC25, BHC25-2, BHC25A, BHC25A-2, BHC255, BHC30, BHC30-2, BHC30A, BHC30A-2, BHC30E, BHC30E-2, BHC30EA, BHC30EA-2, BHC30HR, BHC30HR-2, BHC30HR380, BHC30HRA, BHC30HRA-2, BHC30HRA380, BHC433, BHC433-2, BHC433A, BHC433A-2, BHCHR, GF70, GF70A, LB200, LB200-2, LB200A, LB200A-2, LB215, LB215-2, LB215A, LB215A-2, LB260, LB260-2, LB260A, LB260A-2, LB275, LB275-2, LB275A, LB275A-2, LF321, LF321A, LF322, LF322A, LF322MP, LF322MP-A, LF322RCD, LF324...(Other models you can see in the webshop)		
accessories for	512110		
	GEV No.	512111	Ref. No. 200867
	O-ring EPDM thickness 2.62mm ID ø 45.69mm Qty 1 pcs		

			
GEV No.	517602	Ref. No.	H15818
description	drain fitting ED ø 21.5mm ID ø 12.5mm hose ø 7.5mm		
For models:	FC3E, FC3EA, FC3MA, FC44E, FC44EA, FC4E, FC4EA, FC4EHR, FC4MA		

			
GEV No.	511431	Ref. No.	270403
description	drain fitting thread 1 1/2"		
For models:	G115, G125, G131, G65, G66, G75		
accessories for	511431		
	GEV No.	511309	Ref. No. 270104
	nut thread 1 1/2" ø 66mm H 9mm WS 51 brass Qty 1 pcs		
	GEV No.	516254	Ref. No. 200410
	flat gasket rubber ED ø 66mm ID ø 46mm thickness 2.1mm Qty 1 pcs		

			
GEV No.	511925	Ref. No.	160308
description	drain fitting thread 1 1/2" ED ø 59mm ID ø 40mm		
For models:	FC, FC53, FC533, FC533A, FC53A, FC53CBT, FC53LA, FC53LBT, FC54, FC543, FC543A, FC543E, FC543EA, FC544, FC544A, FC54A, FC54CBT, FC54E, FC54EA, FC54LBT, FCHR, FCHRA, FCHRT, FCHRTA		

			
GEV No.	510805	Ref. No.	160301 160306 160307
description	drain fitting thread 1 1/2" ED ø 68mm ID ø 39mm		
For models:	AC100, AC101, AC105, AC120, AC122, AC135, AC150, AC151, AC152, AC170, AC181, AC182, AC200, AC201, AC202, AC241, AC242, AC2A, AC90, AC91, AC95, ACL100, ACL150, ACR, ACR145, ACR205, ACR225, ACR245, ACR260, ACR265, ACR305, ACR5145, ACR5205, ACR5225, ACR5245, ACR5260, ACR5265, ACR5305, ACS101, ACS101-DIGIT, ACS122, ACS122-DIGIT, ACS151, ACS151-DIGIT, ACS152, ACS152-DIGIT, ACS161-DIGIT, ACS162-DIGIT, ACS91, ACS91-DIGIT...(Other models you can see in the webshop)		
accessories for	510805		
	GEV No.	510498	Ref. No. 180109
	nut thread 1 1/2"		

			
GEV No.	511308	Ref. No.	270408
description	drain fitting thread 1 1/2" H 40mm ID ø 41/35mm		
For models:	G100L, G101L, G115L, G125L, G50L, G50LM, G51L, G60L, G61L, G65L, G75L, GE125, GE75, GL		







			
GEV No.	524582	Ref. No.	270407 270409
description	drain fitting thread 1 1/2" ID ø 35.5mm		
For models:	AC101, AC105, AC120, AC122, AC135, AC150, AC151, AC152, AC170, AC181, AC182, AC200, AC201, AC202, AC241, AC242, AC91, AC95, ACR, ACR145, ACR205, ACR225, ACR245, ACR260, ACR265, ACR305, ACR5145, ACR5205, ACR5225, ACR5245, ACR5260, ACR5265, ACR5305, ACS101, ACS101-DIGIT, ACS122, ACS122-DIGIT, ACS151, ACS151-DIGIT, ACS152, ACS152-DIGIT, ACS161-DIGIT, ACS162-DIGIT, ACS181, ACS181-DIGIT, ACS182, ACS182-DIGIT, ACS201, ACS201-DIGIT, ACS202...(Other models you can see in the webshop)		
accessories for	524582		
	GEV No.	510876	Ref. No. 200412
	flat gasket rubber ED ø 45mm ID ø 33mm thickness 3mm Qty 1 pcs		

Table continues overleaf





accessories for 524582			
	GEV No.	511298	Ref. No. 160201
hose connector hose ø 35mm			
	GEV No.	511309	Ref. No. 270104
nut thread 1½" ø 66mm H 9mm WS 51 brass Qty 1 pcs			
	GEV No.	516254	Ref. No. 200410
flat gasket rubber ED ø 66mm ID ø 46mm thickness 2.1mm Qty 1 pcs			

	1		
GEV No.	511336	Ref. No.	160307 160309
description	drain fitting thread 1½" ID ø 39mm		
For models:	FC, FC53, FC533, FC533A, FC53A, FC53CBT, FC53LA, FC53LBT, FC54, FC543, FC543A, FC543E, FC543EA, FC544, FC544A, FC54A, FC54CBT, FC54E, FC54EA, FC54LBT, FCHR, FCHRA, FCHRT, FCHRTA		

	1		
GEV No.	511294	Ref. No.	180204
description	flange ED ø 130mm H 9mm ID ø 70mm		
For models:	AC100, AC135, AC90, C33, C34, G115, G131, G65, G66, NE00, SE, SNL		

	1		
GEV No.	510876	Ref. No.	200412
description	flat gasket rubber ED ø 45mm ID ø 33mm thickness 3mm Qty 1 pcs		
For models:	AC100, AC101, AC105, AC120, AC122, AC135, AC150, AC151, AC152, AC170, AC181, AC182, AC200, AC201, AC202, AC241, AC242, AC2A, AC90, AC91, AC95, ACL100, ACL150, ACR, ACR145, ACR205, ACR225, ACR245, ACR260, ACR265, ACR305, ACR5145, ACR5205, ACR5225, ACR5245, ACR5260, ACR5265, ACR5305, ACS101, ACS101-DIGIT, ACS122, ACS122-DIGIT, ACS151, ACS151-DIGIT, ACS152, ACS152-DIGIT, ACS161-DIGIT, ACS162-DIGIT, ACS181, ACS181-DIGIT...(Other models you can see in the webshop)		

	1		
GEV No.	511196	Ref. No.	200919
description	flat gasket rubber ED ø 59mm ID ø 48mm thickness 2mm Qty 1 pcs		
For models:	FC, FC53, FC533, FC533A, FC53A, FC53CBT, FC53LA, FC53LBT, FC54, FC543, FC543A, FC543E, FC543EA, FC544, FC544A, FC54A, FC54CBT, FC54E, FC54EA, FC54LBT, FCHR, FCHRA, FCHRT, FCHRTA, GE50RCD		



	1		
GEV No.	516254	Ref. No.	200410
description	flat gasket rubber ED ø 66mm ID ø 46mm thickness 2.1mm Qty 1 pcs		

	1		
GEV No.	511318	Ref. No.	200913
description	flat gasket rubber ED ø 75mm ID ø 59mm thickness 2mm Qty 1 pcs		
For models:	AC122, AC152, AC182, AC202, AC242, BC25, BC25A, BC25HR, BC30, BC30A, BC30HR, BC30HR380, BC30HRA, BR20, BR20A, BR25, BR25A, FC43, FC43A		

	1		
GEV No.	510832	Ref. No.	200906
description	flat gasket rubber ED ø 92mm ID ø 66mm thickness 2mm Qty 1 pcs equiv. no. 200906/33456		
For models:	AC101, AC105, AC120, AC122, AC135, AC150, AC151, AC152, AC170, AC181, AC182, AC200, AC201, AC202, AC241, AC242, AC2A, AC91, AC95, ACL100, ACL150, ACR, ACR145, ACR205, ACR225, ACR245, ACR260, ACR265, ACR305, ACR5145, ACR5205, ACR5225, ACR5245, ACR5260, ACR5265, ACR5305, ACS101, ACS101-DIGIT, ACS122, ACS122-DIGIT, ACS151, ACS151-DIGIT, ACS152, ACS152-DIGIT, ACS161-DIGIT, ACS162-DIGIT, ACS181, ACS181-DIGIT, ACS182, ACS182-DIGIT...(Other models you can see in the webshop)		

	1		
GEV No.	511290	Ref. No.	200436
description	gasket ED ø 129mm ID ø 95mm		
For models:	B10, B10T, B11, B11T, B12, B12T, B20, B20D, B23, B24, B25, B26, B27, LBC210, LBC215, LBC215A, LBC275, LBC275A, LBR, LBR200, LBR215, LBR215A		

	1		
GEV No.	510807	Ref. No.	160202
description	hose connector hose ø 30mm		
For models:	B41, B42, C30, C33, C34, F2, F3, F300, R40, R50, R70		

			
1			
GEV No.	511298	Ref. No.	160201
description	hose connector hose ø 35mm		
For models:	AC100, AC101, AC105, AC120, AC122, AC135, AC150, AC151, AC152, AC170, AC181, AC182, AC200, AC201, AC202, AC241, AC242, AC2A, AC90, AC91, AC95, ACL100, ACL150, ACR, ACR145, ACR205, ACR225, ACR245, ACR260, ACR265, ACR305, ACRS145, ACRS205, ACRS225, ACRS245, ACRS260, ACRS265, ACRS305, ACS101, ACS101-DIGIT, ACS122, ACS122-DIGIT, ACS151, ACS151-DIGIT, ACS152, ACS152-DIGIT, ACS161-DIGIT, ACS162-DIGIT, ACS181, ACS181-DIGIT...(Other models you can see in the webshop)		
accessories for	511298		
	GEV No.	510356	Ref. No.
			180102
	nut thread 1½"		
	GEV No.	510876	Ref. No.
			200412
	flat gasket rubber ED ø 45mm ID ø 33mm thickness 3mm Qty 1 pcs		

			
1			
GEV No.	511329	Ref. No.	180142
description	intake body thread 1¼" ID ø 32mm		
For models:	BHC25, BHC25-2, BHC25A, BHC25A-2, BHC30, BHC30-2, BHC30A, BHC30A-2, BHC30E-2, BHC30EA-2, BHC30HR, BHC30HR-2, BHC30HR380, BHC30HRA, BHC30HRA-2, BHC30HRA380, BHC433, BHC433-2, BHC433A, BHC433A-2, BHCHR, LB200, LB200A, LB215, LB215A, LB260, LB260A, LB275, LB275A, LF315, LF320A, LF320CBT, LF320LA, LF320LBT, LF321, LF321A, LF322, LF322A, LF322MP, LF322MP-A, LF322RCD, LF323, LF323A, LF324, LF324A, LF325E, LF325EA, LF350, LF350A, LF400A...(Other models you can see in the webshop)		

			
1			
GEV No.	511291	Ref. No.	180210
description	intake body thread 1½" ED ø 140mm H 75mm ID ø 85mm hose ø 30mm		
For models:	B10, B10T, B11, B11T, B12, B12T, B20, B20D, B23, B24, B25, B26, B27, LBC210, LBC215, LBC215A, LBC275, LBC275A, LBR, LBR200, LBR215, LBR215A		

			
1			
GEV No.	510819	Ref. No.	180228
description	intake body thread 1½" ED ø 227mm hose ø 46mm		
For models:	C70, C75, C75BT, C75M, C75RCD, F45, F55, F65, F80, F90M, F90MA, LF280-lav-line, LF315, LF320, LF320A, LF320CBT, LF320L, LF320LA, LF320-lav-line, LF320LBT, LF323, LF323A, LF350, LF350A, LF400A, LF450, LF450A, LP360, LP360BT, LP360RCD, LS550		

			
1			
GEV No.	511330	Ref. No.	160310
description	intake body thread 1½" ID ø 38mm		

			
1			
GEV No.	510472	Ref. No.	180235
description	intake body thread 2" ID ø 50mm		
For models:	AC120, AC150, AC170, AC200, ACR, ACR145, ACR205, ACR225, ACR245, ACR260, ACR265, ACR305, C140, C85, GF90, GF90-2004, GF90A, GF90A-2004, GMC, GMC2700, GMC3500, GMC4500, GMC5500, LC380, LC380BT, LC380RCD, LC400, LV1501, LV-LVP, LVP1501, NE02, NE3001, NE3002, NE4001, NE4002, NE5002, NE5501, NE5502, NE7002, NE7501, NE7502, NE9001, NE9002, NE9502, NG02, NG1202, NG1202E, NG602, NG602E, NG902...(Other models you can see in the webshop)		

			
1			
GEV No.	511295	Ref. No.	180203
description	intake body		
For models:	SE, SNL		

			
1			
GEV No.	510804	Ref. No.	160603
description	intake body ED ø 120mm		
For models:	C30, F2, F3, F300, R40, R70		

			
1			
GEV No.	511338	Ref. No.	180207
description	intake body ED ø 128mm ID ø 60mm		
For models:	AC100, AC135, AC90, C33, C34, NE00, SE, SNL		

			
1			
GEV No.	511430	Ref. No.	160204
description	intake body ED ø 31mm ID ø 15/26mm hose ø 21mm		
For models:	B10, B10T, B11, B11T, B12, B12T, LBC210, LBC215, LBC215A, LBC275, LBC275A, LBR, LBR200, LBR215, LBR215A		



			
1			
GEV No.	510815	Ref. No.	180236
description	intake body thread 2" ID ø 51mm		
For models:	AC101, AC105, AC120, AC122, AC135, AC150, AC151, AC152, AC170, AC181, AC182, AC200, AC201, AC202, AC241, AC242, AC2A, AC91, AC95, ACL100, ACL150, ACR, ACR145, ACR205, ACR225, ACR245, ACR260, ACR265, ACR305, ACRS145, ACRS205, ACRS225, ACRS245, ACRS260, ACRS265, ACRS305, ACS101, ACS101-DIGIT, ACS122, ACS122-DIGIT, ACS151, ACS151-DIGIT, ACS152, ACS152-DIGIT, ACS161-DIGIT, ACS162-DIGIT, ACS181, ACS181-DIGIT, ACS182, ACS182-DIGIT...(Other models you can see in the webshop)		

			
1			
GEV No.	519583	Ref. No.	180248
description	intake/drain body thread 1 1/2" ED ø 130mm ID ø 90mm hose ø 50mm		
For models:	C1000E, C1000ERCD, C1001M, C1300E, C1300ERCD, C1301M, GE50RCD, LC1200, LC1200RCD, LC412, LC700, LC700RCD, LC900, LC900RCD, XLC		

			
1			
GEV No.	511319	Ref. No.	180239
description	intake/drain body thread 2" hose ø 26/32mm		
For models:	AC122, AC152, AC182, AC202, AC242, BC25, BC25A, BC25HR, BC30, BC30A, BC30HR, BC30HR380, BC30HRA, BR20, BR20A, BR25, BR25A, FC43, FC43A		

			
1			
GEV No.	511327	Ref. No.	320166
description	lid for inlet valve		
For models:	BHC30HR, BHC30HR-2, BHC30HR380, BHC30HRA, BHC30HRA-2, BHC30HRA380, BHCHR, FC, FC53, FC533, FC533A, FC53A, FC53CBT, FC53LA, FC53LBT, FC54, FC543, FC543A, FC543E, FC543EA, FC544, FC544A, FC54A, FC54CBT, FC54E, FC54EA, FC54LBT, FCHR, FCHRA, FCHRT, FCHRTA, GF70, GF70A		



			
1			
GEV No.	510356	Ref. No.	180102
description	nut thread 1 1/2"		
For models:	AC100, AC101, AC105, AC120, AC122, AC135, AC150, AC151, AC152, AC170, AC181, AC182, AC200, AC201, AC202, AC241, AC242, AC2A, AC90, AC91, AC95, ACL100, ACL150, ACR, ACR145, ACR205, ACR225, ACR245, ACR260, ACR265, ACR305, ACRS145, ACRS205, ACRS225, ACRS245, ACRS260, ACRS265, ACRS305, ACS101, ACS101-DIGIT, ACS122, ACS122-DIGIT, ACS151, ACS151-DIGIT, ACS152, ACS152-DIGIT, ACS161-DIGIT, ACS162-DIGIT, ACS181, ACS181-DIGIT...(Other models you can see in the webshop)		
accessories for	510356		
	GEV No.	Ref. No.	200412
	 flat gasket rubber ED ø 45mm ID ø 33mm thickness 3mm Qty 1 pcs		
	GEV No.	Ref. No.	160201
	 hose connector hose ø 35mm		

			
1			
GEV No.	510498	Ref. No.	180109
description	nut thread 1 1/2"		
For models:	AC100, AC101, AC105, AC120, AC122, AC135, AC150, AC151, AC152, AC170, AC181, AC182, AC200, AC201, AC202, AC241, AC242, AC2A, AC90, AC91, AC95, ACL100, ACL150, ACR, ACR145, ACR205, ACR225, ACR245, ACR260, ACR265, ACR305, ACRS145, ACRS205, ACRS225, ACRS245, ACRS260, ACRS265, ACRS305, ACS101, ACS101-DIGIT, ACS122, ACS122-DIGIT, ACS151, ACS151-DIGIT, ACS152, ACS152-DIGIT, ACS161-DIGIT, ACS162-DIGIT, ACS181, ACS181-DIGIT...(Other models you can see in the webshop)		

			
1			
GEV No.	511309	Ref. No.	270104
description	nut thread 1 1/2" ø 66mm H 9mm WS 51 brass Qty 1 pcs		
For models:	AC101, AC105, AC120, AC122, AC135, AC150, AC151, AC152, AC170, AC181, AC182, AC200, AC201, AC202, AC241, AC242, AC91, AC95, ACR, ACR145, ACR205, ACR225, ACR245, ACR260, ACR265, ACR305, ACRS145, ACRS205, ACRS225, ACRS245, ACRS260, ACRS265, ACRS305, ACS101, ACS101-DIGIT, ACS122, ACS122-DIGIT, ACS151, ACS151-DIGIT, ACS152, ACS152-DIGIT, ACS161-DIGIT, ACS162-DIGIT, ACS181, ACS181-DIGIT, ACS182, ACS182-DIGIT, ACS201, ACS201-DIGIT, ACS202...(Other models you can see in the webshop)		

			
1			
GEV No.	511332	Ref. No.	180145
description	nut thread 1 3/4"		
For models:	BHC25, BHC25-2, BHC25A, BHC25A-2, BHC25S, BHC30, BHC30-2, BHC30A, BHC30A-2, BHC30E, BHC30E-2, BHC30EA, BHC30EA-2, BHC30HR, BHC30HR-2, BHC30HR380, BHC30HRA, BHC30HRA-2, BHC30HRA380, BHC433, BHC433-2, BHC433A, BHC433A-2, BHCHR, LB200, LB200-2, LB200A, LB200A-2, LB215, LB215-2, LB215A, LB215A-2, LB260, LB260-2, LB260A, LB260A-2, LB275, LB275-2, LB275A, LB275A-2, LF321, LF321A, LF322, LF322A, LF322MP, LF322MP-A, LF322RCD, LF324, LF324A, LF325E...(Other models you can see in the webshop)		

			
2			
GEV No.	511317	Ref. No.	160771 160783
description	nut thread 2"		
For models:	AC122, AC152, AC182, AC202, AC242, BC25, BC25A, BC25HR, BC30, BC30A, BC30HR, BC30HR380, BC30HRA, BR20, BR20A, BR25, BR25A, FC43, FC43A		

			
1			
GEV No.	510632	Ref. No.	180251
description	opposite support ED ø 110mm ID ø 50mm		
For models:	FC3E, FC3EA, FC3M, FC3MA, FC3MR, FC44E, FC44EA, FC4E, FC4EA, FC4EHRT, FC4M, FC4MA		
accessories for	510632		
	GEV No.	Ref. No.	200963
			
	flat gasket rubber ED ø 110mm ID ø 88mm thickness 3mm Qty 1 pcs		

			
1			
GEV No.	510469	Ref. No.	191057
description	opposite support ED ø 130mm H 74mm		
For models:	C140, C85, GF90, GF90-2004, GF90A, GF90A-2004, LC380, LC380BT, LC380RCD, LC400		

			
1			
GEV No.	512111	Ref. No.	200867
description	O-ring EPDM thickness 2.62mm ID ø 45.69mm Qty 1 pcs		
For models:	BHC25, BHC25-2, BHC25A, BHC25A-2, BHC25S, BHC30, BHC30-2, BHC30A, BHC30A-2, BHC30E, BHC30E-2, BHC30EA, BHC30EA-2, BHC30HR, BHC30HR-2, BHC30HR380, BHC30HRA, BHC30HRA-2, BHC30HRA380, BHC433, BHC433-2, BHC433A, BHC433A-2, BHCHR, LB200, LB200-2, LB200A, LB200A-2, LB215, LB215-2, LB215A, LB215A-2, LB260, LB260-2, LB260A, LB260A-2, LB275, LB275-2, LB275A, LB275A-2, LF315, LF320A, LF320CBT, LF320LA, LF320LBT, LF321, LF321A, LF322, LF322A, LF322MP...(Other models you can see in the webshop)		

			
1			
GEV No.	511339	Ref. No.	200873
description	O-ring EPDM thickness 3.53mm ID ø 110.7mm Qty 1 pcs		

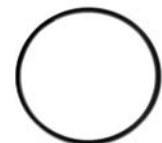
			
1			
GEV No.	510896	Ref. No.	200828
description	O-ring EPDM thickness 3.53mm ID ø 183.75mm Qty 1 pcs		
For models:	B13T, B14T, B15, B15T, B15TM, B16, B16T, B16TM, B18, B18T, B18TM, B19, B19T, B19TM, B41, B42, C30, C70, C75, C75BT, C75M, C75RCD, F2, F20, F3, F300, F45, F55, F65, F80, F90M, F90MA, LF280-lav-line, LF315, LF320, LF320A, LF320CBT, LF320L, LF320LA, LF320-lav-line, LF320LBT, LF323, LF323A, LF350, LF350A, LF400A, LF450, LF450A, LP360, LP360BT...(Other models you can see in the webshop)		

			
1			
GEV No.	511331	Ref. No.	200842
description	O-ring EPDM thickness 3.53mm ID ø 53.57mm Qty 1 pcs		
For models:	BHC25, BHC25-2, BHC25A, BHC25A-2, BHC25S, BHC30, BHC30-2, BHC30A, BHC30A-2, BHC30E, BHC30E-2, BHC30EA, BHC30EA-2, BHC30HR, BHC30HR-2, BHC30HR380, BHC30HRA, BHC30HRA-2, BHC30HRA380, BHC433, BHC433-2, BHC433A, BHC433A-2, BHCHR, LB200, LB200-2, LB200A, LB200A-2, LB215, LB215-2, LB215A, LB215A-2, LB260, LB260-2, LB260A, LB260A-2, LB275, LB275-2, LB275A, LB275A-2, LF321, LF321A, LF322, LF322A, LF322MP, LF322MP-A, LF322RCD, LF324, LF324A, LF325E...(Other models you can see in the webshop)		

			
1			
GEV No.	524483	Ref. No.	200807
description	O-ring EPDM thickness 4mm ID ø 110mm Qty 1 pcs		
For models:	AC100, AC135, AC90, C1000E, C1000ERCD, C1001M, C1300E, C1300ERCD, C1301M, C33, C34, G115, G131, G65, G66, GE50RCD, LC1200, LC1200RCD, LC412, LC700, LC700RCD, LC900, LC900RCD, NE00, SE, SNL, XLC		

			
1			
GEV No.	524771	Ref. No.	160102
description	overflow stock thread 1 1/2" ED ø 60mm		
For models:	AC151, AC152, NE3001, NE4001, NE5501, NE7501, NE9001, NG01, NG601E, NG901E		





			
1			
GEV No.	512109	Ref. No.	180147
description	screw connection thread 1 1/4"		
For models:	BHC25, BHC25-2, BHC25A, BHC25A-2, BHC25S, BHC30, BHC30-2, BHC30A, BHC30A-2, BHC30E, BHC30E-2, BHC30EA, BHC30EA-2, BHC30HR, BHC30HR-2, BHC30HR380, BHC30HRA, BHC30HRA-2, BHC30HRA380, BHC433, BHC433-2, BHC433A, BHC433A-2, BHCHR, GF70, GF70A, LB200, LB200-2, LB200A, LB200A-2, LB215, LB215-2, LB215A, LB215A-2, LB260, LB260-2, LB260A, LB260A-2, LB275, LB275-2, LB275A, LB275A-2, LF315, LF320A, LF320CBT, LF320LA, LF320LBT, LF321, LF321A, LF322...(Other models you can see in the webshop)		

			
1			
GEV No.	519623	Ref. No.	160541
description	spacer piece thread 2 ED ø 85mm H 40mm ID ø 45mm		
For models:	AC122, AC152, AC182, AC202, AC242		

			
1			
GEV No.	524580	Ref. No.	190307
description	T-piece thread 1 1/2"		
For models:	AC120, AC170, AC200, ACR, ACR145, ACR205, ACR225, ACR245, ACR260, ACR265, ACR305, ACRS145, ACRS205, ACRS225, ACRS245, ACRS260, ACRS265, ACRS305, GMC, GMC2700, GMC2702, GMC3500, GMC3502, GMC4500, GMC4502, GMC5500, GMC5502, LV1001, LV1501, LV-LVP, LVP1001, LVP1501, NG01, NG02, NG1202, NG1202E, NG601, NG601E, NG602, NG602E, NG901, NG901E, NG902, NG902E, SE		

			
1			
GEV No.	510499	Ref. No.	180128
description	union nut thread 2"		
For models:	AC101, AC105, AC120, AC122, AC135, AC150, AC151, AC152, AC170, AC181, AC182, AC200, AC201, AC202, AC241, AC242, AC2A, AC91, AC95, ACL100, ACL150, ACR, ACR145, ACR205, ACR225, ACR245, ACR260, ACR265, ACR305, ACRS145, ACRS205, ACRS225, ACRS245, ACRS260, ACRS265, ACRS305, ACS101, ACS101-DIGIT, ACS122, ACS122-DIGIT, ACS151, ACS151-DIGIT, ACS152, ACS152-DIGIT, ACS161-DIGIT, ACS162-DIGIT, ACS181, ACS181-DIGIT, ACS182, ACS182-DIGIT...(Other models you can see in the webshop)		

<p>filters</p> 			
1			
GEV No.	511335	Ref. No.	180822
description	drain filter		
For models:	FC, FCHR, FCHRA, FCHRT, FCHRTA		

			
1			
GEV No.	507546	Ref. No.	332058
description	filter for dishwasher H 132mm L 515mm W 260mm SS		
For models:	GE100, GE115		

			
1			
GEV No.	524577	Ref. No.	330583
description	filter for pre-wash zone H 20mm L 572mm W 197mm		
For models:	AC135, AC150, AC170, AC181, AC182, AC200, ACR, ACR205, ACR245, ACR260, ACR265, GMC, GMC3500, GMC4500, GMC5500		

			
1			
GEV No.	524576	Ref. No.	333007
description	filter H 27mm L 632mm W 410mm		
For models:	NL302, NL302E, NL402, NL402E, NL502, NL502E, NL552, NL552E		

			
1			
GEV No.	518604	Ref. No.	330547
description	filter H 32mm L 150mm W 150mm		
For models:	NE00, NE3001, NE4001, NE5501, NE7501, NE9001, NG00, NG01, NG02, NG1202, NG1202E, NG600, NG600E, NG601, NG601E, NG602, NG602E, NG900, NG900E, NG901, NG901E, NG902, NG902E		

			
1			
GEV No.	519548	Ref. No.	330594
description	filter H 57mm L 300mm W 187mm		

			
1			
GEV No.	519549	Ref. No.	330599
description	filter H 59mm L 463mm W 193mm		

			
1			
GEV No.	511324	Ref. No.	180824
description	flat filter		

			
1			
GEV No.	518601	Ref. No.	332094
description	filter H 77mm L 460mm W 180mm		
For models:	ACS201, ACS201-DIGIT, ACS202, ACS202-DIGIT, ACS241, ACS241-DIGIT, ACS242, ACS242-DIGIT		

			
1			
GEV No.	519531	Ref. No.	330409
description	flat filter for pre-wash zone H 10mm L 485mm W 225mm		
For models:	SNL		

			
1			
GEV No.	519485	Ref. No.	180832
description	filter L 265mm W 250mm		
For models:	LF322, LF322A, LF322MP, LF322MP-A, LF322RCD, LF324, LF324A, LF325E, LF325EA, LF700, LF700A, LFD32E, LFD32EA, LFD32M, LFD32MA		

			
1			
GEV No.	519530	Ref. No.	330508
description	flat filter H 13mm L 545mm W 218mm		
For models:	LV1001, LV1501, LV-LVP, LVP1001, LVP1501, NE00, NE3001, NE4001, NE5501, NE7501, NE9001		

			
1			
GEV No.	518603	Ref. No.	332091
description	filter L 268mm W 235mm mounting pos. left		
For models:	C1000E, C1000ERCD, C1001M, C1300E, C1300ERCD, C1301M, GE50RCD, LC1200, LC1200RCD, LC412, LC700, LC700RCD, LC900, LC900RCD, XLC		

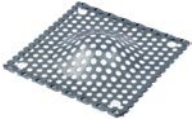
			
1			
GEV No.	524762	Ref. No.	330598
description	flat filter H 18mm L 128mm W 126mm		
For models:	AC151, AC152, ACRS145, ACRS205, ACRS225, ACRS245, ACRS260, ACRS265, ACRS305, NE02, NE3001, NE3002, NE4001, NE4002, NE5002, NE5501, NE5502, NE7002, NE7501, NE7502, NE9001, NE9002, NE9502, NG01, NG02, NG1202E, NG601E, NG602E, NG901E, NG902E, NL302, NL302E, NL402, NL402E, NL502, NL502E, NL552, NL552E		

			
1			
GEV No.	518602	Ref. No.	332090
description	filter L 268mm W 235mm mounting pos. right		
For models:	C1000E, C1000ERCD, C1001M, C1300E, C1300ERCD, C1301M, GE50RCD, LC1200, LC1200RCD, LC412, LC700, LC700RCD, LC900, LC900RCD, XLC		

			
1			
GEV No.	510221	Ref. No.	330584
description	flat filter H 20mm L 570mm W 225mm SS		
For models:	AC120, AC150, AC170, AC200, AC201, AC202, AC241, AC242, ACR, ACR145, ACR205, ACR225, ACR245, ACR260, ACR265, ACR305, ACRS145, ACRS205, ACRS225, ACRS245, ACRS260, ACRS265, ACRS305, GMC, GMC2700, GMC3500, GMC4500, GMC5500		

			
1			
GEV No.	511316	Ref. No.	330597
description	flat filter		
For models:	BC25HR, BC30HR, BC30HR380, BC30HRA		

			
1			
GEV No.	510656	Ref. No.	332003
description	flat filter H 38mm L 428mm W 278mm		
For models:	AC101, AC105, AC122, AC135, AC151, AC152, AC181, AC182, AC201, AC202, AC241, AC242, AC91, AC95		





 <p>1</p>			
GEV No.	510852	Ref. No.	180814 330548
description	flat filter L 160mm W 55mm		
For models:	B13T, B14T, B15, B15T, B15TM, B16, B16T, B16TM, B18, B18T, B18TM, B19, B19T, B19TM, B41, B42, C30, C70, C75, C75BT, C75M, C75RCD, F2, F20, F3, F300, F45, F55, F65, F80, F90M, F90MA, LF280-lav-line, LF315, LF320, LF320A, LF320CBT, LF320L, LF320LA, LF320-lav-line, LF320LBT, LF323, LF323A, LF350, LF350A, LF400A, LF450, LF450A, LP360, LP360BT...(Other models you can see in the webshop)		

 <p>1</p>			
GEV No.	511326	Ref. No.	180828
description	flat filter L 210mm W 210mm		
For models:	BHC30HR, BHC30HR-2, BHC30HR380, BHC30HRA, BHC30HRA-2, BHC30HRA380, BHCHR		

 <p>1</p>			
GEV No.	510475	Ref. No.	330591
description	flat filter L 250mm W 150mm		
For models:	BC25, BC25A, BC30, BC30A, BR20, BR20A, BR25, BR25A, FC43, FC43A		

 <p>1</p>			
GEV No.	510224	Ref. No.	180831
description	flat filter L 250mm W 265mm		
For models:	LF321, LF321A		

 <p>1</p>			
GEV No.	510483	Ref. No.	330586
description	flat filter L 255mm W 160mm		
For models:	C155, C155BT, C155E2, C155RCD, C165, C165E2, C165E2BT, C165E2RCD, C166, C166-2, C95, C95BT, C95E2, C95RCD		

 <p>1</p>			
GEV No.	510482	Ref. No.	330568
description	flat filter L 260mm W 180mm for model C		
For models:	C140, C85		

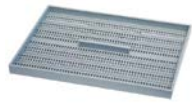
 <p>1</p>			
GEV No.	510851	Ref. No.	180811
description	flat filter L 265mm W 200mm		
For models:	C34, GF90, GF90-2004, GF90A, GF90A-2004, LC380, LC380BT, LC380RCD, LC400		

 <p>1</p>			
GEV No.	512391	Ref. No.	333001
description	flat filter L 535mm W 285mm mounting pos. left/right		
For models:	AC2A, ACL100, ACL150, ACRS145, ACRS205, ACRS225, ACRS245, ACRS260, ACRS265, ACRS305, ACS101, ACS101-DIGIT, ACS122, ACS122-DIGIT, ACS151, ACS151-DIGIT, ACS152, ACS152-DIGIT, ACS161-DIGIT, ACS162-DIGIT, ACS181, ACS181-DIGIT, ACS182, ACS182-DIGIT, ACS201, ACS201-DIGIT, ACS202, ACS202-DIGIT, ACS241, ACS241-DIGIT, ACS242, ACS242-DIGIT, ACS91, ACS91-DIGIT, GMC2702, GMC3502, GMC4502, GMC5502		

 <p>1</p>			
GEV No.	519529	Ref. No.	332007
description	intake filter for wash pump H 150mm L 158mm W 100mm		
For models:	NE3001, NE4001, NE5501, NE7501, NE9001		

 <p>1</p>			
GEV No.	519470	Ref. No.	332092
description	intake filter H 110mm L 457mm W 107mm		
For models:	ACRS205, ACRS225, ACRS245, ACRS260, ACRS265, ACRS305, ACS181, ACS181-DIGIT, ACS182, ACS182-DIGIT, ACS201, ACS201-DIGIT, ACS202, ACS202-DIGIT, ACS241, ACS241-DIGIT, ACS242, ACS242-DIGIT, GMC3502, GMC4502, GMC5502, NL302, NL302E, NL402, NL402E, NL502, NL502E, NL552, NL552E		

 <p>1</p>			
GEV No.	524678	Ref. No.	330566
description	intake filter ø 109mm H 85mm		
For models:	AC120, AC170, AC200, ACR, ACR145, ACR205, ACR225, ACR245, ACR260, ACR265, ACR305, ACRS145, ACRS205, ACRS225, ACRS245, ACRS260, ACRS265, ACRS305, GMC, GMC2700, GMC3500, GMC4500, GMC5500, NE00, NE02, NE3001, NE3002, NE4001, NE4002, NE5002, NE5501, NE5502, NE7002, NE7501, NE7502, NE9001, NE9002, NE9502, NG02, NG1202E, NG602E, NG902E, NL302E, NL402E, NL502E, NL552E, SE		

			
1			
GEV No.	510814	Ref. No.	330592
description	rectangular filter suction		

			
1			
GEV No.	510914	Ref. No.	330528
description	round filters		
For models:	C140, C30, C33, C34, C85, F2, F3, F300, G115, G131, G65, G66, LC380, LC380BT, LC380RCD, LC400, R40, R70		

			
1			
GEV No.	511325	Ref. No.	332029
description	round filters		

			
1			
GEV No.	511334	Ref. No.	332006
description	round filters		
For models:	FC, FCHR, FCHRA, FCHRT, FCHRTA		

			
1			
GEV No.	512215	Ref. No.	H34430
description	round filters		
For models:	GF90, GF90-2004, GF90A, GF90A-2004		

			
1			
GEV No.	511340	Ref. No.	332002
description	round filters ø 100mm H 78mm		
For models:	C155, C155BT, C155E2, C155RCD, C165, C165E2, C165E2BT, C165E2RCD, C166, C166-2, C95, C95BT, C95E2, C95RCD		

			
1			
GEV No.	510474	Ref. No.	180817
description	round filters ø 100mm H 90mm		
For models:	BC25, BC25A, BC30, BC30A, BR20, BR20A, BR25, BR25A, FC43, FC43A		

			
1			
GEV No.	510841	Ref. No.	180809
description	round filters ø 135mm		
For models:	B10, B10T, B11, B11T, B12, B12T, B20, B20D, B23, B24, B25, B26, B27, LBC210, LBC215, LBC215A, LBC275, LBC275A, LBR, LBR200, LBR215, LBR215A		

			
1			
GEV No.	510967	Ref. No.	330502
description	round filters ø 150mm		

			
1			
GEV No.	511571	Ref. No.	180840
description	round filters ø 155mm H 200mm		
For models:	FC3M, FC3MA, FC3MR, FC4M, FC4MA		





			
1			
GEV No.	518606	Ref. No.	180842
description	round filters ø 155mm H 200mm		
For models:	FC3E, FC3EA, FC44E, FC44EA, FC4E, FC4EA, FC4EHRT		

			
1			
GEV No.	519463	Ref. No.	180816
description	round filters ø 80mm H 72mm		
For models:	AC101, AC105, AC120, AC122, AC135, AC150, AC151, AC152, AC170, AC181, AC182, AC200, AC201, AC202, AC241, AC242, AC2A, AC91, AC95, ACL100, ACL150, ACR, ACR145, ACR205, ACR225, ACR245, ACR260, ACR265, ACR305, ACRS145, ACRS205, ACRS225, ACRS245, ACRS260, ACRS265, ACRS305, ACS101, ACS101-DIGIT, ACS122, ACS122-DIGIT, ACS151, ACS151-DIGIT, ACS152, ACS152-DIGIT, ACS161-DIGIT, ACS162-DIGIT, ACS181, ACS181-DIGIT, ACS182, ACS182-DIGIT...(Other models you can see in the webshop)		

			
1			
GEV No.	510850	Ref. No.	180808
description	round filters ø 180mm H 95mm		
For models:	B13T, B14T, B15, B15T, B15TM, B16, B16T, B16TM, B18, B18T, B18TM, B19, B19T, B19TM, B41, C30, C70, C75, C75BT, C75M, C75RCD, F2, F20, F3, F300, F45, F55, F65, F80, F90M, F90MA, LF280-lav-line, LF315, LF320, LF320A, LF320CBT, LF320L, LF320LA, LF320-lav-line, LF320LBT, LF323, LF323A, LF350, LF350A, LF400A, LF450, LF450A, LP360, LP360BT, LP360RCD...(Other models you can see in the webshop)		

			
1			
GEV No.	510639	Ref. No.	333006
description	round filters ø 90mm H 105mm		
For models:	LF322, LF322A, LF322MP, LF322MP-A, LF322RCD, LF324, LF324A, LF325E, LF325EA, LF700, LF700A, LFD32E, LFD32EA, LFD32M, LFD32MA		

			
1			
GEV No.	510942	Ref. No.	330550
description	round filters ø 185mm H 80mm		
For models:	NE00		

			
1			
GEV No.	507391	Ref. No.	330565
description	round filters suction ø 185mm H 100mm		
For models:	AC100, AC135, AC90, SE, SNL		

			
1			
GEV No.	510932	Ref. No.	330526
description	round filters ø 22mm H 88mm		
For models:	AC100, AC101, AC105, AC120, AC122, AC135, AC150, AC151, AC152, AC170, AC181, AC182, AC200, AC201, AC202, AC241, AC242, AC90, AC91, AC95, ACR, ACR145, ACR205, ACR225, ACR245, ACR260, ACR265, ACR305, ACRS145, ACRS205, ACRS225, ACRS245, ACRS260, ACRS265, ACRS305, ACS101, ACS101-DIGIT, ACS122, ACS122-DIGIT, ACS151, ACS151-DIGIT, ACS152, ACS152-DIGIT, ACS161-DIGIT, ACS162-DIGIT, ACS181, ACS181-DIGIT, ACS182, ACS182-DIGIT, ACS201...(Other models you can see in the webshop)		

			
1			
GEV No.	510376	Ref. No.	450223
description	spring for filter fixing		
For models:	BC25, BC25A, BC30, BC30A, BR20, BR20A, BR25, BR25A, FC43, FC43A		

			
1			
GEV No.	511333	Ref. No.	180818
description	round filters ø 240mm H 95mm		
For models:	FC, FC53, FC533, FC533A, FC53A, FC53CBT, FC53LA, FC53LBT, FC54, FC543, FC543A, FC543E, FC544, FC544A, FC54A, FC54CBT, FC54E, FC54EA, FC54LBT, LC1200, LC1200RCD, LC412, LC700, LC700RCD, LC900, LC900RCD		

overflow pipes			
			
1			
GEV No.	524679	Ref. No.	160777
description	cover L 30mm ø 74mm ID ø 59mm for overflow pipe		
For models:	AC120, AC135, AC150, AC170, AC181, AC182, AC200, AC201, AC202, ACR, ACR145, ACR205, ACR225, ACR245, ACR260, ACR265, ACR305, GMC, GMC2700, GMC3500, GMC4500, GMC5500, NE3001, NE4001, NE5501, NE7501, NE9001		



			
1			
GEV No.	510497	Ref. No.	160738
description	cover plate		
For models:	AC100, AC90, NG00, NG01, NG600, NG600E, NG900, NG900E, NG901, NG901E, SNL		

			
1			
GEV No.	510976	Ref. No.	200917
description	gasket \varnothing 26.5mm ED \varnothing 40.5mm		
For models:	AC122, AC152, AC182, AC202, AC242, BC25, BC25A, BC30, BC30A, BR20, BR20A, BR25, BR25A, FC3M, FC3MA, FC3MR, FC43, FC43A, FC4M, FC4MA		

			
1			
GEV No.	511987	Ref. No.	200912
description	gasket \varnothing 27mm ED \varnothing 40mm		
For models:	NE02, NE3002, NE4002, NE5002, NE5502, NE7002, NE7502, NE9002, NE9502, NG02, NG1202, NG1202E, NG902, NG902E		

			
1			
GEV No.	510887	Ref. No.	200469
description	gasket \varnothing 30.9mm		
For models:	AC101, AC105, AC120, AC122, AC135, AC150, AC151, AC152, AC170, AC181, AC182, AC200, AC201, AC202, AC241, AC242, AC91, AC95, ACL100, ACL150, ACR, ACR145, ACR205, ACR225, ACR245, ACR260, ACR265, ACR305, ACRS145, ACRS205, ACRS225, ACRS245, ACRS260, ACRS265, ACRS305, ACS101, ACS101-DIGIT, ACS122, ACS122-DIGIT, ACS151, ACS151-DIGIT, ACS152, ACS152-DIGIT, ACS161-DIGIT, ACS162-DIGIT, ACS181, ACS181-DIGIT, ACS182, ACS182-DIGIT, ACS201...(Other models you can see in the webshop)		

			
1			
GEV No.	510227	Ref. No.	200950
description	gasket Viton ID \varnothing 27mm ED \varnothing 44mm H 7mm		
For models:	C1000E, C1000ERCD, C1001M, C1300E, C1300ERCD, C1301M, C166-2, GE50RCD, LC1200, LC1200RCD, LC412, LC700, LC700RCD, LC900, LC900RCD, XLC		

			
1			
GEV No.	511321	Ref. No.	180725
description	lid for overflow pipe		
For models:	BHC25, BHC25-2, BHC25A, BHC25A-2, BHC25S, BHC30, BHC30-2, BHC30A, BHC30A-2, BHC30E, BHC30E-2, BHC30EA, BHC30EA-2, BHC30HR, BHC30HR-2, BHC30HR380, BHC30HRA, BHC30HRA-2, BHC30HRA380, BHC433, BHC433-2, BHC433A, BHC433A-2, BHCHR, GF70, GF70A, LB200, LB200-2, LB200A, LB200A-2, LB215, LB215-2, LB215A, LB215A-2, LB260, LB260-2, LB260A, LB260A-2, LB275, LB275-2, LB275A, LB275A-2, LF321, LF321A, LF322, LF322A, LF322MP, LF322MP-A, LF322RCD, LF324...(Other models you can see in the webshop)		
accessories for	511321		
	GEV No.	510028	Ref. No. 180730
	overflow pipe L 120mm \varnothing 26mm		

			
1			
GEV No.	524770	Ref. No.	160778
description	lid \varnothing 74mm ID \varnothing 62mm H 40mm for overflow pipe		
For models:	LV1001, LV1501, LV-LVP, LVP1001, LVP1501, NE3001, NE4001, NE5501, NE7501, NE9001		

			
1			
GEV No.	524766	Ref. No.	451127
description	locking pin L 36.5mm \varnothing 5mm ID \varnothing 3.5mm for overflow pipe		
For models:	AC120, AC135, AC150, AC170, AC181, AC182, AC200, AC201, AC202, AC241, AC242, ACR, ACR145, ACR205, ACR225, ACR245, ACR260, ACR265, ACR305, GMC, GMC2700, GMC3500, GMC4500, GMC5500, NE3001, NE4001, NE5501, NE7501, NE9001, NG01, NG601, NG601E, NG901, NG901E		

			
1			
GEV No.	511322	Ref. No.	200869
description	O-ring EPDM thickness 3.53mm ID \varnothing 20.22mm Qty 1 pcs		
For models:	BHC25, BHC25-2, BHC25A, BHC25A-2, BHC25S, BHC30, BHC30-2, BHC30A, BHC30A-2, BHC30E, BHC30E-2, BHC30EA, BHC30EA-2, BHC30HR, BHC30HR-2, BHC30HR380, BHC30HRA, BHC30HRA-2, BHC30HRA380, BHC433, BHC433-2, BHC433A, BHC433A-2, BHCHR, GF70, GF70A, LB200, LB200-2, LB200A, LB200A-2, LB215, LB215-2, LB215A, LB215A-2, LB260, LB260-2, LB260A, LB260A-2, LB275, LB275-2, LB275A, LB275A-2, LF321, LF321A, LF322, LF322A, LF322MP, LF322MP-A, LF322RCD, LF324...(Other models you can see in the webshop)		







			
1			
GEV No.	511297	Ref. No.	170703
description	overflow pipe		





			
1			
GEV No.	511299	Ref. No.	380825
description	overflow pipe		
For models:	G100L, G101L, G115L, G125L, G50L, G50LM, G51L, G60L, G61L, G65L, G75L, GE125, GE75, GL		



			
1			
GEV No.	511307	Ref. No.	380823
description	overflow pipe		
For models:	G125, G75		



			
1			
GEV No.	512214	Ref. No.	H34431
description	overflow pipe		
For models:	GF90, GF90-2004, GF90A, GF90A-2004		

			
1			
GEV No.	511320	Ref. No.	180724
description	overflow pipe L 103mm ø 26mm		
For models:	BHC25, BHC25-2, BHC25A, BHC25A-2, BHC25S, BHC30, BHC30-2, BHC30A, BHC30A-2, BHC30E, BHC30E-2, BHC30EA, BHC30EA-2, BHC30HR, BHC30HR-2, BHC30HRA, BHC30HRA-2, BHC433, BHC433-2, BHC433A, BHC433A-2, LB200, LB200-2, LB200A, LB200A-2, LB215, LB215-2, LB215A, LB215A-2, LB260, LB260-2, LB260A, LB260A-2, LB275, LB275-2, LB275A, LB275A-2		
accessories for	511320		
	GEV No.	511321	Ref. No. 180725
	lid for overflow pipe		
	GEV No.	511322	Ref. No. 200869
	O-ring EPDM thickness 3.53mm ID ø 20.22mm Qty 1 pcs		
	GEV No.	511323	Ref. No. 450232
	compression spring ø 41.3mm L 57mm wire gauge ø 2mm		
	GEV No.	512109	Ref. No. 180147
	screw connection thread 1¼"		
	GEV No.	560249	Ref. No. —
	sheet metal screws ø 3.9mm L 13mm SS Qty 20 pcs DIN 7982/ISO 7050 intake Phillips head ø 7.5mm		

			
1			
GEV No.	524822	Ref. No.	180727
description	overflow pipe L 104mm		
For models:	BHC30HR, BHC30HR380, BHC30HRA, BHC30HRA380, BHCHR		

			
1			
GEV No.	510943	Ref. No.	160116
description	overflow pipe L 111mm ø 60mm		
For models:	NE00		

			
1			
GEV No.	510028	Ref. No.	180730
description	overflow pipe L 120mm ø 26mm		
For models:	GF70, GF70A, LF321, LF321A, LF322, LF322A, LF322MP, LF322MP-A, LF322RCD, LF324, LF324A, LF325E, LF325EA, LF700, LF700A, LFD32E, LFD32EA, LFD32M, LFD32MA		
accessories for	510028		
	GEV No.	511321	Ref. No. 180725
	lid for overflow pipe		
	GEV No.	511322	Ref. No. 200869
	O-ring EPDM thickness 3.53mm ID ø 20.22mm Qty 1 pcs		

			
1			
GEV No.	510255	Ref. No.	170712
description	overflow pipe L 134mm ø 38mm		
For models:	FC, FC53, FC533, FC533A, FC53A, FC53CBT, FC53LA, FC53LBT, FC54, FC543, FC543A, FC543E, FC543EA, FC544, FC544A, FC54A, FC54CBT, FC54E, FC54EA, FC54LBT		
accessories for	510255		
	GEV No.	510887	Ref. No. 200469
	gasket ø 30.9mm		

			
1			
GEV No.	510835	Ref. No.	170711
description	overflow pipe L 150mm ø 38mm		
For models:	FC, FC53, FC533, FC533A, FC53A, FC53CBT, FC53LA, FC53LBT, FC54, FC543, FC543A, FC543E, FC543EA, FC544, FC544A, FC54A, FC54CBT, FC54E, FC54EA, FC54LBT		
accessories for	510835		
	GEV No.	510887	Ref. No. 200469
gasket ø 30.9mm			

			
1			
GEV No.	511292	Ref. No.	170710
description	overflow pipe L 180mm ø 38mm		
For models:	F90M, F90MA, LF315, LF320, LF320A, LF320CBT, LF320L, LF320LA, LF320LBT, LF323, LF323A, LF350, LF350A, LF450, LF450A		
spare parts for	511292		
	GEV No.	510887	Ref. No. 200469
gasket ø 30.9mm			

			
1			
GEV No.	517594	Ref. No.	380818
description	overflow pipe L 150mm ø 38mm		
For models:	AC120, AC170, AC200, ACR, ACR145, ACR205, ACR225, ACR245, ACR260, ACR265, ACR305, ACRS145, ACRS205, ACRS225, ACRS245, ACRS260, ACRS265, ACRS305, GMC, GMC2700, GMC3500, GMC4500, GMC5500, SE		

			
1			
GEV No.	515046	Ref. No.	180708
description	overflow pipe L 190mm ø 37mm		
For models:	C140, C85, LC380, LC380BT, LC380RCD, LC400, NE00, NE3001, NE4001, NE5501, NE7501, NE9001, NG01, NG601E, NG901E		



			
1			
GEV No.	510444	Ref. No.	180702 180704
description	overflow pipe L 160mm ø 40mm		
For models:	B10, B10T, B11, B11T, B12, B12T, B20, B20D, B23, B24, B25, B26, B27, B31, B32, F2, F300, LBC210, LBC215, LBC215A, LBC275, LBC275A, LBR, LBR200, LBR215, LBR215A, R40, R70		



			
1			
GEV No.	524866	Ref. No.	180709
description	overflow pipe L 200mm ø 37mm plastic ID ø 32mm thickness 2mm		
For models:	SNL		



			
1			
GEV No.	510441	Ref. No.	170707
description	overflow pipe L 165mm ø 38mm		
For models:	B13T, B14T, B15, B15T, B15TM, B16, B16T, B16TM, B18, B18T, B18TM, B19, B19T, B19TM, B41, B42, C30, F2, F20, F3, F300, F45, F55, F65, F80, F90M, F90MA, LF280-lav-line, LF315, LF320, LF320A, LF320CBT, LF320L, LF320LA, LF320-lav-line, LF320LBT, LF323, LF323A, LF350, LF350A, LF400A, LF450, LF450A, LS550, R50		
accessories for	510441		
	GEV No.	510887	Ref. No. 200469
gasket ø 30.9mm			



			
1			
GEV No.	510473	Ref. No.	180716
description	overflow pipe L 210mm ø 30mm		
For models:	BC25, BC25A, BC30, BC30A, BR20, BR20A, BR25, BR25A, FC43, FC43A		





			
1			
GEV No.	510442	Ref. No.	170708
description	overflow pipe L 210mm ø 38mm		
For models:	C70, C75, C75BT, C75M, C75RCD, F45, F55, F65, F80, LP360, LP360BT, LP360RCD		
accessories for	510442		
	GEV No.	510887	Ref. No. 200469
	gasket ø 30.9mm		

			
1			
GEV No.	510645	Ref. No.	180729
description	overflow pipe L 283mm ø 42mm		
For models:	LC1200, LC1200RCD, LC412, LC700, LC700RCD, LC900, LC900RCD		
accessories for	510645		
	GEV No.	510227	Ref. No. 200950
	gasket Viton ID ø 27mm ED ø 44mm H 7mm		

			
1			
GEV No.	510630	Ref. No.	170717
description	overflow pipe L 210mm ø 40mm		
For models:	FC3M, FC3MA, FC3MR, FC4M, FC4MA		
accessories for	510630		
	GEV No.	510976	Ref. No. 200917
	gasket ø 26.5mm ED ø 40.5mm		

			
1			
GEV No.	510476	Ref. No.	180715
description	overflow pipe L 400mm ø 40mm		
For models:	C155, C155BT, C155E2, C155RCD, C165, C165E2, C165E2BT, C165E2RCD, C166, C166-2, C95, C95BT, C95E2, C95RCD		
accessories for	510476		
	GEV No.	510887	Ref. No. 200469
	gasket ø 30.9mm		



			
1			
GEV No.	510985	Ref. No.	180703
description	overflow pipe L 215mm ø 36mm		
For models:	C30, C33, C34, F3		

			
1			
GEV No.	517591	Ref. No.	380831
description	overflow pipe L 405mm ø 35mm		
For models:	AC120, AC150, AC170, AC181, AC182, AC200, AC201, AC202, ACR, ACR145, ACR205, ACR225, ACR245, ACR260, ACR265, ACR305, GMC, GMC2700, GMC3500, GMC4500, GMC5500		

			
1			
GEV No.	510494	Ref. No.	180706
description	overflow pipe L 237mm ø 40mm		
For models:	AC100, AC90, SE, SNL		

			
1			
GEV No.	511575	Ref. No.	380836
description	overflow pipe L 420mm ø 35mm		
For models:	AC101, AC105, AC122, AC135, AC151, AC152, AC181, AC182, AC201, AC202, AC241, AC242, AC91, AC95, GE100, GE115, GE60, GE60RCD, GE65, GE65RCD, GE80, LAV1000, LAV1001, LAV1501		

			
1			
GEV No.	511306	Ref. No.	380806
description	overflow pipe L 240mm ø 35mm		
For models:	G115, G131, G65, G66		

			
1			
GEV No.	517593	Ref. No.	180728
description	overflow pipe L 420mm ø 42mm		
For models:	C1000E, C1000ERCD, C1001M, C1300E, C1300ERCD, C1301M, GE50RCD, XLC		
accessories for	517593		
	GEV No.	510227	Ref. No. 200950
	gasket Viton ID ø 27mm ED ø 44mm H 7mm		

			
1			
GEV No.	517592	Ref. No.	380832
description	overflow pipe L 495mm ø 35mm		
For models:	AC101, AC120, AC122, AC135, AC150, AC151, AC152, AC170, AC181, AC182, AC200, AC201, AC202, AC241, AC242, AC91, ACR, ACR145, ACR205, ACR225, ACR245, ACR260, ACR265, ACR305, GMC, GMC2700, GMC3500, GMC4500, GMC5500		

			
1			
GEV No.	524040	Ref. No.	380856
description	overflow pipe L 530mm ø 35mm		
For models:	ACRS205, ACRS225, ACRS245, ACRS260, ACRS265, ACRS305, ACS181, ACS181-DIGIT, ACS182, ACS182-DIGIT, ACS201, ACS201-DIGIT, ACS202, ACS202-DIGIT, ACS241, ACS241-DIGIT, ACS242, ACS242-DIGIT, GMC3502, GMC4502, GMC5502		
accessories for	524040		
	GEV No.	510887	Ref. No. 200469
	gasket ø 30.9mm		

			
1			
GEV No.	517603	Ref. No.	160114
description	overflow pipe L 70mm ø 60mm		
For models:	AC241, AC242, ACL100, ACL150, ACRS145, ACRS205, ACRS225, ACRS245, ACRS260, ACRS265, ACRS305, ACS181, ACS181-DIGIT, ACS182, ACS182-DIGIT, ACS201, ACS201-DIGIT, ACS202, ACS202-DIGIT, ACS241, ACS241-DIGIT, ACS242, ACS242-DIGIT, GMC2702, GMC3502, GMC4502, GMC5502, NE00, SE, SNL		

			
1			
GEV No.	524763	Ref. No.	342008
description	spindle L 185mm ø 10mm thread M6 for overflow pipe		
For models:	AC120, AC135, AC150, AC170, AC181, AC182, AC200, ACR, ACR145, ACR205, ACR225, ACR245, ACR260, ACR265, ACR305, GMC, GMC2700, GMC3500, GMC4500, GMC5500		

			
1			
GEV No.	510944	Ref. No.	321618
description	spraying protection for overflow pipe		
For models:	NE00		

			
1			
GEV No.	517604	Ref. No.	190345
description	standpipe L 110mm ø 32mm		
For models:	ACS122, ACS122-DIGIT, ACS152, ACS152-DIGIT, ACS162-DIGIT, ACS182, ACS182-DIGIT, ACS202, ACS202-DIGIT, ACS242, ACS242-DIGIT		

			
1			
GEV No.	517595	Ref. No.	180723
description	standpipe L 130mm ø 32mm		
For models:	AC122, AC152, AC182, AC202, AC242		

			
1			
GEV No.	524764	Ref. No.	342072
description	tie bar L 220mm ø 10mm thread M10x1.5 for overflow pipe		
For models:	NE02, NE3002, NE4002, NE5002, NE5502, NE7002, NE7502, NE9002, NE9502, NG02, NG1202, NG1202E, NG602, NG602E, NG902, NG902E, NL402, NL402E, NL552, NL552E		



drive shafts



1			
GEV No.	530878	Ref. No.	342926
description	drive shaft D1 ø 30mm for basket transport steel L 242mm		

containers

container lids



1			
GEV No.	510479	Ref. No.	160715
description	container lid suitable for rinse aid container		
For models:	B10T, B11T, B12T, B13T, B14T, B15T, B15TM, B16T, B16TM, B18T, B18TM, B19T, B19TM, B20, B20D, B23, B24, B25, B26, B27, B31, B41, B42, BC25, BC25A, BC25HR, BC30, BC30A, BC30HR, BC30HR380, BC30HRA, BHC25, BHC25-2, BHC25A, BHC25A-2, BHC25S, BHC30, BHC30-2, BHC30A, BHC30A-2, BHC30E, BHC30EA, BHC30HR, BHC30HR-2, BHC30HR380, BHC30HRA, BHC30HRA-2, BHC30HRA380, BHC433, BHC433-2...(Other models you can see in the webshop)		

dosing containers



1			
GEV No.	510480	Ref. No.	190811
description	rinse aid container		
For models:	BC25, BC25A, BC25HR, BC30, BC30A, BC30HR, BC30HR380, BC30HRA, BR20, BR20A, BR25, BR25A, FC43, FC43A		
spare parts for	510480		
	GEV No.	510479	Ref. No. 160715
	container lid suitable for rinse aid container		



1			
GEV No.	510853	Ref. No.	190802
description	rinse aid container		
For models:	B10T, B11T, B12T, B13T, B14T, B15T, B15TM, B16T, B16TM, B18T, B18TM, B19T, B19TM, B20, B20D, B23, B24, B25, B26, B27, B31, B41, B42, BHC25, BHC25-2, BHC25A, BHC25A-2, BHC25S, BHC30, BHC30-2, BHC30A, BHC30A-2, BHC30E, BHC30EA, BHC30HR, BHC30HR-2, BHC30HR380, BHC30HRA, BHC30HRA-2, BHC30HRA380, BHC433, BHC433-2, BHC433A, BHC433A-2, BHCHR, C30		
accessories for	510853		
	GEV No.	510855	Ref. No. 190106
	bracket for rinse aid container		



1			
GEV No.	510854	Ref. No.	190809
description	rinse aid container		
For models:	B10, B11, B12, B15, B16, B18, B19, F20, F45, F55, F65, F80		



1			
GEV No.	510979	Ref. No.	321156
description	trapdoor suitable for polishing agent tank		
For models:	BC25, BC25A, BC25HR, BC30, BC30A, BC30HR, BC30HR380, BC30HRA, BR20, BR20A, BR25, BR25A, FC43, FC43A		

salt tanks









1

GEV No.	511574	Ref. No.	170318
description	opposite support L 90mm W 45mm H 55mm for salt tank		
accessories for	511574		
	GEV No.	504351	Ref. No. 160526
	slide bearing ϕ 10mm external height 7mm		







1

GEV No.	510929	Ref. No.	631302
description	salt tank ϕ 120mm H 117mm hose ϕ 10mm mounting ϕ 70mm overall height 157mm		
For models:	B12, B12T, B14T, B16, B16T, B16TM, B19, B19T, B19TM, B25, B26, B27, B32, BC25A, BC30A, BHC30HR-2, BHC30HRA-2, BR20A, BR25A, F90MA, FC, FC43A, FC533A, FC53A, FC53LA, FC543A, FC543EA, FC544A, FC54A, FC54EA, FCHRA, FCHRTA, GF70A, GF90A, LBC215, LBC215A, LBC275, LBC275A, LBR, LBR215A, LF320A, LF320L, LF320LA, LF321, LF321A, LF322, LF322A, LF322MP, LF322MP-A, LF323A...(Other models you can see in the webshop)		
spare parts for	510929		
	GEV No.	506015	Ref. No. 200822
	O-ring EPDM thickness 3.53mm ID ϕ 39.69mm Qty 1 pcs		
	GEV No.	510018	Ref. No. —
	nut ϕ 92mm H 10.5mm for salt tank ID ϕ 64mm		
	GEV No.	524177	Ref. No. —
	lid ϕ 69mm H 20mm for salt tank ID ϕ 50mm		
accessories for	510929		
	GEV No.	510071	Ref. No. —
	flat gasket rubber ED ϕ 81mm ID ϕ 68mm thickness 3mm for salt tank Qty 1 pcs		
	GEV No.	510654	Ref. No. 200454
	gasket H 6mm D1 ϕ 82mm D2 ϕ 68mm		
	GEV No.	510883	Ref. No. —
	gasket rubber ED ϕ 86mm ID ϕ 66mm thickness 2mm for salt tank Qty 1 pcs		



1

GEV No.	504045	Ref. No.	631304
description	salt tank ϕ 123mm H 90mm		
For models:	BC30HRA, BHC25A, BHC25A-2, BHC30A, BHC30A-2, BHC30E-2, BHC30EA, BHC30EA-2, BHC30HR, BHC30HR-2, BHC30HRA, BHC30HRA-2, BHC30HRA380, BHC433-2, BHC433A, BHC433A-2, BHCHR, LB200A, LB200A-2, LB215A, LB215A-2, LB260A, LB260A-2, LB275A, LB275A-2		
spare parts for	504045		
	GEV No.	510018	Ref. No. —
	nut ϕ 92mm H 10.5mm for salt tank ID ϕ 64mm		
	GEV No.	524148	Ref. No. —
	O-ring EPDM thickness 3.53mm ID ϕ 40.86mm Qty 1 pcs		
	GEV No.	524177	Ref. No. —
	lid ϕ 69mm H 20mm for salt tank ID ϕ 50mm		
accessories for	504045		
	GEV No.	510654	Ref. No. 200454
	gasket H 6mm D1 ϕ 82mm D2 ϕ 68mm		
	GEV No.	510883	Ref. No. —
	gasket rubber ED ϕ 86mm ID ϕ 66mm thickness 2mm for salt tank Qty 1 pcs		

accessories



1

GEV No.	510855	Ref. No.	190106
description	bracket for rinse aid container		
For models:	B10T, B11T, B12T, B13T, B14T, B15T, B15TM, B16T, B16TM, B18T, B18TM, B19T, B19TM, B20, B20D, B23, B24, B25, B26, B27, B31, B41, BHC25, BHC25-2, BHC25A, BHC25A-2, BHC25S, BHC30, BHC30-2, BHC30A, BHC30A-2, BHC30E, BHC30EA, BHC30HR, BHC30HR-2, BHC30HR380, BHC30HRA, BHC30HRA-2, BHC30HRA380, BHC433, BHC433-2, BHC433A, BHC433A-2, BHCHR, C30		





1

GEV No.	510857	Ref. No.	190117
description	bracket for rinse aid container		
For models:	B10, B11, B12, B15, B16, B18, B19		



1

GEV No.	510958	Ref. No.	190130
description	bracket for rinse aid container		
For models:	F20, F45, F55, F65, F80		



1

GEV No.	510981	Ref. No.	350745
description	fastening angle for dosing container		
For models:	C30, C33, C34, R70		



1

GEV No.	510874	Ref. No.	191047
description	frame for container		
For models:	F20, F45, F55, F65, F80		



1

GEV No.	510654	Ref. No.	200454
description	gasket H 6mm D1 ø 82mm D2 ø 68mm		
For models:	B12, B12T, B14T, B16, B16T, B16TM, B19, B19T, B19TM, B25, B26, B27, B32, BC25A, BC30A, BC30HRA, BHC25A, BHC25A-2, BHC30A, BHC30A-2, BHC30E-2, BHC30EA, BHC30EA-2, BHC30HR, BHC30HR-2, BHC30HRA, BHC30HRA-2, BHC30HRA380, BHC433-2, BHC433A, BHC433A-2, BHCHR, BR20A, BR25A, F90MA, FC, FC43A, FC533A, FC53A, FC53LA, FC543A, FC543EA, FC544A, FC54A, FC54EA, FCHRA, FCHRTA, GF70A, GF90-2004, GF90A-2004...(Other models you can see in the webshop)		



1

GEV No.	510226	Ref. No.	180149
description	nut ø 65mm for backflow preventer		
For models:	C1000ERCD, C1300ERCD, GE50RCD, GE60RCD, GE65RCD, LC1200RCD, LC700RCD, LC900RCD, LF322RCD, XLC		



1

GEV No.	510977	Ref. No.	340484
description	pin ø 3mm for container suitable for COMENDA Qty 1 pcs L 50mm		
For models:	B10T, B11T, B12T, B13T, B14T, B15T, B15TM, B16T, B16TM, B18T, B18TM, B19T, B19TM, B20, B20D, B23, B24, B25, B26, B27, B31, B41, B42, BC25, BC25A, BC25HR, BC30, BC30A, BC30HR, BC30HR380, BC30HRA, BHC25, BHC25-2, BHC25A, BHC25A-2, BHC25S, BHC30, BHC30-2, BHC30A, BHC30A-2, BHC30E, BHC30EA, BHC30HR, BHC30HR-2, BHC30HR380, BHC30HRA, BHC30HRA-2, BHC30HRA380, BHC433, BHC433-2...(Other models you can see in the webshop)		



1

GEV No.	504351	Ref. No.	160526
description	slide bearing ø 10mm external height 7mm		



1

GEV No.	510978	Ref. No.	450812
description	spring clip for dosing container suitable for COMENDA Qty 1 pcs		
For models:	B10T, B11T, B12T, B13T, B14T, B15T, B15TM, B16T, B16TM, B18T, B18TM, B19T, B19TM, B20, B20D, B23, B24, B25, B26, B27, B31, B41, B42, BC25, BC25A, BC25HR, BC30, BC30A, BC30HR, BC30HR380, BC30HRA, BHC25, BHC25-2, BHC25A, BHC25A-2, BHC25S, BHC30, BHC30-2, BHC30A, BHC30A-2, BHC30E, BHC30EA, BHC30HR, BHC30HR-2, BHC30HR380, BHC30HRA, BHC30HRA-2, BHC30HRA380, BHC433, BHC433-2...(Other models you can see in the webshop)		

boilers

boilers for dishwashers



1

GEV No.	511427	Ref. No.	330340
description	boiler		
For models:	BC25, BC25A, BC25HR, BC30, BC30A, BC30HR, BC30HR380, BC30HRA, BR20, BR20A, BR25, BR25A, FC43, FC43A		



1

GEV No.	511428	Ref. No.	330353 330374
description	boiler ø 150mm L 340mm		
For models:	BHC25, BHC25-2, BHC25A, BHC25A-2, BHC25S, BHC30, BHC30-2, BHC30A, BHC30A-2, BHC30E, BHC30E-2, BHC30EA, BHC30EA-2, BHC30HR, BHC30HR-2, BHC30HR380, BHC30HRA, BHC30HRA-2, BHC30HRA380, BHC433, BHC433-2, BHC433A, BHC433A-2, BHCHR, LB200, LB200-2, LB200A, LB200A-2, LB215, LB215-2, LB215A, LB215A-2, LB260, LB260-2, LB260A, LB260A-2, LB275, LB275-2, LB275A, LB275A-2		



1

GEV No.	510646	Ref. No.	330372
description	boiler ø 150mm L 440mm		
For models:	FC3E, FC3EA, FC3M, FC3MA, FC3MR, FC44E, FC44EA, FC4E, FC4EA, FC4EHRT, FC4M, FC4MA		



1

GEV No.	511630	Ref. No.	330368
description	boiler ø 150mm L 445mm flange 3 hole flange inlet ø 57.5		
For models:	GF70, GF70A, LF321, LF321A, LF322, LF322A, LF322MP, LF322MP-A, LF324, LF324A, LF325E, LF325EA, LF700, LF700A, LFD32E, LFD32EA, LFD32M, LFD32MA		



1

GEV No.	511629	Ref. No.	330348
description	boiler ø 155mm L 500mm flange 3 hole flange inlet ø 58		



1

GEV No.	511000	Ref. No.	330307 330331 330342
description	boiler ø 160mm L 500mm capacity 10l flange 3 hole flange inlet ø 12		
For models:	C1000E, C1001M, C1300E, C1301M, C140, C155, C155E2, C165, C165E2, C166, C166-2, C30, C33, C34, C70, C75, C75M, C85, C95, C95E2, F2, F3, F300, F45, F55, F65, F80, F90M, F90MA, FC, FC53, FC533, FC533A, FC53A, FC53LA, FC54, FC543, FC543A, FC543E, FC543EA, FC544, FC544A, FC54A, FC54E, FC54EA, FCHR, FCHRA, FCHRT, FCHRTA, G66...(Other models you can see in the webshop)		



1

GEV No.	524998	Ref. No.	330320
description	boiler ø 160mm L 630mm flange 3 hole flange inlet ø 11		
For models:	AC101, AC122, AC2A, AC91, AC95, ACL100, ACL150, ACRS145, ACRS205, ACRS225, ACRS245, ACRS260, ACRS265, ACRS305, ACS101, ACS101-DIGIT, ACS122, ACS122-DIGIT, ACS151-DIGIT, ACS152-DIGIT, ACS161-DIGIT, ACS162-DIGIT, ACS181-DIGIT, ACS182-DIGIT, ACS201-DIGIT, ACS202-DIGIT, ACS241-DIGIT, ACS242-DIGIT, ACS91, ACS91-DIGIT, G131, GMC2702, GMC3502, GMC4502, GMC5502, LAV1001, LAV1501		



1

GEV No.	524999	Ref. No.	330339
description	boiler with insulation ø 200mm L 630mm flange 3 hole flange inlet ø 1/2" IT		
For models:	AC100, AC105, AC120, AC150, AC151, AC152, AC170, AC181, AC182, AC200, AC2A, AC90, ACL100, ACL150, ACR, ACR145, ACR205, ACR225, ACR245, ACR260, ACR265, ACR305, ACRS145, ACRS205, ACRS225, ACRS245, ACRS260, ACRS265, ACRS305, ACS101-DIGIT, ACS122-DIGIT, ACS151, ACS151-DIGIT, ACS152, ACS152-DIGIT, ACS161-DIGIT, ACS162-DIGIT, ACS181, ACS181-DIGIT, ACS182, ACS182-DIGIT, ACS201-DIGIT, ACS202-DIGIT, ACS241-DIGIT, ACS242-DIGIT, ACS91-DIGIT, GMC, GMC2700, GMC2702, GMC3500...(Other models you can see in the webshop)		





1

GEV No.	524997	Ref. No.	330322
description	boiler with insulation ø 230mm L 640mm flange 3 hole flange inlet ø 1/2" IT		
For models:	AC120, AC135, AC150, AC170, AC200, AC201, AC202, AC241, AC242, AC2A, ACL100, ACL150, ACR, ACR145, ACR205, ACR225, ACR245, ACR260, ACR265, ACR305, ACRS145, ACRS205, ACRS225, ACRS245, ACRS260, ACRS265, ACRS305, ACS101-DIGIT, ACS122-DIGIT, ACS151-DIGIT, ACS152-DIGIT, ACS161-DIGIT, ACS162-DIGIT, ACS181-DIGIT, ACS182-DIGIT, ACS201, ACS201-DIGIT, ACS202, ACS202-DIGIT, ACS241, ACS241-DIGIT, ACS242, ACS242-DIGIT, ACS91-DIGIT, GMC, GMC2700, GMC2702, GMC3500, GMC3502, GMC4500...(Other models you can see in the webshop)		

rotation plates

accessories



1

GEV No.	524767	Ref. No.	410118
description	ball for rotation plate ø 7mm SS		
For models:	B10, B10T, B11, B11T, B12, B12T, B20, B20D, B23, B24, B25, B26, B27, BR20, BR20A, BR25, BR25A, LBR, LBR200, LBR215, LBR215A, R40, R50, R70		

softener cartridges

softening columns



1

GEV No.	530000	Ref. No.	640209
description	softener 4-fold L 380mm W 180mm		
For models:	B12, B12T, B14T, B16, B16T, B19, B19T, B25, B26, B27, B32, BC25A, BC30A, BC30HRA, BHC25A, BHC30A, BHC30EA, BHC30HRA, BHC30HRA380, BHC433A, BHCHR, BR20A, BR25A, F90MA, FC, FC43A, FC533A, FC53A, FC53LA, FC543A, FC543EA, FC544A, FC54A, FC54EA, FCHRA, FCHRTA, LBC215, LBC215A, LBC275, LBC275A, LBR, LBR215A, LF320A, LF320L, LF320LA, LF323A, LF350A, LF400A, LF450A		



1

GEV No.	530370	Ref. No.	640216
description	softener 4-fold L 380mm W 180mm		
For models:	BHC25A-2, BHC30A-2, BHC30EA-2, BHC30HRA-2, BHC433A-2, LB200A, LB200A-2, LB215A, LB215A-2, LB260A, LB260A-2, LB275A, LB275A-2, LF321A, LF322A, LF322MP-A, LF324A, LF325EA, LF700A		



1

GEV No.	530371	Ref. No.	640223
description	softener 4-fold L 380mm W 180mm		
For models:	BHC25A-2, BHC30EA-2, BHC30HR-2, BHC30HRA-2, BHC433A-2, LB200A, LB215A, LF322MP-A		



1

GEV No.	530019	Ref. No.	640212
description	softener double		
For models:	GF90A, GF90A-2004		

complete



1

GEV No.	530085	Ref. No.	640222
description	softener type M23 container capacity 0.7l		
For models:	FC3EA, FC3MA, FC44EA, FC4EA, FC4MA		

housing and bezels

fastening angles



1

GEV No.	524765	Ref. No.	331106
description	bracket for drying L 75mm W 15mm thickness 2mm H 57mm		
For models:	NL302, NL302E, NL402, NL402E, NL502, NL502E, NL552, NL552E		



1

GEV No.	510980	Ref. No.	331439
description	fastening angle for front panel		
For models:	F20, F45, F55, F65, F80		



1

GEV No.	510937	Ref. No.	330725
description	mounting angle for solenoid valve		
For models:	B23, B24, B25, B26, B27, C1000E, C1000ERCD, C1300E, C1300ERCD, C140, C155, C155BT, C155E2, C155RCD, C165, C165E2, C165E2BT, C165E2RCD, C166, C166-2, C30, C33, C34, C70, C75, C75BT, C75M, C75RCD, C85, C95, C95BT, C95E2, C95RCD, F2, F3, F300, F45, F55, F65, F80, F90M, F90MA, FC, FC3E, FC3EA, FC3M, FC3MA, FC3MR, FC44E, FC44EA...(Other models you can see in the webshop)		



1

GEV No.	510727	Ref. No.	350839
description	mounting plate		
For models:	B10T		



1

GEV No.	510965	Ref. No.	350862
description	mounting plate for front panel		

miscellaneous



1

GEV No.	524813	Ref. No.	340356 + 340357
description	cover kit for dishwasher		



1

GEV No.	504350	Ref. No.	620222
description	equipment foot for dishwasher L 135-230mm		
For models:	AC100, AC101, AC105, AC120, AC122, AC135, AC150, AC151, AC152, AC170, AC181, AC182, AC200, AC201, AC202, AC241, AC242, AC2A, AC90, AC91, AC95, ACL100, ACL150, ACR, ACR145, ACR205, ACR225, ACR245, ACR260, ACR265, ACR305, ACRS145, ACRS205, ACRS225, ACRS245, ACRS260, ACRS265, ACRS305, ACS101, ACS101-DIGIT, ACS122, ACS122-DIGIT, ACS151, ACS151-DIGIT, ACS152, ACS152-DIGIT, ACS161-DIGIT, ACS162-DIGIT, ACS181, ACS181-DIGIT...(Other models you can see in the webshop)		

model name plates



1

GEV No.	510998	Ref. No.	460159
description	type plate COMENDA F2		
For models:	B20, B20D, B23, B24, B25, B31, B32, C30, F2, F3, F300, R40, R50, R70		

hood mechanics for dishwashers

bolts



1

GEV No.	510988	Ref. No.	340493
description	bolt for hood joint		
For models:	C1000E, C1000ERCD, C1001M, C1300E, C1300ERCD, C1301M, C30, C70, C75, C75BT, C75M, C75RCD, LC1200, LC1200RCD, LC412, LC700, LC700RCD, LC900, LC900RCD, LP360, LP360BT, LP360RCD, XLC		



1

GEV No.	524378	Ref. No.	340443
description	pin ED ø 12mm L 61mm thread M8x1.25 for dishwasher		
For models:	AC100, AC101, AC105, AC120, AC122, AC135, AC150, AC151, AC152, AC170, AC181, AC182, AC200, AC201, AC202, AC241, AC242, AC90, AC91, AC95, ACR, ACR145, ACR205, ACR225, ACR245, ACR260, ACR265, ACR305, ACRS145, ACRS205, ACRS225, ACRS245, ACRS260, ACRS265, ACRS305, ACS101, ACS101-DIGIT, ACS122, ACS122-DIGIT, ACS151, ACS151-DIGIT, ACS152, ACS152-DIGIT, ACS161-DIGIT, ACS162-DIGIT, ACS181, ACS181-DIGIT, ACS182, ACS182-DIGIT, ACS201...(Other models you can see in the webshop)		



bushes



1

GEV No.	697882	Ref. No.	190679
description	bush ED ø 30mm ID ø 8mm L 14mm for hood mechanics plastic		
For models:	FC3E, FC3EA, FC3M, FC3MA, FC3MR, FC44E, FC44EA, FC4E, FC4EA, FC4EHRT, FC4M, FC4MA		



1

GEV No.	510922	Ref. No.	330816
description	bush for door hinge hood mechanics		
For models:	B31, B32, C33, C34, F2, F3, F300, G131, G66, R40, R50, R70		



1

GEV No.	510867	Ref. No.	190632
description	bush hood mechanics		
For models:	C140, C155, C155BT, C155E2, C155RCD, C165, C165E2, C165E2BT, C165E2RCD, C166, C166-2, C85, C95, C95BT, C95E2, C95RCD, LC380, LC380BT, LC380RCD, LC400		



1

GEV No.	510817	Ref. No.	160530
description	spacer bush for handle hood mechanics		
For models:	C140, C85, LC380		



1

GEV No.	510848	Ref. No.	290821
description	spacer bush for switch hood mechanics		
For models:	B10T, B11T, B12T, B13T, B14T, B15T, B15TM, B16T, B16TM, B18T, B18TM, B19T, B19TM, C1001M, C1301M, C155, C155BT, C155RCD, C70, C75, C75BT, C75M, C75RCD, C95, C95BT, C95RCD, F90M, F90MA, FC53CBT, FC53LA, FC53LBT, FC54CBT, FC54LBT, GF90, GF90-2004, GF90A, GF90A-2004, LC1200, LC1200RCD, LC380, LC380BT, LC380RCD, LC400, LC412, LC700, LC700RCD, LC900, LC900RCD, LF315, LF320... (Other models you can see in the webshop)		

spring holders



1

GEV No.	510992	Ref. No.	190616
description	bush for spring holder hood mechanics		
For models:	C33, C34		

guide bars



1

GEV No.	511005	Ref. No.	180604
description	guide bar L 575mm hood mechanics C33, C34, LC380, LC400		
For models:	C33, C34, LC380, LC380BT, LC380RCD, LC400		



1

GEV No.	511202	Ref. No.	180613
description	guide bar L 575mm hood mechanics C85, C140		
For models:	C140, C85, LC380		



1

GEV No.	510948	Ref. No.	180624
description	guide bar L 575mm hood mechanics C95, C155, C165, C166		
For models:	C155, C155BT, C155E2, C155RCD, C165, C165E2, C165E2BT, C165E2RCD, C166, C166-2, C95, C95BT, C95E2, C95RCD		



1

GEV No.	513126	Ref. No.	180642
description	guide bar L 615mm W 30mm H 29mm		
For models:	C1000E, C1000ERCD, C1001M, C1300E, C1300ERCD, C1301M, LC1200, LC1200RCD, LC412, LC700, LC700RCD, LC900, LC900RCD, XLC		



1

GEV No.	510827	Ref. No.	180606
description	guide bar mounting pos. left hood mechanics for door		
For models:	C30, C70, C75, C75BT, C75M, C75RCD, LP360, LP360BT, LP360RCD		



1

GEV No.	510826	Ref. No.	180605
description	guide bar mounting pos. right hood mechanics for door		
For models:	C30, C70, C75, C75BT, C75M, C75RCD, LP360, LP360BT, LP360RCD		

linkage



1

GEV No.	510845	Ref. No.	330206
description	tie bar		

hood handle supports



1

GEV No.	510350	Ref. No.	190608
description	guide for hood handle		
For models:	C30, C33, C34		



1

GEV No.	510211	Ref. No.	190637
description	guide for hood handle L 78mm W 50mm H 22mm without roller		
For models:	C1000E, C1000ERCD, C1001M, C1300E, C1300ERCD, C1301M, C140, C155, C155BT, C155E2, C155RCD, C165, C165E2, C165E2BT, C165E2RCD, C70, C75, C75BT, C75M, C75RCD, C85, C95, C95BT, C95E2, C95RCD, LC1200, LC1200RCD, LC380, LC380BT, LC380RCD, LC400, LC412, LC700, LC700RCD, LC900, LC900RCD, LP360, LP360BT, LP360RCD, XLC		
accessories for	510211		
	GEV No.	510336	Ref. No. 340416
	bolt L 12.5mm thread M3 for hinge SS WS 7		



1

GEV No.	510856	Ref. No.	190110
description	handle holder hood mechanics		
For models:	C30, C70, C75, C75BT, C75M, C75RCD, LP360, LP360BT, LP360RCD		



1

GEV No.	510868	Ref. No.	191013
description	handle holder hood mechanics		
For models:	C1000E, C1000ERCD, C1001M, C1300E, C1300ERCD, C1301M, C140, C155, C155BT, C155E2, C155RCD, C165, C165E2, C165E2BT, C165E2RCD, C166, C166-2, C30, C70, C75, C75BT, C75M, C75RCD, C85, C95, C95BT, C95E2, C95RCD, LC1200, LC1200RCD, LC380, LC380BT, LC380RCD, LC400, LC412, LC700, LC700RCD, LC900, LC900RCD, LP360, LP360BT, LP360RCD, XLC		



1

GEV No.	510869	Ref. No.	191014
description	handle holder hood mechanics		
For models:	C1000E, C1000ERCD, C1001M, C1300E, C1300ERCD, C1301M, C140, C155, C155BT, C155E2, C155RCD, C165, C165E2, C165E2BT, C165E2RCD, C166, C166-2, C30, C70, C75, C75BT, C75M, C75RCD, C85, C95, C95BT, C95E2, C95RCD, LC1200, LC1200RCD, LC380, LC380BT, LC380RCD, LC400, LC412, LC700, LC700RCD, LC900, LC900RCD, LP360, LP360BT, LP360RCD, XLC		

miscellaneous



1

GEV No.	511312	Ref. No.	440703
description	bracket for door contact switch		
For models:	C33, C34, G125, G75		



1

GEV No.	510864	Ref. No.	190607
description	bush for spring holder hood mechanics		
For models:	C1000E, C1000ERCD, C1001M, C1300E, C1300ERCD, C1301M, C140, C155, C155BT, C155E2, C155RCD, C165, C165E2, C165E2BT, C165E2RCD, C166, C166-2, C30, C70, C75, C75BT, C75M, C75RCD, C85, C95, C95BT, C95E2, C95RCD, G125, G125L, G75, G75L, GE125, GE75, GL, LC1200, LC1200RCD, LC380, LC380BT, LC380RCD, LC400, LC412, LC700, LC700RCD, LC900, LC900RCD, LP360, LP360BT, LP360RCD, XLC		



1

GEV No.	510810	Ref. No.	320627
description	fixing plate for guide		
For models:	C30, C70, C75, C75BT, C75M, C75RCD, LP360, LP360BT, LP360RCD		



1

GEV No.	510889	Ref. No.	200497
description	gasket for door guides hood mechanics		
For models:	C140, C155, C155BT, C155E2, C155RCD, C165, C165E2, C165E2BT, C165E2RCD, C166, C166-2, C85, C95, C95BT, C95E2, C95RCD, LC380, LC380BT, LC380RCD, LC400		



			
1			
GEV No.	510882	Ref. No.	200451
description	gasket for opposite support L 100mm hood mechanics rubber H 3mm black W 30mm		
For models:	C30, C70, C75, C75BT, C75M, C75RCD, LF280-lav-line, LF320-lav-line, LP360, LP360BT, LP360RCD		

			
1			
GEV No.	511397	Ref. No.	330917
description	opposite support hood mechanics		
For models:	C30, C75, C75BT, C75M, C75RCD, LP360, LP360BT, LP360RCD		

			
1			
GEV No.	511204	Ref. No.	190638
description	roller		
For models:	C1000E, C1000ERCD, C1001M, C1300E, C1300ERCD, C1301M, C140, C155, C155BT, C155E2, C155RCD, C165, C165E2, C165E2BT, C165E2RCD, C70, C75, C75BT, C75M, C75RCD, C85, C95, C95BT, C95E2, C95RCD, LC1200, LC1200RCD, LC380, LC380BT, LC380RCD, LC400, LC412, LC700, LC700RCD, LC900, LC900RCD, LP360, LP360BT, LP360RCD, XLC		

			
1			
GEV No.	511393	Ref. No.	190149
description	strengthening for handle holder hood mechanics		
For models:	C1000E, C1000ERCD, C1001M, C1300E, C1300ERCD, C1301M, C155, C155BT, C155E2, C155RCD, C165, C165E2, C165E2BT, C165E2RCD, C166, C166-2, C95, C95BT, C95E2, C95RCD, LC1200, LC1200RCD, LC380, LC380BT, LC380RCD, LC400, LC412, LC700, LC700RCD, LC900, LC900RCD, XLC		

basket guides			
guide bars			
			
1			
GEV No.	530459	Ref. No.	620761
description	guide bar L 1320mm W 40mm H 32mm		
For models:	ACS101, ACS101-DIGIT, ACS122, ACS122-DIGIT, ACS151, ACS151-DIGIT, ACS152, ACS152-DIGIT, ACS161-DIGIT, ACS162-DIGIT, ACS181, ACS181-DIGIT, ACS182, ACS182-DIGIT, ACS201, ACS201-DIGIT, ACS202, ACS202-DIGIT, ACS241, ACS241-DIGIT, ACS242, ACS242-DIGIT, ACS91, ACS91-DIGIT		

			
1			
GEV No.	510931	Ref. No.	191051
description	slide guide		
For models:	AC100, AC101, AC105, AC120, AC122, AC135, AC150, AC151, AC152, AC170, AC181, AC182, AC200, AC201, AC202, AC241, AC242, AC90, AC91, AC95, ACR, ACR145, ACR205, ACR225, ACR245, ACR260, ACR265, ACR305, ACRS145, ACRS205, ACRS225, ACRS245, ACRS260, ACRS265, ACRS305, ACS101, ACS101-DIGIT, ACS122, ACS122-DIGIT, ACS151, ACS151-DIGIT, ACS152, ACS152-DIGIT, ACS161-DIGIT, ACS162-DIGIT, ACS181, ACS181-DIGIT, ACS182, ACS182-DIGIT, ACS201...(Other models you can see in the webshop)		

miscellaneous			
			
1			
GEV No.	971144	Ref. No.	190145
description	guide for dishwasher L 100mm W 45mm H 28mm		
For models:	AC101, AC105, AC122, AC135, AC151, AC152, AC181, AC182, AC201, AC202, AC241, AC242, AC91, AC95, ACL100, ACL150, ACRS145, ACRS205, ACRS225, ACRS245, ACRS260, ACRS265, ACRS305, ACS101, ACS101-DIGIT, ACS122, ACS122-DIGIT, ACS151, ACS151-DIGIT, ACS152, ACS152-DIGIT, ACS161-DIGIT, ACS162-DIGIT, ACS181, ACS181-DIGIT, ACS182, ACS182-DIGIT, ACS201, ACS201-DIGIT, ACS202, ACS202-DIGIT, ACS241, ACS241-DIGIT, ACS242, ACS242-DIGIT, ACS91, ACS91-DIGIT		

			
1			
GEV No.	971143	Ref. No.	170324
description	guide for dishwasher L 100mm W 45mm H 30mm		
For models:	AC100, AC120, AC150, AC170, AC200, AC90, ACR, ACR145, ACR205, ACR225, ACR245, ACR260, ACR265, ACR305, SE, SNL		

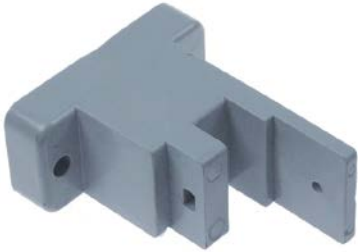

1

GEV No.	512206	Ref. No.	170325
description	guide for guide bar mounting pos. inner L 91mm W 45mm H 113mm		
For models:	AC201, AC202, AC241, AC242, AC2A, ACR, ACR145, ACR205, ACR225, ACR245, ACR260, ACR265, ACR305, ACRS145, ACRS205, ACRS225, ACRS245, ACRS260, ACRS265, ACRS305, SE		



1

GEV No.	512024	Ref. No.	190620
description	guide L 44mm W 34mm H 20mm		
For models:	AC100, AC120, AC150, AC170, AC200, AC90, ACR, ACR145, ACR205, ACR225, ACR245, ACR260, ACR265, ACR305, SE, SNL		

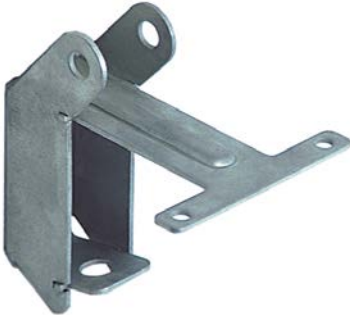

1

GEV No.	511221	Ref. No.	320698
description	lever for basket transport		
For models:	AC100, AC105, AC120, AC135, AC150, AC170, AC200, AC2A, AC90, AC95, ACR, ACR145, ACR205, ACR225, ACR245, ACR260, ACR265, ACR305, ACRS145, ACRS205, ACRS225, ACRS245, ACRS260, ACRS265, ACRS305, ACS101-DIGIT, ACS122-DIGIT, ACS151-DIGIT, ACS152-DIGIT, ACS161-DIGIT, ACS162-DIGIT, ACS181-DIGIT, ACS182-DIGIT, ACS201-DIGIT, ACS202-DIGIT, ACS241-DIGIT, ACS242-DIGIT, ACS91-DIGIT, SE, SNL		



1

GEV No.	970845	Ref. No.	170337
description	roller for transport basket H 8mm ED ϕ 31mm hole ϕ 9.9mm PTFE		
For models:	G100L, G101L, G115L, G125, G125L, GE125, GL		



1

GEV No.	511223	Ref. No.	191019
description	sleeve for magnetic switch L 76mm ϕ 16mm thread M10x1.5 plastic		
For models:	AC100, AC101, AC105, AC120, AC122, AC135, AC150, AC151, AC152, AC170, AC181, AC182, AC200, AC201, AC202, AC241, AC242, AC2A, AC90, AC91, AC95, ACL100, ACL150, ACR, ACR145, ACR205, ACR225, ACR245, ACR260, ACR265, ACR305, ACRS145, ACRS205, ACRS225, ACRS245, ACRS260, ACRS265, ACRS305, ACS101, ACS101-DIGIT, ACS122, ACS122-DIGIT, ACS151, ACS151-DIGIT, ACS152, ACS152-DIGIT, ACS161-DIGIT, ACS162-DIGIT, ACS181, ACS181-DIGIT...(Other models you can see in the webshop)		



1

GEV No.	524584	Ref. No.	160532
description	sliding block for warewashing basket L 110mm W 20mm H 4mm		
For models:	G100L, G101L, G115L, G125L, G50L, G50LM, G51L, G60L, G61L, G65L, G75, G75L, GE75, GL		



1

GEV No.	511224	Ref. No.	341255
description	threaded shaft for basket transport		
For models:	AC100, AC105, AC120, AC135, AC150, AC170, AC200, AC2A, AC90, AC95, ACR, ACR145, ACR205, ACR225, ACR245, ACR260, ACR265, ACR305, ACRS145, ACRS205, ACRS225, ACRS245, ACRS260, ACRS265, ACRS305, SE, SNL		

air traps

air traps



1





GEV No.	510347	Ref. No.	161303	
description	air trap			
For models:	AC120, AC170, AC200, ACR, ACR145, ACR205, ACR225, ACR245, ACR260, ACR265, ACR305, B10, B10T, B11, B11T, B12, B12T, B20, B20D, B23, B24, B25, B26, B27, B31, B32, C140, C85, GF90, GF90-2004, GF90A, GF90A-2004, LBC210, LBC215, LBC215A, LBC275, LBC275A, LBR, LBR200, LBR215, LBR215A, LC380, LC380BT, LC380RCD, LC400, NE00, SE			
spare parts for	510347			
	GEV No.	510877	Ref. No.	200415
	flat gasket rubber ED ϕ 18mm ID ϕ 10mm thickness 3mm Qty 1 pcs			
	GEV No.	560197	Ref. No.	260407
	nut thread M10 H 8mm WS 17 SS DIN/ISO DIN 934 / ISO 4032/8673 Qty 1 pcs			
accessories for	510347			
	GEV No.	510877	Ref. No.	200415
	flat gasket rubber ED ϕ 18mm ID ϕ 10mm thickness 3mm Qty 1 pcs			



Table continues overleaf





accessories for	510347			
	GEV No.	560197	Ref. No.	260407
	nut thread M10 H 8mm WS 17 SS DIN/ISO DIN 934 / ISO 4032/8673 Qty 1 pcs			





GEV No.	510348	Ref. No.	161305
description	air trap		
For models:	C70, C75, C75BT, C75RCD, F45, F55, F65, F80, F90M, F90MA, FC, FC53, FC533, FC533A, FC53A, FC53CBT, FC53LA, FC53LBT, FC54, FC543, FC543A, FC543E, FC543EA, FC544, FC544A, FC54A, FC54CBT, FC54E, FC54EA, FC54LBT, LF280-lav-line, LF315, LF320, LF320A, LF320CBT, LF320L, LF320LA, LF320-lav-line, LF320LBT, LF323, LF323A, LF350, LF350A, LF400A, LF450, LF450A, LP360, LP360BT, LP360RCD, LS550		

spare parts for	510348			
	GEV No.	510354	Ref. No.	160727
	end cap ø 1/2"mm			
	GEV No.	510486	Ref. No.	161306
	air ducting ø 1/2"mm			
	GEV No.	510877	Ref. No.	200415
	flat gasket rubber ED ø 18mm ID ø 10mm thickness 3mm Qty 1 pcs			

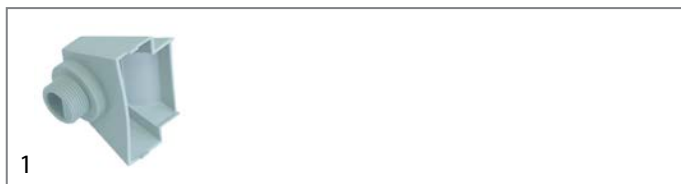

accessories for	510348			
	GEV No.	510354	Ref. No.	160727
	end cap ø 1/2"mm			
	GEV No.	510486	Ref. No.	161306
	air ducting ø 1/2"mm			
	GEV No.	510877	Ref. No.	200415
	flat gasket rubber ED ø 18mm ID ø 10mm thickness 3mm Qty 1 pcs			



GEV No.	510759	Ref. No.	161316
description	air trap		
For models:	BHC25, BHC25-2, BHC25A, BHC25A-2, BHC25S, BHC30, BHC30-2, BHC30A, BHC30A-2, BHC30E, BHC30E-2, BHC30EA, BHC30EA-2, BHC433, BHC433-2, BHC433A, BHC433A-2, GF70, GF70A, LB200, LB200-2, LB200A, LB200A-2, LB215, LB215-2, LB215A, LB215A-2, LB260, LB260-2, LB260A, LB260A-2, LB275, LB275-2, LB275A, LB275A-2, LF321, LF321A, LF322, LF322A, LF322MP, LF322MP-A, LF322RCD, LF324, LF324A, LF325E, LF325EA, LF700, LF700A, LFD32E, LFD32EA...(Other models you can see in the webshop)		





spare parts for	510759			
	GEV No.	502036	Ref. No.	200805
	O-ring EPDM thickness 2.62mm ID ø 28.25mm Qty 1 pcs			
	GEV No.	510760	Ref. No.	161317
	hose connector			
	GEV No.	510761	Ref. No.	200944 21005
	flat gasket rubber D1 ø 38mm D2 ø 25mm thickness 2mm Qty 1 pcs			

accessories for	510759			
	GEV No.	510760	Ref. No.	161317
	hose connector			

	GEV No.	510761	Ref. No.	200944 21005
	flat gasket rubber D1 ø 38mm D2 ø 25mm thickness 2mm Qty 1 pcs			
	GEV No.	512283	Ref. No.	—
	flat gasket rubber D1 ø 38.5mm D2 ø 24.5mm thickness 2mm Qty 1 pcs			



GEV No.	511199	Ref. No.	161308
description	air trap		
For models:	AC101, AC105, AC122, AC135, AC151, AC152, AC181, AC182, AC201, AC202, AC241, AC242, AC2A, AC91, AC95, ACL100, ACL150, ACRS145, ACRS205, ACRS225, ACRS245, ACRS260, ACRS265, ACRS305, ACS101, ACS101-DIGIT, ACS122, ACS122-DIGIT, ACS151, ACS151-DIGIT, ACS152, ACS152-DIGIT, ACS161-DIGIT, ACS162-DIGIT, ACS181, ACS181-DIGIT, ACS182, ACS182-DIGIT, ACS201, ACS201-DIGIT, ACS202, ACS202-DIGIT, ACS241, ACS241-DIGIT, ACS242, ACS242-DIGIT, ACS91, ACS91-DIGIT, C1000E, C1000ERCD...(Other models you can see in the webshop)		

accessories for	511199			
	GEV No.	511283	Ref. No.	200927
	flat gasket rubber ED ø 30mm ID ø 20mm thickness 2mm Qty 1 pcs			
	GEV No.	511284	Ref. No.	270121
	nut			
	GEV No.	511286	Ref. No.	450143
	hose clamp ø 38mm wire gauge ø 3.2mm Qty 1 pcs			
	GEV No.	511289	Ref. No.	161312
	hose ED ø 9.5mm ID ø 5mm L 420mm equiv. no. 161312			



GEV No.	511282	Ref. No.	161310
description	air trap		
For models:	ACL150, ACRS145, ACRS205, ACRS225, ACRS245, ACRS260, ACRS265, ACRS305, ACS161-DIGIT, ACS162-DIGIT, BC25, BC25A, BC25HR, BC30, BC30A, BC30HR, BC30HR380, BC30HRA, BR20, BR20A, BR25, BR25A, FC43, FC43A, GE100, GE115, GE60, GE60RCD, GE65, GE65RCD, GE80, GMC2702, GMC3502, GMC4502, GMC5502, LC1200, LC1200RCD, LC412, LC700, LC700RCD, LC900, LC900RCD		















spare parts for	511282			
	GEV No.	511283	Ref. No.	200927
	flat gasket rubber ED ø 30mm ID ø 20mm thickness 2mm Qty 1 pcs			
	GEV No.	511284	Ref. No.	270121
	nut			
	GEV No.	511285	Ref. No.	161311
	hose ED ø 9.5mm ID ø 5mm L 1075mm equiv. no. 161311			

Table continues overleaf

spare parts for 511282			
	GEV No.	511286	Ref. No. 450143
hose clamp ø 38mm wire gauge ø 3.2mm Qty 1 pcs			
accessories for 511282			
	GEV No.	511283	Ref. No. 200927
flat gasket rubber ED ø 30mm ID ø 20mm thickness 2mm Qty 1 pcs			
	GEV No.	511284	Ref. No. 270121
nut			
	GEV No.	511285	Ref. No. 161311
hose ED ø 9.5mm ID ø 5mm L 1075mm equiv. no. 161311			
	GEV No.	511286	Ref. No. 450143
hose clamp ø 38mm wire gauge ø 3.2mm Qty 1 pcs			

			
1			
GEV No.	512407	Ref. No.	161323
description	air trap		
accessories for	512407		
	GEV No.	511283	Ref. No. 200927
flat gasket rubber ED ø 30mm ID ø 20mm thickness 2mm Qty 1 pcs			
	GEV No.	511284	Ref. No. 270121
nut			
	GEV No.	511286	Ref. No. 450143
hose clamp ø 38mm wire gauge ø 3.2mm Qty 1 pcs			
	GEV No.	511289	Ref. No. 161312
hose ED ø 9.5mm ID ø 5mm L 420mm equiv. no. 161312			

			
1			
GEV No.	524759	Ref. No.	380828
description	air trap ø 48mm H 73mm thread M10x1.5 hose ø 6mm metal		
For models:	ACRS145, ACRS205, ACRS225, ACRS245, ACRS260, ACRS265, ACRS305, GMC, GMC2700, GMC3500, GMC4500, GMC5500, NE02, NE3001, NE3002, NE4001, NE4002, NE5002, NE5501, NE5502, NE7002, NE7501, NE7502, NE9001, NE9002, NE9502, NG01, NG02, NG1202E, NG601E, NG602E, NG901E, NG902E, NL302E, NL402E, NL502E, NL552E		

			
1			
GEV No.	510342	Ref. No.	161301
description	air trap ø 49mm H 155mm		
For models:	AC100, AC120, AC150, AC170, AC200, AC90, ACR, ACR145, ACR205, ACR225, ACR245, ACR260, ACR265, ACR305, C30, C33, C34, F2, F3, F300, G100L, G101L, G115, G115L, G125, G125L, G131, G50L, G50LM, G51L, G60L, G61L, G65, G65L, G66, G75, G75L, GE125, GE75, GF90-2004, GF90A-2004, GL, GMC, GMC2700, GMC3500, GMC4500, GMC5500, NE00, NG00, NG600...(Other models you can see in the webshop)		
spare parts for	510342		
	GEV No.	510877	Ref. No. 200415
flat gasket rubber ED ø 18mm ID ø 10mm thickness 3mm Qty 1 pcs			
	GEV No.	560197	Ref. No. 260407
nut thread M10 H 8mm WS 17 SS DIN/ISO DIN 934 / ISO 4032/8673 Qty 1 pcs			
accessories for	510342		
	GEV No.	510877	Ref. No. 200415
flat gasket rubber ED ø 18mm ID ø 10mm thickness 3mm Qty 1 pcs			
	GEV No.	560197	Ref. No. 260407
nut thread M10 H 8mm WS 17 SS DIN/ISO DIN 934 / ISO 4032/8673 Qty 1 pcs			

air trap accessories

			
1			
GEV No.	510486	Ref. No.	161306
description	air ducting ø 1/2"mm		
For models:	C70, C75, C75BT, C75M, C75RCD, F45, F55, F65, F80, F90M, F90MA, FC, FC53, FC533, FC533A, FC53A, FC53CBT, FC53LA, FC53LBT, FC54, FC543, FC543A, FC543E, FC543EA, FC544, FC544A, FC54A, FC54CBT, FC54E, FC54EA, FC54LBT, FCHR, FCHRA, FCHRT, FCHRTA, LF280-lav-line, LF315, LF320, LF320A, LF320CBT, LF320L, LF320LA, LF320-lav-line, LF320LBT, LF323, LF323A, LF350, LF350A, LF400A, LF450...(Other models you can see in the webshop)		

			
1			
GEV No.	510354	Ref. No.	160727
description	end cap ø 1/2"mm		
For models:	C70, C75, C75BT, C75M, C75RCD, F45, F55, F65, F80, F90M, F90MA, FC, FC53, FC533, FC533A, FC53A, FC53CBT, FC53LA, FC53LBT, FC54, FC543, FC543A, FC543E, FC543EA, FC544, FC544A, FC54A, FC54CBT, FC54E, FC54EA, FC54LBT, FCHR, FCHRA, FCHRT, FCHRTA, LF280-lav-line, LF315, LF320, LF320A, LF320CBT, LF320L, LF320LA, LF320-lav-line, LF320LBT, LF323, LF323A, LF350, LF350A, LF400A, LF450...(Other models you can see in the webshop)		



			
1			
GEV No.	510761	Ref. No.	200944 21005
description	flat gasket rubber D1 ø 38mm D2 ø 25mm thickness 2mm Qty 1 pcs		
For models:	BHC25, BHC25-2, BHC25A, BHC25A-2, BHC25S, BHC30, BHC30-2, BHC30A, BHC30A-2, BHC30E, BHC30E-2, BHC30EA, BHC30EA-2, BHC433, BHC433-2, BHC433A, BHC433A-2, GF70, GF70A, LB200, LB200-2, LB200A, LB200A-2, LB215, LB215-2, LB215A, LB215A-2, LB260, LB260-2, LB260A, LB260A-2, LB275, LB275-2, LB275A, LB275A-2, LF321, LF321A, LF322, LF322A, LF322MP, LF322MP-A, LF322RCD, LF324, LF324A, LF325E, LF325EA, LF700, LF700A, LFD32E, LFD32EA...(Other models you can see in the webshop)		

			
1			
GEV No.	510877	Ref. No.	200415
description	flat gasket rubber ED ø 18mm ID ø 10mm thickness 3mm Qty 1 pcs		
For models:	AC100, AC101, AC120, AC122, AC150, AC151, AC152, AC170, AC181, AC182, AC200, AC201, AC202, AC241, AC242, AC90, AC91, ACR, ACR145, ACR205, ACR225, ACR245, ACR260, ACR265, ACR305, B10, B10T, B11, B11T, B12, B12T, B13T, B14T, B15, B15T, B16, B16T, B18, B18T, B19, B19T, B20, B20D, B23, B24, B25, B26, B27, B31, B32...(Other models you can see in the webshop)		

			
1			
GEV No.	511283	Ref. No.	200927
description	flat gasket rubber ED ø 30mm ID ø 20mm thickness 2mm Qty 1 pcs		
For models:	AC101, AC122, AC151, AC152, AC181, AC182, AC201, AC202, AC241, AC242, AC2A, AC91, ACL100, ACL150, ACRS145, ACRS205, ACRS225, ACRS245, ACRS260, ACRS265, ACRS305, ACS101, ACS101-DIGIT, ACS122, ACS122-DIGIT, ACS151, ACS151-DIGIT, ACS152, ACS152-DIGIT, ACS161-DIGIT, ACS162-DIGIT, ACS181, ACS181-DIGIT, ACS182, ACS182-DIGIT, ACS201, ACS201-DIGIT, ACS202, ACS202-DIGIT, ACS241, ACS241-DIGIT, ACS242, ACS242-DIGIT, ACS91, ACS91-DIGIT, BC25, BC25A, BC30, BC30A, BR20...(Other models you can see in the webshop)		

			
1			
GEV No.	511285	Ref. No.	161311
description	hose ED ø 9.5mm ID ø 5mm L 1075mm equiv. no. 161311		
For models:	AC101, AC105, AC122, AC135, AC151, AC152, AC181, AC182, AC201, AC202, AC241, AC242, AC91, AC95, ACL150, ACRS145, ACRS205, ACRS225, ACRS245, ACRS260, ACRS265, ACRS305, ACS101, ACS101-DIGIT, ACS122, ACS122-DIGIT, ACS151, ACS151-DIGIT, ACS152, ACS152-DIGIT, ACS161-DIGIT, ACS162-DIGIT, ACS181, ACS181-DIGIT, ACS182, ACS182-DIGIT, ACS201, ACS201-DIGIT, ACS202, ACS202-DIGIT, ACS241, ACS241-DIGIT, ACS242, ACS242-DIGIT, ACS91, ACS91-DIGIT, BC25, BC25A, BC25HR, BC30...(Other models you can see in the webshop)		

			
1			
GEV No.	511289	Ref. No.	161312
description	hose ED ø 9.5mm ID ø 5mm L 420mm equiv. no. 161312		
For models:	AC201, AC202, AC241, AC242, AC2A, ACL100, ACL150, ACRS145, ACRS205, ACRS225, ACRS245, ACRS260, ACRS265, ACRS305, ACS101, ACS101-DIGIT, ACS122, ACS122-DIGIT, ACS151, ACS151-DIGIT, ACS152, ACS152-DIGIT, ACS161-DIGIT, ACS162-DIGIT, ACS181, ACS181-DIGIT, ACS182, ACS182-DIGIT, ACS201, ACS201-DIGIT, ACS202, ACS202-DIGIT, ACS241, ACS241-DIGIT, ACS242, ACS242-DIGIT, ACS91, ACS91-DIGIT, C155, C155BT, C155E2, C155RCD, C165, C165E2, C165E2BT, C165E2RCD, C166, C166-2, C95, C95BT...(Other models you can see in the webshop)		

			
1			
GEV No.	511286	Ref. No.	450143
description	hose clamp ø 38mm wire gauge ø 3.2mm Qty 1 pcs		
For models:	AC101, AC105, AC122, AC135, AC151, AC152, AC181, AC182, AC201, AC202, AC241, AC242, AC2A, AC91, AC95, ACL100, ACL150, ACRS145, ACRS205, ACRS225, ACRS245, ACRS260, ACRS265, ACRS305, ACS101, ACS101-DIGIT, ACS122, ACS122-DIGIT, ACS151, ACS151-DIGIT, ACS152, ACS152-DIGIT, ACS161-DIGIT, ACS162-DIGIT, ACS181, ACS181-DIGIT, ACS182, ACS182-DIGIT, ACS201, ACS201-DIGIT, ACS202, ACS202-DIGIT, ACS241, ACS241-DIGIT, ACS242, ACS242-DIGIT, ACS91, ACS91-DIGIT, BC25, BC25A...(Other models you can see in the webshop)		

			
1			
GEV No.	510760	Ref. No.	161317
description	hose connector		
For models:	BHC25, BHC25-2, BHC25A, BHC25A-2, BHC25S, BHC30, BHC30-2, BHC30A, BHC30A-2, BHC30E, BHC30E-2, BHC30EA, BHC30EA-2, BHC433, BHC433-2, BHC433A, BHC433A-2, GF70, GF70A, LB200, LB200-2, LB200A, LB200A-2, LB215, LB215-2, LB215A, LB215A-2, LB260, LB260-2, LB260A, LB260A-2, LB275, LB275-2, LB275A, LB275A-2, LF321, LF321A, LF322, LF322A, LF322MP, LF322MP-A, LF322RCD, LF324, LF324A, LF325E, LF325EA, LF700, LF700A, LFD32E, LFD32EA...(Other models you can see in the webshop)		

			
1			
GEV No.	511284	Ref. No.	270121
description	nut		
For models:	AC101, AC122, AC151, AC152, AC181, AC182, AC201, AC202, AC241, AC242, AC2A, AC91, ACL100, ACL150, ACRS145, ACRS205, ACRS225, ACRS245, ACRS260, ACRS265, ACRS305, ACS101, ACS101-DIGIT, ACS122, ACS122-DIGIT, ACS151, ACS151-DIGIT, ACS152, ACS152-DIGIT, ACS161-DIGIT, ACS162-DIGIT, ACS181, ACS181-DIGIT, ACS182, ACS182-DIGIT, ACS201, ACS201-DIGIT, ACS202, ACS202-DIGIT, ACS241, ACS241-DIGIT, ACS242, ACS242-DIGIT, ACS91, ACS91-DIGIT, BC25, BC25A, BC25HR, BC30, BC30A...(Other models you can see in the webshop)		

mechanics for flight type dishwashers			
			
1			
GEV No.	524589	Ref. No.	342020
description	bolt for tappet L 30mm ø 8mm hole ø 2.5mm suitable for COMENDA		
For models:	AC101, AC105, AC122, AC135, AC151, AC152, AC181, AC182, AC201, AC202, AC241, AC242, AC91, AC95, ACL100, ACL150, ACRS145, ACRS205, ACRS225, ACRS245, ACRS260, ACRS265, ACRS305, ACS101, ACS101-DIGIT, ACS122, ACS122-DIGIT, ACS151, ACS151-DIGIT, ACS152, ACS152-DIGIT, ACS161-DIGIT, ACS162-DIGIT, ACS181, ACS181-DIGIT, ACS182, ACS182-DIGIT, ACS201, ACS201-DIGIT, ACS202, ACS202-DIGIT, ACS241, ACS241-DIGIT, ACS242, ACS242-DIGIT, ACS91, ACS91-DIGIT		

			
1			
GEV No.	511669	Ref. No.	322019
description	bracket for transport system L 132mm W 83mm		
For models:	GMC, GMC2700, GMC2702, GMC3500, GMC3502, GMC4500, GMC4502, GMC5500, GMC5502		

			
1			
GEV No.	504358	Ref. No.	322018
description	bracket for transport system L 190mm W 115mm		
For models:	GMC, GMC2700, GMC2702, GMC3500, GMC3502, GMC4500, GMC4502, GMC5500, GMC5502		

			
1			
GEV No.	504360	Ref. No.	330861
description	bush for transport system L 17mm ID ø 6.3mm ED ø 16mm		
For models:	GMC, GMC2700, GMC2702, GMC3500, GMC3502, GMC4500, GMC4502, GMC5500, GMC5502		

			
1			
GEV No.	524578	Ref. No.	620265
description	cart for basket transport L 505mm W 210mm H 140mm suitable for COMENDA for GMC		
For models:	GMC, GMC2700, GMC2702, GMC3500, GMC3502, GMC4500, GMC4502, GMC5500, GMC5502		

			
1			
GEV No.	504352	Ref. No.	330110
description	connector for transport system L 66mm W 15mm hole ø 6x12mm		
For models:	GMC, GMC2700, GMC2702, GMC3500, GMC3502, GMC4500, GMC4502, GMC5500, GMC5502		

			
1			
GEV No.	504353	Ref. No.	330111
description	connector for transport system L 66mm W 38mm hole ø 6x12mm		
For models:	GMC, GMC2700, GMC2702, GMC3500, GMC3502, GMC4500, GMC4502, GMC5500, GMC5502		

			
1			
GEV No.	504354	Ref. No.	330113
description	connector for transport system L 80mm W 20mm hole ø 8.5mm		
For models:	NE02, NE3001, NE3002, NE4001, NE4002, NE5002, NE5501, NE5502, NE7002, NE7501, NE7502, NE9001, NE9002, NE9502, NG02, NG1202, NG1202E, NG602, NG602E, NG902, NG902E, NL302, NL302E, NL402, NL402E, NL502, NL502E, NL552, NL552E		

			
1			
GEV No.	529234	Ref. No.	510299 620144 620648
description	drive shaft for transport system		
For models:	AC100, AC101, AC105, AC120, AC122, AC135, AC150, AC151, AC152, AC170, AC181, AC182, AC200, AC201, AC202, AC241, AC242, AC90, AC91, AC95, ACR, ACR145, ACR205, ACR225, ACR245, ACR260, ACR265, ACR305, ACRS145, ACRS205, ACRS225, ACRS245, ACRS260, ACRS265, ACRS305, ACS101, ACS101-DIGIT, ACS122, ACS122-DIGIT, ACS151, ACS151-DIGIT, ACS152, ACS152-DIGIT, ACS161-DIGIT, ACS162-DIGIT, ACS181, ACS181-DIGIT, ACS182, ACS182-DIGIT, ACS201...(Other models you can see in the webshop)		





			
1			
GEV No.	541071	Ref. No.	150811
description	duct		
For models:	C33, C34		

			
1			
GEV No.	542126	Ref. No.	330715
description	fastening angle L1 17mm L2 40mm H 39mm ED ø 30mm thickness 2mm		
For models:	AC100, AC101, AC120, AC122, AC150, AC151, AC152, AC170, AC181, AC182, AC200, AC201, AC202, AC241, AC242, AC2A, AC90, AC91, ACL100, ACL150, ACR, ACR145, ACR205, ACR225, ACR245, ACR260, ACR265, ACR305, ACRS145, ACRS205, ACRS225, ACRS245, ACRS260, ACRS265, ACRS305, ACS101, ACS101-DIGIT, ACS122, ACS122-DIGIT, ACS151, ACS151-DIGIT, ACS152, ACS152-DIGIT, ACS161-DIGIT, ACS161-DIGIT, ACS162-DIGIT, ACS181, ACS181-DIGIT, ACS182, ACS182-DIGIT, ACS201... (Other models you can see in the webshop)		

			
1			
GEV No.	524768	Ref. No.	170232
description	finger for stroke arresting device L 80mm W 56mm H 21mm suitable for COMENDA		
For models:	NG02, NG1202, NG1202E, NG602, NG602E, NG902, NG902E		

			
1			
GEV No.	524677	Ref. No.	180201
description	flange for drive shaft ø 85mm hole ø 22mm thickness 14mm suitable for COMENDA		
For models:	NE00, NE02, NE3001, NE3002, NE4001, NE4002, NE5002, NE5501, NE5502, NE7002, NE7501, NE7502, NE9001, NE9002, NE9502, NG00, NG01, NG02, NG1202, NG1202E, NG600, NG600E, NG601, NG601E, NG602, NG602E, NG900, NG900E, NG901, NG901E, NG902, NG902E		

			
1			
GEV No.	524675	Ref. No.	170448
description	gear wheel for transport system ø 175mm hole ø 36mm thickness 13mm suitable for COMENDA		

			
1			
GEV No.	698374	Ref. No.	410292
description	gear wheel ø 114mm hole ø 17mm thickness 30mm suitable for COMENDA		

			
1			
GEV No.	511581	Ref. No.	190146
description	guide for transport system L 45mm W 15mm H 34mm hole ø 8.5mm suitable for COMENDA		
For models:	AC101, AC105, AC122, AC135, AC151, AC152, AC181, AC182, AC201, AC202, AC241, AC242, AC91, AC95, ACL100, ACL150, ACRS145, ACRS205, ACRS225, ACRS245, ACRS260, ACRS265, ACRS305, ACS101, ACS101-DIGIT, ACS122, ACS122-DIGIT, ACS151, ACS151-DIGIT, ACS152, ACS152-DIGIT, ACS161-DIGIT, ACS162-DIGIT, ACS181, ACS181-DIGIT, ACS182, ACS182-DIGIT, ACS201, ACS201-DIGIT, ACS202, ACS202-DIGIT, ACS241, ACS241-DIGIT, ACS242, ACS242-DIGIT, ACS91, ACS91-DIGIT		

			
1			
GEV No.	512491	Ref. No.	190651
description	guide busching for roller spring L 60mm H 8mm W 20mm suitable for COMENDA		
For models:	AC101, AC122, AC151, AC152, AC181, AC182, AC201, AC202, AC241, AC242, AC2A, AC91, ACL100, ACL150, ACRS145, ACRS205, ACRS225, ACRS245, ACRS260, ACRS265, ACRS305, ACS101, ACS101-DIGIT, ACS122, ACS122-DIGIT, ACS151, ACS151-DIGIT, ACS152, ACS152-DIGIT, ACS161-DIGIT, ACS162-DIGIT, ACS181, ACS181-DIGIT, ACS182, ACS182-DIGIT, ACS201, ACS201-DIGIT, ACS202, ACS202-DIGIT, ACS241, ACS241-DIGIT, ACS242, ACS242-DIGIT, ACS91, ACS91-DIGIT, GMC2702, GMC3502, GMC4502, GMC5502, LAV1000... (Other models you can see in the webshop)		

			
1			
GEV No.	701579	Ref. No.	191060
description	holding pin for filter L 25mm ED ø 15.5mm IT M6 suitable for COMENDA		
For models:	AC120, AC170, AC200, ACR, ACR145, ACR205, ACR225, ACR245, ACR260, ACR265, ACR305, GMC, GMC2700, GMC3500, GMC4500, GMC5500, NE3001, NE4001, NE5501, NE7501, NE9001, NG01, NG601E, NG901E		

			
1			
GEV No.	504361	Ref. No.	170238
description	lever L 95mm W 30mm H 35mm		
For models:	NE02, NE3002, NE4002, NE5002, NE5502, NE7002, NE7502, NE9002, NE9502, NL302, NL302E, NL402, NL402E, NL502, NL502E, NL552, NL552E		

			
1			
GEV No.	524761	Ref. No.	170440
description	pulley for impulse ø 114mm hole ø 20mm thickness 26mm suitable for COMENDA		
For models:	LAV1000		

1			
GEV No.	510846	Ref. No.	191015
description	ratchet		

1			
GEV No.	504345	Ref. No.	170336
description	roller for transport system H 10.5mm ϕ 24mm ID ϕ 15mm hole ϕ 6.2mm		
For models:	GMC, GMC2700, GMC2702, GMC3500, GMC3502, GMC4500, GMC4502, GMC5500, GMC5502		

1			
GEV No.	504362	Ref. No.	170303
description	roller for transport system H 10mm ϕ 31mm hole ϕ 8mm		
For models:	GMC, GMC2700, GMC2702, GMC3500, GMC3502, GMC4500, GMC4502, GMC5500, GMC5502		

1			
GEV No.	504346	Ref. No.	170314
description	roller for transport system H 19.5mm ϕ 30mm hole ϕ 9mm		
For models:	LAV1001, LAV1501, LV1001, LV1501, LV-LVP, LVP1001, LVP1501, NE00, NE02, NE3001, NE3002, NE4001, NE4002, NE5002, NE5501, NE5502, NE7002, NE7501, NE7502, NE9001, NE9002, NE9502, NG00, NG01, NG02, NG1202, NG1202E, NG600, NG600E, NG601, NG601E, NG602, NG602E, NG900, NG900E, NG901, NG901E, NG902, NG902E, NL302, NL302E, NL402, NL402E, NL502, NL502E, NL552, NL552E		

1			
GEV No.	524643	Ref. No.	170331
description	roller for transport system W 26mm ϕ 120mm hole ϕ 20mm suitable for COMENDA		
For models:	LAV1001, LAV1501, LV1001, LV1501, LV-LVP, LVP1001, LVP1501		

1			
GEV No.	524583	Ref. No.	290820
description	spacer for impulse ID ϕ 40mm ED ϕ 52mm thickness 7.5mm suitable for MEIKO		
For models:	GMC, GMC2700, GMC3500, GMC4500, GMC5500		

1			
GEV No.	504359	Ref. No.	170215
description	spacer for transport system L 210mm		
For models:	GMC, GMC2700, GMC2702, GMC3500, GMC3502, GMC4500, GMC4502, GMC5500, GMC5502		

1			
GEV No.	524548	Ref. No.	340405
description	spindle for conveyor belt L 610mm ϕ 8mm suitable for COMENDA		
For models:	LV1001, LV1501, LV-LVP, LVP1001, LVP1501, NE00, NE02, NE3001, NE3002, NE4001, NE4002, NE5002, NE5501, NE5502, NE7002, NE7501, NE7502, NE9001, NE9002, NE9502, NL302, NL302E, NL402, NL402E, NL502, NL502E, NL552, NL552E		

1			
GEV No.	510222	Ref. No.	342061
description	spindle for conveyor belt L 698mm ϕ 25mm		
For models:	NE02, NE3002, NE4002, NE5002, NE5502, NE7002, NE7502, NE9002, NE9502		

1			
GEV No.	511174	Ref. No.	170204
description	tappet		
For models:	NE00, NG01, NG601, NG601E, NG901, NG901E		

1			
GEV No.	510651	Ref. No.	170220
description	tappet for dishwasher		
For models:	NE02, NE3001, NE3002, NE4001, NE4002, NE5002, NE5501, NE5502, NE7002, NE7501, NE7502, NE9001, NE9002, NE9502		







1					
GEV No.	524590	Ref. No.	510425		
description	tappet for dishwasher L 58mm W 42mm H 54mm hole ϕ 8.4mm suitable for COMENDA				
For models:	AC101, AC105, AC122, AC135, AC151, AC152, AC181, AC182, AC201, AC202, AC241, AC242, AC91, AC95, ACL100, ACL150, ACRS145, ACRS205, ACRS225, ACRS245, ACRS260, ACRS265, ACRS305, ACS101, ACS101-DIGIT, ACS122, ACS122-DIGIT, ACS151, ACS151-DIGIT, ACS152, ACS152-DIGIT, ACS161-DIGIT, ACS162-DIGIT, ACS181, ACS181-DIGIT, ACS182, ACS182-DIGIT, ACS201, ACS201-DIGIT, ACS202, ACS202-DIGIT, ACS241, ACS241-DIGIT, ACS242, ACS242-DIGIT, ACS91, ACS91-DIGIT				
accessories for	524590				
		GEV No.	524589	Ref. No.	342020
	bolt for tappet L 30mm ϕ 8mm hole ϕ 2.5mm suitable for COMENDA				

Table continues overleaf





accessories for	524590		
	GEV No.	560114	Ref. No. 260505
	plain washer ID ø 8.4mm ED ø 16mm thickness 1.6mm SS Qty 20 pcs DIN 125A for thread M8		
	GEV No.	694401	Ref. No. 451002
	roll pin ø 2mm L 12mm stainless steel 1481		

	1		
GEV No.	504355	Ref. No.	170218
description	tappet for dishwasher L 97mm W 74mm		
For models:	NE02, NE3001, NE3002, NE4001, NE4002, NE5002, NE5501, NE5502, NE7002, NE7501, NE7502, NE9001, NE9002, NE9502, NG02, NG1202, NG1202E, NG602, NG602E, NG902, NG902E, NL302, NL302E, NL402, NL402E, NL502, NL502E, NL552, NL552E		

	1		
GEV No.	504356	Ref. No.	170217
description	tappet for dishwasher L 97mm W 74mm		
For models:	NE02, NE3001, NE3002, NE4001, NE4002, NE5002, NE5501, NE5502, NE7002, NE7501, NE7502, NE9001, NE9002, NE9502, NG02, NG1202, NG1202E, NG602, NG602E, NG902, NG902E, NL302, NL302E, NL402, NL402E, NL502, NL502E, NL552, NL552E		



	1		
GEV No.	504357	Ref. No.	170214
description	tappet for dishwasher L 97mm W 84mm		
For models:	GMC, GMC2700, GMC2702, GMC3500, GMC3502, GMC4500, GMC4502, GMC5500, GMC5502		

	1		
GEV No.	504363	Ref. No.	330224
description	tie bar L 497mm W 6mm thread 2xM6		
For models:	GMC, GMC2700, GMC2702, GMC3500, GMC3502, GMC4500, GMC4502, GMC5500, GMC5502		

pipes			
	1		
GEV No.	510808	Ref. No.	160115
description	pipe L 1000mm ø 9.5mm		
For models:	B41, B42, C140, C155, C155BT, C155E2, C155RCD, C165, C165E2, C165E2BT, C165E2RCD, C166, C166-2, C30, C70, C75, C75BT, C75M, C75RCD, C85, C95, C95BT, C95E2, C95RCD, LC380, LC380BT, LC380RCD, LC400, LP360, LP360BT, LP360RCD		

backflow preventers			
backflow preventers			
	1		
GEV No.	504140	Ref. No.	620243
description	backflow preventer		

	1		
GEV No.	504265	Ref. No.	620535
description	backflow preventer		
For models:	AC2A, ACL100, ACL150, ACRS145, ACRS205, ACRS225, ACRS245, ACRS260, ACRS265, ACRS305, ACS101, ACS101-DIGIT, ACS122, ACS122-DIGIT, ACS151, ACS151-DIGIT, ACS152, ACS152-DIGIT, ACS161-DIGIT, ACS162-DIGIT, ACS181, ACS181-DIGIT, ACS182, ACS182-DIGIT, ACS201, ACS201-DIGIT, ACS202, ACS202-DIGIT, ACS241, ACS241-DIGIT, ACS242, ACS242-DIGIT, ACS91-DIGIT, BC25, BC25A, BC25HR, BC30, BC30A, BC30HR, BC30HR380, BC30HRA, BHC25, BHC25-2, BHC25A, BHC25A-2, BHC25S, BHC30, BHC30-2, BHC30A, BHC30A-2...(Other models you can see in the webshop)		

	1		
GEV No.	510220	Ref. No.	191095
description	backflow preventer		
For models:	C1000ERCD, C1300ERCD, GE50RCD, GE60RCD, GE65RCD, LC1200RCD, LC700RCD, LC900RCD, LF322RCD, XLC		
accessories for	510220		
	GEV No.	510226	Ref. No. 180149
	nut ø 65mm for backflow preventer		
	GEV No.	510234	Ref. No. 200498
	flat gasket rubber ED ø 65mm ID ø 47mm thickness 2mm Qty 1 pcs		



1

GEV No.	510993	Ref. No.	620243
description	backflow preventer		
For models:	BC25, BC25A, BC25HR, BC30, BC30A, BC30HR, BC30HR380, BC30HRA, BHC25, BHC25-2, BHC25A, BHC25A-2, BHC25S, BHC30, BHC30-2, BHC30A, BHC30A-2, BHC30E, BHC30E-2, BHC30EA, BHC30EA-2, BHC30HR, BHC30HR-2, BHC30HR380, BHC30HRA, BHC30HRA-2, BHC30HRA380, BHC433, BHC433-2, BHC433A, BHC433A-2, BHCHR, C1000E, C1001M, C1300E, C1301M, C155, C155E2, C165, C165E2, C166, C166-2, C75, C95, C95E2, F90M, F90MA, FC, FC43, FC43A... (Other models you can see in the webshop)		



1

GEV No.	518605	Ref. No.	191108 191111
description	backflow preventer hose ø 11mm		
For models:	FC3E, FC3EA, FC3MA, FC44E, FC44EA, FC4E, FC4EA, FC4EHRT, FC4MA		

accessories



1

GEV No.	511277	Ref. No.	190330
description	T-piece thread 1/2" ø 18mm		
For models:	BC25, BC25A, BC25HR, BC30, BC30A, BC30HR, BC30HR380, BC30HRA, BHC25, BHC25-2, BHC25A, BHC25A-2, BHC25S, BHC30, BHC30-2, BHC30A, BHC30A-2, BHC30E, BHC30E-2, BHC30EA, BHC30EA-2, BHC30HR, BHC30HR-2, BHC30HR380, BHC30HRA, BHC30HRA-2, BHC30HRA380, BHC433, BHC433-2, BHC433A, BHC433A-2, BHCHR, C1000E, C1001M, C1300E, C1301M, C155, C155E2, C165, C165E2, C166, C166-2, C75, C95, C95E2, F90M, F90MA, FC, FC43, FC43A... (Other models you can see in the webshop)		

miscellaneous



1

GEV No.	510833	Ref. No.	331814
description	angle piece for filter		
For models:	NE02, NE3001, NE3002, NE4001, NE4002, NE5002, NE5501, NE5502, NE7002, NE7501, NE7502, NE9001, NE9002, NE9502		



1

GEV No.	512490	Ref. No.	190692
description	bush L 30mm D1 ø 34mm ID ø 30mm		



1

GEV No.	511003	Ref. No.	190629
description	bush mounting pos. rear		
For models:	B11, B12, B15, B16, B18, B19		



1

GEV No.	511394	Ref. No.	160784
description	lid for tank with thread D1 ø 88mm D2 ø 65mm		
For models:	BHC25, BHC30, BHC30A, BHC30HR, BHC30HR380, BHC30HRA, BHC30HRA380, BHC433, BHC433A, BHCHR, LB215, LB215A, LB275, LB275A		

accessories for	511394		
GEV No.	511395	Ref. No.	200868

	O-ring EPDM thickness 2.62mm ID ø 71.12mm Qty 1 pcs		
---	---	--	--

GEV No.	511396	Ref. No.	160787
----------------	--------	-----------------	--------

	nut		
---	-----	--	--



			
1			
GEV No.	510349	Ref. No.	160755
description	plug D1 ø 87mm mounting ø 72mm ID ø 60mm		
For models:	B11T, B12T, B13T, B14T, B15T, B15TM, B16T, B16TM, B18T, B18TM, B19T, B19TM, BC25, BC25A, BC25HR, BC30, BC30A, BC30HR, BC30HR380, BC30HRA, BHC25, BHC25-2, BHC30, BHC30-2, BHC30A, BHC30A-2, BHC30E, BHC30E-2, BHC30EA, BHC30EA-2, BHC30HR, BHC30HR-2, BHC30HR380, BHC30HRA, BHC30HRA-2, BHC30HRA380, BHC433, BHC433-2, BHC433A, BHC433A-2, BHCHR, BR20, BR20A, BR25, F90M, F90MA, FC, FC43, FC53, FC533...(Other models you can see in the webshop)		
accessories for	510349		
			
GEV No.	510947	Ref. No.	200489
description	flat gasket rubber ED ø 85mm ID ø 73mm thickness 2mm Qty 1 pcs equiv. no. 200489 suitable for COMENDA		

			
Image not available			
1			
GEV No.	970053	Ref. No.	660605
description	ring		

			
1			
GEV No.	524046	Ref. No.	441103 441111 441139
description	vibration damper L 40mm W 25mm H 25mm for pump		
For models:	AC120, AC135, AC150, AC170, AC200, ACS181, ACS181-DIGIT, ACS182, ACS182-DIGIT, ACS201, ACS201-DIGIT, ACS202, ACS202-DIGIT, ACS241, ACS241-DIGIT, ACS242, ACS242-DIGIT, C1000ERCD, C1300ERCD, C140, C155, C155BT, C155E2, C155RCD, C165, C165E2, C165E2BT, C165E2RCD, C166, C166-2, C70, C75, C75BT, C75M, C75RCD, C85, C95, C95BT, C95E2, C95RCD, FC3E, FC3EA, FC3M, FC3MA, FC3MR, FC44E, FC44EA, FC4E, FC4EA, FC4EHRT...(Other models you can see in the webshop)		

door mechanics

bolts

			
1			
GEV No.	511383	Ref. No.	341297
description	bolt		

			
1			
GEV No.	510336	Ref. No.	340416
description	bolt L 12.5mm thread M3 for hinge SS WS 7		
For models:	FC3E, FC3EA, FC3M, FC3MA, FC3MR, FC44E, FC44EA, FC4E, FC4EA, FC4EHRT, FC4M, FC4MA		

springs

torsion springs

			
1			
GEV No.	510652	Ref. No.	391335
description	torsion spring ø 18mm wire gauge ø 3mm Qty 1 pcs		
For models:	FC3E, FC3EA, FC3M, FC3MA, FC3MR, FC44E, FC44EA, FC4E, FC4EA, FC4EHRT, FC4M, FC4MA		

tension springs

			
1			
GEV No.	510228	Ref. No.	450217
description	tension spring ø 12mm total length 165mm wire gauge ø 1mm		
For models:	G100L, G101L, G115, G115L, G50L, G50LM, G51L, G60L, G61L, G65, G65L, GL, LAV1001, LAV1501		

			
1			
GEV No.	511565	Ref. No.	391334
description	tension spring ø 13mm total length 190mm wire gauge ø 1.75mm L1 155mm L2 16mm L3 16mm		
For models:	FC3E, FC3EA, FC3M, FC3MA, FC44E, FC44EA, FC4E, FC4EA, FC4EHRT, FC4M, FC4MA		

			
1			
GEV No.	510064	Ref. No.	450288
description	tension spring ø 13mm total length 78mm wire gauge ø 2.5mm L1 14mm L2 50mm L3 14mm		
For models:	GF70, GF70A, LF321, LF321A, LF322, LF322A, LF322MP, LF322MP-A, LF322RCD, LF324, LF324A, LF325E, LF325EA, LF700, LF700A		

			
1			
GEV No.	519405	Ref. No.	450237
description	tension spring ø 22mm L1 185mm		
For models:	GE100, GE115, GE50RCD, GE60, GE60RCD, GE65, GE65RCD, GE80		

linkage

			
1			
GEV No.	511372	Ref. No.	330227
description	door pin L 168mm thread M5 ø 5mm		
For models:	BC25, BC25A, BC25HR, BC30, BC30A, BC30HR, BC30HR380, BC30HRA, BR20, BR20A, BR25, BR25A, FC43, FC43A, R40, R70		

1 			
GEV No.	511380	Ref. No.	330235
description	door pin L 200mm tie bar ø 5mm		
For models:	BHC25, BHC25-2, BHC25A, BHC25A-2, BHC25S, BHC30, BHC30-2, BHC30A, BHC30A-2, BHC30E, BHC30E-2, BHC30EA, BHC30EA-2, BHC30HR, BHC30HR-2, BHC30HR380, BHC30HRA, BHC30HRA-2, BHC30HRA380, BHC433, BHC433-2, BHC433A, BHC433A-2, BHCHR		

1 			
GEV No.	511386	Ref. No.	330233
description	door pin L 240mm tie bar ø 5mm		
For models:	FC, FC53, FC533, FC533A, FC53A, FC53CBT, FC53LA, FC53LBT, FC54, FC543, FC543A, FC543E, FC543EA, FC544, FC544A, FC54A, FC54CBT, FC54E, FC54EA, FC54LBT, FCHR, FCHRA, FCHRT, FCHRTA		

1 			
GEV No.	510491	Ref. No.	330209
description	door pin L 305mm thread M5 tie bar		
For models:	B18, B18T, B18TM, B19, B19T, B19TM, B41, F2, F20, F3, F300, F45, F55, F65, F80, F90M, F90MA, G115, G65, LF280-lav-line, LF320-lav-line, LF400A, LF450, LF450A, R50		

1 			
GEV No.	511154	Ref. No.	330231
description	door pin tie bar		
For models:	LF315, LF320, LF320A, LF320CBT, LF320L, LF320LA, LF320LBT, LF323, LF323A, LF350, LF350A, LS550		

1 			
GEV No.	519415	Ref. No.	330211
description	tie bar		
For models:	B41, B42, F2, F300, R40, R70		

1 			
GEV No.	519412	Ref. No.	H34440
description	tie bar L 234mm thread M5 ø 4.4mm		
For models:	GF90, GF90A		

threaded shafts

1 			
GEV No.	511373	Ref. No.	341922
description	threaded part ø 10mm L 13mm thread M5 threaded part		
For models:	BC25, BC25A, BC25HR, BC30, BC30A, BC30HR, BC30HR380, BC30HRA, BR20, BR20A, BR25, BR25A, FC43, FC43A		

1 			
GEV No.	510829	Ref. No.	250207
description	threaded part threaded part		
For models:	B18, B18T, B18TM, B19, B19T, B19TM, B41, F2, F20, F3, F300, F45, F55, F65, F80, G115, G65, LF280-lav-line, LF320-lav-line, NG02, NG1202, NG1202E, NG602, NG602E, NG902, NG902E, R50		

1 			
GEV No.	511156	Ref. No.	342010
description	threaded part threaded part		
For models:	F90M, F90MA, FC, FC53, FC533, FC533A, FC53A, FC53CBT, FC53LA, FC53LBT, FC54, FC543, FC543A, FC543E, FC543EA, FC544, FC544A, FC54A, FC54CBT, FC54E, FC54EA, FC54LBT, FCHR, FCHRA, FCHRT, FCHRTA, LF315, LF320, LF320A, LF320CBT, LF320L, LF320LA, LF320LBT, LF323, LF323A, LF350, LF350A, LF400A, LF450, LF450A, LS550		

1 			
GEV No.	511381	Ref. No.	342701
description	threaded part threaded part		
For models:	BHC25, BHC25-2, BHC25A, BHC25A-2, BHC25S, BHC30, BHC30-2, BHC30A, BHC30A-2, BHC30E, BHC30E-2, BHC30EA, BHC30EA-2, BHC30HR, BHC30HR-2, BHC30HR380, BHC30HRA, BHC30HRA-2, BHC30HRA380, BHC433, BHC433-2, BHC433A, BHC433A-2, BHCHR		

sliding plates

1 			
GEV No.	699112	Ref. No.	321948
description	door guides		
For models:	AC120, AC150, AC170, AC200, ACR, ACR145, ACR205, ACR225, ACR245, ACR260, ACR265, ACR305, ACR3145, ACR5205, ACR5225, ACR5245, ACR5260, ACR5265, ACR5305, GMC, GMC2700, GMC3500, GMC4500, GMC5500, SE		

1 			
GEV No.	510492	Ref. No.	160905
description	sliding plate for tie bar		
For models:	B18, B18T, B18TM, B19, B19T, B19TM, B41, BHC25, BHC25-2, BHC25A, BHC25A-2, BHC25S, BHC30, BHC30-2, BHC30A, BHC30A-2, BHC30E, BHC30E-2, BHC30EA, BHC30EA-2, BHC30HR, BHC30HR-2, BHC30HR380, BHC30HRA, BHC30HRA-2, BHC30HRA380, BHC433, BHC433-2, BHC433A, BHC433A-2, BHCHR, F2, F20, F3, F300, F45, F55, F65, F80, F90M, F90MA, FC, FC53, FC533, FC533A, FC53A, FC53CBT, FC53LA, FC53LBT, FC54...(Other models you can see in the webshop)		



			
1			
GEV No.	511371	Ref. No.	160909
description	sliding plate sliding plate		
For models:	BC25, BC25A, BC25HR, BC30, BC30A, BC30HR, BC30HR380, BC30HRA, BR20, BR20A, BR25, BR25A, FC43, FC43A, GF90, GF90A		

hinges

			
1			
GEV No.	511384	Ref. No.	321807
description	door hinge hinge		
For models:	FC, FC53, FC533, FC533A, FC53A, FC53CBT, FC53LA, FC53LBT, FC54, FC543, FC543A, FC543E, FC543EA, FC544, FC544A, FC54A, FC54CBT, FC54E, FC54EA, FC54LBT, FCHR, FCHRA, FCHRT, FCHRTA		

			
1			
GEV No.	511368	Ref. No.	441107
description	door hinge hinge mounting pos. left		
For models:	BC25, BC25A, BC25HR, BC30, BC30A, BC30HR, BC30HR380, BC30HRA, BR20, BR20A, BR25, BR25A, F90M, F90MA, FC43, FC43A, LF315, LF320, LF320A, LF320CBT, LF320L, LF320LA, LF320LBT, LF323, LF323A, LF350, LF350A, LF400A, LF450, LF450A, LS550		

			
1			
GEV No.	511367	Ref. No.	441108
description	door hinge hinge mounting pos. right		
For models:	BC25, BC25A, BC25HR, BC30, BC30A, BC30HR, BC30HR380, BC30HRA, BR20, BR20A, BR25, BR25A, F90M, F90MA, FC43, FC43A, LF315, LF320, LF320A, LF320CBT, LF320L, LF320LA, LF320LBT, LF323, LF323A, LF350, LF350A, LF400A, LF450, LF450A, LS550		

hinge pins

			
1			
GEV No.	510920	Ref. No.	341218
description	hinge pin hinge pin		
For models:	B10, B10T, B11, B11T, B12, B12T, B13T, B14T, B15, B15T, B15TM, B16, B16T, B16TM, B18, B18T, B18TM, B19, B19T, B19TM, B20, B20D, B24, B25, B26, B27, B41, F20, F45, F55, F65, F80, F90M, F90MA, FC, FC3E, FC3EA, FC3M, FC3MA, FC3MR, FC44E, FC44EA, FC4E, FC4EA, FC4EHRT, FC4M, FC4MA, FC53, FC533, FC533A...(Other models you can see in the webshop)		

			
1			
GEV No.	511369	Ref. No.	341921
description	hinge pin hinge pin		
For models:	BC25, BC25A, BC25HR, BC30, BC30A, BC30HR, BC30HR380, BC30HRA, BR20, BR20A, BR25, BR25A, FC43, FC43A		

			
1			
GEV No.	511375	Ref. No.	342087 H15568
description	hinge pin ø 6mm D1 ø 4mm L 55mm thread M4 stainless steel		
For models:	BHC25, BHC25-2, BHC25A, BHC25A-2, BHC25S, BHC30, BHC30-2, BHC30A, BHC30A-2, BHC30E, BHC30E-2, BHC30EA, BHC30EA-2, BHC30HR, BHC30HR-2, BHC30HR380, BHC30HRA, BHC30HRA-2, BHC30HRA380, BHC433, BHC433-2, BHC433A, BHC433A-2, BHCHR, GF70, GF70A, GF90, GF90-2004, GF90A, GF90A-2004		

			
1			
GEV No.	511628	Ref. No.	341927
description	hinge pin ø 6mm L 60mm thread M6x1 stainless steel		
For models:	LB200, LB200-2, LB200A, LB200A-2, LB215, LB215-2, LB215A, LB215A-2, LB260, LB260-2, LB260A, LB260A-2, LB275, LB275-2, LB275A, LB275A-2, LBC210, LBC215, LBC215A, LBC275, LBC275A, LBR, LBR200, LBR215, LBR215A, LF321, LF321A, LF322, LF322A, LF322MP, LF322MP-A, LF322RCD, LF324, LF324A, LF325E, LF325EA, LF700, LF700A		

door seals

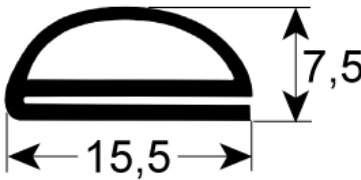
			
1			
GEV No.	511577	Ref. No.	200217
description	door seal L 595mm W 15.5mm H 7mm Qty 1 suitable for COMENDA		
For models:	LF321, LF321A, LF322, LF322A, LF322MP, LF322MP-A, LF322RCD, LF324, LF324A, LF325E, LF325EA, LF700, LF700A		

doors

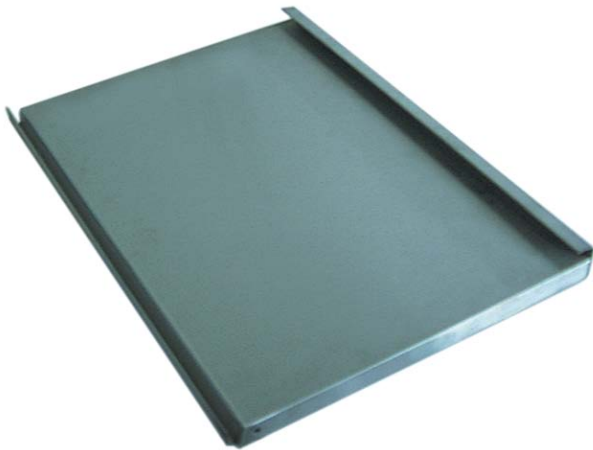

1

GEV No.	510830	Ref. No.	320984
description	door		
For models:	F45, F55, F65, F80		



1

GEV No.	510888	Ref. No.	322941
description	door for dishwasher W 570mm H 465mm		
For models:	FC, FC53, FC533, FC533A, FC53A, FC53CBT, FC53LBT, FC54, FC543, FC543A, FC543E, FC543EA, FC544, FC544A, FC54A, FC54CBT, FC54E, FC54EA, FC54LBT, FCHR, FCHRA, FCHRT, FCHRTA		

door guides



1

GEV No.	510252	Ref. No.	180630 180651/R
description	door guides L 710mm W 30mm H 16mm with brake		
For models:	AC101, AC105, AC122, AC135, AC151, AC152, AC181, AC182, AC201, AC202, AC241, AC242, AC91, AC95, ACL100, ACL150, ACRS145, ACRS205, ACRS225, ACRS245, ACRS260, ACRS265, ACRS305, ACS101, ACS101-DIGIT, ACS122, ACS122-DIGIT, ACS151, ACS151-DIGIT, ACS152, ACS152-DIGIT, ACS161-DIGIT, ACS162-DIGIT, ACS181, ACS181-DIGIT, ACS182, ACS182-DIGIT, ACS201, ACS201-DIGIT, ACS202, ACS202-DIGIT, ACS241, ACS241-DIGIT, ACS242, ACS242-DIGIT, ACS91, ACS91-DIGIT, GMC2702, GMC3502, GMC4502...(Other models you can see in the webshop)		



1

GEV No.	510223	Ref. No.	180628
description	door guides L 740mm W 30mm H 18mm		
For models:	G100L, G101L, G115L, G50L, G50LM, G51L, G60L, G61L, G65L, GL		

door bumpers



1

GEV No.	511305	Ref. No.	210402
description	door bumper		
For models:	AC105, AC120, AC135, AC150, AC170, AC200, AC95, ACR, ACR145, ACR205, ACR225, ACR245, ACR260, ACR265, ACR305, ACS101, ACS101-DIGIT, ACS122, ACS122-DIGIT, ACS151, ACS151-DIGIT, ACS152, ACS152-DIGIT, ACS161-DIGIT, ACS162-DIGIT, ACS181, ACS181-DIGIT, ACS182, ACS182-DIGIT, ACS201, ACS201-DIGIT, ACS202, ACS202-DIGIT, ACS241, ACS241-DIGIT, ACS242, ACS242-DIGIT, ACS91, ACS91-DIGIT, B10, B11, B12, B15, B16, B18, B19, B20, B20D, B23, B24...(Other models you can see in the webshop)		





1

GEV No.	510957	Ref. No.	190619
description	door bumper end stop		
For models:	B18, B18T, B18TM, B19, B19T, B19TM, B41, B42, BHC25, BHC25-2, BHC25A, BHC25A-2, BHC25S, BHC30, BHC30-2, BHC30A, BHC30A-2, BHC30E, BHC30E-2, BHC30EA, BHC30EA-2, BHC30HR, BHC30HR-2, BHC30HR380, BHC30HRA, BHC30HRA-2, BHC30HRA380, BHC433, BHC433-2, BHC433A, BHC433A-2, BHC30, F2, F20, F3, F300, F45, F55, F65, F80, F90M, F90MA, FC, FC53, FC533, FC533A, FC53A, FC53CBT, FC53LA, FC53LBT...(Other models you can see in the webshop)		



			
1			
GEV No.	511176	Ref. No.	190644
description	door bumper end stop		
For models:	BC25, BC25A, BC25HR, BC30, BC30A, BC30HR, BC30HR380, BC30HRA, BR20, BR20A, BR25, BR25A, FC43, FC43A		

			
1			
GEV No.	511699	Ref. No.	H34827
description	door bumper H 27.5mm SS		
For models:	GF90, GF90A		

			
1			
GEV No.	505306	Ref. No.	441138
description	door bumper ø 24.5mm H 44.5mm rubber for dishwasher		
For models:	GE100, GE115, GE50RCD, GE60, GE60RCD, GE65, GE65RCD, GE80		

locks

			
1			
GEV No.	511165	Ref. No.	331112 331116
description	catch hook for door		
For models:	AC100, AC101, AC105, AC120, AC122, AC135, AC150, AC151, AC152, AC170, AC181, AC182, AC200, AC201, AC202, AC241, AC242, AC2A, AC90, AC91, AC95, ACL100, ACL150, ACR, ACR145, ACR205, ACR225, ACR245, ACR260, ACR265, ACR305, ACRS145, ACRS205, ACRS225, ACRS245, ACRS260, ACRS265, ACRS305, ACS101, ACS101-DIGIT, ACS122, ACS122-DIGIT, ACS151, ACS151-DIGIT, ACS152, ACS152-DIGIT, ACS161-DIGIT, ACS162-DIGIT, ACS181, ACS181-DIGIT...(Other models you can see in the webshop)		

			
1			
GEV No.	510008	Ref. No.	180506
description	door catch for dishwasher		
For models:	BC25, BC25A, BC25HR, BC30, BC30A, BC30HR, BC30HR380, BC30HRA, BHC25, BHC25-2, BHC25A, BHC25A-2, BHC25S, BHC30, BHC30-2, BHC30A, BHC30A-2, BHC30E, BHC30E-2, BHC30EA, BHC30EA-2, BHC30HR, BHC30HR-2, BHC30HR380, BHC30HRA, BHC30HRA-2, BHC30HRA380, BHC433, BHC433-2, BHC433A, BHC433A-2, BHCHR, BR20, BR20A, BR25, BR25A, F90M, F90MA, FC, FC43, FC43A, FC53, FC533, FC533A, FC53A, FC53CBT, FC53LA, FC53LBT, FC54, FC543...(Other models you can see in the webshop)		

			
1			
GEV No.	692100	Ref. No.	180508
description	snap lock L 36mm ø 17mm		
For models:	LF321, LF321A, LF322, LF322A, LF322MP, LF322MP-A, LF322RCD, LF324, LF324A, LF325E, LF325EA, LF700, LF700A		

			
1			
GEV No.	510925	Ref. No.	381403
description	snap lock L 70mm W 22mm H 56mm mounting distance 50mm		
For models:	B10, B10T, B11, B11T, B12, B12T, B13T, B14T, B15, B15T, B15TM, B16, B16T, B16TM, B18, B18T, B18TM, B19, B19T, B19TM, B20, B20D, B23, B24, B25, B26, B27, B31, B32, B41, B42, F2, F20, F3, F300, F45, F55, F65, F80, LF280-lav-line, LF320-lav-line, R40, R50, R70		

miscellaneous

			
1			
GEV No.	511377	Ref. No.	261013
description	bearing bearing		
For models:	BHC25, BHC25-2, BHC25A, BHC25A-2, BHC25S, BHC30, BHC30-2, BHC30A, BHC30A-2, BHC30E, BHC30E-2, BHC30EA, BHC30EA-2, BHC30HR, BHC30HR-2, BHC30HR380, BHC30HRA, BHC30HRA-2, BHC30HRA380, BHC433, BHC433-2, BHC433A, BHC433A-2, BHCHR		



1

GEV No.	510938	Ref. No.	331764
description	fixing plate for door seal fixing plate		
For models:	B15TM, B16TM, B18TM, B19TM, F90M, F90MA, FC, FC53, FC533, FC533A, FC53A, FC53CBT, FC53LA, FC53LBT, FC54, FC543, FC543A, FC543E, FC543EA, FC544, FC544A, FC54A, FC54CBT, FC54E, FC54EA, FC54LBT, FCHR, FCHRA, FCHRT, FCHRTA, GE50RCD, LBR, LBR200, LF280-lav-line, LF315, LF320, LF320A, LF320CBT, LF320L, LF320LA, LF320-lav-line, LF320LBT, LF323, LF323A, LF350, LF350A, LF400A, LF450, LF450A, LS550		



1

GEV No.	511378	Ref. No.	450829
description	nut nut		
For models:	BHC25, BHC25-2, BHC25A, BHC25A-2, BHC25S, BHC30, BHC30-2, BHC30A, BHC30A-2, BHC30E, BHC30E-2, BHC30EA, BHC30EA-2, BHC30HR, BHC30HR-2, BHC30HR380, BHC30HRA, BHC30HRA-2, BHC30HRA380, BHC433, BHC433-2, BHC433A, BHC433A-2, BHCHR		



1

GEV No.	511175	Ref. No.	331461
description	plate for tie bar sliding plate		
For models:	G115, G65		



1

GEV No.	510596	Ref. No.	160552
description	roller ED ø 8.5mm ID ø 6.3mm W 6.8mm		
For models:	FC3E, FC3EA, FC3M, FC3MA, FC3MR, FC44E, FC44EA, FC4E, FC4EA, FC4EHRT, FC4M, FC4MA		



1

GEV No.	510324	Ref. No.	160533
description	spacer for handle		



1

GEV No.	524772	Ref. No.	330894
description	spacer piece for door mechanism ED ø 13mm ID ø 8.5mm H 4mm		
For models:	G100L, G101L, G115L, G50L, G50LM, G51L, G60L, G61L, G65L, GL		



1

GEV No.	524451	Ref. No.	H35202
description	threaded bush for tie bar L 12mm D1 ø 9.6mm D2 ø 7.75mm		
For models:	GF90, GF90A		

screw connections



1

GEV No.	511296	Ref. No.	180202
description	blind flange		
For models:	NE00, NE02, NE3001, NE3002, NE4001, NE4002, NE5002, NE5501, NE5502, NE7002, NE7501, NE7502, NE9001, NE9002, NE9502, NG00, NG01, NG02, NG1202, NG1202E, NG600, NG600E, NG601, NG601E, NG602, NG602E, NG900, NG900E, NG901, NG901E, NG902, NG902E		



1

GEV No.	511002	Ref. No.	330841
description	bush mounting pos. front		
For models:	B11, B12, B15, B16, B18, B19		



1

GEV No.	504349	Ref. No.	160780
description	cap H 30mm Qty 1 pcs		
For models:	NE02, NE3002, NE4002, NE5002, NE5502, NE7002, NE7502, NE9002, NE9502, NG02, NG1202, NG1202E, NG602, NG602E, NG902, NG902E, NL302, NL302E, NL402, NL402E, NL502, NL502E, NL552, NL552E		



1

GEV No.	510117	Ref. No.	160788
description	end cap thread M10x1.5 WS 23 plastic Qty 1 pcs thread L 15mm		
For models:	BHC25, BHC25-2, BHC25A, BHC25A-2, BHC25S, BHC30, BHC30-2, BHC30A, BHC30A-2, BHC30E, BHC30E-2, BHC30EA, BHC30EA-2, BHC30HR, BHC30HRA, BHC433, BHC433-2, BHC433A, BHC433A-2, C1000E, C1000ERCD, C1001M, C1300E, C1300ERCD, C1301M, FC3E, FC3EA, FC3M, FC3MA, FC3MR, FC44E, FC44EA, FC4E, FC4EA, FC4EHRT, FC4M, FC4MA, GF70, GF70A, GF90-2004, GF90A-2004, LC1200, LC1200RCD, LC412, LC700, LC700RCD, LC900, LC900RCD, LF321, LF321A...(Other models you can see in the webshop)		



1			
GEV No.	519053	Ref. No.	N/A
description	locknut thread 1/2"		

1			
GEV No.	510457	Ref. No.	180127
description	nut for stff		
For models:	B11T, B12T, B13T, B14T, B15T, B15TM, B16T, B16TM, B18TM, B19TM, LBC215, LBC215A, LBC275, LBC275A		

1			
GEV No.	511276	Ref. No.	260425
description	nut for ventilation		
For models:	BC25HR, BC30HR, BC30HR380, BC30HRA, BHC30HR, BHC30HR-2, BHC30HR380, BHC30HRA, BHC30HRA-2, BHC30HRA380, BHCHR, FC, FCHR, FCHRA, FCHRT, FCHRTA		

1			
GEV No.	511576	Ref. No.	160789
description	nut thread M10x1.5 H 5mm WS 19 plastic Qty 1 pcs		
For models:	BHC25, BHC25-2, BHC25A, BHC25A-2, BHC25S, BHC30, BHC30-2, BHC30A, BHC30A-2, BHC30E, BHC30E-2, BHC30EA, BHC30EA-2, BHC30HR, BHC30HR-2, BHC30HR380, BHC30HRA, BHC30HRA-2, BHC30HRA380, BHC433, BHC433-2, BHC433A, BHC433A-2, BHCHR, C1000E, C1000ERCD, C1001M, C1300E, C1300ERCD, C1301M, FC3E, FC3EA, FC3M, FC3MA, FC3MR, FC44E, FC44EA, FC4E, FC4EA, FC4EHRT, FC4M, FC4MA, GF70, GF70A, GF90-2004, GF90A-2004, LC1200, LC1200RCD, LC412, LC700...(Other models you can see in the webshop)		

1			
GEV No.	510809	Ref. No.	160709
description	screw connection thread 1"		
For models:	AC100, AC101, AC105, AC120, AC122, AC135, AC150, AC151, AC152, AC170, AC181, AC182, AC200, AC201, AC202, AC241, AC242, AC90, AC91, AC95, ACR, ACR145, ACR205, ACR225, ACR245, ACR260, ACR265, ACR305, ACRS145, ACRS205, ACRS225, ACRS245, ACRS260, ACRS265, ACRS305, ACS101, ACS101-DIGIT, ACS122, ACS122-DIGIT, ACS151, ACS151-DIGIT, ACS152, ACS152-DIGIT, ACS161-DIGIT, ACS162-DIGIT, ACS181, ACS181-DIGIT, ACS182, ACS182-DIGIT, ACS201...(Other models you can see in the webshop)		

curtains			
curtains			
1			
GEV No.	533005	Ref. No.	190916
description	curtain W 590mm H 480mm mounting pos. input for dishwasher		
For models:	AC135, AC150, AC170, AC181, AC182, AC200, ACS181, ACS181-DIGIT, ACS182, ACS182-DIGIT, SNL		

1			
GEV No.	533103	Ref. No.	190913 331346
description	curtain W 620mm H 250mm warewashing		
For models:	AC120, AC170, AC200, ACR, ACR145, ACR205, ACR225, ACR245, ACR260, ACR265, ACR305, ACRS145, ACRS205, ACRS225, ACRS245, ACRS260, ACRS265, ACRS305, ACS122, ACS122-DIGIT, ACS152, ACS152-DIGIT, ACS162-DIGIT, ACS181, ACS181-DIGIT, ACS182, ACS182-DIGIT, ACS202, ACS202-DIGIT, ACS242, ACS242-DIGIT, GMC, GMC2700, GMC2702, GMC3500, GMC3502, GMC4500, GMC4502, GMC5500, GMC5502, NE02, NE3001, NE3002, NE4001, NE4002, NE5002, NE5501, NE5502, NE7002, NE7501...(Other models you can see in the webshop)		

1			
GEV No.	510941	Ref. No.	190906 190910
description	curtain W 620mm H 473mm N2S		
For models:	AC100, AC101, AC105, AC120, AC122, AC135, AC150, AC151, AC152, AC170, AC181, AC182, AC200, AC201, AC202, AC241, AC242, AC2A, AC90, AC91, AC95, ACL100, ACL150, ACR, ACR145, ACR205, ACR225, ACR245, ACR260, ACR265, ACR305, ACRS145, ACRS205, ACRS225, ACRS245, ACRS260, ACRS265, ACRS305, ACS101, ACS101-DIGIT, ACS122, ACS122-DIGIT, ACS151, ACS151-DIGIT, ACS152, ACS152-DIGIT, ACS161-DIGIT, ACS162-DIGIT, ACS181, ACS181-DIGIT...(Other models you can see in the webshop)		



GEV No.	511635	Ref. No.	190930
description	curtain W 630mm H 540mm plastic W1 550mm		
For models:	NE02, NE3002, NE4002, NE5002, NE5502, NE7002, NE7502, NE9002, NE9502		

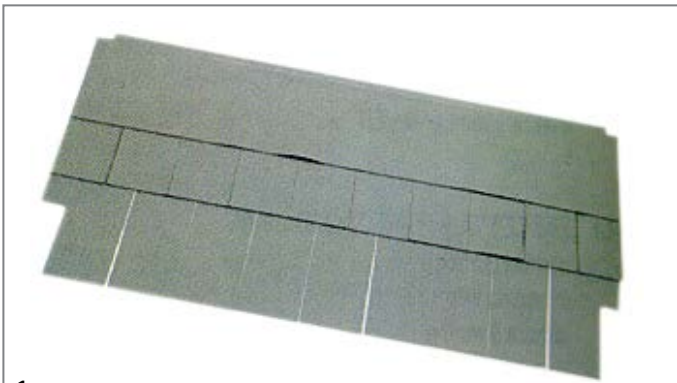

GEV No.	533102	Ref. No.	190909
description	curtain W 690mm H 420mm warewashing		
For models:	LV1001, LV1501, LV-LVP, LVP1001, LVP1501, NE00, NE3001, NE4001, NE5501, NE7501, NE9001		

curtain rods

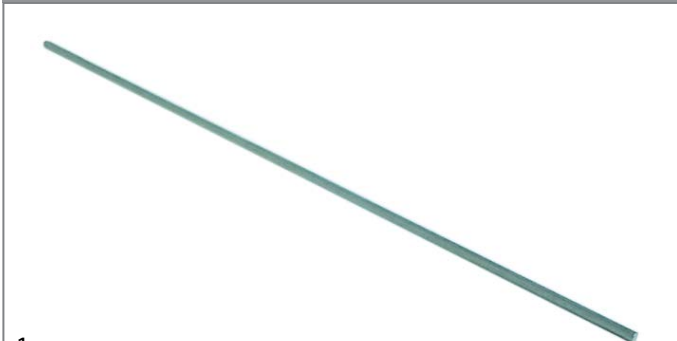

GEV No.	510936	Ref. No.	341210
description	curtain rod		
For models:	LV1001, LV1501, LV-LVP, LVP1001, LVP1501, NE00, NE02, NE3001, NE3002, NE4001, NE4002, NE5002, NE5501, NE5502, NE7002, NE7501, NE7502, NE9001, NE9002, NE9502, NG02, NG1202, NG1202E, NG602, NG602E, NG902, NG902E, NL302, NL302E, NL402, NL402E, NL502, NL502E, NL552, NL552E		



GEV No.	533175	Ref. No.	340422
description	curtain rod L 660mm ø 8mm		
For models:	AC100, AC101, AC105, AC120, AC122, AC135, AC150, AC151, AC152, AC170, AC181, AC182, AC200, AC201, AC202, AC241, AC242, AC2A, AC90, AC91, AC95, ACL100, ACL150, ACR, ACR145, ACR205, ACR225, ACR245, ACR260, ACR265, ACR305, ACRS145, ACRS205, ACRS225, ACRS245, ACRS260, ACRS265, ACRS305, ACS101, ACS101-DIGIT, ACS122, ACS122-DIGIT, ACS151, ACS151-DIGIT, ACS152, ACS152-DIGIT, ACS161-DIGIT, ACS162-DIGIT, ACS181, ACS181-DIGIT...(Other models you can see in the webshop)		

washing and rinsing systems



GEV No.	511008	Ref. No.	190647
description	bush		





GEV No.	510231	Ref. No.	190675
description	bush for rinse arm ø 23mm H 20mm		
For models:	C1001M, C1301M, LC1200, LC1200RCD, LC412, LC700, LC700RCD, LC900, LC900RCD		





GEV No.	510865	Ref. No.	190614
description	bush for wash arm		
For models:	C33, C34		





 <p>1</p>			
GEV No.	511240	Ref. No.	191076
description	bush for wash arm		
For models:	LC380, LC380BT, LC380RCD, LC400		

 <p>1</p>			
GEV No.	511355	Ref. No.	190645
description	bush for wash arm		
For models:	FC54E, FC54EA, LF315, LF320, LF320A, LF320CBT, LF320L, LF320LA, LF320LBT, LF321, LF321A, LF323, LF323A, LF350, LF350A, LP360, LP360BT, LP360RCD, LS550		

 <p>1</p>			
GEV No.	511559	Ref. No.	190669
description	bush for wash arm		
For models:	GE100, GE115, GE60, GE60RCD, GE65, GE65RCD, GE80		

 <p>1</p>			
GEV No.	513318	Ref. No.	190697
description	bush ø 32mm H 28mm thread 3/4" ID ø 15.8mm Qty 1 pcs		

 <p>1</p>			
GEV No.	512211	Ref. No.	190670 H34383
description	bushing for rinse arm		
For models:	BHC25-2, BHC25A-2, BHC30-2, BHC30A-2, BHC30E, BHC30E-2, BHC30EA, BHC30EA-2, BHC30HR-2, BHC30HRA-2, BHC433-2, BHC433A-2, GF90, GF90-2004, GF90A, GF90A-2004		

 <p>1</p>			
GEV No.	512492	Ref. No.	191092 191100
description	collector for rinsing L 60mm W 70mm connection ø 13mm suitable for COMENDA		
For models:	C1000E, C1000ERCD, C1001M, C1300E, C1300ERCD, C1301M, GE50RCD, LC1200, LC1200RCD, LC412, LC700, LC700RCD, LC900, LC900RCD, XLC		

 <p>1</p>			
GEV No.	519571	Ref. No.	180406
description	connecting fitting for wash distributor L 220mm W 120mm H 60mm ED ø 51mm hole ø 42mm thickness 4.75mm		
For models:	AC100, AC101, AC105, AC120, AC122, AC135, AC150, AC151, AC152, AC170, AC181, AC182, AC200, AC201, AC202, AC241, AC242, AC2A, AC90, AC91, AC95, ACL100, ACL150, ACR, ACR145, ACR205, ACR225, ACR245, ACR260, ACR265, ACR305, ACS145, ACS205, ACS225, ACS245, ACS260, ACS265, ACS305, ACS101, ACS101-DIGIT, ACS122, ACS122-DIGIT, ACS151, ACS151-DIGIT, ACS152, ACS152-DIGIT, ACS161-DIGIT, ACS162-DIGIT, ACS181, ACS181-DIGIT...(Other models you can see in the webshop)		
accessories for	519571		
	GEV No.	Ref. No.	200428
	 <p>gasket L 100mm W 100mm</p>		
	GEV No.	Ref. No.	450109
	 <p>hose clamp ø 50-70mm width 9mm Qty 5 pcs DIN 3017</p>		

 <p>1</p>			
GEV No.	507571	Ref. No.	180407
description	end piece for wash distributor L 170mm W 120mm H 60mm ED ø 51mm hole ø 41mm thickness 4.75mm suitable for COMENDA for ACxxx		
For models:	AC100, AC101, AC105, AC120, AC122, AC135, AC150, AC151, AC152, AC170, AC181, AC182, AC200, AC201, AC202, AC241, AC242, AC2A, AC90, AC91, AC95, ACL100, ACL150, ACR, ACR145, ACR205, ACR225, ACR245, ACR260, ACR265, ACR305, ACS145, ACS205, ACS225, ACS245, ACS260, ACS265, ACS305, ACS101, ACS101-DIGIT, ACS122, ACS122-DIGIT, ACS151, ACS151-DIGIT, ACS152, ACS152-DIGIT, ACS161-DIGIT, ACS162-DIGIT, ACS181, ACS181-DIGIT...(Other models you can see in the webshop)		
accessories for	507571		
	GEV No.	Ref. No.	200428
	 <p>gasket L 100mm W 100mm</p>		
	GEV No.	Ref. No.	450109
	 <p>hose clamp ø 50-70mm width 9mm Qty 5 pcs DIN 3017</p>		

			
1			
GEV No.	524644	Ref. No.	330940
description	flange for wash arm support ID ø 31mm ED ø 34mm L 73mm W 73mm mounting distance 53mm hole ø 5mm		
For models:	ACR, ACR145, ACR205, ACR225, ACR245, ACR260, ACR265, ACR305, GMC, GMC2700, GMC3500, GMC4500, GMC5500, LAV1000, LAV1001, LAV1501		

			
1			
GEV No.	524760	Ref. No.	180230
description	flange thread 1 1/4" for wash distributor		
For models:	ACR, ACR145, ACR205, ACR225, ACR245, ACR260, ACR265, ACR305, NE00, NE3001, NE4001, NE5501, NE7501, NE9001, NG01, NG901, NG901E		

			
1			
GEV No.	510884	Ref. No.	200463
description	gasket		
For models:	NE00, NG00, NG600, NG600E, NG900, NG900E, SE		

			
1			
GEV No.	510946	Ref. No.	200434
description	gasket		
For models:	C30, C70, C75, C75BT, C75M, C75RCD, F2, F3, F300, LP360, LP360BT, LP360RCD, R40, R50, R70		

			
1			
GEV No.	511979	Ref. No.	200448
description	gasket for inlet valve ID ø 76mm L 100mm W 100mm thickness 3mm hole distance 78mm		
For models:	G100L, G101L, G115, G115L, G125, G125L, G131, G50L, G50LM, G51L, G60L, G61L, G65, G65L, G66, G75, G75L, GE125, GE75, GL, NE02, NE3002, NE4002, NE5002, NE5502, NE7002, NE7502, NE9002, NE9502, NG02, NG1202, NG1202E, NG602, NG602E, NG902, NG902E, NL302, NL302E, NL402, NL402E, NL502, NL502E, NL552, NL552E		

			
1			
GEV No.	524793	Ref. No.	200936 200959
description	gasket for wash arm mounting pos. upper/lower ø 45mm ID ø 33mm thickness 5mm		
For models:	NE02, NE3002, NE4002, NE5002, NE5502, NE7002, NE7502, NE9002, NE9502, NG02, NG1202, NG1202E, NG602, NG602E, NG902, NG902E		

			
1			
GEV No.	505399	Ref. No.	200977
description	gasket for wash arm ø 21mm ID ø 12mm thickness 5mm		

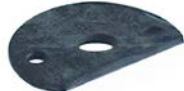
			
1			
GEV No.	510740	Ref. No.	200458
description	gasket for wash arm ø 44mm ID ø 11mm thickness 2mm rubber with flattening		
For models:	B20, B20D, B24, B25, B26, B27		

			
1			
GEV No.	510949	Ref. No.	200483
description	gasket for wash arm support		
For models:	C85		

			
1			
GEV No.	511579	Ref. No.	200955
description	gasket for wash arm support ID ø 36mm thickness 3mm		
For models:	C1000E, C1000ERCD, C1001M, C1300E, C1300ERCD, C1301M, GE50RCD, LC1200, LC1200RCD, LC412, LC700, LC700RCD, LC900, LC900RCD, XLC		





			
1			
GEV No.	504344	Ref. No.	200468
description	gasket for wash arm support ID ø 49mm L 70mm W 70mm thickness 3.5mm		
For models:	ACR, ACR145, ACR205, ACR225, ACR245, ACR260, ACR265, ACR305, GMC, GMC2700, GMC3500, GMC4500, GMC5500, LAV1000, LAV1001, LAV1501, LV1001, LV1501, LV-LVP, LVP1001, LVP1501, NE00, NE3001, NE4001, NE5501, NE7501, NE9001, NG01, NG601, NG601E, NG901, NG901E		

			
2			
GEV No.	511977	Ref. No.	200937
description	gasket for wash arm support ID ø 50mm L 100mm W 78mm thickness 3mm		
For models:	NE02, NE3002, NE4002, NE5002, NE5502, NE7002, NE7502, NE9002, NE9502, NG02, NG1202, NG1202E, NG602, NG602E, NG902, NG902E, NL302, NL302E, NL402, NL402E, NL502, NL502E, NL552, NL552E		

			
1			
GEV No.	510956	Ref. No.	200435
description	gasket for wash pipe ø 40mm		
For models:	C30, C70, C75, C75BT, C75M, C75RCD, F2, F3, F300, LP360, LP360BT, LP360RCD, R40, R70		

			
1			
GEV No.	511978	Ref. No.	200405
description	gasket ID ø 63mm L 100mm W 100mm thickness 3mm		
For models:	AC120, AC150, AC170, AC200, G100L, G101L, G115L, G125, G125L, G50L, G50LM, G51L, G60L, G61L, G65L, G75, G75L, GE125, GE75, GL, LV1001, LV1501, LV-LVP, LVP1001, LVP1501, NE00, NE02, NE3001, NE3002, NE4001, NE4002, NE5002, NE5501, NE5502, NE7002, NE7501, NE7502, NE9001, NE9002, NE9502, NG00, NG01, NG02, NG1202, NG1202E, NG600, NG600E, NG601, NG601E, NG900...(Other models you can see in the webshop)		

			
1			
GEV No.	519462	Ref. No.	200428
description	gasket L 100mm W 100mm		
For models:	AC100, AC101, AC105, AC120, AC122, AC135, AC150, AC151, AC152, AC170, AC181, AC182, AC200, AC201, AC202, AC241, AC242, AC2A, AC90, AC91, AC95, ACL100, ACL150, ACR, ACR145, ACR205, ACR225, ACR245, ACR260, ACR265, ACR305, ACRS145, ACRS205, ACRS225, ACRS245, ACRS260, ACRS265, ACRS305, ACS101, ACS101-DIGIT, ACS122, ACS122-DIGIT, ACS151, ACS151-DIGIT, ACS152, ACS152-DIGIT, ACS161-DIGIT, ACS162-DIGIT, ACS181, ACS181-DIGIT...(Other models you can see in the webshop)		

			
1			
GEV No.	511815	Ref. No.	200928
description	gasket thickness 3.3mm rubber suitable for COMENDA L 55mm W 30mm hole ø 12/7mm hole distance 40mm		
For models:	NE3001, NE4001, NE5501, NE7501, NE9001		



			
1			
GEV No.	511157	Ref. No.	330937
description	holding plate for wash arm		
For models:	ACR, ACR145, ACR205, ACR225, ACR245, ACR260, ACR265, ACR305, GMC, GMC2700, GMC3500, GMC4500, GMC5500, LAV1000, LAV1001, LAV1501, NE3001, NE4001, NE5501, NE7501, NE9001, NG01, NG601, NG601E, NG901, NG901E		

			
1			
GEV No.	530539	Ref. No.	280522
description	hose connector for rinse pipe		
For models:	C155, C155BT, C155E2, C155RCD, C165, C165E2, C165E2BT, C165E2RCD, C166, C166-2, C95, C95BT, C95E2, C95RCD		

			
1			
GEV No.	512387	Ref. No.	190327
description	hose connector for wash pipe		
For models:	C155, C155BT, C155E2, C155RCD, C165, C165E2, C165E2BT, C165E2RCD, C166, C166-2, C95, C95BT, C95E2, C95RCD		

			
1			
GEV No.	512212	Ref. No.	H34998
description	knurled nut thread M10x1.5 ø 30mm H 6.4mm SS		
For models:	GF90, GF90-2004, GF90A, GF90A-2004		



			
1			
GEV No.	510374	Ref. No.	270118
description	nut thread M15x1.25 H 6.5mm WS 27 SS Qty 1 pcs		
For models:	C155, C155BT, C155E2, C155RCD, C165, C165E2, C165E2BT, C165E2RCD, C166, C166-2, C30, C70, C75, C75BT, C75M, C75RCD, C95, C95BT, C95E2, C95RCD, LC380, LC380BT, LC380RCD, LC400, LP360, LP360BT, LP360RCD		

			
1			
GEV No.	518085	Ref. No.	180232 330934
description	opposite support for wash arm mounting pos. upper/lower L 102mm W 102mm		
For models:	AC100, AC101, AC105, AC120, AC122, AC135, AC150, AC151, AC152, AC170, AC181, AC182, AC200, AC201, AC202, AC241, AC242, AC2A, AC90, AC91, AC95, ACL100, ACL150, ACR, ACR145, ACR205, ACR225, ACR245, ACR260, ACR265, ACR305, ACRS145, ACRS205, ACRS225, ACRS245, ACRS260, ACRS265, ACRS305, ACS101, ACS101-DIGIT, ACS122, ACS122-DIGIT, ACS151, ACS151-DIGIT, ACS152, ACS152-DIGIT, ACS161-DIGIT, ACS162-DIGIT, ACS181, ACS181-DIGIT...(Other models you can see in the webshop)		
accessories for	518085		
	GEV No.	510899	Ref. No. 200830
	O-ring EPDM thickness 3.53mm ID ø 37.69mm Qty 1 pcs		
	GEV No.	519462	Ref. No. 200428
	gasket L 100mm W 100mm		

			
1			
GEV No.	505315	Ref. No.	190231
description	opposite support mounting pos. upper		
For models:	FC3E, FC3EA, FC3M, FC3MA, FC3MR, FC44E, FC44EA, FC4E, FC4EA, FC4EHR, FC4M, FC4MA		

			
1			
GEV No.	510801	Ref. No.	160113
description	pipe ID ø 8mm ø 12mm plastic supplied by meter		
For models:	AC101, AC120, AC122, AC150, AC151, AC152, AC170, AC181, AC182, AC200, AC201, AC202, AC241, AC242, AC91, ACR, ACR145, ACR205, ACR225, ACR245, ACR260, ACR265, ACR305, ACRS145, ACRS205, ACRS225, ACRS245, ACRS260, ACRS265, ACRS305, ACS101, ACS101-DIGIT, ACS122, ACS122-DIGIT, ACS151, ACS151-DIGIT, ACS152, ACS152-DIGIT, ACS161-DIGIT, ACS162-DIGIT, ACS181, ACS181-DIGIT, ACS182, ACS182-DIGIT, ACS201, ACS201-DIGIT, ACS202, ACS202-DIGIT, ACS241, ACS241-DIGIT...(Other models you can see in the webshop)		

			
1			
GEV No.	511668	Ref. No.	190674
description	reducer for wash pipe ø 18mm		
For models:	C1001M, C1301M, LC1200, LC1200RCD, LC412, LC700, LC700RCD, LC900, LC900RCD		

			
1			
GEV No.	510481	Ref. No.	190315
description	rinse arm support		
For models:	C140, C155, C155BT, C155E2, C155RCD, C165, C165E2, C165E2BT, C165E2RCD, C166, C166-2, C30, C70, C75, C75BT, C75M, C75RCD, C85, C95, C95BT, C95E2, C95RCD, LC380, LC380BT, LC380RCD, LC400, LP360, LP360BT, LP360RCD		
accessories for	510481		
	GEV No.	511180	Ref. No. 200457
	flat gasket rubber ED ø 24mm ID ø 16mm thickness 3mm Qty 1 pcs		
	GEV No.	511182	Ref. No. 270107
	nut thread 3/8" H 8mm brass WS 24 Qty 1 pcs		

			
1			
GEV No.	511255	Ref. No.	280529
description	rinse arm support mounting pos. upper H 31mm thread 3/8" L 51mm WS 26 hose ø 12mm		
For models:	LBC210, LBC215, LBC215A, LBC275, LBC275A		

			
1			
GEV No.	510333	Ref. No.	380325
description	rinse jet		

			
1			
GEV No.	510256	Ref. No.	332526
description	rinse pipe mounting pos. upper ø 8mm L 300mm SS		
For models:	C1000E, C1000ERCD, C1001M, C1300E, C1300ERCD, C1301M, GE50RCD, LC1200, LC1200RCD, LC412, LC700, LC700RCD, LC900, LC900RCD, XLC		

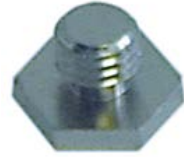
			
1			
GEV No.	511185	Ref. No.	261005
description	screw for wash arm support mounting pos. upper		
For models:	AC101, AC122, AC151, AC152, AC181, AC182, AC201, AC202, AC241, AC242, AC91, ACR, ACR145, ACR205, ACR225, ACR245, ACR260, ACR265, ACR305, ACRS145, ACRS205, ACRS225, ACRS245, ACRS260, ACRS265, ACRS305, B41, C30, C70, C75, C75BT, C75M, C75RCD, C85, F20, F90M, F90MA, FC, FC53, FC533, FC533A, FC53A, FC53CBT, FC53LA, FC53LBT, FC54, FC543, FC543A, FC543E, FC543EA...(Other models you can see in the webshop)		





			
1			
GEV No.	524585	Ref. No.	330218
description	tie bar for wash arm support thread M4 L 69mm		
For models:	NE00, NG00, NG600, NG600E, NG900, NG900E, SE		

			
1			
GEV No.	524672	Ref. No.	330225
description	tie bar for wash arm support thread M4 L 84mm		
For models:	ACR, ACR145, ACR205, ACR225, ACR245, ACR260, ACR265, ACR305, GMC, GMC2700, GMC3500, GMC4500, GMC5500, LAV1000, LAV1001, LAV1501, NE3001, NE4001, NE5501, NE7501, NE9001		

			
1			
GEV No.	510229	Ref. No.	180420
description	T-piece dosing pump ø 28mm L 70mm		
For models:	C1000ERCD, C1300ERCD, FC3M, FC3MR, FC4M, GE50RCD, GE60RCD, GE65RCD, LC1200RCD, LC700RCD, LC900RCD, XLC		

			
1			
GEV No.	510338	Ref. No.	170701
description	union nut dosing pump thread 1/2" ø 32mm H 15mm for dosing pump		
For models:	B10T, B11T, B12T, B13T, B14T, B15T, B15TM, B16T, B16TM, B18T, B18TM, B19T, B19TM, BC25, BC25A, BC25HR, BC30, BC30A, BC30HR, BC30HR380, BC30HRA, BHC25, BHC25-2, BHC25A, BHC25A-2, BHC25S, BHC30, BHC30-2, BHC30A, BHC30A-2, BHC30E, BHC30E-2, BHC30EA, BHC30EA-2, BHC30HR, BHC30HR-2, BHC30HR380, BHC30HRA, BHC30HRA-2, BHC30HRA380, BHC433, BHC433-2, BHC433A, BHC433A-2, BHCHR, BR20, BR20A, BR25, BR25A, C1000E...(Other models you can see in the webshop)		





			
1			
GEV No.	510485	Ref. No.	180123
description	union nut for rinse arm thread 5/8"		
For models:	C140, C155, C155BT, C155E2, C155RCD, C165, C165E2, C165E2BT, C165E2RCD, C166, C166-2, C30, C70, C75, C75BT, C75M, C75RCD, C85, C95, C95BT, C95E2, C95RCD, LC380, LC380BT, LC380RCD, LC400, LP360, LP360BT, LP360RCD		







			
1			
GEV No.	510468	Ref. No.	420307
description	wash pipe		
For models:	F2, F3, F300		



			
1			
GEV No.	511262	Ref. No.	420310/C
description	wash pipe		

washing and rinsing systems (sorted by producer)

COMENDA

			
1			
GEV No.	510746	Ref. No.	430326
description	rinse arm L 405mm mounting pos. upper nozzles 4 mounting ø 12/45mm complete		
For models:	LBC210, LBC215, LBC215A, LBC275, LBC275A		
spare parts for	510746		
	GEV No.	510323	Ref. No. 160734
	end cap for rinse arm		
	GEV No.	510327	Ref. No. 170946
	nozzle for rinse arm		
	GEV No.	510902	Ref. No. 200844
	O-ring EPDM thickness 2mm ID ø 9.5mm Qty 1 pcs		
	GEV No.	528583	Ref. No. 200845 200864
	O-ring EPDM thickness 2.62mm ID ø 9.13mm Qty 1 pcs		

			
1			
GEV No.	510741	Ref. No.	420533
description	wash and rinse arm mounting pos. upper 2 wash arms/ 2 rinse arms		
For models:	B15TM, B16TM, B18TM, B19TM, LBC215, LBC215A, LBC275, LBC275A		
spare parts for	510741		
	GEV No.	510307	Ref. No. 261004 261009
	Thumb screw thread M6 H 3mm thread L 8mm ø 28mm SS		
	GEV No.	510321	Ref. No. 160736
	end cap for wash arm		
	GEV No.	510322	Ref. No. 200812
	O-ring EPDM thickness 1.78mm ID ø 17.17mm Qty 1 pcs		
	GEV No.	510323	Ref. No. 160734
	end cap for rinse arm		
	GEV No.	510325	Ref. No. 170947 170956
	nozzle for wash arm		
	GEV No.	510327	Ref. No. 170946
	nozzle for rinse arm		
	GEV No.	510329	Ref. No. 190624 190649
	bush H 13.5mm D1 ø 20mm D2 ø 16mm D3 ø 12mm for wash arm		
	GEV No.	510901	Ref. No. 200843
	O-ring EPDM thickness 2mm ID ø 13mm Qty 1 pcs		
	GEV No.	510902	Ref. No. 200844
	O-ring EPDM thickness 2mm ID ø 9.5mm Qty 1 pcs		
	GEV No.	528583	Ref. No. 200845 200864
	O-ring EPDM thickness 2.62mm ID ø 9.13mm Qty 1 pcs		

			
1			
GEV No.	512264	Ref. No.	420531
description	wash and rinse arm wash arm L 410mm rinse arm L 410mm mounting pos. lower w. jets 6 r. jets 4 mounting ø 12/45mm 2 wash arms/ 2 rinse arms		
For models:	B13T, B14T, B15T, B15TM, B16T, B16TM, B18T, B18TM, B19T, B19TM, BC25, BC25A, BC30, BC30A, BHC25, BHC25A, BHC30, BHC30A, BHC30HR, BHC30HR380, BHC30HRA, BHC30HRA380, BHC433, BHC433A, BHCHR, F20, FC43, FC43A, LB200, LB200-2, LB200A, LB200A-2, LB215, LB215-2, LB215A, LB215A-2, LB260, LB260-2, LB260A, LB260A-2, LB275, LB275-2, LB275A, LB275A-2, LBC210, LBC215, LBC215A, LBC275, LBC275A		
spare parts for	512264		
	GEV No.	510307	Ref. No. 261004 261009
	Thumb screw thread M6 H 3mm thread L 8mm ø 28mm SS		

spare parts for	512264		
	GEV No.	510321	Ref. No. 160736
	end cap for wash arm		
	GEV No.	510322	Ref. No. 200812
	O-ring EPDM thickness 1.78mm ID ø 17.17mm Qty 1 pcs		
	GEV No.	510323	Ref. No. 160734
	end cap for rinse arm		
	GEV No.	510325	Ref. No. 170947 170956
	nozzle for wash arm		
	GEV No.	510327	Ref. No. 170946
	nozzle for rinse arm		
	GEV No.	510329	Ref. No. 190624 190649
	bush H 13.5mm D1 ø 20mm D2 ø 16mm D3 ø 12mm for wash arm		
	GEV No.	510901	Ref. No. 200843
	O-ring EPDM thickness 2mm ID ø 13mm Qty 1 pcs		
	GEV No.	510902	Ref. No. 200844
	O-ring EPDM thickness 2mm ID ø 9.5mm Qty 1 pcs		
	GEV No.	512265	Ref. No. 140106
	connector holder		
	GEV No.	528583	Ref. No. 200845 200864
	O-ring EPDM thickness 2.62mm ID ø 9.13mm Qty 1 pcs		





			
1			
GEV No.	512385	Ref. No.	420551
description	wash and rinse arm wash arm L 410mm rinse arm L 410mm mounting pos. upper w. jets 6 r. jets 4 mounting ø 12/45mm		
For models:	BC25, BC25A, BC30, BC30A, BHC25, BHC25A, BHC30, BHC30A, BHC30HR, BHC30HR380, BHC30HRA, BHC30HRA380, BHC433, BHC433A, BHCHR, FC43, FC43A, LB200, LB200-2, LB200A, LB200A-2, LB215, LB215-2, LB215A, LB215A-2, LB260, LB260-2, LB260A, LB260A-2, LB275, LB275-2, LB275A, LB275A-2, LBC210, LBC215, LBC215A, LBC275, LBC275A		
spare parts for	512385		
	GEV No.	510307	Ref. No. 261004 261009
	Thumb screw thread M6 H 3mm thread L 8mm ø 28mm SS		
	GEV No.	510322	Ref. No. 200812
	O-ring EPDM thickness 1.78mm ID ø 17.17mm Qty 1 pcs		
	GEV No.	510323	Ref. No. 160734
	end cap for rinse arm		

Table continues overleaf



spare parts for 512385				
	GEV No.	510325	Ref. No.	170947 170956
nozzle for wash arm				
	GEV No.	510327	Ref. No.	170946
nozzle for rinse arm				
	GEV No.	510329	Ref. No.	190624 190649
bush H 13.5mm D1 ø 20mm D2 ø 16mm D3 ø 12mm for wash arm				
	GEV No.	510901	Ref. No.	200843
O-ring EPDM thickness 2mm ID ø 13mm Qty 1 pcs				
	GEV No.	510902	Ref. No.	200844
O-ring EPDM thickness 2mm ID ø 9.5mm Qty 1 pcs				
	GEV No.	512265	Ref. No.	140106
connector holder				
	GEV No.	528583	Ref. No.	200845 200864
O-ring EPDM thickness 2.62mm ID ø 9.13mm Qty 1 pcs				







GEV No.	510275	Ref. No.	420515 420526
----------------	--------	-----------------	------------------

description wash and rinse arm wash arm L 505mm rinse arm L 505mm mounting pos. upper/lower w. jets 8 r. jets 5 mounting ø 12/45mm

For models: C30, C33, C34, C70, C75, C75BT, C75RCD, C85, F2, F3, F300, F45, F55, F65, F80, LF280-lav-line, LF315, LF320, LF320A, LF320CBT, LF320L, LF320LA, LF320-lav-line, LF320LBT, LF321, LF321A, LF323, LF323A, LF350, LF350A, LP360, LP360BT, LP360RCD, LS550

spare parts for 510275				
	GEV No.	510307	Ref. No.	261004 261009
Thumb screw thread M6 H 3mm thread L 8mm ø 28mm SS				
	GEV No.	510321	Ref. No.	160736
end cap for wash arm				
	GEV No.	510322	Ref. No.	200812
O-ring EPDM thickness 1.78mm ID ø 17.17mm Qty 1 pcs				
	GEV No.	510323	Ref. No.	160734
end cap for rinse arm				
	GEV No.	510325	Ref. No.	170947 170956
nozzle for wash arm				
	GEV No.	510327	Ref. No.	170946
nozzle for rinse arm				
	GEV No.	510329	Ref. No.	190624 190649
bush H 13.5mm D1 ø 20mm D2 ø 16mm D3 ø 12mm for wash arm				



spare parts for 510275				
	GEV No.	510902	Ref. No.	200844
O-ring EPDM thickness 2mm ID ø 9.5mm Qty 1 pcs				
	GEV No.	512265	Ref. No.	140106
connector holder				
	GEV No.	528583	Ref. No.	200845 200864
O-ring EPDM thickness 2.62mm ID ø 9.13mm Qty 1 pcs				

	1	GEV No.	510329	Ref. No.	190624 190649
description bush H 13.5mm D1 ø 20mm D2 ø 16mm D3 ø 12mm for wash arm					
For models: B13T, B14T, B15T, B15TM, B16T, B16TM, B18T, B18TM, B19T, B19TM, BC25, BC25A, BC30, BC30A, BHC25, BHC25A, BHC30, BHC30A, BHC30HR, BHC30HR380, BHC30HRA, BHC30HRA380, BHC433, BHC433A, BHCHR, F20, F45, F55, F65, F80, FC43, FC43A, FC54E, FC54EA, LB200, LB200-2, LB200A, LB200A-2, LB215, LB215-2, LB215A, LB215A-2, LB260, LB260-2, LB260A, LB260A-2, LB275, LB275-2, LB275A, LB275A-2...(Other models you can see in the webshop)					

	1	GEV No.	512265	Ref. No.	140106
description connector holder					
For models: B13T, B14T, B15T, B15TM, B16T, B16TM, B18T, B18TM, B19T, B19TM, C140, C70, C75, C75BT, C75RCD, C85, F20, F45, F55, F65, F80, LBC215, LBC215A, LBC275, LBC275A, LC380, LF280-lav-line, LF320-lav-line, LP360					

	1	GEV No.	510323	Ref. No.	160734
description end cap for rinse arm					
For models: B10T, B11T, B12T, B13T, B14T, B15T, B15TM, B16T, B16TM, B18T, B18TM, B19T, B19TM, BC25, BC25A, BC30, BC30A, BHC25, BHC25A, BHC30, BHC30A, BHC30HR, BHC30HR380, BHC30HRA, BHC30HRA380, BHC433, BHC433A, BHCHR, BR20, BR20A, BR25, BR25A, F20, F45, F55, F65, F80, FC43, FC43A, FC54E, FC54EA, LB200, LB200-2, LB200A, LB200A-2, LB215, LB215-2, LB215A, LB215A-2, LB260...(Other models you can see in the webshop)					

	1	GEV No.	510321	Ref. No.	160736
description end cap for wash arm					
For models: B13T, B14T, B15T, B15TM, B16T, B16TM, B18T, B18TM, B19T, B19TM, BC25, BC25A, BC30, BC30A, BHC25, BHC25A, BHC30, BHC30A, BHC30HR, BHC30HR380, BHC30HRA, BHC30HRA380, BHC433, BHC433A, BHCHR, F20, F45, F55, F65, F80, FC43, FC43A, FC54E, FC54EA, LB200, LB200-2, LB200A, LB200A-2, LB215, LB215-2, LB215A, LB215A-2, LB260, LB260-2, LB260A, LB260A-2, LB275, LB275-2, LB275A, LB275A-2...(Other models you can see in the webshop)					

1					
GEV No.	510327	Ref. No.	170946		
description	nozzle for rinse arm				
For models:	B10T, B11T, B12T, B13T, B14T, B15T, B15TM, B16T, B16TM, B18T, B18TM, B19T, B19TM, BC25, BC25A, BC30, BC30A, BHC25, BHC25A, BHC30, BHC30A, BHC30HR, BHC30HR380, BHC30HRA, BHC30HRA380, BHC433, BHC433A, BHCHR, BR20, BR20A, BR25, BR25A, F20, F45, F55, F65, F80, FC43, FC43A, FC54E, FC54EA, LB200, LB200-2, LB200A, LB200A-2, LB215, LB215-2, LB215A, LB215A-2, LB260...(Other models you can see in the webshop)				
accessories for	510327				
		GEV No.	510902	Ref. No.	200844
	O-ring EPDM thickness 2mm ID ø 9.5mm Qty 1 pcs				

1			
GEV No.	510325	Ref. No.	170947 170956
description	nozzle for wash arm		
For models:	B13T, B14T, B15T, B15TM, B16T, B16TM, B18T, B18TM, B19T, B19TM, BC25, BC25A, BC30, BC30A, BHC25, BHC25A, BHC30, BHC30A, BHC30HR, BHC30HR380, BHC30HRA, BHC30HRA380, BHC433, BHC433A, BHCHR, F20, F45, F55, F65, F80, FC43, FC43A, FC54E, FC54EA, LB200, LB200-2, LB200A, LB200A-2, LB215, LB215-2, LB215A, LB215A-2, LB260, LB260-2, LB260A, LB260A-2, LB275, LB275-2, LB275A, LB275A-2...(Other models you can see in the webshop)		

1			
GEV No.	510322	Ref. No.	200812
description	O-ring EPDM thickness 1.78mm ID ø 17.17mm Qty 1 pcs		
For models:	B13T, B14T, B15T, B15TM, B16T, B16TM, B18T, B18TM, B19T, B19TM, BC25, BC25A, BC30, BC30A, BHC25, BHC25A, BHC30, BHC30A, BHC30HR, BHC30HR380, BHC30HRA, BHC30HRA380, BHC433, BHC433A, BHCHR, F20, F45, F55, F65, F80, FC43, FC43A, FC54E, FC54EA, LB200, LB200-2, LB200A, LB200A-2, LB215, LB215-2, LB215A, LB215A-2, LB260, LB260-2, LB260A, LB260A-2, LB275, LB275-2, LB275A, LB275A-2...(Other models you can see in the webshop)		

1			
GEV No.	528583	Ref. No.	200845 200864
description	O-ring EPDM thickness 2.62mm ID ø 9.13mm Qty 1 pcs		
For models:	B10T, B11T, B12T, B13T, B14T, B15T, B15TM, B16T, B16TM, B18T, B18TM, B19T, B19TM, BC25, BC25A, BC30, BC30A, BHC25, BHC25A, BHC30, BHC30A, BHC30HR, BHC30HR380, BHC30HRA, BHC30HRA380, BHC433, BHC433A, BHCHR, BR20, BR20A, BR25, BR25A, C75, C75BT, C75RCD, F20, F45, F55, F65, F80, FC, FC43, FC43A, FC53, FC533, FC533A, FC53A, FC53CBT, FC53LA, FC53LBT...(Other models you can see in the webshop)		

1			
GEV No.	510901	Ref. No.	200843
description	O-ring EPDM thickness 2mm ID ø 13mm Qty 1 pcs		
For models:	B13T, B14T, B15T, B15TM, B16T, B16TM, B18T, B18TM, B19T, B19TM, BC25, BC25A, BC30, BC30A, BHC25, BHC25A, BHC30, BHC30A, BHC30HR, BHC30HR380, BHC30HRA, BHC30HRA380, BHC433, BHC433A, BHCHR, F20, F45, F55, F65, F80, FC43, FC43A, FC54E, FC54EA, LB200, LB200-2, LB200A, LB200A-2, LB215, LB215-2, LB215A, LB215A-2, LB260, LB260-2, LB260A, LB260A-2, LB275, LB275-2, LB275A, LB275A-2...(Other models you can see in the webshop)		

1			
GEV No.	510902	Ref. No.	200844
description	O-ring EPDM thickness 2mm ID ø 9.5mm Qty 1 pcs		
For models:	B10T, B11T, B12T, B13T, B14T, B15T, B15TM, B16T, B16TM, B18T, B18TM, B19T, B19TM, BC25, BC25A, BC30, BC30A, BHC25, BHC25A, BHC30, BHC30A, BHC30HR, BHC30HR380, BHC30HRA, BHC30HRA380, BHC433, BHC433A, BHCHR, BR20, BR20A, BR25, BR25A, F20, F45, F55, F65, F80, FC43, FC43A, FC54E, FC54EA, GF90-2004, GF90A-2004, LB200, LB200-2, LB200A, LB200A-2, LB215, LB215-2, LB215A...(Other models you can see in the webshop)		

1			
GEV No.	510307	Ref. No.	261004 261009
description	Thumb screw thread M6 H 3mm thread L 8mm ø 28mm SS		
For models:	B13T, B14T, B15T, B15TM, B16, B16T, B16TM, B18T, B18TM, B19, B19T, B19TM, B41, B42, BC25, BC25A, BC25HR, BC30, BC30A, BC30HR, BC30HR380, BC30HRA, BHC25, BHC25A, BHC25S, BHC30, BHC30A, BHC30HR, BHC30HR380, BHC30HRA, BHC30HRA380, BHC433, BHC433A, BHCHR, C1000E, C1000ERCD, C1001M, C1300E, C1300ERCD, C1301M, C140, C155, C155BT, C155E2, C155RCD, C165, C165E2, C165E2BT, C165E2RCD, C166...(Other models you can see in the webshop)		

1			
GEV No.	510279	Ref. No.	170622
description	rinse arm		
For models:	B20, B20D, B24, B25, B26, B27		

1			
GEV No.	510743	Ref. No.	331344
description	rinse arm L 270mm mounting pos. lower nozzles 6 complete with nozzle H 390mm		
For models:	B23, B24, B25, B26, B27		



			
1			
GEV No.	510272	Ref. No.	430308
description	rinse arm L 500mm mounting pos. upper/lower nozzles 6 mounting ø 12mm		
For models:	C140, C33, C34, LC380, LC380BT, LC380RCD, LC400		
spare parts for	510272		
	GEV No.	508122	Ref. No. 160718
end cap			
	GEV No.	510303	Ref. No. 200818
O-ring EPDM thickness 1.78mm ID ø 6.75mm Qty 1 pcs			
	GEV No.	510307	Ref. No. 261004 261009
Thumb screw thread M6 H 3mm thread L 8mm ø 28mm SS			
	GEV No.	510309	Ref. No. 170911
nozzle for rinse arm mounting pos. right/left			
	GEV No.	510310	Ref. No. 170704
opposite support for rinse jet			
	GEV No.	510313	Ref. No. 190617
bush H 12mm D1 ø 20mm D2 ø 16mm D3 ø 12mm for wash arm boss			
	GEV No.	510315	Ref. No. 170929
nozzle for rinse arm mounting pos. centre/inside			
	GEV No.	510317	Ref. No. 170930
blank nozzle mounting pos. centre for rinse arm			
	GEV No.	510872	Ref. No. 191030
rinse arm boss			
	GEV No.	560052	Ref. No. 260223
side bolts thread M5 L 10mm SS Qty 20 pcs intake slotted head ø 12.5mm			
	GEV No.	560140	Ref. No. 260402 260418
hexagonal nut thread M4 H 4.8mm SS WS 7 Qty 20 pcs DIN/ISO DIN 985 self-locking			
	GEV No.	560454	Ref. No. 260206
flat-headed bolt thread M4 thread L 22mm SS DIN 84/ISO 1207 Qty 1 pcs intake slotted head ø 7mm head thickness 2.5mm			

			
1			
GEV No.	512209	Ref. No.	H35404
description	rinse arm L 530mm mounting pos. upper/lower nozzles 6 mounting ø 16mm		
For models:	GF90, GF90A		
spare parts for	512209		
	GEV No.	510303	Ref. No. 200818
O-ring EPDM thickness 1.78mm ID ø 6.75mm Qty 1 pcs			
	GEV No.	510309	Ref. No. 170911
nozzle for rinse arm mounting pos. right/left			
	GEV No.	510310	Ref. No. 170704
opposite support for rinse jet			
	GEV No.	511004	Ref. No. 260226
flat-headed bolt thread M4 thread L 12mm SS DIN 84/ISO 1207 Qty 1 pcs intake slotted L 14.5mm			
	GEV No.	512210	Ref. No. H34997
rinse arm shaft			
	GEV No.	512211	Ref. No. 190670 H34383
bushing for rinse arm			
	GEV No.	512212	Ref. No. H34998
knurled nut thread M10x1.5 ø 30mm H 6.4mm SS			
	GEV No.	560140	Ref. No. 260402 260418
hexagonal nut thread M4 H 4.8mm SS WS 7 Qty 20 pcs DIN/ISO DIN 985 self-locking			

			
1			
GEV No.	510739	Ref. No.	170621
description	rinse arm mounting pos. upper		
For models:	B20, B20D, B24, B25, B26, B27		



			
1			
GEV No.	510260	Ref. No.	420515
description	wash and rinse arm 2 wash arms/ 2 rinse arms		
spare parts for	510260		
	GEV No.	508122	Ref. No. 160718
end cap			

Table continues overleaf

spare parts for		510260		
	GEV No.	510300	Ref. No.	160719
	end cap for wash arm			
	GEV No.	510302	Ref. No.	200824
	O-ring EPDM ID ø 12.42mm thickness 1.78mm Qty 1 pcs			
	GEV No.	510303	Ref. No.	200818
	O-ring EPDM thickness 1.78mm ID ø 6.75mm Qty 1 pcs			
	GEV No.	510304	Ref. No.	170915
	nozzle for wash arm mounting pos. right			
	GEV No.	510305	Ref. No.	180213
	opposite support for wash jet			
	GEV No.	510306	Ref. No.	170916
	nozzle for wash arm mounting pos. left			
	GEV No.	510307	Ref. No.	261004 261009
	Thumb screw thread M6 H 3mm thread L 8mm ø 28mm SS			
	GEV No.	510309	Ref. No.	170911
	nozzle for rinse arm mounting pos. right/left			
	GEV No.	510310	Ref. No.	170704
	opposite support for rinse jet			
	GEV No.	510313	Ref. No.	190617
	bush H 12mm D1 ø 20mm D2 ø 16mm D3 ø 12mm for wash arm boss			
	GEV No.	510314	Ref. No.	170927
	nozzle for wash arm mounting pos. centre/inside			
	GEV No.	510317	Ref. No.	170930
	blank nozzle mounting pos. centre for rinse arm			
	GEV No.	510871	Ref. No.	191022
	wash arm boss			
	GEV No.	511004	Ref. No.	260226
	flat-headed bolt thread M4 thread L 12mm SS DIN 84/ISO 1207 Qty 1 pcs intake slotted L 14.5mm			
	GEV No.	512265	Ref. No.	140106
	connector holder			
	GEV No.	560140	Ref. No.	260402 260418
	hexagonal nut thread M4 H 4.8mm SS WS 7 Qty 20 pcs DIN/ISO DIN 985 self-locking			

			
1			
GEV No.	510270	Ref. No.	420510
description	wash and rinse arm L 505mm 2 wash arms/ 2 rinse arms		
For models:	C30, F2, F3, F300		











				
1				
GEV No.	510261	Ref. No.	420516	
description	wash and rinse arm wash arm L 410mm rinse arm L 410mm mounting pos. lower w. jets 6 r. jets 4 mounting ø 12/45mm nozzle type A			
For models:	B13T, B14T, B15T, B15TM, B16, B16T, B16TM, B18T, B18TM, B19, B19T, B19TM, B41, B42, F20			
spare parts for		510261		
	GEV No.	510300	Ref. No.	160719
	end cap for wash arm			
	GEV No.	510302	Ref. No.	200824
	O-ring EPDM ID ø 12.42mm thickness 1.78mm Qty 1 pcs			
	GEV No.	510303	Ref. No.	200818
	O-ring EPDM thickness 1.78mm ID ø 6.75mm Qty 1 pcs			
	GEV No.	510305	Ref. No.	180213
	opposite support for wash jet			
	GEV No.	510306	Ref. No.	170916
	nozzle for wash arm mounting pos. left			
	GEV No.	510307	Ref. No.	261004 261009
	Thumb screw thread M6 H 3mm thread L 8mm ø 28mm SS			
	GEV No.	510309	Ref. No.	170911
	nozzle for rinse arm mounting pos. right/left			
	GEV No.	510310	Ref. No.	170704
	opposite support for rinse jet			
	GEV No.	510313	Ref. No.	190617
	bush H 12mm D1 ø 20mm D2 ø 16mm D3 ø 12mm for wash arm boss			
	GEV No.	510314	Ref. No.	170927
	nozzle for wash arm mounting pos. centre/inside			
	GEV No.	510315	Ref. No.	170929
	nozzle for rinse arm mounting pos. centre/inside			

Table continues overleaf



spare parts for		510261	
	GEV No.	510316	Ref. No. 170928
blank nozzle mounting pos. centre for wash arm			
	GEV No.	510317	Ref. No. 170930
blank nozzle mounting pos. centre for rinse arm			
	GEV No.	510871	Ref. No. 191022
wash arm boss			
	GEV No.	511004	Ref. No. 260226
flat-headed bolt thread M4 thread L 12mm SS DIN 84/ISO 1207 Qty 1 pcs intake slotted L 14.5mm			
	GEV No.	512265	Ref. No. 140106
connector holder			
	GEV No.	560140	Ref. No. 260402 260418
hexagonal nut thread M4 H 4.8mm SS WS 7 Qty 20 pcs DIN/ISO DIN 985 self-locking			

spare parts for		510747	
	GEV No.	510317	Ref. No. 170930
blank nozzle mounting pos. centre for rinse arm			
	GEV No.	510752	Ref. No. 170923
wash jet mounting pos. right			
	GEV No.	510753	Ref. No. 170922
wash jet mounting pos. left			
	GEV No.	510871	Ref. No. 191022
wash arm boss			
	GEV No.	512265	Ref. No. 140106
connector holder			
	GEV No.	560140	Ref. No. 260402 260418
hexagonal nut thread M4 H 4.8mm SS WS 7 Qty 20 pcs DIN/ISO DIN 985 self-locking			

			
1			
GEV No.	510747	Ref. No.	420545
description	wash and rinse arm wash arm L 410mm rinse arm L 410mm mounting pos. lower w. jets 6 r. jets 4 mounting ø 12/45mm nozzle type C		
For models:	BC25HR, BC30HR, BC30HR380, BC30HRA		
spare parts for		510747	
	GEV No.	510300	Ref. No. 160719
end cap for wash arm			
	GEV No.	510302	Ref. No. 200824
O-ring EPDM ID ø 12.42mm thickness 1.78mm Qty 1 pcs			
	GEV No.	510303	Ref. No. 200818
O-ring EPDM thickness 1.78mm ID ø 6.75mm Qty 1 pcs			
	GEV No.	510305	Ref. No. 180213
opposite support for wash jet			
	GEV No.	510307	Ref. No. 261004 261009
Thumb screw thread M6 H 3mm thread L 8mm ø 28mm SS			
	GEV No.	510309	Ref. No. 170911
nozzle for rinse arm mounting pos. right/left			
	GEV No.	510310	Ref. No. 170704
opposite support for rinse jet			
	GEV No.	510313	Ref. No. 190617
bush H 12mm D1 ø 20mm D2 ø 16mm D3 ø 12mm for wash arm boss			
	GEV No.	510315	Ref. No. 170929
nozzle for rinse arm mounting pos. centre/inside			
	GEV No.	510316	Ref. No. 170928
blank nozzle mounting pos. centre for wash arm			

















			
1			
GEV No.	510268	Ref. No.	420538
description	wash and rinse arm wash arm L 410mm rinse arm L 410mm mounting pos. upper w. jets 6 r. jets 4 mounting ø 12/45mm nozzle type A		
For models:	B15TM, B16TM, B18TM, B19TM		
spare parts for		510268	
	GEV No.	508112	Ref. No. —
union nut SS			
	GEV No.	510300	Ref. No. 160719
end cap for wash arm			
	GEV No.	510302	Ref. No. 200824
O-ring EPDM ID ø 12.42mm thickness 1.78mm Qty 1 pcs			
	GEV No.	510303	Ref. No. 200818
O-ring EPDM thickness 1.78mm ID ø 6.75mm Qty 1 pcs			
	GEV No.	510304	Ref. No. 170915
nozzle for wash arm mounting pos. right			
	GEV No.	510305	Ref. No. 180213
opposite support for wash jet			
	GEV No.	510306	Ref. No. 170916
nozzle for wash arm mounting pos. left			
	GEV No.	510307	Ref. No. 261004 261009
Thumb screw thread M6 H 3mm thread L 8mm ø 28mm SS			
	GEV No.	510309	Ref. No. 170911
nozzle for rinse arm mounting pos. right/left			

Table continues overleaf

spare parts for		510268		
	GEV No.	510310	Ref. No.	170704
opposite support for rinse jet				
	GEV No.	510313	Ref. No.	190617
bush H 12mm D1 ø 20mm D2 ø 16mm D3 ø 12mm for wash arm boss				
	GEV No.	510314	Ref. No.	170927
nozzle for wash arm mounting pos. centre/inside				
	GEV No.	510315	Ref. No.	170929
nozzle for rinse arm mounting pos. centre/inside				
	GEV No.	510316	Ref. No.	170928
blank nozzle mounting pos. centre for wash arm				
	GEV No.	510317	Ref. No.	170930
blank nozzle mounting pos. centre for rinse arm				
	GEV No.	510871	Ref. No.	191022
wash arm boss				
	GEV No.	511004	Ref. No.	260226
flat-headed bolt thread M4 thread L 12mm SS DIN 84/ISO 1207 Qty 1 pcs intake slotted L 14.5mm				
	GEV No.	512265	Ref. No.	140106
connector holder				
	GEV No.	560140	Ref. No.	260402 260418
hexagonal nut thread M4 H 4.8mm SS WS 7 Qty 20 pcs DIN/ISO DIN 985 self-locking				

				
1				
GEV No.	510749	Ref. No.	420546	
description	wash and rinse arm wash arm L 410mm rinse arm L 410mm mounting pos. upper w. jets 6 r. jets 4 mounting ø 12/45mm nozzle type C			
For models:	BC25HR, BC30HR, BC30HR380, BC30HRA			
spare parts for		510749		
	GEV No.	510300	Ref. No.	160719
end cap for wash arm				
	GEV No.	510302	Ref. No.	200824
O-ring EPDM ID ø 12.42mm thickness 1.78mm Qty 1 pcs				
	GEV No.	510303	Ref. No.	200818
O-ring EPDM thickness 1.78mm ID ø 6.75mm Qty 1 pcs				
	GEV No.	510305	Ref. No.	180213
opposite support for wash jet				
	GEV No.	510307	Ref. No.	261004 261009
Thumb screw thread M6 H 3mm thread L 8mm ø 28mm SS				

spare parts for		510749		
	GEV No.	510309	Ref. No.	170911
nozzle for rinse arm mounting pos. right/left				
	GEV No.	510310	Ref. No.	170704
opposite support for rinse jet				
	GEV No.	510313	Ref. No.	190617
bush H 12mm D1 ø 20mm D2 ø 16mm D3 ø 12mm for wash arm boss				
	GEV No.	510315	Ref. No.	170929
nozzle for rinse arm mounting pos. centre/inside				
	GEV No.	510316	Ref. No.	170928
blank nozzle mounting pos. centre for wash arm				
	GEV No.	510317	Ref. No.	170930
blank nozzle mounting pos. centre for rinse arm				
	GEV No.	510467	Ref. No.	191055
wash arm boss equiv. no. 191055				
	GEV No.	510752	Ref. No.	170923
wash jet mounting pos. right				
	GEV No.	510753	Ref. No.	170922
wash jet mounting pos. left				
	GEV No.	511004	Ref. No.	260226
flat-headed bolt thread M4 thread L 12mm SS DIN 84/ISO 1207 Qty 1 pcs intake slotted L 14.5mm				
	GEV No.	512265	Ref. No.	140106
connector holder				
	GEV No.	560140	Ref. No.	260402 260418
hexagonal nut thread M4 H 4.8mm SS WS 7 Qty 20 pcs DIN/ISO DIN 985 self-locking				
	GEV No.	560454	Ref. No.	260206
flat-headed bolt thread M4 thread L 22mm SS DIN 84/ISO 1207 Qty 1 pcs intake slotted head ø 7mm head thickness 2.5mm				













				
1				
GEV No.	510750	Ref. No.	420522	
description	wash and rinse arm wash arm L 570mm rinse arm L 570mm w. jets 10 r. jets 6 mounting ø 12/45mm			
For models:	C75M, F90M, F90MA, LF400A, LF450, LF450A			
spare parts for		510750		
	GEV No.	508122	Ref. No.	160718
end cap				
	GEV No.	510300	Ref. No.	160719
end cap for wash arm				

Table continues overleaf





spare parts for		510750	
	GEV No.	510302	Ref. No. 200824
	O-ring EPDM ID ø 12.42mm thickness 1.78mm Qty 1 pcs		
	GEV No.	510303	Ref. No. 200818
	O-ring EPDM thickness 1.78mm ID ø 6.75mm Qty 1 pcs		
	GEV No.	510304	Ref. No. 170915
	nozzle for wash arm mounting pos. right		
	GEV No.	510305	Ref. No. 180213
	opposite support for wash jet		
	GEV No.	510306	Ref. No. 170916
	nozzle for wash arm mounting pos. left		
	GEV No.	510307	Ref. No. 261004 261009
	Thumb screw thread M6 H 3mm thread L 8mm ø 28mm SS		
	GEV No.	510310	Ref. No. 170704
	opposite support for rinse jet		
	GEV No.	510313	Ref. No. 190617
	bush H 12mm D1 ø 20mm D2 ø 16mm D3 ø 12mm for wash arm boss		
	GEV No.	510314	Ref. No. 170927
	nozzle for wash arm mounting pos. centre/inside		
	GEV No.	510315	Ref. No. 170929
	nozzle for rinse arm mounting pos. centre/inside		
	GEV No.	510316	Ref. No. 170928
	blank nozzle mounting pos. centre for wash arm		
	GEV No.	510317	Ref. No. 170930
	blank nozzle mounting pos. centre for rinse arm		
	GEV No.	510752	Ref. No. 170923
	wash jet mounting pos. right		
	GEV No.	510753	Ref. No. 170922
	wash jet mounting pos. left		
	GEV No.	510871	Ref. No. 191022
	wash arm boss		
	GEV No.	511004	Ref. No. 260226
	flat-headed bolt thread M4 thread L 12mm SS DIN 84/ISO 1207 Qty 1 pcs intake slotted L 14.5mm		
	GEV No.	511230	Ref. No. 170941
	rinse jet ø 11mm H 13mm		
	GEV No.	560140	Ref. No. 260402 260418
	hexagonal nut thread M4 H 4.8mm SS WS 7 Qty 20 pcs DIN/ISO DIN 985 self-locking		
	GEV No.	560454	Ref. No. 260206
	flat-headed bolt thread M4 thread L 22mm SS DIN 84/ISO 1207 Qty 1 pcs intake slotted head ø 7mm head thickness 2.5mm		

			
1			
GEV No.	510271	Ref. No.	420511
description	wash arm L 510mm mounting pos. upper/lower nozzles 16 mounting ø 20/57mm		
For models:	C140, C33, C34, LC380, LC380BT, LC380RCD, LC400		
spare parts for		510271	
	GEV No.	510300	Ref. No. 160719
	end cap for wash arm		
	GEV No.	510302	Ref. No. 200824
	O-ring EPDM ID ø 12.42mm thickness 1.78mm Qty 1 pcs		
	GEV No.	510305	Ref. No. 180213
	opposite support for wash jet		
	GEV No.	510346	Ref. No. 280409
	knurled nut thread M17x1 ø 35mm H 6mm SS		
	GEV No.	510352	Ref. No. 170917
	nozzle mounting pos. right type C34		
	GEV No.	510353	Ref. No. 170918
	nozzle mounting pos. left type C34		
	GEV No.	510865	Ref. No. 190614
	bush for wash arm		

			
1			
GEV No.	510317	Ref. No.	170930
description	blank nozzle mounting pos. centre for rinse arm		
For models:	B13T, B14T, B15T, B15TM, B16, B16T, B16TM, B18T, B18TM, B19, B19T, B19TM, B41, B42, BC25HR, BC30HR, BC30HR380, BC30HRA, BHC25S, C140, C30, C33, C34, C70, C75, C75BT, C75M, C75RCD, C85, F2, F20, F3, F300, F45, F55, F65, F80, F90M, F90MA, LC380, LC380BT, LC380RCD, LC400, LF400A, LF450, LF450A, LP360		

			
1			
GEV No.	510316	Ref. No.	170928
description	blank nozzle mounting pos. centre for wash arm		
For models:	B13T, B14T, B15T, B15TM, B16, B16T, B16TM, B18T, B18TM, B19, B19T, B19TM, B41, B42, BC25HR, BC30HR, BC30HR380, BC30HRA, BHC25S, C140, C30, C33, C34, C70, C75, C75BT, C75M, C75RCD, C85, F2, F20, F3, F300, F45, F55, F65, F80, F90M, F90MA, LC380, LC380BT, LC380RCD, LC400, LF400A, LF450, LF450A, LP360		

			
1			
GEV No.	510312	Ref. No.	190621
description	bush for wash arm H 20mm ID ø 20mm ED ø 28/25mm		
For models:	C140, C33, C34, LC380, LC380BT, LC380RCD, LC400		

			
1			
GEV No.	510313	Ref. No.	190617
description	bush H 12mm D1 ø 20mm D2 ø 16mm D3 ø 12mm for wash arm boss		
For models:	B13T, B14T, B15T, B15TM, B16, B16T, B16TM, B18T, B18TM, B19, B19T, B19TM, B41, B42, BC25HR, BC30HR, BC30HR380, BC30HRA, BHC25S, C140, C30, C33, C34, C70, C75, C75BT, C75M, C75RCD, C85, F2, F20, F3, F300, F45, F55, F65, F80, F90M, F90MA, FC, FC53, FC533, FC533A, FC53A, FC53CBT, FC53LA, FC53LBT, FC54, FC543, FC543A...(Other models you can see in the webshop)		

			
1			
GEV No.	512265	Ref. No.	140106
description	connector holder		
For models:	B13T, B14T, B15T, B15TM, B16, B16T, B16TM, B18T, B18TM, B19T, B19TM, C140, C70, C75, C75BT, C75RCD, C85, F20, F45, F55, F65, F80, LBC215, LBC215A, LBC275, LBC275A, LC380, LF280-lav-line, LF320-lav-line, LP360		

			
1			
GEV No.	508122	Ref. No.	160718
description	end cap		

			
1			
GEV No.	510300	Ref. No.	160719
description	end cap for wash arm		
For models:	B13T, B14T, B15T, B15TM, B16, B16T, B16TM, B18T, B18TM, B19, B19T, B19TM, B41, B42, BC25HR, BC30HR, BC30HR380, BC30HRA, BHC25S, C140, C30, C33, C34, C70, C75, C75BT, C75M, C75RCD, C85, F2, F20, F3, F300, F45, F55, F65, F80, F90M, F90MA, LC380, LC380BT, LC380RCD, LC400, LF400A, LF450, LF450A, LP360		

accessories for	510300		
	GEV No.	510302	Ref. No. 200824
	O-ring EPDM ID ø 12.42mm thickness 1.78mm Qty 1 pcs		

			
1			
GEV No.	510346	Ref. No.	280409
description	knurled nut thread M17x1 ø 35mm H 6mm SS		
For models:	C1000E, C1000ERCD, C1001M, C1300E, C1300ERCD, C1301M, C140, C155, C155BT, C155E2, C155RCD, C165, C165E2, C165E2BT, C165E2RCD, C166, C166-2, C33, C34, C95, C95BT, C95E2, C95RCD, G100L, G101L, G50L, G51L, G60L, G61L, GE100, GE115, GE50RCD, GE60, GE60RCD, GE65, GE65RCD, GE80, GF90, GF90-2004, GF90A, GF90A-2004, GL, LC1200, LC1200RCD, LC380, LC412, LC700, LC700RCD, LC900, LC900RCD...(Other models you can see in the webshop)		

			
1			
GEV No.	510315	Ref. No.	170929
description	nozzle for rinse arm mounting pos. centre/inside		
For models:	B13T, B14T, B15T, B15TM, B16, B16T, B16TM, B18T, B18TM, B19, B19T, B19TM, B41, B42, BC25HR, BC30HR, BC30HR380, BC30HRA, BHC25S, C140, C30, C33, C34, C70, C75, C75BT, C75M, C75RCD, C85, F2, F20, F3, F300, F45, F55, F65, F80, F90M, F90MA, LC380, LC380BT, LC380RCD, LC400, LF400A, LF450, LF450A, LP360		

			
1			
GEV No.	510309	Ref. No.	170911
description	nozzle for rinse arm mounting pos. right/left		
For models:	B13T, B14T, B15T, B15TM, B16, B16T, B16TM, B18T, B18TM, B19, B19T, B19TM, B20, B20D, B23, B24, B25, B26, B27, B41, B42, BC25HR, BC30HR, BC30HR380, BC30HRA, BHC25S, C140, C30, C33, C34, C70, C75, C75BT, C75RCD, C85, F2, F20, F3, F300, F45, F55, F65, F80, GF90, GF90-2004, GF90A, GF90A-2004, LC380, LC380BT, LC380RCD...(Other models you can see in the webshop)		

			
1			
GEV No.	510314	Ref. No.	170927
description	nozzle for wash arm mounting pos. centre/inside		
For models:	B13T, B14T, B15T, B15TM, B16, B16T, B16TM, B18T, B18TM, B19, B19T, B19TM, B41, B42, C140, C30, C33, C34, C70, C75, C75BT, C75M, C75RCD, C85, F2, F20, F3, F300, F45, F55, F65, F80, F90M, F90MA, LC380, LC380BT, LC380RCD, LC400, LF400A, LF450, LF450A, LP360		

			
1			
GEV No.	510306	Ref. No.	170916
description	nozzle for wash arm mounting pos. left		
For models:	B13T, B14T, B15T, B15TM, B16, B16T, B16TM, B18T, B18TM, B19, B19T, B19TM, B41, B42, C30, C70, C75, C75BT, C75M, C75RCD, C85, F2, F20, F3, F300, F45, F55, F65, F80, F90M, F90MA, LF400A, LF450, LF450A, LP360		

			
1			
GEV No.	510304	Ref. No.	170915
description	nozzle for wash arm mounting pos. right		
For models:	B13T, B14T, B15T, B15TM, B16, B16T, B16TM, B18T, B18TM, B19, B19T, B19TM, B41, B42, C30, C70, C75, C75BT, C75M, C75RCD, C85, F2, F20, F3, F300, F45, F55, F65, F80, F90M, F90MA, LF400A, LF450, LF450A, LP360		

			
1			
GEV No.	510353	Ref. No.	170918
description	nozzle mounting pos. left type C34		
For models:	C140, C33, C34, LC380, LC380BT, LC380RCD, LC400		





			
1			
GEV No.	510352	Ref. No.	170917
description	nozzle mounting pos. right type C34		
For models:	C140, C33, C34, LC380, LC380BT, LC380RCD, LC400		

			
1			
GEV No.	511230	Ref. No.	170941
description	rinse jet ø 11mm H 13mm		
For models:	C75M, F90M, F90MA, LF400A, LF450, LF450A		

			
1			
GEV No.	510310	Ref. No.	170704
description	opposite support for rinse jet		
For models:	B13T, B14T, B15T, B15TM, B16, B16T, B16TM, B18T, B18TM, B19, B19T, B19TM, B20, B20D, B23, B24, B25, B26, B27, B41, B42, BC25HR, BC30HR, BC30HR380, BC30HRA, BHC25S, C140, C30, C33, C34, C70, C75, C75BT, C75M, C75RCD, C85, F2, F20, F3, F300, F45, F55, F65, F80, F90M, F90MA, GF90, GF90-2004, GF90A, GF90A-2004...(Other models you can see in the webshop)		

			
1			
GEV No.	510307	Ref. No.	261004 261009
description	Thumb screw thread M6 H 3mm thread L 8mm ø 28mm SS		
For models:	B13T, B14T, B15T, B15TM, B16, B16T, B16TM, B18T, B18TM, B19, B19T, B19TM, B41, B42, BC25, BC25A, BC25HR, BC30, BC30A, BC30HR, BC30HR380, BC30HRA, BHC25, BHC25A, BHC25S, BHC30, BHC30A, BHC30HR, BHC30HR380, BHC30HRA, BHC30HRA380, BHC433, BHC433A, BHCHR, C1000E, C1000ERCD, C1001M, C1300E, C1300ERCD, C1301M, C140, C155, C155BT, C155E2, C155RCD, C165, C165E2, C165E2BT, C165E2RCD, C166...(Other models you can see in the webshop)		

			
1			
GEV No.	510305	Ref. No.	180213
description	opposite support for wash jet		
For models:	AC101, AC105, AC120, AC122, AC150, AC151, AC152, AC170, AC200, AC91, AC95, ACR, ACR145, ACR205, ACR225, ACR245, ACR260, ACR265, ACR305, ACRS145, ACRS205, ACRS225, ACRS245, ACRS260, ACRS265, ACRS305, ACS101, ACS101-DIGIT, ACS122, ACS122-DIGIT, ACS151, ACS151-DIGIT, ACS152, ACS152-DIGIT, ACS91, ACS91-DIGIT, B13T, B14T, B15T, B15TM, B16, B16T, B16TM, B18T, B18TM, B19, B19T, B19TM, B41, B42...(Other models you can see in the webshop)		

			
1			
GEV No.	510849	Ref. No.	191027
description	wash arm boss		
For models:	C140, C33, C34, LC380, LC380BT, LC380RCD, LC400		

			
1			
GEV No.	510302	Ref. No.	200824
description	O-ring EPDM ID ø 12.42mm thickness 1.78mm Qty 1 pcs		
For models:	AC101, AC105, AC120, AC122, AC150, AC151, AC152, AC170, AC200, AC91, AC95, ACL150, ACR, ACR145, ACR205, ACR225, ACR245, ACR260, ACR265, ACR305, ACRS145, ACRS205, ACRS225, ACRS245, ACRS260, ACRS265, ACRS305, ACS101, ACS101-DIGIT, ACS122, ACS122-DIGIT, ACS151, ACS151-DIGIT, ACS152, ACS152-DIGIT, ACS161-DIGIT, ACS162-DIGIT, ACS91, ACS91-DIGIT, B13T, B14T, B15T, B15TM, B16, B16T, B16TM, B18T, B18TM, B19, B19T...(Other models you can see in the webshop)		

			
1			
GEV No.	510871	Ref. No.	191022
description	wash arm boss		
For models:	B13T, B14T, B15T, B15TM, B16, B16T, B16TM, B18T, B18TM, B19, B19T, B19TM, B41, B42, BC25HR, BC30HR, BC30HR380, BC30HRA, BHC25S, C30, C70, C75, C75BT, C75M, C75RCD, C85, F2, F20, F3, F300, F45, F55, F65, F80, F90M, F90MA, LF400A, LF450, LF450A, LP360		

			
1			
GEV No.	510303	Ref. No.	200818
description	O-ring EPDM thickness 1.78mm ID ø 6.75mm Qty 1 pcs		
For models:	AC120, AC150, AC170, AC200, ACR, ACR145, ACR205, ACR225, ACR245, ACR260, ACR265, ACR305, B13T, B14T, B15, B15T, B15TM, B16, B16T, B16TM, B18, B18T, B18TM, B19, B19T, B19TM, B41, B42, BC25HR, BC30HR, BC30HR380, BC30HRA, BHC25S, C140, C30, C33, C34, C70, C75, C75BT, C75M, C75RCD, C85, F2, F20, F3, F300, F45, F55, F65...(Other models you can see in the webshop)		

			
1			
GEV No.	510467	Ref. No.	191055
description	wash arm boss equiv. no. 191055		
For models:	B15TM, B16TM, B18TM, B19TM, BC25HR, BC30HR, BC30HR380, BC30HRA, BHC25S		

			
1			
GEV No.	510872	Ref. No.	191030
description	rinse arm boss		
For models:	C140, C33, C34, LC380, LC380BT, LC380RCD, LC400		

			
1			
GEV No.	510753	Ref. No.	170922
description	wash jet mounting pos. left		
For models:	BC25HR, BC30HR, BC30HR380, BC30HRA, BHC25S, C75M, F90M, F90MA, LF400A, LF450, LF450A		

			
1			
GEV No.	510752	Ref. No.	170923
description	wash jet mounting pos. right		
For models:	BC25HR, BC30HR, BC30HR380, BC30HRA, BHC25S, C75M, F90M, F90MA, LF400A, LF450, LF450A		

			
1			
GEV No.	510267	Ref. No.	430306
description	rinse arm		
spare parts for	510267		
	GEV No.	510302	Ref. No. 200824
	O-ring EPDM ID ø 12.42mm thickness 1.78mm Qty 1 pcs		
	GEV No.	510305	Ref. No. 180213
	opposite support for wash jet		
	GEV No.	510330	Ref. No. 160754
	end cap for rinse arm		
	GEV No.	510334	Ref. No. 170926
	nozzle holder mounting pos. upper		
	GEV No.	510369	Ref. No. 380314
	nozzle for rinse arm		

			
1			
GEV No.	510264	Ref. No.	420535
description	wash and rinse arm L 495mm mounting pos. upper/lower nozzles 16 mounting ø 20/57mm complete		
For models:	C1300E, C1300ERCD, C155, C155BT, C155E2, C155RCD, C165, C165E2, C165E2BT, C165E2RCD, C166, C166-2		
spare parts for	510264		
	GEV No.	510346	Ref. No. 280409
	knurled nut thread M17x1 ø 35mm H 6mm SS		
	GEV No.	510823	Ref. No. 190636
	bush for wash arm		
	GEV No.	510825	Ref. No. 160768
	end cap for wash arm		
	GEV No.	511191	Ref. No. 200813
	O-ring EPDM thickness 2.21mm ID ø 16.36mm Qty 1 pcs		

			
1			
GEV No.	510265	Ref. No.	420540
description	wash arm L 500mm mounting pos. upper/lower nozzles 9 mounting ø 20/56.5mm		
For models:	C1000E, C1000ERCD, C95, C95BT, C95E2, C95RCD		
spare parts for	510265		
	GEV No.	510346	Ref. No. 280409
	knurled nut thread M17x1 ø 35mm H 6mm SS		
	GEV No.	510823	Ref. No. 190636
	bush for wash arm		
	GEV No.	510825	Ref. No. 160768
	end cap for wash arm		
	GEV No.	511191	Ref. No. 200813
	O-ring EPDM thickness 2.21mm ID ø 16.36mm Qty 1 pcs		



			
1			
GEV No.	511251	Ref. No.	420505
description	wash arm L 540mm mounting pos. lower nozzles 8 mounting ø 30/82mm		
For models:	G115, G131, G65, G66, G75		
spare parts for	511251		
	GEV No.	510351	Ref. No. 170910
	nozzle for wash arm		
	GEV No.	511004	Ref. No. 260226
	flat-headed bolt thread M4 thread L 12mm SS DIN 84/ISO 1207 Qty 1 pcs intake slotted L 14.5mm		
	GEV No.	511248	Ref. No. 440816
	retaining ring bore ø 48mm thickness 1.9mm stainless steel DIN 472		
	GEV No.	511249	Ref. No. 160820
	slide ring		
	GEV No.	511252	Ref. No. 510284
	knurled nut		
	GEV No.	511253	Ref. No. 180211
	opposite support for wash jet		
	GEV No.	560140	Ref. No. 260402 260418
	hexagonal nut thread M4 H 4.8mm SS WS 7 Qty 20 pcs DIN/ISO DIN 985 self-locking		





			
1			
GEV No.	517605	Ref. No.	420567 420587R
description	wash arm L 550mm nozzles 16		
For models:	GE100, GE115, GE60, GE60RCD, GE65, GE65RCD, GE80		

			
1			
GEV No.	510823	Ref. No.	190636
description	bush for wash arm		
For models:	C1000E, C1000ERCD, C1300E, C1300ERCD, C155, C155BT, C155E2, C155RCD, C165, C165E2, C165E2BT, C165E2RCD, C166, C166-2, C95, C95BT, C95E2, C95RCD, G100L, G101L, G50L, G51L, G60L, G61L, GE100, GE115, GE50RCD, GE60, GE60RCD, GE65, GE65RCD, GE80, GF90, GF90-2004, GF90A, GF90A-2004, GL, LAV1000		

			
1			
GEV No.	510330	Ref. No.	160754
description	end cap for rinse arm		
For models:	AC101, AC105, AC120, AC122, AC150, AC151, AC152, AC170, AC200, AC91, AC95, ACR, ACR145, ACR205, ACR225, ACR245, ACR260, ACR265, ACR305, ACS101, ACS101-DIGIT, ACS122, ACS122-DIGIT, ACS151, ACS151-DIGIT, ACS152, ACS152-DIGIT, ACS91, ACS91-DIGIT, G115, G125, G65, G75, GMC, GMC2700, GMC3500, GMC4500, GMC5500, NE00, NE02, NE3002, NE4002, NE5002, NE5502, NE7002, NE7502, NE9002, NE9502, NG01, NG02...(Other models you can see in the webshop)		

			
1			
GEV No.	510825	Ref. No.	160768
description	end cap for wash arm		
For models:	C1000E, C1000ERCD, C1300E, C1300ERCD, C155, C155BT, C155E2, C155RCD, C165, C165E2, C165E2BT, C165E2RCD, C166, C166-2, C95, C95BT, C95E2, C95RCD, G100L, G101L, G50L, G51L, G60L, G61L, GE100, GE115, GE50RCD, GE60, GE60RCD, GE65, GE65RCD, GE80, GF70, GF70A, GF90, GF90-2004, GF90A, GF90A-2004, GL, XLC		
accessories for	510825		
	GEV No.	511191	Ref. No. 200813
	 O-ring EPDM thickness 2.21mm ID ø 16.36mm Qty 1 pcs		

			
1			
GEV No.	511252	Ref. No.	510284
description	knurled nut		
For models:	G115, G131, G65, G66, G75		

			
1			
GEV No.	510346	Ref. No.	280409
description	knurled nut thread M17x1 ø 35mm H 6mm SS		
For models:	C1000E, C1000ERCD, C1001M, C1300E, C1300ERCD, C1301M, C140, C155, C155BT, C155E2, C155RCD, C165, C165E2, C165E2BT, C165E2RCD, C166, C166-2, C33, C34, C95, C95BT, C95E2, C95RCD, G100L, G101L, G50L, G51L, G60L, G61L, GE100, GE115, GE50RCD, GE60, GE60RCD, GE65, GE65RCD, GE80, GF90, GF90-2004, GF90A, GF90A-2004, GL, LC1200, LC1200RCD, LC380, LC412, LC700, LC700RCD, LC900, LC900RCD...(Other models you can see in the webshop)		

			
1			
GEV No.	510369	Ref. No.	380314
description	nozzle for rinse arm		
For models:	C1000E, C1000ERCD, C1300E, C1300ERCD, C155, C155BT, C155E2, C155RCD, C165, C165E2, C165E2BT, C165E2RCD, C166, C166-2, C75, C75BT, C75RCD, C95, C95BT, C95E2, C95RCD, FC, FC53, FC533, FC533A, FC53A, FC53CBT, FC53LA, FC53LBT, FC54, FC543, FC543A, FC543E, FC543EA, FC544, FC544A, FC54A, FC54CBT, FC54LBT, FCHR, FCHRA, FCHRT, FCHRTA, G115, G125, G131, G65, G66, G75, GE100...(Other models you can see in the webshop)		

			
1			
GEV No.	510351	Ref. No.	170910
description	nozzle for wash arm		
For models:	G115, G131, G65, G66, G75, NE00, R40, R50, R70, SE		

			
1			
GEV No.	510334	Ref. No.	170926
description	nozzle holder mounting pos. upper		
For models:	AC120, AC150, AC170, AC200, ACR, ACR145, ACR205, ACR225, ACR245, ACR260, ACR265, ACR305, G115, G125, G65, G75, GMC, GMC2700, GMC3500, GMC4500, GMC5500, NE00, NG00, NG01, NG02, NG1202, NG1202E, NG600, NG600E, NG601, NG601E, NG602, NG602E, NG900, NG900E, NG901, NG901E, NG902, NG902E, SE, SNL		

			
1			
GEV No.	510305	Ref. No.	180213
description	opposite support for wash jet		
For models:	AC101, AC105, AC120, AC122, AC150, AC151, AC152, AC170, AC200, AC91, AC95, ACR, ACR145, ACR205, ACR225, ACR245, ACR260, ACR265, ACR305, ACRS145, ACRS205, ACRS225, ACRS245, ACRS260, ACRS265, ACRS305, ACS101, ACS101-DIGIT, ACS122, ACS122-DIGIT, ACS151, ACS151-DIGIT, ACS152, ACS152-DIGIT, ACS91, ACS91-DIGIT, B13T, B14T, B15T, B15TM, B16, B16T, B16TM, B18T, B18TM, B19, B19T, B19TM, B41, B42...(Other models you can see in the webshop)		

			
1			
GEV No.	511253	Ref. No.	180211
description	opposite support for wash jet		
For models:	G115, G131, G65, G66, G75, NE00, NG00, NG600, NG600E, NG900, NG900E, SE		

1			
GEV No.	510302	Ref. No.	200824
description	O-ring EPDM ID ø 12.42mm thickness 1.78mm Qty 1 pcs		
For models:	AC101, AC105, AC120, AC122, AC150, AC151, AC152, AC170, AC200, AC91, AC95, ACL150, ACR, ACR145, ACR205, ACR225, ACR245, ACR260, ACR265, ACR305, ACRS145, ACRS205, ACRS225, ACRS245, ACRS260, ACRS265, ACRS305, ACS101, ACS101-DIGIT, ACS122, ACS122-DIGIT, ACS151, ACS151-DIGIT, ACS152, ACS152-DIGIT, ACS161-DIGIT, ACS162-DIGIT, ACS91, ACS91-DIGIT, B13T, B14T, B15T, B15TM, B16, B16T, B16TM, B18T, B18TM, B19, B19T...(Other models you can see in the webshop)		

1			
GEV No.	530293	Ref. No.	200809
description	O-ring EPDM thickness 1.78mm ID ø 8.73mm Qty 1 pcs		
For models:	AC101, AC105, AC122, AC135, AC151, AC152, AC181, AC182, AC201, AC202, AC241, AC242, AC2A, AC91, AC95, ACL100, ACL150, ACRS145, ACRS205, ACRS225, ACRS245, ACRS260, ACRS265, ACRS305, ACS101, ACS101-DIGIT, ACS122, ACS122-DIGIT, ACS151, ACS151-DIGIT, ACS152, ACS152-DIGIT, ACS161-DIGIT, ACS162-DIGIT, ACS181, ACS181-DIGIT, ACS182, ACS182-DIGIT, ACS201, ACS201-DIGIT, ACS202, ACS202-DIGIT, ACS241, ACS241-DIGIT, ACS242, ACS242-DIGIT, ACS91, ACS91-DIGIT, B15, B16...(Other models you can see in the webshop)		

1			
GEV No.	511191	Ref. No.	200813
description	O-ring EPDM thickness 2.21mm ID ø 16.36mm Qty 1 pcs		
For models:	C1000E, C1000ERCD, C1300E, C1300ERCD, C155, C155BT, C155E2, C155RCD, C165, C165E2, C165E2BT, C165E2RCD, C166, C166-2, C95, C95BT, C95E2, C95RCD, G100L, G101L, G50L, G51L, G60L, G61L, GE100, GE115, GE50RCD, GE60, GE60RCD, GE65, GE65RCD, GE80, GF70, GF70A, GF90, GF90-2004, GF90A, GF90A-2004, GL, XLC		

1			
GEV No.	524863	Ref. No.	420116
description	wash arm mounting pos. bottom right L 410mm nozzles 5 mounting ø 35mm		

1			
GEV No.	524862	Ref. No.	420117
description	wash arm mounting pos. lower L 395mm nozzles 3 mounting ø 34mm		

1			
GEV No.	524865	Ref. No.	420138
description	wash arm mounting pos. lower L 430mm nozzles 2 mounting ø 35mm		

1			
GEV No.	524864	Ref. No.	420137
description	wash arm mounting pos. lower L 430mm nozzles 3 mounting ø 35mm		

1			
GEV No.	524861	Ref. No.	420122
description	wash arm mounting pos. upper left L 400mm nozzles 5 mounting ø 35mm		

1			
GEV No.	510266	Ref. No.	430316
description	rinse arm L 490mm mounting pos. upper/lower nozzles 6 mounting ø 12mm		
For models:	C1000E, C1000ERCD, C1300E, C1300ERCD, C155, C155BT, C155E2, C155RCD, C165, C165E2, C165E2BT, C165E2RCD, C166, C166-2, C95, C95BT, C95E2, C95RCD, XLC		
spare parts for	510266		

GEV No.	510307	Ref. No.	261004 261009
description	Thumb screw thread M6 H 3mm thread L 8mm ø 28mm SS		

GEV No.	510369	Ref. No.	380314
description	nozzle for rinse arm		

GEV No.	510813	Ref. No.	190641
description	bush for rinse arm		

GEV No.	511242	Ref. No.	450218
description	connector holder L 30mm H 16mm W 22mm		

GEV No.	530293	Ref. No.	200809
description	O-ring EPDM thickness 1.78mm ID ø 8.73mm Qty 1 pcs		

1			
GEV No.	510283	Ref. No.	430306 430319
description	rinse arm L 540mm mounting pos. upper nozzles 6 mounting ø 16mm		
For models:	G115, G125, G131, G65, G66, G75		

1			
GEV No.	510283	Ref. No.	430306 430319
description	rinse arm L 540mm mounting pos. upper nozzles 6 mounting ø 16mm		
For models:	G115, G125, G131, G65, G66, G75		

1

GEV No.	511244	Ref. No.	430321
description	rinse arm L 550mm mounting pos. upper/lower nozzles 6 mounting ø 15mm		
For models:	G100L, G101L, G50L, G51L, G60L, G61L, GL		







1

GEV No.	517458	Ref. No.	430339
description	rinse arm mounting pos. upper/lower L 700mm nozzles 7 mounting ø 12mm		
For models:	GE100, GE115, GE60, GE60RCD, GE65, GE65RCD, GE80		



1

GEV No.	511250	Ref. No.	430323
description	rinse arm L 595mm mounting pos. upper/lower nozzles 6 mounting ø 16mm		
For models:	G115L, G125L, G50LM, G65L, G75L, GE125, GE75, GL		
spare parts for	511250		
	GEV No.	510230	Ref. No. 450219
	connector holder L 31mm W 25mm H 16mm		
	GEV No.	510307	Ref. No. 261004 261009
	Thumb screw thread M6 H 3mm thread L 8mm ø 28mm SS		
	GEV No.	511245	Ref. No. 190642
	bushing		
	GEV No.	511246	Ref. No. 380333
	nozzle for rinse arm		
	GEV No.	530293	Ref. No. 200809
	O-ring EPDM thickness 1.78mm ID ø 8.73mm Qty 1 pcs		



1

GEV No.	511243	Ref. No.	420542
description	wash arm		
For models:	G100L, G101L, G50L, G51L, G60L, G61L, GF90, GF90-2004, GF90A, GF90A-2004, GL		
spare parts for	511243		
	GEV No.	510346	Ref. No. 280409
	knurled nut thread M17x1 ø 35mm H 6mm SS		
	GEV No.	510823	Ref. No. 190636
	bush for wash arm		
	GEV No.	510825	Ref. No. 160768
	end cap for wash arm		
	GEV No.	511191	Ref. No. 200813
	O-ring EPDM thickness 2.21mm ID ø 16.36mm Qty 1 pcs		









1

GEV No.	517459	Ref. No.	430338
description	rinse arm mounting pos. upper/lower L 605mm nozzles 6 mounting ø 12mm		
For models:	GE100, GE115, GE50RCD, GE60, GE60RCD, GE65, GE65RCD, GE80		





1

GEV No.	511247	Ref. No.	420544
description	wash arm L 600mm mounting pos. upper/lower nozzles 10 mounting ø 30/86mm 4-armed		
For models:	G115L, G125L, G50LM, G65L, G75L, GE125, GE75, GL		
spare parts for	511247		
	GEV No.	511248	Ref. No. 440816
	retaining ring bore ø 48mm thickness 1.9mm stainless steel DIN 472		
	GEV No.	511249	Ref. No. 160820
	slide ring		

			
1			
GEV No.	511558	Ref. No.	420562
description	wash arm L 635mm mounting pos. upper/lower nozzles 10 mounting \varnothing 22/66mm for GE 65/115		
For models:	GE100, GE115, GE60, GE60RCD, GE65, GE65RCD, GE80		
spare parts for	511558		
	GEV No.	510346	Ref. No. 280409
	knurled nut thread M17x1 \varnothing 35mm H 6mm SS		
	GEV No.	510825	Ref. No. 160768
	end cap for wash arm		
	GEV No.	511191	Ref. No. 200813
	O-ring EPDM thickness 2.21mm ID \varnothing 16.36mm Qty 1 pcs		
	GEV No.	511559	Ref. No. 190669
	bush for wash arm		

			
1			
GEV No.	510813	Ref. No.	190641
description	bush for rinse arm		
For models:	C1000E, C1000ERCD, C1001M, C1300E, C1300ERCD, C1301M, C155, C155BT, C155E2, C155RCD, C165, C165E2, C165E2BT, C165E2RCD, C166, C166-2, C95, C95BT, C95E2, C95RCD, GE100, GE115, GE50RCD, GE60, GE60RCD, GE65, GE65RCD, GE80, LC1200, LC1200RCD, LC412, LC700, LC700RCD, LC900, LC900RCD, XLC		

			
1			
GEV No.	510940	Ref. No.	190613
description	bush for rinse arm		
For models:	G115, G125, G131, G65, G66, G75		



			
1			
GEV No.	510823	Ref. No.	190636
description	bush for wash arm		
For models:	C1000E, C1000ERCD, C1300E, C1300ERCD, C155, C155BT, C155E2, C155RCD, C165, C165E2, C165E2BT, C165E2RCD, C166, C166-2, C95, C95BT, C95E2, C95RCD, G100L, G101L, G50L, G51L, G60L, G61L, GE100, GE115, GE50RCD, GE60, GE60RCD, GE65, GE65RCD, GE80, GF90, GF90-2004, GF90A, GF90A-2004, GL, LAV1000		

			
1			
GEV No.	511239	Ref. No.	190656
description	bushing		
For models:	C75, C75BT, C75RCD, FC, FC53, FC533, FC533A, FC53A, FC53CBT, FC53LA, FC53LBT, FC54, FC543, FC543A, FC543E, FC543EA, FC544, FC544A, FC54A, FC54CBT, FC54LBT, FCHR, FCHRA, FCHRT, FCHRTA		

			
1			
GEV No.	511245	Ref. No.	190642
description	bushing		
For models:	G100L, G101L, G115L, G125L, G50L, G50LM, G51L, G60L, G61L, G65L, G75L, GE100, GE115, GE125, GE60, GE60RCD, GE65, GE65RCD, GE75, GE80, GL		

			
1			
GEV No.	511242	Ref. No.	450218
description	connector holder L 30mm H 16mm W 22mm		
For models:	C1000E, C1000ERCD, C1001M, C1300E, C1300ERCD, C1301M, C155, C155BT, C155E2, C155RCD, C165, C165E2, C165E2BT, C165E2RCD, C166, C166-2, C95, C95BT, C95E2, C95RCD, G100L, G101L, G50L, G51L, G60L, G61L, GE100, GE115, GE50RCD, GE60, GE60RCD, GE65, GE65RCD, GE80, GL, LC1200, LC1200RCD, LC412, LC700, LC700RCD, LC900, LC900RCD, XLC		

			
1			
GEV No.	510230	Ref. No.	450219
description	connector holder L 31mm W 25mm H 16mm		
For models:	G115L, G125L, G50LM, G65L, G75L, GE125, GE75, GL		

			
1			
GEV No.	510825	Ref. No.	160768
description	end cap for wash arm		
For models:	C1000E, C1000ERCD, C1300E, C1300ERCD, C155, C155BT, C155E2, C155RCD, C165, C165E2, C165E2BT, C165E2RCD, C166, C166-2, C95, C95BT, C95E2, C95RCD, G100L, G101L, G50L, G51L, G60L, G61L, GE100, GE115, GE50RCD, GE60, GE60RCD, GE65, GE65RCD, GE80, GF70, GF70A, GF90, GF90-2004, GF90A, GF90A-2004, GL, XLC		
accessories for	510825		
	GEV No.	511191	Ref. No. 200813
	O-ring EPDM thickness 2.21mm ID \varnothing 16.36mm Qty 1 pcs		





			
1			
GEV No.	510346	Ref. No.	280409
description	knurled nut thread M17x1 ø 35mm H 6mm SS		
For models:	C1000E, C1000ERCD, C1001M, C1300E, C1300ERCD, C1301M, C140, C155, C155BT, C155E2, C155RCD, C165, C165E2, C165E2BT, C165E2RCD, C166, C166-2, C33, C34, C95, C95BT, C95E2, C95RCD, G100L, G101L, G50L, G51L, G60L, G61L, GE100, GE115, GE50RCD, GE60, GE60RCD, GE65, GE65RCD, GE80, GF90, GF90-2004, GF90A, GF90A-2004, GL, LC1200, LC1200RCD, LC380, LC412, LC700, LC700RCD, LC900, LC900RCD...(Other models you can see in the webshop)		

			
2			
GEV No.	510369	Ref. No.	380314
description	nozzle for rinse arm		
For models:	C1000E, C1000ERCD, C1300E, C1300ERCD, C155, C155BT, C155E2, C155RCD, C165, C165E2, C165E2BT, C165E2RCD, C166, C166-2, C75, C75BT, C75RCD, C95, C95BT, C95E2, C95RCD, FC, FC53, FC533, FC533A, FC53A, FC53CBT, FC53LA, FC53LBT, FC54, FC543, FC543A, FC543E, FC543EA, FC544, FC544A, FC54A, FC54CBT, FC54LBT, FCHR, FCHRA, FCHRT, FCHRTA, G115, G125, G131, G65, G66, G75, GE100...(Other models you can see in the webshop)		

			
1			
GEV No.	511246	Ref. No.	380333
description	nozzle for rinse arm		
For models:	G100L, G101L, G115L, G125L, G50L, G50LM, G51L, G60L, G61L, G65L, G75L, GE125, GE75, GL		



			
1			
GEV No.	530293	Ref. No.	200809
description	O-ring EPDM thickness 1.78mm ID ø 8.73mm Qty 1 pcs		
For models:	AC101, AC105, AC122, AC135, AC151, AC152, AC181, AC182, AC201, AC202, AC241, AC242, AC2A, AC91, AC95, ACL100, ACL150, ACRS145, ACRS205, ACRS225, ACRS245, ACRS260, ACRS265, ACRS305, ACS101, ACS101-DIGIT, ACS122, ACS122-DIGIT, ACS151, ACS151-DIGIT, ACS152, ACS152-DIGIT, ACS161-DIGIT, ACS162-DIGIT, ACS181, ACS181-DIGIT, ACS182, ACS182-DIGIT, ACS201, ACS201-DIGIT, ACS202, ACS202-DIGIT, ACS241, ACS241-DIGIT, ACS242, ACS242-DIGIT, ACS91, ACS91-DIGIT, B15, B16...(Other models you can see in the webshop)		

			
1			
GEV No.	511191	Ref. No.	200813
description	O-ring EPDM thickness 2.21mm ID ø 16.36mm Qty 1 pcs		
For models:	C1000E, C1000ERCD, C1300E, C1300ERCD, C155, C155BT, C155E2, C155RCD, C165, C165E2, C165E2BT, C165E2RCD, C166, C166-2, C95, C95BT, C95E2, C95RCD, G100L, G101L, G50L, G51L, G60L, G61L, GE100, GE115, GE50RCD, GE60, GE60RCD, GE65, GE65RCD, GE80, GF70, GF70A, GF90, GF90-2004, GF90A, GF90A-2004, GL, XLC		

			
1			
GEV No.	510955	Ref. No.	200854
description	O-ring EPDM thickness 3mm ID ø 6mm Qty 1 pcs		
For models:	AC100, AC90, G100L, G101L, G50L, G51L, G60L, G61L, GL, NG02, NG1202, NG1202E, NG602, NG602E, NG902, NG902E		

			
1			
GEV No.	517626	Ref. No.	380317
description	rinse jet H 11mm thread 1/8" WS 13 code 317		
For models:	AC122, AC152, AC182, AC202, AC242, ACS122, ACS122-DIGIT, ACS152, ACS152-DIGIT, ACS162-DIGIT, ACS182, ACS182-DIGIT, ACS202, ACS202-DIGIT, ACS242, ACS242-DIGIT		

			
1			
GEV No.	510307	Ref. No.	261004 261009
description	Thumb screw thread M6 H 3mm thread L 8mm ø 28mm SS		
For models:	B13T, B14T, B15T, B15TM, B16, B16T, B16TM, B18T, B18TM, B19, B19T, B19TM, B41, B42, BC25, BC25A, BC25HR, BC30, BC30A, BC30HR, BC30HR380, BC30HRA, BHC25, BHC25A, BHC25S, BHC30, BHC30A, BHC30HR, BHC30HR380, BHC30HRA, BHC30HRA380, BHC433, BHC433A, BHCHR, C1000E, C1000ERCD, C1001M, C1300E, C1300ERCD, C1301M, C140, C155, C155BT, C155E2, C155RCD, C165, C165E2, C165E2BT, C165E2RCD, C166...(Other models you can see in the webshop)		

			
1			
GEV No.	510258	Ref. No.	430325
description	rinse arm		
spare parts for	510258		
	GEV No.	Ref. No.	170958
	rinse jet		

















			
1			
GEV No.	511233	Ref. No.	430332
description	rinse arm L 495mm mounting pos. lower nozzles 6 mounting ø 12mm		
For models:	C75, C75BT, C75RCD, FC, FC53, FC533, FC533A, FC53A, FC53CBT, FC53LA, FC53LBT, FC54, FC543, FC543A, FC543E, FC543EA, FC544, FC544A, FC54A, FC54CBT, FC54E, FC54EA, FC54LBT, FCHR, FCHRA, FCHRT, FCHRTA		
spare parts for	511233		
	GEV No.	Ref. No.	280413
	knurled nut thread M8 ø 30mm H 4.5mm SS		
	GEV No.	Ref. No.	342706
	rinse arm shaft		

Table continues overleaf

spare parts for		511233		
	GEV No.	511235	Ref. No.	190663
	bushing			
	GEV No.	511236	Ref. No.	170963
	nozzle for rinse arm			
	GEV No.	511237	Ref. No.	200850
	O-ring EPDM thickness 1mm ID ø 7mm Qty 1 pcs			

				
1				
GEV No.	519484	Ref. No.	430343	
description	rinse arm L 495mm mounting pos. upper/lower nozzles 6 mounting ø 12mm			
For models:	C1001M, C1301M, LC1200, LC1200RCD, LC412, LC700, LC700RCD, LC900, LC900RCD			
spare parts for	519484			
	GEV No.	510307	Ref. No.	261004 261009
	Thumb screw thread M6 H 3mm thread L 8mm ø 28mm SS			
	GEV No.	510813	Ref. No.	190641
	bush for rinse arm			
	GEV No.	511236	Ref. No.	170963
	nozzle for rinse arm			
	GEV No.	511237	Ref. No.	200850
	O-ring EPDM thickness 1mm ID ø 7mm Qty 1 pcs			
	GEV No.	511238	Ref. No.	450236
	opposite support for rinse jet			
	GEV No.	511242	Ref. No.	450218
	connector holder L 30mm H 16mm W 22mm			

				
1				
GEV No.	517457	Ref. No.	430347	
description	rinse arm mounting pos. upper/lower L 500mm nozzles 6 thread M10x1.5			
For models:	LF322, LF322A, LF322MP, LF322MP-A, LF322RCD, LF324, LF324A, LF325E, LF325EA, LF700, LF700A, LFD32E, LFD32EA, LFD32M, LFD32MA			



				
1				
GEV No.	518597	Ref. No.	420553	
description	wash arm			
spare parts for	518597			
	GEV No.	509999	Ref. No.	—
	bush for rinse arm H 53mm ø 48.5mm SS			
	GEV No.	510236	Ref. No.	260568
	plain washer ID ø 21mm ED ø 28mm thickness 1mm SS Qty 1 pcs			
	GEV No.	511241	Ref. No.	191075
	knurled nut thread M26x1 stainless steel ø 48.6mm H 10mm			



				
1				
GEV No.	517597	Ref. No.	420560	
description	wash arm L 415mm nozzles 7			
For models:	BHC30E, BHC30EA			

				
1				
GEV No.	510259	Ref. No.	420548	
description	wash arm L 505mm mounting pos. upper/lower nozzles 8 mounting ø 12/41mm			
For models:	C75, C75BT, C75RCD, FC, FC53, FC533, FC533A, FC53A, FC53CBT, FC53LA, FC53LBT, FC54, FC543, FC543A, FC543E, FC543EA, FC544, FC544A, FC54A, FC54CBT, FC54E, FC54EA, FC54LBT, FCHR, FCHRA, FCHRT, FCHRTA, LF322, LF322A, LF322MP, LF322MP-A, LF322RCD, LF324, LF324A, LF325E, LF325EA, LF700, LF700A, LFD32E, LFD32EA, LFD32M, LFD32MA			
spare parts for	510259			
	GEV No.	510313	Ref. No.	190617
	bush H 12mm D1 ø 20mm D2 ø 16mm D3 ø 12mm for wash arm boss			
	GEV No.	511007	Ref. No.	191070
	bush for wash arm support			
	GEV No.	511231	Ref. No.	191069
	wash arm bearing			





			
1			
GEV No.	512410	Ref. No.	420550
description	wash arm L 505mm mounting pos. upper/lower nozzles 8 mounting ø 12/41mm edition FCHR-FCHR		
For models:	FC, FC53, FC533, FC533A, FC53A, FC53CBT, FC53LBT, FC54, FC543, FC543A, FC543E, FC543EA, FC544, FC544A, FC54A, FC54CBT, FC54LBT, FCHR, FCHRA, FCHRT, FCHRTA		

			
1			
GEV No.	518130	Ref. No.	420554 420572R
description	wash arm L 535mm mounting pos. upper/lower nozzles 10 mounting ø 20/58mm complete with rinse pipe		
For models:	C1001M, C1301M, LC1200, LC1200RCD, LC380, LC380BT, LC380RCD, LC400, LC412, LC700, LC700RCD, LC900, LC900RCD		
spare parts for	518130		
	GEV No.	509999	Ref. No. —
	bush for rinse arm H 53mm ø 48.5mm SS		
	GEV No.	511241	Ref. No. 191075
	knurled nut thread M26x1 stainless steel ø 48.6mm H 10mm		

			
1			
GEV No.	524037	Ref. No.	420578
description	wash arm L 520mm mounting pos. upper/lower w. jets 8 r. jets 5 mounting ø 12/45mm		
For models:	FC3E, FC3EA, FC3M, FC3MA, FC3MR, FC44E, FC44EA, FC4E, FC4EA, FC4EHRT, FC4M, FC4MA		
spare parts for	524037		
	GEV No.	510051	Ref. No. 280419
	knurled nut for wash arm thread M10 ø 21mm H 11mm		
	GEV No.	510052	Ref. No. 342790
	rinse arm shaft		

			
1			
GEV No.	511010	Ref. No.	190652
description	bush		
For models:	C75, C75BT, C75RCD, FC, FC53, FC533, FC533A, FC53A, FC53CBT, FC53LA, FC53LBT, FC54, FC543, FC543A, FC543E, FC543EA, FC544, FC544A, FC54A, FC54CBT, FC54LBT, FCHR, FCHRA, FCHRT, FCHRTA		

			
1			
GEV No.	510813	Ref. No.	190641
description	bush for rinse arm		
For models:	C1000E, C1000ERCD, C1001M, C1300E, C1300ERCD, C1301M, C155, C155BT, C155E2, C155RCD, C165, C165E2, C165E2BT, C165E2RCD, C166, C166-2, C95, C95BT, C95E2, C95RCD, GE100, GE115, GE50RCD, GE60, GE60RCD, GE65, GE65RCD, GE80, LC1200, LC1200RCD, LC412, LC700, LC700RCD, LC900, LC900RCD, XLC		

			
1			
GEV No.	530892	Ref. No.	420592
description	wash arm L 520mm mounting pos. upper/lower w. jets 8 r. jets 5 mounting ø 12/45mm		
accessories for	530892		
	GEV No.	530893	Ref. No. 342958V02R
	rinse arm shaft mounting pos. upper/lower ED ø 15mm thread M10x1.5 seat ø 12mm		

			
1			
GEV No.	511007	Ref. No.	191070
description	bush for wash arm support		
For models:	C75, C75BT, C75RCD, FC, FC53, FC533, FC533A, FC53A, FC53CBT, FC53LA, FC53LBT, FC54, FC543, FC543A, FC543E, FC543EA, FC544, FC544A, FC54A, FC54CBT, FC54E, FC54EA, FC54LBT, FCHR, FCHRA, FCHRT, FCHRTA, LF322, LF322A, LF322MP, LF322MP-A, LF322RCD, LF324, LF324A, LF325E, LF325EA, LF700, LF700A, LFD32E, LFD32EA, LFD32M, LFD32MA		

	1		
GEV No.	510313	Ref. No.	190617
description	bush H 12mm D1 ø 20mm D2 ø 16mm D3 ø 12mm for wash arm boss		
For models:	B13T, B14T, B15T, B15TM, B16, B16T, B16TM, B18T, B18TM, B19, B19T, B19TM, B41, B42, BC25HR, BC30HR, BC30HR380, BC30HRA, BHC25S, C140, C30, C33, C34, C70, C75, C75BT, C75M, C75RCD, C85, F2, F20, F3, F300, F45, F55, F65, F80, F90M, F90MA, FC, FC53, FC533, FC533A, FC53A, FC53CBT, FC53LA, FC53LBT, FC54, FC543, FC543A...(Other models you can see in the webshop)		



	2		
GEV No.	510232	Ref. No.	190673
description	bush ø 23mm H 21mm for rinse arm		
For models:	C1001M, C1301M, LC1200, LC1200RCD, LC380, LC380RCD, LC400, LC412, LC700, LC700RCD, LC900, LC900RCD		

	1		
GEV No.	511235	Ref. No.	190663
description	bushing		
For models:	C75, C75BT, C75RCD, FC, FC53, FC533, FC533A, FC53A, FC53CBT, FC53LA, FC53LBT, FC54, FC543, FC543A, FC543E, FC543EA, FC544, FC544A, FC54A, FC54CBT, FC54E, FC54EA, FC54LBT, FCHR, FCHRA, FCHRT, FCHRTA, GF70, GF70A, LC1200, LC700, LC900, LF322, LF322A, LF322MP, LF322MP-A, LF322RCD, LF324, LF324A, LF325E, LF325EA, LF700, LF700A, LFD32E, LFD32EA, LFD32M, LFD32MA		

	1		
GEV No.	511242	Ref. No.	450218
description	connector holder L 30mm H 16mm W 22mm		
For models:	C1000E, C1000ERCD, C1001M, C1300E, C1300ERCD, C1301M, C155, C155BT, C155E2, C155RCD, C165, C165E2, C165E2BT, C165E2RCD, C166, C166-2, C95, C95BT, C95E2, C95RCD, G100L, G101L, G50L, G51L, G60L, G61L, GE100, GE115, GE50RCD, GE60, GE60RCD, GE65, GE65RCD, GE80, GL, LC1200, LC1200RCD, LC412, LC700, LC700RCD, LC900, LC900RCD, XLC		



	1		
GEV No.	510051	Ref. No.	280419
description	knurled nut for wash arm thread M10 ø 21mm H 11mm		
For models:	FC3E, FC3EA, FC3M, FC3MA, FC3MR, FC44E, FC44EA, FC4E, FC4EA, FC4EHR, FC4M, FC4MA		

	1		
GEV No.	511009	Ref. No.	280413
description	knurled nut thread M8 ø 30mm H 4.5mm SS		
For models:	C75, C75BT, C75RCD, FC, FC53, FC533, FC533A, FC53A, FC53CBT, FC53LA, FC53LBT, FC54, FC543, FC543A, FC543E, FC543EA, FC544, FC544A, FC54A, FC54CBT, FC54E, FC54EA, FC54LBT, FCHR, FCHRA, FCHRT, FCHRTA		

	1			
GEV No.	511236	Ref. No.	170963	
description	nozzle for rinse arm			
For models:	BHC25-2, BHC25A-2, BHC30-2, BHC30A-2, BHC30E, BHC30E-2, BHC30EA, BHC30EA-2, BHC30HR-2, BHC30HRA-2, BHC433-2, BHC433A-2, C1001M, C1301M, C75, C75BT, C75RCD, FC, FC53, FC533, FC533A, FC53A, FC53CBT, FC53LA, FC53LBT, FC54, FC543, FC543A, FC543E, FC543EA, FC544, FC544A, FC54A, FC54CBT, FC54E, FC54EA, FC54LBT, FCHR, FCHRA, FCHRT, FCHRTA, GF70, GF70A, LC1200, LC1200RCD, LC412, LC700, LC700RCD, LC900, LC900RCD...(Other models you can see in the webshop)			
accessories for	511236			
	GEV No.	511237	Ref. No.	200850
	O-ring EPDM thickness 1mm ID ø 7mm Qty 1 pcs			
	GEV No.	511238	Ref. No.	450236
	opposite support for rinse jet			







	1		
GEV No.	511238	Ref. No.	450236
description	opposite support for rinse jet		
For models:	BHC25-2, BHC25A-2, BHC30-2, BHC30A-2, BHC30E, BHC30E-2, BHC30EA, BHC30EA-2, BHC30HR-2, BHC30HRA-2, BHC433-2, BHC433A-2, C1001M, C1301M, C75, C75BT, C75RCD, FC, FC53, FC533, FC533A, FC53A, FC53CBT, FC53LA, FC53LBT, FC54, FC543, FC543A, FC543E, FC543EA, FC544, FC544A, FC54A, FC54CBT, FC54E, FC54EA, FC54LBT, FCHR, FCHRA, FCHRT, FCHRTA, GF70, GF70A, LC1200, LC1200RCD, LC412, LC700, LC700RCD, LC900, LC900RCD...(Other models you can see in the webshop)		

	1		
GEV No.	511237	Ref. No.	200850
description	O-ring EPDM thickness 1mm ID ø 7mm Qty 1 pcs		
For models:	BHC25-2, BHC25A-2, BHC30-2, BHC30A-2, BHC30E, BHC30E-2, BHC30EA, BHC30EA-2, BHC30HR-2, BHC30HRA-2, BHC433-2, BHC433A-2, C1001M, C1301M, C75, C75BT, C75RCD, FC, FC53, FC533, FC533A, FC53A, FC53CBT, FC53LA, FC53LBT, FC54, FC543, FC543A, FC543E, FC543EA, FC544, FC544A, FC54A, FC54CBT, FC54E, FC54EA, FC54LBT, FCHR, FCHRA, FCHRT, FCHRTA, GF70, GF70A, LC1200, LC1200RCD, LC412, LC700, LC700RCD, LC900, LC900RCD...(Other models you can see in the webshop)		

	1			
GEV No.	511012	Ref. No.	170958	
description	rinse jet			
For models:	C75, C75BT, C75RCD, FC, FC53, FC533, FC533A, FC53A, FC53CBT, FC53LA, FC53LBT, FC54, FC543, FC543A, FC543E, FC543EA, FC544, FC544A, FC54A, FC54CBT, FC54LBT, FCHR, FCHRA, FCHRT, FCHRTA			
accessories for	511012			
	GEV No.	528583	Ref. No.	200845 200864
	O-ring EPDM thickness 2.62mm ID ø 9.13mm Qty 1 pcs			





			
1			
GEV No.	510307	Ref. No.	261004 261009
description	Thumb screw thread M6 H 3mm thread L 8mm ø 28mm SS		
For models:	B13T, B14T, B15T, B15TM, B16, B16T, B16TM, B18T, B18TM, B19, B19T, B19TM, B41, B42, BC25, BC25A, BC25HR, BC30, BC30A, BC30HR, BC30HR380, BC30HRA, BHC25, BHC25A, BHC25S, BHC30, BHC30A, BHC30HR, BHC30HR380, BHC30HRA, BHC30HRA380, BHC433, BHC433A, BHCHR, C1000E, C1000ERCD, C1001M, C1300E, C1300ERCD, C1301M, C140, C155, C155BT, C155E2, C155RCD, C165, C165E2, C165E2BT, C165E2RCD, C166...(Other models you can see in the webshop)		

			
1			
GEV No.	510276	Ref. No.	430130
description	rinse arm L 450mm mounting pos. upper/lower nozzles 4 mounting ø 34mm complete		
For models:	SE		
spare parts for	510276		
	GEV No.	510305	Ref. No.
			180213
	opposite support for wash jet		
	GEV No.	510334	Ref. No.
			170926
	nozzle holder mounting pos. upper		
	GEV No.	511220	Ref. No.
			380323
	nozzle for rinse arm		
accessories for	510276		
	GEV No.	504347	Ref. No.
			380324
	nozzle for rinse arm thread 1/8" L 11mm		
	GEV No.	524588	Ref. No.
			380321
	rinse jet H 11mm thread 1/8" WS 13 code 321		

			
1			
GEV No.	510277	Ref. No.	430136
description	rinse arm L 485mm mounting pos. upper/lower nozzles 6 mounting ø 25mm complete with nozzle		
For models:	AC100, AC120, AC135, AC150, AC170, AC200, AC90, ACR, ACR145, ACR205, ACR225, ACR245, ACR260, ACR265, ACR305, ACRS145, ACRS205, ACRS225, ACRS245, ACRS260, ACRS265, ACRS305, GMC, GMC2700, GMC3500, GMC4500, GMC5500, SE, SNL		

			
1			
GEV No.	510672	Ref. No.	430184 430185
description	rinse arm mounting pos. upper/lower L 525mm nozzles 6 with bayonet coupling		
For models:	AC101, AC122, AC151, AC152, AC181, AC182, AC201, AC202, AC241, AC242, AC91, ACRS145, ACRS205, ACRS225, ACRS245, ACRS260, ACRS265, ACRS305, ACS151, ACS151-DIGIT, ACS152, ACS152-DIGIT, ACS161-DIGIT, ACS162-DIGIT, ACS181, ACS181-DIGIT, ACS182, ACS182-DIGIT, ACS201, ACS201-DIGIT, ACS202, ACS202-DIGIT, ACS241, ACS241-DIGIT, ACS242, ACS242-DIGIT, GMC2702, GMC3502, GMC4502, GMC5502		

			
1			
GEV No.	517598	Ref. No.	430214
description	rinse arm mounting pos. upper/lower right L 615mm nozzles 6		
For models:	NE02, NE3002, NE4002, NE5002, NE5502, NE7002, NE7502, NE9002, NE9502, NL302, NL302E, NL402, NL402E, NL502, NL502E, NL552, NL552E		

			
1			
GEV No.	524642	Ref. No.	170628 170648
description	wash arm L 284mm mounting pos. upper/lower left nozzles 4 complete with nozzle H 83mm W 63mm		
For models:	AC100, AC101, AC105, AC135, AC90, AC91, AC95, SNL		
spare parts for	524642		
	GEV No.	524586	Ref. No.
			170960
	wash jet H 38mm ø 4.5mm		



1

GEV No.	524673	Ref. No.	420227
description	wash arm L 550mm mounting pos. upper/lower nozzles 6 mounting ø 52mm		
For models:	NE3001, NE4001, NE5501, NE7501, NE9001		



1

GEV No.	524579	Ref. No.	170612
description	wash arm L 98mm mounting pos. upper right nozzles 1 short H 84mm W 63mm		
For models:	AC100, AC101, AC105, AC120, AC135, AC150, AC170, AC200, AC90, AC91, AC95, SNL		



1

GEV No.	517599	Ref. No.	170629
description	wash arm mounting pos. upper right L 102mm W 63mm H 83mm nozzles 1		
For models:	AC100, AC105, AC135, AC90, AC95, SNL		
spare parts for	517599		
	GEV No.	517600	Ref. No. 170921
	wash jet H 39mm ø 34mm		



1

GEV No.	524827	Ref. No.	430186
description	wash arm stationary mounting pos. upper/lower L 525mm nozzles 6		
For models:	AC101, AC122, AC91, ACS101, ACS101-DIGIT, ACS122, ACS122-DIGIT, ACS91, ACS91-DIGIT		



1

GEV No.	517596	Ref. No.	170611
description	wash arm without nozzles mounting pos. upper/lower L 280mm W 64mm H 83.5mm nozzles 4		
For models:	AC100, AC101, AC105, AC135, AC90, AC91, AC95, SNL		



1

GEV No.	517428	Ref. No.	160724
description	end cap for wash arm mounting pos. upper/lower ø 50mm H 16mm		
For models:	AC100, AC101, AC105, AC120, AC135, AC150, AC170, AC200, AC90, AC91, AC95, ACR, ACR145, ACR205, ACR225, ACR245, ACR260, ACR265, ACR305, GMC, GMC2700, GMC3500, GMC4500, GMC5500, NE00, NE3001, NE4001, NE5501, NE7501, NE9001, NG00, NG01, NG600, NG600E, NG900, NG900E, NG901, NG901E, R40, R50, R70, SE, SNL		



1

GEV No.	511631	Ref. No.	200480
description	gasket ID ø 13.5mm ED ø 26mm H 10mm		
For models:	AC100, AC101, AC105, AC120, AC122, AC135, AC150, AC151, AC152, AC170, AC181, AC182, AC200, AC201, AC202, AC241, AC242, AC2A, AC90, AC91, AC95, ACL150, ACR, ACR145, ACR205, ACR225, ACR245, ACR260, ACR265, ACR305, ACS145, ACS205, ACS225, ACS245, ACS260, ACS265, ACS305, ACS101, ACS101-DIGIT, ACS122, ACS122-DIGIT, ACS151, ACS151-DIGIT, ACS152, ACS152-DIGIT, ACS161-DIGIT, ACS162-DIGIT, ACS181, ACS181-DIGIT, ACS182...(Other models you can see in the webshop)		



1

GEV No.	511220	Ref. No.	380323
description	nozzle for rinse arm		
For models:	AC101, AC122, AC91, AC95, ACS101, ACS101-DIGIT, ACS122, ACS122-DIGIT, ACS91, ACS91-DIGIT, SE		





1

GEV No.	504347	Ref. No.	380324
description	nozzle for rinse arm thread 1/8" L 11mm		
For models:	AC100, AC101, AC120, AC122, AC135, AC150, AC151, AC152, AC170, AC181, AC182, AC200, AC201, AC202, AC241, AC242, AC2A, AC90, AC91, ACR, ACR145, ACR205, ACR225, ACR245, ACR260, ACR265, ACR305, ACS145, ACS205, ACS225, ACS245, ACS260, ACS265, ACS305, ACS151, ACS151-DIGIT, ACS152, ACS152-DIGIT, ACS161-DIGIT, ACS162-DIGIT, ACS181, ACS181-DIGIT, ACS182, ACS182-DIGIT, ACS201, ACS201-DIGIT, ACS202, ACS202-DIGIT, ACS241, ACS241-DIGIT...(Other models you can see in the webshop)		





			
1			
GEV No.	510334	Ref. No.	170926
description	nozzle holder mounting pos. upper		
For models:	AC120, AC150, AC170, AC200, ACR, ACR145, ACR205, ACR225, ACR245, ACR260, ACR265, ACR305, G115, G125, G65, G75, GMC, GMC2700, GMC3500, GMC4500, GMC5500, NE00, NG00, NG01, NG02, NG1202, NG1202E, NG600, NG600E, NG601, NG601E, NG602, NG602E, NG900, NG900E, NG901, NG901E, NG902, NG902E, SE, SNL		

			
1			
GEV No.	510305	Ref. No.	180213
description	opposite support for wash jet		
For models:	AC101, AC105, AC120, AC122, AC150, AC151, AC152, AC170, AC200, AC91, AC95, ACR, ACR145, ACR205, ACR225, ACR245, ACR260, ACR265, ACR305, ACRS145, ACRS205, ACRS225, ACRS245, ACRS260, ACRS265, ACRS305, ACS101, ACS101-DIGIT, ACS122, ACS122-DIGIT, ACS151, ACS151-DIGIT, ACS152, ACS152-DIGIT, ACS91, ACS91-DIGIT, B13T, B14T, B15T, B15TM, B16, B16T, B16TM, B18T, B18TM, B19, B19T, B19TM, B41, B42...(Other models you can see in the webshop)		

			
1			
GEV No.	530293	Ref. No.	200809
description	O-ring EPDM thickness 1.78mm ID ø 8.73mm Qty 1 pcs		
For models:	AC101, AC105, AC122, AC135, AC151, AC152, AC181, AC182, AC201, AC202, AC241, AC242, AC2A, AC91, AC95, ACL100, ACL150, ACRS145, ACRS205, ACRS225, ACRS245, ACRS260, ACRS265, ACRS305, ACS101, ACS101-DIGIT, ACS122, ACS122-DIGIT, ACS151, ACS151-DIGIT, ACS152, ACS152-DIGIT, ACS161-DIGIT, ACS162-DIGIT, ACS181, ACS181-DIGIT, ACS182, ACS182-DIGIT, ACS201, ACS201-DIGIT, ACS202, ACS202-DIGIT, ACS241, ACS241-DIGIT, ACS242, ACS242-DIGIT, ACS91, ACS91-DIGIT, B15, B16...(Other models you can see in the webshop)		

			
1			
GEV No.	510955	Ref. No.	200854
description	O-ring EPDM thickness 3mm ID ø 6mm Qty 1 pcs		
For models:	AC100, AC90, G100L, G101L, G50L, G51L, G60L, G61L, GL, NG02, NG1202, NG1202E, NG602, NG602E, NG902, NG902E		

			
1			
GEV No.	524588	Ref. No.	380321
description	rinse jet H 11mm thread 1/8" WS 13 code 321		
For models:	AC120, AC150, AC170, AC200, ACR, ACR145, ACR205, ACR225, ACR245, ACR260, ACR265, ACR305, GMC, GMC2700, GMC3500, GMC4500, GMC5500, NG00, NG01, NG02, NG1202, NG1202E, NG600, NG600E, NG601, NG601E, NG602, NG602E, NG900, NG900E, NG901, NG901E, NG902, NG902E, SE		

			
1			
GEV No.	524587	Ref. No.	170962
description	wash jet H 38mm		
For models:	AC101, AC91		

			
1			
GEV No.	524586	Ref. No.	170960
description	wash jet H 38mm ø 4.5mm		
For models:	AC100, AC101, AC105, AC135, AC90, AC91, AC95		

			
1			
GEV No.	517600	Ref. No.	170921
description	wash jet H 39mm ø 34mm		
For models:	AC100, AC101, AC105, AC135, AC90, AC91, AC95, SNL		

			
1			
GEV No.	517601	Ref. No.	170909
description	wash jet H 39mm ø 34mm		
For models:	AC120, AC135, AC150, AC170, AC200, NE00, NG00, NG600, NG600E, NG900, NG900E, SNL		

			
1			
GEV No.	510737	Ref. No.	170636 430313
description	rinse arm L 205mm mounting pos. upper nozzles 3 mounting ø 12mm complete with nozzle		
For models:	B10T, B11T, B12T, BR20, BR20A, BR25, BR25A, LBR, LBR200, LBR215, LBR215A		





			
1			
GEV No.	510728	Ref. No.	170603
description	wash arm L 250mm mounting pos. lower nozzles 4 mounting ø 25mm suitable for B23-27-10-11		
For models:	B10, B10T, B11, B11T, B12, B12T, B20, B20D, B23, B24, B25, B26, B27, BR20, BR20A, BR25, BR25A, LBR, LBR200, LBR215, LBR215A		
spare parts for	510728		
	GEV No.	510731	Ref. No. 160710
	end cap for wash arm		
	GEV No.	560140	Ref. No. 260402 260418
	hexagonal nut thread M4 H 4.8mm SS WS 7 Qty 20 pcs DIN/ISO DIN 985 self-locking		

Table continues overleaf

spare parts for 510728			
	GEV No.	560376	Ref. No. 260510
lock washer ID ø 4.3mm ED ø 7.3mm SS UNI 1751 A Qty 1 pcs for thread M4			





GEV No.	510280	Ref. No.	170604
description wash arm L 282mm mounting pos. upper nozzles 2 lateral Hmm suitable for B23-12t			
For models: B10T, B11, B11T, B12, B12T, B23, B24, B25, B26, B27, BR25, BR25A, LBR, LBR200, LBR215, LBR215A			





GEV No.	524674	Ref. No.	170605
description wash arm L 500mm nozzles 5 mounting ø 30mm without nozzles			
For models: B31, B32			

	1		
GEV No.	510323	Ref. No.	160734
description end cap for rinse arm			
For models: B10T, B11T, B12T, B13T, B14T, B15T, B15TM, B16T, B16TM, B18T, B18TM, B19T, B19TM, BC25, BC25A, BC30, BC30A, BHC25, BHC25A, BHC30, BHC30A, BHC30HR, BHC30HR380, BHC30HRA, BHC30HRA380, BHC433, BHC433A, BHCHR, BR20, BR20A, BR25, BR25A, F20, F45, F55, F65, F80, FC43, FC43A, FC54E, FC54EA, LB200, LB200-2, LB200A, LB200A-2, LB215, LB215-2, LB215A, LB215A-2, LB260...(Other models you can see in the webshop)			

	1		
GEV No.	510731	Ref. No.	160710
description end cap for wash arm			
For models: B10, B10T, B11, B11T, B12, B12T, B20, B20D, B23, B24, B25, B26, B27, BR20, BR20A, BR25, BR25A, LBR, LBR200, LBR215, LBR215A			

	1		
GEV No.	510761	Ref. No.	200944 21005
description flat gasket rubber D1 ø 38mm D2 ø 25mm thickness 2mm Qty 1 pcs			
For models: BHC25, BHC25-2, BHC25A, BHC25A-2, BHC25S, BHC30, BHC30-2, BHC30A, BHC30A-2, BHC30E, BHC30E-2, BHC30EA, BHC30EA-2, BHC433, BHC433-2, BHC433A, BHC433A-2, GF70, GF70A, LB200, LB200-2, LB200A, LB200A-2, LB215, LB215-2, LB215A, LB215A-2, LB260, LB260-2, LB260A, LB260A-2, LB275, LB275-2, LB275A, LB275A-2, LF321, LF321A, LF322, LF322A, LF322MP, LF322MP-A, LF322RCD, LF324, LF324A, LF325E, LF325EA, LF700, LF700A, LFD32E, LFD32EA...(Other models you can see in the webshop)			

	1		
GEV No.	510885	Ref. No.	200464
description gasket suitable for COMENDA equiv. no. 200464 L 60mm W 30mm			
For models: B10T, B11T, B12T, BR20, BR20A, BR25, BR25A, LBR, LBR200, LBR215, LBR215A			

	1		
GEV No.	510327	Ref. No.	170946
description nozzle for rinse arm			
For models: B10T, B11T, B12T, B13T, B14T, B15T, B15TM, B16T, B16TM, B18T, B18TM, B19T, B19TM, BC25, BC25A, BC30, BC30A, BHC25, BHC25A, BHC30, BHC30A, BHC30HR, BHC30HR380, BHC30HRA, BHC30HRA380, BHC433, BHC433A, BHCHR, BR20, BR20A, BR25, BR25A, F20, F45, F55, F65, F80, FC43, FC43A, FC54E, FC54EA, LB200, LB200-2, LB200A, LB200A-2, LB215, LB215-2, LB215A, LB215A-2, LB260...(Other models you can see in the webshop)			
accessories for 510327			
	GEV No.	510902	Ref. No. 200844
O-ring EPDM thickness 2mm ID ø 9.5mm Qty 1 pcs			

	1		
GEV No.	510734	Ref. No.	170924
description nozzle for wash arm suitable for B23-10-11-12			
For models: B10, B10T, B11, B11T, B12, B12T, B20, B20D, B23, B24, B25, B26, B27, BR20, BR20A, BR25, BR25A, LBR, LBR200, LBR215, LBR215A			

	1		
GEV No.	510736	Ref. No.	170908
description nozzle for wash arm suitable for B23-10-12			
For models: B10, B10T, B11, B11T, B12, B12T, B20, B20D, B23, B24, B25, B26, B27, B31, B32, BR20, BR20A, BR25, BR25A, LBR, LBR200, LBR215, LBR215A			







			
1			
GEV No.	510735	Ref. No.	190618
description	nozzle holder for wash arm		
For models:	B10, B10T, B11, B11T, B12, B12T, B20, B20D, B23, B24, B25, B26, B27, BR20, BR20A, BR25, BR25A, LBR, LBR200, LBR215, LBR215A		

			
1			
GEV No.	510335	Ref. No.	380309
description	rinse jet for glass rinsing		
For models:	B13T, B14T, B15, B15T, B16, B16T, B18, B18T, B19, B19T, B31, B32		

			
1			
GEV No.	511200	Ref. No.	270106
description	nut thread 1" H 6mm brass WS 45 Qty 1 pcs		
For models:	B10, B10T, B11, B11T, B12, B12T, B20, B20D, B23, B24, B25, B26, B27, BR20, BR20A, BR25, BR25A, LBR, LBR200, LBR215, LBR215A		

			
1			
GEV No.	519471	Ref. No.	332552
description	wash arm L 550mm H 440mm mounting pos. upper nozzles 24		
For models:	ACRS145, ACRS205, ACRS225, ACRS245, ACRS260, ACRS265, ACRS305, GMC2702, GMC3502, GMC4502, GMC5502		



			
1			
GEV No.	507309	Ref. No.	200819
description	O-ring EPDM thickness 2.62mm ID ø 17.13mm Qty 1 pcs		
For models:	B10, B10T, B11, B11T, B12, B12T, B20, B20D, B23, B24, B25, B26, B27, B31, B32, BR20, BR20A, BR25, BR25A, C33, C34, LBR, LBR200, LBR215, LBR215A		

spare parts for 519471			
	GEV No.	502073	Ref. No. 200933
	GEV No.	510899	Ref. No. 200830
	GEV No.	519464	Ref. No. 160721 160781

			
1			
GEV No.	528583	Ref. No.	200845 200864
description	O-ring EPDM thickness 2.62mm ID ø 9.13mm Qty 1 pcs		
For models:	B10T, B11T, B12T, B13T, B14T, B15T, B15TM, B16T, B16TM, B18T, B18TM, B19T, B19TM, BC25, BC25A, BC30, BC30A, BHC25, BHC25A, BHC30, BHC30A, BHC30HR, BHC30HR380, BHC30HRA, BHC30HRA380, BHC433, BHC433A, BHCHR, BR20, BR20A, BR25, BR25A, C75, C75BT, C75RCD, F20, F45, F55, F65, F80, FC, FC43, FC43A, FC53, FC533, FC533A, FC53A, FC53CBT, FC53LA, FC53LBT...(Other models you can see in the webshop)		

			
1			
GEV No.	524777	Ref. No.	332557
description	wash arm L 560mm nozzles 12 mounting pos. upper W 255mm H 65mm		
For models:	ACS181, ACS181-DIGIT, ACS182, ACS182-DIGIT		

			
1			
GEV No.	510742	Ref. No.	380604 380605
description	rinse arm L 292mm H 270mm mounting pos. upper nozzles 4 complete with nozzle		
For models:	B13T, B14T, B15, B15T, B16, B16T, B18, B18T, B19, B19T		

			
1			
GEV No.	519464	Ref. No.	160721 160781
description	plug		
For models:	AC122, AC151, AC152, AC181, AC182, AC201, AC202, AC241, AC242, ACL100, ACL150, ACR, ACR145, ACR205, ACR225, ACR245, ACR260, ACR265, ACR305, ACRS145, ACRS205, ACRS225, ACRS245, ACRS260, ACRS265, ACRS305, ACS101, ACS101-DIGIT, ACS122, ACS122-DIGIT, ACS151, ACS151-DIGIT, ACS152, ACS152-DIGIT, ACS161-DIGIT, ACS162-DIGIT, ACS181, ACS181-DIGIT, ACS182, ACS182-DIGIT, ACS201, ACS201-DIGIT, ACS202, ACS202-DIGIT, ACS241, ACS241-DIGIT, ACS242, ACS242-DIGIT, ACS91, ACS91-DIGIT...(Other models you can see in the webshop)		
accessories for	519464		
	GEV No.	502073	Ref. No. 200933
	O-ring EPDM thickness 4mm ID ø 24mm Qty 1 pcs		

			
1			
GEV No.	510331	Ref. No.	270101
description	nut thread 1/2" H 7mm SS WS 30 Qty 1 pcs		
For models:	AC100, AC101, AC105, AC120, AC122, AC135, AC150, AC151, AC152, AC170, AC181, AC182, AC200, AC201, AC202, AC241, AC242, AC2A, AC90, AC91, AC95, ACL100, ACL150, ACR, ACR145, ACR205, ACR225, ACR245, ACR260, ACR265, ACR305, ACRS145, ACRS205, ACRS225, ACRS245, ACRS260, ACRS265, ACRS305, ACS101, ACS101-DIGIT, ACS122, ACS122-DIGIT, ACS151, ACS151-DIGIT, ACS152, ACS152-DIGIT, ACS161-DIGIT, ACS162-DIGIT, ACS181, ACS181-DIGIT...(Other models you can see in the webshop)		

miscellaneous



GEV No.	510339	Ref. No.	380402
----------------	--------	-----------------	--------

description nozzle rinsing



GEV No.	510455	Ref. No.	380313
----------------	--------	-----------------	--------

description rinse jet



GEV No.	512196	Ref. No.	170954
----------------	--------	-----------------	--------

description rinse jet H 18.5mm

For models: AC101, AC105, AC120, AC122, AC151, AC152, AC170, AC200, AC91, AC95, ACL150, ACR, ACR145, ACR205, ACR225, ACR245, ACR260, ACR265, ACR305, ACRS145, ACRS205, ACRS225, ACRS245, ACRS260, ACRS265, ACRS305, ACS101, ACS101-DIGIT, ACS122, ACS122-DIGIT, ACS151, ACS151-DIGIT, ACS152, ACS152-DIGIT, ACS161-DIGIT, ACS162-DIGIT, ACS91, ACS91-DIGIT, GMC, GMC2700, GMC2702, GMC3500, GMC3502, GMC4500, GMC4502, GMC5500, GMC5502, NE00, NE02, NE3001...(Other models you can see in the webshop)



GEV No.	510866	Ref. No.	190623
----------------	--------	-----------------	--------

description union nut for rinse jet ϕ 14mm

For models: ACR, ACR145, ACR205, ACR225, ACR245, ACR260, ACR265, ACR305, GMC, GMC2700, GMC3500, GMC4500, GMC5500, LAV1000, NE00, SE



GEV No.	510828	Ref. No.	170907
----------------	--------	-----------------	--------

description wash jet

wash arm supports

wash arm supports



GEV No.	510466	Ref. No.	191024
----------------	--------	-----------------	--------

description opposite support

For models: F300



GEV No.	510035	Ref. No.	190232
----------------	--------	-----------------	--------

description opposite support mounting pos. lower for wash arm support

For models: FC3E, FC3EA, FC3M, FC3MA, FC3MR, FC44E, FC44EA, FC4E, FC4EA, FC4EHR, FC4M, FC4MA



GEV No.	510461	Ref. No.	190210
----------------	--------	-----------------	--------

description opposite support mounting pos. lower for wash arm support suitable for LBC 215-215A/275-275A

For models: BC25, BC25A, BC25HR, BC30, BC30A, BC30HR, BC30HR380, BC30HRA, FC43, FC43A, LBC210, LBC215, LBC215A, LBC275, LBC275A



GEV No.	510471	Ref. No.	510265
----------------	--------	-----------------	--------

description wash arm support

For models: C30, F2, F3, F300



GEV No.	512411	Ref. No.	190126
----------------	--------	-----------------	--------

description wash arm support ED ϕ 65mm thickness 10mm L 75mm mounting ϕ 23mm ID ϕ 45mm

For models: NE00, NG00, NG600, NG600E, NG900, NG900E, SE



GEV No.	511256	Ref. No.	191083
----------------	--------	-----------------	--------

description wash arm support mounting pos. lower

For models: BHC25, BHC25-2, BHC25A, BHC25A-2, BHC25S, BHC30, BHC30-2, BHC30A, BHC30A-2, BHC30E, BHC30E-2, BHC30EA, BHC30EA-2, BHC30HR, BHC30HR-2, BHC30HR380, BHC30HRA, BHC30HRA-2, BHC30HRA380, BHC433, BHC433-2, BHC433A, BHC433A-2, BHCHR, LB200, LB200-2, LB200A, LB200A-2, LB215, LB215-2, LB215A, LB215A-2, LB260, LB260-2, LB260A, LB260A-2, LB275, LB275-2, LB275A, LB275A-2





GEV No.	511265	Ref. No.	191071
----------------	--------	-----------------	--------

description wash arm support mounting pos. lower

For models: C75, C75BT, C75RCD





			
1			
GEV No.	511269	Ref. No.	341736
description	wash arm support mounting pos. lower		
For models:	G115L, G125L, G50LM, G65L, G75L, GE125, GE75, GL		



			
1			
GEV No.	512027	Ref. No.	190941
description	wash arm support mounting pos. lower		
For models:	LF322, LF322A, LF322MP, LF322MP-A, LF322RCD, LF324, LF324A, LF325E, LF325EA, LF700, LF700A, LFD32E, LFD32EA, LFD32M, LFD32MA		

			
1			
GEV No.	512269	Ref. No.	190223
description	wash arm support mounting pos. lower		
For models:	BHC25, BHC25A, BHC25S, BHC30, BHC30A, BHC30HR, BHC30HR380, BHC30HRA, BHC30HRA380, BHC433, BHC433A, BHC30HR, LB200, LB200-2, LB200A, LB200A-2, LB215, LB215-2, LB215A, LB215A-2, LB260, LB260-2, LB260A, LB260A-2, LB275, LB275-2, LB275A, LB275A-2		

			
1			
GEV No.	510460	Ref. No.	191064
description	wash arm support mounting pos. lower D1 ø 12mm D2 ø 43mm D3 ø 50mm H 133mm		
For models:	BC25, BC25A, BC25HR, BC30, BC30A, BC30HR, BC30HR380, BC30HRA, F90M, F90MA, FC43, FC43A, LF315, LF320, LF320A, LF320CBT, LF320L, LF320LA, LF320LBT, LF323, LF323A, LF350, LF350A, LF400A, LF450, LF450A, LS550		

			
1			
GEV No.	511073	Ref. No.	191068
description	wash arm support mounting pos. lower ED ø 100mm thread M8 ID ø 34mm seat ø 40mm shaft ø 12mm		
For models:	FC, FC53, FC533, FC533A, FC53A, FC53CBT, FC53LA, FC53LBT, FC54, FC543, FC543A, FC543E, FC543EA, FC544, FC544A, FC54A, FC54CBT, FC54E, FC54EA, FC54LBT, FCHR, FCHRA, FCHRT, FCHRTA		

			
1			
GEV No.	524464	Ref. No.	191102
description	wash arm support mounting pos. lower ø 59mm H 88mm ID ø 33mm		
For models:	LF322, LF322A, LF322MP, LF322MP-A, LF322RCD, LF324, LF324A, LF325E, LF325EA, LF700, LF700A, LFD32E, LFD32EA, LFD32M, LFD32MA		

			
1			
GEV No.	510873	Ref. No.	191031
description	wash arm support mounting pos. lower with rinse arm shaft		
For models:	C30, C70, C75, C75M, F2, F3, F45, F55, F65, F80, LP360, LP360BT, LP360RCD		
accessories for	510873		
		GEV No.	510447
		Ref. No.	200829
	O-ring EPDM thickness 5.34mm ID ø 81.92mm Qty 1 pcs		

			
1			
GEV No.	510470	Ref. No.	510201
description	wash arm support mounting pos. upper		
For models:	F2, F3, F300		

			
1			
GEV No.	511259	Ref. No.	190218
description	wash arm support mounting pos. upper		
For models:	FC54E, FC54EA		

			
1			
GEV No.	511266	Ref. No.	190216
description	wash arm support mounting pos. upper		
For models:	C75, C75BT, C75RCD		

			
1			
GEV No.	511268	Ref. No.	510503
description	wash arm support mounting pos. upper		
For models:	LC380, LC380BT, LC380RCD, LC400		

			
1			
GEV No.	511271	Ref. No.	510280
description	wash arm support mounting pos. upper		
For models:	G115, G125, G131, G65, G66, G75		

			
1			
GEV No.	512488	Ref. No.	190215 190944
description	wash arm support mounting pos. upper thread M6		
For models:	FC, FC53, FC533, FC533A, FC53A, FC53CBT, FC53LA, FC53LBT, FC54, FC543, FC543A, FC543E, FC543EA, FC544, FC544A, FC54A, FC54CBT, FC54E, FC54EA, FC54LBT, FCHR, FCHRA, FCHRT, FCHRTA, LF321, LF321A		

			
1			
GEV No.	510319	Ref. No.	510238
description	wash arm support mounting pos. upper/lower		
For models:	C140, C33, C34, G100L, G101L, G50L, G51L, G60L, G61L, GF90, GF90-2004, GF90A, GF90A-2004, GL, LC380, LC380BT, LC380RCD, LC400		

			
1			
GEV No.	524581	Ref. No.	190127
description	wash arm support \varnothing 65mm L 75mm W 65mm H 65mm		
For models:	NE00, NG00, NG600, NG600E, NG900, NG900E, SE		

			
1			
GEV No.	510320	Ref. No.	191025
description	wash arm support with rinse arm shaft mounting pos. lower		
For models:	B13T, B14T, B15, B15T, B15TM, B16, B16T, B16TM, B18, B18T, B18TM, B19, B19T, B19TM, B41, B42, F2, F20, F3, F300, F45, F55, F65, F80, F90M, F90MA, LBC210, LBC215, LBC215A, LBC275, LBC275A, LF280-lav-line, LF315, LF320, LF320A, LF320CBT, LF320L, LF320LA, LF320-lav-line, LF320LBT, LF323, LF323A, LF350, LF350A, LF400A, LF450, LF450A, LS550		

			
1			
GEV No.	510448	Ref. No.	190209
description	wash arm support with rinse arm shaft mounting pos. upper		
For models:	B15TM, B16TM, B18TM, B19TM, BC25, BC25A, BC25HR, BC30, BC30A, BC30HR, BC30HR380, BC30HRA, BHC25, BHC25A, BHC25S, BHC30, BHC30A, BHC30HR, BHC30HR380, BHC30HRA, BHC30HRA380, BHC433, BHC433A, BHCHR, FC43, FC43A, LB200, LB200-2, LB200A, LB200A-2, LB215, LB215-2, LB215A, LB215A-2, LB260, LB260-2, LB260A, LB260A-2, LB275, LB275-2, LB275A, LB275A-2, LBC210, LBC215, LBC215A, LBC275, LBC275A		

			
1			
GEV No.	510114	Ref. No.	190227
description	wash arm support with rinse arm shaft mounting pos. upper/lower \varnothing 74mm H 142mm		
For models:	C1000E, C1000ERCD, C1001M, C1300E, C1300ERCD, C1301M, GE50RCD, LC1200, LC1200RCD, LC412, LC700, LC700RCD, LC900, LC900RCD, XLC		

gaskets

			
1			
GEV No.	510975	Ref. No.	200421
description	gasket D1 \varnothing 40mm D2 \varnothing 70mm thickness 2mm rubber with 4 screw holes wash arm support equiv. no. 200421 suitable for COMENDA		
For models:	F2, F3, F300		

			
1			
GEV No.	510972	Ref. No.	200909
description	gasket with 4 screw holes D1 \varnothing 58mm D2 \varnothing 100mm thickness 2mm wash arm support		
For models:	C155, C155BT, C155E2, C155RCD, C165, C165E2, C165E2BT, C165E2RCD, C166, C166-2, C95, C95BT, C95E2, C95RCD		

			
1			
GEV No.	510302	Ref. No.	200824
description	O-ring EPDM ID \varnothing 12.42mm thickness 1.78mm Qty 1 pcs		
For models:	AC101, AC105, AC120, AC122, AC150, AC151, AC152, AC170, AC200, AC91, AC95, ACL150, ACR, ACR145, ACR205, ACR225, ACR245, ACR260, ACR265, ACR305, ACRS145, ACRS205, ACRS225, ACRS245, ACRS260, ACRS265, ACRS305, ACS101, ACS101-DIGIT, ACS122, ACS122-DIGIT, ACS151, ACS151-DIGIT, ACS152, ACS152-DIGIT, ACS161-DIGIT, ACS162-DIGIT, ACS91, ACS91-DIGIT, B13T, B14T, B15T, B15TM, B16, B16T, B16TM, B18T, B18TM, B19, B19T...(Other models you can see in the webshop)		



			
1			
GEV No.	528333	Ref. No.	200806
description	O-ring EPDM thickness 2.62mm ID ø 13.1mm Qty 1 pcs		
For models:	AC181, AC182, AC201, AC202, AC241, AC242, ACS122, ACS122-DIGIT, ACS152, ACS152-DIGIT, ACS162-DIGIT, ACS182, ACS182-DIGIT, ACS202, ACS202-DIGIT, ACS242, ACS242-DIGIT, B13T, B14T, B15, B15T, B15TM, B16, B16T, B16TM, B18, B18T, B18TM, B19, B19T, B19TM, B41, B42, BC25, BC25A, BC25HR, BC30, BC30A, BC30HR, BC30HR380, BC30HRA, C30, C70, C75, C75BT, C75M, C75RCD, F2, F20, F3...(Other models you can see in the webshop)		

			
1			
GEV No.	510408	Ref. No.	200820
description	O-ring EPDM thickness 5.34mm ID ø 47mm Qty 1 pcs		
For models:	B10T, B11T, B12T, B13T, B14T, B15, B15T, B15TM, B16, B16T, B16TM, B18, B18T, B18TM, B19, B19T, B19TM, B20, B20D, B23, B24, B25, B26, B27, B31, B32, B41, B42, BC25, BC25A, BC25HR, BC30, BC30A, BC30HR, BC30HR380, BC30HRA, BHC25, BHC25-2, BHC25A, BHC25A-2, BHC255, BHC30, BHC30-2, BHC30A, BHC30A-2, BHC30E, BHC30E-2, BHC30EA, BHC30EA-2, BHC30HR...(Other models you can see in the webshop)		

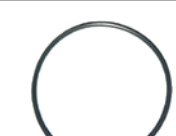
			
1			
GEV No.	510974	Ref. No.	200852
description	O-ring EPDM thickness 2.62mm ID ø 58.42mm Qty 1 pcs		
For models:	C155, C155BT, C155E2, C155RCD, C165, C165E2, C165E2BT, C165E2RCD, C166, C166-2, C95, C95BT, C95E2, C95RCD		

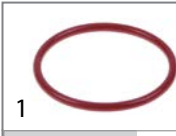

			
1			
GEV No.	510447	Ref. No.	200829
description	O-ring EPDM thickness 5.34mm ID ø 81.92mm Qty 1 pcs		
For models:	B13T, B14T, B15, B15T, B15TM, B16, B16T, B16TM, B18, B18T, B18TM, B19, B19T, B19TM, B41, B42, C30, C70, C75, C75BT, C75M, C75RCD, F2, F20, F3, F300, F45, F55, F65, F80, F90M, F90MA, FC, FC53, FC533, FC533A, FC53A, FC53CBT, FC53LA, FC53LBT, FC54, FC543, FC543A, FC543E, FC543EA, FC544, FC544A, FC54A, FC54CBT, FC54E...(Other models you can see in the webshop)		

			
1			
GEV No.	510973	Ref. No.	200853
description	O-ring EPDM thickness 3.53mm ID ø 63.09mm Qty 1 pcs		
For models:	C155, C155BT, C155E2, C155RCD, C165, C165E2, C165E2BT, C165E2RCD, C166, C166-2, C95, C95BT, C95E2, C95RCD		

			
1			
GEV No.	532594	Ref. No.	200808
description	O-ring silicone thickness 3.53mm ID ø 50.8mm Qty 1 pcs		
For models:	FC3E, FC3EA, FC3M, FC3MA, FC3MR, FC44E, FC44EA, FC4E, FC4EA, FC4EHRT, FC4M, FC4MA		

			
1			
GEV No.	510971	Ref. No.	200855
description	O-ring EPDM thickness 3mm ID ø 43mm Qty 1 pcs		
For models:	BC25, BC25A, BC25HR, BC30, BC30A, BC30HR, BC30HR380, BC30HRA, F90M, F90MA, FC43, FC43A, LF315, LF320, LF320A, LF320CBT, LF320L, LF320LA, LF320LBT, LF323, LF323A, LF350, LF350A, LF400A, LF450, LF450A, LS550		

wash arm bearings

			
1			
GEV No.	511231	Ref. No.	191069
description	wash arm bearing		
For models:	C75, C75BT, C75RCD, FC, FC53, FC533, FC533A, FC53A, FC53CBT, FC53LA, FC53LBT, FC54, FC543, FC543A, FC543E, FC543EA, FC544, FC544A, FC54A, FC54CBT, FC54E, FC54EA, FC54LBT, FCHR, FCHRA, FCHRT, FCHRTA, LF322, LF322A, LF322MP, LF322MP-A, LF322RCD, LF324, LF324A, LF325E, LF325EA, LF700, LF700A, LFD32E, LFD32EA, LFD32M, LFD32MA		
accessories for	511231		
	GEV No.	510313	Ref. No. 190617
bush H 12mm D1 ø 20mm D2 ø 16mm D3 ø 12mm for wash arm boss			

			
1			
GEV No.	510970	Ref. No.	200856
description	O-ring EPDM thickness 3mm ID ø 81mm Qty 1 pcs		
For models:	BC25, BC25A, BC25HR, BC30, BC30A, BC30HR, BC30HR380, BC30HRA, F90M, F90MA, FC43, FC43A, LF315, LF320, LF320A, LF320CBT, LF320L, LF320LA, LF320LBT, LF323, LF323A, LF350, LF350A, LF400A, LF450, LF450A, LS550		



1

GEV No.	510050	Ref. No.	190233
description	wash arm bearing mounting pos. upper/lower suitable for wash arm FC2006		
For models:	FC3E, FC3EA, FC3M, FC3MA, FC3MR, FC44E, FC44EA, FC4E, FC4EA, FC4EHRT, FC4M, FC4MA		



1

GEV No.	510644	Ref. No.	330824
description	wash arm bearing ø 25mm H 52mm		
For models:	C1001M, C1301M, LC1200, LC1200RCD, LC412, LC700, LC700RCD, LC900, LC900RCD		

miscellaneous



1

GEV No.	510449	Ref. No.	260539
description	disc		
For models:	B13T, B14T, B15T, B15TM, B16T, B16TM, B18T, B18TM, B19T, B19TM		



1

GEV No.	511241	Ref. No.	191075
description	knurled nut thread M26x1 stainless steel ø 48.6mm H 10mm		
For models:	C1001M, C1301M, LC1200, LC1200RCD, LC380, LC380BT, LC380RCD, LC400, LC412, LC700, LC700RCD, LC900, LC900RCD		



1

GEV No.	510236	Ref. No.	260568
description	plain washer ID ø 21mm ED ø 28mm thickness 1mm SS Qty 1 pcs		
For models:	C1001M, C1301M, LC1200, LC1200RCD, LC412, LC700, LC700RCD, LC900, LC900RCD		



1

GEV No.	511248	Ref. No.	440816
description	retaining ring bore ø 48mm thickness 1.9mm stainless steel DIN 472		
For models:	G115, G115L, G125L, G131, G50LM, G65, G65L, G66, G75, G75L, GE125, GE75, GL		



1

GEV No.	511249	Ref. No.	160820
description	slide ring		
For models:	G115, G115L, G125L, G131, G50LM, G65, G65L, G66, G75, G75L, GE125, GE75, GL		

rinse arm shafts



1

GEV No.	510052	Ref. No.	342790
description	rinse arm shaft		
For models:	FC3E, FC3EA, FC3M, FC3MA, FC3MR, FC44E, FC44EA, FC4E, FC4EA, FC4EHRT, FC4M, FC4MA		



1

GEV No.	510311	Ref. No.	340448
description	rinse arm shaft		



1

GEV No.	510318	Ref. No.	340499
description	rinse arm shaft		
For models:	C140, C155, C155BT, C155E2, C155RCD, C165, C165E2, C165E2BT, C165E2RCD, C166, C166-2, C33, C34, C95, C95BT, C95E2, C95RCD, G100L, G101L, G50L, G51L, G60L, G61L, GE100, GE115, GE60, GE60RCD, GE65, GE65RCD, GE80, GL, LC380, LC380BT, LC380RCD, LC400		



1

GEV No.	510919	Ref. No.	341215
description	rinse arm shaft		





1

GEV No.	511011	Ref. No.	342051
description	rinse arm shaft		
For models:	C75, C75BT, C75RCD, FC, FC53, FC533, FC533A, FC53A, FC53CBT, FC53LA, FC53LBT, FC54, FC543, FC543A, FC543E, FC543EA, FC544, FC544A, FC54A, FC54CBT, FC54LBT, FCHR, FCHRA, FCHRT, FCHRTA		

accessories for	511011		
	GEV No.	511198	Ref. No.
			—
	bush for wash arm		





			
1			
GEV No.	511234	Ref. No.	342706
description	rinse arm shaft		
For models:	C75, C75BT, C75RCD, FC, FC53, FC533, FC533A, FC53A, FC53CBT, FC53LA, FC53LBT, FC54, FC543, FC543A, FC543E, FC543EA, FC544, FC544A, FC54A, FC54CBT, FC54E, FC54EA, FC54LBT, FCHR, FCHRA, FCHRT, FCHRTA		

			
1			
GEV No.	511270	Ref. No.	341912
description	rinse arm shaft		
For models:	G115L, G125L, G50LM, G65L, G75L, GE125, GE75, GL		

			
1			
GEV No.	511272	Ref. No.	340489
description	rinse arm shaft		
For models:	G115, G125, G131, G65, G66, G75		

			
1			
GEV No.	512210	Ref. No.	H34997
description	rinse arm shaft		
For models:	GF90, GF90-2004, GF90A, GF90A-2004		

			
1			
GEV No.	510489	Ref. No.	340468
description	rinse arm shaft F2 ø 12mm H 82mm		
For models:	C30, F2, F3, F300		

			
1			
GEV No.	511232	Ref. No.	342056
description	rinse arm shaft mounting pos. upper ø 12mm H 50mm thread 3/8" thread L 10mm		
For models:	LBC210, LBC215, LBC215A, LBC275, LBC275A		

			
1			
GEV No.	530893	Ref. No.	342958V02R
description	rinse arm shaft mounting pos. upper/lower ED ø 15mm thread M10x1.5 seat ø 12mm		

gear wheels

			
1			
GEV No.	698347	Ref. No.	410258
description	gear wheel splitting 1/2" teeth 13 shaft intake ø 19mm H 28mm		
For models:	LV1001, LV1501, LV-LVP, LVP1001, LVP1501, NL302, NL302E, NL402, NL402E, NL502, NL502E, NL552, NL552E		

			
1			
GEV No.	698346	Ref. No.	410235
description	gear wheel splitting 1/2" teeth 18 shaft intake ø 17mm H 28mm		

			
1			
GEV No.	698348	Ref. No.	410346
description	gear wheel splitting 1/2" teeth 20 shaft intake ø 49mm H 7mm		

			
1			
GEV No.	698349	Ref. No.	410348
description	gear wheel splitting 1/2" teeth 23 shaft intake ø 49mm H 7mm		

			
1			
GEV No.	698345	Ref. No.	410245
description	gear wheel splitting 1/2" teeth 24 shaft intake ø 17mm H 28mm		

			
1			
GEV No.	699284	Ref. No.	170342
description	gear wheel pair for impulse teeth 7 shaft intake ø 25mm H 37.5mm suitable for COMENDA plastic		
For models:	NE02, NE3002, NE4002, NE5002, NE5502, NE7002, NE7502, NE9002, NE9502, NG02, NG1202, NG1202E, NG602, NG602E, NG902, NG902E, NL302, NL302E, NL402, NL402E, NL502, NL502E, NL552, NL552E		

knobs

producer-specific knobs

COMENDA

			
1			
GEV No.	111418	Ref. No.	450330
description	adjusting knob		
For models:	AC122, AC151, AC152, AC181, AC182, AC201, AC202, AC241, AC242, ACR, ACR145, ACR205, ACR225, ACR245, ACR260, ACR265, ACR305, ACRS145, ACRS205, ACRS225, ACRS245, ACRS260, ACRS265, ACRS305, ACS101, ACS101-DIGIT, ACS122, ACS122-DIGIT, ACS151, ACS151-DIGIT, ACS152, ACS152-DIGIT, ACS161-DIGIT, ACS162-DIGIT, ACS181, ACS181-DIGIT, ACS182, ACS182-DIGIT, ACS201, ACS201-DIGIT, ACS202, ACS202-DIGIT, ACS241, ACS241-DIGIT, ACS242, ACS242-DIGIT, ACS91, ACS91-DIGIT, GMC, GMC2700...(Other models you can see in the webshop)		

			
1			
GEV No.	110061	Ref. No.	450316
description	knob switch zero mark ø 42mm shaft ø 5x5mm black		
For models:	B10, B10T, B11, B11T, B12, B12T, B13T, B15, B16, B18, B19, C140, C70, C85, F20, F45, F55, F65, F80		

			
1			
GEV No.	511193	Ref. No.	180131
description	knob switch zero mark ø 45mm shaft ø 5x5mm green		

			
1			
GEV No.	110918	Ref. No.	180120
description	knob switch zero mark ø 45mm shaft ø 6x6mm black		
For models:	NE00, SE, SNL		
accessories for	110918		
	GEV No.	510923	Ref. No. 440817
	clamping ring for shaft ø 10mm ID ø 9.4mm H 6mm		

			
1			
GEV No.	110093	Ref. No.	450323
description	knob switch zero mark t.max. °C ø 42mm shaft ø 5x5mm shaft flat black		
For models:	AC122, AC151, AC152, AC181, AC182, AC201, AC202, AC241, AC242, ACR, ACR145, ACR205, ACR225, ACR245, ACR260, ACR265, ACR305, ACRS145, ACRS205, ACRS225, ACRS245, ACRS260, ACRS265, ACRS305, BC25, BC25A, BC25HR, BC30, BC30A, BC30HR, BC30HR380, BC30HRA, BHC25, BHC25A, BHC25S, BHC30, BHC30A, BHC30HR, BHC30HR380, BHC30HRA, BHC30HRA380, BHC433, BHC433A, BHCHR, BR20, BR20A, BR25, BR25A, C1001M, C1301M...(Other models you can see in the webshop)		

			
1			
GEV No.	110062	Ref. No.	180111
description	knob switch zero mark t.max. °C ø 45mm shaft ø 5x5mm shaft flat black		
For models:	AC100, AC101, AC105, AC120, AC122, AC135, AC150, AC151, AC152, AC170, AC181, AC182, AC200, AC201, AC202, AC241, AC242, AC90, AC91, AC95, ACR, ACR145, ACR205, ACR225, ACR245, ACR260, ACR265, ACR305, ACS101, ACS122, ACS151, ACS152, ACS181, ACS182, ACS201, ACS202, ACS241, ACS242, ACS91, B20, B20D, B23, B24, B25, B26, B27, B31, B41, B42, C30...(Other models you can see in the webshop)		





 <p>1</p>			
GEV No.	511304	Ref. No.	450315
description	knob thermostat t.max. 90°C 30-90°C ø 43mm shaft ø 6x4.6mm shaft flat -135°		
For models:	AC100, AC101, AC105, AC120, AC122, AC135, AC150, AC151, AC152, AC170, AC181, AC182, AC200, AC201, AC202, AC241, AC242, AC2A, AC90, AC91, AC95, ACL100, ACL150, ACR, ACR145, ACR205, ACR225, ACR245, ACR260, ACR265, ACR305, ACS101, ACS101-DIGIT, ACS122, ACS122-DIGIT, ACS151, ACS151-DIGIT, ACS152, ACS152-DIGIT, ACS161-DIGIT, ACS162-DIGIT, ACS181, ACS181-DIGIT, ACS182, ACS182-DIGIT, ACS201, ACS201-DIGIT, ACS202, ACS202-DIGIT, ACS241...(Other models you can see in the webshop)		

 <p>1</p>			
GEV No.	110310	Ref. No.	191040
description	rosette knob up to ø 45mm		
For models:	AC100, AC101, AC105, AC120, AC122, AC135, AC150, AC151, AC152, AC170, AC181, AC182, AC200, AC201, AC202, AC241, AC242, AC2A, AC90, AC91, AC95, ACL100, ACL150, ACR, ACR145, ACR205, ACR225, ACR245, ACR260, ACR265, ACR305, ACS101, ACS101-DIGIT, ACS122, ACS122-DIGIT, ACS151, ACS151-DIGIT, ACS152, ACS152-DIGIT, ACS161-DIGIT, ACS162-DIGIT, ACS181, ACS181-DIGIT, ACS182, ACS182-DIGIT, ACS201, ACS201-DIGIT, ACS202, ACS202-DIGIT, ACS241...(Other models you can see in the webshop)		

accessories

fascias

 <p>1</p>			
GEV No.	510375	Ref. No.	460776
description	bezel for knob		
For models:	B10, B11, B12, B15, B16, B18, B19, F45		

 <p>1</p>			
GEV No.	511215	Ref. No.	460777
description	bezel for knob		
For models:	F20		

gaskets

 <p>1</p>			
GEV No.	112706	Ref. No.	200921
description	bottom gasket for knob shaft ø 9mm ED ø 34mm Qty 1 pcs rubber		
For models:	AC101, AC105, AC122, AC151, AC152, AC181, AC182, AC201, AC202, AC241, AC242, AC2A, AC91, AC95, ACL100, ACL150, ACS101, ACS101-DIGIT, ACS122, ACS122-DIGIT, ACS151, ACS151-DIGIT, ACS152, ACS152-DIGIT, ACS161-DIGIT, ACS162-DIGIT, ACS181, ACS181-DIGIT, ACS182, ACS182-DIGIT, ACS201, ACS201-DIGIT, ACS202, ACS202-DIGIT, ACS241, ACS241-DIGIT, ACS242, ACS242-DIGIT, ACS91, ACS91-DIGIT, LAV1000, LAV1001, LAV1501, NL302, NL302E, NL402, NL402E, NL502, NL502E, NL552...(Other models you can see in the webshop)		

rosettes

 <p>1</p>			
GEV No.	110105	Ref. No.	191040
description	rosette knob ø 42mm ø 56mm zero mark		

handles and hand wheels

ball handles

 <p>1</p>			
GEV No.	510496	Ref. No.	180126
description	ball handle thread M6 ø 29mm with metal bush black		
For models:	AC100, AC120, AC135, AC150, AC170, AC181, AC182, AC200, AC201, AC202, AC241, AC242, AC90, ACR, ACR145, ACR205, ACR225, ACR245, ACR260, ACR265, ACR305, GMC, GMC2700, GMC3500, GMC4500, GMC5500, LV1001, LV1501, LV-LVP, LVP1001, LVP1501, NE3001, NE4001, NE5501, NE7501, NE9001, NG00, NG01, NG02, NG1202, NG1202E, NG600, NG600E, NG601, NG601E, NG602, NG602E, NG900, NG900E, NG901...(Other models you can see in the webshop)		

handle bars

handle bars

 <p>1</p>			
GEV No.	394000	Ref. No.	331012
description	handle rod tube ø 25mm L 412mm SS		
For models:	AC100, AC120, AC150, AC170, AC200, AC90, ACR, ACR145, ACR205, ACR225, ACR245, ACR260, ACR265, ACR305, G115, G125, GMC, GMC2700, GMC3500, GMC4500, GMC5500, NE00, NG00, NG600, NG600E, NG900, NG900E, SE, SNL		

consoles

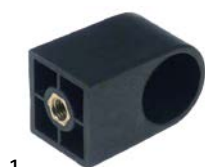

1	GEV No.	510284	Ref. No.	190129
description console for door handle tube ø 25mm H 52mm mounting pos. left/right thread M8				
For models: AC100, AC120, AC150, AC170, AC200, AC90, ACR, ACR145, ACR205, ACR225, ACR245, ACR260, ACR265, ACR305, G115, G125, G65, GMC, GMC2700, GMC3500, GMC4500, GMC5500, LV1001, LV1501, LV-LVP, LVP1001, LVP1501, NE00, NG00, NG600, NG600E, NG900, NG900E, SE, SNL				

handle rails

COMENDA



1	GEV No.	510445	Ref. No.	170805
description handle rail				



1	GEV No.	510493	Ref. No.	170808 170809
description handle rail				
For models: B11, B12				



1	GEV No.	511388	Ref. No.	170809
description handle rail				
For models: B10				
accessories for 511388				
	GEV No.	510818	Ref. No.	210405
end cap				



1	GEV No.	510453	Ref. No.	170810
description handle rail hole distance 460mm				
For models: B15, B16				



1	GEV No.	510454	Ref. No.	170806
description handle rail L 480mm W 52mm H 20mm Qty 1 pcs				
For models: B18, B19				

handle rails



1	GEV No.	510445	Ref. No.	170805
description handle rail				



1	GEV No.	510493	Ref. No.	170808 170809
description handle rail				
For models: B11, B12				



1	GEV No.	511388	Ref. No.	170809
description handle rail				
For models: B10				
accessories for 511388				
	GEV No.	510818	Ref. No.	210405
end cap				



1	GEV No.	510453	Ref. No.	170810
description handle rail hole distance 460mm				
For models: B15, B16				



1	GEV No.	510454	Ref. No.	170806
description handle rail L 480mm W 52mm H 20mm Qty 1 pcs				
For models: B18, B19				



end caps

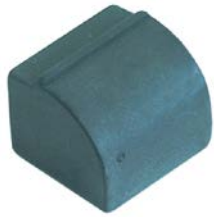

1			
GEV No.	510818	Ref. No.	210405
description	end cap		
For models:	B10T, B11T, B12T, B13T, B14T, B15T, B15TM, B16T, B16TM, B18T, B18TM, B19T, B19TM, BHC25S, F20, F45, F55, F65, F80		

bracket handles



1			
GEV No.	510478	Ref. No.	170801 170812
description	pull handle L 170mm H 37mm mounting distance 150mm thread M5 W 30mm		
For models:	B20, B20D, B23, B24, B25, B26, B27, B31, B32, B41, B42, F90M, F90MA, GF90, GF90A, LBC210, LBC215, LBC215A, LBC275, LBC275A, LBR, LBR200, LBR215, LBR215A, LF280-lav-line, LF315, LF320, LF320A, LF320CBT, LF320L, LF320LA, LF320-lav-line, LF320LBT, LF323, LF323A, LF350, LF350A, LF400A, LF450, LF450A, LS550		

locks

snap locks

producer-specific

COMENDA



1			
GEV No.	692100	Ref. No.	180508
description	snap lock L 36mm ø 17mm		
For models:	LF321, LF321A, LF322, LF322A, LF322MP, LF322MP-A, LF322RCD, LF324, LF324A, LF325E, LF325EA, LF700, LF700A		



1			
GEV No.	510925	Ref. No.	381403
description	snap lock L 70mm W 22mm H 56mm mounting distance 50mm		
For models:	B10, B10T, B11, B11T, B12, B12T, B13T, B14T, B15, B15T, B15TM, B16, B16T, B16TM, B18, B18T, B18TM, B19, B19T, B19TM, B20, B20D, B23, B24, B25, B26, B27, B31, B32, B41, B42, F2, F20, F3, F300, F45, F55, F65, F80, LF280-lav-line, LF320-lav-line, R40, R50, R70		

miscellaneous



1			
GEV No.	701044	Ref. No.	341016
description	angle piece for catch hook L 54mm W 27mm H 8.5mm		
For models:	AC100, AC101, AC105, AC120, AC122, AC135, AC150, AC151, AC152, AC170, AC181, AC182, AC200, AC201, AC202, AC241, AC242, AC2A, AC90, AC91, AC95, ACL100, ACL150, ACR, ACR145, ACR205, ACR225, ACR245, ACR260, ACR265, ACR305, ACRS145, ACRS205, ACRS225, ACRS245, ACRS260, ACRS265, ACRS305, ACS101, ACS101-DIGIT, ACS122, ACS122-DIGIT, ACS151, ACS151-DIGIT, ACS152, ACS152-DIGIT, ACS161-DIGIT, ACS162-DIGIT, ACS181, ACS181-DIGIT...(Other models you can see in the webshop)		

pullouts

rollers

rollers

accessories



1			
GEV No.	560133	Ref. No.	260404
description	hexagonal nut thread M6 H 5mm WS 10 SS DIN/ISO DIN 934 / ISO 4032/8673 Qty 20 pcs		
For models:	AC101, AC122, AC151, AC152, AC181, AC182, AC201, AC202, AC241, AC242, AC91, ACR, ACR145, ACR205, ACR225, ACR245, ACR260, ACR265, ACR305, ACS101, ACS101-DIGIT, ACS122, ACS122-DIGIT, ACS151, ACS151-DIGIT, ACS152, ACS152-DIGIT, ACS161-DIGIT, ACS162-DIGIT, ACS181, ACS181-DIGIT, ACS182, ACS182-DIGIT, ACS201, ACS201-DIGIT, ACS202, ACS202-DIGIT, ACS241, ACS241-DIGIT, ACS242, ACS242-DIGIT, ACS91, ACS91-DIGIT, B10T, B11T, B12T, B13T, B14T, B15T, B15TM...(Other models you can see in the webshop)		

fittings for catering equipment

drain taps

stainless steel

gaskets



1			
GEV No.	510974	Ref. No.	200852
description	O-ring EPDM thickness 2.62mm ID ø 58.42mm Qty 1 pcs		
For models:	C155, C155BT, C155E2, C155RCD, C165, C165E2, C165E2BT, C165E2RCD, C166, C166-2, C95, C95BT, C95E2, C95RCD		

equipment feet and end caps

equipment feet

with fixing plate



GEV No.	504350	Ref. No.	620222
description	equipment foot for dishwasher L 135-230mm		
For models:	AC100, AC101, AC105, AC120, AC122, AC135, AC150, AC151, AC152, AC170, AC181, AC182, AC200, AC201, AC202, AC241, AC242, AC2A, AC90, AC91, AC95, ACL100, ACL150, ACR, ACR145, ACR205, ACR225, ACR245, ACR260, ACR265, ACR305, ACRS145, ACRS205, ACRS225, ACRS245, ACRS260, ACRS265, ACRS305, ACS101, ACS101-DIGIT, ACS122, ACS122-DIGIT, ACS151, ACS151-DIGIT, ACS152, ACS152-DIGIT, ACS161-DIGIT, ACS162-DIGIT, ACS181, ACS181-DIGIT...(Other models you can see in the webshop)		

screw-in feet



GEV No.	510939	Ref. No.	440201
description	equipment foot thread M10 thread L 40mm H 14mm ø 60mm		
For models:	AC100, AC101, AC105, AC120, AC122, AC135, AC150, AC151, AC152, AC170, AC181, AC182, AC200, AC201, AC202, AC241, AC242, AC90, AC91, AC95, ACR, ACR145, ACR205, ACR225, ACR245, ACR260, ACR265, ACR305, C30, F2, F3, F300, F45, F55, F65, F80, FC, FC53, FC533, FC533A, FC53A, FC53CBT, FC53LA, FC53LBT, FC54, FC543, FC543A, FC543E, FC543EA, FC54A...(Other models you can see in the webshop)		

accessories for	510939
	GEV No. 524547 Ref. No. 160753
	plug pipe type 40x40 thickness 1.5mm thread M10 plastic Qty 1 pcs for equipment foot



GEV No.	510904	Ref. No.	210203
description	equipment foot thread M10 thread L 40mm ø 60mm H 30mm Qty 1 pcs		
For models:	C140, C155, C155BT, C155E2, C155RCD, C33, C34, C70, C75, C75BT, C75M, C75RCD, C85, C95, C95BT, C95E2, C95RCD, F45, F55, F65, F80, F90M, F90MA, FC, FC544, FC544A, GF90, GF90-2004, GF90A, GF90A-2004, LC380, LC380BT, LC380RCD, LC400, LF450, LF450A, LP360, LP360BT, LP360RCD, LV1001, LV1501, LV-LVP, LVP1001, LVP1501		



GEV No.	513321	Ref. No.	210207
description	equipment foot thread M10x1.5 thread L 22mm H 29mm WS 25 Qty 1 pcs		
For models:	BHC25, BHC25-2, BHC25A, BHC25A-2, BHC25S, BHC30, BHC30-2, BHC30A, BHC30A-2, BHC30E, BHC30E-2, BHC30EA, BHC30EA-2, BHC30HR, BHC30HR-2, BHC30HR380, BHC30HRA, BHC30HRA-2, BHC30HRA380, BHC433, BHC433-2, BHC433A, BHC433A-2, BHCHR, FC3E, FC3EA, FC3M, FC3MA, FC3MR, FC44E, FC44EA, FC4E, FC4EA, FC4EHRT, FC4M, FC4MA, GF70, GF70A, LF321, LF321A, LF322, LF322A, LF322MP, LF322MP-A, LF322RCD, LF324, LF324A, LF325E, LF325EA, LF700...(Other models you can see in the webshop)		



GEV No.	701098	Ref. No.	441111
description	equipment foot thread M6 thread L 19mm ø 25mm H 25mm Qty 1 pcs		
For models:	C1000E, C1001M, C1300E, C1301M, C155, C155BT, C155E2, C155RCD, C165, C165E2, C165E2BT, C165E2RCD, C166, C166-2, C95, C95BT, C95E2, C95RCD		

bolting feet



GEV No.	692308	Ref. No.	210204
description	equipment foot ø 29mm H 12mm rubber Qty 1 pcs		
For models:	B10, B10T, B11, B11T, B12, B12T, B13T, B14T, B15, B15T, B15TM, B16, B16T, B16TM, B18, B18T, B18TM, B19, B19T, B19TM, B20, B20D, B41, BC25, BC25A, BC25HR, BC30, BC30A, BC30HR, BC30HR380, BC30HRA, BR20, BR20A, BR25, BR25A, F20, FC43, FC43A, LB200, LB200-2, LB200A, LB200A-2, LB215, LB215-2, LB215A, LB215A-2, LB260, LB260-2, LB260A, LB260A-2...(Other models you can see in the webshop)		

equipment feet with stem



GEV No.	701046	Ref. No.	210404
description	equipment foot push-in ø 35mm H 5mm mounting ø 9.5mm overall height 19mm rubber Qty 1 pcs		
For models:	AC100, AC101, AC105, AC120, AC122, AC135, AC150, AC151, AC152, AC170, AC181, AC182, AC200, AC201, AC202, AC241, AC242, AC2A, AC90, AC91, AC95, ACL100, ACL150, ACR, ACR145, ACR205, ACR225, ACR245, ACR260, ACR265, ACR305, ACRS145, ACRS205, ACRS225, ACRS245, ACRS260, ACRS265, ACRS305, ACS101, ACS101-DIGIT, ACS122, ACS122-DIGIT, ACS151, ACS151-DIGIT, ACS152, ACS152-DIGIT, ACS161-DIGIT, ACS162-DIGIT, ACS181, ACS181-DIGIT...(Other models you can see in the webshop)		



end caps and plugs

for square pipes



1

GEV No.	524547	Ref. No.	160753
description	plug pipe type 40x40 thickness 1.5mm thread M10 plastic Qty 1 pcs for equipment foot		
For models:	AC100, AC101, AC105, AC120, AC122, AC135, AC150, AC151, AC152, AC170, AC181, AC182, AC200, AC201, AC202, AC241, AC242, AC90, AC91, AC95, ACR, ACR145, ACR205, ACR225, ACR245, ACR260, ACR265, ACR305		
accessories for	524547		
	GEV No.	510939	Ref. No. 440201
	equipment foot thread M10 thread L 40mm H 14mm ø 60mm		

miscellaneous



1

GEV No.	511153	Ref. No.	160509
description	bracket for equipment foot		
For models:	C140, C155, C155BT, C155E2, C155RCD, C30, C33, C34, C70, C75, C75BT, C75M, C75RCD, C85, C95, C95BT, C95E2, C95RCD, F45, F55, F65, F80, F90M, F90MA, FC, FC544, FC544A, GF90, GF90-2004, GF90A, GF90A-2004, LC380, LC380BT, LC380RCD, LC400, LF450, LF450A, LP360, LP360BT, LP360RCD, R70		

DERBY RUOTE

spare parts and accessories

miscellaneous



1

GEV No.	700134	Ref. No.	260415
description	nut SS thread M8 self-locking		

baskets

warewashing baskets

plastic baskets round



1

GEV No.	970319	Ref. No.	660703
description	mix basket ED ø 380mm H 160mm seat ø 365mm mesh type close-meshed/plastic		
For models:	B10, B10T, B11, B11T, B12, B12T, B20, B20D, B23, B24, B25, B26, B27, BR20, BR20A, BR25, BR25A, LBR, LBR200, LBR215, LBR215A		

steel wire baskets square

glass basket



1

GEV No.	970066	Ref. No.	520131
description	glass basket L 400mm W 400mm H 200mm number of rows 4 rows spacing 85mm		
For models:	B13T, B14T, B15T, B15TM, B16T, B16TM, B18T, B18TM, B19T, B19TM, BC25, BC25A, BC25HR, BC30, BC30A, BC30HRA, BHC25, BHC25-2, BHC25A, BHC25A-2, BHC30, BHC30-2, BHC30A, BHC30A-2, BHC30E, BHC30E-2, BHC30EA, BHC30EA-2, BHC30HR, BHC30HR-2, BHC30HR380, BHC30HRA, BHC30HRA-2, BHC30HRA380, BHC433, BHC433-2, BHC433A, BHC433A-2, BHCHR, F20, FC43, FC43A, LBC215, LBC215A, LBC275, LBC275A		

plastic baskets square

glass basket



1

GEV No.	970041	Ref. No.	660714
description	glass basket L 400mm W 400mm		
For models:	B13T, B14T, B15, B15T, B15TM, B16, B16T, B16TM, B18, B18T, B18TM, B19, B19T, B19TM, BC25, BC25A, BC25HR, BC30, BC30A, BC30HRA, BHC25, BHC25A, BHC30, BHC30A, BHC30E, BHC30EA, BHC30HR, BHC30HR380, BHC30HRA, BHC30HRA380, BHC433, BHC433A, BHCHR, F20		

mix baskets

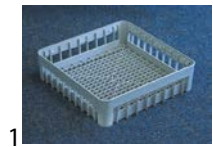



GEV No.	970040	Ref. No.	660712
description	mix basket L 400mm W 400mm H 110mm		
For models:	B13T, B14T, B15, B15T, B15TM, B16, B16T, B16TM, B18, B18T, B18TM, B19, B19T, B19TM, BC25, BC25A, BC25HR, BC30, BC30A, BC30HRA, BHC25, BHC25-2, BHC25A, BHC25A-2, BHC30, BHC30-2, BHC30A, BHC30A-2, BHC30E, BHC30E-2, BHC30EA, BHC30EA-2, BHC30HR, BHC30HR-2, BHC30HR380, BHC30HRA, BHC30HRA-2, BHC30HRA380, BHC433, BHC433-2, BHC433A, BHC433A-2, BHCHR, F20, FC43, FC43A, LBC215, LBC215A, LBC275, LBC275A		
accessories for	970040		
	GEV No.	970043	Ref. No. 520126
	section insert for glasses L 400mm W 400mm number of rows 4		
	GEV No.	970048	Ref. No. 660234 + 660235
	section insert for glasses number of glasses 16		

plate baskets



GEV No.	970045	Ref. No.	660713
description	plate basket L 400mm W 400mm H 110mm		
For models:	BHC25-2, BHC25A-2, BHC30-2, BHC30A-2, BHC30E-2, BHC30EA-2, BHC30HR-2, BHC30HRA-2, BHC433-2, BHC433A-2, F20, FC43, FC43A		

system basket GASTROTOP 500x500mm

universal baskets



GEV No.	973082	Ref. No.	660217 CBR/1
description	mix basket L 500mm W 500mm H 100mm mesh type wide-meshed usable height 75mm		



GEV No.	973119	Ref. No.	660218 CBR/2
description	mix basket L 500mm W 500mm H 150mm usable height 115mm		

glass basket



GEV No.	973080 ¹	Ref. No.	660511 B316
description	glass basket L 500mm W 500mm number of glasses 16 H 186-250mm usable height 151-215mm size of compartment 113x113mm		
spare parts for	973080		
	GEV No.	973000	Ref. No. —
	bolt for glass basket Qty 20 pcs		

¹adjustable height



GEV No.	973091	Ref. No.	660214 B236
description	glass basket L 500mm W 500mm number of glasses 36 H 150mm usable height 115mm size of compartment 73x73mm		

accessories

cutlery inserts



GEV No.	970349	Ref. No.	660519
description	cutlery insert L 130mm W 57mm ømm H 110mm		
For models:	B15TM, B16TM, B18TM, B19TM, BC25, BC25A, BC25HR, BC30, BC30A, BC30HRA, BHC25, BHC25-2, BHC25A, BHC25A-2, BHC25S, BHC30, BHC30-2, BHC30A, BHC30A-2, BHC30E, BHC30E-2, BHC30EA, BHC30EA-2, BHC30HR, BHC30HR-2, BHC30HR380, BHC30HRA, BHC30HRA-2, BHC30HRA380, BHC433, BHC433-2, BHC433A, BHC433A-2, BHCHR, BR20, BR20A, BR25, BR25A, FC43, FC43A, LBC215, LBC215A, LBC275, LBC275A, LBR, LBR200, LBR215, LBR215A		

section inserts for glasses



GEV No.	970043	Ref. No.	520126
description	section insert for glasses L 400mm W 400mm number of rows 4		
For models:	B13T, B14T, B15, B15T, B16, B16T, B18, B18T, B19, B19T, BHC25-2, BHC25A-2, BHC30-2, BHC30A-2, BHC30E-2, BHC30EA-2, BHC30HR-2, BHC30HRA-2, BHC433-2, BHC433A-2, F20		

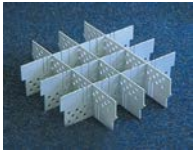

1

GEV No.	970048	Ref. No.	660234 + 660235
description	section insert for glasses number of glasses 16		

basket holders



1

GEV No.	971156	Ref. No.	530238
description	basket support L 585mm W 585mm H 200mm SS		
For models:	C1000E, C1000ERCD, C1001M, C1300E, C1300ERCD, C1301M, LC1200, LC1200RCD, LC412, LC700, LC700RCD, LC900, LC900RCD		

miscellaneous



1

GEV No.	970055	Ref. No.	660803
description	pin for dishwasher rack		



1

GEV No.	970056	Ref. No.	660804, k804\$000
description	pin for dishwasher rack		

plate inserts



1

GEV No.	970044	Ref. No.	520621
description	plate insert L 345mm W 100mm plates 17		

gaskets

O-rings

EPDM



1

GEV No.	510302	Ref. No.	200824
description	O-ring EPDM ID ø 12.42mm thickness 1.78mm Qty 1 pcs		
For models:	AC101, AC105, AC120, AC122, AC150, AC151, AC152, AC170, AC200, AC91, AC95, ACL150, ACR, ACR145, ACR205, ACR225, ACR245, ACR260, ACR265, ACR305, ACRS145, ACRS205, ACRS225, ACRS245, ACRS260, ACRS265, ACRS305, ACS101, ACS101-DIGIT, ACS122, ACS122-DIGIT, ACS151, ACS151-DIGIT, ACS152, ACS152-DIGIT, ACS161-DIGIT, ACS162-DIGIT, ACS91, ACS91-DIGIT, B13T, B14T, B15T, B15TM, B16, B16T, B16TM, B18T, B18TM, B19, B19T...(Other models you can see in the webshop)		



1

GEV No.	504512	Ref. No.	200826
description	O-ring EPDM thickness 1.78mm ID ø 14mm Qty 1 pcs		
For models:	C75M, LBC215, LBC215A, LBC275, LBC275A		



1

GEV No.	528243	Ref. No.	200939
description	O-ring EPDM thickness 1.78mm ID ø 15.6mm Qty 1 pcs		
For models:	C1000ERCD, C1300ERCD, C155BT, C155RCD, C165E2BT, C165E2RCD, C75BT, C75RCD, C95BT, C95RCD, FC3E, FC3EA, FC3MA, FC44E, FC44EA, FC4E, FC4EA, FC4EHRT, FC4MA, FC53CBT, FC53LBT, FC54CBT, FC54LBT, GE50RCD, GF70, GF70A, GF90, GF90-2004, GF90A, GF90A-2004, LC1200RCD, LC380BT, LC380RCD, LC700RCD, LC900RCD, LF320CBT, LF320LBT, LF322RCD, LP360BT, LP360RCD, XLC		

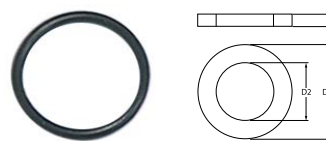

1

GEV No.	510322	Ref. No.	200812
description	O-ring EPDM thickness 1.78mm ID ø 17.17mm Qty 1 pcs		
For models:	B13T, B14T, B15T, B15TM, B16T, B16TM, B18T, B18TM, B19T, B19TM, BC25, BC25A, BC30, BC30A, BHC25, BHC25A, BHC30, BHC30A, BHC30HR, BHC30HR380, BHC30HRA, BHC30HRA380, BHC433, BHC433A, BHCHR, F20, F45, F55, F65, F80, FC43, FC43A, FC54E, FC54EA, LB200, LB200-2, LB200A, LB200A-2, LB215, LB215-2, LB215A, LB215A-2, LB260, LB260-2, LB260A, LB260A-2, LB275, LB275-2, LB275A, LB275A-2...(Other models you can see in the webshop)		

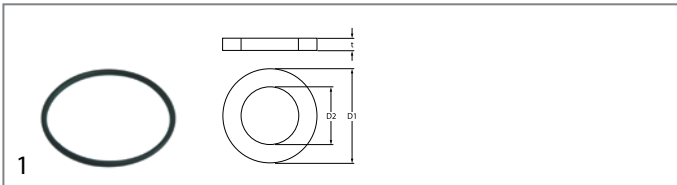

GEV No.	510824	Ref. No.	200849
description	O-ring EPDM thickness 1.78mm ID ø 20.35mm Qty 1 pcs		

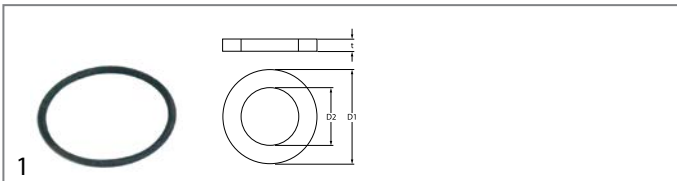

GEV No.	508084	Ref. No.	200817
description	O-ring EPDM thickness 1.78mm ID ø 25.12mm Qty 1 pcs		
For models:	AC101, AC122, AC151, AC152, AC181, AC182, AC201, AC202, AC241, AC242, AC91, ACL100, ACL150, ACS101, ACS101-DIGIT, ACS122, ACS122-DIGIT, ACS151, ACS151-DIGIT, ACS152, ACS152-DIGIT, ACS161-DIGIT, ACS162-DIGIT, ACS181, ACS181-DIGIT, ACS182, ACS182-DIGIT, ACS201, ACS201-DIGIT, ACS202, ACS202-DIGIT, ACS241, ACS241-DIGIT, ACS242, ACS242-DIGIT, ACS91, ACS91-DIGIT		

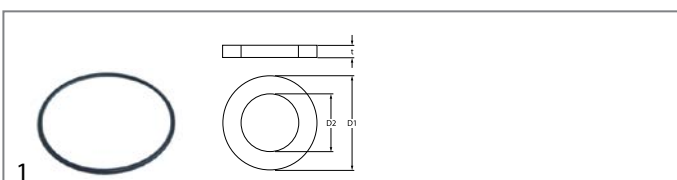

GEV No.	510900	Ref. No.	200833
description	O-ring EPDM thickness 1.78mm ID ø 41mm Qty 1 pcs		
For models:	B13T, B14T, B15, B15T, B15TM, B16, B16T, B16TM, B18, B18T, B18TM, B19, B19T, B19TM, B41, B42, C30, F2, F20, F3, F300, R50		

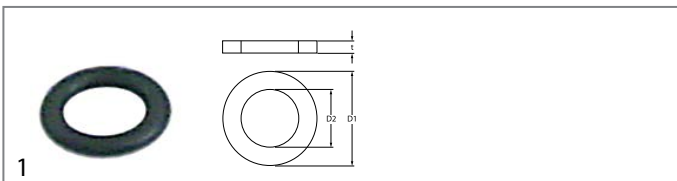

GEV No.	505045	Ref. No.	200973
description	O-ring EPDM thickness 1.78mm ID ø 5.28mm Qty 1 pcs		

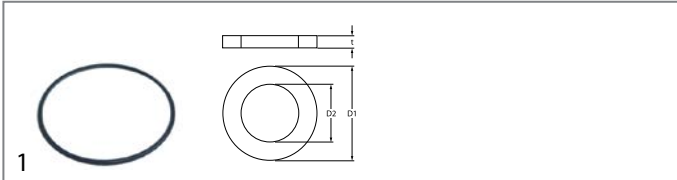

GEV No.	532628	Ref. No.	630417
description	O-ring EPDM thickness 1.78mm ID ø 56.87mm Qty 1 pcs		
For models:	SE		

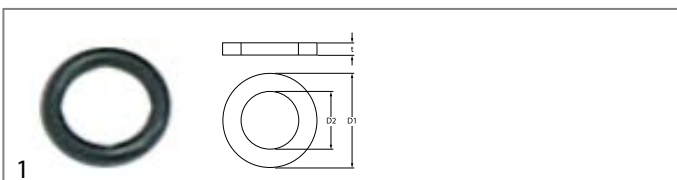

GEV No.	510303	Ref. No.	200818
description	O-ring EPDM thickness 1.78mm ID ø 6.75mm Qty 1 pcs		
For models:	AC120, AC150, AC170, AC200, ACR, ACR145, ACR205, ACR225, ACR245, ACR260, ACR265, ACR305, B13T, B14T, B15, B15T, B15TM, B16, B16T, B16TM, B18, B18T, B18TM, B19, B19T, B19TM, B41, B42, BC25HR, BC30HR, BC30HR380, BC30HRA, BHC25S, C140, C30, C33, C34, C70, C75, C75BT, C75M, C75RCD, C85, F2, F20, F3, F300, F45, F55, F65...(Other models you can see in the webshop)		

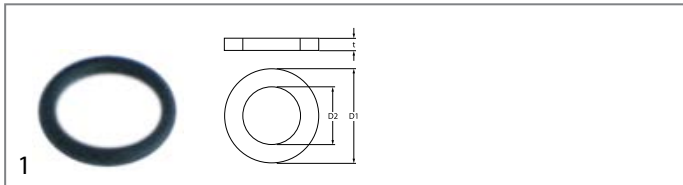

GEV No.	510177	Ref. No.	200809
description	O-ring EPDM thickness 1.78mm ID ø 7.66mm Qty 1 pcs		

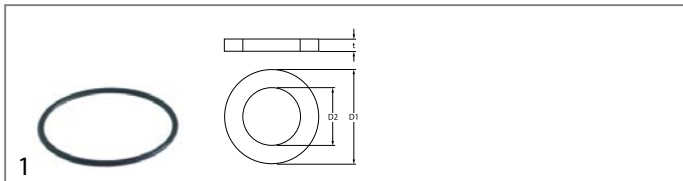

GEV No.	530293	Ref. No.	200809
description	O-ring EPDM thickness 1.78mm ID ø 8.73mm Qty 1 pcs		
For models:	AC101, AC105, AC122, AC135, AC151, AC152, AC181, AC182, AC201, AC202, AC241, AC242, AC2A, AC91, AC95, ACL100, ACL150, ACRS145, ACRS205, ACRS225, ACRS245, ACRS260, ACRS265, ACRS305, ACS101, ACS101-DIGIT, ACS122, ACS122-DIGIT, ACS151, ACS151-DIGIT, ACS152, ACS152-DIGIT, ACS161-DIGIT, ACS162-DIGIT, ACS181, ACS181-DIGIT, ACS182, ACS182-DIGIT, ACS201, ACS201-DIGIT, ACS202, ACS202-DIGIT, ACS241, ACS241-DIGIT, ACS242, ACS242-DIGIT, ACS91, ACS91-DIGIT, B15, B16...(Other models you can see in the webshop)		

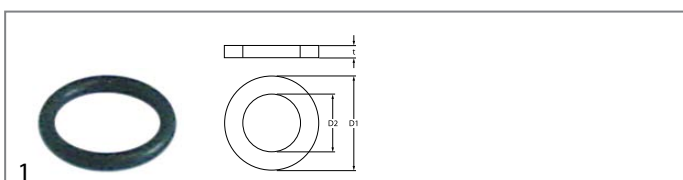

GEV No.	504574	Ref. No.	200844
description	O-ring EPDM thickness 1.78mm ID ø 9.25mm Qty 1 pcs		

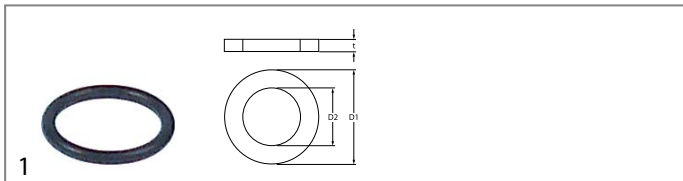

GEV No.	511237	Ref. No.	200850
description	O-ring EPDM thickness 1mm ID ø 7mm Qty 1 pcs		
For models:	BHC25-2, BHC25A-2, BHC30-2, BHC30A-2, BHC30E, BHC30E-2, BHC30EA, BHC30EA-2, BHC30HR-2, BHC30HRA-2, BHC433-2, BHC433A-2, C1001M, C1301M, C75, C75BT, C75RCD, FC, FC53, FC533, FC533A, FC53A, FC53CBT, FC53LA, FC53LBT, FC54, FC543, FC543A, FC543E, FC543EA, FC544, FC544A, FC54A, FC54CBT, FC54E, FC54EA, FC54LBT, FCHR, FCHRA, FCHRT, FCHRTA, GF70, GF70A, LC1200, LC1200RCD, LC412, LC700, LC700RCD, LC900, LC900RCD...(Other models you can see in the webshop)		

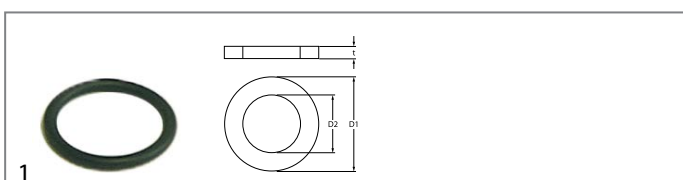

GEV No.	511191	Ref. No.	200813
description	O-ring EPDM thickness 2.21mm ID ø 16.36mm Qty 1 pcs		
For models:	C1000E, C1000ERCD, C1300E, C1300ERCD, C155, C155BT, C155E2, C155RCD, C165, C165E2, C165E2BT, C165E2RCD, C166, C166-2, C95, C95BT, C95E2, C95RCD, G100L, G101L, G50L, G51L, G60L, G61L, GE100, GE115, GE50RCD, GE60, GE60RCD, GE65, GE65RCD, GE80, GF70, GF70A, GF90, GF90-2004, GF90A, GF90A-2004, GL, XLC		

GEV No.	528333	Ref. No.	200806
description	O-ring EPDM thickness 2.62mm ID ø 13.1mm Qty 1 pcs		
For models:	AC181, AC182, AC201, AC202, AC241, AC242, ACS122, ACS122-DIGIT, ACS152, ACS152-DIGIT, ACS162-DIGIT, ACS182, ACS182-DIGIT, ACS202, ACS202-DIGIT, ACS242, ACS242-DIGIT, B13T, B14T, B15, B15T, B15TM, B16, B16T, B16TM, B18, B18T, B18TM, B19, B19T, B19TM, B41, B42, BC25, BC25A, BC25HR, BC30, BC30A, BC30HR, BC30HR380, BC30HRA, C30, C70, C75, C75BT, C75M, C75RCD, F2, F20, F3...(Other models you can see in the webshop)		

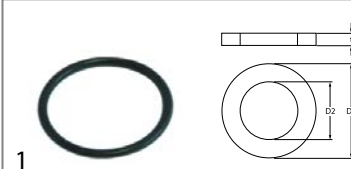

GEV No.	512111	Ref. No.	200867
description	O-ring EPDM thickness 2.62mm ID ø 45.69mm Qty 1 pcs		
For models:	BHC25, BHC25-2, BHC25A, BHC25A-2, BHC25S, BHC30, BHC30-2, BHC30A, BHC30A-2, BHC30E, BHC30E-2, BHC30EA, BHC30EA-2, BHC30HR, BHC30HR-2, BHC30HR380, BHC30HRA, BHC30HRA-2, BHC30HRA380, BHC433, BHC433-2, BHC433A, BHC433A-2, BHCHR, LB200, LB200-2, LB200A, LB200A-2, LB215, LB215-2, LB215A, LB215A-2, LB260, LB260-2, LB260A, LB260A-2, LB275, LB275-2, LB275A, LB275A-2, LF315, LF320A, LF320CBT, LF320LA, LF320LBT, LF321, LF321A, LF322, LF322A, LF322MP...(Other models you can see in the webshop)		

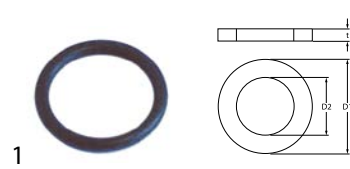

GEV No.	507309	Ref. No.	200819
description	O-ring EPDM thickness 2.62mm ID ø 17.13mm Qty 1 pcs		
For models:	B10, B10T, B11, B11T, B12, B12T, B20, B20D, B23, B24, B25, B26, B27, B31, B32, BR20, BR20A, BR25, BR25A, C33, C34, LBR, LBR200, LBR215, LBR215A		

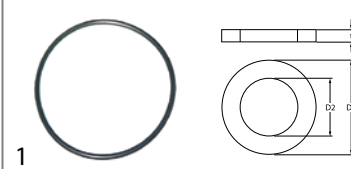

GEV No.	510974	Ref. No.	200852
description	O-ring EPDM thickness 2.62mm ID ø 58.42mm Qty 1 pcs		
For models:	C155, C155BT, C155E2, C155RCD, C165, C165E2, C165E2BT, C165E2RCD, C166, C166-2, C95, C95BT, C95E2, C95RCD		



GEV No.	505073	Ref. No.	200821
description	O-ring EPDM thickness 2.62mm ID ø 20.63mm Qty 1 pcs		
For models:	B15TM, B16TM, B18TM, B19TM, BC25, BC25A, BC25HR, BC30, BC30A, BC30HR, BC30HR380, BC30HRA, BHC25, BHC25-2, BHC25A, BHC25A-2, BHC25S, BHC30, BHC30-2, BHC30A, BHC30A-2, BHC30E, BHC30E-2, BHC30EA, BHC30EA-2, BHC30HR, BHC30HR-2, BHC30HR380, BHC30HRA, BHC30HRA-2, BHC30HRA380, BHC433, BHC433-2, BHC433A, BHC433A-2, BHCHR, FC43, FC43A, GE100, GE115, GE60, GE60RCD, GE65, GE65RCD, GE80, LB200, LB200-2, LB200A, LB200A-2, LB215...(Other models you can see in the webshop)		

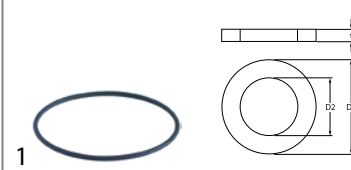

GEV No.	511395	Ref. No.	200868
description	O-ring EPDM thickness 2.62mm ID ø 71.12mm Qty 1 pcs		
For models:	BHC25, BHC25A, BHC30, BHC30A, BHC30HR, BHC30HR380, BHC30HRA, BHC30HRA380, BHC433, BHC433A, BHCHR, LB215, LB215A, LB275, LB275A		

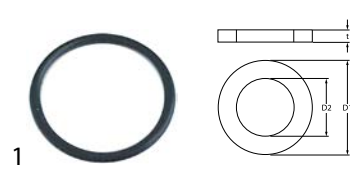

GEV No.	502036	Ref. No.	200805
description	O-ring EPDM thickness 2.62mm ID ø 28.25mm Qty 1 pcs		
For models:	ACR, ACR145, ACR205, ACR225, ACR245, ACR260, ACR265, ACR305, BHC25, BHC25-2, BHC25A, BHC25A-2, BHC25S, BHC30, BHC30-2, BHC30A, BHC30A-2, BHC30E, BHC30E-2, BHC30EA, BHC30EA-2, BHC30HR, BHC30HR-2, BHC30HR380, BHC30HRA, BHC30HRA-2, BHC30HRA380, BHC433, BHC433-2, BHC433A, BHC433A-2, BHCHR, GF70, GF70A, GMC, GMC2700, GMC3500, GMC4500, GMC5500, LB200, LB200-2, LB200A, LB200A-2, LB215, LB215-2, LB215A, LB215A-2, LB260, LB260-2, LB260A...(Other models you can see in the webshop)		

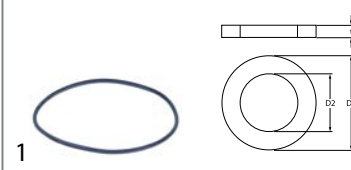

GEV No.	532490	Ref. No.	630421
description	O-ring EPDM thickness 2.62mm ID ø 72.69mm Qty 1 pcs		
For models:	BHC25, BHC25A, BHC25S, BHC30, BHC30A, BHC30HR, BHC30HR380, BHC30HRA, BHC30HRA380, BHC433, BHC433A, BHCHR		

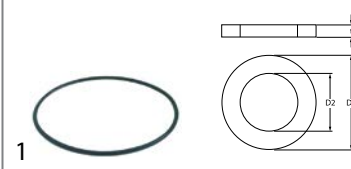

GEV No.	528800	Ref. No.	630427
description	O-ring EPDM thickness 2.62mm ID ø 75.87mm Qty 1 pcs		
For models:	C1000ERCD, C1300ERCD, FC3E, FC3EA, FC3M, FC3MA, FC3MR, FC44E, FC44EA, FC4E, FC4EA, FC4EHRT, FC4M, FC4MA, GE50RCD, LC1200RCD, LC700RCD, LC900RCD, LF322RCD, XLC		

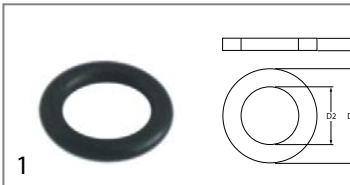

GEV No.	528583	Ref. No.	200845 200864
description	O-ring EPDM thickness 2.62mm ID \varnothing 9.13mm Qty 1 pcs		
For models:	B10T, B11T, B12T, B13T, B14T, B15T, B15TM, B16T, B16TM, B18T, B18TM, B19T, B19TM, BC25, BC25A, BC30, BC30A, BHC25, BHC25A, BHC30, BHC30A, BHC30HR, BHC30HR380, BHC30HRA, BHC30HRA380, BHC433, BHC433A, BHCHR, BR20, BR20A, BR25, BR25A, C75, C75BT, C75RCD, F20, F45, F55, F65, F80, FC, FC43, FC43A, FC53, FC533, FC533A, FC53A, FC53CBT, FC53LA, FC53LBT...(Other models you can see in the webshop)		

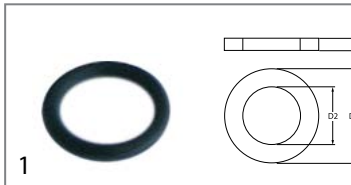

GEV No.	510902	Ref. No.	200844
description	O-ring EPDM thickness 2mm ID \varnothing 9.5mm Qty 1 pcs		
For models:	B10T, B11T, B12T, B13T, B14T, B15T, B15TM, B16T, B16TM, B18T, B18TM, B19T, B19TM, BC25, BC25A, BC30, BC30A, BHC25, BHC25A, BHC30, BHC30A, BHC30HR, BHC30HR380, BHC30HRA, BHC30HRA380, BHC433, BHC433A, BHCHR, BR20, BR20A, BR25, BR25A, F20, F45, F55, F65, F80, FC43, FC43A, FC54E, FC54EA, GF90-2004, GF90A-2004, LB200, LB200-2, LB200A, LB200A-2, LB215, LB215-2, LB215A...(Other models you can see in the webshop)		

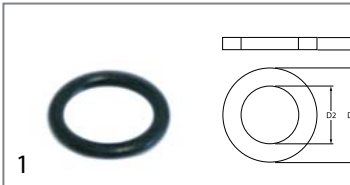

GEV No.	510893	Ref. No.	200810 200845
description	O-ring EPDM thickness 2.62mm ID \varnothing 9.92mm Qty 1 pcs		
For models:	B10, B10T, B11, B11T, B12, B12T, B13T, B14T, B15, B15T, B15TM, B16, B16T, B16TM, B18, B18T, B18TM, B19, B19T, B19TM, B20, B20D, B23, B24, B25, B26, B27, B31, B32, BC25, BC25A, BC25HR, BC30, BC30A, BC30HR, BC30HR380, BC30HRA, BR20, BR20A, BR25, BR25A, F20, F90M, F90MA, FC, FC43, FC43A, FC53, FC533, FC533A...(Other models you can see in the webshop)		

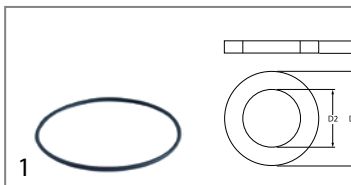

GEV No.	511339	Ref. No.	200873
description	O-ring EPDM thickness 3.53mm ID \varnothing 110.7mm Qty 1 pcs		

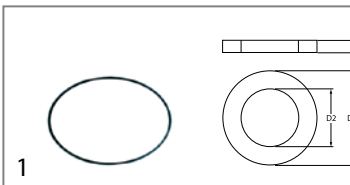

GEV No.	510554	Ref. No.	200142
description	O-ring EPDM thickness 2mm ID \varnothing 120mm Qty 1 pcs		

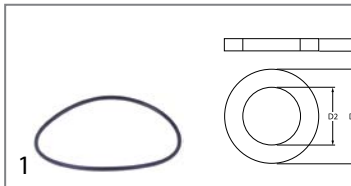

GEV No.	532537	Ref. No.	630433
description	O-ring EPDM thickness 3.53mm ID \varnothing 113.9mm Qty 1 pcs		
For models:	FC3E, FC3EA, FC3M, FC3MA, FC3MR, FC44E, FC44EA, FC4E, FC4EA, FC4EHR, FC4M, FC4MA		

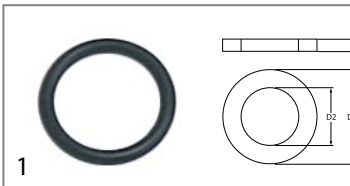

GEV No.	510901	Ref. No.	200843
description	O-ring EPDM thickness 2mm ID \varnothing 13mm Qty 1 pcs		
For models:	B13T, B14T, B15T, B15TM, B16T, B16TM, B18T, B18TM, B19T, B19TM, BC25, BC25A, BC30, BC30A, BHC25, BHC25A, BHC30, BHC30A, BHC30HR, BHC30HR380, BHC30HRA, BHC30HRA380, BHC433, BHC433A, BHCHR, F20, F45, F55, F65, F80, FC43, FC43A, FC54E, FC54EA, LB200, LB200-2, LB200A, LB200A-2, LB215, LB215-2, LB215A, LB215A-2, LB260, LB260-2, LB260A, LB260A-2, LB275, LB275-2, LB275A, LB275A-2...(Other models you can see in the webshop)		

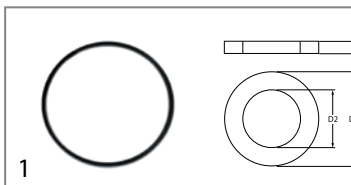

GEV No.	510896	Ref. No.	200828
description	O-ring EPDM thickness 3.53mm ID \varnothing 183.75mm Qty 1 pcs		
For models:	B13T, B14T, B15, B15T, B15TM, B16, B16T, B16TM, B18, B18T, B18TM, B19, B19T, B19TM, B41, B42, C30, C70, C75, C75BT, C75M, C75RCD, F2, F20, F3, F300, F45, F55, F65, F80, F90M, F90MA, LF280-lav-line, LF315, LF320, LF320A, LF320CBT, LF320L, LF320LA, LF320-lav-line, LF320LBT, LF323, LF323A, LF350, LF350A, LF400A, LF450, LF450A, LP360, LP360BT...(Other models you can see in the webshop)		

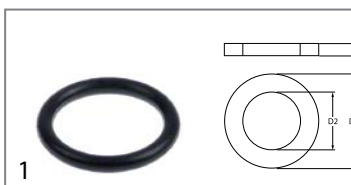

GEV No.	511322	Ref. No.	200869
description	O-ring EPDM thickness 3.53mm ID \varnothing 20.22mm Qty 1 pcs		
For models:	BHC25, BHC25-2, BHC25A, BHC25A-2, BHC255, BHC30, BHC30-2, BHC30A, BHC30A-2, BHC30E, BHC30E-2, BHC30EA, BHC30EA-2, BHC30HR, BHC30HR-2, BHC30HR380, BHC30HRA, BHC30HRA-2, BHC30HRA380, BHC433, BHC433-2, BHC433A, BHC433A-2, BHCHR, GF70, GF70A, LB200, LB200-2, LB200A, LB200A-2, LB215, LB215-2, LB215A, LB215A-2, LB260, LB260-2, LB260A, LB260A-2, LB275, LB275-2, LB275A, LB275A-2, LF321, LF321A, LF322, LF322A, LF322MP, LF322MP-A, LF322RCD, LF324...(Other models you can see in the webshop)		

GEV No.	510895	Ref. No.	200814
description	O-ring EPDM thickness 3.53mm ID ø 34.52mm Qty 1 pcs		
For models:	AC100, AC101, AC105, AC120, AC122, AC135, AC150, AC151, AC152, AC170, AC181, AC182, AC200, AC201, AC202, AC241, AC242, AC90, AC91, AC95, ACR, ACR145, ACR205, ACR225, ACR245, ACR260, ACR265, ACR305, ACRS145, ACRS205, ACRS225, ACRS245, ACRS260, ACRS265, ACRS305, ACS101, ACS101-DIGIT, ACS122, ACS122-DIGIT, ACS151, ACS151-DIGIT, ACS152, ACS152-DIGIT, ACS161-DIGIT, ACS162-DIGIT, ACS181, ACS181-DIGIT, ACS182, ACS182-DIGIT, ACS201...(Other models you can see in the webshop)		



GEV No.	512498	Ref. No.	200877
description	O-ring EPDM thickness 3.53mm ID ø 52.39mm Qty 1 pcs		

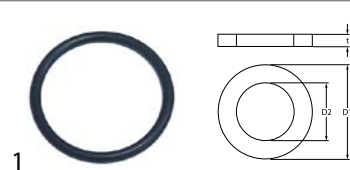

GEV No.	510899	Ref. No.	200830
description	O-ring EPDM thickness 3.53mm ID ø 37.69mm Qty 1 pcs		
For models:	AC100, AC101, AC105, AC120, AC122, AC135, AC150, AC151, AC152, AC170, AC181, AC182, AC200, AC201, AC202, AC241, AC242, AC2A, AC90, AC91, AC95, ACL100, ACL150, ACR, ACR145, ACR205, ACR225, ACR245, ACR260, ACR265, ACR305, ACRS145, ACRS205, ACRS225, ACRS245, ACRS260, ACRS265, ACRS305, ACS101, ACS101-DIGIT, ACS122, ACS122-DIGIT, ACS151, ACS151-DIGIT, ACS152, ACS152-DIGIT, ACS161-DIGIT, ACS162-DIGIT, ACS181, ACS181-DIGIT...(Other models you can see in the webshop)		

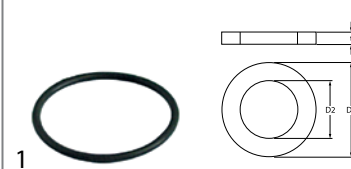

GEV No.	511331	Ref. No.	200842
description	O-ring EPDM thickness 3.53mm ID ø 53.57mm Qty 1 pcs		
For models:	BHC25, BHC25-2, BHC25A, BHC25A-2, BHC25S, BHC30, BHC30-2, BHC30A, BHC30A-2, BHC30E, BHC30E-2, BHC30EA, BHC30EA-2, BHC30HR, BHC30HR-2, BHC30HR380, BHC30HRA, BHC30HRA-2, BHC30HRA380, BHC433, BHC433-2, BHC433A, BHC433A-2, BHCHR, LB200, LB200-2, LB200A, LB200A-2, LB215, LB215-2, LB215A, LB215A-2, LB260, LB260-2, LB260A, LB260A-2, LB275, LB275-2, LB275A, LB275A-2, LF321, LF321A, LF322, LF322A, LF322MP, LF322MP-A, LF322RCD, LF324, LF324A, LF325E...(Other models you can see in the webshop)		



GEV No.	506015	Ref. No.	200822
description	O-ring EPDM thickness 3.53mm ID ø 39.69mm Qty 1 pcs		
For models:	B12T, B14T, B16, B16T, B16TM, B19, B19T, B19TM, BC25A, BC30A, BC30HRA, BHC25-2, BHC25A, BHC25A-2, BHC30-2, BHC30A, BHC30A-2, BHC30E-2, BHC30EA, BHC30EA-2, BHC30HR, BHC30HR-2, BHC30HRA, BHC30HRA-2, BHC30HRA380, BHC433-2, BHC433A, BHC433A-2, BHCHR, BR20A, BR25A, F90MA, FC, FC43A, FC533A, FC53A, FC53LA, FC543A, FC543EA, FC544A, FC54A, FC54EA, FCHRA, FCHRTA, GF70A, GF90-2004, GF90A, GF90A-2004, LB215A, LB215A-2...(Other models you can see in the webshop)		



GEV No.	511828	Ref. No.	200801
description	O-ring EPDM thickness 3.53mm ID ø 56.74mm Qty 1 pcs		
For models:	C30, F2, F3, F300, R40, R70		



GEV No.	528632	Ref. No.	200802
description	O-ring EPDM thickness 3.53mm ID ø 44.04mm Qty 1 pcs		
For models:	NE00, NE02, NE3001, NE3002, NE4001, NE4002, NE5002, NE5501, NE5502, NE7002, NE7501, NE7502, NE9001, NE9002, NE9502, NG00, NG01, NG02, NG1202, NG1202E, NG600, NG600E, NG601, NG601E, NG602, NG602E, NG900, NG900E, NG901, NG901E, NG902, NG902E		



GEV No.	510973	Ref. No.	200853
description	O-ring EPDM thickness 3.53mm ID ø 63.09mm Qty 1 pcs		
For models:	C155, C155BT, C155E2, C155RCD, C165, C165E2, C165E2BT, C165E2RCD, C166, C166-2, C95, C95BT, C95E2, C95RCD		

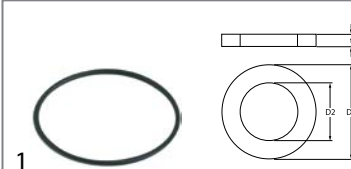

GEV No.	511711	Ref. No.	200834
description	O-ring EPDM thickness 3.53mm ID ø 78.97mm Qty 1 pcs		
For models:	B11, B12, B19, B20, B20D, B24, B25, B26, B27, LB200A, LB200A-2, LB260A, LB260A-2		

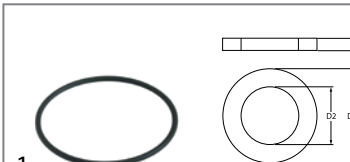

GEV No.	532144	Ref. No.	200803
description	O-ring EPDM thickness 3.53mm ID ø 98.02mm Qty 10 pcs		
For models:	AC100, AC101, AC105, AC120, AC122, AC135, AC150, AC151, AC152, AC170, AC181, AC182, AC200, AC201, AC202, AC241, AC242, AC2A, AC90, AC91, AC95, ACR, ACR145, ACR205, ACR225, ACR245, ACR260, ACR265, ACR305, ACRS145, ACRS205, ACRS225, ACRS245, ACRS260, ACRS265, ACRS305, ACS101, ACS101-DIGIT, ACS122, ACS122-DIGIT, ACS151, ACS151-DIGIT, ACS152, ACS152-DIGIT, ACS161-DIGIT, ACS162-DIGIT, ACS181, ACS181-DIGIT, ACS182, ACS182-DIGIT...(Other models you can see in the webshop)		



GEV No.	510970	Ref. No.	200856
description	O-ring EPDM thickness 3mm ID ø 81mm Qty 1 pcs		
For models:	BC25, BC25A, BC25HR, BC30, BC30A, BC30HR, BC30HR380, BC30HRA, F90M, F90MA, FC43, FC43A, LF315, LF320, LF320A, LF320CBT, LF320L, LF320LA, LF320LBT, LF323, LF323A, LF350, LF350A, LF400A, LF450, LF450A, LS550		



GEV No.	503187	Ref. No.	200872
description	O-ring EPDM thickness 3.6mm ID ø 23mm Qty 1 pcs		
For models:	AC2A		



GEV No.	524483	Ref. No.	200807
description	O-ring EPDM thickness 4mm ID ø 110mm Qty 1 pcs		
For models:	AC100, AC135, AC90, C1000E, C1000ERCD, C1001M, C1300E, C1300ERCD, C1301M, C33, C34, G115, G131, G65, G66, GE50RCD, LC1200, LC1200RCD, LC412, LC700, LC700RCD, LC900, LC900RCD, NE00, SE, SNL, XLC		



GEV No.	510971	Ref. No.	200855
description	O-ring EPDM thickness 3mm ID ø 43mm Qty 1 pcs		
For models:	BC25, BC25A, BC25HR, BC30, BC30A, BC30HR, BC30HR380, BC30HRA, F90M, F90MA, FC43, FC43A, LF315, LF320, LF320A, LF320CBT, LF320L, LF320LA, LF320LBT, LF323, LF323A, LF350, LF350A, LF400A, LF450, LF450A, LS550		



GEV No.	502073	Ref. No.	200933
description	O-ring EPDM thickness 4mm ID ø 24mm Qty 1 pcs		
For models:	AC122, AC151, AC152, AC181, AC182, AC201, AC202, AC241, AC242, ACR, ACR145, ACR205, ACR225, ACR245, ACR260, ACR265, ACR305, ACRS145, ACRS205, ACRS225, ACRS245, ACRS260, ACRS265, ACRS305, ACS101, ACS101-DIGIT, ACS122, ACS122-DIGIT, ACS151, ACS151-DIGIT, ACS152, ACS152-DIGIT, ACS161-DIGIT, ACS162-DIGIT, ACS181, ACS181-DIGIT, ACS182, ACS182-DIGIT, ACS201, ACS201-DIGIT, ACS202, ACS202-DIGIT, ACS241, ACS241-DIGIT, ACS242, ACS242-DIGIT, ACS91, ACS91-DIGIT, GMC2702, GMC3502...(Other models you can see in the webshop)		



GEV No.	510811	Ref. No.	200816
description	O-ring EPDM thickness 3mm ID ø 59.2mm Qty 1 pcs		
For models:	B10T, B11T, B12T, B13T, B14T, B15T, B15TM, B16T, B16TM, B18T, B18TM, B19T, B19TM, BC25, BC25A, BC25HR, BC30, BC30A, BC30HR, BC30HR380, BC30HRA, BHC25, BHC25-2, BHC25A, BHC25A-2, BHC25S, BHC30, BHC30-2, BHC30A, BHC30A-2, BHC30E, BHC30E-2, BHC30EA, BHC30EA-2, BHC30HR, BHC30HR-2, BHC30HR380, BHC30HRA, BHC30HRA-2, BHC30HRA380, BHC433, BHC433-2, BHC433A, BHC433A-2, BHCHR, BR20, BR20A, BR25, BR25A, C1000E...(Other models you can see in the webshop)		



GEV No.	510408	Ref. No.	200820
description	O-ring EPDM thickness 5.34mm ID ø 47mm Qty 1 pcs		
For models:	B10T, B11T, B12T, B13T, B14T, B15, B15T, B15TM, B16, B16T, B16TM, B18, B18T, B18TM, B19, B19T, B19TM, B20, B20D, B23, B24, B25, B26, B27, B31, B32, B41, B42, BC25, BC25A, BC25HR, BC30, BC30A, BC30HR, BC30HR380, BC30HRA, BHC25, BHC25-2, BHC25A, BHC25A-2, BHC25S, BHC30, BHC30-2, BHC30A, BHC30A-2, BHC30E, BHC30E-2, BHC30EA, BHC30EA-2, BHC30HR...(Other models you can see in the webshop)		



GEV No.	510955	Ref. No.	200854
description	O-ring EPDM thickness 3mm ID ø 6mm Qty 1 pcs		
For models:	AC100, AC90, G100L, G101L, G50L, G51L, G60L, G61L, GL, NG02, NG1202, NG1202E, NG602, NG602E, NG902, NG902E		

1

GEV No.	510409	Ref. No.	200815
description	O-ring EPDM thickness 5.34mm ID ø 56.52mm Qty 1 pcs		
For models:	AC100, AC101, AC105, AC120, AC122, AC135, AC150, AC151, AC152, AC170, AC181, AC182, AC200, AC201, AC202, AC241, AC242, AC2A, AC90, AC91, AC95, ACR, ACR145, ACR205, ACR225, ACR245, ACR260, ACR265, ACR305, ACS101, ACS101-DIGIT, ACS122, ACS122-DIGIT, ACS151, ACS151-DIGIT, ACS152, ACS152-DIGIT, ACS161-DIGIT, ACS162-DIGIT, ACS181, ACS181-DIGIT, ACS182, ACS182-DIGIT, ACS201, ACS201-DIGIT, ACS202, ACS202-DIGIT, ACS241, ACS241-DIGIT, ACS242...(Other models you can see in the webshop)		

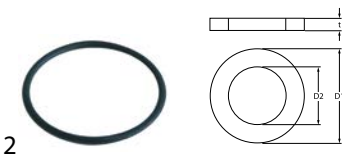

2

GEV No.	510447	Ref. No.	200829
description	O-ring EPDM thickness 5.34mm ID ø 81.92mm Qty 1 pcs		
For models:	B13T, B14T, B15, B15T, B15TM, B16, B16T, B16TM, B18, B18T, B18TM, B19, B19T, B19TM, B41, B42, C30, C70, C75, C75BT, C75M, C75RCD, F2, F20, F3, F300, F45, F55, F65, F80, F90M, F90MA, FC, FC53, FC533, FC533A, FC53A, FC53CBT, FC53LA, FC53LBT, FC54, FC543, FC543A, FC543E, FC543EA, FC544, FC544A, FC54A, FC54CBT, FC54E...(Other models you can see in the webshop)		

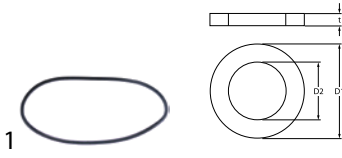

1

GEV No.	510551	Ref. No.	630426 H33855
description	pump cover gasket ID ø 158.3mm pump type 1214/1293/1225/2243/1226/1204/3473/1241 thickness 3.53mm EPDM Qty 1 pcs		
For models:	C1000E, C1000ERCD, C1001M, C1300E, C1300ERCD, C1301M, GE50RCD, GF90, GF90-2004, GF90A, GF90A-2004, NL302, NL302E, NL402, NL402E, NL502, NL502E, NL552, NL552E, XLC		

silicone

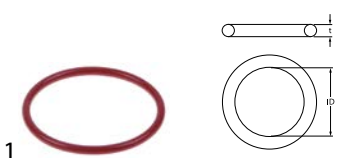

1

GEV No.	532594	Ref. No.	200808
description	O-ring silicone thickness 3.53mm ID ø 50.8mm Qty 1 pcs		
For models:	FC3E, FC3EA, FC3M, FC3MA, FC3MR, FC44E, FC44EA, FC4E, FC4EA, FC4EHRT, FC4M, FC4MA		

Viton



1

GEV No.	528525	Ref. No.	200823
description	O-ring Viton thickness 3.53mm ID ø 18.64mm Qty 1 pcs		

NBR



1

GEV No.	532720	Ref. No.	200878
description	O-ring NBR ID ø 17.86mm thickness 2.62mm Qty 1 pcs		

sealing washers

fibre gaskets



1

GEV No.	510535	Ref. No.	460528
description	flat gasket FIBER ED ø 15mm ID ø 10mm thickness 2mm Qty 1 pcs		
For models:	AC101, AC122, AC151, AC152, AC181, AC182, AC201, AC202, AC241, AC242, AC2A, AC91, ACL100, ACL150, ACR, ACR145, ACR205, ACR225, ACR245, ACR260, ACR265, ACR305, ACRS145, ACRS205, ACRS225, ACRS245, ACRS260, ACRS265, ACRS305, ACS151, ACS151-DIGIT, ACS152, ACS152-DIGIT, ACS161-DIGIT, ACS162-DIGIT, ACS181, ACS181-DIGIT, ACS182, ACS182-DIGIT, ACS201, ACS201-DIGIT, ACS202, ACS202-DIGIT, ACS241, ACS241-DIGIT, ACS242, ACS242-DIGIT, C155, C155BT, C155E2...(Other models you can see in the webshop)		



1

GEV No.	510996	Ref. No.	460502
description	flat gasket FIBER ED ø 31mm ID ø 21.5mm thickness 2mm for thread 1/2" Qty 1 pcs		
For models:	AC100, AC101, AC105, AC120, AC122, AC135, AC151, AC152, AC170, AC181, AC182, AC200, AC201, AC202, AC241, AC242, AC2A, AC90, AC91, AC95, ACL100, ACL150, ACR, ACR145, ACR205, ACR225, ACR245, ACR260, ACR265, ACR305, ACRS145, ACRS205, ACRS225, ACRS245, ACRS260, ACRS265, ACRS305, ACS101, ACS101-DIGIT, ACS122, ACS122-DIGIT, ACS151, ACS151-DIGIT, ACS152, ACS152-DIGIT, ACS161-DIGIT, ACS162-DIGIT, ACS181, ACS181-DIGIT, ACS182...(Other models you can see in the webshop)		



GEV No.	506232	Ref. No.	460535
description	flat gasket fibre ED ø 12.7mm ID ø 6.3mm thickness 2.3mm Qty 1 pcs		
For models:	BHC25, BHC25-2, BHC25A, BHC25A-2, BHC25S, BHC30, BHC30-2, BHC30A, BHC30A-2, BHC30E, BHC30E-2, BHC30EA, BHC30EA-2, BHC30HR, BHC30HR-2, BHC30HR380, BHC30HRA, BHC30HRA-2, BHC30HRA380, BHC433, BHC433-2, BHC433A, BHC433A-2, BHCHR, LB200, LB200-2, LB200A, LB200A-2, LB215, LB215-2, LB215A, LB215A-2, LB260, LB260-2, LB260A, LB260A-2, LB275, LB275-2, LB275A, LB275A-2, LC1200, LC700, LC900, LF322MP, LF322MP-A, LFD32E, LFD32EA, LFD32M, LFD32MA		



GEV No.	521110	Ref. No.	460527
description	flat gasket fibre ED ø 20mm ID ø 13mm thickness 2mm Qty 1 pcs		



GEV No.	506072	Ref. No.	460503
description	flat gasket fibre ED ø 38mm ID ø 27mm thickness 2mm outflow for thread 1 1/4" Qty 1 pcs		
For models:	AC100, AC101, AC105, AC120, AC122, AC135, AC150, AC151, AC152, AC170, AC181, AC182, AC200, AC201, AC202, AC241, AC242, AC2A, AC90, AC91, AC95, ACL150, ACR, ACR145, ACR205, ACR225, ACR245, ACR260, ACR265, ACR305, ACRS145, ACRS205, ACRS225, ACRS245, ACRS260, ACRS265, ACRS305, ACS101, ACS101-DIGIT, ACS122, ACS122-DIGIT, ACS151, ACS151-DIGIT, ACS152, ACS152-DIGIT, ACS161-DIGIT, ACS162-DIGIT, ACS181, ACS181-DIGIT, ACS182...(Other models you can see in the webshop)		



GEV No.	510355	Ref. No.	460501
description	gasket fibre ED ø 24mm ID ø 17mm thickness 2mm Qty 1 pcs		
For models:	AC101, AC105, AC120, AC122, AC135, AC150, AC151, AC152, AC170, AC181, AC182, AC200, AC201, AC202, AC241, AC242, AC91, AC95, ACR, ACR145, ACR205, ACR225, ACR245, ACR260, ACR265, ACR305, ACRS145, ACRS205, ACRS225, ACRS245, ACRS260, ACRS265, ACRS305, ACS101, ACS101-DIGIT, ACS122, ACS122-DIGIT, ACS151, ACS151-DIGIT, ACS152, ACS152-DIGIT, ACS161-DIGIT, ACS162-DIGIT, ACS181, ACS181-DIGIT, ACS182, ACS182-DIGIT, ACS201, ACS201-DIGIT, ACS202...(Other models you can see in the webshop)		

rubber gaskets



GEV No.	510844	Ref. No.	160814
description	flat gasket Qty 1 pcs		



GEV No.	510761	Ref. No.	200944 21005
description	flat gasket rubber D1 ø 38mm D2 ø 25mm thickness 2mm Qty 1 pcs		
For models:	BHC25, BHC25-2, BHC25A, BHC25A-2, BHC25S, BHC30, BHC30-2, BHC30A, BHC30A-2, BHC30E, BHC30E-2, BHC30EA, BHC30EA-2, BHC433, BHC433-2, BHC433A, BHC433A-2, GF70, GF70A, LB200, LB200-2, LB200A, LB200A-2, LB215, LB215-2, LB215A, LB215A-2, LB260, LB260-2, LB260A, LB260A-2, LB275, LB275-2, LB275A, LB275A-2, LF321, LF321A, LF322, LF322A, LF322MP, LF322MP-A, LF322RCD, LF324, LF324A, LF325E, LF325EA, LF700, LF700A, LFD32E, LFD32EA...(Other models you can see in the webshop)		



GEV No.	510631	Ref. No.	200963
description	flat gasket rubber ED ø 110mm ID ø 88mm thickness 3mm Qty 1 pcs		
For models:	FC3E, FC3EA, FC3M, FC3MA, FC3MR, FC44E, FC44EA, FC4E, FC4EA, FC4EHR, FC4M, FC4MA		



GEV No.	518206	Ref. No.	200462
description	flat gasket rubber ED ø 14mm ID ø 9mm thickness 1mm Qty 1 pcs		
For models:	LB200, LB200-2, LB215, LB215-2, LB215A, LB215A-2, LB260, LB260-2, LB275, LB275-2, LB275A, LB275A-2		



GEV No.	512376	Ref. No.	200870
description	flat gasket rubber ED ø 18mm ID ø 10mm thickness 2mm Qty 1 pcs		
For models:	C1000E, C1000ERCD, C1001M, C1300E, C1300ERCD, C1301M, FC3E, FC3EA, FC3M, FC3MA, FC3MR, FC44E, FC44EA, FC4E, FC4EA, FC4EHR, FC4M, FC4MA, GF70, GF70A, GF90-2004, GF90A-2004, LC1200, LC1200RCD, LC412, LC700, LC700RCD, LC900, LC900RCD, LF321, LF321A, LF322, LF322A, LF322MP, LF322MP-A, LF322RCD, LF324, LF324A, LF325E, LF325EA, LF700, LF700A, LFD32E, LFD32EA, LFD32M, LFD32MA, XLC		



GEV No.	510877	Ref. No.	200415
description	flat gasket rubber ED ø 18mm ID ø 10mm thickness 3mm Qty 1 pcs		
For models:	AC100, AC101, AC120, AC122, AC150, AC151, AC152, AC170, AC181, AC182, AC200, AC201, AC202, AC241, AC242, AC90, AC91, ACR, ACR145, ACR205, ACR225, ACR245, ACR260, ACR265, ACR305, B10, B10T, B11, B11T, B12, B12T, B13T, B14T, B15, B15T, B16, B16T, B18, B18T, B19, B19T, B20, B20D, B23, B24, B25, B26, B27, B31, B32...(Other models you can see in the webshop)		





			
1			
GEV No.	510989	Ref. No.	160811
description	flat gasket rubber ED ø 18mm ID ø 8.5mm thickness 1mm Qty 1 pcs		
For models:	C1000E, C1000ERCD, C1001M, C1300E, C1300ERCD, C1301M, C155, C155BT, C155E2, C155RCD, C165, C165E2, C165E2BT, C165E2RCD, C30, C70, C75, C75BT, C75RCD, C95, C95BT, C95E2, C95RCD, LC1200, LC1200RCD, LC380, LC380BT, LC380RCD, LC400, LC412, LC700, LC700RCD, LC900, LC900RCD, LP360, LP360BT, LP360RCD, XLC		

			
1			
GEV No.	510886	Ref. No.	200467
description	flat gasket rubber ED ø 21mm ID ø 11.5mm thickness 2mm Qty 1 pcs		
For models:	BC25, BC25A, BC25HR, BC30, BC30A, BC30HR, BC30HR380, BC30HRA, BHC25, BHC25-2, BHC25A, BHC25A-2, BHC25S, BHC30, BHC30-2, BHC30A, BHC30A-2, BHC30E, BHC30E-2, BHC30EA, BHC30EA-2, BHC30HR, BHC30HR-2, BHC30HR380, BHC30HRA, BHC30HRA-2, BHC30HRA380, BHC433, BHC433-2, BHC433A, BHC433A-2, BHCHR, BR20, BR20A, BR25, BR25A, C166-2, C70, C75, C75BT, C75M, C75RCD, F45, F55, F65, F80, F90M, F90MA, FC, FC3E...(Other models you can see in the webshop)		

			
1			
GEV No.	520054 ¹	Ref. No.	200416
description	flat gasket rubber ED ø 23.5mm ID ø 14mm thickness 2.3mm Qty 10 pcs		
For models:	B11, B12, B15, B16, B18, B19, B23, B24, B25, B26, B27, B32, B41, B42, BC25, BC25A, BC25HR, BC30, BC30A, BC30HR, BC30HR380, BC30HRA, BHC25, BHC25-2, BHC25A, BHC25A-2, BHC25S, BHC30, BHC30-2, BHC30A, BHC30A-2, BHC30E, BHC30E-2, BHC30EA, BHC30EA-2, BHC30HR, BHC30HR-2, BHC30HR380, BHC30HRA, BHC30HRA-2, BHC30HRA380, BHC433, BHC433-2, BHC433A, BHC433A-2, BHCHR, BR20, BR20A, BR25, BR25A...(Other models you can see in the webshop)		

¹Qty 10 pieces

			
1			
GEV No.	511180	Ref. No.	200457
description	flat gasket rubber ED ø 24mm ID ø 16mm thickness 3mm Qty 1 pcs		
For models:	AC2A, B16, B16TM, B19, B19TM, C140, C155, C155BT, C155E2, C155RCD, C165, C165E2, C165E2BT, C165E2RCD, C166, C166-2, C30, C70, C75, C75BT, C75M, C75RCD, C85, C95, C95BT, C95E2, C95RCD, LC380, LC380BT, LC380RCD, LC400, LP360, LP360BT, LP360RCD		

			
1			
GEV No.	511283	Ref. No.	200927
description	flat gasket rubber ED ø 30mm ID ø 20mm thickness 2mm Qty 1 pcs		
For models:	AC101, AC122, AC151, AC152, AC181, AC182, AC201, AC202, AC241, AC242, AC2A, AC91, ACL100, ACL150, ACRS145, ACRS205, ACRS225, ACRS245, ACRS260, ACRS265, ACRS305, ACS101, ACS101-DIGIT, ACS122, ACS122-DIGIT, ACS151, ACS151-DIGIT, ACS152, ACS152-DIGIT, ACS161-DIGIT, ACS162-DIGIT, ACS181, ACS181-DIGIT, ACS182, ACS182-DIGIT, ACS201, ACS201-DIGIT, ACS202, ACS202-DIGIT, ACS241, ACS241-DIGIT, ACS242, ACS242-DIGIT, ACS91, ACS91-DIGIT, BC25, BC25A, BC30, BC30A, BR20...(Other models you can see in the webshop)		

			
1			
GEV No.	510876	Ref. No.	200412
description	flat gasket rubber ED ø 45mm ID ø 33mm thickness 3mm Qty 1 pcs		
For models:	AC100, AC101, AC105, AC120, AC122, AC135, AC150, AC151, AC152, AC170, AC181, AC182, AC200, AC201, AC202, AC241, AC242, AC2A, AC90, AC91, AC95, ACL100, ACL150, ACR, ACR145, ACR205, ACR225, ACR245, ACR260, ACR265, ACR305, ACRS145, ACRS205, ACRS225, ACRS245, ACRS260, ACRS265, ACRS305, ACS101, ACS101-DIGIT, ACS122, ACS122-DIGIT, ACS151, ACS151-DIGIT, ACS152, ACS152-DIGIT, ACS161-DIGIT, ACS162-DIGIT, ACS181, ACS181-DIGIT...(Other models you can see in the webshop)		

			
1			
GEV No.	511196	Ref. No.	200919
description	flat gasket rubber ED ø 59mm ID ø 48mm thickness 2mm Qty 1 pcs		
For models:	FC, FC53, FC533, FC533A, FC53A, FC53CBT, FC53LA, FC53LBT, FC54, FC543, FC543A, FC543E, FC544, FC544A, FC54A, FC54CBT, FC54E, FC54EA, FC54LBT, FCHR, FCHRA, FCHRT, FCHRTA, GE50RCD		

			
1			
GEV No.	510234	Ref. No.	200498
description	flat gasket rubber ED ø 65mm ID ø 47mm thickness 2mm Qty 1 pcs		
For models:	C1000ERCD, C1300ERCD, GE60RCD, GE65RCD, LC1200RCD, LC700RCD, LC900RCD, LF322RCD, XLC		

			
1			
GEV No.	516254	Ref. No.	200410
description	flat gasket rubber ED ø 66mm ID ø 46mm thickness 2.1mm Qty 1 pcs		

			
GEV No.	511318	Ref. No.	200913
description	flat gasket rubber ED ø 75mm ID ø 59mm thickness 2mm Qty 1 pcs		
For models:	AC122, AC152, AC182, AC202, AC242, BC25, BC25A, BC25HR, BC30, BC30A, BC30HR, BC30HR380, BC30HRA, BR20, BR20A, BR25, BR25A, FC43, FC43A		

			
GEV No.	510947	Ref. No.	200489
description	flat gasket rubber ED ø 85mm ID ø 73mm thickness 2mm Qty 1 pcs equiv. no. 200489 suitable for COMENDA		
For models:	AC122, AC152, AC182, AC202, AC242, B11T, B12T, B13T, B14T, B15T, B15TM, B16T, B16TM, B18T, B18TM, B19T, B19TM, BC25, BC25A, BC25HR, BC30, BC30A, BC30HR, BC30HR380, BC30HRA, BHC25, BHC25-2, BHC25A, BHC30, BHC30-2, BHC30A, BHC30A-2, BHC30E, BHC30E-2, BHC30EA, BHC30EA-2, BHC30HR, BHC30HR-2, BHC30HR380, BHC30HRA, BHC30HRA-2, BHC30HRA380, BHC433, BHC433-2, BHC433A, BHC433A-2, BHC30HR, BR20, BR20A, BR25...(Other models you can see in the webshop)		

			
GEV No.	510832	Ref. No.	200906
description	flat gasket rubber ED ø 92mm ID ø 66mm thickness 2mm Qty 1 pcs equiv. no. 200906/33456		
For models:	AC101, AC105, AC120, AC122, AC135, AC150, AC151, AC152, AC170, AC181, AC182, AC200, AC201, AC202, AC241, AC242, AC2A, AC91, AC95, ACL100, ACL150, ACR, ACR145, ACR205, ACR225, ACR245, ACR260, ACR265, ACR305, ACRS145, ACRS205, ACRS225, ACRS245, ACRS260, ACRS265, ACRS305, ACS101, ACS101-DIGIT, ACS122, ACS122-DIGIT, ACS151, ACS151-DIGIT, ACS152, ACS152-DIGIT, ACS161-DIGIT, ACS162-DIGIT, ACS181, ACS181-DIGIT, ACS182, ACS182-DIGIT...(Other models you can see in the webshop)		

			
GEV No.	511158	Ref. No.	200482
description	gasket rubber ED ø 50mm ID ø 35mm thickness 4mm Qty 1 pcs		
For models:	C1000E, C1000ERCD, C1001M, C1300E, C1300ERCD, C1301M, C140, GE50RCD, GF90, GF90-2004, GF90A, GF90A-2004, LC1200, LC1200RCD, LC380, LC380BT, LC380RCD, LC400, LC412, LC700, LC700RCD, LC900, LC900RCD, XLC		

plastic gaskets			
			
GEV No.	510838	Ref. No.	160803
description	gasket plastic ED ø 10.5mm ID ø 5mm thickness 3mm Qty 1 pcs		
For models:	AC101, AC122, AC151, AC152, AC181, AC182, AC201, AC202, AC241, AC242, AC91, B23, B24, B25, B26, B27, B31, B32, F90M, F90MA, LAV1000, LBC210, LBC215, LBC215A, LBC275, LBC275A, LF315, LF320, LF320A, LF320CBT, LF320L, LF320LA, LF320LBT, LF323, LF323A, LF350, LF350A, LF400A, LF450, LF450A, LS550		

			
GEV No.	510839	Ref. No.	160804
description	gasket plastic ED ø 13mm ID ø 6.5mm thickness 4mm Qty 1 pcs		
For models:	B10, B10T, B11, B11T, B12, B12T, B13T, B14T, B15, B15T, B15TM, B16, B16T, B16TM, B18, B18T, B18TM, B19, B19T, B19TM, B20, B20D, B24, B25, B26, B27, BHC25-2, BHC25A-2, BHC30-2, BHC30A-2, BHC30E, BHC30E-2, BHC30EA, BHC30EA-2, BHC30HR-2, BHC30HRA-2, BHC433-2, BHC433A-2, C155, C155BT, C155E2, C155RCD, C165, C165E2, C165E2BT, C165E2RCD, C166, C166-2, C95, C95BT...(Other models you can see in the webshop)		

			
GEV No.	510840	Ref. No.	160805
description	gasket plastic ED ø 16mm ID ø 8.5mm thickness 4mm Qty 1 pcs		
For models:	AC100, AC101, AC120, AC122, AC150, AC151, AC152, AC170, AC181, AC182, AC200, AC201, AC202, AC241, AC242, AC90, AC91, ACR, ACR145, ACR205, ACR225, ACR245, ACR260, ACR265, ACR305, ACRS145, ACRS205, ACRS225, ACRS245, ACRS260, ACRS265, ACRS305, ACS101, ACS101-DIGIT, ACS122, ACS122-DIGIT, ACS151, ACS151-DIGIT, ACS152, ACS152-DIGIT, ACS161-DIGIT, ACS162-DIGIT, ACS181, ACS181-DIGIT, ACS182, ACS182-DIGIT, ACS201, ACS201-DIGIT, ACS202, ACS202-DIGIT...(Other models you can see in the webshop)		

			
GEV No.	511146	Ref. No.	200495
description	gasket plastic ED ø 43mm ID ø 36mm Qty 1 pcs		
For models:	ACR, ACR145, ACR205, ACR225, ACR245, ACR260, ACR265, ACR305, GMC, GMC2700, GMC3500, GMC4500, GMC5500, LAV1000, LV1001, LV1501, LV-LVP, LVP1001, LVP1501, NE3001, NE4001, NE5501, NE7501, NE9001, NG01, NG601, NG601E, NG901, NG901E		

PTFE gaskets			
			
GEV No.	511861	Ref. No.	160832
description	flat gasket with PTFE ED ø 11mm ID ø 4.5mm thickness 0.8mm Qty 1 pcs		
For models:	B10, B11, B12, B15, B16, B18, B19		



foam rubber gaskets

 <p>1</p>			
GEV No.	505302	Ref. No.	200925
description	foam rubber gasket W 20mm thickness 1.5mm self-adhesive Qty 1m		
For models:	C1000E, C1000ERCD, C1001M, C1300E, C1300ERCD, C1301M, LC1200, LC1200RCD, LC412, LC700, LC700RCD, LC900, LC900RCD, XLC		

 <p>1</p>			
GEV No.	505304	Ref. No.	200924
description	foam rubber gasket W 20mm thickness 4mm Qty 600mm punched		
For models:	F90M, F90MA, LF315, LF320, LF320A, LF320CBT, LF320L, LF320LA, LF320LBT, LF323, LF323A, LF350, LF350A, LF400A, LF450, LF450A, LS550		

 <p>1</p>			
GEV No.	511391	Ref. No.	200402
description	foam rubber gasket W 24mm thickness 4mm self-adhesive Qty 1m suitable for COMENDA		
For models:	AC101, AC122, AC151, AC152, AC181, AC182, AC201, AC202, AC241, AC242, AC91, ACR, ACR145, ACR205, ACR225, ACR245, ACR260, ACR265, ACR305, ACS101, ACS101-DIGIT, ACS122, ACS122-DIGIT, ACS151, ACS151-DIGIT, ACS152, ACS152-DIGIT, ACS161-DIGIT, ACS162-DIGIT, ACS181, ACS181-DIGIT, ACS182, ACS182-DIGIT, ACS201, ACS201-DIGIT, ACS202, ACS202-DIGIT, ACS241, ACS241-DIGIT, ACS242, ACS242-DIGIT, ACS91, ACS91-DIGIT, BHC25-2, BHC25A-2, BHC30-2, BHC30A-2, BHC30E-2, BHC30EA-2, BHC30HR-2...(Other models you can see in the webshop)		

 <p>1</p>			
GEV No.	505303	Ref. No.	200957
description	foam rubber gasket W 28mm thickness 2.7mm self-adhesive Qty 640mm punched		
For models:	C1000E, C1000ERCD, C1001M, C1300E, C1300ERCD, C1301M, LC1200, LC1200RCD, LC412, LC700, LC700RCD, LC900, LC900RCD		

 <p>1</p>			
GEV No.	510881	Ref. No.	200433
description	foam rubber gasket W 6mm thickness 2.5mm self-adhesive Qty 1m		
For models:	ACS181, ACS181-DIGIT, ACS182, ACS182-DIGIT, BHC25, BHC25A, BHC25S, BHC30, BHC30A, BHC30E, BHC30EA, BHC30HR, BHC30HR380, BHC30HRA, BHC30HRA380, BHC433, BHC433A, BHCHR, C30, C70, C75, C75BT, C75M, C75RCD, LB200, LB200-2, LB200A, LB200A-2, LB215, LB215-2, LB215A, LB215A-2, LB260, LB260-2, LB260A, LB260A-2, LB275, LB275-2, LB275A, LB275A-2, LBC210, LBC215, LBC215A, LBC275, LBC275A, LBR, LBR200, LBR215, LBR215A, LP360...(Other models you can see in the webshop)		

 <p>1</p>			
GEV No.	510880	Ref. No.	200432 H33408
description	foam rubber gasket W 8mm thickness 4mm self-adhesive Qty supplied by meter		
For models:	ACS101, ACS101-DIGIT, ACS91, ACS91-DIGIT, C140, C33, C34, C85, GE100, GE115, GE125, GE50RCD, GE60, GE60RCD, GE65, GE65RCD, GE75, GE80, GF70, GF70A, LAV1000, LC380, LC380BT, LC380RCD, LC400, NE3001, NE4001, NE5501, NE7501, NE9001, NG01, NG601, NG601E, NG901, NG901E, R40, R70		

shaft gaskets

v-rings

 <p>1</p>			
GEV No.	511631	Ref. No.	200480
description	gasket ID ø 13.5mm ED ø 26mm H 10mm		
For models:	AC100, AC101, AC105, AC120, AC122, AC135, AC150, AC151, AC152, AC170, AC181, AC182, AC200, AC201, AC202, AC241, AC242, AC2A, AC90, AC91, AC95, ACL150, ACR, ACR145, ACR205, ACR225, ACR245, ACR260, ACR265, ACR305, ACRS145, ACRS205, ACRS225, ACRS245, ACRS260, ACRS265, ACRS305, ACS101, ACS101-DIGIT, ACS122, ACS122-DIGIT, ACS151, ACS151-DIGIT, ACS152, ACS152-DIGIT, ACS161-DIGIT, ACS162-DIGIT, ACS181, ACS181-DIGIT, ACS182...(Other models you can see in the webshop)		

shaft gaskets

 <p>1</p>			
GEV No.	697121	Ref. No.	440411
description	shaft seal ID ø 17mm ED ø 40mm thickness 7mm		
For models:	AC100, AC101, AC105, AC120, AC122, AC135, AC150, AC151, AC152, AC170, AC181, AC182, AC200, AC201, AC202, AC241, AC242, AC90, AC91, AC95, ACR, ACR145, ACR205, ACR225, ACR245, ACR260, ACR265, ACR305, ACRS145, ACRS205, ACRS225, ACRS245, ACRS260, ACRS265, ACRS305, ACS101, ACS101-DIGIT, ACS122, ACS122-DIGIT, ACS151, ACS151-DIGIT, ACS152, ACS152-DIGIT, ACS161-DIGIT, ACS162-DIGIT, ACS181, ACS181-DIGIT, ACS182, ACS182-DIGIT, ACS201...(Other models you can see in the webshop)		

 <p>1</p>			
GEV No.	697475	Ref. No.	440402
description	shaft seal ID ø 20mm ED ø 30mm thickness 5mm		
For models:	NE00, NE3001, NE4001, NE5501, NE7501, NE9001, NG00, NG01, NG600, NG600E, NG601, NG601E, NG900, NG900E, NG901, NG901E		



1

GEV No.	698002	Ref. No.	440409
description	shaft seal ID \varnothing 25mm ED \varnothing 40mm thickness 7mm		
For models:	GMC, GMC2700, GMC2702, GMC3500, GMC3502, GMC4500, GMC4502, GMC5500, GMC5502		



1

GEV No.	511988	Ref. No.	440401
description	shaft sealing ID \varnothing 19mm ED \varnothing 31.5mm H 7mm		
For models:	NE00, NG00, NG600, NG600E, NG900, NG900E		



1

GEV No.	698410	Ref. No.	440413
description	shaft sealing ID \varnothing 20mm ED \varnothing 32mm H 7mm		



1

GEV No.	512487	Ref. No.	200979
description	shaft sealing ID \varnothing 29mm ED \varnothing 40mm H 7mm COMENDA		

special gaskets

door seals for dishwashers

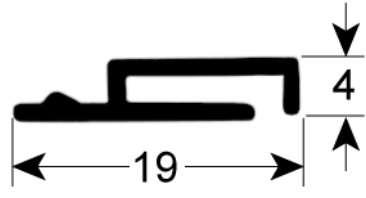

1

GEV No.	510911	Ref. No.	200901
description	door seal		

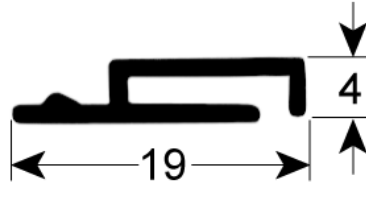

1

GEV No.	511311	Ref. No.	200901 200923
description	door seal L 1000mm dishwasher suitable for COMENDA equiv. no. 200923		
For models:	B10T, B11T, B12T, B13T, B14T, B15T, B15TM, B16T, B16TM, B18T, B18TM, B19T, B19TM, F20, F45, F55, F65, F80, F90M, F90MA, FC, FC53, FC533, FC533A, FC53A, FC53CBT, FC53LA, FC53LBT, FC54, FC543, FC543A, FC543E, FC543EA, FC544, FC544A, FC54A, FC54CBT, FC54E, FC54EA, FC54LBT, FCHR, FCHRA, FCHRT, FCHRTA, GE60, GE65, GE80, LF280-lav-line, LF315, LF320...(Other models you can see in the webshop)		

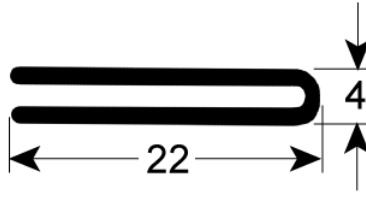

1

GEV No.	511389	Ref. No.	200945
description	door seal L 1370mm dishwasher suitable for COMENDA equiv. no. 200945		
For models:	BHC25, BHC25-2, BHC25A, BHC25A-2, BHC25S, BHC30, BHC30-2, BHC30A, BHC30A-2, BHC30E, BHC30E-2, BHC30EA, BHC30EA-2, BHC30HR, BHC30HR-2, BHC30HR380, BHC30HRA, BHC30HRA-2, BHC30HRA380, BHC433, BHC433-2, BHC433A, BHC433A-2, BHCHR		



1

GEV No.	511310	Ref. No.	200918
description	door seal L 1830mm W 16mm dishwasher suitable for COMENDA equiv. no. 200918		
For models:	BC25, BC25A, BC25HR, BC30, BC30A, BC30HR, BC30HR380, BC30HRA, BHC25, BHC25A, BHC30, BHC30A, BHC30HR, BHC30HRA, BHC433, BHC433A, BR20, BR20A, BR25, BR25A, FC43, FC43A		

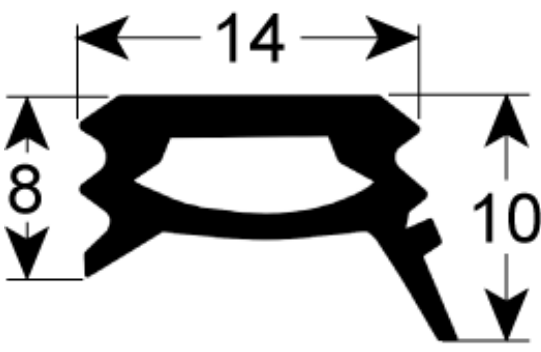

1

GEV No.	901767	Ref. No.	200974
description	door seal L 445mm W 560mm rubber 3-sided		



GEV No.	511990	Ref. No.	H36926
description	door seal L 590mm		
For models:	GF70, GF70A		

GEV No.	511577	Ref. No.	200217
description	door seal L 595mm W 15.5mm H 7mm Qty 1 suitable for COMENDA		
For models:	LF321, LF321A, LF322, LF322A, LF322MP, LF322MP-A, LF322RCD, LF324, LF324A, LF325E, LF325EA, LF700, LF700A		

GEV No.	504279	Ref. No.	200216R
description	door seal L 595mm W 18mm mounting pos. upper H 13mm Qty 1 suitable for COMENDA		
For models:	LF321, LF321A, LF322, LF322A, LF322MP, LF322MP-A, LF322RCD, LF324, LF324A, LF325E, LF325EA, LF700, LF700A		

GEV No.	511390	Ref. No.	200215
description	door seal L 930mm dishwasher suitable for COMENDA equip. no. 200215		
For models:	LB200, LB200-2, LB200A, LB200A-2, LB215, LB215-2, LB215A, LB215A-2, LB260, LB260-2, LB260A, LB260A-2, LB275, LB275-2, LB275A, LB275A-2, LBC210, LBC215, LBC215A, LBC275, LBC275A, LBR, LBR200, LBR215, LBR215A		

GEV No.	511989	Ref. No.	H36883
description	door seal Qty supplied by meter		
For models:	GE100, GE115, GE50RCD, GE60, GE60RCD, GE65, GE65RCD, GE80		

GEV No.	511391	Ref. No.	200402
description	foam rubber gasket W 24mm thickness 4mm self-adhesive Qty 1m suitable for COMENDA		
For models:	AC101, AC122, AC151, AC152, AC181, AC182, AC201, AC202, AC241, AC242, AC91, ACR, ACR145, ACR205, ACR225, ACR245, ACR260, ACR265, ACR305, ACS101, ACS101-DIGIT, ACS122, ACS122-DIGIT, ACS151, ACS151-DIGIT, ACS152, ACS152-DIGIT, ACS161-DIGIT, ACS162-DIGIT, ACS181, ACS181-DIGIT, ACS182, ACS182-DIGIT, ACS201, ACS201-DIGIT, ACS202, ACS202-DIGIT, ACS241, ACS241-DIGIT, ACS242, ACS242-DIGIT, ACS91, ACS91-DIGIT, BHC25-2, BHC25A-2, BHC30-2, BHC30A-2, BHC30E-2, BHC30EA-2, BHC30HR-2...(Other models you can see in the webshop)		

GEV No.	510881	Ref. No.	200433
description	foam rubber gasket W 6mm thickness 2.5mm self-adhesive Qty 1m		
For models:	ACS181, ACS181-DIGIT, ACS182, ACS182-DIGIT, BHC25, BHC25A, BHC255, BHC30, BHC30A, BHC30E, BHC30EA, BHC30HR, BHC30HR380, BHC30HRA, BHC30HRA380, BHC433, BHC433A, BHCHR, C30, C70, C75, C75BT, C75M, C75RCD, LB200, LB200-2, LB200A, LB200A-2, LB215, LB215-2, LB215A, LB215A-2, LB260, LB260-2, LB260A, LB260A-2, LB275, LB275-2, LB275A, LB275A-2, LBC210, LBC215, LBC215A, LBC275, LBC275A, LBR, LBR200, LBR215, LBR215A, LP360...(Other models you can see in the webshop)		

GEV No.	510880	Ref. No.	200432 H33408
description	foam rubber gasket W 8mm thickness 4mm self-adhesive Qty supplied by meter		
For models:	ACS101, ACS101-DIGIT, ACS91, ACS91-DIGIT, C140, C33, C34, C85, GE100, GE115, GE125, GE50RCD, GE60, GE60RCD, GE65, GE65RCD, GE75, GE80, GF70, GF70A, LAV1000, LC380, LC380BT, LC380RCD, LC400, NE3001, NE4001, NE5501, NE7501, NE9001, NG01, NG601, NG601E, NG901, NG901E, R40, R70		

miscellaneous



1

GEV No.	511664	Ref. No.	200419
description	bottom gasket suitable for COMENDA for dishwasher ED ø 35.5mm ID ø 24mm rubber thickness 11mm		
For models:	AC181, AC182, SE		



1

GEV No.	510884	Ref. No.	200463
description	gasket		
For models:	NE00, NG00, NG600, NG600E, NG900, NG900E, SE		



1

GEV No.	510879	Ref. No.	200431
description	gasket external height 4mm microswitch ED ø 9mm ID ø 2.5mm		
For models:	B11, B12, B15, B16, B18, B19, B41, B42, G131, G66, R50		



1

GEV No.	510882	Ref. No.	200451
description	gasket for opposite support L 100mm hood mechanics rubber H 3mm black W 30mm		
For models:	C30, C70, C75, C75BT, C75M, C75RCD, LF280-lav-line, LF320-lav-line, LP360, LP360BT, LP360RCD		

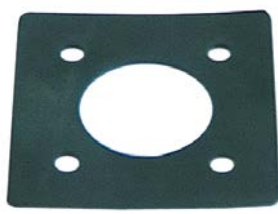

1

GEV No.	510822	Ref. No.	200423
description	gasket L 100mm W 100mm pipe ID ø 48.5mm thickness 3mm		
For models:	C33, C34, SE		



1

GEV No.	511370	Ref. No.	160837
description	gasket L 34mm W 14mm for door guides ID ø 7mm thickness 3mm		
For models:	BC25, BC25A, BC25HR, BC30, BC30A, BC30HR, BC30HR380, BC30HRA, BR20, BR20A, BR25, BR25A, F90M, F90MA, FC43, FC43A, GF90, GF90A, LF315, LF320, LF320A, LF320CBT, LF320L, LF320LA, LF320LBT, LF323, LF323A, LF350, LF350A, LF400A, LF450, LF450A, LS550		



1

GEV No.	510847	Ref. No.	440405
description	gasket polishing agent dosing ID ø 22mm ED ø 32mm external height 5mm		
For models:	B10T, B11T, B12T, B13T, B14T, B15T, B15TM, B16T, B16TM, B18T, B18TM, B19T, B19TM, BC25, BC25A, BC25HR, BC30, BC30A, BC30HR, BC30HR380, BC30HRA, BHC25, BHC25-2, BHC25A, BHC25A-2, BHC25S, BHC30, BHC30-2, BHC30A, BHC30A-2, BHC30E, BHC30E-2, BHC30EA, BHC30EA-2, BHC30HR, BHC30HR-2, BHC30HR380, BHC30HRA, BHC30HRA-2, BHC30HRA380, BHC433, BHC433-2, BHC433A, BHC433A-2, BHCHR, BR20, BR20A, BR25, BR25A, C1000E...(Other models you can see in the webshop)		



1

GEV No.	511981	Ref. No.	460525
description	gasket pump inlet ID ø 75mm L 175mm ED ø 127mm H 2mm		
For models:	G100L, G101L, G115L, G125, G125L, G50L, G50LM, G51L, G60L, G61L, G65L, G75, G75L, GE100, GE115, GE125, GE60, GE60RCD, GE65, GE65RCD, GE75, GE80, GL, NG00, NG01, NG600, NG600E, NG601, NG601E, NG900, NG900E, NG901, NG901E		



1

GEV No.	511980	Ref. No.	460526
description	gasket pump outlet ID ø 57mm L 155mm ED ø 107mm H 2mm		
For models:	G100L, G101L, G115L, G125, G125L, G50L, G50LM, G51L, G60L, G61L, G65L, G75, G75L, GE100, GE115, GE125, GE60, GE60RCD, GE65, GE65RCD, GE75, GE80, GL, NG00, NG01, NG600, NG600E, NG601, NG601E, NG900, NG900E, NG901, NG901E		



1

GEV No.	510885	Ref. No.	200464
description	gasket suitable for COMENDA equip. no. 200464 L 60mm W 30mm		
For models:	B10T, B11T, B12T, BR20, BR20A, BR25, BR25A, LBR, LBR200, LBR215, LBR215A		



thermostat gaskets



GEV No.	501353	Ref. No.	200491
description	gasket for thermostat hole ø 6.6mm L 98mm W 68mm thickness 2mm		
For models:	AC100, AC101, AC105, AC120, AC122, AC135, AC150, AC151, AC152, AC170, AC181, AC182, AC200, AC201, AC202, AC241, AC242, AC90, AC91, AC95, ACL100, ACL150, ACR, ACR145, ACR205, ACR225, ACR245, ACR260, ACR265, ACR305, ACRS145, ACRS205, ACRS225, ACRS245, ACRS260, ACRS265, ACRS305, ACS101, ACS101-DIGIT, ACS122, ACS122-DIGIT, ACS151, ACS151-DIGIT, ACS152, ACS152-DIGIT, ACS161-DIGIT, ACS162-DIGIT, ACS181, ACS181-DIGIT, ACS182... (Other models you can see in the webshop)		



GEV No.	512154	Ref. No.	200494
description	gasket for thermostat ID ø 20mm equiv. no. 200494/H200494 hole distance 41mm suitable for COMENDA, HOONVED		
For models:	B10T, B11T, B12T, B13T, B14T, B15T, B15TM, B16T, B16TM, B18T, B18TM, B19T, B19TM, BC25, BC25A, BC25HR, BC30, BC30A, BC30HR, BC30HR380, BC30HRA, BHC25, BHC25-2, BHC25A, BHC25A-2, BHC25S, BHC30, BHC30-2, BHC30A, BHC30A-2, BHC30E, BHC30E-2, BHC30EA, BHC30EA-2, BHC433, BHC433-2, BHC433A, BHC433A-2, BR20, BR20A, BR25, BR25A, FC43, FC43A, LB200, LB200-2, LB200A, LB200A-2, LB215, LB215-2...(Other models you can see in the webshop)		

gaskets for wash arm support



GEV No.	510934	Ref. No.	200406
description	gasket D1 ø 70mm D2 ø 130mm thickness 2mm with 6 holes wash arm support		
For models:	NE00		

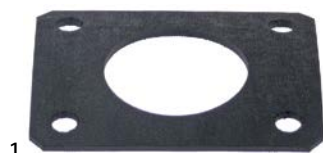

GEV No.	511977	Ref. No.	200937
description	gasket for wash arm support ID ø 50mm L 100mm W 78mm thickness 3mm		
For models:	NE02, NE3002, NE4002, NE5002, NE5502, NE7002, NE7502, NE9002, NE9502, NG02, NG1202, NG1202E, NG602, NG602E, NG902, NG902E, NL302, NL302E, NL402, NL402E, NL502, NL502E, NL552, NL552E		



GEV No.	511815	Ref. No.	200928
description	gasket thickness 3.3mm rubber suitable for COMENDA L 55mm W 30mm hole ø 12/7mm hole distance 40mm		
For models:	NE3001, NE4001, NE5501, NE7501, NE9001		

miscellaneous



GEV No.	698470	Ref. No.	160806
description	gasket ID ø 10mm ED ø 20mm H 5mm PTFE		
For models:	F2, F3, F300		

transmission technology and ball bearings

chains

roller chains 08B-1 single



GEV No.	697897	Ref. No.	410801
description	roller chain DIN/ISO 08 B-1 splitting 1/2" / 12.7mm links 39 internal width 7.75mm rollerø 8.51mm single		
For models:	AC100, AC101, AC105, AC120, AC122, AC135, AC150, AC151, AC152, AC170, AC181, AC182, AC200, AC201, AC202, AC241, AC242, AC90, AC91, AC95, ACR, ACR145, ACR205, ACR225, ACR245, ACR260, ACR265, ACR305, ACRS145, ACRS205, ACRS225, ACRS245, ACRS260, ACRS265, ACRS305, ACS101, ACS101-DIGIT, ACS122, ACS122-DIGIT, ACS151, ACS151-DIGIT, ACS152, ACS152-DIGIT, ACS161-DIGIT, ACS162-DIGIT, ACS181, ACS181-DIGIT, ACS182, ACS182-DIGIT, ACS201...(Other models you can see in the webshop)		

accessories for	697897			
	GEV No.	693276	Ref. No.	410903
	connector single DIN/ISO 08 B-1 splitting 1/2" links 1 L 23mm internal width 11.8mm rollerø 4.3mm metal			
	GEV No.	697841	Ref. No.	410902
	half link single DIN/ISO 08 B-1 splitting 1/2"			

connectors



GEV No.	693276	Ref. No.	410903
description	connector single DIN/ISO 08 B-1 splitting 1/2" links 1 L 23mm internal width 11.8mm rollerø 4.3mm metal		
For models:	AC100, AC101, AC105, AC120, AC122, AC135, AC150, AC151, AC152, AC170, AC181, AC182, AC200, AC201, AC202, AC241, AC242, AC90, AC91, AC95, ACR, ACR145, ACR205, ACR225, ACR245, ACR260, ACR265, ACR305, ACRS145, ACRS205, ACRS225, ACRS245, ACRS260, ACRS265, ACRS305, ACS101, ACS101-DIGIT, ACS122, ACS122-DIGIT, ACS151, ACS151-DIGIT, ACS152, ACS152-DIGIT, ACS161-DIGIT, ACS162-DIGIT, ACS181, ACS181-DIGIT, ACS182, ACS182-DIGIT, ACS201...(Other models you can see in the webshop)		

half links



GEV No.	697841	Ref. No.	410902
description	half link single DIN/ISO 08 B-1 splitting 1/2"		
For models:	AC100, AC101, AC105, AC120, AC122, AC135, AC150, AC151, AC152, AC170, AC181, AC182, AC200, AC201, AC202, AC241, AC242, AC90, AC91, AC95, ACR, ACR145, ACR205, ACR225, ACR245, ACR260, ACR265, ACR305, ACRS145, ACRS205, ACRS225, ACRS245, ACRS260, ACRS265, ACRS305, ACS101, ACS101-DIGIT, ACS122, ACS122-DIGIT, ACS151, ACS151-DIGIT, ACS152, ACS152-DIGIT, ACS161-DIGIT, ACS162-DIGIT, ACS181, ACS181-DIGIT, ACS182, ACS182-DIGIT, ACS201...(Other models you can see in the webshop)		

springs

torsion springs



GEV No.	510652	Ref. No.	391335
description	torsion spring ø 18mm wire gauge ø 3mm Qty 1 pcs		
For models:	FC3E, FC3EA, FC3M, FC3MA, FC3MR, FC44E, FC44EA, FC4E, FC4EA, FC4EHRT, FC4M, FC4MA		

compression springs



GEV No.	511983	Ref. No.	450226
description	compression spring ø 10.55mm L 26mm wire gauge ø 1mm		
For models:	NE02, NE3002, NE4002, NE5002, NE5502, NE7002, NE7502, NE9002, NE9502		



GEV No.	511984	Ref. No.	450220
description	compression spring ø 10mm L 16mm wire gauge ø 1.2mm		
For models:	GMC2702, GMC3502, GMC4502, GMC5502, LAV1001, LAV1501, NG02, NG1202, NG1202E, NG602, NG602E, NG902, NG902E, NL302, NL302E, NL402, NL402E, NL502, NL502E, NL552, NL552E		



GEV No.	511982	Ref. No.	450214
description	compression spring ø 25mm L 83mm wire gauge ø 1.7mm for dosing pump warewashing		
For models:	B10T, B11T, B12T, B13T, B14T, B15T, B15TM, B16T, B16TM, B18T, B18TM, B19T, B19TM, BC25, BC25A, BC25HR, BC30, BC30A, BC30HR, BC30HR380, BC30HRA, BHC25, BHC25-2, BHC25A, BHC25A-2, BHC25S, BHC30, BHC30-2, BHC30A, BHC30A-2, BHC30E, BHC30E-2, BHC30EA, BHC30EA-2, BHC30HR, BHC30HR-2, BHC30HR380, BHC30HRA, BHC30HRA-2, BHC30HRA380, BHC433, BHC433-2, BHC433A, BHC433A-2, BHCHR, BR20, BR20A, BR25, BR25A, C1000E...(Other models you can see in the webshop)		



GEV No.	511323	Ref. No.	450232
description	compression spring ø 41.3mm L 57mm wire gauge ø 2mm		
For models:	BHC25, BHC25-2, BHC25A, BHC25A-2, BHC25S, BHC30, BHC30-2, BHC30A, BHC30A-2, BHC30E, BHC30E-2, BHC30EA, BHC30EA-2, BHC30HR, BHC30HR-2, BHC30HR380, BHC30HRA, BHC30HRA-2, BHC30HRA380, BHC433, BHC433-2, BHC433A, BHC433A-2, BHCHR, GF70, GF70A, LB200, LB200-2, LB200A, LB200A-2, LB215, LB215-2, LB215A, LB215A-2, LB260, LB260-2, LB260A, LB260A-2, LB275, LB275-2, LB275A, LB275A-2, LF321, LF321A, LF322, LF322A, LF322MP, LF322MP-A, LF322RCD, LF324...(Other models you can see in the webshop)		



GEV No.	511376	Ref. No.	450234 H30438
description	compression spring ø 6mm L 25mm wire gauge ø 0.65mm		
For models:	BHC25, BHC25-2, BHC25A, BHC25A-2, BHC25S, BHC30, BHC30-2, BHC30A, BHC30A-2, BHC30E, BHC30E-2, BHC30EA, BHC30EA-2, BHC30HR, BHC30HR-2, BHC30HR380, BHC30HRA, BHC30HRA-2, BHC30HRA380, BHC433, BHC433-2, BHC433A, BHC433A-2, BHCHR, GF70, GF70A, GF90, GF90-2004, GF90A, GF90A-2004		



roller springs

roller springs



1			
GEV No.	511166	Ref. No.	391315
description	roller spring 2kg complete incl. holder		
For models:	AC120, AC150, AC170, AC200, AC2A, ACR, ACR145, ACR205, ACR225, ACR245, ACR260, ACR265, ACR305, ACRS145, ACRS205, ACRS225, ACRS245, ACRS260, ACRS265, ACRS305, GMC, GMC2700, GMC2702, GMC3500, GMC3502, GMC4500, GMC4502, GMC5500, GMC5502, LAV1001, LAV1501, LV1001, LV1501, LV-LVP, LVP1001, LVP1501, NE00, NE3001, NE4001, NE5501, NE7501, NE9001		



1			
GEV No.	511155	Ref. No.	391314
description	roller spring 3kg complete incl. holder		
For models:	AC120, AC150, AC170, AC200, ACR, ACR145, ACR205, ACR225, ACR245, ACR260, ACR265, ACR305, GMC, GMC2700, GMC3500, GMC4500, GMC5500, NE00, NE3001, NE4001, NE5501, NE7501, NE9001		



1			
GEV No.	511663	Ref. No.	391318
description	roller spring 4.5kg complete incl. holder L 125mm W 40mm lug length 125mm		
For models:	AC101, AC122, AC151, AC152, AC181, AC182, AC201, AC202, AC241, AC242, AC91, LAV1001, LAV1501, NE02, NE3001, NE3002, NE4001, NE4002, NE5002, NE5501, NE5502, NE7002, NE7501, NE7502, NE9001, NE9002, NE9502, NG01, NG601, NG601E, NG901, NG901E		

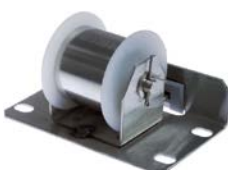

1			
GEV No.	511922	Ref. No.	391309
description	roller spring 4kg complete incl. holder L 125mm W 40mm ID ømm lug length 125mm		
For models:	AC101, AC120, AC122, AC150, AC151, AC152, AC170, AC181, AC182, AC200, AC201, AC202, AC241, AC242, AC91, ACR, ACR145, ACR205, ACR225, ACR245, ACR260, ACR265, ACR305, ACRS145, ACRS205, ACRS225, ACRS245, ACRS260, ACRS265, ACRS305, ACS201, ACS201-DIGIT, ACS202, ACS202-DIGIT, ACS241, ACS241-DIGIT, ACS242, ACS242-DIGIT, G125, G125L, G131, G66, GE125, GL, GMC, GMC2700, GMC2702, GMC3500, GMC3502, GMC4500...(Other models you can see in the webshop)		



1			
GEV No.	511578	Ref. No.	391332
description	roller spring 5.5kg complete incl. holder W 40mm		
For models:	AC101, AC122, AC151, AC152, AC181, AC182, AC201, AC202, AC241, AC242, AC91, ACRS145, ACRS205, ACRS225, ACRS245, ACRS260, ACRS265, ACRS305, GMC2702, GMC3502, GMC4502, GMC5502, LAV1001, LAV1501, NE02, NE3002, NE4002, NE5002, NE5502, NE7002, NE7502, NE9002, NE9502, NG02, NG1202, NG1202E, NG602, NG602E, NG902, NG902E		



1			
GEV No.	511552	Ref. No.	391331
description	roller spring complete incl. holder W 40mm ID ømm lug length 70mm		
For models:	AC101, AC122, AC151, AC152, AC181, AC182, AC201, AC202, AC241, AC242, AC91, ACL100, ACL150, ACS101, ACS101-DIGIT, ACS122, ACS122-DIGIT, ACS151, ACS151-DIGIT, ACS152, ACS152-DIGIT, ACS161-DIGIT, ACS162-DIGIT, ACS181, ACS181-DIGIT, ACS182, ACS182-DIGIT, ACS201, ACS201-DIGIT, ACS202, ACS202-DIGIT, ACS241, ACS241-DIGIT, ACS242, ACS242-DIGIT, ACS91, ACS91-DIGIT, LAV1000, NG02, NG1202, NG1202E, NG602, NG602E, NG902, NG902E, NL302, NL302E, NL402, NL402E, NL502...(Other models you can see in the webshop)		

accessories





1			
GEV No.	512491	Ref. No.	190651
description	guide busching for roller spring L 60mm H 8mm W 20mm suitable for COMENDA		
For models:	AC101, AC122, AC151, AC152, AC181, AC182, AC201, AC202, AC241, AC242, AC2A, AC91, ACL100, ACL150, ACRS145, ACRS205, ACRS225, ACRS245, ACRS260, ACRS265, ACRS305, ACS101, ACS101-DIGIT, ACS122, ACS122-DIGIT, ACS151, ACS151-DIGIT, ACS152, ACS152-DIGIT, ACS161-DIGIT, ACS162-DIGIT, ACS181, ACS181-DIGIT, ACS182, ACS182-DIGIT, ACS201, ACS201-DIGIT, ACS202, ACS202-DIGIT, ACS241, ACS241-DIGIT, ACS242, ACS242-DIGIT, ACS91, ACS91-DIGIT, GMC2702, GMC3502, GMC4502, GMC5502, LAV1000...(Other models you can see in the webshop)		

tension springs





1			
GEV No.	510926	Ref. No.	391312
description	tension spring for hood		
For models:	C30, C70, C75, C75BT, C75M, C75RCD, LP360, LP360BT, LP360RCD		

			
GEV No.	510927	Ref. No.	391313
description	tension spring for hood C34		
For models:	C33, C34		

			
GEV No.	511985	Ref. No.	450203
description	tension spring ø 11mm total length 47mm wire gauge ø 1mm Qty 1 pcs		
For models:	GMC2702, GMC3502, GMC4502, GMC5502, LV1001, LV1501, LV-LVP, LVP1001, LVP1501, NE00, NE3001, NE4001, NE5501, NE7501, NE9001, NG00, NG600, NG600E, NG900, NG900E		

			
GEV No.	511986	Ref. No.	450213
description	tension spring ø 11mm total length 54mm wire gauge ø 1mm Qty 1 pcs		
For models:	NE00, NE3001, NE4001, NE5501, NE7501, NE9001, NG00, NG01, NG600, NG600E, NG601, NG601E, NG900, NG900E, NG901, NG901E		

			
GEV No.	701047	Ref. No.	450229
description	tension spring ø 12mm total length 110mm wire gauge ø 1.2mm		
For models:	NE02, NE3002, NE4002, NE5002, NE5502, NE7002, NE7502, NE9002, NE9502, NG02, NG1202, NG1202E, NG602, NG602E, NG902, NG902E, NL302, NL302E, NL402, NL402E, NL502, NL502E, NL552, NL552E		

			
GEV No.	510228	Ref. No.	450217
description	tension spring ø 12mm total length 165mm wire gauge ø 1mm		
For models:	G100L, G101L, G115, G115L, G50L, G50LM, G51L, G60L, G61L, G65, G65L, GL, LAV1001, LAV1501		

			
GEV No.	510225	Ref. No.	391336
description	tension spring ø 12mm total length 185mm wire gauge ø 1.5mm		
For models:	FC3E, FC3EA, FC3M, FC3MA, FC3MR, FC44E, FC44EA, FC4E, FC4EA, FC4EHR, FC4M, FC4MA		

			
GEV No.	511565	Ref. No.	391334
description	tension spring ø 13mm total length 190mm wire gauge ø 1.75mm L1 155mm L2 16mm L3 16mm		
For models:	FC3E, FC3EA, FC3M, FC3MA, FC44E, FC44EA, FC4E, FC4EA, FC4EHR, FC4M, FC4MA		

			
GEV No.	701045	Ref. No.	450222
description	tension spring ø 13mm total length 195mm wire gauge ø 1.2mm		
For models:	G100L, G101L, G115L, GL		

			
GEV No.	510064	Ref. No.	450288
description	tension spring ø 13mm total length 78mm wire gauge ø 2.5mm L1 14mm L2 50mm L3 14mm		
For models:	GF70, GF70A, LF321, LF321A, LF322, LF322A, LF322MP, LF322MP-A, LF322RCD, LF324, LF324A, LF325E, LF325EA, LF700, LF700A		

			
GEV No.	511580	Ref. No.	H34773
description	tension spring ø 16.5mm total length 98mm wire gauge ø 2.5mm for dishwasher		
For models:	GF90, GF90-2004, GF90A, GF90A-2004		

			
GEV No.	510928	Ref. No.	391316
description	tension spring ø 37mm total length 910mm wire gauge ø 5.3mm for hood C85/140-G75		
For models:	C1000E, C1000ERCD, C1001M, C1300E, C1300ERCD, C1301M, C140, C155, C155BT, C155E2, C155RCD, C165, C165E2, C165E2BT, C165E2RCD, C166, C166-2, C85, C95, C95BT, C95E2, C95RCD, G125, G125L, G75, G75L, GE125, GE75, GL, LC1200, LC1200RCD, LC380, LC380BT, LC380RCD, LC400, LC412, LC700, LC700RCD, LC900, LC900RCD, XLC		

dosing pumps

peristaltic dosing pumps

GERMAC
built-in version
with frequency control













GEV No.	361268	Ref. No.	440632
description	dosing pump GERMAC frequency control 3l/h 230VAC detergent hose ø 4x6mm hose thermoplastic type G300 built-in version dimensions 67x72x101mm		
For models:	BHC25, BHC25-2, BHC25A, BHC25A-2, BHC25S, BHC30, BHC30-2, BHC30A, BHC30A-2, BHC30E, BHC30E-2, BHC30EA, BHC30EA-2, BHC30HR, BHC30HR-2, BHC30HR380, BHC30HRA, BHC30HRA-2, BHC30HRA380, BHC433, BHC433-2, BHC433A, BHC433A-2, BHCHR, FC3E, FC3EA, FC3M, FC3MA, FC3MR, FC44E, FC44EA, FC4E, FC4EA, FC4EHR, FC4M, FC4MA, FC53LA, GF70, GF70A, LF320L, LF320LA, LF321, LF321A, LF322, LF322A, LF322MP, LF322MP-A, LF322RCD, LF324, LF324A...(Other models you can see in the webshop)		
spare parts for	361268		
	GEV No.	361467	Ref. No. —
pump hose GERMAC detergent hose type thermoplastic hose ø 6x10mm for model G43/G45/G53/G54/G55/G300/G305			

Table continues overleaf



spare parts for 361268									
	<table border="1"> <tr> <th>GEV No.</th> <th>361557</th> <th>Ref. No.</th> <th>—</th> </tr> <tr> <td colspan="4">control PCB type G300/G302/G305 GERMAC</td> </tr> </table>	GEV No.	361557	Ref. No.	—	control PCB type G300/G302/G305 GERMAC			
GEV No.	361557	Ref. No.	—						
control PCB type G300/G302/G305 GERMAC									
	<table border="1"> <tr> <th>GEV No.</th> <th>361589</th> <th>Ref. No.</th> <th>—</th> </tr> <tr> <td colspan="4">roller assembly GERMAC suitable for G42/43/45/53/54/55/300/302/305/705</td> </tr> </table>	GEV No.	361589	Ref. No.	—	roller assembly GERMAC suitable for G42/43/45/53/54/55/300/302/305/705			
GEV No.	361589	Ref. No.	—						
roller assembly GERMAC suitable for G42/43/45/53/54/55/300/302/305/705									
accessories for 361268									
	<table border="1"> <tr> <th>GEV No.</th> <th>361106</th> <th>Ref. No.</th> <th>—</th> </tr> <tr> <td colspan="4">container filter with weight and non-return valve SS hose ø 4x6mm ø 21mm L 51mm non return valve lip valve</td> </tr> </table>	GEV No.	361106	Ref. No.	—	container filter with weight and non-return valve SS hose ø 4x6mm ø 21mm L 51mm non return valve lip valve			
GEV No.	361106	Ref. No.	—						
container filter with weight and non-return valve SS hose ø 4x6mm ø 21mm L 51mm non return valve lip valve									
	<table border="1"> <tr> <th>GEV No.</th> <th>520090</th> <th>Ref. No.</th> <th>—</th> </tr> <tr> <td colspan="4">PVC hose ID ø 4mm ED ø 6mm L 2m thickness 1mm t.max. 60°C transparent</td> </tr> </table>	GEV No.	520090	Ref. No.	—	PVC hose ID ø 4mm ED ø 6mm L 2m thickness 1mm t.max. 60°C transparent			
GEV No.	520090	Ref. No.	—						
PVC hose ID ø 4mm ED ø 6mm L 2m thickness 1mm t.max. 60°C transparent									
	<table border="1"> <tr> <th>GEV No.</th> <th>520091</th> <th>Ref. No.</th> <th>—</th> </tr> <tr> <td colspan="4">nylon hose ID ø 4mm ED ø 6mm L 2m thickness 1mm operating p. 10bar burst p. 50bar t.max. 100°C transparent</td> </tr> </table>	GEV No.	520091	Ref. No.	—	nylon hose ID ø 4mm ED ø 6mm L 2m thickness 1mm operating p. 10bar burst p. 50bar t.max. 100°C transparent			
GEV No.	520091	Ref. No.	—						
nylon hose ID ø 4mm ED ø 6mm L 2m thickness 1mm operating p. 10bar burst p. 50bar t.max. 100°C transparent									

spare parts for 361152									
	<table border="1"> <tr> <th>GEV No.</th> <th>361815</th> <th>Ref. No.</th> <th>—</th> </tr> <tr> <td colspan="4">pump hose detergent hose ø 6x10mm hose ø 4x6mm hose type K hose Santoprene type SEKO</td> </tr> </table>	GEV No.	361815	Ref. No.	—	pump hose detergent hose ø 6x10mm hose ø 4x6mm hose type K hose Santoprene type SEKO			
GEV No.	361815	Ref. No.	—						
pump hose detergent hose ø 6x10mm hose ø 4x6mm hose type K hose Santoprene type SEKO									
accessories for 361152									
	<table border="1"> <tr> <th>GEV No.</th> <th>361142</th> <th>Ref. No.</th> <th>—</th> </tr> <tr> <td colspan="4">mounting set detergent hose type 4x6mm hose length 2m PVC 2x hose/container filter/tank intake transparent</td> </tr> </table>	GEV No.	361142	Ref. No.	—	mounting set detergent hose type 4x6mm hose length 2m PVC 2x hose/container filter/tank intake transparent			
GEV No.	361142	Ref. No.	—						
mounting set detergent hose type 4x6mm hose length 2m PVC 2x hose/container filter/tank intake transparent									
	<table border="1"> <tr> <th>GEV No.</th> <th>520090</th> <th>Ref. No.</th> <th>—</th> </tr> <tr> <td colspan="4">PVC hose ID ø 4mm ED ø 6mm L 2m thickness 1mm t.max. 60°C transparent</td> </tr> </table>	GEV No.	520090	Ref. No.	—	PVC hose ID ø 4mm ED ø 6mm L 2m thickness 1mm t.max. 60°C transparent			
GEV No.	520090	Ref. No.	—						
PVC hose ID ø 4mm ED ø 6mm L 2m thickness 1mm t.max. 60°C transparent									
	<table border="1"> <tr> <th>GEV No.</th> <th>520091</th> <th>Ref. No.</th> <th>—</th> </tr> <tr> <td colspan="4">nylon hose ID ø 4mm ED ø 6mm L 2m thickness 1mm operating p. 10bar burst p. 50bar t.max. 100°C transparent</td> </tr> </table>	GEV No.	520091	Ref. No.	—	nylon hose ID ø 4mm ED ø 6mm L 2m thickness 1mm operating p. 10bar burst p. 50bar t.max. 100°C transparent			
GEV No.	520091	Ref. No.	—						
nylon hose ID ø 4mm ED ø 6mm L 2m thickness 1mm operating p. 10bar burst p. 50bar t.max. 100°C transparent									

spare parts			
			
1			
GEV No.	361554	Ref. No.	200608
description	pump hose GERMAC detergent hose type thermoplastic hose ø 5x8mm for model G200/G250/G252		
For models:	BHC25, BHC25-2, BHC25A, BHC25A-2, BHC25S, BHC30, BHC30-2, BHC30A, BHC30A-2, BHC30E, BHC30E-2, BHC30EA, BHC30EA-2, BHC30HR, BHC30HR-2, BHC30HR380, BHC30HRA, BHC30HRA-2, BHC30HRA380, BHC433, BHC433-2, BHC433A, BHC433A-2, BHCHR, FC53LA, GF70, GF70A, LF320L, LF320LA, LF321, LF321A, LF322, LF322A, LF322MP, LF322MP-A, LF322RCD, LF324, LF324A, LF325E, LF325EA, LF400A, LF700, LF700A, LFD32E, LFD32EA, LFD32M, LFD32MA		

piston pumps			
spare parts			
			
1			
GEV No.	510298	Ref. No.	200444
description	lip valve dosing pump suitable for DB2/DS5		

SEKO									
built-in version									
without control									
									
1									
GEV No.	361152 ¹	Ref. No.	440627						
description	dosing pump SEKO without control 3l/h 230VAC detergent hose ø 4x6mm hose type K hose Santoprene suction level 1.5m horizontal/vertical type PG built-in version dimensions 67x95x52mm								
For models:	FC, FCHR, FCHRA, FCHRT, FCHRTA								
spare parts for 361152									
	<table border="1"> <tr> <th>GEV No.</th> <th>361136</th> <th>Ref. No.</th> <th>—</th> </tr> <tr> <td colspan="4">roller assembly for dosing pump hole ø 4.8x4mm</td> </tr> </table>	GEV No.	361136	Ref. No.	—	roller assembly for dosing pump hole ø 4.8x4mm			
GEV No.	361136	Ref. No.	—						
roller assembly for dosing pump hole ø 4.8x4mm									
	<table border="1"> <tr> <th>GEV No.</th> <th>361562</th> <th>Ref. No.</th> <th>—</th> </tr> <tr> <td colspan="4">pump cover for dosing pump yellow</td> </tr> </table>	GEV No.	361562	Ref. No.	—	pump cover for dosing pump yellow			
GEV No.	361562	Ref. No.	—						
pump cover for dosing pump yellow									

membrane dosing pumps									
self-priming									
various									
									
1									
GEV No.	361015	Ref. No.	N/A						
description	dosing pump membrane dosing pump rinse aid inlet 6x8mm outlet 4x6mm pressure connection ø 4x6mm suction connection ø 6x8mm								
spare parts for 361015									
	<table border="1"> <tr> <th>GEV No.</th> <th>361132</th> <th>Ref. No.</th> <th>—</th> </tr> <tr> <td colspan="4">membrane dosing pump</td> </tr> </table>	GEV No.	361132	Ref. No.	—	membrane dosing pump			
GEV No.	361132	Ref. No.	—						
membrane dosing pump									
	<table border="1"> <tr> <th>GEV No.</th> <th>510298</th> <th>Ref. No.</th> <th>200444</th> </tr> <tr> <td colspan="4">lip valve dosing pump suitable for DB2/DS5</td> </tr> </table>	GEV No.	510298	Ref. No.	200444	lip valve dosing pump suitable for DB2/DS5			
GEV No.	510298	Ref. No.	200444						
lip valve dosing pump suitable for DB2/DS5									

¹with accessories

			
1			
GEV No.	361002	Ref. No.	620120
description	dosing pump rinse aid inlet 6x8mm outlet 4x6mm pressure connection ø 4x6mm suction connection ø 6x8mm		
For models:	B10T, B11T, B12T, B13T, B14T, B15, B15T, B15TM, B16, B16T, B16TM, B18, B18T, B18TM, B19, B19T, B19TM, B20, B20D, B23, B24, B25, B26, B27, B31, B32, B41, B42, BC25, BC25A, BC25HR, BC30, BC30A, BC30HR, BC30HR380, BC30HRA, BHC25, BHC25-2, BHC25A, BHC25A-2, BHC25S, BHC30, BHC30-2, BHC30A, BHC30A-2, BHC30E, BHC30E-2, BHC30EA, BHC30EA-2, BHC30HR...(Other models you can see in the webshop)		
spare parts for	361002		
	GEV No.	510297	Ref. No. 630614
	membrane for dosing pump ED ø 83mm thickness 1mm dosing pump equiv. no. 630614 suitable for COMENDA		
	GEV No.	510298	Ref. No. 200444
	lip valve dosing pump suitable for DB2/DS5		
	GEV No.	510299	Ref. No. 180306
	hose connector for dosing pump		
	GEV No.	510338	Ref. No. 170701
	union nut dosing pump thread 1/2" ø 32mm H 15mm for dosing pump		
	GEV No.	510847	Ref. No. 440405
	gasket polishing agent dosing ID ø 22mm ED ø 32mm external height 5mm		
	GEV No.	510870	Ref. No. 191018
	filter support for dosing pump		
	GEV No.	510916	Ref. No. 330543
	filter for dosing pump		

spare parts

			
1			
GEV No.	510916	Ref. No.	330543
description	filter for dosing pump		
For models:	B10T, B11T, B12T, B13T, B14T, B15T, B15TM, B16T, B16TM, B18T, B18TM, B19T, B19TM, BC25, BC25A, BC25HR, BC30, BC30A, BC30HR, BC30HR380, BC30HRA, BHC25, BHC25-2, BHC25A, BHC25A-2, BHC25S, BHC30, BHC30-2, BHC30A, BHC30A-2, BHC30E, BHC30E-2, BHC30EA, BHC30EA-2, BHC30HR, BHC30HR-2, BHC30HR380, BHC30HRA, BHC30HRA-2, BHC30HRA380, BHC433, BHC433-2, BHC433A, BHC433A-2, BHCHR, BR20, BR20A, BR25, BR25A, C1000E...(Other models you can see in the webshop)		

			
1			
GEV No.	510870	Ref. No.	191018
description	filter support for dosing pump		
For models:	B10T, B11T, B12T, B13T, B14T, B15T, B15TM, B16T, B16TM, B18T, B18TM, B19T, B19TM, BC25, BC25A, BC25HR, BC30, BC30A, BC30HR, BC30HR380, BC30HRA, BHC25, BHC25-2, BHC25A, BHC25A-2, BHC25S, BHC30, BHC30-2, BHC30A, BHC30A-2, BHC30E, BHC30E-2, BHC30EA, BHC30EA-2, BHC30HR, BHC30HR-2, BHC30HR380, BHC30HRA, BHC30HRA-2, BHC30HRA380, BHC433, BHC433-2, BHC433A, BHC433A-2, BHCHR, BR20, BR20A, BR25, BR25A, C1000E...(Other models you can see in the webshop)		

			
1			
GEV No.	510847	Ref. No.	440405
description	gasket polishing agent dosing ID ø 22mm ED ø 32mm external height 5mm		
For models:	B10T, B11T, B12T, B13T, B14T, B15T, B15TM, B16T, B16TM, B18T, B18TM, B19T, B19TM, BC25, BC25A, BC25HR, BC30, BC30A, BC30HR, BC30HR380, BC30HRA, BHC25, BHC25-2, BHC25A, BHC25A-2, BHC25S, BHC30, BHC30-2, BHC30A, BHC30A-2, BHC30E, BHC30E-2, BHC30EA, BHC30EA-2, BHC30HR, BHC30HR-2, BHC30HR380, BHC30HRA, BHC30HRA-2, BHC30HRA380, BHC433, BHC433-2, BHC433A, BHC433A-2, BHCHR, BR20, BR20A, BR25, BR25A, C1000E...(Other models you can see in the webshop)		



			
1			
GEV No.	510298	Ref. No.	200444
description	lip valve dosing pump suitable for DB2/DS5		

			
1			
GEV No.	510297	Ref. No.	630614
description	membrane for dosing pump ED ø 83mm thickness 1mm dosing pump equiv. no. 630614 suitable for COMENDA		
For models:	B10T, B11T, B12T, B13T, B14T, B15T, B15TM, B16T, B16TM, B18T, B18TM, B19T, B19TM, BC25, BC25A, BC25HR, BC30, BC30A, BC30HR, BC30HR380, BC30HRA, BHC25, BHC25-2, BHC25A, BHC25A-2, BHC25S, BHC30, BHC30-2, BHC30A, BHC30A-2, BHC30E, BHC30E-2, BHC30EA, BHC30EA-2, BHC30HR, BHC30HR-2, BHC30HR380, BHC30HRA, BHC30HRA-2, BHC30HRA380, BHC433, BHC433-2, BHC433A, BHC433A-2, BHCHR, BR20, BR20A, BR25, BR25A, C1000E...(Other models you can see in the webshop)		

			
1			
GEV No.	510229	Ref. No.	180420
description	T-piece dosing pump ø 28mm L 70mm		
For models:	C1000ERCD, C1300ERCD, FC3M, FC3MR, FC4M, GE50RCD, GE60RCD, GE65RCD, LC1200RCD, LC700RCD, LC900RCD, XLC		



			
1			
GEV No.	510338	Ref. No.	170701
description	union nut dosing pump thread 1/2" ø 32mm H 15mm for dosing pump		
For models:	B10T, B11T, B12T, B13T, B14T, B15T, B15TM, B16T, B16TM, B18T, B18TM, B19T, B19TM, BC25, BC25A, BC25HR, BC30, BC30A, BC30HR, BC30HR380, BC30HRA, BHC25, BHC25-2, BHC25A, BHC25A-2, BHC25S, BHC30, BHC30-2, BHC30A, BHC30A-2, BHC30E, BHC30E-2, BHC30EA, BHC30EA-2, BHC30HR, BHC30HR-2, BHC30HR380, BHC30HRA, BHC30HRA-2, BHC30HRA380, BHC433, BHC433-2, BHC433A, BHC433A-2, BHCHR, BR20, BR20A, BR25, BR25A, C1000E...(Other models you can see in the webshop)		

accessories for	361010		
	GEV No.	520090	Ref. No. —
	PVC hose ID ø 4mm ED ø 6mm L 2m thickness 1mm t.max. 60°C transparent		
	GEV No.	520091	Ref. No. —
	nylon hose ID ø 4mm ED ø 6mm L 2m thickness 1mm operating p. 10bar burst p. 50bar t.max. 100°C transparent		

self-priming with supporting pressure

ELETTROBAR			
			
1			
GEV No.	510298	Ref. No.	200444
description	lip valve dosing pump suitable for DB2/DS5		

			
1			
GEV No.	361387	Ref. No.	620736 H35388
description	dosing pump rinse aid pressure connection ø 8mm suction connection ø 4mm auxiliary pressure connection 10mm		
For models:	FC3E, FC3EA, FC3MA, FC44E, FC44EA, FC4E, FC4EA, FC4EHRT, FC4MA, GF70, GF70A, GF90-2004, GF90A-2004		

GERMAC

spare parts			
			
1			
GEV No.	510298	Ref. No.	200444
description	lip valve dosing pump suitable for DB2/DS5		

spare parts for	361387		
	GEV No.	361383	Ref. No. 200444 200942
	lip valve rinse aid pressure connection ømm suction connection ømm auxiliary pressure connectionmm		
	GEV No.	361384	Ref. No. 630632
	membrane rinse aid pressure connection ømm suction connection ømm auxiliary pressure connectionmm		
	GEV No.	508008	Ref. No. —
	O-ring EPDM thickness 2.62mm ID ø 15.88mm Qty 1 pcs		
accessories for	361387		
	GEV No.	520022	Ref. No. —
	PVC hose ID ø 8mm ED ø 12mm L 10m thickness 2mm t.max. 60°C transparent		
	GEV No.	520090	Ref. No. —
	PVC hose ID ø 4mm ED ø 6mm L 2m thickness 1mm t.max. 60°C transparent		

HOONVED

			
1			
GEV No.	361010	Ref. No.	620788
description	dosing pump rinse aid pressure connection ø 4x6mm suction connection ø 4mm auxiliary pressure connection 10mm HOONVED		
For models:	C1000ERCD, C1300ERCD, C155BT, C155RCD, C165E2BT, C165E2RCD, C75BT, C75RCD, C95BT, C95RCD, FC53CBT, FC53LBT, FC54CBT, FC54LBT, GE50RCD, GF90, GF90A, LC1200RCD, LC380BT, LC380RCD, LC700RCD, LC900RCD, LF320CBT, LF320LBT, LF322RCD, LP360BT, LP360RCD, XLC		
spare parts for	361010		
	GEV No.	361383	Ref. No. 200444 200942
	lip valve rinse aid pressure connection ømm suction connection ømm auxiliary pressure connectionmm		
	GEV No.	361384	Ref. No. 630632
	membrane rinse aid pressure connection ømm suction connection ømm auxiliary pressure connectionmm		

			
1			
GEV No.	361383	Ref. No.	200444 200942
description	lip valve rinse aid pressure connection ømm suction connection ømm auxiliary pressure connectionmm		
For models:	C1000ERCD, C1300ERCD, C155BT, C155RCD, C165E2BT, C165E2RCD, C75BT, C75RCD, C95BT, C95RCD, FC3E, FC3EA, FC3MA, FC44E, FC44EA, FC4E, FC4EA, FC4EHRT, FC4MA, FC53CBT, FC53LBT, FC54CBT, FC54LBT, GE50RCD, GF70, GF70A, GF90, GF90-2004, GF90A, GF90A-2004, LC1200RCD, LC380BT, LC380RCD, LC700RCD, LC900RCD, LF320CBT, LF320LBT, LF322RCD, LP360BT, LP360RCD, XLC		



GEV No.	361384	Ref. No.	630632
description	membrane rinse aid pressure connection ømm suction connection ømm auxiliary pressure connectionmm		
For models:	C1000ERCD, C1300ERCD, C155BT, C155RCD, C165E2BT, C165E2RCD, C75BT, C75RCD, C95BT, C95RCD, FC3E, FC3EA, FC3MA, FC44E, FC44EA, FC4E, FC4EA, FC4EHR, FC4MA, FC53CBT, FC53LBT, FC54CBT, FC54LBT, GE50RCD, GF70, GF70A, GF90, GF90-2004, GF90A, GF90A-2004, LC1200RCD, LC380BT, LC380RCD, LC700RCD, LC900RCD, LF320CBT, LF320LBT, LF322RCD, LP360BT, LP360RCD, XLC		

accessories

container filters



GEV No.	361062	Ref. No.	N/A
description	container filter hose ø 4mm		

container filters with non-return valve



GEV No.	361058	Ref. No.	180726 18719
description	container filter with non-return valve SS hose ø 4x6mm ø 20mm L 56mm		
For models:	BHC25, BHC25-2, BHC25A, BHC25A-2, BHC25S, BHC30, BHC30-2, BHC30A, BHC30A-2, BHC30E, BHC30E-2, BHC30EA, BHC30EA-2, BHC30HR, BHC30HR-2, BHC30HR380, BHC30HRA, BHC30HRA-2, BHC30HRA380, BHC433, BHC433-2, BHC433A, BHC433A-2, BHCHR, FC3E, FC3EA, FC3M, FC3MA, FC3MR, FC44E, FC44EA, FC4E, FC4EA, FC4EHR, FC4M, FC4MA, FC53LA, LF320L, LF320LA, LF321, LF321A, LF322, LF322A, LF322MP, LF322MP-A, LF322RCD, LF324, LF324A, LF325E, LF325EA...(Other models you can see in the webshop)		

intake lances



GEV No.	361118	Ref. No.	180719
description	intake lance with filter L 415mm ø 17mm tube ø 10mm hose ø 4x6mm cable lengthmm PVC		
For models:	BC25, BC25A, BC25HR, BC30, BC30A, BC30HR, BC30HR380, BC30HRA, BR20, BR20A, BR25, BR25A, F90M, F90MA, FC, FC43, FC43A, FC53, FC533, FC533A, FC53A, FC53CBT, FC53LBT, FC54, FC543, FC543A, FC543E, FC543EA, FC544, FC544A, FC54A, FC54CBT, FC54E, FC54EA, FC54LBT, FCHR, FCHRA, FCHRT, FCHRTA, LF315, LF320, LF320A, LF320CBT, LF320LA, LF320LBT, LF323, LF323A, LF350, LF350A, LF450...(Other models you can see in the webshop)		

hoses

silicone hoses



GEV No.	361609	Ref. No.	200130
description	silicone hose ID ø 5mm ED ø 8mm L 5m thickness 1.5mm operating pressure without pressure burst pressure non defined t.max. 200°C transparent dosing Qty 5m for peristaltic pump Shore A 55°		
For models:	BC25, BC25A, BC25HR, BC30, BC30A, BC30HR, BC30HR380, BC30HRA, BHC30E, BHC30EA, BR20, BR20A, BR25, BR25A, FC43, FC43A, LB200, LB200-2, LB215, LB215-2, LB215A, LB260, LB260-2, LB275, LB275-2, LB275A, LF315, LF320, LF320A, LF320LA, LF323, LF323A, LF350, LF350A, LF450, LF450A, LS550		

tank inlets



GEV No.	361270	Ref. No.	180308 251213
description	tank inlet SS M12 hose ø 4mm		
For models:	BC25, BC25A, BC25HR, BC30, BC30A, BC30HR, BC30HR380, BC30HRA, BHC25, BHC25-2, BHC25A, BHC25A-2, BHC25S, BHC30, BHC30-2, BHC30A, BHC30A-2, BHC30E, BHC30E-2, BHC30EA, BHC30EA-2, BHC30HR, BHC30HR-2, BHC30HR380, BHC30HRA, BHC30HRA-2, BHC30HRA380, BHC433, BHC433-2, BHC433A, BHC433A-2, BHCHR, BR20, BR20A, BR25, BR25A, C166-2, F90M, F90MA, FC, FC3E, FC3EA, FC3M, FC3MA, FC3MR, FC43, FC43A, FC44E, FC44EA, FC4E...(Other models you can see in the webshop)		



GEV No.	510816	Ref. No.	180308
description	tank inlet stainless steel M10 hose ø 4mm		
For models:	BC25HR, BC30HR, BC30HR380, BC30HRA, FC, FCHR, FCHRA, FCHRT, FCHRTA		



hoses

supply hoses

stainless steel flexi hoses

universal hoses

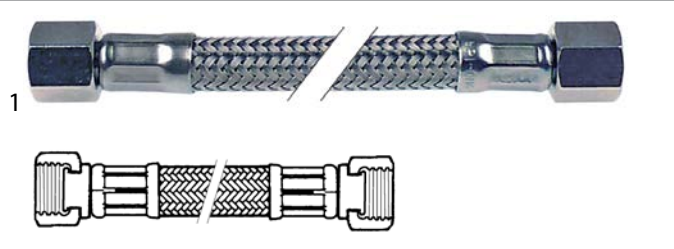

GEV No.	520627	Ref. No.	200715
description	flex hose SS braid straight-straight DN12 connections 3/4" L 2000mm approval DVGW operating p. 10bar test pressure 32bar burst p. 95bar		
For models:	B31, B32, C1000E, C1000ERCD, C1001M, C1300E, C1300ERCD, C1301M, C140, C155, C155BT, C155E2, C155RCD, C165, C165E2, C165E2BT, C165E2RCD, C166, C166-2, C30, C33, C34, C70, C75, C75BT, C75M, C75RCD, C85, C95, C95BT, C95E2, C95RCD, F2, F3, F300, F45, F55, F65, F80, F90M, F90MA, FC, FC3E, FC3EA, FC3M, FC3MA, FC3MR, FC44E, FC44EA, FC4E...(Other models you can see in the webshop)		

drain hoses

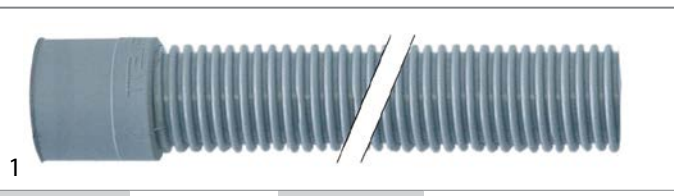

GEV No.	530587	Ref. No.	200721
description	drain hose DN28 L 2000mm straight ϕ inside 32mm straight ext. ϕ 40mm outer hose ϕ 35mm		
For models:	AC151, AC152, ACS151, ACS151-DIGIT, ACS152, ACS152-DIGIT, B13T, B14T, B15, B15T, B15TM, B16, B16T, B16TM, B18, B18T, B18TM, B19, B19T, B19TM, B41, B42, C1000E, C1000ERCD, C1001M, C1300E, C1300ERCD, C1301M, C140, C155, C155BT, C155E2, C155RCD, C165, C165E2, C165E2BT, C165E2RCD, C166, C166-2, C75, C75BT, C75RCD, C85, C95, C95BT, C95E2, C95RCD, F2, F20, F3...(Other models you can see in the webshop)		

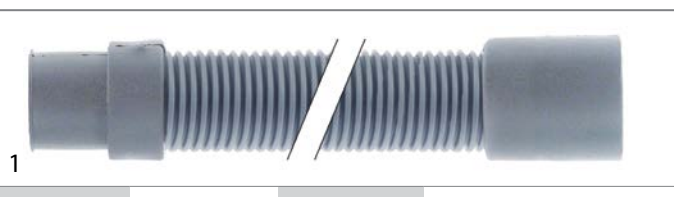

GEV No.	530607	Ref. No.	200779
description	drain hose DN24 L 2000mm A int. ϕ 24mm A ext. ϕ 28mm B int. ϕ 28mm B ext. ϕ 35mm outer hose ϕ 29mm temp.-resist. 90°C		
For models:	BC25, BC25A, BC30, BC30A, BHC25, BHC25-2, BHC25A, BHC25A-2, BHC25S, BHC30, BHC30-2, BHC30A, BHC30A-2, BHC30E, BHC30E-2, BHC30EA, BHC30EA-2, BHC30HR-2, BHC30HRA-2, BHC433, BHC433-2, BHC433A, BHC433A-2, BR20, BR20A, BR25, BR25A, FC3M, FC3MR, FC43, FC43A, FC4M, GF70, GF70A, LB200, LB200-2, LB200A, LB200A-2, LB215, LB215-2, LB215A, LB215A-2, LB260, LB260-2, LB260A, LB260A-2, LB275, LB275-2, LB275A, LB275A-2...(Other models you can see in the webshop)		

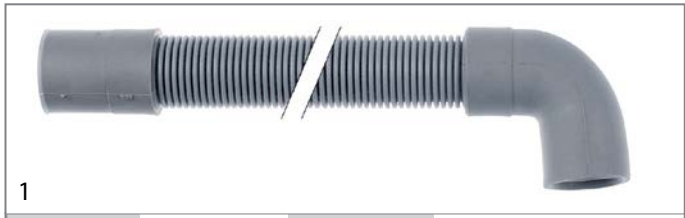

GEV No.	530613	Ref. No.	200346
description	drain hose DN19 L 3000mm straight ϕ inside 21mm straight ext. ϕ 27mm elbow ϕ inside 21mm elbow ext. ϕ 27mm outer hose ϕ 20mm		
For models:	B10T, B11T, B12T, B24, B25, B26, B27, BC25HR, BC30HR, BC30HR380, BC30HRA, BHC25, BHC25-2, BHC25A, BHC25A-2, BHC25S, BHC30, BHC30-2, BHC30A, BHC30A-2, BHC30E, BHC30E-2, BHC30EA, BHC30EA-2, BHC30HR, BHC30HR-2, BHC30HR380, BHC30HRA, BHC30HRA-2, BHC30HRA380, BHC433, BHC433-2, BHC433A, BHC433A-2, BHCHR, C1000E, C1300E, F90M, F90MA, FC, FC3E, FC3EA, FC3M, FC3MA, FC3MR, FC43, FC44E, FC44EA, FC4E, FC4EA...(Other models you can see in the webshop)		

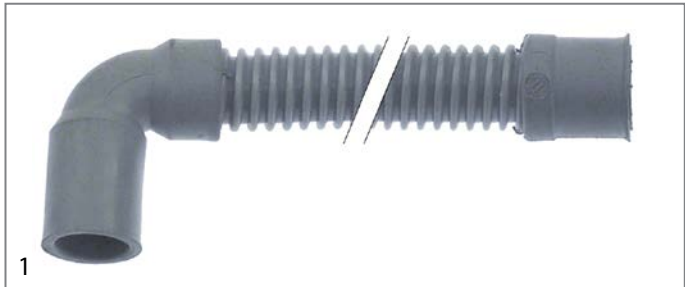

GEV No.	524819	Ref. No.	200303
description	drain hose DN20 L 720mm straight ϕ inside 21mm straight ext. ϕ 28mm elbow ϕ inside 21mm elbow ext. ϕ 28mm outer hose ϕ 25mm		
For models:	FC3E, FC3EA, FC44E, FC44EA, FC4E, FC4EA, FC4EHR		

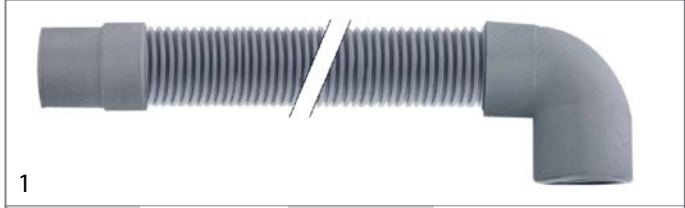

GEV No.	530572	Ref. No.	N/A
description	drain hose DN24 L 2000mm straight ϕ inside 24mm straight ext. ϕ 29mm elbow ϕ inside 29mm elbow ext. ϕ 35mm outer hose ϕ 29mm		

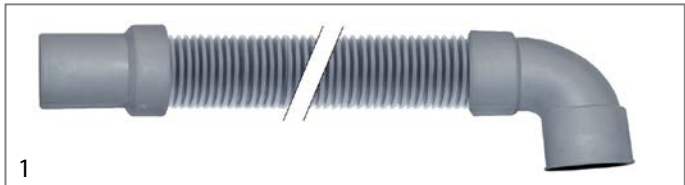

GEV No.	530069	Ref. No.	200794
description	drain hose DN24 L 2000mm straight ϕ inside 32mm straight ext. ϕ 35mm elbow ϕ inside 40mm elbow ext. ϕ 46mm outer hose ϕ 38mm		



industrial hoses

Niplaflex hoses

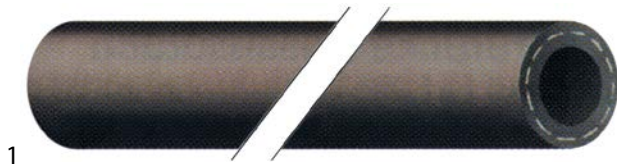

GEV No.	530561	Ref. No.	200122
description	pressure hose ID \varnothing 10mm ED \varnothing 17mm L 5m thickness 3.5mm operating p. 10bar burst p. 30bar t.max. 110°C		



GEV No.	530562	Ref. No.	200122
description	pressure hose ID \varnothing 13mm ED \varnothing 21mm L 5m operating p. 10bar burst p. 30bar t.max. 110°C		

pressure control hoses



GEV No.	530583	Ref. No.	200353
description	pressure control hose ID \varnothing 4.5mm ED \varnothing 10mm L 245mm		
For models:	AC100, AC90, B10, B10T, B11, B11T, B12, B12T, B20, B20D, B23, B24, B25, B26, B27, B31, B32, C30, C33, C34, G100L, G101L, G115, G115L, G125, G125L, G131, G50L, G50LM, G51L, G60L, G61L, G65, G65L, G66, G75, G75L, GE125, GE75, GL, LBC210, LBC215, LBC215A, LBC275, LBC275A, LBR, LBR200, LBR215, LBR215A, LC380...(Other models you can see in the webshop)		



GEV No.	530560	Ref. No.	160121
description	pressure control hose ID \varnothing 5mm ED \varnothing 9mm L 5m operating p. 30bar burst p. 90bar temp.-resist. 60°C		
For models:	B13T, B14T, B15T, B15TM, B16T, B16TM, B18T, B18TM, B19T, B19TM, BHC25, BHC25-2, BHC25A, BHC25A-2, BHC25S, BHC30, BHC30-2, BHC30A, BHC30A-2, BHC30E, BHC30E-2, BHC30EA, BHC30EA-2, BHC433, BHC433-2, BHC433A, BHC433A-2, C1000ERCD, C1300ERCD, C140, C155BT, C155RCD, C165E2BT, C165E2RCD, C166-2, C70, C75, C75BT, C75M, C75RCD, C85, C95BT, C95RCD, F20, F45, F55, F65, F80, F90M, F90MA...(Other models you can see in the webshop)		

PVC hoses

PVC braided hoses

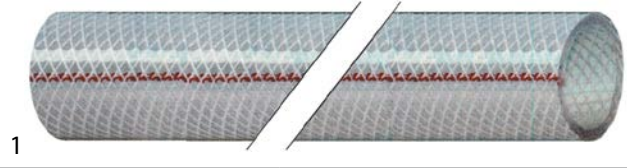

GEV No.	520018	Ref. No.	200129
description	PVC braided hose ID \varnothing 4mm ED \varnothing 10mm L 5m thickness 3mm operating p. 10bar burst p. 30bar t.max. 60°C transparent Qty 5m		
For models:	AC120, AC122, AC150, AC151, AC152, AC170, AC181, AC182, AC200, AC201, AC202, AC241, AC242, ACR, ACR145, ACR205, ACR225, ACR245, ACR260, ACR265, ACR305, GMC, GMC2700, GMC3500, GMC4500, GMC5500, LAV1000, LV1001, LV1501, LV-LVP, LVP1001, LVP1501, NE02, NE3001, NE3002, NE4001, NE4002, NE5002, NE5501, NE5502, NE7002, NE7501, NE7502, NE9001, NE9002, NE9502, NG01, NG02, NG1202, NG1202E...(Other models you can see in the webshop)		

PVC hoses without fabric



GEV No.	520026	Ref. No.	160105
description	PVC hose ID \varnothing 4mm ED \varnothing 6mm L 10m thickness 1mm t.max. 60°C transparent		
For models:	B10T, B11T, B12T, B13T, B14T, B15T, B15TM, B16T, B16TM, B18T, B18TM, B19T, B19TM, B20, B20D, B23, B24, B25, B26, B27, B31, B32, B41, B42, BC25, BC25A, BC25HR, BC30, BC30A, BC30HR, BC30HR380, BC30HRA, BHC25, BHC25-2, BHC25A, BHC25A-2, BHC25S, BHC30, BHC30-2, BHC30A, BHC30A-2, BHC30E-2, BHC30EA-2, BHC30HR, BHC30HR-2, BHC30HR380, BHC30HRA, BHC30HRA-2, BHC30HRA380, BHC433...(Other models you can see in the webshop)		

accessories for	520026			
	GEV No.	361058	Ref. No.	180726 18719
	container filter with non-return valve SS hose \varnothing 4x6mm \varnothing 20mm L 56mm			
	GEV No.	361066	Ref. No.	—
	container filter straight SS hose \varnothing 4x6mm L 37mm non return valve ball valve			
	GEV No.	361106	Ref. No.	—
	container filter with weight and non-return valve SS hose \varnothing 4x6mm \varnothing 21mm L 51mm non return valve lip valve			
	GEV No.	361141	Ref. No.	—
	container filter with weight ceramic hose \varnothing 4mm			
	GEV No.	361230	Ref. No.	—
	container filter with weight stainless steel hose \varnothing 4x6mm			
	GEV No.	361462	Ref. No.	—
	container filter with weight SS hose \varnothing 4x6mm			
	GEV No.	361728	Ref. No.	—
	container filter with 4m 4x6 hose SS hose \varnothing 4x6mm hose length 4000mm			



hoses wire reinforced



GEV No.	530218	Ref. No.	200121
description	drain hose ID ø 45mm ED ø 55mm wire reinforced		
For models:	ACL100, ACL150, ACRS145, ACRS205, ACRS225, ACRS245, ACRS260, ACRS265, ACRS305, ACS181, ACS181-DIGIT, ACS182, ACS182-DIGIT, ACS201, ACS201-DIGIT, ACS202, ACS202-DIGIT, ACS241, ACS241-DIGIT, ACS242, ACS242-DIGIT, GMC2702, GMC3502, GMC4502, GMC5502, LAV1001, LAV1501		

silicone hoses

without fabric



GEV No.	361609	Ref. No.	200130
description	silicone hose ID ø 5mm ED ø 8mm L 5m thickness 1.5mm operating pressure without pressure burst pressure non defined t.max. 200°C transparent dosing Qty 5m for peristaltic pump Shore A 55°		
For models:	BC25, BC25A, BC25HR, BC30, BC30A, BC30HR, BC30HR380, BC30HRA, BHC30E, BHC30EA, BR20, BR20A, BR25, BR25A, FC43, FC43A, LB200, LB200-2, LB215, LB215-2, LB215A, LB260, LB260-2, LB275, LB275-2, LB275A, LF315, LF320, LF320A, LF320LA, LF323, LF323A, LF350, LF350A, LF450, LF450A, LS550		

for peristaltic pumps



GEV No.	361609	Ref. No.	200130
description	silicone hose ID ø 5mm ED ø 8mm L 5m thickness 1.5mm operating pressure without pressure burst pressure non defined t.max. 200°C transparent dosing Qty 5m for peristaltic pump Shore A 55°		
For models:	BC25, BC25A, BC25HR, BC30, BC30A, BC30HR, BC30HR380, BC30HRA, BHC30E, BHC30EA, BR20, BR20A, BR25, BR25A, FC43, FC43A, LB200, LB200-2, LB215, LB215-2, LB215A, LB260, LB260-2, LB275, LB275-2, LB275A, LF315, LF320, LF320A, LF320LA, LF323, LF323A, LF350, LF350A, LF450, LF450A, LS550		

formed hoses

straight



GEV No.	530598	Ref. No.	200318
description	formed hose		
For models:	G100L, G101L, G50L, G51L, G60L, G61L, GL, LV1001, LV1501, LV-LVP, LVP1001, LVP1501, NE00, NE02, NE3001, NE4001, NE4002, NE5501, NE5502, NE7501, NE7502, NE9001, NE9502, NG01, NG601, NG601E, NG901, NG901E, NL402, NL402E, NL552, NL552E		



GEV No.	511347	Ref. No.	200369
description	formed hose D1 ø 36mm D2 ø 28mm L 45mm dishwasher straight equiv. no. 200369		
For models:	B10, B10T, B11, B11T, B12, B12T, B24, B25, B26, B27, LBR, LBR200, LBR215, LBR215A		



GEV No.	511343	Ref. No.	200319
description	formed hose dishwasher straight		
For models:	B20, B20D, B23, B24, B25, B26, B27		





GEV No.	511584	Ref. No.	200757
description	formed hose dishwasher straight equiv. no. 200757		
For models:	C85		





GEV No.	511362	Ref. No.	200758
description	formed hose dishwasher straight equiv. no. 200758		
For models:	AC135, C140, LC380, LC380BT, LC380RCD, LC400		

			
GEV No.	511366	Ref. No.	200759
description	formed hose dishwasher straight equiv. no. 200759		
For models:	AC120, AC122, AC152, AC170, AC182, AC200, AC202, AC242, ACR, ACR145, ACR205, ACR225, ACR245, ACR260, ACR265, ACR305, ACR5145, ACR5205, ACR5225, ACR5245, ACR5260, ACR5265, ACR5305, ACS122, ACS122-DIGIT, ACS152, ACS152-DIGIT, ACS162-DIGIT, ACS182, ACS182-DIGIT, ACS202, ACS202-DIGIT, ACS242, ACS242-DIGIT, C1000ERCD, C1300ERCD, C155BT, C155RCD, C165E2BT, C165E2RCD, C75BT, C75RCD, C95BT, C95RCD, FC53CBT, FC53LBT, FC54CBT, FC54LBT, GMC, GMC2700...(Other models you can see in the webshop)		

			
GEV No.	511350	Ref. No.	200776
description	formed hose dishwasher straight equiv. no. 200776		
For models:	BC25, BC25A, BC25HR, BC30, BC30A, BC30HR, BC30HR380, BC30HRA, FC43, FC43A		

			
GEV No.	506412	Ref. No.	200105
description	formed hose dishwasher straight hose ext. ø 60mm hose int. ø 50mm		
For models:	AC100, AC101, AC105, AC120, AC122, AC135, AC150, AC151, AC152, AC170, AC181, AC182, AC200, AC201, AC202, AC241, AC242, AC2A, AC90, AC91, AC95, ACL100, ACL150, ACR, ACR145, ACR205, ACR225, ACR245, ACR260, ACR265, ACR305, ACR5145, ACR5205, ACR5225, ACR5245, ACR5260, ACR5265, ACR5305, ACS101, ACS101-DIGIT, ACS122, ACS122-DIGIT, ACS151, ACS151-DIGIT, ACS152, ACS152-DIGIT, ACS161-DIGIT, ACS162-DIGIT, ACS181, ACS181-DIGIT...(Other models you can see in the webshop)		

			
GEV No.	511598	Ref. No.	201072
description	formed hose hose ext. ø 35mm hose int. ø 28mm L 68mm black Qty 1		
For models:	C1000ERCD, C1300ERCD, FC3MA, FC4MA, LC1200RCD, LC700RCD, LC900RCD		

<p>form L</p> 			
GEV No.	530054	Ref. No.	200767 201061
description	formed hose		
For models:	AC105, AC120, AC122, AC135, AC150, AC151, AC152, AC170, AC181, AC182, AC200, AC201, AC202, AC241, AC242, AC95, ACR, ACR145, ACR205, ACR225, ACR245, ACR260, ACR265, ACR305, ACS101, ACS101-DIGIT, ACS122, ACS122-DIGIT, ACS151, ACS151-DIGIT, ACS152, ACS152-DIGIT, ACS161-DIGIT, ACS162-DIGIT, ACS181, ACS181-DIGIT, ACS182, ACS182-DIGIT, ACS201, ACS201-DIGIT, ACS202, ACS202-DIGIT, ACS241, ACS241-DIGIT, ACS242, ACS242-DIGIT, ACS91, ACS91-DIGIT, GE100, GE115...(Other models you can see in the webshop)		

			
GEV No.	510799	Ref. No.	200393
description	formed hose end piece A ext. ø 30mm end piece A int. ø 22mm AD2 ø 35mm ø end piece B 27mm L 630mm Qty 1 L-shape		
For models:	F45, F55, F65, F80		

			
GEV No.	524821	Ref. No.	201070
description	formed hose end piece A ext. ø 35mm end piece A int. ø 27mm AD2 ø 35mm ø end piece B 27mm L 145mm Qty 1 warewashing L-shape		
For models:	C1000ERCD, C1300ERCD, GE50RCD, GE60RCD, GE65RCD, LC1200RCD, LC700RCD, LC900RCD, LF322RCD, XLC		

			
GEV No.	511599	Ref. No.	201066
description	formed hose end piece A ext. ø 39mm end piece A int. ø 29mm AD2 ø 39mm ø end piece B 29mm L 98mm rubber Qty 1 L-shape		
For models:	BHC25-2, BHC25A-2, BHC30-2, BHC30A-2, BHC30E, BHC30E-2, BHC30EA, BHC30EA-2, BHC30HR, BHC30HR-2, BHC30HR380, BHC30HRA, BHC30HRA-2, BHC30HRA380, BHC433-2, BHC433A-2, BHCHR, LB200, LB200-2, LB200A, LB200A-2, LB215, LB215-2, LB215A, LB215A-2, LB260, LB260-2, LB260A, LB260A-2, LB275, LB275-2, LB275A, LB275A-2, LF321, LF321A, LF322, LF322A, LF324, LF324A, LF325E, LF325EA, LF700, LF700A		



			
1			
GEV No.	530580	Ref. No.	200726
description	formed hose end piece A ext. ø 47mm end piece A int. ø 36mm AD2 ø 39mm ø end piece B 28mm L 630mm warewashing L-shape Qty 1 black		
For models:	C30		

			
1			
GEV No.	524697	Ref. No.	H26556
description	formed hose end piece A ext. ø 50mm end piece A int. ø 45mm AD2 ø 78mm ø end piece B 54mm L 192mm warewashing Qty 1 black		
For models:	C1000E, C1000ERCD, C1001M, C1300E, C1300ERCD, C1301M, GF90, GF90-2004, GF90A, GF90A-2004, LC1200, LC1200RCD, LC700, LC700RCD, LC900, LC900RCD, XLC		

			
1			
GEV No.	504390	Ref. No.	200612
description	formed hose end piece A ext. ø 56mm end piece A int. ø 45mm AD2 ø 59mm ø end piece B 48mm L 180mm warewashing		
For models:	LF321, LF321A, LF322, LF322A, LF322MP, LF322MP-A, LF322RCD, LF324, LF324A, LF325E, LF325EA, LF700, LF700A, LFD32E, LFD32EA, LFD32M, LFD32MA		

			
1			
GEV No.	524779	Ref. No.	200753
description	formed hose end piece A ext. ø 60mm end piece A int. ø 45mm AD2 ø 54mm ø end piece B 39mm L 410mm L-shape		
For models:	SNL		

			
1			
GEV No.	511352	Ref. No.	201029
description	formed hose end piece A ext. ø 60mm end piece A int. ø 46mm AD2 ø 45mm ø end piece B 29mm warewashing L-shape equiv. no. 201029		
For models:	BHC25, BHC25A, BHC25S, BHC30, BHC30A, BHC30HR, BHC30HR380, BHC30HRA, BHC30HRA380, BHC433, BHC433A, BHCHR		

			
1			
GEV No.	524698	Ref. No.	200728
description	formed hose end piece A ext. ø 66mm end piece A int. ø 52mm AD2 ø 62mm ø end piece B 48mm L 142mm warewashing L-shape Qty 1 black		
For models:	SE		

			
1			
GEV No.	530578	Ref. No.	200749
description	formed hose end piece A ext. ø 69mm end piece A int. ø 60mm AD2 ø 56mm ø end piece B 45mm L 250mm warewashing L-shape Qty 1 black		
For models:	C85		

			
1			
GEV No.	512129	Ref. No.	H29532
description	formed hose end piece A ext. ø 75mm end piece A int. ø 59mm AD2 ø 75mm ø end piece B 59mm warewashing L-shape equiv. no. 29532		
For models:	GF90, GF90-2004, GF90A, GF90A-2004		



1

GEV No.	530577	Ref. No.	200750
description	formed hose L 350mm warewashing L-shape equiv. no. 200750 ID ø 60mm		
For models:	C140, LC380, LC400		



1

GEV No.	530592	Ref. No.	200355
description	formed hose warewashing L-shape equiv. no. 200355		
For models:	C30		



1

GEV No.	530585	Ref. No.	200359
description	formed hose warewashing L-shape		
For models:	C33, C34, XLC		



1

GEV No.	511337	Ref. No.	200372
description	formed hose warewashing L-shape equiv. no. 200372		
For models:	B41, B42, F20		



1

GEV No.	530559	Ref. No.	200312
description	formed hose warewashing L-shape equiv. no. 200312		
For models:	F2, F300, F45, F55, F65, F80		



1

GEV No.	511356	Ref. No.	200389
description	formed hose warewashing L-shape equiv. no. 200389		
For models:	F2, F3, F300, F45, F55, F65, F80, LF280-lav-line, LF320-lav-line		



1

GEV No.	530579	Ref. No.	200724
description	formed hose warewashing L-shape equiv. no. 200724		
For models:	C30, C70, C75, C75M, LP360		



1

GEV No.	530582	Ref. No.	200334
description	formed hose warewashing L-shape equiv. no. 200334		
For models:	F2, F3, F300, F45, F55, F65, F80, LF280-lav-line, LF320-lav-line, R40, R50		



1

GEV No.	511344	Ref. No.	200732
description	formed hose warewashing L-shape equiv. no. 200732		
For models:	B13T, B14T, B15, B15T, B15TM, B16, B16T, B16TM, B18, B18T, B18TM, B19, B19T, B19TM		





			
1			
GEV No.	511345	Ref. No.	200733
description	formed hose warewashing L-shape equiv. no. 200733		
For models:	B13T, B14T, B15, B15T, B16, B16T, B18, B18T, B19, B19T		

			
1			
GEV No.	511186	Ref. No.	200787
description	formed hose warewashing L-shape equiv. no. 200787		
For models:	FC, FC53, FC533, FC533A, FC53A, FC53CBT, FC53LA, FC53LBT, FC54, FC543, FC543A, FC543E, FC543EA, FC544, FC544A, FC54A, FC54CBT, FC54E, FC54EA, FC54LBT, FCHR, FCHRA, FCHRT, FCHRTA		

			
1			
GEV No.	530599	Ref. No.	200311 200735
description	formed hose warewashing L-shape equiv. no. 200735, 200311		
For models:	F2, F300, F45, F55, F65, F80, LF280-lav-line, LF320-lav-line, R40		

			
1			
GEV No.	511364	Ref. No.	201014
description	formed hose warewashing L-shape equiv. no. 201014		
For models:	F90M, F90MA, LF350, LF350A, LF450, LF450A		

			
1			
GEV No.	530544	Ref. No.	200769
description	formed hose warewashing L-shape equiv. no. 200769		
For models:	C155, C155BT, C155E2, C155RCD, C165, C165E2, C165E2BT, C165E2RCD, C166, C166-2, C95, C95BT, C95E2, C95RCD		

			
1			
GEV No.	511365	Ref. No.	201017
description	formed hose warewashing L-shape equiv. no. 201017		
For models:	C155BT, C155RCD, C165E2BT, C165E2RCD, C75BT, C75RCD, C95BT, C95RCD, FC53CBT, FC53LBT, FC54CBT, FC54LBT, LF320CBT, LF320LBT, LF322RCD		

			
1			
GEV No.	511351	Ref. No.	200777
description	formed hose warewashing L-shape equiv. no. 200777		
For models:	BR20, BR20A, BR25, BR25A		

			
1			
GEV No.	511359	Ref. No.	201019
description	formed hose warewashing L-shape equiv. no. 201019		
For models:	C75BT, C75RCD, LP360BT, LP360RCD		

			
1			
GEV No.	511348	Ref. No.	200781
description	formed hose warewashing L-shape equiv. no. 200781		
For models:	LBC210, LBC215, LBC215A, LBC275, LBC275A		

			
1			
GEV No.	511360	Ref. No.	201020
description	formed hose warewashing L-shape equiv. no. 201020		
For models:	C75BT, C75RCD, LP360BT, LP360RCD		



1

GEV No.	511353	Ref. No.	201030
description	formed hose warewashing L-shape equiv. no. 201030		
For models:	BHC25, BHC25A, BHC25S, BHC30, BHC30A, BHC30HR, BHC30HR380, BHC30HRA, BHC30HRA380, BHC433, BHC433A, BHCHR		



1

GEV No.	511346	Ref. No.	200765
description	pressure hose		
For models:	B15TM, B16TM, B18TM, B19TM		



1

GEV No.	512380	Ref. No.	201059
description	pressure hose L-shape		
For models:	BHC25, BHC25-2, BHC25A, BHC25A-2, BHC30, BHC30-2, BHC30A, BHC30A-2, BHC30E, BHC30E-2, BHC30EA, BHC30EA-2, BHC30HR, BHC30HR-2, BHC30HR380, BHC30HRA, BHC30HRA-2, BHC30HRA380, BHC433, BHC433-2, BHC433A, BHC433A-2, BHCHR, LB200, LB200-2, LB200A, LB200A-2, LB215, LB215-2, LB215A, LB215A-2, LB260, LB260-2, LB260A, LB260A-2, LB275, LB275-2, LB275A, LB275A-2		

with branch



1

GEV No.	511208	Ref. No.	200768
description	formed hose warewashing equiv. no. 200768 with piggyback		
For models:	C155, C155BT, C155E2, C155RCD, C165, C165E2, C165E2BT, C165E2RCD, C166, C166-2, C95, C95BT, C95E2, C95RCD		

form S



1

GEV No.	511226	Ref. No.	200755
description	formed hose		
For models:	C70, C75, C75M, LP360		



1

GEV No.	511479	Ref. No.	201004
description	formed hose hose ext. ø 65mm hose int. ø 50mm S-shape		
For models:	AC105, AC122, AC135, AC151, AC152, AC181, AC182, AC201, AC202, AC241, AC242, AC95, GE100, GE115, GE60, GE65, GE80		



1

GEV No.	511342	Ref. No.	200719
description	formed hose S-shape warewashing equiv. no. 200719		
For models:	B10, B10T, B11, B11T, B12, B12T, B20, B20D, B23, B24, B25, B26, B27, BC25HR, BC30HR, BC30HR380, BHC25S, FC43, LBC210, LBC215, LBC215A, LBC275, LBC275A, LBR, LBR200, LBR215, LBR215A		

form U



1

GEV No.	512032	Ref. No.	200611
description	formed hose D1 ø 30mm D2 ø 37mm L 645mm Qty 1		
For models:	LF321, LF321A, LF322, LF322A, LF322MP, LF322MP-A, LF322RCD, LF324, LF324A, LF325E, LF325EA, LF700, LF700A, LFD32E, LFD32EA, LFD32M, LFD32MA		



1

GEV No.	511349	Ref. No.	200778
description	formed hose D1 ø 44mm D2 ø 42mm L 260mm warewashing black Qty 1 U-shape equiv. no. 200778		
For models:	BC25, BC25A, BC25HR, BC30, BC30A, BC30HR, BC30HR380, BC30HRA, BR20, BR20A, BR25, BR25A, FC43, FC43A		



			
1			
GEV No.	511357	Ref. No.	200355 200725
description	formed hose D1 ø 54mm D2 ø 50mm L 330mm warewashing black Qty 1 U-shape equiv. no. 200725		
For models:	C30		

			
1			
GEV No.	524820	Ref. No.	201056
description	formed hose D1 ø 75mm D2 ø 83mm L 340mm warewashing black Qty 1		
For models:	LC1200, LC1200RCD, LC412, LC700, LC700RCD, LC900, LC900RCD		

			
1			
GEV No.	512390	Ref. No.	200391
description	formed hose ext. ø 30 D1 ø 35/28mm D2 ø 36/29mm L 580mm warewashing black		
For models:	F2, F3, F300, F45, F55, F65, F80, LF280-lav-line, LF320-lav-line		

miscellaneous

			
1			
GEV No.	511363	Ref. No.	200788
description	formed hose warewashing equiv. no. 200788		
For models:	LF400A		

for dishwashers

miscellaneous

			
1			
GEV No.	510806	Ref. No.	160108
description	extraction hose ED ø 8mm ID ø 5mm Qty supplied by meter		
For models:	B10T, B11T, B12T, B13T, B14T, B15, B15T, B15TM, B16, B16T, B16TM, B18, B18T, B18TM, B19, B19T, B19TM, B31, B41, B42, BHC25, BHC25-2, BHC25A, BHC25A-2, BHC25S, BHC30, BHC30-2, BHC30A, BHC30A-2, BHC30E-2, BHC30EA-2, BHC30HR, BHC30HR-2, BHC30HR380, BHC30HRA, BHC30HRA-2, BHC433, BHC433-2, BHC433A, BHC433A-2, BHCHR, C1000E, C1000ERCD, C1001M, C1300E, C1300ERCD, C1301M, C155, C155BT, C155E2...(Other models you can see in the webshop)		

			
1			
GEV No.	530590	Ref. No.	200117
description	hose ED ø 15mm ID ø 8mm equiv. no. 200117 Qty supplied by meter		
For models:	B10T, B11T, B12T, B13T, B14T, B15, B15T, B15TM, B16, B16T, B16TM, B18, B18T, B18TM, B19, B19T, B19TM, B41, B42, BC25, BC25A, BC25HR, BC30, BC30A, BC30HR, BC30HR380, BC30HRA, BHC25-2, BHC25A-2, BHC30-2, BHC30A-2, BHC30E-2, BHC30EA-2, BHC30HR-2, BHC30HRA-2, BHC433-2, BHC433A-2, BR20, BR20A, BR25, BR25A, C1000E, C1000ERCD, C1001M, C1300E, C1300ERCD, C1301M, C140, C155, C155BT...(Other models you can see in the webshop)		

			
1			
GEV No.	530589	Ref. No.	200113
description	hose ED ø 22mm ID ø 12mm L 1000mm		
For models:	AC100, AC101, AC105, AC120, AC122, AC135, AC150, AC151, AC152, AC170, AC181, AC182, AC200, AC201, AC202, AC241, AC242, AC2A, AC90, AC91, AC95, ACL100, ACL150, ACR, ACR145, ACR205, ACR225, ACR245, ACR260, ACR265, ACR305, ACRS145, ACRS205, ACRS225, ACRS245, ACRS260, ACRS265, ACRS305, ACS101, ACS101-DIGIT, ACS122, ACS122-DIGIT, ACS151, ACS151-DIGIT, ACS152, ACS152-DIGIT, ACS161-DIGIT, ACS162-DIGIT, ACS181, ACS181-DIGIT...(Other models you can see in the webshop)		

			
1			
GEV No.	511562	Ref. No.	160117
description	hose ED ø 6.3mm ID ø 4.1mm for by-pass L 2150mm polypropylene		
For models:	B16TM, B19TM, BC25A, BC30A, BC30HRA, BHC25A, BHC25A-2, BHC30A, BHC30A-2, BHC30EA, BHC30EA-2, BHC30HR, BHC30HR-2, BHC30HRA, BHC30HRA-2, BHC30HRA380, BHC433A, BHC433A-2, BHCHR, F90MA, FC, FC3E, FC3EA, FC3MA, FC43A, FC44E, FC44EA, FC4E, FC4EA, FC4EHRT, FC4MA, FC533A, FC53A, FC53LA, FC543A, FC543EA, FC544A, FC54A, FC54EA, FCHRA, FCHRTA, GF70A, LB200A, LB200A-2, LB215A, LB215A-2, LB260A, LB260A-2, LB275A, LB275A-2...(Other models you can see in the webshop)		

			
1			
GEV No.	511285	Ref. No.	161311
description	hose ED ø 9.5mm ID ø 5mm L 1075mm equiv. no. 161311		
For models:	AC101, AC105, AC122, AC135, AC151, AC152, AC181, AC182, AC201, AC202, AC241, AC242, AC91, AC95, ACL150, ACRS145, ACRS205, ACRS225, ACRS245, ACRS260, ACRS265, ACRS305, ACS101, ACS101-DIGIT, ACS122, ACS122-DIGIT, ACS151, ACS151-DIGIT, ACS152, ACS152-DIGIT, ACS161-DIGIT, ACS162-DIGIT, ACS181, ACS181-DIGIT, ACS182, ACS182-DIGIT, ACS201, ACS201-DIGIT, ACS202, ACS202-DIGIT, ACS241, ACS241-DIGIT, ACS242, ACS242-DIGIT, ACS91, ACS91-DIGIT, BC25, BC25A, BC25HR, BC30...(Other models you can see in the webshop)		





1

GEV No.	511289	Ref. No.	161312
description	hose ED ø 9.5mm ID ø 5mm L 420mm equiv. no. 161312		
For models:	AC201, AC202, AC241, AC242, AC2A, ACL100, ACL150, ACRS145, ACRS205, ACRS225, ACRS245, ACRS260, ACRS265, ACRS305, ACS101, ACS101-DIGIT, ACS122, ACS122-DIGIT, ACS151, ACS151-DIGIT, ACS152, ACS152-DIGIT, ACS161-DIGIT, ACS162-DIGIT, ACS181, ACS181-DIGIT, ACS182, ACS182-DIGIT, ACS201, ACS201-DIGIT, ACS202, ACS202-DIGIT, ACS241, ACS241-DIGIT, ACS242, ACS242-DIGIT, ACS91, ACS91-DIGIT, C155, C155BT, C155E2, C155RCD, C165, C165E2, C165E2BT, C165E2RCD, C166, C166-2, C95, C95BT...(Other models you can see in the webshop)		



1

GEV No.	511573	Ref. No.	161320
description	hose ED ø 9mm ID ø 5mm L 2400mm Qty 1 ext. ø 9.5		
For models:	C1000E, C1000ERCD, C1001M, C1300E, C1300ERCD, C1301M, GE50RCD, LC1200, LC1200RCD, LC412, LC700, LC700RCD, LC900, LC900RCD, XLC		



1

GEV No.	510843	Ref. No.	180408 h33817
description	T-piece plastic hose ø 10-6-10mm		
For models:	C1000E, C1001M, C1300E, C1301M, C140, C155, C155E2, C165, C165E2, C166, C166-2, C30, C33, C34, C70, C75, C75M, C85, C95, C95E2, F2, F3, F300, F45, F55, F65, F80, F90M, F90MA, FC, FC43, FC43A, FC53, FC533, FC533A, FC53A, FC53LA, FC54, FC543, FC543A, FC543E, FC543EA, FC544, FC544A, FC54A, FC54E, FC54EA, FCHR, FCHRA, FCHRT...(Other models you can see in the webshop)		



1

GEV No.	510842	Ref. No.	180403
description	T-piece plastic hose ø 13-13-13mm 3-way		
For models:	AC101, AC122, AC151, AC152, AC181, AC182, AC201, AC202, AC241, AC242, AC91, ACR, ACR145, ACR205, ACR225, ACR245, ACR260, ACR265, ACR305, B10T, B11T, B12T, B13T, B14T, B15, B15T, B15TM, B16, B16T, B16TM, B18, B18T, B18TM, B19, B19T, B19TM, B20, B20D, B24, B25, B26, B27, B31, B32, BR20A, BR25A, C140, C165, C30, C70...(Other models you can see in the webshop)		



1

GEV No.	511273	Ref. No.	191026
description	cross fitting		
For models:	B20, B20D, B41, B42		

fittings, hose and pipe connectors

hose connectors

without screw connection



1

GEV No.	541109	Ref. No.	190314
description	Y-piece plastic hose ø 8-6-8mm for pressure switch		
For models:	ACR, ACR145, ACR205, ACR225, ACR245, ACR260, ACR265, ACR305, C166-2, FC3E, FC3EA, FC44E, FC44EA, FC4E, FC4EA, GMC, GMC2700, GMC3500, GMC4500, GMC5500, NE00, NG00, NG600, NG600E, NG900, NG900E		



fittings

double nipples



1			
GEV No.	520169	Ref. No.	270308
description	double nipple brass thread 3/4" - 3/4" Qty 1 pcs		
For models:	AC101, AC105, AC122, AC135, AC151, AC152, AC181, AC182, AC201, AC202, AC241, AC242, AC91, AC95, ACS101, ACS101-DIGIT, ACS122, ACS122-DIGIT, ACS151, ACS151-DIGIT, ACS152, ACS152-DIGIT, ACS161-DIGIT, ACS162-DIGIT, ACS181, ACS181-DIGIT, ACS182, ACS182-DIGIT, ACS201, ACS201-DIGIT, ACS202, ACS202-DIGIT, ACS241, ACS241-DIGIT, ACS242, ACS242-DIGIT, ACS91, ACS91-DIGIT, NE02, NE3002, NE4002, NE5002, NE5502, NE7002, NE7502, NE9002, NE9502, NG00, NG600, NG600E...(Other models you can see in the webshop)		



1			
GEV No.	506277	Ref. No.	332162
description	double nipple SS thread 3/8" - 3/4" Qty 1 pcs		



1			
GEV No.	506272	Ref. No.	190696
description	double nipple plastic thread 3/8" - 3/4" Qty 1 pcs		

angle pieces



1			
GEV No.	541924	Ref. No.	280101
description	angle piece thread 1/2" IT - 1/2" IT brass		
For models:	AC101, AC105, AC122, AC151, AC152, AC181, AC182, AC201, AC202, AC241, AC242, AC91, AC95, ACRS145, ACRS205, ACRS225, ACRS245, ACRS260, ACRS265, ACRS305, ACS101, ACS101-DIGIT, ACS122, ACS122-DIGIT, ACS151, ACS151-DIGIT, ACS152, ACS152-DIGIT, ACS161-DIGIT, ACS162-DIGIT, ACS181, ACS181-DIGIT, ACS182, ACS182-DIGIT, ACS201, ACS201-DIGIT, ACS202, ACS202-DIGIT, ACS241, ACS241-DIGIT, ACS242, ACS242-DIGIT, ACS91, ACS91-DIGIT, C75, FC, FC53, FC533, FC54, FC543...(Other models you can see in the webshop)		



1			
GEV No.	510464	Ref. No.	280118
description	angle piece thread 1/4" IT - 3/8" IT brass		
For models:	C155, C155BT, C155E2, C155RCD, C165, C165E2, C165E2BT, C165E2RCD, C166, C166-2, C95, C95BT, C95E2, C95RCD, GF90-2004, GF90A-2004, LC380, LC380BT, LC380RCD, LC400		

hose connectors

brass



1			
GEV No.	511280	Ref. No.	290410
description	hose connector brass straight thread 1/2" hose ø 14mm Qty 1 pcs		
For models:	AC100, AC101, AC105, AC120, AC122, AC135, AC150, AC151, AC152, AC170, AC181, AC182, AC200, AC201, AC202, AC241, AC242, AC90, AC91, AC95, ACR, ACR145, ACR205, ACR225, ACR245, ACR260, ACR265, ACR305, ACRS145, ACRS205, ACRS225, ACRS245, ACRS260, ACRS265, ACRS305, ACS101, ACS101-DIGIT, ACS122, ACS122-DIGIT, ACS151, ACS151-DIGIT, ACS152, ACS152-DIGIT, ACS161-DIGIT, ACS162-DIGIT, ACS181, ACS181-DIGIT, ACS182, ACS182-DIGIT, ACS201...(Other models you can see in the webshop)		



1			
GEV No.	511279	Ref. No.	290407
description	hose connector brass straight thread 3/8" hose ø 12mm Qty 1 pcs		
For models:	AC105, AC135, AC95, B31, B32, B41, B42, C33, C34		



1			
GEV No.	511278	Ref. No.	280509
description	hose connector brass straight thread M8 hose ø 6mm Qty 1 pcs		
For models:	B13T, B14T, B15, B15T, B15TM, B16, B16T, B16TM, B18, B18T, B18TM, B19, B19T, B19TM, B41, B42, F2, F20, F3, F300, R50		



1			
GEV No.	510059	Ref. No.	H34426
description	screw-in nipple brass straight thread 1/4" hose ø 11.5mm Qty 1 pcs		
For models:	GF90, GF90-2004, GF90A, GF90A-2004		

producer-specific



GEV No.	510912	Ref. No.	290217
description	angle piece connection 3/8"-1/2" for pipe ø 12-14mm		
For models:	AC101, AC120, AC122, AC150, AC151, AC152, AC170, AC181, AC182, AC200, AC201, AC202, AC241, AC242, AC91, ACR, ACR145, ACR205, ACR225, ACR245, ACR260, ACR265, ACR305, ACRS145, ACRS205, ACRS225, ACRS245, ACRS260, ACRS265, ACRS305, ACS101, ACS101-DIGIT, ACS122, ACS122-DIGIT, ACS151, ACS151-DIGIT, ACS152, ACS152-DIGIT, ACS161-DIGIT, ACS162-DIGIT, ACS181, ACS181-DIGIT, ACS182, ACS182-DIGIT, ACS201, ACS201-DIGIT, ACS202, ACS202-DIGIT, ACS241, ACS241-DIGIT...(Other models you can see in the webshop)		



GEV No.	510859	Ref. No.	190202
description	hose connector		
For models:	B12, B16, B16TM, B19, B19TM		



GEV No.	510952	Ref. No.	290216
description	hose connector connection 1/2" / 8mm		
For models:	C33, C34, NE3001, NE4001, NE5501, NE7501, NE9001, NG01, NG601, NG601E, NG901, NG901E		



GEV No.	510359	Ref. No.	510290
description	hose connector for rinse arm		
For models:	B23, B24, B25, B26, B27, SE		



GEV No.	361854	Ref. No.	510403
description	hose connector thread 1/2" angled 90° grommet ø 12mm grommet length 22mm WS 26 total length 52mm thread L 12mm brass		
For models:	AC100, AC120, AC150, AC170, AC200, ACR, ACR145, ACR205, ACR225, ACR245, ACR260, ACR265, ACR305, ACRS145, ACRS205, ACRS225, ACRS245, ACRS260, ACRS265, ACRS305, ACS101, ACS101-DIGIT, ACS122, ACS122-DIGIT, ACS151, ACS151-DIGIT, ACS152, ACS152-DIGIT, ACS161-DIGIT, ACS162-DIGIT, ACS181, ACS181-DIGIT, ACS182, ACS182-DIGIT, ACS201, ACS201-DIGIT, ACS202, ACS202-DIGIT, ACS241, ACS241-DIGIT, ACS242, ACS242-DIGIT, ACS91, ACS91-DIGIT, C166-2, GMC, GMC2700, GMC2702, GMC3500, GMC3502...(Other models you can see in the webshop)		



GEV No.	361853	Ref. No.	510407
description	hose connector thread 1/2" T-piece grommet ø 12mm grommet length 22/25mm WS 26 total length 55mm thread L 12mm brass		
For models:	AC100, AC101, AC105, AC120, AC122, AC135, AC150, AC151, AC152, AC170, AC181, AC182, AC200, AC201, AC202, AC241, AC242, AC90, AC91, AC95, ACR, ACR145, ACR205, ACR225, ACR245, ACR260, ACR265, ACR305, ACS101, ACS101-DIGIT, ACS122, ACS122-DIGIT, ACS151, ACS151-DIGIT, ACS152, ACS152-DIGIT, ACS161-DIGIT, ACS162-DIGIT, ACS181, ACS181-DIGIT, ACS182, ACS182-DIGIT, ACS201, ACS201-DIGIT, ACS202, ACS202-DIGIT, ACS241, ACS241-DIGIT, ACS242, ACS242-DIGIT...(Other models you can see in the webshop)		





GEV No.	510954	Ref. No.	190309
description	hose connector thread 3/8" straight		
For models:	B41, B42, C140, C155, C155BT, C155E2, C155RCD, C165, C165E2, C165E2BT, C165E2RCD, C166, C166-2, C30, C70, C75, C75BT, C75M, C75RCD, C85, C95, C95BT, C95E2, C95RCD, LC380, LC380BT, LC380RCD, LC400, LP360, LP360BT, LP360RCD		





GEV No.	511274	Ref. No.	180415
description	manifold 4-way hose ø 12-12-12-12mm plastic		
For models:	BC25, BC25A, BC25HR, BC30, BC30A, BC30HR, BC30HR380, BC30HRA, BHC25, BHC25-2, BHC25A, BHC25A-2, BHC25S, BHC30, BHC30-2, BHC30A, BHC30A-2, BHC30HR, BHC30HR380, BHC30HRA, BH-30HRA380, BHC433, BHC433-2, BHC433A, BHC433A-2, BHCHR, C166-2, FC, FC3M, FC3MR, FC43, FC43A, FC4M, FC533A, FC53A, FC-53CBT, FC53LA, FC53LBT, FC543A, FC543E, FC543EA, FC544A, FC54A, FC54CBT, FC54EA, FC54LBT, FCHR, FCHRA, FCHRT, FCHRTA...(Other models you can see in the webshop)		



GEV No.	511275	Ref. No.	180416
description	T-piece		
For models:	BC25HR, BC30HR, BC30HR380, BC30HRA, BHC30HR, BHC30HR-2, BHC30HR380, BHC30HRA, BHC30HRA-2, BHC30HRA380, BHCHR, FC, FCHR, FCHRA, FCHRT, FCHRTA		

			
1			
GEV No.	510933	Ref. No.	180411
description	T-piece connection 1/4" plastic hose ø 11-4-11mm		
For models:	B16TM, B19TM, BC25A, BC30A, BC30HRA, BHC25A, BHC25A-2, BHC30A, BHC30A-2, BHC30EA, BHC30EA-2, BHC30HR, BHC30HR-2, BHC30HRA, BHC30HRA-2, BHC30HRA380, BHC433A, BHC433A-2, BHC30HR, F90MA, FC, FC3E, FC3EA, FC3MA, FC43A, FC44E, FC44EA, FC4E, FC4EA, FC4EHRT, FC4MA, FC533A, FC53A, FC53LA, FC543A, FC543EA, FC544A, FC54A, FC54EA, FCHRA, FCHRTA, GF70A, LB200A, LB200A-2, LB215A, LB215A-2, LB260A, LB260A-2, LB275A, LB275A-2...(Other models you can see in the webshop)		
accessories for	510933		
	GEV No.	511563	Ref. No. 180130
	union nut thread 1/4" connection 1/4" plastic H 17.5mm for by-pass hose ø 4mm		

			
1			
GEV No.	510984	Ref. No.	190311
description	T-piece plastic		
For models:	C33, C34		

			
1			
GEV No.	511277	Ref. No.	190330
description	T-piece thread 1/2" ø 18mm		
For models:	BC25, BC25A, BC25HR, BC30, BC30A, BC30HR, BC30HR380, BC30HRA, BHC25, BHC25-2, BHC25A, BHC25A-2, BHC25S, BHC30, BHC30-2, BHC30A, BHC30A-2, BHC30E, BHC30E-2, BHC30EA, BHC30EA-2, BHC30HR, BHC30HR-2, BHC30HR380, BHC30HRA, BHC30HRA-2, BHC30HRA380, BHC433, BHC433-2, BHC433A, BHC433A-2, BHC30HR, C1000E, C1001M, C1300E, C1301M, C155, C155E2, C165, C165E2, C166, C166-2, C75, C95, C95E2, F90M, F90MA, FC, FC43, FC43A...(Other models you can see in the webshop)		

			
1			
GEV No.	511563	Ref. No.	180130
description	union nut thread 1/4" connection 1/4" plastic H 17.5mm for by-pass hose ø 4mm		
For models:	B16TM, B19TM, BC25A, BC30A, BC30HRA, BHC25A, BHC25A-2, BHC30A, BHC30A-2, BHC30EA, BHC30EA-2, BHC30HR, BHC30HR-2, BHC30HRA, BHC30HRA-2, BHC30HRA380, BHC433A, BHC433A-2, BHC30HR, F90MA, FC, FC3E, FC3EA, FC3MA, FC43A, FC44E, FC44EA, FC4E, FC4EA, FC4EHRT, FC4MA, FC533A, FC53A, FC53LA, FC543A, FC543EA, FC544A, FC54A, FC54EA, FCHRA, FCHRTA, GF70A, LB200A, LB200A-2, LB215A, LB215A-2, LB260A, LB260A-2, LB275A, LB275A-2...(Other models you can see in the webshop)		

water cycle components

pressure reduction valves

pressure reduction valves

universal

			
1			
GEV No.	520556	Ref. No.	281102
description	pressure reduction valve Caleffi series 5360 connection 1/2" default setting 3bar setting range 0.5-6bar EN1567 p max 25bar t.max. 80°C with manometer brass DVGW/SVGW/WRAS/ACS		
For models:	AC100, AC101, AC120, AC122, AC135, AC150, AC151, AC152, AC170, AC181, AC182, AC200, AC201, AC202, AC241, AC242, AC90, AC91, ACR, ACR145, ACR205, ACR225, ACR245, ACR260, ACR265, ACR305, ACRS145, ACRS205, ACRS225, ACRS245, ACRS260, ACRS265, ACRS305, ACS101, ACS101-DIGIT, ACS122, ACS122-DIGIT, ACS151, ACS151-DIGIT, ACS152, ACS152-DIGIT, ACS161-DIGIT, ACS162-DIGIT, ACS181, ACS181-DIGIT, ACS182, ACS182-DIGIT, ACS201, ACS201-DIGIT, ACS202...(Other models you can see in the webshop)		

			
1			
GEV No.	520870	Ref. No.	281101
description	pressure reduction valve Caleffi series 5360 connection 3/4" default setting 3bar setting range 0.5-6bar p max 25bar t.max. 80°C with manometer brass DVGW/SVGW/WRAS/ACS		
For models:	ACR, ACR145, ACR205, ACR225, ACR245, ACR260, ACR265, ACR305, GMC, GMC2700, GMC3500, GMC4500, GMC5500, NE00, NE02, NE3001, NE3002, NE4001, NE4002, NE5002, NE5501, NE5502, NE7002, NE7501, NE7502, NE9001, NE9002, NE9502, NG00, NG01, NG600, NG600E, NG601, NG601E, NG900, NG900E, NG901, NG901E, NL302, NL302E, NL402, NL402E, NL502, NL502E, NL552, NL552E, SE		



supply filters



GEV No.	520557	Ref. No.	620121
description	supply filter thread 1/2" IT - 1/2" IT total length 140mm brass ø 40mm H 112mm W 54mm		
For models:	AC100, AC101, AC105, AC120, AC122, AC135, AC150, AC151, AC152, AC170, AC181, AC182, AC200, AC201, AC202, AC241, AC242, AC90, AC91, AC95, ACR, ACR145, ACR205, ACR225, ACR245, ACR260, ACR265, ACR305, ACS101, ACS101-DIGIT, ACS122, ACS122-DIGIT, ACS151, ACS151-DIGIT, ACS152, ACS152-DIGIT, ACS161-DIGIT, ACS162-DIGIT, ACS181, ACS181-DIGIT, ACS182, ACS182-DIGIT, ACS201, ACS201-DIGIT, ACS202, ACS202-DIGIT, ACS241, ACS241-DIGIT, ACS242, ACS242-DIGIT...(Other models you can see in the webshop)		

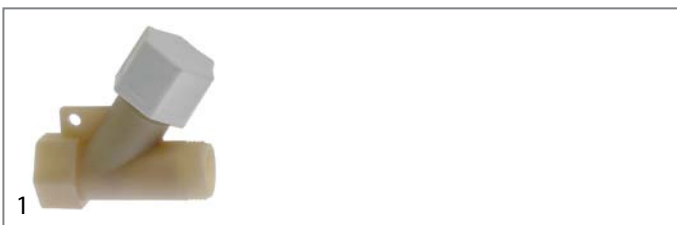

GEV No.	510836	Ref. No.	620209
description	supply filter thread 3/4" ET - 3/4" IT total length 76mm plastic		
For models:	B10T, B11T, B12T, B13T, B14T, B15T, B15TM, B16T, B16TM, B18T, B18TM, B19T, B19TM, B31, B32, B41, BC25, BC25A, BC25HR, BC30, BC30A, BC30HR, BC30HR380, BC30HRA, BHC25, BHC25-2, BHC25A, BHC25A-2, BHC25S, BHC30, BHC30-2, BHC30A, BHC30A-2, BHC30E, BHC30E-2, BHC30EA, BHC30EA-2, BHC30HR, BHC30HR-2, BHC30HR380, BHC30HRA, BHC30HRA-2, BHC30HRA380, BHC433, BHC433-2, BHC433A, BHC433A-2, BHCHR, BR20, BR20A...(Other models you can see in the webshop)		

non-return valves



GEV No.	520274	Ref. No.	290603
description	non-return valve brass connection 3/4" IT - 3/4" IT total length 65mm		
For models:	C166-2		

ancillary products

clamps

hose clamps

DIN 3017 - W2



GEV No.	520111	Ref. No.	450102
description	hose clamp ø 10-16mm width 9mm Qty 10 pcs DIN 3017		
For models:	B10T, B11T, B12, B12T, B13T, B14T, B15, B15T, B15TM, B16, B16T, B16TM, B18, B18T, B18TM, B19, B19T, B19TM, B41, BC25, BC25A, BC25HR, BC30, BC30A, BC30HR, BC30HR380, BC30HRA, BHC25, BHC25-2, BHC25A, BHC25A-2, BHC25S, BHC30, BHC30-2, BHC30A, BHC30A-2, BHC30E, BHC30E-2, BHC30EA, BHC30EA-2, BHC30HR, BHC30HR-2, BHC30HR380, BHC30HRA, BHC30HRA-2, BHC30HRA380, BHC433, BHC433-2, BHC433A, BHC433A-2...(Other models you can see in the webshop)		



GEV No.	520112	Ref. No.	450103
description	hose clamp ø 12-20mm width 9mm Qty 10 pcs DIN 3017		
For models:	AC2A, B10T, B11T, B12, B12T, B13T, B14T, B15, B15T, B15TM, B16, B16T, B16TM, B18, B18T, B18TM, B19, B19T, B19TM, B20, B20D, B24, B25, B26, B27, B41, B42, BC25, BC25A, BC25HR, BC30, BC30A, BC30HR, BC30HR380, BC30HRA, BHC25, BHC25-2, BHC25A, BHC25A-2, BHC25S, BHC30, BHC30-2, BHC30A, BHC30A-2, BHC30E, BHC30E-2, BHC30EA, BHC30EA-2, BHC30HR, BHC30HR-2...(Other models you can see in the webshop)		



GEV No.	520113	Ref. No.	450104
description	hose clamp ø 16-27mm width 9mm Qty 10 pcs DIN 3017		
For models:	AC100, AC101, AC105, AC120, AC122, AC135, AC150, AC151, AC152, AC170, AC181, AC182, AC200, AC201, AC202, AC241, AC242, AC2A, AC90, AC91, AC95, ACL100, ACL150, ACR, ACR145, ACR205, ACR225, ACR245, ACR260, ACR265, ACR305, ACRS145, ACRS205, ACRS225, ACRS245, ACRS260, ACRS265, ACRS305, ACS101, ACS101-DIGIT, ACS122, ACS122-DIGIT, ACS151, ACS151-DIGIT, ACS152, ACS152-DIGIT, ACS161-DIGIT, ACS162-DIGIT, ACS181, ACS181-DIGIT...(Other models you can see in the webshop)		



1

GEV No.	520114	Ref. No.	450114
description	hose clamp ø 20-32mm width 9mm Qty 10 pcs DIN 3017		
For models:	AC122, AC151, AC152, AC182, AC202, AC242, ACL150, ACRS145, ACRS205, ACRS225, ACRS245, ACRS260, ACRS265, ACRS305, ACS122, ACS122-DIGIT, ACS151, ACS151-DIGIT, ACS152, ACS152-DIGIT, ACS161-DIGIT, ACS162-DIGIT, ACS182, ACS182-DIGIT, ACS202, ACS202-DIGIT, ACS242, ACS242-DIGIT, B10, B11, B12, B20, B20D, B23, B24, B25, B26, B27, B31, B32, B41, B42, BHC25, BHC25-2, BHC25A, BHC25A-2, BHC25S, BHC30, BHC30-2, BHC30A...(Other models you can see in the webshop)		



1

GEV No.	520119	Ref. No.	450119
description	hose clamp ø 60-80mm width 9mm Qty 5 pcs DIN 3017		
For models:	AC100, AC122, AC135, AC151, AC152, AC181, AC182, AC201, AC202, AC241, AC242, AC2A, AC90, ACR, ACR145, ACR205, ACR225, ACR245, ACR260, ACR265, ACR305, C1000E, C1000ERCD, C1001M, C1300E, C1300ERCD, C1301M, C155, C155BT, C155E2, C155RCD, C165, C165E2, C165E2BT, C165E2RCD, C166, C166-2, C33, C34, C95, C95BT, C95E2, C95RCD, G100L, G101L, G50L, G51L, G60L, G61L, GE100...(Other models you can see in the webshop)		



2

GEV No.	520115	Ref. No.	450105
description	hose clamp ø 25-40mm width 9mm Qty 10 pcs DIN 3017		
For models:	AC122, AC152, AC182, AC202, AC242, B20, B20D, B23, B24, B25, B26, B27, BC25, BC25A, BC30, BC30A, BHC25-2, BHC25A-2, BHC30-2, BHC30A-2, BHC30E-2, BHC30EA-2, BHC30HR, BHC30HR-2, BHC30HR380, BHC30HRA, BHC30HRA-2, BHC30HRA380, BHC433-2, BHC433A-2, BHCHR, BR20, BR20A, BR25, BR25A, C1000E, C1000ERCD, C1300E, C1300ERCD, F45, F55, F65, F80, F90M, F90MA, FC, FC3E, FC3EA, FC3M, FC3MA...(Other models you can see in the webshop)		



1

GEV No.	520117	Ref. No.	450135
description	hose clamp stainless steel ø 40-60mm width 9mm Qty 5 pcs DIN 3017		
For models:	AC100, AC101, AC120, AC122, AC150, AC151, AC152, AC170, AC181, AC182, AC200, AC201, AC202, AC241, AC242, AC90, AC91, ACR, ACR145, ACR205, ACR225, ACR245, ACR260, ACR265, ACR305, ACRS205, ACRS245, ACRS260, ACRS265, ACS101, ACS101-DIGIT, ACS122, ACS122-DIGIT, ACS181, ACS181-DIGIT, ACS182, ACS182-DIGIT, ACS91, ACS91-DIGIT, B13T, B14T, B15, B15T, B15TM, B16, B16T, B16TM, B18, B18T, B18TM...(Other models you can see in the webshop)		



1

GEV No.	520116	Ref. No.	450106 450107
description	hose clamp ø 32-50mm width 9mm Qty 5 pcs DIN 3017		
For models:	AC101, AC105, AC122, AC135, AC151, AC152, AC91, AC95, ACL100, ACL150, ACRS145, ACRS205, ACRS225, ACRS245, ACRS260, ACRS265, ACRS305, ACS101, ACS101-DIGIT, ACS122, ACS122-DIGIT, ACS151, ACS151-DIGIT, ACS152, ACS152-DIGIT, ACS181, ACS181-DIGIT, ACS182, ACS182-DIGIT, ACS201, ACS201-DIGIT, ACS202, ACS202-DIGIT, ACS241, ACS241-DIGIT, ACS242, ACS242-DIGIT, ACS91, ACS91-DIGIT, B13T, B14T, B15, B15T, B15TM, B16, B16T, B16TM, B18, B18T, B18TM...(Other models you can see in the webshop)		

double wire clamps



1

GEV No.	511286	Ref. No.	450143
description	hose clamp ø 38mm wire gauge ø 3.2mm Qty 1 pcs		
For models:	AC101, AC105, AC122, AC135, AC151, AC152, AC181, AC182, AC201, AC202, AC241, AC242, AC2A, AC91, AC95, ACL100, ACL150, ACRS145, ACRS205, ACRS225, ACRS245, ACRS260, ACRS265, ACRS305, ACS101, ACS101-DIGIT, ACS122, ACS122-DIGIT, ACS151, ACS151-DIGIT, ACS152, ACS152-DIGIT, ACS161-DIGIT, ACS162-DIGIT, ACS181, ACS181-DIGIT, ACS182, ACS182-DIGIT, ACS201, ACS201-DIGIT, ACS202, ACS202-DIGIT, ACS241, ACS241-DIGIT, ACS242, ACS242-DIGIT, ACS91, ACS91-DIGIT, BC25, BC25A...(Other models you can see in the webshop)		



1

GEV No.	520118	Ref. No.	450109
description	hose clamp ø 50-70mm width 9mm Qty 5 pcs DIN 3017		
For models:	AC100, AC101, AC105, AC120, AC135, AC150, AC170, AC181, AC182, AC200, AC201, AC202, AC241, AC242, AC2A, AC90, AC91, AC95, ACL100, ACL150, ACR, ACR145, ACR205, ACR225, ACR245, ACR260, ACR265, ACR305, ACRS145, ACRS205, ACRS225, ACRS245, ACRS260, ACRS265, ACRS305, ACS101, ACS101-DIGIT, ACS122, ACS122-DIGIT, ACS151, ACS151-DIGIT, ACS152, ACS152-DIGIT, ACS161-DIGIT, ACS162-DIGIT, ACS181, ACS181-DIGIT, ACS182, ACS182-DIGIT, ACS201...(Other models you can see in the webshop)		



1

GEV No.	513268	Ref. No.	450134
description	hose clamp ø 8-10mm wire gauge ø 1mm Qty 1 pcs		
For models:	AC101, AC105, AC122, AC135, AC151, AC152, AC181, AC182, AC201, AC202, AC241, AC242, AC91, AC95, BHC25-2, BHC25A-2, BHC30-2, BHC30A-2, BHC30E, BHC30E-2, BHC30EA, BHC30EA-2, BHC433-2, BHC433A-2, C1000E, C1000ERCD, C1001M, C1300E, C1300ERCD, C1301M, C155BT, C155RCD, C165E2BT, C165E2RCD, C75BT, C75RCD, C95BT, C95RCD, FC3E, FC3EA, FC3MA, FC44E, FC44EA, FC4E, FC4EA, FC4EHR, FC4MA, FC53CBT, FC53LBT, FC54CBT...(Other models you can see in the webshop)		



1

GEV No.	510959	Ref. No.	450115
description	hose clamp ø 8mm wire gauge ø 1mm Qty 1 pcs		
For models:	B10T, B11T, B12T, B13T, B14T, B15, B15T, B15TM, B16, B16T, B16TM, B18, B18T, B18TM, B19, B19T, B19TM, B31, B41, B42, BC25, BC25A, BC25HR, BC30, BC30A, BC30HR, BC30HR380, BC30HRA, BHC25, BHC25-2, BHC25A, BHC25A-2, BHC25S, BHC30, BHC30-2, BHC30A, BHC30A-2, BHC30E, BHC30E-2, BHC30EA, BHC30EA-2, BHC30HR, BHC30HR-2, BHC30HR380, BHC30HRA, BHC30HRA-2, BHC30HRA380, BHC433, BHC433-2, BHC433A...(Other models you can see in the webshop)		



1

GEV No.	511147	Ref. No.	450125
description	wire clamp ø 12-14mm wire gauge ø 1.5mm zinc-coated steel Qty 1 pcs		
For models:	AC100, AC120, AC150, AC170, AC200, AC90, ACR, ACR145, ACR205, ACR225, ACR245, ACR260, ACR265, ACR305, ACRS145, ACRS205, ACRS225, ACRS245, ACRS260, ACRS265, ACRS305, ACS101, ACS101-DIGIT, ACS122, ACS122-DIGIT, ACS151, ACS151-DIGIT, ACS152, ACS152-DIGIT, ACS161-DIGIT, ACS162-DIGIT, ACS181, ACS181-DIGIT, ACS182, ACS182-DIGIT, ACS201, ACS201-DIGIT, ACS202, ACS202-DIGIT, ACS241, ACS241-DIGIT, ACS242, ACS242-DIGIT, ACS91, ACS91-DIGIT, B10, B10T, B11, B11T, B12...(Other models you can see in the webshop)		

ø52mm



1

GEV No.	541065	Ref. No.	450905
description	thermometer mounting ø 52mm t.max. 120°C 0 up to +120°C probe ø 6.5mm probe L 28mm capillary pipe 1500mm		
For models:	AC100, AC101, AC105, AC120, AC122, AC135, AC150, AC151, AC152, AC170, AC181, AC182, AC200, AC201, AC202, AC241, AC242, AC90, AC91, AC95, ACS101, ACS101-DIGIT, ACS122, ACS122-DIGIT, ACS151, ACS151-DIGIT, ACS152, ACS152-DIGIT, ACS161-DIGIT, ACS162-DIGIT, ACS181, ACS181-DIGIT, ACS182, ACS182-DIGIT, ACS201, ACS201-DIGIT, ACS202, ACS202-DIGIT, ACS241, ACS241-DIGIT, ACS242, ACS242-DIGIT, ACS91, ACS91-DIGIT, C1001M, C1301M, C140, C155, C155BT, C155RCD...(Other models you can see in the webshop)		

fastening material

spacers



1

GEV No.	694471	Ref. No.	290801
description	spacer thread M3 L 16.5mm		
For models:	GE100, GE115, GE125, GE60, GE60RCD, GE65, GE65RCD, GE75, GE80		

screws

sheet metal screws



1

GEV No.	560095	Ref. No.	260712
description	sheet metal screws ø 2.9mm L 9.5mm SS Qty 20 pcs DIN 7981/ISO 7049 head ø 5.6mm oval head		
For models:	ACS101, ACS101-DIGIT, ACS122, ACS122-DIGIT, ACS151, ACS151-DIGIT, ACS152, ACS152-DIGIT, ACS161-DIGIT, ACS162-DIGIT, ACS181, ACS181-DIGIT, ACS182, ACS182-DIGIT, ACS201, ACS201-DIGIT, ACS202, ACS202-DIGIT, ACS241, ACS241-DIGIT, ACS242, ACS242-DIGIT, ACS91, ACS91-DIGIT, BHC25, BHC25-2, BHC25A, BHC25A-2, BHC25S, BHC30, BHC30-2, BHC30A, BHC30A-2, BHC30E, BHC30E-2, BHC30EA, BHC30EA-2, BHC30HR, BHC30HR-2, BHC30HR380, BHC30HRA, BHC30HRA-2, BHC30HRA380, BHC433, BHC433-2, BHC433A, BHC433A-2, BHCHR		

measuring equipment

thermometers

built-in thermometers

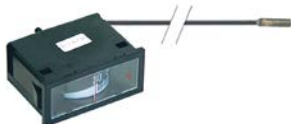

1

GEV No.	541063	Ref. No.	450902
description	thermometer mounting measurements 58x25.5mm 0 up to +120°C capillary pipe 1500mm probe ø 6.5mm probe L 23mm		





1

GEV No.	541086	Ref. No.	450902
description	thermometer mounting measurements 58x25.5mm 0 up to +120°C capillary pipe 2000mm probe ø 6mm probe L 23mm		





			
1			
GEV No.	560103	Ref. No.	260706
description	sheet metal screws ø 3.9mm L 13mm SS Qty 20 pcs DIN 7981/ISO 7049 head ø 7.5mm oval head		
For models:	BHC25, BHC25-2, BHC25A, BHC25A-2, BHC25S, BHC30, BHC30-2, BHC30A, BHC30A-2, BHC30E, BHC30E-2, BHC30EA, BHC30EA-2, BHC30HR, BHC30HR-2, BHC30HR380, BHC30HRA, BHC30HRA-2, BHC30HRA380, BHC433, BHC433-2, BHC433A, BHC433A-2, BHCHR, C1000ERCD, C1300ERCD, C155RCD, C165E2RCD, C75M, C75RCD, C95RCD, FC53CBT, FC53LBT, FC54CBT, FC54LBT, GF90, GF90A, LB200, LB200-2, LB200A, LB200A-2, LB215, LB215-2, LB215A, LB215A-2, LB260, LB260-2, LB260A, LB260A-2, LB275...(Other models you can see in the webshop)		

 <p>Image not available</p>			
1			
GEV No.	511183	Ref. No.	261015
description	sheet-metal screw ø 3.9mm L 13mm		
For models:	BHC25, BHC25-2, BHC25A, BHC25A-2, BHC25S, BHC30, BHC30-2, BHC30A, BHC30A-2, BHC30E, BHC30E-2, BHC30EA, BHC30EA-2, BHC30HR, BHC30HR-2, BHC30HR380, BHC30HRA, BHC30HRA-2, BHC30HRA380, BHC433, BHC433-2, BHC433A, BHC433A-2, BHCHR, LB200, LB200-2, LB200A, LB200A-2, LB215, LB215-2, LB215A, LB215A-2, LB260, LB260-2, LB260A, LB260A-2, LB275, LB275A-2, LB275A, LB275A-2		

			
1			
GEV No.	560231	Ref. No.	H33277
description	sheet metal screws ø 2.9mm L 9.5mm SS Qty 20 pcs DIN 7982/ISO 7050 head ø 5.5mm sunk head		
For models:	GF70, GF70A, GF90, GF90-2004, GF90A, GF90A-2004		

 <p>Image not available</p>			
1			
GEV No.	560532	Ref. No.	260701
description	sheet-metal screw ø 3.5mm L 12mm SS Qty 1 pcs intake slotted head ø 7mm		
For models:	ACS101, ACS101-DIGIT, ACS122, ACS122-DIGIT, ACS151, ACS151-DIGIT, ACS152, ACS152-DIGIT, ACS161-DIGIT, ACS162-DIGIT, ACS181, ACS181-DIGIT, ACS182, ACS182-DIGIT, ACS201, ACS201-DIGIT, ACS202, ACS202-DIGIT, ACS241, ACS241-DIGIT, ACS242, ACS242-DIGIT, ACS91, ACS91-DIGIT, B41, BHC25, BHC25A, BHC25S, BHC30, BHC30A, BHC30E, BHC30E-2, BHC30EA, BHC30EA-2, BHC433, BHC433A, C1000E, C1000ERCD, C1001M, C1300E, C1300ERCD, C1301M, C155, C155BT, C155E2, C155RCD, C165, C165E2, C165E2BT, C165E2RCD...(Other models you can see in the webshop)		

flat-headed bolts			
			
1			
GEV No.	560528	Ref. No.	260203
description	flat-headed bolt thread M3.5 thread L 12mm SS DIN 84/ISO 1207 Qty 1 pcs intake slotted head ø 6mm head thickness 2.5mm		
For models:	ACS101, ACS101-DIGIT, ACS122, ACS122-DIGIT, ACS151, ACS151-DIGIT, ACS152, ACS152-DIGIT, ACS161-DIGIT, ACS162-DIGIT, ACS181, ACS181-DIGIT, ACS182, ACS182-DIGIT, ACS201, ACS201-DIGIT, ACS202, ACS202-DIGIT, ACS241, ACS241-DIGIT, ACS242, ACS242-DIGIT, ACS91, ACS91-DIGIT		

			
1			
GEV No.	511004	Ref. No.	260226
description	flat-headed bolt thread M4 thread L 12mm SS DIN 84/ISO 1207 Qty 1 pcs intake slotted L 14.5mm		
For models:	AC101, AC122, AC151, AC152, AC91, ACR, ACR145, ACR205, ACR225, ACR245, ACR260, ACR265, ACR305, ACS101, ACS101-DIGIT, ACS122, ACS122-DIGIT, ACS151, ACS151-DIGIT, ACS152, ACS152-DIGIT, ACS91, ACS91-DIGIT, B13T, B14T, B15T, B15TM, B16T, B16TM, B18T, B18TM, B19T, B19TM, BC25HR, BC30HR, BC30HR380, BC30HRA, C140, C33, C34, C70, C75, C75BT, C75RCD, C85, F20, F90M, F90MA, G115, G125...(Other models you can see in the webshop)		

			
1			
GEV No.	560454	Ref. No.	260206
description	flat-headed bolt thread M4 thread L 22mm SS DIN 84/ISO 1207 Qty 1 pcs intake slotted head ø 7mm head thickness 2.5mm		
For models:	BC25HR, BC30HR, BC30HR380, BC30HRA, F90M, F90MA, FC3E, FC3EA, FC3M, FC3MA, FC3MR, FC44E, FC44EA, FC4E, FC4EA, FC4EHR, FC4M, FC4MA, LC380, LC380BT, LC380RCD, LC400, LF400A, LF450, LF450A		

			
1			
GEV No.	560529	Ref. No.	260207
description	flat-headed bolt thread M4 thread L 25mm SS DIN 84/ISO 1207 Qty 1 pcs intake slotted head ø 7mm head thickness 2.5mm		
For models:	C140, C33, C34, LC380, LC380BT, LC380RCD, LC400		

oval head screws			
			
1			
GEV No.	560455	Ref. No.	260238
description	oval head screw thread M4 thread L 10mm L 12.5mm head ø 10mm stainless steel intake slotted Qty 1 pcs		
For models:	ACS101, ACS101-DIGIT, ACS122, ACS122-DIGIT, ACS151, ACS151-DIGIT, ACS152, ACS152-DIGIT, ACS161-DIGIT, ACS162-DIGIT, ACS181, ACS181-DIGIT, ACS182, ACS182-DIGIT, ACS201, ACS201-DIGIT, ACS202, ACS202-DIGIT, ACS241, ACS241-DIGIT, ACS242, ACS242-DIGIT, ACS91, ACS91-DIGIT, B10, B11, B12, B15, B16, B18, B19, BC25, BC25A, BC25HR, BC30, BC30A, BC30HR, BC30HR380, BC30HRA, BHC25, BHC25-2, BHC25A, BHC25A-2, BHC25S, BHC30, BHC30-2, BHC30A, BHC30A-2, BHC30E, BHC30E-2...(Other models you can see in the webshop)		

hexagonal screws



GEV No.	560499	Ref. No.	260133
description	hexagonal screw thread M10 thread L 55mm SS WS 17 Qty 1 pcs head thickness 6.5mm DIN 933 / ISO 4017		
For models:	AC101, AC122, AC151, AC152, AC181, AC182, AC201, AC202, AC241, AC242, AC91, ACS101, ACS101-DIGIT, ACS122, ACS122-DIGIT, ACS151, ACS151-DIGIT, ACS152, ACS152-DIGIT, ACS161-DIGIT, ACS162-DIGIT, ACS181, ACS181-DIGIT, ACS182, ACS182-DIGIT, ACS201, ACS201-DIGIT, ACS202, ACS202-DIGIT, ACS241, ACS241-DIGIT, ACS242, ACS242-DIGIT, ACS91, ACS91-DIGIT		



GEV No.	560081	Ref. No.	260138
description	hexagonal screw thread M4 thread L 10mm SS WS 7 Qty 20 pcs DIN 933 / ISO 4017		
For models:	BHC25, BHC25-2, BHC25A, BHC25A-2, BHC25S, BHC30, BHC30-2, BHC30A, BHC30A-2, BHC30E, BHC30E-2, BHC30EA, BHC30EA-2, BHC30HR, BHC30HR-2, BHC30HR380, BHC30HRA, BHC30HRA-2, BHC30HRA380, BHC433, BHC433-2, BHC433A, BHC433A-2, BHCHR, GF70, GF70A, LF322MP, LF322MP-A, LFD32E, LFD32EA, LFD32M, LFD32MA		



GEV No.	560527	Ref. No.	260151
description	hexagonal screw thread M4 thread L 12mm SS WS 7 Qty 1 pcs head thickness 3mm DIN 933 / ISO 4017		
For models:	BC25HR, BC30HR, BC30HR380, BC30HRA, BHC25S, C1000E, C1000ERCD, C1001M, C1300E, C1300ERCD, C1301M, F90M, F90MA, GE50RCD, LB200, LB200-2, LB215, LB215-2, LB215A, LB260, LB260-2, LB275, LB275-2, LB275A, LC1200, LC1200RCD, LC700, LC700RCD, LC900, LC900RCD, LF400A, LF450, LF450A		



GEV No.	560385	Ref. No.	260126
description	hexagonal screw thread M5 thread L 12mm SS WS 8 Qty 1 pcs DIN 933 / ISO 4017		
For models:	AC101, AC122, AC151, AC152, AC181, AC182, AC201, AC202, AC241, AC242, AC91, ACR, ACR145, ACR205, ACR225, ACR245, ACR260, ACR265, ACR305, ACS101, ACS101-DIGIT, ACS122, ACS122-DIGIT, ACS151, ACS151-DIGIT, ACS152, ACS152-DIGIT, ACS161-DIGIT, ACS162-DIGIT, ACS181, ACS181-DIGIT, ACS182, ACS182-DIGIT, ACS201, ACS201-DIGIT, ACS202, ACS202-DIGIT, ACS241, ACS241-DIGIT, ACS242, ACS242-DIGIT, ACS91, ACS91-DIGIT, BHC25, BHC25-2, BHC25A, BHC25A-2, BHC25S, BHC30, BHC30-2...(Other models you can see in the webshop)		



GEV No.	560084	Ref. No.	260126
description	hexagonal screw thread M5 thread L 16mm SS WS 8 Qty 20 pcs DIN 933 / ISO 4017		



GEV No.	524118	Ref. No.	260104
description	hexagonal screw thread M6 thread L 16mm SS WS 10 Qty 1 pcs DIN 933 / ISO 4017		



GEV No.	560087	Ref. No.	260104
description	hexagonal screw thread M6 thread L 16mm SS WS 10 Qty 20 pcs DIN 933 / ISO 4017		
For models:	ACS151, ACS151-DIGIT, ACS152, ACS152-DIGIT, ACS181, ACS181-DIGIT, ACS182, ACS182-DIGIT, ACS201, ACS201-DIGIT, ACS202, ACS202-DIGIT, ACS241, ACS241-DIGIT, ACS242, ACS242-DIGIT, BHC25, BHC25-2, BHC25A, BHC25A-2, BHC25S, BHC30, BHC30-2, BHC30A, BHC30A-2, BHC30E, BHC30E-2, BHC30EA, BHC30EA-2, BHC30HR, BHC30HR-2, BHC30HR380, BHC30HRA, BHC30HRA-2, BHC30HRA380, BHC433, BHC433-2, BHC433A, BHC433A-2, BHCHR, C140, C166, C75, C75BT, C75RCD, C85, GE50RCD, GF70, GF70A, LAV1000...(Other models you can see in the webshop)		





GEV No.	560089	Ref. No.	260106
description	hexagonal screw thread M6 thread L 25mm SS WS 10 Qty 20 pcs DIN 933 / ISO 4017		
For models:	BHC25-2, BHC25A-2, BHC30-2, BHC30A-2, BHC30E, BHC30E-2, BHC30EA, BHC30EA-2, BHC30HR-2, BHC30HRA-2, BHC433-2, BHC433A-2, C75, C75BT, C75RCD, F90M, F90MA, FC, FC53, FC533, FC533A, FC53A, FC53CBT, FC53LA, FC53LBT, FC54, FC543, FC543A, FC543E, FC543EA, FC544, FC544A, FC54A, FC54CBT, FC54E, FC54EA, FC54LBT, FCHR, FCHRA, FCHRT, FCHRTA, LF315, LF320, LF320A, LF320CBT, LF320L, LF320LA, LF320LBT, LF322, LF322A...(Other models you can see in the webshop)		



GEV No.	502214	Ref. No.	260112
description	hexagonal screw thread M8 thread L 16mm SS WS 13 Qty 1 pcs head thickness 5.5mm DIN 933 / ISO 4017		
For models:	AC101, AC120, AC122, AC150, AC170, AC200, AC91, ACR, ACR145, ACR205, ACR225, ACR245, ACR260, ACR265, ACR305, ACS101, ACS101-DIGIT, ACS122, ACS122-DIGIT, ACS151, ACS151-DIGIT, ACS152, ACS152-DIGIT, ACS161-DIGIT, ACS162-DIGIT, ACS181, ACS181-DIGIT, ACS182, ACS182-DIGIT, ACS201, ACS201-DIGIT, ACS202, ACS202-DIGIT, ACS241, ACS241-DIGIT, ACS242, ACS242-DIGIT, ACS91, ACS91-DIGIT, C1000E, C1000ERCD, C1001M, C1300E, C1300ERCD, C1301M, C155, C155E2, C165, C165E2, C166...(Other models you can see in the webshop)		



 <p>1</p>			
GEV No.	510990	Ref. No.	260113
description	hexagonal screw thread M8 thread L 20mm SS WS 13 Qty 1 pcs DIN 933 / ISO 4017		
For models:	ACS101, ACS101-DIGIT, ACS122, ACS122-DIGIT, ACS151, ACS151-DIGIT, ACS152, ACS152-DIGIT, ACS161-DIGIT, ACS162-DIGIT, ACS181, ACS181-DIGIT, ACS182, ACS182-DIGIT, ACS201, ACS201-DIGIT, ACS202, ACS202-DIGIT, ACS241, ACS241-DIGIT, ACS242, ACS242-DIGIT, ACS91, ACS91-DIGIT, C1000E, C1000ERCD, C1001M, C1300E, C1300ERCD, C1301M, C140, C155, C155BT, C155E2, C155RCD, C165, C165E2, C165E2BT, C165E2RCD, C75M, C85, C95, C95BT, C95E2, C95RCD, GE50RCD, LC1200, LC1200RCD, LC380, LC380BT...(Other models you can see in the webshop)		

 <p>1</p>			
GEV No.	560530	Ref. No.	260232
description	side bolts thread M6 L 28mm SS Qty 1 pcs intake slotted head ø 13.5mm		
For models:	B13T, B14T, C75, C75BT, C75RCD, F45, F55, F65, F80, F90M, F90MA, GE100, GE115, GE60, GE60RCD, GE65, GE65RCD, GE80, LF280-lav-line, LF315, LF320, LF320A, LF320CBT, LF320L, LF320LA, LF320-lav-line, LF320LBT, LF323, LF323A, LF350, LF350A, LF400A, LF450, LF450A, LP360, LP360BT, LP360RCD, LS550		

cylinder head bolts

miscellaneous

 <p>1</p>			
GEV No.	510953	Ref. No.	260213 260237
description	cylinder head bolt thread M5 thread L 25mm SS Qty 1 pcs intake slotted		
For models:	B10, B10T, B11, B11T, B12, B12T, B13T, B14T, B15, B15T, B15TM, B16, B16T, B16TM, B18, B18T, B18TM, B19, B19T, B19TM, BC25, BC25A, BC25HR, BC30, BC30A, BC30HR, BC30HR380, BC30HRA, BHC25, BHC25-2, BHC25A, BHC25A-2, BHC25S, BHC30, BHC30-2, BHC30A, BHC30A-2, BHC30E, BHC30E-2, BHC30EA, BHC30EA-2, BHC30HR, BHC30HR-2, BHC30HR380, BHC30HRA, BHC30HRA-2, BHC30HRA380, BHC433, BHC433-2, BHC433A...(Other models you can see in the webshop)		

grub screws

DIN 914/ISO 4027

 <p>1</p>			
GEV No.	504230	Ref. No.	250202
description	grub screw thread M5 L 8mm A2-A2L DIN 914/ISO 4027 WS 2.5 Qty 1 pcs		
For models:	ACRS145, ACRS205, ACRS225, ACRS245, ACRS260, ACRS265, ACRS305, ACS101, ACS101-DIGIT, ACS122, ACS122-DIGIT, ACS151, ACS151-DIGIT, ACS152, ACS152-DIGIT, ACS161-DIGIT, ACS162-DIGIT, ACS181, ACS181-DIGIT, ACS182, ACS182-DIGIT, ACS201, ACS201-DIGIT, ACS202, ACS202-DIGIT, ACS241, ACS241-DIGIT, ACS242, ACS242-DIGIT, ACS91, ACS91-DIGIT, C166-2		

side bolts

 <p>1</p>			
GEV No.	560052	Ref. No.	260223
description	side bolts thread M5 L 10mm SS Qty 20 pcs intake slotted head ø 12.5mm		
For models:	AC101, AC122, AC151, AC152, AC181, AC182, AC201, AC202, AC241, AC242, AC91, ACR, ACR145, ACR205, ACR225, ACR245, ACR260, ACR265, ACR305, ACS101, ACS101-DIGIT, ACS122, ACS122-DIGIT, ACS151, ACS151-DIGIT, ACS152, ACS152-DIGIT, ACS161-DIGIT, ACS162-DIGIT, ACS181, ACS181-DIGIT, ACS182, ACS182-DIGIT, ACS201, ACS201-DIGIT, ACS202, ACS202-DIGIT, ACS241, ACS241-DIGIT, ACS242, ACS242-DIGIT, ACS91, ACS91-DIGIT, BHC25, BHC25-2, BHC25A, BHC25A-2, BHC25S, BHC30, BHC30-2...(Other models you can see in the webshop)		

DIN 916/ISO 4029

 <p>1</p>			
GEV No.	510906	Ref. No.	250206
description	grub screw thread M6 L 8mm stainless steel DIN 914/ISO 4027 WS 3 Qty 1 pcs		
For models:	C1000E, C1000ERCD, C1001M, C1300E, C1300ERCD, C1301M, C140, C155, C155BT, C155E2, C155RCD, C165, C165E2, C165E2BT, C165E2RCD, C166, C166-2, C70, C75, C75BT, C75M, C75RCD, C85, C95, C95BT, C95E2, C95RCD, LC1200, LC1200RCD, LC380, LC380BT, LC380RCD, LC400, LC412, LC700, LC700RCD, LC900, LC900RCD, LP360, LP360BT, LP360RCD		

 <p>1</p>			
GEV No.	560531	Ref. No.	H31910
description	side bolts thread M5 L 11mm SS Qty 1 pcs intake slotted head ø 11mm		
For models:	GE50RCD, GF90, GF90A		

 <p>1</p>			
GEV No.	560207	Ref. No.	250209
description	grub screw thread M8 L 10mm steel DIN 916/ISO 4029 intake internal hexagon WS 4 Qty 1 pcs		

knurled screws



1

GEV No.	510307	Ref. No.	261004 261009
description	Thumb screw thread M6 H 3mm thread L 8mm ø 28mm SS		
For models:	B13T, B14T, B15T, B15TM, B16, B16T, B16TM, B18T, B18TM, B19, B19T, B19TM, B41, B42, BC25, BC25A, BC25HR, BC30, BC30A, BC30HR, BC30HR380, BC30HRA, BHC25, BHC25A, BHC25S, BHC30, BHC30A, BHC30HR, BHC30HR380, BHC30HRA, BHC30HRA380, BHC433, BH-C433A, BHCHR, C1000E, C1000ERCD, C1001M, C1300E, C1300ERCD, C1301M, C140, C155, C155BT, C155E2, C155RCD, C165, C165E2, C165E2BT, C165E2RCD, C166...(Other models you can see in the webshop)		

miscellaneous



1

GEV No.	511006	Ref. No.	260228
description	screw		
For models:	C1000E, C1000ERCD, C1001M, C1300E, C1300ERCD, C1301M, C140, C155, C155BT, C155E2, C155RCD, C165, C165E2, C165E2BT, C165E2RCD, C166, C166-2, C30, C70, C75, C75BT, C75M, C75RCD, C85, C95, C95BT, C95E2, C95RCD, LC1200, LC1200RCD, LC380, LC380BT, LC380RCD, LC400, LC412, LC700, LC700RCD, LC900, LC900RCD, LP360, LP360BT, LP360RCD		

nuts

cap nuts



1

GEV No.	560138	Ref. No.	290702
description	cap nuts thread M8 WS 13 SS Qty 20 pcs DIN/ISO DIN 1587		

knurled nuts



1

GEV No.	511252	Ref. No.	510284
description	knurled nut		
For models:	G115, G131, G65, G66, G75		



1

GEV No.	512212	Ref. No.	H34998
description	knurled nut thread M10x1.5 ø 30mm H 6.4mm SS		
For models:	GF90, GF90-2004, GF90A, GF90A-2004		



1

GEV No.	510346	Ref. No.	280409
description	knurled nut thread M17x1 ø 35mm H 6mm SS		
For models:	C1000E, C1000ERCD, C1001M, C1300E, C1300ERCD, C1301M, C140, C155, C155BT, C155E2, C155RCD, C165, C165E2, C165E2BT, C165E2RCD, C166, C166-2, C33, C34, C95, C95BT, C95E2, C95RCD, G100L, G101L, G50L, G51L, G60L, G61L, GE100, GE115, GE50RCD, GE60, GE60RCD, GE65, GE65RCD, GE80, GF90, GF90-2004, GF90A, GF90A-2004, GL, LC1200, LC1200RCD, LC380, LC412, LC700, LC700RCD, LC900, LC900RCD...(Other models you can see in the webshop)		



1

GEV No.	511009	Ref. No.	280413
description	knurled nut thread M8 ø 30mm H 4.5mm SS		
For models:	C75, C75BT, C75RCD, FC, FC53, FC533, FC533A, FC53A, FC53CBT, FC53LA, FC53LBT, FC54, FC543, FC543A, FC543E, FC543EA, FC544, FC544A, FC54A, FC54CBT, FC54E, FC54EA, FC54LBT, FCHR, FCHRA, FCHRT, FCHRTA		

hexagonal nuts

DIN 934 / ISO 4032/8673



1

GEV No.	560129	Ref. No.	260403
description	hexagonal nut thread M5 H 4mm WS 8 SS DIN/ISO DIN 934 / ISO 4032/8673 Qty 1 pcs		



1

GEV No.	560133	Ref. No.	260404
description	hexagonal nut thread M6 H 5mm WS 10 SS DIN/ISO DIN 934 / ISO 4032/8673 Qty 20 pcs		
For models:	AC101, AC122, AC151, AC152, AC181, AC182, AC201, AC202, AC241, AC242, AC91, ACR, ACR145, ACR205, ACR225, ACR245, ACR260, ACR265, ACR305, ACS101, ACS101-DIGIT, ACS122, ACS122-DIGIT, ACS151, ACS151-DIGIT, ACS152, ACS152-DIGIT, ACS161-DIGIT, ACS162-DIGIT, ACS181, ACS181-DIGIT, ACS182, ACS182-DIGIT, ACS201, ACS201-DIGIT, ACS202, ACS202-DIGIT, ACS241, ACS241-DIGIT, ACS242, ACS242-DIGIT, ACS91, ACS91-DIGIT, B10T, B11T, B12T, B13T, B14T, B15T, B15TM...(Other models you can see in the webshop)		





			
1			
GEV No.	560134	Ref. No.	260405
description	hexagonal nut thread M8 H 6.5mm WS 13 SS DIN/ISO DIN 934 / ISO 4032/8673 Qty 20 pcs		

			
1			
GEV No.	560197	Ref. No.	260407
description	nut thread M10 H 8mm WS 17 SS DIN/ISO DIN 934 / ISO 4032/8673 Qty 1 pcs		
For models:	AC100, AC101, AC120, AC122, AC150, AC151, AC152, AC170, AC181, AC182, AC200, AC201, AC202, AC241, AC242, AC2A, AC90, AC91, ACR, ACR145, ACR205, ACR225, ACR245, ACR260, ACR265, ACR305, ACRS145, ACRS205, ACRS225, ACRS245, ACRS260, ACRS265, ACRS305, ACS101, ACS101-DIGIT, ACS122, ACS122-DIGIT, ACS151, ACS151-DIGIT, ACS152, ACS152-DIGIT, ACS161-DIGIT, ACS162-DIGIT, ACS181, ACS181-DIGIT, ACS182, ACS182-DIGIT, ACS201, ACS201-DIGIT, ACS202...		

			
1			
GEV No.	506166	Ref. No.	260408
description	nut thread M12 H 10mm WS 19 SS DIN/ISO DIN 934 / ISO 4032/8673 Qty 1 pcs		
For models:	BC25, BC25A, BC25HR, BC30, BC30A, BC30HR, BC30HR380, BC30HRA, BHC25, BHC25-2, BHC25A, BHC25A-2, BHC25S, BHC30, BHC30-2, BHC30A, BHC30A-2, BHC30E, BHC30E-2, BHC30EA, BHC30EA-2, BHC30HR, BHC30HR-2, BHC30HR380, BHC30HRA, BHC30HRA-2, BHC30HRA380, BHC433, BHC433-2, BHC433A, BHC433A-2, BHCHR, BR20, BR20A, BR25, BR25A, C1000E, C1300E, C166-2, C70, C75, C75BT, C75M, C75RCD, F90M, F90MA, FC, FC3E, FC3EA, FC3M...		

 <p>Image not available</p>			
1			
GEV No.	520246	Ref. No.	260410
description	nut thread M12 SS		
For models:	F45, F55, F65, F80, LF280-lav-line, LF320-lav-line, NG01, NG601, NG601E, NG901, NG901E		

ISO 4033 / UNI5587			
			
1			
GEV No.	560470	Ref. No.	260406
description	nut thread M8x1.25 H 8mm WS 13 SS Qty 1 pcs DIN/ISO ISO 4033 / UNI5587		
For models:	AC101, AC122, AC151, AC152, AC181, AC182, AC201, AC202, AC241, AC242, AC91, ACR, ACR145, ACR205, ACR225, ACR245, ACR260, ACR265, ACR305, ACRS145, ACRS205, ACRS225, ACRS245, ACRS260, ACRS265, ACRS305, ACS101, ACS101-DIGIT, ACS122, ACS122-DIGIT, ACS151, ACS151-DIGIT, ACS152, ACS152-DIGIT, ACS161-DIGIT, ACS162-DIGIT, ACS181, ACS181-DIGIT, ACS182, ACS182-DIGIT, ACS201, ACS201-DIGIT, ACS202, ACS202-DIGIT, ACS241, ACS241-DIGIT, ACS242, ACS242-DIGIT, ACS91, ACS91-DIGIT...		

DIN 985			
			
1			
GEV No.	560140	Ref. No.	260402 260418
description	hexagonal nut thread M4 H 4.8mm SS WS 7 Qty 20 pcs DIN/ISO DIN 985 self-locking		
For models:	AC101, AC120, AC122, AC150, AC151, AC152, AC170, AC200, AC91, ACR, ACR145, ACR205, ACR225, ACR245, ACR260, ACR265, ACR305, ACS101, ACS101-DIGIT, ACS122, ACS122-DIGIT, ACS151, ACS151-DIGIT, ACS152, ACS152-DIGIT, ACS161-DIGIT, ACS162-DIGIT, ACS181, ACS181-DIGIT, ACS182, ACS182-DIGIT, ACS201, ACS201-DIGIT, ACS202, ACS202-DIGIT, ACS241, ACS241-DIGIT, ACS242, ACS242-DIGIT, ACS91, ACS91-DIGIT, B10T, B11T, B12T, B13T, B14T, B15T, B15TM, B16T, B16TM...		

			
1			
GEV No.	560141	Ref. No.	260414
description	hexagonal nut thread M5 H 5.4mm SS WS 8 Qty 20 pcs DIN/ISO DIN 985 self-locking		
For models:	AC101, AC122, AC151, AC152, AC181, AC182, AC201, AC202, AC241, AC242, AC91, ACR, ACR145, ACR205, ACR225, ACR245, ACR260, ACR265, ACR305, ACS101, ACS101-DIGIT, ACS122, ACS122-DIGIT, ACS151, ACS151-DIGIT, ACS152, ACS152-DIGIT, ACS161-DIGIT, ACS162-DIGIT, ACS181, ACS181-DIGIT, ACS182, ACS182-DIGIT, ACS201, ACS201-DIGIT, ACS202, ACS202-DIGIT, ACS241, ACS241-DIGIT, ACS242, ACS242-DIGIT, ACS91, ACS91-DIGIT, BHC25, BHC25-2, BHC25A, BHC25A-2, BHC25S, BHC30, BHC30-2...		

			
1			
GEV No.	560142	Ref. No.	260412
description	hexagonal nut thread M6 H 6mm SS WS 10 Qty 20 pcs DIN/ISO DIN 985 self-locking		
For models:	AC101, AC122, AC151, AC152, AC181, AC182, AC201, AC202, AC241, AC242, AC91, ACR, ACR145, ACR205, ACR225, ACR245, ACR260, ACR265, ACR305, ACS101, ACS101-DIGIT, ACS122, ACS122-DIGIT, ACS151, ACS151-DIGIT, ACS152, ACS152-DIGIT, ACS161-DIGIT, ACS162-DIGIT, ACS181, ACS181-DIGIT, ACS182, ACS182-DIGIT, ACS201, ACS201-DIGIT, ACS202, ACS202-DIGIT, ACS241, ACS241-DIGIT, ACS242, ACS242-DIGIT, ACS91, ACS91-DIGIT, C155, C155BT, C155E2, C155RCD, C165, C165E2, C165E2BT...		

hexagonal nuts metric (without norm)



1

GEV No.	510374	Ref. No.	270118
description	nut thread M15x1.25 H 6.5mm WS 27 SS Qty 1 pcs		
For models:	C155, C155BT, C155E2, C155RCD, C165, C165E2, C165E2BT, C165E2RCD, C166, C166-2, C30, C70, C75, C75BT, C75M, C75RCD, C95, C95BT, C95E2, C95RCD, LC380, LC380BT, LC380RCD, LC400, LP360, LP360BT, LP360RCD		

hexagonal nuts inch thread



1

GEV No.	511200	Ref. No.	270106
description	nut thread 1" H 6mm brass WS 45 Qty 1 pcs		
For models:	B10, B10T, B11, B11T, B12, B12T, B20, B20D, B23, B24, B25, B26, B27, BR20, BR20A, BR25, BR25A, LBR, LBR200, LBR215, LBR215A		



1

GEV No.	510331	Ref. No.	270101
description	nut thread 1/2" H 7mm SS WS 30 Qty 1 pcs		
For models:	AC100, AC101, AC105, AC120, AC122, AC135, AC150, AC151, AC152, AC170, AC181, AC182, AC200, AC201, AC202, AC241, AC242, AC2A, AC90, AC91, AC95, ACL100, ACL150, ACR, ACR145, ACR205, ACR225, ACR245, ACR260, ACR265, ACR305, ACRS145, ACRS205, ACRS225, ACRS245, ACRS260, ACRS265, ACRS305, ACS101, ACS101-DIGIT, ACS122, ACS122-DIGIT, ACS151, ACS151-DIGIT, ACS152, ACS152-DIGIT, ACS161-DIGIT, ACS162-DIGIT, ACS181, ACS181-DIGIT...(Other models you can see in the webshop)		



1

GEV No.	511182	Ref. No.	270107
description	nut thread 3/8" H 8mm brass WS 24 Qty 1 pcs		
For models:	AC101, AC105, AC120, AC122, AC135, AC150, AC151, AC152, AC170, AC181, AC182, AC200, AC201, AC202, AC241, AC242, AC91, AC95, ACR, ACR145, ACR205, ACR225, ACR245, ACR260, ACR265, ACR305, ACRS145, ACRS205, ACRS225, ACRS245, ACRS260, ACRS265, ACRS305, ACS101, ACS101-DIGIT, ACS122, ACS122-DIGIT, ACS151, ACS151-DIGIT, ACS152, ACS152-DIGIT, ACS161-DIGIT, ACS162-DIGIT, ACS181, ACS181-DIGIT, ACS182, ACS182-DIGIT, ACS201, ACS201-DIGIT, ACS202...(Other models you can see in the webshop)		



1

GEV No.	511309	Ref. No.	270104
description	nut thread 1 1/2" ø 66mm H 9mm WS 51 brass Qty 1 pcs		
For models:	AC101, AC105, AC120, AC122, AC135, AC150, AC151, AC152, AC170, AC181, AC182, AC200, AC201, AC202, AC241, AC242, AC91, AC95, ACR, ACR145, ACR205, ACR225, ACR245, ACR260, ACR265, ACR305, ACRS145, ACRS205, ACRS225, ACRS245, ACRS260, ACRS265, ACRS305, ACS101, ACS101-DIGIT, ACS122, ACS122-DIGIT, ACS151, ACS151-DIGIT, ACS152, ACS152-DIGIT, ACS161-DIGIT, ACS162-DIGIT, ACS181, ACS181-DIGIT, ACS182, ACS182-DIGIT, ACS201, ACS201-DIGIT, ACS202...(Other models you can see in the webshop)		

washers

spring rings



1

GEV No.	560209	Ref. No.	260514
description	lock washer ID ø 10.3mm ED ø 17.2mm SS Qty 1 pcs for thread M10		
For models:	AC101, AC122, AC151, AC152, AC181, AC182, AC201, AC202, AC241, AC242, AC91, ACRS145, ACRS205, ACRS225, ACRS245, ACRS260, ACRS265, ACRS305, ACS101, ACS101-DIGIT, ACS122, ACS122-DIGIT, ACS151, ACS151-DIGIT, ACS152, ACS152-DIGIT, ACS161-DIGIT, ACS162-DIGIT, ACS181, ACS181-DIGIT, ACS182, ACS182-DIGIT, ACS201, ACS201-DIGIT, ACS202, ACS202-DIGIT, ACS241, ACS241-DIGIT, ACS242, ACS242-DIGIT, ACS91, ACS91-DIGIT, FC44E, FC44EA, LAV1000		



1

GEV No.	560376	Ref. No.	260510
description	lock washer ID ø 4.3mm ED ø 7.3mm SS UNI 1751 A Qty 1 pcs for thread M4		
For models:	AC122, AC151, AC152, AC181, AC182, AC201, AC202, AC241, AC242, ACR, ACR145, ACR205, ACR225, ACR245, ACR260, ACR265, ACR305, ACS101, ACS101-DIGIT, ACS122, ACS122-DIGIT, ACS151, ACS151-DIGIT, ACS152, ACS152-DIGIT, ACS161-DIGIT, ACS162-DIGIT, ACS181, ACS181-DIGIT, ACS182, ACS182-DIGIT, ACS201, ACS201-DIGIT, ACS202, ACS202-DIGIT, ACS241, ACS241-DIGIT, ACS242, ACS242-DIGIT, ACS91, ACS91-DIGIT, B10T, B11T, B12T, BHC25, BHC25-2, BHC25A, BHC25A-2, BHC25S, BHC30...(Other models you can see in the webshop)		



1

GEV No.	560122	Ref. No.	260511
description	lock washer ID ø 5.2mm ED ø 9mm SS DIN127 Qty 20 pcs for thread M5		
For models:	AC101, AC122, AC151, AC152, AC181, AC182, AC201, AC202, AC241, AC242, AC91, ACS101, ACS101-DIGIT, ACS122, ACS122-DIGIT, ACS151, ACS151-DIGIT, ACS152, ACS152-DIGIT, ACS161-DIGIT, ACS162-DIGIT, ACS181, ACS181-DIGIT, ACS182, ACS182-DIGIT, ACS201, ACS201-DIGIT, ACS202, ACS202-DIGIT, ACS241, ACS241-DIGIT, ACS242, ACS242-DIGIT, ACS91, ACS91-DIGIT, BHC25, BHC25-2, BHC25A, BHC25A-2, BHC25S, BHC30, BHC30-2, BHC30A, BHC30A-2, BHC30E, BHC30E-2, BHC30EA, BHC30EA-2, BHC30HR, BHC30HR-2...(Other models you can see in the webshop)		



1

GEV No.	560123	Ref. No.	260512
description	lock washer ID ø 6.3mm ED ø 11mm SS DIN127 Qty 20 pcs for thread M6		
For models:	AC101, AC122, AC151, AC152, AC181, AC182, AC201, AC202, AC241, AC242, AC91, ACR, ACR145, ACR205, ACR225, ACR245, ACR260, ACR265, ACR305, ACS101, ACS101-DIGIT, ACS122, ACS122-DIGIT, ACS151, ACS151-DIGIT, ACS152, ACS152-DIGIT, ACS161-DIGIT, ACS162-DIGIT, ACS181, ACS181-DIGIT, ACS182, ACS182-DIGIT, ACS201, ACS201-DIGIT, ACS202, ACS202-DIGIT, ACS241, ACS241-DIGIT, ACS242, ACS242-DIGIT, ACS91, ACS91-DIGIT, B10T, B11T, B12T, B13T, B14T, B15T, B15TM...(Other models you can see in the webshop)		





 <p>1</p>			
GEV No.	560208	Ref. No.	260513
description	lock washer ID ø 8.3mm ED ø 15mm SS Qty 1 pcs		
For models:	AC101, AC122, AC151, AC152, AC181, AC182, AC201, AC202, AC241, AC242, AC2A, AC91, ACR, ACR145, ACR205, ACR225, ACR245, ACR260, ACR265, ACR305, ACRS145, ACRS205, ACRS225, ACRS245, ACRS260, ACRS265, ACRS305, ACS101, ACS101-DIGIT, ACS122, ACS122-DIGIT, ACS151, ACS151-DIGIT, ACS152, ACS152-DIGIT, ACS161-DIGIT, ACS162-DIGIT, ACS181, ACS181-DIGIT, ACS182, ACS182-DIGIT, ACS201, ACS201-DIGIT, ACS202, ACS202-DIGIT, ACS241, ACS241-DIGIT, ACS242, ACS242-DIGIT, ACS91...(Other models you can see in the webshop)		

 <p>1</p>			
GEV No.	560113	Ref. No.	260504
description	plain washer ID ø 6.4mm ED ø 12mm thickness 1.6mm SS Qty 20 pcs DIN 125A for thread M6		
For models:	AC101, AC122, AC151, AC152, AC181, AC182, AC201, AC202, AC241, AC242, AC91, ACR, ACR145, ACR205, ACR225, ACR245, ACR260, ACR265, ACR305, ACS101, ACS101-DIGIT, ACS122, ACS122-DIGIT, ACS151, ACS151-DIGIT, ACS152, ACS152-DIGIT, ACS161-DIGIT, ACS162-DIGIT, ACS181, ACS181-DIGIT, ACS182, ACS182-DIGIT, ACS201, ACS201-DIGIT, ACS202, ACS202-DIGIT, ACS241, ACS241-DIGIT, ACS242, ACS242-DIGIT, ACS91, ACS91-DIGIT, BHC25, BHC25-2, BHC25A, BHC25A-2, BHC25S, BHC30, BHC30-2...(Other models you can see in the webshop)		

washers

DIN 125A

 <p>1</p>			
GEV No.	560312	Ref. No.	260506
description	plain washer ID ø 10.5mm ED ø 20mm thickness 2mm SS Qty 1 pcs DIN 125A for thread M10		
For models:	FC, FC53, FC533, FC533A, FC53A, FC53CBT, FC53LA, FC53LBT, FC54, FC543, FC543A, FC543E, FC544, FC544A, FC54A, FC54CBT, FC54E, FC54EA, FC54LBT, FCHR, FCHRA, FCHRHT, FCHRTA, NE02, NE3002, NE4002, NE5002, NE5502, NE7002, NE7502, NE9002, NE9502		

 <p>1</p>			
GEV No.	560114	Ref. No.	260505
description	plain washer ID ø 8.4mm ED ø 16mm thickness 1.6mm SS Qty 20 pcs DIN 125A for thread M8		
For models:	AC100, AC101, AC105, AC120, AC122, AC135, AC150, AC151, AC152, AC170, AC181, AC182, AC200, AC201, AC202, AC241, AC242, AC2A, AC90, AC91, AC95, ACR, ACR145, ACR205, ACR225, ACR245, ACR260, ACR265, ACR305, ACRS145, ACRS205, ACRS225, ACRS245, ACRS260, ACRS265, ACRS305, ACS101, ACS101-DIGIT, ACS122, ACS122-DIGIT, ACS151, ACS151-DIGIT, ACS152, ACS152-DIGIT, ACS161-DIGIT, ACS162-DIGIT, ACS181, ACS181-DIGIT, ACS182, ACS182-DIGIT...(Other models you can see in the webshop)		

 <p>1</p>			
GEV No.	560332	Ref. No.	260502
description	plain washer ID ø 4.3mm ED ø 9mm thickness 0.8mm SS Qty 1 pcs		
For models:	AC122, AC151, AC152, AC181, AC182, AC201, AC202, AC241, AC242, ACR, ACR145, ACR205, ACR225, ACR245, ACR260, ACR265, ACR305, B10T, B11T, B12T, BHC25, BHC25-2, BHC25A, BHC25A-2, BHC25S, BHC30, BHC30-2, BHC30A, BHC30A-2, BHC30E, BHC30E-2, BHC30EA, BHC30EA-2, BHC30HR, BHC30HR-2, BHC30HR380, BHC30HRA, BHC30HRA-2, BHC30HRA380, BHC433, BHC433-2, BHC433A, BHC433A-2, BHC433A, BHC433A-2, BR20, BR20A, BR25, BR25A, C1000E, C1000ERCD...(Other models you can see in the webshop)		

<p>DIN 9021</p>  <p>1</p>			
GEV No.	560117	Ref. No.	260538
description	plain washer ID ø 6.4mm ED ø 18mm thickness 1.5mm SS Qty 20 pcs DIN 9021 for thread M6		
For models:	AC101, AC122, AC151, AC152, AC181, AC182, AC201, AC202, AC241, AC242, AC91, ACR, ACR145, ACR205, ACR225, ACR245, ACR260, ACR265, ACR305, ACS101, ACS101-DIGIT, ACS122, ACS122-DIGIT, ACS151, ACS151-DIGIT, ACS152, ACS152-DIGIT, ACS161-DIGIT, ACS162-DIGIT, ACS181, ACS181-DIGIT, ACS182, ACS182-DIGIT, ACS201, ACS201-DIGIT, ACS202, ACS202-DIGIT, ACS241, ACS241-DIGIT, ACS242, ACS242-DIGIT, ACS91, ACS91-DIGIT, BHC25, BHC25-2, BHC25A, BHC25A-2, BHC25S, BHC30, BHC30-2...(Other models you can see in the webshop)		

 <p>1</p>			
GEV No.	560112	Ref. No.	260503
description	plain washer ID ø 5.3mm ED ø 10mm thickness 1mm SS Qty 20 pcs DIN 125A for thread M5		
For models:	AC101, AC122, AC151, AC152, AC181, AC182, AC201, AC202, AC241, AC242, AC91, ACR, ACR145, ACR205, ACR225, ACR245, ACR260, ACR265, ACR305, ACS101, ACS101-DIGIT, ACS122, ACS122-DIGIT, ACS151, ACS151-DIGIT, ACS152, ACS152-DIGIT, ACS161-DIGIT, ACS162-DIGIT, ACS181, ACS181-DIGIT, ACS182, ACS182-DIGIT, ACS201, ACS201-DIGIT, ACS202, ACS202-DIGIT, ACS241, ACS241-DIGIT, ACS242, ACS242-DIGIT, ACS91, ACS91-DIGIT, B26, B27, BHC25, BHC25-2, BHC25A, BHC25A-2, BHC25S...(Other models you can see in the webshop)		

miscellaneous

 <p>1</p>			
GEV No.	560492	Ref. No.	260558
description	plain washer ID ø 10mm ED ø 40mm thickness 1mm Qty 1 pcs for probe		
For models:	BHC30HR, BHC30HR-2, BHC30HR380, BHC30HRA, BHC30HRA-2, BHC30HRA380, BHC433		

			
1			
GEV No.	510236	Ref. No.	260568
description	plain washer ID ø 21mm ED ø 28mm thickness 1mm SS Qty 1 pcs		
For models:	C1001M, C1301M, LC1200, LC1200RCD, LC412, LC700, LC700RCD, LC900, LC900RCD		

			
1			
GEV No.	560301	Ref. No.	260530
description	plain washer ID ø 7mm ED ø 22mm thickness 2mm SS Qty 1 pcs		
For models:	AC100, AC90, ACS101, ACS101-DIGIT, ACS122, ACS122-DIGIT, ACS151, ACS151-DIGIT, ACS152, ACS152-DIGIT, ACS161-DIGIT, ACS162-DIGIT, ACS181, ACS181-DIGIT, ACS182, ACS182-DIGIT, ACS201, ACS201-DIGIT, ACS202, ACS202-DIGIT, ACS241, ACS241-DIGIT, ACS242, ACS242-DIGIT, ACS91, ACS91-DIGIT, B24, B25, C1001M, C1301M, C140, C155, C155BT, C155E2, C155RCD, C165, C165E2, C165E2BT, C165E2RCD, C166, C166-2, C75, C75BT, C75RCD, C85, C95, C95BT, C95E2, C95RCD, GE50RCD...(Other models you can see in the webshop)		

fasteners

slot nuts

			
1			
GEV No.	560286	Ref. No.	441122
description	slot nut W 6mm H 6mm L 25mm		
For models:	AC100, AC101, AC105, AC120, AC122, AC135, AC150, AC151, AC152, AC170, AC181, AC182, AC200, AC201, AC202, AC241, AC242, AC90, AC91, AC95, ACR, ACR145, ACR205, ACR225, ACR245, ACR260, ACR265, ACR305, ACRS145, ACRS205, ACRS225, ACRS245, ACRS260, ACRS265, ACRS305, ACS101, ACS101-DIGIT, ACS122, ACS122-DIGIT, ACS151, ACS151-DIGIT, ACS152, ACS152-DIGIT, ACS161-DIGIT, ACS162-DIGIT, ACS181, ACS181-DIGIT, ACS182, ACS182-DIGIT, ACS201...(Other models you can see in the webshop)		

clamps

hose clamps

DIN 3017 - W2

			
1			
GEV No.	520111	Ref. No.	450102
description	hose clamp ø 10-16mm width 9mm Qty 10 pcs DIN 3017		
For models:	B10T, B11T, B12, B12T, B13T, B14T, B15, B15T, B15TM, B16, B16T, B16TM, B18, B18T, B18TM, B19, B19T, B19TM, B41, BC25, BC25A, BC25HR, BC30, BC30A, BC30HR, BC30HR380, BC30HRA, BHC25, BHC25-2, BHC25A, BHC25A-2, BHC25S, BHC30, BHC30-2, BHC30A, BHC30A-2, BHC30E, BHC30E-2, BHC30EA, BHC30EA-2, BHC30HR, BHC30HR-2, BHC30HR380, BHC30HRA, BHC30HRA-2, BHC30HRA380, BHC433, BHC433-2, BHC433A, BHC433A-2...(Other models you can see in the webshop)		

			
1			
GEV No.	520112	Ref. No.	450103
description	hose clamp ø 12-20mm width 9mm Qty 10 pcs DIN 3017		
For models:	AC2A, B10T, B11T, B12, B12T, B13T, B14T, B15, B15T, B15TM, B16, B16T, B16TM, B18, B18T, B18TM, B19, B19T, B19TM, B20, B20D, B24, B25, B26, B27, B41, B42, BC25, BC25A, BC25HR, BC30, BC30A, BC30HR, BC30HR380, BC30HRA, BHC25, BHC25-2, BHC25A, BHC25A-2, BHC25S, BHC30, BHC30-2, BHC30A, BHC30A-2, BHC30E, BHC30E-2, BHC30EA, BHC30EA-2, BHC30HR, BHC30HR-2...(Other models you can see in the webshop)		

			
1			
GEV No.	520113	Ref. No.	450104
description	hose clamp ø 16-27mm width 9mm Qty 10 pcs DIN 3017		
For models:	AC100, AC101, AC105, AC120, AC122, AC135, AC150, AC151, AC152, AC170, AC181, AC182, AC200, AC201, AC202, AC241, AC242, AC2A, AC90, AC91, AC95, ACL100, ACL150, ACR, ACR145, ACR205, ACR225, ACR245, ACR260, ACR265, ACR305, ACRS145, ACRS205, ACRS225, ACRS245, ACRS260, ACRS265, ACRS305, ACS101, ACS101-DIGIT, ACS122, ACS122-DIGIT, ACS151, ACS151-DIGIT, ACS152, ACS152-DIGIT, ACS161-DIGIT, ACS162-DIGIT, ACS181, ACS181-DIGIT...(Other models you can see in the webshop)		

			
1			
GEV No.	520114	Ref. No.	450114
description	hose clamp ø 20-32mm width 9mm Qty 10 pcs DIN 3017		
For models:	AC122, AC151, AC152, AC182, AC202, AC242, ACL150, ACRS145, ACRS205, ACRS225, ACRS245, ACRS260, ACRS265, ACRS305, ACS122, ACS122-DIGIT, ACS151, ACS151-DIGIT, ACS152, ACS152-DIGIT, ACS161-DIGIT, ACS162-DIGIT, ACS182, ACS182-DIGIT, ACS202, ACS202-DIGIT, ACS242, ACS242-DIGIT, B10, B11, B12, B20, B20D, B23, B24, B25, B26, B27, B31, B32, B41, B42, BHC25, BHC25-2, BHC25A, BHC25A-2, BHC25S, BHC30, BHC30-2, BHC30A...(Other models you can see in the webshop)		

			
1			
GEV No.	520115	Ref. No.	450105
description	hose clamp ø 25-40mm width 9mm Qty 10 pcs DIN 3017		
For models:	AC122, AC152, AC182, AC202, AC242, B20, B20D, B23, B24, B25, B26, B27, BC25, BC25A, BC30, BC30A, BHC25-2, BHC25A-2, BHC30-2, BHC30A-2, BHC30E-2, BHC30EA-2, BHC30HR, BHC30HR-2, BHC30HR380, BHC30HRA, BHC30HRA-2, BHC30HRA380, BHC433-2, BHC433A-2, BHCHR, BR20, BR20A, BR25A, C1000E, C1000ERCD, C1300E, C1300ERCD, F45, F55, F65, F80, F90MA, F90MA, FC, FC3E, FC3EA, FC3M, FC3MA...(Other models you can see in the webshop)		





			
1			
GEV No.	520116	Ref. No.	450106 450107
description	hose clamp ø 32-50mm width 9mm Qty 5 pcs DIN 3017		
For models:	AC101, AC105, AC122, AC135, AC151, AC152, AC91, AC95, ACL100, ACL150, ACRS145, ACRS205, ACRS225, ACRS245, ACRS260, ACRS265, ACRS305, ACS101, ACS101-DIGIT, ACS122, ACS122-DIGIT, ACS151, ACS151-DIGIT, ACS152, ACS152-DIGIT, ACS181, ACS181-DIGIT, ACS182, ACS182-DIGIT, ACS201, ACS201-DIGIT, ACS202, ACS202-DIGIT, ACS241, ACS241-DIGIT, ACS242, ACS242-DIGIT, ACS91, ACS91-DIGIT, B13T, B14T, B15, B15T, B15TM, B16, B16T, B16TM, B18, B18T, B18TM...(Other models you can see in the webshop)		

			
1			
GEV No.	520118	Ref. No.	450109
description	hose clamp ø 50-70mm width 9mm Qty 5 pcs DIN 3017		
For models:	AC100, AC101, AC105, AC120, AC135, AC150, AC170, AC181, AC182, AC200, AC201, AC202, AC241, AC242, AC2A, AC90, AC91, AC95, ACL100, ACL150, ACR, ACR145, ACR205, ACR225, ACR245, ACR260, ACR265, ACR305, ACRS145, ACRS205, ACRS225, ACRS245, ACRS260, ACRS265, ACRS305, ACS101, ACS101-DIGIT, ACS122, ACS122-DIGIT, ACS151, ACS151-DIGIT, ACS152, ACS152-DIGIT, ACS161-DIGIT, ACS162-DIGIT, ACS181, ACS181-DIGIT, ACS182, ACS182-DIGIT, ACS201...(Other models you can see in the webshop)		

			
1			
GEV No.	520119	Ref. No.	450119
description	hose clamp ø 60-80mm width 9mm Qty 5 pcs DIN 3017		
For models:	AC100, AC122, AC135, AC151, AC152, AC181, AC182, AC201, AC202, AC241, AC242, AC2A, AC90, ACR, ACR145, ACR205, ACR225, ACR245, ACR260, ACR265, ACR305, C1000E, C1000ERCD, C1001M, C1300E, C1300ERCD, C1301M, C155, C155BT, C155E2, C155RCD, C165, C165E2, C165E2BT, C165E2RCD, C166, C166-2, C33, C34, C95, C95BT, C95E2, C95RCD, G100L, G101L, G50L, G51L, G60L, G61L, GE100...(Other models you can see in the webshop)		

			
1			
GEV No.	520117	Ref. No.	450135
description	hose clamp stainless steel ø 40-60mm width 9mm Qty 5 pcs DIN 3017		
For models:	AC100, AC101, AC120, AC122, AC150, AC151, AC152, AC170, AC181, AC182, AC200, AC201, AC202, AC241, AC242, AC90, AC91, ACR, ACR145, ACR205, ACR225, ACR245, ACR260, ACR265, ACR305, ACRS205, ACRS245, ACRS260, ACRS265, ACS101, ACS101-DIGIT, ACS122, ACS122-DIGIT, ACS181, ACS181-DIGIT, ACS182, ACS182-DIGIT, ACS91, ACS91-DIGIT, B13T, B14T, B15, B15T, B15TM, B16, B16T, B16TM, B18, B18T, B18TM...(Other models you can see in the webshop)		

			
1			
GEV No.	511286	Ref. No.	450143
description	hose clamp ø 38mm wire gauge ø 3.2mm Qty 1 pcs		
For models:	AC101, AC105, AC122, AC135, AC151, AC152, AC181, AC182, AC201, AC202, AC241, AC242, AC2A, AC91, AC95, ACL100, ACL150, ACRS145, ACRS205, ACRS225, ACRS245, ACRS260, ACRS265, ACRS305, ACS101, ACS101-DIGIT, ACS122, ACS122-DIGIT, ACS151, ACS151-DIGIT, ACS152, ACS152-DIGIT, ACS161-DIGIT, ACS162-DIGIT, ACS181, ACS181-DIGIT, ACS182, ACS182-DIGIT, ACS201, ACS201-DIGIT, ACS202, ACS202-DIGIT, ACS241, ACS241-DIGIT, ACS242, ACS242-DIGIT, ACS91, ACS91-DIGIT, BC25, BC25A...(Other models you can see in the webshop)		

			
1			
GEV No.	513268	Ref. No.	450134
description	hose clamp ø 8-10mm wire gauge ø 1mm Qty 1 pcs		
For models:	AC101, AC105, AC122, AC135, AC151, AC152, AC181, AC182, AC201, AC202, AC241, AC242, AC91, AC95, BHC25-2, BHC25A-2, BHC30-2, BHC30A-2, BHC30E, BHC30E-2, BHC30EA, BHC30EA-2, BHC433-2, BHC433A-2, C1000E, C1000ERCD, C1001M, C1300E, C1300ERCD, C1301M, C155BT, C155RCD, C165E2BT, C165E2RCD, C75BT, C75RCD, C95BT, C95RCD, FC3E, FC3EA, FC3MA, FC44E, FC44EA, FC4E, FC4EA, FC4EHR, FC4MA, FC53CBT, FC53LBT, FC54CBT...(Other models you can see in the webshop)		

			
1			
GEV No.	510959	Ref. No.	450115
description	hose clamp ø 8mm wire gauge ø 1mm Qty 1 pcs		
For models:	B10T, B11T, B12T, B13T, B14T, B15, B15T, B15TM, B16, B16T, B16TM, B18, B18T, B18TM, B19, B19T, B19TM, B31, B41, B42, BC25, BC25A, BC25HR, BC30, BC30A, BC30HR, BC30HR380, BC30HRA, BHC25, BHC25-2, BHC25A, BHC25A-2, BHC25S, BHC30, BHC30-2, BHC30A, BHC30A-2, BHC30E, BHC30E-2, BHC30EA, BHC30EA-2, BHC30HR, BHC30HR-2, BHC30HR380, BHC30HRA, BHC30HRA-2, BHC30HRA380, BHC433, BHC433-2, BHC433A...(Other models you can see in the webshop)		



1

GEV No.	511147	Ref. No.	450125
description	wire clamp ø 12-14mm wire gauge ø 1.5mm zinc-coated steel Qty 1 pcs		
For models:	AC100, AC120, AC150, AC170, AC200, AC90, ACR, ACR145, ACR205, ACR225, ACR245, ACR260, ACR265, ACR305, ACRS145, ACRS205, ACRS225, ACRS245, ACRS260, ACRS265, ACRS305, ACS101, ACS101-DIGIT, ACS122, ACS122-DIGIT, ACS151, ACS151-DIGIT, ACS152, ACS152-DIGIT, ACS161-DIGIT, ACS162-DIGIT, ACS181, ACS181-DIGIT, ACS182, ACS182-DIGIT, ACS201, ACS201-DIGIT, ACS202, ACS202-DIGIT, ACS241, ACS241-DIGIT, ACS242, ACS242-DIGIT, ACS91, ACS91-DIGIT, B10, B10T, B11, B11T, B12...(Other models you can see in the webshop)		

miscellaneous



1

GEV No.	510923	Ref. No.	440817
description	clamping ring for shaft ø 10mm ID ø 9.4mm H 6mm		
For models:	AC100, AC122, AC151, AC152, AC181, AC182, AC201, AC202, AC241, AC242, ACR, ACR145, ACR205, ACR225, ACR245, ACR260, ACR265, ACR305, ACRS145, ACRS205, ACRS225, ACRS245, ACRS260, ACRS265, ACRS305, B10, B10T, B11, B11T, B12, B12T, B13T, B14T, B15, B15T, B15TM, B16, B16T, B16TM, B18, B18T, B18TM, B19, B19T, B19TM, B20, B20D, B24, B25, B26...(Other models you can see in the webshop)		

retaining rings

DIN 471



1

GEV No.	528689	Ref. No.	440811
description	retaining ring shaft ø 15mm thickness 1mm steel DIN 471		
For models:	NE00, NE02, NE3001, NE3002, NE4001, NE4002, NE5002, NE5501, NE5502, NE7002, NE7501, NE7502, NE9001, NE9002, NE9502, NG02, NG1202, NG1202E, NG602, NG602E, NG902, NG902E		



1

GEV No.	504519	Ref. No.	440802
description	retaining ring shaft ø 17mm thickness 1mm SS DIN 471		
For models:	NE00, NE3001, NE4001, NE5501, NE7501, NE9001, NG00, NG01, NG600, NG600E, NG601, NG601E, NG900, NG900E, NG901, NG901E		



1

GEV No.	693061	Ref. No.	440820
description	retaining ring shaft ø 25mm thickness 1.2mm steel DIN 471		
For models:	GMC, GMC2700, GMC3500, GMC4500, GMC5500		

DIN 472



1

GEV No.	525153	Ref. No.	440815
description	retaining ring bore ø 32mm thickness 1.1mm DIN 472		
For models:	NE00, NE02, NE3001, NE3002, NE4001, NE4002, NE5002, NE5501, NE5502, NE7002, NE7501, NE7502, NE9001, NE9002, NE9502, NL302, NL302E, NL402, NL402E, NL502, NL502E, NL552, NL552E		



1

GEV No.	511248	Ref. No.	440816
description	retaining ring bore ø 48mm thickness 1.9mm stainless steel DIN 472		
For models:	G115, G115L, G125L, G131, G50LM, G65, G65L, G66, G75, G75L, GE125, GE75, GL		

roll pins



1

GEV No.	694401	Ref. No.	451002
description	roll pin ø 2mm L 12mm stainless steel 1481		
For models:	AC100, AC101, AC105, AC120, AC122, AC135, AC150, AC151, AC152, AC170, AC181, AC182, AC200, AC201, AC202, AC241, AC242, AC90, AC91, AC95, ACL100, ACL150, ACR, ACR145, ACR205, ACR225, ACR245, ACR260, ACR265, ACR305, ACRS145, ACRS205, ACRS225, ACRS245, ACRS260, ACRS265, ACRS305, ACS101, ACS101-DIGIT, ACS122, ACS122-DIGIT, ACS151, ACS151-DIGIT, ACS152, ACS152-DIGIT, ACS161-DIGIT, ACS162-DIGIT, ACS181, ACS181-DIGIT, ACS182...(Other models you can see in the webshop)		



1

GEV No.	560533	Ref. No.	451123
description	roll pin ø 4mm L 16mm SS		
For models:	AC101, AC105, AC122, AC135, AC151, AC152, AC181, AC182, AC201, AC202, AC241, AC242, AC2A, AC91, AC95, ACL150, ACR, ACR145, ACR205, ACR225, ACR245, ACR260, ACR265, ACR305, ACRS145, ACRS205, ACRS225, ACRS245, ACRS260, ACRS265, ACRS305, ACS101, ACS101-DIGIT, ACS122, ACS122-DIGIT, ACS151, ACS151-DIGIT, ACS152, ACS152-DIGIT, ACS161-DIGIT, ACS162-DIGIT, ACS181, ACS181-DIGIT, ACS182, ACS182-DIGIT, ACS201, ACS201-DIGIT, ACS202, ACS202-DIGIT, ACS241...(Other models you can see in the webshop)		



			
1			
GEV No.	692236	Ref. No.	451118
description	roll pin ø 4mm L 40mm		
For models:	LAV1000, LV1001, LV1501, LV-LVP, LVP1001, LVP1501, NE00, NG00, NG600, NG600E, NG900, NG900E		

screw caps

			
1			
GEV No.	510233	Ref. No.	290105
description	screw cap thread 1/2" thread L 12mm brass WS 27 head thickness 7mm		
For models:	AC101, AC105, AC120, AC122, AC135, AC150, AC151, AC152, AC170, AC181, AC182, AC200, AC201, AC202, AC241, AC242, AC2A, AC90, AC91, AC95, ACL100, ACL150, ACR, ACR145, ACR205, ACR225, ACR245, ACR260, ACR265, ACR305, ACR5145, ACR5205, ACR5225, ACR5245, ACR5260, ACR5265, ACR5305, ACS101, ACS101-DIGIT, ACS122, ACS122-DIGIT, ACS151, ACS151-DIGIT, ACS152, ACS152-DIGIT, ACS161-DIGIT, ACS162-DIGIT, ACS181, ACS181-DIGIT, ACS182... (Other models you can see in the webshop)		

consumables

fuses

fine fuses

			
1			
GEV No.	358667	Ref. No.	130263
description	fine fuse size ø5x20mm 0.4A fast-acting rated 250V Qty 10 pcs		

			
1			
GEV No.	358596	Ref. No.	130273
description	fine fuse size ø5x20mm 0.25A slow-acting rated 250V Qty 10 pcs		
For models:	AC122, AC151, AC152, AC181, AC182, AC201, AC202, AC241, AC242, ACR, ACR145, ACR205, ACR225, ACR245, ACR260, ACR265, ACR305, C155BT, C155RCD, C75BT, C75RCD, C95BT, C95RCD, FC53CBT, FC53LA, FC53LBT, FC54CBT, FC54LBT, GF90, GF90A, GMC, GMC2700, GMC3500, GMC4500, GMC5500, LC1200RCD, LC380BT, LC380RCD, LC700RCD, LC900RCD, LF320CBT, LF320L, LF320LA, LF320LBT, LF400A, LP360BT, LP360RCD		

			
1			
GEV No.	358702	Ref. No.	130262
description	fine fuse size ø5x20mm 0.315A slow-acting rated 250V Qty 10 pcs		

			
1			
GEV No.	358602	Ref. No.	130265
description	fine fuse size ø5x20mm 1.6A slow-acting rated 250V Qty 10 pcs		
For models:	AC122, AC151, AC152, AC181, AC182, AC201, AC202, AC241, AC242, ACR, ACR145, ACR205, ACR225, ACR245, ACR260, ACR265, ACR305, GMC, GMC2700, GMC3500, GMC4500, GMC5500, NE3001, NE4001, NE5501, NE7501, NE9001, NG01, NG601, NG601E, NG901, NG901E		

			
1			
GEV No.	358600	Ref. No.	130264
description	fine fuse size ø5x20mm 1A slow-acting rated 250V Qty 10 pcs		
For models:	AC122, AC151, AC152, AC181, AC182, AC201, AC202, AC241, AC242, ACR, ACR145, ACR205, ACR225, ACR245, ACR260, ACR265, ACR305, BHC30E, BHC30EA, C155BT, C155RCD, C75BT, C75RCD, C95BT, C95RCD, FC53CBT, FC53LA, FC53LBT, FC54CBT, FC54E, FC54EA, FC54LBT, GF90, GF90A, GMC, GMC2700, GMC3500, GMC4500, GMC5500, LC1200RCD, LC380BT, LC380RCD, LC700RCD, LC900RCD, LF320CBT, LF320L, LF320LA, LF320LBT, LF400A, LP360BT... (Other models you can see in the webshop)		

			
1			
GEV No.	358603	Ref. No.	130270
description	fine fuse size ø5x20mm 2A slow-acting rated 250V Qty 10 pcs		
For models:	C155BT, C155RCD, C75BT, C75RCD, C95BT, C95RCD, FC53CBT, FC53LA, FC53LBT, FC54CBT, FC54LBT, GF90, GF90A, LC1200RCD, LC380BT, LC380RCD, LC700RCD, LC900RCD, LF320CBT, LF320L, LF320LA, LF320LBT, LF400A, LP360BT, LP360RCD		

			
1			
GEV No.	358606	Ref. No.	130266
description	fine fuse size ø5x20mm 4A slow-acting rated 250V Qty 10 pcs		

			
1			
GEV No.	358609	Ref. No.	130274
description	fine fuse size ø5x20mm 5A slow-acting rated 250V Qty 10 pcs		
For models:	C155BT, C155RCD, C75BT, C75RCD, C95BT, C95RCD, FC53CBT, FC53LA, FC53LBT, FC54CBT, FC54LBT, GF90, GF90A, LC1200RCD, LC380BT, LC380RCD, LC700RCD, LC900RCD, LF320CBT, LF320L, LF320LA, LF320LBT, LF400A, LP360BT, LP360RCD		

			
1			
GEV No.	358607	Ref. No.	130275
description	fine fuse size ø5x20mm 6.3A slow-acting rated 250V Qty 10 pcs		
For models:	AC122, AC151, AC152, AC181, AC182, AC201, AC202, AC241, AC242, ACR, ACR145, ACR205, ACR225, ACR245, ACR260, ACR265, ACR305, C155BT, C155RCD, C75BT, C75RCD, C95BT, C95RCD, FC53CBT, FC53LA, FC53LBT, FC54CBT, FC54LBT, GF90, GF90A, GMC, GMC2700, GMC3500, GMC4500, GMC5500, LC1200RCD, LC380BT, LC380RCD, LC700RCD, LC900RCD, LF320CBT, LF320L, LF320LA, LF320LBT, LF400A, LP360BT, LP360RCD		

ø10x38mm 400V

			
1			
GEV No.	358041	Ref. No.	130236
description	fine fuse size ø10x38mm 20A slow-acting rated 400V type aM Qty 1 pcs		
For models:	AC100, AC101, AC120, AC122, AC150, AC151, AC152, AC170, AC181, AC182, AC200, AC201, AC202, AC241, AC242, AC91, ACR, ACR145, ACR205, ACR225, ACR245, ACR260, ACR265, ACR305, ACR5145, ACR5205, ACR5225, ACR5245, ACR5260, ACR5265, ACR5305, ACS101, ACS101-DIGIT, ACS122, ACS122-DIGIT, ACS151, ACS151-DIGIT, ACS152, ACS152-DIGIT, ACS161-DIGIT, ACS162-DIGIT, ACS181, ACS181-DIGIT, ACS182, ACS182-DIGIT, ACS201, ACS201-DIGIT, ACS202, ACS202-DIGIT, ACS241...(Other models you can see in the webshop)		

ø10x38mm 500V

			
Image not available			
1			
GEV No.	358196	Ref. No.	130246
description	fine fuse size ø10x38mm 12A rated 500V type Gg fast-acting Qty 1 pcs		

			
1			
GEV No.	358027	Ref. No.	130247
description	fine fuse size ø10x38mm 16A rated 500V type Gg fast-acting Qty 1 pcs		
For models:	AC100, AC105, AC120, AC150, AC170, AC200, AC90, AC95, ACR, ACR145, ACR205, ACR225, ACR245, ACR260, ACR265, ACR305, ACR5145, ACR5205, ACR5225, ACR5245, ACR5260, ACR5265, ACR5305, G66, GMC, GMC2700, GMC2702, GMC3500, GMC3502, GMC4500, GMC4502, GMC5500, GMC5502, NE00, NE3001, NE4001, NE5501, NE7501, NE9001, SE, SNL		

			
1			
GEV No.	358028	Ref. No.	130248
description	fine fuse size ø10x38mm 20A rated 500V type Gg fast-acting Qty 1 pcs		
For models:	AC101, AC120, AC122, AC150, AC151, AC152, AC170, AC181, AC182, AC200, AC201, AC202, AC241, AC242, AC91, ACR, ACR145, ACR205, ACR225, ACR245, ACR260, ACR265, ACR305, ACR5145, ACR5205, ACR5225, ACR5245, ACR5260, ACR5265, ACR5305, ACS101, ACS101-DIGIT, ACS122, ACS122-DIGIT, ACS151, ACS151-DIGIT, ACS152, ACS152-DIGIT, ACS161-DIGIT, ACS162-DIGIT, ACS181, ACS181-DIGIT, ACS182, ACS182-DIGIT, ACS201, ACS201-DIGIT, ACS202, ACS202-DIGIT, ACS241, ACS241-DIGIT...(Other models you can see in the webshop)		

			
1			
GEV No.	358032	Ref. No.	130253
description	fine fuse size ø10x38mm 25A rated 500V type Gg fast-acting Qty 1 pcs		
For models:	G115		

			
1			
GEV No.	358021	Ref. No.	130260
description	fine fuse size ø10x38mm 2A rated 500V type gl fast-acting Qty 1 pcs		

			
1			
GEV No.	358024	Ref. No.	130245
description	fine fuse size ø10x38mm 8A rated 500V type gl fast-acting Qty 1 pcs		
For models:	AC120, AC150, AC170, AC200, ACR, ACR145, ACR205, ACR225, ACR245, ACR260, ACR265, ACR305, ACR5145, ACR5205, ACR5225, ACR5245, ACR5260, ACR5265, ACR5305, G100L, G101L, G115L, G125L, G50L, G50LM, G51L, G60L, G61L, G65, G65L, G75, G75L, GL, GMC, GMC2700, GMC2702, GMC3500, GMC3502, GMC4500, GMC4502, GMC5500, GMC5502		

			
1			
GEV No.	358039	Ref. No.	130234
description	fine fuse size ø10x38mm 12A slow-acting rated 500V type aM Qty 1 pcs		
For models:	AC101, AC120, AC122, AC150, AC151, AC152, AC170, AC181, AC182, AC200, AC201, AC202, AC241, AC242, AC90, AC91, ACR, ACR145, ACR205, ACR225, ACR245, ACR260, ACR265, ACR305, ACS101, ACS101-DIGIT, ACS122, ACS122-DIGIT, ACS151, ACS151-DIGIT, ACS152, ACS152-DIGIT, ACS161-DIGIT, ACS162-DIGIT, ACS181, ACS181-DIGIT, ACS182, ACS182-DIGIT, ACS201, ACS201-DIGIT, ACS202, ACS202-DIGIT, ACS241, ACS241-DIGIT, ACS242, ACS242-DIGIT, ACS91, ACS91-DIGIT, G131, G66...(Other models you can see in the webshop)		





			
1			
GEV No.	358040	Ref. No.	130235
description	fine fuse size ø10x38mm 16A slow-acting rated 500V type aM Qty 1 pcs		
For models:	AC120, AC150, AC170, AC200, ACR, ACR145, ACR205, ACR225, ACR245, ACR260, ACR265, ACR305, G66, GMC, GMC2700, GMC3500, GMC4500, GMC5500, LAV1000, NE3001, NE4001, NE5501, NE7501, NE9001		

			
1			
GEV No.	358036	Ref. No.	130231
description	fine fuse size ø10x38mm 6A slow-acting rated 500V type aM Qty 1 pcs		
For models:	AC100, AC101, AC120, AC122, AC150, AC151, AC152, AC170, AC181, AC182, AC200, AC201, AC202, AC241, AC242, AC90, AC91, ACR, ACR145, ACR205, ACR225, ACR245, ACR260, ACR265, ACR305, ACS101, ACS101-DIGIT, ACS122, ACS122-DIGIT, ACS151, ACS151-DIGIT, ACS152, ACS152-DIGIT, ACS161-DIGIT, ACS162-DIGIT, ACS181, ACS181-DIGIT, ACS182, ACS182-DIGIT, ACS201, ACS201-DIGIT, ACS202, ACS202-DIGIT, ACS241, ACS241-DIGIT, ACS242, ACS242-DIGIT, ACS91, ACS91-DIGIT, GMC...(Other models you can see in the webshop)		

			
1			
GEV No.	358033	Ref. No.	130259
description	fine fuse size ø10x38mm 1A slow-acting rated 500V type aM Qty 1 pcs		
For models:	AC101, AC105, AC122, AC151, AC152, AC181, AC182, AC201, AC202, AC241, AC242, AC91, AC95, ACS101, ACS101-DIGIT, ACS122, ACS122-DIGIT, ACS151, ACS151-DIGIT, ACS152, ACS152-DIGIT, ACS161-DIGIT, ACS162-DIGIT, ACS181, ACS181-DIGIT, ACS182, ACS182-DIGIT, ACS201, ACS201-DIGIT, ACS202, ACS202-DIGIT, ACS241, ACS241-DIGIT, ACS242, ACS242-DIGIT, ACS91, ACS91-DIGIT, G100L, G101L, G115, G115L, G125L, G50L, G50LM, G51L, G60L, G61L, G65, G65L, G75...(Other models you can see in the webshop)		

			
1			
GEV No.	358037	Ref. No.	130232
description	fine fuse size ø10x38mm 8A slow-acting rated 500V type aM Qty 1 pcs		
For models:	AC100, AC101, AC120, AC122, AC150, AC151, AC152, AC170, AC181, AC182, AC200, AC201, AC202, AC241, AC242, AC90, AC91, ACR, ACR145, ACR205, ACR225, ACR245, ACR260, ACR265, ACR305, ACS101, ACS101-DIGIT, ACS122, ACS122-DIGIT, ACS151, ACS151-DIGIT, ACS152, ACS152-DIGIT, ACS161-DIGIT, ACS162-DIGIT, ACS181, ACS181-DIGIT, ACS182, ACS182-DIGIT, ACS201, ACS201-DIGIT, ACS202, ACS202-DIGIT, ACS241, ACS241-DIGIT, ACS242, ACS242-DIGIT, ACS91, ACS91-DIGIT, GMC...(Other models you can see in the webshop)		

			
1			
GEV No.	358034	Ref. No.	130260
description	fine fuse size ø10x38mm 2A slow-acting rated 500V type aM Qty 1 pcs		
For models:	AC101, AC122, AC151, AC152, AC181, AC182, AC201, AC202, AC241, AC242, AC91, ACS101, ACS101-DIGIT, ACS122, ACS122-DIGIT, ACS151, ACS151-DIGIT, ACS152, ACS152-DIGIT, ACS161-DIGIT, ACS162-DIGIT, ACS181, ACS181-DIGIT, ACS182, ACS182-DIGIT, ACS201, ACS201-DIGIT, ACS202, ACS202-DIGIT, ACS241, ACS241-DIGIT, ACS242, ACS242-DIGIT, ACS91, ACS91-DIGIT, G100L, G101L, G115, G115L, G125L, G50L, G50LM, G51L, G60L, G61L, G65, G65L, G75, G75L, GE100...(Other models you can see in the webshop)		

			
1			
GEV No.	358035	Ref. No.	130230
description	fine fuse size ø10x38mm 4A slow-acting rated 500V type aM Qty 1 pcs		
For models:	AC100, AC101, AC105, AC120, AC122, AC150, AC151, AC152, AC170, AC181, AC182, AC200, AC201, AC202, AC241, AC242, AC90, AC91, AC95, ACR, ACR145, ACR205, ACR225, ACR245, ACR260, ACR265, ACR305, ACS101, ACS101-DIGIT, ACS122, ACS122-DIGIT, ACS151, ACS151-DIGIT, ACS152, ACS152-DIGIT, ACS161-DIGIT, ACS162-DIGIT, ACS181, ACS181-DIGIT, ACS182, ACS182-DIGIT, ACS201, ACS201-DIGIT, ACS202, ACS202-DIGIT, ACS241, ACS241-DIGIT, ACS242, ACS242-DIGIT, ACS91...(Other models you can see in the webshop)		

A		
alarm devices	36	
B		
bi-metal thermostats	10, 10	
booster pumps I	78	
booster pumps II	79	
C		
cables	84	
cap nuts	210	
castors and bumper angles	167	
clamps	204, 214	
coil heating elements	3	
condensators & interference suppression filters	80	
consumables	217	
contactors	36	
container filters	190	
control equipment	25	
control thermostats	11	
cylinder head bolts	209	
D		
digital timers	36	
door seals for dishwashers	180	
dosing pumps	186	
double nipples	201	
double wire clamps	205, 215	
drain hoses	191	
drain pumps	78	
E		
electric accessories	84	
electrodes	60	
electronic controllers	42	
end caps and plugs	167	
F		
fasteners	214	
fastening material	206	
filters	81	
fine fuses	217	
fittings	201	
flat-headed bolts	207	
float switches	21	
foam rubber gaskets	179	
foil heating elements	10	
formed hoses	193	
fuses	81, 217	
G		
gaskets for wash arm support	183	
grub screws		209
H		
heating elements		3
heating elements for pasta cookers		3
hexagonal nuts		210
hexagonal screws		208
hose clamps		204, 214
hose connectors		200, 201
hoses		191
hoses wire reinforced		193
I		
immersion heating elements		3
indicator lights		26
indicator lights (complete)		28
industrial hoses		192
intake lances		190
K		
knurled nuts		210
knurled screws		210
L		
lamps		26
M		
magnetic switches		23
measuring equipment		206
microswitches		17
motors		61
N		
neon light bulbs		27, 30
Niplaflex hoses		192
non-return valves		204
nuts		210
O		
operating capacitors		80
O-rings		169
oval head screws		207
P		
plunger sockets		13
position switches		18
pressure control hoses		192
pressure reduction valves		203, 203
pressure switches		58
probes		43
programme timers		30
pump hoses		190
pumps		61

push/momentary push switches	16
PVC hoses	192
R	
relays	39
retaining rings	216
ribbon cables	84
rocker/momentary rocker switches	14
roll pins	216
rotary switches	21
S	
safety thermostats	11, 12
screw caps	217
screws	206
sealing washers	175
shaft gaskets	179
sheet metal screws	206
side bolts	209
silicone hoses	190, 193
slot nuts	214
snap locks	165
solenoid valves	48
spring rings	212
stainless steel flexi hoses	191
supply filters	204, 204
supply hoses	191
switches and momentary switches	14
system switches (ROLD)	19
T	
tank inlets	190
terminals	84
thermostat gaskets	183
thermostats	10
time relays	41
timers	30
toggle switches	17
touch sensitive light switches	23
transformers	41
U	
universal hoses	191
W	
wash and rinse pumps	61
washers	213
water cycle components	203