



GAS COMPONENTS



ELECTRIC COMPONENTS



WATER TECHNOLOGY



MECHANICAL COMPONENTS



TOOLS

Spare parts suitable for

CONVOTHERM

Find the complete and up-to-date range of products in our GEV Webshop



Manufacturer catalogue

The most important spare parts and accessories arranged clearly for every manufacturer

- ✓ Complete product range and all appliance data always up to date in the GEV Webshop
- ✓ Alphabetical Index at the end of the catalogue

GEV Webshop

www.gev-online.co.uk

www.gev-online.com



- 🔍 Add to Favourites
- 🔍 Sign In with email address and usual password
- 🔍 Easy-order – place several items in your basket at the same time
- 🔍 Quick Item search – no login needed



heating elements

immersion heating elements

3 hole flange ø47.5mm

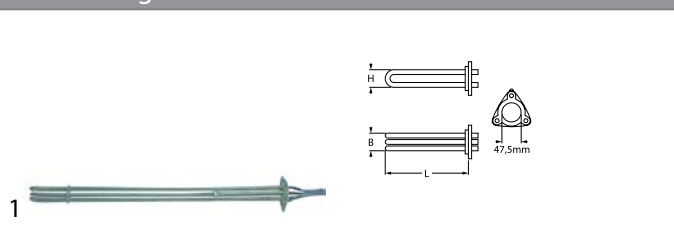

GEV No.	415931	Ref. No.	5007076 5007076K
description	heating element 12000W 220V mounting ø 47.5mm heating circuits 3 L 585mm W 28mm H 28mm number of thermostat sleeves 1 thermostat sleeves ø 6.5mm length thermostat sleeves 170mm thermostat sleeve clinging tube ø 6.3mm hole distance 63mm hole ø 8mm cable length 950mm 3 hole flange immersion heater		
For models:	OD20.20, OS20.20, OSC20.20, OSP20.20		
accessories for	415931		
	GEV No.	510408	Ref. No. 6005015
	O-ring EPDM thickness 5.34mm ID ø 47mm Qty 1 pcs		
	GEV No.	510562	Ref. No. —
	O-ring silicone thickness 5.34mm ID ø 47mm Qty 1 pcs		

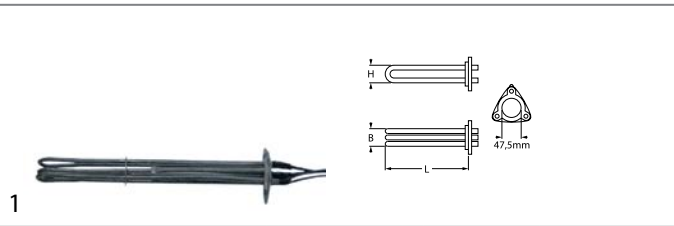

GEV No.	415803	Ref. No.	5007062 5007062K
description	heating element 6000W 230V mounting ø 47.5mm heating circuits 3 L 325mm W 26mm H 38mm number of thermostat sleeves 1 thermostat sleeves ø 6mm length thermostat sleeves 160mm thermostat sleeve clinging tube ø 6.3mm hole distance 62mm hole ø 8mm cable length 790mm connection cable 3 hole flange immersion heater		
For models:	OD10.10, OD10.20, OS10.10, OS10.20, OSC10.10, OSC10.20, OSP10.10, OSP10.20		
spare parts for	415803		
	GEV No.	510408	Ref. No. 6005015
	O-ring EPDM thickness 5.34mm ID ø 47mm Qty 1 pcs		
accessories for	415803		
	GEV No.	510562	Ref. No. —
	O-ring silicone thickness 5.34mm ID ø 47mm Qty 1 pcs		

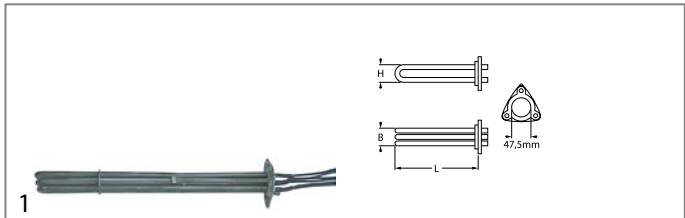

GEV No.	415802	Ref. No.	5007071 5007071K 8007071
description	heating element 9000W 230V mounting ø 47.5mm heating circuits 3 L 385mm W 35mm H 46mm number of thermostat sleeves 1 thermostat sleeves ø 6mm length thermostat sleeves 160mm thermostat sleeve clinging tube ø 8.5mm hole distance 62mm hole ø 8mm cable length 800mm 3 hole flange immersion heater		
For models:	OD10.10, OD10.20, OD12.20, OD20.10, OD20.20, OD6.10, OS10.10, OS10.20, OS12.20, OS20.10, OS6.10, OSC10.10, OSC10.20, OSC12.20, OSC20.10, OSC6.10, OSP10.10, OSP10.20, OSP12.20, OSP20.10, OSP6.10		
accessories for	415802		
	GEV No.	510562	Ref. No. —
	O-ring silicone thickness 5.34mm ID ø 47mm Qty 1 pcs		

miscellaneous



GEV No.	420042	Ref. No.	2619180 5017003
description	heating element 13200W 230V heating circuits 3 L 545mm W 65mm H 33mm number of thermostat sleeves 1 thermostat sleeves ø 8mm length thermostat sleeves 160mm tube ø 8.5mm hole distance 71mm hole ø 7mm cable length 1000mm flange connection immersion heater flange width 57mm flange length 88mm		
For models:	OEB20.20, OES20.20		





GEV No.	417733	Ref. No.	5056321
description	heating element 13300W 230V heating circuits 3 L 275mm W 35mm H 70mm number of thermostat sleeves 2 thermostat sleeves ø 3.5/8mm length thermostat sleeves 120/140mm thermostat sleeve eccentric, clinging tube ø 8.5mm hole distance 67mm hole ø 8mm combi-steamer flange width 82mm flange length 82mm with gasket and nut		







GEV No.	420043	Ref. No.	2619178 5017001
description	heating element 6600W 230V heating circuits 3 L 275mm W 65mm H 37mm number of thermostat sleeves 1 thermostat sleeves ø 7.8mm length thermostat sleeves 150mm tube ø 8.5mm hole distance 71mm hole ø 7mm cable length 1050mm flange connection immersion heater flange width 57mm flange length 88mm		
For models:	OEB10.10, OEB10.20, OEB6.20, OES10.10, OES10.20, OES6.20		
accessories for	420043		



	GEV No.	550992	Ref. No. 6015023
	gasket L 87mm W 57mm hole ø 6mm hole distance 70/40mm 4 holes thickness 3mm suitable for CONVOTHERM		







1 electric components







			
GEV No.	417601	Ref. No.	2619187 5017012
description	heating element 6600W 230V heating circuits 3 L 275mm W 70mm H 25mm hole distance 40x70mm hole ø 6.5mm cable length 1050mm tube ø 8.5mm flange length 87mm flange width 56mm thermostat sleeves ø 6mm number of thermostat sleeves 1 length thermostat sleeves 170mm		
For models:	OEB10.10, OEB10.20, OEB6.20, OES10.10, OES10.20, OES6.20		
accessories for	417601		
	GEV No.	550992	Ref. No. 6015023
	gasket L 87mm W 57mm hole ø 6mm hole distance 70/40mm 4 holes thickness 3mm suitable for CONVOTHERM		

			
GEV No.	417734	Ref. No.	5056320
description	heating element 9000W 230V heating circuits 3 L 210mm W 40mm H 70mm number of thermostat sleeves 2 thermostat sleeves ø 3.5/8mm length thermostat sleeves 119/139mm thermostat sleeve eccentric, clinging tube ø 8.5mm hole distance 67mm hole ø 8mm flange combi-steamer flange width 82mm flange length 82mm		
For models:	OEB10.10, OEB10.20, OEB12.20, OEB20.10, OEB20.20, OEB6.10, OEB6.20, OES10.10, OES10.20, OES12.20, OES20.10, OES6.10, OES6.20		
accessories for	417719		
	GEV No.	550992	Ref. No. 6015023
	gasket L 87mm W 57mm hole ø 6mm hole distance 70/40mm 4 holes thickness 3mm suitable for CONVOTHERM		

			
GEV No.	417719	Ref. No.	2619188 5017013
description	heating element 9900W 230V heating circuits 3 L 415mm W 52mm H 37mm number of thermostat sleeves 1 thermostat sleeves ø 7.5mm length thermostat sleeves 160mm thermostat sleeve eccentric, clinging tube ø 8.5mm hole distance 71mm hole ø 7mm 4 hole flange immersion heater flange width 57mm flange length 88mm		
For models:	OEB10.10, OEB10.20, OEB12.20, OEB20.10, OEB20.20, OEB6.10, OEB6.20, OES10.10, OES10.20, OES12.20, OES20.10, OES6.10, OES6.20		
accessories for	417719		
	GEV No.	550992	Ref. No. 6015023
	gasket L 87mm W 57mm hole ø 6mm hole distance 70/40mm 4 holes thickness 3mm suitable for CONVOTHERM		

			
GEV No.	418685	Ref. No.	2619179 5017002
description	heating element 9900W 230V heating circuits 3 L 415mm W 65mm H 37mm number of thermostat sleeves 1 thermostat sleeves ø 6.5mm length thermostat sleeves 160mm tube ø 8.5mm hole distance 72mm hole ø 7mm flange width 58mm flange length 88mm		
For models:	OEB10.10, OEB10.20, OEB12.20, OEB20.10, OEB6.10, OEB6.20, OES10.10, OES10.20, OES12.20, OES20.10, OES6.10, OES6.20		
accessories for	418685		
	GEV No.	550992	Ref. No. 6015023
	gasket L 87mm W 57mm hole ø 6mm hole distance 70/40mm 4 holes thickness 3mm suitable for CONVOTHERM		



1½"			
			
GEV No.	415874	Ref. No.	5007067 5007068 5007068K
description	heating element 12000/14300W 220/240V heating circuits 3 thread 1½" L 585mm W 40mm H 30mm thermostat sleeves ø 6.5mm length thermostat sleeves 160mm thermostat sleeve eccentric, clinging tube ø 6.3mm cable length 750mm connection cable immersion heater flange with thread hole distance 63mm mounting ø 47.5mm hole ø 8/10mm number of thermostat sleeves 1		
For models:	HUD20.20		
spare parts for	415874		
	GEV No.	510406	Ref. No. 6005065
	flat gasket fibre ED ø 60mm ID ø 48mm thickness 3mm for thread 1½" Qty 1 pcs		
accessories for	415874		
	GEV No.	510424	Ref. No. —
	gasket copper ED ø 55mm ID ø 48mm thickness 2.2mm Centellen for thread 1½"		
	GEV No.	520211	Ref. No. —
	reducer thread 2" ET - 1½" IT brass		
	GEV No.	520212	Ref. No. —
	hexagonal nut thread 1½" brass WS 60 H 8mm		
	GEV No.	550361	Ref. No. —
	blind flange ø 58mm thread 1½"		

			
GEV No.	415500	Ref. No.	5007061 5007061K 5007063 5007063K
description	heating element 7500W 220V heating circuits 3 thread 1½" L 435mm W 33mm H 25mm tube ø 6.3mm cable length 780mm immersion heater flange with thread		
For models:	HUD10.10		
accessories for	415500		
	GEV No.	510406	Ref. No. 6005065
	flat gasket fibre ED ø 60mm ID ø 48mm thickness 3mm for thread 1½" Qty 1 pcs		
	GEV No.	510424	Ref. No. —
	gasket copper ED ø 55mm ID ø 48mm thickness 2.2mm Centellen for thread 1½"		
	GEV No.	520211	Ref. No. —
	reducer thread 2" ET - 1½" IT brass		
	GEV No.	520212	Ref. No. —
	hexagonal nut thread 1½" brass WS 60 H 8mm		
	GEV No.	550361	Ref. No. —
	blind flange ø 58mm thread 1½"		





			
1			
GEV No.	415501	Ref. No.	5007066 5007066K
description	heating element 9000W 230V heating circuits 3 thread 1½" L 430mm W 32mm H 26mm tube ø 6.3mm cable length 820mm connection cable immersion heater flange with thread		
For models:	HUD10.10, HUD12.20, HUD20.10, HUD6.10, OD10.10, OD10.20, OD12.20, OD20.10, OD20.20, OD6.10		
accessories for	415501		
	GEV No.	510406	Ref. No. 6005065
	flat gasket fibre ED ø 60mm ID ø 48mm thickness 3mm for thread 1½" Qty 1 pcs		
	GEV No.	510424	Ref. No. —
	gasket copper ED ø 55mm ID ø 48mm thickness 2.2mm Centellen for thread 1½"		
	GEV No.	520211	Ref. No. —
	reducer thread 2" ET - 1½" IT brass		
	GEV No.	520212	Ref. No. —
	hexagonal nut thread 1½" brass WS 60 H 8mm		
	GEV No.	550361	Ref. No. —
	blind flange ø 58mm thread 1½"		

heating elements for convection

			
1			
GEV No.	420524	Ref. No.	2625104K 2630606
description	heating element 10200W 230V heating circuits 3 ID ø 250mm ED ø 320mm L 350mm H 58mm L1 70mm H1 8mm H2 58mm flange length 90mm flange width 70mm tube ø 8.5mm threaded		
accessories for	420524		
	GEV No.	521013	Ref. No. 2623226 6015025
	gasket set suitable for CONVOTHERM for heating element L 90mm W 71mm Qty 1m graphite hole distance 54/74mm		

			
1			
GEV No.	420558	Ref. No.	5056330
description	heating element 10500W 230V heating circuits 3 ID ø 400mm ED ø 417mm L 472mm H 100mm H1 15mm H2 83mm flange length 90mm flange width 70mm hole distance 55mm connection M5 tube ø 8.5mm cable length 180mm convection heating element flange for combi-steamer series CONVOTHERM 4		

			
1			
GEV No.	418684	Ref. No.	2619192 5017005
description	heating element 10500W 230V heating circuits 3 ID ø 402mm ED ø 420mm L 475mm H 100mm L1 55mm W1 29mm H1 25mm H2 75mm flange length 90mm flange width 70mm hole distance 74mm connection M5 tube ø 8.5mm convection heating element mounting thread M5 rectangular flange with bolt		
For models:	OEB6.10, OES6.10		

			
1			
GEV No.	417718	Ref. No.	5007035 5007035K 5030625
description	heating element 12000W 220V heating circuits 3 ID ø 387mm ED ø 400mm L 430mm H 90mm H1 23mm H2 67mm thread M14 3 hole fixing connection male faston tube ø 6.5mm mounting pos. outer for combi-steamer		
For models:	AR100, AR108, AR28, AR30, AR40, AR50, AR54, HUD10.10, HUD20.10, OD6.10, OSC6.10, OSP10.10, OSP6.10, UG6.10		







			
1			
GEV No.	415385	Ref. No.	5007036 5007036K
description	heating element 15000W 220V heating circuits 3 ID ø 390mm ED ø 405mm L 435mm H 110mm L1 22mm W1 300mm H1 22mm H2 84mm thread M14x1.5 6 hole fixing connection M5 tube ø 8.5mm convection heating element		
For models:	OD10.10, OD20.10, OS10.10, OS20.10, OSC10.10, OSC20.10, OSP10.10, OSP20.10		
accessories for	415385		
	GEV No.	361182	Ref. No. —
	nut thread 1/4" H 5mm nickel-plated brass WS 17 Qty 1 pcs		
	GEV No.	510417	Ref. No. —
	flat gasket fibre ED ø 20mm ID ø 14mm thickness 2mm Qty 1 pcs		
	GEV No.	520228	Ref. No. —
	tooth lock washer ID ø 15.3mm ED ø 24mm steel Qty 1 pcs for thread M14		

Table continues overleaf

accessories for	415385		
	GEV No.	550262	Ref. No. —
	flat gasket copper ED ø 20mm ID ø 14mm thickness 2mm		

	1
---	---

GEV No.	418886	Ref. No.	5007038 5007038K 5007042K
description	heating element 18000W 380V heating circuits 3 ID ø 380mm ED ø 393mm L 435mm H 120mm L1 50mm H1 15mm thread M14x1.5 screw mounting tube ø 6.5mm convection heating element		
For models:	AR72, HUD10.10, HUD20.10, UG10.10, UG20.10		

	1
--	---

GEV No.	418768	Ref. No.	2619181 5017004
description	heating element 18900W 230V heating circuits 3 ID ø 467mm ED ø 484mm L 545mm H 99mm L1 6mm W1 28mm H1 14mm H2 85mm flange length 90mm flange width 70mm connection M4 connection length 112mm tube ø 8.5mm convection heating element with counterflange and cable		
For models:	OEB10.10, OEB20.10, OEB6.20, OES10.10, OES20.10, OES6.20		

	1
---	---

GEV No.	418876	Ref. No.	2619190 5017016
description	heating element 18900W 230V heating circuits 3 ID ø 470mm ED ø 486mm L 540mm H 100mm L1 48mm H1 27mm H2 73mm flange length 90mm flange width 70mm hole distance 55mm connection M5 connection length 115mm tube ø 8.5mm convection heating element		
For models:	OEB10.10, OEB20.10, OEB6.20, OES10.10, OES20.10, OES6.20		

	1
--	---

GEV No.	420557	Ref. No.	5056331
description	heating element 18900W 230V heating circuits 3 ID ø 470mm ED ø 487mm L 540mm H 100mm H1 16mm H2 83mm flange length 90mm flange width 70mm hole distance 55mm connection M5 tube ø 8.5mm cable length 1300mm convection heating element flange connection for combi-steamer series CONVOTHERM 4		

	1
--	---

GEV No.	415386	Ref. No.	5007043 5007043K
description	heating element 24000W 220V thread M14x1.5 12 hole fixing		
For models:	OD10.20, OS10.20, OSC10.20, OSP10.20		

accessories for	415386		
	GEV No.	416027	Ref. No. —
	heating element 12000W 230V heating circuits 3 ID ø 438mm ED ø 450mm L 480mm H 100mm L1 30mm W1 330mm H1 35mm H2 65mm thread M14x1.5 6 hole fixing connection M5 tube ø 6.5mm mounting pos. inner convection heating element		

	GEV No.	416028	Ref. No. —
	heating element 12000W 220V heating circuits 3 ID ø 558mm ED ø 572mm L 610mm H 85mm L1 38mm H1 20mm H2 65mm thread M14x1.5 6 hole fixing connection M5 tube ø 8.5mm mounting pos. outer convection heating element		

accessories for	415386		
	GEV No.	510417	Ref. No. —
	flat gasket fibre ED ø 20mm ID ø 14mm thickness 2mm Qty 1 pcs		

	GEV No.	520228	Ref. No. —
	tooth lock washer ID ø 15.3mm ED ø 24mm steel Qty 1 pcs for thread M14		

	GEV No.	520230	Ref. No. —
	nut thread M14x1.5 H 5mm WS 19 zinc-coated steel Qty 1 pcs		

	GEV No.	521101	Ref. No. —
	nut thread M14x1.5 H 5mm WS 19 SS Qty 1 pcs		

	GEV No.	550262	Ref. No. —
	flat gasket copper ED ø 20mm ID ø 14mm thickness 2mm		

1

GEV No.	420559	Ref. No.	5056332
description	heating element 2x16500W 230V heating circuits 2 ID ø 485mm ED ø 570mm L 590mm H 134mm H1 22mm H2 108mm flange length 175mm flange width 105mm hole distance 80mm connection length M5mm tube ø 8.5mm cable length 1500mm convection heating element flange for combi-steamer series CONVOTHERM		





1

GEV No.	419233	Ref. No.	2618805
description	heating element 5400W 230V heating circuits 2 ID ø 252mm ED ø 269mm L 297mm H 62mm L1 11mm W1 65mm H1 12mm H2 50mm flange length 100mm flange width 22mm hole distance 87mm connection 6.3x0.8 tube ø 8.5mm for combi-steamer mounting thread M5 with mounting accessories OES6.06 Mini P3		
For models:	OES6.06		





1

GEV No.	415129	Ref. No.	5007044 5007044K
description	heating element 30000W		
For models:	HUD12.20, HUD20.20, OD12.20, OD20.10, OD20.20, OS12.20, OS20.20, OSC12.20, OSC20.20, OSP12.20, OSP20.20		
spare parts for	415129		
	GEV No.	Ref. No.	—
	415899		
	GEV No.	Ref. No.	—
	415906		
description	heating element 15000W 220V heating circuits 3 ID ø 437mm ED ø 454mm L 475mm H 98mm L1 18mm W1 305mm H1 19mm H2 79mm thread M14x1.5 6 hole fixing connection M5 tube ø 8.5mm mounting pos. inner convection heating element		
description	heating element 15000W 220V heating circuits 3 ID ø 558mm ED ø 575mm L 605mm H 100mm L1 30mm W1 300mm H1 25mm H2 80mm thread M14x1.5 6 hole fixing connection M5 tube ø 8.5mm mounting pos. outer convection heating element		



1

GEV No.	420156	Ref. No.	2123634 2625181 5017084
description	heating element 6800W 230V heating circuits 2 ID ø 250mm ED ø 265mm L 300mm H 65mm L1 38mm H1 7mm H2 56mm flange length 90mm flange width 70mm connection male faston 6.3mm connection length 77mm tube ø 8.5mm convection heating element flange connection		
accessories for	420156		
	GEV No.	Ref. No.	2623226 6015025
	521013		
description	gasket set suitable for CONVOTHERM for heating element L 90mm W 71mm Qty 1m graphite hole distance 54/74mm		



1

GEV No.	419102	Ref. No.	2619177 5017000
description	heating element 33000W 230/400V heating circuits 6 ID ø 480mm ED ø 570mm L 590mm H 140mm flange length 175mm flange width 105mm		
For models:	OEB10.20, OEB12.20, OEB20.20, OES10.20, OES12.20, OES20.20		



1





GEV No.	415384	Ref. No.	5007033 5007033K
description	heating element 9000W 230V heating circuits 3 ID ø 390mm ED ø 403mm L 440mm H 88mm L1 30mm W1 300mm H1 18mm H2 70mm thread M14x1.5 6 hole fixing connection M5 convection heating element		
For models:	AR28, AR40, OD10.10, OD10.20, OD6.10, OS6.10, OSC6.10, OSP6.10		
spare parts for	415384		
	GEV No.	Ref. No.	—
	510417		
description	flat gasket fibre ED ø 20mm ID ø 14mm thickness 2mm Qty 1 pcs		
accessories for	415384		
	GEV No.	Ref. No.	—
	520228		
description	tooth lock washer ID ø 15.3mm ED ø 24mm steel Qty 1 pcs for thread M14		
	GEV No.	Ref. No.	—
	520230		
description	nut thread M14x1.5 H 5mm WS 19 zinc-coated steel Qty 1 pcs		

Table continues overleaf



accessories for	415384			
	GEV No.	521101	Ref. No.	—
	nut thread M14x1.5 H 5mm WS 19 SS Qty 1 pcs			
	GEV No.	550262	Ref. No.	—
	flat gasket copper ED ø 20mm ID ø 14mm thickness 2mm			



GEV No.	420075	Ref. No.	5007022
description	mounting set suitable for convection heating element		
For models:	AR100, AR108, AR28, AR30, AR40, AR50, AR54, AR72, HUD10.10, HUD20.10, HUD6.10, OD10.10, OD20.10, OD6.10, OS10.10, OS6.10, OSC10.10, OSC6.10, OSP10.10, OSP6.10, UG10.10, UG20.10, UG6.10		

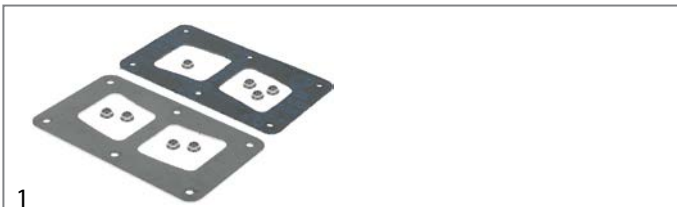

GEV No.	692737	Ref. No.	2623227 6015024
description	mounting set suitable for for combi-steamer L 175mm W 105mm mounting pos. CONVOTHERM		
For models:	OEB10.20, OEB12.20, OEB20.20, OES10.20, OES12.20, OES20.20		

thermostats

bi-metal thermostats

bi-metal thermostats



GEV No.	391049	Ref. No.	5056372
description	bi-metal thermostat hole distance 24mm switch-off temp. 80°C 1NC 1-pole 10A 250V connection F6.3x0.8 suitable for CONVOTHERM		

control and safety thermostats

EGO

control thermostats

55.10/19_ series



GEV No.	375631	Ref. No.	5001032
description	thermostat t.max. 249°C temperature range 55-249°C 1-pole 1NO 16A probe ø 3.1mm probe L 226mm capillary pipe 1270mm capillary pipe isolated 850mm gland nut 3/8"-M8x1 shaft ø ø6x4.6mm shaft L 23mm shaft position upper rotation 318°		
For models:	OD10.20, OD12.20		



GEV No.	375632	Ref. No.	5001020
description	thermostat t.max. 90°C temperature range 30-90°C 1-pole 1CO 16A probe ø 6mm probe L 130mm capillary pipe 1300mm capillary pipe isolated 850mm gland nut M10x1 shaft ø ø6x4.6mm shaft L 23mm shaft position upper rotation 270°		
For models:	OD10.20, OD12.20		

55.13_ series

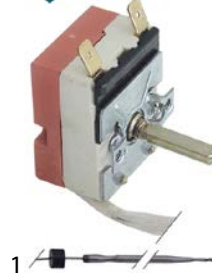

GEV No.	375116	Ref. No.	5001021 5001021K 5001040
description	thermostat t.max. 258°C temperature range 58-258°C 1-pole 1NC 16A probe ø 3.1mm probe L 201mm capillary pipe 1130mm capillary pipe isolatedmm gland nut shaft ø ø6x4.6mm shaft L 23mm shaft position upper rotation 270°		
For models:	AR100, AR108, AR12, AR16, AR18, AR28, AR30, AR40, AR50, AR54, AR72, AR8, HUD10.10, HUD12.20, HUD20.10, HUD20.20, HUD6.10, UG10.10, UG10.20, UG20.10, UG20.20, UG4.05, UG6.05, UG6.10		



safety thermostats

55.13_series



GEV No.	375245	Ref. No.	5019002 5019004
description	safety thermostat switch-off temp. 135°C 1-pole 16A probe ø 6mm probe L 77mm capillary pipe 480mm capillary pipe isolatedmm gland nut probe SS		
For models:	OGB10.10, OGB10.20, OGB12.20, OGB20.10, OGB20.20, OGB6.10, OGB6.20, OGS10.10, OGS10.20, OGS12.20, OGS20.10, OGS20.20, OGS6.10, OGS6.20		



GEV No.	375731	Ref. No.	5001026 5001026+6005081 5001026K
description	safety thermostat switch-off temp. 135°C 1-pole 16A probe ø 6mm probe L 77mm capillary pipe 520mm capillary pipe isolatedmm gland nut probe SS		
For models:	OD10.10, OD10.20, OD12.20, OD20.10, OD20.20, OD6.10		



GEV No.	375117	Ref. No.	5001030 5001030K 51021
description	safety thermostat switch-off temp. 325°C 1-pole 16A probe ø 4mm probe L 91mm capillary pipe 390mm capillary pipe isolatedmm gland nut probe SS		
For models:	OD10.10, OD10.20, OD6.10		



GEV No.	390126	Ref. No.	5001029 5001029K
description	safety thermostat switch-off temp. 340°C 1-pole 1NC 16A probe ø 3.1mm probe L 201mm capillary pipe 1170mm capillary pipe isolatedmm gland nut probe SS		
For models:	AR108, AR72, OD10.10, OD10.20, OD12.20, OD20.10, OD20.20, OD6.10, OS10.10, OS10.20, OS12.20, OS20.10, OS20.20, OS6.10, OSC10.10, OSC10.20, OSC12.20, OSC20.10, OSC20.20, OSC6.10, OSP10.10, OSP10.20, OSP12.20, OSP20.10, OSP20.20, OSP6.10		

55.32_series



GEV No.	375392	Ref. No.	5001039
description	safety thermostat switch-off temp. 360°C 3-pole 1CO/2NC 20A probe ø 4mm probe L 120mm capillary pipe 1490mm capillary pipe isolated 1450mm gland nut probe SS		
For models:	AR12, AR18, AR28, AR40, AR54, AR8, OES6.06		



GEV No.	375017	Ref. No.	2618787
description	safety thermostat switch-off temp. 360°C 3-pole 20A probe ø 4mm probe L 122mm capillary pipe 1490mm capillary pipe isolatedmm probe		
For models:	OES6.06		

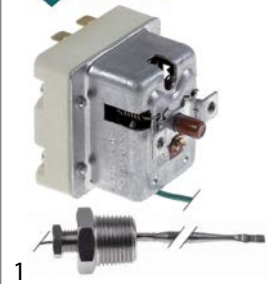

GEV No.	375474	Ref. No.	5001031
description	safety thermostat t.max. 340°C switch-off temp. 340°C 2-pole 1NC/1CO 1x20/1x0.5A probe ø 4mm probe L 120mm capillary pipe 1300mm capillary pipe isolated 900mm gland nut probe		
For models:	OD10.10, OD10.20, OD12.20, OD20.20, OD6.10, OSG10.10, OSG12.20, OSG20.20		



GEV No.	376061	Ref. No.	5056329
description	safety thermostat switch-off temp. 340°C 1-pole 16A probe ø 3mm probe L 160mm capillary pipe 1200mm capillary pipe isolated 1140mm		

56._ series



GEV No.	381480	Ref. No.	5056319
description	safety thermostat switch-off temp. 170°C temperature range 14-170°C 1-pole 16A probe ø 6mm probe L 65mm capillary pipe 1460mm capillary pipe isolated 1400mm probe material SS 230V		

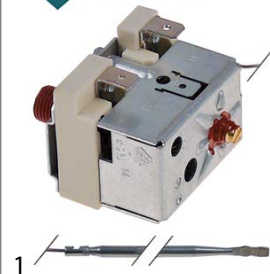

GEV No.	375870	Ref. No.	5001041
description	safety thermostat switch-off temp. 340°C 1-pole 16A probe ø 3mm probe L 160mm capillary pipe 1150mm capillary pipe isolated 1080mm gland nut probe		
For models:	OEB10.10, OEB10.20, OEB12.20, OEB20.10, OEB20.20, OEB6.10, OEB6.20, OES10.10, OES10.20, OES12.20, OES20.10, OES20.20, OES6.10, OES6.20, OGB10.10, OGB10.20, OGB12.20, OGB20.10, OGB20.20, OGB6.10, OGB6.20, OGS10.10, OGS10.20, OGS12.20, OGS20.10, OGS20.20, OGS6.10, OGS6.20, OSC10.10, OSC10.20, OSC12.20, OSC20.10, OSC20.20, OSC6.10, OSG10.10, OSG12.20, OSG20.20, OSG6.10		

accessories

fitting parts



GEV No.	550389	Ref. No.	4006041
description	bracket for contact thermostat		
For models:	HUD12.20, HUD20.20		



GEV No.	550388	Ref. No.	4006031
description	bracket for contact thermostat mounting distance 24.5mm mounting ø 3.8		
For models:	HUD10.10, HUD20.10, HUD20.20, OD10.20, OD12.20		

gland nut accessories

ducts



GEV No.	550148	Ref. No.	6005080
description	gland duct ET M12x0.75 IT M9x1 probe ø max. 6.5mm WS 17 silicone		
For models:	HUD10.10, HUD12.20, HUD20.10, HUD20.20, HUD6.10, OD10.10, OD10.20, OD12.20, OD20.10, OD20.20, OD6.10, OS12.20, OS20.10, OS20.20, OSC12.20, OSC20.10, OSC20.20, OSP12.20, OSP20.10, OSP20.20		

gaskets



GEV No.	699830	Ref. No.	6015026
description	gasket silicone ø 10mm L 8mm		
For models:	OEB10.10, OEB10.20, OEB12.20, OEB20.10, OEB20.20, OEB6.10, OEB6.20, OES10.10, OES10.20, OES12.20, OES20.10, OES20.20, OES6.10, OES6.20, OGB10.10, OGB10.20, OGB12.20, OGB20.10, OGB20.20, OGB6.10, OGB6.20, OGS10.10, OGS10.20, OGS12.20, OGS20.10, OGS20.20, OGS6.10, OGS6.20		



switches and momentary switches

cam switches

on/off



GEV No.	301282	Ref. No.	5003022
description	cam switch sequence 0-1 shaft \varnothing 6x4.6mm shaft L 19.5mm 4-pole rotation 45°		
For models:	OD10.10, OD10.20, OD12.20, OD20.10, OD20.20, OD6.10		

5 operating positions



GEV No.	301277	Ref. No.	5003023
description	cam switch 5 operating positions 7NO sequence 0-1-2-3-4 16A shaft \varnothing 6x4.6mm shaft L 19mm connection male faston 6.3mm plastic		
For models:	OD10.10, OD10.20, OD12.20, OD20.10, OD20.20, OD6.10		

magnetic switches

28.5x19mm



GEV No.	348210	Ref. No.	5056328
description	magnetic switch L 28.5mm W 19mm cable length 450mm PIC MS-328/980A 5214 suitable for CONVOTHERM		

29x19mm

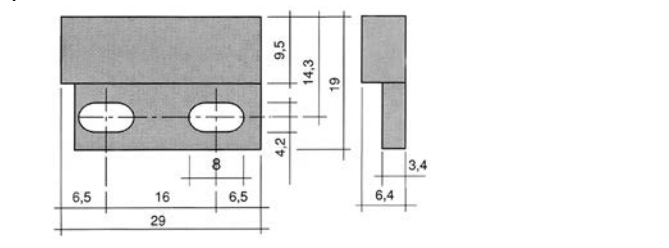

GEV No.	345117	Ref. No.	5003075 5013070
description	magnetic switch L 28.5mm W 19mm 1NO 250V 0.04A P max. 10W connection cable cable length 1000mm		
For models:	OD10.10, OD10.20, OD12.20, OD20.10, OD20.20, OD6.10, OEB10.10, OEB10.20, OEB12.20, OEB20.10, OEB20.20, OEB6.10, OEB6.20, OES10.10, OES10.20, OES12.20, OES20.10, OES20.20, OES6.06, OES6.10, OES6.20, OGB10.10, OGB10.20, OGB12.20, OGB20.10, OGB20.20, OGB6.10, OGB6.20, OGS10.10, OGS10.20, OGS12.20, OGS20.10, OGS20.20, OGS6.10, OGS6.20, OS10.10, OS10.20, OS12.20, OS20.10, OS20.20, OS6.10, OSC10.10, OSC10.20, OSC12.20, OSC20.10, OSC20.20, OSC6.10, OSP10.10, OSP10.20, OSP12.20...(Other models you can see in the webshop)		

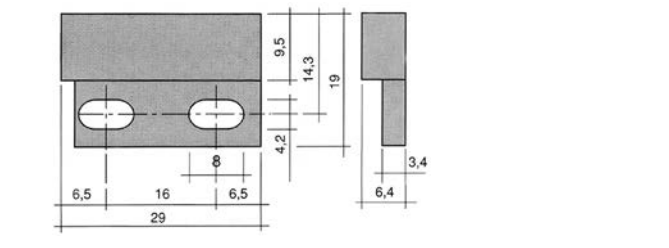

GEV No.	345217	Ref. No.	5003082
description	magnetic switch L 29mm W 19mm 1NO 125V 0.5A P max. 10W connection cable cable length 2000mm		

electric components

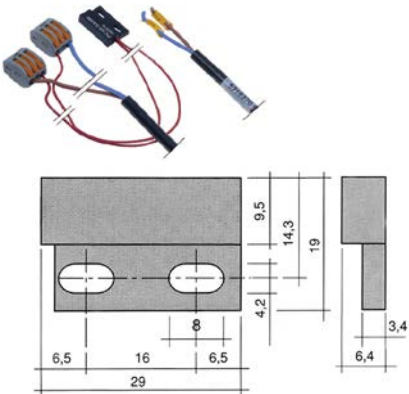
1

GEV No.	347495	Ref. No.	2518798
description	magnetic switch L 29mm W 19mm 1NO 250V 0.3A P max. 10W connection cable cable length 2000mm PIC		
For models:	OES6.06		

M10x0.75

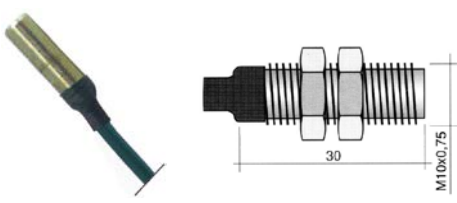

1

GEV No.	345632	Ref. No.	5003079	
description	magnetic switch thread M10x0.75 1NO 250V 0.5A P max. 50W connection cable cable length 2000mm type 102			
For models:	OD10.20, OD12.20, OD20.20, OSG10.10, OSG12.20, OSG20.20, OSG6.10			
accessories for	345632			
	GEV No.	100779	Ref. No.	—
	nut thread M10x0.75 H 3mm WS 14 SS Qty 2 pcs			

accessories

magnets

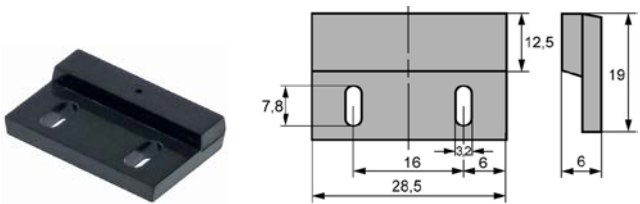

1

GEV No.	345700	Ref. No.	5003076
description	magnet ømm L 29mm H 6.5mm W 19mm hole distance 16mm M3 hole ø 3.5mm		
For models:	OD10.10, OD10.20, OD12.20, OD20.10, OD20.20, OD6.10, OSP6.10		

control equipment

RAFI

Lumotast series

fascias

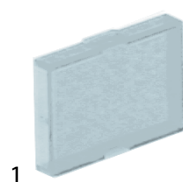

GEV No.	345140	Ref. No.	5003054
description	bezel clear		
For models:	HUD10.10, HUD12.20, HUD20.10, HUD20.20, HUD6.10		

momentary push switches



GEV No.	345139	Ref. No.	5003053
description	momentary push switch mounting measurements ø16mm 230V 1NC/1NO		
For models:	HUD10.10, HUD12.20, HUD20.10, HUD20.20, HUD6.10		

accessories for	345139			
	GEV No.	345140	Ref. No.	5003054
	bezel clear			
	GEV No.	346719	Ref. No.	—
	bezel yellow			
	GEV No.	346720	Ref. No.	—
	bezel rectangular green			
	GEV No.	346721	Ref. No.	—
	bezel rectangular red			
	GEV No.	359590	Ref. No.	—
	light bulb socket T5.5K 24V 3W ø 5.5mm L 22mm clear			
	GEV No.	359591	Ref. No.	—
	light bulb socket T5.5K 48V 3W ø 5.5mm L 22mm clear			
	GEV No.	359592	Ref. No.	—
	light bulb socket T5.5K 12V 3W ø 5.5mm L 22mm clear			
	GEV No.	359593	Ref. No.	—
	light bulb socket T5.5K 60V 0.02A			



TELEMECANIQUE (EFA)

XB4 series

rotary switches



1

GEV No.	347383	Ref. No.	5003031 5003031K 5003035
description	switch mounting measurements ø22mm 2NO 0-1 latching		
For models:	HUD10.10, HUD12.20, HUD20.10, HUD20.20, HUD6.10		

encoders and potentiometers



1

GEV No.	300268	Ref. No.	5056359
description	encoder rotation 360° 0.01A shaft ø 6x5.5mm shaft L 17mm connection for ribbon cable for combi-steamer thread M10x0.75 5V CONVOTHERM 4 0.1Ohm CESI 32/LS EBE		



1

GEV No.	300098	Ref. No.	5009095
description	potentiometer		
For models:	OD10.10, OD10.20, OD12.20, OD20.10, OD20.20, OD6.10		

lamps

indicator lights

indicator lights 3-piece (housing, lens and bulb)

lamps

light bulbs



1

GEV No.	359055	Ref. No.	5003046
description	light bulb socket T1 1/2 12VW 0.08A ø 4.9mm L 13mm		
For models:	OD10.10, OD10.20, OD12.20, OD20.10, OD20.20, OD6.10		

indicator lights (complete)

ø16mm

with plug-in socket



1

GEV No.	362003	Ref. No.	5004026
description	indicator light ø 16mm yellow connection F6.3 temp.-resist. 120°C		
For models:	AR100, AR108, AR12, AR16, AR18, AR28, AR30, AR40, AR50, AR54, AR72, AR8, UG10.10, UG10.20, UG20.10, UG20.20, UG4.05, UG6.05, UG6.10		

screw-on/push-on fit

light bulbs

for ovens



1

GEV No.	359458	Ref. No.	2618779
description	light bulb socket E14 15W 230V with gasket		
For models:	OEB10.10, OEB10.20, OEB12.20, OEB20.10, OEB20.20, OEB6.10, OEB6.20, OES10.10, OES10.20, OES12.20, OES20.10, OES20.20, OES6.06, OES6.10, OES6.20, OGB10.10, OGB10.20, OGB12.20, OGB20.10, OGB20.20, OGB6.10, OGB6.20, OGS10.10, OGS10.20, OGS12.20, OGS20.10, OGS20.20, OGS6.10, OGS6.20		



1

GEV No.	359610	Ref. No.	5005040 5005040K
description	light bulb t.max. 300°C socket E14 15W 230V ø 22mm L 47mm lens L 20mm for oven lamp type Philips		
For models:	HUD10.10, HUD12.20, HUD20.10, HUD20.20, HUD6.10, OD10.10, OD10.20, OD12.20, OD20.10, OD20.20, OD6.10, UG10.10, UG10.20, UG20.10, UG20.20, UG4.05, UG6.05, UG6.10		



1

GEV No.	359612	Ref. No.	5005045
description	light bulb t.max. 300°C socket E14 25W 230V ø 25mm L 56mm lens L 30mm for oven lamp type Philips		

for indicator lights



1

GEV No.	359055	Ref. No.	5003046
description	light bulb socket T1 1/2 12VW 0.08A ø 4.9mm L 13mm		
For models:	OD10.10, OD10.20, OD12.20, OD20.10, OD20.20, OD6.10		



oven lamps

universal oven lamps

mounting diameter 35.5mm



GEV No.	359720	Ref. No.	5005012
description	oven lamp mounting ø 35.5mm 230V 15W socket E14 temp.-resist. 300°C connection male faston 6.3mm hard glas		
For models:	HUD10.10, HUD12.20, HUD20.10, HUD20.20, HUD6.10, OD10.10, OD10.20, OD12.20, OD20.10, OD20.20, OD6.10, UG10.10, UG10.20, UG20.10, UG20.20, UG4.05, UG6.05, UG6.10		
spare parts for	359720		
	GEV No.	359701	Ref. No. 5005016
	lamp socket socket E14 220-230V mounting ø 35.5mm connection male faston 6.3mm 15W		
	GEV No.	359705	Ref. No. 5005017 5005017K 5030620
	oven lamp glass thr.ø 33.5mm ø 52mm hard glas temp.-resist. 350°C		
	GEV No.	359721	Ref. No. 5005025
	gasket silicone ED ø 48mm ID ø 39.5mm thickness 5mm Qty 1 pcs		
	GEV No.	359740	Ref. No. —
	light bulb t.max. 300°C socket E14 15W 230V ø 22mm L 48mm lens L 20mm for oven lamp IMPORT		



GEV No.	359701	Ref. No.	5005016
description	lamp socket socket E14 220-230V mounting ø 35.5mm connection male faston 6.3mm 15W		
For models:	OD10.10, OD10.20, OD12.20, OD20.10, OD20.20, OD6.10, OS10.10, OS10.20, OS12.20, OS20.10, OS20.20, OS6.10, OSC10.10, OSC10.20, OSC12.20, OSC20.10, OSC20.20, OSC6.10, OSG10.10, OSG12.20, OSG20.20, OSG6.10, OSP10.10, OSP10.20, OSP12.20, OSP20.10, OSP20.20, OSP6.10		
accessories for	359701		
	GEV No.	359705	Ref. No. 5005017 5005017K 5030620
	oven lamp glass thr.ø 33.5mm ø 52mm hard glas temp.-resist. 350°C		
	GEV No.	359709	Ref. No. —
	oven lamp glass thr.ø 33.5mm ø 42mm hard glas temp.-resist. 350°C		
	GEV No.	359721	Ref. No. 5005025
	gasket silicone ED ø 48mm ID ø 39.5mm thickness 5mm Qty 1 pcs		
	GEV No.	359942	Ref. No. —
	oven lamp glass thr.ø 33.5mm ø 41mm hard glas temp.-resist. 350°C		



GEV No.	359705	Ref. No.	5005017 5005017K 5030620
description	oven lamp glass thr.ø 33.5mm ø 52mm hard glas temp.-resist. 350°C		
For models:	HUD10.10, HUD12.20, HUD20.10, HUD20.20, HUD6.10, OD10.10, OD10.20, OD12.20, OD20.10, OD20.20, OD6.10, UG10.10, UG10.20, UG20.10, UG20.20, UG4.05, UG6.05, UG6.10		
accessories for	359705		
	GEV No.	359610	Ref. No. 5005040 5005040K
	light bulb t.max. 300°C socket E14 15W 230V ø 22mm L 47mm lens L 20mm for oven lamp type Philips		
	GEV No.	359700	Ref. No. —
	gasket for pizza oven fibre glass ID ø 32.5mm ED ø 55mm thickness 5mm		
	GEV No.	359721	Ref. No. 5005025
	gasket silicone ED ø 48mm ID ø 39.5mm thickness 5mm Qty 1 pcs		
	GEV No.	359837	Ref. No. —
	gasket ID ø 33mm ED ø 46mm thickness 1mm graphite		
	GEV No.	359838	Ref. No. —
	gasket ID ø 33mm ED ø 45mm		



GEV No.	359721	Ref. No.	5005025
description	gasket silicone ED ø 48mm ID ø 39.5mm thickness 5mm Qty 1 pcs		
For models:	HUD10.10, HUD12.20, HUD20.10, HUD20.20, HUD6.10, OD10.10, OD10.20, OD12.20, OD20.10, OD20.20, OD6.10, UG10.10, UG10.20, UG20.10, UG20.20, UG4.05, UG6.05, UG6.10		



55x70mm



GEV No.	360730	Ref. No.	5056316
description	gasket		
accessories for	360730		
	GEV No.	359596	Ref. No. —
	halogen lamp socket G4 12V 10W temp.-resist. 500°C		
	GEV No.	360728	Ref. No. 5056317
	lamp cover complete L 99.5mm W 84.5mm H 8.5mm mounting distance 68/83mm		
	GEV No.	360729	Ref. No. 5056315
	lamp socket socket G4 with cable		







			
1			
GEV No.	360728	Ref. No.	5056317
description	lamp cover complete L 99.5mm W 84.5mm H 8.5mm mounting distance 68/83mm		
accessories for	360728		
	GEV No.	359596	Ref. No. —
	halogen lamp socket G4 12V 10W temp.-resist. 500°C		
	GEV No.	360729	Ref. No. 5056315
	lamp socket socket G4 with cable		
	GEV No.	360730	Ref. No. 5056316
	gasket		

			
1			
GEV No.	359297	Ref. No.	5015003 5015006
description	frame L 95mm W 81mm mounting distance 68/83mm thickness 6mm		
For models:	OEB10.10, OEB10.20, OEB12.20, OEB20.10, OEB20.20, OEB6.10, OEB6.20, OES10.10, OES10.20, OES12.20, OES20.10, OES20.20, OES6.06, OES6.10, OES6.20, OGB10.10, OGB10.20, OGB12.20, OGB20.10, OGB20.20, OGB6.10, OGB6.20, OGS10.10, OGS10.20, OGS12.20, OGS20.10, OGS20.20, OGS6.10, OGS6.20		
accessories for	359297		
	GEV No.	359299	Ref. No. —
	gasket L 91mm W 77mm hole ø 3mm for oven lamp		

			
1			
GEV No.	359296	Ref. No.	5015002
description	lamp glass L 74mm W 58mm thickness 3mm		
For models:	OEB10.10, OEB10.20, OEB12.20, OEB20.10, OEB20.20, OEB6.10, OEB6.20, OES10.10, OES10.20, OES12.20, OES20.10, OES20.20, OES6.06, OES6.10, OES6.20, OGB10.10, OGB10.20, OGB12.20, OGB20.10, OGB20.20, OGB6.10, OGB6.20, OGS10.10, OGS10.20, OGS12.20, OGS20.10, OGS20.20, OGS6.10, OGS6.20		





producer-specific oven lamps			
CONVOTHERM			
			
1			
GEV No.	360641	Ref. No.	6015018 6015020 N/A
description	gasket L 86mm W 71mm PTFE thickness 0.5mm for oven lamp		
For models:	OEB10.10, OEB10.20, OEB12.20, OEB20.10, OEB20.20, OEB6.10, OEB6.20, OES10.10, OES10.20, OES12.20, OES20.10, OES20.20, OES6.06, OES6.10, OES6.20, OGB10.10, OGB10.20, OGB12.20, OGB20.10, OGB20.20, OGB6.10, OGB6.20, OGS10.10, OGS10.20, OGS12.20, OGS20.10, OGS20.20, OGS6.10, OGS6.20		

			
1			
GEV No.	358180	Ref. No.	6015018 6015020
description	gasket L 94mm W 78mm PTFE thickness 3mm for oven lamp		

			
1			
GEV No.	360728	Ref. No.	5056317
description	lamp cover complete L 99.5mm W 84.5mm H 8.5mm mounting distance 68/83mm		
accessories for	360728		
	GEV No.	359596	Ref. No. —
	halogen lamp socket G4 12V 10W temp.-resist. 500°C		
	GEV No.	360729	Ref. No. 5056315
	lamp socket socket G4 with cable		
	GEV No.	360730	Ref. No. 5056316
	gasket		

			
1			
GEV No.	694335	Ref. No.	5015005
description	lamp glass L 87mm W 72mm thickness 3mm		





			
1			
GEV No.	359488	Ref. No.	2618780
description	oven lamp complete mounting measurements 55x70mm 230V 15W socket E14 rectangular connection male faston 6.3mm L 87mm W 70mm		
For models:	OEB10.10, OEB10.20, OEB12.20, OEB20.10, OEB20.20, OEB6.10, OEB6.20, OES10.10, OES10.20, OES12.20, OES20.10, OES20.20, OES6.06, OES6.10, OES6.20, OGB10.10, OGB10.20, OGB12.20, OGB20.10, OGB20.20, OGB6.10, OGB6.20, OGS10.10, OGS10.20, OGS12.20, OGS20.10, OGS20.20, OGS6.10, OGS6.20		
spare parts for	359488		
	GEV No.	358180	Ref. No. 6015018 6015020
	gasket L 94mm W 78mm PTFE thickness 3mm for oven lamp		
	GEV No.	359297	Ref. No. 5015003 5015006
	frame L 95mm W 81mm mounting distance 68/83mm thickness 6mm		
	GEV No.	359299	Ref. No. —
	gasket L 91mm W 77mm hole ø 3mm for oven lamp		
	GEV No.	694335	Ref. No. 5015005
	lamp glass L 87mm W 72mm thickness 3mm		



			
1			
GEV No.	692171	Ref. No.	5005020
description	frame for lamp lenses bore ø 6.3mm D1 ø 72mm D2 ø 56mm L 83mm W 83mm thickness 1mm		
For models:	OD10.10, OD10.20, OD12.20, OD20.10, OD20.20, OD6.10, OS10.10, OS10.20, OS12.20, OS20.10, OS20.20, OS6.10, OSC10.10, OSC10.20, OSC12.20, OSC20.10, OSC20.20, OSC6.10, OSP10.10, OSP10.20, OSP12.20, OSP20.10, OSP20.20, OSP6.10		

			
1			
GEV No.	359643	Ref. No.	5005022
description	lamp glass ø 69mm thickness 4mm		
For models:	OD10.10, OD10.20, OD12.20, OD20.10, OD20.20, OD6.10, OS10.10, OS10.20, OS12.20, OS20.10, OS20.20, OS6.10, OSC10.10, OSC10.20, OSC12.20, OSC20.10, OSC20.20, OSC6.10, OSP10.10, OSP10.20, OSP12.20, OSP20.10, OSP20.20, OSP6.10		

			
1			
GEV No.	359701	Ref. No.	5005016
description	lamp socket socket E14 220-230V mounting ø 35.5mm connection male faston 6.3mm 15W		
For models:	OD10.10, OD10.20, OD12.20, OD20.10, OD20.20, OD6.10, OS10.10, OS10.20, OS12.20, OS20.10, OS20.20, OS6.10, OSC10.10, OSC10.20, OSC12.20, OSC20.10, OSC20.20, OSC6.10, OSG10.10, OSG12.20, OSG20.20, OSG6.10, OSP10.10, OSP10.20, OSP12.20, OSP20.10, OSP20.20, OSP6.10		
accessories for	359701		
	GEV No.	359705	Ref. No. 5005017 5005017K 5030620
	oven lamp glass thr.ø 33.5mm ø 52mm hard glas temp.-resist. 350°C		
	GEV No.	359709	Ref. No. —
	oven lamp glass thr.ø 33.5mm ø 42mm hard glas temp.-resist. 350°C		
	GEV No.	359721	Ref. No. 5005025
	gasket silicone ED ø 48mm ID ø 39.5mm thickness 5mm Qty 1 pcs		
	GEV No.	359942	Ref. No. —
	oven lamp glass thr.ø 33.5mm ø 41mm hard glas temp.-resist. 350°C		

			
1			
GEV No.	358174	Ref. No.	5005022K
description	lamp glass ø 69mm thickness 4mm with gasket		

			
1			
GEV No.	360629	Ref. No.	2628501
description	oven lamp incl. gasket mounting ø 10mm 12V 10W socket G4 CONVOTHERM temp.-resist. 300°C		
spare parts for	360629		
	GEV No.	359596	Ref. No. —
	halogen lamp socket G4 12V 10W temp.-resist. 500°C		

			
1			
GEV No.	360680	Ref. No.	2628500
description	oven lamp incl. gasket mounting ø 10mm 12V 10W socket G4 CONVOTHERM temp.-resist. 300°C		
spare parts for	360680		
	GEV No.	359596	Ref. No. —
	halogen lamp socket G4 12V 10W temp.-resist. 500°C		



lamps





light bulbs

			
1			
GEV No.	359610	Ref. No.	5005040 5005040K
description	light bulb t.max. 300°C socket E14 15W 230V ø 22mm L 47mm lens L 20mm for oven lamp type Philips		
For models:	HUD10.10, HUD12.20, HUD20.10, HUD20.20, HUD6.10, OD10.10, OD10.20, OD12.20, OD20.10, OD20.20, OD6.10, UG10.10, UG10.20, UG20.10, UG20.20, UG4.05, UG6.05, UG6.10		

			
1			
GEV No.	359612	Ref. No.	5005045
description	light bulb t.max. 300°C socket E14 25W 230V ø 25mm L 56mm lens L 30mm for oven lamp type Philips		

sockets

G4 / G5,3 / G6,35

			
1			
GEV No.	360729	Ref. No.	5056315
description	lamp socket socket G4 with cable		
accessories for	360729		
	GEV No.	Ref. No.	—
	359596		
description	halogen lamp socket G4 12V 10W temp.-resist. 500°C		
	GEV No.	Ref. No.	5056317
	360728		
description	lamp cover complete L 99.5mm W 84.5mm H 8.5mm mounting distance 68/83mm		
	GEV No.	Ref. No.	5056316
	360730		
description	gasket		

timers

mechanical timers

			
1			
GEV No.	350023	Ref. No.	5001003 5001003K
description	timer M2 2-pole operation time 90min impulse mechanical 2CO at 250V 16A permanent position no shaft ø 6x4.6mm shaft 6x4.6mm shaft L 23mm mounting distance 28mm connection lateral		
For models:	HUD10.10, HUD12.20, HUD20.10, HUD20.20, HUD6.10, UG10.10, UG10.20, UG20.10, UG20.20, UG4.05, UG6.05, UG6.10		
accessories for	350023		
	GEV No.	Ref. No.	—
	110366		
description	knob switch zero mark t.max. °C ø 44mm shaft ø 6x4.6mm shaft flat upper black		

			
1			
GEV No.	350112	Ref. No.	5001001 5001001K
description	timer M2 2-pole operation time 90min impulse mechanical 2NO at 250V 16A permanent position no shaft ø 6x4.6mm shaft 6x4.6mm shaft L 23mm mounting distance 28mm connection rear		
For models:	AR100, AR108, AR12, AR16, AR18, AR28, AR30, AR40, AR50, AR54, AR72, AR8, UG10.10, UG10.20, UG20.10, UG20.20, UG4.05, UG6.05, UG6.10		

alarm devices

buzzers

			
1			
GEV No.	350053	Ref. No.	4003050
description	buzzer 12VAC connection male faston 3.2mm screw mounting buzzer		
For models:	HUD10.10, HUD12.20, HUD20.10, HUD20.20, HUD6.10, OD10.10, OD10.20, OD12.20, OD20.10, OD20.20, OD6.10, UG10.10, UG10.20, UG20.10, UG20.20, UG4.05, UG6.05, UG6.10		



1

GEV No.	350050	Ref. No.	5003050
description	buzzer 230VAC connection male faston 6.3mm screw mounting thread M4 60dB		

contactors

BENEDIKT & JÄGER

power contactors



1

GEV No.	381476	Ref. No.	5056963
description	power contactor resistive load 130A 230 (AC3/400V) 37kW main contacts 3NO connection screw type K3-74A00		



1

GEV No.	380774	Ref. No.	5056373A
description	power contactor resistive load 32A 230VAC (AC3/400V) 18A/7.5kW main contacts 3NO auxiliary contacts 1NO connection screw connection type K3-18ND10		



1

GEV No.	380775	Ref. No.	5056962
description	power contactor resistive load 65A 230VAC (AC3/400V) 32A/15kW main contacts 3NO auxiliary contacts connection screw connection type K3-32A00230		

auxiliary contacts



1

GEV No.	381456	Ref. No.	5056966
description	auxiliary contact contacts 1NC/1NO AC15 3A connection screw type HKA11		



1

GEV No.	380678	Ref. No.	5056965
description	auxiliary contact contacts 1NO AC15 10A for contactors K2/K3 connection screw type HN10 AC1 25A		

GENERAL ELECTRIC (AEG)

power contactors



1

GEV No.	380247	Ref. No.	4001020 4001020K 4001027 4011000
----------------	--------	-----------------	---

description power contactor resistive load 25A 400VAC (AC3/400V) 9A/4kW main contacts 3NO auxiliary contacts 1NC connection screw connection type AEG LS4K 01A type GE CL00A 301

For models: AR108, AR28, HUD10.10, OD10.10, OD10.20, OD12.20, OD20.10, OD20.20, OD6.10, OEB10.10, OEB10.20, OEB12.20, OEB20.10, OEB20.20, OEB6.10, OEB6.20, OES10.10, OES10.20, OES12.20, OES20.10, OES20.20, OES6.06, OES6.10, OES6.20, OGB10.10, OGB10.20, OGB12.20, OGB20.10, OGB20.20, OGB6.10, OGB6.20, OGS10.10, OGS10.20, OGS12.20, OGS20.10, OGS20.20, OGS6.10, OGS6.20, OSC10.10, OSC10.20, OSC12.20, OSC20.10, OSC20.20, OSC6.10, OSG10.10, OSG12.20, OSG20.20, OSG6.10, OSP10.10, OSP10.20...(Other models you can see in the webshop)



1

GEV No.	380265	Ref. No.	4001041 4011013K
description	power contactor resistive load 60A 230VAC (AC3/400V) 32A/16kW main contacts 3NO auxiliary contacts 1NO connection screw connection type AEG LS15K 00A type GE CL04A 310 H 98mm L 87mm W 55mm		
For models:	AR108, OD10.10, OD10.20, OD12.20, OD20.10, OD20.20, OD6.10, OSC10.10, OSC10.20, OSC12.20, OSC20.10, OSC20.20, OSP10.10, OSP10.20, OSP12.20, OSP20.10, OSP20.20, OSP6.10		



1

GEV No.	381342	Ref. No.	4011001 4011001K 4030609
description	power contactor resistive load 25A 230VAC (AC3/400V) 18A/7.5kW main contacts 3NO auxiliary contacts 1NO/1NC connection elastic terminals type LC1D183P7		
For models:	OEB10.10, OEB10.20, OEB12.20, OEB20.10, OEB20.20, OEB6.10, OEB6.20, OES10.10, OES10.20, OES12.20, OES20.10, OES20.20, OES6.10, OES6.20		

auxiliary contacts



1

GEV No.	380269	Ref. No.	4001072
description	auxiliary contact contacts 1NC AC15 6A for contactors CL+LS_K connection screw AC-12 10A type AEG HS07K 01 type GE BCLF 01		
For models:	HUD10.10, OD10.10, OD10.20, OD12.20, OD20.10, OD20.20, OD6.10		



1

GEV No.	380952	Ref. No.	4001015 4001030 4001030K
description	power contactor resistive load 40A 230VAC (AC3/400V) 25A/11kW main contacts 4NO auxiliary contacts 1NO/1NC connection screw connection type LC1DT40P7		
For models:	AR100, AR108, AR12, AR16, AR18, AR28, AR30, AR40, AR50, AR54, AR72, HUD10.10, HUD12.20, HUD20.10, HUD20.20, HUD6.10, OD10.10, OD10.20, OD12.20, OD20.10, OD20.20, OD6.10, OSC10.10, OSC10.20, OSC12.20, OSC20.10, OSC20.20, OSC6.10, OSP10.10, OSP10.20, OSP12.20, OSP20.10, OSP20.20, OSP6.10, UG10.10, UG20.10, UG6.05		



1

GEV No.	380268	Ref. No.	4001070
description	auxiliary contact contacts 1NO for contactors CL+LS_K connection screw AC-12 10A type AEG HS07K 10 type GE BCLF 10		
For models:	HUD20.20		

ABL SURSUM

motor protection circuit breakers

TELEMECANIQUE (Schneider Electric)

power contactors



1

GEV No.	381204	Ref. No.	4011000K
description	power contactor resistive load 20A 230VAC (AC3/400V) 9A/4kW main contacts 3NO auxiliary contacts 1NO/1NC connection spring terminal type LC1D093P7 with RC circuit LAD4RCU		



1

GEV No.	380300	Ref. No.	4002034	
description	motor protection circuit breaker type Mbs25-016 setting range 1-1.6A (AC3/400V) 0.55kW			
For models:	HUD10.10, HUD20.10, HUD6.10, OD10.10, OD10.20, OD12.20, OD6.10, UG10.20, UG20.20			
accessories for	380300			
	GEV No.	380305	Ref. No.	4002039
	auxiliary contact contacts 1NO/1NC HMS11			



1

GEV No.	380301	Ref. No.	4002035
description	motor protection circuit breaker type Mbs25-025 setting range 1.6-2.5A (AC3/400V) 1.1kW		
For models:	AR18, AR28, AR40, AR54, OD10.10, OD10.20, OD12.20, OD20.10, OD20.20, OD6.10, OSG10.10, OSG12.20, OSG20.20, OSG6.10		



1

GEV No.	380302	Ref. No.	4002036
description	motor protection circuit breaker type Mbs25-040 setting range 2.5-4A (AC3/400V) 1.5kW		
For models:	OD10.10, OD10.20, OD12.20, OD20.20, OD6.10, OSG10.10, OSG12.20, OSG20.20, OSG6.10		



1

GEV No.	380322	Ref. No.	4002032
description	motor protection circuit breaker type SFK0E setting range 0.63-1A (AC3/400V) 0.5kW GENERAL ELECTRIC		
For models:	AR108, AR28, AR40, AR54, AR72, HUD10.10, HUD12.20, HUD20.10, HUD20.20, HUD6.10, OD10.10, OD10.20, OD12.20, OD20.10, OD20.20, OD6.10, UG10.10, UG20.10, UG6.10		

accessories



1

GEV No.	380305	Ref. No.	4002039
description	auxiliary contact contacts 1NO/1NC HMS11		
For models:	HUD12.20, HUD20.20, OD10.10, OD10.20, OD12.20, OD20.10, OD20.20, OD6.10		

solid state relays

CRYDOM



1

GEV No.	403868	Ref. No.	5056381
description	solid state relay CRYDOM 1 phase 90A 480V 4-32VDC L 58mm W 44mm screw type CWD4890P		

relays

power relays

with flange mounting



1





GEV No.	380131	Ref. No.	4000017
description	power relays Italiana Relè 230VAC 16A 3CO connection male faston 6.3mm screw mounting manuf. no. B2-3-230AC		

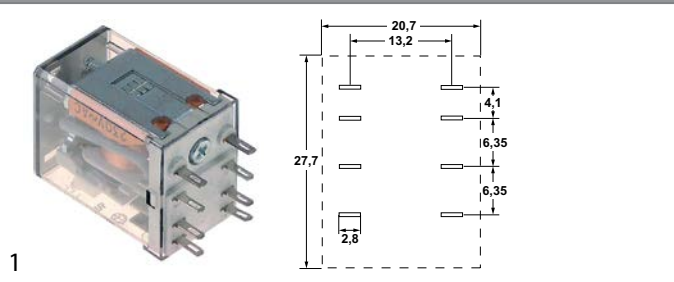

with male contacts

female contact 2.0mm



GEV No.	380377	Ref. No.	4000022
description	power relays FINDER 220-240VAC 10A 2CO connection F2 plug-in connection manuf. no. 55.32.8.230.0000 94.92.3 250V		
For models:	OD10.20, OD12.20		
accessories for	380377		
	GEV No.	380341	Ref. No. —
	relay socket 4-pole contacts 12 300V voltage AC 6A Italiana Relè manuf. no. ZMD4		
	GEV No.	380378	Ref. No. —
	relay socket 2-pole 55/85 dimensions 70.5x30x27mm 250V voltage AC 10A FINDER manuf. no. 94.72		
	GEV No.	380384	Ref. No. —
	relay socket 2-pole contacts male faston 2.8mm 250V voltage AC 10A W 23mm for		
	GEV No.	380399	Ref. No. —
	relay socket 4-pole dimensions 76.2x27x86.1mm 250V voltage AC 1A FINDER manuf. no. 94.94.3		

plug-in/print relays



GEV No.	381090	Ref. No.	4000012
description	print relay 12VDC at 250V 10A with relay socket		
spare parts for	381090		
	GEV No.	380500	Ref. No. —
	print relay 12VDC 2CO at 250V 8A connection pins raster size 5mm REIPOL		

miscellaneous



GEV No.	381091	Ref. No.	4000013
description	print relay 230V voltage AC at 250V 10A with relay socket		
For models:	OD10.10, OD12.20, OD20.20, OD6.10, OSG10.10, OSG12.20, OSG20.20, OSG6.10		

transformers

power supplies



GEV No.	402981	Ref. No.	2618809 5056385
description	power supply primary 100-240VAC secondary 12VDC 60VA secondary 5A H 38mm L 99mm W 155mm connection screw 50/60Hz type ABL1REM12050 combi-steamer P3-devices		
For models:	OES6.06		

probes

producer-specific probes

probes



GEV No.	400024	Ref. No.	5009050
description	temperature probe NTC 100kOhm cable PVC probe -40 up to +125°C cable -10 up to 100°C connection plug thread M10 probe ø6x120mm cable length 0.1m		
For models:	HUD10.10, HUD12.20, HUD20.10, HUD20.20, HUD6.10		





GEV No.	379409	Ref. No.	5001035
description	temperature probe Pt100 cable PVC probe -100 up to 450°C cable -10 up to 100°C connection 2-wire thread M10 probe ø3x60mm cable length 0.7m		
For models:	OD10.10, OD10.20, OD12.20, OD20.20, OD6.10		



GEV No.	379726	Ref. No.	5009053
description	temperature probe Pt100 cable silicone probe -100 up to 450°C cable -50 up to +180°C connection 3-wire thread M10x1 probe ø3x130mm cable length 1.5m		
For models:	OD10.10, OD10.20, OD12.20, OD20.20, OD6.10		



GEV No.	379104	Ref. No.	5009052
description	temperature probe Pt100 cable silicone probe -50 up to +300°C cable -50 up to +200°C connection 2-wire thread M10 probe ø4.5x20mm cable length 3m		
For models:	OD10.10, OD10.20, OD12.20, OD20.10, OD20.20, OD6.10, OSP10.20, OSP12.20		
accessories for	379104		
	GEV No.	510416	Ref. No. 6005016
	flat gasket fibre ED ø 19mm ID ø 10.5mm thickness 1.5mm for thread M10 Qty 1 pcs		



GEV No.	379105	Ref. No.	5001022 5001023
description	temperature probe Pt100 cable silicone probe -50 up to +600°C cable -50 up to +180°C connection 2-wire thread M14x1.5 probe ø3x350mm cable length 2.4m		
For models:	OD10.10, OD10.20, OD12.20, OD20.10, OD20.20, OD6.10		



GEV No.	379410	Ref. No.	5001015
description	temperature probe thermocouple K (NiCr-Ni) cable silicone probe -50 up to 1150°C cable -50 up to +180°C connection 2-wire thread M10 probe ø3x125mm cable length 1.5m		
For models:	OSG10.10, OSG12.20, OSG20.20, OSG6.10		





GEV No.	379420	Ref. No.	5001016
description	temperature probe thermocouple K (NiCr-Ni) cable silicone probe -50 up to 1150°C cable -50 up to +180°C connection 2-wire thread M10 probe ø3x70mm cable length 0.7m		
For models:	OSG10.10, OSG12.20, OSG20.20, OSG6.10		



GEV No.	379412	Ref. No.	5016014K
description	temperature probe thermocouple K (NiCr-Ni) cable silicone probe -50 up to 1150°C cable -50 up to +180°C connection 2-wire thread M5 probe ø4x20mm cable length 2m		



GEV No.	379800	Ref. No.	5002100 5002100K 5002101 5016014K 5030618
description	temperature probe thermocouple K (NiCr-Ni) cable silicone probe -50 up to 1150°C cable -50 up to +180°C connection 2-wire thread M5 probe ø4x20mm cable length 3m		
For models:	OEB10.10, OEB10.20, OEB12.20, OEB20.10, OEB20.20, OEB6.10, OEB6.20, OES10.10, OES10.20, OES12.20, OES20.10, OES20.20, OES6.06, OES6.10, OES6.20, OGB10.10, OGB10.20, OGB12.20, OGB20.10, OGB20.20, OGB6.10, OGB6.20, OGS10.10, OGS10.20, OGS12.20, OGS20.10, OGS20.20, OGS6.10, OGS6.20, OS10.10, OS10.20, OS12.20, OS20.10, OS20.20, OS6.10, OSC10.10, OSC10.20, OSC12.20, OSC20.10, OSC20.20, OSC6.10, OSG20.20, OSP10.10, OSP10.20, OSP12.20, OSP20.10, OSP20.20, OSP6.10		
accessories for	379800		
	GEV No.	521012	Ref. No. 6005260
	gasket graphite ED ø 15mm ID ø 5mm thickness 1.2mm Qty 1 pcs		





GEV No.	402164	Ref. No.	5002102 5002102K 5030619
description	temperature probe thermocouple K (NiCr-Ni) cable silicone probe -50 up to 1150°C cable -50 up to +180°C connection 2-wire thread M8 probe ø3x130/230mm cable length 2.1m		
For models:	OS10.10, OS10.20, OS12.20, OS20.10, OS20.20, OS6.10, OSC10.10, OSC10.20, OSC12.20, OSC20.10, OSC20.20, OSC6.10, OSP10.10, OSP10.20, OSP12.20, OSP20.10, OSP20.20, OSP6.10		





GEV No.	379536	Ref. No.	5016003
description	temperature probe thermocouple K (NiCr-Ni) cable silicone probe -50 up to 1150°C cable -50 up to +180°C connection 2-wire thread probe ø1.5x230mm cable length 2m		
For models:	OEB20.20, OGB10.10, OGB10.20, OGB12.20, OGB20.10, OGB20.20, OGB6.10, OGB6.20, OGS10.10, OGS10.20, OGS12.20, OGS20.10, OGS20.20, OGS6.10, OGS6.20		





			
GEV No.	379440	Ref. No.	5002103 5016017
description	temperature probe thermocouple K (NiCr-Ni) cable silicone probe -50 up to 1150°C cable -50 up to +180°C connection 2-wire thread probe ø1.5x35mm cable length 1.6m		
For models:	OS10.20, OS6.10, OSC10.10, OSC10.20, OSC12.20, OSC20.10, OSC20.20, OSC6.10, OSP10.10, OSP10.20, OSP12.20, OSP20.10, OSP20.20, OSP6.10		

			
GEV No.	379751	Ref. No.	5002104
description	temperature probe thermocouple K (NiCr-Ni) cable silicone probe -50 up to 1150°C cable -50 up to +180°C connection 2-wire thread probe ø1.5x35mm cable length 2.8m		
For models:	OEB10.10, OEB10.20, OEB12.20, OEB20.10, OEB20.20, OEB6.10, OEB6.20, OES10.10, OES10.20, OES12.20, OES20.10, OES20.20, OES6.10, OES6.20, OGB10.10, OGB10.20, OGB12.20, OGB20.10, OGB20.20, OGB6.10, OGB6.20, OS10.10, OS12.20, OS20.10, OS20.20, OSC10.10, OSC12.20, OSC20.10, OSC20.20, OSP10.10, OSP12.20, OSP20.10, OSP20.20		

			
GEV No.	378655	Ref. No.	5056324
description	temperature probe thermocouple K (NiCr-Ni) probe -50 up to 1150°C cable -50 up to +180°C connection coded plug thread M5 probe ø4x20mm cable length 3.2m		

			
GEV No.	381488	Ref. No.	5056323
description	temperature probe thermocouple K (NiCr-Ni) probe -50 up to 1150°C cable -50 up to +180°C thread 2-wire cable length 2.3m		

			
GEV No.	379414	Ref. No.	2219137 5002064
description	temperature probe thermocouple K (NiCr-Ni) probe Sous-Vide cable PTFE probe -50 up to 1150°C cable -50 up to +180°C connection 2-wire thread probe ø1.5x60mm cable length 4m		
For models:	OEB10.10, OEB10.20, OEB12.20, OEB20.10, OEB20.20, OEB6.10, OEB6.20, OES10.10, OES10.20, OES12.20, OES20.10, OES20.20, OES6.10, OES6.20, OGB10.10, OGB10.20, OGB12.20, OGB20.10, OGB20.20, OGB6.10, OGB6.20, OGS10.10, OGS10.20, OGS12.20, OGS20.10, OGS20.20, OGS6.10, OGS6.20		

core probes			
			
GEV No.	379828 ¹	Ref. No.	5002068K
description	core temperature probe 3 point probe cable PTFE probe -40 up to +250°C cable -40 up to +250°C connection 5-wire probe ø4x100mm cable length 4m handle ø 12mm handle length 75mm		

¹ multipoint probe

			
GEV No.	379428 ¹	Ref. No.	5013001 5013022K 5030638 5030676
description	core temperature probe 3 point probe cable PTFE probe -50 up to 1150°C cable -40 up to +250°C connection 5-wire probe ø3x100mm thread cable length 3m handle ø 11mm handle length 75mm		



¹ multipoint probe

			
GEV No.	378536	Ref. No.	5056325
description	core temperature probe 4 point probe cable plastic probe -40 up to +250°C cable -40 up to +250°C connection plug probe ø3.5x100mm thread 5/8" cable length 3m handle ø 11mm handle length 75mm		

			
GEV No.	379103	Ref. No.	5002062 5002062K
description	core temperature probe Pt100 cable PTFE probe -40 up to +250°C cable -40 up to +250°C connection 2-wire probe ø4x100mm thread cable length 4m handle ø 15mm handle length 85mm		
For models:	HUD10.10, HUD12.20, HUD20.10, HUD20.20, HUD6.10, OD10.10, OD10.20, OD12.20, OD20.10, OD20.20, OD6.10, UG10.10, UG10.20, UG20.10, UG20.20, UG6.10		

			
GEV No.	379416	Ref. No.	5002066 5002066K
description	core temperature probe Pt100 cable SS corrugated hose probe -40 up to +250°C cable -40 up to +250°C connection 2-wire probe ø3x100mm thread M15x1 cable length 3m handle ø 12mm handle length 85mm		
For models:	OD6.10		

			
GEV No.	379417	Ref. No.	5002067 5002067K
description	core temperature probe Pt100 cable SS corrugated hose probe -40 up to +250°C cable -40 up to +250°C connection 2-wire probe ø3x100mm thread M15x1.5 cable length 3m handle ø 12mm handle length 85mm		

			
Image not available			
			
GEV No.	379858	Ref. No.	5002069 5002069K
description	core temperature probe thermocouple K (NiCr-Ni) 4 point probe		
For models:	OSG10.10, OSG12.20, OSG20.20, OSG6.10		



			
GEV No.	379139	Ref. No.	5002068 5002068K
description	core temperature probe thermocouple K (NiCr-Ni) cable PTFE probe -40 up to +250°C cable -40 up to +250°C connection 6-wire probe ø4x100mm thread cable length 2.5m handle ø 15mm handle length 85mm		
For models:	OD10.10, OD10.20, OD12.20, OD20.10, OD20.20, OD6.10, OEB10.10, OEB10.20, OEB12.20, OEB20.10, OEB20.20, OEB6.10, OEB6.20, OES10.10, OES10.20, OES12.20, OES20.10, OES20.20, OES6.10, OES6.20, OGB10.10, OGB10.20, OGB12.20, OGB20.10, OGB20.20, OGB6.10, OGB6.20, OGS10.10, OGS10.20, OGS12.20, OGS20.10, OGS20.20, OGS6.10, OGS6.20, OS10.10, OS10.20, OS12.20, OS20.10, OS20.20, OS6.10, OSC10.10, OSC10.20, OSC12.20, OSC20.10, OSC20.20, OSC6.10, OSG10.10, OSG12.20, OSG20.20, OSG6.10...(Other models you can see in the webshop)		

			
GEV No.	381458	Ref. No.	5064012
description	probe 1 point probe cable PTFE connection -40 up to +250 cable length 1.04m handle ø 11mm handle length 72mm		

			
GEV No.	381459	Ref. No.	5064010
description	probe 1 point probe cable PTFE probe -40 up to +250°C connection plug probe ø1.5x60mm handle ø 11mm handle length 70mm		

accessories

plugs/bushes

			
GEV No.	378653	Ref. No.	5064011
description	female connector 2-pole max. 9A protection IP50 chrome-plated brass		

electronics

electronics accessories

			
GEV No.	560416	Ref. No.	6005054
description	plain washer ID ø 4mm ED ø 9.6mm thickness 2mm silicone Qty 1 pcs		
For models:	OD10.10, OD10.20, OD12.20, OD20.10, OD20.20, OD6.10, OEB6.10, OES6.10		

frequency converters

			
GEV No.	403904	Ref. No.	5056374
description	frequency converter 200-240V 50/60 L 131mm W 72mm H 143mm		

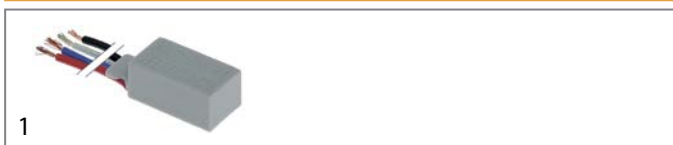

PCBs

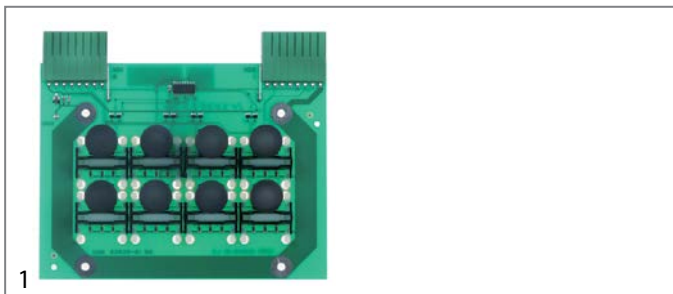
			
GEV No.	403686	Ref. No.	5019301
description	control 5010 IDM module P3+mini 5010 IDM module P3+mini		

			
GEV No.	404007	Ref. No.	5019105 5019304
description	control PCB combi-steamer OEB10.10 control 5010		
For models:	OEB10.10, OEB10.20, OEB12.20, OEB20.10, OEB20.20, OEB6.10, OEB6.20, OES10.10, OES10.20, OES12.20, OES20.10, OES20.20, OES6.10, OES6.20, OGB10.10, OGB10.20, OGB12.20, OGB20.10, OGB20.20, OGB6.10, OGB6.20, OGS10.10, OGS10.20, OGS12.20, OGS20.10, OGS20.20, OGS6.10, OGS6.20		

1

GEV No.	402882	Ref. No.	5019100 5019306 5019406 5019418 5019420
description	control PCB combi-steamer OEx xx.xx L 280mm W 100mm V5.19		
For models:	OEB10.10, OEB10.20, OEB12.20, OEB20.10, OEB20.20, OEB6.10, OEB6.20, OES10.10, OES10.20, OES12.20, OES20.10, OES20.20, OES6.06, OES6.10, OES6.20, OGB10.10, OGB10.20, OGB12.20, OGB20.10, OGB20.20, OGB6.10, OGB6.20, OGS10.10, OGS10.20, OGS12.20, OGS20.10, OGS20.20, OGS6.10, OGS6.20		
accessories for	402882		
	GEV No.	402589	Ref. No. 5019101 5019300 CM5019300
	keypad PCB combi-steamer P3-devices L 337mm W 132mm V5.19 buttons 14		
	GEV No.	403078	Ref. No. 5019011
	programmer suitable for CONVOTHERM P3-devices incl. SD Carte and Software		
	GEV No.	403686	Ref. No. 5019301
	control 5010 IDM module P3+mini 5010 IDM module P3+mini		



1

GEV No.	403794	Ref. No.	5019150
description	control PCB for combi-steamer OES6.06 Mini P3 L 465mm W 95mm model ST5020-BM V5.19		
For models:	OES6.06		



1

GEV No.	402587	Ref. No.	5009017
description	control PCB L 320mm W 118mm cable length 500mm supply 5/12VDC		
For models:	OD10.10, OD10.20, OD12.20, OD20.10, OD20.20, OD6.10		



1

GEV No.	402588	Ref. No.	5009303
description	keypad PCB combi-steamer OS10.10 L 322mm W 117mm buttons 11		
For models:	OS10.10, OS10.20, OS12.20, OS20.10, OS20.20, OS6.10, OSC10.10, OSC10.20, OSC12.20, OSC20.10, OSC20.20, OSC6.10, OSP10.10, OSP10.20, OSP12.20, OSP20.10, OSP20.20, OSP6.10		

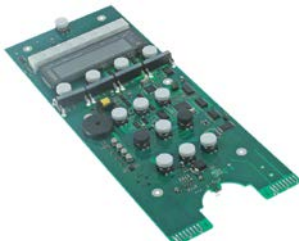

1

GEV No.	402589	Ref. No.	5019101 5019300 CM5019300
description	keypad PCB combi-steamer P3-devices L 337mm W 132mm V5.19 buttons 14		
For models:	OEB10.10, OEB10.20, OEB12.20, OEB20.10, OEB20.20, OEB6.10, OEB6.20, OES10.10, OES10.20, OES12.20, OES20.10, OES20.20, OES6.10, OES6.20, OGB10.10, OGB10.20, OGB12.20, OGB20.10, OGB20.20, OGB6.10, OGB6.20, OGS10.10, OGS10.20, OGS12.20, OGS20.10, OGS20.20, OGS6.10, OGS6.20		
accessories for	402589		
	GEV No.	402882	Ref. No. 5019100 5019306 5019406 5019418 5019420
	control PCB combi-steamer OEx xx.xx L 280mm W 100mm V5.19		

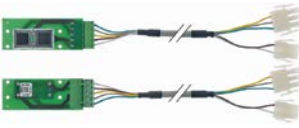

1

GEV No.	403870	Ref. No.	5056362
description	keypad PCB for combi-steamer CONVOTHERM 4 with cable ON-OFF		

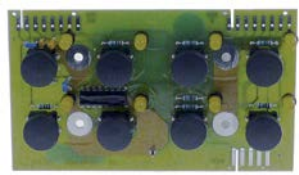

1

GEV No.	402879	Ref. No.	5009302
description	keypad PCB L 118mm W 69mm suitable for convection oven buttons 8		
For models:	OS10.10, OS10.20, OS12.20, OS20.10, OS20.20, OS6.10, OSC10.10, OSC10.20, OSC12.20, OSC20.10, OSC20.20, OSC6.10, OSG10.10, OSG12.20, OSG20.20, OSG6.10, OSP10.10, OSP10.20, OSP12.20, OSP20.10, OSP20.20, OSP6.10		



1

GEV No.	402910	Ref. No.	5009310 5009317
description	PCB		
For models:	OS10.10, OS10.20, OS12.20, OS20.10, OS20.20, OS6.10, OSC10.10, OSC10.20, OSC12.20, OSC20.10, OSC20.20, OSC6.10, OSG10.10, OSG12.20, OSG20.20, OSG6.10, OSP10.10, OSP10.20, OSP12.20, OSP20.10, OSP20.20, OSP6.10		



1

GEV No.	402207	Ref. No.	5009305
description	PCB combi-steamer OS10.10		
For models:	OS10.10, OS10.20, OS12.20, OS20.10, OS20.20, OS6.10, OSC10.10, OSC10.20, OSC12.20, OSC20.10, OSC20.20, OSC6.10, OSG10.10, OSG12.20, OSG20.20, OSG6.10, OSP10.10, OSP10.20, OSP12.20, OSP20.10, OSP20.20, OSP6.10		



1

GEV No.	402208	Ref. No.	5009300
description	PCB combi-steamer OS10.10		
For models:	OS10.10, OS10.20, OS12.20, OS20.10, OS20.20, OS6.10, OSC10.10, OSC10.20, OSC12.20, OSC20.10, OSC20.20, OSC6.10, OSG10.10, OSG12.20, OSG20.20, OSG6.10, OSP10.10, OSP10.20, OSP12.20, OSP20.10, OSP20.20, OSP6.10		



1

GEV No.	403819	Ref. No.	5019103 5019302 5019402
description	PCB for combi-steamer L 280mm W 100mm suitable for CONVO-THERM		
For models:	OGB10.10, OGB10.20, OGB12.20, OGB20.10, OGB20.20, OGB6.10, OGB6.20, OGS10.10, OGS10.20, OGS12.20, OGS20.10, OGS20.20, OGS6.10, OGS6.20		



1

GEV No.	401877	Ref. No.	5009005 5009006 5009007 5009008 5009029 5009029K
description	power PCB combi-steamer OD10.10 suitable for CONVOTHERM with mounting accessories		
For models:	OD10.10, OD10.20, OD12.20, OD20.10, OD20.20, OD6.10		



1

GEV No.	402586	Ref. No.	5009018
description	power PCB L 252mm W 120mm model 28755329 230V 0.1A voltage AC		
For models:	OD10.10, OD10.20, OD12.20, OD20.10, OD20.20, OD6.10		



1

GEV No.	402637	Ref. No.	2619973 5009301 5019154 5019305
description	power supply combi-steamer conversion kit		
For models:	OEB10.10, OEB10.20, OEB12.20, OEB20.10, OEB20.20, OEB6.10, OEB6.20, OES10.10, OES10.20, OES12.20, OES20.10, OES20.20, OES6.06, OES6.10, OES6.20, OGB10.10, OGB10.20, OGB12.20, OGB20.10, OGB20.20, OGB6.10, OGB6.20, OGS10.10, OGS10.20, OGS12.20, OGS20.10, OGS20.20, OGS6.10, OGS6.20, OS10.10, OS10.20, OS12.20, OS20.10, OS20.20, OS6.10, OSC10.10, OSC10.20, OSC12.20, OSC20.10, OSC20.20, OSC6.10, OSG10.10, OSG12.20, OSG20.20, OSG6.10, OSP10.10, OSP10.20, OSP12.20, OSP20.10, OSP20.20...(Other models you can see in the webshop)		





keypads

front foils

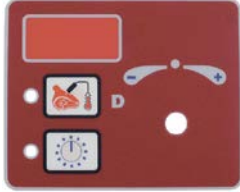
			
1			
GEV No.	403813	Ref. No.	6009103
description	front foil combi-steamer CONVOTHERM L 107mm W 30mm		

			
1			
GEV No.	402943	Ref. No.	6009101
description	front foil red suitable for CONVOTHERM L 108mm W 88mm		

			
1			
GEV No.	402938	Ref. No.	6009102
description	front foil red suitable for CONVOTHERM L 109mm W 89mm		

			
1			
GEV No.	402952	Ref. No.	6009235
description	front foil red suitable for CONVOTHERM L 135mm W 785mm		

solenoid valves

solenoid valves (water)

MÜLLER

medium temperature: 90°C
duty cycle: 100%

			
1			
GEV No.	370003	Ref. No.	5001056
description	solenoid valve double angled 230VAC inlet 3/4" outlet 14.5mm DN10 t.max. 90°C duty cycle 100% MÜLLER		

For models:	HUD10.10, HUD12.20, HUD20.10, HUD20.20, HUD6.10, OD10.10, OD10.20, OD12.20, OD20.10, OD20.20, OD6.10, OS10.10, OS10.20, OS12.20, OS20.10, OS20.20, OS6.10, OSC10.10, OSC10.20, OSC12.20, OSC20.10, OSC20.20, OSC6.10, OSP10.10, OSP10.20, OSP12.20, OSP20.10, OSP20.20, OSP6.10		
--------------------	---	--	--

spare parts for	370003		
		GEV No. 370128	Ref. No. 5001057
		solenoid valve body double angled inlet 3/4" outlet 14.5mm DN10 t.max. 90°C duty cycle 100% MÜLLER 230V double-ways	

		GEV No. 371002	Ref. No. —
		solenoid valve holder MÜLLER flange support	

		GEV No. 371009	Ref. No. 5001074
		compression spring for solenoid coil	

		GEV No. 371011	Ref. No. —
		spare parts kit membrane with long star star high 8mm MÜLLER	

		GEV No. 371017	Ref. No. 5001066
		solenoid coil MÜLLER 230VAC connection male faston 6.3mm	

		GEV No. 371122	Ref. No. —
		solenoid valve filter ø 19mm H 10mm suitable for MÜLLER	

		GEV No. 501161	Ref. No. —
		tap head for solenoid valve holder for solenoid coils	

accessories for	370003		
		GEV No. 371010	Ref. No. —
		solenoid coil 230VAC connection with cable cable length 2000mm	

		GEV No. 371037	Ref. No. —
		solenoid coil 24VAC 50/60Hz connection male faston 6.3mm	

		GEV No. 371038	Ref. No. —
		solenoid coil 230VAC connection appliance plug	



GEV No.	370001	Ref. No.	5001058
description	solenoid valve single angled 230VAC inlet 3/4" outlet 14.5mm DN10 t.max. 90°C duty cycle 100% MÜLLER		
For models:	OD10.10, OD10.20, OD12.20, OD20.10, OD20.20, OD6.10, OS10.10, OS10.20, OS12.20, OS20.10, OS20.20, OS6.10, OSC10.10, OSC10.20, OSC12.20, OSC20.10, OSC20.20, OSC6.10, OSP10.10, OSP10.20, OSP12.20, OSP20.10, OSP20.20, OSP6.10		

spare parts for 370001			
	GEV No.	370126	Ref. No. —
solenoid valve body single angled inlet 3/4" outlet 14.5mm DN10 t.max. 90°C duty cycle 100% MÜLLER plastic			
	GEV No.	371002	Ref. No. —
solenoid valve holder MÜLLER flange support			
	GEV No.	371009	Ref. No. 5001074
compression spring for solenoid coil			
	GEV No.	371011	Ref. No. —
spare parts kit membrane with long star star hight 8mm MÜLLER			
	GEV No.	371017	Ref. No. 5001066
solenoid coil MÜLLER 230VAC connection male faston 6.3mm			
	GEV No.	371122	Ref. No. —
solenoid valve filter ø 19mm H 10mm suitable for MÜLLER			
	GEV No.	501161	Ref. No. —
tap head for solenoid valve holder for solenoid coils			

accessories for 370001			
	GEV No.	371010	Ref. No. —
solenoid coil 230VAC connection with cable cable length 2000mm			
	GEV No.	371037	Ref. No. —
solenoid coil 24VAC 50/60Hz connection male faston 6.3mm			
	GEV No.	371038	Ref. No. —
solenoid coil 230VAC connection appliance plug			

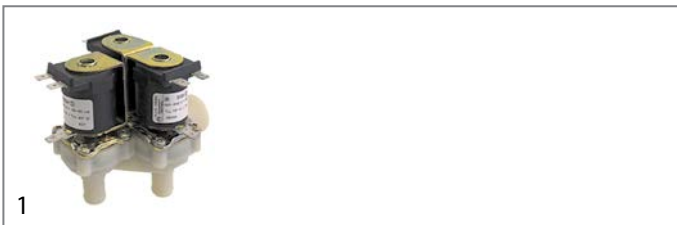

GEV No.	370000	Ref. No.	5001062
description	solenoid valve triple angled 230VAC inlet 3/4" outlet 14.5mm DN10 t.max. 90°C duty cycle 100% MÜLLER		
For models:	OS10.10, OS10.20, OS12.20, OS20.10, OS20.20, OS6.10, OSC10.10, OSC10.20, OSC12.20, OSC20.10, OSC20.20, OSC6.10, OSP10.10, OSP10.20, OSP12.20, OSP20.10, OSP20.20, OSP6.10		

spare parts for 370000			
	GEV No.	370130	Ref. No. —
solenoid valve body triple angled inlet 3/4" outlet 14.5mm DN10 t.max. 90°C duty cycle 100% MÜLLER 230V triple-ways			

spare parts for 370000			
	GEV No.	371002	Ref. No. —
solenoid valve holder MÜLLER flange support			
	GEV No.	371009	Ref. No. 5001074
compression spring for solenoid coil			
	GEV No.	371011	Ref. No. —
spare parts kit membrane with long star star hight 8mm MÜLLER			
	GEV No.	371017	Ref. No. 5001066
solenoid coil MÜLLER 230VAC connection male faston 6.3mm			
	GEV No.	371122	Ref. No. —
solenoid valve filter ø 19mm H 10mm suitable for MÜLLER			
	GEV No.	501161	Ref. No. —
tap head for solenoid valve holder for solenoid coils			

accessories for 370000			
	GEV No.	371010	Ref. No. —
solenoid coil 230VAC connection with cable cable length 2000mm			
	GEV No.	371037	Ref. No. —
solenoid coil 24VAC 50/60Hz connection male faston 6.3mm			
	GEV No.	371038	Ref. No. —
solenoid coil 230VAC connection appliance plug			

spare parts and accessories

valve bodies



GEV No.	370128	Ref. No.	5001057
description	solenoid valve body double angled inlet 3/4" outlet 14.5mm DN10 t.max. 90°C duty cycle 100% MÜLLER 230V double-ways		
For models:	HUD10.10, HUD12.20, HUD20.10, HUD20.20, HUD6.10, OD10.10, OD10.20, OD12.20, OD20.10, OD20.20, OD6.10		

solenoid coils

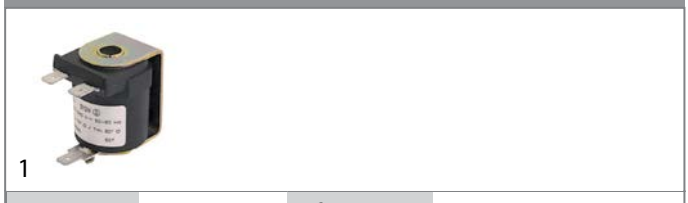

GEV No.	371017	Ref. No.	5001066
description	solenoid coil MÜLLER 230VAC connection male faston 6.3mm		
For models:	HUD10.10, HUD12.20, HUD20.10, HUD20.20, HUD6.10, OD10.10, OD10.20, OD12.20, OD20.10, OD20.20, OD6.10		



miscellaneous



GEV No.	371009	Ref. No.	5001074
description	compression spring for solenoid coil		
For models:	HUD10.10, HUD12.20, HUD20.10, HUD20.20, HUD6.10, OD10.10, OD10.20, OD12.20, OD20.10, OD20.20, OD6.10		

ROBERTSHAW/INVENSYS

medium temperature: 90°C 90°C 60°C
 ambient temperature: 60°C 25°C 60°C
 duty cycle: 40% 100% 100%



GEV No.	372019	Ref. No.	5011050
description	solenoid valve double angled 230VAC inlet 3/4" outlet 11.5mm DN10 EATON (INVENSYS)		
For models:	OES6.06		

solenoid valves with reducers

single



GEV No.	372005	Ref. No.	5056378
description	solenoid valve single straight 200-240VAC inlet 3/4 outlet 10.5 t.max. 90°C duty cycle 100% ROBERTSHAW S02810/00 plastic		



GEV No.	371145	Ref. No.	5001059
description	solenoid valve single straight 230VAC inlet 3/4" outlet 11.5mm input 12l/min		
For models:	OD10.10, OD10.20, OD12.20, OD20.20, OD6.10, OEB10.10, OEB10.20, OEB12.20, OEB20.10, OEB20.20, OEB6.10, OEB6.20, OES10.10, OES10.20, OES12.20, OES20.10, OES20.20, OES6.10, OES6.20, OGB10.10, OGB10.20, OGB12.20, OGB20.10, OGB20.20, OGB6.10, OGB6.20, OGS10.10, OGS10.20, OGS12.20, OGS20.10, OGS20.20, OGS6.10, OGS6.20, OSG10.10, OSG12.20, OSG6.10		

2-fold



GEV No.	374108	Ref. No.	5056379
description	solenoid valve double angled 230 inlet 3/4" outlet 10mm t.max. 90°C ROBERTSHAW plastic connection coded		



GEV No.	372000	Ref. No.	5001080
description	solenoid valve double straight 230VAC inlet 3/4" outlet 11.5mm input 9l/min 10 EATON (INVENSYS)		
For models:	OD10.10, OD10.20, OD12.20, OD20.20, OD6.10, OEB10.10, OEB10.20, OEB12.20, OEB20.10, OEB20.20, OEB6.10, OEB6.20, OES10.10, OES10.20, OES12.20, OES20.10, OES20.20, OES6.10, OES6.20, OGB10.10, OGB10.20, OGB12.20, OGB20.10, OGB20.20, OGB6.10, OGB6.20, OGS10.10, OGS10.20, OGS12.20, OGS20.10, OGS20.20, OGS6.10, OGS6.20, OSG10.10, OSG12.20, OSG20.20, OSG6.10		

RPE



GEV No.	374067	Ref. No.	5011013
description	solenoid valve single straight 230VAC inlet 3/8" outlet 3/8" input/ min output/ min DN10 t.max. 25/60/90°C duty cycle 100% RPE 4115NC230V plastic		



solenoid valves with reducers

single



GEV No.	370744	Ref. No.	5011020 5030489
description	solenoid valve single straight 230VAC inlet 3/4" outlet 11mm input 10-20l/min t.max. 60°C RPE plastic flow regulating valve inlet white male faston 6.3mm		

TP			
			
GEV No.	370021	Ref. No.	5001080
description	solenoid valve double straight 230VAC inlet 3/4" outlet 11.5mm DN10 TP flow regulating valve inlet white		
spare parts for	370021		
	GEV No.	371013	Ref. No. —
solenoid coil TP 230VAC 50/60Hz			
accessories for	370021		
	GEV No.	371220	Ref. No. —
reducer TP flow rate 3l/min red tolerance ±15%			
	GEV No.	371221	Ref. No. —
reducer TP flow rate 5.5l/min yellow tolerance ±15%			
	GEV No.	371222	Ref. No. —
reducer TP flow rate 6l/min grey tolerance ±15%			
	GEV No.	371223	Ref. No. —
reducer TP flow rate 10l/min white tolerance ±15%			
	GEV No.	371224	Ref. No. —
reducer TP flow rate 12l/min bronze tolerance ±15%			
	GEV No.	371225	Ref. No. —
reducer TP flow rate 16l/min light brown tolerance ±15%			
	GEV No.	371226	Ref. No. —
reducer TP flow rate 20l/min red tolerance ±15%			
	GEV No.	371230	Ref. No. —
reducer TP flow rate 0.25l/min red tolerance ±25%			
	GEV No.	371231	Ref. No. —
reducer TP flow rate 0.35l/min violet tolerance ±25%			
	GEV No.	371232	Ref. No. —
reducer TP flow rate 0.5l/min orange tolerance ±25%			
	GEV No.	371233	Ref. No. —
reducer TP flow rate 0.8l/min white tolerance ±25%			
	GEV No.	371234	Ref. No. —
reducer TP flow rate 1l/min light blue tolerance ±25%			
	GEV No.	371235	Ref. No. —
reducer TP flow rate 1.2l/min brown tolerance ±25%			
	GEV No.	371236	Ref. No. —
reducer TP flow rate 1.5l/min light brown tolerance ±25%			
	GEV No.	371237	Ref. No. —
reducer TP flow rate 2.5l/min yellow tolerance ±25%			

accessories for 370021			
	GEV No.	371238	Ref. No. —
reducer TP flow rate 3.4l/min dark green tolerance ±25%			
	GEV No.	371239	Ref. No. —
reducer TP flow rate 5l/min black tolerance ±25%			
	GEV No.	371240	Ref. No. —
reducer TP flow rate 8l/min blue tolerance ±20%			



















TP			
			
GEV No.	370025	Ref. No.	5011000
description	solenoid valve triple straight 230VAC inlet 3/4" outlet 11.5mm DN10 TP		
For models:	OEB10.10, OEB10.20, OEB12.20, OEB20.10, OEB20.20, OEB6.10, OEB6.20, OES10.10, OES10.20, OES12.20, OES20.10, OES20.20, OES6.10, OES6.20, OGB10.10, OGB10.20, OGB12.20, OGB20.10, OGB20.20, OGB6.10, OGB6.20, OGS10.10, OGS10.20, OGS12.20, OGS20.10, OGS20.20, OGS6.10, OGS6.20		
spare parts for	370025		
	GEV No.	371013	Ref. No. —
solenoid coil TP 230VAC 50/60Hz			
accessories for	370025		
	GEV No.	371220	Ref. No. —
reducer TP flow rate 3l/min red tolerance ±15%			
	GEV No.	371221	Ref. No. —
reducer TP flow rate 5.5l/min yellow tolerance ±15%			
	GEV No.	371222	Ref. No. —
reducer TP flow rate 6l/min grey tolerance ±15%			
	GEV No.	371223	Ref. No. —
reducer TP flow rate 10l/min white tolerance ±15%			
	GEV No.	371224	Ref. No. —
reducer TP flow rate 12l/min bronze tolerance ±15%			
	GEV No.	371225	Ref. No. —
reducer TP flow rate 16l/min light brown tolerance ±15%			
	GEV No.	371226	Ref. No. —
reducer TP flow rate 20l/min red tolerance ±15%			
	GEV No.	371230	Ref. No. —
reducer TP flow rate 0.25l/min red tolerance ±25%			
	GEV No.	371231	Ref. No. —
reducer TP flow rate 0.35l/min violet tolerance ±25%			
	GEV No.	371232	Ref. No. —
reducer TP flow rate 0.5l/min orange tolerance ±25%			

Table continues overleaf





accessories for		370025		
	GEV No.	371233	Ref. No.	—
reducer TP flow rate 0.8l/min white tolerance ±25%				
	GEV No.	371234	Ref. No.	—
reducer TP flow rate 1l/min light blue tolerance ±25%				
	GEV No.	371235	Ref. No.	—
reducer TP flow rate 1.2l/min brown tolerance ±25%				
	GEV No.	371236	Ref. No.	—
reducer TP flow rate 1.5l/min light brown tolerance ±25%				
	GEV No.	371237	Ref. No.	—
reducer TP flow rate 2.5l/min yellow tolerance ±25%				
	GEV No.	371238	Ref. No.	—
reducer TP flow rate 3.4l/min dark green tolerance ±25%				
	GEV No.	371239	Ref. No.	—
reducer TP flow rate 5l/min black tolerance ±25%				
	GEV No.	371240	Ref. No.	—
reducer TP flow rate 8l/min blue tolerance ±20%				

pressure switches

for combi-steamers

	1			
GEV No.	541806	Ref. No.	5009061 5009063	
description	pressure control ø 38mm pressure range 0.2-3.0bar connection 1/8" 250V 10A GP600 pressure connection 1/8"			
For models:	OD10.10, OD10.20, OD12.20, OD20.20, OD6.10, OES10.20, OES12.20, OES6.06, OSG10.10, OSG12.20, OSG20.20, OSG6.10			
accessories for	541806			
	GEV No.	541814	Ref. No.	—
protection cap for pressure switch EPDM XP600				

	1			
GEV No.	541779	Ref. No.	2619860 5013052	
description	pressure control ø 45mm pressure range 0-120mbar for combi-steamer suitable for CONVOTHERM p max 4bar			

	1			
GEV No.	542375	Ref. No.	5013053 5056352	
description	pressure control ø 45mm pressure range 13mbar pressure connection ø 12mm for combi-steamer CONVOTHERM suitable for C4 Serie 250V 6A p max 4bar ambient temperature max. 85°C preset at 0.013bar			

	1			
GEV No.	542384	Ref. No.	2629926	
description	pressure control ø 45mm pressure range 150mbar for combi-steamer CONVOTHERM CONVOClean p max 4bar			

	1			
GEV No.	541833	Ref. No.	2619149 5013051	
description	pressure control ø 45mm pressure range 200mbar for cleaning system connection 1/4" suitable for CONVOTHERM p max 4bar preset at 0.2bar pressure connection 1/4"			
For models:	OEB10.10, OEB10.20, OEB12.20, OEB20.10, OEB20.20, OEB6.10, OEB6.20, OES10.10, OES10.20, OES12.20, OES20.10, OES20.20, OES6.10, OES6.20, OGB10.10, OGB10.20, OGB12.20, OGB20.10, OGB20.20, OGB6.10, OGB6.20, OGS10.10, OGS10.20, OGS12.20, OGS20.10, OGS20.20, OGS6.10, OGS6.20			

	1			
GEV No.	541642	Ref. No.	2611026 2611504 5009055 5013050	
description	pressure control ø 45mm pressure range 80mbar connection 12mm pressure connection 12mm			
For models:	OS10.10, OSP10.10, OSP10.20, OSP12.20, OSP20.10, OSP20.20, OSP6.10			



			
1			
GEV No.	541884	Ref. No.	5009055
description	pressure control pressure range 150mbar connection 1/8" pressure connection 1/8"		
For models:	OEB10.10, OEB10.20, OEB12.20, OEB20.20, OEB6.10, OEB6.20, OES6.10, OGB10.10, OGB10.20, OGB12.20, OGB20.10, OGB20.20, OGB6.10, OGB6.20, OS10.10, OS10.20, OS12.20, OS20.10, OS20.20, OS6.10, OSP10.10, OSP10.20, OSP12.20, OSP20.10, OSP20.20, OSP6.10		

electrodes

			
1			
GEV No.	400076	Ref. No.	5009062
description	level electrode 1/2" total length 190mm probe L 125/155mm insulated probe length 113mm connection bullet connector		
For models:	HUD6.10, OD10.10, OD10.20, OD6.10, OS10.10, OS6.10, OSC10.10, OSC20.10, OSC6.10, OSP10.10, OSP6.10		

			
1			
GEV No.	400075	Ref. No.	5009065
description	level electrode 1/2" total length 270mm probe L 185/235mm insulated probe length 113mm connection bullet connector		
For models:	HUD10.10, HUD12.20, HUD20.10, HUD20.20, OD10.10, OD10.20, OD12.20, OD20.10, OD20.20, OS10.20, OS12.20, OS20.10, OS20.20, OSC10.10, OSC10.20, OSC12.20, OSC20.10, OSC20.20, OSP10.10, OSP10.20, OSP12.20, OSP20.10, OSP20.20		

			
1			
GEV No.	400216	Ref. No.	5009068
description	level electrode 1/8" probe L 130mm insulated probe length 114mm		
For models:	OD10.10, OD6.10		

			
1			
GEV No.	400217	Ref. No.	5009066
description	level electrode 1/8" probe L 161mm insulated probe length 114mm		
For models:	OD10.10, OD6.10		

			
1			
GEV No.	400219	Ref. No.	5009067
description	level electrode probe L 235mm		

			
1			
GEV No.	403752	Ref. No.	5019003
description	level electrode total length 190mm probe L 130/160mm insulated probe length 98mm with flange ø 3mm		

			
1			
GEV No.	400218	Ref. No.	5009069
description	level electrode with thread probe L 190mm		

flow meters and flow sensors

flow sensors

			
1			
GEV No.	403753	Ref. No.	5056377
description	flow meter inlet ø 10 outlet ø 10 L 68mm		

fans

axial fans

ebm-papst

			
1			
GEV No.	601121 ¹	Ref. No.	5008068
description	axial fan L 119mm W 119mm H 38mm 12VDC 4.5W bearing ball bearing manuf. no. 4182NX metal connection male faston 2.8mm ebm-papst fan wheel ø 110mm temp.-resist. 75°C		
For models:	OD10.10, OD10.20, OD12.20, OD20.10, OD20.20, OD6.10, OS10.10, OS10.20, OS12.20, OS20.10, OS20.20, OS6.10, OSC10.10, OSC10.20, OSC12.20, OSC20.10, OSC20.20, OSC6.10, OSP10.10, OSP10.20, OSP12.20, OSP20.10, OSP20.20, OSP6.10		

¹with ball bearings

1

GEV No.	601120 ¹	Ref. No.	5008065
description	axial fan L 92mm W 92mm H 25mm 12VDC 0.8W bearing ball bearing manuf. no. 3412 plastic connection cable 1600mm ebm-papst fan wheel ø 85mm temp.-resist. 75°C		
For models:	OD10.10, OD6.10		
accessories for	601120		
	GEV No.	691103	Ref. No. —
	guard ø 90mm mounting distance 83mm for axial fan 92mm		

¹with ball bearings



1

GEV No.	601747 ¹	Ref. No.	2118786
description	axial fan L 92mm W 92mm H 25mm 12VDC 2.3W bearing ball bearing connection cable 300mm SUNON		
For models:	OES6.06		

¹with ball bearings

hot air motors

import



1

GEV No.	601712 ¹	Ref. No.	5018023 5018040
description	axial fan L 120mm W 120mm H 38mm 12VDC 10W bearing ball bearing connection cable 320mm plastic ADDA fan wheel ø 110mm		
For models:	OEB10.10, OEB10.20, OEB12.20, OEB20.10, OEB20.20, OEB6.10, OEB6.20, OES10.10, OES10.20, OES12.20, OES20.10, OES20.20, OES6.10, OES6.20, OGB10.10, OGB10.20, OGB12.20, OGB20.10, OGB20.20, OGB6.10, OGB6.20, OGS10.10, OGS10.20, OGS12.20, OGS20.10, OGS20.20, OGS6.10, OGS6.20		

¹with ball bearings



1

GEV No.	500931	Ref. No.	5008051 5008051K 5008054 5008054K 5030636
description	fan motor 0.32kW L1 200mm L2 80mm D1 ø 14mm 1,5/0,87A at 50Hz 200-240/346-415V at 60Hz 200-254/346-440VV at 50Hz 1400rpm at 60Hz 1700rpm type L7BC4D-675		
For models:	AR100, AR108, AR28, AR40, AR50, AR54, AR72, HUD10.10, HUD12.20, HUD20.10, HUD20.20, HUD6.10, OD10.10, OD10.20, OD12.20, OD20.10, OD20.20, OD6.10, UG10.10, UG20.10, UG20.20, UG6.10		

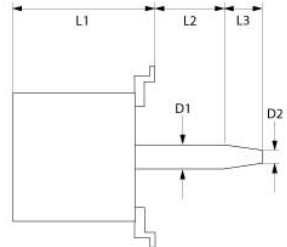
1

GEV No.	601719	Ref. No.	5008036 5008036K 5008049
description	fan motor 200-240/346-415V 200-254/346-480V 3 phase 50/60Hz 0.4/0.68kW 1420/1700rpm speeds 1 L1 152mm L2 44mm L3 54mm ø 125mm 1.2/2.1A at 50Hz 1420rpm at 60Hz 1720rpm type L9Cw4D2-450 D1 ø 15mm D2 ø 14mm		
For models:	OD10.10, OD10.20, OD12.20, OD20.10, OD20.20, OD6.10, OS10.10, OS10.20, OS12.20, OS20.10, OS20.20, OS6.10, OSC10.10, OSC10.20, OSC12.20, OSC20.10, OSC20.20, OSC6.10, OSP10.10, OSP10.20, OSP12.20, OSP20.10, OSP20.20, OSP6.10		



1

GEV No.	602154	Ref. No.	5056318
description	axial fan L 120mm W 120mm H 38mm 12VDC 6.7W bearing ball bearing manuf. no. PMD1212PMB3-A cable length 1500mm SUNON suitable for CONVOTHERM 4 fan wheel ø 110mm housing plastic		

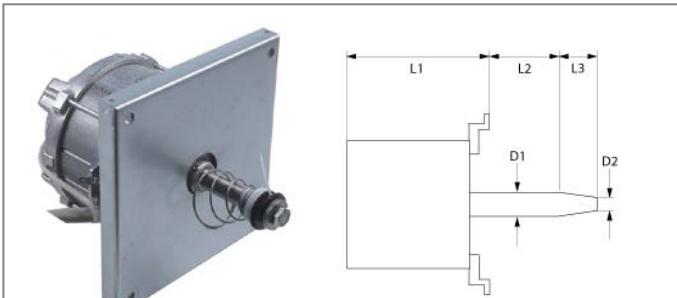

1

GEV No.	601720	Ref. No.	2617286 5018019 5018021
description	fan motor 200-240/346-415V 200-254/346-480V 3 phase 50/60Hz 0.6kW 1380/1650rpm speeds 1 L1 151mm L2 47mm L3 37mm M10x1.5 2.8/1.6A power input 820W type L9Fw4D-605 D1 ø 17mm D2 ø 13.5mm set		
For models:	OEB10.10, OEB20.10, OEB6.10, OEB6.20, OES10.10, OES20.10, OES6.10, OES6.20, OGB10.10, OGB20.10, OGB6.10, OGB6.20, OGS10.10, OGS20.10, OGS6.10, OGS6.20		
spare parts for	601720		
	GEV No.	510686	Ref. No. 6005079
	 gasket set for fan motor ID ø 15mm		



1

GEV No.	602147	Ref. No.	2617287 5018020 5018022
description	fan motor 200-240/346-415V 200-254/346-480V 3 phase 50/60Hz 1.15kW 1410/1700rpm speeds 1 L1 200mm L2 60mm L3 38mm M10 IT 4.0/2.3A at 50Hz 200-240/346-415V at 60Hz 200-254/346-480V at 50Hz 1410rpm at 60Hz 1700rpm type L9FGw4D-607 D1 ø 17mm D2 ø 13.5mm combi-steamer CONVOTHERM series P3 model 10.20/12.20/20.20 with mounting accessories mounting distance 177mm mounting ø 9mm		
For models:	OEB10.20, OEB12.20, OEB20.20, OES10.20, OES12.20, OES20.20, OGB10.20, OGB12.20, OGB20.20, OGS10.20, OGS12.20, OGS20.20		



1

GEV No.	501576	Ref. No.	5056347
description	fan motor 215-320V 3 phase 50Hz 0.35kW 1430rpm L1 140mm L2 49mm L3 35mm 1.6-1.65A type HANNING no. V3A145-040P0035-015-0020S0-819 D1 ø 17mm D2 ø 12.5mm		
spare parts for	501576		
	GEV No.	694646	Ref. No. 2617295
	 shaft sealing set for hot air motors		



1

GEV No.	602138	Ref. No.	2625108 5018057
description	fan motor 230/400V 3 phase 50/60Hz 0.15kW 2740/3270rpm L1 85mm L2 58mm L3 12mm ø 123mm shaft flat length 23mm M5 0.8A type V3A120-025P0015-036-001OS0-841 D1 ø 8mm D2 ø 8x6mm with fixing kit HANNING for CONVOTHERM model OES mini mounting distance 100mm		



1

GEV No.	602027	Ref. No.	2618802
description	fan motor 230V 1 phase 50/60Hz 0.12kW 2800/3400rpm L1 86mm L2 56mm L3 10mm ø 135mm shaft flat length 20.8mm M5 0.8A suitable capacitor 5µF compact type V1A120-025P0012-036-001OS0-840 D1 ø 8mm D2 ø 4.9mm		
For models:	OES6.06		
spare parts for	602027		
	GEV No.	694800	Ref. No. 2618801
	 engine shaft gasket ø 18mm hole ø 8mm Mini series Qty 1 pcs		

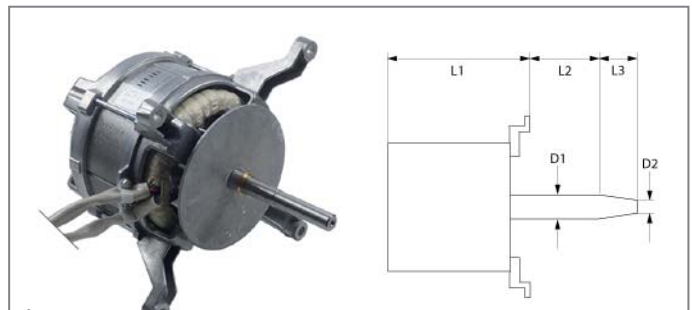

1

GEV No.	601733	Ref. No.	5008060 5008060K
description	fan motor 380-415/380-480V 3 phase 50/60Hz 0.4/0.68kW 1420/1720rpm L1 155mm L2 45mm L3 55mm 0.55/1.1A at 50Hz 380-415V at 60Hz 380-480V at 50Hz 940-1420rpm at 60Hz 1120-1720rpm type L9zAw64D-449 D1 ø 15mm D2 ø 14mm kit		
For models:	OD10.10, OD10.20, OD12.20, OD20.10, OD20.20, OD6.10, OS10.10, OS10.20, OS12.20, OS20.10, OS20.20, OS6.10, OSC10.10, OSC10.20, OSC12.20, OSC20.10, OSC20.20, OSC6.10, OSP10.10, OSP10.20, OSP12.20, OSP20.10, OSP20.20, OSP6.10		

1

GEV No.	605169	Ref. No.	2617285 5018003
description	fan motor 380-415/380-480V 3 phase 50/60Hz 0.9kW 700/1380rpm speeds 2 L1 205mm L2 30mm L3 65mm 0.9/2.1A D1 ø 17mm D2 ø 13.5mm		
For models:	OEB10.20, OEB12.20, OEB20.20, OES10.20, OES12.20, OES20.20, OGB10.20, OGB12.20, OGB20.20, OGS10.20, OGS12.20, OGS20.20		
spare parts for	605169		
	GEV No.	694646	Ref. No. 2617295
	shaft sealing set for hot air motors		



1

GEV No.	514426	Ref. No.	6010001
description	fan wheel D1 ø 350mm H1 110mm blades 12 D2 ø 16.8mm D3 ø 13.2mm H2 15mm H3 75mm		
For models:	OEB10.10, OEB20.10, OEB6.10, OEB6.20, OES10.10, OES20.10, OES6.10, OES6.20, OGB10.10, OGB20.10, OGB6.20, OGS10.10, OGS20.10, OGS6.20		



1

GEV No.	602144	Ref. No.	6000051 6000056
description	fan wheel blades 42 D1 ø 355mm D2 ø 14mm D3 ø 14mm H1 114mm H2 23mm H3 77mm		
For models:	AR100, AR108, AR30, AR40, AR50, AR54, AR72, HUD10.10, HUD12.20, HUD20.10, HUD20.20, HUD6.10, OD10.10, OD10.20, OD20.10, OD6.10, OS10.10, OS20.10, OS6.10, OSC10.10, OSC20.10, OSC6.10, OSP10.10, OSP20.10, OSP6.10, UG10.10, UG20.10, UG20.20, UG6.10		



1

GEV No.	601873	Ref. No.	2619959 6010003
description	fan wheel D1 ø 405mm H1 150mm blades 12 D2 ø 14mm D3 ø 17mm H2 22mm		
For models:	OEB10.20, OEB12.20, OEB20.20, OES10.20, OES12.20, OES20.20, OGB10.20, OGB12.20, OGB20.20, OGS10.20, OGS12.20, OGS20.20		



1

GEV No.	601872	Ref. No.	2618803
description	fan wheel D1 ø 200mm H1 43mm blades 45 D2 ø 8.3mm D3 ø 8.3mm H2 25mm		
For models:	OES6.06		



1

GEV No.	514439	Ref. No.	6015034
description	gasket graphite ED ø 82.5mm ID ø 52.5mm thickness 2mm		
For models:	OGB10.10, OGB10.20, OGB12.20, OGB20.10, OGB20.20, OGB6.10, OGB6.20, OGS10.10, OGS10.20, OGS12.20, OGS20.10, OGS20.20, OGS6.10, OGS6.20		



1

GEV No.	510686	Ref. No.	6005079
description	gasket set for fan motor ID ø 15mm		
For models:	HUD10.10, HUD12.20, HUD20.10, HUD20.20, HUD6.10, OD10.10, OD10.20, OD12.20, OD20.10, OD20.20, OD6.10		



1

GEV No.	402888	Ref. No.	2617283 5018002
description	motor three phase current 0.6kW 380-415V 50/60Hz 3 phase 0.6-1.6A shaft ϕ 17mm shaft length 88mm 710-1390 / 820-1690rpm type L9yzw84D-584 HANNING		
For models:	OEB10.10, OEB20.10, OEB6.10, OEB6.20, OES10.10, OES20.10, OES6.10, OES6.20, OGB10.10, OGB20.10, OGB6.10, OGB6.20, OGS10.10, OGS20.10, OGS6.10, OGS6.20		
accessories for	402888		
	GEV No.	514426	Ref. No. 6010001
	fan wheel D1 ϕ 350mm H1 110mm blades 12 D2 ϕ 16.8mm D3 ϕ 13.2mm H2 15mm H3 75mm		



1

GEV No.	694646	Ref. No.	2617295
description	shaft sealing set for hot air motors		
For models:	OEB10.10, OEB10.20, OEB12.20, OEB20.10, OEB20.20, OEB6.10, OEB6.20, OES10.10, OES10.20, OES12.20, OES20.10, OES20.20, OES6.10, OES6.20, OGB10.10, OGB10.20, OGB12.20, OGB20.10, OGB20.20, OGB6.10, OGB6.20, OGS10.10, OGS10.20, OGS12.20, OGS20.10, OGS20.20, OGS6.10, OGS6.20		

hot air fans

accessories

miscellaneous



1

GEV No.	694800	Ref. No.	2618801
description	engine shaft gasket ϕ 18mm hole ϕ 8mm Mini series Qty 1 pcs		
For models:	OES6.06		

radial fans



1

GEV No.	601181	Ref. No.	5018000
description	radial fan 230V voltage AC 50Hz 100W H1 170mm L1 175mm D1 ϕ 50mm W1 115mm W2 40mm H2 45mm		
For models:	OGB10.10, OGB12.20, OGB20.10, OGB6.10, OGB6.20, OGS10.10, OGS12.20, OGS20.10, OGS6.10, OGS6.20		

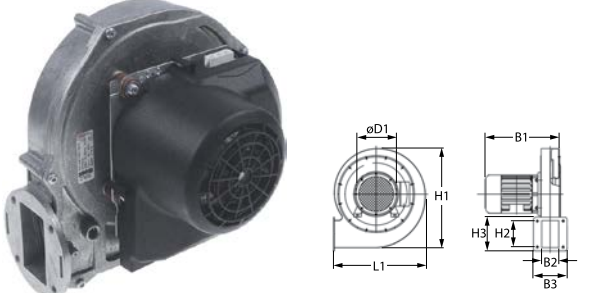

1

GEV No.	601742	Ref. No.	5018001
description	radial fan 230V voltage AC 50Hz 140W H1 190mm L1 190mm D1 ϕ 50mm W1 133mm W2 28mm H2 55mm W3 83mm H3 83mm		
For models:	OGB10.20, OGB12.20, OGB20.10, OGB20.20, OGS10.20, OGS12.20, OGS20.10, OGS20.20		

accessories universal



1

GEV No.	802191	Ref. No.	7015200
description	puller for fan wheel seat ϕ 28/34mm thread M16x1.5 WS 17		
For models:	OEB10.10, OEB10.20, OEB12.20, OEB20.10, OEB20.20, OEB6.10, OEB6.20, OES10.10, OES10.20, OES12.20, OES20.10, OES20.20, OES6.10, OES6.20, OGB10.10, OGB10.20, OGB12.20, OGB20.10, OGB20.20, OGB6.10, OGB6.20, OGS10.10, OGS10.20, OGS12.20, OGS20.10, OGS20.20, OGS6.10, OGS6.20		



pumps

wash and rinse pumps

HANNING

pumps



1

GEV No.	501563	Ref. No.	5056337
description	pump inlet ø 24 outlet ø 24 type UP30-494 200-240V 50/60Hz 1 phase 0.1kW L 146mm capacitor 2.5µF HANNING hose clamps		

drain pumps

HANNING



1

GEV No.	501569	Ref. No.	5056380
description	drain pump 38/43W 200-240V inlet ø 24mm outlet ø 24mm 50/60Hz HANNING type DPS25R-393 type series Haflowtic compact		



1

GEV No.	500096	Ref. No.	2019700 5008079 5008079K
description	drain pump inlet ø 30mm outlet ø 24mm 230V 32W		
For models:	OEB10.10, OEB10.20, OEB12.20, OEB20.10, OEB20.20, OEB6.10, OEB6.20, OES10.10, OES10.20, OES12.20, OES20.10, OES20.20, OES6.10, OES6.20, OGB10.10, OGB10.20, OGB12.20, OGB20.10, OGB20.20, OGB6.10, OGB6.20, OGS10.10, OGS10.20, OGS12.20, OGS20.10, OGS20.20, OGS6.10, OGS6.20, OS10.10, OS10.20, OS12.20, OS20.10, OS20.20, OS6.10, OSC10.10, OSC10.20, OSC12.20, OSC20.10, OSC20.20, OSC6.10, OSP10.10, OSP10.20, OSP12.20, OSP20.10, OSP20.20, OSP6.10		

vibration pumps



1

GEV No.	696786	Ref. No.	6013059
description	bracket for vibration pump L 85mm W 45mm H 70mm mounting distance 25/50mm rubber		



1

GEV No.	500580	Ref. No.	5008011 5008011K 5030635
description	vibration pump 230V 60W 50/60Hz inlet ø 7 outlet ø 1/8" IT CEME type E512 with accessories duty cycle 1/2 ambient temperature max. 60°C medium temp max. 35°C overheating protection 110°C CleanJet		
For models:	OEB10.10, OEB10.20, OEB12.20, OEB20.10, OEB20.20, OEB6.10, OEB6.20, OES10.10, OES10.20, OES12.20, OES20.10, OES20.20, OES6.06, OES6.10, OES6.20, OGB10.10, OGB10.20, OGB12.20, OGB20.10, OGB20.20, OGB6.10, OGB6.20, OGS10.10, OGS10.20, OGS12.20, OGS20.10, OGS20.20, OGS6.10, OGS6.20, OS12.20, OS20.10, OS20.20		



1

GEV No.	499142	Ref. No.	5018028 5018035
description	vibration pump type CP.06.728.0 220/240V 70W 60Hz inlet ø 6 outlet ø 6 with thermal fuse L 130mm		
For models:	OEB10.10, OEB10.20, OEB12.20, OEB20.10, OEB20.20, OEB6.10, OEB6.20, OES10.10, OES10.20, OES12.20, OES20.10, OES20.20, OES6.10, OES6.20, OGB10.10, OGB10.20, OGB12.20, OGB20.10, OGB20.20, OGB6.10, OGB6.20, OGS10.10, OGS10.20, OGS12.20, OGS20.10, OGS20.20, OGS6.10, OGS6.20		



1

GEV No.	501547	Ref. No.	5056376
description	vibration pump type MPP2.02.041.2/ST/S 208-240V 14W 50Hz inlet ø 6.5 outlet ø 7.5 ARS L 87mm		



1

GEV No.	381483	Ref. No.	5056977
description	RC circuit for CONVOTHERM type MT151415 1200hm capacity 0.15µF		

condensators & interference suppression filters

filters

interference suppression filters



1

GEV No.	365218	Ref. No.	4001078
description	interference suppression filter type RC-01 capacity 0.15µF L 37.5mm H 37mm W 10mm 470Ohm		
For models:	OD10.10, OD10.20, OD12.20, OD20.10, OD20.20, OD6.10, OSC10.10, OSC10.20, OSC12.20, OSC20.10, OSC20.20, OSC6.10, OSG10.10, OSG12.20, OSG20.20, OSG6.10, OSP10.10, OSP10.20, OSP12.20, OSP20.10, OSP20.20, OSP6.10		



1

GEV No.	381482	Ref. No.	5056980
description	RC circuit for CONVOTHERM type MT151417 1500hm capacity 0.47µF		



1

GEV No.	381478	Ref. No.	5056981
description	RC circuit for CONVOTHERM type MT151418 1500hm capacity 0.47µF		



1

GEV No.	381479	Ref. No.	5056979
description	RC circuit type SAWI 610303 1500hm capacity 0.47µF		

line filters

with housing



1

GEV No.	365222	Ref. No.	5056974
description	line filter type 5500.2218 250V 50/60Hz conductor 2 with E connection F6.3x0.8 L 65mm H 42mm W 50mm screw aluminium		

fuses

fine fuses

RC circuits



1

GEV No.	380272	Ref. No.	4001077
description	RC circuit for contactors type 910-304-585-50 130-250V 50-60Hz conductor 2 connection cable plastic Qty 1 pcs for contactors LS4_LS15K type AEG LR2K A250 type GE B52R2R		
For models:	OD10.10, OD10.20, OD12.20, OD20.10, OD20.20, OD6.10		

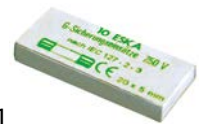



1

GEV No.	358600	Ref. No.	4005064
description	fine fuse size ø5x20mm 1A slow-acting rated 250V Qty 10 pcs		
For models:	HUD10.10, HUD12.20, HUD20.10, HUD20.20, HUD6.10, OD10.10, OD10.20, OD12.20, OD20.10, OD20.20, OD6.10, OEB10.10, OEB10.20, OEB12.20, OEB20.10, OEB20.20, OEB6.10, OEB6.20, OES10.10, OES10.20, OES12.20, OES20.10, OES20.20, OES6.06, OES6.10, OES6.20, OGB10.20, OGB12.20, OGB20.10, OGB20.20, OGS10.10, OGS10.20, OGS12.20, OGS20.10, OGS20.20, OGS6.10, OGS6.20, OSC10.10, OSC10.20, OSC12.20, OSC20.10, OSC20.20, OSC6.10, OSG10.10, OSG12.20, OSG20.20, OSG6.10, OSP10.10, OSP10.20, OSP12.20... (Other models you can see in the webshop)		





			
1			
GEV No.	358603	Ref. No.	4005066 4056944
description	fine fuse size ϕ 5x20mm 2A slow-acting rated 250V Qty 10 pcs		
For models:	AR108, AR12, AR18, AR28, AR40, AR54, AR72, OD10.10, OD10.20, OD12.20, OD20.10, OD20.20, OD6.10, OEB10.10, OEB10.20, OEB12.20, OEB20.10, OEB20.20, OEB6.10, OEB6.20, OES10.10, OES10.20, OES12.20, OES20.10, OES20.20, OES6.10, OES6.20, OGB10.10, OGB10.20, OGB12.20, OGB20.10, OGB20.20, OGB6.10, OGB6.20, OGS10.10, OGS10.20, OGS12.20, OGS20.10, OGS20.20, OGS6.10, OGS6.20, OSC10.10, OSC10.20, OSC12.20, OSC20.10, OSC20.20, OSC6.10, OSG10.10, OSG12.20, OSG20.20...(Other models you can see in the webshop)		

			
1			
GEV No.	358605	Ref. No.	4056945
description	fine fuse size ϕ 5x20mm 3.15A slow-acting rated 250V Qty 10 pcs		

			
1			
GEV No.	358607	Ref. No.	4005068
description	fine fuse size ϕ 5x20mm 6.3A slow-acting rated 250V Qty 10 pcs		
For models:	HUD10.10, HUD12.20, HUD20.10, HUD20.20, HUD6.10, OD10.10, OD10.20, OD12.20, OD20.10, OD20.20, OD6.10, OSG10.10, OSG12.20, OSG20.20, OSG6.10		

			
1			
GEV No.	358751	Ref. No.	4005069
description	fine fuse size ϕ 6.3x32mm 6.3A fast-acting rated 500V Qty 10 pcs		
For models:	OD10.10, OD10.20, OD12.20, OD6.10, OEB10.10, OEB6.10, OEB6.20, OES10.10, OES6.10, OES6.20, OGB10.10, OGB20.10, OGB6.10, OGB6.20, OGS10.10, OGS20.10, OGS6.10, OGS6.20, OSC10.10, OSC10.20, OSC12.20, OSC20.10, OSC6.10, OSP10.10, OSP10.20, OSP12.20, OSP6.10		

<p>slow-acting</p> 			
1			
GEV No.	358188	Ref. No.	4056355
description	fine fuse size ϕ 6.3x32mm 10A slow-acting rated 500V Qty 10 pcs		

			
1			
GEV No.	358189	Ref. No.	4056354
description	fine fuse size ϕ 6.3x32mm 4A slow-acting rated 500V Qty 10 pcs		

<p>fine fuse holders</p> 			
1			
GEV No.	550105	Ref. No.	4004010
description	rail-mounted terminal WIELAND type WK10/SIU 5X20 /V0 suitable fuse ϕ 5x20mm 1.0-16mm ² 10A rated 250V		
For models:	AR108, AR12, AR18, AR28, AR40, AR54, AR72, HUD10.10, HUD12.20, HUD20.10, HUD20.20, HUD6.10, OD10.10, OD10.20, OD12.20, OD20.10, OD20.20, OD6.10, OSC10.10, OSC10.20, OSC12.20, OSC20.10, OSC20.20, OSC6.10, OSP10.10, OSP10.20, OSP12.20, OSP20.10, OSP20.20, OSP6.10		

screw locks

<p>D0-system (NEOZED)</p> 			
1			
GEV No.	358073	Ref. No.	4005053
description	fuse size D01 10A rated 250/400V E14 ϕ 11mm L 36mm Qty 10 pcs		

			
1			
GEV No.	358043	Ref. No.	4005054
description	fuse size D01 16A rated 250/400V E14 ϕ 11mm L 36mm Qty 10 pcs		
For models:	HUD12.20, HUD20.10		

			
1			
GEV No.	358070	Ref. No.	4005050
description	fuse size D01 2A rated 250/400V E14 ϕ 11mm L 36mm Qty 10 pcs		
For models:	AR100, AR108, AR16, AR18, AR28, AR30, AR40, AR50, AR54, AR72, UG10.10, UG10.20, UG20.10, UG20.20, UG6.05, UG6.10		

			
1			
GEV No.	358071	Ref. No.	4005051
description	fuse size D01 4A rated 250/400V E14 ϕ 11mm L 36mm Qty 10 pcs		
For models:	AR100, AR108, AR30, AR40, AR50, AR54, AR72, OES12.20, UG10.10, UG20.10, UG6.10		





			
1			
GEV No.	358072	Ref. No.	4005052
description	fuse size D01 6A rated 250/400V E14 ø 11mm L 36mm Qty 10 pcs		
For models:	OEB20.20, UG20.20		

			
1			
GEV No.	358048	Ref. No.	4005058
description	fuse size D02 20A rated 250/400V E18 ø 15mm L 36mm Qty 10 pcs		
For models:	AR108, HUD20.20, OD10.20, OD12.20, OD20.10, OD20.20, OEB10.20, OEB12.20, OEB20.10		

			
1			
GEV No.	358044	Ref. No.	4005046 4005055
description	fuse size D02 25A rated 250/400V E18 ø 15mm L 36mm Qty 10 pcs		
For models:	AR100, AR108, HUD12.20, HUD20.10, HUD20.20, OD10.20, OD12.20, OD20.10, OD20.20, OEB10.20, OEB12.20, OEB20.20, OES10.20, OES12.20, OES20.20, UG10.20		

			
1			
GEV No.	358045	Ref. No.	2212003 4005056
description	fuse size D02 35A rated 250/400V E18 ø 15mm L 36mm Qty 10 pcs		
For models:	HUD20.10, OD20.20, OEB10.20, OEB12.20, OEB20.10, OES20.10, UG20.10, UG20.20		

			
1			
GEV No.	358046	Ref. No.	4005057
description	fuse size D02 50A rated 250/400V E18 ø 15mm L 36mm Qty 10 pcs		
For models:	OD10.20, OD12.20, OD20.10, OD20.20, OEB10.20, OEB12.20, OEB20.20, OES10.20, OES12.20, OES20.20		

			
1			
GEV No.	358047	Ref. No.	4005059
description	fuse size D02 63A rated 250/400V E18 ø 15mm L 36mm Qty 10 pcs		
For models:	OEB20.10, OES20.10		

gauge pieces (NEOZED)

			
1			
GEV No.	358055	Ref. No.	4005013
description	gauge piece size D01 suitable for 10A		

			
1			
GEV No.	358052	Ref. No.	4005010
description	gauge piece size D01 suitable for 2A		
For models:	AR100, AR108, AR16, AR18, AR28, AR30, AR40, AR50, AR54, AR72, UG10.10, UG10.20, UG20.10, UG20.20, UG6.05, UG6.10		

			
1			
GEV No.	358053	Ref. No.	4005011
description	gauge piece size D01 suitable for 4A		
For models:	AR100, AR108, AR30, AR40, AR50, AR54, AR72, OES12.20, OES20.20, UG10.10, UG20.10, UG6.10		

			
1			
GEV No.	358054	Ref. No.	4005012
description	gauge piece size D01 suitable for 6A		
For models:	UG20.20		

			
1			
GEV No.	358064	Ref. No.	4005021
description	gauge piece size D02 suitable for 16A		
For models:	OD10.20, OD12.20, OD20.10, OSP10.20, OSP12.20		





			
1			
GEV No.	358065	Ref. No.	4005014
description	gauge piece size D02 suitable for 20A		
For models:	AR108, HUD12.20, HUD20.10, HUD20.20, OD10.20, OD12.20, OD20.10, OD20.20, OEB10.20, OEB12.20, OEB20.10, OSC10.20, OSC12.20, OSC20.10, OSC20.20, OSP10.20, OSP12.20, OSP20.10, OSP20.20, OSP6.10		

			
1			
GEV No.	358059	Ref. No.	4004030
description	fuse holder suitable fuse D01 ø 24mm mounting ø 14mm 1-pole-pole 16A rated 400V L 30mm		
For models:	AR100, AR108, AR16, AR18, AR28, AR30, AR40, AR50, AR54, AR72, HUD12.20, HUD20.10, HUD20.20, UG10.10, UG10.20, UG20.10, UG20.20, UG6.05, UG6.10		

			
2			
GEV No.	358066	Ref. No.	4005015
description	gauge piece size D02 suitable for 25A		
For models:	AR100, AR108, OD10.20, OD12.20, OD20.10, OD20.20, OEB10.20, OEB12.20, OEB20.20, OES10.20, OES12.20, OES20.20, OSC10.20, OSC12.20, OSC20.10, OSC20.20, OSP10.20, OSP12.20, OSP20.10, OSP20.20, UG10.20		

			
1			
GEV No.	358058	Ref. No.	4004023 4004025
description	fuse holder suitable fuse D02 1-pole-pole 63A rated 400V		
For models:	AR108, HUD12.20, HUD20.10, HUD20.20, OD10.20, OD12.20, OD20.10, OD20.20, OEB10.20, OEB12.20, OEB20.10, OEB20.20, OES10.20, OES12.20, OES20.10, OES20.20, OSC10.20, OSC12.20, OSC20.10, OSC20.20, OSP10.20, OSP12.20, OSP20.10, OSP20.20, OSP6.10, UG10.20, UG20.10, UG20.20		

			
1			
GEV No.	358067	Ref. No.	4005016
description	gauge piece size D02 suitable for 35A		
For models:	HUD20.10, OD20.20, OEB10.20, OEB12.20, OEB20.10, OES20.10, OSC20.20, OSP20.20, UG20.10, UG20.20		

			
1			
GEV No.	358061	Ref. No.	4004035
description	fuse holder suitable fuse D02 ø 25mm mounting ø 18mm rated 400V L 30mm		
For models:	AR100, AR108, HUD12.20, HUD20.10, OD10.20, OD12.20, OD20.10, OD20.20, OEB10.20, OEB12.20, OEB20.10, OEB20.20, OES10.20, OES12.20, OES20.10, OES20.20, UG10.20, UG20.10, UG20.20		

			
1			
GEV No.	358068	Ref. No.	4005017
description	gauge piece size D02 suitable for 50A		
For models:	OD10.20, OD12.20, OD20.10, OD20.20, OEB10.20, OEB12.20, OEB20.20, OES10.20, OES12.20, OES20.20, OSC10.20, OSC12.20, OSC20.10, OSC20.20, OSP10.20, OSP12.20, OSP20.10, OSP20.20		

<h3>line circuit breakers</h3>			
<h4>SCHNEIDER ELECTRIC</h4>			
			
1			
GEV No.	381457	Ref. No.	5056830
description	line circuit breaker 1-pole tripping type B 63A rated 230/400V connection screw auxiliary contacts 1NO mounting rail		

<h3>fuse holders</h3>			
			
1			
GEV No.	358057	Ref. No.	4004020
description	fuse holder suitable fuse D01 1-pole-pole 16A rated 400V		
For models:	AR100, AR108, AR16, AR18, AR28, AR30, AR40, AR50, AR54, AR72, HUD12.20, HUD20.10, UG10.10, UG10.20, UG20.10, UG20.20, UG6.05, UG6.10		



electric accessories

cables

connection cables



GEV No.	579000	Ref. No.	5009304
description	connection cable L 1900mm 9-pole suitable for CONVOTHERM connection plug plug type RS232 interface		
For models:	OEB10.10, OEB10.20, OEB12.20, OEB20.10, OEB20.20, OEB6.10, OEB6.20, OES10.10, OES10.20, OES12.20, OES20.10, OES20.20, OES6.06, OES6.10, OES6.20, OGB10.10, OGB10.20, OGB12.20, OGB20.10, OGB20.20, OGB6.10, OGB6.20, OGS10.10, OGS10.20, OGS12.20, OGS20.10, OGS20.20, OGS6.10, OGS6.20, OSC10.10, OSC10.20, OSC12.20, OSC20.10, OSC20.20, OSC6.10, OSG10.10, OSG12.20, OSG20.20, OSG6.10, OSP10.10, OSP10.20, OSP12.20, OSP20.10, OSP20.20, OSP6.10		



GEV No.	579006	Ref. No.	5056357
description	data cable L 1020mm 8-pole for combi-steamer suitable for CONVOTHERM plug type RJ45		

terminals

PCB terminal blocks



GEV No.	551367	Ref. No.	5012003
description	PCB terminal block 12-pole raster size 3.5mm		
For models:	OEB10.10, OEB10.20, OEB12.20, OEB20.10, OEB20.20, OEB6.10, OEB6.20, OES10.10, OES10.20, OES12.20, OES20.10, OES20.20, OES6.06, OES6.10, OES6.20, OGB10.10, OGB10.20, OGB12.20, OGB20.10, OGB20.20, OGB6.10, OGB6.20, OGS10.10, OGS10.20, OGS12.20, OGS20.10, OGS20.20, OGS6.10, OGS6.20		



GEV No.	551369	Ref. No.	5002091
description	PCB terminal block 12-pole raster size 3.5mm flat		
For models:	OS10.10, OS10.20, OS12.20, OS20.10, OS20.20, OS6.10, OSC10.10, OSC10.20, OSC12.20, OSC20.10, OSC20.20, OSC6.10, OSG10.10, OSG12.20, OSG20.20, OSG6.10, OSP10.10, OSP10.20, OSP12.20, OSP20.10, OSP20.20, OSP6.10		



GEV No.	550810	Ref. No.	4006003
description	PCB terminal block 12-pole raster size 5mm		
For models:	OD10.10, OD10.20, OD12.20, OD20.10, OD20.20, OD6.10		



GEV No.	551360	Ref. No.	5002097
description	PCB terminal block 16-pole raster size 3.5mm		
For models:	OS10.10, OS10.20, OS12.20, OS20.10, OS20.20, OS6.10, OSC10.10, OSC10.20, OSC12.20, OSC20.10, OSC20.20, OSC6.10, OSG10.10, OSG12.20, OSG20.20, OSG6.10, OSP10.10, OSP10.20, OSP12.20, OSP20.10, OSP20.20, OSP6.10		



GEV No.	550802	Ref. No.	4005093
description	PCB terminal block 4-pole raster size 5mm		
For models:	OD10.10, OD10.20, OD12.20, OD20.10, OD20.20, OD6.10		





GEV No.	551338	Ref. No.	4006022
description	PCB terminal block 6-pole cross section 1.5mm ²		
For models:	OD10.10, OD10.20, OD12.20, OD20.10, OD20.20, OD6.10		





GEV No.	551363	Ref. No.	4006021
description	PCB terminal block 7-pole raster size 7mm cross section 1.5mm ²		
For models:	OD10.10, OD10.20, OD12.20, OD20.10, OD20.20, OD6.10		





			
1			
GEV No.	551370	Ref. No.	5002096
description	PCB terminal block 8-pole raster size 3.5mm flat		
For models:	OEB10.10, OEB10.20, OEB12.20, OEB20.10, OEB20.20, OEB6.10, OEB6.20, OES10.10, OES10.20, OES12.20, OES20.10, OES20.20, OES6.10, OES6.20, OGB10.10, OGB10.20, OGB12.20, OGB20.10, OGB20.20, OGB6.10, OGB6.20, OGS10.10, OGS10.20, OGS12.20, OGS20.10, OGS20.20, OGS6.10, OGS6.20, OS10.10, OS10.20, OS12.20, OS20.10, OS20.20, OS6.10, OSC10.10, OSC10.20, OSC12.20, OSC20.10, OSC20.20, OSC6.10, OSG10.10, OSG12.20, OSG20.20, OSG6.10, OSP10.10, OSP10.20, OSP12.20, OSP20.10, OSP20.20, OSP6.10		

			
2			
GEV No.	551364	Ref. No.	5012002
description	PCB terminal block 8-pole raster size 5mm		
For models:	OEB10.10, OEB10.20, OEB12.20, OEB20.10, OEB20.20, OEB6.10, OEB6.20, OES10.10, OES10.20, OES12.20, OES20.10, OES20.20, OES6.06, OES6.10, OES6.20, OGB10.10, OGB10.20, OGB12.20, OGB20.10, OGB20.20, OGB6.10, OGB6.20, OGS10.10, OGS10.20, OGS12.20, OGS20.10, OGS20.20, OGS6.10, OGS6.20		

			
1			
GEV No.	551365	Ref. No.	5002095
description	PCB terminal block 9-pole raster size 3.5mm		
For models:	OGB10.10, OGB10.20, OGB12.20, OGB20.10, OGB20.20, OGB6.10, OGB6.20, OGS10.10, OGS10.20, OGS12.20, OGS20.10, OGS20.20, OGS6.10, OGS6.20, OS10.10, OS10.20, OS12.20, OS20.10, OS20.20, OS6.10, OSC10.10, OSC10.20, OSC12.20, OSC20.10, OSC20.20, OSC6.10, OSG10.10, OSG12.20, OSG20.20, OSG6.10, OSP10.10, OSP10.20, OSP12.20, OSP20.10, OSP20.20, OSP6.10		

			
1			
GEV No.	551368	Ref. No.	5002098
description	PCB terminal block 9-pole raster size 3.5mm		
For models:	OS10.10, OS10.20, OS12.20, OS20.10, OS20.20, OS6.10, OSC10.10, OSC10.20, OSC12.20, OSC20.10, OSC20.20, OSC6.10, OSG10.10, OSG12.20, OSG20.20, OSG6.10, OSP10.10, OSP10.20, OSP12.20, OSP20.10, OSP20.20, OSP6.10		

			
1			
GEV No.	551361	Ref. No.	5002090
description	PCB terminal block 9-pole raster size 5mm		
For models:	OGB10.10, OGB10.20, OGB12.20, OGB20.10, OGB20.20, OGB6.10, OGB6.20, OGS10.10, OGS10.20, OGS12.20, OGS20.10, OGS20.20, OGS6.10, OGS6.20, OS10.10, OS10.20, OS12.20, OS20.10, OS20.20, OS6.10, OSC10.10, OSC10.20, OSC12.20, OSC20.10, OSC20.20, OSC6.10, OSG10.10, OSG12.20, OSG20.20, OSG6.10, OSP10.10, OSP10.20, OSP12.20, OSP20.10, OSP20.20, OSP6.10		

rail-mounted terminals			
WIELAND			
rail-mounted terminals type 9700A			
			
1			
GEV No.	550373	Ref. No.	4006040
description	rail-mounted terminal WIELAND type 9700A/10 S35 1.5-16mm ² top-hat rail 35mm grey W 10mm L 49mm		
For models:	AR108, HUD12.20, HUD20.20, OD10.10, OD6.10, OSC10.10, OSP10.10, OSP6.10		

			
1			
GEV No.	550382	Ref. No.	4006050
description	rail-mounted terminal WIELAND type 9700A/12 S35 2.5-25mm ² top-hat rail 35mm grey W 12mm L 59mm		
For models:	HUD20.10, OD10.20, OD12.20, OD20.10, OSC10.20, OSC12.20, OSC20.10, OSP10.20, OSP12.20, OSP20.10, OSP6.10		

			
1			
GEV No.	550376	Ref. No.	4006055
description	rail-mounted terminal WIELAND type 9700A/16 S35 2.5-35mm ² top-hat rail 35mm grey W 16mm L 59mm		
For models:	HUD20.20, OD10.20, OD12.20, OD20.10, OD20.20, OSC10.20, OSC12.20, OSC20.10, OSC20.20, OSP10.20, OSP12.20, OSP20.10, OSP20.20		

			
1			
GEV No.	550378	Ref. No.	4006058
description	rail-mounted terminal WIELAND type 9700A/16 SL2 S35 2.5-35mm ² top-hat rail 35mm yellow/green W 16mm L 53mm		
For models:	HUD12.20, HUD20.10, HUD20.20, OD10.20, OD12.20, OD20.10, OD20.20, OSC10.20, OSC12.20, OSC20.10, OSC20.20, OSP10.20, OSP12.20, OSP20.10, OSP20.20, OSP6.10		



			
1			
GEV No.	550371	Ref. No.	4006023
description	rail-mounted terminal WIELAND type 9700A/6 S35 0.5-4mm ² top-hat rail 35mm grey W 6mm L 46.6mm		
For models:	AR18, AR28, HUD10.10, HUD12.20, HUD20.10, HUD20.20, HUD6.10, OD10.10, OD10.20, OD12.20, OD20.10, OD20.20, OD6.10, OSC10.10, OSC20.10, OSC6.10, OSG10.10, OSG12.20, OSG20.20, OSG6.10, OSP10.10, OSP10.20, OSP12.20, OSP20.10, OSP20.20, OSP6.10		

			
1			
GEV No.	550372	Ref. No.	4006026
description	rail-mounted terminal WIELAND type 9700A/6 SL2 S35 0.5-4mm ² top-hat rail 35mm yellow/green W 6mm L 48.5mm		
For models:	AR108, AR18, AR28, AR40, AR54, AR72, HUD10.10, HUD12.20, HUD20.10, HUD20.20, HUD6.10, OD10.10, OD10.20, OD12.20, OD20.10, OD20.20, OD6.10, OSC10.10, OSC10.20, OSC12.20, OSC20.10, OSC20.20, OSC6.10, OSG10.10, OSG12.20, OSG20.20, OSG6.10, OSP10.10, OSP10.20, OSP12.20, OSP20.10, OSP20.20, OSP6.10		

			
1			
GEV No.	550383	Ref. No.	4006033
description	rail-mounted terminal WIELAND type 9700A/8 S35 1.0-10mm ² top-hat rail 35mm blue W 8mm L 46.6mm		
For models:	AR40, AR54, AR72, HUD10.10, OD10.10, OD10.20, OD12.20, OD6.10, OSC10.10, OSC6.10, OSP10.10, OSP6.10		

			
1			
GEV No.	550381	Ref. No.	4006030
description	rail-mounted terminal WIELAND type 9700A/8 S35 1.0-10mm ² top-hat rail 35mm grey W 8mm L 46.6mm		
For models:	AR40, AR54, AR72, HUD10.10, HUD20.10, HUD20.20, OD10.10, OD6.10, OSC10.10, OSC6.10, OSP10.10, OSP6.10		

			
1			
GEV No.	550400 ¹	Ref. No.	4006043
description	installation terminal WIELAND type WK4/D2/2U/V0 0.5-6mm ² TS35+TS32 grey DUO		
For models:	HUD10.10, HUD12.20, HUD20.10, HUD20.20, HUD6.10, OD10.10, OD10.20, OD12.20, OD20.10, OD20.20, OD6.10, OSC10.10, OSC10.20, OSC12.20, OSC20.10, OSC20.20, OSC6.10, OSP10.10, OSP10.20, OSP12.20, OSP20.10, OSP20.20, OSP6.10		

¹duo-modular terminal

			
1			
GEV No.	550105	Ref. No.	4004010
description	rail-mounted terminal WIELAND type WK10/SIU 5X20 /V0 suitable fuse ø5x20mm 1.0-16mm ² 10A rated 250V		
For models:	AR108, AR12, AR18, AR28, AR40, AR54, AR72, HUD10.10, HUD12.20, HUD20.10, HUD20.20, HUD6.10, OD10.10, OD10.20, OD12.20, OD20.10, OD20.20, OD6.10, OSC10.10, OSC10.20, OSC12.20, OSC20.10, OSC20.20, OSC6.10, OSP10.10, OSP10.20, OSP12.20, OSP20.10, OSP20.20, OSP6.10		

			
1			
GEV No.	550410	Ref. No.	4006045
description	end barrier for duo-modular terminal clamps up to 4mm ² grey		
For models:	HUD10.10, HUD12.20, HUD20.10, HUD20.20, HUD6.10		

			
1			
GEV No.	550337	Ref. No.	4004011
description	end barrier for fuse terminal clampsmm ²		
For models:	HUD10.10, HUD12.20, HUD20.10, HUD20.20, HUD6.10, OD10.10, OD10.20, OD12.20, OD20.10, OD6.10		

			
1			
GEV No.	550392	Ref. No.	4006051
description	end barrier for rail-mounted terminal clamps up to 25/35mm ² blue		
For models:	HUD20.10, HUD20.20		



			
1			
GEV No.	550384	Ref. No.	4006024
description	end barrier for rail-mounted terminal clamps up to 4mm ² blue		
For models:	HUD6.10		

			
1			
GEV No.	550394	Ref. No.	4006032
description	isolation barrier for rail-mounted terminal clamps up to 10mm ² blue		
For models:	HUD10.10, HUD20.10		

			
1			
GEV No.	550395	Ref. No.	4006042
description	isolation barrier for rail-mounted terminal clamps up to 16mm ² yellow/green		
For models:	HUD12.20, HUD20.20		

			
1			
GEV No.	550399	Ref. No.	4006052
description	isolation barrier for rail-mounted terminal clamps up to 25/35mm ² green		
For models:	HUD20.10, HUD20.20		

			
1			
GEV No.	550393	Ref. No.	4006025
description	isolation barrier for rail-mounted terminal clamps up to 4mm ² grey		
For models:	HUD10.10, HUD12.20, HUD20.10, HUD20.20, HUD6.10		

miscellaneous

			
1			
GEV No.	551421	Ref. No.	4056408
description	rail-mounted terminal PHOENIX CONTACT type ST 10-TWIN 0.2-16mm ² grey W 10.2mm L 95.7mm max. 57A max 1000V for combi-steamer cross section 10mm ²		

			
1			
GEV No.	551427	Ref. No.	4056402
description	rail-mounted terminal PHOENIX CONTACT type ST 16-TWIN 0.2-25mm ² grey W 12.2mm L 108mm max. 76A max 1000V for combi-steamer cross section 16mm ²		

			
1			
GEV No.	551410	Ref. No.	4056990
description	rail-mounted terminal PHOENIX CONTACT type ST 4 4mm ² blue W 6mm L 56mm max. 30A max 800V		

			
1			
GEV No.	551403	Ref. No.	4056405
description	rail-mounted terminal PHOENIX CONTACT type ST 4 4mm ² grey W 6.2mm L 56mm		

			
1			
GEV No.	551412	Ref. No.	4056404
description	rail-mounted terminal PHOENIX CONTACT type ST 4-PE 4mm ² green/yellow W 35mm L 56mm for combi-steamer CONVOTHERM		

			
1			
GEV No.	551419	Ref. No.	4056985
description	rail-mounted terminal PHOENIX CONTACT type ST2,5-QUATTRO-PE 0.08-4mm ² yellow/green W 5.2mm L 72.5mm for combi-steamer cross section 2.5mm ²		



1

GEV No.	551418	Ref. No.	4056987
description	rail-mounted terminal PHOENIX CONTACT type ST2.5-QUATTRO 0.08-4mm ² blue W 5.2mm L 89.5mm max. 28A max 800V for combi-steamer cross section 2.5mm ²		



1

GEV No.	551417	Ref. No.	4056400
description	rail-mounted terminal PHOENIX CONTACT type ST6 0.2-10mm ² blue W 8.2mm L 69.5mm max. 50A max 1000V for combi-steamer		



1

GEV No.	551424	Ref. No.	4056988
description	rail-mounted terminal PHOENIX CONTACT type ST2.5-QUATTRO 0.08-4mm ² grey W 5.2mm L 72mm max. 24A max 800V for combi-steamer cross section 2.5mm ²		



1

GEV No.	551416	Ref. No.	4056398
description	rail-mounted terminal PHOENIX CONTACT type ST6 0.2-10mm ² grey W 8.2mm L 70mm max. 52A max 1000V for combi-steamer cross section 6mm ²		



1

GEV No.	551392	Ref. No.	4056389
description	rail-mounted terminal PHOENIX CONTACT type ST4-HESI 4mm ² black W 6.2mm L 76.5mm max. 10A max 400V for combi-steamer 6.3x32		



1

GEV No.	551414	Ref. No.	4056399
description	rail-mounted terminal PHOENIX CONTACT type ST6-PE 0.2-10mm ² green/yellow W 8.2mm L 69.5mm		



1

GEV No.	551429	Ref. No.	4056390
description	rail-mounted terminal PHOENIX CONTACT type ST4-QUATTRO-PE 0.08-6mm ² yellow/green W 6.2mm L 82mm for combi-steamer cross section 4mm ²		



1

GEV No.	551430	Ref. No.	4056834
description	rail-mounted terminal PHOENIX CONTACT type ST6-TWIN 0.2-10mm ² grey W 8.2mm L 90.5mm max. 52A max 1000V for combi-steamer cross section 6mm ²		



1

GEV No.	551422	Ref. No.	4056406A
description	rail-mounted terminal PHOENIX CONTACT type ST4-TWIN 0.08-6mm ² grey W 6.2mm L 71.5mm max. 40A max 800V for combi-steamer cross section 4mm ²		



1

GEV No.	551406	Ref. No.	4056411
description	rail-mounted terminal PHOENIX CONTACT type STU10/4x2.5 0.5-16mm ² grey W 10.3mm L 68mm max. 57A max 800V for combi-steamer cross section 10mm ²		

1

GEV No.	551405	Ref. No.	4056410
description	rail-mounted terminal PHOENIX CONTACT type STU35/4x10 1.5-50mm ² grey W 16.2mm L 86mm max. 125A max 1000V for combi-steamer cross section 35mm ²		



1

GEV No.	551426	Ref. No.	4056396
description	rail-mounted terminal PHOENIX CONTACT type USLKG50 16-50mm ² yellow/green W 20mm L 70.5mm for combi-steamer cross section 50mm ²		



1

GEV No.	551423	Ref. No.	4056397
description	rail-mounted terminal PHOENIX CONTACT type UKH50 16-70mm ² blue W 20mm L 70.5mm max. 150A max 1000V for combi-steamer cross section 50mm ²		



1

GEV No.	551408	Ref. No.	4056394
description	rail-mounted terminal PHOENIX CONTACT type UT 35 1.5-50mm ² blue W 16mm L 59mm max. 150A max 1000V for combi-steamer cross section 35mm ²		



1

GEV No.	551415	Ref. No.	4056395
description	rail-mounted terminal PHOENIX CONTACT type UKH50 16-70mm ² grey W 20mm L 76mm max. 150A max 1000V for combi-steamer cross section 50mm ²		



1

GEV No.	551404	Ref. No.	4056392
description	rail-mounted terminal PHOENIX CONTACT type UT 35 1.5-50mm ² grey W 16mm L 60mm max. 150A max 1000V for combi-steamer cross section 35mm ²		



1

GEV No.	551413	Ref. No.	4056989
description	rail-mounted terminal PHOENIX CONTACT type UKH95 25-95mm ² grey W 25mm L 83mm max. 232A max 1000V for combi-steamer		



1

GEV No.	551409	Ref. No.	4056393
description	rail-mounted terminal PHOENIX CONTACT type UT 35-PE 1.5-35mm ² green/yellow W 16mm L 63mm max. 125A for combi-steamer		



1

GEV No.	551425	Ref. No.	4056833
description	rail-mounted terminal PHOENIX CONTACT type USLKG 95 25-95mm ² yellow/green W 25mm L 83mm for combi-steamer cross section 95mm ²		



1

GEV No.	551428	Ref. No.	4056831
description	terminal PHOENIX CONTACT type UHV95 35-95mm ² grey W 40mm L 110mm max. 232A max 1000V for combi-steamer		



accessories universal

terminal block end brackets



1

GEV No.	551389	Ref. No.	4056403
description	isolation barrier for rail-mounted terminal L 108mm W 2.2mm H 44mm PHOENIX CONTACT D-ST 16-TWIN		



1

GEV No.	551388	Ref. No.	4056413A
description	isolation barrier for rail-mounted terminal L 56mm W 2.2mm H 29mm PHOENIX CONTACT D-ST 4		



1

GEV No.	551385	Ref. No.	4056412
description	isolation barrier for rail-mounted terminal L 68mm W 2.2mm H 40.7mm PHOENIX CONTACT D-STU 10		



1

GEV No.	551384	Ref. No.	4056401A
description	isolation barrier for rail-mounted terminal L 69.5mm W 2.2mm H 36mm PHOENIX CONTACT D-ST6		



1

GEV No.	551386	Ref. No.	4056407A
description	isolation barrier for rail-mounted terminal L 71.5mm W 2.2mm H 29mm PHOENIX CONTACT D-ST 4-TWIN		



1

GEV No.	551387	Ref. No.	4056986
description	isolation barrier for rail-mounted terminal L 72mm W 2.2mm H 29mm PHOENIX CONTACT D-ST 2.5-QUATTRO		



1

GEV No.	551391	Ref. No.	4056391A
description	isolation barrier for rail-mounted terminal L 87mm W 2.2mm H 29mm PHOENIX CONTACT D-ST 4-QUATTRO		



1

GEV No.	551393	Ref. No.	4056835
description	isolation barrier for rail-mounted terminal L 90.5mm W 2.2mm H 36mm PHOENIX CONTACT D-ST6 TWIN		



1

GEV No.	551390	Ref. No.	4056409
description	isolation barrier for rail-mounted terminal L 95.5mm W 2.2mm H 42.5mm PHOENIX CONTACT D-ST 10-TWIN		

electronic components

software

service sets



1

GEV No.	403078	Ref. No.	5019011
description	programmer suitable for CONVOTHERM P3-devices incl. SD Carte and Software		



gas valves and ignition boxes

gas control valves

DUNGS



1

GEV No.	106909	Ref. No.	2625175 6006191
description	gas valve 230V 50/60Hz gas inlet 1/2" gas outlet 1/2" total length 105mm DUNGS type GB-LEP 055 D01 542		
For models:	OD10.10, OD12.20, OD20.20, OD6.10, OSG10.10, OSG12.20, OSG20.20, OSG6.10		

HONEYWELL



1

GEV No.	107873	Ref. No.	6056952
description	gas valve type VE420AA1001 230V 50Hz gas inlet 3/4" gas outlet 3/4" pressure range 17-23mbar max 200mbar HONEYWELL suitable for CONVOTHERM 4		



1

GEV No.	107841	Ref. No.	6056955
description	gas valve type VK4115V 220-240V 50/60Hz gas inlet flange 32x32mm gas outlet flange 32x32mm thermocouple connection pilot connection pressure range 15-60mbar max 60mbar HONEYWELL hole distance 24mm M5 flange flange 32x32mmmm		
accessories for	107841		
	GEV No.	102845	Ref. No. —
	gas connection angled 1/2" flange 32x32mm hole distance 24x24mm Tandem		
	GEV No.	102846	Ref. No. —
	gas connection straight 1/2" flange 32x32mm hole distance 24x24mm suitable for Tandem		



1

GEV No.	106012	Ref. No.	6016010
description	gas valve type VK4115V 220-240V 50/60Hz gas inlet flange 32x32mm gas outlet flange 32x32mm thermocouple connection pilot connection pressure range 15-60mbar max 60mbar operator type HONEYWELL flange 32x32mm		
For models:	OGB10.10, OGB10.20, OGB12.20, OGB20.10, OGB20.20, OGB6.10, OGB6.20, OGS10.10, OGS10.20, OGS12.20, OGS20.10, OGS20.20, OGS6.10, OGS6.20		
accessories for	106012		
	GEV No.	102845	Ref. No. —
	gas connection angled 1/2" flange 32x32mm hole distance 24x24mm Tandem		
	GEV No.	102846	Ref. No. —
	gas connection straight 1/2" flange 32x32mm hole distance 24x24mm suitable for Tandem		

SIT

ELETTROSIT









1

GEV No.	101993	Ref. No.	5001051
description	gas valve SIT type ELETTROSIT 230V gas inlet 1/2" gas outlet 1/2" thermocouple connection M9x1 pilot connection M10x1 lateral equiv. no. 0.810.126		
For models:	OD10.20, OD12.20		
spare parts for	101993		
	GEV No.	101312	Ref. No. 5001050
	microswitch		
	GEV No.	101352	Ref. No. —
	solenoid coil 230V 50Hz suitable for ELETTROSIT		
accessories for	101993		
	GEV No.	100006	Ref. No. —
	piezoelectric igniter suitable for ELETTROSIT body plastic blowing connection ø2.4mm ø 14mm		
	GEV No.	100904	Ref. No. —
	locking screw M10x1 for pipe ø 4mm Qty 1 pcs		

Table continues overleaf



accessories for	101993		
	GEV No.	100905	Ref. No. —
	locking screw M10x1 for pipe ø 6mm Qty 1 pcs		
	GEV No.	101301	Ref. No. —
	gas connection thread 1/2" straight ELETTRISIT screw with O-ring		
	GEV No.	101303	Ref. No. —
	gas connection straight thread 3/4" ELETTRISIT		
	GEV No.	101309	Ref. No. —
	extension		
	GEV No.	103104	Ref. No. —
	ignition switch		
	GEV No.	541504	Ref. No. —
	double nipple thread 1/2" - 1/2"		

ignition boxes

DUNGS

			
1			
GEV No.	103102	Ref. No.	6006190
description	ignition box type DGAI.73 model 10.5.0TCL electrodes 2 starting time <10s waiting time >3s safety time <5s 230V 50/60Hz ignition cable male faston 2.8mm DUNGS protection IP20		
For models:	OD10.10, OD12.20, OD20.20, OD6.10, OSG10.10, OSG12.20, OSG20.20, OSG6.10		

HONEYWELL

			
1			
GEV No.	106606	Ref. No.	6016021
description	ignition box HONEYWELL type S4575B 1025 electrodes 3 waiting times safety time 5s 230-240V 4VA 50/60Hz		

			
1			
GEV No.	106755	Ref. No.	6016020 6016022
description	ignition box HONEYWELL type S4575B 1066 electrodes 3 waiting times safety time 5s 230-240V 4VA 50/60Hz		
For models:	OGB10.10, OGB10.20, OGB12.20, OGB20.10, OGB20.20, OGB6.10, OGB6.20, OGS10.10, OGS10.20, OGS12.20, OGS20.10, OGS20.20, OGS6.10, OGS6.20		

			
1			
GEV No.	107860	Ref. No.	6056957
description	ignition box HONEYWELL type S4965V3075 electrodes 1 safety time 5s 230V 2.5VA 50Hz		

ignition parts













pilot burners

SIT

100 series

			
1			
GEV No.	106727	Ref. No.	5001088 6006160
description	pilot burner SIT type 100 series 3 flames LPG nozzle ø 0.35mm gas connection 6mm incl. 1x nozzle 0.25 LPG		
For models:	OD10.20, OD12.20		



accessories			
pilot burner bottom parts			
 <p>1</p>			
GEV No.	107700	Ref. No.	6006101
description	pilot burner bottom part SIT 100 series nozzle \varnothing 0.25mm		
For models:	OD10.20, OD12.20		
spare parts for	107700		
	GEV No.	100916	Ref. No. —
compression spring for pilot burner Qty 1 pcs			
	GEV No.	100917	Ref. No. —
gasket for pilot burner Qty 1 pcs aluminium			
	GEV No.	100918	Ref. No. —
screw for pilot burner			
	GEV No.	102742	Ref. No. —
pilot burner nozzle LPG code 25 bore \varnothing 0.25mm Qty 1 pcs			
accessories for	107700		
	GEV No.	100245	Ref. No. —
pilot burner nozzle LPG code 20 bore \varnothing 0.2mm Qty 1 pcs thread M8x0.75			
	GEV No.	100246	Ref. No. —
pilot burner nozzle natural gas bore \varnothing 0.35mm Qty 1 pcs thread M8x0.75			
	GEV No.	100904	Ref. No. —
locking screw M10x1 for pipe \varnothing 4mm Qty 1 pcs			
	GEV No.	100905	Ref. No. —
locking screw M10x1 for pipe \varnothing 6mm Qty 1 pcs			
	GEV No.	102110	Ref. No. —
pilot tube copper pipe \varnothing 4mm thickness 1mm L 3000mm			
	GEV No.	102111	Ref. No. —
pilot tube copper pipe \varnothing 6mm thickness 1mm L 3000mm			
pilot burner nozzles			
 <p>1</p>			
GEV No.	102972	Ref. No.	6005182
description	pilot burner nozzle natural gas code 40 bore \varnothing 0.4mm Qty 1 pcs		
For models:	OD10.20, OD12.20, OSG10.10, OSG12.20, OSG20.20, OSG6.10		

electrodes			
 <p>1</p>			
GEV No.	102476	Ref. No.	2617322 4018001 C4018001
description	glow plug conversion kit flange length 41mm flange width 20mm \varnothing 11mm mounting distance 29mm cable length 60mm connection male faston 2.8mm total length 101mm L1 73mm L2 28mm 24V		
For models:	OGB10.20, OGB12.20, OGB20.10, OGB20.20, OGS10.20, OGS12.20, OGS20.10, OGS20.20		
 <p>1</p>			
GEV No.	102477	Ref. No.	2617321 4018002
description	glow plug conversion kit flange length 41mm flange width 20mm \varnothing 11mm mounting distance 29mm cable length 60mm connection male faston 2.8mm total length 64mm L1 54mm L2 10mm 24V		
For models:	OGB10.10, OGB20.10, OGB6.10, OGB6.20, OGS10.10, OGS20.10, OGS6.10, OGS6.20		
 <p>1</p>			
GEV No.	106517	Ref. No.	4008101
description	ignition electrode D1 \varnothing 7mm D2 \varnothing 8mm connection M4 L1 13mm BL1 18mm BL2 3mm BL3 23mm		
For models:	OD10.10, OD12.20, OD20.20, OD6.10, OSG10.10, OSG12.20, OSG20.20, OSG6.10		

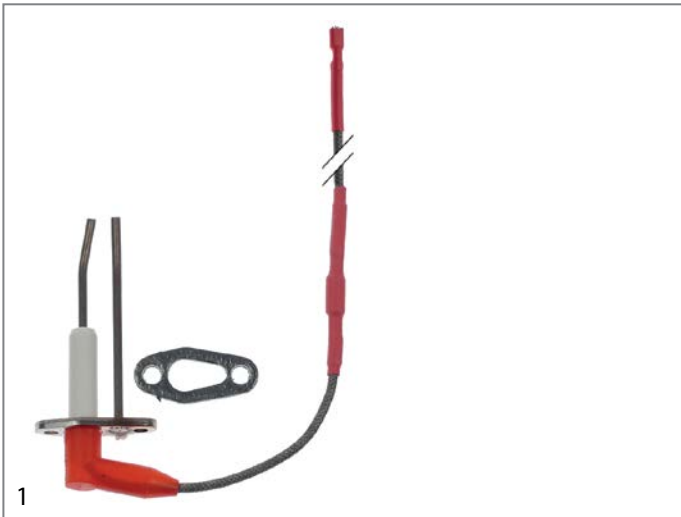

GEV No.	107839	Ref. No.	4056951
description	ignition electrode flange length 38mm flange width 16mm D1 ø 9.5mm L1 36.5mm BL1 30mm connection 2.8x0.8 cable length 400mm fixing dimensions 4.5mm mounting distance 28mm with mounting accessories		

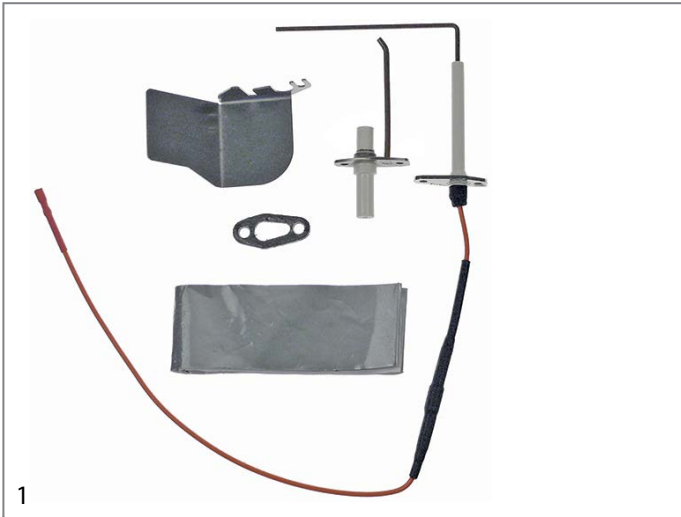

GEV No.	107844	Ref. No.	4056950
description	ignition electrode set flange length 38mm flange width 17mm D1 ø 7mm L1 22mm L2 96mm BL1 62mm connection 2.8x0.8 cable length 400mm mounting distance 28mm M4 with mounting accessories CONVOTHERM model C4 Serie		

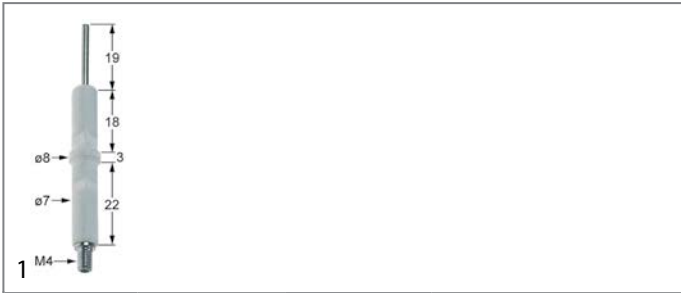

GEV No.	106516	Ref. No.	4008104
description	monitoring electrode D1 ø 7mm D2 ø 8mm connection M4 L1 19mm BL1 18mm BL2 3mm BL3 22mm		
For models:	OD10.10, OD12.20, OD20.20, OD6.10, OSG10.10, OSG12.20, OSG20.20, OSG6.10		

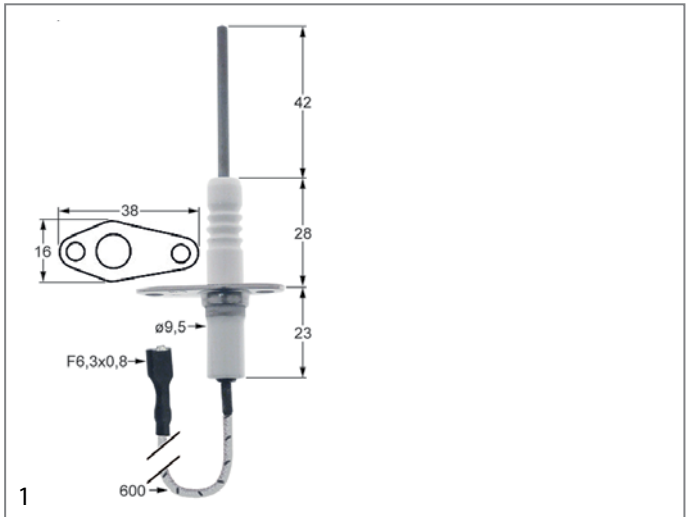

GEV No.	109183 ¹	Ref. No.	2617320 4018000 c4018000
description	monitoring electrode flange length 38mm D1 ø 9.5mm flange width 16mm L1 42mm BL1 28mm BL2 23mm connection F6.3x0.8 cable length 600mm with gasket and shrink tube		
For models:	OGB10.10, OGB10.20, OGB12.20, OGB20.10, OGB20.20, OGB6.10, OGB6.20, OGS10.10, OGS10.20, OGS12.20, OGS20.10, OGS20.20, OGS6.10, OGS6.20		

¹with gasket and shrink tube

ignition cables

pre-assembled cables

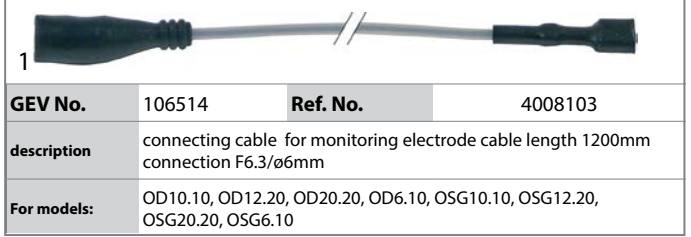

GEV No.	106514	Ref. No.	4008103
description	connecting cable for monitoring electrode cable length 1200mm connection F6.3/ø6mm		
For models:	OD10.10, OD12.20, OD20.20, OD6.10, OSG10.10, OSG12.20, OSG20.20, OSG6.10		



GEV No.	106515	Ref. No.	4008100
description	ignition cable cable length 1200mm connection F2.8/ø6mm		
For models:	OD10.10, OD12.20, OD20.20, OD6.10, OSG10.10, OSG12.20, OSG20.20, OSG6.10		



thermocouples

plug-in thermocouples

plug-in thermocouples with interruption

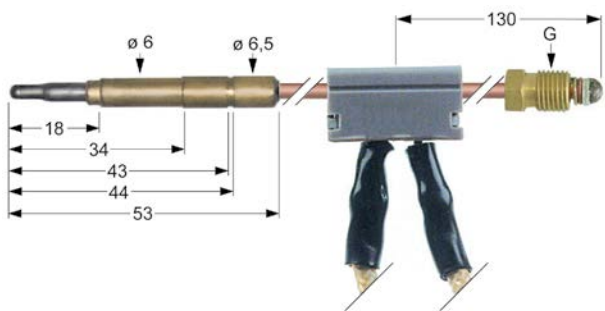

1	GEV No.	103103	Ref. No.	5009048
	description	thermocouple with interrupter M9x1 L 1000mm plug connection ø6.0mm cable		
	For models:	OD10.20, OD12.20		

accessories

miscellaneous



1	GEV No.	519625	Ref. No.	6056351
	description	gasket for thermocouple ø 15mm ID ø 5mm H 1mm graphite suitable for combi-steamer series CONVOTHERM 4 Qty 5 pcs		

gas burners

forced air burners



1	GEV No.	107842	Ref. No.	2010014
	description	burner L 150mm ø 50mm 20kW combi-steamer		
	For models:	OGB10.10, OGB20.10, OGB6.10, OGB6.20, OGS10.10, OGS20.10, OGS6.10, OGS6.20		



1	GEV No.	107840	Ref. No.	2010015
	description	burner L 210mm ø 63mm 40kW combi-steamer CONVOTHERM series P3		
	For models:	OGB10.20, OGB12.20, OGB20.10, OGB20.20, OGS10.20, OGS12.20, OGS20.10, OGS20.20		



1	GEV No.	108150	Ref. No.	6016000 CV6056960
	description	venturi MKN combi-steamer with gasket		
	For models:	OGB10.10, OGB20.10, OGB6.10, OGB6.20, OGS10.10, OGS20.10, OGS6.10, OGS6.20		

accessories

gaskets



1	GEV No.	112834	Ref. No.	6064078
	description	gasket for burner chamber ø 140mm thickness 2mm graphite for combi-steamer suitable for CONVOTHERM 4 series 6.10/6.20/10.10		

gas nozzles

main nozzles

gas nozzles M10x1



1	GEV No.	106405	Ref. No.	6005177
	description	gas injector thread M10x1 bore ø 2mm L 30mm WS 12		

pilot burner nozzles

pilot burner nozzles SIT

100 series



1	GEV No.	102972	Ref. No.	6005182
	description	pilot burner nozzle natural gas code 40 bore ø 0.4mm Qty 1 pcs		
	For models:	OD10.20, OD12.20, OSG10.10, OSG12.20, OSG20.20, OSG6.10		



1	GEV No.	107171	Ref. No.	6006008
	description	pilot burner nozzle SIT natural/liquid gas bore ø 0.25mm Qty 1 pcs		
	For models:	OD10.20, OD12.20, OSG10.10, OSG12.20, OSG20.20, OSG6.10		

auxiliary gas parts

consumables

PTFE tapes



1

GEV No.	890100	Ref. No.	7004052
description	PTFE tape reel L 12m W 12mm -200 up to +260°C approval DIN-DVGW, KTW temperature-resistant, elastic for fine thread thickness 0.1mm		
description	PTFE thread sealing tape for fine metal threads Application: All sanitary and heating circuits in hot and cold water areas. DVGW tested. DIN EN751-3. For fine thread DN < 10. Pressure: up to 20 bar. Temperature range: -60°C to +260°C		

thread sealants



1

GEV No.	890097	Ref. No.	7004016
description	thread sealing LOCTITE 577 medium-strength bottle 50ml pipe thread sealing t.max. 150°C approval BAM and DVGW		
description	LOCTITE® 577™ - bottle 50ml It is designed for the locking and sealing of metal pipes and fittings as well as other cylindrical metal assemblies. The product provides an instant, low-pressure seal for metal pipes and fittings. It will not creep, shrink or block systems by shredding. Suitable for fast application at low temperatures. It has excellent chemical and thermal resistance and offers less migration of liquid product after application to the part.		

equipment-specific units

for coffee grinders

grinding burrs

screws



1

GEV No.	560067	Ref. No.	8001031
description	flat-headed bolt thread M5 thread L 10mm SS DIN 7985/ISO 7045 Qty 20 pcs intake Phillips head ø 8mm head thickness 2mm		
For models:	OEB12.20, OEB20.10, OEB20.20, OES12.20, OES20.10, OES20.20, OGB12.20, OGB20.10, OGB20.20, OGS12.20, OGS20.10, OGS20.20		

for convection ovens/combi-steamers

drain units

drip rails



1

GEV No.	692302	Ref. No.	2018000 2018006
description	drip rail L 500mm ABS plastic hole ø 5.5mm mounting distance 299mm for combi-steamer hose ø 15mm		
For models:	OEB10.10, OEB6.10, OES10.10, OES6.10, OGB10.10, OGB6.10, OGS10.10, OGS6.10		



1

GEV No.	694425	Ref. No.	2616469
description	drip rail L 500mm plastic W 34mm hole ø 5mm for combi-steamer		
For models:	OEB10.10, OEB6.10, OES10.10, OES6.10, OGB10.10, OGB6.10, OGS10.10, OGS6.10		



1

GEV No.	699355	Ref. No.	2556335
description	drip rail L 520mm W 25mm suitable for 6.10/10.10 Convotherm 4		



1

GEV No.	699361	Ref. No.	2556345
description	drip rail push-in L 480mm plastic W 100mm for combi-steamer 6.10/10.10 Convotherm 4		



1

GEV No.	699356	Ref. No.	2556346
description	drip rail push-in L 685mm W 60mm H 95mm suitable for 6.20/10.20 Convotherm 4		



1

GEV No.	692593	Ref. No.	2016300
description	ventilation valve combi-steamer L 120mm W 120mm ø 43mm 12VDCV suitable for Mini series		
For models:	OES6.06		

drain valves



1

GEV No.	696784	Ref. No.	2623535
description	drain connection stainless steel for combi-steamer		

injection nozzles



1

GEV No.	542356	Ref. No.	6005413
description	injection nozzle bore ø 1.5mm WS 14 T1: M10x1		
For models:	OEB10.10, OEB10.20, OEB12.20, OEB20.10, OEB20.20, OEB6.10, OEB6.20, OES10.10, OES10.20, OES12.20, OES20.10, OES20.20, OES6.10, OES6.20, OGB10.10, OGB10.20, OGB12.20, OGB20.10, OGB20.20, OGB6.10, OGB6.20, OGS10.10, OGS10.20, OGS12.20, OGS20.10, OGS20.20, OGS6.10, OGS6.20, OS10.10, OS10.20, OS12.20, OS20.10, OS20.20, OS6.10, OSP10.10, OSP10.20, OSP12.20, OSP20.10, OSP20.20, OSP6.10		

steam generators

steam generators





1

GEV No.	692212	Ref. No.	2306118 2323768
description	steam generator W 610mm H 525mm D 115mm		



1

GEV No.	692594	Ref. No.	2226368 2230016	
description	injection nozzle bore ø 1mm suitable for P3 D1 ø 10mm D2 ø 10mm L 130mm brass for steam generation mounting pos. left			
spare parts for	692594			
	GEV No.	541508	Ref. No.	6006140
	manometer ø 40mm pressure range 0-4bar connection thread 1/8"			
	GEV No.	541806	Ref. No.	5009061 5009063
	pressure control ø 38mm pressure range 0.2-3.0bar connection 1/8" 250V 10A GP600 pressure connection 1/8"			



1

GEV No.	692139	Ref. No.	2000027
description	injection nozzle bore \varnothing 4mm L 40mm for combi-steamer T1: M10x1.5 T2: 3/4"		
For models:	HUD10.10, HUD12.20, HUD20.10, HUD20.20, HUD6.10, OD10.10, OD10.20, OD12.20, OD20.10, OD20.20, OD6.10, OS10.10, OS10.20, OS12.20, OS20.10, OS20.20, OS6.10, OSC10.10, OSC10.20, OSC12.20, OSC20.10, OSC20.20, OSC6.10, OSP10.10, OSP10.20, OSP12.20, OSP20.10, OSP20.20, OSP6.10		





1

GEV No.	692768	Ref. No.	2223452
description	injection nozzle double with pressure switch and monometer bore \varnothing 0.6mm D1 \varnothing 10.5mm D2 \varnothing 10.5mm L 60mm SS/brass for combi-steamer OES/OGS		
spare parts for	692768		
	GEV No.	541508	Ref. No. 6006140
	manometer \varnothing 40mm pressure range 0-4bar connection thread 1/8"		
	GEV No.	541806	Ref. No. 5009061 5009063
	pressure control \varnothing 38mm pressure range 0.2-3.0bar connection 1/8" 250V 10A GP600 pressure connection 1/8"		





1

GEV No.	692177	Ref. No.	2217332
description	injection nozzle with pressure switch and monometer bore \varnothing 0.5mm D1 \varnothing 12mm D2 \varnothing 12mm L 60mm stainless steel for combi-steamer		
For models:	OEB6.10, OES6.06, OES6.10, OGB6.10, OGS6.10		
spare parts for	692177		
	GEV No.	541508	Ref. No. 6006140
	manometer \varnothing 40mm pressure range 0-4bar connection thread 1/8"		
	GEV No.	541806	Ref. No. 5009061 5009063
	pressure control \varnothing 38mm pressure range 0.2-3.0bar connection 1/8" 250V 10A GP600 pressure connection 1/8"		





1

GEV No.	692169	Ref. No.	2217333
description	injection nozzle with pressure switch and monometer bore \varnothing 0.6mm D1 \varnothing 12mm D2 \varnothing 12mm L 60mm brass for combi-steamer		
For models:	OEB10.10, OEB10.20, OEB6.20, OES10.10, OES10.20, OES6.20, OGB10.10, OGB10.20, OGB6.20, OGS10.10, OGS10.20, OGS6.20		
spare parts for	692169		
	GEV No.	541508	Ref. No. 6006140
	manometer \varnothing 40mm pressure range 0-4bar connection thread 1/8"		
	GEV No.	541806	Ref. No. 5009061 5009063
	pressure control \varnothing 38mm pressure range 0.2-3.0bar connection 1/8" 250V 10A GP600 pressure connection 1/8"		



1

GEV No.	692592	Ref. No.	2217335
description	pressure monitor suitable for Mini series bore \varnothing 1mm D1 \varnothing 10mm D2 \varnothing 10mm L 130mm brass for steam generation mounting pos. at the back right		
For models:	OEB20.10, OEB20.20, OES20.10, OES20.20, OGB20.10, OGB20.20, OGS20.10, OGS20.20		
spare parts for	692592		
	GEV No.	541508	Ref. No. 6006140
	manometer \varnothing 40mm pressure range 0-4bar connection thread 1/8"		
	GEV No.	541806	Ref. No. 5009061 5009063
	pressure control \varnothing 38mm pressure range 0.2-3.0bar connection 1/8" 250V 10A GP600 pressure connection 1/8"		



injection pipes



GEV No.	692746	Ref. No.	2225074 6015216
description	injection pipe for combi-steamer H 80mm with gasket and nut ED ø 10mm L 210mm thread M14x1		
For models:	OEB10.10, OEB10.20, OEB12.20, OEB20.10, OEB20.20, OEB6.10, OEB6.20, OES10.10, OES10.20, OES12.20, OES20.10, OES20.20, OES6.10, OES6.20, OGB10.10, OGB10.20, OGB12.20, OGB20.10, OGB20.20, OGB6.10, OGB6.20, OGS10.10, OGS10.20, OGS12.20, OGS20.10, OGS20.20, OGS6.10, OGS6.20		



GEV No.	692736	Ref. No.	2016073 2016305
description	injection pipe for combi-steamer L 210mm H 80mm thread M14x1 ø 10mm		
For models:	OEB10.10, OEB20.10, OEB6.10, OES10.10, OES20.10, OES6.10, OGB10.10, OGB20.10, OGB6.10, OGS10.10, OGS20.10, OGS6.10		

spare parts and accessories



GEV No.	699829	Ref. No.	2004035
description	bracket for cable H 8.5mm ø 29mm M4		
For models:	OEB10.10, OEB10.20, OEB12.20, OEB20.10, OEB20.20, OEB6.10, OEB6.20, OES10.10, OES10.20, OES12.20, OES20.10, OES20.20, OES6.10, OES6.20, OGB10.10, OGB10.20, OGB12.20, OGB20.10, OGB20.20, OGB6.10, OGB6.20, OGS10.10, OGS10.20, OGS12.20, OGS20.10, OGS20.20, OGS6.10, OGS6.20		



GEV No.	696786	Ref. No.	6013059
description	bracket for vibration pump L 85mm W 45mm H 70mm mounting distance 25/50mm rubber		



GEV No.	699840	Ref. No.	6006081
description	drain plug for steam generator H 20mm 1 1/4"		
For models:	OD10.10, OD10.20, OD12.20, OD20.10, OD20.20, OD6.10, OS10.10, OS10.20, OS12.20, OS20.10, OS20.20, OS6.10, OSC10.10, OSC10.20, OSC12.20, OSC20.10, OSC20.20, OSC6.10, OSP10.10, OSP10.20, OSP12.20, OSP20.10, OSP20.20, OSP6.10		



GEV No.	699824	Ref. No.	2615367
description	flange for burner L 84mm W 65mm H 1.2mm		
For models:	OGB10.10, OGB20.10, OGB6.10, OGB6.20, OGS10.10, OGS20.10, OGS6.10, OGS6.20		



GEV No.	112834	Ref. No.	6064078
description	gasket for burner chamber ø 140mm thickness 2mm graphite for combi-steamer suitable for CONVOTHERM 4 series 6.10/6.20/10.10		





GEV No.	519625	Ref. No.	6056351
description	gasket for thermocouple ø 15mm ID ø 5mm H 1mm graphite suitable for combi-steamer series CONVOTHERM 4 Qty 5 pcs		





GEV No.	699821	Ref. No.	6005048
description	grommet for ventilation H 7.5mm ø 60mm ID ø 35mm		
For models:	OD10.10, OD10.20, OD12.20, OD20.10, OD20.20, OD6.10, OEB10.10, OEB10.20, OEB12.20, OEB20.10, OEB20.20, OEB6.10, OEB6.20, OES10.10, OES10.20, OES12.20, OES20.10, OES20.20, OES6.06, OES6.10, OES6.20, OGB10.10, OGB10.20, OGB12.20, OGB20.10, OGB20.20, OGB6.10, OGB6.20, OGS10.10, OGS10.20, OGS12.20, OGS20.10, OGS20.20, OGS6.10, OGS6.20, OS10.10, OS10.20, OS12.20, OS20.10, OS20.20, OS6.10, OSC10.10, OSC10.20, OSC12.20, OSC20.10, OSC20.20, OSC6.10, OSP10.10, OSP10.20, OSP12.20...(Other models you can see in the webshop)		

			
1			
GEV No.	699823	Ref. No.	6005427
description	grommet for ventilation H 9mm ø 83mm ID ø 53mm		
For models:	OEB10.10, OEB10.20, OEB12.20, OEB20.10, OEB20.20, OEB6.10, OEB6.20, OES10.10, OES10.20, OES12.20, OES20.10, OES20.20, OES6.10, OES6.20, OGB10.10, OGB10.20, OGB12.20, OGB20.10, OGB20.20, OGB6.10, OGB6.20, OGS10.10, OGS10.20, OGS12.20, OGS20.10, OGS20.20, OGS6.10, OGS6.20		

			
2			
GEV No.	692738	Ref. No.	2617294
description	mounting set for motor		
For models:	OEB10.10, OEB10.20, OEB12.20, OEB20.10, OEB20.20, OEB6.10, OEB6.20, OES10.10, OES10.20, OES12.20, OES20.10, OES20.20, OES6.10, OES6.20, OGB10.10, OGB10.20, OGB12.20, OGB20.10, OGB20.20, OGB6.10, OGB6.20, OGS10.10, OGS10.20, OGS12.20, OGS20.10, OGS20.20, OGS6.10, OGS6.20		

			
1			
GEV No.	692743	Ref. No.	6014004
description	rosette H 5mm 1/2" ED ø 35mm		
For models:	OEB10.10, OEB10.20, OEB12.20, OEB20.10, OEB20.20, OEB6.10, OEB6.20, OES10.10, OES10.20, OES12.20, OES20.10, OES20.20, OES6.10, OES6.20, OGB10.10, OGB10.20, OGB12.20, OGB20.10, OGB20.20, OGB6.10, OGB6.20, OGS10.10, OGS10.20, OGS12.20, OGS20.10, OGS20.20, OGS6.10, OGS6.20		

			
1			
GEV No.	699827	Ref. No.	6015042
description	rubber gasket for sump H 6mm ø 21mm ID ø 7.5mm		
For models:	OEB10.10, OEB10.20, OEB6.10, OEB6.20, OES10.10, OES10.20, OES6.10, OES6.20, OGB10.10, OGB10.20, OGB6.10, OGB6.20, OGS10.10, OGS10.20, OGS6.10, OGS6.20		

			
1			
GEV No.	699826	Ref. No.	6016030 6064077
description	sealing ring H 3.2mm ø 23mm ID ø 15mm		
For models:	OGB10.10, OGB10.20, OGB12.20, OGB20.10, OGB20.20, OGB6.10, OGB6.20, OGS10.10, OGS10.20, OGS12.20, OGS20.10, OGS20.20, OGS6.10, OGS6.20		

			
1			
GEV No.	699828	Ref. No.	6015062
description	sealing ring ø 14mm ID ø 10mm		
For models:	OEB10.10, OEB10.20, OEB12.20, OEB20.10, OEB20.20, OEB6.10, OEB6.20, OES10.10, OES10.20, OES12.20, OES20.10, OES20.20, OES6.10, OES6.20, OGB10.10, OGB10.20, OGB12.20, OGB20.10, OGB20.20, OGB6.10, OGB6.20, OGS10.10, OGS10.20, OGS12.20, OGS20.10, OGS20.20, OGS6.10, OGS6.20		

			
1			
GEV No.	699817	Ref. No.	2014008 2619152
description	support bracket for carriage L 55mm W 12mm H 22mm		
For models:	OEB10.10, OEB10.20, OEB12.20, OEB20.10, OEB20.20, OEB6.10, OEB6.20, OES10.10, OES10.20, OES12.20, OES20.10, OES20.20, OES6.10, OES6.20, OGB10.10, OGB10.20, OGB12.20, OGB20.10, OGB20.20, OGB6.10, OGB6.20, OGS10.10, OGS10.20, OGS12.20, OGS20.10, OGS20.20, OGS6.10, OGS6.20		

filters

			
1			
GEV No.	700992	Ref. No.	6005024
description	drain filter ø 85mm for combi-steamer		
For models:	HUD10.10, HUD12.20, HUD20.10, HUD20.20, HUD6.10, OD10.10, OD10.20, OD12.20, OD20.10, OD20.20, OD6.10, OS10.10, OS10.20, OS12.20, OS20.10, OS20.20, OS6.10, OSC10.10, OSC10.20, OSC12.20, OSC20.20, OSC6.10, OSP10.10, OSP10.20, OSP12.20, OSP20.20, OSP6.10		

front panels



1	GEV No.	692745	Ref. No.	2117301
	description	control panel model OES/OGS CONVOTHERM series P3 H 600mm W 160mm		
	For models:	OEB10.10, OEB10.20, OEB12.20, OEB20.10, OEB20.20, OEB6.10, OEB6.20, OES10.10, OES10.20, OES12.20, OES20.10, OES20.20, OES6.10, OES6.20, OGB10.10, OGB10.20, OGB12.20, OGB20.10, OGB20.20, OGB6.10, OGB6.20, OGS10.10, OGS10.20, OGS12.20, OGS20.10, OGS20.20, OGS6.10, OGS6.20		



1	GEV No.	699847	Ref. No.	5056365
	description	housing L 245mm H 350mm D 35		

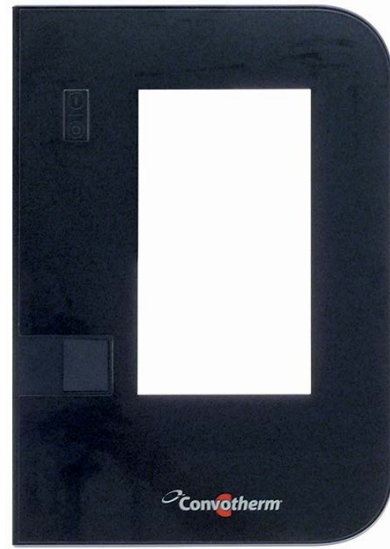

1	GEV No.	699846	Ref. No.	5056364
	description	housing L 250mm H 350mm D 34		

housing and bezels



1	GEV No.	699851	Ref. No.	45056832
	description	cover L 95mm W 65mm H 34mm		

cleaning system

nozzles



1	GEV No.	694801	Ref. No.	2611010
	description	sprinkler nozzle thread M10 hole ø 3.5mm H 29.5mm SS CONVOTHERM		
	For models:	OEB10.10, OEB10.20, OEB12.20, OEB20.10, OEB20.20, OEB6.10, OEB6.20, OES10.10, OES10.20, OES12.20, OES20.10, OES20.20, OES6.10, OES6.20, OGB10.10, OGB10.20, OGB12.20, OGB20.10, OGB20.20, OGB6.10, OGB6.20, OGS10.10, OGS10.20, OGS12.20, OGS20.10, OGS20.20, OGS6.10, OGS6.20, OS10.10, OS10.20, OS12.20, OS20.10, OS20.20, OS6.10, OSP10.10, OSP10.20, OSP12.20, OSP20.10, OSP20.20, OSP6.10		

pumps



GEV No.	501563	Ref. No.	5056337
description	pump inlet ø 24 outlet ø 24 type UP30-494 200-240V 50/60Hz 1 phase 0.1kW L 146mm capacitor 2.5µF HANNING hose clamps		

hoses



GEV No.	542152	Ref. No.	2609347 2617594
description	extraction hose D1 ø 6.5mm D2 ø 10mm L 1700mm detergent		
For models:	OEB10.10, OEB10.20, OEB12.20, OEB20.10, OEB20.20, OEB6.10, OEB6.20, OES10.10, OES10.20, OES12.20, OES20.10, OES20.20, OES6.10, OES6.20, OGB10.10, OGB10.20, OGB12.20, OGB20.10, OGB20.20, OGB6.10, OGB6.20, OGS10.10, OGS10.20, OGS12.20, OGS20.10, OGS20.20, OGS6.10, OGS6.20, OS10.10, OS10.20, OS12.20, OS20.10, OS20.20, OS6.10, OSP10.10, OSP10.20, OSP12.20, OSP20.10, OSP20.20, OSP6.10		



GEV No.	694798	Ref. No.	2054369 2609349 2617598
description	extraction hose D1 ø 6.5mm D2 ø 10mm L 1700mm rinse aid		
For models:	OEB10.10, OEB10.20, OEB12.20, OEB20.10, OEB20.20, OEB6.10, OEB6.20, OES10.10, OES10.20, OES12.20, OES20.10, OES20.20, OES6.10, OES6.20, OGB10.10, OGB10.20, OGB12.20, OGB20.10, OGB20.20, OGB6.10, OGB6.20, OGS10.10, OGS10.20, OGS12.20, OGS20.10, OGS20.20, OGS6.10, OGS6.20, OS10.10, OS10.20, OS12.20, OS20.10, OS20.20, OS6.10, OSP10.10, OSP10.20, OSP12.20, OSP20.10, OSP20.20, OSP6.10		



GEV No.	694802	Ref. No.	7012302
description	hose ext. ø 9.8 D1 ø 6mm L 1300mm EPDM black Qty 1		
For models:	OEB10.10, OEB10.20, OEB12.20, OEB20.10, OEB20.20, OEB6.10, OEB6.20, OES10.10, OES10.20, OES12.20, OES20.10, OES20.20, OES6.10, OES6.20, OGB10.10, OGB10.20, OGB12.20, OGB20.10, OGB20.20, OGB6.10, OGB6.20, OGS10.10, OGS10.20, OGS12.20, OGS20.10, OGS20.20, OGS6.10, OGS6.20		

EQUIPMENT-SPECIFIC UNITS CONVOTHERM

screw connections



GEV No.	361914	Ref. No.	5011003
description	connecting piece 1/2" -3/4" L 82mm plastic		
For models:	OEB10.10, OEB10.20, OEB12.20, OEB20.10, OEB20.20, OEB6.10, OEB6.20, OES10.10, OES10.20, OES12.20, OES20.10, OES20.20, OES6.10, OES6.20, OGB10.10, OGB10.20, OGB12.20, OGB20.10, OGB20.20, OGB6.10, OGB6.20, OGS10.10, OGS10.20, OGS12.20, OGS20.10, OGS20.20, OGS6.10, OGS6.20		

pipes



GEV No.	699816	Ref. No.	6005300
description	connecting fitting L 210mm for water inlet		
For models:	OS10.10, OS10.20, OS12.20, OS20.10, OS20.20, OS6.10, OSC10.10, OSC10.20, OSC12.20, OSC20.10, OSC20.20, OSC6.10, OSP10.10, OSP10.20, OSP12.20, OSP20.10, OSP20.20, OSP6.10		

non-return valves



GEV No.	531322	Ref. No.	6056934
description	backflow preventer for boiler L 88mm connection 10.5/13.5 hose ø 3/4"mm for combi-steamer CONVOTHERM 4		

hoses



GEV No.	506274	Ref. No.	5064082
description	formed hose end piece A ext. ø 28mm end piece A int. ø 22mm AD2 ø 28mm ø end piece B 22mm L 555mm boiler silicone combi-steamer L-shape white		





1

GEV No.	699367	Ref. No.	6064052
description	formed hose int. ø 1 47mm int. ø 2 30mm ED ø 54mm ext. ø 36 L 100mm for combi-steamer		



1

GEV No.	530897	Ref. No.	2364047
description	hose ID ø 10mm ED ø 15mm for boiler suitable for combi-steamer CONVOTHERM 4		



1

GEV No.	699850	Ref. No.	2006056
description	inlet spout L 365mm connection 3/4"		

service kits



1

GEV No.	551407	Ref. No.	8056358
description	mounting set control PCB M4 suitable for CONVOTHERM 4		



1

GEV No.	699818	Ref. No.	5008050
description	mounting set for fan CONVOTHERM		
For models:	AR100, AR108, AR40, AR50, AR54, AR72, HUD10.10, HUD12.20, HUD20.10, HUD20.20, HUD6.10, OD10.10, OD10.20, OD12.20, OD20.10, OD20.20, OD6.10, UG10.10, UG20.10, UG20.20, UG6.10		



1

GEV No.	699819	Ref. No.	2617293
description	mounting set for fan wheel CONVOTHERM		
For models:	OEB10.10, OEB10.20, OEB12.20, OEB20.10, OEB20.20, OEB6.10, OEB6.20, OES10.10, OES10.20, OES12.20, OES20.10, OES20.20, OES6.10, OES6.20, OGB10.10, OGB10.20, OGB12.20, OGB20.10, OGB20.20, OGB6.10, OGB6.20, OGS10.10, OGS10.20, OGS12.20, OGS20.10, OGS20.20, OGS6.10, OGS6.20		



1

GEV No.	699369	Ref. No.	2556368
description	repair kit for door drip tray combi-steamer CONVOTHERM 4		



1

GEV No.	699815	Ref. No.	2618161 6015032
description	seal kit for burner 12-20kW		
For models:	OGB10.10, OGB20.10, OGB6.10, OGB6.20, OGS10.10, OGS20.10, OGS6.10, OGS6.20		



1

GEV No.	699814	Ref. No.	2618162 6015033
description	seal kit for burner 30-40kW no to be sold in France		
For models:	OGB10.20, OGB12.20, OGB20.10, OGB20.20, OGS10.20, OGS12.20, OGS20.10, OGS20.20		



GEV No.	530896	Ref. No.	6056327
description	seal kit suitable for CONVOTHERM 4		

drip water trays

GEV No.	699831	Ref. No.	2004051
description	drip tray L 535mm W 250mm H 40mm		
For models:	OD12.20, OD20.10, OD20.20, OS12.20, OS20.10, OS20.20, OSC12.20, OSC20.10, OSC20.20, OSP12.20, OSP20.10, OSP20.20		

GEV No.	699236	Ref. No.	2616470
description	drip tray L 710mm W 28mm H 22mm		
For models:	OEB10.20, OEB6.20, OES10.20, OES6.20, OGB10.20, OGB6.20, OGS10.20, OGS6.20		

GEV No.	699848	Ref. No.	2556336
description	drip tray L 725mm W 25mm H 22mm		

door mechanics

<p>holders</p>			
GEV No.	699820	Ref. No.	6015248
description	bracket L 29/29mm H 30mm		
For models:	OEB10.10, OEB10.20, OEB6.10, OEB6.20, OES10.10, OES10.20, OES6.10, OES6.20, OGB10.10, OGB10.20, OGB6.10, OGB6.20, OGS10.10, OGS10.20, OGS6.10, OGS6.20		

GEV No.	692792	Ref. No.	6056812
description	bracket L 32mm W 30mm H 26mm stainless steel suitable for combi-steamer series CONVOTHERM 4		

rollers

GEV No.	694333	Ref. No.	2117291
description	roller set ø 60mm W 27.5mm V-shape stainless steel old edition		
For models:	OEB10.10, OEB10.20, OEB12.20, OEB20.10, OEB20.20, OEB6.10, OEB6.20, OES10.10, OES10.20, OES12.20, OES20.10, OES20.20, OES6.10, OES6.20, OGB10.10, OGB10.20, OGB12.20, OGB20.10, OGB20.20, OGB6.10, OGB6.20, OGS10.10, OGS10.20, OGS12.20, OGS20.10, OGS20.20, OGS6.10, OGS6.20		

GEV No.	694604	Ref. No.	2619141
description	roller set U-shape stainless steel new edition		
For models:	OEB10.10, OEB10.20, OEB12.20, OEB20.10, OEB20.20, OEB6.10, OEB6.20, OES10.10, OES10.20, OES12.20, OES20.10, OES20.20, OES6.10, OES6.20, OGB10.10, OGB10.20, OGB12.20, OGB20.10, OGB20.20, OGB6.10, OGB6.20, OGS10.10, OGS10.20, OGS12.20, OGS20.10, OGS20.20, OGS6.10, OGS6.20		

door bumpers



1

GEV No.	699240	Ref. No.	6056370 6056370A
description	door bumper ø 12mm H 10mm Qty 4		



1

GEV No.	694399	Ref. No.	8009056
description	door bumper set 2-piece silicone for combi-steamer ø 20mm		
For models:	OS10.10, OS10.20, OS6.10, OSC10.10, OSC10.20, OSC6.10, OSP10.10, OSP10.20, OSP6.10		
spare parts for	694399		
	GEV No.	694398	Ref. No. 2004195
	door bumper silicone for combi-steamer ø 20mm		

accessories



1

GEV No.	694398	Ref. No.	2004195
description	door bumper silicone for combi-steamer ø 20mm		
For models:	OS10.10, OS10.20, OS12.20, OS20.10, OS20.20, OS6.10, OSC10.10, OSC10.20, OSC12.20, OSC20.10, OSC20.20, OSC6.10, OSG12.20, OSG20.20, OSP10.10, OSP10.20, OSP12.20, OSP20.10, OSP20.20, OSP6.10		



1

GEV No.	694797	Ref. No.	2619155 6012009
description	guide bar W 30mm plastic L 83.5mm black H 19mm incl. screws, nuts and film		
For models:	OEB10.10, OEB10.20, OEB12.20, OEB20.10, OEB20.20, OEB6.10, OEB6.20, OES10.10, OES10.20, OES12.20, OES20.10, OES20.20, OES6.10, OES6.20, OGB10.10, OGB10.20, OGB12.20, OGB20.10, OGB20.20, OGB6.10, OGB6.20, OGS10.10, OGS10.20, OGS12.20, OGS20.10, OGS20.20, OGS6.10, OGS6.20		



1

GEV No.	694803	Ref. No.	2619154 6012008 6012016
description	rail W 25mm plastic L 188mm black H 45mm		
For models:	OEB10.10, OEB10.20, OEB12.20, OEB20.10, OEB20.20, OEB6.10, OEB6.20, OES10.10, OES10.20, OES12.20, OES20.10, OES20.20, OES6.10, OES6.20, OGB10.10, OGB10.20, OGB12.20, OGB20.10, OGB20.20, OGB6.10, OGB6.20, OGS10.10, OGS10.20, OGS12.20, OGS20.10, OGS20.20, OGS6.10, OGS6.20		



1

GEV No.	692794	Ref. No.	2664000
description	stop for guide bar W 20mm L 80mm plastic/rubber suitable for combi-steamer CONVOTHERM		



1

GEV No.	694799	Ref. No.	2619156 6015226
description	stop W 25mm plastic L 60mm black H 20mm incl. screws, nuts and film		
For models:	OEB10.10, OEB10.20, OEB12.20, OEB20.10, OEB20.20, OEB6.10, OEB6.20, OES10.10, OES10.20, OES12.20, OES20.10, OES20.20, OES6.10, OES6.20, OGB10.10, OGB10.20, OGB12.20, OGB20.10, OGB20.20, OGB6.10, OGB6.20, OGS10.10, OGS10.20, OGS12.20, OGS20.10, OGS20.20, OGS6.10, OGS6.20		

vibration pumps



GEV No.	500580	Ref. No.	5008011 5008011K 5030635
description	vibration pump 230V 60W 50/60Hz inlet ø 7 outlet ø 1/8" IT CEME type E512 with accessories duty cycle 1/2 ambient temperature max. 60°C medium temp max. 35°C overheating protection 110°C CleanJet		
For models:	OEB10.10, OEB10.20, OEB12.20, OEB20.10, OEB20.20, OEB6.10, OEB6.20, OES10.10, OES10.20, OES12.20, OES20.10, OES20.20, OES6.06, OES6.10, OES6.20, OGB10.10, OGB10.20, OGB12.20, OGB20.10, OGB20.20, OGB6.10, OGB6.20, OGS10.10, OGS10.20, OGS12.20, OGS20.10, OGS20.20, OGS6.10, OGS6.20, OS12.20, OS20.10, OS20.20		

heat exchangers



GEV No.	520995	Ref. No.	6064017
description	gasket for heat exchanger L 65mm W 65mm hole distance 51mm graphite 50 model CONVOTHERM 4 thickness 2mm		



GEV No.	520994	Ref. No.	6064018
description	gasket for heat exchanger L 89mm W 89mm hole distance 70mm graphite 70 model CONVOTHERM 4 thickness 2mm		



GEV No.	692597	Ref. No.	2010000 2617317 2623208
description	heat exchanger combi-steamer CONVOTHERM		
For models:	OGB10.10, OGB20.10, OGS10.10, OGS20.10		

miscellaneous



GEV No.	523050	Ref. No.	6016500
description	backflow preventer plastic operating medium water for steam generator		
For models:	OEB10.10, OEB10.20, OEB12.20, OEB20.10, OEB20.20, OEB6.10, OEB6.20, OES10.10, OES10.20, OES12.20, OES20.10, OES20.20, OES6.10, OES6.20, OGB10.10, OGB10.20, OGB12.20, OGB20.10, OGB20.20, OGB6.10, OGB6.20, OGS10.10, OGS10.20, OGS12.20, OGS20.10, OGS20.20, OGS6.10, OGS6.20		



GEV No.	710023	Ref. No.	3306319
description	base plate for guide		
For models:	OD20.10		



GEV No.	530777	Ref. No.	2002042
description	bracket for spray gun L 96mm W 75mm H 50mm		
For models:	OD10.10, OD10.20, OD12.20, OD20.10, OD20.20, OD6.10, OEB10.10, OEB10.20, OEB12.20, OEB20.10, OEB20.20, OEB6.10, OEB6.20, OES10.10, OES10.20, OES12.20, OES20.10, OES20.20, OES6.10, OES6.20, OGB10.10, OGB10.20, OGB12.20, OGB20.10, OGB20.20, OGB6.10, OGB6.20, OGS10.10, OGS10.20, OGS12.20, OGS20.10, OGS20.20, OGS6.10, OGS6.20, OS10.10, OS10.20, OS12.20, OS20.10, OS20.20, OS6.10, OSC10.10, OSC10.20, OSC12.20, OSC20.10, OSC20.20, OSC6.10, OSP10.10, OSP10.20, OSP12.20, OSP20.10...(Other models you can see in the webshop)		

accessories for	530777			
	GEV No.	540158	Ref. No.	6005005
	spray gun for appliances 1/2" ET type ECHTERMANN			



GEV No.	699238	Ref. No.	6006030
description	connecting piece with nozzle outlet (with nozzle) L 60mm bore ø 0.5mm for hose 10mm		
For models:	OD6.10, OSG6.10		





1

GEV No.	506225	Ref. No.	6012050
description	door bumper		
For models:	OES6.06		



1

GEV No.	694399	Ref. No.	8009056
description	door bumper set 2-piece silicone for combi-steamer ø 20mm		
For models:	OS10.10, OS10.20, OS6.10, OSC10.10, OSC10.20, OSC6.10, OSP10.10, OSP10.20, OSP6.10		
spare parts for	694399		
	GEV No.	Ref. No.	
	694398	2004195	
	door bumper silicone for combi-steamer ø 20mm		



1

GEV No.	694440	Ref. No.	2618810
description	drip rail L 500mm plastic W 30mm		
For models:	OES6.06		



1

GEV No.	699235	Ref. No.	6056326
description	flap for dehumidification L 155mm W 94mm H 124mm 220VAC		
spare parts for	699235		
	GEV No.	Ref. No.	
	530896	6056327	
	seal kit suitable for CONVOTHERM 4		



1

GEV No.	692171	Ref. No.	5005020
description	frame for lamp lenses bore ø 6.3mm D1 ø 72mm D2 ø 56mm L 83mm W 83mm thickness 1mm		
For models:	OD10.10, OD10.20, OD12.20, OD20.10, OD20.20, OD6.10, OS10.10, OS10.20, OS12.20, OS20.10, OS20.20, OS6.10, OSC10.10, OSC10.20, OSC12.20, OSC20.10, OSC20.20, OSC6.10, OSP10.10, OSP10.20, OSP12.20, OSP20.10, OSP20.20, OSP6.10		



1

GEV No.	902415	Ref. No.	7011010
description	gasket for control panel profile W 155mm L 600mm suitable for CONVOTHERM self-adhesive Qty		
For models:	OEB10.10, OEB10.20, OEB12.20, OEB20.10, OEB20.20, OEB6.10, OEB6.20, OES10.10, OES10.20, OES12.20, OES20.10, OES20.20, OES6.10, OES6.20, OGB10.10, OGB10.20, OGB12.20, OGB20.10, OGB20.20, OGB6.10, OGB6.20, OGS10.10, OGS10.20, OGS12.20, OGS20.10, OGS20.20, OGS6.10, OGS6.20		



1

GEV No.	710022	Ref. No.	2006016
description	guide for tray rack trolley PTFE		
For models:	OD12.20, OD20.10, OD20.20, OS12.20, OS20.10, OS20.20, OSC12.20, OSC20.10, OSC20.20, OSP12.20, OSP20.10, OSP20.20		



1

GEV No.	699839	Ref. No.	6015236
description	guide L 51.5mm W 24mm H 12mm hole ø 4mm		
For models:	OEB6.10, OES6.10		



1

GEV No.	512478	Ref. No.	5011002
description	hose connector thread 3/4" connection distance 75mm		
For models:	OEB10.10, OEB10.20, OEB12.20, OEB20.10, OEB20.20, OEB6.10, OEB6.20, OES10.10, OES10.20, OES12.20, OES20.10, OES20.20, OES6.10, OES6.20, OGB10.10, OGB10.20, OGB12.20, OGB20.10, OGB20.20, OGB6.10, OGB6.20, OGS10.10, OGS10.20, OGS12.20, OGS20.10, OGS20.20, OGS6.10, OGS6.20		

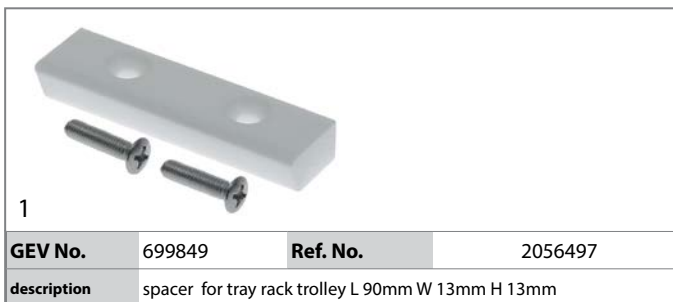
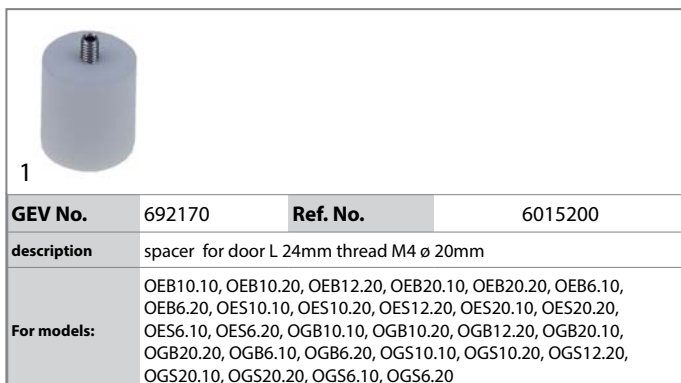
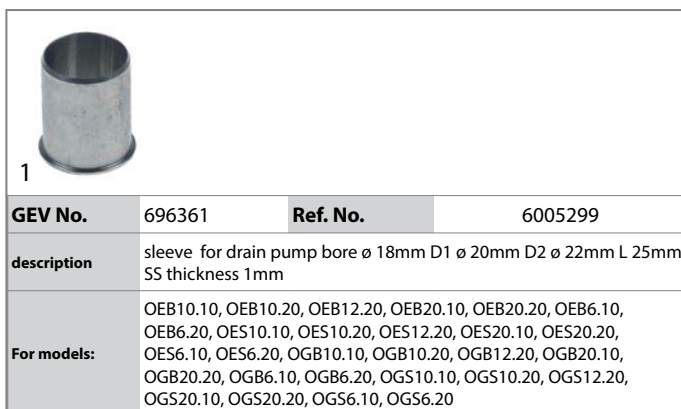
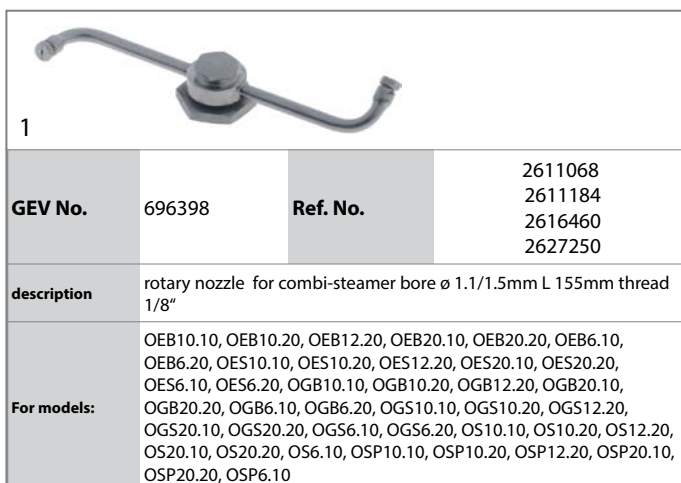

knobs

universal knobs







			
1			
GEV No.	110166	Ref. No.	6003016
description	knob thermostat t.max. 250°C ø 50mm shaft ø 6x4.6mm shaft flat lower black temperature range 50-250°C		
For models:	AR108, AR12, AR18, AR28, AR40, AR54, AR72, AR8, HUD10.10, HUD12.20, HUD20.10, HUD20.20, HUD6.10, UG10.10, UG10.20, UG20.10, UG20.20, UG4.05, UG6.05, UG6.10		

producer-specific knobs

CONVOTHERM

			
1			
GEV No.	112565	Ref. No.	5009313 5009314 5009320
description	knob t.max.°C ø 44mm shaft flat special black for combi-steamer		
For models:	OEB10.10, OEB10.20, OEB12.20, OEB20.10, OEB20.20, OEB6.10, OEB6.20, OES10.10, OES10.20, OES12.20, OES20.10, OES20.20, OES6.06, OES6.10, OES6.20, OGB10.10, OGB10.20, OGB12.20, OGB20.10, OGB20.20, OGB6.10, OGB6.20, OGS10.10, OGS10.20, OGS12.20, OGS20.10, OGS20.20, OGS6.10, OGS6.20, OS10.10, OS10.20, OS12.20, OS20.10, OS20.20, OS6.10, OSC10.10, OSC10.20, OSC12.20, OSC20.10, OSC20.20, OSC6.10, OSG10.10, OSG12.20, OSG20.20, OSG6.10, OSP10.10, OSP10.20, OSP12.20, OSP20.10, OSP20.20...(Other models you can see in the webshop)		

			
1			
GEV No.	110167	Ref. No.	6003011
description	knob time 90min t.max.°C ø 50mm shaft ø 6x4.6mm shaft flat lower black		
For models:	AR100, AR108, AR12, AR16, AR18, AR28, AR30, AR40, AR50, AR54, AR72, AR8, HUD10.10, HUD12.20, HUD20.10, HUD20.20, HUD6.10, UG10.10, UG10.20, UG20.10, UG20.20, UG4.05, UG6.05, UG6.10		

			
1			
GEV No.	112816	Ref. No.	5056360
description	knob without symbol shaft ø 6.5x6mm black combi-steamer CONVOTHERM 4		

miscellaneous

			
1			
GEV No.	112565	Ref. No.	5009313 5009314 5009320
description	knob t.max.°C ø 44mm shaft flat special black for combi-steamer		
For models:	OEB10.10, OEB10.20, OEB12.20, OEB20.10, OEB20.20, OEB6.10, OEB6.20, OES10.10, OES10.20, OES12.20, OES20.10, OES20.20, OES6.06, OES6.10, OES6.20, OGB10.10, OGB10.20, OGB12.20, OGB20.10, OGB20.20, OGB6.10, OGB6.20, OGS10.10, OGS10.20, OGS12.20, OGS20.10, OGS20.20, OGS6.10, OGS6.20, OS10.10, OS10.20, OS12.20, OS20.10, OS20.20, OS6.10, OSC10.10, OSC10.20, OSC12.20, OSC20.10, OSC20.20, OSC6.10, OSG10.10, OSG12.20, OSG20.20, OSG6.10, OSP10.10, OSP10.20, OSP12.20, OSP20.10, OSP20.20...(Other models you can see in the webshop)		

accessories

gaskets

			
1			
GEV No.	112623	Ref. No.	5009108
description	gasket for shaft ø6x4.6		
For models:	OD10.10, OD10.20, OD12.20, OD20.10, OD20.20, OD6.10		







locks



turning lever locks



universal

RAHRBACH

			
1			
GEV No.	690027	Ref. No.	6002048 6002048K
description	handle latch left L 150mm H 59mm		
For models:	OD10.10, OD10.20, OD12.20, OD20.10, OD20.20, OD6.10, OS10.10, OS10.20, OS6.10, OSC10.10, OSC10.20, OSC6.10, OSP10.10, OSP10.20, OSP6.10		
accessories for	690027		
	GEV No.	690045	Ref. No. —
	door catch mounting pos. left off-set 20mm L 110mm H 56mm W 33mm mounting distance 68/68mm zinc die cast series 6300		
	GEV No.	690135	Ref. No. 6002049 6002049K
	door catch mounting pos. left off-set 38mm L 110mm H 74mm W 33mm mounting distance 68/68mm zinc die cast series 1750		
	GEV No.	690137	Ref. No. 6002060
	sliding plate mounting pos. left L 28mm H 3mm W 21mm H2 12.5mm		



			
1			
GEV No.	690500	Ref. No.	6002053 6002053K
description	handle latch right L 185mm H 66mm handle material plastic type 6300 series		
For models:	HUD10.10, HUD12.20, HUD20.10, HUD20.20, HUD6.10, OD10.10, OD10.20, OD12.20, OD20.10, OD20.20, OD6.10, OS10.10, OS10.20, OS12.20, OS20.10, OS20.20, OS6.10, OSC10.10, OSC10.20, OSC12.20, OSC20.10, OSC20.20, OSC6.10, OSG10.10, OSG12.20, OSG6.10, OSP10.10, OSP10.20, OSP12.20, OSP20.10, OSP20.20, OSP6.10, UG10.20		
spare parts for	690500		
	GEV No.	699841	Ref. No. 6002056
accessories for	690500		
	GEV No.	514281	Ref. No. —
	GEV No.	690136	Ref. No. 6002062
	GEV No.	691174	Ref. No. —
	GEV No.	700091	Ref. No. —
	GEV No.	700098	Ref. No. 6002054 6002054K

			
1			
GEV No.	690135	Ref. No.	6002049 6002049K
description	door catch mounting pos. left off-set 38mm L 110mm H 74mm W 33mm mounting distance 68/68mm zinc die cast series 1750		
For models:	OD10.10, OD10.20, OD12.20, OD20.10, OD20.20, OD6.10, OS10.10, OS10.20, OS6.10, OSC10.10, OSC10.20, OSC6.10, OSP10.10, OSP10.20, OSP6.10		
spare parts for	690135		
	GEV No.	690137	Ref. No. 6002060

			
1			
GEV No.	700098	Ref. No.	6002054 6002054K
description	door catch mounting pos. right off-set 38mm L 110mm H 74mm W 33mm mounting distance 68/68mm series 1750		
For models:	HUD10.10, HUD12.20, HUD20.10, HUD20.20, HUD6.10, OD10.10, OD10.20, OD12.20, OD20.10, OD20.20, OD6.10, OSG12.20, OSG20.20, OSG6.10, UG10.20		
accessories for	700098		
	GEV No.	514281	Ref. No. —



			
1			
GEV No.	690137	Ref. No.	6002060
description	sliding plate mounting pos. left L 28mm H 3mm W 21mm H2 12.5mm		
For models:	HUD10.10, HUD12.20, HUD20.10, HUD20.20, HUD6.10, OD10.10, OD10.20, OD12.20, OD20.10, OD20.20, OD6.10, OS10.10, OS10.20, OS6.10, OSC10.10, OSC10.20, OSC6.10, OSP10.10, OSP10.20, OSP6.10		





			
1			
GEV No.	690136	Ref. No.	6002062
description	sliding plate mounting pos. right L 28mm H 3mm W 21mm H2 12.5mm		
For models:	HUD10.10, HUD12.20, HUD20.10, HUD20.20, HUD6.10, OD10.10, OD10.20, OD12.20, OD20.10, OD20.20, OD6.10, OSG10.10, OSG12.20, OSG20.20, OSG6.10		

STUV			
			
1			
GEV No.	700098	Ref. No.	6002054 6002054K
description	door catch mounting pos. right off-set 38mm L 110mm H 74mm W 33mm mounting distance 68/68mm series 1750		
For models:	HUD10.10, HUD12.20, HUD20.10, HUD20.20, HUD6.10, OD10.10, OD10.20, OD12.20, OD20.10, OD20.20, OD6.10, OSG12.20, OSG20.20, OSG6.10, UG10.20		
spare parts for	700098		
	GEV No.	690136	Ref. No. 6002062
accessories for	700098		
	GEV No.	514281	Ref. No. —

producer-specific			
CONVOTHERM			
			
1			
GEV No.	691987	Ref. No.	2216070 2216070K 2230605 6012001 CV2216070
description	door catch with magnetic switch		
For models:	OEB10.10, OEB10.20, OEB12.20, OEB20.10, OEB20.20, OEB6.10, OEB6.20, OES10.10, OES10.20, OES12.20, OES20.10, OES20.20, OES6.10, OES6.20, OGB10.10, OGB10.20, OGB12.20, OGB20.10, OGB20.20, OGB6.10, OGB6.20, OGS10.10, OGS10.20, OGS12.20, OGS20.10, OGS20.20, OGS6.10, OGS6.20		

			
1			
GEV No.	691986	Ref. No.	2525040 6012000
description	handle latch right L 200mm handle material plastic		
For models:	OEB10.10, OEB10.20, OEB12.20, OEB20.10, OEB20.20, OEB6.10, OEB6.20, OES10.10, OES10.20, OES12.20, OES20.10, OES20.20, OES6.10, OES6.20, OGB10.10, OGB10.20, OGB12.20, OGB20.10, OGB20.20, OGB6.10, OGB6.20, OGS10.10, OGS10.20, OGS12.20, OGS20.10, OGS20.20, OGS6.10, OGS6.20		
accessories for	691986		
	GEV No.	691987	Ref. No.
			2216070 2216070K 2230605 6012001 CV2216070
door catch with magnetic switch			

			
1			
GEV No.	690768	Ref. No.	6002043
description	mounting set for turning lever lock		
For models:	HUD10.10, HUD12.20, HUD20.10, HUD20.20, HUD6.10, OD10.10, OD10.20, OD12.20, OD20.10, OD20.20, OD6.10, OS10.10, OS10.20, OS12.20, OS20.10, OS20.20, OS6.10, OSC10.10, OSC10.20, OSC12.20, OSC20.10, OSC20.20, OSC6.10, OSG10.10, OSG12.20, OSG20.20, OSG6.10, OSP10.10, OSP10.20, OSP12.20, OSP20.10, OSP20.20, OSP6.10, UG10.20		
accessories for	690768		
	GEV No.	690027	Ref. No.
			6002048 6002048K
handle latch left L 150mm H 59mm			
	GEV No.	690044	Ref. No.
			—
handle latch right L 185mm H 59mm handle material plastic type 6300 series			

			
1			
GEV No.	690027	Ref. No.	6002048 6002048K
description	handle latch left L 150mm H 59mm		
For models:	OD10.10, OD10.20, OD12.20, OD20.10, OD20.20, OD6.10, OS10.10, OS10.20, OS6.10, OSC10.10, OSC10.20, OSC6.10, OSP10.10, OSP10.20, OSP6.10		
accessories for	690027		
	GEV No.	690045	Ref. No.
			—
door catch mounting pos. left off-set 20mm L 110mm H 56mm W 33mm mounting distance 68/68mm zinc die cast series 6300			
	GEV No.	690135	Ref. No.
			6002049 6002049K
door catch mounting pos. left off-set 38mm L 110mm H 74mm W 33mm mounting distance 68/68mm zinc die cast series 1750			
	GEV No.	690137	Ref. No.
			6002060
sliding plate mounting pos. left L 28mm H 3mm W 21mm H2 12.5mm			

			
1			
GEV No.	690500	Ref. No.	6002053 6002053K
description	handle latch right L 185mm H 66mm handle material plastic type 6300 series		
For models:	HUD10.10, HUD12.20, HUD20.10, HUD20.20, HUD6.10, OD10.10, OD10.20, OD12.20, OD20.10, OD20.20, OD6.10, OS10.10, OS10.20, OS12.20, OS20.10, OS20.20, OS6.10, OSC10.10, OSC10.20, OSC12.20, OSC20.10, OSC20.20, OSC6.10, OSG10.10, OSG12.20, OSG6.10, OSP10.10, OSP10.20, OSP12.20, OSP20.10, OSP20.20, OSP6.10, UG10.20		
spare parts for	690500		
	GEV No.	699841	Ref. No.
			6002056
cover cap for turning lever lock ø 32mm H 14mm			
accessories for	690500		
	GEV No.	514281	Ref. No.
			—
base plate L 110mm W 35mm for door catch thickness 10mm			
	GEV No.	690136	Ref. No.
			6002062
sliding plate mounting pos. right L 28mm H 3mm W 21mm H2 12.5mm			
	GEV No.	691174	Ref. No.
			—
counterpart L 90mm W 60mm for door latch			
	GEV No.	700091	Ref. No.
			—
door catch mounting pos. right off-set 20mm L 110mm H 56mm W 33mm mounting distance 68/68mm zinc die cast series 6300			

Table continues overleaf



accessories for 690500			
	GEV No.	700098	Ref. No. 6002054 6002054K
door catch mounting pos. right off-set 38mm L 110mm H 74mm W 33mm mounting distance 68/68mm series 1750			

	GEV No.	690204	Ref. No. 6002064
description base plate for door catch thickness 10mm			
For models: HUD10.10, HUD12.20, HUD20.10, HUD20.20, HUD6.10, OD12.20, OD20.10, OD20.20			

	GEV No.	690203	Ref. No. 6002066
description base plate for door catch thickness 6mm			
For models: OD10.10, OD10.20, OD6.10			

	GEV No.	699841	Ref. No. 6002056
description cover cap for turning lever lock ø 32mm H 14mm			
For models: HUD10.10, HUD12.20, HUD20.10, HUD20.20, HUD6.10, OD10.10, OD10.20, OD12.20, OD20.10, OD20.20, OD6.10, OS10.10, OS10.20, OS12.20, OS20.10, OS20.20, OS6.10, OSC10.10, OSC10.20, OSC12.20, OSC20.10, OSC20.20, OSC6.10, OSP10.10, OSP10.20, OSP12.20, OSP20.10, OSP20.20, OSP6.10			

	GEV No.	700964	Ref. No. 6002093
description door catch H 45mm mounting pos. left L 81mm W 32mm for screw caps mounting distance 19mm			
For models: OD10.10, OD10.20, OD12.20, OD20.10, OD20.20, OD6.10, OS10.10, OS10.20, OS12.20, OS20.10, OS20.20, OS6.10, OSC10.10, OSC10.20, OSC12.20, OSC20.10, OSC20.20, OSC6.10, OSP10.10, OSP10.20, OSP12.20, OSP20.10, OSP20.20, OSP6.10			

	GEV No.	690135	Ref. No. 6002049 6002049K
description door catch mounting pos. left off-set 38mm L 110mm H 74mm W 33mm mounting distance 68/68mm zinc die cast series 1750			
For models: OD10.10, OD10.20, OD12.20, OD20.10, OD20.20, OD6.10, OS10.10, OS10.20, OS6.10, OSC10.10, OSC10.20, OSC6.10, OSP10.10, OSP10.20, OSP6.10			
spare parts for 690135			
	GEV No.	690137	Ref. No. 6002060
sliding plate mounting pos. left L 28mm H 3mm W 21mm H2 12.5mm			

	GEV No.	690137	Ref. No. 6002060
description sliding plate mounting pos. left L 28mm H 3mm W 21mm H2 12.5mm			
For models: HUD10.10, HUD12.20, HUD20.10, HUD20.20, HUD6.10, OD10.10, OD10.20, OD12.20, OD20.10, OD20.20, OD6.10, OS10.10, OS10.20, OS6.10, OSC10.10, OSC10.20, OSC6.10, OSP10.10, OSP10.20, OSP6.10			

	GEV No.	690136	Ref. No. 6002062
description sliding plate mounting pos. right L 28mm H 3mm W 21mm H2 12.5mm			
For models: HUD10.10, HUD12.20, HUD20.10, HUD20.20, HUD6.10, OD10.10, OD10.20, OD12.20, OD20.10, OD20.20, OD6.10, OSG10.10, OSG12.20, OSG20.20, OSG6.10			





	GEV No.	700963	Ref. No. 6002045
description sliding plate right L 32mm W 18.5mm plastic			
For models: OD10.10, OD10.20, OD12.20, OD20.10, OD20.20, OD6.10, OS10.10, OS10.20, OS12.20, OS20.10, OS20.20, OS6.10, OSC10.10, OSC10.20, OSC12.20, OSC20.10, OSC20.20, OSC6.10, OSP10.10, OSP10.20, OSP12.20, OSP20.10, OSP20.20, OSP6.10			

handle latches
universal
inside fixing
locks

	GEV No.	694054	Ref. No. 2518784
description door handle for headed units L 145mm W 40mm H 62mm spring length 33mm inner black			
For models: OE56.06			
spare parts for 694054			
	GEV No.	514390	Ref. No. —
spring for door handle ø 6mm L 54mm W 27.5mm			
	GEV No.	694675	Ref. No. —
door catch L 88mm W 40mm H 37mm spring length 33mm mounting distance 60mm			
	GEV No.	694734	Ref. No. —
door handle L 165mm W 40mm H 25mm black			
	GEV No.	694735	Ref. No. —
cap ø 32mm black			

Table continues overleaf





accessories for		694054	
GEV No.	691123	Ref. No.	—
			
duct for door opener			
GEV No.	694055	Ref. No.	—
			
door catch L 25mm W 14mm total length 54mm thread M8 thread L 29mm			
GEV No.	694066	Ref. No.	—
			
door catch with spigot 2-stage L 28mm W 14mm H 15mm H1 16mm total length 51mm thread M8 thread L 23mm stainless steel			
GEV No.	694067	Ref. No.	—
			
door catch with spigot 1-stage L 26mm total length 51mm thread M8			

producer-specific

CONVOTHERM

			
1			
GEV No.	694948	Ref. No.	6056498
description	door catch L 30mm W 14mm H 13mm cast iron with spigot mounting thread M4		

			
1			
GEV No.	694949	Ref. No.	6056807
description	door catch L 34.5mm W 14.5mm H 13mm cast iron with spigot mounting thread M4		





			
1			
GEV No.	694947	Ref. No.	6056499
description	door catch L 58mm W 20mm H 17mm cast iron with spigot mounting thread M5 IT		





			
1			
GEV No.	696785	Ref. No.	2528055
description	door handle for combi-steamer L 170mm W 30mm H 37mm spring length 37mm inner black plastic		



1

GEV No.	694054	Ref. No.	2518784
description	door handle for headed units L 145mm W 40mm H 62mm spring length 33mm inner black		
For models:	OES6.06		

spare parts for		694054	
GEV No.	514390	Ref. No.	—
			
spring for door handle ø 6mm L 54mm W 27.5mm			
GEV No.	694675	Ref. No.	—
			
door catch L 88mm W 40mm H 37mm spring length 33mm mounting distance 60mm			
GEV No.	694734	Ref. No.	—
			
door handle L 165mm W 40mm H 25mm black			
GEV No.	694735	Ref. No.	—
			
cap ø 32mm black			

accessories for		694054	
GEV No.	691123	Ref. No.	—
			
duct for door opener			
GEV No.	694055	Ref. No.	—
			
door catch L 25mm W 14mm total length 54mm thread M8 thread L 29mm			
GEV No.	694066	Ref. No.	—
			
door catch with spigot 2-stage L 28mm W 14mm H 15mm H1 16mm total length 51mm thread M8 thread L 23mm stainless steel			
GEV No.	694067	Ref. No.	—
			
door catch with spigot 1-stage L 26mm total length 51mm thread M8			



1

GEV No.	692741	Ref. No.	6056809
description	door handle L 195mm W 53mm H 62mm clamp length 42mm black mounting thread M4 CONVOTHERM model C4 Serie		



1

GEV No.	694919	Ref. No.	6050978 6056384
description	door handle L 195mm W 53mm H 62mm spring length 44mm blue mounting distance 30mm mounting thread M4		



1

GEV No.	750714	Ref. No.	79560
description	hinge off-set 22mm overall height 90mm stainless steel total length 50mm W 16.5mm		

piano hinges

producer-specific

CONVOTHERM

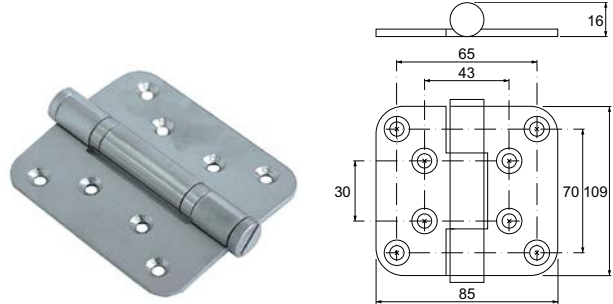

1

GEV No.	690074	Ref. No.	6001041 6001041K
description	hinge L 109mm W 85mm H 16mm mounting distance 65/70mm mounting distance 1 43/30mm hole \varnothing 5.5mm thickness 3mm stainless steel		
For models:	AR108, HUD12.20, HUD20.10, HUD20.20, OD12.20, OD20.10, OD20.20		

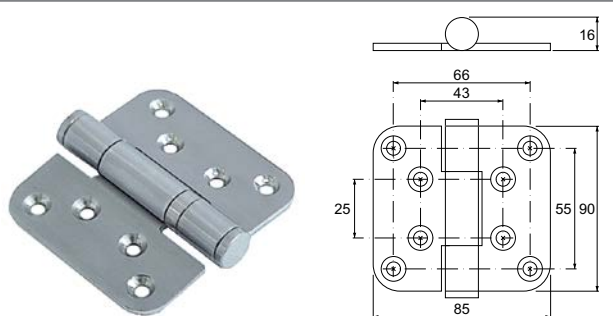

1

GEV No.	690214	Ref. No.	6001032 6001032K
description	hinge L 90mm W 85mm H 16mm mounting distance 66/55mm mounting distance 1 43/25mm hole \varnothing 6mm thickness 3mm stainless steel		
For models:	HUD10.10, HUD6.10, OD10.10, OD10.20, OD6.10, OS10.10, OS10.20, OS6.10, OSC10.10, OSC10.20, OSC6.10, OSP10.10, OSP10.20, OSP6.10		

hinges

overlying hinges

STUV

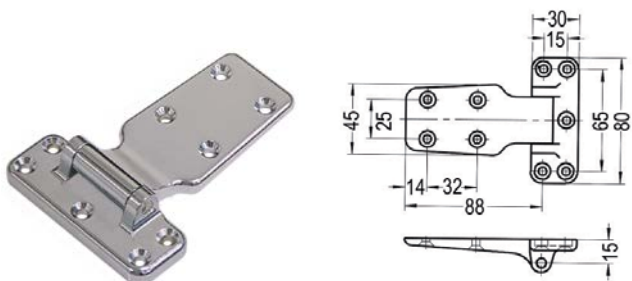

1

GEV No.	700092	Ref. No.	6001031 6001031K
description	hinge off-set 0mm overall height 21mm type 3.50.0139.0 total length 110mm W 80mm face mounted		
For models:	AR12, AR16, AR18, AR28, AR30, AR40, AR50, AR54, AR8, UG6.05, UG6.10		

miscellaneous



1

GEV No.	690049	Ref. No.	6001040 6001040K
description	hinge off-set 0mm overall height 22mm face mounted total length 118.5mm		
For models:	AR100, AR108, AR12, AR18, AR28, AR72, HUD10.10, HUD12.20, HUD20.10, HUD20.20, HUD6.10, UG10.10, UG10.20, UG20.10, UG20.20		





door bearing

 <p>1</p>			
GEV No.	699842	Ref. No.	2517296 2517297 2523667
description	hinge L 128mm W 29mm H 23.5mm mounting pos. upper and bottom thickness 10.5mm bolt 17mm bolt ø 10mm series P3 1 pair		
For models:	OEB10.10, OEB10.20, OEB12.20, OEB20.10, OEB20.20, OEB6.10, OEB6.20, OES10.10, OES10.20, OES12.20, OES20.10, OES20.20, OES6.10, OES6.20, OGB10.10, OGB10.20, OGB12.20, OGB20.10, OGB20.20, OGB6.10, OGB6.20, OGS10.10, OGS10.20, OGS12.20, OGS20.10, OGS20.20, OGS6.10, OGS6.20		

 <p>1</p>			
GEV No.	692788	Ref. No.	2656839
description	hinge mounting pos. lower bolt 18mm bolt ø 10mm hinged at right series CONVOTHERM 4		

 <p>1</p>			
GEV No.	692790	Ref. No.	6056843
description	hinge mounting pos. lower ID ø 10mm hinged at right series CONVOTHERM 4		

 <p>1</p>			
GEV No.	692793	Ref. No.	6056845
description	hinge mounting pos. lower ID ø 10mm hinged at right suitable for combi-steamer series CONVOTHERM 4		

 <p>1</p>			
GEV No.	692784	Ref. No.	6056841
description	hinge mounting pos. right bottom thickness 5mm bolt 18.5mm bolt ø 10mm hinged at right suitable for CONVOTHERM 4		

 <p>1</p>			
GEV No.	692785	Ref. No.	6056840
description	hinge mounting pos. upper bolt 13mm bolt ø 10mm series CONVOTHERM 4 hinged at right		

 <p>1</p>			
GEV No.	692789	Ref. No.	2656838
description	hinge mounting pos. upper bolt 17mm bolt ø 10mm hinged at right series CONVOTHERM 4		

 <p>1</p>			
GEV No.	692786	Ref. No.	6056844
description	hinge mounting pos. upper ID ø 10mm bolt 18mm bolt ø 18mm series CONVOTHERM 4 hinged at right		

 <p>1</p>			
GEV No.	692791	Ref. No.	6056842
description	hinge mounting pos. upper ID ø 10mm bolt 19.5mm bolt ø 9.5mm hinged at right series CONVOTHERM 4		

 <p>1</p>			
GEV No.	699843	Ref. No.	2014003
description	hinge camp L 47mm W 28mm H 9mm mounting distance 22mm mounting pos. upper		
For models:	OEB10.10, OEB10.20, OEB12.20, OEB20.10, OEB20.20, OEB6.10, OEB6.20, OES10.10, OES10.20, OES12.20, OES20.10, OES20.20, OES6.10, OES6.20, OGB10.10, OGB10.20, OGB12.20, OGB20.10, OGB20.20, OGB6.10, OGB6.20, OGS10.10, OGS10.20, OGS12.20, OGS20.10, OGS20.20, OGS6.10, OGS6.20		

miscellaneous

 <p>1</p>			
GEV No.	699844	Ref. No.	2014007
description	hinge curved L 38mm W 23mm		
For models:	OEB10.10, OEB10.20, OEB12.20, OEB20.10, OEB20.20, OEB6.10, OEB6.20, OES10.10, OES10.20, OES12.20, OES20.10, OES20.20, OES6.10, OES6.20, OGB10.10, OGB10.20, OGB12.20, OGB20.10, OGB20.20, OGB6.10, OGB6.20, OGS10.10, OGS10.20, OGS12.20, OGS20.10, OGS20.20, OGS6.10, OGS6.20		

equipment feet and end caps

bullet feet

zamak/SS



1

GEV No.	750715	Ref. No.	6014042
description	bullet foot L 40mm W 40mm H 75-105mm Qty 1 pcs		
For models:	OEB12.20, OEB20.10, OEB20.20, OES12.20, OES20.10, OES20.20, OGB12.20, OGB20.10, OGB20.20, OGS12.20, OGS20.10, OGS20.20		

bolting feet



1

GEV No.	699852	Ref. No.	6056353
description	equipment foot L 150mm W 50mm H 100mm bore ø 8.5mm Qty 1 pcs		



1

GEV No.	699498	Ref. No.	2118799
description	equipment foot ø 40mm H 25mm bore ø 7mm rubber Qty 4 pcs CONVOTHERM		
For models:	OES6.06		

miscellaneous

with spigot

ø125mm



1

GEV No.	710007	Ref. No.	6004065
description	fixed castor ø 125mm		
For models:	AR108, HUD12.20, HUD20.10, HUD20.20, UG20.10, UG20.20		



1

GEV No.	710013	Ref. No.	6004066
description	fixed castor ø 125mm M10 housing SS H 157mm wheel width 32mm		
For models:	AR108, HUD12.20, HUD20.10, HUD20.20, OD10.20, OD12.20, OD20.10, OD20.20, OS12.20, OS20.10, OS20.20, OSC12.20, OSC20.10, OSC20.20, OSG12.20, OSG20.20, OSP12.20, OSP20.10, OSP20.20		



1

GEV No.	710017	Ref. No.	6004055
description	swivel castor ø 125mm		
For models:	AR108, HUD12.20, HUD20.10, HUD20.20, UG20.10, UG20.20		



1

GEV No.	710021	Ref. No.	3303456 6004056
description	swivel castor ø 125mm housing SS		
For models:	AR108, HUD12.20, HUD20.10, HUD20.20, OD10.20, OD12.20, OD20.10, OD20.20, OS12.20, OS20.10, OS20.20, OSC12.20, OSC20.10, OSC20.20, OSG12.20, OSG20.20, OSP12.20, OSP20.10, OSP20.20		

BLICKLE

stainless steel

ø125mm



1

GEV No.	701021	Ref. No.	6014051
description	fixed castor ø 125mm plates fixing 57x48mm housing SS bearing slide bearing H 155mm wheel width 32mm		
For models:	OEB12.20, OEB20.10, OEB20.20, OES12.20, OES20.10, OES20.20, OGB12.20, OGB20.10, OGB20.20, OGS12.20, OGS20.10, OGS20.20		



			
1			
GEV No.	701022	Ref. No.	6014050
description	swivel castor ø 125mm bolt hole ø13.0mm housing SS bearing slide bearing H 158mm wheel width 32mm		
For models:	OEB12.20, OEB20.10, OEB20.20, OES12.20, OES20.10, OES20.20, OGB12.20, OGB20.10, OGB20.20, OGS12.20, OGS20.10, OGS20.20		

			
1			
GEV No.	701023	Ref. No.	6014052
description	swivel castor with swivel brake ø 125mm bolt hole ø13.0mm housing SS bearing slide bearing H 158mm wheel width 32mm		
For models:	OEB12.20, OEB20.10, OEB20.20, OES12.20, OES20.10, OES20.20, OGB12.20, OGB20.10, OGB20.20, OGS12.20, OGS20.10, OGS20.20		

gaskets

gaskets for heated units

window seals

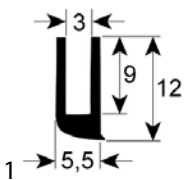
			
1			
GEV No.	901430	Ref. No.	7001040
description	window gasket profile 1502 Qty supplied by meter		
For models:	AR12, AR18, AR8, HUD10.10, HUD12.20, HUD20.10, HUD20.20, HUD6.10, UG10.10, UG10.20, UG20.10, UG20.20, UG6.05, UG6.10		

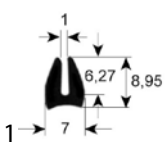
			
1			
GEV No.	900113	Ref. No.	7001041
description	window gasket profile 1560 Qty supplied by meter		
For models:	AR12, AR18, AR28, AR8, HUD10.10, HUD12.20, HUD20.10, HUD20.20, HUD6.10, OD10.10, OD10.20, OD12.20, OD20.10, OD20.20, OD6.10, UG10.10, UG10.20, UG20.10, UG20.20, UG6.05, UG6.10		

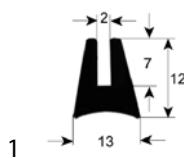
			
1			
GEV No.	900448	Ref. No.	7001045
description	window gasket profile 1630 L 1800mm Qty 1		
For models:	OD10.10, OD6.10, OSG10.10, OSG6.10		

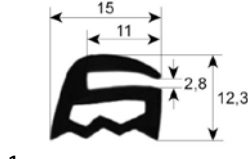
			
1			
GEV No.	900114	Ref. No.	7001042
description	window gasket profile 1870 Qty supplied by meter		
For models:	AR28, HUD10.10, HUD12.20, HUD20.10, HUD20.20, HUD6.10, OD10.10, OD10.20, OD12.20, OD20.10, OD20.20, OD6.10		

door seals

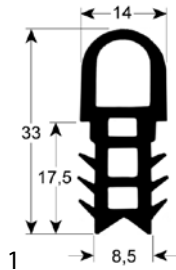
			
1			
GEV No.	900062	Ref. No.	7001017 7001071
description	door seal profile 2060 L 720mm W 625mm Qty 1 outer plug size suitable for CONVOTHERM		
For models:	HUD10.10, OD10.10, OS10.10, OSC10.10, OSC10.20, OSC6.10, OSP10.10, OSP10.20, UG10.10		

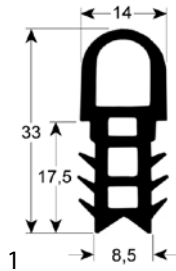
			
1			
GEV No.	900057	Ref. No.	7001013
description	door seal profile 2060 Qty supplied by meter		
For models:	AR72, HUD10.10, HUD12.20, HUD20.10, HUD20.20, HUD6.10, UG10.10, UG10.20, UG20.10, UG20.20, UG4.05, UG6.05, UG6.10		

GEV No.	900061	Ref. No.	7001016
description	door seal profile 2060 W 480mm L 625mm outer plug size Qty 1 suitable for CONVOTHERM 6 x 1/1		
For models:	HUD6.10, OD10.10, OD10.20, OD6.10, OS6.10, OSC6.10, OSP6.10, UG6.10		

GEV No.	900063	Ref. No.	7001018 7001074
description	door seal profile 2060 W 705mm L 1635mm external size Qty 1 short side open		
For models:	AR100, HUD20.10, HUD20.20, OD20.10, OD20.20, OS20.10, OS20.20, OSC20.10, OSC20.20, OSP20.10, OSP20.20, UG20.10		

GEV No.	900950	Ref. No.	7001032
description	door seal profile 2060 W 625mm L 810mm outer plug size suitable for CONVOTHERM OD/OS		
For models:	OD10.20, OS10.20, OSC10.20, OSP10.20		

GEV No.	901289	Ref. No.	7001051
description	door seal profile 2060 W 710mm L 1300mm outer plug size Qty 1 suitable for CONVOTHERM OD20.20 Gas		
For models:	OD20.20		

GEV No.	901145	Ref. No.	7001050
description	door seal profile 2060 W 686mm L 770mm outer plug size Qty 1 suitable for CONVOTHERM		
For models:	OD10.20, OD12.20		

GEV No.	900443	Ref. No.	7001034
description	door seal profile 2420 W 450mm L 460mm outer plug size Qty 1 suitable for CONVOTHERM		
For models:	OD6.10, OSG6.10		

GEV No.	900064	Ref. No.	7001019 7001020
description	door seal profile 2060 W 705mm L 1080mm outer plug size Qty 1 suitable for CONVOTHERM short side open		
For models:	HUD12.20, OD10.20, OD12.20, OD20.10, OD20.20, OS12.20, OSC12.20, OSP12.20, UG20.20		

GEV No.	900444	Ref. No.	7001035
description	door seal profile 2420 W 450mm L 700mm outer plug size Qty 1 suitable for CONVOTHERM		
For models:	OD10.10, OSG10.10		

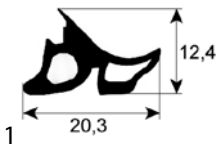

			
GEV No.	901177	Ref. No.	7011051(Alternativ) 7011054(Alternativ)
description	door seal profile 2480 L 1470mm suitable for CONVOTHERM welded		

			
GEV No.	901951	Ref. No.	7011051 7011054 7011060
description	door seal profile 2480 L 1485mm Qty 1 suitable for CONVOTHERM series P3 for model OES 6.06/6.10 mini		
For models:	OES6.06		

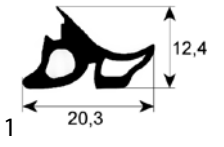
			
GEV No.	901370	Ref. No.	7011052 (alternativ) 7011055 (alternativ) 7011061 (alternativ)
description	door seal profile 2480 L 1880mm Qty 1 suitable for CONVOTHERM model OES 10.10 mini series C4		

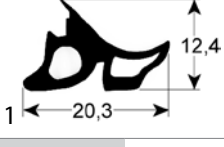
			
GEV No.	902429	Ref. No.	7011052 7011055 7011061
description	door seal profile 2480 L 1880mm Qty 1 suitable for CONVOTHERM model OES 10.10 mini series C4		

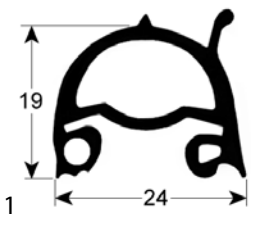
			
GEV No.	901398	Ref. No.	7001079
description	door seal profile 2519 W 695mm L 1410mm external size Qty 1		
For models:	OSG20.20		

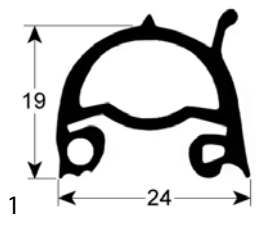
			
GEV No.	901393	Ref. No.	7001078
description	door seal profile 2519 W 695mm L 885mm external size suitable for CONVOTHERM		
For models:	OSG12.20		

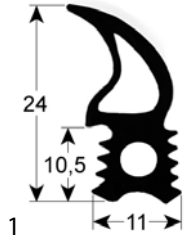
			
GEV No.	902424	Ref. No.	7011003
description	door seal profile 2715 W 460mm H 1495mm outer plug size Qty 1 for model 20.10 series P3 CONVOTHERM		
For models:	OEB20.10, OES20.10, OGB20.10, OGS20.10		

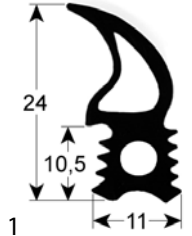
			
GEV No.	902423	Ref. No.	7011001
description	door seal profile 2715 W 460mm H 510mm outer plug size Qty 1 for model 6.10 series P3 CONVOTHERM		
For models:	OEB6.10, OES6.10, OGB6.10, OGS6.10		

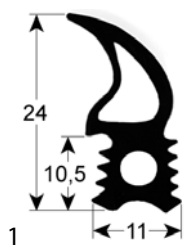
			
GEV No.	902422	Ref. No.	7011002
description	door seal profile 2715 W 460mm H 770mm outer plug size Qty 1 for model 10.10 series P3 CONVOTHERM		
For models:	OEB10.10, OES10.10, OGB10.10, OGS10.10		

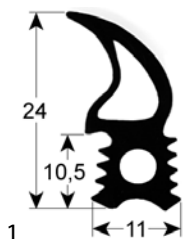

GEV No.	900791	Ref. No.	7011003 (alternativ)
description	door seal profile 2715 W 465mm H 1500mm outer plug size Qty 1		

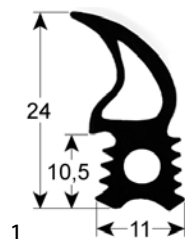

GEV No.	901436	Ref. No.	7011004 (alternativ)
description	door seal profile 2715 W 670mm H 550mm outer plug size Qty 1		

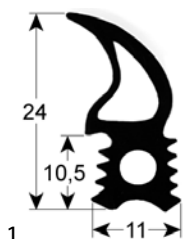

GEV No.	900369	Ref. No.	7011001 (alternativ)
description	door seal profile 2715 W 465mm H 510mm outer plug size Qty 1		

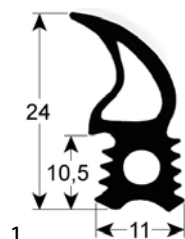

GEV No.	902426	Ref. No.	7011004
description	door seal profile 2715 W 670mm H 550mm outer plug size Qty 1 for model 6.20 series P3 CONVOTHERM		
For models:	OEB6.20, OES6.20, OGB6.20, OGS6.20		

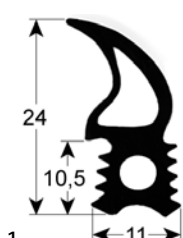

GEV No.	900930	Ref. No.	7011002 (Alternativ)
description	door seal profile 2715 W 465mm H 775mm outer plug size Qty 1		

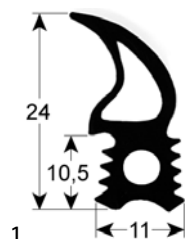

GEV No.	902425	Ref. No.	7011005
description	door seal profile 2715 W 670mm H 770mm outer plug size Qty 1 for model 10.20 series P3 CONVOTHERM		
For models:	OEB10.20, OES10.20, OGB10.20, OGS10.20		

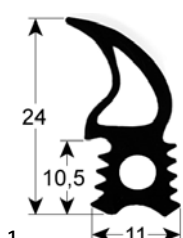

GEV No.	902428	Ref. No.	7011007
description	door seal profile 2715 W 670mm H 1495mm outer plug size Qty 1 for model 20.20 series P3 CONVOTHERM		
For models:	OEB20.20, OES20.20, OGB20.20, OGS20.20		

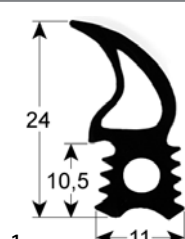

GEV No.	902427	Ref. No.	7011006
description	door seal profile 2715 W 670mm H 965mm outer plug size Qty 1 for model 12.20 series P3 CONVOTHERM		
For models:	OEB12.20, OES12.20, OGB12.20, OGS12.20		

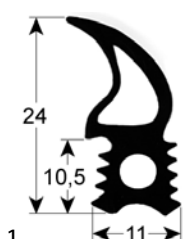

GEV No.	900851	Ref. No.	7011007 (alternativ)
description	door seal profile 2715 W 670mm H 1500mm outer plug size Qty 1		



GEV No.	900853	Ref. No.	7011006 (alternativ)
description	door seal profile 2715 W 670mm H 970mm outer plug size Qty 1		

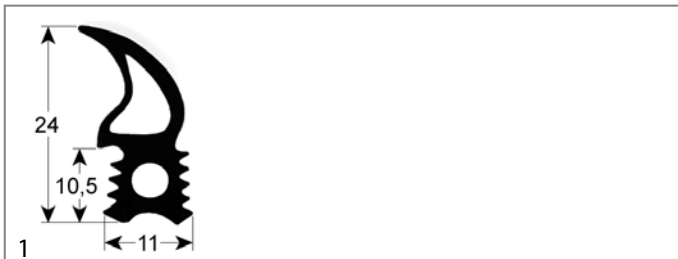

GEV No.	900852	Ref. No.	7011005 (alternativ)
description	door seal profile 2715 W 680mm H 775mm outer plug size Qty 1		

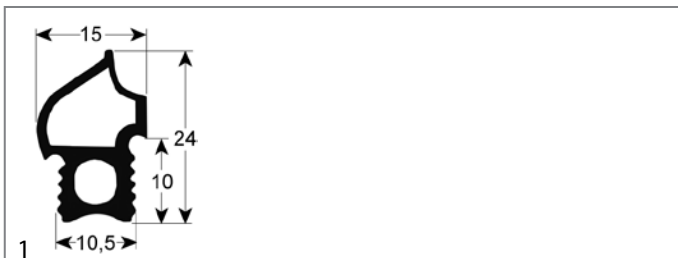

GEV No.	902433	Ref. No.	7056343
description	door seal profile 2717 W 460mm H 1495mm outer plug size Qty 1 CONVOTHERM 20.10 C4 Serie		



GEV No.	902416	Ref. No.	7056338
description	door seal profile 2717 W 460mm H 490mm outer plug size Qty 1 CONVOTHERM 6.10 C4 Serie		

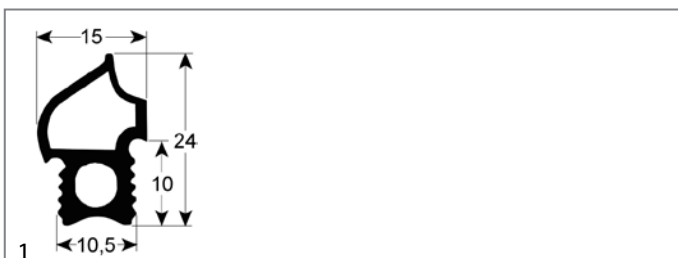

GEV No.	902393	Ref. No.	7056340
description	door seal profile 2717 W 460mm H 760mm outer plug size Qty 1 CONVOTHERM 10.10 C4 Serie		



GEV No.	902430	Ref. No.	7056339
description	door seal profile 2717 W 490mm H 660mm outer plug size Qty 1 CONVOTHERM 6.20 C4 Serie		



GEV No.	902432	Ref. No.	7056342
description	door seal profile 2717 W 660mm H 960mm outer plug size Qty 1 CONVOTHERM 12.20 C4 Serie		



GEV No.	902394	Ref. No.	7056344
description	door seal profile 2717 W 665mm H 1490mm outer plug size Qty 1 CONVOTHERM 20.20 C4 Serie		



GEV No.	902431	Ref. No.	7056341
description	door seal profile 2717 W 66mm H 760mm outer plug size Qty 1 CONVOTHERM 10.20 C4 Serie		



GEV No.	902449	Ref. No.	6016507
description	door seal profile 2800 W 730mm L 1540mm external size Qty 1 suitable for CONVOTHERM for heated trolley		

gaskets for tray rack trolleys

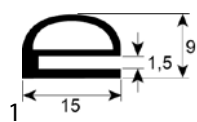

GEV No.	900167	Ref. No.	7001039 7001039K
description	tray rack trolley gasket profile 4030 L 1970mm Qty 1 silicone transparent		
For models:	HUD12.20, HUD20.10, HUD20.20, OD12.20, OD20.10, OD20.20, OS12.20, OS20.10, OS20.20, OSC12.20, OSC20.10, OSC20.20, OSP12.20, OSP20.10, OSP20.20, UG10.10, UG10.20, UG20.10, UG20.20		

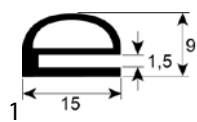

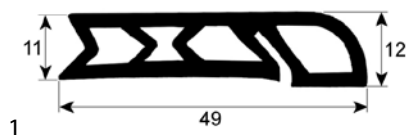

GEV No.	900403	Ref. No.	N/A
description	tray rack trolley gasket profile 4030 Qty supplied by meter silicone transparent		

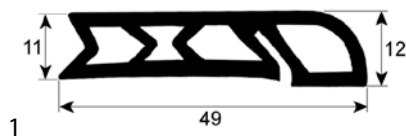

GEV No.	901150	Ref. No.	7011000
description	tray rack trolley gasket profile 4080 L 540mm Qty 1		
For models:	OEB20.10, OES20.10, OGB20.10, OGS20.10		
accessories for	901150		
	GEV No.	560067	Ref. No. 8001031
	flat-headed bolt thread M5 thread L 10mm SS DIN 7985/ISO 7045 Qty 20 pcs intake Phillips head ø 8mm head thickness 2mm		



GEV No.	900850	Ref. No.	7001077 (alternativ)
description	tray rack trolley gasket profile 4080 L 740mm Qty 1		
accessories for	900850		
	GEV No.	560067	Ref. No. 8001031
	flat-headed bolt thread M5 thread L 10mm SS DIN 7985/ISO 7045 Qty 20 pcs intake Phillips head ø 8mm head thickness 2mm		
	GEV No.	694840	Ref. No. —
	guide bar SS L 725mm		



GEV No.	901833 ¹	Ref. No.	2514386 2525227
description	tray rack trolley gasket profile 4085 L 535mm Qty 1 incl. fastening strip		
For models:	OEB20.10, OES20.10, OGB20.10, OGS20.10		

¹incl. mounting rail

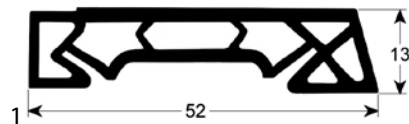

GEV No.	901574	Ref. No.	7011009
description	tray rack trolley gasket profile 4085 L 540mm Qty 1		

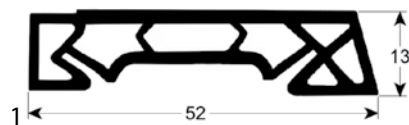

GEV No.	902338	Ref. No.	7056806
description	tray rack trolley gasket profile 4085 L 570mm Qty 1		

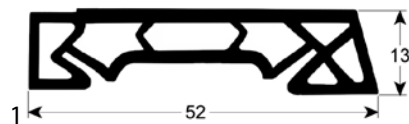

GEV No.	901749	Ref. No.	2514385 2525226 7001077
description	tray rack trolley gasket profile 4085 L 725mm Qty 1 incl. fastening strip		
For models:	OEB12.20, OEB20.20, OES12.20, OES20.20, OGB12.20, OGB20.20, OGS12.20, OGS20.20, OSG12.20		

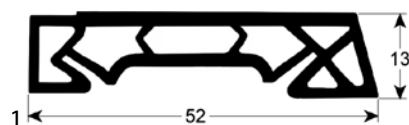

GEV No.	902441	Ref. No.	7011008
description	tray rack trolley gasket profile 4085 L 740mm Qty 1		

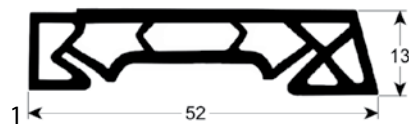

GEV No.	902339	Ref. No.	7056805
description	tray rack trolley gasket profile 4085 L 780mm Qty 1		

gaskets for control panels





GEV No.	902415	Ref. No.	7011010
description	gasket for control panel profile W 155mm L 600mm suitable for CONVOTHERM self-adhesive Qty		
For models:	OEB10.10, OEB10.20, OEB12.20, OEB20.10, OEB20.20, OEB6.10, OEB6.20, OES10.10, OES10.20, OES12.20, OES20.10, OES20.20, OES6.10, OES6.20, OGB10.10, OGB10.20, OGB12.20, OGB20.10, OGB20.20, OGB6.10, OGB6.20, OGS10.10, OGS10.20, OGS12.20, OGS20.10, OGS20.20, OGS6.10, OGS6.20		

miscellaneous			
miscellaneous			
			
GEV No.	902417	Ref. No.	7003066
description	sealing strip Qty supplied by meter self-adhesive suitable for CONVOTHERM size 9x3mm		
For models:	OD10.10, OD10.20, OD12.20, OD20.20, OD6.10, OEB10.10, OEB10.20, OEB12.20, OEB20.10, OEB20.20, OEB6.10, OEB6.20, OES10.10, OES10.20, OES12.20, OES20.10, OES20.20, OES6.06, OES6.10, OES6.20, OGB10.10, OGB10.20, OGB12.20, OGB20.10, OGB20.20, OGB6.10, OGB6.20, OGS10.10, OGS10.20, OGS12.20, OGS20.10, OGS20.20, OGS6.10, OGS6.20, OSG10.10, OSG12.20, OSG20.20, OSG6.10		

O-rings

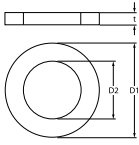
EPDM

 			
GEV No.	532674	Ref. No.	6005236
description	O-ring EPDM thickness 3mm ID ø 53mm Qty 1 pcs		
For models:	OEB10.10, OEB10.20, OEB12.20, OEB20.10, OEB20.20, OEB6.10, OEB6.20, OES10.10, OES10.20, OES12.20, OES20.10, OES20.20, OES6.10, OES6.20, OGB10.10, OGB10.20, OGB12.20, OGB20.10, OGB20.20, OGB6.10, OGB6.20, OGS10.10, OGS10.20, OGS12.20, OGS20.10, OGS20.20, OGS6.10, OGS6.20		

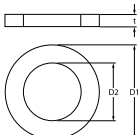
 			
GEV No.	532673	Ref. No.	6015000 6015010
description	O-ring EPDM thickness 4mm ID ø 67mm Qty 1 pcs		
For models:	OEB10.10, OEB10.20, OEB12.20, OEB20.10, OEB20.20, OEB6.10, OEB6.20, OES10.10, OES10.20, OES12.20, OES20.10, OES20.20, OES6.10, OES6.20, OGB10.10, OGB10.20, OGB12.20, OGB20.10, OGB20.20, OGB6.10, OGB6.20, OGS10.10, OGS10.20, OGS12.20, OGS20.10, OGS20.20, OGS6.10, OGS6.20		

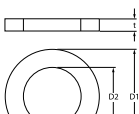
 			
GEV No.	510408	Ref. No.	6005015
description	O-ring EPDM thickness 5.34mm ID ø 47mm Qty 1 pcs		
For models:	OD10.10, OD10.20, OD12.20, OD20.10, OD20.20, OD6.10, OS10.10, OS10.20, OS12.20, OS20.10, OS20.20, OS6.10, OSC10.10, OSC10.20, OSC12.20, OSC20.10, OSC20.20, OSC6.10, OSP10.10, OSP10.20, OSP12.20, OSP20.10, OSP20.20, OSP6.10		

silicone

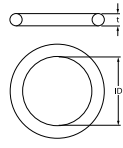
 			
GEV No.	532638	Ref. No.	6005068
description	O-ring silicone thickness 5.34mm ID ø 43.82mm Qty 1 pcs		
For models:	OD6.10, OEB10.10, OEB10.20, OEB12.20, OEB20.10, OEB20.20, OEB6.10, OEB6.20, OES10.10, OES10.20, OES12.20, OES20.10, OES20.20, OES6.10, OES6.20, OGB10.10, OGB10.20, OGB12.20, OGB20.10, OGB20.20, OGB6.10, OGB6.20, OGS10.10, OGS10.20, OGS12.20, OGS20.10, OGS20.20, OGS6.10, OGS6.20		

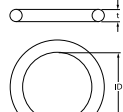
 			
GEV No.	532374	Ref. No.	6005068
description	O-ring silicone thickness 5.34mm ID ø 43.82mm Qty 10 pcs		

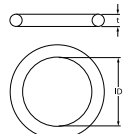
 			
GEV No.	532575	Ref. No.	6005069
description	O-ring silicone thickness 5.34mm ID ø 59.69mm Qty 1 pcs		
For models:	OD10.10, OD10.20, OD12.20, OD20.10, OD20.20, OD6.10, OS10.10, OS10.20, OS12.20, OS20.10, OS20.20, OS6.10, OSC10.10, OSC10.20, OSC12.20, OSC20.10, OSC20.20, OSC6.10, OSP10.10, OSP10.20, OSP12.20, OSP20.10, OSP20.20, OSP6.10		

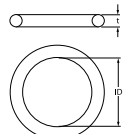
 			
GEV No.	696759	Ref. No.	6056349
description	O-ring silicone thickness 5mm ID ø 44mm Qty 5 pcs		

sealing washers

fibre gaskets

			
GEV No.	510416	Ref. No.	6005016
description	flat gasket fibre ED ø 19mm ID ø 10.5mm thickness 1.5mm for thread M10 Qty 1 pcs		
For models:	OD10.10, OD10.20, OD12.20, OD20.10, OD20.20, OD6.10, OEB10.10, OEB10.20, OEB12.20, OEB20.10, OEB20.20, OEB6.10, OEB6.20, OES10.10, OES10.20, OES12.20, OES20.10, OES20.20, OES6.10, OES6.20, OGB10.10, OGB10.20, OGB12.20, OGB20.10, OGB20.20, OGB6.10, OGB6.20, OGS10.10, OGS10.20, OGS12.20, OGS20.10, OGS20.20, OGS6.10, OGS6.20, OS10.10, OS10.20, OS12.20, OS20.10, OS20.20, OS6.10, OSP10.10, OSP10.20, OSP12.20, OSP20.10, OSP20.20, OSP6.10		



GEV No.	510406	Ref. No.	6005065
description	flat gasket fibre ED ø 60mm ID ø 48mm thickness 3mm for thread 1½" Qty 1 pcs		
For models:	HUD10.10, HUD12.20, HUD20.10, HUD20.20, HUD6.10, OD10.10, OD10.20, OD12.20, OD20.10, OD20.20, OD6.10		

graphite gaskets



GEV No.	691609	Ref. No.	6015028
description	gasket graphite ED ø 150mm ID ø 115mm thickness 2mm Qty 1 pcs		
For models:	OGB10.10, OGB10.20, OGB12.20, OGB20.10, OGB20.20, OGB6.10, OGB6.20, OGS10.10, OGS10.20, OGS12.20, OGS20.10, OGS20.20, OGS6.10, OGS6.20		



GEV No.	521012	Ref. No.	6005260
description	gasket graphite ED ø 15mm ID ø 5mm thickness 1.2mm Qty 1 pcs		
For models:	OEB10.10, OEB10.20, OEB12.20, OEB20.10, OEB20.20, OEB6.10, OEB6.20, OES10.10, OES10.20, OES12.20, OES20.10, OES20.20, OES6.06, OES6.10, OES6.20, OGB10.10, OGB10.20, OGB12.20, OGB20.10, OGB20.20, OGB6.10, OGB6.20, OGS10.10, OGS10.20, OGS12.20, OGS20.10, OGS20.20, OGS6.10, OGS6.20, OS10.10, OS10.20, OS12.20, OS20.10, OS20.20, OS6.10, OSC10.10, OSC10.20, OSC12.20, OSC20.10, OSC20.20, OSC6.10, OSG20.10, OSP10.10, OSP10.20, OSP12.20, OSP20.10, OSP20.20, OSP6.10		



GEV No.	514439	Ref. No.	6015034
description	gasket graphite ED ø 82.5mm ID ø 52.5mm thickness 2mm		
For models:	OGB10.10, OGB10.20, OGB12.20, OGB20.10, OGB20.20, OGB6.10, OGB6.20, OGS10.10, OGS10.20, OGS12.20, OGS20.10, OGS20.20, OGS6.10, OGS6.20		

plastic gaskets



GEV No.	510670	Ref. No.	6005407
description	gasket plastic ED ø 20mm ID ø 15mm thickness 2.9mm Qty 1 pcs		
For models:	OEB6.10, OES6.10, OS10.10, OS10.20, OS12.20, OS20.10, OS20.20, OS6.10, OSP10.10, OSP10.20, OSP12.20, OSP20.10, OSP20.20, OSP6.10		

copper gaskets

DIN-7603-C



GEV No.	510420	Ref. No.	6005055
description	gasket copper ED ø 19.9mm ID ø 14.3mm thickness 2mm Qty 1 pcs		
For models:	HUD10.10, HUD12.20, HUD20.10, HUD20.20, HUD6.10, OD10.10, OD10.20, OD12.20, OD20.10, OD20.20, OD6.10, OEB10.10, OEB10.20, OEB12.20, OEB20.10, OEB20.20, OEB6.10, OEB6.20, OES10.10, OES10.20, OES12.20, OES20.10, OES20.20, OES6.10, OES6.20, OGB10.10, OGB10.20, OGB12.20, OGB20.10, OGB20.20, OGB6.10, OGB6.20, OGS10.10, OGS10.20, OGS12.20, OGS20.10, OGS20.20, OGS6.10, OGS6.20, OS10.10, OS10.20, OS12.20, OS20.10, OS20.20, OS6.10, OSC10.10, OSC10.20, OSC12.20, OSC20.10, OSC20.20...(Other models you can see in the webshop)		

paper gasket



GEV No.	512427	Ref. No.	6005025
description	gasket paper ED ø 54mm ID ø 42.5mm thickness 2mm Qty 1 pcs ø 1 1/4"mm		
For models:	OEB10.10, OEB10.20, OEB12.20, OEB20.10, OEB6.10, OEB6.20, OES10.10, OES10.20, OES12.20, OES20.10, OES6.10, OES6.20, OGB10.10, OGB6.10, OGB6.20, OGS10.10, OGS6.10, OGS6.20		

silicone gaskets



GEV No.	693168	Ref. No.	6005074
description	gasket silicone ED ø 44mm ID ø 4mm thickness 5mm Qty 1 pcs		
For models:	OD10.10, OD10.20, OD12.20, OD20.10, OD20.20, OD6.10, OS10.10, OS10.20, OS12.20, OS20.10, OS20.20, OS6.10, OSC10.10, OSC10.20, OSC12.20, OSC20.10, OSC20.20, OSC6.10, OSP10.10, OSP10.20, OSP12.20, OSP20.10, OSP20.20, OSP6.10		



GEV No.	359721	Ref. No.	5005025
description	gasket silicone ED ø 48mm ID ø 39.5mm thickness 5mm Qty 1 pcs		
For models:	HUD10.10, HUD12.20, HUD20.10, HUD20.20, HUD6.10, OD10.10, OD10.20, OD12.20, OD20.10, OD20.20, OD6.10, UG10.10, UG10.20, UG20.10, UG20.20, UG4.05, UG6.05, UG6.10		



Viton gaskets



1

GEV No.	510577	Ref. No.	6005081
description	flat gasket Viton ED ø 7.5mm ID ø 1mm thickness 5mm Qty 1 pcs		
For models:	HUD10.10, HUD12.20, HUD20.10, HUD20.20, HUD6.10		

shaft gaskets

miscellaneous



1

GEV No.	694646	Ref. No.	2617295
description	shaft sealing set for hot air motors		
For models:	OEB10.10, OEB10.20, OEB12.20, OEB20.10, OEB20.20, OEB6.10, OEB6.20, OES10.10, OES10.20, OES12.20, OES20.10, OES20.20, OES6.10, OES6.20, OGB10.10, OGB10.20, OGB12.20, OGB20.10, OGB20.20, OGB6.10, OGB6.20, OGS10.10, OGS10.20, OGS12.20, OGS20.10, OGS20.20, OGS6.10, OGS6.20		

special gaskets

for combi-steamers



1

GEV No.	560644	Ref. No.	6056494
description	boot for drain pan ED ø 60mm ID ø 44mm CONVOTHERM 4		



1

GEV No.	699822	Ref. No.	6015029
description	gasket for burner chamber ED ø 170mm ID ø 134mm graphite thickness 2mm		
For models:	OGB10.20, OGB12.20, OGB20.20, OGS10.20, OGS12.20, OGS20.20		



1

GEV No.	699825	Ref. No.	6015030
description	gasket L 63mm W 63mm for flues ID ø 42mm graphite thickness 2mm hole distance 50mm		
For models:	OGB10.10, OGB20.10, OGB6.10, OGB6.20, OGS10.10, OGS20.10, OGS6.10, OGS6.20		



1

GEV No.	560636	Ref. No.	6064079
description	gasket suitable for CONVOTHERM burner L 150mm W 150mm with mounting accessories graphite thickness 2mm 10.20/20.20		



1

GEV No.	560643	Ref. No.	6056943
description	gasket suitable for CONVOTHERM combi-steamer L 90mm W 29mm with mounting kit graphite thickness 2mm		



1

GEV No.	699239	Ref. No.	6005067
description	sealing disc ED ø 36mm thickness 5mm aperture 5mmmm		
For models:	HUD10.10, HUD12.20, HUD20.10, HUD20.20, HUD6.10, OD10.10, OD10.20, OD12.20, OD20.10, OD20.20, OD6.10		

miscellaneous



1

GEV No.	514439	Ref. No.	6015034
description	gasket graphite ED ø 82.5mm ID ø 52.5mm thickness 2mm		
For models:	OGB10.10, OGB10.20, OGB12.20, OGB20.10, OGB20.20, OGB6.10, OGB6.20, OGS10.10, OGS10.20, OGS12.20, OGS20.10, OGS20.20, OGS6.10, OGS6.20		



1

GEV No.	521013	Ref. No.	2623226 6015025
description	gasket set suitable for CONVOTHERM for heating element L 90mm W 71mm Qty 1m graphite hole distance 54/74mm		
For models:	OEB10.10, OEB20.10, OEB6.10, OEB6.20, OES10.10, OES20.10, OES6.10, OES6.20		



1

GEV No.	510086	Ref. No.	2006010
description	gasket suitable for CONVOTHERM for tray rack trolley L 55mm W 50mm thickness 15mm		
For models:	OD12.20, OD20.10, OD20.20, OS12.20, OS20.10, OS20.20, OSC12.20, OSC20.10, OSC20.20, OSP12.20, OSP20.10, OSP20.20		



1

GEV No.	514441	Ref. No.	6015040 6056350
description	gasket suitable for CONVOTHERM L 65mm W 55mm thickness 2.5mm		
For models:	OEB10.10, OEB10.20, OEB12.20, OEB20.10, OEB20.20, OEB6.10, OEB6.20, OES10.10, OES10.20, OES12.20, OES20.10, OES20.20, OES6.10, OES6.20, OGB10.10, OGB10.20, OGB12.20, OGB20.10, OGB20.20, OGB6.10, OGB6.20, OGS10.10, OGS10.20, OGS12.20, OGS20.10, OGS20.20, OGS6.10, OGS6.20		

springs

miscellaneous



1

GEV No.	697940	Ref. No.	5009083
description	spring for thermostat shaft diameter 6x4.6mm ømm L 35mm W 20mm H 9mm wire gauge ø 1mm		
For models:	OD10.10, OD10.20, OD12.20, OD20.10, OD20.20, OD6.10		



1

GEV No.	697939	Ref. No.	5009082
description	spring for timer shaft diameter 6x4.6mm		
For models:	OD10.10, OD10.20, OD12.20, OD20.10, OD20.20, OD6.10		

manometers



1

GEV No.	541508	Ref. No.	6006140
description	manometer ø 40mm pressure range 0-4bar connection thread 1/8"		
For models:	OD10.10, OD10.20, OD12.20, OD20.20, OD6.10, OSG10.10, OSG12.20, OSG20.20, OSG6.10		

hose reels and spray guns

spray guns



1

GEV No.	542964	Ref. No.	6011010
description	spray gun for appliances 1/2" ET L 135mm		
For models:	OEB10.10, OEB10.20, OEB6.10, OEB6.20, OES10.10, OES10.20, OES6.10, OES6.20, OGB10.10, OGB10.20, OGB6.10, OGB6.20, OGS10.10, OGS10.20, OGS6.10, OGS6.20		



1

GEV No.	540158	Ref. No.	6005005
description	spray gun for appliances 1/2" ET type ECHTERMANN		
For models:	HUD10.10, HUD12.20, HUD20.10, HUD20.20, HUD6.10, OD10.10, OD10.20, OD12.20, OD20.10, OD20.20, OD6.10, OEB10.10, OEB10.20, OEB12.20, OEB20.10, OEB20.20, OEB6.10, OEB6.20, OES10.10, OES10.20, OES12.20, OES20.10, OES20.20, OES6.10, OES6.20, OGB10.10, OGB10.20, OGB12.20, OGB20.10, OGB20.20, OGB6.10, OGB6.20, OGS10.10, OGS10.20, OGS12.20, OGS20.10, OGS20.20, OGS6.10, OGS6.20, OS10.10, OS10.20, OS12.20, OS20.10, OS20.20, OS6.10, OSC10.10, OSC10.20, OSC12.20, OSC20.10, OSC20.20...(Other models you can see in the webshop)		

1

GEV No.	542038	Ref. No.	6011005
description	spray gun for appliances 3/8" IT L 135mm		



1

GEV No.	542376	Ref. No.	6056382
description	spray gun for appliances 3/8" L 125mm SS		



1

GEV No.	520277	Ref. No.	7012071 7012072
description	shower hose connections 1/2" L 1500mm PVC operating p. 10bar burst p. 30bar t.max. 60°C approval NSF rotary with fabric		
For models:	OEB10.10, OEB10.20, OEB12.20, OES10.10, OES10.20, OES12.20, OGB10.10, OGB10.20, OGB12.20, OGS10.10, OGS10.20, OGS12.20		



1

GEV No.	520096	Ref. No.	7002070 7012073
description	shower hose connections 1/2" L 2000mm PVC operating p. 10bar burst p. 30bar t.max. 60°C approval NSF rotary with fabric		
For models:	HUD10.10, HUD12.20, HUD6.10, OD10.10, OD6.10, OEB20.10, OEB20.20, OES20.10, OES20.20, OGB20.10, OGB20.20, OGS20.10, OGS20.20, OS10.10, OS6.10, OSC10.10, OSC6.10, OSG12.20, OSP10.10, OSP6.10		



1

GEV No.	520097	Ref. No.	7002071
description	shower hose connections 1/2" L 2200mm PVC operating p. 10bar burst p. 30bar t.max. 60°C approval NSF rotary with fabric		
For models:	HUD20.10, OD10.20, OD12.20, OD20.10, OD20.20, OS10.20, OS12.20, OS20.10, OSC10.20, OSC12.20, OSC20.10, OSP10.20, OSP12.20, OSP20.10		



1

GEV No.	520098	Ref. No.	7002072
description	shower hose connections 1/2" L 2600mm PVC operating p. 10bar burst p. 30bar t.max. 60°C approval NSF rotary with fabric		
For models:	HUD20.20, OD20.20, OS20.20, OSC20.20, OSG20.20, OSP20.20		



1

GEV No.	520968	Ref. No.	2625199
description	shower hose connections 3/8" L 1700mm connection 2: 12mm		



1

GEV No.	540008	Ref. No.	6005006 6005006K
description	shower head connection 1/2" metal		
For models:	HUD10.10, HUD12.20, HUD20.10, HUD20.20, HUD6.10, OD10.10, OD10.20, OD12.20, OD20.10, OD20.20, OD6.10, OEB10.10, OEB10.20, OEB12.20, OEB20.10, OEB20.20, OEB6.10, OEB6.20, OES10.10, OES10.20, OES12.20, OES20.10, OES20.20, OES6.10, OES6.20, OGB10.10, OGB10.20, OGB12.20, OGB20.10, OGB20.20, OGB6.10, OGB6.20, OGS10.10, OGS10.20, OGS12.20, OGS20.10, OGS20.20, OGS6.10, OGS6.20, OS10.10, OS10.20, OS12.20, OS20.10, OS20.20, OS6.10, OSC10.10, OSC10.20, OSC12.20, OSC20.10, OSC20.20...(Other models you can see in the webshop)		



1

GEV No.	540961	Ref. No.	6011012
description	wall holder for hand spray		
For models:	OEB10.10, OEB10.20, OEB6.10, OEB6.20, OES10.10, OES10.20, OES6.10, OES6.20, OGB10.10, OGB10.20, OGB6.10, OGB6.20, OGS10.10, OGS10.20, OGS6.10, OGS6.20		



hose reels

appliance hose reels



GEV No.	542319	Ref. No.	2625201 6011015
description	hose reel complete with spray gun hose length 1.5m		



GEV No.	542420	Ref. No.	6056491
description	hose reel for combi-steamer complete with spray gun hose length 1.3m hose ø DN6mm hose type drinking water		



GEV No.	542424	Ref. No.	2625200
description	hose reel for combi-steamer complete with spray gun hose length 1.5m hose ø DN6mm hose type drinking water		

cleaning guns

spare parts and accessories

hoses



GEV No.	699853	Ref. No.	7064050
description	hose ø DN13mm length 960 with clip t.max. 95°C approval FDA		

hoses

supply hoses

plastic/rubber hoses



GEV No.	699853	Ref. No.	7064050
description	hose ø DN13mm length 960 with clip t.max. 95°C approval FDA		

pre-rinse hoses

PVC braided hoses



GEV No.	520277	Ref. No.	7012071 7012072
description	shower hose connections 1/2" L 1500mm PVC operating p. 10bar burst p. 30bar t.max. 60°C approval NSF rotary with fabric		
For models:	OEB10.10, OEB10.20, OEB12.20, OES10.10, OES10.20, OES12.20, OGB10.10, OGB10.20, OGB12.20, OGS10.10, OGS10.20, OGS12.20		





GEV No.	520311	Ref. No.	7012080 7013073
description	shower hose connections 1/2" L 1800mm operating p. 10bar burst p. 18bar t.max. 60°C approval NSF		
For models:	OEB10.10, OEB10.20, OEB12.20, OEB20.10, OEB20.20, OEB6.10, OEB6.20, OES10.10, OES10.20, OES12.20, OES20.10, OES20.20, OES6.10, OES6.20, OGB10.10, OGB10.20, OGB12.20, OGB20.10, OGB20.20, OGB6.10, OGB6.20, OGS10.10, OGS10.20, OGS12.20, OGS20.10, OGS20.20, OGS6.10, OGS6.20		



GEV No.	520096	Ref. No.	7002070 7012073
description	shower hose connections 1/2" L 2000mm PVC operating p. 10bar burst p. 30bar t.max. 60°C approval NSF rotary with fabric		
For models:	HUD10.10, HUD12.20, HUD6.10, OD10.10, OD6.10, OEB20.10, OEB20.20, OES20.10, OES20.20, OGB20.10, OGB20.20, OGS20.10, OGS20.20, OS10.10, OS6.10, OSC10.10, OSC6.10, OSG12.20, OSP10.10, OSP6.10		



			
GEV No.	520097	Ref. No.	7002071
description	shower hose connections 1/2" L 2200mm PVC operating p. 10bar burst p. 30bar t.max. 60°C approval NSF rotary with fabric		
For models:	HUD20.10, OD10.20, OD12.20, OD20.10, OD20.20, OS10.20, OS12.20, OS20.10, OSC10.20, OSC12.20, OSC20.10, OSP10.20, OSP12.20, OSP20.10		

			
GEV No.	520098	Ref. No.	7002072
description	shower hose connections 1/2" L 2600mm PVC operating p. 10bar burst p. 30bar t.max. 60°C approval NSF rotary with fabric		
For models:	HUD20.20, OD20.20, OS20.20, OSC20.20, OSG20.20, OSP20.20		

industrial hoses

rubber hoses - Goldschlange®

			
GEV No.	530540	Ref. No.	7002032
description	pressure hose ID ø 13mm ED ø 21mm L 5m operating p. 30bar burst p. 90bar t.max. 100°C Qty 5m		

Niplaflex hoses

			
GEV No.	530561	Ref. No.	7002033
description	pressure hose ID ø 10mm ED ø 17mm L 5m thickness 3.5mm operating p. 10bar burst p. 30bar t.max. 110°C		
For models:	OD10.10, OD10.20, OD12.20, OD20.20, OD6.10, OEB10.10, OEB10.20, OEB12.20, OEB20.10, OEB20.20, OEB6.10, OEB6.20, OES10.10, OES10.20, OES12.20, OES20.10, OES20.20, OES6.06, OES6.10, OES6.20, OGB10.10, OGB10.20, OGB12.20, OGB20.10, OGB20.20, OGB6.10, OGB6.20, OGS10.10, OGS10.20, OGS12.20, OGS20.10, OGS20.20, OGS6.10, OGS6.20, OSG10.10, OSG12.20, OSG20.20, OSG6.10		

PVC hoses

PVC braided hoses

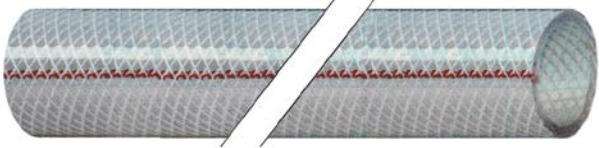
			
GEV No.	530565	Ref. No.	7002031
description	PVC braided hose ID ø 13mm ED ø 19mm L 10m operating p. 10bar burst p. 30bar t.max. 60°C Qty 10m		

silicone hoses

without fabric

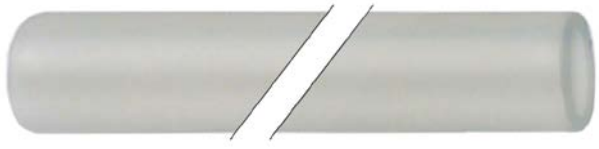
			
GEV No.	530479	Ref. No.	7012300 7012300K 7030646
description	silicone hose ID ø 10mm ED ø 16mm L 0.45m thickness 2.5mm operating pressure without pressure burst pressure non defined t.max. 200°C transparent drain cable ties		
For models:	OEB10.10, OEB6.10, OES10.10, OES6.10, OGB10.10, OGB6.10, OGS10.10, OGS6.10		

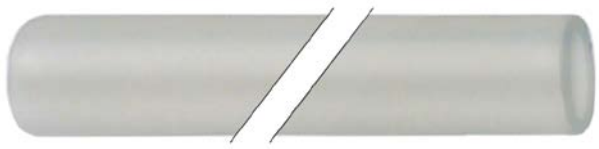
			
GEV No.	530823	Ref. No.	7002012
description	silicone hose ID ø 12mm ED ø 16mm L 1m thickness 2mm operating pressure without pressure burst pressure non defined t.max. 200°C transparent		

formed hoses

straight

			
GEV No.	694648	Ref. No.	7002015 7012305
description	hose ext. ø 20 D1 ø 15mm L 1080mm silicone for combi-steamer black		
For models:	OD10.20, OD12.20		

			
GEV No.	694862	Ref. No.	2030603
description	hose ID ø 12mm ext. ø 16 L 450mm silicone white		



1

GEV No.	699241	Ref. No.	7012003
description	hose ID ø 45mm ext. ø 55 L 800mm for ventilation		
For models:	OEB10.20, OES10.20, OGB10.20, OGS10.20		

form L



1

GEV No.	506274	Ref. No.	5064082
description	formed hose end piece A ext. ø 28mm end piece A int. ø 22mm AD2 ø 28mm ø end piece B 22mm L 555mm boiler silicone combi-steamer L-shape white		



1

GEV No.	699237	Ref. No.	6015100 6015100K 6030644
description	formed hose ext. ø 58 ID ø 48mm ED ø 37.5mm L 164mm for combi-steamer		
For models:	OEB10.10, OEB10.20, OEB12.20, OEB20.10, OEB20.20, OEB6.10, OEB6.20, OES10.10, OES10.20, OES12.20, OES20.10, OES20.20, OES6.10, OES6.20, OGB10.10, OGB10.20, OGB12.20, OGB20.10, OGB20.20, OGB6.10, OGB6.20, OGS10.10, OGS10.20, OGS12.20, OGS20.10, OGS20.20, OGS6.10, OGS6.20		



1

GEV No.	530082	Ref. No.	6006201
description	formed hose ID ø 48mm ED ø 54mm L 110mm black Qty 1 L-shape for combi-steamer		
For models:	OS10.10, OS10.20, OS12.20, OS20.10, OS20.20, OS6.10, OSC10.10, OSC10.20, OSC12.20, OSC20.10, OSC20.20, OSC6.10, OSP10.10, OSP10.20, OSP12.20, OSP20.10, OSP20.20, OSP6.10		



1

GEV No.	699367	Ref. No.	6064052
description	formed hose int. ø 1 47mm int. ø 2 30mm ED ø 54mm ext. ø 36 L 100mm for combi-steamer		



1

GEV No.	530897	Ref. No.	2364047
description	hose ID ø 10mm ED ø 15mm for boiler suitable for combi-steamer CONVOTHERM 4		

fittings, hose and pipe connectors

hose connectors

without screw connection



1

GEV No.	362001	Ref. No.	6005414 6064159
description	hose connector plastic hose ø 6-6mm		
For models:	OEB10.10, OEB10.20, OEB12.20, OEB20.10, OEB20.20, OEB6.10, OEB6.20, OES10.10, OES10.20, OES12.20, OES20.10, OES20.20, OES6.10, OES6.20, OGB10.10, OGB10.20, OGB12.20, OGB20.10, OGB20.20, OGB6.10, OGB6.20, OGS10.10, OGS10.20, OGS12.20, OGS20.10, OGS20.20, OGS6.10, OGS6.20		

hose connectors

plastic



1

GEV No.	361690	Ref. No.	6005423
description	hose connector plastic straight thread 1/8" hose ø 6mm Qty 1 pcs		



			
1			
GEV No.	361754	Ref. No.	6005416
description	hose connector plastic angled thread 1/8" hose ø 6mm Qty 1 pcs		
For models:	OEB10.10, OEB10.20, OEB12.20, OEB20.10, OEB20.20, OEB6.10, OEB6.20, OES10.10, OES10.20, OES12.20, OES20.10, OES20.20, OES6.10, OES6.20, OGB10.10, OGB10.20, OGB12.20, OGB20.10, OGB20.20, OGB6.10, OGB6.20, OGS10.10, OGS10.20, OGS12.20, OGS20.10, OGS20.20, OGS6.10, OGS6.20		

			
1			
GEV No.	520059	Ref. No.	6006076
description	hose connector plastic angled thread 3/4" hose ø 13mm Qty 5 pcs		
For models:	OD10.10, OD10.20, OD12.20, OD20.10, OD20.20, OD6.10, OS10.10, OS10.20, OS12.20, OS20.10, OS20.20, OS6.10, OSC10.10, OSC10.20, OSC12.20, OSC20.10, OSC20.20, OSC6.10, OSP10.10, OSP10.20, OSP12.20, OSP20.10, OSP20.20, OSP6.10		

producer-specific

			
1			
GEV No.	506242	Ref. No.	6014000
description	hose connector ID ø 12/6mm plastic L 195mm ø 16/10mm for combi-steamer		
For models:	OEB10.10, OEB10.20, OEB12.20, OEB20.10, OEB20.20, OEB6.10, OEB6.20, OES10.10, OES10.20, OES12.20, OES20.10, OES20.20, OES6.10, OES6.20, OGB10.10, OGB10.20, OGB12.20, OGB20.10, OGB20.20, OGB6.10, OGB6.20, OGS10.10, OGS10.20, OGS12.20, OGS20.10, OGS20.20, OGS6.10, OGS6.20		

			
1			
GEV No.	501377	Ref. No.	6014001
description	hose connector ID ø 6mm L 96mm ø 10mm for combi-steamer		
For models:	OEB10.10, OEB10.20, OEB12.20, OEB20.10, OEB20.20, OEB6.10, OEB6.20, OES10.10, OES10.20, OES12.20, OES20.10, OES20.20, OES6.10, OES6.20, OGB10.10, OGB10.20, OGB12.20, OGB20.10, OGB20.20, OGB6.10, OGB6.20, OGS10.10, OGS10.20, OGS12.20, OGS20.10, OGS20.20, OGS6.10, OGS6.20		

valves and tank inlets

ball valves

universal

ball valves with lever handle



			
1			
GEV No.	520283	Ref. No.	6006074
description	ball valve connection 1/2" IT - 1/2" ET DN15 total length 59mm with lever handle handle length 85mm		
For models:	OD10.10, OD10.20, OD12.20, OD20.10, OD20.20, OD6.10, OS10.10, OS10.20, OS12.20, OS20.10, OS20.20, OS6.10, OSC10.10, OSC10.20, OSC12.20, OSC20.10, OSC20.20, OSC6.10, OSG10.10, OSG12.20, OSG20.20, OSG6.10, OSP10.10, OSP10.20, OSP12.20, OSP20.10, OSP20.20, OSP6.10		
accessories for	520283		
	GEV No.	520168	Ref. No. —
	double nipple nickel-plated brass thread 1/2" - 1/2" Qty 1 pcs		

water cycle components

pressure reduction valves

pressure reduction valves

producer-specific

			
1			
GEV No.	520993	Ref. No.	2226366 2230014
description	pressure reduction valve Norgren series R91 connection 1/8" nozzle ø 0.6mm setting range 0.1-2bar p max 10bar t.max. 50°C brass		
spare parts for	520993		
	GEV No.	541508	Ref. No. 6006140
	manometer ø 40mm pressure range 0-4bar connection thread 1/8"		
	GEV No.	541806	Ref. No. 5009061 5009063
	pressure control ø 38mm pressure range 0.2-3.0bar connection 1/8" 250V 10A GP600 pressure connection 1/8"		





1

GEV No.	520992	Ref. No.	2230015
description	pressure reduction valve Norgren series R91 connection 1/8" nozzle ø 0.7mm setting range 0.1-2bar p max 10bar t.max. 50°C brass		
spare parts for	520992		
	GEV No.	541508	Ref. No. 6006140
	manometer ø 40mm pressure range 0-4bar connection thread 1/8"		
	GEV No.	541806	Ref. No. 5009061 5009063
	pressure control ø 38mm pressure range 0.2-3.0bar connection 1/8" 250V 10A GP600 pressure connection 1/8"		



1

GEV No.	521047	Ref. No.	2226365 2230013
description	pressure reduction valve Norgren series R91 connection hose ø10mm default settingbar setting range 0.3-3.5bar p max 10bar t.max. 50°C with hose connector and nozzle brass input pressure max. 10bar output pressure max. 3.4bar type R91W-2GK-NEN with pressure switch and monometer connection 10mm		
spare parts for	521047		
	GEV No.	541508	Ref. No. 6006140
	manometer ø 40mm pressure range 0-4bar connection thread 1/8"		
	GEV No.	541806	Ref. No. 5009061 5009063
	pressure control ø 38mm pressure range 0.2-3.0bar connection 1/8" 250V 10A GP600 pressure connection 1/8"		



1

GEV No.	521052	Ref. No.	2230017
description	pressure reduction valve Norgren series R91 connection hose ø10mm default settingbar setting range 0.3-3.5bar p max 10bar t.max. 50°C with hose connection brass connection 10mm		



1

GEV No.	521006	Ref. No.	2217288
description	pressure reduction valve Norgren series R91 connection hose ø10mm default settingbar setting range 0.3-3.5bar p max 10bar t.max. 50°C with hose connection brass input pressure max. 10bar output pressure max. 3.4bar type R91W-2GK-NEN connection 10mm		
For models:	OEB10.10, OEB10.20, OEB12.20, OEB20.10, OEB20.20, OEB6.10, OEB6.20, OES10.10, OES10.20, OES12.20, OES20.10, OES20.20, OES6.06, OES6.10, OES6.20, OGB10.10, OGB10.20, OGB12.20, OGB20.10, OGB20.20, OGB6.10, OGB6.20, OGS10.10, OGS10.20, OGS12.20, OGS20.10, OGS20.20, OGS6.10, OGS6.20		

supply filters



1

GEV No.	520262	Ref. No.	6006061
description	supply filter thread 3/4" IT - 3/4" IT total length 70mm red brass DN20 mesh opening 0.4mm		
For models:	OD10.10, OD10.20, OD12.20, OD20.20, OD6.10, OSG10.10, OSG12.20, OSG20.20, OSG6.10		

non-return valves



1

GEV No.	531322	Ref. No.	6056934
description	backflow preventer for boiler L 88mm connection 10.5/13.5 hose ø 3/4"mm for combi-steamer CONVOTHERM 4		



ancillary products

PTFE tapes

 <p>1</p>			
GEV No.	890100	Ref. No.	7004052
description	PTFE tape reel L 12m W 12mm -200 up to +260°C approval DIN-DVGW, KTW temperature-resistant, elastic for fine thread thickness 0.1mm		
description	PTFE thread sealing tape for fine metal threads Application: All sanitary and heating circuits in hot and cold water areas. DVGW tested. DIN EN751-3. For fine thread DN < 10. Pressure: up to 20 bar. Temperature range: -60°C to +260°C		

thread sealants

 <p>1</p>			
GEV No.	890097	Ref. No.	7004016
description	thread sealing LOCTITE 577 medium-strength bottle 50ml pipe thread sealing t.max. 150°C approval BAM and DVGW		
description	LOCTITE® 577™ - bottle 50ml It is designed for the locking and sealing of metal pipes and fittings as well as other cylindrical metal assemblies. The product provides an instant, low-pressure seal for metal pipes and fittings. It will not creep, shrink or block systems by shredding. Suitable for fast application at low temperatures. It has excellent chemical and thermal resistance and offers less migration of liquid product after application to the part.		

silicone

food-grade silicones

 <p>1</p>			
GEV No.	890106	Ref. No.	7004020
description	silicone TB40 transparent tube 90g -40 up to +160°C		
description	Tomabond - TB40 - tube 90g - transparent For flexible sealing in drinking water, food, water and industrial kitchen areas. Securely joins glass, metal, wood-based materials, ceramic and plastics with high adhesion (1.1 N/mm ²). Fungicide-, algicide- and solvent-free, ageing-resistant. Temperature-resistant from -40 °C to +160 °C Tested and approved by KTW / KSW.		
For models:	AR100, AR108, HUD10.10, HUD12.20, HUD20.10, HUD20.20, HUD6.10, OD10.10, OD10.20, OD12.20, OD20.10, OD20.20, OD6.10, OEB10.10, OEB10.20, OEB12.20, OEB20.10, OEB20.20, OEB6.10, OEB6.20, OES10.10, OES10.20, OES12.20, OES20.10, OES20.20, OES6.06, OES6.10, OES6.20, OGB10.10, OGB10.20, OGB12.20, OGB20.10, OGB20.20, OGB6.10, OGB6.20, OGS10.10, OGS10.20, OGS12.20, OGS20.10, OGS20.20, OGS6.10, OGS6.20, UG10.10, UG10.20, UG20.10, UG20.20, UG6.05, UG6.10		

clamps

hose clamps

DIN 3017 - W2

 <p>1</p>			
GEV No.	520112	Ref. No.	6006086
description	hose clamp ø 12-20mm width 9mm Qty 10 pcs DIN 3017		
For models:	OEB10.10, OEB10.20, OEB12.20, OEB20.10, OEB20.20, OEB6.10, OEB6.20, OES10.10, OES10.20, OES12.20, OES20.10, OES20.20, OES6.06, OES6.10, OES6.20, OGB10.10, OGB10.20, OGB12.20, OGB20.10, OGB20.20, OGB6.10, OGB6.20, OGS10.10, OGS10.20, OGS12.20, OGS20.10, OGS20.20, OGS6.10, OGS6.20		

 <p>1</p>			
GEV No.	520115	Ref. No.	6006087
description	hose clamp ø 25-40mm width 9mm Qty 10 pcs DIN 3017		
For models:	OEB10.10, OEB10.20, OEB12.20, OEB20.10, OEB20.20, OEB6.10, OEB6.20, OES10.10, OES10.20, OES12.20, OES20.10, OES20.20, OES6.10, OES6.20, OGB10.10, OGB10.20, OGB12.20, OGB20.10, OGB20.20, OGB6.10, OGB6.20, OGS10.10, OGS10.20, OGS12.20, OGS20.10, OGS20.20, OGS6.10, OGS6.20		



double wire clamps

			
1			
GEV No.	505348	Ref. No.	8009058
description	wire clamp ø 9.8-10.4mm wire gauge ø 1.2mm zinc-coated steel Qty 100 pcs		
For models:	OEB10.10, OEB10.20, OEB12.20, OEB20.10, OEB20.20, OEB6.10, OEB6.20, OES10.10, OES10.20, OES12.20, OES20.10, OES20.20, OES6.10, OES6.20, OGB10.10, OGB10.20, OGB12.20, OGB20.10, OGB20.20, OGB6.10, OGB6.20, OGS10.10, OGS10.20, OGS12.20, OGS20.10, OGS20.20, OGS6.10, OGS6.20, OS12.20, OS20.10, OS20.20		

flat-headed bolts

			
1			
GEV No.	560067	Ref. No.	8001031
description	flat-headed bolt thread M5 thread L 10mm SS DIN 7985/ISO 7045 Qty 20 pcs intake Phillips head ø 8mm head thickness 2mm		
For models:	OEB12.20, OEB20.10, OEB20.20, OES12.20, OES20.10, OES20.20, OGB12.20, OGB20.10, OGB20.20, OGS12.20, OGS20.10, OGS20.20		

hexagonal screws

			
1			
GEV No.	560083	Ref. No.	8003095
description	hexagonal screw thread M5 thread L 10mm SS WS 8 Qty 20 pcs DIN 933 / ISO 4017		
For models:	OGB10.10, OGB10.20, OGB12.20, OGB20.10, OGB20.20, OGB6.10, OGB6.20, OGS10.10, OGS10.20, OGS12.20, OGS20.10, OGS20.20, OGS6.10, OGS6.20		

			
1			
GEV No.	510990	Ref. No.	8001074
description	hexagonal screw thread M8 thread L 20mm SS WS 13 Qty 1 pcs DIN 933 / ISO 4017		
For models:	OD10.10, OD10.20, OD12.20, OD20.10, OD20.20, OD6.10, OEB12.20, OEB20.10, OEB20.20, OEB6.10, OES12.20, OES20.10, OES20.20, OES6.10, OGB12.20, OGB20.10, OGB20.20, OGS12.20, OGS20.10, OGS20.20, OS10.10, OS10.20, OS12.20, OS20.10, OS20.20, OS6.10, OSC10.10, OSC10.20, OSC12.20, OSC20.10, OSC20.20, OSC6.10, OSP10.10, OSP10.20, OSP12.20, OSP20.10, OSP20.20, OSP6.10		

cylinder head bolts

DIN 912/ISO 4762			
			
1			
GEV No.	560316	Ref. No.	8013002
description	cylinder head bolt thread M8 thread L 25mm WS 6 SS Qty 20 pcs DIN 912/ISO 4762		
For models:	OEB12.20, OEB20.10, OEB20.20, OEB6.10, OES12.20, OES20.10, OES20.20, OES6.10, OGB12.20, OGB20.10, OGB20.20, OGS12.20, OGS20.10, OGS20.20		

tools

hand tools

pullers

			
1			
GEV No.	802191	Ref. No.	7015200
description	puller for fan wheel seat ø 28/34mm thread M16x1.5 WS 17		
For models:	OEB10.10, OEB10.20, OEB12.20, OEB20.10, OEB20.20, OEB6.10, OEB6.20, OES10.10, OES10.20, OES12.20, OES20.10, OES20.20, OES6.10, OES6.20, OGB10.10, OGB10.20, OGB12.20, OGB20.10, OGB20.20, OGB6.10, OGB6.20, OGS10.10, OGS10.20, OGS12.20, OGS20.10, OGS20.20, OGS6.10, OGS6.20		

fastening material

spacers

			
1			
GEV No.	551407	Ref. No.	8056358
description	mounting set control PCB M4 suitable for CONVOTHERM 4		

screws

countersunk screws

			
1			
GEV No.	699832	Ref. No.	8010001
description	countersunk screw thread M6 L 30mm SS DIN 7991/ISO 10642 Qty 1 pcs intake hexagonal		
For models:	OEB10.10, OEB10.20, OEB12.20, OEB20.10, OEB20.20, OEB6.10, OEB6.20, OES10.10, OES10.20, OES12.20, OES20.10, OES20.20, OES6.10, OES6.20, OGB10.10, OGB10.20, OGB12.20, OGB20.10, OGB20.20, OGB6.10, OGB6.20, OGS10.10, OGS10.20, OGS12.20, OGS20.10, OGS20.20, OGS6.10, OGS6.20		



side bolts



1

GEV No.	699834	Ref. No.	8003030
description	side bolts thread M5 L 15mm Qty 1 pcs intake hexagonal		
For models:	OD10.10, OD10.20, OD12.20, OD20.10, OD20.20, OD6.10, OEB10.10, OEB10.20, OEB12.20, OEB20.10, OEB20.20, OEB6.10, OEB6.20, OES10.10, OES10.20, OES12.20, OES20.10, OES20.20, OES6.10, OES6.20, OGB10.10, OGB10.20, OGB12.20, OGB20.10, OGB20.20, OGB6.10, OGB6.20, OGS10.10, OGS10.20, OGS12.20, OGS20.10, OGS20.20, OGS6.10, OGS6.20, OS10.10, OS10.20, OS12.20, OS20.10, OS20.20, OS6.10, OSC10.10, OSC10.20, OSC12.20, OSC20.10, OSC20.20, OSC6.10, OSP10.10, OSP10.20, OSP12.20, OSP20.10...(Other models you can see in the webshop)		



2

GEV No.	699833	Ref. No.	8015000
description	side bolts thread M6 L 8mm DIN 916/ISO 4029 intake hexagonal		
For models:	OEB10.10, OEB10.20, OEB12.20, OEB20.10, OEB20.20, OEB6.10, OEB6.20, OES10.10, OES10.20, OES12.20, OES20.10, OES20.20, OES6.10, OES6.20, OGB10.10, OGB10.20, OGB12.20, OGB20.10, OGB20.20, OGB6.10, OGB6.20, OGS10.10, OGS10.20, OGS12.20, OGS20.10, OGS20.20, OGS6.10, OGS6.20		

nuts

hexagonal nuts

DIN 934 / ISO 4032/8673



1

GEV No.	560129	Ref. No.	8017010
description	hexagonal nut thread M5 H 4mm WS 8 SS DIN/ISO DIN 934 / ISO 4032/8673 Qty 1 pcs		
For models:	OEB10.10, OEB10.20, OEB12.20, OEB20.10, OEB20.20, OEB6.10, OEB6.20, OES10.10, OES10.20, OES12.20, OES20.10, OES20.20, OES6.10, OES6.20, OGB10.10, OGB10.20, OGB12.20, OGB20.10, OGB20.20, OGB6.10, OGB6.20, OGS10.10, OGS10.20, OGS12.20, OGS20.10, OGS20.20, OGS6.10, OGS6.20		

fasteners

cable ties



1

GEV No.	550254	Ref. No.	4007087
description	cable tie W 3.6mm L 140mm white Qty 100 pcs nylon		
For models:	HUD10.10, HUD12.20, HUD20.10, HUD20.20, HUD6.10, OEB10.10, OEB10.20, OEB12.20, OEB20.10, OEB20.20, OEB6.10, OEB6.20, OES10.10, OES10.20, OES12.20, OES20.10, OES20.20, OES6.10, OES6.20, OGB10.10, OGB10.20, OGB12.20, OGB20.10, OGB20.20, OGB6.10, OGB6.20, OGS10.10, OGS10.20, OGS12.20, OGS20.10, OGS20.20, OGS6.10, OGS6.20		

clamps

hose clamps

DIN 3017 - W2



1

GEV No.	520112	Ref. No.	6006086
description	hose clamp ø 12-20mm width 9mm Qty 10 pcs DIN 3017		
For models:	OEB10.10, OEB10.20, OEB12.20, OEB20.10, OEB20.20, OEB6.10, OEB6.20, OES10.10, OES10.20, OES12.20, OES20.10, OES20.20, OES6.06, OES6.10, OES6.20, OGB10.10, OGB10.20, OGB12.20, OGB20.10, OGB20.20, OGB6.10, OGB6.20, OGS10.10, OGS10.20, OGS12.20, OGS20.10, OGS20.20, OGS6.10, OGS6.20		



1

GEV No.	520115	Ref. No.	6006087
description	hose clamp ø 25-40mm width 9mm Qty 10 pcs DIN 3017		
For models:	OEB10.10, OEB10.20, OEB12.20, OEB20.10, OEB20.20, OEB6.10, OEB6.20, OES10.10, OES10.20, OES12.20, OES20.10, OES20.20, OES6.10, OES6.20, OGB10.10, OGB10.20, OGB12.20, OGB20.10, OGB20.20, OGB6.10, OGB6.20, OGS10.10, OGS10.20, OGS12.20, OGS20.10, OGS20.20, OGS6.10, OGS6.20		

double wire clamps



1

GEV No.	505348	Ref. No.	8009058
description	wire clamp ø 9.8-10.4mm wire gauge ø 1.2mm zinc-coated steel Qty 100 pcs		
For models:	OEB10.10, OEB10.20, OEB12.20, OEB20.10, OEB20.20, OEB6.10, OEB6.20, OES10.10, OES10.20, OES12.20, OES20.10, OES20.20, OES6.10, OES6.20, OGB10.10, OGB10.20, OGB12.20, OGB20.10, OGB20.20, OGB6.10, OGB6.20, OGS10.10, OGS10.20, OGS12.20, OGS20.10, OGS20.20, OGS6.10, OGS6.20, OS12.20, OS20.10, OS20.20		

consumables

sprays



1

GEV No.	890293	Ref. No.	7014013
description	penetrating oil Bavariapool korro pro universal can 200ml t.max. 50°C		

sealants and adhesives

food-grade silicones



GEV No.	890106	Ref. No.	7004020
description	silicone TB40 transparent tube 90g -40 up to +160°C		
description	<p>Tomabond - TB40 - tube 90g - transparent</p> <p>For flexible sealing in drinking water, food, water and industrial kitchen areas. Securely joins glass, metal, wood-based materials, ceramic and plastics with high adhesion (1.1 N/mm²). Fungicide-, algicide- and solvent-free, ageing-resistant. Temperature-resistant from -40 °C to +160 °C. Tested and approved by KTW / KSW.</p>		
For models:	AR100, AR108, HUD10.10, HUD12.20, HUD20.10, HUD20.20, HUD6.10, OD10.10, OD10.20, OD12.20, OD20.10, OD20.20, OD6.10, OEB10.10, OEB10.20, OEB12.20, OEB20.10, OEB20.20, OEB6.10, OEB6.20, OES10.10, OES10.20, OES12.20, OES20.10, OES20.20, OES6.06, OES6.10, OES6.20, OGB10.10, OGB10.20, OGB12.20, OGB20.10, OGB20.20, OGB6.10, OGB6.20, OGS10.10, OGS10.20, OGS12.20, OGS20.10, OGS20.20, OGS6.10, OGS6.20, UG10.10, UG10.20, UG20.10, UG20.20, UG6.05, UG6.10		

screw fixings



GEV No.	890063	Ref. No.	7004008 7004012
description	screw fixing LOCTITE 270 bottle 10ml high-strength		
description	<p>LOCTITE® 270™ - bottle 10ml</p> <p>It is designed for the permanent locking and sealing of threaded fasteners. The product cures when confined in the absence of air between close fitting metal surfaces and prevents loosening and leakage from shock and vibration. LOCTITE® 270™ is particularly suited for heavy duty applications such as studs into motor housings, nuts onto studs in pump housings and other fasteners where high strength is required. LOCTITE® 270™ provides robust curing performance. It not only works on active metals (e.g. brass, copper) but also on passive substrates such as stainless steel and plated surfaces. The product offers high temperature performance and oil tolerance. It tolerates minor surface contaminations from various oils, such as cutting, lubrication, anti-corrosion and protection fluids.</p>		
For models:	OD10.10, OD10.20, OD12.20, OD20.10, OD20.20, OD6.10, OEB10.10, OEB10.20, OEB12.20, OEB20.10, OEB20.20, OEB6.10, OEB6.20, OES10.10, OES10.20, OES12.20, OES20.10, OES20.20, OES6.06, OES6.10, OES6.20, OGB10.10, OGB10.20, OGB12.20, OGB20.10, OGB20.20, OGB6.10, OGB6.20, OGS10.10, OGS10.20, OGS12.20, OGS20.10, OGS20.20, OGS6.10, OGS6.20, OSG10.10, OSG12.20, OSG6.10		

thread sealants



GEV No.	890097	Ref. No.	7004016
description	thread sealing LOCTITE 577 medium-strength bottle 50ml pipe thread sealing t.max. 150°C approval BAM and DVGW		
description	<p>LOCTITE® 577™ - bottle 50ml</p> <p>It is designed for the locking and sealing of metal pipes and fittings as well as other cylindrical metal assemblies. The product provides an instant, low-pressure seal for metal pipes and fittings. It will not creep, shrink or block systems by shredding. Suitable for fast application at low temperatures. It has excellent chemical and thermal resistance and offers less migration of liquid product after application to the part.</p>		

PTFE tapes



GEV No.	890100	Ref. No.	7004052
description	PTFE tape reel L 12m W 12mm -200 up to +260°C approval DIN-DVGW, KTW temperature-resistant, elastic for fine thread thickness 0.1mm		
description	<p>PTFE thread sealing tape for fine metal threads</p> <p>Application: All sanitary and heating circuits in hot and cold water areas. DVGW tested. DIN EN751-3. For fine thread DN < 10. Pressure: up to 20 bar. Temperature range: -60°C to +260°C</p>		



lubricants

graphite paste



1

GEV No.	890006	Ref. No.	7014005
description	graphite paste FERMIT NIVO can 500g		
description	Fermit NIVO - can 500g Highly refractory sealing paste for threaded and flanged joints Prevents the sticking of gaskets, bolts, screws etc. which are exposed to intense heat. In the case of flange gaskets and surface seals, coat both sides with the paste. In the case of use as sealants for threads (DIN 2999) at over 160 degrees C, the use of aluminium hemp with Nivo Graphite Paste is recommended as normal hemp becomes scaly at these temperatures and then leaks can occur. Temperature range: 0°C to + 300°C		
For models:	OGB10.10, OGB10.20, OGB12.20, OGB20.10, OGB20.20, OGB6.10, OGB6.20, OGS10.10, OGS10.20, OGS12.20, OGS20.10, OGS20.20, OGS6.10, OGS6.20		

cleaning agents

combi-steamer detergents/descalers

Notice: Articles labelled 'DANGEROUS GOODS' are delivered by road through a forwarder for reasons of safety and are charged separately!



1

GEV No.	890032	Ref. No.	3007014 3007017
description	detergent Convoclean forte 10L		
description			
For models:	OS12.20, OS20.10, OS20.20		



1

GEV No.	802066 ¹	Ref. No.	3007028
description	detergent for combi-steamer CONVOTHERM CONVOCare nozzle detergent 1l concentrate P2 P3 concentrate mixing ratio 1:29 1l		
description	Convotherm ConvoCare K - bottle 1 litre For preventing and dissolving limescale deposits. Particularly suitable in regions with very hard water. Through the use of liquid detergents no residue remains in the cooking chamber. The environment is also considered - all products are compliant with the ISO standard and are biologically degradable. - 1l concentrate - rinse aid for CONVOClean system - must be mixed with water in a ratio of 1:29		
For models:	OEB6.10, OES6.10, OS12.20, OS20.10, OS20.20		

DANGEROUS GOODS

descalers



1

GEV No.	802196	Ref. No.	3007023
description	descaler ConvCal forte 10l		



1

GEV No.	802195	Ref. No.	3007018
description	descaler Convocal for combi-steamer 10l		

fuses

fine fuses

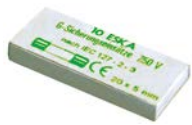

GEV No.	358600	Ref. No.	4005064
description	fine fuse size ø5x20mm 1A slow-acting rated 250V Qty 10 pcs		
For models:	HUD10.10, HUD12.20, HUD20.10, HUD20.20, HUD6.10, OD10.10, OD10.20, OD12.20, OD20.10, OD20.20, OD6.10, OEB10.10, OEB10.20, OEB12.20, OEB20.10, OEB20.20, OEB6.10, OEB6.20, OES10.10, OES10.20, OES12.20, OES20.10, OES20.20, OES6.06, OES6.10, OES6.20, OGB10.20, OGB12.20, OGB20.10, OGB20.20, OGS10.10, OGS10.20, OGS12.20, OGS20.10, OGS20.20, OGS6.10, OGS6.20, OSC10.10, OSC10.20, OSC12.20, OSC20.10, OSC20.20, OSC6.10, OSC6.10, OSG12.20, OSG12.20, OSG20.20, OSG6.10, OSP10.10, OSP10.20, OSP12.20... (Other models you can see in the webshop)		



GEV No.	358603	Ref. No.	4005066 4056944
description	fine fuse size ø5x20mm 2A slow-acting rated 250V Qty 10 pcs		
For models:	AR108, AR12, AR18, AR28, AR40, AR54, AR72, OD10.10, OD10.20, OD12.20, OD20.10, OD20.20, OD6.10, OEB10.10, OEB10.20, OEB12.20, OEB20.10, OEB20.20, OEB6.10, OEB6.20, OES10.10, OES10.20, OES12.20, OES20.10, OES20.20, OES6.10, OES6.20, OGB10.10, OGB10.20, OGB12.20, OGB20.10, OGB20.20, OGB6.10, OGB6.20, OGS10.10, OGS10.20, OGS12.20, OGS20.10, OGS20.20, OGS6.10, OGS6.20, OSC10.10, OSC10.20, OSC12.20, OSC20.10, OSC20.20, OSC6.10, OSG10.10, OSG12.20, OSG20.20...(Other models you can see in the webshop)		

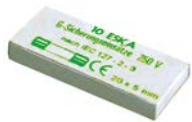

GEV No.	358605	Ref. No.	4056945
description	fine fuse size ø5x20mm 3.15A slow-acting rated 250V Qty 10 pcs		



GEV No.	358607	Ref. No.	4005068
description	fine fuse size ø5x20mm 6.3A slow-acting rated 250V Qty 10 pcs		
For models:	HUD10.10, HUD12.20, HUD20.10, HUD20.20, HUD6.10, OD10.10, OD10.20, OD12.20, OD20.10, OD20.20, OD6.10, OSG10.10, OSG12.20, OSG20.20, OSG6.10		

ø6.3x32mm 500V



GEV No.	358751	Ref. No.	4005069
description	fine fuse size ø6.3x32mm 6.3A fast-acting rated 500V Qty 10 pcs		
For models:	OD10.10, OD10.20, OD12.20, OD6.10, OEB10.10, OEB6.10, OEB6.20, OES10.10, OES6.10, OES6.20, OGB10.10, OGB20.10, OGB6.10, OGB6.20, OGS10.10, OGS20.10, OGS6.10, OGS6.20, OSC10.10, OSC10.20, OSC12.20, OSC20.10, OSC6.10, OSP10.10, OSP10.20, OSP12.20, OSP6.10		

screw locks

D0-system (NEOZED)



GEV No.	358073	Ref. No.	4005053
description	fuse size D01 10A rated 250/400V E14 ø 11mm L 36mm Qty 10 pcs		



GEV No.	358043	Ref. No.	4005054
description	fuse size D01 16A rated 250/400V E14 ø 11mm L 36mm Qty 10 pcs		
For models:	HUD12.20, HUD20.10		



GEV No.	358070	Ref. No.	4005050
description	fuse size D01 2A rated 250/400V E14 ø 11mm L 36mm Qty 10 pcs		
For models:	AR100, AR108, AR16, AR18, AR28, AR30, AR40, AR50, AR54, AR72, UG10.10, UG10.20, UG20.10, UG20.20, UG6.05, UG6.10		





GEV No.	358071	Ref. No.	4005051
description	fuse size D01 4A rated 250/400V E14 ø 11mm L 36mm Qty 10 pcs		
For models:	AR100, AR108, AR30, AR40, AR50, AR54, AR72, OES12.20, UG10.10, UG20.10, UG6.10		





GEV No.	358072	Ref. No.	4005052
description	fuse size D01 6A rated 250/400V E14 ø 11mm L 36mm Qty 10 pcs		
For models:	OEB20.20, UG20.20		





			
1			
GEV No.	358048	Ref. No.	4005058
description	fuse size D02 20A rated 250/400V E18 ø 15mm L 36mm Qty 10 pcs		
For models:	AR108, HUD20.20, OD10.20, OD12.20, OD20.10, OD20.20, OEB10.20, OEB12.20, OEB20.10		

			
1			
GEV No.	358044	Ref. No.	4005046 4005055
description	fuse size D02 25A rated 250/400V E18 ø 15mm L 36mm Qty 10 pcs		
For models:	AR100, AR108, HUD12.20, HUD20.10, HUD20.20, OD10.20, OD12.20, OD20.10, OD20.20, OEB10.20, OEB12.20, OEB20.20, OES10.20, OES12.20, OES20.20, UG10.20		

			
1			
GEV No.	358045	Ref. No.	2212003 4005056
description	fuse size D02 35A rated 250/400V E18 ø 15mm L 36mm Qty 10 pcs		
For models:	HUD20.10, OD20.20, OEB10.20, OEB12.20, OEB20.10, OES20.10, UG20.10, UG20.20		

			
1			
GEV No.	358046	Ref. No.	4005057
description	fuse size D02 50A rated 250/400V E18 ø 15mm L 36mm Qty 10 pcs		
For models:	OD10.20, OD12.20, OD20.10, OD20.20, OEB10.20, OEB12.20, OEB20.20, OES10.20, OES12.20, OES20.20		

			
1			
GEV No.	358047	Ref. No.	4005059
description	fuse size D02 63A rated 250/400V E18 ø 15mm L 36mm Qty 10 pcs		
For models:	OEB20.10, OES20.10		

gauge pieces (NEOZED)			
			
1			
GEV No.	358055	Ref. No.	4005013
description	gauge piece size D01 suitable for 10A		

			
1			
GEV No.	358052	Ref. No.	4005010
description	gauge piece size D01 suitable for 2A		
For models:	AR100, AR108, AR16, AR18, AR28, AR30, AR40, AR50, AR54, AR72, UG10.10, UG10.20, UG20.10, UG20.20, UG6.05, UG6.10		

			
1			
GEV No.	358053	Ref. No.	4005011
description	gauge piece size D01 suitable for 4A		
For models:	AR100, AR108, AR30, AR40, AR50, AR54, AR72, OES12.20, OES20.20, UG10.10, UG20.10, UG6.10		

			
1			
GEV No.	358054	Ref. No.	4005012
description	gauge piece size D01 suitable for 6A		
For models:	UG20.20		

			
1			
GEV No.	358064	Ref. No.	4005021
description	gauge piece size D02 suitable for 16A		
For models:	OD10.20, OD12.20, OD20.10, OSP10.20, OSP12.20		

			
1			
GEV No.	358065	Ref. No.	4005014
description	gauge piece size D02 suitable for 20A		
For models:	AR108, HUD12.20, HUD20.10, HUD20.20, OD10.20, OD12.20, OD20.10, OD20.20, OEB10.20, OEB12.20, OEB20.10, OSC10.20, OSC12.20, OSC20.10, OSC20.20, OSP10.20, OSP12.20, OSP20.10, OSP20.20, OSP6.10		



1 

GEV No.	358066	Ref. No.	4005015
description	gauge piece size D02 suitable for 25A		
For models:	AR100, AR108, OD10.20, OD12.20, OD20.10, OD20.20, OEB10.20, OEB12.20, OEB20.20, OES10.20, OES12.20, OES20.20, OSC10.20, OSC12.20, OSC20.10, OSC20.20, OSP10.20, OSP12.20, OSP20.10, OSP20.20, UG10.20		

1 

GEV No.	358068	Ref. No.	4005017
description	gauge piece size D02 suitable for 50A		
For models:	OD10.20, OD12.20, OD20.10, OD20.20, OEB10.20, OEB12.20, OEB20.20, OES10.20, OES12.20, OES20.20, OSC10.20, OSC12.20, OSC20.10, OSC20.20, OSP10.20, OSP12.20, OSP20.10, OSP20.20		

1 

GEV No.	358067	Ref. No.	4005016
description	gauge piece size D02 suitable for 35A		
For models:	HUD20.10, OD20.20, OEB10.20, OEB12.20, OEB20.10, OES20.10, OSC20.20, OSP20.20, UG20.10, UG20.20		

A			
alarm devices	17	gas control valves	49
appliance hose reels	86	gas nozzles	53
axial fans	32	gaskets for control panels	80
B		gaskets for heated units	75
ball valves	89	gaskets for tray rack trolleys	80
bi-metal thermostats	8, 8	graphite paste	95
C		H	
cable ties	93	hand tools	92
cables	42	heating elements	3
cam switches	11	heating elements for convection	5
castors and bumper angles	74	hexagonal nuts	93
clamps	91, 93	hexagonal screws	92
cleaning agents	95	hose clamps	91, 93
cleaning guns	86	hose connectors	88, 88
combi-steamer detergents/descalers	95	hose reels	86
condensators & interference suppression filters	38	hoses	86, 86
connection cables	42	hot air fans	36
consumables	93	hot air motors	33
contactors	18	I	
control equipment	12	ignition boxes	50
control thermostats	8	ignition cables	52
countersunk screws	92	immersion heating elements	3
cylinder head bolts	92	indicator lights	13
D		indicator lights (complete)	13
descalers	95	industrial hoses	87
door seals	75	L	
double wire clamps	92, 93	lamps	13
drain pumps	37	light bulbs	13
E		lubricants	95
electric accessories	42	M	
electrodes	32	magnetic switches	11
F		mechanical timers	17
fans	32	N	
fasteners	93	Niplaflex hoses	87
fastening material	92	non-return valves	90
filters	38	nuts	93
fine fuses	96	O	
flat-headed bolts	92	O-rings	81
flow sensors	32	oven lamps	14
food-grade silicones	91, 94	overlying hinges	72
forced air burners	53	P	
formed hoses	87	piano hinges	72
fuses	38, 96	pilot burners	50
G		plastic/rubber hoses	86
gas burners	53	pre-rinse hoses	86
		pressure reduction valves	89, 89

pressure switches	31
probes	21
PTFE tapes	54, 91, 94
pullers	92
pumps	37
PVC braided hoses	86
PVC hoses	87

R

radial fans	36
relays	20
rubber hoses - Goldschlange®	87

S

safety thermostats	9
screw fixings	94
screw locks	96
screws	92
sealants and adhesives	94
sealing washers	81
shaft gaskets	83
side bolts	93
silicone	91, 94
silicone hoses	87
solenoid valves	27
solid state relays	20
spray guns	84
spray guns with external thread	84
sprays	93
supply filters	90, 90
supply hoses	86
switches and momentary switches	11

T

terminals	42
thermocouples	53
thermostats	8
thread sealants	54, 91, 94
timers	17
tools	92
transformers	21
turning lever locks	67

V

valves and tank inlets	89
vibration pumps	37

W

wash and rinse pumps	37
water cycle components	89
window seals	75