



**GAS COMPONENTS**



**ELECTRIC COMPONENTS**



**WATER TECHNOLOGY**



**MECHANICAL COMPONENTS**



**TOOLS**

Spare parts suitable for

**COOKING-SYSTEMS**

Find the complete and up-to-date range of products in our GEV Webshop



# Manufacturer catalogue

The most important spare parts and accessories arranged clearly for every manufacturer

- ✓ Complete product range and all appliance data always up to date in the GEV Webshop
- ✓ Alphabetical Index at the end of the catalogue

## GEV Webshop

[www.gev-online.co.uk](http://www.gev-online.co.uk)

[www.gev-online.com](http://www.gev-online.com)



- 🔍 Add to Favourites
- 🔍 Sign In with email address and usual password
- 🔍 Easy-order – place several items in your basket at the same time
- 🔍 Quick Item search – no login needed



## heating elements

### heating elements for ovens

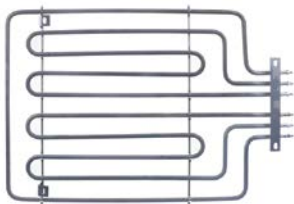

1

<b>GEV No.</b>	419068	<b>Ref. No.</b>	2127
<b>description</b>	heating element 2400W 230V heating circuits 3 L 505mm W 355mm L1 55mm L2 450mm W1 114mm W2 127mm flange length 170mm flange width 45mm hole distance 138mm bridge length 368mm hole ø 12/7mm tube ø 8mm connection M4 connection length 30mm windings 4 rectangular flange dry heating element oven		
<b>For models:</b>	3310, 4902		

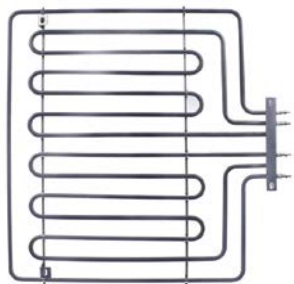

1

<b>GEV No.</b>	419069	<b>Ref. No.</b>	2131
<b>description</b>	heating element 4000W 230V heating circuits 3 L 505mm W 510mm L1 55mm L2 450mm W1 191.5mm W2 127mm flange length 170mm flange width 45mm hole distance 138mm bridge length 520mm hole ø 12/7mm tube ø 8mm connection M4 connection length 30mm windings 6 rectangular flange dry heating element oven		
<b>For models:</b>	3481		

### heating elements for fryers

#### 2 hole fixing

#### group 2



1

<b>GEV No.</b>	419070	<b>Ref. No.</b>	2180
<b>description</b>	heating element 2200W 230V heating circuits 1 L 300mm W 110mm H 170mm L1 35mm L2 15mm L3 250mm thread M12x1.25 mounting distance 102mm tube ø 8mm windings 3 2 hole fixing connection M4 connection length 35mm fryer cover		
<b>For models:</b>	4205, 4255		

#### group 5

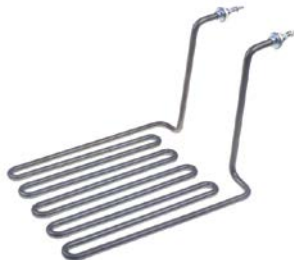

1

<b>GEV No.</b>	419067	<b>Ref. No.</b>	65720019
<b>description</b>	heating element 3000W 220V heating circuits 1 L 300mm W 205mm H 180mm 2 hole fixing connection M4 fryer heaters L1 35mm L2 15mm L3 250mm W1 42.5mm W2 120mm tube ø 8.5mm thread M12x1 mounting distance 112mm connection length 38mm windings 5		
<b>For models:</b>	4208, 4224, 4255, 4288		

### heating elements for griddles

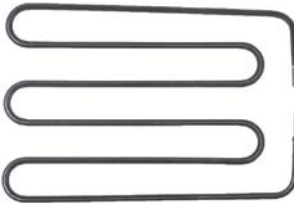



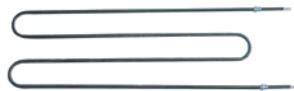

1

<b>GEV No.</b>	419077	<b>Ref. No.</b>	2179
<b>description</b>	heating element 1000W 230V heating circuits 1 L 265mm W 180mm H 25mm tube ø 6.2mm W1 55mm W2 70mm connection M5 gril connection distance 65mm dry heating element		
<b>For models:</b>	4401, 4402E, 4403E, 4404E, 4405E, 4442E, 4443E, 4444E, 4445E, 4462		

### heating elements for pizza ovens



1

<b>GEV No.</b>	416565	<b>Ref. No.</b>	95591400	
<b>description</b>	heating element 1270W 400V L 650mm W 215mm thread 1/4" mounting distance 206mm connection length 81mm connection male faston 6.3mm tube ø 8.5mm heating circuits 1 dry heating element mounting pos. upper 2 hole fixing			
<b>accessories for</b>	416565			
	<b>GEV No.</b>	361182	<b>Ref. No.</b>	—
	nut thread 1/4" H 5mm nickel-plated brass WS 17 Qty 1 pcs			
	<b>GEV No.</b>	510417	<b>Ref. No.</b>	—
	flat gasket fibre ED ø 20mm ID ø 14mm thickness 2mm Qty 1 pcs			
	<b>GEV No.</b>	520228	<b>Ref. No.</b>	—
	tooth lock washer ID ø 15.3mm ED ø 24mm steel Qty 1 pcs for thread M14			
	<b>GEV No.</b>	550262	<b>Ref. No.</b>	—
	flat gasket copper ED ø 20mm ID ø 14mm thickness 2mm			



## heating elements for heated cabinets





<b>GEV No.</b>	418860	<b>Ref. No.</b>	910950017
<b>description</b>	heating element 800W 230V heating circuits 1 L 345mm W 90mm thread M12x1.5 mounting distance 83mm tube ø 6.5mm connection male faston 6.3mm dry heating element 2 hole fixing		

## ceramic heaters

245x60mm



<b>GEV No.</b>	415102	<b>Ref. No.</b>	2088
<b>description</b>	ceramic emitter 400W 230V cable beaded cord L 245mm W 60mm H 35mm		
<b>For models:</b>	3018, 4421		
<b>spare parts for</b>	415102		
	<b>GEV No.</b>	415109	<b>Ref. No.</b> —
	spring clip		
<b>accessories for</b>	415102		
	<b>GEV No.</b>	415110	<b>Ref. No.</b> —
	reflector L 245mm W 95mm H 31mm thickness 0.75mm hole ø 15x40mm		

## coil heating elements



<b>GEV No.</b>	419071	<b>Ref. No.</b>	2264
<b>description</b>	heating element 1000W 230V L 370mm W 50mm H 25mm tube ø 8mm thread M12x1.25 connection M4 connection length 30mm dry heating element heating circuits 1 2 hole fixing		
<b>For models:</b>	3018, 6190, 6190E1		

## radiation heaters



<b>GEV No.</b>	419076	<b>Ref. No.</b>	97032038
<b>description</b>	heating element rectangular L 840mm W 190mm 2500W 230/400V H 40mm cable length 450mm chicken rotisserie		
<b>For models:</b>	5305, 53054, 5310, 53104, 5315, 53154, 5320, 53204, 5330, 53304, 5340, 53404, 5360, 53604, 5380, 53804		

## foil heating elements



<b>GEV No.</b>	419075	<b>Ref. No.</b>	C5421210
<b>description</b>	foil heating element L 400mm W 290mm 1000W 230V t.max. 150°C silicone cable length 2000mm thickness 1mm bain marie		
<b>For models:</b>	3016, 3701, 3701S, 3702, 3702S, 3703, 3703S, 3704, 3704S, 505		

## accessories

## capillary tube clips



<b>GEV No.</b>	550138	<b>Ref. No.</b>	68560069
<b>description</b>	capillary tube clip for pipe ø 8.5mm for circular tube heating elements		
<b>For models:</b>	30172, 30252, 4205, 4208, 4212, 4224, 4255, 4288		

## spring clips



<b>GEV No.</b>	551078	<b>Ref. No.</b>	69340099
<b>description</b>	probe spring for pipe ø 8mm for probe ø 5mm L 30mm W 10mm wire gauge ø 1mm		
<b>For models:</b>	30172, 30252, 4205, 4208, 4212, 4224, 4255, 4288		

## hot plates

## round



## with radiused edge

## for domestic and commercial kitchens



<b>GEV No.</b>	490018	<b>Ref. No.</b>	3216
<b>description</b>	hot plate ø 220mm 2000W 230V connection 4 screw clamps with 8mm spill ring		
<b>For models:</b>	3031, 3310, 4418, 4419, 4481, 4482, 4483		



 <p>1</p>			
<b>GEV No.</b>	490020	<b>Ref. No.</b>	3235
<b>description</b>	hot plate ø 220mm 2600W 230V connection 4 screw clamps with 8mm spill ring		
<b>For models:</b>	3031, 3310		
<b>accessories for</b>	490020		
	<b>GEV No.</b>	550796	<b>Ref. No.</b>
			—
	 <p>fixing plate for hot plate ø220mm</p>		

energy regulators

EGO

1-circuit

 <p>1</p>			
<b>GEV No.</b>	380015	<b>Ref. No.</b>	C5322489
<b>description</b>	energy regulator 230V 13A single-circuit turn direction right shaft ø 6x4.6mm shaft L 23mm mounting thread M4 power release 6-100% no. 50.57021.010		
<b>For models:</b>	5305, 53054, 5310, 53104, 5315, 53154, 5320, 53204, 5330, 53304, 5340, 53404, 5355, 5360, 53604, 5375, 5380, 53804		

thermostats

control and safety thermostats

EGO

control thermostats

55.13\_series

 <p>1</p>			
<b>GEV No.</b>	375505	<b>Ref. No.</b>	2221
<b>description</b>	thermostat t.max. 320°C temperature range 50-320°C 1-pole 1NO 16A probe ø 3mm probe L 160mm capillary pipe 870mm capillary pipe isolatedmm gland nut shaft ø 6x4.6mm shaft L 23mm shaft position upper rotation 270°		
<b>For models:</b>	3007, 3009, 3011, 3310, 3481, 3483, 3615, 3626, 4402E, 4403E, 4404E, 4405E, 4442E, 4443E, 4444E, 4445E, 4902, 4904, 4908		

IMIT / TEMPOMATIC / ARTHERMO

control thermostats

 <p>1</p>			
<b>GEV No.</b>	375939	<b>Ref. No.</b>	C5322059
<b>description</b>	thermostat t.max. 200°C temperature range 0-200°C 1-pole 1CO 16A probe ø 5mm probe L 98mm capillary pipe 1040mm capillary pipe isolatedmm gland nut shaft ø 6x4.6mm shaft L 20mm		
<b>For models:</b>	30172, 30252, 4205, 4208, 4212, 4224, 4255, 4288, FRF20		

safety thermostats

 <p>1</p>			
<b>GEV No.</b>	375941	<b>Ref. No.</b>	C5322209
<b>description</b>	safety thermostat switch-off temp. 238°C 1-pole 1NC 16A probe ø 5mm probe L 100mm capillary pipe 1050mm capillary pipe isolatedmm gland nut 250V		
<b>For models:</b>	30172, 30252, 4205, 4208, 4212, 4224, 4255, 4288, FRF20		

various

control thermostats

 <p>1</p>			
<b>GEV No.</b>	390750	<b>Ref. No.</b>	C5322609
<b>description</b>	thermostat t.max. 240°C 1-pole 1NO 10A shaft ø 6x4.6mm shaft position 20°		
<b>For models:</b>	4401, 4462		

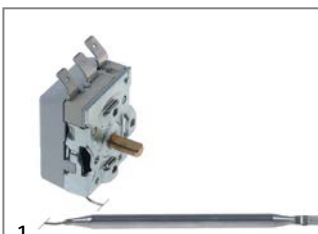

<b>GEV No.</b>	375940	<b>Ref. No.</b>	C5322579
<b>description</b>	thermostat temperature range 30-90°C 1-pole 1CO 16A probe ø 6mm probe L 108mm capillary pipe 1530mm shaft ø 6x4.6mm shaft L 12mm rotation 270° 400V		
<b>For models:</b>	3016, 3018, 3701, 3701S, 3702, 3702S, 3703, 3703S, 3704, 3704S, 4420, 4421		

**safety thermostats**



<b>GEV No.</b>	390754	<b>Ref. No.</b>	92011140
<b>description</b>	safety thermostat switch-off temp. 240°C 1-pole 0.5A probe ø 6mm probe L 79mm capillary pipe 860mm capillary pipe isolated 750mm probe thread M10x1 connection with cable cable length 600mm		
<b>For models:</b>	3026, 3027, 3027V		
<b>spare parts for</b>	390754		
	<b>GEV No.</b>	375783	<b>Ref. No.</b>
			—
<b>description</b>	safety thermostat switch-off temp. 240°C 1-pole 0.5A probe ø 6mm probe L 77mm capillary pipe 860mm capillary pipe isolated 750mm gland nut M10x1 probe SS		

**accessories**

**capillary tube clips**



<b>GEV No.</b>	550138	<b>Ref. No.</b>	68560069
<b>description</b>	capillary tube clip for pipe ø 8.5mm for circular tube heating elements		
<b>For models:</b>	30172, 30252, 4205, 4208, 4212, 4224, 4255, 4288		

**switches and momentary switches**

**rocker/momentary rocker switches**

**ø20mm**

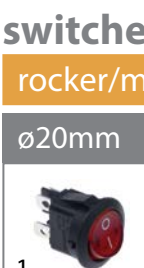

<b>GEV No.</b>	357074	<b>Ref. No.</b>	C5120729
<b>description</b>	rocker switch mounting measurements 20mm red 2NO 250V 10A I O connection male faston 4.8mm ambient temperature max. 85°C protection IP40		
<b>For models:</b>	1161, 3018, 3310, 3481, 3483, 4401, 4421, 4462, 4902, 4904, 4908, 5305, 53054, 5310, 53104, 5315, 53154, 5320, 53204, 5330, 53304, 5340, 53404, 5355, 5360, 53604, 5375, 5380, 53804, 704, 7050, 70501, 7052, 706, 7062, 731, 734, 743, 7460, 7464, 7500, 7502, 75021, 7530, 7535, 75351		

**cam switches**

**4-position**



<b>GEV No.</b>	300007	<b>Ref. No.</b>	3218
<b>description</b>	cam switch 4 operating positions 1NO/2CO sequence 0-1-2-3 16A shaft ø 6x4.6mm shaft L 23mm connection male faston 6.3mm 4-position ceramic		
<b>For models:</b>	3031, 33075, 3310, 3327, 3481, 3483, 4418, 4419, 4481, 4482, 4483, 54244, 54364, 54484		

**lamps**

**indicator lights**

**indicator lights (complete)**

**ø 6mm**

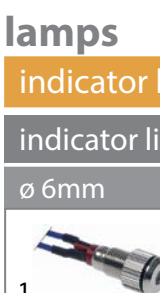

<b>GEV No.</b>	357072	<b>Ref. No.</b>	C5120219 C5120229
<b>description</b>	indicator light ø 6mm 220V red connection cable 300mm cable length 300mm metal		
<b>For models:</b>	3007, 3009, 3011, 3016, 30172, 3018, 30252, 3031, 3033, 33075, 3310, 33115, 3327, 3481, 3483, 3615, 3626, 3701, 3701S, 3702, 3702S, 3703, 3703S, 3704, 3704S, 4205, 4208, 4212, 4224, 4255, 4288, 4402E, 4403E, 4404E, 4405E, 4418, 4419, 4420, 4421, 4442E, 4443E, 4444E, 4445E, 4481, 4482, 4483, 4808, 4902, 4904, 4908...(Other models you can see in the webshop)		

**ø20mm**



<b>GEV No.</b>	357073	<b>Ref. No.</b>	C5120719
<b>description</b>	indicator light ø 20mm 250V red connection male faston 4.8mm temp.-resist. 105°C		
<b>For models:</b>	704, 7050, 70501, 7052, 706, 7062, 731, 734, 743, 7460, 7464, 7500, 7502, 75021, 7530, 7535, 75351		



screw-on/push-on fit

light bulbs

for ovens



<b>GEV No.</b>	359610	<b>Ref. No.</b>	C512409
<b>description</b>	light bulb t.max. 300°C socket E14 15W 230V ø 22mm L 47mm lens L 20mm for oven lamp type Philips		

oven lamps

universal oven lamps

55x100mm



<b>GEV No.</b>	101372	<b>Ref. No.</b>	C5125419
<b>description</b>	oven lamp complete L 100mm W 55mm 230V 25W socket E14 rectangular temp.-resist. 300°C connection male faston 6.3mm		
<b>For models:</b>	5301, 5305, 53054, 5310, 53104, 5315, 53154, 5320, 53204, 5330, 53304, 5336, 5340, 53404, 5348, 5355, 5360, 53604, 5372, 5375, 5380, 53804, 5396, 5424, 54244, 5436, 54364, 5448, 54484, 5453, 5496		

<b>spare parts for</b>	101372			
	<b>GEV No.</b>	359612	<b>Ref. No.</b>	—
	<b>description</b>	light bulb t.max. 300°C socket E14 25W 230V ø 25mm L 56mm lens L 30mm for oven lamp type Philips		
	<b>GEV No.</b>	359698	<b>Ref. No.</b>	—
	<b>description</b>	lamp socket L 100mm W 55mm socket E14 connection male faston 6.3mm		
	<b>GEV No.</b>	359714	<b>Ref. No.</b>	—
	<b>description</b>	gasket for bulb socket		
	<b>GEV No.</b>	359715	<b>Ref. No.</b>	—
	<b>description</b>	lamp glass L 110mm W 65mm thickness 5mm		
	<b>GEV No.</b>	359716	<b>Ref. No.</b>	—
	<b>description</b>	frame for bulb socket		

lamps

light bulbs



<b>GEV No.</b>	359610	<b>Ref. No.</b>	C512409
<b>description</b>	light bulb t.max. 300°C socket E14 15W 230V ø 22mm L 47mm lens L 20mm for oven lamp type Philips		

contactors

LS Industrial Systems

power contactors



<b>GEV No.</b>	380944	<b>Ref. No.</b>	C5123179
<b>description</b>	power contactor resistive load 20A 230VAC (AC3/400V) 12A/5.5kW main contacts 3NO auxiliary contacts 1NO/1NC connection screw connection type GMC-12		
<b>For models:</b>	30252, 3615, 3626, 4904, 4908		

electronic controllers

miscellaneous

refrigeration controllers



<b>GEV No.</b>	378271	<b>Ref. No.</b>	C5322529
<b>description</b>	electronic controller OSAKA type T2001 AN /HSH5 mounting measurements 71x29mm 100-240V voltage AC NTC display 4 digits NTC/PTC		
<b>For models:</b>	1161, 505, 5453, 602, 6021, 6022, 603, 6031, 605, 606, 6190, 6190E1, 704, 7050, 70501, 7052, 706, 7062, 731, 734, 743, 7460, 7464, 7500, 7502, 75021, 7530, 7535, 75351		

motors

gear motors

for grills



<b>GEV No.</b>	499110	<b>Ref. No.</b>	C5020039
<b>description</b>	gear motor CROUZET 230V 50Hz 4rpm shaft ø 6x5mm L 91mm W 64mm H 58mm		
<b>For models:</b>	5305, 53054, 5310, 5315, 5320, 5330, 5340, 5360, 5380		



<b>1</b>			
<b>GEV No.</b>	499111	<b>Ref. No.</b>	534027P
<b>description</b>	gear motor CEG type MM56A4-STD 90W 230V 50Hz 6500rpm L 705mm W 115mm H 550mm chicken rotisserie 0.12HP		
<b>For models:</b>	5310, 53104, 5315, 53154, 5330, 53304, 5340, 53404, 5355, 5360, 53604, 5375, 5380, 53804		

## gas taps

### PEL

#### 20S series



<b>1</b>			
<b>GEV No.</b>	106840	<b>Ref. No.</b>	3780
<b>description</b>	gas tap PEL type 20S gas inlet pipe flange ø21mm bypass nozzle ø 0mm gas outlet M16x1.5 (tube ø 10/8mm) thermocouple connection M8x1 pilot connection shaft ø 8x6.5mm shaft L 22/15mm shaft flat upper		
<b>For models:</b>	5305, 53054, 5310, 53104, 5315, 53154, 5320, 53204, 5330, 53304, 5340, 53404, 5355, 5360, 53604, 5375, 5380, 53804		
<b>spare parts for</b>	106840		
	<b>GEV No.</b>	101060	<b>Ref. No.</b> —
	magnet unit standard L 39mm D1 ø 15.4mm D2 ø 11mm suitable for PEL20-21/JUNKERS/EGA		
	<b>GEV No.</b>	101205	<b>Ref. No.</b> —
	gas tap front part shaft ø 8x6.5mm shaft L 22/15mm shaft flat upper/lower suitable for PEL20		
	<b>GEV No.</b>	101880	<b>Ref. No.</b> —
	gasket Viton ED ø 14mm ID ø 9mm thickness 7.7mm Qty 1 pcs		
	<b>GEV No.</b>	106202	<b>Ref. No.</b> —
	bypass nozzle type PEL20/21 bore ø 0mm thread M5x0.5		
<b>accessories for</b>	106840		
	<b>GEV No.</b>	101230	<b>Ref. No.</b> —
	thermocouple nut T1: M8x1 T2: M18x1 aluminium		
	<b>GEV No.</b>	101278	<b>Ref. No.</b> 3781
	olive for pipe ø 10mm Qty 1 pcs		
	<b>GEV No.</b>	101300	<b>Ref. No.</b> 3782
	union nut thread M16x1.5 tube ø 10mm		
	<b>GEV No.</b>	101450	<b>Ref. No.</b> —
	olive for pipe ø 8mm L 12.7mm Qty 1 pcs ED ø 10mm		
	<b>GEV No.</b>	101451	<b>Ref. No.</b> —
	union nut thread M16x1.5 tube ø 8mm		

#### 21S series



<b>1</b>			
<b>GEV No.</b>	106841	<b>Ref. No.</b>	C5811429
<b>description</b>	gas tap PEL type 21S gas inlet pipe flange ø21mm bypass nozzle ø 0mm gas outlet M16x1.5 (tube ø 10mm) thermocouple connection M9x1 pilot connection M10x1 shaft ø 8x6.5mm shaft L 22/15mm shaft flat right pipe input ø 9mm		
<b>For models:</b>	3013, 3014, 3015, 3302, 33025, 3303, 33035, 3304, 3306, 3331, 3401, 3402, 3404S, 3405S, 3411S, 34121S, 3412S-Vers1, 3412S-Vers2, 3413SE1, 34151S, 3415S, 3501, 3501C, 3504, 3511SE1, 3592, 3911, 3912, 4001, 4437, 4701S, 4702, 4703, 4704, 4801, 4803, 4803E, 4805, 4807, 4811, 4815, 4920, 49201, 49202, 4930, 49301, 5051, 5052S		
<b>spare parts for</b>	106841		
	<b>GEV No.</b>	101060	<b>Ref. No.</b> —
	magnet unit standard L 39mm D1 ø 15.4mm D2 ø 11mm suitable for PEL20-21/JUNKERS/EGA		
	<b>GEV No.</b>	101231	<b>Ref. No.</b> —
	thermocouple nut T1: M9x1 T2: M18x1		
	<b>GEV No.</b>	106202	<b>Ref. No.</b> —
	bypass nozzle type PEL20/21 bore ø 0mm thread M5x0.5		
<b>accessories for</b>	106841		
	<b>GEV No.</b>	100908	<b>Ref. No.</b> —
	union screw thread M10x1 for pipe ø 4mm Qty 1 pcs		
	<b>GEV No.</b>	100909	<b>Ref. No.</b> A1018997
	union screw thread M10x1 for pipe ø 6mm Qty 1 pcs		
	<b>GEV No.</b>	101246	<b>Ref. No.</b> —
	olive for pipe ø 4mm Qty 1 pcs		
	<b>GEV No.</b>	101278	<b>Ref. No.</b> 3781
	olive for pipe ø 10mm Qty 1 pcs		
	<b>GEV No.</b>	101286	<b>Ref. No.</b> —
	olive ID ø 6mm Qty 1 pcs		
	<b>GEV No.</b>	101300	<b>Ref. No.</b> 3782
	union nut thread M16x1.5 tube ø 10mm		
	<b>GEV No.</b>	101450	<b>Ref. No.</b> —
	olive for pipe ø 8mm L 12.7mm Qty 1 pcs ED ø 10mm		
	<b>GEV No.</b>	101451	<b>Ref. No.</b> —
	union nut thread M16x1.5 tube ø 8mm		
	<b>GEV No.</b>	110081	<b>Ref. No.</b> —
	knob ø 70mm shaft ø 8x6.5mm shaft flat universal		
	<b>GEV No.</b>	112206	<b>Ref. No.</b> —
	knob dial plate silver gas tap PEL21/22/23 t.max.°C ED ø 63mm ID ø 45.5mm		











SABAF





1

<b>GEV No.</b>	106842	<b>Ref. No.</b>	C5816299
<b>description</b>	gas tap SABAF type 10 gas inlet pipe flange ø23mm bypass nozzle ø 0mm gas outlet 1/4" (tube ø 8mm) front fixing M13x1 thermocouple connection M8x1 shaft ø 8x6.5mm shaft L 32/12.5mm shaft flat right		
<b>For models:</b>	3300, 35012, 4402, 4402M, 4403, 4403M, 4404, 4404M, 4405, 4405M, 4409, 4410, 4411, 4412, 4413, 44138, 4416, 4417, 4422, 4423, 4424, 4425, 4442, 4443, 4444, 4445, 4462, 4471, 4472, 4473, 5315, 5320, 5330, 5336, 5340, 5348, 5355, 5372, 5375, 5396, 5424, 5436, 5448, 54484, 5496		
<b>spare parts for</b>	106842		
	<b>GEV No.</b>	101051	<b>Ref. No.</b> —
	magnet unit L 27mm D1 ø 12.5mm D2 ø 8.5mm suitable for JUNKERS/EGA/MADEC/SABAF standard		
	<b>GEV No.</b>	101376	<b>Ref. No.</b> —
	gasket ID ø 8mm ED ø 12mm H 3/5mm		
<b>accessories for</b>	106842		
	<b>GEV No.</b>	101277	<b>Ref. No.</b> C5815549
	olive ID ø 8mm Qty 1 pcs		
	<b>GEV No.</b>	101751	<b>Ref. No.</b> —
	bracket		
	<b>GEV No.</b>	520656	<b>Ref. No.</b> —
	union nut thread 1/4" tube ø 6/8mm		



1

<b>GEV No.</b>	106843	<b>Ref. No.</b>	C5816289
<b>description</b>	gas tap SABAF type 10 gas inlet pipe flange ø23mm bypass nozzle ø 0mm gas outlet 1/4" (tube ø 8mm) front fixing thermocouple connection M8x1 shaft ø 8x6.5mm shaft L 47/12.5mm shaft flat right		
<b>For models:</b>	30012, 30032, 30132, 30142, 30152, 3300, 3301, 33022, 33042, 33052, 33062, 33092, 35012		
<b>spare parts for</b>	106843		
	<b>GEV No.</b>	101051	<b>Ref. No.</b> —
	magnet unit L 27mm D1 ø 12.5mm D2 ø 8.5mm suitable for JUNKERS/EGA/MADEC/SABAF standard		
	<b>GEV No.</b>	101376	<b>Ref. No.</b> —
	gasket ID ø 8mm ED ø 12mm H 3/5mm		
<b>accessories for</b>	106843		
	<b>GEV No.</b>	101277	<b>Ref. No.</b> C5815549
	olive ID ø 8mm Qty 1 pcs		
	<b>GEV No.</b>	101751	<b>Ref. No.</b> —
	bracket		

<b>accessories for</b>	106843		
	<b>GEV No.</b>	520656	<b>Ref. No.</b> —
	union nut thread 1/4" tube ø 6/8mm		

gas thermostats

SIT

710 Minisit series



1

<b>GEV No.</b>	101132	<b>Ref. No.</b>	3103
<b>description</b>	gas thermostat SIT type MINISIT 710 t.max. 340°C 100-340°C gas inlet 1/2" gas outlet 3/8" thermocouple connection M9x1 pilot connection M10x1 probe ø 5mm probe L 68mm capillary pipe 1050mm probe type type B1 pressure controller no pressure regulator mbar gland nut ignition gas no		
<b>For models:</b>	3001, 3003, 3005, 3401, 3402, 3501, 3592, 3607, 3611S, 3614S, 3624, 3628H, 3628S, 3683S, 3684S, 3907, 4001, 4812, 4812E, 4815, 4817, 4903, 4907, 4999		
<b>spare parts for</b>	101132		
	<b>GEV No.</b>	101053	<b>Ref. No.</b> —
	magnet unit T1: M9x1 T2: M24x1 L 45mm ø 17mm suitable for Minisit		
	<b>GEV No.</b>	102102	<b>Ref. No.</b> —
	probe 100-340°C probe ø 5mm probe L 68mm capillary pipe 1750mm t.max. 340°C oven/grill probe type type B1 suitable for MINISIT 710		
<b>accessories for</b>	101132		
	<b>GEV No.</b>	100809	<b>Ref. No.</b> 3785
	O-ring EPDM thickness 2mm ID ø 21mm Qty 1 pcs		
	<b>GEV No.</b>	100904	<b>Ref. No.</b> —
	locking screw M10x1 for pipe ø 4mm Qty 1 pcs		
	<b>GEV No.</b>	100905	<b>Ref. No.</b> C5815359
	locking screw M10x1 for pipe ø 6mm Qty 1 pcs		
	<b>GEV No.</b>	101054	<b>Ref. No.</b> —
	magnet unit T1: M10x1 T2: M24x1 L 45mm ø 17mm suitable for Minisit		
	<b>GEV No.</b>	101136	<b>Ref. No.</b> —
	piezoelectric igniter suitable for Minisit with cover cap ømm connection F6.3x0.8		
	<b>GEV No.</b>	101137	<b>Ref. No.</b> —
	cover cap without piezoelectric igniter		
	<b>GEV No.</b>	101267	<b>Ref. No.</b> —
	reducer IT 3/8" ET 1/2" L 21mm		
	<b>GEV No.</b>	101268	<b>Ref. No.</b> —
	gas connection thread 3/8" angled with O-ring MINISIT 710		

Table continues overleaf

accessories for		101132	
	GEV No.	101269	Ref. No. —
gas connection thread 1/2" angled with O-ring MINISIT 710			
	GEV No.	101270	Ref. No. —
screw connection IT 3/8" ET 3/8" L 28mm			
	GEV No.	101272	Ref. No. —
screw connection IT 1/2" ET 3/8" L 57mm			
	GEV No.	101273	Ref. No. —
olive for pipe ø 12mm L 9.5mm brass Qty 1 pcs suitable for universal			
	GEV No.	101274	Ref. No. —
olive for pipe ø 16mm Qty 1 pcs			
	GEV No.	101275	Ref. No. —
union screw thread 1/2" for pipe ø 16mm Qty 1 pcs			
	GEV No.	101276	Ref. No. —
union screw thread 3/8" tube ø 12mm Qty 1 pcs			
	GEV No.	110068	Ref. No. —
knob suitable for Minisit ø 37mm			

## gas valves and ignition boxes

### gas control valves

SIT

NOVASIT

accessories



1

<b>GEV No.</b>	101799	<b>Ref. No.</b>	C582109
<b>description</b>	knob adapter shaft ø 10x8mm shaft L 18mm catch lower suitable for ZANUSSI shaft flat upper		



1

<b>GEV No.</b>	100905	<b>Ref. No.</b>	C5815359
<b>description</b>	locking screw M10x1 for pipe ø 6mm Qty 1 pcs		
<b>For models:</b>	3001, 3003, 3005, 3013, 3014, 3015, 3026, 3027, 3027V, 3302, 3302S, 3303, 3303S, 3304, 3306, 3331, 3401, 3402, 3404S, 3405S, 3411S, 34121S, 3412S-Vers1, 3412S-Vers2, 3413SE1, 34151S, 3415S, 3501, 3501C, 3504, 3511SE1, 3592, 3607, 3611S, 3614S, 3624, 3628H, 3628S, 3683S, 3684S, 3907, 3908, 3911, 3912, 4437, 4701S, 4702, 4703, 4704, 4801...(Other models you can see in the webshop)		

## ignition parts

### pilot burners

SIT

100 series

accessories

pilot burner brackets

universal



1

<b>GEV No.</b>	100894	<b>Ref. No.</b>	3705
<b>description</b>	opposite support for pilot burner suitable for 100 series		
<b>For models:</b>	30012, 30032, 30132, 30142, 3300, 3301, 3302, 33022, 35012, 4409, 4410, 4901		



1

<b>GEV No.</b>	100893	<b>Ref. No.</b>	3786
<b>description</b>	pilot burner bracket suitable for 100 series 2-piece		
<b>For models:</b>	30012, 30032, 30132, 30142, 3300, 3301, 3302, 33022, 35012, 4409, 4410, 4901		



1

<b>GEV No.</b>	100888	<b>Ref. No.</b>	3704
<b>description</b>	screw bolt for pilot burner		
<b>For models:</b>	3300, 3301, 35012, 4409, 4410, 4901		

miscellaneous



1

<b>GEV No.</b>	100885	<b>Ref. No.</b>	C5815189
<b>description</b>	air mixing sleeve for pilot burner Qty 1 pcs		
<b>For models:</b>	3015, 3302, 3302S, 3303, 3303S, 3304, 3306, 3331, 3401, 3402, 3404S, 3405S, 3411S, 34121S, 3412S-Vers1, 3412S-Vers2, 3413SE1, 34151S, 3415S, 3501, 3501C, 3504, 3511SE1, 3592, 4001, 4437, 4920, 49201, 49202, 4930, 49301, 5051, 5052S		



**POLIDORO**  
pilot burners



1

<b>GEV No.</b>	106837	<b>Ref. No.</b>	C5810129
<b>description</b>	pilot burner POLIDORO 3 flames natural gas code 27.2		
<b>For models:</b>	3001, 3003, 3005, 3013, 3014, 3026, 3027, 3027V, 3401, 3402, 3501, 3592, 3607, 3611S, 3614S, 3624, 3628H, 3628S, 3683S, 3684S, 3907, 3908, 3911, 3912, 4001, 4701S, 4702, 4703, 4704, 4801, 4803, 4803E, 4805, 4807, 4811, 4812, 4812E, 4815, 4817, 4903, 4907, 4999		



1

<b>GEV No.</b>	100906	<b>Ref. No.</b>	A1018998
<b>description</b>	screw connection thread M10x1 for ignition electrode brass Qty 1 pcs WS 10		
<b>For models:</b>	3001, 3003, 3005, 3013, 3014, 3026, 3027, 3027V, 3401, 3402, 3501, 3592, 3607, 3611S, 3614S, 3624, 3628H, 3628S, 3683S, 3684S, 3907, 3911, 3912, 4001, 4701S, 4702, 4703, 4704, 4801, 4803, 4803E, 4805, 4807, 4811, 4812, 4812E, 4815, 4817, 4903, 4907, 4999		

**electrodes**

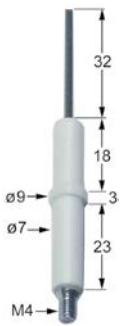

1

<b>GEV No.</b>	100701	<b>Ref. No.</b>	C5810139
<b>description</b>	ignition electrode connection M4 Qty 1 pcs		
<b>For models:</b>	3001, 3003, 3005, 3013, 3014, 3026, 3027, 3027V, 3401, 3402, 3501, 3592, 3607, 3611S, 3614S, 3624, 3628H, 3628S, 3683S, 3684S, 3907, 3908, 3911, 3912, 4001, 4701S, 4702, 4703, 4704, 4801, 4803, 4803E, 4805, 4807, 4811, 4812, 4812E, 4815, 4817, 4903, 4907, 4999		
<b>accessories for</b>	100701		
	<b>GEV No.</b>	<b>Ref. No.</b>	<b>A1018998</b>
	screw connection thread M10x1 for ignition electrode brass Qty 1 pcs WS 10		

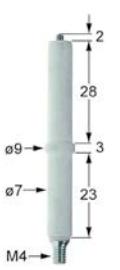

1

<b>GEV No.</b>	102314	<b>Ref. No.</b>	96010061
<b>description</b>	ignition electrode D1 ø 7mm D2 ø 9mm connection M4 L1 2mm BL1 28mm BL2 3mm BL3 23mm to clip		
<b>For models:</b>	3911, 3912		

**ignition cables**

pre-assembled cables



1

<b>GEV No.</b>	102164	<b>Ref. No.</b>	2175
<b>description</b>	ignition cable cable length 1000mm connection F6.3mm / lug M4		
<b>For models:</b>	30012, 3003, 30032, 3005, 3013, 30132, 3014, 30142, 3300, 3301, 3302, 33022, 3401, 3402, 3501, 35012, 3592, 3611S, 3628H, 3628S, 3908, 3911, 3912, 4001, 4409, 4410, 4702, 4703, 4704, 4801, 4803, 4803E, 4805, 4807, 4811, 4815, 4901, 4903, 4907, 4999		



1

<b>GEV No.</b>	102177	<b>Ref. No.</b>	2193
<b>description</b>	ignition cable cable length 600mm connection F6.3mm / lug M4		
<b>For models:</b>	3001, 3003, 3005, 3026, 3027, 3027V, 3607, 3611S, 3614S, 3624, 3683S, 3684S, 4701S, 4702, 4812, 4812E, 4815, 4817		

**piezoelectric igniters**

miscellaneous



1

<b>GEV No.</b>	nla <sup>1</sup>	<b>Ref. No.</b>	3747
<b>description</b>	piezoelectric igniter suitable for Minisit connection F6.3x0.8 ømm		
<b>For models:</b>	3001, 3003, 3005, 3013, 3014, 3027, 3027V, 3300, 3301, 3401, 3402, 3501, 35012, 3592, 3611S, 3614S, 3624, 3628H, 3628S, 3683S, 3684S, 4001, 4409, 4410, 44138, 4702, 4803, 4812, 4815, 4817, 4999		

<sup>1</sup>no longer available

thermocouples



plug-in thermocouples

plug-in thermocouples standard

with barrel socket  $\varnothing 6(6.5)$ mm

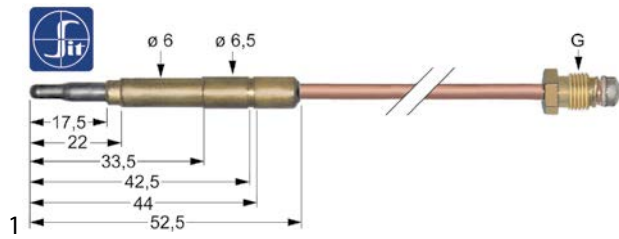
thermocouples SIT



<b>GEV No.</b>	107602	<b>Ref. No.</b>	C5811809
<b>description</b>	thermocouple SIT M8x1 L 850mm plug connection $\varnothing 6.0(6.5)$ mm		
<b>For models:</b>	30012, 30032, 30132, 30142, 3300, 3301, 3302, 33022, 35012, 4409, 4410, 4901		
<b>accessories for</b>	107602		
	<b>GEV No.</b>	100920	<b>Ref. No.</b> —
	thermocouple fitting thread M8x1 / M9x1 Qty 1 pcs		
	<b>GEV No.</b>	100922	<b>Ref. No.</b> —
	thermocouple fitting thread M10x1 / ASA 11/32 Qty 1 pcs		

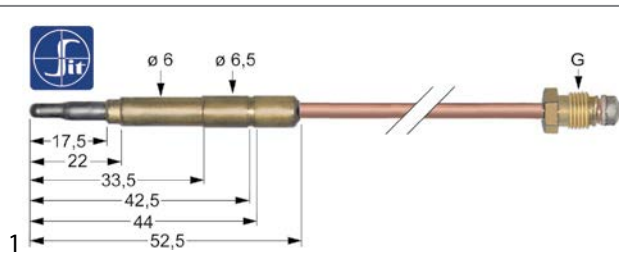

<b>GEV No.</b>	107612	<b>Ref. No.</b>	C5811009
<b>description</b>	thermocouple SIT M9x1 L 1000mm plug connection $\varnothing 6.0(6.5)$ mm		
<b>For models:</b>	4815		

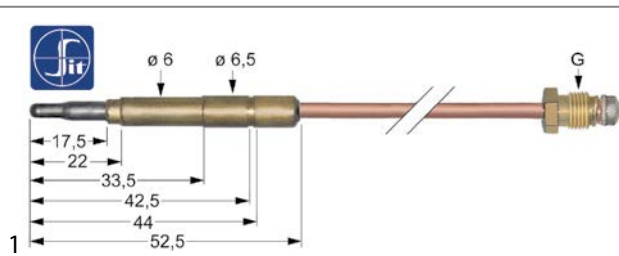

<b>GEV No.</b>	107614	<b>Ref. No.</b>	C5811059
<b>description</b>	thermocouple SIT M9x1 L 1500mm plug connection $\varnothing 6.0(6.5)$ mm		
<b>For models:</b>	3501, 4801, 4803, 4803E, 4805, 4807, 4811		

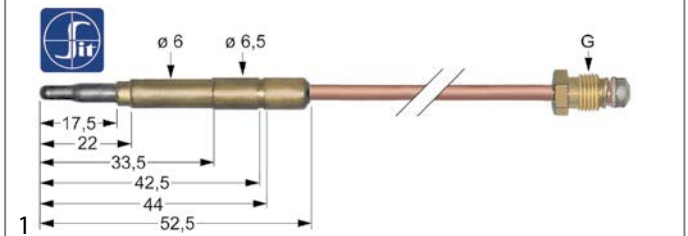

<b>GEV No.</b>	107606	<b>Ref. No.</b>	C5820049
<b>description</b>	thermocouple SIT M9x1 L 320mm plug connection $\varnothing 6.0(6.5)$ mm		
<b>For models:</b>	10P, 20P, 3001, 3003, 3005, 3026, 3027, 3027V, 30P, 3607, 3611S, 3614S, 3624, 3683S, 3684S, 40P, 4701S, 4702, 4812, 4812E, 4817, 5305, 5310, 5315, 5320, 5330, 5340, 5360, 5380, 5P		

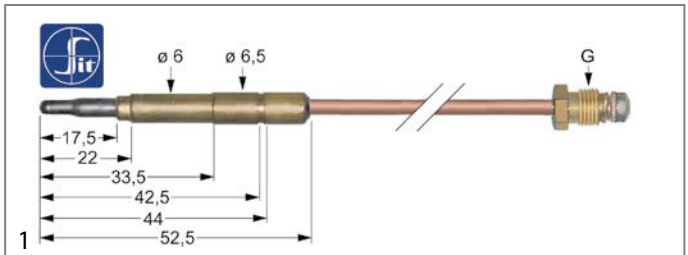

<b>GEV No.</b>	107609	<b>Ref. No.</b>	C5811829
<b>description</b>	thermocouple SIT M9x1 L 600mm plug connection $\varnothing 6.0(6.5)$ mm		
<b>For models:</b>	3003, 3005, 3013, 3014, 3027, 3027V, 3302, 33022, 3401, 3402, 3501, 3592, 3611S, 3628H, 3628S, 3911, 3912, 4001, 4702, 4703, 4704, 4803, 4815, 4901, 4999		

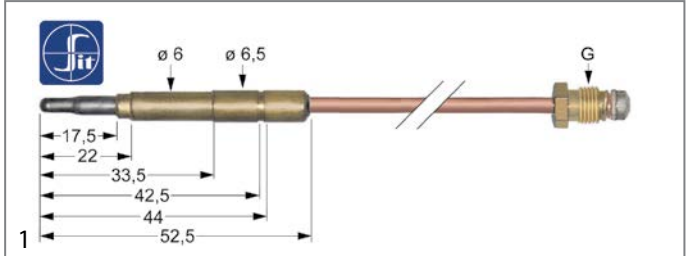

<b>GEV No.</b>	107611	<b>Ref. No.</b>	C5811679
<b>description</b>	thermocouple SIT M9x1 L 850mm plug connection $\varnothing 6.0(6.5)$ mm		
<b>For models:</b>	3401, 4903, 4907, 4999		

threaded thermocouples

threaded thermocouples standard

with socket with thread M8x1

SIT

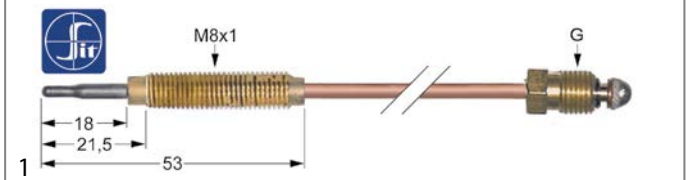

<b>GEV No.</b>	107628	<b>Ref. No.</b>	C5811019
<b>description</b>	thermocouple SIT M8x1 L 320mm M8x1		
<b>For models:</b>	3015, 30152, 3300, 3301, 3302, 33022, 33025, 3303, 33035, 3304, 33042, 33052, 3306, 33062, 33092, 3401, 3402, 3404S, 3405S, 3501, 35012, 3501C, 4402, 4402M, 4403, 4403M, 4404, 4404M, 4405, 4405M, 4410, 4411, 4412, 4413, 44138, 4416, 4417, 4422, 4423, 4424, 4425, 4442, 4443, 4444, 4445, 4462, 4471, 4472, 4473		
<b>accessories for</b>	107628		
	<b>GEV No.</b>	102067	<b>Ref. No.</b> C5811029
	nut thread M8x1 H 3mm brass Qty 1 pcs type SEF 1		



<b>GEV No.</b>	107629	<b>Ref. No.</b>	C5811039
<b>description</b>	thermocouple SIT M8x1 L 450mm M8x1		
<b>For models:</b>	5305, 53054, 5310, 53104, 5315, 53154, 5320, 53204, 5330, 53304, 5340, 53404, 5355, 5360, 53604, 5375, 5380, 53804		
<b>accessories for</b>	107629		
	<b>GEV No.</b>	102067	<b>Ref. No.</b> C5811029
nut thread M8x1 H 3mm brass Qty 1 pcs type SEF 1			

<b>GEV No.</b>	107636	<b>Ref. No.</b>	C5811849
<b>description</b>	thermocouple SIT M9x1 L 600mm M8x1		
<b>For models:</b>	3411S, 34121S, 3412S-Vers1, 3412S-Vers2, 3413SE1, 34151S, 3415S, 3511SE1, 4930, 49301, 5052S		
<b>accessories for</b>	107636		
	<b>GEV No.</b>	102067	<b>Ref. No.</b> C5811029
nut thread M8x1 H 3mm brass Qty 1 pcs type SEF 1			

<b>GEV No.</b>	107638	<b>Ref. No.</b>	C5811049
<b>description</b>	thermocouple SIT M9x1 L 1000mm M8x1		
<b>For models:</b>	3401, 3501, 4001		

<b>GEV No.</b>	107637	<b>Ref. No.</b>	C5811699
<b>description</b>	thermocouple SIT M9x1 L 850mm M8x1		
<b>accessories for</b>	107637		
	<b>GEV No.</b>	102067	<b>Ref. No.</b> C5811029
nut thread M8x1 H 3mm brass Qty 1 pcs type SEF 1			

<b>GEV No.</b>	107640	<b>Ref. No.</b>	C5811109
<b>description</b>	thermocouple SIT M9x1 L 1500mm M8x1		

type Junkers with aluminised tip

<b>GEV No.</b>	102233	<b>Ref. No.</b>	C5811129
<b>description</b>	thermocouple M8x1 L 750mm M8x1		
<b>For models:</b>	3401, 3402, 3404S, 3405S		
<b>accessories for</b>	102233		
	<b>GEV No.</b>	102067	<b>Ref. No.</b> C5811029
nut thread M8x1 H 3mm brass Qty 1 pcs type SEF 1			

<b>GEV No.</b>	107635	<b>Ref. No.</b>	C5811739
<b>description</b>	thermocouple SIT M9x1 L 320mm M8x1		
<b>For models:</b>	3331, 4437, 4920, 49201, 49202		
<b>accessories for</b>	107635		
	<b>GEV No.</b>	102067	<b>Ref. No.</b> C5811029
nut thread M8x1 H 3mm brass Qty 1 pcs type SEF 1			

accessories

nuts

<b>GEV No.</b>	102067	<b>Ref. No.</b>	C5811029
<b>description</b>	nut thread M8x1 H 3mm brass Qty 1 pcs type SEF 1		
<b>For models:</b>	30152, 3300, 3301, 33022, 33042, 33052, 33062, 33092, 35012, 4402, 4402M, 4403, 4403M, 4404, 4404M, 4405, 4405M, 4410, 4411, 4412, 4413, 44138, 4416, 4417, 4422, 4423, 4424, 4425, 4442, 4443, 4444, 4445, 4462, 4471, 4472, 4473, 5305, 53054, 5310, 53104, 5315, 53154, 5320, 53204, 5330, 53304, 5336, 5340, 53404, 5348...(Other models you can see in the webshop)		

## gas burners

### hob burners

#### universal hob burners

#### ARC

#### 65 series





<b>GEV No.</b>	104328	<b>Ref. No.</b>	C5815139
<b>description</b>	burner pipe 4.5kW L 93mm total length 108mm air mixer ø 18.2mm ED ø 32.9mm ID ø 22.7mm		
<b>For models:</b>	3015, 3302, 33025, 3303, 33035, 3304, 3306, 3401, 3402, 3404S, 3405S, 3501, 3501C, 3504, 3592, 4001		



#### SABAF

#### 1 series









<b>GEV No.</b>	104288	<b>Ref. No.</b>	C5815589
<b>description</b>	burner cap 3.6kW ø 120mm		
<b>For models:</b>	30152, 33022, 33042, 33052, 33092, 35012, 4410, 4411, 4412, 4413, 44138, 4416, 4417		
<b>accessories for</b>	104288		
	<b>GEV No.</b>	104289	<b>Ref. No.</b> C5815609
	burner lower part 3/3.6kW for burner cap ø 90/120mm		
	<b>GEV No.</b>	105086	<b>Ref. No.</b> C5815579
	burner ring 3.6kW for burner cap ø 120mm		
	<b>GEV No.</b>	105087	<b>Ref. No.</b> C5815599
	burner head 3.6kW for burner cap ø 120mm		



<b>GEV No.</b>	105087	<b>Ref. No.</b>	C5815599
<b>description</b>	burner head 3.6kW for burner cap ø 120mm		
<b>For models:</b>	30152, 33022, 33042, 33052, 33092, 35012, 4410, 4411, 4412, 4413, 44138, 4416, 4417		
<b>accessories for</b>	105087		
	<b>GEV No.</b>	104288	<b>Ref. No.</b> C5815589
	burner cap 3.6kW ø 120mm		
	<b>GEV No.</b>	105085	<b>Ref. No.</b> —
	burner cap ø 120mm		
	<b>GEV No.</b>	105086	<b>Ref. No.</b> C5815579
	burner ring 3.6kW for burner cap ø 120mm		
	<b>GEV No.</b>	105088	<b>Ref. No.</b> —
	burner cap A ø 110mm with central hole		

<b>accessories for</b>	105087		
	<b>GEV No.</b>	105089	<b>Ref. No.</b> —
	burner ring 3kW for burner cap ø 90mm		



<b>GEV No.</b>	104289	<b>Ref. No.</b>	C5815609
<b>description</b>	burner lower part 3/3.6kW for burner cap ø 90/120mm		
<b>For models:</b>	30152, 33022, 33042, 33052, 33092, 35012, 4410, 4411, 4412, 4413, 44138, 4416, 4417		
<b>accessories for</b>	104289		
	<b>GEV No.</b>	104286	<b>Ref. No.</b> —
	burner cap 3kW ø 90mm		
	<b>GEV No.</b>	104288	<b>Ref. No.</b> C5815589
	burner cap 3.6kW ø 120mm		
	<b>GEV No.</b>	105086	<b>Ref. No.</b> C5815579
	burner ring 3.6kW for burner cap ø 120mm		
	<b>GEV No.</b>	105087	<b>Ref. No.</b> C5815599
	burner head 3.6kW for burner cap ø 120mm		
	<b>GEV No.</b>	105089	<b>Ref. No.</b> —
	burner ring 3kW for burner cap ø 90mm		
	<b>GEV No.</b>	105090	<b>Ref. No.</b> —
	burner head 3kW for burner cap ø 90mm		
	<b>GEV No.</b>	106482	<b>Ref. No.</b> —
	gas injector thread M6x0.75 WS 7 bore ø 1.1mm		
	<b>GEV No.</b>	106485	<b>Ref. No.</b> —
	gas injector thread M6x0.75 WS 7 bore ø 1.6mm		



<b>GEV No.</b>	105086	<b>Ref. No.</b>	C5815579
<b>description</b>	burner ring 3.6kW for burner cap ø 120mm		
<b>For models:</b>	30152, 33022, 33042, 33052, 33092, 35012, 4410, 4411, 4412, 4413, 44138, 4416, 4417		
<b>accessories for</b>	105086		
	<b>GEV No.</b>	105085	<b>Ref. No.</b> —
	burner cap ø 120mm		
	<b>GEV No.</b>	105087	<b>Ref. No.</b> C5815599
	burner head 3.6kW for burner cap ø 120mm		
	<b>GEV No.</b>	105088	<b>Ref. No.</b> —
	burner cap A ø 110mm with central hole		
	<b>GEV No.</b>	105089	<b>Ref. No.</b> —
	burner ring 3kW for burner cap ø 90mm		



accessories

pan supports



1

<b>GEV No.</b>	210029	<b>Ref. No.</b>	31440000
<b>description</b>	pan support W 347mm L 397mm H 43mm suitable for MACFRIN		

tube burners



1

<b>GEV No.</b>	104414	<b>Ref. No.</b>	C5815399
<b>description</b>	tubular burner ø 74mm L 180mm thread 3/8" H 52mm ID ø 25mm W 74mm		
<b>For models:</b>	3026, 3027, 3027V		

ceramic burners



1

<b>GEV No.</b>	101938	<b>Ref. No.</b>	530587M 534030P
<b>description</b>	ceramic burner L 845mm W 86mm firing range 61x801mm chicken rotisserie		
<b>For models:</b>	5305, 53054, 5310, 53104, 5315, 53154, 5320, 53204, 5330, 53304, 5340, 53404, 5355, 5360, 53604, 5375, 5380, 53804		

gas nozzles

main nozzles

gas nozzles M10x1

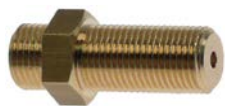

1

<b>GEV No.</b>	107827	<b>Ref. No.</b>	C5812660
<b>description</b>	gas injector thread M10x1 WS 12 bore ø 1.45mm GN		
<b>For models:</b>	4815, 4920, 49201, 49202, 4930, 49301, 5051, 5052S		



1

<b>GEV No.</b>	107828	<b>Ref. No.</b>	C5812680
<b>description</b>	gas injector thread M10x1 WS 12 bore ø 1.9mm GLP		
<b>For models:</b>	4815, 4920, 49201, 49202, 4930, 49301, 5051, 5052S, 5315, 5320, 5330, 5336, 5340, 5348, 5355, 5372, 5375, 5396, 5424, 5436, 5448, 5496		



1

<b>GEV No.</b>	107826	<b>Ref. No.</b>	C5812640
<b>description</b>	gas injector thread M10x1 WS 12 bore ø 1mm GLP		
<b>For models:</b>	4815, 4920, 49201, 49202, 4930, 49301, 5051, 5052S		



1

<b>GEV No.</b>	107829	<b>Ref. No.</b>	C5812689
<b>description</b>	gas injector thread M10x1 WS 12 bore ø 2.2mm GN		
<b>For models:</b>	4930, 49301, 5051, 5052S		

pilot burner nozzles

pilot burner nozzles POLIDORO



1

<b>GEV No.</b>	100000	<b>Ref. No.</b>	C5810169
<b>description</b>	pilot burner nozzle POLIDORO LPG code 22 bore ø 0.22mm Qty 1 pcs		
<b>For models:</b>	3001, 3003, 3005, 3013, 3014, 3026, 3027, 3027V, 3401, 3402, 3501, 3592, 3607, 3611S, 3614S, 3624, 3628H, 3628S, 3683S, 3684S, 3907, 3908, 3911, 3912, 4001, 4701S, 4702, 4703, 4704, 4801, 4803, 4803E, 4805, 4807, 4811, 4812, 4812E, 4815, 4817, 4903, 4907, 4999		



1

<b>GEV No.</b>	106703	<b>Ref. No.</b>	C5810159
<b>description</b>	pilot burner nozzle POLIDORO natural gas code 27.2 bore ø 2x0.27mm Qty 1 pcs		
<b>For models:</b>	3001, 3003, 3005, 3013, 3014, 3026, 3027, 3027V, 3401, 3402, 3501, 3592, 3607, 3611S, 3614S, 3624, 3628H, 3628S, 3683S, 3684S, 3907, 3908, 3911, 3912, 4001, 4701S, 4702, 4703, 4704, 4801, 4803, 4803E, 4805, 4807, 4811, 4812, 4812E, 4815, 4817, 4903, 4907, 4999		



## auxiliary gas parts

### screw connections

#### olives



1

<b>GEV No.</b>	101278	<b>Ref. No.</b>	3781
<b>description</b>	olive for pipe ø 10mm Qty 1 pcs		
<b>For models:</b>	3001, 3003, 30032, 3005, 3013, 30132, 3014, 30142, 3015, 3026, 3027, 3027V, 3302, 33025, 3303, 33035, 3304, 3306, 3331, 3401, 3402, 3404S, 3405S, 3411S, 34121S, 3412S-Vers1, 3412S-Vers2, 3413SE1, 34151S, 3415S, 3501, 3501C, 3504, 3511SE1, 3592, 3607, 3611S, 3614S, 3624, 3628H, 3628S, 3683S, 3684S, 3907, 3908, 3911, 3912, 4001, 4404, 4404M...(Other models you can see in the webshop)		
<b>accessories for</b>	101278		
	<b>GEV No.</b>	100943	<b>Ref. No.</b> —
union nut thread M17x1 tube ø 10mm			
	<b>GEV No.</b>	101300	<b>Ref. No.</b> 3782
union nut thread M16x1.5 tube ø 10mm			
	<b>GEV No.</b>	101478	<b>Ref. No.</b> —
union nut thread 3/8" for pipe ø 10mm			



1

<b>GEV No.</b>	102797	<b>Ref. No.</b>	A1018999
<b>description</b>	olive for pipe ø 6mm Qty 1 pcs		
<b>For models:</b>	3001, 3003, 3005, 3013, 3014, 3026, 3027, 3401, 3402, 3501, 3592, 3607, 3611S, 3614S, 3624, 3628H, 3628S, 3683S, 3684S, 3907, 3908, 3911, 3912, 4001, 4701S, 4702, 4703, 4704, 4801, 4803, 4803E, 4805, 4807, 4811, 4812, 4812E, 4815, 4817, 4903, 4907, 4999		

#### union nuts



1

<b>GEV No.</b>	101296	<b>Ref. No.</b>	C5815539
<b>description</b>	union nut thread M12x1 for pipe ø 8mm		
<b>For models:</b>	3300, 3301, 33062		
<b>accessories for</b>	101296		
	<b>GEV No.</b>	101277	<b>Ref. No.</b> C5815549
olive ID ø 8mm Qty 1 pcs			



1

<b>GEV No.</b>	101300	<b>Ref. No.</b>	3782
<b>description</b>	union nut thread M16x1.5 tube ø 10mm		
<b>For models:</b>	3001, 3003, 30032, 3005, 3013, 30132, 3014, 30142, 3015, 3026, 3027, 3027V, 3302, 33025, 3303, 33035, 3304, 3306, 3331, 3401, 3402, 3404S, 3405S, 3411S, 34121S, 3412S-Vers1, 3412S-Vers2, 3413SE1, 34151S, 3415S, 3501, 3501C, 3504, 3511SE1, 3592, 3607, 3611S, 3614S, 3624, 3628H, 3628S, 3683S, 3684S, 3907, 3908, 3911, 3912, 4001, 4404, 4404M...(Other models you can see in the webshop)		
<b>accessories for</b>	101300		
	<b>GEV No.</b>	101278	<b>Ref. No.</b> 3781
olive for pipe ø 10mm Qty 1 pcs			

#### union screws



1

<b>GEV No.</b>	100905	<b>Ref. No.</b>	C5815359
<b>description</b>	locking screw M10x1 for pipe ø 6mm Qty 1 pcs		
<b>For models:</b>	3001, 3003, 3005, 3013, 3014, 3015, 3026, 3027, 3027V, 3302, 33025, 3303, 33035, 3304, 3306, 3331, 3401, 3402, 3404S, 3405S, 3411S, 34121S, 3412S-Vers1, 3412S-Vers2, 3413SE1, 34151S, 3415S, 3501, 3501C, 3504, 3511SE1, 3592, 3607, 3611S, 3614S, 3624, 3628H, 3628S, 3683S, 3684S, 3907, 3908, 3911, 3912, 4437, 4701S, 4702, 4703, 4704, 4801...(Other models you can see in the webshop)		



1

<b>GEV No.</b>	100906	<b>Ref. No.</b>	A1018998
<b>description</b>	screw connection thread M10x1 for ignition electrode brass Qty 1 pcs WS 10		
<b>For models:</b>	3001, 3003, 3005, 3013, 3014, 3026, 3027, 3027V, 3401, 3402, 3501, 3592, 3607, 3611S, 3614S, 3624, 3628H, 3628S, 3683S, 3684S, 3907, 3911, 3912, 4001, 4701S, 4702, 4703, 4704, 4801, 4803, 4803E, 4805, 4807, 4811, 4812, 4812E, 4815, 4817, 4903, 4907, 4999		





1

<b>GEV No.</b>	100907	<b>Ref. No.</b>	A1018996
<b>description</b>	screw connection thread M10x1 Qty 1 pcs type SEF 1 ømm for thermocouple		
<b>For models:</b>	3001, 3003, 3005, 3013, 3014, 3026, 3027, 3027V, 3401, 3402, 3501, 3592, 3607, 3611S, 3614S, 3624, 3628H, 3628S, 3683S, 3684S, 3907, 3908, 3911, 3912, 4001, 4701S, 4702, 4703, 4704, 4801, 4803, 4803E, 4805, 4807, 4811, 4812, 4812E, 4815, 4817, 4903, 4907, 4999		





 <p>1</p>			
<b>GEV No.</b>	100909	<b>Ref. No.</b>	A1018997
<b>description</b>	union screw thread M10x1 for pipe ø 6mm Qty 1 pcs		
<b>For models:</b>	3001, 3003, 3005, 3013, 3014, 3026, 3027, 3027V, 3401, 3402, 3501, 3592, 3607, 3611S, 3614S, 3624, 3628H, 3628S, 3683S, 3684S, 3907, 3908, 3911, 3912, 4001, 4701S, 4702, 4703, 4704, 4801, 4803, 4803E, 4805, 4807, 4811, 4812, 4812E, 4815, 4817, 4903, 4907, 4999		
<b>accessories for</b>	100909		
	<b>GEV No.</b>	100898	<b>Ref. No.</b> —
	olive for pipe ø 6mm Qty 1 pcs for pilot burner		
	<b>GEV No.</b>	101286	<b>Ref. No.</b> —
	olive ID ø 6mm Qty 1 pcs		
	<b>GEV No.</b>	101287	<b>Ref. No.</b> —
	olive for pipe ø 6mm Qty 1 pcs		
	<b>GEV No.</b>	101288	<b>Ref. No.</b> —
	olive for pipe ø 6mm L 6mm aluminium Qty 1 pcs ED ø 8.5mm		

 <p>1</p>			
<b>GEV No.</b>	693142	<b>Ref. No.</b>	7024S001
<b>description</b>	skewer clamp single for skewer 12x12mm mounting pos. outer skewer 75mm skewer ø 4mm		
<b>For models:</b>	5305, 53054, 5310, 53104, 5315, 53154, 5320, 53204, 5330, 53304, 5340, 53404, 5355, 5360, 53604, 5375, 5380, 53804		
<b>accessories for</b>	693142		
	<b>GEV No.</b>	697481	<b>Ref. No.</b> —
	Thumb screw thread M6 thread L 8mm ø 14mm H 6mm SS		

## equipment-specific units

### for chicken rotisserie

#### skewers

 <p>1</p>			
<b>GEV No.</b>	689000	<b>Ref. No.</b>	70290029
<b>description</b>	skewer square L 835mm thickness 12mm		
<b>For models:</b>	5305, 53054, 5310, 53104, 5315, 53154, 5320, 53204, 5330, 53304, 5340, 53404, 5355, 5360, 53604, 5375, 5380, 53804		

#### spit clamp

 <p>1</p>			
<b>GEV No.</b>	693143	<b>Ref. No.</b>	7024D001
<b>description</b>	skewer clamp crimping range 13x13mm <sup>2</sup> double for skewer 12x12mm mounting pos. inner skewer 2x60mm skewer ø 4mm		
<b>For models:</b>	10P, 20P, 30P, 40P, 5305, 53054, 5310, 53104, 5315, 53154, 5320, 53204, 5330, 53304, 5340, 53404, 5355, 5360, 53604, 5375, 5380, 53804		

## handles and hand wheels

### hand wheels

#### hand wheels

 <p>1</p>			
<b>GEV No.</b>	694357	<b>Ref. No.</b>	C6262619
<b>description</b>	hand wheel ø 200mm D1 ø 50mm bore ø 15mm hole ø 7.2mm thread groove widthmm L1 46mm L2 50mm handle length 90mm with folding handle		
<b>For models:</b>	4812, 4812E, 4817		

### bracket handles

 <p>1</p>			
<b>GEV No.</b>	697944	<b>Ref. No.</b>	70491019
<b>description</b>	handle L 150mm H 38mm mounting distance 135mm thread M6 W 30mm black matt		
<b>For models:</b>	5301, 5302, 5305, 53054, 5310, 53104, 5315, 53154, 5320, 53204, 5330, 53304, 5336, 5340, 53404, 5348, 5355, 5360, 53604, 5372, 5375, 5380, 53804, 5396, 5424, 54244, 5436, 54364, 5448, 54484, 5453, 5496, 6190, 6190E1, 9001, 9002, 9003		

hinges

spring assisted hinges

producer-specific

CORECO

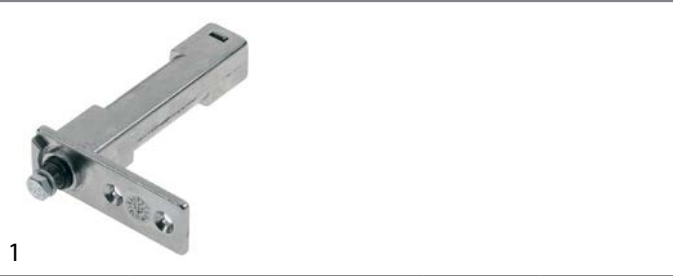

<b>GEV No.</b>	700830	<b>Ref. No.</b>	C6262001
<b>description</b>	spring assisted hinge right/left L 75mm W 26mm H 102mm refrigeration units mounting distance 25mm		
<b>For models:</b>	6190, 6190E1, 7050, 70501, 7052, 706, 7062, 7460, 7464, 7500, 7502, 75021, 7530, 7535, 75351, 9001, 9002, 9003		
<b>accessories for</b>	700830		
	<b>GEV No.</b>	700854	<b>Ref. No.</b> —
	hinge camp type TRB/L1 36mm mounting pos. bottom right L 100mm W 48mm H 17mm zinc die cast, chrome-plated hole distance 6.5x51x28mm shaft diameter torx 12x12mmmm		

FAGOR



<b>GEV No.</b>	700830	<b>Ref. No.</b>	C6262001
<b>description</b>	spring assisted hinge right/left L 75mm W 26mm H 102mm refrigeration units mounting distance 25mm		
<b>For models:</b>	6190, 6190E1, 7050, 70501, 7052, 706, 7062, 7460, 7464, 7500, 7502, 75021, 7530, 7535, 75351, 9001, 9002, 9003		
<b>accessories for</b>	700830		
	<b>GEV No.</b>	700854	<b>Ref. No.</b> —
	hinge camp type TRB/L1 36mm mounting pos. bottom right L 100mm W 48mm H 17mm zinc die cast, chrome-plated hole distance 6.5x51x28mm shaft diameter torx 12x12mmmm		

oven hinges

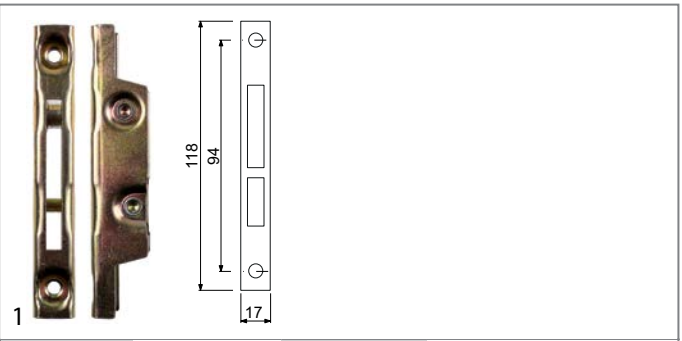

<b>GEV No.</b>	700001	<b>Ref. No.</b>	61980
<b>description</b>	opposite support L 118mm W 17mm mounting distance 94mm		
<b>For models:</b>	3300, 3301, 3302, 33022, 3310, 3401, 3402, 3481, 3483, 3501, 35012, 3592, 3628H, 4001, 4409, 4410, 4815, 4901, 4902, 4903, 4904, 4907, 4908, 4999		

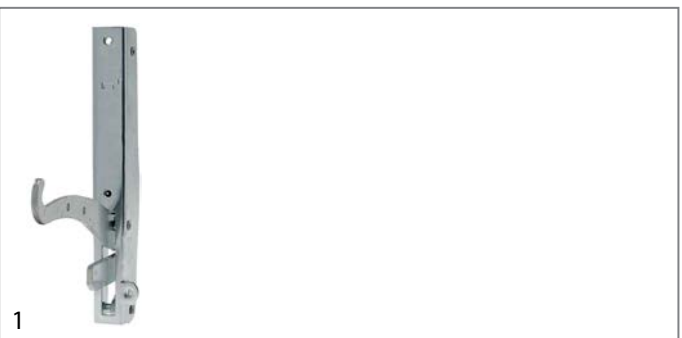

<b>GEV No.</b>	694359	<b>Ref. No.</b>	6160 C6262599
<b>description</b>	oven hinge mounting distance 105mm lever length 129.5mm spring thickness 4mm mounting ear position right L 206mm W 25mm Qty 1 pcs		
<b>For models:</b>	3300, 3302, 33022, 3310, 3401, 3402, 3481, 3483, 3501, 35012, 3592, 3628H, 4001, 4409, 4410, 4815, 4901, 4902, 4903, 4904, 4907, 4908, 4999		

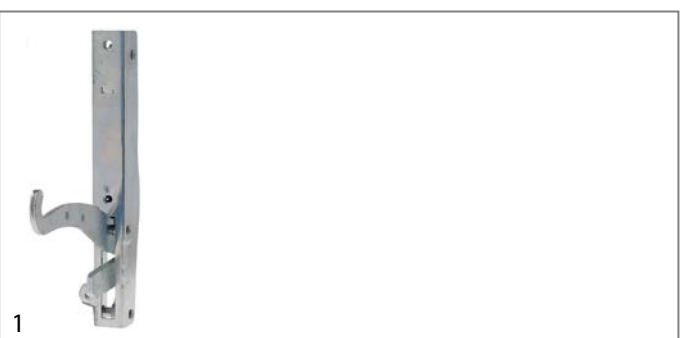



<b>GEV No.</b>	694360	<b>Ref. No.</b>	6163 C6262609
<b>description</b>	oven hinge mounting distance 173mm mounting distance 2 105mm lug mounting 14mm lever length 119mm groove distance 11mm spring thickness 4mm mounting ear position left spring length 111mm L 206mm W 25mm		
<b>For models:</b>	3300, 3302, 33022, 3310, 3401, 3402, 3481, 3483, 3501, 35012, 3592, 3628H, 4001, 4409, 4410, 4815, 4901, 4902, 4903, 4904, 4907, 4908, 4999		



door bearing

			
1			
<b>GEV No.</b>	694358	<b>Ref. No.</b>	C6262002
<b>description</b>	bolt L 25mm W 25mm H 19mm ID ø 7mm for hinge		
<b>For models:</b>	7050, 70501, 7052, 706, 7062, 7460, 7464, 7500, 7502, 75021		

			
1			
<b>GEV No.</b>	694361	<b>Ref. No.</b>	706203P
<b>description</b>	hinge L 100mm W 48mm mounting pos. centre left/right		
<b>For models:</b>	7050, 70501, 7052, 706, 7062, 7460, 7464, 7500, 7502, 75021		

			
1			
<b>GEV No.</b>	694034	<b>Ref. No.</b>	705003P
<b>description</b>	hinge right/left mounting pos. lower for fridge L 130mm W 80mm		
<b>For models:</b>	7050, 70501, 7052, 706, 7062, 7460, 7464, 7500, 7502, 75021, 7530, 7535, 75351		

			
1			
<b>GEV No.</b>	694033	<b>Ref. No.</b>	706003P
<b>description</b>	hinge right/left mounting pos. upper for fridge L 130mm W 80mm		
<b>For models:</b>	7050, 70501, 7052, 706, 7062, 7460, 7464, 7500, 7502, 75021, 7530, 7535, 75351, 9001, 9002, 9003		

fittings for catering equipment

lid hinges

type RUBINETTERIE DEL FRIULI

for square and rectangular lids

spare parts

			
1			
<b>GEV No.</b>	540848	<b>Ref. No.</b>	C6260349
<b>description</b>	torsion spring ø 43mm wire gauge ø 5mm L1 25mm L2 90mm L3 25mm mounting pos. left		
<b>For models:</b>	4801, 4803, 4803E, 4805, 4807, 4808, 4811, 4812, 4812E, 4817		

			
1			
<b>GEV No.</b>	540849	<b>Ref. No.</b>	C6260339
<b>description</b>	torsion spring ø 43mm wire gauge ø 5mm L1 25mm L2 90mm L3 25mm mounting pos. right		
<b>For models:</b>	4801, 4803, 4803E, 4805, 4807, 4808, 4811, 4812, 4812E, 4817		

miscellaneous

spare parts

			
1			
<b>GEV No.</b>	514418	<b>Ref. No.</b>	C6260239
<b>description</b>	adjusting bush ID ø 47mm ED ø 50mm L 63.5mm		
<b>For models:</b>	4801, 4803, 4803E, 4805, 4807, 4808, 4811, 4812, 4812E, 4817		

			
1			
<b>GEV No.</b>	514194	<b>Ref. No.</b>	481240P
<b>description</b>	bracket for lid hinge ID ø 50mm H 89mm		
<b>For models:</b>	4812, 4812E, 4817		



1

<b>GEV No.</b>	514193	<b>Ref. No.</b>	480340P
<b>description</b>	bracket for lid hinge ID $\varnothing$ 51mm H 185mm		
<b>For models:</b>	4801, 4803, 4803E, 4805, 4807, 4808, 4811		

## gaskets

### refrigeration gaskets

#### plug-in gaskets

#### profile 9798

We offer custom-made gaskets for this profile

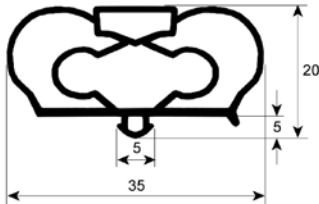

1

<b>GEV No.</b>	901349	<b>Ref. No.</b>	705226P
<b>description</b>	refrigeration gasket profile 9798 W 602mm L 704mm plug size		
<b>For models:</b>	7050, 70501, 7052, 706, 7062, 7460, 7464, 7500, 7502, 75021		

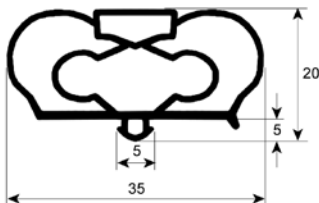

1

<b>GEV No.</b>	901350	<b>Ref. No.</b>	746226P
<b>description</b>	refrigeration gasket profile 9798 W 604mm L 1492mm plug size		
<b>For models:</b>	7460, 7464, 7500, 7502, 75021, 7530, 7535, 75351		

## gaskets for heated units

### door seals

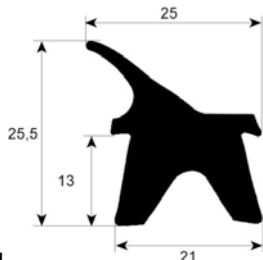

1

<b>GEV No.</b>	901347	<b>Ref. No.</b>	490326P
<b>description</b>	door seal profile 2402 W 350mm L 575mm external size Qty 1		
<b>For models:</b>	3300, 3301, 3302, 33022, 3310, 3401, 3402, 3481, 3483, 3501, 35012, 4409, 4410, 4815, 4901, 4902, 4903, 4904, 4907, 4908		

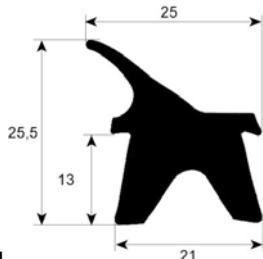

1

<b>GEV No.</b>	901348	<b>Ref. No.</b>	499926P
<b>description</b>	door seal profile 2402 W 350mm L 985mm external size Qty 1		
<b>For models:</b>	3402, 3592, 3628H, 4999		

## O-rings

### EPDM

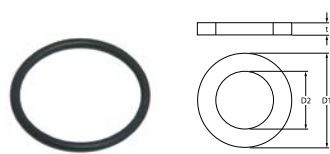



1

<b>GEV No.</b>	100809	<b>Ref. No.</b>	3785
<b>description</b>	O-ring EPDM thickness 2mm ID $\varnothing$ 21mm Qty 1 pcs		
<b>For models:</b>	3001, 3003, 3005, 3026, 3027, 3027V, 3401, 3402, 3501, 3592, 3607, 3611S, 3614S, 3624, 3628H, 3628S, 3683S, 3684S, 3907, 3908, 4812, 4812E, 4815, 4817, 4903, 4907, 4999		





## springs

### torsion springs

			
1			
<b>GEV No.</b>	692179	<b>Ref. No.</b>	6409
<b>description</b>	torsion spring ø 22.3mm L2 45mm wire gauge ø 4.5mm mounting pos. left L1 45mm L3 52mm Qty 1 pcs		
<b>For models:</b>	4401, 4462		
<b>accessories for</b>	692179		
	<b>GEV No.</b>	<b>Ref. No.</b>	
	692178	6407	
	torsion spring ø 22.3mm L2 45mm wire gauge ø 4.5mm mounting pos. right L1 45mm L3 52mm Qty 1 pcs		

			
1			
<b>GEV No.</b>	692178	<b>Ref. No.</b>	6407
<b>description</b>	torsion spring ø 22.3mm L2 45mm wire gauge ø 4.5mm mounting pos. right L1 45mm L3 52mm Qty 1 pcs		
<b>For models:</b>	4401, 4462		
<b>accessories for</b>	692178		
	<b>GEV No.</b>	<b>Ref. No.</b>	
	692179	6409	
	torsion spring ø 22.3mm L2 45mm wire gauge ø 4.5mm mounting pos. left L1 45mm L3 52mm Qty 1 pcs		

			
1			
<b>GEV No.</b>	697943	<b>Ref. No.</b>	440196P
<b>description</b>	torsion spring ø 26mm wire gauge ø 4.5mm folding grill		
<b>For models:</b>	4401		

			
1			
<b>GEV No.</b>	540848	<b>Ref. No.</b>	C6260349
<b>description</b>	torsion spring ø 43mm wire gauge ø 5mm L1 25mm L2 90mm L3 25mm mounting pos. left		
<b>For models:</b>	4801, 4803, 4803E, 4805, 4807, 4808, 4811, 4812, 4812E, 4817		

			
1			
<b>GEV No.</b>	540849	<b>Ref. No.</b>	C6260339
<b>description</b>	torsion spring ø 43mm wire gauge ø 5mm L1 25mm L2 90mm L3 25mm mounting pos. right		
<b>For models:</b>	4801, 4803, 4803E, 4805, 4807, 4808, 4811, 4812, 4812E, 4817		

## fastening material

### screws

<h4>flat-headed bolts</h4>			
			
1			
<b>GEV No.</b>	101516	<b>Ref. No.</b>	1051
<b>description</b>	flat-headed bolt thread M4 thread L 16mm SS DIN 7985/ISO 7045 Qty 1 pcs		
<b>For models:</b>	3001, 3003, 3005, 3026, 3027, 3027V, 3331, 3401, 3402, 3411S, 34121S, 3412S-Vers1, 3412S-Vers2, 3413SE1, 34151S, 3415S, 3501, 3592, 3607, 3611S, 3614S, 3624, 3628H, 3628S, 3683S, 3684S, 3907, 3908, 4812, 4812E, 4815, 4817, 4903, 4907, 4999		

### nuts

<h4>hexagonal nuts</h4>			
<h4>hexagonal nuts metric (without norm)</h4>			
			
1			
<b>GEV No.</b>	102680	<b>Ref. No.</b>	C5815299
<b>description</b>	nut thread M6x0.75 H 2.6mm WS 8 brass Qty 1 pcs type SEF 2		
<b>For models:</b>	3401, 3402, 3501, 3504, 3592, 4001		

			
1			
<b>GEV No.</b>	102067	<b>Ref. No.</b>	C5811029
<b>description</b>	nut thread M8x1 H 3mm brass Qty 1 pcs type SEF 1		
<b>For models:</b>	30152, 3300, 3301, 33022, 33042, 33052, 33062, 33092, 35012, 4402, 4402M, 4403, 4403M, 4404, 4404M, 4405, 4405M, 4410, 4411, 4412, 4413, 44138, 4416, 4417, 4422, 4423, 4424, 4425, 4442, 4443, 4444, 4445, 4462, 4471, 4472, 4473, 5305, 53054, 5310, 53104, 5315, 53154, 5320, 53204, 5330, 53304, 5336, 5340, 53404, 5348...(Other models you can see in the webshop)		



**C**

cam switches	6
capillary tube clips	6
ceramic burners	15
ceramic heaters	4
coil heating elements	4
contactors	7
control thermostats	5,5

**D**

door seals	20
------------	----

**E**

electronic controllers	7
energy regulators	5

**F**

fastening material	21
flat-headed bolts	21
foil heating elements	4

**G**

gas burners	14
gas control valves	10
gas nozzles	15
gas taps	8
gas thermostats	9
gaskets for heated units	20

**H**

heating elements	3
heating elements for fryers	3
heating elements for griddles	3
heating elements for heated cabinets	4
heating elements for ovens	3
heating elements for pizza ovens	3
hexagonal nuts	21
hob burners	14
hot plates	4

**I**

ignition cables	11
indicator lights	6
indicator lights (complete)	6

**L**

lamps	6
light bulbs	7

**M**

motors	7
--------	---

**N**

nuts	21
------	----

**O**

O-rings	20
oven hinges	18
oven lamps	7

**P**

piezoelectric igniters	11
pilot burners	10
plug-in gaskets	20

**R**

radiation heaters	4
refrigeration gaskets	20
rocker/momentary rocker switches	6

**S**

safety thermostats	5
screws	21
spring assisted hinges	18
switches and momentary switches	6

**T**

thermocouples	12
thermostats	5
tube burners	15