



GAS COMPONENTS



ELECTRIC COMPONENTS



WATER TECHNOLOGY



MECHANICAL COMPONENTS



TOOLS

Spare parts suitable for

CORECO

Find the complete and up-to-date range of products in our GEV Webshop



Manufacturer catalogue

The most important spare parts and accessories arranged clearly for every manufacturer

- ✓ Complete product range and all appliance data always up to date in the GEV Webshop
- ✓ Alphabetical Index at the end of the catalogue

GEV Webshop

www.gev-online.co.uk

www.gev-online.com



- 🔍 Add to Favourites
- 🔍 Sign In with email address and usual password
- 🔍 Easy-order – place several items in your basket at the same time
- 🔍 Quick Item search – no login needed



heating elements

heating elements for refrigeration

heating elements for defrosting



GEV No.	417527	Ref. No.	6021250021
description	heating element 350W 230V L 380mm W 115mm H 12mm cable length 1000mm tube ø 8.5mm defrosting connection with cable		

thermostats

refrigeration thermostats

RANCO

K50 series

RANCO



GEV No.	390427 ¹	Ref. No.	6021350023
description	thermostat RANCO type K50L3389 capillary pipe 1200mm		

¹incl. knob

switches and momentary switches

microswitches

with push button

switches with snap-fit



GEV No.	346772	Ref. No.	6010310010 6021130012
description	microswitch with push button 250V 5A 1CO connection male faston 4.8mm L 24x27mm ambient temperature max. 85°C actuating force: 160g		

lamps

indicator lights

indicator lights (complete)

26.5x25.6mm



GEV No.	357173	Ref. No.	6010310011 6021130013
description	indicator light mounting measurements 27.8x25mm red 230V connection male faston 6.3mm temp.-resist. 125°C		

electronic controllers

CAREL

refrigeration controllers

built-in version



GEV No.	378544	Ref. No.	6010370020 6021350097 6021350098
description	electronic controller CAREL 71x29 mounting measurements 71x29mm 230V voltage AC NTC relay outputs 1 CO-12A(2) NTC NTC DI X with probe and fastening material display 3 digits		



GEV No.	378527	Ref. No.	6021350106
description	electronic controller CAREL PYC01L051G mounting measurements 71x29mm built-in depth 74mm 230V voltage AC NTC relay outputs 1 CO-12A(2) NTC NTC DI yes protection IP54 -50 up to +90°C display 3½ digits		



DIXELL

refrigeration controllers

built-in version



1

GEV No.	378526	Ref. No.	6021350114
description	electronic controller DIXELL mounting measurements 30x150mm built-in depth 42mm 230V voltage AC NTC relay outputs 3 NO-16A(8) NO-5A NO-8(3) NTC DI DI incl. probe -40 up to 110°C display 2.5		





ELIWELL

refrigeration controllers

built-in version



1

GEV No.	379645	Ref. No.	6021350015 6021350018
description	electronic controller ELIWELL type ID961 mounting measurements 71x29mm 230V voltage AC NTC/PTC relay outputs 1 relay -55 up to +150°C display 3½ digits compressor relay 15A		
accessories for	379645		
	GEV No.	379053	Ref. No. —
	temperature probe PTC 1kOhm cable PVC probe -50 up to +150°C cable -10 up to 100°C probe ø6x30mm cable length 3m without screw connection 2-wire		
	GEV No.	379064	Ref. No. —
	temperature probe PTC 1kOhm cable silicone probe -50 up to +150°C cable -50 up to +180°C probe ø6x40mm cable length 3m without screw connection 2-wire		
	GEV No.	379161	Ref. No. —
	temperature probe NTC 10kOhm cable thermoplastic probe -40 up to +110°C cable -40 up to +110°C probe ø6x14mm cable length 3m without screw connection 2-wire		
	GEV No.	379782	Ref. No. —
	temperature probe PTC 1kOhm cable thermoplastic probe -50 up to +150°C cable -40 up to +110°C probe ø6x14mm cable length 3m 2-wire resistor 1kOhm		

probes

universal probes

temperature probes



GEV No.	379630	Ref. No.	6021350083
description	temperature probe NTC 10kOhm cable thermoplastic probe -40 up to +110°C cable -40 up to +110°C probe ø6x14mm cable length 2.5m without screw connection 2-wire resistor 10kOhm		

compressors

SECOP DANFOSS

R134A

MBP monophase

Medium evaporation temperature above -20°C



1

GEV No.	605063	Ref. No.	6021010184
description	compressor coolant R134a type NL7.3MF 220-240V 50/60Hz MBP fully hermetic 10.5kg 1/5HP power input 298W cylinder capacity 7.27cm ³ RSIR/CSIR H 197mmWW 198W 261W 336W 425W 530W 652W 794W test method ASHRAE (50Hz)		
spare parts for	605063		
	GEV No.	381528	Ref. No. —
	start relay DANFOSS 117U6016 HST		



HMBP monophase

High/Medium evaporation temperature above -20/-15 °C



GEV No.	605088	Ref. No.	6010010006 6021010004
description	compressor coolant R134a type FR7.5G 220-240V 50Hz HMBP fully hermetic 10.6kg 1/5HP power input 175W cylinder capacity 6.93cm ³ RSIR/CSIR H 196mm 62W 99W 142W 193W 254W 325W 408W 505W 618W test method ASHRAEW		



GEV No.	605193	Ref. No.	6021010142
description	compressor coolant R134a type NL11MF 220-240V 50Hz HMBP 10.5kg 1/3HP cylinder capacity 11.15cm ³ RSIR/CSIR H 203mmWW 321W 418W 534W 670W 832W 1020W 1239W test method ASHRAE		
spare parts for	605193		
	GEV No.	Ref. No.	—
	start relay DANFOSS 117U6022 HST		

R404a/R507

LBP monophase

Lower evaporation temperature below -20°C



GEV No.	605179	Ref. No.	6021010173
description	compressor coolant R404a/R507 type SC10CLX 220-240V 50Hz LBP 13.1kg 1/3HP cylinder capacity 10.29cm ³ CSIR H 209mm 300W 424W 569W 737W 932W 1154W		
spare parts for	605179		
	GEV No.	Ref. No.	—
	start relay DANFOSS 117U6003 HST		



GEV No.	605057	Ref. No.	6021010001
description	compressor coolant R404a/R507 type SC12CL 220-240V 50Hz LBP fully hermetic 12.5kg 3/8HP cylinder capacity 12.87cm ³ CSIR H 209mm 410W 568W 754W 971W 1220W 1505W test method ASHRAE		
spare parts for	605057		
	GEV No.	Ref. No.	—
	start relay DANFOSS 117U6005 HST		



fans

refrigeration fans

cooling motors (complete)



1

GEV No.	601394	Ref. No.	6021050004
description	fan 230V 5W 50/60Hz fan wheel ø 200mm shaft L 12mm feet depth 71mm L 60mm W 83mm H 83mm blade angle 28° connection cable 500mm		



1

GEV No.	601693	Ref. No.	12033477 6001506002 6021050002
description	fan motor 230V 10W 50/60Hz fan wheel ø 254mm feet depth 85mm W 84mm 1300rpm		

cross flow fans

COPREL

with standard coil



1

GEV No.	602155	Ref. No.	6021050037
description	cross flow fan COPREL FFR roller ø 60mm roller length 180mm laminated core thickness 20mm motor position right 230V 50/60Hz 25W universal bearing silicone connection male faston 6.3mm coil type airflow 144m³/h -10 up to +50°C		

electric accessories

cables

accessories

cable glands

cable glands



1

GEV No.	551102	Ref. No.	6003010082
description	cable gland ID ø 10mm mounting ø 12mm Neoprene -30 up to +120°C Qty 1 pcs		

equipment-specific units

for fridges

spare parts and accessories



1

GEV No.	700814	Ref. No.	6003010020
description	bracket for grate for fridge for refrigerated counters plastic		



1

GEV No.	698845	Ref. No.	6003010484
description	protection cap L 15mm W 15mm H 4mm		

miscellaneous



1

GEV No.	692163	Ref. No.	6010520189
description	hinge for fridge mounting pos. left plastic		



1

GEV No.	692164	Ref. No.	6010520188
description	hinge for fridge mounting pos. right plastic		



for blast chiller



1			
GEV No.	698847	Ref. No.	6003010326
description	drain pipe ø 40mm H 95mm 3/4"		

for refrigerated counters

spare parts and accessories



1			
GEV No.	700814	Ref. No.	6003010020
description	bracket for grate for fridge for refrigerated counters plastic		





1			
GEV No.	699229	Ref. No.	6000202215 6003010034
description	drain pipe H 29.5mm ø 29.5mm L 29.5mm		

doors



1			
GEV No.	694309	Ref. No.	M169010084
description	door W 630mm H 435mm thickness 40mm		
accessories for	694309		
	GEV No.	690763	Ref. No. 6033010100
	spring assisted hinge right/left L 111mm W 75mm refrigerator mounting distance 25mm		

accessories for	694309		
	GEV No.	690764	Ref. No. —
	bush W 23.5mm H 53.5mm mounting pos. upper/lower ø 16mm ID ø 10mm grey for hinge		
	GEV No.	901164	Ref. No. 6045010119
	refrigeration gasket profile 9797 W 365mm L 560mm plug size		

for display coolers

housing and bezels



1			
GEV No.	698844	Ref. No.	6003010483
description	bezel for protection L 40mm W 15mm		





locks

edgemoount latches

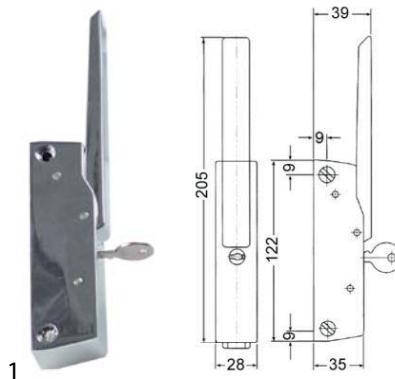
handle latches

CAFF/FERMOD



1			
GEV No.	700556	Ref. No.	6033010007
description	catch L 122mm mounting distance 104mm lockable refrigeration units G 885 W 28mm handle length 135mm overall height 205mm		
accessories for	700556		
	GEV No.	690418	Ref. No. —
	door catch L 36mm W 19mm H 29mm mounting distance 12mm zinc-coated steel for refrigeration units		
	GEV No.	690419	Ref. No. —
	door catch L 52mm W 20mm H 30mm mounting distance 26-37mm zamak for refrigeration units		
	GEV No.	700061	Ref. No. —
	door catch L 58mm W 20mm H 35mm mounting distance 42mm chrome-plated brass for headed units		
	GEV No.	700435	Ref. No. —
	door catch L 58mm W 20mm H 35mm mounting distance 42mm zamak for refrigeration units		



hinges

spring assisted hinges



producer-specific

CORECO





GEV No.	692433	Ref. No.	M169090003 M169090003+6033010098+4x600301009
description	spring assisted hinge complete mounting pos. left		
spare parts for	692433		
	GEV No.	691738	Ref. No. 603301009
	hinge L 100mm W 48mm mounting pos. left thickness 5mm for door for refrigerated counters		
	GEV No.	692602	Ref. No. 6003010486
	base plate L 100mm W 17mm H 1.5mm mounting distance 28/51mm		



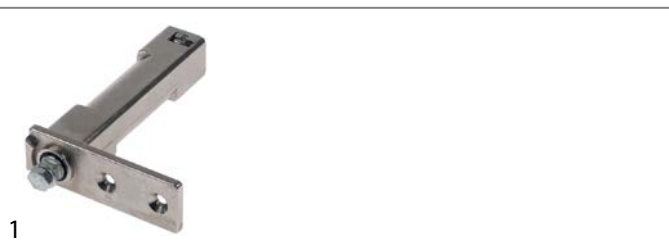

GEV No.	692449	Ref. No.	M169090004
description	spring assisted hinge complete mounting pos. right		
spare parts for	692449		
	GEV No.	691737	Ref. No. M19090004
	hinge L 100mm W 48mm mounting pos. right thickness 5mm for door for refrigerated counters		
	GEV No.	692602	Ref. No. 6003010486
	base plate L 100mm W 17mm H 1.5mm mounting distance 28/51mm		



GEV No.	690763	Ref. No.	6033010100
description	spring assisted hinge right/left L 111mm W 75mm refrigerator mounting distance 25mm		
accessories for	690763		
	GEV No.	691738	Ref. No. 6033010098
	hinge L 100mm W 48mm mounting pos. left thickness 5mm for door for refrigerated counters		
	GEV No.	701161	Ref. No. 6033010130
	hinge camp mounting pos. bottom right L 100mm W 48mm H 17mm shaft diameter 8x8mm		

FAGOR



GEV No.	690763	Ref. No.	6033010100
description	spring assisted hinge right/left L 111mm W 75mm refrigerator mounting distance 25mm		
accessories for	690763		
	GEV No.	691738	Ref. No. 6033010098
	hinge L 100mm W 48mm mounting pos. left thickness 5mm for door for refrigerated counters		
	GEV No.	701161	Ref. No. 6033010130
	hinge camp mounting pos. bottom right L 100mm W 48mm H 17mm shaft diameter 8x8mm		

door bearing



GEV No.	692602	Ref. No.	6003010486
description	base plate L 100mm W 17mm H 1.5mm mounting distance 28/51mm		

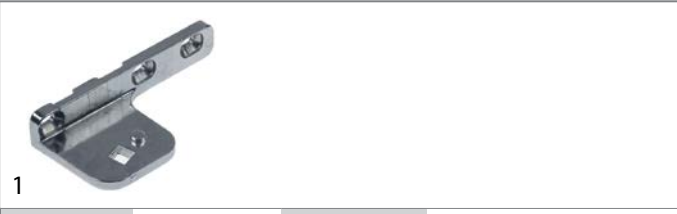

GEV No.	691738	Ref. No.	6033010098
description	hinge L 100mm W 48mm mounting pos. left thickness 5mm for door for refrigerated counters		





GEV No.	691737	Ref. No.	M19090004
description	hinge L 100mm W 48mm mounting pos. right thickness 5mm for door for refrigerated counters		



GEV No.	701161	Ref. No.	6033010130
description	hinge camp mounting pos. bottom right L 100mm W 48mm H 17mm shaft diameter 8x8mm		



			
1			
GEV No.	700854	Ref. No.	6033010084
description	hinge camp type TRB/L1 36mm mounting pos. bottom right L 100mm W 48mm H 17mm zinc die cast, chrome-plated hole distance 6.5x51x28mm shaft diameter torx 12x12mmmm		

			
1			
GEV No.	700855	Ref. No.	6033010083
description	hinge camp type TRB/R1 36mm mounting pos. bottom left L 100mm W 48mm H 17mm zinc die cast, chrome-plated hole distance 6.5x51x28mm shaft diameter torx 12x12mmmm		

pullouts

drawer slides

			
1			
GEV No.	696478	Ref. No.	6033050006
description	drawer slide L 550mm W 17mm H 60mm pair		

equipment feet and end caps

equipment feet

with fixing plate

			
1			
GEV No.	701100	Ref. No.	12009104 12033566 6007050017 X260151 X260151000
description	equipment foot tube ø 64mm plate size 82x82mm hole distance 65x65mm H 135-200mm SS size 2 1/2" Qty 1 pcs		

screw-in feet

			
1			
GEV No.	510115	Ref. No.	6003010275
description	equipment foot thread M10 thread L 40mm ø 30mm H 10mm Qty 1 pcs		
For models:	RVCS1000		

end caps and plugs

for circular pipes

			
1			
GEV No.	698846	Ref. No.	6003010262
description	plug ø 20.5mm H 23.5mm Qty 1 pcs		

shelves and shelf rails

grates

universal

without upstand

			
1			
GEV No.	698836	Ref. No.	6027010003
description	grate W 325mm D 530mm GN 1/1 H 10mm plastic-coated steel wire gauge frame 8mm lengthwise wires gauge 3mm crossing wires 2 grey		

			
1			
GEV No.	698837	Ref. No.	6027010087
description	grate W 560mm D 540mm H 10mm wire gauge frame 8mm lengthwise wires gauge 3.5mm crossing wires 3 grey		



1

GEV No.	698838	Ref. No.	6027010009
description	grate W 650mm D 530mm GN 2/1 H 10mm wire gauge frame 8mm lengthwise wires gauge 3mm crossing wires 2 grey		

shelf rails and supports

producer-specific



1

GEV No.	692664	Ref. No.	6033210017
description	guide L 329mm W 17mm H 17mm mounting pos. left/right		



1

GEV No.	701568	Ref. No.	6033050015
description	guide L 562mm W 16mm H 25.5mm mounting pos. left/right		



1

GEV No.	692110	Ref. No.	6009990002 6009990037 6033050011
description	guide U-shape L 549mm W 15mm H 22mm mounting pos. left/right		



1

GEV No.	692662	Ref. No.	6033050028
description	pair of setting bar L 549mm W 15mm H 24mm mounting pos. left/right		



1

GEV No.	692660	Ref. No.	6033050027
description	pair of setting bar L 562mm W 15mm mounting pos. left/right mounting distance 525mm hook width 12mm inner height 24mm		



1

GEV No.	692661	Ref. No.	6033050029
description	pair of setting bar L 613mm W 15mm H 24mm mounting pos. left/right		



1

GEV No.	692663	Ref. No.	6033050025
description	pair of setting bar L 662mm W 15mm H 24mm mounting pos. left/right		



1

GEV No.	700815	Ref. No.	12037855 12090875 2021500320 6003010124
description	shelf support for grate L 26mm W 20mm H 23mm plastic for fridge		



1

GEV No.	698843	Ref. No.	6033210019
description	shelf support L 42mm W 22mm H 27mm		

gaskets

refrigeration gaskets

plug-in gaskets

profile 9013

We offer custom-made gaskets for this profile

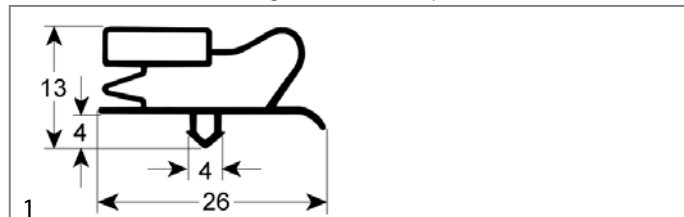

GEV No.	901764	Ref. No.	6045010028
description	refrigeration gasket profile 9013 W 1503mm L 685mm plug size		

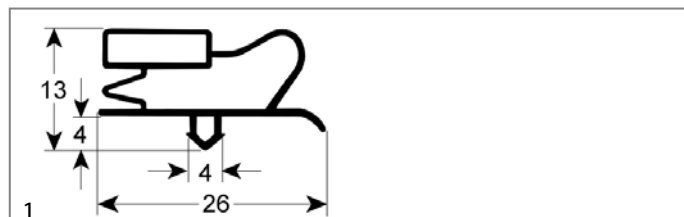

GEV No.	900902	Ref. No.	6010220024 6045010020
description	refrigeration gasket profile 9013 W 155mm L 375mm plug size		

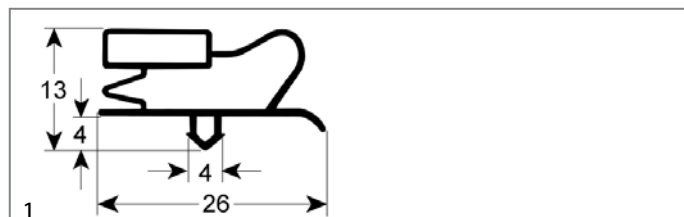

GEV No.	901529	Ref. No.	6045010122
description	refrigeration gasket profile 9013 W 245mm L 370mm plug size		

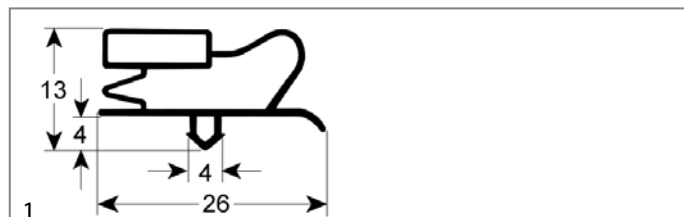

GEV No.	900880	Ref. No.	6010520181 6045010012
description	refrigeration gasket profile 9013 W 255mm L 375mm plug size		

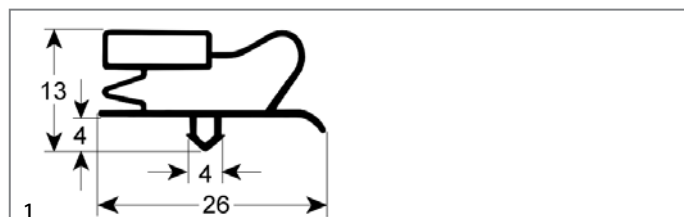

GEV No.	901180	Ref. No.	6010220028 6045010006
description	refrigeration gasket profile 9013 W 380mm L 585mm plug size		

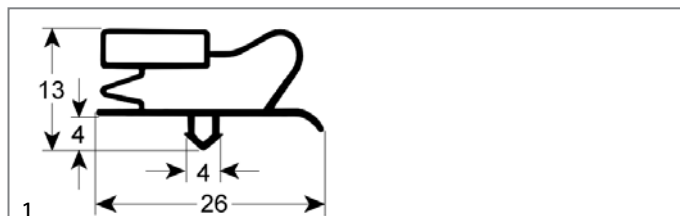

GEV No.	900893	Ref. No.	6045010009
description	refrigeration gasket profile 9013 W 450mm L 580mm plug size		

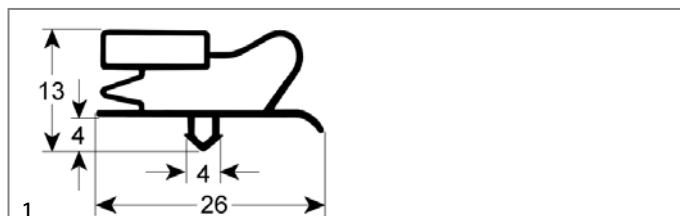

GEV No.	900907	Ref. No.	6045010018
description	refrigeration gasket profile 9013 W 455mm L 770mm plug size		

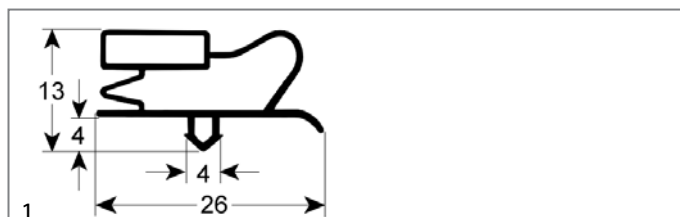

GEV No.	900028	Ref. No.	6010220002 6045010002
description	refrigeration gasket profile 9013 W 618mm L 1500mm plug size door		

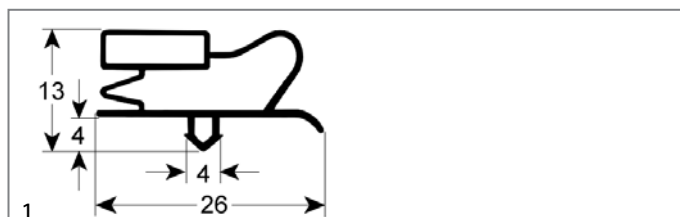

GEV No.	901580	Ref. No.	6010220007 6045010033
description	refrigeration gasket profile 9013 W 618mm L 722mm plug size with magnet		

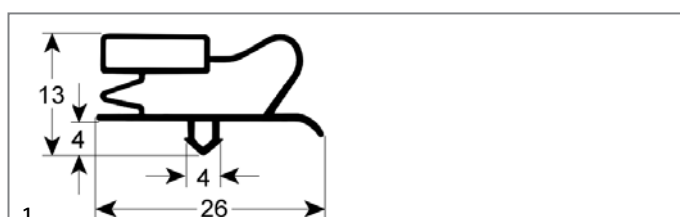

GEV No.	902028	Ref. No.	N/A
description	refrigeration gasket profile 9013 Wmm L 2500mm		

profile 9797

We offer custom-made gaskets for this profile

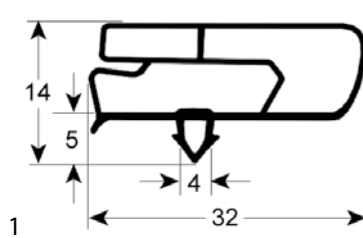

GEV No.	901763	Ref. No.	6045010131
description	refrigeration gasket profile 9797 W 1435mm L 615mm plug size		

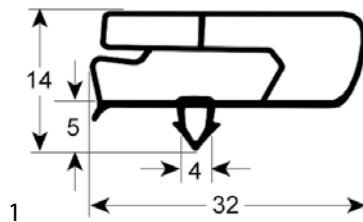

GEV No.	901757	Ref. No.	6045010142
description	refrigeration gasket profile 9797 W 1455mm L 710mm plug size		

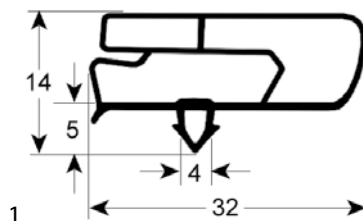

GEV No.	901759	Ref. No.	6010220050 6045010050
description	refrigeration gasket profile 9797 W 1680mm L 580mm plug size		

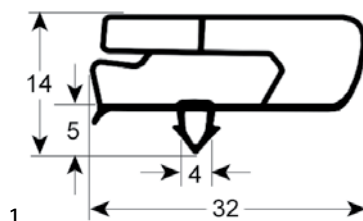

GEV No.	901758	Ref. No.	6045010128
description	refrigeration gasket profile 9797 W 1755mm L 705mm plug size		

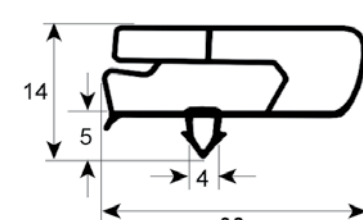

GEV No.	901181	Ref. No.	6045010120
description	refrigeration gasket profile 9797 W 350mm L 370mm plug size		

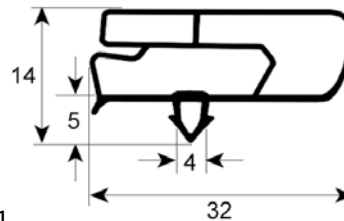

GEV No.	901164	Ref. No.	6045010119
description	refrigeration gasket profile 9797 W 365mm L 560mm plug size		

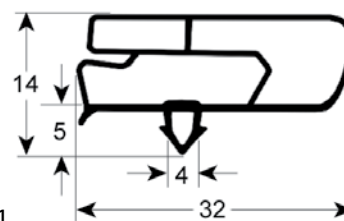

GEV No.	901750	Ref. No.	6045010121
description	refrigeration gasket profile 9797 W 375mm L 140mm plug size		

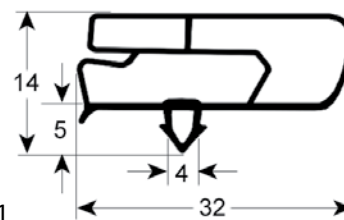

GEV No.	901832	Ref. No.	450100016
description	refrigeration gasket profile 9797 W 385mm L 1465mm plug size L1 1490mm W1 410mm external size suitable for CORECO		

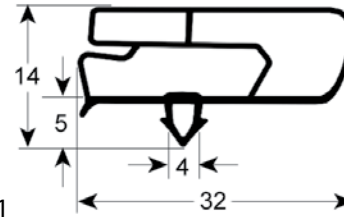

GEV No.	901825	Ref. No.	6045010117
description	refrigeration gasket profile 9797 W 435mm L 135mm plug size L1 160mm W1 460mm external size suitable for CORECO		

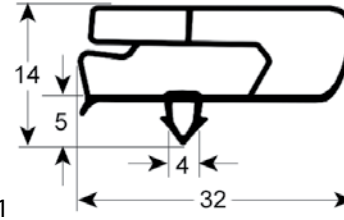

GEV No.	901826	Ref. No.	6045010116
description	refrigeration gasket profile 9797 W 435mm L 345mm plug size L1 370mm W1 460mm external size suitable for CORECO		

GEV No.	901530	Ref. No.	6045010115
description	refrigeration gasket profile 9797 W 440mm L 560mm plug size		

GEV No.	901752	Ref. No.	6045010032
description	refrigeration gasket profile 9797 W 515mm L 440mm plug size		

GEV No.	901754	Ref. No.	6045010124
description	refrigeration gasket profile 9797 W 440mm L 755mm plug size		

GEV No.	901755	Ref. No.	6045010164
description	refrigeration gasket profile 9797 W 525mm L 1325mm plug size		

GEV No.	901751	Ref. No.	6045010118
description	refrigeration gasket profile 9797 W 445mm L 246mm plug size		

GEV No.	901756	Ref. No.	6045010149
description	refrigeration gasket profile 9797 W 525mm L 475mm plug size		

GEV No.	901828	Ref. No.	450100017
description	refrigeration gasket profile 9797 W 465mm L 1465mm plug size L1 1490mm W1 490mm external size suitable for CORECO		

GEV No.	901824	Ref. No.	6045010167
description	refrigeration gasket profile 9797 W 525mm L 615mm plug size L1 640mm W1 550mm external size suitable for CORECO		

GEV No.	901829	Ref. No.	450100018
description	refrigeration gasket profile 9797 W 473mm L 690mm plug size		

GEV No.	901827	Ref. No.	450100005
description	refrigeration gasket profile 9797 W 555mm L 1365mm plug size L1 1490mm W1 580mm external size suitable for CORECO		

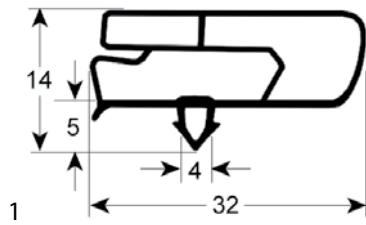

GEV No.	901830	Ref. No.	450100014
description	refrigeration gasket profile 9797 W 555mm L 680mm plug size L1 705mm W1 580mm external size suitable for CORECO		

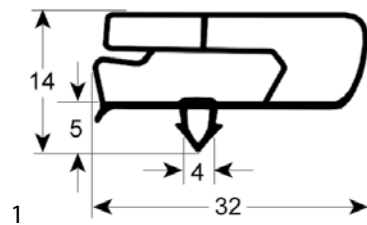

GEV No.	901831	Ref. No.	450100015
description	refrigeration gasket profile 9797 W 725mm L 1465mm plug size L1 1490mm W1 740mm external size suitable for CORECO		

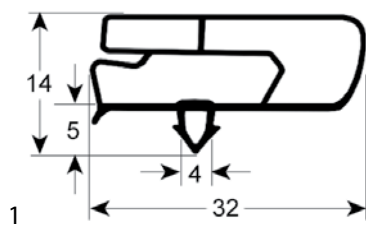

GEV No.	901753	Ref. No.	6045010154
description	refrigeration gasket profile 9797 W 565mm L 440mm plug size		

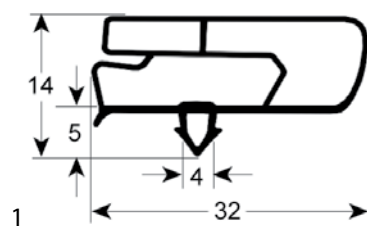

GEV No.	901761	Ref. No.	6045010053
description	refrigeration gasket profile 9797 W 745mm L 400mm plug size		

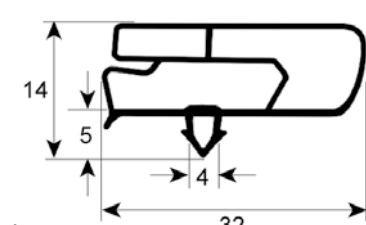

GEV No.	900905	Ref. No.	6045010030
description	refrigeration gasket profile 9797 W 610mm L 1500mm plug size L1 1520mm W1 630mm external size		

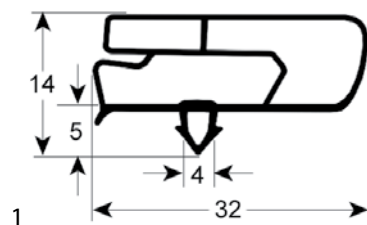

GEV No.	901762	Ref. No.	6045010062
description	refrigeration gasket profile 9797 W 745mm L 555mm plug size		

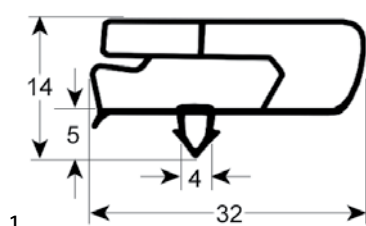

GEV No.	901695	Ref. No.	6045010190
description	refrigeration gasket profile 9797 W 615mm L 1490mm plug size external size 636x1506mm		

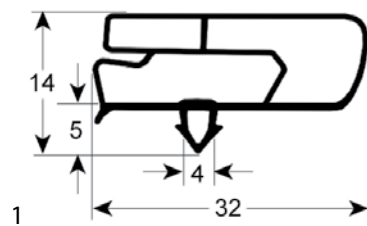

GEV No.	901760	Ref. No.	6045010054
description	refrigeration gasket profile 9797 W 805mm L 460mm plug size		

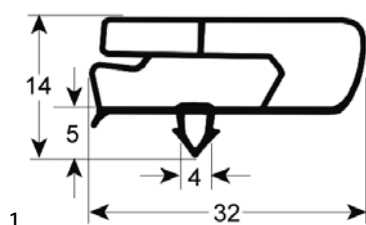

GEV No.	901601	Ref. No.	6045010132
description	refrigeration gasket profile 9797 W 615mm L 670mm plug size		

refrigeration cycle components

filter driers

miscellaneous



GEV No.	750119	Ref. No.	6010270002 6047010003
description	dryer size 40g ø 24mm L 167mm connection 6,3/6,3mm		



evaporators

for fridges

producer-specific



1

GEV No.	750399	Ref. No.	6029010140
description	evaporator L 330mm W 125mm H 90mm total length 535mm overall width 130mm overall height 93mm connection 12mm suitable for FAGOR		



1

GEV No.	750388	Ref. No.	6029010143
description	evaporator L 405mm W 405mm H 125mm complete with fan		

for saladettes

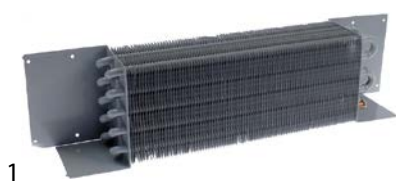

1

GEV No.	750614	Ref. No.	6010030043
description	evaporator L 385mm W 130mm D 90mm H 90mm total length 540mm overall width 130mm overall height 90mm mounting distance 1 530mm mounting distance 2 420mm		

evaporation and condensing trays

miscellaneous



1

GEV No.	750281	Ref. No.	6003050002
description	evaporation tray L 476mm W 427mm H 100mm		

coffee accessories

coffee grounds drawers



1

GEV No.	698839	Ref. No.	6009990065
description	coffee drawer bar ø 35mm L 375mm		

C

cable glands	6, 6
cables	6
coffee grounds drawers	15
compressors	4
cross flow fans	6

E

edgemount latches	7
electric accessories	6
electronic controllers	3
end caps and plugs	9
evaporators	15

F

fans	6
filter driers	14

G

grates	9
--------	---

H

handle latches	7
heating elements	3
heating elements for defrosting	3
heating elements for refrigeration	3

I

indicator lights	3
indicator lights (complete)	3

L

lamps	3
-------	---

M

microswitches	3
---------------	---

P

plug-in gaskets	11
probes	4

R

refrigeration cycle components	14
refrigeration fans	6
refrigeration gaskets	11
refrigeration thermostats	3

S

shelves and shelf rails	9
spring assisted hinges	8
switches and momentary switches	3

T

temperature probes	4
thermostats	3

U

universal probes	4
------------------	---