



GAS COMPONENTS



ELECTRIC COMPONENTS



WATER TECHNOLOGY



MECHANICAL COMPONENTS



TOOLS

Spare parts suitable for

COVEN

Find the complete and up-to-date range of products in our GEV Webshop



Manufacturer catalogue

The most important spare parts and accessories arranged clearly for every manufacturer

- ✓ Complete product range and all appliance data always up to date in the GEV Webshop
- ✓ Alphabetical Index at the end of the catalogue

GEV Webshop

www.gev-online.co.uk

www.gev-online.com



- 🔍 Add to Favourites
- 🔍 Sign In with email address and usual password
- 🔍 Easy-order – place several items in your basket at the same time
- 🔍 Quick Item search – no login needed



heating elements

heating elements for proofing cabinets

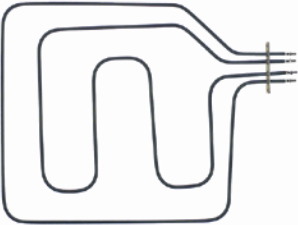

1

GEV No.	419234	Ref. No.	EMRSA025
description	heating element 2500W 240V heating circuits 2 L 538mm W 430mm flange length 100mm flange width 20mm hole distance 86mm connection length 60mm connection M5 tube ø 6.3mm flange leavening cabinet new edition		



1

GEV No.	418972	Ref. No.	EMRSB033 EMRSB38333
description	heating element 3300W 240V heating circuits 1 ID ø 178mm ED ø 190mm L 205mm H 34mm L1 10mm W1 59mm H1 11mm H2 23mm flange length 100mm flange width 21mm hole distance 86mm connection male faston 6.3mm connection length 34mm tube ø 6.3mm convection heating element		

heating elements for convection



1

GEV No.	420084	Ref. No.	EMR10000
description	heating element 10000W 240V heating circuits 3 ID ø 340mm ED ø 350mm L 375mm H 110mm L1 23mm W1 102mm H1 14mm H2 96mm flange length 142mm flange width 25mm hole distance 63mm connection M4 tube ø 6.2mm hole ø 7mm		



1

GEV No.	417288	Ref. No.	EMRSB160
description	heating element 1600W		



1

GEV No.	418986	Ref. No.	EMRSB030
description	heating element 3000W 240V heating circuits 1 ID ø 180mm ED ø 186mm L 210mm H 31mm L1 11mm W1 60mm H1 7mm H2 24.5mm flange length 100mm flange width 22mm hole distance 86mm connection male faston 6.3mm connection length 34.5mm tube ø 6.25mm convection heating element hole ø 5mm rectangular flange		

energy regulators

EGO

1-circuit



1

GEV No.	380015	Ref. No.	EMPUAH00
description	energy regulator 230V 13A single-circuit turn direction right shaft ø 6x4.6mm shaft L 23mm mounting thread M4 power release 6-100% no. 50.57021.010		

thermostats

control and safety thermostats

EGO

control thermostats

55.10/19_ series



1

GEV No.	375860	Ref. No.	EMTS0300
description	thermostat t.max. 289°C temperature range 57-289°C 1-pole INO 16A probe ø 3.1mm probe L 226mm capillary pipe 1780mm capillary pipe isolated 1770mm gland nut shaft ø 6x4.6mm shaft L 23mm shaft position upper° rotation 270° probe material SS		



E·G·O



GEV No.	375654	Ref. No.	EMTS55ME
description	thermostat t.max. 99°C temperature range fixed 99°C 1-pole 1CO 16A probe ø 6mm probe L 74mm capillary pipe 900mm capillary pipe isolated 900mm gland nut		

safety thermostats

55.10/19_series

E·G·O

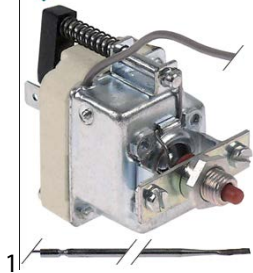

GEV No.	375857	Ref. No.	EMTSS350
description	safety thermostat switch-off temp. 350°C 1-pole 16A probe ø 3.1mm probe L 201mm capillary pipe 870mm capillary pipe isolated 870mm gland nut probe SS		

switches and momentary switches

push/momentary push switches

miscellaneous



GEV No.	347501	Ref. No.	EMDEVMOL
description	push switch black 2CO 250V 16A connection male faston 6.3mm ambient temperature max. 85°C protection IP40		

microswitches

pin-plunger actuated

M10



GEV No.	346078	Ref. No.	EMMS1600
description	microswitch with plunger thread M10x0.75 250V 16A 1CO connection screw		

cam switches

on/off

E·G·O

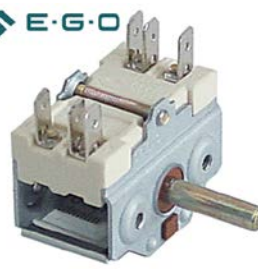

GEV No.	300129	Ref. No.	EMIG1600
description	cam switch 2 operating positions 2NO sequence 0-1 16A shaft ø 6x4.6mm shaft L 23mm connection male faston 6.3mm ceramic		

3 operating positions



GEV No.	347498	Ref. No.	EMIGSFMX
description	cam switch sequence 1-0-2 shaft ø 6x4.6mm shaft L 23mm		

4 operating positions



GEV No.	300236	Ref. No.	EMIGSLMX
description	cam switch 25/32A shaft ø 6x4.6mm shaft L 23mm 3-pole		

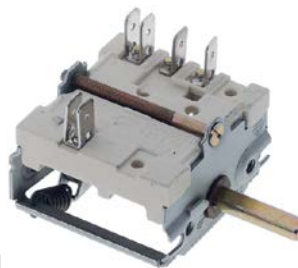

GEV No.	347500	Ref. No.	EMIGSUMX
description	cam switch shaft ø 6x4.6mm shaft L 23mm connection male faston 6.3mm		



encoders and potentiometers

 <p>1</p>			
GEV No.	402935	Ref. No.	EMREST01
description	potentiometer for hot air oven 180Ohm L 214mm ø 32mm		

lamps

indicator lights

indicator lights (complete)			
ø12mm			
with screw socket			
 <p>1</p>			
GEV No.	359027	Ref. No.	EMLSAHRO
description	indicator light ø 12mm 250V green connection male faston 6.3mm		

screw-on/push-on fit

light bulbs			
for ovens			
 <p>1</p>			
GEV No.	359610	Ref. No.	EMPLLAHO
description	light bulb t.max. 300°C socket E14 15W 230V ø 22mm L 47mm lens L 20mm for oven lamp type Philips		

 <p>1</p>			
GEV No.	359740	Ref. No.	EMPLLAHO
description	light bulb t.max. 300°C socket E14 15W 230V ø 22mm L 48mm lens L 20mm for oven lamp IMPORT		

 <p>1</p>			
GEV No.	359612	Ref. No.	EMPLLO25
description	light bulb t.max. 300°C socket E14 25W 230V ø 25mm L 56mm lens L 30mm for oven lamp type Philips		

halogen lamp

for socket G4 / G6.35 / G9

 <p>1</p>			
GEV No.	359945	Ref. No.	EMPLAL25
description	halogen lamp socket G9 230V 25W temp.-resist. 300°C		

oven lamps

universal oven lamps

mounting diameter 35.5mm

 <p>1</p>			
GEV No.	357170	Ref. No.	EMPLP042
description	oven lamp mounting ø 35.5mm 230V 25W socket G9 temp.-resist. 300°C connection F6.3		

 <p>1</p>			
GEV No.	359709	Ref. No.	EMPLG042
description	oven lamp glass thr.ø 33.5mm ø 42mm hard glas temp.-resist. 350°C		

 <p>1</p>			
GEV No.	359705	Ref. No.	EMPLG800
description	oven lamp glass thr.ø 33.5mm ø 52mm hard glas temp.-resist. 350°C		

accessories for	359705		
------------------------	--------	--	--

	GEV No.	359610	Ref. No.	EMPLLAHO
light bulb t.max. 300°C socket E14 15W 230V ø 22mm L 47mm lens L 20mm for oven lamp type Philips				

	GEV No.	359700	Ref. No.	—
gasket for pizza oven fibre glass ID ø 32.5mm ED ø 55mm thickness 5mm				

	GEV No.	359721	Ref. No.	—
gasket silicone ED ø 48mm ID ø 39.5mm thickness 5mm Qty 1 pcs				

	GEV No.	359837	Ref. No.	—
gasket ID ø 33mm ED ø 46mm thickness 1mm graphite				

	GEV No.	359838	Ref. No.	—
gasket ID ø 33mm ED ø 45mm				



55x70mm



1

GEV No.	359297	Ref. No.	EMPLQU25B
description	frame L 95mm W 81mm mounting distance 68/83mm thickness 6mm		
accessories for	359297		
	GEV No.	359299	Ref. No.
			—
	gasket L 91mm W 77mm hole ø 3mm for oven lamp		

lamps

light bulbs



1

GEV No.	359610	Ref. No.	EMPLLAHO
description	light bulb t.max. 300°C socket E14 15W 230V ø 22mm L 47mm lens L 20mm for oven lamp type Philips		



1

GEV No.	359740	Ref. No.	EMPLLAHO
description	light bulb t.max. 300°C socket E14 15W 230V ø 22mm L 48mm lens L 20mm for oven lamp IMPORT		



1

GEV No.	359612	Ref. No.	EMPLL025
description	light bulb t.max. 300°C socket E14 25W 230V ø 25mm L 56mm lens L 30mm for oven lamp type Philips		

halogen lamps

for socket G4 / G6.35 / G9



1

GEV No.	359945	Ref. No.	EMPLAL25
description	halogen lamp socket G9 230V 25W temp.-resist. 300°C		

timers

programme timers



1

GEV No.	360492	Ref. No.	EMC6003 F33245 EMC6003 F3324S
description	timer CDC 6003F engines 1 chambers 3 operation time 324s 230V shaft ø 5mm shaft L 9mm motor type M48L ATS		

mechanical timers





1

GEV No.	350147	Ref. No.	EMTM0120
description	timer 2-pole operation time 120min impulse mechanical 2NO at 250V 16A shaft ø 6x4.6mm shaft L 23.5mm mounting distance 28mm mounting thread M4 connection male faston 6.3mm		



1

GEV No.	350022	Ref. No.	EMFTC120
description	timer M2 2-pole operation time 120min impulse mechanical 2CO at 250V 16A permanent position yes shaft ø 6x4.6mm shaft 6x4.6mm shaft L 23mm mounting distance 28mm connection lateral		
accessories for	350022		
	GEV No.	110366	Ref. No.
			—
	knob switch zero mark t.max. °C ø 44mm shaft ø 6x4.6mm shaft flat upper black		
	GEV No.	110381	Ref. No.
			—
	dial plate graduation 120min permanent position yes rotation 0-300° ø 60mm timers knob ø 45mm with permanent position		



alarm devices

buzzer boards



1

GEV No.	350146	Ref. No.	EMFTES07
description	buzzer board connection male faston 4.8mm		

contactors

SIEMENS

power contactors



1

GEV No.	380652	Ref. No.	EMCNAH25
description	power contactor resistive load 22A 230VAC (AC3/400V) 9A/4kW main contacts 3NO auxiliary contacts 1NC connection screw connection type 3RT10-16-1AP02		



1

GEV No.	380389	Ref. No.	EMCN1H25
description	power contactor resistive load 22A 230VAC (AC3/400V) 9A/4kW main contacts 3NO auxiliary contacts 1NO connection screw connection type 3RT10-16-1AP01		

auxiliary contacts



1

GEV No.	380947	Ref. No.	EMCNAHA4 EMCNAHAU
description	auxiliary contact contacts 1NO/1NC AC15 3A for contactors 3RT102 3 RT103 connection screw connection type 3RH1921-1FA11		



1

GEV No.	380533	Ref. No.	EMCNAAHUM
description	auxiliary contact contacts 3NO/1NC AC15 3A for contactors 3RT101 connection screw connection type 3RT1911-1FA31 resistive load 10A AC-12 10A		

relays

relay sockets



1

GEV No.	380958	Ref. No.	EMRGLZX4
description	relay socket 8-pole connection plug-in connection round 8-pole 250V voltage AC 10A		



1

GEV No.	380137	Ref. No.	EMRGLZX4	
description	relay socket 8-pole connection plug-in connection round 8-pole dimensions 65x28x40mm 380V voltage AC 10A Italiana Relè manuf. no. ZVE8			
accessories for	380137			
	GEV No.	380805	Ref. No.	—
	support bracket			

level relays

miscellaneous



1

GEV No.	402994	Ref. No.	EMRGLVX4	
description	level controller 50/60Hz 8-pole 230V voltage AC 16A type RL30/1S/8			
accessories for	402994			
	GEV No.	380958	Ref. No.	EMRGLZX4
	relay socket 8-pole connection plug-in connection round 8-pole 250V voltage AC 10A			



electronic controllers

TECNOLOGIC

universal controllers

built-in version



1

GEV No.	379486	Ref. No.	EMRESCO4
description	electronic controller TECNOLOGIC type TLK38FCR---- mounting measurements 71x29mm 12V voltage AC/DC Pt100/TC (J,K) relay outputs 1 CO-16A(8) Pt100/TC (J,K) built-in depth 64mm defr. funct. no dependent on probe°C display 4 digits		

probes

producer-specific probes

probes



1

GEV No.	379756	Ref. No.	EMSONTERTEC
description	probe Pt100 cable PTFE probe -100 up to 450°C cable -40 up to +250°C connection 3-wire thread M12x1 probe ø4x50mm cable length 1.5m		



1

GEV No.	379432	Ref. No.	EMSONTERTE
description	temperature probe Pt100 cable PTFE probe -100 up to 450°C cable -40 up to +250°C connection 3-wire thread 1/4" probe ø4x60mm cable length 1.1m		

core probes



1

GEV No.	379431	Ref. No.	EMSONSPEC
description	core temperature probe Pt100 cable PTFE probe -40 up to +250°C cable -40 up to +250°C connection 3-wire probe ø4x100mm thread 1/4" cable length 3m handle ø 12mm handle length 85mm		

electronics

PCBs



1

GEV No.	403200	Ref. No.	ELSCRO5P
description	keypad PCB combi-steamer 6/10/20EMD L 180mm W 90mm buttons 5		



1

GEV No.	402933	Ref. No.	ELSCAR5P
description	PCB autoreverse L 141mm W 63mm		

keypads

front foils



1

GEV No.	403015	Ref. No.	CFRPC10X
description	keypad foil L 167mm W 99mm		















solenoid valves

solenoid valves (water)

ROBERTSHAW/INVENSYS

medium temperature: 90°C 90°C 60°C
 ambient temperature: 60°C 25°C 60°C
 duty cycle: 40% 100% 100%

			
1			
GEV No.	372015	Ref. No.	EMUAASRPE
description	solenoid valve single angled 230VAC inlet 3/4" outlet 11.5mm input 10l/min DN10 EATON (INVENSYS) flow regulating valve inlet white		

TP			
			
			
1			
GEV No.	370025	Ref. No.	EMUA3C04
description	solenoid valve triple straight 230VAC inlet 3/4" outlet 11.5mm DN10 TP		
spare parts for	370025		
		GEV No.	371013
		Ref. No.	—
	solenoid coil TP 230VAC 50/60Hz		
accessories for	370025		
		GEV No.	371220
		Ref. No.	—
	reducer TP flow rate 3l/min red tolerance ±15%		
		GEV No.	371221
		Ref. No.	—
	reducer TP flow rate 5.5l/min yellow tolerance ±15%		
		GEV No.	371222
		Ref. No.	—
	reducer TP flow rate 6l/min grey tolerance ±15%		
		GEV No.	371223
		Ref. No.	—
	reducer TP flow rate 10l/min white tolerance ±15%		
		GEV No.	371224
		Ref. No.	—
	reducer TP flow rate 12l/min bronze tolerance ±15%		
		GEV No.	371225
		Ref. No.	—
	reducer TP flow rate 16l/min light brown tolerance ±15%		
		GEV No.	371226
		Ref. No.	—
	reducer TP flow rate 20l/min red tolerance ±15%		
		GEV No.	371230
		Ref. No.	—
	reducer TP flow rate 0.25l/min red tolerance ±25%		
		GEV No.	371231
		Ref. No.	—
	reducer TP flow rate 0.35l/min violet tolerance ±25%		

accessories for	370025		
		GEV No.	371232
		Ref. No.	—
	reducer TP flow rate 0.5l/min orange tolerance ±25%		
		GEV No.	371233
		Ref. No.	—
	reducer TP flow rate 0.8l/min white tolerance ±25%		
		GEV No.	371234
		Ref. No.	—
	reducer TP flow rate 1l/min light blue tolerance ±25%		
		GEV No.	371235
		Ref. No.	—
	reducer TP flow rate 1.2l/min brown tolerance ±25%		
		GEV No.	371236
		Ref. No.	—
	reducer TP flow rate 1.5l/min light brown tolerance ±25%		
		GEV No.	371237
		Ref. No.	—
	reducer TP flow rate 2.5l/min yellow tolerance ±25%		
		GEV No.	371238
		Ref. No.	—
	reducer TP flow rate 3.4l/min dark green tolerance ±25%		
		GEV No.	371239
		Ref. No.	—
	reducer TP flow rate 5l/min black tolerance ±25%		
		GEV No.	371240
		Ref. No.	—
	reducer TP flow rate 8l/min blue tolerance ±20%		















			
			
1			
GEV No.	370015	Ref. No.	EMUASRPE
description	solenoid valve single angled 230VAC inlet 3/4" outlet 11.5mm DN10 TP		
accessories for	370015		
		GEV No.	371220
		Ref. No.	—
	reducer TP flow rate 3l/min red tolerance ±15%		
		GEV No.	371221
		Ref. No.	—
	reducer TP flow rate 5.5l/min yellow tolerance ±15%		
		GEV No.	371222
		Ref. No.	—
	reducer TP flow rate 6l/min grey tolerance ±15%		
		GEV No.	371223
		Ref. No.	—
	reducer TP flow rate 10l/min white tolerance ±15%		
		GEV No.	371224
		Ref. No.	—
	reducer TP flow rate 12l/min bronze tolerance ±15%		
		GEV No.	371225
		Ref. No.	—
	reducer TP flow rate 16l/min light brown tolerance ±15%		

Table continues overleaf

accessories for		370015	
	GEV No.	371226	Ref. No. —
reducer TP flow rate 20l/min red tolerance ±15%			
	GEV No.	371230	Ref. No. —
reducer TP flow rate 0.25l/min red tolerance ±25%			
	GEV No.	371231	Ref. No. —
reducer TP flow rate 0.35l/min violet tolerance ±25%			
	GEV No.	371232	Ref. No. —
reducer TP flow rate 0.5l/min orange tolerance ±25%			
	GEV No.	371233	Ref. No. —
reducer TP flow rate 0.8l/min white tolerance ±25%			
	GEV No.	371234	Ref. No. —
reducer TP flow rate 1l/min light blue tolerance ±25%			
	GEV No.	371235	Ref. No. —
reducer TP flow rate 1.2l/min brown tolerance ±25%			
	GEV No.	371236	Ref. No. —
reducer TP flow rate 1.5l/min light brown tolerance ±25%			
	GEV No.	371237	Ref. No. —
reducer TP flow rate 2.5l/min yellow tolerance ±25%			
	GEV No.	371238	Ref. No. —
reducer TP flow rate 3.4l/min dark green tolerance ±25%			
	GEV No.	371239	Ref. No. —
reducer TP flow rate 5l/min black tolerance ±25%			
	GEV No.	371240	Ref. No. —
reducer TP flow rate 8l/min blue tolerance ±20%			

solenoid valves with reducers			
	1		
GEV No.	370437	Ref. No.	EMUA2RPE
description	solenoid valve double angled 230VAC inlet 3/4" input 10l/min output 1.2/1.2l/min DN10 t.max. 90°C TP plastic flow regulating valve inlet white outlet 11.5mm output A 1.2l/min output B 1.2l/min flow regulating valve outlet A dark brown flow regulating valve outlet B dark brown		

	1		
GEV No.	370644	Ref. No.	EMUA2C180
description	solenoid valve double straight 220-240VAC inlet 3/4" input 10l/min DN10 TP flow regulating valve inlet white outlet 11.5mm output A 1.5l/min output B 1.5l/min flow regulating valve outlet A brown flow regulating valve outlet B brown		



	1		
GEV No.	370670 ¹	Ref. No.	EMUA3C04
description	solenoid valve straight triple 230VAC inlet 3/4" outlet 11.5mm 10 TP plastic with reducer set		

¹with reducer set

fans

axial fans

import

	1		
GEV No.	601080 ¹	Ref. No.	EMMOAS10
description	axial fan L 119mm W 119mm H 38mm 230VAC 50/60Hz 23/20W bearing ball bearing connection male faston 2.8mm metal ADDA fan wheel ø 110mm temp.-resist. 70°C		
accessories for	601080		
	GEV No.	550898	Ref. No. —
connecting cable cable length 2000mm connection F 2.8 connection distance 7.9mm for axial flow fan			
	GEV No.	692519	Ref. No. —
guard L 120mm W 120mm plastic			

¹with ball bearings





1

GEV No.	601081 ¹	Ref. No.	EMMOAS6
description	axial fan L 80mm W 80mm H 38mm 230VAC 50/60Hz 14/13.5W bearing ball bearing connection male faston 2.8mm metal ADDA fan wheel ø 75mm temp.-resist. 70°C		
accessories for	601081		
	GEV No.	691102	Ref. No. —
	guard ø 75mm mounting distance 71mm for axial fan 80mm		

¹with ball bearings



hot air fans

miscellaneous

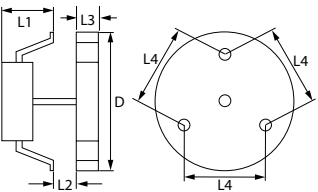

1



GEV No.	601011	Ref. No.	EMMVR150
description	hot air fan 220-240V 40W 50/60Hz L1 65mm L2 15mm L3 25mm L4 87mm fan wheel ø 150mm FIME type C25R8023CLH		
accessories for	601011		
	GEV No.	550879	Ref. No. —
	insulation ø 130mm thickness 3mm hole ø 20mm for hot air fan		
	GEV No.	601260	Ref. No. —
	nut thread M6L IT for hot air fan		

pumps

drain pumps

ASKOLL



1

GEV No.	500346	Ref. No.	MCPOMPAMX
description	drain pump inlet ø 30mm outlet ø 22mm 230V 40W 50Hz ASKOLL type M231 XP with holder		

PLASET



1

GEV No.	500514	Ref. No.	MCPOMPAMX
description	drain pump inlet ø 30mm outlet ø 22mm 230V 34W		

electric accessories

terminals

connection terminals with screw/faston connections



1

GEV No.	550278	Ref. No.	EMMR1102
description	power terminal block 3-pole max. 40A max 400V connection ø6mm ² / F6.3 temp.-resist. 150°C cross section 6mm ²		



1

GEV No.	550411	Ref. No.	EMMR1224
description	power terminal block 6-pole max. 40A max 450V connection $\phi 6\text{mm}^2$ / F6.3 temp.-resist. 150°C cross section 6mm ²		

gas valves and ignition boxes







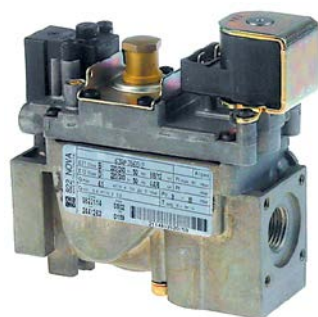

gas control valves

SIT

NOVASIT



1

GEV No.	101914	Ref. No.	EMSIT822N	
description	gas valve SIT series Novasit 822 230V 50Hz gas inlet 1/2" gas outlet 1/2" thermocouple connection pilot connection closed ignition pressurebar pressure range 3-30mbar pressure regulator connection blind equiv. no. 0.822.144			
spare parts for	101914			
	GEV No.	101313	Ref. No.	—
	solenoid coil 230V 50Hz			
	GEV No.	101542	Ref. No.	—
	solenoid coil 50Hz NOVA 822/826/827 suitable for NOVASIT 230V			
accessories for	101914			
	GEV No.	101305	Ref. No.	—
	gas connection straight 1/2" flange 45x45mm ELETTROSIT/V4400/4600/4605 suitable for SIT/HONEYWELL hole distance 36x36mm			
	GEV No.	101306	Ref. No.	—
	gas connection angled flange 45x45mm hole distance 36x36mm 1/2" ELETTROSIT/V4400/4600/4605 screw with O-ring suitable for SIT/HONEYWELL			
	GEV No.	101307	Ref. No.	—
	gas connection straight flange 45x45mm hole distance 36x36mm 3/4" ELETTROSIT/V4400/4600/4605 screw with O-ring suitable for SIT/HONEYWELL			
	GEV No.	101308	Ref. No.	—
	gas connection angled flange 45x45mm hole distance 36x36mm 3/4" ELETTROSIT/V4400/4600/4605 screw with O-ring suitable for SIT/HONEYWELL			
	GEV No.	101503	Ref. No.	—
	O-ring EPDM thickness 2mm ID $\phi 32\text{mm}$ Qty 1 pcs			
	GEV No.	101924	Ref. No.	—
	plug with cable L 1090mm suitable for NOVA 822/826/827			

ignition boxes

BRAHMA



1

GEV No.	107471	Ref. No.	EMCONFIN6G
description	ignition box BRAHMA type CM11 electrodes 2 waiting time 1.5s safety time 10s 230V 7VA 50-60Hz		

ignition parts

pilot burners

SIT

100 series



1

















GEV No.	106906	Ref. No.	EMSITBP0	
description	pilot burner SIT type 100 series 3 flames nozzle $\phi 0.2\text{mm}$ gas connection 6mm			
spare parts for	106906			
	GEV No.	100245	Ref. No.	—
	pilot burner nozzle LPG code 20 bore $\phi 0.2\text{mm}$ Qty 1 pcs thread M8x0.75			
	GEV No.	100855	Ref. No.	—
	pilot burner bracket triple			
	GEV No.	100885	Ref. No.	—
	air mixing sleeve for pilot burner Qty 1 pcs			
	GEV No.	100916	Ref. No.	—
	compression spring for pilot burner Qty 1 pcs			
	GEV No.	100917	Ref. No.	—
	gasket for pilot burner Qty 1 pcs aluminium			
	GEV No.	100918	Ref. No.	—
	screw for pilot burner			
	GEV No.	107162	Ref. No.	—
	pilot burner cap SIT 3 flames Hmm Lmm Qty 1 pcs			
	GEV No.	107701	Ref. No.	—
	pilot burner bottom part SIT 100 series nozzle $\phi 0.2\text{mm}$			
accessories for	106906			
	GEV No.	100245	Ref. No.	—
	pilot burner nozzle LPG code 20 bore $\phi 0.2\text{mm}$ Qty 1 pcs thread M8x0.75			

Table continues overleaf



accessories for		106906	
	GEV No.	100246	Ref. No. —
	pilot burner nozzle natural gas bore \varnothing 0.35mm Qty 1 pcs thread M8x0.75		
	GEV No.	100904	Ref. No. —
	locking screw M10x1 for pipe \varnothing 4mm Qty 1 pcs		
	GEV No.	100905	Ref. No. —
	locking screw M10x1 for pipe \varnothing 6mm Qty 1 pcs		
	GEV No.	102110	Ref. No. —
	pilot tube copper pipe \varnothing 4mm thickness 1mm L 3000mm		
	GEV No.	102111	Ref. No. —
	pilot tube copper pipe \varnothing 6mm thickness 1mm L 3000mm		
	GEV No.	107171	Ref. No. —
	pilot burner nozzle SIT natural/liquid gas bore \varnothing 0.25mm Qty 1 pcs		
	GEV No.	107700	Ref. No. —
	pilot burner bottom part SIT 100 series nozzle \varnothing 0.25mm		
	GEV No.	107702	Ref. No. —
	pilot burner bottom part SIT 100 series nozzle \varnothing 0.35mm		

accessories

ignition electrodes

	GEV No.	100706	Ref. No.	EMSITCA0
	description ignition electrode connection M4 Qty 1 pcs			

electrodes

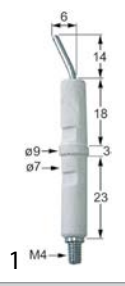
	GEV No.	100706	Ref. No.	EMSITCA0
	description ignition electrode connection M4 Qty 1 pcs			

ignition units

	GEV No.	102485	Ref. No.	EMACA000
	description ignition unit outputs 2 220-240VAC 0.6VA 50-60Hz			

	GEV No.	101002	Ref. No.	EMACA000
	description ignition unit outputs 2 230VAC dimensions 88x23x34mm mounting distance 73mm inlet F6.3x0.8 outlet F2.8x0.8 0.6VA 50/60Hz			

thermocouples

plug-in thermocouples

plug-in thermocouples standard

with barrel socket \varnothing 6(6.5)mm

thermocouples SIT

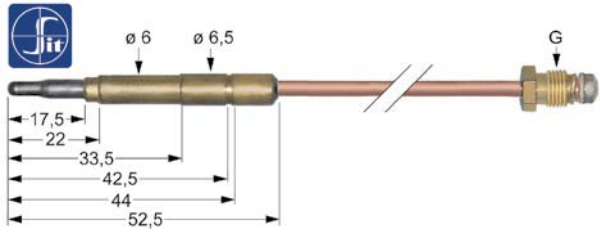
	GEV No.	107614	Ref. No.	EMSITT150 EMSITT20
	description thermocouple SIT M9x1 L 1500mm plug connection \varnothing 6.0(6.5)mm			

equipment-specific units

for convection ovens/combi-steamers

glass panels

	GEV No.	694560	Ref. No.	MCVE0002
	description glass panel L 388mm W 310mm thickness 4mm Qty 1 pcs			

knobs

producer-specific knobs

COVEN



GEV No.	111421	Ref. No.	MCMA0M0T
description	knob zero mark ø 48mm shaft ø 6x4.6mm shaft flat upper black		

locks





handle latches

universal

outside fixing

locks



GEV No.	694065	Ref. No.	MCCHSAMX
description	door handle for headed units L 145mm W 40mm H 62mm spring length 33mm outer black		
spare parts for	694065		
	GEV No.	514390	Ref. No. —
	spring for door handle ø 6mm L 54mm W 27.5mm		
	GEV No.	694734	Ref. No. —
	door handle L 165mm W 40mm H 25mm black		
	GEV No.	694735	Ref. No. —
	cap ø 32mm black		
accessories for	694065		
	GEV No.	694066	Ref. No. —
	door catch with spigot 2-stage L 28mm W 14mm H 15mm H1 16mm total length 51mm thread M8 thread L 23mm stainless steel		
	GEV No.	694067	Ref. No. MCCHAGMX
	door catch with spigot 1-stage L 26mm total length 51mm thread M8		

producer-specific





COVEN

group 1



GEV No.	694850	Ref. No.	MCPR3AMX
description	door catch with spigot 2-stage L 28mm W 14mm H 15mm H1 16mm total length 52mm thread M8		



GEV No.	694065	Ref. No.	MCCHSAMX
description	door handle for headed units L 145mm W 40mm H 62mm spring length 33mm outer black		
spare parts for	694065		
	GEV No.	514390	Ref. No. —
	spring for door handle ø 6mm L 54mm W 27.5mm		
	GEV No.	694734	Ref. No. —
	door handle L 165mm W 40mm H 25mm black		
	GEV No.	694735	Ref. No. —
	cap ø 32mm black		
accessories for	694065		
	GEV No.	694066	Ref. No. —
	door catch with spigot 2-stage L 28mm W 14mm H 15mm H1 16mm total length 51mm thread M8 thread L 23mm stainless steel		
	GEV No.	694067	Ref. No. MCCHAGMX
	door catch with spigot 1-stage L 26mm total length 51mm thread M8		

group 2











GEV No.	694480	Ref. No.	MCPR2AMX
description	door catch with spigot 2-stage type DL24 L 42mm W 12mm H 18mm total length 62mm thread M8x1.25 thread L 20mm chrome-plated		
accessories for	694480		
	GEV No.	694475	Ref. No. MCCHSAMX/2
	door handle for headed units bright finish type 1625L L 160mm W 39mm H 65mm spring length 30mm inner black plastic mounting distance 25mm flange 42x76mm mounting thread M5		

Table continues overleaf

accessories for	694480		
	GEV No.	694476	Ref. No. —
	door handle for headed units matt finish type 1625 L 160mm W 39mm H 65mm spring length 30mm inner black/chrome plastic mounting distance 25mm flange 42x76mm mounting thread M5		





GEV No.	694475	Ref. No.	MCCHSAMX/2
description	door handle for headed units bright finish type 1625L L 160mm W 39mm H 65mm spring length 30mm inner black plastic mounting distance 25mm flange 42x76mm mounting thread M5		
accessories for	694475		
	GEV No.	694477	Ref. No. —
	door catch with spigot 1-stage type SL24 L 31.5mm W 12mm H 19.5mm total length 52mm thread M8x1.25 thread L 20.5mm chrome-plated		
	GEV No.	694478	Ref. No. —
	door catch with spigot 1-stage type SL42 L 31.5mm W 12mm H 19.5mm total length 67.5mm thread M8x1.25 thread L 36mm chrome-plated		
	GEV No.	694479	Ref. No. —
	door catch with spigot 1-stage type SL60 L 31.5mm W 12mm H 19.5mm total length 87mm thread M8x1.25 thread L 55.5mm chrome-plated		
	GEV No.	694480	Ref. No. MCPR2AMX
	door catch with spigot 2-stage type DL24 L 42mm W 12mm H 18mm total length 62mm thread M8x1.25 thread L 20mm chrome-plated		
	GEV No.	694481	Ref. No. —
	door catch with spigot 2-stage type DL42 L 42mm W 12mm H 18mm total length 78.5mm thread M8x1.25 thread L 36.5mm chrome-plated		
	GEV No.	694482	Ref. No. —
	door catch with spigot 2-stage type DL60 L 42mm W 12mm H 18mm total length 98mm thread M8x1.25 thread L 56mm chrome-plated		

edgmount latches

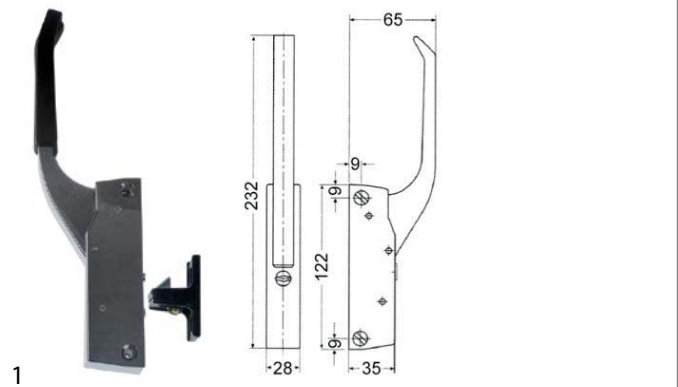

handle latches

CAFF/FERMOD

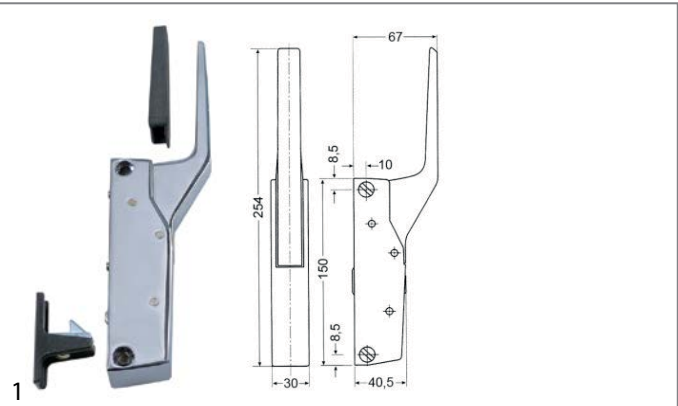

GEV No.	700906	Ref. No.	MCCHIN04P
description	catch L 122mm mounting distance 104mm heated units		
spare parts for	700906		
	GEV No.	690419	Ref. No. —
	door catch L 52mm W 20mm H 30mm mounting distance 26-37mm zamak for refrigeration units		
	GEV No.	700062	Ref. No. —
	handle protection heated units		



GEV No.	701024	Ref. No.	MCCHIN04
description	handle latch L 150mm mounting distance 133mm heated units type 790		
spare parts for	701024		
	GEV No.	700061	Ref. No. MCCHINA04 MCCHNA04
	door catch L 58mm W 20mm H 35mm mounting distance 42mm chrome-plated brass for headed units		
	GEV No.	700062	Ref. No. —
	handle protection heated units		

door catches



1

GEV No.	700061	Ref. No.	MCCHINA04 MCCHNA04
description	door catch L 58mm W 20mm H 35mm mounting distance 42mm chrome-plated brass for headed units		
accessories for	700061		
	GEV No.	690414	Ref. No. —
	handle latch L 150mm mounting distance 133mm non lockable refrigeration units G 791		

snap locks

universal



1

GEV No.	690596	Ref. No.	MCCHPI00
description	snap lock L 60mm W 15mm H 36mm mounting distance 48/28mm spring thickness 1.5mm complete with door catch zamak		

espagnolette locks

universal



1

GEV No.	690041	Ref. No.	MCCHME10
description	cam L 148mm mounting distance 32mm		

shelves and shelf rails

grid attachments



1

GEV No.	689001	Ref. No.	MCPR0003
description	bearing rail L 325mm H 15mm mounting pos. cavity W 15mm stainless steel for COVEN delivery pair		

gaskets

gaskets for heated units

window seals

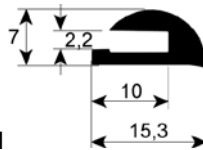

1

GEV No.	901380	Ref. No.	MCGV0003
description	window gasket profile 1883 Qty supplied by meter		

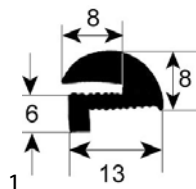

1

GEV No.	900782	Ref. No.	MCGV0002
description	window gasket profile 1889 Qty supplied by meter		

door seals

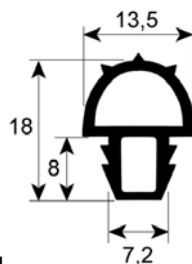

1

GEV No.	901381	Ref. No.	MCGP3/4P
description	door seal profile 2045 Qty supplied by meter		

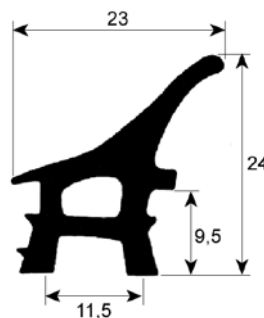

1

GEV No.	900778	Ref. No.	MCGPN004 / 470mm
description	door seal profile 2403 L 470mm Qty 1 mounting pos. vertical		



GEV No.	901382	Ref. No.	MCGPN004 / 490mm
description	door seal profile 2403 L 490mm Qty 1 mounting pos. vertical		

GEV No.	900781	Ref. No.	MCGPN004
description	door seal profile 2403 Qty supplied by meter		

GEV No.	900779	Ref. No.	MCGPN004 / 600mm
description	door seal profile 2403 L 600mm Qty 1 mounting pos. horizontal		

GEV No.	901326	Ref. No.	GUARNIPORTA106 MCGFC06N
description	door seal profile 2785 Qty supplied by meter		

GEV No.	901383	Ref. No.	MCGPN004 / 700mm
description	door seal profile 2403 L 700mm Qty 1 mounting pos. horizontal		

GEV No.	901169	Ref. No.	MCGP0002
description	door seal profile 2948 Qty supplied by meter		

GEV No.	900780	Ref. No.	MCGPN004 / 890mm
description	door seal profile 2403 L 890mm Qty 1		

measuring equipment

thermometers

built-in thermometers

ø60mm

GEV No.	541863	Ref. No.	EMTR0350
description	thermometer mounting ø 60mm 50-350°C probe ø 6mm probe L 19mm capillary pipe 1600mm		

consumables

sealants and adhesives

high temperature silicone



1

GEV No.	890266	Ref. No.	CSR60902
description	high temperature silicone COLLEX RED SILICONE t.max. -40 up to +250°C red tube 80ml		
description	<p>COLLEX RED SILICONE - tube 80ml - red</p> <p>In-situ flat gaskets for transmissions, compressors, pumps, manifolds, etc. Sealing joints for lighting devices and caulking for electric passages. Good resistance to motor oils, water and coolants.</p> <p>Temperature range -40°C to +250°C.</p>		

A		
alarm devices	7	
axial fans	10	
C		
cam switches	4	
consumables	18	
contactors	7	
control thermostats	3	
D		
door catches	16	
door seals	16	
drain pumps	11	
E		
edgemount latches	15	
electric accessories	11	
electronic controllers	8	
energy regulators	3	
espagnolette locks	16	
F		
fans	10	
G		
gas control valves	12	
gaskets for heated units	16	
H		
halogen lamp	5	
handle latches	15	
heating elements	3	
heating elements for convection	3	
heating elements for proofing cabinets	3	
high temperature silicone	18	
hot air fans	11	
I		
ignition boxes	12	
ignition units	13	
indicator lights	5	
indicator lights (complete)	5	
L		
lamps	5	
light bulbs	5	
M		
measuring equipment	17	
mechanical timers	6	
microswitches	4	
O		
oven lamps	5	
P		
pilot burners	12	
probes	8	
programme timers	6	
pumps	11	
push/momentary push switches	4	
R		
relays	7	
S		
safety thermostats	4	
sealants and adhesives	18	
shelves and shelf rails	16	
silicone	18	
snap locks	16	
solenoid valves	9	
switches and momentary switches	4	
T		
terminals	11	
thermocouples	13	
thermostats	3	
timers	6	
W		
window seals	16	