



GAS COMPONENTS



ELECTRIC COMPONENTS



WATER TECHNOLOGY



MECHANICAL COMPONENTS



TOOLS

Spare parts suitable for

CUPPONE

Find the complete and up-to-date range of products in our GEV Webshop



Manufacturer catalogue

The most important spare parts and accessories arranged clearly for every manufacturer

- ✓ Complete product range and all appliance data always up to date in the GEV Webshop
- ✓ Alphabetical Index at the end of the catalogue

GEV Webshop

www.gev-online.co.uk

www.gev-online.com



- 🔍 Add to Favourites
- 🔍 Sign In with email address and usual password
- 🔍 Easy-order – place several items in your basket at the same time
- 🔍 Quick Item search – no login needed



heating elements

heating elements for pizza ovens



GEV No.	415678	Ref. No.	91711901 ME0000002
description	heating element 1000W 230V L 575mm W 160mm flange length 220mm flange width 31mm hole distance 201mm connection length 133mm connection M5 L1 30mm L2 25mm L3 520mm W1 25mm W2 112mm tube ø 10mm heating circuits 1 rectangular flange hole ø 4mm dry heating element		
For models:	EXPRESS P 6, EXPRESS P66, PAOLO 6, PAOLO12		

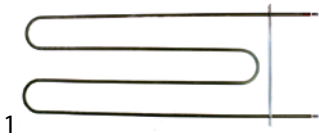

GEV No.	418679	Ref. No.	91711013
description	heating element 1000W 230V L 675mm W 280mm flange length 324mm flange width 25mm hole distance 310mm connection length 135mm connection M4 tube ø 8.5mm heating circuits 1 rectangular flange hole ø 4mm dry heating element		

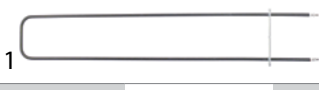

GEV No.	417630	Ref. No.	9171185
description	heating element 1080W 230V L 715mm W 130mm flange length 160mm flange width 24mm hole distance 143mm tube ø 9mm heating circuits 1 mounting pos. upper for pizza oven		



GEV No.	415917	Ref. No.	91711911 ME0000003
description	heating element 1400W 230V L 572mm W 159mm flange length 220mm flange width 32mm hole distance 199mm connection length 134mm connection M5 L1 30mm L2 27mm L3 515mm W1 25mm W2 110mm tube ø 10.2mm heating circuits 1 rectangular flange hole ø 4mm dry heating element		
For models:	EXPRESS P 6, EXPRESS P66, PAOLO 6, PAOLO12		



GEV No.	415918	Ref. No.	91711902 ME0000004
description	heating element 1500W 230V L 875mm W 164mm flange length 220mm flange width 30mm hole distance 202mm connection length 132mm connection M5 L3 815mm W1 25mm W2 110mm tube ø 10mm heating circuits 1 rectangular flange hole ø 4mm dry heating element		
For models:	EXPRESS P 9, EXPRESS P99, PAOLO 9, PAOLO18		

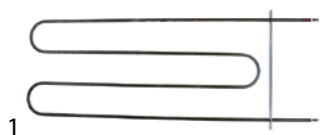

GEV No.	418680	Ref. No.	91711018
description	heating element 1600W 230V L 675mm W 280mm flange length 324mm flange width 25mm hole distance 310mm connection length 135mm connection M4 tube ø 8.5mm heating circuits 1 mounting thread rectangular flange hole ø 4mm dry heating element		



GEV No.	415959	Ref. No.	N/A
description	heating element 1750W 230V L 860mm W 160mm flange length 220mm flange width 30mm hole distance 200mm connection length 112mm connection M5 L3 810mm W1 25mm W2 110mm tube ø 10mm heating circuits 1 rectangular flange hole ø 4mm dry heating element		



GEV No.	415919	Ref. No.	91711912 ME0000005
description	heating element 2000W 230V L 870mm W 160mm flange length 220mm flange width 31mm hole distance 200mm connection length 130mm connection 5 L3 820mm W1 110mm W2 160mm tube ø 10mm heating circuits 1 rectangular flange hole ø 4mm dry heating element		
For models:	EXPRESS P 9, EXPRESS P99, PAOLO 9, PAOLO18		



GEV No.	415677	Ref. No.	N/A
description	heating element 600W 230V L 567mm W 130mm flange length 160mm flange width 22mm hole distance 144mm connection length 132mm connection M5 tube ø 8.5mm heating circuits 1 rectangular flange hole ø 6mm dry heating element		



GEV No.	418853	Ref. No.	91711900
description	heating element 600W 230V L 570mm W 130mm flange length 160mm flange width 22mm hole distance 145mm connection length 27mm heating circuits 1		

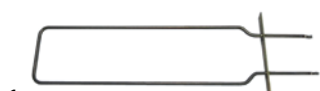

GEV No.	415939	Ref. No.	ME0000000
description	heating element 600W 230V L 570mm W 160mm flange length 220mm flange width 30mm hole distance 200mm connection length 131mm connection M5 L3 520mm W2 113mm tube ø 10mm heating circuits 1 rectangular flange hole ø 4mm dry heating element		
For models:	EXPRESS P 4, EXPRESS P44, PAOLO 4, PAOLO 8		

1 electric components

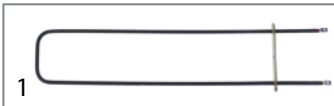

GEV No.	418854	Ref. No.	91711910
description	heating element 800W 230V L 560mm W 130mm flange length 160mm flange width 22mm hole distance 145mm connection length 133mm connection M5 IT tube ø 8.5mm heating circuits 1 rectangular flange hole ø 6mm		



GEV No.	415916	Ref. No.	N/A
description	heating element 800W 230V L 567mm W 128mm flange length 160mm flange width 22mm hole distance 144mm connection length 132mm connection M5 tube ø 8.5mm heating circuits 1 rectangular flange hole ø 6mm dry heating element		

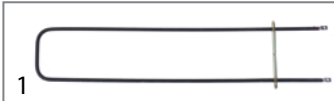

GEV No.	415940	Ref. No.	ME0000001
description	heating element 800W 230V L 570mm W 156mm flange length 220mm flange width 30mm hole distance 202mm connection length 132mm connection M5 tube ø 10mm heating circuits 1 rectangular flange hole ø 4mm dry heating element W1 110mm W2 23mm		
For models:	EXPRESS P 4, EXPRESS P44, PAOLO 4, PAOLO 8		





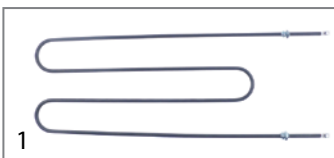

GEV No.	418057	Ref. No.	91711041 ME0000062
description	heating element 1000W 230V L 1060mm W 205mm thread 1/4" mounting distance 196mm connection length 109mm connection M5 tube ø 8.6mm heating circuits 1 dry heating element 2 hole fixing		
For models:	MAX 6/35, MAX 6/35X, MAX 8/35, MAX12/35		
accessories for	418057		
	GEV No.	361182	Ref. No. —
	nut thread 1/4" H 5mm nickel-plated brass WS 17 Qty 1 pcs		
	GEV No.	510417	Ref. No. —
	flat gasket fibre ED ø 20mm ID ø 14mm thickness 2mm Qty 1 pcs		
	GEV No.	520228	Ref. No. —
	tooth lock washer ID ø 15.3mm ED ø 24mm steel Qty 1 pcs for thread M14		
	GEV No.	550262	Ref. No. —
	flat gasket copper ED ø 20mm ID ø 14mm thickness 2mm		

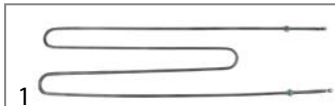

GEV No.	418880	Ref. No.	91711022
description	heating element 1000W 230V L 580mm W 235mm thread 1/4" mounting distance 227mm connection length 110mm connection M5 tube ø 8.5mm heating circuits 1 for pizza oven		





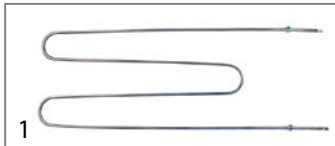

GEV No.	418054	Ref. No.	91711050 ME0000061
description	heating element 1000W 230V L 708mm W 198mm thread 1/4" mounting distance 178mm connection length 108mm connection M5 tube ø 8.5mm heating circuits 1 dry heating element 2 hole fixing		
For models:	MAX 4/35, MAX 4/35X, MAX 6/35, MAX 8/35		
accessories for	418054		
	GEV No.	361182	Ref. No. —
	nut thread 1/4" H 5mm nickel-plated brass WS 17 Qty 1 pcs		
	GEV No.	510417	Ref. No. —
	flat gasket fibre ED ø 20mm ID ø 14mm thickness 2mm Qty 1 pcs		
	GEV No.	520228	Ref. No. —
	tooth lock washer ID ø 15.3mm ED ø 24mm steel Qty 1 pcs for thread M14		
	GEV No.	550262	Ref. No. —
	flat gasket copper ED ø 20mm ID ø 14mm thickness 2mm		



GEV No.	418059	Ref. No.	91711042 ME0000066
description	heating element 1000W 230V L 710mm W 300mm thread 1/4" mounting distance 290mm connection M5 tube ø 8.5mm heating circuits 1 dry heating element 2 hole fixing		
For models:	MAX 6/35L, MAX 6/35LX, MAX12/35L		





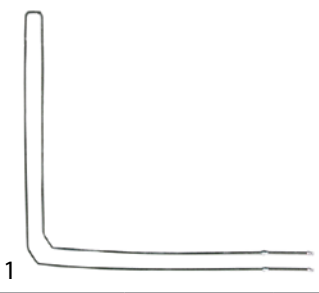

GEV No.	416437	Ref. No.	91711021 ME0000012
description	heating element 1000W 230V L 895mm W 132mm thread 1/4" mounting distance 122mm connection length 110mm connection M4 tube ø 8.5mm heating circuits 1 dry heating element 2 hole fixing		
For models:	EXCELSIOR MAXI PROFI		
accessories for	416437		
	GEV No.	361182	Ref. No. —
	nut thread 1/4" H 5mm nickel-plated brass WS 17 Qty 1 pcs		
	GEV No.	510417	Ref. No. —
	flat gasket fibre ED ø 20mm ID ø 14mm thickness 2mm Qty 1 pcs		
	GEV No.	520228	Ref. No. —
	tooth lock washer ID ø 15.3mm ED ø 24mm steel Qty 1 pcs for thread M14		
	GEV No.	550262	Ref. No. —
	flat gasket copper ED ø 20mm ID ø 14mm thickness 2mm		







GEV No.	418221	Ref. No.	91711062 ME0000107
description	heating element 1400W 230V L 1144mm W 1090mm thread 1/4" mounting distance 100mm connection length 160mm connection M5 tube ø 8.5mm dry heating element mounting pos. bottom at the back 2 hole fixing		
For models:	EVOLUTION DIGITAL, EVOLUTION MECHANICAL		

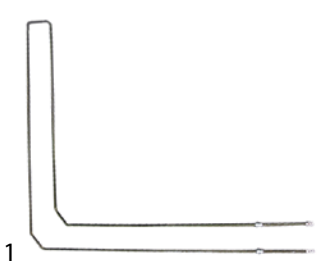





GEV No.	416438	Ref. No.	91711031 ME0000013
description	heating element 1400W 230V L 898mm W 132mm thread 1/4" mounting distance 123mm connection length 98mm connection M5 tube ø 8.5mm heating circuits 1 dry heating element 2 hole fixing		
For models:	EXCELSIOR MAXI PROFI		
spare parts for	416438		
	GEV No.	510417	Ref. No. —
	flat gasket fibre ED ø 20mm ID ø 14mm thickness 2mm Qty 1 pcs		
accessories for	416438		
	GEV No.	361182	Ref. No. —
	nut thread 1/4" H 5mm nickel-plated brass WS 17 Qty 1 pcs		
	GEV No.	520228	Ref. No. —
	tooth lock washer ID ø 15.3mm ED ø 24mm steel Qty 1 pcs for thread M14		
	GEV No.	550262	Ref. No. —
	flat gasket copper ED ø 20mm ID ø 14mm thickness 2mm		



GEV No.	418220	Ref. No.	91711061 ME0000106
description	heating element 1400W 230V L 938mm W 880mm thread 1/4" mounting distance 97mm connection length 24mm connection M5 tube ø 8.7mm dry heating element mounting pos. bottom/centre 2 hole fixing		
For models:	EVOLUTION MECHANICAL		
accessories for	418220		
	GEV No.	361182	Ref. No. —
	nut thread 1/4" H 5mm nickel-plated brass WS 17 Qty 1 pcs		
	GEV No.	510417	Ref. No. —
	flat gasket fibre ED ø 20mm ID ø 14mm thickness 2mm Qty 1 pcs		

accessories for	418220		
	GEV No.	520228	Ref. No. —
	tooth lock washer ID ø 15.3mm ED ø 24mm steel Qty 1 pcs for thread M14		
	GEV No.	550262	Ref. No. —
	flat gasket copper ED ø 20mm ID ø 14mm thickness 2mm		



GEV No.	418061	Ref. No.	91711043 ME0000064
description	heating element 1500W 230V L 1055mm W 280mm thread 1/4" mounting distance 272mm connection length 108mm connection M5 tube ø 8.5mm heating circuits 1 dry heating element 2 hole fixing		
For models:	MAX 9/35, MAX 9/35X, MAX18/35		
accessories for	418061		
	GEV No.	361182	Ref. No. —
	nut thread 1/4" H 5mm nickel-plated brass WS 17 Qty 1 pcs		
	GEV No.	510417	Ref. No. —
	flat gasket fibre ED ø 20mm ID ø 14mm thickness 2mm Qty 1 pcs		
	GEV No.	520228	Ref. No. —
	tooth lock washer ID ø 15.3mm ED ø 24mm steel Qty 1 pcs for thread M14		
	GEV No.	550262	Ref. No. —
	flat gasket copper ED ø 20mm ID ø 14mm thickness 2mm		







GEV No.	420501	Ref. No.	91711343
description	heating element 1500W 230V L 1060mm W 320mm thread 1/4" mounting distance 1060mm connection M5 tube ø 8.5mm heating circuits 1 mounting pos. lower threaded		

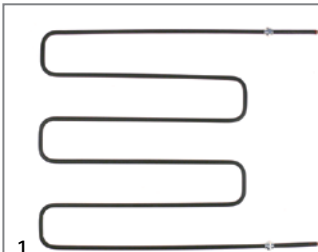





GEV No.	418053	Ref. No.	91711005 ME0000026
description	heating element 1500W 230V L 365mm W 400mm L1 20mm L2 60mm L3 285mm W1 32mm W2 335mm thread M10x1 mounting distance 331mm connection length 85mm connection M5 windings 4 tube ø 6.3mm heating circuits 1 dry heating element mounting pos. upper 2 hole fixing pizza oven		
For models:	MICRO		







GEV No.	418673	Ref. No.	91711010 91715001
description	heating element 1500W 230V L 475mm W 445mm thread 1/4" mounting distance 436.5mm connection length 116mm connection male faston 6.3mm tube ø 8.5mm heating circuits 1 dry heating element 2 hole fixing		
accessories for	418673		
	GEV No.	361182	Ref. No. —
	nut thread 1/4" H 5mm nickel-plated brass WS 17 Qty 1 pcs		
	GEV No.	510417	Ref. No. —
	flat gasket fibre ED ø 20mm ID ø 14mm thickness 2mm Qty 1 pcs		
	GEV No.	520228	Ref. No. —
	tooth lock washer ID ø 15.3mm ED ø 24mm steel Qty 1 pcs for thread M14		
	GEV No.	550262	Ref. No. —
	flat gasket copper ED ø 20mm ID ø 14mm thickness 2mm		







GEV No.	416439	Ref. No.	91711023 ME0000014
description	heating element 1500W 230V L 900mm W 245mm thread 1/4" mounting distance 237mm connection length 110mm connection M5 tube ø 8.5mm heating circuits 1 dry heating element 2 hole fixing		
For models:	EXCELSIOR EXTRAPROFI		
accessories for	416439		
	GEV No.	361182	Ref. No. —
	nut thread 1/4" H 5mm nickel-plated brass WS 17 Qty 1 pcs		
	GEV No.	510417	Ref. No. —
	flat gasket fibre ED ø 20mm ID ø 14mm thickness 2mm Qty 1 pcs		
	GEV No.	520228	Ref. No. —
	tooth lock washer ID ø 15.3mm ED ø 24mm steel Qty 1 pcs for thread M14		
	GEV No.	550262	Ref. No. —
	flat gasket copper ED ø 20mm ID ø 14mm thickness 2mm		

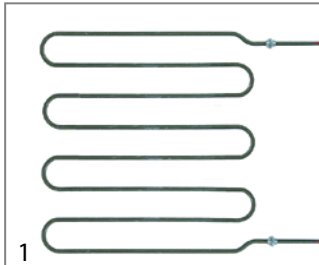

GEV No.	418056	Ref. No.	91711051 ME0000063
description	heating element 1600W 230V L 1060mm W 230mm thread 1/4" mounting distance 221mm connection length 110mm connection M5 tube ø 8.5mm heating circuits 1 dry heating element 2 hole fixing		
For models:	MAX 6/35, MAX 6/35X, MAX 8/35, MAX12/35, MAX18/35		
accessories for	418056		
	GEV No.	361182	Ref. No. —
	nut thread 1/4" H 5mm nickel-plated brass WS 17 Qty 1 pcs		

accessories for	418056		
	GEV No.	510417	Ref. No. —
	flat gasket fibre ED ø 20mm ID ø 14mm thickness 2mm Qty 1 pcs		
	GEV No.	520228	Ref. No. —
	tooth lock washer ID ø 15.3mm ED ø 24mm steel Qty 1 pcs for thread M14		
	GEV No.	550262	Ref. No. —
	flat gasket copper ED ø 20mm ID ø 14mm thickness 2mm		



GEV No.	416434	Ref. No.	91711930 ME0000020
description	heating element 1600W 230V L 480mm W 500mm L1 40mm L2 30mm L3 410mm W1 20mm W2 460mm thread 1/4" mounting distance 452mm connection length 130mm connection grip connection windings 4 tube ø 8.5mm heating circuits 1 dry heating element 2 hole fixing		
For models:	BABY		
accessories for	416434		
	GEV No.	361182	Ref. No. —
	nut thread 1/4" H 5mm nickel-plated brass WS 17 Qty 1 pcs		
	GEV No.	510417	Ref. No. —
	flat gasket fibre ED ø 20mm ID ø 14mm thickness 2mm Qty 1 pcs		
	GEV No.	520228	Ref. No. —
	tooth lock washer ID ø 15.3mm ED ø 24mm steel Qty 1 pcs for thread M14		
	GEV No.	550262	Ref. No. —
	flat gasket copper ED ø 20mm ID ø 14mm thickness 2mm		

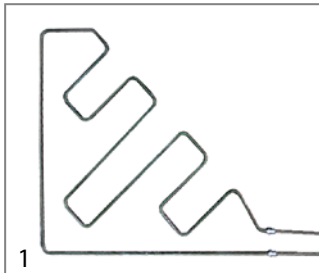





GEV No.	418219	Ref. No.	91711060 ME0000105
description	heating element 1600W 230V L 710mm W 665mm thread 1/4" mounting distance 96mm connection length 148mm connection M5 tube ø 8.5mm heating circuits 1 dry heating element mounting pos. bottom in the front 2 hole fixing		
For models:	EVOLUTION DIGITAL, EVOLUTION MECHANICAL		
accessories for	418219		
	GEV No.	361182	Ref. No. —
	nut thread 1/4" H 5mm nickel-plated brass WS 17 Qty 1 pcs		

Table continues overleaf



accessories for	418219		
	GEV No.	510417	Ref. No. —
	flat gasket fibre ED ø 20mm ID ø 14mm thickness 2mm Qty 1 pcs		
	GEV No.	520228	Ref. No. —
	tooth lock washer ID ø 15.3mm ED ø 24mm steel Qty 1 pcs for thread M14		
	GEV No.	550262	Ref. No. —
	flat gasket copper ED ø 20mm ID ø 14mm thickness 2mm		



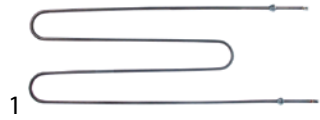

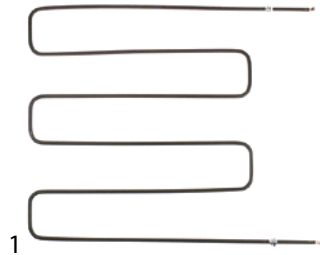

1

GEV No.	418058	Ref. No.	91711052 ME0000067
description	heating element 1600W 230V L 715mm W 275mm thread 1/4" mounting distance 275mm connection M4 tube ø 8.5mm heating circuits 1 dry heating element 2 hole fixing		
For models:	MAX 6/35L, MAX 6/35LX, MAX12/35L		





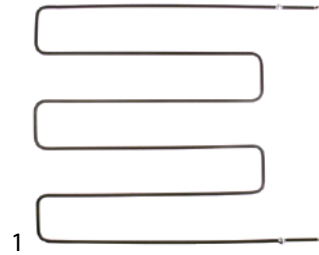

1

GEV No.	418675	Ref. No.	91711011
description	heating element 1800W 230V L 575mm W 550mm thread 1/4" mounting distance 541mm connection length 116mm connection male faston 6.3mm tube ø 8.5mm heating circuits 1 dry heating element 2 hole fixing		
spare parts for	418675		
	GEV No.	510417	Ref. No. —
	flat gasket fibre ED ø 20mm ID ø 14mm thickness 2mm Qty 1 pcs		
accessories for	418675		
	GEV No.	361182	Ref. No. —
	nut thread 1/4" H 5mm nickel-plated brass WS 17 Qty 1 pcs		
	GEV No.	520228	Ref. No. —
	tooth lock washer ID ø 15.3mm ED ø 24mm steel Qty 1 pcs for thread M14		
	GEV No.	550262	Ref. No. —
	flat gasket copper ED ø 20mm ID ø 14mm thickness 2mm		





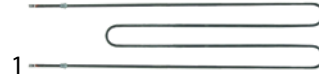

1





GEV No.	418677	Ref. No.	91711012
description	heating element 2000W 230V L 675mm W 650mm thread 1/4" mounting distance 651.5mm connection length 120mm connection male faston 6.3mm tube ø 8.5mm heating circuits 1 dry heating element 2 hole fixing		
accessories for	418677		
	GEV No.	361182	Ref. No. —
	nut thread 1/4" H 5mm nickel-plated brass WS 17 Qty 1 pcs		
	GEV No.	510417	Ref. No. —
	flat gasket fibre ED ø 20mm ID ø 14mm thickness 2mm Qty 1 pcs		
	GEV No.	520228	Ref. No. —
	tooth lock washer ID ø 15.3mm ED ø 24mm steel Qty 1 pcs for thread M14		
	GEV No.	550262	Ref. No. —
	flat gasket copper ED ø 20mm ID ø 14mm thickness 2mm		



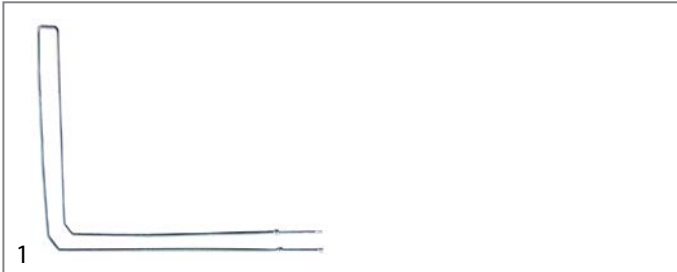



1

GEV No.	416440	Ref. No.	91711033 ME0000015
description	heating element 2000W 230V L 892mm W 245mm thread 1/4" mounting distance 237mm connection length 97mm connection M5 tube ø 8.5mm heating circuits 1 dry heating element 2 hole fixing		
For models:	EXCELSIOR EXTRAPROFI		
spare parts for	416440		
	GEV No.	510417	Ref. No. —
	flat gasket fibre ED ø 20mm ID ø 14mm thickness 2mm Qty 1 pcs		
accessories for	416440		
	GEV No.	361182	Ref. No. —
	nut thread 1/4" H 5mm nickel-plated brass WS 17 Qty 1 pcs		
	GEV No.	520228	Ref. No. —
	tooth lock washer ID ø 15.3mm ED ø 24mm steel Qty 1 pcs for thread M14		
	GEV No.	550262	Ref. No. —
	flat gasket copper ED ø 20mm ID ø 14mm thickness 2mm		

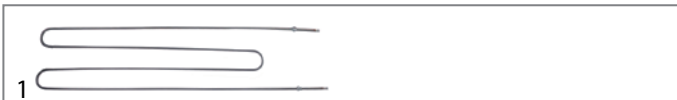





GEV No.	418212	Ref. No.	91711072 ME0000102
description	heating element 2400W 230V L 1043mm W 1090mm thread 1/4" mounting distance 100mm connection length 160mm connection M5 tube ø 8.5mm dry heating element mounting pos. upper/lower 2 hole fixing pizza oven		
For models:	EVOLUTION DIGITAL, EVOLUTION MECHANICAL		
accessories for	418212		
	GEV No.	361182	Ref. No. —
	nut thread 1/4" H 5mm nickel-plated brass WS 17 Qty 1 pcs		
	GEV No.	510417	Ref. No. —
	flat gasket fibre ED ø 20mm ID ø 14mm thickness 2mm Qty 1 pcs		
	GEV No.	520228	Ref. No. —
	tooth lock washer ID ø 15.3mm ED ø 24mm steel Qty 1 pcs for thread M14		
	GEV No.	550262	Ref. No. —
	flat gasket copper ED ø 20mm ID ø 14mm thickness 2mm		

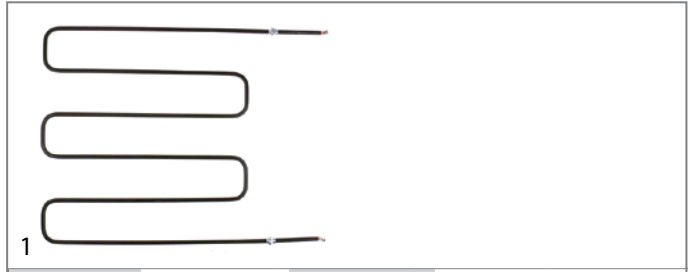





GEV No.	418060	Ref. No.	91711053 ME0000065
description	heating element 2400W 230V L 1060mm W 265mm thread 1/4" mounting distance 257mm connection length 108mm connection M5 tube ø 8.5mm heating circuits 1 dry heating element 2 hole fixing		
For models:	MAX 9/35, MAX 9/35X, MAX18/35		
accessories for	418060		
	GEV No.	361182	Ref. No. —
	nut thread 1/4" H 5mm nickel-plated brass WS 17 Qty 1 pcs		
	GEV No.	510417	Ref. No. —
	flat gasket fibre ED ø 20mm ID ø 14mm thickness 2mm Qty 1 pcs		
	GEV No.	520228	Ref. No. —
	tooth lock washer ID ø 15.3mm ED ø 24mm steel Qty 1 pcs for thread M14		
	GEV No.	550262	Ref. No. —
	flat gasket copper ED ø 20mm ID ø 14mm thickness 2mm		

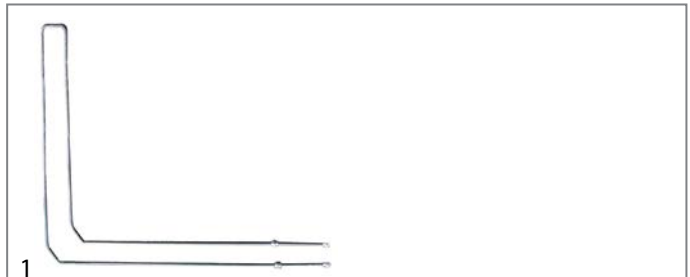





GEV No.	418674	Ref. No.	91711015 91715021
description	heating element 2400W 230V L 475mm W 445mm thread 1/4" mounting distance 436.5mm connection length 116mm connection male faston 6.3mm tube ø 8.5mm dry heating element 2 hole fixing		
accessories for	418674		
	GEV No.	361182	Ref. No. —
	nut thread 1/4" H 5mm nickel-plated brass WS 17 Qty 1 pcs		
	GEV No.	510417	Ref. No. —
	flat gasket fibre ED ø 20mm ID ø 14mm thickness 2mm Qty 1 pcs		
	GEV No.	520228	Ref. No. —
	tooth lock washer ID ø 15.3mm ED ø 24mm steel Qty 1 pcs for thread M14		
	GEV No.	550262	Ref. No. —
	flat gasket copper ED ø 20mm ID ø 14mm thickness 2mm		

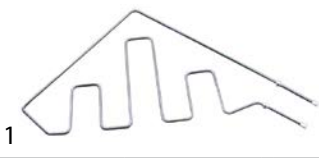

GEV No.	418213	Ref. No.	91711071 ME0000101
description	heating element 2400W 230V L 930mm W 883mm thread 1/4" mounting distance 109mm connection length 159mm connection M5 tube ø 8.5mm dry heating element 2 hole fixing		
For models:	EVOLUTION DIGITAL, EVOLUTION MECHANICAL		
accessories for	418213		
	GEV No.	361182	Ref. No. —
	nut thread 1/4" H 5mm nickel-plated brass WS 17 Qty 1 pcs		
	GEV No.	510417	Ref. No. —
	flat gasket fibre ED ø 20mm ID ø 14mm thickness 2mm Qty 1 pcs		
	GEV No.	520228	Ref. No. —
	tooth lock washer ID ø 15.3mm ED ø 24mm steel Qty 1 pcs for thread M14		
	GEV No.	550262	Ref. No. —
	flat gasket copper ED ø 20mm ID ø 14mm thickness 2mm		

GEV No.	418214	Ref. No.	91711070 ME0000100
description	heating element 2600W 230V L 710mm W 665mm thread 1/4" mounting distance 93mm connection length 151mm connection M5 tube ø 8.5mm heating circuits 1 dry heating element 2 hole fixing W1 101mm W2 564mm		
For models:	EVOLUTION DIGITAL, EVOLUTION MECHANICAL		
accessories for	418214		
	GEV No.	361182	Ref. No. —
	nut thread 1/4" H 5mm nickel-plated brass WS 17 Qty 1 pcs		
	GEV No.	510417	Ref. No. —
	flat gasket fibre ED ø 20mm ID ø 14mm thickness 2mm Qty 1 pcs		
	GEV No.	520228	Ref. No. —
	tooth lock washer ID ø 15.3mm ED ø 24mm steel Qty 1 pcs for thread M14		
	GEV No.	550262	Ref. No. —
	flat gasket copper ED ø 20mm ID ø 14mm thickness 2mm		





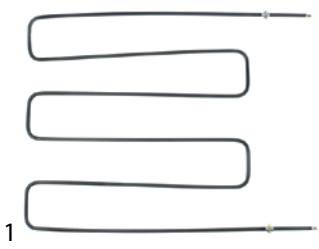

GEV No.	420502	Ref. No.	91711353 91711353-1
description	heating element 2690W 230V L 1060mm W 320mm thread 1/4" mounting distance 106mm connection M5 tube ø 8.5mm heating circuits 1 mounting pos. upper threaded		

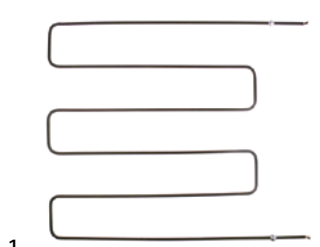





GEV No.	418676	Ref. No.	91711016
description	heating element 2800W 230V L 570mm W 520mm thread 1/4" mounting distance 511mm connection length 118mm connection male faston 6.3mm tube ø 8.5mm heating circuits 1		



GEV No.	418678	Ref. No.	91711017
description	heating element 3200W 230V L 675mm W 650mm thread 1/4" mounting distance 641mm connection length 120mm connection male faston 6.3mm tube ø 8.5mm heating circuits 1 dry heating element 2 hole fixing		
spare parts for	418678		
	GEV No.	510417	Ref. No. —
	flat gasket fibre ED ø 20mm ID ø 14mm thickness 2mm Qty 1 pcs		
accessories for	418678		
	GEV No.	361182	Ref. No. —
	nut thread 1/4" H 5mm nickel-plated brass WS 17 Qty 1 pcs		
	GEV No.	520228	Ref. No. —
	tooth lock washer ID ø 15.3mm ED ø 24mm steel Qty 1 pcs for thread M14		
	GEV No.	550262	Ref. No. —
	flat gasket copper ED ø 20mm ID ø 14mm thickness 2mm		



GEV No.	416435	Ref. No.	91711020 ME0000010
description	heating element 600W 230V L 605mm W 130mm thread 1/4" mounting distance 120mm connection length 110mm connection M4 tube ø 8.5mm heating circuits 1 dry heating element 2 hole fixing pizza oven		
For models:	EXCELSIOR MINI PROFI		
accessories for	416435		
	GEV No.	361182	Ref. No. —
	nut thread 1/4" H 5mm nickel-plated brass WS 17 Qty 1 pcs		
	GEV No.	510417	Ref. No. —
	flat gasket fibre ED ø 20mm ID ø 14mm thickness 2mm Qty 1 pcs		
	GEV No.	520228	Ref. No. —
	tooth lock washer ID ø 15.3mm ED ø 24mm steel Qty 1 pcs for thread M14		
	GEV No.	550262	Ref. No. —
	flat gasket copper ED ø 20mm ID ø 14mm thickness 2mm		

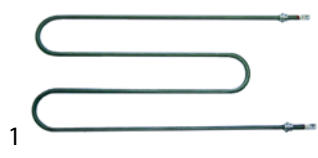



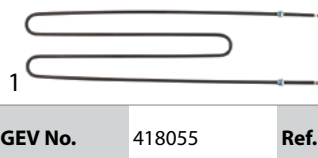

GEV No.	415825	Ref. No.	N/A
description	heating element 600W 400V L 470mm W 200mm thread 1/4" mounting distance 191mm connection length 54mm connection M4 tube ø 8.5mm heating circuits 1 dry heating element mounting pos. upper 2 hole fixing pizza oven		



GEV No.	418055	Ref. No.	91711040 ME0000060
description	heating element 700W 230V L 711mm W 194mm thread 1/4" mounting distance 185mm connection length 121mm connection M5 tube ø 8.8mm heating circuits 1 dry heating element 2 hole fixing		
For models:	MAX 4/35, MAX 4/35X, MAX 6/35, MAX 8/35		

accessories for 418055

	GEV No.	361182	Ref. No.	—
nut thread 1/4" H 5mm nickel-plated brass WS 17 Qty 1 pcs				
	GEV No.	510417	Ref. No.	—
flat gasket fibre ED ø 20mm ID ø 14mm thickness 2mm Qty 1 pcs				
	GEV No.	520228	Ref. No.	—
tooth lock washer ID ø 15.3mm ED ø 24mm steel Qty 1 pcs for thread M14				
	GEV No.	550262	Ref. No.	—
flat gasket copper ED ø 20mm ID ø 14mm thickness 2mm				



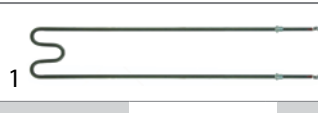

GEV No.	418052	Ref. No.	91711000 ME0000025
description	heating element 800W 230V L 370mm W 390mm L1 30mm L2 55mm L3 285mm W1 30mm W2 330mm thread M10x1 mounting distance 310mm connection length 87mm connection M4 windings 4 tube ø 6.3mm dry heating element mounting pos. lower 2 hole fixing pizza oven		
For models:	MICRO		



GEV No.	416436	Ref. No.	91711030 ME0000011	
description	heating element 800W 230V L 605mm W 130mm thread 1/4" mounting distance 122mm connection length 110mm connection M4 tube ø 8.5mm heating circuits 1 dry heating element 2 hole fixing			
For models:	EXCELSIOR MINI PROFI			
spare parts for	416436			
	GEV No.	510417	Ref. No.	—
flat gasket fibre ED ø 20mm ID ø 14mm thickness 2mm Qty 1 pcs				

accessories for 416436

	GEV No.	361182	Ref. No.	—
nut thread 1/4" H 5mm nickel-plated brass WS 17 Qty 1 pcs				
	GEV No.	520228	Ref. No.	—
tooth lock washer ID ø 15.3mm ED ø 24mm steel Qty 1 pcs for thread M14				
	GEV No.	550262	Ref. No.	—
flat gasket copper ED ø 20mm ID ø 14mm thickness 2mm				

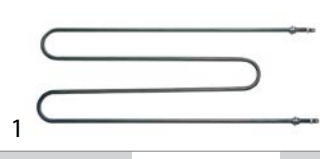

GEV No.	415588	Ref. No.	N/A
description	heating element 800W 415V L 575mm W 200mm thread 1/4" mounting distance 191mm connection length 52mm connection M4 tube ø 8.5mm heating circuits 1 dry heating element mounting pos. lower 2 hole fixing		

heating elements for pizza presses



GEV No.	416441	Ref. No.	91711940 ME0000035
description	heating element 1500W 230V L 355mm W 245mm heating circuits 1 connection M5 connection length 16mm L1 120mm L2 235mm dry heating element tube ø 8.5mm connection distance 11mm		
For models:	P33		

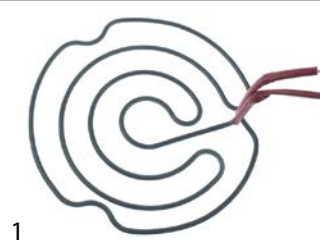

GEV No.	418047	Ref. No.	91711080 ME0000040
description	heating element 1600W 230V L 300mm Wmm heating circuits 1 cable length 1450mm connection length 30mm dry heating element tube ø 6.3mm ext. ø 300		
For models:	P/30		

1

GEV No.	418048	Ref. No.	91711081 91711086 ME0000041
description	heating element 1790W 208V heating circuits 1 cable length 1350mm tube ø 6.3mm ext. ø 300 connection distance 50mm		
For models:	P/35		



1

GEV No.	418050	Ref. No.	ME0000043
description	heating element 2600W 220V heating circuits 1 cable length 1480mm dry heating element tube ø 6.3mm ext. ø 435 connection distance 47mm		
For models:	P/45		

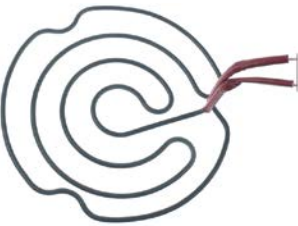

1

GEV No.	419186	Ref. No.	91711280
description	heating element 1790W 220V L 29mm Wmm heating circuits 1 cable length 900mm dry heating element tube ø 6.3mm ext. ø 29		

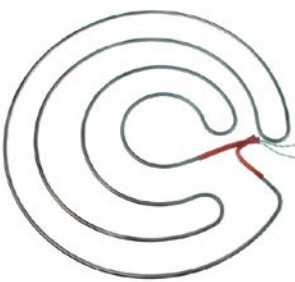

1

GEV No.	418051	Ref. No.	91711084 ME0000044
description	heating element 2900/3200W 208/230V cable length 1400mm dry heating element tube ø 6.3mm ext. ø 475		
For models:	P/50		

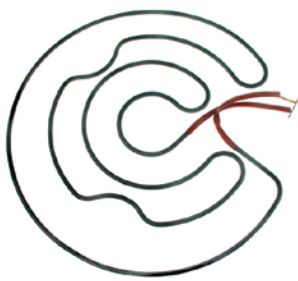

1

GEV No.	418049	Ref. No.	91711082 ME0000042
description	heating element 2200W 220V heating circuits 1 cable length 1480mm dry heating element tube ø 6.3mm ext. ø 385 connection distance 38mm		
For models:	P/40		

thermostats

control and safety thermostats

EGO

control thermostats

55.10/19_ series



GEV No.	375273	Ref. No.	ME0000303 ME0000304
description	thermostat t.max. 200°C temperature range 60-200°C 1-pole 1NO 16A probe ø 6mm probe L 74mm capillary pipe 1500mm capillary pipe isolatedmm gland nut shaft L 23mm shaft position upper rotation 270°		
For models:	P/45, P33		

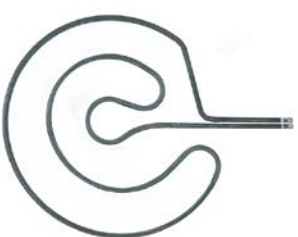

1

GEV No.	416442	Ref. No.	91711941 ME0000036
description	heating element 2500W 230V L 460mm W 355mm connection M5 connection length 16mm L1 130mm L2 330mm dry heating element tube ø 8.5mm connection distance 12mm		
For models:	P/45		



GEV No.	375253	Ref. No.	91310003
description	thermostat t.max. 455°C temperature range 85-455°C 1-pole 1NO 16A probe ø 3.9mm probe L 228mm capillary pipe 870mm capillary pipe isolated 660mm gland nut shaft ø 6x4.6mm shaft L 23mm shaft position upper rotation 270°		



GEV No.	375247	Ref. No.	57100 ME0000300
description	thermostat t.max. 500°C temperature range 75-500°C 1-pole 1NO 16A probe ø 4mm probe L 228mm capillary pipe 900mm capillary pipe isolatedmm gland nut shaft ø 6x4.6mm shaft L 23mm shaft position upper rotation 270°		
For models:	BABY, EXPRESS P 4, EXPRESS P 6, EXPRESS P 9, EXPRESS P44, EXPRESS P66, EXPRESS P99, MICRO, MINI PROFI 90, PAOLO 4, PAOLO 6, PAOLO 8, PAOLO 9, PAOLO12, PAOLO18		

safety thermostats

55.10/19_series



GEV No.	375191	Ref. No.	91310050 ME0000305
description	safety thermostat switch-off temp. 500°C 1-pole 16A probe ø 3.9mm probe L 230mm capillary pipe 870mm capillary pipe isolated 660mm gland nut probe		
For models:	EVOLUTION DIGITAL, G433, G633, G933, GAS-EXCELSIOR G433, GAS-EXCELSIOR G633, GAS-EXCELSIOR G933, MAX 4/35, MAX 6/35, MAX 6/35L, MAX 8/35, MAX 9/35, MAX12/35, MAX12/35L, MAX18/35		

55.32_series



GEV No.	375190	Ref. No.	91310051 ME0000306
description	safety thermostat switch-off temp. 560°C 3-pole 20A probe ø 3.9mm probe L 228mm capillary pipe 870mm capillary pipe isolated 700mm gland nut probe		
For models:	BABY, EVOLUTION MECHANICAL, EXCELSIOR EXTRAPROFI, EXCELSIOR MAXI PROFI, EXCELSIOR MINI PROFI, EXPRESS P 4, EXPRESS P 6, EXPRESS P 9, EXPRESS P44, EXPRESS P66, EXPRESS P99, MAX 4/35X, MAX 6/35LX, MAX 6/35X, MAX 8/35X, MAX 9/35X, MAX12/35LX, MAX12/35X, MAX18/35X, PAOLO 4, PAOLO 6, PAOLO 8, PAOLO 9, PAOLO12, PAOLO18		

JUMO

safety thermostats



GEV No.	376069	Ref. No.	91310057
description	safety thermostat switch-off temp. adjustable 30-500°C 1-pole 1CO 16A probe ø 4mm probe L 183mm capillary pipe 1470mm capillary pipe isolatedmm shaft ø 5.4mm		

switches and momentary switches

rocker/momentary rocker switches



30x11 mm



GEV No.	301012	Ref. No.	ME0000330
description	rocker switch mounting measurements 30x11mm green 1NO/ indicator light 250V 16A 0-I connection male faston 6.3mm ambient temperature max. 85/125°C protection IP40		
For models:	EXPRESS P 4, EXPRESS P 6, EXPRESS P 9, EXPRESS P44, EXPRESS P66, EXPRESS P99		



30x22mm			
			
1			
GEV No.	301020	Ref. No.	91310090 ME0000332
description	momentary rocker switch mounting measurements 30x22mm red 2NO 250V 16A illuminated 0-1 connection male faston 6.3mm ambient temperature max. 100/55°C protection IP65		
For models:	EVOLUTION MECHANICAL, G433, G633, G933, GAS-EXCELSIOR G433, GAS-EXCELSIOR G633, GAS-EXCELSIOR G933, MAX 4/35X, MAX 6/35LX, MAX 6/35X, MAX 8/35X, MAX 9/35X, MAX12/35LX, MAX12/35X, MAX18/35X		

			
1			
GEV No.	301003	Ref. No.	91310085 ME0000331
description	rocker switch mounting measurements 30x22mm green 2NO 250V 16A illuminated 0-1 connection male faston 6.3mm ambient temperature max. 125/55°C protection IP65		
For models:	EVOLUTION MECHANICAL, EXCELSIOR EXTRAPROFI, EXCELSIOR MAXI PROFI, EXCELSIOR MINI PROFI, EXPRESS P 4, EXPRESS P 6, EXPRESS P 9, EXPRESS P44, EXPRESS P66, EXPRESS P99, G433, G633, G933, GAS-EXCELSIOR G433, GAS-EXCELSIOR G633, GAS-EXCELSIOR G933, MAX 4/35X, MAX 6/35LX, MAX 6/35X, MAX 8/35X, MAX 9/35X, MAX12/35LX, MAX12/35X, MAX18/35X, MICRO, PAOLO 4, PAOLO 6, PAOLO 8, PAOLO 9, PAOLO12, PAOLO18		
accessories for	301003		
	GEV No.	301036	Ref. No. —
	protective cover internal size 30x22mm for rocker switch mounting measurementsmm		

microswitches

lever actuated

			
1			
GEV No.	345125	Ref. No.	ME0000491
description	microswitch with lever 250V 16A 1CO connection male faston 6.3mm ambient temperature max. 85°C mounting distance 25mm type C99ZP3 actuating force: 25g lever length 63.5mm		
For models:	P/30, P/35, P/40, P/45, P/50, P33		

roller actuated

roller 0°

			
1			
GEV No.	348145	Ref. No.	91310430
description	microswitch 250V 16A 1CO connection screw thread L 15mm thread M12x1 mounting distance 25.4mm actuating force: 500g type MK V11D15		

			
1			
GEV No.	345639	Ref. No.	ME0000490
description	microswitch with roller plunger 230V 16A 1CO connection solder/ screw connection L1 49mm ambient temperature max. 125°C thread L 14mm thread M10 mounting distance 25mm actuating force: 300g type MS15-1		
For models:	P/30, P/35, P/40, P/45, P/50, P33		

cam switches

operation switches

			
1			
GEV No.	301214	Ref. No.	91310095
description	cam switch 2 operating positions operation switch 16A sequence 0-1 shaft ø 6x4.6mm shaft L 33mm connection male faston 6.3mm plastic ambient temperature max. 150°C		

rotary switches

BREMAS

A1600 series

			
1			
GEV No.	345315 ¹	Ref. No.	ME0000310
description	rotary switch 3 1-0-2 sets of contacts 6 type CA160007 400V 16A shaft ø 5x5mm shaft L 23mm shaft square with knob connection screw		
For models:	EXCELSIOR EXTRAPROFI, EXCELSIOR MAXI PROFI, EXCELSIOR MINI PROFI, PAOLO 4, PAOLO 6, PAOLO 8, PAOLO 9, PAOLO12, PAOLO18		

¹incl. knob

A2500 series

			
1			
GEV No.	345026 ¹	Ref. No.	91310061 ME0000311
description	rotary switch 3 1-0-2 sets of contacts 6 type CS0257088 600V 32A shaft ø 5x5mm shaft L 23mm shaft square connection screw		
For models:	EVOLUTION MECHANICAL, MAX 4/35X, MAX 6/35LX, MAX 6/35X, MAX 8/35X, MAX 9/35X, MAX12/35LX, MAX12/35X, MAX18/35X		

¹incl. knob and dial plate

accessories



1			
GEV No.	111420	Ref. No.	91510090
description	knob switch zero mark ø 34/60mm shaft ø 5x5mm red H 22mm L 50mm		



1			
GEV No.	345780	Ref. No.	ME0000621
description	contact block GENERAL ELECTRIC P9B01VN 1NC max 660V 10A		
For models:	P/30, P/35, P/40, P/45, P/50		

control equipment

BRETER

push buttons



1			
GEV No.	345638	Ref. No.	91310380 ME0000501
description	momentary push switch mounting measurements ø30mm black		
For models:	P/45, P33		



1			
GEV No.	345779	Ref. No.	ME0000620
description	contact block GENERAL ELECTRIC P9B10VN 1NO max 400V 10A brown		
For models:	P/30, P/35, P/40, P/45, P/50		

momentary mushroom switches



1			
GEV No.	346326	Ref. No.	ME0000616
description	mushroom momentary switch mounting measurements ø22mm black		



1			
GEV No.	345640	Ref. No.	91310400 ME0000520
description	contact block BRETER 1NO		
For models:	P/45, P33		



1			
GEV No.	346325	Ref. No.	ME0000615
description	mushroom momentary switch mounting measurements ø22mm red		
For models:	P/30, P/35, P/40, P/45, P/50		

GENERAL ELECTRIC (AEG)

push buttons



1			
GEV No.	346327	Ref. No.	ME0000610
description	push button mounting measurements ø22mm black		
For models:	P/30, P/35, P/40, P/45, P/50		

TELEMECANIQUE (EFA)

ZB2 series

push buttons



1			
GEV No.	348177	Ref. No.	91310374
description	push button mounting measurements ø22mm black OFF		



			
1			
GEV No.	348178	Ref. No.	91310373
description	push button mounting measurements ø22mm green on		

lamps

indicator lights

indicator lights (complete)

ø 6mm

			
1			
GEV No.	359038	Ref. No.	91310116
description	indicator light ø 6mm 230V red		

			
1			
GEV No.	359336	Ref. No.	91310115 ME0000322
description	indicator light ø 6mm 230V green		
For models:	MICRO		

ø10mm

with plug-in socket

			
1			
GEV No.	359036	Ref. No.	ME0000320
description	indicator light ø 10mm clear 230V connection male faston 6.3mm Qty 1 pcs		
For models:	BABY, EXCELSIOR EXTRAPROFI, EXCELSIOR MAXI PROFI, EXCELSIOR MINI PROFI, EXPRESS P 4, EXPRESS P 6, EXPRESS P 9, EXPRESS P44, EXPRESS P66, EXPRESS P99, P/45, P33		

			
1			
GEV No.	359035	Ref. No.	ME0000321
description	indicator light ø 10mm clear 400V connection male faston 6.3mm Qty 1 pcs		
For models:	EVOLUTION MECHANICAL, MAX 4/35X, MAX 6/35LX, MAX 6/35X, MAX 8/35X, MAX 9/35X, MAX12/35LX, MAX12/35X, MAX18/35X, MINI PROFI 90, PAOLO 4, PAOLO 6, PAOLO 8, PAOLO 9, PAOLO12, PAOLO18		

screw-on/push-on fit

light bulbs

for ovens

			
1			
GEV No.	359610	Ref. No.	91310190 ME0000375
description	light bulb t.max. 300°C socket E14 15W 230V ø 22mm L 47mm lens L 20mm for oven lamp type Philips		
For models:	MICRO		

			
1			
GEV No.	359612	Ref. No.	57153
description	light bulb t.max. 300°C socket E14 25W 230V ø 25mm L 56mm lens L 30mm for oven lamp type Philips		
For models:	G18/335		

			
1			
GEV No.	359448	Ref. No.	91310195 ME0000372
description	light bulb t.max. 500°C socket E14 25W 240V ø 24mm L 54mm lens L 21mm for pizza oven not shock-resistant type		

			
1			
GEV No.	359615	Ref. No.	91310191 ME0000370
description	light bulb t.max. 300°C socket E14 25W 230V ø 45mm L 76mm lens L 50mm for oven lamp IMPORT		
For models:	EXCELSIOR EXTRAPROFI, EXCELSIOR MAXI PROFI, EXCELSIOR MINI PROFI, EXPRESS P 4, EXPRESS P 6, EXPRESS P 9, EXPRESS P44, EXPRESS P66, EXPRESS P99, G433, G633, G933, GAS-EXCELSIOR G433, GAS-EXCELSIOR G633, GAS-EXCELSIOR G933, PAOLO 4, PAOLO 6, PAOLO 8, PAOLO 9, PAOLO12, PAOLO18		

halogen lamp

for socket E14 / E27



GEV No.	359728	Ref. No.	91310205
description	halogen lamp socket E14 230V 40W ø 25mm lens L 54mm L 80mm temp.-resist. 300°C Qty 1		

for socket G4 / G6.35 / G9



GEV No.	359599	Ref. No.	91310196
description	halogen lamp socket G4 12V 20W temp.-resist. 500°C		



GEV No.	359946	Ref. No.	91310206 91310207
description	halogen lamp socket G9 230V 40W temp.-resist. 300°C		

for socket GU5.3 / GU10 / GZ5.3



GEV No.	357054	Ref. No.	91310208
description	halogen lamp socket GU5.3 12V 20W ø 50mm H 38mm temp.-resist. 300°C AC/DC		

oven lamps

universal oven lamps



mounting diameter 35.5mm



GEV No.	359701	Ref. No.	91310185 ME0000363
description	lamp socket socket E14 220-230V mounting ø 35.5mm connection male faston 6.3mm 15W		
For models:	MICRO		

accessories for 359701

	GEV No.	359705	Ref. No.	—
	oven lamp glass thr.ø 33.5mm ø 52mm hard glas temp.-resist. 350°C			

	GEV No.	359709	Ref. No.	91610020 ADNM00005
	oven lamp glass thr.ø 33.5mm ø 42mm hard glas temp.-resist. 350°C			
	GEV No.	359721	Ref. No.	—
	gasket silicone ED ø 48mm ID ø 39.5mm thickness 5mm Qty 1 pcs			
	GEV No.	359942	Ref. No.	—
	oven lamp glass thr.ø 33.5mm ø 41mm hard glas temp.-resist. 350°C			

	GEV No.	359709	Ref. No.	91610020 ADNM00005
description	oven lamp glass thr.ø 33.5mm ø 42mm hard glas temp.-resist. 350°C			
For models:	MICRO			

mounting diameter 65.5mm

	GEV No.	359022	Ref. No.	91310180 91310186 ME0000360
description	lamp socket socket E14 mounting ø 65.5mm connection male faston 6.3mm			
For models:	EVOLUTION DIGITAL, EVOLUTION MECHANICAL, EXCELSIOR EXTRA-PROFI, EXCELSIOR MAXI PROFI, EXCELSIOR MINI PROFI, EXPRESS P 4, EXPRESS P 6, EXPRESS P 9, EXPRESS P44, EXPRESS P66, EXPRESS P99, G433, G633, G933, GAS-EXCELSIOR G433, GAS-EXCELSIOR G633, GAS-EXCELSIOR G933, MAX 4/35, MAX 4/35X, MAX 6/35, MAX 6/35L, MAX 6/35LX, MAX 6/35X, MAX 8/35, MAX 8/35X, MAX 9/35, MAX 9/35X, MAX12/35, MAX12/35L, MAX12/35LX, MAX12/35X, MAX18/35, MAX18/35X, PAOLO 4, PAOLO 6, PAOLO 8, PAOLO 9, PAOLO12, PAOLO18			

	GEV No.	357002	Ref. No.	91310187
description	lamp socket socket G9 mounting ø 65.5mm connection male faston 6.3mm			



 <p>1</p>			
GEV No.	359724	Ref. No.	61004 91610021 ADNM00003
description	oven lamp glass thread \varnothing 62mm H 46mm \varnothing 74mm hard glas temp.-resist. 350°C		
For models:	EVOLUTION DIGITAL, EVOLUTION MECHANICAL, EXCELSIOR EXTRA-PROFI, EXCELSIOR MAXI PROFI, EXCELSIOR MINI PROFI, EXPRESS P 4, EXPRESS P 6, EXPRESS P 9, EXPRESS P44, EXPRESS P66, EXPRESS P99, G433, G633, G933, GAS-EXCELSIOR G433, GAS-EXCELSIOR G633, GAS-EXCELSIOR G933, MAX 4/35, MAX 4/35X, MAX 6/35, MAX 6/35L, MAX 6/35LX, MAX 6/35X, MAX 8/35, MAX 8/35X, MAX 9/35, MAX 9/35X, MAX12/35, MAX12/35L, MAX12/35LX, MAX12/35X, MAX18/35, MAX18/35X, PAOLO 4, PAOLO 6, PAOLO 8, PAOLO 9, PAOLO12, PAOLO18		

 <p>1</p>			
GEV No.	359729	Ref. No.	91410000
description	gasket glass fibre ID \varnothing 57mm ED \varnothing 67mm thickness 5mm \varnothing 67mm		

55x70mm			
 <p>1</p>			
GEV No.	358111	Ref. No.	xlo
description	oven lamp complete 12V 20W socket G4 L 70mm W 55mm mounting measurements 55x70mm cable length 300mm		
spare parts for	358111		
	GEV No.	359295	Ref. No. —
	lamp socket for halogen lamp 12V 20W socket G4 mounting measurements 55 x 70mm cable length 135mm		
	GEV No.	359599	Ref. No. 91310196
	halogen lamp socket G4 12V 20W temp.-resist. 500°C		
	GEV No.	359937	Ref. No. 91610025
	lamp glass L 80mm W 65mm mounting measurements 52x67mm		
accessories for	358111		
	GEV No.	358112	Ref. No. —
	gasket L 83mm W 69mm thickness 1mm silicone		

 <p>1</p>			
GEV No.	358148	Ref. No.	91310183 91810185
description	lamp socket socket G4 12-250V mounting measurements 55x70mm connection cable 135mm		

 <p>1</p>			
GEV No.	359937	Ref. No.	91610025
description	lamp glass L 80mm W 65mm mounting measurements 52x67mm		

 <p>1</p>			
GEV No.	359937	Ref. No.	91610025
description	lamp glass L 80mm W 65mm mounting measurements 52x67mm		

lamps
light bulbs

 <p>1</p>			
GEV No.	359610	Ref. No.	91310190 ME0000375
description	light bulb t.max. 300°C socket E14 15W 230V \varnothing 22mm L 47mm lens L 20mm for oven lamp type Philips		
For models:	MICRO		

 <p>1</p>			
GEV No.	359612	Ref. No.	57153
description	light bulb t.max. 300°C socket E14 25W 230V \varnothing 25mm L 56mm lens L 30mm for oven lamp type Philips		
For models:	G18/335		

 <p>1 500°C</p>			
GEV No.	359448	Ref. No.	91310195 ME0000372
description	light bulb t.max. 500°C socket E14 25W 240V \varnothing 24mm L 54mm lens L 21mm for pizza oven not shock-resistant type		

 <p>1</p>			
GEV No.	359615	Ref. No.	91310191 ME0000370
description	light bulb t.max. 300°C socket E14 25W 230V ø 45mm L 76mm lens L 50mm for oven lamp IMPORT		
For models:	EXCELSIOR EXTRAPROFI, EXCELSIOR MAXI PROFI, EXCELSIOR MINI PROFI, EXPRESS P 4, EXPRESS P 6, EXPRESS P 9, EXPRESS P44, EXPRESS P66, EXPRESS P99, G433, G633, G933, GAS-EXCELSIOR G433, GAS-EXCELSIOR G633, GAS-EXCELSIOR G933, PAOLO 4, PAOLO 6, PAOLO 8, PAOLO 9, PAOLO12, PAOLO18		

halogen lamps
for socket E14 / E27

 <p>1</p>			
GEV No.	359728	Ref. No.	91310205
description	halogen lamp socket E14 230V 40W ø 25mm lens L 54mm L 80mm temp.-resist. 300°C Qty 1		

for socket G4 / G6.35 / G9

 <p>1 500°C</p>			
GEV No.	359599	Ref. No.	91310196
description	halogen lamp socket G4 12V 20W temp.-resist. 500°C		

 <p>1</p>			
GEV No.	359946	Ref. No.	91310206 91310207
description	halogen lamp socket G9 230V 40W temp.-resist. 300°C		

for socket GU5,3 / GU10

 <p>1</p>			
GEV No.	357054	Ref. No.	91310208
description	halogen lamp socket GU5.3 12V 20W ø 50mm H 38mm temp.-resist. 300°C AC/DC		

lamp accessories



lenses			
glass panels			
 <p>1</p>			
GEV No.	357250	Ref. No.	91610013
description	lamp glass L 180mm W 84mm thickness 9.5mm for pizza oven		

contactors

LS Industrial Systems

power contactors			
 <p>1</p>			
GEV No.	381167	Ref. No.	91310154
description	power contactor resistive load 20A 230VAC (AC3/400V) 9A/4kW main contacts 4NO auxiliary contacts connection screw connection type GMC-9M/4		

overload switches

 <p>1</p>				
GEV No.	381118	Ref. No.	91310476	
description	overload switch setting range 2.5-4A type GTK-12M LS Industrial Systems			
accessories for	381118			
	GEV No.	380238	Ref. No.	ME0000590
	power contactor resistive load 20A 230VAC (AC3/400V) 8.4A/4kW main contacts 3NO auxiliary contacts 1NO connection screw connection type LS0510A type AEG LS0510A type GE MC1A 310A			



GENERAL ELECTRIC (AEG)

power contactors



1

GEV No.	380238	Ref. No.	ME0000590
description	power contactor resistive load 20A 230VAC (AC3/400V) 8.4A/4kW main contacts 3NO auxiliary contacts 1NO connection screw connection type LS0510A type AEG LS0510A type GE MC1A 310A		
For models:	BABY, EXCELSIOR EXTRAPROFI, EXCELSIOR MAXI PROFI, EXCELSIOR MINI PROFI, EXPRESS P 4, EXPRESS P 6, EXPRESS P 9, EXPRESS P44, EXPRESS P66, EXPRESS P99, PAOLO 4, PAOLO 6, PAOLO 8, PAOLO 9, PAOLO12, PAOLO18		



1

GEV No.	380245	Ref. No.	ME0000597
description	power contactor resistive load 25A 230VAC (AC3/400V) 9A/4kW main contacts 3NO auxiliary contacts 1NC connection screw connection type AEG LS4K 01A type GE CL00A 301 H 85mm		



1

GEV No.	380203	Ref. No.	57142 ME0000595
description	power contactor resistive load 25A 230VAC (AC3/400V) 9A/4kW main contacts 3NO auxiliary contacts 1NC connection screw connection type Fanal DSL9 01 type ISKRA KNL9 01 230V		
For models:	EVOLUTION DIGITAL, EVOLUTION MECHANICAL, EXCELSIOR EXTRA-PROFI, EXCELSIOR MAXI PROFI, EXCELSIOR MINI PROFI, G18/335, MAX 4/35, MAX 4/35X, MAX 6/35, MAX 6/35L, MAX 6/35LX, MAX 6/35X, MAX 8/35, MAX 8/35X, MAX 9/35, MAX 9/35X, MAX12/35, MAX12/35L, MAX12/35LX, MAX12/35X, MAX18/35, MAX18/35X, PAOLO 4, PAOLO 6, PAOLO 8, PAOLO 9, PAOLO12, PAOLO18		



1

GEV No.	380204	Ref. No.	ME0000354
description	power contactor resistive load 25A 230VAC (AC3/400V) 9A/4kW main contacts 3NO auxiliary contacts 1NO connection screw connection type Fanal DSL9 10 type ISKRA KNL9 10		
For models:	MINI PROFI 90, P/30, P/35, P/40, P/45, P/50		

ISKRA (FANAL)

power contactors



1

GEV No.	380212	Ref. No.	ME0000351
description	power contactor resistive load 20A 230VAC (AC3/400V) 8.5A/5.5kW main contacts 3NO auxiliary contacts 1NC connection screw connection type Fanal K07M 01 type ISKRA DSL7 01		
For models:	P/30, P/33, P/35, P/40, P/45, P/50		

LOVATO

power contactors



1

GEV No.	380714	Ref. No.	91310136
description	power contactor resistive load 25A 230VAC (AC3/400V) 9A/4.2kW main contacts 3NO auxiliary contacts 1NO connection screw connection type BF0910A230		



relays

power relays

with bracket mounting

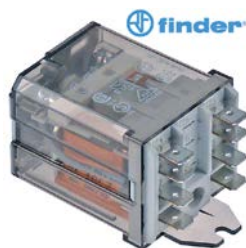

1

GEV No.	380139	Ref. No.	ME0000345
description	power relays FINDER 230VAC 16A 2CO connection F6.3 bracket mounting dimensions 68x38.2x35.8mm manuf. no. 62.82.8.230.0000		
For models:	P/40, P/45, P/50		

time relays

time relays



1

GEV No.	360104	Ref. No.	ME0000571	
description	time relay FINDER 88.12.0.230.0002 time range 0.05s-100h 24-230V AC/DC 2x5A mounting measurements 45x45mm 2CO connection plug-in connection round 8-pole			
For models:	P/30, P/35, P/40, P/45, P/50, P33			
accessories for	360104			
	GEV No.	380638	Ref. No.	—
	relay socket 8-pole dimensions 51x41x23mm 250V 10A FINDER manuf. no. 90.26			

transformers

encapsulated transformers

PMA



1

GEV No.	379054	Ref. No.	91310350 ME0000410
description	transformer primary 230VAC secondary 12VAC 3VA secondary 0.25A H 40mm L 45mm W 50mm connection screw 50/60Hz type 153/M		
For models:	EXCELSIOR EXTRAPROFI, EXCELSIOR MAXI PROFI, EXCELSIOR MINI PROFI, G433, G633, G933, GAS-EXCELSIOR G433, GAS-EXCELSIOR G633, GAS-EXCELSIOR G933, MAX 4/35X, MAX 6/35LX, MAX 6/35X, MAX 8/35X, MAX 9/35X, MAX12/35LX, MAX12/35X, MAX18/35X		

electronic controllers

ELIWELL

universal controllers

built-in version







1



GEV No.	379566	Ref. No.	ME0000309
description	electronic controller ELIWELL type IC912 mounting measurements 71x29mm 12V Pt100/TC-J defr. funct. no		
For models:	MICRO		



1

GEV No.	379605	Ref. No.	91310030	
description	electronic controller ELIWELL type ICPPlus915 model ICP22J135000 mounting measurements 71x29mm 12V voltage AC/DC Pt100/TC (J,K) relay outputs 2 NO-8A(4) NO-8A(4) Pt100/TC (J,K) cooking front measurements 78x37mm built-in depth 59mm mode of operation cooking protection IPx0 accuracy 1% built-in version defr. funct. no depend on probe°C display 3½ digits			
accessories for	379605			
	GEV No.	379050	Ref. No.	—
	temperature probe Pt100 cable Vetrotex probe -200 up to +600°C cable -50 up to +350°C probe ø6x100mm cable length 2.7m without screw connection 3-wire			
	GEV No.	379054	Ref. No.	91310350 ME0000410
	transformer primary 230VAC secondary 12VAC 3VA secondary 0.25A H 40mm L 45mm W 50mm connection screw 50/60Hz type 153/M			
	GEV No.	379785	Ref. No.	—
	temperature probe Pt100 cable silicone probe -100 up to 450°C cable -50 up to +180°C probe ø6x100mm cable length 1.5m without screw connection 2-wire resistor 0.1kOhm			
	GEV No.	379786	Ref. No.	—
	temperature probe Pt100 cable silicone probe -100 up to 450°C cable -50 up to +180°C probe ø6x100mm cable length 3m without screw connection 2-wire resistor 0.1kOhm			
	GEV No.	379787	Ref. No.	—
	temperature probe Pt100 cable Vetrotex probe -200 up to +600°C cable -50 up to +350°C probe ø6x100mm cable length 1.4m without screw connection 2-wire resistor 0.1kOhm			



				
1				
GEV No.	379568	Ref. No.	ME0000299	
description	electronic controller ELIWELL type ICP22JI750000 mounting measurements 71x29mm 230V voltage AC Pt100/TC (J,K) relay outputs 2 CO-8A(4) CO-8A(4) Pt100/TC (J,K,S) DI front measurements 78x37mm built-in depth 60mm mode of operation cooking protection IPx0 accuracy 1% built-in version defr. funct. no -150 to 1350°C display 3½ digits			
For models:	EVOLUTION MECHANICAL, P/30, P/35, P/40, P/45, P/50			
accessories for	379568			
 image not available	GEV No.	378065	Ref. No.	—
	description	alarm device AKO type AKO-520641 mounting measurements 214x214mm 230V voltage AC relay outputs 1 CO-8A(4) up to 4 front measurements 222x222mm yes yes		
	GEV No.	378074	Ref. No.	—
	description	temperature probe thermocouple J (Fe-CuNi) cable Vetrotex probe -50 up to +750°C cable -50 up to +350°C probe ø3x100mm cable length 3m without screw connection 2-wire		
	GEV No.	378075	Ref. No.	—
	description	temperature probe thermocouple K (NiCr-Ni) cable Vetrotex probe -50 up to 1150°C cable -50 up to +350°C probe ø4.5x150mm cable length 3m without screw connection 2-wire		
	GEV No.	379050	Ref. No.	—
	description	temperature probe Pt100 cable Vetrotex probe -200 up to +600°C cable -50 up to +350°C probe ø6x100mm cable length 2.7m without screw connection 3-wire		
GEV No.	379062	Ref. No.	ME0000402	
description	temperature probe thermocouple J (Fe-CuNi) cable Vetrotex probe -50 up to +750°C cable -50 up to +350°C probe ø6x50mm cable length 3m without screw connection 2-wire			

refrigeration controllers

built-in version

			
1			
GEV No.	379018	Ref. No.	ME0000307
description	electronic controller ELIWELL type EWPC902T thermocouple J		

PIXSYS

universal controllers

built-in version

			
1			
GEV No.	379888	Ref. No.	91310031
description	electronic controller PIXSYS type ATR111-B mounting measurements 71x29mm 230V voltage AC NTC/PTC/Pt100/Pt1000/TC(J,K)/mV/mA relay outputs 2 CO-8A(3) 8VDC/20mA NTC/PTC/Pt100/Pt1000/TC(J,K)/mV/mA front measurements 35x77mm built-in depth 54mm protection IP64 accuracy 1% built-in version defr. funct. dependent on probe°C display 3 digits		

			
1			
GEV No.	381309	Ref. No.	ATR121-B
description	electronic controller PIXSYS type ATR121-B mounting measurements 71x29mm 230V voltage AC NTC/PTC/Pt100/Pt1000/TC(J,K)/mV/mA relay outputs 3 CO-8A(3) NO-5A(3) 8VDC/20mA NTC/PTC/Pt100/Pt1000/TC(J,K)/mV/mA front measurements 35x77mm built-in depth 54mm protection IP64 accuracy 1% built-in version defr. funct. no dependent on probe°C display 3 digits		

SHANGFANG

accessories



			
1			
GEV No.	379054	Ref. No.	91310350 ME0000410
description	transformer primary 230VAC secondary 12VAC 3VA secondary 0.25A H 40mm L 45mm W 50mm connection screw 50/60Hz type 153/M		
For models:	EXCELSIOR EXTRAPROFI, EXCELSIOR MAXI PROFI, EXCELSIOR MINI PROFI, G433, G633, G933, GAS-EXCELSIOR G433, GAS-EXCELSIOR G633, GAS-EXCELSIOR G933, MAX 4/35X, MAX 6/35LX, MAX 6/35X, MAX 8/35X, MAX 9/35X, MAX12/35LX, MAX12/35X, MAX18/35X		



probes

universal probes

temperature probes

1 			
GEV No.	379051	Ref. No.	57210 91310211 ME0000400
description	temperature probe thermocouple J (Fe-CuNi) cable Vetrotex probe -50 up to +750°C cable -50 up to +350°C probe ø6x100mm cable length 3m without screw connection cable colours red/blue 2-wire		
For models:	EVOLUTION MECHANICAL, EXCELSIOR EXTRAPROFI, EXCELSIOR MAXI PROFI, EXCELSIOR MINI PROFI, G433, G633, G933, GAS-EXCELSIOR G433, GAS-EXCELSIOR G633, GAS-EXCELSIOR G933, MAX 4/35X, MAX 6/35LX, MAX 6/35X, MAX 8/35X, MAX 9/35X, MAX12/35LX, MAX12/35X, MAX18/35X		
accessories for	379051		
	GEV No.	379877	Ref. No. —
	electronic controller HONEYWELL type DC10N-400 mounting measurements 92x92mm 24/230V voltage AC TC (J) relay outputs 1 CO-10A(6) TC (J) universal built-in depth 55mm protection IP54 accuracy 1% built-in version defr. funct. no 0 up to +400°C display 3 digits		

1 			
GEV No.	379062	Ref. No.	ME0000402
description	temperature probe thermocouple J (Fe-CuNi) cable Vetrotex probe -50 up to +750°C cable -50 up to +350°C probe ø6x50mm cable length 3m without screw connection 2-wire		
For models:	P/30, P/35, P/40, P/45, P/50		

producer-specific probes

probes

1 			
GEV No.	403694	Ref. No.	91310212
description	temperature probe thermocouple J (Fe-CuNi) cable Vetrotex probe -50 up to +750°C cable -50 up to +350°C connection 2-wire thread probe ø6x100mm cable length 0.45m		

1 			
GEV No.	379598	Ref. No.	91310215 ME0000401
description	temperature probe thermocouple K (NiCr-Ni) cable Vetrotex probe -50 up to 1150°C cable -50 up to +350°C connection 2-wire thread probe ø3x200mm cable length 1.5m		
For models:	EVOLUTION DIGITAL, MAX 4/35, MAX 6/35, MAX 6/35L, MAX 8/35, MAX 9/35, MAX12/35, MAX12/35L, MAX18/35		

electronics

PCBs

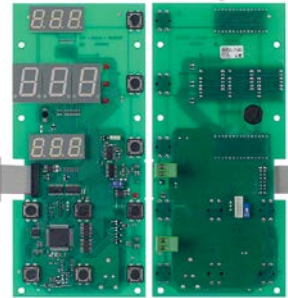
1 			
GEV No.	401149	Ref. No.	3990298082 91310255 ME0000482
description	control PCB		
For models:	EVOLUTION DIGITAL, MAX 4/35, MAX 6/35, MAX 6/35L, MAX 8/35, MAX 9/35, MAX12/35, MAX12/35L, MAX18/35		

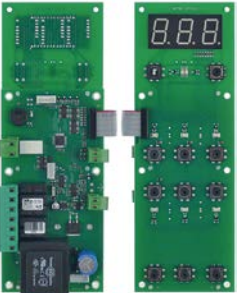
1 			
GEV No.	403693	Ref. No.	91310258
description	control PCB for pizza oven Michelangelo L 230mm W 80mm connection screw clamps		

1 			
GEV No.	400859	Ref. No.	91310250 ME0000480
description	control PCB pizza oven TH4351DC		

1 			
GEV No.	403692	Ref. No.	91310259
description	PCB for pizza oven Michelangelo L 80mm W 32mm connection coded plug for flues		

1

GEV No.	401150	Ref. No.	91310305 91310306 ME0000487
description	PCB pizza oven MAX 4/35		
For models:	EVOLUTION DIGITAL, MAX 4/35, MAX 6/35, MAX 6/35L, MAX 8/35, MAX 9/35, MAX12/35, MAX12/35L, MAX18/35		



1

GEV No.	400814	Ref. No.	60022 91310301 ME0000486
description	PCB pizza oven TH4351DC 2kW		



1

GEV No.	361978	Ref. No.	91310260 91310261
description	PCB pizza oven/pizza press L 125mm W 108mm with display buttons 6		



1

GEV No.	401965	Ref. No.	91310270 ME0000488
description	PCB suitable for EV385		

keypads

front foils



1

GEV No.	401144	Ref. No.	ADNM00220
description	front foil		
For models:	P/30, P/35, P/40, P/45, P/50		



1

GEV No.	401147	Ref. No.	ADNM00155
description	front foil		
For models:	EVOLUTION MECHANICAL		

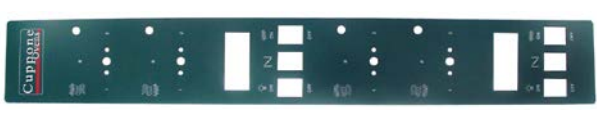

1

GEV No.	401148	Ref. No.	ADNM00156
description	front foil		

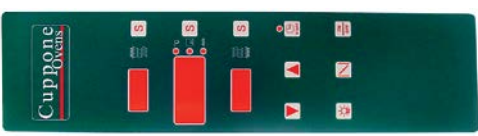

1

GEV No.	401145	Ref. No.	91611080 ADNM00150
description	keypad foil		
For models:	EVOLUTION DIGITAL, MAX 4/35, MAX 6/35, MAX 6/35L, MAX 9/35		



1

GEV No.	401146	Ref. No.	91611090 ADNM00151
description	keypad foil		
For models:	EVOLUTION DIGITAL, MAX 8/35, MAX12/35, MAX12/35L, MAX18/35		



fans

axial fans



import



GEV No.	601131 ¹	Ref. No.	ME0000631
description	axial fan L 119mm W 119mm H 25mm 230VAC 50/60Hz 19/18W bearing ball bearing connection male faston 2.8mm metal ADDA fan wheel ø 110mm temp.-resist. 70°C		
For models:	EVOLUTION DIGITAL, EVOLUTION MECHANICAL		
accessories for	601131		
	GEV No.	550898	Ref. No. —
connecting cable cable length 2000mm connection F 2.8 connection distance 7.9mm for axial flow fan			

¹with ball bearings



GEV No.	601080 ¹	Ref. No.	91310320
description	axial fan L 119mm W 119mm H 38mm 230VAC 50/60Hz 23/20W bearing ball bearing connection male faston 2.8mm metal ADDA fan wheel ø 110mm temp.-resist. 70°C		
accessories for	601080		
	GEV No.	550898	Ref. No. —
connecting cable cable length 2000mm connection F 2.8 connection distance 7.9mm for axial flow fan			
	GEV No.	692519	Ref. No. —
guard L 120mm W 120mm plastic			

¹with ball bearings

motors

gear motors

for ovens

for flues



GEV No.	601247	Ref. No.	91310530+91310540old vers. ME0000630
description	gear motor FIBER type G0655CABN00 230V 50Hz 7.5rpm shaft ø 6mm L 66mm W 50mm H 47mm for air fan		
For models:	EVOLUTION DIGITAL, EVOLUTION MECHANICAL, MAX 4/35, MAX 6/35, MAX 6/35L, MAX 8/35, MAX 9/35, MAX12/35, MAX12/35L, MAX18/35		



GEV No.	602083	Ref. No.	91310530 91310530+91310540
description	gear motor MOTEC type 04BUA1 230V 50Hz 500rpm shaft ø 6mm L 46mm W 48mm H 65mm		

motors

universal



GEV No.	500633	Ref. No.	91411040 MM0000030
description	motor 370W 230V 50Hz 1 phase shaft ø 14mm flange ø 105mm 1400rpm type LME71L4R3 ø 140mm H 200mm L 220mm Lafert 0.37kW		
For models:	P33		



Image not available

1

GEV No.	500635	Ref. No.	MM0000071
description	motor 400V 3 phase		
For models:	P/45		

Image not available

2

GEV No.	500636	Ref. No.	MM0000075
description	motor 400V 3 phase		
For models:	P/30, P/35		



Image not available

1

GEV No.	500637	Ref. No.	MM0000076
description	motor 400V 3 phase		
For models:	P/40, P/45, P/50		

fuses

fine fuses



1

GEV No.	358074	Ref. No.	91310504
description	fine fuse size ø5x20mm 5A fast-acting rated 250V Qty 10 pcs		

fine fuse holders



1

GEV No.	551332	Ref. No.	91310511
description	fuse holder suitable fuse 5x20 10A rated 250V L 42mm W 16mm max. 10A		

gas valves and ignition boxes







gas control valves

SIT

TANDEM



1

GEV No.	101684	Ref. No.	91310340 ME0000431	
description	gas valve 230V 50Hz gas inlet 1/2" gas outlet 1/2" pilot connection level slow ignition standard ignition time 3-7s pressure range 3-50mbar power supply for modulator type SIT equiv. no. 0.830.034			
spare parts for	101684			
	GEV No.	101379	Ref. No.	—
solenoid coil 230V 50Hz suitable for Tandem				
accessories for	101684			
	GEV No.	101274	Ref. No.	—
olive for pipe ø 16mm Qty 1 pcs				
	GEV No.	101275	Ref. No.	—
union screw thread 1/2" for pipe ø 16mm Qty 1 pcs				
	GEV No.	102845	Ref. No.	—
gas connection angled 1/2" flange 32x32mm hole distance 24x24mm Tandem				
	GEV No.	102846	Ref. No.	—
gas connection straight 1/2" flange 32x32mm hole distance 24x24mm suitable for Tandem				
	GEV No.	102847	Ref. No.	—
O-ring				



GEV No.	101189	Ref. No.	058011
description	gas valve 230V 50Hz gas inlet 1/2" gas outlet 1/2" pilot connection M10x1 level slow ignition ignition times pressure range 3-50mbar power supply for modulator equiv. no. 0.830.040 suitable for Tandem		
For models:	G433, G633, G933, GAS-EXCELSIOR G433, GAS-EXCELSIOR G633, GAS-EXCELSIOR G933		
spare parts for	101189		
	GEV No.	101379	Ref. No. —
	solenoid coil 230V 50Hz suitable for Tandem		
accessories for	101189		
	GEV No.	100904	Ref. No. —
	locking screw M10x1 for pipe ø 4mm Qty 1 pcs		
	GEV No.	100905	Ref. No. —
	locking screw M10x1 for pipe ø 6mm Qty 1 pcs		
	GEV No.	101274	Ref. No. —
	olive for pipe ø 16mm Qty 1 pcs		
	GEV No.	101275	Ref. No. —
	union screw thread 1/2" for pipe ø 16mm Qty 1 pcs		
	GEV No.	101925	Ref. No. —
	plug with O-ring thread M10x1 for pilot burner suitable for NOVASIT		
	GEV No.	102845	Ref. No. —
	gas connection angled 1/2" flange 32x32mm hole distance 24x24mm Tandem		
	GEV No.	102846	Ref. No. —
	gas connection straight 1/2" flange 32x32mm hole distance 24x24mm suitable for Tandem		
	GEV No.	102847	Ref. No. —
	O-ring		

ignition boxes

SIT



GEV No.	101685	Ref. No.	91310280 ME0000420
description	ignition box SIT type 503EFD electrodes 2 waiting time 1.5s safety time 10s 220/240V 10VA 50-60Hz protection IP40		
For models:	G433, G633, G933, GAS-EXCELSIOR G433, GAS-EXCELSIOR G633, GAS-EXCELSIOR G933		

ignition parts
electrodes

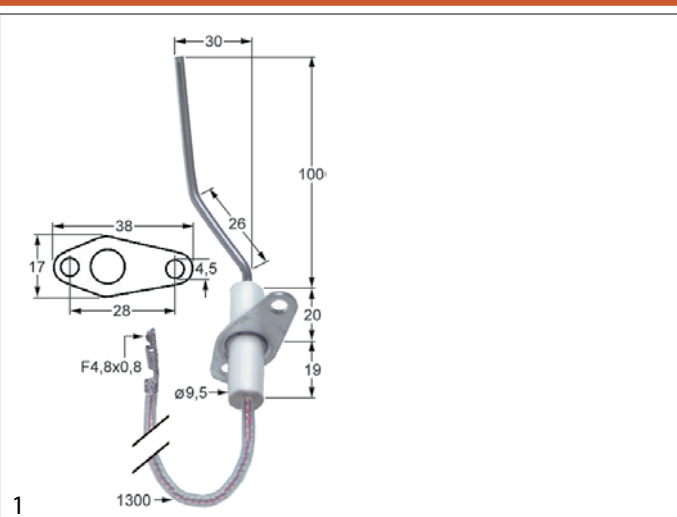

GEV No.	100780	Ref. No.	91310490 ME0000471
description	ignition electrode flange length 38mm flange width 17mm D1 ø 9.5mm L1 100mm L2 30mm L3 26mm BL1 20mm BL2 19mm connection F 4.8x0.8mm cable length 1300mm fixing dimensions ø4.5mm mounting distance 28mm with flange		
For models:	G433, G633, G933, GAS-EXCELSIOR G433, GAS-EXCELSIOR G633, GAS-EXCELSIOR G933		

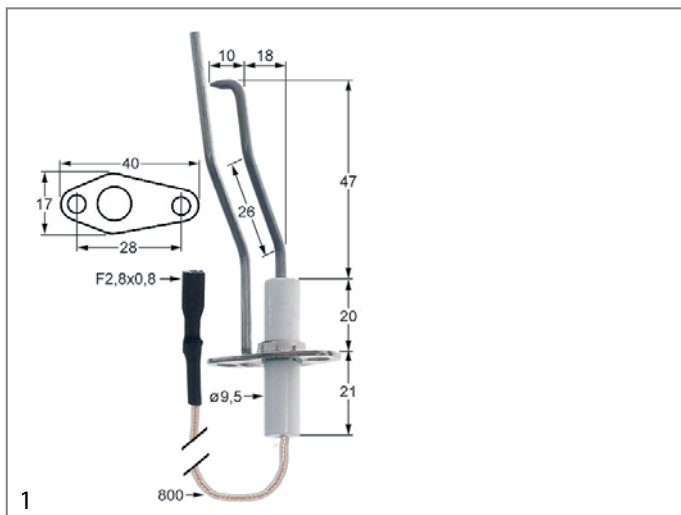

GEV No.	100769	Ref. No.	91310480 ME0000470
description	ignition electrode flange length 40mm flange width 17mm D1 ø 9.5mm L1 47mm L2 18mm L4 10mm L3 26mm BL1 20mm BL2 21mm connection F 2.8x0.8mm cable length 800mm fixing dimensions ø4.5mm mounting distance 28mm with flange with earthing contact		
For models:	G433, G633, G933, GAS-EXCELSIOR G433, GAS-EXCELSIOR G633, GAS-EXCELSIOR G933		

gas nozzles

main nozzles

gas nozzles M13x1

GEV No.	100108	Ref. No.	92210370
description	gas injector thread M13x1 bore ø 1.6mm WS 13		

GEV No.	102783	Ref. No.	92210371
description	gas injector thread M13x1 bore ø 1.8mm WS 13		

GEV No.	100389	Ref. No.	92210372
description	gas injector thread M13x1 bore ø 1.9mm WS 13		

GEV No.	100417	Ref. No.	92210373
description	gas injector thread M13x1 bore ø 2.15mm WS 13		

GEV No.	102789	Ref. No.	92210374
description	gas injector thread M13x1 bore ø 2.45mm WS 13		

GEV No.	100710	Ref. No.	92210375
description	gas injector thread M13x1 bore ø 2.85mm WS 13		

GEV No.	100722	Ref. No.	92210376
description	gas injector thread M13x1 bore ø 2.95mm WS 13		

GEV No.	100866	Ref. No.	92210377
description	gas injector thread M13x1 bore ø 3.1mm WS 13		

GEV No.	100923	Ref. No.	92210378
description	gas injector thread M13x1 bore ø 3.4mm WS 13		

GEV No.	106272	Ref. No.	92210379
description	gas injector thread M13x1 bore ø 3.55mm WS 13		



1

GEV No.	106274	Ref. No.	92210381
description	gas injector thread M13x1 bore ø 3.75mm WS 13		



1

GEV No.	106273	Ref. No.	92210380
description	gas injector thread M13x1 bore ø 3.7mm WS 13		



1

GEV No.	106275	Ref. No.	92210382
description	gas injector thread M13x1 bore ø 3.8mm WS 13		



1

GEV No.	106276	Ref. No.	92210383
description	gas injector thread M13x1 bore ø 4.1mm WS 13		

equipment-specific units

for dough mixers

chains

roller chains 08B-1 single



1

GEV No.	697128	Ref. No.	92410817
description	roller chain DIN/ISO 08 B-1 splitting 1/2" / 12.7mm links 37 internal width 7.75mm rollerø 8.51mm single		

connectors



1

GEV No.	693276	Ref. No.	91410640
description	connector single DIN/ISO 08 B-1 splitting 1/2" links 1 L 23mm internal width 11.8mm rollerø 4.3mm metal		

for pizza press

gearboxes



1

GEV No.	693336	Ref. No.	MM0000112
description	gearbox		
For models:	P/45		



1

GEV No.	693337	Ref. No.	MM0000115
description	gearbox		
For models:	P/30, P/35		



1

GEV No.	693338	Ref. No.	MM0000116
description	gearbox		
For models:	P/40, P/45, P/50		

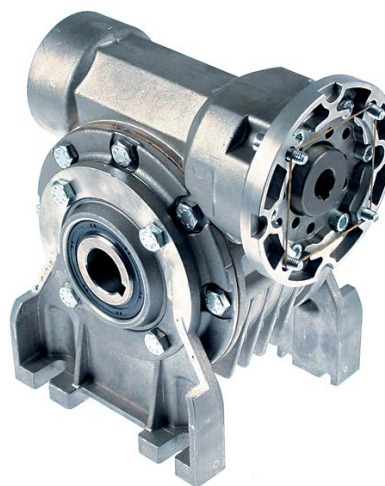

1

GEV No.	601182	Ref. No.	91411510 MM0000111
description	gearbox motor shaft ø 14mm flange ø 105mm transmission 1/80 drive shaft ø 25mm fixing dimensions 86-110mm type MV 63A		
For models:	P33		



for pizza ovens

glass panels

1 

GEV No.	698992	Ref. No.	91610038
description	ceramic washer W 1120mm H 93mm thickness 4mm for pizza oven Qty 1 pcs		

1 

GEV No.	693331	Ref. No.	91610005 ADNM00007
description	glass panel L 1063mm W 93mm rectangular		
For models:	MAX 4/35X, MAX 6/35L, MAX 6/35LX, MAX 6/35X, MAX 8/35X, MAX 9/35, MAX 9/35X, MAX12/35L, MAX12/35LX, MAX12/35X, MAX18/35, MAX18/35X		

1 

GEV No.	700205	Ref. No.	91610010 ADNM00000
description	glass panel L 320mm W 100mm thickness 5mm rectangular		
For models:	EXCELSIOR EXTRAPROFI, EXCELSIOR MAXI PROFI, EXCELSIOR MINI PROFI, EXPRESS P 4, EXPRESS P 6, EXPRESS P 9, EXPRESS P44, EXPRESS P66, EXPRESS P99, G433, G633, G933, GAS-EXCELSIOR G433, GAS-EXCELSIOR G633, GAS-EXCELSIOR G933, MICRO, MINI PROFI 90, PAOLO 4, PAOLO 6, PAOLO 8, PAOLO 9, PAOLO12, PAOLO18		

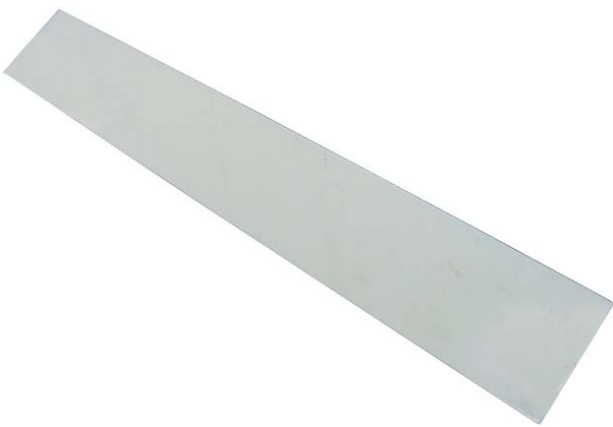
1 

GEV No.	700697	Ref. No.	91610001
description	glass panel L 626mm W 93mm thickness 4mm		
For models:	G035		

1 

GEV No.	693330	Ref. No.	91610002 ADNM00006
description	glass panel L 713mm W 93mm rectangular		
For models:	EVOLUTION DIGITAL, EVOLUTION MECHANICAL, MAX 4/35, MAX 4/35X, MAX 6/35, MAX 6/35LX, MAX 6/35X, MAX 8/35, MAX 8/35X, MAX 9/35X, MAX12/35, MAX12/35LX, MAX12/35X, MAX18/35X		

1 

GEV No.	700703	Ref. No.	91610003
description	glass panel L 726mm W 93mm		

1 

GEV No.	691228	Ref. No.	91610004
description	glass panel L 926mm W 93mm rectangular		

firebricks

1 

GEV No.	850103	Ref. No.	91610056 ADNM00018
description	firebrick L 1050mm W 350mm H 19mm delivery freight forwarding company only		
For models:	MAX 4/35X, MAX 6/35L, MAX 6/35LX, MAX 6/35X, MAX 8/35X, MAX 9/35, MAX 9/35X, MAX12/35L, MAX12/35LX, MAX12/35X, MAX18/35, MAX18/35X		

1 

GEV No.	850128	Ref. No.	91610141
description	firebrick L 1074mm W 358mm H 16mm delivery freight forwarding company only		

 <p>1</p>			
GEV No.	850056	Ref. No.	91610072 ADNM00011
description	firebrick L 330mm W 330mm H 30mm delivery freight forwarding company only		
For models:	G433, G633, G933, GAS-EXCELSIOR G433, GAS-EXCELSIOR G633, GAS-EXCELSIOR G933, MINI PROFI 90		

 <p>1</p>			
GEV No.	850065	Ref. No.	91610060 ADNM00015
description	firebrick L 400mm W 400mm H 19mm delivery freight forwarding company only		
For models:	MICRO		

 <p>1</p>			
GEV No.	850079	Ref. No.	91610062 ADNM00021
description	firebrick L 585mm W 585mm H 19mm delivery freight forwarding company only		
For models:	EVOLUTION DIGITAL, EVOLUTION MECHANICAL		

 <p>1</p>			
GEV No.	850110	Ref. No.	91610110
description	firebrick L 588mm W 294mm H 19mm		

 <p>1</p>			
GEV No.	850080	Ref. No.	ADNM00022
description	firebrick L 590mm W 590mm H 19mm triangular delivery freight forwarding company only		
For models:	EVOLUTION DIGITAL, EVOLUTION MECHANICAL		

 <p>1</p>			
GEV No.	850101	Ref. No.	91610050
description	firebrick L 600mm W 300mm H 20mm grooved delivery freight forwarding company only		

 <p>1</p>			
GEV No.	850018	Ref. No.	91610101 91610130
description	firebrick L 616mm W 308mm H 19mm delivery freight forwarding company only		

 <p>1</p>			
GEV No.	850102	Ref. No.	91610055 ADNM00017
description	firebrick L 700mm W 350mm H 19mm delivery freight forwarding company only		
For models:	MAX 4/35, MAX 4/35X, MAX 6/35, MAX 6/35LX, MAX 6/35X, MAX 8/35, MAX 8/35X, MAX 9/35X, MAX12/35, MAX12/35LX, MAX12/35X, MAX18/35X		





1

GEV No.	850112	Ref. No.	91610102 91610140
description	firebrick L 715mm W 357mm H 20mm delivery freight forwarding company only		



1

GEV No.	850105	Ref. No.	91610051
description	firebrick L 900mm W 300mm H 18mm delivery freight forwarding company only		



1

GEV No.	110618	Ref. No.	91510071 MP0000000
description	knob switch zero mark t.max.°C ø 45mm shaft ø 6x4.6mm shaft flat upper black		
For models:	BABY, EXPRESS P 4, EXPRESS P 6, EXPRESS P 9, EXPRESS P44, EXPRESS P66, EXPRESS P99, MINI PROFI 90		



1

GEV No.	110619	Ref. No.	91510096 MP0000013
description	knob switch zero mark t.max.°C ø 48mm shaft ø 5x5mm shaft flat black		
For models:	EVOLUTION MECHANICAL, EXCELSIOR EXTRAPROFI, EXCELSIOR MAXI PROFI, EXCELSIOR MINI PROFI, MAX 4/35X, MAX 6/35LX, MAX 6/35X, MAX 8/35X, MAX 9/35X, MAX12/35LX, MAX12/35X, MAX18/35X		

knobs

universal knobs



1

GEV No.	110243	Ref. No.	MP0000003
description	knob thermostat t.max. 200°C ø 50mm shaft ø 6x4.6mm shaft flat upper black temperature range 60-200°C		
For models:	P/45, P33		



1

GEV No.	110243	Ref. No.	MP0000003
description	knob thermostat t.max. 200°C ø 50mm shaft ø 6x4.6mm shaft flat upper black temperature range 60-200°C		
For models:	P/45, P33		

producer-specific knobs

CUPPONE



1

GEV No.	111420	Ref. No.	91510090
description	knob switch zero mark ø 34/60mm shaft ø 5x5mm red H 22mm L 50mm		

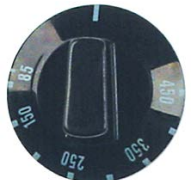

1

GEV No.	111740	Ref. No.	91510083
description	knob thermostat t.max. 450°C ø 49mm shaft ø 6x4.6mm shaft flat upper black temperature range 85-450°C rotation 270°		

handles and hand wheels

hand wheels

spare parts and accessories



1			
GEV No.	693332	Ref. No.	91510020 MP0000022
description	cylindrical handle thread M8 ø 23mm L 62mm rotary		
For models:	MICRO		

cylindrical handles

rotary



1			
GEV No.	693332	Ref. No.	91510020 MP0000022
description	cylindrical handle thread M8 ø 23mm L 62mm rotary		
For models:	MICRO		

fixed



1			
GEV No.	110804	Ref. No.	91510011 MP0000021
description	cylindrical handle thread M12 ø 29mm L 111mm		
For models:	BABY, EXCELSIOR EXTRAPROFI, EXCELSIOR MAXI PROFI, EXCELSIOR MINI PROFI, G433, G633, G933, GAS-EXCELSIOR G433, GAS-EXCELSIOR G633, GAS-EXCELSIOR G933		



1			
GEV No.	110803	Ref. No.	91510010 MP0000020
description	cylindrical handle thread M12 ø 29mm L 87mm		
For models:	EXPRESS P 4, EXPRESS P 6, EXPRESS P 9, EXPRESS P44, EXPRESS P66, EXPRESS P99, PAOLO 4, PAOLO 6, PAOLO 8, PAOLO 9, PAOLO12, PAOLO18		

miscellaneous



1			
GEV No.	693333	Ref. No.	91510000 MP0000026
description	handle		
For models:	EVOLUTION DIGITAL, EVOLUTION MECHANICAL, MAX 4/35, MAX 4/35X, MAX 6/35, MAX 6/35L, MAX 6/35LX, MAX 6/35X, MAX 8/35, MAX 8/35X, MAX 9/35, MAX 9/35X, MAX12/35, MAX12/35L, MAX12/35LX, MAX12/35X, MAX18/35, MAX18/35X		

accessories

miscellaneous



1			
GEV No.	693334	Ref. No.	91510050 MP0000031
description	hand protection for door handle		
For models:	EVOLUTION DIGITAL, EVOLUTION MECHANICAL, MAX 4/35, MAX 4/35X, MAX 6/35, MAX 6/35L, MAX 6/35LX, MAX 6/35X, MAX 8/35, MAX 8/35X, MAX 9/35, MAX 9/35X, MAX12/35, MAX12/35L, MAX12/35LX, MAX12/35X, MAX18/35, MAX18/35X		



1			
GEV No.	690026	Ref. No.	91510060 MP0000030
description	hand protection for door handle ED ø 36mm ID ø 12.3mm D1 ø 22.6-23.5mm		
For models:	EXCELSIOR EXTRAPROFI, EXCELSIOR MAXI PROFI, EXCELSIOR MINI PROFI, G433, G633, G933, GAS-EXCELSIOR G433, GAS-EXCELSIOR G633, GAS-EXCELSIOR G933, PAOLO 4, PAOLO 6, PAOLO 8, PAOLO 9, PAOLO12, PAOLO18		



gaskets

sealing cords

flat



1

GEV No.	698994	Ref. No.	95311031
description	sealing cord flat size 20x2mm self-adhesive L 1124m t.max.°C for discs		

square



1

GEV No.	698993	Ref. No.	95311021
description	sealing cord square size 16x16mm braided L 1560mm t.max. 550°C for door		



1

GEV No.	900505	Ref. No.	92013500 SLMX01050
description	sealing cord square size 16x16mm t.max. 550°C braided L 0.69m for door		
For models:	EVOLUTION DIGITAL, EVOLUTION MECHANICAL, MAX 4/35, MAX 4/35X, MAX 6/35, MAX 6/35LX, MAX 6/35X, MAX 8/35, MAX 8/35X, MAX 9/35X, MAX12/35, MAX12/35LX, MAX12/35X, MAX18/35X		



1

GEV No.	901176	Ref. No.	92013501 92210561
description	sealing cord square size 16x16mm t.max. 550°C braided L 1.2m for door		

transmission technology and ball bearings

ball bearings

deep-groove ball bearings 2RS



1

GEV No.	523513	Ref. No.	91410102
description	deep-groove ball bearing type 6205-2RS shaft ø 25mm ED ø 52mm W 15mm with sealing discs deep-groove ball bearing DIN 625-1		

chains

roller chains 08B-1 single



1

GEV No.	697128	Ref. No.	92410817
description	roller chain DIN/ISO 08 B-1 splitting 1/2" / 12.7mm links 37 internal width 7.75mm rollerø 8.51mm single		



1

GEV No.	698990	Ref. No.	92410822
description	roller chain DIN/ISO 08 B-1 splitting 1/2" / 12.7mm links 61 internal width 7.75mm rollerø 8.51mm single		

connectors



1

GEV No.	694876 ¹	Ref. No.	91410641
description	connector single DIN/ISO 08 B-1 splitting 1/2" links 1 L 23mm internal width 11.8mm rollerø 4.3mm hardend		



1

GEV No.	693276	Ref. No.	91410640
description	connector single DIN/ISO 08 B-1 splitting 1/2" links 1 L 23mm internal width 11.8mm rollerø 4.3mm metal		

half links



1

GEV No.	697841	Ref. No.	91410620
description	half link single DIN/ISO 08 B-1 splitting 1/2"		

springs

tension springs



1

GEV No.	698991	Ref. No.	92410560
description	tension spring ø 15.5mm total length 100mm wire gauge ø 1.5mm L1 15mm L2 70mm L3 15mm for dough mixer Qty 1 pcs		



GEV No.	514073	Ref. No.	92012240 ADME01203
description	tension spring with thread \varnothing 29.8mm total length 125 extendable max. 280mm wire gauge \varnothing 5.2mm		
For models:	EVOLUTION MECHANICAL		

measuring equipment

thermometers

built-in thermometers

\varnothing 60mm



GEV No.	541054	Ref. No.	91410020 MM0000000
description	thermometer mounting \varnothing 60mm t.max. 500°C 0 up to +500°C probe \varnothing 10mm probe L 80mm capillary pipe 700mm		
For models:	BABY, EXPRESS P 4, EXPRESS P 6, EXPRESS P 9, EXPRESS P44, EXPRESS P66, EXPRESS P99, PAOLO 4, PAOLO 6, PAOLO 8, PAOLO 9, PAOLO12, PAOLO18		

consumables

fuses

fine fuses



GEV No.	358074	Ref. No.	91310504
description	fine fuse size \varnothing 5x20mm 5A fast-acting rated 250V Qty 10 pcs		

A		
axial fans	24	
C		
cam switches	13	
consumables	34	
contactors	18	
control equipment	14	
control thermostats	11	
E		
electronic controllers	20	
F		
fans	24	
fine fuses	34	
fuses	25, 34	
G		
gas control valves	25	
gas nozzles	27	
H		
halogen lamp	16	
heating elements	3	
heating elements for pizza ovens	3	
heating elements for pizza presses	10	
I		
ignition boxes	26	
indicator lights	15	
indicator lights (complete)	15	
L		
lamp accessories	18	
lamps	15	
light bulbs	15	
M		
measuring equipment	34	
microswitches	13	
motors	24	
O		
oven lamps	16	
P		
probes	22	
R		
relays	20	
rocker/momentary rocker switches	12	
rotary switches	13	
S		
safety thermostats	12, 12	
sealing cords	33	
switches and momentary switches	12	
T		
temperature probes	22	
thermostats	11	
time relays	20	
transformers	20	
U		
universal probes	22	