



GAS COMPONENTS



ELECTRIC COMPONENTS



WATER TECHNOLOGY



MECHANICAL COMPONENTS



TOOLS

Spare parts suitable for

DELRUE

Find the complete and up-to-date range of products in our GEV Webshop



Manufacturer catalogue

The most important spare parts and accessories arranged clearly for every manufacturer

- ✓ Complete product range and all appliance data always up to date in the GEV Webshop
- ✓ Alphabetical Index at the end of the catalogue

GEV Webshop

www.gev-online.co.uk

www.gev-online.com



- 🔍 Add to Favourites
- 🔍 Sign In with email address and usual password
- 🔍 Easy-order – place several items in your basket at the same time
- 🔍 Quick Item search – no login needed



thermostats

control and safety thermostats

EGO

control thermostats

55.34_series



GEV No.	375143	Ref. No.	NTT11C
description	thermostat t.max. 110°C temperature range 32-110°C 3-pole 3NO 16A probe ø 6mm probe L 138mm capillary pipe 1480mm capillary pipe isolated 1100mm gland nut M9x1 shaft ø 6x4.6mm shaft L 23mm shaft position upper rotation 270°		

accessories for	109515		
	GEV No.	101278	Ref. No. —
	olive for pipe ø 10mm Qty 1 pcs		
	GEV No.	101286	Ref. No. —
	olive ID ø 6mm Qty 1 pcs		
	GEV No.	101300	Ref. No. —
	union nut thread M16x1.5 tube ø 10mm		
	GEV No.	101450	Ref. No. —
	olive for pipe ø 8mm L 12.7mm Qty 1 pcs ED ø 10mm		
	GEV No.	101451	Ref. No. —
	union nut thread M16x1.5 tube ø 8mm		
	GEV No.	110078	Ref. No. —
	knob without symbol ø 70mm shaft ø 6x4.6mm shaft flat universal		
	GEV No.	112206	Ref. No. —
	knob dial plate silver gas tap PEL21/22/23 t.max. °C ED ø 63mm ID ø 45.5mm		

gas taps

PEL

21S series



GEV No.	109515	Ref. No.	GB1353
description	gas tap PEL type 21S gas inlet pipe flange ø21mm bypass nozzle ø 0mm gas outlet M16x1.5 (tube ø 10/8mm) thermocouple connection M8x1 pilot connection M10x1 shaft ø 8x6.5mm shaft L 22/15mm shaft flat upper		
spare parts for	109515		
	GEV No.	101060	Ref. No. —
	magnet unit standard L 39mm D1 ø 15.4mm D2 ø 11mm suitable for PEL20-21/JUNKERS/EGA		
	GEV No.	101206	Ref. No. —
	gas tap front part shaft ø 8x6.5mm shaft L 22/15mm shaft flat upper/lower suitable for PEL21		
	GEV No.	101230	Ref. No. —
	thermocouple nut T1: M8x1 T2: M18x1 aluminium		
accessories for	109515		
	GEV No.	100908	Ref. No. —
	union screw thread M10x1 for pipe ø 4mm Qty 1 pcs		
	GEV No.	100909	Ref. No. —
	union screw thread M10x1 for pipe ø 6mm Qty 1 pcs		
	GEV No.	101246	Ref. No. —
	olive for pipe ø 4mm Qty 1 pcs		

gas burners

hob burners



producer-specific hob burners

DEL RUE



833 series





GEV No.	107011	Ref. No.	N/A
description	burner type 833 ø 80mm L 120mm		
spare parts for	107011		
	GEV No.	108011	Ref. No. N/A
	burner cap type 833 ø 78mm		
	GEV No.	108011	Ref. No. N/A
description	burner cap type 833 ø 78mm		

			
1			
GEV No.	108040	Ref. No.	N/A
description	burner head type 833 ø 80mm		
accessories for	108040		
	GEV No.	108011	Ref. No. N/A
burner cap type 833 ø 78mm			

869 series

			
1			
GEV No.	107002	Ref. No.	N/A
description	burner type 869 ø 80mm L 120mm complete		
spare parts for	107002		
	GEV No.	108031	Ref. No. —
burner cap ø 78mm with central hole			

			
1			
GEV No.	108040	Ref. No.	N/A
description	burner head type 833 ø 80mm		
accessories for	108040		
	GEV No.	108011	Ref. No. N/A
burner cap type 833 ø 78mm			



851 series

			
1			
GEV No.	107067	Ref. No.	N/A
description	burner type 851 ø 120mm L 120mm complete		

			
1			
GEV No.	108017	Ref. No.	N/A
description	burner head ø 120mm seat ø 39mm		

knobs

universal knobs

			
1			
GEV No.	110123	Ref. No.	ET1062
description	knob thermostat t.max. 300°C ø 50mm shaft ø 6x4.6mm shaft flat upper black temperature range 50-300°C rotation 270°		
accessories for	110123		
	GEV No.	110135	Ref. No. NEP1400
rosette knob up to ø 52mm			

accessories

rosettes

			
1			
GEV No.	110135	Ref. No.	NEP1400
description	rosette knob up to ø 52mm		



locks

edgmount latches

handle latches

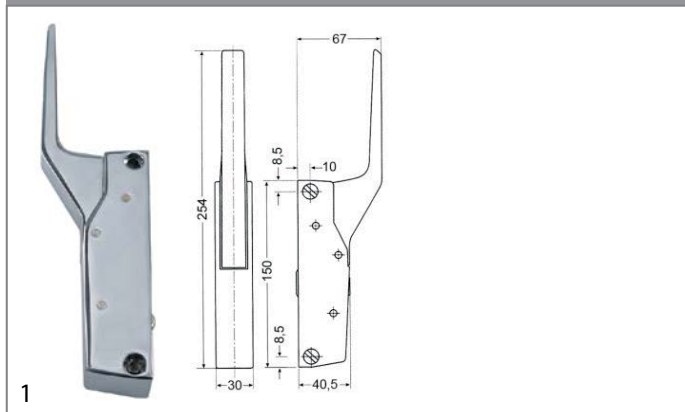
CAFF/FERMOD



GEV No.	700060	Ref. No.	QL1044
description	handle latch L 150mm mounting distance 133mm non lockable heated units G 791		
accessories for	700060		
	GEV No.	700061	Ref. No. —
	door catch L 58mm W 20mm H 35mm mounting distance 42mm chrome-plated brass for headed units		
	GEV No.	700062	Ref. No. —
	handle protection heated units		

C

control thermostats 3

E

edgemount latches 5

G

gas burners 3

gas taps 3

H

handle latches 5

hob burners 3

T

thermostats 3