



**GAS COMPONENTS**



**ELECTRIC COMPONENTS**



**WATER TECHNOLOGY**



**MECHANICAL COMPONENTS**



**TOOLS**

Spare parts suitable for

**DESMON**

Find the complete and up-to-date range of products in our GEV Webshop



# Manufacturer catalogue

The most important spare parts and accessories arranged clearly for every manufacturer

- ✓ Complete product range and all appliance data always up to date in the GEV Webshop
- ✓ Alphabetical Index at the end of the catalogue

## GEV Webshop

[www.gev-online.co.uk](http://www.gev-online.co.uk)

[www.gev-online.com](http://www.gev-online.com)



- 🔍 Add to Favourites
- 🔍 Sign In with email address and usual password
- 🔍 Easy-order – place several items in your basket at the same time
- 🔍 Quick Item search – no login needed



## heating elements

### heating elements for refrigeration

#### heating elements for defrosting



1

<b>GEV No.</b>	417587	<b>Ref. No.</b>	R35-0070
<b>description</b>	heating element 350W 230V L 380mm Wmm Hmm cable length 3.3m tube ø 8.7mm		
<b>For models:</b>	ET 151		

#### heating elements for condensate evaporation



1

<b>GEV No.</b>	420241	<b>Ref. No.</b>	R35-0123
<b>description</b>	heating element 750W 230V L 415mm W 100mm H 95mm cable length 1500mm connection cable tube ø 6mm refrigeration		

#### condensing trays heated



1

<b>GEV No.</b>	695271	<b>Ref. No.</b>	Q32-0196 Q32-0196L
<b>description</b>	condensing tray heated L 410mm W 300mm H 80mm 230V 230W		
<b>For models:</b>	ID140		



1

<b>GEV No.</b>	750212	<b>Ref. No.</b>	89020710
<b>description</b>	condensing tray with heating cable for evaporator L 875mm W 447mm H 115mm		

## heating cables

### drain heating cables



1

<b>GEV No.</b>	418614	<b>Ref. No.</b>	R35-0012
<b>description</b>	drain heating cable 35W 220V ø 6mm L 1910mm L1 (unheated) 870mm L2 (heated) 1040mm silicone connection terminal		

### connection on both sides (metal braided)



1

<b>GEV No.</b>	417643	<b>Ref. No.</b>	R35-0011
<b>description</b>	drain heater 126W 220V L 7600mm L1 (unheated) 1000mm L2 (heated) 6600mm ø 3.6mm		



1

<b>GEV No.</b>	416334	<b>Ref. No.</b>	R35-0216
<b>description</b>	heating cable 188W 230V L1 (unheated) 2x540mm L2 (heated) 7000mm ø 4mm L 8080mm connection terminal		

### miscellaneous



1

<b>GEV No.</b>	418499	<b>Ref. No.</b>	R35-0002
<b>description</b>	heating cable L 7000mm door frame heating 205Ohm/m		

## thermostats

### refrigeration thermostats

#### universal with housing



1

<b>GEV No.</b>	390538	<b>Ref. No.</b>	R30-0051
<b>description</b>	thermostat temperature range -35 up to +35°C probe ø6x110mm capillary pipemm PRODIGY		

1 electric components



## switches and momentary switches

## rocker/momentary rocker switches

30x22mm



1

<b>GEV No.</b>	301000	<b>Ref. No.</b>	R25-0012
<b>description</b>	rocker switch mounting measurements 30x22mm blue 2NO 250V 16A illuminated 0-l connection male faston 6.3mm ambient temperature max. 125/55°C protection IP40		
<b>accessories for</b>	301000		
	<b>GEV No.</b>	301036	<b>Ref. No.</b> —
	protective cover internal size 30x22mm for rocker switch mounting measurementsmm		



1

<b>GEV No.</b>	301003	<b>Ref. No.</b>	R25-0002
<b>description</b>	rocker switch mounting measurements 30x22mm green 2NO 250V 16A illuminated 0-l connection male faston 6.3mm ambient temperature max. 125/55°C protection IP65		
<b>accessories for</b>	301003		
	<b>GEV No.</b>	301036	<b>Ref. No.</b> —
	protective cover internal size 30x22mm for rocker switch mounting measurementsmm		

labelled



1

<b>GEV No.</b>	300125	<b>Ref. No.</b>	R25-0010
<b>description</b>	rocker switch mounting measurements 30x22mm green 2NO 230V 16A 0-l connection male faston 6.3mm ambient temperature max. 125/55°C protection IP65 with cover cap		
<b>accessories for</b>	300125		
	<b>GEV No.</b>	301036	<b>Ref. No.</b> —
	protective cover internal size 30x22mm for rocker switch mounting measurementsmm		

## microswitches

with push button

switches with snap-fit



1

<b>GEV No.</b>	346772	<b>Ref. No.</b>	R25-0086
<b>description</b>	microswitch with push button 250V 5A 1CO connection male faston 4.8mm L 24x27mm ambient temperature max. 85°C actuating force: 160g		

## magnetic switches

65x20mm

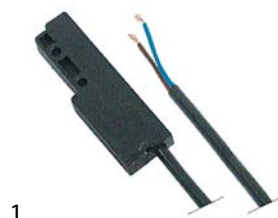

1

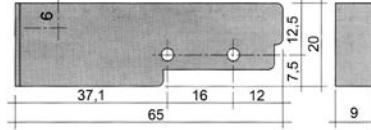

<b>GEV No.</b>	345633	<b>Ref. No.</b>	R25-0043
<b>description</b>	magnetic switch L 65mm W 20mm connection cable		

accessories

magnets

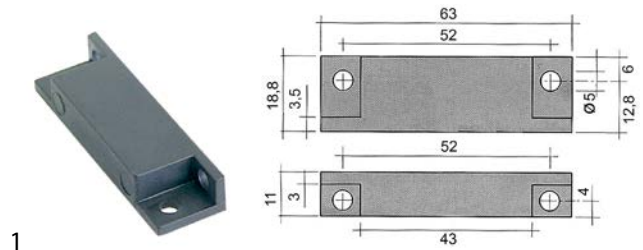

1

<b>GEV No.</b>	345336	<b>Ref. No.</b>	R25-0044
<b>description</b>	magnet $\varnothing$ 4.8mm L 63mm H 11mm W 18.8mm hole distance 51mm M4		

## lamps

## fluorescent lamps

fluorescent lamps

G13



1

<b>GEV No.</b>	359372	<b>Ref. No.</b>	R50-0003
<b>description</b>	fluorescent lamp socket G13 L 895mm 30W 230V Qty 1 pcs		

accessories

starter holders



1

<b>GEV No.</b>	380466	<b>Ref. No.</b>	R50-0007
<b>description</b>	starter holder		





starter			
			
1			
<b>GEV No.</b>	380467	<b>Ref. No.</b>	R50-0006
<b>description</b>	starter 4-80W		

ballasts			
			
1			
<b>GEV No.</b>	401141	<b>Ref. No.</b>	R35-0023
<b>description</b>	electrical ballast 30W 230V for fluorescent lamps Qty 1 pcs		

### fridge lamps

#### producer-specific fridge lamps

DESMON			
			
1			
<b>GEV No.</b>	700650	<b>Ref. No.</b>	80010300
<b>description</b>	lamp complete		

			
1			
<b>GEV No.</b>	700651	<b>Ref. No.</b>	80010320
<b>description</b>	lamp complete		

			
1			
<b>GEV No.</b>	700652	<b>Ref. No.</b>	80010330
<b>description</b>	lamp wall-mounted version		

### relays

#### power relays

##### with bracket mounting

			
1			
<b>GEV No.</b>	380687	<b>Ref. No.</b>	R35-0253
<b>description</b>	power relays FINDER 230VAC 30A 2NO connection F6.3 bracket mounting manuf. no. 66.82.8.230.0300		



### electronic controllers

#### DIXELL















##### refrigeration controllers



###### built-in version

			
1			
<b>GEV No.</b>	402143	<b>Ref. No.</b>	R35-0375
<b>description</b>	electronic controller DIXELL R35-0375 mounting measurements 71x29mm		

				
1				
<b>GEV No.</b>	378363	<b>Ref. No.</b>	R35-XR06CX	
<b>description</b>	electronic controller DIXELL XR06CX-5R0C1 mounting measurements 71x29mm 230V voltage AC NTC relay outputs 3 NO-20A(8) CO-8A(3) NO-5A(2) NTC NTC DI protection IP54 -40 up to +110°C display 3½ digits			
<b>accessories for</b>	378363			
	<b>GEV No.</b>	381249	<b>Ref. No.</b>	—
	 temperature probe NTC 10kOhm cable PVC probe -40 up to +110°C cable -10 up to 100°C connection 2-wire thread probe ø6x14mm cable length 3m			



			
1			
<b>GEV No.</b>	378000	<b>Ref. No.</b>	R35-0141 R35-XR20CX R35-XR20CX -5N0C1
<b>description</b>	electronic controller DIXELL XR20CX-5N0C1 mounting measurements 71x29mm 230V voltage AC NTC/PTC relay outputs 1 NO-20A(8) NTC/PTC NTC/PTC/DI protection IP54 -50 up to +150°C display 3½ digits		
<b>accessories for</b>	378000		
	<b>GEV No.</b>	378194	<b>Ref. No.</b> —
	temperature probe NTC 10kOhm cable PVC probe -20 up to +80°C cable -10 up to 100°C probe ø7x24.5mm cable length 1.5m without screw connection 2-wire		
	<b>GEV No.</b>	378551	<b>Ref. No.</b> —
	adapter for reducer mounting measurements 71x29mm		
	<b>GEV No.</b>	379052	<b>Ref. No.</b> —
	temperature probe PTC 1kOhm cable silicone probe -50 up to +150°C cable -50 up to +180°C probe ø6x40mm cable length 1.5m without screw connection 2-wire		
	<b>GEV No.</b>	379053	<b>Ref. No.</b> —
	temperature probe PTC 1kOhm cable PVC probe -50 up to +150°C cable -10 up to 100°C probe ø6x30mm cable length 3m without screw connection 2-wire		
	<b>GEV No.</b>	379057	<b>Ref. No.</b> —
	temperature probe NTC 10kOhm cable PVC probe -20 up to +80°C cable -10 up to 100°C probe ø6x25mm cable length 3m 2-wire		
	<b>GEV No.</b>	379064	<b>Ref. No.</b> —
	temperature probe PTC 1kOhm cable silicone probe -50 up to +150°C cable -50 up to +180°C probe ø6x40mm cable length 3m without screw connection 2-wire		
	<b>GEV No.</b>	379142	<b>Ref. No.</b> —
	temperature probe PTC 1kOhm cable PVC probe -50 up to +150°C cable -10 up to 100°C probe ø6x30mm cable length 1.5m without screw connection 2-wire		
	<b>GEV No.</b>	379160	<b>Ref. No.</b> —
	temperature probe NTC 10kOhm cable thermoplastic probe -40 up to +110°C cable -40 up to +110°C probe ø6x14mm cable length 1.5m without screw connection 2-wire		
	<b>GEV No.</b>	379161	<b>Ref. No.</b> Q32-0216 Q32-0578 R35-0227
	temperature probe NTC 10kOhm cable thermoplastic probe -40 up to +110°C cable -40 up to +110°C probe ø6x14mm cable length 3m without screw connection 2-wire		
	<b>GEV No.</b>	379343	<b>Ref. No.</b> —
	temperature probe NTC 10kOhm cable silicone probe -40 up to +110°C cable -50 up to +180°C probe ø6x40mm cable length 3m 2-wire		
	<b>GEV No.</b>	379458	<b>Ref. No.</b> —
	temperature probe NTC 10kOhm cable silicone probe -40 up to +110°C cable -50 up to +180°C probe ø6x40mm cable length 1.5m without screw connection 2-wire		
	<b>GEV No.</b>	379781	<b>Ref. No.</b> —
	temperature probe PTC 1kOhm cable thermoplastic probe -50 up to +150°C cable -40 up to +110°C probe ø6x14mm cable length 1.5m without screw connection 2-wire		
	<b>GEV No.</b>	379782	<b>Ref. No.</b> —
	temperature probe PTC 1kOhm cable thermoplastic probe -50 up to +150°C cable -40 up to +110°C probe ø6x14mm cable length 3m 2-wire resistor 1kOhm		

<b>accessories for</b>	378000		
	<b>GEV No.</b>	402818	<b>Ref. No.</b> —
	programming key 4K for electronic controller DIXELL		
	<b>GEV No.</b>	699260	<b>Ref. No.</b> —
	connection cable L 2m connection coded plug		

			
1			
<b>GEV No.</b>	402038	<b>Ref. No.</b>	R35-0143
<b>description</b>	electronic controller DIXELL XR60C-5N3C1 mounting measurements 71x29mm 230V voltage AC NTC		









			
1			
<b>GEV No.</b>	402144	<b>Ref. No.</b>	R35-XR60CX XR60C-5N1C0
<b>description</b>	electronic controller DIXELL XR60CX-5N0C1 mounting measurements 71x29mm 230V voltage AC NTC/PTC relay outputs 3 NO-20A(8) CO-8A(3) NO-5A(2) NTC/PTC NTC/PTC DI -50 up to +150°C display 3½ digits		
<b>accessories for</b>	402144		
	<b>GEV No.</b>	378194	<b>Ref. No.</b> —
	temperature probe NTC 10kOhm cable PVC probe -20 up to +80°C cable -10 up to 100°C probe ø7x24.5mm cable length 1.5m without screw connection 2-wire		
	<b>GEV No.</b>	378551	<b>Ref. No.</b> —
	adapter for reducer mounting measurements 71x29mm		
	<b>GEV No.</b>	379052	<b>Ref. No.</b> —
	temperature probe PTC 1kOhm cable silicone probe -50 up to +150°C cable -50 up to +180°C probe ø6x40mm cable length 1.5m without screw connection 2-wire		
	<b>GEV No.</b>	379053	<b>Ref. No.</b> —
	temperature probe PTC 1kOhm cable PVC probe -50 up to +150°C cable -10 up to 100°C probe ø6x30mm cable length 3m without screw connection 2-wire		
	<b>GEV No.</b>	379057	<b>Ref. No.</b> —
	temperature probe NTC 10kOhm cable PVC probe -20 up to +80°C cable -10 up to 100°C probe ø6x25mm cable length 3m 2-wire		
	<b>GEV No.</b>	379064	<b>Ref. No.</b> —
	temperature probe PTC 1kOhm cable silicone probe -50 up to +150°C cable -50 up to +180°C probe ø6x40mm cable length 3m without screw connection 2-wire		
	<b>GEV No.</b>	379160	<b>Ref. No.</b> —
	temperature probe NTC 10kOhm cable thermoplastic probe -40 up to +110°C cable -40 up to +110°C probe ø6x14mm cable length 1.5m without screw connection 2-wire		

Table continues overleaf



<b>accessories for</b> 402144			
GEV No.	379161	Ref. No.	Q32-0216 Q32-0578 R35-0227
temperature probe NTC 10kOhm cable thermoplastic probe -40 up to +110°C cable -40 up to +110°C probe ø6x14mm cable length 3m without screw connection 2-wire			
GEV No.	379343	Ref. No.	—
temperature probe NTC 10kOhm cable silicone probe -40 up to +110°C cable -50 up to +180°C probe ø6x40mm cable length 3m 2-wire			
GEV No.	379458	Ref. No.	—
temperature probe NTC 10kOhm cable silicone probe -40 up to +110°C cable -50 up to +180°C probe ø6x40mm cable length 1.5m without screw connection 2-wire			
GEV No.	379782	Ref. No.	—
temperature probe PTC 1kOhm cable thermoplastic probe -50 up to +150°C cable -40 up to +110°C probe ø6x14mm cable length 3m 2-wire resistor 1kOhm			
GEV No.	402818	Ref. No.	—
programming key 4K for electronic controller DIXELL			

<b>accessories for</b> 402036			
GEV No.	379161	Ref. No.	Q32-0216 Q32-0578 R35-0227
temperature probe NTC 10kOhm cable thermoplastic probe -40 up to +110°C cable -40 up to +110°C probe ø6x14mm cable length 3m without screw connection 2-wire			
GEV No.	379343	Ref. No.	—
temperature probe NTC 10kOhm cable silicone probe -40 up to +110°C cable -50 up to +180°C probe ø6x40mm cable length 3m 2-wire			
GEV No.	379458	Ref. No.	—
temperature probe NTC 10kOhm cable silicone probe -40 up to +110°C cable -50 up to +180°C probe ø6x40mm cable length 1.5m without screw connection 2-wire			
GEV No.	402818	Ref. No.	—
programming key 4K for electronic controller DIXELL			

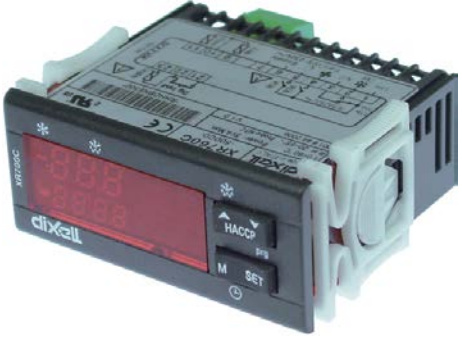

1

<b>GEV No.</b>	378020	<b>Ref. No.</b>	R35-0193
<b>description</b>	electronic controller DIXELL XR760C-500C0 mounting measurements 71x29mm defr. funct. no		



1

<b>GEV No.</b>	378027	<b>Ref. No.</b>	R35-0206
<b>description</b>	electronic controller DIXELL XW760L-5N0C3 mounting measurements 150x30mm		
<b>accessories for</b> 378027			
GEV No.	378194	Ref. No.	—
temperature probe NTC 10kOhm cable PVC probe -20 up to +80°C cable -10 up to 100°C probe ø7x24.5mm cable length 1.5m without screw connection 2-wire			
GEV No.	379057	Ref. No.	—
temperature probe NTC 10kOhm cable PVC probe -20 up to +80°C cable -10 up to 100°C probe ø6x25mm cable length 3m 2-wire			
GEV No.	379160	Ref. No.	—
temperature probe NTC 10kOhm cable thermoplastic probe -40 up to +110°C cable -40 up to +110°C probe ø6x14mm cable length 1.5m without screw connection 2-wire			
GEV No.	379161	Ref. No.	Q32-0216 Q32-0578 R35-0227
temperature probe NTC 10kOhm cable thermoplastic probe -40 up to +110°C cable -40 up to +110°C probe ø6x14mm cable length 3m without screw connection 2-wire			
GEV No.	379343	Ref. No.	—
temperature probe NTC 10kOhm cable silicone probe -40 up to +110°C cable -50 up to +180°C probe ø6x40mm cable length 3m 2-wire			
GEV No.	379458	Ref. No.	—
temperature probe NTC 10kOhm cable silicone probe -40 up to +110°C cable -50 up to +180°C probe ø6x40mm cable length 1.5m without screw connection 2-wire			



1

<b>GEV No.</b>	402036	<b>Ref. No.</b>	R35-0144
<b>description</b>	electronic controller DIXELL XW260L-5N0C0 mounting measurements 150x30mm built-in depth 65.5mm 230V voltage AC NTC relay outputs 4 NO-20A(8) NO-8A(3) NO-8A(3) NO-16A(5) NTC NTC DI DI DI DI yes yes -50 up to +150°C display 3½ digits		
<b>accessories for</b> 402036			
GEV No.	378194	Ref. No.	—
temperature probe NTC 10kOhm cable PVC probe -20 up to +80°C cable -10 up to 100°C probe ø7x24.5mm cable length 1.5m without screw connection 2-wire			
GEV No.	379057	Ref. No.	—
temperature probe NTC 10kOhm cable PVC probe -20 up to +80°C cable -10 up to 100°C probe ø6x25mm cable length 3m 2-wire			
GEV No.	379160	Ref. No.	—
temperature probe NTC 10kOhm cable thermoplastic probe -40 up to +110°C cable -40 up to +110°C probe ø6x14mm cable length 1.5m without screw connection 2-wire			



ELIWELL

refrigeration controllers

built-in version



1

<b>GEV No.</b>	378285	<b>Ref. No.</b>	EISB7-28 R35-EWP0974A-230V
----------------	--------	-----------------	-------------------------------

**description** electronic controller ELIWELL type EWPlus 974 mounting measurements 71x29mm 230V voltage AC NTC/PTC/Pt1000 relay outputs 2 NO-12A CO-8A NO-5A NTC/PTC/Pt1000 NTC/PTC/Pt1000 front measurements 74x32mm built-in depth 59mm yes -50 up to +110°C display 3½ digits

**accessories for** 378285

<b>GEV No.</b>	378184	<b>Ref. No.</b>	—
----------------	--------	-----------------	---

 electronic controller LAE type LCD32Q4E-C mounting measurements 149x30mm 230V voltage AC NTC relay outputs 4 NO-20A(6) NO-12A(4) NO-8A(3) CO-8A(3) NTC NTC DI DI front measurements 169x38mm built-in depth 78mm protection IP55 yes yes -30 up to +30°C display 3 digits

<b>GEV No.</b>	378194	<b>Ref. No.</b>	—
----------------	--------	-----------------	---

 temperature probe NTC 10kOhm cable PVC probe -20 up to +80°C cable -10 up to 100°C probe ø7x24.5mm cable length 1.5m without screw connection 2-wire

<b>GEV No.</b>	379057	<b>Ref. No.</b>	—
----------------	--------	-----------------	---

 temperature probe NTC 10kOhm cable PVC probe -20 up to +80°C cable -10 up to 100°C probe ø6x25mm cable length 3m 2-wire

<b>GEV No.</b>	379160	<b>Ref. No.</b>	—
----------------	--------	-----------------	---

 temperature probe NTC 10kOhm cable thermoplastic probe -40 up to +110°C cable -40 up to +110°C probe ø6x14mm cable length 1.5m without screw connection 2-wire

<b>GEV No.</b>	379161	<b>Ref. No.</b>	Q32-0216 Q32-0578 R35-0227
----------------	--------	-----------------	----------------------------------

 temperature probe NTC 10kOhm cable thermoplastic probe -40 up to +110°C cable -40 up to +110°C probe ø6x14mm cable length 3m without screw connection 2-wire

<b>GEV No.</b>	379343	<b>Ref. No.</b>	—
----------------	--------	-----------------	---

 temperature probe NTC 10kOhm cable silicone probe -40 up to +110°C cable -50 up to +180°C probe ø6x40mm cable length 3m 2-wire

<b>GEV No.</b>	379458	<b>Ref. No.</b>	—
----------------	--------	-----------------	---

 temperature probe NTC 10kOhm cable silicone probe -40 up to +110°C cable -50 up to +180°C probe ø6x40mm cable length 1.5m without screw connection 2-wire



1

<b>GEV No.</b>	378021	<b>Ref. No.</b>	R35-0155 R35-0365
----------------	--------	-----------------	----------------------

**description** electronic controller ELIWELL type ID961 mounting measurements 71x29mm NTC/PTC -55 up to +150°C display 3½ digits

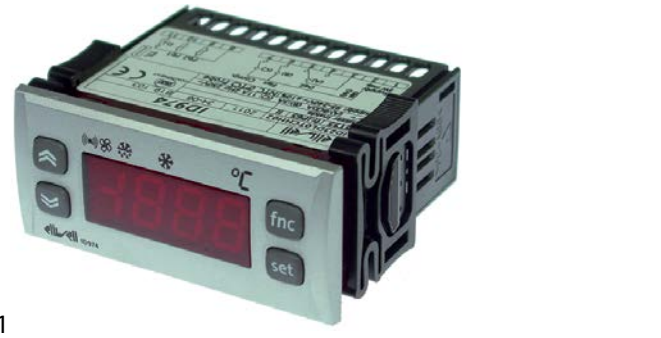

1

<b>GEV No.</b>	378022	<b>Ref. No.</b>	R35-0156 R35-0370
----------------	--------	-----------------	----------------------

**description** electronic controller ELIWELL type ID974 mounting measurements 71x29mm 230V voltage AC NTC/PTC front measurements 33x75mm protection IP65 -50 up to +150°C display 3½ digits

miscellaneous

refrigeration controllers



1

<b>GEV No.</b>	378023	<b>Ref. No.</b>	80110040
----------------	--------	-----------------	----------

**description** electronic controller kit DESMON

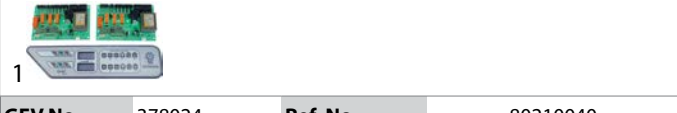

1

<b>GEV No.</b>	378024	<b>Ref. No.</b>	80210040
----------------	--------	-----------------	----------

**description** electronic controller kit DESMON



1

<b>GEV No.</b>	378025	<b>Ref. No.</b>	80080040
----------------	--------	-----------------	----------

**description** electronic controller kit DESMON

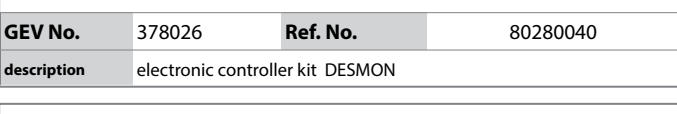

1

<b>GEV No.</b>	378026	<b>Ref. No.</b>	80280040
----------------	--------	-----------------	----------

**description** electronic controller kit DESMON

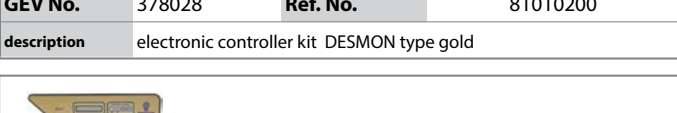

1

<b>GEV No.</b>	378028	<b>Ref. No.</b>	81010200
----------------	--------	-----------------	----------

**description** electronic controller kit DESMON type gold

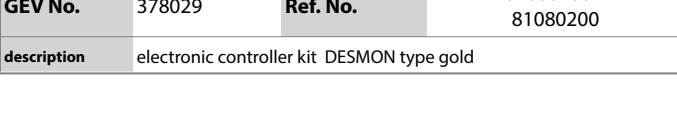

1

<b>GEV No.</b>	378029	<b>Ref. No.</b>	81000200E 81080200
----------------	--------	-----------------	-----------------------

**description** electronic controller kit DESMON type gold





## probes

### universal probes

#### temperature probes



<b>GEV No.</b>	379161	<b>Ref. No.</b>	Q32-0216 Q32-0578 R35-0227
<b>description</b>	temperature probe NTC 10kOhm cable thermoplastic probe -40 up to +110°C cable -40 up to +110°C probe ø6x14mm cable length 3m without screw connection 2-wire		

## electronics

### PCBs



<b>GEV No.</b>	361985	<b>Ref. No.</b>	80100040 80100040E 80190040
<b>description</b>	PCB kit DESMON edition gold		

## keypads

### front foils



<b>GEV No.</b>	511928	<b>Ref. No.</b>	B99-0138
<b>description</b>	keypad foil silver L 290mm W 56mm buttons 6		

## solenoid valves

### solenoid valves (refrigeration)





#### CASTEL

#### valve bodies

#### STANDARD series

suitable for refrigerants R22, R134a, R404A, R407C, R410A, R507



<b>GEV No.</b>	370382	<b>Ref. No.</b>	R30-0036
<b>description</b>	solenoid valve body NC type 1028/M10S p max 45bar connection 10mm soldering connection DN 3mm -35 up to +105°C L 125mm refrigeration straight CASTEL		
<b>accessories for</b>	370382		
	<b>GEV No.</b>	371084	<b>Ref. No.</b> —
	solenoid coil CASTEL 230VAC 8VA 50/60Hz connection cable 1000mm type CM2		
	<b>GEV No.</b>	371090	<b>Ref. No.</b> —
	power socket plug type DIN 43650A screw		
	<b>GEV No.</b>	371301	<b>Ref. No.</b> —
	solenoid coil CASTEL 110VAC 8VA 50/60Hz seat ø 11.5mm connection DIN 43650A type HF2		
	<b>GEV No.</b>	371314	<b>Ref. No.</b> —
	solenoid coil CASTEL 240VAC 8VA 50/60Hz seat ø 11.5mm		
	<b>GEV No.</b>	371321	<b>Ref. No.</b> —
	solenoid coil CASTEL 12/24VAC 50/60Hz seat ø 11.5mm connection DIN 43650A type HF2		

#### CEME

#### valves

#### with pipe clamp



<b>GEV No.</b>	370380	<b>Ref. No.</b>	R30-0031 R30-0035
<b>description</b>	solenoid valve straight CEME type 6806 230V p max 25bar connection 6mm soldering connection -45 up to +125°C refrigeration 50Hz		



## cooling aggregates

<b>GEV No.</b>	379304***	<b>Ref. No.</b>	123456
<b>description</b>			
<b>For models:</b>			

<b>GEV No.</b>	379304***	<b>Ref. No.</b>	123456
<b>description</b>			
<b>For models:</b>			

<b>GEV No.</b>	379304***	<b>Ref. No.</b>	123456
<b>description</b>			
<b>For models:</b>			

<b>GEV No.</b>	379304***	<b>Ref. No.</b>	123456
<b>description</b>			
<b>For models:</b>			

<b>GEV No.</b>	379304***	<b>Ref. No.</b>	123456
<b>description</b>			
<b>For models:</b>			

<b>GEV No.</b>	379304***	<b>Ref. No.</b>	123456
<b>description</b>			
<b>For models:</b>			

<b>GEV No.</b>	379304***	<b>Ref. No.</b>	123456
<b>description</b>			
<b>For models:</b>			

<b>GEV No.</b>	379304***	<b>Ref. No.</b>	123456
<b>description</b>			
<b>For models:</b>			

<b>GEV No.</b>	379304***	<b>Ref. No.</b>	123456
<b>description</b>			
<b>For models:</b>			

<b>GEV No.</b>	379304***	<b>Ref. No.</b>	123456
<b>description</b>			
<b>For models:</b>			

<b>GEV No.</b>	379304***	<b>Ref. No.</b>	123456
<b>description</b>			
<b>For models:</b>			

<b>GEV No.</b>	379304***	<b>Ref. No.</b>	123456
<b>description</b>			
<b>For models:</b>			

## compressors

### ACC/ZEL

R134A

HMBP monophase

High/Medium evaporation temperature above -20/-15 °C



1

<b>GEV No.</b>	605008	<b>Ref. No.</b>	Q32-0431
<b>description</b>	compressor coolant R134a type GL80TB 220-240V 50Hz HMBP fully hermetic 9.5kg 1/5HP power input 554W cylinder capacity 7.6cm <sup>3</sup> CSIR H 175.5mm 165W 215W 290W 390W 500W 615W 727W 840W test method ASHRAE ambient temperature max. 43°C		



1

<b>GEV No.</b>	605009	<b>Ref. No.</b>	Q32-0432
<b>description</b>	compressor coolant R134a type GL90TB 220-240V 50Hz HMBP fully hermetic 10.8kg 1/4HP power input 293W cylinder capacity 8.8cm <sup>3</sup> CSIR H 175.5mm 143W 194W 259W 339W 432W 539W 661W 796W test method ASHRAE		



R404a/R507

LBP monophase

Lower evaporation temperature below -20°C



1

<b>GEV No.</b>	605127	<b>Ref. No.</b>	EISB7-1 Q32-0701 Q32-0708
<b>description</b>	compressor coolant R404a/R507 type MX18FB 220-240V 50Hz LBP 17.3kg 5/8HP cylinder capacity 18.4cm <sup>3</sup> CSR H 230mm 575W 750W 985W 1219W 1498WWWWWW test method ASHRAE ambient temperature max. 43°C		

HMBP monophase

High/Medium evaporation temperature above -20/-15 °C



1

<b>GEV No.</b>	605014	<b>Ref. No.</b>	Q32-0434
<b>description</b>	compressor coolant R404a/R507 type ML80TB 220-240V 50Hz HMBP fully hermetic 11.4kg 3/8HP cylinder capacity 7.57cm <sup>3</sup> CSIR H 175.5mmW 261W 346W 446W 561W 691W 835W 993W 1167W test method ASHRAE ambient temperature max. 43°C		

CUBIGEL

R404a/R507

LBP monophase

Lower evaporation temperature below -20°C



1

<b>GEV No.</b>	605180	<b>Ref. No.</b>	Q32-0705
<b>description</b>	compressor coolant R404a/R507 type MX23FB 220-240V 50Hz LBP 17.5kg 1HP power input 7/8W cylinder capacity 23.2cm <sup>3</sup> CSR H 221mm 749W 982W 1246W 1541W 1868WWWWWW		



1

<b>GEV No.</b>	605075	<b>Ref. No.</b>	Q32-0706
<b>description</b>	compressor coolant R404a/R507a type MX21FB_A 220-240V 50Hz LBP 16.5kg 3/4HP cylinder capacity 20.72cm <sup>3</sup> CSR H 220mm 575W 655W 742W 836W 938WWWWWW test method ASHRAE		

HMBP monophase

High/Medium evaporation temperature above -20/-15 °C



1

<b>GEV No.</b>	605013	<b>Ref. No.</b>	Q32-0438 Q32-0652
<b>description</b>	compressor coolant R404a/R507 type ML60TB 220-240V 50Hz HMBP fully hermetic 10.1kg 1/4HP power input 647W cylinder capacity 5.68cm <sup>3</sup> CSIR H 175.5mmW 244W 319W 407W 511W 628W 760W 906W 1067W test method ASHRAE		



1

<b>GEV No.</b>	605029	<b>Ref. No.</b>	Q32-0439 Q32-0498
<b>description</b>	compressor coolant R404a/R507 type MP12RB 220-240V 50Hz HMBP fully hermetic 13.5kg 1/2HP cylinder capacity 12cm <sup>3</sup> CSIR H 203.6mmW 561W 734W 933W 1157W 1407W 1681W 1982WW test method ASHRAE ambient temperature max. 43°C		



electric components

EMBRACO / ASPERA

R404a/R507



1

<b>GEV No.</b>	605130	<b>Ref. No.</b>	Q32-0269
<b>description</b>	compressor coolant R404a/R507 type EMT6144GK 220-240V 50Hz HMBP fully hermetic 8.1kg 1/6HP cylinder capacity 3.97cm <sup>3</sup> CSIR H 175mmW 246W 307W 377W 459W 552W 656W 774W at +7,2°C 637W		

L'UNITE HERMETIQUE / TECUMSEH

R404A

HMBP monophase

High/Medium evaporation temperature above -20/-15 °C



1

<b>GEV No.</b>	605025	<b>Ref. No.</b>	Q32-0703
<b>description</b>	compressor coolant R404A type AE4430Z-FZ 220-240V 50Hz HMBP fully hermetic 10.2kg 1/4HP power input 427W cylinder capacity 5.7cm <sup>3</sup> CSIR H 186mmWW 258W 346W 441W 550W 682W 794W test method EN 12900 908W		
<b>spare parts for</b>	605025		
	<b>GEV No.</b>	380061	<b>Ref. No.</b> —
	start relay MTRP0027-31 120/240V voltage AC 8A 1NO		



1

<b>GEV No.</b>	605158	<b>Ref. No.</b>	Q32-0747
<b>description</b>	compressor coolant R404A type AE4470Z 220-240V 50Hz HMBP fully hermetic 13.7kg 1/2HP cylinder capacity 12cm <sup>3</sup> CSR H 207mmW 670W 843W 1035W 1251W 1495W 1773W 2088W 2447W		

evaporation and condensing trays

evaporation trays heated



1

<b>GEV No.</b>	750212	<b>Ref. No.</b>	89020710
<b>description</b>	condensing tray with heating cable for evaporator L 875mm W 447mm H 115mm		

condensing trays heated

producer-specific



1

<b>GEV No.</b>	695271	<b>Ref. No.</b>	Q32-0196 Q32-0196L
<b>description</b>	condensing tray heated L 410mm W 300mm H 80mm 230V 230W		
<b>For models:</b>	ID140		

unheated condensing trays



1

<b>GEV No.</b>	750214	<b>Ref. No.</b>	89010180
<b>description</b>	condensing tray unheated L 465mm W 360mm		
<b>accessories for</b>	750214		
	<b>GEV No.</b>	417643	<b>Ref. No.</b> R35-0011
	drain heater 126W 220V L 7600mm L1 (unheated) 1000mm L2 (heated) 6600mm ø 3.6mm		





fans

axial fans

import



1

<b>GEV No.</b>	601080 <sup>1</sup>	<b>Ref. No.</b>	R05-0006
<b>description</b>	axial fan L 119mm W 119mm H 38mm 230VAC 50/60Hz 23/20W bearing ball bearing connection male faston 2.8mm metal ADDA fan wheel ø 110mm temp.-resist. 70°C		
<b>For models:</b>	LUX 3C4		
<b>accessories for</b>	601080		
	<b>GEV No.</b>	550898	<b>Ref. No.</b> —
	connecting cable cable length 2000mm connection F 2.8 connection distance 7.9mm for axial flow fan		
	<b>GEV No.</b>	692519	<b>Ref. No.</b> —
	guard L 120mm W 120mm plastic		

<sup>1</sup>with ball bearings

refrigeration fans

refrigeration motors universal

ELCO

N series - standard



1

<b>GEV No.</b>	601359	<b>Ref. No.</b>	P36-0012 Q32-0132
<b>description</b>	fan motor 18W 230V 50/60Hz bearing slide bearing W 83mm connection 3-wire cable length 1000mm 1300/1550rpm 3 mounting options VNT18-30/150		
<b>spare parts for</b>	601359		
	<b>GEV No.</b>	601413	<b>Ref. No.</b> —
	fixing plate suitable for fanwheel ED ø 32mm shaft ø 7 mounting distance 26mm		



1

<b>GEV No.</b>	601729	<b>Ref. No.</b>	R05-0005
<b>description</b>	fan motor ELCO 10W 230V 50/60Hz L2 54mm L3 79mm cable length 1300mm VN10-20/229		



1

<b>GEV No.</b>	601442	<b>Ref. No.</b>	R35-0026
<b>description</b>	fan motor ELCO 10W 230V 50-60Hz bearing slide bearing L1 45mm L3 83mm W 83mm cable length 1800mm 1300/1550rpm 3 mounting options VN10-20/507 triple		
<b>spare parts for</b>	601442		
	<b>GEV No.</b>	601413	<b>Ref. No.</b> —
	fixing plate suitable for fanwheel ED ø 32mm shaft ø 7 mounting distance 26mm		



1

<b>GEV No.</b>	601358	<b>Ref. No.</b>	R05-0194
<b>description</b>	fan motor ELCO 12W 230V 50Hz W 83mm VNT12-20/334		



RE series



<b>GEV No.</b>	601608	<b>Ref. No.</b>	Q32-0590
<b>description</b>	fan motor 18W 230/240V 50/60Hz W 90mm cable length 1000mm 2600rpm ELCO R18-25/010 3 mounting options bearing slide bearing H 110mm L 90mm		
<b>spare parts for</b>	601608		
	<b>GEV No.</b>	601413	<b>Ref. No.</b> —
	fixing plate suitable for fanwheel ED $\phi$ 32mm shaft $\phi$ 7 mounting distance 26mm		

IMPORT

multi fit fan motors



<b>GEV No.</b>	601022	<b>Ref. No.</b>	R05-0100
<b>description</b>	fan motor 10W 230V 50-60Hz L1 44mm L2 54mm L3 85mm W 84mm cable length 500mm 1300rpm YZF10-20-18/26 5 mounting options bearing slide bearing		

accessories

fan wheels

aluminium

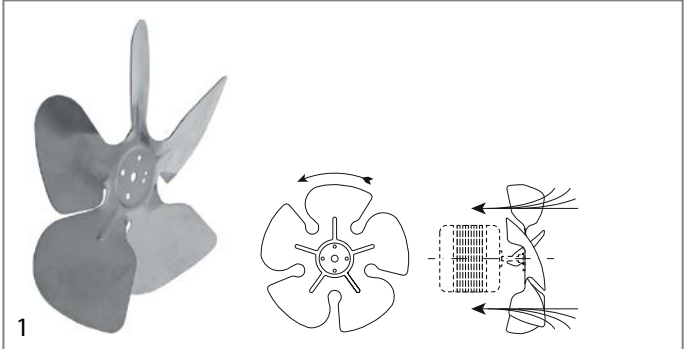

<b>GEV No.</b>	601070	<b>Ref. No.</b>	P36-0027 Q32-0591
<b>description</b>	fan wheel sucking $\phi$ 200mm fan wheel mounting 25.4mm blade angle 28° W 38mm aluminium		

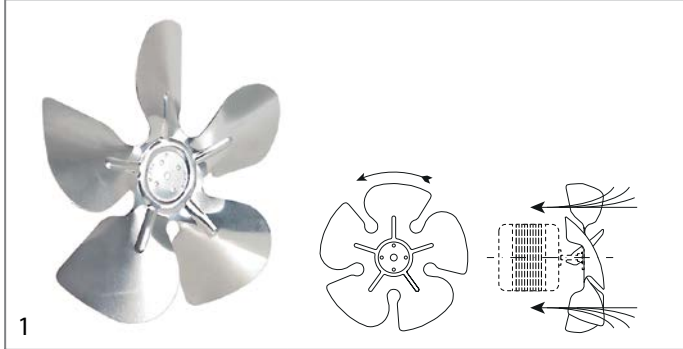

<b>GEV No.</b>	601284	<b>Ref. No.</b>	P36-0028
<b>description</b>	fan wheel sucking $\phi$ 254mm fan wheel mounting 25.4mm blade angle 28° W 42mm aluminium		

cooling motors (various)

accessories for cooling fan





<b>GEV No.</b>	601377	<b>Ref. No.</b>	Q32-0123
<b>description</b>	guard		

cold air circulating fans

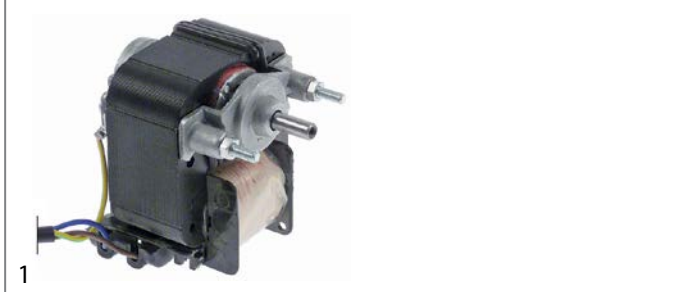
cold air circulating fans





<b>GEV No.</b>	750398	<b>Ref. No.</b>	R35-0019 R35-0177
<b>description</b>	fan motor 230/240V 50/60Hz 35W shaft $\phi$ 6mm shaft L 14mm W 62mm H 73mm		
<b>accessories for</b>	750398		
	<b>GEV No.</b>	601413	<b>Ref. No.</b> —
	fixing plate suitable for fanwheel ED $\phi$ 32mm shaft $\phi$ 7 mounting distance 26mm		
	<b>GEV No.</b>	602184	<b>Ref. No.</b> —
	fixing plate suitable for fanwheel ED $\phi$ 33mm shaft $\phi$ 6 mounting distance 17mm		



cold air circulating fans (other)



<b>GEV No.</b>	601375	<b>Ref. No.</b>	R05-0139 R05-0139 PLASET
<b>description</b>	fan motor 230V 50/60Hz 10W W 84mm H 87mm D 95mm shaft L 25mm shaft ø 8mm PLASET type 20182 cable length 1000mm 1350rpm		
<b>accessories for</b>	601375		
	<b>GEV No.</b>	601282	<b>Ref. No.</b> —
	fan wheel sucking ø 200mm fan wheel mounting 25.4mm blade angle 34° W 44mm aluminium		
	<b>GEV No.</b>	601570	<b>Ref. No.</b> —
	fan wheel blowing ø 200mm fan wheel mounting 25.4mm blade angle 28° W 37mm aluminium		

cross flow fans

COPREL

with standard coil



<b>GEV No.</b>	601248	<b>Ref. No.</b>	Q32-45180
<b>description</b>	cross flow fan TFL 45 roller ø 45mm roller length 180mm laminated core thickness 20mm motor position left 230V/50-60Hz 26W universal bearing silicone connection male faston 6.3mm airflow 123m <sup>3</sup> /h -30 up to +100°C 230V 50Hz		

condensators & interference suppression filters

filters

interference suppression filters



<b>GEV No.</b>	365053	<b>Ref. No.</b>	S06-0036 S06-0038
<b>description</b>	interference suppression filter capacity 0.1µF(X1)+2x5000pF(Y2) 1.5MOhm		

fuses

fine fuses



<b>GEV No.</b>	358666	<b>Ref. No.</b>	R35-0081
<b>description</b>	fine fuse size ø5x20mm 0.315A fast-acting rated 250V Qty 10 pcs		

electric accessories

terminals

terminal blocks with fuse holder



<b>GEV No.</b>	358389	<b>Ref. No.</b>	R25-0054
<b>description</b>	lustre terminal 0-pole max. 10A max 250V suitable fuse ø5x20mm cross section 2.5mm <sup>2</sup> with fuse holder		

equipment-specific units

for fridges

housing and bezels

covers



<b>GEV No.</b>	700905	<b>Ref. No.</b>	H99-1867
<b>description</b>	cover left plastic L 75mm W 50mm H 10mm		



<b>GEV No.</b>	700903	<b>Ref. No.</b>	H99-1868
<b>description</b>	cover right plastic L 75mm W 50mm H 10mm		

## drawers

## accessories



1

<b>GEV No.</b>	750246	<b>Ref. No.</b>	4181432
<b>description</b>	bottom plate for fish tank L 415mm W 370mm H 15mm stainless steel		

## miscellaneous



1

<b>GEV No.</b>	692180	<b>Ref. No.</b>	Q32-0222
<b>description</b>	cover with sump for evaporator L 388mm W 353mm H 114mm plastic for fridge		

## for refrigerated counters

## doors



1

<b>GEV No.</b>	695608	<b>Ref. No.</b>	6101500
<b>description</b>	door suitable for refrigerated counter		
<b>accessories for</b>	695608		
	<b>GEV No.</b>	900595	<b>Ref. No.</b> DT232-5.7.1 H25-0030
	refrigeration gasket profile 9010 W 415mm L 625mm plug size		

## for dishwashers

## mechanics for flight type dishwashers



1

<b>GEV No.</b>	511996	<b>Ref. No.</b>	927083
<b>description</b>	tappet for dishwasher right L 62mm W 52mm H 19mm hole ø 12mm		

## handles and hand wheels

## bracket handles



1

<b>GEV No.</b>	690450	<b>Ref. No.</b>	N/A
<b>description</b>	pull handle L 275mm H 43mm mounting distance 227mm		

## recessed handles



1

<b>GEV No.</b>	695599	<b>Ref. No.</b>	P22-0057
<b>description</b>	handle L 220mm W 107mm H 28mm mounting measurements 204x94mm		

## locks

## locking devices

## producer-specific

## DESMON



1

<b>GEV No.</b>	690976	<b>Ref. No.</b>	80010310
<b>description</b>	key cylinder with slide latch ø 23mm thread M19x1 mounting measurements 16.5x19mm hub 38-45mm shaft ø 11mm thread L 16mm HD/ID		





walk-in fridge catches

CONI TECHNIC



1

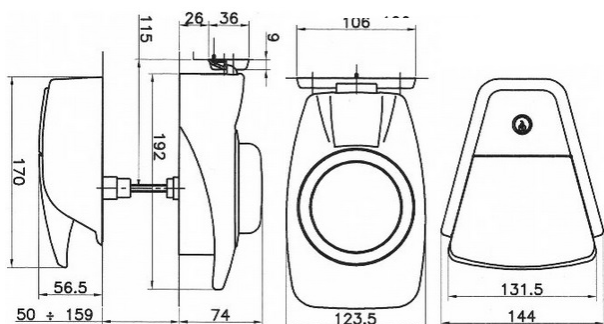

<b>GEV No.</b>	690993	<b>Ref. No.</b>	P28-0161 P28-0162
<b>description</b>	walk-in fridge catch type ActivA door thickness 50-140mm H 192mm W 123.5mm complete with door catch		

miscellaneous



1

<b>GEV No.</b>	700665	<b>Ref. No.</b>	8922500
<b>description</b>	catch		



Image not available

1

<b>GEV No.</b>	700654	<b>Ref. No.</b>	89010200
<b>description</b>	door catch kit		

hinges

spring assisted hinges

producer-specific

DESMON



1

<b>GEV No.</b>	700638	<b>Ref. No.</b>	89000040
<b>description</b>	spring assisted hinge		



1

<b>GEV No.</b>	700646	<b>Ref. No.</b>	89000100
<b>description</b>	spring assisted hinge complete		



1

<b>GEV No.</b>	700641	<b>Ref. No.</b>	89060300 89060310 89060320 89060330
<b>description</b>	spring assisted hinge complete stainless steel		



1

<b>GEV No.</b>	700635	<b>Ref. No.</b>	89100040
<b>description</b>	spring assisted hinge kit		



1

<b>GEV No.</b>	700607	<b>Ref. No.</b>	89110040
<b>description</b>	spring assisted hinge old edition until 2007		



1

<b>GEV No.</b>	701010	<b>Ref. No.</b>	89010020
<b>description</b>	spring assisted hinge kit mounting pos. left/right 400 LT TN-BASIC		



1

<b>GEV No.</b>	701011	<b>Ref. No.</b>	08001000 84189990 P28-0265 P28-0847
<b>description</b>	spring assisted hinge with hinge camp L 74mm W 24mm shaft length 18mm mounting distance 25mm mounting measurements 22x22x100mm		



1

<b>GEV No.</b>	700645	<b>Ref. No.</b>	89100100
<b>description</b>	spring assisted hinge left		

**GIGA**



1

<b>GEV No.</b>	701011	<b>Ref. No.</b>	08001000 84189990 P28-0265 P28-0847
<b>description</b>	spring assisted hinge with hinge camp L 74mm W 24mm shaft length 18mm mounting distance 25mm mounting measurements 22x22x100mm		



1

<b>GEV No.</b>	700620	<b>Ref. No.</b>	89000030
<b>description</b>	spring assisted hinge new edition since 2007		

**door bearing**





1

<b>GEV No.</b>	700606	<b>Ref. No.</b>	H49-0003
<b>description</b>	bush for hinge		





 <p>1</p>			
<b>GEV No.</b>	700605	<b>Ref. No.</b>	89000060
<b>description</b>	door hinge kit		

 <p>1</p>			
<b>GEV No.</b>	700636	<b>Ref. No.</b>	8301160
<b>description</b>	hinge bearing mounting pos. kit with bolt		

 <p>1</p>			
<b>GEV No.</b>	700647	<b>Ref. No.</b>	89000070
<b>description</b>	hinge bearing mounting pos. kit with bolt		
<b>For models:</b>	TSS3		

 <p>1</p>			
<b>GEV No.</b>	700649	<b>Ref. No.</b>	89000620
<b>description</b>	hinge bearing mounting pos. right with bolt		

 <p>1</p>			
<b>GEV No.</b>	700644	<b>Ref. No.</b>	89000310
<b>description</b>	hinge bearing mounting pos. upper left with bolt		

 <p>1</p>			
<b>GEV No.</b>	700648	<b>Ref. No.</b>	89000610
<b>description</b>	hinge bearing mounting pos. upper left with bolt		

 <p>1</p>			
<b>GEV No.</b>	700643	<b>Ref. No.</b>	89000300
<b>description</b>	hinge bearing mounting pos. upper right with bolt		

 <p>1</p>			
<b>GEV No.</b>	692760	<b>Ref. No.</b>	P99-0031
<b>description</b>	hinge camp L 185mm W 50mm H 10mm mounting pos. lower for DESMON		

## equipment feet and end caps

### equipment feet

#### with screw mounting

 <p>1</p>			
<b>GEV No.</b>	701057	<b>Ref. No.</b>	89010400
<b>description</b>	equipment feet kit tube ø 65mm thread M10 thread L 10mm H 115-180mm plastic size 2" Qty 4 pcs		

 <p>1</p>			
<b>GEV No.</b>	701064	<b>Ref. No.</b>	89010420
<b>description</b>	equipment foot tube ø 2"mm thread M10 thread L 10mm H 120-180mm plastic size 2" Qty 6 pcs		

 <p>1</p>			
<b>GEV No.</b>	701058	<b>Ref. No.</b>	89010440
<b>description</b>	equipment foot tube ø 2"mm thread M10 thread L 24mm H 120-180mm stainless steel size 2" Qty 4 pcs		





			
1			
<b>GEV No.</b>	700621	<b>Ref. No.</b>	89010410
<b>description</b>	equipment foot tube ø 80mm thread M10 H 115-180mm plastic Qty 5 pcs		

with fixing plate

			
1			
<b>GEV No.</b>	701059	<b>Ref. No.</b>	89020400
<b>description</b>	equipment foot		

			
1			
<b>GEV No.</b>	701060	<b>Ref. No.</b>	89020410
<b>description</b>	equipment foot		

			
1			
<b>GEV No.</b>	701061	<b>Ref. No.</b>	89030400
<b>description</b>	equipment foot		

			
1			
<b>GEV No.</b>	701062	<b>Ref. No.</b>	89040410
<b>description</b>	equipment foot		

			
1			
<b>GEV No.</b>	701066	<b>Ref. No.</b>	89040400
<b>description</b>	equipment foot		

			
1			
<b>GEV No.</b>	701063	<b>Ref. No.</b>	89030040
<b>description</b>	equipment foot plate size 82x100mm H 120-180mm SS size 2" Qty 8 pcs		

			
1			
<b>GEV No.</b>	701089	<b>Ref. No.</b>	89020040 Q32-0007
<b>description</b>	equipment foot tube ø 64mm plate size 85x100mm hole distance 55x75mm H 120-180mm SS size 2" Qty 1 pcs		

screw-in feet

			
1			
<b>GEV No.</b>	701065	<b>Ref. No.</b>	89010430
<b>description</b>	equipment feet kit thread M10 thread L 36mm ø 48mm H 17mm		

TENTE

with fixing plate

chrome-plated steel

			
1			
<b>GEV No.</b>	701084	<b>Ref. No.</b>	P80-3470
<b>description</b>	swivel castor ø 125mm plate fixing housing chrome-plated steel plate size 105x85mm hole distance 77x66mm capacity 100kg bearing slide bearing wheel body polypropylene tread TPE tyres H 155mm wheel width 32mm Qty 1 pcs		



miscellaneous

with fixing plate

ø125mm



1

<b>GEV No.</b>	701086	<b>Ref. No.</b>	N/A
<b>description</b>	fixed castor ø 125mm plates fixing 102x83mm		



1

<b>GEV No.</b>	701085	<b>Ref. No.</b>	P80-3477 siehe Bemerkung
<b>description</b>	swivel castor with brake ø 125mm plates fixing 102x83mm hole distance 78x60mm tread 32 H 155mm stainless steel		

diverse sets



1

<b>GEV No.</b>	701067	<b>Ref. No.</b>	89010340
<b>description</b>	castor set		

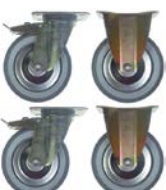

1

<b>GEV No.</b>	701070	<b>Ref. No.</b>	80010350
<b>description</b>	castor set		



1

<b>GEV No.</b>	701068	<b>Ref. No.</b>	81030330
<b>description</b>	castor set ø 125mm plates fixing 102x83mm housing stainless steel		



1

<b>GEV No.</b>	701069	<b>Ref. No.</b>	89010350
<b>description</b>	castor set ø 125mm plates fixing 102x83mm housing zinc-plated sheet steel Qty 5 pcs		



Image not available

1

<b>GEV No.</b>	701078	<b>Ref. No.</b>	81010080
<b>description</b>	swivel castor set		



1

<b>GEV No.</b>	701073	<b>Ref. No.</b>	81020320
<b>description</b>	swivel castor set ø 125mm plate fixing housing zinc-coated steel plate size 102x83mm bearing ball bearing wheel body polypropylene tread TPE tyres wheel width 32mm Qty 4 pcs		



1

<b>GEV No.</b>	701076	<b>Ref. No.</b>	81020300
<b>description</b>	swivel castor set ø 125mm plate fixing housing zinc-coated steel plate size 102x83mm bearing ball bearing wheel body polypropylene tread TPE tyres wheel width 32mm Qty 4 pcs		



1

<b>GEV No.</b>	701071	<b>Ref. No.</b>	81030300
<b>description</b>	swivel castor set ø 125mm plate fixing housing zinc-coated steel plate size 102x83mm bearing ball bearing wheel body polypropylene tread TPE tyres wheel width 32mm Qty 5 pcs		



1

<b>GEV No.</b>	701074	<b>Ref. No.</b>	81030320
<b>description</b>	swivel castor set ø 125mm plate fixing housing zinc-coated steel plate size 102x83mm bearing ball bearing wheel body polypropylene tread TPE tyres wheel width 32mm Qty 5 pcs		



<b>GEV No.</b>	701075	<b>Ref. No.</b>	81010330
<b>description</b>	swivel castor set ø 125mm plate fixing housing zinc-coated steel plate size 102x83mm bearing ball bearing wheel body polypropylene tread TPE tyres wheel width 32mm Qty 6 pcs		





<b>GEV No.</b>	701077	<b>Ref. No.</b>	81040300
<b>description</b>	swivel castor set ø 125mm plate fixing housing zinc-coated steel plate size 102x83mm bearing ball bearing wheel body polypropylene tread TPE tyres wheel width 32mm Qty 6 pcs		



<b>GEV No.</b>	701072	<b>Ref. No.</b>	89010360
<b>description</b>	swivel castor set ø 125mm plate fixing housing zinc-coated steel plate size 102x83mm bearing ball bearing wheel body polypropylene tread TPE tyres wheel width 32mm Qty 8 pcs		



<b>GEV No.</b>	970125	<b>Ref. No.</b>	Q32-0022
<b>description</b>	grate W 325mm D 530mm GN 1/1 plastic-coated steel crossing wires 1 white suitable for refrigerator		
<b>For models:</b>	LUX 3C4		
<b>accessories for</b>	970125		
	<b>GEV No.</b>	690330	<b>Ref. No.</b> —
	rack L 1000mm W 22mm H 4mm aperture 3x8mm hole distance 12.5mm stainless steel		
	<b>GEV No.</b>	694700	<b>Ref. No.</b> —
	shelf support L 31/28mm W 22mm H 18mm SS Qty 12 pcs		
	<b>GEV No.</b>	694701	<b>Ref. No.</b> —
	shelf support L 31/28mm W 22mm H 17mm SS with hook Qty 12 pcs		



## shelves and shelf rails

### grates

#### universal

#### without upstand



<b>GEV No.</b>	970122	<b>Ref. No.</b>	Q32-0022/I
<b>description</b>	grate W 325mm D 530mm GN 1/1 H 8mm stainless steel wire gauge frame 7mm lengthwise wires gauge 4mm crossing wires 1		
<b>accessories for</b>	970122		
	<b>GEV No.</b>	690330	<b>Ref. No.</b> —
	rack L 1000mm W 22mm H 4mm aperture 3x8mm hole distance 12.5mm stainless steel		
	<b>GEV No.</b>	694700	<b>Ref. No.</b> —
	shelf support L 31/28mm W 22mm H 18mm SS Qty 12 pcs		
	<b>GEV No.</b>	694701	<b>Ref. No.</b> —
	shelf support L 31/28mm W 22mm H 17mm SS with hook Qty 12 pcs		



<b>GEV No.</b>	970529	<b>Ref. No.</b>	Q32-6040
<b>description</b>	grate W 400mm D 600mm plastic-coated steel suitable for refrigerator		











<b>GEV No.</b>	970530	<b>Ref. No.</b>	Q32-6040/I
<b>description</b>	grate W 400mm D 600mm SS crossing wires 2 suitable for refrigerator		



#### with upstand





<b>GEV No.</b>	970471	<b>Ref. No.</b>	Q32-0326
<b>description</b>	grate W 485mm D 460mm plastic-coated steel with hinge camp crossing wires 2 suitable for refrigerator for devices with Inox guide rails		

 <p>1</p>			
<b>GEV No.</b>	970473	<b>Ref. No.</b>	Q32-0181 Q32-0182
<b>description</b>	grate W 530mm D 550mm plastic-coated steel with hinge camp wire gauge frame 9mm lengthwise wires gauge 5mm crossing wires 2 suitable for refrigerator with hinge camp		
<b>accessories for</b>	970473		
	<b>GEV No.</b>	690330	<b>Ref. No.</b> —
	rack L 1000mm W 22mm H 4mm aperture 3x8mm hole distance 12.5mm stainless steel		
	<b>GEV No.</b>	694700	<b>Ref. No.</b> —
	shelf support L 31/28mm W 22mm H 18mm SS Qty 12 pcs		
	<b>GEV No.</b>	694701	<b>Ref. No.</b> —
	shelf support L 31/28mm W 22mm H 17mm SS with hook Qty 12 pcs		

 <p>1</p>			
<b>GEV No.</b>	970527	<b>Ref. No.</b>	Q32-0300
<b>description</b>	grate W 530mm D 650mm GN 2/1 chrome-plated steel with hinge camp crossing wires 2 suitable for refrigerator		
<b>accessories for</b>	970527		
	<b>GEV No.</b>	690330	<b>Ref. No.</b> —
	rack L 1000mm W 22mm H 4mm aperture 3x8mm hole distance 12.5mm stainless steel		
	<b>GEV No.</b>	694700	<b>Ref. No.</b> —
	shelf support L 31/28mm W 22mm H 18mm SS Qty 12 pcs		
	<b>GEV No.</b>	694701	<b>Ref. No.</b> —
	shelf support L 31/28mm W 22mm H 17mm SS with hook Qty 12 pcs		

 <p>1</p>			
<b>GEV No.</b>	970492	<b>Ref. No.</b>	Q32-0002
<b>description</b>	grate W 650mm D 530mm GN 2/1 plastic-coated steel with hinge camp for fridge crossing wires 2 grey		
<b>For models:</b>	HD140A, HD70A		
<b>accessories for</b>	970492		
	<b>GEV No.</b>	690991	<b>Ref. No.</b> 400020 4080584 4180014
	guide U-shape L 630mm W 15mm H 19mm mounting pos. left/right		

 <p>1</p>			
<b>GEV No.</b>	970528	<b>Ref. No.</b>	Q32-0002/1
<b>description</b>	grate W 650mm D 530mm GN 2/1 stainless steel with hinge camp crossing wires 2 suitable for refrigerator		

<b>producer-specific</b>			
 <p>1</p>			
<b>GEV No.</b>	970531	<b>Ref. No.</b>	Q32-7100
<b>description</b>	grate W 100mm D 565mm plastic-coated steel suitable for refrigerator		

 <p>1</p>			
<b>GEV No.</b>	970532	<b>Ref. No.</b>	Q32-7800
<b>description</b>	grate W 100mm D 650mm plastic-coated steel suitable for refrigerator		

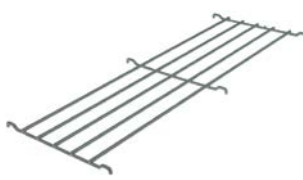
 <p>1</p>			
<b>GEV No.</b>	970533	<b>Ref. No.</b>	Q32-8060
<b>description</b>	grate W 120mm D 650mm plastic-coated steel suitable for refrigerator		

## shelf rails and supports

<b>producer-specific</b>			
 <p>1</p>			
<b>GEV No.</b>	690775	<b>Ref. No.</b>	4180314
<b>description</b>	guide L-shape L 440mm W 17mm H 34mm mounting pos. left/right		



1

<b>GEV No.</b>	690975	<b>Ref. No.</b>	4180234
<b>description</b>	guide L-shape L 570mm W 20mm H 24mm mounting pos. left		



1

<b>GEV No.</b>	690974	<b>Ref. No.</b>	4180214
<b>description</b>	guide L-shape L 570mm W 20mm H 24mm mounting pos. right		



1

<b>GEV No.</b>	700663	<b>Ref. No.</b>	4180124
<b>description</b>	guide L-shape L 642mm W 19mm H 25mm mounting pos. left		



1

<b>GEV No.</b>	700664	<b>Ref. No.</b>	4180114
<b>description</b>	guide L-shape L 642mm W 19mm H 25mm mounting pos. right		



1

<b>GEV No.</b>	700661	<b>Ref. No.</b>	4180104
<b>description</b>	guide U-shape L 460mm W 15mm mounting pos. left/right inner height 17mm		



1

<b>GEV No.</b>	700662	<b>Ref. No.</b>	400019 4080054 4180024
<b>description</b>	guide U-shape L 555mm W 15mm H 18mm mounting pos. left/right		
<b>For models:</b>	LUX 3C4, LUX34C, LUX3C2		



1

<b>GEV No.</b>	690772	<b>Ref. No.</b>	4180034
<b>description</b>	guide U-shape L 568mm W 15mm inner height 18mm mounting pos. left/right		
<b>For models:</b>	HD140A, HD70A		



1

<b>GEV No.</b>	690991	<b>Ref. No.</b>	400020 4080584 4180014
<b>description</b>	guide U-shape L 630mm W 15mm H 19mm mounting pos. left/right		



1

<b>GEV No.</b>	694921	<b>Ref. No.</b>	H49-0063
<b>description</b>	shelf support L 18mm W 23mm H 26mm Qty 1		



1

<b>GEV No.</b>	690969	<b>Ref. No.</b>	P99-0036
<b>description</b>	shelf support L 33/28mm W 22mm H 18mm		



1

<b>GEV No.</b>	694276	<b>Ref. No.</b>	H49-0062
<b>description</b>	shelf support L 34mm W 23mm H 31mm		



## gaskets

### refrigeration gaskets

#### plug-in gaskets

#### profile 9048

We offer custom-made gaskets for this profile

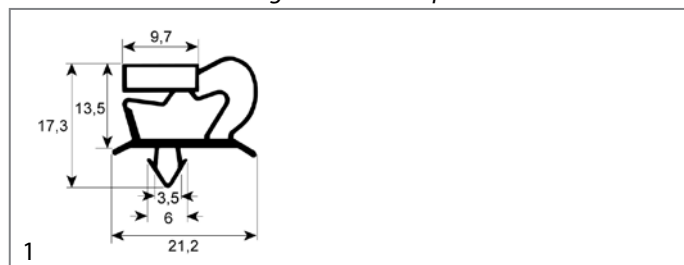

<b>GEV No.</b>	900621	<b>Ref. No.</b>	H25-0057
<b>description</b>	refrigeration gasket profile 9048 W 161mm L 420mm plug size		

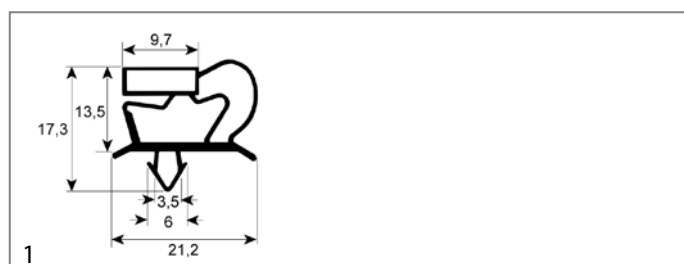

<b>GEV No.</b>	900619	<b>Ref. No.</b>	H25-0014
<b>description</b>	refrigeration gasket profile 9048 W 176mm L 420mm plug size		

#### profile 9010

We offer custom-made gaskets for this profile

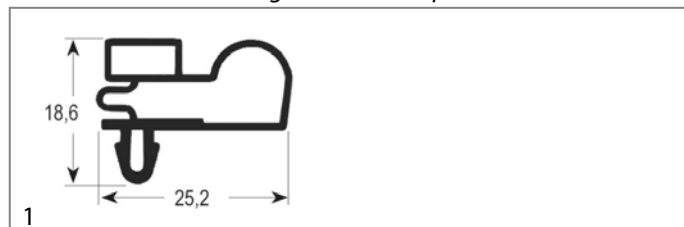

<b>GEV No.</b>	901249	<b>Ref. No.</b>	H25-0015
<b>description</b>	gasket profile 9010 W 650mm L 745mm plug size		

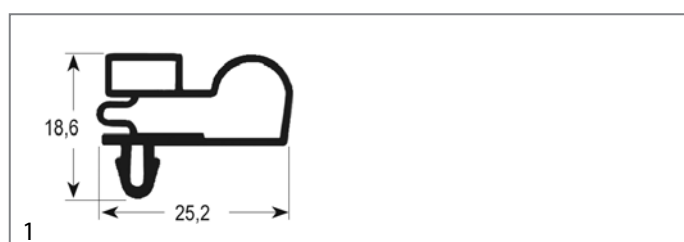

<b>GEV No.</b>	900622	<b>Ref. No.</b>	H25-0058
<b>description</b>	refrigeration gasket profile 9010 W 272mm L 415mm plug size		

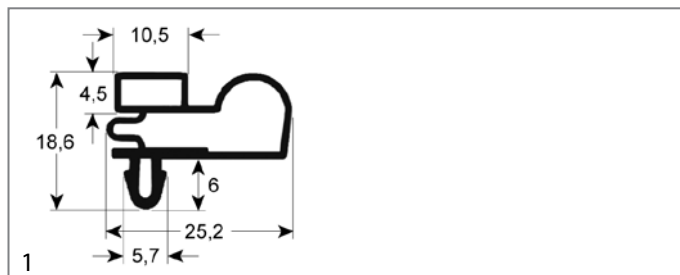

<b>GEV No.</b>	900596	<b>Ref. No.</b>	H25-0029
<b>description</b>	refrigeration gasket profile 9010 W 290mm L 415mm plug size		
<b>For models:</b>	LUX 3C4		

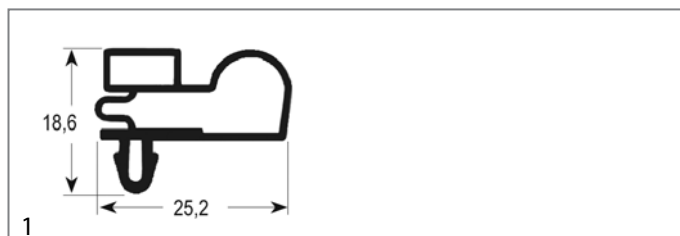

<b>GEV No.</b>	900623	<b>Ref. No.</b>	H25-0059
<b>description</b>	refrigeration gasket profile 9010 W 365mm L 415mm plug size		

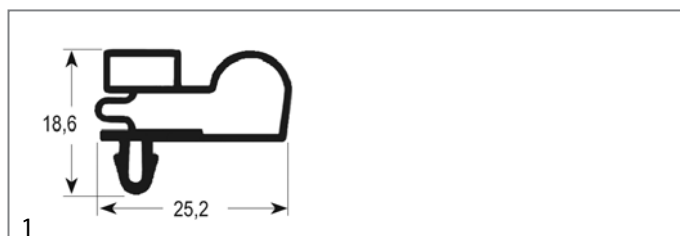

<b>GEV No.</b>	900620	<b>Ref. No.</b>	H25-0022
<b>description</b>	refrigeration gasket profile 9010 W 400mm L 420mm plug size		

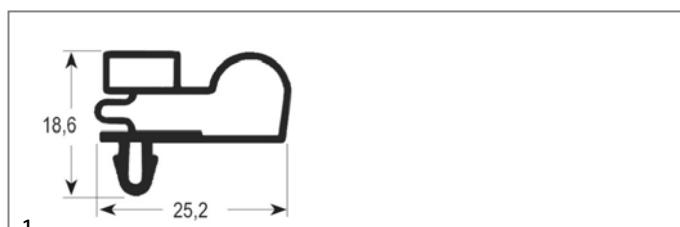

<b>GEV No.</b>	900597	<b>Ref. No.</b>	H25-0053
<b>description</b>	refrigeration gasket profile 9010 W 415mm L 545mm plug size		

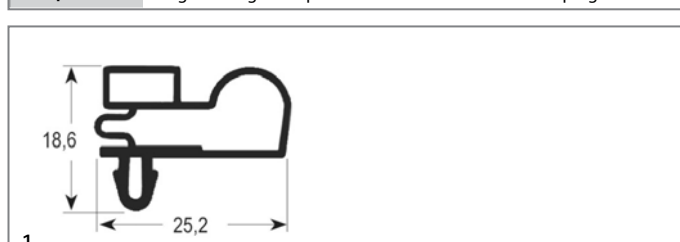

<b>GEV No.</b>	900595	<b>Ref. No.</b>	DT232-5.7.1 H25-0030
<b>description</b>	refrigeration gasket profile 9010 W 415mm L 625mm plug size		
<b>For models:</b>	LUX 3C4		

<b>GEV No.</b>	900616	<b>Ref. No.</b>	H25-0054
<b>description</b>	refrigeration gasket profile 9010 W 416mm L 615mm plug size		

<b>GEV No.</b>	901365	<b>Ref. No.</b>	H25-0160
<b>description</b>	refrigeration gasket profile 9010 W 565mm L 685mm plug size		

<b>GEV No.</b>	901167	<b>Ref. No.</b>	H25-0011
<b>description</b>	refrigeration gasket profile 9010 W 417mm L 600mm plug size		
<b>For models:</b>	SA130		

<b>GEV No.</b>	900598	<b>Ref. No.</b>	H25-0016
<b>description</b>	refrigeration gasket profile 9010 W 655mm L 1550mm plug size		
<b>For models:</b>	70N14, HD140A, HD70A, ID140		

<b>GEV No.</b>	900618	<b>Ref. No.</b>	H25-0024
<b>description</b>	refrigeration gasket profile 9010 W 515mm L 600mm plug size		

<b>GEV No.</b>	900615	<b>Ref. No.</b>	H25-0052
<b>description</b>	refrigeration gasket profile 9010 W 655mm L 755mm plug size		

<b>GEV No.</b>	900617	<b>Ref. No.</b>	H25-0032 H25-0056
<b>description</b>	refrigeration gasket profile 9010 W 515mm L 620mm plug size		

<b>GEV No.</b>	900600	<b>Ref. No.</b>	EISB7-19 H25-0051 H25-0081
<b>description</b>	refrigeration gasket profile 9010 W 660mm L 1585mm plug size		

<b>GEV No.</b>	900614	<b>Ref. No.</b>	H25-0067
<b>description</b>	refrigeration gasket profile 9010 W 555mm L 1400mm plug size		
<b>For models:</b>	AVX400NSP		

<b>GEV No.</b>	901502	<b>Ref. No.</b>	H25-0123
<b>description</b>	refrigeration gasket profile 9010 W 745mm L 1950mm plug size		



<b>GEV No.</b>	902251	<b>Ref. No.</b>	N/A
<b>description</b>	refrigeration gasket profile 9010 Wmm L 2500mm		

<b>GEV No.</b>	750181	<b>Ref. No.</b>	P00886 Q32-0370 TGM2G-49
<b>description</b>	evaporator L 360mm W 95mm H 350mm for Desmon refrigerated counter (PTR,LUX,TLM2A)		
<b>For models:</b>	796251, LUX 3C4		

## refrigeration cycle components

### filter driers

#### miscellaneous

<b>GEV No.</b>	750045	<b>Ref. No.</b>	S06-00051
<b>description</b>	dryer size 20g ø 18.8mm L 144mm connection 6,5/6,5mm type Q20-Q50		

<b>GEV No.</b>	750194	<b>Ref. No.</b>	EISB7-2 EISB7-29 EISB7-30 Q32-0081
<b>description</b>	evaporator L 390mm W 95mm H 350mm complete with fan		
<b>For models:</b>	70N14		

## evaporators

### for fridges

#### producer-specific

<b>GEV No.</b>	750253	<b>Ref. No.</b>	Q32-0345
<b>description</b>	evaporator complete with fan		

## accessories

### housings

<b>GEV No.</b>	695610	<b>Ref. No.</b>	Q32-0229
<b>description</b>	housing for evaporator L 81.5mm W 14mm H 44mm		

<b>GEV No.</b>	692328	<b>Ref. No.</b>	Q32-0594
<b>description</b>	sump for evaporator L 540mm W 465mm H 112mm		

## evaporation and condensing trays

### evaporation trays

			
1			
<b>GEV No.</b>	750211	<b>Ref. No.</b>	Q32-0194
<b>description</b>	evaporation tray L 435mm W 109mm H 25mm		

			
1			
<b>GEV No.</b>	750282	<b>Ref. No.</b>	Q32-0193
<b>description</b>	evaporation tray L 500mm W 81mm H 49mm		

### unheated condensing trays

			
1			
<b>GEV No.</b>	750182	<b>Ref. No.</b>	Q32-0195
<b>description</b>	condensing tray L 540mm W 235mm H 70mm		
<b>For models:</b>	HD70A, ID140		

			
1			
<b>GEV No.</b>	695609	<b>Ref. No.</b>	4181673
<b>description</b>	condensing tray stainless steel for evaporator		

## kitchen accessories

### gastronorm

#### trays and inserts

			
1			
<b>GEV No.</b>	993016	<b>Ref. No.</b>	H65-0006
<b>description</b>	intermediate floor GN 1/1 W 250mm L 455mm H 15mm -40 up to +100°C		

#### GN containers

##### lids

			
1			
<b>GEV No.</b>	993017	<b>Ref. No.</b>	GNC-19
<b>description</b>	lid SS 18/10 GN 1/9 Dmm H 23mm L 175mm W 107mm		

## consumables

### fuses

#### fine fuses

			
1			
<b>GEV No.</b>	358666	<b>Ref. No.</b>	R35-0081
<b>description</b>	fine fuse size ø5x20mm 0.315A fast-acting rated 250V Qty 10 pcs		

<b>A</b>			
axial fans		13	
<b>B</b>			
ballasts		5	
<b>C</b>			
castors and bumper angles		20	
cold air circulating fans		14	
compressors		10	
condensators & interference suppression filters		15	
condensing trays heated		12	
consumables		28	
cooling aggregates		10	
cross flow fans		15	
<b>E</b>			
electric accessories		15	
electronic controllers		5	
evaporation trays heated		12	
evaporators		27	
<b>F</b>			
fans		13	
filter driers		27	
filters		15	
fine fuses		28	
fluorescent lamps		4, 4	
fridge lamps		5	
fuses		15, 28	
<b>G</b>			
gastronorm		28	
grates		22	
<b>H</b>			
heating cables		3	
heating elements		3	
heating elements for condensate evaporation		3	
heating elements for defrosting		3	
heating elements for refrigeration		3	
<b>L</b>			
lamps		4	
<b>M</b>			
magnetic switches		4	
microswitches		4	
<b>P</b>			
plug-in gaskets		25	
probes		9	
<b>R</b>			
refrigeration cycle components		27	
refrigeration fans		13	
refrigeration gaskets		25	
refrigeration motors universal		13	
refrigeration thermostats		3	
relays		5	
rocker/momentary rocker switches		4	
<b>S</b>			
shelves and shelf rails		22	
solenoid valves		9	
spring assisted hinges		17	
starter		5	
switches and momentary switches		4	
<b>T</b>			
temperature probes		9	
terminals		15	
thermostats		3	
<b>U</b>			
unheated condensing trays		12	
universal probes		9	
<b>W</b>			
walk-in fridge catches		17	