



**GAS COMPONENTS**



**ELECTRIC COMPONENTS**



**WATER TECHNOLOGY**



**MECHANICAL COMPONENTS**



**TOOLS**

Spare parts suitable for

**DYNAMIC**

Find the complete and up-to-date range of products in our GEV Webshop



# Manufacturer catalogue

The most important spare parts and accessories arranged clearly for every manufacturer

- ✓ Complete product range and all appliance data always up to date in the GEV Webshop
- ✓ Alphabetical Index at the end of the catalogue

## GEV Webshop

[www.gev-online.co.uk](http://www.gev-online.co.uk)

[www.gev-online.com](http://www.gev-online.com)



- 🔍 Add to Favourites
- 🔍 Sign In with email address and usual password
- 🔍 Easy-order – place several items in your basket at the same time
- 🔍 Quick Item search – no login needed



## switches and momentary switches



### miscellaneous

			
1			
<b>GEV No.</b>	348132	<b>Ref. No.</b>	0908
<b>description</b>	safety switch 250V H 48mm 5A with safety device		
<b>For models:</b>	FD98, FT86, FTP94, Junior-Fouet, Junior-Plus, Junior-Standard, MD95, MMX92, MMX98, MX85, MXP94, PMDH250, PMF250, PMX83, PMX98, SMX500, SMX502, SMX600		

## electronics

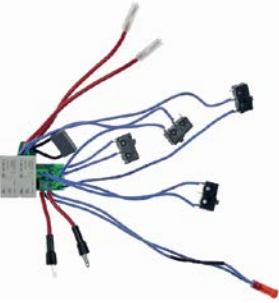

### PCBs

			
1			
<b>GEV No.</b>	403778	<b>Ref. No.</b>	2003
<b>description</b>	control PCB hand blenders MX2000 / MDH2000 / MF2000 / MFAP2000 L 46mm W 40mm with microswitch		
<b>For models:</b>	Master, MDH2000, MF2000, MFAP2000, MX2000, MX2000-DSC		

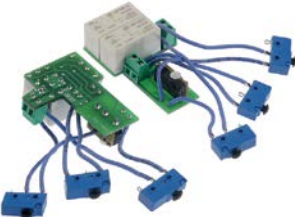
			
1			
<b>GEV No.</b>	403165	<b>Ref. No.</b>	2852
<b>description</b>	PCB GSM1000 speed control		
<b>For models:</b>	Dynamix		
<b>spare parts for</b>	403165		
	<b>GEV No.</b>	696506	<b>Ref. No.</b>
			2858
	 knob for PCB ø 26mm black Qty 1 pcs		

			
1			
<b>GEV No.</b>	403561	<b>Ref. No.</b>	45620
<b>description</b>	PCB hand blenders SMX600/800		
<b>For models:</b>	SMX600-DSC, SMX600-E, SMX800-DSC, SMX800-E		

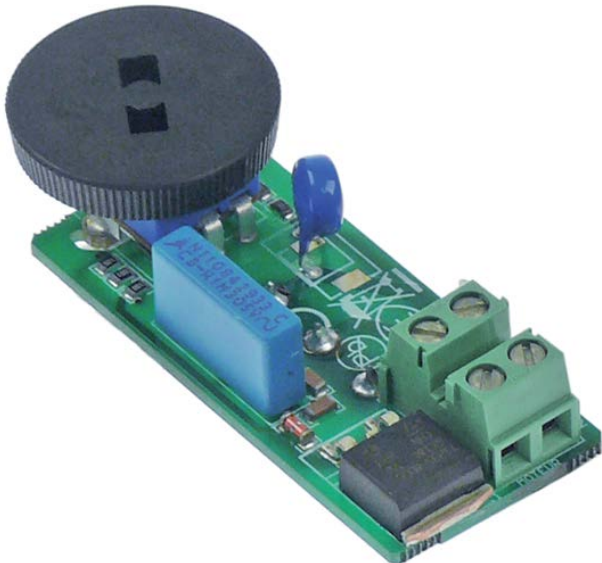
## speed controllers

			
1			
<b>GEV No.</b>	403165	<b>Ref. No.</b>	2852
<b>description</b>	PCB GSM1000 speed control		
<b>For models:</b>	Dynamix		
<b>spare parts for</b>	403165		
	<b>GEV No.</b>	696506	<b>Ref. No.</b>
			2858
	 knob for PCB ø 26mm black Qty 1 pcs		

## motors

### motors

#### for hand blenders

#### motors

			
1			
<b>GEV No.</b>	698257	<b>Ref. No.</b>	9507
<b>description</b>	motor 230V 180W 50Hz shaft ø 6.3mm mounting distance 60mm H 86mm		
<b>For models:</b>	MD95		

			
1			
<b>GEV No.</b>	698378	<b>Ref. No.</b>	2847
<b>description</b>	motor for hand blender 230V 100W shaft ø 6.4mm GSM1000		
<b>For models:</b>	Dynamix		



## accessories



1

<b>GEV No.</b>	698269	<b>Ref. No.</b>	0504
<b>description</b>	motor carbon brush set with spring L 22mm W 6mm H 8mm		
<b>For models:</b>	FT79, FT97, MDH2000, MDH460, MF2000, MF90, MFAP2000, MFAP90, MX2000, MX2000-DSC, MX79, MX91, PP84, PP97, PP97-Plus		

## equipment-specific units

## for hand blenders

## housings



1

<b>GEV No.</b>	699708	<b>Ref. No.</b>	2840M
<b>description</b>	cover for handle blue GSM1000 L 80mm W 42mm		



1

<b>GEV No.</b>	696503	<b>Ref. No.</b>	2851
<b>description</b>	handle for hand blender plastic grey		
<b>For models:</b>	Dynamix		



1

<b>GEV No.</b>	699134	<b>Ref. No.</b>	2849M
----------------	--------	-----------------	-------

**description** housing left blue GSM1000

**accessories for** 699134



<b>GEV No.</b>	699133	<b>Ref. No.</b>	2843M
----------------	--------	-----------------	-------

housing right blue GSM1000



1

<b>GEV No.</b>	699133	<b>Ref. No.</b>	2843M
----------------	--------	-----------------	-------

**description** housing right blue GSM1000

**accessories for** 699133



<b>GEV No.</b>	699134	<b>Ref. No.</b>	2849M
----------------	--------	-----------------	-------

housing left blue GSM1000



1

<b>GEV No.</b>	698386	<b>Ref. No.</b>	2848M
----------------	--------	-----------------	-------

**description** sticker for hand blender silver L 125mm W 25mm thickness 1mm ON-OFF



1

<b>GEV No.</b>	698387	<b>Ref. No.</b>	2853M
----------------	--------	-----------------	-------

**description** sticker for lid silver L 50mm W 27mm

## couplings



1

<b>GEV No.</b>	651038	<b>Ref. No.</b>	9508
----------------	--------	-----------------	------

**description** coupling D1 ø 12.3mm D2 ø 8.6mm int. ø 1 6.5mm int. ø 2 4mm L 35.3mm

**For models:** MD95



 <p>1</p>			
<b>GEV No.</b>	699709	<b>Ref. No.</b>	9051
<b>description</b>	coupling D1 ø 13.5mm D2 ø 22mm int. ø 1 8mm int. ø 2 17mm L1 22mm		
<b>For models:</b>	AP90, Coupe-Legume, Dynacutter, EM98, FM90, MDH2000, MDH460, MF2000, MF90, MFAP2000, MFAP90, PMDH250, PMF250, SMX600-DSC, SMX800-DSC, SMX800-E		

 <p>2</p>			
<b>GEV No.</b>	698308	<b>Ref. No.</b>	45122
<b>description</b>	coupling D1 ø 22.5mm L 15mm teeth 8		
<b>For models:</b>	SMX450, SMX500, SMX502, SMX600, SMX600-E		

 <p>1</p>			
<b>GEV No.</b>	696504	<b>Ref. No.</b>	2846
<b>description</b>	coupling for hand blender D1 ø 19mm int. ø 1 6.3mm L 29.5mm teeth 8 GSM1000		
<b>For models:</b>	Dynamix		

 <p>1</p>			
<b>GEV No.</b>	698307	<b>Ref. No.</b>	45123
<b>description</b>	coupling with roll pin for hand blender D1 ø 15mm D2 ø 19mm int. ø 1 8mm L 12mm teeth 8 SMX		
<b>For models:</b>	Junior-Plus, SMX450, SMX500, SMX502, SMX600, SMX600-E		

 <p>1</p>			
<b>GEV No.</b>	696505	<b>Ref. No.</b>	2860
<b>description</b>	coupling with roll pin for hand blender D1 ø 19mm int. ø 1 8mm teeth 8 GSM1000		

blender sticks

bearing blocks

 <p>1</p>			
<b>GEV No.</b>	698603	<b>Ref. No.</b>	45130
<b>description</b>	bearing for hand blender ø 50mm ID ø 8mm H 34mm SMX450/500/502/600/800		
<b>For models:</b>	SMX450, SMX500, SMX502, SMX600, SMX600-DSC, SMX600-E, SMX800-DSC, SMX800-E		

 <p>1</p>			
<b>GEV No.</b>	698270	<b>Ref. No.</b>	7916
<b>description</b>	bushing with gasket ø 22mm ID ø 8mm H 30mm MASTER/PMF250		
<b>For models:</b>	Master, MDH2000, MDH460, MF2000, MF90, MFAP2000, MFAP90, MMX98, MX2000, MX2000-DSC, MX79, MX85, MX91, PMDH250, PMF250, PMX98		

blades

blades with adaptor (complete)

 <p>1</p>			
<b>GEV No.</b>	698262	<b>Ref. No.</b>	0551 9415
<b>description</b>	knife ø 39mm hole ø 4mm H 12mm		
<b>For models:</b>	Dynamix, MD95, MXP94		

 <p>1</p>			
<b>GEV No.</b>	698261	<b>Ref. No.</b>	0550 9414
<b>description</b>	knife ø 39mm hole ø 4mm H 18mm		
<b>For models:</b>	Dynamix, MD95, MXP94		

 <p>1</p>			
<b>GEV No.</b>	698321	<b>Ref. No.</b>	4004
<b>description</b>	knife ø 45mm hole ø 4mm H 12mm JUNIOR		
<b>For models:</b>	Junior-Plus, Junior-Standard		

 <p>1</p>			
<b>GEV No.</b>	698604	<b>Ref. No.</b>	7917
<b>description</b>	knife ø 58mm hole ø 8mm H 22mm MDH/MF/MFA/MX		
<b>For models:</b>	MDH2000, MDH460, MF2000, MF90, MFAP2000, MFAP90, MX2000, MX2000-DSC, MX79, MX85, MX91		

 <p>1</p>			
<b>GEV No.</b>	698271	<b>Ref. No.</b>	45161
<b>description</b>	knife ø 68mm hole ø 8mm H 30mm SMX		
<b>For models:</b>	SMX450, SMX500, SMX502, SMX600, SMX600-DSC, SMX600-E, SMX800-DSC, SMX800-E		

			
1			
<b>GEV No.</b>	698381	<b>Ref. No.</b>	0552
<b>description</b>	mixer disc $\phi$ 36mm hole $\phi$ 4mm H 0.8mm GSM1000		
<b>For models:</b>	Dynamix		

			
1			
<b>GEV No.</b>	698382	<b>Ref. No.</b>	0553
<b>description</b>	mixer disc $\phi$ 36mm hole $\phi$ 4mm H 3.4mm GSM1000		
<b>For models:</b>	Dynamix		

## blender sticks



			
1			
<b>GEV No.</b>	698379	<b>Ref. No.</b>	2845M
<b>description</b>	blender stick GSM1000 L 234mm flange $\phi$ 66mm		



			
1			
<b>GEV No.</b>	698260	<b>Ref. No.</b>	9510
<b>description</b>	blender stick MXP94 L 215mm flange $\phi$ 70mm mounting distance 60mm with shaft sealing		
<b>For models:</b>	MD95, MXP94		

## spindles

			
1			
<b>GEV No.</b>	699707	<b>Ref. No.</b>	9131
<b>description</b>	drive shaft for hand blender D1 $\phi$ 8mm D2 $\phi$ 14mm L 408mm		
<b>For models:</b>	Master, MX2000, MX2000-DSC, MX91		

			
1			
<b>GEV No.</b>	699706	<b>Ref. No.</b>	45120
<b>description</b>	drive shaft for hand blender with ball bearing D1 $\phi$ 8mm D2 $\phi$ 18mm L 488mm		
<b>For models:</b>	SMX450, SMX500, SMX502, SMX600, SMX600-E		

			
1			
<b>GEV No.</b>	698380	<b>Ref. No.</b>	2844M
<b>description</b>	drive shaft for hand blender with coupling D1 $\phi$ 4mm D2 $\phi$ 8mm L 214mm SS		
<b>spare parts for</b>	698380		
	<b>GEV No.</b>	696505	<b>Ref. No.</b>
			2860
	coupling with roll pin for hand blender D1 $\phi$ 19mm int. $\phi$ 1 8mm teeth 8 GSM1000		

			
1			
<b>GEV No.</b>	698259	<b>Ref. No.</b>	089956
<b>description</b>	drive shaft with coupling D1 $\phi$ 4mm D2 $\phi$ 8mm L 180mm stainless steel		
<b>For models:</b>	MD95		
<b>spare parts for</b>	698259		
	<b>GEV No.</b>	651038	<b>Ref. No.</b>
			9508
	coupling D1 $\phi$ 12.3mm D2 $\phi$ 8.6mm int. $\phi$ 1 6.5mm int. $\phi$ 2 4mm L 35.3mm		

## beaters

## beaters

			
1			
<b>GEV No.</b>	698258	<b>Ref. No.</b>	9424
<b>description</b>	whisk 1 pair $\phi$ 60mm L 190mm hole $\phi$ 6mm JUNIOR		
<b>For models:</b>	FD98, FTP94, Junior-Fouet, Junior-Plus		

## miscellaneous

			
1			
<b>GEV No.</b>	696439	<b>Ref. No.</b>	45138
<b>description</b>	bolt L 155mm M5 Qty 4 pcs		
<b>For models:</b>	SMX450, SMX500, SMX502, SMX600, SMX600-DSC, SMX600-E, SMX800-DSC, SMX800-E		

			
1			
<b>GEV No.</b>	698385	<b>Ref. No.</b>	2841
<b>description</b>	bracket for grab handle L 40mm W 37mm thickness 1.5mm		
<b>For models:</b>	Dynamix		





			
1			
<b>GEV No.</b>	696507	<b>Ref. No.</b>	2854
<b>description</b>	bracket for motor plastic black		
<b>For models:</b>	Dynamix		

			
1			
<b>GEV No.</b>	698605	<b>Ref. No.</b>	0529
<b>description</b>	carbon for hand blender L 28mm W 9mm H 6mm suitable for DYNAMIC for model SMX		
<b>For models:</b>	SMX450, SMX500, SMX502, SMX600, SMX600-DSC, SMX600-E, SMX800-DSC, SMX800-E		

			
1			
<b>GEV No.</b>	696506	<b>Ref. No.</b>	2858
<b>description</b>	knob for PCB ø 26mm black Qty 1 pcs		

			
1			
<b>GEV No.</b>	698607	<b>Ref. No.</b>	9028
<b>description</b>	mixer coupling for hand blender L 25mm ø 17mm suitable for DYNAMIC for model MDH/MF/MFAP/PMDH/PMF/SMX		
<b>For models:</b>	MDH2000, MDH460, MF2000, MF90, MFAP2000, MFAP90, PMDH250, PMF250, SMX600-DSC, SMX800-DSC, SMX800-E		

			
1			
<b>GEV No.</b>	532648	<b>Ref. No.</b>	2859
<b>description</b>	O-ring EPDM thickness 1.5mm ID ø 5mm Qty 1 pcs		



			
1			
<b>GEV No.</b>	698384	<b>Ref. No.</b>	45710
<b>description</b>	protection cap for grab handle plastic black		
<b>For models:</b>	Dynamix, Master, MDH2000, MF2000, MFAP2000, MX2000, MX2000-DSC, SMX600-DSC, SMX600-E, SMX800-DSC, SMX800-E		

			
1			
<b>GEV No.</b>	699710	<b>Ref. No.</b>	9025
<b>description</b>	ring for ball bearing L 15mm thickness 15.5mm ø 30mm		
<b>For models:</b>	MDH2000, MDH460, MF2000, MF90, MFAP2000, MFAP90, MMX98, MX2000, MX2000-DSC, MX91, PMDH250, PMF250, PMX98		

			
1			
<b>GEV No.</b>	698383	<b>Ref. No.</b>	0632
<b>description</b>	shaft sealing ID ø 4mm ED ø 12mm for hand blender H 6.3mm		
<b>For models:</b>	Junior-Plus, Junior-Standard, MD95, MXP94		

for salad washers



			
1			
<b>GEV No.</b>	698255	<b>Ref. No.</b>	2808
<b>description</b>	gear wheel ø 41mm shaft intake ø 14mm W 38mm teeth 12 plastic tooth width 19mm		
<b>For models:</b>	E10, E20		
<b>accessories for</b>	698255		
	<b>GEV No.</b>	<b>Ref. No.</b>	
	698256	2815.1	
	gear wheel pair set shaft intake ø 14mm teeth 12/30 plastic tooth width 14mm for salad spinner		

			
1			
<b>GEV No.</b>	698254	<b>Ref. No.</b>	2806
<b>description</b>	gear wheel with roll pin ø 95mm shaft intake ø 14mm W 21mm teeth 30 plastic tooth width 14mm		
<b>For models:</b>	E10, E20		
<b>accessories for</b>	698254		
	<b>GEV No.</b>	<b>Ref. No.</b>	
	698256	2815.1	
	gear wheel pair set shaft intake ø 14mm teeth 12/30 plastic tooth width 14mm for salad spinner		



1



<b>GEV No.</b>	698256	<b>Ref. No.</b>	2815.1
<b>description</b>	gear wheel pair set shaft intake $\varnothing$ 14mm teeth 12/30 plastic tooth width 14mm for salad spinner		
<b>For models:</b>	E10, E20		
<b>spare parts for</b>	698256		
	<b>GEV No.</b>	698254	<b>Ref. No.</b> 2806
	gear wheel with roll pin $\varnothing$ 95mm shaft intake $\varnothing$ 14mm W 21mm teeth 30 plastic tooth width 14mm		
	<b>GEV No.</b>	698255	<b>Ref. No.</b> 2808
	gear wheel $\varnothing$ 41mm shaft intake $\varnothing$ 14mm W 38mm teeth 12 plastic tooth width 19mm		

## knobs

### miscellaneous

1



<b>GEV No.</b>	696506	<b>Ref. No.</b>	2858
<b>description</b>	knob for PCB $\varnothing$ 26mm black Qty 1 pcs		

## gaskets

### O-rings

#### EPDM

1

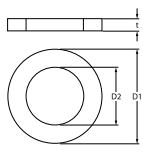
<b>GEV No.</b>	532648	<b>Ref. No.</b>	2859
<b>description</b>	O-ring EPDM thickness 1.5mm ID $\varnothing$ 5mm Qty 1 pcs		

### shaft gaskets

#### shaft gaskets

1



<b>GEV No.</b>	698383	<b>Ref. No.</b>	0632
<b>description</b>	shaft sealing ID $\varnothing$ 4mm ED $\varnothing$ 12mm for hand blender H 6.3mm		
<b>For models:</b>	Junior-Plus, Junior-Standard, MD95, MXP94		

## transmission technology and ball bearings

### ball bearings

#### deep-groove ball bearings 2RS

1



<b>GEV No.</b>	523501	<b>Ref. No.</b>	0601
<b>description</b>	deep-groove ball bearing type 608-2RS shaft $\varnothing$ 8mm ED $\varnothing$ 22mm W 7mm with sealing discs deep-groove ball bearing DIN 625-1		
<b>For models:</b>	Coupe-Legume, Dynacutter, FM90, FT79, FT86, FT97, Junior-Plus, MDH2000, MDH460, MF2000, MF90, MFAP2000, MFAP90, MMX92, MMX98, MX2000, MX2000-DSC, MX79, MX85, MX91, PMDH250, PMF250, PMX83, PMX98, PP84, PP97, PP97-Plus, SMX450, SMX500, SMX502, SMX600, SMX600-DSC, SMX600-E, SMX800-DSC, SMX800-E		

## fastening material

### fasteners

#### roll pins

1



<b>GEV No.</b>	691637	<b>Ref. No.</b>	0744
<b>description</b>	roll pin $\varnothing$ 3mm L 20mm		
<b>For models:</b>	FT79, FT86, FT97, MDH2000, MDH460, MF2000, MF90, MFAP2000, MFAP90, PMF250		



**F**

fasteners	8
fastening material	8

**M**

motors	3
--------	---

**O**

O-rings	8
---------	---

**R**

roll pins	8
-----------	---

**S**

shaft gaskets	8
speed controllers	3
switches and momentary switches	3