



**GAS COMPONENTS**



**ELECTRIC COMPONENTS**



**WATER TECHNOLOGY**



**MECHANICAL COMPONENTS**



**TOOLS**

Spare parts suitable for

**EKU**

Find the complete and up-to-date range of products in our GEV Webshop



# Manufacturer catalogue

The most important spare parts and accessories arranged clearly for every manufacturer

- ✓ Complete product range and all appliance data always up to date in the GEV Webshop
- ✓ Alphabetical Index at the end of the catalogue

## GEV Webshop

[www.gev-online.co.uk](http://www.gev-online.co.uk)

[www.gev-online.com](http://www.gev-online.com)











- 🔍 Add to Favourites
- 🔍 Sign In with email address and usual password
- 🔍 Easy-order – place several items in your basket at the same time
- 🔍 Quick Item search – no login needed

# heating elements

## heating elements for bain maries







1





<b>GEV No.</b>	415091	<b>Ref. No.</b>	1W217
<b>description</b>	heating element 1000W 230V heating circuits 1 L 295mm W 85mm connection length 20mm connection M3 tube ø 6.5mm 2 hole fixing thread M14x1 immersion heater/dry heating element bain marie/ chip scuttle L1 145mm L2 150mm H 18mm mounting distance 79mm		
<b>spare parts for</b>	415091		
	<b>GEV No.</b>	510417	<b>Ref. No.</b> —
	flat gasket fibre ED ø 20mm ID ø 14mm thickness 2mm Qty 1 pcs		
<b>accessories for</b>	415091		
	<b>GEV No.</b>	520228	<b>Ref. No.</b> —
	tooth lock washer ID ø 15.3mm ED ø 24mm steel Qty 1 pcs for thread M14		
	<b>GEV No.</b>	521133	<b>Ref. No.</b> —
	nut thread M14x1.5 H 6mm WS 19 zinc-coated steel Qty 1 pcs		
	<b>GEV No.</b>	527169	<b>Ref. No.</b> —
	hexagonal nut thread M3 H 2.8mm WS 5.5 brass Qty 1 pcs		
	<b>GEV No.</b>	550261	<b>Ref. No.</b> —
	nut thread M14x1 H 4mm WS 19 SS Qty 1 pcs		
	<b>GEV No.</b>	550262	<b>Ref. No.</b> —
	flat gasket copper ED ø 20mm ID ø 14mm thickness 2mm		
	<b>GEV No.</b>	560110	<b>Ref. No.</b> —
	plain washer ID ø 3.2mm ED ø 7mm thickness 0.5mm SS Qty 20 pcs DIN 125A for thread M3		
	<b>GEV No.</b>	560130	<b>Ref. No.</b> —
	hexagonal nut thread M3 H 2.4mm WS 5.5 SS DIN/ISO DIN 934 / ISO 4032/8673 Qty 20 pcs		



1

<b>GEV No.</b>	415092	<b>Ref. No.</b>	4-06
<b>description</b>	heating element 1300W 230V L 290mm W 130mm connection M4 tube ø 6.3mm 2 hole fixing thread M14x1.5 immersion heater L1 140mm L2 150mm H 18mm mounting distance 127mm		
<b>accessories for</b>	415092		
	<b>GEV No.</b>	510417	<b>Ref. No.</b> —
	flat gasket fibre ED ø 20mm ID ø 14mm thickness 2mm Qty 1 pcs		
	<b>GEV No.</b>	520228	<b>Ref. No.</b> —
	tooth lock washer ID ø 15.3mm ED ø 24mm steel Qty 1 pcs for thread M14		
	<b>GEV No.</b>	520230	<b>Ref. No.</b> —
	nut thread M14x1.5 H 5mm WS 19 zinc-coated steel Qty 1 pcs		
	<b>GEV No.</b>	521101	<b>Ref. No.</b> —
	nut thread M14x1.5 H 5mm WS 19 SS Qty 1 pcs		









**accessories for** 415092

	<b>GEV No.</b>	521103	<b>Ref. No.</b>	—
	nut thread M4 H 3mm WS 7 brass Qty 20 pcs			
	<b>GEV No.</b>	521104	<b>Ref. No.</b>	—
	washer ID ø 4.3mm ED ø 8mm thickness 0.5mm brass Qty 20 pcs for thread M4			
	<b>GEV No.</b>	550262	<b>Ref. No.</b>	—
	flat gasket copper ED ø 20mm ID ø 14mm thickness 2mm			
	<b>GEV No.</b>	560111	<b>Ref. No.</b>	—
	plain washer ID ø 4.3mm ED ø 9mm thickness 0.8mm SS Qty 20 pcs DIN 125A for thread M4			
	<b>GEV No.</b>	560131	<b>Ref. No.</b>	—
	hexagonal nut thread M4 H 3.2mm WS 7 SS DIN/ISO DIN 934 / ISO 4032/8673 Qty 20 pcs			

## heating elements for chip scuttles



1

<b>GEV No.</b>	415091	<b>Ref. No.</b>	1W217
<b>description</b>	heating element 1000W 230V heating circuits 1 L 295mm W 85mm connection length 20mm connection M3 tube ø 6.5mm 2 hole fixing thread M14x1 immersion heater/dry heating element bain marie/ chip scuttle L1 145mm L2 150mm H 18mm mounting distance 79mm		
<b>spare parts for</b>	415091		
	<b>GEV No.</b>	510417	<b>Ref. No.</b> —
	flat gasket fibre ED ø 20mm ID ø 14mm thickness 2mm Qty 1 pcs		
<b>accessories for</b>	415091		
	<b>GEV No.</b>	520228	<b>Ref. No.</b> —
	tooth lock washer ID ø 15.3mm ED ø 24mm steel Qty 1 pcs for thread M14		
	<b>GEV No.</b>	521133	<b>Ref. No.</b> —
	nut thread M14x1.5 H 6mm WS 19 zinc-coated steel Qty 1 pcs		
	<b>GEV No.</b>	527169	<b>Ref. No.</b> —
	hexagonal nut thread M3 H 2.8mm WS 5.5 brass Qty 1 pcs		
	<b>GEV No.</b>	550261	<b>Ref. No.</b> —
	nut thread M14x1 H 4mm WS 19 SS Qty 1 pcs		
	<b>GEV No.</b>	550262	<b>Ref. No.</b> —
	flat gasket copper ED ø 20mm ID ø 14mm thickness 2mm		
	<b>GEV No.</b>	560110	<b>Ref. No.</b> —
	plain washer ID ø 3.2mm ED ø 7mm thickness 0.5mm SS Qty 20 pcs DIN 125A for thread M3		
	<b>GEV No.</b>	560130	<b>Ref. No.</b> —
	hexagonal nut thread M3 H 2.4mm WS 5.5 SS DIN/ISO DIN 934 / ISO 4032/8673 Qty 20 pcs		



## heating elements for fryers

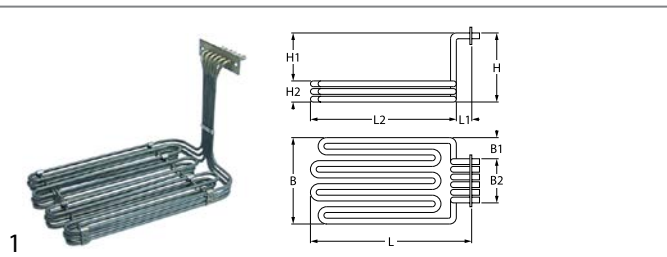

<b>GEV No.</b>	415090	<b>Ref. No.</b>	1-W-218 f.FQE-60-110,1-W-218
----------------	--------	-----------------	---------------------------------

**description** heating element 5500W 230/400V heating circuits 3 L 325mm W 200mm H 210mm L1 15mm L2 310mm W1 67mm W2 66mm H1 183mm H2 25mm windings 12 flange length 115mm flange width 30mm hole distance 95mm hole  $\varnothing$  7mm connection M4 rectangular flange fryer heaters

**accessories for** 415090

	<b>GEV No.</b>	521103	<b>Ref. No.</b>	—
	nut thread M4 H 3mm WS 7 brass Qty 20 pcs			
	<b>GEV No.</b>	521104	<b>Ref. No.</b>	—
	washer ID $\varnothing$ 4.3mm ED $\varnothing$ 8mm thickness 0.5mm brass Qty 20 pcs for thread M4			
	<b>GEV No.</b>	560111	<b>Ref. No.</b>	—
	plain washer ID $\varnothing$ 4.3mm ED $\varnothing$ 9mm thickness 0.8mm SS Qty 20 pcs DIN 125A for thread M4			
	<b>GEV No.</b>	560131	<b>Ref. No.</b>	—
	hexagonal nut thread M4 H 3.2mm WS 7 SS DIN/ISO DIN 934 / ISO 4032/8673 Qty 20 pcs			

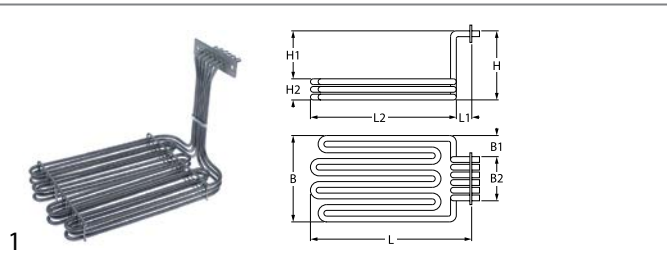

<b>GEV No.</b>	420289	<b>Ref. No.</b>	4-102
----------------	--------	-----------------	-------

**description** heating element 7500W 220V heating circuits 3 L 320mm W 196mm H 215mm L1 15mm L2 305mm W1 60mm W2 67mm H1 185mm H2 32mm windings 4 flange length 115mm flange width 30mm hole distance 95mm hole  $\varnothing$  6.5mm connection screw tube  $\varnothing$  6.2mm rectangular flange fryer

## heating elements for griddles



<b>GEV No.</b>	415076	<b>Ref. No.</b>	373.007.0 1-W-237
----------------	--------	-----------------	-------------------

**description** heating element 1300W 230V heating circuits 1 L 490mm W 78mm H 70mm tube  $\varnothing$  6.3mm W1 17mm W2 44mm connection M4 connection length 20mm dry heating element

**accessories for** 415076

	<b>GEV No.</b>	521103	<b>Ref. No.</b>	—
	nut thread M4 H 3mm WS 7 brass Qty 20 pcs			
	<b>GEV No.</b>	521104	<b>Ref. No.</b>	—
	washer ID $\varnothing$ 4.3mm ED $\varnothing$ 8mm thickness 0.5mm brass Qty 20 pcs for thread M4			
	<b>GEV No.</b>	560111	<b>Ref. No.</b>	—
	plain washer ID $\varnothing$ 4.3mm ED $\varnothing$ 9mm thickness 0.8mm SS Qty 20 pcs DIN 125A for thread M4			

<b>accessories for</b>	415076			
	<b>GEV No.</b>	560131	<b>Ref. No.</b>	—
	hexagonal nut thread M4 H 3.2mm WS 7 SS DIN/ISO DIN 934 / ISO 4032/8673 Qty 20 pcs			

## heating elements for large hobs



<b>GEV No.</b>	418707	<b>Ref. No.</b>	4-208
----------------	--------	-----------------	-------

**description** heating element 1500W 230V L 230mm W 265mm H 70mm tube  $\varnothing$  6.5mm mounting pos. inner connection screw

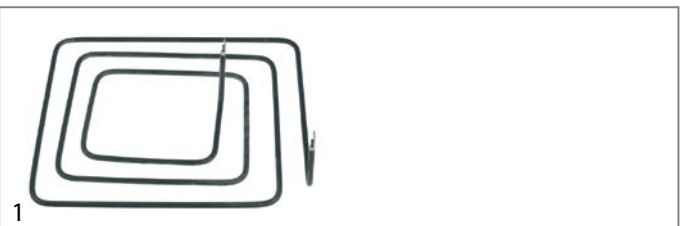

<b>GEV No.</b>	418708	<b>Ref. No.</b>	4-207
----------------	--------	-----------------	-------

**description** heating element 1500W 230V L 255mm W 300mm H 70mm tube  $\varnothing$  6.5mm mounting pos. centre connection screw

## heating elements for tilting bratt pan



<b>GEV No.</b>	415076	<b>Ref. No.</b>	373.007.0 1-W-237
----------------	--------	-----------------	-------------------

**description** heating element 1300W 230V heating circuits 1 L 490mm W 78mm H 70mm tube  $\varnothing$  6.3mm W1 17mm W2 44mm connection M4 connection length 20mm dry heating element

**accessories for** 415076

	<b>GEV No.</b>	521103	<b>Ref. No.</b>	—
	nut thread M4 H 3mm WS 7 brass Qty 20 pcs			
	<b>GEV No.</b>	521104	<b>Ref. No.</b>	—
	washer ID $\varnothing$ 4.3mm ED $\varnothing$ 8mm thickness 0.5mm brass Qty 20 pcs for thread M4			
	<b>GEV No.</b>	560111	<b>Ref. No.</b>	—
	plain washer ID $\varnothing$ 4.3mm ED $\varnothing$ 9mm thickness 0.8mm SS Qty 20 pcs DIN 125A for thread M4			
	<b>GEV No.</b>	560131	<b>Ref. No.</b>	—
	hexagonal nut thread M4 H 3.2mm WS 7 SS DIN/ISO DIN 934 / ISO 4032/8673 Qty 20 pcs			







<b>GEV No.</b>	415250	<b>Ref. No.</b>	4-FI-18
----------------	--------	-----------------	---------

**description** heating element grill 1650W 230V L 490mm W 42mm H 45mm connection M4 dry heating element heating circuits 1 tube  $\varnothing$  8.5mm 2 hole fixing thread 1/4" mounting distance 37mm



			
1			
<b>GEV No.</b>	415077	<b>Ref. No.</b>	TYP 1-W-240
<b>description</b>	heating element stock pot 1300W 230V L 280mm W 150mm H 40mm connection male faston 6.3mm tilting bratt pan heating circuits 1 tube ø 8.5mm bracket mounting hole distance 142mm hole ø 5mm lug length 25mm lug width 15mm		

heating elements for chargrills

			
1			
<b>GEV No.</b>	415095	<b>Ref. No.</b>	1-W-236
<b>description</b>	heating element 1500W 220V L 465mm W 75mm H 55mm 2 hole fixing thread 1/4" mounting distance 70mm connection M4 L1 25mm L2 440mm tube ø 6.3mm dry heating element heating circuits 1		
<b>accessories for</b>	415095		
	<b>GEV No.</b>	521103	<b>Ref. No.</b> —
	nut thread M4 H 3mm WS 7 brass Qty 20 pcs		
	<b>GEV No.</b>	521104	<b>Ref. No.</b> —
	washer ID ø 4.3mm ED ø 8mm thickness 0.5mm brass Qty 20 pcs for thread M4		
	<b>GEV No.</b>	560111	<b>Ref. No.</b> —
	plain washer ID ø 4.3mm ED ø 9mm thickness 0.8mm SS Qty 20 pcs DIN 125A for thread M4		
	<b>GEV No.</b>	560131	<b>Ref. No.</b> —
	hexagonal nut thread M4 H 3.2mm WS 7 SS DIN/ISO DIN 934 / ISO 4032/8673 Qty 20 pcs		

			
1			
<b>GEV No.</b>	415250	<b>Ref. No.</b>	4-FI-18
<b>description</b>	heating element grill 1650W 230V L 490mm W 42mm H 45mm connection M4 dry heating element heating circuits 1 tube ø 8.5mm 2 hole fixing thread 1/4" mounting distance 37mm		

heating elements for salamanders/toast-

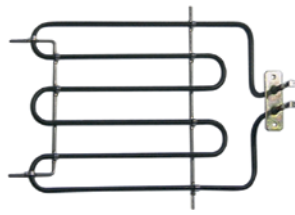
			
1			
<b>GEV No.</b>	415347	<b>Ref. No.</b>	HS 60 E, 15-B-001
<b>description</b>	heating element 1600W 230V heating circuits 1 L 295mm W 205mm H 45mm flange length 70mm flange width 22mm hole distance 56mm connection male faston 6.3mm tube ø 6.3mm mounting thread M5 rectangular flange dry heating element		

			
1			
<b>GEV No.</b>	415141	<b>Ref. No.</b>	SME-63
<b>description</b>	heating element 2900W 230V heating circuits 1 L 425mm W 165mm L1 25mm L2 50mm L3 350mm W1 52mm W2 60mm flange length 100mm flange width 22mm hole distance 88mm tube ø 8.5mm connection length 17mm dry heating element rectangular flange hole ø 5mm H 8.5mm		

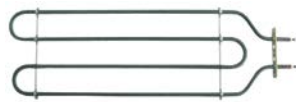
			
1			
<b>GEV No.</b>	415142	<b>Ref. No.</b>	370.423.0 SME70
<b>description</b>	heating element 3500W 230V heating circuits 1 L 525mm W 167mm L1 15mm L2 50mm L3 460mm W1 63mm W2 50mm flange length 100mm flange width 22mm hole distance 31mm tube ø 9mm connection length 54mm dry heating element connection male faston 6.3mm rectangular flange hole ø 10mm H 9mm		

heating elements for convection

			
1			
<b>GEV No.</b>	417586	<b>Ref. No.</b>	3-55
<b>description</b>	heating element 3200W 230V heating circuits 1 ID ø 178mm ED ø 192mm L 260mm H 34mm L1 64mm W1 30mm H1 10mm H2 24mm flange length 70mm flange width 22mm hole distance 56mm connection M4 connection length 34mm tube ø 6.25mm convection heating element mounting thread M4		

			
1			
<b>GEV No.</b>	418019	<b>Ref. No.</b>	14-N-124
<b>description</b>	heating element 3900W 230V heating circuits 3 ID ø 206mm ED ø 218mm L 275mm H 40mm L1 48mm W1 104mm H1 10mm H2 24mm flange length 142mm flange width 25mm hole distance 62.5mm connection M4 connection length 62mm tube ø 6mm convection heating element hole ø 6.5mm rectangular flange		



## radiation heaters

## square



1

<b>GEV No.</b>	490202	<b>Ref. No.</b>	3-09A
<b>description</b>	radiation heater L 300mm W 300mm 4000W 400V H 40mm connection type screw with pan detection		

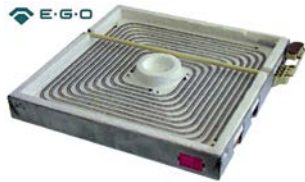

1

<b>GEV No.</b>	490008	<b>Ref. No.</b>	3-09
<b>description</b>	radiation heater L 300mm W 300mm 4000W 400V heating circuits 2 connections 3 square connection type male faston 6.3mm without pan detection EGO		
<b>spare parts for</b>	490008		
	<b>GEV No.</b>	499157	<b>Ref. No.</b>
			—
	protection pipe for temperature probe ceramic L 297mm ED ø 7mm ID ø 5mm		

## accessories

## sealing washers

## O-rings

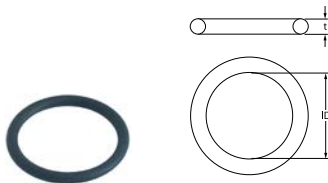

1

<b>GEV No.</b>	505092	<b>Ref. No.</b>	04-3090
<b>description</b>	O-ring EPDM thickness 5.34mm ID ø 43.82mm Qty 1 pcs		

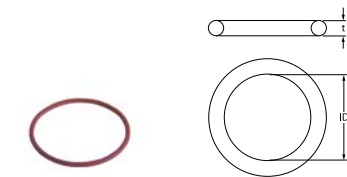

1

<b>GEV No.</b>	521116	<b>Ref. No.</b>	05-0790
<b>description</b>	O-ring Viton thickness 3.53mm ID ø 78.97mm Qty 1 pcs		

## hot plates

## square &amp; rectangular

## with radiused edge



1

<b>GEV No.</b>	490068 <sup>1</sup>	<b>Ref. No.</b>	3-06
<b>description</b>	hot plate dimensions 220x220mm 2600W 400V with spill ring connection 4 screw clamps protector yes square		

<sup>1</sup>incl. protector

1

<b>GEV No.</b>	490074 <sup>1</sup>	<b>Ref. No.</b>	05-0600
<b>description</b>	hot plate dimensions 300x300mm 4000W 400V with spill ring connection 4 screw clamps protector yes square		

<sup>1</sup>incl. protector

## round

## with radiused edge

## for domestic and commercial kitchens



1

<b>GEV No.</b>	490016	<b>Ref. No.</b>	3-02
<b>description</b>	hot plate ø 180mm 2000W 230V connection 4 screw clamps with 8mm spill ring		



1

<b>GEV No.</b>	490021	<b>Ref. No.</b>	3-03A
<b>description</b>	hot plate ø 220mm 2600W 400V connection 4 screw clamps with 8mm spill ring		



## thermostats

### control and safety thermostats

EGO

control thermostats

55.10/19\_series



**GEV No.** 375363 **Ref. No.** 4-FI-004

**description** thermostat t.max. 161°C temperature range 73-161°C 1-pole 1NO 16A probe ø 3mm probe L 144mm capillary pipe 1600mm capillary pipe isolated 1600mm gland nut shaft ø 6x4.6mm shaft L 23mm shaft position upper rotation 270°

55.13\_series



**GEV No.** 375401 **Ref. No.** 230054  
4-117

**description** thermostat t.max. 185°C temperature range 97-185°C 1-pole 1NO 16A probe ø 6mm probe L 87mm capillary pipe 1430mm capillary pipe isolated 1100mm gland nut M9x1 shaft ø 6x4.6mm shaft L 23mm shaft position upper rotation 270°



**GEV No.** 375505 **Ref. No.** 15-BA-18  
3-36

**description** thermostat t.max. 320°C temperature range 50-320°C 1-pole 1NO 16A probe ø 3mm probe L 160mm capillary pipe 870mm capillary pipe isolated 850mm gland nut shaft ø 6x4.6mm shaft L 23mm shaft position upper rotation 270°



**GEV No.** 375005 **Ref. No.** 10-44

**description** thermostat t.max. 85°C temperature range 30-85°C 1-pole 1NO 16A probe ø 6mm probe L 92mm capillary pipe 830mm capillary pipe isolated 850mm gland nut shaft L 23mm shaft position upper rotation 270° probe material SS

**accessories for** 375005



**GEV No.** 110109 **Ref. No.** —  
knob thermostat t.max. 85°C ø 60mm shaft ø 6x4.6mm shaft flat upper silver temperature range 30-85°C rotation 270°



**GEV No.** 110133 **Ref. No.** —  
knob thermostat t.max. 85°C ø 50mm shaft ø 6x4.6mm shaft flat upper black temperature range 30-85°C rotation 270°



**GEV No.** 110240 **Ref. No.** —  
knob thermostat t.max. 85°C ø 50mm shaft ø 6x4.6mm shaft flat upper black temperature range 30-85°C

55.34\_series



**GEV No.** 375410 **Ref. No.** 1-W-228  
4-103

**description** thermostat t.max. 180°C temperature range 95-180°C 3-pole 3NO 16A probe ø 6mm probe L 133mm capillary pipe 1780mm capillary pipe isolated 1400mm gland nut M10x1 shaft ø 6x4.6mm shaft L 23mm shaft position upper rotation 270°

55.40\_series



**GEV No.** 375096 **Ref. No.** 4-116

**description** thermostat t.max. 450°C temperature range 100-450°C 4-pole 4NO 16A probe ø 3.9mm probe L 163mm capillary pipe 1180mm capillary pipe isolated 850mm gland nut shaft ø 6x4.6mm shaft L 23mm shaft position upper rotation 270°

→ electric components



## safety thermostats

## 55.12\_ series



<b>GEV No.</b>	375998	<b>Ref. No.</b>	10-45 230418
<b>description</b>	safety thermostat switch-off temp. 110°C 1-pole NC 10A probe ø 6mm probe L 95mm capillary pipe 880mm capillary pipe isolated 830mm gland nut probe screw connection M10x0.75 connection male faston 6.3mm		

## control thermostats with operation switch

## 55.34\_ series

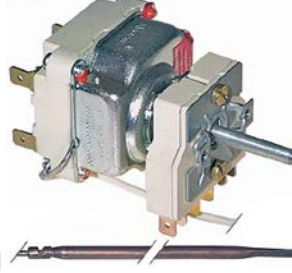

<b>GEV No.</b>	375246	<b>Ref. No.</b>	3-22
<b>description</b>	thermostat t.max. 645°C temperature range 100-615/645°C 2-pole 2NO 16A probe ø 4mm probe L 230mm capillary pipe 1100mm capillary pipe isolated 600mm gland nut shaft ø 6x4.6mm shaft L 25mm shaft position lower rotation 270° outer switch 2NO probe material copper		

## 55.31\_ series

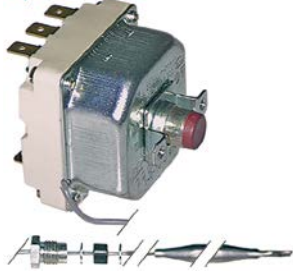

<b>GEV No.</b>	375104	<b>Ref. No.</b>	1-W-213 230057 4-104
<b>description</b>	safety thermostat switch-off temp. 230°C 3-pole 20A probe ø 6mm probe L 167mm capillary pipe 830mm capillary pipe isolated 600mm gland nut M10x1 probe		

## accessories

## connecting bows



<b>GEV No.</b>	550059	<b>Ref. No.</b>	3-47
<b>description</b>	connecting bow short for switch Qty 1 pcs		

## switches and momentary switches

## push/momentary push switches

## 30x22mm



<b>GEV No.</b>	301040 <sup>1</sup>	<b>Ref. No.</b>	10-2369
<b>description</b>	push switch mounting measurements 30x22mm green 2NO 250V 16A illuminated connection male faston 6.3mm ambient temperature max. 85°C protection IP40		

<sup>1</sup>illuminated

## microswitches

## lever actuated



<b>GEV No.</b>	345044	<b>Ref. No.</b>	4-FI-063
<b>description</b>	microswitch with lever 250V 16A 1CO connection male faston 6.3mm ambient temperature max. 85°C mounting distance 25mm type C99ZP3 actuating force: 25g lever length 71mm		

## 56\_ series



<b>GEV No.</b>	390809	<b>Ref. No.</b>	10-45old
<b>description</b>	safety thermostat switch-off temp. 110°C 1-pole 1NC probe ø 6mm probe L 78mm capillary pipe 900mm capillary pipe isolated 800mm gland nut front fixing M10x1		





cam switches

operation switches

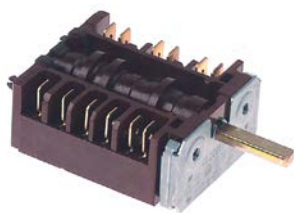

1			
<b>GEV No.</b>	301128	<b>Ref. No.</b>	3-35
<b>description</b>	operation switch 16A shaft $\phi$ 6x4.6mm		



1			
<b>GEV No.</b>	345321	<b>Ref. No.</b>	15-CB-86
<b>description</b>	operation switch 4 operating positions 5NO 16A sequence 0-1-2-3 shaft $\phi$ 6x4.6mm shaft L 23mm connection male faston 6.3mm plastic 3-pole ambient temperature max. 300°C		

magnetic switches

29x19mm

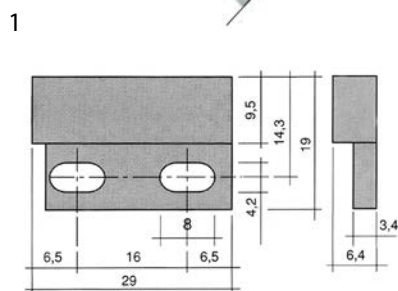

1			
<b>GEV No.</b>	345117	<b>Ref. No.</b>	F.400-G, 606
<b>description</b>	magnetic switch L 28.5mm W 19mm 1NO 250V 0.04A P max. 10W connection cable cable length 1000mm		

lamps

indicator lights

indicator lights (complete)

$\phi$  6mm



1			
<b>GEV No.</b>	359284	<b>Ref. No.</b>	14-N-024
<b>description</b>	indicator light $\phi$ 6mm 24V green cable length 150mm		

22x10mm



1			
<b>GEV No.</b>	357081	<b>Ref. No.</b>	3-24
<b>description</b>	indicator light mounting measurements 22x10mm 230V yellow connection cable 250mm temp.-resist. 120°C		

timers

programme timers



1			
<b>GEV No.</b>	360349	<b>Ref. No.</b>	10-238053
<b>description</b>	timer CDC 11803 engines 1 chambers 3 operation time 150s 230V shaft $\phi$ mm shaft Lmm manuf. no. 11803F1BEE000.0010 motor type M48R ATS type 11803F1 / 238046		

<b>spare parts for</b>	360349		
	<b>GEV No.</b>	<b>Ref. No.</b>	—
	motor kit pinion $\phi$ 6.8mm teeth 15 230V voltage AC 50/60Hz turn direction clockwise motor $\phi$ 48mm H 18.5mm motor type UDS-40NE1RNZ165 cable length 150mm with holder		



1			
<b>GEV No.</b>	360515	<b>Ref. No.</b>	10-18A
<b>description</b>	timer CEM HFD4M16 engines 1 chambers 4 operation time 120s shaft $\phi$ 6x4.6mm shaft L 18mm motor type UDS11NE1RHZ235		



## contactors

ABB

## power contactors



1

<b>GEV No.</b>	380101	<b>Ref. No.</b>	14-N-057
<b>description</b>	power contactor resistive load 20A 230VAC (AC3/400V) 12A/5.5kW main contacts 3NO auxiliary contacts 1NC connection screw connection type B6-30-01 / B7-30-01		



1

<b>GEV No.</b>	380109	<b>Ref. No.</b>	ABB-02
<b>description</b>	power contactor resistive load 30A 230VAC (AC3/400V) 17A/7.5kW main contacts 3NO auxiliary contacts 1NC connection screw connection type A16-30-01		

## electronic controllers

ELIWELL

## universal controllers

## built-in version



1

<b>GEV No.</b>	379605	<b>Ref. No.</b>	IC-N035A
<b>description</b>	electronic controller ELIWELL type ICPlus915 model ICP22J135000 mounting measurements 71x29mm 12V voltage AC/DC Pt100/TC (J,K) relay outputs 2 NO-8A(4) NO-8A(4) Pt100/TC (J,K) cooking front measurements 78x37mm built-in depth 59mm mode of operation cooking protection IPx0 accuracy 1% built-in version defr. funct. no dependend on probe°C display 3½ digits		
<b>accessories for</b>	379605		
	<b>GEV No.</b>	<b>Ref. No.</b>	—
	379050		
	temperature probe Pt100 cable Vetrotex probe -200 up to +600°C cable -50 up to +350°C probe ø6x100mm cable length 2.7m without screw connection 3-wire		
	<b>GEV No.</b>	<b>Ref. No.</b>	—
	379054		
	transformer primary 230VAC secondary 12VAC 3VA secondary 0.25A H 40mm L 45mm W 50mm connection screw 50/60Hz type 153/M		

<b>accessories for</b>	379605		
	<b>GEV No.</b>	<b>Ref. No.</b>	—
	379785		
	temperature probe Pt100 cable silicone probe -100 up to 450°C cable -50 up to +180°C probe ø6x100mm cable length 1.5m without screw connection 2-wire resistor 0.1kOhm		
	<b>GEV No.</b>	<b>Ref. No.</b>	—
	379786		
	temperature probe Pt100 cable silicone probe -100 up to 450°C cable -50 up to +180°C probe ø6x100mm cable length 3m without screw connection 2-wire resistor 0.1kOhm		
	<b>GEV No.</b>	<b>Ref. No.</b>	—
	379787		
	temperature probe Pt100 cable Vetrotex probe -200 up to +600°C cable -50 up to +350°C probe ø6x100mm cable length 1.4m without screw connection 2-wire resistor 0.1kOhm		

## solenoid valves

## solenoid valves (water)

TP



1

<b>GEV No.</b>	370029	<b>Ref. No.</b>	14-76
<b>description</b>	solenoid valve single straight 24VAC inlet 3/4" outlet 11.5mm DN10 TP flow regulating valve inlet white		
<b>spare parts for</b>	370029		
	<b>GEV No.</b>	<b>Ref. No.</b>	—
	371035		
	solenoid coil 24VAC		
<b>accessories for</b>	370029		
	<b>GEV No.</b>	<b>Ref. No.</b>	—
	371220		
	reducer TP flow rate 3l/min red tolerance ±15%		
	<b>GEV No.</b>	<b>Ref. No.</b>	—
	371221		
	reducer TP flow rate 5.5l/min yellow tolerance ±15%		
	<b>GEV No.</b>	<b>Ref. No.</b>	—
	371222		
	reducer TP flow rate 6l/min grey tolerance ±15%		
	<b>GEV No.</b>	<b>Ref. No.</b>	—
	371223		
	reducer TP flow rate 10l/min white tolerance ±15%		
	<b>GEV No.</b>	<b>Ref. No.</b>	—
	371224		
	reducer TP flow rate 12l/min bronze tolerance ±15%		
	<b>GEV No.</b>	<b>Ref. No.</b>	—
	371225		
	reducer TP flow rate 16l/min light brown tolerance ±15%		
	<b>GEV No.</b>	<b>Ref. No.</b>	—
	371226		
	reducer TP flow rate 20l/min red tolerance ±15%		
	<b>GEV No.</b>	<b>Ref. No.</b>	—
	371230		
	reducer TP flow rate 0.25l/min red tolerance ±25%		
	<b>GEV No.</b>	<b>Ref. No.</b>	—
	371231		
	reducer TP flow rate 0.35l/min violet tolerance ±25%		

Table continues overleaf



accessories for		370029		
GEV No.	Ref. No.	Ref. No.	Ref. No.	—
	371232	Ref. No.	Ref. No.	—
reducer TP flow rate 0.5l/min orange tolerance ±25%				
	371233	Ref. No.	Ref. No.	—
reducer TP flow rate 0.8l/min white tolerance ±25%				
	371234	Ref. No.	Ref. No.	—
reducer TP flow rate 1l/min light blue tolerance ±25%				
	371235	Ref. No.	Ref. No.	—
reducer TP flow rate 1.2l/min brown tolerance ±25%				
	371236	Ref. No.	Ref. No.	—
reducer TP flow rate 1.5l/min light brown tolerance ±25%				
	371237	Ref. No.	Ref. No.	—
reducer TP flow rate 2.5l/min yellow tolerance ±25%				
	371238	Ref. No.	Ref. No.	—
reducer TP flow rate 3.4l/min dark green tolerance ±25%				
	371239	Ref. No.	Ref. No.	—
reducer TP flow rate 5l/min black tolerance ±25%				
	371240	Ref. No.	Ref. No.	—
reducer TP flow rate 8l/min blue tolerance ±20%				

accessories for		101095		
GEV No.	Ref. No.	Ref. No.	Ref. No.	—
	100909	Ref. No.	Ref. No.	—
union screw thread M10x1 for pipe ø 6mm Qty 1 pcs				
	101246	Ref. No.	Ref. No.	—
olive for pipe ø 4mm Qty 1 pcs				
	101278	Ref. No.	Ref. No.	—
olive for pipe ø 10mm Qty 1 pcs				
	101286	Ref. No.	Ref. No.	—
olive ID ø 6mm Qty 1 pcs				
	101300	Ref. No.	Ref. No.	—
union nut thread M16x1.5 tube ø 10mm				
	101450	Ref. No.	Ref. No.	—
olive for pipe ø 8mm L 12.7mm Qty 1 pcs ED ø 10mm				
	101451	Ref. No.	Ref. No.	—
union nut thread M16x1.5 tube ø 8mm				
	110081	Ref. No.	Ref. No.	—
knob ø 70mm shaft ø 8x6.5mm shaft flat universal				
	112206	Ref. No.	Ref. No.	—
knob dial plate silver gas tap PEL21/22/23 t.max.°C ED ø 63mm ID ø 45.5mm				

gas taps

PEL

21S series

	1		
<b>GEV No.</b>	101095	<b>Ref. No.</b>	3-203
<b>description</b>	gas tap PEL type 21S gas inlet M16x1.5 (tube ø 10mm) bypass nozzle ø 0.35mm gas outlet M16x1.5 (tube ø 10/8mm) thermocouple connection M8x1 pilot connection M10x1 shaft ø 8x6.5mm shaft L 22/15mm shaft flat lower		
<b>spare parts for</b>	101095		
	GEV No.	100408	Ref. No.
bypass nozzle type PEL20/21 bore ø 0.35mm thread M5x0.5			
	GEV No.	101060	Ref. No.
magnet unit standard L 39mm D1 ø 15.4mm D2 ø 11mm suitable for PEL20-21/JUNKERS/EGA			
	GEV No.	101206	Ref. No.
gas tap front part shaft ø 8x6.5mm shaft L 22/15mm shaft flat upper/lower suitable for PEL21			
	GEV No.	101230	Ref. No.
thermocouple nut T1: M8x1 T2: M18x1 aluminium			
<b>accessories for</b>	101095		
	GEV No.	100908	Ref. No.
union screw thread M10x1 for pipe ø 4mm Qty 1 pcs			

	1		
<b>GEV No.</b>	106298	<b>Ref. No.</b>	06-101 A240067
<b>description</b>	gas tap PEL type 21S gas inlet M16x1.5 (tube ø 10mm) bypass nozzle ø 0.65mm gas outlet M16x1.5 (tube ø 10/8mm) thermocouple connection M8x1 pilot connection M10x1 shaft ø 8x6.5mm shaft L 22/15mm shaft flat lower		
<b>spare parts for</b>	106298		
	GEV No.	100548	Ref. No.
bypass nozzle type PEL20/21 bore ø 0.65mm thread M5x0.5			
	GEV No.	101060	Ref. No.
magnet unit standard L 39mm D1 ø 15.4mm D2 ø 11mm suitable for PEL20-21/JUNKERS/EGA			
	GEV No.	101206	Ref. No.
gas tap front part shaft ø 8x6.5mm shaft L 22/15mm shaft flat upper/lower suitable for PEL21			
	GEV No.	101230	Ref. No.
thermocouple nut T1: M8x1 T2: M18x1 aluminium			
<b>accessories for</b>	106298		
	GEV No.	100908	Ref. No.
union screw thread M10x1 for pipe ø 4mm Qty 1 pcs			
	GEV No.	100909	Ref. No.
union screw thread M10x1 for pipe ø 6mm Qty 1 pcs			





Table continues overleaf

accessories for		106298	
	GEV No.	101246	Ref. No. —
olive for pipe ø 4mm Qty 1 pcs			
	GEV No.	101278	Ref. No. —
olive for pipe ø 10mm Qty 1 pcs			
	GEV No.	101286	Ref. No. —
olive ID ø 6mm Qty 1 pcs			
	GEV No.	101300	Ref. No. —
union nut thread M16x1.5 tube ø 10mm			
	GEV No.	101450	Ref. No. —
olive for pipe ø 8mm L 12.7mm Qty 1 pcs ED ø 10mm			
	GEV No.	101451	Ref. No. —
union nut thread M16x1.5 tube ø 8mm			
	GEV No.	110081	Ref. No. —
knob ø 70mm shaft ø 6x6.5mm shaft flat universal			
	GEV No.	112206	Ref. No. —
knob dial plate silver gas tap PEL21/22/23 t.max.°C ED ø 63mm ID ø 45.5mm			

22S/V series

			
1			
<b>GEV No.</b>	106888	<b>Ref. No.</b>	06-102
<b>description</b>	gas tap PEL type 22S/V gas inlet M20x1.5 (tube ø 12mm) bypass nozzle ø 0.8mm gas outlet M20x1.5 (tube ø 12/10mm) thermocouple connection M8x1 pilot connection M10x1 shaft ø 10x8mm shaft L 25/17mm shaft flat right		

SKG







			
1			
<b>GEV No.</b>	101154	<b>Ref. No.</b>	650/750 132
<b>description</b>	gas tap SKG without ignition flame connection		
<b>spare parts for</b>	101154		
	GEV No.	101060	Ref. No. —
magnet unit standard L 39mm D1 ø 15.4mm D2 ø 11mm suitable for PEL20-21/JUNKERS/EGA			
<b>accessories for</b>	101154		
	GEV No.	101060	Ref. No. —
magnet unit standard L 39mm D1 ø 15.4mm D2 ø 11mm suitable for PEL20-21/JUNKERS/EGA			
	GEV No.	101351	Ref. No. —
mounting strap for gas tap			

accessories for		101154	
	GEV No.	101376	Ref. No. —
gasket ID ø 8mm ED ø 12mm H 3/5mm			

gas thermostats







SIT

630 Eurosit series

			
1			
<b>GEV No.</b>	101409	<b>Ref. No.</b>	4-FI-009
<b>description</b>	gas thermostat type 630 Eurosit series t.max. 280°C 40-280°C gas inlet 3/8" gas outlet 3/8" thermocouple connection M9x1 pilot connection M10x1 probe ø 4mm probe L 72mm capillary pipe 1050mm SIT		
<b>spare parts for</b>	101409		
	GEV No.	101333	Ref. No. —
plug thread 3/8" with O-ring			
<b>accessories for</b>	101409		
	GEV No.	100904	Ref. No. —
locking screw M10x1 for pipe ø 4mm Qty 1 pcs			
	GEV No.	100905	Ref. No. —
locking screw M10x1 for pipe ø 6mm Qty 1 pcs			
	GEV No.	101273	Ref. No. —
olive for pipe ø 12mm L 9.5mm brass Qty 1 pcs suitable for universal			
	GEV No.	101276	Ref. No. —
union screw thread 3/8" tube ø 12mm Qty 1 pcs			



710 Minisit series			
			
<b>GEV No.</b>	101437	<b>Ref. No.</b>	1-W-042 1-W-42
<b>description</b>	gas thermostat SIT type MINISIT 710 t.max. 190°C 110-190°C gas inlet 1/2" gas outlet 3/8" thermocouple connection M9x1 pilot connection M10x1 probe ø 6mm probe L 102mm capillary pipe 1050mm probe type type A3 pressure controller yes pressure regulator 3-18mbar gland nut		
<b>spare parts for</b>	101437		
	<b>GEV No.</b>	101053	<b>Ref. No.</b> —
	magnet unit T1: M9x1 T2: M24x1 L 45mm ø 17mm suitable for Minisit		
	<b>GEV No.</b>	102118	<b>Ref. No.</b> —
	probe 110-190°C probe ø 6mm probe L 102mm capillary pipe 1050mm t.max. 190°C fryer probe type type A3 suitable for MINISIT 710		
<b>accessories for</b>	101437		
	<b>GEV No.</b>	100809	<b>Ref. No.</b> —
	O-ring EPDM thickness 2mm ID ø 21mm Qty 1 pcs		
	<b>GEV No.</b>	100820	<b>Ref. No.</b> —
	gland duct ET M14x1.5 IT M10x0.75 probe ø max. 6.5mm WS 22		
	<b>GEV No.</b>	100904	<b>Ref. No.</b> —
	locking screw M10x1 for pipe ø 4mm Qty 1 pcs		
	<b>GEV No.</b>	100905	<b>Ref. No.</b> —
	locking screw M10x1 for pipe ø 6mm Qty 1 pcs		
	<b>GEV No.</b>	101054	<b>Ref. No.</b> —
	magnet unit T1: M10x1 T2: M24x1 L 45mm ø 17mm suitable for Minisit		
	<b>GEV No.</b>	101136	<b>Ref. No.</b> —
	piezoelectric igniter suitable for Minisit with cover cap ømm connection F6.3x0.8		
	<b>GEV No.</b>	101137	<b>Ref. No.</b> —
	cover cap without piezoelectric igniter		
	<b>GEV No.</b>	101267	<b>Ref. No.</b> —
	reducer IT 3/8" ET 1/2" L 21mm		
	<b>GEV No.</b>	101268	<b>Ref. No.</b> —
	gas connection thread 3/8" angled with O-ring MINISIT 710		
	<b>GEV No.</b>	101269	<b>Ref. No.</b> —
	gas connection thread 1/2" angled with O-ring MINISIT 710		
	<b>GEV No.</b>	101270	<b>Ref. No.</b> —
	screw connection IT 3/8" ET 3/8" L 28mm		

accessories for 101437			
	<b>GEV No.</b>	101272	<b>Ref. No.</b> —
	screw connection IT 1/2" ET 3/8" L 57mm		
	<b>GEV No.</b>	101273	<b>Ref. No.</b> —
	olive for pipe ø 12mm L 9.5mm brass Qty 1 pcs suitable for universal		
	<b>GEV No.</b>	101274	<b>Ref. No.</b> —
	olive for pipe ø 16mm Qty 1 pcs		
	<b>GEV No.</b>	101275	<b>Ref. No.</b> —
	union screw thread 1/2" for pipe ø 16mm Qty 1 pcs		
	<b>GEV No.</b>	101276	<b>Ref. No.</b> —
	union screw thread 3/8" tube ø 12mm Qty 1 pcs		
	<b>GEV No.</b>	110068	<b>Ref. No.</b> —
	knob suitable for Minisit ø 37mm		



			
<b>GEV No.</b>	101432	<b>Ref. No.</b>	1-W-048
<b>description</b>	gas thermostat with push button SIT type MINISIT 710 t.max. 90°C 30-90°C gas inlet 1/2" gas outlet 1/2" thermocouple connection M9x1 pilot connection M10x1 probe ø 8mm probe L 100mm capillary pipe 1050mm probe type type E2 pressure controller yes pressure regulator 3-18mbar gland nut		
<b>For models:</b>	BMG40, BMG60		
<b>spare parts for</b>	101432		
	<b>GEV No.</b>	100809	<b>Ref. No.</b> —
	O-ring EPDM thickness 2mm ID ø 21mm Qty 1 pcs		
	<b>GEV No.</b>	100905	<b>Ref. No.</b> —
	locking screw M10x1 for pipe ø 6mm Qty 1 pcs		
	<b>GEV No.</b>	101053	<b>Ref. No.</b> —
	magnet unit T1: M9x1 T2: M24x1 L 45mm ø 17mm suitable for Minisit		
	<b>GEV No.</b>	101269	<b>Ref. No.</b> —
	gas connection thread 1/2" angled with O-ring MINISIT 710		
	<b>GEV No.</b>	102117	<b>Ref. No.</b> —
	probe 30-90°C probe ø 8mm probe L 100mm capillary pipe 1050mm t.max. 90°C bain marie probe type type E2 suitable for MINISIT 710		
	<b>GEV No.</b>	110068	<b>Ref. No.</b> —
	knob suitable for Minisit ø 37mm		
<b>accessories for</b>	101432		
	<b>GEV No.</b>	100904	<b>Ref. No.</b> —
	locking screw M10x1 for pipe ø 4mm Qty 1 pcs		

Table continues overleaf

accessories for		101432	
	GEV No.	101054	Ref. No. —
magnet unit T1: M10x1 T2: M24x1 L 45mm ø 17mm suitable for Minisit			
	GEV No.	101136	Ref. No. —
piezoelectric igniter suitable for Minisit with cover cap ømm connection F6.3x0.8			
	GEV No.	101137	Ref. No. —
cover cap without piezoelectric igniter			
	GEV No.	101267	Ref. No. —
reducer IT 3/8" ET 1/2" L 21mm			
	GEV No.	101268	Ref. No. —
gas connection thread 3/8" angled with O-ring MINISIT 710			
	GEV No.	101270	Ref. No. —
screw connection IT 3/8" ET 3/8" L 28mm			
	GEV No.	101272	Ref. No. —
screw connection IT 1/2" ET 3/8" L 57mm			
	GEV No.	101273	Ref. No. —
olive for pipe ø 12mm L 9.5mm brass Qty 1 pcs suitable for universal			
	GEV No.	101274	Ref. No. —
olive for pipe ø 16mm Qty 1 pcs			
	GEV No.	101275	Ref. No. —
union screw thread 1/2" for pipe ø 16mm Qty 1 pcs			
	GEV No.	101276	Ref. No. —
union screw thread 3/8" tube ø 12mm Qty 1 pcs			

## ignition parts

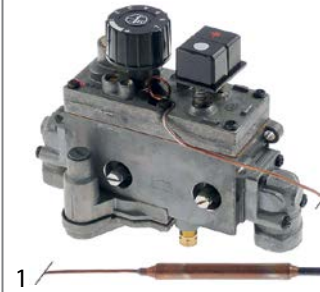
### pilot burners

SIT

100 series

accessories

pilot burner brackets

producer-specific



1	GEV No.	100890	Ref. No.	1314915 Mareno
description pilot burner bracket suitable for 100 series				

pilot burner nozzles			
1			
GEV No.	100245	Ref. No.	3-314 A230126
description pilot burner nozzle LPG code 20 bore ø 0.2mm Qty 1 pcs thread M8x0.75			

## PRO-GAS

### 140 - 145 -150 series

pilot burners			
1			
GEV No.	100859	Ref. No.	1-W-623
description pilot burner type 140 series 1 flame			

spare parts for 100859			
	GEV No.	100205	Ref. No. —
pilot burner nozzle SIT LPG code 19 bore ø 0.23/0.26mm Qty 1 pcs suitable for SIT 150 series			
	GEV No.	100206	Ref. No. —
pilot burner nozzle SIT natural gas code 36 bore ø 0.60/0.55mm Qty 1 pcs suitable for SIT 150 series			
	GEV No.	100897	Ref. No. —
olive for pipe ø 4mm Qty 1 pcs for pilot burner			
	GEV No.	100898	Ref. No. —
olive for pipe ø 6mm Qty 1 pcs for pilot burner			
	GEV No.	100906	Ref. No. —
screw connection thread M10x1 for ignition electrode brass Qty 1 pcs WS 10			
	GEV No.	100907	Ref. No. —
screw connection thread M10x1 Qty 1 pcs type SEF 1 ømm for thermocouple			
	GEV No.	100908	Ref. No. —
union screw thread M10x1 for pipe ø 4mm Qty 1 pcs			
	GEV No.	100909	Ref. No. —
union screw thread M10x1 for pipe ø 6mm Qty 1 pcs			



producer-specific pilot burners

EKU

pilot burners





<b>GEV No.</b>	100082	<b>Ref. No.</b>	N/A
<b>description</b>	pilot burner		
<b>accessories for</b>	100078		
	GEV No.	100202	Ref. No. —
	pilot burner nozzle natural gas code 41 Qty 1 pcs nozzle ø 0.41mm		
	GEV No.	100203	Ref. No. —
	pilot burner nozzle LPG code 25 Qty 1 pcs nozzle ø 0.25mm		
	GEV No.	100834	Ref. No. 3-230 A240110
	pilot burner cap		
	GEV No.	100908	Ref. No. —
	union screw thread M10x1 for pipe ø 4mm Qty 1 pcs		
	GEV No.	100909	Ref. No. —
	union screw thread M10x1 for pipe ø 6mm Qty 1 pcs		
	GEV No.	101282	Ref. No. —
	olive for pipe ø 4mm L 7.4mm Qty 1 pcs		
	GEV No.	101287	Ref. No. —
	olive for pipe ø 6mm Qty 1 pcs		
	GEV No.	101860	Ref. No. —
	nut thread M10x1 H 4mm WS 14 chrome-plated brass Qty 1 pcs		
	GEV No.	107650	Ref. No. 06-123 A230131-10
	pilot burner nozzle SIT LPG code 30 Qty 1 pcs		



<b>GEV No.</b>	100078	<b>Ref. No.</b>	06-122
<b>description</b>	pilot burner for wok range		
<b>accessories for</b>	100078		
	GEV No.	100202	Ref. No. —
	pilot burner nozzle natural gas code 41 Qty 1 pcs nozzle ø 0.41mm		

<b>accessories for</b>	100078		
	GEV No.	100203	Ref. No. —
	pilot burner nozzle LPG code 25 Qty 1 pcs nozzle ø 0.25mm		
	GEV No.	100908	Ref. No. —
	union screw thread M10x1 for pipe ø 4mm Qty 1 pcs		
	GEV No.	100909	Ref. No. —
	union screw thread M10x1 for pipe ø 6mm Qty 1 pcs		
	GEV No.	101282	Ref. No. —
	olive for pipe ø 4mm L 7.4mm Qty 1 pcs		
	GEV No.	101287	Ref. No. —
	olive for pipe ø 6mm Qty 1 pcs		
	GEV No.	102067	Ref. No. —
	nut thread M8x1 H 3mm brass Qty 1 pcs type SEF 1		
	GEV No.	107650	Ref. No. 06-123 A230131-10
	pilot burner nozzle SIT LPG code 30 Qty 1 pcs		





<b>GEV No.</b>	102979	<b>Ref. No.</b>	1-W-651 3-229 A240107
<b>description</b>	pilot burner suitable for MARENO		
<b>accessories for</b>	102979		
	GEV No.	101860	Ref. No. —
	nut thread M10x1 H 4mm WS 14 chrome-plated brass Qty 1 pcs		
	GEV No.	102980	Ref. No. —
	pilot burner mushroom cap with mounting thread		

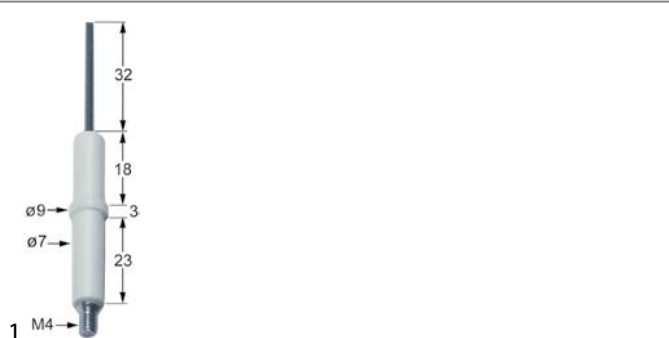

<b>GEV No.</b>	100834	<b>Ref. No.</b>	3-230 A240110
<b>description</b>	pilot burner cap		

electrodes



<b>GEV No.</b>	100701	<b>Ref. No.</b>	1-W-626
<b>description</b>	ignition electrode connection M4 Qty 1 pcs		
<b>accessories for</b>	100701		
	<b>GEV No.</b>	100906	<b>Ref. No.</b> —
	screw connection thread M10x1 for ignition electrode brass Qty 1 pcs WS 10		

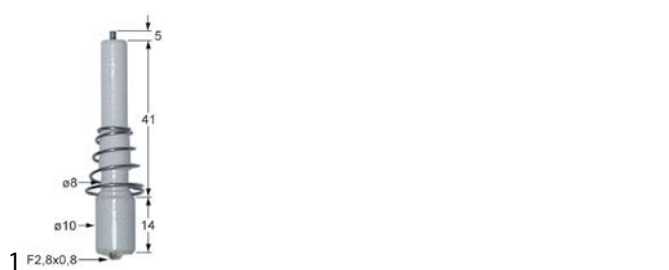

<b>GEV No.</b>	100729	<b>Ref. No.</b>	1-W-396
<b>description</b>	ignition electrode L1 5mm D1 ø 8mm D2 ø 10mm BL1 41mm BL2 14mm connection F 2.8x0.8mm to clip with spring		

thermocouples

- plug-in thermocouples
- plug-in thermocouples standard
- with barrel socket ø6(6.5)mm
- thermocouples SIT

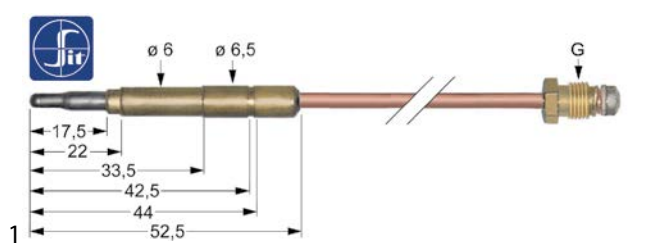

<b>GEV No.</b>	107600	<b>Ref. No.</b>	3-205
<b>description</b>	thermocouple SIT M8x1 L 320mm plug connection ø6.0(6.5)mm		
<b>For models:</b>	60GE4, 60GST4		

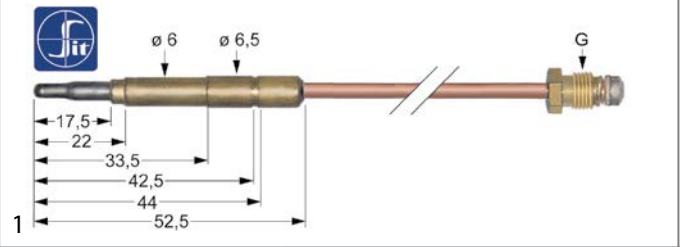

<b>GEV No.</b>	107601	<b>Ref. No.</b>	3-206 A230121
<b>description</b>	thermocouple SIT M8x1 L 600mm plug connection ø6.0(6.5)mm		

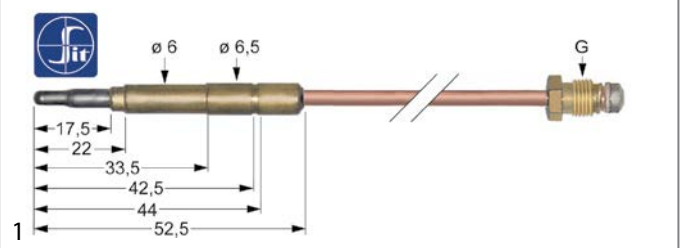

<b>GEV No.</b>	107612	<b>Ref. No.</b>	05-1250
<b>description</b>	thermocouple SIT M9x1 L 1000mm plug connection ø6.0(6.5)mm		

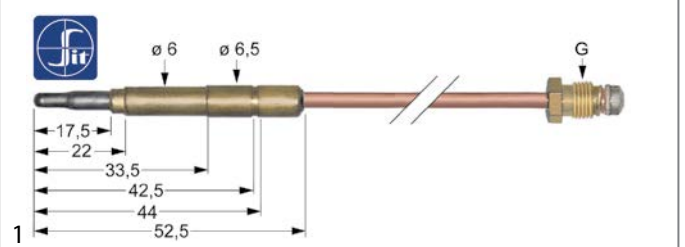

<b>GEV No.</b>	107611	<b>Ref. No.</b>	1-W-631
<b>description</b>	thermocouple SIT M9x1 L 850mm plug connection ø6.0(6.5)mm		

gas burners

hob burners

universal hob burners

GEV

	<b>GEV No.</b>	106379	<b>Ref. No.</b>	N/A
<b>description</b>	air mixing tube for burner cap ø 80mm L 23mm D1 ø 20mm D2 ø 15.6mm D3 ø 14mm			



<b>GEV No.</b>	103068	<b>Ref. No.</b>	1-W-059
<b>description</b>	burner cap ø 100mm		

accessories for 103068

	<b>GEV No.</b>	103067	<b>Ref. No.</b>	1-W-068
	burner ring for burner cap ø 100mm			



	<b>GEV No.</b>	104102	<b>Ref. No.</b>	1-W-066
	burner head for burner cap ø 100mm ext. ø 130			





Table continues overleaf













<b>accessories for</b>	103068		
	GEV No.	104103	Ref. No. —
burner holder suitable for burner ø100mm with nozzle holder			





<b>accessories for</b>	104101		
	GEV No.	104100	Ref. No. 1-W-065
burner head for burner cap ø 80mm			





<b>1</b>			
<b>GEV No.</b>	103066	<b>Ref. No.</b>	1-W-057
<b>description</b>	burner cap ø 80mm		
<b>accessories for</b>	103066		
	GEV No.	103065	Ref. No. 1-W-067
burner ring for burner cap ø 80mm			
	GEV No.	104100	Ref. No. 1-W-065
burner head for burner cap ø 80mm			
	GEV No.	104101	Ref. No. 1-W-064
burner holder for burner cap ø 80mm with nozzle holder with mixing sleeve			

<b>1</b>			
<b>GEV No.</b>	103067	<b>Ref. No.</b>	1-W-068
<b>description</b>	burner ring for burner cap ø 100mm		
<b>accessories for</b>	103067		
	GEV No.	103068	Ref. No. 1-W-059
burner cap ø 100mm			
	GEV No.	104102	Ref. No. 1-W-066
burner head for burner cap ø 100mm ext. ø 130			
	GEV No.	104103	Ref. No. —
burner holder suitable for burner ø100mm with nozzle holder			

<b>1</b>			
<b>GEV No.</b>	104102	<b>Ref. No.</b>	1-W-066
<b>description</b>	burner head for burner cap ø 100mm ext. ø 130		

<b>1</b>			
<b>GEV No.</b>	103065	<b>Ref. No.</b>	1-W-067
<b>description</b>	burner ring for burner cap ø 80mm		
<b>accessories for</b>	103065		
	GEV No.	103066	Ref. No. 1-W-057
burner cap ø 80mm			
	GEV No.	104100	Ref. No. 1-W-065
burner head for burner cap ø 80mm			
	GEV No.	104101	Ref. No. 1-W-064
burner holder for burner cap ø 80mm with nozzle holder with mixing sleeve			

<b>1</b>			
<b>GEV No.</b>	104100	<b>Ref. No.</b>	1-W-065
<b>description</b>	burner head for burner cap ø 80mm		
<b>accessories for</b>	104100		
	GEV No.	103065	Ref. No. 1-W-067
burner ring for burner cap ø 80mm			
	GEV No.	103066	Ref. No. 1-W-057
burner cap ø 80mm			
	GEV No.	104103	Ref. No. —
burner holder suitable for burner ø100mm with nozzle holder			

producer-specific hob burners			
EKU			
900 series			
<b>1</b>			
<b>GEV No.</b>	105051	<b>Ref. No.</b>	05-0463
<b>description</b>	air mixing sleeve L 45mm ED ø 45mm ID ø 42mm aluminium		
<b>accessories for</b>	105051		
	GEV No.	103150	Ref. No. 05-1240
burner lower part for burner cap ø 110/120mm			
	GEV No.	104030	Ref. No. 05-0470
burner head for burner cap ø 80mm			
	GEV No.	104031	Ref. No. 05-0047 05-0472
burner head for burner cap ø 110mm			
	GEV No.	104032	Ref. No. 05-0479
burner head for burner cap ø 120mm			

















<b>1</b>			
<b>GEV No.</b>	104101	<b>Ref. No.</b>	1-W-064
<b>description</b>	burner holder for burner cap ø 80mm with nozzle holder with mixing sleeve		
<b>accessories for</b>	104101		
	GEV No.	103065	Ref. No. 1-W-067
burner ring for burner cap ø 80mm			
	GEV No.	103066	Ref. No. 1-W-057
burner cap ø 80mm			

Table continues overleaf

<b>accessories for</b> 105051				
	GEV No.	104033	Ref. No.	05-0467
burner lower part for burner cap ø 80mm 1. generation				
	GEV No.	104034	Ref. No.	05-0469
burner lower part for burner cap ø 110mm				
	GEV No.	105052	Ref. No.	05-0403
nozzle holder ID ø 10mm nozzle mounting M10x1				
	GEV No.	105265	Ref. No.	—
burner head for burner cap ø 80mm				
	GEV No.	105266	Ref. No.	—
burner lower part for burner cap ø 80mm				
	GEV No.	105269	Ref. No.	—
burner head ø 158mm for burner cap ø 110mm				
	GEV No.	105272	Ref. No.	—
burner lower part for burner cap ø 110mm				
	GEV No.	105274	Ref. No.	—
burner head for burner cap ø 120mm				
	GEV No.	105275	Ref. No.	—
burner lower part for burner cap ø 120mm				

				
1				
<b>GEV No.</b>	103021	<b>Ref. No.</b>	05-0476	
<b>description</b>	burner cap ø 110mm			
<b>accessories for</b>	103021			
	GEV No.	103150	Ref. No.	05-1240
burner lower part for burner cap ø 110/120mm				
	GEV No.	103151	Ref. No.	05-1243
reducer suitable for burner head ø110mm				
	GEV No.	104031	Ref. No.	05-0047 05-0472
burner head for burner cap ø 110mm				
	GEV No.	104034	Ref. No.	05-0469
burner lower part for burner cap ø 110mm				
	GEV No.	105051	Ref. No.	05-0463
air mixing sleeve L 45mm ED ø 45mm ID ø 42mm aluminium				
	GEV No.	105052	Ref. No.	05-0403
nozzle holder ID ø 10mm nozzle mounting M10x1				

				
1				
<b>GEV No.</b>	103022	<b>Ref. No.</b>	05-0481	
<b>description</b>	burner cap ø 120mm with central hole			
<b>accessories for</b>	103022			
	GEV No.	103150	Ref. No.	05-1240
burner lower part for burner cap ø 110/120mm				
	GEV No.	104032	Ref. No.	05-0479
burner head for burner cap ø 120mm				
	GEV No.	104035	Ref. No.	—
burner lower part for burner cap ø 120mm				
	GEV No.	105051	Ref. No.	05-0463
air mixing sleeve L 45mm ED ø 45mm ID ø 42mm aluminium				
	GEV No.	105052	Ref. No.	05-0403
nozzle holder ID ø 10mm nozzle mounting M10x1				

				
1				
<b>GEV No.</b>	103020	<b>Ref. No.</b>	05-0474	
<b>description</b>	burner cap ø 80mm			
<b>accessories for</b>	103020			
	GEV No.	104030	Ref. No.	05-0470
burner head for burner cap ø 80mm				
	GEV No.	104033	Ref. No.	05-0467
burner lower part for burner cap ø 80mm 1. generation				
	GEV No.	105051	Ref. No.	05-0463
air mixing sleeve L 45mm ED ø 45mm ID ø 42mm aluminium				
	GEV No.	105052	Ref. No.	05-0403
nozzle holder ID ø 10mm nozzle mounting M10x1				







				
1				
<b>GEV No.</b>	104031	<b>Ref. No.</b>	05-0047 05-0472	
<b>description</b>	burner head for burner cap ø 110mm			
<b>accessories for</b>	104031			
	GEV No.	103021	Ref. No.	05-0476
burner cap ø 110mm				
	GEV No.	103150	Ref. No.	05-1240
burner lower part for burner cap ø 110/120mm				





Table continues overleaf



<b>accessories for</b>	104031		
	<b>GEV No.</b>	103151	<b>Ref. No.</b> 05-1243
	reducer suitable for burner head ø110mm		
	<b>GEV No.</b>	104034	<b>Ref. No.</b> 05-0469
	burner lower part for burner cap ø 110mm		
	<b>GEV No.</b>	105051	<b>Ref. No.</b> 05-0463
	air mixing sleeve L 45mm ED ø 45mm ID ø 42mm aluminium		
	<b>GEV No.</b>	105052	<b>Ref. No.</b> 05-0403
	nozzle holder ID ø 10mm nozzle mounting M10x1		

	1		
<b>GEV No.</b>	104032	<b>Ref. No.</b>	05-0479
<b>description</b>	burner head for burner cap ø 120mm		
<b>accessories for</b>	104032		
	<b>GEV No.</b>	103022	<b>Ref. No.</b> 05-0481
	burner cap ø 120mm with central hole		
	<b>GEV No.</b>	103150	<b>Ref. No.</b> 05-1240
	burner lower part for burner cap ø 110/120mm		
	<b>GEV No.</b>	105051	<b>Ref. No.</b> 05-0463
	air mixing sleeve L 45mm ED ø 45mm ID ø 42mm aluminium		
	<b>GEV No.</b>	105052	<b>Ref. No.</b> 05-0403
	nozzle holder ID ø 10mm nozzle mounting M10x1		









	1		
<b>GEV No.</b>	104030	<b>Ref. No.</b>	05-0470
<b>description</b>	burner head for burner cap ø 80mm		
<b>accessories for</b>	104030		
	<b>GEV No.</b>	103020	<b>Ref. No.</b> 05-0474
	burner cap ø 80mm		
	<b>GEV No.</b>	104033	<b>Ref. No.</b> 05-0467
	burner lower part for burner cap ø 80mm 1. generation		
	<b>GEV No.</b>	105051	<b>Ref. No.</b> 05-0463
	air mixing sleeve L 45mm ED ø 45mm ID ø 42mm aluminium		
	<b>GEV No.</b>	105052	<b>Ref. No.</b> 05-0403
	nozzle holder ID ø 10mm nozzle mounting M10x1		





	1		
<b>GEV No.</b>	103150	<b>Ref. No.</b>	05-1240
<b>description</b>	burner lower part for burner cap ø 110/120mm		
<b>accessories for</b>	103150		
	<b>GEV No.</b>	103021	<b>Ref. No.</b> 05-0476
	burner cap ø 110mm		
	<b>GEV No.</b>	103022	<b>Ref. No.</b> 05-0481
	burner cap ø 120mm with central hole		
	<b>GEV No.</b>	103151	<b>Ref. No.</b> 05-1243
	reducer suitable for burner head ø110mm		
	<b>GEV No.</b>	104031	<b>Ref. No.</b> 05-0047 05-0472
	burner head for burner cap ø 110mm		
	<b>GEV No.</b>	104032	<b>Ref. No.</b> 05-0479
	burner head for burner cap ø 120mm		
	<b>GEV No.</b>	105051	<b>Ref. No.</b> 05-0463
	air mixing sleeve L 45mm ED ø 45mm ID ø 42mm aluminium		
	<b>GEV No.</b>	105052	<b>Ref. No.</b> 05-0403
	nozzle holder ID ø 10mm nozzle mounting M10x1		

	1		
<b>GEV No.</b>	104034	<b>Ref. No.</b>	05-0469
<b>description</b>	burner lower part for burner cap ø 110mm		
<b>accessories for</b>	104034		
	<b>GEV No.</b>	103021	<b>Ref. No.</b> 05-0476
	burner cap ø 110mm		
	<b>GEV No.</b>	104031	<b>Ref. No.</b> 05-0047 05-0472
	burner head for burner cap ø 110mm		
	<b>GEV No.</b>	105051	<b>Ref. No.</b> 05-0463
	air mixing sleeve L 45mm ED ø 45mm ID ø 42mm aluminium		
	<b>GEV No.</b>	105052	<b>Ref. No.</b> 05-0403
	nozzle holder ID ø 10mm nozzle mounting M10x1		

			
1			
<b>GEV No.</b>	104033	<b>Ref. No.</b>	05-0467
<b>description</b>	burner lower part for burner cap ø 80mm 1. generation		

			
1			
<b>GEV No.</b>	105052	<b>Ref. No.</b>	05-0403
<b>description</b>	nozzle holder ID ø 10mm nozzle mounting M10x1		

<b>accessories for</b> 105052			
	<b>GEV No.</b>	100469	<b>Ref. No.</b> 3-309 A240156
gas injector thread M10x1 WS 12 bore ø 1.15mm			
	<b>GEV No.</b>	100478	<b>Ref. No.</b> —
gas injector thread M10x1 WS 12 bore ø 1.75mm			
	<b>GEV No.</b>	103150	<b>Ref. No.</b> 05-1240
burner lower part for burner cap ø 110/120mm			
	<b>GEV No.</b>	104030	<b>Ref. No.</b> 05-0470
burner head for burner cap ø 80mm			
	<b>GEV No.</b>	104031	<b>Ref. No.</b> 05-0047 05-0472
burner head for burner cap ø 110mm			
	<b>GEV No.</b>	104032	<b>Ref. No.</b> 05-0479
burner head for burner cap ø 120mm			
	<b>GEV No.</b>	104033	<b>Ref. No.</b> 05-0467
burner lower part for burner cap ø 80mm 1. generation			
	<b>GEV No.</b>	104034	<b>Ref. No.</b> 05-0469
burner lower part for burner cap ø 110mm			
	<b>GEV No.</b>	105051	<b>Ref. No.</b> 05-0463
air mixing sleeve L 45mm ED ø 45mm ID ø 42mm aluminium			

			
1			
<b>GEV No.</b>	103151	<b>Ref. No.</b>	05-1243
<b>description</b>	reducer suitable for burner head ø 110mm		
<b>accessories for</b> 103151			
	<b>GEV No.</b>	103021	<b>Ref. No.</b> 05-0476
burner cap ø 110mm			
	<b>GEV No.</b>	103150	<b>Ref. No.</b> 05-1240
burner lower part for burner cap ø 110/120mm			
	<b>GEV No.</b>	104031	<b>Ref. No.</b> 05-0047 05-0472
burner head for burner cap ø 110mm			
	<b>GEV No.</b>	105051	<b>Ref. No.</b> 05-0463
air mixing sleeve L 45mm ED ø 45mm ID ø 42mm aluminium			

<b>accessories for</b> 103151			
	<b>GEV No.</b>	105052	<b>Ref. No.</b> 05-0403
nozzle holder ID ø 10mm nozzle mounting M10x1			

<b>old (2) series</b>			
			
1			
<b>GEV No.</b>	103095	<b>Ref. No.</b>	3-211A A240109
<b>description</b>	burner cap ø 95mm 7kW		

			
1			
<b>GEV No.</b>	103105	<b>Ref. No.</b>	240012-00 3-212B
<b>description</b>	burner head for burner cap ø 95mm 7kW		

			
1			
<b>GEV No.</b>	104111	<b>Ref. No.</b>	240082-00 3-212A
<b>description</b>	burner head for burner cap ø 95mm 7kW		

			
1			
<b>GEV No.</b>	104114	<b>Ref. No.</b>	240041-00 3-207
<b>description</b>	burner lower part for burner cap ø 85mm 3.5kW		

			
1			
<b>GEV No.</b>	104115	<b>Ref. No.</b>	240010-00 3-210 N/A
<b>description</b>	burner lower part for burner cap ø 95mm 7kW		

			
1			
<b>GEV No.</b>	104112	<b>Ref. No.</b>	3-244 A240185
<b>description</b>	gasket for burner cap ø 85mm silicone suitable for burner 3.5kW		











			
1			
<b>GEV No.</b>	104113	<b>Ref. No.</b>	3-245 A240184
<b>description</b>	gasket for burner cap ø 95mm silicone for burner 7kW		

			
1			
<b>GEV No.</b>	520587	<b>Ref. No.</b>	10-109
<b>description</b>	hose clamp stainless steel ø 12-20mm width 25mm Qty 1 pcs		





			
1			
<b>GEV No.</b>	104119	<b>Ref. No.</b>	3-231 A240072
<b>description</b>	nozzle holder		





Snack 2001 series			
			
1			
<b>GEV No.</b>	106379	<b>Ref. No.</b>	N/A
<b>description</b>	air mixing tube for burner cap ø 80mm L 23mm D1 ø 20mm D2 ø 15.6mm D3 ø 14mm		





			
1			
<b>GEV No.</b>	103068	<b>Ref. No.</b>	1-W-059
<b>description</b>	burner cap ø 100mm		
<b>accessories for</b>	103068		
	<b>GEV No.</b>	<b>Ref. No.</b>	
	103067		1-W-068
	burner ring for burner cap ø 100mm		
	<b>GEV No.</b>	<b>Ref. No.</b>	
	104102		1-W-066
	burner head for burner cap ø 100mm ext. ø 130		
	<b>GEV No.</b>	<b>Ref. No.</b>	
	104103		—
	burner holder suitable for burner ø100mm with nozzle holder		

			
1			
<b>GEV No.</b>	103066	<b>Ref. No.</b>	1-W-057
<b>description</b>	burner cap ø 80mm		
<b>accessories for</b>	103066		
	<b>GEV No.</b>	<b>Ref. No.</b>	
	103065		1-W-067
	burner ring for burner cap ø 80mm		
	<b>GEV No.</b>	<b>Ref. No.</b>	
	104100		1-W-065
	burner head for burner cap ø 80mm		
	<b>GEV No.</b>	<b>Ref. No.</b>	
	104101		1-W-064
	burner holder for burner cap ø 80mm with nozzle holder with mixing sleeve		





			
1			
<b>GEV No.</b>	104102	<b>Ref. No.</b>	1-W-066
<b>description</b>	burner head for burner cap ø 100mm ext. ø 130		

			
1			
<b>GEV No.</b>	104100	<b>Ref. No.</b>	1-W-065
<b>description</b>	burner head for burner cap ø 80mm		
<b>accessories for</b>	104100		
	<b>GEV No.</b>	<b>Ref. No.</b>	
	103065		1-W-067
	burner ring for burner cap ø 80mm		
	<b>GEV No.</b>	<b>Ref. No.</b>	
	103066		1-W-057
	burner cap ø 80mm		
	<b>GEV No.</b>	<b>Ref. No.</b>	
	104103		—
	burner holder suitable for burner ø100mm with nozzle holder		



			
1			
<b>GEV No.</b>	104101	<b>Ref. No.</b>	1-W-064
<b>description</b>	burner holder for burner cap ø 80mm with nozzle holder with mixing sleeve		
<b>accessories for</b>	104101		
	<b>GEV No.</b>	<b>Ref. No.</b>	
	103065		1-W-067
	burner ring for burner cap ø 80mm		
	<b>GEV No.</b>	<b>Ref. No.</b>	
	103066		1-W-057
	burner cap ø 80mm		
	<b>GEV No.</b>	<b>Ref. No.</b>	
	104100		1-W-065
	burner head for burner cap ø 80mm		

			
1			
<b>GEV No.</b>	103067	<b>Ref. No.</b>	1-W-068
<b>description</b>	burner ring for burner cap ø 100mm		
<b>accessories for</b>	103067		
	<b>GEV No.</b>	<b>Ref. No.</b>	
	103068		1-W-059
	burner cap ø 100mm		
	<b>GEV No.</b>	<b>Ref. No.</b>	
	104102		1-W-066
	burner head for burner cap ø 100mm ext. ø 130		
	<b>GEV No.</b>	<b>Ref. No.</b>	
	104103		—
	burner holder suitable for burner ø100mm with nozzle holder		



				
<b>GEV No.</b>	103065	<b>Ref. No.</b>	1-W-067	
<b>description</b>	burner ring for burner cap ø 80mm			
<b>accessories for</b>	103065			
	<b>GEV No.</b>	103066	<b>Ref. No.</b>	1-W-057
burner cap ø 80mm				
	<b>GEV No.</b>	104100	<b>Ref. No.</b>	1-W-065
burner head for burner cap ø 80mm				
	<b>GEV No.</b>	104101	<b>Ref. No.</b>	1-W-064
burner holder for burner cap ø 80mm with nozzle holder with mixing sleeve				





## Snack 2001-96, 60, 701, 702, 703 series

				
<b>GEV No.</b>	103143	<b>Ref. No.</b>	1-W-652 3-208 A240108	
<b>description</b>	burner cap ø 85mm 3.5kW			
<b>accessories for</b>	103143			
	<b>GEV No.</b>	103140	<b>Ref. No.</b>	240011-00 3-209
burner head seat ø 75mm for burner cap ø 85mm 3.5kW				

				
<b>GEV No.</b>	103144	<b>Ref. No.</b>	3-211	
<b>description</b>	burner cap ø 95mm 5.5kW			

				
<b>GEV No.</b>	103141	<b>Ref. No.</b>	3-212	
<b>description</b>	burner head ø 95mm suitable for burner 5.5kW			
<b>accessories for</b>	103141			
	<b>GEV No.</b>	103147	<b>Ref. No.</b>	—
burner lower part for burner cap ø 95mm 5.5/7kW				
	<b>GEV No.</b>	103149	<b>Ref. No.</b>	N/A
gasket L 55mm W 62mm for burner 5.5/7kW				
	<b>GEV No.</b>	105230	<b>Ref. No.</b>	—
nozzle holder				
	<b>GEV No.</b>	105259	<b>Ref. No.</b>	—
burner cap ø 95mm with central hole				

				
<b>GEV No.</b>	103140	<b>Ref. No.</b>	240011-00 3-209	
<b>description</b>	burner head seat ø 75mm for burner cap ø 85mm 3.5kW			
<b>accessories for</b>	103140			
	<b>GEV No.</b>	103146	<b>Ref. No.</b>	1-W-646
burner lower part for burner cap ø 85mm 3.5kW				
	<b>GEV No.</b>	103148	<b>Ref. No.</b>	1-W-690
gasket L 47mm W 53mm suitable for burner 3.5kW				
	<b>GEV No.</b>	105230	<b>Ref. No.</b>	—
nozzle holder				
	<b>GEV No.</b>	107203	<b>Ref. No.</b>	—
burner cap ø 85mm 3.5kW				

				
<b>GEV No.</b>	103146	<b>Ref. No.</b>	1-W-646	
<b>description</b>	burner lower part for burner cap ø 85mm 3.5kW			
<b>accessories for</b>	103146			
	<b>GEV No.</b>	103140	<b>Ref. No.</b>	240011-00 3-209
burner head seat ø 75mm for burner cap ø 85mm 3.5kW				
	<b>GEV No.</b>	103148	<b>Ref. No.</b>	1-W-690
gasket L 47mm W 53mm suitable for burner 3.5kW				
	<b>GEV No.</b>	105230	<b>Ref. No.</b>	—
nozzle holder				
	<b>GEV No.</b>	107203	<b>Ref. No.</b>	—
burner cap ø 85mm 3.5kW				















				
<b>GEV No.</b>	103148	<b>Ref. No.</b>	1-W-690	
<b>description</b>	gasket L 47mm W 53mm suitable for burner 3.5kW			
<b>accessories for</b>	103148			
	<b>GEV No.</b>	103140	<b>Ref. No.</b>	240011-00 3-209
burner head seat ø 75mm for burner cap ø 85mm 3.5kW				
	<b>GEV No.</b>	103146	<b>Ref. No.</b>	1-W-646
burner lower part for burner cap ø 85mm 3.5kW				
	<b>GEV No.</b>	105230	<b>Ref. No.</b>	—
nozzle holder				

Table continues overleaf









<b>accessories for</b>	103148		
	<b>GEV No.</b>	107203	<b>Ref. No.</b> —
	burner cap ø 85mm 3.5kW		

	1		
<b>GEV No.</b>	103149	<b>Ref. No.</b>	N/A
<b>description</b>	gasket L 55mm W 62mm for burner 5.5/7kW		
<b>accessories for</b>	103149		
	<b>GEV No.</b>	103141	<b>Ref. No.</b> 3-212
	burner head ø 95mm suitable for burner 5.5kW		
	<b>GEV No.</b>	103145	<b>Ref. No.</b> —
	burner cap ø 95mm 7kW with central hole		
	<b>GEV No.</b>	103147	<b>Ref. No.</b> —
	burner lower part for burner cap ø 95mm 5.5/7kW		
	<b>GEV No.</b>	105230	<b>Ref. No.</b> —
	nozzle holder		
	<b>GEV No.</b>	105259	<b>Ref. No.</b> —
	burner cap ø 95mm with central hole		
	<b>GEV No.</b>	107143	<b>Ref. No.</b> —
	burner head for burner cap ø 95mm 5.5kW		

<b>solid tops</b>			
	1		
<b>GEV No.</b>	105042	<b>Ref. No.</b>	05-0486
<b>description</b>	burner cap ø 175mm with central hole		
<b>accessories for</b>	105042		
	<b>GEV No.</b>	105041	<b>Ref. No.</b> 05-0485
	burner head ø 175mm for solid top suitable for 1000, BS series		
	<b>GEV No.</b>	105484	<b>Ref. No.</b> —
	burner head ø 175mm for solid top suitable for Protagonista series		

	1		
<b>GEV No.</b>	105041	<b>Ref. No.</b>	05-0485
<b>description</b>	burner head ø 175mm for solid top suitable for 1000, BS series		
<b>accessories for</b>	105041		
	<b>GEV No.</b>	105042	<b>Ref. No.</b> 05-0486
	burner cap ø 175mm with central hole		

<b>wok burners</b>			
	1		
<b>GEV No.</b>	104117	<b>Ref. No.</b>	06-107
<b>description</b>	air mixing sleeve for wok range		
<b>accessories for</b>	104117		
	<b>GEV No.</b>	103096	<b>Ref. No.</b> 06-106
	burner cap ø 120mm 9.5kW for wok range		
	<b>GEV No.</b>	104116	<b>Ref. No.</b> —
	burner head 9.5kW for wok range		

	1		
<b>GEV No.</b>	103096	<b>Ref. No.</b>	06-106
<b>description</b>	burner cap ø 120mm 9.5kW for wok range		
<b>accessories for</b>	103096		
	<b>GEV No.</b>	104116	<b>Ref. No.</b> —
	burner head 9.5kW for wok range		
	<b>GEV No.</b>	104117	<b>Ref. No.</b> 06-107
	air mixing sleeve for wok range		

	1		
<b>GEV No.</b>	104734	<b>Ref. No.</b>	06-105
<b>description</b>	burner head for wok range		



## pan supports



1

<b>GEV No.</b>	210151	<b>Ref. No.</b>	1-W-645
<b>description</b>	pan support W 295mm L 545mm gas range		



1

<b>GEV No.</b>	210150	<b>Ref. No.</b>	1-W-644
<b>description</b>	pan support W 340mm L 545mm		

## accessories

## reducers for pan supports



1

<b>GEV No.</b>	210050	<b>Ref. No.</b>	RR
<b>description</b>	reducer for pan support L 260mm W 260mm chrome-plated steel suitable for universal		

## pan supports



1

<b>GEV No.</b>	210035	<b>Ref. No.</b>	06-108
<b>description</b>	pan support ø 353mm H 70mm		
<b>For models:</b>	CHINAHERD		



1

<b>GEV No.</b>	210034	<b>Ref. No.</b>	06-109
<b>description</b>	pan support ø 356mm H 90mm		



1

<b>GEV No.</b>	210151	<b>Ref. No.</b>	1-W-645
<b>description</b>	pan support W 295mm L 545mm gas range		



1

<b>GEV No.</b>	210150	<b>Ref. No.</b>	1-W-644
<b>description</b>	pan support W 340mm L 545mm		

## bar burners

## bar burners



1

<b>GEV No.</b>	104156	<b>Ref. No.</b>	1-W-050
<b>description</b>	bar burner 2 row L 445mm W 200mm ømm H 50mm chargrill stainless steel		
<b>For models:</b>	SNACK2001		



1

<b>GEV No.</b>	105422	<b>Ref. No.</b>	4-PLX-02
<b>description</b>	bar burner 4 row L 480mm W 450mm ømm chargrill		



1

<b>GEV No.</b>	211029	<b>Ref. No.</b>	1-W-280
<b>description</b>	lava rock grid L 464mm W 310mm		





lava rock grids			
			
1			
<b>GEV No.</b>	211029	<b>Ref. No.</b>	1-W-280
<b>description</b>	lava rock grid L 464mm W 310mm		

## accessories

nozzle holders			
			
1			
<b>GEV No.</b>	105052	<b>Ref. No.</b>	05-0403
<b>description</b>	nozzle holder ID ø 10mm nozzle mounting M10x1		
<b>accessories for</b>	105052		
	<b>GEV No.</b>	100469	<b>Ref. No.</b> 3-309 A240156
	gas injector thread M10x1 WS 12 bore ø 1.15mm		
	<b>GEV No.</b>	100478	<b>Ref. No.</b> —
	gas injector thread M10x1 WS 12 bore ø 1.75mm		
	<b>GEV No.</b>	103150	<b>Ref. No.</b> 05-1240
	burner lower part for burner cap ø 110/120mm		
	<b>GEV No.</b>	104030	<b>Ref. No.</b> 05-0470
	burner head for burner cap ø 80mm		
	<b>GEV No.</b>	104031	<b>Ref. No.</b> 05-0047 05-0472
	burner head for burner cap ø 110mm		
	<b>GEV No.</b>	104032	<b>Ref. No.</b> 05-0479
	burner head for burner cap ø 120mm		
	<b>GEV No.</b>	104033	<b>Ref. No.</b> 05-0467
	burner lower part for burner cap ø 80mm 1. generation		
	<b>GEV No.</b>	104034	<b>Ref. No.</b> 05-0469
	burner lower part for burner cap ø 110mm		
	<b>GEV No.</b>	105051	<b>Ref. No.</b> 05-0463
	air mixing sleeve L 45mm ED ø 45mm ID ø 42mm aluminium		

miscellaneous			
			
1			
<b>GEV No.</b>	103151	<b>Ref. No.</b>	05-1243
<b>description</b>	reducer suitable for burner head ø110mm		
<b>accessories for</b>	103151		
	<b>GEV No.</b>	103021	<b>Ref. No.</b> 05-0476
	burner cap ø 110mm		
	<b>GEV No.</b>	103150	<b>Ref. No.</b> 05-1240
	burner lower part for burner cap ø 110/120mm		
	<b>GEV No.</b>	104031	<b>Ref. No.</b> 05-0047 05-0472
	burner head for burner cap ø 110mm		
	<b>GEV No.</b>	105051	<b>Ref. No.</b> 05-0463
	air mixing sleeve L 45mm ED ø 45mm ID ø 42mm aluminium		
	<b>GEV No.</b>	105052	<b>Ref. No.</b> 05-0403
	nozzle holder ID ø 10mm nozzle mounting M10x1		

## gas nozzles

### main nozzles

gas nozzles M6x0.75			
			
1			
<b>GEV No.</b>	100415	<b>Ref. No.</b>	3-237 A240128
<b>description</b>	gas injector thread M6x0.75 WS 7 bore ø 0.85mm		
<b>For models:</b>	60GE4, 60GST4		

gas nozzles M7x1			
			
1			
<b>GEV No.</b>	103129	<b>Ref. No.</b>	1-W-092
<b>description</b>	gas injector thread M7x1 WS 10 bore ø 0.75mm		

			
1			
<b>GEV No.</b>	100517	<b>Ref. No.</b>	1-W-093
<b>description</b>	gas injector thread M7x1 WS 10 bore ø 0.8mm		



## gas nozzles M10x1



1

<b>GEV No.</b>	100464	<b>Ref. No.</b>	1-W-101
----------------	--------	-----------------	---------

<b>description</b>	gas injector thread M10x1 WS 12 bore $\varnothing$ 0.75mm		
--------------------	---	--	--



1

<b>GEV No.</b>	100469	<b>Ref. No.</b>	3-309 A240156
----------------	--------	-----------------	------------------

<b>description</b>	gas injector thread M10x1 WS 12 bore $\varnothing$ 1.15mm		
--------------------	---	--	--

## gas nozzles M13x1



1

<b>GEV No.</b>	102790	<b>Ref. No.</b>	DIV Erdg 255 PLX-60
----------------	--------	-----------------	---------------------

<b>description</b>	gas injector thread M13x1 bore $\varnothing$ 2.55mm WS 13		
--------------------	---	--	--

## pilot burner nozzles

## pilot burner nozzle AB



1

<b>GEV No.</b>	100869	<b>Ref. No.</b>	06-124
----------------	--------	-----------------	--------

<b>description</b>	pilot burner nozzle natural gas code 51 Qty 1 pcs suitable for 160 series nozzle $\varnothing$ 0.51mm		
--------------------	---	--	--

## pilot burner nozzles JUNKERS

## CB 5050\_ series



1

<b>GEV No.</b>	100230	<b>Ref. No.</b>	1-W-119
----------------	--------	-----------------	---------

<b>description</b>	pilot burner nozzle LPG gas pressure 50mbar code 2 Qty 1 pcs suitable for JUNKERS CB5050_		
--------------------	---	--	--

## pilot burner nozzles SIT

## 100 series



1

<b>GEV No.</b>	100245	<b>Ref. No.</b>	3-314 A230126
----------------	--------	-----------------	------------------

<b>description</b>	pilot burner nozzle LPG code 20 bore $\varnothing$ 0.2mm Qty 1 pcs thread M8x0.75		
--------------------	---	--	--

## 160 series



1

<b>GEV No.</b>	107649	<b>Ref. No.</b>	3-225 A230132
----------------	--------	-----------------	------------------

<b>description</b>	pilot burner nozzle SIT LPG code 20 Qty 1 pcs		
--------------------	---	--	--



1

<b>GEV No.</b>	107650	<b>Ref. No.</b>	06-123 A230131-10
----------------	--------	-----------------	----------------------

<b>description</b>	pilot burner nozzle SIT LPG code 30 Qty 1 pcs		
--------------------	---	--	--

## equipment-specific units

## for dishwashers

## air traps

## air traps



1

<b>GEV No.</b>	503337	<b>Ref. No.</b>	10-61
----------------	--------	-----------------	-------

<b>description</b>	air trap		
--------------------	----------	--	--

## washing and rinsing systems



1

<b>GEV No.</b>	511161	<b>Ref. No.</b>	DZT71
----------------	--------	-----------------	-------

<b>description</b>	rinse arm shaft		
--------------------	-----------------	--	--

## knobs

### producer-specific knobs

EKU



1

<b>GEV No.</b>	112183	<b>Ref. No.</b>	06-135
<b>description</b>	knob gas tap with ignition flame ø 63mm shaft ø 8x6.5mm shaft flat upper black		

## locks

### edgemoount latches



#### handle latches

#### producer-specific

INOXTREND





1

<b>GEV No.</b>	690146	<b>Ref. No.</b>	14-N-081
<b>description</b>	handle latch L 172mm mounting distance 134mm non lockable heated units 6200 H 65mm type DUPLO total length 248mm		
<b>accessories for</b>	690146		
	<b>GEV No.</b>	690123	<b>Ref. No.</b> —
	door catch with roller		
	<b>GEV No.</b>	693777	<b>Ref. No.</b> —
	gasket H 6.6mm L 105mm W 45mm L1 78mm W1 25mm for handle		
	<b>GEV No.</b>	693778	<b>Ref. No.</b> —
	door catch		

### MODULAR



1

<b>GEV No.</b>	690146	<b>Ref. No.</b>	14-N-081
<b>description</b>	handle latch L 172mm mounting distance 134mm non lockable heated units 6200 H 65mm type DUPLO total length 248mm		
<b>accessories for</b>	690146		
	<b>GEV No.</b>	690123	<b>Ref. No.</b> —
	door catch with roller		
	<b>GEV No.</b>	693777	<b>Ref. No.</b> —
	gasket H 6.6mm L 105mm W 45mm L1 78mm W1 25mm for handle		
	<b>GEV No.</b>	693778	<b>Ref. No.</b> —
	door catch		

### door catches





1

<b>GEV No.</b>	700061	<b>Ref. No.</b>	14-123
<b>description</b>	door catch L 58mm W 20mm H 35mm mounting distance 42mm chrome-plated brass for headed units		
<b>accessories for</b>	700061		
	<b>GEV No.</b>	690414	<b>Ref. No.</b> —
	handle latch L 150mm mounting distance 133mm non lockable refrigeration units G 791		

## hinges

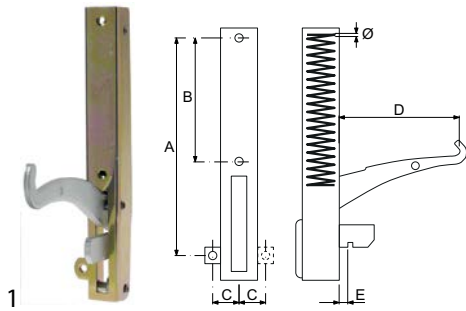
### oven hinges



<b>GEV No.</b>	700005	<b>Ref. No.</b>	3-52A A230084
<b>description</b>	oven hinge mounting distance 173mm mounting distance 2 105mm lug mounting 14mm lever length 118mm groove distance 7mm spring thickness 3.5mm mounting ear position left spring length 112mm W 25mm		
<b>accessories for</b>	700005		
	<b>GEV No.</b>	700001	<b>Ref. No.</b> —
	opposite support L 118mm W 17mm mounting distance 94mm		

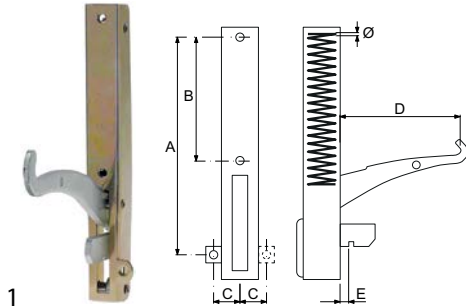

<b>GEV No.</b>	700004	<b>Ref. No.</b>	3-52
<b>description</b>	oven hinge mounting distance 173mm mounting distance 2 105mm lug mounting 14mm lever length 119mm groove distance 7mm spring thickness 3.5mm mounting ear position right spring length 112mm L 206mm W 25mm		
<b>accessories for</b>	700004		
	<b>GEV No.</b>	700001	<b>Ref. No.</b> —
	opposite support L 118mm W 17mm mounting distance 94mm		

## baskets

### fryer baskets

EKU



<b>GEV No.</b>	970156	<b>Ref. No.</b>	1-W-02
<b>description</b>	fryer basket L1 280mm W1 200mm H1 105mm chrome-plated steel		

## gaskets

### refrigeration gaskets

#### plug-in gaskets

profile 9743

We offer custom-made gaskets for this profile

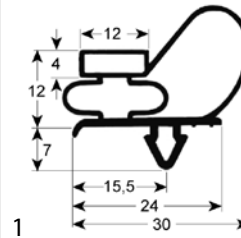

<b>GEV No.</b>	902304	<b>Ref. No.</b>	N/A
<b>description</b>	refrigeration gasket profile 9743 Wmm L 2500mm		

#### profile 9783

We offer custom-made gaskets for this profile

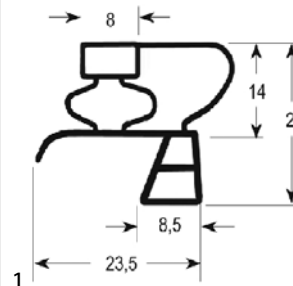

<b>GEV No.</b>	900024	<b>Ref. No.</b>	Mar.2500600
<b>description</b>	refrigeration gasket profile 9783 W 190mm L 357mm plug size drawer refrigeration size 1/3		

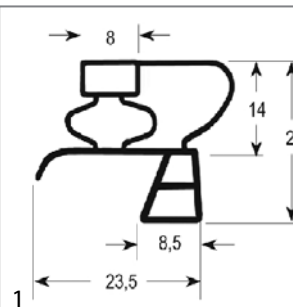

<b>GEV No.</b>	900025	<b>Ref. No.</b>	Mar.2500700
<b>description</b>	refrigeration gasket profile 9783 W 260mm L 355mm plug size drawer refrigeration size 1/2		

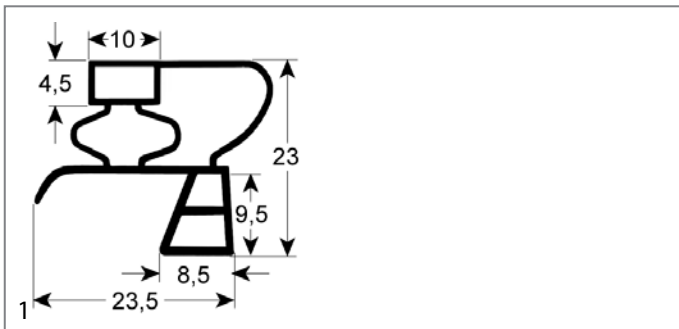

<b>GEV No.</b>	902306	<b>Ref. No.</b>	N/A
<b>description</b>	refrigeration gasket profile 9783 Wmm L 2500mm		

### gaskets for heated units

#### door seals with fixing hook



<b>GEV No.</b>	901676	<b>Ref. No.</b>	3-75
<b>description</b>	door seal W 555mm 3-sided with hook H 285mm		

### O-rings

#### EPDM

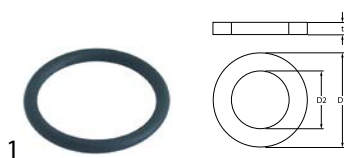

<b>GEV No.</b>	505092	<b>Ref. No.</b>	04-3090
<b>description</b>	O-ring EPDM thickness 5.34mm ID $\phi$ 43.82mm Qty 1 pcs		

#### Viton

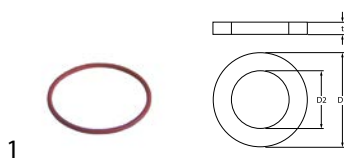

<b>GEV No.</b>	521116	<b>Ref. No.</b>	05-0790
<b>description</b>	O-ring Viton thickness 3.53mm ID $\phi$ 78.97mm Qty 1 pcs		

### springs

#### torsion springs



<b>GEV No.</b>	514234	<b>Ref. No.</b>	8102-10
<b>description</b>	torsion spring $\phi$ 32.3mm L2 188mm wire gauge $\phi$ 5.7mm L1 15mm tilting bratt pan series 900		

### dosing pumps

#### piston pumps

##### with solenoid coil



<b>GEV No.</b>	361013	<b>Ref. No.</b>	10-54
<b>description</b>	dosing pump inlet 4x6mm outlet 5mm 230V rinse aid duty cycle 25% type EKP-M 50Hz impulse 3imp/s		

<b>spare parts for</b>	361013		
------------------------	--------	--	--



<b>GEV No.</b>	361482	<b>Ref. No.</b>	—
<b>description</b>	solenoid coil 230VAC for type EKP-M		



<b>GEV No.</b>	361811	<b>Ref. No.</b>	—
<b>description</b>	hose connector for dosing pump hose $\phi$ 6.3mm T1: M12x1.5 chrome-plated brass		



<b>GEV No.</b>	371090	<b>Ref. No.</b>	—
<b>description</b>	power socket plug type DIN 43650A screw		

<b>accessories for</b>	361013		
------------------------	--------	--	--



<b>GEV No.</b>	361366	<b>Ref. No.</b>	—
<b>description</b>	PCB dishwasher 11F suitable for DB2 type DB2/EV1/EKP-M		



<b>GEV No.</b>	361505	<b>Ref. No.</b>	—
<b>description</b>	screw pipe fitting straight nickel-plated brass thread 3/8" IT hose $\phi$ 6x8mm		

### accessories

#### tank inlets



<b>GEV No.</b>	361856	<b>Ref. No.</b>	10-149 10-149a
<b>description</b>	tank inlet stainless steel M12 hose $\phi$ 4/5/6mm		

### hoses

#### drain hoses

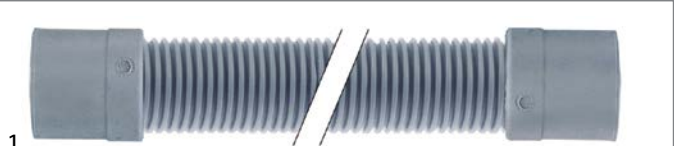

<b>GEV No.</b>	507211	<b>Ref. No.</b>	10-112
<b>description</b>	drain hose DN26 L 1500mm A int. $\phi$ 33mm A ext. $\phi$ 40mm B int. $\phi$ 32mm B ext. $\phi$ 40mm outer hose $\phi$ 35mm		



## drain systems and wash basins

### standpipes

3/4"



1

<b>GEV No.</b>	515049	<b>Ref. No.</b>	G367000
<b>description</b>	standpipe size 3/4" usable height 68mm overall height 94mm ED ø 20mm chrome-plated brass with O-ring		
<b>spare parts for</b>	515049		
	<b>GEV No.</b>	528813	<b>Ref. No.</b> —
	O-ring EPDM thickness 2mm ID ø 17mm Qty 1 pcs		
<b>accessories for</b>	515049		
	<b>GEV No.</b>	515041	<b>Ref. No.</b> —
	drain fitting size 3/4" usable heightmm overall height 30mm ED ø 38mm chrome-plated brass		

## ancillary products

### clamps

#### hose clamps

#### miscellaneous



1

<b>GEV No.</b>	520587	<b>Ref. No.</b>	10-109
<b>description</b>	hose clamp stainless steel ø 12-20mm width 25mm Qty 1 pcs		

## fastening material

### fasteners

#### clamps

#### hose clamps

#### miscellaneous



1

<b>GEV No.</b>	520587	<b>Ref. No.</b>	10-109
<b>description</b>	hose clamp stainless steel ø 12-20mm width 25mm Qty 1 pcs		

<b>B</b>		
bar burners	24	
<b>C</b>		
cam switches	9	
clamps	30, 30	
contactors	10	
control thermostats	7	
<b>D</b>		
door catches	27	
door seals with fixing hook	29	
dosing pumps	29	
drain hoses	29	
drain systems and wash basins	30	
<b>E</b>		
edgemount latches	27	
electronic controllers	10	
<b>F</b>		
fasteners	30	
fastening material	30	
<b>G</b>		
gas burners	16	
gas nozzles	25	
gas taps	11	
gas thermostats	12	
gaskets for heated units	29	
<b>H</b>		
handle latches	27	
heating elements	3	
heating elements for bain maries	3	
heating elements for chargrills	5	
heating elements for chip scuttles	3	
heating elements for convection	5	
heating elements for fryers	4	
heating elements for griddles	4	
heating elements for large hobs	4	
heating elements for salamanders/toasters	5	
heating elements for tilting bratt pan	4	
hob burners	16	
hose clamps	30, 30	
hoses	29	
hot plates	6	
<b>I</b>		
indicator lights	9	
indicator lights (complete)	9	
<b>L</b>		
lamps	9	
<b>M</b>		
magnetic switches	9	
microswitches	8	
<b>O</b>		
O-rings	29	
oven hinges	28	
<b>P</b>		
pilot burners	14	
plug-in gaskets	28	
programme timers	9	
push/momentary push switches	8	
<b>R</b>		
radiation heaters	6	
refrigeration gaskets	28	
<b>S</b>		
safety thermostats	8	
solenoid valves	10	
standpipes	30	
switches and momentary switches	8	
<b>T</b>		
tank inlets	29	
thermocouples	16	
thermostats	7	
timers	9	