



GAS COMPONENTS



ELECTRIC COMPONENTS



WATER TECHNOLOGY



MECHANICAL COMPONENTS



TOOLS

Spare parts suitable for

ELECTROLUX

Find the complete and up-to-date range of products in our GEV Webshop



Manufacturer catalogue

The most important spare parts and accessories arranged clearly for every manufacturer

- ✓ Complete product range and all appliance data always up to date in the GEV Webshop
- ✓ Alphabetical Index at the end of the catalogue

GEV Webshop

www.gev-online.co.uk

www.gev-online.com



- 🔍 Add to Favourites
- 🔍 Sign In with email address and usual password
- 🔍 Easy-order – place several items in your basket at the same time
- 🔍 Quick Item search – no login needed



induction

induction coils







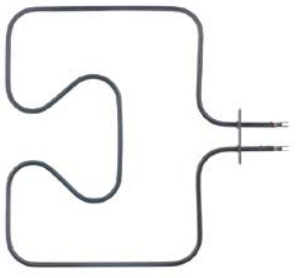

			
1			
GEV No.	404001	Ref. No.	OC0027 0G6556 7893017080 7893017081 7893017082
description	induction coils 5000W 400V for induction device		
For models:	KI/Z1, KI/Z2, KI/Z1A, KI/Z2A, KI/Z1E5A, KI/Z2E5A, QI/Z1, QI/Z2, QI/Z1A, QI/Z2A, QI/Z1E5A, QI/Z2E5A, WI/Z1, WI/Z2, WI/Z1E5, WI/Z2E5, WI/Z1A, WI/Z2A, WI/Z1E5A, WI/Z2E5A		

heating elements

heating elements for ovens

			
1			
GEV No.	418078	Ref. No.	005218 3570338040 3581907700 3581909599
description	heating element 1000W 230V heating circuits 1 L 335mm W 345mm L1 55mm L2 280mm W1 154mm W2 36mm flange length 80mm flange width 16mm hole distance 60mm hole ø 5mm tube ø 6.3mm connection male faston 6.3mm connection length 60mm rectangular flange dry heating element		
For models:	FCF/E4, FCF/E4-3KW, JCF/E4, JCF/E4, ECF/E4, ECF/E4-3KW, ACF/E4, ACF/E4-3KW, NCF/E4, ZCF/E4, ZCF/E4		

			
1			
GEV No.	416977	Ref. No.	OC0310
description	heating element 1500W 230V L 530mm W 148mm H 24mm flange length 162mm flange width 18mm hole distance 72mm connection length 29mm tube ø 6.5mm connection M4 heating circuits 1 rectangular flange hole ø 6.5mm dry heating element		
For models:	KC/E1, KC/E2, KCF/E2, KC/E1E5, KC/E2E5, KCF/E2E5, KCF/M2E5G, QCF/E2E5, WCF/E2E5		

			
1			
GEV No.	415078	Ref. No.	054147 054535 054633 054634 0KF005 2410007210
description	heating element 1500W 240V L 540mm W 150mm H 28mm 2 hole fixing mounting distance 145mm connection M4 tube ø 6.25mm dry heating element thread M10x1 heating circuits 1		
For models:	MCF/GE705, MCF/GE1055, MCF/GE700, MCFGE1050, MCF/GE700D, MCFGE1050D, MCF/E700D, MCF/E700, MCF/E700UK, MCF/E1050D, MCF/E1050, MCF/GE1055UK, MIF/E700, MIF/E700D, MIF/E710, MIF/E710D, MCF/GE702, MCFGE1052, MCF/GE700, MCFGE1050, MF/E700, RCF/M2, RCF/M3, RCF/E2, RCF/E2E5, RIF/E2, MCF/E2Q, RCF/E2Q, XCF/M2, XCFM3, XCF/E2, XIF/E2, JCF/M2, JCFM3, JCF/E2, JIF/E2, MCF/M2, MCF/M3, MCF/E2, MCF/E2E5, MIF/E2, RCF/GE720, RCF/GE730, RCF/GE720, RCF/GE720, RCFE720, RCF/E720, RCF/E700D, RCF/GE700D, RCF/E1050D...(Other models you can see in the webshop)		
accessories for	415078		
	GEV No.	510416	Ref. No. —
	flat gasket fibre ED ø 19mm ID ø 10.5mm thickness 1.5mm for thread M10 Qty 1 pcs		
	GEV No.	510893	Ref. No. —
	O-ring EPDM thickness 2.62mm ID ø 9.92mm Qty 1 pcs		
	GEV No.	520231	Ref. No. —
	nut thread M10x1 H 6mm WS 14 zinc-coated steel Qty 1 pcs		
	GEV No.	521103	Ref. No. —
	nut thread M4 H 3mm WS 7 brass Qty 20 pcs		
	GEV No.	521104	Ref. No. —
	washer ID ø 4.3mm ED ø 8mm thickness 0.5mm brass Qty 20 pcs for thread M4		
	GEV No.	560111	Ref. No. —
	plain washer ID ø 4.3mm ED ø 9mm thickness 0.8mm SS Qty 20 pcs DIN 125A for thread M4		
	GEV No.	560131	Ref. No. —
	hexagonal nut thread M4 H 3.2mm WS 7 SS DIN/ISO DIN 934 / ISO 4032/8673 Qty 20 pcs		



			
1			
GEV No.	417442	Ref. No.	OC0269 OC2813
description	heating element 1500W 400V L 535mm W 140mm H 23mm flange length 162mm flange width 18mm hole distance 72mm connection length 28mm tube ø 6.3mm connection M4 heating circuits 1 rectangular flange hole ø 6mm dry heating element L1 52mm L2 487mm		
For models:	PCF/M2, PCF/M3, PCV/E2, PCV/E3, PCF/E2, PC/E2Q, PCF/E2Q, PCV/E2Q, PIV/E1, PIV/E2, PIF/E2, PIV/E2, PC/E2QE5, PCF/E2QE5, PIV/E1E5, PIV/E2E5, PIF/E2E5, PCF/E2E5, PCF/M2A, PCF/M3A, OCF/M2, OCF/E2, OCF/E2Q, OCF/E2Q, OI/E1, OI/E2, OIF/E2, TCF/M2, TCF/M3, TCF/E2, TCV/E2Q, TIF/E2, TI/E2E5, TCF/M2A, TCF/M3A, TCF/E2M0, TCF/E2QM0, TCF/E3QM0, TCF/E2M4, TCF/E2QM4, TCF/E3QM4, KCF/M2, KC/E1, KC/E2, KCF/E2, KC/E1E5, KC/E2E5, KCF/E2E5, KCF/W2, KCF/M2G...(Other models you can see in the webshop)		

1 electric components

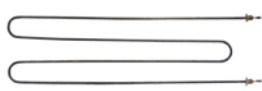

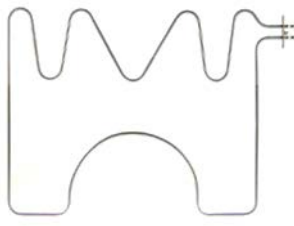
			
1			
GEV No.	415350	Ref. No.	OH9821 OK4982 18011700 70503042603
description	heating element 1600W 400V heating circuits 1 L 610mm W 180mm tube ø 6.5mm 2 hole fixing thread 1/4" dry heating element bain marie mounting distance 173mm		
For models:	CE128-106, CE158-133.3.HV, CE158-244.3, CE158-246.3, CK248-209, D1ABBB, CK248-211.D1ABBB, HCE128-100, HCE128-104, HCE158-252W.3, HCE158-253.3, HLE129-100, HLE129-103, HLE129-104W, HLE159-252W.3.6, HLE159-328.3.HV, HLE159-351W.3.HV, HLE249-200.3, HLE249-208.3, HLE259-088.3.HV, HLE259-089.3.HV, HLE259-384W.3, LE129-101, LE159-261.3, LE159-281.3.6, LE159-318.3.HV, LE159-322.3.HV, LE159-330.3.HV, LE159-337.3.HV, LE159-344.3.MS92, LE159-347.3.HV, LE249-199.3, LE249-203.3, LE249-207.3, LE249-211.3, LE249-215.3, LE249-219.3, LE249-223.3, LE249-232.3, LE249-238.3, LE259-081.3.HV, LE259-082.3.HV, LE259-083.3.HV, LE259-094.3.HV, LE259-099.3.HV, LE259-382.3, LK259-707.D1ACCB, LK259-708.D1ACCB, CK248-205.D1ABBB, CK248-207.D1ABBB, LK159-707.D1BC...(Other models you can see in the webshop)		

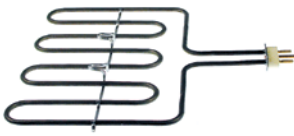
			
1			
GEV No.	418247	Ref. No.	OK9753
description	heating element 2000W 220V L 600mm W 450mm L1 55mm L2 545mm W1 390mm W2 30mm flange length 70mm flange width 15mm hole distance 56mm hole ø 6mm tube ø 6.5mm connection length 30mm connection male faston 6.3mm heating circuits 1 rectangular flange dry heating element oven		

			
1			
GEV No.	418081	Ref. No.	054326 3570041016 3570060016
description	heating element 2000W 230V L 314mm W 290mm L1 11mm L2 213mm W1 126mm W2 33mm connection plug-in connection heating circuits 1 tube ø 6.5mm plug-in connection dry heating element		
For models:	FCF/E4-OLD, FCF/E4D, FCFE4PH, FCF/E4OLD3, FCF/E4OLD4, FCF/E4OLD2, FCF/E4OLD1, FCF/E4D		
accessories for	418081		
	GEV No.	550404	Ref. No. —
	power socket I-II phase 240V max. 16A countries I with screw connection for heating element		
	GEV No.	550405	Ref. No. —
	power socket male faston 6.3mm for heating element 2-pole + earthing		

			
1			
GEV No.	417340	Ref. No.	214613
description	heating element 2000W 400V L 430mm W 150mm L1 50mm L2 380mm W1 60mm W2 30mm windings 3 connection plug-in connection heating circuits 1 tube ø 6.3mm dry heating element hole distance 56mm flange length 70mm flange width 22mm hole ø 3mm		

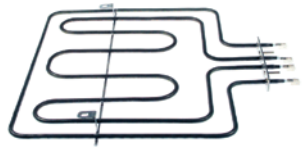
			
1			
GEV No.	418082	Ref. No.	005205 3570337018 3581907668
description	heating element 2550W 230V heating circuits 2 L 333mm W 347mm L1 48mm L2 285mm W1 120mm W2 107mm flange length 120mm flange width 25mm bridge length 368mm hole ø M4mm tube ø 6.3mm connection male faston 6.3mm rectangular flange dry heating element hot air		
For models:	FCF/E4, FCF/E4-3KW, JCF/E4, JCF/E4, ECF/E4, ECF/E4-3KW, ACF/E4, ACF/E4-3KW, NCF/E4, ZCF/E4, ZCF/E4		

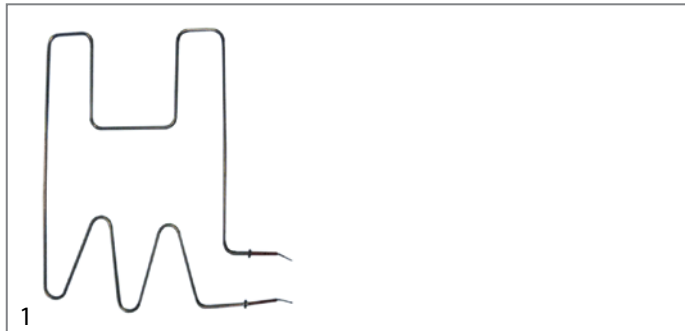

GEV No.	415356	Ref. No.	0G4548 0G4549 0G4550 0H9756 0K4789 0K4790 0K4791 0K4863 0K6349 0K7284 0K7285 0K7294 0K7295 0K8155 0KD888 0KG803 0KG804 0KG805 0KT777 0KV480 0T5490 18001816 18001816K 18001820 18001825 18002887 18002887K 6120434704 72179703 72179704 72179705 72179705K 72310505
description	heating element 2750W 400V heating circuits 1 L 538mm W 618mm L1 58mm L2 480mm W1 523mm W2 95mm mounting distance 86.5mm tube ø 8.5mm connection M4 dry heating element		
For models:	BE1-TA.3, BE1-W.3, BE1-WS-M.3, BE2-A-C.3, BE2-A-M.3, BE2-WS-C.3, BE2-WS-M.3, BE3-C.3, BE3-M.3, CE128-106, CE158-133.3.HV, CE158-244.3, CE158-246.3, CK248-209.D1ABBB, CK248-211.D1ABBB, HCE128-100, HCE128-104, HCE158-252W.3, HCE158-253.3, HLE129-100, HLE129-103, HLE129-104W, HLE159-252W.3.6, HLE159-328.3.HV, HLE159-351W.3.HV, HLE249-200.3, HLE249-208.3, HLE259-088.3.HV, HLE259-089.3.HV, HLE259-384W.3, LE129-101, LE159-261.3, LE159-281.3.6, LE159-318.3.HV, LE159-322.3.HV, LE159-330.3.HV, LE159-337.3.HV, LE159-344.3.MS92, LE159-347.3.HV, LE249-199.3, LE249-203.3, LE249-207.3, LE249-211.3, LE249-215.3, LE249-219.3, LE249-223.3, LE249-232.3, LE249-238.3, LE259-081.3.HV, LE259-082.3.HV...(Other models you can see in the webshop)		

GEV No.	415378	Ref. No.	059237 727999
description	heating element 950W 230V L 550mm W 63mm flange length 90mm flange width 25mm tube ø 8.5mm connection length 64mm heating circuits 1 hole ø 6mm connection male faston 6.3mm rectangular flange dry heating element oven		
For models:	HC/E400, HC/E800, HCF/E800, HCF/GE810, HC/E410, HC/E810, HCF/E810, HFS/E800, ZC/E400, ZC/E800, ZCF/E800, ZCF/GE810, ZC/E410, ZC/E810, ZCF/E810, ZFS/E800, AC/E400, AC/E800, ACF/E800, ACF/GE810, OCF/E800, AFS/E800, HC/E400, HC/E800, ECF/E800, ECF/G-E810		

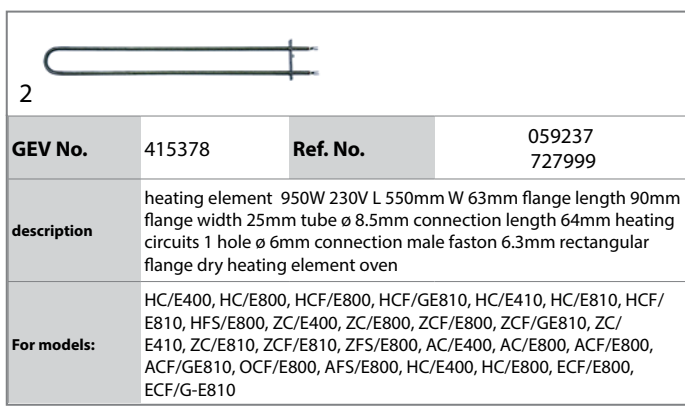

heating elements for bain maries

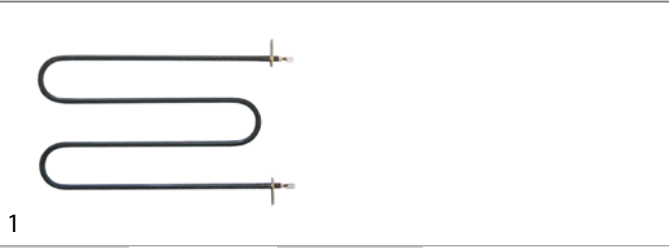

GEV No.	415293	Ref. No.	00269 004910 0K3512
description	heating element 1300W 230V heating circuits 1 L 330mm W 184mm tube ø 8.5mm lug length 40mm lug width 18mm connection male faston 6.3mm hole ø 5mm dry heating element bracket mounting		
For models:	SME350, SME700, SME350, SME700, BM35E6U		



GEV No.	415565	Ref. No.	0K9905
description	heating element 1500W 230V heating circuits 1 L 350mm W 180mm hole distance 22mm connection male faston 6.3mm tube ø 8.5mm compression flange immersion heater flange ø 32mm H 20mm mounting ø 32mm mounting thread M5		
spare parts for	415565		
	GEV No.	510364	Ref. No. —
	gasket Lmm Wmm ø 36mm for heating element thickness 3mm with 4 screw holes		
accessories for	415565		
	GEV No.	510365	Ref. No. —
	counterflange ø 36mm Lmm Wmm		



GEV No.	415051	Ref. No.	0H6163 2422251010
description	heating element 1500W 230V heating circuits 1 L 390mm W 36mm connection male faston 6.3mm tube ø 6.5mm 2 hole fixing thread M10x1 immersion heater mounting distance 30mm		
accessories for	415051		
	GEV No.	510893	Ref. No. —
	O-ring EPDM thickness 2.62mm ID ø 9.92mm Qty 1 pcs		
	GEV No.	521129	Ref. No. —
	nut thread M10 H 6mm SS WS 17 Qty 1 pcs DIN/ISO DIN 439		

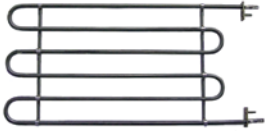

1

GEV No.	415596	Ref. No.	0G2290
description	heating element 1500W 230V heating circuits 1 L 395mm W 198mm tube ø 6.5mm lug length 31mm lug width 16mm connection length 30mm connection male faston 6.3mm dry heating element bracket mounting hole distance 160mm mounting thread M4		
For models:	JFM/G400, 7720-3/90.WB.GN1/1., 7520-3/85.WB.GN1/1., 7721-3/85.WB.GN2/1, 7520-3/90.WB.GN1/1., 7720-3/85.WB.GN1/1., 7521-3/85., 7521-3/90.WB.GN2/1., 7721-3/90.WB.GN2/1., 7521-3/85.WB.GN2/1.W, PFM/G400, 7520-3, 7521-3, 7720-3, 7721-3, 9020-3, 9220-3-0, 9220-3-8		



1

GEV No.	415353	Ref. No.	050309 050933 050934 053553 053558 0K2931
description	heating element 1500W 230V heating circuits 1 L 395mm W 205mm H 25mm L1 50mm L2 345mm connection M4 connection distance 198mm tube ø 8.5mm connection length 20mm dry heating element		
For models:	BB/E1, MM/E350, MM/E700, MM/E350UK, MM/E700UK, MM/E350D, MM/E700D, RB/E1, RB/E2, RBV/E2, XB/E1, XB/E2, XBV/E2, JB/E1, JB/E2, JBV/E2, MB/E1, MB/E2, MBV/E2, 7BME03T, 7BME07T, RM/E350UK, RM/E700UK, T35EBM, T70EBM, XM/E350UK, XM/E700UK, CM/E700, PB/E1, PB/E2, PBV/E2, PB/E2E5, OB/E1, OB/E2, TB/E1, TB/E2, TBV/E2, TB/E2E5, RME300, PRM/E300, M/E300UK, RM/E700, PRM/E700, RM/E700U, RMV/E300, PRMV/E300, RMV/E300UK, RMV/E700, PRMV/E700, RMV/E700...(Other models you can see in the webshop)		



1

GEV No.	415499	Ref. No.	0H6178
description	heating element 1500W 230V heating circuits 1 L 437mm W 227mm L1 37mm L2 400mm W1 147mm W2 80mm connection male faston 6.3mm connection distance 140mm tube ø 6.5mm dry heating element		









1

GEV No.	415350	Ref. No.	0H9821 0K4982 18011700 70503042603
description	heating element 1600W 400V heating circuits 1 L 610mm W 180mm tube ø 6.5mm 2 hole fixing thread 1/4" dry heating element bain marie mounting distance 173mm		
For models:	CE128-106, CE158-133.3.HV, CE158-244.3, CE158-246.3, CK248-209, D1ABBB, CK248-211.D1ABBB, HCE128-100, HCE128-104, HCE158-252W.3, HCE158-253.3, HLE129-100, HLE129-103, HLE129-104W, HLE159-252W.3.6, HLE159-328.3.HV, HLE159-351W.3.HV, HLE249-200.3, HLE249-208.3, HLE259-088.3.HV, HLE259-089.3.HV, HLE259-384W.3, LE129-101, LE159-261.3, LE159-281.3.6, LE159-318.3.HV, LE159-322.3.HV, LE159-330.3.HV, LE159-337.3.HV, LE159-344.3.MS92, LE159-347.3.HV, LE249-199.3, LE249-203.3, LE249-207.3, LE249-211.3, LE249-215.3, LE249-219.3, LE249-223.3, LE249-232.3, LE249-238.3, LE259-081.3.HV, LE259-082.3.HV, LE259-083.3.HV, LE259-094.3.HV, LE259-099.3.HV, LE259-382.3, LK259-707.D1ACCB, LK259-708.D1ACCB, CK248-205.D1ABBB, CK248-207.D1ABBB, LK159-707.D1BC...(Other models you can see in the webshop)		







1



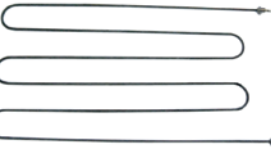

GEV No.	415212	Ref. No.	0H6201 214678 3027400107	
description	heating element 2000W 400V heating circuits 1 L 320mm W 96mm connection M4 tube ø 8.5mm flange with thread thread 1" immersion heater L1 75mm L2 245mm H1 24mm H 40mm thermostat sleeves ø 5mm number of thermostat sleeves 1 length thermostat sleeves 133mm thermostat sleeve clinging			
accessories for	415212			
	GEV No.	510404	Ref. No.	0E2240 0H2578 0H2612 0K6137 0K8703 0KG502 3427TJ1,5
	flat gasket fibre ED ø 44mm ID ø 34mm thickness 2mm Qty 1 pcs			
	GEV No.	510422	Ref. No.	—
	gasket copper ED ø 37.7mm ID ø 32.5mm thickness 2.7mm for thread 1"			
	GEV No.	520233	Ref. No.	—
	nut thread 1" H 6mm brass WS 47 Qty 1 pcs			
	GEV No.	521103	Ref. No.	—
	nut thread M4 H 3mm WS 7 brass Qty 20 pcs			
	GEV No.	521104	Ref. No.	—
	washer ID ø 4.3mm ED ø 8mm thickness 0.5mm brass Qty 20 pcs for thread M4			
	GEV No.	560111	Ref. No.	—
	plain washer ID ø 4.3mm ED ø 9mm thickness 0.8mm SS Qty 20 pcs DIN 125A for thread M4			
	GEV No.	560131	Ref. No.	—
	hexagonal nut thread M4 H 3.2mm WS 7 SS DIN/ISO DIN 934 / ISO 4032/8673 Qty 20 pcs			





 <p>1</p>			
GEV No.	415074	Ref. No.	051998 051999
description	heating element 2300W 230V heating circuits 1 L 641mm W 180mm tube ø 8.5mm lug length 40mm lug width 18mm mounting thread M5 connection length 50mm connection male faston 6.3mm dry heating element rectangular flange		
For models:	KB/E1, KB/E2, HM/E400, HM/E800, QB/E1, QB/E2, ZM/E400, ZM/E800, WB/E1, WB/E2, AM/E400, AM/E800, OM/E800, HMS/E400, HMS/E800, HMA/E800, HMS/E400, HMS/E800, HMA/E800, HM/E400T, HM/E800T, ZHMA/E400, ZHMA/801, ZHMA/E800, ZHMA/E400, ZHM/E800T		

 <p>1</p>			
GEV No.	415624	Ref. No.	0G1843 0K4984 18011702 70503017503
description	heating element 2400W 400V heating circuits 1 L 605mm W 380mm connection male faston 6.3mm tube ø 6.5mm 2 hole fixing thread M14x1.5 dry heating element bain marie Hmm mounting distance 374mm		
For models:	CE128-106, CE158-133.3.HV, CE158-244.3, CE158-246.3, CK248-209, D1ABBB, CK248-211.D1ABBB, HCE128-100, HCE128-104, HCE158-252W.3, HCE158-253.3, HLE129-100, HLE129-103, HLE129-104W, HLE159-252W.3.6, HLE159-328.3.HV, HLE159-351W.3.HV, HLE249-200.3, HLE249-208.3, HLE259-088.3.HV, HLE259-089.3.HV, HLE259-384W.3, LE129-101, LE159-261.3, LE159-281.3.6, LE159-318.3.HV, LE159-322.3.HV, LE159-330.3.HV, LE159-337.3.HV, LE159-344.3.MS92, LE159-347.3.HV, LE249-199.3, LE249-203.3, LE249-207.3, LE249-211.3, LE249-215.3, LE249-219.3, LE249-223.3, LE249-232.3, LE249-238.3, LE259-081.3.HV, LE259-082.3.HV, LE259-083.3.HV, LE259-094.3.HV, LE259-099.3.HV, LE259-382.3, LK259-707.D1ACCB, LK259-708.D1ACCB, CK248-205.D1ABBB, CK248-207.D1ABBB, LK159-707.D1BC...(Other models you can see in the webshop)		

 <p>1</p>			
GEV No.	415908	Ref. No.	0G5201 0K0570 3010500107 6891280189
description	heating element 2500W 230V heating circuits 1 L 385mm W 96mm connection M4 tube ø 8.5mm flange with thread thread 1" immersion heater L1 75mm L2 310mm H1 10mm H 40mm thermostat sleeves ø 5mm number of thermostat sleeves 1 length thermostat sleeves 133mm thermostat sleeve clinging		
accessories for	415908		
	GEV No.	510404	Ref. No.
			0E2240 0H2578 0H2612 0K6137 0K8703 0KG502 3427TJ1,5
	flat gasket fibre ED ø 44mm ID ø 34mm thickness 2mm Qty 1 pcs		
	GEV No.	510422	Ref. No.
			—
	gasket copper ED ø 37.7mm ID ø 32.5mm thickness 2.7mm for thread 1"		
	GEV No.	520233	Ref. No.
			—
	nut thread 1" H 6mm brass WS 47 Qty 1 pcs		

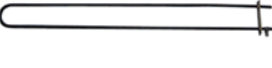
 <p>1</p>			
GEV No.	415481	Ref. No.	0K0566 3021100107
description	heating element 2500W 400V heating circuits 1 L 385mm W 96mm connection M4 flange with thread thread 1" immersion heater L1 75mm L2 310mm H1 20mm H 40mm thermostat sleeves ø 5mm number of thermostat sleeves 1 length thermostat sleeves 133mm thermostat sleeve clinging		
accessories for	415481		
	GEV No.	510404	Ref. No.
			0E2240 0H2578 0H2612 0K6137 0K8703 0KG502 3427TJ1,5
	flat gasket fibre ED ø 44mm ID ø 34mm thickness 2mm Qty 1 pcs		
	GEV No.	510422	Ref. No.
			—
	gasket copper ED ø 37.7mm ID ø 32.5mm thickness 2.7mm for thread 1"		
	GEV No.	520233	Ref. No.
			—
	nut thread 1" H 6mm brass WS 47 Qty 1 pcs		

 <p>1</p>			
GEV No.	415383	Ref. No.	052416
description	heating element 300W 230V heating circuits 1 L 532mm W 54mm flange length 72mm flange width 20mm connection length 45mm connection M5 tube ø 8.5mm rectangular flange hole ø 5mm dry heating element		
For models:	HMA/E800		

 <p>1</p>			
GEV No.	415096	Ref. No.	0A2197
description	heating element 550W 230V heating circuits 1 L 438mm W 44mm flange length 60mm flange width 40mm connection length 38mm connection male faston 6.3mm tube ø 6.3mm rectangular flange hole ø 6mm dry heating element		





 <p>1</p>			
GEV No.	415650	Ref. No.	0K0593
description	heating element 6000W 230V heating circuits 3 L 255mm W 250mm connection length 43mm connection M4 flange with thread thread 1¼" immersion heater H1 13mm H 25mm		
spare parts for	415650		
	GEV No.	510405	Ref. No.
			—
	flat gasket fibre ED ø 56mm ID ø 42mm thickness 2mm for thread 1¼" Qty 1 pcs		

Table continues overleaf





accessories for	415650		
	GEV No.	520232	Ref. No.
			—
	nut thread 1¼" H 5mm nickel-plated brass WS 47 Qty 1 pcs		





	1		
GEV No.	419099	Ref. No.	050534
description	heating element 700W 240V heating circuits 1 L 320mm W 140mm flange length 175mm flange width 20mm hole distance 160mm connection length 40mm connection M5 tube ø 8.5mm rectangular flange hole ø 6mm dry heating element bain marie		
For models:	DCBE21, DCB/E21U, DCBE41, DCB/E41U, DCBE42, DCB/E42U		

	1		
GEV No.	415097	Ref. No.	0A2137
description	heating element 800W 230V heating circuits 1 L 630mm W 44mm flange length 60mm flange width 40mm connection length 32mm connection male faston 6.3mm tube ø 6.3mm rectangular flange hole ø 6mm dry heating element		

heating elements for frying pans

	1		
GEV No.	420137	Ref. No.	0K6869
description	heating element 1000W 380V heating circuits 1 L 395mm W 50mm connection length 9mm connection M4 tube ø 8.3mm 2 hole fixing thread M14x1.5 dry heating element W1 6mm W2 44mm H 27mm mounting distance 36mm		

	1		
	Image not available		
GEV No.	416974	Ref. No.	0H6156 3199800005
description	heating element 1100W 230V		
For models:	7530-3, 7531-3, 7730-3, 7731-3, 9030-3, 9031-3, 9032-3, 9230-3-0, 9230-3-8, 9231-3-0, 9231-3-8, 9232-3-0, 9232-3-8		

	1		
GEV No.	415292	Ref. No.	004932
description	heating element 1100W 230V L 205mm W 110mm connection M4 tube ø 6.3mm 2 hole fixing thread 1/4" dry heating element H 54mm mounting distance 220mm		
For models:	SBRE350, SBRE350		
accessories for	415292		
	GEV No.	361182	Ref. No.
			—
	nut thread 1/4" H 5mm nickel-plated brass WS 17 Qty 1 pcs		
	GEV No.	510417	Ref. No.
			0K6103 0K6660 0K8701
	flat gasket fibre ED ø 20mm ID ø 14mm thickness 2mm Qty 1 pcs		
	GEV No.	520228	Ref. No.
			—
	tooth lock washer ID ø 15.3mm ED ø 24mm steel Qty 1 pcs for thread M14		
	GEV No.	550262	Ref. No.
			—
	flat gasket copper ED ø 20mm ID ø 14mm thickness 2mm		

	1		
GEV No.	420123	Ref. No.	051358
description	heating element 1300W 240V heating circuits 1 L 535mm W 82mm connection cable tube ø 14mm cable length 1000mm dry heating element for tilting bratt pan L1 55mm W1 11mm W2 60mm H 100mm Qty 1 connection distance 50mm		
For models:	HBR/E805UK		

	1		
GEV No.	415184	Ref. No.	059401
description	heating element 2000W 230V heating circuits 1 L 570mm W 86mm connection length 24mm connection M5 tube ø 8.5mm dry heating element griddle H 87mm		
For models:	HR/E400D, HR/E800D, HR/E410, HR/E811, HR/E420, HR/E820, HR/E821, HR/E400, HR/E800, HR/E403DW, HR/E803DW, HBR/E800, HBR/E805, HBR/E801, HBR/E806, HBR/E810, HBR/E815, HBR/E811, HBR/E816, HBR/E800UK, HBR/E800, HBR/E805, HBR/E810, HBR/E815, HBR/E811, HBR/E816, HBR/E800UK, HTR/E410, HTR/E810, ZR/E400D, ZR/E800D, ZR/E410, ZR/E811, ZR/E420, ZR/E820, ZR/E821, ZR/E400, ZR/E800, ZR/E403DW, ZR/E803DW, HBR/E800, ZBR/E805, ZR/G413, BR/E806, ZBR/E810, ZBR/E815, ZBR/E811, ZBR/E816, ZBR/E800UK, ZBR/E800...(Other models you can see in the webshop)		

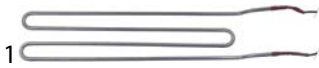

			
GEV No.	420139	Ref. No.	OK4747
description	heating element 2000W 230V heating circuits 1 L 585mm W 105mm connection cable tube ø 8.3mm cable length 1050mm dry heating element L1 55mm L2 20mm L3 510mm H 49mm connection distance 97mm		
For models:	FET060E.MS35P.F88, FET060E.MS35P.W84, FET060E.MS35S.F88, FET080E.MS35P.F88, FET080E.MS35P.W84, FET080E.MS35S.W84, FET100E.MS35P.F88, FET100E.MS35P.W84, FET100E.MS35S.F97, FET060E.MS35S.W84, FET080E.MS35S.F88, FET100E.MS35S.F88, FET100E.MS35S.W84, APABPETOOC, APABPGTOOC, APACPITOOC, APACPGTOOC, APABPIOOOC, APABPITOOC, APACPIOOOC, APACPI-TOOC, FET060E.MS35S.F98, FET060E.MS35S.W94, FET080E.MS35S.F98, FET080E.MS35S.W94, FET100E.MS35S.F98, FET100E.MS35S.W94, FET060E.MS35P.F98, FET060E.MS35P.W94, FET080E.MS35P.F98, FET100E.MS35P.F98, FET100E.MS35P.W94, FET060E.MS35S.F97, FET080E.MS35S.F97, FET060E.MS35P.F97, FET060E.MS35P.H97, FET080E.MS35P.F97, FET080E.MS35P.H97, FET100E.MS35P.F97, FET100E.MS35P.H97, APABPGOOOC, APAC-FOOOC		

			
GEV No.	420129	Ref. No.	OK4748 18001124
description	heating element 2500W 230V heating circuits 1 L 580mm W 115mm connection cable tube ø 8.3mm cable length 1000mm dry heating element for tilting bratt pan L1 55mm L2 20mm L3 505mm H 48mm connection distance 107mm		
For models:	FET060E.MS35P.F88, FET060E.MS35P.W84, FET060E.MS35S.F88, FET080E.MS35P.F88, FET080E.MS35P.W84, FET080E.MS35S.W84, FET100E.MS35P.F88, FET100E.MS35P.W84, FET100E.MS35S.F97, FET060E.MS35S.W84, FET080E.MS35S.F88, FET100E.MS35S.F88, FET100E.MS35S.W84, FET060E.MS35S.F98, FET060E.MS35S.W94, FET080E.MS35S.F98, FET080E.MS35S.W94, FET100E.MS35S.F98, FET100E.MS35S.W94, FET060E.MS35P.F98, FET060E.MS35P.W94, FET080E.MS35P.F98, FET080E.MS35P.W94, FET100E.MS35P.F98, FET100E.MS35P.W94, FET060E.MS35S.F97, FET080E.MS35S.F97, FET060E.MS35P.F97, FET060E.MS35P.H97, FET080E.MS35P.F97, FET080E.MS35P.H97, FET100E.MS35P.F97, FET100E.MS35P.H97		

heating elements for fryers

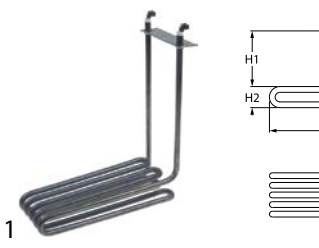
			
GEV No.	420124	Ref. No.	004628
description	heating element 2900W 230V heating circuits 1 L 233mm W 77mm H 245mm rectangular flange connection male faston 6.3mm horizontal immersion heater H1 208mm H2 37mm hole distance 68mm hole ø 6mm flange length 84mm flange width 31mm tube ø 8.5mm connection length 27mm		
For models:	RFR/E1S12, RFR/E2D12, XFR/E1S12, XFR/E2D12, JFR/E1S12, JFR/E2D12, MFR/E1S12, MFR/E2D12		

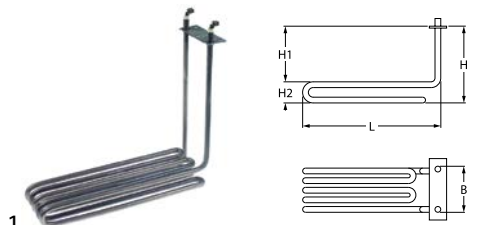
			
GEV No.	416996	Ref. No.	004767
description	heating element 2900W 230V heating circuits 1 L 285mm W 76mm H 245mm rectangular flange connection male faston 6.3mm immersion heater H1 208mm H2 37mm hole distance 68mm hole ø 6.2mm flange length 84mm flange width 31mm tube ø 8.5mm		
For models:	RFR/E2S40, XFR/E2S40, JFR/E2S40, MFR/E2S40		

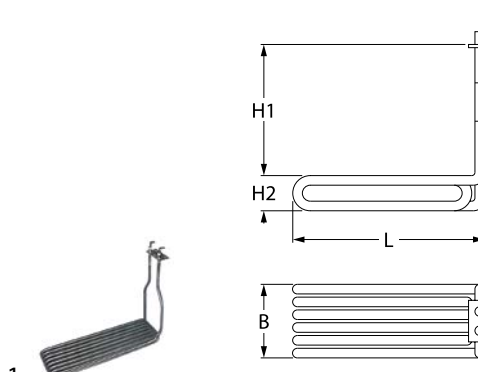
			
GEV No.	415377	Ref. No.	006698 059563 728047
description	heating element 5500W 230V heating circuits 1 L 320mm W 86mm H 248mm rectangular flange connection M5 immersion heater W1 19mm W2 48mm H1 213mm H2 38mm hole distance 40mm hole ø 6mm flange length 60mm flange width 30mm tube ø 8.5mm connection length 26mm		
For models:	KFR/E1C, KFR/E2D, KFR/E1CE5, KFR/E2DE5, HFR/E410, HFR/E810, HFR/E411, HFR/E412, HFR/E418, HFR/E818, ZFR/E410, ZFR/E810, ZFR/E411, ZFR/E412, ZFR/E418, ZFR/E818, AFR/E410, AFR/E810, AFR/E411, AFR/E412, OFR/E810		

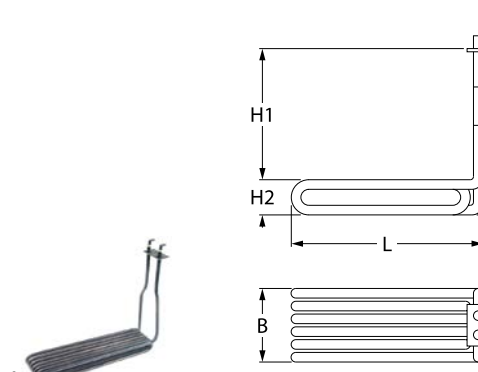
			
GEV No.	418002	Ref. No.	006571
description	heating element 5500W 400V heating circuits 1 L 320mm W 86mm H 248mm rectangular flange connection M5 immersion heater W1 19mm W2 48mm H1 213mm H2 35mm hole distance 40mm hole ø 6mm flange length 60mm flange width 30mm		
For models:	KFR/E1C, KFR/E2D, KFR/E1CE5, KFR/E2DE5, HFR/E431, HFR/E831, QFR/E1C, QFR/E2D, ZFR/E431, ZFR/E831, WFR/E1C, WFR/E2D, AFR/E431, AFR/E831		

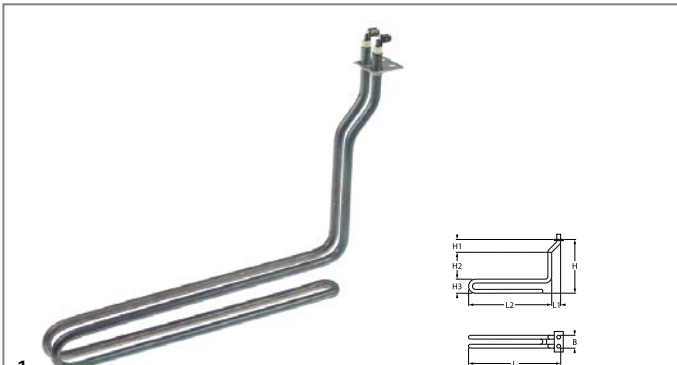

1

GEV No.	416993	Ref. No.	004752
description	heating element 1500W 230V heating circuits 1 L 320mm W 25mm H 215mm rectangular flange connection male faston 6.3mm immersion heater L1 30mm L2 290mm H1 62mm H2 115mm H3 38mm windings 2 hole distance 18mm hole \varnothing 6mm flange length 33mm flange width 33mm tube \varnothing 8.5mm		
For models:	RF/E1D05, XF/E1D05, JF/E1D05, MF/E1D05		



1

GEV No.	416994	Ref. No.	005964
description	heating element 2900W 230V heating circuits 1 L 310mm W 60mm H 195mm rectangular flange connection male faston 6.3mm immersion heater L1 5mm L2 305mm H1 30mm H2 125mm H3 40mm windings 4 hole distance 51mm hole \varnothing 6mm flange length 66mm flange width 31mm tube \varnothing 8.5mm		
For models:	BF/E1S12, RF/E1S12, RF/E2D12, RF/E1S12E5, RF/E2D12E5, XF/E1S12, XF/E2D12, JF/E1S12, JF/E2D12, MF/E1S12, MF/E2D12, MF/E1S12E5, MF/E2D12E5		



1

GEV No.	417631	Ref. No.	0C2616
description	heating element 2900W 230V heating circuits 1 L 270mm W 50mm H 235mm rectangular flange connection male faston 6.3mm immersion heater L1 10mm L2 260mm H1 27mm H2 170mm H3 38mm windings 4 hole distance 53mm hole \varnothing 6mm flange length 67mm flange width 32mm tube \varnothing 8.5mm		
For models:	PFR/E1S12, PFR/E2D12, PFRE2D12E5, OFR/E1S12, OFR/E2D12, TFR/E1S12, TFR/E2D12, TFRE2D12E5, TFRE1S12M0, TFRE2D12M0		

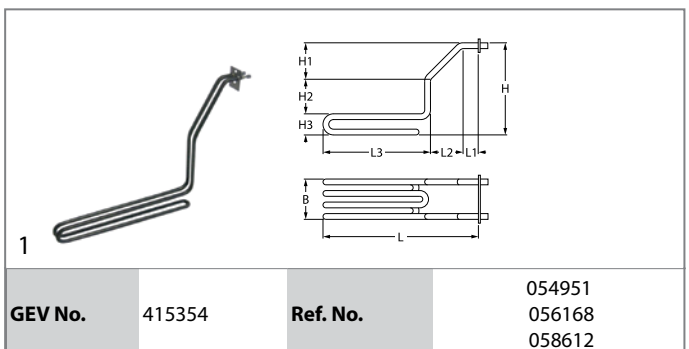

1

GEV No.	415354	Ref. No.	054951 056168 058612
description	heating element 1500W 230V heating circuits 1 L 375mm W 26mm H 275mm rectangular flange connection M4 fryer heaters L1 20mm L2 75mm L3 280mm H1 118mm H2 115mm H3 42mm hole distance 22mm hole \varnothing 6mm flange length 33mm flange width 41mm tube \varnothing 8.5mm		

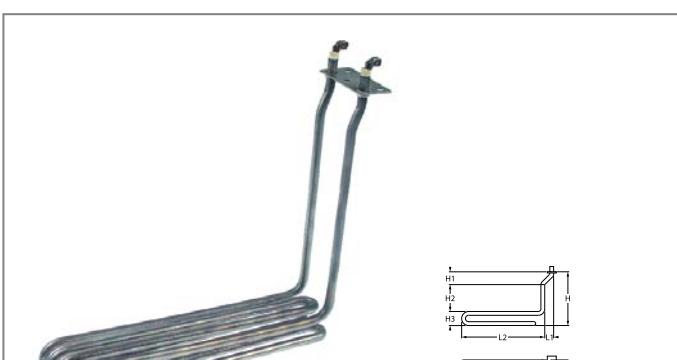

1

GEV No.	416995	Ref. No.	0A5565
description	heating element 2900W 230V heating circuits 1 L 270mm W 60mm H 248mm rectangular flange connection male faston 6.3mm immersion heater L1 8mm L2 262mm H1 30mm H2 178mm H3 39mm windings 4 hole distance 53mm hole \varnothing 6mm flange length 67mm flange width 32mm tube \varnothing 8.5mm		
For models:	RFR/E1S12, RFR/E2D12, XFR/E1S12, XFR/E2D12, MFR/E1S12, MFR/E2D12		

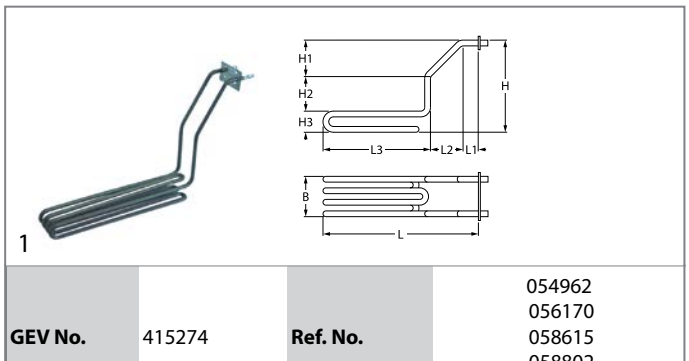

1

GEV No.	415274	Ref. No.	054962 056170 058615 058802 1GOL6D339001
description	heating element 3000W 230V heating circuits 1 L 400mm W 70mm H 270mm rectangular flange connection clamp immersion heater L1 20mm L2 65mm L3 315mm H1 120mm H2 110mm H3 40mm hole distance 34mm hole \varnothing 6.3mm flange length 67mm flange width 40mm tube \varnothing 8.5mm		
For models:	RFR/E305, RFR/E315		

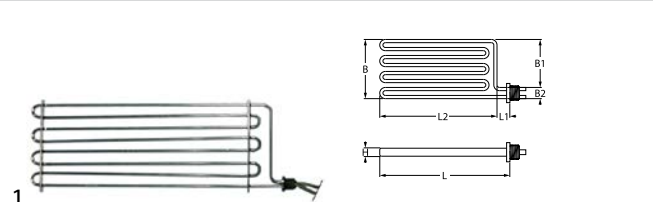
GEV No.	415371	Ref. No.	0H6194 OK0603 OK0622 1180100261 1488000261 214576 3067800161
description	heating element 8000W 230/400V heating circuits 3 mounting pos. left thread M26x1.5 L 555mm W 177mm H 27mm L1 20mm L2 535mm W1 160mm W2 15mm mounting ø 26mm tube ø 17x6mm cable length 600mm flange ø 33mm fryer 1 hole fixing connection length 12mm		

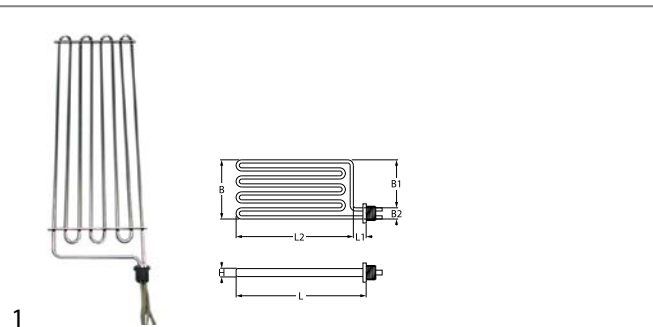

GEV No.	415370	Ref. No.	OK0621 1180100161
description	heating element 8000W 230/400V heating circuits 3 mounting pos. right thread M26x1.5 L 555mm W 177mm H 27mm L1 20mm L2 535mm W1 160mm W2 15mm mounting ø 26mm tube ø 17x6mm cable length 600mm flange ø 33mm 1 hole fixing connection length 12mm fryer		

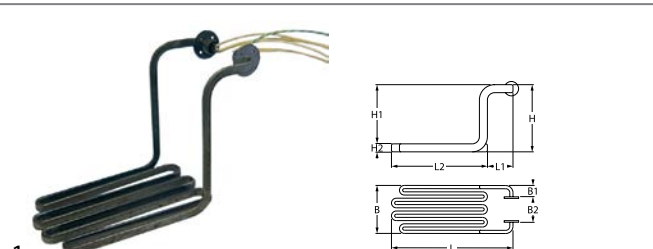

GEV No.	415684	Ref. No.	OK0583 30000851
description	heating element 5010W 400V heating circuits 3 L 384mm W 225mm H 245mm L1 84mm L2 300mm H1 227mm H2 18mm W1 31mm W2 148mm windings 4 cable length 860mm rotation flange		

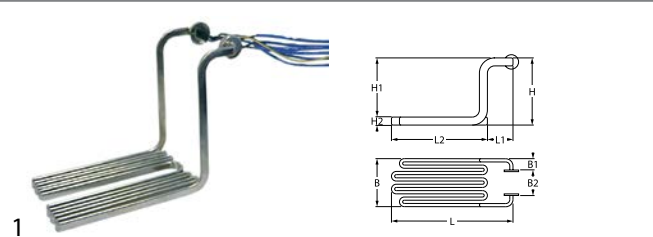



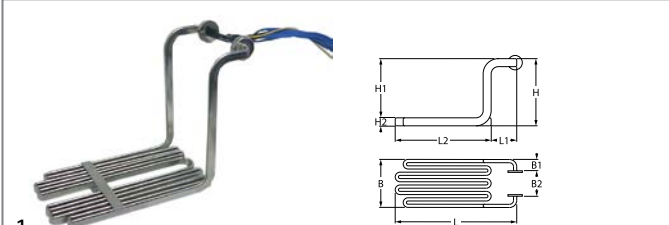

GEV No.	415490	Ref. No.	0H6192 1268700161
description	heating element 5100W 230/400V heating circuits 3 L 345mm W 168mm H 246mm L1 70mm L2 275mm H1 229mm H2 17mm W1 21mm W2 104mm windings 6 flange ø 39mm connection cable rotation flange immersion heater		

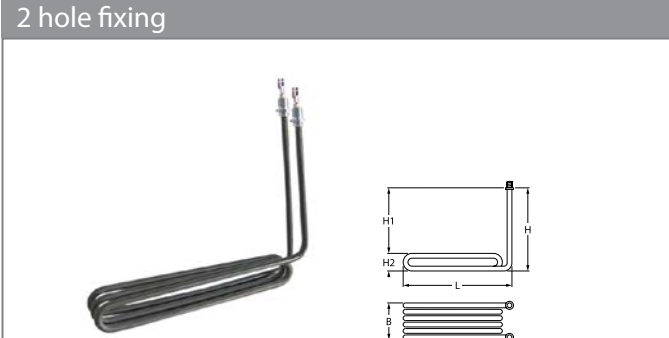

GEV No.	415611	Ref. No.	0H6203 1380100161
description	heating element 7200W 230/400V heating circuits 3 L 350mm W 168mm H 249mm L1 62mm L2 288mm H1 232mm H2 17mm W1 34mm W2 100mm windings 6 flange ø 42mm tube ø 17x6mm cable length 1730mm rotation flange immersion heater		

2 hole fixing



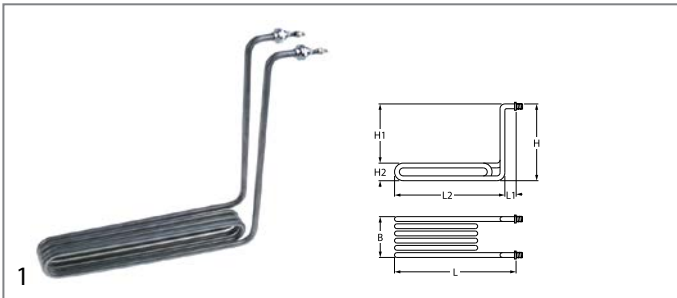

GEV No.	415291	Ref. No.	00282 004926 OK3515	
description	heating element 2000W 230V heating circuits 1 L 250mm W 45mm H 190mm H1 154mm H2 36mm thread 1/4" tube ø 8.5mm mounting distance 30mm windings 3 2 hole fixing connection male faston 6.3mm immersion heater			
For models:	SFRE700, SFRE350, SFRE700, SFRE351, SFRE701			
spare parts for	415291			
	GEV No.	510417	Ref. No.	OK6103 OK6660 OK8701
	flat gasket fibre ED ø 20mm ID ø 14mm thickness 2mm Qty 1 pcs			
accessories for	415291			
	GEV No.	361182	Ref. No.	—
	nut thread 1/4" H 5mm nickel-plated brass WS 17 Qty 1 pcs			
	GEV No.	520228	Ref. No.	—
	tooth lock washer ID ø 15.3mm ED ø 24mm steel Qty 1 pcs for thread M14			
	GEV No.	550262	Ref. No.	—
	flat gasket copper ED ø 20mm ID ø 14mm thickness 2mm			

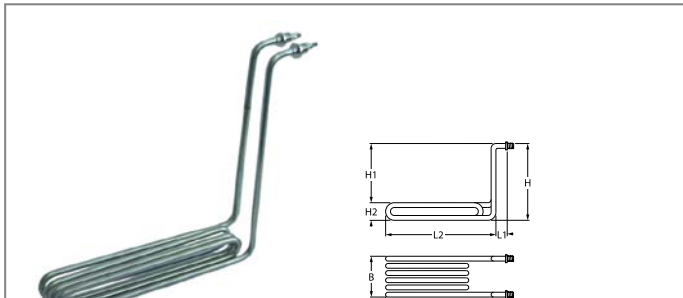

GEV No.	415472	Ref. No.	0H6147
description	heating element 2500W 230V heating circuits 1 L 300mm W 45mm H 270mm L1 33mm L2 267mm H1 232mm H2 39mm thread 1/4" mounting distance 35mm tube ø 8.5mm 2 hole fixing connection M4 connection length 36mm immersion heater windings 4		
spare parts for	415472		
	GEV No.	510417	Ref. No. 0K6103 0K6660 0K8701
	flat gasket fibre ED ø 20mm ID ø 14mm thickness 2mm Qty 1 pcs		
accessories for	415472		
	GEV No.	361182	Ref. No. —
	nut thread 1/4" H 5mm nickel-plated brass WS 17 Qty 1 pcs		
	GEV No.	520228	Ref. No. —
	tooth lock washer ID ø 15.3mm ED ø 24mm steel Qty 1 pcs for thread M14		
	GEV No.	521103	Ref. No. —
	nut thread M4 H 3mm WS 7 brass Qty 20 pcs		
	GEV No.	521104	Ref. No. —
	washer ID ø 4.3mm ED ø 8mm thickness 0.5mm brass Qty 20 pcs for thread M4		
	GEV No.	550262	Ref. No. —
	flat gasket copper ED ø 20mm ID ø 14mm thickness 2mm		
	GEV No.	560111	Ref. No. —
	plain washer ID ø 4.3mm ED ø 9mm thickness 0.8mm SS Qty 20 pcs DIN 125A for thread M4		
	GEV No.	560131	Ref. No. —
	hexagonal nut thread M4 H 3.2mm WS 7 SS DIN/ISO DIN 934 / ISO 4032/8673 Qty 20 pcs		



GEV No.	415498	Ref. No.	0H6148 0K0568 0K0569 214227 2626700303 30000287 415498
description	heating element 2500W 230V heating circuits 1 L 315mm W 40mm H 275mm L1 35mm L2 280mm H1 235mm H2 40mm thread M12x1 mounting distance 25mm tube ø 8.5mm 2 hole fixing connection M4 connection length 18mm fryer windings 4		
For models:	7536-3, 7537-3, 7538-3, 7736-3, 7737-3, 7738-3, 9050-3, 9052-3, 9250-3-0, 9250-3-8, 9252-3-0, 9252-3-8		
accessories for	415498		
	GEV No.	520229	Ref. No. —
	nut thread M12x1 H 4mm WS 16 zinc-coated steel Qty 1 pcs		
	GEV No.	521103	Ref. No. —
	nut thread M4 H 3mm WS 7 brass Qty 20 pcs		
	GEV No.	521104	Ref. No. —
	washer ID ø 4.3mm ED ø 8mm thickness 0.5mm brass Qty 20 pcs for thread M4		
	GEV No.	521131	Ref. No. —
	nut thread M12x1 H 3.5mm WS 17 SS Qty 1 pcs		
	GEV No.	528110	Ref. No. —
	O-ring EPDM thickness 2.62mm ID ø 12.37mm Qty 1 pcs		
	GEV No.	560111	Ref. No. —
	plain washer ID ø 4.3mm ED ø 9mm thickness 0.8mm SS Qty 20 pcs DIN 125A for thread M4		
	GEV No.	560131	Ref. No. —
	hexagonal nut thread M4 H 3.2mm WS 7 SS DIN/ISO DIN 934 / ISO 4032/8673 Qty 20 pcs		



GEV No.	415667	Ref. No.	OK0526 2713300203
description	heating element 4220W 230V heating circuits 1 L 507mm W 45mm H 345mm L1 17mm L2 490mm H1 308mm H2 37mm thread M12x1 mounting distance 37mm tube ø 8.5mm 2 hole fixing connection M4 fryer windings 5		
For models:	7535-3/85., 7535-3/90.FRI.(N), 7735-3/85.FRI.(N), 7735-3/90.FRI.(N), 7535-3, 7735-3, 9055-3, 9255-3-0, 9255-3-8		
accessories for	415667		
	GEV No.	521103	Ref. No. —
	nut thread M4 H 3mm WS 7 brass Qty 20 pcs		
	GEV No.	521104	Ref. No. —
	washer ID ø 4.3mm ED ø 8mm thickness 0.5mm brass Qty 20 pcs for thread M4		
	GEV No.	560111	Ref. No. —
	plain washer ID ø 4.3mm ED ø 9mm thickness 0.8mm SS Qty 20 pcs DIN 125A for thread M4		
	GEV No.	560131	Ref. No. —
	hexagonal nut thread M4 H 3.2mm WS 7 SS DIN/ISO DIN 934 / ISO 4032/8673 Qty 20 pcs		

GEV No.	416997	Ref. No.	052326 052327
description	heating element 4000W 230V heating circuits 1 L 415mm W 95mm H 340mm 2 hole fixing connection M5 immersion heater L1 28mm L2 57mm L3 330mm H1 60mm H2 220mm H3 60mm tube ø 8.5mm thread 1/4"		
For models:	HFR/E420, HFR/E420UK, HFR/E840, HFR/E840, ZHFRE420, ZHFRE840		
accessories for	416997		
	GEV No.	361182	Ref. No. —
	nut thread 1/4" H 5mm nickel-plated brass WS 17 Qty 1 pcs		
	GEV No.	510417	Ref. No. OK6103 OK6660 OK8701
	flat gasket fibre ED ø 20mm ID ø 14mm thickness 2mm Qty 1 pcs		
	GEV No.	520228	Ref. No. —
	tooth lock washer ID ø 15.3mm ED ø 24mm steel Qty 1 pcs for thread M14		
	GEV No.	550262	Ref. No. —
	flat gasket copper ED ø 20mm ID ø 14mm thickness 2mm		
	GEV No.	560112	Ref. No. 0E1119
	plain washer ID ø 5.3mm ED ø 10mm thickness 1mm SS Qty 20 pcs DIN 125A for thread M5		
	GEV No.	560132	Ref. No. —
	hexagonal nut thread M5 H 4mm WS 8 SS DIN/ISO DIN 934 / ISO 4032/8673 Qty 20 pcs		

GEV No.	415470	Ref. No.	0H6180 0H6181
description	heating element 2000W 230V heating circuits 1 L 320mm W 36mm H 265mm L1 36mm L2 280mm H1 215mm H2 40mm thread M12x1 tube ø 8.5mm 2 hole fixing connection M4 fryer windings 3		
accessories for	415470		
	GEV No.	521103	Ref. No. —
	nut thread M4 H 3mm WS 7 brass Qty 20 pcs		
	GEV No.	521104	Ref. No. —
	washer ID ø 4.3mm ED ø 8mm thickness 0.5mm brass Qty 20 pcs for thread M4		
	GEV No.	560111	Ref. No. —
	plain washer ID ø 4.3mm ED ø 9mm thickness 0.8mm SS Qty 20 pcs DIN 125A for thread M4		
	GEV No.	560131	Ref. No. —
	hexagonal nut thread M4 H 3.2mm WS 7 SS DIN/ISO DIN 934 / ISO 4032/8673 Qty 20 pcs		

GEV No.	418340	Ref. No.	OK5928 OKX062
description	heating element 11000W 400V heating circuits 3 L 285mm W 150mm H 255mm H1 225mm H2 30mm special fixing connection cable tube ø 8.5mm immersion heater fryer W1 40mm W2 70mm		
For models:	HLE159-159W.3, HLE159-160W.3, SLE259-100.4.R, SLE159-171.4, SLE259-100.4.L, LE159-160.3, LE159-159.3, HLE159-160.3, HLE159-159.3, CE158-159.3, HCE158-159.3		

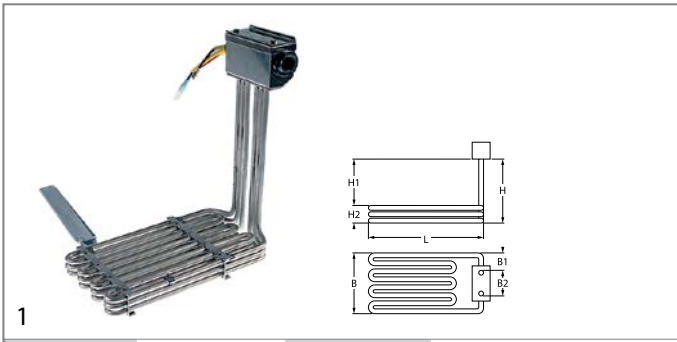

GEV No.	418358	Ref. No.	OKV048 OKZ070
description	heating element 7200W 400V heating circuits 3 L 285mm W 150mm H 255mm H1 225mm H2 30mm cable length 110mm special fixing tube ø 8mm immersion heater W1 40mm W2 70mm		

heating elements for griddles



GEV No.	415480	Ref. No.	0H6182
description	heating element 1000W 220V heating circuits 1 L 457mm W 40mm H 70mm tube ø 8.5mm W1 212mm W2 33mm cable length 270mm griddle connection distance 24mm dry heating element		



GEV No.	415380	Ref. No.	052919 052920
description	heating element 1000W 230V heating circuits 1 L 600mm W 54mm H 82mm tube ø 8.5mm connection M5 connection length 16mm connection distance 46mm dry heating element		
For models:	HRS/E401, HRS/E401UK, HRS/E411, HRS/E801, HRS/E801U, HRS/E811, HR/E401T, HR/E411, HR/E801T, HR/E811T, ZHRA/E401, ZHRA/E411, ZHRA/E801, ZHRA/E811, ZHR/E401T, ZHR/E411T, ZHR/E801, ZHR/E811T		



GEV No.	415482	Ref. No.	0H6155 0H6211 3005600105 415482
description	heating element 1100W 400V heating circuits 1 L 538mm W 45mm H 67mm tube ø 8.5mm W1 252mm W2 34mm cable length 265mm griddle connection distance 25mm dry heating element		
For models:	7731-3/85.GRPL.VCHR., 7531-3/85., 7531-3/90.GRPL.(N), 7530-3/85.GRIPL.(N), 7532-3/85.GRPL.GL-GR, 7530-3/90.GRIPL.(N), 7532-3/90.GRPL.GL-GR, 7730-3/85.GRIPL.(N), 7731-3/85.GRPL.(N), 7732-3/85.GRPL.GL-GR, 7730-3/90.GRIPL.(N), 7731-3/90.GRPL.(N), 7732-3/90.GRPL.GL-GR, 7531-3/85.GRPL.VCHR, 7532-3/85.GRPL.GL-GR, 7530-3, 7531-3, 7730-3, 7731-3, 9030-3, 9031-3, 9032-3, 9230-3-0, 9230-3-8, 9231-3-0, 9231-3-8, 9232-3-0, 9232-3-8		



GEV No.	415079	Ref. No.	053393 053614 OK2907
description	heating element 1250W 230V heating circuits 1 L 473mm W 52mm H 43mm tube ø 8.5mm griddle connection distance 44mm dry heating element		
For models:	MR/E350D, MR/E350UK, MR/E360, MR/E700D, MR/E700UK, MR/E710, MR/E720, MR/E715, MR/E725, MR/E350, MR/E700, MR/E720D, RR/E350D, RR/E350UK, 7FTEF3R, RR/E360UK, RR/E700D, RR/E700UK, RR/E710, RR/E710UK, 7FTEC7L, 7FTEF3L, 7FTEF7L, 7FTEC7M, XR/E350D, XR/E350UK, T36EFT, XR/E700D, XR/E700UK, T71EFT, T79EFT, T35EFT, T70EFT, CR/E720, RR/E300, RRE702, RR/E300UK, RR/E311, RR/E700, RR/E700UK, RR/E711, RRV/E300, RRV/E300, RRV/E311, RRV/E700, RRV/E700, RRV/E711, RR/E300, RR/E300, RR/E700...(Other models you can see in the webshop)		



GEV No.	416985	Ref. No.	004649
description	heating element 1250W 230V heating circuits 1 L 482mm W 54mm H 55mm tube ø 8.5mm connection male faston 6.3mm connection distance 46mm dry heating element		
For models:	RR/E1FL, RR/E1FR, RR/E2FL, RR/E2FM, RRV/E1FL, RRV/E1FR, RRV/E2FL, RRV/E2FM, XR/E1FL, XR/E1FR, XR/E2FL, XR/E2FM, XRV/E1FL, XRV/E1FR, XRV/E2FL, XRV/E2FM, JR/E1FL, JR/E1FR, JR/E2FL, JR/E2FM, JRV/E1FL, JRV/E1FR, JRV/E2FL, JRV/E2FM, MR/E1FL, MR/E1FR, MR/E2FL, MR/E2FM, MRV/E1FL, MRV/E1FR, MRV/E2FL, MRV/E2FM, DR/CCE, DR/CUK, DR/LCE, DR/LUK, ER/LUSA		



GEV No.	415290	Ref. No.	00286 004918 OK3518
description	heating element 1300W 230V heating circuits 1 L 473mm W 80mm H 55mm tube ø 6.5mm connection M4 griddle connection distance 75mm dry heating element		
For models:	SRE350, SRE360, SRE370, SRE700, SRE710, SRE720, SRE350, SRE360, SRE370, SRE700, SRE710, SRE720		



GEV No.	420133	Ref. No.	0U1489 SEL083
description	heating element 1400W 240V heating circuits 1 L 610mm W 40mm tube ø 8mm rectangular flange connection M4 flange length 52mm flange width 20mm hole ø 6.5mm connection length 64mm for grill dry heating element		

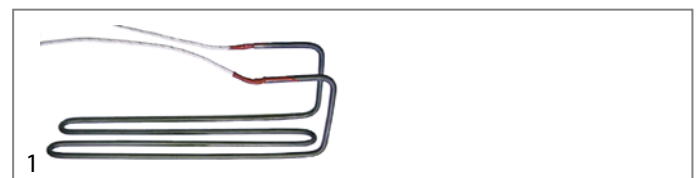

GEV No.	415099	Ref. No.	0A2208
description	heating element 1500W 220V heating circuits 1 L 380mm W 90mm H 124mm tube ø 8.5mm L1 80mm L2 300mm cable length 1000mm connection distance 68mm dry heating element		

GEV No.	415100	Ref. No.	0A2070
description	heating element 1500W 230V heating circuits 1 L 242mm W 155mm H 120mm tube ø 6.5mm L1 50mm L2 192mm cable length 1000mm dry heating element		



GEV No.	416986	Ref. No.	004671
description	heating element 1500W 230V heating circuits 1 L 484mm W 90mm H 50mm tube ø 8.5mm connection male faston 6.3mm griddle connection distance 82mm dry heating element		
For models:	RR/E1CL, RR/E2CL, RRV/E1CL, RRV/E2CL, RR/E2CM, XR/E1CL, XR/E2CL, XRV/E1CL, XRV/E2CL, JR/E1CL, JR/E2CL, JRV/E1CL, JRV/E2CL, MR/E1CL, MR/E2CL, MRV/E1CL, MRV/E2CL, MR/E2CM, PR/E1FL, PR/E1FR, PR/E1CL, PR/E2FL, PR/E2FM, PR/E2CL, PRV/E1FL, PRV/E1FR, PRV/E1CL, PRV/E2FL, PRV/E2FM, PRV/E2CL, PR/E2CM, PR/E1FLO, PR/E1FLE5, PR/E1FRE5, PR/E2FLE5, PR/E2CME5, PR/E2FME5, OR/E1FL, OR/E1FR, OR/E1CL, OR/E2FL, OR/E2FM, OR/E2CL, OR/E2CM, OR/E1FLO, TR/E1FL, TR/E1FR, TR/E1CL, TR/E2FL, TR/E2FM...(Other models you can see in the webshop)		



GEV No.	415075	Ref. No.	0K9222
description	heating element 2000W 220V heating circuits 1 L 573mm W 80mm H 70mm tube ø 9.2mm connection male faston 6.3mm connection length 21mm griddle dry heating element		



GEV No.	415382	Ref. No.	055998
description	heating element 2000W 230V heating circuits 1 L 595mm W 41mm H 40mm tube ø 6.3mm connection M5 connection distance 94mm dry heating element		
For models:	HRS/E802, HRS/E812, HRA/G802, HRA/E802, HR/E802, ZHRAE802CR, ZHRAE812CR, ZHR/E812, ZHR/E802T		



GEV No.	417742	Ref. No.	0G3793 0KK096 0T0055 18011707 70503032301
description	heating element 2000W 440V heating circuits 1 L 325mm W 150mm H 92mm tube ø 8.5mm		



GEV No.	415098	Ref. No.	0A2068 0A2247
description	heating element 2250W 220V heating circuits 1 L 533mm W 75mm H 123mm tube ø 14mm L1 78mm L2 456mm connection cable cable length 2000mm dry heating element		
For models:	RBR/E700, RBR/E700		



GEV No.	415624	Ref. No.	0G1843 0K4984 18011702 70503017503
description	heating element 2400W 400V heating circuits 1 L 605mm W 380mm connection male faston 6.3mm tube ø 6.5mm 2 hole fixing thread M14x1.5 dry heating element bain marie Hmm mounting distance 374mm		
For models:	CE128-106, CE158-133.3.HV, CE158-244.3, CE158-246.3, CK248-209, D1ABBB, CK248-211.D1ABBB, HCE128-100, HCE128-104, HCE158-252W.3, HCE158-253.3, HLE129-100, HLE129-103, HLE129-104W, HLE159-252W.3.6, HLE159-328.3.HV, HLE159-351W.3.HV, HLE249-200.3, HLE249-208.3, HLE259-088.3.HV, HLE259-089.3.HV, HLE259-384W.3, LE129-101, LE159-261.3, LE159-281.3.6, LE159-318.3.HV, LE159-322.3.HV, LE159-330.3.HV, LE159-337.3.HV, LE159-344.3.MS92, LE159-347.3.HV, LE249-199.3, LE249-203.3, LE249-207.3, LE249-211.3, LE249-215.3, LE249-219.3, LE249-223.3, LE249-232.3, LE249-238.3, LE259-081.3.HV, LE259-082.3.HV, LE259-083.3.HV, LE259-094.3.HV, LE259-099.3.HV, LE259-382.3, LK259-707.D1ACCB, LK259-708.D1ACCB, CK248-205.D1ABBB, CK248-207.D1ABBB, LK159-707.D1BC...(Other models you can see in the webshop)		



GEV No.	420132	Ref. No.	006682
description	heating element 2500W 230V heating circuits 1 L 570mm W 90mm H 90mm tube ø 8.6mm connection M5 for griddle connection distance 81.4mm dry heating element		
For models:	KR/E1E5, KR/E1RE5, KR/E2E5, KR/E2RE5, KR/E1CE5, KR/E2CE5, KR/E2CRE5, KR/E1E5P, KR/E1RE5P, KR/E2E5P, KR/E2RE5P, KR/E1CE5P, KR/E2CE5P, KR/E2CRE5P, HR/E834W, HR/E433W, HR/E443W, HR/E833W, HR/E843W, HR/E434W, HR/E844W, QR/E1E5, QR/E1RE5, QR/E2E5, QR/E2RE5, QR/E1CE5, QR/E2CE5, QR/E2CRE5, QR/E1P, QR/E2P, QR/E1RP, QR/E2RP, QR/E1CP, QR/E2CP, QR/E2CRP, QR/E1E5P, QR/E1RE5P, QR/E2E5P, QR/E2RE5P, QR/E1CE5P, QR/E2CE5P, QR/E2CRE5P, ZR/E834W, ZR/E433W, ZR/E443W, ZR/E833W, ZR/E843W, ZR/E434W, ZR/E844W, WR/E1E5...(Other models you can see in the webshop)		



GEV No.	419096	Ref. No.	OU1088
description	heating element 2500W 240V heating circuits 1 L 255mm W 305mm tube ø 8.5mm connection M5 grill dry heating element		
For models:	EMG3-60, EMG3-60-AL, EMG3-60-ZO, EMG4-80, EMG4-80-AL, EMG4-80-ZO, SL/E360, SL/E480		





GEV No.	416987	Ref. No.	006681
description	heating element 2500W 400V heating circuits 1 L 567mm W 90mm H 91mm tube ø 9mm connection M5 connection length 24mm connection distance 81mm dry heating element		
For models:	KR/E1, KR/E2, KR/E1R, KR/E2R, KR/E1C, KR/E2C, KR/E2CR, KRF/E2R, KR/E1P, KR/E2P, KR/E1RP, KR/E2RP, KR/E1CP, KR/E2CP, KR/E2CRP, KRF/E2RP, HR/E413W, HR/E813W, HR/E404W, HR/E804W, HR/E814W, HR/E403W, HR/E803W, QR/E1, QR/E2, QR/E1R, QR/E2R, QR/E1C, QR/E2C, QR/E2CR, QRF/E2R, QR/E1P, QR/E2P, QR/E1RP, QR/E2RP, QR/E1CP, QR/E2CP, QR/E2CRP, QR/E1E5P, QR/E1RE5P, QR/E2E5P, QR/E2RE5P, QR/E1CE5P, QR/E2CE5P, QR/E2CRE5P, QRF/E2RP, ZR/E413W, ZR/E813W, ZR/E404W, ZR/E804W...(Other models you can see in the webshop)		



GEV No.	420529	Ref. No.	OKT757 72472201
description	heating element 2500W 440V heating circuits 1 L 325mm W 222mm H 70mm tube ø 8mm		
For models:	CE128-106, CE158-133.3.HV, CE158-244.3, CE158-246.3, CK248-209, D1ABBB, CK248-211.D1ABBB, HCE128-100, HCE128-104, HCE158-252W.3, HCE158-253.3, HLE129-100, HLE129-103, HLE129-104W, HLE159-252W.3.6, HLE159-328.3.HV, HLE159-351W.3.HV, HLE249-200.3, HLE249-208.3, HLE259-088.3.HV, HLE259-089.3.HV, HLE259-384W.3, LE129-101, LE159-261.3, LE159-281.3.6, LE159-318.3.HV, LE159-322.3.HV, LE159-330.3.HV, LE159-337.3.HV, LE159-344.3.MS92, LE159-347.3.HV, LE249-199.3, LE249-203.3, LE249-207.3, LE249-211.3, LE249-215.3, LE249-219.3, LE249-223.3, LE249-232.3, LE249-238.3, LE259-081.3.HV, LE259-082.3.HV, LE259-083.3.HV, LE259-094.3.HV, LE259-099.3.HV, LE259-382.3, LK259-707.D1ACCB, LK259-708.D1ACCB, CK248-205.D1ABBB, CK248-207.D1ABBB, LK159-707.D1BC...(Other models you can see in the webshop)		



GEV No.	415363	Ref. No.	OK9904
description	heating element 3000W 230V heating circuits 1 L 450mm W 242mm H 20mm tube ø 6.3mm W1 104mm W2 31mm rectangular flange hole distance 56mm cable length 340mm flange length 70mm flange width 23mm hole ø 5mm dry heating element		
accessories for	415363		
	GEV No.	510368	Ref. No. 057534
	gasket L 70mm W 23.5mm hole ø 5mm hole distance 56mm FIBER thickness 2mm for heating element		



GEV No.	416613	Ref. No.	OU3378
description	heating element 3000W 230V heating circuits 1 L 474mm W 285mm H 54mm tube ø 8.5mm connection M4 griddle connection distance 277mm dry heating element		
For models:	FTL35E6U, FTR35E6U, FTC35E6U, FTL70E6U, FTR70E6U, FTC70E6U		



GEV No.	415479	Ref. No.	OH6183 214338 415479
description	heating element 750W 230V heating circuits 1 L 471mm W 30mm Hmm tube ø 6.35mm rectangular flange connection male faston 6.3mm hole distance 36mm flange length 44mm flange width 20mm hole ø 4.5mm connection length 30mm dry heating element		

heating elements for large hobs

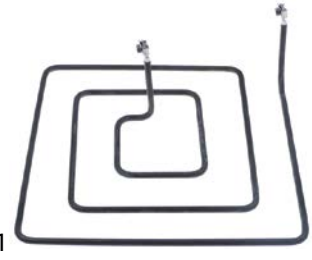

GEV No.	419135	Ref. No.	OK4820 18002171 72093612
description	heating element 1000W 400V L 255mm W 255mm H 75mm tube ø 6.5mm mounting pos. centre connection M5		
For models:	CE128-106, CE158-133.3.HV, CE158-244.3, CE158-246.3, CK248-209, D1ABBB, CK248-211.D1ABBB, HCE128-100, HCE128-104, HCE158-252W.3, HCE158-253.3, CK248-205.D1ABBB, CK248-207.D1ABBB, HCE128-100W, HCE128-103W, HCE128-104W, CE128-101, CE128-102, CE128-105, CE128-107, CE128-108, HCE158-262W.3, HCE158-264.3, HCE158-261.3, HCE158-261W.3, HCE158-263.3, HCE158-232W.3, HCE158-233.3, HCE158-231.3, HCE158-231W.3, HCE158-230.3, CE158-234.3, CE158-236.3, HCE158-254.3, HCE158-251.3, HCE158-251W.3, HCE158-242W.3, HCE158-243.3, HCE158-241.3, HCE158-241W.3, HCE158-240.3, CE158-235.3, CE158-237.3, CE158-245.3, CE158-247.3, HCE158-131W.3.HV, HCE158-135.3.HV, HCE158-121W.3.HV, HCE158-125.3.HV, HCE158-132.3.HV, HCE158-132W.3.HV...(Other models you can see in the webshop)		

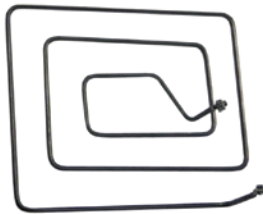

			
1			
GEV No.	415577	Ref. No.	OH9772 OK4815 OK4818 OKF587 OM2123 14R07 15C04 18002166 18002169 72048402
description	heating element 1160W 400V L 295mm W 245mm H 80mm heating circuits 1 tube ø 6.3mm mounting pos. inner connection length 18mm dry heating element 400V		
For models:	HLE129-100, HLE129-103, HLE129-104W, HLE159-252W.3.6, HLE159-328.3.HV, HLE159-351W.3.HV, HLE249-200.3, HLE249-208.3, HLE259-088.3.HV, HLE259-089.3.HV, HLE259-384W.3, LE129-101, LE159-261.3, LE159-281.3.6, LE159-318.3.HV, LE159-322.3.HV, LE159-330.3.HV, LE159-337.3.HV, LE159-344.3.MS92, LE159-347.3.HV, LE249-199.3, LE249-203.3, LE249-207.3, LE249-211.3, LE249-215.3, LE249-219.3, LE249-223.3, LE249-232.3, LE249-238.3, LE259-081.3.HV, LE259-082.3.HV, LE259-083.3.HV, LE259-094.3.HV, LE259-099.3.HV, LE259-382.3, LK259-707.D1ACCB, LK259-708.D1ACCB, LK159-707.D1BC, LK159-708.D1BC, LK259-727.D1ACCB, LK259-728.D1ACCB, HLE129-100W, HLE129-103W, HLE129-104, LE129-102, LE129-105, LE129-107, HLE159-341W.3.MS92, HLE159-361W.3, HLE159-343.3.MS92...(Other models you can see in the webshop)		

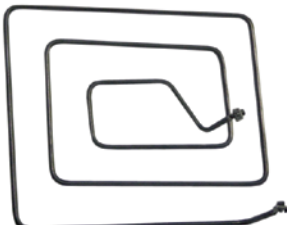
			
1			
GEV No.	420293	Ref. No.	OK4853 OK7427 OKF593 18002870 72048404
description	heating element 1160W 440V L 295mm W 250mm H 95mm heating circuits 1 tube ø 6.25mm mounting pos. inner connection length 20mm connection M5		
For models:	HLE129-100, HLE129-103, HLE129-104W, HLE159-252W.3.6, HLE159-328.3.HV, HLE159-351W.3.HV, HLE249-200.3, HLE249-208.3, HLE259-088.3.HV, HLE259-089.3.HV, HLE259-384W.3, LE129-101, LE159-261.3, LE159-281.3.6, LE159-318.3.HV, LE159-322.3.HV, LE159-330.3.HV, LE159-337.3.HV, LE159-344.3.MS92, LE159-347.3.HV, LE249-199.3, LE249-203.3, LE249-207.3, LE249-211.3, LE249-215.3, LE249-219.3, LE249-223.3, LE249-232.3, LE249-238.3, LE259-081.3.HV, LE259-082.3.HV, LE259-083.3.HV, LE259-094.3.HV, LE259-099.3.HV, LE259-382.3, LK259-707.D1ACCB, LK259-708.D1ACCB, LK159-707.D1BC, LK159-708.D1BC, LK259-727.D1ACCB, LK259-728.D1ACCB, HLE129-100W, HLE129-103W, HLE129-104, LE129-102, LE129-105, LE129-107, HLE159-341W.3.MS92, HLE159-361W.3, HLE159-343.3.MS92...(Other models you can see in the webshop)		

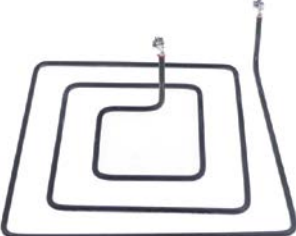
			
1			
GEV No.	419134	Ref. No.	OH9773 OK4819 18002170 72093512
description	heating element 1190W 400V L 285mm W 285mm H 75mm tube ø 6.5mm mounting pos. outer connection M5		
For models:	CE128-106, CE158-133.3.HV, CE158-244.3, CE158-246.3, CK248-209.D1ABBB, CK248-211.D1ABBB, HCE128-100, HCE128-104, HCE158-252W.3, HCE158-253.3, CK248-205.D1ABBB, CK248-207.D1ABBB, HCE128-100W, HCE128-103W, HCE128-104W, CE128-101, CE128-102, CE128-105, CE128-107, CE128-108, HCE158-262W.3, HCE158-264.3, HCE158-261.3, HCE158-261W.3, HCE158-263.3, HCE158-232W.3, HCE158-233.3, HCE158-231.3, HCE158-231W.3, HCE158-230.3, CE158-234.3, CE158-236.3, HCE158-254.3, HCE158-251.3, HCE158-251W.3, HCE158-242W.3, HCE158-243.3, HCE158-241.3, HCE158-241W.3, HCE158-240.3, CE158-235.3, CE158-237.3, CE158-245.3, CE158-247.3, HCE158-131W.3.HV, HCE158-135.3.HV, HCE158-121W.3.HV, HCE158-125.3.HV, HCE158-132.3.HV, HCE158-132W.3.HV...(Other models you can see in the webshop)		

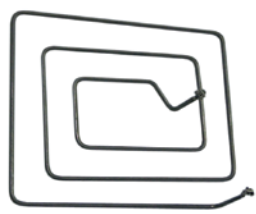
			
1			
GEV No.	415576	Ref. No.	OH9771 OK4814 OK4817 OKF586 OM2122 14R05 15C03 18002165 18002168 72048412
description	heating element 1335W 400V L 320mm W 275mm H 76mm heating circuits 1 tube ø 6.3mm mounting pos. centre connection length 18mm connection male faston dry heating element 400V		
For models:	HLE129-100, HLE129-103, HLE129-104W, HLE159-252W.3.6, HLE159-328.3.HV, HLE159-351W.3.HV, HLE249-200.3, HLE249-208.3, HLE259-088.3.HV, HLE259-089.3.HV, HLE259-384W.3, LE129-101, LE159-261.3, LE159-281.3.6, LE159-318.3.HV, LE159-322.3.HV, LE159-330.3.HV, LE159-337.3.HV, LE159-344.3.MS92, LE159-347.3.HV, LE249-199.3, LE249-203.3, LE249-207.3, LE249-211.3, LE249-215.3, LE249-219.3, LE249-223.3, LE249-232.3, LE249-238.3, LE259-081.3.HV, LE259-082.3.HV, LE259-083.3.HV, LE259-094.3.HV, LE259-099.3.HV, LE259-382.3, LK259-707.D1ACCB, LK259-708.D1ACCB, LK159-707.D1BC, LK159-708.D1BC, LK259-727.D1ACCB, LK259-728.D1ACCB, HLE129-100W, HLE129-103W, HLE129-104, LE129-102, LE129-105, LE129-107, HLE159-341W.3.MS92, HLE159-361W.3, HLE159-343.3.MS92...(Other models you can see in the webshop)		

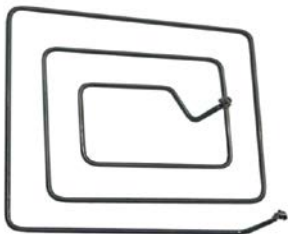

1

GEV No.	420292	Ref. No.	OK4854 OK7426 OKF594 18002871 72048414
description	heating element 1335W 440V L 325mm W 275mm H 95mm heating circuits 1 tube ø 6.25mm mounting pos. centre connection length 20mm connection M5		
For models:	HLE129-100, HLE129-103, HLE129-104W, HLE159-252W.3.6, HLE159-328.3.HV, HLE159-351W.3.HV, HLE249-200.3, HLE249-208.3, HLE259-088.3.HV, HLE259-089.3.HV, HLE259-384W.3, LE129-101, LE159-261.3, LE159-281.3.6, LE159-318.3.HV, LE159-322.3.HV, LE159-330.3.HV, LE159-337.3.HV, LE159-344.3.MS92, LE159-347.3.HV, LE249-199.3, LE249-203.3, LE249-207.3, LE249-211.3, LE249-215.3, LE249-219.3, LE249-223.3, LE249-232.3, LE249-238.3, LE259-081.3.HV, LE259-082.3.HV, LE259-083.3.HV, LE259-094.3.HV, LE259-099.3.HV, LE259-382.3, LK259-707.D1ACCB, LK259-708.D1ACCB, LK159-707.D1BC, LK159-708.D1BC, LK259-727.D1ACCB, LK259-728.D1ACCB, HLE129-100W, HLE129-103W, HLE129-104, LE129-102, LE129-105, LE129-107, HLE159-341W.3.MS92, HLE159-361W.3, HLE159-343.3.MS92...(Other models you can see in the webshop)		

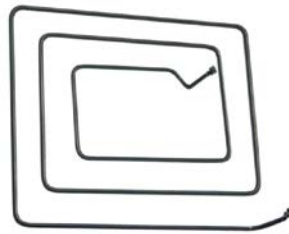

1

GEV No.	420291	Ref. No.	OK4855 OK7425 OK8066 OKF595 18002872 72048424
description	heating element 1505W 440V L 350mm W 300mm H 95mm heating circuits 1 tube ø 6.5mm mounting pos. outer connection length 22mm connection M5		
For models:	HLE129-100, HLE129-103, HLE129-104W, HLE159-252W.3.6, HLE159-328.3.HV, HLE159-351W.3.HV, HLE249-200.3, HLE249-208.3, HLE259-088.3.HV, HLE259-089.3.HV, HLE259-384W.3, LE129-101, LE159-261.3, LE159-281.3.6, LE159-318.3.HV, LE159-322.3.HV, LE159-330.3.HV, LE159-337.3.HV, LE159-344.3.MS92, LE159-347.3.HV, LE249-199.3, LE249-203.3, LE249-207.3, LE249-211.3, LE249-215.3, LE249-219.3, LE249-223.3, LE249-232.3, LE249-238.3, LE259-081.3.HV, LE259-082.3.HV, LE259-083.3.HV, LE259-094.3.HV, LE259-099.3.HV, LE259-382.3, LK259-707.D1ACCB, LK259-708.D1ACCB, LK159-707.D1BC, LK159-708.D1BC, LK259-727.D1ACCB, LK259-728.D1ACCB, HLE129-100W, HLE129-103W, HLE129-104, LE129-102, LE129-105, LE129-107, HLE159-341W.3.MS92, HLE159-361W.3, HLE159-343.3.MS92...(Other models you can see in the webshop)		

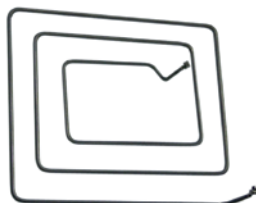

1

GEV No.	415575	Ref. No.	OH9770 OK4813 OK4816 OKF585 OM2121 15C02 18002164 72048422
description	heating element 1505W 400V L 360mm W 295mm H 88mm heating circuits 1 tube ø 6.5mm mounting pos. outer connection length 22mm connection M4 dry heating element 400V		
For models:	HLE129-100, HLE129-103, HLE129-104W, HLE159-252W.3.6, HLE159-328.3.HV, HLE159-351W.3.HV, HLE249-200.3, HLE249-208.3, HLE259-088.3.HV, HLE259-089.3.HV, HLE259-384W.3, LE129-101, LE159-261.3, LE159-281.3.6, LE159-318.3.HV, LE159-322.3.HV, LE159-330.3.HV, LE159-337.3.HV, LE159-344.3.MS92, LE159-347.3.HV, LE249-199.3, LE249-203.3, LE249-207.3, LE249-211.3, LE249-215.3, LE249-219.3, LE249-223.3, LE249-232.3, LE249-238.3, LE259-081.3.HV, LE259-082.3.HV, LE259-083.3.HV, LE259-094.3.HV, LE259-099.3.HV, LE259-382.3, LK259-707.D1ACCB, LK259-708.D1ACCB, LK159-707.D1BC, LK159-708.D1BC, LK259-727.D1ACCB, LK259-728.D1ACCB, HLE129-100W, HLE129-103W, HLE129-104, LE129-102, LE129-105, LE129-107, HLE159-341W.3.MS92, HLE159-361W.3, HLE159-343.3.MS92...(Other models you can see in the webshop)		



1

GEV No.	418697	Ref. No.	OK0618
description	heating element 2000W 400V L 270mm W 230mm H 115mm tube ø 8.5mm mounting pos. inner connection M4		
For models:	7511-3/85.KF.(N), 7512-3/85.KF.BO.(N), 7511-3/90.KF.(N), 7512-3/90.KF.BO.(N), 7711-3/85.KF.(N), 7711-3/90.KF.(N), 7511-3, 7512-3, 7711-3		

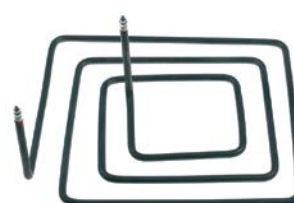

1

GEV No.	418698	Ref. No.	OK0617
description	heating element 2000W 400V L 300mm W 260mm H 115mm tube ø 8.5mm mounting pos. outer connection M4		
For models:	7511-3/85.KF.(N), 7512-3/85.KF.BO.(N), 7511-3/90.KF.(N), 7512-3/90.KF.BO.(N), 7711-3/85.KF.(N), 7711-3/90.KF.(N), 7511-3, 7512-3, 7711-3		

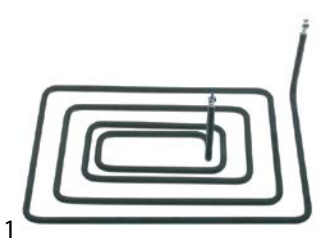
GEV No.	418699	Ref. No.	OH6206 37895
description	heating element 2000W 400V L 345mm W 230mm H 110mm tube ø 8.5mm mounting pos. inner connection M4		

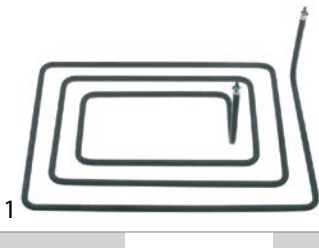

GEV No.	418700	Ref. No.	OH6205 37894
description	heating element 2000W 400V L 380mm W 265mm H 110mm tube ø 8.5mm mounting pos. outer connection M4		

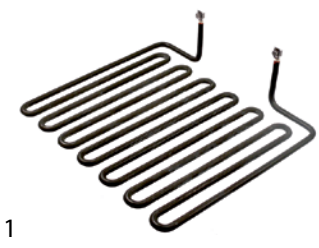

GEV No.	418701	Ref. No.	OG2883 OG3015 72505503
description	heating element 4000W 400V heating circuits 1 L 300mm W 330mm H 80mm tube ø 8.5mm W1 92.5mm W2 145mm connection screw clamp windings 7		
For models:	CE128-106, CE158-133.3.HV, CE158-244.3, CE158-246.3, CK248-209.D1ABBB, CK248-211.D1ABBB, HCE128-100, HCE128-104, HCE158-252W.3, HCE158-253.3, HLE129-100, HLE129-103, HLE129-104W, HLE159-252W.3.6, HLE159-328.3.HV, HLE159-351W.3.HV, HLE249-200.3, HLE249-208.3, HLE259-088.3.HV, HLE259-089.3.HV, HLE259-384W.3, LE129-101, LE159-261.3, LE159-281.3.6, LE159-318.3.HV, LE159-322.3.HV, LE159-330.3.HV, LE159-337.3.HV, LE159-344.3.MS92, LE159-347.3.HV, LE249-199.3, LE249-203.3, LE249-207.3, LE249-211.3, LE249-215.3, LE249-219.3, LE249-223.3, LE249-232.3, LE249-238.3, LE259-081.3.HV, LE259-082.3.HV, LE259-083.3.HV, LE259-094.3.HV, LE259-099.3.HV, LE259-382.3, LK259-707.D1ACCB, LK259-708.D1ACCB, CK248-205.D1ABBB, CK248-207.D1ABBB, LK159-707.D1BC...(Other models you can see in the webshop)		

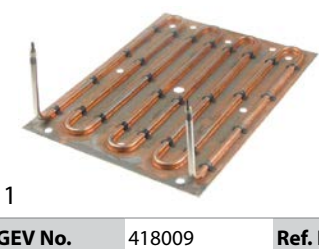

GEV No.	418009	Ref. No.	OK0563
description	heating element 4000W 400V heating circuits 1 L 380mm W 287mm H 116mm tube ø 8.5mm mounting pos. connection M4 dry heating element		



GEV No.	419136	Ref. No.	OK4821 18002172 72093712
description	heating element 810W 400V L 225mm W 225mm H 75mm tube ø 6.5mm mounting pos. inner connection M5		
For models:	CE128-106, CE158-133.3.HV, CE158-244.3, CE158-246.3, CK248-209.D1ABBB, CK248-211.D1ABBB, HCE128-100, HCE128-104, HCE158-252W.3, HCE158-253.3, CK248-205.D1ABBB, CK248-207.D1ABBB, HCE128-100W, HCE128-103W, HCE128-104W, CE128-101, CE128-102, CE128-105, CE128-107, CE128-108, HCE158-262W.3, HCE158-264.3, HCE158-261.3, HCE158-261W.3, HCE158-263.3, HCE158-232W.3, HCE158-233.3, HCE158-231.3, HCE158-231W.3, HCE158-230.3, CE158-234.3, CE158-236.3, HCE158-254.3, HCE158-251.3, HCE158-251W.3, HCE158-242W.3, HCE158-243.3, HCE158-241.3, HCE158-241W.3, HCE158-240.3, CE158-235.3, CE158-237.3, CE158-245.3, CE158-247.3, HCE158-131W.3.HV, HCE158-135.3.HV, HCE158-121W.3.HV, HCE158-125.3.HV, HCE158-132.3.HV, HCE158-132W.3.HV...(Other models you can see in the webshop)		

heating elements for chicken rotisseries

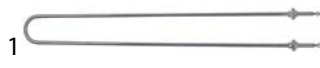

GEV No.	416017	Ref. No.	OG3703 416017 A0352 DEB416017
description	heating element 2400W 220V edition up to serial no. 5350 2 hole fixing thread 3/8" L 735mm W 80mm heating circuits 1 connection M6x1 dry heating element tube ø 10mm mounting distance 86mm chicken rotisserie		

heating elements for refrigeration

heating elements for defrosting



GEV No.	420448	Ref. No.	082188
description	heating element 120W 220V L 198mm W 114mm H 40mm cable length 95mm tube ø 6.5mm refrigeration		
For models:	ALNN220UK, ALNF220UK, ALNN120, ALNF120, ALNN220, ALNF220, ALNSO120, AKNN120, AKNF120, AKNSO120, ASP110UK, ASN110UK, ASF110UK, ASP110, ASS110, ASN110, ASF110, ZILNSO120		



GEV No.	420449	Ref. No.	082733
description	heating element 160W 220V L 370mm W 60mm H 8.5mm cable length 1190mm tube ø 8.5mm refrigeration connection F6.3		
For models:	TRN1301, TRNA1301, TRNM1301, TRN1302, TRNA1302, TRNM1302, TRN1303, TRNA1303, TRNM1303, TRN1801, TRNA1801, TRNM1801, TRN1802, TRNA1802, TRNM1802, TRN1803, TRNA1803, TRNM1803, TRN2201, TRNA2201, TRNM2201, TRN2202, TRNA2202, TRNM2202, TRN2203, TRNA2203, TRNM2203, TRRN1301, TRRN1302, TRRN1303, TRRN1801, TRRN1802, TRRN1803, TRRN2201, TRRN2202, TRRN2203, TRNP1802, TRF1301, TRF1801, TRF2201, TRN1301, TRNA1301, TRNM1301, TRRN1301, TRF1301, TRN1302, TRNA1302, TRNM1302, TRRN1302, TRN1303...(Other models you can see in the webshop)		



GEV No.	420450	Ref. No.	083093
description	heating element 335W 220V L 255mm W 315mm H 35mm cable length 980mm tube ø 8.5mm refrigeration		
For models:	ALN110, ALN120, ALN111, ALNN120, ALNN220, ALNN230, ALN110UK, ALNN220UK, ALNF120, ALNF230, ILN110, ILN110UK, ILN120, ILNN120, ILNN220, ILNN220UK, ILNN230, ALN110UK, ALNN220UK, ALF110UK, ALNF220UK, ILF110, ILF110, ILF120, ILNF120, ILNF220, ILNF220UK, ILNF230, ALN110, ALN120, ALN111, ALF110, ALF120, ALNN120, ALNF120, ALNN220, ALNF220, ALNN230, ALNF230, AKP110, AKS110, AKP120, AKN110, AKN120, AKN111, AKNN120, AKNN220, AKNN230, AKP110UK, AKN110UK...(Other models you can see in the webshop)		



GEV No.	419025	Ref. No.	083530 3650024
description	heating element 400W 230V L 440mm W 70mm H 100mm cable length 500mm tube ø 8.5mm		
For models:	MVR/E1400, MVR/E1050, MVR/E1060, 7BAE10C, 7BAE14S, 7BAE10S, B105RC, B140RC, KVRC/E3, HVR/E1200, QVRC/E3, WVRC/E3, MVR/E3C, MVR/E3, MVR/E4C, MVR/E4		



GEV No.	419101	Ref. No.	0A9683
description	heating element 450W 230V L 380mm W 37mm H 100mm cable length 1100mm tube ø 8.5mm immersion heater		
For models:	ADF110ES, ALN110, ALN120, ADN111, AEN110, AEN120, AKN111, ADF110, ALF110, ADF120, ALF120, AEF110, AEF120, ADNN120, ADNF120, AENN120, AENF120, ADN221, ADNN220, ADNF220, ADNN230, ADNF230, AENN220, AENF220, AENN230, AENF230, ASN110, ASN111, ASF110, AKN110UK, AKF110UK, ASN110UK, ASF110UK, ARDN110, ADN110E, ADF110E, 83012001, 83012033, 83012201, ARDF110L, ARDF120, ARDN120, 83012101, 83012037, ASN110, ASF110, ADN110, ADN120, ADN111, ADF110...(Other models you can see in the webshop)		



GEV No.	420452	Ref. No.	082279
description	heating element 540W 220V L 305mm W 695mm H 10mm cable length 985mm tube ø 8.5mm refrigeration		
For models:	ALN220, ALN240, ALN221, ILN220, ILN220UK, ILN240, ILN221, ILF220, ILF220UK, ILF240, ALN220, ALN240, ALN221, ALF220, ALF240, AKN230, AKN220, AKN240, AKN221, AKN220UK, IKN220, IKF220, AKN230, AKN220, AKN240, AKP221, AKF230, AKF220, AKF240, AKN220UK, AKF220UK, ASN220, ASN220UK, ASN220UK, ASF220UK, ISN220, ISF220, ASN220, ASF220, IKN220, IKN240, IKN240, ISNZ220, IKF220, FVNE11E, IKN221, ETZ1402, ETZ1404, IKN220N, IKF220N...(Other models you can see in the webshop)		



GEV No.	420447	Ref. No.	082731
description	heating element 95W 230V L 425mm W 48mm H 120mm cable length 1200mm tube ø 8.5mm refrigerated counter		
For models:	TRN1301, TRNA1301, TRNM1301, TRN1302, TRNA1302, TRNM1302, TRN1303, TRNA1303, TRNM1303, TRN1801, TRNA1801, TRNM1801, TRN1802, TRNA1802, TRNM1802, TRN1803, TRNA1803, TRNM1803, TRN2201, TRNA2201, TRNM2201, TRN2202, TRNA2202, TRNM2202, TRN2203, TRNA2203, TRNM2203, TRRN1301, TRRN1302, TRRN1303, TRRN1801, TRRN1802, TRRN1803, TRRN2201, TRRN2202, TRRN2203, TRNP1802, TRRF130P, TRRF180P, TRRF220P, TRF1301, TRRF1301, TRF1801, TRRF1801, TRF2201, TRRF2201, TRN1301, TRNA1301, TRNM1301, TRRN1301...(Other models you can see in the webshop)		

heating elements for condensate evaporation



GEV No.	420451	Ref. No.	088377
description	heating element 480W 230V L 365mm W 200mm H 8.5mm cable length 440mm tube ø 8.5mm		
For models:	AZF1103, ALN1103, ALNN1203, ALNN2203, ALF1104, ALN11033, ALF11033, AZF1103, ALF1104, ALF11033, ALNN1203, IKS220N, ISS220N, TZ751R, ISP110N, RS06FX1F, RS06DX2F, RS06F41F, RS06FX1F4, RS06DFX2F, RS13DX2F, RS06FW1F, RS06FX1F6, RS06FX2H, RS06FX1FG, KL650F, RS06FX1FD, KLN650R, KLPF650R, KPF1400R, RS06RX1F, RS06FX1F, RS06DX2F, RS13DX2F, KLPP650R, KLPP1400R, RS06F41FS, KL650F, KE650F, KL650F, KL650F, KE650F, KL650FW, KLP650R, KLPP650R, KPF1300R, RVPE051, RSPE112		





			
GEV No.	418996	Ref. No.	0A8134
description	heating element 95W 220V L 435mm W 56mm H 28mm cable length 3000mm tube ø 6.25mm		
For models:	ILP110, ILP110UK, ILN120, ILP111, ILP220, ILP220UK, ILP240, ILP221, ILN110, ILN110UK, ILN120, ILN111, ILN220, ILN220UK, ILN240, ILN221, ILNN220, ILNN220UK, ILNN230, ALP110UK, ALN110UK, ALF110UK, ILF110, ILF110, ILF120, ILF220, ILF220UK, ILF240, ILNF220, ILNF220UK, ILNF230, ALP110, ALP120, ALP220, ALP240, ALN110, ALN120, ALN220, ALN240, ALF110, ALF120, ALF220, ALF240, ALNN230, ALNF230, AKP110, AKS110, AKP120, AKP230, AKP220...(Other models you can see in the webshop)		

			
GEV No.	418504	Ref. No.	0C0686
description	heating element 2500W 230V L 538mm W 81mm H 44mm connection male faston 6.3mm dry heating element heating circuits 1 tube ø 8.5mm L1 18mm L2 520mm W1 29mm W2 33mm rectangular flange hole distance 28mm flange length 70mm flange width 22mm hole ø M4mm connection length 31mm		
For models:	KBR/E2F, KBR/E2C, KBR/E3F, KBR/E3FH, KBR/E3C, KBR/E3CH, KBR/E2FH, KBR/E2CH, QBR/E2F, QBR/E2C, QBR/E3F, QBR/E3FH, QBR/E3C, QBR/E3CH, QBR/E2FH, QBR/E2CH, WBR/E2F, WBR/E2C, WBR/E3F, WBR/E3FH, WBR/E3C, WBR/E3CH, WBR/E2FH, WBR/E2CH		

heating elements for tilting bratt pan

			
GEV No.	415273	Ref. No.	058345 058349 0K2857 0KB786
description	heating element 1500W 220V L 373mm W 82mm H 78mm connection M5 dry heating element heating circuits 1 tube ø 8.5mm with holder connection distance 80mm		
For models:	MBR/E710D, MBR/E700, MBR/E700UK, MBR/E716, MBR/E706, 7BRE60XN, 7BRE60X, RBR/E700UK, RBR/E716, RBR/E706, XBR/E710D, M70EBP, XBR/E710, CBR/E700, XBR/E716, XBR/E706		

			
GEV No.	418005	Ref. No.	0C0685
description	heating element 2500W 400V L 545mm W 80mm H 48mm connection M4 dry heating element heating circuits 1 tube ø 8.5mm L1 25mm L2 520mm W1 23mm W2 34mm rectangular flange hole distance 56mm flange length 70mm flange width 22mm hole ø 5.5mm		
For models:	KBR/E2F, KBR/E2C, KBR/E2FH, KBR/E2CH, WBR/E2F, WBR/E2C, WBR/E2FH, WBR/E2CH		

			
GEV No.	418016	Ref. No.	002559
description	heating element 1500W 230V L 375mm W 76mm H 75mm connection M5 dry heating element heating circuits 1 tube ø 8.5mm connection distance 68mm		
For models:	MBR/E710D, MBR/E700, MBR/E700UK, MBR/E716, MBR/E706, 7BRE60XN, 7BRE60X, RBR/E700UK, RBR/E716, RBR/E706, XBR/E710D, M70EBP, XBR/E710, CBR/E700, XBR/E716, XBR/E706		

			
GEV No.	418003	Ref. No.	004469
description	heating element 3000W 230V L 137mm W 515mm H 48mm connection male faston 6.3mm dry heating element heating circuits 1 tube ø 8.5mm W1 242mm W2 31mm rectangular flange hole distance 57mm flange length 70mm flange width 22mm hole ø 5mm connection length 97mm		
For models:	RBR/E2FM, RBR/E2IM, RBK/E2FM, XBR/E2FM, XBR/E2IM, XBK/E2FM, JBR/E2FM, MBR/E2FM, MBR/E2IM, MBK/E2FM		

			
GEV No.	418004	Ref. No.	051356
description	heating element 1500W 230V L 530mm H 100mm dry heating element tube ø 14.5mm L1 60mm L2 535mm W1 35mm W2 80mm cable length 1000mm		
For models:	HBR/E801, HBR/E801		

			
accessories for	418003		
GEV No.	510368	Ref. No.	057534
description	gasket L 70mm W 23.5mm hole ø 5mm hole distance 56mm FIBER thickness 2mm for heating element		

			
GEV No.	415098	Ref. No.	0A2068 0A2247
description	heating element 2250W 220V heating circuits 1 L 533mm W 75mm H 123mm tube ø 14mm L1 78mm L2 456mm connection cable cable length 2000mm dry heating element		
For models:	RBR/E700, RBR/E700		

			
GEV No.	420131	Ref. No.	0C2613
description	heating element 3500W 230V L 145mm W 623mm H 50mm connection M4 for tilting bratt pan heating circuits 1 tube ø 8.5mm W1 295mm W2 33mm rectangular flange hole distance 57mm flange length 70mm flange width 22mm hole ø 5mm connection length 100mm		
For models:	PBR/E2FM, PBR/E2IM, OBR/E2FM, OBR/E2IM, TBR/E2FM, TBR/E2IM		

GEV No.	415381	Ref. No.	051355
description	heating element for tilting bratt pan 1300W 220V L 535mm W 82mm H 100mm connection cable dry heating element heating circuits 1 tube ø 14mm L1 55mm W1 11mm W2 60mm cable length 1000mm connection distance 50mm		
For models:	HBR/E820, HBR/E825, ZBR/E820, ZBR/E825, ABR/E820, ABR/E825, HBR/E804, HBR/E1003, HBR/E1013, HBR/E803, HBR/E804, HBR/E1003, HBR/E1013		

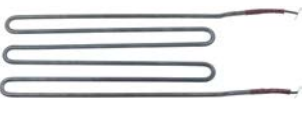

GEV No.	420128	Ref. No.	OK4745 18001114
description	heating element for tilting bratt pan 3000W 230V L 500mm W 165mm H 48mm connection cable dry heating element heating circuits 1 tube ø 8.5mm L1 55mm L2 20mm L3 425mm cable length 1000mm connection distance 156.5mm		
For models:	UET060E.MS35.F88, UET090E.MS35.F88, UET090E.MS35.W84, UET100E.MS35.F88, UET100E.MS35.W84, UET150E.MS35.F88, UET060E.MS35.W84, UET150E.MS35.W84, UET060E.MS35.F98, UET060E.MS35.W94, UET090E.MS35.F98, UET090E.MS35.W94, UET100E.MS35.F98, UET100E.MS35.W94, UET150E.MS35.F98, UET150E.MS35.W94, UET060E.MS35.F97, UET090E.MS35.F97, UET090E.MS35.H97, UET100E.MS35.F97, UET150E.MS35.F97, UET150E.MS35.H97, JUET090E.MS35.F98, JUET090E.MS35.W94, JUET150E.MS35.F98, JUET150E.MS35.W94, JUET090E.MS35.F88, JUET090E.MS35.W84, JUET150E.MS35.F88, JUET150E.MS35.W84		

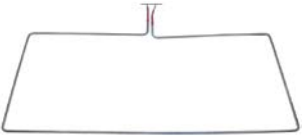

GEV No.	420238	Ref. No.	OK4746 18001116
description	heating element for tilting bratt pan 3000W 230V L 525mm W 975mm connection cable dry heating element heating circuits 1 tube ø 8.5mm L1 50mm L2 475mm W1 465mm W2 45mm cable length 1000mm connection distance 36.5mm		
For models:	UET060E.MS35.F88, UET090E.MS35.F88, UET090E.MS35.W84, UET100E.MS35.F88, UET100E.MS35.W84, UET150E.MS35.F88, UET060E.MS35.W84, UET150E.MS35.W84, UET060E.MS35.F98, UET060E.MS35.W94, UET090E.MS35.F98, UET090E.MS35.W94, UET100E.MS35.F98, UET100E.MS35.W94, UET150E.MS35.F98, UET150E.MS35.W94, UET060E.MS35.F97, UET090E.MS35.F97, UET090E.MS35.H97, UET100E.MS35.F97, UET150E.MS35.F97, UET150E.MS35.H97, JUET090E.MS35.F98, JUET090E.MS35.W94, JUET150E.MS35.F98, JUET150E.MS35.W94, JUET090E.MS35.F88, JUET090E.MS35.W84, JUET150E.MS35.F88, JUET150E.MS35.W84		



GEV No.	420130	Ref. No.	OK4749 18001125
description	heating element for tilting bratt pan 3000W 230V L 590mm W 170mm H 45mm connection cable dry heating element heating circuits 1 tube ø 8.3mm L1 55mm L2 20mm L3 515mm cable length 1000mm connection distance 162mm		
For models:	FET060E.MS35P.F88, FET060E.MS35P.W84, FET060E.MS35.F88, FET080E.MS35P.F88, FET080E.MS35P.W84, FET080E.MS35.W84, FET100E.MS35P.F88, FET100E.MS35P.W84, FET100E.MS35.F97, FET060E.MS35.W84, FET080E.MS35.F88, FET100E.MS35.F88, FET100E.MS35.W84, FET060E.MS35.F98, FET060E.MS35.W94, FET080E.MS35.F98, FET080E.MS35.W94, FET100E.MS35.F98, FET100E.MS35.W94, FET060E.MS35P.F98, FET060E.MS35P.W94, FET100E.MS35P.F98, FET100E.MS35P.W94, FET060E.MS35.F97, FET080E.MS35.F97, FET060E.MS35P.F97, FET060E.MS35P.H97, FET080E.MS35P.H97, FET100E.MS35P.F97, FET100E.MS35P.H97		



GEV No.	415822	Ref. No.	OH6707 OK2189 249213
description	heating element tilting bratt pan 1800W 230V L 540mm W 105mm Hmm connection male faston dry heating element heating circuits 1 tube ø 8.5mm L1 50mm L2 490mm W1 65mm W2 40mm connection length 10mm		
For models:	7746-3/90.KB.(N), 7748-3/90.KB.(N), 7747-3/90.KB.(N), 7545-3/85.KB.(N), 7546-3/85.KB.(N), 7547-3/85.KB.(N), 7548-3/85.KB.(N), 7545-3/90.KB.(N), 7546-3/90., 7547-3/90.KB.(N), 7548-3/90.KB.(N), 7745-3/90.KB.(N), 7745-3/85.KB.(N), 7746-3/85.KB.(N), 7747-3/85.KB.(N), 7748-3/85.KB.(N), 7545-3/85.KB.DWD, 7748-3/85.KB.DWD.ETR, 7548-3/85.KB.DWD, 7546-3, 7548-3, 7746-3, 7748-3, 9045-3, 9046-3, 9047-3, 9048-3, 9245-3-0, 9245-3-8, 9246-3-0, 9246-3-8, 9247-3-0, 9247-3-8, 9248-3-0, 9248-3-8		



GEV No.	415747	Ref. No.	002157 OK4792 18001862
description	heating element tilting bratt pan 2500W 230V L 518mm W 95mm dry heating element heating circuits 1 tube ø 8.5mm cable length 215mm connection distance 87mm		



GEV No.	415355	Ref. No.	OH9767 OK4810 OKF583 18002052
description	heating element tilting bratt pan 2500W 230V L 612mm W 130mm H 8.5mm dry heating element heating circuits 1 tube ø 8.5mm cable length 750mm connection length 17mm connection distance 122mm		



heating elements for contact grills



GEV No.	415648	Ref. No.	0H9684
description	heating element 660W 230V L 212mm W 72mm H 35mm tube ø 6.3mm L1 34mm L2 178mm W1 58mm W2 14mm connection cable length 210mm dry heating element		



GEV No.	416979	Ref. No.	059066
description	heating element 1550W 230V heating circuits 1 L 530mm W 55mm rectangular flange connection M5 tube ø 6.8mm flange width 28mm hole distance 26mm flange length 60mm hole ø 5mm connection length 80mm pasta cooker dry heating element		
For models:	HCP/E400, HCP/E410, HCP/E800, HCP/E810, HCPS/E400, HCPS/E410, ZCP/E400, ZCP/E410, ZCP/E800, ZCP/E810, ZCPS/E400, ZCPS/E410, ACP/E400, ACP/E410, ACP/E800, ACP/E810, ACPS/E400, ACPS/E410, HCP/E800, HCP/E801, HCP/E400, HCP/E401, ZHCP/E800, ZHCP/E400, ZHCP/E401, HCP/E800, ZHCP/E801		

heating elements for pasta cookers

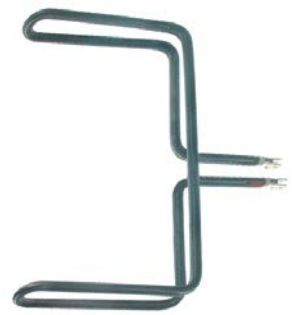

GEV No.	416981	Ref. No.	0A5492
description	heating element 1000W 230V heating circuits 1 L 245mm W 290mm H 40mm connection male faston 6.3mm tube ø 8.5mm L1 92mm L2 153mm W1 125mm W2 33mm connection distance 25mm dry heating element		
For models:	RCP/E1S, RCP/E2D, XCP/E1S, XCP/E2D, JCP/E1S, JCP/E2D, MCP/E1SH, MCP/E1SUH, MCP/E2SUH, MCP/E1S, MCP/E2D, MCP/E2SH, MCP/E2SUH, MCP/E2SUT, MCP/E2SHB, PCP/E1S, PCP/E2D, PCP/E1SH, PCP/E1ELH, OCP/E1S, OCP/E2D, OCP/E1SH, OCP/E2SH, TCP/E1S, TCP/E2D, TCP/E1ELH		



GEV No.	416629	Ref. No.	005816 00595 0K3583 8344502
description	heating element 1600W 230V heating circuits 1 L 368mm W 70mm H 178mm connection M4 tube ø 9mm connection length 24mm dry heating element		
For models:	SCPE350, SCPE350		



GEV No.	420127	Ref. No.	0K5116 18025503 6120435002 72120702 72120703
description	heating element 1400W 230V heating circuits 1 L 530mm W 58mm rectangular flange connection M5 tube ø 6.2mm flange width 28mm L1 75mm L2 40mm L3 415mm W1 33mm W2 25mm hole distance 25mm flange length 60mm hole ø 6mm mounting distance 19mm connection length 28mm dry heating element		
For models:	HLE159-390W.3, AKAROA0000, AKAROF0000, LE159-390.3, HLE159-390.3, AKAROFU00C, AKAROA000C		







GEV No.	416980	Ref. No.	006853
description	heating element 1650W 230V heating circuits 1 L 500mm W 54mm Hmm rectangular flange connection M4 tube ø 8.5mm flange width 30mm L1 110mm L2 395mm W1 50mm W2 10mm hole distance 40mm flange length 60mm hole ø 6mm connection length 15mm dry heating element		
For models:	MCP/E1SH, MCP/E1SUH, MCP/E2SUH, MCP/E2SH, MCP/E2SUH, MCP/E2SUT, MCP/E2SHB, PCP/E2SHP, PCP/E2SH, PCP/E2SH3B, OCP/E2S, OCP/E1SH, OCP/E2SH, TCP/E2S, TCP/E2SH, KCP/E1, KCP/E1R, KCP/E2, KCP/E2R, QCP/E1, QCP/E1R, QCP/E2, QCP/E2R, WCP/E1, WCP/E1R, WCP/E2, WCP/E2R		



GEV No.	415691	Ref. No.	056906
description	heating element 1450W 220V heating circuits 1 L 507mm W 58mm Hmm rectangular flange connection M5 tube ø 6.3mm flange width 28mm W1 25mm W2 33mm hole distance 25mm flange length 60mm hole ø 6.3mm connection length 30mm dry heating element		
For models:	MCP/E700, MCP/E700D, RCP/E2S, MCP/E2S, 7CPE07P, M70EPC, CCP/E700, RCPE700, HCP/E400, HCP/E410, HCP/E800, HCP/E810, HCPS/E400, HCPS/E410, ZCP/E400, ZCP/E410, ZCP/E800, ZCP/E810, ZCPS/E400, ZCPS/E410, ACP/E400, ACP/E410, ACP/E800, ACP/E810, ACPS/E400, ACPS/E410, HCP/E800, HCP/E801, HCP/E400, HCP/E401, ZHCP/E800, ZHCP/E400, ZHCP/E401, HCP/E800, ZHCP/E801, RCP/E700		





GEV No.	420079	Ref. No.	0C1848
description	heating element 3000W 230V heating circuits 3 L 255mm W 33mm H 39mm connection male faston 6.3mm tube ø 8.5mm mounting ø 47.5mm immersion heater		
For models:	ECP/E1ELHU, PCP/E1ELH, TCP/E1ELHU, TCP/E1ELH, KCP/G1RU, KCP/G2RU, KCP/E1RU, KCP/E2RU, KCP/G1R, KCP/G2R, KCP/E1R, KCP/E2R, QCP/G1R, QCP/G2R, QCP/E1R, QCP/E2R, WCP/G1R, WCP/G2R, WCP/E1R, WCP/E2R		
accessories for	420079		046213 055533 067620 0H2559 0L2765 19006668 19006946
		GEV No.	510408
		Ref. No.	
	O-ring EPDM thickness 5.34mm ID ø 47mm Qty 1 pcs		

			
GEV No.	415597	Ref. No.	045984 047505 066109 0C5347 0K2912
description	heating element 3000W 230V heating circuits 3 L 255mm W 38mm H 26mm 3 hole flange connection male faston tube ø 6.3mm thermostat sleeves ø 7.5mm length thermostat sleeves 199mm hole distance 63mm mounting ø 47.5mm hole ø 8/10mm connection length 15mm immersion heater		
For models:	MCP/E700, MCP/G700, MCP/E700D, MCP/G701, MCP/G710, MCP/G711, RCP/E2S, MCP/E2S, 7CPE07P, 7CPG07P, RCP/G701, M70EPC, M70GPC, M70GPC, CCP/G700, CCP/E700, PCP/E2SH, OCP/E2S, TCP/E2S, RCP/G700, RCPE700, HCP/G410D, HCP/G410, HCP/G810, HCP/E410, HCP/E810, HCPS/E410, ZCP/G410, ZCP/G810, ZCP/E410, ZCP/E810, ZCPS/E410, ACP/G400, ACP/G410, ACP/G800, ACP/G810, ACP/E400, ACP/E410, ACP/E800, ACP/E810, ACPS/G400, ACPS/E400, ACPS/E410, LS510, LS520, LS520F, LS521, LS521F, ZLS510, ZLS520...(Other models you can see in the webshop)		
accessories for	415597		
			
GEV No.	510408	Ref. No.	046213 055533 067620 0H2559 0L2765 1900668 19006946
O-ring EPDM thickness 5.34mm ID ø 47mm Qty 1 pcs			
			
GEV No.	510562	Ref. No.	—
O-ring silicone thickness 5.34mm ID ø 47mm Qty 1 pcs			



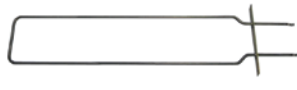

heating elements for pizza ovens

			
GEV No.	415678	Ref. No.	004151 91711901
description	heating element 1000W 230V L 575mm W 160mm flange length 220mm flange width 31mm hole distance 201mm connection length 133mm connection M5 L1 30mm L2 25mm L3 520mm W1 25mm W2 112mm tube ø 10mm heating circuits 1 rectangular flange hole ø 4mm dry heating element		
For models:	ZCMME6, ZCBME12		





			
GEV No.	415917	Ref. No.	004152 91711911
description	heating element 1400W 230V L 572mm W 159mm flange length 220mm flange width 32mm hole distance 199mm connection length 134mm connection M5 L1 30mm L2 27mm L3 515mm W1 25mm W2 110mm tube ø 10.2mm heating circuits 1 rectangular flange hole ø 4mm dry heating element		
For models:	ZCMME6, ZCBME12		

			
GEV No.	415918	Ref. No.	004153 91711902
description	heating element 1500W 230V L 875mm W 164mm flange length 220mm flange width 30mm hole distance 202mm connection length 132mm connection M5 L3 815mm W1 25mm W2 110mm tube ø 10mm heating circuits 1 rectangular flange hole ø 4mm dry heating element		
For models:	ZCMME9, ZCBME18		



			
GEV No.	415919	Ref. No.	004154 91711912
description	heating element 2000W 230V L 870mm W 160mm flange length 220mm flange width 31mm hole distance 200mm connection length 130mm connection 5 L3 820mm W1 110mm W2 160mm tube ø 10mm heating circuits 1 rectangular flange hole ø 4mm dry heating element		
For models:	ZCMME9, ZCBME18		



			
GEV No.	416437	Ref. No.	004199 0C3608 91711021
description	heating element 1000W 230V L 895mm W 132mm thread 1/4" mounting distance 122mm connection length 110mm connection M4 tube ø 8.5mm heating circuits 1 dry heating element 2 hole fixing		
For models:	ZCMDE6, ZCBDE12, PDE830, PDE1230, PDE12L30, PDE1830, PDE835, PDE1235, PDE12L35, PDE1835, PME430, PME630, PME6L30, PME930, PME435, PME635, PME6L35, PME935, PME830, PME1230, PME12L30, PME1830, PME835, PME1235, PME12L35, PME1835		
accessories for	416437		
			
GEV No.	361182	Ref. No.	—
nut thread 1/4" H 5mm nickel-plated brass WS 17 Qty 1 pcs			
			
GEV No.	510417	Ref. No.	OK6103 OK6660 OK8701
flat gasket fibre ED ø 20mm ID ø 14mm thickness 2mm Qty 1 pcs			
			
GEV No.	520228	Ref. No.	—
tooth lock washer ID ø 15.3mm ED ø 24mm steel Qty 1 pcs for thread M14			
			
GEV No.	550262	Ref. No.	—
flat gasket copper ED ø 20mm ID ø 14mm thickness 2mm			







			
GEV No.	416438	Ref. No.	004200 0C3614 91711031
description	heating element 1400W 230V L 898mm W 132mm thread 1/4" mounting distance 123mm connection length 98mm connection M5 tube ø 8.5mm heating circuits 1 dry heating element 2 hole fixing		
For models:	ZCMDE6, ZCBDE12, PDE830, PDE1230, PDE12L30, PDE1830, PDE835, PDE1235, PDE12L35, PDE1835, PME430, PME630, PME6L30, PME930, PME435, PME635, PME6L35, PME935, PME830, PME1230, PME12L30, PME1830, PME835, PME1235, PME12L35, PME1835		
spare parts for	416438		
	GEV No.	510417	Ref. No. 0K6103 0K6660 0K8701
flat gasket fibre ED ø 20mm ID ø 14mm thickness 2mm Qty 1 pcs			
accessories for	416438		
	GEV No.	361182	Ref. No. —
nut thread 1/4" H 5mm nickel-plated brass WS 17 Qty 1 pcs			
	GEV No.	520228	Ref. No. —
tooth lock washer ID ø 15.3mm ED ø 24mm steel Qty 1 pcs for thread M14			
	GEV No.	550262	Ref. No. —
flat gasket copper ED ø 20mm ID ø 14mm thickness 2mm			

			
GEV No.	418053	Ref. No.	0C6494 91711005
description	heating element 1500W 230V L 365mm W 400mm L1 20mm L2 60mm L3 285mm W1 32mm W2 335mm thread M10x1 mounting distance 331mm connection length 85mm connection M5 windings 4 tube ø 6.3mm heating circuits 1 dry heating element mounting pos. upper 2 hole fixing pizza oven		

			
GEV No.	416439	Ref. No.	004201 0C3616 91711023
description	heating element 1500W 230V L 900mm W 245mm thread 1/4" mounting distance 237mm connection length 110mm connection M5 tube ø 8.5mm heating circuits 1 dry heating element 2 hole fixing		
For models:	ZCMDE9, ZCBDE18, PDE830, PDE1230, PDE12L30, PDE1830, PDE835, PDE1235, PDE12L35, PDE1835, PME430, PME630, PME6L30, PME930, PME435, PME635, PME6L35, PME935, PME830, PME1230, PME12L30, PME1830, PME835, PME1235, PME12L35, PME1835		
accessories for	416439		
	GEV No.	361182	Ref. No. —
nut thread 1/4" H 5mm nickel-plated brass WS 17 Qty 1 pcs			
	GEV No.	510417	Ref. No. 0K6103 0K6660 0K8701
flat gasket fibre ED ø 20mm ID ø 14mm thickness 2mm Qty 1 pcs			

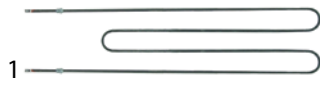
accessories for	416439		
	GEV No.	520228	Ref. No. —
tooth lock washer ID ø 15.3mm ED ø 24mm steel Qty 1 pcs for thread M14			
	GEV No.	550262	Ref. No. —
flat gasket copper ED ø 20mm ID ø 14mm thickness 2mm			

			
GEV No.	419090	Ref. No.	0K7632
description	heating element 1670W 230V L 440mm W 144mm tube ø 8.5mm heating circuits 1 dry heating element		
For models:	HC-AR, HC-CS		



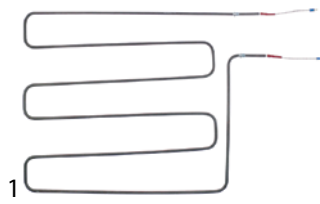

			
GEV No.	416440	Ref. No.	004202 0C3606
description	heating element 2000W 230V L 892mm W 245mm thread 1/4" mounting distance 237mm connection length 97mm connection M5 tube ø 8.5mm heating circuits 1 dry heating element 2 hole fixing		
For models:	ZCMDE9, ZCBDE18, PDE830, PDE1230, PDE12L30, PDE1830, PDE835, PDE1235, PDE12L35, PDE1835, PME430, PME630, PME6L30, PME930, PME435, PME635, PME6L35, PME935, PME830, PME1230, PME12L30, PME1830, PME835, PME1235, PME12L35, PME1835		
spare parts for	416440		
	GEV No.	510417	Ref. No. 0K6103 0K6660 0K8701
flat gasket fibre ED ø 20mm ID ø 14mm thickness 2mm Qty 1 pcs			
accessories for	416440		
	GEV No.	361182	Ref. No. —
nut thread 1/4" H 5mm nickel-plated brass WS 17 Qty 1 pcs			
	GEV No.	520228	Ref. No. —
tooth lock washer ID ø 15.3mm ED ø 24mm steel Qty 1 pcs for thread M14			
	GEV No.	550262	Ref. No. —
flat gasket copper ED ø 20mm ID ø 14mm thickness 2mm			

			
GEV No.	418157	Ref. No.	0KM980
description	heating element 2100W 230V L 675mm W 550mm L1 35mm L2 640mm W1 415mm W2 135mm thread 1/4" mounting distance 127mm connection length 90mm connection male faston 6.3mm tube ø 8.5mm cable length 140mm heating circuits 1 dry heating element 2 hole fixing pizza oven		







heating elements for chargrills



GEV No.	416435	Ref. No.	004197 0C3605 91711020
description	heating element 600W 230V L 605mm W 130mm thread 1/4" mounting distance 120mm connection length 110mm connection M4 tube ø 8.5mm heating circuits 1 dry heating element 2 hole fixing pizza oven		
For models:	ZCMDE4, ZCBDE8, PDE830, PDE1230, PDE12L30, PDE1830, PDE835, PDE1235, PDE12L35, PDE1835, PME430, PME630, PME6L30, PME930, PME435, PME635, PME6L35, PME935, PME830, PME1230, PME12L30, PME1830, PME835, PME1235, PME12L35, PME1835		
accessories for	416435		
	GEV No.	361182	Ref. No. —
	nut thread 1/4" H 5mm nickel-plated brass WS 17 Qty 1 pcs		
	GEV No.	510417	Ref. No. OK6103 OK6660 OK8701
	flat gasket fibre ED ø 20mm ID ø 14mm thickness 2mm Qty 1 pcs		
	GEV No.	520228	Ref. No. —
	tooth lock washer ID ø 15.3mm ED ø 24mm steel Qty 1 pcs for thread M14		
	GEV No.	550262	Ref. No. —
	flat gasket copper ED ø 20mm ID ø 14mm thickness 2mm		



GEV No.	416436	Ref. No.	004198 0C3615 91711030
description	heating element 800W 230V L 605mm W 130mm thread 1/4" mounting distance 122mm connection length 110mm connection M4 tube ø 8.5mm heating circuits 1 dry heating element 2 hole fixing		
For models:	ZCMDE4, ZCBDE8, PDE830, PDE1230, PDE12L30, PDE1830, PDE835, PDE1235, PDE12L35, PDE1835, PME430, PME630, PME6L30, PME930, PME435, PME635, PME6L35, PME935, PME830, PME1230, PME12L30, PME1830, PME835, PME1235, PME12L35, PME1835, PDG433, PDG633, PDG933		
spare parts for	416436		
	GEV No.	510417	Ref. No. OK6103 OK6660 OK8701
	flat gasket fibre ED ø 20mm ID ø 14mm thickness 2mm Qty 1 pcs		
accessories for	416436		
	GEV No.	361182	Ref. No. —
	nut thread 1/4" H 5mm nickel-plated brass WS 17 Qty 1 pcs		
	GEV No.	520228	Ref. No. —
	tooth lock washer ID ø 15.3mm ED ø 24mm steel Qty 1 pcs for thread M14		
	GEV No.	550262	Ref. No. —
	flat gasket copper ED ø 20mm ID ø 14mm thickness 2mm		







GEV No.	415376	Ref. No.	002403
description	heating element 1800W 230V L 615mm W 88mm H 23mm hole distance 40mm windings 2 flange length 60mm flange width 30mm connection male faston 6.3mm heating circuits 1 tube ø 8.5mm hole ø 6.5mm rectangular flange dry heating element		
For models:	HG/E400, HG/E800, ZG/E400, ZG/E800, AG/E400, AG/E800		



GEV No.	416978	Ref. No.	0C0495
description	heating element 2500W 400V L 625mm W 90mm H 40mm W1 20mm W2 48.5mm L1 15mm flange length 60mm flange width 30mm hole distance 40mm connection M5 heating circuits 1 tube ø 8.5mm connection length 54mm hole ø 6mm rectangular flange dry heating element		
For models:	KGR/E1, KGR/E2, QGR/E1, QGR/E2, WGR/E1, WGR/E2		



GEV No.	415647	Ref. No.	0K9752
description	heating element 1000W 230V heating circuits 1 L 440mm W 30mm H 6.5mm 2 hole fixing thread M10x1 mounting distance 33mm dry heating element tube ø 6.5mm cable length 320mm connection length 41mm		
accessories for	415647		
	GEV No.	510416	Ref. No. —
	flat gasket fibre ED ø 19mm ID ø 10.5mm thickness 1.5mm for thread M10 Qty 1 pcs		
	GEV No.	510893	Ref. No. —
	O-ring EPDM thickness 2.62mm ID ø 9.92mm Qty 1 pcs		
	GEV No.	520231	Ref. No. —
	nut thread M10x1 H 6mm WS 14 zinc-coated steel Qty 1 pcs		
	GEV No.	521129	Ref. No. —
	nut thread M10 H 6mm SS WS 17 Qty 1 pcs DIN/ISO DIN 439		











GEV No.	415288	Ref. No.	004907 00513
description	heating element 1350W 230V L 396mm W 80mm H 37mm thread 1/4" mounting distance 72mm tube ø 6.3mm connection M4 heating circuits 1 2 hole fixing dry heating element		
For models:	SGE350, SGE350		
accessories for	415288		
	GEV No.	361182	Ref. No. —
	nut thread 1/4" H 5mm nickel-plated brass WS 17 Qty 1 pcs		
	GEV No.	510417	Ref. No. OK6103 OK6660 OK8701
	flat gasket fibre ED ø 20mm ID ø 14mm thickness 2mm Qty 1 pcs		

Table continues overleaf



accessories for	415288		
	GEV No.	520228	Ref. No. —
	tooth lock washer ID ø 15.3mm ED ø 24mm steel Qty 1 pcs for thread M14		
	GEV No.	550262	Ref. No. —
	flat gasket copper ED ø 20mm ID ø 14mm thickness 2mm		

	GEV No.	415646	Ref. No.	OK9751
description	heating element 700W 230V heating circuits 1 L 444mm W 37mm 2 hole fixing thread M10x1 mounting distance 30mm dry heating element tube ø 6.5mm cable length 440mm connection length 22mm			

accessories for	415646		
	GEV No.	510416	Ref. No. —
	flat gasket fibre ED ø 19mm ID ø 10.5mm thickness 1.5mm for thread M10 Qty 1 pcs		
	GEV No.	510893	Ref. No. —
	O-ring EPDM thickness 2.62mm ID ø 9.92mm Qty 1 pcs		
	GEV No.	520231	Ref. No. —
	nut thread M10x1 H 6mm WS 14 zinc-coated steel Qty 1 pcs		
	GEV No.	521129	Ref. No. —
	nut thread M10 H 6mm SS WS 17 Qty 1 pcs DIN/ISO DIN 439		

	GEV No.	415352	Ref. No.	053613 054773 054774 OK2916
description	heating element 2750W 240V L 480mm W 125mm H 41mm L1 70mm L2 40mm L3 370mm W1 23mm W2 79mm connection M4 connection distance 72mm tube ø 8.5mm heating circuits 1 dry heating element			
For models:	MG/E350D, MG/E350UK, MG/E700D, MG/E700UK, MG/E350, MG/E700, RG/E350D, RG/E350UK, RG/E700D, RG/E700UK, 7GLE03T, 7GLE07T, XG/E350D, XG/E350UK, XG/E700D, XG/E700UK, T35ECG, T70ECG, RG/E300, PRG/E300, RG/E300UK, RG/E700, PRG/E700, RG/E700U, RG/E300			

	GEV No.	420138	Ref. No.	053451
description	heating element 3000W 230V L 480mm W 125mm H 41mm L1 70mm L2 40mm L3 370mm W1 23mm W2 79mm connection M4 connection distance 72mm tube ø 8.5mm heating circuits 1 dry heating element			
For models:	MG/E350D, MG/E350UK, MG/E700D, MG/E700UK, MG/E350, MG/E700, RG/E1, RG/E2, RGV/E1, RGV/E2, XG/E1, XG/E2, XGV/E1, XGV/E2, JG/E1, JG/E2, MG/E1, MG/E2, MGV/E1, MGV/E2, RG/E350D, RG/E350UK, RG/E700D, RG/E700UK, 7GLE03T, 7GLE07T, XG/E350D, XG/E350UK, XG/E700D, XG/E700UK, T35ECG, T70ECG, PG/E1, PG/E2, PG/E1E5, PG/E2E5, TG/E1, TG/E2, TG/E1E5, TG/E2E5, RG/E300, PRG/E300, RG/E300UK, RG/E700, PRG/E700, RG/E700U, RG/E300			

heating elements for salamanders/toast-

	GEV No.	420271	Ref. No.	003014 OKD844 RC00003708
description	heating element 1000W 230V L 215mm W 95mm L1 25mm L2 25mm L3 165mm W1 16mm W2 63mm hole distance 96mm connection M4 tube ø 8.5mm flange length 106mm flange width 32mm heating circuits 1 hole ø 5mm tilt flange dry heating element H 8.5mm			

	GEV No.	416653	Ref. No.	003016 OKD963 3804
description	heating element 2000W 230V L 225mm W 283mm L1 15mm L2 210mm W1 110mm W2 63mm hole distance 96mm connection M4 tube ø 8.5mm flange length 106mm flange width 32mm heating circuits 1 hole ø 5mm tilt flange dry heating element H 8.5mm			

	GEV No.	416654	Ref. No.	003012 03706 OKD874 TI3706
description	heating element 2000W 230V L 230mm W 230mm L1 22mm L2 208mm W1 83mm W2 63mm hole distance 96mm tube ø 8.5mm flange length 106mm flange width 32mm heating circuits 1 hole ø 5mm tilt flange dry heating element H 8.5mm			

	GEV No.	420446	Ref. No.	0M0709
description	heating element 2000W 230V L 718mm W 32mm H 32mm tube ø 11.2mm connection M4			



GEV No.	415279	Ref. No.	OK3586
description	heating element 1500W 230V heating circuits 1 L 223mm W 430mm L1 12mm L2 211mm W1 200mm W2 30mm flange length 70mm flange width 23mm hole distance 56mm tube ø 6.3mm windings 4 dry heating element connection M4 rectangular flange hole ø 6mm H 6.3mm		
For models:	SCG700, SCG700		

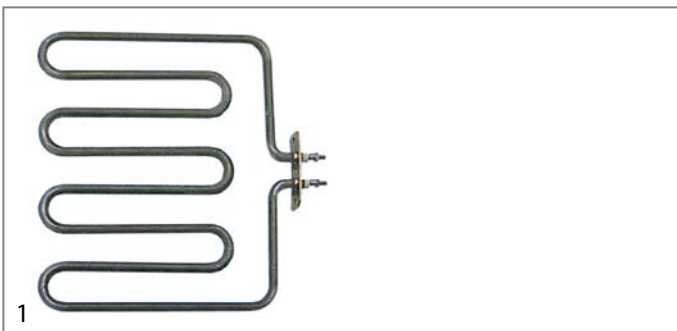

GEV No.	415622	Ref. No.	00109 OKD843
description	heating element 2000W 230V heating circuits 1 L 229mm W 255mm L1 17mm L2 212mm W1 112mm W2 32mm flange length 70mm flange width 23mm hole distance 25mm tube ø 8.5mm connection length 20mm dry heating element connection M4 rectangular flange hole ø 5mm H 8.5mm		

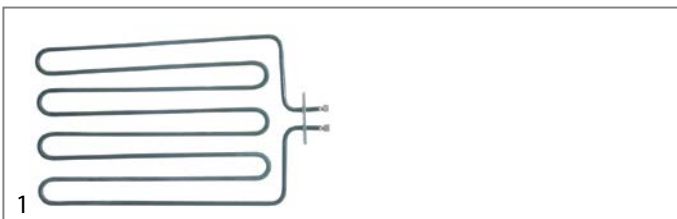

GEV No.	416581	Ref. No.	052836
description	heating element 3000W 230V heating circuits 1 L 357mm W 226mm L1 20mm L2 337mm W1 98mm W2 30mm flange length 70mm flange width 22mm hole distance 57mm tube ø 6.3mm dry heating element connection M5 rectangular flange hole ø 6mm H 6.3mm		
For models:	SL/E802, SLE802UK, SALE08		

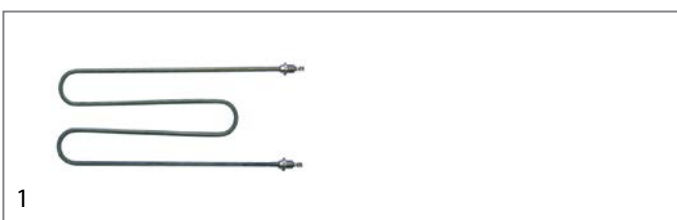

GEV No.	415281	Ref. No.	OK3494
description	heating element 1000W 230V L 290mm W 130mm 2 hole fixing thread M12x1.25 mounting distance 123mm connection male faston 6.3mm dry heating element tube ø 6.3mm heating circuits 1 H 6.3mm		

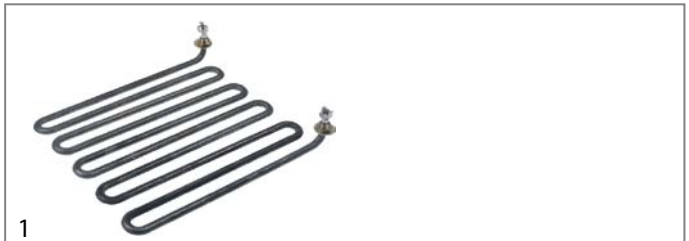

GEV No.	420126	Ref. No.	OK4778 18001707 74184404
description	heating element 2100W 230V heating circuits 1 L 260mm W 220mm H 22mm thread M12x1 connection length 212mm tube ø 8.3mm connection M5 dry heating element for salamander grill		
For models:	VSE-S.3, VSE-S.4.MARINE, VSE-S.3.JUNO, VSE-W.3, VSE-W.4.MARINE, VSE-W.3.JUNO		



GEV No.	415559	Ref. No.	OG1797 OK3007 OK4777 OKI818 18001705 74184401
description	heating element 2100W 400V heating circuits 1 L 260mm W 217mm H 20mm thread M14x1.25 mounting distance 210mm connection length 14mm tube ø 6.5mm 2 hole fixing dry heating element		
For models:	VSE-S.3, VSE-S.4.MARINE, VSE-S.3.JUNO, VSE-W.3, VSE-W.4.MARINE, VSE-W.3.JUNO		

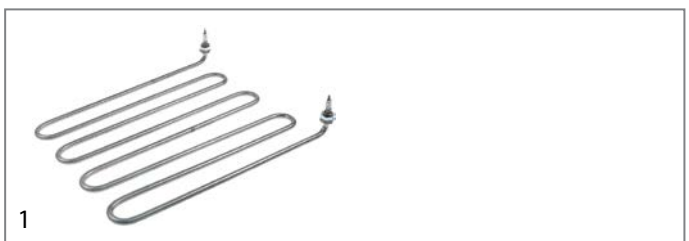







GEV No.	415558	Ref. No.	OH9753 OK4784 18001728 725830036	
description	heating element 2600W 400V L 361mm W 310mm H 30mm thread M14x1.5 mounting distance 280mm connection length 34mm tube ø 8.5mm connection M4 2 hole fixing dry heating element			
accessories for	415558			
	GEV No.	510417	Ref. No.	OK6103 OK6660 OK8701
	flat gasket fibre ED ø 20mm ID ø 14mm thickness 2mm Qty 1 pcs			
	GEV No.	520228	Ref. No.	—
	tooth lock washer ID ø 15.3mm ED ø 24mm steel Qty 1 pcs for thread M14			
	GEV No.	520230	Ref. No.	—
	nut thread M14x1.5 H 5mm WS 19 zinc-coated steel Qty 1 pcs			

Table continues overleaf



accessories for	415558		
	GEV No.	521101	Ref. No. —
	nut thread M14x1.5 H 5mm WS 19 SS Qty 1 pcs		
	GEV No.	550262	Ref. No. —
	flat gasket copper ED ø 20mm ID ø 14mm thickness 2mm		

	1		
GEV No.	415537	Ref. No.	0H6169
description	heating element 3200W 230V heating circuits 2 L 493mm W 250mm thread M14x1.5 mounting distance 35mm connection length 45mm connection male faston 6.3mm tube ø 8.5mm dry heating element 4 hole fixing		

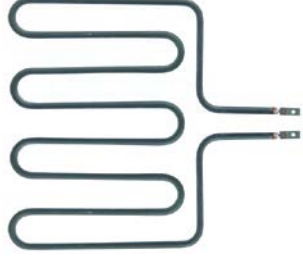
	1		
GEV No.	416579	Ref. No.	056783 0HB159 0K9369 4175223 417522300
description	heating element 1900W 220V heating circuits 1 L 245mm W 240mm L1 63mm L2 182mm W1 98mm W2 45mm connection distance 16mm connection M4 dry heating element tube ø 6.3mm H 6.3mm		
For models:	SL/E901, SAL-E2, SALE06		

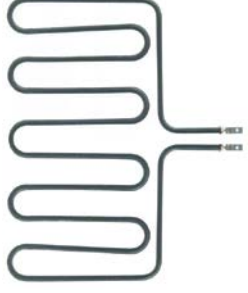
	1		
GEV No.	416580	Ref. No.	056782 0HB160 0K9368 4175222 417522200
description	heating element 2000W 220V heating circuits 1 L 240mm W 333mm L1 60mm L2 180mm W1 149mm W2 35mm connection distance 29mm connection M4 dry heating element tube ø 6.3mm H 6.3mm		
For models:	SL/E851, SAL-E1, SALE04		

heating elements for heated trolleys

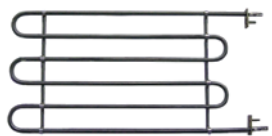
	1		
GEV No.	415596	Ref. No.	0G2290
description	heating element 1500W 230V heating circuits 1 L 395mm W 198mm tube ø 6.5mm lug length 31mm lug width 16mm connection length 30mm connection male faston 6.3mm dry heating element bracket mounting hole distance 160mm mounting thread M4		
For models:	JFM/G400, 7720-3/90.WB.GN1/1., 7520-3/85.WB.GN1/1., 7721-3/85.WB.GN2/1, 7520-3/90.WB.GN1/1., 7720-3/85.WB.GN1/1., 7521-3/85., 7521-3/90.WB.GN2/1., 7721-3/90.WB.GN2/1., 7521-3/85.WB.GN2/1.W, PFM/G400, 7520-3, 7521-3, 7720-3, 7721-3, 9020-3, 9220-3-0, 9220-3-8		

	1		
GEV No.	419130	Ref. No.	053577
description	heating element 1500W 230V L 388mm W 208mm connection M4 tube ø 8.5mm heating circuits 1 hole distance 230mm flange length 245mm flange width 20mm hole ø 6mm		
For models:	CCB10, CCB20		

	1		
GEV No.	420303	Ref. No.	0KA636
description	heating element bain marie 700W 230V L 400mm W 200mm connection male faston 6.3mm dry heating element tube ø 6.25mm heating circuits 1 connection distance 193mm		

	1		
GEV No.	415619	Ref. No.	0H9822 0K4986 18011704 70502013003
description	heating element heated cabinet 1000W 400V L 605mm W 200mm H 20mm connection M4 dry heating element 2 hole fixing thread M14x1.5 tube ø 8.5mm mounting distance 195mm		



heating cables

drain heating cables



GEV No.	419151	Ref. No.	087138
description	drain heating cable 144W 230V ø 8mm L 2360mm L1 (unheated) 1600mm L2 (heated) 760mm for evaporator Qty 1		
For models:	ADF110ES, ADF110ESP, ADF110, ALF110, ADF120, ALF120, AEF110, AEF120, ADN220, ADN230, AENF220, AENF230, ASF110, AKF110UK, ASF110UK, ADF110E, 83012201, ARDF110L, ARDF120, ASF110, ADF110, ADF120, ADN220, ADN230, ADN230, ADN230, ADF11060, ZPR06F1F, PR06F1FBR, PS06F1F6M, PS06FE1F, PS06F1F, PS06F1FR, PS06FE2F, PR06F1F4, PR06F1F, PR06F1FR, PR06FE2F, PR06RE1F, PR06FE1F, RH06FE1FS, MP602, MCD650F, MCD650F2, MP1200, RH06FE1F, RH06FE1FDU, RH06FEP1F, ICF6212F, ICF6212F... (Other models you can see in the webshop)		

connection on both sides

with male fastons



GEV No.	419153	Ref. No.	085976
description	heating cable 27.5W 230V L 7200mm L1 (unheated) 1700mm L2 (heated) 5500mm silicone ø 4.5mm connection male faston 6.3mm Qty 1		
For models:	ALN120, AEN120, ADN120, AENN120, ALN240, AEN240, ADF240, AEF240, ADN230, AENN230, ARDNN120, ADN120, ADN120, ADN240, ADN230, RS06RXH, E06N0M2C, E06N1M2C, E06N0D2C, EC6N0M2C, EC6N0D2C, E14N0M4C, E14N1M4C, E14N0D4C, E14C0M4C, E14C1M4C, E14C0D4C, EC4N0M3C, EC4N0D3C, C06RD2F, C06RM2F, C06CD2F, C06CM2F, C14RD4F, C14RM4F, C14FD4F, C14F-M4F, C14CD3F, C14CM3F, RH06RD2F, RH06RD2FR, RH06DD2F, RH06D-D2FR, RH14RD4F, RH14DD3F, RS12RD2G, E06N0D2C, EC6N0D2C, E14N0D4C, EC4N0D3C...(Other models you can see in the webshop)		



GEV No.	419152	Ref. No.	0A9698
description	heating cable 56.4W 230V L 7800mm L1 (unheated) 2200mm L2 (heated) 5600mm ø 4.5mm connection male faston 6.3mm Qty 1		
For models:	ADF120, ALF120, AEF120, ADN120, AENN120, ADN230, AENF230, ARDF120, ADF120, ADN120, ADF240, ADN230, MP602, MCD650F2, MP1200, MCD650FP2, MCD65F2LR, E06C0M2C, E06C1M2C, E06C0D2C, E06C0D2C, EC6N0M2C, EC6M0D2C, EC4M0M3C, EC4M0D3C, C06FD2F, C06FD2FA, C06FM2F, C06CFD2F, C06CFD2FR, C06CM2F, C14CFD3F, KLPF650R, E06C0D2C, MCD650F2A, RH06F-D2F, C06FD2FR, RH06DD2FR, RH06DFD2F, C06CFD2I, C14FD4F, RH06FD1F6, E06C0D2C, EC6M0D2C, E14C0D4C, FDNE062, FVNE062, FVNM062, KVNE332, KMNE332...(Other models you can see in the webshop)		

with male faston and wire end ferrule



GEV No.	420062	Ref. No.	082247 089912
description	heating cable 42.3W 230V L 6300mm L1 (unheated) 2100mm L2 (heated) 4200mm ø 4.5mm Qty 1		
For models:	ALF220, ALF220, AZF1103, AZF2203, AKF230, AKF220, IKNN220, IKNF120, AKF220, AKF220UK, ASF110, ASF110, ASF110, ALF1104, ALF11033, AZF1103, ALF1104, ALF11033, AZP2203, AZF2203, ISPZ110, IKNF, FVNE051, FVNE11E, ISS110N, TE751L, TZ751L, TZ751GT, TE1502GT, ETZ601, ETZ1402, ETZ601GT, ETE601, ETE1402, ETE601L, ETZ601L, TE751R, TZ751R, TE1502, TZ1502, TE751GT, ISP110N, ISN110N, TZ1502GT, RS06FX1F, RS13FX2F, IKNF220N, RS06F41F, RS06FX1F4, RS13FX42F...(Other models you can see in the webshop)		

heating cartridges



GEV No.	417570	Ref. No.	083814
description	heating cartridge 110W 230V ø 12mm L 120mm thread 3/8" cable length 1000mm universal		



GEV No.	417227	Ref. No.	083814 1CZJ713A001
description	heating cartridge 90W 230V ø 12mm L 124mm thread 3/8" cable length 4000mm Hmm Wmm condensate evaporation		

heater battery



GEV No.	415122	Ref. No.	0k4812
description	heater battery mounting distance 185mm W 40mm H 35mm 2000W 230V temperature restriction 105°C heating circuits 2 connection cable cable length 340mm L 197mm for cross flow fan		



			
1			
GEV No.	420240	Ref. No.	0E3385 0W6266
description	heater battery mounting distance mm W 90mm H 45mm 6000W 240/415V temperature restriction 125°C heating circuits 6 connection male faston 6.3mm cable length mm L 360mm		
For models:	D166E, D166ECOP, T4350, T3900, D200E, D200G, DI200E, DI200G, T3900, T390013, D650E, D650G, D650V, T419002, T419003, PD9, T353019, T3190, T3190, T3250_EL, T3250_GAS, T3250_EL, T3250_GAS, T3650, T3650, T3650, T3350_EL, T3350_GAS, T3350_EL, T3350_GAS, T3530, T3530, T3190E, T3190G, T419001, T419005, T329001, T329002, T329003, T329004, T329005, T329006, T329007, T329008, T329009, T329010, T329011, T329012, T4300S01, T4300S02...(Other models you can see in the webshop)		

heating rods



			
1			
GEV No.	420077	Ref. No.	054737
description	heating rod 1100W 220V L 679mm W 39mm H 10mm cable length 1000mm		
For models:	BR180Z, BR180E		



			
1			
GEV No.	420083	Ref. No.	054735
description	heating rod 500W 220V L 290mm W 40mm H 10mm cable length 1500mm		
For models:	BR80EZ, BR180Z, BR100Z, BR100E, BR180E, BR80E		

			
1			
GEV No.	420082	Ref. No.	054736
description	heating rod 750W 220V L 440mm W 40mm H 10mm cable length 1000mm		
For models:	BR80EZ, BR180Z, BR100Z, BR100E, BR180E, BR80E		

ceramic heaters



245x60mm

			
1			
GEV No.	415104	Ref. No.	0A2843 0G3479 0K3898 0K9795 0KG007 10000221 1RCTCOFTE010 VOL10000221
description	ceramic emitter 1000W 230V cable beaded cord L 245mm W 60mm H 35mm		
For models:	MCC/E350D, MCC/E350, RW/E1, XW/E1, JW/E1, MW/E1, RCC/E350, T35ECS, CCC/E350, PW/E1, OW/E1, TW/E1, KW/E1, QW/E1, WW/E1		
spare parts for	415104		
	GEV No.	415109	Ref. No. —
	spring clip		
accessories for	415104		
	GEV No.	415110	Ref. No. —
	reflector L 245mm W 95mm H 31mm thickness 0.75mm hole ø 15x40mm		

			
1			
GEV No.	415102	Ref. No.	058144
description	ceramic emitter 400W 230V cable beaded cord L 245mm W 60mm H 35mm		
For models:	QME300I, QME600I		
spare parts for	415102		
	GEV No.	415109	Ref. No. —
	spring clip		
accessories for	415102		
	GEV No.	415110	Ref. No. —
	reflector L 245mm W 95mm H 31mm thickness 0.75mm hole ø 15x40mm		

1

GEV No.	415103	Ref. No.	00288 004898
description	ceramic emitter 650W 230V cable beaded cord L 245mm W 60mm H 35mm		
For models:	SCCE350, SCCE350, SCCE350		
spare parts for	415103		
	GEV No.	415109	Ref. No. —
	spring clip		
accessories for	415103		
	GEV No.	415110	Ref. No. —
	reflector L 245mm W 95mm H 31mm thickness 0.75mm hole ϕ 15x40mm		

pilot heating elements



1



GEV No.	415460	Ref. No.	0H6199 0K0550 0KC471 450191G3
description	heating element 1000W 230V heating circuits 1 flange 70x18mm L 230mm W 65mm connection male faston 6.3mm tube ϕ 8.5mm immersion heater expansion flange connection length 20mm silicone TD ϕ 8mm		
For models:	7573-3/85.KES100.(N), 7574-3/85.KES150.(N), 7575-3/85.KES250.(N), 7576-3/85.KES300.(N), 7573-3/90.KES100.(N), 7574-3/90.KES150.(N), 7575-3/90.KES250.(N), 7576-3/90.KES300.(N), 7573-3, 7574-3, 7575-3, 7576-3, 7577-3, 7773-3, 7773-3/85.KES100, 7773-3/90.KES100, 7774-3, 7774-3/85.KES150, 7774-3/90.KES150, 7775-3, 7775-3/85.KES250, 7775-3/90.KES250, 7776-3, 7776-3/85.KES300, 7776-3/90.KES300, 9100-3, 9104-3, 9113-3, 9190-3, 9191-3, 9193-3, 9195-3, 9300-3-0, 9300-3-8, 9304-3-0, 9304-3-8, 9313-3-0, 9313-3-8, 9390-3, 9391-3, 9393-3, 9395-3		
accessories for	415460		
	GEV No.	375044	Ref. No. 0H6141 0KE595
	safety thermostat switch-off temp. 178°C 1-pole 16A probe ϕ 4mm probe L 91mm capillary pipe 1730mm capillary pipe isolated 1600mm gland nut probe with sealing sleeve screw connection M8x1 sealing sleeve 8.6x32mm		

immersion heating elements

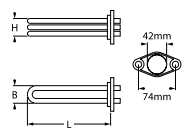
2 hole flange 74mm



1

GEV No.	415188	Ref. No.	070307
description	heating element 2400W 230V mounting ϕ 42mm heating circuits 2 L 248mm W 33mm H 25mm hole distance 75mm hole ϕ 9.5mm connection M4 immersion heater 2 hole flange		
For models:	LB035C, LB035R, LB035Q, LB040R, LB040Q, LB040AUS, G350C, LBICEQ010, LBIOET010, LBIOET014, LBIOEQ010, G350, G350DP, LBIOEQ014, G400, G400DP		
accessories for	415188		
	GEV No.	521124	Ref. No. 060009 070308
	flat gasket rubber ED ϕ 52mm ID ϕ 42mm thickness 6mm Qty 1 pcs		
	GEV No.	550444	Ref. No. —
	protection cap ϕ 47mm H 40mm		

3 hole flange ϕ 47.5mm

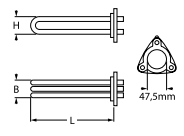
1

GEV No.	418683	Ref. No.	0E5953 0L1852
description	heating element 10500W 230V heating circuits 3 L 390mm W 35mm H 35mm number of thermostat sleeves 1 thermostat sleeves ϕ 8.5mm length thermostat sleeves 270mm tube ϕ 8.5mm hole distance 62mm hole ϕ 6.5mm		
For models:	RT100ED, RT100ES, RT140ED, RT140ES, RT190ED, RT190ES, RT190H-DED, RT190HDES, RT270ED, RT270ES, RT270HDED, RT270HDES, RT100ERF, RT100ELF, RT140ERF, RT140ELF, RT142ERF, RT142ELF, RT190ERF, RT190ELF, RT190HERF, RT190HELFL, RT270ERF, RT270ELFL, RT270HERF, RT270HELFL, RT100ERG, RT100ELG, RT140ERG, RT140ELG, RT190ERG, RT190ELG, RT190HERG, RT190HELGL, RT270ERG, RT270ELG, RT270HERG, RT270HELGL, RT10ED, RT10ES, RT10SR, RT10SL, RT10ED/230, RT10ES/230, RT10ERF60, RT10ELF60, RT10ERF, RT10ELFL, RT10ERBF60, RT10ELBF60...(Other models you can see in the webshop)		
spare parts for	418683		
	GEV No.	510408	Ref. No. 046213 055533 067620 0H2559 0L2765 19006668 19006946
	O-ring EPDM thickness 5.34mm ID ϕ 47mm Qty 1 pcs		
accessories for	418683		
	GEV No.	510562	Ref. No. —
	O-ring silicone thickness 5.34mm ID ϕ 47mm Qty 1 pcs		



GEV No.	418017	Ref. No.	0C6470
description	heating element 10750W 230V mounting \varnothing 47.5mm heating circuits 3 L 542mm W 35mm H 26mm number of thermostat sleeves 1 thermostat sleeves \varnothing 8mm length thermostat sleeves 180mm thermostat sleeve not clinging tube \varnothing 6.3mm hole distance 62mm hole \varnothing 6mm connection M5 3 hole flange immersion heater		
accessories for	418017		
	GEV No.	510408	Ref. No.
			046213 055533 067620 0H2559 0L2765 19006668 19006946
	O-ring EPDM thickness 5.34mm ID \varnothing 47mm Qty 1 pcs		
	GEV No.	510562	Ref. No.
			—
	O-ring silicone thickness 5.34mm ID \varnothing 47mm Qty 1 pcs		

GEV No.	420314	Ref. No.	0E5956 0L1853
description	heating element 12000W 230V mounting \varnothing 47.5mm heating circuits 3 L 464mm W 32mm H 35mm number of thermostat sleeves 1 thermostat sleeves \varnothing 7mm length thermostat sleeves 265mm thermostat sleeve eccentric, clinging tube \varnothing 8.4mm hole distance 62mm hole \varnothing 6.5mm connection male faston 6.3mm 3 hole flange immersion heater		
For models:	TW1ERECO, TW1ELECO, TW1SRECO, TW1SLECO, RT100ED, RT100ES, RT140ED, RT140ES, RT190ED, RT190ES, RT190HDED, RT190HDES, RT270ED, RT270ES, RT270HDED, RT270HDES, RT100ERF, RT100ELF, RT140ERF, RT140ELF, RT142ERF, RT142ELF, RT190ERF, RT190ELF, RT190HERF, RT190HEL, RT270ERF, RT270ELF, RT270HERF, RT270HEL, RT100ERG, RT100ELG, RT140ERG, RT140ELG, RT190ERG, RT190ELG, RT190HERG, RT190HEL, RT270ERG, RT270ELG, RT270HERG, RT270HEL, RT10ED, RT10ES, RT10SR, RT10SL, RT10ED/230, RT10ES/230, RT10ERF60, RT10ELF60...(Other models you can see in the webshop)		

GEV No.	420311	Ref. No.	0L0019
description	heating element 12000W 230V mounting \varnothing 47.5mm heating circuits 3 L 464mm W 32mm H 36mm number of thermostat sleeves 1 thermostat sleeves \varnothing 7mm length thermostat sleeves 265mm thermostat sleeve eccentric, clinging tube \varnothing 8.4mm hole distance 62mm hole \varnothing 6.5mm connection M5 3 hole flange immersion heater		
For models:	RT10SR, RT10SL, RT10ERF60, RT10ELF60, RT10ERF, RT10ELF, RT10ERBF60, RT10ELBF60, RT10ERG, RT10ELG, RT10SRB, RT10SLB, RT10ERBF, RT10ELBF, RT10ERBG, RT10ELBG, RT10SRC, RT10SLC, RT10ERC, RT10ELC, RT10ERCG, RT10ELCG, RT10SRCB, RT10SLCB, RT10ERCBF, RT10ELCBF, RT10ERCBG, RT10ELCBG, RT10ERASIA, RT10ELASIA, RT10SRASIA, RT10SLASIA, RT10ERCINA, RT10ELCINA, RT10ERROWH, RT10ELROWH, RT10ERH, RT10ELH, RT10ERROW, RT10ELROW, RT10ERROW6, RT10ELROW6, WT90ER, WT90EL, WT90ER60, WT90EL60, WT90ERB60, WT90ELB60, WT90ERG, WT90ELG...(Other models you can see in the webshop)		

GEV No.	419082	Ref. No.	0F0051 0K8362
description	heating element 13000W 230V mounting \varnothing 47.5mm heating circuits 3 L 585mm W 30mm H 40mm number of thermostat sleeves 1 thermostat sleeves \varnothing 5mm length thermostat sleeves 225mm thermostat sleeve centred, adjacent tube \varnothing 8.5mm hole distance 62.5mm hole \varnothing 6.5mm connection length 17mm connection M5 3 hole flange immersion heater		
For models:	CS20ME4/200-3, CS20ME4/230-3, CS20ME6/230-3, CS20ME4/400-3N, CS20ME6/400-3N, CS20ME4/400-3NE, CS20ME4/400-3, CS20ME4/440-3, CS20MT4/400-3N, CS20MT6/400-3N, CS20GE4/200-3, CS20GE4/230-3, CS20GE6/230-3, CS20GE4/400-3N, CS20GE6/400-3N, CS20GE4/400-3NE, CS20GE4/400-3, CS20GE4/440-3, CS20GT4/400-3N, CS20GT6/400-3N, CS20LCE4/200-3, CS20LCE4/230-3, CS20LCE4/400-3N, CS20LCE6/400-3N, CS20LCE4/400-3, CS20LCE4/440-3, CS20LCT4/400-3N, CS20LCT6/400-3N		

GEV No.	419083	Ref. No.	058214 058672
description	heating element 17000W 220V mounting \varnothing 47.5mm heating circuits 3 L 590mm W 35mm H 40mm tube \varnothing 8.5mm hole distance 62.5mm hole \varnothing 6.5mm connection M5 3 hole flange immersion heater		
For models:	FCVE10-2, FCVE10-4, FCVE103CE, FCVE10-2UK, FCVE10-4UK, ZOFCV/E102, ZOFCV/E104		
accessories for	419083		
	GEV No.	510408	Ref. No.
			046213 055533 067620 0H2559 0L2765 19006668 19006946
	O-ring EPDM thickness 5.34mm ID \varnothing 47mm Qty 1 pcs		



GEV No.	415063	Ref. No.	058995 0C5336 0H2521 0K8360 0KF066 60050288 7800589959
description	heating element 17000W 230V mounting \varnothing 47.5mm heating circuits 3 L 590mm W 29mm H 38mm number of thermostat sleeves 1 thermostat sleeves \varnothing 4mm length thermostat sleeves 225mm thermostat sleeve centre tube \varnothing 8.5mm hole distance 63mm hole \varnothing 10mm connection M5 3 hole flange immersion heater		
For models:	FCV/E10L3, FCV/E10L6, FVC/E101/1, FCS101E4, FCS101EP, FCS101EXLN, FCS101EX, FCVE10-P, FCVE10PUK, CS10ME4/200-3, CS10ME4/230-3, CS10ME6/230-3, CS10ME4/400-3N, CS10ME6/400-3N, CS10ME4/400-3N/EO, CS10ME4/400-3/50HZ/M, CS10ME4/440-3/60HZ/M, CS10MT4/400-3N, CS10MT6/400-3N, CS10GE4/200-3, CS10GE4/230-3, CS10GE6/230-3, CS10GE4/400-3N, CS10GE6/400-3N, CS10GE4/400-3N/EO, CS10GE4/400-3/50HZ/M, CS10GE4/440-3/60HZ/M, CS10GT4/400-3N, CS10GT6/400-3N, CS10LCE4/200-3, CS10LCE4/230-3, CS10LCE6/230-3, CS10LCE4/400-3N, CS10LCE6/400-3N, CS10LCE4/400-3N/EO, CS10LCE4/400-3/50HZ/, CS10LCE4/440-3/60HZ/, CS10LCT4/400-3N, CS10LCT6/400-3N, CS20ME4/200-3, CS20ME4/230-3, CS20ME6/230-3, CS20ME4/400-3N, CS20ME6/400-3N, CS20ME4/400-3NE, CS20ME4/400-3, CS20ME4/440-3, CS20MT4/400-3N, CS20MT6/400-3N, CS20GE4/200-3... (Other models you can see in the webshop)		
accessories for	415063		
	GEV No.	510408	Ref. No.
	046213 055533 067620 0H2559 0L2765 19006668 19006946		
O-ring EPDM thickness 5.34mm ID \varnothing 47mm Qty 1 pcs			
	GEV No.	510562	Ref. No.
	—		
O-ring silicone thickness 5.34mm ID \varnothing 47mm Qty 1 pcs			



GEV No.	419084	Ref. No.	059003
description	heating element 17000W 240V mounting \varnothing 47.5mm heating circuits 3 L 590mm W 32mm H 40mm number of thermostat sleeves 1 thermostat sleeves \varnothing 5mm length thermostat sleeves 225mm thermostat sleeve centred, adjacent tube \varnothing 8.5mm hole distance 62.5mm hole \varnothing 6.5mm connection M5 3 hole flange immersion heater		
For models:	FCVE10-P, FCVE10PUK		



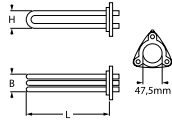



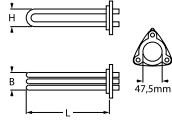

GEV No.	417730	Ref. No.	0F0095 0K8363 482530509
description	heating element 17000W 254V heating circuits 3 L 585mm W 34mm H 36mm number of thermostat sleeves 1 length thermostat sleeves 225mm tube \varnothing 8.5mm hole distance 62mm hole \varnothing 6.5mm for combi-steamer		
For models:	CS10ME4/200-3, CS10ME4/230-3, CS10ME6/230-3, CS10ME4/400-3N, CS10ME6/400-3N, CS10ME4/400-3N/EO, CS10ME4/400-3/50HZ/M, CS10ME4/440-3/60HZ/M, CS10MT4/400-3N, CS10MT6/400-3N, CS10GE4/200-3, CS10GE4/230-3, CS10GE6/230-3, CS10GE4/400-3N, CS10GE6/400-3N, CS10GE4/400-3N/EO, CS10GE4/400-3/50HZ/M, CS10GE4/440-3/60HZ/M, CS10GT4/400-3N, CS10GT6/400-3N, CS10LCE4/200-3, CS10LCE4/230-3, CS10LCE6/230-3, CS10LCE4/400-3N, CS10LCE6/400-3N, CS10LCE4/400-3N/EO, CS10LCE4/400-3/50HZ/, CS10LCE4/440-3/60HZ/, CS10LCT4/400-3N, CS10LCT6/400-3N, CS20ME4/200-3, CS20ME4/230-3, CS20ME6/230-3, CS20ME4/400-3N, CS20ME6/400-3N, CS20ME4/400-3N/EO, CS20ME4/400-3/50HZ/M, CS20ME4/440-3/60HZ/M, CS20MT4/400-3N, CS20MT6/400-3N, CS20GE4/200-3, CS20GE4/230-3, CS20GE6/230-3, CS20GE4/400-3N, CS20GE6/400-3N, CS20GE4/400-3NE, CS20GE4/400-3, CS20GE4/440-3, CS20GT4/400-3N, CS20GT6/400-3N... (Other models you can see in the webshop)		

GEV No.	416130	Ref. No.	049371
description	heating element 2800W 230V mounting \varnothing 47.5mm heating circuits 1 L 310mm W 8.5mm H 39mm tube \varnothing 8.5mm hole distance 63mm hole \varnothing 6mm connection male faston 6.3mm 3 hole flange immersion heater		
For models:	LS32, WT302, LS33, WT303, FL32, FL33, C32, C33, Z32, Z33		
accessories for	416130		
	GEV No.	510408	Ref. No.
	046213 055533 067620 0H2559 0L2765 19006668 19006946		
O-ring EPDM thickness 5.34mm ID \varnothing 47mm Qty 1 pcs			
	GEV No.	510562	Ref. No.
	—		
O-ring silicone thickness 5.34mm ID \varnothing 47mm Qty 1 pcs			

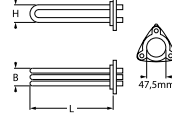

 			
1			
GEV No.	416135	Ref. No.	049980
description	heating element 2800W 230V mounting \varnothing 47.5mm heating circuits 1 L 375mm W 8.5mm H 40mm tube \varnothing 8.5mm hole distance 62.5mm hole \varnothing 6.5mm connection male faston 6.3mm 3 hole flange immersion heater		
For models:	WT4, WT4D, WT4WS1, WT4DWS1, WT4D60, WT4DDG, EUC1, EUC1DP, EUC1WS, EUC1DPWS, EUC1DP60, LS5/1, LS5/1DP, LS5/1WS, LS5/1WSDP, LS5/1DP60, LS5/1DPAUS, LS5/1DP60, NUC1, NUC1DP, NUC1WS, NUC1DPWS, NUC1DP60, NUC1DPA, ZUCA1, UC5DP, UC5WSDP, UC5/1, UC5/1DP, FL5DDG		
accessories for	416135		
	GEV No.	510408	Ref. No. 046213 055533 067620 0H2559 0L2765 19006668 19006946
	O-ring EPDM thickness 5.34mm ID \varnothing 47mm Qty 1 pcs		
	GEV No.	510562	Ref. No.
	O-ring silicone thickness 5.34mm ID \varnothing 47mm Qty 1 pcs		

 			
1			
GEV No.	415174	Ref. No.	048489 048927 049060 0L1634
description	heating element 3000W 230V mounting \varnothing 47.5mm heating circuits 3 L 160mm W 33mm H 39mm tube \varnothing 6.3mm hole distance 65mm hole \varnothing 8mm connection length 39mm connection male faston 6.3mm 3 hole flange immersion heater		
For models:	LS32F, LV32F, LV32/60, WT302F, WT302/60, LS33F, LV33F, LS33/60, WT303F, WT303/60, LB1, LB1WS, LB1WSDP, LB1/RBP, LB1/TOP, LB1/60, WT1WSDP, LB2DPSAUS, LB1G, LB1WSG, WT2TOP60, WT2DPDI, WT2WSDPDI, LB1TOP, WT2TOPDI, LB2WS, LB2, LB2WSDP, LB2/TOP, LB2/RBP, LB2WS60, WT2WSDP, WT2WSDPD, LB2WSG, WT2WS, WT1, WT1WS, WT1TOP, WT2TOP, WT2DPAUS, WT2, LB2DPDI, LB2WSDPDI, LB2WSDPD, LB2TOP, NGW, NGWDPDD, LS62, LS62D, LS62/UKRP... (Other models you can see in the webshop)		
spare parts for	415174		
	GEV No.	510408	Ref. No. 046213 055533 067620 0H2559 0L2765 19006668 19006946
	O-ring EPDM thickness 5.34mm ID \varnothing 47mm Qty 1 pcs		
accessories for	415174		
	GEV No.	510408	Ref. No. 046213 055533 067620 0H2559 0L2765 19006668 19006946
	O-ring EPDM thickness 5.34mm ID \varnothing 47mm Qty 1 pcs		

accessories for	415174		
	GEV No.	521012	Ref. No.
	gasket graphite ED \varnothing 15mm ID \varnothing 5mm thickness 1.2mm Qty 1 pcs		
 			
1			
GEV No.	415069	Ref. No.	045518 046627 052620 0L1875
description	heating element 4500W 220V mounting \varnothing 47.5mm heating circuits 3 L 310mm W 30.5mm H 29mm tube \varnothing 6.3mm connection male faston 6.3mm 3 hole flange immersion heater		
For models:	MPN/EI760, MPNEI760UK, MPN/EI760D, 7PIE06, RPN/EI760UK, RPN/EI760D, M70EIKE, XPN/EI760UK, XPN/EI760D, RPN/EI760, HPN/EI810, HPN/EI810, HPA/EI810, HPN/EI810, HPN/EI810, HPA/EI815, LS365F, LS365, LS365PH, LS365D, LS365, LS365/63, LS367, LSE720DK, LS500UK, LS501UK, LS720, LS365F, LS720N		
accessories for	415069		
	GEV No.	510408	Ref. No. 046213 055533 067620 0H2559 0L2765 19006668 19006946
	O-ring EPDM thickness 5.34mm ID \varnothing 47mm Qty 1 pcs		
	GEV No.	520235	Ref. No.
	3 hole flange hole distance 70.5mm perforation \varnothing 6.5mm ID \varnothing 53.5mm		
	GEV No.	520236	Ref. No. 003362 065558 0K2022 0K2917 0KD441 H24512000
	flange for heating element ID \varnothing 50mm ED \varnothing 90mm hole \varnothing 6.5mm 3 holes		
	GEV No.	521012	Ref. No.
	gasket graphite ED \varnothing 15mm ID \varnothing 5mm thickness 1.2mm Qty 1 pcs		
	GEV No.	550002	Ref. No.
	tension strap H 10mm L 21mm W 10mm hole \varnothing 6.5mm for heating element		
	GEV No.	550362	Ref. No.
	blind flange \varnothing 64mm mounting \varnothing 47.5mm		







1

GEV No.	415067	Ref. No.	002523 048928
description	heating element 4500W 230V mounting ϕ 47.5mm heating circuits 3 L 218mm W 34mm H 29mm tube ϕ 6.3mm hole ϕ 8x10mm connection male faston 6.3mm 3 hole flange immersion heater		
For models:	MPN/EI760, MPNEI760UK, MPN/EI760D, RPI/E240, RPI/E260, RPI/E260P, XPI/E240, XPI/E260, XPI/E260P, JPI/E240, JPI/E260, MPI/E240, MPI/E260, MPI/E260P, 7PIE06, RPN/EI760UK, RPN/EI760D, M70EIKE, XPN/EI760UK, XPN/EI760D, PPI/E260P, OPI/E260P, TPI/E260P, KPI/E06, HPN/EI806, HPN/EI805, QPI/E06, ZPN/EI805, WPI/E06, APN/EI805, WT1/3DP, WT2/3DP, LB2DP3, WT2DPD3, LS61, LS61/60, WT32/4,5, WT32/UK, WT32/UKRP, WT32/4,5N, WT33/4,5, WT33/UK, WT33/UKRP, WT33/4,5N, WT34/4,5, WT34/UKRP, WT34/4,5N, LS7/9, LS10D, LS10... (Other models you can see in the webshop)		





1

GEV No.	416128	Ref. No.	049955 0L2129 0L2652
description	heating element 4500W 230V mounting ϕ 47.5mm heating circuits 3 L 265mm W 30mm H 35mm tube ϕ 8.5mm hole distance 60mm hole ϕ 10mm connection male faston 6.3mm 3 hole flange immersion heater		
For models:	WT4B, WT4DB, WT46, WT4DG, WT4BWS, WT4BDWS, NUC3DD, EUC3, EUC3WS, EUC3DP, EUC3DPWS, EUC1G, EUC3DD, LS5/3, LS5/3DP, LS5/3WS, LS5/3WSDP, FUCA3DD, LS5/3WSDPD, LB5DPG, KUC3, KUC3DP, NUC3, NUC3WS, NUC3DP, NUC3DPWS, NUC3DDWS, ZUCA3, FL5, FL5DP, LV5, LV5DP, LV5/3WSDP, FL5/3WSDP, LD5DP, LD5, NUC1G, NUCA1DDG		
accessories for	416128		
	GEV No.	510408	Ref. No. 046213 055533 067620 0H2559 0L2765 19006668 19006946
O-ring EPDM thickness 5.34mm ID ϕ 47mm Qty 1 pcs			
	GEV No.	510562	Ref. No.
O-ring silicone thickness 5.34mm ID ϕ 47mm Qty 1 pcs			



1

GEV No.	415066	Ref. No.	026453 047847 049307 052905 0H2476 0K8125 0L1849 0L1876
description	heating element 4500W 230V mounting ϕ 47.5mm heating circuits 3 L 310mm W 30mm H 36mm number of thermostat sleeves 1 thermostat sleeves ϕ 7mm length thermostat sleeves 185mm thermostat sleeve eccentric, clinging tube ϕ 6.3mm hole distance 64mm hole ϕ 10mm connection male faston 6.3mm 3 hole flange immersion heater		
For models:	MPN/EI760, MPNEI760UK, 7PIE06, RPN/EI760UK, M70EIKE, XPN/EI760UK, RPN/EI760, LS32/4.5, LS32UK/RP, C55, WT302/4.5, WT302UK/RP, LS33/4.5, LS33UK/RP, C55A, WT303/4.5, WT303UK/RP, LS540F, LS541F, LS540, LS540D, LS520D, LS520M, LS520K, LS521D, LS521M, LS521K, LS521, LS4, LS62/UK, LS63/UK, LS64/UK, WT32/UK, WT33/UK, WT34/UK, WT50/UK3, RT100ED, RT100ES, RT140ED, RT140ES, RT190ED, RT190ES, RT190HDED, RT190HDES, RT270ED, RT270ES, RT270HDED, RT270HDES, RT100ERF, RT100ELF... (Other models you can see in the webshop)		
accessories for	415066		
	GEV No.	510408	Ref. No. 046213 055533 067620 0H2559 0L2765 19006668 19006946
O-ring EPDM thickness 5.34mm ID ϕ 47mm Qty 1 pcs			
	GEV No.	510562	Ref. No.
O-ring silicone thickness 5.34mm ID ϕ 47mm Qty 1 pcs			



1

GEV No.	420335	Ref. No.	048284 0H2568
description	heating element 4500W 230V mounting ϕ 47.5mm heating circuits 3 L 375mm W 32mm H 34mm tube ϕ 6.25mm hole ϕ 8x10mm connection male faston 6.3mm 3 hole flange immersion heater		
For models:	LS8/9, WT50/9, WT50/UK9RF		

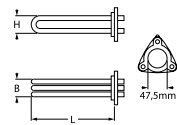



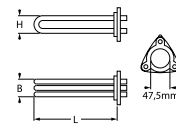

1			
GEV No.	418189	Ref. No.	002524 057698
description	heating element 4700W 230V mounting ϕ 47.5mm heating circuits 3 L 393mm W 40mm H 35mm number of thermostat sleeves 1 thermostat sleeves ϕ 7mm length thermostat sleeves 275mm thermostat sleeve eccentric, clinging tube ϕ 6.3mm hole distance 68mm hole ϕ 8/10mm connection male faston 6.3mm 3 hole flange immersion heater		
For models:	MPN/EI760, MPNEI760UK, MPN/EI760D, RPI/E240, RPI/E260, RPI/E260P, XPI/E240, XPI/E260, XPI/E260P, JPI/E240, JPI/E260, MPI/E240, MPI/E260, MPI/E260P, 7PIE06, RPN/EI760UK, RPN/EI760D, M70EIKE, XPN/EI760UK, XPN/EI760D, Xfv/E700, PPI/E260P, OPI/E260P, TPI/E260P, RPN/EI760, KPI/E06, HPN/EI806, HPN/EI805, QPI/E06, ZPN/EI805, WPI/E06, APN/EI805		
accessories for	418189		
	GEV No.	510562	Ref. No. —
	O-ring silicone thickness 5.34mm ID ϕ 47mm Qty 1 pcs		

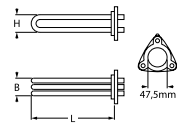



1			
GEV No.	420081	Ref. No.	049455
description	heating element 6000W 230V mounting ϕ 47.5mm heating circuits 3 L 260mm W 27mm H 37mm number of thermostat sleeves 1 thermostat sleeves ϕ 7.2mm length thermostat sleeves 170mm tube ϕ 6.2mm hole distance 62.5mm hole ϕ 6.5mm connection male faston 6.3mm 3 hole flange immersion heater		
For models:	LS10/UK1, LS10/UK3, LS8/UK1, LS8UK3, WT50/UK1		



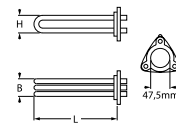

1			
GEV No.	415080	Ref. No.	049116 058012 066110 076035 OL1850 OL1878
description	heating element 6000W 220V mounting ϕ 47.5mm heating circuits 3 L 310mm W 35mm H 40mm number of thermostat sleeves 1 thermostat sleeves ϕ 7mm length thermostat sleeves 180mm thermostat sleeve clinging tube ϕ 6.3mm hole distance 63mm hole ϕ 8mm connection length 28mm connection male faston 6.3mm 3 hole flange immersion heater		
For models:	HCPA/EI1219, HQN/EI917, HQN/EI1225, HQNEI817, HQNEI122, LS1080UK, CT142DXE, CT142SXE, CT142DXEUK, CT142SXEU, CT142DXV, CT142SXV, CT190DXE, CT190SX, CT190DXEUK, CT190SXEU, CT190DXV, CT190SXV, CT191DXE, CT191SX, CT191DXEUK, CT191SXEU, CT191DXV, CT191SXV, RT100ED, RT100ES, RT140ED, RT140ES, RT190ED, RT190ES, RT190HDED, RT190HDES, RT270ED, RT270ES, RT270HDED, RT270HDES, RT100ERF, RT100ELF, RT140ERF, RT140ELF, RT142ERF, RT142ELF, RT190ERF, RT190ELF, RT190HERF, RT190HEL, RT270ERF, RT270ELF, RT270HERF, RT270HEL... (Other models you can see in the webshop)		
spare parts for	415080		
	GEV No.	510408	Ref. No. 046213 055533 067620 0H2559 0L2765 19006668 19006946
	O-ring EPDM thickness 5.34mm ID ϕ 47mm Qty 1 pcs		
accessories for	415080		
	GEV No.	510408	Ref. No. 046213 055533 067620 0H2559 0L2765 19006668 19006946
	O-ring EPDM thickness 5.34mm ID ϕ 47mm Qty 1 pcs		



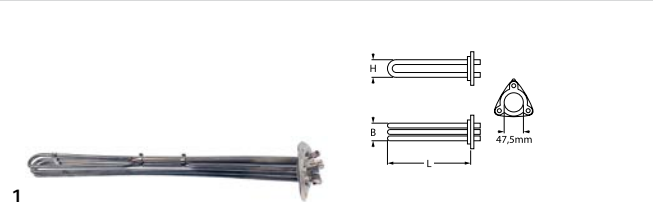

1			
GEV No.	415068	Ref. No.	048221 048513
description	heating element 6000W 230V mounting ϕ 47.5mm heating circuits 3 L 370mm W 32mm H 36mm thermostat sleeves ϕ 7mm length thermostat sleeves 165mm thermostat sleeve eccentric, non clinging tube ϕ 8.5mm hole distance 62mm hole ϕ 8mm connection male faston 6.3mm 3 hole flange immersion heater		
For models:	LS7D, LS7, LS7UK/RP, LV70, LS7F, LS7DEK, LS7/1UK, LS7/DP, LS7/60, WT40/9, WT40/F, LS7HD, WT40UKRP, PH4/WT40, PH4RBP/WT40, LS10D, LS10, LS10UKRP, LC100, LS10/60, LS10/1, LS10/12KW, LS10F, LS10DEK, LS10/1UKRP, LS10DP, LS10/HD, SH55, LO10, LS12F, LS12DEK, LS12HD, LS12/UK3, ECOTEMP12INS, LS10N, LS8D, LS8, LS8UK/RP, LC80, LS8F, LS8DEK, LS8/60, LS8/1UKRP, LS8/DP, WT50/F9, WT50/6, WT50/1UKRP, WT50/1, D800/6, WT50/N... (Other models you can see in the webshop)		
spare parts for	415068		
	GEV No.	510408	Ref. No. 046213 055533 067620 0H2559 0L2765 19006668 19006946
	O-ring EPDM thickness 5.34mm ID ϕ 47mm Qty 1 pcs		



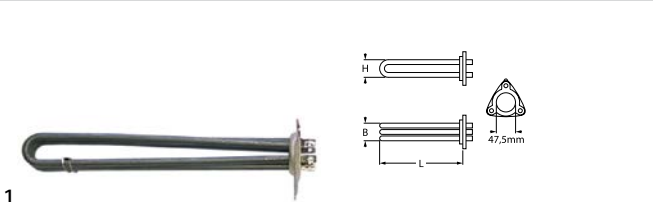

GEV No.	415379	Ref. No.	003409 003410 051632 052621 0K3478 0K3491 0L1877 15516 21213 21632
description	heating element 6000W 230V mounting \varnothing 47.5mm heating circuits 3 L 479mm W 36mm H 33mm number of thermostat sleeves 1 thermostat sleeves \varnothing 7mm length thermostat sleeves 270mm thermostat sleeve eccentric, clinging tube \varnothing 6.3mm hole distance 62mm hole \varnothing 8mm connection male faston 6.3mm 3 hole flange immersion heater		
For models:	KPI/E25, HPN/EI855, HPN/EI1255, QPI/E25, ZPN/EI1255, WPI/E25, HCPA/EI1219, HQN/EI917, HQN/EI1225, HPN/EI810, HPN/EI810, HPA/EI810, HPN/EI810, HPN/EI810, HPA/EI815, HQNEI817, HQNEI122, LS1080		
accessories for	415379		
		GEV No.	521012 Ref. No. —
	gasket graphite ED \varnothing 15mm ID \varnothing 5mm thickness 1.2mm Qty 1 pcs		

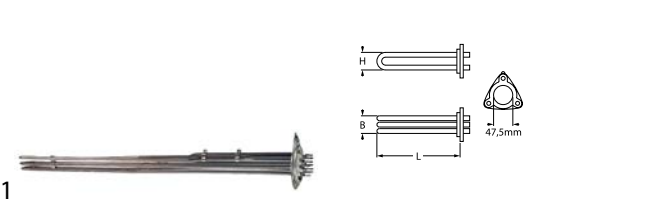

GEV No.	415394	Ref. No.	058666
description	heating element 7900W 230V mounting \varnothing 47.5mm heating circuits 3 L 287mm W 33mm H 35mm tube \varnothing 8.5mm hole distance 63mm hole \varnothing 8mm connection M5 3 hole flange immersion heater		
For models:	XFV/E700, FCVE6-1U, FCVE6-3U, FCVE6-1, FCVE6-3, FCVE6-3CE, FCVE6-1UK, FCVE6-3UK, FCVM62E, FCVM62EUK, FCV/E6-1, FCV/E6-1		
accessories for	415394		
		GEV No.	510408 Ref. No. 046213 055533 067620 0H2559 0L2765 19006668 19006946
	O-ring EPDM thickness 5.34mm ID \varnothing 47mm Qty 1 pcs		
		GEV No.	510562 Ref. No. —
	O-ring silicone thickness 5.34mm ID \varnothing 47mm Qty 1 pcs		





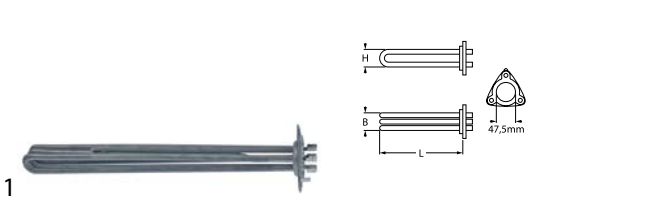

GEV No.	418126	Ref. No.	059665
description	heating element 7500W 220V mounting \varnothing 47.5mm heating circuits 3 L 550mm W 37mm H 37mm number of thermostat sleeves 1 thermostat sleeves \varnothing 7mm length thermostat sleeves 185mm thermostat sleeve upper tube \varnothing 6.5mm hole distance 6.5mm hole \varnothing 10mm connection male faston 6.3mm 3 hole flange immersion heater		
For models:	HPN/EI815D, HPN/EI810, HPN/EI815, HPA/EI825, HPNS/EI815, HPNS/EI815D, CR20EI, ZPN/EI815D, ZPN/EI810, ZPN/EI815, ZPNS/EI815, ZPNS/EI815D, CR20EI, APN/EI815D, APN/EI810, APN/EI815, APN/ED816, APNS/EI815		
spare parts for	418126		
		GEV No.	510408 Ref. No. 046213 055533 067620 0H2559 0L2765 19006668 19006946
	O-ring EPDM thickness 5.34mm ID \varnothing 47mm Qty 1 pcs		
accessories for	418126		
		GEV No.	510562 Ref. No. —
	O-ring silicone thickness 5.34mm ID \varnothing 47mm Qty 1 pcs		



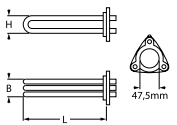

GEV No.	420310	Ref. No.	0E5955 0L1851
description	heating element 8000W 230V mounting \varnothing 47.5mm heating circuits 3 L 384mm W 32mm H 35mm number of thermostat sleeves 1 thermostat sleeves \varnothing 7mm length thermostat sleeves 265mm thermostat sleeve eccentric, clinging tube \varnothing 8.5mm hole distance 62.5mm hole \varnothing 6.5mm connection male faston 6.3mm 3 hole flange immersion heater		
For models:	RT100ED, RT100ES, RT140ED, RT140ES, RT190ED, RT190ES, RT190HDED, RT190HDES, RT270ED, RT270ES, RT270HDED, RT270HDES, RT100ERF, RT100ELF, RT140ERF, RT140ELF, RT142ERF, RT142ELF, RT190ERF, RT190ELF, RT190HERF, RT190HEL, RT270ERF, RT270ELF, RT270HERF, RT270HELF, RT100ERG, RT100ELG, RT140ERG, RT140ELG, RT190ERG, RT190ELG, RT190HERG, RT190HEL, RT270ERG, RT270ELG, RT270HERG, RT270HEL, RT100EDF, RT100ESF, RT140EDFWHIRPOOL, RT140ESFWHIRPOOL, RT190EDFWHIRPOOL, RT190ESFWHIRPOOL, RT142EDFWHIRPOOL, RT142ESFWHIRPOOL, RT190HDEDFWHIRPOOL, RT190HDESFWHIRPOOL, RT270EDFWHIRPOOL, RT270ESFWHIRPOOL...(Other models you can see in the webshop)		

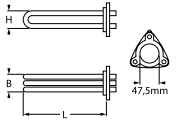

 			
GEV No.	415690	Ref. No.	002835 OK0538 60050339
description	heating element 9000W 230V mounting ø 47.5mm heating circuits 3 L 290mm W 32mm H 38mm number of thermostat sleeves 1 thermostat sleeves ø 5mm length thermostat sleeves 175mm thermostat sleeve centre tube ø 8.5mm hole distance 63mm hole ø 10mm connection M5 3 hole flange immersion heater		
For models:	FCV/E6L4, FCS061EP, FCS061E4, FCS061EXLN, FCS061EX, 5711-3-6, 5711-3-7, 5711-3-8, 5711-3-10, 5711-3-8CH, 5711-3-10CH, ECV/E6T4, RCV061E4, ZCV/E6T4		
accessories for	415690		
	GEV No.	510408	Ref. No. 046213 055533 067620 0H2559 0L2765 19006668 19006946
	O-ring EPDM thickness 5.34mm ID ø 47mm Qty 1 pcs		
	GEV No.	510562	Ref. No. —
	O-ring silicone thickness 5.34mm ID ø 47mm Qty 1 pcs		

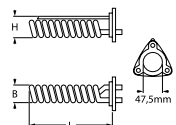
 			
GEV No.	419092	Ref. No.	0F0011
description	heating element 9600W 230V mounting ø 47.5mm heating circuits 3 L 585mm W 40mm H 40mm number of thermostat sleeves 1 thermostat sleeves ø 5mm length thermostat sleeves 222mm thermostat sleeve centred, adjacent tube ø 8.5mm hole distance 62.5mm hole ø 6.5mm connection length 18mm connection M5 3 hole flange immersion heater		
For models:	CS7ME4/200-3, CS7ME4/230-3, CS7ME4/400-3N, CS7ME6/400-3N, CS7ME4/400-3N/EO, CS7ME4/400-3/50HZ/MA, CS7ME4/440-3/60HZ/MA, CS7MT4/400-3N, CS7GE4/200-3, CS7GE4/230-3, CS7GE4/400-3N, CS7GE6/400-3N, CS7GE4/400-3N/EO, CS7GE4/400-3/50HZ/MA, CS7GE4/440-3/60HZ/MA, CS7GT4/400-3N, CS7LCE4/200-3, CS7LCE4/230-3, CS7LCE4/400-3N, CS7LCE6/400-3N, CS7LCE4/400-3N/EO, CS7LCE4/400-3/50HZ/M, CS7LCE4/440-3/60HZ/M, CS7LCT4/400-3N		

 			
GEV No.	415668	Ref. No.	OK3789 OKK047
description	heating element 2625W 230V mounting ø 47.5mm heating circuits 1 L 190mm W 41mm H 54mm number of thermostat sleeves 1 thermostat sleeves ø 7mm length thermostat sleeves 170mm thermostat sleeve eccentric, non clinging tube ø 6.3mm hole distance 62mm hole ø 8mm connection M4 3 hole flange immersion heater		
spare parts for	415668		
	GEV No.	510408	Ref. No. 046213 055533 067620 0H2559 0L2765 19006668 19006946
	O-ring EPDM thickness 5.34mm ID ø 47mm Qty 1 pcs		
accessories for	415668		
	GEV No.	510562	Ref. No. —
	O-ring silicone thickness 5.34mm ID ø 47mm Qty 1 pcs		







 			
GEV No.	415002	Ref. No.	069455 069672 0A6035 230090
description	heating element 3000W 230V mounting ø 47.5mm heating circuits 1 L 198mm W 35mm H 44mm number of thermostat sleeves 1 thermostat sleeves ø 7mm length thermostat sleeves 175mm thermostat sleeve not clinging tube ø 6.3mm hole distance 64mm hole ø 8mm connection M4 3 hole flange immersion heater		
For models:	LTB11, LTB12, LTB22, LTB11UK, LTB12UK, LTB22UK, LTB11, LTB22, 910-00-021, 910-00-023, 910-00-031, 910-00-033, 911-00-022, 911-00-024, 911-00-032, 911-00-034, CRYSTAL 11, CRYSTAL 22		
accessories for	415002		
	GEV No.	510408	Ref. No. 046213 055533 067620 0H2559 0L2765 19006668 19006946
	O-ring EPDM thickness 5.34mm ID ø 47mm Qty 1 pcs		
	GEV No.	510562	Ref. No. —
	O-ring silicone thickness 5.34mm ID ø 47mm Qty 1 pcs		
	GEV No.	521103	Ref. No. —
	nut thread M4 H 3mm WS 7 brass Qty 20 pcs		
	GEV No.	521104	Ref. No. —
	washer ID ø 4.3mm ED ø 8mm thickness 0.5mm brass Qty 20 pcs for thread M4		
	GEV No.	560111	Ref. No. —
	plain washer ID ø 4.3mm ED ø 9mm thickness 0.8mm SS Qty 20 pcs DIN 125A for thread M4		

Table continues overleaf

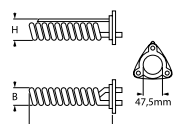

accessories for	415002		
	GEV No.	560131	Ref. No. —
	hexagonal nut thread M4 H 3.2mm WS 7 SS DIN/ISO DIN 934 / ISO 4032/8673 Qty 20 pcs		

3 hole flange ø57.5mm

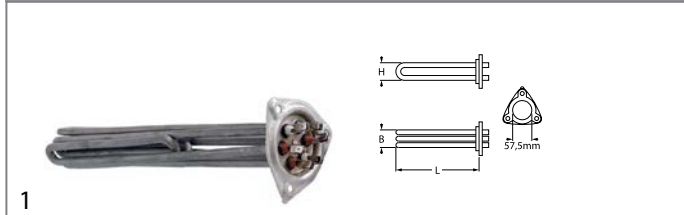

GEV No.	416134	Ref. No.	049997 0L1772 0L2727
----------------	--------	-----------------	----------------------------

description heating element 10500W 230V mounting ø 57.5mm heating circuits 3 L 335mm W 52mm H 52mm tube ø 8.5mm hole distance 73mm hole ø 8/10mm connection male faston 6.3mm 3 hole flange immersion heater INCOLOY-800

For models: LS14EA, LS14EAI, LS14EAI/AU, LS14EAASIA, LS14EA/G, LS10EA, LS14EAI/DD, WT65EB, WT65EBI, WT65EBIA, WT65EB60, WT65EBIDG, WT65EBASIA, WT65EIM50, LS14EADP/G, WT65MED, LS14EAWWS, LS14ADPWSG, LS14EAIWS, WT65EBWS, WT65BIDWSG, WT65EBIWS, WT65MEDWS, ET12EWS, LS14SANA, WT65EBID, WT65EBIWS, PW1SMG, PW1MG, PW1MUK, PW160HZ, PW1MHG, PW2MG, PW2MUK, PW2M60, WT830M, WT830MUK, WT830M60G, WT850M, WT850MUK, WT850M60G, WT830MHG, PW2SMG, ET830M, ET830MH, ET850M, PW1EAG, PW2EAG, WT830EA, WT850EA...(Other models you can see in the webshop)

spare parts for	416134		
	GEV No.	510409	Ref. No. 007029 047156 049909 0E5037 0K9011 543613600 740483105
	O-ring EPDM thickness 5.34mm ID ø 56.52mm Qty 1 pcs		

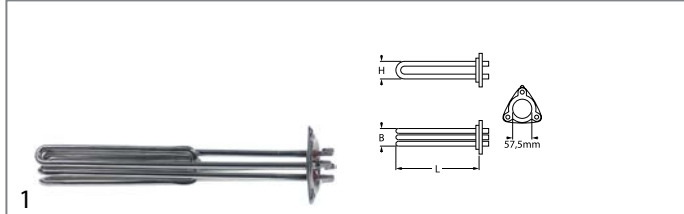

GEV No.	417731	Ref. No.	0L0009 0L2466 0L2724 7IOL0009
----------------	--------	-----------------	--

description heating element 10500W 254V heating circuits 3 L 335mm W 50mm H 50mm hole ø 8.5mm connection F6.3x0.8 screw immersion heater

For models: WT65EIM60, EHTAIUSPH6

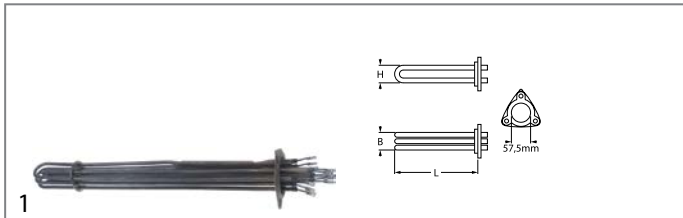

GEV No.	419085	Ref. No.	007078
----------------	--------	-----------------	--------

description heating element 17000W 230V mounting ø 57.5mm heating circuits 6 L 450mm W 42mm H 42mm number of thermostat sleeves 1 thermostat sleeves ø 4.5mm length thermostat sleeves 180mm thermostat sleeve eccentric, clinging tube ø 6.2mm hole distance 69mm hole ø 6.5mm connection length 75mm connection male faston 6.3mm 3 hole flange immersion heater

For models: FCZ101EAN, FCZ101EBN, CL521, AOS101EA2N, AOS101EB2N, AOS101EANQ, AOS101EBNQ

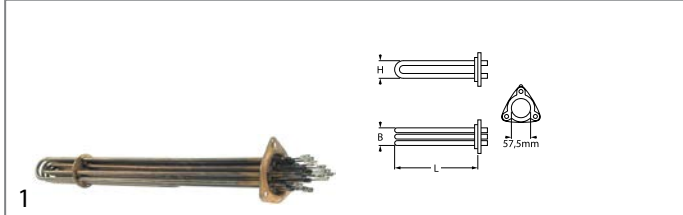



GEV No.	418154	Ref. No.	007076 0C5384
----------------	--------	-----------------	------------------

description heating element 17000W 400V mounting ø 57.5mm heating circuits 6 L 450mm W 39mm H 41mm number of thermostat sleeves 1 thermostat sleeves ø 4.5mm length thermostat sleeves 180mm thermostat sleeve eccentric, clinging tube ø 6.3mm hole distance 69mm hole ø 6.5mm connection length 75mm connection male faston 6.3mm 3 hole flange immersion heater

For models: FCZ101EAA, FCZ101EAH, FCZ101EBA, FCZ101EBH, CL611, AOW101EA, AOS101EA, AOS101EB, AOS101EB6M, AOS101EA0H, AOS101EB0H, AOS101EAAQ, AOS101EBAQ, AOS101EAHQ, AOS101EBHQ, EJN101EAA, RDR101EAA, EJN101EBA, RDR101EBA

spare parts for	418154		
	GEV No.	510409	Ref. No. 007029 047156 049909 0E5037 0K9011 543613600 740483105
	O-ring EPDM thickness 5.34mm ID ø 56.52mm Qty 1 pcs		

accessories for	418154		
	GEV No.	510409	Ref. No. 007029 047156 049909 0E5037 0K9011 543613600 740483105
	O-ring EPDM thickness 5.34mm ID ø 56.52mm Qty 1 pcs		

	GEV No.	550002	Ref. No. —
	tension strap H 10mm L 21mm W 10mm hole ø 6.5mm for heating element		



1

GEV No.	418155	Ref. No.	007101 0C5383
description	heating element 2400W 400V mounting ø 57.5mm heating circuits 6 L 570mm W 40mm H 40mm number of thermostat sleeves 1 thermostat sleeves ø 4.5mm length thermostat sleeves 180mm thermostat sleeve eccentric, clinging tube ø 6.3mm hole distance 69mm hole ø 6.5mm connection male faston 6.3mm 3 hole flange immersion heater		
For models:	FCZ102EAA, FCZ201EAA, FCZ202EAA, FCZ201EAH, FCZ102E-BA, FCZ201EBA, FCZ202EBA, FCZ201EBH, CL121, AOS201EA, AOS201EB, AOS201EB6M, AOS202EA2N, AOS202EB2N, AOS201EA0H, AOS201EB0H, AOS102EA, AOS102EB, AOS202EA, AOS202EB, AOS102EAAQ, AOS102EBAQ, AOS201EAAQ, AOS201E-BAQ, AOS202EAAQ, AOS202EBAQ, AOS201EAHQ, AOS201EB- HQ, AOS201EBFQ, AOS201EAA1, AOS202EAA1, AOS201EAH1, AOS201EAF1, AOS201EAQ1, AOS202EAK1, AOS201EBA1, AOS202E- BA1, AOS201EBH1, AOS201EBF1, AOS202EBK1, AOS201ECM1, AOS201ECB1, EJM102EAA, EJM201EAA, EJM202EAA, RDR201EAA, EJM102EBA, EJM201EBA, EJM202EBA, RDR201EBA		

2

GEV No.	417715	Ref. No.	049899 0L2107 0L2651
description	heating element 4500W 230V mounting ø 57.5mm heating circuits 3 L 335mm W 33mm H 40mm tube ø 8.5mm hole distance 70mm hole ø 6.4mm connection male faston 6.3mm		
For models:	EUCAI, EUCAIDP, EUCAIWS, EUCAIG, EUCAIWSG, EUCAIMLWS, EUCI, EUCAIDPNW, ZUCI, ZUCID, ZUCAI, ZUCAIDP, ZUCAIDPWS, ZUCAIG, ZUCAIDDWS, ZUCAID, ZUCAI60, ZUCAIDD, EUCAIDD, WT38D, WT37/4.5, WT38/4.5, WT38/4.5NW, AUCI, AUCAI, AUCAIDP, AUCAID- PWS, AUCAIG, AUCAIWSG		
accessories for	417715		
	GEV No.	532685	Ref. No. 0L2304
	O-ring silicone thickness 3.34mm ID ø 56.52mm Qty 1 pcs		

1

GEV No.	416129	Ref. No.	049898 0L2108 0L2725
description	heating element 6000W 230V mounting ø 57.5mm heating circuits 3 L 330mm W 36mm H 40mm tube ø 8.5mm hole distance 70mm hole ø 7.8mm connection length 28mm connection male faston 6.3mm 3 hole flange immersion heater		
For models:	LS6EP, LS6EP/DD, LS6EADD, LS6EA/DPDD, WT38TDE, WT38/M50, LS6EADP3, LS6EADPWS, LS6EADPWSG, WT38WS, WT38WSG, WT38MEDWS, WT38PM50, LS6EADPDWS, WT38DWS, LS6SANA, EUCAI60, WT38M50/4, LS6EA/UK, LS6EA/DPUK, EUCAIML, EUCAIMLG, EUCAICLG, EUCAIWL, LS6EA/60, EUCIM, WT38D, WT37, WT38, WT37/UK, WT38CUK, WT38UK, WT38/60, WT38MED, WT38WL, LS6EA, LS6EA/DP, LS6EAH, LS6MCD, ET12E, FL620EP, ET5EDG, LV6EP, H3300, LV6EADPWS, FL620ADPWS, H1310SANA, FL620EAG, FL620DPWSG, LV1000...(Other models you can see in the webshop)		
accessories for	416129		
	GEV No.	510409	Ref. No. 007029 047156 049909 0E5037 0K9011 543613600 740483105
	O-ring EPDM thickness 5.34mm ID ø 56.52mm Qty 1 pcs		

1

GEV No.	420080	Ref. No.	0L1006
description	heating element 6000W 230V mounting ø 57.5mm heating circuits 3 L 340mm W 36mm H 42mm tube ø 8.5mm hole distance 70mm hole ø 6.5mm connection M4 immersion heater		
For models:	WT60/GJ60, WT60/GJ50, PH10/12-RP, EHTAO, EHTAROW, EHT- AROW60, ZHTAROW, ZHTAROW60, EHTAO60, ZHTAO, ZHTAO60, WTC90ERB, WTC90ELB, WTC140ERA, WTC140ELA, WTC140ERB, WTC140ELB, WTC180ERA, WTC180ELA, WTC180ERB, WTC180ELB, WTC220ERA, WTC220ELA, WTC220ERB, WTC220ELB, WTC90ERBG, WT- C90ELBG, WTC140ERAG, WTC140ELAG, WTC140ERBG, WTC140ELBG, WTC180ERAG, WTC180ELAG, WTC180ERBG, WTC180ELBG, WT- C220ERAG, WTC220ELAG, WTC220ERBG, WTC220ELBG, WTM140ERA, WTM140ELA, WTM140ERB, WTM140ELB, WTM165ERA, WTM165ELA, WTM165ERB, WTM165ELB, WTM200ERA, WTM200ELA, WTM200ERB...		
	(Other models you can see in the webshop)		

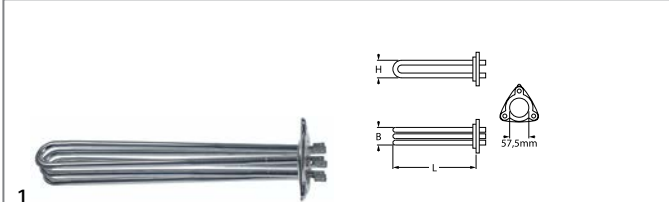

GEV No.	420309	Ref. No.	0L2246 0L2766
description	heating element 7000W 230V mounting \varnothing 57.5mm heating circuits 3 L 315mm W 37mm H 42mm number of thermostat sleeves 0 tube \varnothing 8.5mm hole distance 69mm hole \varnothing 6.5mm connection male faston 6.3mm 3 hole flange immersion heater stainless steel		
For models:	PW1SMG, PW1MG, PW1MUK, PW1MHG, WT830M, WT830MUK, WT830M60G, WT830MHG, ET830M, ET830MH, PW1EAG, WT830EA, WT830EAG, PW100MG, PW100M, PW100MHG		
accessories for	420309		
	GEV No.	510409	Ref. No. 007029 047156 049909 0E5037 0K9011 543613600 740483105
O-ring EPDM thickness 5.34mm ID \varnothing 56.52mm Qty 1 pcs			

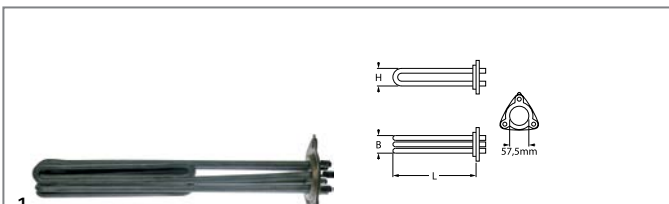

GEV No.	418779	Ref. No.	049992 0L1630 0L2653 0TR570
description	heating element 9000W 230V mounting \varnothing 57.5mm heating circuits 3 L 340mm W 52mm H 54mm tube \varnothing 8.5mm hole distance 72mm hole \varnothing 8mm with integrated fuse INCOLOY		
For models:	LS6EP, WT37LEV/9, EUCAICL, EUCAICLW, WT38C, WT38C60, LU7PDP, LU7ADP, LU7ADPWS, WTU40PDP, WTU40ADP, WTU40ADPWS, WTU40ADPD, LS14EA/60, WT65E, WT65EI, ECOTEMP12S, WT65EIA, WT65E60, WT65ROW, LS14ROW, LS14ROW60, EHTA, EHTA60, EHTAWS, EHTAI, EHTAID, EHTAIWS, EHTAIDWS, EHTAIG, EHTAIWSG, EHTAIAU, EHTAIMLAU, ZHTAWS, ZHTAID, ZHTAIWS, ZHTAIAU, ZHTA, ZHTA60, ZHTAI, EHTAIUSPH5, LS9P, LS9PDD, LS9AUK/3, LS9P60, WT55P, WT55P60, WT55AUK/3, LS9ADG1, WT55ADG1...(Other models you can see in the webshop)		
spare parts for	418779		
	GEV No.	510409	Ref. No. 007029 047156 049909 0E5037 0K9011 543613600 740483105
O-ring EPDM thickness 5.34mm ID \varnothing 56.52mm Qty 1 pcs			

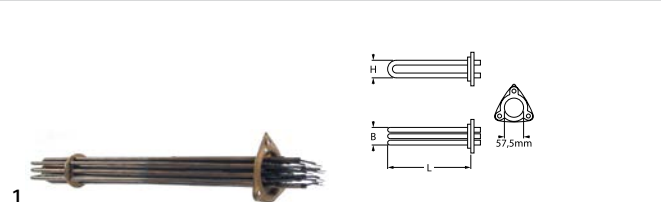

GEV No.	418153	Ref. No.	007030 0C5381
description	heating element 9000W 400V mounting \varnothing 57.5mm heating circuits 6 L 440mm W 38mm H 40mm number of thermostat sleeves 1 thermostat sleeves \varnothing 4mm length thermostat sleeves 180mm thermostat sleeve eccentric, clinging hole distance 68mm hole \varnothing 6mm connection male faston 6.3mm 3 hole flange immersion heater		
For models:	FCZ061EAA, FCZ061EAH, FCZ061EBA, FCZ061EBH, AOS061EA, AOS061EB, AOS061EB6M, AOS061EA0H, AOS061EB0H, AOS061EAAQ, AOS061EBAQ, AOS061EAHQ, AOS061EBHQ, AOS061EAA1, AOS061EAH1, AOS061EAF1, AOS061EBA1, AOS061EBH1, AOS061EBF1, AOS061ECM1, AOS061ECB1, EJN061EAA, RDR061EAA, EJN061EBA, RDR061EBA		

3 hole flange \varnothing 60.0mm
connection straight
group 2

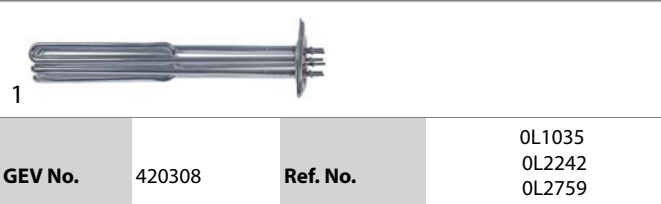

GEV No.	420308	Ref. No.	0L1035 0L2242 0L2759 617632101
description	heating element 10500W 230V mounting \varnothing 60mm heating circuits 3 L 340mm W 50mm H 50mm number of thermostat sleeves 0 tube \varnothing 8.3mm hole distance 69mm hole \varnothing 6.5mm connection M4 3 hole flange immersion heater right stainless steel		
For models:	WTC90ERB, WTC90ELB, WTC140ERA, WTC140ELA, WTC140ERB, WTC140ELB, WTC180ERA, WTC180ELA, WTC180ERB, WTC180ELB, WTC220ERA, WTC220ELA, WTC220ERB, WTC220ELB, WTC90ERBG, WTC90ELBG, WTC140ERAG, WTC140ELAG, WTC140ERBG, WTC140ELBG, WTC180ERAG, WTC180ELAG, WTC180ERBG, WTC180ELBG, WTC220ERAG, WTC220ELAG, WTC220ERBG, WTC220ELBG, WTM140ERA, WTM140ELA, WTM140ERB, WTM140ELB, WTM165ERA, WTM165ELA, WTM165ERB, WTM165ELB, WTM200ERA, WTM200ELA, WTM200ERB, WTM200ELB, WTM250ERA, WTM250ELA, WTM250ERB, WTM250ELB, WTM300ERA, WTM300ELA, WTM300ERB, WTM300ELB, WTM180ERA, WTM180ELA...(Other models you can see in the webshop)		



with compression flange 50 x 26mm

GEV No.	415272	Ref. No.	049059
description	heating element 800W 230V heating circuits 1 flange 50x26mm L 160mm W 34mm H 20mm tube ø 8.5mm connection male faston 6.3mm immersion heater compression flange		
For models:	LB1, LB1WS, LB1WSDP, LB1/RBP, LB1/TOP, LB1/60, WT1WSDP, LB2D-PSAUS, LB1G, LB1WSG, WT2TOP60, WT2DPDI, WT2WSDPDI, LB1TOP, WT2TOPDI, LB2WS, LB2, LB2WSDP, LB2/TOP, LB2/RBP, LB2WS60, WT2WSDP, WT2WSDPD, LB2WSG, WT2WS, WT1, WT1WS, WT1TOP, WT2TOP, WT1/3DP, WT2/3DP, WT2DPAUS, WT2, LB2DPDI, LB2WSDPDI, LB2WSDPD, LB2TOP, LB2DP3, WT2DPD3, NGW, NGWDPDD, UC1, UC2WS, GW1, GW1WS, LV1WS, LV1WSDP, LV2WSDP, LV2WS, GW2D-PG...(Other models you can see in the webshop)		
spare parts for	415272		
	GEV No.	510387	Ref. No. 048483 50301684
	gasket L 46mm W 22mm ømm EPDM for heating element for flange 50x26mm		
accessories for	415272		
	GEV No.	510388	Ref. No. —
	counterflange ømm hole distancemm perforation ømm L 43mm W 21mm SS for heating element for flange 50x26mm		

GEV No.	415070	Ref. No.	048228 048924 0KE906 0L2340 415070
description	heating element 2200W 230V compression flange flange 50x26mm L 355mm W 75mm H 25mm L1 65mm L2 290mm W1 25mm connection male faston 6.3mm heating circuits 1 tube ø 6.3mm immersion heater W2 50mm		
For models:	LS32, LS32/4.5, LS32UK/RP, LS32F, LV32F, C55, LV32/60, WT302, WT302/4.5, WT302UK/RP, WT302F, WT302/60, LS33, LS33/4.5, LS33UK/RP, LS33F, C55A, LS33/60, WT303, WT303/4.5, WT303UK/RP, WT303F, WT303/60, LS61, LS61/60, LS6EP, LS6EP/DD, LS6EADD, LS6EA/DPDD, WT38TDE, LS6EADP3, LS6EADPWS, WT38WS, WT38MEDWS, WT37LEV/9, LS6EADPDWS, WT38DWS, LS6SANA, LS6EA/UK, LS6EA/DPUK, LS6EA/60, LS62, LS62D, LS62/UJRP, LS62F, LV62, LS62/60, ECOTEMP5, LS62/1P...(Other models you can see in the webshop)		
accessories for	415070		
	GEV No.	510387	Ref. No. 048483 50301684
	gasket L 46mm W 22mm ømm EPDM for heating element for flange 50x26mm		
	GEV No.	510388	Ref. No. —
	counterflange ømm hole distancemm perforation ømm L 43mm W 21mm SS for heating element for flange 50x26mm		

GEV No.	416133	Ref. No.	049954 0L2109
description	heating element 2000W 230V compression flange flange 50x26mm L 365mm W 80mm H 27mm L1 95mm L2 270mm W1 30mm connection male faston 6.3mm heating circuits 1 tube ø 6.3mm immersion heater		
For models:	WT4, WT4B, WT4D, WT4DB, WT46, WT4DG, WT4WS1, WT4BWS, WT4DWS1, WT4BDWS, NUC3DD, WT4D60, WT4DDG, EUC1, EUC1DP, EUC1WS, EUC1DPWS, EUC3, EUC3WS, EUC3DP, EUC3DPWS, EUC1G, EUC1DP60, EUC3DD, ZUCADDROW, ZUCADDROW6, LS5/1, LS5/1DP, LS5/1WS, LS5/1WSDP, LS5/3, LS5/3DP, LS5/3WS, LS5/3WSDP, FUCA3DD, LS5/3WSDPD, LB5DPG, LS5/1DP60, LS5/1DPAUS, LS5/1D-PCS, KUC3, KUC3DP, NUC1, NUC1DP, NUC1WS, NUC1DPWS, NUC3, NUC3WS, NUC3DP, NUC3DPWS...(Other models you can see in the webshop)		
accessories for	416133		
	GEV No.	510387	Ref. No. 048483 50301684
	gasket L 46mm W 22mm ømm EPDM for heating element for flange 50x26mm		
	GEV No.	510388	Ref. No. —
	counterflange ømm hole distancemm perforation ømm L 43mm W 21mm SS for heating element for flange 50x26mm		

GEV No.	416132	Ref. No.	048491 0L1870
description	heating element 3000W 230V compression flange flange 50x26mm L 360mm W 70mm H 25mm L1 60mm L2 300mm W1 20mm connection male faston 6.3mm heating circuits 1 tube ø 8.5mm immersion heater W2 50mm		
For models:	LU7PDP, LU7ADP, LU7ADPWS, WTU40PDP, WTU40ADP, WTU40AD-PPWS, WTU40ADPD, ECOTEMP12-, LS10/60, ECOTEMP12SW, ECOTEMP-12INS, LS14EA, ET12E, LS14EAI, LS14EAI/AU, LS14EA/60, LS14EAA-SIA, LS14EA/G, LS10EA, LS14EAI/DD, WT65E, WT65EB, WT65EI, ECOTEMP12S, WT65EBI, WT65EBIA, WT65EIA, WT65E60, WT65EB60, WT65EBIDG, WT65EBASIA, LS14EADP/G, WT65MED, LS14EAWS, LS14ADPWSG, LS14EAIWS, WT65EBWS, WT65BIDWSG, WT65EBIWS, WT65MEDWS, ET12EWS, LS14ROW, LS14SANA, WT65EBID, WT65E-BIWS, LS14ROW60, EHTA, EHTA60, EHTAWS, EHTAI...(Other models you can see in the webshop)		
accessories for	416132		
	GEV No.	510387	Ref. No. 048483 50301684
	gasket L 46mm W 22mm ømm EPDM for heating element for flange 50x26mm		
	GEV No.	510388	Ref. No. —
	counterflange ømm hole distancemm perforation ømm L 43mm W 21mm SS for heating element for flange 50x26mm		



with compression flange 62 x 26mm



GEV No.	417539	Ref. No.	0E2326
description	heating element 2000W 230V heating circuits 1 flange 60x26mm L 350mm W 41.4mm		

with expansion flange 70 x 18mm



GEV No.	415460	Ref. No.	0H6199 0K0550 0KC471 450191G3
description	heating element 1000W 230V heating circuits 1 flange 70x18mm L 230mm W 65mm connection male faston 6.3mm tube ø 8.5mm immersion heater expansion flange connection length 20mm silicone TD ø 8mm		

For models: 7573-3/85.KES100.(N), 7574-3/85.KES150.(N), 7575-3/85.KES250.(N), 7576-3/85.KES300.(N), 7573-3/90.KES100.(N), 7574-3/90.KES150.(N), 7575-3/90.KES250.(N), 7576-3/90.KES300.(N), 7573-3, 7574-3, 7575-3, 7576-3, 7577-3, 7773-3, 7773-3/85.KES100, 7773-3/90.KES100, 7774-3, 7774-3/85.KES150, 7774-3/90.KES150, 7775-3, 7775-3/85.KES250, 7775-3/90.KES250, 7776-3, 7776-3/85.KES300, 7776-3/90.KES300, 9100-3, 9104-3, 9113-3, 9190-3, 9191-3, 9193-3, 9195-3, 9300-3-0, 9300-3-8, 9304-3-0, 9304-3-8, 9313-3-0, 9313-3-8, 9390-3, 9391-3, 9393-3, 9395-3

accessories for 415460

	GEV No.	375044	Ref. No.	0H6141 0KE595
safety thermostat switch-off temp. 178°C 1-pole 16A probe ø 4mm probe L 91mm capillary pipe 1730mm capillary pipe isolated 1600mm gland nut probe with sealing sleeve screw connection M8x1 sealing sleeve 8.6x32mm				



GEV No.	418648	Ref. No.	049613 049616 049755
description	heating element 2000W 230V heating circuits 1 flange 70x18mm L 325mm W 65mm connection male faston 6.3mm tube ø 8.5mm immersion heater expansion flange connection length 20mm silicone		

For models: LS10, LS10UKDP, ET12E, LS10/60HZ, LS10CW, LS10INS, LS10N, LS10DP, LS10HD, LS10UK/1, LS10UK/3, LS12ASIA, HT1200, HT1000, HT1000INS, HT1200INS, HT1000DP, HT1200DP



GEV No.	418825	Ref. No.	049614 049756
description	heating element 3000W 230V heating circuits 1 L 310mm W 68mm tube ø 8.5mm connection length 31mm mounting measurements 70x18mm		

For models: LS10, LS10UKDP, LS10/60HZ, HT1200INS, LS10N, LS12INS, LS12, LS12DP, LS12/60HZ, HT1200DEK, WT60DP, WT60, WT60INS, WT60NAU, WT60/60HZ, WT60N, WT609NINS, LS12HD, WT60NAUDP, ECOTEM-P12S, HT1200, HT1200INS, HT1000DP, HT1200DP



GEV No.	420054	Ref. No.	049615 049757 0KE957
description	heating element 3500W 230V heating circuits 1 flange 70x18mm L 310mm W 68mm Hmm connection male faston 6.3mm tube ø 8.5mm immersion heater expansion flange		

For models: LS10CW, LS10DP, LS12CW, WT60CW, WT60UKDPCW, WT60INSCW, WT60NAUCW, WT60/60HZC, LS12UK/3CW, LS12NAU, LS12UKDPCW, WT60U40050, WT60MX2206, LS12CWINS, LS12ASIA, WT60ASIA, PW1MG, PW1MUK, PW160HZ, PW1MHG, PW2MG, PW2MUK, PW2M60, WT830M, WT830MUK, WT830M60G, WT850M, WT850MUK, WT850M60G, WT830MHG, PW100M, PW200M, PW100MHG, LV100M, LV200M, HT1000



GEV No.	415461	Ref. No.	0H6170 0K0535 415461
description	heating element 4000W 230V heating circuits 2 flange 80x28mm L 237mm W 64mm connection male faston 6.3mm tube ø 8.5mm immersion heater expansion flange		



GEV No.	415462	Ref. No.	0H6202 450181B3
description	heating element 4000W 400V heating circuits 2 flange 70x18mm L 256mm W 65mm connection male faston 6.3mm tube ø 8.5mm immersion heater expansion flange silicone		





GEV No.	415459	Ref. No.	0H6146 0K0506 0KE597 0T0012 213742 213743 60050490
description	heating element 5600W 230V heating circuits 2 flange 70x18mm L 272mm W 64mm connection male faston 6.3mm tube ø 8.5mm immersion heater expansion flange H 19mm		

For models: 5611-3-10, 5611-3-6, 5611-3-8, 5612-3-10, 5612-3-6, 5612-3-8, 5614-3-10, 5614-3-6, 5614-3-8



			
1			
GEV No.	415557	Ref. No.	OH6164
description	heating element 5600W 400V heating circuits 2 L 272mm W 64mm tube ø 8.5mm connection male faston 6.3mm immersion heater expansion flange 70x18mm		
For models:	7573-3/85.KES100.(N), 7574-3/85.KES150.(N), 7575-3/85.KES250.(N), 7576-3/85.KES300.(N), 7573-3/90.KES100.(N), 7574-3/90.KES150.(N), 7575-3/90.KES250.(N), 7576-3/90.KES300.(N), 7573-3, 7574-3, 7575-3, 7576-3, 7577-3, 7773-3, 7773-3/85.KES100, 7773-3/90.KES100, 7774-3, 7774-3/85.KES150, 7774-3/90.KES150, 7775-3, 7775-3/85.KES250, 7775-3/90.KES250, 7776-3, 7776-3/85.KES300, 7776-3/90.KES300, 9100-3, 9101-3, 9102-3, 9104-3, 9111-3, 9113-3, 9190-3, 9191-3, 9193-3, 9195-3, 9300-3-0, 9300-3-8, 9301-3-0, 9301-3-8, 9302-3-0, 9302-3-8, 9304-3-0, 9304-3-8, 9311-3-0, 9311-3-8, 9313-3-0, 9313-3-8, 9390-3, 9391-3, 9393-3...(Other models you can see in the webshop)		

			
2			
GEV No.	415463	Ref. No.	OH6171 OK0584 450171C3
description	heating element 6000W 230V heating circuits 2 flange 70x18mm L 385mm W 59mm connection male faston 6.3mm tube ø 8.5mm immersion heater expansion flange		

			
1			
GEV No.	415464	Ref. No.	OH6198
description	heating element 6000W 400V heating circuits 2 flange 70x18mm L 380mm W 65mm connection male faston 6.3mm tube ø 8.5mm immersion heater expansion flange		

			
1			
GEV No.	415345	Ref. No.	OK0551 214095
description	heating element 6000W 400V heating circuits 2 flange 70x18mm L 534mm W 65mm connection male faston 6.3mm tube ø 6.3mm immersion heater expansion flange connection length 22mm		

with expansion flange (others)

			
1			
GEV No.	419064	Ref. No.	OW1W1V OW2038 471983705
description	heating element 1800W 240V L 290mm W 40mm heating circuits 1 connection F6.3 tube ø 8mm immersion heater		
For models:	W365H, W375H5, W375H, W375N, W375N, W375N., PW9, PW92, W365H01, W365H02, W365H03, W365H04, W375H01, W375H02, W375H03, W375H04, W385H0, W31100H, W375N01, W375N02, W375N03, W375N04, W375N05, W375N06, W3600X01, W3600X02, W365H05, W375H05, W375N07, W375N08, W375N09, W375N10, W385M01, W385M02, W385M03, W375N11, W375N12, W365H06, W365H07		

			
1			
GEV No.	420279	Ref. No.	OW1W03 OW2037
description	heating element 2500W 240V flange 1mm L 290mm W 39mm heating circuits 1 mounting measurements 22x48mm connection male faston 6.3mm expansion flange tube ø 8.5mm immersion heater		
For models:	W365H, W375H5, W375H, W375N, W375N, W375N., W365H01, W365H02, W365H03, W365H04, W375H01, W375H02, W375H03, W375H04, W375N01, W375N02, W375N03, W375N04, W375N05, W375N06, W365H05, W375H05, W375N07, W375N08, W375N09, W375N10, W385M01, W385M02, W385M03, W375N11, W375N12, W365H06, W365H07		

with round flange ø47.5mm

			
1			
GEV No.	419086	Ref. No.	056012
description	heating element 17000W 220V heating circuits 6 mounting ø 47.5mm L 470mm W 42mm H 42mm round flange cable length 380mm immersion heater tube ø 6.3mm connection length 130mm		
For models:	FV4E, FCVE10-2, FCVE10-4, FCVE10-2UK, FCVE10-4UK, ZOFCV/E102, ZOFCV/E104, FV4E		

			
1			
GEV No.	418156	Ref. No.	055464
description	heating element 17000W 240V heating circuits 3 mounting ø 47.5mm L 470mm W 36mm H 40mm round flange connection cable cable length 350mm immersion heater tube ø 6.3mm		
For models:	FCVE10-2, FCVE10-4, FCVE10-2UK, FCVE10-4UK, ZOFCV/E102, ZOFCV/E104		

accessories for	418156		
	GEV No.	510408	Ref. No.
			046213 055533 067620 0H2559 0L2765 19006668 19006946

O-ring EPDM thickness 5.34mm ID ø 47mm Qty 1 pcs

	GEV No.	510562	Ref. No.
			—

O-ring silicone thickness 5.34mm ID ø 47mm Qty 1 pcs

	GEV No.	520235	Ref. No.
			—

3 hole flange hole distance 70.5mm perforation ø 6.5mm ID ø 53.5mm

	GEV No.	520236	Ref. No.
			003362 065558 OK2022 OK2917 OKD441 H24512000







flange for heating element ID ø 50mm ED ø 90mm hole ø 6.5mm 3 holes



	GEV No.	550002	Ref. No.
			—

tension strap H 10mm L 21mm W 10mm hole ø 6.5mm for heating element

	GEV No.	550362	Ref. No.
			—

blind flange ø 64mm mounting ø 47.5mm

				
1				
GEV No.	415809	Ref. No.	055384 056013	
description	heating element 24000W 400V heating circuits 3 mounting ø 47.5mm round flange connection cable immersion heater			
For models:	FCVE20-2, FCVE20-4, FCVE203CE, FCVE20-2UK, FCVE20-4UK, ZOFCV/E202, ZOFCV/E204			
accessories for	415809			
	GEV No.	510408	Ref. No. 046213 055533 067620 0H2559 0L2765 19006668 19006946	
	O-ring EPDM thickness 5.34mm ID ø 47mm Qty 1 pcs			
	GEV No.	510562	Ref. No.	—
	O-ring silicone thickness 5.34mm ID ø 47mm Qty 1 pcs			
	GEV No.	520235	Ref. No.	—
	3 hole flange hole distance 70.5mm perforation ø 6.5mm ID ø 53.5mm			
	GEV No.	520236	Ref. No. 003362 065558 0K2022 0K2917 0KD441 H24512000	
	flange for heating element ID ø 50mm ED ø 90mm hole ø 6.5mm 3 holes			
	GEV No.	550002	Ref. No.	—
	tension strap H 10mm L 21mm W 10mm hole ø 6.5mm for heating element			
	GEV No.	550362	Ref. No.	—
	blind flange ø 64mm mounting ø 47.5mm			

			
1			
GEV No.	415652	Ref. No.	002751 0C5337 60050289
description	heating element 24000W 400V heating circuits 6 mounting ø 47.5mm L 585mm W 32mm H 35mm round flange connection male faston 6.3mm immersion heater tube ø 6.3mm connection length 86mm thermostat sleeves ø 5mm number of thermostat sleeves 1 length thermostat sleeves 155mm thermostat sleeve clinging		
For models:	FCV/E102/1L3, FCV/E20L3, FCVE202L3, FCV/E102/1L6, FCV/E20L6, FCVE202L6, FVC/E102/1, FVC/E201/1, FVC/E202/1, FCS102E4, FCS102EP, FCS201E4, FCS201EP, FCS202E4, FCS202EP, FCS102EX, FCS201EX, 5714-3-6, 5714-3-7, 5714-3-8, 5714-3-8E, 5714-3-10, 5717-3-6, 5717-3-7, 5717-3-8, 5717-3-8E, 5717-3-10, 5717-3-8C, ECVE102T4, ECV/E20T4, ECVE202T4, ECV/E102/1T6, ECV/E20T6, ECVE202T6, ACVE102C4, ACV/E20C4, ACVE202C4, ACV/E102/1C6, ACVE20C6, ACV/E202/1, ZCV/E102/1, ZCV/E20T4, ZCV/E202/1, ZCV/E102/1T6, ZCV/E20T6, ZCV/E202/1		
spare parts for	415652		
	GEV No.	510408	Ref. No. 046213 055533 067620 0H2559 0L2765 19006668 19006946
	O-ring EPDM thickness 5.34mm ID ø 47mm Qty 1 pcs		





accessories for	415652			
	GEV No.	510408	Ref. No. 046213 055533 067620 0H2559 0L2765 19006668 19006946	
	O-ring EPDM thickness 5.34mm ID ø 47mm Qty 1 pcs			
	GEV No.	510562	Ref. No.	—
	O-ring silicone thickness 5.34mm ID ø 47mm Qty 1 pcs			
	GEV No.	520235	Ref. No.	—
	3 hole flange hole distance 70.5mm perforation ø 6.5mm ID ø 53.5mm			
	GEV No.	520236	Ref. No. 003362 065558 0K2022 0K2917 0KD441 H24512000	
	flange for heating element ID ø 50mm ED ø 90mm hole ø 6.5mm 3 holes			
	GEV No.	550002	Ref. No.	—
	tension strap H 10mm L 21mm W 10mm hole ø 6.5mm for heating element			
	GEV No.	550362	Ref. No.	—
	blind flange ø 64mm mounting ø 47.5mm			
	GEV No.	550460	Ref. No.	—
	kable set			



			
1			
GEV No.	420118	Ref. No.	0K4731 18001100
description	heating element 3000W 230V heating circuits 3 L 225mm W 39mm H 33mm tube ø 8.3mm number of thermostat sleeves 0 connection male faston 6.3mm connection length 17mm immersion heater round flange mounting ø 47.5mm		
For models:	ACSGRT, IVAAOE0000, HVAAOE00RO, GVAOE0000, GVAOE0-ORO, FVAOE00RO, IVKAOE0000, FVKAOE00RO, HVABOE00RO, GVABOE0000, GVABOE00RO, FVABOE00RO, FVFBOEXORO, IVKBOE-0000, FVKBOE00RO, IVACOE00RO, BON080EF88, GVACOE00RO, FVACOE00RO, IVACOMOORO, GVACOMOORO, GVFCOEX000, GVFCOEXORO, FVFCOEXORO, FVKCOE00RO, IVAEOE0000, IVAEOE-ORO, HVAEOE00RO, GVAEOE00RO, FVAEOE00RO, IVAEOMOORO, GVAEOMOORO, FVOEOEX000, FVFE0EXORO, HVKEOE00RO, GVKE-OEOORO, FVKEOE00RO, GVAHOE0000, GVAHOE00RO, FVAHOE-ORO, GVAHOMOORO, FVFHOEXORO, BON150SF98, BOT080S.MH25.W94, BOT080S.MS25.W94, BOT100E.MS35.H97, BOT150S.MH25.F98, BOT150S.MH25.W94, BOT200S.MH25.F18, BOT200S.MH25.W14... (Other models you can see in the webshop)		





			
GEV No.	420119	Ref. No.	OK4732 18001101
description	heating element 3000W 230V heating circuits 3 L 230mm W 42mm H 33mm tube ø 8.4mm thermostat sleeves ø 5mm length thermostat sleeves 190mm number of thermostat sleeves 1 thermostat sleeve eccentric, clinging/not clinging connection male faston 6.3mm connection length 16mm immersion heater round flange mounting ø 47.5mm		
For models:	ACSGRT, IVAAOE0000, HVAEOEOORO, GVAEOEO000, GVAEOEOORO, FVAEOEOORO, IVKAOEO000, FVKAEOEOORO, HVABOEOORO, GVABOEO000, GVABOEOORO, FVABOEOORO, FVFBEOEXORO, IVKBOEO000, FVKBOEOORO, IVACOEORO, BON080EF88, GVACOEORO, FVACOEORO, IVACOMOORO, GVACOMOORO, GVFCOEX000, GVFCOEXORO, FVFCOEXORO, FVKCOEOORO, IVAEOEO000, IVAEOEOORO, HVAEOEOORO, GVAEOEOORO, FVAEOEOORO, IVAEOMOORO, GVAEOMOORO, FVOEOEX000, FVFEEXORO, HVKEOEOORO, GVKEOEOORO, FVKEOEOORO, GVAHOEO000, GVAHOEOORO, FVAHOEOORO, GVAHOMOORO, FVFOEXORO, BON150SF98, BOT080S.MH25.W94, BOT080S.MS25.W94, BOT100E.MS35.H97, BOT150S.MH25.F98, BOT150S.MH25.W94, BOT200S.MH25.F18, BOT200S.MH25.W14... (Other models you can see in the webshop)		



			
GEV No.	417657	Ref. No.	OK4798 18002022
description	heating element 3x1500W 230V heating circuits 3 mounting ø 47.5mm L 500mm W 38mm H 38mm round flange immersion heater tube ø 6.3mm thermostat sleeves ø 7mm number of thermostat sleeves 1 length thermostat sleeves 280mm thermostat sleeve eccentric, clinging		

			
GEV No.	415026	Ref. No.	052619 065557 0L1874
description	heating element 4500W 220/380V mounting ø 47.5mm immersion heater		
For models:	MPN/EI760, MPNEI760UK, 7PIE06, RPN/EI760UK, M70EIKE, XPN/EI760UK, RPN/EI760, HPN/EI810, HPN/EI810, HPA/EI810, HPN/EI810, HPN/EI810, HPA/EI815, LS360F, LS360DK, LS365F, LS365, LS365PH, LS540DK, LS360D, LS365D, LS360, LS365, LS360/63, LS365/63, LS367, LS860DK, LS500F, LS501, LS540/63, LS541, LS360, LS365F, HB3PNT		
accessories for	415026		
	GEV No.	510408	Ref. No. 046213 055533 067620 0H2559 0L2765 19006668 19006946
O-ring EPDM thickness 5.34mm ID ø 47mm Qty 1 pcs			
	GEV No.	510562	Ref. No.
O-ring silicone thickness 5.34mm ID ø 47mm Qty 1 pcs			
	GEV No.	520235	Ref. No.
3 hole flange hole distance 70.5mm perforation ø 6.5mm ID ø 53.5mm			

accessories for	415026		
	GEV No.	520236	Ref. No. 003362 065558 0K2022 0K2917 0KD441 H24512000
flange for heating element ID ø 50mm ED ø 90mm hole ø 6.5mm 3 holes			
	GEV No.	550002	Ref. No.
tension strap H 10mm L 21mm W 10mm hole ø 6.5mm for heating element			
	GEV No.	550362	Ref. No.
blind flange ø 64mm mounting ø 47.5mm			

			
GEV No.	420125	Ref. No.	056489
description	heating element 4500W 220V heating circuits 3 L 345mm W 39mm H 33mm tube ø 8.3mm number of thermostat sleeves 0 connection male faston 6.3mm connection length 18mm immersion heater round flange mounting ø 47.5mm		
For models:	FVE3, FVE3, VAPE3		







			
GEV No.	420121	Ref. No.	OK4733 18001102 18001102K
description	heating element 4500W 230V heating circuits 3 L 330mm W 39mm H 33mm tube ø 8.4mm number of thermostat sleeves 0 connection male faston 6.3mm connection length 17mm immersion heater round flange mounting ø 47.5mm		
For models:	ACSGRT, GWACOEORO, FWAAMOORO, GWACOMOORO, IWKCOEO000, HWAHOEOORO, GWAHOEO000, GWAHOEOORO, FWAHOEOORO, BEN150EW87, HWAJOEOORO, GWAJOEOORO, FWAJOEOORO, BEN200EW87, GWAJOMOORO, FWFJOEX000, FWFJOEXORO, BEN300E.S35.H97, GWAKOEOORO, FWAKEOEOORO, IWAKOMOORO, GWAKOMOORO, FWFKOEXORO, FWKKEOEOORO, IWALOE0000, IWALOEORO, BEN400E.S35.H97, BEN400EF97, FWALOEORO, GWALOMOORO, IVAAOEO000, HVAAOEOORO, GVAEOEO000, GVAEOEOORO, FVAEOEOORO, IVKAOEO000, FVKAEOEOORO, HVABOEOORO, GVABOEO000, GVABOEOORO, FVABOEOORO, FVFBEOEXORO, IVKBOEO000, FVKBOEOORO, IVACOEORO, BON080EF88, GVACOEORO, FVACOEORO, IVACOMOORO, GVACOMOORO...(Other models you can see in the webshop)		

			
GEV No.	418782	Ref. No.	0G1632 0K4734 18001103 18001103K
description	heating element 4500W 230V heating circuits 3 L 330mm W 43mm H 33mm tube ø 6.3mm thermostat sleeves ø 6.25mm length thermostat sleeves 203mm number of thermostat sleeves 1 connection male faston 6.3mm immersion heater round flange mounting ø 47.5mm with temperature protection		
For models:	ACSGRT, GWACOE00RO, FWAAMO00RO, GWACOMO0RO, IWKCOE0000, HWAHOE00RO, GWAHOE0000, GWAHOE00RO, FWAHOE00RO, BEN150EW87, HWAJOE00RO, GWAJOE00RO, FWAJOE00RO, BEN200EW87, GWAJOM00RO, FWFJOEX000, FWFJOEX0RO, BEN300E.S35.H97, GWAKOE00RO, FWAKOE00RO, IWAKOMO0RO, GWAKOMO0RO, FWFKOEX0RO, FWKKEOE0RO, IWALOE0000, IWALOE00RO, BEN400E.S35.H97, BEN400EF97, FWALOE00RO, GWALOMO0RO, IVAAOE0000, HVAAOE00RO, GVAAOE0000, GVAAOE00RO, FVAAOE00RO, IVKAOE0000, FVKAOE00RO, HVABOE00RO, GVABOE0000, GVABOE00RO, FVABOE00RO, FVFB0EX0RO, IVKBOE0000, FVKBOE00RO, IVACOE00RO, BON080EF88, GVACOE00RO, FVACOE00RO, IVACOMO0RO, GVACOMO0RO...(Other models you can see in the webshop)		
accessories for	418782		
	GEV No.	510408	Ref. No. 046213 055533 067620 0H2559 0L2765 19006668 19006946
O-ring EPDM thickness 5.34mm ID ø 47mm Qty 1 pcs			

accessories for	415598		
	GEV No.	550362	Ref. No. —
blind flange ø 64mm mounting ø 47.5mm			







			
GEV No.	417702	Ref. No.	OKT719
description	heating element 4500W 255V heating circuits 3 mounting ø 47.5mm L 330mm W 38mm H 30mm round flange connection male faston 6.3mm immersion heater tube ø 8.5mm thermostat sleeves ø 4mm number of thermostat sleeves 1 length thermostat sleeves 190mm thermostat sleeve centred, adjacent		
For models:	ACSGRT, GWACOE00RO, FWAAMO00RO, GWACOMO0RO, IWKCOE0000, HWAHOE00RO, GWAHOE0000, GWAHOE00RO, FWAHOE00RO, BEN150EW87, HWAJOE00RO, GWAJOE00RO, FWAJOE00RO, BEN200EW87, GWAJOM00RO, FWFJOEX000, FWFJOEX0RO, BEN300E.S35.H97, GWAKOE00RO, FWAKOE00RO, IWAKOMO0RO, GWAKOMO0RO, FWFKOEX0RO, FWKKEOE0RO, IWALOE0000, IWALOE00RO, BEN400E.S35.H97, BEN400EF97, FWALOE00RO, GWALOMO0RO, IVAAOE0000, HVAAOE00RO, GVAAOE0000, GVAAOE00RO, FVAAOE00RO, IVKAOE0000, FVKAOE00RO, HVABOE00RO, GVABOE0000, GVABOE00RO, FVABOE00RO, FVFB0EX0RO, IVKBOE0000, FVKBOE00RO, IVACOE00RO, BON080EF88, GVACOE00RO, FVACOE00RO, IVACOMO0RO, GVACOMO0RO...(Other models you can see in the webshop)		

			
GEV No.	420140	Ref. No.	OK4735
description	heating element 6000W 230V heating circuits 3 L 434mm W 38mm H 35mm tube ø 8.5mm number of thermostat sleeves 0 connection male faston 6.3mm connection length 17mm immersion heater round flange mounting ø 47.5mm		
For models:	ACSGRT, GWACOE00RO, FWAAMO00RO, GWACOMO0RO, IWKCOE0000, HWAHOE00RO, GWAHOE0000, GWAHOE00RO, FWAHOE00RO, BEN150EW87, HWAJOE00RO, GWAJOE00RO, FWAJOE00RO, BEN200EW87, GWAJOM00RO, FWFJOEX000, FWFJOEX0RO, BEN300E.S35.H97, GWAKOE00RO, FWAKOE00RO, IWAKOMO0RO, GWAKOMO0RO, FWFKOEX0RO, FWKKEOE0RO, IWALOE0000, IWALOE00RO, BEN400E.S35.H97, BEN400EF97, FWALOE00RO, GWALOMO0RO, IVAAOE0000, HVAAOE00RO, GVAAOE0000, GVAAOE00RO, FVAAOE00RO, IVKAOE0000, FVKAOE00RO, HVABOE00RO, GVABOE0000, GVABOE00RO, FVABOE00RO, FVFB0EX0RO, IVKBOE0000, FVKBOE00RO, IVACOE00RO, BON080EF88, GVACOE00RO, FVACOE00RO, IVACOMO0RO, GVACOMO0RO...(Other models you can see in the webshop)		

			
GEV No.	415598	Ref. No.	046622 046623
description	heating element 4500W 230V heating circuits 3 mounting ø 47.5mm L 350mm W 28mm H 34mm round flange connection male faston 6.3mm immersion heater tube ø 6.5mm thermostat sleeves ø 6.5mm number of thermostat sleeves 1 length thermostat sleeves 305mm thermostat sleeve centre not clinging		
For models:	LSE720DK, LS720, LS720N		
spare parts for	415598		
	GEV No.	510408	Ref. No. 046213 055533 067620 0H2559 0L2765 19006668 19006946
O-ring EPDM thickness 5.34mm ID ø 47mm Qty 1 pcs			
accessories for	415598		
	GEV No.	510562	Ref. No. —
O-ring silicone thickness 5.34mm ID ø 47mm Qty 1 pcs			
	GEV No.	520235	Ref. No. —
3 hole flange hole distance 70.5mm perforation ø 6.5mm ID ø 53.5mm			
	GEV No.	520236	Ref. No. 003362 065558 0K2022 0K2917 0KD441 H24512000
flange for heating element ID ø 50mm ED ø 90mm hole ø 6.5mm 3 holes			
	GEV No.	550002	Ref. No. —
tension strap H 10mm L 21mm W 10mm hole ø 6.5mm for heating element			







			
GEV No.	420120	Ref. No.	OK4736 18001105
description	heating element 6000W 230V heating circuits 3 L 435mm W 43mm H 33mm tube ø 8.5mm thermostat sleeves ø 5mm length thermostat sleeves 190mm number of thermostat sleeves 1 thermostat sleeve eccentric, clinging/not clinging connection male faston 6.3mm connection length 17mm immersion heater round flange mounting ø 47.5mm		
For models:	ACSGRT, GWACOE00RO, FWAAMO00RO, GWACOMO0RO, IWKCOE0000, HWAHOE00RO, GWAHOE0000, GWAHOE00RO, FWAHOE00RO, BEN150EW87, HWAJOE00RO, GWAJOE00RO, FWAJOE00RO, BEN200EW87, GWAJOM00RO, FWFJOEX000, FWFJOEX0RO, BEN300E.S35.H97, GWAKOE00RO, FWAKOE00RO, IWAKOMO0RO, GWAKOMO0RO, FWFKOEX0RO, FWKKEOE0RO, IWALOE0000, IWALOE00RO, BEN400E.S35.H97, BEN400EF97, FWALOE00RO, GWALOMO0RO, IVAAOE0000, HVAAOE00RO, GVAAOE0000, GVAAOE00RO, FVAAOE00RO, IVKAOE0000, FVKAOE00RO, HVABOE00RO, GVABOE0000, GVABOE00RO, FVABOE00RO, FVFB0EX0RO, IVKBOE0000, FVKBOE00RO, IVACOE00RO, BON080EF88, GVACOE00RO, FVACOE00RO, IVACOMO0RO, GVACOMO0RO...(Other models you can see in the webshop)		



			
GEV No.	415405	Ref. No.	045559 058011 0L1879
description	heating element 6000W 230V heating circuits 3 L 465mm W 38mm H 24mm tube ø 6.3mm connection male faston 6.3mm immersion heater round flange mounting ø 47.5mm		
For models:	HQN/EI917, HQN/EI1225, HQNEI817, HQNEI122, CT142DXE, CT142SXE, CT142DXEUK, CT142SXEUUK, CT142DXV, CT142SXV, CT190DXE, CT190SXE, CT190DXEUK, CT190SXEUUK, CT190DXV, CT190SXV, CT191DXE, CT191SXE, CT191DXEUK, CT191SXEUUK, CT191DXV, CT191SXV, CT192DXE, CT192SXE, CT192DXEUK, CT192SXEUUK, CT192DXV, CT192SXV, CT240DXE, CT240SXE, CT240DXEUK, CT240SX, CT240DXV, CT240SXVUK, CT241DXE, CT241SXE, CT241DXEUK, CT241SXEUUK, CT241DXV, CT241SXV, CT142DXEZ, CT142SXEZ, CT142DXVZ, CT142SXVZ, CT190DXEZ, CT190SXEZ, CT190DXV, CT190SXV, CT191DXE, CT191SXE...(Other models you can see in the webshop)		
spare parts for	415405		
	GEV No.	504148	Ref. No. —
	boiler		
accessories for	415405		
	GEV No.	520235	Ref. No. —
	3 hole flange hole distance 70.5mm perforation ø 6.5mm ID ø 53.5mm		
	GEV No.	520236	Ref. No. 003362 065558 0K2022 0K2917 0KD441 H24512000
	flange for heating element ID ø 50mm ED ø 90mm hole ø 6.5mm 3 holes		
	GEV No.	521012	Ref. No. —
	gasket graphite ED ø 15mm ID ø 5mm thickness 1.2mm Qty 1 pcs		
	GEV No.	550002	Ref. No. —
	tension strap H 10mm L 21mm W 10mm hole ø 6.5mm for heating element		
	GEV No.	550362	Ref. No. —
	blind flange ø 64mm mounting ø 47.5mm		

			
GEV No.	419097	Ref. No.	0H9761 0H9762 0K4801 0K4802 0K4807
description	heating element 6000W 230V heating circuits 3 mounting ø 47.5mm L 500mm W 38mm H 38mm round flange immersion heater tube ø 6.3mm thermostat sleeves ø 7mm number of thermostat sleeves 1 length thermostat sleeves 280mm thermostat sleeve eccentric, clinging		

			
GEV No.	420122	Ref. No.	0K6397
description	heating element 6000W 240V heating circuits 3 L 430mm W 39mm H 33mm tube ø 8.5mm thermostat sleeves ø 5mm length thermostat sleeves 190mm number of thermostat sleeves 1 thermostat sleeve eccentric, clinging/not clinging connection male faston 6.3mm connection length 17mm immersion heater round flange mounting ø 47.5mm		
For models:	ACSGRT, GWACOE00RO, FWAAMO00RO, GWACOMO0RO, IWKC0E0000, HWAHOE00RO, GWAHOE0000, GWAHOE00RO, FWAHOE00RO, BEN150EW87, HWAJOE00RO, GWAJOE00RO, FWAJOE00RO, BEN200EW87, GWAJOMO0RO, FWFJOEX000, FWFJOEX0RO, BEN300E.S35.H97, GWAKOE00RO, FWAKOE00RO, IWAKOMO0RO, GWAKOMO0RO, FWFKOE00RO, FWKKOE00RO, IVALOE0000, IVALOE00RO, BEN400E.S35.H97, BEN400EF97, FVALOE00RO, GVALOMO0RO, IVAAOE0000, HVAAOE00RO, GVAAOE0000, GVAAOE00RO, FVAAOE00RO, IVKAOE0000, FVKAOE00RO, HVABOE00RO, GVABOE0000, GVABOE00RO, FVABOE00RO, FVFB0EX0RO, IVKBOE0000, FVKBOE00RO, IVACOE00RO, BON080EF88, GVACOE00RO, FVACOE00RO, IVACOMO0RO, GVACOMO0RO...(Other models you can see in the webshop)		

			
GEV No.	418188	Ref. No.	055431 055463 056011 0K9195
description	heating element 7500W 220V heating circuits 3 mounting ø 47.5mm L 260mm W 35mm H 32mm round flange cable length 1040mm immersion heater tube ø 6.2mm		
For models:	FCVE6-1U, FCVE6-3U, FCVE6-1, FCVE6-3, FCVE6-1UK, FCVE6-3UK, FCVE203CE, FCV/E6-1, FCV/E6-1		
accessories for	418188		
	GEV No.	510408	Ref. No. 046213 055533 067620 0H2559 0L2765 19006668 19006946
	O-ring EPDM thickness 5.34mm ID ø 47mm Qty 1 pcs		
	GEV No.	510562	Ref. No. —
	O-ring silicone thickness 5.34mm ID ø 47mm Qty 1 pcs		
	GEV No.	520235	Ref. No. —
	3 hole flange hole distance 70.5mm perforation ø 6.5mm ID ø 53.5mm		
	GEV No.	520236	Ref. No. 003362 065558 0K2022 0K2917 0KD441 H24512000
	flange for heating element ID ø 50mm ED ø 90mm hole ø 6.5mm 3 holes		
	GEV No.	550002	Ref. No. —
	tension strap H 10mm L 21mm W 10mm hole ø 6.5mm for heating element		
	GEV No.	550362	Ref. No. —
	blind flange ø 64mm mounting ø 47.5mm		

with round flange ø57.5mm



GEV No.	420313	Ref. No.	OE5066 OL1836
description	heating element 10000W 230V heating circuits 3 mounting ø 57.5mm L 455mm W 44mm H 42mm round flange connection male faston 6.3mm immersion heater tube ø 6.2mm thermostat sleeves ø 7mm number of thermostat sleeves 1 length thermostat sleeves 225mm thermostat sleeve eccentric, non clinging		
For models:	RT100ED, RT100ES, RT100SR, RT100SL, RT140ED, RT140ES, RT140SR, RT140SL, RT190ED, RT190ES, RT190SR, RT190SL, RT190HDED, RT190HDES, RT190HSR, RT190HSL, RT270ED, RT270ES, RT270SR, RT270SL, RT270HDED, RT270HDES, RT270HSR, RT270HSL, RT100ERF, RT100ELF, RT100VD, RT100VS, RT140ERF, RT140ELF, RT140VD, RT140VS, RT142ERF, RT142ELF, RT190ERF, RT190ELF, RT190VD, RT190VS, RT190HERF, RT190HEL, RT190HDVDF, RT190HDVSF, RT270ERF, RT270ELF, RT270VDF, RT270VSF, RT270HERF, RT270HEL, RT270HDVDF, RT270HDVSF...(Other models you can see in the webshop)		

accessories for 420313

	GEV No.	510409	Ref. No.	007029 047156 049909 OE5037 OK9011 543613600 740483105
O-ring EPDM thickness 5.34mm ID ø 56.52mm Qty 1 pcs				
	GEV No.	550002	Ref. No.	—
tension strap H 10mm L 21mm W 10mm hole ø 6.5mm for heating element				



GEV No.	418983	Ref. No.	OE5213 OK7530
description	heating element 12000W 220V heating circuits 3 mounting ø 57.5mm L 455mm W 40mm H 30mm connection M5 immersion heater tube ø 6.3mm connection length 20mm thermostat sleeves ø 6mm number of thermostat sleeves 1 length thermostat sleeves 290mm thermostat sleeve upper dishwasher		
For models:	FT36EDTS, FT36ESTS, FT36VDTS, FT36VSTS, FT36ED, FT36ES, FT36VD, FT36VS, FT50ED, FT50ES, FT50VD, FT50VS, FT72ED, FT72ES, FT72VD, FT72VS, FT36EDT, FT36EST, FT36VDT, FT36VST, FT50EDT, FT50EST, FT50VDT, FT50VST, FT72EDT, FT72EST, FT72VDT, FT72VST, FT36WED, FT36WES, FT36WVD, FT36WVS, FT50WED, FT50WES, FT50WVD, FT50WVS, FT72WED, FT72WES, FT72WVD, FT72WVS, FT36WEDT, FT36WEST, FT36WVDT, FT36WVST, FT50WEDT, FT50WEST, FT50WVDT, FT50WVST, FT72WEDT, FT72WEST...(Other models you can see in the webshop)		



GEV No.	419021	Ref. No.	OE5116 0H2515 OK8251 OL1837
description	heating element 12000W 230V heating circuits 3 mounting ø 57.5mm L 460mm W 44mm H 34mm connection male faston 6.3mm tube ø 6.25mm thermostat sleeves ø 7mm number of thermostat sleeves 1 length thermostat sleeves 230mm thermostat sleeve eccentric, non clinging		
For models:	PW2MG, PW2MUK, PW2M60, WT850M, WT850MUK, WT850M60G, RT100ED, RT100ES, RT140ED, RT140ES, RT190ED, RT190ES, RT190HDED, RT190HDES, RT270ED, RT270ES, RT270HDED, RT270HDES, RT100ERF, RT100ELF, RT140ERF, RT140ELF, RT142ERF, RT142ELF, RT190ERF, RT190ELF, RT190HERF, RT190HEL, RT270ERF, RT270ELF, RT270HERF, RT270HEL, RT100ERG, RT100ELG, RT140ERG, RT140ELG, RT190ERG, RT190ELG, RT190HERG, RT190HEL, RT270ERG, RT270ELG, RT270HERG, RT270HEL, RT10ED, RT10ES, RT10SR, RT10SL, RT10ED/230, RT10ES/230...(Other models you can see in the webshop)		



GEV No.	420315	Ref. No.	OK8506 30001786
description	heating element 12000W 230V heating circuits 3 mounting ø 57.5mm L 480mm W 36mm H 57mm round flange connection M5 immersion heater tube ø 6.2mm H1 45mm H2 12mm L1 40mm L2 440mm number of thermostat sleeves 0		
For models:	FT36EDTS, FT36ESTS, FT36VDTS, FT36VSTS, FT36ED, FT36ES, FT36VD, FT36VS, FT50ED, FT50ES, FT50VD, FT50VS, FT72ED, FT72ES, FT72VD, FT72VS, FT36EDT, FT36EST, FT36VDT, FT36VST, FT50EDT, FT50EST, FT50VDT, FT50VST, FT72EDT, FT72EST, FT72VDT, FT72VST, FT36WED, FT36WES, FT36WVD, FT36WVS, FT50WED, FT50WES, FT50WVD, FT50WVS, FT72WED, FT72WES, FT72WVD, FT72WVS, FT36WEDT, FT36WEST, FT36WVDT, FT36WVST, FT50WEDT, FT50WEST, FT50WVDT, FT50WVST, FT72WEDT, FT72WEST...(Other models you can see in the webshop)		



GEV No.	419132	Ref. No.	OE5162 OL1861
description	heating element 12000W 230V heating circuits 3 mounting ø round flange ø57.5mm L 460mm W 35mm H 55mm round flange immersion heater tube ø 6.2mm H2 35mm L1 40mm L2 400mm		
For models:	RT100ED, RT100ES, RT100SR, RT100SL, RT140ED, RT140ES, RT140SR, RT140SL, RT190ED, RT190ES, RT190SR, RT190SL, RT190HDED, RT190HDES, RT190HSR, RT190HSL, RT270ED, RT270ES, RT270SR, RT270SL, RT270HDED, RT270HDES, RT270HSR, RT270HSL, RT100ERF, RT100ELF, RT100VD, RT100VS, RT140ERF, RT140ELF, RT140VD, RT140VS, RT142ERF, RT142ELF, RT190ERF, RT190ELF, RT190VD, RT190VS, RT190HERF, RT190HEL, RT190HDVDF, RT190HDVSF, RT270ERF, RT270ELF, RT270VDF, RT270VSF, RT270HERF, RT270HEL, RT270HDVDF, RT270HDVSF...(Other models you can see in the webshop)		

accessories for 419132





	GEV No.	510409	Ref. No.	007029 047156 049909 OE5037 OK9011 543613600 740483105
O-ring EPDM thickness 5.34mm ID ø 56.52mm Qty 1 pcs				
	GEV No.	560400	Ref. No.	—
flat-headed bolt thread M5 thread L 8mm SS DIN 84/ISO 1207 Qty 1 pcs intake slotted head ø 8.3mm head thickness 3.2mm				
	GEV No.	699566	Ref. No.	—
connection terminal for heating element				





GEV No.	420317	Ref. No.	OK8505 30200035 6120444401
description	heating element 15000W 230V heating circuits 3 mounting ø 57.5mm L 480mm W 32mm H 60mm round flange connection M5 immersion heater tube ø 6.3mm H1 40mm H2 20mm L1 450mm L2 30mm number of thermostat sleeves 0		
For models:	FT36EDTS, FT36ESTS, FT36VDTS, FT36VSTS, FT36ED, FT36ES, FT36VD, FT36VS, FT50ED, FT50ES, FT50VD, FT50VS, FT72ED, FT72ES, FT72VD, FT72VS, FT36EDT, FT36EST, FT36VDT, FT36VST, FT50EDT, FT50EST, FT50VDT, FT50VST, FT72EDT, FT72EST, FT72VDT, FT72VST, FT36WED, FT36WES, FT36WVD, FT36WVS, FT50WED, FT50WES, FT50WVD, FT50WVS, FT72WED, FT72WES, FT72WVD, FT72WVS, FT36WEDT, FT36WEST, FT36WVDT, FT36WVST, FT50WEDT, FT50WEST, FT50WVDT, FT50WVST, FT72WEDT, FT72WEST...(Other models you can see in the webshop)		











			
GEV No.	418982	Ref. No.	OE5115 OK8250 OL1833
description	heating element 4000W 230V heating circuits 3 mounting ø 57.5mm L 455mm W 40mm H 32mm connection male faston 6.3mm immersion heater tube ø 6.3mm thermostat sleeves ø 6mm number of thermostat sleeves 1 length thermostat sleeves 290mm thermostat sleeve upper dishwasher		
For models:	RT100ED, RT100ES, RT100SR, RT100SL, RT140ED, RT140ES, RT140SR, RT140SL, RT190ED, RT190ES, RT190SR, RT190SL, RT190HDED, RT190HDES, RT190HSR, RT190HSL, RT270ED, RT270ES, RT270SR, RT270SL, RT270HDED, RT270HDES, RT270HSR, RT270HSL, RT100ERF, RT100ELF, RT100VD, RT100VS, RT140ERF, RT140ELF, RT140VD, RT140VS, RT142ERF, RT142ELF, RT190ERF, RT190ELF, RT190VD, RT190VS, RT190HERF, RT190HEL, RT190HDVDF, RT190HDVSF, RT270ERF, RT270ELF, RT270VDF, RT270VSF, RT270HERF, RT270HEL, RT270HDVDF, RT270HDVSF...(Other models you can see in the webshop)		

											
GEV No.	420316	Ref. No.	OE5114 OK8249 OL1834 20391212								
description	heating element 6000W 230V heating circuits 3 mounting ø 57.5mm L 463mm W 40mm H 40mm round flange connection male faston 6.3mm immersion heater tube ø 6.25mm thermostat sleeves ø 6.5mm number of thermostat sleeves 1 length thermostat sleeves 308mm thermostat sleeve eccentric, clinging										
For models:	FT36EDTS, FT36ESTS, FT36VDTS, FT36VSTS, FT36ED, FT36ES, FT36VD, FT36VS, FT50ED, FT50ES, FT50VD, FT50VS, FT72ED, FT72ES, FT72VD, FT72VS, FT36EDT, FT36EST, FT36VDT, FT36VST, FT50EDT, FT50EST, FT50VDT, FT50VST, FT72EDT, FT72EST, FT72VDT, FT72VST, WTF2ERC, WTF2ELC, WTF2SRC, WTF2SLC, WTF2HERC, WTF2HEL, WTF2HSRC, WTF2HSLC, WTF3ERC, WTF3ELC, WTF3SRC, WTF3SLC, WTF3HERC, WTF3HEL, WTF3HSRC, WTF3HSLC, WTF2ERB, WTF2ELB, WTF2SRB, WTF2SLB, WTF2HERB, WTF2HEL, B...(Other models you can see in the webshop)										
accessories for	420316	<table border="1"> <tr> <td></td> <td></td> <td></td> <td>007029 047156 049909 0E5037 0K9011 543613600 740483105</td> </tr> <tr> <td></td> <td>GEV No.</td> <td>510409</td> <td>Ref. No.</td> </tr> </table> <p>O-ring EPDM thickness 5.34mm ID ø 56.52mm Qty 1 pcs</p>					007029 047156 049909 0E5037 0K9011 543613600 740483105		GEV No.	510409	Ref. No.
			007029 047156 049909 0E5037 0K9011 543613600 740483105								
	GEV No.	510409	Ref. No.								

			
GEV No.	419087	Ref. No.	OK7528
description	heating element 6900/7500W 230/240V heating circuits 3 mounting ø 57.5mm L 325mm W 40mm H 40mm round flange connection male faston 6.3mm immersion heater tube ø 6.3mm thermostat sleeves ø 6.2mm number of thermostat sleeves 1 length thermostat sleeves 300mm thermostat sleeve eccentric, clinging		
For models:	AR170S, AR170S, AR170S, AR170S, AR170S, AR170S, AR170S, AR170S, AR170S, AR340S, AR340S, AR340S, AR340S, AR340S, AR340S, AR340S, AR340S, AR10ES, AR10ES, AR10ES, AR10ES, AR10ES, AR10ES, AR10ES, AR10ES, AR10ESP, AR10ESP, AR10ESP, AR10ESP, AR10ESP, AR10ESP, AR10ESP, AR10ES, AR10ES, AR10ES, AR10ES, AR10ES, AR10ES, AR10ESP, AR10ESP, AR10ESP, AR10ESP, AR10ESP, AR10ESP, AR10ESP, AR10ESP, AR10ESP, AR10ESP, AR10ESP, AR10ESP...(Other models you can see in the webshop)		



			
GEV No.	420224	Ref. No.	OH2277
description	heating element 7500W 220V heating circuits 3 mounting ø 57.5mm L 324mm W 40mm H 42mm flange connection connection male faston 6.3mm immersion heater tube ø 6mm thermostat sleeves ø 7mm number of thermostat sleeves 1 length thermostat sleeves 290mm thermostat sleeve eccentric, clinging		
For models:	PW1MG, PW1MUK, PW160HZ, PW1MHG, WT830M, WT830MUK, WT830M60G, WT830MHG, PW100M, PW100MHG		

											
GEV No.	418615	Ref. No.	OE5161 OK8245 OL1859								
description	heating element 7500W 230V heating circuits 3 mounting ø round flange ø57.5mmmm L 440mm W 35mm H 55mm round flange immersion heater tube ø 6.2mm H1 20mm H2 35mm L1 40mm L2 400mm										
For models:	RT100ED, RT100ES, RT100SR, RT100SL, RT140ED, RT140ES, RT140SR, RT140SL, RT190ED, RT190ES, RT190SR, RT190SL, RT190HDED, RT190HDES, RT190HSR, RT190HSL, RT270ED, RT270ES, RT270SR, RT270SL, RT270HDED, RT270HDES, RT270HSR, RT270HSL, RT100ERF, RT100ELF, RT100VD, RT100VS, RT140ERF, RT140ELF, RT140VD, RT140VS, RT142ERF, RT142ELF, RT190ERF, RT190ELF, RT190VD, RT190VS, RT190HERF, RT190HEL, RT190HDVDF, RT190HDVSF, RT270ERF, RT270ELF, RT270VDF, RT270VSF, RT270HERF, RT270HEL, RT270HDVDF, RT270HDVSF...(Other models you can see in the webshop)										
spare parts for	418615	<table border="1"> <tr> <td></td> <td></td> <td></td> <td>007029 047156 049909 0E5037 0K9011 543613600 740483105</td> </tr> <tr> <td></td> <td>GEV No.</td> <td>510409</td> <td>Ref. No.</td> </tr> </table> <p>O-ring EPDM thickness 5.34mm ID ø 56.52mm Qty 1 pcs</p>					007029 047156 049909 0E5037 0K9011 543613600 740483105		GEV No.	510409	Ref. No.
			007029 047156 049909 0E5037 0K9011 543613600 740483105								
	GEV No.	510409	Ref. No.								
accessories for	418615	<table border="1"> <tr> <td></td> <td></td> <td></td> <td>—</td> </tr> <tr> <td></td> <td>GEV No.</td> <td>550002</td> <td>Ref. No.</td> </tr> </table> <p>tension strap H 10mm L 21mm W 10mm hole ø 6.5mm for heating element</p>					—		GEV No.	550002	Ref. No.
			—								
	GEV No.	550002	Ref. No.								



			
GEV No.	420318	Ref. No.	047155
description	heating element 8000W 220V heating circuits 3 mounting ø 57.5mm L 475mm W 56mm H 41mm round flange connection M5 immersion heater tube ø 8.4mm thermostat sleeves ø 7.5mm number of thermostat sleeves 1 length thermostat sleeves 265mm thermostat sleeve eccentric, clinging		
For models:	CT142DXE, CT142SXE, CT142DXEUK, CT142SXEUK, CT142DXV, CT142SXV, CT190DXE, CT190SXE, CT190DXEUK, CT190SXEUK, CT190DXV, CT190SXV, CT191DXE, CT191SXE, CT191DXEUK, CT191SXEUK, CT191DXV, CT191SXV, CT142DXEZ, CT142SXEZ, CT142DXVZ, CT142SXVZ, CT190DXEZ, CT190SXEZ, CT190DXVZ, CT190SXVZ, CT191DXE, CT191SXE, CT191DXV, CT191SXV		





			
GEV No.	420312	Ref. No.	OE5113 OL1835
description	heating element 8000W 230V heating circuits 3 mounting ø 57.5mm L 455mm W 40mm H 42mm round flange connection male faston 6.3mm immersion heater tube ø 6.2mm thermostat sleeves ø 7mm number of thermostat sleeves 1 length thermostat sleeves 225mm thermostat sleeve eccentric, non clinging		
For models:	RT100ED, RT100ES, RT100SR, RT100SL, RT140ED, RT140ES, RT140SR, RT140SL, RT190ED, RT190ES, RT190SR, RT190SL, RT190HDED, RT190HDES, RT190HSR, RT190HSL, RT270ED, RT270ES, RT270SR, RT270SL, RT270HDED, RT270HDES, RT270HSR, RT270HSL, RT100ERF, RT100ELF, RT100VD, RT100VS, RT140ERF, RT140ELF, RT140VD, RT140VS, RT142ERF, RT142ELF, RT190ERF, RT190ELF, RT190VD, RT190VS, RT190HERF, RT190HELF, RT190HDVDF, RT190HDVSF, RT270ERF, RT270ELF, RT270VDF, RT270VSF, RT270HERF, RT270HELF, RT270HDVDF, RT270HDVSF...(Other models you can see in the webshop)		

			
GEV No.	420306	Ref. No.	OE5163 OL1860
description	heating element 9000W 230V heating circuits 3 mounting ø 57.5mm L 450mm W 34mm H 60mm round flange ø57.5mm connection M5 immersion heater tube ø 6.5mm H1 36mm H2 24mm L1 50mm L2 400mm number of thermostat sleeves 0		
For models:	RT100ED, RT100ES, RT100SR, RT100SL, RT140ED, RT140ES, RT140SR, RT140SL, RT190ED, RT190ES, RT190SR, RT190SL, RT190HDED, RT190HDES, RT190HSR, RT190HSL, RT270ED, RT270ES, RT270SR, RT270SL, RT270HDED, RT270HDES, RT270HSR, RT270HSL, RT100ERF, RT100ELF, RT100VD, RT100VS, RT140ERF, RT140ELF, RT140VD, RT140VS, RT142ERF, RT142ELF, RT190ERF, RT190ELF, RT190VD, RT190VS, RT190HERF, RT190HELF, RT190HDVDF, RT190HDVSF, RT270ERF, RT270ELF, RT270VDF, RT270VSF, RT270HERF, RT270HELF, RT270HDVDF, RT270HDVSF...(Other models you can see in the webshop)		
accessories for	420306		
	GEV No.	510409	Ref. No. 007029 047156 049909 0E5037 0K9011 543613600 740483105
O-ring EPDM thickness 5.34mm ID ø 56.52mm Qty 1 pcs			

special flanges

			
GEV No.	416975	Ref. No.	OK0516
description	heating element 15000W 400V heating circuits 6 L 263mm W 240mm H 80mm tube ø 6.5mm connection cable cable length 1500mm immersion heater special fixing hole distance 48/56mm flange length 335mm flange width 125mm hole ø 10mm		
For models:	7561-3.KES60.RW, 7751-3/85.KES60, 7550-3/85.KES40.(N), 7551-3/85.KES60, 7550-3/90.KES40.(N), 7551-3/90.KES60, 7561-3/85.KES60.RW., 7561-3/90.KES60.RW., 7585-3/85.KK40.MOTK., 7586-3/85.KK60.MOTK., 7585-3/90.KK40.MOTK., 7586-3/90.KK60.MOTL., 7550-3, 7551-3, 7560-3, 7561-3, 7580-3, 7581-3, 7750-3, 7750-3/85.KES40, 7750-3/90.KES40, 7751-3, 7751-3/90.KES60, 7780-3, 7781-3, 7785-3/85.KK40.MOTK., 7785-3/90.KK40.MOTK., 7786-3/85.KK60.MOTK., 7786-3/90.KK60.MOTK., 9111-3, 9113-3, 9171-3, 9172-3, 9181-3, 9182-3, 9311-3-0, 9311-3-8, 9313-3-0, 9313-3-8, 9371-3-0, 9371-3-8, 9372-3-0, 9372-3-8, 9381-3-0, 9381-3-8, 9382-3-0, 9382-3-8, 9411-3, 9413-3, 9414-3...(Other models you can see in the webshop)		
accessories for	416975		
	GEV No.	510560	Ref. No. 0G0027 0H6992 0K5577 19006925 2871981 700645
gasket EPDM thickness 6mm ID ø 200mm dimensions 280x70mm Qty 1 pcs for heating element			

			
GEV No.	415797	Ref. No.	OK0517
description	heating element 18000W 400V heating circuits 6 L 325mm W 240mm H 45mm tube ø 6.5mm connection cable cable length 1250mm immersion heater rectangular flange hole distance 62mm flange length 336mm flange width 126mm hole ø 10mm		
For models:	7562-3.KES80.RW, 7563-3.KES100.RW, 7552-3/85.KES80.(N), 7553-3/85.KES100.(N), 7552-3/90.KES80.(N), 7553-3/90.KES100.(N), 7562-3/85.KES80.RW., 7563-3/85.KES100.RW., 7562-3/90.KES80.RW., 7563-3/90.KES100.RW., 7587-3/85.KK80.MOTK., 7588-3/85.KK100.MOTK, 7587-3/90.KK80.MOTK., 7588-3/90.KK100.MOTK, 7552-3, 7553-3, 7562-3, 7563-3, 7582-3, 7583-3, 7752-3, 7752-3/85.KES80, 7752-3/90.KES80, 7753-3, 7753-3/85.KES100, 7753-3/90.KES100, 7782-3, 7783-3, 7787-3/85.KK80.MOTK., 7787-3/90.KK80.MOTK., 7788-3/85.KK100.MOTK, 7788-3/90.KK100.MOTK, 9114-3, 9115-3, 9172-3, 9173-3, 9174-3, 9183-3, 9184-3, 9314-3-0, 9314-3-8, 9315-3-0, 9315-3-8, 9372-3-0, 9372-3-8, 9373-3-0, 9373-3-8, 9374-3-0, 9374-3-8, 9383-3-0...(Other models you can see in the webshop)		
accessories for	415797		
	GEV No.	510560	Ref. No. 0G0027 0H6992 0K5577 19006925 2871981 700645
gasket EPDM thickness 6mm ID ø 200mm dimensions 280x70mm Qty 1 pcs for heating element			



 <p>1</p>			
GEV No.	415798	Ref. No.	OK0521
description	heating element 22500W 400V heating circuits 6 immersion heater rectangular flange		
accessories for	415798		
	GEV No.	510560	Ref. No.
			OG0027 OH6992 OK5577 19006925 2871981 700645
	gasket EPDM thickness 6mm ID ø 200mm dimensions 280x70mm Qty 1 pcs for heating element		

 <p>1</p>			
GEV No.	415799	Ref. No.	OH6152 OH6153
description	heating element 25200W 400V heating circuits 6 L 470mm W 235mm H 90mm connection cable cable length 1500mm immersion heater special fixing hole distance 48/56mm hole ø 10mm		
For models:	7564-3.KES150.RW, 7554-3/85.KES150.(N), 7554-3/90.KES150.(N), 7564-3/85.KES150.RW., 7564-3/90.KES150.RW., 7585-3/85.KK40.MOTK., 7585-3/90.KK40.MOTK., 7554-3, 7564-2, 7568-3, 7569-3/85.KK200.MOTK, 7569-3/90.KK200.MOTK, 7584-3, 7589-3/85.KK150.MOTK, 7589-3/90.KK150.MOTK, 7754-3, 7754-3/85.KES150, 7754-3/90.KES150, 7768-3, 7769-3/85.KK200.MOTK, 7769-3/90.KK200.MOTK, 7784-3, 7785-3/85.KK40.MOTK., 7789-3/85.KK150.MOTK, 7789-3/90.KK150.MOTK, 9116-3, 9174-3, 9175-3, 9176-3, 9185-3, 9316-3-0, 9316-3-8, 9374-3-0, 9374-3-8, 9375-3-0, 9375-3-8, 9376-3-0, 9376-3-8, 9385-3-0, 9385-3-8, 9386-3-0		
accessories for	415799		
	GEV No.	510560	Ref. No.
			OG0027 OH6992 OK5577 19006925 2871981 700645
	gasket EPDM thickness 6mm ID ø 200mm dimensions 280x70mm Qty 1 pcs for heating element		



 <p>1</p>			
GEV No.	419089	Ref. No.	OKJ275
description	heating element 6000W 220V heating circuits 3 L 225mm W 140mm H 100mm hole ø 9mm cable length 250mm tube ø 8.5mm flange length 235mm flange width 125mm immersion heater		



miscellaneous			
 <p>1</p>			
GEV No.	420305	Ref. No.	OC5840
description	heating element 17000W 400V heating circuits 6 L 395mm W 76mm H 61mm flange connection hole ø 6mm connection male faston 6.3mm flange length 105mm flange width 87mm tube ø 8.5mm immersion heater number of thermostat sleeves 1 length thermostat sleeves 120mm thermostat sleeve eccentric, clinging/not clinging		
For models:	FCZ101EAA, FCZ101EAH, FCZ101EAN, FCZ101ETA, FCZ101ETH, FCZ101ETN, FCZ101EBA, FCZ101EBH, FCZ101EBN, FCZ101EBC, FCZ101EBA2, FCZ101EBH2, FCZ101EBN2, FCZ101EBC2, FCZ101ECA, FCZ101ECH, FCZ101ECN, FCZ101ECA2, FCZ101ECH2, FCZ101ECN2, AOW101EA, AOW101EABU, AOS101EAA1, AOS101EAH1, AOS101EAN1, AOS101EAC1, AOS101EAE1, AOS101EAF1, AOS101EAQ1, AOS101EAM1, AOS101EAB1, AOS101EAK1, AOS101EAT1, AOS101ETA1, AOS101ETH1, AOS101ETN1, AOS101ETC1, AOS101ETE1, AOS101ETF1, AOS101ETM1, AOS101ETK1, AOS101EBA1, AOS101EBH1, AOS101EBN1, AOS101EBC1, AOS101EBE1, AOS101EBF1, AOS101EBK1, AOS101EBA2, AOS101EBH2...(Other models you can see in the webshop)		
accessories for	420305		
	GEV No.	901629	Ref. No.
			OC5834
	flange gasket L 101mm W 83mm hole ø 6mm hole distancemm 7 holes thickness 5mm for heating element		

 <p>1</p>			
GEV No.	420284	Ref. No.	OC5841
description	heating element 24000W 400V heating circuits 6 L 535mm W 60mm H 75mm 7 hole fixing connection male faston 6.3mm flange length 105mm flange width 87mm tube ø 8.4mm immersion heater number of thermostat sleeves 1 length thermostat sleeves 120mm thermostat sleeve eccentric, clinging thermostat sleeves ø 4.7mm		
For models:	FCZ102EAA, FCZ102ETA, FCZ201ETA, FCZ202ETA, FCZ201ETH, FCZ201ETN, FCZ102EBA, FCZ102EBA2, FCZ201EBA2, FCZ202EBA2, FCZ201EBH2, FCZ201EBN2, FCZ201EBC2, FCZ102ECA, FCZ102ECA2, FCZ201ECA2, FCZ202ECA2, FCZ201ECH2, FCZ201ECN2, AOS102EAA1, AOS201EAA1, AOS202EAA1, AOS201EAH1, AOS102EAC1, AOS201EAF1, AOS102EAS1, AOS201EAQ1, AOS102EAM1, AOS102EAB1, AOS102EAK1, AOS201EAK1, AOS202EAK1, AOS102EAT1, AOS201EAT1, AOS202EAT1, AOS102ETA1, AOS201ETA1, AOS202ETA1, AOS201ETH1, AOS201ETN1, AOS201ETC1, AOS201ETE1, AOS201ETF1, AOS102ETM1, AOS201ETM1, AOS202ETM1, AOS102ETK1, AOS201ETK1, AOS202ETK1, AOS102EBA1...(Other models you can see in the webshop)		
accessories for	420284		
	GEV No.	901629	Ref. No.
			OC5834
	flange gasket L 101mm W 83mm hole ø 6mm hole distancemm 7 holes thickness 5mm for heating element		













			
1			
GEV No.	420548	Ref. No.	0C5839
description	heating element 9000W 400V heating circuits 6 L 235mm W 85mm H 58mm flange connection hole ø 6mm connection male faston 6.3mm flange length 105mm flange width 90mm tube ø 8.5mm number of thermostat sleeves 1 length thermostat sleeves 125mm thermostat sleeve eccentric, clinging		
For models:	FCZ061EAA, FCZ061EAH, FCZ061EAN, FCZ061ETA, FCZ061ETH, FCZ061ETN, FCZ061EBA, FCZ061EBH, FCZ061EBN, FCZ061EBC, FCZ061EBA2, FCZ061EBH2, FCZ061EBN2, FCZ061EBC2, FCZ061ECA, FCZ061ECH, FCZ061ECN, FCZ061ECA2, FCZ061ECH2, FCZ061ECN2, AOS061EAA1, AOS061EAH1, AOS061EAN1, AOS061EAC1, AOS061EAE1, AOS061EAF1, AOS061EAM1, AOS061EAB1, AOS061EAK1, AOS061EAT1, AOS061ETA1, AOS061ETH1, AOS061ETN1, AOS061ETC1, AOS061ETE1, AOS061ETF1, AOS061ETM1, AOS061ETK1, AOS061EBA1, AOS061EBH1, AOS061EBN1, AOS061EBC1, AOS061EBE1, AOS061EBF1, AOS061EBK1, AOS061EBA2, AOS061EBH2, AOS061EBN2, AOS061EBC2, AOS061EBE2...(Other models you can see in the webshop)		

			
1			
GEV No.	415580	Ref. No.	0G0334 0H9764 0K4804 18002029 1GVL0C955001 740403
description	heating element 5000W 400V heating circuits 1 L 404mm W 23mm H 80mm cable length 400mm connection length 85mm immersion heater flange with thread H1 52mm H2 28mm thread 3/4"		
For models:	VARIOSTEAM/S-33.3/F, STEAM-O-MAT		
accessories for	415580		
	GEV No.	510403	Ref. No. —
	flat gasket fibre ED ø 36.5mm ID ø 27mm thickness 2mm Qty 1 pcs		
	GEV No.	510421	Ref. No. —
	gasket copper ED ø 31.8mm ID ø 26.4mm thickness 2.2mm for thread 3/4"		
	GEV No.	520234	Ref. No. —
	nut thread 3/4" H 5mm brass WS 30 Qty 1 pcs		

			
1			
GEV No.	415390	Ref. No.	0H6173
description	heating element 7500W 230V heating circuits 3 thread 1 1/4" L 410mm W 35mm H 28mm tube ø 6.5mm immersion heater flange with thread		
accessories for	415390		
	GEV No.	510405	Ref. No. —
	flat gasket fibre ED ø 56mm ID ø 42mm thickness 2mm for thread 1 1/4" Qty 1 pcs		
	GEV No.	520232	Ref. No. —
	nut thread 1 1/4" H 5mm nickel-plated brass WS 47 Qty 1 pcs		







accessories for	415390		
	GEV No.	528021	Ref. No. —
	flat gasket PTFE ED ø 53mm ID ø 42.5mm thickness 3mm Qty 1 pcs equiv. no. 12001/02286 suitable for Astoria/Aurora/Brasilia/Wega		

			
1			
GEV No.	415401	Ref. No.	214119
description	heating element 4500W 230V heating circuits 3 thread 1 1/2" L 315mm W 33mm H 30mm thermostat sleeves ø 6mm length thermostat sleeves 240mm connection M4x0.75 immersion heater flange with thread no original spare part		
accessories for	415401		
	GEV No.	510406	Ref. No. —
	flat gasket fibre ED ø 60mm ID ø 48mm thickness 3mm for thread 1 1/2" Qty 1 pcs		
accessories for	415401		
	GEV No.	510424	Ref. No. —
	gasket copper ED ø 55mm ID ø 48mm thickness 2.2mm Centellen for thread 1 1/2"		
	GEV No.	520211	Ref. No. —
	reducer thread 2" ET - 1 1/2" IT brass		
	GEV No.	520212	Ref. No. 066079
	hexagonal nut thread 1 1/2" brass WS 60 H 8mm		
	GEV No.	550361	Ref. No. —
	blind flange ø 58mm thread 1 1/2"		





			
1			
GEV No.	415392	Ref. No.	0K0548 1274600137 214066 415392
description	heating element 6000W 400V heating circuits 3 thread 1 1/2" L 405mm W 36mm H 33mm thermostat sleeves ø 9mm length thermostat sleeves 360mm thermostat sleeve not clinging tube ø 8.5mm connection M4 immersion heater connection length 60mm flange with thread number of thermostat sleeves 1		
accessories for	415392		
	GEV No.	510406	Ref. No. —
	flat gasket fibre ED ø 60mm ID ø 48mm thickness 3mm for thread 1 1/2" Qty 1 pcs		
accessories for	415392		
	GEV No.	510424	Ref. No. —
	gasket copper ED ø 55mm ID ø 48mm thickness 2.2mm Centellen for thread 1 1/2"		
	GEV No.	520211	Ref. No. —
	reducer thread 2" ET - 1 1/2" IT brass		
	GEV No.	520212	Ref. No. 066079
	hexagonal nut thread 1 1/2" brass WS 60 H 8mm		
	GEV No.	550361	Ref. No. —
	blind flange ø 58mm thread 1 1/2"		



			
GEV No.	415403	Ref. No.	OH6160 415403
description	heating element 7500W 230V heating circuits 3 thread 1½" L 495mm W 36mm H 33mm thermostat sleeves ø 9mm length thermostat sleeves 400mm thermostat sleeve centre not clinging tube ø 8.5mm connection M4 immersion heater connection length 35mm flange with thread number of thermostat sleeves 1		
accessories for	415403		
	GEV No.	510406	Ref. No. —
	flat gasket fibre ED ø 60mm ID ø 48mm thickness 3mm for thread 1½" Qty 1 pcs		
	GEV No.	510424	Ref. No. —
	gasket copper ED ø 55mm ID ø 48mm thickness 2.2mm Centellen for thread 1½"		
	GEV No.	520211	Ref. No. —
	reducer thread 2" ET - 1½" IT brass		
	GEV No.	520212	Ref. No. 066079
	hexagonal nut thread 1½" brass WS 60 H 8mm		
	GEV No.	550361	Ref. No. —
	blind flange ø 58mm thread 1½"		

			
GEV No.	415404	Ref. No.	214067
description	heating element 9000W 230V heating circuits 3 thread 1½" L 600mm W 39mm H 37mm thermostat sleeves ø 9mm length thermostat sleeves 450mm thermostat sleeve centre not clinging tube ø 8.5mm connection M4 immersion heater flange with thread number of thermostat sleeves 1		
spare parts for	415404		
	GEV No.	510406	Ref. No. —
	flat gasket fibre ED ø 60mm ID ø 48mm thickness 3mm for thread 1½" Qty 1 pcs		
accessories for	415404		
	GEV No.	510424	Ref. No. —
	gasket copper ED ø 55mm ID ø 48mm thickness 2.2mm Centellen for thread 1½"		
	GEV No.	520211	Ref. No. —
	reducer thread 2" ET - 1½" IT brass		
	GEV No.	520212	Ref. No. 066079
	hexagonal nut thread 1½" brass WS 60 H 8mm		
	GEV No.	550361	Ref. No. —
	blind flange ø 58mm thread 1½"		

			
GEV No.	419166	Ref. No.	OPRF12
description	heating element 1400W 230V heating circuits 1 L 235mm W 50mm H 30mm thread M10x1 tube ø 6.3mm connection male faston 6.3mm		

			
GEV No.	415909	Ref. No.	OHA117
description	heating element 2000W 230V heating circuits 1 L 243mm W 34mm H 24mm L1 35mm L2 204mm thread M10x1 mounting distance 28mm tube ø 6.3mm 2 hole fixing connection male faston 6.3mm immersion heater		
For models:	LB035C, G350C, LBICEQ010		
accessories for	415909		
	GEV No.	510416	Ref. No. —
	flat gasket fibre ED ø 19mm ID ø 10.5mm thickness 1.5mm for thread M10 Qty 1 pcs		
	GEV No.	510893	Ref. No. —
	O-ring EPDM thickness 2.62mm ID ø 9.92mm Qty 1 pcs		
	GEV No.	520231	Ref. No. —
	nut thread M10x1 H 6mm WS 14 zinc-coated steel Qty 1 pcs		
	GEV No.	521129	Ref. No. —
	nut thread M10 H 6mm SS WS 17 Qty 1 pcs DIN/ISO DIN 439		











			
GEV No.	415010	Ref. No.	069437 069671 069791 230085
description	heating element 2000W 230V heating circuits 1 L 260mm W 125mm H 20mm L1 110mm L2 150mm W1 42mm W2 83mm thread M10x1 mounting distance 70mm tube ø 6.5mm connection M4 immersion heater 2 hole fixing		
For models:	LTB11, LTB12, LTB22, LTB11UK, LTB12UK, LTB22UK, LTB11, LTB22, 910-00-021, 910-00-023, 910-00-031, 910-00-033, 911-00-022, 911-00-024, 911-00-032, 911-00-034, CRYSTAL 11, CRYSTAL 22		
spare parts for	415010		
	GEV No.	510416	Ref. No. —
	flat gasket fibre ED ø 19mm ID ø 10.5mm thickness 1.5mm for thread M10 Qty 1 pcs		
accessories for	415010		
	GEV No.	504306	Ref. No. 069438 075646 0E5524 0KK028
	gasket fibre ED ø 16mm ID ø 10mm thickness 2mm Qty 1 pcs		
	GEV No.	510893	Ref. No. —
	O-ring EPDM thickness 2.62mm ID ø 9.92mm Qty 1 pcs		
	GEV No.	520231	Ref. No. —
	nut thread M10x1 H 6mm WS 14 zinc-coated steel Qty 1 pcs		
	GEV No.	521103	Ref. No. —
	nut thread M4 H 3mm WS 7 brass Qty 20 pcs		
	GEV No.	521104	Ref. No. —
	washer ID ø 4.3mm ED ø 8mm thickness 0.5mm brass Qty 20 pcs for thread M4		
	GEV No.	521129	Ref. No. —
	nut thread M10 H 6mm SS WS 17 Qty 1 pcs DIN/ISO DIN 439		







Table continues overleaf





accessories for 415010			
	GEV No.	560111	Ref. No. —
plain washer ID ø 4.3mm ED ø 9mm thickness 0.8mm SS Qty 20 pcs DIN 125A for thread M4			
	GEV No.	560131	Ref. No. —
hexagonal nut thread M4 H 3.2mm WS 7 SS DIN/ISO DIN 934 / ISO 4032/8673 Qty 20 pcs			

			
GEV No.	415073	Ref. No.	046284 047484 047506 047507
description	heating element 2200W 220V heating circuits 1 L 403mm W 138mm H 22mm L1 124mm L2 279mm W1 27mm W2 84mm thread M14x1 mounting distance 80mm tube ø 8.5mm 2 hole fixing connection M5 immersion heater		
For models:	LS500F, LS501F, LS540F, LS540DK, LS541F, LS540, LSD551, LSD55V, LS500F, LS500UK, LS501, LS501UK, LS540D, LS540/63, LS541, LS510, LS520, LS520D, LS520F, LS520M, LS520K, LS521, LS521D, LS521F, LS521M, LS521K, LS521, LS4, LS500, LS501, LS540, ZLS510, ZLS520, ZLS521, ALS540, ALLS521, ALLS520, ALS510, C51, C52, C50, LS520ZD, LS521ZD, CF314, LS510MZ, LS520MZ, LS521MZ		

accessories for 415073			
	GEV No.	510417	Ref. No. 0K6103 0K6660 0K8701
flat gasket fibre ED ø 20mm ID ø 14mm thickness 2mm Qty 1 pcs			
	GEV No.	520228	Ref. No. —
tooth lock washer ID ø 15.3mm ED ø 24mm steel Qty 1 pcs for thread M14			
	GEV No.	521133	Ref. No. —
nut thread M14x1.5 H 6mm WS 19 zinc-coated steel Qty 1 pcs			
	GEV No.	550261	Ref. No. 006245 0K9627 514875601
nut thread M14x1 H 4mm WS 19 SS Qty 1 pcs			
	GEV No.	550262	Ref. No. —
flat gasket copper ED ø 20mm ID ø 14mm thickness 2mm			
	GEV No.	560112	Ref. No. 0E1119
plain washer ID ø 5.3mm ED ø 10mm thickness 1mm SS Qty 20 pcs DIN 125A for thread M5			
	GEV No.	560132	Ref. No. —
hexagonal nut thread M5 H 4mm WS 8 SS DIN/ISO DIN 934 / ISO 4032/8673 Qty 20 pcs			

			
GEV No.	415072	Ref. No.	046404 046418 047620 047848 048000 048086 0H2485 0K8766
description	heating element 2200W 230V heating circuits 1 L 325mm W 83mm H 25mm thread M14x1 mounting distance 75mm tube ø 8.5mm connection male faston 6.3mm 2 hole fixing immersion heater		
For models:	LS360F, LS360DK, LS365F, LS365, LS365PH, LS360D, LS365D, LS360, LS365, LS360/63, LS365/63, LS367, LS720F, LSE720DK, LSE720PH, LS860F, LS860DK, LS860PH, LS1080F, LS1080UK, LS1080PH, LSE721F, LS861F, LS1080M, LS1080, LS1080D, LS1080UK, LS1080/63, LSE721, LS720, LSE720UK, LS721UK, LSE720D, LS860, LS860, LS860D, LS860UK, LS861UK, LS860/63, LS861, LS520D, LS520K, LS521D, LS521M, LS521K, LS521, LS360, LS365F, 652120Z, LS860...(Other models you can see in the webshop)		
accessories for 415072			
	GEV No.	510417	Ref. No. 0K6103 0K6660 0K8701
flat gasket fibre ED ø 20mm ID ø 14mm thickness 2mm Qty 1 pcs			
	GEV No.	520228	Ref. No. —
tooth lock washer ID ø 15.3mm ED ø 24mm steel Qty 1 pcs for thread M14			
	GEV No.	521133	Ref. No. —
nut thread M14x1.5 H 6mm WS 19 zinc-coated steel Qty 1 pcs			
	GEV No.	550261	Ref. No. 006245 0K9627 514875601
nut thread M14x1 H 4mm WS 19 SS Qty 1 pcs			
	GEV No.	550262	Ref. No. —
flat gasket copper ED ø 20mm ID ø 14mm thickness 2mm			

			
GEV No.	419098	Ref. No.	0K6870
description	heating element 3200W 380V heating circuits 1 L 465mm W 130mm H 28mm thread M14x1.5 mounting distance 122mm tube ø 8.5mm immersion heater 2 hole fixing		

1

GEV No.	420142	Ref. No.	OKJ338
description	heating element 4000W 380V heating circuits 1 H 120mm tube ø 8.3mm connection M4 immersion heater 12 hole fixing for kettle W1 52mm H1 28mm H2 92mm thread M14x1.5 ø 79mm windings 7 mounting distance 44mm		



1

GEV No.	420141	Ref. No.	OK8600
description	heating element 5000W 230V heating circuits 1 L 116mm W 79mm tube ø 8.5mm connection M4 immersion heater 2 hole fixing for kettle W1 53mm H1 29mm H2 88mm thread M14x1.5 ø 79mm windings 7 mounting distance 45mm		
For models:	EBE40., EBE40, EBE40., EBE040, EBE60., EBE60., EBE60., EBE60, EBE80., EBE80., EBE80, EBE100., EBE100., EBE100., EBE100, BASIC40, BASIC60, BASIC80., BASIC100, EBE40AWF, EBE60AWF, EBE80AWF, EBE100AWF		

2 connections

angled

group 1



1

GEV No.	418007	Ref. No.	059680
description	heating element 1050W 230V heating circuits 1 L 425mm W 41.5mm H 92mm tube ø 8.5mm connection M5 dry heating element connection distance 33mm		
For models:	HPN/ED811, HPN/ED816, HPA/ED825, ZPN/ED811, ZPN/ED816, APN/EI815D, APN/EI810, APN/EI815, APN/ED816, APNS/EI815		



1

GEV No.	418008	Ref. No.	059679
description	heating element 1250W 230V heating circuits 1 L 485mm W 44mm H 95mm tube ø 8.7mm connection M5 connection length 22mm dry heating element connection distance 35mm		
For models:	HPN/ED811, HPN/ED816, HPA/ED825, ZPN/ED811, ZPN/ED816, APN/EI815D, APN/EI810, APN/EI815, APN/ED816, APNS/EI815		



1

GEV No.	418006	Ref. No.	059681
description	heating element 750W 230V heating circuits 1 L 317mm W 41.5mm H 92mm tube ø 8.5mm connection M5 dry heating element connection distance 33mm		
For models:	HPN/ED811, HPN/ED816, HPA/ED825, ZPN/ED811, ZPN/ED816, APN/EI815D, APN/EI810, APN/EI815, APN/ED816, APNS/EI815		

heating elements for convection



1

GEV No.	415119	Ref. No.	0A2017
description	heating element 1600W 230V heating circuits 1 ID ø 179mm ED ø 197mm L 254mm H 30mm L1 51mm W1 31mm H1 9mm H2 21mm flange length 70mm flange width 22mm hole distance 56mm connection male faston 6.3mm connection length 41mm tube ø 6.3mm convection heating element hole ø 4mm rectangular flange		
For models:	655-00-106, 655-00-107		
accessories for	415119		
		GEV No.	510368
		Ref. No.	057534
	gasket L 70mm W 23.5mm hole ø 5mm hole distance 56mm FIBER thickness 2mm for heating element		



1

GEV No.	415123	Ref. No.	0H6212 1748100123 214759
description	heating element 1750W 220V heating circuits 1 ID ø 186mm ED ø 199mm L 222mm H 29mm L1 14mm W1 30mm H1 9mm H2 20mm flange length 70mm flange width 22mm hole distance 56mm connection male faston 6.3mm tube ø 6.3mm convection heating element hole ø 5mm rectangular flange		
accessories for	415123		
		GEV No.	510368
		Ref. No.	057534
	gasket L 70mm W 23.5mm hole ø 5mm hole distance 56mm FIBER thickness 2mm for heating element		





1

GEV No.	418468	Ref. No.	0H6210 214742
description	heating element 2000W 230V heating circuits 1 ID ø 192mm ED ø 203mm L 215mm H 32mm L1 8mm H1 12mm H2 18mm flange length 70mm flange width 22mm hole distance 56mm connection male faston 6.3mm tube ø 6.5mm convection heating element hole ø 6.5mm rectangular flange		



1

GEV No.	415118	Ref. No.	031485 OKI814
description	heating element 2400W 230V heating circuits 1 ID ø 178mm ED ø 190mm L 221mm H 28mm L1 15mm W1 30mm H1 11mm H2 19mm flange length 100mm flange width 22mm hole distance 86mm connection male faston 6.3mm connection length 32mm tube ø 6.3mm convection heating element hole ø 5mm rectangular flange		
For models:	TC1200TOP, TC1210TOP, TC1400TOP, TC1410TOP, TC1600TOP, TC1610TOP, TC1800TOP, TC1810TOP, TC2000TOP, TC2010TOP, TCD1200TOP, TCD1400TOP, TCD1600TOP, TCD1800TOP, TCD2000TOP, TC1000, TC1010, TC1200, TC1210, TC1400, TC1410, TC1600, TC1610, TC1800, TC1810, TC2000, TC2010, TCD1000, TCD1200, TCD1400, TCD1600, TCD1800, TCD2000, TC1200, TC1210, TC1400, TC1410, TC1600, TC1610, TC1800, TC1810, TC2000, TC2010, TCD1200, TCD1400, TCD1600, TCD1800, TCD2000, MTC1200P, MTC1400P... (Other models you can see in the webshop)		
accessories for	415118		
	GEV No.	510368	Ref. No. 057534
	gasket L 70mm W 23.5mm hole ø 5mm hole distance 56mm FIBER thickness 2mm for heating element		



1



GEV No.	415117	Ref. No.	054317 054843 055028 2410053850
description	heating element 2500W 220V heating circuits 1 ID ø 175mm ED ø 195mm L 245mm H 55mm L1 50mm W1 30mm H1 25mm H2 10mm flange length 70mm flange width 22mm hole distance 56mm connection male faston 6.3mm horizontal tube ø 6.5mm convection heating element hole ø 5mm rectangular flange		
For models:	FCF02EV, FCF02EOEM, FCF/E2, FCF/E2D, FCF/E2UK, FCF/E4-OLD, FCF/E4D, FCFE4PH, FCF/E4OLD3, FCF/E2, FCF/E4OLD4, FCF/E2, FCF/E4OLD2, FCF/E4OLD1, FCF/E4D, FCF/E2D, BCFCV101/1, BCFCV102/1, BCFCV101/1, BCFCV102/1		
spare parts for	415117		
	GEV No.	510368	Ref. No. 057534
	gasket L 70mm W 23.5mm hole ø 5mm hole distance 56mm FIBER thickness 2mm for heating element		

accessories for 415117

	GEV No.	510426	Ref. No.	0H6829
	gasket L 72mm W 20mm hole distance 56mm silicone thickness 2mm for heating element			



1

GEV No.	415966	Ref. No.	004934 00568 OK3580 RCO0568000	
description	heating element 2500W 230V heating circuits 1 ID ø 176mm ED ø 188mm L 210mm H 28mm L1 22mm W1 30mm H1 3mm H2 25mm flange length 70mm flange width 22mm hole distance 56mm connection male faston 6.3mm tube ø 6.3mm convection heating element hole ø 5mm rectangular flange			
spare parts for	415966			
	GEV No.	510368	Ref. No.	057534
	gasket L 70mm W 23.5mm hole ø 5mm hole distance 56mm FIBER thickness 2mm for heating element			
accessories for	415966			
	GEV No.	510368	Ref. No.	057534
	gasket L 70mm W 23.5mm hole ø 5mm hole distance 56mm FIBER thickness 2mm for heating element			





1

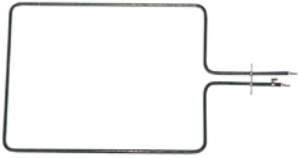

GEV No.	419245	Ref. No.	OC4061
description	heating element 2500W 230V heating circuits 1 ID ø 180mm ED ø 192mm L 250mm H 30mm L1 45mm W1 61mm flange length 70mm flange width 22mm hole distance 56mm connection F6.3x0.8 tube ø 6mm for combi-steamer hole ø 5mm flange		
For models:	FCF/E4, FCF/E4-3KW, FCF4E, FCF4E-3KW, ECF4E, ECF4E3KW, ECF/E4, ECF/E4-3KW, ACF/E4, ACF/E4-3KW, ACF4E, ACF4E3KW		





 <p>1</p>			
GEV No.	415351	Ref. No.	054609 054610 054613 054614 056945 058145
description	heating element 2500W 230V heating circuits 1 ID ømm L 544mm L1 100mm W1 160mm flange length 70mm flange width 22mm hole distance 56mm ED ømm connection male faston 6.3mm tube ø 8.5mm dry heating element hole ø 50mm rectangular flange L2 444mm W2 33mm W 350mm		
For models:	FCF/E6-0, FCF061ELN, FCF6EHOR, FCF061ENS, FCFE6-1J, FCFE6D, FCFE6D, FCFE6, FCFE6UK, PFCFE6, ECF/E6-0, ECF061ENS, ECF061E5M, ECF061ECV, FCF/E6, ACF/E6-0, JCF/E6-1, JCF/E6-2, RCF061E, AFCF/E6, NCF/E6-0, COCO6E, FCFE061, ZCF/E6-0		

 <p>2</p>			
GEV No.	419091	Ref. No.	005217
description	heating element 2500W 230V heating circuits 11 ID ø 180mm ED ø 199mm L 245mm H 28mm L1 46mm W1 27mm H1 4mm H2 24mm flange length 70mm flange width 22mm hole distance 56mm connection male faston 6.3mm vertical connection length 45mm tube ø 6.3mm convection heating element hole ø 5mm rectangular flange		
For models:	FCF/E4, FCF/E4-3KW, JCF/E4, JCF/E4, ECF/E4, ECF/E4-3KW, ACF/E4, ACF/E4-3KW, NCF/E4, ZCF/E4, ZCF/E4		

 <p>1</p>							
GEV No.	415116	Ref. No.	0H6157 0H6209 OK0546 OK0606 415116				
description	heating element 2600W 230V heating circuits 1 ID ø 190mm ED ø 210mm L 220mm H 28mm L1 10mm W1 31mm H1 5mm H2 23mm flange length 70mm flange width 22mm hole distance 56mm connection male faston 6.3mm tube ø 6.5mm convection heating element hole ø 5mm rectangular flange						
accessories for	415116						
 <table border="1"> <tr> <td>GEV No.</td> <td>510368</td> <td>Ref. No.</td> <td>057534</td> </tr> </table> <p>gasket L 70mm W 23.5mm hole ø 5mm hole distance 56mm FIBER thickness 2mm for heating element</p>				GEV No.	510368	Ref. No.	057534
GEV No.	510368	Ref. No.	057534				

 <p>1</p>							
GEV No.	418083	Ref. No.	054980 055503 2410053880				
description	heating element 3000W 230V heating circuits 1 ID ø 179mm ED ø 190mm L 245mm H 35mm L1 45mm W1 30mm H1 10mm H2 25mm flange length 70mm flange width 22mm hole distance 56mm connection male faston 6.3mm connection length 18mm tube ø 6.3mm convection heating element hole ø 5mm rectangular flange						
For models:	FCF/E4, FCF/E4-3KW, FCF/E4-OLD, FCF/E4D, FCFE4PH, FCVE20/P-V, FCVE20-V, FCVE20VUK, JCF/E4, JCF/E4, ECF/E4, ECF/E4-3KW, FCF/E4OLD3, ACF/E4, ACF/E4-3KW, NCF/E4, FCF/E4OLD2, FCF/E4OLD1, FCF/E4D, ZCF/E4, ZCF/E4, FCV/E20-V						
accessories for	418083						
 <table border="1"> <tr> <td>GEV No.</td> <td>510368</td> <td>Ref. No.</td> <td>057534</td> </tr> </table> <p>gasket L 70mm W 23.5mm hole ø 5mm hole distance 56mm FIBER thickness 2mm for heating element</p>				GEV No.	510368	Ref. No.	057534
GEV No.	510368	Ref. No.	057534				

 <p>1</p>			
GEV No.	418470	Ref. No.	0H6168 214154 214166 60050388
description	heating element 3000W 230V heating circuits 2 ID ø 350mm ED ø 365mm L 390mm H 118mm W1 62mm H1 34mm H2 84mm flange length 85mm flange width 30mm connection length 90mm tube ø 6.5mm dry heating element hole ø 6.5mm rectangular flange L1 40mm		
For models:	5611-3-10, 5611-3-6, 5611-3-8		

 <p>1</p>			
GEV No.	418487	Ref. No.	OK3049 OKA698 293688
description	heating element 3150W 230V heating circuits 3 ID ø 201mm ED ø 218mm L 275mm H 41mm L1 54mm W1 63mm H1 3mm H2 38mm flange length 93mm flange width 22mm hole distance 78mm connection male faston 6.3mm connection length 65mm tube ø 8.5mm convection heating element hole ø 5mm rectangular flange		



GEV No.	419088	Ref. No.	OK8242 20408701
description	heating element 3200W 230V heating circuits 3 ID ø 384mm ED ø 400mm L 440mm H 106mm L1 35mm W1 166mm H1 16mm H2 90mm flange length 205mm flange width 43mm connection length 160mm tube ø 8.5mm cable length 480mm convection heating element mounting thread M14x1.5 rectangular flange		





GEV No.	418150	Ref. No.	006984 0C5362 0C6500
description	heating element 3200W 400V heating circuits 2 ID ø 383mm ED ø 400mm L 536mm H 60mm L1 136mm W1 32mm H1 36mm H2 24mm flange length 80mm flange width 45mm hole distance 60mm connection male faston 6.3mm connection length 30mm tube ø 8.5mm convection heating element hole ø 6mm rectangular flange		
For models:	FCZ061EAA, FCZ061EAH, FCZ061EAN, FCZ061ETA, FCZ061ETH, FCZ061ETN, FCZ061EBA, FCZ061EBH, FCZ061EBN, FCZ061EBC, FCZ061EBA2, FCZ061EBH2, FCZ061EBN2, FCZ061EBC2, FCZ061ECA, FCZ061ECH, FCZ061ECN, FCZ061ECA2, FCZ061ECH2, FCZ061ECN2, AOS061EA, AOS061EB, AOS061EB6M, AOS061EA0H, AOS061EB0H, AOS061EAAQ, AOS061EBAQ, AOS061EAHQ, AOS061EBHQ, AOS061EAA1, AOS061EAH1, AOS061EAN1, AOS061EAC1, AOS061EAE1, AOS061EAF1, AOS061EAM1, AOS061EAB1, AOS061EAK1, AOS061EAT1, AOS061ETA1, AOS061ETH1, AOS061ETN1, AOS061ETC1, AOS061ETE1, AOS061ETF1, AOS061ETM1, AOS061ETK1, AOS061EBA1, AOS061EBH1, AOS061EBN1...(Other models you can see in the webshop)		
accessories for	418150		
	GEV No.	550257	Ref. No. 002689 60050277
	gasket L 137mm W 79mm thickness 3.5mm for heating element suitable for JUNO equiv. no. 02689		





GEV No.	415368	Ref. No.	055430 055439 056930
description	heating element 3750W 220V heating circuits 3 L 535mm H 34mm L1 95mm W1 157mm flange length 78mm flange width 50mm hole distance 60mm connection male faston 6.3mm connection length 97mm tube ø 8.5mm dry heating element hole ø 6mm rectangular flange L2 440mm W2 33mm W 348mm		
For models:	FCVE6-1U, FCVE6-3U, FCVE6-1, FCVE6-3, FCVE6-3CE, FCVE6-1UK, FCVE6-3UK, FCV/E6-1, FCV/E6-1		







GEV No.	415657	Ref. No.	002757 0K0537 60050301
description	heating element 4500W 230V heating circuits 3 L 534mm W 350mm H 70mm L1 96mm L2 438mm W1 160mm W2 33mm H1 37mm H2 33mm flange length 76mm flange width 50mm hole distance 60mm hole ø 6mm tube ø 8.5mm convection heating element connection male faston 6.3mm connection length 103mm rectangular flange		
For models:	FCV/E6L3, FCV/E6L4, FCS061EP, FCS061E3CI, FCS061E4, FCS061EXLN, FCS061EX, 5711-3-6, 5711-3-7, 5711-3-8, 5711-3-10, 5711-3-8CH, 5711-3-10CH, 5701-3-2, 5701-3-3, ECV/E6T4, RCV061E2, RCV061E4, ACV/E6C3, NCV/E6L2, ZCV/E6T4		
accessories for	415657		
	GEV No.	550256	Ref. No. 055327 60050210
	gasket L 75mm W 50mm hole ø 5mm hole distance 59.5mm rubber thickness 3mm for heating element suitable for JUNO equiv. no. 55327		
	GEV No.	550257	Ref. No. 002689 60050277
	gasket L 137mm W 79mm thickness 3.5mm for heating element suitable for JUNO equiv. no. 02689		





GEV No.	415654	Ref. No.	002688 60050271
description	heating element 5666W 230V heating circuits 2 ID ø 465mm ED ø 480mm L 580mm H 65mm L1 90mm W1 32mm H1 34mm H2 31mm flange length 80mm flange width 45mm hole distance 56mm connection M5 connection length 108mm tube ø 8.5mm convection heating element hole ø 6mm rectangular flange		
For models:	FCV/E10L2, FCV/E10L3, FCV/E20L3, FCV/E10L6, FCV/E20L6, FVC/E101/1, FVC/E201/1, FCFE101-0, FCFE201-0, FCS101E2, FCS101E4, FCS101EP, FCS201E4, FCS201EP, FCS101EXLN, FCS101EX, FCS201EX, FCS201EXLN, 5712-3-6, 5712-3-7, 5712-3-8, 5712-3-8E, 5712-3-10, 5712-3-8CH, 5712-3-10C, 5714-3-6, 5714-3-7, 5714-3-8, 5714-3-8E, 5714-3-10, 5717-3-6, 5702-3-2, 5702-3-3, 5704-3-2, 5704-3-3, ECFE101-0, ECV/E10T4, ECV/E20T4, ECV/E10T6, ECV/E20T6, ECV/E10IGP, ACFE101-0, ACFE201-0, JCF/E101/1-1, JCF/E101/1-2, RCV101E2, RCV101E4, RCF101E, ACV/E10C2, ACV/E10C4...(Other models you can see in the webshop)		
accessories for	415654		
	GEV No.	550256	Ref. No. 055327 60050210
	gasket L 75mm W 50mm hole ø 5mm hole distance 59.5mm rubber thickness 3mm for heating element suitable for JUNO equiv. no. 55327		
	GEV No.	550257	Ref. No. 002689 60050277
	gasket L 137mm W 79mm thickness 3.5mm for heating element suitable for JUNO equiv. no. 02689		







 <p>1</p>			
GEV No.	415389	Ref. No.	053838 053839 054620 054621 058196 058197
description	heating element 5666W 230V heating circuits 2 ID ø 470mm ED ø 487mm L 590mm H 66mm L1 105mm W1 33mm H1 37mm H2 29mm flange length 80mm flange width 45mm hole distance 60mm connection M5 tube ø 8.5mm convection heating element hole ø 6mm rectangular flange		
For models:	FCFE10, FCFE10UK, FCVE10, FCVE10-2, FCVE10-4, FCVE103CE, FCVE10-2UK, FCVE10-4UK, FCVE20/P-V, FCVE20-V, FCVE20VUK, FCVE10-P, FCVE10PUK, FCF/E10, ZOFVCV/E102, ZOFVCV/E104, FF/E10, COCO10E, FCFE101, FCF/E20-V		
accessories for	415389		
	GEV No.	550256	Ref. No. 055327 60050210
	gasket L 75mm W 50mm hole ø 5mm hole distance 59.5mm rubber thickness 3mm for heating element suitable for JUNO equiv. no. 55327		

 <p>1</p>			
GEV No.	418151	Ref. No.	007064 0C5364 0C6501
description	heating element 5670W 400V heating circuits 2 ID ø 467mm ED ø 483mm L 585mm H 60mm L1 102mm W1 33mm H1 32mm H2 28mm flange length 80mm flange width 45mm hole distance 60mm connection male faston 6.3mm tube ø 8.5mm convection heating element hole ø 6mm rectangular flange		
For models:	FCZ101EAA, FCZ201EAA, FCZ101EAH, FCZ201EAH, FCZ101EAN, FCZ101ETA, FCZ201ETA, FCZ101ETH, FCZ201ETH, FCZ101ETN, FCZ201ETN, FCZ101EBA, FCZ201EBA, FCZ101EBH, FCZ201EBH, FCZ101EBN, FCZ101EBC, FCZ201EBC, FCZ101EBA2, FCZ201EBA2, FCZ101EBH2, FCZ201EBH2, FCZ101EBN2, FCZ201EBN2, FCZ101EBC2, FCZ201EBC2, FCZ101ECA, FCZ201ECA, FCZ101ECH, FCZ201ECH, FCZ101ECN, FCZ101ECA2, FCZ201ECA2, FCZ101ECH2, FCZ201ECH2, FCZ101ECN2, FCZ201ECN2, AOS101EA, AOS101EB, AOS201EA, AOS201EB, AOS101EB6M, AOS201EB6M, AOS101EA0H, AOS101EB0H, AOS201EA0H, AOS201EB0H, AOS101EAAQ, AOS101EBAQ, AOS201EAAQ...(Other models you can see in the webshop)		
accessories for	418151		
	GEV No.	550257	Ref. No. 002689 60050277
	gasket L 137mm W 79mm thickness 3.5mm for heating element suitable for JUNO equiv. no. 02689		



 <p>1</p>			
GEV No.	415393	Ref. No.	055481 056970 60050224
description	heating element 8000W 230V heating circuits 2 L 150mm W 545mm H 134mm L1 33mm L2 117mm W1 29mm H1 19mm H2 115mm flange length 76mm flange width 50mm hole distance 60mm connection M5 tube ø 8.5mm convection heating element hole ø 6mm rectangular flange		
For models:	FCVE20-2, FCVE20-4, FCVE203CE, FCVE20-2UK, FCVE20-4UK, FCVE20-P, FCVE20PUK, ZOFVCV/E202, ZOFVCV/E204		

 <p>1</p>			
GEV No.	415391	Ref. No.	054050 054051 054288 054289 056929 056934
description	heating element 8000W 230V heating circuits 2 L 170mm W 505mm H 128mm L1 33mm L2 138mm W1 29mm H1 13mm H2 115mm flange length 76mm flange width 50mm hole distance 60mm connection M5 connection length 104mm tube ø 8.5mm convection heating element hole ø 6mm rectangular flange		
For models:	FCFE20, FCFE20UK, FCFE40, FCFE40D, FCFE40UK, PFCFE40F, FCVE20, FCF/E20, FCFE202, FF/E40, FF/E20, AFCE/E40, COCO20E, 4238N, FCFE201		

			
GEV No.	415656	Ref. No.	0A5330 0G2201 0K0553 60050272
description	heating element 8000W 400V heating circuits 2 ID ø 560mm ED ø 580mm L 630mm H 68mm L1 50mm W1 33mm H1 37mm H2 29mm flange length 80mm flange width 45mm hole distance 60mm connection M5 connection length 15mm tube ø 8.5mm convection heating element hole ø 6mm rectangular flange		
For models:	FCV/E102/1L3, FCVE202L3, FCV/E102/1L6, FCVE202L6, FVC/E102/1, FVC/E202/1, FCFE102-0, FCFE201-0, FCFE202-0, FCF201ENS, FCS102E4, FCS102EP, FCS202E4, FCS202EP, FCS102EX, FCS202EX, 5717-3-7, 5717-3-8, 5717-3-8E, 5717-3-10, 5717-3-8C, 5707-3-2, 5707-3-3, ECFE102-0, ECFE201-0, ECFE202-0, ECF201ENS, ECVE102T4, ECVE202T4, ECV/E102/1T6, ECVE202T6, ACFE102-0, ACFE201-0, ACFE202-0, JCF/E102/1-1, JCF/E102/1-2, RCF201E, ACVE102C4, ACVE202C4, ACV/E102/1C6, ACV/E202/1, NCF/E102/1, ZCV/E102/1, ZCV/E202/1, ZCV/E102/1T6, ZCV/E202/1, ZCF/E102/1, ZCF/E202/1-0		
accessories for	415656		
	GEV No.	550256	Ref. No. 055327 60050210
	gasket L 75mm W 50mm hole ø 5mm hole distance 59.5mm rubber thickness 3mm for heating element suitable for JUNO equiv. no. 55327		
	GEV No.	550257	Ref. No. 002689 60050277
	gasket L 137mm W 79mm thickness 3.5mm for heating element suitable for JUNO equiv. no. 02689		

			
GEV No.	418152	Ref. No.	0C1173 0C5365 0C6502
description	heating element 8000W 400V heating circuits 2 ID ø 569mm ED ø 580mm L 700mm H 60mm L1 120mm W1 33mm H1 34mm H2 26mm flange length 80mm flange width 45mm hole distance 60mm connection male faston 6.3mm connection length 20mm tube ø 8.5mm dry heating element hole ø 6mm rectangular flange		
For models:	FCZ102EAA, FCZ202EAA, FCZ102ETA, FCZ202ETA, FCZ102EBA, FCZ202EBA, FCZ102EBA2, FCZ202EBA2, FCZ102ECA, FCZ202ECA, FCZ102ECA2, FCZ202ECA2, AOS102EA, AOS102EB, AOS202EA, AOS202EB, AOS102EAAQ, AOS102EBAQ, AOS202EAAQ, AOS202EBAQ, AOS102EAA1, AOS202EAA1, AOS102EAC1, AOS102EAS1, AOS102EAM1, AOS202EAM1, AOS102EAB1, AOS202EAB1, AOS102EAK1, AOS202EAK1, AOS102EAT1, AOS202EAT1, AOS102ETA1, AOS202ETA1, AOS102ETM1, AOS202ETM1, AOS102ETK1, AOS202ETK1, AOS102EBA1, AOS202EBA1, AOS102EBC1, AOS102EBK1, AOS202EBK1, AOS102EBA2, AOS202EBA2, AOS102EBK2, AOS202EBK2, AOS102ECA1, AOS202ECA1, AOS102ECM1...(Other models you can see in the webshop)		
accessories for	418152		
	GEV No.	550257	Ref. No. 002689 60050277
	gasket L 137mm W 79mm thickness 3.5mm for heating element suitable for JUNO equiv. no. 02689		

			
GEV No.	420117	Ref. No.	055465 056973
description	heating element 8000W 415V heating circuits 2 L 170mm W 505mm H 133mm L1 32mm L2 138mm W1 29mm H1 33mm H2 100mm flange length 76mm flange width 50mm hole distance 60mm connection M5 connection length 102mm tube ø 8.5mm convection heating element hole ø 6mm rectangular flange		
For models:	FCVE20-2, FCVE20-4, FCVE203CE, FCVE20-2UK, FCVE20-4UK, FCVE20-P, FCVE20PUK, ZOFCV/E202, ZOFCV/E204		

			
GEV No.	415487	Ref. No.	0H6800 0K0601 415487
description	heating element 1000W 230V heating circuits 1 L 445mm W 65mm flange length 70mm flange width 22mm hole distance 28mm connection length 25mm connection male faston 6.3mm tube ø 6.5mm hole ø 3mm W1 30mm rectangular flange convection heating element		
accessories for	415487		
	GEV No.	510368	Ref. No. 057534
	gasket L 70mm W 23.5mm hole ø 5mm hole distance 56mm FIBER thickness 2mm for heating element		

			
GEV No.	420468	Ref. No.	0E5126 0E5253
description	heating element 1375W 230V heating circuits 1 L 370mm W 87mm W2 56.5mm flange length 23mm flange width 13mm hole distance 382mm connection length 95mm connection F6.3 tube ø 8.5mm W1 30.5mm rectangular flange		
For models:	RT100ED, RT100ES, RT100SR, RT100SL, RT140ED, RT140ES, RT140SR, RT140SL, RT190ED, RT190ES, RT190SR, RT190SL, RT190HDED, RT190HDES, RT190HSR, RT190HSL, RT270ED, RT270ES, RT270SR, RT270SL, RT270HDED, RT270HDES, RT270HSR, RT270HSL, RT100ERF, RT100ELF, RT100VD, RT100VS, RT140ERF, RT140ELF, RT140VD, RT140VS, RT142ERF, RT142ELF, RT190ERF, RT190ELF, RT190VD, RT190VS, RT190HERF, RT190HELF, RT190HDVDF, RT190HDVSF, RT270ERF, RT270ELF, RT270VDF, RT270VSF, RT270HERF, RT270HELF, RT270HDVDF, RT270HDVSF...(Other models you can see in the webshop)		





GEV No.	415488	Ref. No.	OH6195
description	heating element 1500W 230V heating circuits 1 L 435mm W 175mm L1 55mm L2 380mm W2 30mm flange length 70mm flange width 22mm hole distance 56mm connection length 36mm connection male faston 6.3mm tube ø 6.3mm hole ø 3mm W1 72mm rectangular flange for hot air oven		
accessories for	415488		
	GEV No.	510368	Ref. No. 057534
	gasket L 70mm W 23.5mm hole ø 5mm hole distance 56mm FIBER thickness 2mm for heating element		



GEV No.	418469	Ref. No.	OH6208 OK0579 214728
description	heating element 1500W 240V heating circuits 1 L 350mm W 95mm L1 30mm L2 320mm W2 80mm flange length 70mm flange width 22mm hole distance 56.5mm connection length 15mm connection male faston 6.3mm tube ø 6.3mm hole ø 3.5mm W1 15mm rectangular flange convection heating element windings 2		







GEV No.	415485	Ref. No.	OH6197 OK0607
description	heating element 2000W 230V heating circuits 1 L 360mm W 155mm L1 35mm L2 325mm W2 30mm flange length 70mm flange width 22mm hole distance 28mm connection length 63mm connection male faston 6.3mm tube ø 6.3mm W1 62mm rectangular flange convection heating element mounting thread M4		
spare parts for	415485		
	GEV No.	510368	Ref. No. 057534
	gasket L 70mm W 23.5mm hole ø 5mm hole distance 56mm FIBER thickness 2mm for heating element		





GEV No.	415242	Ref. No.	OH6213 OK0628 214767
description	heating element 2x3500W 230V heating circuits 2 L 240mm W 390mm H 30mm W2 50mm flange length 70mm flange width 22mm hole distance 56mm connection length 20mm connection male faston 6.3mm tube ø 6.5mm hole ø 5mm W1 290mm rectangular flange convection heating element		
accessories for	415242		
	GEV No.	510368	Ref. No. 057534
	gasket L 70mm W 23.5mm hole ø 5mm hole distance 56mm FIBER thickness 2mm for heating element		







GEV No.	415457	Ref. No.	OH6166 OH6186 OK0557 214137 30074001 3007400132 415457 60050386
description	heating element 3000W 230V heating circuits 2 L 330mm W 135mm L1 60mm L2 270mm H 30mm W2 110mm flange length 85mm flange width 30mm connection length 105mm connection male faston 6.3mm tube ø 6.5mm hole ø 6.5mm W1 25mm rectangular flange hot air		
For models:	5611-3-10, 5611-3-6, 5611-3-8, 5612-3-10, 5612-3-6, 5612-3-8, 5614-3-10, 5614-3-6, 5614-3-8		
accessories for	415457		
	GEV No.	510561	Ref. No. OH7021 60050466
	O-ring silicone thickness 3mm ID ø 55mm Qty 1 pcs		
	GEV No.	520239	Ref. No. OH6648 60050430
	counterflange L 110mm W 35mm		
	GEV No.	521142	Ref. No. OH6665 OK1831 246294 60050436
	gasket L 68mm W 13mm for heating element		
	GEV No.	528203	Ref. No. —
	gasket rubber ED ø 18mm ID ø 12mm thickness 3mm Qty 1 pcs		





radiation heaters



			
GEV No.	415458	Ref. No.	0H6188 1295400233 214494 415458
description	heating element 3000W 230V heating circuits 2 L 575mm W 150mm W2 125mm flange length 70mm flange width 22mm hole distance 55mm connection length 20mm connection male faston 6.3mm tube ø 6.5mm hole ø 3mm W1 25mm rectangular flange convection heating element		
spare parts for	415458		
	GEV No.	510368	Ref. No. 057534
	gasket L 70mm W 23.5mm hole ø 5mm hole distance 56mm FIBER thickness 2mm for heating element		



			
GEV No.	415616	Ref. No.	0H6189 1300100133
description	heating element 3000W 380V heating circuits 2 L 575mm W 150mm W2 125mm flange length 70mm flange width 22mm hole distance 28mm connection length 20mm connection male faston 6.3mm tube ø 6.3mm hole ø 4mm W1 25mm rectangular flange dry heating element		
accessories for	415616		
	GEV No.	510368	Ref. No. 057534
	gasket L 70mm W 23.5mm hole ø 5mm hole distance 56mm FIBER thickness 2mm for heating element		

			
GEV No.	415806	Ref. No.	0H6176
description	heating element 5200W 230V heating circuits 2 L 240mm W 390mm H 30mm W2 50mm flange length 70mm flange width 22mm hole distance 56mm connection male faston 6.3mm tube ø 6.5mm hole ø 5mm W1 290mm rectangular flange convection heating element		
accessories for	415806		
	GEV No.	510368	Ref. No. 057534
	gasket L 70mm W 23.5mm hole ø 5mm hole distance 56mm FIBER thickness 2mm for heating element		

			
GEV No.	418910	Ref. No.	032072
description	heating element 810W 240V heating circuits 1 L 250mm W 60.5mm connection length 42mm connection male faston 6.3mm tube ø 8.5mm thread M12x1 convection heating element mounting distance 52mm		
For models:	DL14/AC, DL14/C, DL21/C, SM08C., SM15CP, SM15C., SM15CA, SM15/CS., SM21/CP, SM21C., SM21CA., SM15VA., SM21VA., SM08C, SM15CP, SM15C, SM15CA, SM15/CS, SM21C, SM21C, SM21CA, SM15VA, SM21VA		

			
GEV No.	490153	Ref. No.	002557 0C4077
description	radiation heater octagonal 3400W 230V L 300mm W 300mm heating circuits 2 H 30mm with heating coil energy regulation with temperature signalization connections 4+2 connection type cable cable length 900mm AD		
For models:	HI/E400, HI/E800, KI/E1, KI/E2, KI/E2E5, ZI/E400, ZI/E800, QI/E1, QI/E2, QI/E2E5, AI/E400, AI/E800, WI/E1, WI/E2, WI/E2E5		

			
GEV No.	490159	Ref. No.	0C2128 0K0611
description	radiation heater L 300mm W 300mm 3500W 230V connections 3 square without pan detection EGO		
For models:	KT/E1, KT/E2, QT/E1, QT/E2, WT/E2		
spare parts for	490159		
	GEV No.	499157	Ref. No. —
	protection pipe for temperature probe ceramic L 297mm ED ø 7mm ID ø 5mm		

			
GEV No.	490008	Ref. No.	0K0589 0K4822 0K4861 0K6389 18002173
description	radiation heater L 300mm W 300mm 4000W 400V heating circuits 2 connections 3 square connection type male faston 6.3mm without pan detection EGO		
For models:	CE128-106, CE158-133.3.HV, CE158-244.3, CE158-246.3, CK248-209.D1ABBB, CK248-211.D1ABBB, HCE128-100, HCE128-104, HCE158-252W.3, HCE158-253.3, HLE129-100, HLE129-103, HLE129-104W, HLE159-252W.3.6, HLE159-328.3.HV, HLE159-351W.3.HV, HLE249-200.3, HLE249-208.3, HLE259-088.3.HV, HLE259-089.3.HV, HLE259-384W.3, LE129-101, LE159-261.3, LE159-281.3.6, LE159-318.3.HV, LE159-322.3.HV, LE159-330.3.HV, LE159-337.3.HV, LE159-344.3.MS92, LE159-347.3.HV, LE249-199.3, LE249-203.3, LE249-207.3, LE249-211.3, LE249-215.3, LE249-219.3, LE249-223.3, LE249-232.3, LE249-238.3, LE259-081.3.HV, LE259-082.3.HV, LE259-083.3.HV, LE259-094.3.HV, LE259-099.3.HV, LE259-382.3, LK259-707.D1ACCB, LK259-708.D1ACCB, CK248-205.D1ABBB, CK248-207.D1ABBB, LK159-707.D1BC...(Other models you can see in the webshop)		
spare parts for	490008		
	GEV No.	499157	Ref. No. —
	protection pipe for temperature probe ceramic L 297mm ED ø 7mm ID ø 5mm		



 <p>1</p>			
GEV No.	416998	Ref. No.	004755
description	radiation heater rectangular 2700W 230V L 410mm W 165mm heating circuits 3 connections 3x 2 IRCA for fryer		
For models:	RF/E1S08, RF/E2D08, RFR/E1S08, RFR/E2D08, RF/E1S07, RF/E2D07, RFR/E1S07, RFR/E2D07, XF/E1S08, XF/E2D08, XFR/E1S08, XFR/E2D08, XF/E1S07, XF/E2D07, XFR/E1S07, XFR/E2D07, JF/E1S08, JF/E2D08, JFR/E1S08, JFR/E2D08, JF/E1S07, JF/E2D07, JFR/E1S07, JFR/E2D07, MF/E1S08, MF/E2D08, MFR/E1S08, MFR/E2D08, MF/E1S07, MF/E2D07, MFR/E1S07, MFR/E2D07, PF/E1S07, PF/E2D07, PFR/E1S07, PFR/E2D07, PF/E1S07E5, PFR/E2D07E5, OF/E1S07, OFR/E1S07, OFR/E2D07, TF/E1S07, TF/E2D07, TFR/E1S07, TFR/E2D07, TF/E1S07E5, TFRE2D07E5		

 <p>1</p>			
GEV No.	416999	Ref. No.	005942 0G4494 0K1523 17012747
description	radiation heater rectangular 5000W 230V L 410mm W 280mm heating circuits 3 connections 3x 2 IRCA for fryer		
For models:	BFR/E1S14, RMV/E1C, RMV/E2C, RFR/E1S14, RFR/E2D14, XMV/E1C, XMV/E2C, XFR/E1S14, XFR/E2D14, JMV/E1C, JMV/E2C, JFR/E1S14, JFR/E2D14, MMV/E1C, MMV/E2C, MFR/E1S14, MFR/E2D14, PMV/E1C, PMV/E2C, PFR/E1S14, PFR/E2D14, OMV/E1C, OMV/E2C, TMV/E1C, TMV/E2C, TFR/E1S14, TFR/E2D14, KMV/E2C, KFR/E1A, KFR/E2B, QMV/E2C, QFR/E1A, QFR/E2B, WFR/E1A, WFR/E2B, AFAUOFOOOC, AFAUOAOOOO, AFAROF0OOC, AFAROA0OOC		

 <p>1</p>			
GEV No.	490197	Ref. No.	0C5945 0C7624
description	radiation heater rectangular 6000W 230V L 405mm W 255mm H 45mm heating circuits 3		
For models:	BCP/E1		

 <p>1</p>			
GEV No.	417732	Ref. No.	0C7411 617839A00
description	radiation heater rectangular 8500W 400V L 550mm W 424mm H 33mm heating circuits 3 connections 3 HICOOK for tilting bratt pan		

 <p>1</p>			
GEV No.	418000	Ref. No.	006158 17012750
description	radiation heater rectangular 9000W 400V L 432mm W 340mm heating circuits 3 IRCA for fryer		
For models:	KFR/E1E, KFR/E2F, KFH/E1, KFH/E1ELH, KFH/E1EH, HFH/E430, HFR/E430, HFR/E830, HFH/G435, HFRS/E430, QFR/E1E, QFR/E2F, QFH/E1, QFH/E1ELH, QFH/E1H, ZFH/E430, ZFR/E430, ZFR/E830, ZFH/G435, ZFRS/E430, WFR/E1E, WFR/E2F, WFH/E1, WFH/E1ELH, WFH/E1EH, AFR/E430, AFR/E830, AFH/E435, AFRS/E430, AFAUOFOOOC, AFAUOAOOOO, AFAROF0OOC, AFAROA0OOC		

1-circuit			
 <p>1</p>			
GEV No.	490042	Ref. No.	0C0812
description	radiation heater ø 200mm 1800W 230V heating circuits 1 energy regulation with temperature signalization with ribbon heater connections 2+2 connection type male faston 6.3mm EGO		
For models:	SIE350, SVE700, SIE350, SVE700		

2-circuit			
 <p>1</p>			
GEV No.	490133	Ref. No.	059043
description	radiation heater ø 230mm 2100W 230V		
For models:	MI/E350, MI/E700, MIF/E700, MI/E350D, MI/E700D, MIF/E700D		

 <p>1</p>			
GEV No.	490028	Ref. No.	005008
description	radiation heater ø 230mm 2100W 230V heating circuits 2 energy regulation with temperature signalization partial power 650W with heating coil connections 3+2 connection type male faston 6.3mm EGO		
For models:	RI/E1, RI/E2, RIF/E2, RIV/E2, XI/E1, XI/E2, XIF/E2, XIV/E2, JI/E1, JI/E2, JIF/E2, JIV/E2, MI/E1, MI/E2, MIF/E2, MIV/E2, PI/E1, PI/E2, PIF/E2, PIV/E2, PI/E1E5, PI/E2E5, PIF/E2E5, OI/E1, OI/E2, OIF/E2, TI/E1, TI/E2, TIF/E2, TIV/E2, TI/E1E5, TI/E2E5, TIF/E2E5		



1			
GEV No.	490134	Ref. No.	059432
description	radiation heater ø 230mm 2200W 230V heating circuits 2		
For models:	MI/E700, MIF/E700, MI/E700D, MIF/E700D		



1			
GEV No.	490044	Ref. No.	0A5299
description	radiation heater ø 230mm 2200W 230V heating circuits 2 energy regulation with temperature signalization partial power 750W with ribbon heater connections 3+2 connection type male faston 6.3mm EGO		
For models:	MI/E360, MI/E710, MIF/E710, MI/E360D, MI/E710D, MIF/E710D, XMI/E360, XMI/E710, XMIF/E710, CI/E710, CIF/E710		



1			
GEV No.	416371	Ref. No.	032094 088274 1EFICA917002
description	foil heating element L 400mm W 290mm 1000W 230V t.max. 140°C with temperature limiter silicone cable length 2000mm thickness 1mm		
For models:	DL14/C, DL14/CP, DL21/C, DL21/CP, FS07C, FS11C, FS11C2, NFS15C, FS15C2, FSV07C2X, FSV11C3X, FSV15C4X, FSV07C2C, FSV11C3C, FSV15C4C, FSV11C3CX, FSV15C4CX, FSV11C3CC, FSV15C4CC, FSL07C2, FSL11C3, FSL15C4, SSBMHC12, SSBMHC16, SSBMHC20, SSBMB12, SSBMB16, SSBMHB20, SSBMHC12HD, SSBMHC16HD, SSBMHC20H, SSBMB8, SSBMHC8, DBMAC12, DBMAC16, DBMAC20, DBMP12, DBMP16, DBMP20, ZLB12H, ZLB16H, ZLB20H, ZLB12B, ZLB16B, ZLB20B, ZLB12HHD, ZLB16HHD, ZLB20HHD, ZLB08B, ZLB08H...(Other models you can see in the webshop)		

foil heating elements

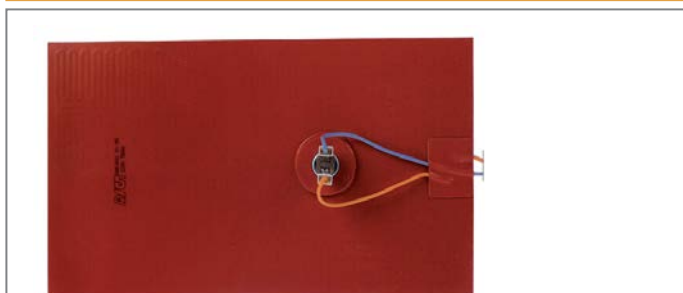

1			
GEV No.	418763	Ref. No.	032086
description	foil heating element L 290mm W 175mm 500W 230V t.max. 150°C with temperature limiter 140°C silicone cable length 1000mm switch-off temp. 140°C		
For models:	DL07/C, DL21/C, DL21/CP, DI-WHW2, DI-WHW3, DI-WHW4, DI-WHW5, DI-WHW6, MDBM31, DB/G31, MDBM21, DB/G21, MDBM33, MDBM22, MDBM31H, MDBM21H, MDBM33H, MDBM22H, DB/G33, DB/G22		

hot plates

square & rectangular

with radiused edge

1			
GEV No.	490065	Ref. No.	0A2198
description	hot plate dimensions 220x220mm 2000W 230V with spill ring connection 4 screw clamps protector no square		



1			
GEV No.	490067	Ref. No.	0KM342
description	hot plate dimensions 220x220mm 2000W 400V with spill ring connection 4 screw clamps protector no square		
accessories for	490067		
	GEV No.	693464	Ref. No.
			—
	sealing cord ø 10mm Qty supplied by meter		



1

GEV No.	490066 ¹	Ref. No.	006220 0A2199
description	hot plate dimensions 220x220mm 2600W 230V with spill ring connection 4 screw clamps protector yes square		
For models:	MC/E2Q, MCF/E2Q, MCV/E2Q, RC/E2Q, RCF/E2Q, RCV/E2Q, PC/E2Q, PCF/E2Q, PCV/E2Q, PC/E2QE5, PCF/E2QE5, OC/E2Q, OCF/E2Q, TC/E2Q, TCF/E2Q, TCV/E2Q, TC/E2QE5, TCF/E2QE5		

¹incl. protector



1

GEV No.	490176 ¹	Ref. No.	034442 0C6244 537025800
description	hot plate dimensions 220x220mm 2600W 440V with spill ring connection 4 screw clamps protector yes		
For models:	TCV/E2QM0, TCV/E3QM0, TCV/E2QM4, TCV/E3QM4		

¹incl. protector



1

GEV No.	490054 ¹	Ref. No.	0A2020
description	hot plate dimensions 300x300mm 2500W 230V with spill ring connection 4 screw clamps protector yes		

¹incl. protector



1

GEV No.	490128 ¹	Ref. No.	0K0339
description	hot plate dimensions 300x300mm 2500W 400V with spill ring connection 4 screw clamps protector yes square		

¹incl. protector



1

GEV No.	490056 ¹	Ref. No.	052196 052198 OKD869 0KE969
description	hot plate dimensions 300x300mm 3000W 230V with spill ring connection 4 screw clamps protector yes square		
For models:	CE128-106, CE158-133.3.HV, CE158-244.3, CE158-246.3, CK248-209, D1ABBB, CK248-211.D1ABBB, HCE128-100, HCE128-104, HCE158-252W.3, HCE158-253.3, CK248-205.D1ABBB, CK248-207.D1ABBB, HCE128-100W, HCE128-103W, HCE128-104W, CE128-101, CE128-102, CE128-105, CE128-107, CE128-108, HCE158-262W.3, HCE158-264.3, HCE158-261.3, HCE158-261W.3, HCE158-263.3, HCE158-232W.3, HCE158-233.3, HCE158-231.3, HCE158-231W.3, HCE158-230.3, CE158-234.3, CE158-236.3, HCE158-254.3, HCE158-251.3, HCE158-251W.3, HCE158-242W.3, HCE158-243.3, HCE158-241.3, HCE158-241W.3, HCE158-240.3, CE158-235.3, CE158-237.3, CE158-245.3, CE158-247.3, HCE158-131W.3.HV, HCE158-135.3.HV, HCE158-121W.3.HV, HCE158-125.3.HV, HCE158-132.3.HV, HCE158-132W.3.HV...(Other models you can see in the webshop)		

¹incl. protector



1

GEV No.	490057 ¹	Ref. No.	052197 0G0485 OK4755 OK4756 OK4768 OK6681 0KE281 OKF577 OTR597 18001351 18001352
description	hot plate dimensions 300x300mm 3000W 400V with spill ring connection 4 screw clamps protector yes square		
For models:	CE128-106, CE158-133.3.HV, CE158-244.3, CE158-246.3, CK248-209, D1ABBB, CK248-211.D1ABBB, HCE128-100, HCE128-104, HCE158-252W.3, HCE158-253.3, CK248-205.D1ABBB, CK248-207.D1ABBB, HCE128-100W, HCE128-103W, HCE128-104W, CE128-101, CE128-102, CE128-105, CE128-107, CE128-108, HCE158-262W.3, HCE158-264.3, HCE158-261.3, HCE158-261W.3, HCE158-263.3, HCE158-232W.3, HCE158-233.3, HCE158-231.3, HCE158-231W.3, HCE158-230.3, CE158-234.3, CE158-236.3, HCE158-254.3, HCE158-251.3, HCE158-251W.3, HCE158-242W.3, HCE158-243.3, HCE158-241.3, HCE158-241W.3, HCE158-240.3, CE158-235.3, CE158-237.3, CE158-245.3, CE158-247.3, HCE158-131W.3.HV, HCE158-135.3.HV, HCE158-121W.3.HV, HCE158-125.3.HV, HCE158-132.3.HV, HCE158-132W.3.HV...(Other models you can see in the webshop)		

¹incl. protector



1

GEV No.	490177	Ref. No.	0KE113
description	hot plate dimensions 300x300mm 3000W 440V with spill ring connection 4 screw clamps protector no		
For models:	CE128-106, CE158-133.3.HV, CE158-244.3, CE158-246.3, CK248-209, D1ABBB, CK248-211.D1ABBB, HCE128-100, HCE128-104, HCE158-252W.3, HCE158-253.3, CK248-205.D1ABBB, CK248-207.D1ABBB, HCE128-100W, HCE128-103W, HCE128-104W, CE128-101, CE128-102, CE128-105, CE128-107, CE128-108, HCE158-262W.3, HCE158-264.3, HCE158-261.3, HCE158-261W.3, HCE158-263.3, HCE158-232W.3, HCE158-233.3, HCE158-231.3, HCE158-231W.3, HCE158-230.3, CE158-234.3, CE158-236.3, HCE158-254.3, HCE158-251.3, HCE158-251W.3, HCE158-242W.3, HCE158-243.3, HCE158-241.3, HCE158-241W.3, HCE158-240.3, CE158-235.3, CE158-237.3, CE158-245.3, CE158-247.3, HCE158-131W.3.HV, HCE158-135.3.HV, HCE158-121W.3.HV, HCE158-125.3.HV, HCE158-132.3.HV, HCE158-132W.3.HV...(Other models you can see in the webshop)		



1

GEV No.	490071 ¹	Ref. No.	052199 052201
description	hot plate dimensions 300x300mm 4000W 230V with spill ring connection 4 screw clamps protector yes square		
For models:	HC/E410, HC/E810, HCF/E810, KC/E1, KC/E2, KCF/E2, KC/E1E5, KC/E2E5, KCF/E2E5, ZC/E410, ZC/E810, ZCF/E810, QC/E1E5, QC/E2E5, QCF/E2E5, WC/E1E5, WC/E2E5, WCF/E2E5		

¹incl. protector



1

GEV No.	490074 ¹	Ref. No.	052200 0G0858 0G2905 0K0340 0K0368 490074
description	hot plate dimensions 300x300mm 4000W 400V with spill ring connection 4 screw clamps protector yes square		
For models:	HC/E400, HC/E800, HCF/E800, KC/E1, KC/E2, KCF/E2, KC/E1E5, KC/E2E5, KCF/E2E5, ZC/E400, ZC/E800, ZCF/E800, QC/E1, QC/E2, QCF/E2, QC/E2M0, QCF/E2M0, AC/E400, AC/E800, ACF/E800, OCF/E800, WC/E1, WC/E2, WCF/E2, AFS/E800, HC/E400, HC/E800, ECF/E800, AEARAAJOOO, AEARHAJOOO, AEARAFJOOO, AEARHFJOOO, AEAUAJGOO, AEAUHAJGOO, AEAUAFJGOO, AEAUHFJGOO, AEAXJAKFFO, AEA-XHAKFFO, AEAXJFKFFO, AEAXHFKFFO, AEAUCAJGOO, AEAXLAKFFO, AEAUCFJGOO, AEAXLFKFFO, AEARABJOOO, AEARHBJOOO, AEAUABJGOO, AEAUHBGOO, AEAXJBKFFO, AEAXHBKFFO...(Other models you can see in the webshop)		

¹incl. protector



1

GEV No.	490194 ¹	Ref. No.	0C2524
description	hot plate dimensions 300x300mm 4000W 440V with spill ring connection M5 protector yes		
For models:	QC/E2M4, QCF/E2M4		

¹incl. protector



1

GEV No.	490187	Ref. No.	0G0233 0K4758 18001430 18001431
description	hot plate dimensions 350x400mm 4500W 380V with spill ring		

tiltable



1

GEV No.	490085	Ref. No.	0K9761 210747
description	hot plate dimensions 300x300mm 2500W 230V with cast edge tilt boiling plate connection 3 screw clamps H 43mm square		

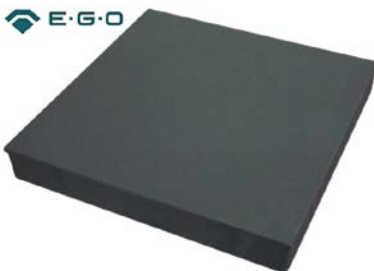

1

GEV No.	490086	Ref. No.	0H6083
description	hot plate dimensions 300x300mm 2500W 400V with cast edge tilt boiling plate connection 3 screw clamps H 43mm square		





1

GEV No.	490088	Ref. No.	0H6079 490088
description	hot plate dimensions 300x300mm 2500W 400V with cast edge tilt boiling plate connection 4 screw clamps H 43mm square		
For models:	7701-3/85, 7501-3/85., 7501-3/90.HE.4PL.(N), 7502-3/85., 7500-3/85. HE.2PL.(N), 7503-3/85.HE.6PL, 7504-3/85.HE.6PL.BO, 7505-3/85, 7500-3/90.HE.2PL.(N), 7502-3/90.HE.4PL.BO., 7503-3/90.HE.6PL.(N), 7504-3/90.HE.6PL.BO., 7505-3/90.HE.6PL.BO., 7700-3/85, 7703-3/85, 7700-3/90.HE.2PL.(N), 7701-3/90.HE.4PL.(N), 7703-3/90.HE.6PL.(N), 7502-3/85.HE.4PL.BO., 7505-3/85.HE.6PL.BO., 7503-3/85.HE.6PL. EO, 7501-3/85.HE.4PL.EO, 7500-3/85.HE.2PL.EO, 7504-3/90.HE.6PL. BO., 7500-3, 7501-3, 7502-3, 7503-3, 7504-3, 7505-3, 7700-3, 7701-3, 7703-3, 9000-3, 9002-3, 9004-3, 9006-3, 9200-3-0, 9200-3-8, 9201-3-0, 9201-3-8, 9203-3-0, 9203-3-8		



1

GEV No.	490089	Ref. No.	0H1252 0K0371 0K9760
description	hot plate dimensions 300x300mm 4000W 230V with cast edge tilt boiling plate connection 4 screw clamps H 43mm square		



1

GEV No.	490090	Ref. No.	0H6081 0H6082 0K0381 0K1335 490090
description	hot plate dimensions 300x300mm 4000W 400V with cast edge tilt boiling plate connection 4 screw clamps H 43mm square		
For models:	7701-3/85, 7501-3/85., 7501-3/90.HE.4PL.(N), 7502-3/85., 7500-3/85. HE.2PL.(N), 7503-3/85.HE.6PL, 7504-3/85.HE.6PL.BO, 7505-3/85, 7502-3/90.HE.4PL.BO., 7503-3/90.HE.6PL.(N), 7504-3/90.HE.6PL.BO., 7505-3/90.HE.6PL.BO., 7700-3/85, 7703-3/85, 7700-3/90.HE.2PL. (N), 7701-3/90.HE.4PL.(N), 7703-3/90.HE.6PL.(N), 7502-3/85.HE.4PL. BO., 7505-3/85.HE.6PL.BO., 7503-3/85.HE.6PL.EO, 7501-3/85.HE.4PL. EO, 7504-3/90.HE.6PL.BO., 7501-3, 7502-3, 7503-3, 7504-3, 7505-3, 7701-3, 7703-3, 9002-3, 9004-3, 9006-3, 9201-3-0, 9201-3-8, 9203-3-0, 9203-3-8		

miscellaneous



1

GEV No.	490165	Ref. No.	0G0308 0H9741 0H9742 0K4759 0K4760 0K4761 18001434 18001435 19001434
description	hot plate dimensions 350x400mm 4000W 400V connection 2x3		

round

with radiused edge

for domestic and commercial kitchens



1

GEV No.	490010	Ref. No.	058104 6001065
description	hot plate ø 145mm 1000W 230V connection 4 screw clamps with 8mm spill ring		
For models:	QCE300, QCE600, QCE601		





1

GEV No.	490012	Ref. No.	050725 053406 053607 0K2890
description	hot plate ø 145mm 1500W 230V connection 4 screw clamps with 8mm spill ring		
For models:	MCF/E700D, MCF/E700, MCF/E700UK, MCF/E1050D, MCF/E1050, MC/ E700D, MC/E700UK, MC/E1050D, MC/E700, MC/E1050, RC/E1, RC/ E2, RCV/E2, RCV/E3, RCF/E2, RCF/E2E5, XC/E1, XC/E2, XCV/E2, XCV/ E3, XCF/E2, JC/E1, JC/E2, JCVE2, JCV/E3, JCF/E2, MC/E1, MC/E2, MCV/ E2, MCV/E3, MCF/E2, MCF/E2E5, RCF/E720, RCF/E720, RC/E700D, RCF/ E700D, RCF/E1050D, RCF/E700UK, RC/E700UK, RC/E1050D, 74CE07T, 74CE07F, 76CE10F, XCF/E1050, RCF/E720		

			
1			
GEV No.	490014	Ref. No.	OG0730 OG5200 OG6313 153005
description	hot plate ø 180mm 1500W 230V connection 4 screw clamps with 8mm spill ring		

			
1			
GEV No.	490015	Ref. No.	003930
description	hot plate ø 180mm 1500W 400V connection 4 screw clamps with 8mm spill ring		
For models:	BC/E1, BCF/E2, RC/E1, RC/E2, RCV/E2, RCV/E3, RCF/E2MO, RCVF/E3MO, XC/E1, XC/E2, XCV/E2, XCV/E3, XCF/E2, JC/E1, JC/E2, JCVE2, JCV/E3, JCF/E2, MC/E1, MC/E2, MCV/E2, MCV/E3		



			
1			
GEV No.	490016	Ref. No.	00290 004914 01P24 OK0350 OK9762 OM0651 210383
description	hot plate ø 180mm 2000W 230V connection 4 screw clamps with 8mm spill ring		
For models:	SCE350, SCE700, SCE350, SCE700		

			
1			
GEV No.	490017	Ref. No.	0H6076 OK0343 OK0352
description	hot plate ø 180mm 2000W 400V connection 4 screw clamps with 8mm spill ring		

			
1			
GEV No.	490018	Ref. No.	0H6078 OK0329 OK0334 OK9940 490018
description	hot plate ø 220mm 2000W 230V connection 4 screw clamps with 8mm spill ring		
For models:	7511-2, 7512-2, 7512-9, 7711-2		

			
1			
GEV No.	490130	Ref. No.	050724
description	hot plate ø 220mm 2000W 230V connection 4 screw clamps with 8mm spill ring		
For models:	RC/E320, RC/E320U, RC/E720, RC/E720, RCV/G320, RCV/E720, RCFE720, RCF/E720, RC/E320, RC/E720, RCV/E320, RCV/E720, RCF/E720		

			
1			
GEV No.	490019	Ref. No.	OG0733 OK0345 OK0356 OKG657 OKT346 153010
description	hot plate ø 220mm 2000W 400V connection 4 screw clamps with 8mm spill ring		

			
1			
GEV No.	490020	Ref. No.	053407 053606 OK2889
description	hot plate ø 220mm 2600W 230V connection 4 screw clamps with 8mm spill ring		
For models:	RC/E320, RC/E320U, RC/E720, RC/E720, MCF/E700D, MCF/E700, MCF/E700UK, MCF/E1050D, MCF/E1050, MC/E350D, MC/E350UK, MC/E700D, MC/E700UK, MC/E1050D, MC/E350, MC/E700, MC/E1050, RC/E1, RC/E2, RCV/E2, RCV/E3, RCF/E2, RCF/E2E5, XC/E1, XC/E2, XCV/E2, XCV/E3, XCF/E2, JC/E1, JC/E2, JCVE2, JCV/E3, JCF/E2, MC/E1, MC/E2, MCV/E2, MCV/E3, MCF/E2, MCF/E2E5, RCV/G320, RCV/E720, RCFE720, RCF/E720, RC/E350D, RC/E700D, RCF/E700D, RCF/E1050D, RCF/E700UK, RC/E350UK, RC/E700UK...(Other models you can see in the webshop)		
accessories for	490020		
		GEV No.	550796
	fixing plate for hot plate ø220mm	Ref. No.	—



			
1			
GEV No.	490021	Ref. No.	003931 0K4729 0K4730 18001060 18001085
description	hot plate ø 220mm 2600W 400V connection 4 screw clamps with 8mm spill ring		
For models:	BC/E1, BCF/E2, RC/E1, RC/E2, RCV/E2, RCV/E3, RCF/E2MO, RCVF/E3MO, XC/E1, XC/E2, XCV/E2, XCV/E3, XCF/E2, JC/E1, JC/E2, JCV/E2, JCV/E3, JCF/E2, MC/E1, MC/E2, MCV/E2, MCV/E3, TC/E1M0, TCF/E2M0, TCF/E2M4		

			
2			
GEV No.	490175	Ref. No.	003929
description	hot plate ø 220mm 2600W 440V connection 4 screw clamps with 8mm spill ring		
For models:	RC/E1, RC/E2, RCV/E2, RCV/E3, RCF/E2M4, RCVF/E3M4, XC/E1, XC/E2, XCV/E2, XCV/E3, XCF/E2, JC/E1, JC/E2, JCV/E2, JCV/E3, JCF/E2, MC/E1, MC/E2, MCV/E2, MCV/E3, TCV/E2M0, TC/E1M4, TCV/E2M4		

			
1			
GEV No.	490061	Ref. No.	0K0331 0K0578 490061
description	hot plate ø 300mm 2500W 230V connection 4 screw clamps with 8mm spill ring		

			
1			
GEV No.	490063	Ref. No.	0H6080 210372
description	hot plate ø 300mm 2500W 400V connection 4 screw clamps with 8mm spill ring		

with cast brim			
with screw connection			
			
1			
GEV No.	490100	Ref. No.	0K0374
description	hot plate ø 400mm 5000W 230V connection 2x 3 screw clamps with cast edge H 42mm		

miscellaneous			
			
1			
GEV No.	490158	Ref. No.	0K0362
description	hot plate dimensions 300x300mm 2500W 230V		

accessories			
fasteners			
			
1			
GEV No.	550129	Ref. No.	0C0114 0G4300 0K2533 0K2534 17012743 NZI518807000
description	bearing screw for tilt boiling plate straight thread M12x80		
For models:	ZFT/E1, ZFT/E1E5, ZFT/E1M4, ZFT/E1M0, ZFT/E1L, ZFT/E1LE5, RFT/E1, RFT/E1E5, RFT/E1M4, RFT/E1M0, ZFT/E2, ZFT/E2E5, ZFT/E2M4, ZFT/E2M0, ZFT/E2L, ZFT/E2LE5		

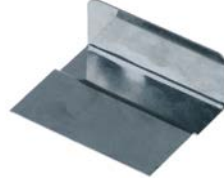
			
1			
GEV No.	691457	Ref. No.	0C2114
description	protector for probe		
For models:	KT/E1, KT/E2, QT/E1, QT/E2, WT/E1, WT/E2		



energy regulators

EGO

1-circuit



1

GEV No.	380015	Ref. No.	003030 003031 003529 005270 026861 055016 058406 06501 0A2482 0C1605 0C4929 0F0089 0G0652 0G2652 0H6103 0H6137 0H7480 0HB171 0K0502 0K2964 0K3459 0K3763 0K3874 0K5029 0K7769 0K8611 0K9374 0K9741 0K9775 0K9784 0KB064 0KE181 0KJ148 0KJ210 0KS980 0KW347 10063 18015440 203160 30001227 3016217 315078803 53701330 750011
----------------	--------	-----------------	--

description	energy regulator 230V 13A single-circuit turn direction right shaft ø 6x4.6mm shaft L 23mm mounting thread M4 power release 6-100% no. 50.57021.010		
For models:	MPN/EI760, MPNEI760UK, MPN/EI760D, BCP/E1, RMV/E1C, RMV/E2C, RPI/G260P, RCP/E2S, XMV/E1C, XMV/E2C, XPI/G260P, JMV/E1C, JMV/E2C, MCP/E1SH, MCP/E1SUH, MCP/E2SUHS, MMV/E1C, MMV/E2C, MPI/G260P, MCP/E2S, MCP/E2SH, MCP/E2SUH, MCP/E2SUT, MCP/E2SHB, 7PIE06, RPN/EI760UK, RPN/EI760D, M70EIKE, XPN/EI760UK, XPN/EI760D, PMV/E1C, PMV/E2C, PPD/G260, PPI/G260P, PPI/E260P, PCP/E2SHP, PCP/E1SH, PCP/E2SH, PCP/E2SH3B, OMV/E1C, OMV/E2C, OPD/G260, OPI/G260P, OPI/E260P, OCP/E2S, OCP/E1SH, OCP/E2SH, TMV/E1C, TMV/E2C, TPD/G260...(Other models you can see in the webshop)		

2-circuit



1

GEV No.	380004	Ref. No.	059046 05946 380004
description	energy regulator 230V 13A dual circuit turn direction right shaft L 23mm no. 50.67021.590 with operation switch 2-pole		
For models:	MI/E350, MI/E700, MIF/E700, MI/E350D, MI/E700D, MIF/E700D, MI/E360, MI/E710, MIF/E710, MI/E360D, MI/E710D, MIF/E710D, RI/E1, RI/E2, RIF/E2, RIV/E2, XI/E1, XI/E2, XIF/E2, XIV/E2, JI/E1, JI/E2, JIF/E2, JIV/E2, MI/E1, MI/E2, MIF/E2, MIV/E2, XMI/E360, XMI/E710, XMIF/E710, CI/E710, CIF/E710, PI/E1, PI/E2, PIF/E2, PIV/E2, PI/E1E5, PI/E2E5, PIF/E2E5, OI/E1, OI/E2, OIF/E2, TI/E1, TI/E2, TIF/E2, TIV/E2, TI/E1E5, TI/E2E5, TIF/E2E5...(Other models you can see in the webshop)		



1

GEV No.	380027	Ref. No.	004902 0C6530 0K3520
description	energy regulator EGO 230V 13A dual circuit turn direction right shaft ø 6x4.6mm shaft L 23mm mounting thread M4 power release 6-70% no. 50.55021.100		
For models:	SIE350, SVE700, SIE350, SVE700		

thermostats

bi-metal thermostats

safety bi-metal thermostats



1

GEV No.	390480	Ref. No.	0L2895
description	bi-metal safety thermostat hole distance 23.8mm switch-off temp. 105°C 1NC 1-pole 16A connection F6.3 2 hole fixing		







1

GEV No.	390199	Ref. No.	003329
description	bi-metal safety thermostat hole distance 24mm switch-off temp. 210°C 1NC 1-pole 16A connection F6.3		
For models:	MFR/G380, MFR/G381, RF/G1S07, RF/G2D07, RFR/G1S07, RFR/G2D07, RF/E1S08, RF/E2D08, RFR/E1S08, RFR/E2D08, XF/G1S07, XRF/G2D07, XFR/G1S07, XFR/G2D07, XF/E1S08, XF/E2D08, XFR/E1S08, XFR/E2D08, JF/G1S07, JF/G2D07, JFR/G1S07, JFR/G2D07, JF/E1S08, JF/E2D08, JFR/E1S08, JFR/E2D08, MF/G1S07, MF/G2D07, MFR/G1S07, MFR/G2D07, MF/E1S08, MF/E2D08, MFR/E1S08, MFR/E2D08, 7FRG03T, CFR/G381, T35GFR, JFR/G400, PFR/G400		





			
GEV No.	390590	Ref. No.	085286 0KK203
description	bi-metal safety thermostat hole distance 24mm switch-off temp. °C 1NC 1-poleAV connection plug 2 hole fixing		
For models:	IMF28A, IMF28W, IMF35A, IMF35W, IMF58A, IMF58W, IMF80A, IMF80W, FGC33AS42, FGC46AS42, MF250WB20, FGC24AB, FGC24WB, FGC29AB, FGC29WB, FGC40A, FGC40W, FGC90A, FGC90W, FGC143AB, FGC143WB, FGS94AB, FGS94WB, FGS140A, FGC25A, CB246W, CIM38AB, CIM38WB, CIM85AB, CIM15WB, CIM235WB, FIM150ASB, FIM150WSB, FIM285ASB, FIM285WSB, CIM50AB, FIM50WB, FGC24ABS, FGC24WBAB, FGC29AB, FGC29WB, CIM38AB, CIM38WB, CIM50AB, FIM50WB, FGC143AB, FGC143WB, CB184A, CB249A, CB316A...(Other models you can see in the webshop)		

			
GEV No.	375967	Ref. No.	048750
description	bi-metal safety thermostat hole distance 45mm 1-pole 16A connection F6.3		

			
GEV No.	390138	Ref. No.	048287 048887 0K8665
description	bi-metal safety thermostat hole distance 45mm switch-off temp. 112°C 1NC 1-pole 16A connection F6.3		
For models:	LS32, LS32/4.5, LS32F, LV32F, C55, LV32/60, WT302, WT302/4.5, WT302F, WT302/60, LS33, LS33/4.5, LS33F, LV33F, C55A, LS33/60, WT303, WT303/4.5, WT303F, WT303/60, LB1, LB1WS, LB1WSDP, LB1/RBP, LB1/TOP, LB1/60, WT1WSDP, LB2DPSAUS, LB1G, LB1WSG, WT2TOP60, WT2DPDI, WT2WSDPDI, LB1TOP, WT2TOPDI, LB2WS, LB2, LB2WSDP, LB2/TOP, LB2/RBP, LB2WS60, WT2WSDP, WT2WSDPD, LB2WSG, WT2WS, WT1, WT1WS, WT1TOP, WT2TOP, WT1/3DP...(Other models you can see in the webshop)		
accessories for	390138		
		GEV No.	504736
		Ref. No.	048987
	bracket for contact thermostat		
		GEV No.	550388
		Ref. No.	—
	bracket for contact thermostat mounting distance 24.5mm mounting ø 3.8		

			
GEV No.	390526	Ref. No.	082618 083113 37T31-501513
description	bi-metal safety thermostat hole distance 23.5mm switch-off temp. 25°C 1NO 1-poleAV connection F6.3		
For models:	ICP130, ICN110UK, ALN110, ALN120, ALN111, ALN220, ALN240, ALN221, ALNN120, ALNN220, ALNN230, ALNSO120, ALN110UK, ALNN220UK, ALNF120, ALNF230, ILN220, ILN220UK, ILN240, ILNN120, ILNN230, ALN110UK, ALNN220UK, ALNF220UK, ILNF120, ILNF230, ALN110, ALN120, ALN111, ALN220, ALN240, ALN221, ALNN120, ALNF120, ALNN220, ALNF220, ALNN230, ALNF230, ALNSO120, AKP110, AKS110, AKP120, AKN110, AKN120, AKN111, AKN230, AKN220, AKN240, AKN221, AKNN120...(Other models you can see in the webshop)		

			
GEV No.	390764	Ref. No.	082619 083106
description	bi-metal safety thermostat hole distance 23.5mm switch-off temp. °C 1NC 1-poleA connection cable length 1200mm temperature range 7-8°C		
For models:	ALF110, ALF220UK, ALNF220, ALF110, ALF120, ALF220, ALF240, ALNF120, ALNF220, ALNF230, ILN110, ILN110UK, ILN120, ILNSO120, ILNN220, ILNN220UK, ALF110UK, ILF110, ILF120, ILF220, ILF220UK, ILF240, ILNF120, ILNF220, ILNF220UK, ILNF230, ALF110, ALF120, ALF220, ALF240, ALNF120, ALNF220, ALNF230, AKP110, AKS110, AKP120, AKS220, AKN110, AKN120, AKP110UK, AKN110UK, AKF240, AKNF120, AKNF220, AKNF230, AKF110UK, AKF110, AKF120, AKF230...(Other models you can see in the webshop)		

			
GEV No.	390749	Ref. No.	OKL023
description	bi-metal safety thermostat switch-off temp. 210°C 2-pole connection F6.3		
For models:	FCV31E3, 7CO30, CCO30G, ECO312CF, OTS100		

bi-metal thermostats

			
GEV No.	375666	Ref. No.	005203 0KG530 3570559017
description	bi-metal thermostat 1NO 1-pole 10A 250V connection F6.3 M4		
For models:	FCF/E4, FCF/E4-3KW, JCF/E4, JCF/E4, ECF/E4, ECF/E4-3KW, ACF/E4, ACF/E4-3KW, NCF/E4, ZCF/E4, ZCF/E4		

			
GEV No.	375927	Ref. No.	OPE024
description	bi-metal thermostat hole distance 23.5mm switch-off temp. 50°C 1NO 10A connection F6.3		
For models:	FS07C, FS11C, FS11C2, NFS15C, FS15C2, FSV07C2X, FSV11C3X, FSV15C4X, FSV07C2C, FSV11C3C, FSV15C4C, FSV11C3CX, FSV15C4CX, FSV11C3CC, FSV15C4CC		





			
1			
GEV No.	390101	Ref. No.	045495 047508 048487 0H2569 OK8773 26344400
description	bi-metal thermostat hole distance 38mm switch-off temp. 53°C 1CO 1-pole 16A connection F6.3 2 hole fixing		
For models:	LS360F, LS360DK, LS365F, LS365, LS365PH, LS500F, LS501F, LS540F, LS540DK, LS541F, LS360D, LS365D, LS360, LS365, LS360/63, LS365/63, LS367, LS720F, LSE720DK, LSE720PH, LS860F, LS860DK, LS860PH, LS1080F, LS1080UK, LS1080PH, LSE721F, LS861F, LS540, LS1080M, LS1080, LS1080D, LS1080UK, LS1080/63, LS500F, LS500UK, LS501, LS501UK, LS540D, LS540/63, LSE721, LS720, LSE720UK, LS721UK, LSE720D, LS541, LS860, LS860D, LS860UK...(Other models you can see in the webshop)		

			
2			
GEV No.	375958	Ref. No.	0H2279 OK7537
description	bi-metal thermostat hole distance 40mm 1NO 1-pole connection F6.3 for tank		
For models:	D180, D180, D180, D180, D180, D180, D180, D180, D180, D180, D180, D180, D180, D180, D180, AR170S, AR170S, AR170S, AR170S, AR170S, AR170S, AR170S, AR170S, AR170S, AR170S, AR170S, AR340S, AR340S, AR340S, AR340S, AR340S, AR340S, AR340S, AR340S, AR340S, AR340S, AR6ES, AR6ES, AR6ES, AR6ES, AR6ES, AR6ES, AR6ES, AR6ES, AR6ES, AR6ES, AR6ES, AR6ES...(Other models you can see in the webshop)		

			
1			
GEV No.	390468	Ref. No.	048804
description	bi-metal thermostat hole distance 40mm switch-off temp. 60°C 1CO 1-pole 16A connection F6.3 2 hole fixing		
For models:	LS32, LS32/4.5, LS32UK/RP, LS32F, LV32F, C55, LV32/60, WT302, WT302/4.5, WT302UK/RP, WT302F, WT302/60, LS33, LS33/4.5, LS33UK/RP, LS33F, LV33F, C55A, LS33/60, WT303, WT303/4.5, WT303UK/RP, WT303F, WT303/60, LB1, LB1WS, LB1WSDP, LB1/RBP, LB1/TOP, LB1/60, WT1WSDP, LB2DPSAUS, LB1G, LB1WSG, WT2TOP60, WT2DPDI, WT2WSDPDI, LB1TOP, WT2TOPDI, LB2WS, LB2, LB2WSDP, LB2/TOP, LB2/RBP, LB2WS60, WT2WSDP, WT2WSDPD, LB2WSG, WT2WS, WT1...(Other models you can see in the webshop)		

			
1			
GEV No.	375956	Ref. No.	0A9671
description	bi-metal thermostat hole distance mm switch-off temp. 40°C 1NC 1-pole 10A 250V connection male faston 6.3mm defrosting cable length 1600mm		
For models:	BCF180A, BCF180DA, BCF180RPA, , BCW201R, BCFW201R, BCF120A, BCF120RA, ADN220ES, ADF110ES, ADF220ES, ADN110ESP, ADF110ESP, BLAST C/FREEZER, BLAST C/FREEZER, BLAST C/FREEZER, BLAST C/FREEZER, BLAST C/FREEZER, BLAST C/FREEZER, BLAST C/FREEZER, ALN110, ALN120, ADN111, AEN110, AEN120, ADF110, ALF110, ADF120, ALF120, AEF110, AEF120, ADNN120, ADN120, AENN120, AENF120, ALN220, ALN240, ADN221, AEN220, AEN240, AEN221, ADF220, ADF240, AEF220, AEF240, ADNN220, ADN120, ADN220, ADN220, AENN220...(Other models you can see in the webshop)		

			
1			
GEV No.	375953	Ref. No.	0H2320 OK7651 OKB609
description	bi-metal thermostat switch-off temp. 110°C 1NC 1-pole 230V		
For models:	AR170S, AR170S, AR170S, AR170S, AR170S, AR170S, AR170S, AR170S, AR170S, AR170S, AR170S, AR170S, AR340S, AR340S, AR340S, AR340S, AR340S, AR340S, AR340S, AR10ES, AR10ES, AR10ES, AR10ES, AR10ES, AR10ES, AR10ES, AR10ESP, AR10ESP, AR10ESP, AR10ESP, AR10ES, AR10ES, AR10ES, AR10ES, AR10ES, AR10ES, AR10ES, AR10ES, AR10ES, AR10ES, AR10ES, AR10ES, AR10ESP, AR10ESP, AR10ESP...(Other models you can see in the webshop)		

			
1			
GEV No.	375959	Ref. No.	0A8707
description	temperature limiter hole distance 34mm switch-off temp. 85°C 1NC 10A 250V connection F6.3 Qty 1 pcs		
For models:	ICP130, ICN110UK, TRNP1802, TRRF130P, TRRF180P, TRRF220P, TRF1301, TRRF1301, TRF1801, TRRF1801, TRF2201, TRRF2201, TRN1301, TRNA1301, TRNM1301, TRF1301, TRRF1301, TRRF130P, TRN1302, TRNA1302, TRNM1302, TRN1303, TRNA1303, TRNM1303, TRN1801, TRNA1801, ARNM1801, TRF1801, TRRF1801, TRRF180P, TRN1802, TRNA1802, TRNM1802, TRN1803, TRNA1803, TRNM1803, TRN2201, TRNA2201, TRNM2201, TRF2201, TRRF2201, TRRF220P, TRN2202, TRNA2202, TRNM2202, TRN2203, TRNA2203, TRNM2203, TRNP1802, ICP130...(Other models you can see in the webshop)		

			
1			
GEV No.	375964	Ref. No.	088567
description	thermostat 1NC 1-pole 10A 250V cable length 750mm		
For models:	BCFW201R, AOFPS102CR, AOF5102CR, EABC101R, AOFPS201CR, AOFPS101CR, AOF5101CR, AOF102R, RBFP10.1-, AOF201R, AOF101CR, AOF102CR, AOF201CR, TC10, TC651DX, EABC101R, 1DR.TC, AOF201CRR, AOF201RRU, 1DR.TC, TC651DEX, 1DR.TC, TC651DEX2, EBCS72CR, EBCS51CR, TC10, TC10		



control and safety thermostats

EGO

control thermostats

55.10/19_ series



GEV No.	375055	Ref. No.	0A2018
description	thermostat t.max. 110°C temperature range 30-110°C 1-pole 1CO 16A probe ø 6mm probe L 130mm capillary pipe 1500mm capillary pipe isolatedmm gland nut shaft L 23mm shaft position upper rotation 318° 250V		
For models:	HGRV, KITCALDO		



GEV No.	375568	Ref. No.	0H6126 9755190098
description	thermostat t.max. 140°C temperature range 50-140°C 1-pole 1NO 0.5A probe ø 6mm probe L 107mm capillary pipe 860mm capillary pipe isolatedmm gland nut shaft ø 6x4.6mm shaft L 23mm shaft position° shaft position rotation 270°		
For models:	7550-2, 7551-2, 7552-2, 7553-2, 7573-2, 7574-2, 7575-2, 7576-2, 7773-2, 7774-2, 7775-2, 7776-2, 9100-2, 9101-2, 9102-2, 9104-2, 9113-2, 9114-2, 9115-2, 9116-2		



GEV No.	375488	Ref. No.	031480 OKW857 18002898 50000051
description	thermostat t.max. 175°C temperature range 45-170°C 1-pole 1NO 16A probe ø 3mm probe L 219mm capillary pipe 900mm capillary pipe isolated 900mm gland nut shaft ø 6x4.6mm shaft L 23mm shaft position upper rotation 270° shaft flat upper		
For models:	TC1200TOP, TC1210TOP, TC1400TOP, TC1410TOP, TC1600TOP, TC1610TOP, TC1800TOP, TC1810TOP, TC2000TOP, TC2010TOP, TCD1200TOP, TCD1400TOP, TCD1600TOP, TCD1800TOP, TCD2000TOP, TC1000, TC1010, TC1200, TC1210, TC1400, TC1410, TC1600, TC1610, TC1800, TC1810, TC2000, TC2010, TCD1000, TCD1200, TCD1400, TCD1600, TCD1800, TCD2000, TC1200, TC1210, TC1400, TC1410, TC1600, TC1610, TC1800, TC1810, TC2000, TC2010, TCD1200, TCD1400, TCD1600, TCD1800, TCD2000, TC1000, TC1000...(Other models you can see in the webshop)		

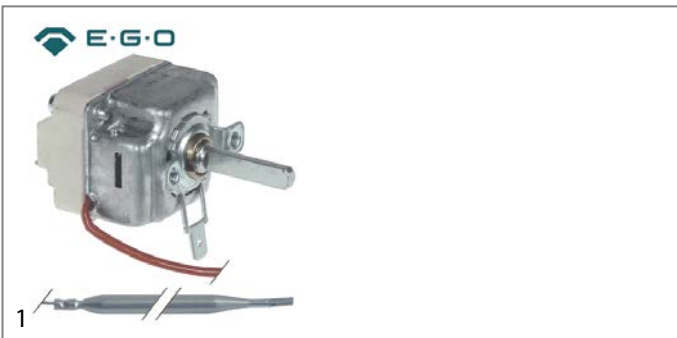

GEV No.	375309	Ref. No.	006749 00779
description	thermostat t.max. 180°C temperature range 95-180°C 1-pole 1NO 16A probe ø 6mm probe L 130mm capillary pipe 1500mm capillary pipe isolated 1100mm gland nut shaft L 23mm shaft position upper rotation 270°		



GEV No.	390053	Ref. No.	050412
description	thermostat t.max. 188°C temperature range 90-185°C 1-pole 1NO 16A probe ø 4mm probe L 231mm capillary pipe 1300mm capillary pipe isolated 1300mm gland nut shaft ø 6x4.6mm shaft L 23mm shaft position upper rotation 270°		
For models:	MFR/G350, MFR/G700, MFR/G350D, MFR/G700D, MFR/G350F, MFR/G700F, MFR/G350E, MFR/G700E, RFR/G350, RFR/G700, RFR/G350D, RFR/G700D, RFR/G350F, RFR/G700F, RBR/E700UK, M35GFR, M70GFR, XFR/G350D, XFR/G700D, XFR/G350F, XFR/G700F, XBR/E710, CBR/E700, CFR/G700, RFR/G301, RFR/G301, RFR/G701, RFR/G701F, HBR/G805, HBR/E805UK, RFR/G301, RFR/G701		

electric components



GEV No.	390046	Ref. No.	0KJ142
description	thermostat t.max. 190°C temperature range 104-190°C 1-pole 1NO 16A probe ø 6mm probe L 133mm capillary pipe 870mm capillary pipe isolatedmm gland nut M9x1 shaft ø 6x4.6mm shaft L 23mm shaft position lower rotation 270° probe material SS		



GEV No.	375273	Ref. No.	004168 0C6949
description	thermostat t.max. 200°C temperature range 60-200°C 1-pole 1NO 16A probe ø 6mm probe L 74mm capillary pipe 1500mm capillary pipe isolatedmm gland nut shaft L 23mm shaft position upper rotation 270°		
For models:	ZFC33, ZFC45		



GEV No.	390156	Ref. No.	051360 0K2925
description	thermostat t.max. 260°C temperature range 50-260°C 1-pole 1NO 16A probe ø 4mm probe L 115mm capillary pipe 1300mm capillary pipe isolated 1300mm gland nut shaft ø 6x4.6mm shaft L 23mm shaft position upper rotation 270°		
For models:	MBR/E710D, MBR/E700, MBR/E700UK, MBR/E716, MBR/E706, 7BRE60XN, 7BRE60X, RBR/E700UK, RBR/E716, RBR/E706, XBR/E710D, M70EBP, XBR/E716, XBR/E706, HBR/G803, HBR/G804, HBR/G803, HBR/G804, HBR/G803, HBR/G1003, HBR/G1003, HBR/G1004, HBR/E803, HBR/E804, HBR/E1003, HBR/G803, HBR/G804, HBR/G1013, HBR/E1013, HBR/G803, HBR/G804, HBR/G1003, HBR/G1013, HBR/E803, HBR/E804, HBR/E1003, HBR/E1013, HBR/G1004		



GEV No.	390068	Ref. No.	029918 057937 0K2960 446570201
description	thermostat t.max. 269°C temperature range 55-269°C 1-pole 1CO 16A probe ø 3.1mm probe L 219mm capillary pipe 1280mm capillary pipe isolated 1270mm gland nut shaft ø 6x4.6mm shaft L 23mm shaft position upper° rotation 318°		
For models:	FCF02EV, FCF02EOEM, FCF/E3, FCF/E2, FCF/E2D, FCF/E2UK, FCFG6D, FCFE6D, FCFE6D, FCFG10, FCFG10D, FCFG10NL, FCFE10, FCFE10UK, FCFG20, FCFG20D, FCFG20F, PFCFG20, FCFE20, FCFE20UK, FCFG40, FCFG41, FCFG40D, FCFG40F, PFCFG40F, FCFE40, FCFE40D, FCFE40UK, PFCFE40F, FCFG6, FCFG6F, PFCFG6, FCFE6, FCFE6UK, PFCFE6, FCVE10, FCVE20, FCVE6-1U, FCVE6-3U, FCVE6-1, FCVE6-3, FCVE6-1UK, FCVE6-3UK, FCVG6-1, FCVG6-3, FCVG6-1UK, FCVG6-3UK, FCVE10-2, FCVE10-4, FCVE10-2UK...(Other models you can see in the webshop)		



GEV No.	375664	Ref. No.	054323
description	thermostat t.max. 287°C temperature range 60-287°C 1-pole 1NO 16A probe ø 3.1mm probe L 226mm capillary pipe 1470mm capillary pipe isolated 350mm gland nut shaft ø 6x4.6mm shaft L 23mm shaft position upper rotation 270°		
For models:	FCF/E4-OLD, FCF/E4D, FCFE4PH, FCF/E4OLD3, FCF/E4OLD4, FCF/E4OLD2, FCF/E4OLD1, FCF/E4D		



GEV No.	375327	Ref. No.	006941 00769
description	thermostat t.max. 297°C temperature range 58-297°C 1-pole 1NO 16A probe ø 3.03mm probe L 219mm capillary pipe 870mm capillary pipe isolatedmm gland nut shaft L 23mm shaft position upper rotation 270°		
For models:	FTL35E6U, FTR35E6U, FTC35E6U, FTL70E6U, FTR70E6U, FTC70E6U		



GEV No.	375667	Ref. No.	056384 0F0088 0K0645 30000815
description	thermostat t.max. 300°C temperature range 68-300°C 1-pole 1NO 16A probe ø 3.1mm probe L 226mm capillary pipe 980mm capillary pipe isolated 980mm gland nut shaft ø 6x4.6mm shaft L 23mm shaft position upper rotation 318°		
For models:	FCF/G6-0, FCFG101/0, FCFG102-0, FCFG201-0, FCFG202-0, FCF/E6-0, FCFE101-0, FCFE102-0, FCFE201-0, FCFE202-0, FCF061ELN, FCF101ELN, FCF6EHOR, FCFG10160H, FCF061ENS, FCF101ENS, FCF102ENS, FCF201ENS, FCFG102-0T, FCF/G6-1-JAP, FCF/G101/1-1-JAP, FCF/G102/1-1-JAP, FCFE6-1J, FCFE101-1J, FCFE102-1J, FCF/G101/1, FCFE6J50, FCFE6J60, FCFG10J, FCFG10J, FCFE10J, FCFE10J, FCFG20J, FCFG20J, FCFE20J, FCFE20J, FCFG40J, FCFG40J, FCFE40J, FCFE40J, FCFG6J, FCFG6J, FCFG6J, FCFG6J, FCFG10J, FCFG10J, FCFG20J, FCFE20J, FCFG41J, FCFG40J...(Other models you can see in the webshop)		



GEV No.	375661	Ref. No.	056701 74310830
description	thermostat t.max. 500°C temperature range 75-500°C 1-pole 1NO 16A probe ø 3.9mm probe L 228mm capillary pipe 1470mm capillary pipe isolated 960mm gland nut shaft ø 6x4.6mm shaft L 23mm shaft position upper rotation 270°		
For models:	FZG18, FZE18, FPE30, FPE18, FZ/G18, FZ/E18, FP/E30, FP/E18		



GEV No.	375002	Ref. No.	004939 00569
description	thermostat t.max. 320°C temperature range 55-320°C 1-pole 1NO 16A probe ø 3.1 mm probe L 226mm capillary pipe 870mm capillary pipe isolated 850mm gland nut shaft L 23mm shaft position upper rotation 270°		



GEV No.	390415	Ref. No.	070311
description	thermostat t.max. 60°C temperature range fixed 60°C 1-pole 1CO 16A probe ø 6mm probe L 129mm capillary pipe 1470mm capillary pipe isolated 1430mm gland nut shaft Lmm shaft position		



GEV No.	375253	Ref. No.	004155 91310003
description	thermostat t.max. 455°C temperature range 85-455°C 1-pole 1NO 16A probe ø 3.9mm probe L 228mm capillary pipe 870mm capillary pipe isolated 660mm gland nut shaft ø 6x4.6mm shaft L 23mm shaft position upper rotation 270°		
For models:	ZCMME6, ZCBME12, ZCMME4, ZCBME8, ZCMME9, ZCBME18		



GEV No.	375113	Ref. No.	055367 056671 0K2952 60050222
description	thermostat t.max. 76°C temperature range fixed 76°C 1-pole 1CO 16A probe ø 3.1 mm probe L 226mm capillary pipe 870mm capillary pipe isolated 870mm gland nut shaft Lmm shaft position probe material SS		
For models:	FDV40G, FDV40E, FDV40GZ, FDV40EL, FDV40GA, FDV20G, FDV20E, FDV20GZ, FDV20EL, FDV20GA, FCVE6-1U, FCVE6-3U, FCVE6-1, FCVE6-3, FCVE6-3CE, FCVE6-1UK, FCVE6-3UK, FCVG6-1, FCVG6-3, FCVG6-1UK, FCVG6-3UK, FCVE10-2, FCVE10-4, FCVE103CE, FCVE10-2UK, FCVE10-4UK, FCVG10-2, FCVG10-4, FCVG10-1SG, FCVG10-2, FCVG10-4D, FCVG10-2UK, FCVG10-4UK, FCVG10-2, FCVG10-4, FCVE20-2, FCVE20-4, FCVE203CE, FCVE20/P-V, FCVE20-2UK, FCVE20-4UK, FCVG20-2, FCVG20-4, FCVG20-2, FCVG20-4D, FCVG20-2UK, FCVG20-4UK, FCVG20-4, FCVG20-4D, FCVE20-V...(Other models you can see in the webshop)		

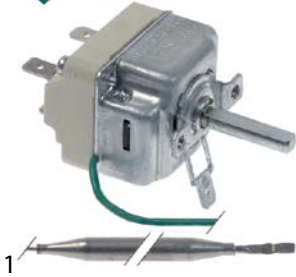

GEV No.	390040	Ref. No.	003262 050931 051920
description	thermostat t.max. 90°C temperature range 30-90°C 1-pole 1CO 16A probe ø 6mm probe L 130mm capillary pipe 2040mm capillary pipe isolated 1940mm gland nut shaft ø 6x4.6mm shaft L 23mm shaft position upper rotation 270° probe material SS		
For models:	ZHMA/E400, BCFCV101/1, BCFCV102/1, BCFCV101/1, BCFCV102/1		

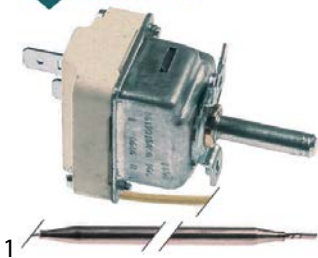

GEV No.	375809	Ref. No.	0K3061
description	thermostat t.max. 90°C temperature range 30-90°C 1-pole 1NO 16A probe ø 6mm probe L 130mm capillary pipe 1800mm capillary pipe isolated 1800mm gland nut shaft ø 6x4.6mm shaft L 23mm shaft position upper rotation 270°		

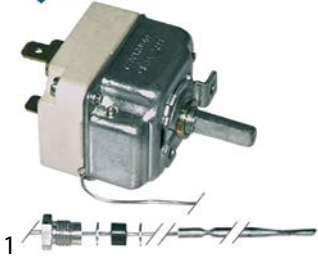

GEV No.	375042	Ref. No.	0H6440
description	thermostat t.max. 98°C temperature range 50-98°C 1-pole 1CO 16A probe ø 3.1mm probe L 334mm capillary pipe 2410mm capillary pipe isolated 1400mm gland nut M9x1 shaft L 23mm shaft position upper rotation 270° probe material SS		

55.13_ series

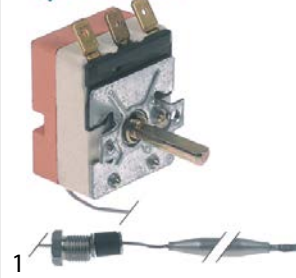

GEV No.	375871	Ref. No.	0E5032 0H2117 0K7035 0K7164 0KE345
description	thermostat t.max. 110°C temperature range 30-110°C 1-pole 1CO 16A probe ø 6mm probe L 113mm capillary pipe 2930mm capillary pipe isolatedmm gland nut M9x1 shaft ø 6x4.6mm shaft L 23mm shaft position upper rotation 270° H 40mm W 35mm D 30mm		
For models:	PW1EFL, PW1EFLF, PW1EFL/60HZ, PW2EFL, PW2EFLF, PW2EFL/60HZ, PW2VFL, WT830EFL, WT830EFLF, WT830EFL/60HZ, WT850, WT850EFLF, WT850EFL/60HZ, WT850SFL, FT36EDTS, FT36ESTS, FT36VDTs, FT36VSTs, FT36ED, FT36ES, FT36VD, FT36VS, FT50ED, FT50ES, FT50VD, FT50VS, FT72ED, FT72ES, FT72VD, FT72VS, FT36EDT, FT36EST, FT36VDT, FT36VST, FT50EDT, FT50EST, FT50VDT, FT50VST, FT72EDT, FT72EST, FT72VDT, FT72VST, TW1ERECO, TW1ELECO, TW1SRECO, TW1SLECO, WT730ER, WT730EL, WT730SR, WT730SL...(Other models you can see in the webshop)		

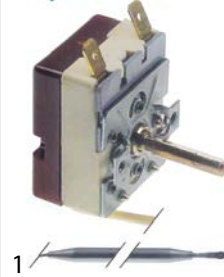

GEV No.	375567	Ref. No.	0K0659
description	thermostat t.max. 110°C temperature range 30-110°C 1-pole 1NO 16A probe ø 6mm probe L 115mm capillary pipe 1130mm capillary pipe isolated 800mm gland nut shaft ø 6x4.6mm shaft L 23mm shaft position upper rotation 270°		
For models:	9006-3		

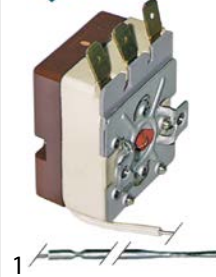

GEV No.	375067	Ref. No.	0K0673
description	thermostat t.max. 125°C temperature range fixed 125°C 1-pole probe ø 3.03mm probe L 147mm capillary pipe 830mm capillary pipe isolatedmm gland nut probe material SS		

GEV No.	375492	Ref. No.	003123 058163 6010005
description	thermostat t.max. 190°C temperature range 94-190°C 1-pole 1NO 16A probe ø 6mm probe L 94mm capillary pipe 1090mm capillary pipe isolated 960mm gland nut M10x1 shaft ø 6x4.6mm shaft L 23mm shaft position upper rotation 310° probe material SS		
For models:	QFE300, QFE302, QFE600, QFE602		



GEV No.	375835	Ref. No.	0H6241 215671
description	thermostat t.max. 280°C temperature range 50-280°C 1-pole 1CO 16A probe ø 3.1mm probe L 160mm capillary pipe 1430mm capillary pipe isolated 800mm gland nut shaft ø 6x4.6mm shaft L 23mm shaft position upper rotation 270°		



GEV No.	375041	Ref. No.	0H6439 0K0493 232908 60050403
description	thermostat t.max. 250°C temperature range 50-250°C 1-pole 1CO 16A probe ø 3.1mm probe L 160mm capillary pipe 1430mm capillary pipe isolated 800mm gland nut M9x1 shaft L 23mm shaft position upper rotation 270°		



GEV No.	375505	Ref. No.	0H2049 0H6124 0K0644 0K6907 0KA528 0KS225 375011 4678012008 PE3000700
description	thermostat t.max. 320°C temperature range 50-320°C 1-pole 1NO 16A probe ø 3mm probe L 160mm capillary pipe 870mm capillary pipe isolated 800mm gland nut shaft ø 6x4.6mm shaft L 23mm shaft position upper rotation 270°		



GEV No.	375069	Ref. No.	0K0634 0K0646 0K0674 375069
description	thermostat t.max. 255°C temperature range 50-255°C 1-pole 1CO 16A probe ø 3.03mm probe L 160mm capillary pipe 1430mm capillary pipe isolated 800mm gland nut shaft L 23mm probe material SS		



GEV No.	375810	Ref. No.	0H9843 0K2995 0K5039 740401
description	thermostat t.max. 80°C temperature range fixed 80°C 1-pole 1NC 16A probe ø 7.5mm probe L 30.5mm capillary pipe 810mm capillary pipe isolated 800mm gland nut shaft L 23mm		
For models:	VARIOTEAM/S-33.3/F, STEAM-O-MAT		



GEV No.	390664	Ref. No.	049255 0L2122 9755132688
description	thermostat t.max. 83°C temperature range 29-83°C 1-pole 1CO 16A probe ø 6mm probe L 115mm capillary pipe 870mm capillary pipe isolated gland nut shaft Lmm shaft position° shaft position rotation 260°		
For models:	LS32, LS32/4.5, LS32UK/RP, LS32F, LV32F, C55, LV32/60, WT302, WT302/4.5, WT302UK/RP, WT302F, WT302/60, LS33, LS33/4.5, LS33UK/RP, LS33F, LV33F, C55A, LS33/60, WT303, WT303/4.5, WT303UK/RP, WT303F, WT303/60, LB1, LB1WS, LB1WSDP, WT1WSDP, WT2TOP60, WT2DPDI, WT2WSDPDI, LB1TOP, WT2TOPDI, LB2WS, LB2, LB2WSDP, WT2WSDP, WT2WSDPD, WT2WS, WT1, WT1WS, WT1TOP, WT2TOP, WT1/3DP, WT2/3DP, WT2DPAUS, WT2, LB2DPDI, LB2WSDPDI, LB2WSDPD...(Other models you can see in the webshop)		

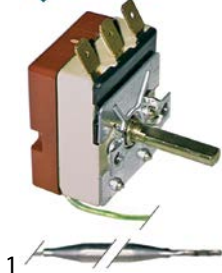

GEV No.	375006	Ref. No.	069422 0A6040 236022 236043
description	thermostat t.max. 85°C temperature range 30-85°C 1-pole 1CO 16A probe ø 6mm probe L 92mm capillary pipe 3150mm capillary pipe isolated 300mm gland nut shaft L 23mm shaft position upper rotation 270° probe material SS		
For models:	LTB11, LTB12, LTB22, LTB11UK, LTB12UK, LTB22UK, LTB11, LTB22, 910-00-021, 910-00-023, 910-00-031, 910-00-033, 911-00-022, 911-00-024, 911-00-032, 911-00-034, CRYSTAL 11, CRYSTAL 22		



GEV No.	390663	Ref. No.	046524 048266 049243 068012 068582 OKF095 0L1633
description	thermostat t.max. 91°C temperature range 29-91°C 1-pole 1CO 15A probe ø 6mm probe L 113mm capillary pipe 1470mm capillary pipe isolated gland nut shaft Lmm rotation 260°		
For models:	LS500F, LS501F, LS540F, LS540DK, LS541F, LS720F, LSE720DK, LSE720PH, LS860F, LS860DK, LS860PH, LS1080F, LS1080UK, LS1080PH, LSE721F, LS861F, LS540, LS1080M, LS1080, LS1080D, LS1080UK, LS1080/63, LS500F, LS500UK, LS501, LS501UK, LS540D, LS540/63, LSE721, LS720, LSE720UK, LS721UK, LSE720D, LS541, LS860, LS860, LS860D, LS860UK, LS861UK, LS860/63, LS861, LS61, LS61/60, LS62, LS62D, LS62/UKRP, LS62F, LV62, LS62/60, LS62/1P...(Other models you can see in the webshop)		

55.17_ series

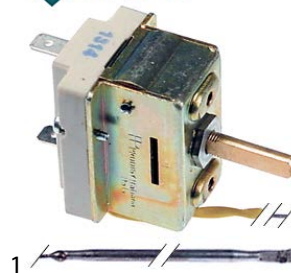



GEV No.	375665	Ref. No.	005207 3581901703 3581913146 3890776036
description	thermostat t.max. 282°C temperature range 96-282°C 1-pole 1NO 16A probe ø 3.03mm probe L 196mm capillary pipe 1240mm capillary pipe isolated 350mm gland nut shaft ø 6x4.6mm shaft L 22mm shaft position left rotation 270°		
For models:	FCF/E4, FCF/E4-3KW, JCF/E4, JCF/E4, ECF/E4, ECF/E4-3KW, ACF/E4, ACF/E4-3KW, NCF/E4, ZCF/E4, ZCF/E4		



			
			
GEV No.	390687	Ref. No.	070350
description	thermostat t.max. 85°C temperature range fixed 85°C 1-pole 1CO 16A probe ø 6mm probe L 115mm capillary pipe 1500mm capillary pipe isolated 1420mm gland nut shaft Lmm shaft position° shaft position		
For models:	LB035C, LB035R, LB035Q, LB040R, LB040Q, LB040AUS, G350C, LBICEQ010, LBIOET010, LBIOET014, LBIOEQ010, G350, G350DP, LBIOEQ014, G400, G400DP, LCFBE003		

			
			
GEV No.	375147	Ref. No.	0H6138 213073
description	thermostat t.max. 255°C temperature range 30-255°C 2-pole 2CO 16A probe ø 3.03mm probe L 147mm capillary pipe 1440mm capillary pipe isolated 1250mm gland nut shaft ø ø6x4.6mm shaft L 23mm shaft position right rotation 270°		
For models:	5611-3-6		

55.18_series			
			
			
GEV No.	375950	Ref. No.	0E3691 0KB677
description	thermostat t.max. 238°C temperature range 50-200°C 1-pole probe ø 3mm probe L 158mm capillary pipe 890mm capillary pipe isolated 760mm shaft ø 6x4.6mm shaft L 23mm shaft position upper rotation 270°		
For models:	FCV31E3, 7CO30, CCO30G, ECO312CF, OTS100		

55.34_series			
			
			
GEV No.	375671	Ref. No.	032858 0A2237 0A3055 0H6228
description	thermostat t.max. 110°C temperature range 30-110°C 3-pole 3NO 16A probe ø 6mm probe L 131mm capillary pipe 1200mm capillary pipe isolated 600mm gland nut shaft ø ø6x4.6mm shaft L 23mm shaft position upper rotation 318°		
For models:	LPS/75, LPS/75, DI-HTGW1, DI-HTGW2, DI-HTGW3, DI-HTGW4, DB/A31, DB/A21, DB/A33, DB/A22, CCB10, CCB20, 710-00-115, 710-00-115, 711-00-115, 711-00-115, 710-00-122, 710-00-122, 711-00-122, 711-00-122, 0WC142, 655-00-106, 655-00-107, 655-00-110, 656-00-106		

55.22_series			
			
			
GEV No.	375080	Ref. No.	0H6133 0H6242 212795 215672 60050392 723408 9755342045
description	thermostat t.max. 102°C temperature range 30-90 / 50-102°C 2-pole 2CO 16A probe ø 3.1mm probe L 334mm capillary pipe 1440mm capillary pipe isolated 1400mm gland nut shaft ø ø6x4.6mm shaft L 23mm shaft position upper rotation 270° probe thread 1/4"		
For models:	5611-3-6, 5611-3-8, 5612-3-6, 5612-3-8, 5614-3-6, 5614-3-8		



GEV No.	375143	Ref. No.	004911 01T01 0G0500 0G0953 0G4943 0H6220 0K0636 0K1540 0K3513 0K3852 0K3926 0K8428 0K9764 0K1132 0KQ973 0M0720 2061 214948 375143 VO2061
description	thermostat t.max. 110°C temperature range 32-110°C 3-pole 3NO 16A probe ø 6mm probe L 138mm capillary pipe 1480mm capillary pipe isolated 1100mm gland nut M9x1 shaft ø 6x4.6mm shaft L 23mm shaft position upper rotation 270°		
For models:	SME350, SME700, SME350, SME700, BM35E6U, 7720-3/90.WB.GN1/1., 7520-3/85.WB.GN1/1., 7721-3/85.WB.GN2/1, 7520-3/90.WB.GN1/1., 7720-3/85.WB.GN1/1., 7521-3/85., 7521-3/90.WB.GN2/1., 7721-3/90.WB.GN2/1., 7521-3/85.WB.GN2/1.W, 7520-3, 7521-3, 7720-3, 7721-3, 9006-9, 9020-3, 9220-3-0, 9220-3-8		



GEV No.	390055	Ref. No.	026860
description	thermostat t.max. 160°C temperature range 66-160°C 3-pole 3NO 16A probe ø 8mm probe L 115mm capillary pipe 800mm capillary pipe isolated 800mm gland nut shaft ø 6x4.6mm shaft L 23mm shaft position upper° rotation 270° with disc probe thread M14x1 disc ø 12.5mm		



GEV No.	390058	Ref. No.	0A2003 0A2599
description	thermostat t.max. 175°C temperature range 100-175°C 3-pole 3NO 16A probe ø 6mm probe L 131mm capillary pipe 2000mm capillary pipe isolated 600mm gland nut shaft ø 6x4.6mm shaft L 23mm shaft position upper° rotation 318°		



GEV No.	375957	Ref. No.	0H6233 0K9780 0KC027 0KC472 0KC473
description	thermostat t.max. 180°C temperature range 100-180°C 3-pole 3NO 16A probe ø 6mm probe L 133mm capillary pipe 910mm capillary pipe isolated 770mm gland nut M9x1 shaft ø 6x4.6mm shaft L 23mm shaft position upper rotation 270°		



GEV No.	375699	Ref. No.	0K3854 0K9907 0KA538 0KA541
description	thermostat t.max. 180°C temperature range 90-180°C 3-pole 3CO 16A probe ø 6mm probe L 133mm capillary pipe 880mm capillary pipe isolated 800mm gland nut shaft ø 6x4.6mm shaft L 23mm shaft position upper rotation 270°		



GEV No.	375022	Ref. No.	0H6127 18005611 212698 30000060 375022
description	thermostat t.max. 180°C temperature range 95-180°C 3-pole 3NO 16A probe ø 6mm probe L 133mm capillary pipe 1780mm capillary pipe isolated 1400mm gland nut M9x1 shaft ø 6x4.6mm shaft L 23mm rotation 270°		
For models:	SLE159-170, SLE159-180, 7535-3/85., 7535-3/90.FRI.(N), 7735-3/85.FRI.(N), 7735-3/90.FRI.(N), 7535-3, 7536-3, 7537-3, 7538-3, 7735-3, 7736-3, 7737-3, 7738-3, 9050-3, 9052-3, 9055-3, 9250-3-0, 9250-3-8, 9252-3-0, 9252-3-8, 9255-3-0, 9255-3-8		



GEV No.	375576	Ref. No.	005940 OKG557
description	thermostat t.max. 185°C temperature range 60-185°C 3-pole 3NO 16A probe ø 4mm probe L 229mm capillary pipe 1200mm capillary pipe isolated 1150mm gland nut shaft ø 6x4.6mm shaft L 23mm shaft position upper rotation 270°		
For models:	RFR/E1S14, RFR/E2D14, RF/E1S07, RF/E2D07, RFR/E1S07, RFR/E2D07, XFR/E1S14, XFR/E2D14, XF/E1S07, XF/E2D07, XFR/E1S07, XFR/E2D07, JFR/E1S14, JFR/E2D14, JF/E1S07, JF/E2D07, JFR/E1S07, JFR/E2D07, MFR/E1S14, MFR/E2D14, MF/E1S07, MF/E2D07, MFR/E1S07, MFR/E2D07, PF/E1S07, PF/E2D07, PFR/E1S07, PFR/E2D07, PF/E1S07E5, PFRE2D07E5, OF/E1S07, OFR/E1S07, OFR/E2D07, TF/E1S07, TF/E2D07, TFR/E1S07, TFR/E2D07, TF/E1S07E5, TFRE2D07E5		



GEV No.	390056	Ref. No.	00281 004925 OK3514
description	thermostat t.max. 185°C temperature range 100-185°C 3-pole 3NO 16A probe ø 4mm probe L 231mm capillary pipe 2600mm capillary pipe isolated 1000mm gland nut shaft ø 6x4.6mm shaft L 23mm shaft position upper* rotation 270°		
For models:	SFRE700, SFRE350, SFRE700		



GEV No.	376400	Ref. No.	OG2760
description	thermostat t.max. 185°C temperature range 60-185°C 3-pole 3NO probe ø 4mm probe L 235mm capillary pipe 1180mm capillary pipe isolated 1060mm gland nut M9x1 shaft ø 6x4.6mm shaft L 24mm shaft position upper rotation 270°		
For models:	AFAUOFOOOC, AFAUOAOOOO, AFAROFOOOC, AFAROAOOOO		



GEV No.	375839	Ref. No.	004548 051361 054931 057345
description	thermostat t.max. 185°C temperature range 60-185°C 3-pole 3NC 16A probe ø 4mm probe L 229mm capillary pipe 2600mm capillary pipe isolated 1000mm gland nut shaft ø 6x4.6mm shaft L 23mm shaft position upper* rotation 270°		
For models:	MFR/E355, MFR/E355UK, MFR/E355D, MFR/E705, MFR/E705UK, MFR/E705D, RF/E1S08, RF/E2D08, RFR/E1S08, RFR/E2D08, XF/E1S08, XF/E2D08, XFR/E1S08, XFR/E2D08, JF/E1S08, JF/E2D08, JFR/E1S08, JFR/E2D08, MF/E1S08, MF/E2D08, MFR/E1S08, MFR/E2D08, RFRE302, RFR/E302UK, RFRE305, RFR/E305, RFR/E701, RFR/E701, RFRE312, RFR/E312, RFRE315, RFR/E315, RFR/E711, RFR/E711U, HFR/G420, HFR/G840, RFR/E305, RFR/E302, RFR/E701, RFR/E315, RFR/E711, RFR/E312		



GEV No.	375766	Ref. No.	002587 OKI250 18015469 320104
description	thermostat t.max. 190°C temperature range 120-190°C 3-pole 1CO/2NO 16A probe ø 6mm probe L 133mm capillary pipe 880mm capillary pipe isolated 350mm gland nut shaft ø 6x4.6mm shaft L 23mm shaft position upper rotation 270°		



GEV No.	375043	Ref. No.	0H6221 OK1541 214840
description	thermostat t.max. 200°C temperature range 65-200°C 3-pole 3NO 16A probe ø 6mm probe L 77mm capillary pipe 880mm capillary pipe isolated 800mm gland nut M9x1 shaft ø 6x4.6mm shaft L 23mm shaft position upper rotation 270°		



GEV No.	375763	Ref. No.	OK4097 OKL450 OKW841 OM2160 631111 63115A 725629
description	thermostat t.max. 206°C temperature range 120-206°C 3-pole 1CO/2NO 16A probe ø 4mm probe L 157mm capillary pipe 1780mm capillary pipe isolated 1500mm gland nut shaft ø 6x4.6mm shaft L 23mm shaft position upper rotation 270°		
For models:	HLE159-159W.3, HLE159-160W.3, SLE259-100.4.R, SLE159-171.4, SLE259-100.4.L, LE159-160.3, LE159-159.3, HLE159-160.3, HLE159-159.3, CE158-159.3, HCE158-159.3		



GEV No.	375675	Ref. No.	OC1000
description	thermostat t.max. 210°C temperature range fixed 210°C 2-pole 2NC 0.5A probe ø 6mm probe L 74mm capillary pipe 1250mm capillary pipe isolated 1100mm gland nut		
For models:	KPD/G10, KPD/G15, KPD/G15A, QPD/G10, QPD/G15, WPD/G10, WPD/G15, WPD/G15A		



GEV No.	375559	Ref. No.	002402 OC7528
description	thermostat t.max. 230°C temperature range 95-230°C 3-pole 3NO 16A probe ø 4mm probe L 128mm capillary pipe 1250mm capillary pipe isolated 1000mm gland nut shaft ø 6x4.6mm shaft L 23mm shaft position upper rotation 270°		
For models:	PR/E1CL, PR/E2CL, PRV/E1FL, PRV/E1FR, PRV/E1CL, PRV/E2FL, PRV/E2FM, PRV/E2CL, PR/E2CM, PR/E1FLO, PR/E2CMES, PGV/E1, PGV/E2, OR/E1CL, OR/E2CL, OR/E1FLO, TR/E2FL, TR/E2FM, TRV/E1CL, TRV/E2FL, TRV/E2CL, TR/E2CM, TR/E1FLO, TR/E2FLES, TR/E2CRE5, TR/E2FME5, TGV/E1, TGV/E2, KGR/E1, KGR/E2, HG/E400, HG/E800, QGR/E1, QGR/E2, ZG/E400, ZG/E800, WGR/E1, WGR/E2, AG/E400, AG/E800		



GEV No.	390074	Ref. No.	051362
description	thermostat t.max. 260°C temperature range 60-240/80-260°C 3-pole 3NO 10A probe ø 4mm probe L 130mm capillary pipe 1300mm capillary pipe isolatedmm gland nut shaft ø 6x4.6mm		
For models:	FCVE10, FCVE20, HBR/E801, HBR/E801		



GEV No.	375587	Ref. No.	059235 375587 727992
description	thermostat t.max. 285°C temperature range 100-285°C 3-pole 3NO 16A probe ø 3mm probe L 219mm capillary pipe 1150mm capillary pipe isolated 1130mm gland nut shaft ø 6x4.6mm shaft L 23mm shaft position upper rotation 270°		
For models:	BCF/E2, BR/E1FL, BR/E1FR, BR/E2FL, BR/E2FR, PCF/M2, PCF/M3, PCV/E2, PCV/E3, PCF/E2, PC/E2Q, PCF/E2Q, PCV/E2Q, PI/E1, PI/E2, PIF/E2, PIV/E2, PC/E2QE5, PCF/E2QE5, PI/E1E5, PI/E2E5, PIF/E2E5, PCF/E2E5, PCF/M2E5, PCF/M2A, PCF/M3A, OCF/M2, OCF/E2, OC/E2Q, OCF/E2Q, OI/E1, OI/E2, OIF/E2, TCF/M2, TCF/M3, TCF/E2, TCV/E2Q, TIF/E2, TCF/E2QE5, TI/E2E5, TCF/E2E5, TCF/M2E5, TCF/M2A, TCF/M3A, TCF/E2M0, TCF/E2QM0, TCF/E3QM0, TCF/E2M4, TCF/E2QM4, TCF/E3QM4...(Other models you can see in the webshop)		





GEV No.	375183	Ref. No.	00285 004917 0K3517
description	thermostat t.max. 298°C temperature range 50-298°C 3-pole 3NO 16A probe ø 3mm probe L 219mm capillary pipe 900mm capillary pipe isolatedmm gland nut shaft ø 6x4.6mm shaft L 23mm shaft position upper rotation 318°		
For models:	SRE350, SRE360, SRE370, SRE700, SRE710, SRE720, SRE350, SRE360, SRE370, SRE700, SRE710, SRE720		



GEV No.	375192	Ref. No.	OK5018
description	thermostat t.max. 300°C temperature range 50-300°C 3-pole 3NO 16A probe ø 3mm probe L 219mm capillary pipe 900mm capillary pipe isolatedmm gland nut shaft ø 6x4.6mm shaft L 23mm shaft position upper rotation 270°		



GEV No.	375560	Ref. No.	004363
description	thermostat t.max. 300°C temperature range 115-300°C 3-pole 3NO 10A probe ø 3mm probe L 144mm capillary pipe 1150mm capillary pipe isolated 1130mm gland nut shaft ø 6x4.6mm shaft L 23mm shaft position upper rotation 270°		
For models:	RR/E1FL, RR/E1FR, RR/E1CL, RR/E2FL, RR/E2FM, RR/E2CL, RRV/E1FL, RRV/E1FR, RRV/E1CL, RRV/E2FL, RRV/E2FM, RRV/E2CL, RR/E2CM, XR/E1FL, XR/E1FR, XR/E1CL, XR/E2FL, XR/E2FM, XR/E2CL, XRV/E1FL, XRV/E1FR, XRV/E1CL, XRV/E2FL, XRV/E2FM, XRV/E2CL, JR/E1FL, JR/E1FR, JR/E1CL, JR/E2FL, JR/E2FM, JR/E2CL, JRV/E1FL, JRV/E1FR, JRV/E1CL, JRV/E2FL, JRV/E2FM, JRV/E2CL, MR/E1FL, MR/E1FR, MR/E1CL, MR/E2FL, MR/E2FM, MR/E2CL, MRV/E1FL, MRV/E1FR, MRV/E1CL, MRV/E2FL, MRV/E2FM, MRV/E2CL, MR/E2CM...(Other models you can see in the webshop)		



GEV No.	375038	Ref. No.	OC1413 OG0955 OH6217 OK2827 OK3758 OK7279 OK9355 OK9763 OKC023 OKG661 OKI522 OKK117 OM0722 11151588 18015446 180706 203494 232030 6203010010 ALI180706 CODE:180706
description	thermostat t.max. 300°C temperature range 50-300°C 3-pole 3NO 16A probe ø 6mm probe L 79mm capillary pipe 1740mm capillary pipe isolated 800mm gland nut shaft ø 6x4.6mm shaft L 23mm shaft position upper rotation 270°		
For models:	APABPETOOC, APABPGTOOC, APACPITOOC, APACPGTOOC, APABPI-OOOC, APABPITOOC, APACPIOOOC, APACPITOOC, APABPGOOOC, APACPFOOOC, 7744-3/85.KB.(N), 7542-3/85., 7544-3/85.KB.(N), 7542-3/90.KB.(N), 7544-3/90.KB.(N), 7742-3/90.KB.(N), 7742-3/85.KB.(N), 7744-3/90.KB.(N), 7746-3/90.KB.(N), 7748-3/90.KB.(N), 7747-3/90.KB.(N), 7541-3/85.KB.(N), 7545-3/85.KB.(N), 7546-3/85.KB.(N), 7547-3/85.KB.(N), 7548-3/85.KB.(N), 7545-3/90.KB.(N), 7546-3/90., 7547-3/90.KB.(N), 7548-3/90.KB.(N), 7745-3/90.KB.(N), 7745-3/85.KB.(N), 7746-3/85.KB.(N), 7747-3/85.KB.(N), 7748-3/85.KB.(N), 7542-3/85.KB.DWD, 7544-3/85.KB.220V3, 7545-3/85.KB.DWD, 7742-3/85.KB.DWD.ETR, ZFT/E1, ZFT/E1E5, ZFT/E1M4, ZFT/E1M0, ZFT/E1L, ZFT/E1LE5, RFT/E1, RFT/E1E5, RFT/E1M4, RFT/E1M0, ZFT/E2...(Other models you can see in the webshop)		
accessories for	375038		
		GEV No.	110123
		Ref. No.	—
	knob thermostat t.max. 300°C ø 50mm shaft ø 6x4.6mm shaft flat upper black temperature range 50-300°C rotation 270°		

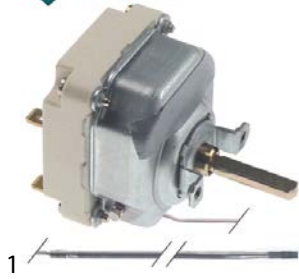

GEV No.	375569	Ref. No.	0H6218 214831
description	thermostat t.max. 300°C temperature range 60-300°C 3-pole 3NO 16A probe ø 3.1mm probe L 263mm capillary pipe 1180mm capillary pipe isolated 800mm gland nut shaft ø 6x4.6mm shaft L 23mm shaft position upper rotation 270°		
For models:	7508-3/85., 7502-3/85., 7500-3/85.HE.2PL.(N), 7504-3/85.HE.6PL.BO, 7505-3/85, 7512-3/85.KF.BO.(N), 7502-3/90.HE.4PL.BO., 7504-3/90.HE.6PL.BO., 7505-3/90.HE.6PL.BO., 7508-3/90.HE.CER.BO., 7512-3/90.KF.BO.(N), 7700-3/85, 7700-3/90.HE.2PL.(N), 7502-3/85.HE.4PL.BO., 7508-3/85.HE.CER.BO., 7505-3/85.HE.6PL.BO., 7508-3/85.HE.CER.BO., 7506-3/85.HE.CER.2KZ, 7508-3/85.HE.CER.BO., 7506-3/85.HE.CER.2KZ, 7510-3/85.HE.CER.6KZ, 7504-3/90.HE.6PL.BO., 7502-3, 7502-9, 7504-3, 7505-3, 7508-3, 7510-3/90.HE.CER.6KZ, 7512-3, 7512-9, 9002-3, 9004-2, 9004-3, 9006-3, 9012-3, 9015-3, 9598-3-0, 9598-3-8		

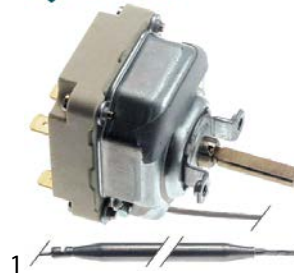

GEV No.	375420	Ref. No.	0H6216
description	thermostat t.max. 320°C temperature range 110-320°C 3-pole 3NO 16A probe ø 6mm probe L 96mm capillary pipe 1780mm capillary pipe isolated 1600mm gland nut shaft ø 6x4.6mm shaft L 23mm shaft position upper rotation 270°		
For models:	7731-3/85.GRPL.VCHR., 7531-3/85., 7531-3/90.GRPL.(N), 7530-3/85.GRIPL.(N), 7532-3/85.GRPL.GL-GR, 7530-3/90.GRIPL.(N), 7532-3/90.GRPL.GL-GR, 7730-3/85.GRIPL.(N), 7731-3/85.GRPL.(N), 7732-3/85.GRPL.GL-GR, 7730-3/90.GRIPL.(N), 7731-3/90.GRPL.(N), 7732-3/90.GRPL.GL-GR, 7531-3/85.GRPL.VCHR, 7532-3/85.GRPL.GL-GR, 7530-3, 7531-3, 7730-3, 7731-3, 9030-3, 9031-3, 9032-3, 9230-3-0, 9230-3-8, 9231-3-0, 9231-3-8, 9232-3-0, 9232-3-8		



GEV No.	375453	Ref. No.	052916 0K2906
description	thermostat t.max. 308°C temperature range 100-300°C 3-pole 3NO 16A probe ø 6mm probe L 75mm capillary pipe 1150mm capillary pipe isolatedmm gland nut shaft ø 6x4.6mm shaft L 23mm rotation 270° probe material SS		
For models:	MR/E350D, MR/E350UK, MR/E360, MR/E700D, MR/E700UK, MR/E710, MR/E720, MR/E715, MR/E725, MR/E350, MR/E700, MR/E720D, RR/E350D, RR/E350UK, 7FTEF3R, RR/E360UK, RR/E700D, RR/E700UK, RR/E710, RR/E710UK, 7FTEC7L, 7FTEF3L, 7FTEF7L, 7FTEC7M, XR/E350D, XR/E350UK, T36EFT, XR/E700D, XR/E700UK, T71EFT, T79EFT, T35EFT, T70EFT, CR/E720, RR/E300, RRE702, RR/E300UK, RR/E311, RR/E700, RR/E700UK, RR/E711, RRV/E300, RRV/E300, RRV/E311, RRV/E700, RRV/E700, RRV/E711, HRS/E401, HRS/E401UK, HRS/E411...(Other models you can see in the webshop)		



GEV No.	375412	Ref. No.	0A2206 0K2915
description	thermostat t.max. 320°C temperature range 50-320°C 3-pole 3NO 16A probe ø 3.1mm probe L 226mm capillary pipe 1480mm capillary pipe isolated 1400mm gland nut shaft ø 6x4.6mm shaft L 23mm shaft position upper rotation 318°		
For models:	MG/E350D, MG/E350UK, MG/E700D, MG/E700UK, MG/E350, MG/E700, RG/E1, RG/E2, RGV/E1, RGV/E2, XG/E1, XG/E2, XGV/E1, XGV/E2, JG/E1, JG/E2, MG/E1, MG/E2, MGV/E1, MGV/E2, RG/E350D, RG/E350UK, RG/E700D, RG/E700UK, 7GLE03T, 7GLE07T, XG/E350D, XG/E350UK, XG/E700D, XG/E700UK, T35ECC, T70ECC, PG/E1, PG/E2, PG/E1E5, PG/E2E5, TG/E1, TG/E2, TG/E1E5, TG/E2E5		

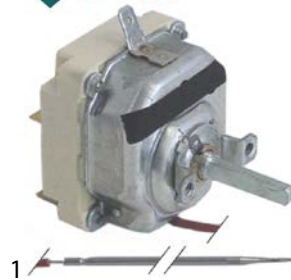

GEV No.	375621	Ref. No.	0K8421 537000900
description	thermostat t.max. 320°C temperature range 50-320°C 3-pole 3NO 16A probe ø 3mm probe L 219mm capillary pipe 1200mm capillary pipe isolated 1200mm gland nut shaft ø 6x4.6mm shaft L 23mm shaft position upper rotation 318°		



E-G-O



GEV No.	375424	Ref. No.	052099
description	thermostat t.max. 320°C temperature range 60-320°C 3-pole 3NO 16A probe ø 4mm probe L 128mm capillary pipe 1800mm capillary pipe isolated 1300mm gland nut shaft ø 6x4.6mm shaft L 23mm shaft position upper rotation 270°		
For models:	MCF/GE705, MCF/GE1055, MCF/GE700, MCFGE1050, MCF/GE700D, MCFGE1050D, MCF/E700D, MCF/E700, MCF/E700UK, MCF/E1050D, MCF/E1050, MCF/GE1055UK, MIF/E700, MIF/E700D, MIF/E710, MIF/E710D, MCF/GE702, MCFGE1052, MCF/GE700, MCFGE1050, MF/E700, RCF/M2, RCF/M3, RCF/E2, RCF/E2MO, RCF/E2M4, RCVF/E3MO, RCVF/E3M4, RCF/E2E5, RIF/E2, MCF/E2Q, RCF/E2Q, XCF/M2, XCFM3, XCF/E2, XIF/E2, JCF/M2, JCFM3, JCF/E2, JIF/E2, MCF/M2, MCF/M3, MCF/E2, MCF/E2E5, MIF/E2, RCF/GE720, RCF/GE730, RCF/GE720, RCF/GE720, RCFE720...(Other models you can see in the webshop)		

E-G-O



GEV No.	390038	Ref. No.	045169 0C5345 0K2919 0K5114 0K1260 460985204 721196
description	thermostat t.max. 90°C temperature range 30-90°C 3-pole 3CO 16A probe ø 6mm probe L 215mm capillary pipe 900mm capillary pipe isolated gland nut shaft Lmm		
For models:	MCP/E700, MCP/G700, MCP/E700D, MCP/G701, MCP/G710, MCP/G711, RCP/E2S, MCP/E2S, 7CPE07P, 7CPG07P, RCP/G701, M70EPC, M70GPC, M70GPC, CCP/G700, CCP/E700, PCP/E2SHP, OCP/E2S, TCP/E2S, RCP/G700, RCPE700, HCP/G410D, HCP/G410, HCP/G810, HCP/E410, HCP/E810, HCPS/E410, ZCP/G410, ZCP/G810, ZCP/E410, ZCP/E810, ZCPS/E410, ACP/G400, ACP/G410, ACP/G800, ACP/G810, ACP/E400, ACP/E410, ACP/E800, ACP/E810, ACPS/G400, ACPS/E400, ACPS/E410, LS360F, LS360DK, LS365F, LS365, LS365PH, LS360, LS365... (Other models you can see in the webshop)		

E-G-O



GEV No.	375107	Ref. No.	293586
description	thermostat t.max. 350°C temperature range 60-350°C 3-pole 3NO 16A probe ø 4mm probe L 128mm capillary pipe 880mm capillary pipe isolated 800mm gland nut shaft L 23mm shaft position upper rotation 270°		

E-G-O



GEV No.	375210	Ref. No.	049191
description	thermostat t.max. 90°C temperature range 38-90°C 3-pole 3CO 16A probe ø 6mm probe L 215mm capillary pipe 900mm capillary pipe isolated 900mm gland nut shaft Lmm rotation 270°		
For models:	LB1, LB1WS, LB1WSDP, LB1/RBP, LB1/TOP, LB1/60, LB2DPSAUS, LB1G, LB1WSG, LB2WS, LB2, LB2WSDP, LB2/TOP, LB2/RBP, LB2WS60, LB2WSG, UC1, UC2WS, GW1, GW1WS, LV1WS, LV1WSDP, LV2WSDP, LV2WS, GW2WS, GW2, Z1, Z1/WS, Z1TOP, Z2, Z2TOP		

E-G-O



GEV No.	375565	Ref. No.	0C0270
description	thermostat t.max. 350°C temperature range fixed 350°C 3-pole 3NC 16A probe ø 3mm probe L 190mm capillary pipe 900mm capillary pipe isolated 900mm gland nut shaft Lmm		
For models:	KCF/M2, KC/E1, KC/E2, KCF/E2, KC/E1E5, KC/E2E5, KCF/E2E5, KCF/W2, KCF/M2G, KCF/M2E5G, KRF/E2R, KRF/E2RP, KBR/G2F, KBR/G2C, KBR/G3F, KBR/G3FH, KBR/G3C, KBR/G3CH, KBR/E2F, KBR/E2C, KBR/E3F, KBR/E3FH, KBR/E3C, KBR/E3CH, KBR/G2FH, KBR/G2CH, KBR/E2FH, KBR/E2CH, QCF/M2, QCF/E2, QCF/E2E5, QCF/E2M0, QCF/E2M4, QCF/W2, QRF/E2R, QRF/E2RP, QBR/G2F, QBR/G2C, QBR/G3F, QBR/G3FH, QBR/G3C, QBR/G3CH, QBR/E2F, QBR/E2C, QBR/E3F, QBR/E3FH, QBR/E3C, QBR/E3CH, QBR/G2FH, QBR/G2CH...(Other models you can see in the webshop)		



GEV No.	375411	Ref. No.	031284 031532 050237 050932 052000 0K2929 60050027
description	thermostat t.max. 93°C temperature range 30-93°C 3-pole 3NO 16A probe ø 6mm probe L 129mm capillary pipe 1480mm capillary pipe isolated 1100mm gland nut M10x1 shaft ø 6x4.6mm shaft L 23mm shaft position upper rotation 270°		
For models:	MM/E700, MM/E700UK, MM/E700D, RB/E2, RBV/E2, XB/E2, XBV/E2, JB/E2, JBV/E2, MB/E2, MBV/E2, 7BME07T, RM/E700UK, PB/E1, PB/E2, PBV/E2, PB/E2E5, OB/E2, TB/E1, TB/E2, TBV/E2, TB/E2E5, RM/E700, PRM/E700, RM/E700U, RMV/E700, PRMV/E700, RMV/E700, RMAE700, PRMA/E700, RMA/E700, KB/E2, HM/E800, QB/E2, ZM/E800, WB/E2, AM/E800, OM/E800, HMS/E800, HMA/E800, HMA/E800, HM/E800T, ZHMA/E800, RM/E700, RMV/E700, RMA/E700, DL07/C, DL14/C, DL14/CP, DL21/C...(Other models you can see in the webshop)		

55.10/19_ series



GEV No.	375254	Ref. No.	00031 006748 0K3496 TEC00031
description	safety thermostat 1-pole capillary pipe isolatedmm gland nut switch-off temp. 295°C probe		



GEV No.	391035	Ref. No.	0KT880
description	thermostat temperature range 50-300°C 3-pole 3NO 16A probe ø 4mm probe L 292mm capillary pipe 2300mm capillary pipe isolated 2260mm gland nut shaft ø 6x4.6mm shaft L 25.5mm shaft position upper rotation 270°		



GEV No.	375324	Ref. No.	006942 00770
description	safety thermostat capillary pipe 1200mm probe ø 4mm 1-pole probe L 116mm 16A capillary pipe isolated 1000mm gland nut switch-off temp. 360°C probe		
For models:	FTL35E6U, FTR35E6U, FTC35E6U, FTL70E6U, FTR70E6U, FTC70E6U		

safety thermostats

51._ series



GEV No.	375078	Ref. No.	0H6145 375.078
description	safety thermostat switch-off temp. 313°C 1-pole 0.5A probe ø 3.1mm probe L 160mm capillary pipe 830mm capillary pipe isolatedmm gland nut probe SS		

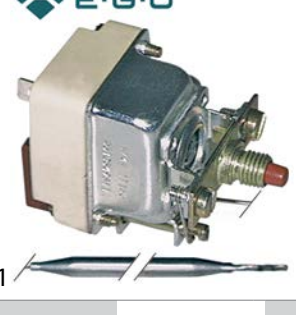

GEV No.	375250	Ref. No.	00427 004912 004931 0K3555 0K3610 7803	
description	safety thermostat capillary pipe 870mm probe ø 6mm 1-pole probe L 129mm 16A capillary pipe isolatedmm gland nut switch-off temp. 130°C probe SS			
For models:	SME350, SME700, SME350, SME700, SMG350, SMG700, BM35E6U			
spare parts for	375250			
	GEV No.	551083	Ref. No.	0A2187
	cap for safety thermostat thread M8x1			



GEV No.	375278	Ref. No.	056745 0K2963
description	safety thermostat switch-off temp. 140°C 1-pole 16A probe ø 6mm probe L 74mm capillary pipe 900mm capillary pipe isolated 900mm gland nut probe		
For models:	FCVG6-1, FCGV6-3, FCGV6-1UK, FCGV6-3UK, FCGV10-2, FCGV10-4, FCGV10-2, FCGV10-4D, FCGV10-2UK, FCGV10-4UK, FCGV10-2, FCGV10-4, FCGV20-2, FCGV20-4, FCGV20-2, FCGV20-4D, FCGV20-2UK, FCGV20-4UK, FCGV20-4, FCGV20-4D, FCGV/G6-1, ZOFV/G6-3, ZOFV/G102, ZOFV/G104, ZOFV/G202, ZOFV/G204, AFCV/G6-1, AFCV/G6-3, SCO/G6-3, AFCV/G101, AFCV/G103, SCO/G10-3, AFCV/G201, AFCV/G203, SCO/G20-3		



GEV No.	375191	Ref. No.	004108
description	safety thermostat switch-off temp. 500°C 1-pole 16A probe ø 3.9mm probe L 230mm capillary pipe 870mm capillary pipe isolated 660mm gland nut probe		
For models:	MAX18/35X, ZCMDG6, ZCMDG4, ZCMDG9, ZCBDG8, ZCBDG12, ZCBDG18, PDE830, PDE1230, PDE12L30, PDE1830, PDE835, PDE1235, PDE12L35, PDE1835		



GEV No.	390060	Ref. No.	00450 004951 0K3563
description	safety thermostat switch-off temp. 230°C 1-pole 0.5A probe SS probe ø 6mm probe L 77mm capillary pipe 870mm capillary pipe isolated-mm gland nut		
For models:	SFRG350, SFRG700, SFRG350, SFRG700		
accessories for	390060		
	GEV No.	551083	Ref. No. 0A2187
	cap for safety thermostat thread M8x1		

55.11_series



GEV No.	375767	Ref. No.	031482 0KW855 18002892 50000053
description	safety thermostat switch-off temp. 170°C 1-pole 16A probe ø 3.1mm probe L 160mm capillary pipe 650mm capillary pipe isolated 600mm gland nut probe		
For models:	TC1200TOP, TC1210TOP, TC1400TOP, TC1410TOP, TC1600TOP, TC1610TOP, TC1800TOP, TC1810TOP, TC2000TOP, TC2010TOP, TCD1200TOP, TCD1400TOP, TCD1600TOP, TCD1800TOP, TCD2000TOP, TC1000, TC1010, TC1200, TC1210, TC1400, TC1410, TC1600, TC1610, TC1800, TC1810, TC2000, TC2010, TCD1000, TCD1200, TCD1400, TCD1600, TCD1800, TCD2000, TC1200, TC1210, TC1400, TC1410, TC1600, TC1610, TC1800, TC1810, TC2000, TC2010, TCD1200, TCD1400, TCD1600, TCD1800, TCD2000, MTC1200P, MTC1400P.. (Other models you can see in the webshop)		



GEV No.	390062	Ref. No.	0A2011
description	safety thermostat switch-off temp. 235°C 1-pole 0.5A probe ø 6mm probe L 130mm capillary pipe 1800mm capillary pipe isolated 1500mm gland nut M9x1 probe SS		
For models:	MBR/G700UK, XBR/G701UK, BOFR/G500, ROFR/G1000		
accessories for	390062		
	GEV No.	551083	Ref. No. 0A2187
	cap for safety thermostat thread M8x1		



55.13_series





GEV No.	375854	Ref. No.	OE1108 OE5086 OK6886 OK6888 OK7886 OK8886 OKX072 467660804 467660809
description	safety thermostat switch-off temp. 126°C 1-pole 16A probe ø 6mm probe L 129mm capillary pipe 1730mm capillary pipe isolated 800mm gland nut M9x1 shaft ø 6x4.6mm starting temperature 120°C probe		
For models:	HCCS20W, HCCS20W, PW1EFL, PW1EFLF, PW1EFL/60HZ, PW2EFL, PW2EFLF, PW2EFL/60HZ, PW2VFL, WT830EFL, WT830EFLF/60HZ, WT850, WT850EFL, WT850EFL/60HZ, WT850SFL, FT36EDTS, FT36ESTS, FT36VDTs, FT36VSTs, FT36ED, FT36ES, FT36VD, FT36VS, FT50ED, FT50ES, FT50VD, FT50VS, FT72ED, FT72ES, FT72VD, FT72VS, FT36EDT, FT36EST, FT36VDT, FT36VST, FT50EDT, FT50EST, FT50VDT, FT50VST, FT72EDT, FT72EST, FT72VDT, FT72VST, WTF2ERC, WTF2ELC, WTF2SRC, WTF2SLC, WTF2HERC, WTF2HELC...(Other models you can see in the webshop)		

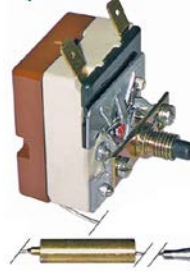

GEV No.	375157	Ref. No.	OK0649 180710 375157 718RVZ 9755135224
description	safety thermostat switch-off temp. 140°C 1-pole 16A probe ø 5mm probe L 96mm capillary pipe 1470mm capillary pipe isolatedmm gland nut probe		
For models:	7573-2, 7574-2, 7575-2, 7576-2, 7773-2, 7774-2, 7775-2, 7776-2		



GEV No.	375044	Ref. No.	OH6141 OKE595	
description	safety thermostat switch-off temp. 178°C 1-pole 16A probe ø 4mm probe L 91mm capillary pipe 1730mm capillary pipe isolated 1600mm gland nut probe with sealing sleeve screw connection M8x1 sealing sleeve 8.6x32mm			
For models:	7573-3/85.KES100.(N), 7574-3/85.KES150.(N), 7575-3/85.KES250.(N), 7576-3/85.KES300.(N), 7573-3/90.KES100.(N), 7574-3/90.KES150.(N), 7575-3/90.KES250.(N), 7576-3/90.KES300.(N), 7573-3, 7574-3, 7575-3, 7576-3, 7577-3, 7773-3, 7773-3/85.KES100, 7773-3/90.KES100, 7774-3, 7774-3/85.KES150, 7774-3/90.KES150, 7775-3, 7775-3/85.KES250, 7775-3/90.KES250, 7776-3, 7776-3/85.KES300, 7776-3/90.KES300, 9100-3, 9104-3, 9113-3, 9300-3-0, 9300-3-8, 9304-3-0, 9304-3-8, 9313-3-0, 9313-3-8			
accessories for	375044			
	GEV No.	102067	Ref. No.	055033 0992014
nut thread M8x1 H 3mm brass Qty 1 pcs type SEF 1				
	GEV No.	551083	Ref. No.	0A2187
cap for safety thermostat thread M8x1				



GEV No.	375106	Ref. No.	OH6142 OH9844 OK4131 OK5041 OKX292 18015468 700741 70074101
description	safety thermostat switch-off temp. 190°C 1-pole 16A probe ø 3.1mm probe L 178mm capillary pipe 350mm capillary pipe isolatedmm gland nut M9x1 probe SS		
For models:	7561-3.KES60.RW, 7562-3.KES80.RW, 7563-3.KES100.RW, 7564-3.KES150.RW, 7751-3/85.KES60, 7550-3/85.KES40.(N), 7551-3/85.KES60, 7552-3/85.KES80.(N), 7553-3/85.KES100.(N), 7554-3/85.KES150.(N), 7550-3/90.KES40.(N), 7551-3/90.KES60, 7552-3/90.KES80.(N), 7553-3/90.KES100.(N), 7554-3/90.KES150.(N), 7561-3/85.KES60.RW, 7562-3/85.KES80.RW, 7563-3/85.KES100.RW, 7564-3/85.KES150.RW, 7561-3/90.KES60.RW, 7562-3/90.KES80.RW, 7563-3/90.KES100.RW, 7564-3/90.KES150.RW, 7585-3/85.KK40.MOTK, 7586-3/85.KK60.MOTK, 7587-3/85.KK80.MOTK, 7588-3/85.KK100.MOTK, 7585-3/90.KK40.MOTK, 7586-3/90.KK60.MOTL, 7587-3/90.KK80.MOTK, 7588-3/90.KK100.MOTK, 7550-3, 7551-3, 7552-3, 7553-3, 7554-3, 7560-3, 7561-3, 7562-3, 7563-3, 7564-2, 7568-3, 7569-3/85.KK200.MOTK, 7569-3/90.KK200.MOTK, 7580-3, 7581-3, 7582-3, 7583-3, 7584-3, 7589-3/85.KK150.MOTK...(Other models you can see in the webshop)		



E·G·O



GEV No.	375156	Ref. No.	0K1877 375156
description	safety thermostat switch-off temp. 291°C 1-pole 16A probe ø 5mm probe L 90mm capillary pipe 870mm capillary pipe isolatedmm gland nut probe SS		

E·G·O



GEV No.	375076	Ref. No.	0H6243 215673 60050393
description	safety thermostat switch-off temp. 350°C 1-pole 1NO 16A probe ø 3.03mm probe L 141mm capillary pipe 830mm capillary pipe isolated 450mm gland nut probe SS		
For models:	5611-3-10, 5611-3-6, 5611-3-8, 5612-3-10, 5612-3-6, 5612-3-8, 5614-3-10, 5614-3-6, 5614-3-8		

55.14_series

E·G·O



GEV No.	375260	Ref. No.	003121 058162 60010006 6010006
description	safety thermostat switch-off temp. 240°C 1-pole 16A probe ø 6mm probe L 77mm capillary pipe 1280mm capillary pipe isolated 1050mm gland nut M10x1 probe SS		
For models:	QFE300, QFE302, QFE600, QFE602		

55.31_series

E·G·O



GEV No.	375524	Ref. No.	0G1838 0K7766
description	safety thermostat switch-off temp. 135°C 3-pole 20A probe ø 6mm probe L 173mm capillary pipe 1430mm capillary pipe isolated 800mm gland nut M9x1 probe SS		
For models:	AR6ES, EBE40L, EBE60L, EBE80L, EBE100L		

E·G·O



GEV No.	390165	Ref. No.	051644 0H2008 0K2938 446578212
description	safety thermostat switch-off temp. 140°C 3-pole 20A probe ø 6mm probe L 173mm capillary pipe 830mm capillary pipe isolated 800mm gland nut probe SS		
For models:	MPN/EI760, MPNEI760UK, MPN/EI760D, 7PIE06, RPN/EI760UK, RPN/EI760D, M70EIKE, XPN/EI760UK, XPN/EI760D, RPN/EI760, RPN/EI760, HM/E400, HM/E800, ZM/E400, ZM/E800, AM/E400, AM/E800, OM/E800, HCP/E800, HCP/E400, RPN/EI760, LS540F, LS541F, LSE720DK, LS540, LS540D, LS540/63, LS720, LS541, LS520D, LS520K, LS521D, LS521K, LS521, LS540, ALS540, LS720N, LS520ZD, LS521ZD, LS860, LS1080		

E·G·O



GEV No.	390045	Ref. No.	051637
description	safety thermostat switch-off temp. 160°C 3-pole 0.5A probe ø 6mm probe L 173mm capillary pipe 830mm capillary pipe isolated 800mm gland nut probe SS		
For models:	XFV/G700, XFV/E700, APN/GI816D, HCPA/G1219, HCPA/GI1219, HCPA/EI1219, HQN/G1917, HQN/G1917, HQN/GI1225, HQN/GI122, HPN/GI810, HPN/GI810, HPN/GI815, HPA/GI815, HPA/GI815, HPN/GI810, HPN/GI810, HPN/GI815, HPN/GI815, HQN/G1917, HQN/GI122		



GEV No.	375573	Ref. No.	059552
description	safety thermostat switch-off temp. 225°C 3-pole 20A probe ø 6mm probe L 157mm capillary pipe 940mm capillary pipe isolated 800mm gland nut probe SS		
For models:	HCP/E400, HCP/E410, HCP/E800, HCP/E810, HCPS/E400, HCPS/E410, ZCP/E400, ZCP/E410, ZCP/E800, ZCP/E810, ZCPS/E400, ZCPS/E410, ACP/E400, ACP/E410, ACP/E800, ACP/E810, ACPS/E400, ACPS/E410		



GEV No.	375521	Ref. No.	0H7487
description	safety thermostat switch-off temp. 240°C 3-pole 20A probe ø 6mm probe L 177mm capillary pipe 2380mm capillary pipe isolated 1100mm gland nut M9x1 probe SS		



GEV No.	375108	Ref. No.	052331 0K4322 727932
description	safety thermostat switch-off temp. 250°C 3-pole 1x20/2x0.5A probe ø 6mm probe L 157mm capillary pipe 1230mm capillary pipe isolated 800mm gland nut probe SS		
For models:	MFR/G350, MFR/G700, MFR/G350D, MFR/G700D, MFR/G350F, MFR/G700F, MFR/G350E, MFR/G700E, MFR/G740, MFR/G350, MFR/G351, MFR/G700, MFR/G701, RFR/G350, RFR/G700, RFR/G350D, RFR/G700D, RFR/G350F, RFR/G700F, RFR/G741, 7FRG03S, 7FRG07S, M35GFR, M70GFR, XFR/G350D, XFR/G700D, XFR/G350F, XFR/G700F, XFR/G351, CFR/G741, M35GFR, M70GFR, CFR/G351, CFR/G700, CFR/G351, CFR/G701, RFR/G301, RFR/G300, RFR/G301, RFR/G701, RFR/G701F, HFR/G410D, HFR/G810D, HFR/G410NL, HFR/G810NL, HFH/G400U, HFH/G401U, HBR/E800, HBR/E805, HBR/E810...(Other models you can see in the webshop)		



GEV No.	390087	Ref. No.	051369 0H1261
description	safety thermostat switch-off temp. 250°C 3-pole 20A probe ø 6mm probe L 239mm capillary pipe 2530mm capillary pipe isolated 1600/210/375mm gland nut probe SS		
For models:	MFR/G350NL, MFR/G700NL, MFR/E355, MFR/E355UK, MFR/E355D, MFR/E705, MFR/E705UK, MFR/E705D, MFR/E740, RFR/E356, RFR/E741, RFR/E701, XFR/G350NL, XFR/G700NL, CFR/E702, HFR/G420NL, HFR/G840, HFR/E420, HFR/E420UK, HFR/E840, HFR/E840, HFR/E421, ZHFRE420, HFR/E421, ZHFRE840		

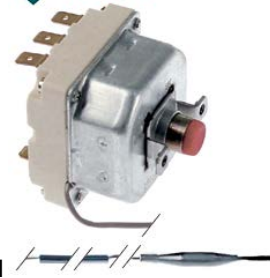

GEV No.	375641	Ref. No.	054932 0K2948
description	safety thermostat switch-off temp. 250°C 3-pole 20A probe ø 6mm probe L 239mm capillary pipe 2530mm capillary pipe isolated 1600/210mm gland nut probe SS		
For models:	MBR/E700UK, MFR/E350, MFR/E700, MFR/E370, MFR/E350UK, MFR/E700UK, MFR/E370UK, MFR/E370D, MFR/E350D, MFR/E700D, 7FRE03S, 7FRE07S, 7FRE23S, RFR/E350UK, RFR/E700UK, RFR/E370UK, RBR/E700UK, T35EFR, T70EFR, T36EFR, XFR/E350UK, XFR/E700UK, XFR/E370UK, XBR/E710, CBR/E700, CFR/E350, CFR/E700, RFR/E302, RFR/E302UK, RFR/E305, RFR/E305, RFR/E701, RFR/E701, RFR/E312, RFR/E312, RFR/E315, RFR/E315, RFR/E711, RFR/E711U, RFR/E305, RFR/E302, RFR/E701, RFR/E315, RFR/E711, RFR/E312		



GEV No.	375588	Ref. No.	053183 0KE986
description	safety thermostat switch-off temp. 285°C 3-pole 1x20/2x0.5A probe ø 6mm probe L 157mm capillary pipe 940mm capillary pipe isolated 940mm gland nut probe		
For models:	HPN/GD811, HPN/GD816, HPA/GD825, ZPN/GD811, ZPN/GD816, 2PDAG15, APN/GI810, APN/GI815, APN/GI816, APN/GD811, APN/GD816, APNS/GI816, OPN/GI815, HPN/G810, HPN/G815, HPA/G815, HPN/G810, HPN/G815, HPA/G815		



GEV No.	375047	Ref. No.	0H6136
description	safety thermostat switch-off temp. 320°C 3-pole 20A probe ø 6mm probe L 177mm capillary pipe 1430mm capillary pipe isolated 800mm gland nut M9x1 probe SS		



GEV No.	375571	Ref. No.	051454 0K2887 727998
description	safety thermostat switch-off temp. 350°C 3-pole 20A probe ø 6mm probe L 157mm capillary pipe 940mm capillary pipe isolated 890mm gland nut probe SS		
For models:	MCF/GE705, MCF/GE1055, MCF/GE700, MCFGE1050, MCF/GE700D, MCFGE1050D, MCF/E700D, MCF/E700, MCF/E700UK, MCF/E1050D, MCF/E1050, MCF/GE1055UK, MIF/E700, MIF/E700D, MIF/E710, MIF/E710D, MCF/GE702, MCFGE1052, MCF/GE700, MCFGE1050, MBR/E710D, MBR/E700, MBR/E700UK, MBR/E716, MBR/E706, RCF/E700D, RCF/GE700D, RCF/E1050D, RCFGE1050D, RCF/E700UK, 74CE07F, 76CE10F, RCF/GE700, RC/G702, RC/G1052, RCF/GE702, RCF/GE1052, 74FE07F, RCF/GE1051, 7BRE60XN, 7BRE60X, RBR/E700UK, RBR/E716, RBR/E706, XCF/GE700D, M70GCK/E, M70ECK/E, XCF/E1050, XCF/E700UK, XMIF/E710...(Other models you can see in the webshop)		



GEV No.	375377	Ref. No.	051643 0K2892
description	safety thermostat switch-off temp. 350°C 3-pole 3NC 1x20/2x0.5A probe ø 6mm probe L 157mm capillary pipe 1230mm capillary pipe isolated 1100mm gland nut probe		
For models:	MR/G721, MR/G1071, MR/G1070, MR/G720, MR/G725, MR/G1075, MR/G726, MR/G1076, RR/G720D, 7FTGC7L, 7FTGC1L, RR/G1070D, 7FTGC7M, RR/G1076, XR/G720D, XR/G1070D, T79GFT, T109GFT, HBR/G820, HBR/G825, ABR/G820, ABR/G825, HQN/G1225, HBR/G803, HBR/G804, HBR/G803, HBR/G804, HBR/G803, HBR/G1003, HBR/G1003, HBR/G1004, HBR/G803, HBR/G804, HBR/G1013, HBR/G803, HBR/G804, HBR/G1003, HBR/G1013, HQN/G1225, HBR/G1004		

55.32_ series



GEV No.	375394	Ref. No.	0K3967 375015
description	safety thermostat switch-off temp. 135°C 3-pole 1CO/2NC 20A probe ø 6mm probe L 73mm capillary pipe 1490mm capillary pipe isolated 1350mm gland nut M9x1 probe SS		



GEV No.	375209	Ref. No.	004862
description	safety thermostat switch-off temp. 140°C 3-pole 20A probe ø 6mm probe L 89mm capillary pipe 900mm capillary pipe isolated 900mm gland nut probe SS		
For models:	FDV40E, FDV40EL, FDV20E, FDV20EL, RPI/E240, RPI/E260, RPI/E260P, XPI/E240, XPI/E260, XPI/E260P, JPI/E240, JPI/E260, MPI/E240, MPI/E260, MPI/E260P, KPI/E10, KPI/E15, KPI/E15A, KPI/E06, KPI/G18, KPI/G25, KPI/E15H, KPI/E10H, HPN/EI815D, HPN/EI810, HPN/EI815, HPA/EI825, HPNS/EI815, HPNS/EI815D, QPI/E10, QPI/E15, QPI/E06, QPI/G18, QPI/G25, QPI/E15H, QPI/E10H, ZPN/EI815D, ZPN/EI810, ZPN/EI815, ZPNS/EI815, ZPNS/EI815D, WB/E1, WB/E2, WPI/E10, WPI/E15, WPI/E15A, WPI/E06, WPI/E15H, WPI/E10H, APN/EI810...(Other models you can see in the webshop)		



GEV No.	390920	Ref. No.	0C2983
description	safety thermostat switch-off temp. 140°C 3-pole 3CO 20A probe ø 6mm probe L 88mm capillary pipe 900mm capillary pipe isolated 770mm gland nut probe		
For models:	PPI/E260P, OPI/E260P, TPI/E260P, FCZ061EAA, FCZ101EAA, FCZ102EAA, FCZ061EAH, FCZ101EAH, FCZ061EAN, FCZ101EAN, FCZ201ETA, FCZ202ETA, FCZ201ETH, FCZ201ETN, FCZ061EBA, FCZ101EBA, FCZ102EBA, FCZ061EBH, FCZ101EBH, FCZ061EBN, FCZ101EBN, FCZ061EBC, FCZ101EBC, FCZ201EBC, FCZ201EBA2, FCZ202EBA2, FCZ201EBH2, FCZ201EBN2, FCZ201EBC2, FCZ061ECA, FCZ101ECA, FCZ102ECA, FCZ061ECH, FCZ101ECH, FCZ061ECN, FCZ101ECN, FCZ201ECA2, FCZ202ECA2, FCZ201ECH2, FCZ201ECN2, AOS061EAA1, AOS101EAA1, AOS102EAA1, AOS201EAA1, AOS202EAA1, AOS061EAH1, AOS101EAH1, AOS201EAH1, AOS061EAN1, AOS101EAN1...(Other models you can see in the webshop)		

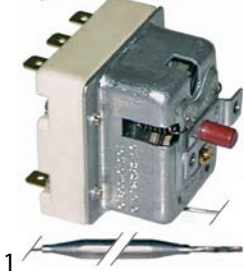

GEV No.	390167	Ref. No.	059079
description	safety thermostat switch-off temp. 140°C 3-pole capillary pipe isolatedmm gland nut		
For models:	FCVG10-P, FCGV10PUK, FCGV20-P, FCGV20PUK		

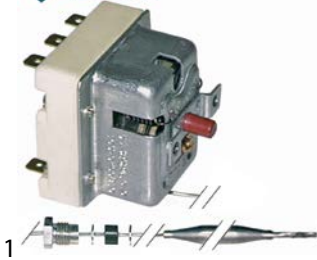

GEV No.	375150	Ref. No.	0H6219 OK3900 375150
description	safety thermostat switch-off temp. 145°C 3-pole 20A probe ø 3mm probe L 178mm capillary pipe 1790mm capillary pipe isolatedmm gland nut M9x1 probe		

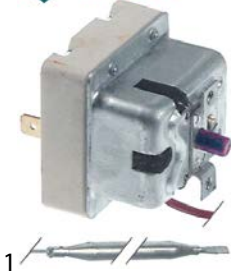

GEV No.	375622	Ref. No.	003530
description	safety thermostat switch-off temp. 147°C 1-pole 20A probe ø 6mm probe L 89mm capillary pipe 900mm capillary pipe isolated 800mm gland nut probe		
For models:	KPI/E25, HPN/EI855, HPN/EI1255, QPI/E25, ZPN/EI1255, WPI/E25, C150W, C300A, C300W, CB1565W, CB246W, CB416W, CB955W, DSS42W, C80W, CB1565A, C80A, CB246A, CB416A, C150A, CB955A, FRESHMAKER, ICEWATER45, ICEWATER45, DSS42A		



GEV No.	375170	Ref. No.	002711 60050329 60050366
description	safety thermostat switch-off temp. 150°C 1-pole 20A probe ø 6mm probe L 74mm capillary pipe 1700mm capillary pipe isolated 1100mm gland nut probe		
For models:	FDV40G, FDV40GZ, FDV40GA, FDV20G, FDV20GZ, FDV20GA, FCV/G10L3, FCGV10L3T, FCGV102L3, FCV/G20L3, FCGV202L3, FCGV10L3J, FCGV102L3J, FCV/G10L6JAP, FCV/G102/1L6JAP, FCV/G61/1, FCV/G6L4, FCV/G10L6, FCV/G102/1L6, FCV/G20L6, FCGV202L6, FCV/G101/1, FCV/G102/1, FCV/G201/1, FCV/G202/1, FCS061G4, FCS101G4, FCS101G4DT, FCS101GP9J, FCS101G49J, FCS101GP, FCS102G4, FCS102GA9J, FCS102G49J, FCS102GP, FCS201G4, FCS201GP, FCS202G4, FCS202GP, FCS101GX9J, FCS101GX, FCS102GX9J, FCS102GX, FCS201GX, FCS202GX, FCF/E4-OLD, FCF/E4D, FCFE4PH, 5711-2-6, 5711-2-7...(Other models you can see in the webshop)		



GEV No.	375657	Ref. No.	005319 005681 0C1147
description	safety thermostat switch-off temp. 150°C 2-pole 1x20/1x0.5A probe ø 6mm probe L 74mm capillary pipe 1700mm capillary pipe isolated 1100mm gland nut probe SS		
For models:	FCZ061GAG, FCZ101GAG, FCZ102GAG, FCZ201GAG, FCZ202GAG, FCZ061GAD, FCZ101GAD, FCZ102GAD, FCZ201GAD, FCZ202GAD, FCZ101GTG, FCZ102GTG, FCZ201GTG, FCZ202GTG, FCZ101GTD, FCZ102GTD, FCZ201GTD, FCZ202GTD, FCZ061GBG, FCZ101GBG, FCZ102GBG, FCZ201GBG, FCZ202GBG, FCZ061GBD, FCZ101GBD, FCZ102GBD, FCZ201GBD, FCZ202GBD, FCZ061GBI, FCZ101GBI, FCZ201GBI, FCZ101GBG2, FCZ102GBG2, FCZ201GBG2, FCZ202GBG2, FCZ101GBD2, FCZ102GBD2, FCZ201GBD2, FCZ202GBD2, FCZ101GBI2, FCZ102GBI2, FCZ201GBI2, FCZ061GCG, FCZ061GCD, FCZ101GCG2, FCZ102GCG2, FCZ201GCG2, FCZ202GCG2, FCZ101GCD2, FCZ102GCD2...(Other models you can see in the webshop)		



GEV No.	375937	Ref. No.	004075 10737 21737
description	safety thermostat switch-off temp. 160°C 3-pole probe ø 6mm probe L 88mm capillary pipe 900mm capillary pipe isolated 895mm gland nut starting temperature 143°C		
For models:	HPN/GI855, HPN/GI1255, ZPN/GI1255		



GEV No.	375558	Ref. No.	004742
description	safety thermostat switch-off temp. 170°C 3-pole 20A probe ø 6mm probe L 87mm capillary pipe 900mm capillary pipe isolated 800mm gland nut probe SS		
For models:	RCP/E1S, RCP/E2D, XCP/E1S, XCP/E2D, JCP/E1S, JCP/E2D, MCP/E1S, MCP/E2D, PCP/E1S, PCP/E2D, PCP/E1SH, OCP/E1S, OCP/E2D, OCP/E1SH, OCP/E2SH, TCP/E1S, TCP/E2D		



GEV No.	375328	Ref. No.	005815 1007
description	safety thermostat switch-off temp. 162°C 3-pole 20A probe ø 6mm probe L 77mm capillary pipe 900mm capillary pipe isolatedmm gland nut probe		
For models:	SBRE350, SCPE350, SBRE350, SCPE350		



GEV No.	391041	Ref. No.	0G1961 0K5143 18025561
description	safety thermostat switch-off temp. 180°C 3-pole 20A probe ø 4mm probe L 163mm capillary pipe 1190mm capillary pipe isolated 800mm		
For models:	ACSGRT, GWACOE00RO, FWAAO00RO, GWACOMO0RO, IWKCOE0000, HWAHOE00RO, GWAHOE0000, GWAHOE00RO, FWAHOE00RO, BEN150EW87, HWAJOE00RO, GWAJOE00RO, FWAJOE00RO, BEN200EW87, GWAJOMO0RO, FWFJOEX000, FWFJOEX0RO, BEN300E.S35.H97, GWAKOE00RO, FWAKOE00RO, IWAKOMO0RO, GWAKOMO0RO, FWFKOEX0RO, FWKKOE00RO, IWALOE0000, IWALOE00RO, BEN400E.S35.H97, BEN400EF97, FWALOE00RO, GWALOMO0RO, IVAAOE0000, HVAAOE00RO, GVAEOE0000, GVAEOE00RO, FVAEOE00RO, IVKAOE0000, FVKAOE00RO, HVABOE00RO, GVABOE0000, GVABOE00RO, FVABOE00RO, FVFB0EX0RO, IVKBOE0000, FVKBOE00RO, IVACOE00RO, BON080EF88, GVACOE00RO, FVACOE00RO, IVACOMO0RO, GVACOMO0RO...(Other models you can see in the webshop)		



GEV No.	375577	Ref. No.	005295
description	safety thermostat switch-off temp. 170°C 3-pole 0.5A probe ø 6mm probe L 87mm capillary pipe 900mm capillary pipe isolated 800mm gland nut probe		
For models:	KPI/G10, KPI/G15, KPI/G15A, HPN/GI810, HPN/GI815, HPN/GI816, HPA/GI825, HPNS/GI816, ZPN/GI810, 2PIG15, ZPN/GI816, 2PIAG15, ZPNS/GI816, WPI/G10, WPI/G15, WPI/G15A, APN/GI810, APN/GI815, APN/GI816, APN/GD811, APN/GD816, APNS/GI816, OPN/GI815		



GEV No.	390064	Ref. No.	0A2204
description	safety thermostat switch-off temp. 220°C 3-pole 3NC 20A probe ø 6mm probe L 133mm capillary pipe 1890mm capillary pipe isolated 700mm gland nut probe SS		



GEV No.	375575	Ref. No.	0C4279
description	safety thermostat switch-off temp. 230°C 1-pole 20A probe ø 6mm probe L 87mm capillary pipe 890mm capillary pipe isolated gland nut probe SS		
For models:	BF/G1S07, BFR/G1S14, RFR/G1S14, RFR/G2D14, RFR/E1S14, RFR/E2D14, RF/G1S07, RF/G2D07, RFR/G1S07, RFR/G2D07, MFR/G1S14, MFR/G2D14, MFR/E1S14, MFR/E2D14, MF/G1S07, MF/G2D07, MFR/G1S07, MFR/G2D07, PF/G1S07, PF/G2D07, PFR/G1S07, PFR/G2D07, PFR/G1S14, PFR/G2D14, PFRG2D14HV, PFRG1S14HV, OF/G1S07, OFR/G1S07, OFR/G2D07, OFR/G1S14, OFR/G2D14, TF/G1S07, TF/G2D07, TFR/G1S07, TFR/G2D07, TFR/G1S14, TFR/G2D14, KFR/G1A, KFR/G2B, KFR/G1E, KFR/G2F, KFH/G1, KFH/G1ELH, KFH/G1EH, QFR/G1A, QFR/G2B, QFR/G1E, QFR/G2F, QFH/G1, QFH/G1ELH...(Other models you can see in the webshop)		



GEV No.	391029	Ref. No.	0C4463
description	safety thermostat switch-off temp. 230°C temperature range 16-230°C 3-pole 3NC 20A probe ø 6mm probe L 89mm capillary pipe 895mm capillary pipe isolated 750mm gland nut shaft ømm starting temperature°C probe SS		
For models:	BF/E1S12, BFR/E1S14, RF/E1S07, RF/E2D07, RFR/E1S07, RFR/E2D07, MF/E1S07, MF/E2D07, MFR/E1S07, MFR/E2D07, PF/E1S07, PF/E2D07, PFR/E1S07, PFR/E2D07, PFR/E1S14, PFR/E2D14, PF/E1S07E5, PFRE2D07E5, OF/E1S07, OFR/E1S07, OFR/E2D07, TF/E1S07, TF/E2D07, TFR/E1S07, TFR/E2D07, TFR/E1S14, TFR/E2D14, TF/E1S07E5, TFRE2D07E5, KFR/E1A, KFR/E2B, KFR/E1E, KFR/E2F, QFR/E1A, QFR/E2B, QFR/E1E, QFR/E2F, QFH/E1, QFH/E1ELH, QFH/E1H, WFR/E1A, WFR/E2B, WFR/E1E, WFR/E2F, WFH/E1, WFH/E1ELH, WFH/E1EH		

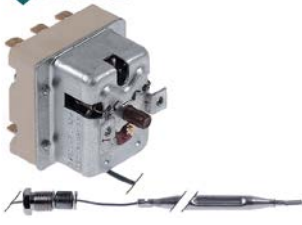

GEV No.	375393	Ref. No.	0KJ144
description	safety thermostat switch-off temp. 235°C 3-pole 1CO/2NC 20A probe ø 6mm probe L 87mm capillary pipe 1790mm capillary pipe isolated 1710mm gland nut M9x1 probe SS		

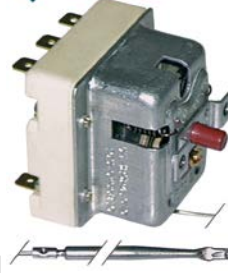

GEV No.	390113	Ref. No.	0K5033
description	safety thermostat switch-off temp. 240°C 3-pole 3NC 20A probe ø 4mm probe L 157mm capillary pipe 890mm capillary pipe isolated 350mm gland nut probe SS		



GEV No.	375586	Ref. No.	056435 0A5435
description	safety thermostat switch-off temp. 245°C 1-pole 0.5A probe ø 6mm probe L 77mm capillary pipe 1290mm capillary pipe isolated 1100mm gland nut probe SS		
For models:	MFR/G360, RFR/G1S12, RFR/G2D12, RFR/G2S40, RPI/G260, RPI/G260P, XFR/G1S12, XFR/G2D12, XFR/G2S40, XPI/G260, XPI/G260P, JFR/G1S12, JFR/G2D12, JFR/G2S40, JPI/G260, MFR/G1S12, MFR/G2D12, MFR/G2S40, MPI/G260, MPI/G260P, RFR/G360, T35GFR, PFR/G2S40, TFR/G2S40, RF/G300, HFR/G410, HFR/G810, HFR/G411, HFR/G412, HPA/GD825, ZFR/G410, ZFR/G810, ZFR/G411, ZFR/G412, RF/G300		



GEV No.	375585	Ref. No.	006282 11151614
description	safety thermostat switch-off temp. 245°C 3-pole 0.5A probe ø 6mm probe L 79mm capillary pipe 900mm capillary pipe isolated 900mm gland nut probe SS		
For models:	KB/E1, KB/E2, KFR/G1E, KFR/G2F, KFR/E1E, KFR/E2F, KFH/G1, KFH/E1, KFH/G1ELH, KFH/E1ELH, KFH/G1EH, KFH/E1EH, HFH/G430, HFH/E430, HFR/G430, HFR/G830, HFR/E430, HFR/E830, HFH/G435, HFH/E435, HFH/G430, HFH/E430, QB/E1, QB/E2, QFR/G1E, QFR/G2F, QFR/E1E, QFR/E2F, QFH/G1, QFH/E1, QFH/G1ELH, QFH/E1ELH, QFH/G1EH, QFH/E1H, ZFH/G430, ZFH/E430, ZFR/G430, ZFR/G830, ZFR/E430, ZFR/E830, ZFH/G435, ZFH/E435, ZFRS/G430, ZFRS/E430, WFR/G1E, WFR/G2F, WFR/E1E, WFR/E2F, WFH/G1, WFH/E1...(Other models you can see in the webshop)		



GEV No.	375578	Ref. No.	004472
description	safety thermostat switch-off temp. 245°C 3-pole 20A probe ø 6mm probe L 87mm capillary pipe 2700mm capillary pipe isolated 1600mm gland nut probe SS		
For models:	RBK/E2FM, RF/E1D05, RFR/E1S12, RFR/E2D12, RFR/E2S40, RF/E1S12, RF/E2D12, RF/E1S12, RF/E2D12, RF/E1S12E5, RF/E2D12E5, RFR/E1S12, RFR/E2D12, XBK/E2FM, XF/E1D05, XFR/E1S12, XFR/E2D12, XFR/E2S40, XF/E1S12, XF/E2D12, XF/E1S12, XF/E2D12, XR/E1CL, XR/E2CL, XRV/E1CL, XRV/E2CL, XFR/E1S12, XFR/E2D12, JF/E1D05, JFR/E1S12, JFR/E2D12, JFR/E2S40, JF/E1S12, JF/E2D12, JF/E1S12, JF/E2D12, JR/E1CL, JR/E2CL, JRV/E1CL, JRV/E2CL, MBK/E2FM, MF/E1D05, MFR/E1S12, MFR/E2D12, MFR/E2S40, MF/E1S12, MF/E2D12, MF/E1S12, MF/E2D12, MF/E1S12E5...(Other models you can see in the webshop)		



GEV No.	375916	Ref. No.	005931 11151612
description	safety thermostat switch-off temp. 259°C 1-pole 0.5A probe ø 6mm probe L 88mm capillary pipe 900mm capillary pipe isolated 100mm gland nut starting temperature 239°C probe		
For models:	RFR/G1S14, RFR/G2D14, RF/G1S07, RF/G2D07, RFR/G1S07, RFR/G2D07, XFR/G1S14, XFR/G2D14, XF/G1S07, XF/G2D07, XFR/G1S07, XFR/G2D07, JFR/G1S14, JFR/G2D14, JF/G1S07, JF/G2D07, JFR/G2D07, JFR/G2D07, MFR/G1S14, MFR/G2D14, MF/G1S07, MF/G2D07, MFR/G1S07, MFR/G2D07, ACPG25, PF/G1S07, PF/G2D07, PFR/G1S07, PFR/G2D07, PFR/G1S14, PFR/G2D14, PFRG2D14HV, PFRG1S14HV, OF/G1S07, OFR/G1S07, OFR/G2D07, OFR/G1S14, OFR/G2D14, TF/G1S07, TF/G2D07, TFR/G1S07, TFR/G2D07, TFR/G1S14, TFR/G2D14, KFR/G1A, KFR/G2B, KFR/G1T, QFR/G1A, QFR/G2B, QFR/G1T...(Other models you can see in the webshop)		



GEV No.	375580	Ref. No.	005941 OKG536
description	safety thermostat switch-off temp. 250°C 3-pole 20A probe ø 6mm probe L 89mm capillary pipe 900mm capillary pipe isolated 900mm gland nut probe SS		
For models:	RFR/E1S14, RFR/E2D14, RF/E1S07, RF/E2D07, RFR/E1S07, RFR/E2D07, XFR/E1S14, XFR/E2D14, XF/E1S07, XF/E2D07, XFR/E1S07, XFR/E2D07, JFR/E1S14, JFR/E2D14, JF/E1S07, JF/E2D07, JFR/E1S07, JFR/E2D07, MFR/E1S14, MFR/E2D14, MF/E1S07, MF/E2D07, MFR/E1S07, MFR/E2D07, PF/E1S07, PF/E2D07, PFR/E1S07, PFR/E2D07, PFR/E1S14, PFR/E2D14, PF/E1S07E5, PFRE2D07E5, OF/E1S07, OFR/E1S07, OFR/E2D07, TF/E1S07, TF/E2D07, TFR/E1S07, TFR/E2D07, TFR/E1S14, TFR/E2D14, TF/E1S07E5, TFRE2D07E5, KFR/E1A, KFR/E2B, QFR/E1A, QFR/E2B, WFR/E1A, WFR/E2B		



GEV No.	375557	Ref. No.	006283 006307
description	safety thermostat switch-off temp. 270°C 3-pole 20A probe ø 6mm probe L 79mm capillary pipe 900mm capillary pipe isolated 900mm gland nut probe SS		
For models:	RR/E1CL, RR/E2CL, RRV/E1CL, RRV/E2CL, RR/E2CM, MR/E1CL, MR/E2CL, MRV/E1CL, MRV/E2CL, MR/E2CM, PR/E1CL, PR/E2CL, PRV/E1CL, PRV/E2CL, PR/E2CM, PR/E2CME5, OR/E1FL, OR/E1FR, OR/E1CL, OR/E2FL, OR/E2FM, OR/E2CL, OR/E2CM, TR/E1CL, TR/E2CL, TRV/E1CL, TRV/E2CL		



GEV No.	375340	Ref. No.	00063 004921 OK3499
description	safety thermostat switch-off temp. 295°C 3-pole 20A probe ø 4mm probe L 120mm capillary pipe 1800mm capillary pipe isolatedmm gland nut probe material SS		
For models:	SFRE700, SFRE350, SFRE700, SFRE351, SFRE701		

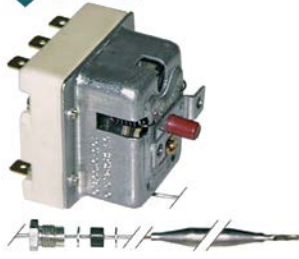

GEV No.	375045	Ref. No.	0H6140 0H6215 OK3118 0KE602 18005614 213149 214803 30000058
description	safety thermostat switch-off temp. 315°C 3-pole 3NC 20A probe ø 6mm probe L 77mm capillary pipe 1490mm capillary pipe isolated 1100mm gland nut M9x1 probe SS		
For models:	SLE159-170, SLE159-180, 7535-3/85., 7535-3/90.FRI.(N), 7735-3/85.FRI.(N), 7735-3/90.FRI.(N), 7535-3, 7536-3, 7537-3, 7538-3, 7735-3, 7736-3, 7737-3, 7738-3, 9050-3, 9052-3, 9055-3, 9250-3-0, 9250-3-8, 9252-3-0, 9252-3-8, 9255-3-0, 9255-3-8		



GEV No.	375659	Ref. No.	007042
description	safety thermostat switch-off temp. 338°C 2-pole 1x20/1x0.5A probe ø 6mm probe L 53mm capillary pipe 900mm capillary pipe isolated 900mm gland nut probe screw-in probe probe thread M10x1		
For models:	FCZ061EAA, FCZ101EAA, FCZ102EAA, FCZ201EAA, FCZ202EAA, FCZ061EAH, FCZ101EAH, FCZ201EAH, FCZ061EAN, FCZ101EAN, FCZ201EAN, FCZ061ETA, FCZ101ETA, FCZ102ETA, FCZ201ETA, FCZ202ETA, FCZ061ETH, FCZ101ETH, FCZ201ETH, FCZ061ETN, FCZ101ETN, FCZ201ETN, FCZ061GAG, FCZ101GAG, FCZ102GAG, FCZ201GAG, FCZ202GAG, FCZ061GAD, FCZ101GAD, FCZ102GAD, FCZ201GAD, FCZ202GAD, FCZ101GTG, FCZ102GTG, FCZ201GTG, FCZ202GTG, FCZ101GTD, FCZ102GTD, FCZ201GTD, FCZ202GTD, FCZ061EBA, FCZ101EBA, FCZ102EBA, FCZ201EBA, FCZ202EBA, FCZ061EBH, FCZ101EBH, FCZ201EBH, FCZ061EBN, FCZ101EBN...(Other models you can see in the webshop)		



GEV No.	375789	Ref. No.	005320 005680
description	safety thermostat switch-off temp. 338°C 2-pole 20A probe ø 11mm probe L 16mm capillary pipe 900mm capillary pipe isolated 900mm gland nut screw-in probe probe thread M14x1		
For models:	FCVG6L3CJ, FCV/G6L3C, FCV/G61/1, FCV/G61/1, FCV/G61/1, FCV/G61/1, FCV/G6L3CT, FCV/G6L3CJ, 5711-2-8CH, 5711-2-10CH, 5721-2-7, 5721-2-10, 5711-3-8CH, 5711-3-10CH, 5712-3-8CH, 5712-3-10C, 5717-3-8M, 5717-3-8C, 5717-3-8M, 5712-2-10F, 5712-2-10S, 5714-2-10F, 5714-2-10S, 5711-3-10F, 5711-3-10S, 5712-3-10F, 5712-3-10S, 5714-3-10F, 5714-3-10S, 5702-2-2, 5702-2-3, 5704-2-2, 5704-2-3, 5707-2-2, 57074-2-3, 5701-3-2, 5701-3-3, 5702-3-2, 5702-3-3, 5704-3-2, 5704-3-3, 5707-3-2, 5707-3-3, ECV/G6T4C, ECV/G61/1, ECV/G61/1, ECV/E101GP, RCV061G2, ACV/G6C3C, ZCV/G6T4C, ZCV/G61/1		



GEV No.	375455	Ref. No.	002599 002730 0F0057 0K0515 0K8486 60050253 911986
description	safety thermostat switch-off temp. 350°C 1-pole 16A probe ø 11mm probe L 16mm capillary pipe 900mm capillary pipe isolated 900mm gland nut probe screw-in probe probe thread M14x1		
For models:	FCV/G10L3, FCVG10L3T, FCVG102L3, FCV/G20L3, FCVG202L3, FCVE6L3J, FCV/E10L3JAP, FCV/E102/1L3JAP, FCV/E10L6JAP, FCV/E102/1L6JAP, FCVG10L3J, FCVG102L3J, FCV/G10L6JAP, FCV/G102/1L6JAP, FCV/G10L2, FCV/E10L2, FCV/G61/1, FCV/E10L3, FCV/E6L3, FCV/E102/1L3, FCV/E20L3, FCVE202L3, FCV/E6L4, FCV/G10L6, FCV/E10L6, FCV/G102/1L6, FCV/E102/1L6, FCV/G20L6, FCV/E20L6, FCVG202L6, FCVE202L6, FCV/E101/1, FCV/G101/1, FVC/E101/1, FCV/G102/1, FVC/E102/1, FCV/G201/1, FVC/E201/1, FCV/G202/1, FVC/E202/1, FCF/E6-0, FCFE101-0, FCFE102-0, FCFE201-0, FCFE202-0, FCF061ELN, FCF101ELN, FCF6EHOR, FCF061ENS, FCF101ENS...(Other models you can see in the webshop)		



GEV No.	390141	Ref. No.	006826 0H6135 0KI518 11151589
description	safety thermostat switch-off temp. 350°C 3-pole 3NC 20A probe ø 6mm probe L 77mm capillary pipe 1490mm capillary pipe isolated 800mm gland nut probe SS		
For models:	APABPETOOC, APABPGTOOC, APACPITOOC, APACPGTOOC, APABPI- OOOC, APABPITOOC, APACPIOOC, APACPITOOC, APRBPETOOB, APR- BPETOOB, APRBPETOOB, APRBPETOOB, APRBPETOOB, APRBPETOOB, APRCPETOOB, APRCPETOOB, APRCPETOOB, APRCPETOOB, APRCPETOOB, APRCPIOOB, APABPGOOOC, APACPF00OC, 7731-3/85.GRPL. VCHR., 7744-3/85.KB.(N), 7531-3/85., 7531-3/90.GRPL.(N), 7542-3/85., 7544-3/85.KB.(N), 7542-3/90.KB.(N), 7544-3/90.KB.(N), 7742-3/90. KB.(N), 7742-3/85.KB.(N), 7744-3/90.KB.(N), 7746-3/90.KB.(N), 7748- 3/90.KB.(N), 7747-3/90.KB.(N), 7541-3/85.KB.(N), 7545-3/85.KB.(N), 7546-3/85.KB.(N), 7547-3/85.KB.(N), 7548-3/85.KB.(N), 7545-3/90. KB.(N), 7546-3/90., 7547-3/90.KB.(N), 7548-3/90.KB.(N), 7745-3/90. KB.(N), 7745-3/85.KB.(N), 7746-3/85.KB.(N), 7747-3/85.KB.(N), 7748- 3/85.KB.(N)...(Other models you can see in the webshop)		



GEV No.	375579	Ref. No.	003594 053980 057442 0G2269 19013336 727829
description	safety thermostat switch-off temp. 360°C 1-pole 0.5A probe ø 6mm probe L 74mm capillary pipe 1500mm capillary pipe isolated 1500mm gland nut probe		
For models:	MBR/G701, MBR/G706, MBR/G701UK, MBR/G751, MBR/G756, RBR/ G2FM, RBR/G2IM, XBR/G2FM, XBR/G2IM, JBR/G2FM, MBR/G2FM, MBR/ G2IM, 7BRG60, 7BRG60X, RBR/G701UK, RBR/G751, RBR/G756, XBR/ G701, M70GBP, XBR/G751, XBR/G756, PBR/G2FM, PBR/G2IM, OBR/ G2FM, OBR/G2IM, TBR/G2FM, TBR/G2IM, HR/G420D, HR/G820D, HR/ G420, HR/G820, HR/G821, HBR/G800, HBR/G805, HBR/G801, HBR/ G806, HBR/G810, HBR/G815, HBR/G811, HBR/G816, HBR/G800D, HBR/ G805D, HBR/G801D, HBR/G806D, HBR/G810D, HBR/G815D, HBR/ G811D, HBR/G816D, HBR/E800, HBR/E805...(Other models you can see in the webshop)		



GEV No.	375344	Ref. No.	OPRE75
description	safety thermostat switch-off temp. 360°C 1-pole 0.5A probe ø 4mm probe L 120mm capillary pipe 1500mm capillary pipe isolated 1500mm gland nut probe		



GEV No.	375563	Ref. No.	004600
description	safety thermostat switch-off temp. 360°C 3-pole 1x20/2x0.5A probe ø 6mm probe L 79mm capillary pipe 1200mm capillary pipe isolated 1200mm gland nut probe SS		
For models:	BCF/E2, RR/G1CL, RR/G2CL, RRV/G1CL, RRV/G2CL, RR/G2CM, XR/ G1CL, XR/G2CL, XRV/G1CL, XRV/G2CL, XR/G2CM, JR/G1CL, JR/G2CL, JRV/G1CL, JRV/G2CL, MR/G1CL, MR/G2CL, MRV/G1CL, MRV/G2CL, MR/G2CM, PCF/M2, PCF/M3, PCV/E2, PCV/E3, PCF/E2, PC/E2Q, PCF/ E2Q, PCV/E2Q, PI/E1, PI/E2, PIF/E2, PIV/E2, PC/E2QE5, PCF/E2QE5, PI/ E1E5, PI/E2E5, PIF/E2E5, PCF/E2E5, PCF/M2E5, PR/G1CL, PR/G2CL, PRV/G1CL, PRV/G2CL, PR/G2CM, PCF/M2A, PCF/M3A, OCF/M2, OCF/ E2, OC/E2Q, OCF/E2Q...(Other models you can see in the webshop)		

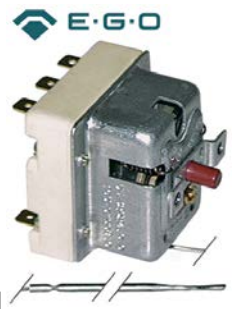

GEV No.	390142	Ref. No.	00305 004919 0H6134 OK3522 390142
description	safety thermostat switch-off temp. 360°C 3-pole 20A probe ø 3.1mm probe L 188mm capillary pipe 1490mm capillary pipe isolated 800mm gland nut probe SS		
For models:	SRE350, SRE360, SRE370, SRE700, SRE710, SRE720, SRE350, SRE360, SRE370, SRE700, SRE710, SRE720, 7508-3/85., 7502-3/85., 7500-3/85. HE.2PL.(N), 7504-3/85.HE.6PL.BO., 7505-3/85., 7512-3/85.KF.BO.(N), 7502-3/90.HE.4PL.BO., 7504-3/90.HE.6PL.BO., 7505-3/90.HE.6PL.BO., 7508-3/90.HE.CER.BO., 7512-3/90.KF.BO.(N), 7700-3/85., 7700-3/90. HE.2PL.(N), 7502-3/85.HE.4PL.BO., 7508-3/85.HE.CER.BO., 7505-3/85. HE.6PL.BO., 7508-3/85.HE.CER.BO., 7506-3/85.HE.CER.2KZ, 7508-3/85. HE.CER.BO., 7506-3/85.HE.CER.2KZ, 7510-3/85.HE.CER.6KZ, 7504-3/90. HE.6PL.BO., 7502-3, 7502-9, 7504-3, 7504-9, 7505-3, 7505-9-9, 7508-3, 7510-3/90.HE.CER.6KZ, 7512-3, 7512-9, 9002-3, 9004-3, 9006-3, 9012-3, 9015-3, 9598-3-0...(Other models you can see in the webshop)		



GEV No.	375562	Ref. No.	004269 11151622
description	safety thermostat switch-off temp. 360°C 3-pole 20A probe ø 4mm probe L 120mm capillary pipe 900mm capillary pipe isolated 900mm gland nut probe SS		
For models:	RCF/M2, RCF/M3, RCF/E2, RCF/E2MO, RCF/E2M4, RCVF/E3MO, RCVF/E3M4, RCF/E2E5, RBR/E2FM, RBR/E2IM, RMV/E1C, RMV/E2C, RMV/G1C, RMV/G2C, RIF/E2, MCF/E2Q, RCF/E2Q, XCF/M2, XCFM3, XCF/E2, XBR/E2FM, XBR/E2IM, XMV/E1C, XMV/E2C, XMV/G1C, XMV/G2C, XIF/E2, JCF/M2, JCFM3, JCF/E2, JBR/E2FM, JMV/E1C, JMV/E2C, JIF/E2, MCF/M2, MCF/M3, MCF/E2, MCF/E2E5, MBR/E2FM, MBR/E2IM, MMV/E1C, MMV/E2C, MMV/G1C, MMV/G2C, MIF/E2, PBR/E2FM, PBR/E2IM, PMV/G1C, PMV/G2C, PMV/E1C...(Other models you can see in the webshop)		



GEV No.	375190	Ref. No.	004205
description	safety thermostat switch-off temp. 560°C 3-pole 20A probe ø 3.9mm probe L 228mm capillary pipe 870mm capillary pipe isolated 700mm gland nut probe		
For models:	ZCMDE6, ZCBDE12, ZCMME6, ZCBME12, ZCMDE4, ZCBDE8, ZCMME4, ZCBME8, ZCMDE9, ZCBDE18, ZCMME9, ZCBME18, FFPS16, FFPS32, PME430, PME630, PME6L30, PME930, PME435, PME635, PME6L35, PME935, PME830, PME1230, PME12L30, PME1830, PME835, PME1235, PME12L35, PME1835		

55.33_ series



GEV No.	376027	Ref. No.	OKI686
description	safety thermostat switch-off temp. 295°C 3-pole 20A probe ø 4mm probe L 128mm capillary pipe 1770mm capillary pipe isolated 1750mm gland nut probe SS		

accessories



GEV No.	551083	Ref. No.	0A2187
description	cap for safety thermostat thread M8x1		
For models:	MBR/E710D, MBR/E700, MBR/E700UK, MBR/G701, MBR/G706, MBR/G701UK, MBR/G751, MBR/G756, MBR/E716, MBR/E706, 7BRE60XN, 7BRE60X, RBR/E700UK, 7BRG60, 7BRG60X, RBR/G701UK, RBR/G751, RBR/G756, RBR/E716, RBR/E706, XBR/E710D, M70EBP, XBR/E710, XBR/G701, M70GBP, XBR/G701UK, XBR/G751, XBR/G756, CBR/G700, CBR/E700, XBR/E716, XBR/E706, HFR/E410, HFR/E810, HFR/E411, HFR/E412, HFR/E418, HFR/E818, HBR/G800, HBR/G805, HBR/G810, HBR/G815, HBR/G811, HBR/G816, HBR/G800UK, HBR/G821UK, ZFR/E410, ZFR/E810, ZFR/E411, ZFR/E412...(Other models you can see in the webshop)		



control thermostats with operation switch

55.10/19_ series

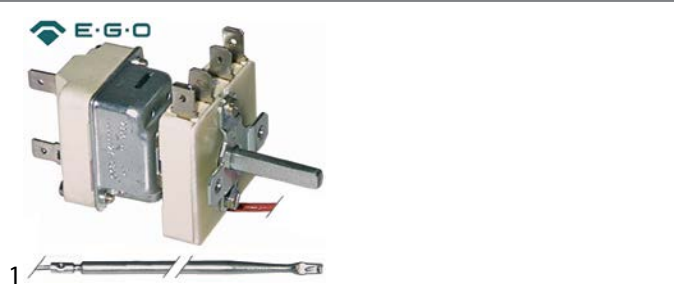

GEV No.	390052	Ref. No.	052330 0H1260 0K2945 0K7813 728019
description	thermostat t.max. 185°C temperature range 90-185°C 1-pole 1NO 15A probe ø 4mm probe L 229mm capillary pipe 2500mm capillary pipe isolated 1200/200mm gland nut shaft ø 6x4.6mm shaft L 23mm shaft position upper rotation 270° outer switch 2NO		
For models:	MFR/E350, MFR/E700, MFR/E370, MFR/E350UK, MFR/E700UK, MFR/E370UK, MFR/E370D, MFR/E350D, MFR/E700D, MFR/E355, MFR/E355UK, MFR/E355D, MFR/E705, MFR/E705UK, MFR/E705D, MFR/E740, BF/E1S12, BFR/E1S14, RBK/E2FM, RF/E1D05, RFR/E1S12, RFR/E2D12, RFR/E2S40, RF/E1S12, RF/E2D12, RF/E1S12, RF/E2D12, RF/E1S12E5, RF/E2D12E5, RFR/E1S12, RFR/E2D12, XBK/E2FM, XF/E1D05, XFR/E1S12, XFR/E2D12, XFR/E2S40, XF/E1S12, XF/E2D12, XF/E1S12, XF/E2D12, XFR/E1S12, XFR/E2D12, JF/E1D05, JFR/E1S12, JFR/E2D12, JFR/E2S40, JF/E1S12, JF/E2D12, JF/E1S12, JF/E2D12...(Other models you can see in the webshop)		

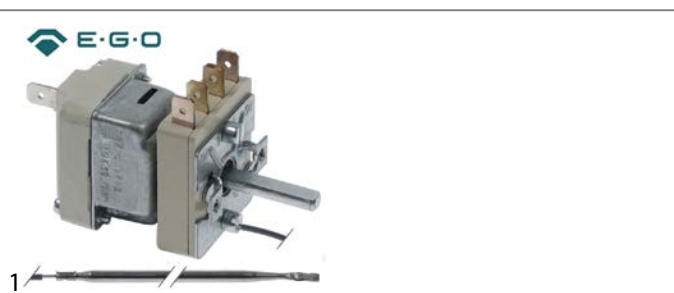

GEV No.	375584	Ref. No.	002602 003049 0G2351 727935 727963
description	thermostat t.max. 185°C temperature range 91-185°C 1-pole 1NO 0.5A probe ø 4mm probe L 235mm capillary pipe 2420mm capillary pipe isolated 1200mm gland nut shaft ø 6x4.6mm shaft L 23mm shaft position upper rotation 270° outer switch 2NO		
For models:	MFR/G740, RFR/G2S40, XFR/G2S40, JFR/G2S40, MFR/G2S40, RFR/G741, XFR/G351, CFR/G741, CFR/G351, PFR/G2S40, TFR/G2S40, HFR/G410, HFR/G810, HFR/G411, HFR/G412, FC1G, FC2G, HFH/G400U, HFH/G401U, HBR/G800UK, HBR/G821UK, ZFR/G410, ZFR/G810, ZFR/G411, ZFR/G412, RF/G1680, RF/G2480, ZBR/G821, ZBR/G826, ZBR/G800UK, AFR/G410, AFR/G810, M40GFR90, AFR/G411, AFR/G412, OFR/G810, OBR/G800UK		



GEV No.	375581	Ref. No.	002109
description	thermostat t.max. 260°C temperature range 55-260°C 1-pole 1NO 16A probe ø 4mm probe L 116mm capillary pipe 1300mm capillary pipe isolated 1300mm gland nut shaft ø 6x4.6mm shaft L 23mm shaft position upper rotation 270° outer switch 2NO		
For models:	RBR/E2FM, RBR/E2IM, RMV/E1C, RMV/E2C, XBR/E2FM, XBR/E2IM, XMV/E1C, XMV/E2C, JBR/E2FM, JMV/E1C, JMV/E2C, MBR/E2FM, MBR/E2IM, MMV/E1C, MMV/E2C, PBR/E2FM, PBR/E2IM, PMV/E1C, PMV/E2C, OBR/E2FM, OBR/E2IM, OMV/E1C, OMV/E2C, TBR/E2FM, TBR/E2IM, TMV/E1C, TMV/E2C, KBR/G2F, KBR/G2C, KBR/G3F, KBR/G3FH, KBR/G3C, KBR/G3CH, KBR/E2F, KBR/E2C, KBR/E3F, KBR/E3FH, KBR/E3C, KBR/E3CH, KMV/E2C, KBR/G2FH, KBR/G2CH, KBR/E2FH, KBR/E2CH, HBR/G800, HBR/G805, HBR/G801, HBR/G806, HBR/G810, HBR/G815...		

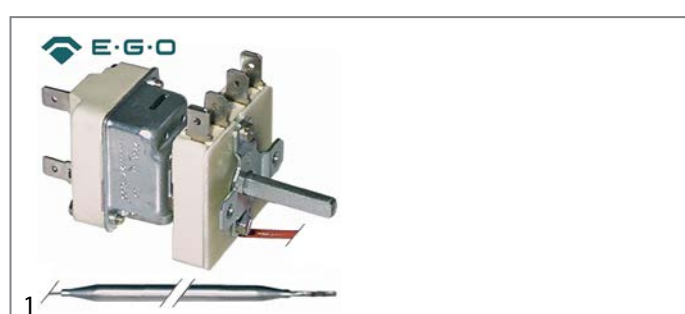

GEV No.	390039	Ref. No.	051142 0K2930
description	thermostat t.max. 90°C temperature range 30-90°C 1-pole 1CO 16A probe ø 6mm probe L 173mm capillary pipe 980mm capillary pipe isolated 980mm gland nut shaft ø 6x4.6mm shaft L 23mm shaft position upper rotation 270° outer switch 2NO		
For models:	BB/E1, MM/E350, MM/E350UK, MM/E350D, RB/E1, RB/E2, RBV/E2, XB/E1, JB/E1, MB/E1U, MB/E1, MB/E2, MBV/E2, 7BME03T, RM/E350UK, PB/E1, OB/E1, TB/E1, RME300, PRM/E300, M/E300UK, RMV/E300, PRMV/E300, RMV/E300UK, RMAE700, PRMA/E700, RMA/E700, KB/E1, HM/E400, QB/E1, WB/E1, AM/E400, JFM/G400, RM/E300, RMV/E300, RMA/E700, PFM/G400, ZLRLPLBPL, ZLRRPLHLB, DETCLDXN, DETCLDXSP, SSEPRFPFN, SSEPRFPWL, ZLRRHPL, ZLRLHPL		
accessories for	390039		
	GEV No.	111934	Ref. No. —
	knob thermostat t.max. 90°C ø 50mm shaft ø 6x4.6mm shaft flat upper black temperature range 30-90°C rotation 270°		



55.13_series

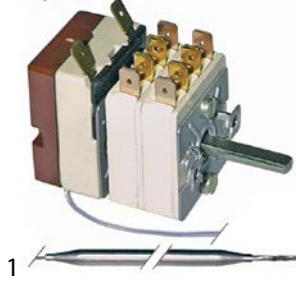

GEV No.	375053	Ref. No.	OH9836 OK5023 18015429
description	thermostat t.max. 110°C temperature range 30-110°C 1-pole 1NO 16A probe ø 6mm probe L 113mm capillary pipe 830mm capillary pipe isolated 800mm gland nut shaft ø 6x4.6mm shaft L 23mm shaft position upper rotation 270° outer switch 2NO/2NO		
For models:	CE128-106, CE158-133.3.HV, CE158-244.3, CE158-246.3, CK248-209, D1ABBB, CK248-211.D1ABBB, HCE128-100, HCE128-104, HCE158-252W.3, HCE158-253.3, HLE129-100, HLE129-103, HLE129-104W, HLE159-252W.3.6, HLE159-328.3.HV, HLE159-351W.3.HV, HLE249-200.3, HLE249-208.3, HLE259-088.3.HV, HLE259-089.3.HV, HLE259-384W.3, LE129-101, LE159-261.3, LE159-281.3.6, LE159-318.3.HV, LE159-322.3.HV, LE159-330.3.HV, LE159-337.3.HV, LE159-344.3.MS92, LE159-347.3.HV, LE249-199.3, LE249-203.3, LE249-207.3, LE249-211.3, LE249-215.3, LE249-219.3, LE249-223.3, LE249-232.3, LE249-238.3, LE259-081.3.HV, LE259-082.3.HV, LE259-083.3.HV, LE259-094.3.HV, LE259-099.3.HV, LE259-382.3, LK259-707.D1ACCB, LK259-708.D1ACCB, CK248-205.D1ABBB, CK248-207.D1ABBB, LK159-707.D1BC...(Other models you can see in the webshop)		

55.34_series



GEV No.	375570	Ref. No.	OK0662
description	thermostat t.max. 470°C temperature range 100-470°C 1-pole 1NO 16A probe ø 3.9mm probe L 228mm capillary pipe 1110mm capillary pipe isolated 600mm gland nut shaft ø 6x4.6mm shaft L 24mm shaft position upper rotation 270° outer switch 2NO		
For models:	7511-3/85.KF.(N), 7512-3/85.KF.BO.(N), 7511-3/90.KF.(N), 7512-3/90.KF.BO.(N), 7711-3/85.KF.(N), 7711-3/90.KF.(N), 7511-3, 7512-3, 7711-3		



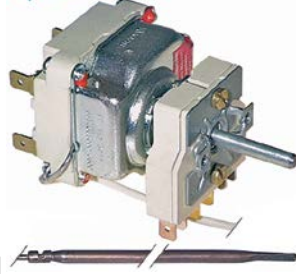

GEV No.	375877	Ref. No.	OG2529 621535
description	thermostat t.max. 530°C temperature range 100-530°C 3-pole 3NO 16A probe ø 3.9mm probe L 228mm capillary pipe 1110mm capillary pipe isolated 1000mm gland nut shaft ø 6x4.6mm shaft L 23mm shaft position shaft position 90° rotation 270° outer switch 0-1 with operation switch		
For models:	ALARHFSOOO, ALARHASOOO, ALARHBSOOO, ALAWHFSOOO, ALAWHASOOO, ALAWHBSOOO, ALARAFOOOO, ALARHF0000, ALARAAOOOO, ALARHAOOOO, ALARABOOOO, ALARHB0000, ALAWAF0000, ALAWHF0000, ALAWAAOOOO, ALAWHAOOOO, ALAWABOOOO, ALAWHB0000, ALAWCF0000, ALAWCAOOOO, ALAWCB0000, ALAROI0000, ALAWOI0000, ALAWOISOOB, ALAROI0000, ALARAFSOOC, ALARAASOOC, ALARABSOOC, ALAWAFSOOC, ALAWAASOOC, ALAWABSOOC, ALAWCFSOOC, ALAWCASOOC, ALAWCBSOOC		



GEV No.	375246	Ref. No.	01R77 01T05 01T09 OG0956 OK0496 OM0724 OM0728
description	thermostat t.max. 645°C temperature range 100-615/645°C 2-pole 2NO 16A probe ø 4mm probe L 230mm capillary pipe 1100mm capillary pipe isolated 600mm gland nut shaft ø 6x4.6mm shaft L 25mm shaft position lower rotation 270° outer switch 2NO probe material copper		
For models:	7508-3/85., 7506-3/85.HE.CER.2KZ, 7507-3/85., 7506-3/90.HE.CER.2KZ, 7507-3/90.HE.CER.4KZ, 7508-3/90.HE.CER.BO., 7706-3/85.HE.CER.2KZ, 7707-3/85.HE.4KF.CER, 7706-3/90.HE.CER.2KZ, 7707-3/90.HE.4KF.CER, 7508-3/85.HE.CER.BO., 7508-3/85.HE.CER.BO., 7506-3/85.HE.CER.2KZ, 7506-3/85.HE.CER.2KZ, 7508-3/85.HE.CER.BO., 7507-3/85.HE.CER.4KZ, 7506-3/85.HE.CER.2KZ, 7510-3/85.HE.CER.6KZ, 7507-3/85.HE.CER.4KZ, 7507-3/85.HE.CER.4KZ, 7506-3, 7507-3, 7508-3, 7510-3/90.HE.CER.6KZ, 7706-3, 7707-3, 9012-3, 9211-3-0, 9211-3-8		

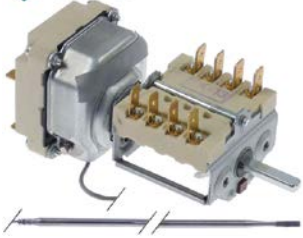

 			
GEV No.	390919	Ref. No.	002582 0K5022 0K7287 18015428 477650028
description	thermostat temperature range 50-300°C 3-pole 3NO 16A probe ø 4mm probe L 292mm capillary pipe 2300mm capillary pipe isolated 2260mm gland nut shaft ø 6x4.6mm shaft L 25.5mm shaft position upper rotation 270° outer switch 49.41015.500		
For models:	BE1-TA.3, BE1-W.3, BE1-WS-M.3, BE2-A-C.3, BE2-A-M.3, BE2-WS-C.3, BE2-WS-M.3, BE3-C.3, BE3-M.3, CE128-106, CE158-133.3.HV, CE158-244.3, CE158-246.3, CK248-209.D1ABBB, CK248-211.D1ABBB, HCE128-100, HCE128-104, HCE158-252W.3, HCE158-253.3, HLE129-100, HLE129-103, HLE129-104W, HLE159-252W.3.6, HLE159-328.3.HV, HLE159-351W.3.HV, HLE249-200.3, HLE249-208.3, HLE259-088.3.HV, HLE259-089.3.HV, HLE259-384W.3, LE129-101, LE159-261.3, LE159-281.3.6, LE159-318.3.HV, LE159-322.3.HV, LE159-330.3.HV, LE159-337.3.HV, LE159-344.3.MS92, LE159-347.3.HV, LE249-199.3, LE249-203.3, LE249-207.3, LE249-211.3, LE249-215.3, LE249-219.3, LE249-223.3, LE249-232.3, LE249-238.3, LE259-081.3.HV, LE259-082.3.HV...(Other models you can see in the webshop)		
spare parts for	390919		
			00070 004908 0A2134 0G0268 0G0517 0G0921 0G2119 0H6605 0K3016 0K3500 0K4911 0K5472 0K9781 18005010 19005011 727993
	GEV No.	300002	Ref. No.
			0A2205 0G0270 0H6775 0K5001 0KM937 0KT779 18015163 253566 537001200 5370012005 617078 721205
	GEV No.	550059	Ref. No.
			connecting bow short for switch Qty 1 pcs

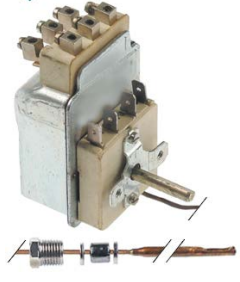
63._ series			
 			
GEV No.	390514	Ref. No.	0K0492
description	thermostat t.max. 300°C temperature range 50-300°C 3-pole 3NO 15A probe ø 4.76mm probe L 293.5mm capillary pipe 1800mm shaft ø 6x4.6mm shaft L 23mm shaft position upper° rotation 318° outer switch 2NO		

IMIT / TEMPOMATIC / ARTERMO control thermostats			
			
GEV No.	390005	Ref. No.	069423 0H1277 236042
description	thermostat t.max. 85°C temperature range 25-85°C 1-pole 1CO 15A probe ø 11mm probe L 35mm capillary pipe 600mm capillary pipe isolated 600mm gland nut shaft ø 6x4.6mm shaft L 8mm shaft position upper° rotation 270° screw-in probe		
For models:	LTB11, LTB12, LTB22, LTB11UK, LTB12UK, LTB22UK, LTB11, LTB22, 910-00-021, 910-00-023, 910-00-031, 910-00-033, 911-00-022, 911-00-024, 911-00-032, 911-00-034, CRYSTAL 11, CRYSTAL 22		
accessories for	390005		
	GEV No.	510417	Ref. No.
			0K6103 0K6660 0K8701
	flat gasket fibre ED ø 20mm ID ø 14mm thickness 2mm Qty 1 pcs		
	GEV No.	550261	Ref. No.
			006245 0K9627 514875601
	nut thread M14x1 H 4mm WS 19 SS Qty 1 pcs		



safety thermostats



GEV No.	375941	Ref. No.	053012
description	safety thermostat switch-off temp. 238°C 1-pole 1NC 16A probe ø 5mm probe L 100mm capillary pipe 1050mm capillary pipe isolated-mm gland nut 250V		
For models:	FE250D, FE250S, FEC/250D, FEC/250S, HFR/G1680, HFR/E1680, HFR/G2480, HFR/E2480		

CAMPINI

control thermostats



GEV No.	375838	Ref. No.	OHA200 20617 9020617
description	safety thermostat t.max. 124°C temperature range°C 1-pole 1CO 16A probe ø 6mm probe L 70mm capillary pipe 1970mm capillary pipe isolated 1970mm gland nut shaft ømm shaft Lmm shaft position rotation° probe material SS		
For models:	LB040AUS, G350C, LBIOET010, LBIOET014, LBIOEQ010, G350, G350DP, LBIOEQ014, G400, G400DP, LCFBE003		

RATHGEBER

control thermostats

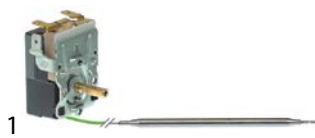

GEV No.	375702	Ref. No.	OKA778 33060401
description	thermostat t.max. 110°C temperature range 30-110°C 1-pole 1NO 16A probe ø 6mm probe L 140mm capillary pipe 2400mm capillary pipe isolated 1700mm gland nut shaft ø 6x4.6mm shaft L 17mm shaft position upper rotation 270°		

various

control thermostats with operation switch



GEV No.	375425	Ref. No.	0H6123
description	thermostat t.max. 360°C temperature range 130-400°C 2-pole probe L 228mm		
For models:	7701-3/85, 7501-3/85., 7501-3/90.HE.4PL.(N), 7502-3/85., 7500-3/85. HE.2PL.(N), 7503-3/85.HE.6PL, 7504-3/85.HE.6PL.BO, 7505-3/85, 7502-3/90.HE.4PL.BO., 7503-3/90.HE.6PL.(N), 7504-3/90.HE.6PL.BO., 7505-3/90.HE.6PL.BO., 7700-3/85, 7703-3/85, 7700-3/90.HE.2PL.(N), 7701-3/90.HE.4PL.(N), 7703-3/90.HE.6PL.(N), 7502-3/85.HE.4PL.BO., 7505-3/85.HE.6PL.BO., 7503-3/85.HE.6PL.EO, 7501-3/85.HE.4PL.EO, 7504-3/90.HE.6PL.BO., 7501-3, 7502-3, 7503-3, 7504-3, 7505-3, 7701-3, 7703-3, 9002-3, 9004-3, 9006-3, 9201-3-0, 9201-3-8, 9203-3-0, 9203-3-8		

control thermostats with actual value



GEV No.	379722	Ref. No.	0K7631 0KB607
description	thermostat t.max. 120°C temperature range 0-120°C 1-pole 1CO 10A probe ø 8.5mm probe L 32mm capillary pipe 1600mm mounting ø 60mm		
For models:	HC-AR, HC-CS		



GEV No.	379035	Ref. No.	0137315 0H6479 6137315
description	thermostat t.max. 120°C temperature range 0-120°C 1-pole 1CO 5A probe ø 10mm probe L 32mm capillary pipe 1500mm capillary pipe isolated 1500mm gland nut M10x1 mounting ø 80mm		



GEV No.	379727	Ref. No.	0K1133
description	thermostat t.max. 120°C temperature range 0-120°C 1-pole 1CO 5A probe ø 8.5mm probe L 32mm capillary pipe isolated 1520mm		
For models:	HCCS20W, HCCS20W, HC-CS, HC-CS		



refrigeration thermostats

universal without housing



GEV No.	390534	Ref. No.	0A8246
description	thermostat temperature range -35 up to +35°C probe ø6x110mm capillary pipe 1800mm PRODIGY		
For models:	EWE601, EWZ601, EWDE602, EWDZ602, 12800100.1, 12800110.1, 12800110.1, 12800100.1, 15600116.1, 15600120.1		
accessories for	390534		
	GEV No.	110305	Ref. No. —
	knob thermostat t.max. 35°C temperature range -35 up to +35°C ø 45mm shaft ø 6x4.6mm shaft flat inclined rotation 270° white		

DANFOSS

service thermostats DANFOSS

All Danfoss thermostats are supplied with fastening material application:

- 390552 - **fridges
- 390553 - **Refrigerators with defrosting push button
- 390554 - **/**Refrigerators with automatic defrosting
- 390555 - absorption refrigerators
- 390557 - Deep cooler with active signal
- 390558 - Freezing with passive signal
- 390559 - bottle cooler 390559



GEV No.	390559	Ref. No.	OK8399
description	thermostat type 077B7008 capillary pipe 2000mm temperature range -8.5 up to +11.5°C probe ømm probe Lmm		

RANCO

K22 series



GEV No.	390524	Ref. No.	023591 085284 087969 23004 B23004 B23591 R23591
description	thermostat RANCO type K22L1082 probe ømm probe Lmm capillary pipe 2000mm temperature range -22 up to -3°C		
For models:	FGC33AS42, FGC46AS42, FGC65A42, FGC24AB, FGC24WB, FGC29AB, FGC29WB, FGC40A, FGC40W, FGC67AB, FGC67WB, FGC90A, FGC90W, FGC143AB, FGC143WB, FGC25A, CB246W, CIM38AB, CIM38WB, CIM85AB, CIM15WB, CIM50AB, FIM50WB, FGC24ABS, FGC24WBAB, FGC29AB, FGC29WB, CIM38AB, CIM38WB, CIM50AB, FIM50WB, FGC143AB, FGC143WB, CB184A, CB249A, CB316A, CB425A, CB840A, FGC24AB, FGC24WB, FGC29AB, , FGC67AB, FGC67WB, FGC143AB, FGC143WB, CIM38AB, CIM38WB, CIM85AB, CIM15WB...(Other models you can see in the webshop)		





GEV No.	390589	Ref. No.	087804 092561 23597 R23597
description	thermostat RANCO type K22L1083 probe ø 2mm probe Lmm capillary pipe 2300mm		
For models:	CIM235AB, CIM235WB, VM500W+BI, VM500A+BI, VB250A, VB250W, VM900A, VM900W		





GEV No.	390260	Ref. No.	081673
description	thermostat RANCO type K22L2533 capillary pipe 2030mm		
For models:	TRRN1301, TRRN1302, TRRN1303, TRRN1801, TRRN1802, TRRN1803, TRRN2201, TRRN2202, TRRN2203		

			
GEV No.	390539	Ref. No.	099551 0A8963 0KE844
description	thermostat RANCO type K22L3521 probe ømm probe Lmm capillary pipe 2000mm temperature range -2 up to +8°C		
For models:	TRN1301, TRNA1301, TRNM1301, TRN1302, TRNA1302, TRNM1302, TRN1303, TRNA1303, TRNM1303, TRN1801, TRNA1801, TRNM1801, TRN1802, TRNA1802, TRNM1802, TRN1803, TRNA1803, TRNM1803, TRN2201, TRNA2201, TRNM2201, TRN2202, TRNA2202, TRNM2202, TRN2203, TRNA2203, TRNM2203, TRRN1301, TRRN1302, TRRN1303, TRRN1801, TRRN1802, TRRN1803, TRRN2201, TRRN2202, TRRN2203, TRNP1802, TRRF130P, TRRF180P, TRRF220P, TRF1301, TRRF1301, TRF1801, TRRF1801, TRF2201, TRRF2201, TRN1301, TRNA1301, TRNM1301, TRRF1301...(Other models you can see in the webshop)		

			
GEV No.	390223	Ref. No.	083697
description	thermostat RANCO type K22L2560 capillary pipe 2000mm probe ø10x110mm		
For models:	ESQC41F, ESQC41FR, ESQC41F, ESQC41FR		

			
GEV No.	390209	Ref. No.	086033 0H9305 0K7414
description	thermostat RANCO type K22L1020 probe ø 9mm probe L 40mm capillary pipe 2000mm temperature range -20.5 up to -1.5°C		

			
GEV No.	390277	Ref. No.	0KM735
description	thermostat RANCO type K22L3020 probe ø 9mm probe L 40mm capillary pipe 1600mm temperature range -26.5 up to -19.5°C		

			
GEV No.	390279	Ref. No.	34444194
description	thermostat RANCO type K22L3022 probe ø 9mm probe L 35mm capillary pipe 1600mm		

K50 series

			
GEV No.	390208	Ref. No.	086026
description	thermostat RANCO type K50L3006 probe ømm probe Lmm capillary pipe 2000mm temperature range +1.5 up to +4°C		

			
GEV No.	390271	Ref. No.	0A8089 0KE820
description	thermostat RANCO type K50L3078 probe ømm probe Lmm capillary pipe 2000mm temperature range -7 up to -3°C		
For models:	721-00-115, 721-00-116, 721-00-122, 721-00-123, 125-00-100, 125-00-102, 125-00-103, 125-00-100, 125-00-102, 125-00-103, 23000150.1, 23000151.1, 23100150.1, 23100151.1, 133-01-110, 133-01-111, 133-06-110, 133-06-111, GF4060, 721-00-116, 721-00-122, 721-00-123		

			
GEV No.	390288	Ref. No.	085314 091526 0KV418 R23034
description	thermostat RANCO type K50L3163 probe ømm probe Lmm capillary pipe 2100mm temperature range -24 up to -14°C		
For models:	MF250WB20, FGS500A, FGS500W, FGS94AB, FGS94WB, FIM150ASB, FIM150WSB, FIM285ASB, FIM285WSB, VM250A+BI, VM250W+BI		

GEV No.	390224	Ref. No.	0A8728
description	thermostat RANCO type K50L3199 capillary pipe 2000mm		
For models:	ICF110, ICF110, ICF110, ESQF41F, NICF40, ESQF41F, ET401S, ET401SCS, EC406SGC, EC404SGC, EC404SGC, ZICF40, ZICF40		



GEV No.	390272	Ref. No.	0A8135
description	thermostat RANCO type K50P1117 probe ømm probe Lmm capillary pipe 2000mm temperature range -32 up to -12°C		



GEV No.	390588	Ref. No.	089078
description	thermostat RANCO type K50L3274 probe ø 2mm probe Lmm capillary pipe 3000mm		
For models:	MF250WB20, C150W, C300A, C300W, CB1565W, CB246W, CB416W, CB955W, DSS42W, C80W, CB1565A, C80A, CB246A, CB416A, C150A, CB955A, DSS42A, G500A, MUSTER350A, MUSTER800A, GB1555W, GB1555A, G500W		



GEV No.	390540	Ref. No.	OXS870 E1730 K50P1459
description	thermostat RANCO type K50P1459 capillary pipe 400mm temperature range -22.5 up to +2°C		



GEV No.	390286	Ref. No.	085283
description	thermostat RANCO type K50L3383 probe ømm probe Lmm capillary pipe 1500mm temperature range +1 up to +3°C		
For models:	IMF28A, IMF28W, IMF35A, IMF35W, IMF58A, IMF58W, IMF80A, IMF80W, FGC33AS42, FGC46AS42, FGC65A42, MC140AB20, MC140WB20, MC200AB20, MC200WB20, FGC24AB, FGC24WB, FGC29AB, FGC29WB, FGC40A, FGC40W, FGC67AB, FGC67WB, FGC90A, FGC90W, FGC143AB, FGC143WB, FGS94AB, FGS94WB, FGC-F25A, CB246W, CIM38AB, CIM38WB, CIM85AB, CIM15WB, FIM150ASB, FIM150WSB, CIM50AB, FIM50WB, FGC24ABS, FGC24WBAB, FGC29AB, FGC29WB, CIM38AB, CIM38WB, CIM50AB, FIM50WB, FGC143AB, FGC143WB, CB184A...(Other models you can see in the webshop)		

K52 series



GEV No.	390214	Ref. No.	0A8653
description	thermostat RANCO type K52L4512 probe ø 11mm probe L 30mm capillary pipe 2100mm temperature range -6.4 up to +3.2°C		
For models:	ICP110, ICP111, ICP112, ICP110, ICP111, ICP112, NEPV40, NEPV40, NEPEV40, NEPEV40, NEPA40, NEPEV40, NEPV40, EKE421S, EK401U, EK401UGT, EKE421GTS, EK401UCS, 120.06.402, EP406SRC, EP406SRV, EP406VRC, EP406VRV, EP404VRC, EN404VAC, EP408SRV, 12006402.1, EP406SRC, EP406SRV, EP406VRC, EP406VRV, EP408SRV, EP404VRC, RVPE041, RVPE04V, RVPE04W, ZICP110, ZICV40		



GEV No.	390255	Ref. No.	083520
description	thermostat RANCO type K50P1115/012 capillary pipe 2000mm temperature range +1.5 up to +11°C		
For models:	MVR/E1400, MVR/E1050, MVR/E1060, 7BAE10C, 7BAE14S, 7BAE10S, B105RC, B140RC, KVRC/E3, HVR/E1200, QVRC/E3, WVRC/E3, MVR/E3C, MVR/E3, MVR/E4C, MVR/E4		

K55 series

RANCO



GEV No.	390259	Ref. No.	081688 082025 084032 60050015
description	thermostat RANCO type K55L5026 probe ømm probe Lmm capillary pipe 2000mm temperature range +0.5 up to +8.0°C		
For models:	IKP110, IKP220, IKS110, IKS220, ISP110, ISP220, ISS110, ISS220, TR1202, TR1221, TR1603, TR1622, TR1641, TR2004, TR2023, TR2042, IKPZ110, IKPZ120, IKS110, IKP220, IKPZ240, IKS220, ISPZ110, ISSZ110, ISPZ220, ISSZ220, TR1202, TR1221, TR1603, TR1622, TR1641, TR2004, TR2023, TR2042, IKP110N, IKS110N, IKP220N, IKS220N, ISP110N, ISS110, ISP220N, ISS220, EP406VAV, DVP500V11C, DVP501V11C, MVP502V11C, DVN500V11C, DVN501V11C, DVP500V11V, DVP501V11V...(Other models you can see in the webshop)		

RANCO



GEV No.	390251	Ref. No.	081689
description	thermostat RANCO type K55L5027 capillary pipe 2000mm temperature range -1.4 up to +5.4°C		
For models:	ICP130, ICN110UK, ALP110, ALP120, ALP111, ALP220, ALP240, ALP221, ALN110, ALN120, ALN111, ALN220, ALN240, ALN221, ALNN120, ALNN220, ALNN230, ALNSO120, ALP110UK, ALN110UK, ALNN220UK, ALF110, ALF220UK, ALNF220, ALF110, ALF120, ALF220, ALF240, ALNF120, ALNF220, ALNF230, AKP110, AKS110, AKP120, AKP111, AKP230, AKP220, AKS220, AKP240, AKP221, AKN110, AKN120, AKN111, AKN230, AKN220, AKN240, AKN221, AKNN120, AKNN220, AKNN230...(Other models you can see in the webshop)		

RANCO



GEV No.	390252	Ref. No.	082246 082254 082985 085000
description	thermostat RANCO type K55L5070 capillary pipe 2500mm temperature range -22 up to -7°C		
For models:	ALP110, ALP120, ALP111, ALP220, ALP240, ALP221, ALN110, ALN120, ALN111, ALN220, ALN240, ALN221, ALNN120, ALNN220, ALNN230, ALNSO120, ALP110UK, ALN110UK, ALNN220UK, ALF110, ALF220UK, ALNF220, ALF110, ALF120, ALF220, ALF240, ALNF120, ALNF220, ALNF230, ALP110UK, ALN110UK, ALNN220UK, ALF110UK, ALNF220UK, ALP110, ALP120, ALP111, ALP220, ALP240, ALP221, ALN110, ALN120, ALN111, ALN220, ALN240, ALN221, ALF110, ALF120, ALF220, ALF240...(Other models you can see in the webshop)		

RANCO



GEV No.	390250	Ref. No.	083125
description	thermostat RANCO type K55L5078 probe ømm probe Lmm capillary pipe 2000mm temperature range +2 up to +10°C		
For models:	ALP110, ALP120, ALP111, ALP220, ALP240, ALP221, ALN110, ALN120, ALN111, ALN220, ALN240, ALN221, ALNN120, ALNN220, ALNN230, ALNSO120, ALP110UK, ALN110UK, ALNN220UK, ALF110, ALF220UK, ALNF220, ALF110, ALF120, ALF220, ALF240, ALNF120, ALNF220, ALNF230, ALP110UK, ALN110UK, ALNN220UK, ALF110UK, ALNF220UK, ALP110, ALP120, ALP111, ALP220, ALP240, ALP221, ALN110, ALN120, ALN111, ALN220, ALN240, ALN221, ALF110, ALF120, ALF220, ALF240...(Other models you can see in the webshop)		

RANCO



GEV No.	390248	Ref. No.	083135
description	thermostat RANCO type K55L5079 capillary pipe 2000mm temperature range +2 up to +10°C		
For models:	ALP110, ALP120, ALP111, ALP220, ALP240, ALP221, ALN110, ALN120, ALN111, ALN220, ALN240, ALN221, ALNN120, ALNN220, ALNN230, ALNSO120, ALP110UK, ALN110UK, ALNN220UK, ALF110, ALF220UK, ALNF220, ALF110, ALF120, ALF220, ALF240, ALNF120, ALNF220, ALNF230, ALP110UK, ALN110UK, ALNN220UK, ALF110UK, ALNF220UK, ALP110, ALP120, ALP111, ALP220, ALP240, ALP221, ALN110, ALN120, ALN111, ALN220, ALN240, ALN221, ALF110, ALF120, ALF220, ALF240...(Other models you can see in the webshop)		

RANCO





GEV No.	390217	Ref. No.	083147 646715500
description	thermostat RANCO type K55L5080 probe ømm probe Lmm capillary pipe 2000mm temperature range -3 up to +10°C		
For models:	TRNP1802, TRN1301, TRNA1301, TRNM1301, TRN1302, TRNA1302, TRNM1302, TRN1303, TRNA1303, TRNM1303, TRN1801, TRNA1801, ARNM1801, TRN1802, TRNA1802, TRNM1802, TRN1803, TRNA1803, TRNM1803, TRN2201, TRNA2201, TRNM2201, TRN2202, TRNA2202, TRNM2202, TRN2203, TRNA2203, TRNM2203, TRNP1802, SAL250, ES950, MLP139V12C, MLP132V12C, MLP130V12C, 13000130.1, KTP100, KTSM100, KKSM100, 13000131.1, 13000132.1		





			
GEV No.	390542	Ref. No.	087516 0A9547
description	thermostat RANCO type K55P5851 probe ø 2mm probe Lmm capillary pipe 2500mm		
For models:	RS24, EP406VRPUK, RW24, C04PVF4D, C04PVG4D, E04P6SRC, EP406VRC, E04P6VRV, E04P4VRC, E04P4VRV		

			
GEV No.	390210	Ref. No.	OKM596
description	thermostat RANCO type K55L1042 capillary pipe 1100mm temperature range +1.7 up to +9.5°C probe ø10x110mm		

			
GEV No.	375962	Ref. No.	085889
description	thermostat RANCO type K55-L5106 probe ø 2mm probe L 200mm capillary pipe 2500mm 1NC shaft ø 6x4mm 1-pole with capillary probe		
For models:	FS24, E04C6SCGUK, C04FSF4D, E04C6SGC, E04C4SGC, E04C6SGV, E04C4SGV		

			
GEV No.	375961	Ref. No.	0A9688
description	thermostat RANCO type K55-L5110 probe ø 12mm probe L 29mm capillary pipe 1500mm 1NC shaft ø 6x4mm 1-pole capillary pipe isolated 1500mm with capillary probe		
For models:	AEF110, AEF120, AENF220, AENF230, ASF110, APF113, APF114, APP224/60, APF114, APF223, APF224, APF22B, E06C0M1C, E06C-1M1C, E06C0M2C, E06C1M2C, EC4MOM2C, EC4MOMC3, E05C0M1C, E05C1M1C, C06FM1F, C06FM2F, C14CFM2F, C14CFM3F, C05FM1F, M06C0M1C, M06C9M1C, M06C2M1C, M06C9M1V, M13C0M2C, M13C9M2C, M13C2M2C, CM06FF3M, CM06FF4M, CM06FFWM, CM-13FF3M, CM13FF4M, CM13FFWM, CM06FF3M, CM13FF3M, FVNM061, FVNM062, KMFE933, FVNM051, KMFE662		

			
GEV No.	375966	Ref. No.	087165 0A9690
description	thermostat RANCO type K55-L5112 probe ø 11.5mm probe L 27mm capillary pipe 1550mm temperature range -3.6 up to +12°C		
For models:	AEN110, AEN120, AENN120, AENF120, AEN220, AEN240, AENN220, AENF220, AENN230, AENF230, ASN110, ASN220, E06N0M1C, E06N-1M1C, E06N0M2C, E06N1M2C, EC6N0M2C, EC6N0M2C, E14N0M2C, E14N1M2C, E14N0M4C, E14N1M4C, EC4NOM2C, EC4MOM2C, EC4NOM3C, EC4MOM3C, E05N0M1C, E05N1M1C, E12N0M2C, E12N-1M2C, C06RM1F, C06RM2F, C06CM2F, C06CM2F, C14RM2F, C14RM4F, C14CM2F, C14CFM2F, C14CM3F, C14CFM3F, C05RM1F, C12RM2F, RVNM061, RVNM062, KMNE332, KMNE332, RVNM142, RVNM142, KMFE933, RVNM051...(Other models you can see in the webshop)		

			
GEV No.	375965	Ref. No.	087173
description	thermostat RANCO type K55-L5115 probe ø 12mm probe L 29mm capillary pipe 1600mm 1NC shaft ø 6x4mm 1-pole capillary pipe isolated 1600mm		
For models:	AEF220, AEF240, ASF220, E14C0M2C, E14C1M2C, E14C0M4C, E14C1M4C, E12C0M2C, E12C1M2C, C14FM2F, C14FM4F, C12FM2F, RH06RD1G, RS05RD1G, FVNM142, FVNM144, FVNM122		

			
GEV No.	375963	Ref. No.	087360
description	thermostat RANCO type K55-L5119 probe ø 12mm probe L 28mm capillary pipe 1500mm 1NC shaft ø 6x4mm 1-pole capillary pipe isolated 1500mm with capillary probe		
For models:	APP113, APP114, APP223, APP224, APP114/60, APP224/60, APP11B, APP113V, APP22B, APP224V, M06P0M1C, M06P9M1C, M06P2M1C, M06P9M1V, M13P0M2C, M13P9M2C, M13P2M2C, M13P9M2V, CM06RF3M, CM06RF4M, CM06RFWM, CM13RF3M, CM13RF4M, CM13RFWM, CM06RF3M, CM13RF3M		

K60 series

RANCO



GEV No.	390257	Ref. No.	081378
description	thermostat RANCO type K60L2034 capillary pipe 900mm temperature range -17 up to -10°C		
For models:	DCBR40, DCB/R40F, DCB/R40U, DCB/R40/61, DCBR41, DCB/R41F, DCB/R41U, DCB/R41-6, DCBR61, DCB/R61U, DCB/R61-6		

RANCO



GEV No.	390247	Ref. No.	083177
description	thermostat RANCO type K60L2112 capillary pipe 2000mm		
For models:	DLP14/F, DLP21/F, DL14/F, DL21/F, DL14/F, DL21/F, DLP14/F, DLP21/F, DL14/F, DL21/F, DLP14/F, DLP21/F		

RANCO



GEV No.	390246	Ref. No.	083178
description	thermostat RANCO type K60L2141 capillary pipe 830mm		
For models:	DLP14/F, DLP21/F, DL14/F, DL21/F, DL14/F, DL21/F, DLP14/F, DLP21/F, DL14/F, DL21/F, DLP14/F, DLP21/F		

RANCO



GEV No.	390543	Ref. No.	OKS869 E1739 K60P1106
description	thermostat RANCO type K60P1106 capillary pipe 400mm		

K61 series

RANCO



GEV No.	390212	Ref. No.	086078
description	thermostat RANCO type K61L1500 probe ømm probe Lmm capillary pipe 750mm T war -11.5°C T cold 22°C		

RANCO



GEV No.	390586	Ref. No.	086288 62026411
description	thermostat RANCO type K61L1504 probe ø 2mm probe Lmm capillary pipe 1800mm T war 11.5°C T cold 22°C		

miscellaneous producers



GEV No.	390721	Ref. No.	086037
description	thermostat probe ø 2.3mm capillary pipe 1850mm evaporator		

accessories

fitting parts



GEV No.	504736	Ref. No.	048987
description	bracket for contact thermostat		
For models:	LS32, LS32/4.5, LS32F, LV32F, C55, LV32/60, WT302, WT302/4.5, WT302F, WT302/60, LS33, LS33/4.5, LS33F, LV33F, C55A, LS33/60, WT303, WT303/4.5, WT303F, WT303/60, LB1, LB1WS, LB1WSDP, LB1/RBP, LB1/TOP, LB1/60, WT1WSDP, LB2DPSAUS, LB1G, LB1WSG, WT2TOP60, WT2DPDI, WT2WSDPDI, LB1TOP, WT2TOPDI, LB2WS, LB2, LB2WSDP, LB2/TOP, LB2/RBP, LB2WS60, WT2WSDP, WT2WSDPD, LB2WSG, WT2WS, WT1, WT1WS, WT1TOP, WT2TOP, WT1/3DP...(Other models you can see in the webshop)		



			
1			
GEV No.	550140	Ref. No.	0H7152
description	bracket for probe		

			
1			
GEV No.	697994	Ref. No.	002774
description	bracket for probe		
For models:	RR/E1CL, RR/E2CL, RRV/E1CL, RRV/E2CL, RR/E2CM, XR/E1CL, XR/E2CL, XRV/E1CL, XRV/E2CL, JR/E1CL, JR/E2CL, JRV/E1CL, JRV/E2CL, MR/E1CL, MR/E2CL, MRV/E1CL, MRV/E2CL, MR/E2CM, FCV/G10L3, FCVG10L3T, FCVG102L3, FCV/G20L3, FCVG202L3, FCVG10L3J, FCVG102L3J, FCV/G10L6JAP, FCV/G102/1L6JAP, FCV/G61/1, FCV/G61/1, FCV/G61/1, FCV/G6L4, FCV/G10L6, FCV/G102/1L6, FCV/G20L6, FCVG202L6, FCV/G101/1, FCV/G102/1, FCV/G201/1, FCV/G202/1, FCF/E4-OLD, FCF/E4D, FCFE4PH, 5711-2-6, 5711-2-7, 5711-2-8, 5711-2-10, 5711-2-8CH, 5711-2-10CH, 5712-2-6, 5712-2-7...(Other models you can see in the webshop)		

probe clips

clamps

for thermostat

			
1			
GEV No.	550877	Ref. No.	0K5594
description	probe clip for pipe ømm for probe ø 8mm Qty 1 pcs		
For models:	ACSGRT, GWACOE00RO, FWAAM00RO, GWACOMO0RO, IWKCOE0000, HWAHOE00RO, GWAHOE0000, GWAHOE00RO, FWAHOE00RO, BEN150EW87, HWAJOE00RO, GWAJOE00RO, FWAJOE00RO, BEN200EW87, GWAJOMO0RO, FWFJOEX000, FWFJOEX0RO, BEN300E.S35.H97, GWAKOE00RO, FWAKE00RO, IWAKOMO0RO, GWAKOMO0RO, FWFKOEX0RO, FWKOE00RO, IWALOE0000, IWALOE00RO, BEN400E.S35.H97, BEN400EF97, FWALOE00RO, GWALOMO0RO, IVAAOE0000, HVAEOE00RO, GVAEOE0000, GVAEOE00RO, FVAEOE00RO, IVKAOE0000, FVKAEOE00RO, HVABOE00RO, GVABOE0000, GVABOE00RO, FVABOE00RO, FVFB0EX0RO, IVKBOE0000, FVKBOE00RO, IVACOEO0RO, BON080EF88, GVACOE00RO, FVACOE00RO, IVACOMO0RO, GVACOMO0RO...(Other models you can see in the webshop)		

			
1			
GEV No.	550403	Ref. No.	056330 0K9608 728044
description	probe clip for pipe ø 8.5mm for probe ø 6mm Qty 1 pcs		
For models:	MFR/E350, MFR/E700, MFR/E370, MFR/E350UK, MFR/E700UK, MFR/E370UK, MFR/E370D, MFR/E350D, MFR/E700D, BF/E1S12, RF/E1D05, RFR/E1S12, RFR/E2D12, RFR/E2S40, RF/E1S12, RF/E2D12, RF/E1S12, RF/E2D12, RF/E1S12E5, RF/E2D12E5, RFR/E1S12, RFR/E2D12, XF/E1D05, XFR/E1S12, XFR/E2D12, XFR/E2S40, XF/E1S12, XF/E2D12, XF/E1S12, XF/E2D12, XFR/E1S12, XFR/E2D12, JF/E1D05, JFR/E1S12, JFR/E2D12, JFR/E2S40, JF/E1S12, JF/E2D12, JF/E1S12, JF/E2D12, MF/E1D05, MFR/E1S12, MFR/E2D12, MFR/E2S40, MF/E1S12, MF/E2D12, MF/E1S12, MF/E2D12, MF/E1S12E5, MF/E2D12E5...(Other models you can see in the webshop)		

for safety thermostat			
			
1			
GEV No.	550117	Ref. No.	0H6833 0KC593 0KD207
description	probe clip for pipe ø 8.5mm for probe ø 6mm Qty 1 pcs		
For models:	7573-3/85.KES100.(N), 7574-3/85.KES150.(N), 7575-3/85.KES250.(N), 7576-3/85.KES300.(N), 7573-3/90.KES100.(N), 7574-3/90.KES150.(N), 7575-3/90.KES250.(N), 7576-3/90.KES300.(N), 7573-3, 7574-3, 7575-3, 7576-3, 7577-3, 7773-3, 7773-3/85.KES100, 7773-3/90.KES100, 7774-3, 7774-3/85.KES150, 7774-3/90.KES150, 7775-3, 7775-3/85.KES250, 7775-3/90.KES250, 7776-3, 7776-3/85.KES300, 7776-3/90.KES300, 9100-3, 9104-3, 9113-3, 9300-3-0, 9300-3-8, 9304-3-0, 9304-3-8, 9313-3-0, 9313-3-8		

			
1			
GEV No.	550401	Ref. No.	057519 066823
description	probe clip for pipe ø 9mm for probe ø 6mm Qty 1 pcs		
For models:	MCF/G1090, MCF/G1095, MCF/G995, MG/E350D, MG/E350UK, MG/E700D, MG/E700UK, MG/E350, MG/E700, RCF/G2, RCF/G3, RCF/G9, RG/E1, RG/E2, RGV/E1, RGV/E2, RTF/G2, RSF/G2, RSF/G3, MCF/G2A, MCF/G3A, XCF/G2, XCF/G3, XCF/G9, XG/E1, XG/E2, XGV/E1, XGV/E2, XTF/G2, XSF/G2, XSF/G3, JCF/G2, JCF/G3, JG/E1, JG/E2, JTF/G2, MCF/G2, MCF/G3, MCF/G9, MG/E1, MG/E2, MGV/E1, MGV/E2, MTF/G2, MSF/G2, MSF/G3, RCF/G1095, RG/E350D, RG/E350UK, RG/E700D...(Other models you can see in the webshop)		

spring clips

for thermostat

			
1			
GEV No.	550398	Ref. No.	004929 0K3528
description	probe spring for pipe ø 2x8.5mm for probe ø 4mm L 42mm W 11mm Qty 1 pcs		
For models:	SFRE700, SFRE350, SFRE700, SFRE350, SFRE351, SFRE700, SFRE701		

for safety thermostat

			
1			
GEV No.	550005	Ref. No.	0H6907
description	probe clip for pipe ø 17x6mm for probe ø 6mm Qty 1 pcs for flat tube heating element		

			
1			
GEV No.	550539	Ref. No.	00091 004923 0K3504
description	probe clip for pipe ø 8.5mm for probe ø 4mm Qty 1 pcs		
For models:	SFRE700, SFRE350, SFRE700, SFRE350, SFRE351, SFRE700, SFRE701		



miscellaneous



GEV No.	504757	Ref. No.	0L0280
description	screw connection ID ø 10mm for probe		
For models:	WT4, WT4B, WT4D, WT4DB, WT46, WT4DG, WT4WS1, WT4BWS, WT4DWS1, WT4BDWS, NUC3DD, WT4D60, WT4DDG, EUC1, EUC1DP, EUC1WS, EUC1DPWS, EUC3, EUC3WS, EUC3DP, EUC3DPWS, EUC1G, EUC1DP60, EUC3DD, ZUCADDROW, ZUCADDROW6, LS5/1, LS5/1DP, LS5/1WS, LS5/1WSDP, LS5/3, LS5/3DP, LS5/3WS, LS5/3WSDP, FUCA3DD, LS5/3WSDPD, LB5DPG, LS5/1DP60, LS5/1DPAUS, LS5/1DPCS, KUC3, KUC3DP, NUC1, NUC1DP, NUC1WS, NUC1DPWS, NUC3, NUC3WS, NUC3DP, NUC3DPWS...(Other models you can see in the webshop)		

capillary tube clips



GEV No.	550004	Ref. No.	0H6906
description	capillary tube clip for pipe ø 17x6mm for flat tube heating element		



GEV No.	550138	Ref. No.	052262 0H6922 0KT898 18005602 279916 SK50399AUSFB
description	capillary tube clip for pipe ø 8.5mm for circular tube heating elements		
For models:	MFR/E350, MFR/E700, MFR/E370, MFR/E350UK, MFR/E700UK, MFR/E370UK, MFR/E370D, MFR/E350D, MFR/E700D, BF/E1S12, RF/E1D05, RF/E1S12, RF/E2D12, RF/E1S12E5, RF/E2D12E5, RFR/E1S12, RFR/E2D12, XF/E1D05, XFR/E1S12, XFR/E2D12, XFR/E2S40, XF/E1S12, XF/E2D12, XF/E1S12, XF/E2D12, XFR/E1S12, XFR/E2D12, JF/E1D05, JFR/E1S12, JFR/E2D12, JFR/E2S40, JF/E1S12, JF/E2D12, JF/E1S12, JF/E2D12, MF/E1D05, MF/E1S12, MF/E2D12, MF/E1S12E5, MF/E2D12E5, MFR/E1S12, MFR/E2D12, 7FRE03S, 7FRE07S, 7FRE23S, RFR/E350UK, RFR/E700UK, RFR/E370UK, T3SEFR, T70EFR...(Other models you can see in the webshop)		

gland nut accessories

ducts



GEV No.	550271	Ref. No.	0K9769 624042
description	gland duct ET M12x0.75 IT M9x1 with gasket and nut		



gaskets



GEV No.	510452	Ref. No.	006098
description	gasket silicone ø 7.8mm L 7mm		
For models:	RFR/G1S14, RFR/G2D14, RFR/E1S14, RFR/E2D14, RF/G1S07, RF/G2D07, RFR/G1S07, RFR/G2D07, RF/E1S07, RF/E2D07, RFR/E1S07, RFR/E2D07, XFR/G1S14, XFR/G2D14, XFR/E1S14, XFR/E2D14, XF/G1S07, XF/G2D07, XFR/G1S07, XFR/G2D07, XF/E1S07, XF/E2D07, XFR/E1S07, XFR/E2D07, JFR/G1S14, JFR/G2D14, JFR/E1S14, JFR/E2D14, JF/G1S07, JF/G2D07, JFR/G2D07, JFR/G2D07, JF/E1S07, JF/E2D07, JFR/E1S07, JFR/E2D07, MFR/G1S14, MFR/G2D14, MFR/E1S14, MFR/E2D14, MF/G1S07, MF/G2D07, MFR/G1S07, MFR/G2D07, MF/E1S07, MF/E2D07, MFR/E1S07, MFR/E2D07		

bolts with slot



GEV No.	520243	Ref. No.	027061	
description	bolt with slot thread M9x1 Qty 10 pcs nickel-plated brass			
accessories for	520243			
	GEV No.	510591	Ref. No.	—
	washer with slot ED ø 8.8mm slit width 1.2mm Qty 10			
	GEV No.	510592	Ref. No.	—
	gasket ø 8x8.7mm Qty 10 pcs slotted silicone			

locking screws





GEV No.	504738	Ref. No.	067899 0KX146 214195500 722935	
description	screw connection for probe thread M12x1 ID ø 6.3mm L 18mm			
For models:	MCP/E700, MCP/G700, MCP/E700D, MCP/G701, MCP/G710, MCP/G711, RCP/E2S, MCP/E2S, 7CPE07P, 7CPG07P, RCP/G701, M70EPC, M70GPC, M70GPC, CCP/G700, CCP/E700, PCP/E2SHP, OCP/E2S, TCP/E2S, RCP/G700, HCP/G410D, HCP/G410, HCP/G810, HCP/E410, HCP/E810, HCP/E410, ZCP/G410, ZCP/G810, ZCP/E410, ZCP/E810, ZCPS/E410, ACP/G400, ACP/G410, ACP/G800, ACP/G810, ACP/E400, ACP/E410, ACP/E800, ACP/E810, ACPS/G400, ACPS/E400, ACPS/E410, LS32, LS32/4.5, LS32UK/RP, LS32F, LV32F, C55, LV32/60, WT4...(Other models you can see in the webshop)			
accessories for	504738			
	GEV No.	528485	Ref. No.	067898 070339 086109 0H2570 0KK903 530501200 60074
	O-ring EPDM thickness 1.78mm ID ø 6.07mm Qty 1 pcs			



			
1			
GEV No.	550926	Ref. No.	059295 17012752
description	union screw thread M12x1 probe ø max. 4mm SS		
For models:	MFR/G740, MFR/G350, MFR/G351, MFR/G700, MFR/G701, BF/G1S07, BFR/G1S14, BFR/E1S14, RFR/G1S12, RFR/G2D12, RFR/G2S40, XFR/G1S12, XFR/G2D12, XFR/G2S40, JFR/G1S12, JFR/G2D12, JFR/G2S40, MCP/E1SH, MCP/E1SUH, MCP/E2SUHS, MFR/G1S12, MFR/G2D12, MFR/G2S40, MCP/E2SH, MCP/E2SUH, MCP/E2SUT, MCP/E2SHB, RFR/G741, 7FRG03S, 7FRG07S, CFR/G741, M35GFR, M70GFR, CFR/G351, CFR/G701, PF/G1S07, PF/G2D07, PFR/G1S07, PFR/G2D07, PFR/G1S14, PFR/G2D14, PF/E1S07, PF/E2D07, PFR/E1S07, PFR/E2D07, PFR/E1S14, PFR/E2D14, PF/E1S07E5, PFRE2D07E5, ECP/E1ELHU...(Other models you can see in the webshop)		

			
1			
GEV No.	550925	Ref. No.	002076 17012753
description	union screw thread M12x1 probe ø max. 6mm SS		
For models:	MFR/G740, MFR/G350, MFR/G351, MFR/G700, MFR/G701, RFR/G1S12, RFR/G2D12, RFR/G2S40, XFR/G1S12, XFR/G2D12, XFR/G2S40, JFR/G1S12, JFR/G2D12, JFR/G2S40, MFR/G1S12, MFR/G2D12, MFR/G2S40, RFR/G741, 7FRG03S, 7FRG07S, CFR/G741, M35GFR, M70GFR, CFR/G351, CFR/G701, XFR/G700, PFR/G2S40, TFR/G2S40, KFR/G1E, KFR/G2F, KFR/E1E, KFR/E2F, KFH/G1, KFH/E1, KFH/G1ELH, KFH/E1ELH, KFH/G1EH, KFH/E1EH, HFR/G410, HFR/G810, HFR/G410D, HFR/G810D, HFR/G410NL, HFR/G810NL, HFR/G411, HFR/G412, HFR/G430, HFR/G430, HFR/G430, HFR/G830...(Other models you can see in the webshop)		

connecting bows			
			
1			
GEV No.	550060	Ref. No.	006712 01103 01P01 054376 0A2039 0H6283 0KQ972 0M0643 VO2215
description	connecting bow long for thermostat Qty 1 pcs		
For models:	RF/E1S08, RF/E2D08, RFR/E1S08, RFR/E2D08, RFR/E1S14, RFR/E2D14, RF/E1S07, RF/E2D07, RFR/E1S07, RFR/E2D07, XF/E1S08, XF/E2D08, XFR/E1S08, XFR/E2D08, XFR/E1S14, XFR/E2D14, XF/E1S07, XF/E2D07, XFR/E1S07, XFR/E2D07, JF/E1S08, JF/E2D08, JFR/E1S08, JFR/E2D08, JFR/E1S14, JFR/E2D14, JF/E1S07, JF/E2D07, JFR/E1S07, JFR/E2D07, MF/E1S08, MF/E2D08, MFR/E1S08, MFR/E2D08, MFR/E1S14, MFR/E2D14, MF/E1S07, MF/E2D07, MFR/E1S07, MFR/E2D07, PF/E1S07, PF/E2D07, PFR/E1S07, PFR/E2D07, PF/E1S07E5, PFRE2D07E5, OF/E1S07, OFR/E1S07, OFR/E2D07, TF/E1S07...(Other models you can see in the webshop)		

			
1			
GEV No.	550059	Ref. No.	0A2205 0G0270 0H6775 0K5001 0KM937 0KT779 18015163 253566 537001200 5370012005 617078 721205
description	connecting bow short for switch Qty 1 pcs		
For models:	BR/E1FL, BR/E1FR, BR/E2FL, BR/E2FR, RR/E1FL, RR/E1FR, RR/E1CL, RR/E2FL, RR/E2FM, RR/E2CL, RRV/E1FL, RRV/E1FR, RRV/E1CL, RRV/E2FL, RRV/E2FM, RRV/E2CL, RR/E2CM, RG/E1, RG/E2, RGV/E1, RGV/E2, XR/E1FL, XR/E1FR, XR/E1CL, XR/E2FL, XR/E2FM, XR/E2CL, XRV/E1FL, XRV/E1FR, XRV/E1CL, XRV/E2FL, XRV/E2FM, XRV/E2CL, XG/E1, XG/E2, XGV/E1, XGV/E2, JR/E1FL, JR/E1FR, JR/E1CL, JR/E2FL, JR/E2FM, JR/E2CL, JRV/E1FL, JRV/E1FR, JRV/E1CL, JRV/E2FL, JRV/E2FM, JRV/E2CL, JG/E1...(Other models you can see in the webshop)		

switches and momentary switches
rocker/momentary rocker switches

25.5x25mm			
			
1			
GEV No.	347115 ¹	Ref. No.	092131
description	rocker switch mounting measurements 25.5x25mm clear 2CO 250V 16A illuminated connection male faston 6.3mm ambient temperature max. 85°C protection IP40		

¹illuminated

			
1			
GEV No.	347542	Ref. No.	085977
description	rocker switch mounting measurements 25x25mm white 2CO 250V 16A I-II connection male faston 6.3mm ambient temperature max. 85°C protection IP40		
For models:	C06RD1F, C06RD1FL, C06RD2F, C06RD1G, C06RM1F, C06RM2F, C06RM1G, C06FD1F, C06FD1FL, C06FD2F, C06CD2F, C06CFD2F, C06CFD2FR, C06CM2F, C06CM2F, C14RD2F, C14RD4F, C14RD2G, C14RM2F, C14RM4F, C14RM2G, C14CD2F, C14CFD2F, C14CD3F, C14CFD3F, C14CM2F, C14CFM2F, C14CM3F, C14CFM3F, C05RM1F, C05RM1G, C12RM2F, C12RM2G, RSD36, RGD36, FSD36, RSD313, RS25, FS25, RS212, RDNE061, RVNE062, RVNE06V, RVNM061, RVNM062, RVNM06V, FDFE061, FDFNE062, KVPE332, KVNE332...(Other models you can see in the webshop)		



27.8x25mm

			
1			
GEV No.	347656 ¹	Ref. No.	085987 089175 092130 099274
description	rocker switch mounting measurements 27.8x25mm green 2NO 250V 16A illuminated 0-I connection male faston 6.3mm		
For models:	83012001, 83012033, 83012201, ARDF110L, ARDF120, ARDNN120, 83012101, ARDN220, ARDN221, ARDNF220, 83012037, ASN110, ASF110, ASN220, ASF220, ADN110, ADN120, ADN111, ADF110, ADF120, ADNN120, ADNF120, ADN220, ADN240, ADN221, ADF220, ADF240, ADNN220, ADNF220, ADNN230, ADNF230, ADN11060, ADF11060, ADN22060, ADF2206, ZPRO4R1F, ZPRO4F1F, ZPRO6R1F, ZPRO6F1F, STRP1101, STRP1102, STRP1601, TRN224C, TRN224D, TRN224E, STRP1602, STRP1603, STRP2201, STRP2202, STRP2203... (Other models you can see in the webshop)		

¹illuminated



			
1			
GEV No.	347546	Ref. No.	099275
description	rocker switch mounting measurements 27.8x25mm white 2CO 250V 16A I/II %HUM connection male faston 6.3mm ambient temperature max. 85°C protection IP40		
For models:	83012001, 83012033, 83012101, 83012037, ASN110, ASN220, ADN110, ADN120, ADNN120, ADN220, ADN240, ADNN220, ADNF220, ADNN230, ADNF230, ADN11060, TRN224C, TRN224D, TRN224E, TRN132A, TRN132B, TRN132C, TRNA132A, TRNA132B, TRNA132C, TRRN132A, TRRN132B, TRRN132C, TRN183A, TRN183B, TRN183C, TRN183D, TRNA183A, TRNA183B, TRNA183C, TRNA183D, TRRN183A, TRRN183B, TRRN183C, TRRN1842D, TRN22A4, TRN224B, TRNA224A, TRNA224B, TRRN224A, TRRN224B, PR04R1FBR, PR06R1FBR, PR06R2FBR, PR06R1F4... (Other models you can see in the webshop)		



30x11mm

			
1			
GEV No.	301014	Ref. No.	OK6805 OKB556 201120021 301014 464129209 4641292091 990700
description	momentary rocker switch mounting measurements 30x11mm black 1NO 250V 16A connection male faston 6.3mm ambient temperature max. 85/125°C protection IP40 mounting ømm male faston 6.3mm		
For models:	D180, D180, D180, D180, D180		

			
1			
GEV No.	301012	Ref. No.	004110
description	rocker switch mounting measurements 30x11mm green 1NO/ indicator light 250V 16A 0-I connection male faston 6.3mm ambient temperature max. 85/125°C protection IP40		
For models:	ZCMDG6, ZCMDG4, ZCMDG9		



30x22mm

			
1			
GEV No.	301003	Ref. No.	004158 083086 91310085
description	rocker switch mounting measurements 30x22mm green 2NO 250V 16A illuminated 0-I connection male faston 6.3mm ambient temperature max. 125/55°C protection IP65		
For models:	ZCMD6, ZCBDE12, ZCMM6, ZCBME12, ZCMD4, ZCBDE8, ZCMM4, ZCBME8, ZCMD9, ZCBDE18, ZCMM9, ZCBME18, ZCBDG8, ZCBDG12, ZCBDG18, FFPS16, FFPS32, PDE830, PDE1230, PDE12L30, PDE1830, PDE835, PDE1235, PDE12L35, PDE1835, PME430, PME630, PME6L30, PME930, PME435, PME635, PME6L35, PME935, PME830, PME1230, PME12L30, PME1830, PME835, PME1235, PME12L35, PME1835, PDG433, PDG633, PDG933		
accessories for	301003		
	GEV No.	301036	Ref. No. 002150
	protective cover internal size 30x22mm for rocker switch mounting measurementsmm		

			
1			
GEV No.	301001	Ref. No.	005899 0C4924 91310090
description	rocker switch mounting measurements 30x22mm red 2NO 250V 16A illuminated 0-I connection male faston 6.3mm ambient temperature max. 125/55°C protection IP65		
For models:	ZCBDG8, ZCBDG12, ZCBDG18		
accessories for	301001		
	GEV No.	301036	Ref. No. 002150
	protective cover internal size 30x22mm for rocker switch mounting measurementsmm		



			
1			
GEV No.	301091	Ref. No.	OK7092 301091
description	rocker switch mounting measurements 30x22mm red 2NO 400V 10A illuminated 0-I connection male faston 6.3mm ambient temperature max. 125/55°C protection IP40		





			
1			
GEV No.	301009	Ref. No.	050491 081679 081682 082390 085634 089013 0A8248 0HB342 3700100 40111709 660800901
description	rocker switch mounting measurements 30x22mm white 2NO 250V 16A illuminated 0-I connection male faston 6.3mm ambient temperature max. 125/55°C protection IP65		
For models:	ICF110, ICP110, ICP111, ICP130, ICP112, ITP120UK, ICF110, ICN110UK, ICF110, ITP120UK, AP20, ILP110, ILP110UK, ILN120, ILP111, ILP220, ILP220UK, ILP240, ILP221, ILN110, ILN110UK, ILN120, ILN111, ILN220, ILN220UK, ILN240, ILNSO120, ILN221, ILNN120, ILNN220, ILNN220UK, ILF110, ILF110, ILF120, ILF220, ILF220UK, ILF240, ILNF120, ILNF220, ILNF220UK, IKP110, IKP220, IKN110, IKN220, IKNSO120, IKNN120, IKNN220, IKNN230, IKS110, IKS220...(Other models you can see in the webshop)		
accessories for	301009		
		GEV No.	301036 Ref. No. 002150
	protective cover internal size 30x22mm for rocker switch mounting measurementsmm		

			
1			
GEV No.	301036	Ref. No.	002150
description	protective cover internal size 30x22mm for rocker switch mounting measurementsmm		
For models:	HBR/G801, HBR/G806, HBR/G811, HBR/G816, HBR/G801D, HBR/G806D, HBR/G811D, HBR/G816D, HBR/E801, HBR/E806, HBR/E811, HBR/E816, ZBR/G801, ZBR/G806, ZBR/G811, ZBR/G816, ZBR/G801D, ZBR/G806D, ZBR/G811D, ZBR/G816D, ZR/G413, BR/E806, ZBR/E811, ZBR/E816, ABR/G801, ABR/G806, ABR/G811, ABR/G816, ABR/G801D, ABR/G806D, ABR/G811D, ABR/G816D, ABR/E801, ABR/E806, ABR/E811, ABR/E816		



			
1			
GEV No.	301314	Ref. No.	082873
description	rocker switch mounting measurements 30x22mm white 2NO 250V 16A ON-OFF connection male faston 6.3mm ambient temperature max. 100/55°C protection IP40		
For models:	ICP111, ICP112, ICP110, ICP112, NEPEV40, NEPEV40, NEPEV40, 400LTPVN, ES2M, ES3M, RVPE04V, RVPE04W, ZICV40, ZICP40, ZICFV40, ZICFV40		



			
1			
GEV No.	345711	Ref. No.	082473
description	rocker switch mounting measurements 30x22mm white 2CO 250V 16A I-II connection male faston 6.3mm ambient temperature max. 100/55°C protection IP40		
For models:	ILP110, ILP110UK, ILN120, ILP220, ILP220UK, ILP240, ILN110, ILN110UK, ILN120, ILN220, ILN220UK, ILN240, ILNN220, ILNN220UK, ILNF220, ILNF220UK, ESR141212F, ESR142F, ESR14412F, ESR142G, ESR4212FR, ESR4212F, ESR41FR, ESF41F, ESR41F, ESR61F, ESR621/2F, ESR621/2F, ESR61FR, EUKR142N, EUKF41F, EUKR142F, EUKR141212, EUKR14412F, ESR41F60HZ, ESR422F60HZ, ESR61F60, ESR622F60, ESR142F60, ESR1412F60HZ, ESR1442F60HZ, ESR142G60HZ, ESF41G60, ESF41G, ESR421/2F, ESR41FR, ESR41F...(Other models you can see in the webshop)		
accessories for	345711		
		GEV No.	301036 Ref. No. 002150
	protective cover internal size 30x22mm for rocker switch mounting measurementsmm		

			
1			
GEV No.	345714	Ref. No.	082486
description	rocker switch mounting measurements 30x22mm green 2NO 250V 16A illuminated refrigeration connection male faston 6.3mm ambient temperature max. 85°C protection IP40		
For models:	ILNN120, ILF110, ILF110, ILF120, ILF220, ILF220UK, ILF240, ILNF120, ILNF220, ILNF220UK, ICP111, ZBRAV806, ZBRAV805, ZBRAVV805, ZBRAV706, ZBRAV705, ZBRAVV705, ESF61G60, ESF41GR, ESF41G60HZ, ESF61GR, ESF41F, IKN111, IKN221, ISP221N, ESF41GR, PTVN2719, PTVN2519, PTVN2724, PTVN2524, FVNE061, FVNE132, KVNE662, ZILNN120, KVNE332, KVNE932, FVNE062, ZILNF230, ILF120, ZICP110, ILF110		



blank			
			
1			
GEV No.	345390	Ref. No.	054547 055014
description	momentary rocker switch mounting measurements 30x22mm red 1NC 230V 16A illuminated connection male faston 6.3mm ambient temperature max. 125/55°C protection IP65 with cover cap		
For models:	FCFG10, FCFG10D, FCFG10NL, FCFG20, FCFG20D, FCFG20F, PFCFG20, FCFG40, FCFG41, FCFG40D, FCFG40F, PFCFG40F, FCFG20J, FCFG20J, FCFG40J, FCFG40J, FCFG20J, FCFG20J, FCFG41J, FCFG40J, FCFG101, FCFG201, FCFG202, FCFG202, FF/G20, FF/G40, COCO10G, COCO20G, 4236N, ZOFCE/G10D, ZOFCE/G20D		
accessories for	345390		
		GEV No.	301036 Ref. No. 002150
	protective cover internal size 30x22mm for rocker switch mounting measurementsmm		





			
1			
GEV No.	346297	Ref. No.	056880 OK2911
description	rocker switch mounting measurements 30x22mm orange 2NO 230V 16A illuminated connection male faston 6.3mm ambient temperature max. 125/55°C protection IP65		
For models:	MCP/E700, MCP/G700, MCP/E700D, RCP/G700, RCPE700		
accessories for	346297		
	GEV No.	301036	Ref. No. 002150
	protective cover internal size 30x22mm for rocker switch mounting measurementsmm		



			
1			
GEV No.	346298	Ref. No.	056878 056879 OK2905
description	rocker switch mounting measurements 30x22mm yellow 2NO 230V 16A illuminated II connection male faston 6.3mm ambient temperature max. 125/55°C protection IP65 with cover cap		
For models:	MCP/E700, MCP/G700, MCP/E700D, 7CPE07P, 7CPG07P, M70EPC, M70GPC, CCP/E700, RCP/G700, RCPE700, RCP/G700, RCP/E700		
accessories for	346298		
	GEV No.	301036	Ref. No. 002150
	protective cover internal size 30x22mm for rocker switch mounting measurementsmm		



labelled

			
1			
GEV No.	300125	Ref. No.	053810 056702 056703 081680 085609 0HA083 OK8650 OKM979 OPE186 20528 23327 74500120 9020528 B23327
description	rocker switch mounting measurements 30x22mm green 2NO 230V 16A 0-I connection male faston 6.3mm ambient temperature max. 125/55°C protection IP65 with cover cap		
For models:	WMMGHUK, WMMHPLUK, MTC1200P, MTC1400P, MTC1600P, MTC1800P, MTC2000P, MTC1210P, MTC1410P, MTC1610P, MTC1810P, MTC2010P, M7CD1200P, M7CD1400P, M7CD1600P, M7CD1800P, M7CD2000P, MSR1207, MSR1407, MSR1607, MSR1807, MSR2007, MSR1217, MSR1417, MSR1617, MSR1817, MSR2017, MSRP1207, MSRP1407, MSRP1607, MSRP1807, MSRP2007, LPS/75, 7CPE07P, 7CPG07P, M70EPC, M70GPC, CCP/E700, FCFG10, FCFG10D, FCFG10NL, FCFE10, FCFE10UK, FCFG20, FCFG20D, FCFG20F, PFCFG20, FCFE20, FCFE20UK, FCFE20V...(Other models you can see in the webshop)		
accessories for	300125		
	GEV No.	301036	Ref. No. 002150
	protective cover internal size 30x22mm for rocker switch mounting measurementsmm		

with symbol

			
1			
GEV No.	346385	Ref. No.	054552 401D3501
description	rocker switch mounting measurements 30x22mm green 2CO 230V 16A illuminated fan connection male faston 6.3mm ambient temperature max. 125/55°C protection IP65 with cover cap		
For models:	FCFG10, FCFG10D, FCFG10NL, FCFE10, FCFE10UK, FCFG20, FCFG20D, FCFG20F, PFCFG20, FCFE20, FCFE20UK, FCFG101, FCFG201, FCF/E10, FCF/E20, COCO10G, COCO10E, COCO20G, COCO20E, FCFE101, FCFE201, ZOFCF/G10D, ZOFCF/G20D		
accessories for	346385		
	GEV No.	301036	Ref. No. 002150
	protective cover internal size 30x22mm for rocker switch mounting measurementsmm		

			
1			
GEV No.	346386	Ref. No.	058808
description	rocker switch mounting measurements 30x22mm green 2CO 250V 16A illuminated I-II connection male faston 6.3mm ambient temperature max. 85°C protection IP65 with cover cap		
For models:	FCFE10, FCFE10UK, FCFE20, FCFE20UK, FCFE10J, FCFE10J, FCFE20J, FCFE20J, COCO10E, COCO20E, FCFE101, FCFE201		
accessories for	346386		
	GEV No.	301036	Ref. No. 002150
	protective cover internal size 30x22mm for rocker switch mounting measurementsmm		

			
1			
GEV No.	346384	Ref. No.	053837
description	rocker switch mounting measurements 30x22mm green 2NO 250V 16A illuminated I-II connection male faston 6.3mm ambient temperature max. 125/55°C protection IP65 with cover cap		
For models:	FCFE10, FCFE10UK, FCFE20, FCFE20UK, FCF/E10, FCF/E20, COCO10E, COCO20E, FCFE101, FCFE201		
accessories for	346384		
	GEV No.	301036	Ref. No. 002150
	protective cover internal size 30x22mm for rocker switch mounting measurementsmm		



			
1			
GEV No.	345713	Ref. No.	082391
description	rocker switch mounting measurements 30x22mm white/yellow 1NO/NO 250V 16A illuminated lighting, I-II connection male faston 6.3mm ambient temperature max. 100/55°C protection IP40		
For models:	ILP111, ILP221, ILN111, ILN221, ESR142GR, ESR142G, ESR41GR, ESR41G, ESR41G60HZ, ESR142G60HZ, ESF41F60, ESR41G, ESMR41G, ESR41GR, ESM41G, ETE601GT, ESR41G, ESR142G, EUKR41GR, ESR142GR, EKZ601GT, EKE601GT, ETE601GT, ZLP111, ZLP221, ZLN111, ZLN221, RVPE132, RVNE312V, RPPE13V		

			
1			
GEV No.	345161 ¹	Ref. No.	054518 082446 0K2150 0K3029 60050016
description	push switch mounting ø 25mm green 2NO 250V 16A illuminated connection male faston 6.3mm ambient temperature max. 85°C protection IP40		
For models:	MFR/G350, MFR/G700, MFR/G350D, MFR/G700D, MFR/G350F, MFR/G700F, MFR/G350E, MFR/G700E, MVR/E1400, MVR/E1050, MVR/E1060, MCP/G700, RC/G1, RC/G2, RCV/G2, RCV/G3, RCF/G2, RCF/G3, RSF/G2, RSV/G2, RSF/G3, MCF/G2A, MCF/G3A, XC/G1, XC/G2, XCV/G2, XCV/G3, XCF/G2, XCF/G3, XSF/G2, XSV/G2, XSF/G3, JC/G1, JC/G2, JCV/G2, JCV/G3, JCF/G2, JCF/G3, MC/G1, MC/G2, MCV/G2, MCV/G3, MCF/G2, MCF/G3, MSF/G2, MSV/G2, MSF/G3, RFR/G350, RFR/G700, RFR/G350D...(Other models you can see in the webshop)		

¹illuminated

			
1			
GEV No.	345715	Ref. No.	082328
description	push switch mounting ø 25mm white 2NO 250V 16A illuminated connection male faston 6.3mm ambient temperature max. 85°C protection IP40		
For models:	ISP110, SFM21/C, SM15/F, SM21/F, SMP15/F, SMP21/F, SFM21/F, SM15/F, SM21/F, SMP15/F, SMP21/F, IKPZ110, IKPZ120, IKNZ110, IKNZ120, IKS110, IKP220, IKPZ240, IKN220, IKN240, IKS220, ISPZ110, ISNZ110, ISSZ110, ISPZ220, ISNZ220, ISSZ220, ILF110, ILF110, IKF220, IKNF, FVNE051, FVNE11E, ISS110		

			
1			
GEV No.	347428	Ref. No.	0C2129
description	momentary push switch mounting ø 25mm black NO 250V 16A connection male faston 6.3mm ambient temperature max. 85°C protection IP40 with rubber collar		
For models:	PCP/E2SH, PCP/E1SH, PCP/E2SH, PCP/E2SH3B, OCP/E2S, OCP/E1SH, OCP/E2SH, TCP/E2S, TCP/E2SH, QBR/G2F, QBR/G2C, QBR/G3F, QBR/G3FH, QBR/G3C, QBR/G3CH, QBR/E2F, QBR/E2C, QBR/E3F, QBR/E3FH, QBR/E3C, QBR/E3CH, QBR/G2FH, QBR/G2CH, QBR/E2FH, QBR/E2CH		

			
1			
GEV No.	345039	Ref. No.	053979 0K3030 60050204 727947
description	protective cover round ED ø 33mm external size 23mm internal size 21mm H 12mm clear mounting ø 25mm		
For models:	RC/G320, RC/G330, RC/G320F, RC/G720, RC/G730, MCF/G705, MCF/G1055, MCF/G700, MCF/G1050, MCF/G705E, MCF/G1055E, MCF/G700D, MCF/G700, MCF/G705F, MCF/G1055F, MCF/G705NL, MCF/GE705, MCF/GE1055, MCF/GE700, MCFGE1050, MCF/GE700D, MCFGE1050D, MCF/G1050D, MCFG1055NL, MC/G355, MC/G350, MC/G355E, MC/G350D, MC/G355F, MC/G355NL, MC/G705, MC/G700, MC/G705E, MC/G700D, MC/G705NL, MC/G1055, MC/G1050, MC/G1050D, MC/G1055NL, MC/G705F, MCF/GE1055UK, MCF/G1090, MCF/G1095, MC/G352, MC/G702, MC/G1052, MCF/G702, MCF/GE702, MCF/G1052, MCFGE1052...(Other models you can see in the webshop)		
accessories for	345039		
		GEV No.	345001
		Ref. No.	—
	momentary push switch mounting ø 25mm yellow 1NO/indicator light 250V 16A cover connection male faston 6.3mm ambient temperature max. 85°C protection IP65		

2 hole fixing			
			
1			
GEV No.	345021	Ref. No.	046340 046348
description	momentary push switch 2NO		
For models:	LS360F, LS365F, LS500F, LS501F, LS540F, LS540DK, LS541F, LS367, LS720F, LSE720DK, LSE720PH, LS860F, LS860DK, LS860PH, LS1080F, LS1080UK, LS1080PH, LSE721F, LS861F, LS540, LS1080M, LS1080, LS1080D, LS1080UK, LS1080/63, LS500F, LS500UK, LS501, LS501UK, LS540D, LS540/63, LSE721, LS720, LSE720UK, LS721UK, LSE720D, LS541, LS860, LS860, LS860D, LS860UK, LS861UK, LS860/63, LS861, LS500, LS501, LS540, 652120Z, LS860, LS1080...(Other models you can see in the webshop)		

			
1			
Image not available			
GEV No.	345999	Ref. No.	045165
description	push switch 2NO 250V 16A connection male faston 6.3mm protection IP40		
For models:	LS365, LS365PH, LS365D, LS365, LS365/63, LS365F		





			
1			
GEV No.	346879	Ref. No.	OKK220
description	push switch green 2NO/indicator light 250V 16A illuminated connection male faston 6.3mm ambient temperature max. 125/55°C protection IP40		

accessories

fitting parts

			
1			
GEV No.	345998	Ref. No.	048575
description	fixing plate		

			
1			
GEV No.	347831	Ref. No.	0G2438 769131
description	stop for switch shaft ø 6x4.6mm		
For models:	ACSGRT, BOT080S.MH25.W94, BOT080S.MS25.W94, BOT100E.MS35.H97, BOT150S.MH25.F98, BOT150S.MH25.W94, BOT200S.MH25.F18, BOT200S.MH25.W14, BOT400E.MS35.W14, BOT400S.MH25.F18, FET060E.MS35P.F88, FET060E.MS35P.W84, FET060E.MS35S.F88, FET080E.MS35P.F88, FET080E.MS35P.W84, FET080E.MS35S.W84, FET100E.MS35P.F88, FET100E.MS35P.W84, FET100G.MS25P.H97, UET060E.MS35.F88, UET090E.MS35.F88, UET090E.MS35.W84, UET100E.MS35.F88, UET100E.MS35.W84, UET150E.MS35.F88, BOT150E.MS35.H97, FET100E.MS35S.F97, FET060E.MS35S.W84, FET080E.MS35S.F88, FET080G.MS25S.F98, FET080G.MS25S.W94, FET100E.MS35S.F88, FET100E.MS35S.W84, UET060E.MS35.W84, UET150E.MS35.W84, BOT040E.MS35.F88, BOT040S.MH25.F98, BOT040E.MS35.W84, BOT040S.MH25.W94, BOT060E.MS35.F88, BOT060S.MH25.F98, BOT060E.MS35.W84, BOT060S.MH25.W94, BOT080E.MS35.F88, BOT080S.MH25.F98, BOT080E.MS35.W84, BOT100S.MH25.F98, BOT100S.MH25.W94, BOT300S.MH25.F18, BOT300S.MH25.W14... (Other models you can see in the webshop)		
accessories for	347831		
	GEV No.	347830	Ref. No. 0G2405 0K5151 0K1513 769363
switch for tilting kettle with potentiometer			

push buttons

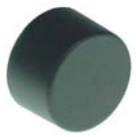
			
1			
GEV No.	346311	Ref. No.	003768
description	push button		
For models:	FCF/G6-0, FCFG101/0, FCFG102-0, FCFG201-0, FCFG202-0, FCF/E6-0, FCFE101-0, FCFE102-0, FCFE201-0, FCFE202-0, FCF061ELN, FCF101ELN, FCF6EHOR, FCFG10160H, FCF061ENS, FCF101ENS, FCF102ENS, FCF201ENS, FCFG102-0T, FCF/G6-1-JAP, FCF/G101/1-1-JAP, FCF/G102/1-1-JAP, FCFE6-1J, FCFE101-1J, FCFE102-1J, FCF/G101/1, 5702-2-3, 5704-2-3, 57074-2-3, 5701-3-3, 5702-3-3, 5704-3-3, 5707-3-3, ECF/G6/0, ECFG101-0, ECFG102-0, ECFG201-0, ECFG202-0, ECF/E6-0, ECFE101-0, ECFE102-0, ECFE201-0, ECFE202-0, ECF061ENS, ECF101ENS, ECF102ENS, ECF201ENS, ECF061E5M, ECF061ECV, ACF/G6-0... (Other models you can see in the webshop)		

			
1			
GEV No.	345729	Ref. No.	083049
description	push button external size 23x23mm black		
For models:	ALN110, ALN120, ADF110, ALF110, ADF120, ALF120, AEF110, AEF120, ADNN120, ADNF120, AENF120, ALN220, ALN240, ADF220, ADF240, AEF220, AEF240, ADNN220, ADNF220, ADNN230, ADNF230, AENF230, AENF240, ASF110, ASF220, AKN110UK, AKF110UK, AKN220UK, AKF220UK, ASN110UK, ASF110UK, ASN220UK, ASF220UK, APP113, APP114, APF113, APF114, APP223, APP224, ARDN110, APP114/60, APP224/60, APP224/60, APP11B, APP113V, APF114, APP22B, APP224V, APF223, APF224... (Other models you can see in the webshop)		

element holders

			
1			
GEV No.	346310	Ref. No.	003767
description	element holder ø 24mm		
For models:	FCF/G6-0, FCFG101/0, FCFG102-0, FCFG201-0, FCFG202-0, FCF/E6-0, FCFE101-0, FCFE102-0, FCFE201-0, FCFE202-0, FCF061ELN, FCF101ELN, FCF6EHOR, FCFG10160H, FCF061ENS, FCF101ENS, FCF102ENS, FCF201ENS, FCFG102-0T, FCF/G6-1-JAP, FCF/G101/1-1-JAP, FCF/G102/1-1-JAP, FCFE6-1J, FCFE101-1J, FCFE102-1J, FCF/G101/1, 5702-2-3, 5704-2-3, 57074-2-3, 5701-3-3, 5702-3-3, 5704-3-3, 5707-3-3, ECF/G6/0, ECFG101-0, ECFG102-0, ECFG201-0, ECFG202-0, ECF/E6-0, ECFE101-0, ECFE102-0, ECFE201-0, ECFE202-0, ECF061ENS, ECF101ENS, ECF102ENS, ECF201ENS, ECF061E5M, ECF061ECV, ACF/G6-0... (Other models you can see in the webshop)		

protective covers

			
1			
GEV No.	346577	Ref. No.	0H6588
description	protective cover		



microswitches

universal



GEV No.	345042	Ref. No.	085298 0D6615 0KQ309
description	microswitch with plunger 250V 16A 1CO connection male faston 6.3mm L 28mm ambient temperature max. 125°C mounting distance 22mm type EF83161.3 actuating force: 75g blue/black		
For models:	MULTI2-01, TRS-3-02, TRS-3-03, TRS-1-02, TRS-1-03, MINIG-01, MULTIG-01, MULTI2-02, BE5-01, BE5-02, TRS-3-04, TRS-3-05, BE5-03, TRS-1-04, MULTIG-02, BE5-04, TRS-1-05, MULTIG-03, BE5A-01, TRS-1-06, MULTI2-03, TRS-1-07, MULTIG-04, MULTIG-05, TRS-1-08, TRS-3-06, BE5-05, TRS-3-07, TRS-1-09, EL25-01, BE5A-02, TR200-04, TR200-03, MULTI2-04, CPX-01, TBX130-09, TR200-01, TR200-02, MULTI2-05, TRX-01, TRX-02, TBX130-10, TBX1201OLD, MULTIG-06, TRS-1-10, TRS-1-11, MULTIG-07, TR22-01, TR24, TRS-3-08...(Other models you can see in the webshop)		
accessories for	345042		
	GEV No.	345043	Ref. No. —
	lever set 5-piece		

lever actuated



GEV No.	345102	Ref. No.	0A8015
description	microswitch with lever 1NO connection cable		
For models:	ICP130, ICN110UK, BC11, BC22, BC44H, BCF11, BCF22, ALNSO120, ILNSO120, ILNN120, ILNF120, ALNN120, ALNF120, ALNSO120, AKNSO120, IKNN120, IKNF120, AKNN120, AKNF120, AKNSO120, ICP130, NIP40, NIP40, EKE411UF, 12001720, EN406VAC, EN404VAC, EN404VAC, EP406VAV, EN406VAC, EP406VAV, EN404VAC, EVNN-60V22C, EVNN61V22C, EVNC60V22C, EVNC61V22C, EVNN60V22C, EEVNN601, DVNN60V22C, DVNN61V22C, EVNC60V22C, EVNC61V22C, DVNC60V22C, DVNC61V22C, MVNN60V22C, MVNN61V22C, MVNC60V22C, MVNC61V22C, 11400120, EEVA10/1...(Other models you can see in the webshop)		

GEV No.	347006	Ref. No.	0G2121 0K5144 18025562 762144 763034
description	microswitch with lever 250V 1NO connection with cable ambient temperature max. 85°C		
For models:	ACSGRT, BOT080S.MH25.W94, BOT080S.MS25.W94, BOT100E.MS35.H97, BOT150S.MH25.F98, BOT150S.MH25.W94, BOT200S.MH25.F18, BOT200S.MH25.W14, BOT400E.MS35.W14, BOT400S.MH25.F18, FET060E.MS35PF88, FET060E.MS35PW84, FET060E.MS35S.F88, FET080E.MS35PF88, FET080E.MS35PW84, FET080E.MS35S.W84, FET100E.MS35PF88, FET100E.MS35PW84, FET100G.MS25P.H97, UET060E.MS35.F88, UET090E.MS35.F88, UET090E.MS35.W84, UET100E.MS35.F88, UET100E.MS35.W84, UET150E.MS35.F88, BOT150E.MS35.H97, FET100E.MS35S.F97, FET060E.MS35S.W84, FET080E.MS35S.F88, FET080G.MS25S.F98, FET080G.MS25S.W94, FET100E.MS35S.F88, FET100E.MS35S.W84, UET060E.MS35.W84, UET150E.MS35.W84, BOT040E.MS35.F88, BOT040S.MH25.F98, BOT040E.MS35.W84, BOT040S.MH25.W94, BOT060E.MS35.F88, BOT060S.MH25.F98, BOT060E.MS35.W84, BOT060S.MH25.W94, BOT080E.MS35.F88, BOT080S.MH25.F98, BOT080E.MS35.W84, BOT100S.MH25.F98, BOT100S.MH25.W94, BOT300S.MH25.F18, BOT300S.MH25.W14...(Other models you can see in the webshop)		

GEV No.	346362	Ref. No.	058344 0A2145 0A2194 0K2976
description	microswitch with lever connection cable		
For models:	MBR/G710D, MBR/E710D, MBR/E700, MBR/E700UK, MBR/E716, MBR/E706, RBR/G710D, 7BRE60XN, 7BRE60X, RBR/E700UK, RBR/E716, RBR/E706, XBR/E710D, M70EBP, XBR/E710, XBR/G751, XBR/G756, CBR/E700, XBR/E716, XBR/E706, RBR/E700, RBR/E700		

GEV No.	346927	Ref. No.	0HA094
description	microswitch with lever 250V 10A 2CO connection male faston 6.3mm Lmm ambient temperature max. 125°C mounting distance 22mm double type VRSR01DA1 actuating force: 220g		
For models:	LB035C, LB035R, LB035Q, LB040R, LB040Q, LB040AUS, G350C, LBIOET010, LBIOET014, LBIOEQ010, G350, G350DP, LBIOEQ014, G400, G400DP, LCFBE003		





 <p>1</p>			
GEV No.	345254	Ref. No.	046286 053671 054550 057580 058405 066874 081352 081692 0K7808 60050203
description	microswitch with lever 250V 16A 1CO connection male faston 6.3mm ambient temperature max. 120°C mounting distance 22mm actuating force: 60g lever length 58mm		
For models:	AP20, BC44, BCF44, ALP110, ALP120, ALP111, ALP220, ALP240, ALP221, ALN110, ALN120, ALN111, ALN220, ALN240, ALN221, ALNN120, ALNN220, ALNN230, ALNSO120, ALP110UK, ALN110UK, ALNN220UK, ALF110, ALF220UK, ALNF220, ALF110, ALF120, ALF220, ALF240, ALNF120, ALNF220, ALNF230, BC44, BCF44, ILP110, ILP110UK, ILN120, ILP111, ILP220, ILP220UK, ILP240, ILP221, ILN110, ILN110UK, ILN120, ILN111, ILN220, ILN220UK, ILN240, ILNSO120... (Other models you can see in the webshop)		

 <p>2</p>			
GEV No.	345257	Ref. No.	069484 218002
description	microswitch with lever 250V 16A 1CO connection male faston 6.3mm L 29mm L1 33mm ambient temperature max. 120°C mounting distance 22mm actuating force: 130g lever length 31.5mm		
For models:	LTB11, LTB12, LTB22, LTB11UK, LTB12UK, LTB22UK, LTB11, LTB22, 910-00-021, 910-00-023, 910-00-031, 910-00-033, 911-00-022, 911-00-024, 911-00-032, 911-00-034, CRYSTAL 11, CRYSTAL 22		

 <p>1</p>			
GEV No.	345107	Ref. No.	046379 047485 0H2586 0KB678 306E2334 640606500 OMRV1531C6 S640603300
description	microswitch with lever 250V 16A 1CO connection male faston 6.3mm L 98mm ambient temperature max. 125°C mounting distance 22mm actuating force: 30g lever length 90mm		
For models:	FCV31E3, 7CO30, CCO30G, ECO312CF, OTS100, LB80EPH, LB80E, LB120EPH, LB120E, LB160EPH, LB160E, LB160V, CLB160E, CLB160V, LB70E, LB110E, LS540F, LS540DK, LS541F, LS365D, LS540, LSDS51, LSDS5V, LS540D, LS540/63, LS541, LS510, LS520, LS520D, LS520F, LS520M, LS520K, LS521, LS521D, LS521F, LS521M, LS521K, LS521, LS4, LS540, ZLS510, ZLS520, ZLS521, ALS540, ALLS521, ALLS520, ALS510, LB80E, LB70E, LB120E... (Other models you can see in the webshop)		

 <p>1</p>			
GEV No.	346072	Ref. No.	00204 004904 0E0209 OHM414 OK7559
description	microswitch with lever 250V 6A 1CO connection male faston 6.3mm ambient temperature max. 85°C lever length 71mm		
For models:	SGE350, SGE350, FT36EDTS, FT36ESTS, FT36VDTS, FT36VSTS, FT36ED, FT36ES, FT36VD, FT36VS, FT50ED, FT50ES, FT50VD, FT50VS, FT72ED, FT72ES, FT72VD, FT72VS, FT36EDT, FT36EST, FT36VDT, FT36VST, FT50EDT, FT50EST, FT50VDT, FT50VST, FT72EDT, FT72EST, FT72VDT, FT72VST, FT36WED, FT36WES, FT36WVD, FT36WVS, FT50WED, FT50WES, FT50WVD, FT50WVS, FT72WED, FT72WES, FT72WVD, FT72WVS, FT36WEDT, FT36WEST, FT36WVDT, FT36WVST, FT50WEDT, FT50WEST, FT50WVDT, FT50WVST... (Other models you can see in the webshop)		

 <p>1</p>			
GEV No.	345049	Ref. No.	OK3764
description	microswitch with lever CO connection male faston		

 <p>1</p>			
GEV No.	345757	Ref. No.	OK1003 831613IW3 83163080
description	microswitch with plunger 250V 16A 1CO connection male faston 6.3mm L 28mm ambient temperature max. 125°C mounting distance 22mm type EF83161.3 actuating force: 75g blue/black		
For models:	5611-3-10, 5611-3-8, 5612-3-10, 5612-3-8, 5614-3-10, 5614-3-8		

 <p>1</p>			
GEV No.	347007	Ref. No.	046322 075935
description	microswitch with lever 250V 16A 1NO connection male faston 6.3mm ambient temperature max. 85°C lever length 55mm		
For models:	CT92DXE, CT92SXE, CT92DXEUK, CT92SXEU, CT92DXV, CT92SXV, CT92DXVUK, CT92SXVUK, CT140EDX, CT140ESX, CT140EDXUK, CT140SXEU, CT140VDX, CT140VSX, CT141EDX, CT141ESX, CT141E-DUK, CT141ESUK, CT141VDX, CT141VSX, CT142DXE, CT142SXEU, CT142DXEUK, CT142SXEU, CT142DXV, CT142SXV, CT190DXE, CT190SXEU, CT190DXEUK, CT190SXEU, CT190DXV, CT190SXV, CT-191DXE, CT191SXEU, CT191DXEUK, CT191SXEU, CT191DXV, CT191SXV, CT192DXE, CT192SXEU, CT192DXEUK, CT192SXEU, CT192DXV, CT192SXV, CT240DXE, CT240SXEU, CT240DXEUK, CT240SXEU, CT240DXV, CT240SXVUK... (Other models you can see in the webshop)		



roller-lever actuated

microswitches



1

GEV No.	345253	Ref. No.	0T3953
description	microswitch with handle with a switch 250V 15A 1CO connection male faston 6.3mm L 28mm L1 37mm ambient temperature max. 125°C mounting distance 22mm type RL6-1-F-GE-P12-5-L actuating force: 80g grey lever length 28mm		



1

GEV No.	345041	Ref. No.	0H6597 18005617 245536 345041
description	microswitch with handle with a switch 250V 16A 1CO connection male faston 6.3mm ambient temperature max. 85°C black lever length 20.5mm		
For models:	SLE159-170, SLE159-180, 7535-3/85., 7535-3/90.FRI.(N), 7735-3/85.FRI.(N), 7735-3/90.FRI.(N), 7535-3, 7536-3, 7537-3, 7538-3, 7735-3, 7736-3, 7737-3, 7738-3, 9050-3, 9052-3, 9055-3, 9250-3-0, 9250-3-8, 9252-3-0, 9252-3-8, 9255-3-0, 9255-3-8		

heavy duty version



1

GEV No.	346979	Ref. No.	0L0204 0L1942
description	microswitch with handle with a switch 250V 5A 1CO connection male faston 6.3mm L 25mm L1 49mm ambient temperature max. 85°C mounting distance 22mm type MF45 actuating force: 150g lever length 25mm		
For models:	PW1EAG, PW2EAG, WT830EA, WT850EA, WT830EAG, WT850EAG		

with mounting components



1

GEV No.	347528	Ref. No.	049619
description	microswitch with handle with a switch 250V 10A 1CO connection male faston 6.3mm L 20.5mm ambient temperature max. 125°C mounting distance 22mm actuating force: 120g black/green		
For models:	LS14EAI/AU, WT60NAUCW, WT60NAU, WT60NAUDP, LS12NAU, WT65EBIA, WT65EIA, WT65MED, WT65MEDWS, EHTAIAU, EHTAIMLAU, ZHTAIAU, H1510SANA		

non-standard



1

GEV No.	347008	Ref. No.	0E5629 0K8742 30001008 D2VW5L2A1M
description	microswitch with handle with a switch 250V 5A 1CO connection cable ambient temperature max. 85°C lever length 20mm		
For models:	PW1EFL, PW1EFLF, PW1EFL/60HZ, PW2EFL, PW2EFLF, PW2EFL/60HZ, PW2VFL, WT830EFL, WT830EFLF, WT830EFL/60HZ, WT850, WT850EFL, WT850EFL/60HZ, WT850SFL, PW1EAG, PW2EAG, WT830EA, WT850EA, WT830EAG, WT850EAG, LO1EFL, LO2EFL		

pin-plunger actuated



1

GEV No.	345326	Ref. No.	0E1685
description	microswitch with plunger 250V 16A 1NO connection male faston 6.3mm ambient temperature max. 85°C mounting distance 22mm type XP52Z11 actuating force: 350g red stroke 15mm		
For models:	W3400H06, W355HE, W3400H, W3400H, W355HQSR, W355H, W355H, WE66MP, WE66MP, WE106MP, LC12EC, LACE12M/EI, CLC12EC, LACE22M, LACV22M/V, CLC22VC, WE55QSR_EL, W3400H01, W3400H02, W3400H03, W3400H04		



1

GEV No.	345042	Ref. No.	085298 0D6615 0KQ309
description	microswitch with plunger 250V 16A 1CO connection male faston 6.3mm L 28mm ambient temperature max. 125°C mounting distance 22mm type EF83161.3 actuating force: 75g blue/black		
For models:	MULTI2-01, TRS-3-02, TRS-3-03, TRS-1-02, TRS-1-03, MINIG-01, MULTIG-01, MULTI2-02, BE5-01, BE5-02, TRS-3-04, TRS-3-05, BE5-03, TRS-1-04, MULTIG-02, BE5-04, TRS-1-05, MULTIG-03, BE5A-01, TRS-1-06, MULTI2-03, TRS-1-07, MULTIG-04, MULTIG-05, TRS-1-08, TRS-3-06, BE5-05, TRS-3-07, TRS-1-09, EL25-01, BE5A-02, TR200-04, TR200-03, MULTI2-04, CPX-01, TBX130-09, TR200-01, TR200-02, MULTI2-05, TRX-01, TRX-02, TBX130-10, TBX1201OLD, MULTIG-06, TRS-1-10, TRS-1-11, MULTIG-07, TR22-01, TR24, TRS-3-08...(Other models you can see in the webshop)		
accessories for	345042		
	GEV No.	345043	Ref. No. —
lever set 5-piece			





1

GEV No.	345105	Ref. No.	0KI505
description	microswitch with plunger 250V 16A 1CO connection male faston 6.3mm L 28mm ambient temperature max. 125°C mounting distance 22mm type SM-51 actuating force: 280g black		
For models:	MF250WB20		





M10			
			
1			
GEV No.	345032	Ref. No.	002785 005031 046063 058926 0F0072 0H6565 0K2018 0K2969 0K8366 0KE535 0KI395 245031 245040 345032 60050200 60050480
description	microswitch with plunger thread M10x1 thread L 12mm 250V 16A 1CO connection male faston 6.3mm stroke 7mm mounting distance 22mm L 28mm ambient temperature max. 125°C type SP9603 actuating force: 180g		
For models:	MFR/E355, MFR/E355UK, MFR/E355D, MFR/E705, MFR/E705UK, MFR/E705D, MFR/E740, BF/E1S12, FDV40G, FDV40E, FDV40GZ, FDV40EL, FDV40GA, FDV20G, FDV20E, FDV20GZ, FDV20EL, FDV20GA, RF/E1D05, RFR/E1S12, RFR/E2D12, RFR/E2S40, RF/E1S12, RF/E2D12, RF/E1S12, RF/E2D12, RF/E1S12E5, RF/E2D12E5, RFR/E1S12, RFR/E2D12, XF/E1D05, XFR/E1S12, XFR/E2D12, XFR/E2S40, XF/E1S12, XF/E2D12, XF/E1S12, XF/E2D12, XFR/E1S12, XFR/E2D12, JF/E1D05, JFR/E1S12, JFR/E2D12, JFR/E2S40, JF/E1S12, JF/E2D12, JF/E1S12, JF/E2D12, MF/E1D05, MFR/E1S12...(Other models you can see in the webshop)		

			
1			
GEV No.	345156	Ref. No.	OKW537
description	microswitch with plunger thread M10x1 thread L 13mm 250V 16A 1CO connection male faston 6.3mm stroke 6mm mounting distance 25mm L 46mm L1 13mm ambient temperature max. 85°C type C4A-ZN3 actuating force: 340g		

			
1			
GEV No.	347004	Ref. No.	087151
description	microswitch with plunger thread M10x1 thread L 16mm 250V 10A 1NO connection male faston 6.3mm stroke 8mm mounting distance 22mm ambient temperature max. 85°C actuating force: 160g		
For models:	ADNN120, ADN120, AENN120, AENF120, ARDNN120, 83012101, ADNN120, ADN120, ALNN1203, ALNN1203, RS06DX2F, RS06DFX2F, RH06DD2U, RH06DFD2U, MP602, MP602/60, MP1200, MP1200, MCD650FP2, EC6N0M2C, EC6N0M2C, EC6N0D2C, EC6M0D2C, C06CD2F, C06CFD2F, C06CFD2FR, C06CM2F, C06CM2F, KLPP650R, RS06DX2F, KLPP650R, RH06DD2F, RH06DD2FR, RH06DFD2F, C06CFD2I, EC6N0D2C, EC6M0D2C, KLP650R, KLPP650R, KVPE332, KVNE332, KMNE332, KMNE332		

M12			
			
1			
GEV No.	347009	Ref. No.	0H2312 0K7633 XO1E1G6Z1 XO1E1G6Z122
description	microswitch with plunger thread M12x1 380V 20A 1CO connection screw ambient temperature max. 85°C		
For models:	AR170, AR170, AR170, AR170, AR170, AR170, AR170, AR170, AR170, AR170, AR170S, AR170S, AR170S, AR170S, AR170S, AR170S, AR170S, AR170S, AR170S, AR170S, AR170S, AR340, AR340, AR340, AR340, AR340, AR340, AR340, AR340, AR340S, AR340S, AR340S, AR340S, AR340S, AR340S, AR340S, AR340S, AR340S, AR340S, AR340S, AR85, AR85, AR85, AR85, AR85, AR85, AR85, AR85...(Other models you can see in the webshop)		

miscellaneous			
			
1			
GEV No.	346289	Ref. No.	OG1767 M1S66011KY
description	microswitch with plunger thread M12 thread L 14mm 250V 4A 1CO connection cable stroke 5mm ambient temperature max. 85°C cable 5500mm type 101055425 actuating force: 250g		
For models:	9190-3, 9191-3, 9193-3, 9195-3, 9390-3, 9391-3, 9393-3, 9395-3		

with push button			
switches with snap-fit			
			
1			
GEV No.	345249	Ref. No.	084403
description	microswitch with push button 250V 0.25A 1NO connection male faston 6.3mm L 26x12mm ambient temperature max. 85°C actuating force: 500g		
For models:	BC100A, BC100DA, BC100RA, BC100RDA, BC180A, BC180DA, BC180RA, BC180RDA, BC180RPA, BCF100A, BCF100DA, BCF100RA, BCF100RDA, BCF180A, BCF180DA, BCF180RA, BCF180RDA, BCF180RPA, BC120A, BC120RA, BCF120A, BCF120RA, AZP1103, AZF1103, AZP2203, AZF2203, AZP1103, AZP2203, ALN1103, ALNN1203, ALN2203, ALNN2203, AZP6430, ALF1104, AZP13430, AZF13430, ALN11033, ALF11033, BC0144, BC072, ESBC72R, ESBC144R, ESBF70, ESBF70R, ESBF144, ESBF144R, MRF4808660, MRF6018660, MRF401/86, MRF601/86...(Other models you can see in the webshop)		



			
1			
GEV No.	347027	Ref. No.	0A9383
description	microswitch with push button 250V 1A 1CO connection male faston 2.8mm L 26x12mm ambient temperature max. 85°C type XKA-304B1AAJ11 actuating force: 50g		
For models:	ALNN120, ALNF120, ALN110, ALN120, ADN111, AEN110, AEN120, AKN111, ADF110, ALF110, ADF120, ALF120, AEF110, AEF120, ADNN120, ADNF120, AENN120, AENF120, ALN220, ALN240, ADN221, AEN220, AEN240, AEN221, ADF220, ADF240, AEF220, AEF240, ADNN220, ADNF220, ADNN230, ADNF230, AENN220, AENF220, AENN230, AENF230, ASN110, ASN111, ASF110, ASN220, ASN221, ASF220, AKN110UK, AKF110UK, AKN220UK, AKF220UK, ASN110UK, ASF110UK, ASN220UK, ASF220UK...(Other models you can see in the webshop)		

			
2			
GEV No.	346772	Ref. No.	087485
description	microswitch with push button 250V 5A 1CO connection male faston 4.8mm L 24x27mm ambient temperature max. 85°C actuating force: 160g		
For models:	ADN220ES, ADF110ES, ADF220ES, ADN110ESP, ADF110ESP, ALN110, ALN120, ADN111, AEN110, AEN120, ADF110, ALF110, ADF120, ALF120, AEF110, AEF120, ADNN120, ADNF120, AENN120, AENF120, ALN220, ALN240, ADN221, AEN220, AEN240, AEN221, ADF220, ADF240, AEF220, AEF240, ADNN220, ADNF220, ADNN230, ADNF230, AENN220, AENF220, AENN230, AENF230, ASN110, ASF110, ASN220, ASN221, ASF220, AKN110UK, AKF110UK, AKN220UK, AKF220UK, ASN110UK, ASF110UK, ASN220UK...(Other models you can see in the webshop)		

roller actuated

roller 0°

			
1			
GEV No.	345639	Ref. No.	004174
description	microswitch with roller plunger 230V 16A 1CO connection solder/screw connection L1 49mm ambient temperature max. 125°C thread L 14mm thread M10 mounting distance 25mm actuating force: 300g type MS15-1		
For models:	ZFC33, ZFC45		

roller 90°

			
1			
GEV No.	346574	Ref. No.	0K2153 MP2101BT32
description	microswitch with roller plunger 250V 10A connection cable ambient temperature max. 85°C		
For models:	9481-3, 9482-3, 9581-3, 9582-3		

			
1			
GEV No.	346290	Ref. No.	0H6583
description	microswitch with roller plunger 250V 6A 1CO connection cable L1 31mm ambient temperature max. 85°C thread L 20mm thread M10 mounting distance 22mm actuating force: 220g MP320 protection IP67		
For models:	9041-3, 9043-3, 9045-3, 9047-3, 9181-3, 9181-5, 9186-5, 9241-3-0, 9241-3-8, 9243-3-0, 9243-3-8, 9245-3-0, 9245-3-8, 9247-3-0, 9247-3-8, 9374-5-8, 9375-3-0, 9381-3-0, 9381-3-8, 9381-5-0, 9381-5-8, 9386-3-0		

non-standard

			
1			
GEV No.	345777	Ref. No.	004288
description	microswitch		

			
1			
GEV No.	346389	Ref. No.	0G1829 0H7125
description	microswitch connection male faston		
For models:	5611-3-10, 5611-3-6, 5611-3-8, 5612-3-10, 5612-3-6, 5612-3-8, 5614-3-10, 5614-3-6, 5614-3-8		

			
1			
GEV No.	301207	Ref. No.	004241
description	microswitch operation switch mounting distance 24mm 250V 0.5A NO connection male faston 4.8mm type 209 actuating force: 400g		
For models:	RC/G1, RC/G2, RCV/G2, RCV/G3, RCF/G2, RCF/G3, RCF/M2, RCF/M3, RSF/G2, RSV/G2, RSF/G3, MCF/G2A, MCF/G3A, XC/G1, XC/G2, XCV/G2, XCV/G3, XCF/G2, XCF/G3, XCF/M2, XCFM3, XSF/G2, XSV/G2, XSF/G3, JC/G1, JC/G2, JCV/G2, JCV/G3, JCF/G2, JCF/G3, JCF/M2, JCFM3, MC/G1, MC/G2, MCV/G2, MCV/G3, MCF/G2, MCF/G3, MCF/M2, MCF/M3, MSF/G2, MSV/G2, MSF/G3		





accessories			
 <p>1</p>			
GEV No.	524966	Ref. No.	049858
description	actuator for microswitch L 275mm W 120mm H 44mm		
For models:	RT10ED, RT10ES, RT10SR, RT10SL, RT10ED/230, RT10ES/230, RT10ERF60, RT10ELF60, RT10ERF, RT10ELF, RT10ERBF60, RT10ELBF60, RT10ERG, RT10ELG, RT10EDH, RT10ESH, RT10SRB, RT10SLB, RT10ED/230H, RT10ES/230H, RT10ERBF, RT10ELBF, RT10ERBG, RT10ELBG, RT10EDECO, RT10ESECO, RT10SRC, RT10SLC, RT10ED/230E, RT10ES/230E, RT10ERCF, RT10ELCF, RT10ERCG, RT10ELCG, RT10EDHE, RT10ESHE, RT10SRCB, RT10SLCB, RT10ED/230HE, RT10ES/230HE, RT10ERCBF, RT10ELCBF, RT10ERCBG, RT10ELCBG, RT10ERASIA, RT10ELASIA, RT10SRASIA, RT10SLASIA, RT10ERCINA, RT10ELCINA...(Other models you can see in the webshop)		

 <p>2</p>			
GEV No.	348103	Ref. No.	045404
description	insulation for microswitch L 46mm W 26mm		
For models:	AP20, BC44, BCF44, ALP110, ALP120, ALP111, ALP220, ALP240, ALP221, ALN110, ALN120, ALN111, ALN220, ALN240, ALN221, ALNN220, ALNN230, ALNSO120, ALP110UK, ALN110UK, ALNN220UK, ALF110, ALF220UK, ALNF220, ALF110, ALF120, ALF220, ALF240, ALNF220, ALNF230, BC44, BCF44, ILP110, ILP110UK, ILN120, ILP111, ILP220, ILP220UK, ILP240, ILP221, ILN110, ILN110UK, ILN120, ILN111, ILN220, ILN220UK, ILN240, ILN221, ILNN220, ILNN220UK...(Other models you can see in the webshop)		

position switches

BERNSTEIN			
 <p>1</p>			
GEV No.	346296	Ref. No.	0H6698
description	position switch with handle with a switch 1NO/1NC protection IP65 BERNSTEIN		
For models:	7744-3/85.KB.(N), 7542-3/85., 7544-3/85.KB.(N), 7542-3/90.KB.(N), 7544-3/90.KB.(N), 7742-3/90.KB.(N), 7742-3/85.KB.(N), 7744-3/90.KB.(N), 7746-3/90.KB.(N), 7748-3/90.KB.(N), 7747-3/90.KB.(N), 7585-3/85.KK40.MOTK., 7586-3/85.KK60.MOTK., 7587-3/85.KK80.MOTK., 7588-3/85.KK100.MOTK., 7585-3/90.KK40.MOTK., 7586-3/90.KK60.MOTL., 7587-3/90.KK80.MOTK., 7588-3/90.KK100.MOTK., 7541-3/85.KB.(N), 7545-3/85.KB.(N), 7546-3/85.KB.(N), 7547-3/85.KB.(N), 7548-3/85.KB.(N), 7545-3/90.KB.(N), 7546-3/90., 7547-3/90.KB.(N), 7548-3/90.KB.(N), 7745-3/90.KB.(N), 7745-3/85.KB.(N), 7746-3/85.KB.(N), 7747-3/85.KB.(N), 7748-3/85.KB.(N), 7542-3/85.KB.DWD, 7544-3/85.KB.220V3, 7545-3/85.KB.DWD, 7742-3/85.KB.DWD.ETR, 7742-3/85.KB.DWD, 7748-3/85.KB.DWD.ETR, 7548-3/85.KB.DWD, 7542-3, 7544-3, 7546-3, 7548-3, 7568-3, 7569-3/85.KK200.MOTK, 7569-3/90.KK200.MOTK, 7580-3, 7581-3, 7582-3...(Other models you can see in the webshop)		

PIZZATO			
FD series			
 <p>1</p>			
GEV No.	345057	Ref. No.	0H6689 XCK J 1 0511
description	position switch cast aluminum 1NO/1NC 400V 3A L 98mm W 40mm H 35mm protection IP67 actuating force: 450g screw connection PG13.5 mounting distance 30x60mm		

FR series			
 <p>1</p>			
GEV No.	345144	Ref. No.	046884 053241 054423 054424 464963 470942
description	position switch plastic 1NC/1NO 400V 3A L 92mm W 31mm H 31mm protection IP67 actuating force: 360g screw connection PG13.5 mounting distance 22mm screw		
For models:	HCPA/G1219, HCPA/GI 1219, ZCPAG1219, ZCPA/GI 1219, HCPA/G1219, HCPA/GI1219, HCPA/V1219, HCPA/EI1219, CR15G, HCPA/G121, HCPA/G121, CT92DXE, CT92SXE, CT92DXEUK, CT92SXEUK, CT92DXV, CT92SXV, CT92DXVUK, CT92SXVUK, CT140EDX, CT140ESX, CT140EDXUK, CT140SXEUK, CT140VDX, CT140VSX, CT141EDX, CT141ESX, CT141EDUK, CT141ESUK, CT141VDX, CT141VSX, CT142DXE, CT142SXE, CT142DXEUK, CT142SXEUK, CT142DXV, CT142SXV, CT190DXE, CT190SXE, CT190DXEUK, CT190SXEUK, CT190DXV, CT190SXV, CT191DXE, CT191SXE, CT191DXEUK, CT191SXV, CT191SXVUK, CT192DXE...(Other models you can see in the webshop)		

SIEMENS			
3SE3 series			
switches (complete)			
 <p>1</p>			
GEV No.	346288	Ref. No.	0K2158 3SE21001E 3SE31001E
description	position switch		

TELEMECANIQUE (EFA)			
 <p>1</p>			
GEV No.	345823	Ref. No.	048159
description	position switch		
For models:	LS720F, LSE720DK, LS860F, LS1080F, LS720, LS720N		



1

GEV No.	346807	Ref. No.	0H9724 0K3679 0K4382 126283 751005
description	position switch plastic 1NO/1NC 400V 3A L 116.7mm W 40mm H 36mm protection IP67 actuating force: 1800g screw connection M19 mounting distance 30x60mm		
For models:	VARIOSTEAM/S-33.3/F, STEAM-O-MAT		

system switches (ROLD)



1

GEV No.	345723	Ref. No.	082916
description	adjusting screw		
For models:	ALP110, ALP120, ALP111, ALP220, ALP240, ALP221, ALN110, ALN120, ALN111, ALN220, ALN240, ALN221, ALNN120, ALNN220, ALNN230, ALNSO120, ALP110UK, ALN110UK, ALNN220UK, ALF110, ALF220UK, ALNF220, ALF110, ALF120, ALF220, ALF240, ALNF120, ALNF220, ALNF230, ALP110UK, ALN110UK, ALNN220UK, ALF110UK, ALNF220UK, ALP110, ALP120, ALP111, ALP220, ALP240, ALP221, ALN110, ALN120, ALN111, ALN220, ALN240, ALN221, ALF110, ALF120, ALF220, ALF240...(Other models you can see in the webshop)		



1

GEV No.	345721	Ref. No.	083050
description	blank cap holder		
For models:	ALP110, ALP120, ALP111, ALP220, ALP240, ALP221, ALN110, ALN120, ALN111, ALN220, ALN240, ALN221, ALNN120, ALNN220, ALNN230, ALNSO120, ALP110UK, ALN110UK, ALNN220UK, ALF110, ALF220UK, ALNF220, ALF110, ALF120, ALF220, ALF240, ALNF120, ALNF220, ALNF230, ALP110UK, ALN110UK, ALNN220UK, ALF110UK, ALNF220UK, ALP110, ALP120, ALP111, ALP220, ALP240, ALP221, ALN110, ALN120, ALN111, ALN220, ALN240, ALN221, ALF110, ALF120, ALF220, ALF240...(Other models you can see in the webshop)		



1

GEV No.	345724	Ref. No.	082919
description	cap size 23x23mm black MIN/MED/MAX		
For models:	AEN110, AEN120, AKN111, AEF110, AEF120, AENN120, AENF120, AEN220, AEN240, AEN221, AEF220, AEF240, AENN220, AENF220, AENN230, AENF230, ASN110, ASN111, ASF110, ASN220, ASN221, ASF220, APP113, APP114, APF113, APF114, APP223, APP224, APP114/60, APP224/60, APP224/60, APP11B, APP113V, APF114, APP22B, APP224V, APF223, APF224, APF22B, ESMLR60W, ESMLF60W, ESMLR60S, ESMLF60S, RS24, FS24, RFIS24, KZ1502, KE1502GT, TE1502, TZ1502...(Other models you can see in the webshop)		



1

GEV No.	345604	Ref. No.	083047
description	element holder single mounting measurements 28.5x28.5mm black for push buttons 23x23mm		
For models:	RS24, FS24, RFIS24, E04P8SRVUK, MLP2V2, MLP2V12, MLP3V3, MLP3V22, MLP3V14, MLP4V4, MLP4V32, MLP4V24, C04PVF4D, C04NVF4D, C04FSF4D, C04PVG4D, C04FISHD, R04P6SRGB, R04P6SRB, R04P6SWB, E04P4VRC, E04N4VAC, E04C4SGC, E04N4VAC, E04P8SRV, E04P4VRV, E04C4SGV		



1

GEV No.	345603	Ref. No.	083048
description	element holder triple mounting measurements 28.5x77.5mm black for push buttons 23x23mm		
For models:	AEN120, AEF120, AEN240, AEF240, ES950, E06N0M1C, E06N1M1C, E06N1M2C, E06N0M1V, E06N1M1V, E06NOD1C, E06NOD2C, E06NOD1V, E06C0M1C, E06C1M1C, E06C1M2C, E06F0D1C, E06COD1C, E06C0D2C, E06COD2C, E06COD1V, EC6N0M2C, EC6N0M2C, EC6N0D2C, EC6M0D2C, E14N0M2C, E14N1M2C, E14N1M4C, E14N0M2V, E14N1M2V, E14N0D2C, E14N0D4C, E14N0D2V, E14C0M2C, E14C1M2C, E14C1M4C, E14C0D2C, E14C0D4C, E14C0D2V, EC4NOM2C, EC4MOM2C, EC4NOM3C, EC4MOM3C, EC4NOD2C, EC4MOD2C, EC4NOD3C, EC4MODC3, E05N0M1C, E05N1M1C, E05N0M1V...(Other models you can see in the webshop)		





1

GEV No.	345601	Ref. No.	0A8268
description	indicator lamp holder V ø 11mm		
For models:	EMVN500, MVN112V12C, DVP500V11C, DVP501V11C, MVP502V11C, DVN500V11C, DVN501V11C, DVP500V11V, DVP501V11V, MVP502V11V, EDVN500, DVN501V11V, DVP600V11C, DVP601V11C, MVP602V11C, DVP600V12C, DVP601V12C, DVN600V11C, DVN601V11C, DVN600V12C, DVN601V12C, DVP600V11V, DVP601V11V, EMVP602, DVN600V11V, EDVN601, DVP110V12C, DVP111V12C, MVP112V12C, DVN110V12C, DVN111V12C, DVP110V12V, DVP111V12V, MVP112V12V, EDVN1100, EDVN1101, DVP130V12C, DVP131V12C, MVP132V12C, DVN130V12C, DVN131V12C, DVP130V14C, DVP131V14C, DVN130V14C, DVN131V14C, DVP130V12V, DVP131V12V, EEVNI1301, DVN130V12V, EDVN1300...(Other models you can see in the webshop)		





			
1			
GEV No.	345733	Ref. No.	0A8267 0KE828
description	indicator light lens yellow defrosting		
For models:	721-00-115, 721-00-116, 721-00-122, 721-00-123, 125-00-100, 125-00-102, 125-00-103, 125-00-100, 125-00-102, 125-00-103, 23000150.1, 23000151.1, 23100150.1, 23100151.1, 15600116.1, 15600120.1, GF4060, 721-00-116, 721-00-122, 721-00-123		

			
2			
GEV No.	345832	Ref. No.	049068
description	momentary switch unit 1CO 250V 16A connection male faston 6.3mm		
For models:	LB1, LB1WS, LB1WSDP, LB1/RBP, LB1/TOP, LB1/60, WT1WSDP, LB2D-PSAUS, LB1G, LB1WSG, WT2TOP60, WT2DPDI, WT2WSDPDI, LB1TOP, WT2TOPDI, LB2WS, LB2, LB2WSDP, LB2/TOP, LB2/RBP, LB2WS60, WT2WSDP, WT2WSDPD, LB2WSG, WT2WS, WT1, WT1WS, WT1TOP, WT2TOP, WT1/3DP, WT2/3DP, WT2DPAUS, WT2, LB2DPDI, LB2WSDPDI, LB2WSDPD, LB2TOP, LB2DP3, WT2DPD3, NGW, NGWDPDD, UC1, UC2WS, GW1, GW1WS, LV1WS, LV1WSDP, LV2WSDP, LV2WS, GW2D-PG...(Other models you can see in the webshop)		

			
1			
GEV No.	345825	Ref. No.	049315
description	momentary switch unit 1NO 250V 16A connection male faston 6.3mm		
For models:	LS32, LS32/4.5, LS32UK/RP, LS32F, LV32F, C55, LV32/60, WT302, WT302/4.5, WT302UK/RP, WT302F, WT302/60, LS33, LS33/4.5, LS33UK/RP, LS33F, LV33F, C55A, LS33/60, WT303, WT303/4.5, WT303UK/RP, WT303F, WT303/60, FL32, FL32/4.5, FL33, FL33/4.5, C32, C32/4.5, C33, C33/4.5, Z32, Z32/4.5, Z33, Z33/4.5		

			
1			
GEV No.	345734	Ref. No.	0A8264
description	push button 230V green illuminated ømm		
For models:	400LTPVN, EKE421S, EK401U, EK401UGT, EKE421GTS, ET401S, ET401SGT, EKE411UF, 12001720, EC406SGC, EC406SGV, 120.06.402, EP406SRC, EP406SRV, EP406VRC, EP406VRV, EN406VAC, EN404VAC, EC406SGC, EC406SGV, EP406VAV, EP408SRV, 12006402.1, EP406SRC, EP406SRV, EP406VRC, EP406VRV, EN406VAC, EP406VAV, EP408SRV, 721-00-115, 721-00-116, 721-00-122, 721-00-123, 125-00-100, 125-00-102, 125-00-103, 125-00-100, 125-00-102, 125-00-103, 23000150.1, 23000151.1, 23100150.1, 23100151.1, 15600116.1, 15600120.1, GF4060, 721-00-116, 721-00-122, 721-00-123...(Other models you can see in the webshop)		

			
1			
GEV No.	345739	Ref. No.	083202
description	push button L 25mm W 19.5mm black		
For models:	ALP110, ALP120, ALP111, ALP220, ALP240, ALP221, ALN110, ALN120, ALN111, ALN220, ALN240, ALN221, ALNN120, ALNN220, ALNN230, ALNSO120, ALP110UK, ALN110UK, ALNN220UK, ALF110, ALF220UK, ALNF220, ALF110, ALF120, ALF220, ALF240, ALNF120, ALNF220, ALNF230, ALP110UK, ALN110UK, ALNN220UK, ALF110UK, ALNF220UK, ALP110, ALP120, ALP111, ALP220, ALP240, ALP221, ALN110, ALN120, ALN111, ALN220, ALN240, ALN221, ALF110, ALF120, ALF220, ALF240...(Other models you can see in the webshop)		

			
1			
GEV No.	345737	Ref. No.	083200
description	push button L 25mm W 19.5mm black 0-1		
For models:	ALP110, ALP120, ALP111, ALP220, ALP240, ALP221, ALN110, ALN120, ALN111, ALN220, ALN240, ALN221, ALNN120, ALNN220, ALNN230, ALNSO120, ALP110UK, ALN110UK, ALNN220UK, ALF110, ALF220UK, ALNF220, ALF110, ALF120, ALF220, ALF240, ALNF120, ALNF220, ALNF230, ALP110UK, ALN110UK, ALNN220UK, ALF110UK, ALNF220UK, ALP110, ALP120, ALP111, ALP220, ALP240, ALP221, ALN110, ALN120, ALN111, ALN220, ALN240, ALN221, ALF110, ALF120, ALF220, ALF240...(Other models you can see in the webshop)		

			
1			
GEV No.	345740	Ref. No.	083209
description	push button L 25mm W 19.5mm black light		
For models:	ALP110, ALP120, ALP111, ALP220, ALP240, ALP221, ALN110, ALN120, ALN111, ALN220, ALN240, ALN221, ALNN120, ALNN220, ALNN230, ALNSO120, ALP110UK, ALN110UK, ALNN220UK, ALF110, ALF220UK, ALNF220, ALF110, ALF120, ALF220, ALF240, ALNF120, ALNF220, ALNF230, ALP110UK, ALN110UK, ALNN220UK, ALF110UK, ALNF220UK, ALP110, ALP120, ALP111, ALP220, ALP240, ALP221, ALN110, ALN120, ALN111, ALN220, ALN240, ALN221, ALF110, ALF120, ALF220, ALF240...(Other models you can see in the webshop)		

			
1			
GEV No.	345746	Ref. No.	0A8271
description	push button L 25mm W 19.5mm black light		
For models:	400LTPVN, E04P6VRVUK, E04P8SRVUK, NEPEV40, 400LTPVN, EK401UGT, EKE421GTS, ET401SGT, EC406SGV, EP406SRV, EP406VRV, EC406SGV, EP406VAV, EP408SRV, C04NVGWD, R04P6SRGB, EP406SRV, EP406VRV, EP406VAV, EP408SRV, R04P6SRB, R04P6SWB, E04P6SRV, E04P6VRV, E04P8SRV, E04C6SGV, 721-00-115, 721-00-116, 721-00-122, 721-00-123, 125-00-100, 125-00-102, 125-00-103, 125-00-100, 125-00-102, 125-00-103, GF4060, 721-00-116, 721-00-122, 721-00-123		





			
1			
GEV No.	345738	Ref. No.	083201
description	push button L 25mm W 19.5mm black moisture		
For models:	ALP110, ALP120, ALP111, ALP220, ALP240, ALP221, ALN110, ALN120, ALN111, ALN220, ALN240, ALN221, ALNN120, ALNN220, ALNN230, ALNSO120, ALP110UK, ALN110UK, ALNN220UK, ALF110, ALF220UK, ALNF220, ALF110, ALF120, ALF220, ALF240, ALNF120, ALNF220, ALNF230, ALP110UK, ALN110UK, ALNN220UK, ALF110UK, ALNF220UK, ALP110, ALP120, ALP111, ALP220, ALP240, ALP221, ALN110, ALN120, ALN111, ALN220, ALN240, ALN221, ALF110, ALF120, ALF220, ALF240...(Other models you can see in the webshop)		

			
1			
GEV No.	345732	Ref. No.	0A8269
description	push button L 25mm W 19.5mm black ventilation		
For models:	23000150.1, 23000151.1, 23100150.1, 23100151.1		

			
1			
GEV No.	347863	Ref. No.	049091
description	push button ø 23mm green		
For models:	LB1, LB1WS, LB1WSDP, WT1WSDP, WT2TOP60, WT2DPDI, WT2WSDPDI, LB1TOP, WT2TOPDI, LB2WS, LB2, LB2WSDP, WT2WSDP, WT2WSDPD, WT2WS, WT1, WT1WS, WT1TOP, WT2TOP, WT1/3DP, WT2/3DP, WT2, LB2DPDI, LB2WSDPDI, LB2WSDPD, LB2TOP, LB2DP3, WT2DPD3, NGW, NGWDPDD, GW1, GW1WS, GW2DPG, GW2WSDPG, GW2G, GW2WSG, GW2WS, GW2		

			
1			
GEV No.	345833	Ref. No.	049062
description	push button ø 23mm grey		
For models:	LB1, LB1WS, LB1WSDP, LB1/RBP, LB1/TOP, LB1/60, WT1WSDP, LB2DPSAUS, LB1G, LB1WSG, WT2TOP60, WT2DPDI, WT2WSDPDI, LB1TOP, WT2TOPDI, LB2WS, LB2, LB2WSDP, LB2/TOP, LB2/RBP, LB2WS60, WT2WSDP, WT2WSDPD, LB2WSG, WT2WS, WT1, WT1WS, WT1TOP, WT2TOP, WT1/3DP, WT2/3DP, WT2DPAUS, WT2, LB2DPDI, LB2WSDPDI, LB2WSDPD, LB2TOP, LB2DP3, WT2DPD3, NGW, NGWDPDD, UC1, UC2WS, GW1, GW1WS, LV1WS, LV1WSDP, LV2WSDP, LV2WS, GW2DPG...(Other models you can see in the webshop)		

			
1			
GEV No.	345829	Ref. No.	049325
description	push button ø 23mm grey drain pump		
For models:	LS33, LS33/4.5, LS33UK/RP, LS33F, LV33F, C55A, LS33/60, WT303, WT303/4.5, WT303UK/RP, WT303F, WT303/60, FL33, FL33/4.5, C33, C33/4.5, Z33, Z33/4.5		

			
1			
GEV No.	345827	Ref. No.	049317
description	push button ø 23mm grey Sinus		
For models:	LS32, LS32/4.5, LS32UK/RP, LS32F, LV32F, C55, LV32/60, WT302, WT302/4.5, WT302UK/RP, WT302F, WT302/60, LS33, LS33/4.5, LS33UK/RP, LS33F, LV33F, C55A, LS33/60, WT303, WT303/4.5, WT303UK/RP, WT303F, WT303/60, FL32, FL32/4.5, FL33, FL33/4.5, C32, C32/4.5, C33, C33/4.5, Z32, Z32/4.5, Z33, Z33/4.5		

			
1			
GEV No.	345834	Ref. No.	049065
description	push button ø 23mm yellow		
For models:	LB1, LB1WS, LB1WSDP, LB1/RBP, LB1/TOP, LB1/60, WT1WSDP, LB2DPSAUS, LB1G, LB1WSG, LB2WS, LB2, LB2WSDP, LB2/TOP, LB2/RBP, LB2WS60, WT2WSDP, WT2WSDPD, LB2WSG, WT2WS, WT1, WT1WS, WT1TOP, WT2TOP, WT1/3DP, WT2/3DP, WT2DPAUS, UC1, UC2WS, LV1WS, LV1WSDP, LV2WSDP, LV2WS, Z1, Z1/WS, Z1TOP, Z2, Z2TOP		

			
1			
GEV No.	345828	Ref. No.	049318
description	push button ø 23mm yellow start / I		
For models:	LS32, LS32/4.5, LS32UK/RP, LS32F, LV32F, C55, LV32/60, WT302, WT302/4.5, WT302UK/RP, WT302F, WT302/60, LS33, LS33/4.5, LS33UK/RP, LS33F, LV33F, C55A, LS33/60, WT303, WT303/4.5, WT303UK/RP, WT303F, WT303/60, FL32, FL32/4.5, FL33, FL33/4.5, C32, C32/4.5, C33, C33/4.5, Z32, Z32/4.5, Z33, Z33/4.5		

			
1			
GEV No.	347989	Ref. No.	049383
description	push button ø 23mm yellow start / II		
For models:	C55, C55A		





			
1			
GEV No.	345727	Ref. No.	0A8691
description	push button size 23x23mm black 0-1 with lens		
For models:	ALN110, ALN120, ADN111, AEN110, AEN120, AKN111, ADF110, ALF110, ADF120, ALF120, AEF110, AEF120, ADNN120, ADNF120, AENN120, AENF120, ALN220, ALN240, ADN221, AEN220, AEN240, AEN221, ADF220, ADF240, AEF220, AEF240, ADNN220, ADNF220, ADNN230, ADNF230, AENN220, AENF220, AENN230, AENF230, ASN110, ASN111, ASF110, ASN220, ASN221, ASF220, AKN110UK, AKF110UK, AKN220UK, AKF220UK, ASN110UK, ASF110UK, ASN220UK, ASF220UK, APP113, APP114...(Other models you can see in the webshop)		

			
1			
GEV No.	345745	Ref. No.	0A8747
description	push button size 23x23mm black ventilation with lens		
For models:	PTVN2719, PTVN2519, PTVN2724, PTVN2524, EDOIN28013, EDOIN28013, EDON420121B, EDON280120, EDON280112, EDON280111, EDON280104, EDON280103, EDON280102, EDON280113, EDON280105, EDON420130, EDON420122, EDON420121, EDON420114, EDON420105, EDON420106, EDON420123, EDON420115, EDON570140, EDON570132, EDON570131, EDON570124, EDON570122, EDON570108, EDON570133, EDON570125, EDON720150, EDON720142, EDON720133, EDON720134, EDON720132, EDON720126, EDON720143, EDON720135, EDORN28120, EDORN28112, EDORN28111, EDORN28104, EDORN28103, EDORN28113, EDORN28105, EDORN28130, EDORN42122, EDORN42114, EDORN42106...(Other models you can see in the webshop)		

			
1			
GEV No.	345726	Ref. No.	082937
description	push button size 23x23mm black light with lens		
For models:	ADN111, ADN221, APP113V, APP224V, E04P8SRVUK, E06NOD1V, E06COM1V, E06C1M1V, E06COD1V, E14N0D2V, E14C0M2V, E14C1M2V, E14C0D2V, M06P9M1V, M06C9M1V, M13P9M2V, EMVN500, MVN112V12C, DVP500V11C, DVP501V11C, MVP502V11C, DVN500V11C, DVN501V11C, DVP500V11V, DVP501V11V, MVP502V11V, EDVN500, DVN501V11V, DVP600V11C, DVP601V11C, MVP602V11C, DVP600V12C, DVP601V12C, DVN600V11C, DVN601V11C, DVN600V12C, DVN601V12C, DVP600V11V, DVP601V11V, EMVP602, DVN600V11V, EDVN601, DVP110V12C, DVP111V12C, MVP112V12C, DVN110V12C, DVN111V12C, DVP110V12V, DVP111V12V, MVP112V12V...(Other models you can see in the webshop)		

			
1			
GEV No.	345731	Ref. No.	0A8272
description	rotary disc red/black disc ø 16.9mm		
For models:	ALP110, ALP120, ALP111, ALP220, ALP240, ALP221, ALN110, ALN120, ALN111, ALN220, ALN240, ALN221, ALN120, ALNN220, ALNN230, ALNSO120, ALP110UK, ALN110UK, ALNN220UK, ALF110, ALF220UK, ALNF220, ALF110, ALF120, ALF220, ALF240, ALNF120, ALNF220, ALNF230, ALP110UK, ALN110UK, ALNN220UK, ALF110UK, ALNF220UK, ALP110, ALP120, ALP111, ALP220, ALP240, ALP221, ALN110, ALN120, ALN111, ALN220, ALN240, ALN221, ALF110, ALF120, ALF220, ALF240...(Other models you can see in the webshop)		

			
1			
GEV No.	345725	Ref. No.	082901
description	push button size 23x23mm black moisture with lens		
For models:	ALN110, ALN120, ADN111, AEN110, AEN120, AKN111, ADNN120, ADNF120, AENN120, AENF120, ALN220, ALN240, ADN221, AEN220, AEN240, AEN221, ADNN220, ADNF220, ADNN230, ADNF230, AENN220, AENF220, AENN230, AENF230, ASN110, ASN111, ASN220, ASN221, AKN110UK, AKN220UK, ASN110UK, ASN220UK, ARDN110, E06N0M1C, E06N1M1C, E06N0M2C, E06N1M2C, E06N0M1V, E06N1M1V, E06NOD1C, E06NOD2C, E06NOD1V, EC6N0M2C, EC6N0M2C, EC6NOD2C, EC6M0D2C, E14N0M2C, E14N1M2C, E14N0M4C, E14N1M4C...(Other models you can see in the webshop)		

			
1			
GEV No.	346824	Ref. No.	087253 0K9675
description	rotary disc red/black disc ø 20.6mm		
For models:	ALN110, ALN120, ADN111, AEN110, AEN120, AKN111, ALF110, ADF120, ALF120, AEF110, AEF120, ADNN120, ADNF120, AENN120, AENF120, ALN220, ALN240, ADN221, AEN220, AEN240, AEN221, ADF220, ADF240, AEF220, AEF240, ADNN220, ADNF220, ADNN230, ADNF230, AENN220, AENF220, AENN230, AENF230, ASN110, ASN111, ASF110, ASN220, ASN221, ASF220, AKN110UK, AKF110UK, AKN220UK, AKF220UK, ASN110UK, ASF110UK, ASN220UK, ASF220UK, APP113, APP114, APF113...(Other models you can see in the webshop)		



			
1			
GEV No.	345719	Ref. No.	0A8273 E1506
description	switch 1CO 250V 16A connection male faston 6.3mm		
For models:	ALP110, ALP120, ALP111, ALP220, ALP240, ALP221, ALN110, ALN120, ALN111, ALN220, ALN240, ALN221, ALNN120, ALNN220, ALNN230, ALNSO120, ALP110UK, ALN110UK, ALNN220UK, ALF110, ALF220UK, ALNF220, ALF110, ALF120, ALF220, ALF240, ALNF120, ALNF220, ALNF230, ALP110UK, ALN110UK, ALNN220UK, ALF110UK, ALNF220UK, ALP110, ALP120, ALP111, ALP220, ALP240, ALP221, ALN110, ALN120, ALN111, ALN220, ALN240, ALN221, ALF110, ALF120, ALF220, ALF240...(Other models you can see in the webshop)		

			
2			
GEV No.	345722	Ref. No.	0A8274 OKN445 70MAI3605
description	switch 1NO 250V 16A connection male faston 6.3mm		
For models:	ALP110, ALP120, ALP111, ALP220, ALP240, ALP221, ALN110, ALN120, ALN111, ALN220, ALN240, ALN221, ALNN120, ALNN220, ALNN230, ALNSO120, ALP110UK, ALN110UK, ALNN220UK, ALF110, ALF220UK, ALNF220, ALF110, ALF120, ALF220, ALF240, ALNF120, ALNF220, ALNF230, ALP110UK, ALN110UK, ALNN220UK, ALF110UK, ALNF220UK, ALP110, ALP120, ALP111, ALP220, ALP240, ALP221, ALN110, ALN120, ALN111, ALN220, ALN240, ALN221, ALF110, ALF120, ALF220, ALF240...(Other models you can see in the webshop)		

			
1			
GEV No.	345651	Ref. No.	003766 OK3391
description	switch 2CO 250V 16A connection male faston 6.3mm		
For models:	FCF/G6-0, FCFG101/0, FCFG102-0, FCFG201-0, FCFG202-0, FCF/E6-0, FCFE101-0, FCFE102-0, FCFE201-0, FCFE202-0, FCF061ELN, FCF101ELN, FCF6EHOR, FCFG10160H, FCF061ENS, FCF101ENS, FCF102ENS, FCF201ENS, FCFG102-0T, FCF/G6-1-JAP, FCF/G101/1-1-JAP, FCF/G102/1-1-JAP, FCFE6-1J, FCFE101-1J, FCFE102-1J, FCF/G101/1, 5702-2-3, 5704-2-3, 57074-2-3, 5701-3-3, 5702-3-3, 5704-3-3, 5707-3-3, ECF/G6/0, ECFG101-0, ECFG102-0, ECFG201-0, ECFG202-0, ECF/E6-0, ECFE101-0, ECFE102-0, ECFE201-0, ECFE202-0, ECF061ENS, ECF101ENS, ECF102ENS, ECF201ENS, ECF061E5M, ECF061ECV, ACF/G6-0...(Other models you can see in the webshop)		

			
1			
GEV No.	345826	Ref. No.	049326
description	switch 2CO 250V 16A connection male faston 6.3mm		
For models:	LS33, LS33/4.5, LS33UK/RP, LS33F, LV33F, C55A, LS33/60, WT303, WT303/4.5, WT303UK/RP, WT303F, WT303/60, FL33, FL33/4.5, C33, C33/4.5, Z33, Z33/4.5		

			
1			
GEV No.	345831	Ref. No.	049063
description	switch 2CO 250V 16A connection male faston 6.3mm		
For models:	LB1, LB1WS, LB1WSDP, LB1/RBP, LB1/TOP, LB1/60, WT1WSDP, LB2D-PSAUS, LB1G, LB1WSG, WT2TOP60, WT2DPDI, WT2WSDPDI, LB1TOP, WT2TOPDI, LB2WS, LB2, LB2WSDP, LB2/TOP, LB2/RBP, LB2WS60, WT2WSDP, WT2WSDPD, LB2WSG, WT2WS, WT1, WT1WS, WT1TOP, WT2TOP, WT1/3DP, WT2/3DP, WT2DPAUS, WT2, LB2DPDI, LB2WSDPDI, LB2WSDPD, LB2TOP, LB2DP3, WT2DPD3, NGW, NGWDPDD, UC1, UC2WS, GW1, GW1WS, LV1WS, LV1WSDP, LV2WSDP, LV2WS, GW2D-PG...(Other models you can see in the webshop)		

			
1			
GEV No.	345720	Ref. No.	0A8754
description	switch 2NO 250V 16A connection male faston 6.3mm		
For models:	ALP110, ALP120, ALP111, ALP220, ALP240, ALP221, ALN110, ALN120, ALN111, ALN220, ALN240, ALN221, ALNN120, ALNN220, ALNN230, ALNSO120, ALP110UK, ALN110UK, ALNN220UK, ALF110, ALF220UK, ALNF220, ALF110, ALF120, ALF220, ALF240, ALNF120, ALNF220, ALNF230, ALP110UK, ALN110UK, ALNN220UK, ALF110UK, ALNF220UK, ALP110, ALP120, ALP111, ALP220, ALP240, ALP221, ALN110, ALN120, ALN111, ALN220, ALN240, ALN221, ALF110, ALF120, ALF220, ALF240...(Other models you can see in the webshop)		

			
1			
GEV No.	345824	Ref. No.	049316
description	switch 2NO 250V 16A connection male faston 6.3mm		
For models:	LS32, LS32/4.5, LS32UK/RP, LS32F, LV32F, C55, LV32/60, WT302, WT302/4.5, WT302UK/RP, WT302F, WT302/60, LS33, LS33/4.5, LS33UK/RP, LS33F, LV33F, C55A, LS33/60, WT303, WT303/4.5, WT303UK/RP, WT303F, WT303/60, FL32, FL32/4.5, FL33, FL33/4.5, C32, C32/4.5, C33, C33/4.5, Z32, Z32/4.5, Z33, Z33/4.5		

			
1			
GEV No.	347547	Ref. No.	0A8266
description	switch 2NO 250V 16A connection male faston 6.3mm		
For models:	NEPV40, NEPV40, NEPV40, NEPA40, 400LTPVN, NEPV40, EKE421S, EK401U, EK401UGT, EKE421GTS, ET401S, ET401SGT, EKE411UF, 12001720, EC406SGC, EC406SGV, 120.06.402, EP406SRC, EP406SRV, EP406VRC, EP406VRV, EN406VAC, EN404VAC, EC406SGC, EC406SGV, EP406VAV, EP408SRV, 12006402.1, EP406SRC, EP406SRV, EP406VRC, EP406VRV, EN406VAC, EP406VAV, EP408SRV, 721-00-115, 721-00-116, 721-00-122, 721-00-123, 125-00-100, 125-00-102, 125-00-103, 125-00-100, 125-00-102, 125-00-103, 23000150.1, 23000151.1, 23100150.1, 23100151.1, 15600116.1...(Other models you can see in the webshop)		



float switches

GEV No.	345822	Ref. No.	049309 049454 049478 L1031BDA0090
description	float switch thread M16x1.5 1NO or 1NC ø 17.4mm L 98mm mounting ø 16mm 250V 0.5A cable cable length 2000mm		
For models:	LS32UK/RP, WT302UK/RP, LS33UK/RP, WT303UK/RP, LS65, LS62/UK, LS63/UK, LS64/UK, WT35, WT32/UK, WT33/UK, WT34/UK, LC100, LS10/UK1, LS10/UK3, LS12/UK3, LS8/UK1, LS8UK3, WT50/UK1, WT50/UK3		

GEV No.	345484	Ref. No.	0E5808 0K8328 30001703 RSF44Y100RF
description	float switch thread M16x1.5 1NO or 1NC ø 17.5mm L 92mm mounting ø 16mm 250V 1A cable cable length 2000mm		
For models:	PW1EFL, PW1EFLF, PW1EFL/60HZ, PW2EFL, PW2EFLF, PW2EFL/60HZ, PW2VFL, WT830EFL, WT830EFLF, WT830EFL/60HZ, WT850, WT850EFLF, WT850EFL/60HZ, WT850SFL, LO1EFL, LO2EFL		

floats

GEV No.	695036	Ref. No.	0KV717
description	float for ice maker ø 75mm L 115mm H 40mm plastic		



cam switches

on/off



1			
GEV No.	301087	Ref. No.	047498 S641601800
description	cam switch 2 operating positions 2NO sequence 0-1 10A shaft ø 6x4.6mm shaft L 23mm connection male faston 6.3mm ON-OFF plastic		
For models:	LS510, LS520, LS520D, LS520F, LS520M, LS520K, LS4, ZLS510, ZLS520, ALLS520, ALS510, C51, C52, C50, LS520ZD, CF314, LS510MZ, LS520MZ		



2			
GEV No.	300088	Ref. No.	002382 003119 032677
description	cam switch 2 operating positions 4NO sequence 0-1 16A shaft ø 6x4.6mm shaft L 23mm connection male faston 6.3mm ceramic		
For models:	FCVMG62, QFE302, QFE602, DL14/C, DL14/CP, DL21/C, DL21/CP, SM08C., SM15CP, SM15C., SM15CA., SM15/CS., SM21/CP, SM21C., SM21CA., SM15VP, SM15VA., SM21VP, SM21VA., DI-RT2, DI-RT3, DI-RT4, DI-RT5, DI-RT6, DI-BARW2, DI-BARW3, DI-BARW4, DI-BARW5, DI-BARW6, DI-RW2, DI-RW3, DI-RW4, DI-RW5, DI-RW6, DB/G31, DB/G21, DB/G33, DB/G22, SM08C, SM15CP, SM15C, SM15CA, SM15/CS, SM21C, SM21C, SM21CA, SM15VP, SM15VA, SM21VP, SM21VA		

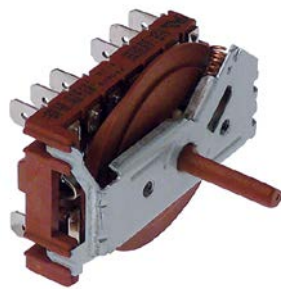



1			
GEV No.	300218	Ref. No.	0E5222 0K8266 740610
description	cam switch 2 operating positions 6NO sequence 0-1 16A shaft ø 6x4.6mm shaft L 23mm connection male faston 6.3mm plastic		
For models:	RT100ED, RT100ES, RT100SR, RT100SL, RT140ED, RT140ES, RT140SR, RT140SL, RT190ED, RT190ES, RT190SR, RT190SL, RT190HDED, RT190HDES, RT190HSR, RT190HSL, RT270ED, RT270ES, RT270SR, RT270SL, RT270HDED, RT270HDES, RT270HSR, RT270HSL, RT100ERF, RT100ELF, RT100VD, RT100VS, RT140ERF, RT140ELF, RT140VD, RT140VS, RT142ERF, RT142ELF, RT190ERF, RT190ELF, RT190VD, RT190VS, RT190HERF, RT190HELF, RT190HDVDF, RT190HDVDF, RT270ERF, RT270ELF, RT270VDF, RT270VSF, RT270HERF, RT270HELF, RT270HDVDF, RT270HDVDF...(Other models you can see in the webshop)		

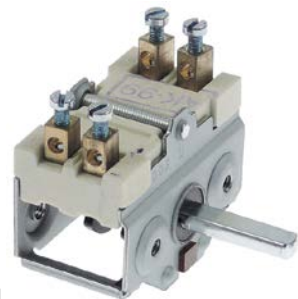

1			
GEV No.	300074	Ref. No.	0A2162 0A2227 0KE807
description	cam switch 4 operating positions 2NO sequence 0-1-0-1 16A shaft ø 6x4.6mm shaft L 23mm connection male faston 6.3mm ceramic		
For models:	MBR/G710D, MBR/E710D, MBR/E700, MBR/E700UK, MBR/E716, MBR/E706, MCC/E350D, MCC/E350, FDV40G, FDV40GZ, FDV40GA, FDV20G, FDV20GZ, FDV20GA, RW/E1, XW/E1, JW/E1, MW/E1, RBR/G710D, 7BRE60XN, 7BRE60X, RBR/E700UK, RBR/E716, RBR/E706, RCC/E350, XBR/E710D, M70EBP, XBR/E710, XBR/G751, XBR/G756, CBR/E700, XBR/E716, XBR/E706, T35ECS, CCC/E350, PW/E1, OW/E1, TW/E1, RBR/E700, RBR/E700, KW/E1, HFR/G410NL, HFR/G810NL, HPN/GI810, HPN/GI815, HPN/GI806, HPN/GI805, QW/E1, ZPN/GI810, 2PIG15...(Other models you can see in the webshop)		



1			
GEV No.	300020	Ref. No.	003565 028390 0C3192 I01591
description	cam switch 4 operating positions 2NO sequence 0-1-0-1 16A shaft ø 6x4.6mm shaft L 23mm connection screw ceramic		
For models:	KPI/G18, KPI/G25, HPN/GI855, HPN/GI1255, QPI/G18, QPI/G25, ZPN/GI1255, FCVE6-3CE, FCVE103CE, FCVE203CE, HQN/EI917, HQN/EI1225, HPN/EI810, HPN/EI810, HPA/EI810, HBR/G803, HBR/G804, HBR/G803, HBR/G804, HBR/G803, HBR/G805, HBR/G1003, HBR/G1003, HBR/G1004, HBR/G803, HBR/G804, HBR/G1013, HBR/G803, HBR/G804, HBR/G1003, HBR/G1013, HPN/EI810, HPN/EI810, HPA/EI815, HQNEI817, HQNEI122, AFCV/G6-3, AFCV/G103, AFCV/G203, HBR/G1004, ZHMA/E400		
accessories for	300020		
	GEV No.	110135	Ref. No. —
	rosette knob up to ø 52mm		
	GEV No.	110231	Ref. No. —
	knob switch 0-1-0-1 t.max.°C° 50mm shaft ø 6x4.6mm shaft flat upper black		



1

GEV No.	300017	Ref. No.	0A2241 0H6603 245596
description	cam switch 4 operating positions 4NO sequence 0-1-0-1 16A shaft ø 6x4.6mm shaft L 23mm connection male faston 6.3mm ceramic		
For models:	RB/E1, RB/E2, RBV/E2, XB/E2, XBV/E2, JB/E2, JBV/E2, MB/E1, MB/E2, MBV/E2, PB/E2, PBV/E2, PB/E2E5, OB/E2, TB/E2, TBV/E2, TB/E2E5, KB/E2, HM/E800, HG/E400, HG/E800, QB/E2, ZM/E800, ZG/E400, ZG/E800, WB/E2, AM/E800, OM/E800, AG/E400, AG/E800, 7508-3/85., 7500-3/85.HE.2PL.(N), 7505-3/85, 7506-3/85.HE.CER.2KZ, 7507-3/85., 7505-3/90.HE.6PL.BO., 7506-3/90.HE.CER.2KZ, 7507-3/90.HE.CER.4KZ, 7508-3/90.HE.CER.BO., 7700-3/85, 7706-3/85.HE.CER.2KZ, 7707-3/85.HE.4KF.CER, 7700-3/90.HE.2PL.(N), 7706-3/90.HE.CER.2KZ, 7707-3/90.HE.4KF.CER, 7508-3/85.HE.CER.BO., 7505-3/85.HE.6PL.BO., 7508-3/85.HE.CER.BO., 7506-3/85.HE.CER.2KZ, 7506-3/85.HE.CER.2KZ...(Other models you can see in the webshop)		

4-position

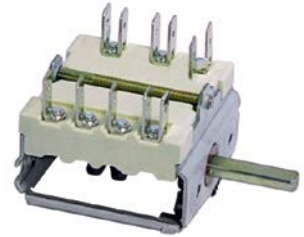

1

GEV No.	300007	Ref. No.	0H6602 0H9803 0K4913 18005014 300007
description	cam switch 4 operating positions 1NO/2CO sequence 0-1-2-3 16A shaft ø 6x4.6mm shaft L 23mm connection male faston 6.3mm 4-position ceramic		
For models:	BE1-TA.3, BE1-W.3, BE1-WS-M.3, BE2-A-C.3, BE2-A-M.3, BE2-WS-C.3, BE2-WS-M.3, BE3-C.3, BE3-M.3, BE1-WS-C.3		



1

GEV No.	300021	Ref. No.	0K4921 0K9771
description	cam switch 4 operating positions 4NO sequence 0-1-0-1 16A shaft ø 6x4.6mm shaft L 23mm connection screw ceramic		



1

GEV No.	300103	Ref. No.	029147 0H1255 0H6389 0H6598 0K1383 0K2147 SEC117
description	cam switch 4 operating positions 1NO/2CO sequence 0-1-2-3 32A shaft ø 6x4.6mm shaft L 23mm connection screw ceramic		
For models:	7508-3/85., 7502-3/85., 7500-3/85.HE.2PL.(N), 7504-3/85.HE.6PL.BO., 7505-3/85, 7506-3/85.HE.CER.2KZ, 7512-3/85.KF.BO.(N), 7502-3/90.HE.4PL.BO., 7504-3/90.HE.6PL.BO., 7505-3/90.HE.6PL.BO., 7506-3/90.HE.CER.2KZ, 7508-3/90.HE.CER.BO., 7512-3/90.KF.BO.(N), 7700-3/85, 7700-3/90.HE.2PL.(N), 7502-3/85.HE.4PL.BO., 7508-3/85.HE.CER.BO., 7505-3/85.HE.6PL.BO., 7508-3/85.HE.CER.BO., 7506-3/85.HE.CER.2KZ, 7506-3/85.HE.CER.2KZ, 7508-3/85.HE.CER.BO., 7509-3/85.HE.CER.6KZ, 7506-3/85.HE.CER.2KZ, 7510-3/85.HE.CER.6KZ, 7509-3/85.HE.CER.6KZ, 7509-3/85.HE.CER.6KZ, 7504-3/90.HE.6PL.BO., 7502-3, 7502-9, 7504-3, 7504-9, 7505-3, 7505-9-9, 7508-3, 7510-3/90.HE.CER.6KZ, 7512-3, 7512-9, 7709-3/85, 7709-3/90, 9002-3, 9004-2, 9004-3, 9006-3, 9012-3, 9015-3, 9598-3-0, 9598-3-8		



1

GEV No.	300102	Ref. No.	050857 0H6388 0H6682 0H7497 0K2939 0KC014 0KG608 0KZA39 203564 247200
description	cam switch 4 operating positions 4NO sequence 0-1-0-1 32A shaft ø 6x4.6mm shaft L 23mm connection screw ceramic		
For models:	MFR/E355, MFR/E355UK, MFR/E355D, MFR/E705, MFR/E705UK, MFR/E705D, MPN/E1760, MPN/E1760UK, MCP/E700, MCP/E700D, 7PIE06, RPN/E1760UK, 7CPE07P, M70EIKE, XPN/E1760UK, M70EPC, CCP/E700, RFR/E302, RFR/E302UK, RFR/E305, RFR/E305, RFR/E701, RFR/E701, RFR/E312, RFR/E312, RFR/E315, RFR/E315, RFR/E711, RFR/E711U, RPN/E1760, RPN/E1760, RCPE700, HMS/E800, HMA/E800, HM/E800T, HPN/E810, HPN/E815, HBR/E801, HBR/E803, HBR/E804, HBR/E805UK, HBR/E1003, HBR/E1013, HCP/E800, HCP/E400, HBR/E801, HBR/E803, HBR/E804, HBR/E1003, HBR/E1013...(Other models you can see in the webshop)		

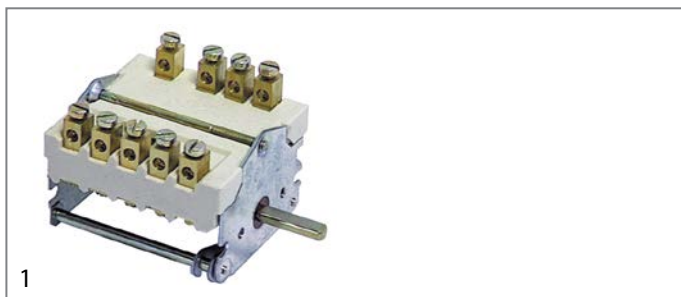

1

GEV No.	300104	Ref. No.	01C16 01C21 0H6683 0KE653 0M0519 247202
description	cam switch 4 operating positions 3NO/1CO sequence 0-1-2-3 32A shaft ø 6x4.6mm shaft L 23mm connection screw ceramic		
For models:	7561-3.KES60.RW, 7562-3.KES80.RW, 7563-3.KES100.RW, 7564-3.KES150.RW, 7751-3/85.KES60, 7550-3/85.KES40.(N), 7551-3/85.KES60, 7552-3/85.KES80.(N), 7553-3/85.KES100.(N), 7554-3/85.KES150.(N), 7550-3/90.KES40.(N), 7551-3/90.KES60, 7552-3/90.KES80.(N), 7553-3/90.KES100.(N), 7554-3/90.KES150.(N), 7561-3/85.KES60.RW, 7562-3/85.KES80.RW, 7563-3/85.KES100.RW, 7564-3/85.KES150.RW, 7561-3/90.KES60.RW, 7562-3/90.KES80.RW, 7563-3/90.KES100.RW, 7564-3/90.KES150.RW, 7573-3/85.KES100.(N), 7574-3/85.KES150.(N), 7575-3/85.KES250.(N), 7576-3/85.KES300.(N), 7573-3/90.KES100.(N), 7574-3/90.KES150.(N), 7575-3/90.KES250.(N), 7576-3/90.KES300.(N), 7585-3/85.KK40.MOTK., 7586-3/85.KK60.MOTK., 7587-3/85.KK80.MOTK., 7588-3/85.KK100.MOTK., 7585-3/90.KK40.MOTK., 7586-3/90.KK60.MOTL., 7587-3/90.KK80.MOTK., 7588-3/90.KK100.MOTK., 7550-3, 7551-3, 7552-3, 7553-3, 7554-3, 7560-3, 7561-3, 7562-3, 7563-3, 7564-2, 7568-3...(Other models you can see in the webshop)		

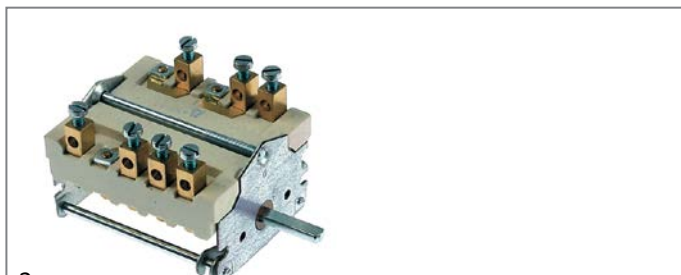

2

GEV No.	300194	Ref. No.	0K2034
description	cam switch 4 operating positions 4NO sequence 0-1-2-3 16A shaft ø 6x4.6mm shaft L 23mm connection screw 4-position ceramic		

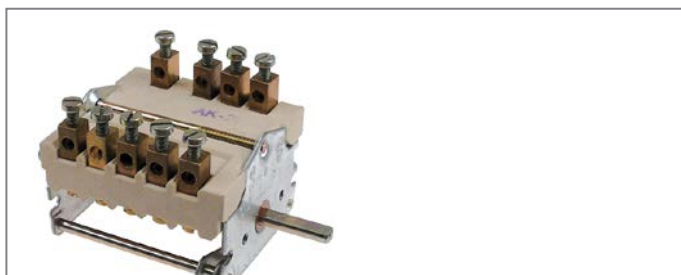

1

GEV No.	300224	Ref. No.	0K1380
description	cam switch 4 operating positions sequence 0-1-2-3 3-pole		

5-position



1

GEV No.	300147	Ref. No.	052749
description	cam switch 5 operating positions 1NO/2CO sequence 0-1-2-3-4 16A shaft ø 6x4.6mm shaft L 23mm connection screw 5-position		



1

GEV No.	300075	Ref. No.	025300
description	cam switch 5 operating positions 2NO/2CO sequence 0-1-2-3-4 32A shaft ø 6x4.6mm shaft L 23mm connection screw 5-position ceramic		

7-position





1

GEV No.	300004	Ref. No.	00291 004915 0H6685 0K6627 0K7430 0K9774 247243 SEC133
description	cam switch 7 operating positions 1NO/2CO sequence 0-1-2-3-4-5-6 16A shaft ø 6x4.6mm shaft L 23mm connection male faston 6.3mm 7-position ceramic		

For models:	SCE350, SCE700, SCFE700, SCE350, SCE700, SCFE700, PC35E6U, PC70E6U, 7701-3/85, 7501-3/85., 7501-3/90.HE.4PL.(N), 7502-3/85., 7500-3/85.HE.2PL.(N), 7503-3/85.HE.6PL, 7504-3/85.HE.6PL.BO, 7505-3/85, 7500-3/90.HE.2PL.(N), 7502-3/90.HE.4PL.BO., 7503-3/90.HE.6PL.(N), 7504-3/90.HE.6PL.BO., 7505-3/90.HE.6PL.BO., 7700-3/85, 7703-3/85, 7700-3/90.HE.2PL.(N), 7701-3/90.HE.4PL.(N), 7703-3/90.HE.6PL.(N), 7502-3/85.HE.4PL.BO., 7505-3/85.HE.6PL.BO., 7503-3/85.HE.6PL.EO, 7501-3/85.HE.4PL.EO, 7500-3/85.HE.2PLEO, 7504-3/90.HE.6PL.BO., 7500-3, 7501-3, 7502-3, 7503-3, 7504-3, 7505-3, 7700-3, 7701-3, 7703-3, 9000-3, 9002-3, 9004-3, 9006-3, 9200-3-0, 9200-3-8, 9201-3-0, 9201-3-8, 9203-3-0...(Other models you can see in the webshop)		
--------------------	---	--	--

1

GEV No.	300025	Ref. No.	0A2021 0G0649 0KM938 537000300
description	cam switch 7 operating positions 1NO/2CO sequence 0-1-2-3-4-5-6 16A shaft ø 6x4.6mm shaft L 23mm connection screw 7-position ceramic		
accessories for	300025		
	GEV No.	112172	Ref. No. —
	knob universal ø 70mm black without adaptor/dial plate		
	GEV No.	112213	Ref. No. —
	knob dial plate silver switch 7-position t.max.°C ED ø 63mm ID ø 45.5mm		
	GEV No.	112311	Ref. No. —
	knob adapter shaft ø 6x4.6mm L 0mm with spring		

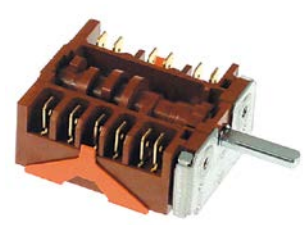

1

GEV No.	300177	Ref. No.	053408 059238 0K2888 4627266813
description	cam switch 7 operating positions 6NO sequence 0-1-2-3-4-5-6 16A shaft ø 6x4.6mm shaft L 23mm connection male faston 6.3mm 7-position		
For models:	RC/E320, RC/E320U, RC/E720, RC/E720, MCF/E700D, MCF/E700, MCF/E700UK, MCF/E1050D, MCF/E1050, MC/E350D, MC/E350UK, MC/E700D, MC/E700UK, MC/E1050D, MC/E350, MC/E700, MC/E1050, BC/E1, BCF/E2, RC/E1, RC/E2, RCV/E2, RCV/E3, RCF/E2, RCF/E2MO, RCF/E2M4, RCVF/E3MO, RCVF/E3M4, RCF/E2E5, MC/E2Q, MCF/E2Q, MCV/E2Q, RC/E2Q, RCF/E2Q, RCV/E2Q, XC/E1, XC/E2, XCV/E2, XCV/E3, XCF/E2, JC/E1, JC/E2, JCV/E2, JCV/E3, JCF/E2, MC/E1, MC/E2, MCV/E2, MCV/E3, MCF/E2...(Other models you can see in the webshop)		



1

GEV No.	300106	Ref. No.	01C25 01C32 0A2022 0G0920 0H1256 0H6394 0H9805 0K4922 0K6968 0K7289 0KC015 0M0527 18005037 18005083 180514 30000755
description	cam switch 7 operating positions 1NO/2CO sequence 0-1-2-3-4-5-6 32A shaft ø 6x4.6mm shaft L 23mm connection screw 7-position shaft flat upper		
For models:	CE128-106, CE158-133.3.HV, CE158-244.3, CE158-246.3, CK248-209.D1ABBB, CK248-211.D1ABBB, HCE128-100, HCE128-104, HCE158-252W.3, HCE158-253.3, CK248-205.D1ABBB, CK248-207.D1ABBB, HCE128-100W, HCE128-103W, HCE128-104W, CE128-101, CE128-102, CE128-105, CE128-107, CE128-108, HCE158-262W.3, HCE158-264.3, HCE158-261.3, HCE158-261W.3, HCE158-263.3, HCE158-232W.3, HCE158-233.3, HCE158-231.3, HCE158-231W.3, HCE158-230.3, CE158-234.3, CE158-236.3, HCE158-254.3, HCE158-251.3, HCE158-251W.3, HCE158-242W.3, HCE158-243.3, HCE158-241.3, HCE158-241W.3, HCE158-240.3, CE158-235.3, CE158-237.3, CE158-245.3, CE158-247.3, HCE158-131W.3.HV, HCE158-135.3.HV, HCE158-121W.3.HV, HCE158-125.3.HV, HCE158-132.3.HV, HCE158-132W.3.HV...(Other models you can see in the webshop)		



1

GEV No.	300237	Ref. No.	0H9804 0H9820 0K4914 18005022 18005422 700320
description	cam switch 7-position shaft ø 6x4.6mm shaft L 23mm ambient temperature max. 150°C		

2 operating positions



1

GEV No.	300054	Ref. No.	0H6604
description	cam switch 2 operating positions speed sequence 0-1 shaft ø 6x4.6mm connection male faston 9-pole		



3 operating positions



1

GEV No.	347996	Ref. No.	0L3145
description	cam switch 3 operating positions 2NO/1CO sequence 0-1-2 32A shaft \varnothing 6x4.6mm shaft L 23mm connection male faston 6.3mm		



1

GEV No.	345172	Ref. No.	048524
description	cam switch 3 operating positions 2NO/2CO sequence 0-1-2 32A shaft \varnothing 6x4.6mm shaft L 23mm connection male faston 6.3mm		
For models:	LS10D, LS10, LS10UKRP, LC100, ECOTEMP12-, LS10/60, LS10/1, LS10/12KW, LS10F, LS10DEK, LS10/1UKRP, LS10SW, LS10/50J, LS10/60J, LS10/HD, SH55, LS12D, LS12, LS12UK/PP, LC120, LS12/60, LS12F, LS12DEK, LS12HD, LS12/UK3, ECOTEMP12SW, ECOTEMP12INS, LS12MEX, LS10N, LS8D, LS8, LS8UK/PP, LC80, LS8F, LS8DEK, LS8/9, LS8/60, LS8/1UKRP, WT50/9, WT50/UK9RF, WT50/F9, WT50/6, WT50/1UKRP, WT50/1, D800/9, D800/6, WT50/60, WT50/N, LS8/HD, LS8/9DD...(Other models you can see in the webshop)		
accessories for	345172		
	GEV No.	110137	Ref. No.
			048273 048288 048402 0E5217 OKU315
	knob switch zero mark \varnothing 44mm shaft \varnothing 6x4.6mm shaft flat left black		

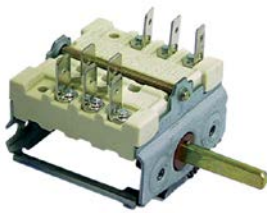

1

GEV No.	345171	Ref. No.	048271
description	cam switch 3 operating positions 3NO sequence 0-1-2 16A shaft \varnothing 6x4.6mm shaft L 26mm connection male faston 6.3mm ceramic		
For models:	LS7D, LS7, LS7UK/PP, LV70, LS7F, LS7DEK, LS7/1UK, LS7/9, LS7/60, WT40/9, WT40/F, LS7HD, WT40/J50, WT40/J60, WT40UKRP, PH4/WT40, PH4RBP/WT40, LS10D, LS10, LS10UKRP, LC100, LS10/60, LS10/1, LS10/12KW, LS10F, LS10DEK, LS10/1UKRP, LS10SW, LS12D, LS12, LS12UK/PP, LC120, LS12/60, LS12F, LS12DEK, RT10ED, RT10ES, RT10SR, RT10SL, RT10ED/230, RT10ES/230, RT10ERF60, RT10ELF60, RT10ERF, RT10ELF, RT10ERBF60, RT10ELBF60, RT10ERG, RT10ELG, RT10EDH...(Other models you can see in the webshop)		
accessories for	345171		
	GEV No.	112340	Ref. No.
			046356 048340 048527 089816 46356
	knob switch zero mark t.max. $^{\circ}$ C temperature range $^{\circ}$ C \varnothing 40mm shaft \varnothing 6x4.6mm shaft flat left black		



1

GEV No.	346469	Ref. No.	0H9806 0H9806
description	cam switch 3 operating positions 3NO/1CO sequence 0-1-2 32A shaft \varnothing 6x4.6mm shaft L 23mm connection screw		
For models:	VSE-S.3, VSE-S.4.MARINE, VSE-S.3.JUNO, VSE-W.3, VSE-W.4.MARINE, VSE-W.3.JUNO		



1

GEV No.	300039	Ref. No.	0H6590
description	cam switch 3 operating positions main + selector switch sequence 1-2-3 16A shaft \varnothing 6x4.6mm connection male faston 6-pole		

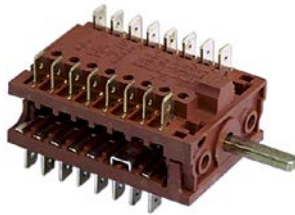

1

GEV No.	300042	Ref. No.	0H6101 60050377
description	cam switch 3 operating positions speed/power sequence 1-2-3 shaft \varnothing 6x4.6mm connection male faston 16-pole		



1

GEV No.	300036	Ref. No.	0H6392 VI255
description	cam switch 3 operating positions steaming manual sequence 0-1-2 shaft \varnothing 6x4.6mm connection male faston 2-pole		



4 operating positions



1

GEV No.	347883	Ref. No.	0C9725
description	cam switch 4 operating positions 11NO sequence 0-1-2-3 16A shaft ø 6x4.6mm shaft L 23mm connection male faston 6.3mm		



1

GEV No.	301186	Ref. No.	049144
description	cam switch 4 operating positions 7NO sequence 1-0-2-3 16A shaft ø 6x4.6mm shaft L 23mm connection male faston 6.3mm plastic		
For models:	LC100, LS10DP, LO10, LS10/UK1, LS10/UK3, LS12DP, LS12/UK3, LS8/DP, WT50/J50, WT50/J60, LS8/UK1, LS8UK3, WT50/UK1, WT50/UK3		

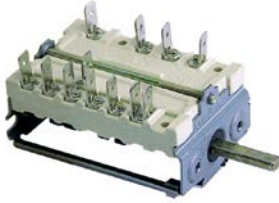

1

GEV No.	300010	Ref. No.	057934
description	cam switch 4 operating positions 2NO/2CO sequence 0-1-2-3 16A shaft ø 6x4.6mm shaft L 23mm connection male faston 6.3mm ceramic		



1

GEV No.	347483	Ref. No.	0C7965
description	cam switch 4 operating positions 8NO sequence 0-1-2-3 16A shaft ø 6x4.6mm shaft L 17mm connection male faston 6.3mm plastic		



1

GEV No.	300037	Ref. No.	0H6387
description	cam switch 4 operating positions 4NO sequence 0-1-2-3 16A shaft ø 6x4.6mm shaft L 23mm connection male faston 6.3mm		

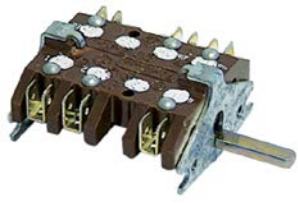

1

GEV No.	300035	Ref. No.	0H6391 4H217
description	cam switch 4 operating positions main + selector switch sequence 0-1-2-3 16A shaft ø 6x4.6mm shaft L 23mm connection male faston plastic		



1

GEV No.	301216	Ref. No.	059544 4624866803 721198
description	cam switch 4 operating positions 5NO sequence 0-1-2-3 16A shaft ø 6x4.6mm shaft L 23mm connection male faston 6.3mm		
For models:	MCP/G700, MCP/G701, MCP/G710, MCP/G711, RPI/E240, RPI/E260, RPI/G260P, RPI/E260P, RCP/E2S, XPI/E240, XPI/E260, XPI/G260P, XPI/E260P, JPI/E240, JPI/E260, MCP/E1SH, MCP/E1SUH, MCP/E2SUHS, MPI/E240, MPI/E260, MPI/G260P, MPI/E260P, MCP/E2S, MCP/E2SH, MCP/E2SUH, MCP/E2SUT, MCP/E2SHB, 7CPG07P, RCP/G701, M70GPC, M70GPC, CCP/G700, PPD/G260, PPI/G260P, PPI/E260P, PCP/E2SHP, PCP/E1SH, PCP/E2SH, PCP/E2SH3B, OPD/G260, OPI/G260P, OPI/E260P, OCP/E2S, OCP/E1SH, OCP/E2SH, TPD/G260, TPI/G260P, TPI/E260P, TCP/E2S, TCP/E2SH...(Other models you can see in the webshop)		

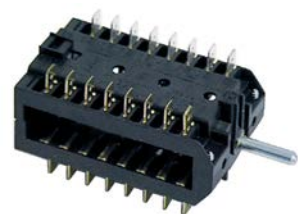

1

GEV No.	300043	Ref. No.	0H6098 212236 300043 60050374
description	cam switch 4 operating positions motor performance shaft ø 6x4.6mm connection male faston 16-pole		
For models:	5611-3-8, 5612-3-8, 5614-3-8		

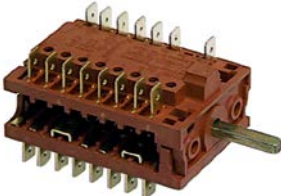

1

GEV No.	300065	Ref. No.	OK2032 60050417
description	cam switch 4 operating positions power/ program shaft ø 6x4.6mm connection male faston 16-pole		

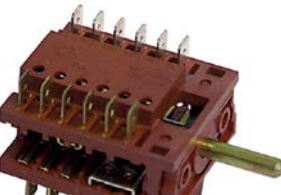

1

GEV No.	300041	Ref. No.	0H6100 12CH027 212242 60050376
description	cam switch 4 operating positions programme 16A shaft ø 6x4.6mm connection male faston 12-pole		

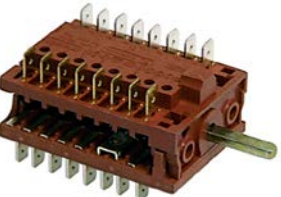

1

GEV No.	300066	Ref. No.	OK1007
description	cam switch 4 operating positions programme shaft ø 6x4.6mm connection male faston 16-pole		



1

GEV No.	301090	Ref. No.	050783 053866
description	cam switch 4 operating positions sequence 0-1-2-3 shaft ø 6x4.6mm connection male faston 7-pole		
For models:	MCF/GE705, MCF/GE1055, MCF/GE700, MCFGE1050, MCF/GE700D, MCFGE1050D, MCF/E700D, MCF/E700, MCF/E700UK, MCF/E1050D, MCF/E1050, MCF/GE1055UK, MIF/E700, MIF/E700D, MIF/E710, MIF/E710D, MCF/GE702, MCFGE1052, MCF/GE700, MCFGE1050, MF/E700, RCF/GE720, RCF/GE730, RCF/GE720, RCF/GE720, RCFE720, RCF/E720, RCF/E700D, RCF/GE700D, RCF/E1050D, RCFGE1050D, RCF/E700UK, 74CE07F, 76CE10F, RCF/GE700, RC/G702, RC/G1052, RCF/GE702, RCF/GE1052, 74FE07F, RCF/GE1051, XCF/GE700D, M70GCK/E, M70ECK/E, XCF/E1050, XCF/E700UK, XMIF/E710, M70GCH/E, M105GCK/E, CCF/E700...(Other models you can see in the webshop)		



1

GEV No.	301215	Ref. No.	OC0320
description	cam switch 4 operating positions shaft ø 6x4.6mm connection male faston 11-pole		
For models:	BCF/E2, BCP/E1, PCF/M2, PCF/M3, PCV/E2, PCV/E3, PCF/E2, PC/E2Q, PCF/E2Q, PCV/E2Q, PI/E1, PI/E2, PIF/E2, PIV/E2, PC/E2QE5, PCF/E2QE5, PI/E1E5, PI/E2E5, PIF/E2E5, PCF/E2E5, PCF/M2E5, PCF/M2A, PCF/M3A, OCF/M2, OCF/E2, OC/E2Q, OCF/E2Q, OI/E1, OI/E2, OIF/E2, TCF/M2, TCF/M3, TCF/E2, TCV/E2Q, TIF/E2, TCF/E2QE5, TI/E2E5, TCF/E2E5, TCF/M2E5, TCF/M2A, TCF/M3A, TCF/E2M0, TCF/E2QM0, TCF/E3QM0, TCF/E2M4, TCF/E2QM4, TCF/E3QM4, KCF/M2, KC/E1, KC/E2...(Other models you can see in the webshop)		



1

GEV No.	345750	Ref. No.	0H6291
description	cam switch 4 operating positions shaft ø 6x4.6mm connection male faston 16-pole		



1

GEV No.	301187	Ref. No.	049145
description	cam switch 4 operating positions shaft ø 6x4.6mm connection male faston 4-pole		
For models:	LS7/DP, LC100, LS10DP, LO10, LS10/UK1, LS10/UK3, LS12DP, LS12/UK3, WT50/J50, WT50/J60, WT50/UK1, WT50/UK3		

5 operating positions



1

GEV No.	301296	Ref. No.	OC9080
description	cam switch 5 operating positions 6NO/1CO sequence 0-1-2-3-4 16A shaft ø 6x4.6mm shaft L 24mm connection male faston 6.3mm plastic		

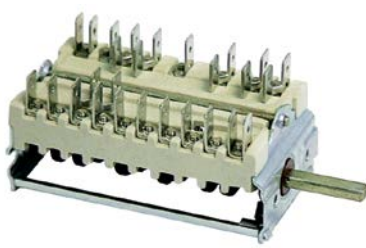
1

GEV No.	300009	Ref. No.	051647 0K2940 0W2001
description	cam switch 5 operating positions changeover switch sequence 0-1-2-3-4 16A shaft ø 6x4.6mm connection male faston 8-pole		
For models:	MPN/EI760, MPNEI760UK, MCP/E700, MCP/E700D, 7PIE06, RPN/EI760UK, 7CPE07P, M70EIKE, XPN/EI760UK, M70EPC, CCP/E700, RPN/EI760, RPN/EI760, RCPE700, HPN/E810, HPN/E815, HCP/E800, HCP/E400, HPN/E810, HPN/E815, RPN/EI760, RCP/E700		



1

GEV No.	301229	Ref. No.	005213
description	cam switch 5 operating positions sequence 0-1-2-3-4 shaft ø 6x4.6mm connection male faston 3-pole		
For models:	FCF/E4, FCF/E4-3KW, JCF/E4, JCF/E4, ECF/E4, ECF/E4-3KW, ACF/E4, ACF/E4-3KW, NCF/E4, ZCF/E4, ZCF/E4		

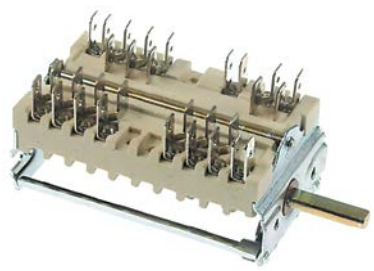

1

GEV No.	301211	Ref. No.	004268
description	cam switch 5 operating positions sequence 0-1-2-3-4 shaft ø 6x4.6mm connection male faston 7-pole		
For models:	RCF/M2, RCF/M3, RCF/E2, RCF/E2MO, RCF/E2M4, RCVF/E3MO, RCVF/E3M4, RCF/E2E5, RIF/E2, MCF/E2Q, RCF/E2Q, XCF/M2, XCFM3, XCF/E2, XIF/E2, JCF/M2, JCFM3, JCF/E2, JIF/E2, MCF/M2, MCF/M3, MCF/E2, MCF/E2E5, MIF/E2		

6 operating positions



1

GEV No.	345170	Ref. No.	048270
description	cam switch 6 operating positions 1CO sequence 0-1-2-3-4-5 16A shaft ø 6x4.6mm shaft L 23mm connection male faston 6.3mm ceramic		
For models:	LS7D, LS7, LS7UK/RP, LV70, LS7F, LS7DEK, LS7/1UK, LS7/9, LS7/60, WT40/9, WT40/F, LS7HD, WT40/J50, WT40/J60, WT40UKRP, PH4/WT40, PH4RBP/WT40, LS10D, LS10, LS10UKRP, LC100, ECOTEMP12-, LS10/60, LS10/1, LS10/12KW, LS10F, LS10DEK, LS10/1UKRP, LS10SW, LS10/50J, LS10/60J, LS10/HD, SH55, LS12F, LS12DEK, LS12HD, LS12/UK3, ECOTEMP12SW, ECOTEMP12INS, LS12MEX, LS10N, LS8D, LS8, LS8UK/RP, LC80, LS8F, LS8DEK, LS8/9, LS8/60, LS8/1UKRP... (Other models you can see in the webshop)		
accessories for	345170		
	GEV No.	112340	Ref. No. 046356 048340 048527 089816 46356
	knob switch zero mark t.max.°C temperature range°C ø 40mm shaft ø 6x4.6mm shaft flat left black		

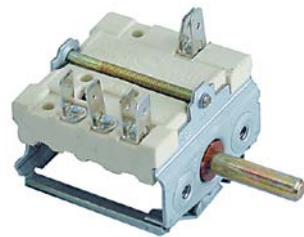

1

GEV No.	301184	Ref. No.	048286
description	cam switch 6 operating positions programme shaft ø 6x4.6mm connection male faston 1-pole		
For models:	LS10D, LS10, LS10UKRP, LS10/12KW, LS10SW, LS12D, LS12, LS12UK/RP, LC120, LS12/60, LS12F, LS12DEK, LS12HD, LS12MEX, HT1200elm		

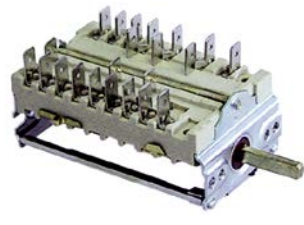

1

GEV No.	301092	Ref. No.	058806
description	cam switch 6 operating positions selection/ program shaft ø 6x4.6mm connection male faston 7-pole		
For models:	FCVE6-1U, FCVE6-3U, FCVE6-1, FCVE6-3, FCVE6-1UK, FCVE6-3UK, FCVE10-2, FCVE10-4, FCVE10-2UK, FCVE10-4UK, FCVE20-2, FCVE20-4, FCVE20-2UK, FCVE20-4UK, FCV/E6-1, FCV/E6-1, ZOFCV/E102, ZOFCV/E104, ZOFCV/E202, ZOFCV/E204		

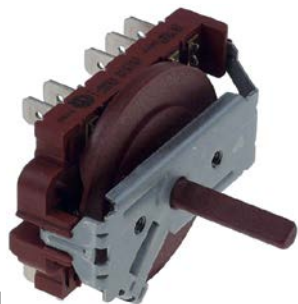

1

GEV No.	347519	Ref. No.	0E5810
description	cam switch 6 operating positions sequence 0-1-2-3-4-5 shaft ø 6x4.6mm shaft L 26mm 3-pole		
For models:	PW1EFL, PW1EFLF, PW1EFL/60HZ, PW2EFL, PW2EFLF, PW2EFL/60HZ, PW2VFL, WT830EFL, WT830EFLF, WT830EFL/60HZ, WT850, WT850EFL, WT850EFL/60HZ, WT850SFL, LO1EFL, LO2EFL		

7 operating positions



1

GEV No.	301210	Ref. No.	004741 4207000025
description	cam switch 7 operating positions 7NO sequence 0-1-2-3-4-5-6 16A shaft ø 6x4.6mm shaft L 23mm connection male faston 6.3mm plastic		
For models:	RPI/E240, RPI/E260, RPI/E260P, RCP/E1S, RCP/E2D, XPI/E240, XPI/E260, XPI/E260P, XCP/E1S, XCP/E2D, JPI/E240, JPI/E260, JCP/E1S, JCP/E2D, MPI/E240, MPI/E260, MPI/E260P, MCP/E1S, MCP/E2D, PCP/E1S, PCP/E2D, OCP/E1S, OCP/E2D, TCP/E1S, TCP/E2D		

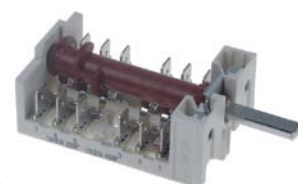

1

GEV No.	300233	Ref. No.	002661 0K2019 245029 245034
description	cam switch 7 operating positions shaft ø 6x4.6mm shaft L 23mm 5-pole		
For models:	FCV/G10L3, FCV/G6L3TOWNGAS, FCV/G6L3, FCGV10L3T, FCGV10L3, FCGV20L3, FCGV20L3, FCVE6L3J, FCV/E10L3JAP, FCV/E102/1L3JAP, FCV/G6L3JAP, FCGV10L3J, FCGV102L3J, FCGV6L3CJ, FCV/E61/1, FCV/G10L2, FCV/E101/1, FCV/E10L2, FCV/E61/1, FCV/E101/2, FCV/G6L3C, FCV/G61/1, FCGV6L3CT, FCGV6L3CJ, FCV/E10L3, FCV/E102/1, FCV/E6L3, FCV/E102/1L3, FCV/E20L3, FCVE20L3, FCV/E101/1, FCS061E44J, FCS061G48J, FCS061G3DI, FCS061E3CI, FCS101E2, FCS061G4DT, FCS061G49J, FCS101G2, FCS201E4, FCS202E4, FCS201G4, FCS202G4, 5711-2-6, 5711-2-7, 5712-2-6, 5712-2-7, 5714-2-6, 5714-2-7, 5717-2-6...(Other models you can see in the webshop)		

8 operating positions

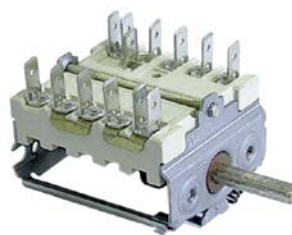

1

GEV No.	301094	Ref. No.	055017 780517
description	cam switch 8 operating positions 7NO sequence 0-1-2-3-4-5-6-7 16A shaft ø 6x4.6mm shaft L 23mm connection male faston 6.3mm ceramic		
For models:	FCF/G6-0, FCFG101/0, FCFG102-0, FCFG201-0, FCFG202-0, FCF/E6-0, FCFE101-0, FCFE102-0, FCFE201-0, FCFE202-0, FCF061ELN, FCF101ELN, FCF6EHOR, FCFG10160H, FCFG102-0T, FCF/G6-1-JAP, FCF/G101/1-1-JAP, FCF/G102/1-1-JAP, FCFE6-1J, FCFE101-1J, FCFE102-1J, FCF/G101/1, FCFG10, FCFG10D, FCFG10NL, FCFE10, FCFE10UK, FCFG20, FCFG20D, FCFG20F, PFCFG20, FCFE20, FCFE20UK, FCFG40, FCFG41, FCFG40D, FCFG40F, PFCFG40F, FCFE40, FCFE40D, FCFE40UK, PFCFE40F, FCFG10J, FCFE10J, FCFE10J, FCFE10J, FCFE20J, FCFG20J, FCFE20J, FCFE20J...(Other models you can see in the webshop)		

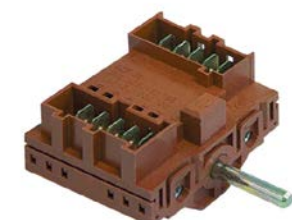

1

GEV No.	345169	Ref. No.	048829
description	cam switch 8 operating positions connection male faston 5-pole		
For models:	LS61, LS61/60, LS62, LS62D, LS62/UKRP, LS62F, LV62, LS62/60, ECOTEMP5, LS62/1P, LS62HD, LS65, LS62/UK, LS63, LS63D, LS63/UKRP, LS63F, LV63, LS63/60, LS63/1P, LS63/UK, LS64, LS64/UKRP, LV64, ECOTEMP5S, LS64/1P, LS64/UK, ECOTEMP5SW, WT32, WT32/4,5, WT32/UK, WT32/UKRP, WT32/F6, WT32/J60, WT32/J50, WT32/4,5N, WT35, WT32/UK, WT33, WT33/4,5, WT33/UK, WT33/UKRP, WT33/F, D500, WT33/M50, WT33/M60, WT33/60, WT33/4,5N, WT33/UK, WT30U400...(Other models you can see in the webshop)		
accessories for	345169		
	GEV No.	110907	Ref. No. 048830
	knob switch zero mark ø 44mm shaft ø 6x4.6mm shaft flat left black		

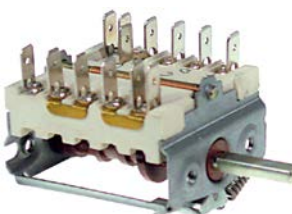

1



GEV No.	301238	Ref. No.	003761 005450
description	cam switch 8 operating positions shaft ø 6x4.6mm connection male faston 4-pole		
For models:	5702-2-2, 5702-2-3, 5704-2-2, 5704-2-3, 5707-2-2, 57074-2-3, 5701-3-2, 5701-3-3, 5702-3-2, 5702-3-3, 5704-3-2, 5704-3-3, 5707-3-2, 5707-3-3, JCF/G6-1, JCF/G101/1-1, JCF/G102/1-1, JCF/E6-1, JCF/E101/1-1, JCF/E102/1-1, JCF/G6-2, JCF/G101/1-2, JCF/G102/1-2, JCF/E6-2, JCF/E101/1-2, JCF/E102/1-2		





with potentiometer

			
1			
GEV No.	347022	Ref. No.	0G2875 11151627 94030504
description	cam switch 0-1 16A shaft ø 6x4.6mm shaft L 23mm connection male faston 6.3mm 10K/J cable length 400mm 2-pole with potentiometer plug type 10-pole		
For models:	AIARHFFOBB, AIARHAFOBB, AIARHBFOBB, AIAWHFFOBB, AIAWHAF-FOBB, AIAWHBFFOBB, AIAROIFFOBB, AIAWOIFFOBB, AIARAFFOBB, AI-ARAAFFOBB, AIARABFFOBB, AIAWAFFOBB, AIAWAFFOBB, AIAWABFFOBB		

			
1			
GEV No.	348104	Ref. No.	0C0084 0C9700
description	cam switch 10 operating positions 1NO sequence 0-1-2-3-4-5-6-7-8-9 16A shaft ø 6x4.6mm shaft L 23mm connection coded plug outer switch yes cable length 45mm 0.1-10KOhm LED		
For models:	MI/Z1, RI/Z1, XI/Z1, MI/Z2, RI/Z2, XI/Z2, MI/Z1U, MI/Z2U, PI/Z1, PI/Z2, PI/Z1E5, PI/Z2E5, PIW/Z1, PI/Z2F, OI/Z1, OI/Z2, TI/Z1, TI/Z2, TI/Z1E5, TI/Z2E5, TIW/Z1, TI/Z2F, QI/Z1, QI/Z2, QI/Z1E5, QI/Z2E5, WI/Z1, WI/Z2, WI/Z1E5, WI/Z2E5		

			
1			
GEV No.	345331	Ref. No.	0G3299 7894032507
description	cam switch 2 operating positions 1NO sequence 0-1 16A shaft ø 6x4.6mm shaft L 23mm connection coded plug cable length 2400mm 0.1-10KOhm cable 8-pole 2-pole with potentiometer		
spare parts for	345331		
	GEV No.	345119	Ref. No. —
	 cam switch 2 operating positions 2NO sequence 0-1 16A shaft ø 6x4.6mm shaft L 23mm connection soldering connection operation switch cable lengthmm 10kOhm plastic with potentiometer		
	GEV No.	402070	Ref. No. 0G0317 0G2166 18025493 722952 82361+20301
	 potentiometer 10KOhm rotation 360° shaft ø 6x4.6mm shaft L 18mm connection male faston 2.8mm thread M10x0.75 thread L 9mm		

			
1			
GEV No.	347514	Ref. No.	0G3298 7894032506
description	cam switch 2 operating positions 2NO sequence 0-1 16A shaft ø 6x4.6mm shaft L 23mm connection coded plug cable length 2400mm 0.1-10KOhm cable 10-pole 2-pole with potentiometer		
spare parts for	347514		
	GEV No.	345119	Ref. No. —
	 cam switch 2 operating positions 2NO sequence 0-1 16A shaft ø 6x4.6mm shaft L 23mm connection soldering connection operation switch cable lengthmm 10kOhm plastic with potentiometer		

			
1			
GEV No.	346984	Ref. No.	0H9852 0K5063 0M2134 14R19 15I01 18025422 72000601
description	cam switch 2 operating positions 4NO sequence 0-1 32A shaft ø 6x4.6mm shaft L 23mm connection cable 2400mm cable length 2400mm 50kOhm ceramic		
For models:	CE128-106, CE158-133.3.HV, CE158-244.3, CE158-246.3, CK248-209, D1ABBB, CK248-211.D1ABBB, HCE128-100, HCE128-104, HCE158-252W.3, HCE158-253.3, HLE129-100, HLE129-103, HLE129-104W, HLE159-252W.3.6, HLE159-328.3.HV, HLE159-351W.3.HV, HLE249-200.3, HLE249-208.3, HLE259-088.3.HV, HLE259-089.3.HV, HLE259-384W.3, LE129-101, LE159-261.3, LE159-281.3.6, LE159-318.3.HV, LE159-322.3.HV, LE159-330.3.HV, LE159-337.3.HV, LE159-344.3.MS92, LE159-347.3.HV, LE249-199.3, LE249-203.3, LE249-207.3, LE249-211.3, LE249-215.3, LE249-219.3, LE249-223.3, LE249-232.3, LE249-238.3, LE259-081.3.HV, LE259-082.3.HV, LE259-083.3.HV, LE259-094.3.HV, LE259-099.3.HV, LE259-382.3, LK259-707.D1ACCB, LK259-708.D1AC- CB, CK248-205.D1ABBB, CK248-207.D1ABBB, LK159-707.D1BC...(Other models you can see in the webshop)		

			
1			
GEV No.	300260	Ref. No.	0K1631
description	potentiometer sequence 0-1		
For models:	QI/Z1A, QI/Z2A, QI/Z1E5A, QI/Z2E5A, WI/Z1A, WI/Z2A, WI/Z1E5A, WI/Z2E5A, VI230., VI400, VI440., VW230., VW400, VW440.		



operation switches

E-G-O



1

GEV No.	300002	Ref. No.	00070 004908 0A2134 0G0268 0G0517 0G0921 0G2119 0H6605 0K3016 0K3500 0K4911 0K5472 0K9781 18005010 19005011 727993
description	cam switch 2 operating positions 4NO 16A sequence 0-1 shaft ø 6x4.6mm shaft L 23mm connection male faston 6.3mm ceramic		
For models:	BR/E1FL, BR/E1FR, BR/E2FL, BR/E2FR, MM/E700, MM/E700UK, MM/E700D, MG/E350D, MG/E350UK, MG/E700D, MG/E700UK, MG/E350, MG/E700, RR/E1FL, RR/E1FR, RR/E1CL, RR/E2FL, RR/E2FM, RR/E2CL, RRV/E1FL, RRV/E1FR, RRV/E1CL, RRV/E2FL, RRV/E2FM, RRV/E2CL, RR/E2CM, RG/E1, RG/E2, RGV/E1, RGV/E2, XR/E1FL, XR/E1FR, XR/E1CL, XR/E2FL, XR/E2FM, XR/E2CL, XRV/E1FL, XRV/E1FR, XRV/E1CL, XRV/E2FL, XRV/E2FM, XRV/E2CL, XG/E1, XG/E2, XGV/E1, XGV/E2, JR/E1FL, JR/E1FR, JR/E1CL, JR/E2FL...(Other models you can see in the webshop)		



1

GEV No.	300080	Ref. No.	002164 01553PB 026945 0G3354 0K2928 0K3015 0K4968 0K8419 18005612 180515 2317 537000200 V02071 VOL180515
description	cam switch 2 operating positions 4NO 16A sequence 0-1 shaft ø 6x4.6mm shaft L 23mm connection screw operation switch ceramic ambient temperature max. 150°C		
For models:	MR/E350D, MR/E350UK, MR/E360, MR/E700D, MR/E700UK, MR/E710, MR/E720, MR/E715, MR/E725, MR/E350, MR/E700, MR/E720D, RR/E350D, RR/E350UK, 7FTEF3R, RR/E360UK, RR/E700D, RR/E700UK, RR/E710, RR/E710UK, 7FTEC7L, 7FTEF3L, 7FTEF7L, 7FTEC7M, XR/E350D, XR/E350UK, T36EFT, XR/E700D, XR/E700UK, T71EFT, T79EFT, T35EFT, T70EFT, CR/E720, RR/E300, RRE702, RR/E300UK, RR/E311, RR/E700, RR/E700UK, RR/E711, RM/E700, PRM/E700, RM/E700U, RRV/E300, RRV/E300, RRV/E311, RRV/E700, RRV/E700, RRV/E711...(Other models you can see in the webshop)		
accessories for	300080		
	GEV No.	551456	Ref. No. —
	gasket for switch ED ø 14mm ID ø 2.5mm thickness 3.5mm white		

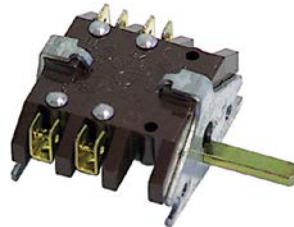

1

GEV No.	300040	Ref. No.	0K2151 10302025000
description	cam switch 2 operating positions operation switch 16A sequence 0-1 shaft ø 6x4.6mm connection male faston 2-pole ambient temperature max. 270°C		
For models:	9100-3, 9101-3, 9102-3, 9104-3, 9106-3, 9108-3, 9111-3, 9113-2, 9113-3, 9114-2, 9114-3, 9115-2, 9115-3, 9116-2, 9116-3, 9171-3, 9172-3, 9173-3, 9174-3, 9175-3, 9176-3, 9181-3, 9182-3, 9183-3, 9184-3, 9185-3, 9300-3-0, 9300-3-8, 9301-3-0, 9301-3-8, 9302-3-0, 9302-3-8, 9304-3-0, 9304-3-8, 9306-3-0, 9306-3-8, 9308-3-0, 9311-3-0, 9311-3-8, 9313-3-0, 9313-3-8, 9314-3-0, 9314-3-8, 9315-3-0, 9315-3-8, 9316-3-0, 9316-3-8, 9317-3-8, 9371-3-0, 9371-3-8...(Other models you can see in the webshop)		

1

GEV No.	301214	Ref. No.	0H6595 OK1004 4621066809
description	cam switch 2 operating positions operation switch 16A sequence 0-1 shaft ø 6x4.6mm shaft L 33mm connection male faston 6.3mm plastic ambient temperature max. 150°C		
For models:	7550-5.KES40, 7551-5.KES60, 7552-5.KES80, 7553-5.KES100, 7554-5.KES150, 7561-3.KES60.RW, 7562-3.KES80.RW, 7563-3.KES100.RW, 7564-3.KES150.RW, 7581-5.KK60, 7582-5.KK80, 7583-5.KK100, 7574-5.KES150, 7575-5.KES250, 7750-5.KES40, 7751-5.KES60, 7752-5.KES80, 7753-5.KES100, 7754-5.KES150, 7781-5.KK60, 7782-5.KK80, 7783-5.KK100, 7576-5.KES300, 7573-5.KES100, 7580-5.KK40, 7584-5.KK150, 7780-5.KK40, 7751-3/85.KES60, 7550-3/85.KES40.(N), 7551-3/85.KES60, 7552-3/85.KES80.(N), 7553-3/85.KES100.(N), 7554-3/85.KES150.(N), 7550-3/90.KES40.(N), 7551-3/90.KES60, 7552-3/90.KES80.(N), 7553-3/90.KES100.(N), 7554-3/90.KES150.(N), 7550-5/85.KES40.(N), 7551-5/85.KES60.(N), 7552-5/85.KES80.(N), 7553-5/85.KES100.(N), 7554-5/85.KES150.(N), 7550-5/90.KES40.(N), 7551-5/90.KES60.(N), 7552-5/90.KES80.(N), 7553-5/90.KES100.(N), 7554-5/90.KES150.(N), 7561-3/85.KES60.RW, 7562-3/85.KES80.RW....(Other models you can see in the webshop)		



1

GEV No.	300181	Ref. No.	0H6599 245555
description	cam switch 3 operating positions operation switch 32A sequence 0-1-2 shaft ø 6x4.6mm connection screw clamp 4-pole ambient temperature max. 330°C		
For models:	7535-3/85., 7535-3/90.FRI.(N), 7735-3/85.FRI.(N), 7735-3/90.FRI.(N), 7535-3, 7538-3, 7735-3, 7738-3, 9052-3, 9252-3-0, 9252-3-8		

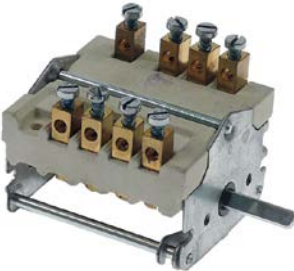

1

GEV No.	300180	Ref. No.	006649 720388
description	cam switch 2 operating positions operation switch 32A sequence 0-1 shaft ø 6x4.6mm shaft L 23mm connection screw ceramic		
For models:	PGV/E1, PGV/E2, TGV/E1, TGV/E2, KR/E1, KR/E2, KR/E1R, KR/E2R, KR/E1C, KR/E2C, KR/E2CR, KR/E1E5, KR/E1RE5, KR/E2E5, KR/E2RE5, KR/E1CE5, KR/E2CE5, KR/E2CRE5, KRF/E2R, KR/E1P, KR/E2P, KR/E1RP, KR/E2RP, KR/E1CP, KR/E2CP, KR/E2CRP, KR/E1E5P, KR/E1RE5P, KR/E2E5P, KR/E2RE5P, KR/E1CE5P, KR/E2CE5P, KR/E2CRE5P, KRF/E2RP, KGR/E1, KGR/E2, HR/E834W, HR/E413W, HR/E813W, HR/E404W, HR/E804W, HR/E814W, HR/E433W, HR/E443W, HR/E833W, HR/E843W, HR/E434W, HR/E844W, HR/E403W, HR/E803W....(Other models you can see in the webshop)		



1

GEV No.	301095	Ref. No.	054324 3570524011
description	cam switch 4 operating positions operation switch sequence 0-1-2-3 shaft ø 6x4.6mm connection male faston 3-pole ambient temperature max. 270°C		
For models:	FCF/E4-OLD, FCF/E4D, FCFE4PH, FCF/E4OLD3, FCF/E4OLD4, FCF/E4OLD2, FCF/E4OLD1, FCF/E4D		



1

GEV No.	345764	Ref. No.	0H6102 21531A
description	cam switch 5 operating positions operation switch sequence 0-1-2-3-4 shaft ø 6x4.6mm 5-pole ambient temperature max. 270°C		

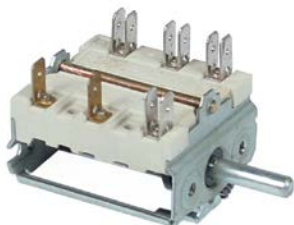

1

GEV No.	301142	Ref. No.	055473
description	cam switch 2 operating positions operation switch sequence 1-2 shaft ø 6x4.6mm connection male faston 3-pole ambient temperature max. 270°C		
For models:	FCVE20-V, FCVE20VUK, FCVM62E, FCVM62EUK, FCVMG62, ZOFCV/G6-3, FCV/E20-V		



1

GEV No.	300200	Ref. No.	01C29 031481 054375 058125 0A2036 0H6589 0H6688 0H9802 0K4287 0K4443 0K4912 0K5045 0K8843 0KT763 0KW856 0M0524 12344145 18002897 18005012 18025012 1805012 50000052 6030015 722894 M01C29
description	operation switch 2 operating positions 2NO 16A sequence 0-1 shaft \varnothing 6x4.6mm shaft L 23mm connection male faston 6.3mm operation switch ceramic		
For models:	TC1200TOP, TC1210TOP, TC1400TOP, TC1410TOP, TC1600TOP, TC1610TOP, TC1800TOP, TC1810TOP, TC2000TOP, TC2010TOP, TCD1200TOP, TCD1400TOP, TCD1600TOP, TCD1800TOP, TCD2000TOP, TC1000, TC1010, TC1200, TC1210, TC1400, TC1410, TC1600, TC1610, TC1800, TC1810, TC2000, TC2010, TCD1000, TCD1200, TCD1400, TCD1600, TCD1800, TCD2000, TC1200, TC1210, TC1400, TC1410, TC1600, TC1610, TC1800, TC1810, TC2000, TC2010, TCD1200, TCD1400, TCD1600, TCD1800, TCD2000, TC1000, TC1000...(Other models you can see in the webshop)		

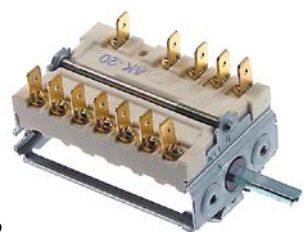

2

GEV No.	300178	Ref. No.	0H6284 220909
description	operation switch 3 operating positions 3NO/2CO 16A sequence 0-1-2 shaft \varnothing 6x4.6mm shaft L 23mm connection male faston 6.3mm ceramic ambient temperature max. 270°C		
For models:	7536-3, 7537-3, 7736-3, 7737-3, 9050-3, 9055-3, 9250-3-0, 9250-3-8, 9255-3-0, 9255-3-8		

miscellaneous

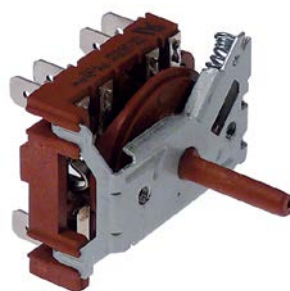

1

GEV No.	300221	Ref. No.	0E3017 0E5131 0K8165 640458
description	cam switch 2 operating positions 4NO sequence 1-2 16A shaft \varnothing 6x4.6mm shaft L 23mm connection male faston 6.3mm plastic		
For models:	EBS50., EBS50H, EBS100., EBS100H, EBS150., EBS150H, EBS200., EBS200H, EBS300., EBS300H, EBV50., EBV50H, EBV100., EBV100H, EBV150, EBV150H, EBV200., EBV200H, EBV300., EBV300H, EBVC50, EBVC50H, EBVC100, EBVC100H, EBVC150, EBVC150H, EBVC200, EBVC200H, EBVC300, EBVC300H, EBP100., EBP100M, EBP150, EBP150M, EBP200., EBP200M, EBP300., EBP300M, EBPC100, EBPC100M, EBPC150, EBPC150M, EBPC200, EBPC200M, EBPC300, EBPC300M, MED50H, MED100H, MED150H, MED200H...(Other models you can see in the webshop)		



1

GEV No.	301299	Ref. No.	0C6245
description	cam switch 8 operating positions 5NO sequence 0-1-2-3-4-5-6-7 16A shaft \varnothing 6x4.6mm shaft L 23mm connection male faston 6.3mm plastic		
For models:	FCF/E6-0, FCFE101-0, FCFE102-0, FCFE201-0, FCFE202-0, FCF061ELN, FCF101ELN, FCF6EHOR, FCF061ENS, FCF101ENS, FCF102ENS, FCF201ENS, FCFE6-1J, FCFE101-1J, FCFE102-1J, ECF/E6-0, ECFE101-0, ECFE102-0, ECFE201-0, ECFE202-0, ECF061ENS, ECF101ENS, ECF102ENS, ECF201ENS, ECF061E5M, ECF061ECV, ACF/E6-0, ACFE101-0, ACFE102-0, ACFE201-0, ACFE202-0, RCF061E, RCF101E, RCF201E		

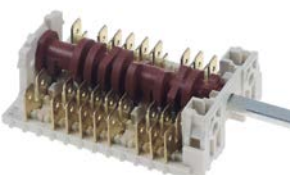

1

GEV No.	345198	Ref. No.	0E3697
description	cam switch shaft \varnothing 6x4.6mm shaft L 23mm 6-pole		
For models:	FCV31E3, 7CO30, CCO30G, ECO312CF, OTS100		



rotary switches

BREMAS

A1600 series

 <p>1</p>			
GEV No.	345315 ¹	Ref. No.	004156 91310060
description	rotary switch 3 1-0-2 sets of contacts 6 type CA160007 400V 16A shaft ø 5x5mm shaft L 23mm shaft square with knob connection screw		
For models:	ZCMME6, ZCBME12, ZCMME4, ZCBME8, ZCMME9, ZCBME18, PME430, PME630, PME6L30, PME930, PME435, PME635, PME6L35, PME935, PME830, PME1230, PME12L30, PME1830, PME835, PME1235, PME12L35, PME1835		

¹incl. knob

 <p>1</p>			
GEV No.	301182	Ref. No.	046649 S641600702
description	rotary switch 4 0-1-2-3 sets of contacts 13 type SCH.0713/6194 600V 20A shaft ø 4x5mm shaft L 25mm square connection male faston 6.3mm		
For models:	LS365, LS365PH, LS365D, LS365, LS365/63, LS365F		

accessories

 <p>1</p>			
GEV No.	111420	Ref. No.	004147 0C9554
description	knob switch zero mark ø 34/60mm shaft ø 5x5mm red H 22mm L 50mm		
For models:	ZCMME6, ZCBME12, ZCMME4, ZCBME8, ZCMME9, ZCBME18		

miscellaneous

 <p>1</p>			
GEV No.	300327	Ref. No.	046879
description	rotary switch		

GOTTAK

 <p>1</p>			
GEV No.	347723	Ref. No.	OK8614
description	rotary switch 3 1-2-3 sets of contacts 5 type 46RCTH 400V 16A shaft ø 6x4.6mm shaft L 23mm shaft oval connection male faston 6.3mm 3 operating positions		
For models:	EBE40., EBE40., EBE40., EBE040, EBE60., EBE60., EBE60., EBE60, EBE80., EBE80., EBE80., EBE80, EBE100., EBE100., EBE100., EBE100, EBS50., EBS50H, EBS100., EBS100H, EBS150., EBS150H, EBS200., EBS200H, EBS300., EBS300H, EBV50., EBV50H, EBV100., EBV100H, EBV150, EBV150H, EBV200., EBV200H, EBV300., EBV300H, EBVC50, EBVC50H, EBVC100, EBVC100H, EBVC150, EBVC150H, EBVC200, EBVC200H, EBVC300, EBVC300H, EBP100., EBP100M, EBP150, EBP150M...(Other models you can see in the webshop)		

 <p>1</p>			
GEV No.	300219	Ref. No.	0E5132 OK8253 680306
description	switch 3 operating positions 3NO sequence 0-1 momentary switch 16A shaft ø 6x4.6mm shaft L 23mm connection male faston 6.3mm plastic		
For models:	RT100ED, RT100ES, RT100SR, RT100SL, RT140ED, RT140ES, RT140SR, RT140SL, RT190ED, RT190ES, RT190SR, RT190SL, RT190HDED, RT190HDES, RT190HSR, RT190HSL, RT270ED, RT270ES, RT270SR, RT270SL, RT270HDED, RT270HDES, RT270HSR, RT270HSL, RT100ERF, RT100ELF, RT100VD, RT100VS, RT140ERF, RT140ELF, RT140VD, RT140VS, RT142ERF, RT142ELF, RT190ERF, RT190ELF, RT190VD, RT190VS, RT190HERF, RT190HELF, RT190HDVDF, RT190HDVSF, RT270ERF, RT270ELF, RT270VDF, RT270VSF, RT270HERF, RT270HELF, RT270HDVDF, RT270HDVSF...(Other models you can see in the webshop)		

KRAUS & NAIMER

rotary switches

 <p>1</p>			
GEV No.	301206	Ref. No.	OG2095 OK4923 18005107 31110001 751000
description	rotary switch 4 0-1-2-3 sets of contacts 8 type CA11-AT08A188 690V 7.5A shaft ø 4.8x6mm shaft L 18mm shaft round connection screw code 37/000100 marking 7BC540		
For models:	7561-3.KES60.RW, 7562-3.KES80.RW, 7563-3.KES100.RW, 7564-3.KES150.RW, 7561-3/85.KES60.RW., 7562-3/85.KES80.RW., 7563-3/85.KES100.RW., 7564-3/85.KES150.RW., 7561-3/90.KES60.RW., 7562-3/90.KES80.RW., 7563-3/90.KES100.RW., 7564-3/90.KES150.RW., 7560-3, 7561-3, 7562-3, 7563-3, 7564-2, 9411-3, 9411-5, 9413-3, 9413-5, 9414-3, 9414-5, 9415-3, 9415-5, 9416-3, 9416-5		



miscellaneous



1			
GEV No.	346390	Ref. No.	0H9723 0H9811 0K3676 0K4925 0K7350 0K8029 0K8090 0KE475 126191 18005109 22126191 60053
description	rotary switch sets of contacts 1 2 0-1 250V 16A illuminated connection male faston 6.3mm mounting measurements 25x25mm		
For models:	VARIOTEAM/S-33.3/F, STEAM-O-MAT, AR6ES, AR6ES, AR6ES, AR6ES, AR6ES, AR6ES, AR6ES, AR6ES, AR6ES, AR6ES, AR6ES, AR6ES, AR6ES, AR10ES, AR10ES, AR10ES, AR10ES, AR10ES, AR10ES, AR10ES, AR10ES, AR10ESP, AR10ESP, AR10ESP, AR10ESP, AR10ES, AR10ES, AR10ES, AR10ES, AR10ES, AR10ES, AR10ES, AR10ES, AR10ESP, AR10ESP, AR10ESP, AR10ESP...(Other models you can see in the webshop)		

magnetic switches

29x19mm

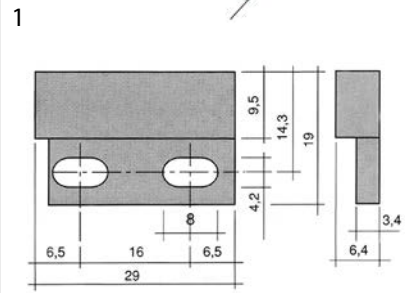
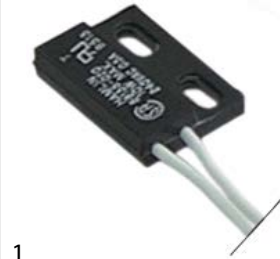

GEV No.	345117	Ref. No.	048392
description	magnetic switch L 28.5mm W 19mm 1NO 250V 0.04A P max. 10W connection cable length 1000mm		
For models:	LS7D, LS7, LS7UK/RP, LV70, LS7F, LS7DEK, LS7/1UK, LS7/60, WT40/9, WT40/F, FL700, HYDRA700, Z70		

touch sensitive light switches



1			
GEV No.	402043	Ref. No.	086451 OKM709
description	light barrier L 180mm W 35mm H 46mm		

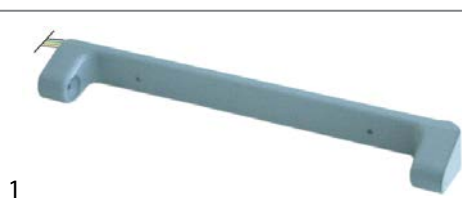

1			
GEV No.	402009	Ref. No.	086475 OT4520
description	light barrier L 310mm W 35mm H 47mm		

35x22mm

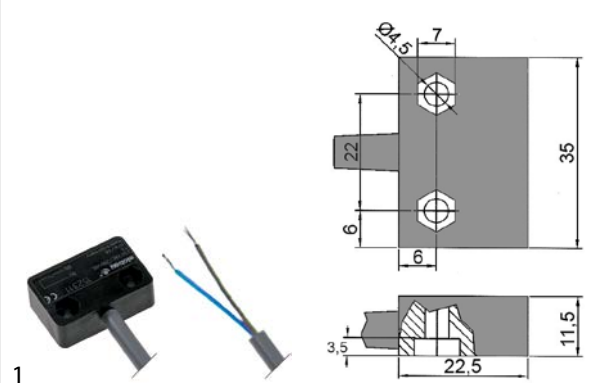

GEV No.	347003	Ref. No.	0E5185 OK7171 OK8714
description	magnetic switch L 35mm W 22mm 1NO 230V 1A 60W		
For models:	FT36EDTS, FT36ESTS, FT36VDTs, FT36VSTs, FT36ED, FT36ES, FT36VD, FT36VS, FT50ED, FT50ES, FT50VD, FT50VS, FT72ED, FT72ES, FT72VD, FT72VS, FT36EDT, FT36EST, FT36VDT, FT36VST, FT50EDT, FT50EST, FT50VDT, FT50VST, FT72EDT, FT72EST, FT72VDT, FT72VST, FT36WED, FT36WES, FT36WVD, FT36WVS, FT50WED, FT50WES, FT50WVD, FT50WVS, FT72WED, FT72WES, FT72WVD, FT72WVS, FT36WEDT, FT36WEST, FT36WVDT, FT36WVST, FT50WEDT, FT50WEST, FT50WVDT, FT50WVST, FT72WEDT, FT72WEST...(Other models you can see in the webshop)		



36x13mm

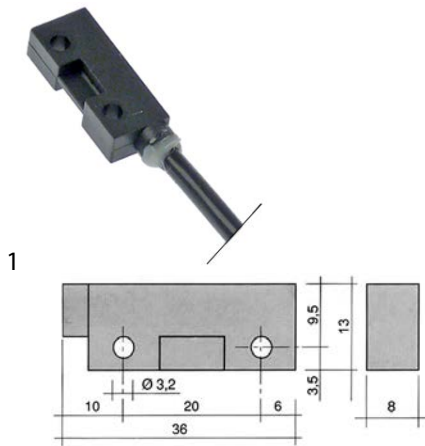

1

GEV No.	345118 ¹	Ref. No.	083881
description	magnetic switch L 36mm W 13mm 1NO 250V 1A P max. 50W connection cable cable length 980mm		
accessories for	345118		
	GEV No.	345399	Ref. No. —
magnet ø 3.3mm L 40mm H 8mm W 13mm hole distance 30mm M3			

¹with coded connector

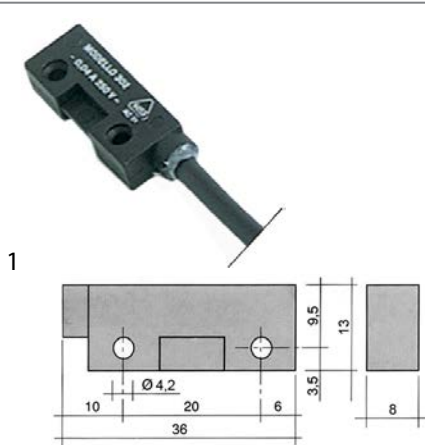

1

GEV No.	345820 ¹	Ref. No.	049226
description	magnetic switch L 36mm W 13mm 1NO 250V 1A P max. 50W connection plug cable length 290mm		
For models:	LS32, LS32/4.5, LS32UK/RP, LS32F, LV32F, C55, LV32/60, WT302, WT302/4.5, WT302UK/RP, WT302F, WT302/60, LS33, LS33/4.5, LS33UK/RP, LS33F, LV33F, C55A, LS33/60, WT303, WT303/4.5, WT303UK/RP, WT303F, WT303/60, LS61, LS61/60, LS62, LS62D, LS62/UKRP, LS62F, LV62, LS62/60, LS62/1P, LS62HD, LS65, LS62/UK, LS63, LS63D, LS63/UKRP, LS63F, LV63, LS63/60, LS63/1P, LS63/UK, LS64, LS64/UKRP, LV64, LS64/1P, LS64/UK, WT32...(Other models you can see in the webshop)		

¹with coded connector



1

GEV No.	347557	Ref. No.	068492 069659 088578
description	magnetic switch L 36mm W 13mm 1NO cable length 800mm H 8mm mounting distance 22mm		
For models:	AQC22U US, AQC31U US, AQC60U, AQC119U US, , BC28A6, Crosswise, , BCF15A6, , BC15A, Crosswise, BC28A, Crosswise, BC56HA, BCF15A, Crosswise, BCF28A, Crosswise, BCF56HA, BC10A, BLAST C/FREEZER, BCF7A, BLAST C/FREEZER, ZAE71D, ZA/E71DXUK, ZAE71S, ZA/E71SXUK, ZAE101D, ZA/E101DXU, ZAE101S, ZA/E101SUK, RBC102, RI75RE1F, RIO75RE1FR, RIO93RE1F, RIO93RE1FR, RIO93RE1FU, RBF611560, Crosswise, RBC061, Crosswise, RBC6.1-15, Crosswise, RBC101, Crosswise, RBC10.1-2...(Other models you can see in the webshop)		

36x26mm

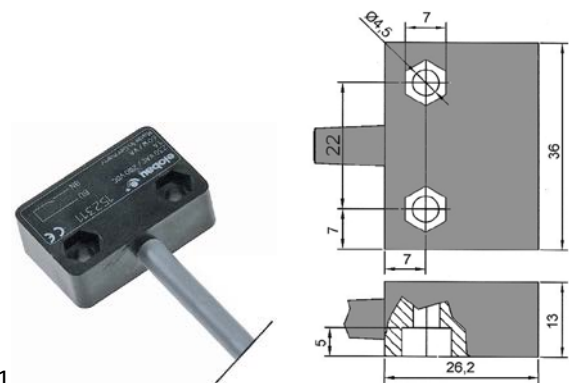

1

GEV No.	346999	Ref. No.	049969 0E5854
description	magnetic switch L 36mm W 26mm 1NC 230V 3A P max. 60W connection cable cable length 2000mm polarised		
For models:	RT10ED, RT10ES, RT10SR, RT10SL, RT10ED/230, RT10ES/230, RT10ERF60, RT10ELF60, RT10ERF, RT10ELF, RT10ERBF60, RT10ELBF60, RT10ERG, RT10ELG, RT10EDH, RT10ESH, RT10SRB, RT10SLB, RT10ED/230H, RT10ES/230H, RT10ERBF, RT10ELBF, RT10ERBG, RT10ELBG, RT10EDECO, RT10ESECO, RT10SRC, RT10SLC, RT10ED/230E, RT10ES/230E, RT10ERCF, RT10ELCF, RT10ERCG, RT10ELCG, RT10EDHE, RT10ESHE, RT10SRCB, RT10SLCB, RT10ED/230HE, RT10ES/230HE, RT10ERCBF, RT10ELCBF, RT10ERCBG, RT10ELCBG, RT10ERASIA, RT10ELASIA, RT10SRASIA, RT10SLASIA, RT10ERCINA, RT10ELCINA...(Other models you can see in the webshop)		
accessories for	346999		
	GEV No.	347001	Ref. No. 088361 0E0102 0K6712 0KE287 301606 461137802 4611378029
magnet ømm L 23mm H 18mm W 16mm ID ømm ED ømm M5			



51x16mm



1

GEV No.	348168	Ref. No.	032634 0D6673 OKJ006
description	magnetic switch L 51mm W 16mm 1NO 240V 2A P max. 12W cable length 350mm		

ø 6mm



1

GEV No.	345818	Ref. No.	048893
description	magnetic switch 250V 0.01A connection cable		
For models:	LS7D, LS7, LS7UK/RP, LV70, LS7F, LS7DEK, LS7/1UK, LS7/9, LS7/60, WT40/9, WT40/F, LS7HD, WT40/J50, WT40/J60, WT40UKRP, PH4/WT40, PH4RBP/WT40, FL700, HYDRA700, Z70		



1

GEV No.	345819 ¹	Ref. No.	048831 A0611BDAE030
description	magnetic switch 250V 1A P max. 50W probe L 29mm 1NO connection plug cable length 300mm		
For models:	LS61, LS61/60, LS62, LS62D, LS62/UKRP, LS62F, LV62, LS62/60, ECOTEMP5, LS62/1P, LS62HD, LS63, LS63D, LS63/UKRP, LS63F, LV63, LS63/60, LS63/1P, LS64, LS64/UKRP, LV64, ECOTEMP5S, LS64/1P, ECOTEMP5SW, WT32, WT32/4,5, WT32/UK, WT32/UKRP, WT32/F6, WT32/J60, WT32/J50, WT32/4,5N, WT33, WT33/4,5, WT33/UK, WT33/UKRP, WT33/F, D500, WT33/M50, WT33/M60, WT33/60, WT33/4,5N, WT30U400, WT30U440, WT34, WT34/4,5, WT34/UKRP, D510, WT34/4,5N, LS7/DP...(Other models you can see in the webshop)		

¹with coded connector



1

GEV No.	345146	Ref. No.	048268 048486
description	magnetic switch 250V 1A P max. 50W probe L 29mm 1NO connection plug cable length 980mm		
For models:	LB1, LB1WS, LB1WSDP, LB1/RBP, LB1/TOP, LB1/60, WT1WSDP, LB2D-PSAUS, LB1G, LB1WSG, WT2TOP60, WT2DPDI, WT2WSDPDI, LB1TOP, WT2TOPDI, LB2WS, LB2, LB2WSDP, LB2/TOP, LB2/RBP, LB2WS60, WT2WSDP, WT2WSDPD, LB2WSG, WT2WS, WT1, WT1WS, WT1TOP, WT2TOP, WT1/3DP, WT2/3DP, WT2DPAUS, WT2, LB2DPDI, LB2WSDPDI, LB2WSDPD, LB2TOP, LB2DP3, WT2DPD3, LS10D, LS10, LS10UKRP, LC100, LS10/60, LS10/1, LS10/12KW, LS10F, LS10DEK, LS10/1UKRP, LS10SW...(Other models you can see in the webshop)		

ø 9mm



1

GEV No.	347190	Ref. No.	049970 0E0006 0E2321 30001021
description	magnetic switch 150V 0.5A P max. 10W probe L 30mm 1NC connection cable cable length 1500mm		
For models:	LN34, LN34, LN34, LN34, LN46, LN46, LN46, LN72, LN72, LN72, LN72, RT100ED, RT100ES, RT100SR, RT100SL, RT140ED, RT140ES, RT140SR, RT140SL, RT190ED, RT190ES, RT190SR, RT190SL, RT190HDED, RT190HDES, RT190HSR, RT190HSL, RT270ED, RT270ES, RT270SR, RT270SL, RT270HDED, RT270HDES, RT270HSR, RT270HSL, RT100ERF, RT100ELF, RT100VD, RT100VS, RT140ERF, RT140ELF, RT140VD, RT140VS, RT142ERF, RT142ELF, RT190ERF, RT190ELF, RT190VD, RT190VS...(Other models you can see in the webshop)		



ø10mm			
1			
GEV No.	347899	Ref. No.	0E2185 OK8715
description	magnetic switch 12V 1A P max. 10W probe L 26mm 1NC connection cable length 1500mm kit		
For models:	RT100ED, RT100ES, RT100SR, RT100SL, RT140ED, RT140ES, RT140SR, RT140SL, RT190ED, RT190ES, RT190SR, RT190SL, RT190HDED, RT190HDES, RT190HSR, RT190HSL, RT270ED, RT270ES, RT270SR, RT270SL, RT270HDED, RT270HDES, RT270HSR, RT270HSL, RT100ERF, RT100ELF, RT100VD, RT100VS, RT140ERF, RT140ELF, RT140VD, RT140VS, RT142ERF, RT142ELF, RT190ERF, RT190ELF, RT190VD, RT190VS, RT190HERF, RT190HELF, RT190HDVDF, RT190HDVSF, RT270ERF, RT270ELF, RT270VDF, RT270VSF, RT270HERF, RT270HELF, RT270HDVDF, RT270HDVSF...(Other models you can see in the webshop)		

1			
GEV No.	348200	Ref. No.	077482744000 OK8504
description	magnetic switch VA P max.W Wmm probe L 27mm probe ø 10mm cable length 1600mm		

M10x1			
1			
GEV No.	346376	Ref. No.	056468
description	magnetic switch thread M10x1 L 40mm 1NO 250V 1A connection cable 50W		
For models:	7CPE07P, 7CPG07P, M70EPC, M70GPC, FCVE6-1U, FCVE6-3U, FCVE6-1, FCVE6-3, FCVE6-1UK, FCVE6-3UK, FCVG6-1, FCVG6-3, FCVG6-1UK, FCVG6-3UK, FCV/E6-1, FCV/E6-1, FCV/G6-1, ZOFVCV/G6-3, AFCV/G6-1, AFCV/G6-3, RCP/G700		

accessories			
magnets			
1			
GEV No.	347900	Ref. No.	OK7361 3308099P
description	magnet ø 10mm L 27mm Hmm Wmm hole ømm		
For models:	FT36EDTS, FT36ESTS, FT36VDTS, FT36VSTS, FT36ED, FT36ES, FT36VD, FT36VS, FT50ED, FT50ES, FT50VD, FT50VS, FT72ED, FT72ES, FT72VD, FT72VS, FT36EDT, FT36EST, FT36VDT, FT36VST, FT50EDT, FT50EST, FT50VDT, FT50VST, FT72EDT, FT72EST, FT72VDT, FT72VST, FT36WED, FT36WES, FT36WVD, FT36WVS, FT50WED, FT50WES, FT50WVD, FT50WVS, FT72WED, FT72WES, FT72WVD, FT72WVS, FT36WEDT, FT36WEST, FT36WVDT, FT36WVST, FT50WEDT, FT50WEST, FT50WVDT, FT50WVST, FT72WEDT, FT72WEST...(Other models you can see in the webshop)		

1			
GEV No.	347002	Ref. No.	048254 048667
description	magnet ø 6mm L 30mm Hmm Wmm ED ø 6mm		
For models:	LS10D, LS10, LS10UKRP, LC100, ECOTEMP12-, LS10/60, LS10/1, LS10/12KW, LS10F, LS10DEK, LS10/1UKRP, LS10SW, LS10/50J, LS10/60J, LS10DP, LS10/HD, SH55, LO10, LS10/UK1, LS10/UK3, LS12D, LS12, LS12UK/RP, LC120, LS12DP, LS12/60, LS12F, LS12DEK, WT60/emF, WT60/12UK, WT60/9, WT60/12, WT60/12UKRP, WT60/9in, WT60/12in, LS12HD, PH10/12, LS12/UK3, ECOTEMP12SW, ECOTEMP12INS, LS12MEX, LS10N, LS8D, LS8, LS8UK/RP, LC80, LS8F, LS8DEK, LS8/9, LS8/60...(Other models you can see in the webshop)		

1			
GEV No.	347001	Ref. No.	088361 0E0102 OK6712 0KE287 301606 461137802 4611378029
description	magnet ømm L 23mm H 18mm W 16mm ID ømm ED ømm M5		
For models:	PW1EAG, PW2EAG, WT830EA, WT850EA, WT830EAG, WT850EAG, FT36EDTS, FT36ESTS, FT36VDTS, FT36VSTS, FT36ED, FT36ES, FT36VD, FT36VS, FT50ED, FT50ES, FT50VD, FT50VS, FT72ED, FT72ES, FT72VD, FT72VS, FT36EDT, FT36EST, FT36VDT, FT36VST, FT50EDT, FT50EST, FT50VDT, FT50VST, FT72EDT, FT72EST, FT72VDT, FT72VST, FT36WED, FT36WES, FT36WVD, FT36WVS, FT50WED, FT50WES, FT50WVD, FT50WVS, FT72WED, FT72WES, FT72WVD, FT72WVS, FT36WEDT, FT36WEST, FT36WVDT, FT36WVST...(Other models you can see in the webshop)		

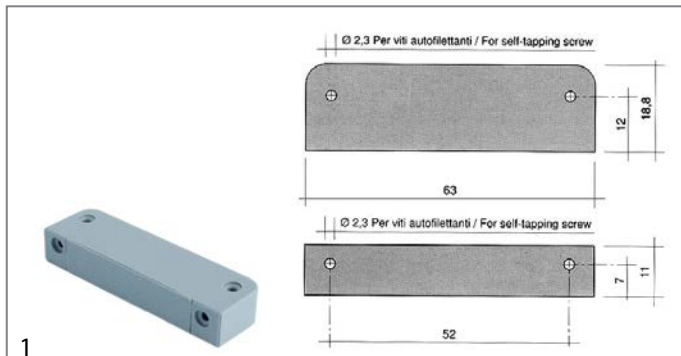

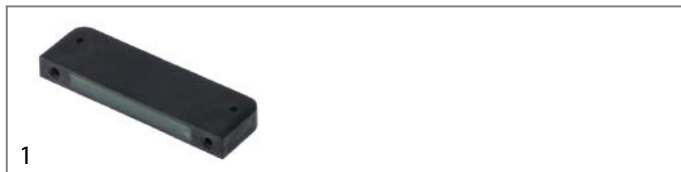

GEV No.	519049	Ref. No.	049627
description	magnet ømm L 63mm H 10.7mm W 18.8mm hole distance 52mm M2 hole ø 2mm		
For models:	FCZ061EAA, FCZ101EAA, FCZ102EAA, FCZ201EAA, FCZ202EAA, FCZ061EAH, FCZ101EAH, FCZ201EAH, FCZ061EAN, FCZ101EAN, FCZ201EAN, FCZ061ETA, FCZ101ETA, FCZ102ETA, FCZ201ETA, FCZ202ETA, FCZ061ETH, FCZ101ETH, FCZ201ETH, FCZ061ETN, FCZ101ETN, FCZ201ETN, FCZ061GAG, FCZ101GAG, FCZ102GAG, FCZ202GAG, FCZ061GAD, FCZ101GAD, FCZ102GAD, FCZ202GAD, FCZ101GTG, FCZ102GTG, FCZ101GTD, FCZ102GTD, FCZ061EBA, FCZ101EBA, FCZ102EBA, FCZ201EBA, FCZ202EBA, FCZ061EBH, FCZ101EBH, FCZ201EBH, FCZ061EBN, FCZ101EBN, FCZ201EBN, FCZ061EBC, FCZ101EBC, FCZ201EBC, FCZ061EBA2, FCZ101EBA2...(Other models you can see in the webshop)		
accessories for	519049		
	GEV No.	560095	Ref. No. —
	sheet metal screws ø 2.9mm L 9.5mm SS Qty 20 pcs DIN 7981/ISO 7049 head ø 5.6mm oval head		

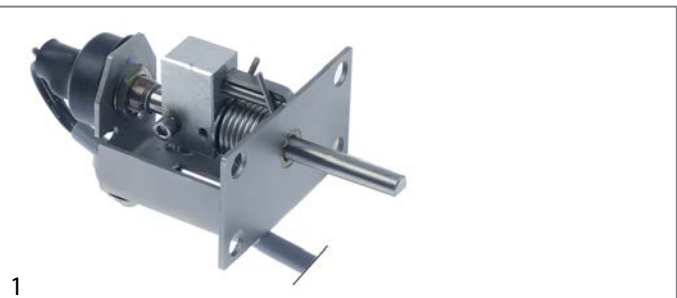

GEV No.	347200	Ref. No.	OL1001 OL2534
description	magnet ømm L 63mm H 7.3mm W 19mm hole distance 52.5mm M2 hole ø 2.25mm		
For models:	WT1WSDP, NGW, NGWDPDD, PW1SMG, PW1MG, PW1MUK, PW1MHG, PW2MG, PW2MUK, WT830M, WT830MUK, WT830M60G, WT850M, WT850MUK, WT850M60G, WT830MHG, WT830M208U, WT830M240U, WT830H208U, WT830H240U, WT850M208U, WT850M240U, PW2SMG, ET830M, ET830MH, ET850M, WTC90ERB, WTC90ELB, WTC140ERA, WTC140ELA, WTC140ERB, WTC140ELB, WTC180ERA, WTC180ELA, WTC180ERB, WTC180ELB, WTC220ERA, WTC220ELA, WTC220ERB, WTC220ELB, WTC90ERBG, WTC90ELBG, WTC140ERAG, WTC140ELAG, WTC140ERBG, WTC140ELBG, WTC180ERAG, WTC180ELAG, WTC180ERBG, WTC180ELBG...(Other models you can see in the webshop)		

miscellaneous



GEV No.	347830	Ref. No.	0G2405 0K5151 0K1513 769363
description	switch for tilting kettle with potentiometer		
For models:	ACSGRT, BOT080S.MH25.W94, BOT080S.MS25.W94, BOT100E.MS35.H97, BOT150S.MH25.F98, BOT150S.MH25.W94, BOT200S.MH25.F18, BOT200S.MH25.W14, BOT400E.MS35.W14, BOT400S.MH25.F18, FET060E.MS35P.F88, FET060E.MS35P.W84, FET060E.MS35S.F88, FET080E.MS35P.F88, FET080E.MS35P.W84, FET080E.MS35S.W84, FET100E.MS35P.F88, FET100E.MS35P.W84, FET100G.MS25P.H97, UET060E.MS35.F88, UET090E.MS35.F88, UET090E.MS35.W84, UET100E.MS35.F88, UET100E.MS35.W84, UET150E.MS35.F88, BOT150E.MS35.H97, FET100E.MS35S.F97, FET060E.MS35S.W84, FET080E.MS35S.F88, FET080G.MS25S.F98, FET080G.MS25S.W94, FET100E.MS35S.F88, FET100E.MS35S.W84, UET150E.MS35.W84, BOT040E.MS35.F88, BOT040S.MH25.F98, BOT040E.MS35.W84, BOT040S.MH25.W94, BOT060E.MS35.F88, BOT060S.MH25.F98, BOT060E.MS35.W84, BOT060S.MH25.W94, BOT080E.MS35.F88, BOT080S.MH25.F98, BOT080E.MS35.W84, BOT100S.MH25.F98, BOT100S.MH25.W94, BOT300S.MH25.F18, BOT300S.MH25.W14...(Other models you can see in the webshop)		
accessories for	347830		
	GEV No.	347831	Ref. No. 0G2438 769131
	stop for switch shaft ø 6x4.6mm		

control equipment

MOELLER/EATON

push buttons - signal lamps

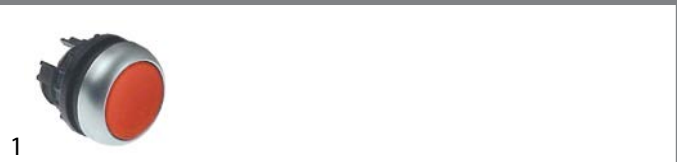

GEV No.	346294	Ref. No.	OK2149 RLTRT
description	push button mounting measurements ø22mm red		
For models:	7573-2, 7574-2, 7575-2, 7576-2, 7773-2, 7774-2, 7775-2, 7776-2		

switch blocks



GEV No.	346292	Ref. No.	OK2181
description	contact block screw 1NO		
For models:	7573-2, 7574-2, 7575-2, 7576-2, 7773-2, 7774-2, 7775-2, 7776-2		



switches (complete)

push/momentary push switches



1

GEV No.	346367	Ref. No.	0A2234
----------------	--------	-----------------	--------

description	momentary push switch mounting measurements ø22mm black 1NO water momentary		
--------------------	---	--	--



1

GEV No.	346366	Ref. No.	0A2232
----------------	--------	-----------------	--------

description	momentary push switch mounting measurements ø22mm black 1NO/1CO arrow momentary		
--------------------	---	--	--



1

GEV No.	346291	Ref. No.	0KX188 2010741
----------------	--------	-----------------	-------------------

description	momentary push switch mounting measurements ø22mm red 1NO		
--------------------	---	--	--



1

GEV No.	346438	Ref. No.	0G3875 180655 180665
----------------	--------	-----------------	----------------------------

description	momentary push switch mounting measurements ø22mm white complete on		
--------------------	---	--	--



1

GEV No.	346340	Ref. No.	0A2196 0K2980
----------------	--------	-----------------	------------------

description	switch mounting measurements ø22mm red complete EMERGENCY SHUT-DOWN		
--------------------	---	--	--

For models:	MBR/G710D, RBR/G710D, XBR/E710D, XBR/E716, RBR/E700, ZRBR/G700D		
--------------------	---	--	--

SCHLEGEL

symbol plates



1

GEV No.	345752	Ref. No.	0H6290 0K9347
----------------	--------	-----------------	------------------

description	symbol plate white operating temperature		
--------------------	--	--	--



1

GEV No.	345756	Ref. No.	0K1006
----------------	--------	-----------------	--------

description	symbol plate white reset		
--------------------	--------------------------	--	--

For models:	9100-2, 9101-2, 9102-2, 9104-2, 9113-2, 9114-2, 9115-2, 9116-2		
--------------------	--	--	--

GEV special

ø16mm

push buttons



1

GEV No.	345754	Ref. No.	005139 0H6288
----------------	--------	-----------------	------------------

description	push button square clear ø 16mm		
--------------------	---------------------------------	--	--

For models:	FCVG202L3, FCS201G4, FCS202G4, 5717-2-6, 5714-2-7, 5714-2-6L, 5714-2-7L, ECVG202T4, ACVG202C4, ZCV/G202/1, 9100-2, 9101-2, 9102-2, 9104-2, 9113-2, 9114-2, 9115-2, 9116-2		
--------------------	---	--	--



1

GEV No.	345265	Ref. No.	0H6287
----------------	--------	-----------------	--------

description	contact block 1NC/1NO 250V 6A equiv. no. 51.971.022		
--------------------	---	--	--

For models:	9100-2, 9101-2, 9102-2, 9104-2, 9113-2, 9114-2, 9115-2, 9116-2		
--------------------	--	--	--



1

GEV No.	345751	Ref. No.	005138 0H6286 H22091400
----------------	--------	-----------------	-------------------------------

description	contact block 2NO/2NC		
--------------------	-----------------------	--	--

For models:	FCVG202L3, FCS201G4, FCS202G4, FCS202GP, 5717-2-6, 5714-2-7, 5714-2-6L, 5714-2-7L, ECVG202T4, ACVG202C4, ZCV/G202/1		
--------------------	---	--	--



switches



1

GEV No.	345753	Ref. No.	005137 0H6285 512850 H22091300
description	switch mounting measurements ø16mm latching		
For models:	FCVG202L3, FCS201G4, FCS202G4, 5717-2-6, 5714-2-7, 5714-2-6L, 5714-2-7L, ECVG202T4, ACVG202C4, ZCV/G202/1		



1

GEV No.	345755	Ref. No.	OK1005 751.185.0
description	switch mounting measurements ø16mm momentary		
For models:	9100-2, 9101-2, 9102-2, 9104-2, 9113-2, 9114-2, 9115-2, 9116-2		

ø22mm

key lock switches



1

GEV No.	345244	Ref. No.	0H6694
description	key lock switch mounting measurements ø22mm latching sequence 0-1		
For models:	9190-3, 9191-3, 9193-3, 9195-3, 9390-3, 9391-3, 9393-3, 9395-3, 9481-3, 9482-3, 9581-3, 9582-3		

rotary switches



1

GEV No.	345263	Ref. No.	OK2156 7040950
description	rotary selector mounting measurements ø22mm black momentary sequence 0-1		
For models:	9481-3, 9482-3, 9581-3, 9582-3		



1

GEV No.	345260	Ref. No.	0H6692
description	rotary selector mounting measurements ø22mm black momentary sequence 1-0-2		
For models:	7747-3/90.KB.(N), 7585-3/85.KK40.MOTK., 7586-3/85.KK60.MOTK., 7587-3/85.KK80.MOTK., 7588-3/85.KK100.MOTK, 7585-3/90.KK40.MOTK., 7586-3/90.KK60.MOTL., 7587-3/90.KK80.MOTK., 7588-3/90.KK100.MOTK, 7585-5/85.KK40.MOTK., 7586-5/85.KK60.MOTK., 7587-5/85.KK80.MOTK., 7588-5/85.KK100.MOTK, 7589-5/85.KK150.MOTK, 7585-5/90.KK40.MOTK., 7586-5/90.KK60.MOTK., 7587-5/90.KK80.MOTK., 7588-5/90.KK100.MOTK, 7589-5/90.KK150.MOTK, 7569-5/90.KK200.MOTK, 7541-3/85.KB.(N), 7543-3/85.KB.(N), 7541-3/90.KB.(N), 7543-3/90.KB.(N), 7545-3/85.KB.(N), 7547-3/85.KB.(N), 7545-3/90.KB.(N), 7547-3/90.KB.(N), 7741-3/85.KB.(N), 7743-3/85.KB.(N), 7741-3/90.KB.(N), 7743-3/90.KB.(N), 7745-3/85.KB.(N), 7745-3/90.KB.(N), 7747-3/85.KB.(N), 7545-3/85.KB.DWD, 7543-3/90.KB.EO.ETRO, 7541-3/90.KB.EO.ETRO, 7569-3/85.KK200.MOTK, 7569-3/90.KK200.MOTK, 7569-5/85.KK200.MOTK, 7589-3/85.KK150.MOTK, 7589-3/90.KK150.MOTK, 7769-3/85.KK200.MOTK, 7769-3/90.KK200.MOTK, 7769-5/85.KK200.MOTK, 7769-5/90.KK200.MOTK, 7785-3/85.KK40.MOTK., 7785-3/90.KK40.MOTK., 7785-5/85.KK40.MOTK...(Other models you can see in the webshop)		

switch blocks



1

GEV No.	345272	Ref. No.	0H6695
description	contact block 1NC/1NO 660V max. 16(4)A connection screw		
For models:	9481-3, 9482-3, 9581-3, 9582-3		



1

GEV No.	345261	Ref. No.	0H6693
description	contact block 2NO 660V max. 16(4)A connection screw		
For models:	7747-3/90.KB.(N), 7585-3/85.KK40.MOTK., 7586-3/85.KK60.MOTK., 7587-3/85.KK80.MOTK., 7588-3/85.KK100.MOTK, 7585-3/90.KK40.MOTK., 7586-3/90.KK60.MOTL., 7587-3/90.KK80.MOTK., 7588-3/90.KK100.MOTK, 7585-5/85.KK40.MOTK., 7586-5/85.KK60.MOTK., 7587-5/85.KK80.MOTK., 7588-5/85.KK100.MOTK, 7589-5/85.KK150.MOTK, 7585-5/90.KK40.MOTK., 7586-5/90.KK60.MOTK., 7587-5/90.KK80.MOTK., 7588-5/90.KK100.MOTK, 7589-5/90.KK150.MOTK, 7569-5/90.KK200.MOTK, 7541-3/85.KB.(N), 7543-3/85.KB.(N), 7541-3/90.KB.(N), 7543-3/90.KB.(N), 7545-3/85.KB.(N), 7547-3/85.KB.(N), 7545-3/90.KB.(N), 7547-3/90.KB.(N), 7741-3/85.KB.(N), 7743-3/85.KB.(N), 7743-3/90.KB.(N), 7745-3/85.KB.(N), 7741-3/90.KB.(N), 7743-3/90.KB.(N), 7745-3/90.KB.(N), 7745-3/85.KB.(N), 7747-3/85.KB.(N), 7545-3/85.KB.DWD, 7543-3/90.KB.EO.ETRO, 7541-3/90.KB.EO.ETRO, 7569-3/85.KK200.MOTK, 7569-3/90.KK200.MOTK, 7569-5/85.KK200.MOTK, 7589-3/85.KK150.MOTK, 7589-3/90.KK150.MOTK, 7769-3/85.KK200.MOTK, 7769-3/90.KK200.MOTK, 7769-5/85.KK200.MOTK, 7769-5/90.KK200.MOTK, 7785-3/85.KK40.MOTK., 7785-3/90.KK40.MOTK., 7785-5/85.KK40.MOTK...(Other models you can see in the webshop)		

LOVATO

metal series

switches (complete)



GEV No.	345420	Ref. No.	070323 0HA001 0HA108
description	push switch mounting measurements ø22mm green 1NO 250V connection screw 16A protection IP40		

RAFI

Lumotast series

momentary push switches



GEV No.	346576	Ref. No.	0H6587
description	momentary push switch mounting measurements ø16mm 230V 3NC/3NO		

SCHNEIDER ELECTRIC

push buttons



GEV No.	347661	Ref. No.	0D7662 0KR665 24046 570000024046 DS24046
description	push button set mounting measurements ø22mm 2-piece red/green		
For models:	MC40AS-01, MULTI2-01, TRS-3-02, TRS-3-03, TRS-1-02, TRS-1-03, MULTI2-02, BM20AS-01, MC40AS-02, TRS-3-04, TRS-3-05, PL15-01, BM20AS-02, TRS-1-04, PL15-02, PL15-03, BM20AS-03, BM20AS-04, BM30AS-01, BM30AS-02, MC40AS-03, TRS-1-05, BM20AS-05, BM30AS-03, TRS-1-06, MULTI2-03, BM20AS-06, TRS-1-07, TRS-1-08, TRS-3-06, TRS-3-07, TRS-1-09, PL15-06, PL15-05, BM30S-01, BM20AS-07, BM20AS-12, MC40S-01, MC40AS-04, MC40AS-05, MC40S-02, BM20S-01, BM20S-02, BM20S-03, TR200-04, TR200-03, MULTI2-04, BM30AS-04, BM30S-02, BM20AS-13...(Other models you can see in the webshop)		

SIEMENS

3SB series ø22mm new

push buttons



GEV No.	347543	Ref. No.	049238 0L0615
description	push button mounting measurements ø22mm white		
For models:	LS14EA, ET12E, LS14EAI, LS14EAI/AU, LS14EA/60, LS14EAASIA, LS14EA/G, LS10EA, LS14EAI/DD, WT65E, WT65EB, WT65EI, ECOTEMP12S, WT65EBI, WT65EBIA, WT65EIA, WT65E60, WT65EB60, WT65EBIDG, WT65EBASIA, WT65EIM50, WT65EIM60, LS14EADP/G, WT65MED, WT65EJ50, WT65EJ60, WT65MEDWS, WT65ROW, LS14ROW, LS14SANA, WT65EBID, LS14ROW60, WT65ROW60, EHTA, EHTA60, EHTAI, EHTAID, EHTAIG, EHTAIAU, EHTAIMLAU, ZHTAID, ZHTAIAU, ZHTA, ZHTA60, ZHTAI, EHTAIUSPH5, EHTAIUSPH6, H3500, H1510SANA, HT1200BIDG...(Other models you can see in the webshop)		





GEV No.	347545	Ref. No.	075600 075656 0L1243
description	push button mounting measurements ø22mm yellow		
For models:	LO/E480, PLO480/E, LO480EUK, LO480E/63, LO480VAPORESTD, PLO480V, LO480V/63-60HZ, LO/E250, PLO250E, LO/E250UK, LO250E/63, LOPE25, LOPE48, LO480Z-VAPORE		







GEV No.	346630	Ref. No.	075601 0L0616
description	contact block SIEMENS 3SB3400-0B 1NO max 400V 10A black		
For models:	LS14EA, ET12E, LS14EAI, LS14EAI/AU, LS14EA/60, LS14EAASIA, LS14EA/G, LS10EA, LS14EAI/DD, WT65E, WT65EB, WT65EI, ECOTEMP12S, WT65EBI, WT65EBIA, WT65EIA, WT65E60, WT65EB60, WT65EBIDG, WT65EBASIA, WT65EIM50, WT65EIM60, LS14EADP/G, WT65MED, WT65EJ50, WT65EJ60, WT65MEDWS, WT65ROW, LS14ROW, LS14SANA, WT65EBID, LS14ROW60, WT65ROW60, EHTA, EHTA60, EHTAI, EHTAID, EHTAIG, EHTAIAU, EHTAIMLAU, ZHTAID, ZHTAIAU, ZHTA, ZHTA60, ZHTAI, EHTAIUSPH5, EHTAIUSPH6, LO/E480, PLO480/E, LO480EUK...(Other models you can see in the webshop)		
accessories for	346630		
	GEV No.	347520	Ref. No. —
	push button mounting measurements ø22mm non-illuminated black		





lamp elements			
 <p>1</p>			
GEV No.	347539	Ref. No.	075602 0L1244
description	indicator socket SIEMENS 3SB3400-1A black max 250V socket Ba9s 250V ambient temperature max. 165°C 2.5W		
For models:	LO/E480, PLO480/E, LO480EUK, LO480E/63, LO480VAPORESTD, PLO480V, LO480V/63-60HZ, LO/E250, PLO250E, LO/E250UK, LO250E/63, LOPE25, LOPE48, LO480Z-VAPORE		

signal element			
 <p>1</p>			
GEV No.	347897	Ref. No.	075605 3SB10016BE06
description	signal element mounting measurements ø22mm green		
For models:	LO/E480, PLO480/E, LO480EUK, LO480E/63, LO480VAPORESTD, PLO480V, LO480V/63-60HZ, LO/E250, PLO250E, LO/E250UK, LO250E/63, LOPE25, LOPE48, LO480Z-VAPORE		

 <p>1</p>			
GEV No.	347898	Ref. No.	075604 3SB30016AA20
description	signal element mounting measurements ø22mm red		
For models:	LO/E480, PLO480/E, LO480EUK, LO480E/63, LO480VAPORESTD, PLO480V, LO480V/63-60HZ, LO/E250, PLO250E, LO/E250UK, LO250E/63, LOPE25, LOPE48, LO480Z-VAPORE		

rotary switches				
 <p>1</p>				
GEV No.	345674	Ref. No.	075657 0L1368	
description	rotary selector mounting measurements ø22mm black latching sequence 0-1			
For models:	LO/E480, PLO480/E, LO480EUK, LO480E/63, LO480VAPORESTD, PLO480V, LO480V/63-60HZ, LO/E250, PLO250E, LO/E250UK, LO250E/63, LOPE25, LOPE48, LO480Z-VAPORE			
accessories for	345674			
	GEV No.	346602	Ref. No.	—
	contact block SIEMENS 3SB3400-0D 2NO max 400V 10A black			
	GEV No.	346603	Ref. No.	—
	contact block SIEMENS 3SB3400-0E 2NC max 400V 10A black			

accessories for 345674				
	GEV No.	346630	Ref. No.	075601 0L0616
	contact block SIEMENS 3SB3400-0B 1NO max 400V 10A black			
	GEV No.	346631	Ref. No.	—
	contact block SIEMENS 3SB3400-0C 1NC max 400V 10A black			
	GEV No.	346632	Ref. No.	—
	contact block SIEMENS 3SB3400-0D 1NC/1NO max 400V 10A black			

TELEMECANIQUE (EFA)

XB2 series			
switches (complete)			
 <p>1</p>			
GEV No.	346575	Ref. No.	0H6687 0K2035
description	momentary push switch mounting measurements ø22mm green 1NC/1NO		
For models:	9190-3, 9191-3, 9193-3, 9195-3, 9390-3, 9391-3, 9393-3, 9395-3		

XB4 series			
signal element			
 <p>1</p>			
GEV No.	347538	Ref. No.	0E0110 0K9103 763110600
description	signal element mounting measurements ø22mm green 2.4W 250V 1-pole		
For models:	FT36EDTS, FT36ESTS, FT36VDTS, FT36VSTS, FT36ED, FT36ES, FT36VD, FT36VS, FT50ED, FT50ES, FT50VD, FT50VS, FT72ED, FT72ES, FT72VD, FT72VS, FT36EDT, FT36EST, FT36VDT, FT36VST, FT50EDT, FT50EST, FT50VDT, FT50VST, FT72EDT, FT72EST, FT72VDT, FT72VST, FT36WED, FT36WES, FT36WVD, FT36WVS, FT50WED, FT50WES, FT50WVD, FT50WVS, FT72WED, FT72WES, FT72WVD, FT72WVS, FT36WEDT, FT36WEST, FT36WVDT, FT36WVST, FT50WEDT, FT50WEST, FT50WVDT, FT50WVST, FT72WEDT, FT72WEST...(Other models you can see in the webshop)		



1

GEV No.	347527	Ref. No.	0E0109 OK9104 763110700
description	signal element mounting measurements ø22mm red		
For models:	FT36EDTS, FT36ESTS, FT36VDTs, FT36VSTs, FT36ED, FT36ES, FT36VD, FT36VS, FT50ED, FT50ES, FT50VD, FT50VS, FT72ED, FT72ES, FT72VD, FT72VS, FT36EDT, FT36EST, FT36VDT, FT36VST, FT50EDT, FT50EST, FT50VDT, FT50VST, FT72EDT, FT72EST, FT72VDT, FT72VST, FT36WED, FT36WES, FT36WVD, FT36WVS, FT50WED, FT50WES, FT50WVD, FT50WVS, FT72WED, FT72WES, FT72WVD, FT72WVS, FT36WEDT, FT36WEST, FT36WVDT, FT36WVST, FT50WEDT, FT50WEST, FT50WVDT, FT50WVST, FT72WEDT, FT72WEST...(Other models you can see in the webshop)		

momentary mushroom switches



1

GEV No.	346942	Ref. No.	0E2208
description	emergency stop switch mounting measurements ø22mm complete		
For models:	WT730WSRTS, WT730WSLTS, WT760SRTM, WT760WSLTM, WT790WSRTM, WT790WSLTM, LN34, LN34, LN34, LN34, LN46, LN46, LN46, LN46, LN72, LN72, LN72, LN72, LN34, LN34, LN34, LN34, LN46, LN46, LN46, LN46, LN72, LN72, LN72, LN72		

switches (complete)



1

GEV No.	347544	Ref. No.	0HB250 OK9111
description	push button mounting measurements ø22mm black 1NO 240V 1-pole 3A		
For models:	EBS50., EBS50H, EBS100., EBS100H, EBS150., EBS150H, EBS200., EBS200H, EBS300., EBS300H, EBV50., EBV50H, EBV100., EBV100H, EBV150, EBV150H, EBV200., EBV200H, EBV300., EBV300H, EBVC50, EBVC50H, EBVC100, EBVC100H, EBVC150, EBVC150H, EBVC200, EBVC200H, EBVC300, EBVC300H, EBP100., EBP100M, EBP150, EBP150M, EBP200., EBP200M, EBP300., EBP300M, EBPC100, EBPC100M, EBPC150, EBPC150M, EBPC200, EBPC200M, EBPC300, EBPC300M, MED50H, MED100H, MED150H, MED200H...(Other models you can see in the webshop)		



1

GEV No.	347525	Ref. No.	0H2641 OK9113
description	push button mounting measurements ø22mm green 2NO 240V 2-pole 3A illuminated		
For models:	D820, D820, D820, D820, D840, D840, HC-AR, AR85, AR85, AR85, AR85, AR85, AR85, AR85, AR85, HC-CS, EBS50L, EBS100L, EBA100L, EBP100L, EBS200L, EBA200L, EBP200L, EBS300L, EBA300L, EBP300L		

miscellaneous



1

GEV No.	346300	Ref. No.	OK3365
description	indicator socket socket Ba9s		
For models:	7573-2, 7574-2, 7575-2, 7576-2, 7773-2, 7774-2, 7775-2, 7776-2		



1

GEV No.	347988	Ref. No.	059051
description	rotary selector mounting measurements ø22mm green sequence 1NO/indicator light 24V 6A 1-pole		
For models:	HCPA/G1219, HCPA/GI 1219, CR20V, CR20EI, CR22G, ZCPAG1219, ZCPA/GI 1219, CR20V, CR20EI, CR22G, CR15G, CR/41G, CR42G, CR/41E, CR/41V, CR/42V, CR40G, CR40V, CR/40E, CR/42E, LV301R, LV200, LV300, LV300R, LV500R, LV501R		

lamps



1

GEV No.	359606	Ref. No.	0H9799 OK2043 OK4896 OK4897 176769 18003946	
description	neon light bulb socket Ba9s 220V 2W clear ø 10mm L 28mm			
For models:	7573-2, 7574-2, 7575-2, 7576-2, 7773-2, 7774-2, 7775-2, 7776-2			
accessories for	359606			
	GEV No.	359832	Ref. No.	—
	lamp socket mounting measurements ø16.2mm socket Ba9s connection male faston 6.3mm			
	GEV No.	359853	Ref. No.	—
	lamp socket mounting measurements ø18.2mm socket Ba9s connection male faston 6.3mm			





 <p>1</p>			
GEV No.	359807	Ref. No.	0E0016 0K9110
description	light bulb socket Ba9s 24V 2W ø 10mm L 28mm clear		
For models:	FT36EDTS, FT36ESTS, FT36VDTS, FT36VSTS, FT36ED, FT36ES, FT36VD, FT36VS, FT50ED, FT50ES, FT50VD, FT50VS, FT72ED, FT72ES, FT72VD, FT72VS, FT36EDT, FT36EST, FT36VDT, FT36VST, FT50EDT, FT50EST, FT50VDT, FT50VST, FT72EDT, FT72EST, FT72VDT, FT72VST, FT36WED, FT36WES, FT36WVD, FT36WVS, FT50WED, FT50WES, FT50WVD, FT50WVS, FT72WED, FT72WES, FT72WVD, FT72WVS, FT36WEDT, FT36WEST, FT36WVDT, FT36WVST, FT50WEDT, FT50WEST, FT50WVDT, FT50WVST, FT72WEDT, FT72WEST...(Other models you can see in the webshop)		

 <p>2</p>			
GEV No.	357087	Ref. No.	053894 075026
description	light bulb socket Ba9s 30V 2W ø 10mm L 28mm		
For models:	FCVE10, FCVE20, FV4N, FVGC4, FV4G, FV4E, FV4N, FV4G, FV4E, FVAC041, LO/E480, PLO480/E, LO480EUK, LO480E/63, LO480VAPO-RESTD, PLO480V, LO480V/63-60HZ, LO/E250, PLO250E, LO/E250UK, LO250E/63, LOPE25, LOPE48, LO480Z-VAPORE		

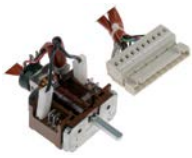
encoders and potentiometers

 <p>1</p>			
GEV No.	347022	Ref. No.	0G2875 11151627 94030504
description	cam switch 0-1 16A shaft ø 6x4.6mm shaft L 23mm connection male faston 6.3mm 10K/J cable length 400mm 2-pole with potentiometer plug type 10-pole		
For models:	AIARHFFOBB, AIARHAFOBB, AIARHBFOBB, AIAWHFFOBB, AIAWHAF-FOBB, AIAWHBFFOBB, AIAROIFOBB, AIAWOIFFOBB, AIARAFFOBB, AI-ARAAFOBB, AIARABFOBB, AIAWAFFOBB, AIAWAAFFOBB, AIAWABFFOBB		

 <p>1</p>			
GEV No.	348104	Ref. No.	0C0084 0C9700
description	cam switch 10 operating positions 1NO sequence 0-1-2-3-4-5-6-7-8-9 16A shaft ø 6x4.6mm shaft L 23mm connection coded plug outer switch yes cable length 45mm 0.1-10KOhm LED		
For models:	MI/Z1, RI/Z1, XI/Z1, MI/Z2, RI/Z2, XI/Z2, MI/Z1U, MI/Z2U, PI/Z1, PI/Z2, PI/Z1E5, PI/Z2E5, PIW/Z1, PI/Z2F, OI/Z1, OI/Z2, TI/Z1, TI/Z2, TI/Z1E5, TI/Z2E5, TIW/Z1, TI/Z2F, QI/Z1, QI/Z2, QI/Z1E5, QI/Z2E5, WI/Z1, WI/Z2, WI/Z1E5, WI/Z2E5		

 <p>1</p>			
GEV No.	345331	Ref. No.	0G3299 7894032507
description	cam switch 2 operating positions 1NO sequence 0-1 16A shaft ø 6x4.6mm shaft L 23mm connection coded plug cable length 2400mm 0.1-10KOhm cable 8-pole 2-pole with potentiometer		
spare parts for	345331		
GEV No.	345119	Ref. No.	—
description	cam switch 2 operating positions 2NO sequence 0-1 16A shaft ø 6x4.6mm shaft L 23mm connection soldering connection operation switch cable lengthmm 10kOhm plastic with potentiometer		
GEV No.	402070	Ref. No.	0G0317 0G2166 18025493 722952 82361+20301
description	potentiometer 10KOhm rotation 360° shaft ø 6x4.6mm shaft L 18mm connection male faston 2.8mm thread M10x0.75 thread L 9mm		

 <p>1</p>			
GEV No.	347514	Ref. No.	0G3298 7894032506
description	cam switch 2 operating positions 2NO sequence 0-1 16A shaft ø 6x4.6mm shaft L 23mm connection coded plug cable length 2400mm 0.1-10KOhm cable 10-pole 2-pole with potentiometer		
spare parts for	347514		
GEV No.	345119	Ref. No.	—
description	cam switch 2 operating positions 2NO sequence 0-1 16A shaft ø 6x4.6mm shaft L 23mm connection soldering connection operation switch cable lengthmm 10kOhm plastic with potentiometer		





			
1			
GEV No.	346984	Ref. No.	0H9852 0K5063 0M2134 14R19 15I01 18025422 72000601
description	cam switch 2 operating positions 4NO sequence 0-1 32A shaft ø 6x4.6mm shaft L 23mm connection cable 2400mm cable length 2400mm 50kOhm ceramic		
For models:	CE128-106, CE158-133.3.HV, CE158-244.3, CE158-246.3, CK248-209, D1ABBB, CK248-211.D1ABBB, HCE128-100, HCE128-104, HCE158-252W.3, HCE158-253.3, HLE129-100, HLE129-103, HLE129-104W, HLE159-252W.3.6, HLE159-328.3.HV, HLE159-351W.3.HV, HLE249-200.3, HLE249-208.3, HLE259-088.3.HV, HLE259-089.3.HV, HLE259-384W.3, LE129-101, LE159-261.3, LE159-281.3.6, LE159-318.3.HV, LE159-322.3.HV, LE159-330.3.HV, LE159-337.3.HV, LE159-344.3.MS92, LE159-347.3.HV, LE249-199.3, LE249-203.3, LE249-207.3, LE249-211.3, LE249-215.3, LE249-219.3, LE249-223.3, LE249-232.3, LE249-238.3, LE259-081.3.HV, LE259-082.3.HV, LE259-083.3.HV, LE259-094.3.HV, LE259-099.3.HV, LE259-382.3, LK259-707.D1ACCB, LK259-708.D1ACCB, CK248-205.D1ABBB, CK248-207.D1ABBB, LK159-707.D1BC...(Other models you can see in the webshop)		

			
1			
GEV No.	400178	Ref. No.	0H7178
description	potentiometer 47KOhm		
For models:	9013-3, 9015-3, 9213-3-0, 9213-3-8		

			
1			
GEV No.	402071	Ref. No.	0G2907 77927301
description	potentiometer cable length 1200mm		
For models:	AVAHOF000C, AVABOE000C, AVACOE000C, AVAEOE000C, AVAHOE000C, AVABOETOOC, AVACOETOOC, AVAEOETOOC, AVAHOETOOC, AVABOFTOOC, AVACOFTOOC, AVAEOFTOOC, AVAHOFTOOC, AVRBOA0000, AVRCOA0000, AVREOA0000, AVRBOFO000, AVRCOFO000, AVREOFO000, AVRBOAT000, AVRCOAT000, AVREOAT000, AVRBOFT000, AVRCOFT000, AVREOFT000, AWACOE000C, AWACOETOOC, AWACOG000C, AWACOGTOOC, AWAHOE000C, AWAHOETOOC, AWAHOG000C, AWAHOGTOOC, AWAJOE000C, AWAJOETOOC, AWAJOG000C, AWAJOGTOOC, AVABOFO000, AVACOF000C, AVAEOFO000		

			
2			
GEV No.	403557	Ref. No.	0C0974
description	potentiometer 0.6KOhm shaft ø 6mm shaft L 14mm thread M9 plug type male faston cable length 155mm		
For models:	FCS061GP, FCS061EP, FCS101EP4J, FCS101EP, FCS101GP9J, FCS102EP4J, FCS101GP, FCS102EP, FCS102GA9J, FCS201EP, FCS102GP, FCS202EP, FCS201GP, FCS202GP, FCS061EXLN, FCS061EX, FCS101EX4J, FCS101EXLN, FCS101EX, FCS102EX4J, FCS102EX, FCS201EX, FCS201EXLN, FCS202EX, FCS101GX9J, FCS101GX, FCS102GX9J, FCS102GX, FCS201GX, FCS202GX		

			
1			
GEV No.	300267	Ref. No.	0KJ776
description	potentiometer kit shaft ø 6mm cable length 240mm		
For models:	BE5-01, BE5-02, BE5-03, BE5-04, BE5A-01, BE5-05, BE5A-02, DM55-01, BE5A-03, BE5A-04, BE5-06, BE5-07, BE5A-05, BE5-09, BE5-12, BE5-11, BE5-13, BE5-14, BE5-08, BE5-05, BE5A-02		

			
1			
GEV No.	402070	Ref. No.	0G0317 0G2166 18025493 722952 82361+20301
description	potentiometer 10KOhm rotation 360° shaft ø 6x4.6mm shaft L 18mm connection male faston 2.8mm thread M10x0.75 thread L 9mm		
For models:	HLI159-371W.3, HLI159-373.3, HLI259-390W.3, LI159-375.3, LI159-376.3, LI259-372.3, LI259-379.3, LI159-380.3, HLI159-373W.3, HLI159-374.3, HLI259-375W.3, LI159-371.3, LI159-372.3, LI159-379.3, HLI159-371.3, HLI159-372.3, LI159-373.3, LI159-374.3, LI159-385.3, LI159-386.3, LI259-375.3, LI259-376.3, LI259-371.3, LI259-373.3, LI259-374.3, LI259-377.3, LI259-378.3, HLI259-375.3, HLI259-376.3, LI259-390.3, LI259-391.3, LI259-392.3, LI259-393.3, LI259-394.3, LI259-395.3, HLI259-390.3, HLI259-391.3, CI158-104.3, CI158-105.3, CI158-115.3, HCI158-104.3, HCI158-105.3, CI158-106.3, CI158-107.3, CI158-118.3, CI248-135.3, CI248-136.3, HCI248-135.3, HCI248-136.3		



lamps

indicator lights

indicator lights 2-piece (lens and indicator lamp)

indicator light lenses

ø 6mm (type SQ-20)

 <p>1</p>			
GEV No.	359803	Ref. No.	054151 0HB189 0K2899 0K9373 6608012 660801201
description	indicator light lens green Qty 1 pcs ø 6mm		
For models:	RC/E320, RC/E320U, RC/E720, RC/E720, RCF/GE720, RCF/GE730, RCF/GE720, RCF/GE720, RCV/G320, RCV/E720, RCFE720, RCF/E720, RR/E300, RRE702, RR/E300UK, RR/E311, RR/E700, RR/E700UK, RR/E711, RG/E300, PRG/E300, RG/E300UK, RG/E700, PRG/E700, RG/E700U, RME300, PRM/E300, M/E300UK, RM/E700, PRM/E700, RM/E700U, RFR/E302, RFR/E302UK, RFR/E305, RFR/E305, RFR/E701, RFR/E701, RFR/E312, RFR/E312, RFR/E315, RFR/E315, RFR/E711, RFR/E711U, RRV/E300, RRV/E300, RRV/E311, RRV/E700, RRV/E700, RRV/E711, RMV/E300...(Other models you can see in the webshop)		



 <p>2</p>			
GEV No.	359804	Ref. No.	053812 056706 075589 2729W000A9
description	indicator light lens yellow Qty 1 pcs ø 6mm		
For models:	WMGHUK, TC1000, TC1000, TC1010, 134TCA0, TCD1000, TCD1000, TC1400, TC1400, TCD1410, TCD1400, TC1410, 4061410, TC1600, TC1600, TC1610, TC1610, TCD1600, TCD1600, TC2000, TC2000, TCD2000, TCD2000, TC2010, TC2010, RCF/GE720, RCF/GE730, RCF/GE720, RCF/GE720, RCFE720, RCF/E720, RR/E300, RRE702, RR/E300UK, RR/E311, RR/E700, RR/E700UK, RR/E711, RME300, PRM/E300, M/E300UK, RM/E700, PRM/E700, RM/E700U, RFR/E302, RFR/E302UK, RFR/E305, RFR/E305, RFR/E701, RFR/E701...(Other models you can see in the webshop)		



ø10mm (type SRZ-2)

 <p>1</p>			
GEV No.	359067	Ref. No.	OHA054
description	indicator light housings mounting measurements ø10mm green square		
For models:	LB035C, LB035R, LB035Q, LB040R, LB040Q, LB040AUS, G350C, LBIOET010, LBIOET014, LBIOEQ010, G350, G350DP, LBIOEQ014, G400, G400DP, LCFBE003		

ø10mm (type SRZ-3)

 <p>1</p>			
GEV No.	359228	Ref. No.	0KI363
description	indicator light housings mounting measurements ø10mm clear round Qty 1 pcs		
For models:	AVAHOFOOOC, ACAWCBOOOC, ALAWCFOOOO, ALAWCAOOOO, ALAWCBOOOO, STE23A1A.582255, ACAWCAOOOC, ACAWCFOOOC, ACAWCAROOC, AHATRAOOOC, AHATUAOOOC, AHATRFOOOC, AHATUFOOOC, AHATQAOOOC, AHATTAOOOC, AHATQFOOOC, AHATTFOOOC, AHATSAOOOC, AHATVAOOOC, AHATSF00OC, AHATVFOOOC, APABPETOOC, APABPGTOOC, APACPITOOOC, APACPGTOOC, AVABOE00OC, AVACOE00OC, AVAE0E00OC, AVAHOE00OC, AVABOETOOC, AVACOETOOC, AVAEOETOOC, AVAHOETOOC, AVABOFTOOC, AVACOFTOOC, AVAEOFTOOC, AVAHOFTOOC, AAATAAOOOC, AAATHAOOOC, AAATAFOOOC, AAATHFOOOC, AAATABOOOC, AAATHBOOC, AEAUCAJGOO, AEAXLAKFFO, AEAUCFJGOO, AEAXLKFFO, AEAUCBJGOO, AEAXLBKFFO, AGPWCAGBOO...(Other models you can see in the webshop)		

 <p>1</p>			
GEV No.	359123	Ref. No.	00053 004896 0K3498 0KI364 5789W000G9 72593808
description	indicator light housings mounting measurements ø10mm green round Qty 1 pcs		
For models:	SCE350, SCE700, SCFE700, SIE350, SVE700, SRE350, SRE360, SRE370, SRE700, SRE710, SRE720, SFRE700, SCCE350, SME350, SME700, SGE350, SBRE350, SCPE350, SCE350, SCE700, SCFE700, SIE350, SVE700, SRE350, SRE360, SRE370, SRE700, SRE710, SRE720, SFRE350, SFRE700, SCCE350, SME350, SME700, SGE350, SBRE350, SCPE350, PC35E6U, PC70E6U, BM35E6U, FTL35E6U, FTR35E6U, FTC35E6U, FT-L70E6U, FTR70E6U, FTC70E6U, SFRE350, SFRE351, SFRE700, SFRE701...(Other models you can see in the webshop)		
accessories for	359123		
	GEV No.	359132	Ref. No. 00052 004895 0K3497
	indicator lamp green 250V connection male faston 6.3mm protection IP54 ambient temperature max. 85°C		

 <p>1</p>			
GEV No.	359124	Ref. No.	00319 004928 0K3526
description	indicator light housings mounting measurements ø10mm yellow round Qty 1 pcs		
For models:	SFRE700, SFRE350, SFRE700, SFRE350, SFRE351, SFRE700, SFRE701		
accessories for	359124		
	GEV No.	359132	Ref. No. 00052 004895 0K3497
	indicator lamp green 250V connection male faston 6.3mm protection IP54 ambient temperature max. 85°C		



ø12mm (type SDK-3)



GEV No.	359792	Ref. No.	047750 0KE900 5329081000
description	indicator light housings mounting measurements ø12mm blue Qty 1 pcs		
For models:	LS365F, LS360D, LSE720DK, LS540D, LS720, LS520D, LS520K, LS521D, LS521K, LS521, ECOTEMP5, ECOTEMP55, ECOTEMP5SW, WT32, WT32/4,5, WT32/UK, WT32/UKRP, WT32/F6, WT32/J60, WT32/J50, WT32/4,5N, WT35, WT32/UK, WT33, WT33/4,5, WT33/UK, WT33/UKRP, WT33/F, D500, WT33/M50, WT33/M60, WT33/60, WT33/4,5N, WT33/UK, WT30U400, WT30U440, WT34, WT34/4,5, WT34/UKRP, D510, WT34/4,5N, WT40/9, WT40/F, WT40/J50, WT40/J60, WT40/UKRP, PH4/WT40, PH4RBP/WT40, LS10DEK, LS10/1UKRP...(Other models you can see in the webshop)		

ø13mm (type SF-3)



GEV No.	359975	Ref. No.	0K6375
description	indicator light housings mounting measurements ø13mm green round Qty 1 pcs		
For models:	HLE129-100, HLE129-103, HLE129-104W, HLE159-252W.3.6, HLE159-328.3.HV, HLE159-351W.3.HV, HLE249-200.3, HLE249-208.3, HLE259-088.3.HV, HLE259-089.3.HV, HLE259-384W.3, HLI159-371W.3, HLI159-373.3, HLI259-390W.3, LE129-101, LE159-261.3, LE159-281.3.6, LE159-318.3.HV, LE159-322.3.HV, LE159-330.3.HV, LE159-337.3.HV, LE159-344.3.MS92, LE159-347.3.HV, LE249-199.3, LE249-203.3, LE249-207.3, LE249-211.3, LE249-215.3, LE249-219.3, LE249-223.3, LE249-232.3, LE249-238.3, LE259-081.3.HV, LE259-082.3.HV, LE259-083.3.HV, LE259-094.3.HV, LE259-099.3.HV, LE259-382.3, LI159-375.3, LI159-376.3, LI259-372.3, LI259-379.3, LK259-707.D1ACCB, LK259-708.D1ACCB, LK159-707.D1BC, LK159-708.D1BC, LK259-727.D1ACCB, LK259-728.D1ACCB, HLE129-100W, HLE129-103W...(Other models you can see in the webshop)		



GEV No.	359976	Ref. No.	0C0250
description	indicator light housings mounting measurements ø13mm red round Qty 1 pcs with adapter		

ø13mm (type SFK-3)





GEV No.	359225	Ref. No.	046289 5329080000
description	indicator light housings mounting measurements ø13mm clear Qty 1 pcs		
For models:	LS360F, LS360DK, LS365F, LS365, LS365PH, LS500F, LS501F, LS540F, LS540DK, LS541F, LS360D, LS365D, LS360, LS365, LS360/63, LS365/63, LS367, LS720F, LSE720DK, LSE720PH, LS860F, LS860DK, LS860PH, LS1080F, LS1080UK, LS1080PH, LSE721F, LS861F, LS540, LS1080M, LS1080, LS1080D, LS1080UK, LS1080/63, LS500F, LS500UK, LS501, LS501UK, LS540D, LS540/63, LSE721, LS720, LSE720UK, LS721UK, LSE720D, LS541, LS860, LS860, LS860D, LS860UK...(Other models you can see in the webshop)		

GEV No.	359126	Ref. No.	075096 0C2587 0L3030 5329080300
description	indicator light housings mounting measurements ø13mm green Qty 1 pcs		
For models:	TC1200TOP, TC1210TOP, TC1400TOP, TC1410TOP, TC1600TOP, TC1610TOP, TC1800TOP, TC1810TOP, TC2000TOP, TC2010TOP, TCD1200TOP, TCD1400TOP, TCD1600TOP, TCD1800TOP, TCD2000TOP, TC1000, TC1010, TC1200, TC1210, TC1400, TC1410, TC1600, TC1610, TC1800, TC1810, TC2000, TC2010, TCD1000, TCD1200, TCD1400, TCD1600, TCD1800, TCD2000, TC1000, TC1000, TC1010, 134TCA0, TCD1000, TCD1000, TC1400, TC1400, TCD1410, TCD1400, TC1410, 4061410, TC1600, TC1600, TC1610, TC1610, TCD1600...(Other models you can see in the webshop)		

GEV No.	359128	Ref. No.	075097
description	indicator light housings mounting measurements ø13mm red round Qty 1 pcs		
For models:	CT140EDX, CT140ESX, CT140EDXUK, CT140SXEU, CT140VDX, CT140VSX, CT141EDX, CT141ESX, CT141EDUK, CT141ESUK, CT141VDX, CT141VSX, CT142DXE, CT142SXEU, CT142DXEUK, CT142SXEU, CT142DXV, CT142SXV, CT190DXE, CT190SXEU, CT190DXEUK, CT190SXEU, CT190DXV, CT190SXV, CT191DXE, CT191SXEU, CT191DXE, CT191SXEU, CT191DXV, CT191SXV, CT192DXE, CT192SXEU, CT192DXEUK, CT192SXEU, CT192DXV, CT192SXV, CT240DXE, CT240SXEU, CT240DXEUK, CT240SX, CT240DXV, CT240SXVUK, CT241DXE, CT241SXEU, CT241DXEUK, CT241SXEU, CT241DXV, CT241SXV, CT140EDXZ, CT140ESXZ...(Other models you can see in the webshop)		

GEV No.	359127	Ref. No.	031611 075095 0C2182 0HB339 5329080400 665601400
description	indicator light housings mounting measurements ø13mm yellow Qty 1 pcs		
For models:	TC1200TOP, TC1210TOP, TC1400TOP, TC1410TOP, TC1600TOP, TC1610TOP, TC1800TOP, TC1810TOP, TC2000TOP, TC2010TOP, TCD1200TOP, TCD1400TOP, TCD1600TOP, TCD1800TOP, TCD2000TOP, TC1000, TC1010, TC1200, TC1210, TC1400, TC1410, TC1600, TC1610, TC1800, TC1810, TC2000, TC2010, TCD1000, TCD1200, TCD1400, TCD1600, TCD1800, TCD2000, TC1200, TC1210, TC1400, TC1410, TC1600, TC1610, TC1800, TC1810, TC2000, TC2010, TCD1200, TCD1400, TCD1600, TCD1800, TCD2000, LPS/75, LPS/75...(Other models you can see in the webshop)		





indicator lamps for socket type SQ			
			
GEV No.	359109	Ref. No.	054150 0HB138 0K2894 6608011 660801101
description	indicator lamp 230V green connection male faston 6.3mm no lens ø 6mm		
For models:	RC/E320, RC/E320U, RC/E720, RC/E720, RCF/GE720, RCF/GE730, RCF/GE720, RCF/GE720, RCV/G320, RCV/E720, RCFE720, RCF/E720, RR/E300, RRE702, RR/E300UK, RR/E311, RR/E700, RR/E700UK, RR/E711, RG/E300, PRG/E300, RG/E300UK, RG/E700, PRG/E700, RG/E700U, RME300, PRM/E300, M/E300UK, RM/E700, PRM/E700, RM/E700U, RFRE302, RFR/E302UK, RFRE305, RFR/E305, RFR/E701, RFR/E701, RFRE312, RFR/E312, RFRE315, RFR/E315, RFR/E711, RFR/E711U, RRV/E300, RRV/E300, RRV/E311, RRV/E700, RRV/E700, RRV/E711, RMV/E300...(Other models you can see in the webshop)		
accessories for	359109		
			
GEV No.	359806	Ref. No.	—
description	indicator light lens clear Qty 1 pcs ø 6mm		

			
GEV No.	359110	Ref. No.	053811 056707 06601 0K9372 0KE182 2752120578
description	indicator lamp 230V white connection male faston 6.3mm no lens ø 6mm		
For models:	TC1000, TC1000, TC1010, 134TCA0, TCD1000, TCD1000, TC1400, TC1400, TCD1410, TCD1400, TC1410, 4061410, TC1600, TC1600, TC1610, TC1610, TCD1600, TCD1600, TC2000, TC2000, TCD2000, TCD2000, TC2010, TC2010, RCF/GE720, RCF/GE730, RCF/GE720, RCF/GE720, RCFE720, RCF/E720, RR/E300, RRE702, RR/E300UK, RR/E311, RR/E700, RR/E700UK, RR/E711, RME300, PRM/E300, M/E300UK, RM/E700, PRM/E700, RM/E700U, RFRE302, RFR/E302UK, RFRE305, RFR/E305, RFR/E701, RFR/E701, RFRE312...(Other models you can see in the webshop)		

indicator lamps for socket type SRZ / SDK / SDY / SFK			
			
GEV No.	359130	Ref. No.	031607 046076 046241 048488 048691 048832 072049 0C0249 0HA088 0HB343 0W1E5Y 0W3318 20042 9020042
description	indicator lamp 230V clear connection male faston 6.3mm ø 8mm		
For models:	TC1200TOP, TC1210TOP, TC1400TOP, TC1410TOP, TC1600TOP, TC1610TOP, TC1800TOP, TC1810TOP, TC2000TOP, TC2010TOP, TCD1200TOP, TCD1400TOP, TCD1600TOP, TCD1800TOP, TCD2000TOP, TC1000, TC1010, TC1200, TC1210, TC1400, TC1410, TC1600, TC1610, TC1800, TC1810, TC2000, TC2010, TCD1000, TCD1200, TCD1400, TCD1600, TCD1800, TCD2000, TC1200, TC1210, TC1400, TC1410, TC1600, TC1610, TC1800, TC1810, TC2000, TC2010, TCD1200, TCD1400, TCD1600, TCD1800, TCD2000, TC1000, TC1000...(Other models you can see in the webshop)		

			
GEV No.	359129	Ref. No.	075110
description	indicator lamp 24V clear connection male faston 6.3mm		
For models:	CT92DXE, CT92SXE, CT92DXEUK, CT92SXEUK, CT92DXV, CT92SXV, CT92DXVUK, CT92SXVUK, CT140EDX, CT140ESX, CT140EDXUK, CT140SXUK, CT140VDX, CT140VSX, CT141EDX, CT141ESX, CT141E-DUK, CT141ESUK, CT141VDX, CT141VSX, CT142DXE, CT142SXE, CT142DXEUK, CT142SXUK, CT142DXV, CT142SXV, CT190DXE, CT190SXE, CT190DXEUK, CT190SXUK, CT190DXV, CT190SXV, CT-191DXE, CT191SXE, CT191DXEUK, CT191SXUK, CT191DXV, CT191SXV, CT192DXE, CT192SXE, CT192DXEUK, CT192SXUK, CT192DXV, CT192SXV, CT240DXE, CT240SXE, CT240DXEUK, CT240SX, CT240DXV, CT240SXVUK...(Other models you can see in the webshop)		

			
GEV No.	359131	Ref. No.	0K1361
description	indicator lamp 400V clear connection male faston 6.3mm		
For models:	AVAHOFOOOC, ACAWCBOOOC, ALAWCFOOOO, ALAWCAOOOO, ALAWCBOOOO, STE23A1A.582255, ACAWCAOOOC, ACAWCFOOOC, ACAWCAROOC, AHATRAOOOC, AHATUAOOOC, AHATRFOOOC, AHATUFOOOC, AHATQAOOOC, AHATTAOOOC, AHATQFOOOC, AHATTFOOOC, AHATSAOOOC, AHATVAOOOC, AHATSF00OC, AHAT-VFOOOC, APABPETOOC, APABPGTOOC, APACPITOOC, APACPGTOOC, AVABOE00OC, AVACOE00OC, AVAEOEOOOC, AVAHOEOOOC, AVABOETOOC, AVACOETOOC, AVAEOETOOC, AVAHOETOOC, AVABOF-TOOC, AVACOFTOOC, AVAEOFTOOC, AVAHOFTOOC, AAATAOOOC, AAATHAOOOC, AAATAFOOOC, AAATHFOOOC, AAATABOOOC, AAATHBOOOC, AEAUCAJGOO, AEAXLAKFFO, AEAUCFJGOO, AEAXLK-FFO, AEAUCBJGOO, AEAXLBKFFO, AGPWCAGBOO...(Other models you can see in the webshop)		

			
GEV No.	359133	Ref. No.	0K1362 72593804
description	indicator lamp 400V green connection male faston 6.3mm		
For models:	AVAHOFOOOC, ACARHAOO, ACARAFOO, ACARHFOO, ACARABOO, ACARHBOO, ACAWHFRO, ACAWAFOO, ACAWHFOO, ACAWHAOO, ACAWHBOO, ACAWABOO, ACAWHBOO, ACAWCBOOOC, ALARHFSO-OO, ALARHASOOO, ALARHBSOOO, ALAWHFSOOO, ALAWHASOOO, ALAWHBSOOO, ALARAFOOOO, ALARHFOOOO, ALARAAOOOO, ALARHAOOOO, ALARABOOOO, ALARHBOOOO, ALAWAFOOOO, ALAWHFOOOO, ALAWAAOOOO, ALAWHAOOOO, ALAWABOOOO, ALAWHBOOOO, ALAWCFOOOO, ALAWCAOOOO, ALAWCBOOOO, ACARAARO, ACAWAARO, ACAWCAOOOC, ACAWCFOOOC, ACAWCAROOC, ABARAAOOOO, ABARHAOOOO, ABARAF00OOO, ABARHFOOOO, ABARACOOOO, ABARHCOOOO, ABAR-AOOOO, ABAR-FOOOO, ABARCOOOO, ABAR-COOOO...(Other models you can see in the webshop)		

			
1			
GEV No.	359132	Ref. No.	00052 004895 0K3497
description	indicator lamp green 250V connection male faston 6.3mm protection IP54 ambient temperature max. 85°C		
For models:	SCE350, SCE700, SCFE700, SIE350, SVE700, SRE350, SRE360, SRE370, SRE700, SRE710, SRE720, SFRE700, SCCE350, SME350, SME700, SGE350, SBRE350, SCPE350, SCFGE700, SCFGE1050, SCE350, SCE700, SCFE700, SIE350, SVE700, SRE350, SRE360, SRE370, SRE700, SRE710, SRE720, SFRE350, SFRE700, SCCE350, SME350, SME700, SGE350, SBRE350, SCPE350, SCFGE700, SCFGE1050, PC35E6U, PC70E6U, BM35E6U, FTL35E6U, FTR35E6U, FTC35E6U, FTL70E6U, FTR70E6U, FTC70E6U...(Other models you can see in the webshop)		



indicator lights 3-piece (housing, lens and bulb)			
ø19.2mm			
			
1			
GEV No.	359108	Ref. No.	0H6108 0H6109 0H6110 212569
description	indicator light ø 19.2mm green		

			
1			
GEV No.	359107	Ref. No.	0H6111 212570
description	indicator light ø 19.2mm yellow socket E14		

lamps			
light bulbs			
			
1			
GEV No.	359656	Ref. No.	0H2639 0K9109 0KC506
description	light bulb socket Ba9s 130V 2W ø 10mm L 28mm		
For models:	AR85, AR85, AR85, AR85, AR85, AR85, AR85, AR85, HC-CS, EBS50L, EBS100L, EBA100L, EBP100L, EBS200L, EBA200L, EBP200L, EBS300L, EBA300L, EBP300L		

			
1			
GEV No.	359807	Ref. No.	0E0016 0K9110
description	light bulb socket Ba9s 24V 2W ø 10mm L 28mm clear		
For models:	FT36EDTS, FT36ESTS, FT36VDTs, FT36VSTs, FT36ED, FT36ES, FT36VD, FT36VS, FT50ED, FT50ES, FT50VD, FT50VS, FT72ED, FT72ES, FT72VD, FT72VS, FT36EDT, FT36EST, FT36VDT, FT36VST, FT50EDT, FT50EST, FT50VDT, FT50VST, FT72EDT, FT72EST, FT72VDT, FT72VST, FT36WED, FT36WES, FT36WVD, FT36WVS, FT50WED, FT50WES, FT50WVD, FT50WVS, FT72WED, FT72WES, FT72WVD, FT72WVS, FT36WEDT, FT36WEST, FT36WVDT, FT36WVST, FT50WEDT, FT50WEST, FT50WVDT, FT50WVST, FT72WEDT, FT72WEST...(Other models you can see in the webshop)		

			
1			
GEV No.	357087	Ref. No.	053894 075026
description	light bulb socket Ba9s 30V 2W ø 10mm L 28mm		
For models:	FCVE10, FCVE20, FV4N, FVGC4, FV4G, FV4E, FV4N, FV4G, FV4E, FVAC041, LO/E480, PLO480/E, LO480EUK, LO480E/63, LO480VAPORESTD, PLO480V, LO480V/63-60HZ, LO/E250, PLO250E, LO/E250UK, LO250E/63, LOPE25, LOPE48, LO480Z-VAPORE		

neon light bulbs			
			
1			
GEV No.	359606	Ref. No.	0H9799 0K2043 0K4896 0K4897 176769 18003946
description	neon light bulb socket Ba9s 220V 2W clear ø 10mm L 28mm		
For models:	7573-2, 7574-2, 7575-2, 7576-2, 7773-2, 7774-2, 7775-2, 7776-2		
accessories for	359606		
	GEV No.	359832	Ref. No. —
	lamp socket mounting measurements ø16.2mm socket Ba9s connection male faston 6.3mm		
	GEV No.	359853	Ref. No. —
	lamp socket mounting measurements ø18.2mm socket Ba9s connection male faston 6.3mm		

			
1			
GEV No.	359602	Ref. No.	002592 07150205 0H7036 0H7144 0K3356 0K4892 0K9814 0KC231 18003900 188211410 30001874 72036132
description	neon light bulb socket E14 230V clear ø 14mm L 30mm		
For models:	BE1-TA.3, BE1-W.3, BE1-WS-M.3, BE2-A-C.3, BE2-A-M.3, BE2-WS-C.3, BE2-WS-M.3, BE3-C.3, BE3-M.3, BE1-WS-C.3		





			
1			
GEV No.	359603	Ref. No.	002585 052204 07150215 0G0967 0H7037 0K4893 0K7293 0K9813 0KC232 18003901 188211420 565628 72036130
description	neon light bulb socket E14 380V clear ø 14mm L 30mm		
For models:	BE1-TA.3, BE1-W.3, BE1-WS-M.3, BE2-A-C.3, BE2-A-M.3, BE2-WS-C.3, BE2-WS-M.3, BE3-C.3, BE3-M.3, BE1-WS-C.3		

			
1			
GEV No.	359378	Ref. No.	0A2224 0G2390 0H6615 0K2046 0KD884 0KI684 0U4330 1010100503 3122720378 63406
description	indicator light ø 10mm 230V green connection male faston 6.3mm socket screw base		
For models:	5702-2-2, 5702-2-3, 5704-2-2, 5704-2-3, 5707-2-2, 57074-2-3, 5701-3-2, 5701-3-3, 5702-3-2, 5702-3-3, 5704-3-2, 5704-3-3, 5707-3-2, 5707-3-3, ROMA/E500, BOFR/G500, ROFR/G1000, ROBR/G1000, ROBR/G1010, ROBR/G1510, ROPN/G1000, ROPN/G1015, ROPN/G1020, ROM/E500, 5611-3-6, 5612-3-6, 5614-3-6		

indicator lights (complete)

ø 6mm			
			
1			
GEV No.	357084	Ref. No.	003032
description	indicator lamp ø 6mm 240V green		

			
1			
GEV No.	359380	Ref. No.	0A2408 0KI685 0KV042 6327 63408
description	indicator light ø 10mm 230V red connection male faston 6.3mm socket screw base		
For models:	MVR/E1400, MVR/E1050, MVR/E1060, 7BAE10C, 7BAE14S, 7BAE10S, B105RC, B140RC, KVRC/E3, HVR/E1200, QVRC/E3, WVRC/E3, MVR/E3C, MVR/E3, MVR/E4C, MVR/E4		

			
1			
GEV No.	345836	Ref. No.	049064 272017030T
description	indicator light ø 6mm 230V green cable length 250mm		
For models:	LB1, LB1WS, LB1WSDP, LB1/RBP, LB1/TOP, LB1/60, WT1WSDP, LB2D-PSAUS, LB1G, LB1WSG, WT2TOP60, WT2DPDI, WT2WSDPDI, LB1TOP, WT2TOPDI, LB2WS, LB2, LB2WSDP, LB2/TOP, LB2/RBP, LB2WS60, WT2WSDP, WT2WSDPD, LB2WSG, WT2WS, WT1, WT1WS, WT1TOP, WT2TOP, WT1/3DP, WT2/3DP, WT2DPAUS, WT2, LB2DPDI, LB2WSDPDI, LB2WSDPD, LB2TOP, LB2DP3, WT2DPD3, NGW, NGWDPDD, UC1, UC2WS, GW1, GW1WS, LV1WS, LV1WSDP, LV2WSDP, LV2WS, GW2D-PG...(Other models you can see in the webshop)		

			
1			
GEV No.	359379	Ref. No.	0A2225 3122006478
description	indicator light ø 10mm 230V yellow connection male faston 6.3mm socket screw base		
For models:	ROMA/E500, BOFR/G500, ROFR/G1000, ROBR/G1000, ROBR/G1010, ROBR/G1510, ROPN/G1000, ROPN/G1015, ROPN/G1020, ROM/E500		

ø10mm

with screw socket

			
1			
GEV No.	359995	Ref. No.	OKL449
description	indicator light ø 10mm 230V clear connection male faston 6.3mm		

with plug-in socket

			
1			
GEV No.	359232	Ref. No.	0H6106 1010100603 60050379
description	indicator light ø 10mm clear 230V connection male faston 2.8mm Qty 1 pcs		

			
GEV No.	359139	Ref. No.	004169 058544 0K2965 28H2740378
description	indicator light ø 10mm green 230V connection male faston 6.3mm Qty 1 pcs		
For models:	MCP/E700, MCP/E700D, FDV40G, FDV40E, FDV40GZ, FDV40EL, FDV40GA, FDV20G, FDV20E, FDV20GZ, FDV20EL, FDV20GA, 7CPE07P, M70EPC, CCP/E700, FCF/G6-0, FCFG101/0, FCFG102-0, FCFG201-0, FCFG202-0, FCF/E6-0, FCFE101-0, FCFE102-0, FCFE201-0, FCFE202-0, FCF061ELN, FCF101ELN, FCF6EHOR, FCFG10160H, FCF061ENS, FCF101ENS, FCF102ENS, FCF201ENS, FCFG102-0T, FCF/G6-1-JAP, FCF/G101/1-1-JAP, FCF/G102/1-1-JAP, FCFE6-1J, FCFE101-1J, FCFE102-1J, FCF/G101/1, FCF/E2, FCF/E2D, FCF/E2UK, FCF/E4-OLD, FCF/E4D, FCFE4PH, FCFG6D, FCFE6D, FCFE6D...(Other models you can see in the webshop)		

			
GEV No.	359019	Ref. No.	004157 91310111
description	indicator light ø 10mm green 400V connection male faston 6.3mm Qty 1 pcs		
For models:	ZCMME6, ZCBME12, ZCMME4, ZCBME8, ZCMME9, ZCBME18, PME430, PME630, PME6L30, PME930, PME435, PME635, PME6L35, PME935, PME830, PME1230, PME12L30, PME1830, PME835, PME1235, PME12L35, PME1835		

			
GEV No.	359138	Ref. No.	005214 056429 0C3052 0C4181 3570553101
description	indicator light ø 10mm red 230V connection male faston 6.3mm Qty 1 pcs		
For models:	FCF/E4, FCF/E4-3KW, FCF4E, FCF4E-3KW, ECF4E, ECF4E3KW, JCF/E4, JCF/E4, ECF/E4, ECF/E4-3KW, ACF/E4, ACF/E4-3KW, ACF4E, ACF4E3KW, NCF/E4, ZCF/E4, ZCF/E4		



			
GEV No.	359231	Ref. No.	0H6616 0K2047
description	indicator light ø 10mm yellow 230V connection male faston 2.8mm Qty 1 pcs		
For models:	5702-2-2, 5702-2-3, 5704-2-2, 5704-2-3, 5707-2-2, 57074-2-3, 5701-3-2, 5701-3-3, 5702-3-2, 5702-3-3, 5704-3-2, 5704-3-3, 5707-3-2, 5707-3-3, 5611-3-6, 5612-3-6, 5614-3-6		



			
GEV No.	359140	Ref. No.	005215 058522 28H2120478
description	indicator light ø 10mm yellow 230V connection male faston 6.3mm Qty 1 pcs		
For models:	FDV40G, FDV40E, FDV40GZ, FDV40EL, FDV40GA, FDV20G, FDV20E, FDV20GZ, FDV20EL, FDV20GA, FCF/G6-0, FCFG101/0, FCFG102-0, FCFG201-0, FCFG202-0, FCF/E6-0, FCFE101-0, FCFE102-0, FCFE201-0, FCFE202-0, FCF061ELN, FCF101ELN, FCF6EHOR, FCFG10160H, FCF061ENS, FCF101ENS, FCF102ENS, FCF201ENS, FCFG102-0T, FCF/G6-1-JAP, FCF/G101/1-1-JAP, FCF/G102/1-1-JAP, FCFE6-1J, FCFE101-1J, FCFE102-1J, FCF/G101/1, FCF/E4, FCF/E4-3KW, FCF/E2, FCF/E2D, FCF/E2UK, FCF/E4-OLD, FCF/E4D, FCFE4PH, FCFG6D, FCFE6D, FCFE6D, FCFG10, FCFG10D, FCFG10NL...(Other models you can see in the webshop)		

ø12mm			
with screw socket			
			
GEV No.	359027	Ref. No.	003531
description	indicator light ø 12mm 250V green connection male faston 6.3mm		
For models:	HPN/EI855, HPN/EI1255, ZPN/EI1255		

ø12.5mm			
			
GEV No.	359999	Ref. No.	0H2633 0K9096
description	indicator light ø 12.5mm 230V clear connection male faston 6.3mm		
For models:	HCCS20W, HCCS20W, EBE40., EBE40., EBE40., EBE040, EBE60., EBE60., EBE60., EBE60, EBE80., EBE80., EBE80., EBE80., EBE80, EBE100., EBE100., EBE100., EBE100, EBS50., EBS50H, EBS100., EBS100H, EBS150., EBS150H, EBS200., EBS200H, EBS300., EBS300H, EBV50., EBV50H, EBV100., EBV100H, EBV150, EBV150H, EBV200., EBV200H, EBV300., EBV300H, EBVC50, EBVC50H, EBVC100, EBVC100H, EBVC150, EBVC150H, EBVC200, EBVC200H, EBVC300, EBVC300H, EBP100., EBP100M...(Other models you can see in the webshop)		



ø13mm			
with screw socket			
			
1			
GEV No.	359145	Ref. No.	0C3487 OH6619 18005620 5322720379 622885
description	indicator light ø 13mm 230V green t.max. 120°C		
For models:	DLP/SCE, DLP/SUK, ELP/SUSA, DLP/LCE, DLP/LUK, ELP/LUSA, 7561-3.KES60.RW, 7562-3.KES80.RW, 7563-3.KES100.RW, 7564-3.KES150.RW, 7581-5.KK60, 7582-5.KK80, 7583-5.KK100, 7781-5.KK60, 7782-5.KK80, 7783-5.KK100, 7580-5.KK40, 7584-5.KK150, 7780-5.KK40, 7744-3/85.KB.(N), 7508-3/85., 7542-3/85., 7544-3/85.KB.(N), 7542-3/90.KB.(N), 7544-3/90.KB.(N), 7742-3/90.KB.(N), 7742-3/85.KB.(N), 7744-3/90.KB.(N), 7561-3/85.KES60.RW., 7562-3/85.KES80.RW., 7563-3/85.KES100.RW., 7564-3/85.KES150.RW., 7561-3/90.KES60.RW., 7562-3/90.KES80.RW., 7563-3/90.KES100.RW., 7564-3/90.KES150.RW., 7573-3/85.KES100.(N), 7574-3/85.KES150.(N), 7575-3/85.KES250.(N), 7576-3/85.KES300.(N), 7573-3/90.KES100.(N), 7574-3/90.KES150.(N), 7575-3/90.KES250.(N), 7576-3/90.KES300.(N), 7576-3/90.KES300.(N), 7580-5/85.KK40.(N), 7581-5/85.KK60.(N), 7582-5/85.KK80.(N), 7583-5/85.KK100.(N), 7584-5-85.KK150.(N), 7580-5/90.KK40.(N)...(Other models you can see in the webshop)		
accessories for	359145		
	GEV No.	510302	Ref. No. 047986 OH2550 OQ0014 543619100
	O-ring EPDM ID ø 12.42mm thickness 1.78mm Qty 1 pcs		
	GEV No.	511505	Ref. No. —
	O-ring EPDM thickness 1.78mm ID ø 12.42mm Qty 10 pcs		

			
1			
GEV No.	359146	Ref. No.	OH6618 18005621 5322080479
description	indicator light ø 13mm 230V yellow		
For models:	7561-3.KES60.RW, 7562-3.KES80.RW, 7563-3.KES100.RW, 7564-3.KES150.RW, 7581-5.KK60, 7582-5.KK80, 7583-5.KK100, 7580-5.KK40, 7584-5.KK150, 7780-5.KK40, 7751-3/85.KES60, 7744-3/85.KB.(N), 7542-3/85., 7544-3/85.KB.(N), 7542-3/90.KB.(N), 7544-3/90.KB.(N), 7742-3/90.KB.(N), 7742-3/85.KB.(N), 7744-3/90.KB.(N), 7550-3/85.KES40.(N), 7551-3/85.KES60, 7552-3/85.KES80.(N), 7553-3/85.KES100.(N), 7554-3/85.KES150.(N), 7550-3/90.KES40.(N), 7551-3/90.KES60, 7552-3/90.KES80.(N), 7553-3/90.KES100.(N), 7554-3/90.KES150.(N), 7562-3/85.KES80.RW., 7563-3/85.KES100.RW., 7564-3/85.KES150.RW., 7561-3/90.KES60.RW., 7562-3/90.KES80.RW., 7563-3/90.KES100.RW., 7564-3/90.KES150.RW., 7580-5/85.KK40.(N), 7581-5/85.KK60.(N), 7582-5/85.KK80.(N), 7583-5/85.KK100.(N), 7584-5-85.KK150.(N), 7580-5/90.KK40.(N), 7581-5/90.KK60.(N), 7582-5/90.KK80.(N), 7583-5/90.KK100.(N), 7584-5-90.KK150.(N)...(Other models you can see in the webshop)		
accessories for	359146		
	GEV No.	510302	Ref. No. 047986 OH2550 OQ0014 543619100
	O-ring EPDM ID ø 12.42mm thickness 1.78mm Qty 1 pcs		
	GEV No.	511505	Ref. No. —
	O-ring EPDM thickness 1.78mm ID ø 12.42mm Qty 10 pcs		

			
1			
GEV No.	357085	Ref. No.	OE5134 OK8276
description	indicator light ø 13mm 24V clear connection male faston 6.3mm screw base		
For models:	PW1EFL, PW1EFLF, PW1EFL/60HZ, PW2EFL, PW2EFLF, PW2EFL/60HZ, PW2VFL, WT830EFL, WT830EFLF, WT830EFL/60HZ, WT850, WT850EFLF, WT850EFL/60HZ, WT850SFL, TW1ERECCO, TW1ELECO, TW1SRECCO, TW1SLECO, RT100ED, RT100ES, RT100SR, RT100SL, RT140ED, RT140ES, RT140SR, RT140SL, RT190ED, RT190ES, RT190SR, RT190SL, RT190HDED, RT190HDES, RT190HSR, RT190HSL, RT270ED, RT270ES, RT270SR, RT270SL, RT270HDED, RT270HDES, RT270HSR, RT270HSL, RT100ERF, RT100ELF, RT100VD, RT100VS, RT140ERF, RT140ELF, RT140VD, RT140VS... (Other models you can see in the webshop)		



with plug-in socket



GEV No.	359364	Ref. No.	005010 058596 058658 0K2922 0KF056 727941 727996 728026
description	indicator light ø 13mm green 230V		
For models:	MCF/GE705, MCF/GE1055, MCF/GE700, MCFGE1050, MCF/GE700D, MCFGE1050D, MCF/E700D, MCF/E700, MCF/E700UK, MCF/E1050D, MCF/E1050, MC/E350D, MC/E350UK, MC/E700D, MC/E700UK, MC/E1050D, MCF/GE1055UK, MC/E350, MC/E700, MC/E1050, MI/E350, MI/E700, MIF/E700, MI/E350D, MI/E700D, MIF/E700D, MI/E360, MI/E710, MIF/E710, MI/E360D, MI/E710D, MIF/E710D, MBR/G710D, MFR/E355, MFR/E355UK, MFR/E355D, MFR/E705, MFR/E705UK, MFR/E705D, MFR/E740, MPN/E1760, MPNEI760UK, BC/E1, BCF/E2, BF/E1S12, BFR/E1S14, BR/E1FL, BR/E1FR, BR/E2FL, BR/E2FR...(Other models you can see in the webshop)		



GEV No.	359365	Ref. No.	005011 058631 058659 0KF058 727997 728027
description	indicator light ø 13mm yellow 230V		
For models:	MCF/GE705, MCF/GE1055, MCFGE1050, MCF/GE700D, MCFGE1050D, MCF/E700D, MCF/E700, MCF/E700UK, MCF/E1050D, MCF/E1050, MCF/GE1055UK, MIF/E700, MIF/E700D, MIF/E710, MIF/E710D, MFR/G350, MFR/G700, MFR/G350D, MFR/G700D, MFR/G350F, MFR/G700F, MFR/G350E, MFR/G700E, MFR/E355, MFR/E355UK, MFR/E355D, MFR/E705, MFR/E705UK, MFR/E705D, MFR/E740, BCF/E2, BF/E1S12, BFR/E1S14, BR/E1FL, BR/E1FR, BR/E2FL, BR/E2FR, MF/E700, RCF/M2, RCF/M3, RCF/E2, RCF/E2MO, RCF/E2M4, RCVF/E3MO, RCVF/E3M4, RCF/E2E5, RBR/E2FM, RBR/E2IM, RBK/E2FM, RMV/E1C...(Other models you can see in the webshop)		

ø14mm

with plug-in socket



GEV No.	359151	Ref. No.	026456 053148 053154 068694 0HB053 0W2002 42U2780387 4619400
description	indicator light ø 14mm green 400V connection male faston 6.3mm temp.-resist. 120°C		
For models:	HCF/E800, HCF/E800UK, HCF/E800, HCF/GE81, HCF/GE81, HCF/GE80, HCF/GE80, HRS/E401, HRS/E401UK, HRS/E411, HRS/E801, HRS/E801U, HRS/E802, HRS/E812, HRS/E811, HRA/E802, HR/E401T, HR/E411, HR/E801T, HR/E811T, HR/E802, HMS/E400, HMS/E800, HMA/E800, HMS/E400, HMS/E800, HMA/E800, HM/E400T, HM/E800T, HQN/EI917, HQN/EI1225, HPN/E810, HPN/EI810, HPN/E815, HPN/EI810, HPA/EI810, HBR/G803, HBR/G804, HBR/G803, HBR/G804, HBR/G803, HBR/G805, HBR/G1003, HBR/G1003, HBR/G1004, HBR/E801, HBR/E803, HBR/E804, HBR/E805UK, HBR/E1003...(Other models you can see in the webshop)		



GEV No.	359150	Ref. No.	026385 053150 053153 068624 0K7814 42U2120187
description	indicator light ø 14mm red 400V connection male faston 6.3mm temp.-resist. 105°C square		
For models:	HQN/EI917, HQN/EI1225, HPN/E810, HPN/EI810, HPN/E815, HPN/EI810, HPA/EI810, HBR/G803, HBR/G804, HBR/G803, HBR/G804, HBR/G803, HBR/G805, HBR/G1003, HBR/G1003, HBR/G1004, HBR/E803, HBR/E804, HBR/E805UK, HBR/E1003, HBR/G803, HBR/G804, HBR/G1013, HBR/E1013, HCP/E800, HCP/E400, HBR/G803, HBR/G804, HBR/G1003, HBR/G1013, HBR/E803, HBR/E804, HBR/E1003, HBR/E1013, HPN/E810, HPN/E815, HPN/EI810, HPA/EI815, HQNEI817, HQNEI122		



GEV No.	359152	Ref. No.	045272 053149 053155 068625 42U2120487
description	indicator light ø 14mm yellow 400V connection male faston 6.3mm temp.-resist. 105°C square		
For models:	HCF/E800, HCF/E800UK, HCF/E800, HCF/GE81, HCF/GE81, HCF/GE80, HCF/GE80, HRS/G802, HRS/G812, HRS/E411, HRS/E801U, HRS/E802, HRS/E812, HRA/G802, HRA/E802, HR/E411, HR/E802, HMS/E400, HMS/E800, HMA/E800, HMS/E400, HMS/E800, HMA/E800, HM/E400T, HM/E800T, HBR/G803, HBR/G804, HBR/G803, HBR/G804, HBR/G803, HBR/G805, HBR/G1003, HBR/G1003, HBR/G1004, HBR/E801, HBR/E803, HBR/E804, HBR/E805UK, HBR/E1003, HBR/G803, HBR/G804, HBR/G1013, HBR/E1013, HFR/G420, HFR/G420, HFR/G420NL, HFR/G840, HFR/G840, HFR/G840, HFR/G840...(Other models you can see in the webshop)		

ø16mm

with plug-in socket





GEV No.	359518	Ref. No.	006849 0G2317 245888
description	indicator light ø 16mm 230V green		
For models:	7550-5.KES40, 7551-5.KES60, 7552-5.KES80, 7553-5.KES100, 7554-5.KES150, 7574-5.KES150, 7575-5.KES250, 7750-5.KES40, 7751-5.KES60, 7752-5.KES80, 7753-5.KES100, 7754-5.KES150, 7576-5.KES300, 7573-5.KES100, 7720-3/90.WB.GN1/1., 7520-3/85.WB.GN1/1., 7731-3/85.GRPL.VCHR., 7701-3/85, 7721-3/85.WB.GN2/1, 7751-3/85.KES60, 7501-3/85., 7531-3/85., 7501-3/90.HE.APL.(N), 7531-3/90.GRPL.(N), 7502-3/85., 7520-3/90.WB.GN1/1., 7720-3/85.WB.GN1/1., 7746-3/90.KB.(N), 7748-3/90.KB.(N), 7747-3/90.KB.(N), 7550-3/85.KES40.(N), 7551-3/85.KES60, 7552-3/85.KES80.(N), 7553-3/85.KES100.(N), 7554-3/85.KES150.(N), 7550-3/90.KES40.(N), 7551-3/90.KES60, 7552-3/90.KES80.(N), 7553-3/90.KES100.(N), 7554-3/90.KES150.(N), 7550-5/85.KES40.(N), 7551-5/85.KES60.(N), 7552-5/85.KES80.(N), 7553-5/85.KES100.(N), 7554-5/85.KES150.(N), 7550-5/90.KES40.(N), 7551-5/90.KES60.(N), 7552-5/90.KES80.(N), 7553-5/90.KES100.(N), 7554-5/90.KES150.(N)...(Other models you can see in the webshop)		





ø19mm			
			
1			
GEV No.	345768	Ref. No.	0H6107 0K0480
description	indicator light ø 19mm 230V red		

			
1			
GEV No.	359519	Ref. No.	002584 0H2175 0K4898 0K7286 0KE384 18003952 30000074 72036101
description	indicator light housings mounting measurements ø19mm socket E14 clear		
For models:	BE1-TA.3, BE1-W.3, BE1-WS-M.3, BE2-A-C.3, BE2-A-M.3, BE2-WS-C.3, BE2-WS-M.3, BE3-C.3, BE3-M.3, BE1-WS-C.3		

ø20mm			
			
1			
GEV No.	359516	Ref. No.	002162 0K4903 18003967 249780 70031902
description	indicator light ø 20mm 230V clear		
For models:	BE1-TA.3, BE1-W.3, BE1-WS-M.3, BE2-A-C.3, BE2-A-M.3, BE2-WS-C.3, BE2-WS-M.3, BE3-C.3, BE3-M.3, CEB068, BE1-WS-C.3, CEB069, UEB068, UEB069, CGB068, CGB069, UGB068, UGB069		

			
1			
GEV No.	359514	Ref. No.	002161 0G0220 0K3006 0K4900 0K4902 18003964 18003966 249618 249816 70031901 70031909
description	indicator light ø 20mm 230V green connection male faston 6.3mm ambient temperature max. 125°C		
For models:	CEB068, CEB069, UEB068, UEB069, CGB068, CGB069, UGB068, UGB069		

ø22mm			
			
1			
GEV No.	359508	Ref. No.	0K4580 0K4859 0K4905 12011865 18002879 18003969 199161 72457405
description	indicator light ø 22mm 230V clear connection screw		
For models:	CE128-106, CE158-133.3.HV, CE158-244.3, CE158-246.3, CK248-209, D1ABBB, CK248-211.D1ABBB, HCE128-100, HCE128-104, HCE158-252W.3, HCE158-253.3, HLE129-100, HLE129-103, HLE129-104W, HLE159-252W.3.6, HLE159-328.3.HV, HLE159-351W.3.HV, HLE249-200.3, HLE249-208.3, HLE259-088.3.HV, HLE259-089.3.HV, HLE259-384W.3, LE129-101, LE159-261.3, LE159-281.3.6, LE159-318.3.HV, LE159-322.3.HV, LE159-330.3.HV, LE159-337.3.HV, LE159-344.3.MS92, LE159-347.3.HV, LE249-199.3, LE249-203.3, LE249-207.3, LE249-211.3, LE249-215.3, LE249-219.3, LE249-223.3, LE249-232.3, LE249-238.3, LE259-081.3.HV, LE259-082.3.HV, LE259-083.3.HV, LE259-094.3.HV, LE259-099.3.HV, LE259-382.3, LK259-707.D1ACCB, LK259-708.D1AC-CB, CK248-205.D1ABBB, CK248-207.D1ABBB, LK159-707.D1BC...(Other models you can see in the webshop)		

			
1			
GEV No.	359506	Ref. No.	0G1917 0K5043 0K5094 0K5120 0KG881 0KI198 18002877 18015471 18025474 18025507 199175 72457401
description	indicator light ø 22mm 230V green connection screw temp.-resist. 60°C		
For models:	CE128-106, CE158-133.3.HV, CE158-244.3, CE158-246.3, CK248-209, D1ABBB, CK248-211.D1ABBB, HCE128-100, HCE128-104, HCE158-252W.3, HCE158-253.3, HLE129-100, HLE129-103, HLE129-104W, HLE159-252W.3.6, HLE159-328.3.HV, HLE159-351W.3.HV, HLE159-390W.3, HLE249-200.3, HLE249-208.3, HLE259-088.3.HV, HLE259-089.3.HV, HLE259-384W.3, HLI159-371W.3, HLI159-373.3, HLI259-390W.3, LE129-101, LE159-261.3, LE159-281.3.6, LE159-318.3.HV, LE159-322.3.HV, LE159-330.3.HV, LE159-337.3.HV, LE159-344.3.MS92, LE159-347.3.HV, LE249-199.3, LE249-203.3, LE249-207.3, LE249-211.3, LE249-215.3, LE249-219.3, LE249-223.3, LE249-232.3, LE249-238.3, LE259-081.3.HV, LE259-082.3.HV, LE259-083.3.HV, LE259-094.3.HV, LE259-099.3.HV, LE259-382.3, LI159-375.3...(Other models you can see in the webshop)		





			
1			
GEV No.	359512	Ref. No.	OK6368 OK6559 199155 72457406
description	indicator light ø 22mm 400V clear connection screw temp.-resist. 60°C		
For models:	CE128-106, CE158-133.3.HV, CE158-244.3, CE158-246.3, CK248-209, D1ABBB, CK248-211.D1ABBB, HCE128-100, HCE128-104, HCE158-252W.3, HCE158-253.3, HLE129-100, HLE129-103, HLE129-104W, HLE159-252W.3.6, HLE159-328.3.HV, HLE159-351W.3.HV, HLE249-200.3, HLE249-208.3, HLE259-088.3.HV, HLE259-089.3.HV, HLE259-384W.3, LE129-101, LE159-261.3, LE159-281.3.6, LE159-318.3.HV, LE159-322.3.HV, LE159-330.3.HV, LE159-337.3.HV, LE159-344.3.MS92, LE159-347.3.HV, LE249-199.3, LE249-203.3, LE249-207.3, LE249-211.3, LE249-215.3, LE249-219.3, LE249-223.3, LE249-232.3, LE249-238.3, LE259-081.3.HV, LE259-082.3.HV, LE259-083.3.HV, LE259-094.3.HV, LE259-099.3.HV, LE259-382.3, LK259-707.D1ACCB, LK259-708.D1ACCB, CK248-205.D1ABBB, CK248-207.D1ABBB, LK159-707.D1BC...(Other models you can see in the webshop)		

			
2			
GEV No.	359510	Ref. No.	OG2093 OK4858 OK6366 OK8427 OKJ579 18002876 18015421 199154 199174 724574 72457402
description	indicator light ø 22mm 400V green connection screw temp.-resist. 60°C		
For models:	CE128-106, CE158-133.3.HV, CE158-244.3, CE158-246.3, CK248-209, D1ABBB, CK248-211.D1ABBB, HCE128-100, HCE128-104, HCE158-252W.3, HCE158-253.3, HLE129-100, HLE129-103, HLE129-104W, HLE159-252W.3.6, HLE159-328.3.HV, HLE159-351W.3.HV, HLE249-200.3, HLE249-208.3, HLE259-088.3.HV, HLE259-089.3.HV, HLE259-384W.3, LE129-101, LE159-261.3, LE159-281.3.6, LE159-318.3.HV, LE159-322.3.HV, LE159-330.3.HV, LE159-337.3.HV, LE159-344.3.MS92, LE159-347.3.HV, LE249-199.3, LE249-203.3, LE249-207.3, LE249-211.3, LE249-215.3, LE249-219.3, LE249-223.3, LE249-232.3, LE249-238.3, LE259-081.3.HV, LE259-082.3.HV, LE259-083.3.HV, LE259-094.3.HV, LE259-099.3.HV, LE259-382.3, LK259-707.D1ACCB, LK259-708.D1ACCB, CK248-205.D1ABBB, CK248-207.D1ABBB, LK159-707.D1BC...(Other models you can see in the webshop)		

ø25mm			
			
1			
GEV No.	358138	Ref. No.	OK5929
description	indicator light housings mounting measurements 25mm socket E14 red connection screw clamp 2W 250V		

28.5x28.5mm			
			
1			
GEV No.	345728	Ref. No.	0A8692
description	indicator light lens 23x23 orange defrost		
For models:	EMVN500, MVN112V12C, DVP500V11C, DVP501V11C, MVP502V11C, DVN500V11C, DVN501V11C, DVP500V11V, DVP501V11V, MVP502V11V, EDVN500, DVN501V11V, DVP600V11C, DVP601V11C, MVP602V11C, DVP600V12C, DVP601V12C, DVN600V11C, DVN601V11C, DVN600V12C, DVN601V12C, DVP600V11V, DVP601V11V, EMVP602, DVN600V11V, EDVN601, DVP110V12C, DVP111V12C, MVP112V12C, DVN110V12C, DVN111V12C, DVP110V12V, DVP111V12V, MVP112V12V, EDVN1100, EDVN1101, DVP130V12C, DVP131V12C, MVP132V12C, DVN130V12C, DVN131V12C, DVP130V14C, DVP131V14C, DVN130V14C, DVN131V14C, DVP130V12V, DVP131V12V, EEVNI1301, DVN130V12V, EDVN1300...(Other models you can see in the webshop)		

30x22mm			
			
1			
GEV No.	359156	Ref. No.	OKM981
description	indicator light mounting measurements 30x22mm 230V yellow connection male faston 6.3mm temp.-resist. 125/55°C type RL2		

31x10mm			
			
1			
GEV No.	359306	Ref. No.	0H6581
description	indicator light mounting measurements 31x10mm 230V white/red/green		
For models:	7507-2, 7508-2, 7707-2		

33x10mm			
			
1			
GEV No.	359842	Ref. No.	056501
description	indicator light mounting measurements 33x10mm 24V white		
For models:	FCVE6-3CE, FCVE103CE, FCVE203CE, FCVM62E, FCVM62EUK, FCV-MG62, AFCV/G6-1, AFCV/G6-3, SCO/G6-3, AFCV/G101, AFCV/G103, SCO/G10-3, AFCV/G201, AFCV/G203, SCO/G20-3		





34x12mm

			
1			
GEV No.	359311	Ref. No.	0H6614
description	indicator light mounting measurements 34x12mm 230V green/red		

miscellaneous

 <p>Image not available</p>			
1			
GEV No.	359301	Ref. No.	0K3357
description	indicator light		

			
1			
GEV No.	359006	Ref. No.	069417 0K3776 226006
description	indicator light white 230V		
For models:	LTB12, LTB22, LTB12UK, LTB22UK, LTB22, CRYSTAL 22		

 <p>Image not available</p>			
1			
GEV No.	359758	Ref. No.	0K3095
description	indicator light yellow		



blank elements

			
1			
GEV No.	359844	Ref. No.	005212 0C3049 3556043077 3556146011
description	indicator light lens red ø 6mm		
For models:	FCF/E4, FCF/E4-3KW, FCF4E, FCF4E-3KW, ECF4E, ECF4E3KW, JCF/E4, JCF/E4, ECF/E4, ECF/E4-3KW, ACF/E4, ACF/E4-3KW, ACF4E, ACF4E3KW, NCF/E4, ZCF/E4, ZCF/E4		

			
1			
GEV No.	359845	Ref. No.	005211 3556043085 3556146029
description	indicator light lens yellow ø 6mm		
For models:	FCF/E4, FCF/E4-3KW, FCF4E, FCF4E-3KW, ECF4E, ECF4E3KW, JCF/E4, JCF/E4, ECF/E4, ECF/E4-3KW, ACF/E4, ACF/E4-3KW, ACF4E, ACF4E3KW, NCF/E4, ZCF/E4, ZCF/E4		

screw-on/push-on fit

neon light bulbs

			
1			
GEV No.	359606	Ref. No.	0H9799 0K2043 0K4896 0K4897 176769 18003946
description	neon light bulb socket Ba9s 220V 2W clear ø 10mm L 28mm		
For models:	7573-2, 7574-2, 7575-2, 7576-2, 7773-2, 7774-2, 7775-2, 7776-2		
accessories for	359606		
	GEV No.	359832	Ref. No. —
	 lamp socket mounting measurements ø16.2mm socket Ba9s connection male faston 6.3mm		
	GEV No.	359853	Ref. No. —
	 lamp socket mounting measurements ø18.2mm socket Ba9s connection male faston 6.3mm		

			
1			
GEV No.	359602	Ref. No.	002592 07150205 0H7036 0H7144 0K3356 0K4892 0K9814 0KC231 18003900 188211410 30001874 72036132
description	neon light bulb socket E14 230V clear ø 14mm L 30mm		
For models:	BE1-TA.3, BE1-W.3, BE1-WS-M.3, BE2-A-C.3, BE2-A-M.3, BE2-WS-C.3, BE2-WS-M.3, BE3-C.3, BE3-M.3, BE1-WS-C.3		



			
1			
GEV No.	359603	Ref. No.	002585 052204 07150215 0G0967 0H7037 0K4893 0K7293 0K9813 0KC232 18003901 188211420 565628 72036130
description	neon light bulb socket E14 380V clear ø 14mm L 30mm		
For models:	BE1-TA.3, BE1-W.3, BE1-WS-M.3, BE2-A-C.3, BE2-A-M.3, BE2-WS-C.3, BE2-WS-M.3, BE3-C.3, BE3-M.3, BE1-WS-C.3		

light bulbs			
for ovens			
			
1			
GEV No.	359610	Ref. No.	0A2883 0H7035 0K6588 0KE265 0KS867 3000031017 6061052 E767
description	light bulb t.max. 300°C socket E14 15W 230V ø 22mm L 47mm lens L 20mm for oven lamp type Philips		

			
1			
GEV No.	359612	Ref. No.	004112 004161 054319 054840 056709 0C3044 0C3568 0H2405 0H6613 0K3859 0K6585 0K7928 245812 300003101 440403 91310191 B26E14
description	light bulb t.max. 300°C socket E14 25W 230V ø 25mm L 56mm lens L 30mm for oven lamp type Philips		
For models:	HCCS20W, HCCS20W, FCF02EV, FCF02EOEM, FCF/G6-0, FCFG101/0, FCFG102-0, FCFG201-0, FCFG202-0, FCF/E6-0, FCFE101-0, FCFE102-0, FCFE201-0, FCFE202-0, FCF061ELN, FCF101ELN, FCF6EHOR, FCFG10160H, FCF061ENS, FCF101ENS, FCF102ENS, FCF201ENS, FCFG102-0T, FCF/G6-1-JAP, FCF/G101/1-1-JAP, FCF/G102/1-1-JAP, FCFE6-1J, FCFE101-1J, FCFE102-1J, FCF/G101/1, FCF/E3, FCF/E4, FCF/E4-3KW, FCF4E, FCF4E-3KW, FCF/E2, FCF/E2D, FCF/E2UK, FCF/E4-OLD, FCF/E4D, FCFE4PH, FCFG40, FCFG41, FCFG40D, FCFG40F, PFCFG40F, FCFE40, FCFE40D, FCFE40UK, PFCFE40F...(Other models you can see in the webshop)		

			
1			
GEV No.	359611	Ref. No.	081696 0S0596
description	light bulb t.max. 300°C socket E14 40W 230V ø 45mm L 75mm lens L 50mm for oven lamp IMPORT		
For models:	AP20, ALP110, ALP120, ALP220, ALP240, ALN110, ALN120, ALN220, ALN240, ALNN120, ALNN220, ALNN230, ALNSO120, ALP110UK, ALN110UK, ALNN220UK, ALF110, ALF220UK, ALNF220, ALF110, ALF120, ALF220, ALF240, ALNF120, ALNF220, ALNF230, ADN220ES, ADF110ES, ADF220ES, ADN110ESP, ADF110ESP, ILP110, ILP110UK, ILN120, ILP111, ILP220, ILP220UK, ILP240, ILP221, ILN110, ILN110UK, ILN120, ILN111, ILN220, ILN220UK, ILN240, ILN221, ILNN220, ILN220UK, ALP110UK...(Other models you can see in the webshop)		

for indicator lights			
			
1			
GEV No.	359656	Ref. No.	0H2639 0K9109 0KC506
description	light bulb socket Ba9s 130V 2W ø 10mm L 28mm		
For models:	AR85, AR85, AR85, AR85, AR85, AR85, AR85, AR85, HC-CS, EBS50L, EBS100L, EBA100L, EBP100L, EBS200L, EBA200L, EBP200L, EBS300L, EBA300L, EBP300L		



			
1			
GEV No.	359807	Ref. No.	OE0016 OK9110
description	light bulb socket Ba9s 24V 2W ø 10mm L 28mm clear		
For models:	FT36EDTS, FT36ESTS, FT36VDTs, FT36VSTs, FT36ED, FT36ES, FT36VD, FT36VS, FT50ED, FT50ES, FT50VD, FT50VS, FT72ED, FT72ES, FT72VD, FT72VS, FT36EDT, FT36EST, FT36VDT, FT36VST, FT50EDT, FT50EST, FT50VDT, FT50VST, FT72EDT, FT72EST, FT72VDT, FT72VST, FT36WED, FT36WES, FT36WVD, FT36WVS, FT50WED, FT50WES, FT50WVD, FT50WVS, FT72WED, FT72WES, FT72WVD, FT72WVS, FT36WEDT, FT36WEST, FT36WVDT, FT36WVST, FT50WEDT, FT50WEST, FT50WVDT, FT50WVST, FT72WEDT, FT72WEST...(Other models you can see in the webshop)		

			
1			
GEV No.	357087	Ref. No.	053894 075026
description	light bulb socket Ba9s 30V 2W ø 10mm L 28mm		
For models:	FCVE10, FCVE20, FV4N, FVGC4, FV4G, FV4E, FV4N, FV4G, FV4E, FVAC041, LO/E480, PLO480/E, LO480EUK, LO480E/63, LO480VAPO-RESTD, PLO480V, LO480V/63-60HZ, LO/E250, PLO250E, LO/E250UK, LO250E/63, LOPE25, LOPE48, LO480Z-VAPORE		

halogen lamp
for socket E14 / E27

			
1			
GEV No.	359728	Ref. No.	006645
description	halogen lamp socket E14 230V 40W ø 25mm lens L 54mm L 80mm temp.-resist. 300°C Qty 1		
For models:	MAX18/35X		

for socket G4 / G6.35 / G9

			
1			
GEV No.	357191	Ref. No.	OC4396 OC9877
description	halogen lamp socket G4 12V 10W temp.-resist. 300°C OSRAM HALOSTAR OVEN		
For models:	FCZ061EAA, FCZ101EAA, FCZ102EAA, FCZ202EAA, FCZ061EAH, FCZ101EAH, FCZ061EAN, FCZ101EAN, FCZ061ETA, FCZ101ETA, FCZ102ETA, FCZ201ETA, FCZ202ETA, FCZ061ETH, FCZ101ETH, FCZ201ETH, FCZ061ETN, FCZ101ETN, FCZ201ETN, FCZ061GAG, FCZ102GAG, FCZ201GAG, FCZ202GAG, FCZ061GAD, FCZ102GAD, FCZ201GAD, FCZ202GAD, FCZ101GTG, FCZ102GTG, FCZ201GTG, FCZ202GTG, FCZ101GTD, FCZ102GTD, FCZ201GTD, FCZ202GTD, FCZ061EBA, FCZ101EBA, FCZ102EBA, FCZ202EBA, FCZ061EBH, FCZ101EBH, FCZ061EBN, FCZ101EBN, FCZ061EBC, FCZ101EBC, FCZ061EBA2, FCZ101EBA2, FCZ102EBA2, FCZ201EBA2, FCZ202EBA2...(Other models you can see in the webshop)		

			
1 500°C			
GEV No.	359596	Ref. No.	0H7038 0H7039 359596 565729 60050471
description	halogen lamp socket G4 12V 10W temp.-resist. 500°C		
For models:	5611-3-10, 5611-3-6, 5611-3-8, 5612-3-10, 5612-3-6, 5612-3-8, 5614-3-10, 5614-3-6, 5614-3-8		

			
1 500°C			
GEV No.	359599	Ref. No.	002956 007056 0C2803 0K2984 0K8586 0KE767 0W1780 60050318
description	halogen lamp socket G4 12V 20W temp.-resist. 500°C		

			
1			
GEV No.	359946	Ref. No.	0C5605 0C5813 0C8662 8085641028
description	halogen lamp socket G9 230V 40W temp.-resist. 300°C		
For models:	MAX18/35X, PDE830, PDE1230, PDE12L30, PDE1830, PDE835, PDE1235, PDE12L35, PDE1835		

linear lamps

halogen lamps

			
1			
GEV No.	359313	Ref. No.	032118 093041 099154 0TTF29
description	halogen lamp socket R7s L 117.6mm 230V 150W IMPORT		
For models:	WMGHUK, DL07/NA, DL14/NA, DL14/AC, DL07/C, DL14/F, DL21/F, DL-P14/F, DLP21/F, SM08C., SM15CP, SM15C., SM15CA., SM15/CS., SM21/CP, SM21C., SM21CA., SM15VP., SM15VA., SM21VP., SM21VA., SMPV07, FSV07C2X, FSV11C3X, FSV15C4X, FSV07C2C, CM07C, FSV11C3C, FSV15C4C, FSV11C3CX, CM07C2, FSV15C4CX, FSV11C3CC, FSV15C4CC, CM11C, CM11C2, CM15C, CM15C2, DI07HWD, SM08C, SM15C, SM15/CS, SM21C, SM15F, SM21F, SMP15F, SMP21F, ZSM08/C, ZSM15/C, ZSM15/CS...(Other models you can see in the webshop)		



infrared lamps

with base type X lug



GEV No.	359617	Ref. No.	0k3359
description	infrared lamp 1000W 220V L 365mm lens L 340mm total length 480mm with mounting strap		

with base type Z ceramic



GEV No.	359625	Ref. No.	0K9756 19250701
description	infrared lamp socket Z-ceramic L 226mm 220-250V 500W cable length 195mm IMPORT		

fridge lamps



GEV No.	358118	Ref. No.	090199
description	light bulb socket E12 40W 130V ø 50mm L 70mm lens L 50mm clear		
For models:	83012201, ARDF110L, ARDF120, ASF110, ADF110, ADF120, ADN240, ADF11060, PROGRE1FUS, RH06RE1FUS, RH06FE1FUS, RH14RE2FUS, RH14FE2FUS, RH06DD2U, RH06DFD2U, RH14DD2FU, RH14DFD2FU, RH14DD3U, RH14DFD3U, MCD650F, MCD650F2, RH06RE1FEU, RH06FE1FEU, RH14RE2FEU, RH14FE2FEU, PR43RE1FEU, RH06RE2HU, RH14RE4HU, RH14FE4HU, RH06FE1FDU, RH14FE2FDU, RH06R1FERU, RH06F1FERU, RH14R2FERU, RH14F2FERU, RH06R1FD4U, RH06REHRU, RH06FE2HRU, RH14RE4HRU, RH14FE4HRU, RH06FD1F, FSD36, RH06FD1FL, RH06FD1FR, RH06FD2F, C06FD2FR, FS25, RS05FD1F, RH06FD1F6, E05COD1C...(Other models you can see in the webshop)		

producer-specific fridge lamps

ELECTROLUX



GEV No.	357106	Ref. No.	081697
description	lamp glass L 103mm W 65mm plastic		
For models:	AP20, ALP110, ALP120, ALP220, ALP240, ALN110, ALN120, ALN220, ALN240, ALNN120, ALNN220, ALNN230, ALNSO120, ALP110UK, ALN110UK, ALNN220UK, ALF110, ALF220UK, ALNF220, ALF110, ALF120, ALF220, ALF240, ALNF120, ALNF220, ALNF230, ADN220ES, ADF110ES, ADF220ES, ADN110ESP, ADF110ESP, ILP110, ILP110UK, ILN120, ILP111, ILP220, ILP220UK, ILP240, ILP221, ILN110, ILN110UK, ILN120, ILN111, ILN220, ILN220UK, ILN240, ILN221, ILNN220, ILN220UK, ALP110UK...(Other models you can see in the webshop)		



GEV No.	357108	Ref. No.	082326
description	socket socket E14 250V mounting ø 27mm mounting thread 1/8"		
For models:	ALP110, ALP120, ALP220, ALP240, ALN110, ALN120, ALN220, ALN240, ALNN120, ALNN220, ALNN230, ALNSO120, ALP110UK, ALN110UK, ALNN220UK, ALF110, ALF220UK, ALNF220, ALF110, ALF120, ALF220, ALF240, ALNF120, ALNF220, ALNF230, ILP110, ILP110UK, ILN120, ILP111, ILP220, ILP220UK, ILP240, ILP221, ILN110, ILN110UK, ILN120, ILN111, ILN220, ILN220UK, ILN240, ILN221, ILNN220, ILNN220UK, ALP110UK, ALN110UK, ALNN220UK, ALF110UK, ALNF220UK, ILF110, ILF110...(Other models you can see in the webshop)		

oven lamps

universal oven lamps

mounting diameter 28.5mm



GEV No.	359317	Ref. No.	0H7040 0K3358 567783
description	oven lamp mounting ø 28.5mm 12V 5W socket G4 temp.-resist. 300°C cable length 300mm		
For models:	5611-3-10, 5611-3-6, 5611-3-8, 5612-3-10, 5612-3-6, 5612-3-8, 5614-3-10, 5614-3-6, 5614-3-8		
spare parts for	359317		
	GEV No.	359308	Ref. No. 0H6582 60050416 7791450300
	oven lamp glass		





GEV No.	359308	Ref. No.	0H6582 60050416 7791450300
description	oven lamp glass		
For models:	5611-3-10, 5611-3-6, 5611-3-8, 5612-3-10, 5612-3-6, 5612-3-8, 5614-3-10, 5614-3-6, 5614-3-8		

mounting diameter 35.5mm











GEV No.	360738	Ref. No.	0E3681
description	oven lamp complete L 69mm W 42mm 250V 15W socket E14 temp.-resist. 350°C connection F6.3x0.8		
For models:	FCV31E3, 7CO30, CCO30G, ECO312CF, OTS100		



			
1			
GEV No.	359718	Ref. No.	0H6105 7722251616
description	oven lamp mounting ø 35.5mm 230V 15W socket E14 temp.-resist. 300°C connection male faston 6.3mm hard glas		
spare parts for	359718		
		GEV No.	359701
		Ref. No.	002625 0C5508 60050296
	lamp socket socket E14 220-230V mounting ø 35.5mm connection male faston 6.3mm 15W		
		GEV No.	359740
		Ref. No.	—
	light bulb t.max. 300°C socket E14 15W 230V ø 22mm L 48mm lens L 20mm for oven lamp IMPORT		

			
1			
GEV No.	357080	Ref. No.	007055
description	lamp socket socket G4 mounting ø 35.5mm connection cable 2400mm		
For models:	FCZ061EAA, FCZ101EAA, FCZ061EAH, FCZ101EAH, FCZ061EAN, FCZ101EAN, FCZ061ETA, FCZ101ETA, FCZ061ETH, FCZ101ETH, FCZ061ETN, FCZ101ETN, FCZ061GAG, FCZ101GAG, FCZ102GAG, FCZ061GAD, FCZ101GAD, FCZ102GAD, FCZ101GTG, FCZ102GTG, FCZ101GTD, FCZ102GTD, FCZ061EBA, FCZ101EBA, FCZ061EBH, FCZ101EBH, FCZ061EBN, FCZ101EBN, FCZ061EBC, FCZ101EBC, FCZ061EBA2, FCZ101EBA2, FCZ061EBH2, FCZ101EBH2, FCZ061EBN2, FCZ101EBN2, FCZ061EBC2, FCZ101EBC2, FCZ061GBG, FCZ101GBG, FCZ102GBG, FCZ061GBD, FCZ101GBD, FCZ102GBD, FCZ061GBI, FCZ101GBI, FCZ101GBG2, FCZ102GBG2, FCZ101GBD2, FCZ102GBD2...(Other models you can see in the webshop)		

			
1			
GEV No.	359701	Ref. No.	002625 0C5508 60050296
description	lamp socket socket E14 220-230V mounting ø 35.5mm connection male faston 6.3mm 15W		
For models:	FCF/G6-0, FCFG101/0, FCFG102-0, FCFG201-0, FCFG202-0, FCF/E6-0, FCFE101-0, FCFE102-0, FCFE201-0, FCFE202-0, FCF061ELN, FCF101ELN, FCF6EHOR, FCFG10160H, FCF061ENS, FCF101ENS, FCF102ENS, FCF201ENS, FCFG102-0T, FCF/G6-1-JAP, FCF/G101/1-1-JAP, FCF/G102/1-1-JAP, FCFE6-1J, FCFE101-1J, FCFE102-1J, FCF/G101/1, ECF/G6/0, ECFG101-0, ECFG102-0, ECFG201-0, ECFG202-0, ECF/E6-0, ECFE101-0, ECFE102-0, ECFE201-0, ECFE202-0, ECF061ENS, ECF101ENS, ECF102ENS, ECF201ENS, ECF061E5M, ECF061ECV, ACF/G6-0, ACFG101-0, ACFG102-0, ACFG201-0, ACFG202-0, ACF/E6-0, ACFE101-0, ACFE102-0...(Other models you can see in the webshop)		
accessories for	359701		
		GEV No.	359705
		Ref. No.	—
	oven lamp glass thr.ø 33.5mm ø 52mm hard glas temp.-resist. 350°C		
		GEV No.	359709
		Ref. No.	—
	oven lamp glass thr.ø 33.5mm ø 42mm hard glas temp.-resist. 350°C		
		GEV No.	359721
		Ref. No.	—
	gasket silicone ED ø 48mm ID ø 39.5mm thickness 5mm Qty 1 pcs		
		GEV No.	359942
		Ref. No.	—
	oven lamp glass thr.ø 33.5mm ø 41mm hard glas temp.-resist. 350°C		

			
1			
GEV No.	359841	Ref. No.	007105
description	lamp socket socket G4 mounting ø 35.5mm connection cable 3500mm		
For models:	FCZ201EAA, FCZ202EAA, FCZ201EAH, FCZ201EAN, FCZ201ETA, FCZ202ETA, FCZ201ETH, FCZ201ETN, FCZ201GAG, FCZ202GAG, FCZ201GAD, FCZ202GAD, FCZ201GTG, FCZ202GTG, FCZ201GTD, FCZ202GTD, FCZ201EBA, FCZ202EBA, FCZ201EBH, FCZ201EBN, FCZ201EBC, FCZ201EBA2, FCZ202EBA2, FCZ201EBH2, FCZ201EBN2, FCZ201EBC2, FCZ201GBG, FCZ202GBG, FCZ201GBD, FCZ202GBD, FCZ201GBI, FCZ201GBG2, FCZ202GBG2, FCZ201GBD2, FCZ202GBD2, FCZ201GBI2, FCZ201ECA, FCZ202ECA, FCZ201ECH, FCZ201ECN, FCZ201ECA2, FCZ202ECA2, FCZ201ECH2, FCZ201ECN2, FCZ201GCG, FCZ202GCG, FCZ201GCD, FCZ202GCD, FCZ201GCG2, FCZ202GCG2...(Other models you can see in the webshop)		
accessories for	359841		
		GEV No.	359763
		Ref. No.	002626 0F0075 0K8368 0KE752 30001788 60050280
	frame without socket		
		GEV No.	359764
		Ref. No.	002627 0F0071 0K8365
	lamp glass ø 44mm		
		GEV No.	359765
		Ref. No.	002628 0F0150 0K8376 60050281
	lamp holder ID ø 38mm ED ø 76mm		



			
1			
GEV No.	359762	Ref. No.	002709 006106 0C1555 60050279
description	lamp socket socket G4 mounting ø 35.5mm connection cable 450mm		
For models:	FCV/G10L3, FCV/G6L3TOWNGAS, FCV/G6L3, FCVG10L3T, FCVG102L3, FCV/E101/1, FCV/G20L3, FCVG202L3, FCVE6L3J, FCV/E10L3JAP, FCV/E102/1L3JAP, FCV/E10L6JAP, FCV/E102/1L6JAP, FCV/G6L-3JAP, FCVG10L3J, FCVG102L3J, FCV/G10L6JAP, FCV/G102/1L6JAP, FCVG6L3CJ, FCV/E61/1, FCV/G10L2, FCV/E61/1, FCV/E101/1, FCV/E101/1, FCV/E10L2, FCV/E102/1, FCV/E61/1, FCV/E61/1, FCV/E101/1, FCV/E101/2, FCV/G6L3C, FCV/G61/1, FCV/G61/1, FCV/G61/1, FCV/G61/1, FCVG6L3CT, FCVG6L3CJ, FCV/E10L3, FCV/E102/1, FCV/E6L3, FCV/E102/1L3, FCV/E20L3, FCVE202L3, FCV/G6L4, FCV/E6L4, FCV/E101/1, FCV/G10L6, FCV/E10L6, FCV/G102/1L6, FCV/E102/1L6...(Other models you can see in the webshop)		

mounting diameter 65.5mm			
			
1			
GEV No.	357078	Ref. No.	033804
description	oven lamp mounting ø 65.5mm 230V 40W socket G9 temp.-resist. 300°C connection male faston 6.3mm hard glas		
For models:	MP712BT, MP928BT, MC2036BT, MPV920BT, MPV924BT, MCV2032BT, BP1124BT, BC1432BT, BC1832BT, BC2232BT, EP1112T, EP1428T, EC1428T, EC1828T, EC2228T, EP1116T, EP1120T, EP1124T, EP1128T, EP1132T, EP1136T, EP1140T, EP1412T, EP1416T, EP1420T, EP1424T, EP1432T, EP1436T, EP1440T, EC1412T, EC1416T, EC1420T, EC1424T, EC1432T, EC1436T, EC1440T, EC1816T, EC1820T, EC1824T, EC1832T, EC1836T, EC1840T, EC2220T, EC2224T, EC2232T, EC2236T, EC2240T, MPV712BT, MPV716BT, MPV720BT...(Other models you can see in the webshop)		

mounting diameter 47.8mm			
			
1			
GEV No.	357187	Ref. No.	056708
description	oven lamp mounting ø 47.8mm 230V 15W socket E14 temp.-resist. 300°C connection male faston 6.3mm hard glas		
For models:	FZG18, FZE18, FPE30, FPE18, FZ/G18, FZ/E18, FP/E30, FP/E18		
spare parts for	357187		
	GEV No.	359610	Ref. No. 0A2883 0H7035 0K6588 0KE265 0KS867 3000031017 6061052 E767
	light bulb t.max. 300°C socket E14 15W 230V ø 22mm L 47mm lens L 20mm for oven lamp type Philips		
	GEV No.	359725	Ref. No. —
	oven lamp glass thread ø 44mm H 43mm ø 54mm hard glas temp.-resist. 350°C		

			
1			
GEV No.	359022	Ref. No.	004160
description	lamp socket socket E14 mounting ø 65.5mm connection male faston 6.3mm		
For models:	MAX18/35X, ZCMDG6, ZCMDE6, ZCBDE12, ZCMME6, ZCBME12, ZCMDG4, ZCMDE4, ZCBDE8, ZCMME4, ZCBME8, ZCMDG9, ZCMDE9, ZCBDE18, ZCMME9, ZCBME18, ZCBDG8, ZCBDG12, ZCBDG18, FFPS16, FFPS32, PDE830, PDE1230, PDE12L30, PDE1830, PDE835, PDE1235, PDE12L35, PDE1835, PME430, PME630, PME6L30, PME930, PME435, PME635, PME6L35, PME935, PME830, PME1230, PME12L30, PME1830, PME835, PME1235, PME12L35, PME1835		





			
1			
GEV No.	359724	Ref. No.	003451 004163
description	oven lamp glass thread ø 62mm H 46mm ø 74mm hard glas temp.-resist. 350°C		
For models:	MAX18/35X, ZCMDG6, ZCBDE12, ZCMME6, ZCBME12, ZCMDG4, ZCBDE8, ZCMME4, ZCBME8, ZCMDE9, ZCBDE18, ZCMME9, ZCBME18, ZCBDG8, ZCBDG12, ZCBDG18, FFPS16, FFPS32, ZMMDG4, ZMBDG8, ZMMDG4, ZMMDG6, ZMBDG12, ZMMDG6, FPS/18, FPS/30, PDE830, PDE1230, PDE12L30, PDE1830, PDE835, PDE1235, PDE12L35, PDE1835, PME430, PME630, PME6L30, PME930, PME435, PME635, PME6L35, PME935, PME830, PME1230, PME12L30, PME1830, PME835, PME1235, PME12L35, PME1835		





 <p>1</p>			
GEV No.	357083	Ref. No.	005875
description	sealing ring metal ID ø 62.5mm ED ø 80mm thickness 3mm		
For models:	MAX18/35X, ZCMM6, ZCBME12, ZCMM4, ZCBME8, ZCMM9, ZCBME18, PDE830, PDE1230, PDE12L30, PDE1830, PDE835, PDE1235, PDE12L35, PDE1835, PME430, PME630, PME6L30, PME930, PME435, PME635, PME6L35, PME935, PME830, PME1230, PME12L30, PME1830, PME835, PME1235, PME12L35, PME1835		

55x70mm			
 <p>1</p>			
GEV No.	357164	Ref. No.	OKL472
description	oven lamp complete 230V 25W socket G9 rectangular connection male faston 6.3mm L 70mm W 55mm		
For models:	HCCS20W, HCCS20W, A-O-H/S, A-O-H/W, A-O-H/PT, A-O-H/M50, A-O-H/M60, HC-CS, HC-CS		

55x100mm			
 <p>1</p>			
GEV No.	359698	Ref. No.	054991 055021 0G3691 77722210423
description	lamp socket L 100mm W 55mm socket E14 connection male faston 6.3mm		
For models:	FCFG40, FCFG41, FCFG40D, FCFG40F, PFCFG40F, FCFE40, FCFE40D, FCFE40UK, PFCFE40F, FCFG40J, FCFE40J, FCFE40J, FCFG41J, FCFG40J, FCVE6-1U, FCVE6-3U, FCVE6-1, FCVE6-3, FCVE6-3CE, FCVE6-1UK, FCVE6-3UK, FCVG6-1, FCVG6-3, FCVG6-1UK, FCVG6-3UK, FCVE10-2, FCVE10-4, FCVE103CE, FCVE10-2UK, FCVE10-4UK, FCVG10-2, FCVG10-4, FCVG10-1SG, FCVG10-2, FCVG10-4D, FCVG10-2UK, FCVG10-4UK, FCVG10-2, FCVG10-4, FCVE20-2, FCVE20-4, FCVE203CE, FCVE20/P-V, FCVE20-2UK, FCVE20-4UK, FCVG20-2, FCVG20-4, FCVG20-2, FCVG20-4D...(Other models you can see in the webshop)		
spare parts for	359698		
	GEV No.	358119	Ref. No. —
frame L 118mm W 72mm mounting distance 143mm for bulb socket			
	GEV No.	358122	Ref. No. —
gasket L 112mm W 68mm silicone thickness 3mm for bulb socket			
	GEV No.	358123	Ref. No. —
lamp glass L 112mm W 68mm			

spare parts for 359698			
	GEV No.	359612	Ref. No.
			004112 004161 054319 054840 056709 0C3044 0C3568 0H2405 0H6613 0K3859 0K6585 0K7928 245812 300003101 440403 91310191 B26E14
light bulb t.max. 300°C socket E14 25W 230V ø 25mm L 56mm lens L 30mm for oven lamp type Philips			
	GEV No.	359714	Ref. No.
			055022 0H2410 0H6672 0K7946
gasket for bulb socket			
	GEV No.	359715	Ref. No.
			0H6989 284255 7872150100
lamp glass L 110mm W 65mm thickness 5mm			
	GEV No.	359716	Ref. No.
			0H7118
frame for bulb socket			







accessories for 359698			
	GEV No.	359612	Ref. No.
			004112 004161 054319 054840 056709 0C3044 0C3568 0H2405 0H6613 0K3859 0K6585 0K7928 245812 300003101 440403 91310191 B26E14
light bulb t.max. 300°C socket E14 25W 230V ø 25mm L 56mm lens L 30mm for oven lamp type Philips			
	GEV No.	359938	Ref. No. —
borosilicate glass L 115mm W 69mm			

 <p>1</p>			
GEV No.	359716	Ref. No.	0H7118
description	frame for bulb socket		
For models:	9030-2, 9031-2		

			
1			
GEV No.	359714	Ref. No.	055022 0H2410 0H6672 0K7946
description	gasket for bulb socket		
For models:	FCFG40, FCFG41, FCFG40D, FCFG40F, PFCFG40F, FCFE40, FCFE40D, FCFE40UK, PFCFE40F, FCFG40J, FCFG40J, FCFE40J, FCFE40J, FCFG41J, FCFG40J, FCVE6-1U, FCVE6-3U, FCVE6-1, FCVE6-3, FCVE6-3CE, FCVE6-1UK, FCVE6-3UK, FCGV6-1, FCGV6-3, FCGV6-1UK, FCGV6-3UK, FCVE10-2, FCVE10-4, FCVE103CE, FCVE10-2UK, FCVE10-4UK, FCGV10-2, FCGV10-4, FCGV10-ISG, FCGV10-2, FCGV10-4D, FCGV10-2UK, FCGV10-4UK, FCGV10-2, FCGV10-4, FCVE20-2, FCVE20-4, FCVE203CE, FCVE20/P-V, FCVE20-2UK, FCVE20-4UK, FCGV20-2, FCGV20-4, FCGV20-2, FCGV20-4D...(Other models you can see in the webshop)		





			
1			
GEV No.	359715	Ref. No.	0H6989 284255 7872150100
description	lamp glass L 110mm W 65mm thickness 5mm		
For models:	9030-2, 9031-2, 9100-2, 9101-2, 9102-2, 9104-2		

			
1			
GEV No.	359698	Ref. No.	054991 055021 0G3691 77722210423
description	lamp socket L 100mm W 55mm socket E14 connection male faston 6.3mm		
For models:	FCFG40, FCFG41, FCFG40D, FCFG40F, PFCFG40F, FCFE40, FCFE40D, FCFE40UK, PFCFE40F, FCFG40J, FCFG40J, FCFE40J, FCFE40J, FCFG41J, FCFG40J, FCVE6-1U, FCVE6-3U, FCVE6-1, FCVE6-3, FCVE6-3CE, FCVE6-1UK, FCVE6-3UK, FCGV6-1, FCGV6-3, FCGV6-1UK, FCGV6-3UK, FCVE10-2, FCVE10-4, FCVE103CE, FCVE10-2UK, FCVE10-4UK, FCGV10-2, FCGV10-4, FCGV10-ISG, FCGV10-2, FCGV10-4D, FCGV10-2UK, FCGV10-4UK, FCGV10-2, FCGV10-4, FCVE20-2, FCVE20-4, FCVE203CE, FCVE20/P-V, FCVE20-2UK, FCVE20-4UK, FCGV20-2, FCGV20-4, FCGV20-2, FCGV20-4D...(Other models you can see in the webshop)		
spare parts for	359698		
	GEV No.	358119	Ref. No. —
frame L 118mm W 72mm mounting distance 143mm for bulb socket			
	GEV No.	358122	Ref. No. —
gasket L 112mm W 68mm silicone thickness 3mm for bulb socket			
	GEV No.	358123	Ref. No. —
lamp glass L 112mm W 68mm			



spare parts for 359698			
	GEV No.	359612	Ref. No.
			004112 004161 054319 054840 056709 0C3044 0C3568 0H2405 0H6613 0K3859 0K6585 0K7928 245812 300003101 440403 91310191 B26E14
light bulb t.max. 300°C socket E14 25W 230V ø 25mm L 56mm lens L 30mm for oven lamp type Philips			
	GEV No.	359714	Ref. No.
			055022 0H2410 0H6672 0K7946
gasket for bulb socket			
	GEV No.	359715	Ref. No.
			0H6989 284255 7872150100
lamp glass L 110mm W 65mm thickness 5mm			
	GEV No.	359716	Ref. No.
			0H7118
frame for bulb socket			
accessories for 359698			
	GEV No.	359612	Ref. No.
			004112 004161 054319 054840 056709 0C3044 0C3568 0H2405 0H6613 0K3859 0K6585 0K7928 245812 300003101 440403 91310191 B26E14
light bulb t.max. 300°C socket E14 25W 230V ø 25mm L 56mm lens L 30mm for oven lamp type Philips			
	GEV No.	359938	Ref. No. —
borosilicate glass L 115mm W 69mm			

			
1			
GEV No.	359765	Ref. No.	002628 0F0150 0K8376 60050281
description	lamp holder ID ø 38mm ED ø 76mm		
For models:	FCZ061EAA, FCZ101EAA, FCZ102EAA, FCZ201EAA, FCZ202EAA, FCZ061EAH, FCZ101EAH, FCZ201EAH, FCZ061EAN, FCZ101EAN, FCZ201EAN, FCZ061ETA, FCZ101ETA, FCZ102ETA, FCZ201ETA, FCZ202ETA, FCZ061ETH, FCZ101ETH, FCZ201ETH, FCZ061ETN, FCZ101ETN, FCZ201ETN, FCZ061GAG, FCZ101GAG, FCZ102GAG, FCZ201GAG, FCZ202GAG, FCZ061GAD, FCZ101GAD, FCZ102GAD, FCZ201GAD, FCZ202GAD, FCZ101GTG, FCZ102GTG, FCZ201GTG, FCZ202GTG, FCZ101GTD, FCZ102GTD, FCZ201GTD, FCZ202GTD, FCZ061EBA, FCZ101EBA, FCZ102EBA, FCZ201EBA, FCZ202EBA, FCZ061EBH, FCZ101EBH, FCZ201EBH, FCZ061EBN, FCZ101EBN...(Other models you can see in the webshop)		

			
1			
GEV No.	359762	Ref. No.	002709 006106 0C1555 60050279
description	lamp socket socket G4 mounting ø 35.5mm connection cable 450mm		
For models:	FCV/G10L3, FCV/G6L3TOWNGAS, FCV/G6L3, FCV/G10L3T, FCV/G102L3, FCV/E101/1, FCV/G20L3, FCV/G202L3, FCVE6L3J, FCV/E10L3JAP, FCV/E102/1L3JAP, FCV/E10L6JAP, FCV/E102/1L6JAP, FCV/G6L3JAP, FCV/G10L3J, FCV/G102L3J, FCV/G10L6JAP, FCV/G102/1L6JAP, FCV/G6L3CJ, FCV/E61/1, FCV/G10L2, FCV/E61/1, FCV/E101/1, FCV/E101/1, FCV/E10L2, FCV/E102/1, FCV/E61/1, FCV/E61/1, FCV/E101/1, FCV/E101/2, FCV/G6L3C, FCV/G61/1, FCV/G61/1, FCV/G61/1, FCV/G61/1, FCV/G6L3CT, FCV/G6L3CJ, FCV/E10L3, FCV/E102/1, FCV/E6L3, FCV/E102/1L3, FCV/E20L3, FCVE202L3, FCV/G6L4, FCV/E6L4, FCV/E101/1, FCV/G10L6, FCV/E10L6, FCV/G102/1L6, FCV/E102/1L6...(Other models you can see in the webshop)		

			
1			
GEV No.	359841	Ref. No.	007105
description	lamp socket socket G4 mounting ø 35.5mm connection cable 3500mm		
For models:	FCZ201EAA, FCZ202EAA, FCZ201EAH, FCZ201EAN, FCZ201ETA, FCZ202ETA, FCZ201ETH, FCZ201ETN, FCZ201GAG, FCZ202GAG, FCZ201GAD, FCZ202GAD, FCZ201GTG, FCZ202GTG, FCZ201GTD, FCZ202GTD, FCZ201EBA, FCZ202EBA, FCZ201EBH, FCZ201EBN, FCZ201EBC, FCZ201EBA2, FCZ202EBA2, FCZ201EBH2, FCZ201EBN2, FCZ201EBC2, FCZ201GBG, FCZ202GBG, FCZ201GBD, FCZ202GBD, FCZ201GBI, FCZ201GBG2, FCZ202GBG2, FCZ201GBD2, FCZ202GBD2, FCZ201GBI2, FCZ201ECA, FCZ202ECA, FCZ201ECH, FCZ201ECN, FCZ201ECA2, FCZ202ECA2, FCZ201ECH2, FCZ201ECN2, FCZ201GCG, FCZ202GCG, FCZ201GCD, FCZ202GCD, FCZ201GCG2, FCZ202GCG2...(Other models you can see in the webshop)		
accessories for	359841		
	GEV No.	359763	Ref. No. 002626 0F0075 0K8368 0KE752 30001788 60050280
frame without socket			
	GEV No.	359764	Ref. No. 002627 0F0071 0K8365
lamp glass ø 44mm			
	GEV No.	359765	Ref. No. 002628 0F0150 0K8376 60050281
lamp holder ID ø 38mm ED ø 76mm			

			
1			
GEV No.	360647	Ref. No.	0C4459
description	reflector		
For models:	FCZ061EAA, FCZ101EAA, FCZ102EAA, FCZ201EAA, FCZ202EAA, FCZ061EAH, FCZ101EAH, FCZ201EAH, FCZ061EAN, FCZ101EAN, FCZ201EAN, FCZ061ETA, FCZ101ETA, FCZ102ETA, FCZ201ETA, FCZ202ETA, FCZ061ETH, FCZ101ETH, FCZ201ETH, FCZ061ETN, FCZ101ETN, FCZ201ETN, FCZ061GAG, FCZ101GAG, FCZ102GAG, FCZ201GAG, FCZ202GAG, FCZ061GAD, FCZ101GAD, FCZ102GAD, FCZ201GAD, FCZ202GAD, FCZ101GTG, FCZ102GTG, FCZ201GTG, FCZ202GTG, FCZ101GTD, FCZ102GTD, FCZ201GTD, FCZ202GTD, FCZ061EBA, FCZ101EBA, FCZ102EBA, FCZ201EBA, FCZ202EBA, FCZ061EBH, FCZ101EBH, FCZ201EBH, FCZ061EBN, FCZ101EBN...(Other models you can see in the webshop)		

			
1			
GEV No.	359376	Ref. No.	054320
description	lamp socket socket E14		
For models:	FCF/E4, FCF/E4-3KW, FCF/E4-OLD, FCF/E4D, FCFE4PH, JCF/E4, JCF/E4, ECF/E4, ECF/E4-3KW, FCF/E4OLD3, ACF/E4, ACF/E4-3KW, FCF/E4OLD4, NCF/E4, FCF/E4OLD2, FCF/E4OLD1, FCF/E4D, ZCF/E4, ZCF/E4		
accessories for	359376		
	GEV No.	359377	Ref. No. 054318
oven lamp glass H 30mm ø 47mm			





			
1			
GEV No.	359377	Ref. No.	054318
description	oven lamp glass H 30mm ø 47mm		
For models:	FCF/E4, FCF/E4-3KW, FCF/E4-OLD, FCF/E4D, FCFE4PH, JCF/E4, JCF/E4, ECF/E4, ECF/E4-3KW, FCF/E4OLD3, ACF/E4, ACF/E4-3KW, FCF/E4OLD4, NCF/E4, FCF/E4OLD2, FCF/E4OLD1, FCF/E4D, ZCF/E4, ZCF/E4		
accessories for	359377		
			
GEV No.	359376	Ref. No.	054320
	lamp socket socket E14		

			
1			
GEV No.	359611	Ref. No.	081696 050596
description	light bulb t.max. 300°C socket E14 40W 230V ø 45mm L 75mm lens L 50mm for oven lamp IMPORT		
For models:	AP20, ALP110, ALP120, ALP220, ALP240, ALN110, ALN120, ALN220, ALN240, ALNN120, ALNN220, ALNN230, ALNSO120, ALP110UK, ALN110UK, ALNN220UK, ALF110, ALF220UK, ALNF220, ALF110, ALF120, ALF220, ALF240, ALNF120, ALNF220, ALNF230, ADN220ES, ADF110ES, ADF220ES, ADN110ESP, ADF110ESP, ILP110, ILP110UK, ILN120, ILP111, ILP220, ILP220UK, ILP240, ILP221, ILN110, ILN110UK, ILN120, ILN111, ILN220, ILN220UK, ILN240, ILN221, ILNN220, ILN220UK, ALP110UK...(Other models you can see in the webshop)		

lamps			
light bulbs			
			
1			
GEV No.	359610	Ref. No.	0A2883 0H7035 0K6588 0KE265 0KS867 3000031017 6061052 E767
description	light bulb t.max. 300°C socket E14 15W 230V ø 22mm L 47mm lens L 20mm for oven lamp type Philips		

halogen lamps			
for socket E14 / E27			
			
1			
GEV No.	359728	Ref. No.	006645
description	halogen lamp socket E14 230V 40W ø 25mm lens L 54mm L 80mm temp.-resist. 300°C Qty 1		
For models:	MAX18/35X		

			
1			
GEV No.	359612	Ref. No.	004112 004161 054319 054840 056709 0C3044 0C3568 0H2405 0H6613 0K3859 0K6585 0K7928 245812 300003101 440403 91310191 B26E14
description	light bulb t.max. 300°C socket E14 25W 230V ø 25mm L 56mm lens L 30mm for oven lamp type Philips		
For models:	HCCS20W, HCCS20W, FCF02EV, FCF02EOEM, FCF/G6-0, FCFG101/0, FCFG102-0, FCFG201-0, FCFG202-0, FCF/E6-0, FCFE101-0, FCFE102-0, FCFE201-0, FCFE202-0, FCF061ELN, FCF101ELN, FCF6EHOR, FCFG10160H, FCF061ENS, FCF101ENS, FCF102ENS, FCF201ENS, FCFG102-OT, FCF/G6-1-JAP, FCF/G101/1-1-JAP, FCF/G102/1-1-JAP, FCFE6-1J, FCFE101-1J, FCFE102-1J, FCF/G101/1, FCF/E3, FCF/E4, FCF/E4-3KW, FCF4E, FCF4E-3KW, FCF/E2, FCF/E2D, FCF/E2UK, FCF/E4-OLD, FCF/E4D, FCFE4PH, FCFG40, FCFG41, FCFG40D, FCFG40F, PFCFG40F, FCFE40, FCFE40D, FCFE40UK, PFCFE40F...(Other models you can see in the webshop)		

for socket G4 / G6.35 / G9			
			
1			
GEV No.	357191	Ref. No.	0C4396 0C9877
description	halogen lamp socket G4 12V 10W temp.-resist. 300°C OSRAM HALOSTAR OVEN		
For models:	FCZ061EAA, FCZ101EAA, FCZ102EAA, FCZ202EAA, FCZ061EAH, FCZ101EAH, FCZ061EAN, FCZ101EAN, FCZ061ETA, FCZ101ETA, FCZ102ETA, FCZ201ETA, FCZ202ETA, FCZ061ETH, FCZ101ETH, FCZ201ETH, FCZ061ETN, FCZ101ETN, FCZ201ETN, FCZ061GAG, FCZ102GAG, FCZ201GAG, FCZ202GAG, FCZ061GAD, FCZ102GAD, FCZ201GAD, FCZ202GAD, FCZ101GTG, FCZ102GTG, FCZ201GTG, FCZ202GTG, FCZ101GTD, FCZ102GTD, FCZ201GTD, FCZ202GTD, FCZ061EBA, FCZ101EBA, FCZ102EBA, FCZ202EBA, FCZ061EBH, FCZ101EBH, FCZ061EBN, FCZ101EBN, FCZ061EBC, FCZ101EBC, FCZ061EBA2, FCZ101EBA2, FCZ102EBA2, FCZ201EBA2, FCZ202EBA2...(Other models you can see in the webshop)		

			
1			
GEV No.	359596	Ref. No.	0H7038 0H7039 359596 565729 60050471
description	halogen lamp socket G4 12V 10W temp.-resist. 500°C		
For models:	5611-3-10, 5611-3-6, 5611-3-8, 5612-3-10, 5612-3-6, 5612-3-8, 5614-3-10, 5614-3-6, 5614-3-8		



lamp accessories

gaskets



1

GEV No.	359766	Ref. No.	OK2106 246314
description	gasket L 100mm W 76mm		
For models:	5611-3-10, 5611-3-6, 5611-3-8, 5612-3-10, 5612-3-6, 5612-3-8, 5614-3-10, 5614-3-6, 5614-3-8		

timers

programme timers



1

GEV No.	360633	Ref. No.	003833 0C8731 0C8755
description	time switch kit 14000F3 operation time 120min impulse electric shaft ø 6x4.6mm shaft L 20mm CDC 230V engines 1 chambers 2		
For models:	FDV40G, FDV40E, FDV40GZ, FDV40EL, FDV40GA, FDV20G, FDV20E, FDV20GZ, FDV20EL, FDV20GA, FCF02EV, FCF02EOEM, FCV/G10L3, FCV/G6L3TOWNGAS, FCV/G6L3, FCVG10L3T, FCVG102L3, FCV/G20L3, FCVG202L3, FCVE6L3J, FCV/E10L3JAP, FCV/E102/1L3JAP, FCV/G6L3JAP, FCVG10L3J, FCVG102L3J, FCVG6L3CJ, FCV/G10L2, FCV/E10L2, FCV/G6L3C, FCV/G61/1, FCVG6L3CT, FCVG6L3CJ, FCV/E10L3, FCV/E6L3, FCV/E102/1L3, FCV/E20L3, FCVE202L3, FCF/G6-0, FCFG101/0, FCFG102-0, FCFG201-0, FCFG202-0, FCF/E6-0, FCFE101-0, FCFE102-0, FCFE201-0, FCFE202-0, FCF061ELN, FCF101ELN, FCF6EHOR...(Other models you can see in the webshop)		

GEV No.	350017	Ref. No.	0H6755 0KE659 252205 60050442 WT1597A
description	timer		
For models:	5611-3-6, 5612-3-6, 5614-3-6		

GEV No.	359599	Ref. No.	002956 007056 0C2803 0K2984 0K8586 0KE767 0W1780 60050318
description	halogen lamp socket G4 12V 20W temp.-resist. 500°C		

GEV No.	359946	Ref. No.	0C5605 0C5813 0C8662 8085641028
description	halogen lamp socket G9 230V 40W temp.-resist. 300°C		
For models:	MAX18/35X, PDE830, PDE1230, PDE12L30, PDE1830, PDE835, PDE1235, PDE12L35, PDE1835		

sockets

G4 / G5,3 / G6,35

GEV No.	359304	Ref. No.	0K3362
description	lamp socket socket G4 24V ø 17mm H 9mm connection cable 120mm mounting distance 12mm with 2 hole fixing mounting thread M3 cable length 120mm Qty 1 pcs		

E14

GEV No.	359307	Ref. No.	0K2016
description	lamp socket socket E14 L 28mm with 2 hole fixing		

residual heat indicators

GEV No.	359326	Ref. No.	059047
description	residual heat indicator 4-fold		
For models:	MI/E350, MI/E700, MIF/E700, MI/E350D, MI/E700D, MIF/E700D, MI/E360, MI/E710, MIF/E710, MI/E360D, MI/E710D, MIF/E710D, RI/E1, RI/E2, RIF/E2, RIV/E2, XI/E1, XI/E2, XIF/E2, XIV/E2, JI/E1, JI/E2, JIF/E2, JIV/E2, MI/E1, MI/E2, MIF/E2, MIV/E2, XMI/E360, XMI/E710, XMIF/E710, CI/E710, CIF/E710, PI/E1, PI/E2, PIF/E2, PIV/E2, PI/E1E5, PI/E2E5, PIF/E2E5, OI/E1, OI/E2, OIF/E2, TI/E1, TI/E2, TIF/E2, TIV/E2, TI/E1E5, TI/E2E5, TIF/E2E5...(Other models you can see in the webshop)		

1

GEV No.	360280	Ref. No.	046621 S646604001
description	timer		
For models:	LS360F, LS365F, LS367, LS720F, LSE720DK, LSE720PH, LSE721F, LSE721, LS720, LSE720UK, LS721UK, LSE720D, 652120Z, LS720N, LSE720Z		



1

GEV No.	360283	Ref. No.	068671 S446052314
description	timer		
For models:	LS360DK, LS365, LS365PH, LS360D, LS365D, LS360, LS365, LS360, LS365F, HB3PNT		



1

GEV No.	360005	Ref. No.	069420 069673 069925 0H1278 238011
description	timer BIGATTI D94 engines 1 chambers 1 operation time 20min 230V shaft ømm shaft Lmm manif. no. WE006 motor type 82354021L		
For models:	LTB11, LTB12, LTB22, LTB12UK, LTB22UK, LTB11, LTB22, CRYSTAL 11, CRYSTAL 22		



1

GEV No.	360506	Ref. No.	070310
description	timer BIGATTI D94 engines 1 chambers 3 operation time 120s 230V 50/60Hz shaft ø 6x4.6mm shaft L 28mm manif. no. AD006 motor type UDS40NE1RKZ165		



1

GEV No.	360027	Ref. No.	0R0015 (old version)
description	timer BIGATTI D94 engines 1 chambers 3 operation time 240s 230V shaft ø 6x4.6mm shaft L 28mm manif. no. GEV004 motor type UDS40NE1RK		





1

GEV No.	360508	Ref. No.	OKU798
description	timer BIGATTI engines 1 chambers 2 operation time 60min 230V 50/60Hz shaft ø 6x5mm shaft L 19.5mm manif. no. D94.04 / CCS011 motor type UDS11UD5RKZ253 for oven		



1

GEV No.	360349	Ref. No.	069926	
description	timer CDC 11803 engines 1 chambers 3 operation time 150s 230V shaft ømm shaft Lmm manif. no. 11803F1BEE000.0010 motor type M48R ATS type 11803F1 / 238046			
For models:	LTB11, LTB12, LTB22, LTB11UK, LTB12UK, LTB22UK, LTB11, LTB22, 910-00-021, 910-00-023, 910-00-031, 910-00-033, 911-00-022, 911-00-024, 911-00-032, 911-00-034, CRYSTAL 11, CRYSTAL 22			
spare parts for	360349			
	GEV No.	360673	Ref. No.	—
	 motor kit pinion ø 6.8mm teeth 15 230V voltage AC 50/60Hz turn direction clockwise motor ø 48mm H 18.5mm motor type UDS-40NE1RNZ165 cable length 150mm with holder			



1

GEV No.	360719	Ref. No.	OCA557
description	timer CDC 11902F3 engines 1 chambers 2 operation time 144min 230V shaft ø 6x4.6mm shaft L 20mm manuf. no. 11902F3DFE000.0010		



1

GEV No.	360691	Ref. No.	OR0015
description	timer CDC 11903F1 engines 1 chambers 3 operation time 240s 230V shaft ø 6x4.6mm shaft L 28mm manuf. no. 11903F1AGE000.0010		



1

GEV No.	360524	Ref. No.	OKL019
description	timer CDC 11904 engines 1 chambers 4 operation time 12min 230V shaft ømm shaft Lmm manuf. no. 11904F1 / BDR000.0000 motor type M48R ATS		
spare parts for	360524		
	GEV No.	Ref. No.	—
	motor CDC pinion ø 4.9mm teeth 10 230V voltage AC 50/60Hz turn direction right motor ø 47mm H 19.3mm motor type M48R ATS for timer cable length 260mm 1.9/2.5W		



1

GEV No.	360566	Ref. No.	099423
description	timer CDC 11904 engines 1 chambers 4 operation time 15min 115V 60Hz shaft ømm shaft Lmm manuf. no. 11904F1BEI000.0010 motor type M48R ATS voltage AC		
For models:	FGC33AS42, FGC46AS42, FGC65A42, FGC29AB, FGC29WB, FGC40A, FGC40W, FGC67AB, FGC67WB, FGC90A, FGC90W, FGC143AB, FGC143WB, FGC25A, CB246W, CIM38AB, CIM38WB, CIM85AB, CIM15WB, CIM50AB, FIM50WB, FGC29AB, FGC29WB, CIM38AB, CIM38WB, CIM50AB, FIM50WB, FGC143AB, FGC143WB, CB249A, CB316A, CB425A, CB840A, FGC29AB, , FGC67AB, FGC67WB, FGC143AB, FGC143WB, CIM38AB, CIM38WB, CIM85AB, CIM15WB, CIM50AB, FIM50WB, FGC29WB, C150W, C300A, C300W, CB1565W...(Other models you can see in the webshop)		



1

GEV No.	360733	Ref. No.	OL3674
description	timer CDC 49050V engines 2 chambers 5 operation time 6s / 2min 230V manuf. no. 49050V0AOEFB.1000		





1

GEV No.	360677	Ref. No.	OL3642
description	timer CDC 4905DV engines 2 chambers 5 operation time 6s / 3min 230V		





1

GEV No.	360635	Ref. No.	OL3420
description	timer CDC 4907DV engines 2 chambers 7 operation time 6s / 6min 230V shaft ømm shaft Lmm manuf. no. 4907DV0ASE000.1000 motor type M48R 230V		
spare parts for	360635		
	GEV No.	Ref. No.	—
	motor CDC pinion ø 4.9mm teeth 10 230V voltage AC 50/60Hz turn direction right motor ø 47mm H 19.3mm motor type M48R ATS for timer cable length 260mm 1.9/2.5W		





1

GEV No.	360334	Ref. No.	003833 OK2302
description	timer FIBER P04 engines 1 chambers 2 operation time 120min 230V shaft ø 6x4.6mm shaft L 20mm manuf. no. P045J02W401 motor type M51BJ0R6400 impulse electric		
spare parts for	360334		
	GEV No.	Ref. No.	—
	motor kit pinion ø 6.8mm teeth 15 230V voltage AC 50/60Hz turn direction clockwise motor ø 48mm H 18.5mm motor type UDS-40NE1RNZ165 cable length 150mm with holder		





1

GEV No.	360165	Ref. No.	085285
description	timer FIBER P20 engines 1 chambers 4 operation time 10min 230V shaft ømm shaft Lmm manif. no. P205J04J14 motor type M51B-J0R6400		
For models:	FGC33AS42, FGC46AS42, FGC65A42, FGC24AB, FGC24WB, FGC29AB, FGC29WB, FGC40A, FGC40W, FGC67AB, FGC67WB, FGC90A, FGC90W, FGC143AB, FGC143WB, FGC25A, CB246W, CIM38AB, CIM38WB, CIM85AB, CIM15WB, CIM50AB, FIM50WB, FGC24ABS, FGC24WBAB, FGC29AB, FGC29WB, CIM38AB, CIM38WB, CIM50AB, FIM50WB, FGC143AB, FGC143WB, CB184A, CB249A, CB316A, CB425A, CB840A, FGC24AB, FGC24WB, FGC29AB, , FGC67AB, FGC67WB, FGC143AB, FGC143WB, CIM38AB, CIM38WB, CIM85AB, CIM15WB...(Other models you can see in the webshop)		
spare parts for	360165		
	GEV No.	360673	Ref. No. —
	motor kit pinion ø 6.8mm teeth 15 230V voltage AC 50/60Hz turn direction clockwise motor ø 48mm H 18.5mm motor type UDS-40NE1RNZ165 cable length 150mm with holder		





1

GEV No.	360154	Ref. No.	085329
description	timer FIBER P20 engines 1 chambers 4 operation time 15min 230V shaft ømm shaft Lmm manif. no. P205J04J714 motor type M51B-J0R6400		
For models:	FGC33AS42, FGC46AS42, FGC65A42, FGC29AB, FGC29WB, FGC40A, FGC40W, FGC67AB, FGC67WB, FGC90A, FGC90W, FGC143AB, FGC143WB, FGC25A, CB246W, CIM38AB, CIM38WB, CIM85AB, CIM15WB, CIM50AB, FIM50WB, FGC29AB, FGC29WB, CIM38AB, CIM38WB, CIM50AB, FIM50WB, FGC143AB, FGC143WB, CB249A, CB316A, CB425A, CB840A, FGC29AB, , FGC67AB, FGC67WB, FGC143AB, FGC143WB, CIM38AB, CIM38WB, CIM85AB, CIM15WB, CIM50AB, FIM50WB, FGC29WB, C150W, C300A, C300W, CB1565W...(Other models you can see in the webshop)		
spare parts for	360154		
	GEV No.	360673	Ref. No. —
	motor kit pinion ø 6.8mm teeth 15 230V voltage AC 50/60Hz turn direction clockwise motor ø 48mm H 18.5mm motor type UDS-40NE1RNZ165 cable length 150mm with holder		





1

GEV No.	360167	Ref. No.	085324
description	timer FIBER P20 engines 1 chambers 4 operation time 12min 230V 50/60Hz shaft ømm shaft Lmm manif. no. P205J04J514 motor type M51BJ0R0000		
spare parts for	360167		
	GEV No.	360673	Ref. No. —
	motor kit pinion ø 6.8mm teeth 15 230V voltage AC 50/60Hz turn direction clockwise motor ø 48mm H 18.5mm motor type UDS-40NE1RNZ165 cable length 150mm with holder		





1

GEV No.	360374	Ref. No.	099322
description	timer FIBER P20 engines 1 chambers 4 operation time 8min 230V shaft ømm shaft Lmm		
For models:	MC140AB20, MC140WB20, MC200AB20, MC200WB20, CIM235AB, CIM235WB, VM500W+BI, VM500A+BI, VM350A+BI, VM350W+BI		
spare parts for	360374		
	GEV No.	360673	Ref. No. —
	motor kit pinion ø 6.8mm teeth 15 230V voltage AC 50/60Hz turn direction clockwise motor ø 48mm H 18.5mm motor type UDS-40NE1RNZ165 cable length 150mm with holder		





1

GEV No.	360163	Ref. No.	086213 71086213
description	timer FIBER P23 engines 1 chambers 1 operation time 15min 230V shaft L 30mm manif. no. P235JR1J706 motor type M51BJ0R6400		
spare parts for	360163		
	GEV No.	360673	Ref. No. —
	motor kit pinion ø 6.8mm teeth 15 230V voltage AC 50/60Hz turn direction clockwise motor ø 48mm H 18.5mm motor type UDS-40NE1RNZ165 cable length 150mm with holder		





1

GEV No.	360162	Ref. No.	086034
description	timer FIBER P23 engines 1 chambers 2 operation time 12min 230V manif. no. P235JR2J501 motor type M51BJ0R6400		
spare parts for	360162		
	GEV No.	360673	Ref. No. —
	motor kit pinion ø 6.8mm teeth 15 230V voltage AC 50/60Hz turn direction clockwise motor ø 48mm H 18.5mm motor type UDS-40NE1RNZ165 cable length 150mm with holder		





1

GEV No.	360024	Ref. No.	069419 069669 069674 0A6044 0A6086 0A6087 0H1279 0K3795 238046 238053 360349
description	timer FIBER P25 engines 1 chambers 3 operation time 2min 230V shaft ømm shaft Lmm manif. no. P255J03H3N6 motor type M51B-J0L6400		
spare parts for	360024		
	GEV No.	360674	Ref. No. —
	motor kit pinion ø 6.8mm teeth 15 230V voltage AC 50/60Hz turn direction counterclockwise motor ø 48mm H 18.5mm motor type UDS40NE1RNZ165 cable length 150mm with holder		





1

GEV No.	360277	Ref. No.	049076 049251
description	timer FIBER P25 engines 1 chambers 4 operation time 22.5min 230V shaft ømm shaft Lmm manif. no. P255J04L2F9 motor type M51BJ0R6400		
For models:	LB1WS, LB1WSDP, LB1/TOP, WT1WSDP, LB1WSG, WT2WSDPDI, LB1TOP, WT2TOPDI, LB2WS, LB2WSDP, LB2/TOP, LB2/RBP, WT2WSDP, WT2WSDPD, LB2WSG, WT2WS, WT1WS, WT1TOP, WT2TOP, LB2WSDPDI, LB2WSDPD, LB2TOP, UC2WS, GW1WS, LV1WS, LV1WSDP, LV2WSDP, LV2WS, GW2WSDPG, GW2WSG, GW2WS		
spare parts for	360277		
	GEV No.	360673	Ref. No. —
	motor kit pinion ø 6.8mm teeth 15 230V voltage AC 50/60Hz turn direction clockwise motor ø 48mm H 18.5mm motor type UDS-40NE1RNZ165 cable length 150mm with holder		







1

GEV No.	360073	Ref. No.	048647
description	timer FIBER P25 engines 2 chambers 5 operation time 6s / 2min 230V shaft ømm shaft Lmm manuf. no. P255J05JD84 motor type M51B-J0R6400 / M51BJ0L6400		
spare parts for	360073		
	GEV No.	360673	Ref. No. —
	motor kit pinion ø 6.8mm teeth 15 230V voltage AC 50/60Hz turn direction clockwise motor ø 48mm H 18.5mm motor type UDS-40NE1RNZ165 cable length 150mm with holder		
	GEV No.	360674	Ref. No. —
	motor kit pinion ø 6.8mm teeth 15 230V voltage AC 50/60Hz turn direction counterclockwise motor ø 48mm H 18.5mm motor type UDS40NE1RNZ165 cable length 150mm with holder		





1

GEV No.	360071	Ref. No.	048303
description	timer FIBER P25 engines 2 chambers 5 operation time 6s / 3min 230V shaft ømm shaft Lmm manuf. no. P255J05JB62 motor type M51B-J0R6400 / M51BJ0L6400		
For models:	LS7D, LS7, LS7UK/RP, LV70, LS7F, LS7DEK, LS7/1UK, LS7/9, WT40/9, WT40/F, LS7HD, WT40/J50, WT40UKRP, PH4/WT40, PH4RBP/WT40, WT50/1UKRP, WT50/1, FL700, HYDRA700, Z70		
spare parts for	360071		
	GEV No.	360673	Ref. No. —
	motor kit pinion ø 6.8mm teeth 15 230V voltage AC 50/60Hz turn direction clockwise motor ø 48mm H 18.5mm motor type UDS-40NE1RNZ165 cable length 150mm with holder		
	GEV No.	360674	Ref. No. —
	motor kit pinion ø 6.8mm teeth 15 230V voltage AC 50/60Hz turn direction counterclockwise motor ø 48mm H 18.5mm motor type UDS40NE1RNZ165 cable length 150mm with holder		



1

GEV No.	360278	Ref. No.	049256
description	timer FIBER P25 engines 2 chambers 7 operation time 6s / 6min 230V shaft ømm shaft Lmm manuf. no. P255J07JFK4 motor type M51B-J0R6400 / M51BJ0L6400		
For models:	LB1, LB1WS, LB1WSDP, LB1/RBP, LB1/TOP, LB1/60, WT1WSDP, LB2D-PSAUS, LB1G, LB1WSG, WT2DPDI, WT2WSDPDI, LB1TOP, WT2TOPDI, LB2WS, LB2, LB2WSDP, LB2/TOP, LB2/RBP, LB2WS60, WT2WSDP, WT2WSDPD, LB2WSG, WT2WS, WT1, WT1WS, WT1TOP, WT2TOP, WT1/3DP, WT2/3DP, WT2, LB2DPDI, LB2WSDPDI, LB2WSDPD, LB2TOP, LB2DP3, WT2DPD3, UC1, UC2WS, GW1, GW1WS, GW2DPG, GW2WSDPG, GW2G, GW2WSG, GW2WS, GW2, Z1, Z1/WS, Z1TOP...(Other models you can see in the webshop)		
spare parts for	360278		
	GEV No.	360673	Ref. No. —
	motor kit pinion ø 6.8mm teeth 15 230V voltage AC 50/60Hz turn direction clockwise motor ø 48mm H 18.5mm motor type UDS-40NE1RNZ165 cable length 150mm with holder		



1

GEV No.	360456	Ref. No.	045909 066907
description	timer FIBER P34 engines 1 chambers 2 operation time 36min 230V shaft ø 5X3mm shaft L 22mm manuf. no. P345J02L867 motor type M51BJ0L6400		



1

GEV No.	360051	Ref. No.	0KM738
description	timer FIBER P36 engines 1 chambers 2 operation time 15min 230V shaft ømm shaft Lmm manuf. no. P365JR2J717 motor type M51B-J0R6400		
spare parts for	360051		
	GEV No.	360673	Ref. No. —
	motor kit pinion ø 6.8mm teeth 15 230V voltage AC 50/60Hz turn direction clockwise motor ø 48mm H 18.5mm motor type UDS-40NE1RNZ165 cable length 150mm with holder		





electric timers





1			
GEV No.	350007	Ref. No.	0H6118
description	timer CR5 operation time 120min time spreadmin 2CO at 250V 16A permanent position no impulse electric shaft \varnothing 6x4.6mm shaft L 24mm mounting distance 28mm connection lateral 2-pole		



1			
GEV No.	350015	Ref. No.	OKI405
description	timer MS65 without bell operation time 120min time spreadmin 1CO/1NO at 250V 16A permanent position yes impulse electric shaft \varnothing 6x4.6mm shaft L 23mm mounting distance 28mm connection lateral 2-pole		
For models:	AR170, AR170, AR170, AR170, AR170, AR170, AR170, AR170, AR170		
accessories for	350015		
	GEV No.	110366	Ref. No. —
	knob switch zero mark t.max. $^{\circ}$ C $^{\circ}$ C \varnothing 44mm shaft \varnothing 6x4.6mm shaft flat upper black		
	GEV No.	111206	Ref. No. —
	dial plate graduation 120min permanent position no rotation 10-300 $^{\circ}$ \varnothing 60mm timers knob \varnothing 45mm		



1			
GEV No.	350005	Ref. No.	212622
description	timer MS65 without bell operation time 30min time spreadmin 2CO at 250V 16A permanent position no impulse electric shaft \varnothing 6x4.6mm shaft L 23mm mounting distance 28mm connection lateral 2-pole		
accessories for	350005		
	GEV No.	110366	Ref. No. —
	knob switch zero mark t.max. $^{\circ}$ C $^{\circ}$ C \varnothing 44mm shaft \varnothing 6x4.6mm shaft flat upper black		
	GEV No.	111207	Ref. No. —
	dial plate graduation 30min permanent position no rotation 30-300 $^{\circ}$ \varnothing 60mm timers knob \varnothing 45mm		



1			
GEV No.	350143	Ref. No.	0H6117 OK0484 212606 350006 MSWT6501A
description	timer MS65 without bell operation time 60min time spreadmin 2CO at 250V 16A permanent position no time range 0-60min impulse electric shaft \varnothing 6x4.6mm shaft L 22mm EATON (INVENSYS) ambient temperature max. 85 $^{\circ}$ C 50Hz 2-pole 230V		

mechanical timers



1			
GEV No.	350170	Ref. No.	OG2148 0H6114 0H9817 OK4949 OK5238 16006000 18005374 19000731 212583 26006000 700321 701067
description	timer 600 2-pole operation time 60min impulse mechanical 2NO at 250V 16A permanent position no shaft \varnothing 6x4.6mm shaft L 21mm mounting distance 28mm		



1			
GEV No.	350169	Ref. No.	0H6112 0H6116 16016000
description	timer 601 2-pole operation time 60min impulse mechanical 2CO at 250V 16A permanent position no shaft \varnothing 6x4.6mm shaft \varnothing 6x4.6mm shaft L 21mm mounting distance 28mm connection lateral		

1

GEV No.	350012	Ref. No.	0H6750 0K2269
description	timer 601 with bell 2-pole operation time 120min impulse mechanical 2CO at 250V 16A permanent position yes shaft ø 6x4.6mm shaft L 22mm mounting distance 28mm connection lateral		



1

GEV No.	350105	Ref. No.	0H6113 0H6757
description	timer 601 with bell 2-pole operation time 90min impulse mechanical 1CO/1NO at 250V 16A permanent position yes shaft ø 6x4.6mm shaft L 22mm mounting distance 28mm connection rear		





1

GEV No.	350061	Ref. No.	003431 005216 0C6345 3570057012
description	timer DTJ with bell 2-pole operation time 120min impulse mechanical 2NO at 250V 16A permanent position yes shaft ø 6x4.6mm shaft 6x4.6mm shaft L 24mm mounting distance 28mm connection lateral		
For models:	FCF/E4, FCF/E4-3KW, FCF/E4-OLD, FCF/E4D, FCFE4PH, JCF/E4, JCF/E4, ECF/E4, ECF/E4-3KW, FCF/E4OLD3, ACF/E4, ACF/E4-3KW, FCF/E4OLD4, NCF/E4, FCF/E2, FCF/E4OLD2, FCF/E4OLD1, FCF/E4D, ZCF/E4, ZCF/E4		



1

GEV No.	350030	Ref. No.	0K3053 EMTMC120
description	timer M2 2-pole operation time 120min impulse mechanical 2NO at 250V 16A permanent position no shaft ø 6x4.6mm shaft 6x4.6mm shaft L 23mm mounting distance 28mm connection lateral		
accessories for	350030		
	GEV No.	110366	Ref. No. —
	knob switch zero mark t.max.°C ø 44mm shaft ø 6x4.6mm shaft flat upper black		
	GEV No.	111199	Ref. No. —
	dial plate graduation 120min permanent position no rotation 0-330° ø 60mm timers knob ø 45mm		





1

GEV No.	350032	Ref. No.	0KN622
description	timer M2 2-pole operation time 15min impulse mechanical 2NO at 250V 16A permanent position no shaft ø 6x4.6mm shaft 6x4.6mm shaft L 18mm mounting distance 28mm connection rear		
accessories for	350032		
	GEV No.	110366	Ref. No. —
	knob switch zero mark t.max.°C ø 44mm shaft ø 6x4.6mm shaft flat upper black		
	GEV No.	110371	Ref. No. —
	dial plate graduation 15min permanent position no rotation 30-330° ø 60mm timers knob ø 45mm		





1

GEV No.	350018	Ref. No.	0H6684 350018
description	timer M2 2-pole operation time 60min impulse mechanical 2CO at 250V 16A permanent position yes shaft ø 6x4.6mm shaft 6x4.6mm shaft L 23mm mounting distance 28mm connection lateral		
accessories for	350018		
	GEV No.	110366	Ref. No. —
	knob switch zero mark t.max.°C ø 44mm shaft ø 6x4.6mm shaft flat upper black		
	GEV No.	111202	Ref. No. —
	dial plate graduation 60min permanent position yes rotation 0-300° ø 60mm timers knob ø 45mm with permanent position		



1

GEV No.	350009	Ref. No.	056485
description	timer M2 with bell 2-pole operation time 60min impulse mechanical 2NO at 250V 16A permanent position no shaft ø 6x4.6mm shaft 6x4.6mm shaft L 24mm mounting distance 28mm connection lateral		
For models:	FVE3, FVE3, VAPE3		
accessories for	350009		
	GEV No.	110366	Ref. No. —
	knob switch zero mark t.max.°C ø 44mm shaft ø 6x4.6mm shaft flat upper black		
	GEV No.	110373	Ref. No. —
	dial plate graduation 60min permanent position no rotation 30-300° ø 60mm timers knob ø 45mm		

			
1			
GEV No.	350141	Ref. No.	OK6863
description	timer TF 2-pole operation time 120min 2NO at 250V 16A permanent position no shaft ø 6x4.6mm shaft L 23mm mounting distance 28mm mounting thread M3 ambient temperature max. 80°C		

			
1			
GEV No.	350222	Ref. No.	OC3935
description	timer with bell 2-pole operation time 90min impulse mechanical at 250V 16A shaft ø 6x4.6mm shaft L 21mm ambient temperature max. 125°C		
For models:	FCF/E4, FCF/E4-3KW, FCF4E, FCF4E-3KW, ECF4E, ECF4E3KW, ECF/E4, ECF/E4-3KW, ACF/E4, ACF/E4-3KW, ACF4E, ACF4E3KW		

audible timers

			
1			
GEV No.	350036	Ref. No.	004938
description	audible timer operation time 60min ø 55mm shaft ø 6x4.6mm shaft L 22mm mounting distance 28mm		
For models:	PPL5GG, PPFL5GG		

defrost timers

BIGATTI			
			
1			
GEV No.	360188	Ref. No.	0A8781
description	defrost timer BIGATTI type D94.00 defrosting interval 2x per 24h defrosting time 60smin fan delaymin 230V		
For models:	SAL250, ES950, MLP609V11C, MLP609V11V, MLP139V12C, MLP139V12V, MLP602V11C, MLP602V11V, MLP132V12C, MLP132V12V, MLP600V11C, MLP130V12C, 130-00-130.1, KTSM100, KKSM100, KTP100, 13000130.1, KTP100, KTSM100, KKSM100, 130-00-131-1, 13000132.1, 13000131.1, 13000132.1		

			
1			
GEV No.	360058	Ref. No.	081983 082593 0A8088 0T0211 30000514 446092100 640700200 SB382
description	defrost timer type SB3.82 defrosting interval 1-12x in 24h defrosting time 2-54min fan delay 0-15min 230V defr. funct. 1-12x per 24h		
For models:	ICP130, ICN110UK, AEN110, AEN120, AKN111, AEF110, AEF120, AENN120, AENF120, AEN220, AEN240, AEN221, AEF220, AEF240, AENN220, AENF220, AENN230, AENF230, ASN110, ASN111, ASF110, ASN220, ASN221, ASF220, APF113, APF114, APP224/60, AKP110, AKS110, AKP120, AKP111, AKP230, AKP220, AKS220, AKP240, AKP221, AKN110, AKN120, AKN111, AKN230, AKN220, AKN240, AKN221, AKNN120, AKNN220, AKNN230, AKNSO120, IKP110, AKP110UK, AKP220UK...(Other models you can see in the webshop)		

CDC			
			
1			
GEV No.	360193	Ref. No.	094755
description	defrost timer CDC type 13102 defrosting interval 1-12x in 24h defrosting time 2-50min fan delay 0-10min 230V 50Hz defr. funct. 1-12x per 24h with delay of fan 0-10min		

DECO			
			
1			
GEV No.	360056	Ref. No.	0K2267
description	defrost timer DECO type S2N defrosting interval 1x per 24h defrosting time 0-540min fan delaymin 230V outlet 1 channel defr. funct. 1x per 24h		



miscellaneous



1

GEV No.	379008	Ref. No.	082389 082397 082485
description	defrost timer ELIWELL type EWTS70 12V AC/DCV mounting measurements 71x29mm front measurements 74x32mm built-in depth 60mm		
For models:	ILP110, ILP110UK, ILN120, ILP111, ILP220, ILP220UK, ILP240, ILP221, ILN110, ILN110UK, ILN120, ILN111, ILN220, ILN220UK, ILN240, ILNSO120, ILN221, ILNN120, ILNN220, ILNN220UK, ILF110, ILF110, ILF120, ILF220, ILF220UK, ILF240, ILNF120, ILNF220, ILNF220UK, ZLP110, ZLP111, ZLP220, ZLP221, ZLN110, ZLN111, ZLN220, ZLN221, ZLNN220, FVNE061, FVNE132, KVNE662, ZILNN120, KVNE332, ZILNN230, KVNE932, ZILNSO120, ZILN120, FVNE062, ZILNF120, ZILNF230...(Other models you can see in the webshop)		
accessories for	379008		
	GEV No.	379054	Ref. No. 004120 004121 081675 083833 0A2497
transformer primary 230VAC secondary 12VAC 3VA secondary 0.25A H 40mm L 45mm W 50mm connection screw 50/60Hz type 153/M			



1

GEV No.	360187	Ref. No.	084277 084986 0T5163 221286
description	defrost timer type RZ-2001-21 defrosting interval 4H defrosting time 15min fan delay 5min 230V 50Hz defr. funct. 4x per 24h		
For models:	ESMLR60W, ESMLR60S, RFIS24, KZ1502, TE1502, MLP2V2, MLP2V12, MLP3V3, MLP3V22, MLP3V14, MLP4V4, MLP4V32, MLP4V24, C04NVFWD, C04NVGWD, C04NVF4D, C04FISHD, MLP609V11C, MLP609V11V, MLP602V11C, MLP602V11V, MLP139V12C, MLP132V12C, MLP139V12V, MLP132V12V, MLP600V11C, MLP130V12C, E04N6VAC, E04N4VAC, E04N4VAC		

alarm devices

alarm units



1

GEV No.	350056	Ref. No.	055368 0A2504 0A2505 0F0169 OKN825
description	alarm device 220-240VAC ømm H 25mm wall-mounted version mounting distancemm 83dB protection IPx0		
For models:	FDV40G, FDV40E, FDV40GZ, FDV40EL, FDV40GA, FDV20G, FDV20E, FDV20GZ, FDV20EL, FDV20GA, RCP/E2S, MCP/E2S, PCP/E2SHP, OCP/E2S, TCP/E2S, TFRE1S12M0, TFRE2D12M0, TFRE1S12M4, TFRE2D12M4, FCF02EV, FCF02EOEM, FCF/G6-0, FCFG101/0, FCFG102-0, FCFG201-0, FCFG202-0, FCF/E6-0, FCFE101-0, FCFE102-0, FCFE201-0, FCFE202-0, FCF061ELN, FCF101ELN, FCF6EHOR, FCFG10160H, FCF061ENS, FCF101ENS, FCF102ENS, FCF201ENS, FCFG102-0T, FCF/G6-1-JAP, FCF/G101/1-1-JAP, FCF/G102/1-1-JAP, FCFE6-1J, FCFE101-1J, FCFE102-1J, FCF/G101/1, FCF/E3, FCF/E2, FCF/E2D...(Other models you can see in the webshop)		

buzzers



1

GEV No.	350050	Ref. No.	0G1057 0H6572 0H6596 0K2031 244123 245527 705559
description	buzzer 230VAC connection male faston 6.3mm screw mounting thread M4 60dB		
For models:	5702-2-2, 5702-2-3, 5704-2-2, 5704-2-3, 5707-2-2, 57074-2-3, 5701-3-2, 5701-3-3, 5702-3-2, 5702-3-3, 5704-3-2, 5704-3-3, 5707-3-2, 5707-3-3, 5611-3-6, 5612-3-6, 5614-3-6		



1

GEV No.	350085	Ref. No.	059001 0G1993 ZZ111162
description	buzzer connection plug-in connection		
For models:	FCVE20/P-V, FCVE10-P, FCVE10PUK, FCGV10-P, FCGV10PUK, FCVE20-P, FCVE20PUK, FCGV20-P, FCGV20PUK, 5611-3-10, 5612-3-10, 5614-3-10		



contactors

ABB

auxiliary contactors



1

GEV No.	380122	Ref. No.	0H6545 0K1879 307P060
description	auxiliary contactor 230VAC AC1 10A AC15 3A connection screw connection contacts 2NO/2NC N22E		
For models:	5611-3-10, 5611-3-6, 5611-3-8, 5612-3-10, 5612-3-6, 5612-3-8, 5614-3-10, 5614-3-6, 5614-3-8, 7538-3, 7738-3		

BENEDIKT & JÄGER

power contactors



1

GEV No.	380777	Ref. No.	0H2643 0K9134
description	auxiliary contactor resistive load 20A 230VAC main contacts 4NO type K2-07A40230		



1

GEV No.	381471	Ref. No.	0C2244
description	power contactor resistive load 110A 230 (AC3/400V) 22kW main contacts 3NO connection screw type K3-50A00		
For models:	FCZ102EAA, FCZ102ETA, FCZ202ETA, FCZ102EBA, FCZ102EBA2, FCZ202EBA2, FCZ102ECA, FCZ102ECA2, FCZ202ECA2, AOS102EAMQ, AOS102EABQ, AOS102EAA1, AOS102EAC1, AOS102EAS1, AOS102EAM1, AOS202EAM1, AOS102EAB1, AOS202EAB1, AOS102EAK1, AOS102EAT1, AOS102ETA1, AOS202ETA1, AOS102ETM1, AOS202ETM1, AOS102ETK1, AOS202ETK1, AOS102EBA1, AOS102EBC1, AOS102EBK1, AOS102EBA2, AOS202EBA2, AOS102EBK2, AOS202EBK2, AOS102ECA1, AOS102ECM1, AOS102ECB1, AOS102ECA2, AOS202ECA2, AOS102ECM2		



1

GEV No.	381184	Ref. No.	048736 0L0286
description	power contactor resistive load 25A 180-210VAC (AC3/400V) 10A/4kW main contacts 3NO auxiliary contacts 1NC connection screw connection type K3-10ND01 180		
For models:	LV32/60, WT302/60, LS33/60, WT303/60, LS61, LS61/60, WT38/M50, WT38PM50, WT38M50/4, EUCIM, EUCIM60, EUCAIUSPH6, LS62, LS62D, LS62/UKRP, LS62F, LV62, LS62/60, LS62/1P, LS62HD, LS63, LS63D, LS63/UKRP, LS63F, LV63, LS63/60, LS63/1P, LS64, LS64/UKRP, LV64, LS64/1P, WT38/M60, WT38PM60, WT38M60/4, WT32/J60, WT32/J50, WT33/M60, WT33/60, LS7/60, WT40/J50, WT40/J60, LS10SW, LS10/50J, LS10/60J, LS12/60, LS12MEX, LS14EA/60, WT65E60, WT65EB60, WT60U44060...(Other models you can see in the webshop)		



1

GEV No.	381472	Ref. No.	0C7622
description	power contactor resistive load 25A 230 (AC3/400V) 4kW main contacts 4NO connection screw		



1

GEV No.	380672	Ref. No.	005170 0H7049 K209A01
description	power contactor resistive load 25A 230VAC (AC3/400V) 10A/4kW main contacts 3NO auxiliary contacts 1NC connection screw connection type K2-09A01230		
For models:	5711-3-6, 5711-3-7, 5711-3-8, 5711-3-10, 5711-3-8CH, 5711-3-10CH, 5712-3-6, 5712-3-7, 5712-3-8, 5712-3-8E, 5712-3-10, 5712-3-8CH, 5712-3-10C, 5711-3-10F, 5711-3-10S, 5704-2-2, 5704-2-3, 5707-2-2, 57074-2-3, 5701-3-3, 5702-3-3, 7747-3/90.KB.(N), 7545-3/85.KB.(N), 7547-3/85.KB.(N), 7545-3/90.KB.(N), 7547-3/90.KB.(N), 7745-3/90.KB.(N), 7745-3/85.KB.(N), 7747-3/85.KB.(N), 7545-3/85.KB.DWD, RFT/E1, RFT/E1E5, RFT/E1M4, RFT/E1M0, 5611-3-10, 5611-3-6, 5611-3-8, 5614-3-10, 5614-3-6, 5614-3-8, 9041-3, 9043-3, 9241-3-0, 9241-3-8, 9243-3-0, 9243-3-8		



			
1			
GEV No.	380773	Ref. No.	
description	power contactor resistive load 25A 230VAC (AC3/400V) 10A/4kW main contacts 3NO auxiliary contacts 1NC connection screw connection type K3-10A10230		
For models:	EBS50, EBS50, EBS50, EBS50, EBV50, EBV50, EBV50, EBV50, EBV50, EBS100, EBS100, EBS100, EBS100, EBV100, EBV100, EBV100, EBV100, EBV100, EBV-C100, EBV-C100, EBV-C100, EBV-C100, EBV-C100, EBS200, EBS200, EBS200, EBS200, EBV200, EBV200, EBV200, EBV200, EBV200, EBV-C200, EBV-C200, EBV-C200, EBV-C200, EBV-C200, EBS300, EBS300, EBS300, EBS300, EBV300, EBV300, EBV300, EBV300, EBV300, EBV-C300, EBV-C300, EBV-C300, EBV-C300...(Other models you can see in the webshop)		

			
1			
GEV No.	380665	Ref. No.	N/A
description	power contactor resistive load 25A 230VAC (AC3/400V) 10A/4kW main contacts 3NO auxiliary contacts 1NO connection screw connection type K2-09A10230		

			
1			
GEV No.	380772	Ref. No.	
description	power contactor resistive load 25A 230VAC (AC3/400V) 10A/4kW main contacts 3NO auxiliary contacts 1NO connection screw connection type K3-10A10230		
For models:	AP20, BC100A, BC100DA, BC100RA, BC100RDA, BC180A, BC180DA, BC180RA, BC180RDA, BC180RPA, BC22, BC44, BC44H, BCF11, BCF22, BCF44, BCF44H, BCF100A, BCF100DA, BCF100RA, BCF100RDA, BCF180A, BCF180DA, BCF180RA, BCF180RDA, BCF180RPA, , BCW061, BCW101, BCW102, BCFW061, BCFW101, BC22, BC44, BC44H, BCF11, BCF22, BCF44, BCF44H, BC120A, BC120RA, BC120A, BCF120A, BCF120RA, BCWS061T, BCFW102, BLAST C/FREEZER, BLAST C/FREEZER, BLAST C/FREEZER, BLAST C/FREEZER...(Other models you can see in the webshop)		
spare parts for	undefined		
accessories for	undefined		

			
1			
GEV No.	380675	Ref. No.	
description	power contactor resistive load 25A 230VAC (AC3/400V) 12A/5.5kW main contacts 3NO auxiliary contacts 1NC connection screw connection type K2-12A01230		
For models:	FCV/E20L3, FCV/E20L6, FVC/E201/1, 5711-3-6, 5711-3-7, 5711-3-8, 5711-3-10, 5711-3-8CH, 5711-3-10CH, 5712-3-6, 5712-3-7, 5712-3-8, 5712-3-8E, 5712-3-10, 5712-3-8CH, 5712-3-10C, 5714-3-6, 5714-3-7, 5714-3-8, 5714-3-8E, 5714-3-10, 5717-3-6, 5712-3-10F, 5712-3-10S, 5701-3-2, 5702-3-2, 5704-3-2, 5704-3-3, ECV/E20T4, ECV/E20T6, ACV/E20C4, ACVE20C6, ZCV/E20T4, ZCV/E20T6, 5611-3-10, 5611-3-6, 5611-3-8, 5612-3-10, 5612-3-6, 5612-3-8, 5614-3-10, 5614-3-6, 5614-3-8		
GEV No.		Ref. No.	0H7050 0K3383 0KE713 582309 K212A01

			
1			
GEV No.	380679	Ref. No.	002168 003598 072881 072882 0K4939 0K6150 0K9125 0KC417 0KE719 0KF296 0K1948 0W0632 11151353 18005215 35500005 63562202 728013 7511209 7835500005
description	power contactor resistive load 25A 230VAC (AC3/400V) 12A/5.5kW main contacts 3NO auxiliary contacts 1NO connection screw connection type K2-12A01230		
For models:	RBR/E2FM, RBR/E2IM, RBK/E2FM, RPI/E260P, RCP/E2S, RF/E1S12E5, RF/E2D12E5, XBR/E2FM, XBR/E2IM, XBK/E2FM, XPI/E260P, JBR/E2FM, MBR/E2FM, MBR/E2IM, MBK/E2FM, MPI/E260P, MCP/E2S, MF/E1S12E5, MF/E2D12E5, PFR/E1S14, PFR/E2D14, HFR/E410, HFR/E810, HFR/E411, HFR/E412, HBR/E820, HBR/E825, HBR/E800, HBR/E805, HPN/EI810, HPN/ED811, HPN/ED816, HPA/ED825, HCP/E400, HCP/E410, HCP/E800, HCP/E810, HCPS/E400, HCPS/E410, ZFR/E410, ZFR/E810, ZFR/E411, ZFR/E412, ZBR/E820, ZBR/E825, ZBR/E800, ZBR/E805, ZPN/EI810, ZPN/ED811, ZPN/ED816...(Other models you can see in the webshop)		

			
1			
GEV No.	380674	Ref. No.	005171 0H7051 0KK107 582310 60050338
description	power contactor resistive load 25A 230VAC (AC3/400V) 12A/5.5kW main contacts 4NO connection screw connection type K2-12A0040230		
For models:	FCV/E20L3, FCVE202L3, FCVE202L6, FVC/E202/1, 5711-3-7, 5711-3-8, 5711-3-10, 5712-3-6, 5712-3-7, 5712-3-8, 5712-3-8E, 5712-3-10, 5712-3-8CH, 5712-3-10C, 5714-3-7, 5714-3-8, 5714-3-8E, 5714-3-10, 5717-3-6, ECVE202T4, ECVE202T6, HLI159-371W.3, HLI159-373.3, HLI259-390W.3, LI159-375.3, LI159-376.3, LI259-372.3, LI259-379.3, LI159-380.3, HLI159-373W.3, HLI159-374.3, HLI259-375W.3, LI159-371.3, LI159-372.3, LI159-379.3, HLI159-371.3, HLI159-372.3, LI159-373.3, LI159-374.3, LI159-385.3, LI159-386.3, LI259-375.3, LI259-376.3, LI259-371.3, LI259-373.3, LI259-374.3, LI259-377.3, LI259-378.3, HLI259-375.3, HLI259-376.3...(Other models you can see in the webshop)		

			
1			
GEV No.	381079	Ref. No.	004012 0E0182 0E2270 0E5568 0K6151 0K8680 0K8733 0K9123 0KC432 0KE712 5SX23407 63562204
description	power contactor resistive load 25A 230VAC (AC3/400V) 16A/7.5kW main contacts 3NO auxiliary contacts 1NO connection screw connection type K2-16A10230		
For models:	FCVG6L3CJ, FCV/E61/1, FCV/E61/1, FCV/E61/1, FCV/E61/1, FCV/E101/1, FCVG6L3CJ, TT210E, D166E, TT210G, T4250, D166ECOP, T4250, T4350, TT130, TT130C, D200E, D200G, DI200E, DI200G, D350E, D350G, D350V, TT350, TT350, TT350, TT600E, TT600G, TT600V, D650E, D650G, D650V, D1000V, T353019, T2130, T2130C, T3190, T3190, T3250_EL, T3250_GAS, T3250_EL, T3250_GAS, T3650, T3650, T3650, T1000, T3350_EL, T3350_GAS, T3350_EL, T3350_GAS...(Other models you can see in the webshop)		

			
1			
GEV No.	380959	Ref. No.	058670 0KZ813 K3-10ND10 24
description	power contactor resistive load 25A 24VAC (AC3/400V) 10A/4kW main contacts 3NO auxiliary contacts 1NO connection screw connection type K3-10ND10 24		
For models:	FCVE6-3CE, FCVE103CE, FCVE203CE, FCVE20/P-V, FCVMG62, FCVE10-P, FCVE10PUK, FCVG10-P, FCVG10PUK, FCVE20-P, FCVE20PUK, FCVG20-P, FCVG20PUK, WTF2ERC, WTF2ELC, WTF2SRC, WTF2SLC, WTF2HERC, WTF2HELC, WTF2HSRC, WTF2HSLC, WTF3ERC, WTF3ELC, WTF3SRC, WTF3SLC, WTF3HERC, WTF3HELC, WTF3HSRC., WTF3HSLC, WTF2ERB., WTF2ELB, WTF2SRB, WTF2SLB, WTF2HERB, WTF2HELB, WTF2HSRB, WTF2HSLB, WTF3ERB, WTF3ELB, WTF3SRB, WTF3SLB, WTF3HERB, WTF3HELB, WTF3HSRB, WTF3HSLB, WTF4HERB, WTF4HELB, WTF4HSRB, WTF4HSLB, WTF2ERA...(Other models you can see in the webshop)		



			
1			
GEV No.	380779	Ref. No.	046994 054259 058004 075723 0E0020 0E1291 0K3968 0K8545 0K9127 0KG583 0L0360 0TR640 30001827 60050202 S648602300 S648608000 S648608700
description	power contactor resistive load 25A 24VAC (AC3/400V) 14A/5.5kW main contacts 3NO auxiliary contacts 1NO connection screw connection type K3-14ND10		
For models:	LV4800HERC, WT200ELP, Z480PESECO, DTVSX, H512LVELEPL, H512LVLEPL, WT150HELG, WT730ERT, WTF4HSRB, WT150ELEPL+RBP, RT10ERCBF, WT140ELP, H522VELECO, WT730WSRTS, CT1915XE, WT100EL, H522LVERC, RT140ERCFC, WT200HERC, RT190ELG, WT95ERF, RT34HDEDEP, CT191DXE, WT790WSLTM, CT190SXV, A/DTEDX, LV4800ELC, RT100ELCG, RT270EDEPLU, RT140EPLS, WT190HEL, WT150SLEPL, RT270HDESECOFWHIRPOO, WTF4HELA, RT2500EDBERGERAND, WT150SLM, WT95SL, FT72VDT, RT4800HDEDEPLBERGERA, WT100SRP, RT142ESECOFWHIRPOOL, RT140EDEPLF, WT150HSLC, CT140EDX, RT100ESECO, FP50A, RT190VDU, WTF4HSLB, H522LVLEPL, RT270EDECO...(Other models you can see in the webshop)		

			
1			
GEV No.	380774	Ref. No.	006437 006438 006879 058805 0KA632 0KI328 60050260 62790702 68767513210 7835500017
description	power contactor resistive load 32A 230VAC (AC3/400V) 18A/7.5kW main contacts 3NO auxiliary contacts 1NO connection screw connection type K3-18ND10		
For models:	BF/E1S12, BFR/E1S14, MCP/E1SH, MCP/E1SUH, MCP/E2SUHS, MCP/E2SH, MCP/E2SUH, MCP/E2SUT, MCP/E2SHB, PBR/E2FM, PBR/E2IM, PMV/E1C, PMV/E2C, PF/E1D05, PF/E1S12, PF/E2D12, PF/E1D05E5, PF/E1S12E5, PF/E2D12E5, PPI/E260P, ECP/E1ELHU, PCP/E2SHP, PCP/E15SH, PCP/E2SH, PCP/E2SH3B, PCP/E1ELH, OBR/E2FM, OBR/E2IM, OMV/E1C, OMV/E2C, OF/E1S12, OF/E2D12, OPI/E260P, OCP/E2S, OCP/E1SH, OCP/E2SH, TBR/E2FM, TBR/E2IM, TMV/E1C, TMV/E2C, TF/E1D05, TF/E1S12, TF/E2D12, TFR/E1S12, TFR/E2D12, TFR/E1S14, TFR/E2D14, TF/E1D05E5, TF/E1S12E5, TF/E2D12E5...(Other models you can see in the webshop)		

			
1			
GEV No.	381176	Ref. No.	0KV658
description	power contactor resistive load 32A 230VAC (AC3/400V) 30A/15kW main contacts 3NO auxiliary contacts 1NO connection screw connection type K3-30A00230		

			
1			
GEV No.	380789	Ref. No.	OK9132 OKC513
description	power contactor resistive load 32A 230VAC main contacts 3 auxiliary contacts 1 with 2 auxiliary contacts NC		

			
1			
GEV No.	381171	Ref. No.	006157 056600 0E0177 0K3969 0K6190 0K9124
description	power contactor resistive load 32A 24VAC (AC3/400V) 22A/11kW main contacts 3NO auxiliary contacts 1NO connection screw connection type K3-22ND10		
For models:	HFH/E430, ZFH/E430, FV4E, FV4E, FT36EDTS, FT36ESTS, FT36VDTs, FT36VSTs, FT36ED, FT36ES, FT36VD, FT36VS, FT50ED, FT50ES, FT50VD, FT50VS, FT72ED, FT72ES, FT72VD, FT72VS, FT36EDT, FT36EST, FT36VDT, FT36VST, FT50EDT, FT50EST, FT50VDT, FT50VST, FT72EDT, FT72EST, FT72VDT, FT72VST, FT36WED, FT36WES, FT36WVD, FT36WVS, FT50WED, FT50WES, FT50WVD, FT50WVS, FT72WED, FT72WES, FT72WVD, FT72WVS, FT36WEDT, FT36WEST, FT36WVDT, FT36WVST, FT50WEDT, FT50WEST...(Other models you can see in the webshop)		



1

GEV No.	380673	Ref. No.	0H7052 OK3384 OK9307 582311
description	power contactor resistive load 45A 230VAC (AC3/400V) 11kW		
For models:	FDV40E, FDV40EL, FDV20E, FDV20EL, FCV/E20L3, FCVE202L3, FCVE202L6, 5717-3-7, 5717-3-8, 5717-3-8E, 5717-3-10, 5717-3-8M, 5717-3-8C, 5711-3-10F, 5711-3-10S, 5707-3-2, 5707-3-3, ECVE202T4, ECVE202T6, ZFT/E1M0, ACVE202C4, ACV/E202/1, ZCV/E202/1, ZCV/E202/1, 5612-3-10, 5612-3-6, 5612-3-8, 5614-3-10, 5614-3-6, 5614-3-8		



1

GEV No.	380521	Ref. No.	005238 OK3385 60050337
description	power contactor resistive load 45A 230VAC (AC3/400V) 23A/11kW main contacts 4NO connection screw connection type K2-23A0040230		
For models:	5717-3-7, 5717-3-8, 5717-3-8E, 5717-3-10, 5717-3-8M, 5717-3-8C		



1

GEV No.	380637	Ref. No.	002167 052329 054928 057950 059943 0H9713 0K4938 0K9129 0KE717 0KI949 0W0690 11151355 11151409 18005214 K223X022
description	power contactor resistive load 45A 230VAC main contacts 3NO auxiliary contacts 1NO connection screw type K2-23A10 230		
For models:	MFR/E740, RFR/E2S40, XFR/E2S40, JFR/E2S40, MFR/E2S40, RFR/E741, CFR/E702, HFR/E418, HFR/E818, HFR/E430, HFR/E830, HFRS/E430, HFR/E431, HFR/E831, HBR/E810, HBR/E815, HBR/E811, HBR/E816, HPN/EI815D, HPN/EI815, HPA/EI825, HPNS/EI815, HPNS/EI815D, ZFR/E418, ZFR/E818, ZFR/E430, ZFR/E830, ZFRS/E430, ZFR/E431, ZFR/E831, ZBR/E810, ZBR/E815, ZBR/E811, ZBR/E816, ZPN/EI815D, ZPN/EI815, ZPNS/EI815, ZPNS/EI815D, AFR/E430, AFR/E830, AFRS/E430, AFR/E431, AFR/E831, ABR/E810, ABR/E815, ABR/E811, ABR/E816, ABR/E810, ABR/E815, ABR/E811...(Other models you can see in the webshop)		



1

GEV No.	381173	Ref. No.	0C9763
description	power contactor resistive load 50A 230VAC (AC3/400V) 24A/11kW main contacts 3NO auxiliary contacts 1NO connection torx type K3-24B00 50/60Hz		

1

GEV No.	381085	Ref. No.	0L0355 648613200
description	power contactor resistive load 50A 230VAC (AC3/400V) 24A/11kW main contacts 3NO auxiliary contacts connection screw connection type K3-24A00230		
For models:	FCZ102EAA, FCZ102ETA, FCZ202ETA, FCZ102EBA, FCZ102EBA2, FCZ202EBA2, FCZ102ECA, FCZ102ECA2, FCZ202ECA2, FCFE101-0, FCFE102-0, FCFE201-0, FCFE202-0, FCF101ELN, FCF101ENS, FCF102ENS, FCF201ENS, FCFE101-1J, FCFE102-1J, ECFE101-0, ECFE102-0, ECFE201-0, ECFE202-0, ECF101ENS, ECF102ENS, ECF201ENS, AOS102EAA1, AOS102EAC1, AOS102EAS1, AOS062EAM1, AOS102EAM1, AOS062EAB1, AOS102EAB1, AOS102EAK1, AOS102EAT1, AOS102ETA1, AOS202ETA1, AOS062ETM1, AOS102ETM1, AOS202ETM1, AOS102ETK1, AOS202ETK1, AOS102EBA1, AOS102EBC1, AOS102EBK1, AOS102EBA2, AOS202EBA2, AOS102EBK2, AOS202EBK2, AOS102ECA1...(Other models you can see in the webshop)		



1

GEV No.	380776	Ref. No.	007104 0G3044 11151645
description	power contactor resistive load 80A 230VAC (AC3/400V) 40A/18.5kW main contacts 3NO auxiliary contacts connection screw connection type K3-40A00230 contacts		
For models:	FCZ201EAA, FCZ202EAA, FCZ201EAH, FCZ201ETA, FCZ202ETA, FCZ201ETH, FCZ201ETN, FCZ201EBA, FCZ202EBA, FCZ201EBH, FCZ201EBC, FCZ201EBA2, FCZ202EBA2, FCZ201EBN2, FCZ201EBC2, FCZ202ECA, FCZ201ECA2, FCZ202ECA2, FCZ201ECH2, FCZ201ECN2, FCS101E44J, FCS101EP4J, FCS201E4, FCS201EP, FCS101EX4J, FCS201EX, CL221, AOS201EA, AOS201EB, AOS201EB5M, AOS201EB6M, AOS102EA2N, AOS102EB2N, AOS202EA2N, AOS202EB2N, AOS201EA0H, AOS201EB0H, AOS202EA, AOS202EB, AOS201EAAQ, AOS201EBAQ, AOS202EAAQ, AOS202EBAQ, AOS102EANQ, AOS102EBN2, AOS202EANQ, AOS202EBN2, AOS201EAHQ, AOS201EBHQ...(Other models you can see in the webshop)		



2

GEV No.	380775	Ref. No.	007080
description	power contactor resistive load 65A 230VAC (AC3/400V) 32A/15kW main contacts 3NO auxiliary contacts connection screw connection type K3-32A00230		
For models:	KPI/E10, KPI/E15, KPI/E15A, KPI/E15H, KPI/E10H, KFR/E1E, KFR/E2F, KFR/E1C, KFR/E2D, KFR/E1CE5, KFR/E2DE5, QPI/E10, QPI/E15, QPI/E15H, QPI/E10H, QFR/E1E, QFR/E2F, QFR/E1C, QFR/E2D, WPI/E10, WPI/E15, WPI/E15A, WPI/E15H, WPI/E10H, WFR/E1E, WFR/E2F, WFR/E1C, WFR/E2D, FCZ101EAA, FCZ102EAA, FCZ101EAH, FCZ101EAN, FCZ201EAN, FCZ101ETA, FCZ102ETA, FCZ201ETA, FCZ202ETA, FCZ101ETH, FCZ201ETH, FCZ101ETN, FCZ201ETN, FCZ101EBA, FCZ102EBA, FCZ101EBH, FCZ101EBN, FCZ201EBN, FCZ101EBC, FCZ201EBC, FCZ101EBA2, FCZ102EBA2...(Other models you can see in the webshop)		



1

GEV No.	380676	Ref. No.	059993 0E2844 0H7054 0KE189 0TRA70 0W2968 0W3846 289700582313 K245A00 K245A01
description	power contactor resistive load 80A 230VAC (AC3/400V) 45A/20kW main contacts 3NO connection screw connection type K2-45A00230		
For models:	EBS50, EBS50, EBS50, EBS50, EBV50, EBV50, EBV50, EBV50, EBV50, EBS100, EBS100, EBS100, EBS100, EBV100, EBV100, EBV100, EBV100, EBV100, EBV-C100, EBV-C100, EBV-C100, EBS200, EBS200, EBS200, EBS200, EBV200, EBV200, EBV200, EBV200, EBV200, EBV-C200, EBV-C200, EBV-C200, EBV-C200, EBS300, EBS300, EBS300, EBS300, EBV300, EBV300, EBV300, EBV300, EBV300, EBV-C300, EBV-C300, EBV-C300, EBV-C300, EBS50...(Other models you can see in the webshop)		



auxiliary contacts



1

GEV No.	380677	Ref. No.	047046 059086 0E0888 0H7044 0K9121 0KC515 11151408 60050473 HN01 S640605500
description	auxiliary contact contacts 1NC AC15 10A for contactors K2/K3 connection screw type HN01 AC1 25A		
For models:	EBS50, EBS50, EBS50, EBS50, EBV50, EBV50, EBV50, EBV50, EBV50, EBS100, EBS100, EBS100, EBS100, EBV100, EBV100, EBV100, EBV100, EBV100, EBV-C100, EBV-C100, EBV-C100, EBS200, EBS200, EBS200, EBS200, EBV200, EBV200, EBV200, EBV200, EBV-C200, EBV-C200, EBV-C200, EBV-C200, EBS300, EBS300, EBS300, EBS300, EBV300, EBV300, EBV300, EBV300, EBV300, EBV-C300, EBV-C300, EBV-C300, EBV-C300, EBV50...(Other models you can see in the webshop)		



1

GEV No.	381086	Ref. No.	OK8700
description	auxiliary contact contacts 1NC AC15 10A for contactors K2/K5 connection screw type HA01 AC1 25A		
For models:	CS7ME4/200-3, CS7ME4/230-3, CS7ME4/400-3N, CS7ME6/400-3N, CS7ME4/400-3N/EO, CS7ME4/400-3/50HZ/MA, CS7ME4/440-3/60HZ/MA, CS7MT4/400-3N, CS7GE4/200-3, CS7GE4/230-3, CS7GE4/400-3N, CS7GE6/400-3N, CS7GE4/400-3N/EO, CS7GE4/400-3/50HZ/MA, CS7GT4/400-3N, CS7LCE4/200-3, CS7LCE4/230-3, CS7LCE4/400-3N, CS7LCE6/400-3N, CS7LCE4/400-3N/EO, CS7LCE4/400-3/50HZ/M, CS7LCE4/440-3/60HZ/M, CS7LCT4/400-3N, CS10ME4/200-3, CS10ME4/230-3, CS10ME6/230-3, CS10ME4/400-3N, CS10ME6/400-3N, CS10ME4/400-3N/EO, CS10ME4/400-3/50HZ/M, CS10ME4/440-3/60HZ/M, CS10MT4/400-3N, CS10MT6/400-3N, CS10GE4/200-3, CS10GE4/230-3, CS10GE6/230-3, CS10GE4/400-3N, CS10GE6/400-3N, CS10GE4/400-3N/EO, CS10GE4/400-3/50HZ/M, CS10GE4/440-3/60HZ/M, CS10GT4/400-3N, CS10GT6/400-3N, CS10LCE4/200-3, CS10LCE4/230-3, CS10LCE6/230-3, CS10LCE4/400-3N, CS10LCE6/400-3N, CS10LCE4/400-3N/EO...(Other models you can see in the webshop)		



1

GEV No.	380678	Ref. No.	046995 0C4704 0E0418 0H7043 0H7045 0K9119 0KA929 0KE890 11151407 1SHN10 60050474 NHI11PKZM0 S640605400
description	auxiliary contact contacts 1NO AC15 10A for contactors K2/K3 connection screw type HN10 AC1 25A		
For models:	EBS50, EBS50, EBS50, EBS50, EBV50, EBV50, EBV50, EBV50, EBS100, EBS100, EBS100, EBS100, EBV100, EBV100, EBV100, EBV100, EBV100, EBV-C100, EBV-C100, EBV-C100, EBV-C100, EBV-C100, EBV-C100, EBV200, EBV200, EBV200, EBV200, EBV200, EBV-C200, EBV-C200, EBV-C200, EBV-C200, EBS300, EBS300, EBS300, EBV300, EBV300, EBV300, EBV300, EBV-C300, EBV-C300, EBV-C300, EBV-C300, EBV-C300, EBV-C300, AOW101EA, AOW101EABU, LC10E, LC12E, CLC12, LACE12M/EI, CLC22...(Other models you can see in the webshop)		



1

GEV No.	380781	Ref. No.	048497 0E5657 0K5986 HA10
description	auxiliary contact contacts 1NO AC15 6A for contactors K2/K5 connection screw type HA10 AC1 25A		
For models:	EBS50, EBS50H, EBS100, EBS100H, EBS150, EBS150H, EBS200, EBS200H, EBS300, EBS300H, EBV50, EBV50H, EBV100, EBV100H, EBV150, EBV150H, EBV200, EBV200H, EBV300, EBV300H, EBVC50, EBVC50H, EBVC100, EBVC100H, EBVC150, EBVC150H, EBVC200, EBVC200H, EBVC300, EBVC300H, EBP100, EBP100M, EBP150, EBP150M, EBP200, EBP200M, EBP300, EBP300M, EBPC100, EBPC100M, EBPC150, EBPC150M, EBPC200, EBPC200M, EBPC300, EBPC300M, MED50H, MED100H, MED150H, MED200H...(Other models you can see in the webshop)		



GENERAL ELECTRIC (AEG)

power contactors



1

GEV No.	380246	Ref. No.	0KQ380
description	power contactor resistive load 25A 400VAC (AC3/400V) 9A/4kW main contacts 3NO auxiliary contacts 1NO connection screw connection type AEG LS4K 10A type GE CL00A 310		
For models:	CUTE0523, CUTE0538, KT055, KT056, K55		



2

GEV No.	380262	Ref. No.	0K3374
description	power contactor resistive load 32A 230VAC (AC3/400V) 17A/7.5kW main contacts 3NO auxiliary contacts 1NC connection screw connection type AEG LS7K01A type GE CL02A 301 H 85mm		

ISKRA (FANAL)

power contactors



1

GEV No.	380211	Ref. No.	086169
description	power contactor 230VAC		



1

GEV No.	380213	Ref. No.	086215
description	power contactor resistive load 20A 230VAC (AC3/400V) 8.5A/5.5kW main contacts 3NO auxiliary contacts 1NO connection screw connection type Fanal DSL7 10 type ISKRA K07M 10		



1

GEV No.	380204	Ref. No.	003027 004206 0K3606 6208
description	power contactor resistive load 25A 230VAC (AC3/400V) 9A/4kW main contacts 3NO auxiliary contacts 1NO connection screw connection type Fanal DSL9 10 type ISKRA KNL9 10		
For models:	SGE350, SGE350, GR35E6U, MAX18/35X, ZCMDE6, ZCBDE12, ZCMDE4, ZCBDE8, ZCMDE9, ZCBDE18, FFPS16, FFPS32		

LOVATO

power contactors



1

GEV No.	380782	Ref. No.	0KD792
description	power contactor resistive load 40A 230VAC (AC3/400V) 12.5kW main contacts 3NO connection screw connection		

MOELLER/EATON

power contactors



1

GEV No.	380493	Ref. No.	0K3375 0K3479
description	contactor resistive load 55A 230VAC main contacts 3NO		



1

GEV No.	380511	Ref. No.	0H6623 DIL0431 DILEM01
description	power contactor resistive load 16A 230VAC main contacts 3NO auxiliary contacts 1NC		
For models:	9481-3, 9482-3, 9581-3, 9582-3		



1

GEV No.	380519	Ref. No.	OK3373 DIL0AM
description	power contactor resistive load 35A 230VAC		



1

GEV No.	380518	Ref. No.	OK3371 582250
description	power contactor resistive load 20A 230VAC		



1

GEV No.	380516	Ref. No.	0H7048 DIL0M11
description	power contactor resistive load 35A 230VAC (AC3/400V) 7.5kW main contacts 3NO auxiliary contacts NC/NO connection screw connection type DIL00M/11		



1

GEV No.	380515	Ref. No.	0H7047 DIL00M10
description	power contactor resistive load 20A 230VAC (AC3/400V) 4kW main contacts 4		

auxiliary contactors



1

GEV No.	380669	Ref. No.	0H6543 DILER31230
description	power contactor resistive load 10A 230VAC main contacts 3NO auxiliary contacts 1NC		
For models:	7585-3/85.KK40.MOTK., 7586-3/85.KK60.MOTK., 7587-3/85.KK80.MOTK., 7588-3/85.KK100.MOTK., 7585-3/90.KK40.MOTK., 7586-3/90.KK60.MOTK., 7587-3/90.KK80.MOTK., 7588-3/90.KK100.MOTK., 7585-5/85.KK40.MOTK., 7586-5/85.KK60.MOTK., 7587-5/85.KK80.MOTK., 7588-5/85.KK100.MOTK., 7589-5/85.KK150.MOTK., 7585-5/90.KK40.MOTK., 7586-5/90.KK60.MOTK., 7587-5/90.KK80.MOTK., 7588-5/90.KK100.MOTK., 7589-5-90.KK150.MOTK., 7569-5/90.KK200.MOTK., 7569-3/85.KK200.MOTK., 7569-3/90.KK200.MOTK., 7569-5/85.KK200.MOTK., 7589-3/85.KK150.MOTK., 7589-3/90.KK150.MOTK., 7769-3/85.KK200.MOTK., 7769-3/90.KK200.MOTK., 7769-5/85.KK200.MOTK., 7769-5/90.KK200.MOTK., 7785-3/85.KK40.MOTK., 7785-3/90.KK40.MOTK., 7785-5/85.KK40.MOTK., 7785-5/90.KK40.MOTK., 7786-3/85.KK60.MOTK., 7786-3/90.KK60.MOTK., 7786-5/85.KK60.MOTK., 7786-5/90.KK60.MOTK., 7787-3/85.KK80.MOTK., 7787-3/90.KK80.MOTK., 7787-5/85.KK80.MOTK., 7787-5/90.KK80.MOTK., 7788-3/85.KK100.MOTK., 7788-3/90.KK100.MOTK., 7788-5/85.KK100.MOTK., 7788-5/90.KK100.MOTK., 7789-3/85.KK150.MOTK., 7789-3/90.KK150.MOTK., 7789-5/85.KK150.MOTK., 7789-5/90.KK150.MOTK., 9045-3, 9047-3...(Other models you can see in the webshop)		



1

GEV No.	380171	Ref. No.	0H6542 0H7046 OK1883 OK2061 OKN149 582249 DILEM10
description	power contactor resistive load 20A 230VAC (AC3/400V) 9A/4kW main contacts 3NO auxiliary contacts 1NO connection screw connection type DILEM 10		



TELEMECANIQUE (Schneider Electric)

power contactors



1	GEV No.	381231	Ref. No.	OKQ438
description	power contactor resistive load 20A 230VAC (AC3/400V) 9A/4kW main contacts 3NO auxiliary contacts 1NO connection screw connection type LC1K0910P7			
For models:	K35, T5, K35, K35-11, K55-01, K35-01, K55-02, T55-01, K35-02, K35-03, K55-03, K35-04, K55-04, S4A3STD, S4A1STD, S8A3STD, S8A1STD, K35-05, K35-06, K55-05, K55-06, K35-07, K35-08, K55-07, K35-09, K55-08, K35-17, K35-15, K35-23, K35-13, K35-21, K55-12, K35-14, K35-16, K35-19, K35-22, K35-20, K35-12, K55-10, K35-24, K35-25, K35-06, K35-05, K35-07, K35-10, K55-09			



1	GEV No.	380479	Ref. No.	OK2051
description	power contactor resistive load 25A 230VAC (AC3/400V) 9A/4kW main contacts 3NO auxiliary contacts 1NO/1NC connection screw connection type LC1D09P7			

ABL SURSUM

motor protection circuit breakers



1	GEV No.	380303	Ref. No.	083472
description	motor protection circuit breaker type Mbs25-063 setting range 4-6.3A (AC3/400V) 3kW			
For models:	BC100A, BC100DA, BC100RA, BC100RDA, BC180A, BC180DA, BC180RA, BC180RDA, BC180RPA, BC44, BC44H, BCF22, BCF100A, BCF100DA, BCF100RA, BCF100RDA, BCF180A, BCF180DA, BCF180RA, BCF180RDA, BCF180RPA, BC44, BC44H, BCF22, BC120A, BC120RA, BCF120A, BCF120RA, BC44, BC44H, BCF22, BC56VA, Crosswise 20, BC56HA, BCF28A, ESBF20, ESBC40, AOCP2028R, AOCP2028RD, AOCP2028RT, ESK40H, AOFP2028R, AOFP2028RD, AOFP2028RT, EABP31, EABC301, AOFP061U, AOFP061TU, AOCP061T...(Other models you can see in the webshop)			

ALLEN BRADLEY

power contactors



1	GEV No.	380517	Ref. No.	0H6547 CA4510
description	power contactor resistive load 20A 230VAC (AC3/400V) 5.3A/2.2kW main contacts 3NO auxiliary contacts 1NO connection screw connection type 100-M05NKF3S			

TRIPUS (Eichhoff)

small relay switches

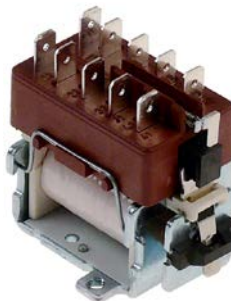

1	GEV No.	380120	Ref. No.	0H6541 240602 307P065
description	small relay switch 230V AC1 16A main contacts 4NO connection Faston 6.3mm type 307P002 resistive load 16A			
For models:	7561-3.KES60.RW, 7562-3.KES80.RW, 7563-3.KES100.RW, 7564-3.KES150.RW, 7720-3/90.WB.GN1/1., 7520-3/85.WB.GN1/1., 7731-3/85.GRPL.VCHR., 7701-3/85, 7721-3/85.WB.GN2/1, 7501-3/85., 7531-3/85., 7501-3/90.HE.4PL.(N), 7531-3/90.GRPL.(N), 7508-3/85., 7502-3/85., 7520-3/90.WB.GN1/1., 7720-3/85.WB.GN1/1., 7561-3/85.KES60.RW., 7562-3/85.KES80.RW., 7563-3/85.KES100.RW., 7564-3/85.KES150.RW., 7561-3/90.KES60.RW., 7562-3/90.KES80.RW., 7563-3/90.KES100.RW., 7564-3/90.KES150.RW., 7500-3/85.HE.2PL.(N), 7503-3/85.HE.6PL, 7504-3/85.HE.6PL.BO, 7505-3/85, 7506-3/85.HE.CER.2KZ, 7507-3/85., 7511-3/85.KF.(N), 7512-3/85.KF.BO.(N), 7530-3/85.GRIPL.(N), 7532-3/85.GRPL.GL-GR, 7521-3/85., 7500-3/90.HE.2PL.(N), 7502-3/90.HE.4PL.BO., 7503-3/90.HE.6PL.(N), 7504-3/90.HE.6PL.BO., 7505-3/90.HE.6PL.BO., 7506-3/90.HE.CER.2KZ, 7507-3/90.HE.CER.4KZ, 7508-3/90.HE.CER.BO., 7511-3/90.KF.(N), 7512-3/90.KF.BO.(N), 7530-3/90.GRIPL.(N), 7532-3/90.GRPL.GL-GR, 7521-3/90.WB.GN2/1., 7700-3/85...(Other models you can see in the webshop)			



1	GEV No.	380119	Ref. No.	0H7194 307P010 60050496
description	small relay switch 230V main contacts 2NO/2NC connection Faston 6.3mm resistive load 16A			



1

GEV No.	380121	Ref. No.	0H6544 0H7193 501966 60050495 601962
description	small relay switch 230V main contacts 3NO/1NC auxiliary contacts knob ø70mm (227-piece) connection Faston 6.3mm type E3250 resistive load 16A		
For models:	7560-3, 7561-3, 7562-3, 7563-3, 7564-2, 9050-3, 9100-3, 9101-3, 9102-3, 9104-3, 9106-3, 9108-3, 9111-3, 9113-3, 9114-3, 9115-3, 9116-3, 9250-3-0, 9250-3-8, 9300-3-0, 9300-3-8, 9301-3-0, 9301-3-8, 9302-3-0, 9302-3-8, 9304-3-0, 9304-3-8, 9306-3-0, 9306-3-8, 9308-3-0, 9311-3-0, 9311-3-8, 9313-3-0, 9313-3-8, 9314-3-0, 9314-3-8, 9315-3-0, 9315-3-8, 9316-3-0, 9316-3-8, 9317-3-8, 9411-3, 9413-3, 9414-3, 9415-3, 9416-3		

miscellaneous

accessories



1

GEV No.	400699	Ref. No.	OG1781
description	switching delay SV3/50 3s 50VA type 52159 suitable for JUNO		
For models:	9190-3, 9191-3, 9193-3, 9195-3, 9390-3, 9391-3, 9393-3, 9395-3		

power contactors



1

GEV No.	380391	Ref. No.	003305 21215 I09313
description	power contactor 230V resistive load 110A (AC3/400V) 55/30kW main contacts 3NO connection screw		
For models:	KPI/E25, QPI/E25, WPI/E25		



1

GEV No.	380157	Ref. No.	0K2053
description	power contactor resistive load 32A		

solid state relays

CRYDOM



1

GEV No.	403038	Ref. No.	0G5742 OK5070
description	solid state relay CRYDOM 1 phase 50A 480V 4-32VDC L 57mm W 45mm screw type CWD4850P		
For models:	CE128-106, CE158-133.3.HV, CE158-244.3, CE158-246.3, CK248-209.D1ABBB, CK248-211.D1ABBB, HCE128-100, HCE128-104, HCE158-252W.3, HCE158-253.3, HLE129-100, HLE129-103, HLE129-104W, HLE159-252W.3.6, HLE159-328.3.HV, HLE159-351W.3.HV, HLE249-200.3, HLE249-208.3, HLE259-088.3.HV, HLE259-089.3.HV, HLE259-384W.3, LE129-101, LE159-261.3, LE159-281.3.6, LE159-318.3.HV, LE159-322.3.HV, LE159-330.3.HV, LE159-337.3.HV, LE159-344.3.MS92, LE159-347.3.HV, LE249-199.3, LE249-203.3, LE249-207.3, LE249-211.3, LE249-215.3, LE249-219.3, LE249-223.3, LE249-232.3, LE249-238.3, LE259-081.3.HV, LE259-082.3.HV, LE259-083.3.HV, LE259-094.3.HV, LE259-099.3.HV, LE259-382.3, LK259-707.D1ACCB, LK259-708.D1ACCB, CK248-205.D1ABBB, CK248-207.D1ABBB, LK159-707.D1BC...(Other models you can see in the webshop)		

relays

power relays

with DIN rail mounting

upper



1

GEV No.	380183	Ref. No.	048265 048438
description	power relays FINDER 230VAC 12A 2CO connection male faston 4.8mm DIN rail manuf. no. 56.32.8.230.0007		
For models:	LB1, LB1WS, LB1/RBP, LB1/60, WT1WSDP, LB1G, LB1WSG, LB2WS, LB2, LB2/RBP, LB2WS60, LB2WSG, WT2WS, WT1, WT1WS, WT2DPAUS, WT2, NGW, NGWDPDD, LS7D, LS7, LS7UK/RP, LV70, LS7F, LS7DEK, LS7/1UK, LS7/9, LS7/60, WT40/9, WT40/F, LS7HD, WT40UKRP, PH4/WT40, PH4RBP/WT40, LS10D, LS10, LS10UKRP, LC100, LS10/60, LS10/1, LS10/12KW, LS10F, LS10DEK, LS10/1UKRP, LS10SW, LS12D, LS12, LS12UK/RP, LC120, LS12/60...(Other models you can see in the webshop)		
accessories for	380183		
	GEV No.	380476	Ref. No. —
	relay socket dimensions 78x27x33.5mm 250V voltage AC 10A FINDER manuf. no. 96.72		

1

GEV No.	380196	Ref. No.	048611
description	power relays FINDER 230VAC 12A 4CO connection male faston 4.8mm DIN rail manuf. no. 56.34.8.230.0007		
For models:	DI-WHW2, DI-WHW3, DI-WHW4, DI-WHW5, DI-WHW6, DI07HWD, DI12HWD, DI14HWD, DI12HWW, DI14HWW, LB1WS, LB1WSDP, LB1/TOP, WT1WSDP, LB1WSG, WT2TOP60, WT2DPDI, WT2WSDPDI, LB1TOP, WT2TOPDI, LB2WS, LB2WSDP, LB2/TOP, LB2/RBP, LB2WS60, WT2WSDP, WT2WSDPD, LB2WSG, WT1WS, WT1TOP, WT2TOP, WT1/3DP, WT2/3DP, LB2DPDI, LB2WSDPDI, LB2WSDPD, LB2TOP, LB2DP3, WT2DPD3, LS10D, LS10, LS10UKRP, LC100, ECOTEMP12-, LS10/60, LS10/1, LS10/12KW, LS10F, LS10DEK, LS10/1UKRP...(Other models you can see in the webshop)		



1

GEV No.	380130	Ref. No.	046318 046380 S648606100
description	power relays Italiana Relè 230VAC 16A 3NO connection male faston 6.3mm screw mounting manuf. no. B1-3-230AC		
For models:	LS360F, LS360DK, LS365F, LS365, LS365PH, LS500F, LS501F, LS540F, LS540DK, LS541F, LS360D, LS365D, LS360, LS365, LS365/63, LS367, LS720F, LSE720DK, LSE720PH, LS860F, LS860DK, LS860PH, LS1080F, LS1080UK, LS1080PH, LSE721F, LS861F, LS540, LS1080M, LS1080, LS1080D, LS1080UK, LS1080/63, LSDS51, LSDS5V, LS500F, LS500UK, LS501, LS501UK, LS540D, LS540/63, LSE721, LS720, LSE720UK, LS721UK, LSE720D, LS541, LS860, LS860, LS860D...(Other models you can see in the webshop)		

with flange mounting



1

GEV No.	380921	Ref. No.	054543 082482 085092
description	plug-in relay 230VAC 16A 2CO connection male faston screw mounting		
For models:	ILN110, ILN110UK, ILN120, ILN220, ILN220UK, ILN240, ILNN120, ILNN220, ILNN220UK, ILNN230, ILF110, ILF110, ILF120, ILF220, ILF220UK, ILF240, ILNF120, ILNF220, ILNF220UK, ILNF230, FCFG20, FCFG20D, FCFG20F, PFCFG20, FCFG40, FCFG41, FCFG40D, FCFG40F, PFCFG40F, FCFG201, FCFG202, FCFG202, SM15F, SM21F, SMP15F, SMP21F, COCO20G, 4236N, ZSM15/F, ZSM21/F, ZSMP15/F, ZSMP21/F, ZLN110, ZLN220, ZLNN220, FVNE061, FVNE132, KVNE662, ZILNN120, KVNE332...(Other models you can see in the webshop)		

with bracket mounting



1

GEV No.	380052	Ref. No.	088267
description	power relays 230VAC 25A 2NO connection male faston 6.3mm flange support		
For models:	, , BC28A6, Crosswise, , BCF15A6, BC15A, Crosswise, BC28A, Crosswise, BCF15A, Crosswise, BC10A, BLAST C/FREEZER, BCF7A, BLAST C/FREEZER, FCZ061EAA, FCZ101EAA, FCZ102EAA, FCZ061EAH, FCZ101EAH, FCZ061EAN, FCZ101EAN, FCZ061ETA, FCZ101ETA, FCZ102ETA, FCZ201ETA, FCZ202ETA, FCZ061ETH, FCZ101ETH, FCZ201ETH, FCZ061ETN, FCZ101ETN, FCZ201ETN, FCZ061EBA, FCZ101EBA, FCZ102EBA, FCZ061EBH, FCZ101EBH, FCZ061EBN, FCZ101EBN, FCZ061EBC, FCZ101EBC, FCZ201EBC, FCZ061EBA2, FCZ101EBA2, FCZ102EBA2, FCZ201EBA2, FCZ202EBA2, FCZ061EBH2...(Other models you can see in the webshop)		



1

GEV No.	380131	Ref. No.	046001 053737 081261
description	power relays Italiana Relè 230VAC 16A 3CO connection male faston 6.3mm screw mounting manuf. no. B2-3-230AC		
For models:	AP20, ILP110, ILP110UK, ILN120, ILP111, ILP220, ILP220UK, ILP240, ILP221, ILN110, ILN110UK, ILN120, ILN111, ILN220, ILN220UK, ILN240, ILN221, ILNN220, ILNN220UK, ILNN230, ILF110, ILF110, ILF120, ILF220, ILF220UK, ILF240, ILNF120, ILNF220, ILNF220UK, ILNF230, FCVE10-2, FCVE10-4, FCVE10-2UK, FCVE10-4UK, FCVG10-2, FCVG10-4, FCVG10-2UK, FCVG10-4UK, FCVE20-2, FCVE20-4, FCVE20-2UK, FCVE20-4UK, FCVG20-2, FCVG20-4, FCVG20-2UK, FCVG20-4UK, ZOFCV/E102, ZOFCV/E104, ZOFCV/G102, ZOFCV/G104...(Other models you can see in the webshop)		



1

GEV No.	380626	Ref. No.	031295 031314 031609 031610 058557 058857 069882 083215 60050261 727944
description	power relays FINDER 230VAC 10A 2CO connection male faston 4.8mm bracket mounting manuf. no. 62.62.8.230.0000		
For models:	BC11, BC22, BC44, BC44H, BCF11, BCF22, BCF44, BCF44H, BCF15A6, , , BCFW061, BCFW101, ALN110, ALN120, ALNN120, ALNN220, ALNN230, ALN110UK, ALNN220UK, ALF110, ALF220UK, ALNF220, ALF110, ALF120, ALF220, ALF240, ALNF120, ALNF220, ALNF230, BC11, BC22, BC44, BC44H, BCF11, BCF22, BCF44, BCF44H, BCWS061T, BCFW102, ALN110UK, ALNN220UK, ALF110UK, ALNF220UK, ALN110, ALN120, ALF110, ALF120, ALF220, ALF240...(Other models you can see in the webshop)		



1

GEV No.	380139	Ref. No.	OPE302
description	power relays FINDER 230VAC 16A 2CO connection F6.3 bracket mounting dimensions 68x38.2x35.8mm manuf. no. 62.82.8.230.0000		
For models:	MTC1200P, MTC1400P, MTC1600P, MTC1800P, MTC2000P, MTC1210P, MTC1410P, MTC1610P, MTC1810P, MTC2010P, MTCD1200P, MTCD1400P, MTCD1600P, MTCD1800P, MTCD2000P, MSR1207, MSR1407, MSR1607, MSR1807, MSR2007, MSR1217, MSR1417, MSR1617, MSR1817, MSR2017, MSRP1207, MSRP1407, MSRP1607, MSRP1807, MSRP2007		



2

GEV No.	380312	Ref. No.	056446 056466 085296 086214 0D0013
description	power relays FINDER 230VAC 10A 3CO connection male faston 4.8mm bracket mounting dimensions 52x32.2x36.5mm manuf. no. 60.63.8.230.0000		
For models:	MCP/G700, 7CPE07P, 7CPG07P, M70EPC, M70GPC, RCP/G700, HBR/G801, HBR/G806, HBR/G811, HBR/G816, HBR/G801D, HBR/G806D, HBR/G811D, HBR/G816D, HBR/E801, HBR/E806, HBR/E811, HBR/E816, ZBR/G801, ZBR/G806, ZBR/G811, ZBR/G816, ZBR/G801D, ZBR/G806D, ZBR/G811D, ZBR/G816D, ZR/G413, BR/E806, ZBR/E811, ZBR/E816, ABR/G801, ABR/G806, ABR/G811, ABR/G816, ABR/G801D, ABR/G806D, ABR/G811D, ABR/G816D, ABR/E801, ABR/E806, ABR/E811, ABR/E816, FCZ061EAA, FCZ101EAA, FCZ102EAA, FCZ061EAH, FCZ101EAH, FCZ061EAN, FCZ101EAN, FCZ061ETA...(Other models you can see in the webshop)		



1

GEV No.	380403	Ref. No.	088197 0A9596
description	power relays FINDER 230VAC 16A 3CO connection F6.3 bracket mounting manuf. no. 62.83.8.230.0500		
For models:	BC100A, BC100DA, BC100RA, BC100RDA, BC180A, BC180DA, BC180RA, BC180RDA, BC180RPA, BCF100A, BCF100DA, BCF100RA, BCF100RDA, BCF180A, BCF180DA, BCF180RA, BCF180RDA, BCF180RPA, AQC119U US, , , BCW061, BCW101, BCW201R, BCW102, BCFW061, BCFW101, BCFW201R, BC120A, BC120RA, BCF120A, BCF120RA, BCWS061T, BCFW102, BLAST C/FREEZER, BLAST C/FREEZER, BLAST C/FREEZER, BLAST C/FREEZER, BLAST C/FREEZER, BLAST C/FREEZER, BCFWS102, BCFWS101, AZF1103, AZF2203, BC56VA, Crosswise 20, BC56HA, BCF28A...(Other models you can see in the webshop)		

1

GEV No.	380702	Ref. No.	005033 005034 0K2397 0K2398 0K2445 0T3793 261956 261957
description	power relays FINDER 230VAC 16A 3NO connection male faston 6.3mm flange dimensions 36x38x68mm manuf. no. 62.83.8.230.0300 230V		
For models:	FCZ102GTG, FCZ102GTD, FCZ102GBG2, FCZ102GBD2, FCZ102GBI2, FCZ102GCG2, FCZ102GCD2, FCV/G20L3, FCVG202L3, FCV/G20L6, FCV/E20L6, FCVG202L6, FCVE202L6, FCV/G201/1, FVC/E201/1, FCV/G202/1, FVC/E202/1, FCS201E4, FCS201EP, FCS202E4, FCS202EP, FCS201G4, FCS201GP, FCS202G4, FCS202GP, FCS201EX, FCS201EXLN, FCS202EX, FCS201GX, FCS202GX, 5711-2-7, 5711-2-8, 5711-2-10, 5711-2-8CH, 5711-2-10CH, 5712-2-7, 5712-2-8, 5712-2-10, 5714-2-6, 5714-2-7, 5714-2-8, 5714-2-10, 5717-2-6, 5714-2-7, 5714-2-8, 5714-2-10, 5711-2-7L, 5711-2-8L, 5711-2-10L, 5712-2-7L...(Other models you can see in the webshop)		



1

GEV No.	381123	Ref. No.	0A9723 SKRM703730
description	power relays SCHRACK 230VAC 16A 3CO connection male faston bracket mounting manuf. no. RM703730 400V		
For models:	ADNN120, ADNF120, AENN120, AENF120, ARDNN120, 83012101, ADNN120, ADNF120, MCD650FP2, EC6N0M2C, EC6N0M2C, EC6N0D2C, EC6M0D2C, C06CD2F, C06CFD2F, C06CFD2FR, C06C-M2F, C06CM2F, RH06DD2F, RH06DD2FR, RH06DFD2F, C06CFD2I, EC6N0D2C, EC6M0D2C, KVPE332, KVNE332, KMNE332, KMNE332		

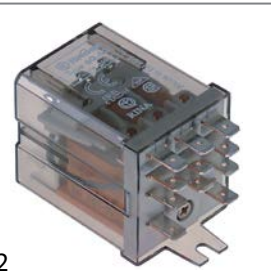

2

GEV No.	380636	Ref. No.	056510 60050217
description	power relays FINDER 24VAC 10A 3CO connection male faston 4.8mm bracket mounting manuf. no. 60.63.8.024.0000		
For models:	BC100A, BC100DA, BC100RA, BC100RDA, BC180A, BC180DA, BC180RA, BC180RDA, BC180RPA, BCF100A, BCF100DA, BCF100RA, BCF100RDA, BCF180A, BCF180DA, BCF180RA, BCF180RDA, BCF180RPA, AQC31U US, AQC60U, AQC119U US, , , BC28A6, Crosswise, , , BC-F15A6, , , BCW061, BCW101, BCW201R, BCW102, BCFW061, BCFW101, BCFW201R, BC120A, BC120RA, BCF120A, BCF120RA, BCWS061T, BCFW102, BLAST C/FREEZER, BLAST C/FREEZER, BLAST C/FREEZER, BLAST C/FREEZER... (Other models you can see in the webshop)		

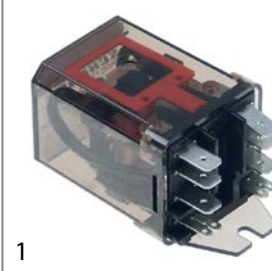

1

GEV No.	380950	Ref. No.	0A9500
description	relay SCHRACK 230VAC 25A 2CO connection F6.3 with mounting strap at 250V 25A manuf. no. RM805730 250V 4-pole		
For models:	SSWC12, SSWC16, SSWC20, SSWB12, SSWB16, SSWB20, DRVAF12, DRVAF16, DRVAF20, DRVP12, DRVP16, DRVP20, ZLRW12C, ZLRW16C, ZLRW20C, ZLRW12B, ZLRW16B, ZLRW20B		

with special fixing



1

GEV No.	380185	Ref. No.	085647
description	power relays Italiana Relè 230VAC 30A 1NO connection F6.3 bracket mounting dimensions 36.5x32.2x51.8mm manuf. no. A10-230AC-FA		
For models:	DLV14/F, DLVT14/F, DLV21/F, DLVT21/F, ZDLV14/F, ZDLVT14/F, DLV21/F, DLVT21/F, ADLV14/F, ADLVT14/F, DLV21/F, DLVT21/F, SMV15/F, SMV21/F, SMV15/F, SMV21/F		



1

GEV No.	380318	Ref. No.	048888
description	power relays SCHRACK 230VAC 16A 2NO connection coded plug manuf. no. 0419 120301 00 2-pole		
For models:	LS32, LS32/4.5, LS32UK/RP, LS32F, LV32F, C55, LV32/60, WT302, WT302/4.5, WT302UK/RP, WT302F, WT302/60, LS33, LS33/4.5, LS33UK/RP, LS33F, LV33F, C55A, LS33/60, WT303, WT303/4.5, WT303UK/RP, WT303F, WT303/60, LS61, LS61/60, WT38/M50, WT-38PM50, WT38M50/4, EUCIM, EUCIM60, EUCAIUSPH6, LS62, LS62D, LS62/UKRP, LS62F, LV62, LS62/60, ECOTEMP5, LS62/1P, LS62HD, LS65, LS62/UK, LS63, LS63D, LS63/UKRP, LS63F, LV63, LS63/60, LS63/1P... (Other models you can see in the webshop)		



with male contacts

bullet connectors, 11 contacts



GEV No.	380132	Ref. No.	OK3700 128657
description	power relays Italiana Relè 230VAC 10A 3CO connection plug-in connection round 11-pole manif. no. C43-230AC ZVE11 250V 11-pole		
accessories for	380132		
	GEV No.	380136	Ref. No. 049236
	relay socket 11-pole connection plug-in connection round 11-pole dimensions 65x28x40mm 250V voltage AC 10A Italiana Relè manif. no. ZVE11		

female contact 4.8mm



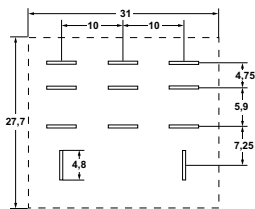

GEV No.	380475	Ref. No.	0H9815 OK4944 18005327 700522 LY2
description	power relays FINDER 220-240VAC 12A 2CO connection F4.8 raster size 10mm plug-in connection manif. no. 56.32.8.230.0040 250V 2-pole connection 4.8mm		
accessories for	380475		
	GEV No.	380476	Ref. No. —
	relay socket dimensions 78x27x33.5mm 250V voltage AC 10A FINDER manif. no. 96.72		





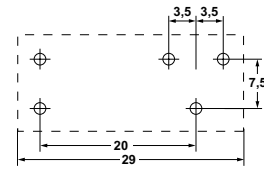

GEV No.	380854	Ref. No.	0E5170 OK8710
description	power relays FINDER 24VAC 16A 3CO connection F4.8 raster size 10mm plug-in connection manif. no. 62.33.8.024.0000 250V connection 4.8mm		
For models:	PW1EFL, PW1EFLF, PW1EFL/60HZ, PW2EFL, PW2EFLF, PW2EFL/60HZ, PW2VFL, WT830EFL, WT830EFLF, WT830EFL/60HZ, WT850, WT850EFL, WT850EFL/60HZ, WT850SFL, FT36EDTS, FT36ESTS, FT36VDTs, FT36VSTs, FT36ED, FT36ES, FT36VD, FT36VS, FT50ED, FT50ES, FT50VD, FT50VS, FT72ED, FT72ES, FT72VD, FT72VS, FT36EDT, FT36EST, FT36VDT, FT36VST, FT50EDT, FT50EST, FT50VDT, FT50VST, FT72EDT, FT72EST, FT72VDT, FT72VST, FT36WED, FT36WES, FT36WVD, FT36WVS, FT50WED, FT50WES, FT50WVD, FT50WVS...(Other models you can see in the webshop)		

plug-in/print relays

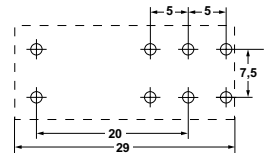

GEV No.	380797	Ref. No.	048791
description	print relay 230VAC 1CO at 250V 10A connection pins raster size 3.5mm FINDER manif. no. 40.31.8.230.0000 95.83.3/95.63		
For models:	LO10		
accessories for	380797		
	GEV No.	380663	Ref. No. —
	relay socket 250V voltage AC 10A FINDER manif. no. 95.83.3		

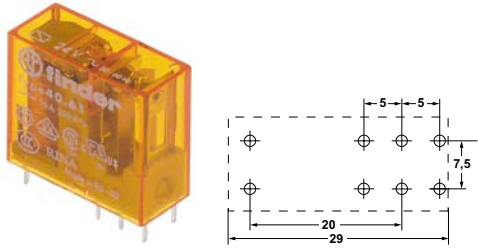

GEV No.	380333	Ref. No.	0E5849 OK4551 OK4947 OK6309 11031629 11031637 18005339
description	print relay 230VAC 2CO at 250V 8A connection pins raster size 5mm FINDER manif. no. 40.52.8.230.0000 95.65/95.75		
For models:	RT10ED, RT10ES, RT10SR, RT10SL, RT10ED/230, RT10ES/230, RT10ERF60, RT10ELF60, RT10ERF, RT10ELF, RT10ERBF60, RT10ELBF60, RT10ERG, RT10ELG, RT10EDH, RT10ESH, RT10SRB, RT10SLB, RT10ED/230H, RT10ES/230H, RT10ERBF, RT10ELBF, RT10ERBG, RT10ELBG, RT10EDECO, RT10ESECO, RT10SRC, RT10SLC, RT10ED/230E, RT10ES/230E, RT10ERCFC, RT10ELCF, RT10ERCG, RT10ELCG, RT10EDHE, RT10ESHE, RT10SRCB, RT10SLCB, RT10ED/230HE, RT10ES/230HE, RT10ERCBF, RT10ELCBF, RT10ERCBG, RT10ELCBG, RT10ERASIA, RT10ELASIA, RT10SRASIA, RT10SLASIA, RT10ERCINA, RT10ELCINA...(Other models you can see in the webshop)		
accessories for	380333		
	GEV No.	380340	Ref. No. —
	relay socket dimensions 62x36x15mm 250V voltage AC 10A Italiana Relè manif. no. ZMEM/5		
	GEV No.	380505	Ref. No. —
	relay socket 2CO 40.52 dimensions 81.9x15.5x75mm 250V voltage AC 10A FINDER manif. no. 95.95.3		
	GEV No.	381181	Ref. No. —
	relay socket 2-pole 40.51/40.52/40.61 connection screw clamp dimensions 15.8x78.6mm 250V voltage AC 10A FINDER manif. no. 95.75		

1

GEV No.	380853	Ref. No.	0E5172 0K8712
description	print relay 24VAC 1CO at 250V 16A connection pins raster size 5mm FINDER manuf. no. 40.61.8.024.0000 95.65/95.75		
For models:	PW1EFL, PW1EFLF, PW1EFL/60HZ, PW2EFL, PW2EFLF, PW2EFL/60HZ, WT830EFL, WT830EFLF, WT830EFL/60HZ, WT850, WT850EFLF, WT850EFL/60HZ, WT850SFL, FT36EDTS, FT36ESTS, FT36VDT, FT36VDT, FT36ED, FT36ES, FT36VD, FT36VS, FT50ED, FT50ES, FT50VD, FT50VS, FT72ED, FT72ES, FT72VD, FT72VS, FT36EDT, FT36EST, FT36VDT, FT36VST, FT50EDT, FT50EST, FT50VDT, FT50VST, FT72EDT, FT72EST, FT72VDT, FT72VST, FT36WED, FT36WES, FT36WVD, FT36WVS, FT50WED, FT50WES, FT50WVD, FT50WVS...(Other models you can see in the webshop)		

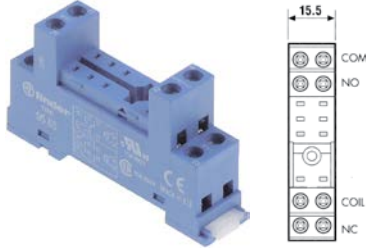

1

GEV No.	380953	Ref. No.	0E5173
description	relay socket 8-pole 250V 10A FINDER manuf. no. 95.65		
For models:	RT100ED, RT100ES, RT100SR, RT100SL, RT140ED, RT140ES, RT140SR, RT140SL, RT190ED, RT190ES, RT190SR, RT190SL, RT190HDED, RT190HDES, RT190HSR, RT190HSL, RT270ED, RT270ES, RT270SR, RT270SL, RT270HDED, RT270HDES, RT270HSR, RT270HSL, RT100ERF, RT100ELF, RT100VD, RT100VS, RT140ERF, RT140ELF, RT140VD, RT140VS, RT142ERF, RT142ELF, RT190ERF, RT190ELF, RT190VD, RT190VS, RT190HERF, RT190HEL, RT190HDVDF, RT190HDVSF, RT270ERF, RT270ELF, RT270VDF, RT270VSF, RT270HERF, RT270HEL, RT270HDVDF, RT270HDVSF...(Other models you can see in the webshop)		

relay sockets





1

GEV No.	380136	Ref. No.	049236
description	relay socket 11-pole connection plug-in connection round 11-pole dimensions 65x28x40mm 250V voltage AC 10A Italiana Relè manuf. no. ZVE11		
For models:	LS7HD, LS10UKRP, LS10/HD, LS12HD, LS8/HD		
accessories for	380136		
	GEV No.	380805	Ref. No. —
	support bracket		



1

GEV No.	380137	Ref. No.	053912
description	relay socket 8-pole connection plug-in connection round 8-pole dimensions 65x28x40mm 380V voltage AC 10A Italiana Relè manuf. no. ZVE8		
For models:	FVGC4, FV4G, FV4E, HCPA/G1219, HCPA/G1219, HCPA/V1219, FV4G, FV4E, FVAC041, HCPA/G121, HCPA/G121		
accessories for	380137		
	GEV No.	380805	Ref. No. —
	support bracket		



1

GEV No.	380802	Ref. No.	002786
description	relay socket 4-pole 55/85 dimensions 70.5x30x27mm 250V voltage AC 10A FINDER manuf. no. 94.74		
For models:	HBR/G800, HBR/G805, HBR/G810, HBR/G815, HBR/G811, HBR/G816, HBR/G800UK, ZBR/G800, ZBR/G805, ZBR/G810, ZBR/G815, ZBR/G811, ZBR/G816, ZBR/G800UK, ABR/G800, ABR/G805, ABR/G810, ABR/G815, ABR/G811, ABR/G816, OBR/G800UK		
accessories for	380802		
	GEV No.	380804	Ref. No. —
	support bracket		



level relays

GICAR



1				004837 005048 055359 055458 0A8502 0C0937 0H6151 0H6585 0K9194 0KE598 0M2262 18E18 213810 60050385 BR63051 MBR63051	
GEV No.	400018	Ref. No.			
description	level relay 230V voltage AC connection F6.3 type RL30/3ES/F/G				
For models:	FDV40G, FDV40E, FDV40GZ, FDV40EL, FDV40GA, FDV20G, FDV20E, FDV20GZ, FDV20EL, FDV20GA, KPI/G15H, KPI/E15H, KPI/G10H, KPI/E10H, QPI/G15H, QPI/E15H, QPI/G10H, QPI/E10H, WPI/G15H, WPI/E15H, WPI/G10H, WPI/E10H, FCVG202L3, FCVG202L6, FCV/G202/1, FCS201G4, FCS202G4, FCS202GP, FCS202GX, FVE3, FCVE6-1U, FCVE6-3U, FCVE6-1, FCVE6-3, FCVE6-1UK, FCVE6-3UK, FCVG6-1, FCVG6-3, FCVG6-1UK, FCVG6-3UK, FCVE10-2, FCVE10-4, FCVE10-2UK, FCVE10-4UK, FCVG10-2, FCVG10-4, FCVG10-2, FCVG10-4D, FCVG10-2UK, FCVG10-4UK...(Other models you can see in the webshop)				

miscellaneous



1					
GEV No.	402951	Ref. No.		053913	
description	level controller 50/60Hz 24V voltage AC 10A type RL30/3ES/11				
For models:	CRN22G, CRN/20G, CRN30G, CRN15G, CRN15V, CRN15E, CRN/22GZ, CRN20GZ, CRN30GZ, CRN15GZ, CRN15V-Z, CRN15EZ, CRN20GA, CRN30GA, CRN15GA, CRN15VA, CRN15EA, FCVE10, FCVE20, FVGC4, FV4G, FV4E, CR42G, CR42V, CR42E, CR/40G, CR/40V, CR40E, FV4G, FV4E, FVAC041				



1				
GEV No.	400743	Ref. No.		0H6240 80/3VZI
description	level relay			
For models:	9190-3, 9191-3, 9193-3, 9195-3, 9390-3, 9391-3, 9393-3, 9395-3			



1				
GEV No.	400176	Ref. No.		OG1804 ER104
description	level relay 1CO 230V voltage AC			



1				
GEV No.	401638	Ref. No.		056496 60050216 911987
description	level relay 24V type RL30/3ES/F/G			
For models:	FCVE6-3CE, FCVE103CE, FCVE203CE, FCVM62E, FCVM62EUK, FCVE10-P, FCVE10PUK, FCVG10-P, FCVG10PUK, FCVE20-P, FCVE20PUK, FCVG20-P, FCVG20PUK, AFCV/G6-1, AFCV/G6-3, SCO/G6-3, AFCV/G101, AFCV/G103, SCO/G10-3, AFCV/G201, AFCV/G203, SCO/G20-3			



1				
GEV No.	400002	Ref. No.		0H6222 0K0643 0KF903 214871 60050390
description	level relay type FTL 160			
For models:	5611-3-10, 5611-3-6, 5611-3-8, 5612-3-10, 5612-3-6, 5612-3-8, 5614-3-10, 5614-3-6, 5614-3-8			



supervisory relays



1

GEV No.	401610	Ref. No.	N/A
description	supervisory relay revolutions		



1

GEV No.	381148	Ref. No.	0C1240
description	time relay FINDER 85.02.0.024.0000 time range 0.05s - 100h 24VAC/DC 10A 2CO		
For models:	CRN22G, CRN/20G, CRN30G, CRN15G, CRN15V, CRN15E, CRN/22GZ, CRN20GZ, CRN30GZ, CRN15GZ, CRN15V-Z, CRN15EZ, CRN20GA, CRN30GA, CRN15GA, CRN15VA, CRN15EA, CR42G, CR42V, CR42E, CR/40G, CR/40V, CR40E		

time relays

time relays





1

GEV No.	380682	Ref. No.	0H6817 0K2378 BHRFN MHR1
description	time relay CROUZET time range 1s-100h 24VDC		
For models:	5611-3-10, 5611-3-8, 5612-3-10, 5612-3-8, 5614-3-10, 5614-3-8		



1

GEV No.	380622	Ref. No.	049235
description	time relay FINDER 88.02.0.230.0002 time range 0.05s-100h 24-230V AC/DC 2x8A mounting measurements 45x45mm		
For models:	LS7HD, LS10UKRP, LS10/HD, LS12HD, LS8/HD		
accessories for	380622		
	GEV No.	Ref. No.	—
	380667		
	relay socket 11-pole dimensions 56x43x31mm 250V voltage AC 10A FINDER manif. no. 90.27		





1

GEV No.	380381	Ref. No.	0H6818
description	time relay DOLD MK7614.32 time range 0.15s-30min 230VAC 2x4A 2CO connection grip connection		
For models:	9190-3, 9191-3, 9193-3, 9195-3, 9390-3, 9391-3, 9393-3, 9395-3		



1

GEV No.	360104	Ref. No.	004181
description	time relay FINDER 88.12.0.230.0002 time range 0.05s-100h 24-230V AC/DC 2x5A mounting measurements 45x45mm 2CO connection plug-in connection round 8-pole		
For models:	ZFC33, ZFC45		
accessories for	360104		
	GEV No.	Ref. No.	—
	380638		
	relay socket 8-pole dimensions 51x41x23mm 250V 10A FINDER manif. no. 90.26		



1

GEV No.	380380	Ref. No.	006156
description	time relay FIBER T45Sc25 time range 0s-120h 24VAC 5A mounting measurements 45x45mm connection plug-in connection round 8-pole		
For models:	HFH/G430, HFH/E430, ZFH/G430, ZFH/E430		

			
1			
GEV No.	350200	Ref. No.	OE0019 OE5342 OE5669 0H2266 0K7996 0K8355 0K8727 0KA728 0KA729 0KC433 0KE414 0KT395 30000877 88826135 BCRU11524V
description	time relay OMRON H3DK-M1 time range 0.1s-1200h 24-240V AC/DC 5A mounting measurements DIN railmm connection screw clamp		
For models:	EBS50., EBS50H, EBS100., EBS100H, EBS150., EBS150H, EBS200., EBS200H, EBS300., EBS300H, EBV50., EBV50H, EBV100., EBV100H, EBV150., EBV150H, EBV200., EBV200H, EBV300., EBV300H, EBVC50., EBVC50H, EBVC100., EBVC100H, EBVC150., EBVC150H, EBVC200., EBVC200H, EBVC300., EBVC300H, EBP100., EBP100M, EBP150., EBP150M, EBP200., EBP200M, EBP300., EBP300M, EBPC100., EBPC100M, EBPC150., EBPC150M, EBPC200., EBPC200M, EBPC300., EBPC300M, MED50H, MED100H, MED150H, MED200H...(Other models you can see in the webshop)		

			
1			
GEV No.	380681	Ref. No.	0K2401
description	time relay TESCH E67.3x105 time range 3-60s 230VAC 5A		

			
1			
GEV No.	360357	Ref. No.	0H6122
description	time relay TESCH V333x01 time range 0s-60h 220-240VAC 4x4A 4CO		

			
1			
GEV No.	360407	Ref. No.	075659 S646604800 S646604801
description	timer FINDER T2352203F0 time range 0.5s-120h 24VAC 2x6A mounting measurements 45x70mm 2CO		
For models:	LO/E480, PLO480/E, LO480EUK, LO480E/63, LO480VAPORESTD, PLO480V, LO480V/63-60HZ, LO/E250, PLO250E, LO/E250UK, LO250E/63, LOPE25, LOPE48, LO480Z-VAPORE		

transformers

open transformers

with clamp terminal

			
1			
GEV No.	401266	Ref. No.	056512 34432503 60050218
description	transformer primary 230V secondary 12/24V 100VA		
For models:	FCVE6-3CE, FCVE103CE, FCVE203CE, FCVE20/P-V, FCVE10-P, FCVE-10PUK, FCVG10-P, FCVG10PUK, FCVE20-P, FCVE20PUK, FCVG20-P, FCVG20PUK, AFCV/G6-1, AFCV/G6-3, SCO/G6-3, AFCV/G101, AFCV/G103, SCO/G10-3, AFCV/G201, AFCV/G203, SCO/G20-3		

toroidal core transformers

			
1			
GEV No.	401663	Ref. No.	0E5290 0K8319 0KG588 0L0174
description	transformer primary 230V secondary 12V 25VA		
For models:	RT100ED, RT100ES, RT100SR, RT100SL, RT140ED, RT140ES, RT140SR, RT140SL, RT190ED, RT190ES, RT190SR, RT190SL, RT190HDED, RT190HDES, RT190HSR, RT190HSL, RT270ED, RT270ES, RT270SR, RT270SL, RT270HDED, RT270HDES, RT270HSR, RT270HSL, RT100ERF, RT100ELF, RT100VD, RT100VS, RT140ERF, RT140ELF, RT140VD, RT140VS, RT142ERF, RT142ELF, RT190ERF, RT190ELF, RT190VD, RT190VS, RT190HERF, RT190HELF, RT190HDVDF, RT190HDVSF, RT270ERF, RT270ELF, RT270VDF, RT270VSF, RT270HERF, RT270HELF, RT270HDVDF, RT270HDVSF...(Other models you can see in the webshop)		



			
1			
GEV No.	379395	Ref. No.	006159
description	transformer primary 240V secondary 24V 200VA		
For models:	MCP/E1SH, MCP/E2SH, MCP/E2SHB, PCP/E1SH, PCP/E2SH, PCP/E2SH3B, PCP/E1ELH, OCP/E1SH, OCP/E2SH, TCP/E2SH, TCP/E1ELH, KFH/G1, KFH/E1, KFH/G1ELH, KFH/E1ELH, KFH/G1EH, KFH/E1EH, HFH/G430, HFH/E430, HFH/G435, HFH/G435, QFH/G1, QFH/E1, QFH/G1ELH, QFH/E1ELH, QFH/G1EH, QFH/E1H, ZFH/G430, ZFH/E430, ZFH/G435, ZFH/G435, WFH/G1, WFH/E1, WFH/G1ELH, WFH/E1ELH, WFH/G1EH, WFH/E1EH, AFH/G435, AFH/E435, ZFT/E1L, ZFT/E1LES, ZFT/E2L, ZFT/E2LE5		

with screw connection			
			
1			
GEV No.	401665	Ref. No.	0E5247 OKK018 OL0074 OL1158
description	transformer primary 230/400V secondary 24-48V 400VA connection screw 50-60Hz		
For models:	FP50A, FP50AM, FP70A, FP70A, FP100A, FP100A, FP50A, FP70A, FP100A, PW1EFL, PW1EFL, PW1EFL/60HZ, PW2EFL, PW2EFL, PW2EFL/60HZ, PW2VFL, WT830EFL, WT830EFL/60HZ, WT850, WT850EFL, WT850EFL/60HZ, WT850SFL, RT100ED, RT100ES, RT100SR, RT100SL, RT140ED, RT140ES, RT140SR, RT140SL, RT190ED, RT190ES, RT190SR, RT190SL, RT190HDED, RT190HDES, RT190HSR, RT190HSL, RT270ED, RT270ES, RT270SR, RT270SL, RT270HDED, RT270HDES, RT270HSR, RT270HSL, RT100ERF, RT100ELF, RT100VD... (Other models you can see in the webshop)		

encapsulated transformers

multiple connections

			
1			
GEV No.	401346	Ref. No.	0H6808
description	transformer 20VA		
For models:	5611-3-10, 5611-3-6, 5611-3-8, 5612-3-10, 5612-3-6, 5612-3-8, 5614-3-10, 5614-3-6, 5614-3-8		

			
1			
GEV No.	401546	Ref. No.	OK2761
description	transformer primary 230V secondary 12V 10VA		
For models:	5611-3-10, 5612-3-10, 5614-3-10		

PMA

			
1			
GEV No.	401267	Ref. No.	007045
description	transformer primary 230V secondary 12/24V 60/40VA secondary 5/1.7A connection screw 50Hz		
For models:	FCZ102EAA, FCZ201EAA, FCZ202EAA, FCZ201EAH, FCZ102GAG, FCZ102GAD, FCZ102EBA, FCZ201EBA, FCZ202EBA, FCZ201EBH, FCZ102GBG, FCZ102GBD, FCZ102ECA, FCZ201ECA, FCZ202ECA, FCZ201ECH, FCZ102GCG, FCZ102GCD, FCS061GP, FCS061EP, FCS101EP4J, FCS101EP, FCS101GP9J, FCS101GP, FCS102GA9J, FCS201EP, FCS102GP, FCS202EP, FCS201GP, FCS202GP, FCS061EXLN, FCS061EX, FCS101EX4J, FCS101EX, FCS201EX, FCS201EXLN, FCS202EX, FCS101GX9J, FCS101GX, FCS102GX9J, FCS102GX, FCS201GX, FCS202GX, AOW101EA, AOS061EA, AOS061EB, AOS101EA, AOS101EB, AOS201EA, AOS201EB...(Other models you can see in the webshop)		



electric components

			
1			
GEV No.	379054	Ref. No.	004120 004121 081675 083833 0A2497
description	transformer primary 230VAC secondary 12VAC 3VA secondary 0.25A H 40mm L 45mm W 50mm connection screw 50/60Hz type 153/M		
For models:	ALN110, ALN120, ADN111, ADF110, ALF110, ADF120, ALF120, ADNN120, ADNF120, ALN220, ALN240, ADN221, ADF220, ADF240, ADNN220, ADNF220, ADNN230, ADNF230, AKN110UK, AKF110UK, AKN220UK, AKF220UK, ASN110UK, ASF110UK, ASN220UK, ASF220UK, ARDN110, AZP1103, AZF1103, AZP2203, AZF2203, 83012001, 83012033, 83012201, ARDF110L, ARDF120, ARDN120, 83012101, ARDN220, ARDN221, ARDNF220, 83012037, AZP1103, AZP2203, ASN110, ASF110, ASN220, ASF220, ADN110, ADN120... (Other models you can see in the webshop)		

			
2			
GEV No.	401174	Ref. No.	082378
description	transformer primary 230VAC secondary 12VAC 6VA secondary 0.5A connection screw 50Hz		
For models:	ICF110, ICP130, ITP120UK, ICN110UK, ICF110, ITP120UK, ILP110, ILP110UK, ILN120, ILP111, ILP220, ILP220UK, ILP240, ILP221, ILN110, ILN110UK, ILN120, ILN111, ILN220, ILN220UK, ILN240, ILNSO120, ILN221, ILNN120, ILNN220, ILNN220UK, ILNN230, ILF110, ILF110, ILF120, ILF220, ILF220UK, ILF240, ILNF120, ILNF220, ILNF220UK, ILNF230, TRNP1802, TRRN1301, TRRN1302, TRRN1303, TRRN1801, TRRN1802, TRRN1803, TRRN2201, TRRN2202, TRRN2203, KVRC/E3, HVR/E1200, QVRC/E3...(Other models you can see in the webshop)		

for lighting

			
1			
GEV No.	401547	Ref. No.	002710 002856 0C9422 0F0083 0K8481 17008908 60050262
description	transformer primary 230V secondary 11.5V 50W		
For models:	FCV/G10L3, FCV/G6L3TOWNGAS, FCV/G6L3, FCVG10L3T, FCV/G20L3, FCVG20L3, FCVE6L3J, FCV/E10L3JAP, FCV/E10L6JAP, FCV/G6L3JAP, FCV/G10L3J, FCV/G10L6JAP, FCVG6L3CJ, FCV/G10L2, FCV/E10L2, FCV/G6L3C, FCV/G61/1, FCV/G61/1, FCV/G61/1, FCV/G61/1, FCV/G6L3CT, FCVG6L3CJ, FCV/E10L3, FCV/E6L3, FCV/E20L3, FCVE20L3, FCV/G6L4, FCV/E6L4, FCV/G10L6, FCV/E10L6, FCV/G20L6, FCV/E20L6, FCVG20L6, FCVE20L6, FCV/E101/1, FCV/G101/1, FVC/E101/1, FCV/G201/1, FVC/E201/1, FCV/G202/1, FVC/E202/1, FCS061G3DI, FCS061E3CI, FCS061G4, FCS101E2, FCS061G4DT, FCS101E44J, FCS061G49J, FCS101G2, FCS101E4...(Other models you can see in the webshop)		

miscellaneous

			
Image not available			
1			
GEV No.	403448	Ref. No.	083389
description	transformer for blast chiller suitable for ZANUSSI		
For models:	BC11, BC22, BC44, BC44H, BCF11, BCF22, BCF44, BCF44H, BC11, BC22, BC44, BC44H, BCF11, BCF22, BCF44, BCF44H, BC0144, BC072, ESB-C72R, ESBF10, ESB-C144R, ESBF70, ESBF70R, ESBF144, ESB-C10, ESB-C10R, ESB-C20, ESB-C20R, ESBF20, ESB-C40, ESBF40, ESBF144R, ESK40H, ESF40H, EEVA10/1, EEVA20/1, EEVA40/1, EEVA40/2, EEVAC10/1, EEVAC20/1, EEVAC40/1, EEVAC40/2, EEVA10/1, EEVA20/1, EEVA40/1, EEVA40/2, EEVAC10/1, EEVAC20/1, EEVAC40/1, EEVAC40/2...(Other models you can see in the webshop)		

electronic controllers

CAREL

refrigeration controllers

built-in version

			
1			
GEV No.	379512	Ref. No.	091609
description	electronic controller CAREL IRELF0EN215 mounting measurements 71x29mm built-in depth 70.5mm 230V voltage AC NTC relay outputs 3 CO-8A(4) CO-8A(4) CO-6A(1) NTC NTC DI yes without plug protection IP54 -50 up to +99°C display 3 digits		
For models:	ZVR1780, ZVR2180, ZVR1930, ZVR2400, RS06PX1F6M, FULL DOOR FREEZER, RCSN2M2, RCSN2M12, RCSN3M3, RCSN3M22, RCSN3M14, RCSN4M4, RCSN4M32, RCSN4M24, RCSN2M2U, RCSN3M3U, RCSN4M4U, RCSN2M2R, RCSN2M12R, RCSN3M3R, RCSN3M22R, RCSN3M14R, RCSN4M4R, RCSN4M32R, RCSN4M24R, RS06RX1F, FULL DOOR FREEZER, RS06FX1F, RS06DX2F, RS13RX2F, RS13DX2F, RS06PX1F, RS06PX1F6, RS06R41F, RS06DFX2F, RS13PX2F, RS13PX2F6, RS13P42F, RS13DFX2F, RS06PW1F, FULL DOOR FREEZER, RS06FW1F, RS13PW2F, RCSN2M2T, RCSN3M3T, RCSN4M4T, FULL DOOR FREEZER, RS06FX1F6, RS06RXH, FULL DOOR FREEZER...(Other models you can see in the webshop)		



			
1			
GEV No.	379509	Ref. No.	092355
description	electronic controller CAREL IRELF0HN245 mounting measurements 71x29mm built-in depth 70.5mm 115/230V voltage AC NTC relay outputs 3 CO-12A(4) CO-8A(4) NTC NTC DI yes protection IP54 -50 up to +99°C display 3 digits		
For models:	ASN110, ASF110, ASN220, ASF220, ADN110, ADN120, ADN111, ADF110, ADF120, ADNN120, ADNF120, ADN220, ADN240, ADN221, ADF220, ADNN220, ADNF220, ADNN230, ADNF230, ADN11060, ADF11060, ADN22060, ADF2206, ZPR04R1F, ZPR04F1F, ZPR06R1F, ZPR06F1F, TRN224C, TRN224D, TRN224E, TRN132A, TRN132B, TRN132C, TRNA132A, TRNA132B, TRNA132C, TRRN132A, TRRN132B, TRRN132C, TRN183A, TRN183B, TRN183C, TRN183D, TRNA183A, TRNA183B, TRNA183C, TRNA183D, TRRN183A, TRRN183B, TRRN183C... (Other models you can see in the webshop)		

accessories for	402193		
	GEV No.	379458	Ref. No.
			0S0299
	temperature probe NTC 10kOhm cable silicone probe -40 up to +110°C cable -50 up to +180°C probe ø6x40mm cable length 1.5m without screw connection 2-wire		
	GEV No.	402818	Ref. No.
			—
	programming key 4K for electronic controller DIXELL		

DIXELL

refrigeration controllers
built-in version



1			
GEV No.	402193	Ref. No.	091015
description	electronic controller DIXELL XW30L mounting measurements 150x30mm built-in depth 50mm 230V voltage AC NTC/PTC relay outputs 3 NO-20A(8) NO-8A(3) NO-8A(3) NTC/PTC NTC/PTC protection IP65 -50 up to +150°C display 3½ digits		
For models:	DI2RDP, DI3RDP, DI4RDP, DI2RDPR, DI3RDPR, DI4RDPR, DI2RDPO, DI3RDPO, DI4RDPO, DIRRDPOR, DI3RDPOR, DI4RDPOR, DI2RWV, DI3RWV, DI4RWV, DI2RWVR, DI3RWVR, DI4RWVR, DI2RWVO, DI3RWVO, DI4RWVO, DI2RWVOR, DI3RWVOR, DI4RWVOR, DI2ROD, DI3ROD, DI4ROD, DI2RODR, DI3RODR, DI4ROPR, DIVRW2R, DIVRW3R, DIVRW4R, DIVRWG2R, DIVRWG3R, DIVRWG4R, DIVRWD2R, DIVRWD3R, DIVRWD4R		
accessories for	402193		
	GEV No.	378194	Ref. No.
			—
	temperature probe NTC 10kOhm cable PVC probe -20 up to +80°C cable -10 up to 100°C probe ø7x24.5mm cable length 1.5m without screw connection 2-wire		
	GEV No.	379057	Ref. No.
			—
	temperature probe NTC 10kOhm cable PVC probe -20 up to +80°C cable -10 up to 100°C probe ø6x25mm cable length 3m 2-wire		
	GEV No.	379160	Ref. No.
			—
	temperature probe NTC 10kOhm cable thermoplastic probe -40 up to +110°C cable -40 up to +110°C probe ø6x14mm cable length 1.5m without screw connection 2-wire		
	GEV No.	379161	Ref. No.
			0A9498
	temperature probe NTC 10kOhm cable thermoplastic probe -40 up to +110°C cable -40 up to +110°C probe ø6x14mm cable length 3m without screw connection 2-wire		
	GEV No.	379343	Ref. No.
			092182 099570
	temperature probe NTC 10kOhm cable silicone probe -40 up to +110°C cable -50 up to +180°C probe ø6x40mm cable length 3m 2-wire		

DOLD
universal controllers

mounting measurements 92x92mm



1			
GEV No.	379919	Ref. No.	0H6246 931500003 A215696
description	electronic controller DOLD DPG 96 C mounting measurements 90x90mm 230V voltage AC Pt100/TC(J/K/S) 0-10V/4-20mA -150 up to +1700°C display 2x 4 digits relay outputs 4 relays 8A 8A 8A 8A Templn1 yes Templn2 yes Templn3 yes DigilN1 yes DigilN2 yes DigilN3 yes built-in depth 140mm		
For models:	9190-3, 9191-3, 9193-3, 9195-3, 9390-3, 9391-3, 9393-3, 9395-3		

ELIWELL

universal controllers
built-in version



1			
GEV No.	379559	Ref. No.	081683 081685 084224 0S0989
description	electronic controller ELIWELL type IC901 mounting measurements 71x29mm 12V voltage AC/DC NTC/PTC relay outputs 1 relay refrigeration front measurements 74x32mm built-in depth 60mm protection IP65 accuracy superior to 0.5% from final value% defr. funct. no -55 up to +150°C display 2½ digit Templn1 yes 15A		
For models:	MRF4808660, MRF6018660, MRF401/86, MRF601/86, MRF240/86, MRF480/86, MRF601/86		
accessories for	379559		
	GEV No.	379053	Ref. No.
			—
	temperature probe PTC 1kOhm cable PVC probe -50 up to +150°C cable -10 up to 100°C probe ø6x30mm cable length 3m without screw connection 2-wire		
	GEV No.	379064	Ref. No.
			085961 0A9600 0D6591 31876
	temperature probe PTC 1kOhm cable silicone probe -50 up to +150°C cable -50 up to +180°C probe ø6x40mm cable length 3m without screw connection 2-wire		

Table continues overleaf

accessories for 379559			
GEV No.	379161	Ref. No.	0A9498
temperature probe NTC 10kOhm cable thermoplastic probe -40 up to +110°C cable -40 up to +110°C probe ø6x14mm cable length 3m without screw connection 2-wire			
GEV No.	379782	Ref. No.	—
temperature probe PTC 1kOhm cable thermoplastic probe -50 up to +150°C cable -40 up to +110°C probe ø6x14mm cable length 3m 2-wire resistor 1kOhm			



GEV No.	379562	Ref. No.	081684 082484 084337 084338 085047 091357 646724001
----------------	--------	-----------------	---

description electronic controller ELIWELL type IC902 mounting measurements 71x29mm 12V voltage AC/DC NTC/PTC relay outputs 1 relay front measurements 74x32mm built-in depth 61mm protection IP65 accuracy superior to 0.5% from final value% defr. funct. no -55 up to +150°C display 2½ digit TempIn yes 8A

For models: ILF110, ILF110, ILF120, ILF220, ILF220UK, ILF240, ILNF120, ILNF220, ILNF220UK, RI16H1F, RI16H2FT, EMVN500, MVN112V12C, DVP500V11C, DVP501V11C, MVP502V11C, DVN500V11C, DVN501V11C, DVP500V11V, DVP501V11V, MVP502V11V, EDVN500, DVN501V11V, DVP600V11C, DVP601V11C, MVP602V11C, DVP600V12C, DVP601V12C, DVN600V11C, DVN601V11C, DVN600V12C, DVN601V12C, DVP600V11V, DVP601V11V, EMVP602, DVN600V11V, EDVN601, DVP110V12C, DVP111V12C, MVP112V12C, DVN110V12C, DVN111V12C, DVP110V12V, DVP111V12V, MVP112V12V, EDVN110, EDVN1101, DVP130V12C, DVP131V12C, MVP132V12C...(Other models you can see in the webshop)

accessories for 379562			
GEV No.	379052	Ref. No.	083583 050302
temperature probe PTC 1kOhm cable silicone probe -50 up to +150°C cable -50 up to +180°C probe ø6x40mm cable length 1.5m without screw connection 2-wire			
GEV No.	379064	Ref. No.	085961 0A9600 OD6591 31876
temperature probe PTC 1kOhm cable silicone probe -50 up to +150°C cable -50 up to +180°C probe ø6x40mm cable length 3m without screw connection 2-wire			
GEV No.	379161	Ref. No.	0A9498
temperature probe NTC 10kOhm cable thermoplastic probe -40 up to +110°C cable -40 up to +110°C probe ø6x14mm cable length 3m without screw connection 2-wire			
GEV No.	379782	Ref. No.	—
temperature probe PTC 1kOhm cable thermoplastic probe -50 up to +150°C cable -40 up to +110°C probe ø6x14mm cable length 3m 2-wire resistor 1kOhm			



GEV No.	379566	Ref. No.	004109
description	electronic controller ELIWELL type IC912 mounting measurements 71x29mm 12V Pt100/TC-J defr. funct. no		
For models:	ZCMDG6, ZCMDG4, ZCMDG9, ZCBDG8, ZCBDG12, ZCBDG18		





GEV No.	379567	Ref. No.	006154 0C3421
----------------	--------	-----------------	------------------

description electronic controller ELIWELL type ICPlus902 model ICP11J0550000 mounting measurements 71x29mm 24V voltage AC Pt100/TC (J,K) relay outputs 1 CO-8A(3) Pt100/TC (J,K) built-in depth 60mm defr. funct. -150 to 1350°C display 3½ digits

For models: MCP/E1SH, MCP/E1SUH, MCP/E2SUHS, MCP/E2SH, MCP/E2SUH, MCP/E2SUT, MCP/E2SHB, PCP/E1SH, PCP/E2SH, PCP/E2SH3B, OCP/E1SH, OCP/E2SH, TCP/E2SH, HFH/G430, HFH/E430, ZFH/G430, ZFH/E430

accessories for 379567

	GEV No.	378064	Ref. No.	—
alarm device AKO type AKO-520631 mounting measurements 214x214mm 230V voltage AC relay outputs 1 CO-8A(4) up to 1 front measurements 222x222mm protection accuracy% yes yes				
	GEV No.	378075	Ref. No.	—
temperature probe thermocouple K (NiCr-Ni) cable Vetrotex probe -50 up to 1150°C cable -50 up to +350°C probe ø4.5x150mm cable length 3m without screw connection 2-wire				
	GEV No.	379050	Ref. No.	—
temperature probe Pt100 cable Vetrotex probe -200 up to +600°C cable -50 up to +350°C probe ø6x100mm cable length 2.7m without screw connection 3-wire				
	GEV No.	379062	Ref. No.	—
temperature probe thermocouple J (Fe-CuNi) cable Vetrotex probe -50 up to +750°C cable -50 up to +350°C probe ø6x50mm cable length 3m without screw connection 2-wire				
	GEV No.	379131	Ref. No.	—
temperature probe Pt100 cable Vetrotex probe -200 up to +600°C cable -50 up to +350°C probe ø6x85mm cable length 3m without screw connection 3-wire resistance at 0°C 100Ohm				
	GEV No.	400583	Ref. No.	—
transformer primary 230VAC secondary 24VAC 10VA secondary 0.4A connection screw 50Hz				



			
1			
GEV No.	379689	Ref. No.	OS1642
description	electronic controller ELIWELL type ICPlus902 model ICP16D0350000 mounting measurements 71x29mm 12V voltage AC/DC NTC/PTC relay outputs 1 CO-15A(8) NTC/PTC universal front measurements 74x32mm built-in depth 60mm accuracy superior to 0.5% from final value% built-in version defr. funct. no -50 up to +150°C display 3½ digits		
accessories for	379689		
	GEV No.	378194	Ref. No. —
	temperature probe NTC 10kOhm cable PVC probe -20 up to +80°C cable -10 up to 100°C probe ø7x24.5mm cable length 1.5m without screw connection 2-wire		
	GEV No.	379052	Ref. No. 083583 050302
	temperature probe PTC 1kOhm cable silicone probe -50 up to +150°C cable -50 up to +180°C probe ø6x40mm cable length 1.5m without screw connection 2-wire		
	GEV No.	379053	Ref. No. —
	temperature probe PTC 1kOhm cable PVC probe -50 up to +150°C cable -10 up to 100°C probe ø6x30mm cable length 3m without screw connection 2-wire		
	GEV No.	379054	Ref. No. 004120 004121 081675 083833 0A2497
	transformer primary 230VAC secondary 12VAC 3VA secondary 0.25A H 40mm L 45mm W 50mm connection screw 50/60Hz type 153/M		
	GEV No.	379057	Ref. No. —
	temperature probe NTC 10kOhm cable PVC probe -20 up to +80°C cable -10 up to 100°C probe ø6x25mm cable length 3m 2-wire		
	GEV No.	379064	Ref. No. 085961 0A9600 0D6591 31876
	temperature probe PTC 1kOhm cable silicone probe -50 up to +150°C cable -50 up to +180°C probe ø6x40mm cable length 3m without screw connection 2-wire		
	GEV No.	379142	Ref. No. 050301
	temperature probe PTC 1kOhm cable PVC probe -50 up to +150°C cable -10 up to 100°C probe ø6x30mm cable length 1.5m without screw connection 2-wire		
	GEV No.	379160	Ref. No. —
	temperature probe NTC 10kOhm cable thermoplastic probe -40 up to +110°C cable -40 up to +110°C probe ø6x14mm cable length 1.5m without screw connection 2-wire		
	GEV No.	379161	Ref. No. 0A9498
	temperature probe NTC 10kOhm cable thermoplastic probe -40 up to +110°C cable -40 up to +110°C probe ø6x14mm cable length 3m without screw connection 2-wire		
	GEV No.	379343	Ref. No. 092182 099570
	temperature probe NTC 10kOhm cable silicone probe -40 up to +110°C cable -50 up to +180°C probe ø6x40mm cable length 3m 2-wire		
	GEV No.	379458	Ref. No. 0S0299
	temperature probe NTC 10kOhm cable silicone probe -40 up to +110°C cable -50 up to +180°C probe ø6x40mm cable length 1.5m without screw connection 2-wire		
	GEV No.	379781	Ref. No. —
	temperature probe PTC 1kOhm cable thermoplastic probe -50 up to +150°C cable -40 up to +110°C probe ø6x14mm cable length 1.5m without screw connection 2-wire		

accessories for	379689		
	GEV No.	379782	Ref. No. —
	temperature probe PTC 1kOhm cable thermoplastic probe -50 up to +150°C cable -40 up to +110°C probe ø6x14mm cable length 3m 2-wire resistor 1kOhm		

			
1			
GEV No.	379690	Ref. No.	OS0295 OS0789
description	electronic controller ELIWELL type ICPlus902 model ICP16D0750000 mounting measurements 71x29mm 230V voltage AC NTC/PTC relay outputs 1 CO-15A(8) NTC/PTC built-in depth 60mm defr. funct. -50 up to +150°C display 3½ digits		
accessories for	379690		
	GEV No.	378194	Ref. No. —
	temperature probe NTC 10kOhm cable PVC probe -20 up to +80°C cable -10 up to 100°C probe ø7x24.5mm cable length 1.5m without screw connection 2-wire		
	GEV No.	379052	Ref. No. 083583 050302
	temperature probe PTC 1kOhm cable silicone probe -50 up to +150°C cable -50 up to +180°C probe ø6x40mm cable length 1.5m without screw connection 2-wire		
	GEV No.	379053	Ref. No. —
	temperature probe PTC 1kOhm cable PVC probe -50 up to +150°C cable -10 up to 100°C probe ø6x30mm cable length 3m without screw connection 2-wire		
	GEV No.	379057	Ref. No. —
	temperature probe NTC 10kOhm cable PVC probe -20 up to +80°C cable -10 up to 100°C probe ø6x25mm cable length 3m 2-wire		
	GEV No.	379064	Ref. No. 085961 0A9600 0D6591 31876
	temperature probe PTC 1kOhm cable silicone probe -50 up to +150°C cable -50 up to +180°C probe ø6x40mm cable length 3m without screw connection 2-wire		
	GEV No.	379142	Ref. No. 050301
	temperature probe PTC 1kOhm cable PVC probe -50 up to +150°C cable -10 up to 100°C probe ø6x30mm cable length 1.5m without screw connection 2-wire		
	GEV No.	379160	Ref. No. —
	temperature probe NTC 10kOhm cable thermoplastic probe -40 up to +110°C cable -40 up to +110°C probe ø6x14mm cable length 1.5m without screw connection 2-wire		
	GEV No.	379161	Ref. No. 0A9498
	temperature probe NTC 10kOhm cable thermoplastic probe -40 up to +110°C cable -40 up to +110°C probe ø6x14mm cable length 3m without screw connection 2-wire		
	GEV No.	379343	Ref. No. 092182 099570
	temperature probe NTC 10kOhm cable silicone probe -40 up to +110°C cable -50 up to +180°C probe ø6x40mm cable length 3m 2-wire		
	GEV No.	379458	Ref. No. 0S0299
	temperature probe NTC 10kOhm cable silicone probe -40 up to +110°C cable -50 up to +180°C probe ø6x40mm cable length 1.5m without screw connection 2-wire		

Table continues overleaf



accessories for 379690			
GEV No.	379781	Ref. No.	—
temperature probe PTC 1kOhm cable thermoplastic probe -50 up to +150°C cable -40 up to +110°C probe ø6x14mm cable length 1.5m without screw connection 2-wire			
GEV No.	379782	Ref. No.	—
temperature probe PTC 1kOhm cable thermoplastic probe -50 up to +150°C cable -40 up to +110°C probe ø6x14mm cable length 3m 2-wire resistor 1kOhm			



GEV No.	379832	Ref. No.	0S1643
description	electronic controller ELIWELL type ICPlus915 model ICP22DI750000 mounting measurements 71x29mm 230V voltage AC NTC/PTC relay outputs 2 CO-8A(3) CO-8A(3) NTC/PTC NTC/PTC built-in depth 59mm defr. funct. -50 to +140°C display 3½ digits		

refrigeration controllers

built-in version



GEV No.	379025	Ref. No.	05877 089903 091289 099695 0S0786
description	electronic controller ELIWELL type ID961LX mounting measurements 71x29mm 230V voltage AC NTC/PTC relay outputs 1 front measurements 76.2x35mm protection IP65 -55 up to +150°C display 3½ digits		
For models:	AZP1103, AZP110360, AZP6430, AZP2203, AZP220360, AZP13430, RS06PX1F, RS06PX1F6, RS06R41F, RS13PX2F, RS13PX2F6, RS13P42F, RS06PW1F, RS13PW2F, SAL25L2C94, RS06N41F, RS06F41FS, KL650R, KLP1300R, RS0PX1FD, RS13PX2FD, KL650R, KEP650R, KL650R, KLP1300R, KEP1300R, KLP1300R, SAL25L2C9, PTR259, SAL25T12, SAL25N12, SAL25T20, SAL25N20, SAL25N04, SAL25T04, RS06N41F		



GEV No.	379572	Ref. No.	083698 083746 083799 0A8908 0A8909 0A8933 0A9230 0K6601 0T1387 461601
----------------	--------	-----------------	--

description electronic controller ELIWELL type ID970 model ID12C00TCD300 mounting measurements 71x29mm 12V voltage AC/DC NTC/PTC relay outputs 2 NO-8A(3) CO-8A(3) NTC/PTC built-in depth 67mm -55 up to +150°C display 3½ digits

For models: ESR142GR, ESR14412FR, ESR141212FR, ESR142FR, ESR141212F, ESR142F, ESR14412F, ESR142G, ESF142FR, ESR4212FR, ESR4212F, ESR41GR, ESR41FR, ESR41G, ESF41FR, ESR41F, ESQC41F, ESQC41FR, , EUKR142N, , EUKR142F, EUKR141212, EUKR14412F, , ESR41F60HZ, ESR422F60HZ, ESR41G60HZ, ESR142F60, ESR1412F60HZ, ESR1442F-60HZ, ESR142G60HZ, ESF41GR, ECZ602, ETZ601, ETZ602, ETZ1402, ETZ1404, ETZ601GT, ESQC41F, ESQC41FR, ETE601, ETE602, ETE1402, ETE1404, ETE601GT, ETE601L, ETZ601L, ECE602, ESR41F...(Other models you can see in the webshop)

accessories for 379572

GEV No.	378194	Ref. No.	—
temperature probe NTC 10kOhm cable PVC probe -20 up to +80°C cable -10 up to 100°C probe ø7x24.5mm cable length 1.5m without screw connection 2-wire			
GEV No.	379052	Ref. No.	083583 0S0302
temperature probe PTC 1kOhm cable silicone probe -50 up to +150°C cable -50 up to +180°C probe ø6x40mm cable length 1.5m without screw connection 2-wire			
GEV No.	379053	Ref. No.	—
temperature probe PTC 1kOhm cable PVC probe -50 up to +150°C cable -10 up to 100°C probe ø6x30mm cable length 3m without screw connection 2-wire			
GEV No.	379054	Ref. No.	004120 004121 081675 083833 0A2497
transformer primary 230VAC secondary 12VAC 3VA secondary 0.25A H 40mm L 45mm W 50mm connection screw 50/60Hz type 153/M			
GEV No.	379057	Ref. No.	—
temperature probe NTC 10kOhm cable PVC probe -20 up to +80°C cable -10 up to 100°C probe ø6x25mm cable length 3m 2-wire			
GEV No.	379064	Ref. No.	085961 0A9600 0D6591 31876
temperature probe PTC 1kOhm cable silicone probe -50 up to +150°C cable -50 up to +180°C probe ø6x40mm cable length 3m without screw connection 2-wire			
GEV No.	379142	Ref. No.	0S0301
temperature probe PTC 1kOhm cable PVC probe -50 up to +150°C cable -10 up to 100°C probe ø6x30mm cable length 1.5m without screw connection 2-wire			
GEV No.	379160	Ref. No.	—
temperature probe NTC 10kOhm cable thermoplastic probe -40 up to +110°C cable -40 up to +110°C probe ø6x14mm cable length 1.5m without screw connection 2-wire			

Table continues overleaf



accessories for 379572			
GEV No.	379161	Ref. No.	0A9498
temperature probe NTC 10kOhm cable thermoplastic probe -40 up to +110°C cable -40 up to +110°C probe ø6x14mm cable length 3m without screw connection 2-wire			
GEV No.	379343	Ref. No.	092182 099570
temperature probe NTC 10kOhm cable silicone probe -40 up to +110°C cable -50 up to +180°C probe ø6x40mm cable length 3m 2-wire			
GEV No.	379458	Ref. No.	0S0299
temperature probe NTC 10kOhm cable silicone probe -40 up to +110°C cable -50 up to +180°C probe ø6x40mm cable length 1.5m without screw connection 2-wire			
GEV No.	379781	Ref. No.	—
temperature probe PTC 1kOhm cable thermoplastic probe -50 up to +150°C cable -40 up to +110°C probe ø6x14mm cable length 1.5m without screw connection 2-wire			
GEV No.	379782	Ref. No.	—
temperature probe PTC 1kOhm cable thermoplastic probe -50 up to +150°C cable -40 up to +110°C probe ø6x14mm cable length 3m 2-wire resistor 1kOhm			
GEV No.	379804	Ref. No.	—
protector for electronic controller 71x29 L 93mm W 65mm plexiglas			



GEV No.	379575	Ref. No.	089176 K0020100
description	electronic controller ELIWELL type ID971 mounting measurements 71x29mm 230V voltage AC NTC/PTC relay outputs 2 relays -55 up to +150°C display 3½ digits RoomTempIN yes DEF Probe yes DEF Relay 8A compressor relay 8A		
For models:	STRP1101, STRP1102, STRP1601, STRP1602, STRP1603, STRP2201, STRP2202, STRP2203, STRP1101S, STRP1601S, STRP2201S, STRP1602R, STRP1603R, STRP2201R, STRP2202R, STRP2203R, STRP1101R, STRP1102R, STRP1601R, RCSN2M2, RCSN2M12, RCSN3M3, RCSN3M22, RCSN3M14, RCSN4M4, RCSN4M32, RCSN4M24, RCSN2M2U, RCSN3M3U, RCSN4M4U, RCSN2M2R, RCSN2M12R, RCSN3M3R, RCSN3M22R, RCSN3M14R, RCSN4M4R, RCSN4M32R, RCSN4M24R, RCSN2M2T, RCSN3M3T, RCSN4M4T, HB2P, HB1P2C12, HB1P3C, HB4C, HB3P, HB2P2C, HB1P4C, HB6C, HB4P...(Other models you can see in the webshop)		
accessories for 379575			
GEV No.	379053	Ref. No.	—
temperature probe PTC 1kOhm cable PVC probe -50 up to +150°C cable -10 up to 100°C probe ø6x30mm cable length 3m without screw connection 2-wire			
GEV No.	379064	Ref. No.	085961 0A9600 0D6591 31876
temperature probe PTC 1kOhm cable silicone probe -50 up to +150°C cable -50 up to +180°C probe ø6x40mm cable length 3m without screw connection 2-wire			
GEV No.	379161	Ref. No.	0A9498
temperature probe NTC 10kOhm cable thermoplastic probe -40 up to +110°C cable -40 up to +110°C probe ø6x14mm cable length 3m without screw connection 2-wire			
GEV No.	379782	Ref. No.	—
temperature probe PTC 1kOhm cable thermoplastic probe -50 up to +150°C cable -40 up to +110°C probe ø6x14mm cable length 3m 2-wire resistor 1kOhm			



GEV No.	381440	Ref. No.	099334
description	electronic controller ELIWELL type ID974 230V voltage AC NTC/PTC protection IP65		
For models:	83012101, ADNN120, MCD650FP2, RH06DD2FR, EC6N0D2C, EC-6M0D2C		



GEV No.	378135	Ref. No.	087656 087780 088395
----------------	--------	-----------------	----------------------------

description	electronic controller ELIWELL type ID974 mounting measurements 71x29mm 12V voltage AC/DC NTC/PTC relay outputs 3 relays -50 up to +150°C display 3½ digits RoomTempIN yes DEF Probe yes DEF Relay 8A fan relay 8A compressor relay 15A		
For models:	AZP1103, AZF1103, AZP2203, AZF2203, AZP1103, AZP2203, ALN1103, ALNN1203, ALN2203, ALNN2203, AZP6430, ALF1104, AZP13430, AZF13430, ALN11033, ALF11033, KLN650R, KLPP650R, KLN1400R, KPF1400R, RS06RX1F, RS06FX1F, RS06DX2F, RS13FX2F, RS13DX2F, RS-13RX2F, KLPP650R, KLPP1400R, KL650R, KL650F, KLP1400R, KLP1400F, KEP6500R, KE650F, KEP1400R, KEP1400F, KL650R, KL650F, KLP1400R, KLP1400F		

accessories for 378135			
GEV No.	379053	Ref. No.	—
temperature probe PTC 1kOhm cable PVC probe -50 up to +150°C cable -10 up to 100°C probe ø6x30mm cable length 3m without screw connection 2-wire			
GEV No.	379064	Ref. No.	085961 0A9600 0D6591 31876
temperature probe PTC 1kOhm cable silicone probe -50 up to +150°C cable -50 up to +180°C probe ø6x40mm cable length 3m without screw connection 2-wire			
GEV No.	379161	Ref. No.	0A9498
temperature probe NTC 10kOhm cable thermoplastic probe -40 up to +110°C cable -40 up to +110°C probe ø6x14mm cable length 3m without screw connection 2-wire			
GEV No.	379782	Ref. No.	—
temperature probe PTC 1kOhm cable thermoplastic probe -50 up to +150°C cable -40 up to +110°C probe ø6x14mm cable length 3m 2-wire resistor 1kOhm			



1

GEV No.	379577	Ref. No.	085975 085983 087161 087169 087858 089904 089913 099276 0A9251 0A9520 0A9678 0A9733 0A9737 0A9777 0S0303 0S0788
description	electronic controller ELIWELL type ID974 mounting measurements 71x29mm 230V voltage AC NTC/PTC relay outputs 3 relays -50 up to +150°C display 3½ digits RoomTempIN yes DEF Probe yes DEF Relay 8A fan relay 5A compressor relay 8A		
For models:	ALN110, ALN120, ADF110, ALF110, ADF120, ALF120, ADNN120, ADNF120, ALN220, ALN240, ADN221, ADF220, ADF240, ADNN220, ADNF220, ADNN230, ADNF230, AKN110UK, AKF110UK, AKN220UK, AKF220UK, ASN110UK, ASF110UK, ASN220UK, ASF220UK, ARDN110, 83012001, 83012033, 83012201, ARDF110L, ARDF120, ARDNN120, 83012101, ARDN220, ARDN221, ARDNF220, 83012037, ASN110, ASF110, ASN220, ASF220, ADN110, ADN120, ADN111, ADF110, ADF120, ADNN120, ADNF120, ADN220, ADN240...(Other models you can see in the webshop)		
accessories for	379577		
	GEV No.	379053	Ref. No. —
	temperature probe PTC 1kOhm cable PVC probe -50 up to +150°C cable -10 up to 100°C probe ø6x30mm cable length 3m without screw connection 2-wire		
	GEV No.	379064	Ref. No. 085961 0A9600 0D6591 31876
	temperature probe PTC 1kOhm cable silicone probe -50 up to +150°C cable -50 up to +180°C probe ø6x40mm cable length 3m without screw connection 2-wire		
	GEV No.	379161	Ref. No. 0A9498
	temperature probe NTC 10kOhm cable thermoplastic probe -40 up to +110°C cable -40 up to +110°C probe ø6x14mm cable length 3m without screw connection 2-wire		
	GEV No.	379782	Ref. No. —
	temperature probe PTC 1kOhm cable thermoplastic probe -50 up to +150°C cable -40 up to +110°C probe ø6x14mm cable length 3m 2-wire resistor 1kOhm		



1

GEV No.	378644	Ref. No.	082388 082396 0S0296
description	electronic controller ELIWELL type IDPlus 902 model IDP11D0300000 mounting measurements 71x29mm 12V voltage AC/DC NTC/PTC/Pt1000 relay outputs 1 CO-8A NTC/PTC/Pt1000 DI		
For models:	ILP110, ILP110UK, ILN120, ILP111, ILP220, ILP220UK, ILP240, ILP221, ILN110, ILN110UK, ILN120, ILN111, ILN220, ILN220UK, ILN240, ILNSO120, ILN221, ILNN120, ILNN220, ILNN220UK, ILNF120, ILNF220, ILNF220UK, EMVN500, MVN112V12C, DVP500V11C, DVP501V11C, MVP502V11C, DVN500V11C, DVN501V11C, DVP500V11V, DVP501V11V, MVP502V11V, EDVN500, DVN501V11V, DVP600V11C, DVP601V11C, MVP602V11C, DVP600V12C, DVP601V12C, DVN600V11C, DVN601V11C, DVN600V12C, DVN601V12C, DVP600V11V, DVP601V11V, EMVP602, DVN600V11V, EDVN601, DVP110V12C... (Other models you can see in the webshop)		
accessories for	378644		
	GEV No.	378261	Ref. No. —
	temperature probe NTC 10kOhm cable thermoplastic probe -40 up to +110°C cable -40 up to +110°C probe ø6x35mm cable length 3m without screw connection 2-wire		
	GEV No.	379057	Ref. No. —
	temperature probe NTC 10kOhm cable PVC probe -20 up to +80°C cable -10 up to 100°C probe ø6x25mm cable length 3m 2-wire		
	GEV No.	379160	Ref. No. —
	temperature probe NTC 10kOhm cable thermoplastic probe -40 up to +110°C cable -40 up to +110°C probe ø6x14mm cable length 1.5m without screw connection 2-wire		
	GEV No.	379161	Ref. No. 0A9498
	temperature probe NTC 10kOhm cable thermoplastic probe -40 up to +110°C cable -40 up to +110°C probe ø6x14mm cable length 3m without screw connection 2-wire		
	GEV No.	379342	Ref. No. —
	temperature probe NTC 10kOhm cable PVC probe -20 up to +80°C cable -10 up to 100°C probe ø6x25mm cable length 1.5m 2-wire protection IP67		
	GEV No.	379343	Ref. No. 092182 099570
	temperature probe NTC 10kOhm cable silicone probe -40 up to +110°C cable -50 up to +180°C probe ø6x40mm cable length 3m 2-wire		
	GEV No.	379458	Ref. No. 0S0299
	temperature probe NTC 10kOhm cable silicone probe -40 up to +110°C cable -50 up to +180°C probe ø6x40mm cable length 1.5m without screw connection 2-wire		
	GEV No.	379860	Ref. No. —
	temperature probe NTC 10kOhm cable PVC probe -20 up to +80°C cable -10 up to 100°C probe ø6x40mm cable length 1.5m without screw connection 2-wire		



1			
GEV No.	378298	Ref. No.	0S1453
description	electronic controller ELIWELL type IDPlus 961 model IDP17D0700000 mounting measurements 71x29mm 230V voltage AC NTC/PTC/Pt1000 relay outputs 1 NO-12A(12) NTC/PTC/Pt1000 front measurements 74x32mm built-in depth 67mm protection IP65 -55 up to +150°C display 3½ digits		
accessories for	378298		
	GEV No.	379052	Ref. No. 083583 0S0302
	temperature probe PTC 1kOhm cable silicone probe -50 up to +150°C cable -50 up to +180°C probe ø6x40mm cable length 1.5m without screw connection 2-wire		
	GEV No.	379053	Ref. No. —
	temperature probe PTC 1kOhm cable PVC probe -50 up to +150°C cable -10 up to 100°C probe ø6x30mm cable length 3m without screw connection 2-wire		
	GEV No.	379064	Ref. No. 085961 0A9600 0D6591 31876
	temperature probe PTC 1kOhm cable silicone probe -50 up to +150°C cable -50 up to +180°C probe ø6x40mm cable length 3m without screw connection 2-wire		
	GEV No.	379142	Ref. No. 0S0301
	temperature probe PTC 1kOhm cable PVC probe -50 up to +150°C cable -10 up to 100°C probe ø6x30mm cable length 1.5m without screw connection 2-wire		
	GEV No.	379160	Ref. No. —
	temperature probe NTC 10kOhm cable thermoplastic probe -40 up to +110°C cable -40 up to +110°C probe ø6x14mm cable length 1.5m without screw connection 2-wire		
	GEV No.	379161	Ref. No. 0A9498
	temperature probe NTC 10kOhm cable thermoplastic probe -40 up to +110°C cable -40 up to +110°C probe ø6x14mm cable length 3m without screw connection 2-wire		
	GEV No.	379162	Ref. No. —
	temperature probe NTC 10kOhm cable thermoplastic probe -40 up to +110°C cable -40 up to +110°C probe ø6x14mm cable length 6m 2-wire		
	GEV No.	379169	Ref. No. —
	temperature probe NTC 10kOhm cable thermoplastic probe -40 up to +110°C cable -40 up to +110°C probe ø6x14mm cable length 2m without screw connection 2-wire		
	GEV No.	379199	Ref. No. —
	temperature probe PTC 1kOhm cable PVC probe -50 up to +150°C cable -10 up to 100°C probe ø6x30mm cable length 5m without screw connection 2-wire		
	GEV No.	379343	Ref. No. 092182 099570
	temperature probe NTC 10kOhm cable silicone probe -40 up to +110°C cable -50 up to +180°C probe ø6x40mm cable length 3m 2-wire		
	GEV No.	379458	Ref. No. 0S0299
	temperature probe NTC 10kOhm cable silicone probe -40 up to +110°C cable -50 up to +180°C probe ø6x40mm cable length 1.5m without screw connection 2-wire		
	GEV No.	379630	Ref. No. —
	temperature probe NTC 10kOhm cable thermoplastic probe -40 up to +110°C cable -40 up to +110°C probe ø6x14mm cable length 2.5m without screw connection 2-wire resistor 10kOhm		

accessories for	378298		
	GEV No.	379804	Ref. No. —
	protector for electronic controller 71x29 L 93mm W 65mm plexiglas		
	GEV No.	381407	Ref. No. —
	temperature probe Pt1000 probe -50 up to +110°C cable silicone°C probe ø5x20mm cable length 3m protection IP68		



1			
GEV No.	378437	Ref. No.	033426
description	electronic controller ELIWELL type IDPlus 971 model IDP29DB300000 mounting measurements 71x29mm 12V voltage AC/DC NTC/PTC/Pt1000 relay outputs 2 NO-12A(12) CO-8A(4) NTC/PTC/Pt1000 NTC/PTC/Pt1000 DI front measurements 74x32mm built-in depth 67mm protection IP65 yes -55 up to +150°C display 3½ digits		
For models:	MEATFREEZER67, PFF119, SM15/F, SM21/F, SM15/FP, SM21/FP, SMP15/F, SMP21/F, SMP15/FP, SMP21/FP, SM15/F, SM21/F, SM15/FP, SM21/FP, SMP15/FP, SMP21/FP, SMP15/F, SMP21/F		
accessories for	378437		
	GEV No.	378261	Ref. No. —
	temperature probe NTC 10kOhm cable thermoplastic probe -40 up to +110°C cable -40 up to +110°C probe ø6x35mm cable length 3m without screw connection 2-wire		
	GEV No.	379052	Ref. No. 083583 0S0302
	temperature probe PTC 1kOhm cable silicone probe -50 up to +150°C cable -50 up to +180°C probe ø6x40mm cable length 1.5m without screw connection 2-wire		
	GEV No.	379053	Ref. No. —
	temperature probe PTC 1kOhm cable PVC probe -50 up to +150°C cable -10 up to 100°C probe ø6x30mm cable length 3m without screw connection 2-wire		
	GEV No.	379054	Ref. No. 004120 004121 081675 083833 0A2497
	transformer primary 230VAC secondary 12VAC 3VA secondary 0.25A H 40mm L 45mm W 50mm connection screw 50/60Hz type 153/M		
	GEV No.	379064	Ref. No. 085961 0A9600 0D6591 31876
	temperature probe PTC 1kOhm cable silicone probe -50 up to +150°C cable -50 up to +180°C probe ø6x40mm cable length 3m without screw connection 2-wire		
	GEV No.	379142	Ref. No. 0S0301
	temperature probe PTC 1kOhm cable PVC probe -50 up to +150°C cable -10 up to 100°C probe ø6x30mm cable length 1.5m without screw connection 2-wire		
	GEV No.	379160	Ref. No. —
	temperature probe NTC 10kOhm cable thermoplastic probe -40 up to +110°C cable -40 up to +110°C probe ø6x14mm cable length 1.5m without screw connection 2-wire		
	GEV No.	379161	Ref. No. 0A9498
	temperature probe NTC 10kOhm cable thermoplastic probe -40 up to +110°C cable -40 up to +110°C probe ø6x14mm cable length 3m without screw connection 2-wire		

Table continues overleaf



accessories for		378437		
GEV No.	379342	Ref. No.	—	
	temperature probe NTC 10kOhm cable PVC probe -20 up to +80°C cable -10 up to 100°C probe ø6x25mm cable length 1.5m 2-wire protection IP67			
GEV No.	379343	Ref. No.	092182 099570	
	temperature probe NTC 10kOhm cable silicone probe -40 up to +110°C cable -50 up to +180°C probe ø6x40mm cable length 3m 2-wire			
GEV No.	379458	Ref. No.	050299	
	temperature probe NTC 10kOhm cable silicone probe -40 up to +110°C cable -50 up to +180°C probe ø6x40mm cable length 1.5m without screw connection 2-wire			
GEV No.	379637	Ref. No.	—	
	temperature probe PTC 1kOhm cable PVC probe -50 up to +150°C cable -10 up to 100°C probe ø6x35mm cable length 2m without screw connection 2-wire			
GEV No.	379781	Ref. No.	—	
	temperature probe PTC 1kOhm cable thermoplastic probe -50 up to +150°C cable -40 up to +110°C probe ø6x14mm cable length 1.5m without screw connection 2-wire			
GEV No.	379782	Ref. No.	—	
	temperature probe PTC 1kOhm cable thermoplastic probe -50 up to +150°C cable -40 up to +110°C probe ø6x14mm cable length 3m 2-wire resistor 1kOhm			
	GEV No.	379804	Ref. No.	—
	protector for electronic controller 71x29 L 93mm W 65mm plexiglas			
GEV No.	379860	Ref. No.	—	
	temperature probe NTC 10kOhm cable PVC probe -20 up to +80°C cable -10 up to 100°C probe ø6x40mm cable length 1.5m without screw connection 2-wire			
GEV No.	381407	Ref. No.	—	
	temperature probe Pt1000 probe -50 up to +110°C cable silicone°C probe ø5x20mm cable length 3m protection IP68			



1

GEV No.	378304	Ref. No.	050787
description	electronic controller ELIWELL type IDPlus 971 model IDP29DB700000 mounting measurements 71x29mm 230V voltage AC NTC/PTC/Pt1000 relay outputs 2 NO-12A(12) CO-8A(4) NTC/PTC/Pt1000 NTC/PTC/Pt1000 DI front measurements 74x32mm built-in depth 67mm protection IP65 yes -55 up to +150°C display 3½ digits		
accessories for		378304	
GEV No.	379052	Ref. No.	083583 050302
	temperature probe PTC 1kOhm cable silicone probe -50 up to +150°C cable -50 up to +180°C probe ø6x40mm cable length 1.5m without screw connection 2-wire		
GEV No.	379053	Ref. No.	—
	temperature probe PTC 1kOhm cable PVC probe -50 up to +150°C cable -10 up to 100°C probe ø6x30mm cable length 3m without screw connection 2-wire		
GEV No.	379064	Ref. No.	085961 0A9600 0D6591 31876
	temperature probe PTC 1kOhm cable silicone probe -50 up to +150°C cable -50 up to +180°C probe ø6x40mm cable length 3m without screw connection 2-wire		

accessories for		378304		
GEV No.	379142	Ref. No.	050301	
	temperature probe PTC 1kOhm cable PVC probe -50 up to +150°C cable -10 up to 100°C probe ø6x30mm cable length 1.5m without screw connection 2-wire			
GEV No.	379160	Ref. No.	—	
	temperature probe NTC 10kOhm cable thermoplastic probe -40 up to +110°C cable -40 up to +110°C probe ø6x14mm cable length 1.5m without screw connection 2-wire			
GEV No.	379161	Ref. No.	0A9498	
	temperature probe NTC 10kOhm cable thermoplastic probe -40 up to +110°C cable -40 up to +110°C probe ø6x14mm cable length 3m without screw connection 2-wire			
GEV No.	379162	Ref. No.	—	
	temperature probe NTC 10kOhm cable thermoplastic probe -40 up to +110°C cable -40 up to +110°C probe ø6x14mm cable length 6m 2-wire			
GEV No.	379169	Ref. No.	—	
	temperature probe NTC 10kOhm cable thermoplastic probe -40 up to +110°C cable -40 up to +110°C probe ø6x14mm cable length 2m without screw connection 2-wire			
GEV No.	379199	Ref. No.	—	
	temperature probe PTC 1kOhm cable PVC probe -50 up to +150°C cable -10 up to 100°C probe ø6x30mm cable length 5m without screw connection 2-wire			
GEV No.	379343	Ref. No.	092182 099570	
	temperature probe NTC 10kOhm cable silicone probe -40 up to +110°C cable -50 up to +180°C probe ø6x40mm cable length 3m 2-wire			
GEV No.	379458	Ref. No.	050299	
	temperature probe NTC 10kOhm cable silicone probe -40 up to +110°C cable -50 up to +180°C probe ø6x40mm cable length 1.5m without screw connection 2-wire			
GEV No.	379630	Ref. No.	—	
	temperature probe NTC 10kOhm cable thermoplastic probe -40 up to +110°C cable -40 up to +110°C probe ø6x14mm cable length 2.5m without screw connection 2-wire resistor 10kOhm			
	GEV No.	379804	Ref. No.	—
	protector for electronic controller 71x29 L 93mm W 65mm plexiglas			
GEV No.	381407	Ref. No.	—	
	temperature probe Pt1000 probe -50 up to +110°C cable silicone°C probe ø5x20mm cable length 3m protection IP68			

eliwell



1

GEV No.	378299	Ref. No.	051454
description	electronic controller ELIWELL type IDPlus 974 model IDP2EDB700000 mounting measurements 71x29mm 230V voltage AC NTC/PTC/Pt1000 relay outputs 3 NO-12A(12) CO-8A(4) NO-5A(2) NTC/PTC/Pt1000 NTC/PTC/Pt1000 NTC/PTC/Pt1000 DI front measurements 74x32mm built-in depth 67mm protection IP65 yes -55 up to +150°C display 3½ digits		
accessories for		378299	
GEV No.	379052	Ref. No.	083583 050302
	temperature probe PTC 1kOhm cable silicone probe -50 up to +150°C cable -50 up to +180°C probe ø6x40mm cable length 1.5m without screw connection 2-wire		

Table continues overleaf



accessories for		378299	
GEV No.	379053	Ref. No.	—
	temperature probe PTC 1kOhm cable PVC probe -50 up to +150°C cable -10 up to 100°C probe ø6x30mm cable length 3m without screw connection 2-wire		
GEV No.	379064	Ref. No.	085961 0A9600 0D6591 31876
	temperature probe PTC 1kOhm cable silicone probe -50 up to +150°C cable -50 up to +180°C probe ø6x40mm cable length 3m without screw connection 2-wire		
GEV No.	379142	Ref. No.	0S0301
	temperature probe PTC 1kOhm cable PVC probe -50 up to +150°C cable -10 up to 100°C probe ø6x30mm cable length 1.5m without screw connection 2-wire		
GEV No.	379160	Ref. No.	—
	temperature probe NTC 10kOhm cable thermoplastic probe -40 up to +110°C cable -40 up to +110°C probe ø6x14mm cable length 1.5m without screw connection 2-wire		
GEV No.	379161	Ref. No.	0A9498
	temperature probe NTC 10kOhm cable thermoplastic probe -40 up to +110°C cable -40 up to +110°C probe ø6x14mm cable length 3m without screw connection 2-wire		
GEV No.	379162	Ref. No.	—
	temperature probe NTC 10kOhm cable thermoplastic probe -40 up to +110°C cable -40 up to +110°C probe ø6x14mm cable length 6m 2-wire		
GEV No.	379169	Ref. No.	—
	temperature probe NTC 10kOhm cable thermoplastic probe -40 up to +110°C cable -40 up to +110°C probe ø6x14mm cable length 2m without screw connection 2-wire		
GEV No.	379199	Ref. No.	—
	temperature probe PTC 1kOhm cable PVC probe -50 up to +150°C cable -10 up to 100°C probe ø6x30mm cable length 5m without screw connection 2-wire		
GEV No.	379343	Ref. No.	092182 099570
	temperature probe NTC 10kOhm cable silicone probe -40 up to +110°C cable -50 up to +180°C probe ø6x40mm cable length 3m 2-wire		
GEV No.	379458	Ref. No.	0S0299
	temperature probe NTC 10kOhm cable silicone probe -40 up to +110°C cable -50 up to +180°C probe ø6x40mm cable length 1.5m without screw connection 2-wire		
GEV No.	379630	Ref. No.	—
	temperature probe NTC 10kOhm cable thermoplastic probe -40 up to +110°C cable -40 up to +110°C probe ø6x14mm cable length 2.5m without screw connection 2-wire resistor 10kOhm		
GEV No.	379804	Ref. No.	—
	protector for electronic controller 71x29 L 93mm W 65mm plexiglas		
GEV No.	381407	Ref. No.	—
	temperature probe Pt1000 probe -50 up to +110°C cable silicone°C probe ø5x20mm cable length 3m protection IP68		

built-in version 2-piece



GEV No.	378138	Ref. No.	017741 099221
description	electronic controller ELIWELL type IS974LX model IS24DI0XCD000 mounting measurements 71x29mmV voltage relay outputs DI built-in depth 30mm°C display 3½ digits		
For models:	12-16+FB4G, 16-16+FB7G, 20-16FB13, 24-16FB13, 28-16+FB13, 12-20+FB7G, 16-20FB13, 20-20+FB13, 24-20+FB13, 28-20+FB16, 12-24+FB7G, 16-24FB13, 20-24+FB13, 24-24+FB16, 28-24+FB16, 16-28+FB13, 20-28+FB16, 24-28+FB16, 12-16+FB6N, 16-16+FB13, 20-16+FB13, 24-16+FB13, 28-16+FB20, 12-20+FB13, 16-20+FB13, 20-20FB13, 24-20+FB20, 28-20+FB20, 12-24+FB13, 16-24+FB13, 20-24+FB20, 24-24+FB20, 28-24+FB20, 16-28+FB20, 20-28+FB20, 24-28+FB20, KLM2A+FB4G, KLM2B+FB7G, KLM3A+FB7G, KLM-3B+FB13, KLM3C+FB13, KLM4A+FB7G, KLM4B+FB13, KLM4C+FB13, KLM4D+FB16, KLM5A+FB13, KLM5B+FB13, KLM5C+FB16, KLM5D+FB16, KLM2AN+FB6...(Other models you can see in the webshop)		
accessories for	378138		
	GEV No.	379534	Ref. No. 091207
	connection cable type EC0000110 connection RJ45 L 1000mm for ELIWELL/universal		



GEV No.	378140	Ref. No.	091189
description	load module ELIWELL type EWEM243 model DS440000DC702 mounting measurements 70x85mm 230V voltage AC NTC/PTC relay outputs 4 NO-15A(12) CO-10A(7) NO-16A(8) NO-16A(8) NTC/PTC NTC/PTC built-in depth 61mm yes -55 up to +150°C display		
accessories for	378140		
	GEV No.	378138	Ref. No. 017741 099221
	electronic controller ELIWELL type IS974LX model IS24DI0XCD000 mounting measurements 71x29mmV voltage relay outputs DI built-in depth 30mm°C display 3½ digits		
	GEV No.	378194	Ref. No. —
	temperature probe NTC 10kOhm cable PVC probe -20 up to +80°C cable -10 up to 100°C probe ø7x24.5mm cable length 1.5m without screw connection 2-wire		
	GEV No.	379052	Ref. No. 083583 0S0302
	temperature probe PTC 1kOhm cable silicone probe -50 up to +150°C cable -50 up to +180°C probe ø6x40mm cable length 1.5m without screw connection 2-wire		
	GEV No.	379053	Ref. No. —
	temperature probe PTC 1kOhm cable PVC probe -50 up to +150°C cable -10 up to 100°C probe ø6x30mm cable length 3m without screw connection 2-wire		

Table continues overleaf



accessories for		378140		
GEV No.	379057	Ref. No.	—	
temperature probe NTC 10kOhm cable PVC probe -20 up to +80°C cable -10 up to 100°C probe ø6x25mm cable length 3m 2-wire				
GEV No.	379064	Ref. No.	085961 0A9600 0D6591 31876	
temperature probe PTC 1kOhm cable silicone probe -50 up to +150°C cable -50 up to +180°C probe ø6x40mm cable length 3m without screw connection 2-wire				
GEV No.	379142	Ref. No.	0S0301	
temperature probe PTC 1kOhm cable PVC probe -50 up to +150°C cable -10 up to 100°C probe ø6x30mm cable length 1.5m without screw connection 2-wire				
GEV No.	379161	Ref. No.	0A9498	
temperature probe NTC 10kOhm cable thermoplastic probe -40 up to +110°C cable -40 up to +110°C probe ø6x14mm cable length 3m without screw connection 2-wire				
GEV No.	379781	Ref. No.	—	
temperature probe PTC 1kOhm cable thermoplastic probe -50 up to +150°C cable -40 up to +110°C probe ø6x14mm cable length 1.5m without screw connection 2-wire				
GEV No.	379782	Ref. No.	—	
temperature probe PTC 1kOhm cable thermoplastic probe -50 up to +150°C cable -40 up to +110°C probe ø6x14mm cable length 3m 2-wire resistor 1kOhm				
GEV No.	381400	Ref. No.	—	
connection cable L 3000mm 10-pole for ELIWELL/universal				

accessories for		379398		
GEV No.	379534	Ref. No.	091207	
connection cable type EC0000110 connection RJ45 L 1000mm for ELIWELL/universal				

accessories for		379398		
GEV No.	379533	Ref. No.	—	
load module ELIWELL type EWEM233 model DS340000DC700 mounting measurements 70x85mm 230V voltage AC NTC/PTC relay outputs 3 NO-15A(12) CO-10A(7) NO-16A(8) NTC/PTC NTC/PTC front measurements 70mm built-in depth 61mm protection IPx0 yes -55 up to +150°C display				

accessories for		379398		
GEV No.	379534	Ref. No.	091207	
connection cable type EC0000110 connection RJ45 L 1000mm for ELIWELL/universal				

electronic thermometers



accessories for		379504		
GEV No.	379504	Ref. No.	0S0790	
description thermometer ELIWELL type EM300 mounting measurements 71x29mm 230V voltage AC -50 up to +110°C NTC/PTC display 3½ digits front measurements 35x76mm protection IP65				
accessories for		379504		
GEV No.	378194	Ref. No.	—	
temperature probe NTC 10kOhm cable PVC probe -20 up to +80°C cable -10 up to 100°C probe ø7x24.5mm cable length 1.5m without screw connection 2-wire				
GEV No.	379052	Ref. No.	083583 0S0302	
temperature probe PTC 1kOhm cable silicone probe -50 up to +150°C cable -50 up to +180°C probe ø6x40mm cable length 1.5m without screw connection 2-wire				
GEV No.	379053	Ref. No.	—	
temperature probe PTC 1kOhm cable PVC probe -50 up to +150°C cable -10 up to 100°C probe ø6x30mm cable length 3m without screw connection 2-wire				
GEV No.	379057	Ref. No.	—	
temperature probe NTC 10kOhm cable PVC probe -20 up to +80°C cable -10 up to 100°C probe ø6x25mm cable length 3m 2-wire				
GEV No.	379064	Ref. No.	085961 0A9600 0D6591 31876	
temperature probe PTC 1kOhm cable silicone probe -50 up to +150°C cable -50 up to +180°C probe ø6x40mm cable length 3m without screw connection 2-wire				
GEV No.	379142	Ref. No.	0S0301	
temperature probe PTC 1kOhm cable PVC probe -50 up to +150°C cable -10 up to 100°C probe ø6x30mm cable length 1.5m without screw connection 2-wire				
GEV No.	379160	Ref. No.	—	
temperature probe NTC 10kOhm cable thermoplastic probe -40 up to +110°C cable -40 up to +110°C probe ø6x14mm cable length 1.5m without screw connection 2-wire				
GEV No.	379161	Ref. No.	0A9498	
temperature probe NTC 10kOhm cable thermoplastic probe -40 up to +110°C cable -40 up to +110°C probe ø6x14mm cable length 3m without screw connection 2-wire				
GEV No.	379343	Ref. No.	092182 099570	
temperature probe NTC 10kOhm cable silicone probe -40 up to +110°C cable -50 up to +180°C probe ø6x40mm cable length 3m 2-wire				
GEV No.	379458	Ref. No.	0S0299	
temperature probe NTC 10kOhm cable silicone probe -40 up to +110°C cable -50 up to +180°C probe ø6x40mm cable length 1.5m without screw connection 2-wire				

Table continues overleaf



accessories for 379504			
GEV No.	379781	Ref. No.	—
temperature probe PTC 1kOhm cable thermoplastic probe -50 up to +150°C cable -40 up to +110°C probe ø6x14mm cable length 1.5m without screw connection 2-wire			
GEV No.	379782	Ref. No.	—
temperature probe PTC 1kOhm cable thermoplastic probe -50 up to +150°C cable -40 up to +110°C probe ø6x14mm cable length 3m 2-wire resistor 1kOhm			

accessories for 378131			
GEV No.	379160	Ref. No.	—
temperature probe NTC 10kOhm cable thermoplastic probe -40 up to +110°C cable -40 up to +110°C probe ø6x14mm cable length 1.5m without screw connection 2-wire			
GEV No.	379781	Ref. No.	—
temperature probe PTC 1kOhm cable thermoplastic probe -50 up to +150°C cable -40 up to +110°C probe ø6x14mm cable length 1.5m without screw connection 2-wire			
GEV No.	379944	Ref. No.	—
temperature probe Pt1000 cable Vetrotex probe -70 up to +500°C cable -50 up to +350°C connection 2-wire thread probe ø6x180mm cable length 1.7m			

accessories
load modules



1

GEV No.	379056	Ref. No.	083196
description	load module ELIWELL type EWDR Slave 230V voltage AC		
For models:	ALP110, ALP120, ALP111, ALP220, ALP240, ALP221, ALN110, ALN120, ALN111, ALN220, ALN240, ALN221, ALNN120, ALNN220, ALNN230, ALNSO120, ALP110UK, ALN110UK, ALNN220UK, ALF110, ALF220UK, ALNF220, ALF110, ALF120, ALF220, ALF240, ALNF120, ALNF220, ALNF230, ALP110UK, ALN110UK, ALNN220UK, ALF110UK, ALNF220UK, ALP110, ALP120, ALP111, ALP220, ALP240, ALP221, ALN110, ALN120, ALN111, ALN220, ALN240, ALN221, ALF110, ALF120, ALF220, ALF240...(Other models you can see in the webshop)		

JUMO

universal controllers

built-in version



1

GEV No.	400989	Ref. No.	00340448 00382110 0G4303 0H6501 0K1799 236163
description	electronic controller JUMO type iTRON 04 mounting measurements 92x92mm 110-240V voltage AC Pt100/TC(J/K/S)/V/mA relay outputs 2 relays defr. funct. no -200 up to +1300°C display 4 digits Templn1 yes 3A 3A		
For models:	9481-3, 9482-3, 9581-3, 9582-3		

EVCO - EVERY CONTROL

universal controllers

built-in version



1

GEV No.	378131	Ref. No.	053540
description	electronic controller EVERY CONTROL EVK411M mounting measurements 71x29mm 12V voltage AC/DC NTC/PTC/Pt100/Pt1000 relay outputs 1 CO-16A(8) NTC/PTC/Pt100/Pt1000/TC(J,K)/mV/mA yes protection IP65 dependent on probe°C display 3½ digits		
accessories for	378131		
GEV No.	379050	Ref. No.	—
temperature probe Pt100 cable Vetrotex probe -200 up to +600°C cable -50 up to +350°C probe ø6x100mm cable length 2.7m without screw connection 3-wire			



LAE

electronic thermometers

built-in version



GEV No.	379775	Ref. No.	049944 0E5090
description	thermometer LAE LTS12PTI-2 mounting measurements 71x29mm built-in depth 70mm 24V voltage AC/DC PTC/Pt100 depend on probe°C display 3 digits 1 RoomTempIN PTC/Pt100 defr. funct. no		
For models:	RT100ED, RT100ES, RT100SR, RT100SL, RT140ED, RT140ES, RT140SR, RT140SL, RT190ED, RT190ES, RT190SR, RT190SL, RT190HDED, RT190HDES, RT190HSR, RT190HSL, RT270ED, RT270ES, RT270SR, RT270SL, RT270HDED, RT270HDES, RT270HSR, RT270HSL, RT100ERF, RT100ELF, RT100VD, RT100VS, RT140ERF, RT140ELF, RT140VD, RT140VS, RT142ERF, RT142ELF, RT190ERF, RT190ELF, RT190VD, RT190VS, RT190HERF, RT190HELf, RT190HDVDF, RT190HDVSF, RT270ERF, RT270ELF, RT270VDF, RT270VSF, RT270HERF, RT270HELf, RT270HDVDF, RT270HDVSF...(Other models you can see in the webshop)		
accessories for	379775		
	GEV No.	378272	Ref. No. 0L0500
	temperature probe PTC cable silicone probe -50 up to +150°C cable -50 up to +180°C connection 2-wire thread probe ø6x70mm cable length 4.85m		
	GEV No.	379776	Ref. No. —
	temperature probe PTC 1kOhm cable PVC probe -40 up to +105°C cable -10 up to 100°C probe ø6x35mm cable length 5m without screw connection 2-wire resistor 1kOhm		

PIXSYS

universal controllers

built-in version



GEV No.	379888	Ref. No.	0C3100
description	electronic controller PIXSYS type ATR111-B mounting measurements 71x29mm 230V voltage AC NTC/PTC/Pt100/Pt1000/TC(J,K)/mV/mA relay outputs 2 CO-8A(3) 8VDC/20mA NTC/PTC/Pt100/Pt1000/TC(J,K)/mV/mA front measurements 35x77mm built-in depth 54mm protection IP64 accuracy 1% built-in version defr. funct. depend on probe°C display 3 digits		
For models:	PME430, PME630, PME6L30, PME930, PME435, PME635, PME6L35, PME935, PME830, PME1230, PME12L30, PME1830, PME835, PME1235, PME12L35, PME1835, PDG433, PDG633, PDG933		

SHANGFANG

accessories



GEV No.	379054	Ref. No.	004120 004121 081675 083833 0A2497
description	transformer primary 230VAC secondary 12VAC 3VA secondary 0.25A H 40mm L 45mm W 50mm connection screw 50/60Hz type 153/M		
For models:	ALN110, ALN120, ADN111, ADF110, ALF110, ADF120, ALF120, ADNN120, ADNF120, ALN220, ALN240, ADN221, ADF220, ADF240, ADNN220, ADNF220, ADNN230, ADNF230, AKN110UK, AKF110UK, AKN220UK, AKF220UK, ASN110UK, ASF110UK, ASN220UK, ASF220UK, ARDN110, AZP1103, AZF1103, AZP2203, AZF2203, 83012001, 83012033, 83012201, ARDF110L, ARDF120, ARDN120, 83012101, ARDN220, ARDN221, ARDNF220, 83012037, AZP1103, AZP2203, ASN110, ASF110, ASN220, ASF220, ADN110, ADN120... (Other models you can see in the webshop)		

STÖRK-TRONIC

universal controllers

built-in version



GEV No.	379339	Ref. No.	0KI206 174300
description	electronic controller STÖRK-TRONIK type ST73-31.10 mounting measurements 60mm 230V voltage AC Pt100 relay outputs 1 NO-12A(6) Pt100 front measurements 72x72mm built-in depth 64mm defr. funct. -60 up to +400°C display 3 digits		



refrigeration controllers

built-in version



1

GEV No.	379339	Ref. No.	OKI206 174300
description	electronic controller STÖRK-TRONIK type ST73-31.10 mounting measurements 60mm 230V voltage AC Pt100 relay outputs 1 NO-12A(6) Pt100 front measurements 72x72mm built-in depth 64mm defr. funct. -60 up to +400°C display 3 digits		

miscellaneous

electronic thermometers



1

GEV No.	379022	Ref. No.	082875
description	thermometer mounting measurements 28.5x70.5mm -55 up to +99°C type EWTM 101		
For models:	ICF110, ICP130, ICN110UK, ICF110, BCF44H, EC406SGC, EEVAC40/2, AF431		

miscellaneous



1

GEV No.	381419	Ref. No.	OK5017 0T5975
description	electronic controller kit type ERT4V 230V Pt1000 +50 up to +130°C relay outputs 1CO		

universal controllers



1

GEV No.	379084	Ref. No.	0H6244 0K0672 60050394 9041000038
description	electronic controller Pt100 electronic thermostat		
For models:	7550-5.KES40, 7551-5.KES60, 7552-5.KES80, 7553-5.KES100, 7554-5.KES150, 7561-3.KES60.RW, 7562-3.KES80.RW, 7563-3.KES100.RW, 7564-3.KES150.RW, 7581-5.KK60, 7582-5.KK80, 7583-5.KK100, 7574-5.KES150, 7575-5.KES250, 7750-5.KES40, 7751-5.KES60, 7752-5.KES80, 7753-5.KES100, 7754-5.KES150, 7781-5.KK60, 7782-5.KK80, 7783-5.KK100, 7576-5.KES300, 7573-5.KES100, 7580-5.KK40, 7584-5.KK150, 7780-5.KK40, 7751-3/85.KES60, 7550-3/85.KES40.(N), 7551-3/85.KES60, 7552-3/85.KES80.(N), 7553-3/85.KES100.(N), 7554-3/85.KES150.(N), 7550-3/90.KES40.(N), 7551-3/90.KES60, 7552-3/90.KES80.(N), 7553-3/90.KES100.(N), 7554-3/90.KES150.(N), 7550-5/85.KES40.(N), 7551-5/85.KES60.(N), 7552-5/85.KES80.(N), 7553-5/85.KES100.(N), 7554-5/85.KES150.(N), 7550-5/90.KES40.(N), 7551-5/90.KES60.(N), 7552-5/90.KES80.(N), 7553-5/90.KES100.(N), 7554-5/90.KES150.(N), 7561-3/85.KES60.RW., 7562-3/85.KES80.RW....(Other models you can see in the webshop)		

speed controllers



1

GEV No.	402957	Ref. No.	032279
description	speed controller voltage input 230V vottage output 46-184V/115-230VV 1200W max. 10A load current 6A wall-mounted version length external size 135mm width external size 74mm D 72mm for range hoods		
For models:	MPV10/20B, MPV10/24B, MCV20/32B, RCV1, MPV8/12B, MPV8/16B, MPV8/20B, MPV8/28B, MPV8/32B, MPV8/12D, MPV8/16D, MPV8/20D, MPV8/28D, MPV8/32D, MPV10/12B, MPV10/16B, MPV10/28B, MPV10/32B, MPV10/12D, MPV10/16D, MPV10/28D, MPV10/32D, RCV2, MC14/12D, MPV8/36B, MPV8/40B, MPV8/36D, MPV8/40D, MPV10/36B, MPV10/40B, MPV10/36D, MPV10/40D, MPV12/12B, MPV12/16B, MPV12/20B, MPV12/24B, MPV12/28B, MPV12/32B, MPV12/36B, MPV12/40B, MPV12/12D, MPV12/16D, MPV12/20D, MPV12/24D, MPV12/28D, MPV12/32D, MPV12/36D, MPV12/40D, MCV14/12B, MCV14/16B...(Other models you can see in the webshop)		



1

GEV No.	402956	Ref. No.	032986
description	speed controller voltage input 230V vottage output min. 69-138/max. 110-230VV 1800W max. 13A load current 8A wall-mounted version length external size 170mm width external size 105mm D 82mm for range hoods		
For models:	MPV10/20B, MPV10/24B, MCV20/32B, RCV1, MPV8/12B, MPV8/16B, MPV8/20B, MPV8/28B, MPV8/32B, MPV8/12D, MPV8/16D, MPV8/20D, MPV8/28D, MPV8/32D, MPV10/12B, MPV10/16B, MPV10/28B, MPV10/32B, MPV10/12D, MPV10/16D, MPV10/28D, MPV10/32D, RCV2, MC14/12D, MPV8/36B, MPV8/40B, MPV8/36D, MPV8/40D, MPV10/36B, MPV10/40B, MPV10/36D, MPV10/40D, MPV12/12B, MPV12/16B, MPV12/20B, MPV12/24B, MPV12/28B, MPV12/32B, MPV12/36B, MPV12/40B, MPV12/12D, MPV12/16D, MPV12/20D, MPV12/24D, MPV12/28D, MPV12/32D, MPV12/36D, MPV12/40D, MCV14/12B, MCV14/16B...(Other models you can see in the webshop)		



			
GEV No.	401660	Ref. No.	032967
description	speed controller voltage input 230V/50HzV votage output dynamic via humidity porbeV 1200W max. 10A load current 6A length external size 135mm width external size 74mm D 72mm with moisture probe for range hoods		
For models:	KOV10E1-1, KFV101/1, KFV102/1, KLWV6-10GE		

program switches

			
GEV No.	400992	Ref. No.	006880 006966
description	electronic controller CROUZET relay outputs 4 relays 100-240V ACV		
For models:	MCP/E1SH, MCP/E1SUH, MCP/E2SUHS, MCP/E2SH, MCP/E2SUH, MCP/E2SUT, MCP/E2SHB, PCP/E2SH, OCP/E1SH, OCP/E2SH, TCP/E2SH		

probes

universal probes

level probes

			
GEV No.	381392	Ref. No.	032678
description	level probe thread M5 screw connection		
For models:	SM08C, SM15CP, SM15C, SM15/CS, SM21/CP, SM21C, DI-WHW2, DI-WHW3, DI-WHW4, DI-WHW5, DI-WHW6, DI12HWW, DI14HWW, SM08C, SM15CP, SM15C, SM15/CS, SM21C, SM21C		

temperature probes

			
GEV No.	379458	Ref. No.	050299
description	temperature probe NTC 10kOhm cable silicone probe -40 up to +110°C cable -50 up to +180°C probe ø6x40mm cable length 1.5m without screw connection 2-wire		

			
GEV No.	379343	Ref. No.	092182 099570
description	temperature probe NTC 10kOhm cable silicone probe -40 up to +110°C cable -50 up to +180°C probe ø6x40mm cable length 3m 2-wire		
For models:	AZF1103, ARDN220, ARDN221, ARDNF220, ASN220, ASF220, ADNN120, ADNF120, ADN220, ADN240, ADN221, ADF220, ADF240, ADN22060, ADF2206, ZPRO4F1F, ZPRO6F1F, ALF1104, ALF11033, ALN1103, ALN11033, AZF1103, ALF1104, ALF11033, ALNN1203, AZP2203, ALN2203, AZF2203, AZF13430, ALNN2203, 1-DOOR FREEZER, PS04F1F, 1-DOOR FREEZER, PS04F1FR, PS06F1F, PS06F1FR, PS06FE2F, PS04F1F6M, IKS220N, ISS220N, FULL DOOR FREEZER, TZ751R, ISP110N, ISP220N, RS06RX1F, FULL DOOR FREEZER, RS-06FX1F, RS06DX2F, RS13RX2F, RS13FX2F...(Other models you can see in the webshop)		

			
GEV No.	379161	Ref. No.	0A9498
description	temperature probe NTC 10kOhm cable thermoplastic probe -40 up to +110°C cable -40 up to +110°C probe ø6x14mm cable length 3m without screw connection 2-wire		
For models:	ADNN120, ADNF120, ALN220, ALN240, ADN221, ADF220, ADF240, AKN220UK, AKF220UK, ASN220UK, ASF220UK, EC6N0D2C, EC-6M0D2C, E14N0D2C, E14N0D4C, E14N0D2V, E14C0D2C, E14C0D4C, E14C0D2V, C06CD2F, C06CFD2F, C14RD2F, C14RD4F, C14RD2G, C14FD2F, C14FD4F, RSD313, FSD313, RS212, FS212, EDVP10VR1, EDVP20VR1, EDVP10VR1, EDVP20VR1, EDVP10VR1, EDVP10VR1, EDVP20VR14V, EDVP20VR12V, KVPE332, KVNE332, RVNE142, RVNE144, RVNE14V, FVNE142, FVNE144		

			
GEV No.	379730	Ref. No.	088011
description	temperature probe NTC cable PVC probe -40 up to +110°C cable -10 up to 100°C probe ø6x40mm cable length 3m cable colours brown/blue plug		
For models:	FS11F, FS15F, FS15F2, FSP11F, FSP15F, FSP15F2, FSV11F, FSV15F, FS-V15F2, SSODWC12, SSODDPC12, SSODWC16, SSODDPC16, SSWC12, SSWC16, SSWC20, SSDPC12, SSDPC16, SSDPC16, SSODWCS12, SSODWCS16, SSODWC20, SSODDPC20, DVRVAF12, DVRPAF12, DVRVAF16, DVRPAF16, DRVAF12, DRVAF16, DRVAF20, DRPAF12, DRPAF16, DRPAF20, ZLRW12C, ZLRW16C, ZLRW20C, ZLRP12C, ZLRP16C, ZLRP20C, ZLRDW12C, ZLRDW16C, ZLRDD12C, ZLRDD16C, ZLRDW12S, ZLRDW16S, ZLRDW20C, ZLRDD20C		

			
GEV No.	378291	Ref. No.	092173
description	temperature probe NTC cable silicone probe -40 up to +110°C cable -50 up to +180°C probe ø6x20mm cable length 1.45m cable colours black/white 2-wire		
For models:	FV 2M, DUAL 2 DOORS, DUAL 2 DOORS, FV 2M, FV 2M, PR04F1FBR, PR06F1FBR, PS04R1F, PS04R1FR, PR04F1F, PR04F1FR, PR06F1F, PR06F1FR, PR06FE2F, PR04F1F6M, PS04R1FLR, PS04R2F, PS04R1G, PS-04R1FHC, PS04R1FLHC, PS06R1F, PS06R1FR, PS06R1FRL, PS09R2FHC, PS06R1FHC, PS06R1FLHC, PS04F1F, PS04F2F, PS04F1FR, PS04F1FRL, PS04F1FHC, PS04F1FLHC, PS09F1FR, PS04R1FM, PS04F1FM, PS06R1FM, RS06DX2F, RS06DFX2F, RCSF16G1X, WE751G, RIO75R1F, RIO75R1FR, RIO75R1G, RIO75R2FGT, SAL25L2C94, RUCF16W1C, RUCF16X1C, RUCF16W1C, RUCF16X1, RUCF16X1G...(Other models you can see in the webshop)		



GEV No.	378292	Ref. No.	092183 099722
description	temperature probe NTC cable silicone probe -40 up to +110°C cable -50 up to +180°C probe ø6x95mm cable length 3.9m cable colours black/white 2-wire		
For models:	FV Dual, FV Dual, ARDNN120, 83012101, ADNN120, ADNF120, ALNN1203, RS06DX2F, RS06DFX2F, MCD650FP2, FV Dual, FV Dual, FV, FV, FV Dual, FV Dual, FV Dual, FV Dual, FV Dual, FV, FV, FV, FV Dual, FV Dual, FV Dual, FV Dual 1/2 doors, FV Dual 1/2 doors, FV Dual 1/2 doors, FV, FV, FV Dual, FV Dual, FV Dual, FV Dual 1/2 doors, RH06DD2F, RH06DD2FR, RH06DFD2F, C06CFD2I, EC6N0D2C, EC6M0D2C, KLP650R, KLPP650R, FV Dual, FV Dual, FV Dual, FV Dual, FV Dual, FV Dual, FV Dual, FV Dual, FV Dual		

GEV No.	379142	Ref. No.	0S0301
description	temperature probe PTC 1kOhm cable PVC probe -50 up to +150°C cable -10 up to 100°C probe ø6x30mm cable length 1.5m without screw connection 2-wire		

GEV No.	379052	Ref. No.	083583 0S0302
description	temperature probe PTC 1kOhm cable silicone probe -50 up to +150°C cable -50 up to +180°C probe ø6x40mm cable length 1.5m without screw connection 2-wire		
For models:	BC11, BC22, BC44, BC44H, BC11, BC22, BC44, BC44H, BC0144, BC072, ESBC72R, ESBC144R, ESBC10, ESBC10R, ESBC20, ESBC20R, ESBC40, ESBC40R, IKNSO120, ESK40H, EEVA10/1, EEVA20/1, EEVA40/1, EEVA40/2, EEVA10/1, EEVA20/1, EEVA40/1, EEVA40/2, ATPE061, ATPE101, ATPE201, ATPE102, AB100, AB210, AB430, AB431		

GEV No.	379064	Ref. No.	085961 0A9600 0D6591 31876
description	temperature probe PTC 1kOhm cable silicone probe -50 up to +150°C cable -50 up to +180°C probe ø6x40mm cable length 3m without screw connection 2-wire		
For models:	BC11, BC22, BC44, BC44H, BCF11, BCF22, BCF44H, BCF44, BC7, BCF7, BC7, BCF7, TRK55VV-02, TRK45VV-02, TRK70VV-02, EEVA10/1, EEVA201, EEVA40/1, EEVA40/2, EEVAC10/1, EEVAC201, EEVAC40/2, EEVAC40/1, ESK20, ESK40V, ESK40H, ESK10, ESBC40, BC72, BC72R, BC144, BC144R, ESF10, ESF40H, ESBF40, ESF40V, ESF40VR, BCF72, BCF72R, BCF144, BCF144R, BE431, TBC44H, BFE431, TBCF44H, ESK40VZ, BC72D, BC72RD, BC144D, BC144RD...(Other models you can see in the webshop)		

GEV No.	379693	Ref. No.	004116
description	temperature probe thermocouple J (Fe-CuNi) cable Vetrotex probe 0 up to +350°C cable°C probe ø6x100mm cable length 1.35m without screw connection cable colours red/blue 2-wire		
For models:	ZCMDG6, ZCMDG4, ZCMDG9, ZCBDG8, ZCBDG12, ZCBDG18, PME430, PME630, PME6L30, PME930, PME435, PME635, PME6L35, PME935, PME830, PME1230, PME12L30, PME1830, PME835, PME1235, PME12L35, PME1835, PDG433, PDG633, PDG933		

producer-specific probes

probes

GEV No.	378509	Ref. No.	092179
description	probe NTC 10kOhm cable PVC probe -40 up to +110°C cable -10 up to 100°C connection 2-wire thread probe ø6x40mm cable length 3m		
For models:	RCSN2M2, RCSN2M12, RCSN3M3, RCSN3M22, RCSN3M14, RCSN4M4, RCSN4M32, RCSN4M24, RCSN2M2U, RCSN3M3U, RCSN4M4U, RCSN2M2R, RCSN2M12R, RCSN3M3R, RCSN3M22R, RCSN3M14R, RCSN4M4R, RCSN4M32R, RCSN4M24R, RI16R1F, RI16R2FT, RI16R2FGT, RCSN2M2T, RCSN3M3T, RCSN4M4T, RI16R1G, RCSN2M24, RCSN3M34, RCSN4M44, RCSF2M24, RCSF3M34, HB2PA60, HB4CA60, HB2PUA60, HB4CUA60, HB3PA60, HB6CA60, HB3PUA60, HB6CUA60, COMP84, COMP72, COMP48, COMP36, COMN9, HB2PNT, HB3PNT, HB4PNT, HB2PNTR, HB3PNTR, HB4PNTR...(Other models you can see in the webshop)		

GEV No.	379513	Ref. No.	092178 099657
description	probe NTC cable PVC probe -40 up to +110°C cable -10 up to 100°C connection 2-wire thread probe ø6x40mm cable length 1.5m		
For models:	83012001, 83012033, 83012201, ARDF110L, ARDF120, ARDNN120, 83012101, 83012037, ASN110, ASF110, ADN110, ADN120, ADN111, ADF110, ADF120, ADNN120, ADNF120, ADNN220, ADNF220, ADNN230, ADNF230, ADN11060, ADF11060, TRN224C, TRN224D, TRN224E, TRN132A, TRN132B, TRN132C, TRNA132A, TRNA132B, TRNA132C, TRRN132A, TRRN132B, TRRN132C, TRN183A, TRN183B, TRN183C, TRN183D, TRNA183A, TRNA183B, TRNA183C, TRNA183D, TRRN183A, TRRN183B, TRRN183C, TRRN1842D, TRN224A, TRN224B, TRNA224A...(Other models you can see in the webshop)		

GEV No.	379476	Ref. No.	0G2011 0H9899 0K5142 0K5154 18025560 18025572
description	probe Pt1000 cable PTFE probe -100 up to 450°C cable -40 up to +250°C connection male faston 4.8mm thread probe ø6/10x22mm cable length 2m		
For models:	ACSGRT, GWACOEOORO, FWAAMOORO, GWACOMOORO, IWKCOE-OORO, HWAHOEOORO, GWAHOEOORO, GWAHOEOORO, FWAHOEOORO, BEN150EW87, HWAJOEOORO, GWAJOEOORO, FWAJOEOORO, BEN200EW87, GWAJOMOORO, FWFJOEXOOO, FWFJOEXORO, BEN300E.S35.H97, GWAKOEOORO, FWAKOEOORO, IWAKOMOORO, GWAKOMOORO, FWFKOEXORO, FWKKOEOORO, IVALOEOORO, IVALOEOORO, BEN400E.S35.H97, BEN400EF97, FVALOEOORO, GVALOMOORO, IVAAOEOORO, HVAAOEOORO, GVAAOEOORO, GVAAOEOORO, FVAAOEOORO, IVKAOEOORO, FVKAEOEOORO, HVABOEOORO, GVABOEOORO, GVABOEOORO, FVABOEOORO, FVFBEOEXORO, IVKBOEO-OORO, FVKBOEOORO, IVACOEOORO, BON080EF88, GVACOEOORO, FVACOEOORO, IVACOMOORO, GVACOMOORO...(Other models you can see in the webshop)		



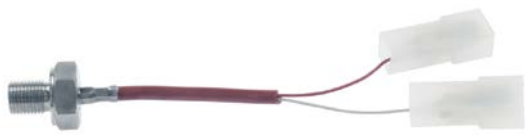

			
GEV No.	379147	Ref. No.	0H6229 9111000007
description	temperature probe NTC 10kOhm cable silicone probe -40 up to +110°C cable -50 up to +180°C connection F6.3 thread M10x1 probe ø10x10mm cable length 0.08m		

			
GEV No.	379734	Ref. No.	087480 088345 092188
description	temperature probe NTC 10kOhm cable silicone probe -40 up to +110°C cable -50 up to +180°C connection plug thread probe ø6x-19mm cable length 2m		
For models:	BC100A, BC100DA, BC100RA, BC100RDA, BC180A, BC180DA, BC180RA, BC180RDA, BC180RPA, BCF100A, BCF100DA, BCF100RA, BCF100RDA, BCF180A, BCF180DA, BCF180RA, BCF180RDA, BCF180RPA, AQC22U US, AQC31U US, AQC60U, AQC119U US, , , BC28A6, Crosswise, , , BCF15A6, , , BCW061, BCW101, BCW102, BCFW061, BCFW101, BC120A, BC120RA, BCF120A, BCF120RA, ADN220ES, ADF110ES, ADF220ES, ADN110ESP, ADF110ESP, BCWS061T, BCFW102, BLAST C/FREEZER, BLAST C/FREEZER, BLAST C/FREEZER...(Other models you can see in the webshop)		

			
GEV No.	403104	Ref. No.	093441
description	temperature probe NTC 10kOhm cable silicone probe -40 up to +110°C cable -50 up to +180°C connection plug thread probe ø6x-20mm cable length 4.25m		



			
GEV No.	379735	Ref. No.	088039
description	temperature probe NTC 10kOhm cable silicone probe -40 up to +110°C cable -50 up to +180°C connection plug thread probe ø9x-30mm cable length 0.9m		
For models:	SSODWC12, SSODDPC12, SSODWC16, SSODDPC16, SSODWB12, SSODDPB12, SSODWB16, SSODDPD16, SSWC12, SSWC16, SSWC20, SSWB12, SSWB16, SSWB20, SSDPC12, SSDPC16, SSDPC16, SSDPD12, SSDPD16, SSDPD20, SSODWCS12, SSODWCS16, SSODWC20, SSODDPC20, DVRVAF12, DVRPAF12, DVRVAF16, DVRPAF16, DVRVP12, DVRPP12, DVRVP16, DVRPP16, DRVAF12, DRVAF16, DRVAF20, DRVP12, DRVP16, DRVP20, DRPAF12, DRPAF16, DRPAF20, DRPP12, DRPP16, DRPP20, ZLRW12C, ZLRW16C, ZLRW20C, ZLRW12B, ZLRW16B, ZLRW20B...(Other models you can see in the webshop)		

			
GEV No.	379826	Ref. No.	092360
description	temperature probe NTC 10kOhm probe -40 up to +110°C connection 2-wire thread probe 23mm cable length 2m		
For models:	FV 1M, FV 1M, FV 1M, FV 1M, FV 1M, FV 1M, FV Dual, FV Dual, FV 2M, FV 2M, FV 2M, DUAL 2 DOORS, DUAL 2 DOORS, FV 2M, FV 2M, FV 1M, FV 1M, FV 1M, FV 1M, FV 2M, FV 2M, ASN110, ASF110, ASN220, ASF220, ADN110, ADN120, ADN111, ADF110, ADF120, ADNN120, ADNF120, ADN220, ADN240, ADN221, ADF220, ADNN220, ADNF220, ADNN230, ADNF230, ADN11060, ADF11060, ADN22060, ADF2206, ZPRO4R1F, ZPRO4F1F, ZPRO6R1F, ZPRO6F1F, PS04R1GM, PS06F1F6M...(Other models you can see in the webshop)		

			
GEV No.	379918	Ref. No.	006609
description	temperature probe NTC 200kOhm cable PTFE probe -40 up to +125°C cable -40 up to +250°C connection plug thread probe ø4x-40mm cable length 1m		
For models:	ECP/E1ELHU, PCP/E1ELH, TCP/E1ELHU, TCP/E1ELH, KFH/G1, KFH/E1, KFH/G1ELH, KFH/E1ELH, KFH/G1EH, KFH/E1EH, HFH/G435, HFH/G435, QFH/G1, QFH/E1, QFH/G1ELH, QFH/E1ELH, QFH/G1EH, QFH/E1H, ZFH/G435, ZFH/G435, WFH/G1, WFH/E1, WFH/G1ELH, WFH/E1ELH, WFH/G1EH, WFH/E1EH, AFH/G435, AFH/E435, CPD42G-Z, CPD40GZ, CPD42V-Z, CPD42E-Z, CPD40VZ, CPD40EZ, DR/CCE, DR/CUK, DR/LCE, DR/LUK, ER/LUSA, DPG/RTCE, DPG/RTUK, DPG/FTCE, DPG/FTUK		



1

GEV No.	379902	Ref. No.	049643 049666 OKR811 379217101 B57276K482A5
description	temperature probe NTC 4.8kOhm cable probe -10 up to 100°C cable°C connection male faston 6.3mm thread probe ø10x30mm cable lengthm		
For models:	WT4, WT4B, WT4D, WT4DB, WT46, WT4DG, WT4WS1, WT4BWS, WT4DWS1, WT4BDWS, NUC3DD, WT4D60, WT4DDG, EUC1, EUC1DP, EUC1WS, EUC1DPWS, EUC3, EUC3WS, EUC3DP, EUC3DPWS, EUC1G, EUC1DP60, EUC3DD, ZUCADDROW, ZUCADDROW6, LS5/1, LS5/1DP, LS5/1WS, LS5/1WSDP, LS5/3, LS5/3DP, LS5/3WS, LS5/3WSDP, FUCA3DD, LS5/3WSDPD, LB5DPG, LS5/1DP60, LS5/1DPAUS, LS5/1DPCS, KUC3, KUC3DP, NUC1, NUC1DP, NUC1WS, NUC1DPWS, NUC3, NUC3WS, NUC3DP, NUC3DPWS...(Other models you can see in the webshop)		
accessories for	379902		
	GEV No.	504574	Ref. No. 046376
	O-ring EPDM thickness 1.78mm ID ø 9.25mm Qty 1 pcs		
	GEV No.	504757	Ref. No. 0L0280
	screw connection ID ø 10mm for probe		



1

GEV No.	379901	Ref. No.	049884
description	temperature probe NTC 4.8kOhm cable PVC probe -40 up to +110°C cable -10 up to 100°C connection male faston 6.3mm thread probe ø6x50mm cable length 0.1m		
For models:	WT4, WT4B, WT4D, WT4DB, WT46, WT4DG, WT4WS1, WT4BWS, WT4DWS1, WT4BDWS, WT4D60, WT4DDG, LS5/1, LS5/1DP, LS5/1WS, LS5/1WSDP, LS5/3, LS5/3DP, LS5/3WS, LS5/3WSDP, LS5/3WSDPD, LB5DPG, LS5/1DP60, LS5/1DPAUS, LS5/1DPCS, LS6EP, LS6EP/DD, LS6EADD, LS6EA/DPDD, WT38TDE, WT38/M50, LS6EADP3, WT38PM50, WT37LEV/9, LS6SANA, WT38M50/4, LS6EA/UK, LS6EA/DPUK, LS6EA/60, WT38D, WT37, WT38, WT37/4.5, WT38/4.5, WT37/UK, WT38C, WT38C60, WT38CUK, WT38/4.5NW, WT38UK...(Other models you can see in the webshop)		



1

GEV No.	378334	Ref. No.	093442
description	temperature probe NTC cable PVC probe -40 up to +110°C cable -10 up to 100°C connection coded plug thread probe ø6x19mm cable length 3.2m		



1

GEV No.	378337	Ref. No.	0E5482 30000012
description	temperature probe NTC cable PVC probe -40 up to +110°C cable -10 up to 100°C connection coded plug thread probe ø6x30mm cable length 5m		
For models:	RT100ED, RT100ES, RT100SR, RT100SL, RT140ED, RT140ES, RT140SR, RT140SL, RT190ED, RT190ES, RT190SR, RT190SL, RT190HDED, RT190HDES, RT190HSR, RT190HSL, RT270ED, RT270ES, RT270SR, RT270SL, RT270HDED, RT270HDES, RT270HSR, RT270HSL, RT100ERF, RT100ELF, RT100VD, RT100VS, RT140ERF, RT140ELF, RT140VD, RT140VS, RT142ERF, RT142ELF, RT190ERF, RT190ELF, RT190VD, RT190VS, RT190HERF, RT190HEL, RT190HDVDF, RT190HDVDF, RT270ERF, RT270ELF, RT270VDF, RT270VSF, RT270HERF, RT270HEL, RT270HDVDF, RT270HDVDF...(Other models you can see in the webshop)		



1

GEV No.	379736	Ref. No.	088041
description	temperature probe NTC cable PVC probe -40 up to +110°C cable -10 up to 100°C connection plug thread probe ø9x30mm cable length 3.2/3.8m		
For models:	SSODWC12, SSODDPC12, SSODWC16, SSODDPC16, SSDPC12, SSDPC16, SSDPC16, SSODWCS12, SSODWCS16, SSODWC20, SSODDPC20, DVRVAF12, DVRPAF12, DVRVAF16, DVRPAF16, DRPAF12, DRPAF16, DRPAF20, ZLRP12C, ZLRP16C, ZLRP20C, ZLRDW12C, ZLRDW16C, ZLRDD12C, ZLRDD16C, ZLRDW12S, ZLRDW16S, ZLRDW20C, ZLRDD20C		

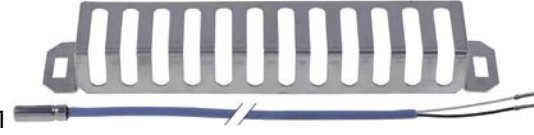

1

GEV No.	379733	Ref. No.	087130
description	temperature probe NTC cable silicone probe -40 up to +110°C cable -50 up to +180°C connection 2-wire thread probe ø6x19mm cable length 4m		
For models:	ALN110, ALN120, ADN111, ADF110, ALF110, ADF120, ALF120, ADN1120, ADN120, ADN220, ALN240, ADN221, ADF220, ADF240, ADN220, ADN220, ADN220, ADN220, ADN220, AKN110UK, AKF110UK, AKN220UK, AKF220UK, ASN110UK, ASF110UK, ASN220UK, ASF220UK, ARDN110, EO6NOD1C, EO6NOD2C, EO6NOD1V, EO6F0D1C, EO6COD1C, EO6COD2C, EO6COD2C, EO6COD1V, EC6NOD2C, EC6MOD2C, E14NOD2C, E14NOD4C, E14NOD2V, E14COD2C, E14COD4C, E14COD2V, EC4NOD2C, EC4MOD2C, EC4NOD3C, EC4MOD3C, C06RD1F, C06RD1FL, C06RD2F...(Other models you can see in the webshop)		



1

GEV No.	381255	Ref. No.	092180 099658
description	temperature probe NTC cable silicone probe -40 up to +110°C cable -50 up to +180°C connection plug thread probe ø5.9x40mm cable length 1.5m		
For models:	BC180A, BC180DA, BC180RA, BC180RDA, BC180RPA, BCF180A, BCF180DA, BCF180RA, BCF180RDA, BCF180RPA, AQC22U US, AQC31U US, AQC60U, AQC119U US, , , BC28A6, Crosswise, , , BCF15A6, , , BCW061, BCFW061, BC120A, BC120RA, BCF120A, BCF120RA, ADF110ES, ADN110ESP, ADF110ESP, BCWS061T, ADN110E, ADF110E, BC15A, Crosswise, BC28A, Crosswise, BC56HA, BCF15A, Crosswise, BCF28A, Crosswise, BCF56HA, BCFWS061, BCFWS061T, BLAST C/FREEZER, BC10A, BLAST C/FREEZER...(Other models you can see in the webshop)		

GEV No.	379107	Ref. No.	056675 058669 60050229
description	temperature probe Pt100 probe -100 up to 450°C cable -40 up to +250°C connection 2-wire thread probe ø5x50mm cable length 1.4m		
For models:	FCVE6-3CE, FCVE103CE, FCVE203CE, FCVE20/P-V, FCVE10-P, FCVE-10PUK, FCVG10-P, FCVG10PUK, FCVE20-P, FCVE20PUK, FCVG20-P, FCVG20PUK, AFCV/G6-1, AFCV/G6-3, SCO/G6-3, AFCV/G101, AFCV/G103, SCO/G10-3, AFCV/G201, AFCV/G203, SCO/G20-3		



GEV No.	379404	Ref. No.	0K8490 30000826 E290103
description	temperature probe Pt1000 cable glass fibre probe -70 up to +500°C cable -50 up to +350°C connection male faston thread probe ø4x-60mm cable length 1.6m		



GEV No.	378336	Ref. No.	0K7575 30000492
description	temperature probe Pt1000 cable silicone probe -50 up to +200°C cable -50 up to +180°C connection bullet receptacle ø2mm thread probe ø10x30mm cable length 8m		
For models:	FT36EDTS, FT36ESTS, FT36VDTs, FT36VSTs, FT36ED, FT36ES, FT36VD, FT36VS, FT50ED, FT50ES, FT50VD, FT50VS, FT72ED, FT72ES, FT72VD, FT72VS, FT36EDT, FT36EST, FT36VDT, FT36VST, FT50EDT, FT50EST, FT50VDT, FT50VST, FT72EDT, FT72EST, FT72VDT, FT72VST, FT36WED, FT36WES, FT36WVD, FT36WVS, FT50WED, FT50WES, FT50WVD, FT50WVS, FT72WED, FT72WES, FT72WVD, FT72WVS, FT36WEDT, FT36WEST, FT36WVDT, FT36WVST, FT50WEDT, FT50WEST, FT50WVDT, FT50WVST, FT72WEDT, FT72WEST...(Other models you can see in the webshop)		





GEV No.	378335	Ref. No.	0E5990
description	temperature probe Pt1000 cable silicone probe -50 up to +200°C cable -50 up to +180°C connection coded plug thread probe ø6x50mm cable length 6m		
For models:	RT100ED, RT100ES, RT140ED, RT140ES, RT190ED, RT190ES, RT190SR, RT190SL, RT190HDED, RT190HDES, RT190HSR, RT190HSL, RT270ED, RT270ES, RT270SR, RT270SL, RT270HDED, RT270HDES, RT270HSR, RT270HSL, RT100ERF, RT100ELF, RT140ERF, RT140ELF, RT142ERF, RT142ELF, RT190ERF, RT190ELF, RT190VD, RT190VS, RT190HERF, RT190HEL, RT190HDVDF, RT190HDVSF, RT270ERF, RT270ELF, RT270VDF, RT270VSF, RT270HERF, RT270HEL, RT270HDVDF, RT270HDVSF, RT100ERG, RT100ELG, RT140ERG, RT140ELG, RT190ERG, RT190ELG, RT190VDU, RT190VSU...(Other models you can see in the webshop)		



GEV No.	379100	Ref. No.	002615 0C5342 0F0087 0K0676 0K0681 0K3624 0K9704 0KE606 0KE749 0T4243 215727 60050278
description	temperature probe Pt1000 cable silicone probe -70 up to +500°C cable -50 up to +180°C connection male faston 4.8mm thread probe ø4x235mm cable length 1.8m		
For models:	FCV/G10L3, FCV/G6L3TOWNGAS, FCV/G6L3, FCVG10L3T, FCVG102L3, FCV/E101/1, FCV/G20L3, FCVG202L3, FCVE6L3J, FCV/E10L3JAP, FCV/E102/1L3JAP, FCV/E10L6JAP, FCV/E102/1L6JAP, FCV/G6L-3JAP, FCVG10L3J, FCVG102L3J, FCV/G10L6JAP, FCV/G102/1L6JAP, FCVG6L3CJ, FCV/E61/1, FCV/G10L2, FCV/E61/1, FCV/E101/1, FCV/E101/1, FCV/E10L2, FCV/E102/1, FCV/E61/1, FCV/E61/1, FCV/E101/1, FCV/E101/2, FCV/G6L3C, FCV/G61/1, FCV/G61/1, FCV/G61/1, FCV/G61/1, FCV/G61/1, FCV/G6L3CT, FCV/G6L3CJ, FCV/E10L3, FCV/E102/1, FCV/E6L3, FCV/E102/1L3, FCV/E20L3, FCVE202L3, FCV/G6L4, FCV/E6L4, FCV/E101/1, FCV/G10L6, FCV/E10L6, FCV/G102/1L6, FCV/E102/1L6...(Other models you can see in the webshop)		

accessories for 379100

	GEV No.	693745	Ref. No.	002624 0C3641 0F0165 237382
	gasket PTFE ED ø 20mm ID ø 15mm thickness 1mm Qty 1 pcs			
	GEV No.	697993	Ref. No.	002701 0F0158
	sleeve for temperature probe ø 11mm ID ø 4.3mm H 22.4mm			



GEV No.	378012	Ref. No.	0H9845 0K2997 0K5047 18025400 70040101 700401015
description	temperature probe PTC 2kOhm cable probe -50 up to +150°C cable°C connection F6.3 thread M10x1 cable lengthm		
For models:	VARIOSTEAM/S-33.3/F, STEAM-O-MAT		





GEV No.	402006	Ref. No.	086369 62040406
description	temperature probe PTC 2kOhm cable PVC probe -50 up to +150°C cable -10 up to 100°C connection plug thread probe ø5x60mm cable length 1.5m		
For models:	CIM15A, CIM15W, CIM30A, CIM30W, CIM45A, CIM45W, CIM65A, CIM65W		





GEV No.	402008	Ref. No.	086341
description	temperature probe PTC 2kOhm cable PVC probe -50 up to +150°C cable -10 up to 100°C connection plug thread probe ø6x50mm cable length 1.2m		
For models:	CIM120AS, CIM120WS		





			
GEV No.	402191	Ref. No.	086340 0H9322 0KM745 30003179 62040401 62040411 SC62040401
description	temperature probe PTC 2kOhm cable TPE probe -50 up to +150°C cable -40 up to +110°C connection plug thread probe ø5x20mm cable length 1.8m		
For models:	CIM120AS, CIM120WS		

			
GEV No.	402005	Ref. No.	086339 086344 0H9327 0K8396 0KD786 62040400 62040410 P1CA66P16UCS
description	temperature probe PTC 2kOhm cable TPE probe -50 up to +150°C cable -40 up to +110°C connection plug thread probe ø6x50mm cable length 1.6m		
For models:	CIM15A, CIM15W, CIM30A, CIM30W, CIM45A, CIM45W, CIM65A, CIM65W, CIM120AS, CIM120WS		

			
GEV No.	378272	Ref. No.	0L0500
description	temperature probe PTC cable silicone probe -50 up to +150°C cable -50 up to +180°C connection 2-wire thread probe ø6x70mm cable length 4.85m		

			
GEV No.	379973	Ref. No.	003439
description	temperature probe thermocouple cable ceramic probe -50 up to +750°C cable -100 up to +1300°C connection grip connection thread probe ø10x100mm cable lengthm		
For models:	ZMMDE4, ZMMDE6, FPS/18, FPS/30		

			
GEV No.	379146	Ref. No.	0195 0H6247
description	temperature probe thermocouple J (Fe-CuNi) cable Vetrotex probe -50 up to +750°C cable -50 up to +350°C connection 2-wire thread 1/2" probe ø6x5mm cable length 2m		
For models:	9481-3, 9482-3, 9581-3, 9582-3		

			
GEV No.	379427	Ref. No.	002171 0H9847 0K5052 0K5058 0M2152 14T06 15502 18025415 750008 75000802
description	temperature probe thermocouple K (NiCr-Ni) cable glass fibre probe -50 up to 1150°C cable -50 up to +350°C connection 2-wire thread probe ø4x20mm cable length 2.6m		
For models:	CE128-106, CE158-133.3.HV, CE158-244.3, CE158-246.3, CK248-209, D1ABBB, CK248-211.D1ABBB, HCE128-100, HCE128-104, HCE158-252W.3, HCE158-253.3, HLE129-100, HLE129-103, HLE129-104W, HLE159-252W.3.6, HLE159-328.3.HV, HLE159-351W.3.HV, HLE249-200.3, HLE249-208.3, HLE259-088.3.HV, HLE259-089.3.HV, HLE259-384W.3, LE129-101, LE159-261.3, LE159-281.3.6, LE159-318.3.HV, LE159-322.3.HV, LE159-330.3.HV, LE159-337.3.HV, LE159-344.3.MS92, LE159-347.3.HV, LE249-199.3, LE249-203.3, LE249-207.3, LE249-211.3, LE249-215.3, LE249-219.3, LE249-223.3, LE249-232.3, LE249-238.3, LE259-081.3.HV, LE259-082.3.HV, LE259-083.3.HV, LE259-094.3.HV, LE259-099.3.HV, LE259-382.3, LK259-707.D1ACCB, LK259-708.D1ACCB, CK248-205.D1ABBB, CK248-207.D1ABBB, LK159-707.D1BC...(Other models you can see in the webshop)		

			
GEV No.	379717	Ref. No.	0C0326 0C6539
description	temperature probe thermocouple K (NiCr-Ni) cable PTFE probe -50 up to 1150°C cable -40 up to +250°C connection plug thread probe ø4x70mm cable length 1.1m		
For models:	FCZ061EAA, FCZ102EAA, FCZ201EAA, FCZ202EAA, FCZ061EAH, FCZ201EAH, FCZ061EAN, FCZ201EAN, FCZ101GAG, FCZ102GAG, FCZ201GAG, FCZ202GAG, FCZ101GAD, FCZ102GAD, FCZ201GAD, FCZ202GAD, FCZ061EBA, FCZ102EBA, FCZ201EBA, FCZ202EBA, FCZ061EBH, FCZ201EBH, FCZ201EBN, FCZ101GBG, FCZ102GBG, FCZ201GBG, FCZ202GBG, FCZ101GBD, FCZ102GBD, FCZ201GBD, FCZ202GBD, FCZ061ECA, FCZ102ECA, FCZ201ECA, FCZ202ECA, FCZ061ECH, FCZ201ECH, FCZ061ECN, FCZ201ECN, FCZ101GCG, FCZ102GCG, FCZ201GCG, FCZ202GCG, FCZ101GCD, FCZ102GCD, FCZ201GCD, FCZ202GCD, AOS101GA, AOS101GB, AOS061EAAQ...(Other models you can see in the webshop)		



electric components

GEV No.	379715	Ref. No.	OC0324 OC6538
description	temperature probe thermocouple K (NiCr-Ni) cable PVC probe -50 up to 1150°C cable -10 up to 100°C connection plug thread probe ø4x70mm cable length 0.5m		
For models:	FCZ061EAA, FCZ102EAA, FCZ201EAA, FCZ202EAA, FCZ061EAH, FCZ201EAH, FCZ061EAN, FCZ201EAN, FCZ101GAG, FCZ102GAG, FCZ201GAG, FCZ202GAG, FCZ101GAD, FCZ102GAD, FCZ201GAD, FCZ202GAD, FCZ061EBA, FCZ102EBA, FCZ201EBA, FCZ202EBA, FCZ061EBH, FCZ201EBH, FCZ201EBN, FCZ101GBG, FCZ102GBG, FCZ201GBG, FCZ202GBG, FCZ101GBD, FCZ102GBD, FCZ201GBD, FCZ202GBD, FCZ061ECA, FCZ102ECA, FCZ201ECA, FCZ202ECA, FCZ061ECH, FCZ201ECH, FCZ061ECN, FCZ201ECN, FCZ101GCG, FCZ102GCG, FCZ201GCG, FCZ202GCG, FCZ101GCD, FCZ102GCD, FCZ201GCD, FCZ202GCD, AOS101GA, AOS101GB, AOS061EAAQ.. (Other models you can see in the webshop)		

GEV No.	379716	Ref. No.	OC0325
description	temperature probe thermocouple K (NiCr-Ni) cable PVC probe -50 up to 1150°C cable -10 up to 100°C connection plug thread probe ø4x70mm cable length 0.85m		
For models:	FCZ061EAA, FCZ102EAA, FCZ201EAA, FCZ202EAA, FCZ061EAH, FCZ201EAH, FCZ061EAN, FCZ201EAN, FCZ201GAG, FCZ202GAG, FCZ201GAD, FCZ202GAD, FCZ061EBA, FCZ102EBA, FCZ201EBA, FCZ202EBA, FCZ061EBH, FCZ201EBH, FCZ201EBN, FCZ201GBG, FCZ202GBG, FCZ201GBD, FCZ202GBD, FCZ061ECA, FCZ102ECA, FCZ201ECA, FCZ202ECA, FCZ061ECH, FCZ201ECH, FCZ061ECN, FCZ201ECN, FCZ201GCG, FCZ202GCG, FCZ201GCD, FCZ202GCD, AOS101GB, AOS061EAAQ, AOS061EBAQ, AOS102EAAQ, AOS102EBAQ, AOS202EAAQ, AOS202EBAQ, AOS061EANQ, AOS061EBNQ, AOS102EANQ, AOS102EBNQ, AOS202EANQ, AOS202EBNQ, AOS061EACQ, AOS061EBCQ..(Other models you can see in the webshop)		

GEV No.	379889	Ref. No.	OC3457
description	temperature probe thermocouple K (NiCr-Ni) cable PVC probe -50 up to 1150°C cable -10 up to 100°C connection plug thread probe ø4x70mm cable length 2m		
For models:	FCS201G4		

GEV No.	379092	Ref. No.	002172 0K5055 0KF607 0KG863 0KT883 0M2151 14T05 15S01 18015409 18025409 18025412 702844003 716888 75000801
description	temperature probe thermocouple K (NiCr-Ni) cable silicone probe -50 up to 1150°C cable -50 up to +180°C connection 2-wire thread probe ø4x20mm cable length 2.6m		
For models:	CEB068, CEB069, UEB068, UEB069		
accessories for	379092		
	GEV No.	378128	Ref. No.
			0KE127 75901204 75901304
bayonet adapter L 59mm thread M6x1 ID ø 7/4mm ED ø 12mm			

accessories for	379092		
	GEV No.	379094	Ref. No.
			OG2155 0K5056 18025413 75901301 759020
bayonet adapter L 39mm thread M6x1 ID ø 7/4mm ED ø 12mm			

GEV No.	379098	Ref. No.	0G0032 0K5623 19011203 720527
description	temperature probe thermocouple K (NiCr-Ni) cable Vetrotex probe -50 up to 1150°C cable -50 up to +350°C connection 2-wire thread M6/M10 probe ø6x20mm cable length 2.1m		
For models:	CGB068, CGB069, UGB068, UGB069		

GEV No.	379148	Ref. No.	0H6267
description	temperature probe thermocouple K (NiCr-Ni) cable Vetrotex probe -50 up to 1150°C cable -50 up to +350°C connection 2-wire thread M8 probe ø8x70mm cable length 1.6m		
For models:	9013-3, 9015-3, 9030-3, 9031-3, 9032-3, 9213-3-0, 9213-3-8, 9230-3-0, 9230-3-8, 9231-3-0, 9231-3-8, 9232-3-0, 9232-3-8		

GEV No.	379145	Ref. No.	0H6269
description	temperature probe thermocouple K (NiCr-Ni) cable Vetrotex probe -50 up to 1150°C cable -50 up to +350°C connection 2-wire thread probe ø3x100mm cable length 2m		
For models:	7744-3/85.KB.(N), 7508-3/85., 7502-3/85., 7542-3/85., 7544-3/85.KB.(N), 7542-3/90.KB.(N), 7544-3/90.KB.(N), 7742-3/90.KB.(N), 7742-3/85.KB.(N), 7744-3/90.KB.(N), 7746-3/90.KB.(N), 7748-3/90.KB.(N), 7747-3/90.KB.(N), 7541-3/85.KB.(N), 7543-3/85.KB.(N), 7541-3/90.KB.(N), 7543-3/90.KB.(N), 7545-3/85.KB.(N), 7546-3/85.KB.(N), 7547-3/85.KB.(N), 7548-3/85.KB.(N), 7545-3/90.KB.(N), 7546-3/90., 7547-3/90.KB.(N), 7548-3/90.KB.(N), 7741-3/85.KB.(N), 7743-3/85.KB.(N), 7741-3/90.KB.(N), 7743-3/90.KB.(N), 7745-3/90.KB.(N), 7745-3/85.KB.(N), 7746-3/85.KB.(N), 7747-3/85.KB.(N), 7748-3/85.KB.(N), 7500-3/85.HE.2PL.(N), 7504-3/85.HE.6PL.BO, 7505-3/85, 7512-3/85.KF.BO.(N), 7502-3/90.HE.4PL.BO., 7504-3/90.HE.6PL.BO., 7505-3/90.HE.6PL.BO., 7508-3/90.HE.CER.BO., 7512-3/90.KF.BO.(N), 7700-3/85, 7700-3/90.HE.2PL.(N), 7502-3/85.HE.4PL.BO., 7508-3/85.HE.CER.BO., 7505-3/85.HE.6PL.BO., 7508-3/85.HE.CER.BO., 7542-3/85.KB.DWD... (Other models you can see in the webshop)		

GEV No.	379713	Ref. No.	004209 0C3567
description	temperature probe thermocouple K (NiCr-Ni) cable Vetrotex probe -50 up to 1150°C cable -50 up to +350°C connection 2-wire thread probe ø3x200mm cable length 1.5m		
For models:	MAX18/35X, ZCMDE6, ZCBDE12, ZCMDE4, ZCBDE8, ZCMDE9, ZCBDE18, FFP516, FFP532, PDE830, PDE1230, PDE12L30, PDE1830, PDE835, PDE1235, PDE12L35, PDE1835		



1			
GEV No.	102272	Ref. No.	0H6237 45002663001B
description	thermocouple		

core probes

1			
GEV No.	378412 ¹	Ref. No.	0C3964 0C6616
description	core temperature probe multipoint probe cable SS corrugated hose probe -40 up to +250°C cable -40 up to +250°C connection plug probe ø3.5x100mm thread cable length 1.74m handle ø 10mm handle length 85mm		
For models:	AOW101EA, AOW101EABU		

¹ multipoint probe

1			
GEV No.	379724	Ref. No.	0C1522
description	core temperature probe multipoint probe cable SS corrugated hose probe -40 up to +250°C cable -40 up to +250°C connection plug probe ø3.5x95mm thread cable length 1.6m handle ø 10mm handle length 58mm		
For models:	FCS101EP4J, FCS101EP, FCS101GP9J, FCS101GP, FCS102GA9J, FCS102GP, FCS101EX4J, FCS101EX, FCS101GX9J, FCS101GX, FCS102GX9J, FCS102GX		

1			
GEV No.	401944	Ref. No.	088348 092704
description	core temperature probe NTC 10kOhm cable silicone probe -40 up to +120°C cable -50 up to +180°C connection plug probe ø5x80mm thread cable length 3m handle ø 10mm handle length 100mm L1 150mm L2 70mm		
For models:	BC100A, BC100DA, BC100RA, BC100RDA, BC180A, BC180DA, BC180RA, BC180RDA, BC180RPA, BCF100A, BCF100DA, BCF100RA, BCF100RDA, BCF180A, BCF180DA, BCF180RA, BCF180RDA, BCF180RPA, AQC31U US, AQC60U, AQC119U US, , BC28A6, Crosswise, , BCF15A6, , BC120A, BC120RA, BCF120A, BCF120RA, BC15A, Crosswise, BC28A, Crosswise, BC56VA, Crosswise 20, BC56HA, BCF15A, Crosswise, BCF28A, Crosswise, BCF64A, Crosswise 20, BCF56HA, BC10A, BLAST C/FREEZER, BCF7A, BLAST C/FREEZER...(Other models you can see in the webshop)		

1			
GEV No.	401549	Ref. No.	0H6131 0H6496 31503510 60050409
description	core temperature probe Pt100 cable PTFE probe -100 up to 450°C cable -40 up to +250°C connection 2-wire probe ø4.5x80mm thread cable length 1.8m handle ø 8mm handle length 70mm		
For models:	5611-3-10, 5611-3-8		

1			
GEV No.	379091	Ref. No.	0H6492 0H6497 0T3795 31503507 60050411 E33.0158
description	core temperature probe Pt100 cable PTFE probe -40 up to +250°C cable -40 up to +250°C connection 2-wire probe ø4.5x80mm thread cable length 1.3m handle ø 8mm handle length 70mm		
For models:	5612-3-10, 5612-3-8		

1			
GEV No.	379096	Ref. No.	0H6493 0H6498 236147 31503508
description	core temperature probe Pt100 cable PTFE probe -40 up to +250°C cable -40 up to +250°C connection 2-wire probe ø4.5x80mm thread cable length 1.5m handle ø 8mm handle length 70mm		
For models:	5614-3-10, 5614-3-8		



GEV No.	379037	Ref. No.	059002
description	core temperature probe Pt100 cable SS corrugated hose probe -40 up to +250°C cable -40 up to +250°C connection 2-wire probe ø4x100mm thread M12 cable length 2.2m handle ø 9mm handle length 90mm		
For models:	FCVE103CE, FCVE10-P, FCVE10PUK, FCVG10-P, FCVG10PUK, AFCV/G103		



GEV No.	379961	Ref. No.	002330 058199
description	core temperature probe Pt100 cable SS corrugated hose probe -40 up to +250°C cable -40 up to +250°C connection 2-wire probe ø4x100mm thread M12 cable length 2.8m handle ø 9mm handle length 80mm		
For models:	FCVE20/P-V, FCVE20-V, FCVE20VUK, FCV/E20-V		



GEV No.	379721	Ref. No.	0E3423 0H2363 0H2364 0K7782 0K7784 0K7785 0K8594
description	core temperature probe Pt100 cable SS corrugated hose probe -40 up to +250°C cable -40 up to +250°C connection bullet receptacle ø2mm probe ø4x100mm thread M16x1 cable length 3.9m handle ø 10mm handle length 45mm		
For models:	D820, D820, D820, D820, AR170S, AR170S, AR170S, AR170S, AR170S, AR170S, AR170S, AR170S, AR170S, AR340S, AR340S, AR340S, AR340S, AR340S, AR340S, AR340S, AR340S, AR340S, AR10ES, AR10ES, AR10ES, AR10ES, AR10ES, AR10ES, AR10ES, AR10ES, AR10ESP, AR10ESP, AR10ESP, AR10ESP, AR10ESP, AR10ESP, AR10ESP, AR10ES, AR10ES, AR10ES, AR10ES, AR10ES, AR10ES, AR10ES, AR10ESP, AR10ESP, AR10ESP...(Other models you can see in the webshop)		



GEV No.	379095	Ref. No.	055472 0K2962 60050213
description	core temperature probe Pt100 cable SS corrugated hose probe -40 up to +250°C cable -40 up to +250°C connection coded plug probe ø4x100mm thread M12 cable length 1.45m handle ø 9mm handle length 85mm		
For models:	FCVE6-3CE, FCVE203CE, FCVE20-P, FCVE20PUK, FCVG20-P, FCVG-20PUK, ZOFVCV/G6-3, AFCV/G6-1, AFCV/G6-3, AFCV/G103, AFCV/G203		



GEV No.	379979	Ref. No.	0H6262
description	core temperature probe Pt100 cable SS tube probe -40 up to +250°C cable -40 up to +250°C connection 2-wire probe ø5x100mm thread cable length 2m handle ø 9mm handle length 45mm		



GEV No.	379978	Ref. No.	0H6490 0H6494 31503509
description	core temperature probe Pt100 cable SS/plastic probe -40 up to +250°C cable -40 up to +250°C connection 2-wire probe ø5x100mm thread cable length 1.6m handle ø 9mm handle length 45mm		

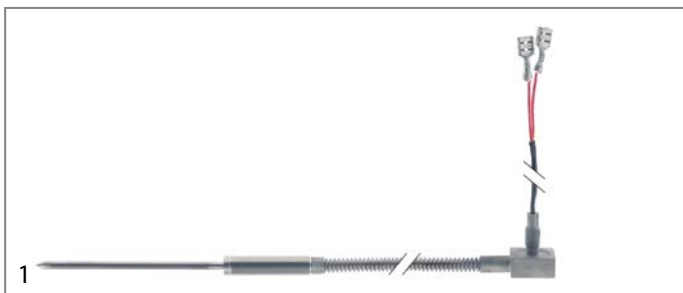

GEV No.	379061	Ref. No.	003094 003853 0F0085 0H6499 0K9184
description	core temperature probe Pt1000 cable SS corrugated hose probe -40 up to +250°C cable -40 up to +250°C connection 2-wire probe ø4x100mm thread M8 cable length 2.5m handle ø 10mm handle length 45mm		
For models:	FCV/G20L3, FCVG202L3, FCV/E20L3, FCVE202L3, FCV/G20L6, FCV/E20L6, FCVG202L6, FCVE202L6, FCFG201-0, FCFG202-0, FCFE201-0, FCFE202-0, FCF201ENS, CS20ME4/200-3, CS20ME4/230-3, CS20ME6/230-3, CS20ME4/400-3N, CS20ME6/400-3N, CS-20ME4/400-3NE, CS20ME4/400-3, CS20ME4/440-3, CS20MT4/400-3N, CS20MT6/400-3N, CS20GE4/200-3, CS20GE4/230-3, CS20GE6/230-3, CS20GE4/400-3N, CS20GE6/400-3N, CS20GE4/400-3NE, CS-20GE4/400-3, CS20GE4/440-3, CS20GT4/400-3N, CS20GT6/400-3N, CS20LCE4/200-3, CS20LCE4/230-3, CS20LCE6/230-3, CS20LCE4/400-3N, CS20LCE6/400-3N, CS20LCE4/400-3, CS20LCE4/440-3, CS20LCT4/400-3N, CS20LCT6/400-3N, C204200-3, C20230-3, C204400-3N, C206400-3N, C20T4/400-, C20P4200-3, C20P4230-3...(Other models you can see in the webshop)		



GEV No.	379407	Ref. No.	0K8488 E290105
description	core temperature probe Pt1000 cable SS corrugated hose probe -40 up to +250°C cable -40 up to +250°C connection 2-wire probe ø4x100mm thread M8 cable length 2.7m handle ø 10mm handle length 45mm		

GEV No.	379060	Ref. No.	002673 0F0084 OK8487 60050267 L675
description	core temperature probe Pt1000 cable SS corrugated hose probe -40 up to +250°C cable -40 up to +250°C connection 2-wire probe ø4x100mm thread M8 cable length 2m handle ø 10mm handle length 45mm		
For models:	FCV/G10L3, FCV/G6L3TOWNGAS, FCV/G6L3, FCGV10L3T, FCVE6L3J, FCV/E10L3JAP, FCV/E10L6JAP, FCV/G6L3JAP, FCGV10L3J, FCV/G10L6JAP, FCGV6L3CJ, FCV/E61/1, FCV/E61/1, FCV/E61/1, FCV/E61/1, FCV/E101/1, FCV/E101/2, FCV/G6L3C, FCV/G61/1, FCV/G61/1, FCV/G61/1, FCV/G61/1, FCV/G61/1, FCV/G61/1, FCV/G6L3CT, FCGV6L3CJ, FCV/E10L3, FCV/E6L3, FCV/G6L4, FCV/E6L4, FCV/G10L6, FCV/E10L6, FCF/G6-0, FCFG101/0, FCFG102-0, FCF/E6-0, FCFE101-0, FCFE102-0, FCF061ELN, FCF101ELN, FCF6EHOR, FCFG10160H, FCF061ENS, FCF101ENS, FCF102ENS, FCFG102-0T, FCF/G6-1-JAP, FCF/G101/1-1-JAP, FCFE6-1J, FCFE101-1J, FCFE102-1J, FCF/G101/1...(Other models you can see in the webshop)		



GEV No.	379406	Ref. No.	006192
description	core temperature probe Pt1000 cable SS corrugated hose probe -40 up to +250°C cable -40 up to +250°C connection 2-wire probe ø4x100mm thread M8 cable length 2m handle ø 10mm handle length 50mm		
For models:	FCV/G10L3, FCGV10L3T, FCV/E101/1, FCGV10L3J, FCV/E101/1, FCV/E101/1, FCV/E101/1, FCFE101-0, FCFE102-0, FCF101ELN, FCF101ENS, FCF102ENS, FCFE101-1J, FCFE102-1J, FCS101E4J, FCS101E4, FCS101G4, FCS101G4DT, FCS102E4J, FCS101G4J, FCS102E4, FCS102G4, FCS102G4J, 5712-2-7, 5712-2-8, 5712-2-10, 5712-2-7L, 5712-2-8L, 5712-2-10L, 5712-3-7, 5712-3-8, 5712-3-8E, 5712-3-10, ECFE101-0, ECFE102-0, ECF101ENS, ECF102ENS, ECV/G10T4, ECV/E10T4, ECV/G10T4J, ACFE101-0, ACFE102-0, RCV101G4, RCV101E4, RCF101E, ACV/G10C4, ACV/E10C4, NCV/G10L4, ZCV/G10T4, ZCV/E10T4		



GEV No.	379976	Ref. No.	002821 60050250
description	core temperature probe Pt1000 cable SS corrugated hose probe -40 up to +250°C cable -40 up to +250°C connection male faston 6.3mm probe ø4x100mm thread M8 cable length 3.1m handle ø 9mm handle length 50/55mm		
For models:	FCVG102L3, FCV/E102/1L3JAP, FCV/E102/1L6JAP, FCGV102L3J, FCV/G102/1L6JAP, FCV/E102/1, FCV/E102/1, FCV/E102/1L3, FCV/G102/1L6, FCV/E102/1L6, FCFG101/0, FCFG102-0, FCFE102-0, FCFG102-0T, FCF/G102/1-1-JAP, FCFE102-1J, FCS101G4, FCS101G4DT, FCS101G4J, FCS102G4, FCS102G4J, ECFG101-0, ECFE102-0, ECFE102-0, ECVG102T4, ECFE102T4, ECV/G102/1T6, ECV/E102/1T6, ACFG101-0, ACFG102-0, ACFE102-0, JCF/G102/1-2, JCF/E102/1-2, RCF101G, ACV/G102C4, ACVE102C4, ACV/G102/1C6, ACV/E102/1C6, NCF/G101/1, NCF/G102/1, NCF/E102/1, NCV/G102/1, ZCV/G102/1, ZCV/E102/1, ZCV/G102/1T6, ZCF/G101/1, ZCF/G102/1, ZCF/E102/1		



GEV No.	379977	Ref. No.	006174
description	core temperature probe Pt1000 cable SS corrugated hose probe -40 up to +250°C cable -40 up to +250°C connection male faston probe ø4x100mm thread cable length 2.6m handle ø 10mm handle length 50mm		
For models:	FCV/G20L3, FCGV202L3, FCV/G20L6, FCGV202L6, FCS201E4, FCS202E4, FCS201G4, FCS202G4, 5714-2-7, 5714-2-8, 5714-2-10, 5714-2-7L, 5714-2-8L, 5714-2-10L, 5714-2-7L, 5714-2-8L, 5714-2-10L, 5714-2-10L, 5714-2-7L, 5714-2-8L, 5714-2-10L, 5714-3-7, 5714-3-8, 5714-3-8E, 5714-3-10, 5717-3-7, 5717-3-8, 5717-3-8E, 5717-3-10, 5717-3-8M, 5717-3-8M, ECV/G20T4, ECVG202T4, ECV/G20T4J, ECV/G20T6, ECVG202T6, ACV/G20C4, ACV/G20C4, ACV/G20C6, ACV/G20C6, ZCV/G20T4, ZCV/G202/1, ZCV/G20T6, ZCV/G202/1		



GEV No.	379964	Ref. No.	006525
description	core temperature probe Pt1000 cable SS corrugated hose probe -40 up to +250°C cable -40 up to +250°C connection male faston probe ø5.5x110mm thread cable length 2.5m handle ø 10mm handle length 100mm		
For models:	FCV/G101/1, FVC/E101/1		

GEV No.	379965	Ref. No.	006526
description	core temperature probe Pt1000 cable SS corrugated hose probe -40 up to +250°C cable -40 up to +250°C connection male faston probe ø5x100mm thread cable length 2.6m handle ø 10mm handle length 100mm		
For models:	FCV/G201/1, FVC/E201/1, FCV/G202/1, FVC/E202/1		

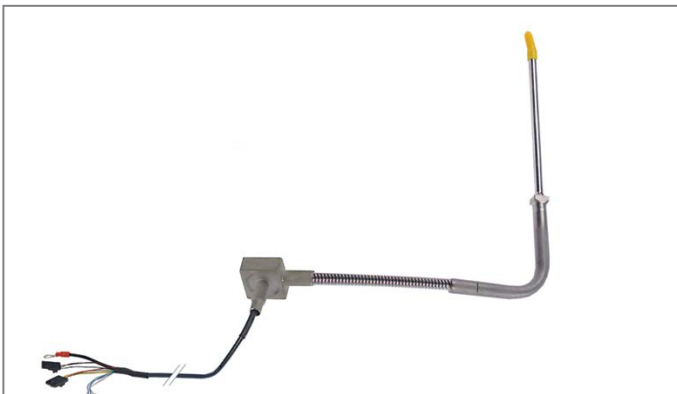

GEV No.	379954	Ref. No.	006527
description	core temperature probe Pt1000 cable SS corrugated hose probe -40 up to +250°C cable -40 up to +250°C connection plug probe ø5x100mm thread M8 cable length 3.2m handle ø 9mm handle length 50/50mm		
For models:	FCV/G102/1, FVC/E102/1		



GEV No.	379620	Ref. No.	085561 087464 088044
description	core temperature probe PTC 1kOhm cable silicone probe -40 up to +120°C cable -50 up to +180°C connection 2-wire probe ø4.5x80mm thread cable length 4m handle ø 10mm handle length 120mm L1 150mm L2 60mm		
For models:	BC11, BC22, BC44, BC44H, BC11, BC22, BC44, BC44H, BCF11, BCF22, BCF44H, BCF44, BC7, BCF7, BC7, BCF7, BC0144, BC072, ESBC72R, ESBC144R, ESK40H, EEVA10/1, EEVA201, EEVA40/1, EEVA40/2, EEVAC10/1, EEVAC201, EEVAC40/2, EEVAC40/1, ESK20, ESK40V, ESK40H, ESK10, ESBC40, BC72, BC72R, BC144, BC144R, ESF10, ESF40H, ESBF40, ESF40V, ESF40VR, BCF72, BCF72R, BCF144, BCF144R, BE431, TBC44H, BFE431...(Other models you can see in the webshop)		

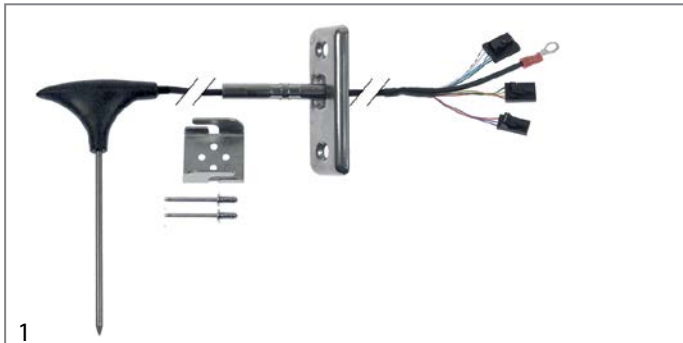

GEV No.	381473	Ref. No.	0C6574 0CB236
description	core temperature probe TC (K) cable PTFE cable length 800/1700m		
For models:	FCZ201ETA, FCZ202ETA, FCZ201ETH, FCZ201ETN, FCZ201EBA2, FCZ202EBA2, FCZ201EBH2, FCZ201EBN2, FCZ201EBC2, FCZ201ECA2, FCZ202ECA2, FCZ201ECH2, FCZ201ECN2, AOS201ETA1, AOS202ETA1, AOS201ETH1, AOS201ETN1, AOS201ETC1, AOS201ETE1, AOS201ETF1, AOS201ETM1, AOS202ETM1, AOS201ETK1, AOS202ETK1, AOS201EBA2, AOS202EBA2, AOS201EBH2, AOS201EBN2, AOS201EBC2, AOS201EBE2, AOS201EBF2, AOS201EBK2, AOS202EBK2, AOS201ECA2, AOS202ECA2, AOS201ECH2, AOS201ECN2		



GEV No.	379718 ¹	Ref. No.	0C4240
description	core temperature probe thermocouple K (NiCr-Ni) cable PTFE probe -40 up to +250°C cable -40 up to +250°C connection plug probe ø3.5x100mm thread cable length 2.2m handle ø 9mm handle length 45/50mm		

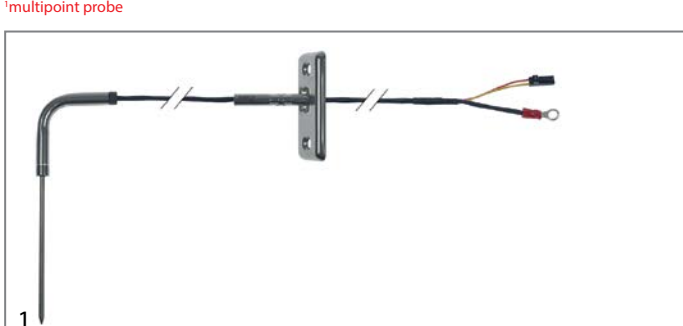

GEV No.	381460	Ref. No.	0C4241
description	core temperature probe thermocouple K (NiCr-Ni) cable PTFE probe -40 up to +250°C cable -40 up to +250°C connection plug probe ø3.5x100mm thread cable length 2.2m handle ø 9mm handle length 45/50mm		
For models:	FCZ061EAA, FCZ101EAA, FCZ102EAA, FCZ061EAH, FCZ101EAH, FCZ061EAN, FCZ101EAN, FCZ061ETA, FCZ101ETA, FCZ102ETA, FCZ061ETH, FCZ101ETH, FCZ061ETN, FCZ101ETN, FCZ101GTG, FCZ102GTG, FCZ101GTD, FCZ102GTD, FCZ061EBA, FCZ101EBA, FCZ102EBA, FCZ061EBH, FCZ101EBH, FCZ061EBN, FCZ101EBN, FCZ061EBC, FCZ101EBC, FCZ061EBA2, FCZ101EBA2, FCZ102EBA2, FCZ061EBH2, FCZ101EBH2, FCZ061EBN2, FCZ101EBN2, FCZ061EBC2, FCZ101EBC2, FCZ061GBG, FCZ101GBG, FCZ102GBG, FCZ061GBD, FCZ101GBD, FCZ102GBD, FCZ101GBI, FCZ101GBG2, FCZ102GBG2, FCZ101GBD2, FCZ102GBD2, FCZ101GBI2, FCZ102GBI2, FCZ061ECA...(Other models you can see in the webshop)		

¹multipoint probe

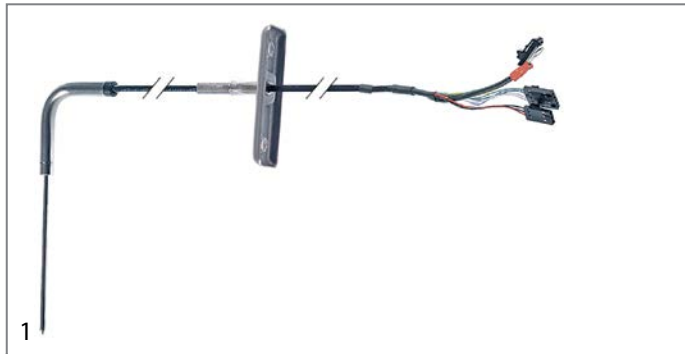

GEV No.	381513	Ref. No.	0C4240 0CB214
description	core temperature probe thermocouple K (NiCr-Ni) cable PTFE probe -40 up to +250°C cable -40 up to +250°C connection plug probe ø3.5x100mm thread cable length 2.2m handle ø9mm handle length 45/50mm		
For models:	FCZ061EAA, FCZ101EAA, FCZ102EAA, FCZ061EAH, FCZ101EAH, FCZ061EAN, FCZ101EAN, FCZ061ETA, FCZ101ETA, FCZ102ETA, FCZ061ETH, FCZ101ETH, FCZ061ETN, FCZ101ETN, FCZ061GAG, FCZ101GAG, FCZ102GAG, FCZ061GAD, FCZ101GAD, FCZ102GAD, FCZ101GTG, FCZ102GTG, FCZ101GTD, FCZ102GTD, FCZ061EBA, FCZ101EBA, FCZ102EBA, FCZ061EBH, FCZ101EBH, FCZ061EBN, FCZ101EBN, FCZ061EBC, FCZ101EBC, FCZ061EBA2, FCZ101EBA2, FCZ102EBA2, FCZ061EBH2, FCZ101EBH2, FCZ061EBN2, FCZ101EBN2, FCZ061EBC2, FCZ101EBC2, FCZ101GBG2, FCZ102GBG2, FCZ101GBD2, FCZ102GBD2, FCZ101GBI2, FCZ102GBI2, FCZ061ECA, FCZ101ECA...(Other models you can see in the webshop)		



GEV No.	379958	Ref. No.	006983
description	core temperature probe thermocouple K (NiCr-Ni) cable PTFE probe -40 up to +250°C cable -40 up to +250°C connection plug probe ø3.5x100mm thread cable length 2.5m handle ø9mm handle length 45/50mm		
For models:	AOS061EB, AOS061EB3J, AOS061EB2N, AOS061EB5M, AOS061EB6M, AOS061EB0H		

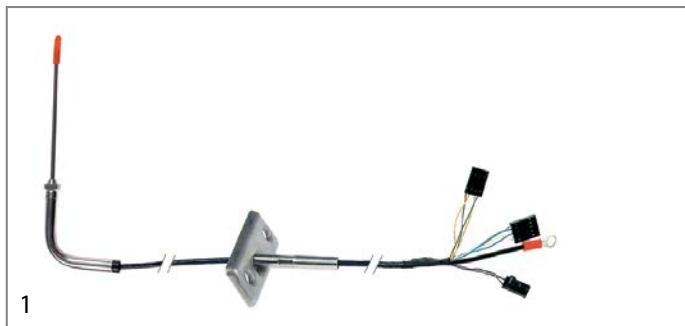

GEV No.	379956	Ref. No.	006982
description	core temperature probe thermocouple K (NiCr-Ni) cable PTFE probe -40 up to +250°C cable -40 up to +250°C connection plug probe ø3.5x100mm thread cable length 2.5m handle ø9mm handle length 45/50mm		
For models:	AOS061EA, AOS061EA3J, AOS061EA2N, AOS061EA0H, AOS061GA, AOS101GA		



GEV No.	379969	Ref. No.	0C1164
description	core temperature probe thermocouple K (NiCr-Ni) cable PTFE probe -40 up to +250°C cable -40 up to +250°C connection plug probe ø3.5x100mm thread cable length 2.5m handle ø9mm handle length 45/50mm		
For models:	AOS061GAEU, AOS061GAAU, AOS061EABU, AOS061EAFU, AOS061EA, AOS061EA3J, AOS061EA2N, AOS061EA0H, AOS061GA		



GEV No.	379955	Ref. No.	007109
description	core temperature probe thermocouple K (NiCr-Ni) cable PTFE probe -40 up to +250°C cable -40 up to +250°C connection plug probe ø3.5x100mm thread cable length 2.6m handle ø9mm handle length 45/50mm		
For models:	AOS101EA, AOS101EA3J, AOS101EA2N, AOS101EA0H		

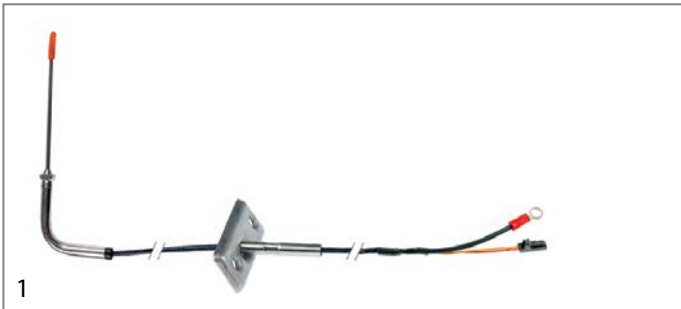

GEV No.	379957	Ref. No.	007063 0C0224
description	core temperature probe thermocouple K (NiCr-Ni) cable PTFE probe -40 up to +250°C cable -40 up to +250°C connection plug probe ø3.5x100mm thread cable length 2.6m handle ø 9mm handle length 45/50mm		
For models:	AOS101EB, AOS101EB3J, AOS101EB2N, AOS101EB5M, AOS101EB6M, AOS101EB0H		

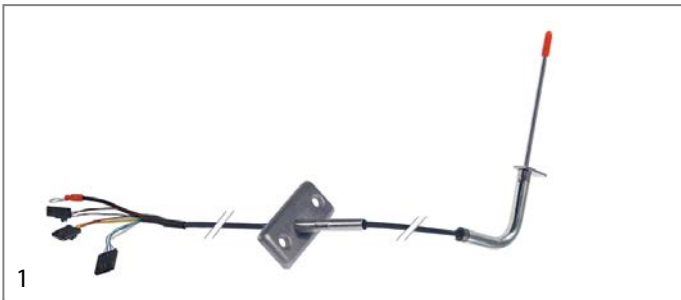

GEV No.	379960	Ref. No.	0C0956
description	core temperature probe thermocouple K (NiCr-Ni) cable PTFE probe -40 up to +250°C cable -40 up to +250°C connection plug probe ø3.5x100mm thread cable length 2.6m handle ø 9mm handle length 45/50mm		
For models:	AOS101GAEU, AOS101GAAU, AOS101EABU, AOS101EAFU, AOS061EA, AOS101EA, AOS061EA3J, AOS101EA3J, AOS061EA2N, AOS101EA2N, AOS061EA0H, AOS101EA0H, AOS101GA		



GEV No.	379723	Ref. No.	0C1212
description	core temperature probe thermocouple K (NiCr-Ni) cable PTFE probe -40 up to +250°C cable -40 up to +250°C connection plug probe ø3.5x100mm thread cable length 2.85m handle ø 9mm handle length 50/50mm		
For models:	AOS102GAEU, AOS102GAAU, AOS102EA2N, AOS102EA, AOS102GB		



GEV No.	379959	Ref. No.	0C1383
description	core temperature probe thermocouple K (NiCr-Ni) cable PTFE probe -40 up to +250°C cable -40 up to +250°C connection plug probe ø3.5x100mm thread cable length 3.2m handle ø 9mm handle length 45/50mm		
For models:	FCZ201GTG, FCZ202GTG, FCZ201GTD, FCZ202GTD, FCZ201EBA, FCZ202EBA, FCZ201EBH, FCZ201EBN, FCZ201EBC, FCZ201GBG, FCZ202GBG, FCZ201GBD, FCZ202GBD, FCZ201GBI, FCZ201GBG2, FCZ202GBG2, FCZ201GBD2, FCZ202GBD2, FCZ201GBI2, FCZ201ECA, FCZ202ECA, FCZ201ECH, FCZ201ECN, FCZ201GCG, FCZ202GCG, FCZ201GCD, FCZ202GCD, FCZ201GCG2, FCZ202GCG2, FCZ201GCD2, FCZ202GCD2, AOS201EB, AOS201EB3J, AOS201EB2N, AOS202EB2N, AOS201EB0H, AOS202EB, AOS202GB, AOS201EBAQ, AOS202EBAQ, AOS201EBNQ, AOS202EBNQ, AOS201EBCQ, AOS201EBHQ, AOS201GBGQ, AOS202GBGQ, AOS201GBDQ, AOS202GBDQ, AOS201EAC1, AOS201EAQ1...(Other models you can see in the webshop)		

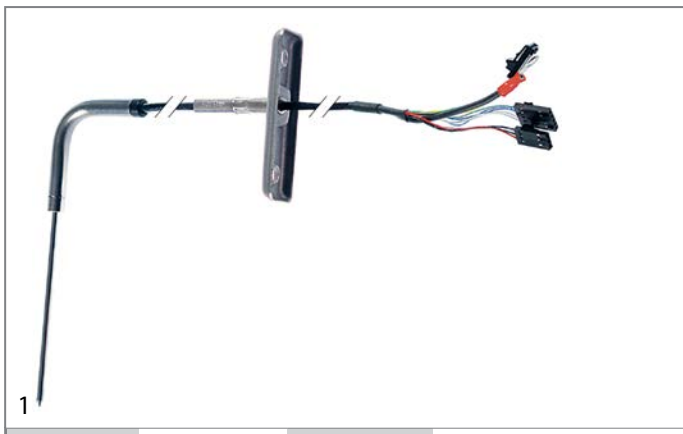

GEV No.	379970 ¹	Ref. No.	0C1404
description	core temperature probe thermocouple K (NiCr-Ni) cable PTFE probe -40 up to +250°C cable -40 up to +250°C connection plug probe ø3.5x100mm thread cable length 3.2m handle ø 9mm handle length 45/50mm		
For models:	FCZ201EAA, FCZ202EAA, FCZ201EAH, FCZ201EAN, FCZ201GAG, FCZ202GAG, FCZ201GAD, FCZ202GAD, FCZ201GTG, FCZ202GTG, FCZ201GTD, FCZ202GTD, FCZ201EBC, FCZ201GBG2, FCZ202GBG2, FCZ201GBD2, FCZ202GBD2, FCZ201GBI2, FCZ201GCG2, FCZ202GCG2, FCZ201GCD2, FCZ202GCD2, AOS201GAEU, AOS202GAEU, AOS201GAAU, AOS202GAAU, AOS201EABU, AOS201EAFU, AOS201EA, AOS201EA3J, AOS201EA2N, AOS202EA2N, AOS201EA0H, AOS202EA, AOS202GA, AOS201EAAQ, AOS202EAAQ, AOS201EANQ, AOS202EANQ, AOS201EACQ, AOS201EAHQ, AOS201EBFQ, AOS201GAGQ, AOS202GAGQ, AOS201GADQ, AOS202GADQ, AOS201GAIQ, AOS201GALQ, AOS201EAMQ, AOS201EABQ...(Other models you can see in the webshop)		

¹multipoint probe

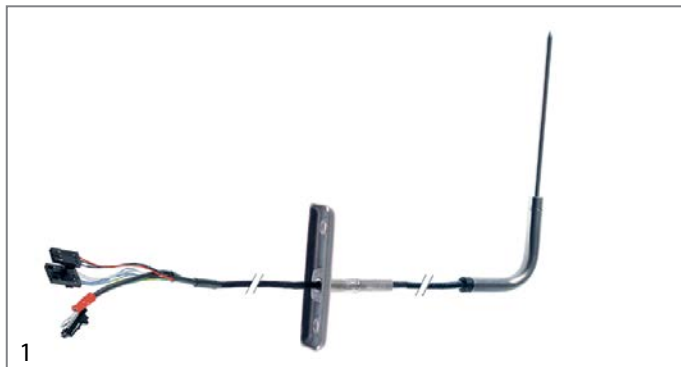

GEV No.	379725	Ref. No.	007093
description	core temperature probe thermocouple K (NiCr-Ni) cable PTFE probe -40 up to +250°C cable -40 up to +250°C connection plug probe ø3.5x100mm thread cable length 3m handle ø 9mm handle length 50/50mm		
For models:	CL511, CL521, AOS201EA, AOS201EA3J, AOS201EA2N, AOS201EA0H		



GEV No.	379967	Ref. No.	0C0225
description	core temperature probe thermocouple K (NiCr-Ni) cable PTFE probe -40 up to +250°C cable -40 up to +250°C connection plug probe ø3.5x90mm thread cable length 3.1m handle ø 9mm handle length 45/50mm		
For models:	AOS201EB, AOS201EB3J, AOS201EB2N, AOS201EB0H, AOS201GB		



GEV No.	379968	Ref. No.	0C1146
description	core temperature probe thermocouple K (NiCr-Ni) cable PTFE probe -50 up to +250°C cable -50 up to +250°C connection plug probe ø3.5x100mm thread cable length 3.9m handle ø 9mm handle length 45/50mm		
For models:	AOS201GA		

GEV No.	378185	Ref. No.	083582
description	temperature probe PTC 1kOhm cable silicone probe -50 up to +150°C cable -50 up to +180°C connection 2-wire probe ø5x100mm thread cable length 3m handle ø 13.5mm handle length 90mm -40 up to +150°C		
For models:	BC11, BC22, BC44, BC44H, ESBC10, ESBC10R, ESBC20, ESBC20R, ESBC40, ESBC40R, EEVA10/1, EEVA20/1, EEVA40/1, EEVA40/2, ATPE061, ATPE101, ATPE201, ATPE102		

Hall sensors

GEV No.	402044	Ref. No.	086346
description	Hall sensor L 29mm W 26mm H 26mm mounting distance 10mm cable length 1250mm		



sensors

GEV No.	379966	Ref. No.	006995 0C6465
description	lambda sensor probe ø 12mm 5-pole probe L 50mm		
For models:	FCZ061EAA, FCZ101EAA, FCZ102EAA, FCZ201EAA, FCZ202EAA, FCZ061EAH, FCZ101EAH, FCZ201EAH, FCZ061EAN, FCZ101EAN, FCZ201EAN, FCZ061ETA, FCZ101ETA, FCZ102ETA, FCZ061ETH, FCZ101ETH, FCZ061ETN, FCZ101ETN, FCZ061GAG, FCZ101GAG, FCZ102GAG, FCZ201GAG, FCZ202GAG, FCZ061GAD, FCZ101GAD, FCZ102GAD, FCZ201GAD, FCZ202GAD, FCZ101GTG, FCZ102GTG, FCZ201GTG, FCZ202GTG, FCZ101GTD, FCZ102GTD, FCZ201GTD, FCZ202GTD, FCZ061EBA, FCZ101EBA, FCZ102EBA, FCZ061EBH, FCZ101EBH, FCZ061EBN, FCZ101EBN, FCZ061EBC, FCZ101EBC, FCZ201EBC, FCZ061EBA2, FCZ101EBA2, FCZ102EBA2, FCZ061EBH2...		
accessories for	379966		

	GEV No.	101248	Ref. No.	004374 027478 050682 058370 0957007 0G2222 0K4315 214051400 727855
	olive for pipe ø 12mm Qty 1 pcs suitable for PEL			
	GEV No.	101251	Ref. No.	—
	union nut thread M20x1.5 for pipe ø 12mm			





			
1			
GEV No.	401664	Ref. No.	0L0456
description	sensor L 50mm thread M12x1 cable length 2000m		
For models:	LS14EAI/AU, WT65EBIA, WT65EIA, WT65MED, WT65MEDWS, EHTAIAU, EHTAIMLAU, ZHTAIAU, H1510SANA		

			
1			
GEV No.	401611	Ref. No.	099774
description	sensor ø 18mm L 44mm thread M10x1 cable length 1450mm		
accessories for	401611		
	GEV No.	521129	Ref. No. —
	nut thread M10 H 6mm SS WS 17 Qty 1 pcs DIN/ISO DIN 439		

accessories

adapters

			
1			
GEV No.	379093	Ref. No.	0K5057 75901203 75901303
description	bayonet adapter L 18mm thread M6x1 ID ø 7/4mm ED ø 12mm		
For models:	CEB068, CEB069, UEB068, UEB069		

			
1			
GEV No.	378127	Ref. No.	0G2154 0Kl657 18025414 75901202 75901302
description	bayonet adapter L 32mm thread M6x1 ID ø 7/4mm ED ø 12mm		
For models:	CEB068, CEB069, UEB068, UEB069		

			
1			
GEV No.	379094	Ref. No.	0G2155 0K5056 18025413 75901301 759020
description	bayonet adapter L 39mm thread M6x1 ID ø 7/4mm ED ø 12mm		
For models:	CE128-106, CE158-133.3.HV, CE158-244.3, CE158-246.3, CK248-209, D1ABBB, CK248-211.D1ABBB, HCE128-100, HCE128-104, HCE158-252W.3, HCE158-253.3, HLE129-100, HLE129-103, HLE129-104W, HLE159-252W.3.6, HLE159-328.3.HV, HLE159-351W.3.HV, HLE249-200.3, HLE249-208.3, HLE259-088.3.HV, HLE259-089.3.HV, HLE259-384W.3, LE129-101, LE159-261.3, LE159-281.3.6, LE159-318.3.HV, LE159-322.3.HV, LE159-330.3.HV, LE159-337.3.HV, LE159-344.3.MS92, LE159-347.3.HV, LE249-199.3, LE249-203.3, LE249-207.3, LE249-211.3, LE249-215.3, LE249-219.3, LE249-223.3, LE249-232.3, LE249-238.3, LE259-081.3.HV, LE259-082.3.HV, LE259-083.3.HV, LE259-094.3.HV, LE259-099.3.HV, LE259-382.3, LK259-707.D1ACCB, LK259-708.D1ACCB, CK248-205.D1ABBB, CK248-207.D1ABBB, LK159-707.D1BC...(Other models you can see in the webshop)		

accessories for	379094		
	GEV No.	379092	Ref. No.
			002172 0K5055 0KF607 0KG863 0KT883 0M2151 14T05 15501 18015409 18025409 18025412 702844003 716888 75000801
	temperature probe thermocouple K (NiCr-Ni) cable silicone probe -50 up to 1150°C cable -50 up to +180°C connection 2-wire thread probe ø4x20mm cable length 2.6m		

			
1			
GEV No.	378128	Ref. No.	0KE127 75901204 75901304
description	bayonet adapter L 59mm thread M6x1 ID ø 7/4mm ED ø 12mm		
For models:	CE128-106, CE158-133.3.HV, CE158-244.3, CE158-246.3, CK248-209, D1ABBB, CK248-211.D1ABBB, HCE128-100, HCE128-104, HCE158-252W.3, HCE158-253.3, HLE129-100, HLE129-103, HLE129-104W, HLE159-252W.3.6, HLE159-328.3.HV, HLE159-351W.3.HV, HLE249-200.3, HLE249-208.3, HLE259-088.3.HV, HLE259-089.3.HV, HLE259-384W.3, LE129-101, LE159-261.3, LE159-281.3.6, LE159-318.3.HV, LE159-322.3.HV, LE159-330.3.HV, LE159-337.3.HV, LE159-344.3.MS92, LE159-347.3.HV, LE249-199.3, LE249-203.3, LE249-207.3, LE249-211.3, LE249-215.3, LE249-219.3, LE249-223.3, LE249-232.3, LE249-238.3, LE259-081.3.HV, LE259-082.3.HV, LE259-083.3.HV, LE259-094.3.HV, LE259-099.3.HV, LE259-382.3, LK259-707.D1ACCB, LK259-708.D1ACCB, CK248-205.D1ABBB, CK248-207.D1ABBB, LK159-707.D1BC...(Other models you can see in the webshop)		



fasteners			
 <p>1</p>			
GEV No.	693748	Ref. No.	002674 0K2277 0K9619 0KD468
description	bracket for core temperature probe		
For models:	FDV40G, FDV40E, FDV40GZ, FDV40EL, FDV40GA, FDV20G, FDV20E, FDV20GZ, FDV20EL, FDV20GA, FCV/G10L3, FCV/G6L3TOWNGAS, FCV/G6L3, FCVG10L3T, FCV/G20L3, FCVG20L3, FCVE6L3J, FCV/E10L3JAP, FCV/E10L6JAP, FCV/G6L3JAP, FCVG10L3J, FCV/G10L6JAP, FCVG6L3CJ, FCV/E61/1, FCV/E61/1, FCV/E61/1, FCV/E61/1, FCV/E101/1, FCV/E101/2, FCV/G6L3C, FCV/G61/1, FCV/G61/1, FCV/G61/1, FCV/G61/1, FCVG6L3CT, FCVG6L3CJ, FCV/E10L3, FCV/E6L3, FCV/E20L3, FCVE20L3, FCV/G6L4, FCV/E6L4, FCV/G10L6, FCV/E10L6, FCV/G20L6, FCV/E20L6, FCVG20L6, FCVE20L6, FCF/G6-0, FCFG101/0...(Other models you can see in the webshop)		

miscellaneous			
 <p>1</p>			
GEV No.	402040	Ref. No.	086347
description	cable for level electrode cable length 1800mm		

 <p>1</p>			
GEV No.	550924	Ref. No.	002075 0K4316 17012751 727878
description	gasket for probe ID 6mm EPDM		
For models:	MFR/G740, MFR/G350, MFR/G351, MFR/G700, MFR/G701, RFR/G1S12, RFR/G2D12, RFR/G2S40, XFR/G1S12, XFR/G2D12, XFR/G2S40, JFR/G1S12, JFR/G2D12, JFR/G2S40, MFR/G1S12, MFR/G2D12, MFR/G2S40, RFR/G741, 7FRG03S, 7FRG07S, CFR/G741, M35GFR, M70GFR, CFR/G351, CFR/G701, XFV/G700, PFR/G2S40, TFR/G2S40, KFR/G1E, KFR/G2F, KFR/E1E, KFR/E2F, KFH/G1, KFH/E1, KFH/G1ELH, KFH/E1ELH, KFH/G1EH, KFH/E1EH, HFR/G410, HFR/G810, HFR/G410D, HFR/G810D, HFR/G410NL, HFR/G810NL, HFR/G411, HFR/G412, FC1G, HFR/E1680, FC2G, HFR/E2480...(Other models you can see in the webshop)		

 <p>1</p>			
GEV No.	504330	Ref. No.	048526
description	gasket for temperature probe 9mm ID 3mm H 7mm mounting 0 rubbermm		
For models:	ECOTEMP5, LS65, LS64, LS64/UKRP, LV64, ECOTEMP5S, LS64/1P, LS64/UK, ECOTEMP5SW, WT35, WT33/M50, WT33/M60, WT30U400, WT30U440, WT34, WT34/4,5, WT34/UKRP, D510, WT34/4,5N, WT34/UK, LS10D, LS10, LS10UKRP, LC100, ECOTEMP12-, LS10/60, LS10/1, LS10/12KW, LS10F, LS10DEK, LS10/1UKRP, LS10SW, LS10/50J, LS10/60J, LS10DP, LS10/HD, SH55, LO10, LS10/UK1, LS10/UK3, LS12D, LS12, LS12UK/RP, LC120, LS12DP, LS12/60, LS12F, LS12DEK, LS12HD, LS12/UK3...(Other models you can see in the webshop)		

 <p>1</p>			
GEV No.	697993	Ref. No.	002701 0F0158
description	sleeve for temperature probe 11mm ID 4.3mm H 22.4mm		
For models:	FCZ101EAA, FCZ102EAA, FCZ101EAH, FCZ101EAN, FCZ101ETA, FCZ102ETA, FCZ202ETA, FCZ101ETH, FCZ101ETN, FCZ101EBA, FCZ102EBA, FCZ101EBH, FCZ101EBN, FCZ101EBC, FCZ101EBA2, FCZ102EBA2, FCZ202EBA2, FCZ101EBH2, FCZ101EBN2, FCZ101EBC2, FCZ101ECA, FCZ102ECA, FCZ101ECH, FCZ101ECN, FCZ101ECA2, FCZ102ECA2, FCZ202ECA2, FCZ101ECH2, FCZ101ECN2, FCV/G10L3, FCV/G6L3TOWNGAS, FCV/G6L3, FCVG10L3T, FCVG102L3, FCV/E101/1, FCV/G20L3, FCVG202L3, FCVE6L3J, FCV/E10L3JAP, FCV/E102/1L3JAP, FCV/E10L6JAP, FCV/E102/1L6JAP, FCV/G6L3JAP, FCVG10L3J, FCVG102L3J, FCV/G10L6JAP, FCV/G102/1L6JAP, FCVG6L3CJ, FCV/E61/1, FCV/G10L2...(Other models you can see in the webshop)		

electronics

frequency converters

 <p>1</p>			
GEV No.	403904	Ref. No.	0W1UUA 0W5543 0W6668 32106001
description	frequency converter 200-240V 50/60 L 131mm W 72mm H 143mm		
For models:	IC44819E, IC44819G, IC4481901, IC4481902, IC4481903, IC4481904, IC4481905, IC4482101, IC4482102, IC4482103, IC4482104, IC4482105, IC4482501, IC4482502, IC4482503, IC4482504, IC4482505, IC4482801, IC4482802, IC4482803, IC4482804, IC4482805, IC4483201, IC4483202, IC4483203, IC4483204, IC4483205, IC44819LF1, IC44819LF2, IC44819LF3, IC44819LF4, IC44819LF5, IC44821LF1, IC44821LF2, IC44821LF3, IC44821LF4, IC44821LF5, IC44825LF1, IC44825LF2, IC44825LF3, IC44825LF4, IC44825LF5, IC44828LF1, IC44828LF2, IC44828LF3, IC44828LF4, IC44828LF5, IC44832LF1, IC44832LF2, IC44832LF3...(Other models you can see in the webshop)		

housing for PCBs

 <p>1</p>			
GEV No.	695663	Ref. No.	086336
description	housing PCB L 230mm W 142mm H 57mm		
For models:	CIM15A, CIM15W, CIM30A, CIM30W, CIM45A, CIM45W, CIM65A, CIM65W, CIM120AS, CIM120WS		



			
1			
GEV No.	694206	Ref. No.	086552
description	lid PCB L 180mm W 110mm H 9mm		
accessories for	694206		
			
GEV No.	694205	Ref. No.	—
description	housing PCB L 180mm W 110mm H 40mm		

rectifiers

			
1			
GEV No.	401257	Ref. No.	002715 0960150 60050314
description	plug with rectifier		
For models:	FDV40G, FDV40GZ, FDV40GA, FDV20G, FDV20GZ, FDV20GA, BRN70G, BRN/70GZ, BR70GZ, BRNG70A, FCV/G10L6JAP, FCV/G102/1L6JAP, FCV/G6L4, FCV/G10L6, FCV/G102/1L6, FCV/G20L6, FCVG202L6, FCV/G101/1, FCV/G102/1, FCS101GP9J, FCS101GP, FCS102G4, FCS102GA9J, FCS102GP, FCS101GX9J, FCS101GX, FCS102GX9J, FCS102GX, 5711-2-6, 5711-2-7, 5711-2-8, 5711-2-10, 5711-2-8CH, 5711-2-10CH, 5712-2-6, 5712-2-7, 5712-2-8, 5712-2-10, 5714-2-7, 5714-2-8, 5714-2-10, 5714-2-7, 5714-2-8, 5714-2-10, 5711-2-6L, 5711-2-7L, 5711-2-8L, 5711-2-10L, 5712-2-6L, 5712-2-7L...(Other models you can see in the webshop)		

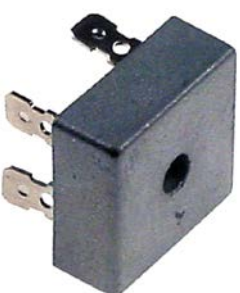
			
1			
GEV No.	379396	Ref. No.	006147
description	rectifier		
For models:	MCP/E1SH, MCP/E1SUH, MCP/E2SUHS, MCP/E2SH, MCP/E2SUH, MCP/E2SUT, MCP/E2SHB, PCP/E1SH, PCP/E2SH, PCP/E2SH3B, TCP/E2SH, KF/H/G1, KF/H/E1, KF/H/G1ELH, KF/H/E1ELH, KF/H/G1EH, KF/H/E1EH, HF/H/G430, HF/H/E430, HF/H/G401U, HF/H/G435, HF/H/G435, QFH/G1, QFH/E1, QFH/G1ELH, QFH/E1ELH, QFH/G1EH, QFH/E1H, ZFH/G430, ZFH/E430, ZFH/G435, ZFH/G435, WF/H/G1, WF/H/E1, WF/H/G1ELH, WF/H/E1ELH, WF/H/G1EH, WF/H/E1EH, AFH/G435, AFH/E435		

PCBs

			
1			
GEV No.	401527	Ref. No.	0H6957 0KE675 281061 450404 60050456
description	control PCB		
For models:	5611-3-8, 5612-3-8, 5614-3-8		

			
1			
GEV No.	401575	Ref. No.	0H9793 0K4880 0K4881 18003807 18003807T 740155
description	control PCB		
For models:	VARIOSTEAM/S-33.3/F, STEAM-O-MAT		

			
1			
GEV No.	400179	Ref. No.	002665 0C3758 0K1014 452200210 452470000 60050323
description	control PCB combi-steamer FCV/G 101/1 102/1		
For models:	FCV/G10L3, FCV/G6L3TOWNGAS, FCV/G6L3, FCVG10L3T, FCVG102L3, FCV/G20L3, FCVG202L3, FCVE6L3J, FCV/E10L3JAP, FCV/E102/1L3JAP, FCV/G6L3JAP, FCVG10L3J, FCVG102L3J, FCVG6L3CJ, FCV/E61/1, FCV/G10L2, FCV/E101/1, FCV/E10L2, FCV/E61/1, FCV/E101/2, FCV/G6L3C, FCV/G61/1, FCVG6L3CT, FCVG6L3CJ, FCV/E10L3, FCV/E102/1, FCV/E6L3, FCV/E102/1L3, FCV/E20L3, FCVE202L3, FCV/E101/1, FCS061G-3DI, FCS061E3CI, FCS101E2, FCS101G2, 5711-2-6, 5711-2-7, 5712-2-6, 5712-2-7, 5714-2-6, 5714-2-7, 5717-2-6, 5714-2-7, 5711-2-6L, 5711-2-7L, 5721-2-7, 5712-2-6L, 5712-2-7L, 5714-2-6L, 5714-2-7L...(Other models you can see in the webshop)		

1

GEV No.	400188	Ref. No.	002725 OK1015 452200310
description	control PCB combi-steamer FCV/G 101/1 102/1		
For models:	FCV/G61/1, FCV/G61/1, FCV/G6L4, FCV/E6L4, FCV/G101/1, FVC/E101/1, FCV/G102/1, FVC/E102/1, FCV/G201/1, FVC/E201/1, FCV/G202/1, FVC/E202/1, FCS061E44J, FCS061G48J, FCS061G4, FCS061G4DT, FCS101E44J, FCS061G49J, FCS101E4, FCS101G4, FCS101G4DT, FCS102E44J, FCS101G49J, FCS102E4, FCS102G4, FCS201E4, FCS102G49J, FCS202E4, 5711-2-8, 5711-2-8CH, 5712-2-8, 5714-2-8, 5714-2-8, 5711-2-8L, 5712-2-8L, 5714-2-8L, 5714-2-8L, 5711-3-8, 5711-3-8CH, 5712-3-8, 5712-3-8E, 5712-3-8CH, 5714-3-8, 5714-3-8E, 5717-3-8, 5717-3-8E, 5717-3-8M, 5717-3-8C, 5717-3-8M, ECV/G6T4...(Other models you can see in the webshop)		



1

GEV No.	403583	Ref. No.	0C4891 0C7350
description	control PCB combi-steamer FCZ06/10/20 L 450mm W 155mm display with core temperature probe		
For models:	FCZ061EAA, FCZ101EAA, FCZ102EAA, FCZ061EAH, FCZ101EAH, FCZ061EAN, FCZ101EAN, FCZ061ETA, FCZ101ETA, FCZ102ETA, FCZ201ETA, FCZ202ETA, FCZ061ETH, FCZ101ETH, FCZ201ETH, FCZ061ETN, FCZ101ETN, FCZ201ETN, FCZ101GTG, FCZ102GTG, FCZ201GTG, FCZ202GTG, FCZ101GTD, FCZ102GTD, FCZ201GTD, FCZ202GTD, FCZ061EBA, FCZ101EBA, FCZ102EBA, FCZ061EBH, FCZ101EBH, FCZ061EBN, FCZ101EBN, FCZ061EBC, FCZ101EBC, FCZ061EBA2, FCZ101EBA2, FCZ102EBA2, FCZ201EBA2, FCZ202EBA2, FCZ061EBH2, FCZ101EBH2, FCZ201EBH2, FCZ061EBN2, FCZ101EBN2, FCZ201EBN2, FCZ061EBC2, FCZ101EBC2, FCZ201EBC2, FCZ101GBG2...(Other models you can see in the webshop)		



1

GEV No.	403444	Ref. No.	088591
description	control PCB L 290mm W 80mm cable length 800mm green display 2x4 digits		
For models:	BC100A, BC100DA, BC100RA, BC100RDA, BC180A, BC180DA, BC180RA, BC180RDA, BC180RPA, BCF100A, BCF100DA, BCF100RA, BCF100RDA, BCF180A, BCF180DA, BCF180RA, BCF180RDA, BCF180RPA, AQC22U US, AQC31U US, AQC60U, AQC119U US, , , BC28A6, , , BCF15A6, , , BC120A, BC120RA, BCF120A, BCF120RA, BC15A, BC28A, BC56VA, BC56HA, BCF15A, BCF28A, BCF64A, BCF56HA, BC10A, BCF7A, LVA100B, LVA100Z, LVA100B, LVA100, LVA100-A, LVA/100-BU...(Other models you can see in the webshop)		

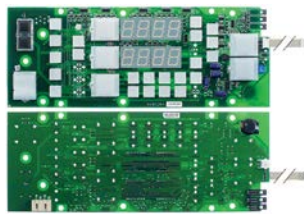

1

GEV No.	403727	Ref. No.	088590
description	control PCB L 330mm W 130mm		
For models:	RBF611560, RBC061, RBC6.1-15, RBC101, RBC10.1-2, RBC20.1-56, RBF061, RBF6.1-15R, RBF101, RBF20.1-64, RBC051, RBF051		



1

GEV No.	401526	Ref. No.	0H6128 212766 60050380
description	control PCB suitable for JUNO		





1

GEV No.	400184	Ref. No.	002720 0C3765 OK1017 452200510 452470020 60050269
description	control PCB with keypad		
For models:	FCV/E101/1, FCV/E10L6JAP, FCV/E102/1L6JAP, FCV/G10L6JAP, FCV/G102/1L6JAP, FCV/E61/1, FCV/E101/1, FCV/E102/1, FCV/E61/1, FCV/E101/1, FCV/G61/1, FCV/G10L6, FCV/E10L6, FCV/G102/1L6, FCV/E102/1L6, FCV/G20L6, FCV/E20L6, FCV/G202L6, FCV/E101/1, 5711-2-10, 5711-2-10CH, 5712-2-10, 5714-2-10, 5714-2-10, 5711-2-10L, 5721-2-10, 5712-2-10L, 5714-2-10L, 5714-2-10L, 5711-3-10CH, 5712-3-10, 5712-3-10C, 5714-3-10, 5717-3-6, 5717-3-10, 5712-2-10F, 5712-2-10S, 5714-2-10F, 5714-2-10S, 5711-3-10F, 5711-3-10S, 5712-3-10F, 5712-3-10S, 5714-3-10F, 5714-3-10S, ECV/G10T6, ECV/E10T6, ECV/G102/1T6...(Other models you can see in the webshop)		

			
1			
GEV No.	361953	Ref. No.	0C6571 0C8805 0CA070
description	display L 162mm W 308mm suitable for combi-steamer suitable for ELECTROLUX model FCZ/AOS		
For models:	FCZ061ETA, FCZ101ETA, FCZ102ETA, FCZ201ETA, FCZ202ETA, FCZ061ETH, FCZ101ETH, FCZ201ETH, FCZ061ETN, FCZ101ETN, FCZ201ETN, FCZ101GTG, FCZ102GTG, FCZ201GTG, FCZ202GTG, FCZ101GTD, FCZ102GTD, FCZ201GTD, FCZ202GTD, FCZ061EBA2, FCZ101EBA2, FCZ102EBA2, FCZ201EBA2, FCZ202EBA2, FCZ061EBH2, FCZ101EBH2, FCZ201EBH2, FCZ061EBN2, FCZ101EBN2, FCZ201EBN2, FCZ061EBC2, FCZ101EBC2, FCZ201EBC2, FCZ101GBG2, FCZ102GBG2, FCZ201GBG2, FCZ202GBG2, FCZ101GBD2, FCZ102GBD2, FCZ201GBD2, FCZ202GBD2, FCZ101GBI2, FCZ102GBI2, FCZ201GBI2, FCZ061ECA2, FCZ101ECA2, FCZ102ECA2, FCZ202ECA2, FCZ061ECH2...(Other models you can see in the webshop)		

			
1			
GEV No.	400741	Ref. No.	006644 006803 0C6364
description	keypad PCB		
For models:	ECP/E1ELHU, PCP/E1ELH, TCP/E1ELHU, TCP/E1ELH, KFH/G1, KFH/E1, KFH/G1ELH, KFH/E1ELH, KFH/G1EH, KFH/E1EH, HFH/G435, HFH/G435, QFH/G1, QFH/E1, QFH/G1ELH, QFH/E1ELH, QFH/G1EH, QFH/E1H, ZFH/G435, ZFH/G435, WFH/G1, WFH/E1, WFH/G1ELH, WFH/E1ELH, WFH/G1EH, WFH/E1EH, AFH/G435, AFH/E435		

			
1			
GEV No.	400916	Ref. No.	049882 0L0047 0L0552 452670320
description	keypad PCB		
For models:	WT4, WT4B, WT4D, WT4DB, WT46, WT4DG, WT4D60, WT4DDG, LS5/1, LS5/1DP, LS5/3, LS5/3DP, LB5DPG, LS5/1DP60, LS5/1DPAUS, LS5/1D-PCS, LS6EP, LS6EP/DD, WT38TDE, WT38/M50, WT38PM50, WT37LEV/9, WT38M50/4, WT38D, WT37, WT38, WT37/4.5, WT38/4.5, WT37/UK, WT38C, WT38C60, WT38CUK, WT38/4.5NW, WT38UK, WT37J60, WT37J50, WT38/60, WT38/M60, WT38MED, WT38PM60, WT38M60/4, WT38WL, FL5, FL5DP, LV5, LV5DP, UC5DP, LD5DP, LD5, UC5/1...(Other models you can see in the webshop)		

			
1			
GEV No.	401525	Ref. No.	0H6130 60050382
description	keypad PCB		

			
1			
GEV No.	401531	Ref. No.	0H6956 0K2759 0K2760 281056 60050455 MW501021
description	keypad PCB		
For models:	5611-3-10, 5612-3-10, 5614-3-10		

			
1			
GEV No.	401667	Ref. No.	002683 0C3759 0H6292 452200420 452470030
description	keypad PCB		
For models:	FCV/G10L2, FCV/E10L2, FCS101E2, FCS101G2, 5711-2-6, 5712-2-6, 5714-2-6, 5717-2-6, 5711-2-6L, 5712-2-6L, 5714-2-6L, 5711-3-6, 5712-3-6, 5714-3-6, RCV101G2, RCV101E2, ACV/G10C2, ACV/E10C2, NCV/G6L2, NCV/G10L2, NCV/E6L2, NCV/E10L2		

			
1			
GEV No.	401742	Ref. No.	087338
description	keypad PCB		
For models:	BC11, BC22, BC44, BC44H, EEVA10/1, EEVA201, EEVA40/1, EEVA40/2, ESK20, ESK40V, ESK40H, ESK10, ESBC40, BC72, BC72R, BC144, BC144R, BE431, TBC44H, BC72D, BC72RD, BC144D, BC144RD, BC144RT, ATPE061, ATPE101, ATPE201, ATPE102		

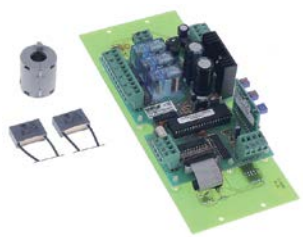
1

GEV No.	401743	Ref. No.	084714
description	keypad PCB		
For models:	BC11, BC22, BC44, BC44H, BC11, BC22, BC44, BC44H, BC0144, BC072, ESBC72R, ESBC144R, ESBC10, ESBC10R, ESBC20, ESBC20R, ESBC40, ESBC40R, ESK40H, EEVA10/1, EEVA20/1, EEVA40/1, EEVA40/2, EEVA10/1, EEVA20/1, EEVA40/1, EEVA40/2, ATPE061, ATPE101, ATPE201, ATPE102, AB100, AB210, AB430, AB431		



2

GEV No.	401745	Ref. No.	087481 17000222
description	keypad PCB		
For models:	ADN220ES, ADF110ES, ADF220ES, ADN110ESP, ADF110ESP, ADN110E, ADF110E, ADN220E, ADF220E, TRN132AE, TRN183AE, TRN224AE, TRF132AE, TRF183AE, FS07C, FS11C, FS11C2, NFS15C, FS15C2, FS11F, FS15F, FS15F2, FSP11F, FSP15F, FSP15F2, FSV11F, FSV15F, FSV15F2, SSBMHC12, SSBMHC16, SSBMHC20, SSBMB12, SSBMB16, SSBMHB20, SSABMHC12, SSABMHC16, SSABMHC20, SSTGT8, SSTGT12, SSTGT16, SSTGT20, SSTGB8, SSTGB12, SSTGB16, SSTGB20, SSNT8, SSNT12, SSNT18, SSNT20, SSODWC12...(Other models you can see in the webshop)		



1

GEV No.	400747	Ref. No.	0C0043 452370000 675837902
description	keypad PCB combi-steamer FCZ06/10/20		
For models:	FCZ061EAA, FCZ101EAA, FCZ102EAA, FCZ201EAA, FCZ202EAA, FCZ061EAH, FCZ101EAH, FCZ201EAH, FCZ061EAN, FCZ101EAN, FCZ201EAN, FCZ061GAG, FCZ101GAG, FCZ102GAG, FCZ201GAG, FCZ202GAG, FCZ061GAD, FCZ101GAD, FCZ102GAD, FCZ201GAD, FCZ202GAD, FCZ061EBA, FCZ101EBA, FCZ102EBA, FCZ061EBH, FCZ101EBH, FCZ061EBN, FCZ101EBN, FCZ061EBC, FCZ101EBC, FCZ061ECA, FCZ101ECA, FCZ102ECA, FCZ061ECH, FCZ101ECH, FCZ061ECN, FCZ101ECN, AOS061GAEU, AOS101GAEU, AOS102GAEU, AOS201GAEU, AOS202GAEU, AOS061GAAU, AOS101GAAU, AOS102GAAU, AOS201GAAU, AOS202GAAU, AOS061EABU, AOS101EABU, AOS201EABU...(Other models you can see in the webshop)		



1

GEV No.	400749	Ref. No.	0C0041 452370100 675838802
description	keypad PCB combi-steamer FCZ06/10/20		
For models:	FCZ061EAA, FCZ101EAA, FCZ102EAA, FCZ061EAH, FCZ101EAH, FCZ061EAN, FCZ101EAN, FCZ061ETA, FCZ101ETA, FCZ102ETA, FCZ201ETA, FCZ202ETA, FCZ061ETH, FCZ101ETH, FCZ201ETH, FCZ061ETN, FCZ101ETN, FCZ201ETN, FCZ101GTG, FCZ102GTG, FCZ201GTG, FCZ202GTG, FCZ101GTD, FCZ102GTD, FCZ201GTD, FCZ202GTD, FCZ061EBA, FCZ101EBA, FCZ102EBA, FCZ201EBA, FCZ202EBA, FCZ061EBH, FCZ101EBH, FCZ201EBH, FCZ061EBN, FCZ101EBN, FCZ201EBN, FCZ061EBC, FCZ101EBC, FCZ201EBC, FCZ061EBA2, FCZ101EBA2, FCZ102EBA2, FCZ201EBA2, FCZ061EBH2, FCZ101EBH2, FCZ201EBH2, FCZ061EBN2, FCZ101EBN2...(Other models you can see in the webshop)		



1

GEV No.	403861	Ref. No.	0L3875
description	keypad PCB dishwasher L 345mm W 50mm cable lengthmm DIWAP_2		

			
1			
GEV No.	400923	Ref. No.	049623 049754 049998 0KE956 0L0548 0L0549 0L0708 0L0709 0L1237 0L1240 0L1566 0L1568 0L1627 0L1973 0L2482 0L3876 452670220 452670620
description	keypad PCB dishwasher LS14/ET12		
For models:	WT60/GJ60, WT60/GJ50, PH10/12-RP, LS10, LS14EA, LS10UKDP, ET12E, LS10/60HZ, LS10CW, LS10INS, HT1200INS, LS14EAI, LS10N, LS10DP, LS10HD, LS14EAI/AU, LS14EA/60, LS10UK/1, LS10UK/3, LS12INS, LS12, LS12DP, LS12/60HZ, LS12CW, HT1200DEK, LS14EASIA, LS14EA/G, WT60DP, WT60, WT60CW, WT60UKDPCW, WT60INS, WT60INSCW, WT60NAUCW, WT60NAU, LS10EA, WT60/60HZ, WT60/60HZC, WT60N, WT60NINS, LS12HD, LS14EAI/DD, WT65E, WT65EB, WT65EI, WT60NAUDP, LS12UK/3CW, LS12NAU, LS12UKDPCW, ECOTEMP12S... (Other models you can see in the webshop)		

			
2			
GEV No.	402966	Ref. No.	0L0061 0L0550 0L0710 0L1235
description	keypad PCB dishwasher LS9 L 195mm W 80mm with display buttons 5		
For models:	WT65ROW, LS14ROW, LS14ROW60, WT65ROW60, LS9P, LS9PDD, LS9AUK/3, LS9P60, WT55P, WT55P60, WT55AUK/3, LS9ADG1, WT55ADG1, LS9PAUS, WT55PM50, WT55PM60, H2500, HT900, LV900P, LD900, HT900ADG1		

			
1			
GEV No.	401625	Ref. No.	049897 0L0279 0L0538 0L0707 0L1242 0L1579 452670720
description	keypad PCB dishwasher WT30		
For models:	LS6EP, LS6EP/DD, LS6EADD, LS6EA/DPDD, WT38TDE, WT38/M50, LS6EADP3, WT38PM50, WT37LEV/9, LS6SANA, WT38M50/4, LS6EA/UK, LS6EA/DPUK, LS6EA/60, WT38D, WT37, WT38, WT37/4.5, WT38/4.5, WT37/UK, WT38C, WT38C60, WT38CUK, WT38/4.5NW, WT38UK, WT37J60, WT37J50, LS6AH240U, WT30H208U, WT30H240U, WT30H208DU, WT30H240DU, WT30H208RU, WT30H240RU, LS6AH-208DU, LS6AH208U, WT38/60, WT38/M60, WT38MED, LS6AH240DU, LS6AH208RU, LS6AH240RU, WT30M208U, WT30M240U, WT30M-208DU, WT30M240DU, WT30M208RU, WT30M240RU, WT30C208DU, WT30C240DU...(Other models you can see in the webshop)		

			
1			
GEV No.	401867	Ref. No.	0L0277 0L0553 0L0726 0L1241 0L1565 0L1567 0L1626 452670540
description	keypad PCB dishwasher WT4 with display		
For models:	WT4, WT4B, WT4D, WT4DB, WT46, WT4DG, WT4WS1, WT4BWS, WT4DWS1, WT4BDWS, NUC3DD, WT4D60, WT4DDG, EUC1, EUC1DP, EUC1WS, EUC1DPWS, EUC3, EUC3WS, EUC3DP, EUC3DPWS, EUC1G, EUC1DP60, EUC3DD, ZUCADDROW, ZUCADDROW6, LS5/1, LS5/1DP, LS5/1WS, LS5/1WSDP, LS5/3, LS5/3DP, LS5/3WS, LS5/3WSDP, FUCA3DD, LS5/3WSDPD, LB5DPG, LS5/1DP60, LS5/1DPAUS, LS5/1D-PCS, KUC3, KUC3DP, NUC1, NUC1DP, NUC1WS, NUC1DPWS, NUC3, NUC3WS, NUC3DP, NUC3DPWS...(Other models you can see in the webshop)		

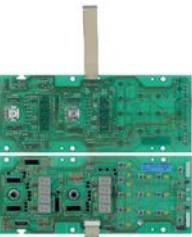
			
1			
GEV No.	403859	Ref. No.	0C3763
description	keypad PCB for combi-steamer L 275mm W 110mm suitable for ELECTROLUX, ZANUSSI		
For models:	FCS201G4, FCS202G4		





			
1			
GEV No.	401753	Ref. No.	085925 MW555041
description	keypad PCB for HACCP with main PCB		
For models:	BC11, BC22, BC44, BC44H, BC7, BC7, EEVA10/1, EEVA201, EEVA40/1, EEVA40/2, ESK20, ESK40V, ESK40H, ESK10, ESB40, BC72, BC72R, BC144, BC144R, BE431, TBC44H, ESK40VZ, BC72D, BC72RD, BC144D, BC144RD, BC144RT, ESK7, EABP0071, ESK7, ATPE061, ATPE101, ATPE201, ATPE102		

			
1			
GEV No.	404003	Ref. No.	0C0025 7898800002
description	keypad PCB for induction device		
For models:	KI/Z1, KI/Z2, KI/Z1E5, KI/Z2E5		

			
1			
GEV No.	402964	Ref. No.	0D7009
description	keypad PCB for induction device DZ/H1CE L 102mm W 41mm buttons 6		
For models:	DZ/H1CE, DW/H1CE, DZ/C2CE, DZ/L2CE, DZH1G, DWH1G, DZC2G, DZL2G		

			
1			
GEV No.	403860	Ref. No.	0C7011
description	keypad PCB for pizza oven L 125mm W 117mm suitable for ELECTROLUX, ZANUSSI		

			
1			
GEV No.	400996	Ref. No.	006624 0C6362 452380000
description	main PCB		
For models:	KFH/G1, KFH/E1, KFH/G1ELH, KFH/E1ELH, KFH/G1EH, KFH/E1EH, HFH/G435, HFH/G435, QFH/G1, QFH/E1, QFH/G1ELH, QFH/E1ELH, QFH/G1EH, QFH/E1H, ZFH/G435, ZFH/G435, WFH/G1, WFH/E1, WFH/G1ELH, WFH/E1ELH, WFH/G1EH, WFH/E1EH, AFH/G435, AFH/E435		

 <p style="text-align: center;">Image not available</p>			
1			
GEV No.	401586	Ref. No.	005464 006673 0K1019 0K1028 452340145 675830100
description	main PCB		
For models:	5711-2-10, 5711-2-10CH, 5712-2-10, 5714-2-10, 5714-2-10, 5711-2-10L, 5721-2-10, 5712-2-10L, 5714-2-10L, 5714-2-10L, 5711-3-10, 5711-3-10CH, 5712-3-10, 5712-3-10C, 5714-3-10, 5717-3-6, 5717-3-10, 5712-2-10F, 5712-2-10S, 5714-2-10F, 5714-2-10S, 5711-3-10F, 5711-3-10S, 5712-3-10F, 5712-3-10S, 5714-3-10F, 5714-3-10S		

			
1			
GEV No.	400189	Ref. No.	005463 006435 006674 0K1018 0K1027 221507 452300140 452340140 452340165 675835400
description	main PCB combi-steamer 260200-245		
For models:	5711-2-6, 5711-2-7, 5711-2-8, 5711-2-8CH, 5712-2-6, 5712-2-7, 5712-2-8, 5714-2-6, 5714-2-7, 5714-2-8, 5717-2-6, 5714-2-7, 5714-2-8, 5711-2-6L, 5711-2-7L, 5711-2-8L, 5721-2-7, 5712-2-6L, 5712-2-7L, 5712-2-8L, 5714-2-6L, 5714-2-7L, 5714-2-8L, 5714-2-6L, 5714-2-7L, 5714-2-8L, 5711-3-6, 5711-3-7, 5711-3-8, 5711-3-8CH, 5712-3-6, 5712-3-7, 5712-3-8, 5712-3-8E, 5712-3-8CH, 5714-3-6, 5714-3-7, 5714-3-8, 5714-3-8E, 5717-3-7, 5717-3-8, 5717-3-8E, 5717-3-8M, 5717-3-8C		



1

GEV No.	403025	Ref. No.	0C0968 0C3766 0C4347
description	main PCB combi-steamer COP35 LIV. ACTIVE L 334mm W 110mm 230V		
For models:	FCS061GP, FCS061EP, FCS101EP4J, FCS101EP, FCS101GP9J, FCS102EP4J, FCS101GP, FCS102EP, FCS102GA9J, FCS201EP, FCS102GP, FCS202EP, FCS201GP, FCS202GP, FCS061EXLN, FCS061EX, FCS101EX4J, FCS101EXLN, FCS101EX, FCS102EX4J, FCS102EX, FCS201EX, FCS201EXLN, FCS202EX, FCS101GX9J, FCS101GX, FCS102GX9J, FCS102GX, FCS201GX, FCS202GX		



1

GEV No.	403608	Ref. No.	003546 006613 006717 0C3764
description	main PCB convection oven L 340mm W 115mm display		
For models:	FCV/E101/1, FCV/E10L6JAP, FCV/E102/1L6JAP, FCV/G10L6JAP, FCV/G102/1L6JAP, FCV/E61/1, FCV/E101/1, FCV/E102/1, FCV/E61/1, FCV/E101/1, FCV/G61/1, FCV/G10L6, FCV/E10L6, FCV/G102/1L6, FCV/E102/1L6, FCV/G20L6, FCV/E20L6, FCV/G202L6, FCVE202L6, FCV/E101/1, ECV/G10T6, ECV/E10T6, ECV/G102/1T6, ECV/E102/1T6, ECV/G20T6, ECV/E20T6, ECVG202T6, ECVE202T6, ECV/E10IGP, ACV/G10C6, ACV/G102/1C6, ACV/G20C6, ACVG202C6, ACV/E10C6, ACV/E102/1C6, ACVE20C6, ACV/E202/1, ZCV/G10T6, ZCV/E10T6, ZCV/G102/1T6, ZCV/E102/1T6, ZCV/G20T6, ZCV/E20T6, ZCV/G202/1, ZCV/E202/1		



1

GEV No.	401637	Ref. No.	049622 049653 049654 049750 049751 049752 049753 049845 049854 049910 0KE951 0KE955 0KU198 0L0012 0L0045 0L0261 0L02621 0L0541 0L0705 0L1239 0L1412 0L1811 0L2583 452670170 452670181
description	main PCB dishwasher		
For models:	WT4B, WT4DB, WT46, WT4DG, WT4WS1, WT4BWS, WT4DWS1, WT4BDWS, NUC3DD, EUC1, EUC1WS, EUC1DPWS, EUC3, EUC3WS, EUC3DP, EUC3DPWS, EUC3DD, ZUCADDROW, ZUCADDROW6, LS5/1WS, LS5/1WSDP, LS5/3, LS5/3DP, LS5/3WS, LS5/3WSDP, FUCA3DD, LS5/3WSDPD, LB5DPG, KUC3, KUC3DP, NUC1WS, NUC1DPWS, NUC3, NUC3WS, NUC3DP, NUC3DPWS, NUC3DDWS, ZUCA1, ZUCA3, EUCADDROW, EUCADDROW6, LS6EP, LS6EP/DD, LS6EADD, LS6EA/DPDD, WT38TDE, WT38/M50, LS6EADP3, WT38PM50, WT37LEV/9...(Other models you can see in the webshop)		

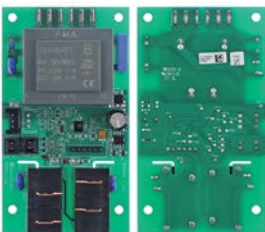

1

GEV No.	403740	Ref. No.	0C7416 0C9995
description	main PCB tilting bratt pan L 106mm W 60mm		

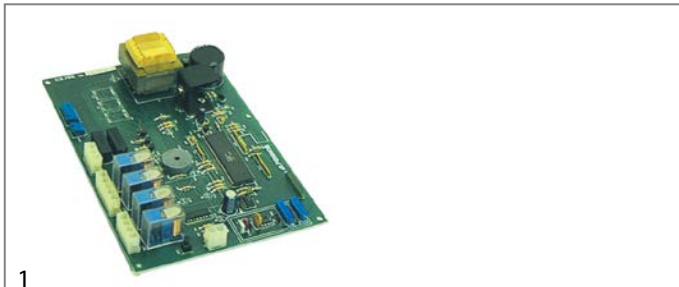

1			
GEV No.	400205	Ref. No.	0A8287
description	PCB		
For models:	EVN600V11C, EEVN601, EVN600V12C, EEVN601, EVN600V11V, EEVN601, EVN130V12C, EVN131V12C, EEVN1300, EEVN1301, EEVN1300, EEVN1301, EVN600V11C, EVN601V11C, EVN600V12C, EVN601V12C, EVN600V11V, EVN601V11V, EVN130V12C, EVN131V12C, EVN130V14C, EVN130V12V, EVN130V12V, EVN131V12V, EVC600V11C, EVC601V11C, EVC600V12C, EVC601V12C, EVC600V11V, EVC601V11V, EVC130V12C, EVC131V12C, EMC132V14C, EVC131V14C, EVC130V12V, EVC131V12V, EVNN60V22C, EVNN61V22C, EVNN13022C, EVNN13122C, EVNI13023C, EVNI13123C, EVN610V12C, EVN611V12C, EVNC60V22C, EVNC61V22C, EVNC13023C, EVNC13123C, EVNN-60V22C, EEVNN601...(Other models you can see in the webshop)		

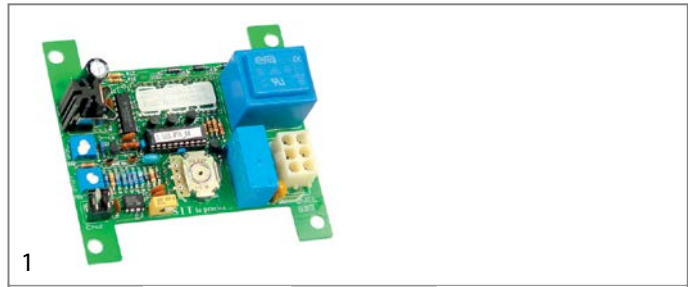

1			
GEV No.	400744	Ref. No.	003763 0590893 0F0170 0K0671 0KE777
description	PCB		
For models:	FCF/G6-0, FCFG101/0, FCFG102-0, FCFG201-0, FCFG202-0, FCF/E6-0, FCFE101-0, FCFE102-0, FCFE201-0, FCFE202-0, FCF061ELN, FCF101ELN, FCF6EHOR, FCFG10160H, FCF061ENS, FCF101ENS, FCF102ENS, FCF201ENS, FCFG102-0T, FCF/G6-1-JAP, FCF/G101/1-1-JAP, FCF/G102/1-1-JAP, FCFE6-1J, FCFE101-1J, FCFE102-1J, FCF/G101/1, C7E4/200-3, C7E4/230-3, C7E4/400-3N, C7E6/400-3N, C7PE4/200-3, C7PE4/230-3, C7PE4/400-3N, C7PT4/400-3N, C104200-3, C104230-3, C104400-3N, C106400-3N, C10T4/400-, C10P4200-3, C10P4230-3, C10P44003N, C10P64003N, C10PT4/400, C204200-3, C20230-3, C204400-3N, C206400-3N, C20T4/400-, C20P4200-3...(Other models you can see in the webshop)		



1			
GEV No.	400742	Ref. No.	0H6483 0K1791 0K1792 0ERTK
description	PCB		
For models:	7550-5.KES40, 7551-5.KES60, 7552-5.KES80, 7553-5.KES100, 7554-5.KES150, 7561-3.KES60.RW, 7562-3.KES80.RW, 7563-3.KES100.RW, 7564-3.KES150.RW, 7581-5.KK60, 7582-5.KK80, 7583-5.KK100, 7574-5.KES150, 7575-5.KES250, 7750-5.KES40, 7751-5.KES60, 7752-5.KES80, 7753-5.KES100, 7754-5.KES150, 7781-5.KK60, 7782-5.KK80, 7783-5.KK100, 7576-5.KES300, 7573-5.KES100, 7580-5.KK40, 7584-5.KK150, 7780-5.KK40, 7751-3/85.KES60, 7744-3/85.KB.(N), 7542-3/85., 7544-3/85.KB.(N), 7542-3/90.KB.(N), 7544-3/90.KB.(N), 7742-3/90.KB.(N), 7742-3/85.KB.(N), 7744-3/90.KB.(N), 7746-3/90.KB.(N), 7748-3/90.KB.(N), 7747-3/90.KB.(N), 7550-3/85.KES40.(N), 7551-3/85.KES60, 7552-3/85.KES80.(N), 7553-3/85.KES100.(N), 7554-3/85.KES150.(N), 7550-3/90.KES40.(N), 7551-3/90.KES60, 7552-3/90.KES80.(N), 7553-3/90.KES100.(N), 7554-3/90.KES150.(N), 7550-5/85.KES40.(N)...(Other models you can see in the webshop)		

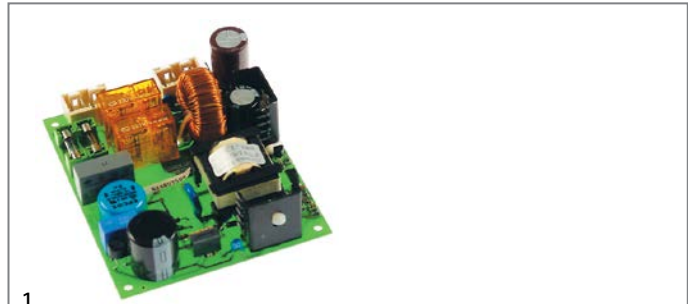

1			
GEV No.	400752	Ref. No.	0C1071
description	PCB		
For models:	AOS061GAEU, AOS101GAEU, AOS102GAEU, AOS201GAEU, AOS-202GAEU, AOS061GAAU, AOS101GAAU, AOS102GAAU, AOS201GAAU, AOS202GAAU, AOS061GA, AOS061GB, AOS101GA, AOS101GB, AOS-201GA, AOS201GB, AOS102GB, AOS102GA, AOS202GB, AOS202GA		

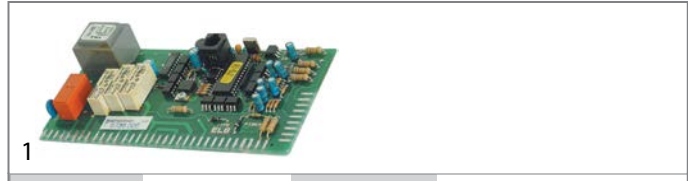

1			
GEV No.	400929	Ref. No.	048848 048926 0KE927 0TR563
description	PCB		
For models:	LS63, LS63D, LS63/UKRP, LS63F, LV63, LS63/60, LS63/1P, LS64, LS64/UKRP, LV64, LS64/1P, WT32, WT32/4,5, WT32/UK, WT32/UKRP, WT32/F6, WT32/J60, WT32/J50, WT32/4,5N, WT33, WT33/4,5, WT33/UK, WT33/UKRP, WT33/F, D500, WT33/60, WT33/4,5N, WT34, WT34/4,5, WT34/UKRP, D510, WT34/4,5N, FL630, Z63, Z64		



1

GEV No.	400930	Ref. No.	049150
description	PCB		
For models:	LS8/DP, WT50/J50, WT50/J60		



1

GEV No.	400931	Ref. No.	049141
description	PCB		
For models:	LS10DP		



1

GEV No.	400932	Ref. No.	049147
description	PCB		
For models:	LS12DP		



1

GEV No.	401130	Ref. No.	003689
description	PCB		



1

GEV No.	401343	Ref. No.	059033
description	PCB		
For models:	FCVG10-P, FCVG10PUK, FCVG20-P, FCVG20PUK, AFCV/G101, AFCV/G103, SCO/G10-3, AFCV/G201, AFCV/G203, SCO/G20-3		



1

GEV No.	401524	Ref. No.	0H6129 60050381
description	PCB		



1

GEV No.	401614	Ref. No.	OKL024 22453 22454 DS22454
description	PCB		
For models:	B2000K-01, B2000K-02, B2000K-03, B2000K-04, B2000T-01, B2000T-02, B2000T-03, B2000-4-01, B2000K-05, B2000MU-01, B2000-4-02, B2000-5-01, B2000-3-01, B2000MU-02, B2000K-06, B2000-4-03, B2000-5-02, B2000-6-01, B2000K-07, B2000-6-02, B2000-6-03, B2000-5-03, B2000-6-04, B2000K-08, B2000-4-04, B2000-5-04, B2000-5-05, B2000-6-05, B2000K-09, B2000-5-13, B2000-5-06, B2000-6-06, B2000-4-05, B2000-6-07, B2000K-10, B2000-4-06, B2000-5-07, B2000K-11, B2000-4-07, B2000-6-08, B2000K-12, B2000-5-08, B2000MU-03, B2000MU-04, B2000-5-09, B2000-6-13, B2000MU-05, B2000MU-06, B2000MU-07, B2000K-13...(Other models you can see in the webshop)		



1			
GEV No.	401744	Ref. No.	087627 087628 087629 087630 087632 087633 088526 088527 089089 092023 092562 099161 452710110 648R03603
description	PCB		
For models:	BCW201R, BCFW201R, ADN220ES, ADF110ES, ADF220ES, ADN110ESP, ADF110ESP, ADN110E, ADF110E, ADN220E, ADF220E, TRN132AE, TRN183AE, TRN224AE, TRF132AE, TRF183AE, PS04RE1F, PS06RE1F, PS04FE1F, PS06FE1F, PR04RE1F, PR06RE1F, PR04FE1F, PR06FE1F, AOF-PS201CR, RI75RE1F, RI075RE1FR, RI093RE1F, RI093RE1FR, AOFPS201RU, AOFPS201RCU, RH06RE1FUS, RH06FE1FUS, RH14RE2FUS, RH14FE2FUS, RI016RE1F, RI16RE1FR, RCER2M2, RCER3M3, RCER4M4, RCEF2M2X, RCEF3M3, RH14RE2FS, RH06FE1FS, RH14FE2FS, RH06RE1F, RH06FE1F, RH14RE2F, RH14FE2F, RCSER2M2...(Other models you can see in the webshop)		
accessories for	401744		
	GEV No.	403477	Ref. No. 099468
	cable harness L 800mm suitable for ELECTROLUX, ZANUSSI connection coded plug		

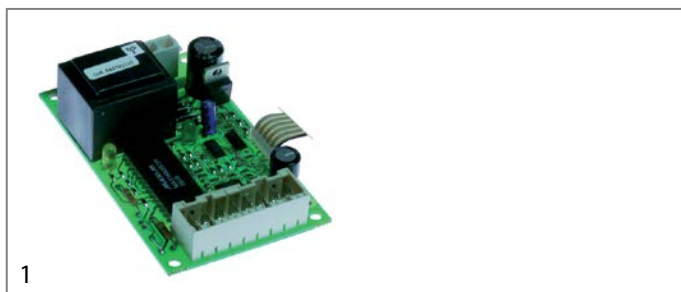

1			
GEV No.	401942	Ref. No.	088570 092100
description	PCB		
For models:	BC100A, BC100DA, BC100RA, BC100RDA, BC180A, BC180DA, BC180RA, BC180RDA, BC180RPA, BCF100A, BCF100DA, BCF100RA, BCF100RDA, BCF180A, BCF180DA, BCF180RA, BCF180RDA, BCF180RPA, AQC60U, AQC119U US, BC28A6, Crosswise, , , , BC120A, BC120RA, BCF120A, BCF120RA, Crosswise, BC28A, Crosswise, BC56HA, Crosswise, BCF28A, Crosswise, BCF56HA, BLAST C/FREEZER, BLAST C/FREEZER, RBC102, AOCP2028R, AOCP2028RD, AOCP2028RT, AOFPS2028R, AOFPS2028RD, AOFPS2028RT, EABP31, EABP51, EABPR101, EABC501... (Other models you can see in the webshop)		

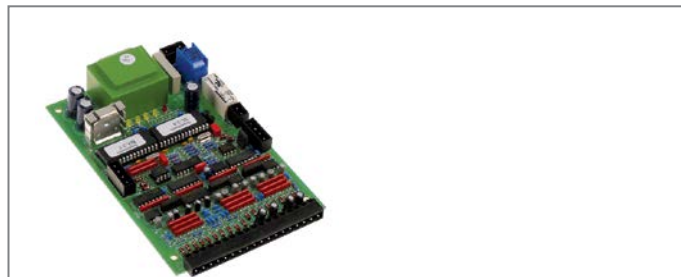

1			
GEV No.	401964	Ref. No.	0G1955 0H9859 0K5071 0K5072 0K5161 0K5198 0M2136 0M2140 11031644 14R21 14S01 15P01 15P05 18025432 18025432T 18025580 18055432 721657 7216571 72165723331 724956
description	PCB		
For models:	CE128-106, CE158-133.3.HV, CE158-244.3, CE158-246.3, CK248-209, D1ABBB, CK248-211.D1ABBB, HCE128-100, HCE128-104, HCE158-252W.3, HCE158-253.3, HLE129-100, HLE129-103, HLE129-104W, HLE159-252W.3.6, HLE159-328.3.HV, HLE159-351W.3.HV, HLE249-200.3, HLE249-208.3, HLE259-088.3.HV, HLE259-089.3.HV, HLE259-384W.3, LE129-101, LE159-261.3, LE159-281.3.6, LE159-318.3.HV, LE159-322.3.HV, LE159-330.3.HV, LE159-337.3.HV, LE159-344.3.MS92, LE159-347.3.HV, LE249-199.3, LE249-203.3, LE249-207.3, LE249-211.3, LE249-215.3, LE249-219.3, LE249-223.3, LE249-232.3, LE249-238.3, LE259-081.3.HV, LE259-082.3.HV, LE259-083.3.HV, LE259-094.3.HV, LE259-099.3.HV, LE259-382.3, LK259-707.D1ACCB, LK259-708.D1ACCB, CK248-205.D1ABBB, CK248-207.D1ABBB, LK159-707.D1BC...(Other models you can see in the webshop)		



GEV No.	403442	Ref. No.	088344 088610 090018 092854 093125 093158 095194 099177 0TTD58
description	PCB blast freezer BC100 L 165mm W 120mm suitable for ZANUSSI 50/60Hz 230V H 40mm 2.8A Qty 1 pcs		
For models:	BC100A, BC100DA, BC100RA, BC100RDA, BC180A, BC180DA, BC180RA, BC180RDA, BC180RPA, BCF100A, BCF100DA, BCF100RA, BCF100RDA, BCF180A, BCF180DA, BCF180RA, BCF180RDA, BCF180RPA, AQC22U US, AQC31U US, AQC60U, AQC119U US, , , BC28A6, Crosswise, , , BCF15A6, , , BC120A, BC120RA, BCF120A, BCF120RA, BCWS061T, BLAST C/FREEZER, BLAST C/FREEZER, BLAST C/FREEZER, BLAST C/FREEZER, BLAST C/FREEZER, BLAST C/FREEZER, BLAST C/FREEZER, BLAST C/FREEZER, BCFWS102, BCFWS101, BC15A, BC28A, Crosswise, BC56VA, Crosswise 20...(Other models you can see in the webshop)		



GEV No.	403443	Ref. No.	085926
description	PCB blast freezer BCF 72/144 suitable for ZANUSSI		
For models:	BCF11, BCF22, BCF44H, BCF44, BCF7, BCF7, EEVAC10/1, EEVAC201, EEVAC40/2, EEVAC40/1, ESF10, ESF40H, ESBF40, ESF40VR, BCF72, BCF72R, BCF144, BCF144R, BFE431, TBCF44H, BCF72D, BCF72RD, BCF144D, BCF144RD, ESF5, EABC0071, EABC0071, ESF5, AF100, AF210, AF431, AF430		



GEV No.	400187	Ref. No.	002666 452200410 60050298
description	PCB combi-steamer FCV/G 101/1 102/1		
For models:	FCV/G6L3TOWNGAS, FCV/G6L3, FCV/G20L3, FCVG202L3, FCVE6L3J, FCV/E10L3JAP, FCV/E102/1L3JAP, FCV/G6L3JAP, FCVG6L3CJ, FCV/E61/1, FCV/E101/1, FCV/E61/1, FCV/E101/2, FCV/G6L3C, FCV/G61/1, FCV/G61/1, FCV/G61/1, FCVG6L3CT, FCVG6L3CJ, FCV/E10L3, FCV/E102/1, FCV/E6L3, FCV/E102/1L3, FCV/E20L3, FCVE202L3, FCV/G6L4, FCV/E6L4, FCV/E101/1, FCV/G101/1, FVC/E101/1, FCV/G102/1, FVC/E102/1, FCV/G201/1, FVC/E201/1, FCV/G202/1, FVC/E202/1, FCS061E44J, FCS061G48J, FCS061GP, FCS061G3DI, FCS061E3CI, FCS061G4, FCS061G4DT, FCS101E44J, FCS061G49J, FCS101E4, FCS101G4, FCS101G4DT, FCS102E44J, FCS101G49J...(Other models you can see in the webshop)		



GEV No.	400751	Ref. No.	007047
description	PCB combi-steamer FCZ06/10/20 level A		
For models:	FCZ061EAA, FCZ101EAA, FCZ102EAA, FCZ201EAA, FCZ202EAA, FCZ061EAH, FCZ101EAH, FCZ201EAH, FCZ061EAN, FCZ101EAN, FCZ201EAN, FCZ061ETA, FCZ101ETA, FCZ102ETA, FCZ201ETA, FCZ202ETA, FCZ061ETH, FCZ101ETH, FCZ201ETH, FCZ061ETN, FCZ101ETN, FCZ201ETN, FCZ061GAG, FCZ101GAG, FCZ102GAG, FCZ201GAG, FCZ202GAG, FCZ061GAD, FCZ101GAD, FCZ201GAD, FCZ202GAD, FCZ101GTG, FCZ102GTG, FCZ201GTG, FCZ202GTG, FCZ101GTD, FCZ102GTD, FCZ201GTD, FCZ202GTD, FCZ061EBA, FCZ101EBA, FCZ102EBA, FCZ061EBH, FCZ101EBH, FCZ061EBN, FCZ101EBN, FCZ061EBC, FCZ101EBC, FCZ201EBC, FCZ061EBA2...(Other models you can see in the webshop)		

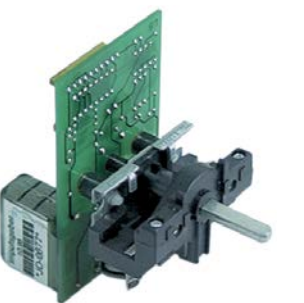

GEV No.	400003	Ref. No.	0H6601 0K2036 60050418
description	PCB combi-steamer JUNO		





GEV No.	360275	Ref. No.	049411
description	PCB dishwasher LS 32/60 + WT 302/60		
For models:	LS32, LS32/4.5, LS32F, LV32F, LV32/60, WT302, WT302/4.5, WT302F, WT302/60, FL32, FL32/4.5, C32, C32/4.5, Z32, Z32/4.5		



GEV No.	360276	Ref. No.	049412
description	PCB dishwasher LS 33/60 + WT 303/60		
For models:	LS33, LS33/4.5, LS33F, LV33F, LS33/60, WT303, WT303/4.5, WT303F, WT303/60, FL33, FL33/4.5, C33, C33/4.5, Z33, Z33/4.5		



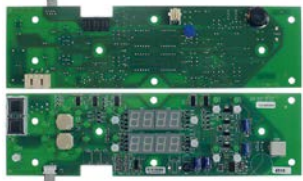

			
1			
GEV No.	400928	Ref. No.	048833
description	PCB dishwasher LS61-LS62		
For models:	LS61, LS61/60, LS64, LS64/UKRP, LV64, LS64/1P, FL610, FL620, Z62		

			
1			
GEV No.	400917	Ref. No.	049952 0L0046 0L0547 0L0706 0L1236 0L1410 0L1810 0L2582 452670152 673611T00
description	PCB dishwasher WT 4		
For models:	WT4, WT4D, WT4D60, WT4DDG, EUC1, EUC1DP, EUC1G, EUC1DP60, LS5/1, LS5/1DP, LS5/1DP60, LS5/1DPAUS, LS5/1DPCS, NUC1, NUC1DP, NUC1DP60, NUC1DPA, WT65ROW, LS14ROW, LS14ROW60, WT65ROW60, UC5DP, UC5/1, UC5/1DP, FL5DDG, NUC1G		

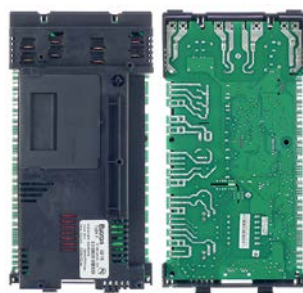
			
1			
GEV No.	361975	Ref. No.	092700
description	PCB for blast chiller BC/RB series L 290mm W 80mm		
For models:	BC100A, BC100DA, BC100RA, BC100RDA, BCF100A, BCF100DA, BCF100RA, BCF100RDA, BCF180A, BCF180DA, BCF180RA, BCF180RDA, BCF180RPA, AQC22U US, AQC31U US, AQC60U, AQC119U US, , , BC28A6, Crosswise, , , BCF15A6, , , BCF120A, BCF120RA, BC15A, Crosswise, BC28A, Crosswise, BC56VA, Crosswise 20, BC56HA, BCF15A, Crosswise, BCF28A, Crosswise, BCF64A, Crosswise 20, BCF56HA, BC10A, BLAST C/FREEZER, BCF7A, BLAST C/FREEZER, RBC102, RBF611560, Crosswise, RBC061...(Other models you can see in the webshop)		

			
1			
GEV No.	360708	Ref. No.	0L2888 0L3601
description	PCB for dishwasher L 265mm W 130mm suitable for ELECTROLUX, ZANUSSI		

			
1			
GEV No.	402137	Ref. No.	086520
description	PCB for float switch		

 <p>Image not available</p>			
1			
GEV No.	400990	Ref. No.	0K2758 70085612
description	PCB for stirrer complete		
For models:	7560-3, 7561-3, 7562-3, 7563-3, 7564-2, 9411-3, 9411-5, 9413-3, 9413-5, 9414-3, 9414-5, 9415-3, 9415-5, 9416-3, 9416-5		

			
1			
GEV No.	401943	Ref. No.	090019
description	PCB HACCP interface		
For models:	BC100A, BC100DA, BC100RA, BC100RDA, BC180A, BC180DA, BC180RA, BC180RDA, BC180RPA, BCF100A, BCF100DA, BCF100RA, BCF100RDA, BCF180A, BCF180DA, BCF180RA, BCF180RDA, BCF180RPA, AQC119U US, , , BC120A, BC120RA, BCF120A, BCF120RA, BC56HA, BCF56HA, RBC102, EABP31, EABP51, EABPR101, EABC501, EABC101R, EABC301, FRABC5621, EBAP100, EABPD100, EABPR100, EABPRD100, EABP180, EABPD180, EABPR180, EABPRD180, EABPRP180, EABF100, EABCD100, EABCR100, EABCRD100, EABC180, EABCD180...(Other models you can see in the webshop)		

1

GEV No.	402003	Ref. No.	086368 0H9321 62040305 62040316
description	PCB ice maker AC045/055		
For models:	CIM15A, CIM15W, CIM30A, CIM30W, CIM45A, CIM45W, CIM65A, CIM65W		



1

GEV No.	401799	Ref. No.	086586	
description	PCB ice maker N201/N301/N501 230V			
accessories for	401799			
	GEV No.	701450	Ref. No.	—
	connection cable L 1300mm 2-pole level sensor suitable for ice maker connection plug plug type coded plug			



1

GEV No.	404002	Ref. No.	0C0028 0C0028R 7899310026 789931002600
description	PCB induction device frequency transformation		
For models:	KI/Z1, KI/Z2, QI/Z1, QI/Z2, WI/Z1, WI/Z2, WI/Z1E5, WI/Z2E5		



1

GEV No.	697908	Ref. No.	034100
description	PCB L 102mm W 95mm 50/60Hz 230/400V		

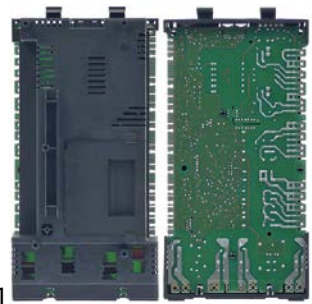

1

GEV No.	403863	Ref. No.	0L1291
description	PCB L 250mm W 130mm suitable for ELECTROLUX		
For models:	WTC90ERB, WTC90ELB, WTC140ERA, WTC140ELA, WTC140ERB, WTC140ELB, WTC180ERA, WTC180ELA, WTC180ERB, WTC180ELB, WTC220ERA, WTC220ELA, WTC220ERB, WTC220ELB, WTC90ERBG, WTC90ELBG, WTC140ERAG, WTC140ELAG, WTC140ERBG, WTC140ELBG, WTC180ERAG, WTC180ELAG, WTC180ERBG, WTC180ELBG, WTC220ERAG, WTC220ELAG, WTC220ERBG, WTC220ELBG, WT44BR208, WT44BL240, WT44BR240, WT44CL208, WT44CR208, WT44CL240, WT44CR240, WT66BL208, WT66BR208, WT66BL240, WT66BR240, WT66CL208, WT66CR208, WT66CL240, WT66CR240, RTC90ERB, RTC90ELB, RTC90ERC, RTC90ELC, RTC140ERA, RTC140ELA... (Other models you can see in the webshop)		



1

GEV No.	400814	Ref. No.	004213
description	PCB pizza oven TH4351DC 2kW		
For models:	ZCMDE9, ZCBDE18, FFP532, PDE830, PDE1230, PDE12L30, PDE1830, PDE835, PDE1235, PDE12L35, PDE1835		





1

GEV No.	400177	Ref. No.	0H6132 0H6144
description	PCB range JUN90133		
For models:	9013-3, 9015-3, 9213-3-0, 9213-3-8		

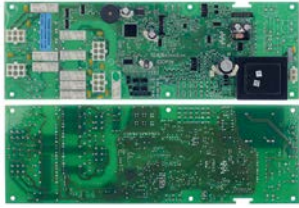

			
1			
GEV No.	403058	Ref. No.	0KQ429 23394 DS23394
description	PCB vegetable slicers TRS		
For models:	MC40AS-01, TR260-01, TRS-3-02, TRS-3-03, TR260-02, TR260-03, TRS-1-02, TR260-04, TRS-1-03, MULTIG-01, BM20AS-01, MC40AS-02, K25-01, TRS-3-04, TRS-3-05, PL15-01, BM20AS-02, K25-02, MINIG-02, TRS-1-04, MULTIG-02, RC14-01, CD4-02, CD8-02, PL15-02, PL15-03, BM20AS-03, BM20AS-04, BM30AS-01, BM30AS-02, MC40AS-03, TRS-1-05, MULTIG-03, RC14-02, BM20AS-05, BM30AS-03, PL4-01, PL8-01, TRS-1-06, BM20AS-06, TRS-1-07, MULTIG-04, MINIG-03, MULTIG-05, RC14-03, TRS-1-08, TRS-3-06, TBS120-01, TBS140-02, TBS140-01...(Other models you can see in the webshop)		

			
1			
GEV No.	400748	Ref. No.	004105 006612 006716 0C3761 452300130131 452340130 452440200
description	power PCB combi-steamer FCV/G 101/1 102/1		
For models:	FCV/G10L3, FCV/G10L3T, FCV/G102L3, FCV/G20L3, FCV/G202L3, FCV/E10L3JAP, FCV/E102/1L3JAP, FCV/G10L3J, FCV/G102L3J, FCV/E101/1, FCV/E101/2, FCV/G61/1, FCV/E10L3, FCV/E102/1, FCV/E102/1L3, FCV/E20L3, FCVE202L3, RCV101G2, RCV101E2		

			
1			
GEV No.	401573	Ref. No.	0H9794 0K4882 0K4883 18003808 18003808T 740046
description	power PCB		
For models:	VARIOSTEAM/S-33.3/F, STEAM-O-MAT		

			
1			
GEV No.	401572	Ref. No.	004079 006517 0C3762 0KE782 452340190 452340200 452440300
description	power PCB combi-steamer FCV/G 101/1 102/1		
For models:	FCV/G61/1, FCV/G61/1, FCV/G6L4, FCV/E6L4, FCV/G101/1, FVC/E101/1, FCV/G102/1, FVC/E102/1, FCV/G201/1, FVC/E201/1, FCV/G202/1, FVC/E202/1, FCS061E44J, FCS061G48J, FCS061G4, FCS061G4DT, FCS101E44J, FCS061G49J, FCS101E4, FCS101G4, FCS101G4DT, FCS102E44J, FCS101G49J, FCS102E4, FCS102G4, FCS201E4, FCS102G49J, FCS202E4, FCS201G4, FCS202G4, FCS061E4, ECV/G6T4, ECV/E6T4, ECV/G10T4, ECV/E10T4, ECVG102T4, ECV/E102T4, ECV/G20T4, ECV/E20T4, ECVG202T4, ECV/E202T4, ECV/G6T4C, ECV/G10T4J, ECV/G61/1, ECV/G61/1, RCV061E4, RCV101G4, RCV101E4, ACV/G10C4, ACV/G102C4...(Other models you can see in the webshop)		

			
1			
GEV No.	401617	Ref. No.	002684 006611 006715 0C3757 452300111110 452340110 452440100 60050299
description	power PCB combi-steamer FCV 6GL		
For models:	FCV/G6L3TOWNGAS, FCV/G6L3, FCVE6L3J, FCV/G6L3JAP, FCV/G6L3CJ, FCV/E61/1, FCV/G10L2, FCV/E10L2, FCV/E61/1, FCV/G6L3C, FCV/G6L3CT, FCV/G6L3CJ, FCV/E6L3, FCV/E101/1, FCS061G3DI, FCS061E3CI, FCS101E2, FCS101G2, RCV061G2, RCV061E2, RCV101G2, RCV101E2, ACV/G10C2, ACV/E10C2, ACV/G6C3, ACV/G6C3C, ACV/E6C3, NCV/G6L2, NCV/G10L2, NCV/E6L2, NCV/E10L2		



central units



1

GEV No.	400750	Ref. No.	OC0042 OC4890 OC5150 OTT685 452371010 675837800
description	power PCB combi-steamer FCZ06/10/20		
For models:	FCZ061EAA, FCZ101EAA, FCZ102EAA, FCZ201EAA, FCZ202EAA, FCZ061EAH, FCZ101EAH, FCZ201EAH, FCZ061EAN, FCZ101EAN, FCZ201EAN, FCZ061ETA, FCZ101ETA, FCZ102ETA, FCZ201ETA, FCZ202ETA, FCZ061ETH, FCZ101ETH, FCZ201ETH, FCZ061ETN, FCZ101ETN, FCZ201ETN, FCZ061GAG, FCZ101GAG, FCZ102GAG, FCZ201GAG, FCZ202GAG, FCZ061GAD, FCZ101GAD, FCZ102GAD, FCZ201GAD, FCZ202GAD, FCZ101GTG, FCZ102GTG, FCZ201GTG, FCZ202GTG, FCZ101GTD, FCZ102GTD, FCZ201GTD, FCZ202GTD, FCZ061EBA, FCZ101EBA, FCZ102EBA, FCZ061EBH, FCZ101EBH, FCZ061EBN, FCZ101EBN, FCZ061EBC, FCZ101EBC, FCZ061EBA...(Other models you can see in the webshop)		

Triacs



1

GEV No.	400079	Ref. No.	0H7060
description	Triac		
For models:	9013-3, 9015-3, 9213-3-0, 9213-3-8		



1

GEV No.	402072	Ref. No.	OH9854 OK5065 OM2153 14T07 15T01 18025424 720020
description	Triac		



1

GEV No.	402004	Ref. No.	086576 62046202
description	control box		
accessories for	402004		
GEV No.	402005	Ref. No.	086339 086344 0H9327 0K8396 0KD786 62040400 62040410 P1CA66P16UCS
description	temperature probe PTC 2kOhm cable TPE probe -50 up to +150°C cable -40 up to +110°C connection plug thread probe ø6x50mm cable length 1.6m		
GEV No.	402044	Ref. No.	086346
description	Hall sensor L 29mm W 26mm H 26mm mounting distance 10mm cable length 1250mm		
GEV No.	402191	Ref. No.	086340 0H9322 0KM745 30003179 62040401 62040411 SC62040401
description	temperature probe PTC 2kOhm cable TPE probe -50 up to +150°C cable -40 up to +110°C connection plug thread probe ø5x20mm cable length 1.8m		



1

GEV No.	401841	Ref. No.	086597
description	control box for ice-cube maker 24V 50-60Hz		



1

GEV No.	402042	Ref. No.	086294 086553 0T4522
description	control box suitable for SFT 012		
For models:	CIM120AS, CIM120WS		





keypads

front foils

			
GEV No.	401131	Ref. No.	003714
description	front foil		

			
GEV No.	401132	Ref. No.	003838
description	front foil		
For models:	FCFG101/0, FCFG102-0, FCFG201-0, FCFG202-0, FCFE101-0, FCFE102-0, FCFE201-0, FCFE202-0, FCF101ELN, FCFG102-0T, FCF/G101/1-1-JAP, FCF/G102/1-1-JAP, FCFE101-1J, FCFE102-1J, FCF/G101/1, ECFG101-0, ECFG102-0, ACFG101-0, ACFG102-0, RCF101G, NCF/G101/1, NCF/G102/1, ZCF/G101/1, ZCF/G102/1		

			
GEV No.	401212	Ref. No.	003834
description	front foil		
For models:	FCV/G6L3TOWNGAS, FCV/G6L3, FCVE6L3J, FCV/G6L3JAP, FCVG6L3CJ, FCV/E61/1, FCV/G6L3C, FCV/G61/1, FCVG6L3CT, FCVG6L3CJ, FCV/E6L3		

			
GEV No.	401216	Ref. No.	003835
description	front foil		
For models:	FCV/G10L2, FCV/E10L2		

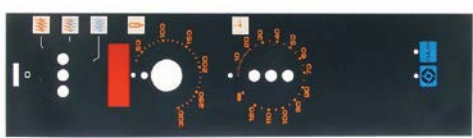
			
GEV No.	401248	Ref. No.	002831
description	front foil		

			
GEV No.	401250	Ref. No.	003832
description	front foil		
For models:	FCV/G10L3, FCVG10L3T, FCVG102L3, FCV/G20L3, FCVG202L3, FCV/E10L3JAP, FCV/E102/1L3JAP, FCVG10L3J, FCVG102L3J, FCV/E101/2, FCV/E10L3, FCV/E102/1L3, FCV/E20L3, FCVE202L3		

			
GEV No.	403721	Ref. No.	091565 094226
description	front foil blast freezer L 310mm W 74mm		
For models:	Crosswise, RBC061, Crosswise, RBC6.1-15, Crosswise, RBC101, Crosswise, RBC10.1-2, Crosswise 20, RBC20.1-56, BLAST C/FREEZER, RBC051		

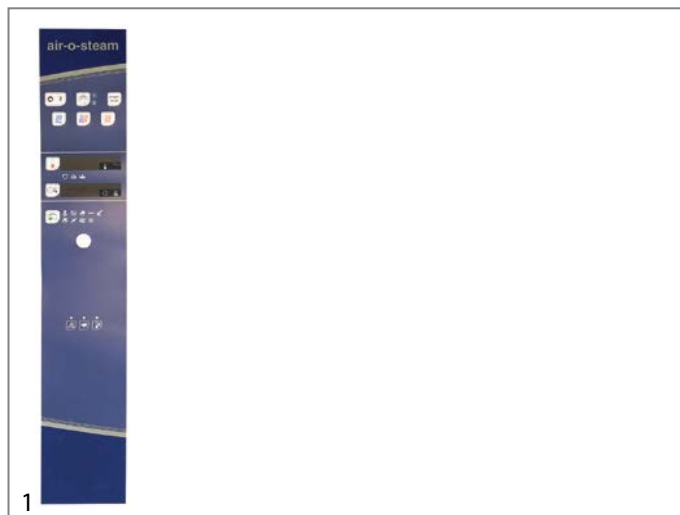

GEV No.	512428	Ref. No.	0C6553
description	front foil combi-steamer FCZ10 suitable for ELECTROLUX for air-o-steam L 890mm W 160mm		
For models:	FCZ101ETA, FCZ102ETA, FCZ101ETH, FCZ101ETN, FCZ101GTG, FCZ102GTG, FCZ101GTD, FCZ102GTD, FCZ101EBA2, FCZ102EBA2, FCZ101EBH2, FCZ101EBN2, FCZ101EBC2, FCZ101GBG2, FCZ102GBG2, FCZ101GBD2, FCZ102GBD2, FCZ101GBI2, FCZ102GBI2, FCZ101ECA2, FCZ102ECA2, FCZ101ECH2, FCZ101ECN2, FCZ101GCG2, FCZ102GCG2, FCZ101GCD2, FCZ102GCD2, AOS101ETA1, AOS102ETA1, AOS101ETH1, AOS101ETN1, AOS101ETC1, AOS101ETE1, AOS101ETF1, AOS101ETM1, AOS102ETM1, AOS101ETK1, AOS102ETK1, AOS101GTG1, AOS102GTG1, AOS101GTD1, AOS102GTD1, AOS101GTP1, AOS102GTP1, AOS101GTW1, AOS102GTW1, AOS101EBA2, AOS102EBA2, AOS101EBH2, AOS101EBN2...(Other models you can see in the webshop)		



GEV No.	403722	Ref. No.	092383
description	front foil freezer L 365mm W 115mm		
For models:	PS04FE1F, PS06FE1F, RH06FE1FS, RH06FE1FEU, RH14FE2FEU, RH06FE2HU, RH14FE4HU, RH06F1FERU, RH14F2FERU, RH06FE2HRU, RH14FE4HRU, RH06FEP1F		





GEV No.	401211	Ref. No.	007057
description	keypad foil		
For models:	AOS061GAEU, AOS101GAEU, AOS102GAEU, AOS201GAEU, AOS202GAEU, AOS061GAU, AOS101GAU, AOS102GAU, AOS201GAU, AOS202GAU, AOS061EABU, AOS101EABU, AOS201EABU, AOS202EABU, AOS061EAFU, AOS101EAFU, AOS201EAFU, AOS061EA, AOS101EA, AOS201EA, AOS061EA3J, AOS101EA3J, AOS201EA3J, AOS061EA2N, AOS101EA2N, AOS201EA2N, AOS102EA2N, AOS202EA2N, AOS061EA0H, AOS101EA0H, AOS201EA0H, AOS102EA, AOS202EA, AOS061GA, AOS101GA, AOS201GA, AOS102GB, AOS202GB, AOS061EAAQ, AOS101EAAQ, AOS102EAAQ, AOS201EAAQ, AOS202EAAQ, AOS061EANQ, AOS101EANQ, AOS102EANQ, AOS201EANQ, AOS202EANQ, AOS061EACQ, AOS101EACQ, AOS201EACQ...(Other models you can see in the webshop)		

electric components



			
1			
GEV No.	401213	Ref. No.	003664
description	keypad foil		
For models:	FCV/G61/1, FCV/G61/1, FCV/G6L4, FCV/E6L4		

			
1			
GEV No.	401214	Ref. No.	007058
description	keypad foil		
For models:	FCZ061EAA, FCZ101EAA, FCZ102EAA, FCZ061EAH, FCZ101EAH, FCZ061EAN, FCZ101EAN, FCZ061EBA, FCZ101EBA, FCZ102EBA, FCZ061EBH, FCZ101EBH, FCZ061EBN, FCZ101EBN, FCZ061EBC, FCZ101EBC, FCZ061ECA, FCZ101ECA, FCZ102ECA, FCZ061ECH, FCZ101ECH, FCZ061ECN, FCZ101ECN, AOS061EB, AOS101EB, AOS201EB, AOS061EB3J, AOS101EB3J, AOS201EB3J, AOS061EB2N, AOS101EB2N, AOS201EB2N, AOS061EB5M, AOS061EB6M, AOS102EB2N, AOS202EB2N, AOS061EB0H, AOS101EB0H, AOS201EB0H, AOS102EB, AOS202EB, AOS061GB, AOS101GB, AOS201GB, AOS102GA, AOS202GA, AOS061EBAQ, AOS101EBAQ, AOS102EBAQ, AOS201EBAQ... (Other models you can see in the webshop)		

			
1			
GEV No.	401215	Ref. No.	056680
description	keypad foil		
For models:	FCVE103CE, FCVE203CE		

			
1			
GEV No.	401217	Ref. No.	059288
description	keypad foil		
For models:	FCVE20/P-V, FCVE10-P, FCVE10PUK, FCVG10-P, FCVG10PUK, FCVE20-P, FCVE20PUK, FCVG20-P, FCVG20PUK		

			
1			
GEV No.	401247	Ref. No.	002719
description	keypad foil		
For models:	FCV/E101/1, FCV/E10L6JAP, FCV/E102/1L6JAP, FCV/G10L6JAP, FCV/G102/1L6JAP, FCV/E101/1, FCV/E102/1, FCV/E101/1, FCV/G10L6, FCV/E10L6, FCV/G102/1L6, FCV/E102/1L6, FCV/G20L6, FCV/E20L6, FCVG202L6, FCVE202L6		

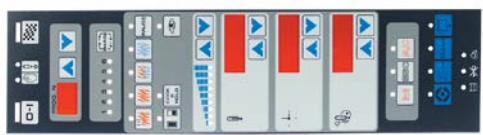
			
1			
GEV No.	401249	Ref. No.	005623
description	keypad foil		
For models:	FCV/E61/1, FCV/E61/1, FCV/G61/1		

			
1			
GEV No.	401251	Ref. No.	006529
description	keypad foil		
For models:	FCV/G101/1, FVC/E101/1, FCV/G102/1, FVC/E102/1, FCV/G201/1, FVC/E201/1, FCV/G202/1, FVC/E202/1		

			
1			
GEV No.	401347	Ref. No.	0K2622 NZ9205875212
description	keypad foil		
For models:	5614-3-10		

			
1			
GEV No.	401354	Ref. No.	0K2637
description	keypad foil		
For models:	7550-5.KES40, 7551-5.KES60, 7552-5.KES80, 7553-5.KES100, 7554-5.KES150, 7561-3.KES60.RW, 7562-3.KES80.RW, 7563-3.KES100.RW, 7564-3.KES150.RW, 7581-5.KK60, 7582-5.KK80, 7583-5.KK100, 7574-5.KES150, 7575-5.KES250, 7750-5.KES40, 7751-5.KES60, 7752-5.KES80, 7753-5.KES100, 7754-5.KES150, 7781-5.KK60, 7782-5.KK80, 7783-5.KK100, 7576-5.KES300, 7573-5.KES100, 7580-5.KK40, 7584-5.KK150, 7780-5.KK40, 7720-3/90.WB.GN1/1., 7520-3/85.WB.GN1/1., 7731-3/85.GRPL.VCHR., 7721-3/85.WB.GN2/1, 7751-3/85.KES60, 7531-3/85., 7531-3/90.GRPL.(N), 7508-3/85., 7502-3/85., 7520-3/90.WB.GN1/1., 7720-3/85.WB.GN1/1., 7550-3/85.KES40.(N), 7551-3/85.KES60, 7552-3/85.KES80.(N), 7553-3/85.KES100.(N), 7554-3/85.KES150.(N), 7550-3/90.KES40.(N), 7551-3/90.KES60, 7552-3/90.KES80.(N), 7553-3/90.KES100.(N), 7554-3/90.KES150.(N), 7550-5/85.KES40.(N), 7551-5/85.KES60.(N)...(Other models you can see in the webshop)		

			
1			
GEV No.	401518	Ref. No.	0K1581
description	keypad foil		

			
1			
GEV No.	401519	Ref. No.	0K1582
description	keypad foil		

			
1			
GEV No.	401520	Ref. No.	0K1583
description	keypad foil		



			
1			
GEV No.	401521	Ref. No.	OK1584
description	keypad foil		

			
1			
GEV No.	401522	Ref. No.	OK1585
description	keypad foil		

			
1			
GEV No.	401523	Ref. No.	OK1586
description	keypad foil		

			
1			
GEV No.	401532	Ref. No.	OK2620
description	keypad foil		
For models:	5612-3-10		

			
1			
GEV No.	401533	Ref. No.	OK2617
description	keypad foil		
For models:	5611-3-6		

			
1			
GEV No.	401534	Ref. No.	0H6893
description	keypad foil		
For models:	5611-3-8		

			
1			
GEV No.	401535	Ref. No.	OK2618
description	keypad foil		
For models:	5611-3-10		

			
1			
GEV No.	401536	Ref. No.	OK2619
description	keypad foil		
For models:	5612-3-6		

			
1			
GEV No.	401537	Ref. No.	0H6894
description	keypad foil		
For models:	5612-3-8		

			
1			
GEV No.	401538	Ref. No.	OK2621
description	keypad foil		
For models:	5614-3-6		

			
1			
GEV No.	401539	Ref. No.	0H6895
description	keypad foil		
For models:	5614-3-8		

			
1			
GEV No.	401541	Ref. No.	005274 006054 OK1590 OK1609
description	keypad foil		
For models:	5711-2-7, 5711-2-7L, 5721-2-7, 5711-3-7		

			
1			
GEV No.	401543	Ref. No.	005282 005417
description	keypad foil		
For models:	5714-2-7, 5714-2-7, 5714-2-7L, 5714-2-7L, 5714-3-7, 5717-3-7		



			
1			
GEV No.	401544	Ref. No.	005225 005325 006050
description	keypad foil		
For models:	5714-2-8, 5714-2-8, 5714-2-8L, 5714-2-8L, 5714-3-8, 5714-3-8E, 5717-3-8, 5717-3-8E, 5717-3-8M, 5717-3-8C, 5717-3-8M		

			
1			
GEV No.	401545	Ref. No.	005418 0H6442 0K1597
description	keypad foil		
For models:	5714-2-10, 5714-2-10, 5714-2-10L, 5714-2-10L, 5714-3-10, 5717-3-6, 5717-3-10, 5714-2-10F, 5714-2-10S, 5714-3-10F, 5714-3-10S, 5702-2-3, 5704-2-3, 57074-2-3, 5701-3-3, 5702-3-3, 5704-3-3, 5707-3-3		

			
1			
GEV No.	401551	Ref. No.	005101
description	keypad foil		
For models:	FVC/E201/1, FVC/E202/1, 5711-2-8, 5711-2-8CH, 5711-2-8L, 5711-3-8, 5711-3-8CH		

			
1			
GEV No.	401552	Ref. No.	005287
description	keypad foil		
For models:	5711-2-10, 5711-2-10CH, 5711-2-10L, 5721-2-10, 5711-3-10, 5711-3-10CH, 5711-3-10F, 5711-3-10S		

			
1			
GEV No.	401553	Ref. No.	005278
description	keypad foil		
For models:	5712-2-7, 5712-2-7L, 5712-3-7		

			
1			
GEV No.	401554	Ref. No.	005280 005416
description	keypad foil		
For models:	5714-2-6, 5717-2-6, 5714-2-6L, 5714-2-6L, 5714-3-6		

			
1			
GEV No.	401555	Ref. No.	006058
description	keypad foil		
For models:	5721-2-10, 5711-3-10		

			
1			
GEV No.	401556	Ref. No.	005452
description	keypad foil		
For models:	5702-2-3, 5702-3-3		

			
1			
GEV No.	401574	Ref. No.	OK3018 OK4333 740162
description	keypad foil		
For models:	STEAM-O-MAT		

			
1			
GEV No.	401577	Ref. No.	005459
description	keypad foil		
For models:	5701-3-2		

			
1			
GEV No.	401578	Ref. No.	005457
description	keypad foil		
For models:	5701-3-3		

			
1			
GEV No.	401579	Ref. No.	005449
description	keypad foil		
For models:	5702-2-2, 5702-3-2		

			
1			
GEV No.	401580	Ref. No.	005455
description	keypad foil		
For models:	5704-2-2, 5707-2-2, 5704-3-2, 5707-3-2		

			
1			
GEV No.	401581	Ref. No.	005453
description	keypad foil		
For models:	5704-2-3, 57074-2-3, 5704-3-3, 5707-3-3		





1 			
GEV No.	401582	Ref. No.	005276
description	keypad foil		
For models:	5712-2-6, 5712-2-6L, 5712-3-6		

1 			
GEV No.	401583	Ref. No.	005266 006048 0K1596
description	keypad foil		
For models:	5712-2-10, 5712-2-10L, 5712-3-10, 5712-3-10C, 5712-2-10F, 5712-2-10S, 5712-3-10F, 5712-3-10S		

1 			
GEV No.	404004	Ref. No.	0C0026
description	keypad foil		
For models:	KI/Z1, KI/Z1E5, KI/Z1A		

1 			
GEV No.	404005	Ref. No.	0C0038
description	keypad foil		
For models:	KI/Z2, KI/Z2E5, KI/Z2A		

1 			
GEV No.	401754	Ref. No.	087198
description	keypad foil blast chiller suitable for ZANUSSI L 237mm W 74mm buttons 11		
For models:	BC22, BC44, BC44H, BC7, BC7		

1 			
GEV No.	401746	Ref. No.	085793
description	keypad foil blast chiller suitable for ZANUSSI L 238mm W 75mm buttons 11		
For models:	ESK20, ESK40V, ESK40H, ESK10, ESBC40, BC72, BC72R, BC144, BC144R, BE431, BFE431, ESK40VZ, BC72D, BC72RD, BC144D, BC144RD, BC144RT, ESK7, ESK7, RBC07A, RBC10A, RBC20A, RBC402A		

1 			
GEV No.	403866	Ref. No.	088438
description	keypad foil for bain marie blue suitable for ELECTROLUX, ZANUSSI L 238mm W 74mm		
For models:	ZLB12H, ZLB16H, ZLB20H, ZLBD12H, ZLBD16H, ZLBD20H, ZLT08H, ZLT12H, ZLAB12H, ZLAB16H, ZLAB20H, ZLB08H		

1 			
GEV No.	400994	Ref. No.	006608
description	keypad foil for fryer		
For models:	KFH/E1, KFH/G1ELH, KFH/E1ELH, KFH/E1EH, HFH/G435, HFH/G435		

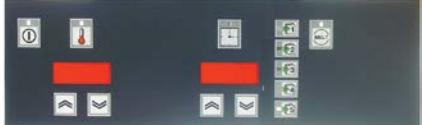
1 			
GEV No.	400998	Ref. No.	0C1015
description	keypad foil for fryer		
For models:	KFH/G1, KFH/E1, KFH/E1ELH, KFH/E1EH		

1 			
GEV No.	400999	Ref. No.	0C1016
description	keypad foil for fryer		
For models:	KFH/E1, KFH/E1ELH, KFH/G1EH, KFH/E1EH		

1 			
GEV No.	401815	Ref. No.	085766
description	keypad foil L 237mm W 74mm		
For models:	BC11		

1 			
GEV No.	403728	Ref. No.	088583
description	keypad foil L 310mm W 115mm		
For models:	RBC061, RBC6.1-15, RBC101, RBC10.1-2, RBC20.1-56, RBC051		

1 			
GEV No.	403054	Ref. No.	0L0005
description	keypad foil LS14AU L 190mm W 120mm buttons 7		
For models:	LS14EAI/AU		



membrane keypads

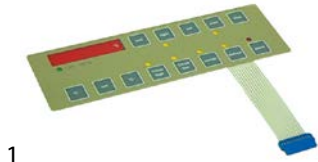

1

GEV No.	400204	Ref. No.	0A8247 0A8798
description	membrane keypad		
For models:	ECE602, EVN600V11C, EEVN601, EVN600V12C, EEVN601, EVN-600V11V, EEVN601, EVN130V12C, EVN131V12C, EEVN1300, EEVN1301, EEVN1300, EEVN1301, EVN600V11C, EVN601V11C, EVN600V12C, EVN601V12C, EVN600V11V, EVN601V11V, EVN-130V12C, EVN131V12C, EVN130V14C, EVN130V12C, EVN130V12V, EVN131V12V, EVC600V11C, EVC601V11C, EVC600V12C, EVC601V12C, EVC600V11V, EVC601V11V, EVC130V12C, EVC131V12C, EMC132V14C, EVC131V14C, EVC130V12V, EVC131V12V, EVNN60V22C, EVNN61V22C, EVNN13022C, EVNN13122C, EVNI13023C, EVNI13123C, EVN-610V12C, EVN611V12C, EVNC60V22C, EVNC61V22C, EVNC13023C, EVNC13123C, EVNN60V22C...(Other models you can see in the webshop)		

1



GEV No.	400915	Ref. No.	049956 0TR569
description	membrane keypad		
For models:	LS5/1, LS5/1DP, LS5/3, LS5/3DP, LS5/1DP60		

1



GEV No.	400918	Ref. No.	04920 049920
description	membrane keypad		
For models:	LS6EP, LS6EADD, LS6EA/DPDD, LS6EADP3, LS6EADPWS, LS6EAD-PWSG, LS6EADPWS, LS6EA/UK, LS6EA/DPUK, LS6EA/60, LS6AH240U, LS6AH208DU, LS6AH208U, LS6AH240DU, LS6AH208RU, LS6AH240RU, LS6EA, LS6EA/DP, LS6MCD, LU7ADP, LU7ADPWS		

1

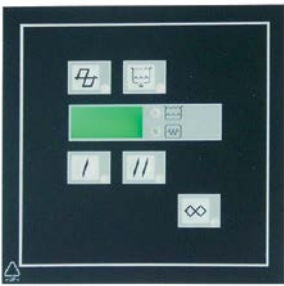

GEV No.	400924	Ref. No.	049605
description	membrane keypad		
For models:	LS10, LS10UKDP, LS10/60HZ, LS10CW, LS10INS, LS10N, LS10DP, LS10HD, LS10UK/1, LS10UK/3, LS12ASIA, HT1200, HT1000, HT1000INS, HT1200INS, HT1000DP, HT1200DP		

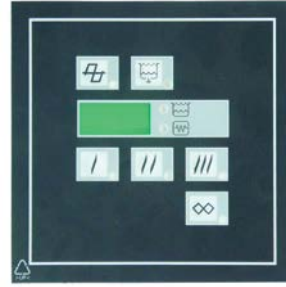

1

GEV No.	400925	Ref. No.	049606
description	membrane keypad		
For models:	LS10DP, LS12INS, LS12, LS12DP, LS12/60HZ, LS12CW, LS12HD, LS12UK/3CW, LS12UKDPCW, LS12CWINS, LS12ASIA		

1



GEV No.	400926	Ref. No.	049604
description	membrane keypad		
For models:	WT60NAUCW, WT60NAU, WT60NAUDP, LS12NAU		

1



GEV No.	400921	Ref. No.	0L0008
description	membrane keypad buttons 5 suitable for LS10 L 190mm W 120mm		
For models:	LS10EA		

1



GEV No.	400922	Ref. No.	0L0001
description	membrane keypad buttons 6 suitable for LS14 L 190mm W 120mm		
For models:	LS14EA, LS14EAI, LS14EA/60, LS14EAASIA, LS14EA/G, LS14EAI/DD, LS14EADP/G, LS14AH240U, LS14H208DU, LS14H208U, LS14H-240DU, LS14H208RU, LS14H240RU, LS14EAWS, LS14ADPWSG, LS14EAIWS		



control panel



1

GEV No.	111657	Ref. No.	052272
description	control panel		
For models:	HFR/G420, HFR/G420NL, HFR/G840, HFR/G840, HFR/G840, HFR/G421, HFR/G420, HFR/G840		



1

GEV No.	111668	Ref. No.	051280
description	control panel ignition		
For models:	HBR/G803, HBR/G804, HBR/G803, HBR/G804, HBR/G803, HBR/G805, HBR/G1003, HBR/G1003, HBR/G1004, HBR/G803, HBR/G804, HBR/G1013		



1

GEV No.	694677	Ref. No.	047479
description	front panel dishwasher 501030 L 201mm W 3.3mm H 85mm W2 13mm		
For models:	LSDS51, LS510, LS520, LS520D, LS520F, LS520M, LS521, LS521D, LS521F, LS521M, LS521, LS4		



1

GEV No.	694430	Ref. No.	099277
description	gasket L 167mm W 36mm thickness 1mm foam		
For models:	83012001, 83012033, 83012201, 83012101, 83012037, ASN110, ASF110, ASN220, ASF220, ADN110, ADN120, ADN111, ADF110, ADF120, ADNN120, ADN220, ADN240, ADN221, ADF220, ADF240, ADNN220, ADNF220, ADNN230, ADNF230, ADN11060, ADF11060, ADN22060, ADF2206, ZPR04R1F, ZPR04F1F, ZPR06R1F, ZPR06F1F, TRN224C, TRN224D, TRN224E, TRN132A, TRN132B, TRN132C, TRNA132A, TRNA132B, TRNA132C, TRRN132A, TRRN132B, TRRN132C, TRN183A, TRN183B, TRN183C, TRN183D, TRNA183A, TRNA183B... (Other models you can see in the webshop)		



1

GEV No.	694428	Ref. No.	099303
description	gasket L 167mm W 44mm thickness 1mm foam		
For models:	ADN220, ADN240, TRN224C, TRN224D, TRN224E, TRN132A, TRN132B, TRN132C, TRNA132A, TRNA132B, TRNA132C, TRN183A, TRN183B, TRN183C, TRN183D, TRNA183A, TRNA183B, TRNA183C, TRNA183D, TRN22A4, TRN224B, TRNA224A, TRNA224B, TRRN224B, TRF132A, TRFA132A, TRF183A, TRFA183A, TRN132AS, TRN183AS, PR04R1F-BR, PR04R1GBR, PR06R1FBR, PR06R2FBR, PR04F1FBR, PR06F1FBR, PR04R1F4, PR04F1F4, PR06R1F4, PR06F1F4, PR04R1F, PR04R1FR, PR04R2F, PR04R1G, PR04R1GR, PR06R1F, PR06R1FR, PR06R2F, PR06R2FR, PR04F1F... (Other models you can see in the webshop)		



1

GEV No.	694427	Ref. No.	089191
description	gasket L 168mm W 40mm thickness 1mm foam		
For models:	83012201, ARDF110L, ARDF120, ARDNN120, 83012101, ARDN220, ARDN221, ARDNF220, ASF110, ASN220, ASF220, ADF110, ADF120, ADNN120, ADNF120, ADN220, ADN240, ADN221, ADF220, ADF240, ADF11060, ADN22060, ADF2206, TRN224C, TRN224D, TRN224E, TRN132A, TRN132B, TRN132C, TRNA132A, TRNA132B, TRNA132C, TRRN132A, TRRN132B, TRRN132C, TRN183A, TRN183B, TRN183C, TRN183D, TRNA183A, TRNA183B, TRNA183C, TRNA183D, TRRN183A, TRRN183B, TRRN183C, TRRN1842D, TRN22A4, TRN224B, TRNA224A... (Other models you can see in the webshop)		



1

GEV No.	504731	Ref. No.	048274
description	gasket L 310mm suitable for ZANUSSI equiv. no. 048274 external weith 160mm		
For models:	LS10D, LS10, LS10UKRP, LC100, LS10/60, LS10/1, LS10/12KW, LS10F, LS10DEK, LS10/1UKRP, LS10SW, LS10/50J, LS10/60J, LS10DP, LS10/HD, SH55, LO10, LS10/UK1, LS10/UK3, LS12D, LS12, LS12UK/RP, LC120, LS12DP, LS12/60, LS12F, LS12DEK, LS12HD, LS12/UK3, ECOTEMP12SW, ECOTEMP12INS, LS12MEX, LS10N, LS8D, LS8, LS8UK/RP, LC80, LS8F, LS8DEK, LS8/9, LS8/60, LS8/1UKRP, LS8/DP, LS8/HD, LS8/UK1, LS8UK3, LS8/9DD, LS8DEK, HT1200elm, HT1000elm... (Other models you can see in the webshop)		



1

GEV No.	504714	Ref. No.	049061
description	switch panel		
For models:	LB1, LB1WS, LB1WSDP, LB1/RBP, LB1/TOP, LB1/60, LB2DPSAUS, LB1G, LB1WSG, LB2WS, LB2, LB2WSDP, LB2/TOP, LB2/RBP, LB2WS60, LB2WSG, UC1, UC2WS		



1

GEV No.	504716	Ref. No.	049313
description	switch panel		
For models:	LS32, LS32/4.5, LS32UK/RP, LS32F, LV32/60, LS33, LS33/4.5, LS33UK/RP, LS33F		



1

GEV No.	504718	Ref. No.	048903
description	switch panel		
For models:	LS63, LS63D, LS63/UKRP, LS63F, LS63/60, LS63/1P, LS63/UK		



1 

GEV No.	504720	Ref. No.	047545 047561 047633 047839 047840
description	switch panel		
For models:	LS510, LS520, LS520D, LS520F, LS520K, LS521, LS521D, LS521F, LS521M, LS521K, LS521, C51, C52		

2 

GEV No.	504722	Ref. No.	046732
description	switch panel		
For models:	LS860F		

1 

GEV No.	504723	Ref. No.	048648
description	switch panel		
For models:	LS8D, LS8, LS8UK/RP, LS8F, LS8/9, LS8/60, LS8/1UKRP, LS8/HD, LS8/UK1, LS8UK3, LS8/9DD		

1 

GEV No.	504724	Ref. No.	049151
description	switch panel		
For models:	LS8/DP		

1 

GEV No.	504726	Ref. No.	048590 048593 0KG561
description	switch panel		
For models:	LS10D, LS10, LS10UKRP, LS10/60, LS10/1, LS10/12KW, LS10F, LS10/1UKRP, LS10/50J, LS10/60J, LS10/HD, LS10/UK1, LS10/UK3, LS12DEK, LS12HD, LS10N, HT1200elm, HT1000elm, HYDRA1000		

1 

GEV No.	504727	Ref. No.	049143
description	switch panel		
For models:	LS10DP		

1 

GEV No.	504729	Ref. No.	048285 048473 048598 049148
description	switch panel		
For models:	LS10D, LS10UKRP, LC100, LS10SW, LS12D, LS12, LS12UK/RP, LS12DP, LS12/60, LS12F, LS12HD, LS12/UK3, LS12MEX		

1 

GEV No.	347554	Ref. No.	099389
description	switch panel for display refrigerator L 168mm W 37mm black with scitches ON-OFF, lighting		
For models:	ADN111, ADN220, ADN221, E12N0D2C, E06N0D1V, E06C0D1V, E14N0D2V, E14C0D2V		
spare parts for	347554		
	GEV No.	345278	Ref. No. —
	rocker switch mounting measurements 25.5x25mm green 2NO 250V 16A illuminated 0-I connection male faston 6.3mm protection IP40		
accessories for	347554		



GEV No.	379577	Ref. No.	085975 085983 087161 087169 087858 089904 089913 099276 0A9251 0A9520 0A9678 0A9733 0A9737 0A9777 0S0303 0S0788
	electronic controller ELIWELL type ID974 mounting measurements 71x29mm 230V voltage AC NTC/PTC relay outputs 3 relays -50 up to +150°C display 3½ digits RoomTempIN yes DEF Probe yes DEF Relay 8A fan relay 5A compressor relay 8A		



			
GEV No.	347551	Ref. No.	099273
description	switch panel L 168mm W 37mm black with scitches ON-OFF, moisture		
For models:	83012001, 83012033, 83012101, 83012037, ASN110, ASN220, ADN110, ADN120, ADNN120, ADN220, ADN240, ADNN220, ADNF220, ADNN230, ADNF230, ADN11060, ADN22060, TRN224C, TRN224D, TRN224E, TRN132A, TRN132B, TRN132C, TRNA132A, TRNA132B, TRNA132C, TRRN132A, TRRN132B, TRRN132C, TRN183A, TRN183B, TRN183C, TRN183D, TRNA183A, TRNA183B, TRNA183C, TRNA183D, TRRN183A, TRRN183B, TRRN183C, TRRN1842D, TRN224A, TRN224B, TRNA224A, TRNA224B, TRRN224A, TRRN224B, MCD650P, MCD650FP2, EDON590124...(Other models you can see in the webshop)		

			
GEV No.	347552	Ref. No.	099304
description	switch panel L 168mm W 37mm blue with scitches ON-OFF, moisture		
For models:	ADN220, ADN240, TRN224C, TRN224D, TRN224E, TRN132A, TRN132B, TRN132C, TRNA132A, TRNA132B, TRNA132C, TRN183A, TRN183B, TRN183C, TRN183D, TRNA183A, TRNA183B, TRNA183C, TRNA183D, TRN224A, TRN224B, TRNA224A, TRNA224B, PR04R1FBR, PR06R1FBR, PR06R2FBR, PR06R1F4, PR04R1F, PR04R1FR, PR04R2F, PR06R1F, PR06R1FR, PR06R2F, PR06R2FR, PR04R1FM, PR04R1F6M, PR04R1F1M, PR06R1F6M, RCDR4M24, RCDR4M16, RCDR4M08, RCDR2M20, RCDR2M12, RCDR2M20U, RCDR2M12U, RCDR2M04R, RCDR3M22, RCDR3M0U, RCDR3M22U, RCDE4M40...(Other models you can see in the webshop)		

			
GEV No.	347553	Ref. No.	099307
description	switch panel L 168mm W 37mm blue with switch ON-OFF		
For models:	ADN220, ADN240, TRN224B, TRF132A, TRFA132A, TRF183A, TRFA183A, TRN132AS, TRN183AS, PR04F1FBR, PR06F1FBR, PR04F1F4, PR06F1F4, PR04F1F, PR04F1FR, PR06F1F, PR06F1FR, PR06FE2F, PR04F1F6M, RCDFM20UX, RCDF3M30U, RCDF2M20, RCDFM20U, RCDF2M20R, RCDF3M30, RCDF3M30U, RCDF3M30R, RCDRS2M20, RCDR3M30H, RH06FE1FDU, RH14FE2FDU, RH06FD1F, RH06FD1FL, RH06FD1FR, RH06FD2F, C06FD2FR, RH06DFD2F, C06CFD2I, RH14FD2F, FSD313, C14FD4F, RH14DFD2, RH14DFD3F, FS25, RS05FD1F, FS212, RS12FD2F, RH06FD1F6, RH14FD2F6, E29NCO20...(Other models you can see in the webshop)		

			
GEV No.	347550	Ref. No.	099278
description	switch panel refrigerator 650LT/1400LT L 168mm W 37mm black with switch ON-OFF		
For models:	83012201, 83012101, ASF110, ASF220, ADF110, ADF120, ADF220, ADF240, ADNF220, ADNF230, ADF11060, ADF2206, TRN224B, TRF132A, TRFA132A, TRRF132A, TRF183A, TRFA183A, TRRF183A, TRN132AS, TRN183AS, MCD650F, MCD650F2, RCDRS2M20, RCDR3M30H, E29C200I, E29C200IA, E29C200R, E44C300I, E44C300IA, E44C300R, RH06DD2FR, E05C0D1C, E12COM2, E06C0D1C, E06C0D2C, EC6M0D2C, E14C0D2C, E14C0D4C, EC4M0D2C, EC4M0D3C, FRA650F, FRA1400F, E29NCO20, E44NCO30, E06C0D1C		

			
GEV No.	504717	Ref. No.	048827 049128 0KE925
description	switch panel warewashing LS 60/61		
For models:	LS61, LS61/60, LS62, LS62D, LS62/UKRP, LS62F, LV62, LS62/60, LS62/1P, LS62HD, LS62/UK		

accessories

			
GEV No.	400997	Ref. No.	002670 0F0086 0K8489 0T5656 60050319 869066
description	push button		
For models:	AQC22U US, AQC31U US, AQC60U, , , BC28A6, Crosswise, , BCF15A6, , ADN220ES, ADF110ES, ADF220ES, ADN110E, ADF110E, ADN220E, AD-F220E, BC15A, BC28A, Crosswise, BCF15A, BCF28A, Crosswise, BC10A, BCF7A, KFH/G1, KFH/E1, KFH/G1ELH, KFH/E1ELH, KFH/G1EH, KFH/E1EH, HFH/G435, HFH/G435, QFH/G1, QFH/E1, QFH/G1ELH, QFH/E1ELH, QFH/G1EH, QFH/E1H, ZFH/G435, ZFH/G435, WFH/G1, WFH/E1, WFH/G1ELH, WFH/E1ELH, WFH/G1EH, WFH/E1EH, AFH/G435, AFH/E435, EBS50...(Other models you can see in the webshop)		

solenoid valves

solenoid valves (water)

ELBI			
straight			
			
GEV No.	373009	Ref. No.	046795 046796 047534 048180
description	solenoid valve double straight 24V inlet 3/4" outlet 13.5mm DN10 t.max. 90°C duty cycle 100% ELBI		
For models:	CT92DXE, CT92SXE, CT92DXEUK, CT92SXEUK, CT92DXV, CT92SXV, CT92DXVUK, CT92SXVUK, CT140EDX, CT140ESX, CT140EDXUK, CT140SXEUK, CT140VDX, CT140VSX, CT141EDX, CT141ESX, CT141E-DUK, CT141ESUK, CT141VDX, CT141VSX, CT142DXE, CT142SXE, CT142DXEUK, CT142SXEUK, CT142DXV, CT142SXV, CT190DXE, CT190SXE, CT190DXEUK, CT190SXEUK, CT190DXV, CT190SXV, CT-191DXE, CT191SXE, CT191DXE, CT191SXEUK, CT191DXV, CT191SXV, CT192DXE, CT192SXE, CT192DXEUK, CT192SXEUK, CT192DXV, CT192SXV, CT240DXE, CT240SXE, CT240DXEUK, CT240SXV, CT240DXV, CT240SXVUK...(Other models you can see in the webshop)		





GEV No.	373017	Ref. No.	003608 046655 047370 053827 055132 055529 056486 057577 086014 086500 0H9339 0K8513 0KD793
description	solenoid valve single straight 230VAC inlet 3/4" outlet 11.5mm DN10 ELBI		
For models:	CIM15A, CIM15W, CIM45A, CIM45W, CIM65A, CIM65W, VO40G, FDV40G, FDV40E, FDV40GZ, FDV40EL, FDV40GA, FDV20G, FDV20E, FDV20GZ, FDV20EL, FDV20GA, RPI/E240, RPI/E260, RPI/G260P, RPI/E260P, XPI/E240, XPI/E260, XPI/G260P, XPI/E260P, JPI/E240, JPI/E260, MPI/E240, MPI/E260, MPI/G260P, MPI/E260P, PPD/G260, PPI/G260P, PPI/E260P, OPD/G260, OPI/G260P, OPI/E260P, TPD/G260, TPI/G260P, TPI/E260P, KPI/G10, KPI/G15, KPI/E10, KPI/E15, KPD/G10, KPD/G15, KPD/G15A, KPI/G15A, KPI/E15A, KPI/G06...(Other models you can see in the webshop)		





GEV No.	373018	Ref. No.	072282
description	solenoid valve single straight 230VAC inlet 3/4" outlet 14mm DN10 ELBI		
For models:	LC5E, LC5E		
spare parts for	373018		
	GEV No.	370467	Ref. No. —
solenoid valve filter suitable for ELBI			

angled



GEV No.	373019	Ref. No.	069295
description	solenoid valve double angled 230VAC inlet 3/4" outlet 11.5mm DN10 ELBI		
spare parts for	373019		
	GEV No.	370467	Ref. No. —
solenoid valve filter suitable for ELBI			



GEV No.	373010	Ref. No.	049230
description	solenoid valve double angled 230VAC inlet 3/4" outlet 13.5mm DN10 t.max. 90°C duty cycle 100% ELBI		
For models:	LS7HD, LS10UKRP, LS10/HD, SH55, LS12HD, LS10HD, LS12HD, LS8/HD		
spare parts for	373010		
	GEV No.	370467	Ref. No. —
solenoid valve filter suitable for ELBI			





GEV No.	373012	Ref. No.	048817
description	solenoid valve single angled 230VAC inlet 3/4" outlet 13.5mm input 20l/min t.max. 90°C duty cycle 100% ELBI flow regulating valve inlet orange		
For models:	WT4, WT4B, WT4D, WT4DB, WT46, NUC3DD, WT4D60, WT4DDG, EUC1, EUC1DP, EUC3, EUC3DP, EUC1G, EUC1DP60, EUC3DD, LS5/1, LS5/1DP, LS5/3, LS5/3DP, LS5/1DP60, LS5/1DPAUS, LS5/1DPCS, KUC3, KUC3DP, NUC1, NUC1DP, NUC3, NUC3DP, NUC1DP60, NUC1DPA, LS61, LS61/60, LS6EP, LS6EP/DD, LS62, LS62D, LS62/UKRP, LS62F, LV62, LS62/60, ECOTEMP5, LS62/1P, LS62HD, LS63, LS63D, LS63/UKRP, LS63F, LV63, LS63/60, LS63/1P...(Other models you can see in the webshop)		



GEV No.	370253	Ref. No.	049308 049334 319610
description	solenoid valve single angled 230VAC inlet 3/4" outlet 14mm input 3.5l/min t.max. 90°C ELBI plastic flow regulating valve inlet orange		
For models:	LS32, LS32/4.5, LS32UK/RP, LS32F, LV32F, C55, LV32/60, WT302, WT302/4.5, WT302UK/RP, WT302F, WT302/60, LS33, LS33/4.5, LS33UK/RP, LS33F, LV33F, C55A, LS33/60, WT303, WT303/4.5, WT303UK/RP, WT303F, WT303/60, LS65, LS62/UK, LS63/UK, LS64/UK, WT35, WT32/UK, WT33/UK, WT34/UK, FL32, FL32/4.5, FL33, FL33/4.5, C32, C32/4.5, C33, C33/4.5, Z32, Z32/4.5, Z33, Z33/4.5		



			
1			
GEV No.	373008	Ref. No.	049077 0L3442
description	solenoid valve triple angled 230VAC inlet 3/4" outlet 13.5mm ELBI output B 0.5l/min flow regulating valve outlet B red		
For models:	LB1WS, LB1WSDP, LB1/TOP, WT1WSDP, LB2DPSAUS, LB1WSG, WT2TOP60, WT2WSDPDI, LB1TOP, WT2TOPDI, LB2WS, LB2WSDP, LB2/TOP, LB2/RBP, LB2WS60, WT2WSDP, WT2WSDPD, LB2WSG, WT2WS, WT1WS, WT1TOP, WT2TOP, LB2WSDPDI, LB2WSDPD, LB2TOP, UC2WS, GW1WS, LV1WS, LV1WSDP, LV2WSDP, LV2WS, GW2WSDPG, GW2WSG, GW2WS		

			
1			
GEV No.	370736	Ref. No.	0L0260 0L3444
description	solenoid valve triple angled 230VAC inlet 3/4" outlet 14.5mm t.max. 90°C ELBI plastic flow regulating valve inlet black output A 2l/min output B 0.5l/min flow regulating valve outlet A white flow regulating valve outlet B red		
For models:	WT4WS1, WT4BWS, WT4DWS1, WT4BDWS, EUC1WS, EUC1DPWS, EUC3WS, EUC3DPWS, LS5/1WS, LS5/1WSDP, LS5/3WS, LS5/3WSDP, LS5/3WSDPD, NUC1WS, NUC1DPWS, NUC3WS, NUC3DPWS, NUC3DDWS, LV5/3WSDP, FL5/3WSDP, UC5WSDP		

INTERELEKTRIK

medium temperature: 90°C 90°C 60°C
 ambient temperature: 60°C 25°C 60°C
 duty cycle: 40% 100% 100%

with reducers











			
1			
Image not available			
GEV No.	370659	Ref. No.	0G1981
description	solenoid valve double straight 230VAC inlet 3/4" outlet 11.5mm t.max. 90°C INTERELEKTRIK plastic flow regulating valve inlet white		
For models:	5611-3-10, 5611-3-6, 5611-3-8, 5612-3-10, 5612-3-6, 5612-3-8		

MÜLLER

medium temperature: 90°C
 duty cycle: 100%

			
1			
GEV No.	370117	Ref. No.	066379 0G2089 0G2196 0H6531 111053 60050401
description	solenoid valve single straight 230VAC inlet 3/4" outlet 11.5mm DN10 t.max. 90°C duty cycle 100% MÜLLER		
For models:	5611-3-10, 5611-3-6, 5611-3-8, 5612-3-10, 5612-3-6, 5612-3-8, 5614-3-10, 5614-3-6, 5614-3-8		
spare parts for	370117		
	GEV No.	370133	Ref. No. —
solenoid valve body single straight inlet 3/4" outlet 11.5mm DN10 t.max. 90°C duty cycle 100% MÜLLER 230V			
	GEV No.	371002	Ref. No. —
solenoid valve holder MÜLLER flange support			
	GEV No.	371009	Ref. No. —
compression spring for solenoid coil			
	GEV No.	371011	Ref. No. —
spare parts kit membrane with long star star height 8mm MÜLLER			
	GEV No.	371017	Ref. No. —
solenoid coil MÜLLER 230VAC connection male faston 6.3mm			
	GEV No.	371122	Ref. No. —
solenoid valve filter ø 19mm H 10mm suitable for MÜLLER			
	GEV No.	501161	Ref. No. —
tap head for solenoid valve holder for solenoid coils			
accessories for	370117		
	GEV No.	371010	Ref. No. —
solenoid coil 230VAC connection with cable cable length 2000mm			
	GEV No.	371037	Ref. No. —
solenoid coil 24VAC 50/60Hz connection male faston 6.3mm			
	GEV No.	371038	Ref. No. —
solenoid coil 230VAC connection appliance plug			



			
1			
GEV No.	370172	Ref. No.	0H6404
description	solenoid valve triple straight 230VAC inlet 3/4" outlet 11.5mm DN10 t.max. 90°C duty cycle 100% MÜLLER		
spare parts for	370172		
	GEV No.	370132	Ref. No. —
	solenoid valve body triple straight inlet 3/4" outlet 11.5mm DN10 t.max. 90°C duty cycle 100% MÜLLER 230V		
	GEV No.	371002	Ref. No. —
	solenoid valve holder MÜLLER flange support		
	GEV No.	371009	Ref. No. —
	compression spring for solenoid coil		
	GEV No.	371011	Ref. No. —
	spare parts kit membrane with long star star hight 8mm MÜLLER		
	GEV No.	371017	Ref. No. —
	solenoid coil MÜLLER 230VAC connection male faston 6.3mm		
	GEV No.	371122	Ref. No. —
	solenoid valve filter ø 19mm H 10mm suitable for MÜLLER		
	GEV No.	501161	Ref. No. —
	tap head for solenoid valve holder for solenoid coils		
accessories for	370172		
	GEV No.	371010	Ref. No. —
	solenoid coil 230VAC connection with cable cable length 2000mm		
	GEV No.	371037	Ref. No. —
	solenoid coil 24VAC 50/60Hz connection male faston 6.3mm		
	GEV No.	371038	Ref. No. —
	solenoid coil 230VAC connection appliance plug		

ROBERTSHAW/INVENSYS

medium temperature: 90°C 90°C 60°C
 ambient temperature: 60°C 25°C 60°C
 duty cycle: 40% 100% 100%

			
1			
GEV No.	372021	Ref. No.	045631 046427 047536 0H9966 0K5389 1200020 120020 127291 19003298
description	solenoid valve double straight 230VAC inlet 3/4" outlet 11.5mm DN10 EATON (INVENSYS)		
For models:	LB80EPH, LB80E, LB120EPH, LB120E, LB160EPH, LB160E, LB160V, CLB160E, CLB160V, VARIOSTEAM/S-33.3/F, STEAM-O-MAT, LB80E, LB120E, LB160EZ, LB160V, CLB160E, CLB160V, EWM120, EWM160		

			
1			
GEV No.	372016	Ref. No.	0K3088
description	solenoid valve single angled 230VAC inlet 3/4" outlet 14mm DN10 EATON (INVENSYS)		

solenoid valves with reducers

single			
			
1			
GEV No.	372028	Ref. No.	056350 0C0688 0C4984
description	solenoid valve single angled 230VAC inlet 3/4" outlet 11.5mm input 10l/min t.max. 90°C duty cycle 100% EATON (INVENSYS) plastic flow regulating valve inlet white		
For models:	KBR/G2F, KBR/G2C, KBR/G3F, KBR/G3FH, KBR/G3C, KBR/G3CH, KBR/E2F, KBR/E2C, KBR/E3F, KBR/E3FH, KBR/E3C, KBR/E3CH, KBR/G2FH, KBR/G2CH, KBR/E2FH, KBR/E2CH, QBR/G2F, QBR/G2C, QBR/G3F, QBR/G3FH, QBR/G3C, QBR/G3CH, QBR/E2F, QBR/E2C, QBR/E3F, QBR/E3FH, QBR/E3C, QBR/E3CH, QBR/G2FH, QBR/G2CH, QBR/E2FH, QBR/E2CH, WBR/G2F, WBR/G2C, WBR/G3F, WBR/G3FH, WBR/G3C, WBR/G3CH, WBR/E2F, WBR/E2C, WBR/E3F, WBR/E3FH, WBR/E3C, WBR/E3CH, WBR/G2FH, WBR/G2CH, WBR/E2FH, WBR/E2CH		



GEV No.	370554	Ref. No.	049452 049983
description	solenoid valve single angled 230VAC inlet 3/4" outlet 14.5mm input 5.5l/min t.max. 90°C plastic		
For models:	LS32UK/RP, WT302UK/RP, WT4DG, LS33UK/RP, WT303UK/RP, LB5DPG, LS6EA/UK, LS6EA/DPUK, WT38D, WT37/UK, WT38UK, LS10/UK1, LS10/UK3, LS12/UK3, LS10UKDP, LS10UK/1, LS10UK/3, LS14EA/G, WT60UKDPCW, LS12UK/3CW, LS12UKDPCW, WT65EBIDG, LS14EAD-P/G, LS8/UK1, LS8UK3, WT50/UK1, WT50/UK3, LS9AUK/3, WT55AUK/3, LS9ADG1, WT55ADG1, PW1EAG, PW2EAG, WT830EAG, WT850E-AG, RT10SR, RT10SL, RT10ERF60, RT10ELF60, RT10ERF, RT10ELF, RT10ERBF60, RT10ELBF60, RT10ERG, RT10ELG, RT10SRB, RT10SLB, RT10ERBF, RT10ELBF, RT10ERBG...(Other models you can see in the webshop)		



GEV No.	370254	Ref. No.	049626 088194
description	solenoid valve single angled 230VAC inlet 3/4" outlet 14mm input 12l/min t.max. 90°C EATON (INVENSYS) plastic flow regulating valve inlet grey		
For models:	SSBMHC12, SSBMHC16, SSBMHC20, SSBMB12, SSBMB16, SSBMHB20, SSBMB8, SSBMHC8, DBMAC12, DBMAC16, DBMAC20, DBMP12, DBMP16, DBMP20, ZLB12H, ZLB16H, ZLB20H, ZLB12B, ZLB16B, ZLB20B, ZLB08B, ZLB08H, DI2BM, DI3BM, DI4BM, DI2BMO, DI3BMO, DI4BMO, LS6EADD, LS6EA/DPDD, WT38/M50, LS6EADP3, WT37LEV/9, WT38M50/4, LS6EA/60, WT38D, WT37, WT38, WT37/4.5, WT38/4.5, WT38/4.5NW, WT38/60, WT38MED, WT38M60/4, LS6EA, LS6EA/DP, LS6MCD, LS10, LS14EA...(Other models you can see in the webshop)		



GEV No.	374047	Ref. No.	0L0776 0L3447 0W0706
description	solenoid valve single straight 230VAC inlet 3/4" outlet 13.5mm input 5.5l/min t.max. 90°C EATON (INVENSYS) plastic flow regulating valve inlet yellow		
For models:	W355HE, W355HQR, W355H, W355H, W455H04, W455HQR, LC12EC, CLC12EC, LB81E, LB81BP, LB81COP, LB121E, LB121BP, LB161E, LB161BP, LB161V, CLB161E, CLB161V, WE55QSR_EL, LS6EADPWS, LS6EADPWSG, WT38WS, WT38WSG, WT38MEDWS, LS6EADPDWS, WT38DWS, EUCAI, EUCAIDP, EUCAI60, EUCAIWS, EUCAIG, EUCAIWSG, EUCAIML, EUCAIMLWS, EUCAIWL, EUCAICLW, EUCAIDPNW, ZUCAI, ZUCAIDP, ZUCAIDPWS, ZUCAIG, ZUCAIDDWS, ZUCAID, ZUCAI60, EUCAIUSPH6, ZUCAIDD, EUCAIDD, EUCAIDPJ, EUCAIDPJ60, LU7PDP...(Other models you can see in the webshop)		



GEV No.	370639	Ref. No.	0L0568
description	solenoid valve single straight 230VAC inlet 3/4" outlet 14mm input 10l/min flow regulating valve inlet white		
For models:	LS6EADD, LS6EA/DPDD, WT38/M50, LS6EADP3, WT37LEV/9, LS-6SANA, EUCAI, EUCAIDP, EUCAI60, WT38M50/4, EUCAIML, EUCAIWL, LS6EA/60, EUCAICLW, EUCAIDPNW, ZUCAI, ZUCAIDP, ZUCAID, ZUCAI60, ZUCAIDD, EUCAIDD, EUCAIDPJ, EUCAIDPJ60, WT38D, WT37, WT38, WT37/4.5, WT38/4.5, WT38/4.5NW, WT38/60, WT38/M60, WT38MED, WT38M60/4, WT38WL, LS6EA, LS6EA/DP, LS6MCD, LU7PDP, LU7ADP, LU7ADPWS, WTU40PDP, WTU40ADP, WTU40AD-PWS, WTU40ADPD, LS14EA, ET12E, LS14EAI, LS14EAI/AU, LS14EA/60, LS14EAASIA...(Other models you can see in the webshop)		



GEV No.	370622	Ref. No.	0L0566 0L3445
description	solenoid valve single straight 230VAC inlet 3/4" outlet 14mm input 20l/min t.max. 90°C EATON (INVENSYS) plastic		
For models:	LS6EP, LS6EP/DD, WT38PM50, EUCCI, EUCIM, EUCIM60, ZUCI, ZUCID, WT38PM60, LU7PDP, LU7ADP, LU7ADPWS, WTU40PDP, WTU40ADP, WTU40ADPWS, WTU40ADPD, LS14EA, ET12E, LS14EAI, LS14EAI/AU, LS14EA/60, LS14EAASIA, LS14EA/G, LS10EA, LS14EAI/DD, ECOTEM-P12S, LS14EADP/G, WT65ROW, LS14ROW, LS14SANA, LS14ROW60, WT65ROW60, LS9P, LS9PDD, LS9P60, WT55P, WT55P60, LS9PAUS, WT-55PM50, WT55PM60, EHT, EHT60, EHTM, EHTM60, NHT, NHTD, NHT60, KHT, NHTM, NHTM60...(Other models you can see in the webshop)		

2-fold



GEV No.	370775	Ref. No.	0696808400 0C5517
description	solenoid valve double straight 230VAC inlet 3/4 outlet 12mm EATON (INVENSYS) output A 0.25l/min output B 5l/min		
For models:	FCZ102EAA, FCZ102ETA, FCZ201ETA, FCZ202ETA, FCZ201ETH, FCZ201ETN, FCZ101GTG, FCZ102GTG, FCZ201GTG, FCZ202GTG, FCZ101GTD, FCZ102GTD, FCZ201GTD, FCZ202GTD, FCZ102EBA, FCZ102EBA2, FCZ201EBA2, FCZ202EBA2, FCZ201EBH2, FCZ-2201EBN2, FCZ201EBC2, FCZ101GBG2, FCZ102GBG2, FCZ201GBG2, FCZ202GBG2, FCZ101GBD2, FCZ102GBD2, FCZ201GBD2, FCZ202GBD2, FCZ101GBI2, FCZ102GBI2, FCZ201GBI2, FCZ102ECA, FCZ102ECA2, FCZ201ECA2, FCZ202ECA2, FCZ201ECH2, FCZ201ECN2, FCZ101GCG2, FCZ102GCG2, FCZ201GCG2, FCZ202GCG2, FCZ-101GCD2, FCZ102GCD2, FCZ201GCD2, FCZ202GCD2, AOS102EAA1, AOS201EAA1, AOS202EAA1, AOS201EAH1...(Other models you can see in the webshop)		





			
GEV No.	372002	Ref. No.	0C5516 696808300
description	solenoid valve double straight 230VAC inlet 3/4" outlet 11.5mm 10 t.max. 90°C Invensys plastic output A 0.25l/min output B 2.5l/min flow regulating valve outlet A transparent/white flow regulating valve outlet B dark brown		
For models:	FCZ061EAA, FCZ101EAA, FCZ061EAH, FCZ101EAH, FCZ061EAN, FCZ101EAN, FCZ061ETA, FCZ101ETA, FCZ061ETH, FCZ101ETH, FCZ061ETN, FCZ101ETN, FCZ061GAG, FCZ061GAD, FCZ061EBA, FCZ101EBA, FCZ061EBH, FCZ101EBH, FCZ061EBN, FCZ101EBN, FCZ061EBC, FCZ101EBC, FCZ061EBA2, FCZ101EBA2, FCZ061EBH2, FCZ101EBH2, FCZ061EBN2, FCZ101EBN2, FCZ061EBC2, FCZ101EBC2, FCZ061GBG, FCZ061GBD, FCZ061ECA, FCZ101ECA, FCZ061ECH, FCZ101ECH, FCZ061ECN, FCZ101ECN, FCZ061ECA2, FCZ101ECA2, FCZ061ECH2, FCZ101ECH2, FCZ061ECN2, FCZ101ECN2, AOS061EAA1, AOS101EAA1, AOS061EAH1, AOS101EAH1, AOS061EAN1, AOS101EAN1...(Other models you can see in the webshop)		

			
GEV No.	370355	Ref. No.	0C1113 0C1133 0C1933
description	solenoid valve single angled 230VAC inlet 3/4" outlet 11.5mm DN10 EATON (INVENSYS)		
For models:	FCZ061EAA, FCZ101EAA, FCZ102EAA, FCZ201EAA, FCZ202EAA, FCZ061EAH, FCZ101EAH, FCZ201EAH, FCZ061EAN, FCZ101EAN, FCZ201EAN, FCZ061GAG, FCZ101GAG, FCZ102GAG, FCZ201GAG, FCZ202GAG, FCZ061GAD, FCZ101GAD, FCZ102GAD, FCZ201GAD, FCZ202GAD, FCZ061EBA, FCZ101EBA, FCZ061EBH, FCZ101EBH, FCZ101EBN, FCZ061EBC, FCZ101EBC, FCZ201EBC, FCZ061GBI, FCZ101GBI, FCZ201GBI, FCZ102ECA, FCZ201ECA, FCZ202ECA, FCZ201ECH, FCZ201ECN, FCZ061GCG, FCZ101GCG, FCZ102GCG, FCZ201GCG, FCZ202GCG, FCZ061GCD, FCZ101GCD, FCZ102GCD, FCZ201GCD, FCZ202GCD, FCS201EX, FCS201EXLN, FCS202EX...(Other models you can see in the webshop)		

<p>3-fold</p> 			
GEV No.	370345	Ref. No.	002859 0C1934 0K1872 60050324
description	solenoid valve triple straight 230VAC inlet 3/4" outlet 11.5mm t.max. 90°C EATON (INVENSYS) plastic output B 0.25l/min output C 1.2l/min flow regulating valve outlet B white flow regulating valve outlet C blue		
For models:	FCZ061EAA, FCZ101EAA, FCZ102EAA, FCZ201EAA, FCZ061EAH, FCZ101EAH, FCZ201EAH, FCZ061EAN, FCZ101EAN, FCZ201EAN, FCZ101GAG, FCZ102GAG, FCZ201GAG, FCZ101GAD, FCZ102GAD, FCZ201GAD, FCZ061EBA, FCZ101EBA, FCZ102EBA, FCZ201EBA, FCZ061EBH, FCZ101EBH, FCZ201EBH, FCZ101EBN, FCZ201EBN, FCZ101GBG, FCZ102GBG, FCZ201GBG, FCZ101GBD, FCZ102GBD, FCZ201GBD, FCZ061GBI, FCZ101GBI, FCZ201GBI, FCV/G6L4, AOS-061GAEU, AOS101GAEU, AOS102GAEU, AOS201GAEU, AOS061GAAU, AOS101GAAU, AOS102GAAU, AOS201GAAU, AOW101EA, AOS061EABU, AOS101EABU, AOS201EABU, AOS061EAFU, AOS101EAFU, AOS201EAFU...(Other models you can see in the webshop)		

			
GEV No.	374107	Ref. No.	0C6081
description	solenoid valve single straight 230VAC inlet 1" duty cycle 100% plastic		
For models:	FCF02EV, FCF02EOEM, FCF/E6-0, FCFE101-0, FCFE102-0, FCFE201-0, FCFE202-0, FCF061ELN, FCF101ELN, FCF6EHOR, FCF061ENS, FCF101ENS, FCF102ENS, FCF201ENS, FCFE6-1J, FCFE101-1J, FCFE102-1J, ECF/E6-0, ECFE101-0, ECFE102-0, ECFE201-0, ECFE202-0, ECF061ENS, ECF101ENS, ECF102ENS, ECF201ENS, ECF061E5M, ECF061ECV, ACF/E6-0, ACFE101-0, ACFE102-0, ACFE201-0, ACFE202-0, RCF061E, RCF101E, RCF201E		

<p>with coded terminal</p> 			
GEV No.	370269	Ref. No.	069262 072364
description	solenoid valve double straight 230VAC inlet 3/4" outlet 11.5mm DN10 EATON (INVENSYS)		
For models:	LC7E, LC10E, LC12E, CLC12E, LACE12M/EI, CLC22E, CLC22, LACE22M, CLC22V, CLC22V, LACV22M/V, CLC40V, LC7E, LC12E, CLC12E, CLC22E, CLC22V, CLC22E, CLC22V		

			
GEV No.	370267	Ref. No.	0C3254
description	solenoid valve single straight 230VAC inlet 3/4" outlet 11.5mm DN10 EATON (INVENSYS)		
For models:	QPD/G10, QPD/G15, FCZ102EAA, FCZ061EBA, FCZ101EBA, FCZ102EBA, FCZ201EBA, FCZ202EBA, FCZ061EBH, FCZ101EBH, FCZ201EBH, FCZ101EBN, FCZ201EBN, FCZ061EBC, FCZ101EBC, FCZ201EBC, FCZ061GBG, FCZ101GBG, FCZ102GBG, FCZ201GBG, FCZ202GBG, FCZ061GBD, FCZ101GBD, FCZ102GBD, FCZ201GBD, FCZ202GBD, FCZ061GBI, FCZ101GBI, FCZ201GBI, FCZ102ECA, FCF6EHOR, FCF-G10160H, AOS101EBEQ, AOS102EAA1, AOS102EAC1, AOS102EAS1, AOS201EAQ1, AOS102EAM1, AOS102EAB1, AOS102EAK1, AOS102EAT1, AOS202EAT1, AOS101GAQ1, AOS061GAU1, AOS101GAU1, AOS202GAU1, AOS102EBA1, AOS201EBA1, AOS202EBA1, AOS201EBH1...(Other models you can see in the webshop)		

spare parts and accessories

reducers

outlet side

			
1			
GEV No.	371252	Ref. No.	0H9953 0K5369 126559 19003236
description	reducer type EATON (INVENSYS) flow rate 1.2l/min pressure range 0 up to 10bar tolerance ±15/25% blue		
For models:	VARIOSTEAM/S-33.3/F, STEAM-O-MAT		

			
1			
GEV No.	371253	Ref. No.	0H9952 0K5368 128598 19003235
description	reducer type EATON (INVENSYS) flow rate 2.5l/min pressure range 0 up to 10bar tolerance ±15/25% brown		
For models:	VARIOSTEAM/S-33.3/F, STEAM-O-MAT		

inlet side

			
1			
GEV No.	371241	Ref. No.	0E5528
description	reducer type EATON (INVENSYS) flow rate 5.5l/min pressure range 1-10bar tolerance ±15/25% yellow		
For models:	RT10ED, RT10ES, RT10SR, RT10SL, RT10ED/230, RT10ES/230, RT10ERF, RT10ELF, RT10ERG, RT10ELG, RT10EDH, RT10ESH, RT10SRB, RT10SLB, RT10ED/230H, RT10ES/230H, RT10ERBF, RT10ELBF, RT10ERBG, RT10ELBG, RT10EDECO, RT10ESECO, RT10SRC, RT10SLC, RT10ED/230E, RT10ES/230E, RT10ERCF, RT10ELCF, RT10ERCG, RT10ELCG, RT10EDHE, RT10ESHE, RT10SRCB, RT10SLCB, RT10ED/230HE, RT10ES/230HE, RT10ERCBF, RT10ELCBF, RT10ERCBG, RT10ELCBG, WT90ER, WT90EL, WT90SR, WT90SL, WT90ER/230, WT90EL/230, WT90ERF, WT90ELF, WT90ERG, WT90ELG...(Other models you can see in the webshop)		

RPE

special outlet

			
1			
GEV No.	514448	Ref. No.	0C6224
description	collector 3-way 230VAC suitable for combi-steamer		

			
1			
GEV No.	370453	Ref. No.	0H9328
description	solenoid valve single angled 230VAC inlet 11.5mm outlet 11.5mm RPE		

solenoid valves with reducers

single

			
1			
GEV No.	698496	Ref. No.	0C6225 0C6374
description	water distributor 230VAC RPE for combi-steamer		
For models:	FCZ061EAA, FCZ101EAA, FCZ102EAA, FCZ061EAH, FCZ101EAH, FCZ061EAN, FCZ101EAN, FCZ061ETA, FCZ101ETA, FCZ102ETA, FCZ061ETH, FCZ101ETH, FCZ061ETN, FCZ101ETN, FCZ061GAG, FCZ061GAD, FCZ101GTG, FCZ102GTG, FCZ101GTD, FCZ102GTD, FCZ061EBA, FCZ101EBA, FCZ102EBA, FCZ061EBH, FCZ101EBH, FCZ061EBN, FCZ101EBN, FCZ061EBC, FCZ101EBC, FCZ061EBA2, FCZ101EBA2, FCZ102EBA2, FCZ061EBH2, FCZ101EBH2, FCZ061EBN2, FCZ101EBN2, FCZ061EBC2, FCZ101EBC2, FCZ101GBG2, FCZ102GBG2, FCZ101GBD2, FCZ102GBD2, FCZ101GBI2, FCZ102GBI2, FCZ061ECA, FCZ101ECA, FCZ102ECA, FCZ061ECH, FCZ101ECH, FCZ061ECN... (Other models you can see in the webshop)		

TP





















			
1			
GEV No.	370021	Ref. No.	069463 0A6046 0M2265 240003
description	solenoid valve double straight 230VAC inlet 3/4" outlet 11.5mm DN10 TP flow regulating valve inlet white		
For models:	LTB11, LTB11UK, LTB11, 910-00-021, 910-00-023, 910-00-031, 910-00-033, 911-00-022, 911-00-024, 911-00-032, 911-00-034, CRYSTAL 11, BBM 0401, BBM 0402		
spare parts for	370021		
	GEV No.	Ref. No.	—
	 solenoid coil TP 230VAC 50/60Hz		
accessories for	370021		
	GEV No.	Ref. No.	—
	 reducer TP flow rate 3l/min red tolerance ±15%		
	GEV No.	Ref. No.	—
	 reducer TP flow rate 5.5l/min yellow tolerance ±15%		
	GEV No.	Ref. No.	—
	 reducer TP flow rate 6l/min grey tolerance ±15%		

Table continues overleaf



accessories for		370021	
GEV No.	371223	Ref. No.	0E5551
	reducer TP flow rate 10l/min white tolerance ±15%		
	reducer TP flow rate 12l/min bronze tolerance ±15%		
	reducer TP flow rate 16l/min light brown tolerance ±15%		
	reducer TP flow rate 20l/min red tolerance ±15%		
	reducer TP flow rate 0.25l/min red tolerance ±25%		
	reducer TP flow rate 0.35l/min violet tolerance ±25%		
	reducer TP flow rate 0.5l/min orange tolerance ±25%		
	reducer TP flow rate 0.8l/min white tolerance ±25%		
	reducer TP flow rate 1l/min light blue tolerance ±25%		
	reducer TP flow rate 1.2l/min brown tolerance ±25%		
	reducer TP flow rate 1.5l/min light brown tolerance ±25%		
	reducer TP flow rate 2.5l/min yellow tolerance ±25%		
	reducer TP flow rate 3.4l/min dark green tolerance ±25%		
	reducer TP flow rate 5l/min black tolerance ±25%		
	reducer TP flow rate 8l/min blue tolerance ±20%		

































			
1			
GEV No.	370111	Ref. No.	0KZ810
description	solenoid valve double straight 24VAC inlet 3/4" outlet 11.5mm DN10 TP		
For models:	WTF2ERC, WTF2ELC, WTF2SRC, WTF2SLC, WTF2HERC, WTF2HEL, WTF2HSRC, WTF2HSLC, WTF3ERC, WTF3ELC, WTF3SRC, WTF3SLC, WTF3HERC, WTF3HEL, WTF3HSRC., WTF3HSLC, WTF2ERB., WTF2ELB, WTF2SRB, WTF2SLB, WTF2HERB, WTF2HELB, WTF2HSRB, WTF2HSLB, WTF3ERB, WTF3ELB, WTF3SRB, WTF3SLB, WTF3HERB, WTF3HELB, WTF3HSRB, WTF3HSLB, WTF4HERB, WTF4HELB, WTF4HSRB, WTF4HSLB, WTF2ERA, WTF2ELA, WTF2SRA, WTF2SLA, WTF2HERA, WTF2HELA, WTF2HSRA, WTF2HSLA, WTF3ERA, WTF3ELA, WTF3SRA, WTF3SLA, WTF3HERA, WTF3HELA...(Other models you can see in the webshop)		
accessories for		370111	
	reducer TP flow rate 3l/min red tolerance ±15%		
	reducer TP flow rate 5.5l/min yellow tolerance ±15%		
	reducer TP flow rate 6l/min grey tolerance ±15%		
	reducer TP flow rate 10l/min white tolerance ±15%		
	reducer TP flow rate 12l/min bronze tolerance ±15%		
	reducer TP flow rate 16l/min light brown tolerance ±15%		
	reducer TP flow rate 20l/min red tolerance ±15%		
	reducer TP flow rate 0.25l/min red tolerance ±25%		
	reducer TP flow rate 0.35l/min violet tolerance ±25%		
	reducer TP flow rate 0.5l/min orange tolerance ±25%		
	reducer TP flow rate 0.8l/min white tolerance ±25%		
	reducer TP flow rate 1l/min light blue tolerance ±25%		
	reducer TP flow rate 1.2l/min brown tolerance ±25%		
	reducer TP flow rate 1.5l/min light brown tolerance ±25%		

Table continues overleaf

accessories for 370111				
	GEV No.	371237	Ref. No.	—
reducer TP flow rate 2.5l/min yellow tolerance ±25%				
	GEV No.	371238	Ref. No.	—
reducer TP flow rate 3.4l/min dark green tolerance ±25%				
	GEV No.	371239	Ref. No.	—
reducer TP flow rate 5l/min black tolerance ±25%				
	GEV No.	371240	Ref. No.	—
reducer TP flow rate 8l/min blue tolerance ±20%				

  1				
GEV No.	370017	Ref. No.	070312 20006 9020006	
description	solenoid valve single straight 230VAC inlet 3/4" outlet 11.5mm DN10 TP p max 10bar			
For models:	LB035C, LB035R, LB035Q, LB040R, LB040Q, LB040AUS, G350C, LBICEQ010, LBIOEQ010, G350, G350DP, LBIOEQ014, G400, G400DP			
spare parts for	370017			
	GEV No.	371013	Ref. No.	—
solenoid coil TP 230VAC 50/60Hz				
accessories for	370017			
	GEV No.	371220	Ref. No.	—
reducer TP flow rate 3l/min red tolerance ±15%				
	GEV No.	371221	Ref. No.	—
reducer TP flow rate 5.5l/min yellow tolerance ±15%				
	GEV No.	371222	Ref. No.	—
reducer TP flow rate 6l/min grey tolerance ±15%				
	GEV No.	371223	Ref. No.	0E5551
reducer TP flow rate 10l/min white tolerance ±15%				
	GEV No.	371224	Ref. No.	—
reducer TP flow rate 12l/min bronze tolerance ±15%				
	GEV No.	371225	Ref. No.	—
reducer TP flow rate 16l/min light brown tolerance ±15%				
	GEV No.	371226	Ref. No.	0E5526
reducer TP flow rate 20l/min red tolerance ±15%				
	GEV No.	371230	Ref. No.	—
reducer TP flow rate 0.25l/min red tolerance ±25%				
	GEV No.	371231	Ref. No.	—
reducer TP flow rate 0.35l/min violet tolerance ±25%				

accessories for 370017				
	GEV No.	371232	Ref. No.	—
reducer TP flow rate 0.5l/min orange tolerance ±25%				
	GEV No.	371233	Ref. No.	—
reducer TP flow rate 0.8l/min white tolerance ±25%				
	GEV No.	371234	Ref. No.	—
reducer TP flow rate 1l/min light blue tolerance ±25%				
	GEV No.	371235	Ref. No.	—
reducer TP flow rate 1.2l/min brown tolerance ±25%				
	GEV No.	371236	Ref. No.	—
reducer TP flow rate 1.5l/min light brown tolerance ±25%				
	GEV No.	371237	Ref. No.	—
reducer TP flow rate 2.5l/min yellow tolerance ±25%				
	GEV No.	371238	Ref. No.	—
reducer TP flow rate 3.4l/min dark green tolerance ±25%				
	GEV No.	371239	Ref. No.	—
reducer TP flow rate 5l/min black tolerance ±25%				
	GEV No.	371240	Ref. No.	—
reducer TP flow rate 8l/min blue tolerance ±20%				

 1				
GEV No.	370655	Ref. No.	047533	
description	solenoid valve single straight 230VAC inlet 3/4" outlet 11.5mm DN10 TP plastic flow regulating valve inlet pink 8VA			
For models:	LB110E			



 1				
GEV No.	370029	Ref. No.	058996 60050233	
description	solenoid valve single straight 24VAC inlet 3/4" outlet 11.5mm DN10 TP flow regulating valve inlet white			
For models:	FCVE10-P, FCVE10PUK, FCVG10-P, FCVG10PUK, FCVE20-P, FCVE20PUK, FCVG20-P, FCVG20PUK			
spare parts for	370029			
	GEV No.	371035	Ref. No.	—
solenoid coil 24VAC				

Table continues overleaf



accessories for		370029		
GEV No.	Ref. No.	Ref. No.	Ref. No.	Ref. No.
	371220	Ref. No.	—	—
reducer TP flow rate 3l/min red tolerance ±15%				
	371221	Ref. No.	—	—
reducer TP flow rate 5.5l/min yellow tolerance ±15%				
	371222	Ref. No.	—	—
reducer TP flow rate 6l/min grey tolerance ±15%				
	371223	Ref. No.	0E5551	—
reducer TP flow rate 10l/min white tolerance ±15%				
	371224	Ref. No.	—	—
reducer TP flow rate 12l/min bronze tolerance ±15%				
	371225	Ref. No.	—	—
reducer TP flow rate 16l/min light brown tolerance ±15%				
	371226	Ref. No.	0E5526	—
reducer TP flow rate 20l/min red tolerance ±15%				
	371230	Ref. No.	—	—
reducer TP flow rate 0.25l/min red tolerance ±25%				
	371231	Ref. No.	—	—
reducer TP flow rate 0.35l/min violet tolerance ±25%				
	371232	Ref. No.	—	—
reducer TP flow rate 0.5l/min orange tolerance ±25%				
	371233	Ref. No.	—	—
reducer TP flow rate 0.8l/min white tolerance ±25%				
	371234	Ref. No.	—	—
reducer TP flow rate 1l/min light blue tolerance ±25%				
	371235	Ref. No.	—	—
reducer TP flow rate 1.2l/min brown tolerance ±25%				
	371236	Ref. No.	—	—
reducer TP flow rate 1.5l/min light brown tolerance ±25%				
	371237	Ref. No.	—	—
reducer TP flow rate 2.5l/min yellow tolerance ±25%				
	371238	Ref. No.	—	—
reducer TP flow rate 3.4l/min dark green tolerance ±25%				
	371239	Ref. No.	—	—
reducer TP flow rate 5l/min black tolerance ±25%				
	371240	Ref. No.	—	—
reducer TP flow rate 8l/min blue tolerance ±20%				



































				
1				
GEV No.	370032	Ref. No.	0E5070 0K1409	
description	solenoid valve single straight 24VAC inlet 3/4" outlet 14mm DN10 TP flow regulating valve inlet white			
For models:	WTF2ERC, WTF2ELC, WTF2SRC, WTF2SLC, WTF2HERC, WTF2HEL, WTF2HSRC, WTF2HSLC, WTF3ERC, WTF3ELC, WTF3SRC, WTF3SLC, WTF3HERC, WTF3HELC, WTF3HSRC., WTF3HSLC, WTF2ERB., WTF2ELB, WTF2SRB, WTF2SLB, WTF2HERB, WTF2HELB, WTF2HSRB, WTF2HSLB, WTF3ERB, WTF3ELB, WTF3SRB, WTF3SLB, WTF3HERB, WTF3HELB, WTF3HSRB, WTF3HSLB, WTF4HERB, WTF4HELB, WTF4HSRB, WTF4HSLB, WTF2ERA, WTF2ELA, WTF2SRA, WTF2SLA, WTF2HERA, WTF2HELA, WTF2HSRA, WTF2HSLA, WTF3ERA, WTF3ELA, WTF3SRA, WTF3SLA, WTF3HERA, WTF3HELA...(Other models you can see in the webshop)			
spare parts for	370032			
	GEV No.	371035	Ref. No.	—
solenoid coil 24VAC				
accessories for	370032			
	GEV No.	371220	Ref. No.	—
reducer TP flow rate 3l/min red tolerance ±15%				
	GEV No.	371221	Ref. No.	—
reducer TP flow rate 5.5l/min yellow tolerance ±15%				
	GEV No.	371222	Ref. No.	—
reducer TP flow rate 6l/min grey tolerance ±15%				
	GEV No.	371223	Ref. No.	0E5551
reducer TP flow rate 10l/min white tolerance ±15%				
	GEV No.	371224	Ref. No.	—
reducer TP flow rate 12l/min bronze tolerance ±15%				
	GEV No.	371225	Ref. No.	—
reducer TP flow rate 16l/min light brown tolerance ±15%				
	GEV No.	371226	Ref. No.	0E5526
reducer TP flow rate 20l/min red tolerance ±15%				
	GEV No.	371230	Ref. No.	—
reducer TP flow rate 0.25l/min red tolerance ±25%				
	GEV No.	371231	Ref. No.	—
reducer TP flow rate 0.35l/min violet tolerance ±25%				
	GEV No.	371232	Ref. No.	—
reducer TP flow rate 0.5l/min orange tolerance ±25%				
	GEV No.	371233	Ref. No.	—
reducer TP flow rate 0.8l/min white tolerance ±25%				
	GEV No.	371234	Ref. No.	—
reducer TP flow rate 1l/min light blue tolerance ±25%				

Table continues overleaf



accessories for 370032				
	GEV No.	371235	Ref. No.	—
reducer TP flow rate 1.2l/min brown tolerance ±25%				
	GEV No.	371236	Ref. No.	—
reducer TP flow rate 1.5l/min light brown tolerance ±25%				
	GEV No.	371237	Ref. No.	—
reducer TP flow rate 2.5l/min yellow tolerance ±25%				
	GEV No.	371238	Ref. No.	—
reducer TP flow rate 3.4l/min dark green tolerance ±25%				
	GEV No.	371239	Ref. No.	—
reducer TP flow rate 5l/min black tolerance ±25%				
	GEV No.	371240	Ref. No.	—
reducer TP flow rate 8l/min blue tolerance ±20%				

 				
1				
GEV No.	370025	Ref. No.	069464 0A6045 240002	
description	solenoid valve triple straight 230VAC inlet 3/4" outlet 11.5mm DN10 TP			
For models:	LTB12, LTB22, LTB12UK, LTB22UK, LTB22, 910-00-021, 910-00-023, 910-00-031, 910-00-033, 911-00-022, 911-00-024, 911-00-032, 911-00-034, CRYSTAL 22			
spare parts for	370025			
	GEV No.	371013	Ref. No.	—
solenoid coil TP 230VAC 50/60Hz				
accessories for	370025			
	GEV No.	371220	Ref. No.	—
reducer TP flow rate 3l/min red tolerance ±15%				
	GEV No.	371221	Ref. No.	—
reducer TP flow rate 5.5l/min yellow tolerance ±15%				
	GEV No.	371222	Ref. No.	—
reducer TP flow rate 6l/min grey tolerance ±15%				
	GEV No.	371223	Ref. No.	0E5551
reducer TP flow rate 10l/min white tolerance ±15%				
	GEV No.	371224	Ref. No.	—
reducer TP flow rate 12l/min bronze tolerance ±15%				
	GEV No.	371225	Ref. No.	—
reducer TP flow rate 16l/min light brown tolerance ±15%				
	GEV No.	371226	Ref. No.	0E5526
reducer TP flow rate 20l/min red tolerance ±15%				

accessories for 370025				
	GEV No.	371230	Ref. No.	—
reducer TP flow rate 0.25l/min red tolerance ±25%				
	GEV No.	371231	Ref. No.	—
reducer TP flow rate 0.35l/min violet tolerance ±25%				
	GEV No.	371232	Ref. No.	—
reducer TP flow rate 0.5l/min orange tolerance ±25%				
	GEV No.	371233	Ref. No.	—
reducer TP flow rate 0.8l/min white tolerance ±25%				
	GEV No.	371234	Ref. No.	—
reducer TP flow rate 1l/min light blue tolerance ±25%				
	GEV No.	371235	Ref. No.	—
reducer TP flow rate 1.2l/min brown tolerance ±25%				
	GEV No.	371236	Ref. No.	—
reducer TP flow rate 1.5l/min light brown tolerance ±25%				
	GEV No.	371237	Ref. No.	—
reducer TP flow rate 2.5l/min yellow tolerance ±25%				
	GEV No.	371238	Ref. No.	—
reducer TP flow rate 3.4l/min dark green tolerance ±25%				
	GEV No.	371239	Ref. No.	—
reducer TP flow rate 5l/min black tolerance ±25%				
	GEV No.	371240	Ref. No.	—
reducer TP flow rate 8l/min blue tolerance ±20%				

































 				
1				
GEV No.	370019	Ref. No.	0H6403 370020	
description	solenoid valve double angled 230VAC inlet 3/4" outlet 11.5mm DN10 TP plastic			
spare parts for	370019			
	GEV No.	371013	Ref. No.	—
solenoid coil TP 230VAC 50/60Hz				
accessories for	370019			
	GEV No.	371220	Ref. No.	—
reducer TP flow rate 3l/min red tolerance ±15%				
	GEV No.	371221	Ref. No.	—
reducer TP flow rate 5.5l/min yellow tolerance ±15%				
	GEV No.	371222	Ref. No.	—
reducer TP flow rate 6l/min grey tolerance ±15%				

Table continues overleaf





















accessories for		370015		
	GEV No.	371236	Ref. No.	—
reducer TP flow rate 1.5l/min light brown tolerance ±25%				
	GEV No.	371237	Ref. No.	—
reducer TP flow rate 2.5l/min yellow tolerance ±25%				
	GEV No.	371238	Ref. No.	—
reducer TP flow rate 3.4l/min dark green tolerance ±25%				
	GEV No.	371239	Ref. No.	—
reducer TP flow rate 5l/min black tolerance ±25%				
	GEV No.	371240	Ref. No.	—
reducer TP flow rate 8l/min blue tolerance ±20%				

 				
1				
GEV No.	370016	Ref. No.	045701 046320 047466 047529 047531 047532 047843 048178 048179 048571 048894 069178 069179 OT3867 319536 696609700	
description	solenoid valve single angled 230VAC inlet 3/4" outlet 14mm DN10 TP			
For models:	RBR/E700, RBR/E700, LB120EPH, LB120E, LB160EPH, LB160E, LB160V, CLB160E, CLB160V, LB110E, LS500F, LS501F, LS540F, LS540DK, LS541F, LS720F, LSE720DK, LSE720PH, LS860F, LS860DK, LS860PH, LS1080F, LS1080UK, LS1080PH, LSE721F, LS861F, LS540, LS1080M, LS1080, LS1080D, LS1080UK, LS1080/63, LS500F, LS500UK, LS501, LS501UK, LS540D, LS540/63, LSE721, LS720, LSE720UK, LS721UK, LSE720D, LS541, LS860, LS860D, LS860UK, LS861UK, LS860/63...(Other models you can see in the webshop)			
spare parts for	370016			
	GEV No.	371013	Ref. No.	—
solenoid coil TP 230VAC 50/60Hz				
accessories for	370016			
	GEV No.	371220	Ref. No.	—
reducer TP flow rate 3l/min red tolerance ±15%				
	GEV No.	371221	Ref. No.	—
reducer TP flow rate 5.5l/min yellow tolerance ±15%				
	GEV No.	371222	Ref. No.	—
reducer TP flow rate 6l/min grey tolerance ±15%				
	GEV No.	371223	Ref. No.	0E5551
reducer TP flow rate 10l/min white tolerance ±15%				

accessories for		370016		
	GEV No.	371224	Ref. No.	—
reducer TP flow rate 12l/min bronze tolerance ±15%				
	GEV No.	371225	Ref. No.	—
reducer TP flow rate 16l/min light brown tolerance ±15%				
	GEV No.	371226	Ref. No.	0E5526
reducer TP flow rate 20l/min red tolerance ±15%				
	GEV No.	371230	Ref. No.	—
reducer TP flow rate 0.25l/min red tolerance ±25%				
	GEV No.	371231	Ref. No.	—
reducer TP flow rate 0.35l/min violet tolerance ±25%				
	GEV No.	371232	Ref. No.	—
reducer TP flow rate 0.5l/min orange tolerance ±25%				
	GEV No.	371233	Ref. No.	—
reducer TP flow rate 0.8l/min white tolerance ±25%				
	GEV No.	371234	Ref. No.	—
reducer TP flow rate 1l/min light blue tolerance ±25%				
	GEV No.	371235	Ref. No.	—
reducer TP flow rate 1.2l/min brown tolerance ±25%				
	GEV No.	371236	Ref. No.	—
reducer TP flow rate 1.5l/min light brown tolerance ±25%				
	GEV No.	371237	Ref. No.	—
reducer TP flow rate 2.5l/min yellow tolerance ±25%				
	GEV No.	371238	Ref. No.	—
reducer TP flow rate 3.4l/min dark green tolerance ±25%				
	GEV No.	371239	Ref. No.	—
reducer TP flow rate 5l/min black tolerance ±25%				
	GEV No.	371240	Ref. No.	—
reducer TP flow rate 8l/min blue tolerance ±20%				
	GEV No.	503139	Ref. No.	—
solenoid valve filter ø 19.5mm H 16mm				





			
1			
GEV No.	370031	Ref. No.	0H2513 0L0175
description	solenoid valve single angled 24VAC inlet 3/4" outlet 14mm DN10 TP		
For models:	PW1EFL, PW1EFLF, PW1EFL/60HZ, PW2EFL, PW2EFLF, PW2EFL/60HZ, PW2VFL, WT830EFL, WT830EFLF, WT830EFL/60HZ, WT850, WT850EFLF, WT850EFL/60HZ, WT850SFL, FT36EDTS, FT36ESTS, FT36VDTs, FT36VSTs, FT36ED, FT36ES, FT36VD, FT36VS, FT50ED, FT50ES, FT50VD, FT50VS, FT72ED, FT72ES, FT72VD, FT72VS, FT36EDT, FT36EST, FT36VDT, FT36VST, FT50EDT, FT50EST, FT50VDT, FT50VST, FT72EDT, FT72EST, FT72VDT, FT72VST, FT36WED, FT36WES, FT36WVD, FT36WVS, FT50WED, FT50WES, FT50WVD, FT50WVS...(Other models you can see in the webshop)		
accessories for	370031		
	GEV No.	371220	Ref. No. —
	reducer TP flow rate 3l/min red tolerance ±15%		
	GEV No.	371221	Ref. No. —
	reducer TP flow rate 5.5l/min yellow tolerance ±15%		
	GEV No.	371222	Ref. No. —
	reducer TP flow rate 6l/min grey tolerance ±15%		
	GEV No.	371223	Ref. No. 0E5551
	reducer TP flow rate 10l/min white tolerance ±15%		
	GEV No.	371224	Ref. No. —
	reducer TP flow rate 12l/min bronze tolerance ±15%		
	GEV No.	371225	Ref. No. —
	reducer TP flow rate 16l/min light brown tolerance ±15%		
	GEV No.	371226	Ref. No. 0E5526
	reducer TP flow rate 20l/min red tolerance ±15%		
	GEV No.	371230	Ref. No. —
	reducer TP flow rate 0.25l/min red tolerance ±25%		
	GEV No.	371231	Ref. No. —
	reducer TP flow rate 0.35l/min violet tolerance ±25%		
	GEV No.	371232	Ref. No. —
	reducer TP flow rate 0.5l/min orange tolerance ±25%		
	GEV No.	371233	Ref. No. —
	reducer TP flow rate 0.8l/min white tolerance ±25%		
	GEV No.	371234	Ref. No. —
	reducer TP flow rate 1l/min light blue tolerance ±25%		
	GEV No.	371235	Ref. No. —
	reducer TP flow rate 1.2l/min brown tolerance ±25%		
	GEV No.	371236	Ref. No. —
	reducer TP flow rate 1.5l/min light brown tolerance ±25%		

accessories for	370031		
	GEV No.	371237	Ref. No. —
	reducer TP flow rate 2.5l/min yellow tolerance ±25%		
	GEV No.	371238	Ref. No. —
	reducer TP flow rate 3.4l/min dark green tolerance ±25%		
	GEV No.	371239	Ref. No. —
	reducer TP flow rate 5l/min black tolerance ±25%		
	GEV No.	371240	Ref. No. —
	reducer TP flow rate 8l/min blue tolerance ±20%		

solenoid valves with reducers

			
1			
GEV No.	370437	Ref. No.	085328 099773
description	solenoid valve double angled 230VAC inlet 3/4" input 10l/min output 1.2/1.2l/min DN10 t.max. 90°C TP plastic flow regulating valve inlet white outlet 11.5mm output A 1.2l/min output B 1.2l/min flow regulating valve outlet A dark brown flow regulating valve outlet B dark brown		

			
1			
GEV No.	370436	Ref. No.	085274
description	solenoid valve double angled 230VAC inlet 3/4" inputl/min output 0.6/0.6l/min DN10 t.max. 90°C TP plastic outlet 11.5mm output A 0.6l/min output B 0.6l/min flow regulating valve outlet A orange flow regulating valve outlet B orange		
For models:	FGC24AB, FGC24WB, FGC24ABS, FGC24WBAB, CB184A, FGC24AB, FGC24WB, C150W, C300A, C300W, CB1565W, CB246W, CB416W, CB955W, DSS42W, C80W, CB1565A, C80A, CB246A, CB416A, C150A, CB955A, DSS42A		

			
1			
GEV No.	370395	Ref. No.	085310
description	solenoid valve double angled 230VAC inlet 3/4" inputl/min output 0.8/0.8l/min DN10 t.max. 90°C TP plastic outlet 11.5mm output A 0.8l/min output B 0.8l/min flow regulating valve outlet A white flow regulating valve outlet B white		
For models:	CPX-01, CPX-04, CPX-06, CPX-04, CPX-05, CPX-07		



1

GEV No.	370434	Ref. No.	085339
description	solenoid valve double angled 230VAC inlet 3/4" input/min output 2,5/2,5l/min DN10 t.max. 90°C TP plastic outlet 11.5mm output A 2.5l/min output B 2.5l/min flow regulating valve outlet A yellow flow regulating valve outlet B yellow		



1

GEV No.	370336	Ref. No.	0C0561
description	solenoid valve double angled 230VAC inlet 3/4" plastic outlet 11.5mm		



1

GEV No.	370337	Ref. No.	056872
description	solenoid valve double angled 230VAC inlet 3/4" plastic outlet 11.5mm output A 8l/min output B 0.6l/min flow regulating valve outlet A dark blue flow regulating valve outlet B orange		
For models:	MCP/E700, MCP/G700, MCP/E700D, RCP/E2S, MCP/E1SH, MCP/E1SUH, MCP/E2SUHS, MCP/E2S, MCP/E2SH, MCP/E2SUH, MCP/E2SUT, MCP/E2SHB, M70GPC, RCP/G700, RCPE700, HCP/G410D, HCP/G410, HCP/G810, HCP/E410, HCP/E810, HCPS/E410, ACP/G400, ACP/G410, ACP/G800, ACP/G810, ACP/E400, ACP/E410, ACP/E800, ACP/E810, ACP/G400, ACP/E400, ACP/E410		



1

GEV No.	370343	Ref. No.	055444
description	solenoid valve double angled 230VAC inlet 3/4" t.max. 90°C TP plastic outlet 11.5mm output B 1l/min flow regulating valve outlet B light blue		
For models:	FDV40G, FDV40GZ, FDV40GA, FDV20G, FDV20E, FDV20GZ, FDV20EL, FDV20GA, FCV/G10L3, FCVG10L3T, FCVG102L3, FCV/G20L3, FCVG202L3, FCV/E10L3JAP, FCV/E102/1L3JAP, FCVG10L3J, FCVG102L3J, FCV/E101/1, FCV/E101/2, FCV/G61/1, FCV/E10L3, FCV/E102/1, FCV/E102/1L3, FCV/E20L3, FCVG202L6, FCV/G201/1, FCS101E44J, FCS101E4, FCS102E44J, FCS102E4, FCS201G4, FCS202GP, FCVG6-1, FCVG6-3, FCVG6-1UK, FCVG6-3UK, FCVE10-2, FCVE10-4, FCVE10-2UK, FCVE10-4UK, FCVG10-2, FCVG10-4, FCVG10-2UK, FCVG10-4UK, FCVE20-2, FCVE20-4, FCVE20-2UK, FCVE20-4UK, FCVG20-2, FCVG20-4...(Other models you can see in the webshop)		



1

GEV No.	370657	Ref. No.	056894
description	solenoid valve double angled 230VAC inlet 3/4" TP plastic outlet 11.5mm output A 1l/min output B 8l/min flow regulating valve outlet A dark blue flow regulating valve outlet B light blue		
For models:	7CPE07P, 7CPG07P, M70EPC, M70GPC, CCP/E700, ZCP/G410, ZCP/G810, ZCP/E410, ZCP/E810, ZCPS/E410, RCP/G700, RCP/E700		



1

GEV No.	370651	Ref. No.	0C1435
description	solenoid valve double angled 24V inlet 3/4" TP plastic outlet 11.5mm output B 0.25l/min flow regulating valve outlet B red		
For models:	CRN22G, CRN20G, CRN30G, CRN15G, CRN15V, CRN15E, CRN22GZ, CRN20GZ, CRN30GZ, CRN15GZ, CRN15V-Z, CRN15EZ, CRN20GA, CRN30GA, CRN15GA, CRN15VA, CRN15EA, CPD42G-Z, CPD40GZ, CPD42V-Z, CPD42E-Z, CR42G, CR42V, CR42E, CR/40G, CR/40V, CR40E, CPD40VZ, CPD40EZ		



1

GEV No.	370342	Ref. No.	046654 047579 057814 60050303
description	solenoid valve double straight 230VAC inlet 3/4" input 16l/min t.max. 90°C TP plastic flow regulating valve inlet light brown outlet 11.5mm output B 0.25l/min flow regulating valve outlet B red		
For models:	FCV/G6L3TOWNGAS, FCV/G6L3, FCV/E101/1, FCVE6L3J, FCV/G6L3JAP, FCVG6L3CJ, FCV/E61/1, FCV/G10L2, FCV/E10L2, FCV/E61/1, FCV/G6L3C, FCV/G61/1, FCVG6L3CT, FCVG6L3CJ, FCV/E6L3, FCV/E101/1, FCS061E44J, FCS061G48J, FCS061G3DI, FCS061E3CI, FCS101E2, FCS061G4DT, FCS061G49J, FCS101G2, FCVG10-ISG, ECV/G6T4C, ECV/E10IGP, LSD551, LSD55V, RCV061G2, RCV061E2, RCV101G2, RCV101E2, ACV/G10C2, ACV/E10C2, ACV/G6C3, ACV/G6C3C, ACV/E6C3, NCV/G6L2, NCV/G10L2, NCV/E6L2, NCV/E10L2, FCVG10-ISG, ZCV/G6T4C		



GEV No.	370341	Ref. No.	002753 60050300
description	solenoid valve single straight 230VAC inlet 3/4" outlet 11.5mm output 1l/min t.max. 90°C TP plastic flow regulating valve outlet light blue output A 1l/min		
For models:	FCV/G6L3TOWNGAS, FCV/G6L3, FCVE6L3J, FCV/G6L3JAP, FCV/E61/1, FCV/E61/1, FCV/E61/1, FCV/E61/1, FCV/E6L3, FCV/G6L4, FCV/E6L4, FCS061E44J, FCS061EP, FCS061E3CI, FCS061E4, FCS061EXLN, FCS061EX, 5711-2-6, 5711-2-7, 5711-2-8, 5711-2-10, 5711-2-8CH, 5711-2-10CH, 5711-2-6L, 5711-2-7L, 5711-2-8L, 5711-2-10L, 5711-3-6, 5711-3-7, 5711-3-8, 5711-3-10, 5711-3-8CH, 5711-3-10CH, 5711-3-10F, 5711-3-10S, ECV/G6T4, ECV/E6T4, RCV061E2, RCV061E4, ACV/G6C3, ACV/E6C3, NCV/G6L2, NCV/E6L2, ZCV/G6T4, ZCV/E6T4		



GEV No.	370658	Ref. No.	OK8035
description	solenoid valve triple straight 230VAC inlet 3/4" outlet 11.5mm input 5.5l/min 10 t.max. 90°C TP plastic flow regulating valve inlet yellow output A 1l/min output C 0.25l/min flow regulating valve outlet A light blue flow regulating valve outlet C red		
For models:	AR6ES, AR6ES, AR6ES, AR6ES, AR6ES, AR6ES, AR6ES, AR6ES, AR6ES, AR6ES, AR6ES, AR6ES, AR6ES, AR6ES, AR6ES, AR6ES, AR10ES, AR10ES, AR10ES, AR10ES, AR10ES, AR10ES, AR10ESP, AR10ESP, AR10ESP, AR10ESP, AR10ESP, AR10ES, AR10ES, AR10ES, AR10ES, AR10ES, AR10ESP, AR10ESP, AR10ESP, AR10ESP, AR10ESP, AR10ESP, AR10ESP, AR10ESP, AR10ESP, AR10ESP... (Other models you can see in the webshop)		



GEV No.	370344	Ref. No.	002712 047539 047540 069296 OK1519 OK1523 50300010 60050292
description	solenoid valve triple angled 230VAC inlet 3/4" outlet 11.5mm t.max. 90°C TP plastic output B 0.25l/min output C 1l/min flow regulating valve outlet B red flow regulating valve outlet C light blue		
For models:	FCVG202L3, FCV/E10L6JAP, FCV/E102/1L6JAP, FCV/G10L6JAP, FCV/G102/1L6JAP, FCV/E61/1, FCV/E101/1, FCV/E102/1, FCV/E61/1, FCV/E101/1, FCV/G61/1, FCV/G61/1, FCV/E6L4, FCV/G10L6, FCV/E10L6, FCV/G102/1L6, FCV/E102/1L6, FCV/G20L6, FCV/E20L6, FCVG202L6, FCV/E101/1, FCV/G101/1, FVC/E101/1, FCV/G102/1, FVC/E102/1, FCV/G201/1, FVC/E201/1, FCV/G202/1, FCS061GP, FCS061EP, FCS061G4, FCS101EP4J, FCS101G4, FCS101EP, FCS101G4DT, FCS101GP9J, FCS102EP4J, FCS101G49J, FCS101GP, FCS102EP, FCS102G4, FCS201E4, FCS102GA9J, FCS201EP, FCS102G49J, FCS102GP, FCS201GP, FCS202G4, FCS202GP, FCS061E4... (Other models you can see in the webshop)		



GEV No.	370375	Ref. No.	OF0001 OK8512
description	solenoid valve triple straight 230VAC inlet 3/4" outlet 11.5mm t.max. 90°C TP plastic output A 2.5l/min output C 0.25l/min flow regulating valve outlet A yellow flow regulating valve outlet C red		
For models:	FCVE202L6, FVC/E202/1, FCS202E4, FCS202EP, FCS202EX, CS-7ME4/200-3, CS7ME4/230-3, CS7ME4/400-3N, CS7ME6/400-3N, CS7ME4/400-3N/EO, CS7ME4/400-3/50HZ/MA, CS7ME4/440-3/60HZ/MA, CS7MT4/400-3N, CS7GE4/200-3, CS7GE4/230-3, CS7GE4/400-3N, CS7GE6/400-3N, CS7GE4/400-3N/EO, CS7GE4/400-3/50HZ/MA, CS7GE4/440-3/60HZ/MA, CS7GT4/400-3N, CS7LCE4/200-3, CS7LCE4/230-3, CS7LCE4/400-3N, CS7LCE6/400-3N, CS7LCE4/400-3N/EO, CS7LCE4/400-3/50HZ/M, CS7LCE4/440-3/60HZ/M, CS7LCT4/400-3N, CS10ME4/200-3, CS10ME4/230-3, CS10ME6/230-3, CS10ME4/400-3N, CS10ME6/400-3N, CS10ME4/400-3N/EO, CS10ME4/400-3/50HZ/M, CS10ME4/440-3/60HZ/M, CS10MT4/400-3N, CS10MT6/400-3N, CS10GE4/200-3, CS10GE4/230-3, CS10GE6/230-3, CS10GE4/400-3N, CS10GE6/400-3N, CS10GE4/400-3N/EO, CS10GE4/400-3/50HZ/M, CS10GE4/440-3/60HZ/M, CS10GT4/400-3N, CS10GT6/400-3N, CS10LCE4/200-3... (Other models you can see in the webshop)		



GEV No.	370347	Ref. No.	0A2415 60050239
description	solenoid valve triple angled 24V inlet 3/4" outlet 11.5mm plastic output C 1l/min		
For models:	FCVE103CE, FCVE203CE, FCVE10-P, FCVE10PUK, FCVG10-P, FCVG-10PUK, FCVE20-P, FCVE20PUK, FCVG20-P, FCVG20PUK, AFCV/G6-1, AFCV/G6-3, SCO/G6-3, AFCV/G101, AFCV/G103, SCO/G10-3, AFCV/G201, AFCV/G203, SCO/G20-3		





GEV No.	370250	Ref. No.	047538 0E0330
description	solenoid valve triple straight 230VAC inlet 3/4" outlet 11.5mm t.max. 90°C TP plastic output B 0.25l/min flow regulating valve outlet B red		
For models:	LCS, LB70E, LB110E, LB70E, LCSZ		





spare parts and accessories			
reducers			
inlet side			
			
GEV No.	371223	Ref. No.	0E5551
description	reducer TP flow rate 10l/min white tolerance ±15%		
For models:	RT100ED, RT100ES, RT140ED, RT140ES, RT190ED, RT190ES, RT190HDED, RT190HDES, RT270ED, RT270ES, RT270HDED, RT270HDES, RT100ERF, RT100ELF, RT140ERF, RT140ELF, RT142ERF, RT142ELF, RT190ERF, RT190ELF, RT190HERF, RT190HEL, RT270ERF, RT270ELF, RT270HERF, RT270HEL, RT100ERG, RT100ELG, RT140ERG, RT140ELG, RT190ERG, RT190ELG, RT190HERG, RT190HEL, RT270ERG, RT270ELG, RT270HERG, RT270HEL, RT100EDF, RT100ESF, RT140EDFWHIRPOOL, RT140ESFWHIRPOOL, RT190EDFWHIRPOOL, RT190ESFWHIRPOOL, RT142EDFWHIRPOOL, RT142ESFWHIRPOOL, RT190HDEDFWHIRPOOL, RT190HDESFWHIRPOOL, RT270EDFWHIRPOOL, RT270ESFWHIRPOOL...(Other models you can see in the webshop)		

			
GEV No.	371218	Ref. No.	0L0178
description	reducer TP flow rate 20l/min orange tolerance ±15%		
For models:	RT100ED, RT100ES, RT100SR, RT100SL, RT140ED, RT140ES, RT140SR, RT140SL, RT190ED, RT190ES, RT190SR, RT190SL, RT190HDED, RT190HDES, RT190HSR, RT190HSL, RT270ED, RT270ES, RT270SR, RT270SL, RT270HDED, RT270HDES, RT270HSR, RT270HSL, RT100ERF, RT100ELF, RT100VD, RT100VS, RT140ERF, RT140ELF, RT140VD, RT140VS, RT142ERF, RT142ELF, RT190ERF, RT190ELF, RT190VD, RT190VS, RT190HERF, RT190HEL, RT190HDVDF, RT190HDVSF, RT270ERF, RT270ELF, RT270VDF, RT270VSF, RT270HERF, RT270HEL, RT270HDVDF, RT270HDVSF...(Other models you can see in the webshop)		

			
GEV No.	371226	Ref. No.	0E5526
description	reducer TP flow rate 20l/min red tolerance ±15%		
For models:	WTF2ERC, WTF2ELC, WTF2SRC, WTF2SLC, WTF2HERC, WTF2HELC, WTF2HSRC, WTF2HSLC, WTF3ERC, WTF3ELC, WTF3SRC, WTF3SLC, WTF3HERC, WTF3HELC, WTF3HSRC, WTF3HSLC, WTF2ERB, WTF2ELB, WTF2SRB, WTF2SLB, WTF2HERB, WTF2HELB, WTF2HSRB, WTF2HSLB, WTF3ERB, WTF3ELB, WTF3SRB, WTF3SLB, WTF3HERB, WTF3HELB, WTF3HSRB, WTF3HSLB, WTF4HERB, WTF4HELB, WTF4HSRB, WTF4HSLB, WTF2ERA, WTF2ELA, WTF2SRA, WTF2SLA, WTF2HERA, WTF2HELA, WTF2HSRA, WTF2HSLA, WTF3ERA, WTF3ELA, WTF3SRA, WTF3SLA, WTF3HERA, WTF3HELA...(Other models you can see in the webshop)		

various			
			
GEV No.	370673	Ref. No.	0E1423 0W2063
description	solenoid valve 3-way 230VAC BÜRKERT		
For models:	W355HE, W365H, W375H5, W3105H, W3130H, W3130H, W3240H, W3240H_EL, W3240H_CLA, W3180H, W3130H, W3180H, W3180H, W3180H, W3105H, W3105H, W3105H, W355H, W375H, W3105H, W3130H, W3180H, W3300H, W3300H, W355H, LB81E, LB81BP, LB81COP, W375N, W375N, W375N, W3105N, W3105N, W3105N, W3130N, LB121E, LB121BP, W3130N, W3130N, W3130N, W3130N, W3130N, W3130N, W3180N, W3180N...(Other models you can see in the webshop)		

			
GEV No.	370496	Ref. No.	086582
description	solenoid valve straight 220VAC outlet 14mm plastic inlet 14mm		

metal			
ASCO			
2-way			
			
GEV No.	370470	Ref. No.	053933 053935
description	solenoid valve 2-ways 24 V inlet 1/2" outlet 1/2" connection 1/2" slide-on receptacle DIN -20° up to 85°C Asco membranes NBR (water) brass		
For models:	FCVE10, FV4N, FVGC4, FV4G, FV4E, FV4N, FV4G, FV4E, FVAC041		



solenoid valves steam (water)

2-way



1			
GEV No.	370848	Ref. No.	OKU554 428096600 7STL428096600
description	solenoid valve 2-ways 230V inlet 1/2" outlet 1/2" body brass DN 12.5mm t.max. 85°C Asco coil type F p max 10bar 50-60Hz		
For models:	EBS50., EBS50H, EBS100., EBS100H, EBS150., EBS150H, EBS200., EBS200H, EBS300., EBS300H, EBV50., EBV50H, EBV100., EBV100H, EBV150., EBV150H, EBV200., EBV200H, EBV300., EBV300H, EBVC50, EBVC50H, EBVC100, EBVC100H, EBVC150, EBVC150H, EBVC200, EBVC200H, EBVC300, EBVC300H, EBP100., EBP100M, EBP150, EBP150M, EBP200., EBP200M, EBP300., EBP300M, EBPC100, EBPC100M, EBPC150, EBPC150M, EBPC200, EBPC200M, EBPC300, EBPC300M, MED50H, MED100H, MED150H, MED200H...(Other models you can see in the webshop)		

BÜRKERT

2-way

6213 series



1			
GEV No.	370335	Ref. No.	OK0670 125656Y
description	solenoid valve 2-ways 230VAC connection 3/8" DN 10mm slide-on receptacle DIN -30 up to 120°C BÜRKERT type series 6213 membranes EPDM p max 10bar 50Hz		
For models:	9190-3, 9191-3, 9193-3, 9195-3, 9390-3, 9391-3, 9393-3, 9395-3		

solenoid valves steam (water)

2-way

0407 series



1			
GEV No.	370334	Ref. No.	OK1425
description	solenoid valve 2-ways 230VAC connection 1" DN 25mm slide-on receptacle DIN 180°C BÜRKERT type series 0407 membranes PTFE p max 10bar		
For models:	7550-5.KES40, 7551-5.KES60, 7552-5.KES80, 7553-5.KES100, 7554-5.KES150, 7581-5.KK60, 7582-5.KK80, 7583-5.KK100, 7574-5.KES150, 7575-5.KES250, 7750-5.KES40, 7751-5.KES60, 7752-5.KES80, 7753-5.KES100, 7754-5.KES150, 7781-5.KK60, 7782-5.KK80, 7783-5.KK100, 7576-5.KES300, 7573-5.KES100, 7580-5.KK40, 7584-5.KK150, 7780-5.KK40, 7550-5/85.KES40.(N), 7551-5/85.KES60.(N), 7552-5/85.KES80.(N), 7553-5/85.KES100.(N), 7554-5/85.KES150.(N), 7550-5/90.KES40.(N), 7551-5/90.KES60.(N), 7552-5/90.KES80.(N), 7553-5/90.KES100.(N), 7554-5/90.KES150.(N), 7573-5/85.KES100.(N), 7574-5/85.KES150.(N), 7575-5/85.KES250.(N), 7576-5/85.KES300.(N), 7573-5/90.KES100.(N), 7574-5/90.KES150.(N), 7575-5/90.KES250.(N), 7576-5/90.KES300.(N), 7580-5/85.KK40.(N), 7581-5/85.KK60.(N), 7582-5/85.KK80.(N), 7583-5/85.KK100.(N), 7584-5-85.KK150.(N), 7580-5/90.KK40.(N), 7581-5/90.KK60.(N), 7582-5/90.KK80.(N), 7583-5/90.KK100.(N)...(Other models you can see in the webshop)		

CEME



solenoid valves





1			
GEV No.	370348	Ref. No.	007015
description	solenoid valve 2-ways 230VAC connection 1/2" L 60mm t.max. 90°C membranes NBR p max 10bar p min 0.25bar brass		
For models:	AOW101EA, AOS061EA, AOS101EA, AOS061EA3J, AOS101EA3J, AOS061EA2N, AOS101EA2N, AOS061EA0H, AOS101EA0H, AOS061GA, AOS101GA, AOW101EABU		





			
1			
GEV No.	370350	Ref. No.	007017
description	solenoid valve SS 230V inlet 6.5mm outlet 6.5mm -10 up to 140°C hose ø 6mm combi-steamer body SS 50Hz		
For models:	AOS061EA, AOS101EA, AOS201EA, AOS061EA3J, AOS101EA3J, AOS201EA3J, AOS061EA2N, AOS101EA2N, AOS201EA2N, AOS061EA0H, AOS101EA0H, AOS201EA0H, AOS061GA, AOS101GA, AOS201GA		

LUCIFER			
2-way			
7321(PM133) series			
			
1			
GEV No.	371184	Ref. No.	046900 075736
description	solenoid valve 2-ways 24VAC connection 3/4" L 100mm DN 20mm slide-on receptacle DIN fixed 90°C LUCIFER-PARKER type series 7321(PM133) coil type DZ02A2 membranes NBR (water) p max 20bar p min 0.1bar		
spare parts for	371184		
	GEV No.	371083	Ref. No. —
	solenoid coil LUCIFER-PARKER 24VAC 9VA 50Hz coil type DZ02A2 seat ø 15mm		
accessories for	371184		
	GEV No.	371090	Ref. No. —
	power socket plug type DIN 43650A screw		

MÜLLER			
2-way			
			
1			
GEV No.	370035	Ref. No.	079041 0H6405 370035
description	solenoid valve 2-ways 230VAC inlet 3/4" ET outlet 1/2" IT L 57mm water MÜLLER		

			
1			
GEV No.	370036	Ref. No.	0K1420
description	solenoid valve 2-ways 230VAC inlet 3/4" ET outlet 1/2" IT L 57mm water MÜLLER		

ODE			
2-way			
			
1			
GEV No.	370356	Ref. No.	0C1121
description	solenoid valve 2-ways 230VAC inlet 3/4" outlet 3/4" connection 3/4" L 104mm DN 19mm slide-on receptacle DIN -10 up to +90°C ODE type series 21W3 coil type BDA membranes NBR (water) p max 16bar p min 0.2bar		
For models:	FCZ201EAA, FCZ202EAA, FCZ201EAH, FCZ201EAN, FCZ201GAG, FCZ202GAG, FCZ201GAD, FCZ202GAD, FCZ201EBC, FCZ201GBI, FCZ201ECA, FCZ202ECA, FCZ201ECH, FCZ201ECN, FCZ201GCG, FCZ202GCG, FCZ201GCD, FCZ202GCD, AOS202GAEU, AOS202GAAU, AOS201EA, AOS201EA3J, AOS201EA2N, AOS202EA2N, AOS201EA0H, AOS202EA, AOS201GA, AOS202GA, AOS201EAAQ, AOS202EAAQ, AOS201EANQ, AOS202EANQ, AOS201EACQ, AOS201EAHQ, AOS201GAGQ, AOS202GAGQ, AOS201GADQ, AOS202GADQ, AOS201GAIQ, AOS201GALQ, AOS201EAA1, AOS202EAA1, AOS201EAH1, AOS201EAN1, AOS201EAC1, AOS201EAE1, AOS201EAF1, AOS201EAQ1, AOS201EAM1, AOS202EAM1...(Other models you can see in the webshop)		
spare parts for	370356		
	GEV No.	371150	Ref. No. —
	solenoid coil ODE 230VAC 16VA coil type BDV seat ø 13.5mm 750Ohm		
accessories for	370356		
	GEV No.	371090	Ref. No. —
	power socket plug type DIN 43650A screw		



GEV No.	370653	Ref. No.	OC1148
description	solenoid valve brass 2-ways 230VAC inlet 1/2" outlet 1/2" connection 1/2" L 66mm DN 13mm t.max. 90°C -10 up to +90°C ODE type series 21WA4 coil type BDF membranes NBR (water) p max 16bar p min 0.2bar 50/60Hz		
For models:	FCZ061EAA, FCZ101EAA, FCZ102EAA, FCZ061EAH, FCZ101EAH, FCZ061EAN, FCZ101EAN, FCZ061GAG, FCZ101GAG, FCZ102GAG, FCZ061GAD, FCZ101GAD, FCZ102GAD, FCZ061EBC, FCZ101EBC, FCZ061GBI, FCZ101GBI, FCZ061ECA, FCZ101ECA, FCZ102ECA, FCZ061ECH, FCZ101ECH, FCZ061ECN, FCZ101ECN, FCZ061GCG, FCZ101GCG, FCZ102GCG, FCZ061GCD, FCZ101GCD, FCZ102GCD, FCS061EXLN, FCS061EX, FCS101EX4J, FCS101EXLN, FCS101EX, FCS102EX4J, FCS102EX, FCS201EX, FCS201EXLN, FCS202EX, FCS101GX9J, FCS101GX, FCS102GX9J, FCS102GX, FCS201GX, FCS202GX, AOW101EA, AOS061EA, AOS101EA, AOS061EA3J...(Other models you can see in the webshop)		

solenoid valves steam (water)

21A series



GEV No.	370349 ¹	Ref. No.	007016
description	solenoid valve stainless steel 230VAC connection 1/4" L 40mm 2-way DN 5.5mm slide-on receptacle DIN -10 up to 140°C ODE type series 21A coil type BDA membranes FKM (water/steam) p max 3.5bar		
For models:	AOS061EA, AOS101EA, AOS201EA, AOS061EA3J, AOS101EA3J, AOS201EA3J, AOS061EA2N, AOS101EA2N, AOS201EA2N, AOS061EA0H, AOS101EA0H, AOS201EA0H, AOS061GA, AOS101GA, AOS201GA		
spare parts for	370349		
	GEV No.	371150	Ref. No. —
	solenoid coil ODE 230VAC 16VA coil type BDV seat ø 13.5mm 7500hm		
accessories for	370349		
	GEV No.	371090	Ref. No. —
	power socket plug type DIN 43650A screw		

¹SS housing

PARKER

spare parts and accessories

solenoid coils





GEV No.	371098	Ref. No.	086050 086051 086177 086534 0H9317 0KD791 30003387 30003527 62030 62030000 62030608 62030628 62030648 62041906
description	solenoid coil 220-230VAC 50/60Hz seat ø 14mm cable length 1000mm 14W		
For models:	CIM15A, CIM15W, CIM30A, CIM30W, CIM45A, CIM45W, CIM65A, CIM65W, CIM120AS, CIM120WS		

SIRAI

2-way

L180-B series







GEV No.	370391	Ref. No.	003778
description	solenoid valve 2-ways 24VAC connection 3/4" L 79mm DN 18mm -10 up to +90°C coil type Z610A membranes NBR (water) p max 12bar p min 0.35bar		
For models:	CR/41G, CR42G, CR/41E, CR/41V, CR/42V, CR40G, CR40V, CR/40E, CR/42E, LV200		
accessories for	370391		
	GEV No.	371091	Ref. No. —
	power socket plug type DIN 43650B cable lengthmm small		



			
GEV No.	370329	Ref. No.	068464
description	solenoid valve 2-ways 24VAC inlet 1/2" outlet 1/2" connection 1/2" L 66mm DN 13.5mm slide-on receptacle compact -10 up to +90°C SIRAI type series L180-B coil type Z610A membranes NBR (water) p max 12bar p min 0.35bar		
For models:	ZAE101D, ZA/E101DXU, ZAE101S, ZA/E101SUK, ZA/V101DX, ZAV101S		
spare parts for	370329		
	GEV No.	371070	Ref. No. —
	GEV No.	371171	Ref. No. —
accessories for	370329		
	GEV No.	371091	Ref. No. —

			
GEV No.	370047	Ref. No.	067356 0H2412
description	solenoid valve brass 2-ways 230VAC inlet 1/2" outlet 1/2" connection 1/2" L 66mm DN 13.5mm slide-on receptacle compact -10 up to +90°C SIRAI type series L180-B coil type Z610A membranes NBR (water) p max 12bar p min 0.35bar 50/60Hz		
For models:	D480, D48, D48, D48, D480, D48, D48, D48, D48, D48, D48, D480, D48, D48, D48, D48, D480, D48, D48, D48, D48, D480, D480		
spare parts for	370047		
	GEV No.	371085	Ref. No. —
	GEV No.	371171	Ref. No. —
accessories for	370047		
	GEV No.	371091	Ref. No. —

solenoid valves steam (water)			
2-way			
L145-R series			
			
GEV No.	370323	Ref. No.	065297
description	solenoid valve 2-ways 230VAC inlet 3/4" outlet 3/4" connection 3/4" L 79mm DN 16mm slide-on receptacle DIN -60 up to +170°C SIRAI type series L145-R coil type Z534A membranes PTFE (steam) p max 6bar p min 0.4bar		
spare parts for	370323		
	GEV No.	371067	Ref. No. —
	GEV No.	371165	Ref. No. —
accessories for	370323		
	GEV No.	371090	Ref. No. —

			
GEV No.	370311	Ref. No.	068465 075011
description	solenoid valve 2-ways 24VAC connection 1" L 105mm DN 18.5mm slide-on receptacle DIN -60 up to +170°C SIRAI type series L145-R coil type Z534A membranes PTFE (steam) p max 6bar p min 0.4bar		
spare parts for	370311		
	GEV No.	371068	Ref. No. —
	GEV No.	371166	Ref. No. —
accessories for	370311		
	GEV No.	371090	Ref. No. —



L153-D series

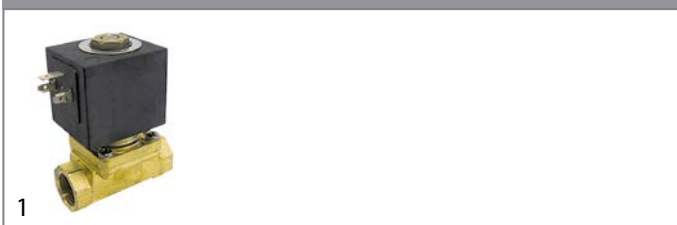

GEV No.	370079	Ref. No.	0E5974 0KP279
description	solenoid valve 2-ways 230VAC connection 3/4" L 79mm DN 17mm slide-on receptacle DIN -10 up to 140°C SIRAI type series L153-D coil type Z134A membranes EPDM (steam/water) p max 8bar p min 0.1bar 50Hz		
For models:	EBS50, EBS50, EBS50, EBS50, EBV50, EBV50, EBV50, EBV50, EBV50, EBS100, EBS100, EBS100, EBS100, EBV100, EBV100, EBV100, EBV100, EBV100, EBV-C100, EBV-C100, EBV-C100, EBV-C100, EBV-C100, EBS200, EBS200, EBS200, EBS200, EBV200, EBV200, EBV200, EBV200, EBV200, EBV-C200, EBV-C200, EBV-C200, EBV-C200, EBV-C200, EBS300, EBS300, EBS300, EBS300, EBV300, EBV300, EBV300, EBV300, EBV-C300, EBV-C300, EBV-C300, EBV-C300...(Other models you can see in the webshop)		
accessories for	370079		
	GEV No.	371077	Ref. No. —
	solenoid coil 230VAC 24VA SIRAI coil type Z110A/Z114A/Z134A seat ø 14mm		



GEV No.	370325	Ref. No.	0E2200 77482174003
description	solenoid valve 2-ways 24VAC inlet 3/4" outlet 3/4" connection 3/4" L 79mm DN 17mm slide-on receptacle DIN -10 up to 140°C SIRAI type series L153-D coil type Z134A membranes EPDM (steam/water) p max 8bar p min 0.1bar 50Hz		
For models:	FT36EDTS, FT36ESTS, FT36VDTS, FT36VSTS, FT36ED, FT36ES, FT36VD, FT36VS, FT50ED, FT50ES, FT50VD, FT50VS, FT72ED, FT72ES, FT72VD, FT72VS, FT36EDT, FT36EST, FT36VDT, FT36VST, FT50EDT, FT50EST, FT50VDT, FT50VST, FT72EDT, FT72EST, FT72VDT, FT72VST, FT36WED, FT36WES, FT36WVD, FT36WVS, FT50WED, FT50WES, FT50WVD, FT50WVS, FT72WED, FT72WES, FT72WVD, FT72WVS, FT36WEDT, FT36WEST, FT36WVDT, FT36WVST, FT50WEDT, FT50WEST, FT50WVDT, FT50WVST, FT72WEDT, FT72WEST...(Other models you can see in the webshop)		

spare parts and accessories

solenoid coils

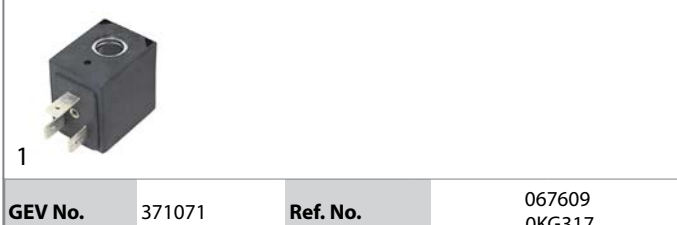

GEV No.	371071	Ref. No.	067609 0KG317
description	solenoid coil 230VAC 10VA SIRAI coil type Z610A seat ø 10mm H 33mm L 33mm W 25mm 50/60Hz		
accessories for	371071		
	GEV No.	371091	Ref. No. —
	power socket plug type DIN 43650B cable lengthmm small		

membranes

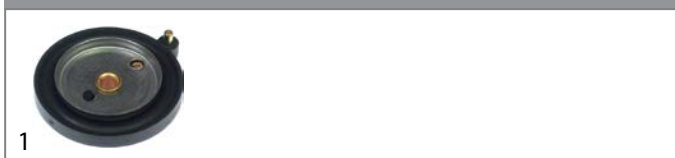

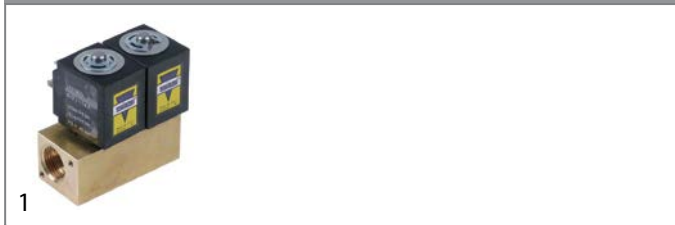

GEV No.	371170	Ref. No.	069017
description	membrane series L180-B membrane type NBR (water)		

solenoid valves (various)



GEV No.	370378	Ref. No.	0C2390
description	solenoid valve 230VAC inlet 1/2" outlet 1,1-4,5mm SIRAI coil type ZA34A 230V brass		
For models:	PCP/E2SHP, PCP/E1SH, PCP/E2SH, PCP/E2SH3B, PCP/E1ELH, OCP/E2S, OCP/E1SH, OCP/E2SH, TCP/E2S, TCP/E2SH, TCP/E1ELH, KCP/G1, KCP/G1R, KCP/G2, KCP/G2R, KCP/E1, KCP/E1R, KCP/E2, KCP/E2R, QCP/G1, QCP/G1R, QCP/G2, QCP/G2R, QCP/E1, QCP/E1R, QCP/E2, QCP/E2R, WCP/G1, WCP/G1R, WCP/G2, WCP/G2R, WCP/E1, WCP/E1R, WCP/E2, WCP/E2R, DCP/G400		

spare parts for

GEV No.	371150	Ref. No.	—
	solenoid coil ODE 230VAC 16VA coil type BDV seat ø 13.5mm 7500hm		
GEV No.	371176	Ref. No.	—
	solenoid coil 230VAC 14VA SIRAI coil type ZA34A seat ø 14mm		



GEV No.	370376	Ref. No.	0H6377 231015
description	solenoid valve double 230V		



GEV No.	370377	Ref. No.	0H6377 140327
description	solenoid valve inlet 2" outlet 2"		



drain valves

 <p>1</p>			
GEV No.	370735	Ref. No.	0I0950 0L2506
description	drain valve electric 24V 50/60Hz NC inlet 55mm outlet 1½"/38mm MDB-C-55M SO plastic		
For models:	WTC90ERB, WTC90ELB, WTC140ERA, WTC140ELA, WTC140ERB, WTC140ELB, WTC180ERA, WTC180ELA, WTC180ERB, WTC180ELB, WTC220ERA, WTC220ELA, WTC220ERB, WTC220ELB, WTC90ERBG, WTC90ELBG, WTC140ERAG, WTC140ELAG, WTC140ERBG, WTC140ELBG, WTC180ERAG, WTC180ELAG, WTC180ERBG, WTC180ELBG, WTC220ERAG, WTC220ELAG, WTC220ERBG, WTC220ELBG, WT44BL208, WT44BR208, WT44BL240, WT44BR240, WT44CL208, WT44CR208, WT44CL240, WT44CR240, WT66BL208, WT66BR208, WT66BL240, WT66BR240, WT66CL208, WT66CR208, WT66CL240, WT66CR240, WTM140ERA, WTM140ELA, WTM140ERB, WTM140ELB, WTM165ERA, WTM165ELA...(Other models you can see in the webshop)		

solenoid valves (gas)

BRAHMA

solenoid valves

 <p>1</p>			
GEV No.	101948 ¹	Ref. No.	059509 0HB227 OK3447 10036 9923199
description	solenoid valve 230VAC DN 15mm connection 1/2" L 72mm BRAHMA coil type 18811003 p max 0.5bar reg. no. 63AQ0626		
For models:	KPI/G18, KPI/G25, HPN/GI810, HPN/GI815, HPN/GI855, HPN/GI1255, HPN/GI806, HPN/GI805, QPI/G18, QPI/G25, ZPN/GI810, 2PIG15, ZPN/GI1255, ZPN/GI805, APN/GI810, APN/GI815, APN/GI816, APN/GD811, APN/GD816, APNS/GI816, OPN/GI815, APN/GI805		
spare parts for	101948		
	GEV No.	101968	Ref. No. 005548 18811003
	solenoid valve 230VAC 20VA seat ø 17mm coil type 13902001 BRAHMA		

¹aluminium housing

spare parts and accessories

solenoid coils

 <p>1</p>			
GEV No.	101968	Ref. No.	005548 18811003
description	solenoid valve 230VAC 20VA seat ø 17mm coil type 13902001 BRAHMA		
For models:	HPN/GI810, HPN/GI815, ZPN/GI810, 2PIG15, APN/GI810, APN/GI815		

KROMSCHRÖDER

 <p>1</p>			
GEV No.	101472 ¹	Ref. No.	0H6411 85229010 VG6K03T5G
description	solenoid valve 230VAC connection M12x1 L 52mm KROMSCHRÖDER p max 0.36bar p min 0bar reg. no. CE-0085AP0975		
For models:	7507-2, 7508-2, 7707-2		

¹aluminium housing

solenoid valves (refrigeration)

CASTEL

valve bodies

STANDARD series

suitable for refrigerants R22, R134a, R404A, R407C, R410A, R507





 <p>1</p>			
GEV No.	370151	Ref. No.	087965
description	solenoid valve body NC type 1028/2 S p max 45bar connection 1/4" soldering connection DN 2.2mm -35 up to +105°C L 125mm refrigeration straight CASTEL		
accessories for	370151		
	GEV No.	371084	Ref. No. —
	solenoid coil CASTEL 230VAC 8VA 50/60Hz connection cable 1000mm type CM2		
	GEV No.	371090	Ref. No. —
	power socket plug type DIN 43650A screw		
	GEV No.	371301	Ref. No. —
	solenoid coil CASTEL 110VAC 8VA 50/60Hz seat ø 11.5mm connection DIN 43650A type HF2		

Table continues overleaf





various
valve bodies



1

GEV No.	370429	Ref. No.	086372
description	solenoid valve body angled DN 2.5mm connection 6mm soldering connection refrigeration		
For models:	CIM65A, CIM65W		
accessories for	370429		

	GEV No.	371098	Ref. No.	086050 086051 086177 086534 0H9317 OKD791 30003387 30003527 62030 62030000 62030608 62030628 62030648 62041906
solenoid coil 220-230VAC 50/60Hz seat ø 14mm cable length 1000mm 14W				



1

GEV No.	370454	Ref. No.	086533
description	solenoid valve body DN 3mm connection 6mm soldering connection refrigeration angled 90°		
accessories for	370454		

	GEV No.	371033	Ref. No.	—
solenoid coil PARKER 230VAC 9VA coil type YB09 with cable seat ø 14mm				

Solenoid valve - accessories



1

GEV No.	370855	Ref. No.	058946
description	reducer 0.5 ED ø 12mm for solenoid valve brass		
For models:	FCV/E101/1, FCV/G10L2, FCV/E10L2, FCV/E101/1, FCS101E2, FCS101G2, FCVG10-ISG, ECV/E10IGP, RCV101G2, RCV101E2, ACV/G10C2, ACV/E10C2, NCV/G10L2, NCV/E10L2, FCVG10-ISG, BCFCV101/1, BCFCV102/1, BCFCV101/1, BCFCV102/1		



1

GEV No.	370856	Ref. No.	002752
description	reducer 1.25 ED ø 11mm for solenoid valve L 30mm brass		
For models:	FCV/G6L3TOWNGAS, FCV/G6L3, FCVE6L3J, FCV/G6L3JAP, FCVG6L3CJ, FCV/E61/1, FCV/E61/1, FCV/E61/1, FCV/E61/1, FCV/G6L3C, FCV/G61/1, FCV/G61/1, FCV/G61/1, FCV/G61/1, FCV/G6L3CT, FCVG6L3CJ, FCV/E6L3, FCV/G6L4, FCV/E6L4, FCS061E44J, FCS061G48J, FCS061GP, FCS061EP, FCS061G3DI, FCS061E3CI, FCS061G4, FCS061G4DT, FCS061G49J, FCS061E4, FCS061EXLN, FCS061EX, 5711-2-6, 5711-2-7, 5711-2-8, 5711-2-10, 5711-2-8CH, 5711-2-10CH, 5711-2-6L, 5711-2-7L, 5711-2-8L, 5711-2-10L, 5721-2-7, 5721-2-10, 5711-3-7, 5711-3-8, 5711-3-10, 5711-3-10F, 5711-3-10S, 5704-2-2, 5704-2-3...(Other models you can see in the webshop)		



1

GEV No.	370847	Ref. No.	002728
description	reducer 1.8 ED ø 11mm for solenoid valve brass		
For models:	FCV/G10L3, FCVG10L3T, FCV/E101/1, FCV/E10L3JAP, FCV/E10L6JAP, FCVG10L3J, FCV/G10L6JAP, FCV/G10L2, FCV/E101/1, FCV/E101/1, FCV/E10L2, FCV/E101/1, FCV/E101/2, FCV/E10L3, FCV/E101/1, FCV/G10L6, FCV/E10L6, FCV/E101/1, FCV/G101/1, FVC/E101/1, FCS101E2, FCS101E44J, FCS101EP4J, FCS101G2, FCS101E4, FCS101G4, FCS101EP, FCS101G4DT, FCS101GP9J, FCS101G49J, FCS101GP, FCS101GX9J, FCS101GX, CS7ME4/200-3, CS7ME4/230-3, CS7ME4/400-3N, CS7ME6/400-3N, CS7ME4/400-3N/EO, CS7ME4/400-3/50HZ/MA, CS7ME4/440-3/60HZ/MA, CS7MT4/400-3N, CS7GE4/200-3, CS7GE4/230-3, CS7GE4/400-3N, CS7GE6/400-3N, CS7GE4/400-3N/EO, CS7GE4/400-3/50HZ/MA, CS7GE4/440-3/60HZ/MA, CS7GT4/400-3N, CS7LCE4/200-3...(Other models you can see in the webshop)		

ball valves electric



1

GEV No.	401140	Ref. No.	005026 0K1518 60050497
description	ball valve inlet 1" IT outlet 1" IT with plug 230V L 152mm 50/60Hz closed off-current mode of operation electric connection cable 200mm size DN25		
For models:	FCVG202L3, FCV/G20L6, FCV/E20L6, FCVG202L6, FCVE202L6, FCV/G201/1, FVC/E201/1, FVC/E202/1, 5712-2-7, 5712-2-8, 5712-2-10, 5714-2-7, 5714-2-8, 5714-2-10, 5717-2-6, 5714-2-7, 5714-2-8, 5714-2-10, 5712-2-7L, 5712-2-8L, 5712-2-10L, 5714-2-7L, 5714-2-8L, 5714-2-10L, 5714-2-6L, 5714-2-7L, 5714-2-8L, 5714-2-10L, 5711-3-7, 5711-3-8, 5711-3-10, 5711-3-8CH, 5711-3-10CH, 5712-3-7, 5712-3-8, 5712-3-8E, 5712-3-10, 5712-3-8CH, 5712-3-10C, 5714-3-7, 5714-3-8, 5714-3-8E, 5714-3-10, 5717-3-6, 5717-3-7, 5717-3-8, 5717-3-8E, 5717-3-10, 5717-3-8M, 5717-3-8C...(Other models you can see in the webshop)		



1 electric components



1

GEV No.	400001	Ref. No.	201915
description	ball valve inlet 1/2" IT outlet 1/2" IT with manual unlocking 230V L 58mm 50Hz closed off-current mode of operation electric connection plug		



1

GEV No.	400293	Ref. No.	059004 0L0949
description	ball valve inlet 3/4" IT outlet 3/4" IT electric 24V 50/60Hz cable length 250mm		
For models:	FCVE10-P, FCVE10PUK, FCVG10-P, FCVG10PUK, FCVE20-P, FCVE20PUK, FCVG20-P, FCVG20PUK, WTM140ERA, WTM140ELA, WTM140ERB, WTM140ELB, WTM165ERA, WTM165ELA, WTM165ERB, WTM165ELB, WTM200ERA, WTM200ELA, WTM200ERB, WTM200ELB, WTM250ERA, WTM250ELA, WTM250ERB, WTM250ELB, WTM300ERA, WTM300ELA, WTM300ERB, WTM300ELB, WTM180ERA, WTM180ELA, WTM180ERB, WTM180ELB, WTM140SRA, WTM140SLA, WTM165SRA, WTM165SLA, WTM180SRA, WTM180SLA, WTM200SRA, WTM200SLA, WTM250SRA, WTM250SLA, WTM300SRA, WTM300SLA, RTM140ERA, RTM140ELA, RTM140ERB, RTM140ELB, RTM165ERA, RTM165ELA...(Other models you can see in the webshop)		



1

GEV No.	401139	Ref. No.	002713 0C0882 0F0171 0K1526 0K8453 0K9349 2255318 60050290 696804201 867016 8670160
description	ball valve inlet 3/4" IT outlet 3/4" IT with plug 230V L 65mm 50/60Hz closed off-current mode of operation electric connection cable 200mm		
For models:	FCZ061EAA, FCZ101EAA, FCZ102EAA, FCZ201EAA, FCZ202EAA, FCZ061EAH, FCZ101EAH, FCZ201EAH, FCZ061EAN, FCZ101EAN, FCZ201EAN, FCZ061ETA, FCZ101ETA, FCZ102ETA, FCZ201ETA, FCZ202ETA, FCZ061ETH, FCZ101ETH, FCZ201ETH, FCZ061ETN, FCZ101ETN, FCZ201ETN, FCZ061GAG, FCZ101GAG, FCZ102GAG, FCZ201GAG, FCZ202GAG, FCZ061GAD, FCZ101GAD, FCZ102GAD, FCZ201GAD, FCZ202GAD, FCZ101GTG, FCZ102GTG, FCZ201GTG, FCZ202GTG, FCZ101GTD, FCZ102GTD, FCZ201GTD, FCZ202GTD, FCZ061EBA, FCZ101EBA, FCZ102EBA, FCZ201EBA, FCZ202EBA, FCZ061EBH, FCZ101EBH, FCZ201EBH, FCZ061EBN, FCZ101EBN...(Other models you can see in the webshop)		

pressure switches

for warewashing

ø 58mm with male faston 6.3mm

with connection horizontal



1

GEV No.	541008	Ref. No.	046601 0L0609
description	pressure control pressure range 105/60mbar connection 6mm ø 58mm pressure connection horizontal warewashing		
For models:	LS720F, LSE720DK, LSE720PH, LS860F, LS860DK, LS860PH, LS1080F, LS1080UK, LS1080PH, LSE721F, LS861F, LS1080M, LS1080, LS1080D, LS1080UK, LS1080/63, LSE721, LS720, LSE720UK, LS721UK, LSE720D, LS860, LS860, LS860D, LS860UK, LS861UK, LS860/63, LS861, 652120Z, LS860, LS1080, LS720N, LS860, DMAST2CUK, LSE720Z, LS860, LS1080, LS860, LS1080		





			
1			
GEV No.	541009	Ref. No.	046653 066113
description	pressure control pressure range 160/80mbar connection 6mm ø 58mm pressure connection horizontal warewashing		
For models:	CT92DXE, CT92SX, CT92DXEUK, CT92SXEU, CT92DXV, CT92SXV, CT92DXVUK, CT92SXVUK, CT140EDX, CT140ESX, CT140EDXUK, CT140SXEU, CT140VDX, CT140VSX, CT141EDX, CT141ESX, CT141E-DUK, CT141ESUK, CT141VDX, CT141VSX, CT142DXE, CT142SX, CT142DXEUK, CT142SXEU, CT142DXV, CT142SXV, CT190DXE, CT190SX, CT190DXEUK, CT190SXEU, CT190DXV, CT190SXV, CT191DXE, CT191SX, CT191DXEUK, CT191SXEU, CT191DXV, CT191SXV, CT192DXE, CT192SX, CT192DXEUK, CT192SXEU, CT192DXV, CT192SXV, CT240DXE, CT240SX, CT240DXEUK, CT240SX, CT240DXV, CT240SXVUK...(Other models you can see in the webshop)		

			
1			
GEV No.	543030	Ref. No.	OKZ785
description	pressure control pressure range 40/15mbar connection 6mm ø 58mm pressure connection horizontal warewashing		
For models:	WTF2ERC, WTF2ELC, WTF2SRC, WTF2SLC, WTF2HERC, WTF2HELC, WTF2HSRC, WTF2HSLC, WTF3ERC, WTF3ELC, WTF3SRC, WTF3SLC, WTF3HERC, WTF3HELC, WTF3HSRC, WTF3HSLC, WTF2ERB, WTF2ELB, WTF2SRB, WTF2SLB, WTF2HERB, WTF2HELB, WTF2HSRB, WTF2HSLB, WTF3ERB, WTF3ELB, WTF3SRB, WTF3SLB, WTF3HERB, WTF3HELB, WTF3HSRB, WTF3HSLB, WTF4HERB, WTF4HELB, WTF4HSRB, WTF4HSLB, WTF2ERA, WTF2ELA, WTF2SRA, WTF2SLA, WTF2HERA, WTF2HELA, WTF2HSRA, WTF2HSLA, WTF3ERA, WTF3ELA, WTF3SRA, WTF3SLA, WTF3HERA, WTF3HELA...(Other models you can see in the webshop)		

			
1			
GEV No.	541834	Ref. No.	049775
description	pressure control pressure range 180/80mbar connection male faston 6.3mm ø 58mm pressure connection horizontal warewashing pressure connection ø 6mm		
For models:	LS32UK/RP, WT302UK/RP, LS33UK/RP, WT303UK/RP, LS65, LS62/UK, LS63/UK, LS64/UK, WT35, WT32/UK, WT33/UK, WT34/UK, LS8/UK1, LS8UK3, WT50/UK1, WT50/UK3		

			
1			
GEV No.	541314	Ref. No.	046503
description	pressure control pressure range 46/26mbar connection 6mm ø 58mm pressure connection horizontal warewashing pressure connection ø 6mm		
For models:	LB8G, LB8G/63, LB8GF, LB8GPH, LB8G, LB8GPHm, LB8G		

			
1			
GEV No.	541179	Ref. No.	048267 0L0599 548267
description	pressure control pressure range 240/130mbar connection 6mm ø 58mm pressure connection horizontal warewashing pressure connection ø 6mm		
For models:	LS10D, LS10, LS10UKRP, LC100, ECOTEMP12-, LS10/60, LS10/1, LS10/12KW, LS10F, LS10DEK, LS10/1UKRP, LS10SW, LS10/50J, LS10/60J, LS10/HD, SH55, LS12D, LS12, LS12UK/RP, LC120, LS12/60, LS12F, LS12DEK, LS12HD, LS12/UK3, ECOTEMP12SW, ECOTEMP12INS, LS12MEX, LS10N, HT1200elm, HT1000elm, HYDRA1200, HYDRA1000, LSCE10, LSCE12		

			
1			
GEV No.	541005	Ref. No.	046444
description	pressure control pressure range 50/10mbar connection 6mm ø 58mm pressure connection horizontal warewashing		

			
1			
GEV No.	541838	Ref. No.	075660
description	pressure control pressure range 310/180mbar connection male faston 6.3mm ø 58mm pressure connection horizontal dishwasher pressure connection ø 6mm		
For models:	LO/E480, PLO480/E, LO480EUK, LO480E/63, LO480VAPORESTD, PLO480V, LO480V/63-60HZ, LO/E250, PLO250E, LO/E250UK, LO250E/63, LOPE25, LOPE48, LO480Z-VAPORE		

			
1			
GEV No.	541003	Ref. No.	069434 0H1273 224003
description	pressure control pressure range 55/35mbar connection 6mm ø 58mm pressure connection horizontal warewashing pressure connection ø 6mm		
For models:	LTB11, LTB12, LTB22, LTB11UK, LTB12UK, LTB22UK, LTB11, LTB22, 910-00-021, 910-00-023, 910-00-031, 910-00-033, 911-00-022, 911-00-024, 911-00-032, 911-00-034, CRYSTAL 11, CRYSTAL 22		



1			
GEV No.	541006	Ref. No.	045494 046352 048453 048723 049485 065545 0T3889
description	pressure control pressure range 60/20mbar connection 6mm ø 58mm pressure connection horizontal warewashing suitable for ZANUSSI pressure connection ø 6mm		
For models:	LS360F, LS360DK, LS500F, LS501F, LS540F, LS540DK, LS541F, LS360D, LS360, LS360/63, LS540, LS500F, LS500UK, LS501, LS501UK, LS540D, LS540/63, LS541, LS510, LS520, LS520D, LS520F, LS520M, LS520K, LS4, LS7D, LS7, LS7UK/RP, LV70, LS7F, LS7DEK, LS7/1UK, LS7/9, LS7/60, WT40/9, WT40/F, LS7HD, WT40/J50, WT40/J60, WT40UKRP, PH4/WT40, PH4RBP/WT40, LS8D, LS8, LS8UK/RP, LC80, LS8F, LS8DEK, LS8/9, LS8/60...(Other models you can see in the webshop)		



1			
GEV No.	541178	Ref. No.	049620
description	pressure control pressure range 250/130 390mbar connection 6mm ø 58mm pressure connection horizontal warewashing suitable for ZANUSSI pressure connection ø 6mm		
For models:	LU7PDP, LU7ADP, LU7ADPWS, WTU40PDP, WTU40ADP, WTU-40ADPWS, WTU40ADPD, WT60/GJ60, WT60/GJ50, PH10/12-RP, LS10, LS14EA, LS10UKDP, ET12E, LS10/60HZ, LS10CW, LS10INS, HT1200INS, LS14EA, LS10N, LS10DP, LS10HD, LS14EA/AU, LS14EA/60, LS10UK/1, LS10UK/3, LS12INS, LS12, LS12DP, LS12/60HZ, LS12CW, HT1200DEK, LS14EAASIA, LS14EA/G, WT60DP, WT60, WT60CW, WT60UKDPCW, WT60INS, WT60INSCW, WT60NAUCW, WT60NAU, LS10EA, WT60/60HZ, WT60/60HZC, WT60N, WT609NINS, LS12HD, LS14EA/DD, WT65E...(Other models you can see in the webshop)		



1			
GEV No.	541017	Ref. No.	070324 20053 9020053
description	pressure control with mounting strap pressure range 40/20mbar connection 6mm ø 58mm pressure connection horizontal warewashing		
For models:	LB035C, LB035R, LB035Q, LB040R, LB040Q, LB040AUS, G350C, LBICEQ010, LBIOET010, LBIOET014, LBIOEQ010, G350, G350DP, LBIOEQ014, G400, G400DP		



1			
GEV No.	541175	Ref. No.	037302 049305 049881
description	pressure control pressure range 60/20-110mbar connection 6mm ø 58mm pressure connection horizontal warewashing suitable for ZANUSSI pressure connection ø 6mm		
For models:	LS32, LS32/4.5, LS32UK/RP, LS32F, LV32F, LV32/60, WT4, WT4B, WT4D, WT302, WT302/4.5, WT302UK/RP, WT302F, WT302/60, WT4DB, WT46, WT4DG, WT4WS1, WT4BWS, WT4DWS1, WT4BDWS, NUC3DD, WT4D60, WT4DDG, EUC1, EUC1DP, EUC1WS, EUC1DPWS, EUC3, EUC3WS, EUC3DP, EUC3DPWS, EUC1G, EUC1DP60, EUC3DD, ZUCADDROW, ZUCADDROW6, LS5/1, LS5/1DP, LS5/1WS, LS5/1WSDP, LS5/3, LS5/3DP, LS5/3WS, LS5/3WSDP, FUCA3DD, LS5/3WSDPD, LB5DPG, LS5/1DP60, LS5/1DPAUS...(Other models you can see in the webshop)		

ø 58mm with coded plug



1			
GEV No.	541171	Ref. No.	049058
description	pressure control pressure range 110/55mbar connection 6mm ø 58mm pressure connection horizontal warewashing suitable for ZANUSSI pressure connection ø 6mm		
For models:	LB1, LB1WS, LB1/RBP, LB1/60, WT1WSDP, LB1G, LB1WSG, LB2WS, LB2, LB2/RBP, LB2WS60, LB2WSG, WT2WS, WT1, WT1WS, WT2, NGW, NGWDPDD, UC1, UC2WS, GW1, GW1WS, LV1WS, LV1WSDP, LV2WSDP, LV2WS, GW2G, GW2WSG, GW2WS, GW2		

ø 84mm with coded plug



1			
GEV No.	541177	Ref. No.	049081
description	pressure control 2 pressure ranges pressure range 110/55 165/135mbar connection 6mm ø 84mm pressure connection horizontal warewashing suitable for ZANUSSI pressure connection ø 6mm		
For models:	LB1WSDP, LB1/TOP, WT1WSDP, LB2DPSAUS, WT2TOP60, WT2DPDI, WT2WSDPDI, LB1TOP, WT2TOPDI, LB2WSDP, LB2/TOP, WT2WSDP, WT2WSDPD, WT2WS, WT1TOP, WT2TOP, WT1/3DP, WT2/3DP, WT2DPAUS, LB2DPDI, LB2WSDPDI, LB2WSDPD, LB2TOP, LB2DP3, WT2DPD3, NGWDPDD, LV1WSDP, LV2WSDP, GW2DPG, GW2WSDPG		



1

GEV No.	541523	Ref. No.	0E3731 0E5565 OKU529 428130000
description	pressure control 2 pressure ranges pressure range 40/15 55/35mbar connection 6mm ø 84mm pressure connection horizontal pressure connection ø 6mm		
For models:	TW1ERECO, TW1ELECO, TW1SRECO, TW1SLECO, RT100ED, RT100ES, RT100SR, RT100SL, RT140ED, RT140ES, RT140SR, RT140SL, RT190ED, RT190ES, RT190SR, RT190SL, RT190HDED, RT190HDES, RT190HSR, RT190HSL, RT270ED, RT270ES, RT270SR, RT270SL, RT270HDED, RT270HDES, RT270HSR, RT270HSL, RT100ERF, RT100ELF, RT100VD, RT100VS, RT140ERF, RT140ELF, RT140VD, RT140VS, RT142ERF, RT142ELF, RT190ERF, RT190ELF, RT190VD, RT190VS, RT190HERF, RT190HEL, RT190HDVDF, RT190HDVSF, RT270ERF, RT270ELF, RT270VDF, RT270VSF...(Other models you can see in the webshop)		



1

GEV No.	541173	Ref. No.	048826 792499
description	pressure control pressure range 2 pointsmbar connection coded plug ø 84mm pressure connection horizontal warewashing pressure connection ø 6mm		
For models:	LS61, LS61/60, LS62, LS62D, LS62/UKRP, LS62F, LV62, LS62/60, ECOTEMP5, LS62/1P, LS62HD, LS65, LS62/UK, LS63, LS63D, LS63/UKRP, LS63F, LV63, LS63/60, LS63/1P, LS63/UK, LS64, LS64/UKRP, LV64, ECOTEMP5S, LS64/1P, LS64/UK, ECOTEMP5SW, WT32, WT32/4,5, WT32/UK, WT32/UKRP, WT32/F6, WT32/J60, WT32/J50, WT32/4,5N, WT35, WT32/UK, WT33, WT33/4,5, WT33/UK, WT33/UKRP, WT33/F, D500, WT33/M50, WT33/M60, WT33/60, WT33/4,5N, WT33/UK, WT30U400...(Other models you can see in the webshop)		



1

GEV No.	541176	Ref. No.	049361 0L0508 792117
description	pressure control 2 pressure ranges pressure range 60/20 110/80mbar connection 6mm ø 84mm pressure connection horizontal warewashing suitable for ZANUSSI		
For models:	LS32, LS32/4.5, LS32UK/RP, LS32F, LV32F, C55, LV32/60, WT302, WT302/4.5, WT302UK/RP, WT302F, WT302/60, LS33, LS33/4.5, LS33UK/RP, LS33F, LV33F, C55A, LS33/60, WT303, WT303/4.5, WT303UK/RP, WT303F, WT303/60, FL32, FL32/4.5, FL33, FL33/4.5, C32, C32/4.5, C33, C33/4.5, Z32, Z32/4.5, Z33, Z33/4.5		



1

GEV No.	541174	Ref. No.	049142
description	pressure control pressure range 2 pointsmbar connection coded plug ø 84mm pressure connection horizontal warewashing pressure connection ø 6mm		
For models:	LC100, LS10DP, LO10, LS10/UK1, LS10/UK3, LS12DP, LS12/UK3		

accessories



1

GEV No.	541109	Ref. No.	069195
description	Y-piece plastic hose ø 8-6-8mm for pressure switch		
For models:	LB8G, LB8G/63, LB8GF, LB8GPH, LB8G, LB8GPHm, LB8G		





1

GEV No.	541957	Ref. No.	0E0014 0E2501 OK8526 OK8562 30200020 SIGRP07NR2
description	pressure control conversion kit pressure range 40/15mbar ø 84mm pressure connection ø 6mm		
For models:	FT36EDTS, FT36ESTS, FT36VDTS, FT36VSTS, FT36ED, FT36ES, FT36VD, FT36VS, FT50ED, FT50ES, FT50VD, FT50VS, FT72ED, FT72ES, FT72VD, FT72VS, FT36EDT, FT36EST, FT36VDT, FT36VST, FT50EDT, FT50EST, FT50VDT, FT50VST, FT72EDT, FT72EST, FT72VDT, FT72VST, FT36WED, FT36WES, FT36WVD, FT36WVS, FT50WED, FT50WES, FT50WVD, FT50WVS, FT72WED, FT72WES, FT72WVD, FT72WVS, FT36WEDT, FT36WEST, FT36WVDT, FT36WVST, FT50WEDT, FT50WEST, FT50WVDT, FT50WVST, FT72WEDT, FT72WEST...(Other models you can see in the webshop)		





for steam control

			
1			
GEV No.	541516	Ref. No.	002318 003940 054784
description	pressure control ø 34mm pressure connection vertical steam control pressure range 0.2-6.0bar connection 1/4" 1CO pressure connection 1/4"		
For models:	CR20EI, CR20EI, HCPA/GI1219, HCPA/EI1219		

			
1			
GEV No.	541799	Ref. No.	0C1126
description	pressure control ø 34mm pressure range 0.2-6.0bar connection 15mm CEME difference 0.1-0.8bar pressure connection 15mm		
For models:	FCZ061EAA, FCZ101EAA, FCZ102EAA, FCZ201EAA, FCZ202EAA, FCZ061EAH, FCZ101EAH, FCZ201EAH, FCZ061EAN, FCZ101EAN, FCZ201EAN, FCZ061GAG, FCZ101GAG, FCZ102GAG, FCZ201GAG, FCZ202GAG, FCZ061GAD, FCZ101GAD, FCZ102GAD, FCZ201GAD, FCZ202GAD, FCZ061EBC, FCZ101EBC, FCZ201EBC, FCZ061GBI, FCZ101GBI, FCZ201GBI, FCZ061ECA, FCZ101ECA, FCZ102ECA, FCZ201ECA, FCZ202ECA, FCZ061ECH, FCZ101ECH, FCZ201ECH, FCZ061ECN, FCZ101ECN, FCZ201ECN, FCZ061GCG, FCZ101GCG, FCZ102GCG, FCZ201GCG, FCZ202GCG, FCZ061GCD, FCZ101GCD, FCZ102GCD, FCZ201GCD, FCZ202GCD, FCS061EXLN, FCS061EX... (Other models you can see in the webshop)		

			
1			
GEV No.	541043	Ref. No.	0H6696 0KE654
description	pressure control ø 45mm pressure connection vertical steam control pressure range 0.44/0.38bar connection 1/4" pressure connection 1/4"		

			
1			
GEV No.	541035	Ref. No.	0H6699 158020002
description	pressure control ø 45mm pressure range 0.9mbar pressure connection vertical steam control pressure range 0.75bar connection 1/4" difference 0.16bar pressure connection 1/4"		
For models:	7561-3.KES60.RW, 7562-3.KES80.RW, 7563-3.KES100.RW, 7564-3.KES150.RW, 7751-3/85.KES60, 7550-3/85.KES40.(N), 7551-3/85.KES60, 7552-3/85.KES80.(N), 7553-3/85.KES100.(N), 7554-3/85.KES150.(N), 7550-3/90.KES40.(N), 7551-3/90.KES60, 7552-3/90.KES80.(N), 7553-3/90.KES100.(N), 7554-3/90.KES150.(N), 7561-3/85.KES60.RW., 7562-3/85.KES80.RW., 7563-3/85.KES100.RW., 7564-3/85.KES150.RW., 7561-3/90.KES60.RW., 7562-3/90.KES80.RW., 7563-3/90.KES100.RW., 7564-3/90.KES150.RW., 7573-3/85.KES100.(N), 7574-3/85.KES150.(N), 7575-3/85.KES250.(N), 7576-3/85.KES300.(N), 7573-3/90.KES100.(N), 7574-3/90.KES150.(N), 7575-3/90.KES250.(N), 7576-3/90.KES300.(N), 7585-3/85.KK40.MOTK., 7586-3/85.KK60.MOTK., 7587-3/85.KK80.MOTK., 7588-3/85.KK100.MOTK, 7585-3/90.KK40.MOTK., 7586-3/90.KK60.MOTL., 7587-3/90.KK80.MOTK., 7588-3/90.KK100.MOTK, 7550-3, 7551-2, 7551-3, 7552-2, 7552-3, 7553-2, 7553-3, 7554-3, 7560-3, 7561-3...(Other models you can see in the webshop)		

			
1			
GEV No.	541903	Ref. No.	0C4083
description	pressure control ø 45mm triggering pressure 0.5bar reset pressure 0.3bar pressure connection vertical steam control pressure range 0.3/0.5bar connection 1/4" pressure connection 1/4"		
For models:	PPI/G260P, PPI/E260P, OPI/E260P, TPI/G260P, TPI/E260P, KPI/E10, KPI/E15, KPI/E15A, KPI/E06, QPI/E10, QPI/E15, QPI/G06, QPI/E15H, QPI/E10H, WPI/E10, WPI/E15, WPI/E15A, WPI/G06, WPI/E06, WPI/G15H, WPI/E15H, WPI/G10H, WPI/E10H		

			
1			
GEV No.	541377	Ref. No.	0C3159 185070 DEB185070
description	pressure control pressure connection vertical steam control pressure range adjustable 0.1-0.6bar pressure connection 1/4" IT		

			
1			
GEV No.	541026	Ref. No.	0175191 0175192 0H6402 0KC032 0KC033
description	pressure control pressure connection vertical steam control pressure range adjustable 0.1-1.1bar pressure connection ø 3/8" ETmm		

			
2			
GEV No.	541350	Ref. No.	0A2480 0C3190 HB46A214 I16994
description	pressure control pressure range adjustable 0.3-0.8bar connection 1/4" CO 250V 10A ambient temperature max. 60°C pressure connection 1/4"		
For models:	RPI/G260P, RPI/E260P, XPI/G260P, XPI/E260P, MPI/G260P, MPI/E260P, OPI/G260P, KPI/G10, KPI/G15, KPI/G15A, KPI/G06, KPI/G18, KPI/G25, KPI/E25, KPI/G15H, KPI/E15H, KPI/G10H, KPI/E10H, HPN/GI810, HPN/GI815, HPN/EI810, HPN/EI815, HPA/EI825, HPNS/EI815, HPN/GI806, HPN/GI805, HPN/EI805, QPI/G10, QPI/G15, QPI/E06, QPI/G18, QPI/G25, QPI/E25, QPI/G15H, QPI/G10H, ZPN/GI810, 2PIG15, ZPN/EI810, ZPN/EI815, ZPNS/EI815, ZPN/GI805, ZPN/EI805, WPI/G10, WPI/G15, WPI/G15A, WPI/E25, APN/GI810, APN/GI815, APN/GI816, APN/EI815D...(Other models you can see in the webshop)		

			
1			
GEV No.	541022	Ref. No.	OK1396 MCS4
description	pressure control steam control pressure connection vertical pressure range adjustable 0.25-4.5bar connection 1/4" pressure connection 1/4" IT		

for combi-steamers

			
1			
GEV No.	541335	Ref. No.	054540
description	pressure control		
For models:	ABR/G800D, ABR/G805D, ABR/G801D, ABR/G806D, ABR/G810D, ABR/G815D, ABR/G811D, ABR/G816D, FCFG20, FCFG20D, FCFG20F, PFCFG20, FCFG40, FCFG41, FCFG40D, FCFG40F, PFCFG40F, FV4G, FCFG20J, FCFG20J, FCFG40J, FCFG40J, FCFG20J, FCFG41J, FCFG40J, FCVMG62, FCFG201, FCFG202, FCFC202, FV4G, FF/G20, FF/G40, COCO20G, 4236N, ZOFCE/G20D		

			
1			
GEV No.	541349	Ref. No.	003533 055052 058407 0K3469 10094 6460110800
description	pressure control		
For models:	HPN/GI810, HPN/GI815, HPN/EI815D, HPN/EI810, HPN/EI815, HPA/EI825, HPN/GI855, HPN/GI1255, HPN/EI855, HPN/EI1255, HPNS/EI815, HPNS/EI815D, ZPN/GI810, 2PIG15, ZPN/EI815D, ZPN/EI810, ZPN/EI815, ZPN/GI1255, ZPN/EI1255, ZPNS/EI815, ZPNS/EI815D, APN/GI810, APN/GI815, APN/GI816, APN/EI815D, APN/EI810, APN/EI815, APN/GD811, APN/GD816, APN/ED816, APNS/GI816, APNS/EI815, OPN/GI815, FV4N, FVGC4, FV4G, FV4E, FV4N, FV4G, FV4E, FVAC041		

			
1			
GEV No.	542127	Ref. No.	0C6217
description	pressure control pressure range 200-3000mbar pressure range 0.2 - 3bar connection 8mm MA-TER 250V 12A pressure connection 8mm		
For models:	FCZ061EAA, FCZ101EAA, FCZ102EAA, FCZ061EAH, FCZ101EAH, FCZ061EAN, FCZ101EAN, FCZ061ETA, FCZ101ETA, FCZ102ETA, FCZ201ETA, FCZ202ETA, FCZ061ETH, FCZ101ETH, FCZ201ETH, FCZ061ETN, FCZ101ETN, FCZ201ETN, FCZ061GAG, FCZ061GAD, FCZ101GTG, FCZ102GTG, FCZ201GTG, FCZ202GTG, FCZ101GTD, FCZ102GTD, FCZ201GTD, FCZ202GTD, FCZ061EBA, FCZ101EBA, FCZ102EBA, FCZ061EBH, FCZ101EBH, FCZ061EBN, FCZ101EBN, FCZ061EBC, FCZ101EBC, FCZ061EBA2, FCZ101EBA2, FCZ102EBA2, FCZ201EBA2, FCZ202EBA2, FCZ061EBH2, FCZ101EBH2, FCZ201EBH2, FCZ061EBN2, FCZ101EBN2, FCZ201EBN2, FCZ061EBC2, FCZ101EBC2...(Other models you can see in the webshop)		



for pasta cookers

			
1			
GEV No.	541471	Ref. No.	0C0872 11031662
description	pressure control ø 55mm pressure range 320/200mbar connection 6mm		
For models:	ECP/E1ELHU, PCP/E2SHP, PCP/E2SH, PCP/E2SH3B, PCP/E1ELH, OCP/E2S, OCP/E1SH, OCP/E2SH, TCP/E1ELHU, TCP/E2S, TCP/E2SH, TCP/E1ELH, KCP/G1RU, KCP/G2RU, KCP/E1RU, KCP/E2RU, KCP/G1, KCP/G1R, KCP/G2, KCP/G2R, KCP/E1, KCP/E1R, KCP/E2, KCP/E2R, KCP/G1U, KCP/G2U, KCP/E1U, KCP/E2U, QCP/G1, QCP/G1R, QCP/G2, QCP/G2R, QCP/E1, QCP/E1R, QCP/E2, QCP/E2R, WCP/G1, WCP/G1R, WCP/G2, WCP/G2R, WCP/E1, WCP/E1R, WCP/E2, WCP/E2R, DCP/G400		

for boiling pans

			
1			
GEV No.	541459	Ref. No.	0G2935 0H9972 0K5405 11151577 128270 19003783 242PC15M 4594025
description	pressure control with cable		
For models:	VARIOSTEAM/S-33.3/F, STEAM-O-MAT		

for refrigeration



<p>RANCO</p> <p>DWFK series</p> 			
1			
GEV No.	541451	Ref. No.	085088
description	pressure control RANCO high pressure		
For models:	BC100A, BC100DA, BC180A, BC180DA, BCF100A, BCF100DA, BCF180A, BCF180DA, , , BCW061, BCW101, BCW102, BCFW061, BCFW101, BCF11, BCF22, BCF44, BCF44H, BC120A, BCF120A, ADN220ES, ADF220ES, BCWS061T, BCFW102, BLAST C/FREEZER, BLAST C/FREEZER, BLAST C/FREEZER, BCF11, BCF22, BCF44H, BCF44, BCFWS102, BCFWS101, BC56VA, Crosswise 20, BCF28A, Crosswise, BCF64A, Crosswise 20, BCF56HA, BCFWS061, BCFWS061T, BLAST C/FREEZER, ESBF10, ESBF20, ESBF40, MRF4808660, MRF6018660, RBC102...(Other models you can see in the webshop)		

SAGI NO MIYA

			
1			
GEV No.	541480	Ref. No.	087803
description	pressure control HD reset manual p max 33bar refrigeration type FTB-3UC37 connection male faston 6.3mm switch-off pressure 30bar -20 to +70°C		
For models:	MF250WB20, MC140AB20, MC140WB20, MC200AB20, MC200WB20, FGS500A, FGS500W, CIM235AB, CIM235WB, FIM285ASB, FIM285WSB, VM500W+BI, VM500A+BI, VM250A+BI, VM250W+BI, VM350A+BI, VM350W+BI, C150W, C300A, C300W, CB1565W, CB246W, CB416W, CB955W, DSS42W, C80W, CB1565A, C80A, CB246A, CB416A, C150A, CB955A, DSS42A, G500A, MUSTER350A, MUSTER800A, GB1555W, GB1555A, G500W, VB250A, VB250W, VM900A, VM900W		

			
1			
GEV No.	541479	Ref. No.	OKK218
description	pressure control HD reset automatic refrigeration type HTB-X114 connection 2.4mm		
For models:	IMF28A, IMF28W, IMF35A, IMF35W, IMF58A, IMF58W, IMF80A, IMF80W, FGC33AS42, FGC46AS42, FGC65A42, MF250WB20, MC140AB20, MC140WB20, MC200AB20, MC200WB20, FGS500A, FGS500W, FGC24AB, FGC24WB, FGC29AB, FGC29WB, FGC40A, FGC40W, FGC67AB, FGC67WB, FGC90A, FGC90W, FGC143AB, FGC143WB, FGS94AB, FGS94WB, FGS140A, FGC25A, CB246W, CIM38AB, CIM38WB, CIM85AB, CIM15WB, CIM235AB, CIM235WB, FIM150ASB, FIM150WSB, FIM285ASB, FIM285WSB, CIM50AB, FIM50WB, FGC24ABS, FGC24WBAB, FGC29AB...(Other models you can see in the webshop)		

JOHNSON CONTROLS

			
1			
GEV No.	541116	Ref. No.	086039
description	pressure control HD switch pressure 10bar reset automatic switching diff. 1.1bar pressure range 7-29bar p max 38bar refrigeration type P20EA-9950C connection soldering connection 6.35mm CO JOHNSON CONTROLS pressure connection soldering connection 6.35mm		
			
1			
GEV No.	541117	Ref. No.	086183
description	pressure control HD switch pressure 24bar reset manual switching diff. 4.7bar pressure range 7-29bar p max 38bar refrigeration type P20GA-9950T connection male faston 6.3mm CO JOHNSON CONTROLS pressure connection soldering connection 6.35mm		



accessories

			
1			
GEV No.	541837	Ref. No.	049413
description	bracket for pressure switches		
For models:	LS32, LS32/4.5, LS32UK/RP, LS32F, LV32F, C55, LV32/60, WT302, WT302/4.5, WT302UK/RP, WT302F, WT302/60, LS33, LS33/4.5, LS33UK/RP, LS33F, LV33F, C55A, LS33/60, WT303, WT303/4.5, WT303UK/RP, WT303F, WT303/60, FL32, FL32/4.5, FL33, FL33/4.5, C32, C32/4.5, C33, C33/4.5, Z32, Z32/4.5, Z33, Z33/4.5		

			
1			
GEV No.	400121	Ref. No.	055346 0H2444 0K2067 0K8045 908161
description	level electrode 1/4" total length 121mm probe L 94mm insulated probe length 90mm PTFE insulated connection angled, male faston 6.3mm stainless steel		
For models:	FCV/G6L4, FCVE6-1U, FCVE6-3U, FCVE6-1, FCVE6-3, FCVE6-1UK, FCVE6-3UK, FCVG6-1, FCVG6-3, FCVG6-1UK, FCVG6-3UK, FCVE10-2, FCVE10-4, FCVE10-2UK, FCVE10-4UK, FCVG10-2, FCVG10-4, FCVG10-2UK, FCVG10-4UK, FCVE20-2, FCVE20-4, FCVE20-2UK, FCVE20-4UK, FCVG20-2, FCVG20-4, FCVG20-2UK, FCVG20-4UK, 5711-2-6, 5711-2-7, 5711-2-8, 5711-2-10, 5711-2-8CH, 5711-2-10CH, 5711-2-6L, 5711-2-7L, 5711-2-8L, 5711-2-10L, ECV/G6T4, FCV/E6-1, FCV/E6-1, FCV/G6-1, ZOFCV/G6-3, ZOFCV/E102, ZOFCV/E104, ZOFCV/G102, ZOFCV/G104, ZOFCV/E202, ZOFCV/E204, ZOFCV/G202, ZOFCV/G204...(Other models you can see in the webshop)		

electrodes

			
1			
GEV No.	400698	Ref. No.	0H6629
description	level electrode 1/2" probe L 123mm insulated probe length 107mm		
For models:	9190-3, 9191-3, 9193-3, 9195-3, 9390-3, 9391-3, 9393-3, 9395-3		

			
1			
GEV No.	401355	Ref. No.	0C1086
description	level electrode 1/4" total length 130mm probe L 102mm insulated probe length 98mm PTFE insulated connection angled, male faston 6.3mm stainless steel		
For models:	AOS061GAEU, AOS061GAAU, AOS061GA, AOS061GB		

			
1			
GEV No.	401264	Ref. No.	007033 0C4098
description	level electrode 1/4" total length 103mm probe L 76mm insulated probe length 71mm PTFE insulated connection angled, male faston 6.3mm stainless steel ø 2.5mm		
For models:	FCZ061EAA, FCZ101EAA, FCZ061EAH, FCZ101EAH, FCZ061EAN, FCZ101EAN, FCZ061ETA, FCZ101ETA, FCZ061ETH, FCZ101ETH, FCZ061ETN, FCZ101ETN, FCZ061GAG, FCZ101GAG, FCZ102GAG, FCZ201GAG, FCZ202GAG, FCZ061GAD, FCZ101GAD, FCZ102GAD, FCZ201GAD, FCZ202GAD, FCZ101GTG, FCZ102GTG, FCZ201GTG, FCZ202GTG, FCZ101GTD, FCZ102GTD, FCZ201GTD, FCZ202GTD, FCZ061EBA, FCZ101EBA, FCZ061EBH, FCZ101EBH, FCZ061EBN, FCZ101EBN, FCZ061EBC, FCZ101EBC, FCZ061EBA2, FCZ101EBA2, FCZ061EBH2, FCZ101EBH2, FCZ061EBN2, FCZ101EBN2, FCZ061EBC2, FCZ101EBC2, FCZ061GBG, FCZ101GBG, FCZ102GBG, FCZ201GBG...(Other models you can see in the webshop)		

			
1			
GEV No.	401261	Ref. No.	003878 0H6627 0K2066
description	level electrode 1/4" total length 138mm probe L 112mm insulated probe length 108mm PTFE insulated connection angled, male faston 6.3mm stainless steel ø 2.5mm		
For models:	FCV/E61/1, FCV/E101/1, FCV/E101/1, FCV/E102/1, FCV/E61/1, FCV/E101/1, FCV/E101/2, FCV/E10L3, FCV/E102/1, FCV/E102/1L3, FCV/E6L4, FCV/E10L6, FCV/E102/1L6, FCV/E101/1, FCV/E101/1, FCV/E102/1, FCS061EP, FCS101E44J, FCS101EP4J, FCS101E4, FCS101EP, FCS102E44J, FCS102EP4J, FCS102E4, FCS102EP, FCS061E4, FCS061EXLN, FCS061EX, FCS101EX4J, FCS101EXLN, FCS101EX, FCS102EX4J, FCS102EX, FCS201EX, FCS201EXLN, FCS202EX, 5711-3-6, 5711-3-7, 5711-3-8, 5711-3-10, 5711-3-8CH, 5711-3-10CH, 5712-3-6, 5712-3-7, 5712-3-8, 5712-3-8E, 5712-3-10, 5712-3-8CH, 5712-3-10C, 5714-3-6...(Other models you can see in the webshop)		

			
1			
GEV No.	401258	Ref. No.	0A2838 0K3039 60050240
description	level electrode 1/4" total length 120mm probe L 94mm insulated probe length 90mm PTFE insulated connection angled, male faston 6.3mm stainless steel ø 2.5mm		
For models:	FCVE10-2, FCVE10-4, FCVE103CE, FCVE10-2UK, FCVE10-4UK, FCVG10-2, FCVG10-4, FCVG10-2, FCVG10-4D, FCVG10-2UK, FCVG10-4UK, FCVG10-2, FCVG10-4, FCVE20-2, FCVE20-4, FCVE203CE, FCVE20-2UK, FCVE20-4UK, FCVG20-2, FCVG20-4, FCVG20-2, FCVG20-4D, FCVG20-2UK, FCVG20-4UK, FCVG20-4, FCVG20-4D, FCVE10-P, FCVE10PUK, FCVG10-P, FCVG10PUK, FCVE20-P, FCVE20PUK, FCVG20-P, FCVG-20PUK, ZOFCV/E102, ZOFCV/E104, ZOFCV/G102, ZOFCV/G104, ZOFCV/E202, ZOFCV/E204, ZOFCV/G202, ZOFCV/G204, AFCV/G101, AFCV/G103, SCO/G10-3, AFCV/G201, AFCV/G203, SCO/G20-3		



			
1			
GEV No.	401345	Ref. No.	OC1201
description	level electrode 1/4" total length 142mm probe L 116mm insulated probe length 112mm PTFE insulated connection angled, male faston 6.3mm stainless steel ø 2.5mm		
For models:	FCZ102EAA, FCZ201EAA, FCZ201EAH, FCZ201EAN, FCZ102ETA, FCZ201ETA, FCZ201ETH, FCZ201ETN, FCZ102EBA, FCZ201EBA, FCZ201EBH, FCZ201EBN, FCZ201EBC, FCZ102EBA2, FCZ201EBA2, FCZ201EBH2, FCZ201EBN2, FCZ201EBC2, FCZ102ECA, FCZ102ECA2, FCZ201ECA2, FCZ201ECH2, FCZ201ECN2, AOS102GAEU, AOS102GAAU, AOS201EABU, AOS201EAFU, AOS201EA, AOS201EB, AOS201EA3J, AOS201EB3J, AOS201EA2N, AOS201EB2N, AOS201E-B5M, AOS201EB6M, AOS102EA2N, AOS102EB2N, AOS201EA0H, AOS201EB0H, AOS102EA, AOS102EB, AOS102GB, AOS102GA, AOS102EAAQ, AOS102EBAQ, AOS201EAAQ, AOS201EBAQ, AOS102EANQ, AOS102EBNQ, AOS201EANQ...(Other models you can see in the webshop)		

			
1			
GEV No.	401263	Ref. No.	OC1105
description	level electrode 1/4" total length 220mm probe L 195mm insulated probe length 189mm PTFE insulated connection angled, male faston 6.3mm stainless steel ø 2.5mm		
For models:	AOS201GAEU, AOS202GAEU, AOS201GAAU, AOS202GAAU, AOS201GA, AOS201GB, AOS202GB, AOS202GA		

			
1			
GEV No.	401259	Ref. No.	053909 OC0438
description	level electrode 1/4" total length 155mm probe L 128mm insulated probe length 124mm PTFE insulated connection angled, male faston 6.3mm stainless steel ø 2.5mm		
For models:	FVG4, FV4G, FV4E, FCVE6-1U, FCVE6-3U, FCVE6-1, FCVE6-3, FCVE6-3CE, FCVE6-1UK, FCVE6-3UK, FCGV10-2, FCGV10-4, FCGV10-2, FCGV10-4D, FCGV10-2UK, FCGV10-4UK, FCGV10-2, FCGV10-4, FCVE20/P-V, FCGV20-2, FCGV20-4, FCGV20-2, FCGV20-4D, FCGV20-2UK, FCGV20-4UK, FCGV20-4, FCGV20-4D, FCVE20-V, FCVE20VUK, FCVM62E, FCVM62EUK, FCGV10-P, FCGV10PUK, FCGV20-P, FCGV20PUK, FCV/E6-1, FCV/E6-1, ZOFV/G102, ZOFV/G104, ZOFV/G202, ZOFV/G204, FV4G, FV4E, FVAC041, AFCV/G101, AFCV/G103, SCO/G10-3, AFCV/G201, AFCV/G203, SCO/G20-3...(Other models you can see in the webshop)		

			
1			
GEV No.	400404	Ref. No.	0H6635 60050422 908172
description	level electrode 1/4" total length 240mm probe L 216mm insulated probe length 209mm PTFE insulated connection angled, male faston 6.3mm stainless steel ø 2.5mm		
For models:	5612-3-6, 5612-3-8		

			
1			
GEV No.	401262	Ref. No.	OC1055
description	level electrode 1/4" total length 159mm probe L 130mm insulated probe length 126mm PTFE insulated connection angled, male faston 6.3mm stainless steel ø 2.5mm		
For models:	AOS101GAEU, AOS202GAEU, AOS101GAAU, AOS202GAAU, AOS101GA, AOS101GB, AOS202GB, AOS202GA		

			
1			
GEV No.	401265	Ref. No.	005879 OC0439
description	level electrode 1/4" total length 240mm probe L 216mm insulated probe length 210mm PTFE insulated connection angled, male faston 6.3mm stainless steel ø 2.5mm		
For models:	FCZ202EAA, FCZ202EBA, FCV/E20L3, FCVE202L3, FCV/E20L6, FCVE202L6, FVC/E201/1, FVC/E202/1, FCS201E4, FCS201EP, FCS202E4, FCS202EP, FCS201EX, FCS202EX, 5714-3-7, 5714-3-8, 5714-3-8E, 5714-3-10, 5717-3-7, 5717-3-8, 5717-3-8E, 5717-3-10, 5717-3-8M, 5717-3-8M, AOS202EA2N, AOS202EB2N, AOS202EA, AOS202EB, AOS202EAAQ, AOS202EBAQ, AOS202EANQ, AOS202EB-NQ, ECV/E20T4, ECV/E20T4, ECV/E20T6, ECV/E20T6, AOS202EAA1, AOS202EAM1, AOS202EAB1, AOS202EAK1, AOS202EAT1, AOS202E-BA1, AOS202EBK1, EJV202EAA, EJV202EBA, ACV/E20C4, ACVE202C4, ACVE202C6, ACV/E202/1, ZCV/E20T4...(Other models you can see in the webshop)		

			
1			
GEV No.	400402	Ref. No.	0H6624
description	level electrode 1/4" total length 193mm probe L 166mm insulated probe length 161mm PTFE insulated connection angled, male faston 6.3mm stainless steel ø 2.5mm		

			
1			
GEV No.	400405	Ref. No.	0H6626 246024 60050421 908179
description	level electrode 1/4" total length 345mm probe L 320mm insulated probe length 310mm PTFE insulated connection F6.3 stainless steel ø 2.5mm		
For models:	5614-3-6, 5614-3-8		

			
1			
GEV No.	400403	Ref. No.	0H6625 908178
description	level electrode 1/4" total length 210mm probe L 183mm insulated probe length 172mm PTFE insulated connection angled, male faston 6.3mm stainless steel ø 2.5mm		
For models:	5611-3-10, 5611-3-6, 5611-3-8, 5612-3-10, 5612-3-6, 5612-3-8		

			
1			
GEV No.	401255	Ref. No.	005765
description	level electrode 1/4" total length 64mm probe L 37mm insulated probe length 33mm PTFE insulated connection angled, male faston 6.3mm ø 2.5mm marking L		
For models:	FCV/G61/1, FCV/G61/1, FCV/G61/1, FCS061GP, FCS061G4, 5721-2-7, 5721-2-10, ECV/G61/1, ECV/G61/1, ZCV/G61/1		



GEV No.	401254	Ref. No.	005766
description	level electrode 1/4" total length 74mm probe L 47mm insulated probe length 41mm PTFE insulated connection angled, male faston 6.3mm stainless steel ø 2.5mm marking S		
For models:	FCV/G61/1, FCV/G61/1, FCV/G61/1, FCS061GP, FCS061G4, 5721-2-7, 5721-2-10, ECV/G61/1, ECV/G61/1, ZCV/G61/1		



GEV No.	400120	Ref. No.	056449 OK2068
description	level electrode 1/4" total length 83mm probe L 62mm insulated probe length 57mm PTFE insulated connection angled, male faston 6.3mm stainless steel ø 2.5mm		
For models:	FCV/G6L4, FCVG6-1, FCVG6-3, FCVG6-1UK, FCVG6-3UK, 5711-2-6, 5711-2-7, 5711-2-8, 5711-2-10, 5711-2-8CH, 5711-2-10CH, 5711-2-6L, 5711-2-7L, 5711-2-8L, 5711-2-10L, ECV/G6T4, FCV/G6-1, ZOFCV/G6-3, AFCV/G6-1, AFCV/G6-3, SCO/G6-3, ZCV/G6T4		



GEV No.	361642	Ref. No.	059784 0C5350 C22LL105100 C22LLE105100
description	level electrode M16x1 probe L 14mm insulated probe length 0mm cable length 1000mm		
For models:	M70EPC, M70GPC, CCP/E700, ZCP/G410, ZCP/G810, ZCP/E410, ZCP/E810, ZCPS/E410		



GEV No.	400012	Ref. No.	0H7090 60050478 826510
description	level electrode probe L 35/20/11mm insulated probe length 11mm with 3 probes connection M4		



GEV No.	400124	Ref. No.	002694 003084 0F0010 0K8460 0K9176 0KE754 60050287 908500 9085006
description	level electrode push-in total length 128mm probe L 103mm insulated probe length 93mm PTFE insulated connection F6.3 ø 2.5mm		
For models:	FCV/E10L3, FCV/E102/1L3, FCV/E6L4, FCV/E10L6, FCV/E102/1L6, FCS101EP4J, FCS101EP, FCS102EP4J, FCS102EP, FCS101EX4J, FCS101EXLN, FCS101EX, FCS102EX4J, FCS102EX, CS7ME4/200-3, CS-7ME4/230-3, CS7ME4/400-3N, CS7ME6/400-3N, CS7ME4/400-3N/EO, CS7ME4/400-3/50HZ/MA, CS7ME4/440-3/60HZ/MA, CS7MT4/400-3N, CS7GE4/200-3, CS7GE4/230-3, CS7GE4/400-3N, CS7GE6/400-3N, CS-7GE4/400-3N/EO, CS7GE4/400-3/50HZ/MA, CS7GE4/440-3/60HZ/MA, CS7GT4/400-3N, CS7LCE4/200-3, CS7LCE4/230-3, CS7LCE4/400-3N, CS7LCE6/400-3N, CS7LCE4/400-3N/EO, CS7LCE4/400-3/50HZ/M, CS7LCE4/440-3/60HZ/M, CS7LCT4/400-3N, CS10ME4/200-3, CS-10ME4/230-3, CS10ME6/230-3, CS10ME4/400-3N, CS10ME6/400-3N, CS10ME4/400-3N/EO, CS10ME4/400-3/50HZ/M, CS10ME4/440-3/60H-Z/M, CS10MT4/400-3N, CS10MT6/400-3N, CS10GE4/200-3, CS-10GE4/230-3...(Other models you can see in the webshop)		





GEV No.	401548	Ref. No.	004891 005235 OK2064
description	level electrode push-in total length 175mm probe L 151mm insulated probe length 142mm PTFE insulated connection F6.3 ø 2.5mm		
For models:	5717-3-7, 5717-3-8, 5717-3-8E, 5717-3-10, 5717-3-8M, 5717-3-8C, 5714-3-10F, 5714-3-10S		





GEV No.	403856	Ref. No.	OK8459
description	level electrode push-in total length 247mm probe L 6mm insulated probe length 215mm connection male faston 6.3mm unbraided ø 2.5mm		



			
1			
GEV No.	378013	Ref. No.	0G0209 0H9789 0K2996 0K4871 0K6075 0KC030 18003728 50001140 61654 IEG14
description	level electrode to clip		
For models:	VARIOSTEAM/S-33.3/F, STEAM-O-MAT		

			
1			
GEV No.	693744	Ref. No.	055435
description	spacer piece for level electrode size 5mm		
For models:	FCV/E10L3JAP, FCV/E102/1L3JAP, FCV/E10L6JAP, FCV/E102/1L6JAP, FCV/E61/1, FCV/E101/1, FCV/E101/1, FCV/E102/1, FCV/E61/1, FCV/E101/1, FCV/E101/2, FCV/E10L3, FCV/E102/1, FCV/E102/1L3, FCV/E20L3, FCVE20L3, FCV/E6L4, FCV/E10L6, FCV/E102/1L6, FCV/E20L6, FCVE20L6, FCV/E101/1, FVC/E101/1, FVC/E102/1, FVC/E201/1, FVC/E202/1, FCS061EP, FCS101E44J, FCS101EP4J, FCS101E4, FCS101EP, FCS102E44J, FCS102EP4J, FCS102E4, FCS102EP, FCS201E4, FCS202E4, FCS061E4, FCS061EXLN, FCS061EX, FCS101EX4J, FCS101EXLN, FCS101EX, FCS102EX4J, FCS102EX, FV4G, FVE3, FCVE6-1U, FCVE6-3U, FCVE6-1...(Other models you can see in the webshop)		

			
1			
GEV No.	400011	Ref. No.	0H7101
description	level electrode total length 46mm insulated probe length 40mm with 3 probes connection M4		

			
1			
GEV No.	693743	Ref. No.	055347 0K3038
description	spacer piece for level electrode size 9mm		
For models:	FCZ061EAA, FCZ101EAA, FCZ102EAA, FCZ201EAA, FCZ202EAA, FCZ061EAH, FCZ101EAH, FCZ201EAH, FCZ061EAN, FCZ101EAN, FCZ201EAN, FCZ061ETA, FCZ101ETA, FCZ102ETA, FCZ201ETA, FCZ202ETA, FCZ061ETH, FCZ101ETH, FCZ201ETH, FCZ061ETN, FCZ101ETN, FCZ201ETN, FCZ061EBA, FCZ101EBA, FCZ102EBA, FCZ201EBA, FCZ202EBA, FCZ061EBH, FCZ101EBH, FCZ201EBH, FCZ061EBN, FCZ101EBN, FCZ201EBN, FCZ061EBC, FCZ101EBC, FCZ201EBC, FCZ061EBA2, FCZ101EBA2, FCZ102EBA2, FCZ201EBA2, FCZ202EBA2, FCZ061EBH2, FCZ101EBH2, FCZ201EBH2, FCZ061EBN2, FCZ101EBN2, FCZ201EBN2, FCZ061EBC2, FCZ101EBC2, FCZ201EBC2... (Other models you can see in the webshop)		

			
1			
GEV No.	401260	Ref. No.	002632
description	level electrode total length 75mm probe L 50mm insulated probe length 46mm PTFE insulated connection angled, male faston 6.3mm ø 2.5mm		
For models:	FDV40G, FDV40GZ, FDV40GA, FDV20G, FDV20GZ, FDV20GA, FCV/G10L3, FCVG10L3T, FCVG102L3, FCV/G20L3, FCVG20L3, FCVG10L3J, FCVG102L3J, FCV/G10L6JAP, FCV/G102/1L6JAP, FCV/G10L6, FCV/G102/1L6, FCV/G20L6, FCVG20L6, FCV/G101/1, FCV/G102/1, FCV/G201/1, FCV/G202/1, FCS101G4, FCS101G4DT, FCS101GP9J, FCS101G49J, FCS101GP, FCS102G4, FCS102GA9J, FCS102G49J, FCS102GP, FCS201G4, FCS201GP, FCS202G4, FCS202GP, FCS101GX9J, FCS101GX, FCS102GX9J, FCS102GX, FCS201GX, FCS202GX, 5712-2-6, 5712-2-7, 5712-2-8, 5712-2-10, 5714-2-6, 5714-2-7, 5714-2-8, 5714-2-10...(Other models you can see in the webshop)		

compressors

ACC/ZEL

R134A

HMBP monophase

High/Medium evaporation temperature above -20/-15 °C

			
1			
GEV No.	400123	Ref. No.	002633 0F0161
description	spacer piece for level electrode		
For models:	FDV40G, FDV40GZ, FDV40GA, FDV20G, FDV20E, FDV20GZ, FDV20EL, FDV20GA, FCV/G10L3, FCVG10L3T, FCVG102L3, FCV/G20L3, FCVG20L3, FCVG10L3J, FCVG102L3J, FCV/G10L6JAP, FCV/G102/1L6JAP, FCV/E20L3, FCVE20L3, FCV/G10L6, FCV/G102/1L6, FCV/G20L6, FCV/E20L6, FCVG20L6, FCVE20L6, FCV/G101/1, FCV/G102/1, FCV/G201/1, FVC/E201/1, FCV/G202/1, FVC/E202/1, FCS101G4, FCS101G4DT, FCS101GP9J, FCS101G49J, FCS101GP, FCS102G4, FCS201E4, FCS102GA9J, FCS201EP, FCS102G49J, FCS202E4, FCS102GP, FCS202EP, FCS201G4, FCS201GP, FCS202G4, FCS202GP, FCS201EX, FCS201EXLN...(Other models you can see in the webshop)		

			
1			
GEV No.	605012	Ref. No.	085501
description	compressor coolant R134a type GL45TB 220-240V 50Hz HMBP fully hermetic 8.4kg 1/6HP power input 342W cylinder capacity 4.5cm ³ CSIR H 175.5mmW 76W 101W 134W 175W 223W 278W 342W 413W test method ASHRAE ambient temperature max. 43°C		



1			
GEV No.	605007	Ref. No.	085876 30003328 736083
description	compressor coolant R134a type GL60TB 220-240V 50Hz HMBP fully hermetic 9.5kg 1/5HP power input 437W cylinder capacity 5.7cm ³ CSIR H 175.5mm 95W 128W 170W 222W 284W 355W 437W 528W test method ASHRAE ambient temperature max. 43°C		
For models:	ADNN120, ADNF120, AENN120, AENF120, APP113, APP114, APP114/60, AZP1103, ARDNN120, 83012101, AZP1103, ADNN120, ADNF120, ZPR04R1F, ALN1103, ALNN1203, ALNN2203, AZP6430, ALN11033, APP11B, APP113V, AZP1103, ALN1103, AZP6430, ALN11033, ALNN1203, ALNN2203, ZBRAV806, ZBRAV805, ZBRAV805, ZBRAV706, ZBRAV705, ZBRAVV705, ZVR1780, ZVR2180, ZVR1930, ZVR2400, PS04RE1F, 1-DOOR REFRIG, PS04R1F, 2-DOOR REFRIG, PS04R2F, 1-GL.DOOR REFRIG, PS04R1G, PS04R1FM, PR04R1F4, PR04R1F, PR04R2F, PR04R1G, PR04R1FM...(Other models you can see in the webshop)		



1			
GEV No.	605010	Ref. No.	083752 30003112
description	compressor coolant R134a type GP12TB 220-240V 50Hz HMBP fully hermetic 11.2kg 3/8HP power input 661W cylinder capacity 12cm ³ CSIR H 203.6mmW 143W 194W 259W 339W 432W 539W 661W 796W test method ASHRAE ambient temperature max. 43°C		
For models:	ALP111, ALN111, ALNSO120, ADN220ES, ADF220ES, ALN220, ALN240, ADN221, AEN220, AEN240, AEN221, ADNN230, ADNF230, AENN230, AENF230, ASN220, ASN221, AKN220UK, ASN220UK, ADN220E, ADF220E, ARDN220, ARDN221, ASN220, ADN220, ADN240, ADN221, ADNN220, ADNF220, ADNN230, ADNF230, ADN22060, AKP111, AKS220, AKN111, AKNSO120, ASS220, TRN1301, TRNA1301, TRNM1301, TRN1302, TRNA1302, TRNM1302, TRN1303, TRNA1303, TRNM1303, TRN1801, TRNA1801, TRNM1801, TRN1802...(Other models you can see in the webshop)		



1			
GEV No.	605009	Ref. No.	083718 086461 67010000 709796
description	compressor coolant R134a type GL90TB 220-240V 50Hz HMBP fully hermetic 10.8kg 1/4HP power input 293W cylinder capacity 8.8cm ³ CSIR H 175.5mmW 143W 194W 259W 339W 432W 539W 661W 796W test method ASHRAE		
For models:	ICP111, ICP130, ICP112, ICN110UK, ALP110, ALP120, ALN110, ALN120, ALNN120, ALNN220, ALNN230, ALP110UK, ALN110UK, ALNN220UK, ALNF120, ADF110ES, ALN110, ALN120, ADN111, AEN110, AEN120, AKN111, ADNN220, ADNF220, ADNN230, AENN220, AENN230, ASN110, ASN111, AKN110UK, ASN110UK, APP223, APP224, BC7, ARDN110, ADN110E, ADF110E, APP224/60, AZP2203, 83012001, 83012033, BC7, ASN110, ADN110, ADN120, ADN111, ADNN220, ADNF220, ADNN230, ADN11060...(Other models you can see in the webshop)		



1			
GEV No.	605011	Ref. No.	083728 740493
description	compressor coolant R134a type GP14TB 220-240V 50Hz HMBP fully hermetic 11.5kg 3/8HP power input 566W cylinder capacity 14cm ³ CSIR H 203.6mm 191W 271W 373W 497W 643W 810W 999W 1209W test method ASHRAE ambient temperature max. 43°C		
For models:	ALP220, ALP240, ALN220, ALN240, ALNN230, ALNF230, BC11, BC11, BC15A, Crosswise, AKP230, AKP220, AKP240, AKN230, AKN220, AKN240, AKNN230, AKP220UK, AKN220UK, ASP220, ASN220, ASP220UK, ASN220UK, UCN2, ESR141212F, ESR142F, ESR14412F, ESQF41FR, EUKR142N, EUKR142F, EUKR141212, EUKR14412F, ESBC10, IKNNP230, ESQF41FR, RIO16RE1F, RI16R1F, RI16R2FT, RI16R2FGT, Crosswise, RBC061, ESR142F, ESR141212F, ESR14412F, EUKR142N, EUKR142F, EUKR141212, EUKR14412F, RI16R1G, EKE1402...(Other models you can see in the webshop)		



R404a/R507

LBP monophase

Lower evaporation temperature below -20°C



1

GEV No.	605073	Ref. No.	088401 0A9615
description	compressor coolant R404a/R507 type MP14FB 220-240V 50Hz LBP fully hermetic 13.9kg 1/2HP cylinder capacity 14cm ³ CSIR H 203.6mm 439W 584W 746W 926W 1124WWWWWW test method ASHRAE		
For models:	83012101, ADFN120, ZPR04F1F, DLP21/F, DL21/F, DL21/F, DLP21/F, SSWC12, SSWC16, SSWC20, SSWB12, SSWB16, SSWB20, DRVAF12, DRVAF16, DRVAF20, DRVP12, DRVP16, DRVP20, ZLRW12C, ZLRW16C, ZLRW20C, ZLRW12B, ZLRW16B, ZLRW20B, DI2RDP, DI3RDP, DI4RDP, DI2RDPO, DI3RDPO, DI4RDPO, PS04FE1F, 1-DOOR FREEZER, PS04F1F, PR04F1F, PR04FE1F, RS06DFX2F, MCD650FP2, KLPF650R, RH06DFD2F, EC6M0D2C, KLP650R, 1-DOOR FREEZER, R04FSF4M, R04FSFWG, R04FSF4, R04FSFW, E04C6SGV, E04C4SGV		



1

GEV No.	605127	Ref. No.	091221
description	compressor coolant R404a/R507 type MX18FB 220-240V 50Hz LBP 17.3kg 5/8HP cylinder capacity 18.4cm ³ CSR H 230mm 575W 750W 985W 1219W 1498WWWWWW test method ASHRAE ambient temperature max. 43°C		
For models:	BCF7A, BLAST C/FREEZER, BLAST C/FREEZER, RBF051, FRABCF711, BLAST C/FREEZER, EBAC005		

R600A

LBP monophase

Lower evaporation temperature below -20°C



1

GEV No.	605242	Ref. No.	4055045639
description	compressor coolant R600a type HMK12AA 220-240V 50Hz LBP 8.5kg 1/5HP cylinder capacity 11.2cm ³ RSIR H 170mm 137W 181W 233W 291W 355WWWWWW test method ASHRAE		

CUBIGEL

R134A

LBP monophase

Lower evaporation temperature below -20°C



1

GEV No.	605197	Ref. No.	0A9556
description	compressor coolant R134a type GL60AA 220-240V 50Hz LBP 9.1kg 1/6HP power input 126W cylinder capacity 5.99cm ³ RSIR H 175mm 98W 135W 178W 227W 283WWWWWW test method ASHRAE ambient temperature max. 43°C		
For models:	E04P6VRVUK, E04P8SRVUK, MP402C, MP402, C04PVG4D, R04P6SRGB, R04P6SRB, R04P6SWB, E04P6SRV, E04P6VRV, E04P8SRV, E04P4VRV		



HMBP monophase

High/Medium evaporation temperature above -20/-15 °C



GEV No.	605196	Ref. No.	0T3279
description	compressor coolant R134a type GD36MB 220-240V 50Hz HMBP 6.7kg 1/10HP power input 180W cylinder capacity 3.62cm ³ CSIR H 162mmW 88W 97W 107W 118W 130W 144W 160W 176W test method ASHRAE		



GEV No.	605211	Ref. No.	084763
description	compressor coolant R134a type GS34TB 220-240V 50Hz HMBP 22.7kg 1HP cylinder capacity 34.4cm ³ CSRW 523W 820W 1173W 1580W 2042W 2559W 3131W 3758W		
For models:	SSODWC12, SSODDPC12, SSODWC16, SSODDPC16, SSODWB12, SSODDPB12, SSODWB16, SSODDPD16, SSDPC12, SSDPC16, SSDPC16, SSDPD12, SSDPD16, SSDPD20, SSODWCS12, SSODWCS16, DVRVAF12, DVRPAF12, DVRVAF16, DVRPAF16, DVRVP12, DVRPP12, DVRVP16, DVRPP16, DRPAF12, DRPAF16, DRPAF20, DRPP12, DRPP16, DRPP20, ZLRP12C, ZLRP16C, ZLRP20C, ZLRP12B, ZLRP16B, ZLRP20B, ZLRD-W12C, ZLRDW16C, ZLRDW12B, ZLRDW16B, ZLRDD12C, ZLRDD16C, ZLRDD12B, ZLRDD16B, ZLRDW12S, ZLRDW16S, DI2RWV, DI3RWV, DI4RWV, DI2RWVO...(Other models you can see in the webshop)		

R404a/R507

LBP monophase

Lower evaporation temperature below -20°C



GEV No.	605138	Ref. No.	087001
description	compressor coolant R404a/R507 type MP12FB 220-240V 50Hz LBP 12kg 3/8HP cylinder capacity 12cm ³ CSIR H 215mm 381W 510W 657W 819W 999W test method ASHRAE		
For models:	DLP14/F, DL14/F, DL14/F, DLP14/F		



GEV No.	605195	Ref. No.	084499 0A9727
description	compressor coolant R404a/R507 type MS34FB 220-240V 50Hz LBP 22.7kg 1HP cylinder capacity 34.4cm ³ CSR H 276mm 1267W 1733W 2259W 2843W 3487W test method ASHRAE		
For models:	UCF2, E14C0M2V, E14C1M2V, E14C0D2V, E14C0D2V		



1

GEV No.	605254	Ref. No.	093454
description	compressor coolant R134a type NJ6220Z-A 220-240V 50Hz HBP 20.3kg 1HP cylinder capacity 26.2cm ³ CSIRWWW 962W 1263W 1638W 2087W 2610W 3206W test method EN 12900		
For models:	Crosswise, Crosswise, Crosswise		



1

GEV No.	605175	Ref. No.	093474
description	compressor coolant R134a type NJ6226Z 220-240V 50Hz HBP 19.8kg 1 1/4HP cylinder capacity 34.37cm ³ CSR H 253mmWWW 1144W 1497W 1892W 2340W 2852W 3438W		



1

GEV No.	605079	Ref. No.	092312
description	compressor coolant R134a type NT6215Z 220-240V 50Hz HBP fully hermetic 17kg 1/2HP cylinder capacity 17.4cm ³ CSIR H 207mmWWW 484W 646W 843W 1071W 1326W 1606W test method EN 12900		
For models:	DMAST, DMPC, DMAST2C, DMPC2C, DMAST2CH, DMAST2CUK, DMASTCT, DMASTCTW, DMAST2CW		



1

GEV No.	605115	Ref. No.	0TTP29
description	compressor coolant R134a type T6217Z 220-240V 50Hz HBP fully hermetic 16.8kg 1/2HP cylinder capacity 22.4cm ³ CSIR H 225mmWWW 718W 973W 1275W 1624W 2020W 2464W test method ASHRAE		

HMBP monophase
High/Medium evaporation temperature above -20/-15 °C



1

GEV No.	605016	Ref. No.	093232
description	compressor coolant R134a type EM65HHR 220-240V 50Hz HBP fully hermetic 7.62kg 1/6HP cylinder capacity 5.54cm ³ CSIRWWW 287W 389W 499W 617W 742W test method ASHRAE 842W		
For models:	FV 1M, FV 1M, FV 1M, DUAL 2 DOORS, FV 1M, FV 1M, FV 1M, 1-DOOR REFR		



R290A

LBP monophase

Lower evaporation temperature below -20°C

R290



1

GEV No.	605202	Ref. No.	093422
description	compressor coolant R290 type NT2170U 220-240V 50Hz LBP 17kg 3/4HP cylinder capacity 20.44cm ³ CSIR H 220mm 544W 698W 883W 1097W 1340WWWWWW test method ASHRAE		
For models:	FV 1M, FV 1M, FV 1M, FV 1M, FV 1M, FV Dual, DUAL 2 DOORS, FV 2M, FV 1M, FV 1M, FV Dual, DUAL 2 DOORS, FV 1M, FV 1M, FV Dual 1/2 doors, FV 1M, FV 1M, FV Dual 1/2 doors, FV 1M, FV 1M, FV Dual, FV 1M, FV 1M, FV Dual 1/2 doors, FV 1M, FV 1M, FV 1M, FV 1M, FV Dual, DUAL 2 DOORS, FV 2M, FV 1M, FV 1M, FV Dual, DUAL 2 DOORS, APS06F1FHC, PS09F2FHC, PS09F1FHCL, PS09F1FHC		

R290



2

GEV No.	605203	Ref. No.	093423
description	compressor coolant R290 type NT2210U 220-240V 50Hz LBP 17.8kg 1 1/4HP cylinder capacity 27.8cm ³ CSIR H 234mm 798W 1024W 1301W 1627W 2003WWWWWW		
For models:	FV 2M, FV 2M, FV 2M, FV 2M, FV 2M, FV 2M, FV 2M, FV 2M, FV 2M, FV 2M, FV 2M, FV 2M, FV 2M, FV 2M		

MBP monophase

Medium evaporation temperature above -20°C

R290



1

GEV No.	605200	Ref. No.	093425
description	compressor coolant R290 type EMT6144U 220-240V 50Hz MBP 7.8kg 1/6HP cylinder capacity 4.5cm ³ CSIR H 166mmWW 228W 280W 342W 416W 502W 598W 705W test method EN 12900		
For models:	PS04R2F, PS04R1G, PS04R1FHC, PS04R1FLHC, PS09R2FHC, PS06R1FHC, PS06R1FLHC, FV 1M, FV 1M, FV 1M, FV 1M, FV 1M, DUAL 2 DOORS, DUAL 2 DOORS, FV 2M, FV 1M, FV 1M, FV 1M, DUAL 2 DOORS, DUAL 2 DOORS, FV 1M, FV 1M, FV 1M, FV 1M, FV 1M, DUAL 2 DOORS, DUAL 2 DOORS, FV 2M, FV 1M, FV 1M, FV 1M, DUAL 2 DOORS, DUAL 2 DOORS, APS04R1FHC, APS06R1FHC		

R290



1

GEV No.	605201	Ref. No.	093426
description	compressor coolant R290 type EMT6152U 220-240V 50Hz MBP 7.8kg 1/5HP cylinder capacity 5.2cm ³ CSIR H 166mmWW 278W 346W 418W 500W 595W 710W 844W test method EN 12900		
For models:	FV 2M, FV Dual, FV 2M, FV 2M, FV Dual, FV Dual 1/2 doors, FV 2M, FV 2M, FV 2M, FV 2M, FV Dual, FV 2M, FV 2M, FV Dual		



R404a/R507

LBP monophase

Lower evaporation temperature below -20°C



GEV No.	605019	Ref. No.	089914
description	compressor coolant R404A type T2168GK 230V 50Hz LBP fully hermetic 17kg cylinder capacity 17.39cm ³ CSIR 326W 492W 683W 906W 1167W 1473W test method ASHRAE		
For models:	ADF110ES, ADF110E, 83012201, ARDF110L, ARDF120, ASF110, ADF110, ADF120, ADNN220, ADNF220, ADNN230, ADNF230, ADF11060, ZPRO6F1F, AZF1103, ALF1104, ALF11033, PS06FE1F, PS06F1F, PS06FE2F, PR06F1F4, PR06F1F, PR06FE2F, IKS220N, ISS220N, TZ751R, ISP110N, FULL DOOR FREEZER, RS06FX1F, RS06F41F, FULL DOOR FREEZER, RS06FX1F4, RS13DFX2F, FULL DOOR FREEZER, RS06FW1F, RH06FE1FS, MCD650F, MCD650F2, RH06FE1F, RS06FX1F6, FULL DOOR FREEZER, RS06FX2H, RH06FE1FDU, FULL DOOR FREEZER, RS06FX1FG, FULL DOOR FREEZER, RS06F41FS, MCD65F2LR, KL650F, FULL DOOR FREEZER...(Other models you can see in the webshop)		



GEV No.	605152	Ref. No.	093374
description	compressor coolant R404a/R507 type NEK2134GK 220-240V 50Hz LBP 11kg 1/2HP cylinder capacity 8.77cm ³ CSIR H 180mm 227W 302W 394W 501W 621W 753WWWWWW test method ASHRAE		



GEV No.	605186	Ref. No.	093630
description	compressor coolant R404a/R507 type NEK2150GK 220-240V 50Hz LBP 11.6kg 1/2HP cylinder capacity 12.12cm ³ CSIR H 206mm 408W 522W 657W 814W 995WWWWWW test method EN 12900		



GEV No.	605144	Ref. No.	093233
description	compressor coolant R404a/R507 type NEK2168GK 220-240V 50Hz LBP 22.9kg 3/4HP cylinder capacity 14.28cm ³ CSR H 200mm 345W 454W 587W 742W 921W 1123WWWWWW		
For models:	1-DOOR FREEZER, 1-DOOR FREEZER, DOOR FREEZ. 400LT		



GEV No.	605174	Ref. No.	084076
description	compressor coolant R404a/R507 type NJ2192GK 220-240V 50Hz LBP 20.4kg 1 1/4HP cylinder capacity 26.2cm ³ CSR H 265mm 685W 989W 1342W 1745W 2196W 2196WWWWWW		
For models:	ALF220UK, ALF220, ALF240, ADF220ES, ADF220, ADF240, AEF220, AEF240, ASF220, AKF220UK, ASF220UK, ADF220E, ARDNF220, ASF220, ADF220, ADF240, ADF2206, AKF240, AKF230, AKF220, ASF220, TRF1301, TRF1801, TRF2201, ESF61GR, TE1502GT, ETE1402, ETE1404, ETE601GT, TE1502, TE751GT, RH14FE2FS, RH14FE2F, RH14FE2FDU, E14C0M2C, E14C1M2C, E14C0M4C, E14C1M4C, E14C0D2C, E14C0D4C, E12C0M2C, E12C1M2C, C14FD2F, C14FD4F, C14FM2F, C14FM4F, C12FM2F, FSD313, FS212, RH14FD2F...(Other models you can see in the webshop)		



1

GEV No.	605081	Ref. No.	085097
description	compressor coolant R404a/R507 type NJ2212GK 220-240V 50Hz LBP fully hermetic 21.5kg 1 1/2HP power input 1150W cylinder capacity 34cm ³ CSR H 277mm 880W 1269W 1738W 2289W 2921W 2921WWWWWW test method ASHRAE		
For models:	MK10+FB3GN, 12-16+FB4G, 16-16+FB7G, 20-16FB13, 24-16FB13, 28-16+FB13, 12-20+FB7G, 16-20FB13, 20-20+FB13, MF0616T, MF0716T, MF0620T, MF0820T, MF0920T, MF0724T, MF0924T, MF0928T, 24-20+FB13, 28-20+FB16, 12-24+FB7G, 16-24FB13, 20-24+FB13, 24-24+FB16, 28-24+FB16, 16-28+FB13, 20-28+FB16, 24-28+FB16, MF0616RT, MF0716RT, MF0620RT, MF0820RT, MF0920RT, MF0724RT, MF0924RT, MF0928RT, 12-16+FB6N, 16-16+FB13, 20-16+FB13, 24-16+FB13, 28-16+FB20, 12-20+FB13, 16-20+FB13, 20-20FB13, 24-20+FB20, 28-20+FB20, 12-24+FB13, 16-24+FB13, 20-24+FB20, 24-24+FB20, 28-24+FB20...(Other models you can see in the webshop)		



1

GEV No.	605005	Ref. No.	0A9368
description	compressor coolant R404a/R507 type T2155GK 230V 50Hz LBP fully hermetic 16.3kg power input 458W cylinder capacity 14.5cm ³ CSR H 221mm 368W 524W 717W 948W 1215W test method ASHRAE		
For models:	ALNF120, ALNF230, ADN120, AENF120, 83012101, ADN120, AKNF120, AKNF230, TE752R, ECE602, EC6N0M2C, EC6M0D2C, C06CF-D2F, C06CM2F, RH06DFD2F, EC6M0D2C, DVNC13023C, DVNC13123C, MVNC13023C, MVNC13123C, ZILNF230, KVNE332, KMNE332		



1

GEV No.	605164	Ref. No.	092785
description	compressor coolant R404a/R507 type NT2178GK 220-240V 50Hz LBP 17kg 1HP cylinder capacity 17.4cm ³ CSR H 220mm 442W 610W 808W 1032W 1285W 1565WWWWWW		
For models:	ADF110ES, FV 1M, FV 1M, FV 1M, FV Dual, FV 1M, FV 1M, BLAST C/ FREEZER, RH06FE1FS, BLAST C/FREEZER, FV 1M, FV 1M, FV 1M, FV 1M, FV 1M, FV Dual, FV, FV 1M, ESP72HFG, FV 1M, FV Dual, FV, DUAL 2 DOORS, FV, DUAL 2 DOORS, FV 1M, FV 1M, FV 1M, BLAST C/FREEZER, E06COE1CE, BLAST C/FREEZER, FV 1M, FV 1M, FV 1M, FV 1M, FV 1M, FV 1M, FV Dual, FV 1M, FV 1M, FV Dual, 1-DOOR FREEZER, 1-DOOR FREEZER, 2 1/2-DOORS FREEZER		

HMBP monophase
High/Medium evaporation temperature above -20/-15 °C



1

GEV No.	605004	Ref. No.	0S1499
description	compressor coolant R404a/R507 type EMT6152GK 220-240V 50Hz HMBP fully hermetic 7.8kg 1/5HP cylinder capacity 4.5cm ³ CSIR H 166mmWWW 267W 332W 351W 437W 535W 646W 769W test method ASHRAE		



1

GEV No.	605078	Ref. No.	093735
description	compressor coolant R404a/R507 type NT2180GK 220-240V 50Hz LBP fully hermetic 17.3kg 1HP cylinder capacity 20.44cm ³ CSIR H 221mm 515W 598W 682W 769W 859W 956WWWWWW test method ASHRAE		



1

GEV No.	605139	Ref. No.	093208 0T1106 NB6165GK
description	compressor coolant R404a/R507 type EMT6165GK 220-240V 50Hz HMBP 7.92kg 1/4HP cylinder capacity 5.19cm ³ CSIR H 180mmWW 315W 384W 477W 570W 689W 808W test method ASHRAE		



1

GEV No.	605162	Ref. No.	093373
description	compressor coolant R404a/R507 type NEK6181GK 220-240V 50Hz HMBP 10.4kg 1/4HP cylinder capacity 7.28cm ³ CSIR H 190mmWW 454W 533W 677W 826W 1000W 1198W 1422W		



1

GEV No.	605161	Ref. No.	093377
description	compressor coolant R404a/R507 type NEK6210GK 220-240V 50Hz HMBP fully hermetic 8.5kg 3/8HP cylinder capacity 8.78cm ³ CSIR H 200mmW 566W 674W 815W 988W 1195W 1435W 1707W		



1

GEV No.	605125	Ref. No.	017556 017650 017754 033983 085551 091161 AAEM4430E I010583 NEK6213GK
description	compressor coolant R404a/R507 type NEK6213GK 220-240V 50Hz HMBP 11.6kg 1/2HP cylinder capacity 12.12cm ³ CSIR H 206mmW 695W 884W 1093W 1333W 1600W 1894W 2215W test method ASHRAE		
For models:	MK10+FB3GN, MN0316T, MN0516T, MN0616T, MN0420T, MN0620T, 12-16+FB4G, 16-16+FB7G, 20-16FB13, 24-16FB13, 28-16+FB13, 12-20+FB7G, 16-20FB13, 20-20+FB13, 24-20+FB13, 28-20+FB16, 12-24+FB7G, 16-24FB13, 20-24+FB13, 24-24+FB16, 28-24+FB16, 16-28+FB13, MN0316RT, MN0516RT, MN0616RT, MN0420RT, MN0620RT, 20-28+FB16, 24-28+FB16, 12-16+MSG4, 16-16+MSG7, 12-20+MSG7, 12-24+MSG7, 12-16+FB6N, 16-16+FB13, 20-16+FB13, 24-16+FB13, 28-16+FB20, 12-20+FB13, 16-20+FB13, 20-20FB13, 24-20+FB20, 28-20+FB20, 12-24+FB13, 16-24+FB13, 20-24+FB20, 24-24+FB20, 28-24+FB20, MN0316S, MN0516S...(Other models you can see in the webshop)		



1

GEV No.	605178	Ref. No.	092239
description	compressor coolant R404a/R507 type NEK6217GK 220-240V 50Hz HMBP 11.6kg 5/8HP cylinder capacity 14.3cm ³ CSR H 206mmW 777W 954W 955W 1171W 1386W 1651W 1916W		



1

GEV No.	605190	Ref. No.	092906
description	compressor coolant R404a/R507 type NJ9232GK 220-240V 50Hz HMBP 22.1kg 1 1/4HP cylinder capacity 26.2cm ³ CSR H 277mmWW 1093W 1470W 1911W 2413W 2973W 3588W 4255W ambient temperature max. 45°C		

L'UNITE HERMETIQUE / TECUMSEH

R404A

LBP monophase

Lower evaporation temperature below -20°C



1

GEV No.	605134	Ref. No.	091950
description	compressor coolant R404A type CAJ2446Z 220-240V 50Hz LBP 23kg 1.2HP cylinder capacity 26.1cm ³ CSR H 280mm 797W 1110W 1423W 1821W 2290W test method EN 12900 549W		
For models:	ADN220ES, ADF220ES, ADF220E, ASF220, ADF220, RH14FE2FS, RH14FE2F, RH14FD2F, RS12FD2F, E14C0D2C, E14C0E2C, E14N0E2CE, FRA1400F, E14F0E2CE, RH14FD2F4		



1

GEV No.	605136	Ref. No.	091149
description	compressor coolant R404A type CAJ2464Z 220-240V 50Hz LBP fully hermetic 21.5kg 1.5HP cylinder capacity 34.5cm ³ CSR H 282mm 1108W 1579W 1850W 2317W 2855W test method EN 12900 820W		
For models:	BCF15A, Crosswise, Crosswise, RBF061, Crosswise, EEVAC151, FRAB-CF1511, Crosswise, KBCF61CW		

HMBP monophase

High/Medium evaporation temperature above -20/-15 °C



1

GEV No.	605025	Ref. No.	087221 089170 FRCAD316
description	compressor coolant R404A type AE4430Z-FZ 220-240V 50Hz HMBP fully hermetic 10.2kg 1/4HP power input 427W cylinder capacity 5.7cm ³ CSIR H 186mmWW 258W 346W 441W 550W 682W 794W test method EN 12900 908W		
For models:	STRP1101, STRP1102, STRP1601, STRP1602, STRP1603, STRP2201, STRP2202, STRP2203, STRP1101S, STRP1601S, STRP2201S, STRP1602R, STRP1603R, STRP2201R, STRP2202R, STRP2203R, STRP1101R, STRP1102R, STRP1601R, AZP220360, RCSN2M2, RCSN2M12, RCSN3M3, RCSN3M22, RCSN3M14, RCSN4M4, RCSN4M32, RCSN4M24, RCSN2M2U, RCSN3M3U, RCSN4M4U, RCSN2M2R, RCSN2M12R, RCSN3M3R, RCSN3M22R, RCSN3M14R, RCSN4M4R, RCSN4M32R, RCSN4M24R, RS13PX2F6, RCSN2M2T, RCSN3M3T, RCSN4M4T, RCSN2M24, RCSN3M34, RCSN4M44, HB2PNT, HB3PNT, HB4PNT, RCSHD26W...(Other models you can see in the webshop)		
spare parts for	605025		
	GEV No.	380061	Ref. No. —
	start relay MTRP0027-31 120/240V voltage AC 8A 1NO		



1

GEV No.	605026	Ref. No.	089652 0D2530
description	compressor coolant R404A type CAJ9480Z 220-240V 50Hz HMBP fully hermetic 22kg 3/4HP cylinder capacity 15.2cm ³ CSR H 271mm 393W 571W 774W 1009W 1284W 1607W 1989W 2334W test method EN 12900 2699W		



1

GEV No.	605218	Ref. No.	0T4121
description	compressor coolant R404a/R507 type CAE9460Z-F 220-240V 50Hz HMBP 13.6kg 1/2HP cylinder capacity 11.3cm ³ CSR H 212mmWWWW 711W 908W 1141W 1545WW		



SECOP DANFOSS

R404a/R507

LBP monophase

Lower evaporation temperature below -20°C



GEV No.	605056	Ref. No.	084464 099925
description	compressor coolant R404a/R507 type SC18CLX.2 220-240V 50Hz LBP fully hermetic 13.7kg 5/8HP cylinder capacity 17.69cm ³ CSR H 219mm 562W 691W 881W 1095W 1332W 1593W test method ASHRAE		
For models:	ALF110, ALNF220, ALF110, ALF120, ALNF220, AKP110, AKS110, AKP120, AKN110, AKN120, AKP110UK, AKN110UK, AKNF220, AKF110UK, AKF110, AKF120, ASF110, ASF110, STRP1101, STRP1102, STRP1601, STRP1602, STRP1603, STRP2201, STRP2202, STRP2203, STRP1101S, STRP1601S, STRP2201S, STRP1602R, TRN224B, TRF132A, TRFA132A, TRF183A, TRFA183A, TRF132AE, TRF183AE, STRP1603R, STRP2201R, STRP2202R, STRP2203R, STRP1101R, STRP1102R, STRP1601R, AZP2203, ESQF41F, ESF142F, EUKF142F, MRF4808660, MRF401/86...(Other models you can see in the webshop)		

fans

axial fans

ebm-papst



GEV No.	601715 ¹	Ref. No.	002690 004000 006878 058855 0C1478 60050254
description	axial fan L 119mm W 119mm H 38mm 230VAC 50Hz 18W bearing ball bearing manuf. no. 4656ZW metal connection cable 310mm ebm-papst fan wheel ø 110mm temp.-resist. 75°C		
For models:	MCP/E1SH, MCP/E1SUH, MCP/E2SUHS, MCP/E2SH, MCP/E2SUH, MCP/E2SUT, MCP/E2SHB, ECP/E1ELHU, PCP/E1SH, PCP/E2SH, PCP/E2SH3B, PCP/E1ELH, OCP/E1SH, OCP/E2SH, TCP/E1ELHU, TCP/E2SH, TCP/E1ELH, FCV/E101/1, FCVE6L3J, FCV/E10L3JAP, FCV/E102/1L3JAP, FCV/E10L6JAP, FCV/E102/1L6JAP, FCVG6L3CJ, FCV/E61/1, FCV/E61/1, FCV/E101/1, FCV/E101/1, FCV/E102/1, FCV/E61/1, FCV/E61/1, FCV/E101/1, FCV/E101/2, FCV/G6L3C, FCV/G61/1, FCV/G61/1, FCV/G61/1, FCV/G61/1, FCV/G6L3CT, FCV/G6L3CJ, FCV/E10L3, FCV/E102/1, FCV/E102/1L3, FCV/E6L4, FCV/E101/1, FCV/E10L6, FCV/E102/1L6, FCV/E101/1, FVC/E101/1, FVC/E102/1...(Other models you can see in the webshop)		

¹with ball bearings



GEV No.	601458 ¹	Ref. No.	0C2378
description	axial fan L 119mm W 119mm H 38mm 230VAC 50Hz 19W bearing ball bearing manuf. no. 4656N metal connection male faston 2.8mm ebm-papst fan wheel ø 110mm temp.-resist. 85°C		
For models:	KT/E1, KT/E2, KMV/E2C, QT/E1, QT/E2, WT/E1, WT/E2		
accessories for	601458		
	GEV No.	692497	Ref. No. —
	guard ø 105mm mounting distance 150mm for axial fan ebm-papst-mm		

¹with ball bearings

evaporation and condensing trays

condensing trays heated

universal

heating cartridges



GEV No.	417570	Ref. No.	083814
description	heating cartridge 110W 230V ø 12mm L 120mm thread 3/8" cable length 1000mm universal		



GEV No.	417227	Ref. No.	083814 1CZXJ713A001
description	heating cartridge 90W 230V ø 12mm L 124mm thread 3/8" cable length 4000mm Hmm Wmm condensate evaporation		





1

GEV No.	601038 ¹	Ref. No.	083528
description	axial fan L 80mm W 80mm H 38mm 230VAC 50/60Hz 12W bearing ball bearing manuf. no. 8556N metal connection cable 300mm ebmpast fan wheel ø 75mm temp.-resist. 90°C airflow 50m ³ /h		
accessories for	601038		
	GEV No.	691102	Ref. No. —
	guard ø 75mm mounting distance 71 mm for axial fan 80mm		

¹with ball bearings

import





1

GEV No.	601604 ¹	Ref. No.	088012 088034
description	axial fan L 119mm W 119mm H 38mm 230VAC 50/60Hz 17/15W bearing slide bearing manuf. no. AA1282HS-AT connection cable 300mm fan wheel ø 110mm temp.-resist. 70°C input current 0.1A airflow 130m ³ /h 2600rpm		

¹with slide bearings



1

GEV No.	601080 ¹	Ref. No.	002656 087945 0C4106 0C4423 0D6787 0E2261 0K7491 0W5643 60050297
description	axial fan L 119mm W 119mm H 38mm 230VAC 50/60Hz 23/20W bearing ball bearing connection male faston 2.8mm metal ADDA fan wheel ø 110mm temp.-resist. 70°C		
For models:	FCZ061EAA, FCZ101EAA, FCZ102EAA, FCZ201EAA, FCZ202EAA, FCZ061EAH, FCZ101EAH, FCZ201EAH, FCZ061EAN, FCZ101EAN, FCZ201EAN, FCZ061ETA, FCZ101ETA, FCZ102ETA, FCZ201ETA, FCZ202ETA, FCZ061ETH, FCZ101ETH, FCZ201ETH, FCZ061ETN, FCZ101ETN, FCZ201ETN, FCZ061GAG, FCZ101GAG, FCZ102GAG, FCZ201GAG, FCZ202GAG, FCZ061GAD, FCZ101GAD, FCZ102GAD, FCZ201GAD, FCZ202GAD, FCZ101GTG, FCZ102GTG, FCZ201GTG, FCZ202GTG, FCZ101GTD, FCZ102GTD, FCZ201GTD, FCZ202GTD, FCZ061EBA, FCZ101EBA, FCZ102EBA, FCZ201EBA, FCZ202EBA, FCZ061EBH, FCZ101EBH, FCZ201EBH, FCZ061EBN, FCZ101EBN..(Other models you can see in the webshop)		
accessories for	601080		
	GEV No.	550898	Ref. No. —
	connecting cable cable length 2000mm connection F 2.8 connection distance 7.9mm for axial flow fan		
	GEV No.	692519	Ref. No. —
	guard L 120mm W 120mm plastic		

¹with ball bearings



1

GEV No.	601130 ¹	Ref. No.	006125
description	axial fan L 80mm W 80mm H 25mm 230VAC 50/60Hz 13/14W bearing ball bearing connection male faston 2.8mm metal ADDA fan wheel ø 75mm temp.-resist. 70°C airflow 30.6m ³ /h		
For models:	KI/E1, KI/E2, KI/E2E5, KFR/E2F, HFH/G430, HFH/E430, HFR/E830, HFH/G400U, HFH/G401U, HFH/G435, HFH/G435, QI/E1, QI/E2, QI/E2E5, QFR/E2F, ZFH/G430, ZFH/E430, ZFH/G435, ZFH/G435, WI/E1, WI/E2, WI/E2E5, WFR/E2F, AFR/E830, AFH/G435, AFH/E435		
accessories for	601130		
	GEV No.	550898	Ref. No. —
	connecting cable cable length 2000mm connection F 2.8 connection distance 7.9mm for axial flow fan		

¹with ball bearings



refrigeration fans





refrigeration motors universal

ELCO

N series - multi fit



1

GEV No.	601427	Ref. No.	086207 050561
description	fan motor ELCO 10W 230V 50/60Hz bearing slide bearing L1 49mm L2 59mm L3 86.5mm W 83mm connection cable 500mm 1300/1550rpm 5 mounting options VNT10-20/028		
spare parts for	601427		
	GEV No.	560140	Ref. No. —
	hexagonal nut thread M4 H 4.8mm SS WS 7 Qty 20 pcs DIN/ISO DIN 985 self-locking		
	GEV No.	560332	Ref. No. —
	plain washer ID ø 4.3mm ED ø 9mm thickness 0.8mm SS Qty 1 pcs		
	GEV No.	560340	Ref. No. —
	hexagonal nut thread M4 H 3.2mm WS 7 SS DIN/ISO DIN 934 / ISO 4032/8673 Qty 1 pcs		
	GEV No.	601413	Ref. No. —
	fixing plate suitable for fanwheel ED ø 32mm shaft ø 7 mounting distance 26mm		



1

GEV No.	601528	Ref. No.	050562
description	fan motor ELCO 16W 230V 50/60Hz bearing slide bearing L1 48mm L2 64mm L3 91.5mm W 83mm connection cable 500mm 1300/1550rpm 5 mounting options VNT16-25/029		
spare parts for	601528		
	GEV No.	601413	Ref. No. —
	fixing plate suitable for fanwheel ED ø 32mm shaft ø 7 mounting distance 26mm		



1

GEV No.	602057	Ref. No.	051119
description	fan motor ELCO 18W 230V 50/60Hz bearing slide bearing connection cable 500mm 1300/1550rpm 5 mounting options VNT18-30/312		
spare parts for	602057		
	GEV No.	601413	Ref. No. —
	fixing plate suitable for fanwheel ED ø 32mm shaft ø 7 mounting distance 26mm		



1

GEV No.	601529	Ref. No.	082647 086310 050563
description	fan motor ELCO 25W 230V 50/60Hz bearing slide bearing L1 53mm L2 84mm L3 111.5mm W 83mm connection cable 500mm 1300/1550rpm 5 mounting options VNT25-40/030		
For models:	DLV21/F, DLV21/F, DLVT21/F, DLVT21/F, DLV21/F, DLVT21/F, DLV21/F, DLVT21/F, ZDLV21/F, ZDLVT21/F, ADLV21/F, ADLVT21/F, SMV21/F, SMIT, SMV21/F, SMIT, SMV21/F, CIM120AS, RI, TRNE02V, MMRE21A		
spare parts for	601529		
	GEV No.	601413	Ref. No. —
	fixing plate suitable for fanwheel ED ø 32mm shaft ø 7 mounting distance 26mm		



1





GEV No.	601430	Ref. No.	0KD790
description	fan motor ELCO 5W 230V 50/60Hz bearing slide bearing L1 48mm L2 52mm L3 79.5mm W 83mm connection cable 500mm 1300/1550rpm 5 mounting options VNT5-13/027		
spare parts for	601430		
	GEV No.	560140	Ref. No. —
	hexagonal nut thread M4 H 4.8mm SS WS 7 Qty 20 pcs DIN/ISO DIN 985 self-locking		

Table continues overleaf



spare parts for		601430	
	GEV No.	560332	Ref. No. —
	plain washer ID ø 4.3mm ED ø 9mm thickness 0.8mm SS Qty 1 pcs		
	GEV No.	560340	Ref. No. —
	hexagonal nut thread M4 H 3.2mm WS 7 SS DIN/ISO DIN 934 / ISO 4032/8673 Qty 1 pcs		
	GEV No.	601413	Ref. No. —
	fixing plate suitable for fanwheel ED ø 32mm shaft ø 7 mounting distance 26mm		

N series - standard



GEV No.	601444	Ref. No.	087168
description	fan motor 25W 230V 50Hz W 83mm cable length 2000mm 1300/1550rpm VNT25-40/003		
For models:	BC100A, BC100DA, BC180A, BC180DA, BCF100A, BCF100DA, BCF180A, BCF180DA, BCW061, BCFW061, BC120A, BCF120A, ADN220ES, ADF220ES, BCWS061T, ADF220, ADF240, AEF220, AEF240, ASF220, AKF220UK, ASF220UK, ADF220E, BC15A, Crosswise, BCF15A, Crosswise, ARDNF220, ASF220, ADF220, ADF240, ADF2206, BCFWS061, BCFWS061T, BLAST C/FREEZER, AOF5061CT, EABP31, EABC301, AOF061U, AOF061TU, AOFPS061C, AOFPS061CT, BLAST C/FREEZER, RH14FE2FS, RH14FE2F, AOC061T, Crosswise, RBC061, Crosswise...(Other models you can see in the webshop)		



GEV No.	601772	Ref. No.	083910 084745 0A9350
description	fan motor ELCO 10W 230V 50/60Hz bearing ball bearing connection male faston 6.3mm cable length 1850mm 1300/1550rpm 3 mounting options VN10-20		
For models:	ICP111, ICP130, ICP112, ICF110, ICN110UK, ICF110, ADN220ES, ADF110ES, ADF220ES, ALN220, ALN240, ADN221, AEN220, AEN240, AEN221, ADF220, ADF240, AEF220, AEF240, ASN220, ASN221, ASF220, AKN220UK, AKF220UK, ASN220UK, ASF220UK, APP113, APP114, APP223, APP224, ADN110E, ADF110E, ADN220E, ADF220E, APP114/60, APP224/60, APP224/60, AZP1103, AZP2203, AZF2203, 83012001, 83012033, 83012201, ARDF110L, ARDF120, ARDN220, ARDN221, ARDNF220, 83012037, AZP1103...(Other models you can see in the webshop)		



GEV No.	601775	Ref. No.	085367 085674
description	fan motor ELCO 230V 50/60Hz 1300/1550rpm		
For models:	ADNN120, ADNF120, AENN120, AENF120, ARDNN120, 83012101, ADNN120, ADNF120, ZPR04R1F, ZPR04F1F, STRP1101, STRP1102, STRP1601, STRP1602, STRP1603, STRP2201, STRP2202, STRP2203, STRP1101S, STRP1601S, STRP2201S, STRP1602R, STRP1603R, STRP2201R, STRP2202R, STRP2203R, STRP1101R, STRP1102R, STRP1601R, ZBRAV806, ZBRAV805, ZBRAVV805, ZBRAV706, ZBRAV705, ZBRAVV705, DLP14/F, DLP21/F, DL14/F, DL21/F, DL14/F, DL21/F, DLP14/F, DLP21/F, PR04R1FBR, PR04R1GBR, PR04F1FBR, PS04R1GM, PS04RE1F, PS04FE1F, 1-DOOR REFRIG...(Other models you can see in the webshop)		

BT series - capacitor motors



GEV No.	601420 ¹	Ref. No.	087799 088013
description	fan motor 45W 230V 50Hz L1 53mm L2 18mm L3 120mm W 103mm cable length 500mm 1300rpm ELCO 3FBT 50-40/15 3 mounting options bearing slide bearing		
For models:	BC28A6, Crosswise, BC28A, Crosswise, SSODWC12, SSODDPC12, SSODWC16, SSODDPC16, SSODWB12, SSODDPB12, SSODWB16, SSODDPD16, SSWC12, SSWC16, SSWC20, SSWB12, SSWB16, SSWB20, SSDPC12, SSDPC16, SSDPC16, SSDPD12, SSDPD16, SSDPD20, SSODWCS12, SSODWCS16, DVRVAF12, DVRPAF12, DVRVAF16, DVRPAF16, DVRVP12, DVRPP12, DVRVP16, DVRPP16, DRVAF12, DRVAF16, DRVAF20, DRVP12, DRVP16, DRVP20, DRPAF12, DRPAF16, DRPAF20, DRPP12, DRPP16, DRPP20, ZLRW12C, ZLRW16C, ZLRW20C, ZLRW12B...(Other models you can see in the webshop)		

¹incl. capacitor



IMPORT

multi fit fan motors



GEV No.	601022	Ref. No.	0A8789
description	fan motor 10W 230V 50-60Hz L1 44mm L2 54mm L3 85mm W 84mm cable length 500mm 1300rpm YZF10-20-18/26 5 mounting options bearing slide bearing		
For models:	ITP120UK, ITP120UK, ALP110, ALP120, ALP111, ALP220, ALP240, ALP221, ALN110, ALN120, ALN111, ALN220, ALN240, ALN221, ALNN120, ALNN220, ALNN230, ALNSO120, ALP110UK, ALN110UK, ALNN220UK, ALF220UK, ALF220, ALF240, ALNF120, ALNF230, ILP110, ILP110UK, ILN120, ILP220, ILP220UK, ILP240, ILN110, ILN110UK, ILN120, ILN220, ILN220UK, ILN240, ILNSO120, ILNN120, ILNN220, ILN220UK, ILNN230, ALP110UK, ALN110UK, ALNN220UK, ALF110UK, ALNF220UK, ILNF120, ILNF220...(Other models you can see in the webshop)		



GEV No.	601023	Ref. No.	081961 081966 082213 0A8419
description	fan motor 16W 230V 50-60Hz L1 45mm L2 61mm L3 92mm W 84mm cable length 500mm 1300rpm YZF16-25-18/26 5 mounting options bearing slide bearing		
For models:	ALF110, ALNF220, ALF110, ALF120, ALNF220, ALF110UK, ILF110, ILF110, ILF120, ILF220, ILF220UK, ILF240, ILNF220, ILNF220UK, ILNF230, ALF110, ALF120, ALF220, ALF240, ALNF220, ALNF230, ADF110, ALF110, ADF120, ALF120, AEF110, AEF120, ADNN120, ADNF120, AENN120, AENF120, ADNF220, ADNF230, AENF220, AENF230, ASF110, AKF110UK, ASF110UK, APF113, APF114, BCF7, ADF110E, APP224/60, AZF1103, 83012201, ARDF110L, ARDF120, ARDNN120, 83012101, BCF7...(Other models you can see in the webshop)		



GEV No.	601024	Ref. No.	081066 081394
description	fan motor 25W 230V 50-60Hz L1 49mm L2 80mm L3 112mm W 84mm cable length 500mm 1300rpm YZF25-40-18/26 5 mounting options bearing slide bearing shaft ø 8mm		
For models:	ILF220, ILF220UK, ILF240, DCBR61, DCB/R61U, DCB/R61-6, FVNE132		



GEV No.	601020	Ref. No.	0A8400 0A9108
description	fan motor 5W 230V 50-60Hz L1 44mm L2 48mm L3 79mm W 84mm cable length 500mm 1300rpm YZF5-13-18/26 5 mounting options bearing slide bearing		
For models:	ICP130, ICN110UK, SAL250, ICP130, ESQC41F, ESQC41FR, ESQF41F, ESQF41FR, ESMLR60W, ESMLR60S, NICP40, ESQF41FR, ESQC41F, ESQC41FR, ESQF41F, KZ1502, TE1502, NICP40, EKE411UF, EWE601, EWZ601, EWDE602, EWDZ602, ES950, 12001720, EN406VAC, EN404VAC, EN404VAC, EP406VAV, MLP609V11C, MLP609V11V, MLP139V12C, MLP139V12V, MLP602V11C, MLP602V11V, MLP132V12C, MLP132V12V, MLP600V11C, MLP130V12C, MLC600V11C, MLP609V11C, MLP609V11V, MLP602V11V, MLP139V12C, MLP132V12C, MLP139V12V, MLP132V12V, EN406VAC, EP406VAV, EN404VAC...(Other models you can see in the webshop)		

miscellaneous



GEV No.	601524	Ref. No.	OKM742
description	fan motor 35W 230V 50/60Hz L3 153mm W 83mm cable length 1600mm 1300rpm with capacitor capacitor 2.5µF		

accessories

fan wheels

aluminium

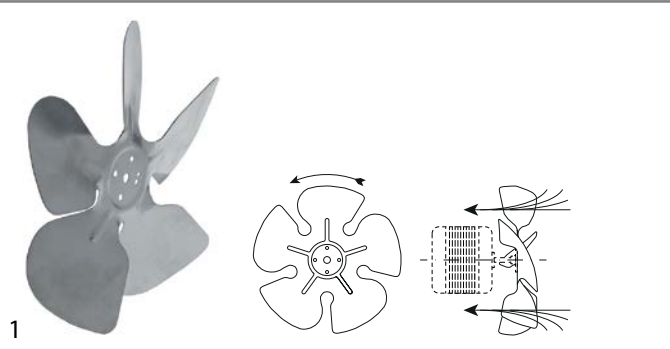

GEV No.	601070	Ref. No.	084041 OKM741
description	fan wheel sucking ø 200mm fan wheel mounting 25.4mm blade angle 28° W 38mm aluminium		
For models:	APP114/60, APP224/60, APP224/60, ADN11060, ADF11060, IKP110, IKN110, IKNN120, IKNN220, IKS110, IKNF120, AKS110, ASS110, ISP110, ISN110, ISS110, ASS110, TR1202, TR1221, TR1603, TR1622, TR1641, TR2004, TR2023, TR2042, IKPZ110, IKPZ120, IKNZ110, IKNZ120, IKS110, ISPZ110, ISNZ110, ISSZ110, TR1202, TR1221, TR1603, TR1622, TR1641, TR2004, TR2023, TR2042, ESR4212F, ESR41G, ESR41F, , , , ESR41F60HZ, ESR422F60HZ...(Other models you can see in the webshop)		

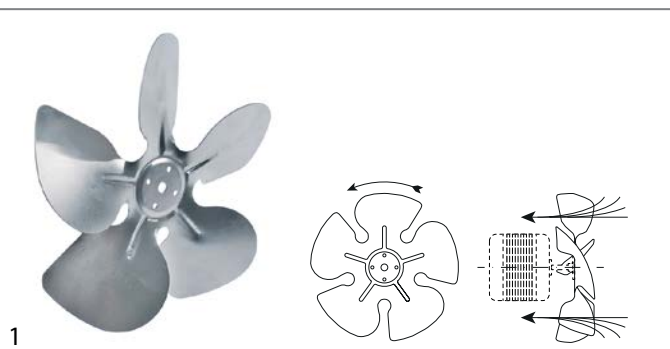

GEV No.	601282	Ref. No.	082874
description	fan wheel sucking ø 200mm fan wheel mounting 25.4mm blade angle 34° W 44mm aluminium		
For models:	ICF110, ITP120UK, ITP120UK, ADF110ES, ILNF120, ALN110, ALN120, ADN111, AEN110, AEN120, AKN111, ADF110, ALF110, ADF120, ALF120, AEF110, AEF120, ADNN220, ADNF220, ADNN230, ADNF230, AENN220, AENF220, AENN230, AENF230, ASN110, ASN111, ASF110, SM250, AKN110UK, AKF110UK, ASN110UK, ASF110UK, APP113, APP114, APF113, APF114, APP223, APP224, ARDN110, ADN110E, ADF110E, APP114/60, APP224/60, APP224/60, 83012201, ARDF110L, ARDF120, ASN110, ASF110...(Other models you can see in the webshop)		

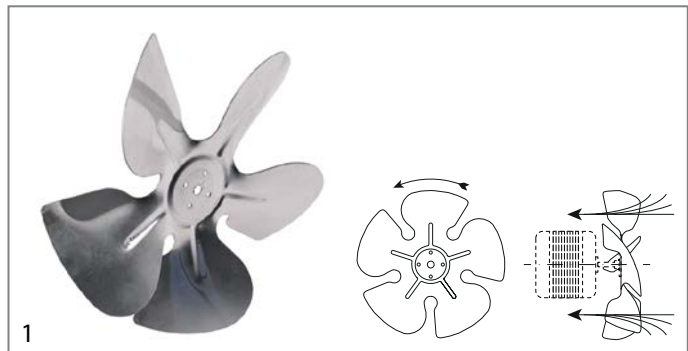

GEV No.	601172	Ref. No.	082230 086327 0A8420 60050126
description	fan wheel sucking ø 230mm fan wheel mounting 25.4mm blade angle 34° W 50mm aluminium		
For models:	CIM65A, CIM65W, ICP111, ICP130, ICP112, ICF110, ICN110UK, ICF110, AQC22U US, , , ALP110, ALP120, ALP111, ALP220, ALP240, ALP221, ALN110, ALN120, ALN111, ALN220, ALN240, ALN221, ALNN120, ALNN220, ALNN230, ALNSO120, ALP110UK, ALN110UK, ALNN220UK, ALF110, ALF220UK, ALNF220, ALF110, ALF120, ALF220, ALF240, ALNF120, ALNF220, ALNF230, ADN220ES, ADF220ES, ILP110, ILP110UK, ILN120, ILP111, ILP220, ILP220UK, ILP240, ILP221...(Other models you can see in the webshop)		

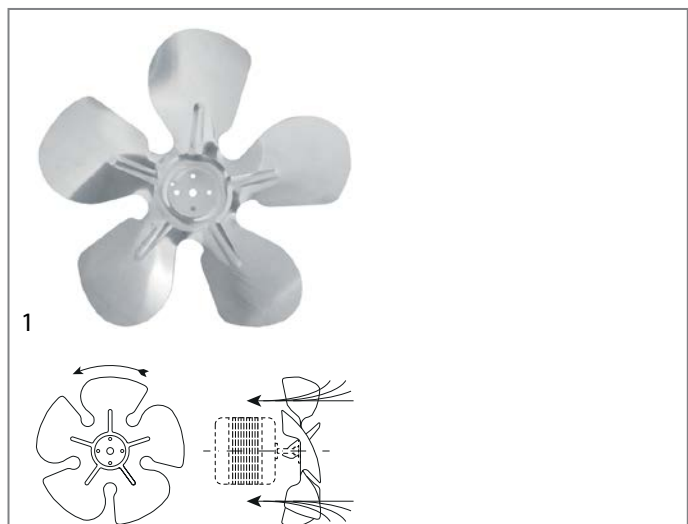

GEV No.	601387	Ref. No.	086311
description	fan wheel sucking ø 254mm fan wheel mounting 25.4mm blade angle 34° W 50mm aluminium		
For models:	CIM120AS		

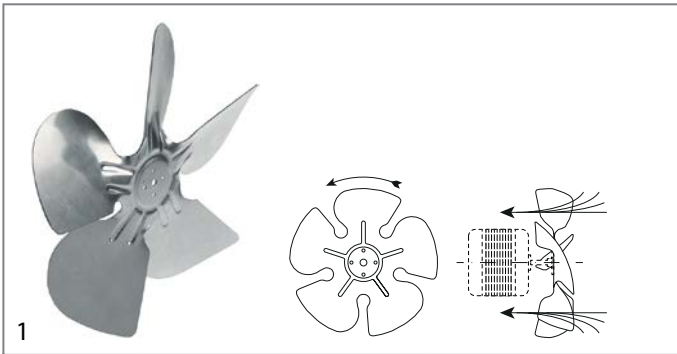

GEV No.	601555	Ref. No.	087797 OKM740
description	fan wheel sucking ø 300mm fan wheel mounting 25.4mm blade angle 25° W 45mm aluminium		
For models:	CIM235AB, CIM235WB, VM500W+BI, VM500A+BI, C150W, C300A, C300W, CB1565W, CB246W, CB416W, CB955W, DSS42W, C80W, CB1565A, C80A, CB246A, CB416A, C150A, CB955A, DSS42A, G500A, GB1555W, GB1555A, G500W, VB250A, VB250W, VM900A, VM900W		

plastic

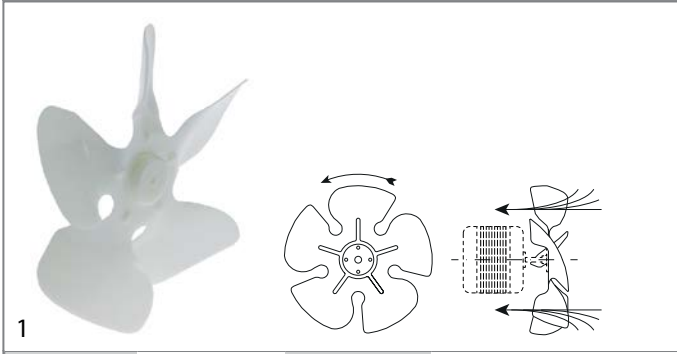

GEV No.	602109	Ref. No.	093418
description	fan wheel sucking ø 150mm plastic		
For models:	FV 1M, FV 1M, FV 1M, FV Dual, FV Dual, FV 1M, FV 1M, FV 1M, FV 1M, FV Dual, FV Dual, FV 1M, FV 1M, FV 1M, FV 1M, FV Dual, DUAL 2 DOORS, FV 1M, ESP72HFG, FV 1M, FV Dual, FV Dual, FV 1M, FV 1M, FV Dual, FV Dual, DUAL 2 DOORS, FV 1M, FV 1M, FV Dual, FV 1M, FV 1M, FV 1M, FV Dual, FV Dual, FV 1M, FV 1M, FV 1M, FV Dual, FV Dual, FV 1M, FV 1M, FV 1M, FV Dual, FV Dual, DUAL 2 DOORS, FV 1M, FV 1M, FV Dual, FV Dual...(Other models you can see in the webshop)		

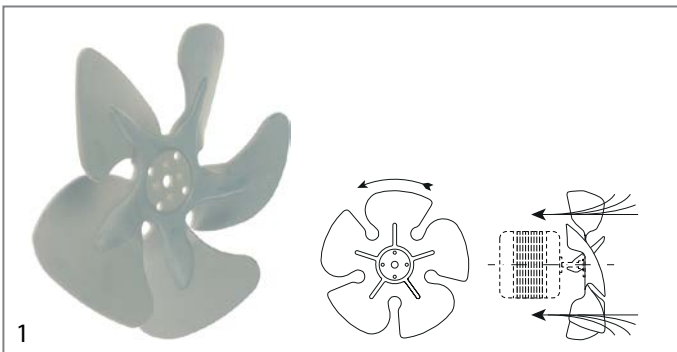

GEV No.	601412	Ref. No.	085287
description	fan wheel sucking ø 154mm fan wheel mounting 25.4mm blade angle 28° W 34mm plastic		
For models:	FGC33A542, FGC46A542, FGC65A42, MF250WB20, FGS500A, FGS500W, FGC24AB, FGC24WB, FGC29AB, FGC29WB, FGC40A, FGC40W, FGC67AB, FGC67WB, FGC90A, FGC90W, FGC143AB, FGC143WB, FGS94AB, FGS94WB, FGS140A, FGC25A, CB246W, CIM38AB, CIM38WB, CIM85AB, CIM15WB, FIM150ASB, FIM150WSB, FIM285ASB, FIM285WSB, CIM50AB, FIM50WB, FGC24ABS, FGC24W-BAB, FGC29AB, FGC29WB, CIM38AB, CIM38WB, CIM50AB, FIM50WB, FGC143AB, FGC143WB, CB184A, CB249A, CB316A, CB425A, CB840A, FGC24AB, FGC24WB...(Other models you can see in the webshop)		

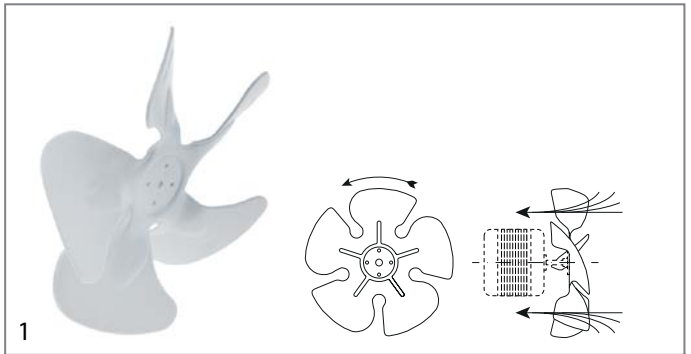

GEV No.	601773	Ref. No.	089696
description	fan wheel sucking ø 200mm fan wheel mounting 25.4mm blade angle 34° W 51mm plastic		
For models:	ADF110ES, ADN110ESP, ADN110E, ADF110E, 83012001, 83012033, 83012201, ARDF110L, ARDF120, 83012037, ASN110, ASF110, ADN110, ADN120, ADN111, ADF110, ADF120, ADNN220, ADNF220, ADNN230, ADNF230, ADN11060, ADF11060, ZPRO6R1F, ZPRO6F1F, STRP1101, STRP1102, STRP1601, STRP1602, STRP1603, STRP2201, STRP2202, STRP2203, STRP1101S, STRP1601S, STRP2201S, STRP1602R, STRP1603R, STRP2201R, STRP2202R, STRP2203R, STRP1101R, STRP1102R, STRP1601R, PR06R1FBR, PR06R2FBR, PR06F1FBR, PS06F1F6M, PS06RE1F, PS06FE1F...(Other models you can see in the webshop)		

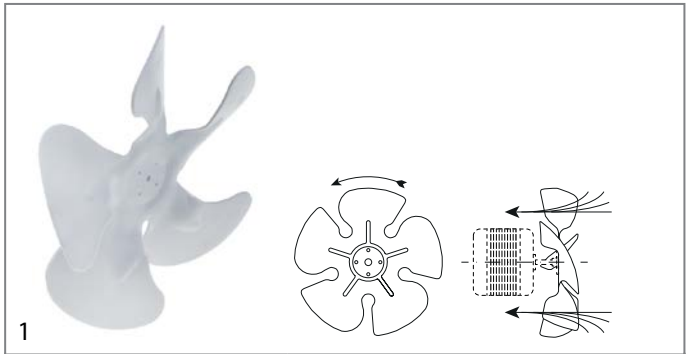

GEV No.	601774	Ref. No.	089697
description	fan wheel sucking ø 230mm fan wheel mounting 25.4mm blade angle 31° W 52mm plastic		
For models:	ADF110ES, ADN110ESP, FV 1M, FV 1M, FV 1M, FV 1M, FV 1M, FV Dual, FV Dual, FV 2M, FV 2M, FV 2M, DUAL 2 DOORS, DUAL 2 DOORS, FV 2M, FV 2M, FV 1M, FV 1M, FV 2M, ADN110E, ADF110E, AZF1103, ARDNN120, 83012101, ASF110, ADF110, ADF120, ADNN120, ADNF120, ADNN220, ADNF220, ADNN230, ADNF230, BLAST C/FREEZER, ZPRO6F1F, ALF1104, ALF11033, AZF1103, ALF1104, ALF11033, PS06FE1F, PS06F1F, PS06FE2F, PR06F1F4, PS04R1F, PR06F1F, PR06FE2F, PS04R2F, PS04R1G...(Other models you can see in the webshop)		



aluminium

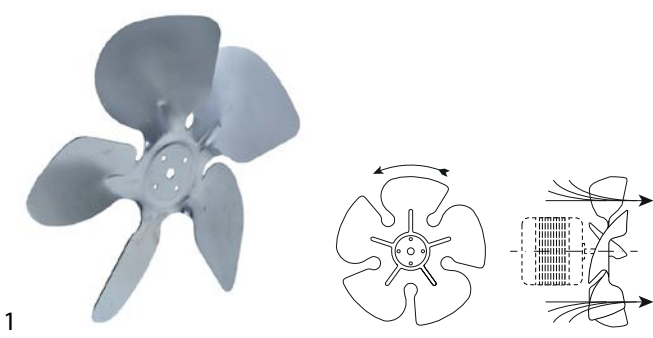

1

GEV No.	601570	Ref. No.	088376
description	fan wheel blowing ø 200mm fan wheel mounting 25.4mm blade angle 28° W 37mm aluminium		
For models:	AZP1103, AZF1103, AZP1103, ALN1103, ALNN1203, ALNN2203, AZP6430, ALF1104, ALN11033, ALF11033, AZP1103, AZP110360, ALN1103, AZP6430, ALN11033, AZF1103, ALF1104, ALF11033, ALNN1203, ALNN2203, IKS220N, ISS220N, TZ751R, ISP110N, ISP220N, RS06RX1F, RS06FX1F, RS06DX2F, RS13DX2F, RS06PX1F, RS06PX1F6, RS06R41F, RS06NX1F, RS06F41F, RS06FX1F4, RS06DFX2F, RS13DFX2F, RS06PW1F, RS06FW1F, ILN220N, RS06FX1F6, RS06RXH, RS06FX2H, RS06RX1FG, RS06FX1FG, RS06N41F, RS06F41FS, KL650R, KL650F, RS0PX1FD...(Other models you can see in the webshop)		

fan guards



1

GEV No.	601581	Ref. No.	083440
description	grid for fan wheel ø 200mm H 25mm mounting distance 1 236mm mounting distance 2 94.5mm		
For models:	ITP120UK, ITP120UK, ILNF120, ALNF120, ALN110, ALN120, ADN111, AEN110, AEN120, AKN111, ADF110, ALF110, ADF120, ALF120, AEF110, AEF120, ADNN120, ADNF120, AENN120, AENF120, ADNN220, ADNF220, ADNN230, ADNF230, AENN220, AENF220, AENN230, AENF230, ASN110, ASN111, ASF110, AKN110UK, AKF110UK, ASN110UK, ASF110UK, APP113, APP114, ARDN110, APP114/60, ADNN220, ADNF220, ADNN230, IKNF120, AKNF120, APP11B, APP113V, ESR4212F, ESR41G, ESR41F, ...(Other models you can see in the webshop)		

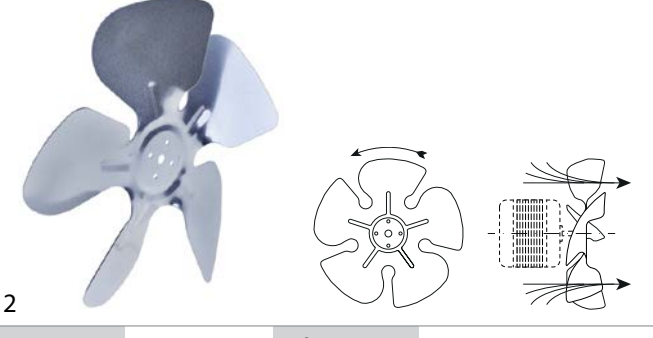

2

GEV No.	601571	Ref. No.	085532
description	fan wheel blowing ø 230mm fan wheel mounting 25.4mm blade angle 28° W 43mm aluminium		
For models:	APP224/60, AZP1103, ADN220, ADN22060, ADF2206, AZP110360, AZP2203, AZP220360, EUKR61/N, ESMF41F, PS04R1GM, PS04R1F6M, PS04R1F1M, PS04F1F6M, PR04R1F6M, PR04R1F1M, PR04F1F6M, MRF4808660, MRF6018660, PROGRE1FUS, RH14RE2FUS, RH14FE2FUS, RI093RE1FU, RS06PX1F6, RS13PX2F6, RH14RE2FEU, RH14FE2FEU, PR43RE1FEU, RI93RE1FEU, RH14RE4HU, RH14FE4HU, RCSER2M2U, RCSER3M3U, RCSER4M4U, RCEF2M2U, RCEF3M3U, RS13FX2F6, EUKR61N, RH14FE2FDU, RH14R2FERU, RH14F2FERU, RH14RE4HRU, RH14FE4HRU, RS06N41F, RS06F41FS, CM13RF3M, RH14RD2F6, RH14FD2F6, R04NVF4, R04NVF4F...(Other models you can see in the webshop)		

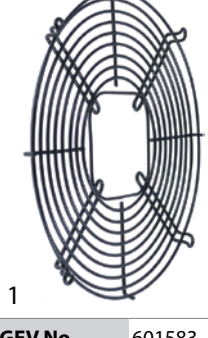

1

GEV No.	601583	Ref. No.	083157
description	grid for fan wheel ø 254mm H 17mm mounting distance 1 290mm mounting distance 2 94.5mm		
For models:	, ALP110, ALP120, ALP111, ALP220, ALP240, ALP221, ALN110, ALN120, ALN111, ALN220, ALN240, ALN221, ALNN120, ALNN220, ALNN230, ALNSO120, ALP110UK, ALN110UK, ALNN220UK, ALF220UK, ALF220, ALF240, ALNF120, ALNF230, ILP110, ILP110UK, ILN120, ILP220, ILP220UK, ILP240, ILN110, ILN110UK, ILN120, ILN220, ILN220UK, ILN240, ILNSO120, ILNN120, ILNN220, ILNN220UK, ILNN230, ALP110UK, ALN110UK, ALNN220UK, ALF110UK, ALNF220UK, ILNF120, ILNF220, ILNF220UK...(Other models you can see in the webshop)		

cooling motors (complete)



			
1			
GEV No.	601716	Ref. No.	081703 092795
description	fan 230V 10W 50/60Hz fan wheel ø 230mm shaft L 13mm L 79.5mm W 277mm mounting distance 67mm ø 277mm cable length 3500mm		
For models:	ALP110, ALP120, ALP111, ALP220, ALP240, ALP221, ALN110, ALN120, ALN111, ALN220, ALN240, ALN221, ALNN120, ALNN220, ALNN230, ALP110UK, ALN110UK, ALNN220UK, ALF110, ALF220UK, ALNF220, ALF110, ALF120, ALF220, ALF240, ALNF120, ALNF220, ALNF230, ILP110, ILP110UK, ILN120, ILP111, ILP220, ILP220UK, ILP240, ILP221, ILN110, ILN110UK, ILN120, ILN111, ILN220, ILN220UK, ILN240, ILN221, ILNN120, ILNN220, ILNN220UK, ILNN230, ALP110UK, ALN110UK... (Other models you can see in the webshop)		
spare parts for	601716		
		GEV No.	601571 Ref. No. 085532
	fan wheel blowing ø 230mm fan wheel mounting 25.4mm blade angle 28° W 43mm aluminium		

cold air circulating fans (complete)

ebm-papst

A2E series

			
1			
GEV No.	601959	Ref. No.	084722 088603
description	fan A2E250-AE65-02 fan wheel ø 250mm blades 5 230V 50/60Hz 115/165W 2550/2750rpm cable length 1800mm ebm-papst blowing		
For models:	BCF44H, , BCF15A6, BC44H, BCF44H, BC44H, BCF44H, BC15A, Crosswise, BCF15A, Crosswise, ESK40H, ESF40H, Crosswise, RBC061, Crosswise, RBC6.1-15, Crosswise, RBF061, Crosswise, RBF6.1-15R, BLAST C/ FREEZER, RBF0616, EEVA40/2, EEVAC40/2, ESK40H, ESF40H, TBC44H, TBCF44H, Crosswise, EABP0101, Crosswise, EEVAC151, FRABC1511, FRABCF1511, Crosswise, KBCF61CW, EEVAC40/2, EEVA40/2, EEVAC40/2, AF431, AB431, AF431, ATPE102, AF431		

			
1			
GEV No.	601707	Ref. No.	083407 083514 084727 084729 088624 090014
description	fan A2E300-AC47-02 fan wheel ø 300mm blades 5 230V 50/60Hz 140/190W ø 92mm H 100mm 2900rpm cable length 450mm blowing suitable capacitor 5µF		
For models:	BC22, BC44, BCF11, BCF22, BCF44, BC28A6, Crosswise, , , BC22, BC44, BCF11, BCF22, BCF44, BC22, BC44, BCF11, BCF22, BCF44, BC28A, Crosswise, BC56HA, BCF28A, Crosswise, BCF56HA, ESBF10, ESBBC20, ESBBC20R, ESBF20, ESBBC40, ESBBC40R, ESBF40, RBC102, Crosswise, RBC101, Crosswise, RBC10.1-2, Crosswise, RBF101, Crosswise, RBF1016, BLAST C/FREEZER, EEVA201, EEVA40/1, EEVAC10/1, EEVAC201, EEVAC40/1, ESK20, ESK40V...(Other models you can see in the webshop)		
accessories for	601707		
		GEV No.	365017 Ref. No. 037268 083406 0K9108 0L2035
	operating capacitor capacity 5µF 450V tolerance 5% 50/60Hz ambient temperature max. -25 to +85°C ø 28mm L 54mm M8 plastic connection male faston 6.3mm 16.10.08 protection		
		GEV No.	601949 Ref. No. —
	guard ebm-papst for fan wheel ø 300mm ø 330mm hole distance 368mm H 65mm		

A4E series

			
1			
GEV No.	602123	Ref. No.	088350 094830
description	fan A4E330-AP20-21 fan wheel ø 330mm blades 5 230V 50/60Hz 105/135W mounting distance 285mm hole ø 5mm 1360/1520rpm cable length 1600mm ebm-papst with protective grid		
For models:	, , BCW101, BCFW101, BCFWS101, BCF28A, Crosswise, BCF56HA, RBC102, EABP51, EABC501, AOFPS101C, AOFPS10160, Crosswise, RBF101, AOCP101, AOFPS101, AOCP101C, AOFPS101C, EABP51C, EABC51C, Crosswise, RBF1016, Crosswise, EABC0201, FRABCF2811, FRABCF5621, EABC642, EABCS51C, HORBCF50		

			
1			
GEV No.	601119	Ref. No.	0A8401 0A8656 0A9308
description	fan 230V 50/60Hz 2W ø 100mm type C09R1731 fan wheel ø 100mm connection male faston 6.3mm shaft L 23mm		
For models:	ICP110, ICP111, ICP112, ITP120UK, ITP120UK, ICP110, RS24, NEPV40, NEPEV40, EP406VRPUK, MP402C, NEPV40, NEPA40, NEPEV40, MP402, EK401U, EK401UGT, EK401UCS, MRP402, RW24, R04PVF4M, EP406VRC, EP406VRV, EP404VRC, R04PVFWG, R04PVF4, R04PVG4, R04PVFW, R04PVGW, C04PVF4D, C04PVG4D, EP406VRC, EP406VRV, EP404VRC, E04P6SRC, EP406VRC, E04P6VRV, E04P4VRC, E04P4VRV, DOC121V11C, DOP121V11C, DOP120V11C, DOC121V11C, DOP121V11C, DOP120V11C, RVPE041, RVPE04V, RVPE04W, ZICP110		

cold air circulating fans (other)

			
1			
GEV No.	601554	Ref. No.	OKM759
description	fan motor 230V 50-60Hz 100W W 105mm H 105mm D 220mm shaft L 80mm shaft ø 12mm EURO MOTORS type 10111-40100 cable length 1500mm 1100rpm		

cross flow fans

ebm-papst

			
1			
GEV No.	601034	Ref. No.	081795
description	cross flow fan ebm-papst QLK45/1200-2513 roller ø 45mm roller length 120mm laminated core thickness 13mm motor position right 230V/50Hz 17W refrigeration bearing rubber connection male faston 6.3mm airflow 80m³/h 0 up to +60°C		

			
1			
GEV No.	601047	Ref. No.	0H6923 60050453
description	cross flow fan ebm-papst QLZ06/0600-2513 roller ø 60mm roller length 60mm laminated core thickness 13mm motor position right 230V/50Hz 17W refrigeration bearing rubber connection male faston 6.3mm airflow 40m³/h 0 up to +60°C		
For models:	5611-3-10, 5611-3-6, 5611-3-8, 5612-3-10, 5612-3-6, 5612-3-8, 5614-3-10, 5614-3-6, 5614-3-8		

			
1			
GEV No.	601274	Ref. No.	OKZ459
description	cross flow fan roller ø 60mm roller length 2x180mm motor position centre 36W universal bearing silicone connection 200 230V cable length 200mm 50Hz		



			
1			
GEV No.	601174	Ref. No.	0G2872 0G2982 11151615
description	cross flow fan roller ø 65mm roller length 300mm motor position right 53W universal bearing silicone connection F 6.3 230V throughput 250m³/h 50/60Hz		
For models:	AIARHFFOQB, AIARHAFQOQB, AIARHBFOQB, AIAWHFFFOQB, AIAWHAFQOQB, AIAWHBFFOQB, AIAROIQOQB, AIAWOIFFOQB, AIAWAAKQOQB, AIAWABKQOQB, AIAWAFKQOQB, AIAROIQOQB, AIARAQOQB, AIARABKQOQB, AIARAFQOQB, AIAWOIKQOQB, AIARAAGOQB, AIARABQOQB, AIARAFQOQB, AIAROIQOQB, AIAWAAQOQB, AIAWABQOQB, AIAWAFQOQB, AIAWOIQOQB, AIARAFFOQB, AIARAFFOQB, AIARABFOQB, AIAWAFFOQB, AIAWAAFFOQB, AIAWABFFOQB		



			
1			
GEV No.	601505	Ref. No.	OH9848 OK2721 OK5059 OK9183 11151416 18025416
description	cross flow fan QLN65/2400A17-3030L roller ø 65mm roller length 240mm laminated core thickness 29mm motor position right 230V/50Hz 22W refrigeration bearing silicone connection F 6.3 0 up to +60°C 230V throughput 200m ³ /h 50Hz		
For models:	HLI159-371W.3, HLI159-373.3, HLI259-390W.3, LI159-375.3, LI159-376.3, LI259-372.3, LI259-379.3, LI159-380.3, HLI159-373W.3, HLI159-374.3, HLI259-375W.3, LI159-371.3, LI159-372.3, LI159-379.3, HLI159-371.3, HLI159-372.3, LI159-373.3, LI159-374.3, LI159-385.3, LI159-386.3, LI259-375.3, LI259-376.3, LI259-371.3, LI259-373.3, LI259-374.3, LI259-377.3, LI259-378.3, HLI259-375.3, HLI259-376.3, LI259-390.3, LI259-391.3, LI259-392.3, LI259-393.3, LI259-394.3, LI259-395.3, HLI259-390.3, HLI259-391.3, CI158-104.3, CI158-105.3, CI158-115.3, HCI158-104.3, HCI158-105.3, CI158-106.3, CI158-107.3, CI158-118.3, CI248-135.3, CI248-136.3, HCI248-135.3, HCI248-136.3, 7514-3/85. HE.2KF.IND...(Other models you can see in the webshop)		

			
1			
GEV No.	601102	Ref. No.	082730 0A9148
description	cross flow fan TFL 45 roller ø 45mm roller length 300mm motor position left 230V/50Hz 35W refrigeration bearing rubber connection male faston 6.3mm airflow 268m ³ /h -10 up to +60°C 230V 50Hz		
For models:	TRN1301, TRNA1301, TRNM1301, TRN1302, TRNA1302, TRNM1302, TRN1303, TRNA1303, TRNM1303, TRN1801, TRNA1801, TRNM1801, TRN1802, TRNA1802, TRNM1802, TRN1803, TRNA1803, TRNM1803, TRN2201, TRNA2201, TRNM2201, TRN2202, TRNA2202, TRNM2202, TRN2203, TRNA2203, TRNM2203, TRRN1301, TRRN1302, TRRN1303, TRRN1801, TRRN1802, TRRN1803, TRRN2201, TRRN2202, TRRN2203, TRNP1802, TRRF130P, TRRF180P, TRRF220P, TRF1301, TRRF1301, TRF1801, TRRF1801, TRF2201, TRRF2201, TRN1301, TRNA1301, TRNM1301, TRRN1301...(Other models you can see in the webshop)		

COPREL			
with standard coil			
			
1			
GEV No.	601101	Ref. No.	083737 0T1550 292202657 30001372
description	cross flow fan COPREL TFL(FN) roller ø 60mm roller length 300mm laminated core thickness 30mm motor position left 230V/50Hz 43W refrigeration bearing rubber connection male faston 6.3mm coil type airflow 268m ³ /h -10 up to +60°C		
For models:	ESR4212FR, ESR4212F, ESR41GR, ESR41FR, ESR41G, ESF41FR, ESR41F, , , , ESR41F60HZ, ESR422F60HZ, ESR41G60HZ, ESF41GR, TE1502GT, TZ1502GT, KE1502GT, KZ1502GT, ESR41F, ESR41G, ESR41FR, ESF41FR, ESR421/2F, EUKR41GR, ESR421/2FR, ESF41GR, EUKR41N, EUKR421/2F, UKR41F, PDVN501V11C, PDVN501V12C, PDVN507V11C, PDVN-507V11C		

			
1			
GEV No.	601453	Ref. No.	005204 3370000154 3581908187
description	cross flow fan TFR 180 roller ø 60mm roller length 180mm laminated core thickness 16mm motor position right 230V/50-60Hz 17W universal bearing silicone connection male faston 6.3mm airflow 100m ³ /h -30 up to +100°C 230V 50Hz		
For models:	FCF/E4, FCF/E4-3KW, JCF/E4, JCF/E4, ECF/E4, ECF/E4-3KW, ACF/E4, ACF/E4-3KW, NCF/E4, ZCF/E4, ZCF/E4		
accessories for	601453		
	GEV No.	Ref. No.	—
	 heater battery mounting distance 185mm W 40mm H 35mm 2000W 230V temperature restriction 105°C heating circuits 2 connection cable cable length 150mm L 192mm for cross flow fan		

			
1			
GEV No.	601454	Ref. No.	031297 081704 084027
description	cross flow fan TFR 45 roller ø 45mm roller length 120mm motor position right 230V/50Hz 17W universal bearing silicone connection male faston 6.3mm airflow 85m ³ /h -30 up to +100°C 230V 50Hz		



with moulded coils

			
1			
GEV No.	601456	Ref. No.	0A8087
description	cross flow fan roller ø 45mm roller length 180mm laminated core thickness 15mm motor position right 230V/50Hz 26W universal bearing silicone connection male faston 6.3mm -30 up to +100°C 230V 50/60Hz		
For models:	125-00-100, 125-00-102, 125-00-103, 125-00-100, 125-00-102, 125-00-103, 133-01-110, 133-01-111, 133-06-110, 133-06-111		

			
1			
GEV No.	601455	Ref. No.	OK4850
description	cross flow fan roller ø 60mm roller length 2x180mm laminated core thickness 35mm motor position centre 230V/50Hz 30W universal bearing silicone connection F 6.3 airflow 280m³/h -30 up to +100°C total length 470mm		

			
1			
GEV No.	601340	Ref. No.	0A2272 0A3008 300778
description	cross flow fan roller ø 60mm roller length 180mm laminated core thickness 30mm motor position right 230V/50Hz 19W universal bearing silicone connection male faston 6.3mm -30 up to +100°C 230V 50Hz		
accessories for	601340		
	GEV No.	415122	Ref. No. 0k4812
	heater battery mounting distance 185mm W 40mm H 35mm 2000W 230V temperature restriction 105°C heating circuits 2 connection cable cable length 340mm L 197mm for cross flow fan		
	GEV No.	420267	Ref. No. —
	heater battery mounting distance 185mm W 40mm H 35mm 2000W 230V temperature restriction 105°C heating circuits 2 connection cable cable length 340mm L 197mm for cross flow fan		

cross flow fan with heater battery			
roller diameter ø60mm			
			
1			
GEV No.	601191	Ref. No.	0H6474 0KC251 0KC252 0KG838 207002305002 83111300322 83111300390
description	cross flow fan roller length 180mm roller ø 60mm motor position right 230V 50Hz 17W heat output 2000W bearing silicone with temperature limiter		

double fans

			
1			
GEV No.	601026	Ref. No.	0G0161 0K3707 0K5906 129623 22129623 601026 722129623
description	cross flow fan COPREL TFD(FD) roller ø 60mm roller length 2x180mm laminated core thickness 35mm motor position centre 230V/50-60Hz 42W refrigeration bearing rubber connection male faston 6.3mm coil type airflow 255m³/h -10 up to +60°C		

accessories for cross flow fans			
heater battery			
			
1			
GEV No.	415122	Ref. No.	0k4812
description	heater battery mounting distance 185mm W 40mm H 35mm 2000W 230V temperature restriction 105°C heating circuits 2 connection cable cable length 340mm L 197mm for cross flow fan		





			
1			
GEV No.	420240	Ref. No.	0E3385 0W6266
description	heater battery mounting distance mm W 90mm H 45mm 6000W 240/415V temperature restriction 125°C heating circuits 6 connection male faston 6.3mm cable length mm L 360mm		
For models:	D166E, D166E COP, T4350, T3900, D200E, D200G, DI200E, DI200G, T3900, T390013, D650E, D650G, D650V, T419002, T419003, PD9, T353019, T3190, T3190, T3250_EL, T3250_GAS, T3250_EL, T3250_GAS, T3650, T3650, T3650, T3350_EL, T3350_GAS, T3350_EL, T3350_GAS, T3530, T3530, T3190E, T3190G, T419001, T419005, T329001, T329002, T329003, T329004, T329005, T329006, T329007, T329008, T329009, T329010, T329011, T329012, T4300S01, T4300S02...(Other models you can see in the webshop)		

hot air motors

			
1			
GEV No.	511313	Ref. No.	005132 0K9191
description	centring piece for fan motor		
For models:	5711-2-6, 5711-2-7, 5711-2-8, 5711-2-10, 5711-2-8CH, 5711-2-10CH, 5712-2-6, 5712-2-7, 5712-2-8, 5712-2-10, 5714-2-6, 5714-2-7, 5714-2-8, 5714-2-10, 5717-2-6, 5714-2-7, 5714-2-8, 5714-2-10, 5711-2-6L, 5711-2-7L, 5711-2-8L, 5711-2-10L, 5712-2-6L, 5712-2-7L, 5712-2-8L, 5712-2-10L, 5714-2-6L, 5714-2-7L, 5714-2-8L, 5714-2-10L, 5714-2-6L, 5714-2-7L, 5714-2-8L, 5714-2-10L, 5711-3-6, 5711-3-7, 5711-3-8, 5711-3-10, 5711-3-8CH, 5711-3-10CH, 5712-3-6, 5712-3-7, 5712-3-8, 5712-3-8E, 5712-3-10, 5712-3-8CH, 5712-3-10C, 5714-3-6, 5714-3-7, 5714-3-8...(Other models you can see in the webshop)		

			
1			
GEV No.	511302	Ref. No.	0H6643 0K2093 246195 60050427
description	engine shaft gasket ID \varnothing 16mm ED \varnothing 40mm for 55/56 series		
For models:	5611-3-10, 5611-3-6, 5611-3-8, 5612-3-10, 5612-3-6, 5612-3-8, 5614-3-10, 5614-3-6, 5614-3-8		

			
1			
GEV No.	511314	Ref. No.	0H6862
description	engine shaft gasket ID \varnothing 19mm ED \varnothing 30mm for 54 series		

			
1			
GEV No.	511303	Ref. No.	0H6644 0K2094 246196 60050428
description	engine shaft gasket ID \varnothing 27mm ED \varnothing 40mm for 55/56 series		

			
1			
GEV No.	511315	Ref. No.	0H6513
description	engine shaft gasket ID \varnothing 29mm ED \varnothing 40mm for 54 series		

			
1			
GEV No.	601040	Ref. No.	054570 054829 10521400
description	fan motor		
For models:	FCFG6D, FCVE6D, FCVE6D, FCFG6, FCFG6F, PFCFG6, FCVE6, FCVE6UK, PFCVE6, FCVE6-1U, FCVE6-3U, FCVE6-1, FCVE6-3, FCVE6-1UK, FCVE6-3UK, FCVG6-1, FCVG6-3, FCVG6-1UK, FCVG6-3UK, FCF/G6, FCF/E6, FCF/E6-1, FCF/E6-1, FCF/G6-1, ZOFVCV/G6-3, AFCV/G6-1, AFCV/G6-3, COCO6G, COCO6E, COCVC423AF, FCVE061, ZOFVCV/G6D		

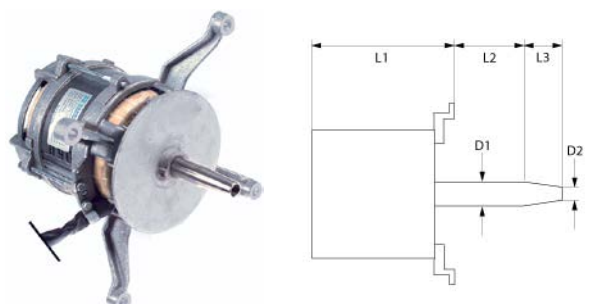
			
1			
GEV No.	601351	Ref. No.	0H6556 0K1912 131058149
description	fan motor 220-230V 3 phase 50Hz 0.02/0.16kW 710/1390rpm speeds 2 L1 150mm L2 27mm L3 35mm M10R IT 0.35/0.9A power input 60/250W at 50Hz 710/1390rpm type L7mw84D-149 no. R2 D1 \varnothing 17mm D2 \varnothing 13mm		

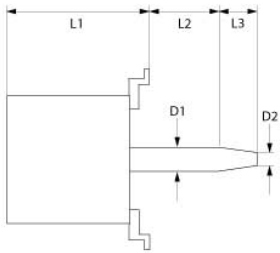
1

GEV No.	500103	Ref. No.	0H6929 OK2763 131091099
description	fan motor 220-240/380-415V 3 phase 50/60Hz 0.25kW 1400rpm speeds 1 L1 150mm L2 32mm L3 40mm ϕ 125mm M10R IT at 50Hz 1400rpm at 60Hz 1700rpm type L7Aw4D-099 no. X3 D1 ϕ 17mm D2 ϕ 14mm		
For models:	5611-3-6, 5612-3-6, 5614-3-6		



1

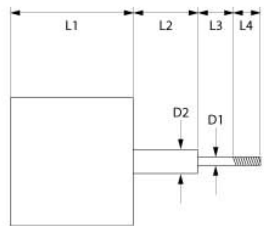

GEV No.	601041	Ref. No.	053826 054836 10522500
description	fan motor 220-240/380-415V 3 phase 50Hz 0.19kW 1350rpm 1/0.58A		
For models:	FCFG10, FCFG10D, FCFG10NL, FCFE10, FCFE10UK, FCVE10, FCVE10-2, FCVE10-4, FCVE10-2UK, FCVE10-4UK, FCGV10-2, FCGV10-4, FCGV10-2, FCGV10-4D, FCGV10-2UK, FCGV10-4UK, FCGV10-2, FCGV10-4, FCFG101, FCF/E10, ZOFCV/E102, ZOFCV/E104, ZOFCV/G102, ZOFCV/G104, COCO10G, COCO10E, FCFE101, ZOFCF/G10D		

1

GEV No.	601449	Ref. No.	058667 OK3026 10925440
description	fan motor 220-240/380-415V 3 phase 50Hz 0.19kW 1350rpm speeds 1 L1 105mm L2 74mm L3 35mm L4 12mm D1 ϕ 9x10mm D2 ϕ 12mm M6R IT 0.58/1A type FIR1092 no. 1092 shaft flat length 9mm		
For models:	FCFG10, FCFG10D, FCFG10NL, FCFE10, FCFE10UK, FCVE10-2, FCVE10-4, FCVE103CE, FCVE10-2UK, FCVE10-4UK, FCGV10-1SG, FCVE20VUK, FCFG101, ZOFCV/E102, ZOFCV/E104, FF/E10, FF/G10, COCO10G, COCO10E, FCGV10-1SG, FCFE101, ZOFCF/G10D		

accessories for 601449

	GEV No.	693846	Ref. No.	054830 058731
spacer piece for fan motor				
	GEV No.	693847	Ref. No.	058729
fixing plate for hot air motors ED ϕ 230mm H 2.5mm ID ϕ 16mm				

accessories for 601449

	GEV No.	694297	Ref. No.	058957
flange for hot air motors ED ϕ 270mm H 3.5mm ID ϕ 16mm				



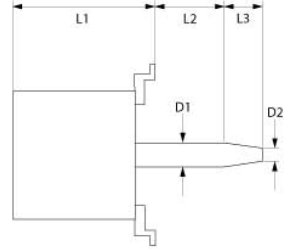

1

GEV No.	601378	Ref. No.	054011 054012 054837 058607 1093V5440
description	fan motor 220-240/380-415V 3 phase 50Hz 0.35kW 1350rpm speeds 1 L1 143mm L2 91mm L3 34mm D1 ϕ 10mm D2 ϕ 16mm M6R IT 1.8/1A number of pole pairs 4 at 50Hz 1350rpm type FIR1093/V		
For models:	FCFG20, FCFG20D, FCFG20F, PFCFG20, FCFE20, FCFE20UK, FCFG40, FCFG41, FCFG40D, FCFG40F, PFCFG40F, FCFE40, FCFE40D, FCFE40UK, PFCFE40F, FCVE20, FCVE20-2, FCVE20-4, FCVE203CE, FCVE20-2UK, FCVE20-4UK, FCGV20-2, FCGV20-4, FCGV20-2, FCGV20-4D, FCGV20-2UK, FCGV20-4UK, FCGV20-4, FCGV20-4D, FCFG201, FCFG202, FCFC202, FCF/E20, FCFE202, ZOFCV/E202, ZOFCV/E204, ZOFCV/G202, ZOFCV/G204, FF/E40, FF/E20, FF/G20, FF/G40, AFCE/E40, COCO20G, COCO20E, 4236N, 4238N, FCFE201, ZOFCF/G20D		

1

GEV No.	500836	Ref. No.	0H6925 131209037 280125
description	fan motor 220-240/380-415V 3 phase 50Hz 0.37kW 1400rpm speeds 1 L1 175mm L2 47mm L3 31mm M14R IT 2.85/1.65A power input 580W Cos(f) 0.55 at 50Hz 1400rpm type L9Cw4D-037 no. S2 D1 ϕ 23mm D2 ϕ 20mm		

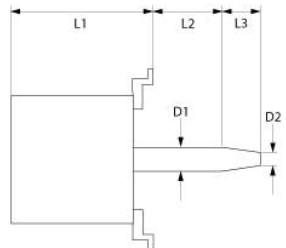
1

GEV No.	500105	Ref. No.	0H6932 131091093
description	fan motor 220-240/380-415V 3 phase 50Hz 0.37kW 1400rpm speeds 1 L1 182mm L2 26mm L3 50mm ϕ 125mm M14R IT 2.85/1.65A power input 580W Cos(f) 0.55 at 50Hz 1400rpm type L9Cw4D-161 no. R7 D1 ϕ 25mm D2 ϕ 20mm		



1

GEV No.	500815	Ref. No.	058994
description	fan motor 220-240V 1 phase 50Hz 0.07/0.2kW 950/1350rpm speeds 2 L1 140mm L2 70mm L3 35mm L4 22mm D1 ø 9/10mm D2 ø 12mm 2 speeds M6R IT 0.55/0.70A at 50Hz 230V at 50Hz 950/1350rpm suitable capacitor 10µF 4P/6P type LM/FB80 no. 386328 shaft flat length 14mm		
For models:	FCVE10-P, FCVE10PUK, FCVG10-P, FCVG10PUK, AFCV/G101, AFCV/G103, SCO/G10-3		

1

GEV No.	601360	Ref. No.	058587 10922330
description	fan motor 220V 1 phase 50Hz 0.1kW 1350rpm speeds 1 L1 105mm L2 66mm L3 35mm D1 ø 10mm D2 ø 12mm M6R IT 0.9A number of pole pairs 4 suitable capacitor 4µF/450V at 50Hz 1350rpm type FIR1092/M		
For models:	FCFG6D, FCFE6D, FCFE6D, FCFG6, FCFG6F, PFCFG6, FCFE6, FCFE6UK, PFCFE6, FCVE6-1U, FCVE6-3U, FCVE6-1, FCVE6-3, FCVE6-3CE, FCVE6-1UK, FCVE6-3UK, FCVG6-1, FCVG6-3, FCVG6-1UK, FCVG6-3UK, FCF/G6, FCF/E6, FCV/E6-1, FCV/E6-1, FCV/G6-1, ZOFCV/G6-3, AFCV/G6-1, AFCV/G6-3, SCO/G6-3, AFCF/E6, FF/G6, COCO6G, COCO6E, COCVE423AF, FCFE061, ZOFCF/G6D		

1

GEV No.	601366	Ref. No.	0K2720 131098098 280159
description	fan motor 220-240V 3 phase 50/60HzkW speeds 1 L1 140mm L2 27mm L3 35mm M10R IT Y/YY type L7mw84D-098 no. RD D1 ø 17mm D2 ø 13mm		

1

GEV No.	500814	Ref. No.	005750
description	fan motor 230V 1 phase 50/60Hz 0.19kW 1400/1700rpm speeds 1 L1 145mm L2 51mm L3 35mm D1 ø 10mm D2 ø 16mm M6R IT 1.3A at 50Hz 1400rpm at 60Hz 1700rpm suitable capacitor 10µF shaft flat length 12mm		
For models:	FCV/G6L3C, FCV/G61/1, FCV/G61/1, FCVG6L3CT, FCS061G3DI, FCS061G4DT, RCV061G2, ACV/G6C3C		

1

GEV No.	601370	Ref. No.	0K2716
description	fan motor 220-240V 3 phase 50HzkWrpm speeds 2 L1 221mm L2 27mm L3 50mm D1 ø 25mm D2 ø 20mm M14R IT Y/YY type L9UWID-13		

GEV No.	500141	Ref. No.	002616 0F0007 0K8482 0KE545 60050295
description	fan motor 230V 1 phase 50/60Hz 0.19kW 1450/1750rpm speeds 1 L1 150mm L2 52mm L3 35mm D1 ø 9/10mm D2 ø 14mm M6R IT 1.3A Cos(fi) 0.91 at 50Hz 1450rpm at 60Hz 1750rpm type LM80/4 no. 596477 shaft flat length 12mm		
For models:	FCV/G10L3, FCV/G6L3TOWNGAS, FCV/G6L3, FCVG10L3T, FCV/E101/1, FCV/G20L3, FCVE6L3J, FCV/E10L3JAP, FCV/E61/1, FCV/G10L2, FCV/E101/1, FCV/E10L2, FCV/E61/1, FCV/E101/2, FCV/E10L3, FCV/E6L3, FCV/E20L3, FCV/E101/1, FCF/G6-0, FCFG101/0, FCFG102-0, FCFG201-0, FCF/E6-0, FCFE101-0, FCFE102-0, FCFE201-0, FCFE202-0, FCF061ELN, FCF101ELN, FCF6EHOR, FCFG10160H, FCF061ENS, FCF101ENS, FCF102ENS, FCF201ENS, FCFG102-0T, FCFE6-1J, FCFE101-1J, FCFE102-1J, FCF/G101/1, FCS061E3CI, FCS101E2, FCS101G2, CS7ME4/200-3, CS7ME4/230-3, CS7ME4/400-3N, CS7ME6/400-3N, CS7ME4/400-3N/EO, CS7ME4/400-3/50HZ/MA, CS7ME4/440-3/60HZ/MA...(Other models you can see in the webshop)		

GEV No.	501574	Ref. No.	0C5287
description	fan motor 230V 1 phase 50/60Hz 0.24/0.31kW 1400/1700rpm L1 143mm L2 52mm L3 35mm D1 ø 10mm D2 ø 11mm M5 1.1/1.4A Cos(fi) 0.94/0.96 at 50Hz 230V at 60Hz 230V at 50Hz 1400rpm at 60Hz 1700rpm with capacitor type FIR no. 1096A2350		
For models:	FCZ061EAA, FCZ101EAA, FCZ061EAH, FCZ101EAH, FCZ061EAN, FCZ101EAN, FCZ061ETA, FCZ101ETA, FCZ201ETA, FCZ061ETH, FCZ101ETH, FCZ201ETH, FCZ061ETN, FCZ101ETN, FCZ201ETN, FCZ101GTG, FCZ201GTG, FCZ101GTD, FCZ201GTD, FCZ061EBA, FCZ101EBA, FCZ061EBH, FCZ101EBH, FCZ061EBN, FCZ101EBN, FCZ061EBC, FCZ101EBC, FCZ061EBA2, FCZ101EBA2, FCZ201EBA2, FCZ061EBH2, FCZ101EBH2, FCZ201EBH2, FCZ061EBN2, FCZ101EBN2, FCZ201EBN2, FCZ061EBC2, FCZ101EBC2, FCZ201EBC2, FCZ101GBG2, FCZ201GBG2, FCZ101GBD2, FCZ201GBD2, FCZ101GBI2, FCZ201GBI2, FCZ061ECA, FCZ101ECA, FCZ061ECH, FCZ101ECH, FCZ061ECN...(Other models you can see in the webshop)		

GEV No.	500143	Ref. No.	002739
description	fan motor 230V 1 phase 50/60Hz 0.35kW 1400/1700rpm speeds 1 L1 165mm L2 91mm L3 35mm D1 ø 9/10mm D2 ø 16mm M6R IT 2.7A Cos(fi) 0.9 at 50Hz 230V at 60Hz 230V at 50Hz 1400rpm at 60Hz 1700rpm suitable capacitor 16µF/450V type LM80/4 no. 556749 shaft flat length 13mm		
For models:	FCVG102L3, FCVG202L3, FCFV/E102/1L3JAP, FCFV/E102/1, FCFV/E102/1L3, FCFV/E202L3, FCFG101/0, FCFG102-0, FCFG202-0, FCFE101-0, FCFE102-0, FCFE201-0, FCFE202-0, FCF101ELN, FCF101ENS, FCF102ENS, FCF201ENS, FCFG102-0T, FCFE101-1J, FCFE102-1J, 5717-2-6, 5714-2-6L, 5707-2-2, 5707-3-2, ECFG101-0, ECFG102-0, ECFG202-0, ECFE101-0, ECFE102-0, ECFE201-0, ECFE202-0, ECF101ENS, ECF102ENS, ECF201ENS, ACFG101-0, ACFG102-0, ACFG202-0, ACFE101-0, ACFE102-0, ACFE201-0, ACFE202-0, JCF/G102/1-1, JCF/E102/1-1, RCF101G, RCF101E, RCF201E, NCF/G101/1, NCF/G102/1, NCF/E102/1, ZCF/G101/1...(Other models you can see in the webshop)		

GEV No.	601222	Ref. No.	006998
description	fan motor 230V 1 phase 50Hz 0.06/0.19kW 890/1395rpm speeds 2 L1 165mm L2 49mm L3 35mm D1 ø 10mm D2 ø 16mm M6R IT 1.6/1.4A Cos(fi) 0.85 at 50Hz 230V at 60Hz 230V at 50Hz 890/1395rpm at 60Hz 950/1695rpm suitable capacitor 12.5µF/450V 4P/6P type LM/FB80 no. 496040 shaft flat length 13mm		
For models:	FCZ061EAA, FCZ101EAA, FCZ201EAA, FCZ061EAH, FCZ101EAH, FCZ201EAH, FCZ061EAN, FCZ101EAN, FCZ201EAN, FCZ061ETA, FCZ101ETA, FCZ201ETA, FCZ061ETH, FCZ101ETH, FCZ201ETH, FCZ061ETN, FCZ101ETN, FCZ201ETN, FCZ061GAG, FCZ101GAG, FCZ201GAG, FCZ061GAD, FCZ101GAD, FCZ201GAD, FCZ101GTG, FCZ201GTG, FCZ101GTD, FCZ201GTD, FCZ061EBA, FCZ101EBA, FCZ201EBA, FCZ061EBH, FCZ101EBH, FCZ201EBH, FCZ061EBN, FCZ101EBN, FCZ201EBN, FCZ061EBC, FCZ101EBC, FCZ201EBC, FCZ061EBA2, FCZ101EBA2, FCZ201EBA2, FCZ061EBH2, FCZ101EBH2, FCZ201EBH2, FCZ061EBN2, FCZ101EBN2, FCZ201EBN2, FCZ061EBC2, FCZ101EBC2, FCZ201EBC2...(Other models you can see in the webshop)		

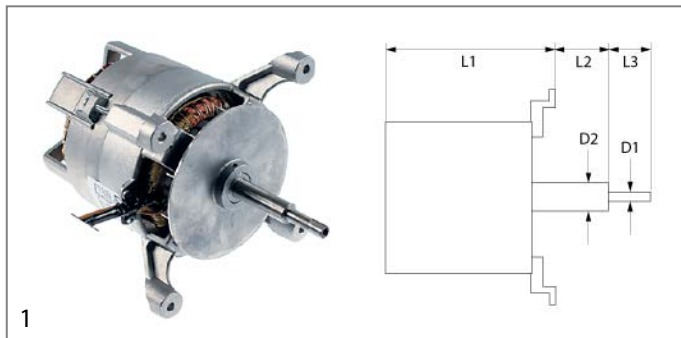

GEV No.	500142	Ref. No.	002698 005028 60050275
description	fan motor 230V 1 phase 50Hz 0.06/0.19kW 930/1380rpm speeds 2 L1 160mm L2 52mm L3 35mm D1 ø 9/10mm D2 ø 16mm M6R IT 1.5/0.7A Cos(φ) 0.9 at 50Hz 930/1380rpm at 60Hz 1100/1700rpm suitable capacitor 12.5µF/400V 4P/6P type LM/FB80 no. 552059 shaft flat length 12mm		
For models:	FCV/E10L6JAP, FCV/E61/1, FCV/E101/1, FCV/E61/1, FCV/E101/1, FCV/G61/1, FCV/G6L4, FCV/E6L4, FCV/G10L6, FCV/E10L6, FCV/G20L6, FCV/E20L6, FCV/E101/1, FCV/G101/1, FVC/E101/1, FCV/G201/1, FVC/E201/1, FCS061E44J, FCS061EP, FCS101E44J, FCS101EP4J, FCS101E4, FCS101G4, FCS101EP, FCS101G4DT, FCS101GP, FCS201E4, FCS201EP, FCS201G4, FCS201GP, FCS061E4, FCS061EXLN, FCS061EX, FCS101EX4J, FCS101EX, FCS201EX, FCS101GX, FCS201GX, 5711-2-7, 5711-2-8, 5711-2-10, 5711-2-8CH, 5711-2-10CH, 5712-2-7, 5712-2-8, 5712-2-10, 5714-2-7, 5714-2-8, 5714-2-10, 5711-2-7L...(Other models you can see in the webshop)		

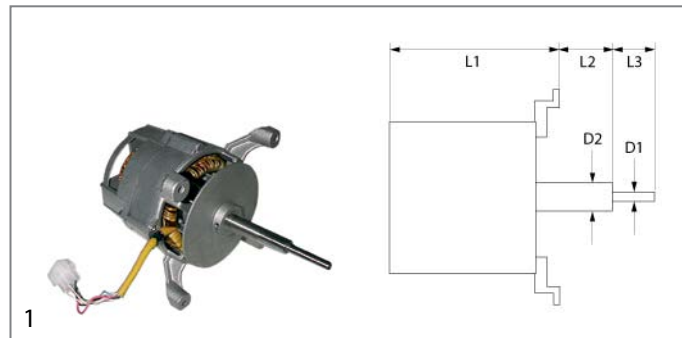

GEV No.	500144	Ref. No.	002748 005237 0K2755 0K2764 60050276
description	fan motor 230V 1 phase 50Hz 0.11/0.35kW 900/1400rpm speeds 2 L1 165mm L2 91mm L3 35mm D1 ø 9/10mm D2 ø 16mm M6R IT 2.7/1.3A at 50Hz 230V at 60Hz 230V at 50Hz 900/1400rpm at 60Hz 1080/1680rpm suitable capacitor 16µF/450V 4P/6P type LM/FB80 no. 358008 shaft flat length 12mm		
For models:	FCV/E102/1L6JAP, FCV/E102/1, FCV/G102/1L6, FCV/E102/1L6, FCV/G202L6, FCVE202L6, FCV/G102/1, FVC/E102/1, FCV/G202/1, FVC/E202/1, FCS102E44J, FCS102EP4J, FCS102E4, FCS102EP, FCS102G4, FCS202E4, FCS102GP, FCS202EP, FCS202G4, FCS202GP, FCS102EX4J, FCS102EX, FCS202EX, FCS102GX, FCS202GX, 5714-2-7, 5714-2-8, 5714-2-10, 5714-2-7L, 5714-2-8L, 5714-2-10L, 5717-3-7, 5717-3-8, 5717-3-8E, 5717-3-10, 5717-3-8C, 57074-2-3, 5707-3-3, ECVG102T4, ECVE102T4, ECVG202T4, ECVE202T4, ECV/G102/1T6, ECV/E102/1T6, ECVG202T6, ECVE202T6, JCF/G102/1-2, JCF/E102/1-2, ACVCG102C4, ACVCG202C4...(Other models you can see in the webshop)		

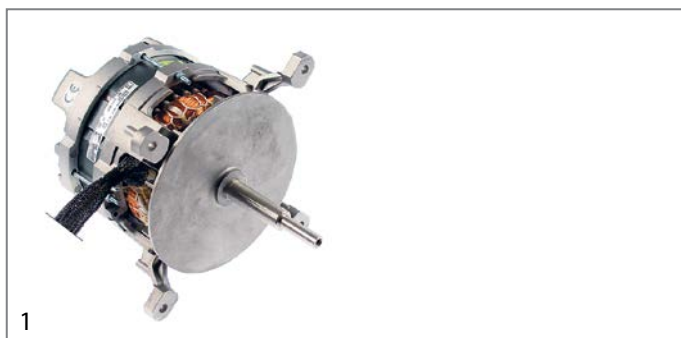

GEV No.	500653	Ref. No.	005748
description	fan motor 230V 1 phase 50Hz 0.06/0.19kW 930/1425rpm speeds 2 L1 150mm L2 52mm L3 35mm D1 ø 10mm D2 ø 16mm M6R IT 1.3/0.8A power input 0.19W at 50Hz 930/1425rpm suitable capacitor 10µF shaft flat length 12mm		
For models:	FCV/G61/1, FCS061GP, FCS061G4, 5721-2-7, 5721-2-10, ECV/G6T4C, ECV/G61/1, ECV/G61/1, ZCV/G6T4C, ZCV/G61/1		

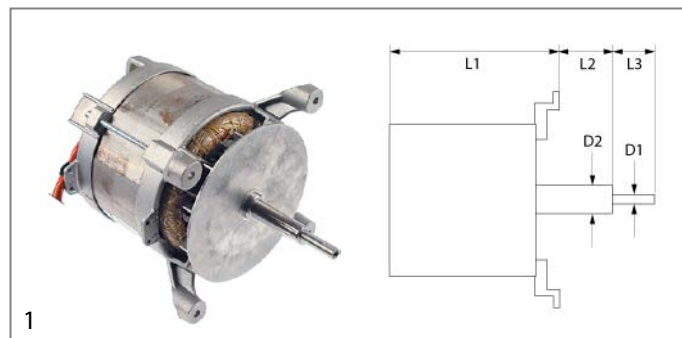

GEV No.	500816	Ref. No.	0C1171 0C6563 611810000
description	fan motor 230V 1 phase 50Hz 0.22/0.75kW 955/1460rpm speeds 2 L1 175mm L2 52mm L3 32mm D1 ø 10mm D2 ø 16mm M6R IT 1.0/2.4A number of pole pairs 4P/6P Cos(φ) 0.84 at 50Hz 230V at 60Hz 230V at 50Hz 955/1460rpm at 60Hz 1145/1750rpm suitable capacitor 31.5/16µF 4P/6P type LM/FB 100L no. 494886 shaft flat length 13mm		
For models:	FCZ102EAA, FCZ202EAA, FCZ102ETA, FCZ202ETA, FCZ102GAG, FCZ202GAG, FCZ102GAD, FCZ202GAD, FCZ102GTG, FCZ202GTG, FCZ102GTD, FCZ202GTD, FCZ102EBA, FCZ202EBA, FCZ102EBA2, FCZ202EBA2, FCZ102GBG, FCZ202GBG, FCZ102GBD, FCZ202GBD, FCZ102GBG2, FCZ202GBG2, FCZ102GBD2, FCZ202GBD2, FCZ102G-BI2, FCZ102ECA, FCZ102ECA2, FCZ202ECA2, FCZ102GCG2, FCZ-202GCG2, FCZ102GCD2, FCZ202GCD2, AOS102GAEU, AOS202GAEU, AOS102EA2N, AOS102EB2N, AOS202EA2N, AOS202EB2N, AOS102EA, AOS102EB, AOS202EA, AOS202EB, AOS102GB, AOS102GA, AOS202GB, AOS202GA, AOS102EAAQ, AOS102EBAQ, AOS202EAAQ, AOS202EBAQ...(Other models you can see in the webshop)		



1

GEV No.	602159	Ref. No.	058807
description	fan motor 240V 1 phase 50Hz 0.1kW 1350rpm L1 105mm L2 66mm L3 35mm D1 \varnothing 10mm D2 \varnothing 12mm M6 IT 0.83A suitable capacitor 4 μ F/450V at 50Hz 1350rpm type FIR1092/M no. 611803301		
For models:	FCFE6D, FCFE6D, FCFE6, FCFE6UK, PFCFE6, FCVE6-1U, FCVE6-3U, FCVE6-1, FCVE6-3, FCVE6-1UK, FCVE6-3UK, FCVG6-1, FCVG6-3, FCVG6-1UK, FCVG6-3UK, FCF/E6, FCV/E6-1, FCV/E6-1, FCV/G6-1, ZOFCV/G6-3, COCO6E, FCFE061		



1

GEV No.	601352	Ref. No.	0H6555 0K1910
description	fan motor 380-400V 3 phase 50Hz 0.02/0.16kW 710/1390rpm speeds 2 L1 140mm L2 27mm L3 35mm M10R IT 0.2/0.5A power input 60/250W at 50Hz 710/1390rpm Y/YY type L7mw84D-148 no. T1 D1 \varnothing 17mm D2 \varnothing 13mm		



1

GEV No.	500108	Ref. No.	0G2197 0H6930 0H6958 60050457
description	fan motor 380-415V 3 phase 50/60Hz 0.03/0.2kWrpm speeds 2 L1 155mm L2 30mm L3 31mm M10R IT Y/YY type L7mw84D-097 no. V5 D1 \varnothing 17mm D2 \varnothing 13mm		
For models:	5611-3-10, 5611-3-8, 5612-3-10, 5612-3-8, 5614-3-10, 5614-3-8		



1

GEV No.	601367	Ref. No.	0H6933 131098094 280162
description	fan motor 380-415V 3 phase 50/60HzkWrpm speeds 2 L1 175mm L2 25mm L3 48mm M14R IT Y/YY type L9rw84D-094 no. U3 D1 \varnothing 25mm D2 \varnothing 20mm		



1

GEV No.	602082	Ref. No.	002740 0C8306
description	fan wheel blades 6 D1 \varnothing 440mm D2 \varnothing 10mm D3 \varnothing 10mm H1 154mm H2 15mm		
For models:	FCVG102L3, FCVG202L3, FCV/E102/1L3, FCVE202L3, FCV/G102/1L6, FCV/E102/1L6, FCVG202L6, FCVE202L6, FCV/G102/1, FVC/E102/1, FCV/G202/1, FVC/E202/1, FCFE101-0, FCFE102-0, FCFE201-0, FCFE202-0, FCF101ELN, FCF101ENS, FCF102ENS, FCF201ENS, FCFE101-1J, FCFE102-1J, FCS102E4, FCS102EP, FCS102G4, FCS202E4, FCS102GP, FCS202EP, FCS202G4, FCS202GP, FCS102EX, FCS202EX, FCS102GX, FCS202GX, 5717-2-6, 5714-2-7, 5714-2-8, 5714-2-10, 5714-2-6L, 5714-2-7L, 5714-2-8L, 5714-2-10L, 5717-3-7, 5717-3-8, 5717-3-8E, 5717-3-10, 5717-3-8M, 5717-3-8C, 5717-3-8M, 5707-2-2... (Other models you can see in the webshop)		



1

GEV No.	601365	Ref. No.	0G1989 280036
description	fan wheel D1 \varnothing 225mm H1 60mm blades 12 D2 \varnothing 19.5mm D3 \varnothing 23mm H2 25.5mm		



1

GEV No.	601235	Ref. No.	054585 055422
description	fan wheel D1 ø 280mm H1 100mm blades 6 D2 ø 10mm D3 ø 10mm H2 37mm H3 10mm		
For models:	FCFG6D, FCFE6D, FCFE6D, FCFG6, FCFG6F, PFCFG6, FCFE6, FCFE6UK, PFCFE6, FCFE6J50, FCFG6J, FCFG6J, FCVE6-1U, FCVE6-3U, FCVE6-1, FCVE6-3, FCVE6-3CE, FCVE6-1UK, FCVE6-3UK, FCVG6-1, FCVG6-3, FCVG6-1UK, FCVG6-3UK, FCF/G6, FCF/E6, FCV/E6-1, FCV/E6-1, FCV/G6-1, ZOFCV/G6-3, AFCV/G6-1, AFCV/G6-3, SCO/G6-3, AFCF/E6, FF/G6, COCO6G, COCO6E, COCVE423AF, FCFE061, ZOFCF/G6D		



1

GEV No.	601371	Ref. No.	002871 0C8325 0K2739
description	fan wheel D1 ø 280mm H1 100mm blades 6 D2 ø 10mm D3 ø 10mm H2 37mm H3 23mm		
For models:	FCVE6L3J, FCV/G6L3JAP, FCV/E61/1, FCV/E61/1, FCV/E61/1, FCV/E61/1, FCV/G61/1, FCV/G61/1, FCV/G61/1, FCVG6L3CJ, FCV/G6L4, FCV/E6L4, FCF/G6-1-JAP, FCFE6-1J, FCS061E44J, FCS061G49J, 5711-2-6, 5711-2-7, 5711-2-8, 5711-2-10, 5711-2-8CH, 5711-2-10CH, 5711-2-6L, 5711-2-7L, 5711-2-8L, 5711-2-10L, 5721-2-7, 5721-2-10, 5711-3-6, 5711-3-7, 5711-3-8, 5711-3-10, 5711-3-8CH, 5711-3-10CH, 5711-3-10S, 5701-3-2, 5701-3-3, ECV/G6T4, ECV/E6T4, ECV/G61/1, ECV/G61/1, RCV061E4, ZCV/G61/1, ZCV/G6T4, ZCV/E6T4		



1

GEV No.	601220	Ref. No.	002754 003560 0C6462 0F0176 0K2704 0K8507
description	fan wheel D1 ø 280mm H1 100mm blades 6 D2 ø 10mm D3 ø 10mm H2 37mm H3 22mm		
For models:	FCV/G6L3TOWNGAS, FCV/G6L3, FCVG6L3CJ, FCV/G6L3C, FCV/G61/1, FCV/G61/1, FCV/G61/1, FCV/G61/1, FCVG6L3CT, FCVG6L3CJ, FCV/E6L3, FCV/G6L4, FCV/E6L4, FCF/G6-0, FCF/E6-0, FCF061ELN, FCF6E-HOR, FCF061ENS, FCF/G6-1-JAP, FCFE6-1J, FCS061G48J, FCS061GP, FCS061EP, FCS061G3DI, FCS061E3CI, FCS061G4, FCS061G4DT, FCS061E4, FCS061EXLN, FCS061EX, CS7ME4/200-3, CS7ME4/230-3, CS7ME4/400-3N, CS7ME6/400-3N, CS7ME4/400-3N/EO, CS-7ME4/400-3/50HZ/MA, CS7ME4/440-3/60HZ/MA, CS7MT4/400-3N, CS7GE4/200-3, CS7GE4/230-3, CS7GE4/400-3N, CS7GE6/400-3N, CS-7GE4/400-3N/EO, CS7GE4/400-3/50HZ/MA, CS7GE4/440-3/60HZ/MA, CS7GT4/400-3N, CS7LCE4/200-3, CS7LCE4/230-3, CS7LCE4/400-3N, CS7LCE6/400-3N...(Other models you can see in the webshop)		



1

GEV No.	601344	Ref. No.	0H6507 237139 8330078
description	fan wheel D1 ø 280mm H1 127mm blades 12 D2 ø 13mm D3 ø 16mm H2 37mm		
For models:	5611-3-10, 5611-3-6, 5611-3-8		



1

GEV No.	601236	Ref. No.	007000 0C7029
description	fan wheel D1 ø 280mm H1 130mm blades 10 D2 ø 10mm D3 ø 10mm H2 38mm H3 23mm		
For models:	FCZ061EAA, FCZ061EAH, FCZ061EAN, FCZ061ETA, FCZ061ETH, FCZ061ETN, FCZ061GAG, FCZ061GAD, FCZ061EBA, FCZ061EBH, FCZ061EBN, FCZ061EBC, FCZ061EBA2, FCZ061EBH2, FCZ061EBN2, FCZ061EBC2, FCZ061GBG, FCZ061GBD, FCZ061GBI, FCZ061ECA, FCZ061ECH, FCZ061ECN, FCZ061ECA2, FCZ061ECH2, FCZ061ECN2, FCZ061GCG, FCZ061GCD, AOS061GAEU, AOS061GAAU, AOS061EABU, AOS061EAFU, AOS061EA, AOS061EB, AOS061EA3J, AOS061EB3J, AOS061EA2N, AOS061EB2N, AOS061EB5M, AOS061EB6M, AOS061EA0H, AOS061EB0H, AOS061GA, AOS061GB, AOS061EAAQ, AOS061EBAQ, AOS061EANQ, AOS061EBNQ, AOS061EACQ, AOS061EBCQ, AOS061EAHQ...(Other models you can see in the webshop)		



1

GEV No.	601219	Ref. No.	002617 0C6461 0KG540
description	fan wheel D1 ø 350mm H1 135mm blades 6 D2 ø 10mm D3 ø 10mm H2 13mm H3 24mm		
For models:	FCV/G10L3, FCVG10L3T, FCV/G20L3, FCV/G10L2, FCV/E10L2, FCV/E10L3, FCV/E20L3, FCV/G10L6, FCV/E10L6, FCV/G20L6, FCV/E20L6, FCV/E101/1, FCV/G101/1, FVC/E101/1, FCV/G201/1, FVC/E201/1, FCFE101-0, FCFE102-0, FCFE201-0, FCFE202-0, FCF101ELN, FCF101ENS, FCF102ENS, FCF201ENS, FCFE101-1J, FCFE102-1J, FCS101E2, FCS101G2, FCS101E4, FCS101G4, FCS101EP, FCS101GP, FCS201E4, FCS201EP, FCS201G4, FCS201GP, FCS101EX, FCS201EX, FCS101GX, FCS201GX, 5712-2-6, 5712-2-7, 5712-2-8, 5712-2-10, 5714-2-6, 5714-2-7, 5714-2-8, 5714-2-10, 5712-2-6L, 5712-2-7L...(Other models you can see in the webshop)		



2

GEV No.	601343	Ref. No.	0H6510 0H6946 0K2738 237146 8330117
description	fan wheel D1 ø 350mm H1 127mm blades 6 D2 ø 13mm D3 ø 16mm H2 37mm		
For models:	5612-3-10, 5612-3-6, 5612-3-8, 5614-3-10, 5614-3-6, 5614-3-8		



1

GEV No.	601233	Ref. No.	0C1129 0C6463
description	fan wheel D1 ø 350mm H1 135mm blades 6 D2 ø 10mm D3 ø 10mm H2 37.5mm		
For models:	FCZ101EAA, FCZ201EAA, FCZ101EAH, FCZ201EAH, FCZ101EAN, FCZ201EAN, FCZ101ETA, FCZ201ETA, FCZ101ETH, FCZ201ETH, FCZ101ETN, FCZ201ETN, FCZ101GAG, FCZ201GAG, FCZ101GAD, FCZ201GAD, FCZ101GTG, FCZ201GTG, FCZ101GTD, FCZ201GTD, FCZ101EBA, FCZ201EBA, FCZ101EBH, FCZ201EBH, FCZ101EBN, FCZ201EBN, FCZ101EBC, FCZ201EBC, FCZ101EBA2, FCZ201EBA2, FCZ101EBH2, FCZ201EBH2, FCZ101EBN2, FCZ201EBN2, FCZ101EBC2, FCZ201EBC2, FCZ101GBG, FCZ201GBG, FCZ101GBD, FCZ201GBD, FCZ101GBI, FCZ201GBI, FCZ101GBG2, FCZ201GBG2, FCZ101GBD2, FCZ201GBD2, FCZ101GBI2, FCZ201GBI2, FCZ101ECA, FCZ201ECA...(Other models you can see in the webshop)		



1

GEV No.	601197	Ref. No.	053782 054890
description	fan wheel D1 ø 350mm H1 135mm blades 6 D2 ø 9.5mm D3 ø 9.5mm H2 38mm H3 20mm		
For models:	FCFG101/0, FCFG102-0, FCFG201-0, FCFE101-0, FCFE201-0, FCF101ELN, FCFG102-0T, FCF/G101/1-1-JAP, FCFG10, FCFG10D, FCFG10NL, FCFE10, FCFE10UK, FCVE10, FCFG10J, FCFE10J, FCFG10J, FCVE10-2, FCVE10-4, FCVE103CE, FCVE10-2UK, FCVE10-4UK, FCFG10-2, FCFG10-4, FCFG10-5G, FCFG10-2, FCFG10-4D, FCFG10-2UK, FCFG10-4UK, FCFG10-2, FCFG10-4, FCFE10-P, FCFE10PUK, FCFG10-P, FCFG10PUK, ECFG101-0, ECFG102-0, ECFG201-0, ECFE101-0, FCFG101, FCF/E10, ZOFCV/E102, ZOFCV/E104, ZOFCV/G102, ZOFCV/G104, ACFG101-0, ACFG102-0, ACFG201-0, ACFE101-0, ACFE201-0... (Other models you can see in the webshop)		



1

GEV No.	601218	Ref. No.	000274 054014 054914 055378
description	fan wheel D1 ø 440mm H1 152mm blades 6 D2 ø 10mm D3 ø 10mm H2 37mm H3 31mm		
For models:	FCFE102-0, FCFE202-0, FCFG20, FCFG20D, FCFG20F, PFCFG20, FCFE20, FCFE20UK, FCFG40, FCFG41, FCFG40D, FCFG40F, PFCFG40F, FCFE40, FCFE40D, FCFE40UK, PFCFE40F, FCVE20, FCFG20J, FCFE20J, FCFG40J, FCFE40J, FCFG20J, FCFG41J, FCVE20-2, FCVE20-4, FCVE203CE, FCVE20-2UK, FCVE20-4UK, FCFG20-2, FCFG20-4, FCFG20-2, FCFG20-4D, FCFG20-2UK, FCFG20-4UK, FCFG20-4, FCFG20-4D, FCVE20-P, FCVE20PUK, FCFG20-P, ECFE102-0, FCFG-20PUK, FCFG201, FCFG202, FCFC202, FCF/E20, FCFE202, ZOFCV/E202, ZOFCV/E204, ZOFCV/G202... (Other models you can see in the webshop)		



1

GEV No.	601234	Ref. No.	0C1172 0C6464
description	fan wheel D1 ø 380mm H1 170mm blades 12 D2 ø 10mm D3 ø 10mm H2 38mm H3 19mm		
For models:	FCZ102EAA, FCZ202EAA, FCZ102ETA, FCZ202ETA, FCZ102GAG, FCZ202GAG, FCZ102GAD, FCZ202GAD, FCZ102GTG, FCZ202GTG, FCZ102GTD, FCZ202GTD, FCZ102EBA, FCZ202EBA, FCZ102EBA2, FCZ202EBA2, FCZ102GBG, FCZ202GBG, FCZ102GBD, FCZ202GBD, FCZ102GBG2, FCZ202GBG2, FCZ102GBD2, FCZ202GBD2, FCZ102GBI2, FCZ102ECA, FCZ202ECA, FCZ102ECA2, FCZ202ECA2, FCZ102GCG, FCZ202GCG, FCZ102GCD, FCZ202GCD, FCZ102GCG2, FCZ202GCG2, FCZ102GCD2, FCZ202GCD2, AOS102GAEU, AOS-202GAEU, AOS102GAU, AOS202GAU, AOS102EA2N, AOS102EB2N, AOS202EA2N, AOS202EB2N, AOS102EA, AOS102EB, AOS202EA, AOS202EB, AOS102GB... (Other models you can see in the webshop)		



1

GEV No.	601232	Ref. No.	003715 0C8307
description	fan wheel D1 ø 440mm H1 155mm blades 6 D2 ø 10mm D3 ø 16mm H2 51mm H3 39mm		
For models:	FCFG101/0, FCFG102-0, FCFG202-0, FCFG102-0T, FCF/G102/1-1-JAP, ECFG101-0, ECFG102-0, ECFG202-0, ACFG101-0, ACFG102-0, ACFG202-0, JCF/G102/1-1, JCF/G102/1-2, RCF101G, NCF/G101/1, NCF/G102/1, ZCF/G101/1, ZCF/G102/1, ZCF/G202/1		

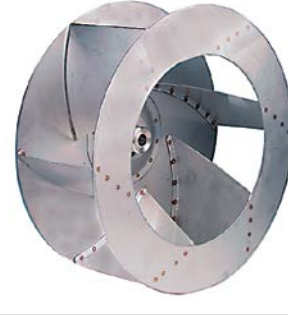

1

GEV No.	601342	Ref. No.	0H0819 0H6947 280409
description	fan wheel D1 ø 450mm H1 178mm blades 6 D2 ø 19.5mm D3 ø 23.5mm H2 45mm		



GEV No.	693847	Ref. No.	058729
description	fixing plate for hot air motors ED ø 230mm H 2.5mm ID ø 16mm		
For models:	FCFG6D, FCFE6D, FCFE6D, FCFG10, FCFG10D, FCFG10NL, FCFE10, FCFE10UK, FCFG6, FCFG6F, PFCFG6, FCFE6, FCFE6UK, PFCFE6, FCFE6J50, FCFE6J60, FCFG10J, FCFG10J, FCFE10J, FCFE10J, FCFG6J, FCFG6J, FCFG6J, FCFG6J, FCFG10J, FCFG10J, FCVE6-1U, FCVE6-3U, FCVE6-1, FCVE6-3, FCVE6-3CE, FCVE6-1UK, FCVE6-3UK, FCFG6-1, FCFG6-3, FCFG6-1UK, FCFG6-3UK, FCVE10-2, FCVE10-4, FCVE103CE, FCVE10-2UK, FCVE10-4UK, FCFG10-ISG, FCVE20/P-V, FCVE20-V, FCVE20VUK, FCFVM62E, FCFVM62EUK, FCFVMG62, FCVE10-P...(Other models you can see in the webshop)		



GEV No.	694297	Ref. No.	058957
description	flange for hot air motors ED ø 270mm H 3.5mm ID ø 16mm		
For models:	FCVE6-1U, FCVE6-3U, FCVE6-1, FCVE6-3, FCVE6-3CE, FCVE6-1UK, FCVE6-3UK, FCFG6-1, FCFG6-3, FCFG6-1UK, FCFG6-3UK, FCVE10-2, FCVE10-4, FCVE103CE, FCVE10-2UK, FCVE10-4UK, FCFG10-ISG, FCVE20/P-V, FCVE20-V, FCVE20VUK, FCVE10-P, FCVE10PUK, FCFG10-P, FCFG10PUK, FCV/E6-1, FCV/E6-1, FCV/G6-1, ZOFCV/G6-3, ZOFCV/E102, ZOFCV/E104, AFCV/G6-1, AFCV/G6-3, SCO/G6-3, AFCV/G101, AFCV/G103, SCO/G10-3, FCFG10-ISG, FCV/E20-V		



GEV No.	693410	Ref. No.	055339
description	gasket for hot air motors		
For models:	FCVE6-1U, FCVE6-3U, FCVE6-1, FCVE6-3, FCVE6-3CE, FCVE6-1UK, FCVE6-3UK, FCFG6-1, FCFG6-3, FCFG6-1UK, FCFG6-3UK, FCVE10-2, FCVE10-4, FCVE103CE, FCVE10-2UK, FCVE10-4UK, FCFG10-2, FCFG10-4, FCFG10-ISG, FCFG10-2, FCFG10-4D, FCFG10-2UK, FCFG10-4UK, FCFG10-2, FCFG10-4, FCVE20/P-V, FCVE20-V, FCVE20VUK, FCVE10-P, FCVE10PUK, FCFG10-P, FCFG10PUK, FCV/E6-1, FCV/E6-1, FCV/G6-1, ZOFCV/G6-3, ZOFCV/E102, ZOFCV/E104, ZOFCV/G102, ZOFCV/G104, AFCV/G6-1, AFCV/G6-3, SCO/G6-3, AFCV/G101, AFCV/G103, SCO/G10-3, FCFG10-ISG, FCV/E20-V		



GEV No.	693411	Ref. No.	055377 60050211
description	gasket for hot air motors		
For models:	FCVE20-2, FCVE20-4, FCVE203CE, FCVE20-2UK, FCVE20-4UK, FCFG20-2, FCFG20-4, FCFG20-2, FCFG20-4D, FCFG20-2UK, FCFG20-4UK, FCFG20-4, FCFG20-4D, FCVE20-P, FCVE20PUK, FCFG20-P, FCFG20PUK, ZOFCV/E202, ZOFCV/E204, ZOFCV/G202, ZOFCV/G204, AFCV/G201, AFCV/G203, SCO/G20-3		



GEV No.	514378	Ref. No.	005291
description	guard ø 260mm for hot air motors		
For models:	FCV/G20L3, FCV/E20L3, FCV/G20L6, FCV/E20L6, FCV/G201/1, FCV/E201/1, FCS201E4, FCS201EP, FCS202EP, FCS201G4, FCS201GP, FCS201EX, FCS201EXLN, FCS202EX, FCS201GX, 5712-2-6, 5712-2-7, 5712-2-8, 5712-2-10, 5714-2-6, 5714-2-7, 5714-2-8, 5714-2-10, 5712-2-6L, 5712-2-7L, 5712-2-8L, 5712-2-10L, 5714-2-6L, 5714-2-7L, 5714-2-8L, 5714-2-10L, 5712-3-6, 5712-3-7, 5712-3-8, 5712-3-8E, 5712-3-10, 5712-3-8CH, 5712-3-10C, 5714-3-6, 5714-3-7, 5714-3-8, 5714-3-8E, 5714-3-10, 5717-3-6, 5712-2-10F, 5712-2-10S, 5714-2-10F, 5714-2-10S, 5712-3-10F, 5712-3-10S...(Other models you can see in the webshop)		



GEV No.	511300	Ref. No.	002873 0F0199 0G0014 0K2486 0K5556 0K8687 0K8840 1140203517 12044490 19006832 60050274
description	O-ring Viton thickness 3.53mm ID ø 28.17mm for 57 series for motor shaft		
For models:	FCZ061EAA, FCZ101EAA, FCZ102EAA, FCZ201EAA, FCZ202EAA, FCZ061EAH, FCZ101EAH, FCZ201EAH, FCZ061EAN, FCZ101EAN, FCZ201EAN, FCZ061ETA, FCZ101ETA, FCZ102ETA, FCZ201ETA, FCZ202ETA, FCZ061ETH, FCZ101ETH, FCZ201ETH, FCZ061ETN, FCZ101ETN, FCZ201ETN, FCZ061GAG, FCZ101GAG, FCZ102GAG, FCZ201GAG, FCZ202GAG, FCZ061GAD, FCZ101GAD, FCZ102GAD, FCZ201GAD, FCZ202GAD, FCZ101GTG, FCZ102GTG, FCZ201GTG, FCZ202GTG, FCZ101GTD, FCZ102GTD, FCZ201GTD, FCZ202GTD, FCZ061EBA, FCZ101EBA, FCZ102EBA, FCZ201EBA, FCZ202EBA, FCZ061EBH, FCZ101EBH, FCZ201EBH, FCZ061EBN, FCZ101EBN...(Other models you can see in the webshop)		



GEV No.	511301	Ref. No.	002699 0F0096 0K0447 0KE120 0KE540 60050273
description	shaft seal ID ø 16mm ED ø 38mm thickness 18mm		
For models:	FCZ061EAA, FCZ101EAA, FCZ102EAA, FCZ201EAA, FCZ202EAA, FCZ061EAH, FCZ101EAH, FCZ201EAH, FCZ061EAN, FCZ101EAN, FCZ201EAN, FCZ061ETA, FCZ101ETA, FCZ102ETA, FCZ201ETA, FCZ202ETA, FCZ061ETH, FCZ101ETH, FCZ201ETH, FCZ061ETN, FCZ101ETN, FCZ201ETN, FCZ061GAG, FCZ101GAG, FCZ102GAG, FCZ201GAG, FCZ202GAG, FCZ061GAD, FCZ101GAD, FCZ102GAD, FCZ201GAD, FCZ202GAD, FCZ101GTG, FCZ102GTG, FCZ201GTG, FCZ202GTG, FCZ101GTD, FCZ102GTD, FCZ201GTD, FCZ202GTD, FCZ061EBA, FCZ101EBA, FCZ102EBA, FCZ201EBA, FCZ202EBA, FCZ061EBH, FCZ101EBH, FCZ201EBH, FCZ061EBN, FCZ101EBN...(Other models you can see in the webshop)		



hot air fans

ebm-papst



1

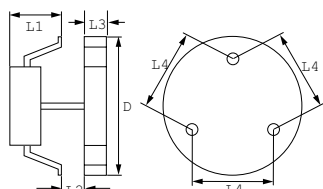

GEV No.	602163	Ref. No.	094165
description	fan type iQ3612-310250 ebm-papst 1800rpm conversion kit 220-240V 24W 0.2A fan wheel ø 154mm		



1

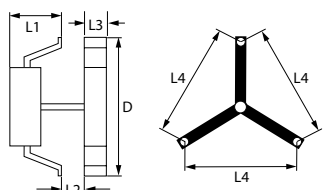

GEV No.	602160	Ref. No.	0KJ865
description	hot air fan 230V 31W type RRL152/0020 B42-3025LH/4iu ebm-papst		
For models:	HCCS20W, HCCS20W, A-O-H/S, A-O-H/W, A-O-H/PT, A-O-H/M50, A-O-H/M60, HC-CS, HC-CS		



1

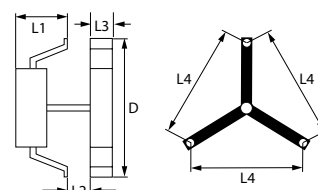

GEV No.	601198	Ref. No.	054842
description	hot air fan 230V 38W L1 65mm L2 20mm L3 25mm L4 130mm fan wheel ø 153mm type RRC140/0024A18 ebm-papst		
For models:	FCF02EV, FCF02EOEM, FCF/E3, FCF/E2, FCF/E2D, FCF/E2UK, FCF/E2, FCF/E2, FCF/E2D, BCFCV101/1, BCFCV102/1, BCFCV101/1, BCFCV102/1		

HEIDOLPH



1

GEV No.	500147	Ref. No.	0H6926
description	hot air fan 230V 37W D 85mm distance fan wheel - fixing 40mm mounting distance 28mm HEIDOLPH type 113.30.000431B		

miscellaneous



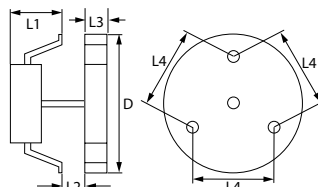

1

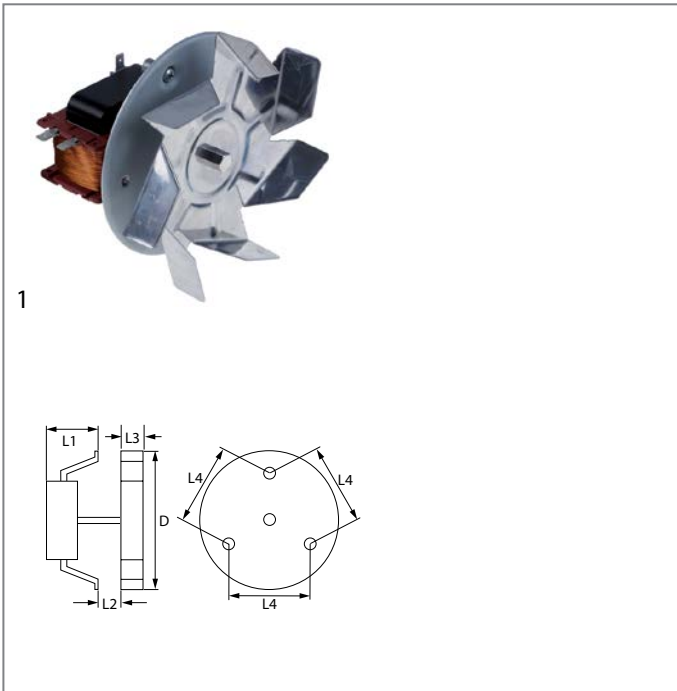

GEV No.	601273	Ref. No.	0K3048 MOTOVENT001
description	hot air fan 220-240V 32W 50/60Hz L1 60mm L2 10mm L3 25mm L4 87mm fan wheel ø 155mm FIME type C20X0E01/15CLH		



GEV No.	601011	Ref. No.	004933 00565 031063 031249 031484 OK3578 OKI639
description	hot air fan 220-240V 40W 50/60Hz L1 65mm L2 15mm L3 25mm L4 87mm fan wheel ø 150mm FIME type C25R8023CLH		
For models:	TC1200TOP, TC1210TOP, TC1400TOP, TC1410TOP, TC1600TOP, TC1610TOP, TC1800TOP, TC1810TOP, TC2000TOP, TC2010TOP, TCD1200TOP, TCD1400TOP, TCD1600TOP, TCD1800TOP, TCD2000TOP, TC1000, TC1010, TC1200, TC1210, TC1400, TC1410, TC1600, TC1610, TC1800, TC1810, TC2000, TC2010, TCD1000, TCD1200, TCD1400, TCD1600, TCD1800, TCD2000, MTC1200P, MTC1400P, MTC1600P, MTC1800P, MTC2000P, MTC1210P, MTC1410P, MTC1610P, MTC1810P, MTC2010P, MTCD1200P, MTCD1400P, MTCD1600P, MTCD1800P, MTCD2000P, MSR1207, MSR1407...(Other models you can see in the webshop)		
accessories for	601011		
	GEV No.	550879	Ref. No. —
	insulation ø 130mm thickness 3mm hole ø 20mm for hot air fan		
	GEV No.	601260	Ref. No. —
	nut thread M6L IT for hot air fan		

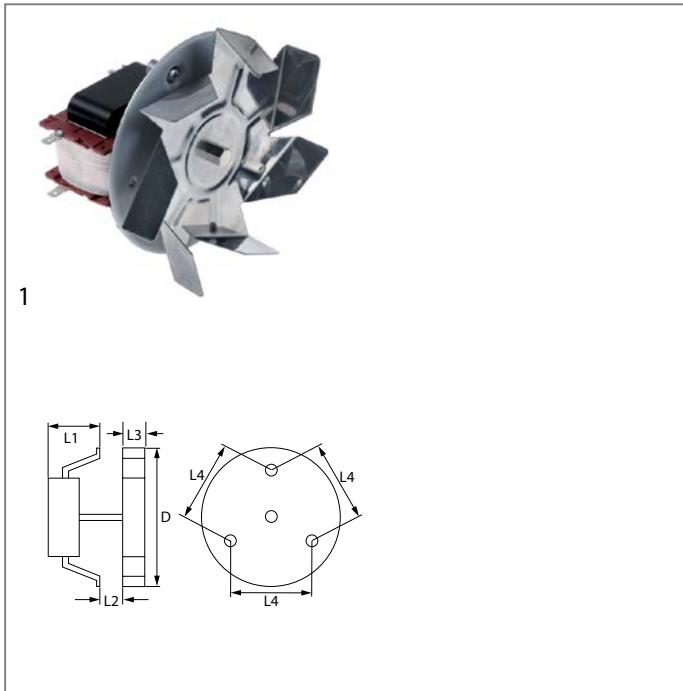

GEV No.	601125	Ref. No.	0A2010
description	hot air fan 220-240V 45W 50/60Hz L1 70mm L2 11mm L3 25mm L4 87mm fan wheel ø 150mm FIME type C30R0479CLF		
For models:	0WC142, 655-00-106, 655-00-107, 655-00-110, 656-00-106		
accessories for	601125		
	GEV No.	550879	Ref. No. —
	insulation ø 130mm thickness 3mm hole ø 20mm for hot air fan		



GEV No.	601199	Ref. No.	005202 3570114102 3581907619 3581913773
description	hot air fan 220-240V 24-28W L1 60mm L2 25mm L3mm L4 87mm fan wheel ømm PLASET type M0850		
For models:	FCF/E4, FCF/E4-3KW, JCF/E4, JCF/E4, ECF/E4, ECF/E4-3KW, ACF/E4, ACF/E4-3KW, NCF/E4, ZCF/E4, ZCF/E4		





1

GEV No.	601201	Ref. No.	054314 054315
description	hot air fan 230V 26W fan wheel ø 150mm		
For models:	FCF/E4-OLD, FCF/E4D, FCFE4PH, FCF/E4OLD3, FCF/E4OLD4, FCF/E4OLD2, FCF/E4OLD1, FCF/E4D		

accessories

fan wheels for hot air fans



1

GEV No.	601200	Ref. No.	005221
description	fan wheel ø 150mm W 20mm shaft intake ø 6x5mm zinc-plated blades 7		
For models:	FCF/E4, FCF/E4-3KW, JCF/E4, JCF/E4, ECF/E4, ECF/E4-3KW, ACF/E4, ACF/E4-3KW, NCF/E4, ZCF/E4, ZCF/E4		

group 6



1

GEV No.	601731	Ref. No.	OKB666
description	hot air fan 220-230VAC 50W L1 71mm L2 4mm L3 6mm L4 87mm fan wheel ø 81mm PLASET type P/N M4307		
For models:	FCV31E3, 7CO30, CCO30G, ECO312CF, OTS100		



1

GEV No.	601346	Ref. No.	0H6948 0H6951
description	fan wheel ø 180mm W 27mm shaft intake ø 7mm blades 8		



1

GEV No.	601711	Ref. No.	083603
description	hot air fan 230V 130W 0.58A 1370rpm L1 62mm L2 16mm L3 66mm fan wheel ø 330mm ebm-papst		
For models:	BC22, BC44, BC44H, BCF22, BCF44, BC22, BC44, BC44H, BCF22, BCF44H, BC22, BC44, BC44H, BCF22, BCF44H, ESBC20, ESBC20R, ESBF20, ESBC40, ESK40H, ESF40H, EEVA201, EEVA40/1, EEVA40/2, EEVAC201, EEVAC40/2, ESK20, ESK40V, ESK40H, ESBC40, ESF40H, BE431, TBC44H, TBCF44H, ESK40VZ, EEVA20/1, EEVA40/1, EEVA40/2, EEVAC20/1, EEVAC40/1, EEVA20/1, EEVA40/1, EEVA40/2, EEVAC20/1, EEVAC40/2, ATPE101, ATPE201, ATPE102, ATCE101, AF430...(Other models you can see in the webshop)		

radial fans



1

GEV No.	601238	Ref. No.	002639 60050312
description	radial fan 230V voltage AC 50Hz 40W H1 205mm L1 205mm D1 ø 150mm W1 103mm W2 32mm H2 83mm W3 34mm H3 86mm		
For models:	FDV40G, FDV40GZ, FDV40GA, FDV20G, FDV20GZ, FDV20GA, FCV/G10L3, FCVG10L3T, FCVG102L3, FCV/G20L3, FCVG202L3, FCVG10L3J, FCVG102L3J, FCV/G10L6JAP, FCV/G102/1L6JAP, FCV/G10L2, FCV/G10L6, FCV/G102/1L6, FCV/G20L6, FCVG202L6, FCV/G101/1, FCV/G102/1, FCV/G201/1, FCV/G202/1, FCS101G2, FCS101G4, FCS101G4DT, FCS101GP9J, FCS101G49J, FCS101GP, FCS102G4, FCS-102GA9J, FCS102G49J, FCS102GP, FCS201G4, FCS201GP, FCS202G4, FCS202GP, FCS101GX9J, FCS101GX, FCS102GX9J, FCS102GX, FCS-201GX, FCS202GX, 5712-2-6, 5712-2-7, 5712-2-8, 5712-2-10, 5714-2-6, 5714-2-7...(Other models you can see in the webshop)		



1

GEV No.	601732	Ref. No.	0C4103
description	radial fan 230V voltage AC 50Hz 70W H1 174mm L1 176mm W1 99mm W2 40mm H2 45.5mm W3 83mm H3 83mm		
For models:	FCZ061GAG, FCZ101GAG, FCZ102GAG, FCZ201GAG, FCZ202GAG, FCZ061GAD, FCZ101GAD, FCZ102GAD, FCZ201GAD, FCZ202GAD, FCZ101GTG, FCZ102GTG, FCZ201GTG, FCZ202GTG, FCZ101GTD, FCZ102GTD, FCZ201GTD, FCZ202GTD, FCZ061GBG, FCZ101GBG, FCZ102GBG, FCZ201GBG, FCZ202GBG, FCZ061GBD, FCZ101GBD, FCZ102GBD, FCZ201GBD, FCZ202GBD, FCZ061GBI, FCZ101GBI, FCZ201GBI, FCZ101GBG2, FCZ102GBG2, FCZ201GBG2, FCZ202GBG2, FCZ101GBD2, FCZ102GBD2, FCZ201GBD2, FCZ202GBD2, FCZ101GBI2, FCZ102GBI2, FCZ201GBI2, FCZ061GCG, FCZ101GCG, FCZ102GCG, FCZ201GCG, FCZ202GCG, FCZ061GCD, FCZ101GCD, FCZ102GCD... (Other models you can see in the webshop)		



1

GEV No.	500817	Ref. No.	0C1112
description	radial fan 24V voltage DC 50Hz 55W H1 180mm L1 180mm D1 ø 50mm W1 112mm W2 40mm H2 45mm W3 83mm H3 83mm		
For models:	AOS102GAEU, AOS201GAEU, AOS202GAEU, AOS102GAAU, AOS201GAAU, AOS202GAAU, AOS201GA, AOS201GB, AOS102GB, AOS102GA, AOS202GB, AOS202GA		

extractor fans

speed controllers



1

GEV No.	402957	Ref. No.	032279
description	speed controller voltage input 230V voltage output 46-184V/115-230VV 1200W max. 10A load current 6A wall-mounted version length external size 135mm width external size 74mm D 72mm for range hoods		
For models:	MPV10/20B, MPV10/24B, MCV20/32B, RCV1, MPV8/12B, MPV8/16B, MPV8/20B, MPV8/28B, MPV8/32B, MPV8/12D, MPV8/16D, MPV8/20D, MPV8/28D, MPV8/32D, MPV10/12B, MPV10/16B, MPV10/28B, MPV10/32B, MPV10/12D, MPV10/16D, MPV10/28D, MPV10/32D, RCV2, MC14/12D, MPV8/36B, MPV8/40B, MPV8/36D, MPV8/40D, MPV10/36B, MPV10/40B, MPV10/36D, MPV10/40D, MPV12/12B, MPV12/16B, MPV12/20B, MPV12/24B, MPV12/28B, MPV12/32B, MPV12/36B, MPV12/40B, MPV12/12D, MPV12/16D, MPV12/20D, MPV12/24D, MPV12/28D, MPV12/32D, MPV12/36D, MPV12/40D, MCV14/12B, MCV14/16B...(Other models you can see in the webshop)		



1

GEV No.	402956	Ref. No.	032986
description	speed controller voltage input 230V voltage output min. 69-138/max. 110-230VV 1800W max. 13A load current 8A wall-mounted version length external size 170mm width external size 105mm D 82mm for range hoods		
For models:	MPV10/20B, MPV10/24B, MCV20/32B, RCV1, MPV8/12B, MPV8/16B, MPV8/20B, MPV8/28B, MPV8/32B, MPV8/12D, MPV8/16D, MPV8/20D, MPV8/28D, MPV8/32D, MPV10/12B, MPV10/16B, MPV10/28B, MPV10/32B, MPV10/12D, MPV10/16D, MPV10/28D, MPV10/32D, RCV2, MC14/12D, MPV8/36B, MPV8/40B, MPV8/36D, MPV8/40D, MPV10/36B, MPV10/40B, MPV10/36D, MPV10/40D, MPV12/12B, MPV12/16B, MPV12/20B, MPV12/24B, MPV12/28B, MPV12/32B, MPV12/36B, MPV12/40B, MPV12/12D, MPV12/16D, MPV12/20D, MPV12/24D, MPV12/28D, MPV12/32D, MPV12/36D, MPV12/40D, MCV14/12B, MCV14/16B...(Other models you can see in the webshop)		



1

GEV No.	401660	Ref. No.	032967
description	speed controller voltage input 230V/50Hz voltage output dynamic via humidity probe 1200W max. 10A load current 6A length external size 135mm width external size 74mm D 72mm with moisture probe for range hoods		
For models:	KOV10E1-1, KFV101/1, KFV102/1, KLWV6-10GE		

accessories universal



1

GEV No.	693846	Ref. No.	054830 058731
description	spacer piece for fan motor		
For models:	FCFG6D, FCFE6D, FCFE6D, FCFG10, FCFG10D, FCFG10NL, FCFE10, FCFE10UK, FCFG20, FCFG20D, FCFG20F, PFCFG20, FCFE20, FCFE20UK, FCFG40, FCFG41, FCFG40D, FCFG40F, PFCFG40F, FCFE40, FCFE40D, FCFE40UK, PFCFE40F, FCFG6, FCFG6F, PFCFG6, FCFE6, FCFE6UK, PFCFE6, FCVE10, FCFG10J, FCFG10J, FCFE10J, FCFE10J, FCFG20J, FCFG20J, FCFE20J, FCFE20J, FCFG40J, FCFG40J, FCFE40J, FCFE40J, FCFG10J, FCFG10J, FCFG20J, FCFG20J, FCFG41J, FCFG40J, FCVE6-1U, FCVE6-3U...(Other models you can see in the webshop)		



speed controllers



1

GEV No.	401660	Ref. No.	032967
description	speed controller voltage input 230V/50HzV vottage output dynamic via humidity porbeV 1200W max. 10A load current 6A length external size 135mm width external size 74mm D 72mm with moisture probe for range hoods		
For models:	KOV10E1-1, KFV101/1, KFV102/1, KLWV6-10GE		

motors

gear motors

for ice-cube maker

for paddles



1

GEV No.	500407	Ref. No.	0T3960
description	gear motor LIP type 123MR 8W 220/240V voltage AC 50/60Hz 50rpm turn direction counterclockwise shaft ø 4mm shaft intake ø 6.2mm groove width 2.3mm shaft L 8mm shaft ø 4mm W 74mm		

miscellaneous

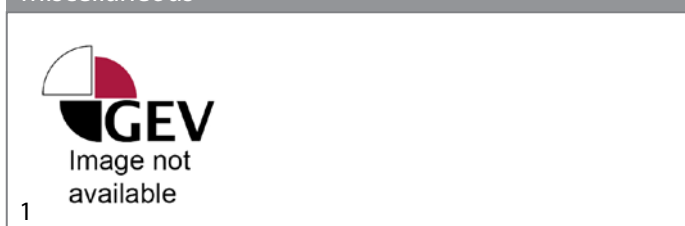

1

GEV No.	500678	Ref. No.	N/A
description	gear motor		

for gyros grills



1

GEV No.	500805	Ref. No.	OK9826
description	gear motor AEG type M008 230V 50/60Hz 2rpm shaft ø 10mm L 71mm W 71mm H 48mm for gyro grills		

for tilting bratt pans



1

GEV No.	500627	Ref. No.	002144
description	gear motor CROUZET type 82222006 230V 50Hz 1 phase shaft ø 7x8mm L 170mm W 65mm H 80mm for tilting bratt pan		
For models:	HBR/G801, HBR/G806, HBR/G811, HBR/G816, HBR/G801D, HBR/G806D, HBR/G811D, HBR/G816D, HBR/E801, HBR/E806, HBR/E811, HBR/E816, ZBR/G801, ZBR/G806, ZBR/G811, ZBR/G816, ZBR/G801D, ZBR/G806D, ZBR/G811D, ZBR/G816D, ZR/G413, BR/E806, ZBR/E811, ZBR/E816, ABR/G801, ABR/G806, ABR/G811, ABR/G816, ABR/G801D, ABR/G806D, ABR/G811D, ABR/G816D, ABR/E801, ABR/E806, ABR/E811, ABR/E816		



1

GEV No.	500618	Ref. No.	OK2746 OK2747 280793 677SP1
description	gear motor for tilting bratt pan		

For models:

7747-3/90.KB.(N), 7585-3/85.KK40.MOTK., 7586-3/85.KK60.MOTK., 7587-3/85.KK80.MOTK., 7588-3/85.KK100.MOTK., 7585-3/90.KK40.MOTK., 7586-3/90.KK60.MOTL., 7587-3/90.KK80.MOTK., 7588-3/90.KK100.MOTK., 7585-5/85.KK40.MOTK., 7586-5/85.KK60.MOTK., 7587-5/85.KK80.MOTK., 7588-5/85.KK100.MOTK., 7589-5/85.KK150.MOTK., 7585-5/90.KK40.MOTK., 7586-5/90.KK60.MOTK., 7587-5/90.KK80.MOTK., 7588-5/90.KK100.MOTK., 7589-5-90.KK150.MOTK., 7569-5/90.KK200.MOTK., 7541-3/85.KB.(N), 7543-3/85.KB.(N), 7541-3/90.KB.(N), 7543-3/90.KB.(N), 7545-3/85.KB.(N), 7547-3/85.KB.(N), 7545-3/90.KB.(N), 7547-3/90.KB.(N), 7741-3/85.KB.(N), 7743-3/85.KB.(N), 7741-3/90.KB.(N), 7743-3/90.KB.(N), 7745-3/90.KB.(N), 7745-3/85.KB.(N), 7747-3/85.KB.(N), 7545-3/85.KB.DWD, 7543-3/90.KB.EO.ETRO, 7541-3/90.KB.EO.ETRO, 7569-3/85.KK200.MOTK., 7569-3/90.KK200.MOTK., 7569-5/85.KK200.MOTK., 7589-3/85.KK150.MOTK., 7589-3/90.KK150.MOTK., 7769-3/85.KK200.MOTK., 7769-3/90.KK200.MOTK., 7769-5/85.KK200.MOTK., 7769-5/90.KK200.MOTK., 7785-3/85.KK40.MOTK., 7785-3/90.KK40.MOTK., 7785-5/85.KK40.MOTK...(Other models you can see in the webshop)



GEV No.	501577	Ref. No.	OK4754
description	gear motor SKF/ATB type MAX30-A220450A10100-005 24V voltage DC L 480mm W 185mm H 120mm for tilting bratt pan		
For models:	FET060E.MS35P.F88, FET060E.MS35P.W84, FET060E.MS35S.F88, FET080E.MS35P.F88, FET080E.MS35P.W84, FET080E.MS35S.W84, FET100E.MS35P.F88, FET100E.MS35P.W84, FET100G.MS25P.H97, UET060E.MS35.F88, UET090E.MS35.F88, UET090E.MS35.W84, UET100E.MS35.F88, UET100E.MS35.W84, UET150E.MS35.F88, FET100E.MS35S.F97, FET060E.MS35S.W84, FET080E.MS35S.F88, FET080G.MS25S.F98, FET080G.MS25S.W94, FET100E.MS35S.F88, FET100E.MS35S.W84, UET060E.MS35.W84, UET150E.MS35.W84, BOT060G.MS25.H97, GUWCOE0000, GUXCOE0000, GUYCOE0000, GUWEOE0000, GUXEOE0000, GUYEOE0000, GUWEOE0000, GUXEOE0000, GUYEOE0000, GUWEOE000Z, GUXEOE000Z, GUYEOE000Z, GUWHOEO000, GUXHOEO000, GUYHOEO000, GUWHOEO000, GUXHOEO000, GUYHOEO000, KUXJOEO000, KUYJOEO000, KUWJOEO000...(Other models you can see in the webshop)		



GEV No.	501580	Ref. No.	OG1855 OK1855 OK4753 OKI516
description	gear motor SKF/ATB type MAX30-C220450A101N0-005 24V L 490mm W 185mm H 120mm		
For models:	ACSGRT, BOT080S.MH25.W94, BOT080S.MS25.W94, BOT100E.MS35.H97, BOT150S.MH25.F98, BOT150S.MH25.W94, BOT200S.MH25.F18, BOT200S.MH25.W14, BOT400E.MS35.W14, BOT400S.MH25.F18, FET060E.MS35P.F88, FET060E.MS35P.W84, FET060E.MS35S.F88, FET080E.MS35P.F88, FET080E.MS35P.W84, FET080E.MS35S.W84, FET100E.MS35P.F88, FET100E.MS35P.W84, FET100G.MS25P.H97, UET060E.MS35.F88, UET090E.MS35.F88, UET090E.MS35.W84, UET100E.MS35.F88, UET100E.MS35.W84, UET150E.MS35.F88, BOT150E.MS35.H97, FET100E.MS35S.F97, FET060E.MS35S.W84, FET080E.MS35S.F88, FET080G.MS25S.F98, FET080G.MS25S.W94, FET100E.MS35S.F88, FET100E.MS35S.W84, UET060E.MS35.W84, UET150E.MS35.W84, BOT040E.MS35.F88, BOT040S.MH25.F98, BOT040E.MS35.W84, BOT040S.MH25.W94, BOT060E.MS35.F88, BOT060S.MH25.F98, BOT060E.MS35.W84, BOT060S.MH25.W94, BOT080E.MS35.F88, BOT080S.MH25.F98, BOT080E.MS35.W84, BOT100S.MH25.F98, BOT100S.MH25.W94, BOT300S.MH25.F18, BOT300S.MH25.W14...(Other models you can see in the webshop)		

for ovens

for flues



GEV No.	360342	Ref. No.	OC0883 OC5501
description	gear motor FIBER type P245J01C620 230V voltage AC 50/60Hz 2rpm shaft ø 6mm L 76mm W 55mm H 48mm motor type M51BJOR0000		
For models:	FCZ061EAA, FCZ101EAA, FCZ102EAA, FCZ201EAA, FCZ202EAA, FCZ061EAH, FCZ101EAH, FCZ201EAH, FCZ061EAN, FCZ101EAN, FCZ201EAN, FCZ061ETA, FCZ101ETA, FCZ102ETA, FCZ201ETA, FCZ202ETA, FCZ061ETH, FCZ101ETH, FCZ201ETH, FCZ061ETN, FCZ101ETN, FCZ201ETN, FCZ061GAG, FCZ101GAG, FCZ102GAG, FCZ201GAG, FCZ202GAG, FCZ061GAD, FCZ101GAD, FCZ102GAD, FCZ201GAD, FCZ202GAD, FCZ101GTG, FCZ102GTG, FCZ201GTG, FCZ202GTG, FCZ101GTD, FCZ102GTD, FCZ201GTD, FCZ202GTD, FCZ061EBA, FCZ101EBA, FCZ102EBA, FCZ201EBA, FCZ202EBA, FCZ061EBH, FCZ101EBH, FCZ201EBH, FCZ061EBN, FCZ101EBN...(Other models you can see in the webshop)		

miscellaneous



GEV No.	500620	Ref. No.	OK4843 OK4847 18002807 281028 30003223 75400101
description	gear motor for kettle		
For models:	7561-3.KES60.RW, 7562-3.KES80.RW, 7563-3.KES100.RW, 7564-3.KES150.RW, 7561-3/85.KES60.RW, 7562-3/85.KES80.RW, 7563-3/85.KES100.RW, 7564-3/85.KES150.RW, 7561-3/90.KES60.RW, 7562-3/90.KES80.RW, 7563-3/90.KES100.RW, 7564-3/90.KES150.RW, 7560-3, 7561-3, 7562-3, 7563-3, 7564-2, 9411-3, 9411-5, 9413-3, 9413-5, 9414-3, 9414-5, 9415-3, 9415-5, 9416-3, 9416-5		



GEV No.	501432	Ref. No.	OC8687 OC8692
description	gear motor METEOR type 956 6W 230V 50Hz 2rpm shaft ø 6mm combi-steamer		



motors

for tilting bratt pans



1

GEV No.	500823	Ref. No.	052802
description	motor 170W 230V 50Hz 1 phase shaft ø 17mm shaft length 60mm 320/2800rpm type 20571252 ø 160mm H 235mm mounting distance 145mm capacitor 16µF SOLE 0.17kW		
For models:	HBR/G1013, HBR/E1013, HBR/G1013, HBR/E1013		

for microwaves



1

GEV No.	500628	Ref. No.	002794
description	motor 20W 230V 50Hz shaft ø 9mm shaft length 12mm flange ø 73mm 1400rpm type M81A25G4GE H 80mm L 95mm W 80mm capacitor 1.5µF PANASONIC 0.02kW		
For models:	KBR/G2FH, KBR/G2CH, KBR/E2FH, KBR/E2CH, HBR/G811, HBR/G816, HBR/E811, HBR/E816, QBR/G2FH, QBR/G2CH, QBR/E2FH, QBR/E2CH, ZBR/G811, ZBR/G816, ZBR/E811, ZBR/E816, WBR/G2FH, WBR/G2CH, WBR/E2FH, WBR/E2CH, ABR/G811, ABR/G816, ABR/E811, ABR/E816		

spindle motors

MAGNETIC



1

GEV No.	500672	Ref. No.	0H6953 DSP455020001
description	spindle motor type DSP4550-200-01 280W 400V 50Hz 3 phase shaft ø 30mm for tilting bratt pan L 450mm W 100mm H 185mm hub 200mm MAGNETIC		
For models:	9481-3, 9482-3, 9581-3, 9582-3		

MECVEL



1

GEV No.	500621	Ref. No.	006690
description	spindle motor type PP041.0012 24V voltage DC shaft ø 16mm for pasta cooker L 255mm W 60mm H 135mm MECVEL		
For models:	MCP/E1SH, MCP/E1SUH, MCP/E2SUHS, MCP/E2SH, MCP/E2SUH, MCP/E2SUT, MCP/E2SHB, KFH/E1, KFH/G1ELH, KFH/E1ELH, KFH/E1EH, HFH/G430, HFH/E430, HFH/G435, HFH/G435, QFH/G1ELH, QFH/E1ELH, ZFH/G430, ZFH/E430, ZFH/G435, ZFH/G435, WFH/G1ELH, WFH/E1ELH, AFH/G435, AFH/E435		

SKF/ATB



1

GEV No.	501577	Ref. No.	OK4754
description	gear motor SKF/ATB type MAX30-A220450A10100-005 24V voltage DC L 480mm W 185mm H 120mm for tilting bratt pan		
For models:	FET060E.MS35P.F88, FET060E.MS35P.W84, FET060E.MS35S.F88, FET080E.MS35P.F88, FET080E.MS35P.W84, FET080E.MS35S.W84, FET100E.MS35P.F88, FET100E.MS35P.W84, FET100G.MS25P.H97, UET060E.MS35S.F88, UET090E.MS35S.F88, UET090E.MS35.W84, UET100E.MS35S.F88, UET100E.MS35S.W84, UET150E.MS35S.F88, FET100E.MS35S.F97, FET060E.MS35S.W84, FET080E.MS35S.F88, FET080G.MS25S.F98, FET080G.MS25S.W94, FET100E.MS35S.F88, FET100E.MS35S.W84, UET060E.MS35S.W84, UET150E.MS35S.W84, BOT060G.MS25S.H97, GUWCOE0000, GUXCOE0000, GUYCOE0000, GUWEOE0000, GUXEOE0000, GUYEOE0000, GUWEOE0000, GUXEOE0000, GUYEOE0000, GUXEOE0000, GUYEOE0000, GUWEOE0000, GUXEOE0000, GUYEOE0000, GUYHOE0000, GUWEOE0000, GUXHOE0000, GUYHOE0000, GUWEOE0000, GUXHOE0000, GUYHOE0000, KUXJOE0000, KUYJOE0000, KUWJOE0000...(Other models you can see in the webshop)		



1

GEV No.	501580	Ref. No.	0G1855 0K1855 0K4753 0K1516
description	gear motor SKF/ATB type MAX30-C220450A101N0-005 24V L 490mm W 185mm H 120mm		
For models:	ACSGRT, BOT080S.MH25.W94, BOT080S.MS25.W94, BOT100E.MS35.H97, BOT150S.MH25.F98, BOT150S.MH25.W94, BOT200S.MH25.F18, BOT200S.MH25.W14, BOT400E.MS35.W14, BOT400S.MH25.F18, FET060E.MS35P.F88, FET060E.MS35P.W84, FET060E.MS35S.F88, FET080E.MS35P.F88, FET080E.MS35P.W84, FET080E.MS35S.W84, FET100E.MS35P.F88, FET100E.MS35P.W84, FET100G.MS25P.H97, UET060E.MS35S.F88, UET090E.MS35S.F88, UET090E.MS35S.W84, UET100E.MS35S.F88, UET100E.MS35S.W84, UET150E.MS35S.F88, BOT150E.MS35S.H97, FET100E.MS35S.F97, FET060E.MS35S.W84, FET080E.MS35S.F88, FET080G.MS25S.F98, FET080G.MS25S.W94, FET100E.MS35S.F88, FET100E.MS35S.W84, UET060E.MS35S.W84, UET150E.MS35S.W84, BOT040E.MS35S.F88, BOT040S.MH25.F98, BOT040E.MS35S.W84, BOT040S.MH25.W94, BOT060E.MS35S.F88, BOT060S.MH25.F98, BOT060E.MS35S.W84, BOT060S.MH25.W94, BOT080E.MS35.F88, BOT080S.MH25.F98, BOT080E.MS35S.W84, BOT100S.MH25.F98, BOT100S.MH25.W94, BOT300S.MH25.F18, BOT300S.MH25.W14...(Other models you can see in the webshop)		



pumps

wash and rinse pumps

ALBA (C&A)

pumps



1

GEV No.	500129	Ref. No.	049057 0L0406 30000332
description	pump inlet ø 32mm outlet ø 30mm type C6300 230V 50Hz 1 phase 0.28kW 0.38HP L 200mm rotation direction left capacitor 6.3µF auxiliary pressure connection 13mm supporting pressure closed ALBA PUMPS (C&A)		
For models:	WT1WSDP, WT2WSDP, WT2WSDPD, WT2WS, WT1, WT1WS, WT1TOP, WT2TOP, WT1/3DP, WT2/3DP, WT2DPAUS, Z1, Z1/WS, Z1TOP, Z2, Z2TOP		
spare parts for	500129		
	GEV No.	365012	Ref. No. 049260 OKB768 909
	operating capacitor capacity 6.3µF 450V tolerance 5% 50Hz ambient temperature max. -25 to +85°C ø 30mm L 61mm M8 plastic connection male faston 6.3mm protection		
	GEV No.	510695	Ref. No. —
	mechanical shaft seal height counter ring 5.5mm ID ø 11mm		
	GEV No.	521227	Ref. No. 049187 C550
	impellor ø 78mm H 24mm rotation direction left thread M6R shaft ø 11mm shaft length 28mm		
	GEV No.	521522	Ref. No. 049186 C540
	pump cover ALBA PUMPS (C&A) inlet ø 32mm outlet ø 30mm auxiliary pressure connection 13mm supporting pressure closed turn direction left ø 106mm ID ø 82mm inner height 31mm		
	GEV No.	521705	Ref. No. 049188
	pump cover gasket EPDM thickness 2mm ID ø 80mm Qty 1 pcs		







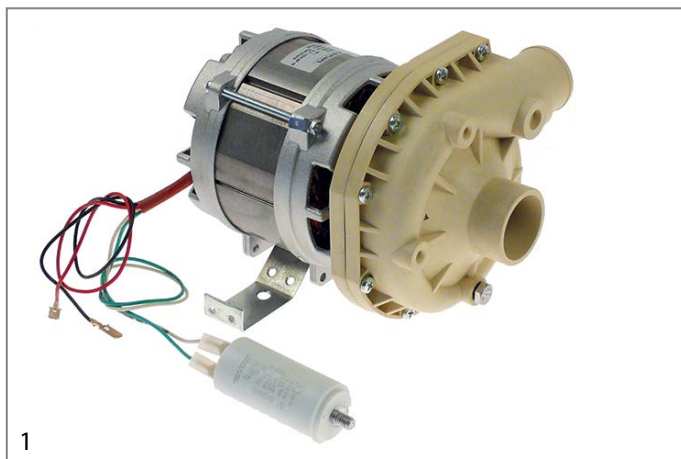

1

GEV No.	500113	Ref. No.	048304 0KE912 B2562520
description	pump inlet ø 45mm outlet ø 40mm type C3100 400V 50Hz 3 phase 0.75kW 1HP L 215mm rotation direction right ALBA PUMPS (C&A)		
For models:	LS7D, LS7, LS7UK/RP, LV70, LS7F, LS7DEK, LS7/9, WT40/9, WT40/F, LS7HD, WT40/J50, WT40/J60, PH4/WT40, LS8D, LS8, LS8UK/RP, LC80, LS8F, LS8DEK, LS8/9, WT50/9, WT50/UK9RF, WT50/F9, WT50/6, D800/9, D800/6, WT50/N, LS8/HD, LS8/9DD, LS8DEK, FL700, HT800, HYDRA700, HYDRA800, Z70, Z80		
spare parts for	500113		
	GEV No.	504320	Ref. No. 049172
	pump cover gasket ID ø 160.75mm thickness 3.53mm EPDM Qty 1 pcs		
	GEV No.	510693	Ref. No. 069543 141002
	mechanical shaft seal for shaft ø 12mm slide ring ext. ø 24mm slide ring H 15.5mm slide ring int. ø 11mm counter ring mounting ø 24mm height counter ring 8mm counter ring int. ø 13.5mm		
	GEV No.	521238	Ref. No. 048982
	impellor ø 103mm H 32mm rotation direction right thread M7L seat ø 9.2mm blades 6		
	GEV No.	521531	Ref. No. 048981
	pump cover ALBA PUMPS (C&A) inlet ø 45mm outlet ø 40mm turn direction right ø 153mm ID ø 127mm inner height 24mm		
	GEV No.	521709	Ref. No. 048984 OR0120
	O-ring EPDM thickness 3mm ID ø 126mm Qty 1 pcs		



1			
GEV No.	500114	Ref. No.	048885 2049 B2571600
description	pump inlet ø 45mm outlet ø 40mm type C5800/2013 230V 50Hz 1 phase 0.75kW 1HP L 225mm rotation direction right capacitor 16µF ALBA PUMPS (C&A)		
For models:	LS32, LS32/4.5, LS32UK/RP, LS32F, LV32F, C55, WT302, WT302/4.5, WT302UK/RP, WT302F, LS33, LS33/4.5, LS33UK/RP, LS33F, LV33F, C55A, WT303, WT303/4.5, WT303UK/RP, WT303F, LS61, LS61/60, LS62, LS62D, LS62/UKRP, LS62F, LV62, LS62/60, ECOTEMP5, LS62/1P, LS62HD, LS65, LS62/UK, LS63, LS63D, LS63/UKRP, LS63F, LV63, LS63/60, LS63/1P, LS63/UK, LS64, LS64/UKRP, LV64, ECOTEMP5S, LS64/1P, LS64/UK, ECOTEMP5SW, WT32, WT32/4.5...(Other models you can see in the webshop)		
spare parts for	500114		
	GEV No.	365021	Ref. No. 052797 0A2914 BC0164521
	operating capacitor capacity 16µF 425V tolerance 5% 50/60Hz ambient temperature max. -25 to +85°C ø 35mm L 73mm single M8 plastic connection male faston 6.3mm 416.10.99 protection		
	GEV No.	509021	Ref. No. —
	impellor ø 102mm H 32mm shaft intake ø 9/8mm rotation direction right		
	GEV No.	510693	Ref. No. 069543 141002
	mechanical shaft seal for shaft ø 12mm slide ringext. ø 24mm slide ring H 15.5mm slide ring int. ø 11mm counter ring mounting ø 24mm height counter ring 8mm counter ring int. ø 13.5mm		
	GEV No.	521531	Ref. No. 048981
	pump cover ALBA PUMPS (C&A) inlet ø 45mm outlet ø 40mm turn direction right ø 153mm ID ø 127mm inner height 24mm		



1			
GEV No.	500090	Ref. No.	046370 0H2457 0K8075 2602
description	pump inlet ø 45mm outlet ø 40mm type C5803 230V 50Hz 1 phase 0.55kW 0.75HP L 210mm rotation direction right capacitor 12.5µF ALBA PUMPS (C&A)		
For models:	LS360F, LS360DK, LS365F, LS365, LS365PH, LS360D, LS365D, LS360, LS365, LS365/63, LS367, LSDS51, LSDS5V, LS510, LS520, LS520D, LS520F, LS520M, LS520K, LS521, LS521D, LS521F, LS521M, LS521K, LS521, LS4, LS360, LS365F, ZLS510, ZLS520, ZLS521, ALLS521, ALLS520, ALS510, HB3PNT, C51, C52, C50, LS520ZD, LS521ZD, CF314, LS510MZ, LS520MZ, LS521MZ, D480, D48, D48, D48, D480, D48...		
For models:	(Other models you can see in the webshop)		
spare parts for	500090		
	GEV No.	365014	Ref. No. 054922 066235 0K2386 0K3032 0L0335 S694601702
	operating capacitor capacity 12.5µF 450V tolerance 5%Hz ambient temperature max. -25 to +85°C ø 35mm L 70mm M8 plastic connection male faston 6.3mm 455.C3DS.12.5 protection		
	GEV No.	504320	Ref. No. 049172
	pump cover gasket ID ø 160.75mm thickness 3.53mm EPDM Qty 1 pcs		
	GEV No.	509021	Ref. No. —
	impellor ø 102mm H 32mm shaft intake ø 9/8mm rotation direction right		
	GEV No.	510692	Ref. No. 048983
	mechanical shaft seal for shaft ø 11mm slide ringext. ø 24mm slide ring H 13mm counter ring mounting ø 26mm height counter ring 8mm counter ring int. ø 14mm		
	GEV No.	521531	Ref. No. 048981
	pump cover ALBA PUMPS (C&A) inlet ø 45mm outlet ø 40mm turn direction right ø 153mm ID ø 127mm inner height 24mm		
	GEV No.	521709	Ref. No. 048984 OR0120
	O-ring EPDM thickness 3mm ID ø 126mm Qty 1 pcs		



FIR
pumps



1			
GEV No.	500394	Ref. No.	049310
description	pump inlet ø 28mm outlet ø 26mm type 4213.1500 230V 50Hz 1 phase 0.28kW 0.38HP L 195mm rotation direction left capacitor 6.3µF FIR		
For models:	LS32UK/RP, WT302UK/RP, WT4DG, WT4WS1, LS33UK/RP, WT4BWS, WT4DWS1, WT4BDWS, WT303UK/RP, LS5/1WS, LS5/1WSDP, LS5/3WS, LS5/3WSDP, LS5/3WSDPD, LB5DPG, LS6EADD, LS6EA/DPDD, WT38T-DE, LS6EADP3, LS6EADPWS, LS6EADPWSG, WT38WS, WT38WSG, WT38MEDWS, WT37LEV/9, LS6EADPDWS, WT38DWS, LS6EA/UK, LS6EA/DPUK, WT38D, WT37, WT38, LS65, LS62/UK, WT37/4.5, WT38/4.5, WT37/UK, WT38C, WT38CUK, WT38/4.5NW, LS63/UK, WT38UK, LS64/UK, WT38MED, WT35, WT32/UK, WT33/UK, LS6EA, LS6EA/DP, LS6M-CD...(Other models you can see in the webshop)		
spare parts for	500394		
	GEV No.	510384	Ref. No. —
	pump cover inlet ø 28mm outlet ø 26mm ø 100mm ID ø 76mm		
	GEV No.	510532	Ref. No. —
	impellor ø 72mm H 22mm shaft ø 11mm shaft length 32mm blades 3		
	GEV No.	510695	Ref. No. —
	mechanical shaft seal height counter ring 5.5mm ID ø 11mm		
	GEV No.	521703	Ref. No. —
	pump cover gasket EPDM thickness 2.5mm ID ø 75mm Qty 1 pcs		
accessories for	500394		
	GEV No.	365012	Ref. No. 049260 0KB768 909
	operating capacitor capacity 6.3µF 450V tolerance 5% 50Hz ambient temperature max. -25 to +85°C ø 30mm L 61mm M8 plastic connection male faston 6.3mm protection		

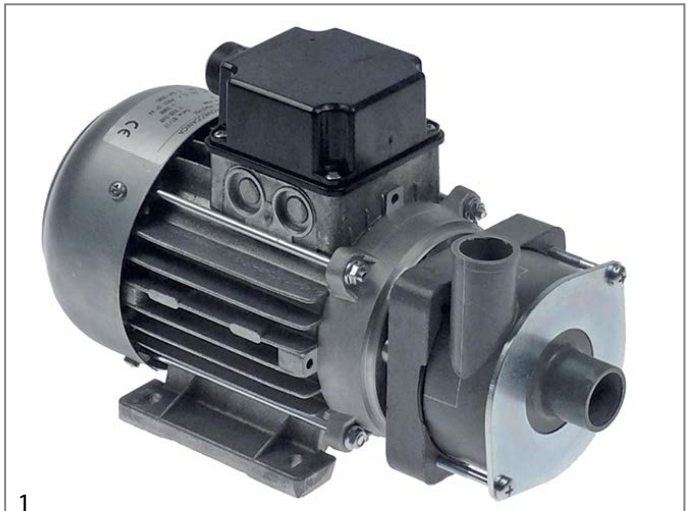

1			
GEV No.	501586	Ref. No.	OK8524 WT100U-482 77 21-02
description	pump inlet ø 28mm outlet ø 26mm type 4248.4600 220-240V 60Hz 1 phase 0.07kW L 270mm rotation direction right capacitor 5µF FIR		
For models:	FT36EDTS, FT36ESTS, FT36VDT5, FT36VSTS, FT36ED, FT36ES, FT36VD, FT36VS, FT50ED, FT50ES, FT50VD, FT50VS, FT72ED, FT72ES, FT72VD, FT72VS, FT36EDT, FT36EST, FT36VDT, FT36VST, FT50EDT, FT50EST, FT50VDT, FT50VST, FT72EDT, FT72EST, FT72VDT, FT72VST, FT36WED, FT36WES, FT36WVD, FT36WVS, FT50WED, FT50WES, FT50WVD, FT50WVS, FT72WED, FT72WES, FT72WVD, FT72WVS, FT36WEDT, FT36WEST, FT36WVDT, FT36WVST, FT50WEDT, FT50WEST, FT50WVDT, FT50WVST, FT72WEDT, FT72WEST...(Other models you can see in the webshop)		



1

GEV No.	499261	Ref. No.	0L1098 52132160
description	pump inlet ø 30mm outlet ø 26mm type 5213.2160 208-240V 60Hz 1 phase 0.28kW L 195mm rotation direction left capacitor 6.3µF FIR		
For models:	LS6AH240U, WT30H208U, WT30H240U, WT30H208DU, WT30H240DU, WT30H208RU, WT30H240RU, LS6AH208DU, LS6AH208U, LS6AH-240DU, LS6AH208RU, LS6AH240RU, WT30M208U, WT30M240U, WT30M208DU, WT30M240DU, WT30M208RU, WT30M240RU, WT30C-208DU, WT30C240DU, WT30H208WS, WT30H240WS, LS14AH240U, WT65H208U, WT65H240U, LS14H208DU, LS14AH208U, LS14H-240DU, LS14H208RU, LS14H240RU, WT65H208DU, WT65H240DU, WT65H208RU, WT65H240RU, WT65M208U, WT65M240U, WT65M-208DU, WT65M240DU, WT65M208RU, WT65M240RU, WT65H208WS, WT65H240WS, WT830M208U, WT830M240U, WT830H208U, WT830H240U, WT850M208U, WT850M240U		
spare parts for	499261		
	GEV No.	699372	Ref. No. —
	flange for pump with cover type 5213 L 103mm W 103mm H 69mm		



1







GEV No.	499262	Ref. No.	0L1104 52132450
description	pump inlet ø 30mm outlet ø 26mm type 5213.2450 220-240V 50Hz 1 phase 0.28kW L 195mm rotation direction left capacitor 6.3µF FIR		
For models:	RT100ED, RT100ES, RT100SR, RT100SL, RT140ED, RT140ES, RT140SR, RT140SL, RT190ED, RT190ES, RT190SR, RT190SL, RT190HDED, RT190HDES, RT190HSR, RT190HSL, RT270ED, RT270ES, RT270SR, RT270SL, RT270HDED, RT270HDES, RT270HSR, RT270HSL, RT100ERF, RT100ELF, RT100VD, RT100VS, RT140ERF, RT140ELF, RT140VD, RT-140VS, RT142ERF, RT142ELF, RT190ERF, RT190ELF, RT190VD, RT190VS, RT190HERF, RT190HELF, RT190HDVDF, RT190HDVSF, RT270ERF, RT270ELF, RT270VDF, RT270VSF, RT270HERF, RT270HELF, RT270HD-VDF, RT270HDVSF...(Other models you can see in the webshop)		



1

GEV No.	499266	Ref. No.	0L1112 52133951
description	pump inlet ø 30mm outlet ø 26mm type 5213.3951 400V 50Hz 1 phase 0.28kW L 195mm rotation direction left capacitor 6.3µF FIR		
For models:	RT100ED, RT100ES, RT100SR, RT100SL, RT140ED, RT140ES, RT140SR, RT140SL, RT190ED, RT190ES, RT190SR, RT190SL, RT190HDED, RT190HDES, RT190HSR, RT190HSL, RT270ED, RT270ES, RT270SR, RT270SL, RT270HDED, RT270HDES, RT270HSR, RT270HSL, RT100ERF, RT100ELF, RT100VD, RT100VS, RT140ERF, RT140ELF, RT140VD, RT-140VS, RT142ERF, RT142ELF, RT190ERF, RT190ELF, RT190VD, RT190VS, RT190HERF, RT190HELF, RT190HDVDF, RT190HDVSF, RT270ERF, RT270ELF, RT270VDF, RT270VSF, RT270HERF, RT270HELF, RT270HD-VDF, RT270HDVSF...(Other models you can see in the webshop)		
spare parts for	499266		
	GEV No.	699372	Ref. No. —
	flange for pump with cover type 5213 L 103mm W 103mm H 69mm		







GEV No.	500598	Ref. No.	0L1030 0L1079 0L1640 0L2597 5213EB2451
description	pump inlet ø 30mm outlet ø 26mm type 5213E2450 230V 50Hz 1 phase 0.22kW 0.1HP L 190mm rotation direction left capacitor 5µF FIR		
For models:	EUC1WS, EUC1DPWS, EUC3WS, EUC3DPWS, ZUCADDROW, FUCA3DD, NUC1WS, NUC1DPWS, NUC3WS, NUC3DPWS, NUC3DDWS, ZUCA1, ZUCA3, EUCADDROW, LS6EADD, LS6EA/DPDD, WT38TDE, LS6EADP3, LS6EADPWS, LS6EADPWSG, WT38WS, WT38WSG, WT38MEDWS, WT37LEV/9, LS6EADPDWS, WT38DWS, LS6SANA, EUCAI, EUCAIDP, EUCAIWS, LS6EA/UK, LS6EA/DPUK, EUCAIG, EUCAIWSG, EUCAIML, EUCAIMLWS, EUCAIMLG, EUCAICL, EUCAICLG, EUCAIWL, EUCAICLW, EUCAIDPNW, ZUCAI, ZUCAIDP, ZUCAIDPWS, ZUCAIG, ZUCAIDDWS, ZUCAID, ZUCAIDD, EUCAIDD...(Other models you can see in the webshop)		
spare parts for	500598		
	GEV No.	365017	Ref. No. 037268 083406 0K9108 0L2035
	operating capacitor capacity 5µF 450V tolerance 5% 50/60Hz ambient temperature max. -25 to +85°C ø 28mm L 54mm M8 plastic connection male faston 6.3mm 16.10.08 protection		
	GEV No.	502265	Ref. No. —
	pump cover inlet ø 30mm outlet ø 26mm ID ø 89mm inner height 35mm		
	GEV No.	510695	Ref. No. —
	mechanical shaft seal height counter ring 5.5mm ID ø 11mm		
	GEV No.	521203	Ref. No. —
	impellor ø 72mm H 18mm thread M7 shaft ø 11mm shaft length 32mm blades 3		
	GEV No.	532718	Ref. No. —
	O-ring EPDM thickness 4mm ID ø 80mm Qty 1 pcs		
	GEV No.	699372	Ref. No. —
	flange for pump with cover type 5213 L 103mm W 103mm H 69mm		



GEV No.	501579	Ref. No.	049916 0L3398 611623800
description	pump inlet ø 45 outlet ø 40 type B257.4461 255/440V 60Hz 3 phase 0.736kW rotation direction right FIR		
For models:	EUCIM60, EUCAIUSPH6, WT38/M60, WT38PM60, WT38M60/4		



GEV No.	500396	Ref. No.	049876 0L3395 B2571605
description	pump inlet ø 45mm outlet ø 40mm type B257.1700 230V 50Hz 1 phase 0.75kW 1HP L 220mm rotation direction right capacitor 16µF FIR		
For models:	WT4B, WT4DB, WT4BWS, WT4BDWS, LS5/3, LS5/3DP, LS5/3WS, LS5/3WSDP, LS5/3WSDPD, LS6EP, LS6EP/DD, LS6EADD, LS6EA/DPDD, WT38TDE, LS6EADP3, WT37LEV/9, LS6SANA, EUCAI, EUCAIDP, LS6EA/UK, LS6EA/DPUK, EUCAIG, EUCAIML, EUCAIMLG, EUCAICL, EUCAICLG, EUCAIWL, EUCAICLW, EUCI, EUCAIDPNW, ZUCI, ZUCID, ZUCAI, ZUCAIDP, ZUCAIG, ZUCAID, ZUCAIDD, EUCAIDD, WT38D, WT37, WT38, WT37/4.5, WT38/4.5, WT37/UK, WT38C, WT38CUK, WT38/4.5NW, WT38UK, WT38MED, WT38WL...(Other models you can see in the webshop)		
spare parts for	500396		
	GEV No.	365021	Ref. No. 052797 0A2914 BC0164521
	operating capacitor capacity 16µF 425V tolerance 5% 50/60Hz ambient temperature max. -25 to +85°C ø 35mm L 73mm single M8 plastic connection male faston 6.3mm 416.10.99 protection		
	GEV No.	510508	Ref. No. —
	pump cover FIR inlet ø 45mm outlet ø 40mm pump type PU 0.5/3911 turn direction right ø 160mm ID ø 125mm inner height 25mm		
	GEV No.	510692	Ref. No. 048983
	mechanical shaft seal for shaft ø 11mm slide ringext. ø 24mm slide ring H 13mm counter ring mounting ø 26mm height counter ring 8mm counter ring int. ø 14mm		
	GEV No.	521001	Ref. No. —
	impellor ø 91mm H 30mm pump type B267.4050 rotation direction right		
	GEV No.	521702	Ref. No. 048630
	pump cover gasket thickness 3.5x4.5mm Qty 1 pcs		







1

GEV No.	499268	Ref. No.	0L0172
description	pump inlet ø 62mm outlet ø 61mm type 4290.6600 220-254/380-440V 60Hz 3 phase 1.5kW L 350mm rotation direction right FIR		
For models:	RT100ED, RT100ES, RT100SR, RT100SL, RT140ED, RT140ES, RT140SR, RT140SL, RT190ED, RT190ES, RT190SR, RT190SL, RT190HDED, RT190HDES, RT190HSR, RT190HSL, RT270ED, RT270ES, RT270SR, RT270SL, RT270HDED, RT270HDES, RT270HSR, RT270HSL, RT100ERF, RT100ELF, RT100VD, RT100VS, RT140ERF, RT140ELF, RT140VD, RT140VS, RT142ERF, RT142ELF, RT190ERF, RT190ELF, RT190VD, RT190VS, RT190HERF, RT190HEL, RT190HDVDF, RT190HDVSF, RT270ERF, RT270ELF, RT270VDF, RT270VSF, RT270HERF, RT270HEL, RT270HDVDF, RT270HDVSF...(Other models you can see in the webshop)		



1

GEV No.	500986	Ref. No.	0L0039 42902700
description	pump inlet ø 62mm outlet ø 62mm type 4290.2700 220-240/380-415V 50Hz 3 phase 1.5kW 2HP L 350mm rotation direction right FIR		
For models:	RT100ED, RT100ES, RT100SR, RT100SL, RT140ED, RT140ES, RT140SR, RT140SL, RT190ED, RT190ES, RT190SR, RT190SL, RT190HDED, RT190HDES, RT190HSR, RT190HSL, RT270ED, RT270ES, RT270SR, RT270SL, RT270HDED, RT270HDES, RT270HSR, RT270HSL, RT100ERF, RT100ELF, RT100VD, RT100VS, RT140ERF, RT140ELF, RT140VD, RT140VS, RT142ERF, RT142ELF, RT190ERF, RT190ELF, RT190VD, RT190VS, RT190HERF, RT190HEL, RT190HDVDF, RT190HDVSF, RT270ERF, RT270ELF, RT270VDF, RT270VSF, RT270HERF, RT270HEL, RT270HDVDF, RT270HDVSF...(Other models you can see in the webshop)		
spare parts for	500986		
	GEV No.	510687	Ref. No. —
	mechanical shaft seal for shaft ø 18mm height counter ring 8mm ID ø 17mm ED ø 39mm H 15mm mounting ø 42mm int. ø 1 21mm		
	GEV No.	521017	Ref. No. 0L0255
	impellor ø 120mm H 35mm rotation direction right thread M14L seat ø 18mm blades 6		

spare parts for	500986		
	GEV No.	521026	Ref. No. 049250 049769 0G1665 0K7898
	pump cover gasket ID ø 182.5mm thickness 5x4.5mm		
	GEV No.	521028	Ref. No. —
	pump cover FIR inlet ø 62mm outlet ø 62mm turn direction right ø 215mm ID ø 175mm inner height 40mm		
	GEV No.	521039	Ref. No. —
	fanwheel cover ID ø 156mm ED ø 161mm H 76mm for wash pump		





1

GEV No.	500985	Ref. No.	0E5169 0E5208 0E5335 0E5355 0K8338 0L0437 647669083
description	pump inlet ø 62mm outlet ø 64mm type 4290.2700 220-240/380-415V 50Hz 3 phase 1.5kW 2HP L 350mm rotation direction right FIR installation kit inclusive		
For models:	TW1ERECO, TW1ELECO, TW1SRECO, TW1SLECO, RT100ED, RT100ES, RT100SR, RT100SL, RT140ED, RT140ES, RT140SR, RT140SL, RT190ED, RT190ES, RT190SR, RT190SL, RT190HDED, RT190HDES, RT190HSR, RT190HSL, RT270ED, RT270ES, RT270SR, RT270SL, RT270HDED, RT270HDES, RT270HSR, RT270HSL, RT100ERF, RT100ELF, RT100VD, RT100VS, RT140ERF, RT140ELF, RT140VD, RT140VS, RT142ERF, RT142ELF, RT190ERF, RT190ELF, RT190VD, RT190VS, RT190HERF, RT190HEL, RT190HDVDF, RT190HDVSF, RT270ERF, RT270ELF, RT270VDF, RT270VSF...(Other models you can see in the webshop)		



GEV No.	500112	Ref. No.	046574 12111000
description	pump inlet \varnothing 63mm outlet \varnothing 47mm 230/400V 50Hz 3 phase 0.55kW 0.75HP L 305mm rotation direction right FIR		
For models:	LS540F, LS540DK, LS540, ALS540		
spare parts for	500112		
	GEV No.	510601	Ref. No. 048464 069170 1210315
	impellor \varnothing 103mm H 25mm rotation direction right thread M8L seat \varnothing 12.2mm blades 6		
	GEV No.	510693	Ref. No. 069543 141002
	mechanical shaft seal for shaft \varnothing 12mm slide ring ext. \varnothing 24mm slide ring H 15.5mm slide ring int. \varnothing 11mm counter ring mounting \varnothing 24mm height counter ring 8mm counter ring int. \varnothing 13.5mm		
	GEV No.	521513	Ref. No. 0L0305 1295303B
	pump cover FIR inlet \varnothing 63mm outlet \varnothing 47mm turn direction right ID \varnothing 150mm inner height 32mm		
	GEV No.	524416	Ref. No. 033694 048626 0H2156 0K7248 0KE922 0KM569
	pump cover gasket thickness 4x4mm Qty 1 pcs		







GEV No.	500056	Ref. No.	046280 046281 046283 046346 047195 068710 12115T10 12141000
description	pump inlet \varnothing 63mm outlet \varnothing 47mm type 1211.2706 230/400V 50Hz 3 phase 0.55kW 0.75HP L 305mm rotation direction right FIR		
For models:	LSE720DK, LS540D, LS720, CT142DXE, CT142SXE, CT142DXEUK, CT142SXEUUK, CT142DXV, CT142SXV, CT190DXE, CT190SXE, CT190DXEUK, CT190SXEUUK, CT190DXV, CT190SXV, CT191DXE, CT191SXE, CT191DXEUK, CT191SXEUUK, CT191DXV, CT191SXV, CT192DXE, CT192SXE, CT192DXEUK, CT192SXEUUK, CT192DXV, CT192SXV, CT240DXE, CT240SXE, CT240DXEUK, CT240SXEUUK, CT240DXV, CT240SXV, CT241DXE, CT241SXE, CT241DXEUK, CT241SXEUUK, CT241DXV, CT241SXV, CT142DXEZ, CT142SXEVZ, CT190DXEZ, CT190SXEZ, CT190DXV, CT190SXV, CT191DXE, CT191SXE, CT191DXV... (Other models you can see in the webshop)		
spare parts for	500056		
	GEV No.	510601	Ref. No. 048464 069170 1210315
	impellor \varnothing 103mm H 25mm rotation direction right thread M8L seat \varnothing 12.2mm blades 6		
	GEV No.	510693	Ref. No. 069543 141002
	mechanical shaft seal for shaft \varnothing 12mm slide ring ext. \varnothing 24mm slide ring H 15.5mm slide ring int. \varnothing 11mm counter ring mounting \varnothing 24mm height counter ring 8mm counter ring int. \varnothing 13.5mm		
	GEV No.	521513	Ref. No. 0L0305 1295303B
	pump cover FIR inlet \varnothing 63mm outlet \varnothing 47mm turn direction right ID \varnothing 150mm inner height 32mm		



GEV No.	499228	Ref. No.	0E6012 12932725
description	pump inlet ø 63mm outlet ø 47mm type 1293.2725 220-240/380-415V 50Hz 3 phase 0.55kW L 302mm rotation direction right FIR		
For models:	RT190ED, RT190ES, RT190SR, RT190SL, RT190HDED, RT190HDES, RT190HSR, RT190HSL, RT270ED, RT270ES, RT270SR, RT270SL, RT270HDED, RT270HDES, RT270HSR, RT270HSL, RT142ERF, RT142ELF, RT190ERF, RT190ELF, RT190VD, RT190VS, RT190HERF, RT190HEL, RT190HDVDF, RT190HDVSF, RT270ERF, RT270ELF, RT270VDF, RT270VSF, RT270HERF, RT270HEL, RT270HDVDF, RT270HDVSF, RT190ERG, RT190ELG, RT190VDU, RT190VSU, RT190HERG, RT190HEL, RT190HDVDU, RT190HDVSU, RT270ERG, RT270ELG, RT270VDU, RT270VSU, RT270HERG, RT270HEL, RT270HDVDU, RT270HDVSU...(Other models you can see in the webshop)		



GEV No.	500258	Ref. No.	0K7245
description	pump inlet ø 63mm outlet ø 53mm type 1204.2725 230/400V 50Hz 3 phase 1.5kW 2.01HP L 320mm rotation direction left FIR		
For models:	D480, D48, D48, D48, D480, D48, D48, D48, D48, D48, D48, D48, D480, D48, D48, D48, D48, D48, D48, D48, D48, D48, D480, D480, D48, D48, D48, D48, D48, D480, D480, D48, D48, D480, D480		
spare parts for	500258		
	GEV No.	510531	Ref. No. —
	pump cover FIR inlet ø 63mm outlet ø 53mm auxiliary pressure connection M16x1.5mm supporting pressure open turn direction left ø 185mm ID ø 150mm inner height 37mm		
	GEV No.	510604	Ref. No. —
	impellor ø 118mm H 34mm M8R rotation direction left		
	GEV No.	510693	Ref. No. 069543 141002
	mechanical shaft seal for shaft ø 12mm slide ring ext. ø 24mm slide ring H 15.5mm slide ring int. ø 11mm counter ring mounting ø 24mm height counter ring 8mm counter ring int. ø 13.5mm		





spare parts for	500258		
	GEV No.	511667	Ref. No. —
	fan wheel ø 123mm H 17mm shaft intake ø 15mm		
	GEV No.	524416	Ref. No. 033694 048626 0H2156 0K7248 0KE922 0KM569
	pump cover gasket thickness 4x4mm Qty 1 pcs		

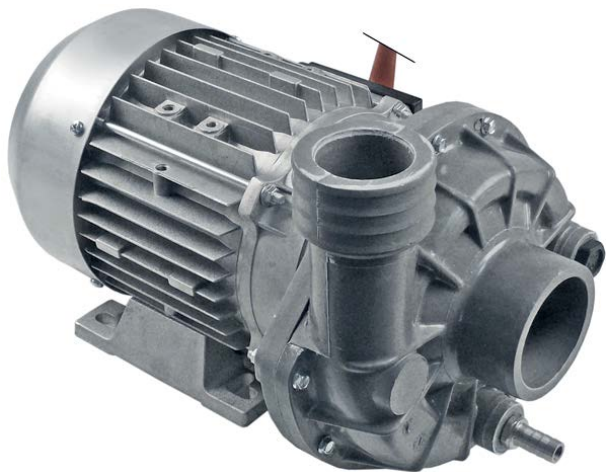

GEV No.	500397	Ref. No.	046563 046567 046603 047708 22541000
description	pump inlet ø 70mm outlet ø 60mm type 2254.1000 230/400V 50Hz 3 phase 1.1kW 1.5HP L 320mm rotation direction right FIR		
For models:	LS860F, LS860DK, LS860PH, LS1080F, LS1080UK, LS1080PH, LS861F, LS1080M, LS1080, LS1080D, LS1080UK, LS1080/63, LS860, LS860, LS860D, LS860UK, LS861UK, LS860/63, LS861, LS860, LS1080, LS860, DMAST2CUK, LS860, LS1080, LS860, LS1080		
spare parts for	500397		
	GEV No.	510693	Ref. No. 069543 141002
	mechanical shaft seal for shaft ø 12mm slide ring ext. ø 24mm slide ring H 15.5mm slide ring int. ø 11mm counter ring mounting ø 24mm height counter ring 8mm counter ring int. ø 13.5mm		
	GEV No.	521515	Ref. No. 049177 0L0496 22543035
	pump cover inlet ø 70mm outlet ø 60mm		
	GEV No.	524416	Ref. No. 033694 048626 0H2156 0K7248 0KE922 0KM569
	pump cover gasket thickness 4x4mm Qty 1 pcs		







1

GEV No.	500115	Ref. No.	048216 22542561
description	pump inlet ø 70mm outlet ø 60mm type 2254.2561 230/400V 50Hz 3 phase 1.5kW 2HP L 325mm rotation direction right FIR		
For models:	LS10D, LS10, LS10UKRP, LC100, ECOTEMP12-, LS10/60, LS10/1, LS10/12KW, LS10F, LS10DEK, LS10/1UKRP, LS10SW, LS10DP, LS10/HD, SH55, LO10, LS10/UK3, LS12D, LS12, LS12UK/RP, LC120, LS12DP, LS12F, LS12DEK, LS12HD, LS12/UK3, ECOTEMP12SW, ECOTEMP12INS, LS12MEX, LS10N, LS10, LS14EA, LS10UKDP, ET12E, LS10/60HZ, LS10CW, LS10INS, HT1200INS, LS14EAI, LS10N, LS10DP, LS10HD, LS14EAI/AU, LS10UK/3, LS12INS, LS12, LS12DP, LS12CW, HT1200DEK, LS14EAASIA...(Other models you can see in the webshop)		
spare parts for	500115		
	GEV No.	504313	Ref. No. 049561 OKB773
	hose connector thread M12x1.75 grommet ø 11.3mm grommet length 23mm WS 17 total length 43mm thread L 15mm stainless steel IT M8x1.25		
	GEV No.	510693	Ref. No. 069543 141002
	mechanical shaft seal for shaft ø 12mm slide ring ext. ø 24mm slide ring H 15.5mm slide ring int. ø 11mm counter ring mounting ø 24mm height counter ring 8mm counter ring int. ø 13.5mm		
	GEV No.	521014	Ref. No. 048624 12253155
	impellor ø 110mm H 32mm rotation direction right thread M8L shaft ø 28mm shaft length 3mm seat ø 12.2mm blades 6		
	GEV No.	521515	Ref. No. 049177 0L0496 22543035
	pump cover inlet ø 70mm outlet ø 60mm		
	GEV No.	524416	Ref. No. 033694 048626 0H2156 OK7248 0KE922 OKM569
	pump cover gasket thickness 4x4mm Qty 1 pcs		







1

GEV No.	499264	Ref. No.	0L0027 22542562
description	pump inlet ø 70mm outlet ø 60mm type 2254.2562 220-240/380-415V 50Hz 3 phase 1.5kW L 322mm rotation direction right FIR		
For models:	LS14EA, ET12E, LS14EAI, LS14EAI/AU, LS14EAASIA, LS14EA/G, LS10EA, LS14EAI/DD, WT65E, WT65EB, WT65EI, ECOTEMP12S, WT65EBI, WT65EBIA, WT65EIA, WT65EBIDG, WT65EBASIA, WT65EIM50, LS14EADP/G, WT65MED, LS14EAWS, LS14ADPWSG, LS14EAIWS, WT65EBWS, WT65BIDWSG, WT65EBIWS, WT65MEDWS, ET12EWS, LS14SANA, WT65EBID, WT65EBIWS, EHTAIMLAU, EHTAIUSPH5, H3500, HT1200WS, HT1200IWS, H1510SANA, LV1200IWS, HT1200BIDG, HT1200BIDW, HT1200, HT1000, HT1200INS, ET12EIG, ET12EI, LV1000, LV1200INS, ET12EICWG, ET12EICW, ET12EIWS...(Other models you can see in the webshop)		
spare parts for	499264		
	GEV No.	510694	Ref. No. 048623 049171
	mechanical shaft seal for shaft ø 13mm height counter ring 8mm ID ø 11.5mm H 16mm mounting ø 24/26mm int. ø 11.4mm		
	GEV No.	521014	Ref. No. 048624 12253155
	impellor ø 110mm H 32mm rotation direction right thread M8L shaft ø 28mm shaft length 3mm seat ø 12.2mm blades 6		
	GEV No.	521515	Ref. No. 049177 0L0496 22543035
	pump cover inlet ø 70mm outlet ø 60mm		
	GEV No.	524416	Ref. No. 033694 048626 0H2156 OK7248 0KE922 OKM569
	pump cover gasket thickness 4x4mm Qty 1 pcs		



1

GEV No.	499265	Ref. No.	0L0097 22545881
description	pump inlet ø 70mm outlet ø 60mm type 2254.5881 255/440V 60Hz 3 phase 1.5kW L 322mm rotation direction right FIR		
For models:	WT65EIM60, EHTAIUSPH6		
spare parts for	499265		
	GEV No.	502276	Ref. No. 0L0494
	impellor ø 90mm H 30mm thread M8L		
	GEV No.	504313	Ref. No. 049561 0KB773
	hose connector thread M12x1.75 grommet ø 11.3mm grommet length 23mm WS 17 total length 43mm thread L 15mm stainless steel IT M8x1.25		
	GEV No.	510693	Ref. No. 069543 141002
	mechanical shaft seal for shaft ø 12mm slide ring ext. ø 24mm slide ring H 15.5mm slide ring int. ø 11mm counter ring mounting ø 24mm height counter ring 8mm counter ring int. ø 13.5mm		
	GEV No.	521515	Ref. No. 049177 0L0496 22543035
	pump cover inlet ø 70mm outlet ø 60mm		
	GEV No.	524416	Ref. No. 033694 048626 0H2156 0K7248 0KE922 0KMS69
	pump cover gasket thickness 4x4mm Qty 1 pcs		

HANNING

pumps



1

GEV No.	499072	Ref. No.	0E2971 0K8525 30200012
description	pump inlet ø 62mm outlet ø 54mm type PS90S-107 220-240/380-415V 50Hz 3 phase 2.7kW 3.6HP L 380mm rotation direction right HANNING		
For models:	PW1EFL, PW1EFLF, PW1EFL/60HZ, PW2EFL, PW2EFLF, PW2EFL/60HZ, PW2VFL, WT830EFL, WT830EFLF, WT830EFL/60HZ, WT850, WT850EFLF, WT850EFL/60HZ, WT850SFL, FT36EDTS, FT36ESTS, FT36VDTs, FT36VSTs, FT36ED, FT36ES, FT36VD, FT36VS, FT50ED, FT50ES, FT50VD, FT50VS, FT72ED, FT72ES, FT72VD, FT72VS, FT36EDT, FT36EST, FT36VDT, FT36VST, FT50EDT, FT50EST, FT50VDT, FT50VST, FT72EDT, FT72EST, FT72VDT, FT72VST, WTF2ERC, WTF2ELC, WTF2SRC, WTF2SLC, WTF2HERC, WTF2HELCL, WTF2HSRC, WTF2HSLC...(Other models you can see in the webshop)		



LGB

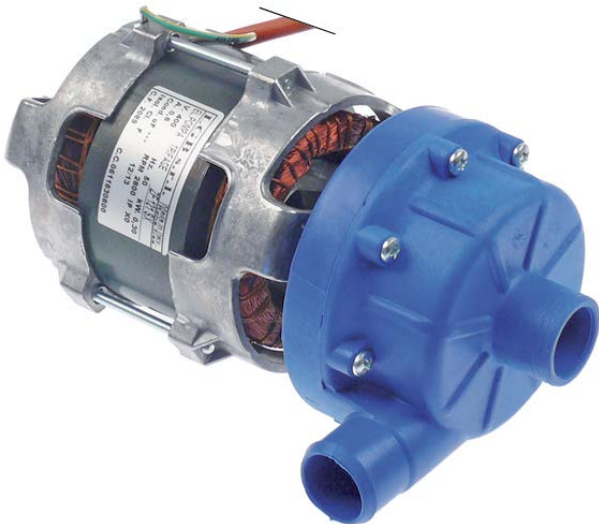



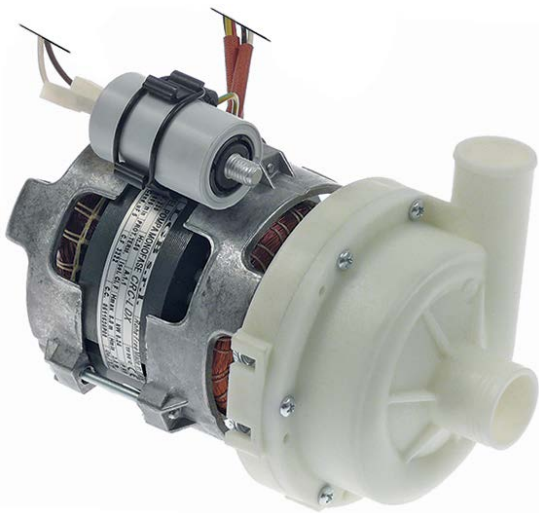

1			
GEV No.	499263	Ref. No.	0L0947
description	pump inlet ø 28mm outlet ø 26.5mm type ZF1215X 400V 50Hz 3 phase 0.3kW L 195mm rotation direction right LGB		
For models:	WTM140ERA, WTM140ELA, WTM140ERB, WTM140ELB, WTM165ERA, WTM165ELA, WTM165ERB, WTM165ELB, WTM200ERA, WTM200ELA, WTM200ERB, WTM200ELB, WTM250ERA, WTM250ELA, WTM250ERB, WTM250ELB, WTM300ERA, WTM300ELA, WTM300ERB, WTM300ELB, WTM180ERA, WTM180ELA, WTM180ERB, WTM180ELB, WTM140SRA, WTM140SLA, WTM165SRA, WTM165SLA, WTM180SRA, WTM180SLA, WTM200SRA, WTM200SLA, WTM250SRA, WTM250SLA, WTM300SRA, WTM300SLA, RTM140ERA, RTM140ELA, RTM140ERB, RTM140ELB, RTM165ERA, RTM165ELA, RTM165ERB, RTM165ELB, RTM180ERA, RTM180ELA, RTM180ERB, RTM180ELB, RTM200ERA, RTM200ELA... (Other models you can see in the webshop)		







2			
GEV No.	499358	Ref. No.	0L2858
description	pump inlet ø 28mm outlet ø 26mm type CRC-L DX 230V 50Hz 1 phase 0.24kW rotation direction left capacitor 5µF LGB		

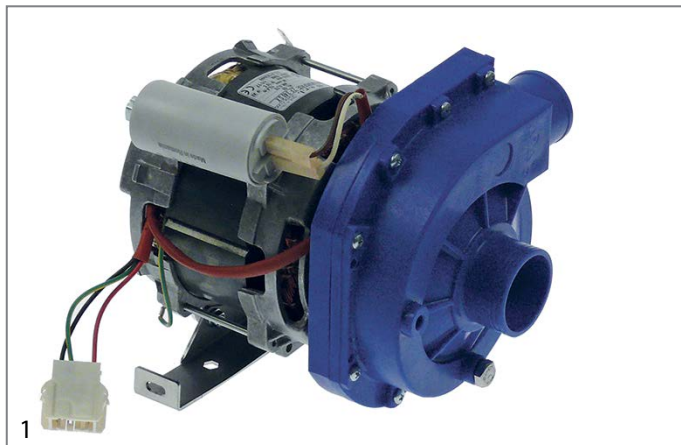





1			
GEV No.	500466	Ref. No.	049889 0L0571 1537 1722
description	pump inlet ø 28mm outlet ø 28mm type ZFC1121DX 230V 50Hz 1 phase 0.35kW 0.47HP L 200mm rotation direction left capacitor 6.3µF LGB		
For models:	LB1, LB1WS, LB1WSDP, LB1/RBP, LB1/TOP, LB1/60, WT1WSDP, LB2DPSAUS, LB1G, LB1WSG, WT2DPDI, WT2WSDPDI, LB1TOP, WT2TOPDI, LB2WS, LB2, LB2WSDP, LB2/TOP, LB2/RBP, LB2WS60, WT2WSDP, WT2WSDPD, LB2WSG, WT2WS, WT1, WT1WS, WT1TOP, WT2TOP, WT1/3DP, WT2/3DP, WT2DPAUS, WT2, LB2DPDI, LB2WSDPDI, LB2WSDPD, LB2TOP, LB2DP3, WT2DPD3, NGW, NGWDPDD, UC1, UC2WS, GW1, GW1WS, LV1WS, LV1WSDP, LV2WSDP, LV2WS, GW2DPG, GW2WSDPG...(Other models you can see in the webshop)		
spare parts for	500466		
	GEV No.	365012	Ref. No. 049260 OKB768 909
	operating capacitor capacity 6.3µF 450V tolerance 5% 50Hz ambient temperature max. -25 to +85°C ø 30mm L 61mm M8 plastic connection male faston 6.3mm protection		
	GEV No.	510703	Ref. No. 0H2154 0H2155 0H2522 OK7246 OK8387 OKA834 AB122414T AC13268B
	mechanical shaft seal for shaft ø 13mm slide ring H 13mm height counter ring 5.5mm ED ø 26mm		
	GEV No.	521007	Ref. No. —
	pump cover LGB inlet ø 28mm outlet ø 26mm turn direction left		
	GEV No.	521008	Ref. No. 0L1366 0L1455
	impellor ø 72mm H 22mm rotation direction left thread M7R shaft ø 13mm shaft length 12mm		
	GEV No.	528800	Ref. No. —
	O-ring EPDM thickness 2.62mm ID ø 75.87mm Qty 1 pcs		







GEV No.	499361	Ref. No.	OL0126 1665
description	pump inlet ø 45mm outlet ø 38mm type ZF340SX 230V 50Hz 1 phase 0.7kW 0.95HP L 210mm rotation direction right connection coded plug capacitor 12.5µF supporting pressure M8 LGB with mounting angle		
For models:	WT4, WT4B, WT4D, WT4DB, WT4DG, WT4WS1, WT4BWS, WT4DWS1, WT4BDWS, NUC3DD, WT4DDG, EUC1, EUC1DP, EUC1WS, EUC1DPWS, EUC3, EUC3WS, EUC3DP, EUC3DPWS, EUC1G, EUC3DD, ZUCADDROW, LS5/1, LS5/1DP, LS5/1WS, LS5/1WSDP, LS5/3, LS5/3DP, LS5/3WS, LS5/3WSDP, FUCA3DD, LS5/3WSDPD, LB5DPG, LS5/1DPAUS, LS5/1D-PCS, KUC3, KUC3DP, NUC1, NUC1DP, NUC1WS, NUC1DPWS, NUC3, NUC3WS, NUC3DP, NUC3DPWS, NUC3DDWS, NUC1DPA, ZUCA1, ZUCA3, EUCADDROW...(Other models you can see in the webshop)		
spare parts for	499361		
	GEV No.	365014	Ref. No. 054922 066235 0K2386 0K3032 0L0335 S694601702
	operating capacitor capacity 12.5µF 450V tolerance 5%Hz ambient temperature max. -25 to +85°C ø 35mm L 70mm M8 plastic connection male faston 6.3mm 45S.C3D5.12.5 protection		
	GEV No.	507589	Ref. No. —
	pump cover inlet ø 45mm outlet ø 38mm for 499361		
	GEV No.	510702	Ref. No. —
	mechanical shaft seal height counter ring 5.5mm ID ø 12mm		
	GEV No.	521246	Ref. No. 0L0332 0L1391
	impellor ø 103mm H 26mm thread M8L shaft ø 20mm shaft length 7mm seat ø 8.2mm blades 6		
	GEV No.	521714	Ref. No. 0L1392
	pump cover gasket thickness 4x4mm Qty 1 pcs		







GEV No.	499163	Ref. No.	OL1914 611636B00
description	pump inlet ø 62mm outlet ø 50mm type ZF522VSX 230V 50Hz 1 phase 0.76kW 1HP L 255mm rotation direction right capacitor 16µF LGB		
For models:	LU7PDP, LU7ADP, LU7ADPWS, WTU40PDP, WTU40ADP, WTU40ADPWS, WTU40ADPD, WT60/GJ60, EHTA, EHTAWS, EHTAI, EHTAID, EHTAIWS, EHTAIDWS, EHTAIG, EHTAIWSG, EHTAIAU, ZHTAWS, ZHTAID, ZHTAIWS, ZHTAIAU, ZHTA, ZHTAI, EHTAO, EHT, EHTG, NHT, NHTD, EHTAROW, ZHTAROW, ZHTAO, KHT, ET7ADP, LU700PDP, LU700ADP, LU700ADPWS, OHTAROW, ET12AI, ET12AIT, NHTG, AHTAWS, AHTAIWS, AHTAIG, AHTAIWSG, AHTA, AHTAI		
spare parts for	499163		
	GEV No.	365021	Ref. No. 052797 0A2914 BC0164521
	operating capacitor capacity 16µF 425V tolerance 5% 50/60Hz ambient temperature max. -25 to +85°C ø 35mm L 73mm single M8 plastic connection male faston 6.3mm 416.10.99 protection		
	GEV No.	510551	Ref. No. 0049 0L0338
	pump cover gasket ID ø 158.3mm pump type 1214/1293/1225/2243/1226/1204/3473/1241 thickness 3.53mm EPDM Qty 1 pcs		
	GEV No.	510693	Ref. No. 069543 141002
	mechanical shaft seal for shaft ø 12mm slide ring ext. ø 24mm slide ring H 15.5mm slide ring int. ø 11mm counter ring mounting ø 24mm height counter ring 8mm counter ring int. ø 13.5mm		
	GEV No.	521239	Ref. No. 0L0339 0L1987
	impellor ø 110mm H 26mm rotation direction right thread M8L shaft ø 19.5mm shaft length 17mm seat ø 8.2mm blades 6		
	GEV No.	521536	Ref. No. —
	pump cover ALBA / LGB inlet ø 62mm outlet ø 50mm auxiliary pressure connection 12mm supporting pressure closed turn direction right ø 180mm ID ø 150mm inner height 38mm		



1				
GEV No.	500943	Ref. No.	0L0092 ZF522VSX	
description	pump inlet ø 62mm outlet ø 50mm type ZF522VSX 230V 50Hz 1 phase 0.7kW 0.95HP L 250mm rotation direction right capacitor 16µF LGB			
For models:	LU7PDP, LU7ADP, LU7ADPWS, WTU40PDP, WTU40ADP, WTU40ADPWS, WTU40ADPPD, LS9P, LS9PDD, WT55P, LS9ADG1, WT55ADG1, LS9PAUS, WT55PM50, H2500, ET7ADP, HT900, LD900, HT900ADG1, LU700PDP, LU700ADP, LU700ADPWS			
spare parts for	500943			
	GEV No.	365021	Ref. No.	052797 0A2914 BC0164521
	operating capacitor capacity 16µF 425V tolerance 5% 50/60Hz ambient temperature max. -25 to +85°C ø 35mm L 73mm single M8 plastic connection male faston 6.3mm 416.10.99 protection			
	GEV No.	510551	Ref. No.	0049 0L0338
	pump cover gasket ID ø 158.3mm pump type 1214/1293/1225/2243/1226/1204/3473/1241 thickness 3.53mm EPDM Qty 1 pcs			
	GEV No.	510694	Ref. No.	048623 049171
	mechanical shaft seal for shaft ø 13mm height counter ring 8mm ID ø 11.5mm H 16mm mounting ø 24/26mm int. ø 1 14mm			
	GEV No.	521239	Ref. No.	0L0339 0L1987
	impellor ø 110mm H 26mm rotation direction right thread M8L shaft ø 19.5mm shaft length 17mm seat ø 8.2mm blades 6			
	GEV No.	521536	Ref. No.	—
	pump cover ALBA / LGB inlet ø 62mm outlet ø 50mm auxiliary pressure connection 12mm supporting pressure closed turn direction right ø 180mm ID ø 150mm inner height 38mm			



1				
GEV No.	499267	Ref. No.	0L0565	
description	pump inlet ø 62mm outlet ø 50mm type ZF523VSX 230/400V 60Hz 3 phase 1.1kW L 282mm rotation direction right LGB			
For models:	LS14ROW60, WT65ROW60, LS9P60, WT55P60			
spare parts for	499267			
	GEV No.	510551	Ref. No.	0049 0L0338
	pump cover gasket ID ø 158.3mm pump type 1214/1293/1225/2243/1226/1204/3473/1241 thickness 3.53mm EPDM Qty 1 pcs			
	GEV No.	510693	Ref. No.	069543 141002
	mechanical shaft seal for shaft ø 12mm slide ring ext. ø 24mm slide ring H 15.5mm slide ring int. ø 11mm counter ring mounting ø 24mm height counter ring 8mm counter ring int. ø 13.5mm			
	GEV No.	521093	Ref. No.	—
	impellor ø 85mm H 29mm thread M8L shaft ø 20mm shaft length 10mm			
	GEV No.	521536	Ref. No.	—
	pump cover ALBA / LGB inlet ø 62mm outlet ø 50mm auxiliary pressure connection 12mm supporting pressure closed turn direction right ø 180mm ID ø 150mm inner height 38mm			



1





GEV No.	500468	Ref. No.	0L0060 0L0564 1489 42954050
description	pump inlet ø 63mm outlet ø 48mm type ZF523VVSX 230/400V 50Hz 3 phase 1kW 1.36HP L 280mm rotation direction right LGB		
For models:	WT65ROW, LS14ROW, LS9P, LS9PDD, LS9AUK/3, WT55P, WT55AUK/3, LS9PAUS, WT55PM50, EHTM, NHTM, H2500, HT900, LD900		
spare parts for	500468		
	GEV No.	510551	Ref. No. 0049 0L0338
	pump cover gasket ID ø 158.3mm pump type 1214/1293/1225/2243/1226/1204/3473/1241 thickness 3.53mm EPDM Qty 1 pcs		
	GEV No.	510693	Ref. No. 069543 141002
	mechanical shaft seal for shaft ø 12mm slide ringext. ø 24mm slide ring H 15.5mm slide ring int. ø 11mm counter ring mounting ø 24mm height counter ring 8mm counter ring int. ø 13.5mm		
	GEV No.	521058	Ref. No. —
	fanwheel cover suitable for LGB ID ø 138mm ED ø 142mm H 59mm plastic		
	GEV No.	521097	Ref. No. 0L0819 13881R
	impellor ø 100mm H 31mm thread M8L shaft ø 20mm shaft length 14mm		

OLYMPIA

pumps



1

GEV No.	500003	Ref. No.	069540 069675 069804 069805 0A6081 0K3711 0K3713
description	pump inlet ø 45mm outlet ø 32mm type T30 230V 50Hz 1 phase 0.29kW 0.39HP L 190mm rotation direction right capacitor 8µF OLYMPIA		
For models:	LTB11, LTB12, LTB22, LTB11UK, LTB12UK, LTB22UK, LTB11, LTB22, 910-00-021, 910-00-023, 910-00-031, 910-00-033, 911-00-022, 911-00-024, 911-00-032, 911-00-034, CRYSTAL 11, CRYSTAL 22		
spare parts for	500003		
	GEV No.	365013	Ref. No. 049126 BC0084520
	operating capacitor capacity 8µF 400V tolerance 5%Hz ambient temperature max. -25 to +85°C ø 31.5mm L 55mm M8 plastic connection male faston 6.3mm protection		
	GEV No.	510512	Ref. No. —
	pump cover OLYMPIA inlet ø 45mm outlet ø 31mm outlet 2 ø 24mm direction right ø 130mm ID ø 124mm inner height 20mm		
	GEV No.	510554	Ref. No. —
	O-ring EPDM thickness 2mm ID ø 120mm Qty 1 pcs		
	GEV No.	510615	Ref. No. 069545 0H1266 124006
	impellor ø 90mm H 22mm rotation direction right thread M10L blades 4		
	GEV No.	510693	Ref. No. 069543 141002
	mechanical shaft seal for shaft ø 12mm slide ringext. ø 24mm slide ring H 15.5mm slide ring int. ø 11mm counter ring mounting ø 24mm height counter ring 8mm counter ring int. ø 13.5mm		





booster pumps I



GEV No.	499210	Ref. No.	0E5532
description	pump inlet ø 1" IT outlet ø 1" IT type CH2-30 220-240V 50Hz 1 phase 480W L 320mm		
For models:	RT100ED, RT100ES, RT100SR, RT100SL, RT140ED, RT140ES, RT140SR, RT140SL, RT190ED, RT190ES, RT190SR, RT190SL, RT190HDED, RT190HDES, RT190HSR, RT190HSL, RT270ED, RT270ES, RT270SR, RT270SL, RT270HDED, RT270HDES, RT270HSR, RT270HSL, RT100ERF, RT100ELF, RT100VD, RT100VS, RT140ERF, RT140ELF, RT140VD, RT140VS, RT142ERF, RT142ELF, RT190ERF, RT190ELF, RT190VD, RT190VS, RT190HERF, RT190HELF, RT190HDVDF, RT190HDVSF, RT270ERF, RT270ELF, RT270VDF, RT270VSF, RT270HERF, RT270HELF, RT270HDVDF, RT270HDVSF...(Other models you can see in the webshop)		



GEV No.	500395	Ref. No.	048910 049162 049229 0556 0741
description	pump inlet ø 3/8" IT outlet ø 3/8" IT type PS45DX 230V 50Hz 0.35kW capacitor 8µF LGB		
For models:	LS32, LS32/4.5, LS32F, LV32F, C55, LV32/60, WT302, WT302/4.5, WT302F, WT302/60, LS33, LS33/4.5, LS33F, LV33F, C55A, LS33/60, WT303, WT303/4.5, WT303F, WT303/60, LB1/RBP, LB1/TOP, WT1WSDP, WT2TOP60, LB1TOP, WT2TOPDI, LB2/TOP, LB2/RBP, WT2WSDP, WT2WSDPD, WT2WS, WT1, WT1WS, WT1TOP, WT2TOP, WT1/3DP, WT2/3DP, WT2DPAUS, LB2TOP, LS62/UKRP, ECOTEMP5, LS62HD, LS63/UKRP, LS64/UKRP, ECOTEMP5S, WT32/UKRP, WT32/J60, WT32/J50, WT33/UKRP, WT34/UKRP...(Other models you can see in the webshop)		
spare parts for	500395		
	GEV No.	365013	Ref. No. 049126 BC0084520
	operating capacitor capacity 8µF 400V tolerance 5%Hz ambient temperature max. -25 to +85°C ø 31.5mm L 55mm M8 plastic connection male faston 6.3mm protection		
	GEV No.	698400	Ref. No. —
	pump cover gasket pump type PS46 thickness 2mm ID ø 66mm Qty 1 pcs		

drain pumps

ASKOLL



GEV No.	499212	Ref. No.	048844 0L0690 0L0692 0L0994
description	drain pump inlet ø 35mm outlet ø 30mm 220-240V 30W 50Hz ASKOLL type M 87 with thermal fuse		
For models:	LS32UK/RP, WT4D, WT302UK/RP, WT4DB, WT4DG, LS33, LS33/4.5, LS33UK/RP, LS33F, LV33F, C55A, WT4DWS1, WT4BDWS, WT303, WT303/4.5, WT303UK/RP, WT303F, NUC3DD, WT4DDG, EUC1, EUC1DP, EUC1DPWS, EUC3DP, EUC3DPWS, EUC1G, EUC3DD, ZUCADDROW, LS5/1DP, LS5/1WSDP, LS5/3DP, LS5/3WSDP, FUCA3DD, LS5/3WSDPD, LB5DPG, LS5/1DPAUS, LS5/1DPCS, KUC3DP, NUC1DP, NUC1DPWS, NUC3DP, NUC3DPWS, NUC3DDWS, NUC1DPA, EUCADDROW, LB1WSDP, LB1/TOP, WT1WSDP, LB2DPSAUS, WT2DPDI, WT2WSDPDI...(Other models you can see in the webshop)		

HANNING



GEV No.	502286	Ref. No.	048939 0L0527 0L0693 0L2133 0L2657
description	drain pump 32W 200-400V inlet ø 35mm outlet ø 30mm 50/60Hz HANNING type DP025-275		
For models:	LS33/60, WT303/60, WT4D60, LS5/1DP60, EUCAIDPJ, EUCAIDPJ60, WT38C60, LS63/60, LS6AH240U, WT30H208U, WT30H240U, WT30H-208DU, WT30H240DU, WT30H208RU, WT30H240RU, LS6AH208DU, LS6AH208U, WT38/60, WT38/M60, LS6AH240DU, LS6AH208RU, LS6AH240RU, WT30M208U, WT30M240U, WT30M208DU, WT30M-240DU, WT30M208RU, WT30M240RU, WT30C208DU, WT30C240DU, WT38PM60, WT38M60/4, WT30H208WS, WT30H240WS, WT33/M60, WT33/60, WT30U440, LS14AH240U, WT65H208U, WT65H240U, LS14H208DU, LS14AH208U, LS14H240DU, LS14H208RU, LS14H-240RU, WT65H208DU, WT65H240DU, WT65H208RU, WT65H240RU, WT65M208U...(Other models you can see in the webshop)		



1

GEV No.	501578	Ref. No.	0L2838
description	pump 32W 200-240V inlet ø 35mm outlet ø 30mm 50/60Hz HAN-NING type DP025-373 input current 0.45A		

PLASET



1

GEV No.	500207	Ref. No.	046647 046651
description	drain pump inlet ø 25mm outlet ø 22mm 230V 90W 50Hz PLASET type 8411		
For models:	LS365F, LS365, LS365PH, LS365D, LS365, LS365/63, LS367, LS365F		



1

GEV No.	500206	Ref. No.	047562 0H2573 OK8760 611610300
description	drain pump with auxiliary pressure connection inlet ø 25mm outlet ø 22mm 230V 90W 50Hz PLASET type 8411		
For models:	LSDS5I, LSDS5V, LS521, LS521D, LS521F, LS521M, LS521K, LS521, ZLS510, ZLS520, ZLS521, ALLS521, LS520ZD, LS521ZD, LS510MZ, LS520MZ, LS521MZ		

booster pumps II

accessories



1

GEV No.	365015	Ref. No.	057576 0F0032 0K4727 0K8508 0KJ296 MP810UF
----------------	--------	-----------------	---

description

operating capacitor capacity 10µF 400V tolerance 5%Hz ambient temperature max. -25 to +85°C ø 35.5mm L 59mm M8 plastic connection male faston 6.3mm protection

For models:

CS7ME4/200-3, CS7ME4/230-3, CS7ME4/400-3N, CS7ME6/400-3N, CS7ME4/400-3N/EO, CS7ME4/400-3/50HZ/MA, CS7ME4/440-3/60HZ/MA, CS7MT4/400-3N, CS7GE4/200-3, CS7GE4/230-3, CS7GE4/400-3N, CS7GE6/400-3N, CS7GE4/400-3N/EO, CS7GE4/400-3/50HZ/MA, CS7GE4/440-3/60HZ/MA, CS7GT4/400-3N, CS7LCE4/200-3, CS7LCE4/230-3, CS7LCE4/400-3N, CS7LCE6/400-3N, CS7LCE4/400-3N/EO, CS7LCE4/400-3/50HZ/M, CS7LCE4/440-3/60HZ/M, CS7LCT4/400-3N, CS10ME4/200-3, CS10ME4/230-3, CS10ME6/230-3, CS10ME4/400-3N, CS10ME6/400-3N, CS10ME4/400-3N/EO, CS10ME4/400-3/50HZ/M, CS10ME4/440-3/60HZ/M, CS10MT4/400-3N, CS10MT6/400-3N, CS10GE4/200-3, CS10GE4/230-3, CS10GE6/230-3, CS10GE4/400-3N, CS10GE6/400-3N, CS10GE4/400-3N/EO, CS10GE4/400-3/50HZ/M, CS10GE4/440-3/60HZ/M, CS10GT4/400-3N, CS10GT6/400-3N, CS10LCE4/200-3, CS10LCE4/230-3, CS10LCE6/230-3, CS10LCE4/400-3N, CS10LCE6/400-3N, CS10LCE4/400-3N/EO...(Other models you can see in the webshop)





1





GEV No.	365017	Ref. No.	037268 083406 0K9108 0L2035
description	operating capacitor capacity 5µF 450V tolerance 5% 50/60Hz ambient temperature max. -25 to +85°C ø 28mm L 54mm M8 plastic connection male faston 6.3mm 16.10.08 protection		
For models:	BC22, BC44, BC44H, BCF11, BCF22, BCF44, AQC60U, AQC119U US, BC28A6, Crosswise, , , , BCW061, BCW101, BCW102, BCFW061, BCFW101, BC22, BC44, BCF11, BCF22, BCF44, BCWS061T, BCFW102, BC22, BC44, BCF11, BCF22, BCF44, BCFWS102, BCFWS101, BC28A, Crosswise, BC56VA, Crosswise 20, BC56HA, BCF28A, Crosswise, BCF64A, Crosswise 20, BCF56HA, BCFWS061, BCFWS061T, BLAST C/FREEZER, LS6EADD, LS6EA/DPDD, WT38TDE, LS6EADP3, LS6EAD-PWS...(Other models you can see in the webshop)		

			
1			
GEV No.	365012	Ref. No.	049260 0KB768 909
description	operating capacitor capacity 6.3µF 450V tolerance 5% 50Hz ambient temperature max. -25 to +85°C ø 30mm L 61mm M8 plastic connection male faston 6.3mm protection		
For models:	LS32UK/RP, WT302UK/RP, LS33UK/RP, WT303UK/RP, LB1, LB1WS, LB1WSDP, WT1WSDP, WT2TOP60, WT2DPDI, WT2WSDPDI, LB1TOP, WT2TOPDI, LB2WS, LB2, LB2WSDP, WT2WSDP, WT2WSDPD, WT2WS, WT1, WT1WS, WT1TOP, WT2TOP, WT1/3DP, WT2/3DP, WT2DPAUS, WT2, LB2DPDI, LB2WSDPDI, LB2WSDPD, LB2TOP, LB2DP3, WT2DPD3, NGW, NGWDPDD, LS6EADD, LS6EA/DPDD, LS6EADP3, LS6SANA, LS6EA/UK, LS6EA/DPUK, LS6EA/60, EUCAIUSPH6, LS65, LS62/UK, LS63/UK, WT37J60, WT37J50, LS64/UK, LS6AH240U...(Other models you can see in the webshop)		

vibration pumps

			
1			
GEV No.	499317	Ref. No.	OCA120
description	vibration pump 208-240V 46-60/38-54W 50/60Hz inlet ø 6 outlet ø 5 CEME type B46 kit L 142mm		

			
1			
GEV No.	499192	Ref. No.	0C2341 0c6947 0C8347 0C9067
description	vibration pump 230/240V 35W 50/60Hz inlet ø 6 outlet ø 5 L 141mm DEFOND type PX76 kit		

			
1			
GEV No.	500566	Ref. No.	007018 0C2341
description	vibration pump 230V 32W 50Hz inlet ø 7 outlet ø 1/8" IT CEME type E512/A32		
For models:	FCZ061EAA, FCZ101EAA, FCZ102EAA, FCZ201EAA, FCZ202EAA, FCZ061EAH, FCZ101EAH, FCZ201EAH, FCZ061EAN, FCZ101EAN, FCZ201EAN, FCZ061ETA, FCZ101ETA, FCZ102ETA, FCZ201ETA, FCZ202ETA, FCZ061ETH, FCZ101ETH, FCZ201ETH, FCZ061ETN, FCZ101ETN, FCZ201ETN, FCZ061GAG, FCZ101GAG, FCZ102GAG, FCZ201GAG, FCZ202GAG, FCZ061GAD, FCZ101GAD, FCZ102GAD, FCZ201GAD, FCZ202GAD, FCZ101GTG, FCZ102GTG, FCZ201GTG, FCZ202GTG, FCZ101GTD, FCZ102GTD, FCZ201GTD, FCZ202GTD, FCZ061EBA, FCZ101EBA, FCZ102EBA, FCZ061EBH, FCZ101EBH, FCZ061EBN, FCZ101EBN, FCZ061EBC, FCZ101EBC, FCZ201EBC...(Other models you can see in the webshop)		
accessories for	500566		
	GEV No.	510303	Ref. No. 0C1935
	O-ring EPDM thickness 1.78mm ID ø 6.75mm Qty 1 pcs		
	GEV No.	520512	Ref. No. 0C1116
	reducer WS 17 IT 1/4" ET 1/8" total length 28mm		
	GEV No.	542346	Ref. No. 0C4198
	hose connector thread 1/4" with O-ring hose ø 5mm stainless steel Qty 1 pcs		

			
1			
GEV No.	499142	Ref. No.	ORT040 5018028
description	vibration pump type CP06.728.0 220/240V 70W 60Hz inlet ø 6 outlet ø 6 with thermal fuse L 130mm		





			
1			
GEV No.	499060	Ref. No.	0C5371
description	vibration pump type E512 208/240V 60W 50-60Hz inlet ø 7 outlet ø 1/4" CEME L 150mm		
For models:	FCZ201ETA, FCZ202ETA, FCZ201ETH, FCZ201ETN, FCZ201GTG, FCZ201GTD, FCZ201EBA2, FCZ202EBA2, FCZ201EBH2, FCZ201EBN2, FCZ201EBC2, FCZ201GBG2, FCZ201GBD2, FCZ201GBI2, FCZ201ECA2, FCZ202ECA2, FCZ201ECH2, FCZ201ECN2, FCZ201GCG2, FCZ201GCD2, AOS201ETA1, AOS202ETA1, AOS201ETH1, AOS201ETN1, AOS201ETC1, AOS201ETE1, AOS201ETF1, AOS201ETM1, AOS202ETM1, AOS201ETK1, AOS202ETK1, AOS201GTG1, AOS201GTD1, AOS201GTP1, AOS201GTW1, AOS201EBA2, AOS202EBA2, AOS201EBH2, AOS201EBN2, AOS201EBC2, AOS201EBE2, AOS201EBF2, AOS201EBK2, AOS202EBK2, AOS201GBG2, AOS201GBD2, AOS201GBW2, AOS201ECA2, AOS202ECA2, AOS201ECH2...(Other models you can see in the webshop)		
spare parts for	499060		
		GEV No. 510303	Ref. No. 0C1935
	O-ring EPDM thickness 1.78mm ID ø 6.75mm Qty 1 pcs		
accessories for	499060		
		GEV No. 542346	Ref. No. 0C4198
	hose connector thread 1/4" with O-ring hose ø 5mm stainless steel Qty 1 pcs		



			
1			
GEV No.	499269	Ref. No.	0L0267
description	vibration pump type ET200BR 230V 19W 50Hz inlet ø 4 outlet ø 7 CEME L 70mm		
For models:	WT4WS1, WT4BWS, WT4DWS1, WT4BDWS, EUC1WS, EUC1DPWS, EUC3WS, EUC3DPWS, LS5/1WS, LS5/1WSDP, LS5/3WS, LS5/3WSDP, LS5/3WSDPD, NUC1WS, NUC1DPWS, NUC3WS, NUC3DPWS, NUC3DDWS, LV5/3WSDP, FL5/3WSDP, UC5WSDP		

			
1			
GEV No.	499107	Ref. No.	0KB664 680801400
description	vibration pump type MP3 230V 5W 50Hz inlet ø 3 outlet ø 3 Invensys L 54mm		
For models:	FCV31E3, 7CO30, CCO30G, ECO312CF, OTS100		

pumps for ice machines

			
1			
GEV No.	500753	Ref. No.	086626
description	pump BECKETT type U62 230V 50/60Hz inlet ø 25mm outlet ø 25mm L 130mm rotation direction right for ice-cube maker capacitor 4µF		

			
1			
GEV No.	500590	Ref. No.	089699 23377 7BRE23377
description	pump FIR type 4240.2300 120W 230V 50/60Hz inlet ø 22mm outlet ø 22mm L 240mm rotation direction right for ice-cube maker capacitor 5µF		

For models:	FGC33AS42, FGC46AS42, FGC65A42, FGC29AB, FGC29WB, FGC40A, FGC40W, FGC67AB, FGC67WB, FGC90A, FGC90W, FGC29A, CB246W, CIM38AB, CIM38WB, CIM85AB, CIM15WB, CIM50AB, FIM50WB, FGC29AB, FGC29WB, CIM38AB, CIM38WB, CIM50AB, FIM50WB, CB249A, CB316A, CB425A, CB840A, FGC29AB, FGC67AB, FGC67WB, CIM38AB, CIM38WB, CIM85AB, CIM15WB, CIM50AB, FIM50WB, FGC29WB		
spare parts for	500590		
		GEV No. 601412	Ref. No. 085287
	fan wheel sucking ø 154mm fan wheel mounting 25.4mm blade angle 28° W 34mm plastic		
		GEV No. 601413	Ref. No. —
	fixing plate suitable for fanwheel ED ø 32mm shaft ø 7 mounting distance 26mm		

			
1			
GEV No.	500660	Ref. No.	090173
description	pump FIR type 4240A.2300 120W 230V 50/60Hz inlet ø 22mm outlet ø 22mm L 230mm rotation direction right for ice-cube maker capacitor 5µF		



1			
GEV No.	500200	Ref. No.	OKM595 OU1035
description	pump GRE 100W 230V 50Hz inlet ø 24mm outlet ø 23mm L 145mm rotation direction right		
For models:	LB040AUS, G350, G350DP, G400, G400DP		





1			
GEV No.	500759	Ref. No.	086680
description	pump GRE 30W 230V 60Hz outlet ø 12.5mm L 137mm rotation direction right for ice maker		



1			
GEV No.	500752	Ref. No.	086456
description	pump GRE 60W 230V 60Hz inlet ø 16mm outlet ø 21mm L 110mm rotation direction right for ice maker		



1			
GEV No.	500045	Ref. No.	OKM744
description	pump GRE type 100W 230V 50Hz inlet ø 24mm outlet ø 21mm L 150mm rotation direction left for ice-cube maker total length 230mm		
spare parts for	500045		
	GEV No.	532082	Ref. No. —
	O-ring EPDM thickness 2.62mm ID ø 61.6mm Qty 10 pcs		
accessories for	500045		
	GEV No.	695417	Ref. No. —
	insulation for pump		



1			
GEV No.	500597	Ref. No.	086545
description	pump GRE type MH50F 60W 230V 50Hz outlet ø 21mm L 110mm rotation direction right for ice maker		



1			
GEV No.	500763	Ref. No.	086510
description	pump HARTELL type U21B 25W 230V 50/60Hz outlet ø 19mm L 120mm for ice maker 0.33HP capacitor 12.5µF		



1			
GEV No.	500750	Ref. No.	086624
description	pump MORRILL type MSP 230V 50/60Hz outlet ø 21/27mm L 115mm rotation direction right		



1			
GEV No.	500165	Ref. No.	085322 23002 7BRE23002 B23002
description	pump REBO type 63/35 120W 230V 50/60Hz inlet ø 28mm outlet ø 26mm L 180mm rotation direction right for ice-cube maker capacitor 5µF		
spare parts for	500165		

	GEV No.	365017	Ref. No.	037268 083406 0K9108 0L2035
	operating capacitor capacity 5µF 450V tolerance 5% 50/60Hz ambient temperature max. -25 to +85°C ø 28mm L 54mm M8 plastic connection male faston 6.3mm 16.10.08 protection			



	GEV No.	601412	Ref. No.	085287
	fan wheel sucking ø 154mm fan wheel mounting 25.4mm blade angle 28° W 34mm plastic			



Table continues overleaf



spare parts for 500165			
	GEV No.	601413	Ref. No. —
fixing plate suitable for fanwheel ED ø 32mm shaft ø 7 mounting distance 26mm			



GEV No.	500166	Ref. No.	085340
description	pump REBO type 63/45 150W 230V 50/60Hz inlet ø 28mm outlet ø 26mm L 200mm rotation direction right capacitor 5µF		
For models:	C150W, C300A, C300W, CB1565W, CB246W, CB416W, CB955W, DSS42W, C80W, CB1565A, C80A, CB246A, CB416A, C150A, CB955A, DSS42A		

spare parts for 500166			
	GEV No.	365017	Ref. No. 037268 083406 0K9108 0L2035
operating capacitor capacity 5µF 450V tolerance 5% 50/60Hz ambient temperature max. -25 to +85°C ø 28mm L 54mm M8 plastic connection male faston 6.3mm 16.10.08 protection			
	GEV No.	601412	Ref. No. 085287
fan wheel sucking ø 154mm fan wheel mounting 25.4mm blade angle 28° W 34mm plastic			
	GEV No.	601413	Ref. No. —
fixing plate suitable for fanwheel ED ø 32mm shaft ø 7 mounting distance 26mm			



GEV No.	500047	Ref. No.	086047 086054
description	pump REBO type MH30F1 30W 230V 50Hz outlet ø 12.7mm L 135mm rotation direction left		
For models:	CIM15A, CIM15W, CIM30A, CIM30W, CIM45A, CIM45W		



GEV No.	500761	Ref. No.	06052302 086389 0KM637 0KM737 30000369 62028308 62043300 62043302 67000214 79311327
description	pump REBO type MH30F1 30W 230V 50Hz outlet ø 13mm L 135mm rotation direction right for ice maker		
For models:	CIM15A, CIM15W, CIM45A, CIM45W		



GEV No.	500204	Ref. No.	0KM679
description	pump REBO type MH50F 60W 230V 50Hz inlet ø 19mm outlet ø 19mm L 125mm rotation direction right for ice-cube maker		



GEV No.	500048	Ref. No.	086124 086390
description	pump REBO type MH50F 60W 230V 50Hz outlet ø 18mm L 137mm rotation direction right for ice maker		
For models:	CIM65A, CIM65W		



GEV No.	500203	Ref. No.	086166 0886166 0KM739
description	pump REBO type MH50F 60W 230V 50Hz outlet ø 21mm L 110mm rotation direction right for ice maker		
For models:	CIM120AS, CIM120WS		





1

GEV No.	500046	Ref. No.	086091
description	pump REBO type NR40 40W 230V 50Hz inlet ø 12mm outlet ø 12mm L 75mm rotation direction right for ice-cube maker		



1

GEV No.	500161	Ref. No.	OKK204
description	pump REBO type NR40 55W 230V 50Hz outlet ø 17mm L 110mm rotation direction left for ice-cube maker		
For models:	FGC24AB, FGC24WB, FGC24ABS, FGC24WBAB, CB184A, FGC24AB, FGC24WB, C150W, C300A, C300W, CB1565W, CB246W, CB416W, CB955W, DSS42W, C80W, CB1565A, C80A, CB246A, CB416A, C150A, CB955A, FRESHMAKER, ICEWATER45, ICEWATER45, DSS42A		
spare parts for	500161		
	GEV No.	500970	Ref. No. 087810 23073
	pump motor 55W 230V 50Hz REBO L 205mm type outlet ømm suitable for for ice maker		



1

GEV No.	500593	Ref. No.	089772
description	pump REBO type NR40 55W 230V 50Hz outlet ø 17mm L 110mm rotation direction left for ice-cube maker		
For models:	MC200AB20, MC200WB20, CIM235AB, CIM235WB, VM500W+BI, VM500A+BI, VM350A+BI, VM350W+BI		



1

GEV No.	500970	Ref. No.	087810 23073
description	pump motor 55W 230V 50Hz REBO L 205mm type outlet ømm suitable for for ice maker		
For models:	MC140AB20, MC140WB20, MC200AB20, MC200WB20, FGC24AB, FGC24WB, CIM235AB, CIM235WB, FGC24ABS, FGC24WBAB, CB184A, FGC24AB, FGC24WB, VM500W+BI, VM500A+BI, VM350A+BI, VM350W+BI, C150W, C300A, C300W, CB1565W, CB246W, CB416W, CB955W, DSS42W, C80W, CB1565A, C80A, CB246A, CB416A, C150A, CB955A, FRESHMAKER, ICEWATER45, ICEWATER45, DSS42A, MUSTER350A, MUSTER800A, VB250A, VB250W, VM900A, VM900W		

condensators & interference suppression filters

starting capacitors



1

GEV No.	365152	Ref. No.	0A8764 101522 102384 123126 123211 132705 30001693
description	starting capacitor 330V 50/60Hz duty cycle 1.7% capacity 52µF		
For models:	ICP110, ICP111, ICP130, ICP112, ITP120UK, ICN110UK, ITP120UK, ALP110, ALP120, ALP111, ALN110, ALN120, ALN111, ALNN120, ALNN220, ALNN230, ALNSO120, ALP110UK, ALN110UK, ALNN220UK, ALNF120, ADN220ES, ADF220ES, ILP110, ILP110UK, ILN120, ILN110, ILN110UK, ILN120, ILNSO120, ILNN120, ILNN220, ILNN220UK, ILNN230, ALP110UK, ALN110UK, ALNN220UK, ALNF220UK, ILNF120, ILNF220, ILNF220UK, ALP110, ALP120, ALP111, ALN110, ALN120, ALN111, ALNN120, ALNF120, ALNN220...(Other models you can see in the webshop)		



1

GEV No.	365220	Ref. No.	0C4813
description	starting capacitor 80µF 250V 60Hz ø 55mm L 137mm AL		
For models:	FCZ102GTG, FCZ202GTG, FCZ102GTD, FCZ202GTD, FCZ102GBG2, FCZ202GBG2, FCZ102GBD2, FCZ202GBD2, FCZ102GBI2, FCZ102GCG2, FCZ202GCG2, FCZ102GCD2, FCZ202GCD2, AOS202GAPQ, AOS062GAP1, AOS102GAP1, AOS202GAP1, AOS102GAU1, AOS102GTG1, AOS202GTG1, AOS102GTD1, AOS202GTD1, AOS062GTP1, AOS102GTP1, AOS202GTP1, AOS102GTW1, AOS202GTW1, AOS102GBG2, AOS202GBG2, AOS102GBD2, AOS202GBD2, AOS102GBW2, AOS202GBW2, AOS062GCP1, AOS202GCP1, AOS102GCG2, AOS202GCG2, AOS102GCD2, AOS202GCD2, AOS062GCP2, AOS102GCP2		



1

GEV No.	365096	Ref. No.	083449 086174 0KQ662
description	starting capacitor 88µF 330V		
For models:	ECN075, ECN100, MCGR1000, ALF110, ALF220UK, ALNF220, ALF110, ALF120, ALF220, ALF240, ALNF220, ALNF220UK, ILF240, ALF110, ALF120, ALF220, ALF240, ALNF220, ALNF230, BCF11, ADF110, ALF110, ADF120, ALF120, AEF110, AEF120, ADF220, ADF240, AEF220, AEF240, ADN220, ADN230, AENF220, AENF230, ASF110, ASF220, AKF110UK, AKF220UK, ASF110UK, ASF220UK, ADF220E, AZF1103, BCF15A, Crosswise, 83012201, ARDF110L, ARDF120...(Other models you can see in the webshop)		



operating capacitors

plastic



GEV No.	365015	Ref. No.	057576 0F0032 OK4727 OK8508 OKJ296 MP810UF
----------------	--------	-----------------	---

description operating capacitor capacity 10µF 400V tolerance 5%Hz ambient temperature max. -25 to +85°C ø 35.5mm L 59mm M8 plastic connection male faston 6.3mm protection

For models: CS7ME4/200-3, CS7ME4/230-3, CS7ME4/400-3N, CS7ME6/400-3N, CS7ME4/400-3N/EO, CS7ME4/400-3/50HZ/MA, CS7ME4/440-3/60HZ/MA, CS7MT4/400-3N, CS7GE4/200-3, CS7GE4/230-3, CS7GE4/400-3N, CS7GE6/400-3N, CS7GE4/400-3N/EO, CS7GE4/400-3/50HZ/MA, CS7GE4/440-3/60HZ/MA, CS7GT4/400-3N, CS7LCE4/200-3, CS7LCE4/230-3, CS7LCE4/400-3N, CS7LCE6/400-3N, CS7LCE4/400-3N/EO, CS7LCE4/400-3/50HZ/M, CS7LCE4/440-3/60HZ/M, CS7LCT4/400-3N, CS10ME4/200-3, CS10ME4/230-3, CS10ME6/230-3, CS10ME4/400-3N, CS10ME6/400-3N, CS10ME4/400-3N/EO, CS10ME4/400-3/50HZ/M, CS10ME4/440-3/60HZ/M, CS10MT4/400-3N, CS10MT6/400-3N, CS10GE4/200-3, CS10GE4/230-3, CS10GE6/230-3, CS10GE4/400-3N, CS10GE6/400-3N, CS10GE4/400-3N/EO, CS10GE4/400-3/50HZ/M, CS10GE4/440-3/60HZ/M, CS10GT4/400-3N, CS10GT6/400-3N, CS10LCE4/200-3, CS10LCE4/230-3, CS10LCE6/230-3, CS10LCE4/400-3N, CS10LCE6/400-3N, CS10LCE4/400-3N/EO...(Other models you can see in the webshop)



GEV No.	365014	Ref. No.	054922 066235 OK2386 OK3032 OL0335 S694601702
----------------	--------	-----------------	--

description operating capacitor capacity 12.5µF 450V tolerance 5%Hz ambient temperature max. -25 to +85°C ø 35mm L 70mm M8 plastic connection male faston 6.3mm 45S.C3DS.12.5 protection

For models: HCPA/V1219, HCPA/EI1219



GEV No.	365021	Ref. No.	052797 0A2914 BC0164521
----------------	--------	-----------------	-------------------------------

description operating capacitor capacity 16µF 425V tolerance 5% 50/60Hz ambient temperature max. -25 to +85°C ø 35mm L 73mm single M8 plastic connection male faston 6.3mm 416.10.99 protection

For models: MBR/G710D, MBR/E710D, RBR/G710D, 7BRE60XN, XBR/E710D, XBR/G751, XBR/G756, XBR/E716, RBR/E700, FCFG10J, FCFG10J, FCFG6J, FCFG6J, FCFG6J, FCFG6J, FCFG10J, FCFG10J, FCVE20-P, FCVE20PUK, FCGV20-P, FCGV20PUK, HBR/G1013, HBR/E1013, HBR/G1013, HBR/E1013, LS32, LS32/4.5, LS32UK/RP, LS32F, LV32F, C55, LV32/60, WT302, WT302/4.5, WT302UK/RP, WT302F, WT302/60, LS33, LS33/4.5, LS33UK/RP, LS33F, LV33F, C55A, LS33/60, WT303, WT303/4.5, WT303UK/RP, WT303F, WT303/60, LS61...(Other models you can see in the webshop)



GEV No.	365031	Ref. No.	084721
----------------	--------	-----------------	--------

description operating capacitor capacity 4µF 450V tolerance 5% 50/60Hz ambient temperature max. -25 to +85°C ø 31mm L 58mm M8 plastic connection male faston 6.3mm protection

For models: BCF44H, AQC119U US, , , BCF15A6, , , BCW101, BCW102, BCFW101, BCF44H, BCFW102, BC44H, BCF44H, BCFWS102, BCFWS101, BC15A, Crosswise, BC56VA, Crosswise 20, BC56HA, BCF15A, Crosswise, BCF28A, Crosswise, BCF64A, Crosswise 20, BCF56HA, RBC102, AOFF-S102C, ESK40H, ESF40H, EABP51, EABC501, AOFF102U, AOFFS101C, AOC102, AOC102R, AOFF102, AOFF102R, AOFF10160, Crosswise, RBC061, Crosswise, RBC6.1-15, Crosswise 20, RBC20.1-56, Crosswise, RBF061, Crosswise...(Other models you can see in the webshop)



GEV No.	365017	Ref. No.	037268 083406 OK9108 OL2035
----------------	--------	-----------------	--------------------------------------

description operating capacitor capacity 5µF 450V tolerance 5% 50/60Hz ambient temperature max. -25 to +85°C ø 28mm L 54mm M8 plastic connection male faston 6.3mm 16.10.08 protection

For models: BC22, BC44, BC44H, BCF11, BCF22, BCF44, AQC60U, AQC119U US, BC28A6, Crosswise, , , BCW061, BCW101, BCW102, BCFW061, BCFW101, BC22, BC44, BCF11, BCF22, BCF44, BCWS061T, BCFW102, BC22, BC44, BCF11, BCF22, BCF44, BCFWS102, BCFWS101, BC28A, Crosswise, BC56VA, Crosswise 20, BC56HA, BCF28A, Crosswise, BCF64A, Crosswise 20, BCF56HA, BCFWS061, BCFWS061T, BLAST C/FREEZER, LS6EADD, LS6EA/DPDD, WT38TDE, LS6EADP3, LS6EAD-PWS...(Other models you can see in the webshop)



GEV No.	365012	Ref. No.	049260 OKB768 909
----------------	--------	-----------------	-------------------------

description operating capacitor capacity 6.3µF 450V tolerance 5% 50Hz ambient temperature max. -25 to +85°C ø 30mm L 61mm M8 plastic connection male faston 6.3mm protection

For models: LS32UK/RP, WT302UK/RP, LS33UK/RP, WT303UK/RP, LB1, LB1WS, LB1WSDP, WT1WSDP, WT2TOP60, WT2DPDI, WT2WSDPDI, LB1TOP, WT2TOPDI, LB2WS, LB2, LB2WSDP, WT2WSDP, WT2WSDPD, WT2WS, WT1, WT1WS, WT1TOP, WT2TOP, WT1/3DP, WT2/3DP, WT2DPAUS, WT2, LB2DPDI, LB2WSDPDI, LB2WSDPD, LB2TOP, LB2DP3, WT2DPD3, NGW, NGWDPDD, LS6EADD, LS6EA/DPDD, LS6EADP3, LS6SANA, LS6EA/UK, LS6EA/DPUK, LS6EA/60, EUCAIUSPH6, LS65, LS62/UK, LS63/UK, WT37J60, WT37J50, LS64/UK, LS6AH240U...(Other models you can see in the webshop)

1 electric components



GEV No.	365027	Ref. No.	0C4812
description	operating capacitor capacity 60µF 400V tolerance 5%Hz ambient temperature max. -25 to +85°C ø 49mm L 115mm M8 plastic connection male faston 6.3mm protection		
For models:	FCZ101GTG, FCZ102GTG, FCZ201GTG, FCZ202GTG, FCZ101GTD, FCZ102GTD, FCZ201GTD, FCZ202GTD, FCZ101GBG2, FCZ102GBG2, FCZ201GBG2, FCZ202GBG2, FCZ101GBD2, FCZ102GBD2, FCZ201GBD2, FCZ202GBD2, FCZ101GBI2, FCZ102GBI2, FCZ201GBI2, FCZ101GCG2, FCZ102GCG2, FCZ201GCG2, FCZ202GCG2, FCZ101GCD2, FCZ102GCD2, FCZ201GCD2, FCZ202GCD2, AOS061GAPQ, AOS101GAPQ, AOS102GAPQ, AOS201GAPQ, AOS202GAPQ, AOS101GAQ1, AOS061GAP1, AOS062GAP1, AOS101GAP1, AOS102GAP1, AOS201GAP1, AOS202GAP1, AOS101GTG1, AOS102GTG1, AOS201GTG1, AOS202GTG1, AOS101GTD1, AOS102GTD1, AOS201GTD1, AOS202GTD1, AOS062GTP1, AOS101GTP1, AOS102GTP1...(Other models you can see in the webshop)		



GEV No.	365140	Ref. No.	037269 047541 047883 694604400 S694604400
description	operating capacitor capacity 12.5µF 450V tolerance 5% 60Hz ambient temperature max. -25 up to +70°C ø 40mm L 83mm M8 aluminium connection male faston 6.3mm C.87.8BF2 MKP protection		
For models:	FCZ061EAA, FCZ101EAA, FCZ201EAA, FCZ202EAA, FCZ061EAH, FCZ101EAH, FCZ201EAH, FCZ202EAH, FCZ101EAN, FCZ201EAN, FCZ061ETA, FCZ101ETA, FCZ201ETA, FCZ061ETH, FCZ101ETH, FCZ201ETH, FCZ061ETN, FCZ101ETN, FCZ201ETN, FCZ061GAG, FCZ101GAG, FCZ201GAG, FCZ061GAD, FCZ101GAD, FCZ201GAD, FCZ101GTG, FCZ201GTG, FCZ101GTD, FCZ201GTD, FCZ061EBA, FCZ101EBA, FCZ201EBA, FCZ202EBA, FCZ061EBH, FCZ101EBH, FCZ201EBH, FCZ061EBN, FCZ101EBN, FCZ201EBN, FCZ061EBC, FCZ101EBC, FCZ201EBC, FCZ061EBA2, FCZ101EBA2, FCZ201EBA2, FCZ061EBH2, FCZ101EBH2, FCZ201EBH2, FCZ061EBN2, FCZ101EBN2...(Other models you can see in the webshop)		



GEV No.	365013	Ref. No.	049126 BC0084520
description	operating capacitor capacity 8µF 400V tolerance 5%Hz ambient temperature max. -25 to +85°C ø 31.5mm L 55mm M8 plastic connection male faston 6.3mm protection		
For models:	LS32, LS32/4.5, LS32F, LV32F, C55, LV32/60, WT302, WT302/4.5, WT302F, WT302/60, LS33, LS33/4.5, LS33F, LV33F, C55A, LS33/60, WT303, WT303/4.5, WT303F, WT303/60, NUC3DD, EUC1, EUC1DP, EUC3, EUC3DP, EUC1G, EUC1DP60, EUC3DD, KUC3, KUC3DP, NUC1, NUC1DP, NUC3, NUC3DP, NUC1DP60, NUC1DPA, LB1, LB1WS, LB1WSDP, LB1/RBP, LB1/TOP, WT1WSDP, WT2TOP60, WT2DPDI, WT2WSDPDI, LB1TOP, WT2TOPDI, LB2WS, LB2, LB2WSDP...(Other models you can see in the webshop)		



GEV No.	365142	Ref. No.	084323 0C1187 0H6812 2253262
description	operating capacitor capacity 15µF 450V with metal case tolerance 5% 50/60Hz ø 40mm L 110mm M8x1.25		
For models:	ECN050, ECN075, ECB120, ADF110, ALF110, ADF120, ALF120, AEF110, AEF120, ADNF120, AENF120, ADNF220, ADNF230, AENF220, AENF230, ASF110, AKF110UK, ASF110UK, APP224/60, AZF2203, 83012201, ARDF110L, ARDF120, ASF110, ADF110, ADF120, ADF11060, ADF2206, BCF7A, STRP1101, STRP1102, STRP1601, STRP1602, STRP1603, STRP2201, STRP2202, STRP2203, STRP1101S, STRP1601S, STRP2201S, STRP1602R, AZF13430, STRP1603R, STRP2201R, STRP2202R, STRP2203R, STRP1101R, STRP1102R, STRP1601R, APF223...(Other models you can see in the webshop)		

metal





GEV No.	365139	Ref. No.	056148 0U0403 18000902 416332729 60050283 754000
description	operating capacitor capacity 10µF 450V tolerance 5% 60Hz ambient temperature max. -25 up to +70°C ø 40mm L 83mm M8 aluminium connection male faston 6.3mm C.87.8BF2 MKP protection		
For models:	FCZ061EBC, FCZ101EBC, FCV/G10L3, FCV/G6L3TOWNGAS, FCV/G6L3, FCV/G6L3JAP, FCV/E101/1, FCVE6L3J, FCV/E10L3JAP, FCV/E10L6JAP, FCV/G6L3JAP, FCV/E61/1, FCV/G10L2, FCV/E61/1, FCV/E101/1, FCV/E101/1, FCV/E10L2, FCV/E102/1, FCV/E61/1, FCV/E61/1, FCV/E101/1, FCV/E101/2, FCV/G6L3C, FCV/G61/1, FCV/G61/1, FCV/G61/1, FCV/G61/1, FCV/G6L3CT, FCV/E10L3, FCV/E102/1, FCV/E6L3, FCV/G6L4, FCV/E6L4, FCV/E101/1, FCV/G10L6, FCV/E10L6, FCV/E101/1, FCV/G101/1, FVC/E101/1, FCF/G6-0, FCFG101/0, FCFG102-0, FCFG201-0, FCF/E6-0, FCFE101-0, FCFE102-0, FCFE201-0, FCFE202-0, FCF061ELN, FCF101ELN...(Other models you can see in the webshop)		



GEV No.	365160	Ref. No.	047744 0H1044 416334429 BC0204521
description	operating capacitor capacity 20µF 420V tolerance 5% 60Hz ambient temperature max. -25 up to +70°C ø 45mm L 82mm M8 aluminium connection male faston 6.3mm C.87.8BF2 protection		
For models:	CUTE0523, CUTE0538, FCV/G102L3, FCV/E102/1L3JAP, FCV/E102/1L6JAP, FCV/E102/1L3, FCV/G102/1L6, FCV/E102/1L6, FCV/G102/1, FVC/E102/1, FVC/E202/1, FCFG101/0, FCFG102-0, FCFG202-0, FCFE101-0, FCFE102-0, FCFE201-0, FCFE202-0, FCF101ELN, FCF101ENS, FCF102ENS, FCF201ENS, FCFG102-0T, FCFE101-1J, FCFE102-1J, FCS102E44J, FCS102EP4J, FCS102E4, FCS102EP, FCS102G4, FCS202E4, FCS102GP, FCS202EP, FCS202G4, FCS202GP, FCS102EX4J, FCS102EX, FCS202EX, FCS102GX, FCS202GX, ECFG101-0, ECFG102-0, ECFG202-0, ECFE101-0, ECFE102-0, ECFE201-0, ECFE202-0, ECF101ENS, ECF102ENS, ECF201ENS...(Other models you can see in the webshop)		



			
1			
GEV No.	365141	Ref. No.	0C1186 416335164
description	operating capacitor capacity 31.5µF 450V with metal case tolerance 5% ø 45mm L 132mm M8x1.25		
For models:	FCZ102EAA, FCZ202EAA, FCZ102ETA, FCZ202ETA, FCZ202GAG, FCZ202GAD, FCZ102GTG, FCZ202GTG, FCZ102GTD, FCZ202GTD, FCZ102EBA, FCZ202EBA, FCZ102EBA2, FCZ202EBA2, FCZ202GBG, FCZ202GBD, FCZ102GBG2, FCZ202GBG2, FCZ102GBD2, FCZ202GBD2, FCZ102GBI2, FCZ102ECA, FCZ202ECA, FCZ102ECA2, FCZ202ECA2, FCZ202GCG, FCZ202GCD, FCZ102GCG2, FCZ202GCG2, FCZ-102GCD2, FCZ202GCD2, AOS102GAEU, AOS202GAEU, AOS102EA2N, AOS102EB2N, AOS202EA2N, AOS202EB2N, AOS102EA, AOS102EB, AOS202EA, AOS202EB, AOS102GB, AOS102GA, AOS202GB, AOS-202GA, AOS102EAAQ, AOS102EBAQ, AOS202EAAQ, AOS202EBAQ, AOS102EANQ...(Other models you can see in the webshop)		

			
1			
GEV No.	365003	Ref. No.	0K2387
description	operating capacitor capacity 6µF 400V tolerance 5% 50/60Hz ambient temperature max. -25 to +85°C ø 30mm L 85mm M8 aluminium connection cable 300mm MKP protection IP65		

ferrite rings

			
1			
GEV No.	699391	Ref. No.	0L3881
description	ferrite ring ID ø 12.5mm ED ø 30.5mm H 40mm for protection		

			
1			
GEV No.	365054	Ref. No.	005517
description	ferrite ring ID ø 22mm ED ø 38mm H 17mm for protection		
For models:	MCP/E1SH, MCP/E1SUH, MCP/E2SUHS, MCP/E2SH, MCP/E2SUH, MCP/E2SUT, MCP/E2SHB, PCP/E1SH, PCP/E2SH, PCP/E2SH3B, OCP/E1SH, OCP/E2SH, TCP/E2SH, KCP/G1, KCP/G1R, KCP/G2, KCP/G2R, KCP/E1, KCP/E1R, KCP/E2, KCP/E2R, QCP/G1, QCP/G1R, QCP/G2, QCP/G2R, QCP/E1, QCP/E1R, QCP/E2, QCP/E2R, WCP/G1, WCP/G1R, WCP/G2, WCP/G2R, WCP/E1, WCP/E1R, WCP/E2, WCP/E2R, APN/ED816, DCP/G400		

filters

interference suppression filters

			
1			
GEV No.	365143	Ref. No.	003510 728024
description	interference suppression filter 275V capacity 47nF 100Ohm		
For models:	RBR/E2FM, RBR/E2IM, RBK/E2FM, RF/E1D05, RF/E1S08, RF/E2D08, RFR/E1S08, RFR/E2D08, RFR/E1S12, RFR/E2D12, RFR/E2S40, RF/E1S12, RF/E2D12, RF/E1S12, RF/E1S12E5, RFR/E1S12, XBR/E2FM, XBR/E2IM, XBK/E2FM, XF/E1D05, XF/E1S08, XF/E2D08, XFR/E1S08, XFR/E2D08, XFR/E1S12, XFR/E2D12, XFR/E2S40, XF/E1S12, XF/E2D12, XF/E1S12, XF/E2D12, XFR/E1S12, XFR/E2D12, JBR/E2FM, JF/E1D05, JF/E1S08, JF/E2D08, JFR/E1S08, JFR/E2D08, JFR/E1S12, JFR/E2D12, JFR/E2S40, JF/E1S12, JF/E2D12, JF/E1S12, JF/E2D12, MBR/E2FM, MBR/E2IM, MBK/E2FM, MF/E1D05...(Other models you can see in the webshop)		

			
1			
GEV No.	365046	Ref. No.	046217 084035 0G2043 4011135001 60050076
description	interference suppression filter type 10S7E-G1474253105-Q 115/250V 50/60Hz conductor 2 with E connection male faston 6.3mm L 40mm ø 40mm Hmm Wmm M8 plastic Qty 1 pcs		
For models:	ILP111, ILP220, ILP220UK, ILP240, ILP221, ILN111, ILN220, ILN220UK, ILN240, ILN221, ILF220, ILF220UK, ILF240, TRN1301, TRNA1301, TRNM1301, TRN1302, TRNA1302, TRNM1302, TRN1303, TRNA1303, TRNM1303, TRN1801, TRNA1801, ARNM1801, TRN1802, TRNA1802, TRNM1802, TRN1803, TRNA1803, TRNM1803, TRN2201, TRNA2201, TRNM2201, TRN2202, TRNA2202, TRNM2202, TRN2203, TRNA2203, TRNM2203, TR1202, TR1221, TR1603, TR1622, TR1641, TR2004, TR2023, TR2042, MCF/G1095, MC/G352...(Other models you can see in the webshop)		

			
1			
GEV No.	365050	Ref. No.	049303 0KE945
description	interference suppression filter type 411.13.5901D 250V 50Hz conductor 4 plug connection male faston 6.3mm L 50mm ø 38mm Hmm Wmm plug plastic Qty 1 pcs		
For models:	RF/E1D05, RF/E1S08, RF/E2D08, RFR/E1S08, RFR/E2D08, RFR/E1S12, RFR/E2D12, RFR/E2S40, RF/E1S12, RF/E2D12, RFR/E1S14, RFR/E2D14, RF/E1S12, RCP/E2S, RI/E1, RI/E2, RIF/E2, RIV/E2, RF/E1S07, RF/E2D07, RFR/E1S07, RFR/E2D07, RF/E1S12E5, RFR/E1S12, XF/E1D05, XF/E1S08, XF/E2D08, XFR/E1S08, XFR/E2D08, XFR/E1S12, XFR/E2D12, XFR/E2S40, XF/E1S12, XF/E2D12, XFR/E1S14, XFR/E2D14, XF/E1S12, XF/E2D12, XI/E1, XI/E2, XIF/E2, XIV/E2, XF/E1S07, XF/E2D07, XFR/E1S07, XFR/E2D07, XFR/E1S12, XFR/E2D12, JF/E1D05, JF/E1S08...(Other models you can see in the webshop)		



			
1			
GEV No.	365045	Ref. No.	OK4865 18002893 365045 50000059
description	interference suppression filter type FC701Y2F 250V 50-60Hz conductor 2 with E connection cable 200mm L 40mm ø 30mm Hmm Wmm plastic Qty 1 pcs		

line filters
with housing

			
1			
GEV No.	365154	Ref. No.	049901
description	line filter type 411141410 250V 50/60Hz conductor 2 with E connection male faston 6.3mm L 64mm ø 38mm Hmm Wmm support plastic Qty 1 pcs		
For models:	WT4, WT4B, WT4D, WT4DB, WT46, WT4DG, WT4BWS, WT4BDWS, NUC3DD, WT4D60, WT4DDG, EUC1, EUC3, EUC3WS, EUC3DP, EUC3DPWS, EUC3DD, ZUCADDROW, ZUCADDROW6, LS5/1, LS5/1DP, LS5/3, LS5/3DP, LS5/3WS, LS5/3WSDP, FUCA3DD, LS5/3WSDPD, LB5DPG, LS5/1DP60, LS5/1DPAUS, LS5/1DPCS, KUC3, KUC3DP, NUC3, NUC3WS, NUC3DP, NUC3DPWS, NUC3DDWS, ZUCA3, EUCADDROW, EUCADDROW6, LS6EP, LS6EP/DD, LS6EADD, LS6EA/DPDD, WT38TDE, LS6EADP3, LS6EADPWS, LS6EADPWSG, WT38WS...(Other models you can see in the webshop)		

			
1			
GEV No.	365077	Ref. No.	059078 0K2392 411105236
description	line filter type 411524410 250V 50/60Hz conductor 2 with E connection male faston 6.3mm L 50mm ø 38mm Hmm Wmm M8 plastic Qty 1 pcs		
For models:	FDV40G, FDV40E, FDV40GZ, FDV40EL, FDV40GA, FDV20G, FDV20E, FDV20GZ, FDV20EL, FDV20GA, KFR/E1E, KFR/E2F, KFR/E1C, KFR/E2D, KFR/E1CE5, KFR/E2DE5, KFH/G1, KFH/E1, KFH/G1ELH, KFH/E1ELH, KFH/G1EH, KFH/E1EH, HFH/G430, HFH/E430, HFR/E430, HFR/E830, HFH/G435, HFH/G435, HFRS/E430, HFR/E431, HFR/E831, QFR/E1E, QFR/E2F, QFR/E1C, QFR/E2D, QFH/G1, QFH/E1, QFH/G1ELH, QFH/E1ELH, QFH/G1EH, QFH/E1H, ZFH/G430, ZFH/E430, ZFR/E430, ZFR/E830, ZFH/G435, ZFH/G435, ZFRS/E430, ZFR/E431, ZFR/E831...(Other models you can see in the webshop)		

RC circuits			
			
1			
GEV No.	365211	Ref. No.	085601
description	interference suppression filter type XRY RC MKPX2 275V connection plug		
For models:	FGS140A, C150W, C300A, C300W, CB1565W, CB246W, CB416W, CB955W, DSS42W, C80W, CB1565A, C80A, CB246A, CB416A, C150A, CB955A, FRESHMAKER, ICEWATER45, ICEWATER45, DSS42A, G500A, GB1555W, GB1555A, G500W, VB250A, VB250W, VM900A, VM900W		

fuses
fine fuses

			
1			
GEV No.	358666	Ref. No.	0W3499
description	fine fuse size ø5x20mm 0.315A fast-acting rated 250V Qty 10 pcs		
For models:	C240, C260, D1000V, T1000, T1000, T1000, C24001, C240R01, C26001, C260R01, C290R01, C260R02, C240R02		

			
1			
GEV No.	358669	Ref. No.	0W5452
description	fine fuse size ø5x20mm 0.63A fast-acting rated 250V Qty 10 pcs		
For models:	T4250, T4250, T4350, T419002, T419003, PD9, T353019, T3650, T3650, T3650, T3530, T3530, T419001, T419005, T425001, T425002, T425003, T425004, T425005, T425006, T425007, T425008, T425009, T425010, T425011, T425012, T329001, T329002, T329003, T329004, T329005, T329006, T329007, T329008, T329009, T329010, T329011, T329012, T4300S01, T4300S02, T435001, T435002, T435003, T435004, T435005, T435006, T435007, T435008, T435009, T435010...(Other models you can see in the webshop)		

			
1			
GEV No.	358610	Ref. No.	002347 058869 0W3317
description	fine fuse size ø5x20mm 10A fast-acting rated 250V Qty 10 pcs		
For models:	FCZ102EAA, FCZ102ETA, FCZ102GAG, FCZ102GAD, FCZ101GTG, FCZ102GTG, FCZ101GTD, FCZ102GTD, FCZ102EBA, FCZ102EBA2, FCZ102GBG, FCZ102GBD, FCZ061GBI, FCZ101GBI, FCZ101GBG2, FCZ102GBG2, FCZ101GBD2, FCZ102GBD2, FCZ101GBI2, FCZ102GBI2, FCZ102ECA, FCZ102ECA2, FCZ102GCG, FCZ102GCD, FCZ101GCG2, FCZ102GCG2, FCZ101GCD2, FCZ102GCD2, FCFE201-0, FCFE202-0, FCFE201ENS, FCVM62E, FCVM62EUK, FCVMG62, 5714-2-7, 5714-2-8, 5714-2-10, 5717-2-6, 5714-2-7, 5714-2-8, 5714-2-10, 5714-2-7L, 5714-2-8L, 5714-2-10L, 5714-2-6L, 5714-2-7L, 5714-2-8L, 5714-2-10L, 5714-3-6, 5714-3-7...(Other models you can see in the webshop)		





			
1			
GEV No.	358611	Ref. No.	005136 652802200
description	fine fuse size ø5x20mm 16A fast-acting rated 250V Qty 10 pcs		
For models:	FCZ202ETA, FCZ202GAG, FCZ202GAD, FCZ201GTG, FCZ202GTG, FCZ201GTD, FCZ202GTD, FCZ202EBA2, FCZ202GBG, FCZ202GBD, FCZ201GBI, FCZ201GBG2, FCZ202GBG2, FCZ201GBD2, FCZ202GBD2, FCZ201GBI2, FCZ202ECA2, FCZ202GCG, FCZ202GCD, FCZ201GCG2, FCZ202GCG2, FCZ201GCD2, FCZ202GCD2, FCVG202L3, FCVE202L3, FCVG202L6, FCVE202L6, FVC/G202/1, FVC/E202/1, FCFE201-0, FCFE202-0, FCF201ENS, FCS202E4, FCS202EP, FCS201GP, FCS202G4, FCS202GP, FCS202EX, FCS201GX, FCS202GX, 5714-2-7, 5714-2-8, 5714-2-10, 5714-2-7L, 5714-2-8L, 5714-2-10L, 5717-3-7, 5717-3-8, 5717-3-8E, 5717-3-10...(Other models you can see in the webshop)		

			
1			
GEV No.	358671	Ref. No.	0W5451
description	fine fuse size ø5x20mm 1A fast-acting rated 250V Qty 10 pcs		
For models:	T4250, T4250, T4350, T419002, T419003, PD9, T353019, T3650, T3650, T3650, T3530, T3530, T419001, T419005, T425001, T425002, T425003, T425004, T425005, T425006, T425007, T425008, T425009, T425010, T425011, T425012, T329001, T329002, T329003, T329004, T329005, T329006, T329007, T329008, T329009, T329010, T329011, T329012, T4300S01, T4300S02, T435001, T435002, T435003, T435004, T435005, T435006, T435007, T435008, T435009, T435010...(Other models you can see in the webshop)		

			
1			
GEV No.	358532	Ref. No.	0A8438
description	fine fuse size ø5x20mm 2A fast-acting rated 250V Qty 10 pcs		

			
1			
GEV No.	358677	Ref. No.	053741 057783 083602 088227 090017 0H0516 0KD887 0KP602 0KP604 0KT789 60050226 728014
description	fine fuse size ø5x20mm 4A fast-acting rated 250V Qty 10 pcs		
For models:	BCF11, AQC119U US, , , BCW061, BCFW061, BCF11, BCWS061T, BC56VA, Crosswise 20, BC56HA, BCF64A, Crosswise 20, BCF56HA, BCFWS061, BCFWS061T, BLAST C/FREEZER, MBR/E710D, MBR/E700, MBR/E700UK, MBR/E716, MBR/E706, MFR/E350, MFR/E700, MFR/E370, MFR/E350UK, MFR/E700UK, MFR/E370UK, MFR/E370D, MFR/E350D, MFR/E700D, MFR/E355, MFR/E355UK, MFR/E355D, MFR/E705, MFR/E705UK, MFR/E705D, MFR/E740, RBR/E2FM, RBR/E2IM, RBK/E2FM, RCP/E2S, XBR/E2FM, XBR/E2IM, XBK/E2FM, JBR/E2FM, MBR/E2FM, MBR/E2IM, MBK/E2FM, MCP/E2S...(Other models you can see in the webshop)		

			
1			
GEV No.	358533	Ref. No.	002348 005077 053534 058871 068914 072068 083499 0C1480 0C2237 0F0187 0H7033 0K8698 11019129 60050255 CF00023
description	fine fuse size ø5x20mm 6.3A fast-acting rated 250V Qty 10 pcs		
For models:	BC44, BC44H, BCW101, BCW102, BCFW101, BC44, BC44H, BCFW102, BC44, BC44H, BCFWS102, BCFWS101, STRP1101, STRP1102, STRP1601, STRP1602, STRP1603, STRP2201, STRP2202, STRP2203, STRP1101S, STRP1601S, STRP2201S, STRP1602R, STRP1603R, STRP2201R, STRP2202R, STRP2203R, STRP1101R, STRP1102R, STRP1601R, FDV40G, FDV40E, FDV40GZ, FDV40EL, FDV40GA, FDV20G, FDV20E, FDV20GZ, FDV20EL, FDV20GA, MCP/E1SH, MCP/E1SUH, MCP/E2SUHS, MCP/E2SH, MCP/E2SUH, MCP/E2SUT, MCP/E2SHB, ECP/E1ELHU, PCP/E1SH...(Other models you can see in the webshop)		

			
1			
GEV No.	358695	Ref. No.	005032 0H9825 0K3350 0K4542 0K4994 11019096 18013703 4005032
description	fine fuse size ø5x20mm 3.15A medium lag rated 250V Qty 10 pcs		
For models:	FCV/G20L3, FCVG202L3, FVC/E20L3, FCVE202L3, FVC/G20L6, FVC/E20L6, FCVG202L6, FCVE202L6, FVC/G201/1, FVC/E201/1, FVC/E202/1, 5714-2-7, 5714-2-8, 5714-2-10, 5714-2-7, 5714-2-8, 5714-2-10L, 5714-2-7L, 5714-2-8L, 5714-2-10L, 5714-3-7, 5714-3-8, 5714-3-8E, 5714-3-10, 5717-3-7, 5717-3-8, 5717-3-8E, 5717-3-10, 5717-3-8M, 5717-3-8M, ECV/G20T4, ECV/E20T4, ECVG202T4, ECV/E202T4, ECV/G20T4J, ECV/G20T6, ECV/E20T6, ECVG202T6, ECV/E202T6, CE128-106, CE158-133.3.HV, CE158-244.3, CE158-246.3, CEB068, CK248-209.D1ABBB, CK248-211.D1ABBB, HCE128-100...(Other models you can see in the webshop)		



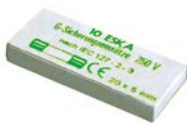

			
1			
GEV No.	358594	Ref. No.	002820 0F0189 0H7031 11019111
description	fine fuse size ø5x20mm 0.16A slow-acting rated 250V Qty 10 pcs		
For models:	FCV/G10L3, FCV/G6L3TOWNGAS, FCV/G6L3, FCV/G10L3T, FCV/G10L3J, FCV/E101/1, FCV/G20L3, FCV/G20L3, FCVE6L3J, FCV/E10L3JAP, FCV/E102/1L3JAP, FCV/E10L6JAP, FCV/E102/1L6JAP, FCV/G6L-3JAP, FCV/G10L3J, FCV/G10L3J, FCV/G10L6JAP, FCV/G102/1L6JAP, FCV/G6L3CJ, FCV/E61/1, FCV/G10L2, FCV/E61/1, FCV/E101/1, FCV/E101/1, FCV/E10L2, FCV/E102/1, FCV/E61/1, FCV/E61/1, FCV/E101/1, FCV/E101/2, FCV/G6L3C, FCV/G61/1, FCV/G61/1, FCV/G61/1, FCV/G61/1, FCV/G6L3CT, FCV/G6L3CJ, FCV/E10L3, FCV/E102/1, FCV/E6L3, FCV/E102/1L3, FCV/E20L3, FCVE20L3, FCV/G6L4, FCV/E6L4, FCV/E101/1, FCV/G10L6, FCV/E10L6, FCV/G102/1L6, FCV/E102/1L6...(Other models you can see in the webshop)		

			
2			
GEV No.	358592	Ref. No.	086338 3049003
description	fine fuse size ø5x20mm 0.1A slow-acting rated 250V Qty 10 pcs		
For models:	CIM120AS, CIM120WS		

			
1			
GEV No.	358596	Ref. No.	002920
description	fine fuse size ø5x20mm 0.25A slow-acting rated 250V Qty 10 pcs		
For models:	FCV/G10L3, FCV/G6L3TOWNGAS, FCV/G6L3, FCV/G10L3T, FCVE6L3J, FCV/E10L3JAP, FCV/E10L6JAP, FCV/G6L3JAP, FCV/G10L3J, FCV/G10L6JAP, FCV/G6L3CJ, FCV/E61/1, FCV/G10L2, FCV/E61/1, FCV/E10L2, FCV/E61/1, FCV/E61/1, FCV/G6L3C, FCV/G61/1, FCV/G61/1, FCV/G61/1, FCV/G61/1, FCV/G61/1, FCV/G6L3CT, FCV/G6L3CJ, FCV/E10L3, FCV/E6L3, FCV/G6L4, FCV/E6L4, FCV/G10L6, FCV/E10L6, FCV/E101/1, FCV/G101/1, FCV/E101/1, FCS061G48J, FCS061GP, FCS061G3DI, FCS061E-3CI, FCS061G4, FCS101E2, FCS061G4DT, FCS101E44J, FCS061G49J, FCS101G2, FCS101E4, FCS101G4, FCS101G4DT, FCS101G49J, AOW101EA, 5711-2-8CH, 5711-2-10CH...(Other models you can see in the webshop)		

			
1			
GEV No.	358703	Ref. No.	002750 0F0188 0K8741 60050264
description	fine fuse size ø5x20mm 0.4A slow-acting rated 250V Qty 10 pcs		
For models:	FCV/G10L3, FCV/E101/1, FCV/E102/1L3JAP, FCV/E102/1L6JAP, FCV/G10L3J, FCV/G102/1L6JAP, FCV/E101/1, FCV/E101/1, FCV/E102/1, FCV/E101/1, FCV/E101/2, FCV/E102/1, FCV/E102/1L3, FCV/E101/1, FCV/G102/1L6, FCV/E102/1L6, FCV/G102/1, FCV/E102/1, FCS102E44J, FCS102E4, FCS102G4, FCS201E4, FCS102G49J, FCS202E4, FCS202G4, CS7ME4/200-3, CS7ME4/230-3, CS7ME4/400-3N, CS7ME6/400-3N, CS7ME4/400-3N/EO, CS7ME4/400-3/50HZ/MA, CS7ME4/440-3/60HZ/MA, CS7MT4/400-3N, CS7GE4/200-3, CS7GE4/230-3, CS7GE4/400-3N, CS7GE6/400-3N, CS7GE4/400-3N/EO, CS7GE4/400-3/50HZ/MA, CS7GE4/440-3/60HZ/MA, CS7GT4/400-3N, CS7LCE4/200-3, CS7LCE4/230-3, CS7LCE4/400-3N, CS7LCE6/400-3N, CS7LCE4/400-3N/EO, CS7LCE4/400-3/50HZ/M, CS7LCE4/440-3/60HZ/M, CS7LCT4/400-3N, CS10ME4/200-3...(Other models you can see in the webshop)		

			
1			
GEV No.	358599	Ref. No.	0C2301
description	fine fuse size ø5x20mm 0.8A slow-acting rated 250V Qty 10 pcs		
For models:	FCZ061EAA, FCZ101EAA, FCZ102EAA, FCZ201EAA, FCZ202EAA, FCZ061EAH, FCZ101EAH, FCZ201EAH, FCZ061EAN, FCZ101EAN, FCZ201EAN, FCZ061ETA, FCZ101ETA, FCZ201ETA, FCZ201ETA, FCZ202ETA, FCZ061ETH, FCZ101ETH, FCZ201ETH, FCZ061ETN, FCZ101ETN, FCZ201ETN, FCZ061GAG, FCZ101GAG, FCZ102GAG, FCZ201GAG, FCZ202GAG, FCZ061GAD, FCZ101GAD, FCZ102GAD, FCZ201GAD, FCZ202GAD, FCZ101GTG, FCZ102GTG, FCZ201GTG, FCZ202GTG, FCZ101GTD, FCZ102GTD, FCZ201GTD, FCZ202GTD, FCZ061EBA, FCZ101EBA, FCZ102EBA, FCZ201EBA, FCZ202EBA, FCZ061EBH, FCZ101EBH, FCZ201EBH, FCZ061EBN, FCZ101EBN...(Other models you can see in the webshop)		

			
1			
GEV No.	358608	Ref. No.	0C5431 0L1295
description	fine fuse size ø5x20mm 10A slow-acting rated 250V Qty 10 pcs		
For models:	FCZ102EAA, FCZ102ETA, FCZ102EBA, FCZ102EBA2, FCZ102ECA, FCZ102ECA2, AOS102EAA1, AOS102EAC1, AOS102EA51, AOS062EAM1, AOS102EAM1, AOS062EAB1, AOS102EAB1, AOS102EAK1, AOS102EAT1, AOS102ETA1, AOS062ETM1, AOS102ETM1, AOS102ETK1, AOS102EBA1, AOS102EBC1, AOS102EBK1, AOS102EBA2, AOS102EBK2, AOS102ECA1, AOS062ECM1, AOS102ECM1, AOS062ECB1, AOS102ECB1, AOS102ECA2, AOS062ECM2, AOS102ECM2, WTC90ERB, WTC90ELB, WTC140ERA, WTC140ELA, WTC140ERB, WTC140ELB, WTC180ERA, WTC180ELA, WTC180ERB, WTC180ELB, WTC220ERA, WTC220ELA, WTC220ERB, WTC220ELB, WTC90ERBG, WTC90ELBG, WTC140ERAG, WTC140ELAG...(Other models you can see in the webshop)		



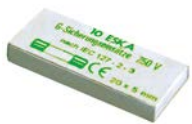

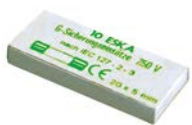
			
1			
GEV No.	358603	Ref. No.	090098 0A8438
description	fine fuse size ϕ 5x20mm 2A slow-acting rated 250V Qty 10 pcs		
For models:	BC100A, BC100DA, BC100RA, BC100RDA, BC180A, BC180DA, BC180RA, BC180RDA, BC180RPA, BCF100A, BCF100DA, BCF100RA, BCF100RDA, BCF180A, BCF180DA, BCF180RA, BCF180RDA, BCF180RPA, BCW201R, BCFW201R, BC120A, BC120RA, BCF120A, BCF120RA, BLAST C/FREEZER, BLAST C/FREEZER, BLAST C/FREEZER, BLAST C/FREEZER, BC0144, BC072, ESBC72R, ESBC144R, ESBF70, ESBF70R, ESBF144, ESBF144R, AOCP2028R, AOCP2028RD, AOCP2028RT, AOFP2028R, AOFP2028RD, AOFP2028RT, EABPR101, EABC101R, AOFP201CR, AOFP201RU, AOFP202RU...(Other models you can see in the webshop)		

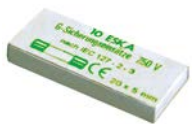
			
1			
GEV No.	358605	Ref. No.	0C4996
description	fine fuse size ϕ 5x20mm 3.15A slow-acting rated 250V Qty 10 pcs		
For models:	BCP/E1, PCP/E1ELH, TCP/E1ELH, FCZ201GTG, FCZ201GTD, FCZ201GBG2, FCZ201GBD2, FCZ201GBI2, FCZ201GCG2, FCZ201GCD2, AOS201GTG1, AOS201GTD1, AOS201GTP1, AOS201GTW1, AOS201GBG2, AOS201GBD2, AOS201GBW2, AOS201GCG2, AOS201GCD2, LWC44AR208, LWC44AL208, LWC44AR240, LWC44AL240, LWC66AR208, LWC66AL208, LWC66AR240, LWC66AL240		

			
1			
GEV No.	358607	Ref. No.	007054
description	fine fuse size ϕ 5x20mm 6.3A slow-acting rated 250V Qty 10 pcs		
For models:	AOS061EA, AOS061EB, AOS101EA, AOS101EB, AOS061EA3J, AOS061EB3J, AOS101EA3J, AOS101EB3J, AOS061EA2N, AOS061EB2N, AOS101EA2N, AOS101EB2N, AOS061EB5M, AOS101EB5M, AOS201EB5M, AOS061EB6M, AOS101EB6M, AOS201EB6M, AOS102EA2N, AOS102EB2N, AOS202EA2N, AOS202EB2N, AOS061EA0H, AOS061EB0H, AOS101EA0H, AOS101EB0H, AOS102EA, AOS102EB, AOS202EA, AOS202EB, AOS061GA, AOS101GA, AOS201GA, AOS201GB, AOS102GB, AOS102GA, AOS202GB, AOS202GA		

			
1			
GEV No.	358751	Ref. No.	0C2230
description	fine fuse size ϕ 6.3x32mm 6.3A fast-acting rated 500V Qty 10 pcs		
For models:	FCZ061EAA, FCZ101EAA, FCZ061EAH, FCZ101EAH, FCZ061EAN, FCZ101EAN, FCZ061ETA, FCZ101ETA, FCZ201ETA, FCZ061ETH, FCZ101ETH, FCZ201ETH, FCZ061ETN, FCZ101ETN, FCZ201ETN, FCZ061EBA, FCZ101EBA, FCZ061EBH, FCZ101EBH, FCZ061EBN, FCZ101EBN, FCZ061EBC, FCZ101EBC, FCZ061EBA2, FCZ101EBA2, FCZ201EBA2, FCZ061EBH2, FCZ101EBH2, FCZ201EBH2, FCZ061EBN2, FCZ101EBN2, FCZ201EBN2, FCZ061EBC2, FCZ101EBC2, FCZ201EBC2, FCZ061ECA, FCZ101ECA, FCZ061ECH, FCZ101ECH, FCZ061ECN, FCZ101ECN, FCZ061ECA2, FCZ101ECA2, FCZ201ECA2, FCZ061ECH2, FCZ101ECH2, FCZ201ECH2, FCZ061ECN2, FCZ101ECN2, FCZ201ECN2...(Other models you can see in the webshop)		

			
1			
GEV No.	358020	Ref. No.	048995
description	fine fuse size ϕ 10x38mm 1A rated 500V type Gg fast-acting Qty 1 pcs		
For models:	WT33/M50, WT33/M60, WT30U400, WT30U440		

			
1			
GEV No.	358032	Ref. No.	047131
description	fine fuse size ϕ 10x38mm 25A rated 500V type Gg fast-acting Qty 1 pcs		
For models:	LS7/9, CT92DXE, CT92SXE, CT92DXEUK, CT92SXEUK, CT92DXV, CT92SXV, CT92DXVUK, CT92SXVUK, CT140EDX, CT140ESX, CT140EDXUK, CT140SXUK, CT140VDX, CT140VSX, CT141EDX, CT141ESX, CT141EDUK, CT141ESUK, CT141VDX, CT141VSX, CT142DXE, CT142SXE, CT142DXEUK, CT142SXUK, CT142DXV, CT142SXV, CT190DXE, CT190SXE, CT190DXEUK, CT190SXUK, CT190DXV, CT190SXV, CT191DXE, CT191SXE, CT191DXEUK, CT191SXUK, CT191DXV, CT191SXV, CT192DXE, CT192SXE, CT192DXEUK, CT192SXUK, CT192DXV, CT192SXV, CT240DXE, CT240SXE, CT240DXEUK, CT240SXUK, CT240DXV...(Other models you can see in the webshop)		

various			
			
1			
GEV No.	358397	Ref. No.	0H9861 0K5074 0M2131 14R15 15F01 18025434 2600102 721730 ET25
description	fuse size 76mm 25A rated 690V Qty 1 pcs		
For models:	CE128-106, CE158-133.3.HV, CE158-244.3, CE158-246.3, CK248-209.D1ABBB, CK248-211.D1ABBB, HCE128-100, HCE128-104, HCE158-252W.3, HCE158-253.3, HLE129-100, HLE129-103, HLE129-104W, HLE159-252W.3.6, HLE159-328.3.HV, HLE159-351W.3.HV, HLE249-200.3, HLE249-208.3, HLE259-088.3.HV, HLE259-089.3.HV, HLE259-384W.3, LE129-101, LE159-261.3, LE159-281.3.6, LE159-318.3.HV, LE159-322.3.HV, LE159-330.3.HV, LE159-337.3.HV, LE159-344.3.MS92, LE159-347.3.HV, LE249-199.3, LE249-203.3, LE249-207.3, LE249-211.3, LE249-215.3, LE249-219.3, LE249-223.3, LE249-232.3, LE249-238.3, LE259-081.3.HV, LE259-082.3.HV, LE259-083.3.HV, LE259-094.3.HV, LE259-099.3.HV, LE259-382.3, LK259-707.D1ACCB, LK259-708.D1ACCB, CK248-205.D1ABBB, CK248-207.D1ABBB, LK159-707.D1BC...(Other models you can see in the webshop)		





fine fuse holders

			
1			
GEV No.	358029	Ref. No.	077552203700 0F0031 0K8694 7D552203700
description	fuse holder suitable fuse ϕ 5x20mm ϕ 14.5mm thread M16x1 1-pole 10A rated 500V connection F6.3		
For models:	EBE40., EBE40, EBE40., EBE040, EBE60., EBE60., EBE60., EBE60, EBE80., EBE80., EBE80., EBE80, EBE100., EBE100., EBE100., EBE100, BASIC40, BASIC60, BASIC80., BASIC100, EBE40AWF, EBE60AWF, EBE80AWF, EBE100AWF, FCZ061EAA, FCZ101EAA, FCZ102EAA, FCZ201EAA, FCZ202EAA, FCZ061EAH, FCZ101EAH, FCZ201EAH, FCZ061EAN, FCZ101EAN, FCZ201EAN, FCZ061ETA, FCZ101ETA, FCZ102ETA, FCZ201ETA, FCZ202ETA, FCZ061ETH, FCZ101ETH, FCZ201ETH, FCZ061ETN, FCZ101ETN, FCZ201ETN, FCZ061GAG, FCZ101GAG, FCZ102GAG, FCZ201GAG...(Other models you can see in the webshop)		

			
2			
GEV No.	358396	Ref. No.	056582 60050251
description	fuse holder suitable fuse ϕ 5x20mm ϕ 15mm mounting ϕ 12.5mm 16A rated 250V L 46mm connection male faston 4.8mm		
For models:	MBR/E710D, MBR/E700, MBR/E700UK, MBR/E716, MBR/E706, BCP/E1, FDV40G, FDV40E, FDV40GZ, FDV40EL, FDV40GA, FDV20G, FDV20E, FDV20GZ, FDV20EL, FDV20GA, 7BRE60XN, 7BRE60X, RBR/E700UK, RBR/E716, RBR/E706, XBR/E710D, M70EBP, XBR/E710, CBR/E700, XBR/E716, XBR/E706, PPD/G260, PPI/G260P, ECP/E1ELHU, PCP/E1ELH, OPD/G260, OPI/G260P, TPD/G260, TPI/G260P, TCP/E1ELHU, TCP/E1ELH, TFRE1S12M0, TFRE2D12M0, TFRE1S12M4, TFRE2D12M4, KPI/G10, KPI/G15, KPD/G10, KPD/G15, KPD/G15A, KPI/G15A, KPI/G06, KPI/G15H, KPI/G10H...(Other models you can see in the webshop)		

			
1			
GEV No.	358394	Ref. No.	0H6523 60050414
description	fuse holder suitable fuse ϕ 5x30mm mounting ϕ 18.3mm 6.3A rated 500V connection F2.8		

			
1			
GEV No.	358395	Ref. No.	0H6526
description	screw cap suitable fuse ϕ 14.5mm mounting ϕ mm thread M9x1 6.3A rated 250V connection suitable for fuse holder		

			
1			
GEV No.	358096	Ref. No.	075737
description	fuse holder suitable fuse ϕ 10x38mm 32A rated 690V cross section 1.5-25mm ²		
For models:	WT33/M50, WT33/M60, WT30U400, WT30U440, LS7/9, CT92DXE, CT92SXE, CT92DXEUK, CT92SXEUK, CT92DXV, CT92SXV, CT92DXVUK, CT92SXVUK, CT140EDX, CT140ESX, CT140EDXUK, CT140SXEUK, CT140VDX, CT140VSX, CT141EDX, CT141ESX, CT141EDUK, CT141E-SUK, CT141VDX, CT141VSX, CT142DXE, CT142SXE, CT142DXEUK, CT142SXEUK, CT142DXV, CT142SXV, CT190DXE, CT190SXE, CT190DXEUK, CT190SXEUK, CT190DXV, CT190SXV, CT191DXE, CT191SXE, CT191DXEUK, CT191SXEUK, CT191DXV, CT191SXV, CT192DXE, CT192SXE, CT192DXEUK, CT192SXEUK, CT192DXV, CT192SXV, CT240DXE...(Other models you can see in the webshop)		

overload switches

			
1			
GEV No.	358519	Ref. No.	0H6691 44100041
description	overload switch drop-away current 0.05A		
For models:	5611-3-10, 5611-3-6, 5611-3-8, 5612-3-10, 5612-3-6, 5612-3-8, 5614-3-10, 5614-3-6, 5614-3-8		

			
1			
GEV No.	358523	Ref. No.	0H6104 44100141 60050378
description	overload switch drop-away current 0.6A		

line circuit breakers

miscellaneous

			
1			
GEV No.	380689	Ref. No.	0G0213 0K3682 126681 804616505
description	line circuit breaker		
For models:	VARIOSTEAM/S-33.3/F, STEAM-O-MAT		



electric accessories

cables

power supply cables



GEV No.	550944	Ref. No.	0D0725 22464
description	power cord		
For models:	B2000K-01, B2000K-02, B2000K-03, B2000K-04, B2000T-01, B2000T-02, B2000T-03, B2000-4-01, B2000K-05, B2000MU-01, B2000-4-02, B2000-5-01, B2000-3-01, B2000MU-02, B2000K-06, B2000-4-03, B2000-5-02, B2000-6-01, B2000K-07, B2000-6-02, B2000-6-03, B2000-5-03, B2000-6-04, B2000K-08, B2000-4-04, B2000-5-04, B2000-5-05, B2000-6-05, B2000K-09, B2000-5-13, B2000-5-06, B2000-6-06, B2000-4-05, B2000-6-07, B2000K-10, B2000-4-06, B2000-5-07, B2000K-11, B2000-4-07, B2000-6-08, B2000K-12, B2000-5-08, B2000MU-03, B2000MU-04, B2000-5-09, B2000-6-13, B2000MU-05, B2000MU-06, B2000MU-07, B2000K-13...(Other models you can see in the webshop)		

copper wire

up to 200°C



GEV No.	550081	Ref. No.	0K3285 0KX287 18025408 700404
description	copper wire 1.5mm ² permanent temperature -60 up to +200°C conductor nickel-plated copper wire insulation glass fibre braiding/silicone rubber Qty 10m green/yellow t.max. 250°C rated 300/500V test voltage 2000V		

cable harnesses



GEV No.	401849	Ref. No.	002763 60050352
description	connecting cable		
For models:	FDV40G, FDV40E, FDV40GZ, FDV40EL, FDV40GA, FDV20G, FDV20E, FDV20GZ, FDV20EL, FDV20GA, FCV/G10L3, FCV/G10L3T, FCV/G10L3, FCV/G20L3, FCV/G20L3, FCV/E10L3JAP, FCV/E102/1L3JAP, FCV/E10L6JAP, FCV/E102/1L6JAP, FCV/G10L3J, FCV/G10L3J, FCV/G10L6JAP, FCV/G102/1L6JAP, FCV/E61/1, FCV/E101/1, FCV/E101/1, FCV/E102/1, FCV/E61/1, FCV/E101/1, FCV/E101/2, FCV/G61/1, FCV/G61/1, FCV/G61/1, FCV/E10L3, FCV/E102/1, FCV/E102/1L3, FCV/E20L3, FCVE20L3, FCV/G6L4, FCV/E6L4, FCV/G10L6, FCV/E10L6, FCV/G102/1L6, FCV/E102/1L6, FCV/G20L6, FCV/E20L6, FCV/G20L6, FCVE20L6, FCV/E101/1, FCV/G101/1...(Other models you can see in the webshop)		

connection cables



GEV No.	403477	Ref. No.	099468
description	cable harness L 800mm suitable for ELECTROLUX, ZANUSSI connection coded plug		
For models:	ADN220ES, ADF110ES, ADF220ES, ADN110ESP, ADF110ESP, ADN110E, TRN132AE, TRN183AE, TRN224AE, TRF132AE, TRF183AE, PS04RE1F, PS06RE1F, PS04FE1F, PS06FE1F, RH14RE2FS, RH06FE1FS, RH14FE2FS, RH06RE1F, RCSER2M2, RCSER3M3, RCSER4M4, RCEF2M2, RCEF3M3, RH06RE1FEU, RH06FE1FEU, RH14RE2FEU, RH14FE2FEU, RH06RE2HU, RH06FE2HU, RH14RE4HU, RH14FE4HU, RH06R1FERU, RH06F1FERU, RH14R2FERU, RH14F2FERU, RH06REHRU, RH06FE2HRU, RH14RE4HRU, RH14FE4HRU, RH06REP1F, RH06FEP1F, E06N0E1C, E06COE1CE, E14N-0E2CE, E14F0E2CE, E06N291C, E06C291C, DOOR REFR. 400LT, DOOR FREEZ. 400LT...(Other models you can see in the webshop)		



GEV No.	403294	Ref. No.	0C6110
description	connection cable L 1130mm for lambda sensor connection coded plug		



GEV No.	699204	Ref. No.	0C3678
description	kable set L 630mm suitable for combi-steamer		
For models:	FCZ061EAA, FCZ061EAH, FCZ061EAN, FCZ061ETA, FCZ061ETH, FCZ061ETN, FCZ061EBA, FCZ061EBH, FCZ061EBN, FCZ061EBC, FCZ061EBA2, FCZ061EBH2, FCZ061EBN2, FCZ061EBC2, FCZ061ECA, FCZ061ECH, FCZ061ECN, FCZ061ECA2, FCZ061ECH2, FCZ061ECN2, AOW101EA, AOW101EABU, AOS061EAA1, AOS061EAH1, AOS061EAN1, AOS061EAC1, AOS061EAE1, AOS061EAF1, AOS061EAM1, AOS061EAB1, AOS061EAK1, AOS061EAT1, AOS061ETA1, AOS061ETH1, AOS061ETN1, AOS061ETC1, AOS061ETE1, AOS061ETF1, AOS061ETM1, AOS061ETK1, AOS061EBA1, AOS061EBH1, AOS061EBN1, AOS061EBC1, AOS061EBE1, AOS061EBF1, AOS061EBK1, AOS061EBA2, AOS061EBH2, AOS061EBN2...(Other models you can see in the webshop)		

terminals and connectors

insulated

ring terminals



GEV No.	550166	Ref. No.	09990591 0K2459 550166
description	ring terminal size M6 ø6.5mm 1.5-2.5mm ² Qty 100 pcs insulation PVC Cu gal Sn blue t.max. 75°C		





not insulated			
female fastons			
iron nickel-plated			
			
1			
GEV No.	550001	Ref. No.	OK3331 OK3332
description	female faston size 6.3x0.8mm 1.0-2.5mm ² straight Fe gal Ni t.max. 340°C Qty 100 pcs		

bullet connectors			
			
1			
GEV No.	550334	Ref. No.	0H7029 60050469
description	plug connector size 3.5mm 0.25-1.5mm ² Cu gal Sn t.max. 125°C Qty 1 pcs		

wire end ferrules			
			
1			
GEV No.	550183	Ref. No.	OK4532
description	wire end ferrules 2.5mm ² Cu gal Sn t.max. 110°C L 12mm Qty 100 pcs		
For models:	FET060E.MS35P.F88, FET060E.MS35P.W84, FET060E.MS35S.F88, FET080E.MS35P.F88, FET080E.MS35P.W84, FET080E.MS35S.W84, FET100E.MS35P.F88, FET100E.MS35P.W84, UET060E.MS35.F88, UET090E.MS35.F88, UET090E.MS35.W84, UET100E.MS35.F88, UET100E.MS35.W84, UET150E.MS35.F88, FET100E.MS35S.F97, FET060E.MS35S.W84, FET080E.MS35S.F88, FET100E.MS35S.F88, FET100E.MS35S.W84, UET060E.MS35.W84, UET150E.MS35.W84, GPWBOEOOBO, GPXBOEOOBO, GPYBOEOOBO, GPWCOEOOBO, GPXCOEOOBO, GPYCOEOOBO, GPWEOEOOBO, GPXEOEOOBO, GPYEOEOOBO, GXWBOEOOOO, GXXBOEOOOO, GXYBOEOOOO, GXWDOEOOOO, GXXDOEOOOO, GXYDOEOOOO, GXWEOEOOOO, GXXEOEOOOO, GXYEOEOOOO, GXWHOEOOOO, GXXHOEOOOO, GXYHOEOOOO, FET060E.MS35S.F98, FET060E.MS35S.W94, FET080E.MS35S.F98, FET080E.MS35S.W94, FET100E.MS35S.F98, FET100E.MS35S.W94, FET060E.MS35P.F98, FET060E.MS35P.W94...(Other models you can see in the webshop)		

plug connectors

			
1			
GEV No.	550328	Ref. No.	0H7030 60050470
description	female bullet ø 3.5mm		

			
1			
GEV No.	550330	Ref. No.	0H7027 556513 60050467
description	plug connector 12-pole		

			
1			
GEV No.	550333	Ref. No.	0H7028 60050468
description	plug connector 12-pole		

			
1			
GEV No.	550334	Ref. No.	0H7029 60050469
description	plug connector size 3.5mm 0.25-1.5mm ² Cu gal Sn t.max. 125°C Qty 1 pcs		

terminals

porcelain clamps

			
1			
GEV No.	550115	Ref. No.	053805
description	porcelain terminal block 2-pole 10mm ² max. 30A max 450V L 37mm W 37mm H 23mm mounting distancemm Qty 1 pcs		
For models:	TC1200TOP, TC1210TOP, TC1400TOP, TC1410TOP, TC1600TOP, TC1610TOP, TC1800TOP, TC1810TOP, TC2000TOP, TC2010TOP, TCD1200TOP, TCD1400TOP, TCD1600TOP, TCD1800TOP, TCD2000TOP, TC1000, TC1010, TC1200, TC1210, TC1400, TC1410, TC1600, TC1610, TC1800, TC1810, TC2000, TC2010, TCD1000, TCD1200, TCD1400, TCD1600, TCD1800, TCD2000, TC1200, TC1210, TC1400, TC1410, TC1600, TC1610, TC1800, TC1810, TC2000, TC2010, TCD1200, TCD1400, TCD1600, TCD1800, TCD2000, TC1000, TC1000...(Other models you can see in the webshop)		

			
1			
GEV No.	555002	Ref. No.	054331
description	porcelain terminal block 2-pole max. 15A max 380V L 70mm W 36mm H 39mm mounting distance 12mm		
For models:	FCF/E4-OLD, FCF/E4D, FCFE4PH, FCF/E4OLD3, FCF/E4OLD4, FCF/E4OLD2, FCF/E4OLD1, FCF/E4D		





			
1			
GEV No.	550114	Ref. No.	054042
description	porcelain terminal block 4-pole 2.5mm ² hole distance 18mm max. 10A max 250V L 40mm W 20mm H 15mm mounting distance 18mm Qty 1 pcs		
For models:	MCF/GE705, MCF/GE1055, MCF/GE700, MCFGE1050, MCF/GE700D, MCFGE1050D, MC/E350D, MC/E350UK, MC/E700D, MC/E700UK, MC/E1050D, MCF/GE1055UK, MC/E350, MC/E700, MC/E1050, MI/E350, MI/E700, MI/E350D, MI/E700D, MI/E360, MI/E710, MI/E360D, MI/E710D, MCF/GE702, MCFGE1052, MCF/GE700, MCFGE1050, MR/E350D, MR/E350UK, MR/E360, MR/E700D, MR/E700UK, MR/E710, MR/E720, MR/E715, MR/E725, MR/E350, MR/E700, MR/E720D, MFR/E355, MFR/E355UK, MFR/E355D, MPN/EI760, MPNEI760UK, MTF/GE1050, MT/G700F, MTF/G700F, MTF/G1055F, MTFGE1055F, MM/E700...(Other models you can see in the webshop)		

			
1			
GEV No.	550278	Ref. No.	046357 0KE877 727938
description	power terminal block 3-pole max. 40A max 400V connection ø6mm ² / F6.3 temp.-resist. 150°C cross section 6mm ²		
For models:	MCF/G702, MCF/G1052, MCF/G700, MCF/G1050, MBR/G710D, MFR/G350, MFR/G700, MFR/G350D, MFR/G700D, MFR/G350F, MFR/G700F, MFR/G350E, MFR/G700E, FDV40G, FDV40GZ, FDV40GA, FDV20G, FDV20GZ, FDV20GA, RC/G1, RC/G2, RCV/G2, RCV/G3, RCF/G2, RCF/G3, RSF/G2, RSV/G2, RSF/G3, RPI/G260P, RW/E1, RB/E1, MCF/G2A, MCF/G3A, XC/G1, XC/G2, XCV/G2, XCV/G3, XCF/G2, XCF/G3, XSF/G2, XSV/G2, XSF/G3, XPI/G260P, XW/E1, XB/E1, JC/G1, JC/G2, JCV/G2, JCV/G3, JCF/G2...(Other models you can see in the webshop)		

terminal blocks			
			
1			
GEV No.	550232	Ref. No.	0W3543
description	lustre terminal 12-pole cross section 2.5mm ² max. 32A max 450V temp.-resist. 150°C		
For models:	LB81E, LB81BP, LB81COP, LB121E, LB121BP, LB161E, LB161BP, LB161V, CLB161E, CLB161V, T3900, T3900, T3900I3, T353019, T2130, T2130C, T3190, T3190, T3250_EL, T3250_GAS, T3250_EL, T3250_GAS, T3650, T3650, T3650, T3350_EL, T3350_GAS, T3350_EL, T3350_GAS, T3530, T3530, T3190E, T3190G, T329001, T329002, T329003, T329004, T329005, T329006, T329007, T329008, T329009, T329010, T329011, T329012, T353001, T353002, T353003, T353004, T353005...(Other models you can see in the webshop)		

			
1			
GEV No.	550411	Ref. No.	046347 048574 0E0994 0E1603 0E5176 0KE434 0KE541 0KG206
description	power terminal block 6-pole max. 40A max 450V connection ø6mm ² / F6.3 temp.-resist. 150°C cross section 6mm ²		
For models:	CMV11-F, CMV11F, CMV15-F, CMV15F, CMV15F2, CM15F2, CMP15F2, CMV11-F, CMV15/F, LS32/4.5, LS32UK/RP, LS32F, LV32F, C55, LV32/60, WT302/4.5, WT302UK/RP, WT302F, WT302/60, LS33/4.5, LS33UK/RP, LS33F, LV33F, C55A, LS33/60, WT303/4.5, WT303UK/RP, WT303F, WT303/60, LB8G, LB8G/63, LB8GF, LB8GPH, LB80EPH, LB80E, LB120EPH, LB120E, LB160EPH, LB160E, LB160V, CLB160E, CLB160V, W3400H06, W355HE, W365H, W375H5, W3105H, W3130H, W3130H, W3240H...(Other models you can see in the webshop)		

connection terminals with screw/faston connections			
			
1			
GEV No.	505212	Ref. No.	058873 0C9052
description	power terminal block 2-pole max. 20A max 600V connection ø2.5mm ² / F6.3 temp.-resist. 150°C cross section 4mm ²		
For models:	RCP/E2S, MCP/E1SH, MCP/E1SUH, MCP/E2SUHS, MCP/E2S, MCP/E2SH, MCP/E2SUH, MCP/E2SUT, MCP/E2SHB, M70EIKE, XPN/EI-760UK, XPN/EI760D, PCP/E2SHP, PCP/E1SH, PCP/E2SH, PCP/E2SH3B, OCP/E2S, OCP/E1SH, OCP/E2SH, TCP/E2S, TCP/E2SH, TFR1S12M0, TFR2D12M0, TFR1S12M4, TFR2D12M4, HPN/ED811, HPN/ED816, HPA/ED825, HPN/GI806, HPN/GI805, HCP/E400, HCP/E410, HCP/E800, HCP/E810, HCPS/E400, HCPS/E410, HGRV, ZPN/ED811, ZPN/ED816, ZPN/GI805, ZCP/E400, ZCP/E410, ZCP/E800, ZCP/E810, ZCPS/E400, ZCPS/E410, APN/EI815D, APN/EI810, APN/EI815, APN/ED816...(Other models you can see in the webshop)		

			
1			
GEV No.	550977 ¹	Ref. No.	— 005420 058613
description	power terminal block 6-pole max. 40A max 450V connection ø6mm ² / F6.3 temp.-resist. 150°C cross section 6mm ² with ground lug		
For models:	MPN/EI760, MPNEI760UK, MPN/EI760D, BCF/E2, RCF/M2, RCF/M3, RC/E1, RC/E2, RCV/E2, RCV/E3, RCF/E2, RCF/E2M0, RCF/E2M4, RCVF/E3M0, RCVF/E3M4, RMV/E1C, RMV/E2C, RF/E1D05, RFR/E1S12, RFR/E2D12, RFR/E2S40, RF/E1S12, RF/E2D12, RFR/E1S14, RFR/E2D14, RF/E1S12, RF/E2D12, RR/E1FL, RR/E1FR, RR/E1CL, RR/E2FL, RR/E2FM, RR/E2CL, RR/E1FL, RR/E1FR, RR/E1CL, RR/E2FL, RR/E2FM, RRV/E2CL, RR/E2CM, RG/E1, RG/E2, RGV/E1, RGV/E2, RPI/E240, RPI/E260, RPI/E260P, RCP/E1S, RCP/E2D, RI/E1...(Other models you can see in the webshop)		

¹with ground lug



PCB terminal blocks

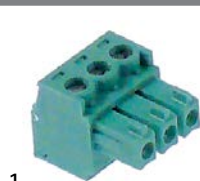

GEV No.	550791	Ref. No.	099743 1508231
description	PCB terminal block 3-pole raster size 3.81mm		
For models:	FV 1M, FV 1M, FV 1M, FV 1M, FV 1M, FV 1M, FV Dual, FV Dual, FV 2M, FV 2M, FV 2M, FV 2M, DUAL 2 DOORS, DUAL 2 DOORS, FV 2M, FV 2M, FV 1M, FV 1M, FV 1M, FV 1M, FV 2M, FV 2M, ASN110, ASF110, ASN220, ASF220, ADN110, ADN120, ADN111, ADF110, ADF120, ADNN120, ADNF120, ADN220, ADN240, ADN221, ADF220, ADNN220, ADNF220, ADNN230, ADNF230, ADN11060, ADF11060, ADN22060, ADF2206, ZPR04R1F, ZPR04F1F, ZPR06R1F, ZPR06F1F, TRN224C...(Other models you can see in the webshop)		



GEV No.	550805	Ref. No.	099740 640324
description	PCB terminal block 7-pole raster size 5mm		
For models:	FV 1M, FV 1M, FV 1M, FV 1M, FV 1M, FV 1M, FV Dual, FV Dual, FV 2M, FV 2M, FV 2M, FV 2M, DUAL 2 DOORS, DUAL 2 DOORS, FV 2M, FV 2M, FV 1M, FV 1M, FV 1M, FV 1M, FV 2M, FV 2M, ASN110, ASF110, ASN220, ASF220, ADN110, ADN120, ADN111, ADF110, ADF120, ADNN120, ADNF120, ADN220, ADN240, ADN221, ADF220, ADNN220, ADNF220, ADNN230, ADNF230, ADN11060, ADF11060, ADN22060, ADF2206, ZPR04R1F, ZPR04F1F, ZPR06R1F, ZPR06F1F, TRN224C...(Other models you can see in the webshop)		

rail-mounted terminals

rail-mounted terminal blocks



GEV No.	550598	Ref. No.	058875
description	rail-mounted terminal block 5-pole contacts 3P+N+E cross section 1.0-10mm ²		
For models:	MIF/E700, MIF/E700D, MIF/E710, MIF/E710D, MBR/E710D, MBR/E700, MBR/E700UK, MBR/E716, MBR/E706, MFR/E705, MFR/E705UK, MFR/E705D, 7BRE60XN, 7BRE60X, RBR/E700UK, RBR/E716, RBR/E706, XMIF/E710, CIF/E710, XBR/E710D, M70EBP, XBR/E710, CBR/E700, XBR/E716, XBR/E706, PIW/Z1, PI/Z2F, PG/E1, PG/E1E5, TIW/Z1, TI/Z2F, TG/E1, TG/E1E5, HCF/E800, HCF/GE810, KRF/E2R, KRF/E2RP, ZCF/E800, ZCF/GE810, QCF/M2, QCF/W2, QRF/E2R, QRF/E2RP, ACF/GE810, WRF/E2R, WRF/E2RP, ECF/G-E810, FCZ061EAA, FCZ061EAH, FCZ061EAN...(Other models you can see in the webshop)		



GEV No.	550599	Ref. No.	059239
description	rail-mounted terminal block 5-pole contacts 3P+N+E cross section 1.0-10mm ²		
For models:	MI/Z1, RI/Z1, XI/Z1, MI/Z2, RI/Z2, XI/Z2, MI/Z1U, MI/Z2U, PI/Z1, PI/Z2, PI/Z1E5, PI/Z2E5, PGV/E1, PGV/E2, OI/Z1, TI/Z1, TI/Z1E5, TGV/E1, TGV/E2, HC/E400, HC/E800, HCF/E800, HC/E410, HC/E810, HCF/E810, KI/E1, KI/E2, KI/E2E5, KI/Z1, KI/Z2, KI/Z1A, KR/E1, KR/E2, KR/E1R, KR/E2R, KR/E1C, KR/E2C, KR/E2CR, KR/E1E5, KR/E1RE5, KR/E2E5, KR/E2RE5, KR/E1CE5, KR/E2CE5, KR/E2CRE5, KR/E1P, KR/E2P, KR/E1RP, KR/E2RP, KR/E1C...(Other models you can see in the webshop)		



GEV No.	550922	Ref. No.	002691 0E5850 0F0112 0KT397 1090199S
description	rail-mounted terminal block 5-pole contacts 3P+N+E cross section 1.5-16mm ²		
For models:	MI/Z1, RI/Z1, XI/Z1, MI/Z2, RI/Z2, XI/Z2, MI/Z1U, MI/Z2U, PCF/M2, PCF/M3, PC/E2Q, PCF/E2Q, PCV/E2Q, PI/Z1, PI/Z2, PC/E2QE5, PCF/E2QE5, PI/Z1E5, PI/Z2E5, PCF/M2E5, PF/E2D12E5, PFRE2D12E5, PCF/M2A, PCF/M3A, OCF/M2, OC/E2Q, OCF/E2Q, OI/Z2, TCF/M2, TCF/M3, TCF/E2Q, TCF/E2Q, TI/Z2, TCF/E2QE5, TI/Z2E5, TCF/M2E5, TF/E2D12E5, TF-RE2D12E5, TCF/M2A, TCF/M3A, TCF/E2M0, TCF/E2QM0, TCF/E3QM0, TCF/E2M4, TCF/E2QM4, TCF/E3QM4, KCF/M2, KC/E1, KC/E2, KCF/E2...(Other models you can see in the webshop)		





GEV No.	551081 ¹	Ref. No.	058608 2238003
description	rail-mounted terminal block 5-pole contacts 3P+N+E cross section 1.5-16mm ² with fuse terminal suitable fuse ø5x30mm		
For models:	MFR/E740, RFR/E741, CFR/E702, HCF/E810, KPI/E10, KPI/E15, KPI/E15A, KPI/E15H, KPI/E10H, KBR/E2F, KBR/E2C, KBR/E3F, KBR/E3FH, KBR/E3C, KBR/E3CH, KBR/E2FH, KBR/E2CH, KFR/E1C, KFR/E2D, KFR/E1CE5, KFR/E2DE5, HFR/E418, HBR/E800, HBR/E805, HBR/E801, HBR/E806, HBR/E810, HBR/E815, HBR/E811, HBR/E816, HBR/E800UK, HBR/E820, HBR/E825, HBR/E800, HBR/E805, HBR/E810, HBR/E815, HBR/E811, HBR/E816, HBR/E800UK, QPI/E10, QPI/E15, QPI/E15H, QPI/E10H, QBR/E2F, QBR/E2C, QBR/E3F, QBR/E3FH, QBR/E3C, QBR/E3CH...(Other models you can see in the webshop)		

¹with fused terminal block



			
1			
GEV No.	551082	Ref. No.	058707
description	rail-mounted terminal block 5-pole cross section 35mm ² suitable fuse ø5x30mm		
For models:	FDV40E, FDV40EL, FDV20E, FDV20EL, FCZ202EAA, FCZ202ETA, FCZ202EBA, FCZ202EBA2, FCZ202ECA, FCZ202ECA2, FCFE201-0, FCFE202-0, FCFE201ENS, FCFE40, FCFE40UK, PFCFE40F, FCFE40J, FCFE40J, FCFE20/P-V, AOS202EA2N, AOS202EB2N, AOS202EA, AOS202EB, AOS202EAAQ, AOS202EBAQ, ECFE201-0, ECFE202-0, ECF201ENS, AOS202EAA1, AOS202EAK1, AOS202EAT1, AOS202ETA1, AOS202ETM1, AOS202ETK1, AOS202EBA1, AOS202EBK1, AOS202EBA2, AOS202EBK2, AOS202ECA1, AOS202ECA2, FCFE202, EJM202EAA, EJM202EBA, EJM202ECA, ACFE201-0, ACFE202-0, RCF201E, FF/E40, AFCF/E40, 4238N...(Other models you can see in the webshop)		

			
1			
GEV No.	550597	Ref. No.	006854 0C0616
description	rail-mounted terminal block 5-pole with fuse holder		
For models:	MCP/E1SH, MCP/E1SUH, MCP/E2SUHS, MCP/E2SH, MCP/E2SUH, MCP/E2SUT, MCP/E2SHB, PCP/E1SH, PCP/E2SH, PCP/E2SH3B, OCP/E1SH, OCP/E2SH, TCP/E2SH, KFR/E2F, KFR/E1C, KFR/E2D, KFR/E1CE5, KFR/E2DE5, KCP/G1, KCP/G1R, KCP/G2, KCP/G2R, KCP/E1, KCP/E1R, KCP/E2, KCP/E2R, HFR/E810, HFR/E830, HFR/E831, QFR/E2F, QFR/E2D, QCP/G1, QCP/G1R, QCP/G2, QCP/G2R, QCP/E1, QCP/E1R, QCP/E2, QCP/E2R, ZFR/E810, ZFR/E830, ZFR/E831, WFR/E2F, WFR/E2D, WCP/G1, WCP/G1R, WCP/G2, WCP/G2R, WCP/E1, WCP/E1R...(Other models you can see in the webshop)		

			
1			
GEV No.	551072	Ref. No.	059794
description	rail-mounted terminal block cross section 6mm ² suitable fuse 5x20/5x25mm		
For models:	MFR/E355, MFR/E355UK, MFR/E355D, MFR/E705, MFR/E705UK, MFR/E705D, RBR/E2FM, RBR/E2IM, RBK/E2FM, RCP/E2S, XBR/E2FM, XBR/E2IM, XBK/E2FM, JBR/E2FM, MBR/E2FM, MBR/E2IM, MBK/E2FM, MCP/E2S, RFR/E356, RFR/E701, PBR/E2FM, PBR/E2IM, PPI/E260P, PCP/E2SHP, OBR/E2FM, OBR/E2IM, OPI/E260P, OCP/E2S, TBR/E2FM, TBR/E2IM, TPI/E260P, TCP/E2S, KPI/E06, KCP/E1RU, KCP/G1U, KCP/G2U, KCP/E1U, HFR/E410, HFR/E411, HFR/E412, HPN/EI815D, HPN/EI810, HPN/EI815, HPN/ED811, HPN/ED816, HPA/ED825, HPA/EI825, HPNS/EI815, HPNS/EI815D, HPN/EI806...(Other models you can see in the webshop)		





miscellaneous			
			
1			
GEV No.	551084	Ref. No.	OK0707 KT800
description	terminal		

terminal boxes			
			
1			
GEV No.	551123	Ref. No.	049618 0L0111
description	terminal box L 145mm W 145mm H 54mm with strain relief 500V Qty 1 pcs		
For models:	WT4B, WT4DB, WT46, WT4DG, WT4BWS, WT4BDWS, NUC3DD, EUC1, EUC3, EUC3WS, EUC3DP, EUC3DPWS, EUC3DD, ZUCADDROW, ZUCADDROW6, LS5/3, LS5/3DP, LS5/3WS, LS5/3WSDP, FUCA3DD, LS5/3WSDPD, LB5DPG, KUC3, KUC3DP, NUC3, NUC3WS, NUC3DP, NUC3DPWS, NUC3DDWS, ZUCA3, EUCADDROW, EUCADDROW6, LS6EP, LS6EP/DD, LS6EADD, LS6EA/DPDD, WT38TDE, WT38/M50, LS6EADP3, LS6EADPWS, LS6EADPWSG, WT38WS, WT38WSG, WT38MEDWS, WT38PM50, WT37LEV/9, LS6EADPDWS, WT38DWS, LS6SANA, EUCAI...(Other models you can see in the webshop)		

electronic magnets

			
1			
GEV No.	370647	Ref. No.	0L0542
description	electronic magnet 24V voltage DC L 42mm W 30mm H 62mm 15W		
For models:	WT38TDE, LS6SANA, EUCAIMLG		







20S series			
			
GEV No.	101094	Ref. No.	054109 054628 054629 0K2868 7989B1
description	gas tap PEL type 20S gas inlet M16x1.5 (tube ø 10mm) bypass nozzle ø 0.35mm gas outlet M16x1.5 (tube ø 10/8mm) thermocouple connection M8x1 pilot connection shaft ø 8x6.5mm shaft L 22/15mm shaft flat lower		
For models:	RC/G330, RC/G730, MCF/G700, MCF/G1050, MCF/GE700, MCFGE1050, MCF/GE700D, MCFGE1050D, MCF/G1050D, MC/G350, MC/G700, MC/G1050, MCF/G1090, MCF/G1095, MCF/G995, MC/G352, MC/G702, MC/G1052, MCF/G702, MCF/GE702, MCF/G1052, MCFGE1052, MC/G350, MC/G700, MC/G1050, MCF/G700, MCF/GE700, MCF/G1050, MCFGE1050, MTF/G700D, MTF/G1050D, MTF/G700, MTF/G1050, MTF/GE1050, RCV/G330, RCV/G720, RCF/G730, RCFG1030, RCF/GE730, RC/G350, RC/G700, RCF/G700, RCF/G1050, RCF/GE700D, RCFGE1050D, RC/G350F, RC/G700F, RCF/G700, MCF/G1050, RCF/GE700...(Other models you can see in the webshop)		
spare parts for	101094		
	GEV No.	100408	Ref. No. —
	bypass nozzle type PEL20/21 bore ø 0.35mm thread M5x0.5		
	GEV No.	101060	Ref. No. 056595 0982 0H6238
	magnet unit standard L 39mm D1 ø 15.4mm D2 ø 11mm suitable for PEL20-21/JUNKERS/EGA		
	GEV No.	101205	Ref. No. 059854
	gas tap front part shaft ø 8x6.5mm shaft L 22/15mm shaft flat upper/lower suitable for PEL20		
	GEV No.	101230	Ref. No. —
	thermocouple nut T1: M8x1 T2: M18x1 aluminium		
accessories for	101094		
	GEV No.	101278	Ref. No. 060325 0C0150 0G0794 0G1111 0G2610 0K1976 0KW924 0T1946 101278 17012732 17012758 19012727
	olive for pipe ø 10mm Qty 1 pcs		
	GEV No.	101300	Ref. No. 0A2125 0G2957
	union nut thread M16x1.5 tube ø 10mm		
	GEV No.	101450	Ref. No. —
	olive for pipe ø 8mm L 12.7mm Qty 1 pcs ED ø 10mm		
	GEV No.	101451	Ref. No. —
	union nut thread M16x1.5 tube ø 8mm		
	GEV No.	110081	Ref. No. —
	knob ø 70mm shaft ø 8x6.5mm shaft flat universal		





accessories for	101094		
	GEV No.	110083	Ref. No. —
	knob dial plate gas tap without ignition flame silver		



GEV No.	101958	Ref. No.	004237 7989B19
description	gas tap PEL type 20S gas inlet M16x1.5 (tube ø 10mm) bypass nozzle ø 0.35mm gas outlet M16x1.5 (tube ø 10/8mm) thermocouple connection M8x1 pilot connection shaft ø 8x6.5mm shaft L 40/15mm shaft flat upper without ignition flame connection		
For models:	RC/G1, RC/G2, RCV/G2, RCV/G3, RCF/G2, RCF/G3, RCF/G9, RCF/M2, RCF/M3, RSF/G2, RSV/G2, RSF/G3, MCF/G2A, MCF/G3A, XC/G1, XC/G2, XCV/G2, XCV/G3, XCF/G2, XCF/G3, XCF/G9, XCF/M2, XCFM3, XSF/G2, XSV/G2, XSF/G3, JC/G1, JC/G2, JCV/G2, JCV/G3, JCF/G2, JCF/G3, JCF/M2, JCFM3, MC/G1, MC/G2, MCV/G2, MCV/G3, MCF/G2, MCF/G3, MCF/G9, MCF/M2, MCF/M3, MSF/G2, MSV/G2, MSF/G3		

spare parts for	101958		
	GEV No.	101060	Ref. No. 056595 0982 0H6238
	magnet unit standard L 39mm D1 ø 15.4mm D2 ø 11mm suitable for PEL20-21/JUNKERS/EGA		
	GEV No.	101230	Ref. No. —
	thermocouple nut T1: M8x1 T2: M18x1 aluminium		
	GEV No.	101876	Ref. No. —
	gas tap front part shaft ø 8x6.5mm shaft L 39/15mm shaft flat right/left suitable for PEL20		

accessories for	101958		
	GEV No.	101278	Ref. No. 060325 0C0150 0G0794 0G1111 0G2610 0K1976 0KW924 0T1946 101278 17012732 17012758 19012727
	olive for pipe ø 10mm Qty 1 pcs		

	GEV No.	101300	Ref. No. 0A2125 0G2957
	union nut thread M16x1.5 tube ø 10mm		
	GEV No.	101450	Ref. No. —
	olive for pipe ø 8mm L 12.7mm Qty 1 pcs ED ø 10mm		
	GEV No.	101451	Ref. No. —
	union nut thread M16x1.5 tube ø 8mm		
	GEV No.	110081	Ref. No. —
	knob ø 70mm shaft ø 8x6.5mm shaft flat universal		
	GEV No.	110083	Ref. No. —
	knob dial plate gas tap without ignition flame silver		



21S series



GEV No.	101095	Ref. No.	059353 059355 059460 0A2169 7988B1 7988B7
----------------	--------	-----------------	--

description gas tap PEL type 21S gas inlet M16x1.5 (tube ø 10mm) bypass nozzle ø 0.35mm gas outlet M16x1.5 (tube ø 10/8mm) thermocouple connection M8x1 pilot connection M10x1 shaft ø 8x6.5mm shaft L 22/15mm shaft flat lower

For models: RG/G1, RG/G2, RGV/G1, RGV/G2, XG/G1, XG/G2, XGV/G1, XGV/G2, JG/G1, JG/G2, JGV/G1, JGV/G2, MG/G1, MG/G2, MGV/G1, MGV/G2, PG/G1, PG/G2, PG/G1HV, PG/G2HV, OG/G1, OG/G2, TG/G1, TG/G2, HC/G410, HC/G810, HCF/G810, HC/G410D, HC/G810D, HCF/G810D, HCF/G1210D, HCF/G1610D, HC/G410NL, HC/G810NL, HCF/G810NL, HC/G1210, HCF/G1210, EC/G1610, HCF/G1610, HCF/GE810, HC/G410, HC/G810, HC/G1210, HCF/G810, HCF/G1210, HCF/G1610, HCF/G811, HC/G411, HC/G811, HC/G1211...(Other models you can see in the webshop)

spare parts for 101095

	GEV No.	100408	Ref. No.	—
---	----------------	--------	-----------------	---

bypass nozzle type PEL20/21 bore ø 0.35mm thread M5x0.5

	GEV No.	101060	Ref. No.	056595 0982 0H6238
---	----------------	--------	-----------------	--------------------------

magnet unit standard L 39mm D1 ø 15.4mm D2 ø 11mm suitable for PEL20-21/JUNKERS/EGA

	GEV No.	101206	Ref. No.	002185
---	----------------	--------	-----------------	--------

gas tap front part shaft ø 8x6.5mm shaft L 22/15mm shaft flat upper/lower suitable for PEL21

	GEV No.	101230	Ref. No.	—
---	----------------	--------	-----------------	---

thermocouple nut T1: M8x1 T2: M18x1 aluminium

accessories for 101095

	GEV No.	100908	Ref. No.	046755 052125 0958013 0G2219 0K1348 0K5753 0KE882 0KL495 19012956 727742 727781
---	----------------	--------	-----------------	---

union screw thread M10x1 for pipe ø 4mm Qty 1 pcs

	GEV No.	100909	Ref. No.	003859 057821
---	----------------	--------	-----------------	------------------

union screw thread M10x1 for pipe ø 6mm Qty 1 pcs

	GEV No.	101246	Ref. No.	052127 727782
---	----------------	--------	-----------------	------------------

olive for pipe ø 4mm Qty 1 pcs

accessories for 101095

	GEV No.	101278	Ref. No.	060325 0C0150 0G0794 0G1111 0G2610 0K1976 0KW924 0T1946 101278 17012732 17012758 19012727
---	----------------	--------	-----------------	--

olive for pipe ø 10mm Qty 1 pcs

	GEV No.	101286	Ref. No.	020992 053666
---	----------------	--------	-----------------	------------------

olive ID ø 6mm Qty 1 pcs

	GEV No.	101300	Ref. No.	0A2125 0G2957
---	----------------	--------	-----------------	------------------

union nut thread M16x1.5 tube ø 10mm

	GEV No.	101450	Ref. No.	—
---	----------------	--------	-----------------	---

olive for pipe ø 8mm L 12.7mm Qty 1 pcs ED ø 10mm

	GEV No.	101451	Ref. No.	—
---	----------------	--------	-----------------	---

union nut thread M16x1.5 tube ø 8mm

	GEV No.	110081	Ref. No.	—
---	----------------	--------	-----------------	---

knob ø 70mm shaft ø 8x6.5mm shaft flat universal

	GEV No.	112206	Ref. No.	—
--	----------------	--------	-----------------	---

knob dial plate silver gas tap PEL21/22/23 t.max.°C ED ø 63mm ID ø 45.5mm

















GEV No.	103329	Ref. No.	059361
----------------	--------	-----------------	--------

description gas tap PEL type 21S gas inlet M16x1.5 (tube ø 10mm) bypass nozzle ø 0.35mm gas outlet M16x1.5 (tube ø 10/8mm) thermocouple connection M8x1 pilot connection M10x1 shaft ø 8x6.5mm shaft L 22/15mm shaft flat upper

For models: HC/G410D, HC/G810D, HCF/G810D, HCF/G1210D, HCF/G1610D, HC/G410NL, HC/G810NL, HCF/G810NL, HT/G800D, HTF/G800D, HTF/G1210D, HT/G800NL, HTF/G800NL, HTFG1210NL, ZC/G410D, ZC/G810D, ZCF/G810D, ZCF/G1210D, ZHCFG1610D, ZT/G800D, ZTF/G800D, ZTF/G1210D, AC/G410D, AC/G810D, ACF/G810D, AC/G410NL, AC/G810NL, ACF/G810NL, AT/G800D, ATF/G800D, ATF/G1210D, AT/G800NL, ATF/G800NL, ATFG1210NL



 <p>1</p>			
GEV No.	101397	Ref. No.	004961 0K3616 50014
description	gas tap PEL type 21S gas inlet M16x1.5 (tube ø 10mm) bypass nozzle ø 0.35mm gas outlet M16x1.5 (tube ø 10/8mm) thermocouple connection M9x1 pilot connection M10x1 shaft ø 8x6.5mm shaft L 22/15mm shaft flat lower		
For models:	SCPG350, SCPG350, SGG350, SGG700		
spare parts for	101397		
	GEV No.	100408	Ref. No. —
	bypass nozzle type PEL20/21 bore ø 0.35mm thread M5x0.5		
	GEV No.	101060	Ref. No. 056595 0982 0H6238
	magnet unit standard L 39mm D1 ø 15.4mm D2 ø 11mm suitable for PEL20-21/JUNKERS/EGA		
	GEV No.	101206	Ref. No. 002185
	gas tap front part shaft ø 8x6.5mm shaft L 22/15mm shaft flat upper/lower suitable for PEL21		
accessories for	101397		
	GEV No.	100908	Ref. No. 046755 052125 0958013 0G2219 0K1348 0K5753 0KE882 0KL495 19012956 727742 727781
	union screw thread M10x1 for pipe ø 4mm Qty 1 pcs		
	GEV No.	100909	Ref. No. 003859 057821
	union screw thread M10x1 for pipe ø 6mm Qty 1 pcs		
	GEV No.	101246	Ref. No. 052127 727782
	olive for pipe ø 4mm Qty 1 pcs		
	GEV No.	101278	Ref. No. 060325 0C0150 0G0794 0G1111 0G2610 0K1976 0KW924 0T1946 101278 17012732 17012758 19012727
	olive for pipe ø 10mm Qty 1 pcs		
	GEV No.	101286	Ref. No. 020992 053666
	olive ID ø 6mm Qty 1 pcs		
	GEV No.	101300	Ref. No. 0A2125 0G2957
	union nut thread M16x1.5 tube ø 10mm		
	GEV No.	101450	Ref. No. —
	olive for pipe ø 8mm L 12.7mm Qty 1 pcs ED ø 10mm		

accessories for	101397		
	GEV No.	101451	Ref. No. —
	union nut thread M16x1.5 tube ø 8mm		
	GEV No.	110081	Ref. No. —
	knob ø 70mm shaft ø 8x6.5mm shaft flat universal		
	GEV No.	112206	Ref. No. —
	knob dial plate silver gas tap PEL21/22/23 t.max.°C ED ø 63mm ID ø 45.5mm		

 <p>1</p>			
GEV No.	106875	Ref. No.	004282 0C1676
description	gas tap PEL type 21S gas inlet M16x1.5 (tube ø 10mm) bypass nozzle ø 0mm gas outlet M16x1.5 (tube ø 10/8mm) thermocouple connection M8x1 pilot connection M10x1 shaft ø 8x6.5mm shaft L 39/15mm shaft flat lower		
For models:	RR/G1FL, RR/G1FR, RR/G2FL, RR/G2FM, RRV/G1FL, RRV/G1FR, RRV/G2FL, RRV/G2FM, RTV/G2, RTF/G2, RSF/G2, RSV/G2, RSF/G3, XR/G1FL, XR/G1FR, XR/G2FL, XR/G2FM, XRV/G1FL, XRV/G1FR, XRV/G2FL, XRV/G2FM, XTV/G2, XTF/G2, XSF/G2, XSV/G2, XSF/G3, JR/G1FL, JR/G1FR, JR/G2FL, JR/G2FM, JRV/G1FL, JRV/G1FR, JRV/G2FL, JRV/G2FM, JTV/G2, JTF/G2, MR/G1FL, MR/G1FR, MR/G2FL, MR/G2FM, MRV/G1FL, MRV/G1FR, MRV/G2FL, MRV/G2FM, MTV/G2, MTF/G2, MSF/G2, MSV/G2, MSF/G3		



















 <p>1</p>			
GEV No.	101897	Ref. No.	0C0205
description	gas tap PEL type 21S gas inlet pipe flange ø21mm bypass nozzle ø 0.35mm gas outlet M16x1.5 (tube ø 10/8mm) thermocouple connection M8x1 pilot connection M10x1 shaft ø 8x6.5mm shaft L 32/25mm shaft flat upper		
For models:	BCP/G1, PC/G1, PC/G2, PCV/G2, PCV/G3, PCF/G2, PCF/G3, PCF/G9, PCF/M2, PCF/M3, PCF/M2E5, PR/G1FL, PR/G1FR, PR/G2FL, PR/G2FM, PRV/G1FL, PRV/G1FR, PRV/G2FL, PRV/G2FM, PTV/G2, PTF/G2, PSF/G2, PSV/G2, PSF/G3, PGV/G1, PGV/G2, PG/G1, PG/G2, PCP/G1S, PCP/G2D, PCV/G2N, PCF/G3N, PC/G2HV, PCV/G3N, PCF/G2N, PG/G1HV, PC/G1HV, PGV/G1HV, PG/G2HV, PTV/G2N, PGV/G2HV, PR/G1FLHV, PRV/G2FLHV, PC/G1A, PC/G2A, PCV/G2A, PCV/G3A, PCF/G2A, PCF/G3A, PCF/M2A...(Other models you can see in the webshop)		
spare parts for	101897		
	GEV No.	101060	Ref. No. 056595 0982 0H6238
	magnet unit standard L 39mm D1 ø 15.4mm D2 ø 11mm suitable for PEL20-21/JUNKERS/EGA		
	GEV No.	101230	Ref. No. —
	thermocouple nut T1: M8x1 T2: M18x1 aluminium		
	GEV No.	101875	Ref. No. 0S0661
	gas tap front part shaft ø 8x6.5mm shaft L 32/25mm shaft flat upper/lower type PEL21		
	GEV No.	528347	Ref. No. —
	O-ring Viton thickness 1.78mm ID ø 2.9mm Qty 1 pcs		











Table continues overleaf



accessories for 101897				
	GEV No.	100908	Ref. No.	046755 052125 0958013 0G2219 0K1348 0K5753 0KE882 0KL495 19012956 727742 727781
union screw thread M10x1 for pipe ø 4mm Qty 1 pcs				
	GEV No.	100909	Ref. No.	003859 057821
union screw thread M10x1 for pipe ø 6mm Qty 1 pcs				
	GEV No.	101246	Ref. No.	052127 727782
olive for pipe ø 4mm Qty 1 pcs				
	GEV No.	101278	Ref. No.	060325 0C0150 0G0794 0G1111 0G2610 0K1976 0KW924 0T1946 101278 17012732 17012758 19012727
olive for pipe ø 10mm Qty 1 pcs				
	GEV No.	101286	Ref. No.	020992 053666
olive ID ø 6mm Qty 1 pcs				
	GEV No.	101300	Ref. No.	0A2125 0G2957
union nut thread M16x1.5 tube ø 10mm				
	GEV No.	110081	Ref. No.	—
knob ø 70mm shaft ø 8x6.5mm shaft flat universal				
	GEV No.	112206	Ref. No.	—
knob dial plate silver gas tap PEL21/22/23 t.max.°C ED ø 63mm ID ø 45.5mm				

				
1				
GEV No.	106060	Ref. No.	0KI367 11171260 726524 777059	
description	gas tap PEL type 21S/O gas inlet pipe flange ø21mm bypass nozzle ø 0mm gas outlet M16x1.5 (tube ø 10/8mm) thermocouple connection M8x1 pilot connection M10x1 shaft ø 6x4.6mm shaft L 45/19mm shaft flat upper			
For models:	AGGRHFGOOO, AGGRHAGOOO, AGGRHBGOOM, AGGRABGOOO, AGGRHBGOOO, AGGWHFGBOO, AGGWHAGBOO, AGGWHBGBOM, AGGWABGBOO, AGGWHBGBOO, ALGWHFOOOO, ALGWHAOOOO, ALGWHCOOOO, AGGYIFGFCO, AGGYIAGFCO, AGGYIBGFCO, AGGRAAGOOM, AGGRAFGOOM, AGGWAAGBOM, AGGWAFGBOM, AGGYJAGFCM, AGGYJFGFCM, AGGYJBGFCM, AGGWDBGBOO, AGGWDFGBOO, AGGW DAGBOM, AGGWDFGBOM, AGGWDBGBOM, AGGYKFGFCO, AGGYKBGFCO, AGGYKAGFCM, AGGYKFGFCM, AGGYKBGFCM, AGPWCAGBOO, AGPWCAGBOM, AGPWCAGBOM, AGPWCAGBOM, AGGYLAGFCO, AGGYLFGFCO, AGGYLAGFCM, AGGYLFGFCM, AGGYLBGFCM, ALPWCAOOOO, ALGWDFOOOO, ALGWDCOOOO, AGGROIGOOO, AGGWOIGBOO, AGGYOIGFCO, AGGROIGOOM, AGGWOIGBOM... (Other models you can see in the webshop)			
spare parts for	106060			
	GEV No.	101060	Ref. No.	056595 0982 0H6238
magnet unit standard L 39mm D1 ø 15.4mm D2 ø 11mm suitable for PEL20-21/JUNKERS/EGA				
	GEV No.	101230	Ref. No.	—
thermocouple nut T1: M8x1 T2: M18x1 aluminium				
accessories for	106060			
	GEV No.	101278	Ref. No.	060325 0C0150 0G0794 0G1111 0G2610 0K1976 0KW924 0T1946 101278 17012732 17012758 19012727
olive for pipe ø 10mm Qty 1 pcs				
	GEV No.	101300	Ref. No.	0A2125 0G2957
union nut thread M16x1.5 tube ø 10mm				









22N/V series			
			
1			
GEV No.	101690	Ref. No.	052145 792004
description	gas tap PEL type 22N/V gas inlet M20x1.5 (tube ø 12mm) bypass nozzle ø 0.35mm gas outlet M20x1.5 (tube ø 12/10mm) thermo-couple connection pilot connection M10x1 shaft ø 10x8mm shaft L 25/17mm shaft flat lower		
For models:	HCF/GE80, HCF/GE80, PHCF/GE8		
spare parts for	101690		
	GEV No.	100259	Ref. No. —
	bypass nozzle type PEL22 bore ø 0.35mm thread M6x0.5		
	GEV No.	101201	Ref. No. 056597
	gas tap front part shaft ø 10x8mm shaft L 25/17mm shaft flat upper/lower suitable for PEL22		
	GEV No.	101241	Ref. No. —
	gas connection thread M20x1.5 tube ø 12/10mm for PEL gas taps vertical		
	GEV No.	101460	Ref. No. —
	O-ring ø 12.37mm D1 ø 2.62mm suitable for PEL22		
	GEV No.	101461	Ref. No. —
	screw kit suitable for PEL22 Qty 4 pcs		
accessories for	101690		
	GEV No.	100908	Ref. No. 046755 052125 0958013 0G2219 0K1348 0K5753 0KE882 0KL495 19012956 727742 727781
	union screw thread M10x1 for pipe ø 4mm Qty 1 pcs		
	GEV No.	100909	Ref. No. 003859 057821
	union screw thread M10x1 for pipe ø 6mm Qty 1 pcs		
	GEV No.	101240	Ref. No. 050053
	gas connection thread M20x1.5 tube ø 12/10mm for PEL gas taps with gasket and screws horizontal		
	GEV No.	101246	Ref. No. 052127 727782
	olive for pipe ø 4mm Qty 1 pcs		
	GEV No.	101248	Ref. No. 004374 027478 050682 058370 0957007 0G2222 0K4315 214051400 727855
	olive for pipe ø 12mm Qty 1 pcs suitable for PEL		

accessories for	101690		
	GEV No.	101249	Ref. No. 052128
	olive for pipe ø 10mm Qty 1 pcs		
	GEV No.	101250	Ref. No. —
	union nut thread M20x1.5 for pipe ø 10mm		
	GEV No.	101251	Ref. No. —
	union nut thread M20x1.5 for pipe ø 12mm		
	GEV No.	101286	Ref. No. 020992 053666
	olive ID ø 6mm Qty 1 pcs		
	GEV No.	110080	Ref. No. —
	knob ø 70mm shaft ø 10x8mm shaft flat universal		
	GEV No.	112206	Ref. No. —
	knob dial plate silver gas tap PEL21/22/23 t.max. °C ED ø 63mm ID ø 45.5mm		

			
1			
GEV No.	106169	Ref. No.	OG0113 19012965 792008
description	gas tap PEL type 22N/V gas inlet M20x1.5 (tube ø 12mm) bypass nozzle ø 0.35mm gas outlet M20x1.5 (tube ø 12/10mm) thermo-couple connection pilot connection M10x1 shaft ø 6x4.6mm shaft L 45/20mm shaft flat left		
spare parts for	106169		
	GEV No.	100259	Ref. No. —
	bypass nozzle type PEL22 bore ø 0.35mm thread M6x0.5		
	GEV No.	101213	Ref. No. 0K5371
	gas tap front part shaft ø 6x4.6mm shaft L 45/20mm shaft flat right/left suitable for PEL22		
	GEV No.	101241	Ref. No. —
	gas connection thread M20x1.5 tube ø 12/10mm for PEL gas taps vertical		
	GEV No.	101460	Ref. No. —
	O-ring ø 12.37mm D1 ø 2.62mm suitable for PEL22		
	GEV No.	101461	Ref. No. —
	screw kit suitable for PEL22 Qty 4 pcs		
accessories for	106169		
	GEV No.	100908	Ref. No. 046755 052125 0958013 0G2219 0K1348 0K5753 0KE882 0KL495 19012956 727742 727781
	union screw thread M10x1 for pipe ø 4mm Qty 1 pcs		

Table continues overleaf

accessories for		106169		
	GEV No.	100909	Ref. No.	003859 057821
union screw thread M10x1 for pipe ø 6mm Qty 1 pcs				
	GEV No.	101246	Ref. No.	052127 727782
olive for pipe ø 4mm Qty 1 pcs				
	GEV No.	101248	Ref. No.	004374 027478 050682 058370 0957007 0G2222 0K4315 214051400 727855
olive for pipe ø 12mm Qty 1 pcs suitable for PEL				
	GEV No.	101249	Ref. No.	052128
olive for pipe ø 10mm Qty 1 pcs				
	GEV No.	101250	Ref. No.	—
union nut thread M20x1.5 for pipe ø 10mm				
	GEV No.	101251	Ref. No.	—
union nut thread M20x1.5 for pipe ø 12mm				
	GEV No.	101286	Ref. No.	020992 053666
olive ID ø 6mm Qty 1 pcs				

22S/O series





































1				0G0111 0K5756 0T4339 19012950 19012962 791921
GEV No.	106022	Ref. No.		
description	gas tap PEL type 22S/O gas inlet M20x1.5 (tube ø 12mm) bypass nozzle ø 0.35mm gas outlet M20x1.5 (tube ø 12/10mm) thermocouple connection M8x1 pilot connection M10x1 shaft ø 6x4.6mm shaft L 45/20mm shaft flat left			
For models:	CG148-001.A1AB, CG148-003.A2AB, CG248-201.A1ABBB, CG248-203.A1ABBB, CK248-209.D1ABBB, CK248-211.D1ABBB, LG159-703.A1BC, LG159-703.A2BC, LG159-704.A1BC, LG159-706.A1BC, LG259-711.A1ACC, LG259-712.A1ACC, LK259-707.D1ACC, LK259-708.D1ACC, LG259-739.A1ACC, LG259-740.A1ACC, CK248-205.D1ABBB, CK248-207.D1ABBB, LK159-707.D1BC, LK159-708.D1BC, LK259-727.D1ACC, LK259-728.D1ACC, LG159-704.A2BC, LK159-707.D2BC, LK159-708.D2BC, LG259-711.A2ACC, LG259-712.A2ACC, LK259-727.D2ACC, LK259-728.D2ACC, LK259-707.D2ACC, LK259-708.D2ACC, CK248-205.D2ABBB, CK248-207.D2ABBB, CK248-209.D2ABBB, CK248-211.D2ABBB, CG148-004.A1AB, CG148-005.A1AB, CG148-006.A1AB, CG248-240.A1ABBB, CG248-243.A1ABBB, CG248-244.A1ABBB, CG248-212.A1ABBB, CG248-213.A1ABBB, LG159-705.A1BC, LG159-753.A1BC, LG259-758.A1ACC, LG259-754.A1ACC, LG259-757.A1ACC, CG148-001.A3AB, CG148-003.A2AB...(Other models you can see in the webshop)			
spare parts for	106022			
	GEV No.	101058	Ref. No.	02B04 02E03 056594 0884 0H9943 0K0660 0K5349 0M0791 101058 19002904
magnet unit L 39mm D1 ø 15.4mm D2 ø 13.5mm suitable for PEL22/EGA24197 standard				
	GEV No.	101213	Ref. No.	0K5371
gas tap front part shaft ø 6x4.6mm shaft L 45/20mm shaft flat right/left suitable for PEL22				
	GEV No.	101230	Ref. No.	—
thermocouple nut T1: M8x1 T2: M18x1 aluminium				
	GEV No.	101240	Ref. No.	050053
gas connection thread M20x1.5 tube ø 12/10mm for PEL gas taps with gasket and screws horizontal				
	GEV No.	101460	Ref. No.	—
O-ring ø 12.37mm D1 ø 2.62mm suitable for PEL22				
	GEV No.	101461	Ref. No.	—
screw kit suitable for PEL22 Qty 4 pcs				
accessories for	106022			
	GEV No.	100908	Ref. No.	046755 052125 0958013 0G2219 0K1348 0K5753 0KE882 0KL495 19012956 727742 727781
union screw thread M10x1 for pipe ø 4mm Qty 1 pcs				

Table continues overleaf

















accessories for		106022	
	GEV No.	100909	Ref. No. 003859 057821
union screw thread M10x1 for pipe ø 6mm Qty 1 pcs			
	GEV No.	101241	Ref. No. —
gas connection thread M20x1.5 tube ø 12/10mm for PEL gas taps vertical			
	GEV No.	101246	Ref. No. 052127 727782
olive for pipe ø 4mm Qty 1 pcs			
	GEV No.	101248	Ref. No. 004374 027478 050682 058370 0957007 0G2222 0K4315 214051400 727855
olive for pipe ø 12mm Qty 1 pcs suitable for PEL			
	GEV No.	101249	Ref. No. 052128
olive for pipe ø 10mm Qty 1 pcs			
	GEV No.	101250	Ref. No. —
union nut thread M20x1.5 for pipe ø 10mm			
	GEV No.	101251	Ref. No. —
union nut thread M20x1.5 for pipe ø 12mm			
	GEV No.	101286	Ref. No. 020992 053666
olive ID ø 6mm Qty 1 pcs			

 <p>1</p>			
GEV No.	101086	Ref. No.	0A2001 0M0883 0S0595 791911 791924
description	gas tap PEL type 22S/O gas inlet M20x1.5 (tube ø 12mm) bypass nozzle ø 0.35mm gas outlet M20x1.5 (tube ø 12/10mm) thermocouple connection M9x1 pilot connection M10x1 shaft ø 10x8mm shaft L 25/17mm shaft flat lower		
For models:	ROG 640 A 1 FD, ROG 640 A 1FD + 1 FS, ROG 640 A 2 FD, ROG 640 A 2 FD + 1 FS, ROG 640 B 1 FD, ROG 640 A 1FD + 1 FS, ROG 640 B 2 FD, ROG 640 B 2 FD + 1 FS, TFV 1300, TFV 1301, TFV 1302, TFV 1303, TFV 1304, TFV 1305, TFV 1308, TFI 1401, TFI 1402, TFI 1403, TFI 1404, TFI 1407, TFI 1408, TFI 1409, TFI 1410, TPC 1500, TPC 1501, TPC 1502, TPC 1503, TPC 1504, TPC 1505, TPC 1506, TPC 1507, TPC 1508, TPC 1509, TPC 1510, TPC 1511, ROG 425 SP		
spare parts for		101086	
	GEV No.	100259	Ref. No. —
bypass nozzle type PEL22 bore ø 0.35mm thread M6x0.5			
	GEV No.	101058	Ref. No. 02B04 02E03 056594 0884 0H9943 0K0660 0K5349 0M0791 101058 19002904
magnet unit L 39mm D1 ø 15.4mm D2 ø 13.5mm suitable for PEL22/ EGA24197 standard			









spare parts for		101086	
	GEV No.	101201	Ref. No. 056597
gas tap front part shaft ø 10x8mm shaft L 25/17mm shaft flat upper/lower suitable for PEL22			
	GEV No.	101231	Ref. No. —
thermocouple nut T1: M9x1 T2: M18x1			
	GEV No.	101240	Ref. No. 0S0053
gas connection thread M20x1.5 tube ø 12/10mm for PEL gas taps with gasket and screws horizontal			
	GEV No.	101460	Ref. No. —
O-ring ø 12.37mm D1 ø 2.62mm suitable for PEL22			
	GEV No.	101461	Ref. No. —
screw kit suitable for PEL22 Qty 4 pcs			
accessories for		101086	
	GEV No.	100908	Ref. No. 046755 052125 0958013 0G2219 0K1348 0K5753 0KE882 0KL495 19012956 727742 727781
union screw thread M10x1 for pipe ø 4mm Qty 1 pcs			
	GEV No.	100909	Ref. No. 003859 057821
union screw thread M10x1 for pipe ø 6mm Qty 1 pcs			
	GEV No.	101241	Ref. No. —
gas connection thread M20x1.5 tube ø 12/10mm for PEL gas taps vertical			
	GEV No.	101246	Ref. No. 052127 727782
olive for pipe ø 4mm Qty 1 pcs			
	GEV No.	101248	Ref. No. 004374 027478 050682 058370 0957007 0G2222 0K4315 214051400 727855
olive for pipe ø 12mm Qty 1 pcs suitable for PEL			
	GEV No.	101249	Ref. No. 052128
olive for pipe ø 10mm Qty 1 pcs			
	GEV No.	101250	Ref. No. —
union nut thread M20x1.5 for pipe ø 10mm			
	GEV No.	101251	Ref. No. —
union nut thread M20x1.5 for pipe ø 12mm			
	GEV No.	101286	Ref. No. 020992 053666
olive ID ø 6mm Qty 1 pcs			
	GEV No.	110080	Ref. No. —
knob ø 70mm shaft ø 10x8mm shaft flat universal			
	GEV No.	112206	Ref. No. —
knob dial plate silver gas tap PEL21/22/23 t.max.°C ED ø 63mm ID ø 45.5mm			



			
1			
GEV No.	106023	Ref. No.	002574 0K5619 19011196 791957
description	gas tap PEL type 22S/O gas inlet M20x1.5 (tube \varnothing 12mm) bypass nozzle \varnothing 0mm gas outlet M20x1.5 (tube \varnothing 12/10mm) thermocouple connection M8x1 pilot connection M10x1 shaft \varnothing 6x4.6mm shaft L 29/19.5mm shaft flat lower		
For models:	CG148-001.A1AB, CG148-003.A2AB, CG248-201.A1ABBB, CG248-203.A1ABBB, CK248-209.D1ABBB, CK248-211.D1ABBB, LG159-703.A1BC, LG159-703.A2BC, LG159-704.A1BC, LG159-706.A1BC, LG259-711.A1ACCB, LG259-712.A1ACCB, LK259-707.D1ACCB, LK259-708.D1ACCB, LG259-739.A1ACCB, LG259-740.A1ACCB, CK248-205.D1ABBB, CK248-207.D1ABBB, LK159-707.D1BC, LK159-708.D1BC, LK259-727.D1ACCB, LK259-728.D1ACCB, LG159-704.A2BC, LK159-707.D2BC, LK159-708.D2BC, LG259-711.A2ACCB, LG259-712.A2ACCB, LK259-727.D2ACCB, LK259-728.D2ACCB, LK259-707.D2ACCB, LK259-708.D2ACCB, CK248-205.D2ABBB, CK248-207.D2ABBB, CK248-209.D2ABBB, CK248-211.D2ABBB, CG148-004.A1AB, CG148-005.A1AB, CG148-006.A1AB, CG248-240.A1ABBB, CG248-243.A1ABBB, CG248-244.A1ABBB, CG248-212.A1ABBB, CG248-213.A1ABBB, LG159-705.A1BC, LG159-753.A1BC, LG259-758.A1ACCB, LG259-754.A1ACCB, LG259-757.A1ACCB, CG148-001.A3AB, CG148-003.A2AB...(Other models you can see in the webshop)		
spare parts for	106023		
	GEV No.	101058	Ref. No. 02B04 02E03 056594 0884 0H9943 0K0660 0K5349 0M0791 101058 19002904
	magnet unit L 39mm D1 \varnothing 15.4mm D2 \varnothing 13.5mm suitable for PEL22/EGA24197 standard		
	GEV No.	101230	Ref. No. —
	thermocouple nut T1: M8x1 T2: M18x1 aluminium		
	GEV No.	101240	Ref. No. 0S0053
	gas connection thread M20x1.5 tube \varnothing 12/10mm for PEL gas taps with gasket and screws horizontal		
	GEV No.	101460	Ref. No. —
	O-ring \varnothing 12.37mm D1 \varnothing 2.62mm suitable for PEL22		
	GEV No.	101461	Ref. No. —
	screw kit suitable for PEL22 Qty 4 pcs		
	GEV No.	106154	Ref. No. —
	gas tap front part shaft \varnothing 6x4.6mm shaft L 29/19.5mm shaft flat upper/lower suitable for PEL22		
accessories for	106023		
	GEV No.	100908	Ref. No. 046755 052125 0958013 0G2219 0K1348 0K5753 0KE882 0KL495 19012956 727742 727781
	union screw thread M10x1 for pipe \varnothing 4mm Qty 1 pcs		

accessories for	106023		
	GEV No.	100909	Ref. No. 003859 057821
	union screw thread M10x1 for pipe \varnothing 6mm Qty 1 pcs		
	GEV No.	101246	Ref. No. 052127 727782
	olive for pipe \varnothing 4mm Qty 1 pcs		
	GEV No.	101248	Ref. No. 004374 027478 050682 058370 0957007 0G2222 0K4315 214051400 727855
	olive for pipe \varnothing 12mm Qty 1 pcs suitable for PEL		
	GEV No.	101249	Ref. No. 052128
	olive for pipe \varnothing 10mm Qty 1 pcs		
	GEV No.	101250	Ref. No. —
	union nut thread M20x1.5 for pipe \varnothing 10mm		
	GEV No.	101251	Ref. No. —
	union nut thread M20x1.5 for pipe \varnothing 12mm		
	GEV No.	101286	Ref. No. 020992 053666
	olive ID \varnothing 6mm Qty 1 pcs		
	GEV No.	110080	Ref. No. —
	knob \varnothing 70mm shaft \varnothing 10x8mm shaft flat universal		
	GEV No.	112206	Ref. No. —
	knob dial plate silver gas tap PEL21/22/23 t.max. $^{\circ}$ C ED \varnothing 63mm ID \varnothing 45.5mm		



22S/V series			
			
1			
GEV No.	101084	Ref. No.	0G0112 0G0272 OK5757 OK5758
description	gas tap PEL type 22S/V gas inlet M20x1.5 (tube ø 12mm) bypass nozzle ø 0.35mm gas outlet M20x1.5 (tube ø 12/10mm) thermocouple connection M8x1 pilot connection M10x1 shaft ø 6x4.6mm shaft L 45/20mm shaft flat left		
For models:	CG148-001.A1AB, CG148-003.A2AB, CG248-201.A1ABBB, CG248-203.A1ABBB, CK248-209.D1ABBB, CK248-211.D1ABBB, LG159-703.A1BC, LG159-703.A2BC, LG159-704.A1BC, LG159-706.A1BC, LG259-711.A1ACCB, LG259-712.A1ACCB, LK259-707.D1ACCB, LK259-708.D1ACCB, LG259-739.A1ACCB, LG259-740.A1ACCB, CK248-205.D1ABBB, CK248-207.D1ABBB, LK159-707.D1BC, LK159-708.D1BC, LK259-727.D1ACCB, LK259-728.D1ACCB, LG159-704.A2BC, LK159-707.D2BC, LK159-708.D2BC, LG259-711.A2ACCB, LG259-712.A2ACCB, LK259-727.D2ACCB, LK259-728.D2ACCB, LK259-707.D2ACCB, LK259-708.D2ACCB, CK248-205.D2ABBB, CK248-207.D2ABBB, CK248-209.D2ABBB, CK248-211.D2ABBB, CG148-004.A1AB, CG148-005.A1AB, CG148-006.A1AB, CG248-240.A1ABBB, CG248-243.A1ABBB, CG248-244.A1ABBB, CG248-212.A1ABBB, CG248-213.A1ABBB, LG159-705.A1BC, LG159-753.A1BC, LG259-758.A1ACCB, LG259-754.A1ACCB, LG259-757.A1ACCB, CG148-001.A3AB, CG148-003.A2AB...(Other models you can see in the webshop)		
spare parts for	101084		
	GEV No.	100259	Ref. No. —
	bypass nozzle type PEL22 bore ø 0.35mm thread M6x0.5		
	GEV No.	101058	Ref. No.
			02B04 02E03 056594 0884 0H9943 0K0660 0K5349 0M0791 101058 19002904
	magnet unit L 39mm D1 ø 15.4mm D2 ø 13.5mm suitable for PEL22/EGA24197 standard		
	GEV No.	101213	Ref. No. 0K5371
	gas tap front part shaft ø 6x4.6mm shaft L 45/20mm shaft flat right/left suitable for PEL22		
	GEV No.	101230	Ref. No. —
	thermocouple nut T1: M8x1 T2: M18x1 aluminium		
	GEV No.	101241	Ref. No. —
	gas connection thread M20x1.5 tube ø 12/10mm for PEL gas taps vertical		
	GEV No.	101460	Ref. No. —
	O-ring ø 12.37mm D1 ø 2.62mm suitable for PEL22		
	GEV No.	101461	Ref. No. —
	screw kit suitable for PEL22 Qty 4 pcs		



















accessories for 101084			
	GEV No.	100908	Ref. No.
			046755 052125 0958013 0G2219 OK1348 OK5753 0KE882 OKL495 19012956 727742 727781
	union screw thread M10x1 for pipe ø 4mm Qty 1 pcs		
	GEV No.	100909	Ref. No. 003859 057821
	union screw thread M10x1 for pipe ø 6mm Qty 1 pcs		
	GEV No.	101201	Ref. No. 056597
	gas tap front part shaft ø 10x8mm shaft L 25/17mm shaft flat upper/lower suitable for PEL22		
	GEV No.	101202	Ref. No. —
	gas tap front part shaft ø 8x10mm shaft L 25/17mm shaft flat right/left suitable for PEL22		
	GEV No.	101203	Ref. No. —
	gas tap front part shaft ø 9x10mm shaft L 28/13mm shaft flat upper/lower suitable for PEL22		
	GEV No.	101213	Ref. No. 0K5371
	gas tap front part shaft ø 6x4.6mm shaft L 45/20mm shaft flat right/left suitable for PEL22		
	GEV No.	101231	Ref. No. —
	thermocouple nut T1: M9x1 T2: M18x1		
	GEV No.	101240	Ref. No. 0S0053
	gas connection thread M20x1.5 tube ø 12/10mm for PEL gas taps with gasket and screws horizontal		
	GEV No.	101246	Ref. No. 052127 727782
	olive for pipe ø 4mm Qty 1 pcs		
	GEV No.	101248	Ref. No.
			004374 027478 050682 058370 0957007 0G2222 0K4315 214051400 727855
	olive for pipe ø 12mm Qty 1 pcs suitable for PEL		
	GEV No.	101249	Ref. No. 052128
	olive for pipe ø 10mm Qty 1 pcs		
	GEV No.	101250	Ref. No. —
	union nut thread M20x1.5 for pipe ø 10mm		
	GEV No.	101251	Ref. No. —
	union nut thread M20x1.5 for pipe ø 12mm		
	GEV No.	101286	Ref. No. 020992 053666
	olive ID ø 6mm Qty 1 pcs		
	GEV No.	101290	Ref. No. —
	thermocouple nut T1: M10x1 T2: M18x1 suitable for PEL20/21		
	GEV No.	101449	Ref. No. —
	gas tap front part shaft ø 8x10mm shaft L 35/17mm shaft flat upper/lower suitable for PEL22		

Table continues overleaf

accessories for 101084				
	GEV No.	110078	Ref. No.	—
knob without symbol ø 70mm shaft ø 6x4.6mm shaft flat universal				
	GEV No.	112206	Ref. No.	—
knob dial plate silver gas tap PEL21/22/23 t.max.°C ED ø 63mm ID ø 45.5mm				



GEV No.	101087	Ref. No.	052146 052432 053192 053449 0G2251 0HB063 0K1347 0K2908 3352409 335240901 791804
----------------	--------	-----------------	--

description gas tap PEL type 22S/V gas inlet M20x1.5 (tube ø 12mm) bypass nozzle ø 0.35mm gas outlet M20x1.5 (tube ø 12/10mm) thermocouple connection M9x1 pilot connection M10x1 shaft ø 10x8mm shaft L 25/17mm shaft flat upper

For models: MR/G351, MR/G701, MR/G350, MR/G360, MR/G360F, MR/G700, MR/G710, MR/G715, MR/G361, MR/G711, MR/G716, MT/G700D, MTF/G700D, MTF/G1050D, MT/G700, MTF/G700, MTF/G1050, MTF/GE1050, MT/G700F, MTF/G700F, MTF/G1055F, MTFGE1055F, MT/G350, MT/G352, MCP/G700, MCP/G701, MCP/G710, MCP/G711, MCP/G705, MCP/G706, MG/G350D, MG/G700D, MG/G350, MG/G350E, MG/G350F, MG/G700, MG/G700E, MG/G700F, MG/G1050, MG/G1050F, MG/G1051, RPD/G240, RPD/G260, RPI/G260, RCP/G15, RCP/G2D, XPD/G240, XPD/G260, XPI/G260, XCP/G15...(Other models you can see in the webshop)

spare parts for 101087				
-------------------------------	--	--	--	--

	GEV No.	100259	Ref. No.	—
bypass nozzle type PEL22 bore ø 0.35mm thread M6x0.5				

	GEV No.	101058	Ref. No.	02B04 02E03 056594 0884 0H9943 0K0660 0K5349 0M0791 101058 19002904
magnet unit L 39mm D1 ø 15.4mm D2 ø 13.5mm suitable for PEL22/EGA24197 standard				

	GEV No.	101201	Ref. No.	056597
gas tap front part shaft ø 10x8mm shaft L 25/17mm shaft flat upper/lower suitable for PEL22				

	GEV No.	101231	Ref. No.	—
thermocouple nut T1: M9x1 T2: M18x1				

	GEV No.	101241	Ref. No.	—
gas connection thread M20x1.5 tube ø 12/10mm for PEL gas taps vertical				

	GEV No.	101460	Ref. No.	—
O-ring ø 12.37mm D1 ø 2.62mm suitable for PEL22				

spare parts for 101087				
	GEV No.	101461	Ref. No.	—
screw kit suitable for PEL22 Qty 4 pcs				

accessories for 101087				
	GEV No.	100908	Ref. No.	046755 052125 0958013 0G2219 0K1348 0K5753 0KE882 0KL495 19012956 727742 727781
union screw thread M10x1 for pipe ø 4mm Qty 1 pcs				

	GEV No.	100909	Ref. No.	003859 057821
union screw thread M10x1 for pipe ø 6mm Qty 1 pcs				

	GEV No.	101240	Ref. No.	050053
gas connection thread M20x1.5 tube ø 12/10mm for PEL gas taps with gasket and screws horizontal				

	GEV No.	101246	Ref. No.	052127 727782
olive for pipe ø 4mm Qty 1 pcs				

	GEV No.	101248	Ref. No.	004374 027478 050682 058370 0957007 0G2222 0K4315 214051400 727855
olive for pipe ø 12mm Qty 1 pcs suitable for PEL				

	GEV No.	101249	Ref. No.	052128
olive for pipe ø 10mm Qty 1 pcs				

	GEV No.	101250	Ref. No.	—
union nut thread M20x1.5 for pipe ø 10mm				







	GEV No.	101251	Ref. No.	—
union nut thread M20x1.5 for pipe ø 12mm				

	GEV No.	101286	Ref. No.	020992 053666
olive ID ø 6mm Qty 1 pcs				

	GEV No.	110080	Ref. No.	—
knob ø 70mm shaft ø 10x8mm shaft flat universal				

	GEV No.	112206	Ref. No.	—
knob dial plate silver gas tap PEL21/22/23 t.max.°C ED ø 63mm ID ø 45.5mm				



 <p>1</p>			
GEV No.	101981	Ref. No.	0C0489
description	gas tap PEL type 22S/V gas inlet M20x1.5 (tube ø 12mm) bypass nozzle ø 0mm gas outlet M20x1.5 (tube ø 12/10mm) thermocouple connection M9x1 pilot connection M10x1 shaft ø 10x8mm shaft L 34/26mm shaft flat upper		
For models:	KGR/G1, KGR/G2, KGR/T1, KGR/T2, QGR/G1, QGR/G2, QGR/T1, QGR/T2, WGR/G1, WGR/G2		
spare parts for	101981		
	GEV No.	101058	Ref. No. 02B04 02E03 056594 0884 0H9943 0K0660 0K5349 0M0791 101058 19002904
magnet unit L 39mm D1 ø 15.4mm D2 ø 13.5mm suitable for PEL22/EGA24197 standard			
	GEV No.	101231	Ref. No. —
thermocouple nut T1: M9x1 T2: M18x1			
	GEV No.	101241	Ref. No. —
gas connection thread M20x1.5 tube ø 12/10mm for PEL gas taps vertical			
	GEV No.	101449	Ref. No. —
gas tap front part shaft ø 8x10mm shaft L 35/17mm shaft flat upper/lower suitable for PEL22			
	GEV No.	101460	Ref. No. —
O-ring ø 12.37mm D1 ø 2.62mm suitable for PEL22			
	GEV No.	101461	Ref. No. —
screw kit suitable for PEL22 Qty 4 pcs			
accessories for	101981		
	GEV No.	100908	Ref. No. 046755 052125 0958013 0G2219 0K1348 0K5753 0KE882 0KL495 19012956 727742 727781
union screw thread M10x1 for pipe ø 4mm Qty 1 pcs			
	GEV No.	100909	Ref. No. 003859 057821
union screw thread M10x1 for pipe ø 6mm Qty 1 pcs			
	GEV No.	101246	Ref. No. 052127 727782
olive for pipe ø 4mm Qty 1 pcs			
	GEV No.	101248	Ref. No. 004374 027478 050682 058370 0957007 0G2222 0K4315 214051400 727855
olive for pipe ø 12mm Qty 1 pcs suitable for PEL			

accessories for	101981		
	GEV No.	101249	Ref. No. 052128
olive for pipe ø 10mm Qty 1 pcs			
	GEV No.	101250	Ref. No. —
union nut thread M20x1.5 for pipe ø 10mm			
	GEV No.	101251	Ref. No. —
union nut thread M20x1.5 for pipe ø 12mm			
	GEV No.	101286	Ref. No. 020992 053666
olive ID ø 6mm Qty 1 pcs			
	GEV No.	110080	Ref. No. —
knob ø 70mm shaft ø 10x8mm shaft flat universal			
	GEV No.	112206	Ref. No. —
knob dial plate silver gas tap PEL21/22/23 t.max. °C ED ø 63mm ID ø 45.5mm			

23S/O series

 <p>1</p>			
GEV No.	101092	Ref. No.	0A2146 796909
description	gas tap PEL type 23S/O gas inlet M28x1.5 (tube ø 20mm) bypass nozzle ø 0.35mm gas outlet M24x1.5 (tube ø 16mm) thermocouple connection M10x1 pilot connection M10x1 shaft ø 10x8mm shaft L 25/17mm shaft flat upper		
spare parts for	101092		
	GEV No.	100455	Ref. No. —
bypass nozzle type PEL23/24 bore ø 0.35mm thread M8x0.5			
	GEV No.	101059	Ref. No. 0C1521
magnet unit T1: M10x1 T2: M22x1 L 46mm ø 18mm suitable for PEL23S M10x1			
	GEV No.	101204	Ref. No. —
gas tap front part shaft ø 10x8mm shaft L 25/17mm shaft flat upper/lower suitable for PEL23S			
	GEV No.	101244	Ref. No. —
gas connection thread M24x1.5 tube ø 12/16mm horizontal for PEL gas taps			
	GEV No.	101463	Ref. No. —
screw suitable for PEL23S Qty 4 pcs			
	GEV No.	528455	Ref. No. —
O-ring Viton thickness 2.62mm ID ø 18.72mm Qty 1 pcs			

Table continues overleaf

accessories for		101092	
	GEV No.	100908	Ref. No.
			046755 052125 0958013 0G2219 0K1348 0K5753 0KE882 0KL495 19012956 727742 727781
	union screw thread M10x1 for pipe ø 4mm Qty 1 pcs		
	GEV No.	100909	Ref. No.
			003859 057821
	union screw thread M10x1 for pipe ø 6mm Qty 1 pcs		
	GEV No.	101246	Ref. No.
			052127 727782
	olive for pipe ø 4mm Qty 1 pcs		
	GEV No.	101252	Ref. No.
			—
	union nut thread M24x1.5 for pipe ø 12mm		
	GEV No.	101253	Ref. No.
			054816
	union nut thread M24x1.5 PEL for pipe ø 16mm		
	GEV No.	101254	Ref. No.
			054814 09074
	union nut thread M28x1.5 tube ø 20mm		
	GEV No.	101255	Ref. No.
			—
	olive for pipe ø 12mm Qty 1 pcs		
	GEV No.	101256	Ref. No.
			052671 054817 059063 0960 0A2399
	olive for pipe ø 16mm Qty 1 pcs		
	GEV No.	101257	Ref. No.
			052007 054815
	olive for pipe ø 20mm Qty 1 pcs		
	GEV No.	101286	Ref. No.
			020992 053666
	olive ID ø 6mm Qty 1 pcs		
	GEV No.	110080	Ref. No.
			—
	knob ø 70mm shaft ø 10x8mm shaft flat universal		
	GEV No.	112206	Ref. No.
			—
	knob dial plate silver gas tap PEL21/22/23 t.max.°C ED ø 63mm ID ø 45.5mm		







			
1			
GEV No.	101091	Ref. No.	02R06 02R59 054811 059505 0K2949 0K3448 0M0884 10038 796904
description	gas tap PEL type 23S/O gas inlet M28x1.5 (tube ø 20mm) bypass nozzle ø 0.35mm gas outlet M24x1.5 (tube ø 16mm) thermocouple connection M9x1 pilot connection M10x1 shaft ø 10x8mm shaft L 35/19mm shaft flat upper		
For models:	MPN/GD761, MPN/GI761, MPN/GI760D, MPN/GD760, MPN/GD760F, MPN/GI760, MPN/GI760F, 7PDG06, 7PIG06, RPN/GD760F, RPN/GI760F, XPN/GI760D, M70GDKE, M70GIKE, XPN/GD760F, XPN/GI760F, RPN/G760, RPN/G760, PRPN/G760, RPN/GI760, RPN/GI760, RPN/GI760, PRPN/GI76, KPI/G18, KPI/G25, HPN/GI810, HPN/GI815, HPN/GI815D, HPN/GI816, HPN/GI816, HPN/GD811, HPN/GD816, HPA/GD825, HPA/GI825, HPN/GI855, HPN/GI1255, HPN/EI855, HPN/EI1255, HPNS/GI816, HPN/GI806, HPN/GI805, QPI/G18, QPI/G25, ZPN/GI810, 2PIG15, ZPN/GI816, ZPN/GI816D, ZPN/GD811, ZPN/GD816, 2PDAG15...(Other models you can see in the webshop)		
spare parts for	101091		
	GEV No.	100455	Ref. No.
			—
	bypass nozzle type PEL23/24 bore ø 0.35mm thread M8x0.5		
	GEV No.	101045	Ref. No.
			056596 09581
	magnet unit T1: M9x1 T2: M22x1 L 46mm ø 18mm suitable for PEL23S M9x1		
	GEV No.	101244	Ref. No.
			—
	gas connection thread M24x1.5 tube ø 12/16mm horizontal for PEL gas taps		
	GEV No.	101336	Ref. No.
			059853
	gas tap front part shaft ø 10x8mm shaft L 35/17mm shaft flat upper/lower suitable for PEL23S		
	GEV No.	101463	Ref. No.
			—
	screw suitable for PEL23S Qty 4 pcs		
accessories for		101091	
	GEV No.	100908	Ref. No.
			046755 052125 0958013 0G2219 0K1348 0K5753 0KE882 0KL495 19012956 727742 727781
	union screw thread M10x1 for pipe ø 4mm Qty 1 pcs		
	GEV No.	100909	Ref. No.
			003859 057821
	union screw thread M10x1 for pipe ø 6mm Qty 1 pcs		
	GEV No.	101246	Ref. No.
			052127 727782
	olive for pipe ø 4mm Qty 1 pcs		
	GEV No.	101252	Ref. No.
			—
	union nut thread M24x1.5 for pipe ø 12mm		

Table continues overleaf



accessories for		101091	
	GEV No.	101253	Ref. No. 054816
union nut thread M24x1.5 PEL for pipe ø 16mm			
	GEV No.	101254	Ref. No. 054814 09074
union nut thread M28x1.5 tube ø 20mm			
	GEV No.	101255	Ref. No. —
olive for pipe ø 12mm Qty 1 pcs			
	GEV No.	101256	Ref. No. 052671 054817 059063 0960 0A2399
olive for pipe ø 16mm Qty 1 pcs			
	GEV No.	101257	Ref. No. 052007 054815
olive for pipe ø 20mm Qty 1 pcs			
	GEV No.	101286	Ref. No. 020992 053666
olive ID ø 6mm Qty 1 pcs			
	GEV No.	110080	Ref. No. —
knob ø 70mm shaft ø 10x8mm shaft flat universal			
	GEV No.	112206	Ref. No. —
knob dial plate silver gas tap PEL21/22/23 t.max.°C ED ø 63mm ID ø 45.5mm			

accessories for		101630	
	GEV No.	100908	Ref. No. 046755 052125 0958013 0G2219 0K1348 0K5753 0KE882 0KL495 19012956 727742 727781
union screw thread M10x1 for pipe ø 4mm Qty 1 pcs			
	GEV No.	100909	Ref. No. 003859 057821
union screw thread M10x1 for pipe ø 6mm Qty 1 pcs			
	GEV No.	100945	Ref. No. —
roll pin ø 3.2mm L 10mm			
	GEV No.	101218	Ref. No. —
shaft extension JUNKERS			
	GEV No.	101219	Ref. No. —
shaft extension L 25mm JUNKERS			
	GEV No.	101246	Ref. No. 052127 727782
olive for pipe ø 4mm Qty 1 pcs			
	GEV No.	101286	Ref. No. 020992 053666
olive ID ø 6mm Qty 1 pcs			
	GEV No.	110064	Ref. No. —
knob			
	GEV No.	110066	Ref. No. —
knob screw			
	GEV No.	550396	Ref. No. —
shaft extension L 25mm JUNKERS			

23S/V series

			
GEV No.	101630	Ref. No.	02R61 OK1387 OK9985 OKB943 101097 101630 7741330001
description	gas tap PEL type 23S/V gas inlet 1/2" IT bypass nozzle ø 0.35mm gas outlet 1/2" MT (tube ø 14mm) thermocouple connection M10x1 pilot connection M10x1 shaft ø 10mm shaft L 25mm shaft flat		
spare parts for	101630		
	GEV No.	100455	Ref. No. —
bypass nozzle type PEL23/24 bore ø 0.35mm thread M8x0.5			
	GEV No.	101059	Ref. No. 0C1521
magnet unit T1: M10x1 T2: M22x1 L 46mm ø 18mm suitable for PEL23S M10x1			
	GEV No.	102767	Ref. No. —
gas tap front part shaft ø 10mm shaft L 26.5mm shaft flat suitable for PEL23S			

alternatives to EGA

GPEL20 series

with pipe outlet

























			
GEV No.	101608	Ref. No.	0H6258 0H6259 0H6700 0K0216
description	gas tap alternatives to EGA type GPEL20R with pipe outlet without ignition flame connection gas inlet M15x1 (tube ø 10mm) bypass nozzle ø 0.35mm gas outlet M17x1 (tube ø 10mm) thermocouple connection M8x1 shaft ø 8x7mm shaft L 34/15mm shaft flat lower		
spare parts for	101608		
	GEV No.	100408	Ref. No. —
bypass nozzle type PEL20/21 bore ø 0.35mm thread M5x0.5			

Table continues overleaf





spare parts for 101608				
	GEV No.	101060	Ref. No.	056595 0982 0H6238
magnet unit standard L 39mm D1 ø 15.4mm D2 ø 11mm suitable for PEL20-21/JUNKERS/EGA				
	GEV No.	101230	Ref. No.	—
thermocouple nut T1: M8x1 T2: M18x1 aluminium				
accessories for 101608				
	GEV No.	100926	Ref. No.	—
centring piece thread M17x1				
	GEV No.	100942	Ref. No.	—
union nut thread M15x1 for pipe ø 10mm				
	GEV No.	100943	Ref. No.	OKL494 100943 17012734
union nut thread M17x1 tube ø 10mm				
	GEV No.	101278	Ref. No.	060325 0C0150 0G0794 0G1111 0G2610 0K1976 0KW924 0T1946 101278 17012732 17012758 19012727
olive for pipe ø 10mm Qty 1 pcs				

GPEL21 series				
with nozzle outlet				
				
1				
GEV No.	101983	Ref. No.	0H6397 101983 12215	
description	gas tap alternatives to EGA type GPEL21D with nozzle outlet (with nozzle) gas inlet M15x1 (tube ø 10mm) external nozzle ø 1.35mm internal nozzle ø 0.66mm bypass nozzle ø 0.35mm mixing pipe connection M17x1 thermocouple connection M10x1 pilot connection M10x1 shaft ø 8x7mm shaft L 34/15mm shaft flat lower			
For models:	5614-3-10, 5614-3-6, 5614-3-8			
spare parts for 101983				
	GEV No.	100300	Ref. No.	0G1792 100300
gas injector thread M12x1 WS 14 bore ø 1.35mm				
	GEV No.	100310	Ref. No.	0H6356 100310
internal nozzle bore ø 0.66mm suitable for EGA26400/26440				
	GEV No.	100408	Ref. No.	—
bypass nozzle type PEL20/21 bore ø 0.35mm thread M5x0.5				

spare parts for 101983				
	GEV No.	100908	Ref. No.	046755 052125 0958013 0G2219 0K1348 0K5753 0KE882 0KL495 19012956 727742 727781
union screw thread M10x1 for pipe ø 4mm Qty 1 pcs				
	GEV No.	100927	Ref. No.	—
torsion spring L 2.8-8.0mm for internal nozzle ø 3mm bore ømm				
	GEV No.	101233	Ref. No.	OK2512
union nut thread M10x1 JUNKERS				
	GEV No.	101246	Ref. No.	052127 727782
olive for pipe ø 4mm Qty 1 pcs				
	GEV No.	101526	Ref. No.	—
O-ring Viton thickness 1.78mm ID ø 4.48mm Qty 1 pcs				
	GEV No.	101593	Ref. No.	—
adjusting screw for internal nozzle thread M8x0.75				
	GEV No.	101806	Ref. No.	—
gas tap front part shaft ø 8x7mm shaft L 34/15mm shaft flat upper/lower suitable for PEL21				
accessories for 101983				
	GEV No.	100909	Ref. No.	003859 057821
union screw thread M10x1 for pipe ø 6mm Qty 1 pcs				
	GEV No.	100926	Ref. No.	—
centring piece thread M17x1				
	GEV No.	100942	Ref. No.	—
union nut thread M15x1 for pipe ø 10mm				
	GEV No.	101278	Ref. No.	060325 0C0150 0G0794 0G1111 0G2610 0K1976 0KW924 0T1946 101278 17012732 17012758 19012727
olive for pipe ø 10mm Qty 1 pcs				
	GEV No.	101286	Ref. No.	020992 053666
olive ID ø 6mm Qty 1 pcs				



			
1			
GEV No.	101668	Ref. No.	0H6399 101668 12229 231553
description	gas tap alternatives to EGA type GPEL21D with nozzle outlet (with nozzle) gas inlet M15x1 (tube ø 10mm) external nozzle ø 1.35mm internal nozzle ø 1.2mm bypass nozzle ø 0.35mm mixing pipe connection M17x1 thermocouple connection M10x1 pilot connection M10x1 shaft ø 8x7mm shaft L 34/15mm shaft flat lower tube ø 10mm shaft length knob 15mm		
spare parts for	101668		
	GEV No.	100300	Ref. No. 0G1792 100300
	gas injector thread M12x1 WS 14 bore ø 1.35mm		
	GEV No.	100313	Ref. No. 0G1785 0K1252
	internal nozzle bore ø 1.20mm suitable for EGA26400/26440		
	GEV No.	100908	Ref. No. 046755 052125 0958013 0G2219 0K1348 0K5753 0KE882 0KL495 19012956 727742 727781
	union screw thread M10x1 for pipe ø 4mm Qty 1 pcs		
	GEV No.	100927	Ref. No. —
	torsion spring L 2.8-8.0mm for internal nozzle ø 3mm bore ømm		
	GEV No.	101060	Ref. No. 056595 0982 0H6238
	magnet unit standard L 39mm D1 ø 15.4mm D2 ø 11mm suitable for PEL20-21/JUNKERS/EGA		
	GEV No.	101233	Ref. No. 0K2512
	union nut thread M10x1 JUNKERS		
	GEV No.	101246	Ref. No. 052127 727782
	olive for pipe ø 4mm Qty 1 pcs		
	GEV No.	101526	Ref. No. —
	O-ring Viton thickness 1.78mm ID ø 4.48mm Qty 1 pcs		
	GEV No.	101593	Ref. No. —
	adjusting screw for internal nozzle thread M8x0.75		
	GEV No.	101806	Ref. No. —
	gas tap front part shaft ø 8x7mm shaft L 34/15mm shaft flat upper/lower suitable for PEL21		
accessories for	101668		
	GEV No.	100909	Ref. No. 003859 057821
	union screw thread M10x1 for pipe ø 6mm Qty 1 pcs		
	GEV No.	100926	Ref. No. —
	centring piece thread M17x1		

accessories for	101668		
	GEV No.	100942	Ref. No. —
	union nut thread M15x1 for pipe ø 10mm		
	GEV No.	101278	Ref. No. 060325 0C0150 0G0794 0G1111 0G2610 0K1976 0KW924 0T1946 101278 17012732 17012758 19012727
	olive for pipe ø 10mm Qty 1 pcs		
	GEV No.	101286	Ref. No. 020992 053666
	olive ID ø 6mm Qty 1 pcs		





















			
1			
GEV No.	101642	Ref. No.	0H6395 101642
description	gas tap alternatives to EGA type GPEL21D with nozzle outlet (with nozzle) gas inlet M15x1 (tube ø 10mm) external nozzle ø 1.55mm internal nozzle ø 0.8mm bypass nozzle ø 0.45mm mixing pipe connection M17x1 thermocouple connection M10x1 pilot connection M10x1 shaft ø 8x7mm shaft L 34/15mm shaft flat lower		
spare parts for	101642		
	GEV No.	100301	Ref. No. 0G3804 100301 72506026
	gas injector thread M12x1 WS 14 bore ø 1.55mm		
	GEV No.	100311	Ref. No. 0H6372
	internal nozzle bore ø 0.80mm suitable for EGA26400/26440		
	GEV No.	100554	Ref. No. 002900 0KX139 19013314 72779003 835835900
	bypass nozzle type PEL20/21 bore ø 0.45mm thread M5x0.5		
	GEV No.	100908	Ref. No. 046755 052125 0958013 0G2219 0K1348 0K5753 0KE882 0KL495 19012956 727742 727781
	union screw thread M10x1 for pipe ø 4mm Qty 1 pcs		
	GEV No.	100927	Ref. No. —
	torsion spring L 2.8-8.0mm for internal nozzle ø 3mm bore ømm		
	GEV No.	101060	Ref. No. 056595 0982 0H6238
	magnet unit standard L 39mm D1 ø 15.4mm D2 ø 11mm suitable for PEL20-21/JUNKERS/EGA		

Table continues overleaf

spare parts for 101642			
	GEV No.	101233	Ref. No. 0K2512
union nut thread M10x1 JUNKERS			
	GEV No.	101246	Ref. No. 052127 727782
olive for pipe ø 4mm Qty 1 pcs			
	GEV No.	101526	Ref. No. —
O-ring Viton thickness 1.78mm ID ø 4.48mm Qty 1 pcs			
	GEV No.	101593	Ref. No. —
adjusting screw for internal nozzle thread M8x0.75			
	GEV No.	101806	Ref. No. —
gas tap front part shaft ø 8x7mm shaft L 34/15mm shaft flat upper/lower suitable for PEL21			
accessories for 101642			
	GEV No.	100909	Ref. No. 003859 057821
union screw thread M10x1 for pipe ø 6mm Qty 1 pcs			
	GEV No.	100926	Ref. No. —
centring piece thread M17x1			
	GEV No.	100942	Ref. No. —
union nut thread M15x1 for pipe ø 10mm			
	GEV No.	101278	Ref. No. 060325 0C0150 0G0794 0G1111 0G2610 0K1976 0KW924 0T1946 101278 17012732 17012758 19012727
olive for pipe ø 10mm Qty 1 pcs			
	GEV No.	101286	Ref. No. 020992 053666
olive ID ø 6mm Qty 1 pcs			

			
1			
GEV No.	101767	Ref. No.	0H6400 101767
description	gas tap alternatives to EGA type GPPEL21D with nozzle outlet (with nozzle) gas inlet M15x1 (tube ø 10mm) external nozzle ø 1.55mm internal nozzle ø 1.4mm bypass nozzle ø 0.45mm mixing pipe connection M17x1 thermocouple connection M10x1 pilot connection M10x1 shaft ø 8x7mm shaft L 34/15mm shaft flat lower		
spare parts for 101767			
	GEV No.	100301	Ref. No. 0G3804 100301 72506026
gas injector thread M12x1 WS 14 bore ø 1.55mm			
	GEV No.	100322	Ref. No. 0K1254 100322
internal nozzle bore ø 1.40mm suitable for EGA26400/26440			

spare parts for 101767			
	GEV No.	100554	Ref. No. 002900 0KX139 19013314 72779003 835835900
bypass nozzle type PEL20/21 bore ø 0.45mm thread M5x0.5			

















			
1			
GEV No.	101731	Ref. No.	0H6396 101731
description	gas tap alternatives to EGA type GPPEL21D with nozzle outlet (with nozzle) gas inlet M15x1 (tube ø 10mm) external nozzle ø 2.05mm internal nozzle ø 1.05mm bypass nozzle ø 0.55mm mixing pipe connection M17x1 thermocouple connection M10x1 pilot connection M10x1 shaft ø 8x7mm shaft L 34/15mm shaft flat lower		
spare parts for 101731			
	GEV No.	100303	Ref. No. 0C3517 0G1794 100303 622582
gas injector thread M12x1 WS 14 bore ø 2.05mm			
	GEV No.	100312	Ref. No. 0H6357
internal nozzle bore ø 1.05mm suitable for EGA26400/26440			
	GEV No.	100550	Ref. No. 002911 0G0857
bypass nozzle type PEL20/21 bore ø 0.55mm thread M5x0.5			
	GEV No.	100908	Ref. No. 046755 052125 0958013 0G2219 0K1348 0K5753 0KE882 0KL495 19012956 727742 727781
union screw thread M10x1 for pipe ø 4mm Qty 1 pcs			
	GEV No.	100927	Ref. No. —
torsion spring L 2.8-8.0mm for internal nozzle ø 3mm bore ømm			
	GEV No.	101060	Ref. No. 056595 0982 0H6238
magnet unit standard L 39mm D1 ø 15.4mm D2 ø 11mm suitable for PEL20-21/JUNKERS/EGA			
	GEV No.	101233	Ref. No. 0K2512
union nut thread M10x1 JUNKERS			
	GEV No.	101246	Ref. No. 052127 727782
olive for pipe ø 4mm Qty 1 pcs			
	GEV No.	101526	Ref. No. —
O-ring Viton thickness 1.78mm ID ø 4.48mm Qty 1 pcs			
	GEV No.	101593	Ref. No. —
adjusting screw for internal nozzle thread M8x0.75			
	GEV No.	101806	Ref. No. —
gas tap front part shaft ø 8x7mm shaft L 34/15mm shaft flat upper/lower suitable for PEL21			

Table continues overleaf











accessories for		101731	
	GEV No.	100909	Ref. No. 003859 057821
union screw thread M10x1 for pipe ø 6mm Qty 1 pcs			
	GEV No.	100926	Ref. No. —
centring piece thread M17x1			
	GEV No.	100942	Ref. No. —
union nut thread M15x1 for pipe ø 10mm			
	GEV No.	101278	Ref. No. 060325 0C0150 0G0794 0G1111 0G2610 0K1976 0KW924 0T1946 101278 17012732 17012758 19012727
olive for pipe ø 10mm Qty 1 pcs			
	GEV No.	101286	Ref. No. 020992 053666
olive ID ø 6mm Qty 1 pcs			







GEV No.	101641	Ref. No.	0H6401 101641
----------------	--------	-----------------	------------------

description gas tap alternatives to EGA type GPEL21D with nozzle outlet (with nozzle) gas inlet M15x1 (tube ø 10mm) external nozzle ø 2.05mm internal nozzle ø 1.9mm bypass nozzle ø 0.55mm mixing pipe connection M17x1 thermocouple connection M10x1 pilot connection M10x1 shaft ø 7x8mm shaft L 34/15mm shaft flat lower

spare parts for		101641	
	GEV No.	100303	Ref. No. 0C3517 0G1794 100303 622582
gas injector thread M12x1 WS 14 bore ø 2.05mm			
	GEV No.	100310	Ref. No. 0H6356 100310
internal nozzle bore ø 0.66mm suitable for EGA26400/26440			
	GEV No.	100550	Ref. No. 002911 0G0857
bypass nozzle type PEL20/21 bore ø 0.55mm thread M5x0.5			
	GEV No.	100908	Ref. No. 046755 052125 0958013 0G2219 0K1348 0K5753 0KE882 0KL495 19012956 727742 727781
union screw thread M10x1 for pipe ø 4mm Qty 1 pcs			
	GEV No.	100927	Ref. No. —
torsion spring L 2.8-8.0mm for internal nozzle ø 3mm bore ømm			

spare parts for		101641	
	GEV No.	101060	Ref. No. 056595 0982 0H6238
magnet unit standard L 39mm D1 ø 15.4mm D2 ø 11mm suitable for PEL20-21/JUNKERS/EGA			
	GEV No.	101233	Ref. No. 0K2512
union nut thread M10x1 JUNKERS			
	GEV No.	101246	Ref. No. 052127 727782
olive for pipe ø 4mm Qty 1 pcs			
	GEV No.	101526	Ref. No. —
O-ring Viton thickness 1.78mm ID ø 4.48mm Qty 1 pcs			
	GEV No.	101593	Ref. No. —
adjusting screw for internal nozzle thread M8x0.75			
	GEV No.	101806	Ref. No. —
gas tap front part shaft ø 8x7mm shaft L 34/15mm shaft flat upper/lower suitable for PEL21			

accessories for		101641	
	GEV No.	100909	Ref. No. 003859 057821
union screw thread M10x1 for pipe ø 6mm Qty 1 pcs			
	GEV No.	100926	Ref. No. —
centring piece thread M17x1			
	GEV No.	100942	Ref. No. —
union nut thread M15x1 for pipe ø 10mm			
	GEV No.	101278	Ref. No. 060325 0C0150 0G0794 0G1111 0G2610 0K1976 0KW924 0T1946 101278 17012732 17012758 19012727
olive for pipe ø 10mm Qty 1 pcs			
	GEV No.	101286	Ref. No. 020992 053666
olive ID ø 6mm Qty 1 pcs			

with pipe outlet



GEV No.	101618	Ref. No.	0K1392 101628
----------------	--------	-----------------	------------------

description gas tap alternatives to EGA type GPEL21R with pipe outlet gas inlet M15x1 (tube ø 10mm) bypass nozzle ø 0.35mm gas outlet M17x1 (tube ø 10mm) thermocouple connection M10x1 pilot connection M10x1 shaft ø 8x7mm shaft L 34/15mm shaft flat lower













spare parts for		101618	
	GEV No.	100408	Ref. No. —
bypass nozzle type PEL20/21 bore ø 0.35mm thread M5x0.5			

Table continues overleaf

spare parts for 101618			
	GEV No.	101060	Ref. No. 056595 0982 0H6238
magnet unit standard L 39mm D1 ø 15.4mm D2 ø 11mm suitable for PEL20-21/JUNKERS/EGA			
	GEV No.	101290	Ref. No. —
thermocouple nut T1: M10x1 T2: M18x1 suitable for PEL20/21			
	GEV No.	101806	Ref. No. —
gas tap front part shaft ø 8x7mm shaft L 34/15mm shaft flat upper/lower suitable for PEL21			
accessories for 101618			
	GEV No.	100908	Ref. No. 046755 052125 0958013 0G2219 0K1348 0K5753 0KE882 0KL495 19012956 727742 727781
union screw thread M10x1 for pipe ø 4mm Qty 1 pcs			
	GEV No.	100909	Ref. No. 003859 057821
union screw thread M10x1 for pipe ø 6mm Qty 1 pcs			
	GEV No.	100926	Ref. No. —
centring piece thread M17x1			
	GEV No.	100942	Ref. No. —
union nut thread M15x1 for pipe ø 10mm			
	GEV No.	100943	Ref. No. 0KL494 100943 17012734
union nut thread M17x1 tube ø 10mm			
	GEV No.	101246	Ref. No. 052127 727782
olive for pipe ø 4mm Qty 1 pcs			
	GEV No.	101278	Ref. No. 060325 0C0150 0G0794 0G1111 0G2610 0K1976 0KW924 0T1946 101278 17012732 17012758 19012727
olive for pipe ø 10mm Qty 1 pcs			
	GEV No.	101286	Ref. No. 020992 053666
olive ID ø 6mm Qty 1 pcs			
	GEV No.	110227	Ref. No. 0H6718 0H6723 0H6789 0K2343 256428 256708
knob gas tap with ignition flame t.max.°C ø 77mm shaft ø 8x7mm shaft flat lower silver			











1			
GEV No.	101643	Ref. No.	0H6051 0H6052 0H6054 0H6380 0H6398 101643 200933 ARTNR12218
description	gas tap alternatives to EGA type GP21R with pipe outlet gas inlet M15x1 (tube ø 10mm) bypass nozzle ø 0.45mm gas outlet M17x1 (tube ø 10mm) thermocouple connection M10x1 pilot connection M10x1 shaft ø 8x7mm shaft L 34/15mm shaft flat lower		
For models:	7500-2, 7501-2, 7502-2, 7502-9, 7503-2, 7504-2, 7504-9, 7505-2-9, 7505-9-9, 7508-2, 7700-2, 7701-2, 7703-2, 9000-2, 9001-2, 9002-2, 9004-2, 9006-9, 9201-2, 9203-2		
spare parts for 101643			
	GEV No.	100554	Ref. No. 002900 0KX139 19013314 72779003 835835900
bypass nozzle type PEL20/21 bore ø 0.45mm thread M5x0.5			
	GEV No.	100908	Ref. No. 046755 052125 0958013 0G2219 0K1348 0K5753 0KE882 0KL495 19012956 727742 727781
union screw thread M10x1 for pipe ø 4mm Qty 1 pcs			
	GEV No.	101060	Ref. No. 056595 0982 0H6238
magnet unit standard L 39mm D1 ø 15.4mm D2 ø 11mm suitable for PEL20-21/JUNKERS/EGA			
	GEV No.	101246	Ref. No. 052127 727782
olive for pipe ø 4mm Qty 1 pcs			
	GEV No.	101290	Ref. No. —
thermocouple nut T1: M10x1 T2: M18x1 suitable for PEL20/21			
	GEV No.	101806	Ref. No. —
gas tap front part shaft ø 8x7mm shaft L 34/15mm shaft flat upper/lower suitable for PEL21			
accessories for 101643			
	GEV No.	100909	Ref. No. 003859 057821
union screw thread M10x1 for pipe ø 6mm Qty 1 pcs			
	GEV No.	100926	Ref. No. —
centring piece thread M17x1			
	GEV No.	100942	Ref. No. —
union nut thread M15x1 for pipe ø 10mm			

Table continues overleaf



accessories for 101643				060325 0C0150 0G0794 0G1111 0G2610 0K1976 0KW924 0T1946 101278 17012732 17012758 19012727
	GEV No.	101278	Ref. No.	
olive for pipe ø 10mm Qty 1 pcs				
	GEV No.	101286	Ref. No.	020992 053666
olive ID ø 6mm Qty 1 pcs				



GEV No.	101664	Ref. No.	0H6053 0K0215 101664 12275 12394
description	gas tap alternatives to EGA type GPEL21R with pipe outlet gas inlet M15x1 (tube ø 10mm) bypass nozzle ø 0.55mm gas outlet M17x1 (tube ø 10mm) thermocouple connection M10x1 pilot connection M10x1 shaft ø 8x7mm shaft L 34/15mm shaft flat lower		
For models:	7500-2, 7501-2, 7502-2, 7502-9, 7503-2, 7504-2, 7504-9, 7505-2-9, 7505-9-9, 7508-2, 7700-2, 7701-2, 7703-2, 9000-2, 9001-2, 9002-2, 9004-2, 9006-9, 9201-2, 9203-2		

spare parts for 101664				046755 052125 0958013 0G2219 0K1348 0K5753 0KE882 0KL495 19012956 727742 727781
	GEV No.	100550	Ref. No.	002911 0G0857
bypass nozzle type PEL20/21 bore ø 0.55mm thread M5x0.5				
	GEV No.	100908	Ref. No.	
union screw thread M10x1 for pipe ø 4mm Qty 1 pcs				
	GEV No.	101060	Ref. No.	056595 0982 0H6238
magnet unit standard L 39mm D1 ø 15.4mm D2 ø 11mm suitable for PEL20-21/JUNKERS/EGA				
	GEV No.	101246	Ref. No.	052127 727782
olive for pipe ø 4mm Qty 1 pcs				
	GEV No.	101290	Ref. No.	—
thermocouple nut T1: M10x1 T2: M18x1 suitable for PEL20/21				
	GEV No.	101806	Ref. No.	—
gas tap front part shaft ø 8x7mm shaft L 34/15mm shaft flat upper/lower suitable for PEL21				
accessories for 101664				003859 057821
	GEV No.	100909	Ref. No.	
union screw thread M10x1 for pipe ø 6mm Qty 1 pcs				

accessories for 101664				
	GEV No.	100942	Ref. No.	—
union nut thread M15x1 for pipe ø 10mm				
	GEV No.	100943	Ref. No.	0KL494 100943 17012734
union nut thread M17x1 tube ø 10mm				
	GEV No.	101278	Ref. No.	060325 0C0150 0G0794 0G1111 0G2610 0K1976 0KW924 0T1946 101278 17012732 17012758 19012727
olive for pipe ø 10mm Qty 1 pcs				
	GEV No.	101286	Ref. No.	020992 053666
olive ID ø 6mm Qty 1 pcs				









GEV No.	101644	Ref. No.	0K0214 0T1682 101644 200920
description	gas tap alternatives to EGA type GPEL21R with pipe outlet gas inlet M15x1 (tube ø 10mm) bypass nozzle ø 0.65mm gas outlet M17x1 (tube ø 10mm) thermocouple connection M10x1 pilot connection M10x1 shaft ø 8x7mm shaft L 34/15mm shaft flat lower		
For models:	7501-2, 7502-2, 7502-9, 7503-2, 7504-2, 7504-9, 7505-2-9, 7505-9-9, 7701-2, 7703-2, 9001-2, 9002-2, 9004-2, 9006-9		

spare parts for 101644				002991 0KX137 19013312 72779001 835818500
	GEV No.	100548	Ref. No.	
bypass nozzle type PEL20/21 bore ø 0.65mm thread M5x0.5				
	GEV No.	100908	Ref. No.	046755 052125 0958013 0G2219 0K1348 0K5753 0KE882 0KL495 19012956 727742 727781
union screw thread M10x1 for pipe ø 4mm Qty 1 pcs				
	GEV No.	101060	Ref. No.	056595 0982 0H6238
magnet unit standard L 39mm D1 ø 15.4mm D2 ø 11mm suitable for PEL20-21/JUNKERS/EGA				
	GEV No.	101246	Ref. No.	052127 727782
olive for pipe ø 4mm Qty 1 pcs				

Table continues overleaf





spare parts for 101644				
	GEV No.	101290	Ref. No.	—
	thermocouple nut T1: M10x1 T2: M18x1 suitable for PEL20/21			
	GEV No.	101806	Ref. No.	—
	gas tap front part shaft ø 8x7mm shaft L 34/15mm shaft flat upper/lower suitable for PEL21			
accessories for 101644				
	GEV No.	100909	Ref. No.	003859 057821
	union screw thread M10x1 for pipe ø 6mm Qty 1 pcs			
	GEV No.	100926	Ref. No.	—
	centring piece thread M17x1			
	GEV No.	100942	Ref. No.	—
	union nut thread M15x1 for pipe ø 10mm			
	GEV No.	101278	Ref. No.	060325 0C0150 0G0794 0G1111 0G2610 0K1976 0KW924 0T1946 101278 17012732 17012758 19012727
	olive for pipe ø 10mm Qty 1 pcs			
	GEV No.	101286	Ref. No.	020992 053666
	olive ID ø 6mm Qty 1 pcs			



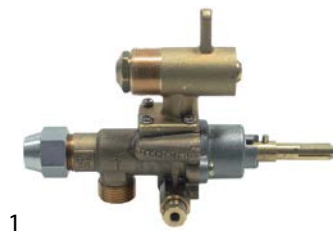









GPEL22 series

with nozzle outlet















1

GEV No.	101659	Ref. No.	OK1358 OK1359 101659	
description	gas tap alternatives to EGA type GPEL22D with nozzle outlet (with nozzle) gas inlet M18x1.5 (tube ø 12mm) external nozzle ø 2.2mm internal nozzle ø 1.15mm bypass nozzle ø 0.35mm mixing pipe connection M22x1 thermocouple connection M8x1 pilot connection M10x1 shaft ø 8x7mm shaft L 34/15mm shaft flat lower			
spare parts for 101659				
	GEV No.	100259	Ref. No.	—
	bypass nozzle type PEL22 bore ø 0.35mm thread M6x0.5			
	GEV No.	100330	Ref. No.	—
	gas injector thread M15x1 bore ø 2.20mm WS 17			
	GEV No.	100341	Ref. No.	OK1129 OK1274
	internal nozzle bore ø 1.15mm type EGA/PEL22			

spare parts for 101659				
	GEV No.	100908	Ref. No.	046755 052125 0958013 0G2219 0K1348 0K5753 0KE882 0KL495 19012956 727742 727781
	union screw thread M10x1 for pipe ø 4mm Qty 1 pcs			
	GEV No.	100927	Ref. No.	—
	torsion spring L 2.8-8.0mm for internal nozzle ø 3mm bore ømm			
	GEV No.	101058	Ref. No.	02B04 02E03 056594 0884 0H9943 0K0660 0K5349 0M0791 101058 19002904
	magnet unit L 39mm D1 ø 15.4mm D2 ø 13.5mm suitable for PEL22/ EGA24197 standard			
	GEV No.	101230	Ref. No.	—
	thermocouple nut T1: M8x1 T2: M18x1 aluminium			
	GEV No.	101246	Ref. No.	052127 727782
	olive for pipe ø 4mm Qty 1 pcs			
	GEV No.	101460	Ref. No.	—
	O-ring ø 12.37mm D1 ø 2.62mm suitable for PEL22			
	GEV No.	101527	Ref. No.	—
	O-ring Viton thickness 1.78mm ID ø 6.75mm Qty 1 pcs			
	GEV No.	101594	Ref. No.	—
	adjusting screw for internal nozzle thread M10x0.75			
	GEV No.	101820	Ref. No.	—
	gas tap front part shaft ø 7x8mm shaft L 34/15mm shaft flat upper/lower			
accessories for 101659				
	GEV No.	100909	Ref. No.	003859 057821
	union screw thread M10x1 for pipe ø 6mm Qty 1 pcs			
	GEV No.	100944	Ref. No.	—
	union nut thread M18x1.5 for pipe ø 12mm			
	GEV No.	101273	Ref. No.	—
	olive for pipe ø 12mm L 9.5mm brass Qty 1 pcs suitable for universal			
	GEV No.	101286	Ref. No.	020992 053666
	olive ID ø 6mm Qty 1 pcs			



			
1			
GEV No.	101649	Ref. No.	OK1360 OK1388 101649 30000849
description	gas tap alternatives to EGA type GPEL22D with nozzle outlet (with nozzle) gas inlet M18x1.5 (tube ø 12mm) external nozzle ø 2.6mm internal nozzle ø 1.35mm bypass nozzle ø 0.4mm mixing pipe connection M22x1 thermocouple connection M8x1 pilot connection M10x1 shaft ø 8x7mm shaft L 34/15mm shaft flat upper		
spare parts for	101649		
	GEV No.	100281	Ref. No. —
bypass nozzle type PEL22 bore ø 0.4mm thread M6x0.5			
	GEV No.	100457	Ref. No. —
gas injector thread M15x1 bore ø 2.60mm WS 17			
	GEV No.	100648	Ref. No. —
internal nozzle bore ø 1.35mm type EGA/PEL22			
	GEV No.	100908	Ref. No. 046755 052125 0958013 0G2219 OK1348 OK5753 OKE882 OKL495 19012956 727742 727781
union screw thread M10x1 for pipe ø 4mm Qty 1 pcs			
	GEV No.	100927	Ref. No. —
torsion spring L 2.8-8.0mm for internal nozzle ø 3mm bore ømm			
	GEV No.	101058	Ref. No. 02B04 02E03 056594 0884 0H9943 0K0660 0K5349 0M0791 101058 19002904
magnet unit L 39mm D1 ø 15.4mm D2 ø 13.5mm suitable for PEL22/ EGA24197 standard			
	GEV No.	101230	Ref. No. —
thermocouple nut T1: M8x1 T2: M18x1 aluminium			
	GEV No.	101246	Ref. No. 052127 727782
olive for pipe ø 4mm Qty 1 pcs			
	GEV No.	101460	Ref. No. —
O-ring ø 12.37mm D1 ø 2.62mm suitable for PEL22			
	GEV No.	101527	Ref. No. —
O-ring Viton thickness 1.78mm ID ø 6.75mm Qty 1 pcs			
	GEV No.	101594	Ref. No. —
adjusting screw for internal nozzle thread M10x0.75			

spare parts for	101649		
	GEV No.	101820	Ref. No. —
gas tap front part shaft ø 7x8mm shaft L 34/15mm shaft flat upper/lower			
accessories for	101649		
	GEV No.	100909	Ref. No. 003859 057821
union screw thread M10x1 for pipe ø 6mm Qty 1 pcs			
	GEV No.	100944	Ref. No. —
union nut thread M18x1.5 for pipe ø 12mm			
	GEV No.	101273	Ref. No. —
olive for pipe ø 12mm L 9.5mm brass Qty 1 pcs suitable for universal			
	GEV No.	101286	Ref. No. 020992 053666
olive ID ø 6mm Qty 1 pcs			















with pipe outlet			
			
1			
GEV No.	101620	Ref. No.	OG1095
description	gas tap alternatives to EGA type GPEL22R with pipe outlet gas inlet M18x1.5 (tube ø 12mm) bypass nozzle ø 0.35mm gas outlet M18x1.5 (tube ø 12mm) thermocouple connection M8x1 pilot connection M10x1 shaft ø 6x4.6mm shaft L 35/21mm shaft flat upper		
spare parts for	101620		
	GEV No.	100259	Ref. No. —
bypass nozzle type PEL22 bore ø 0.35mm thread M6x0.5			
	GEV No.	101058	Ref. No. 02B04 02E03 056594 0884 0H9943 0K0660 0K5349 0M0791 101058 19002904
magnet unit L 39mm D1 ø 15.4mm D2 ø 13.5mm suitable for PEL22/ EGA24197 standard			
	GEV No.	101230	Ref. No. —
thermocouple nut T1: M8x1 T2: M18x1 aluminium			
	GEV No.	101460	Ref. No. —
O-ring ø 12.37mm D1 ø 2.62mm suitable for PEL22			
	GEV No.	101823	Ref. No. —
gas tap front part shaft ø 6x4.6mm shaft L 35/21mm shaft flat upper/lower suitable for PEL22			

Table continues overleaf



accessories for		101620	
	GEV No.	100908	Ref. No.
			046755 052125 0958013 0G2219 0K1348 0K5753 0KE882 0KL495 19012956 727742 727781
	union screw thread M10x1 for pipe ø 4mm Qty 1 pcs		
	GEV No.	100909	Ref. No.
			003859 057821
	union screw thread M10x1 for pipe ø 6mm Qty 1 pcs		
	GEV No.	100944	Ref. No.
			—
	union nut thread M18x1.5 for pipe ø 12mm		
	GEV No.	101246	Ref. No.
			052127 727782
	olive for pipe ø 4mm Qty 1 pcs		
	GEV No.	101273	Ref. No.
			—
	olive for pipe ø 12mm L 9.5mm brass Qty 1 pcs suitable for universal		
	GEV No.	101286	Ref. No.
			020992 053666
	olive ID ø 6mm Qty 1 pcs		
	GEV No.	110078	Ref. No.
			—
	knob without symbol ø 70mm shaft ø 6x4.6mm shaft flat universal		
	GEV No.	112206	Ref. No.
			—
	knob dial plate silver gas tap PEL21/22/23 t.max.°C ED ø 63mm ID ø 45.5mm		

			
1			
GEV No.	101621	Ref. No.	0K1351
description	gas tap alternatives to EGA type GPEL22R with pipe outlet gas inlet M18x1.5 (tube ø 12mm) gas outlet M18x1.5 (tube ø 12mm) thermocouple connection M8x1 shaft ø 8x7mm shaft L 34/15mm shaft flat lower		
spare parts for	101621		
	GEV No.	100259	Ref. No.
			—
	bypass nozzle type PEL22 bore ø 0.35mm thread M6x0.5		
	GEV No.	101058	Ref. No.
			02B04 02E03 056594 0884 0H9943 0K0660 0K5349 0M0791 101058 19002904
	magnet unit L 39mm D1 ø 15.4mm D2 ø 13.5mm suitable for PEL22/ EGA24197 standard		
	GEV No.	101290	Ref. No.
			—
	thermocouple nut T1: M10x1 T2: M18x1 suitable for PEL20/21		
	GEV No.	101460	Ref. No.
			—
	O-ring ø 12.37mm D1 ø 2.62mm suitable for PEL22		

spare parts for		101621	
	GEV No.	101820	Ref. No.
			—
	gas tap front part shaft ø 7x8mm shaft L 34/15mm shaft flat upper/lower		
accessories for	101621		
	GEV No.	100908	Ref. No.
			046755 052125 0958013 0G2219 0K1348 0K5753 0KE882 0KL495 19012956 727742 727781
	union screw thread M10x1 for pipe ø 4mm Qty 1 pcs		
	GEV No.	100909	Ref. No.
			003859 057821
	union screw thread M10x1 for pipe ø 6mm Qty 1 pcs		
	GEV No.	100944	Ref. No.
			—
	union nut thread M18x1.5 for pipe ø 12mm		
	GEV No.	101246	Ref. No.
			052127 727782
	olive for pipe ø 4mm Qty 1 pcs		
	GEV No.	101273	Ref. No.
			—
	olive for pipe ø 12mm L 9.5mm brass Qty 1 pcs suitable for universal		
	GEV No.	101286	Ref. No.
			020992 053666
	olive ID ø 6mm Qty 1 pcs		

alternatives to JUNKERS

			
1			
GEV No.	101630	Ref. No.	02R61 0K1387 0K9985 0KB943 101097 101630 7741330001
description	gas tap PEL type 23S/V gas inlet 1/2" IT bypass nozzle ø 0.35mm gas outlet 1/2" MT (tube ø 14mm) thermocouple connection M10x1 pilot connection M10x1 shaft ø 10mm shaft L 25mm shaft flat		
spare parts for	101630		
	GEV No.	100455	Ref. No.
			—
	bypass nozzle type PEL23/24 bore ø 0.35mm thread M8x0.5		
	GEV No.	101059	Ref. No.
			0C1521
	magnet unit T1: M10x1 T2: M22x1 L 46mm ø 18mm suitable for PEL23S M10x1		
	GEV No.	102767	Ref. No.
			—
	gas tap front part shaft ø 10mm shaft L 26.5mm shaft flat suitable for PEL23S		

Table continues overleaf



accessories for		101630		
	GEV No.	100908	Ref. No.	046755 052125 0958013 0G2219 0K1348 0K5753 0KE882 0KL495 19012956 727742 727781
union screw thread M10x1 for pipe ø 4mm Qty 1 pcs				
	GEV No.	100909	Ref. No.	003859 057821
union screw thread M10x1 for pipe ø 6mm Qty 1 pcs				
	GEV No.	100945	Ref. No.	—
roll pin ø 3.2mm L 10mm				
	GEV No.	101218	Ref. No.	—
shaft extension JUNKERS				
	GEV No.	101219	Ref. No.	—
shaft extension L 25mm JUNKERS				
	GEV No.	101246	Ref. No.	052127 727782
olive for pipe ø 4mm Qty 1 pcs				
	GEV No.	101286	Ref. No.	020992 053666
olive ID ø 6mm Qty 1 pcs				
	GEV No.	110064	Ref. No.	—
knob				
	GEV No.	110066	Ref. No.	—
knob screw				
	GEV No.	550396	Ref. No.	—
shaft extension L 25mm JUNKERS				

COPRECI

CPMM18700



1

GEV No.	107584	Ref. No.	0C5480
description	gas tap COPRECI type CPMM18700 gas inlet pipe flange ø21mm bypass nozzle ø 0.8mm gas outlet 3/8" (tube ø 10mm) thermocouple connection M8x1 pilot connection closed shaft ø 8x6.5mm shaft L 37/25mm shaft flat upper		
For models:	BC/G1, BCF/G2, BG/G1, BG/G2, OCF/G9UK, TCF/G9, TCF/G9UK		

SABAF



1

GEV No.	101396	Ref. No.	00369 004956 0K3535 615003110XXX	
description	gas tap SABAF type 10 gas inlet pipe flange ø16mm bypass nozzle ø 0mm gas outlet 1/4" (tube ø 8mm) front fixing thermocouple connection M8x1 shaft ø 8x6.5mm shaft L 26/12mm shaft flat lower			
For models:	SCG350, SCG700, SCG1050, SCG350, SCG700, SCG1050, SRG350, SRG360, SRG700, SRG710, SMG350, SMG700, PPL5GG, PPFL5GG			
spare parts for	101396			
	GEV No.	101376	Ref. No.	—
gasket ID ø 8mm ED ø 12mm H 3/5mm				
	GEV No.	101751	Ref. No.	—
bracket				
	GEV No.	106724	Ref. No.	—
magnet unit L 30mm D1 ø 12.5mm D2 ø 8.5mm suitable for SABAF				
accessories for	101396			
	GEV No.	101277	Ref. No.	—
olive ID ø 8mm Qty 1 pcs				
	GEV No.	101751	Ref. No.	—
bracket				
	GEV No.	520656	Ref. No.	—
union nut thread 1/4" tube ø 6/8mm				
	GEV No.	560082	Ref. No.	—
hexagonal screw thread M4 thread L 16mm SS WS 7 Qty 20 pcs DIN 933 / ISO 4017				

EGA

24197 series

gas taps



GEV No.	101150	Ref. No.	OK0213 OK1354 OK1355 OK1362 OK9957
description	gas tap EGA type 24197 series with pipe outlet		
For models:	7511-2, 7512-2, 7512-9, 7711-2, 9012-2, 9211-2-0		
spare parts for	101150		
	GEV No.	101058	Ref. No. 02B04 02E03 056594 0884 0H9943 OK0660 OK5349 0M0791 101058 19002904
	magnet unit L 39mm D1 ø 15.4mm D2 ø 13.5mm suitable for PEL22/ EGA24197 standard		
	GEV No.	101230	Ref. No. —
	thermocouple nut T1: M8x1 T2: M18x1 aluminium		
accessories for	101150		
	GEV No.	100944	Ref. No. —
	union nut thread M18x1.5 for pipe ø 12mm		
	GEV No.	101273	Ref. No. —
	olive for pipe ø 12mm L 9.5mm brass Qty 1 pcs suitable for universal		
	GEV No.	101284	Ref. No. OK2491 OKC184 OKL219 101284 17012733
	olive for pipe ø 4mm Qty 1 pcs		
	GEV No.	101285	Ref. No. OK2490 OKC185 OKL220 101285 17012735
	union screw thread M8x1 for pipe ø 4mm Qty 1 pcs JUNKERS		



GEV No.	106251	Ref. No.	013008 OK1389
description	gas tap type EGA24197		
spare parts for	106251		
	GEV No.	100238	Ref. No. —
	internal nozzle bore ø 1.35mm suitable for EGA 23268,26400,26440		
	GEV No.	100457	Ref. No. —
	gas injector thread M15x1 bore ø 2.60mm WS 17		
	GEV No.	100927	Ref. No. —
	torsion spring L 2.8-8.0mm for internal nozzle ø 3mm bore ø mm		
	GEV No.	101058	Ref. No. 02B04 02E03 056594 0884 0H9943 OK0660 OK5349 0M0791 101058 19002904
	magnet unit L 39mm D1 ø 15.4mm D2 ø 13.5mm suitable for PEL22/ EGA24197 standard		
	GEV No.	101230	Ref. No. —
	thermocouple nut T1: M8x1 T2: M18x1 aluminium		
accessories for	106251		
	GEV No.	100944	Ref. No. —
	union nut thread M18x1.5 for pipe ø 12mm		
	GEV No.	101273	Ref. No. —
	olive for pipe ø 12mm L 9.5mm brass Qty 1 pcs suitable for universal		
	GEV No.	101284	Ref. No. OK2491 OKC184 OKL219 101284 17012733
	olive for pipe ø 4mm Qty 1 pcs		
	GEV No.	101285	Ref. No. OK2490 OKC185 OKL220 101285 17012735
	union screw thread M8x1 for pipe ø 4mm Qty 1 pcs JUNKERS		



gas thermostats

SIT

630 Eurosit series



GEV No.	101992	Ref. No.	003334 004947 0630321 0630337 0K3561
description	gas thermostat type 630 Eurosit series t.max. 190°C 110-190°C gas inlet 3/8" gas outlet 3/8" thermocouple connection M9x1 pilot connection M10x1 probe ø 4mm probe L 202mm capillary pipe 1050mm SIT		
For models:	MFR/G380, MFR/G381, MFR/G350, MFR/G351, MFR/G700, MFR/G701, BF/G1S07, RBK/G2FM, RF/G1S07, RF/G2D07, RFR/G1S07, RFR/G2D07, RFR/G1S12, RFR/G2D12, RFR/G1S14, RFR/G2D14, RF/G1S07, RF/G2D07, RFR/G1S07, RFR/G2D07, XBK/G2FM, XF/G1S07, XRF/G2D07, XFR/G1S07, XFR/G2D07, XFR/G1S12, XFR/G2D12, XFR/G1S14, XFR/G2D14, XF/G1S07, XF/G2D07, XFR/G1S07, XFR/G2D07, JF/G1S07, JF/G2D07, JFR/G1S07, JFR/G2D07, JFR/G1S12, JFR/G2D12, JFR/G1S14, JFR/G2D14, JF/G1S07, JF/G2D07, JFR/G2D07, JFR/G2D07, MBK/G2FM, MF/G1S07, MF/G2D07, MFR/G1S07, MFR/G2D07...(Other models you can see in the webshop)		
accessories for	101992		
	GEV No.	100904	Ref. No. 052833 0K2497 100904 102504
	locking screw M10x1 for pipe ø 4mm Qty 1 pcs		
	GEV No.	100905	Ref. No. 052834 0958031
	locking screw M10x1 for pipe ø 6mm Qty 1 pcs		
	GEV No.	101273	Ref. No. —
	olive for pipe ø 12mm L 9.5mm brass Qty 1 pcs suitable for universal		
	GEV No.	101276	Ref. No. —
	union screw thread 3/8" tube ø 12mm Qty 1 pcs		
	GEV No.	101333	Ref. No. 056009
	plug thread 3/8" with O-ring		
	GEV No.	510655	Ref. No. —
	gasket silicone ø 7.8mm L 5mm blue Shore 55° Qty 10 pcs		













	GEV No.	101915	Ref. No. 002096 058772 0630318 0630327 0630330 0C6235 0K2003 0K2891
description	gas thermostat type 630 Eurosit series t.max. 320°C 80-320°C gas inlet 3/8" gas outlet 3/8" thermocouple connection M9x1 pilot connection M10x1 probe ø 4mm probe L 72mm capillary pipe 1050mm SIT		
For models:	MCF/G1090, MCF/G1095, MCF/G995, MR/G721, MR/G1071, MR/G1070, MR/G720, MR/G725, MR/G1075, MR/G726, MR/G1076, RBR/G2FM, RBR/G2IM, RR/G1CL, RR/G2CL, RRV/G1CL, RRV/G2CL, RR/G2CM, XBR/G2FM, XBR/G2IM, XR/G1CL, XR/G2CL, XRV/G1CL, XRV/G2CL, XR/G2CM, JBR/G2FM, JR/G1CL, JR/G2CL, JRV/G1CL, JRV/G2CL, MBR/G2FM, MBR/G2IM, MR/G1CL, MR/G2CL, MRV/G1CL, MRV/G2CL, MR/G2CM, RCF/G1095, RR/G720D, 7FTGC7L, 7FTGC1L, RR/G1070D, 7FTGC7M, RR/G1076, CCF/G995, CCF/G996, XR/G720D, XR/G1070D, T79GFT, T109GFT...(Other models you can see in the webshop)		
accessories for	101915		
	GEV No.	100825	Ref. No. —
	gas tap spindle shaft ø 8x6.5mm shaft L 22/14mm suitable for EUROSIT		
	GEV No.	100904	Ref. No. 052833 0K2497 100904 102504
	locking screw M10x1 for pipe ø 4mm Qty 1 pcs		
	GEV No.	100905	Ref. No. 052834 0958031
	locking screw M10x1 for pipe ø 6mm Qty 1 pcs		
	GEV No.	100949	Ref. No. —
	gasket suitable for 630 Eurosit series		
	GEV No.	101273	Ref. No. —
	olive for pipe ø 12mm L 9.5mm brass Qty 1 pcs suitable for universal		
	GEV No.	101276	Ref. No. —
	union screw thread 3/8" tube ø 12mm Qty 1 pcs		
	GEV No.	101333	Ref. No. 056009
	plug thread 3/8" with O-ring		
	GEV No.	101390	Ref. No. —
	gas tap spindle shaft ø 6x4.6mm shaft L 32/15mm gas tap with ignition flame suitable for ZANUSSI, MARENO for gas thermostat EUROSIT		
	GEV No.	101392	Ref. No. 00447 004948 058773 0997223 0K3562 0KT743 727735
	adapter suitable for 630 Eurosit series		

Table continues overleaf













accessories for 101915					
	<table border="1"> <tr> <th>GEV No.</th> <th>110357</th> <th>Ref. No.</th> <th>002130 002131 0KT742 727736</th> </tr> </table> <p>gas tap spindle shaft ø 8x6.5mm shaft L 36/12mm suitable for 630 Eurosit series</p>	GEV No.	110357	Ref. No.	002130 002131 0KT742 727736
GEV No.	110357	Ref. No.	002130 002131 0KT742 727736		
	<table border="1"> <tr> <th>GEV No.</th> <th>110358</th> <th>Ref. No.</th> <th>003391</th> </tr> </table> <p>adapter shaft ø 10x8mm shaft L 29/18mm suitable for 630 Eurosit series</p>	GEV No.	110358	Ref. No.	003391
GEV No.	110358	Ref. No.	003391		



GEV No.	101769	Ref. No.	0630206 0C8183 0K2004		
description	gas thermostat type 630 Eurosit series t.max. 340°C 100-340°C gas inlet 3/8" gas outlet 3/8" thermocouple connection M10x1 pilot connection M10x1 probe ø 4mm probe L 72mm capillary pipe 1050mm SIT				
For models:	7502-2, 7504-2, 7505-2-9, 7507-2, 7508-2, 7511-2, 7530-2, 7531-2, 7542-2, 7544-2, 7707-2, 7730-2, 7731-2, 7742-2, 7744-2				
accessories for 101769					
	<table border="1"> <tr> <th>GEV No.</th> <th>100904</th> <th>Ref. No.</th> <th>052833 0K2497 100904 102504</th> </tr> </table> <p>locking screw M10x1 for pipe ø 4mm Qty 1 pcs</p>	GEV No.	100904	Ref. No.	052833 0K2497 100904 102504
GEV No.	100904	Ref. No.	052833 0K2497 100904 102504		
	<table border="1"> <tr> <th>GEV No.</th> <th>100905</th> <th>Ref. No.</th> <th>052834 0958031</th> </tr> </table> <p>locking screw M10x1 for pipe ø 6mm Qty 1 pcs</p>	GEV No.	100905	Ref. No.	052834 0958031
GEV No.	100905	Ref. No.	052834 0958031		
	<table border="1"> <tr> <th>GEV No.</th> <th>101273</th> <th>Ref. No.</th> <th>—</th> </tr> </table> <p>olive for pipe ø 12mm L 9.5mm brass Qty 1 pcs suitable for universal</p>	GEV No.	101273	Ref. No.	—
GEV No.	101273	Ref. No.	—		
	<table border="1"> <tr> <th>GEV No.</th> <th>101276</th> <th>Ref. No.</th> <th>—</th> </tr> </table> <p>union screw thread 3/8" tube ø 12mm Qty 1 pcs</p>	GEV No.	101276	Ref. No.	—
GEV No.	101276	Ref. No.	—		
	<table border="1"> <tr> <th>GEV No.</th> <th>101333</th> <th>Ref. No.</th> <th>056009</th> </tr> </table> <p>plug thread 3/8" with O-ring</p>	GEV No.	101333	Ref. No.	056009
GEV No.	101333	Ref. No.	056009		





















GEV No.	101125	Ref. No.	OG2294		
description	gas thermostat type 630 Eurosit series t.max. 340°C 100-340°C gas inlet 3/8" gas outlet 3/8" thermocouple connection M9x1 pilot connection M10x1 probe ø 4mm probe L 72mm capillary pipe 1050mm SIT				
accessories for 101125					
	<table border="1"> <tr> <th>GEV No.</th> <th>100825</th> <th>Ref. No.</th> <th>—</th> </tr> </table> <p>gas tap spindle shaft ø 8x6.5mm shaft L 22/14mm suitable for EUROSIT</p>	GEV No.	100825	Ref. No.	—
GEV No.	100825	Ref. No.	—		
	<table border="1"> <tr> <th>GEV No.</th> <th>100904</th> <th>Ref. No.</th> <th>052833 0K2497 100904 102504</th> </tr> </table> <p>locking screw M10x1 for pipe ø 4mm Qty 1 pcs</p>	GEV No.	100904	Ref. No.	052833 0K2497 100904 102504
GEV No.	100904	Ref. No.	052833 0K2497 100904 102504		
	<table border="1"> <tr> <th>GEV No.</th> <th>100905</th> <th>Ref. No.</th> <th>052834 0958031</th> </tr> </table> <p>locking screw M10x1 for pipe ø 6mm Qty 1 pcs</p>	GEV No.	100905	Ref. No.	052834 0958031
GEV No.	100905	Ref. No.	052834 0958031		
	<table border="1"> <tr> <th>GEV No.</th> <th>100949</th> <th>Ref. No.</th> <th>—</th> </tr> </table> <p>gasket suitable for 630 Eurosit series</p>	GEV No.	100949	Ref. No.	—
GEV No.	100949	Ref. No.	—		
	<table border="1"> <tr> <th>GEV No.</th> <th>101273</th> <th>Ref. No.</th> <th>—</th> </tr> </table> <p>olive for pipe ø 12mm L 9.5mm brass Qty 1 pcs suitable for universal</p>	GEV No.	101273	Ref. No.	—
GEV No.	101273	Ref. No.	—		
	<table border="1"> <tr> <th>GEV No.</th> <th>101276</th> <th>Ref. No.</th> <th>—</th> </tr> </table> <p>union screw thread 3/8" tube ø 12mm Qty 1 pcs</p>	GEV No.	101276	Ref. No.	—
GEV No.	101276	Ref. No.	—		
	<table border="1"> <tr> <th>GEV No.</th> <th>101333</th> <th>Ref. No.</th> <th>056009</th> </tr> </table> <p>plug thread 3/8" with O-ring</p>	GEV No.	101333	Ref. No.	056009
GEV No.	101333	Ref. No.	056009		
	<table border="1"> <tr> <th>GEV No.</th> <th>101390</th> <th>Ref. No.</th> <th>—</th> </tr> </table> <p>gas tap spindle shaft ø 6x4.6mm shaft L 32/15mm gas tap with ignition flame suitable for ZANUSSI, MARENO for gas thermostat EUROSIT</p>	GEV No.	101390	Ref. No.	—
GEV No.	101390	Ref. No.	—		
	<table border="1"> <tr> <th>GEV No.</th> <th>101392</th> <th>Ref. No.</th> <th>00447 004948 058773 0997223 0K3562 0KT743 727735</th> </tr> </table> <p>adapter suitable for 630 Eurosit series</p>	GEV No.	101392	Ref. No.	00447 004948 058773 0997223 0K3562 0KT743 727735
GEV No.	101392	Ref. No.	00447 004948 058773 0997223 0K3562 0KT743 727735		
	<table border="1"> <tr> <th>GEV No.</th> <th>110357</th> <th>Ref. No.</th> <th>002130 002131 0KT742 727736</th> </tr> </table> <p>gas tap spindle shaft ø 8x6.5mm shaft L 36/12mm suitable for 630 Eurosit series</p>	GEV No.	110357	Ref. No.	002130 002131 0KT742 727736
GEV No.	110357	Ref. No.	002130 002131 0KT742 727736		
	<table border="1"> <tr> <th>GEV No.</th> <th>110358</th> <th>Ref. No.</th> <th>003391</th> </tr> </table> <p>adapter shaft ø 10x8mm shaft L 29/18mm suitable for 630 Eurosit series</p>	GEV No.	110358	Ref. No.	003391
GEV No.	110358	Ref. No.	003391		



710 Minisit series



GEV No.	101135	Ref. No.	003655 056434 056688 058160 7020200
description	gas thermostat SIT type MINISIT 710 t.max. 190°C 110-190°C gas inlet 1/2" gas outlet 3/8" thermocouple connection M9x1 pilot connection M10x1 probe ø 6mm probe L 102mm capillary pipe 1050mm probe type type A3 pressure controller no pressure regulator mbar gland nut		
For models:	MBR/G700UK, MFR/G360, MFG1500Z, MFG2200Z, RFR/G360, T35GFR, RF/G300, RF/G350D, RF/G700D, QFG300, QFG600, RF/G300, NFG/20, NFG20+20, 110FR2, NFG/20, NFG20+20, PFR/G840, 1FRG08S		
spare parts for	101135		
	GEV No.	101053	Ref. No. 0006443 056587 75800560
	magnet unit T1: M9x1 T2: M24x1 L 45mm ø 17mm suitable for Minisit		
	GEV No.	102118	Ref. No. 056590
	probe 110-190°C probe ø 6mm probe L 102mm capillary pipe 1050mm t.max. 190°C fryer probe type type A3 suitable for MINISIT 710		
accessories for	101135		
	GEV No.	100809	Ref. No. —
	O-ring EPDM thickness 2mm ID ø 21mm Qty 1 pcs		
	GEV No.	100820	Ref. No. —
	gland duct ET M14x1.5 IT M10x0.75 probe ø max. 6.5mm WS 22		
	GEV No.	100904	Ref. No. 052833 0K2497 100904 102504
	locking screw M10x1 for pipe ø 4mm Qty 1 pcs		
	GEV No.	100905	Ref. No. 052834 0958031
	locking screw M10x1 for pipe ø 6mm Qty 1 pcs		
	GEV No.	101054	Ref. No. 0006442 0K0669
	magnet unit T1: M10x1 T2: M24x1 L 45mm ø 17mm suitable for Minisit		
	GEV No.	101136	Ref. No. 003128 0073208 051567 054269 0H6049 0K5721 19012785 75800552
	piezoelectric igniter suitable for Minisit with cover cap ømm connection F6.3x0.8		
	GEV No.	101137	Ref. No. 056577 0903052
	cover cap without piezoelectric igniter		
	GEV No.	101267	Ref. No. —
	reducer IT 3/8" ET 1/2" L 21mm		

accessories for	101135		
	GEV No.	101268	Ref. No. —
	gas connection thread 3/8" angled with O-ring MINISIT 710		
	GEV No.	101269	Ref. No. —
	gas connection thread 1/2" angled with O-ring MINISIT 710		
	GEV No.	101270	Ref. No. —
	screw connection IT 3/8" ET 3/8" L 28mm		
	GEV No.	101272	Ref. No. —
	screw connection IT 1/2" ET 3/8" L 57mm		
	GEV No.	101273	Ref. No. —
	olive for pipe ø 12mm L 9.5mm brass Qty 1 pcs suitable for universal		
	GEV No.	101274	Ref. No. —
	olive for pipe ø 16mm Qty 1 pcs		
	GEV No.	101275	Ref. No. 052668
	union screw thread 1/2" for pipe ø 16mm Qty 1 pcs		
	GEV No.	101276	Ref. No. —
	union screw thread 3/8" tube ø 12mm Qty 1 pcs		
	GEV No.	110068	Ref. No. 054268 0916124 0A2172 0G2403 0K2272 0K5811 19016055 75800553
	knob suitable for Minisit ø 37mm		





















	GEV No.	101437	Ref. No. 052685 058496
	gas thermostat SIT type MINISIT 710 t.max. 190°C 110-190°C gas inlet 1/2" gas outlet 3/8" thermocouple connection M9x1 pilot connection M10x1 probe ø 6mm probe L 102mm capillary pipe 1050mm probe type type A3 pressure controller yes pressure regulator 3-18mbar gland nut		
For models:	RFR/G700		
spare parts for	101437		
	GEV No.	101053	Ref. No. 0006443 056587 75800560
	magnet unit T1: M9x1 T2: M24x1 L 45mm ø 17mm suitable for Minisit		
	GEV No.	102118	Ref. No. 056590
	probe 110-190°C probe ø 6mm probe L 102mm capillary pipe 1050mm t.max. 190°C fryer probe type type A3 suitable for MINISIT 710		

Table continues overleaf



accessories for		101437	
	GEV No.	100809	Ref. No. —
O-ring EPDM thickness 2mm ID ø 21mm Qty 1 pcs			
	GEV No.	100820	Ref. No. —
gland duct ET M14x1.5 IT M10x0.75 probe ø max. 6.5mm WS 22			
	GEV No.	100904	Ref. No. 052833 0K2497 100904 102504
locking screw M10x1 for pipe ø 4mm Qty 1 pcs			
	GEV No.	100905	Ref. No. 052834 0958031
locking screw M10x1 for pipe ø 6mm Qty 1 pcs			
	GEV No.	101054	Ref. No. 0006442 0K0669
magnet unit T1: M10x1 T2: M24x1 L 45mm ø 17mm suitable for Minisit			
	GEV No.	101136	Ref. No. 003128 0073208 051567 054269 0H6049 0K5721 19012785 75800552
piezoelectric igniter suitable for Minisit with cover cap ømm connection F6.3x0.8			
	GEV No.	101137	Ref. No. 056577 0903052
cover cap without piezoelectric igniter			
	GEV No.	101267	Ref. No. —
reducer IT 3/8" ET 1/2" L 21mm			
	GEV No.	101268	Ref. No. —
gas connection thread 3/8" angled with O-ring MINISIT 710			
	GEV No.	101269	Ref. No. —
gas connection thread 1/2" angled with O-ring MINISIT 710			
	GEV No.	101270	Ref. No. —
screw connection IT 3/8" ET 3/8" L 28mm			
	GEV No.	101272	Ref. No. —
screw connection IT 1/2" ET 3/8" L 57mm			
	GEV No.	101273	Ref. No. —
olive for pipe ø 12mm L 9.5mm brass Qty 1 pcs suitable for universal			
	GEV No.	101274	Ref. No. —
olive for pipe ø 16mm Qty 1 pcs			
	GEV No.	101275	Ref. No. 052668
union screw thread 1/2" for pipe ø 16mm Qty 1 pcs			
	GEV No.	101276	Ref. No. —
union screw thread 3/8" tube ø 12mm Qty 1 pcs			

accessories for		101437	
	GEV No.	110068	Ref. No. 054268 0916124 0A2172 0G2403 0K2272 0K5811 19016055 75800553
knob suitable for Minisit ø 37mm			

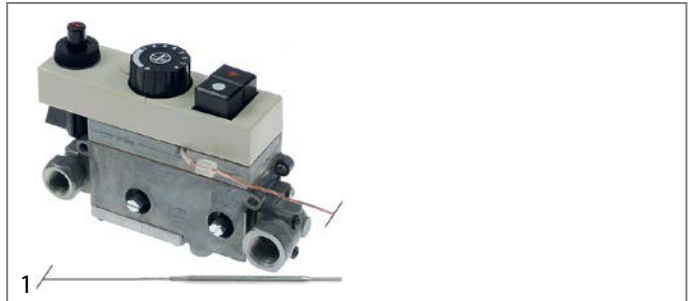











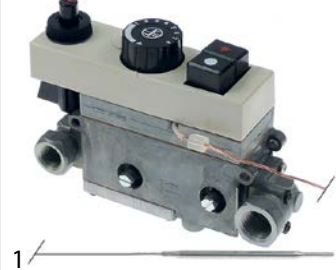



accessories for		103327	
	GEV No.	103327	Ref. No. 053368
description gas thermostat SIT type MINISIT 710 t.max. 190°C 50-190°C gas inlet 1/2" gas outlet 3/8" thermocouple connection M9x1 pilot connection M10x1 probe ø 5mm probe L 98mm capillary pipe 1200mm probe type type A2 pressure controller no pressure regulator mbar gland nut			
spare parts for		103327	
	GEV No.	101053	Ref. No. 0006443 056587 75800560
magnet unit T1: M9x1 T2: M24x1 L 45mm ø 17mm suitable for Minisit			
	GEV No.	102103	Ref. No. 056591
probe 60-200°C probe ø 5mm probe L 98mm capillary pipe 1050mm t.max. 200°C fryer probe type type A2 suitable for MINISIT 710			
accessories for		103327	
	GEV No.	100809	Ref. No. —
O-ring EPDM thickness 2mm ID ø 21mm Qty 1 pcs			
	GEV No.	100820	Ref. No. —
gland duct ET M14x1.5 IT M10x0.75 probe ø max. 6.5mm WS 22			
	GEV No.	100904	Ref. No. 052833 0K2497 100904 102504
locking screw M10x1 for pipe ø 4mm Qty 1 pcs			
	GEV No.	100905	Ref. No. 052834 0958031
locking screw M10x1 for pipe ø 6mm Qty 1 pcs			
	GEV No.	101054	Ref. No. 0006442 0K0669
magnet unit T1: M10x1 T2: M24x1 L 45mm ø 17mm suitable for Minisit			
	GEV No.	101136	Ref. No. 003128 0073208 051567 054269 0H6049 0K5721 19012785 75800552
piezoelectric igniter suitable for Minisit with cover cap ømm connection F6.3x0.8			
	GEV No.	101137	Ref. No. 056577 0903052
cover cap without piezoelectric igniter			











Table continues overleaf











accessories for		103327	
	GEV No.	101267	Ref. No. —
reducer IT 3/8" ET 1/2" L 21mm			
	GEV No.	101268	Ref. No. —
gas connection thread 3/8" angled with O-ring MINISIT 710			
	GEV No.	101269	Ref. No. —
gas connection thread 1/2" angled with O-ring MINISIT 710			
	GEV No.	101270	Ref. No. —
screw connection IT 3/8" ET 3/8" L 28mm			
	GEV No.	101272	Ref. No. —
screw connection IT 1/2" ET 3/8" L 57mm			
	GEV No.	101273	Ref. No. —
olive for pipe ø 12mm L 9.5mm brass Qty 1 pcs suitable for universal			
	GEV No.	101274	Ref. No. —
olive for pipe ø 16mm Qty 1 pcs			
	GEV No.	101275	Ref. No. 052668
union screw thread 1/2" for pipe ø 16mm Qty 1 pcs			
	GEV No.	101276	Ref. No. —
union screw thread 3/8" tube ø 12mm Qty 1 pcs			
	GEV No.	110068	Ref. No. 054268 0916124 0A2172 0G2403 0K2272 0K5811 19016055 75800553
knob suitable for Minisit ø 37mm			

			
1 / 			
GEV No.	106061	Ref. No.	002577 0710628 0K5692 19012657 75800501
description	gas thermostat SIT type MINISIT 710 t.max. 340°C 100-340°C		
spare parts for	106061		
	GEV No.	100809	Ref. No. —
O-ring EPDM thickness 2mm ID ø 21mm Qty 1 pcs			
	GEV No.	101053	Ref. No. 0006443 056587 75800560
magnet unit T1: M9x1 T2: M24x1 L 45mm ø 17mm suitable for Minisit			

spare parts for		106061	
	GEV No.	101136	Ref. No. 003128 0073208 051567 054269 0H6049 0K5721 19012785 75800552
piezoelectric igniter suitable for Minisit with cover cap ømm connection F6.3x0.8			
	GEV No.	101269	Ref. No. —
gas connection thread 1/2" angled with O-ring MINISIT 710			
	GEV No.	101516	Ref. No. —
flat-headed bolt thread M4 thread L 16mm SS DIN 7985/ISO 7045 Qty 1 pcs			
	GEV No.	101517	Ref. No. —
flat-headed bolt thread M4 thread L 23mm			
	GEV No.	102107	Ref. No. 056593
probe 100-340°C probe ø 4mm probe L 72mm capillary pipe 1050mm t.max. 340°C oven/grill probe type type C1 suitable for MINISIT 710			
	GEV No.	107564	Ref. No. 0C8450
piezoelectric igniter body plastic blowing connection F6.3x0.8 ø 22mm			
	GEV No.	110068	Ref. No. 054268 0916124 0A2172 0G2403 0K2272 0K5811 19016055 75800553
knob suitable for Minisit ø 37mm			
accessories for	106061		
	GEV No.	101273	Ref. No. —
olive for pipe ø 12mm L 9.5mm brass Qty 1 pcs suitable for universal			
	GEV No.	101274	Ref. No. —
olive for pipe ø 16mm Qty 1 pcs			
	GEV No.	101275	Ref. No. 052668
union screw thread 1/2" for pipe ø 16mm Qty 1 pcs			
	GEV No.	101276	Ref. No. —
union screw thread 3/8" tube ø 12mm Qty 1 pcs			
	GEV No.	101278	Ref. No. 060325 0C0150 0G0794 0G1111 0G2610 0K1976 0KW924 0T1946 101278 17012732 17012758 19012727
olive for pipe ø 10mm Qty 1 pcs			
	GEV No.	101279	Ref. No. —
union screw thread 3/8" for pipe ø 10mm Qty 1 pcs			

			
GEV No.	101435	Ref. No.	052068 053193 053289 0710629
description	gas thermostat SIT type MINISIT 710 t.max. 340°C 100-340°C gas inlet 1/2" gas outlet 3/8" thermocouple connection M9x1 pilot connection M10x1 probe ø 4mm probe L 72mm capillary pipe 1050mm probe type type C1 pressure controller no pressure regulator mbar gland nut		
For models:	PCG1210, PCG1210F, PCG1210D, PCG1200NL, PTFG810, HRS/G802, HRS/G802, HRS/G812, HRA/G802, HR/G802T, HT/G800F, ZPC/G1210, ZPTF/G1000, HCA/G810, HCF/G1210, ZHCF/G161, ZHRAG802CR, HCA/G810, HCF/G1210, HCF/G1610, HRA/G812, HRA/G812, ZHR/G802, ZHRA/G812, HRA/G802, ZHR/G802		
spare parts for	101435		
	GEV No.	101053	Ref. No. 0006443 056587 75800560
	magnet unit T1: M9x1 T2: M24x1 L 45mm ø 17mm suitable for Minisit		
	GEV No.	102107	Ref. No. 056593
	probe 100-340°C probe ø 4mm probe L 72mm capillary pipe 1050mm t.max. 340°C oven/grill probe type type C1 suitable for MINISIT 710		
accessories for	101435		
	GEV No.	100809	Ref. No. —
	O-ring EPDM thickness 2mm ID ø 21mm Qty 1 pcs		
	GEV No.	100904	Ref. No. 052833 0K2497 100904 102504
	locking screw M10x1 for pipe ø 4mm Qty 1 pcs		
	GEV No.	100905	Ref. No. 052834 0958031
	locking screw M10x1 for pipe ø 6mm Qty 1 pcs		
	GEV No.	101054	Ref. No. 0006442 0K0669
	magnet unit T1: M10x1 T2: M24x1 L 45mm ø 17mm suitable for Minisit		
	GEV No.	101136	Ref. No. 003128 0073208 051567 054269 0H6049 0K5721 19012785 75800552
	piezoelectric igniter suitable for Minisit with cover cap ømm connection F6.3x0.8		
	GEV No.	101137	Ref. No. 056577 0903052
	cover cap without piezoelectric igniter		
	GEV No.	101267	Ref. No. —
	reducer IT 3/8" ET 1/2" L 21mm		
	GEV No.	101268	Ref. No. —
	gas connection thread 3/8" angled with O-ring MINISIT 710		

accessories for	101435		
	GEV No.	101269	Ref. No. —
	gas connection thread 1/2" angled with O-ring MINISIT 710		
	GEV No.	101270	Ref. No. —
	screw connection IT 3/8" ET 3/8" L 28mm		
	GEV No.	101272	Ref. No. —
	screw connection IT 1/2" ET 3/8" L 57mm		
	GEV No.	101273	Ref. No. —
	olive for pipe ø 12mm L 9.5mm brass Qty 1 pcs suitable for universal		
	GEV No.	101274	Ref. No. —
	olive for pipe ø 16mm Qty 1 pcs		
	GEV No.	101275	Ref. No. 052668
	union screw thread 1/2" for pipe ø 16mm Qty 1 pcs		
	GEV No.	101276	Ref. No. —
	union screw thread 3/8" tube ø 12mm Qty 1 pcs		
	GEV No.	110068	Ref. No. 054268 0916124 0A2172 0G2403 0K2272 0K5811 19016055 75800553
	knob suitable for Minisit ø 37mm		



















			
GEV No.	101132	Ref. No.	003276 056833 0710650 310200 SGT251 TU1993
description	gas thermostat SIT type MINISIT 710 t.max. 340°C 100-340°C gas inlet 1/2" gas outlet 3/8" thermocouple connection M9x1 pilot connection M10x1 probe ø 5mm probe L 68mm capillary pipe 1050mm probe type type B1 pressure controller no pressure regulator mbar gland nut ignition gas no		
For models:	MBR/G710D, MBR/G700, MBR/G700F, MBR/G700UK, MBR/G701, MBR/G706, MBR/G701UK, MBR/G751, MBR/G756, RBR/G710D, RBR/G700, RBR/G700F, 7BRG60, 7BRG60X, RBR/G701UK, RBR/G751, RBR/G756, XBR/G710D, XBR/G700, XBR/G710, XBR/G700F, XBR/G700UK, XBR/G701, M70GBP, XBR/G751, XBR/G756, CBR/G700, RBR/G700, RBR/E700, RBR/G700, NC4/FV, NC6/FVL, NC6/FV, NC6/2FV, NC8/2FV, 1TPG18F, 1104F/G, 1106F/2G, 1108F/2G, NC4/FV, NC6/FV, NC6/2FV, NC8/2FV, NC6/FVL, PCF/GG840, PCF/GG1260, PCF/GG1680, PTF/GG1835, ZRBR/G700, ZRBR/G700D...(Other models you can see in the webshop)		
spare parts for	101132		
	GEV No.	101053	Ref. No. 0006443 056587 75800560
	magnet unit T1: M9x1 T2: M24x1 L 45mm ø 17mm suitable for Minisit		

Table continues overleaf



spare parts for		101132	
	GEV No.	102102	Ref. No. 056592
probe 100-340°C probe ø 5mm probe L 68mm capillary pipe 1750mm t.max. 340°C oven/grill probe type type B1 suitable for MINISIT 710			
accessories for		101132	
	GEV No.	100809	Ref. No. —
O-ring EPDM thickness 2mm ID ø 21mm Qty 1 pcs			
	GEV No.	100904	Ref. No. 052833 0K2497 100904 102504
locking screw M10x1 for pipe ø 4mm Qty 1 pcs			
	GEV No.	100905	Ref. No. 052834 0958031
locking screw M10x1 for pipe ø 6mm Qty 1 pcs			
	GEV No.	101054	Ref. No. 0006442 0K0669
magnet unit T1: M10x1 T2: M24x1 L 45mm ø 17mm suitable for Minisit			
	GEV No.	101136	Ref. No. 003128 0073208 051567 054269 0H6049 0K5721 19012785 75800552
piezoelectric igniter suitable for Minisit with cover cap ømm connection F6.3x0.8			
	GEV No.	101137	Ref. No. 056577 0903052
cover cap without piezoelectric igniter			
	GEV No.	101267	Ref. No. —
reducer IT 3/8" ET 1/2" L 21mm			
	GEV No.	101268	Ref. No. —
gas connection thread 3/8" angled with O-ring MINISIT 710			
	GEV No.	101269	Ref. No. —
gas connection thread 1/2" angled with O-ring MINISIT 710			
	GEV No.	101270	Ref. No. —
screw connection IT 3/8" ET 3/8" L 28mm			
	GEV No.	101272	Ref. No. —
screw connection IT 1/2" ET 3/8" L 57mm			
	GEV No.	101273	Ref. No. —
olive for pipe ø 12mm L 9.5mm brass Qty 1 pcs suitable for universal			
	GEV No.	101274	Ref. No. —
olive for pipe ø 16mm Qty 1 pcs			
	GEV No.	101275	Ref. No. 052668
union screw thread 1/2" for pipe ø 16mm Qty 1 pcs			
	GEV No.	101276	Ref. No. —
union screw thread 3/8" tube ø 12mm Qty 1 pcs			

accessories for		101132	
	GEV No.	110068	Ref. No. 054268 0916124 0A2172 0G2403 0K2272 0K5811 19016055 75800553
knob suitable for Minisit ø 37mm			









			
1			
GEV No.	101796	Ref. No.	0H6235
description	gas thermostat SIT type MINISIT 710 t.max. 340°C 100-340°C gas inlet 1/2" gas outlet 3/8" thermocouple connection M9x1 pilot connection M10x1 probe ø 5mm probe L 68mm capillary pipe 1800mm probe type type B1 pressure controller yes pressure regulator 3-18mbar gland nut		
For models:	7530-2, 7531-2, 7542-2, 7544-2, 9030-2, 9031-2, 9042-2, 9044-2		
spare parts for	101796		
	GEV No.	100026	Ref. No. 002578 0028398 054273 0K5687 0K1359 19012631
ignition cable cable length 1000mm connection ø4mm / F6.3mm			
	GEV No.	100809	Ref. No. —
O-ring EPDM thickness 2mm ID ø 21mm Qty 1 pcs			
	GEV No.	101053	Ref. No. 0006443 056587 75800560
magnet unit T1: M9x1 T2: M24x1 L 45mm ø 17mm suitable for Minisit			
	GEV No.	101136	Ref. No. 003128 0073208 051567 054269 0H6049 0K5721 19012785 75800552
piezoelectric igniter suitable for Minisit with cover cap ømm connection F6.3x0.8			
	GEV No.	101268	Ref. No. —
gas connection thread 3/8" angled with O-ring MINISIT 710			
	GEV No.	102102	Ref. No. 056592
probe 100-340°C probe ø 5mm probe L 68mm capillary pipe 1750mm t.max. 340°C oven/grill probe type type B1 suitable for MINISIT 710			
	GEV No.	107564	Ref. No. 0C8450
piezoelectric igniter body plastic blowing connection F6.3x0.8 ø 22mm			
	GEV No.	110269	Ref. No. 0H6734
knob thermostat t.max. 100°C 50-100°C ø 72mm shaft ø 6x4.6mm shaft flat lower			

Table continues overleaf

accessories for		101796	
	GEV No.	100904	Ref. No. 052833 0K2497 100904 102504
locking screw M10x1 for pipe ø 4mm Qty 1 pcs			
	GEV No.	100905	Ref. No. 052834 0958031
locking screw M10x1 for pipe ø 6mm Qty 1 pcs			
	GEV No.	101054	Ref. No. 0006442 0K0669
magnet unit T1: M10x1 T2: M24x1 L 45mm ø 17mm suitable for Minisit			
	GEV No.	101267	Ref. No. —
reducer IT 3/8" ET 1/2" L 21mm			
	GEV No.	101270	Ref. No. —
screw connection IT 3/8" ET 3/8" L 28mm			
	GEV No.	101272	Ref. No. —
screw connection IT 1/2" ET 3/8" L 57mm			
	GEV No.	101273	Ref. No. —
olive for pipe ø 12mm L 9.5mm brass Qty 1 pcs suitable for universal			
	GEV No.	101274	Ref. No. —
olive for pipe ø 16mm Qty 1 pcs			
	GEV No.	101275	Ref. No. 052668
union screw thread 1/2" for pipe ø 16mm Qty 1 pcs			
	GEV No.	101276	Ref. No. —
union screw thread 3/8" tube ø 12mm Qty 1 pcs			
	GEV No.	110068	Ref. No. 054268 0916124 0A2172 0G2403 0K2272 0K5811 19016055 75800553
knob suitable for Minisit ø 37mm			



GEV No.	102872	Ref. No.	0710619 0H6570
description	gas thermostat SIT type MINISIT 710 t.max. 340°C 120-340°C gas inlet 3/8" gas outlet 3/8" thermocouple connection M10x1 pilot connection M10x1 probe ø 5mm probe L 68mm capillary pipe 1050mm probe type type B2 pressure controller no pressure regulator mbar gland nut		
spare parts for	102872		
	GEV No.	100068	Ref. No. —
pilot burner 2 flames gas connection 6mm			
	GEV No.	100809	Ref. No. —
O-ring EPDM thickness 2mm ID ø 21mm Qty 1 pcs			

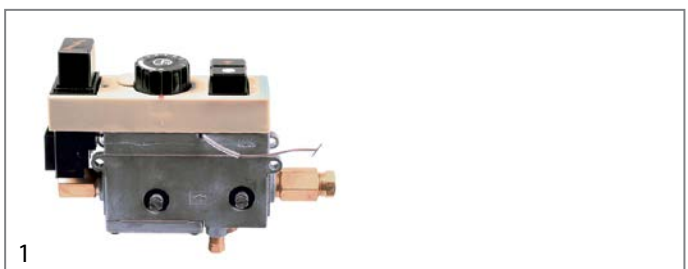

spare parts for		102872	
	GEV No.	101054	Ref. No. 0006442 0K0669
magnet unit T1: M10x1 T2: M24x1 L 45mm ø 17mm suitable for Minisit			
	GEV No.	101136	Ref. No. 003128 0073208 051567 054269 0H6049 0K5721 19012785 75800552
piezoelectric igniter suitable for Minisit with cover cap ømm connection F6.3x0.8			
	GEV No.	101505	Ref. No. 054270
gas connection thread 3/8" angled without O-ring MINISIT 710			
	GEV No.	101516	Ref. No. —
flat-headed bolt thread M4 thread L 16mm SS DIN 7985/ISO 7045 Qty 1 pcs			



GEV No.	101768	Ref. No.	0710618 0H6571
description	gas thermostat SIT type MINISIT 710 t.max. 380°C 160-380°C gas inlet 3/8" gas outlet 3/8" thermocouple connection M10x1 probe ø 5mm probe L 68mm capillary pipe 1050mm probe type type B2 pressure controller no		
For models:	7502-2, 7504-2, 7508-2, 7512-2, 9002-2, 9004-2, 9012-2		
spare parts for	101768		
	GEV No.	101054	Ref. No. 0006442 0K0669
magnet unit T1: M10x1 T2: M24x1 L 45mm ø 17mm suitable for Minisit			
	GEV No.	101136	Ref. No. 003128 0073208 051567 054269 0H6049 0K5721 19012785 75800552
piezoelectric igniter suitable for Minisit with cover cap ømm connection F6.3x0.8			
	GEV No.	110068	Ref. No. 054268 0916124 0A2172 0G2403 0K2272 0K5811 19016055 75800553
knob suitable for Minisit ø 37mm			
accessories for	101768		
	GEV No.	101273	Ref. No. —
olive for pipe ø 12mm L 9.5mm brass Qty 1 pcs suitable for universal			
	GEV No.	101276	Ref. No. —
union screw thread 3/8" tube ø 12mm Qty 1 pcs			

Table continues overleaf





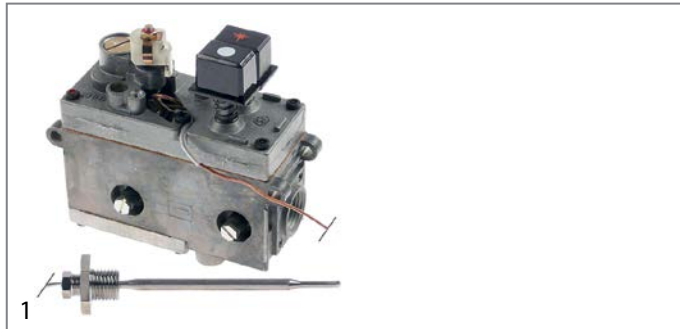









accessories for		101768	
	GEV No.	101278	Ref. No.
			060325 0C0150 0G0794 0G1111 0G2610 0K1976 0KW924 0T1946 101278 17012732 17012758 19012727
	olive for pipe ø 10mm Qty 1 pcs		
	GEV No.	101279	Ref. No.
			—
	union screw thread 3/8" for pipe ø 10mm Qty 1 pcs		



GEV No.	101133	Ref. No.	0H6231
description	gas thermostat without accessories SIT type MINISIT 710 t.max. 200°C 60-200°C gas inlet 1/2" gas outlet 3/8" thermocouple connection M10x1 pilot connection M10x1 probe ø 5mm probe L 95mm capillary pipe 1050mm probe type type D2 pressure controller no pressure regulator mbar gland nut M14x1.5 ignition gas 4mm		
spare parts for	101133		
	GEV No.	101054	Ref. No.
			0006442 0K0669
	magnet unit T1: M10x1 T2: M24x1 L 45mm ø 17mm suitable for Minisit		
	GEV No.	102844	Ref. No.
			—
	probe 60-200°C probe ø 5mm probe L 98mm capillary pipe 1050mm t.max. 200°C fryer probe type type D2 suitable for MINISIT 710 gland nut M14x1.5		
accessories for	101133		
	GEV No.	100809	Ref. No.
			—
	O-ring EPDM thickness 2mm ID ø 21mm Qty 1 pcs		
	GEV No.	100820	Ref. No.
			—
	gland duct ET M14x1.5 IT M10x0.75 probe ø max. 6.5mm WS 22		
	GEV No.	100904	Ref. No.
			052833 0K2497 100904 102504
	locking screw M10x1 for pipe ø 4mm Qty 1 pcs		
	GEV No.	100905	Ref. No.
			052834 0958031
	locking screw M10x1 for pipe ø 6mm Qty 1 pcs		
	GEV No.	101053	Ref. No.
			0006443 056587 75800560
	magnet unit T1: M9x1 T2: M24x1 L 45mm ø 17mm suitable for Minisit		

accessories for		101133	
	GEV No.	101136	Ref. No.
			003128 0073208 051567 054269 0H6049 0K5721 19012785 75800552
	piezoelectric igniter suitable for Minisit with cover cap ømm connection F6.3x0.8		
	GEV No.	101137	Ref. No.
			056577 0903052
	cover cap without piezoelectric igniter		
	GEV No.	101267	Ref. No.
			—
	reducer IT 3/8" ET 1/2" L 21mm		
	GEV No.	101268	Ref. No.
			—
	gas connection thread 3/8" angled with O-ring MINISIT 710		
	GEV No.	101269	Ref. No.
			—
	gas connection thread 1/2" angled with O-ring MINISIT 710		
	GEV No.	101270	Ref. No.
			—
	screw connection IT 3/8" ET 3/8" L 28mm		
	GEV No.	101272	Ref. No.
			—
	screw connection IT 1/2" ET 3/8" L 57mm		
	GEV No.	101273	Ref. No.
			—
	olive for pipe ø 12mm L 9.5mm brass Qty 1 pcs suitable for universal		
	GEV No.	101274	Ref. No.
			—
	olive for pipe ø 16mm Qty 1 pcs		
	GEV No.	101275	Ref. No.
			052668
	union screw thread 1/2" for pipe ø 16mm Qty 1 pcs		
	GEV No.	101276	Ref. No.
			—
	union screw thread 3/8" tube ø 12mm Qty 1 pcs		
	GEV No.	110068	Ref. No.
			054268 0916124 0A2172 0G2403 0K2272 0K5811 19016055 75800553
	knob suitable for Minisit ø 37mm		

			
GEV No.	101130	Ref. No.	052431
description	gas thermostat without cap, button and angle SIT type MINISIT 710 t.max. 100°C 30-100°C gas inlet 1/2" gas outlet 3/8" thermocouple connection M9x1 pilot connection M10x1 probe ø 5mm probe L 122mm capillary pipe 1050mm probe type type A1 pressure controller no pressure regulator gland nut		
For models:	HMA/G800, HMA/G800D, ZHMA/G80, ZHMA/G80		
spare parts for	101130		
	GEV No.	101053	Ref. No. 0006443 056587 75800560
	magnet unit T1: M9x1 T2: M24x1 L 45mm ø 17mm suitable for Minisit		
	GEV No.	102100	Ref. No. 056646 0928567
	probe 30-100°C probe ø 5mm probe L 122mm capillary pipe 1050mm t.max. 100°C bain marie probe type type A1 suitable for MINISIT 710		
accessories for	101130		
	GEV No.	100809	Ref. No. —
	O-ring EPDM thickness 2mm ID ø 21mm Qty 1 pcs		
	GEV No.	100820	Ref. No. —
	gland duct ET M14x1.5 IT M10x0.75 probe ø max. 6.5mm WS 22		
	GEV No.	100904	Ref. No. 052833 0K2497 100904 102504
	locking screw M10x1 for pipe ø 4mm Qty 1 pcs		
	GEV No.	100905	Ref. No. 052834 0958031
	locking screw M10x1 for pipe ø 6mm Qty 1 pcs		
	GEV No.	101054	Ref. No. 0006442 0K0669
	magnet unit T1: M10x1 T2: M24x1 L 45mm ø 17mm suitable for Minisit		
	GEV No.	101136	Ref. No. 003128 0073208 051567 054269 0H6049 0K5721 19012785 75800552
	piezoelectric igniter suitable for Minisit with cover cap ømm connection F6.3x0.8		
	GEV No.	101137	Ref. No. 056577 0903052
	cover cap without piezoelectric igniter		
	GEV No.	101267	Ref. No. —
	reducer IT 3/8" ET 1/2" L 21mm		
	GEV No.	101268	Ref. No. —
	gas connection thread 3/8" angled with O-ring MINISIT 710		
	GEV No.	101269	Ref. No. —
	gas connection thread 1/2" angled with O-ring MINISIT 710		

accessories for	101130		
	GEV No.	101270	Ref. No. —
	screw connection IT 3/8" ET 3/8" L 28mm		
	GEV No.	101272	Ref. No. —
	screw connection IT 1/2" ET 3/8" L 57mm		
	GEV No.	101273	Ref. No. —
	olive for pipe ø 12mm L 9.5mm brass Qty 1 pcs suitable for universal		
	GEV No.	101274	Ref. No. —
	olive for pipe ø 16mm Qty 1 pcs		
	GEV No.	101275	Ref. No. 052668
	union screw thread 1/2" for pipe ø 16mm Qty 1 pcs		
	GEV No.	101276	Ref. No. —
	union screw thread 3/8" tube ø 12mm Qty 1 pcs		
	GEV No.	110068	Ref. No. 054268 0916124 0A2172 0G2403 0K2272 0K5811 19016055 75800553
	knob suitable for Minisit ø 37mm		





			
GEV No.	101131	Ref. No.	052952 054267
description	gas thermostat without cap, button and angle SIT type MINISIT 710 t.max. 190°C 50-190°C gas inlet 1/2" gas outlet 3/8" thermocouple connection M9x1 pilot connection M10x1 probe ø 5mm probe L 98mm capillary pipe 1200mm probe type type A2 pressure controller no pressure regulator gland nut		
For models:	XBR/G701UK, CBR/G700, RFR/G300		
spare parts for	101131		
	GEV No.	101053	Ref. No. 0006443 056587 75800560
	magnet unit T1: M9x1 T2: M24x1 L 45mm ø 17mm suitable for Minisit		
	GEV No.	102103	Ref. No. 056591
	probe 60-200°C probe ø 5mm probe L 98mm capillary pipe 1050mm t.max. 200°C fryer probe type type A2 suitable for MINISIT 710		
accessories for	101131		
	GEV No.	100809	Ref. No. —
	O-ring EPDM thickness 2mm ID ø 21mm Qty 1 pcs		
	GEV No.	100820	Ref. No. —
	gland duct ET M14x1.5 IT M10x0.75 probe ø max. 6.5mm WS 22		

Table continues overleaf



accessories for		101131	
	GEV No.	100904	Ref. No. 052833 0K2497 100904 102504
locking screw M10x1 for pipe ø4mm Qty 1 pcs			
	GEV No.	100905	Ref. No. 052834 0958031
locking screw M10x1 for pipe ø6mm Qty 1 pcs			
	GEV No.	101054	Ref. No. 0006442 0K0669
magnet unit T1: M10x1 T2: M24x1 L 45mm ø 17mm suitable for Minisit			
	GEV No.	101136	Ref. No. 003128 0073208 051567 054269 0H6049 0K5721 19012785 75800552
piezoelectric igniter suitable for Minisit with cover cap ømm connection F6.3x0.8			
	GEV No.	101137	Ref. No. 056577 0903052
cover cap without piezoelectric igniter			
	GEV No.	101267	Ref. No. —
reducer IT 3/8" ET 1/2" L 21mm			
	GEV No.	101268	Ref. No. —
gas connection thread 3/8" angled with O-ring MINISIT 710			
	GEV No.	101269	Ref. No. —
gas connection thread 1/2" angled with O-ring MINISIT 710			
	GEV No.	101270	Ref. No. —
screw connection IT 3/8" ET 3/8" L 28mm			
	GEV No.	101272	Ref. No. —
screw connection IT 1/2" ET 3/8" L 57mm			
	GEV No.	101273	Ref. No. —
olive for pipe ø 12mm L 9.5mm brass Qty 1 pcs suitable for universal			
	GEV No.	101274	Ref. No. —
olive for pipe ø 16mm Qty 1 pcs			
	GEV No.	101275	Ref. No. 052668
union screw thread 1/2" for pipe ø 16mm Qty 1 pcs			
	GEV No.	101276	Ref. No. —
union screw thread 3/8" tube ø 12mm Qty 1 pcs			
	GEV No.	110068	Ref. No. 054268 0916124 0A2172 0G2403 0K2272 0K5811 19016055 75800553
knob suitable for Minisit ø 37mm			

accessories			
probes			
	1		
GEV No.	102107	Ref. No.	056593
description	probe 100-340°C probe ø 4mm probe L 72mm capillary pipe 1050mm t.max. 340°C oven/grill probe type type C1 suitable for MINISIT 710		
For models:	LG159-703.A1BC, LG159-703.A2BC, LG159-704.A1BC, LG159-706.A1BC, LG259-711.A1ACCB, LG259-712.A1ACCB, LK259-707.D1ACCB, LK259-708.D1ACCB, LG259-739.A1ACCB, LG259-740.A1ACCB, LK159-707.D1BC, LK159-708.D1BC, LK259-727.D1ACCB, LK259-728.D1ACCB, LG159-704.A2BC, LK159-707.D2BC, LK159-708.D2BC, LG259-711.A2ACCB, LG259-712.A2ACCB, LK259-727.D2ACCB, LK259-728.D2ACCB, LK259-707.D2ACCB, LK259-708.D2ACCB, LG159-705.A1BC, LG159-753.A1BC, LG259-758.A1ACCB, LG259-754.A1ACCB, LG259-757.A1ACCB, LG159-703.0.FF, LG159-703.0.GD, LG159-703.0.GK, LG159-703.0.ZS, LG159-703.0.SS, LG159-704.0.GD, LG159-704.0.SS, LG159-704.0.ZS, LK159-708.3.NS, LK159-708.3.SS, LK159-708.3.ZF, LG159-705.0.SS, LG159-706.0.NZ, LG159-706.0.ZN, LG159-753.0.ZZ, LG259-711.0.FF/ZZ, LG259-711.0.FN/NN, LG259-711.0.GL/GL, LG259-711.0.NS/NN, LG259-711.0.SS/SS, LG259-711.0.SZ/ZS, LG259-711.0.ZS/ZS...(Other models you can see in the webshop)		

	1		
GEV No.	102102	Ref. No.	056592
description	probe 100-340°C probe ø 5mm probe L 68mm capillary pipe 1750mm t.max. 340°C oven/grill probe type type B1 suitable for MINISIT 710		













	1		
GEV No.	102118	Ref. No.	056590
description	probe 110-190°C probe ø 6mm probe L 102mm capillary pipe 1050mm t.max. 190°C fryer probe type type A3 suitable for MINISIT 710		
accessories for	102118		
	GEV No.	100820	Ref. No. —
gland duct ET M14x1.5 IT M10x0.75 probe ø max. 6.5mm WS 22			









	1		
GEV No.	102100	Ref. No.	056646 0928567
description	probe 30-100°C probe ø 5mm probe L 122mm capillary pipe 1050mm t.max. 100°C bain marie probe type type A1 suitable for MINISIT 710		



			
GEV No.	102103	Ref. No.	056591
description	probe 60-200°C probe ø 5mm probe L 98mm capillary pipe 1050mm t.max. 200°C fryer probe type type A2 suitable for MINISIT 710		

MERTIK

			
GEV No.	101966	Ref. No.	0C0444
description	gas thermostat MERTIK t.max. 110°C 30-110°C gas inlet lateral 3/8" gas outlet lateral 3/8" thermocouple connection M9x1 capillary pipe 720mm probe ø 6mm probe L 80mm		
For models:	PBV/G2, TBV/G2, KB/G1, KB/G2, QB/G1, QB/G2, WB/G1, WB/G2		
spare parts for	101966		
	GEV No.	106221	Ref. No. —
magnet unit L 32mm D1 ø 19mm D2 ø 14mm suitable for MERTIK			
accessories for	101966		
	GEV No.	100015	Ref. No. —
ignition cable cable length 600mm connection ø2.4mm / ø2.4mm			
	GEV No.	100018	Ref. No. 00123 0028521 004943 059578 0U3507
ignition cable cable length 600mm connection ø2.4mm / ø4mm permanent temperature 200°C			
	GEV No.	100179	Ref. No. —
ignition cable cable length 1200mm connection F2.8mm / ø2.4mm			
	GEV No.	100193	Ref. No. —
ignition cable cable length 1200mm connection ø2.4mm / ø4mm			
	GEV No.	100197	Ref. No. —
ignition cable cable length 600mm connection F2.8mm / ø2.4mm			
	GEV No.	100904	Ref. No. 052833 0K2497 100904 102504
locking screw M10x1 for pipe ø 4mm Qty 1 pcs			
	GEV No.	101273	Ref. No. —
olive for pipe ø 12mm L 9.5mm brass Qty 1 pcs suitable for universal			
	GEV No.	101276	Ref. No. —
union screw thread 3/8" tube ø 12mm Qty 1 pcs			
	GEV No.	102180	Ref. No. 005559
ignition cable cable length 1200mm connection ø2.4mm / ø2.4mm			
	GEV No.	106701	Ref. No. 0C5400
knob adapter thickness 14mm ED ø 26mm shaft 8x6.5mm plastic			

accessories for	101966		
	GEV No.	106718	Ref. No. —
union screw for gas thermostat MERTIK M9x1 for thermocouple ET M22x1			
	GEV No.	112387	Ref. No. —
knob dial plate universal red			
	GEV No.	112388	Ref. No. —
knob dial plate universal silver			
	GEV No.	112598	Ref. No. —
knob dial plate MERTIK gas regulator (piezoelectric igniter) silver			
	GEV No.	112599	Ref. No. —
knob dial plate MERTIK gas regulator (piezoelectric igniter) red			
	GEV No.	112601	Ref. No. —
knob dial plate silver gas thermostat MERTIK 1-8 t.max.°C ED ø 59mm ID ø 45.5mm			
	GEV No.	112602	Ref. No. —
knob dial plate red gas thermostat MERTIK 1-8 t.max.°C ED ø 59mm ID ø 45.5mm			
	GEV No.	112949	Ref. No. —
knob MERTIK gas regulator ø 62mm shaft flat upper black special fixing shaft 8x6.5			
	GEV No.	112950	Ref. No. —
knob MERTIK gas regulator ø 32mm black for piezoelectric igniter			





			
GEV No.	106205	Ref. No.	0C1729
description	gas thermostat MERTIK t.max. 340°C 100-340°C gas inlet bottom 3/8" gas outlet bottom 3/8" thermocouple connection M9x1 capillary pipe 720mm probe ø 4mm probe L 68mm		
For models:	KCF/G3A, KCF/G3HA, KCF/G3AG, QCF/G3A, QCF/G3HA		
spare parts for	106205		
	GEV No.	106221	Ref. No. —
magnet unit L 32mm D1 ø 19mm D2 ø 14mm suitable for MERTIK			
accessories for	106205		
	GEV No.	100015	Ref. No. —
ignition cable cable length 600mm connection ø2.4mm / ø2.4mm			
	GEV No.	100018	Ref. No. 00123 0028521 004943 059578 0U3507
ignition cable cable length 600mm connection ø2.4mm / ø4mm permanent temperature 200°C			
	GEV No.	100179	Ref. No. —
ignition cable cable length 1200mm connection F2.8mm / ø2.4mm			

Table continues overleaf

















accessories for 106205				
	GEV No.	100193	Ref. No.	—
	ignition cable cable length 1200mm connection ø2.4mm / ø4mm			
	GEV No.	100197	Ref. No.	—
	ignition cable cable length 600mm connection F2.8mm / ø2.4mm			
	GEV No.	100904	Ref. No.	052833 0K2497 100904 102504
	locking screw M10x1 for pipe ø 4mm Qty 1 pcs			
	GEV No.	101273	Ref. No.	—
	olive for pipe ø 12mm L 9.5mm brass Qty 1 pcs suitable for universal			
	GEV No.	101276	Ref. No.	—
	union screw thread 3/8" tube ø 12mm Qty 1 pcs			
	GEV No.	102180	Ref. No.	005559
	ignition cable cable length 1200mm connection ø2.4mm / ø2.4mm			
	GEV No.	106701	Ref. No.	0C5400
	knob adapter thickness 14mm ED ø 26mm shaft 8x6.5mm plastic			
	GEV No.	106718	Ref. No.	—
	union screw for gas thermostat MERTIK M9x1 for thermocouple ET M22x1			
	GEV No.	112387	Ref. No.	—
	knob dial plate universal red			
	GEV No.	112388	Ref. No.	—
	knob dial plate universal silver			
	GEV No.	112598	Ref. No.	—
	knob dial plate MERTIK gas regulator (piezoelectric igniter) silver			
	GEV No.	112599	Ref. No.	—
	knob dial plate MERTIK gas regulator (piezoelectric igniter) red			
	GEV No.	112601	Ref. No.	—
	knob dial plate silver gas thermostat MERTIK 1-8 t.max.°C ED ø 59mm ID ø 45.5mm			
	GEV No.	112602	Ref. No.	—
	knob dial plate red gas thermostat MERTIK 1-8 t.max.°C ED ø 59mm ID ø 45.5mm			
	GEV No.	112949	Ref. No.	—
	knob MERTIK gas regulator ø 62mm shaft flat upper black special fixing shaft 8x6.5			
	GEV No.	112950	Ref. No.	—
	knob MERTIK gas regulator ø 32mm black for piezoelectric igniter			















1				
GEV No.	101957	Ref. No.	006692 11061226	
description	gas thermostat MERTIK t.max. 340°C 100-340°C gas inlet bottom 3/8" gas outlet lateral 3/8" thermocouple connection M9x1 capillary pipe 720mm probe ø 4mm probe L 68mm			
For models:	HR/G403W, HR/G803W, HR/G413W, HR/G813W, HR/G404W, HR/G804W, HR/G814W, ZR/G403W, ZR/G803W, ZR/G413W, ZR/G813W, ZR/G404W, ZR/G804W, ZR/G814W, WRF/GT2R, AR/G403W, AR/G803W, AR/G413W, AR/G813W, AR/G404W, AR/G804W, AR/G814W, AHGTRAOOOO, AHGTUAOOOO, AHGTRFOOOO, AHGTUFOOOO, AHGTRIOOOO, AHGTTIOOOO, AHGTQAOOOO, AHGTQFOOOO, AHGTTAOOO, AHGTTFOOOO, AHGTVIOOOO, AHGTSAOOOO, AHGTSFOOOO, AHGTVAOOOO, AHGTVFOOOO			
spare parts for	101957			
	GEV No.	106221	Ref. No.	—
	magnet unit L 32mm D1 ø 19mm D2 ø 14mm suitable for MERTIK			
accessories for	101957			
	GEV No.	100015	Ref. No.	—
	ignition cable cable length 600mm connection ø2.4mm / ø2.4mm			
	GEV No.	100018	Ref. No.	00123 0028521 004943 059578 0U3507
	ignition cable cable length 600mm connection ø2.4mm / ø4mm permanent temperature 200°C			
	GEV No.	100179	Ref. No.	—
	ignition cable cable length 1200mm connection F2.8mm / ø2.4mm			
	GEV No.	100193	Ref. No.	—
	ignition cable cable length 1200mm connection ø2.4mm / ø4mm			
	GEV No.	100197	Ref. No.	—
	ignition cable cable length 600mm connection F2.8mm / ø2.4mm			
	GEV No.	100904	Ref. No.	052833 0K2497 100904 102504
	locking screw M10x1 for pipe ø 4mm Qty 1 pcs			
	GEV No.	101273	Ref. No.	—
	olive for pipe ø 12mm L 9.5mm brass Qty 1 pcs suitable for universal			
	GEV No.	101276	Ref. No.	—
	union screw thread 3/8" tube ø 12mm Qty 1 pcs			
	GEV No.	102180	Ref. No.	005559
	ignition cable cable length 1200mm connection ø2.4mm / ø2.4mm			
	GEV No.	106701	Ref. No.	0C5400
	knob adapter thickness 14mm ED ø 26mm shaft 8x6.5mm plastic			
	GEV No.	106718	Ref. No.	—
	union screw for gas thermostat MERTIK M9x1 for thermocouple ET M22x1			

Table continues overleaf



accessories for		101957	
	GEV No.	112387	Ref. No. —
knob dial plate universal red			
	GEV No.	112388	Ref. No. —
knob dial plate universal silver			
	GEV No.	112598	Ref. No. —
knob dial plate MERTIK gas regulator (piezoelectric igniter) silver			
	GEV No.	112599	Ref. No. —
knob dial plate MERTIK gas regulator (piezoelectric igniter) red			
	GEV No.	112601	Ref. No. —
knob dial plate silver gas thermostat MERTIK 1-8 t.max.°C ED ø 59mm ID ø 45.5mm			
	GEV No.	112602	Ref. No. —
knob dial plate red gas thermostat MERTIK 1-8 t.max.°C ED ø 59mm ID ø 45.5mm			
	GEV No.	112949	Ref. No. —
knob MERTIK gas regulator ø 62mm shaft flat upper black special fixing shaft 8x6.5			
	GEV No.	112950	Ref. No. —
knob MERTIK gas regulator ø 32mm black for piezoelectric igniter			

			
1			
GEV No.	101959	Ref. No.	006460
description	gas thermostat MERTIK t.max. 340°C 100-340°C gas inlet bottom 3/8" gas outlet lateral 3/8" thermocouple connection M9x1 capillary pipe 720mm probe ø 4mm probe L 68mm pressure regulator 2.5-20mbar		
For models:	RMV/G1C, RMV/G2C, XMV/G1C, XMV/G2C, MMV/G1C, MMV/G2C, PMV/G1C, PMV/G2C, OMV/G1C, OMV/G2C, TMV/G1C, TMV/G2C, KMV/G2C, QMV/G2C		
spare parts for	101959		
	GEV No.	106221	Ref. No. —
magnet unit L 32mm D1 ø 19mm D2 ø 14mm suitable for MERTIK			
accessories for	101959		
	GEV No.	100015	Ref. No. —
ignition cable cable length 600mm connection ø2.4mm / ø2.4mm			
	GEV No.	100018	Ref. No. 00123 0028521 004943 059578 0U3507
ignition cable cable length 600mm connection ø2.4mm / ø4mm permanent temperature 200°C			
	GEV No.	100179	Ref. No. —
ignition cable cable length 1200mm connection F2.8mm / ø2.4mm			
	GEV No.	100193	Ref. No. —
ignition cable cable length 1200mm connection ø2.4mm / ø4mm			
	GEV No.	100197	Ref. No. —
ignition cable cable length 600mm connection F2.8mm / ø2.4mm			

accessories for		101959	
	GEV No.	100904	Ref. No. 052833 OK2497 100904 102504
locking screw M10x1 for pipe ø 4mm Qty 1 pcs			
	GEV No.	101273	Ref. No. —
olive for pipe ø 12mm L 9.5mm brass Qty 1 pcs suitable for universal			
	GEV No.	101276	Ref. No. —
union screw thread 3/8" tube ø 12mm Qty 1 pcs			
	GEV No.	102180	Ref. No. 005559
ignition cable cable length 1200mm connection ø2.4mm / ø2.4mm			
	GEV No.	106701	Ref. No. 0C5400
knob adapter thickness 14mm ED ø 26mm shaft 8x6.5mm plastic			
	GEV No.	106718	Ref. No. —
union screw for gas thermostat MERTIK M9x1 for thermocouple ET M22x1			
	GEV No.	112387	Ref. No. —
knob dial plate universal red			
	GEV No.	112388	Ref. No. —
knob dial plate universal silver			
	GEV No.	112556	Ref. No. 0C5251
knob switch zero mark t.max.°C temperature range°C ø 46mm shaft MERTIK shaft ømm shaft flat			
	GEV No.	112598	Ref. No. —
knob dial plate MERTIK gas regulator (piezoelectric igniter) silver			
	GEV No.	112599	Ref. No. —
knob dial plate MERTIK gas regulator (piezoelectric igniter) red			
	GEV No.	112601	Ref. No. —
knob dial plate silver gas thermostat MERTIK 1-8 t.max.°C ED ø 59mm ID ø 45.5mm			
	GEV No.	112602	Ref. No. —
knob dial plate red gas thermostat MERTIK 1-8 t.max.°C ED ø 59mm ID ø 45.5mm			
	GEV No.	112949	Ref. No. —
knob MERTIK gas regulator ø 62mm shaft flat upper black special fixing shaft 8x6.5			
	GEV No.	112950	Ref. No. —
knob MERTIK gas regulator ø 32mm black for piezoelectric igniter			



			
GEV No.	106397	Ref. No.	0C5250
description	gas thermostat MERTIK type GV30T t.max. 340°C 100-340°C gas inlet bottom 3/8" gas inlet lateral gas outlet bottom 3/8" gas outlet lateral thermocouple connection M9x1 pilot connection M10x1 capillary pipe 720mm probe ø 4mm probe L 68mm shaft ø 8x6.5mm shaft L 13mm cable length 1550mm gland nut		
For models:	PCV/G2A, PCV/G3A, PCF/G2A, PCF/G3A, OCF/G9UK, TCF/G9, TCF/G9UK, TCV/G2A, TCV/G3A, TCF/G2A, TCF/G3A		
accessories for	106397		
	GEV No.	100015	Ref. No. —
	ignition cable cable length 600mm connection ø2.4mm / ø2.4mm		
	GEV No.	100018	Ref. No. 00123 0028521 004943 059578 0U3507
	ignition cable cable length 600mm connection ø2.4mm / ø4mm permanent temperature 200°C		
	GEV No.	100179	Ref. No. —
	ignition cable cable length 1200mm connection F2.8mm / ø2.4mm		
	GEV No.	100193	Ref. No. —
	ignition cable cable length 1200mm connection ø2.4mm / ø4mm		
	GEV No.	100197	Ref. No. —
	ignition cable cable length 600mm connection F2.8mm / ø2.4mm		
	GEV No.	100904	Ref. No. 052833 0K2497 100904 102504
	locking screw M10x1 for pipe ø 4mm Qty 1 pcs		
	GEV No.	101273	Ref. No. —
	olive for pipe ø 12mm L 9.5mm brass Qty 1 pcs suitable for universal		
	GEV No.	101276	Ref. No. —
	union screw thread 3/8" tube ø 12mm Qty 1 pcs		
	GEV No.	102180	Ref. No. 005559
	ignition cable cable length 1200mm connection ø2.4mm / ø2.4mm		
	GEV No.	106701	Ref. No. 0C5400
	knob adapter thickness 14mm ED ø 26mm shaft 8x6.5mm plastic		
	GEV No.	106718	Ref. No. —
	union screw for gas thermostat MERTIK M9x1 for thermocouple ET M22x1		
	GEV No.	112387	Ref. No. —
	knob dial plate universal red		
	GEV No.	112388	Ref. No. —
	knob dial plate universal silver		

accessories for	106397		
	GEV No.	112556	Ref. No. 0C5251
	knob switch zero mark t.max.°C temperature range°C ø 46mm shaft MERTIK shaft ømm shaft flat		
	GEV No.	112598	Ref. No. —
	knob dial plate MERTIK gas regulator (piezoelectric igniter) silver		
	GEV No.	112599	Ref. No. —
	knob dial plate MERTIK gas regulator (piezoelectric igniter) red		
	GEV No.	112601	Ref. No. —
	knob dial plate silver gas thermostat MERTIK 1-8 t.max.°C ED ø 59mm ID ø 45.5mm		
	GEV No.	112602	Ref. No. —
	knob dial plate red gas thermostat MERTIK 1-8 t.max.°C ED ø 59mm ID ø 45.5mm		
	GEV No.	112949	Ref. No. —
	knob MERTIK gas regulator ø 62mm shaft flat upper black special fixing shaft 8x6.5		
	GEV No.	112950	Ref. No. —
	knob MERTIK gas regulator ø 32mm black for piezoelectric igniter		















			
GEV No.	101855	Ref. No.	0C5245
description	gas thermostat MERTIK type GV30T t.max. 340°C 100-340°C gas inlet bottom 3/8" gas inlet lateral gas outlet bottom gas outlet lateral 3/8" thermocouple connection M9x1 pilot connection M10x1 capillary pipe 720mm probe ø 4mm probe L 68mm shaft ø 8x6.5mm shaft L 13mm cable length 900mm gland nut		
For models:	BR/G1FL, BR/G1FR, BR/G2FL, BR/G2FR		
spare parts for	101855		
	GEV No.	106221	Ref. No. —
	magnet unit L 32mm D1 ø 19mm D2 ø 14mm suitable for MERTIK		
accessories for	101855		
	GEV No.	100015	Ref. No. —
	ignition cable cable length 600mm connection ø2.4mm / ø2.4mm		
	GEV No.	100018	Ref. No. 00123 0028521 004943 059578 0U3507
	ignition cable cable length 600mm connection ø2.4mm / ø4mm permanent temperature 200°C		
	GEV No.	100179	Ref. No. —
	ignition cable cable length 1200mm connection F2.8mm / ø2.4mm		
	GEV No.	100193	Ref. No. —
	ignition cable cable length 1200mm connection ø2.4mm / ø4mm		



Table continues overleaf

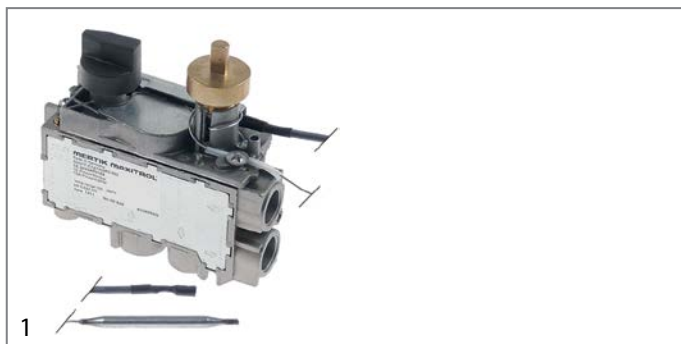





















accessories for		106814	
	GEV No.	106718	Ref. No. —
	union screw for gas thermostat MERTIK M9x1 for thermocouple ET M22x1		
	GEV No.	112387	Ref. No. —
	knob dial plate universal red		
	GEV No.	112388	Ref. No. —
	knob dial plate universal silver		
	GEV No.	112598	Ref. No. —
	knob dial plate MERTIK gas regulator (piezoelectric igniter) silver		
	GEV No.	112599	Ref. No. —
	knob dial plate MERTIK gas regulator (piezoelectric igniter) red		
	GEV No.	112601	Ref. No. —
	knob dial plate silver gas thermostat MERTIK 1-8 t.max.°C ED ø 59mm ID ø 45.5mm		
	GEV No.	112602	Ref. No. —
	knob dial plate red gas thermostat MERTIK 1-8 t.max.°C ED ø 59mm ID ø 45.5mm		
	GEV No.	112949	Ref. No. —
	knob MERTIK gas regulator ø 62mm shaft flat upper black special fixing shaft 8x6.5		
	GEV No.	112950	Ref. No. —
	knob MERTIK gas regulator ø 32mm black for piezoelectric igniter		



GEV No.	101564	Ref. No.	0C5249
description	gas thermostat MERTIK type GV31T t.max. 110°C 30-110°C gas inlet bottom gas inlet lateral 3/8" gas outlet bottom gas outlet lateral 3/8" thermocouple connection M9x1 pilot connection M10x1 capillary pipe 720mm probe ø 6mm probe L 78mm cable length 900mm gland nut pipe input ø 12mm pipe output ø 12mm		
spare parts for	101564		
	GEV No.	106221	Ref. No. —
	magnet unit L 32mm D1 ø 19mm D2 ø 14mm suitable for MERTIK		
accessories for	101564		
	GEV No.	100015	Ref. No. —
	ignition cable cable length 600mm connection ø2.4mm / ø2.4mm		
	GEV No.	100018	Ref. No. 00123 0028521 004943 059578 0U3507
	ignition cable cable length 600mm connection ø2.4mm / ø4mm permanent temperature 200°C		
	GEV No.	100179	Ref. No. —
	ignition cable cable length 1200mm connection F2.8mm / ø2.4mm		

accessories for		101564	
	GEV No.	100193	Ref. No. —
	ignition cable cable length 1200mm connection ø2.4mm / ø4mm		
	GEV No.	100197	Ref. No. —
	ignition cable cable length 600mm connection F2.8mm / ø2.4mm		
	GEV No.	101273	Ref. No. —
	olive for pipe ø 12mm L 9.5mm brass Qty 1 pcs suitable for universal		
	GEV No.	101276	Ref. No. —
	union screw thread 3/8" tube ø 12mm Qty 1 pcs		
	GEV No.	102180	Ref. No. 005559
	ignition cable cable length 1200mm connection ø2.4mm / ø2.4mm		
	GEV No.	106701	Ref. No. 0C5400
	knob adapter thickness 14mm ED ø 26mm shaft 8x6.5mm plastic		
	GEV No.	106718	Ref. No. —
	union screw for gas thermostat MERTIK M9x1 for thermocouple ET M22x1		
	GEV No.	112387	Ref. No. —
	knob dial plate universal red		
	GEV No.	112388	Ref. No. —
	knob dial plate universal silver		
	GEV No.	112598	Ref. No. —
	knob dial plate MERTIK gas regulator (piezoelectric igniter) silver		
	GEV No.	112599	Ref. No. —
	knob dial plate MERTIK gas regulator (piezoelectric igniter) red		
	GEV No.	112601	Ref. No. —
	knob dial plate silver gas thermostat MERTIK 1-8 t.max.°C ED ø 59mm ID ø 45.5mm		
	GEV No.	112602	Ref. No. —
	knob dial plate red gas thermostat MERTIK 1-8 t.max.°C ED ø 59mm ID ø 45.5mm		
	GEV No.	112949	Ref. No. —
	knob MERTIK gas regulator ø 62mm shaft flat upper black special fixing shaft 8x6.5		
	GEV No.	112950	Ref. No. —
	knob MERTIK gas regulator ø 32mm black for piezoelectric igniter		

			
GEV No.	101979	Ref. No.	006574 0C0624
description	gas thermostat MERTIK type GV31T t.max. 190°C 110-190°C gas inlet bottom 3/8" gas inlet lateral 3/8" gas outlet bottom 3/8" gas outlet lateral 3/8" thermocouple connection M9x1 capillary pipe 720mm probe ø 4mm probe L 160mm pressure regulator 5-40mbar		
For models:	PFR/G1S14, PFR/G2D14, PFRG2D14HV, PFRG1S14HV, OFR/G1S14, OFR/G2D14, TFR/G1S14, TFR/G2D14, KFR/G1A, KFR/G2B, KFR/G1E, KFR/G2F, KFR/G1T, HFR/G430, HFR/G830, HFRS/G430, QFR/G1A, QFR/G2B, QFR/G1E, QFR/G2F, QFR/G1T, ZFR/G430, ZFR/G830, ZFRS/G430, WFR/G1A, WFR/G2B, WFR/G1E, WFR/G2F, AFR/G430, AFR/G830, AFRS/G430		
spare parts for	101979		
	GEV No.	106221	Ref. No. —
	magnet unit L 32mm D1 ø 19mm D2 ø 14mm suitable for MERTIK		
accessories for	101979		
	GEV No.	100015	Ref. No. —
	ignition cable cable length 600mm connection ø2.4mm / ø2.4mm		
	GEV No.	100018	Ref. No. 00123 0028521 004943 059578 0U3507
	ignition cable cable length 600mm connection ø2.4mm / ø4mm permanent temperature 200°C		
	GEV No.	100179	Ref. No. —
	ignition cable cable length 1200mm connection F2.8mm / ø2.4mm		
	GEV No.	100193	Ref. No. —
	ignition cable cable length 1200mm connection ø2.4mm / ø4mm		
	GEV No.	100197	Ref. No. —
	ignition cable cable length 600mm connection F2.8mm / ø2.4mm		
	GEV No.	100904	Ref. No. 052833 0K2497 100904 102504
	locking screw M10x1 for pipe ø 4mm Qty 1 pcs		
	GEV No.	101273	Ref. No. —
	olive for pipe ø 12mm L 9.5mm brass Qty 1 pcs suitable for universal		
	GEV No.	101276	Ref. No. —
	union screw thread 3/8" tube ø 12mm Qty 1 pcs		
	GEV No.	102180	Ref. No. 005559
	ignition cable cable length 1200mm connection ø2.4mm / ø2.4mm		
	GEV No.	106701	Ref. No. 0C5400
	knob adapter thickness 14mm ED ø 26mm shaft 8x6.5mm plastic		
	GEV No.	106718	Ref. No. —
	union screw for gas thermostat MERTIK M9x1 for thermocouple ET M22x1		

accessories for	101979		
	GEV No.	112387	Ref. No. —
	knob dial plate universal red		
	GEV No.	112388	Ref. No. —
	knob dial plate universal silver		
	GEV No.	112598	Ref. No. —
	knob dial plate MERTIK gas regulator (piezoelectric igniter) silver		
	GEV No.	112599	Ref. No. —
	knob dial plate MERTIK gas regulator (piezoelectric igniter) red		
	GEV No.	112601	Ref. No. —
	knob dial plate silver gas thermostat MERTIK 1-8 t.max.°C ED ø 59mm ID ø 45.5mm		
	GEV No.	112602	Ref. No. —
	knob dial plate red gas thermostat MERTIK 1-8 t.max.°C ED ø 59mm ID ø 45.5mm		
	GEV No.	112949	Ref. No. —
	knob MERTIK gas regulator ø 62mm shaft flat upper black special fixing shaft 8x6.5		
	GEV No.	112950	Ref. No. —
	knob MERTIK gas regulator ø 32mm black for piezoelectric igniter		





			
GEV No.	101960	Ref. No.	0C0209
description	gas thermostat MERTIK type GV31T t.max. 340°C 100-340°C gas inlet bottom 3/8" gas outlet bottom 3/8" thermocouple connection M9x1 capillary pipe 720mm probe ø 4mm probe L 72mm		
For models:	PCV/G2, PCV/G3, PCF/G2, PCF/G3, PCF/G9, PTF/G2, PSF/G2, PCV/G2N, PCF/G3N, PCV/G3N, PCF/G2N, OCV/G2, OCF/G2, OCF/G3, OTV/G2, OTF/G2, OSF/G2, OSV/G2, TCV/G2, TCV/G3, TCF/G2, TCF/G3, TTF/G2, TSF/G2, KCF/G2, KCF/G3, KCF/G4, KCF/T2, KCF/T3, KCF/T4, KCF/G2H, KCF/G3H, KCF/G2L, KCF/G2G, KCF/G3G, KCF/G4G, KCF/G2HG, KCF/G3HG, KCF/G2LG, KS/G2, KSF/G2, KSCF/G3, QCF/G2, QCF/G3, QCF/G4, QCF/T2, QCF/T3, QCF/T4, QCF/G2H, QCF/G3H...(Other models you can see in the webshop)		
spare parts for	101960		
	GEV No.	106221	Ref. No. —
	magnet unit L 32mm D1 ø 19mm D2 ø 14mm suitable for MERTIK		
accessories for	101960		
	GEV No.	100015	Ref. No. —
	ignition cable cable length 600mm connection ø2.4mm / ø2.4mm		
	GEV No.	100018	Ref. No. 00123 0028521 004943 059578 0U3507
	ignition cable cable length 600mm connection ø2.4mm / ø4mm permanent temperature 200°C		

Table continues overleaf

















accessories for		101960	
	GEV No.	100179	Ref. No. —
	ignition cable cable length 1200mm connection F2.8mm / ø2.4mm		
	GEV No.	100193	Ref. No. —
	ignition cable cable length 1200mm connection ø2.4mm / ø4mm		
	GEV No.	100197	Ref. No. —
	ignition cable cable length 600mm connection F2.8mm / ø2.4mm		
	GEV No.	100904	Ref. No. 052833 0K2497 100904 102504
	locking screw M10x1 for pipe ø 4mm Qty 1 pcs		
	GEV No.	100908	Ref. No. 046755 052125 0958013 0G2219 0K1348 0K5753 0KE882 0KL495 19012956 727742 727781
	union screw thread M10x1 for pipe ø 4mm Qty 1 pcs		
	GEV No.	101246	Ref. No. 052127 727782
	olive for pipe ø 4mm Qty 1 pcs		
	GEV No.	101248	Ref. No. 004374 027478 050682 058370 0957007 0G2222 0K4315 214051400 727855
	olive for pipe ø 12mm Qty 1 pcs suitable for PEL		
	GEV No.	101273	Ref. No. —
	olive for pipe ø 12mm L 9.5mm brass Qty 1 pcs suitable for universal		
	GEV No.	101276	Ref. No. —
	union screw thread 3/8" tube ø 12mm Qty 1 pcs		
	GEV No.	101278	Ref. No. 060325 0C0150 0G0794 0G1111 0G2610 0K1976 0KW924 0T1946 101278 17012732 17012758 19012727
	olive for pipe ø 10mm Qty 1 pcs		
	GEV No.	102180	Ref. No. 005559
	ignition cable cable length 1200mm connection ø2.4mm / ø2.4mm		
	GEV No.	106701	Ref. No. 0C5400
	knob adapter thickness 14mm ED ø 26mm shaft 8x6.5mm plastic		
	GEV No.	106718	Ref. No. —
	union screw for gas thermostat MERTIK M9x1 for thermocouple ET M22x1		
	GEV No.	112387	Ref. No. —
	knob dial plate universal red		

accessories for		101960	
	GEV No.	112388	Ref. No. —
	knob dial plate universal silver		
	GEV No.	112598	Ref. No. —
	knob dial plate MERTIK gas regulator (piezoelectric igniter) silver		
	GEV No.	112599	Ref. No. —
	knob dial plate MERTIK gas regulator (piezoelectric igniter) red		
	GEV No.	112601	Ref. No. —
	knob dial plate silver gas thermostat MERTIK 1-8 t.max.°C ED ø 59mm ID ø 45.5mm		
	GEV No.	112602	Ref. No. —
	knob dial plate red gas thermostat MERTIK 1-8 t.max.°C ED ø 59mm ID ø 45.5mm		
	GEV No.	112949	Ref. No. —
	knob MERTIK gas regulator ø 62mm shaft flat upper black special fixing shaft 8x6.5		
	GEV No.	112950	Ref. No. —
	knob MERTIK gas regulator ø 32mm black for piezoelectric igniter		

1			
GEV No.	106813	Ref. No.	0C5247
description	gas thermostat MERTIK type GV31T-C1A7AGK0-003 t.max. 340°C 100-340°C gas inlet bottom 3/8" gas inlet lateral gas outlet bottom 3/8" gas outlet lateral thermocouple connection M9x1 pilot connection M10x1 capillary pipe 720mm probe ø 4mm probe L 68mm cable length 1300mm gland nut		
For models:	BCF/G2, PCV/G2A, PCV/G3A, PCF/G2A, PCF/G3A, TCV/G2A, TCV/G3A, TCF/G2A, TCF/G3A, KRF/GT2R, KRF/GT2RP, QRF/GT2R, QRF/GT2RP, WRF/GT2RP		
spare parts for	106813		
	GEV No.	106221	Ref. No. —
	magnet unit L 32mm D1 ø 19mm D2 ø 14mm suitable for MERTIK		
accessories for	106813		
	GEV No.	100015	Ref. No. —
	ignition cable cable length 600mm connection ø2.4mm / ø2.4mm		
	GEV No.	100018	Ref. No. 00123 0028521 004943 059578 0U3507
	ignition cable cable length 600mm connection ø2.4mm / ø4mm permanent temperature 200°C		
	GEV No.	100179	Ref. No. —
	ignition cable cable length 1200mm connection F2.8mm / ø2.4mm		
	GEV No.	100193	Ref. No. —
	ignition cable cable length 1200mm connection ø2.4mm / ø4mm		
	GEV No.	100197	Ref. No. —
	ignition cable cable length 600mm connection F2.8mm / ø2.4mm		

Table continues overleaf



accessories for		106813	
	GEV No.	100904	Ref. No. 052833 0K2497 100904 102504
locking screw M10x1 for pipe ø 4mm Qty 1 pcs			
	GEV No.	101273	Ref. No. —
olive for pipe ø 12mm L 9.5mm brass Qty 1 pcs suitable for universal			
	GEV No.	101276	Ref. No. —
union screw thread 3/8" tube ø 12mm Qty 1 pcs			
	GEV No.	102180	Ref. No. 005559
ignition cable cable length 1200mm connection ø2.4mm / ø2.4mm			
	GEV No.	106701	Ref. No. 0C5400
knob adapter thickness 14mm ED ø 26mm shaft 8x6.5mm plastic			
	GEV No.	106718	Ref. No. —
union screw for gas thermostat MERTIK M9x1 for thermocouple ET M22x1			
	GEV No.	112387	Ref. No. —
knob dial plate universal red			
	GEV No.	112388	Ref. No. —
knob dial plate universal silver			
	GEV No.	112598	Ref. No. —
knob dial plate MERTIK gas regulator (piezoelectric igniter) silver			
	GEV No.	112599	Ref. No. —
knob dial plate MERTIK gas regulator (piezoelectric igniter) red			
	GEV No.	112601	Ref. No. —
knob dial plate silver gas thermostat MERTIK 1-8 t.max.°C ED ø 59mm ID ø 45.5mm			
	GEV No.	112602	Ref. No. —
knob dial plate red gas thermostat MERTIK 1-8 t.max.°C ED ø 59mm ID ø 45.5mm			
	GEV No.	112949	Ref. No. —
knob MERTIK gas regulator ø 62mm shaft flat upper black special fixing shaft 8x6.5			
	GEV No.	112950	Ref. No. —
knob MERTIK gas regulator ø 32mm black for piezoelectric igniter			































			
GEV No.	106700	Ref. No.	0C5248 11061264 835859703
description	gas thermostat MERTIK type GV31T-C5AXE2K0 t.max. 190°C 110-190°C gas inlet bottom 3/8" gas inlet lateral 3/8" gas outlet bottom 3/8" gas outlet lateral 3/8" thermocouple connection M9x1 pilot connection M10x1 capillary pipe 720mm probe ø 4mm probe L 165mm shaft ø 8x6.5mm shaft L 13mm cable length 900mm		
For models:	BFR/G1S14, WFR/G1T		
accessories for	106700		
	GEV No.	100015	Ref. No. —
ignition cable cable length 600mm connection ø2.4mm / ø2.4mm			
	GEV No.	100018	Ref. No. 00123 0028521 004943 059578 0U3507
ignition cable cable length 600mm connection ø2.4mm / ø4mm permanent temperature 200°C			
	GEV No.	100179	Ref. No. —
ignition cable cable length 1200mm connection F2.8mm / ø2.4mm			
	GEV No.	100193	Ref. No. —
ignition cable cable length 1200mm connection ø2.4mm / ø4mm			
	GEV No.	100197	Ref. No. —
ignition cable cable length 600mm connection F2.8mm / ø2.4mm			
	GEV No.	100904	Ref. No. 052833 0K2497 100904 102504
locking screw M10x1 for pipe ø 4mm Qty 1 pcs			
	GEV No.	101273	Ref. No. —
olive for pipe ø 12mm L 9.5mm brass Qty 1 pcs suitable for universal			
	GEV No.	101276	Ref. No. —
union screw thread 3/8" tube ø 12mm Qty 1 pcs			
	GEV No.	102180	Ref. No. 005559
ignition cable cable length 1200mm connection ø2.4mm / ø2.4mm			
	GEV No.	106701	Ref. No. 0C5400
knob adapter thickness 14mm ED ø 26mm shaft 8x6.5mm plastic			
	GEV No.	106702	Ref. No. 0C0625
plug thread 3/8" with O-ring L 12mm WS 8 brass suitable for MERTIK			
	GEV No.	106718	Ref. No. —
union screw for gas thermostat MERTIK M9x1 for thermocouple ET M22x1			
	GEV No.	112387	Ref. No. —
knob dial plate universal red			

Table continues overleaf





accessories for		106700	
	GEV No.	112388	Ref. No. —
knob dial plate universal silver			
	GEV No.	112598	Ref. No. —
knob dial plate MERTIK gas regulator (piezoelectric igniter) silver			
	GEV No.	112599	Ref. No. —
knob dial plate MERTIK gas regulator (piezoelectric igniter) red			
	GEV No.	112601	Ref. No. —
knob dial plate silver gas thermostat MERTIK 1-8 t.max.°C ED ø 59mm ID ø 45.5mm			
	GEV No.	112602	Ref. No. —
knob dial plate red gas thermostat MERTIK 1-8 t.max.°C ED ø 59mm ID ø 45.5mm			
	GEV No.	112949	Ref. No. —
knob MERTIK gas regulator ø 62mm shaft flat upper black special fixing shaft 8x6.5			
	GEV No.	112950	Ref. No. —
knob MERTIK gas regulator ø 32mm black for piezoelectric igniter			

accessories for		101076	
	GEV No.	100908	Ref. No. 046755 052125 0958013 0G2219 0K1348 0K5753 0KE882 0KL495 19012956 727742 727781
union screw thread M10x1 for pipe ø 4mm Qty 1 pcs			
	GEV No.	100909	Ref. No. 003859 057821
union screw thread M10x1 for pipe ø 6mm Qty 1 pcs			
	GEV No.	101246	Ref. No. 052127 727782
olive for pipe ø 4mm Qty 1 pcs			
	GEV No.	101248	Ref. No. 004374 027478 050682 058370 0957007 0G2222 0K4315 214051400 727855
olive for pipe ø 12mm Qty 1 pcs suitable for PEL			
	GEV No.	101249	Ref. No. 052128
olive for pipe ø 10mm Qty 1 pcs			
	GEV No.	101250	Ref. No. —
union nut thread M20x1.5 for pipe ø 10mm			
	GEV No.	101251	Ref. No. —
union nut thread M20x1.5 for pipe ø 12mm			
	GEV No.	101286	Ref. No. 020992 053666
olive ID ø 6mm Qty 1 pcs			
	GEV No.	110079	Ref. No. —
knob dial plate gas thermostat 1-8 silver			
	GEV No.	110080	Ref. No. —
knob ø 70mm shaft ø 10x8mm shaft flat universal			

PEL

24ST series



GEV No.	101076	Ref. No.	058369
description	gas thermostat PEL type 24ST 120-320°C gas inlet M20x1.5 (tube ø 12mm) bypass nozzle ø 0.35mm gas outlet M20x1.5 (tube ø 12/10mm) thermocouple connection M9x1 pilot connection M10x1 capillary pipe 1200mm probe ø 6mm probe L 100mm shaft ø 10x8mm shaft L 27/17mm shaft flat upper		
For models:	NC6/2FV, NFT/2GL, NFT/2GR, NFT/2GLC, 110FTL/N, 1102FTL/N, 110FTR/N, 1102FTR/N, NC6/2FV, NFT/2GL, NFT/4GL, NFT/2GR, NFT/4GR, NFT/4GLR, NFT/4GLRC, NFT/2GLC, NFT/4GLC, PRA/G420, PRA/G430, PRA/G440, PRA/G840, PRA/G850, PRA/G860, 1FTGF4L, 1FTGF4R, 1FTGC4L, 1FTGF8L, 1FTGF8R, 1FTGC8L, ROCF/G1000, ROTF/G1000, ROSD/G1000, ROSF/G1000, RORA/G500, RORA/G1000, ROR/G500, ROR/G1000		
spare parts for	101076		
	GEV No.	100455	Ref. No. —
bypass nozzle type PEL23/24 bore ø 0.35mm thread M8x0.5			
	GEV No.	101058	Ref. No. 02B04 02E03 056594 0884 0H9943 0K0660 0K5349 0M0791 101058 19002904
magnet unit L 39mm D1 ø 15.4mm D2 ø 13.5mm suitable for PEL22/EGA24197 standard			
	GEV No.	106200	Ref. No. —
nut thread M9x1 suitable for PEL 24/25S			















24STS series



GEV No.	101160 ¹	Ref. No.	026335 335292530 890003 899905
description	gas thermostat PEL type 24STS 120-320°C gas inlet M20x1.5 (tube ø 12/10mm) bypass nozzle ø 0.35mm gas outlet M20x1.5 (tube ø 12/10mm) thermocouple connection M9x1 pilot connection M10x1 capillary pipe 1200mm probe ø 6mm probe L 100mm shaft ø 10x8mm shaft L 27/17mm shaft flat upper		

spare parts for	101160		
	GEV No.	101058	Ref. No. 02B04 02E03 056594 0884 0H9943 OK0660 OK5349 OM0791 101058 19002904
magnet unit L 39mm D1 ø 15.4mm D2 ø 13.5mm suitable for PEL22/EGA24197 standard			

accessories for	101160			
	GEV No.	101235	Ref. No.	—
gas connection thread M20x1.5 tube ø 12/10mm for PEL gas taps horizontal				
	GEV No.	101236	Ref. No.	—
gas connection thread M20x1.5 tube ø 12/10mm for PEL gas taps vertical				
	GEV No.	101239	Ref. No.	—
adapter thread 3/8" ø 10mm left-hand thread				
	GEV No.	101240	Ref. No.	050053
gas connection thread M20x1.5 tube ø 12/10mm for PEL gas taps with gasket and screws horizontal				
	GEV No.	101241	Ref. No.	—
gas connection thread M20x1.5 tube ø 12/10mm for PEL gas taps vertical				
	GEV No.	101248	Ref. No.	004374 027478 050682 058370 0957007 0G2222 OK4315 214051400 727855
olive for pipe ø 12mm Qty 1 pcs suitable for PEL				
	GEV No.	101249	Ref. No.	052128
olive for pipe ø 10mm Qty 1 pcs				
	GEV No.	101250	Ref. No.	—
union nut thread M20x1.5 for pipe ø 10mm				
	GEV No.	101251	Ref. No.	—
union nut thread M20x1.5 for pipe ø 12mm				



accessories for	101160			
	GEV No.	101460	Ref. No.	—
O-ring ø 12.37mm D1 ø 2.62mm suitable for PEL22				
	GEV No.	101461	Ref. No.	—
screw kit suitable for PEL22 Qty 4 pcs				
	GEV No.	110079	Ref. No.	—
knob dial plate gas thermostat 1-8 silver				
	GEV No.	110080	Ref. No.	—
knob ø 70mm shaft ø 10x8mm shaft flat universal				

25ST series



GEV No.	101955	Ref. No.	004257 006597 990016
description	gas thermostat PEL type 25ST 140 up to approx. 300°C gas inlet M16x1.5 (tube ø 10mm) bypass nozzle ø 0.5mm gas outlet M16x1.5 (tube ø 10/8mm) thermocouple connection M8x1 pilot connection M10x1 capillary pipe 1200mm probe ø 6mm probe L 120mm shaft ø 8x6.5mm shaft L 38/15mm shaft flat upper		

For models:	RCF/G2, RCF/G3, RCF/G9, RTF/G2, RSF/G2, RSV/G2, RSF/G3, MCF/G2A, MCF/G3A, XCF/G2, XCF/G3, XCF/G9, XTV/G2, XTF/G2, XSF/G2, XSV/G2, XSF/G3, JCF/G2, JCF/G3, JTV/G2, JTF/G2, MCF/G2, MCF/G3, MCF/G9, MTF/G2, MSF/G2, MSV/G2, MSF/G3		
--------------------	--	--	--

spare parts for	101955			
	GEV No.	100390	Ref. No.	—
bypass nozzle type PEL22 bore ø 0.5mm thread M6x0.5				
	GEV No.	101060	Ref. No.	056595 0982 0H6238
magnet unit standard L 39mm D1 ø 15.4mm D2 ø 11mm suitable for PEL20-21/JUNKERS/EGA				
	GEV No.	106199	Ref. No.	—
nut thread M8x1				











accessories for	101955			
	GEV No.	100908	Ref. No.	046755 052125 0958013 0G2219 OK1348 OK5753 0KE882 OKL495 19012956 727742 727781
union screw thread M10x1 for pipe ø 4mm Qty 1 pcs				
	GEV No.	100909	Ref. No.	003859 057821
union screw thread M10x1 for pipe ø 6mm Qty 1 pcs				
	GEV No.	101246	Ref. No.	052127 727782
olive for pipe ø 4mm Qty 1 pcs				



Table continues overleaf





¹incl. knob and connectors



accessories for		101955	
	GEV No.	101278	Ref. No.
			060325 0C0150 0G0794 0G1111 0G2610 0K1976 0KW924 0T1946 101278 17012732 17012758 19012727
	olive for pipe ø 10mm Qty 1 pcs		
	GEV No.	101286	Ref. No.
			020992 053666
	olive ID ø 6mm Qty 1 pcs		
	GEV No.	101300	Ref. No.
			0A2125 0G2957
	union nut thread M16x1.5 tube ø 10mm		
	GEV No.	101450	Ref. No.
			—
	olive for pipe ø 8mm L 12.7mm Qty 1 pcs ED ø 10mm		
	GEV No.	101451	Ref. No.
			—
	union nut thread M16x1.5 tube ø 8mm		
	GEV No.	110079	Ref. No.
			—
	knob dial plate gas thermostat 1-8 silver		
	GEV No.	110081	Ref. No.
			—
	knob ø 70mm shaft ø 8x6.5mm shaft flat universal		

conversion kits			
	1		
GEV No.	106751	Ref. No.	054635 0C0006 0K2869
description	gas thermostat PEL type 25ST 150-290°C gas inlet M16x1.5 pipe input ø 10mm gas outlet M16x1.5 pipe output ø 10/8mm thermo-couple connection M8x1 probe ø 6mm probe L 120mm capillary pipe 1200mm shaft ø 8x6.5mm shaft L 25mm bypass nozzle ø 0.45/0.5/0.55/0.8/0.9mm conversion kit L1 25mm L2 15mm incl. gas/ignition gas line, nozzles, knob shaft flat upper		
For models:	MCF/G700, XCF/G700D, XCF/G1050D		

SABAF			
	1		
GEV No.	101694	Ref. No.	006843
description	gas thermostat SABAF t.max. 300°C gas inlet pipe flange bypass nozzle ø 0.38mm gas outlet M13x1 IT (tube ø 8mm) gas outlet 2 thermocouple connection M8x1 capillary pipe 850mm probe ø 4mm probe L 150mm shaft ø 8x6.5mm shaft flat lower L1 29mm L2 29mm		
spare parts for	101694		
	GEV No.	101060	Ref. No.
			056595 0982 0H6238
	magnet unit standard L 39mm D1 ø 15.4mm D2 ø 11mm suitable for PEL20-21/JUNKERS/EGA		





accessories for		101694	
	GEV No.	101277	Ref. No.
			—
	olive ID ø 8mm Qty 1 pcs		
	GEV No.	101376	Ref. No.
			—
	gasket ID ø 8mm ED ø 12mm H 3/5mm		
	GEV No.	101477	Ref. No.
			—
	union screw thread M13x1 tube ø 8mm Qty 1 pcs		
	GEV No.	101751	Ref. No.
			—
	bracket		

gas valves and ignition boxes

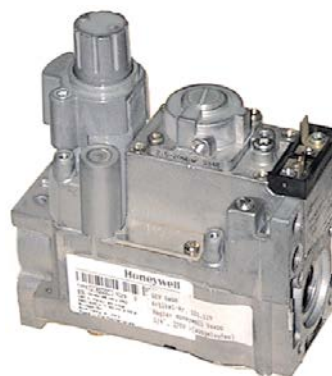
gas control valves





HONEYWELL



1				
GEV No.	106229	Ref. No.		002178 056719 74310590
description	gas valve type V4600A1031 230V 50Hz gas inlet 1/2" gas outlet 1/2" thermocouple connection 11/32" pilot connection M11x1 pressure range 5-50mbar operator type 230V (V404A 1071) suitable for HONEYWELL			
For models:	FZG18, FZ/G18			
accessories for	106229			
	GEV No.	101305	Ref. No.	—
	gas connection straight 1/2" flange 45x45mm ELETTROSIT/V4400/4600/4605 suitable for SIT/HONEYWELL hole distance 36x36mm			
	GEV No.	101306	Ref. No.	0A5398
	gas connection angled flange 45x45mm hole distance 36x36mm 1/2" ELETTROSIT/V4400/4600/4605 screw with O-ring suitable for SIT/HONEYWELL			
	GEV No.	101307	Ref. No.	—
	gas connection straight flange 45x45mm hole distance 36x36mm 3/4" ELETTROSIT/V4400/4600/4605 screw with O-ring suitable for SIT/HONEYWELL			
	GEV No.	101308	Ref. No.	—
	gas connection angled flange 45x45mm hole distance 36x36mm 3/4" ELETTROSIT/V4400/4600/4605 screw with O-ring suitable for SIT/HONEYWELL			
	GEV No.	101494	Ref. No.	—
	locking screw thread M11x1 for pipe ø 6mm Qty 1 pcs			



1

GEV No.	106059	Ref. No.	0H6536 V4600C1128B
description	gas valve type V4600C 220/240V 50Hz gas inlet flange 45x45mm gas outlet flange 45x45mm thermocouple connection 11/32" pilot connection M11x1 pressure range 2.5-20mbar operator type 220/240V (V404A 1071 4) pressure controller type V5306E suitable for HONEYWELL		
accessories for	106059		
	GEV No.	101305	Ref. No. —
	gas connection straight 1/2" flange 45x45mm ELETTROSIT/V4400/4600/4605 suitable for SIT/HONEYWELL hole distance 36x36mm		
	GEV No.	101306	Ref. No. 0A5398
	gas connection angled flange 45x45mm hole distance 36x36mm 1/2" ELETTROSIT/V4400/4600/4605 screw with O-ring suitable for SIT/HONEYWELL		
	GEV No.	101307	Ref. No. —
	gas connection straight flange 45x45mm hole distance 36x36mm 3/4" ELETTROSIT/V4400/4600/4605 screw with O-ring suitable for SIT/HONEYWELL		
	GEV No.	101308	Ref. No. —
	gas connection angled flange 45x45mm hole distance 36x36mm 3/4" ELETTROSIT/V4400/4600/4605 screw with O-ring suitable for SIT/HONEYWELL		
	GEV No.	101494	Ref. No. —
	locking screw thread M11x1 for pipe ø 6mm Qty 1 pcs		





1

GEV No.	106007	Ref. No.	005925 VK4105A1118B
description	gas valve type VK4105A 220-240V 50/60Hz gas inlet flange 32x32mm gas outlet flange 32x32mm thermocouple connection pilot connection pressure range 15-60mbar max 60mbar operator type suitable for HONEYWELL flange 32x32mm		
For models:	FCV/G20L3, FCVG202L3, FCVG6L3CJ, FCV/G6L3C, FCV/G61/1, FCV/G61/1, FCV/G61/1, FCV/G61/1, FCVG6L3CT, FCVG6L3CJ, FCS061G48J, FCS061GP, FCS061G3D, FCS061G4, FCS061G4DT, FCS061G49J, 5721-2-7, 5721-2-10, ECV/G6T4C, ECV/G61/1, ECV/G61/1, RCV061G2, ACV/G6C3C, ZCV/G6T4C, ZCV/G61/1		
accessories for	106007		
	GEV No.	102845	Ref. No. —
	gas connection angled 1/2" flange 32x32mm hole distance 24x24mm Tandem		
	GEV No.	102846	Ref. No. —
	gas connection straight 1/2" flange 32x32mm hole distance 24x24mm suitable for Tandem		



1

GEV No.	106008	Ref. No.	006596 VK4105P2037B
description	gas valve type VK4105P 220/240V 50/60Hz gas inlet 1/2" NPT gas outlet 1/2" NPT thermocouple connection pilot connection pressure range 15-60mbar max 60mbar operator type HONEYWELL suitable for coil type 220/240V (V4336A 2220) flange 32x32mm		
For models:	FCV/G20L6, FCVG202L6, FCV/G201/1, FCV/G202/1, FCS201G4, FCS201GP, FCS202G4, FCS202GP, FCS201GX, FCS202GX, ECV/G20T4, ECVG202T4, ECV/G20T6, ECVG202T6, ACV/G20C4, ACVG202C4, ACVG202C6		
accessories for	106008		
	GEV No.	102845	Ref. No. —
	gas connection angled 1/2" flange 32x32mm hole distance 24x24mm Tandem		
	GEV No.	102846	Ref. No. —
	gas connection straight 1/2" flange 32x32mm hole distance 24x24mm suitable for Tandem		

SIT
ELETTROSIT



1



GEV No.	101993	Ref. No.	0H6072
description	gas valve SIT type ELETROSIT 230V gas inlet 1/2" gas outlet 1/2" thermocouple connection M9x1 pilot connection M10x1 lateral equiv. no. 0.810.126		
spare parts for	101993		
	GEV No.	101312	Ref. No. 004217 054539 056601 0927011 0927012 0H6997
	microswitch		
	GEV No.	101352	Ref. No. —
	solenoid coil 230V 50Hz suitable for ELETROSIT		
accessories for	101993		
	GEV No.	100006	Ref. No. —
	piezoelectric igniter suitable for ELETROSIT body plastic blowing connection ø2.4mm ø 14mm		

Table continues overleaf



accessories for		101993	
	GEV No.	100904	Ref. No. 052833 0K2497 100904 102504
locking screw M10x1 for pipe ø 4mm Qty 1 pcs			
	GEV No.	100905	Ref. No. 052834 0958031
locking screw M10x1 for pipe ø 6mm Qty 1 pcs			
	GEV No.	101301	Ref. No. —
gas connection thread 1/2" straight ELETROSIT screw with O-ring			
	GEV No.	101303	Ref. No. —
gas connection straight thread 3/4" ELETROSIT			
	GEV No.	101309	Ref. No. 051281 055805
extension			
	GEV No.	103104	Ref. No. —
ignition switch			
	GEV No.	541504	Ref. No. —
double nipple thread 1/2" - 1/2"			

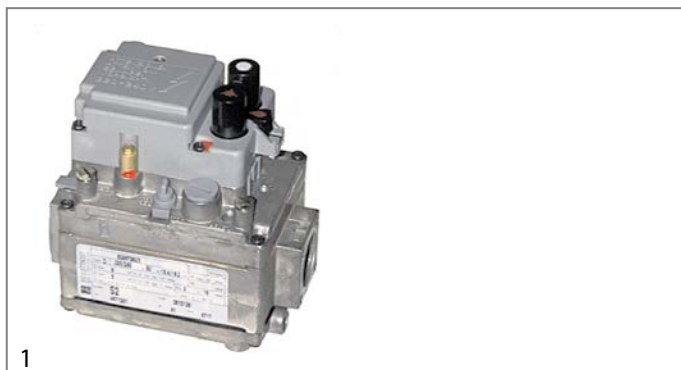

GEV No.	101123	Ref. No.	0810138 0A2035
description	gas valve SIT type ELETROSIT 230V gas inlet 3/4" gas outlet 3/4" thermocouple connection M9x1 pilot connection M10x1 bottom equiv. no. 0.810.138		
For models:	VO40G		
spare parts for	101123		
	GEV No.	101312	Ref. No. 004217 054539 056601 0927011 0927012 0H6997
microswitch			
	GEV No.	101352	Ref. No. —
solenoid coil 230V 50Hz suitable for ELETROSIT			
accessories for	101123		
	GEV No.	100006	Ref. No. —
piezoelectric igniter suitable for ELETROSIT body plastic blowing connection ø2.4mm ø 14mm			
	GEV No.	100904	Ref. No. 052833 0K2497 100904 102504
locking screw M10x1 for pipe ø 4mm Qty 1 pcs			
	GEV No.	100905	Ref. No. 052834 0958031
locking screw M10x1 for pipe ø 6mm Qty 1 pcs			

accessories for		101123	
	GEV No.	101301	Ref. No. —
gas connection thread 1/2" straight ELETROSIT screw with O-ring			
	GEV No.	101303	Ref. No. —
gas connection straight thread 3/4" ELETROSIT			
	GEV No.	101309	Ref. No. 051281 055805
extension			

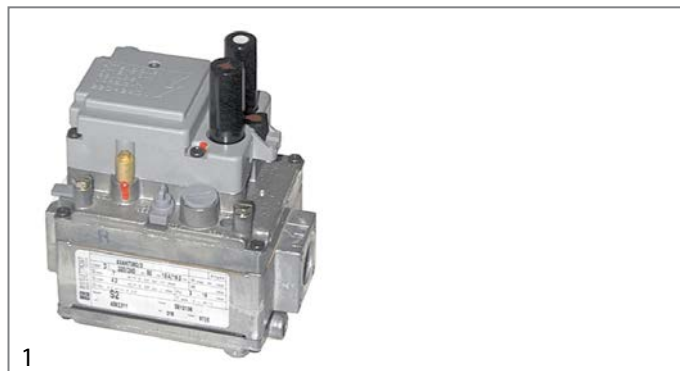



GEV No.	101127	Ref. No.	053643 054538 057543 0810175 0K7815
description	gas valve SIT type ELETROSIT 230V gas inlet 3/4" gas outlet 3/4" thermocouple connection M9x1 pilot connection M10x1 lateral equiv. no. 0.810.175		
For models:	FCFG10, FCFG10D, FCFG10NL, FCFG20, FCFG20D, FCFG20F, PFCFG20, FCFG40, FCFG41, FCFG40D, FCFG40F, PFCFG40F, FCFG10J, FCFG10J, FCFG20J, FCFG20J, FCFG40J, FCFG40J, FCFG10J, FCFG10J, FCFG20J, FCFG20J, FCFG41J, FCFG40J, HCPA/G1219, HCPA/G1219, HBR/G803, HBR/G804, HBR/G803, HBR/G804, HBR/G803, HBR/G805, HBR/G1003, HBR/G1003, HBR/G1004, HBR/G803, HBR/G804, HBR/G1013, HFR/G420, HFR/G420, HFR/G420NL, HFR/G840, HFR/G840, HFR/G840, HFR/G840, HFR/G421, FCFG101, FCFG201, FCFG202, FCFC202...(Other models you can see in the webshop)		

spare parts for		101127	
	GEV No.	101312	Ref. No. 004217 054539 056601 0927011 0927012 0H6997
microswitch			
	GEV No.	101352	Ref. No. —
solenoid coil 230V 50Hz suitable for ELETROSIT			
accessories for	101127		
	GEV No.	100006	Ref. No. —
piezoelectric igniter suitable for ELETROSIT body plastic blowing connection ø2.4mm ø 14mm			
	GEV No.	100904	Ref. No. 052833 0K2497 100904 102504
locking screw M10x1 for pipe ø 4mm Qty 1 pcs			
	GEV No.	100905	Ref. No. 052834 0958031
locking screw M10x1 for pipe ø 6mm Qty 1 pcs			
	GEV No.	101301	Ref. No. —
gas connection thread 1/2" straight ELETROSIT screw with O-ring			







Table continues overleaf



accessories for 101127				
	GEV No.	101303	Ref. No.	—
gas connection straight thread 3/4" ELETTROSIT				
	GEV No.	101309	Ref. No.	051281 055805
extension				









1

GEV No.	101122	Ref. No.	053242 054437 0810110
description	gas valve SIT type ELETTROSIT 24V gas inlet 3/4" gas outlet 3/4" thermocouple connection M9x1 equiv. no. 0.810.171 pilot outlet M10x1		
For models:	HFR/G1680, HFR/G2480		
spare parts for	101122		
	GEV No.	101312	Ref. No.
004217 054539 056601 0927011 0927012 0H6997			
microswitch			
accessories for 101122			
	GEV No.	100006	Ref. No.
—			
piezoelectric igniter suitable for ELETTROSIT body plastic blowing connection ø2.4mm ø 14mm			
	GEV No.	100904	Ref. No.
052833 0K2497 100904 102504			
locking screw M10x1 for pipe ø 4mm Qty 1 pcs			
	GEV No.	100905	Ref. No.
052834 0958031			
locking screw M10x1 for pipe ø 6mm Qty 1 pcs			
	GEV No.	101301	Ref. No.
—			
gas connection thread 1/2" straight ELETTROSIT screw with O-ring			
	GEV No.	101303	Ref. No.
—			
gas connection straight thread 3/4" ELETTROSIT			
	GEV No.	101309	Ref. No.
051281 055805			
extension			

NOVASIT



1

GEV No.	101187	Ref. No.	002606 0820301 0K4318 0KW916 11061248 727565 727904
description	gas valve SIT series Novasit 820 0.17VHz gas inlet 1/2" gas outlet 1/2" thermocouple connection M9x1 pilot connection M10x1 ignition pressure regulator pressure range 5-50mbar pressure regulator connection blind equiv. no. 0.820.301 supply Operator millivolt		
For models:	MFR/G740, RFR/G2S40, XFR/G2S40, JFR/G2S40, MFR/G2S40, RFR/G741, XFR/G351, CFR/G741, CFR/G351, PFR/G2S40, TFR/G2S40, FC1G, FC2G, HBR/G800, HBR/G805, HBR/G810, HBR/G815, HBR/G811, HBR/G816, HBR/G800UK, HBR/G821UK, RF/G1680, RF/G2480, ZBR/G821, ZBR/G826, ZBR/G800, ZBR/G805, ZBR/G810, ZBR/G815, ZBR/G811, ZBR/G816, ZBR/G800UK, ABR/G800, ABR/G805, ABR/G810, ABR/G815, ABR/G811, ABR/G816, OBR/G800UK		
spare parts for	101187		
	GEV No.	101065	Ref. No.
0006245 056589 0K2953			
magnet unit with cable L 44mm D1 ø 30mm D2 ø 20mm suitable for NOVASIT			
accessories for 101187			
	GEV No.	100110	Ref. No.
002783 0190603			
pilot burner SIT type 190 series 3 flames nozzle ømm gas connectionmm			
	GEV No.	101305	Ref. No.
—			
gas connection straight 1/2" flange 45x45mm ELETTROSIT/V4400/4600/4605 suitable for SIT/HONEYWELL hole distance 36x36mm			
	GEV No.	101306	Ref. No.
0A5398			
gas connection angled flange 45x45mm hole distance 36x36mm 1/2" ELETTROSIT/V4400/4600/4605 screw with O-ring suitable for SIT/HONEYWELL			
	GEV No.	101307	Ref. No.
—			
gas connection straight flange 45x45mm hole distance 36x36mm 3/4" ELETTROSIT/V4400/4600/4605 screw with O-ring suitable for SIT/HONEYWELL			
	GEV No.	101308	Ref. No.
—			
gas connection angled flange 45x45mm hole distance 36x36mm 3/4" ELETTROSIT/V4400/4600/4605 screw with O-ring suitable for SIT/HONEYWELL			
	GEV No.	102116	Ref. No.
002607 0240002 0940002 0K4319 11061247 727905			
thermopile ROBERTSHAW L 900mm probe ø 9mm probe L 57mm 250-750mV screw connection 7/16"			







1			
GEV No.	101760	Ref. No.	006182 0820060
description	gas valve SIT series Novasit 820 220V 50Hz gas inlet 1/2" gas outlet 1/2" thermocouple connection M9x1 pilot connection M10x1 ignition pressure 3-5mbar pressure range 3-30mbar pressure regulator connection blind equiv. no. 0.820.060		
For models:	FCFG10160H, FCF/G101/1, ACFG10160H		
spare parts for	101760		
	GEV No.	101065	Ref. No. 0006245 056589 0K2953
magnet unit with cable L 44mm D1 ø 30mm D2 ø 20mm suitable for NOVASIT			
	GEV No.	101867	Ref. No. —
solenoid coil 220V 60Hz			
accessories for	101760		
	GEV No.	100006	Ref. No. —
piezoelectric igniter suitable for ELETTROSIT body plastic blowing connection ø2.4mm ø 14mm			
	GEV No.	100904	Ref. No. 052833 0K2497 100904 102504
locking screw M10x1 for pipe ø 4mm Qty 1 pcs			
	GEV No.	100905	Ref. No. 052834 0958031
locking screw M10x1 for pipe ø 6mm Qty 1 pcs			
	GEV No.	101305	Ref. No. —
gas connection straight 1/2" flange 45x45mm ELETTROSIT/V4400/4600/4605 suitable for SIT/HONEYWELL hole distance 36x36mm			
	GEV No.	101306	Ref. No. 0A5398
gas connection angled flange 45x45mm hole distance 36x36mm 1/2" ELETTROSIT/V4400/4600/4605 screw with O-ring suitable for SIT/HONEYWELL			
	GEV No.	101307	Ref. No. —
gas connection straight flange 45x45mm hole distance 36x36mm 3/4" ELETTROSIT/V4400/4600/4605 screw with O-ring suitable for SIT/HONEYWELL			
	GEV No.	101308	Ref. No. —
gas connection angled flange 45x45mm hole distance 36x36mm 3/4" ELETTROSIT/V4400/4600/4605 screw with O-ring suitable for SIT/HONEYWELL			
	GEV No.	101312	Ref. No. 004217 054539 056601 0927011 0927012 0H6997
microswitch			
	GEV No.	101313	Ref. No. 0967064 0K3020
solenoid coil 230V 50Hz			

accessories for	101760		
	GEV No.	101314	Ref. No. —
solenoid coil 24V 50Hz			
	GEV No.	101317	Ref. No. 0960103 0K3022
plug with cable L 1000mm suitable for NOVASIT			
	GEV No.	101318	Ref. No. —
cover cap for solenoid coil suitable for NOVASIT			
	GEV No.	101503	Ref. No. —
O-ring EPDM thickness 2mm ID ø 32mm Qty 1 pcs			



1			
GEV No.	101980	Ref. No.	0C0848 0K3021
description	gas valve SIT series Novasit 820 230V 50Hz gas inlet 1/2" gas outlet 1/2" thermocouple connection ASA 11/32 pilot connection M10x1 ignition pressure 3-5mbar pressure range 3-30mbar pressure regulator connection blind equiv. no. 0.820.020		
For models:	7550-2, 7551-2, 7552-2, 7553-2		
spare parts for	101980		
	GEV No.	101065	Ref. No. 0006245 056589 0K2953
magnet unit with cable L 44mm D1 ø 30mm D2 ø 20mm suitable for NOVASIT			
	GEV No.	101313	Ref. No. 0967064 0K3020
solenoid coil 230V 50Hz			
accessories for	101980		
	GEV No.	100006	Ref. No. —
piezoelectric igniter suitable for ELETTROSIT body plastic blowing connection ø2.4mm ø 14mm			
	GEV No.	101305	Ref. No. —
gas connection straight 1/2" flange 45x45mm ELETTROSIT/V4400/4600/4605 suitable for SIT/HONEYWELL hole distance 36x36mm			
	GEV No.	101306	Ref. No. 0A5398
gas connection angled flange 45x45mm hole distance 36x36mm 1/2" ELETTROSIT/V4400/4600/4605 screw with O-ring suitable for SIT/HONEYWELL			
	GEV No.	101307	Ref. No. —
gas connection straight flange 45x45mm hole distance 36x36mm 3/4" ELETTROSIT/V4400/4600/4605 screw with O-ring suitable for SIT/HONEYWELL			
	GEV No.	101308	Ref. No. —
gas connection angled flange 45x45mm hole distance 36x36mm 3/4" ELETTROSIT/V4400/4600/4605 screw with O-ring suitable for SIT/HONEYWELL			



Table continues overleaf

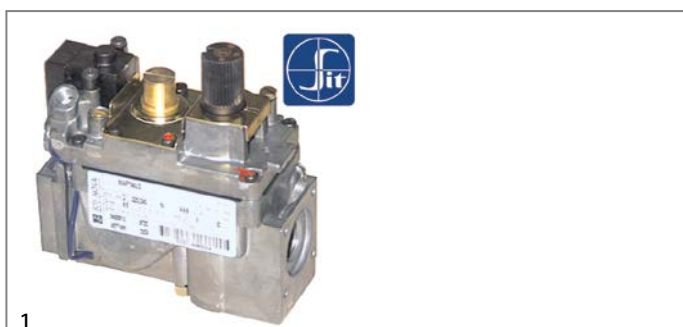



accessories for		101980	
	GEV No.	101312	Ref. No.
			004217 054539 056601 0927011 0927012 0H6997
	microswitch		
	GEV No.	101314	Ref. No.
			—
	solenoid coil 24V 50Hz		
	GEV No.	101317	Ref. No.
			0960103 0K3022
	plug with cable L 1000mm suitable for NOVASIT		
	GEV No.	101318	Ref. No.
			—
	cover cap for solenoid coil suitable for NOVASIT		







1

GEV No.	101162	Ref. No.	055446 0820010 0KF020
description	gas valve SIT series Novasit 820 230V 50Hz gas inlet 1/2" gas outlet 1/2" thermocouple connection M9x1 pilot connection M10x1 ignition pressure 3-5mbar pressure range 3-30mbar pressure regulator connection blind equiv. no. 0.820.010		
For models:	AFR/G410D, AFR/G810D, AFR/G410NL, FCVG10-2, FCVG10-4, FCVG10-1SG, FCVG10-2, FCVG10-4D, FCVG10-2UK, FCVG10-4UK, FCVG10-2, FCVG10-4, FCVG20-2, FCVG20-4, FCVG20-2, FCVG20-4D, FCVG20-2UK, FCVG20-4UK, FCVG20-4, FCVG20-4D, ZOFCV/G102, ZOFCV/G104, ZOFCV/G202, ZOFCV/G204, FCVG10-1SG, BOFR/G500, ROFR/G1000, ROBR/G1000, ROBR/G1010, ROBR/G1510, ROPN/G1000, ROPN/G1015, ROPN/G1020		

spare parts for		101162	
	GEV No.	101065	Ref. No.
			0006245 056589 0K2953
	magnet unit with cable L 44mm D1 ø 30mm D2 ø 20mm suitable for NOVASIT		
	GEV No.	101313	Ref. No.
			0967064 0K3020
	solenoid coil 230V 50Hz		



accessories for		101162	
	GEV No.	100006	Ref. No.
			—
	piezoelectric igniter suitable for ELETTROSIT body plastic blowing connection ø2.4mm ø 14mm		
	GEV No.	101305	Ref. No.
			—
	gas connection straight 1/2" flange 45x45mm ELETTROSIT/V4400/4600/4605 suitable for SIT/HONEYWELL hole distance 36x36mm		
	GEV No.	101306	Ref. No.
			0A5398
	gas connection angled flange 45x45mm hole distance 36x36mm 1/2" ELETTROSIT/V4400/4600/4605 screw with O-ring suitable for SIT/HONEYWELL		
	GEV No.	101307	Ref. No.
			—
	gas connection straight flange 45x45mm hole distance 36x36mm 3/4" ELETTROSIT/V4400/4600/4605 screw with O-ring suitable for SIT/HONEYWELL		

accessories for		101162	
	GEV No.	101308	Ref. No.
			—
	gas connection angled flange 45x45mm hole distance 36x36mm 3/4" ELETTROSIT/V4400/4600/4605 screw with O-ring suitable for SIT/HONEYWELL		
	GEV No.	101312	Ref. No.
			004217 054539 056601 0927011 0927012 0H6997
	microswitch		
	GEV No.	101314	Ref. No.
			—
	solenoid coil 24V 50Hz		
	GEV No.	101317	Ref. No.
			0960103 0K3022
	plug with cable L 1000mm suitable for NOVASIT		
	GEV No.	101318	Ref. No.
			—
	cover cap for solenoid coil suitable for NOVASIT		



1

GEV No.	101761	Ref. No.	003719 0820034
description	gas valve SIT series Novasit 820 230V 50Hz gas inlet 1/2" gas outlet 1/2" thermocouple connection M9x1 pilot connection M10x1 ignition pressure 3-5mbar pressure range 3-30mbar pressure regulator connection connection RP equiv. no. 0.820.034		
For models:	FCFG101/0, FCFG102-0, FCFG201-0, FCFG202-0, FCFG102-0T, FCF/ G101/1-1-JAP, FCF/G102/1-1-JAP, ECFG101-0, ECFG102-0, ECFG201-0, ECFG202-0, ACFG101-0, ACFG102-0, ACFG201-0, ACFG202-0, JCF/ G101/1-1, JCF/G102/1-1, RCF101G, NCF/G101/1, NCF/G102/1, ZCF/ G101/1, ZCF/G102/1, ZCF/G201/1, ZCF/G202/1		

spare parts for		101761	
	GEV No.	101065	Ref. No.
			0006245 056589 0K2953
	magnet unit with cable L 44mm D1 ø 30mm D2 ø 20mm suitable for NOVASIT		
	GEV No.	101313	Ref. No.
			0967064 0K3020
	solenoid coil 230V 50Hz		



accessories for		101761	
	GEV No.	100006	Ref. No.
			—
	piezoelectric igniter suitable for ELETTROSIT body plastic blowing connection ø2.4mm ø 14mm		
	GEV No.	101305	Ref. No.
			—
	gas connection straight 1/2" flange 45x45mm ELETTROSIT/V4400/4600/4605 suitable for SIT/HONEYWELL hole distance 36x36mm		
	GEV No.	101306	Ref. No.
			0A5398
	gas connection angled flange 45x45mm hole distance 36x36mm 1/2" ELETTROSIT/V4400/4600/4605 screw with O-ring suitable for SIT/HONEYWELL		

Table continues overleaf



accessories for 101761				
	GEV No.	101307	Ref. No.	—
gas connection straight flange 45x45mm hole distance 36x36mm 3/4" ELETTROSIT/V4400/4600/4605 screw with O-ring suitable for SIT/HONEYWELL				
	GEV No.	101308	Ref. No.	—
gas connection angled flange 45x45mm hole distance 36x36mm 3/4" ELETTROSIT/V4400/4600/4605 screw with O-ring suitable for SIT/HONEYWELL				
	GEV No.	101312	Ref. No.	004217 054539 056601 0927011 0927012 0H6997
microswitch				
	GEV No.	101314	Ref. No.	—
solenoid coil 24V 50Hz				
	GEV No.	101317	Ref. No.	0960103 0K3022
plug with cable L 1000mm suitable for NOVASIT				
	GEV No.	101318	Ref. No.	—
cover cap for solenoid coil suitable for NOVASIT				

accessories for 101956				
	GEV No.	101306	Ref. No.	0A5398
gas connection angled flange 45x45mm hole distance 36x36mm 1/2" ELETTROSIT/V4400/4600/4605 screw with O-ring suitable for SIT/HONEYWELL				
	GEV No.	101307	Ref. No.	—
gas connection straight flange 45x45mm hole distance 36x36mm 3/4" ELETTROSIT/V4400/4600/4605 screw with O-ring suitable for SIT/HONEYWELL				
	GEV No.	101308	Ref. No.	—
gas connection angled flange 45x45mm hole distance 36x36mm 3/4" ELETTROSIT/V4400/4600/4605 screw with O-ring suitable for SIT/HONEYWELL				
	GEV No.	101312	Ref. No.	004217 054539 056601 0927011 0927012 0H6997
microswitch				
	GEV No.	101314	Ref. No.	—
solenoid coil 24V 50Hz				
	GEV No.	101317	Ref. No.	0960103 0K3022
plug with cable L 1000mm suitable for NOVASIT				
	GEV No.	101318	Ref. No.	—
cover cap for solenoid coil suitable for NOVASIT				



1

GEV No.	101956	Ref. No.	002903 0820031	
description	gas valve SIT series Novasit 820 230V 50Hz gas inlet 1/2" gas outlet 1/2" thermocouple connection M9x1 pilot connection M10x1 ignition pressurembar pressure range 5-50mbar pressure regulator connection blind equiv. no. 0.820.031			
For models:	PPD/G260, PPI/G260P, OPD/G260, OPI/G260P, TPD/G260, TPI/G260P, KPI/G10, KPI/G15, KPD/G10, KPD/G15, KPD/G15A, KPI/G15A, KPI/G06, KPI/G15H, KPI/G10H, KBR/G2F, KBR/G2C, KBR/G3F, KBR/G3FH, KBR/G3C, KBR/G3CH, KBR/G2FH, KBR/G2CH, KFH/G1, KFH/G1ELH, KFH/G1EH, KCP/G1, KCP/G1R, KCP/G2, KCP/G2R, HFR/G410, HFR/G810, HFR/G410D, HFR/G810D, HFR/G410NL, HFR/G810NL, HFR/G411, HFR/G412, HFH/G430, HFH/G400U, HFH/G401U, HFH/G435, HBR/G820, HBR/G825, QPI/G10, QPI/G15, QPD/G10, QPD/G15, QPI/G06, QPI/G15H...(Other models you can see in the webshop)			
spare parts for	101956			
	GEV No.	101065	Ref. No.	0006245 056589 0K2953
magnet unit with cable L 44mm D1 ø 30mm D2 ø 20mm suitable for NOVASIT				
	GEV No.	101313	Ref. No.	0967064 0K3020
solenoid coil 230V 50Hz				
accessories for 101956				
	GEV No.	100006	Ref. No.	—
piezoelectric igniter suitable for ELETTROSIT body plastic blowing connection ø2.4mm ø 14mm				
	GEV No.	101305	Ref. No.	—
gas connection straight 1/2" flange 45x45mm ELETTROSIT/V4400/4600/4605 suitable for SIT/HONEYWELL hole distance 36x36mm				







1

GEV No.	103130	Ref. No.	0C2408	
description	gas valve SIT series Novasit 820 24V 50Hz gas inlet 1/2" gas outlet 1/2" thermocouple connection M9x1 pilot connection M10x1 ignition pressurembar pressure range 5-50mbar pressure regulator connection blind			
For models:	CRN22G, CRN/20G, CRN30G, CRN15G, CRN/22GZ, CRN20GZ, CRN-30GZ, CRN15GZ, CRN20GA, CRN30GA, CRN15GA, CR42G, CR/40G			
spare parts for	103130			
	GEV No.	101314	Ref. No.	—
solenoid coil 24V 50Hz				
accessories for 103130				
	GEV No.	101313	Ref. No.	0967064 0K3020
solenoid coil 230V 50Hz				





				
1				
GEV No.	101967	Ref. No.	059473 0822110	
description	gas valve SIT series Novasit 822 230V 50Hz gas inlet 1/2" gas outlet 1/2" thermocouple connection pilot connection M10x1 ignition pressure 3-5mbar pressure range 3-30mbar pressure regulator connection perforated equiv. no. 0.822.110			
For models:	HBR/G800, HBR/G805, HBR/G801, HBR/G806, HBR/G810, HBR/G815, HBR/G811, HBR/G816, HBR/G800D, HBR/G805D, HBR/G801D, HBR/G806D, HBR/G810D, HBR/G815D, HBR/G811D, HBR/G816D, HBR/G800NL, HBR/G805NL, HBR/G810NL, HBR/G800UK, ZBR/G800, ZBR/G805, ZBR/G801, ZBR/G806, ZBR/G810, ZBR/G815, ZBR/G811, ZBR/G816, ZBR/G800D, ZBR/G805D, ZBR/G801D, ZBR/G806D, ZBR/G810D, ZBR/G815D, ZBR/G811D, ZBR/G816D, ZBR/G800UK, ABR/G800, ABR/G805, ABR/G801, ABR/G806, ABR/G810, ABR/G815, ABR/G811, ABR/G816, ABR/G800D, ABR/G805D, ABR/G801D, ABR/G806D, ABR/G810D...(Other models you can see in the webshop)			
spare parts for	101967			
	GEV No.	101313	Ref. No.	0967064 0K3020
	solenoid coil 230V 50Hz			
	GEV No.	101542	Ref. No.	—
	solenoid coil 50Hz NOVA 822/826/827 suitable for NOVASIT 230V			
accessories for	101967			
	GEV No.	100904	Ref. No.	052833 0K2497 100904 102504
	locking screw M10x1 for pipe ø 4mm Qty 1 pcs			
	GEV No.	100905	Ref. No.	052834 0958031
	locking screw M10x1 for pipe ø 6mm Qty 1 pcs			
	GEV No.	101305	Ref. No.	—
	gas connection straight 1/2" flange 45x45mm ELETTRISIT/V4400/4600/4605 suitable for SIT/HONEYWELL hole distance 36x36mm			
	GEV No.	101306	Ref. No.	0A5398
	gas connection angled flange 45x45mm hole distance 36x36mm 1/2" ELETTRISIT/V4400/4600/4605 screw with O-ring suitable for SIT/HONEYWELL			
	GEV No.	101307	Ref. No.	—
	gas connection straight flange 45x45mm hole distance 36x36mm 3/4" ELETTRISIT/V4400/4600/4605 screw with O-ring suitable for SIT/HONEYWELL			
	GEV No.	101308	Ref. No.	—
	gas connection angled flange 45x45mm hole distance 36x36mm 3/4" ELETTRISIT/V4400/4600/4605 screw with O-ring suitable for SIT/HONEYWELL			
	GEV No.	101503	Ref. No.	—
	O-ring EPDM thickness 2mm ID ø 32mm Qty 1 pcs			
	GEV No.	101924	Ref. No.	—
	plug with cable L 1090mm suitable for NOVA 822/826/827			

				
1				
GEV No.	106858	Ref. No.	059032	
description	gas valve SIT series Novasit 825 24V 50Hz gas inlet 1/2" gas outlet 1/2" thermocouple connection M9x1 pilot connection M10x1 ignition pressure 3-5mbar pressure range 3-37mbar pressure regulator connection standard			
For models:	FCVG10-P, FCVG10PUK, FCVG20-P, FCVG20PUK, AFCV/G101, AFCV/G103, SCO/G10-3, AFCV/G201, AFCV/G203, SCO/G20-3			







SIGMA				
				
1				
GEV No.	106009	Ref. No.	0848037 0C1057	
description	gas valve 230V 50Hz gas inlet 3/4" gas outlet 3/4" pressure range 0.5-12mbar Sigma equiv. no. 0.848.037			
For models:	FCZ061GAG, FCZ101GAG, FCZ102GAG, FCZ201GAG, FCZ202GAG, FCZ061GAD, FCZ101GAD, FCZ102GAD, FCZ201GAD, FCZ202GAD, FCZ101GTG, FCZ102GTG, FCZ201GTG, FCZ202GTG, FCZ101GTD, FCZ102GTD, FCZ201GTD, FCZ202GTD, FCZ061GBG, FCZ101GBG, FCZ102GBG, FCZ201GBG, FCZ202GBG, FCZ061GBD, FCZ101GBD, FCZ102GBD, FCZ201GBD, FCZ202GBD, FCZ061GBI, FCZ101GBI, FCZ201GBI, FCZ101GBG2, FCZ102GBG2, FCZ201GBG2, FCZ202GBG2, FCZ101GBD2, FCZ102GBD2, FCZ201GBD2, FCZ202GBD2, FCZ101GBI2, FCZ102GBI2, FCZ201GBI2, FCZ061GCG, FCZ101GCG, FCZ102GCG, FCZ201GCG, FCZ202GCG, FCZ061GCD, FCZ101GCD, FCZ102GCD...(Other models you can see in the webshop)			
spare parts for	106009			
	GEV No.	106214	Ref. No.	—
	solenoid coil 230V 50Hz Sigma			
accessories for	106009			
	GEV No.	107222	Ref. No.	—
	plug for solenoid valve 3-pole cable length 1070mm			

accessories for 101984	
	GEV No. 102847 Ref. No. —
O-ring	









GEV No. 101189	Ref. No.	002340 005897 0830040 OK1416 60050358
description gas valve 230V 50Hz gas inlet 1/2" gas outlet 1/2" pilot connection M10x1 level slow ignition ignition times pressure range 3-50mbar power supply for modulator equiv. no. 0.830.040 suitable for Tandem		
For models: FCV/G10L3, FCVG10L3T, FCVG102L3, FCV/G20L3, FCVG202L3, FCVG10L3J, FCVG102L3J, FCV/G10L2, FCV/G6L4, FCS101G2, FCV-MG62, 5711-2-6, 5711-2-7, 5711-2-8, 5711-2-10, 5711-2-8CH, 5711-2-10CH, 5712-2-6, 5714-2-6, 5717-2-6, 5711-2-6L, 5711-2-7L, 5711-2-8L, 5711-2-10L, 5712-2-6L, 5714-2-6L, 5714-2-6L, 5712-2-10F, 5714-2-10F, 5702-2-2, 5704-2-2, 5707-2-2, ECV/G6T4, ZCBGD8, ZCBDG12, ZCBDG18, RCV101G2, ACV/G10C2, NCV/G10L2, ZCV/G6T4, 7573-2, 7574-2, 7575-2, 7576-2, 7773-2, 7774-2, 7775-2, 7776-2, 9100-2, 9101-2...(Other models you can see in the webshop)		
spare parts for 101189		
	GEV No. 101379 Ref. No.	002452 0967090 60050316
solenoid coil 230V 50Hz suitable for Tandem		
accessories for 101189		
	GEV No. 100904 Ref. No.	052833 OK2497 100904 102504
locking screw M10x1 for pipe ø 4mm Qty 1 pcs		
	GEV No. 100905 Ref. No.	052834 0958031
locking screw M10x1 for pipe ø 6mm Qty 1 pcs		
	GEV No. 101274 Ref. No.	—
olive for pipe ø 16mm Qty 1 pcs		
	GEV No. 101275 Ref. No.	052668
union screw thread 1/2" for pipe ø 16mm Qty 1 pcs		
	GEV No. 101925 Ref. No.	059474 17011108
plug with O-ring thread M10x1 for pilot burner suitable for NOVASIT		
	GEV No. 102845 Ref. No.	—
gas connection angled 1/2" flange 32x32mm hole distance 24x24mm Tandem		
	GEV No. 102846 Ref. No.	—
gas connection straight 1/2" flange 32x32mm hole distance 24x24mm suitable for Tandem		
	GEV No. 102847 Ref. No.	—
O-ring		



GEV No. 106219	Ref. No.	0830020 0G2188 0K4391 0K5838 19016169 758014 7580141 762701
description gas valve 230V 50Hz gas inlet 1/2" gas outlet 1/2" pilot connection M10x1 level slow ignition standard ignition time 3-7s Tandem equiv. no. 0.830.020		
For models: FET100G.MS25P.H97, FET080G.MS25S.F98, FET080G.MS25S.W94, BOT060G.MS25.H97, BOT060G.MS25.F98, BOT060G.MS25.W94, BOT080G.MS25.F98, BOT080G.MS25.W94, BOT100G.MS25.F98, BOT100G.MS25.W94, BOT150G.MS25.F18, BOT150G.MS25.W14, BOT060G.MS25.F97, BOT100G.MS25.F97, BOT150G.MS25.F17, FET060G.MS25S.F98, FET060G.MS25S.W94, FET100G.MS25S.F98, FET100G.MS25S.W94, FET060G.MS25P.F98, FET060G.MS25P.W94, FET080G.MS25P.F98, FET080G.MS25P.W94, FET100G.MS25P.F98, FET100G.MS25P.W94, CGB068, CGB069, UGB068, UGB069, FET060G.MS25P.F97, FET100G.MS25P.F97, UET090G.MS25.F98, UET090G.MS25.W94, UET150G.MS25.F98, UET150G.MS25.W94, UET090G.MS25.F97, UET150G.MS25.F97, BON060G.S.F98, BON080G.S.F98, BON100G.S.F98		
spare parts for 106219		
	GEV No. 101379 Ref. No.	002452 0967090 60050316
solenoid coil 230V 50Hz suitable for Tandem		
accessories for 106219		
	GEV No. 101274 Ref. No.	—
olive for pipe ø 16mm Qty 1 pcs		
	GEV No. 101275 Ref. No.	052668
union screw thread 1/2" for pipe ø 16mm Qty 1 pcs		
	GEV No. 101925 Ref. No.	059474 17011108
plug with O-ring thread M10x1 for pilot burner suitable for NOVASIT		
	GEV No. 101936 Ref. No.	—
gasket with screw Tandem		
	GEV No. 102845 Ref. No.	—
gas connection angled 1/2" flange 32x32mm hole distance 24x24mm Tandem		
	GEV No. 102846 Ref. No.	—
gas connection straight 1/2" flange 32x32mm hole distance 24x24mm suitable for Tandem		





			
1			
GEV No.	106230	Ref. No.	005526 0830100
description	gas valve 24V 50Hz gas inlet 1/2" gas outlet 1/2" pilot connection M10x1 level slow ignition ignition times pressure range 3-50mbar power supply for modulator SIT equiv. no. 0.830.100		
For models:	CR42G, CR40G		
accessories for	106230		
	GEV No.	101274	Ref. No. —
olive for pipe ø 16mm Qty 1 pcs			
	GEV No.	101275	Ref. No. 052668
union screw thread 1/2" for pipe ø 16mm Qty 1 pcs			
	GEV No.	101925	Ref. No. 059474 1701108
plug with O-ring thread M10x1 for pilot burner suitable for NOVASIT			
	GEV No.	102845	Ref. No. —
gas connection angled 1/2" flange 32x32mm hole distance 24x24mm Tandem			
	GEV No.	102846	Ref. No. —
gas connection straight 1/2" flange 32x32mm hole distance 24x24mm suitable for Tandem			

ignition boxes

			
1			
GEV No.	102340	Ref. No.	0A5167
description	ignition box BRAHMA type SM191.1 electrodes 1 waiting time 1.5s safety time 10s 230V 7VA 50-60Hz		
For models:	HBR/G800, HBR/G805, HBR/G801, HBR/G806, HBR/G810, HBR/G815, HBR/G811, HBR/G816, HBR/G800D, HBR/G805D, HBR/G801D, HBR/G806D, HBR/G810D, HBR/G815D, HBR/G811D, HBR/G816D, HBR/G800NL, HBR/G805NL, HBR/G810NL, HBR/G800UK, ZBR/G800, ZBR/G805, ZBR/G801, ZBR/G806, ZBR/G810, ZBR/G815, ZBR/G811, ZBR/G816, ZBR/G800D, ZBR/G805D, ZBR/G801D, ZBR/G806D, ZBR/G810D, ZBR/G815D, ZBR/G811D, ZBR/G816D, ZBR/G800UK, AFR/G410D, ABR/G800, ABR/G805, ABR/G801, ABR/G806, ABR/G810, ABR/G815, ABR/G811, ABR/G816, ABR/G800D, ABR/G805D, ABR/G801D, ABR/G806D... (Other models you can see in the webshop)		

			
1			
GEV No.	107149	Ref. No.	0G2158 0G6519 0K5839 19016170 769713
description	ignition box type DGA1.73 model 5.1.0TLL electrodes 2 starting time <10s waiting time 3s safety time 5s 230V 50/60Hz ignition cable male faston 2.8mm DUNGS protection IP20		
For models:	FET100G.MS25P.H97, FET080G.MS25S.F98, FET080G.MS25S.W94, BOT060G.MS25.H97, BOT060G.MS25.F98, BOT060G.MS25.W94, BOT080G.MS25.F98, BOT080G.MS25.W94, BOT100G.MS25.F98, BOT100G.MS25.W94, BOT150G.MS25.F18, BOT150G.MS25.W14, BOT060G.MS25.F97, BOT100G.MS25.F97, BOT150G.MS25.F17, FET060G.MS25S.F98, FET060G.MS25S.W94, FET100G.MS25S.F98, FET100G.MS25S.W94, FET060G.MS25P.F98, FET060G.MS25P.W94, FET100G.MS25P.F97, UET090G.MS25.F98, UET090G.MS25.W94, UET150G.MS25.F98, UET150G.MS25.W94, UET090G.MS25.F97, UET150G.MS25.F97, BON060G.S.F98, BON080G.S.F98, BON100G.S.F98		

			
1			
GEV No.	101165	Ref. No.	002351 0C0921 0E1499 0K2372 60050362 S4560A1008 S4560A1008B
description	ignition box HONEYWELL type S4560A 1008 equiv. no. S4560A 1008 electrodes 1 waiting time 0s safety time 10s 220-240V 10VA 50Hz		
For models:	BRN70G, BRN/70GZ, BR70GZ, BRNG70A, FCV/G6L4, FCVMG62, 5711-2-6, 5711-2-7, 5711-2-8, 5711-2-10, 5711-2-8CH, 5711-2-10CH, 5711-2-6L, 5711-2-7L, 5711-2-8L, 5711-2-10L, ECV/G6T4, HCPA/G1219, CPD42G-Z, CPD40GZ, CPD42V-Z, CPD42E-Z, CPD40VZ, CPD40EZ, D200E, D200G, D200GC/OP, DI200E, DI200G, D350E, D350G, D350V, TT350, TT350, TT600E, TT600G, TT600V, D650E, D650G, D650V, D1000V, T353019, T3650, T3650, T3650, T1000, T3530, T3530, T1000... (Other models you can see in the webshop)		
spare parts for	101165		
	GEV No.	358696	Ref. No. —
fine fuse size ø5x20mm 4A medium lag rated 250V Qty 10 pcs			





			
1			
GEV No.	101166	Ref. No.	0C0064 0K0326 0K0327 0KC667 101166 S4560B1006
description	ignition box HONEYWELL type S4560B 1006 electrodes 1 waiting time 0s safety time 10s 220-240V 10VA 50Hz		
For models:	45-100-122, 45-100-123, 45-100-125, 45-100-132, 45-100-133, 45-100-135, 7573-2, 7574-2, 7575-2, 7576-2, 7773-2, 7774-2, 7775-2, 7776-2, 9100-2, 9101-2, 9102-2, 9104-2, 9113-2, 9114-2, 9115-2, 9116-2		

			
1			
GEV No.	102347	Ref. No.	002641 0K1525 102347 60050363 S4560M1010B
description	ignition box HONEYWELL type S4560M 1010 electrodes 1 waiting time 10s safety time 5s 220-240V 10VA 50Hz		
For models:	FDV40G, FDV40GZ, FDV40GA, FDV20G, FDV20GZ, FDV20GA, FCV/G10L3, FCVG10L3T, FCVG102L3, FCV/G20L3, FCVG202L3, FCVG10L3J, FCVG102L3J, FCV/G10L6JAP, FCV/G102/1L6JAP, FCV/G10L2, FCV/G10L6, FCV/G102/1L6, FCV/G20L6, FCVG202L6, FCV/G101/1, FCV/G102/1, FCS101G2, FCS101G4, FCS101G4DT, FCS101GP9J, FCS101G49J, FCS101GP, FCS102G4, FCS102GA9J, FCS102G49J, FCS102GP, 5712-2-6, 5712-2-7, 5712-2-8, 5712-2-10, 5714-2-6, 5714-2-7, 5714-2-8, 5714-2-10, 5717-2-6, 5714-2-7, 5714-2-8, 5714-2-10, 5712-2-6L, 5712-2-7L, 5712-2-8L, 5712-2-10L, 5714-2-6L, 5714-2-7L...(Other models you can see in the webshop)		

			
1			
GEV No.	101184	Ref. No.	005924 101184 S4565C1033B
description	ignition box HONEYWELL type S4565C 1033 equiv. no. S4565C 1033 electrodes 2 waiting times safety time 5s 220-240V 4VA 50/60Hz		
For models:	FCV/G20L3, FCVG202L3, FCVG6L3CJ, FCV/G6L3C, FCV/G61/1, FCV/G61/1, FCV/G61/1, FCV/G61/1, FCVG6L3CT, FCVG6L3CJ, FCV/G20L6, FCVG202L6, FCV/G201/1, FCV/G202/1, FCS061G48J, FCS061GP, FCS061G3DI, FCS061G4, FCS061G4DT, FCS061G49J, FCS101G4, FCS101G4DT, FCS101G49J, FCS102G4, FCS102G49J, FCS201G4, FCS201GP, FCS202G4, FCS202GP, FCS101GX9J, FCS101GX, FCS102GX9J, FCS102GX, FCS201GX, FCS202GX, 5721-2-7, 5721-2-10, ECV/G20T4, ECVG202T4, ECV/G6T4C, ECV/G61/1, ECV/G20T4J, ECV/G61/1, ECV/G20T6, ECVG202T6, RCV061G2, ACV/G6C3C, ACV/G20C4, ACVG202C4, ACVG202C6...(Other models you can see in the webshop)		

			
1			
GEV No.	101685	Ref. No.	005898 91310280
description	ignition box SIT type 503EFD electrodes 2 waiting time 1.5s safety time 10s 220/240V 10VA 50-60Hz protection IP40		
For models:	ZCBDG8, ZCBDG12, ZCBDG18		

			
1			
GEV No.	101990	Ref. No.	005908 0537307
description	ignition box SIT type 537ABC electrodes 3 waiting time 1.5s safety time 5s 230V 10VA 50-60Hz protection IP40		
For models:	FCVG6L3CJ, FCV/G6L3C, FCV/G61/1, FCV/G61/1, FCV/G61/1, FCV/G61/1, FCVG6L3CT, FCVG6L3CJ, 5721-2-7, 5721-2-10, ECV/G6T4C, ECV/G61/1, ECV/G61/1, RCV061G2, ACV/G6C3C, ZCV/G6T4C, ZCV/G61/1		

1

GEV No.	102299	Ref. No.	0G3480
description	ignition box SIT type 577DBC electrodes 1 waiting time 1.5s safety time 10s 220/240V 20VA 50-60Hz protection IP40		
For models:	AVRBOA0000, AVRCOA0000, AVREOA0000, AVRBOFO000, AVRCOFO000, AVREOFO000, AVRBOAT000, AVRCOAT000, AVREOAT000, AVRBOFT000, AVRCOFT000, AVREOFT000		

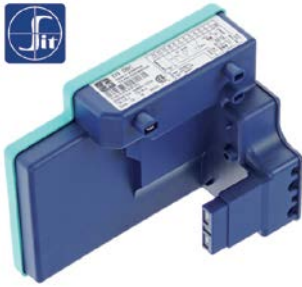

1

GEV No.	107224	Ref. No.	0C8189
description	ignition box SIT type 579DBC electrodes 2 waiting time 1.5s safety time 6s 220/240V 12VA 50/60Hz		



1

GEV No.	102346	Ref. No.	0577307 0C1059 0C1878
description	ignition box SIT type 577DBC electrodes 2 waiting time 1.5s safety time 6s 220/240V 20VA 50/60Hz protection IP40		
For models:	AOS061GAEU, AOS101GAEU, AOS102GAEU, AOS201GAEU, AOS-202GAEU, AOS061GAAU, AOS101GAAU, AOS102GAAU, AOS201GAAU, AOS202GAAU, AOS061GA, AOS061GB, AOS101GA, AOS101GB, AOS-201GA, AOS201GB, AOS102GB, AOS102GA, AOS202GB, AOS202GA		



1

GEV No.	102589	Ref. No.	0C4260
description	ignition box SIT type 579DBC electrodes 1 waiting time 1.5s safety time 3.5s 220/240V 12VA 50/60Hz		
For models:	FCZ102EAA, FCZ061GAG, FCZ101GAG, FCZ102GAG, FCZ201GAG, FCZ202GAG, FCZ061GAD, FCZ101GAD, FCZ102GAD, FCZ201GAD, FCZ202GAD, FCZ101GTG, FCZ102GTG, FCZ201GTG, FCZ202GTG, FCZ101GTD, FCZ102GTD, FCZ201GTD, FCZ202GTD, FCZ102EBA, FCZ061GBG, FCZ101GBG, FCZ102GBG, FCZ201GBG, FCZ202GBG, FCZ061GBD, FCZ101GBD, FCZ102GBD, FCZ201GBD, FCZ202GBD, FCZ061GBI, FCZ101GBI, FCZ201GBI, FCZ101GBG2, FCZ102GBG2, FCZ201GBG2, FCZ202GBG2, FCZ101GBD2, FCZ102GBD2, FCZ201GBD2, FCZ202GBD2, FCZ101GBI2, FCZ102GBI2, FCZ201GBI2, FCZ102ECA, FCZ061GCG, FCZ101GCG, FCZ102GCG, FCZ201GCG, FCZ202GCG...(Other models you can see in the webshop)		



safety valves

SIT



440 series



1



GEV No.	101100	Ref. No.	0440013 050106	
description	gas valve pressure range 50mbar gas inlet 1/2" gas outlet 1/2" pilot connection M10x1 (tube ø 6mm) thermocouple connection M9x1 type 0.440.013			
For models:	FP/G1-ZO			
accessories for	101100			
	GEV No.	100904	Ref. No.	052833 0K2497 100904 102504
	locking screw M10x1 for pipe ø 4mm Qty 1 pcs			
	GEV No.	100905	Ref. No.	052834 0958031
	locking screw M10x1 for pipe ø 6mm Qty 1 pcs			



			
1			
GEV No.	101101	Ref. No.	025434 026888 0440007 057915 335235200
description	gas valve pressure range 50mbar gas inlet 3/4" gas outlet 3/4" pilot connection M10x1 (tube ø 6mm) thermocouple connection M9x1 type SIT D3		
accessories for	101101		
	GEV No.	100904	Ref. No. 052833 0K2497 100904 102504
locking screw M10x1 for pipe ø 4mm Qty 1 pcs			
	GEV No.	100905	Ref. No. 052834 0958031
locking screw M10x1 for pipe ø 6mm Qty 1 pcs			

gas solenoid valves

BRAHMA

			
1			
GEV No.	101948 ¹	Ref. No.	059509 0HB227 0K3447 10036 9923199
description	solenoid valve 230VAC DN 15mm connection 1/2" L 72mm BRAHMA coil type 18811003 p max 0.5bar reg. no. 63AQ0626		
For models:	KPI/G18, KPI/G25, HPN/GI810, HPN/GI815, HPN/GI855, HPN/GI1255, HPN/GI806, HPN/GI805, QPI/G18, QPI/G25, ZPN/GI810, 2PIG15, ZPN/GI1255, ZPN/GI805, APN/GI810, APN/GI815, APN/GI816, APN/GD811, APN/GD816, APNS/GI816, OPN/GI815, APN/GI805		
spare parts for	101948		
	GEV No.	101968	Ref. No. 005548 18811003
solenoid valve 230VAC 20VA seat ø 17mm coil type 13902001 BRAHMA			

¹aluminium housing

KROMSCHRÖDER



1

GEV No.	101472 ¹	Ref. No.	0H6411 85229010 VG6K03T5G
description	solenoid valve 230VAC connection M12x1 L 52mm KROMSCHRÖDER p max 0.36bar p min 0bar reg. no. CE-0085AP0975		
For models:	7507-2, 7508-2, 7707-2		

¹aluminium housing

ignition parts

pilot burners

SIT

100 series



1

















GEV No.	107103	Ref. No.	027239 0K9223 100047
description	pilot burner SIT 1 flame nozzle ø 0.2mm gas connection 6mm		
spare parts for	107103		
	GEV No.	100245	Ref. No. 003633 006188 056799 0977030 0G0082 0G2785 0G2786 0G5006 0K2946 0KD857 19012718 19022995
pilot burner nozzle LPG code 20 bore ø 0.2mm Qty 1 pcs thread M8x0.75			
	GEV No.	100885	Ref. No. 057251
air mixing sleeve for pilot burner Qty 1 pcs			
	GEV No.	100916	Ref. No. —
compression spring for pilot burner Qty 1 pcs			
	GEV No.	100917	Ref. No. —
gasket for pilot burner Qty 1 pcs aluminium			
	GEV No.	100918	Ref. No. —
screw for pilot burner			

Table continues overleaf



spare parts for 107103				
	GEV No.	107160	Ref. No.	—
pilot burner cap SIT 1 flame Hmm Lmm Qty 1 pcs				
	GEV No.	107166	Ref. No.	—
pilot burner head SIT 1 flame Hmm Lmm Qty 1 pcs				
	GEV No.	107701	Ref. No.	—
pilot burner bottom part SIT 100 series nozzle ø 0.2mm				
accessories for 107103				
	GEV No.	100246	Ref. No.	02137 056656 056797 0977031 0G0150 0G2787 0K1318 0K2895 0K3558 0K5866 0KW952 0M0833 19022988 19022989 M02137 MOL02137
pilot burner nozzle natural gas bore ø 0.35mm Qty 1 pcs thread M8x0.75				
	GEV No.	100904	Ref. No.	052833 0K2497 100904 102504
locking screw M10x1 for pipe ø 4mm Qty 1 pcs				
	GEV No.	100905	Ref. No.	052834 0958031
locking screw M10x1 for pipe ø 6mm Qty 1 pcs				
	GEV No.	102110	Ref. No.	006249 054810 0C0152 0C0153 0C0626 517824900 517870202
pilot tube copper pipe ø 4mm thickness 1mm L 3000mm				
	GEV No.	102111	Ref. No.	—
pilot tube copper pipe ø 6mm thickness 1mm L 3000mm				
	GEV No.	107171	Ref. No.	058330 058753 0977051 0G2234
pilot burner nozzle SIT natural/liquid gas bore ø 0.25mm Qty 1 pcs				
	GEV No.	107700	Ref. No.	052281
pilot burner bottom part SIT 100 series nozzle ø 0.25mm				
	GEV No.	107702	Ref. No.	052686 0901404 11061232 727912
pilot burner bottom part SIT 100 series nozzle ø 0.35mm				







	1				0190901 0190904 052144 053201 056751
GEV No.	107138	Ref. No.			
description	pilot burner SIT type 100 series 1 flame natural gas nozzle ø 0.35mm gas connectionmm				
For models:	PCG810, PCG1210, PCG1610, PCG810F, PCG1210F, PCG1610F, PCG810D, PCG1210D, PCG1610D, PCG800NL, PCG1200NL, PCG1600NL, PCSG810, PCSG1210, PCSG1610, HCSG410, HCS/G410D, HCS/G400, PHCS/G400, HCS/G400F, HCF/G800F, PHCF/G800, HCS/G400NL, HCS/G400DK, HCSG810, HCS/G810D, HCS/G800, HCS/G800F, HCS/G800, HCS/G800NL, HCS/G800DK, HCFG810, HCF/G810D, HCF/GE81, HCF/GE81, HCF/GE81, HCF/G800, HCF/G800NL, HCF/G800DK, HCF/GE80, HCF/GE80, PHCF/GE8, HCFG1210, HCF/G1210D, HCF/G1200, HCF/G1200F, PHCF/G1200, HCF/G1200N, HCF/G1200D, HCFG1610...(Other models you can see in the webshop)				
spare parts for 107138					
	GEV No.	100245	Ref. No.		003633 006188 056799 0977030 0G0082 0G2785 0G2786 0G5006 0K2946 0KD857 19012718 19022995
pilot burner nozzle LPG code 20 bore ø 0.2mm Qty 1 pcs thread M8x0.75					
	GEV No.	100246	Ref. No.		02137 056656 056797 0977031 0G0150 0G2787 0K1318 0K2895 0K3558 0K5866 0KW952 0M0833 19022988 19022989 M02137 MOL02137
pilot burner nozzle natural gas bore ø 0.35mm Qty 1 pcs thread M8x0.75					
	GEV No.	100916	Ref. No.		—
compression spring for pilot burner Qty 1 pcs					
	GEV No.	100917	Ref. No.		—
gasket for pilot burner Qty 1 pcs aluminium					
	GEV No.	100918	Ref. No.		—
screw for pilot burner					
	GEV No.	107171	Ref. No.		058330 058753 0977051 0G2234
pilot burner nozzle SIT natural/liquid gas bore ø 0.25mm Qty 1 pcs					

Table continues overleaf

accessories for 107138				
	GEV No.	100904	Ref. No.	052833 0K2497 100904 102504
locking screw M10x1 for pipe ø 4mm Qty 1 pcs				
	GEV No.	100905	Ref. No.	052834 0958031
locking screw M10x1 for pipe ø 6mm Qty 1 pcs				
	GEV No.	102110	Ref. No.	006249 054810 0C0152 0C0153 0C0626 517824900 517870202
pilot tube copper pipe ø 4mm thickness 1mm L 3000mm				
	GEV No.	102111	Ref. No.	—
pilot tube copper pipe ø 6mm thickness 1mm L 3000mm				





1				
GEV No.	106901	Ref. No.	0100016 027073 0H6314	
description	pilot burner SIT type 100 series 1 flame nozzle ø 0.2mm gas connection 6mm			
For models:	MBR/G710D, MBR/G700, MBR/G700F, MBR/G700UK, MBR/G701, MBR/G706, MBR/G701UK, MBR/G751, MBR/G756, RBR/G710D, RBR/G700, RBR/G700F, 7BRG60, 7BRG60X, RBR/G701UK, RBR/G751, RBR/G756, XBR/G710D, XBR/G700, XBR/G710, XBR/G700F, XBR/G700UK, XBR/G701, M70GBP, XBR/G701UK, XBR/G751, XBR/G756, CBR/G700, RBR/G700, RBR/E700, RBR/G700, NC2/AV, NC4/AV, NC6/AV, NC4/FV, NC6/FVL, NC6/FV, NC6/2FV, NC8/2FV, 1TPG18F, 1102F/N, 1104F/N, 1104F/G, 1104F/E, 1106F/N, 1106F/2G, 1108F/N, 1108F/2G, NC2/AV, NC4/AV...(Other models you can see in the webshop)			
spare parts for 106901				
	GEV No.	100854	Ref. No.	052246 052256 0978009 0978021 0G2925 0G2926 727917 727918
pilot burner bracket double				
	GEV No.	100916	Ref. No.	—
compression spring for pilot burner Qty 1 pcs				
	GEV No.	100917	Ref. No.	—
gasket for pilot burner Qty 1 pcs aluminium				
	GEV No.	100918	Ref. No.	—
screw for pilot burner				
accessories for 106901				
	GEV No.	100904	Ref. No.	052833 0K2497 100904 102504
locking screw M10x1 for pipe ø 4mm Qty 1 pcs				
	GEV No.	100905	Ref. No.	052834 0958031
locking screw M10x1 for pipe ø 6mm Qty 1 pcs				

accessories for 106901				
	GEV No.	102110	Ref. No.	006249 054810 0C0152 0C0153 0C0626 517824900 517870202
pilot tube copper pipe ø 4mm thickness 1mm L 3000mm				
	GEV No.	102111	Ref. No.	—
pilot tube copper pipe ø 6mm thickness 1mm L 3000mm				
	GEV No.	102742	Ref. No.	—
pilot burner nozzle LPG code 25 bore ø 0.25mm Qty 1 pcs				

1				
GEV No.	106904	Ref. No.	0100013 0K5708 0KC422 19012732	
description	pilot burner SIT type 100 series 1 flame nozzle ø 0.2mm gas connection 6mm			
spare parts for	106904			
	GEV No.	100245	Ref. No.	003633 006188 056799 0977030 0G0082 0G2785 0G2786 0G5006 0K2946 0KD857 19012718 19022995
pilot burner nozzle LPG code 20 bore ø 0.2mm Qty 1 pcs thread M8x0.75				
	GEV No.	100855	Ref. No.	00411 005618
pilot burner bracket triple				
	GEV No.	100885	Ref. No.	057251
air mixing sleeve for pilot burner Qty 1 pcs				
	GEV No.	100916	Ref. No.	—
compression spring for pilot burner Qty 1 pcs				
	GEV No.	100917	Ref. No.	—
gasket for pilot burner Qty 1 pcs aluminium				
	GEV No.	100918	Ref. No.	—
screw for pilot burner				
	GEV No.	107160	Ref. No.	—
pilot burner cap SIT 1 flame Hmm Lmm Qty 1 pcs				
	GEV No.	107166	Ref. No.	—
pilot burner head SIT 1 flame Hmm Lmm Qty 1 pcs				

Table continues overleaf



spare parts for 106904	
	GEV No. 107701 Ref. No. — pilot burner bottom part SIT 100 series nozzle ø 0.2mm
accessories for 106904	
	02137 056656 056797 0977031 0G0150 0G2787 0K1318 0K2895 0K3558 0K5866 0KW952 0M0833 19022988 19022989 M02137 MOL02137
	GEV No. 100246 Ref. No. — pilot burner nozzle natural gas bore ø 0.35mm Qty 1 pcs thread M8x0.75
	GEV No. 100904 Ref. No. 052833 0K2497 100904 102504 locking screw M10x1 for pipe ø 4mm Qty 1 pcs
	GEV No. 100905 Ref. No. 052834 0958031 locking screw M10x1 for pipe ø 6mm Qty 1 pcs
	006249 054810 0C0152 0C0153 0C0626 517824900 517870202
	GEV No. 102110 Ref. No. — pilot tube copper pipe ø 4mm thickness 1mm L 3000mm
	GEV No. 102111 Ref. No. — pilot tube copper pipe ø 6mm thickness 1mm L 3000mm
	GEV No. 107171 Ref. No. 058330 058753 0977051 0G2234 pilot burner nozzle SIT natural/liquid gas bore ø 0.25mm Qty 1 pcs
	GEV No. 107700 Ref. No. 052281 pilot burner bottom part SIT 100 series nozzle ø 0.25mm
	GEV No. 107702 Ref. No. 052686 0901404 11061232 727912 pilot burner bottom part SIT 100 series nozzle ø 0.35mm

















	
1	
GEV No. 106902	Ref. No. 0100020 029776 02R31 02V37 0G0096 0K5732 0M0903 0M0904 19012839 330296100
description	pilot burner SIT type 100 series 2 flames nozzle ø 0.2mm gas connection 6mm
For models:	CG148-001.A1AB, CG148-003.A2AB, CG248-201.A1ABBB, CG248-203.A1ABBB, CK248-209.D1ABBB, CK248-211.D1ABBB, LG159-703.A1BC, LG159-703.A2BC, LG159-704.A1BC, LG159-706.A1BC, LG259-711.A1ACCB, LG259-712.A1ACCB, LK259-707.D1ACCB, LK259-708.D1ACCB, LG259-739.A1ACCB, LG259-740.A1ACCB, CK248-205.D1ABBB, CK248-207.D1ABBB, LK159-707.D1BC, LK159-708.D1BC, LK259-727.D1ACCB, LK259-728.D1ACCB, LG159-704.A2BC, LK159-707.D2BC, LK159-708.D2BC, LG259-711.A2ACCB, LG259-712.A2ACCB, LK259-727.D2ACCB, LK259-728.D2ACCB, LK259-707.D2ACCB, LK259-708.D2ACCB, CK248-205.D2ABBB, CK248-207.D2ABBB, CK248-209.D2ABBB, CK248-211.D2ABBB, CG148-004.A1AB, CG148-005.A1AB, CG148-006.A1AB, CG248-240.A1ABBB, CG248-243.A1ABBB, CG248-244.A1ABBB, CG248-212.A1ABBB, CG248-213.A1ABBB, LG159-705.A1BC, LG159-753.A1BC, LG259-758.A1ACCB, LG259-754.A1ACCB, LG259-757.A1ACCB, CG148-001.A3AB, CG148-003.A2AB...(Other models you can see in the webshop)
spare parts for 106902	
	GEV No. 100245 Ref. No. 003633 006188 056799 0977030 0G0082 0G2785 0G2786 0G5006 0K2946 0KD857 19012718 19022995 pilot burner nozzle LPG code 20 bore ø 0.2mm Qty 1 pcs thread M8x0.75
	GEV No. 100842 Ref. No. — pilot burner cap 2 flames Qty 1 pcs
	GEV No. 100885 Ref. No. 057251 air mixing sleeve for pilot burner Qty 1 pcs
	GEV No. 100916 Ref. No. — compression spring for pilot burner Qty 1 pcs
	GEV No. 100917 Ref. No. — gasket for pilot burner Qty 1 pcs aluminium
	GEV No. 100918 Ref. No. — screw for pilot burner
	GEV No. 107161 Ref. No. — pilot burner cap SIT 2 flames Hmm Lmm Qty 1 pcs

Table continues overleaf



accessories for		106902	
	GEV No.	100246	Ref. No. 02137 056656 056797 0977031 0G0150 0G2787 0K1318 0K2895 0K3558 0K5866 0KW952 0M0833 19022988 19022989 M02137 MOL02137
pilot burner nozzle natural gas bore \varnothing 0.35mm Qty 1 pcs thread M8x0.75			
	GEV No.	100904	Ref. No. 052833 0K2497 100904 102504
locking screw M10x1 for pipe \varnothing 4mm Qty 1 pcs			
	GEV No.	100905	Ref. No. 052834 0958031
locking screw M10x1 for pipe \varnothing 6mm Qty 1 pcs			
	GEV No.	102110	Ref. No. 006249 054810 0C0152 0C0153 0C0626 517824900 517870202
pilot tube copper pipe \varnothing 4mm thickness 1mm L 3000mm			
	GEV No.	102111	Ref. No. —
pilot tube copper pipe \varnothing 6mm thickness 1mm L 3000mm			
	GEV No.	107171	Ref. No. 058330 058753 0977051 0G2234
pilot burner nozzle SIT natural/liquid gas bore \varnothing 0.25mm Qty 1 pcs			
	GEV No.	107700	Ref. No. 052281
pilot burner bottom part SIT 100 series nozzle \varnothing 0.25mm			
	GEV No.	107702	Ref. No. 052686 0901404 11061232 727912
pilot burner bottom part SIT 100 series nozzle \varnothing 0.35mm			



1



















GEV No.	106905	Ref. No.	004946
description	pilot burner SIT type 100 series 2 flames nozzle \varnothing 0.2mm gas connection 6mm		
For models:	SFRG350, SFRG700, SFRG350, SFRG700		
spare parts for	106905		
	GEV No.	100245	Ref. No. 003633 006188 056799 0977030 0G0082 0G2785 0G2786 0G5006 0K2946 0KD857 19012718 19022995
pilot burner nozzle LPG code 20 bore \varnothing 0.2mm Qty 1 pcs thread M8x0.75			
	GEV No.	100855	Ref. No. 00411 005618
pilot burner bracket triple			
	GEV No.	100885	Ref. No. 057251
air mixing sleeve for pilot burner Qty 1 pcs			
	GEV No.	100916	Ref. No. —
compression spring for pilot burner Qty 1 pcs			
	GEV No.	100917	Ref. No. —
gasket for pilot burner Qty 1 pcs aluminium			
	GEV No.	100918	Ref. No. —
screw for pilot burner			
	GEV No.	107161	Ref. No. —
pilot burner cap SIT 2 flames Hmm Lmm Qty 1 pcs			
	GEV No.	107701	Ref. No. —
pilot burner bottom part SIT 100 series nozzle \varnothing 0.2mm			
accessories for	106905		
	GEV No.	100246	Ref. No. 02137 056656 056797 0977031 0G0150 0G2787 0K1318 0K2895 0K3558 0K5866 0KW952 0M0833 19022988 19022989 M02137 MOL02137
pilot burner nozzle natural gas bore \varnothing 0.35mm Qty 1 pcs thread M8x0.75			
	GEV No.	100904	Ref. No. 052833 0K2497 100904 102504
locking screw M10x1 for pipe \varnothing 4mm Qty 1 pcs			

Table continues overleaf



accessories for		106905	
	GEV No.	100905	Ref. No. 052834 0958031
locking screw M10x1 for pipe ø 6mm Qty 1 pcs			
	GEV No.	102110	Ref. No. 006249 054810 0C0152 0C0153 0C0626 517824900 517870202
pilot tube copper pipe ø 4mm thickness 1mm L 3000mm			
	GEV No.	102111	Ref. No. —
pilot tube copper pipe ø 6mm thickness 1mm L 3000mm			
	GEV No.	107171	Ref. No. 058330 058753 0977051 0G2234
pilot burner nozzle SIT natural/liquid gas bore ø 0.25mm Qty 1 pcs			
	GEV No.	107700	Ref. No. 052281
pilot burner bottom part SIT 100 series nozzle ø 0.25mm			
	GEV No.	107702	Ref. No. 052686 0901404 11061232 727912
pilot burner bottom part SIT 100 series nozzle ø 0.35mm			

 <p>1</p>			
GEV No.	106903	Ref. No.	004216 0190015 020152 053001
description	pilot burner SIT type 100 series 3 flames nozzle ø 0.2mm gas connection 6mm		
For models:	FG250D, FG250S, FGC/250D, FGC/250S, HFR/G1680, HFR/G2480, LB8G, LB8G/63, LB8GF, LB8GPH, LB8G, LB8GPHm, FT/G2V, LB8G		
spare parts for		106903	
	GEV No.	100245	Ref. No. 003633 006188 056799 0977030 0G0082 0G2785 0G2786 0G5006 0K2946 0KD857 19012718 19022995
pilot burner nozzle LPG code 20 bore ø 0.2mm Qty 1 pcs thread M8x0.75			
	GEV No.	100854	Ref. No. 052246 052256 0978009 0978021 0G2925 0G2926 727917 727918
pilot burner bracket double			
	GEV No.	100885	Ref. No. 057251
air mixing sleeve for pilot burner Qty 1 pcs			























spare parts for		106903	
	GEV No.	100916	Ref. No. —
compression spring for pilot burner Qty 1 pcs			
	GEV No.	100917	Ref. No. —
gasket for pilot burner Qty 1 pcs aluminium			
	GEV No.	100918	Ref. No. —
screw for pilot burner			
	GEV No.	107162	Ref. No. —
pilot burner cap SIT 3 flames Hmm Lmm Qty 1 pcs			
	GEV No.	107701	Ref. No. —
pilot burner bottom part SIT 100 series nozzle ø 0.2mm			
accessories for		106903	
	GEV No.	100245	Ref. No. 003633 006188 056799 0977030 0G0082 0G2785 0G2786 0G5006 0K2946 0KD857 19012718 19022995
pilot burner nozzle LPG code 20 bore ø 0.2mm Qty 1 pcs thread M8x0.75			
	GEV No.	100246	Ref. No. 02137 056656 056797 0977031 0G0150 0G2787 0K1318 0K2895 0K3558 0K5866 0KW952 0M0833 19022988 19022989 M02137 MOL02137
pilot burner nozzle natural gas bore ø 0.35mm Qty 1 pcs thread M8x0.75			
	GEV No.	100904	Ref. No. 052833 0K2497 100904 102504
locking screw M10x1 for pipe ø 4mm Qty 1 pcs			
	GEV No.	100905	Ref. No. 052834 0958031
locking screw M10x1 for pipe ø 6mm Qty 1 pcs			
	GEV No.	102110	Ref. No. 006249 054810 0C0152 0C0153 0C0626 517824900 517870202
pilot tube copper pipe ø 4mm thickness 1mm L 3000mm			
	GEV No.	102111	Ref. No. —
pilot tube copper pipe ø 6mm thickness 1mm L 3000mm			

Table continues overleaf



accessories for		106903	
	GEV No.	107171	Ref. No.
			058330 058753 0977051 0G2234
pilot burner nozzle SIT natural/liquid gas bore ø 0.25mm Qty 1 pcs			
	GEV No.	107700	Ref. No.
			052281
pilot burner bottom part SIT 100 series nozzle ø 0.25mm			
	GEV No.	107702	Ref. No.
			052686 0901404 11061232 727912
pilot burner bottom part SIT 100 series nozzle ø 0.35mm			

 <p>1</p>			
GEV No.	106906	Ref. No.	00119 004962 005783 0100001 0100009 0100054 026823 02R32 02V38 054335 0H6331 0K3507 0KQ947 0M0905 75204011002 M02V38
description	pilot burner SIT type 100 series 3 flames nozzle ø 0.2mm gas connection 6mm		
For models:	BR80GZ, SCPG350, SCPG350, SGG350, SGG700, HCPA/G1219, HCPA/G11219, BR180GZ, BR100GZ, BR100G, BR80G, BR180G, NC4/FV, NC6/FVL, NC6/FV, NC6/2FV, NC8/2FV, NCG1V, NCG2V, NFG/20, NFG20+20, NFT/2GL, NFT/2GR, NFT/2GLC, 1TPG18F, 110FTL/N, 1104F/G, 1106F/2G, 1102FTL/N, 110FTR/N, 1102FTR/N, 1108F/2G, 110CP1, 110FR2, NC4/FV, NC6/FV, NC6/2FV, NC8/2FV, NC6/FVL, NFT/2GL, NFT/4GL, NFT/2GR, NFT/4GR, NFT/4GLR, NFT/4GLRC, NFT/2GLC, NFT/4GLC, NCG1V, NCG2V, NFG/20...(Other models you can see in the webshop)		
spare parts for		106906	
	GEV No.	100245	Ref. No.
			003633 006188 056799 0977030 0G0082 0G2785 0G2786 0G5006 0K2946 0KD857 19012718 19022995
pilot burner nozzle LPG code 20 bore ø 0.2mm Qty 1 pcs thread M8x0.75			
	GEV No.	100855	Ref. No.
			00411 005618
pilot burner bracket triple			
	GEV No.	100885	Ref. No.
			057251
air mixing sleeve for pilot burner Qty 1 pcs			
	GEV No.	100916	Ref. No.
			—
compression spring for pilot burner Qty 1 pcs			

spare parts for		106906	
	GEV No.	100917	Ref. No.
			—
gasket for pilot burner Qty 1 pcs aluminium			
	GEV No.	100918	Ref. No.
			—
screw for pilot burner			
	GEV No.	107162	Ref. No.
			—
pilot burner cap SIT 3 flames Hmm Lmm Qty 1 pcs			
	GEV No.	107701	Ref. No.
			—
pilot burner bottom part SIT 100 series nozzle ø 0.2mm			









accessories for		106906	
	GEV No.	100245	Ref. No.
			003633 006188 056799 0977030 0G0082 0G2785 0G2786 0G5006 0K2946 0KD857 19012718 19022995
pilot burner nozzle LPG code 20 bore ø 0.2mm Qty 1 pcs thread M8x0.75			
	GEV No.	100246	Ref. No.
			02137 056656 056797 0977031 0G0150 0G2787 0K1318 0K2895 0K3558 0K5866 0KW952 0M0833 19022988 19022989 M02137 MOL02137
pilot burner nozzle natural gas bore ø 0.35mm Qty 1 pcs thread M8x0.75			
	GEV No.	100904	Ref. No.
			052833 0K2497 100904 102504
locking screw M10x1 for pipe ø 4mm Qty 1 pcs			
	GEV No.	100905	Ref. No.
			052834 0958031
locking screw M10x1 for pipe ø 6mm Qty 1 pcs			
	GEV No.	102110	Ref. No.
			006249 054810 0C0152 0C0153 0C0626 517824900 517870202
pilot tube copper pipe ø 4mm thickness 1mm L 3000mm			
	GEV No.	102111	Ref. No.
			—
pilot tube copper pipe ø 6mm thickness 1mm L 3000mm			
	GEV No.	107171	Ref. No.
			058330 058753 0977051 0G2234
pilot burner nozzle SIT natural/liquid gas bore ø 0.25mm Qty 1 pcs			

Table continues overleaf



accessories for 106906	
	GEV No. 107700 Ref. No. 052281
pilot burner bottom part SIT 100 series nozzle ø 0.25mm	
	GEV No. 107702 Ref. No. 052686 0901404 11061232 727912
pilot burner bottom part SIT 100 series nozzle ø 0.35mm	









GEV No. 106907	Ref. No.	002572 0190083 0190085 02V35 050812 050813 051141 051624 051976 057737 058329 058715 0C0494 0G0100 0G0302 0K2942 0K5618 0K5698 0K5737 0K7809 0KE453 0M0902 19001195 19011195 19012868 330299600 720151 75204011001
-----------------------	-----------------	---

description pilot burner SIT type 100 series 3 flames nozzle ø 0.35mm gas connection 6mm

For models: MCF/G705, MCF/G1055, MCF/G700, MCF/G1050, MCF/G705E, MCF/G1055E, MCF/G700, MCF/G705F, MCF/G1055F, MCF/G702, MCF/G1052, MCF/G700, MCF/G1050, MR/G351, MR/G701, MR/G721, MR/G1071, MR/G350, MR/G360, MR/G700, MR/G700NL, MR/G710, MR/G1070, MR/G720, MR/G715, MR/G725, MR/G1075, MR/G361, MR/G711, MR/G716, MR/G726, MR/G1076, MFR/G360, MPN/GD761, MPN/GI761, MPN/GI760D, MPN/GD760, MPN/GD760F, MPN/GI760, MPN/GI760F, MT/G700D, MTF/G700D, MTF/G1050D, MT/G700, MTF/G700, MTF/G1050, MTF/GE1050, MT/G700F, MTF/G700F, MTF/G1055F... (Other models you can see in the webshop)

spare parts for 106907	
	GEV No. 100246 Ref. No. 02I37 056656 056797 0977031 0G0150 0G2787 0K1318 0K2895 0K3558 0K5866 0KW952 0M0833 19022988 19022989 M02I37 MOL02I37
pilot burner nozzle natural gas bore ø 0.35mm Qty 1 pcs thread M8x0.75	

spare parts for 106907	
	GEV No. 100855 Ref. No. 00411 005618
pilot burner bracket triple	
	GEV No. 100885 Ref. No. 057251
air mixing sleeve for pilot burner Qty 1 pcs	
	GEV No. 100916 Ref. No. —
compression spring for pilot burner Qty 1 pcs	
	GEV No. 100917 Ref. No. —
gasket for pilot burner Qty 1 pcs aluminium	
	GEV No. 100918 Ref. No. —
screw for pilot burner	
	GEV No. 107162 Ref. No. —
pilot burner cap SIT 3 flames Hmm Lmm Qty 1 pcs	
	GEV No. 107702 Ref. No. 052686 0901404 11061232 727912
pilot burner bottom part SIT 100 series nozzle ø 0.35mm	









accessories for 106907	
	GEV No. 100245 Ref. No. 003633 006188 056799 0977030 0G0082 0G2785 0G2786 0G5006 0K2946 0KD857 19012718 19022995
pilot burner nozzle LPG code 20 bore ø 0.2mm Qty 1 pcs thread M8x0.75	
	GEV No. 100904 Ref. No. 052833 0K2497 100904 102504
locking screw M10x1 for pipe ø 4mm Qty 1 pcs	
	GEV No. 100905 Ref. No. 052834 0958031
locking screw M10x1 for pipe ø 6mm Qty 1 pcs	
	GEV No. 102110 Ref. No. 006249 054810 0C0152 0C0153 0C0626 517824900 517870202
pilot tube copper pipe ø 4mm thickness 1mm L 3000mm	
	GEV No. 102111 Ref. No. —
pilot tube copper pipe ø 6mm thickness 1mm L 3000mm	
	GEV No. 107171 Ref. No. 058330 058753 0977051 0G2234
pilot burner nozzle SIT natural/liquid gas bore ø 0.25mm Qty 1 pcs	
	GEV No. 107700 Ref. No. 052281
pilot burner bottom part SIT 100 series nozzle ø 0.25mm	

Table continues overleaf





accessories for 106907			
	GEV No.	107701	Ref. No. —
pilot burner bottom part SIT 100 series nozzle ø 0.2mm			





GEV No.	106908	Ref. No.	0190089
description	pilot burner SIT type 100 series 3 flames nozzle ø 0.35mm gas connection 6mm		

spare parts for 106908

	GEV No.	100246	Ref. No.	02137 056656 056797 0977031 0G0150 0G2787 0K1318 0K2895 0K3558 0K5866 0KW952 0M0833 19022988 19022989 M02137 MOL02137
pilot burner nozzle natural gas bore ø 0.35mm Qty 1 pcs thread M8x0.75				

	GEV No.	100854	Ref. No.	052246 052256 0978009 0978021 0G2925 0G2926 727917 727918
pilot burner bracket double				

	GEV No.	100885	Ref. No.	057251
air mixing sleeve for pilot burner Qty 1 pcs				

	GEV No.	100916	Ref. No.	—
compression spring for pilot burner Qty 1 pcs				

	GEV No.	100917	Ref. No.	—
gasket for pilot burner Qty 1 pcs aluminium				

	GEV No.	100918	Ref. No.	—
screw for pilot burner				

	GEV No.	107162	Ref. No.	—
pilot burner cap SIT 3 flames Hmm Lmm Qty 1 pcs				

	GEV No.	107702	Ref. No.	052686 0901404 11061232 727912
pilot burner bottom part SIT 100 series nozzle ø 0.35mm				

accessories for 106908				
	GEV No.	100245	Ref. No.	003633 006188 056799 0977030 0G0082 0G2785 0G2786 0G5006 0K2946 0KD857 19012718 19022995
pilot burner nozzle LPG code 20 bore ø 0.2mm Qty 1 pcs thread M8x0.75				

pilot burner nozzle LPG code 20 bore ø 0.2mm Qty 1 pcs thread M8x0.75

	GEV No.	100904	Ref. No.	052833 0K2497 100904 102504
locking screw M10x1 for pipe ø 4mm Qty 1 pcs				

	GEV No.	100905	Ref. No.	052834 0958031
locking screw M10x1 for pipe ø 6mm Qty 1 pcs				

GEV No.	102111	Ref. No.	—	
----------------	--------	-----------------	---	--

pilot tube copper pipe ø 6mm thickness 1mm L 3000mm

	GEV No.	107171	Ref. No.	058330 058753 0977051 0G2234
pilot burner nozzle SIT natural/liquid gas bore ø 0.25mm Qty 1 pcs				

	GEV No.	107700	Ref. No.	052281
pilot burner bottom part SIT 100 series nozzle ø 0.25mm				

	GEV No.	107701	Ref. No.	—
pilot burner bottom part SIT 100 series nozzle ø 0.2mm				





GEV No.	101846	Ref. No.	00445 0K3560	
description	pilot burner SIT type 100 series 3 flames nozzle ømm gas connectionmm without nozzle			

spare parts for 101846

	GEV No.	100843	Ref. No.	—
pilot burner cap 3 flames Qty 1 pcs				

	GEV No.	100916	Ref. No.	—
compression spring for pilot burner Qty 1 pcs				

	GEV No.	100917	Ref. No.	—
gasket for pilot burner Qty 1 pcs aluminium				

	GEV No.	100918	Ref. No.	—
screw for pilot burner				











	GEV No.	102643	Ref. No.	—
pilot burner cap 3 flames Qty 5 pcs				

Table continues overleaf



accessories for 101846				052246 052256 0978009 0978021 0G2925 0G2926 727917 727918
	GEV No.	100854	Ref. No.	
pilot burner bracket double				
	GEV No.	100855	Ref. No.	00411 005618
pilot burner bracket triple				
	GEV No.	102740	Ref. No.	—
pilot burner nozzle LPG code 20 bore ø 0.2mm Qty 1 pcs				
	GEV No.	102741	Ref. No.	—
pilot burner nozzle natural gas code 35 bore ø 0.35mm Qty 1 pcs				
	GEV No.	102742	Ref. No.	—
pilot burner nozzle LPG code 25 bore ø 0.25mm Qty 1 pcs				
	GEV No.	102972	Ref. No.	003327 0K1319
pilot burner nozzle natural gas code 40 bore ø 0.4mm Qty 1 pcs				
	GEV No.	102973	Ref. No.	—
pilot burner nozzle natural gas bore ø 0.45mm Qty 1 pcs				

			
1			
GEV No.	102665	Ref. No.	006128 11061212
description	pilot burner cap 3 flames suitable for 100 series H 28mm L 87mm Qty 1 pcs		
For models:	KFR/G1E, KFR/G2F, KFH/G1, KFH/G1ELH, KFH/G1EH, HFH/G430, HFR/G430, HFR/G830, HFH/G400U, HFH/G401U, HFH/G435, HFRS/G430, QFR/G1E, QFR/G2F, QFH/G1, QFH/G1ELH, QFH/G1EH, ZFH/G430, ZFR/G430, ZFR/G830, ZFH/G435, ZFRS/G430, WFR/G1E, WFR/G2F, WFH/G1, WFH/G1ELH, WFH/G1EH, AFR/G430, AFR/G830, AFH/G435, AFRS/G430, AFGROA0000, AFGROFO000, AFGUOA0000, AFGUOFO000		



			
1			
GEV No.	102664	Ref. No.	059301 0KF072 727916
description	pilot burner cap 3 flames suitable for 100 series H 29mm L 40mm		
For models:	XFR/G351, CFR/G351, KFR/G1T, HFR/G410, HFR/G810, HFR/G410D, HFR/G810D, HFR/G410NL, HFR/G810NL, HFR/G411, HFR/G412, FC1G, FC2G, QFR/G1T, ZFR/G410, ZFR/G810, ZFR/G410D, ZFR/G810D, ZFR/G411, ZFR/G412, RF/G1680, RF/G2480, WFR/G1T, AFR/G410, AFR/G810, AFR/G410D, AFR/G810D, AFR/G410NL, M40GFR90, AFR/G411, AFR/G412, OFR/G810		

accessories

pilot burner caps

			
1			
GEV No.	102816	Ref. No.	003394
description	pilot burner cap 3 flames suitable for 100 series H 25mm L 64mm		
For models:	MFR/G740, RFR/G741, CFR/G741		

			
1			
GEV No.	102662	Ref. No.	003328
description	pilot burner cap 3 flames suitable for 100 series H 28mm L 55mm Qty 1 pcs		
For models:	MFR/G380, MFR/G381, BF/G1S07, RF/G1S07, RF/G2D07, RFR/G1S07, RFR/G2D07, RF/G1S07, RF/G2D07, RFR/G1S07, RFR/G2D07, XF/G1S07, XFR/G2D07, XFR/G1S07, XFR/G2D07, XF/G1S07, XF/G2D07, XFR/G1S07, XFR/G2D07, JF/G1S07, JF/G2D07, JFR/G1S07, JFR/G2D07, JF/G1S07, JF/G2D07, JFR/G2D07, MF/G1S07, MF/G2D07, MFR/G1S07, MFR/G2D07, MF/G1S07, MF/G2D07, MFR/G1S07, MFR/G2D07, 7FRG03T, CFR/G381, T35GFR, PF/G1S07, PF/G2D07, PFR/G1S07, PFR/G2D07, OF/G1S07, OFR/G1S07, OFR/G2D07, TF/G1S07, TF/G2D07, TFR/G1S07, TFR/G2D07, JFR/G400...(Other models you can see in the webshop)		

				
1				
GEV No.	102663	Ref. No.	0A5441 11061231	
description	pilot burner cap 3 flames suitable for 100 series H 29mm L 64mm Qty 1 pcs			
For models:	BFR/G1S14, RFR/G2S40, RFR/G1S14, RFR/G2D14, XFR/G2S40, XFR/G1S14, XFR/G2D14, JFR/G2S40, JFR/G1S14, JFR/G2D14, MFR/G2S40, MFR/G1S14, MFR/G2D14, PFR/G1S14, PFR/G2D14, PFR/G2S40, PFRG2D14HV, PFRG1S14HV, OFR/G1S14, OFR/G2D14, TFR/G1S14, TFR/G2D14, TFR/G2S40, KFR/G1A, KFR/G2B, QFR/G1A, QFR/G2B, WFR/G1A, WFR/G2B, AFGROA0000, AFGROFO000, AFGUOA0000, AFGUOFO000			
accessories for	102663			
	GEV No.	100885	Ref. No.	057251
air mixing sleeve for pilot burner Qty 1 pcs				



1

GEV No.	100836	Ref. No.	052280
description	pilot burner cap 3 flames suitable for 100 series H 30mm L 48mm		
For models:	MFR/G350, MFR/G700, MFR/G350D, MFR/G700D, MFR/G350F, MFR/G700F, MFR/G350E, MFR/G700E, MFR/G350NL, MFR/G700NL, MFR/G350, MFR/G351, MFR/G700, MFR/G701, RFR/G1S12, RFR/G2D12, XFR/G1S12, XFR/G2D12, JFR/G1S12, JFR/G2D12, MFR/G1S12, MFR/G2D12, RFR/G350, RFR/G700, RFR/G350D, RFR/G700D, RFR/G350F, RFR/G700F, 7FRG03S, 7FRG07S, M35GFR, M70GFR, XFR/G350D, XFR/G700D, XFR/G350F, XFR/G700F, XFR/G350NL, XFR/G700NL, M35GFR, M70GFR, CFR/G700, CFR/G351, CFR/G701, RFR/G300, RFR/G301, RFR/G300, RFR/G300, PRFR/G300, RFR/G301, PRFR/G300...(Other models you can see in the webshop)		







1

GEV No.	100833	Ref. No.	OH6050 OKE589 100833
description	pilot burner cap SIT suitable for 100 series Hmm Lmm Qty 1 pcs		







pilot burner bottom parts









1



GEV No.	107700	Ref. No.	052281	
description	pilot burner bottom part SIT 100 series nozzle ø 0.25mm			
For models:	RFR/G301, RFR/G300, RFR/G301, RFR/G701, RFR/G701F, HFR/G420, HFR/G420, HFR/G840, HFR/G840, HFR/G840, HFR/G421, HFR/G420, ZHFRG421, HFR/G840, RFR/G301, RFR/G701			
spare parts for	107700			
	GEV No.	100916	Ref. No.	—
	compression spring for pilot burner Qty 1 pcs			
	GEV No.	100917	Ref. No.	—
	gasket for pilot burner Qty 1 pcs aluminium			
	GEV No.	100918	Ref. No.	—
	screw for pilot burner			
	GEV No.	102742	Ref. No.	—
	pilot burner nozzle LPG code 25 bore ø 0.25mm Qty 1 pcs			

accessories for 107700

	GEV No.	100245	Ref. No.	003633 006188 056799 0977030 0G0082 0G2785 0G2786 0G5006 0K2946 0KD857 19012718 19022995
	pilot burner nozzle LPG code 20 bore ø 0.2mm Qty 1 pcs thread M8x0.75			
	GEV No.	100246	Ref. No.	02137 056656 056797 0977031 0G0150 0G2787 0K1318 0K2895 0K3558 0K5866 0KW952 0M0833 19022988 19022989 M02137 MOL02137
	pilot burner nozzle natural gas bore ø 0.35mm Qty 1 pcs thread M8x0.75			
	GEV No.	100904	Ref. No.	052833 0K2497 100904 102504
	locking screw M10x1 for pipe ø 4mm Qty 1 pcs			
	GEV No.	100905	Ref. No.	052834 0958031
	locking screw M10x1 for pipe ø 6mm Qty 1 pcs			
	GEV No.	102110	Ref. No.	006249 054810 0C0152 0C0153 0C0626 517824900 517870202
	pilot tube copper pipe ø 4mm thickness 1mm L 3000mm			
	GEV No.	102111	Ref. No.	—
	pilot tube copper pipe ø 6mm thickness 1mm L 3000mm			







 <p>1</p>			
GEV No.	107702	Ref. No.	052686 0901404 11061232 727912
description	pilot burner bottom part SIT 100 series nozzle ø 0.35mm		
For models:	MR/G700NL, MFR/G350, MFR/G700, MFR/G350D, MFR/G700D, MFR/G350F, MFR/G700F, MFR/G350E, MFR/G700E, MFR/G350NL, MFR/G700NL, MFR/G740, MFR/G380, MFR/G381, MFR/G350, MFR/G351, MFR/G700, MFR/G701, RF/G1S07, RF/G2D07, RFR/G1S07, RFR/G2D07, RFR/G1S12, RFR/G2D12, RFR/G2S40, RFR/G1S14, RFR/G2D14, RF/G1S07, RF/G2D07, RFR/G1S07, RFR/G2D07, XFR/G1S07, XFR/G2D07, XFR/G1S07, XFR/G2D07, XFR/G1S12, XFR/G2D12, XFR/G2S40, XFR/G1S14, XFR/G2D14, XFR/G1S07, XFR/G2D07, JF/G1S07, JF/G2D07, JFR/G1S07, JFR/G2D07, JFR/G1S12, JFR/G2D12... (Other models you can see in the webshop)		
spare parts for	107702		
			
GEV No.	100246	Ref. No.	02137 056656 056797 0977031 0G0150 0G2787 0K1318 0K2895 0K3558 0K5866 0KW952 0M0833 19022988 19022989 M02137 MOL02137
description	pilot burner nozzle natural gas bore ø 0.35mm Qty 1 pcs thread M8x0.75		
			
GEV No.	100916	Ref. No.	—
description	compression spring for pilot burner Qty 1 pcs		
			
GEV No.	100917	Ref. No.	—
description	gasket for pilot burner Qty 1 pcs aluminium		
accessories for	107702		
			
GEV No.	100245	Ref. No.	003633 006188 056799 0977030 0G0082 0G2785 0G2786 0G5006 0K2946 0KD857 19012718 19022995
description	pilot burner nozzle LPG code 20 bore ø 0.2mm Qty 1 pcs thread M8x0.75		
			
GEV No.	100904	Ref. No.	052833 0K2497 100904 102504
description	locking screw M10x1 for pipe ø 4mm Qty 1 pcs		
			
GEV No.	100905	Ref. No.	052834 0958031
description	locking screw M10x1 for pipe ø 6mm Qty 1 pcs		

accessories for	107702		
			
GEV No.	102110	Ref. No.	006249 054810 0C0152 0C0153 0C0626 517824900 517870202
description	pilot tube copper pipe ø 4mm thickness 1mm L 3000mm		
			
GEV No.	102111	Ref. No.	—
description	pilot tube copper pipe ø 6mm thickness 1mm L 3000mm		
			
GEV No.	102742	Ref. No.	—
description	pilot burner nozzle LPG code 25 bore ø 0.25mm Qty 1 pcs		

 <p>1</p>			
GEV No.	100880	Ref. No.	003614 006725 0901405
description	pilot burner bottom part SIT 100 series nozzle ø 0.4mm		
For models:	BF/G1S07, BFR/G1S14, PF/G1S07, PF/G2D07, PFR/G1S07, PFR/G2D07, PFR/G1S14, PFR/G2D14, PFR/G2S40, PFRG2D14HV, PFRG1S14HV, OF/G1S07, OFR/G1S07, OFR/G2D07, OFR/G1S14, OFR/G2D14, TF/G1S07, TF/G2D07, TFR/G1S07, TFR/G2D07, TFR/G1S14, TFR/G2D14, TFR/G2S40, KFR/G1A, KFR/G2B, KFR/G1E, KFR/G2F, KFH/G1, KFH/G1ELH, KFH/G1EH, KFR/G1T, FC1G, FC2G, HFH/G430, QFR/G1A, QFR/G2B, QFR/G1E, QFR/G2F, QFH/G1, QFH/G1ELH, QFH/G1EH, QFR/G1T, RF/G1680, RF/G2480, ZFH/G430, WFR/G1A, WFR/G2B, WFR/G1E, WFR/G2F, WFH/G1...(Other models you can see in the webshop)		

pilot burner brackets			
universal			
 <p>1</p>			
GEV No.	100854	Ref. No.	052246 052256 0978009 0978021 0G2925 0G2926 727917 727918
description	pilot burner bracket double		
For models:	MFR/G350, MFR/G700, MFR/G350D, MFR/G700D, MFR/G350F, MFR/G700F, MFR/G350E, MFR/G700E, MFR/G350NL, MFR/G700NL, MFR/G740, MFR/G380, MFR/G381, MFR/G350, MFR/G351, MFR/G700, MFR/G701, BF/G1S07, BFR/G1S14, BG/G1, BG/G2, RF/G1S07, RF/G2D07, RFR/G1S07, RFR/G2D07, RFR/G1S12, RFR/G2D12, RFR/G2S40, RFR/G1S14, RFR/G2D14, RF/G1S07, RF/G2D07, RFR/G1S07, RFR/G2D07, XFR/G1S07, XFR/G2D07, XFR/G1S07, XFR/G2D07, XFR/G1S12, XFR/G2D12, XFR/G2S40, XFR/G1S07, XFR/G2D07, JF/G1S07, JF/G2D07, JFR/G1S07...(Other models you can see in the webshop)		

			
1			
GEV No.	100855	Ref. No.	00411 005618
description	pilot burner bracket triple		
For models:	SFRG350, SFRG700, SCPG350, SFRG350, SFRG700, SRG350, SRG360, SRG700, SRG710, SMG350, SMG700, SCPG350		
accessories for	100855		
	GEV No.	100855	Ref. No. 00411 005618
	pilot burner bracket triple		
	GEV No.	100886	Ref. No. —
	pilot burner bracket suitable for 100 series 3-piece		
	GEV No.	100888	Ref. No. —
	screw bolt for pilot burner		

pilot burner nozzles			
			
1			
GEV No.	100247	Ref. No.	056750
description	pilot burner nozzle LPG bore ø 0.2mm Qty 1 pcs suitable for SIT 100 series thread M8x0.75		
For models:	HCSG410, HCS/G410D, HCS/G400, PHCS/G400, HCS/G400F, HCF/G800F, PHCF/G800, HCS/G400NL, HCS/G400DK, HCSG810, HCS/G810D, HCS/G800, HCS/G800F, HCS/G800, HCS/G800NL, HCS/G800DK, HCFG810, HCF/G810D, HCF/GE81, HCF/GE81, HCF/G800, HCF/G800NL, HCF/G800DK, HCF/GE80, HCF/GE80, HCFG1210, HCF/G1210D, HCF/G1200F, PHCF/G1200, HCF/G1200N, HCF/G1200D, HCFG1610, HCF/G1610D, HCF/G1600, HCF/G1600F, PHCF/G1600, HCF/G1600N, HCF/G1600D, HC/G410, HC/G810, HTF/G1210, HTF/G1210, HTF/G1200, HCA/G410, HCA/G810, HCA/G810, HCF/G1210, ZHCF/G161...(Other models you can see in the webshop)		

			
1			
GEV No.	100245	Ref. No.	003633 006188 056799 0977030 0G0082 0G2785 0G2786 0G5006 0K2946 0KD857 19012718 19022995
description	pilot burner nozzle LPG code 20 bore ø 0.2mm Qty 1 pcs thread M8x0.75		
For models:	MBR/G710D, MBR/G700, MBR/G700F, MBR/G700UK, MBR/G701, MBR/G706, MBR/G701UK, MBR/G751, MBR/G756, MFG1500Z, MFG2200Z, FG250D, FG250S, FGC/250D, FGC/250S, RBR/G710D, RBR/G700, RBR/G700F, 7BRG60, 7BRG60X, RBR/G701UK, RBR/G751, RBR/G756, XBR/G710D, XBR/G700, XBR/G710, XBR/G700F, XBR/G700UK, XBR/G701, M70GBP, XBR/G701UK, XBR/G751, XBR/G756, CBR/G700, RBR/G700, RBR/E700, RBR/G700, BR80GZ, PCG810, PCG1210, PCG1610, PCG810F, PCG1210F, PCG1610F, PCG810D, PCG1210D, PCG1610D, PCG800NL, PCG1200NL, PCG1600NL...(Other models you can see in the webshop)		

			
1			
GEV No.	100246	Ref. No.	02137 056656 056797 0977031 0G0150 0G2787 0K1318 0K2895 0K3558 0K5866 0KW952 0M0833 19022988 19022989 M02137 MOL02137
description	pilot burner nozzle natural gas bore ø 0.35mm Qty 1 pcs thread M8x0.75		
For models:	MCF/G705, MCF/G1055, MCF/G700, MCF/G1050, MCF/G705E, MCF/G1055E, MCF/G700D, MCF/G700, MCF/G705F, MCF/G1055F, MCF/G705NL, MCF/G1050D, MCFG1055NL, MCF/G702, MCF/G1052, MCF/G700, MCF/G1050, MR/G351, MR/G701, MR/G721, MR/G1071, MR/G350, MR/G350F, MR/G350NL, MR/G350E, MR/G360, MR/G360F, MR/G700, MR/G700F, MR/G700NL, MR/G700E, MR/G710, MR/G710F, MR/G1070, MR/G720, MR/G715, MR/G725, MR/G1075, MR/G361, MR/G711, MR/G716, MR/G726, MR/G1076, MBR/G710D, MBR/G700, MBR/G700F, MBR/G700UK, MBR/G701, MBR/G706, MBR/G701UK...(Other models you can see in the webshop)		

			
1			
GEV No.	100248	Ref. No.	056578
description	pilot burner nozzle natural gas bore ø 0.3mm Qty 1 pcs suitable for SIT 100 series		
For models:	PCG810, PCG1210, PCG1610, PCG810F, PCG1210F, PCG1610F, PCG810D, PCG1210D, PCG1610D, PCG800NL, PCG1200NL, PCG1600NL, HCSG410, HCS/G410D, HCS/G400, PHCS/G400, HCS/G400F, HCF/G800F, PHCF/G800, HCS/G400NL, HCS/G400DK, HCSG810, HCS/G810D, HCS/G800, HCS/G800F, HCS/G800, HCS/G800NL, HCS/G800DK, HCFG810, HCF/G810D, HCF/GE81, HCF/GE81, HCF/G800, HCF/G800NL, HCF/G800DK, HCF/GE80, HCF/GE80, HCFG1210, HCF/G1210D, HCF/G1200, HCF/G1200F, PHCF/G1200, HCF/G1200N, HCF/G1200D, HCFG1610, HCF/G1610D, HCF/G1600, HCF/G1600F, PHCF/G1600, HCF/G1600NL...(Other models you can see in the webshop)		

			
1			
GEV No.	102972	Ref. No.	003327 0K1319
description	pilot burner nozzle natural gas code 40 bore ø 0.4mm Qty 1 pcs		
For models:	MFR/G740, MFR/G380, MFR/G381, BF/G1S07, BFR/G1S14, RF/G1S07, RF/G2D07, RFR/G1S07, RFR/G2D07, RFR/G2S40, RFR/G1S14, RFR/G2D14, RF/G1S07, RF/G2D07, RFR/G1S07, RFR/G2D07, XF/G1S07, XRF/G2D07, XFR/G1S07, XFR/G2D07, XFR/G2S40, XFR/G1S14, XFR/G2D14, XF/G1S07, XF/G2D07, XFR/G1S07, XFR/G2D07, JF/G1S07, JF/G2D07, JFR/G1S07, JFR/G2D07, JFR/G2S40, JFR/G1S14, JFR/G2D14, JF/G1S07, JF/G2D07, JFR/G2D07, JFR/G2D07, MF/G1S07, MF/G2D07, MFR/G1S07, MFR/G2D07, MFR/G2S40, MFR/G1S14, MFR/G2D14, MF/G1S07, MF/G2D07, MFR/G1S07, MFR/G2D07, RFR/G741...(Other models you can see in the webshop)		



ignition electrodes			
GEV No.	100706	Ref. No.	02B06 02E10 051565 051977 056754 058135 0915036 0915055 0C0488 0G0083 0H6630 0K5703 0K9080 0KI377 0KQ943 0M0792 19012724 6010046 752040111 M02E10
description	ignition electrode connection M4 Qty 1 pcs		
For models:	MCF/G705, MCF/G1055, MCF/G700, MCF/G1050, MCF/G705E, MCF/G1055E, MCF/G700D, MCF/G700, MCF/G705F, MCF/G1055F, MCF/G705NL, MCF/G1050D, MCF/G1055NL, MCF/G702, MCF/G1052, MCF/G700, MCF/G1050, MR/G351, MR/G701, MR/G721, MR/G1071, MR/G350, MR/G350F, MR/G350NL, MR/G350E, MR/G360, MR/G360F, MR/G700, MR/G700F, MR/G700NL, MR/G700E, MR/G710, MR/G710F, MR/G1070, MR/G720, MR/G715, MR/G725, MR/G1075, MR/G361, MR/G711, MR/G716, MR/G726, MR/G1076, MBR/G710D, MBR/G700, MBR/G700F, MBR/G700UK, MBR/G701, MBR/G706, MBR/G701UK...(Other models you can see in the webshop)		

GEV No.	100707	Ref. No.	003272 054336 058385 0915037 0A2856 300903
description	ignition electrode D1 ø 7mm D2 ø 9mm connection ø2.4mm L1 14mm L2 6mm BL1 18mm BL2 3mm BL3 23mm to clip Qty 1 pcs		
For models:	HCPA/G1219, HCPA/GI1219, HCPA/G121, HCPA/G121, NC4/FV, NC6/FVL, NC6/FV, NC6/2FV, NC8/2FV, NCG1V, NCG2V, NFG/20, NFG20+20, NFT/2GL, NFT/2GR, NFT/2GLC, 1TPG18F, 110FTL/N, 1104F/G, 1106F/2G, 1102FTL/N, 110FTR/N, 1102FTR/N, 1108F/2G, 110CP1, 110FR2, NC4/FV, NC6/FV, NC6/2FV, NC8/2FV, NC6/FVL, NFT/2GL, NFT/4GL, NFT/2GR, NFT/4GR, NFT/4GLR, NFT/4GLRC, NFT/2GLC, NFT/4GLC, NCG1V, NCG2V, NFG/20, NFG20+20, NTP/A, 090213, 090214, PCF/GG840, PCF/GG1260, PCF/GG1680, PTF/GG1835...(Other models you can see in the webshop)		

miscellaneous			
GEV No.	100885	Ref. No.	057251
description	air mixing sleeve for pilot burner Qty 1 pcs		

GEV No.	101343	Ref. No.	056579
description	bolt for pilot burner		
For models:	PCG810, PCG1210, PCG1610, PCG810F, PCG1210F, PCG1610F, PCG810D, PCG1210D, PCG1610D, PCG800NL, PCG1200NL, PCG1600NL, HCSG410, HCS/G410D, HCS/G400, PHCS/G400, HCS/G400F, HCF/G800F, PHCF/G800, HCS/G400NL, HCS/G400DK, HCSG810, HCS/G810D, HCS/G800, HCS/G800F, HCS/G800, HCS/G800NL, HCS/G800DK, HCFG810, HCF/G810D, HCF/GE81, HCF/GE81, HCF/G800, HCF/G800NL, HCF/G800DK, HCF/GE80, HCF/GE80, HCFG1210, HCF/G1210D, HCF/G1200, HCF/G1200F, PHCF/G1200, HCF/G1200N, HCF/G1200D, HCFG1610, HCF/G1610D, HCF/G1600, HCF/G1600F, PHCF/G1600, HCF/G1600N...(Other models you can see in the webshop)		

GEV No.	101342	Ref. No.	056580
description	cover for pilot burner		
For models:	PCG810, PCG1210, PCG1610, PCG810F, PCG1210F, PCG1610F, PCG810D, PCG1210D, PCG1610D, PCG800NL, PCG1200NL, PCG1600NL, HCSG410, HCS/G410D, HCS/G400, PHCS/G400, HCS/G400F, HCF/G800F, PHCF/G800, HCS/G400NL, HCS/G400DK, HCSG810, HCS/G810D, HCS/G800, HCS/G800F, HCS/G800, HCS/G800NL, HCS/G800DK, HCFG810, HCF/G810D, HCF/GE81, HCF/GE81, HCF/G800, HCF/G800NL, HCF/G800DK, HCF/GE80, HCF/GE80, HCFG1210, HCF/G1210D, HCF/G1200, HCF/G1200F, PHCF/G1200, HCF/G1200N, HCF/G1200D, HCFG1610, HCF/G1610D, HCF/G1600, HCF/G1600F, PHCF/G1600, HCF/G1600N...(Other models you can see in the webshop)		



140 - 145 -150 series





GEV No.	100126	Ref. No.	002055 G1800410
description	pilot burner SIT type 140 series 1 flame nozzle ømm gas connecti- onmm		
For models:	VQ40G, HCPA/G1219, HCPA/GI 1219, ZCPAG1219, ZCPA/GI 1219, CR15G		

accessories for 100126			
	GEV No.	100204	Ref. No. 003792 004127 059216 07873 0977115 0C3214 0G2263 0G2415 0KT837 19013305 72780001 ADME01110







pilot burner nozzle SIT LPG code 14 bore ø 0.18/0.20mm Qty 1 pcs
suitable for 140 series

	GEV No.	100205	Ref. No.	—
pilot burner nozzle SIT LPG code 19 bore ø 0.23/0.26mm Qty 1 pcs suitable for SIT 150 series				







	GEV No.	100206	Ref. No.	003626
pilot burner nozzle SIT natural gas code 36 bore ø 0.60/0.55mm Qty 1 pcs suitable for SIT 150 series				







	GEV No.	100207	Ref. No. 003784 003871 059215 0977113 0G2264 0G2416 19013306 72780002	
pilot burner nozzle SIT natural gas code 27 bore ø 0.40/0.38mm suitable for SIT 140 series				

	GEV No.	100216	Ref. No.	—
pilot burner nozzle SIT natural gas code 38 bore ø 0.45mm Qty 1 pcs suitable for SIT 150 series				

accessories for 100126				
	GEV No.	100701	Ref. No. 002564 004125 02B07 02E11 02I24 052610 056640 059380 059988 07714927 0915015 0915024 0A2473 0G2066 0G2265 0G2419 0H6628 0H6708 0H6802 0K4320 0KW911 0M0793 0M0823 1215009 19013340 727758 727820 72792 727920 M02E11	
ignition electrode connection M4 Qty 1 pcs				
	GEV No.	100897	Ref. No. 059161 0957009 0G2262 727799	
olive for pipe ø 4mm Qty 1 pcs for pilot burner				
	GEV No.	100898	Ref. No.	003863
olive for pipe ø 6mm Qty 1 pcs for pilot burner				
	GEV No.	100906	Ref. No. 003610 056641 057960 0974037 0G2227 0K5791 11061230 19013341 727759	
screw connection thread M10x1 for ignition electrode brass Qty 1 pcs WS 10				
	GEV No.	100907	Ref. No. 003609 0C0121 11061236	
screw connection thread M10x1 Qty 1 pcs type SEF 1 ømm for thermocouple				
	GEV No.	100908	Ref. No. 046755 052125 0958013 0G2219 0K1348 0K5753 0KE882 0KL495 19012956 727742 727781	
union screw thread M10x1 for pipe ø 4mm Qty 1 pcs				
	GEV No.	100909	Ref. No. 003859 057821	
union screw thread M10x1 for pipe ø 6mm Qty 1 pcs				



 <p>1</p>			
GEV No.	107134	Ref. No.	005503 0140104 11061224
description	pilot burner SIT type 140 series 1 flame nozzle ømm gas connect-onmm		
accessories for	107134		
	GEV No.	100204	Ref. No. 003792 004127 059216 07873 0977115 0C3214 0G2263 0G2415 0KT837 19013305 72780001 ADME01110
pilot burner nozzle SIT LPG code 14 bore ø 0.18/0.20mm Qty 1 pcs suitable for 140 series			
	GEV No.	100205	Ref. No. —
pilot burner nozzle SIT LPG code 19 bore ø 0.23/0.26mm Qty 1 pcs suitable for SIT 150 series			
	GEV No.	100206	Ref. No. 003626
pilot burner nozzle SIT natural gas code 36 bore ø 0.60/0.55mm Qty 1 pcs suitable for SIT 150 series			
	GEV No.	100207	Ref. No. 003784 003871 059215 0977113 0G2264 0G2416 19013306 72780002
pilot burner nozzle SIT natural gas code 27 bore ø 0.40/0.38mm suitable for SIT 140 series			
	GEV No.	100216	Ref. No. —
pilot burner nozzle SIT natural gas code 38 bore ø 0.45mm Qty 1 pcs suitable for SIT 150 series			
	GEV No.	100701	Ref. No. 002564 004125 02B07 02E11 02I24 052610 056640 059380 059988 07714927 0915015 0915024 0A2473 0G2066 0G2265 0G2419 0H6628 0H6708 0H6802 0K4320 0KW911 0M0793 0M0823 1215009 19013340 727758 727820 72792 727920 M02E11
ignition electrode connection M4 Qty 1 pcs			

accessories for	107134		
	GEV No.	100897	Ref. No. 059161 0957009 0G2262 727799
olive for pipe ø 4mm Qty 1 pcs for pilot burner			
	GEV No.	100898	Ref. No. 003863
olive for pipe ø 6mm Qty 1 pcs for pilot burner			
	GEV No.	100906	Ref. No. 003610 056641 057960 0974037 0G2227 0K5791 11061230 19013341 727759
screw connection thread M10x1 for ignition electrode brass Qty 1 pcs WS 10			
	GEV No.	100907	Ref. No. 003609 0C0121 11061236
screw connection thread M10x1 Qty 1 pcs type SEF 1 ømm for thermocouple			
	GEV No.	100908	Ref. No. 046755 052125 0958013 0G2219 0K1348 0K5753 0KE882 0KL495 19012956 727742 727781
union screw thread M10x1 for pipe ø 4mm Qty 1 pcs			
	GEV No.	100909	Ref. No. 003859 057821
union screw thread M10x1 for pipe ø 6mm Qty 1 pcs			













 <p>1</p>			
GEV No.	107887	Ref. No.	0C7102
description	pilot burner SIT type 140 series 1 flame nozzle ømm gas connect-onmm		
accessories for	107887		
	GEV No.	100204	Ref. No. 003792 004127 059216 07873 0977115 0C3214 0G2263 0G2415 0KT837 19013305 72780001 ADME01110
pilot burner nozzle SIT LPG code 14 bore ø 0.18/0.20mm Qty 1 pcs suitable for 140 series			
	GEV No.	100205	Ref. No. —
pilot burner nozzle SIT LPG code 19 bore ø 0.23/0.26mm Qty 1 pcs suitable for SIT 150 series			
	GEV No.	100206	Ref. No. 003626
pilot burner nozzle SIT natural gas code 36 bore ø 0.60/0.55mm Qty 1 pcs suitable for SIT 150 series			

Table continues overleaf



accessories for 107887				
	GEV No.	100207	Ref. No.	003784 003871 059215 0977113 0G2264 0G2416 19013306 72780002
pilot burner nozzle SIT natural gas code 27 bore ø 0.40/0.38mm suitable for SIT 140 series				
	GEV No.	100216	Ref. No.	—
pilot burner nozzle SIT natural gas code 38 bore ø 0.45mm Qty 1 pcs suitable for SIT 150 series				
	GEV No.	100701	Ref. No.	002564 004125 02B07 02E11 02I24 052610 056640 059380 059988 07714927 0915015 0915024 0A2473 0G2066 0G2265 0G2419 0H6628 0H6708 0H6802 0K4320 0KW911 0M0793 0M0823 1215009 19013340 727758 727820 72792 727920 M02E11
ignition electrode connection M4 Qty 1 pcs				
	GEV No.	100897	Ref. No.	059161 0957009 0G2262 727799
olive for pipe ø 4mm Qty 1 pcs for pilot burner				
	GEV No.	100898	Ref. No.	003863
olive for pipe ø 6mm Qty 1 pcs for pilot burner				
	GEV No.	100906	Ref. No.	003610 056641 057960 0974037 0G2227 0K5791 11061230 19013341 727759
screw connection thread M10x1 for ignition electrode brass Qty 1 pcs WS 10				
	GEV No.	100907	Ref. No.	003609 0C0121 11061236
screw connection thread M10x1 Qty 1 pcs type SEF 1 ømm for thermocouple				

accessories for 107887				
	GEV No.	100908	Ref. No.	046755 052125 0958013 0G2219 0K1348 0K5753 0KE882 0KL495 19012956 727742 727781
union screw thread M10x1 for pipe ø 4mm Qty 1 pcs				
	GEV No.	100909	Ref. No.	003859 057821
union screw thread M10x1 for pipe ø 6mm Qty 1 pcs				



















				
1				
GEV No.	100094	Ref. No.	0140102 059214 0KE197 19013304 727798	
description pilot burner SIT type 140 series 1 flame nozzle ømm gas connectionmm for thermocouple ø 5mm				
For models: HC/G410, HC/G810, HCF/G810, HC/G410D, HC/G810D, HCF/G810D, HCF/G1210D, HCF/G1610D, HC/G410NL, HC/G810NL, HCF/G810NL, HC/G1210, HCF/G1210, EC/G1610, HCF/G1610, HCF/GE810, HC/G410, HC/G810, HC/G1210, HCF/G810, HCF/G1210, HCF/G1610, HCF/G811, HC/G411, HC/G811, HC/G1211, HC/G800U, HC/G1200U, HC/G1600U, HCF/G800U, HCF/G1200U, HCF/G1600U, HT/G800D, HTF/G810, HTF/G800D, HTF/G1210, HTF/G1210D, HT/G800NL, HTF/G800NL, HTF-G1210NL, HFS/G800, ZC/G410, ZC/G810, ZCF/G810, ZC/G410D, ZC/G810D, ZCF/G810D, ZCF/G1210D, ZHCFG1610D, ZC/G1210...(Other models you can see in the webshop)				
accessories for 100094				
	GEV No.	100182	Ref. No.	003547 0G3755 727778
cover for pilot burner Qty 1 pcs				
	GEV No.	100204	Ref. No.	003792 004127 059216 07873 0977115 0C3214 0G2263 0G2415 0KT837 19013305 72780001 ADME01110
pilot burner nozzle SIT LPG code 14 bore ø 0.18/0.20mm Qty 1 pcs suitable for 140 series				
	GEV No.	100205	Ref. No.	—
pilot burner nozzle SIT LPG code 19 bore ø 0.23/0.26mm Qty 1 pcs suitable for SIT 150 series				
	GEV No.	100206	Ref. No.	003626
pilot burner nozzle SIT natural gas code 36 bore ø 0.60/0.55mm Qty 1 pcs suitable for SIT 150 series				

Table continues overleaf









accessories for		100094	
	GEV No.	100207	Ref. No.
			003784 003871 059215 0977113 0G2264 0G2416 19013306 72780002
	pilot burner nozzle SIT natural gas code 27 bore ø 0.40/0.38mm suitable for SIT 140 series		
	GEV No.	100216	Ref. No.
			—
	pilot burner nozzle SIT natural gas code 38 bore ø 0.45mm Qty 1 pcs suitable for SIT 150 series		
	GEV No.	100897	Ref. No.
			059161 0957009 0G2262 727799
	olive for pipe ø 4mm Qty 1 pcs for pilot burner		
	GEV No.	100898	Ref. No.
			003863
	olive for pipe ø 6mm Qty 1 pcs for pilot burner		
	GEV No.	100908	Ref. No.
			046755 052125 0958013 0G2219 0K1348 0K5753 0KE882 0KL495 19012956 727742 727781
	union screw thread M10x1 for pipe ø 4mm Qty 1 pcs		
	GEV No.	100909	Ref. No.
			003859 057821
	union screw thread M10x1 for pipe ø 6mm Qty 1 pcs		
	GEV No.	102110	Ref. No.
			006249 054810 0C0152 0C0153 0C0626 517824900 517870202
	pilot tube copper pipe ø 4mm thickness 1mm L 3000mm		
	GEV No.	102111	Ref. No.
			—
	pilot tube copper pipe ø 6mm thickness 1mm L 3000mm		









			
1			
GEV No.	107114 ¹	Ref. No.	003527 003635 004124 004283 0140015 059379 0C3193 0G2266 0G2418 0H6312 19013339 21624 727819 I07868 MM0000256
description	pilot burner SIT type 140 series 2 flames nozzle 0mm gas connectionmm		
For models:	MT/G350, MT/G352, RCF/G9, RBR/G2FM, RBR/G2IM, RBK/G2FM, RR/G1FL, RR/G1FR, RR/G1CL, RR/G2FL, RR/G2FM, RR/G2CL, RRV/G1FL, RRV/G1FR, RRV/G1CL, RRV/G2FL, RRV/G2FM, RRV/G2CL, RR/G2CM, RTV/G2, RTF/G2, RSF/G2, RSV/G2, RSF/G3, RBV/G2, XCF/G9, XBR/G2FM, XBR/G2IM, XBR/G2FM, XR/G1FL, XR/G1FR, XR/G1CL, XR/G2FL, XR/G2FM, XR/G2CL, XRV/G1FL, XRV/G1FR, XRV/G1CL, XRV/G2FL, XRV/G2FM, XRV/G2CL, XR/G2CM, XTV/G2, XTF/G2, XSF/G2, XSV/G2, XSF/G3, XBV/G2, JBR/G2FM, JR/G1FL...(Other models you can see in the webshop)		
accessories for	107114		
	GEV No.	100204	Ref. No. 003792 004127 059216 07873 0977115 0C3214 0G2263 0G2415 0KT837 19013305 72780001 ADME01110
	pilot burner nozzle SIT LPG code 14 bore ø 0.18/0.20mm Qty 1 pcs suitable for 140 series		
	GEV No.	100205	Ref. No. —
	pilot burner nozzle SIT LPG code 19 bore ø 0.23/0.26mm Qty 1 pcs suitable for SIT 150 series		
	GEV No.	100206	Ref. No. 003626
	pilot burner nozzle SIT natural gas code 36 bore ø 0.60/0.55mm Qty 1 pcs suitable for SIT 150 series		
	GEV No.	100207	Ref. No. 003784 003871 059215 0977113 0G2264 0G2416 19013306 72780002
	pilot burner nozzle SIT natural gas code 27 bore ø 0.40/0.38mm suitable for SIT 140 series		
	GEV No.	100216	Ref. No. —
	pilot burner nozzle SIT natural gas code 38 bore ø 0.45mm Qty 1 pcs suitable for SIT 150 series		







¹incl. thermocouple fitting

accessories for	107114		
	GEV No.	100216	Ref. No. —
	pilot burner nozzle SIT natural gas code 38 bore ø 0.45mm Qty 1 pcs suitable for SIT 150 series		
	GEV No.	100897	Ref. No. 059161 0957009 0G2262 727799
	olive for pipe ø 4mm Qty 1 pcs for pilot burner		
	GEV No.	100898	Ref. No. 003863
	olive for pipe ø 6mm Qty 1 pcs for pilot burner		
	GEV No.	100908	Ref. No. 046755 052125 0958013 0G2219 0K1348 0K5753 0KE882 0KL495 19012956 727742 727781
	union screw thread M10x1 for pipe ø 4mm Qty 1 pcs		
	GEV No.	100909	Ref. No. 003859 057821
	union screw thread M10x1 for pipe ø 6mm Qty 1 pcs		
	GEV No.	102110	Ref. No. 006249 054810 0C0152 0C0153 0C0626 517824900 517870202
	pilot tube copper pipe ø 4mm thickness 1mm L 3000mm		
	GEV No.	102111	Ref. No. —
	pilot tube copper pipe ø 6mm thickness 1mm L 3000mm		









 <p>1</p>			
GEV No.	107114 ¹	Ref. No.	003527 003635 004124 004283 0140015 059379 0C3193 0G2266 0G2418 0H6312 19013339 21624 727819 107868 MM0000256
description	pilot burner SIT type 140 series 2 flames nozzle ømm gas connectionmm		
For models:	MT/G350, MT/G352, RCF/G9, RBR/G2FM, RBR/G2IM, RBK/G2FM, RR/G1FL, RR/G1FR, RR/G1CL, RR/G2FL, RR/G2FM, RR/G2CL, RRV/G1FL, RRV/G1FR, RRV/G1CL, RRV/G2FL, RRV/G2FM, RRV/G2CL, RR/G2CM, RTV/G2, RTF/G2, RSF/G2, RSV/G2, RSF/G3, RBV/G2, XCF/G9, XBR/G2FM, XBR/G2IM, XBK/G2FM, XR/G1FL, XR/G1FR, XR/G1CL, XR/G2FL, XR/G2FM, XR/G2CL, XRV/G1FL, XRV/G1FR, XRV/G1CL, XRV/G2FL, XRV/G2FM, XRV/G2CM, XTV/G2, XTF/G2, XSF/G2, XSV/G2, XSF/G3, XBV/G2, JBR/G2FM, JR/G1FL...(Other models you can see in the webshop)		
spare parts for	107114		
	GEV No.	100907	Ref. No. 003609 0C0121 11061236
	screw connection thread M10x1 Qty 1 pcs type SEF 1 ømm for thermocouple		
accessories for	107114		
	GEV No.	100204	Ref. No. 003792 004127 059216 07873 0977115 0C3214 0G2263 0G2415 0KT837 19013305 72780001 ADME01110
	pilot burner nozzle SIT LPG code 14 bore ø 0.18/0.20mm Qty 1 pcs suitable for 140 series		
	GEV No.	100205	Ref. No.
	pilot burner nozzle SIT LPG code 19 bore ø 0.23/0.26mm Qty 1 pcs suitable for SIT 150 series		
	GEV No.	100206	Ref. No. 003626
	pilot burner nozzle SIT natural gas code 36 bore ø 0.60/0.55mm Qty 1 pcs suitable for SIT 150 series		
	GEV No.	100207	Ref. No. 003784 003871 059215 0977113 0G2264 0G2416 19013306 72780002
	pilot burner nozzle SIT natural gas code 27 bore ø 0.40/0.38mm suitable for SIT 140 series		
	GEV No.	100216	Ref. No.
	pilot burner nozzle SIT natural gas code 38 bore ø 0.45mm Qty 1 pcs suitable for SIT 150 series		







¹incl. thermocouple fitting

accessories for	107114		
	GEV No.	100216	Ref. No. —
	pilot burner nozzle SIT natural gas code 38 bore ø 0.45mm Qty 1 pcs suitable for SIT 150 series		
	GEV No.	100897	Ref. No. 059161 0957009 0G2262 727799
	olive for pipe ø 4mm Qty 1 pcs for pilot burner		
	GEV No.	100898	Ref. No. 003863
	olive for pipe ø 6mm Qty 1 pcs for pilot burner		
	GEV No.	100908	Ref. No. 046755 052125 0958013 0G2219 0K1348 0K5753 0KE882 0KL495 19012956 727742 727781
	union screw thread M10x1 for pipe ø 4mm Qty 1 pcs		
	GEV No.	100909	Ref. No. 003859 057821
	union screw thread M10x1 for pipe ø 6mm Qty 1 pcs		
	GEV No.	102110	Ref. No. 006249 054810 0C0152 0C0153 0C0626 517824900 517870202
	pilot tube copper pipe ø 4mm thickness 1mm L 3000mm		
	GEV No.	102111	Ref. No.
	pilot tube copper pipe ø 6mm thickness 1mm L 3000mm		









			
1			
GEV No.	107114 ¹	Ref. No.	003527 003635 004124 004283 0140015 059379 0C3193 0G2266 0G2418 0H6312 19013339 21624 727819 I07868 MM0000256
description	pilot burner SIT type 140 series 2 flames nozzle 6mm gas connectionmm		
For models:	MT/G350, MT/G352, RCF/G9, RBR/G2FM, RBR/G2IM, RBK/G2FM, RR/G1FL, RR/G1FR, RR/G1CL, RR/G2FL, RR/G2FM, RR/G2CL, RRV/G1FL, RRV/G1FR, RRV/G1CL, RRV/G2FL, RRV/G2FM, RRV/G2CL, RR/G2CM, RTV/G2, RTF/G2, RSF/G2, RSV/G2, RSF/G3, RBV/G2, XCF/G9, XBR/G2FM, XBR/G2IM, XBR/G2FM, XR/G1FL, XR/G1FR, XR/G1CL, XR/G2FL, XR/G2FM, XR/G2CL, XRV/G1FL, XRV/G1FR, XRV/G1CL, XRV/G2FL, XRV/G2FM, XRV/G2CL, XR/G2CM, XTV/G2, XTF/G2, XSF/G2, XSV/G2, XSF/G3, XBV/G2, JBR/G2FM, JR/G1FL...(Other models you can see in the webshop)		
spare parts for	107114		
	GEV No.	100907	Ref. No. 003609 0C0121 11061236
	screw connection thread M10x1 Qty 1 pcs type SEF 1 6mm for thermocouple		
accessories for	107114		
	GEV No.	100204	Ref. No. 003792 004127 059216 07873 0977115 0C3214 0G2263 0G2415 0KT837 19013305 72780001 ADME01110
	pilot burner nozzle SIT LPG code 14 bore 0.18/0.20mm Qty 1 pcs suitable for 140 series		
	GEV No.	100205	Ref. No.
	pilot burner nozzle SIT LPG code 19 bore 0.23/0.26mm Qty 1 pcs suitable for SIT 150 series		
	GEV No.	100206	Ref. No. 003626
	pilot burner nozzle SIT natural gas code 36 bore 0.60/0.55mm Qty 1 pcs suitable for SIT 150 series		
	GEV No.	100207	Ref. No. 003784 003871 059215 0977113 0G2264 0G2416 19013306 72780002
	pilot burner nozzle SIT natural gas code 27 bore 0.40/0.38mm suitable for SIT 140 series		
	GEV No.	100216	Ref. No.
	pilot burner nozzle SIT natural gas code 38 bore 0.45mm Qty 1 pcs suitable for SIT 150 series		







¹incl. thermocouple fitting

accessories for	107114		
	GEV No.	100216	Ref. No. —
	pilot burner nozzle SIT natural gas code 38 bore 0.45mm Qty 1 pcs suitable for SIT 150 series		
	GEV No.	100897	Ref. No. 059161 0957009 0G2262 727799
	olive for pipe 4mm Qty 1 pcs for pilot burner		
	GEV No.	100898	Ref. No. 003863
	olive for pipe 6mm Qty 1 pcs for pilot burner		
	GEV No.	100908	Ref. No. 046755 052125 0958013 0G2219 OK1348 OK5753 OKE882 OKL495 19012956 727742 727781
	union screw thread M10x1 for pipe 4mm Qty 1 pcs		
	GEV No.	100909	Ref. No. 003859 057821
	union screw thread M10x1 for pipe 6mm Qty 1 pcs		
	GEV No.	102110	Ref. No. 006249 054810 0C0152 0C0153 0C0626 517824900 517870202
	pilot tube copper pipe 4mm thickness 1mm L 3000mm		
	GEV No.	102111	Ref. No. —
	pilot tube copper pipe 6mm thickness 1mm L 3000mm		



 <p>1</p>			
GEV No.	107114 ¹	Ref. No.	003527 003635 004124 004283 0140015 059379 0C3193 0G2266 0G2418 0H6312 19013339 21624 727819 107868 MM0000256
description	pilot burner SIT type 140 series 2 flames nozzle ømm gas connectionmm		
For models:	MT/G350, MT/G352, RCF/G9, RBR/G2FM, RBR/G2IM, RBK/G2FM, RR/G1FL, RR/G1FR, RR/G1CL, RR/G2FL, RR/G2FM, RR/G2CL, RRV/G1FL, RRV/G1FR, RRV/G1CL, RRV/G2FL, RRV/G2FM, RRV/G2CL, RR/G2CM, RTV/G2, RTF/G2, RSF/G2, RSV/G2, RSF/G3, RBV/G2, XCF/G9, XBR/G2FM, XBR/G2IM, XBR/G2FM, XR/G1FL, XR/G1FR, XR/G1CL, XR/G2FL, XR/G2FM, XR/G2CL, XRV/G1FL, XRV/G1FR, XRV/G1CL, XRV/G2FL, XRV/G2FM, XRV/G2CL, XRV/G2CM, XTV/G2, XTF/G2, XSF/G2, XSV/G2, XSF/G3, XBV/G2, JBR/G2FM, JR/G1FL...(Other models you can see in the webshop)		
spare parts for	107114		
	GEV No.	100907	Ref. No. 003609 0C0121 11061236
screw connection thread M10x1 Qty 1 pcs type SEF 1 ømm for thermocouple			
accessories for	107114		
	GEV No.	100204	Ref. No. 003792 004127 059216 07873 0977115 0C3214 0G2263 0G2415 0KT837 19013305 72780001 ADME01110
pilot burner nozzle SIT LPG code 14 bore ø 0.18/0.20mm Qty 1 pcs suitable for 140 series			
	GEV No.	100205	Ref. No.
pilot burner nozzle SIT LPG code 19 bore ø 0.23/0.26mm Qty 1 pcs suitable for SIT 150 series			
	GEV No.	100206	Ref. No.
pilot burner nozzle SIT natural gas code 36 bore ø 0.60/0.55mm Qty 1 pcs suitable for SIT 150 series			
	GEV No.	100207	Ref. No. 003784 003871 059215 0977113 0G2264 0G2416 19013306 72780002
pilot burner nozzle SIT natural gas code 27 bore ø 0.40/0.38mm suitable for SIT 140 series			
	GEV No.	100216	Ref. No.
pilot burner nozzle SIT natural gas code 38 bore ø 0.45mm Qty 1 pcs suitable for SIT 150 series			

¹incl. thermocouple fitting

accessories for	107114		
	GEV No.	100216	Ref. No.
pilot burner nozzle SIT natural gas code 38 bore ø 0.45mm Qty 1 pcs suitable for SIT 150 series			
	GEV No.	100897	Ref. No. 059161 0957009 0G2262 727799
olive for pipe ø 4mm Qty 1 pcs for pilot burner			
	GEV No.	100898	Ref. No.
olive for pipe ø 6mm Qty 1 pcs for pilot burner			
	GEV No.	100908	Ref. No. 046755 052125 0958013 0G2219 0K1348 0K5753 0KE882 0KL495 19012956 727742 727781
union screw thread M10x1 for pipe ø 4mm Qty 1 pcs			
	GEV No.	100909	Ref. No. 003859 057821
union screw thread M10x1 for pipe ø 6mm Qty 1 pcs			
	GEV No.	102110	Ref. No. 006249 054810 0C0152 0C0153 0C0626 517824900 517870202
pilot tube copper pipe ø 4mm thickness 1mm L 3000mm			
	GEV No.	102111	Ref. No.
pilot tube copper pipe ø 6mm thickness 1mm L 3000mm			

 <p>1</p>			
GEV No.	107114 ¹	Ref. No.	003527 003635 004124 004283 0140015 059379 0C3193 0G2266 0G2418 0H6312 19013339 21624 727819 107868 MM0000256
description	pilot burner SIT type 140 series 2 flames nozzle ømm gas connectionmm		
For models:	MT/G350, MT/G352, RCF/G9, RBR/G2FM, RBR/G2IM, RBK/G2FM, RR/G1FL, RR/G1FR, RR/G1CL, RR/G2FL, RR/G2FM, RR/G2CL, RRV/G1FL, RRV/G1FR, RRV/G1CL, RRV/G2FL, RRV/G2FM, RRV/G2CL, RR/G2CM, RTV/G2, RTF/G2, RSF/G2, RSV/G2, RSF/G3, RBV/G2, XCF/G9, XBR/G2FM, XBR/G2IM, XBR/G2FM, XR/G1FL, XR/G1FR, XR/G1CL, XR/G2FL, XR/G2FM, XR/G2CL, XRV/G1FL, XRV/G1FR, XRV/G1CL, XRV/G2FL, XRV/G2FM, XRV/G2CL, XRV/G2CM, XTV/G2, XTF/G2, XSF/G2, XSV/G2, XSF/G3, XBV/G2, JBR/G2FM, JR/G1FL...(Other models you can see in the webshop)		
spare parts for	undefined		
accessories for	undefined		

¹incl. thermocouple fitting



160 series



GEV No.	100109	Ref. No.	0160002 0A2472 0G2299 0KT741 727753
----------------	--------	-----------------	---

description pilot burner SIT type 160 series 1 flame nozzle ømm gas connectionmm

For models: MCF/G1090, MCF/G1095, MCF/G995, RCF/G2, RCF/G3, RG/G1, RG/G2, RGV/G1, RGV/G2, RTF/G2, RSF/G2, RSV/G2, RSF/G3, RPD/G240, RPD/G260, RPI/G260, RPI/G260P, MCF/G2A, MCF/G3A, XCF/G2, XCF/G3, XG/G1, XG/G2, XGV/G1, XGV/G2, XTF/G2, XSF/G2, XSV/G2, XSF/G3, XPD/G240, XPD/G260, XPI/G260, XPI/G260P, JCF/G2, JCF/G3, JG/G1, JG/G2, JGV/G1, JGV/G2, JTF/G2, JPD/G240, JPD/G260, JPI/G260, MCF/G2, MCF/G3, MG/G1, MG/G2, MG/G1, MG/G2, MTF/G2...(Other models you can see in the webshop)

spare parts for 100109

	GEV No.	100907	Ref. No.	003609 0C0121 11061236
screw connection thread M10x1 Qty 1 pcs type SEF 1 ømm for thermocouple				

accessories for 100109

	GEV No.	100202	Ref. No.	—
pilot burner nozzle natural gas code 41 Qty 1 pcs nozzle ø 0.41mm				

	GEV No.	100203	Ref. No.	—
pilot burner nozzle LPG code 25 Qty 1 pcs nozzle ø 0.25mm				

	GEV No.	100701	Ref. No.	002564 004125 02B07 02E11 02L24 052610 056640 059380 059988 07714927 0915015 0915024 0A2473 0G2066 0G2265 0G2419 0H6628 0H6708 0H6802 0K4320 0KW911 0M0793 0M0823 1215009 19013340 727758 727820 72792 727920 M02E11
ignition electrode connection M4 Qty 1 pcs				

	GEV No.	100801	Ref. No.	—
gasket for pilot burner Qty 1 pcs				

	GEV No.	100869	Ref. No.	—
pilot burner nozzle natural gas code 51 Qty 1 pcs suitable for 160 series nozzle ø 0.51mm				

accessories for 100109

	GEV No.	100906	Ref. No.	003610 056641 057960 0974037 0G2227 0K5791 11061230 19013341 727759
screw connection thread M10x1 for ignition electrode brass Qty 1 pcs WS 10				

	GEV No.	100908	Ref. No.	046755 052125 0958013 0G2219 0K1348 0K5753 0KE882 0KL495 19012956 727742 727781
union screw thread M10x1 for pipe ø 4mm Qty 1 pcs				

	GEV No.	100909	Ref. No.	003859 057821
union screw thread M10x1 for pipe ø 6mm Qty 1 pcs				

	GEV No.	101282	Ref. No.	—
olive for pipe ø 4mm L 7.4mm Qty 1 pcs				

	GEV No.	101287	Ref. No.	—
olive for pipe ø 6mm Qty 1 pcs				

	GEV No.	102110	Ref. No.	006249 054810 0C0152 0C0153 0C0626 517824900 517870202
pilot tube copper pipe ø 4mm thickness 1mm L 3000mm				

	GEV No.	102111	Ref. No.	—
pilot tube copper pipe ø 6mm thickness 1mm L 3000mm				

	GEV No.	107650	Ref. No.	053667 057388
pilot burner nozzle SIT LPG code 30 Qty 1 pcs				



GEV No.	100053	Ref. No.	0160012 058383 0M2248 BR34030
----------------	--------	-----------------	--

description pilot burner SIT type 160 series 2 flames nozzle ømm gas connectionmm











For models: ROCF/G1000, ROTF/G1000, ROSD/G1000, ROSF/G1000, RORA/G500, RORA/G1000, ROR/G500, ROR/G1000



spare parts for 100053

	GEV No.	100907	Ref. No.	003609 0C0121 11061236
screw connection thread M10x1 Qty 1 pcs type SEF 1 ømm for thermocouple				

Table continues overleaf



accessories for		100053	
	GEV No.	100202	Ref. No. —
pilot burner nozzle natural gas code 41 Qty 1 pcs nozzle ø 0.41mm			
	GEV No.	100203	Ref. No. —
pilot burner nozzle LPG code 25 Qty 1 pcs nozzle ø 0.25mm			
	GEV No.	100701	Ref. No. —
002564 004125 02B07 02E11 02I24 052610 056640 059380 059988 07714927 0915015 0915024 0A2473 0G2066 0G2265 0G2419 0H6628 0H6708 0H6802 0K4320 0KW911 0M0793 0M0823 1215009 19013340 727758 727820 72792 727920 M02E11			
ignition electrode connection M4 Qty 1 pcs			
	GEV No.	100801	Ref. No. —
gasket for pilot burner Qty 1 pcs			
	GEV No.	100869	Ref. No. —
pilot burner nozzle natural gas code 51 Qty 1 pcs suitable for 160 series nozzle ø 0.51mm			
	GEV No.	100906	Ref. No. —
003610 056641 057960 0974037 0G2227 0K5791 11061230 19013341 727759			
screw connection thread M10x1 for ignition electrode brass Qty 1 pcs WS 10			
	GEV No.	100908	Ref. No. —
046755 052125 0958013 0G2219 0K1348 0K5753 0KE882 0KL495 19012956 727742 727781			
union screw thread M10x1 for pipe ø 4mm Qty 1 pcs			
	GEV No.	100909	Ref. No. —
union screw thread M10x1 for pipe ø 6mm Qty 1 pcs			
	GEV No.	101282	Ref. No. —
olive for pipe ø 4mm L 7.4mm Qty 1 pcs			
	GEV No.	101287	Ref. No. —
olive for pipe ø 6mm Qty 1 pcs			

accessories for		100053	
	GEV No.	102110	Ref. No. —
pilot tube copper pipe ø 4mm thickness 1mm L 3000mm			
	GEV No.	102111	Ref. No. —
pilot tube copper pipe ø 6mm thickness 1mm L 3000mm			
	GEV No.	107650	Ref. No. —
pilot burner nozzle SIT LPG code 30 Qty 1 pcs			













			
GEV No.	100054	Ref. No.	003204 0160022 02R34 02V40 0M0906
description	pilot burner SIT type 160 series 2 flames nozzle ømm gas connectionmm		
For models:	MCP/G700, MCP/G701, MCP/G710, MCP/G711, MCP/G705, MCP/G706, 7CPG07P, RCP/G701, RCP/G706, M70GPC, M70GPC, XCP/G706, CCP/G700		
spare parts for		100054	
	GEV No.	100907	Ref. No. —
screw connection thread M10x1 Qty 1 pcs type SEF 1 ømm for thermocouple			
accessories for		100054	
	GEV No.	100202	Ref. No. —
pilot burner nozzle natural gas code 41 Qty 1 pcs nozzle ø 0.41mm			
	GEV No.	100203	Ref. No. —
pilot burner nozzle LPG code 25 Qty 1 pcs nozzle ø 0.25mm			

Table continues overleaf



accessories for		100054	
	GEV No.	100701	Ref. No.
			002564 004125 02B07 02E11 02I24 052610 056640 059380 059988 07714927 0915015 0915024 0A2473 0G2066 0G2265 0G2419 0H6628 0H6708 0H6802 0K4320 0KW911 0M0793 0M0823 1215009 19013340 727758 727820 72792 727920 M02E11
ignition electrode connection M4 Qty 1 pcs			
	GEV No.	100801	Ref. No.
			—
gasket for pilot burner Qty 1 pcs			
	GEV No.	100869	Ref. No.
			—
pilot burner nozzle natural gas code 51 Qty 1 pcs suitable for 160 series nozzle ø 0.51mm			
	GEV No.	100906	Ref. No.
			003610 056641 057960 0974037 0G2227 0K5791 11061230 19013341 727759
screw connection thread M10x1 for ignition electrode brass Qty 1 pcs WS 10			
	GEV No.	100908	Ref. No.
			046755 052125 0958013 0G2219 0K1348 0K5753 0KE882 0KL495 19012956 727742 727781
union screw thread M10x1 for pipe ø 4mm Qty 1 pcs			
	GEV No.	100909	Ref. No.
			003859 057821
union screw thread M10x1 for pipe ø 6mm Qty 1 pcs			
	GEV No.	101282	Ref. No.
			—
olive for pipe ø 4mm L 7.4mm Qty 1 pcs			
	GEV No.	101287	Ref. No.
			—
olive for pipe ø 6mm Qty 1 pcs			

accessories for		100054	
	GEV No.	102110	Ref. No.
			006249 054810 0C0152 0C0153 0C0626 517824900 517870202
pilot tube copper pipe ø 4mm thickness 1mm L 3000mm			
	GEV No.	102111	Ref. No.
			—
pilot tube copper pipe ø 6mm thickness 1mm L 3000mm			
	GEV No.	107650	Ref. No.
			053667 057388
pilot burner nozzle SIT LPG code 30 Qty 1 pcs			















	1		
GEV No.	100056	Ref. No.	0160032 058146 058502
description	pilot burner SIT type 160 series 3 flames nozzle ømm gas connectionmm		
For models:	RF/G350D, RF/G700D, HCP/G800, HCP/G400		
spare parts for	100056		
	GEV No.	100907	Ref. No.
			003609 0C0121 11061236
screw connection thread M10x1 Qty 1 pcs type SEF 1 ømm for thermocouple			
accessories for	100056		
	GEV No.	100202	Ref. No.
			—
pilot burner nozzle natural gas code 41 Qty 1 pcs nozzle ø 0.41mm			
	GEV No.	100203	Ref. No.
			—
pilot burner nozzle LPG code 25 Qty 1 pcs nozzle ø 0.25mm			
	GEV No.	100701	Ref. No.
			002564 004125 02B07 02E11 02I24 052610 056640 059380 059988 07714927 0915015 0915024 0A2473 0G2066 0G2265 0G2419 0H6628 0H6708 0H6802 0K4320 0KW911 0M0793 0M0823 1215009 19013340 727758 727820 72792 727920 M02E11
ignition electrode connection M4 Qty 1 pcs			

Table continues overleaf



accessories for 100056				
	GEV No.	100801	Ref. No.	—
gasket for pilot burner Qty 1 pcs				
	GEV No.	100869	Ref. No.	—
pilot burner nozzle natural gas code 51 Qty 1 pcs suitable for 160 series nozzle ø 0.51mm				
	GEV No.	100870	Ref. No.	053665 0957014 0G2291 727756
olive for pipe ø 4mm Qty 1 pcs suitable for 160 series for pilot burner				
	GEV No.	100906	Ref. No.	003610 056641 057960 0974037 0G2227 0K5791 11061230 19013341 727759
screw connection thread M10x1 for ignition electrode brass Qty 1 pcs WS 10				
	GEV No.	100908	Ref. No.	046755 052125 0958013 0G2219 0K1348 0K5753 0KE882 0KL495 19012956 727742 727781
union screw thread M10x1 for pipe ø 4mm Qty 1 pcs				
	GEV No.	100909	Ref. No.	003859 057821
union screw thread M10x1 for pipe ø 6mm Qty 1 pcs				
	GEV No.	101287	Ref. No.	—
olive for pipe ø 6mm Qty 1 pcs				
	GEV No.	102110	Ref. No.	006249 054810 0C0152 0C0153 0C0626 517824900 517870202
pilot tube copper pipe ø 4mm thickness 1mm L 3000mm				
	GEV No.	102111	Ref. No.	—
pilot tube copper pipe ø 6mm thickness 1mm L 3000mm				
	GEV No.	107650	Ref. No.	053667 057388
pilot burner nozzle SIT LPG code 30 Qty 1 pcs				



















				
1				
GEV No.	100105	Ref. No.	0160074 057411 0H6336	
description	pilot burner SIT type 160 series 3 flames nozzle ømm gas connecti- onmm			
For models:	HBR/G820, HBR/G825, HBR/G821UK, ZBR/G821, ZBR/G826, ABR/G820, ABR/G825, FCFG6D, FCFG10, FCFG10D, FCFG10NL, FCFG6, FCFG6F, PFCFG6, FCFG10J, FCFG10J, FCFG6J, FCFG6J, FCFG6J, FCFG6J, FCFG10J, FCFG10J, HBR/G803, HBR/G804, HBR/G803, HBR/G804, HBR/G803, HBR/G805, HBR/G1003, HBR/G1003, HBR/G1004, HBR/ G803, HBR/G804, HBR/G1013, FCF/G6, FCFG101, HBR/G803, HBR/ G804, HBR/G1003, HBR/G1013, FF/G6, FF/G10, COCO10G, COCO6G, COCVE423AF, HBR/G1004, ZOFCE/G10D, ZOFCE/G6D, 7502-2, 7504- 2...(Other models you can see in the webshop)			
accessories for 100105				
	GEV No.	100202	Ref. No.	—
pilot burner nozzle natural gas code 41 Qty 1 pcs nozzle ø 0.41mm				
	GEV No.	100203	Ref. No.	—
pilot burner nozzle LPG code 25 Qty 1 pcs nozzle ø 0.25mm				
	GEV No.	100701	Ref. No.	002564 004125 02B07 02E11 02I24 052610 056640 059380 059988 07714927 0915015 0915024 0A2473 0G2066 0G2265 0G2419 0H6628 0H6708 0H6802 0K4320 0KW911 0M0793 0M0823 1215009 19013340 727758 727820 72792 727920 M02E11
ignition electrode connection M4 Qty 1 pcs				
	GEV No.	100801	Ref. No.	—
gasket for pilot burner Qty 1 pcs				
	GEV No.	100869	Ref. No.	—
pilot burner nozzle natural gas code 51 Qty 1 pcs suitable for 160 series nozzle ø 0.51mm				
	GEV No.	100906	Ref. No.	003610 056641 057960 0974037 0G2227 0K5791 11061230 19013341 727759
screw connection thread M10x1 for ignition electrode brass Qty 1 pcs WS 10				







Table continues overleaf





accessories for		100105	
	GEV No.	100908	Ref. No.
			046755 052125 0958013 0G2219 0K1348 0K5753 0KE882 0KL495 19012956 727742 727781
union screw thread M10x1 for pipe ø 4mm Qty 1 pcs			
	GEV No.	100909	Ref. No.
			003859 057821
union screw thread M10x1 for pipe ø 6mm Qty 1 pcs			
	GEV No.	101282	Ref. No.
			—
olive for pipe ø 4mm L 7.4mm Qty 1 pcs			
	GEV No.	101287	Ref. No.
			—
olive for pipe ø 6mm Qty 1 pcs			
	GEV No.	102110	Ref. No.
			006249 054810 0C0152 0C0153 0C0626 517824900 517870202
pilot tube copper pipe ø 4mm thickness 1mm L 3000mm			
	GEV No.	102111	Ref. No.
			—
pilot tube copper pipe ø 6mm thickness 1mm L 3000mm			
	GEV No.	107650	Ref. No.
			053667 057388
pilot burner nozzle SIT LPG code 30 Qty 1 pcs			

			
1			
GEV No.	101898	Ref. No.	0160501 0C0744
description	pilot burner SIT type 160 series 3 flames nozzle ømm gas connecti-onmm		
For models:	BCF/G2, KPI/G10, KPI/G15, KPD/G10, KPD/G15, KPD/G15A, KPI/G15A, KPI/G15H, KPI/G10H, QPI/G10, QPI/G15, QPD/G10, QPD/G15, QPI/G15H, QPI/G10H, WPI/G10, WPI/G15, WPD/G10, WPD/G15, WPD/G15A, WPI/G15A, WPI/G15H, WPI/G10H		
spare parts for	101898		
	GEV No.	100907	Ref. No.
			003609 0C0121 11061236
screw connection thread M10x1 Qty 1 pcs type SEF 1 ømm for thermocouple			
accessories for	101898		
	GEV No.	100202	Ref. No.
			—
pilot burner nozzle natural gas code 41 Qty 1 pcs nozzle ø 0.41mm			
	GEV No.	100203	Ref. No.
			—
pilot burner nozzle LPG code 25 Qty 1 pcs nozzle ø 0.25mm			

accessories for		101898	
	GEV No.	100701	Ref. No.
			002564 004125 02B07 02E11 02I24 052610 056640 059380 059988 07714927 0915015 0915024 0A2473 0G2066 0G2265 0G2419 0H6628 0H6708 0H6802 0K4320 0KW911 0M0793 0M0823 1215009 19013340 727758 727820 72792 727920 M02E11
ignition electrode connection M4 Qty 1 pcs			
	GEV No.	100801	Ref. No.
			—
gasket for pilot burner Qty 1 pcs			
	GEV No.	100869	Ref. No.
			—
pilot burner nozzle natural gas code 51 Qty 1 pcs suitable for 160 series nozzle ø 0.51mm			
	GEV No.	100906	Ref. No.
			003610 056641 057960 0974037 0G2227 0K5791 11061230 19013341 727759
screw connection thread M10x1 for ignition electrode brass Qty 1 pcs WS 10			
	GEV No.	100908	Ref. No.
			046755 052125 0958013 0G2219 0K1348 0K5753 0KE882 0KL495 19012956 727742 727781
union screw thread M10x1 for pipe ø 4mm Qty 1 pcs			
	GEV No.	100909	Ref. No.
			003859 057821
union screw thread M10x1 for pipe ø 6mm Qty 1 pcs			
	GEV No.	101282	Ref. No.
			—
olive for pipe ø 4mm L 7.4mm Qty 1 pcs			
	GEV No.	101287	Ref. No.
			—
olive for pipe ø 6mm Qty 1 pcs			



 <p>1</p>			
GEV No.	101898	Ref. No.	0160501 0C0744
description	pilot burner SIT type 160 series 3 flames nozzle ømm gas connecti- onmm		
For models:	BCF/G2, KPI/G10, KPI/G15, KPD/G10, KPD/G15, KPD/G15A, KPI/G15A, KPI/G15H, KPI/G10H, QPI/G10, QPI/G15, QPD/G10, QPD/G15, QPI/ G15H, QPI/G10H, WPI/G10, WPI/G15, WPD/G10, WPD/G15, WPD/ G15A, WPI/G15A, WPI/G15H, WPI/G10H		
spare parts for	101898		
	GEV No.	100907	Ref. No. 003609 0C0121 11061236
	screw connection thread M10x1 Qty 1 pcs type SEF 1 ømm for thermocouple		
accessories for	101898		
	GEV No.	100202	Ref. No. —
	pilot burner nozzle natural gas code 41 Qty 1 pcs nozzle ø 0.41mm		
	GEV No.	100203	Ref. No. —
	pilot burner nozzle LPG code 25 Qty 1 pcs nozzle ø 0.25mm		
	GEV No.	100701	Ref. No. 002564 004125 02B07 02E11 02I24 052610 056640 059380 059988 07714927 0915015 0915024 0A2473 0G2066 0G2265 0G2419 0H6628 0H6708 0H6802 0K4320 0KW911 0M0793 0M0823 1215009 19013340 727758 727820 72792 72792 M02E11
	ignition electrode connection M4 Qty 1 pcs		
	GEV No.	100869	Ref. No. —
	pilot burner nozzle natural gas code 51 Qty 1 pcs suitable for 160 series nozzle ø 0.51mm		
	GEV No.	100906	Ref. No. 003610 056641 057960 0974037 0G2227 0K5791 11061230 19013341 727759
	screw connection thread M10x1 for ignition electrode brass Qty 1 pcs WS 10		

accessories for	101898		
	GEV No.	100908	Ref. No. 046755 052125 0958013 0G2219 0K1348 0K5753 0KE882 0KL495 19012956 727742 727781
	union screw thread M10x1 for pipe ø 4mm Qty 1 pcs		
	GEV No.	100909	Ref. No. 003859 057821
	union screw thread M10x1 for pipe ø 6mm Qty 1 pcs		
	GEV No.	101282	Ref. No. —
	olive for pipe ø 4mm L 7.4mm Qty 1 pcs		
	GEV No.	101287	Ref. No. —
	olive for pipe ø 6mm Qty 1 pcs		
	GEV No.	107650	Ref. No. 053667 057388
	pilot burner nozzle SIT LPG code 30 Qty 1 pcs		













190 series			
 <p>1</p>			
GEV No.	100110	Ref. No.	002783 0190603
description	pilot burner SIT type 190 series 3 flames nozzle ømm gas connecti- onmm		
For models:	HBR/G800, HBR/G805, HBR/G810, HBR/G815, HBR/G811, HBR/G816, HBR/G800UK, ZBR/G800, ZBR/G805, ZBR/G810, ZBR/G815, ZBR/G811, ZBR/G816, ZBR/G800UK, ABR/G800, ABR/G805, ABR/G810, ABR/G815, ABR/G811, ABR/G816, OBR/G800UK		
accessories for	100110		
	GEV No.	100202	Ref. No. —
	pilot burner nozzle natural gas code 41 Qty 1 pcs nozzle ø 0.41mm		
	GEV No.	100203	Ref. No. —
	pilot burner nozzle LPG code 25 Qty 1 pcs nozzle ø 0.25mm		

Table continues overleaf



accessories for		100110	
	GEV No.	100701	Ref. No.
			002564 004125 02B07 02E11 02I24 052610 056640 059380 059988 07714927 0915015 0915024 0A2473 0G2066 0G2265 0G2419 0H6628 0H6708 0H6802 0K4320 0KW911 0M0793 0M0823 1215009 19013340 727758 727820 72792 727920 M02E11
ignition electrode connection M4 Qty 1 pcs			
	GEV No.	100906	Ref. No.
			003610 056641 057960 0974037 0G2227 0K5791 11061230 19013341 727759
screw connection thread M10x1 for ignition electrode brass Qty 1 pcs WS 10			
	GEV No.	100907	Ref. No.
			003609 0C0121 11061236
screw connection thread M10x1 Qty 1 pcs type SEF 1 ømm for thermocouple			
	GEV No.	100908	Ref. No.
			046755 052125 0958013 0G2219 0K1348 0K5753 0KE882 0KL495 19012956 727742 727781
union screw thread M10x1 for pipe ø 4mm Qty 1 pcs			
	GEV No.	100909	Ref. No.
			003859 057821
union screw thread M10x1 for pipe ø 6mm Qty 1 pcs			
	GEV No.	101282	Ref. No.
			—
olive for pipe ø 4mm L 7.4mm Qty 1 pcs			
	GEV No.	101287	Ref. No.
			—
olive for pipe ø 6mm Qty 1 pcs			
	GEV No.	102110	Ref. No.
			006249 054810 0C0152 0C0153 0C0626 517824900 517870202
pilot tube copper pipe ø 4mm thickness 1mm L 3000mm			

accessories for		100110	
	GEV No.	102111	Ref. No.
			—
pilot tube copper pipe ø 6mm thickness 1mm L 3000mm			
	GEV No.	107650	Ref. No.
			053667 057388
pilot burner nozzle SIT LPG code 30 Qty 1 pcs			

JUNKERS

CB 502 series

pilot burners













	GEV No.	100085	Ref. No.	OK1206 100085
description pilot burner JUNKERS type CB502031 natural gas nozzle no.6 gas connection 6mm with primary air				
spare parts for 100085				
	GEV No.	100227	Ref. No.	—
pilot burner nozzle natural gas gas pressure 25mbar code 6 Qty 1 pcs suitable for JUNKERS CB50203_				
	GEV No.	100704	Ref. No.	—
ignition electrode D1 ø 9mm connection M4 D2 ø 11mm L1 17mm L2 17mm BL1 13mm BL2 4mm BL3 22mm				
	GEV No.	100909	Ref. No.	003859 057821
union screw thread M10x1 for pipe ø 6mm Qty 1 pcs				
	GEV No.	101287	Ref. No.	—
olive for pipe ø 6mm Qty 1 pcs				
	GEV No.	101292	Ref. No.	—
union screw for igniter suitable for CB 502/505 Qty 1 pcs				
	GEV No.	101295	Ref. No.	—
clamping collet for thermocouple suitable for CB 502/505 Qty 1 pcs				
accessories for		100085		
	GEV No.	100220	Ref. No.	0G0060 0K1176 0K3754 0K5672 100220 102520 14200011 19012576
pilot burner nozzle LPG gas pressure 50mbar code 2 Qty 1 pcs suitable for JUNKERS CB503_				
	GEV No.	100221	Ref. No.	—
pilot burner nozzle LPG gas pressure 30mbar code 29 Qty 1 pcs suitable for JUNKERS CB50203_				
	GEV No.	100222	Ref. No.	OK1126 OK5348 100222 102522 8708200005
pilot burner nozzle LPG gas pressure 50mbar code 5 Qty 1 pcs suitable for JUNKERS CB50203_				

Table continues overleaf



accessories for		100085	
	GEV No.	100223	Ref. No. —
pilot burner nozzle natural gas gas pressure 20mbar code 3 Qty 1 pcs suitable for JUNKERS CB503_			
	GEV No.	100224	Ref. No. —
pilot burner nozzle natural gas gas pressure 25mbar code 26 Qty 1 pcs suitable for JUNKERS CB503_			
	GEV No.	100225	Ref. No. —
pilot burner nozzle LPG gas pressure 30mbar code 39 Qty 1 pcs suitable for JUNKERS CB503_			
	GEV No.	100226	Ref. No. —
pilot burner nozzle LPG gas pressure 50mbar code 15 suitable for JUNKERS			
	GEV No.	100228	Ref. No. —
pilot burner nozzle town gas gas pressure 8mbar code 4 Qty 1 pcs suitable for JUNKERS CB50203_			
	GEV No.	101281	Ref. No. —
olive for pipe ø 4mm L 8.7mm Qty 1 pcs suitable for CB 502/503			
	GEV No.	101283	Ref. No. —
union screw thread M10x1 for pipe ø 4mm Qty 1 pcs			

CB 503 series



pilot burners





GEV No.	100058	Ref. No.	OK0205 OK3755 100058
----------------	--------	-----------------	----------------------------









description pilot burner JUNKERS type CB503006 natural gas nozzle no.26 gas connection 4mm

spare parts for 100058

	GEV No.	100224	Ref. No. —
pilot burner nozzle natural gas gas pressure 25mbar code 26 Qty 1 pcs suitable for JUNKERS CB503_			
	GEV No.	101281	Ref. No. —
olive for pipe ø 4mm L 8.7mm Qty 1 pcs suitable for CB 502/503			
	GEV No.	101283	Ref. No. —
union screw thread M10x1 for pipe ø 4mm Qty 1 pcs			

accessories for 100058

	GEV No.	100220	Ref. No.	OG0060 OK1176 OK3754 OK5672 100220 102520 14200011 19012576
pilot burner nozzle LPG gas pressure 50mbar code 2 Qty 1 pcs suitable for JUNKERS CB503_				
	GEV No.	100221	Ref. No.	—
pilot burner nozzle LPG gas pressure 30mbar code 29 Qty 1 pcs suitable for JUNKERS CB50203_				

accessories for		100058		
	GEV No.	100222	Ref. No.	OK1126 OK5348 100222 102522 8708200005
pilot burner nozzle LPG gas pressure 50mbar code 5 Qty 1 pcs suitable for JUNKERS CB50203_				
	GEV No.	100223	Ref. No.	—
pilot burner nozzle natural gas gas pressure 20mbar code 3 Qty 1 pcs suitable for JUNKERS CB503_				
	GEV No.	100226	Ref. No.	—
pilot burner nozzle LPG gas pressure 50mbar code 15 suitable for JUNKERS				
	GEV No.	100227	Ref. No.	—
pilot burner nozzle natural gas gas pressure 25mbar code 6 Qty 1 pcs suitable for JUNKERS CB50203_				
	GEV No.	100228	Ref. No.	—
pilot burner nozzle town gas gas pressure 8mbar code 4 Qty 1 pcs suitable for JUNKERS CB50203_				
	GEV No.	100909	Ref. No.	003859 057821
union screw thread M10x1 for pipe ø 6mm Qty 1 pcs				
	GEV No.	101287	Ref. No.	—
olive for pipe ø 6mm Qty 1 pcs				
	GEV No.	102110	Ref. No.	006249 054810 0C0152 0C0153 0C0626 517824900 517870202
pilot tube copper pipe ø 4mm thickness 1mm L 3000mm				
	GEV No.	102111	Ref. No.	—
pilot tube copper pipe ø 6mm thickness 1mm L 3000mm				

CB 505 series

pilot burners



GEV No.	100059	Ref. No.	OK0204 OKV639 100059 183305
----------------	--------	-----------------	--------------------------------------

description pilot burner JUNKERS type CB505004 1 flame natural gas nozzle no.4 gas connection 4mm with primary air

spare parts for 100059





















	GEV No.	100231	Ref. No.	—
pilot burner nozzle natural gas gas pressure 25mbar code 4 Qty 1 pcs suitable for JUNKERS CB5050_				
	GEV No.	100703	Ref. No.	203190
ignition electrode D1 ø 9mm connection M4 D2 ø 11mm L1 8mm BL1 13mm BL2 4mm BL3 22mm to clip				
	GEV No.	100805	Ref. No.	—
gasket for pilot burner fibre				







Table continues overleaf

spare parts for 100059				
	GEV No.	101282	Ref. No.	—
olive for pipe ø 4mm L 7.4mm Qty 1 pcs				
	GEV No.	101283	Ref. No.	—
union screw thread M10x1 for pipe ø 4mm Qty 1 pcs				
	GEV No.	101292	Ref. No.	—
union screw for igniter suitable for CB 502/505 Qty 1 pcs				
accessories for 100059				
	GEV No.	100217	Ref. No.	—
pilot burner nozzle LPG gas pressure 30mbar code 3 Qty 1 pcs suitable for JUNKERS CB5050_				
	GEV No.	100230	Ref. No.	OK1189 100230 102530
pilot burner nozzle LPG gas pressure 50mbar code 2 Qty 1 pcs suitable for JUNKERS CB5050_				
	GEV No.	100232	Ref. No.	—
pilot burner nozzle natural gas gas pressure 25mbar code 9 Qty 1 pcs suitable for JUNKERS CB5050_				
	GEV No.	100233	Ref. No.	—
pilot burner nozzle LPG gas pressure 50mbar code 8 Qty 1 pcs suitable for JUNKERS CB5050_				
	GEV No.	100234	Ref. No.	—
pilot burner nozzle natural gas gas pressure 20mbar code 14 Qty 1 pcs suitable for JUNKERS CB5050_				
	GEV No.	100907	Ref. No.	003609 0C0121 11061236
screw connection thread M10x1 Qty 1 pcs type SEF 1 ømm for thermocouple				
	GEV No.	100909	Ref. No.	003859 057821
union screw thread M10x1 for pipe ø 6mm Qty 1 pcs				
	GEV No.	101288	Ref. No.	—
olive for pipe ø 6mm L 6mm aluminium Qty 1 pcs ED ø 8.5mm				

				
1				
GEV No.	100060	Ref. No.	0H6333 0KB952 100060	
description	pilot burner JUNKERS type CB505070 2 flames natural gas nozzle no.4 gas connection 4mm with primary air			
spare parts for 100060				
	GEV No.	100231	Ref. No.	—
pilot burner nozzle natural gas gas pressure 25mbar code 4 Qty 1 pcs suitable for JUNKERS CB5050_				
	GEV No.	100703	Ref. No.	203190
ignition electrode D1 ø 9mm connection M4 D2 ø 11mm L1 8mm BL1 13mm BL2 4mm BL3 22mm to clip				
	GEV No.	100805	Ref. No.	—
gasket for pilot burner fibre				

spare parts for 100060				
	GEV No.	100907	Ref. No.	003609 0C0121 11061236
screw connection thread M10x1 Qty 1 pcs type SEF 1 ømm for thermocouple				
	GEV No.	101282	Ref. No.	—
olive for pipe ø 4mm L 7.4mm Qty 1 pcs				
	GEV No.	101283	Ref. No.	—
union screw thread M10x1 for pipe ø 4mm Qty 1 pcs				
	GEV No.	101292	Ref. No.	—
union screw for igniter suitable for CB 502/505 Qty 1 pcs				
accessories for 100060				
	GEV No.	100217	Ref. No.	—
pilot burner nozzle LPG gas pressure 30mbar code 3 Qty 1 pcs suitable for JUNKERS CB5050_				
	GEV No.	100230	Ref. No.	OK1189 100230 102530
pilot burner nozzle LPG gas pressure 50mbar code 2 Qty 1 pcs suitable for JUNKERS CB5050_				
	GEV No.	100232	Ref. No.	—
pilot burner nozzle natural gas gas pressure 25mbar code 9 Qty 1 pcs suitable for JUNKERS CB5050_				
	GEV No.	100233	Ref. No.	—
pilot burner nozzle LPG gas pressure 50mbar code 8 Qty 1 pcs suitable for JUNKERS CB5050_				
	GEV No.	100234	Ref. No.	—
pilot burner nozzle natural gas gas pressure 20mbar code 14 Qty 1 pcs suitable for JUNKERS CB5050_				
	GEV No.	100909	Ref. No.	003859 057821
union screw thread M10x1 for pipe ø 6mm Qty 1 pcs				
	GEV No.	101288	Ref. No.	—
olive for pipe ø 6mm L 6mm aluminium Qty 1 pcs ED ø 8.5mm				



POLIDORO			
pilot burners			
 <p>1</p>			
GEV No.	100051	Ref. No.	054032
description	pilot burner POLIDORO 3 flames code gas connectionmm		
For models:	BCP/G1, RMV/G1C, RMV/G2C, RCP/G1S, RCP/G2D, XMV/G1C, XMV/G2C, XCP/G1S, XCP/G2D, JCP/G1S, JCP/G2D, MMV/G1C, MMV/G2C, MCP/G1S, MCP/G2D, ACPG25, PCP/G1S, PCP/G2D, OCP/G1S, OCP/G2D, TCP/G1S, TCP/G2D, KP/G2, KMV/G2C, KCP/G1RU, KCP/G2RU, KCP/G1, KCP/G1R, KCP/G2, KCP/G2R, KCP/G1U, KCP/G2U, QP/G2, QMV/G2C, QCP/G1, QCP/G1R, QCP/G2, QCP/G2R, WCP/G1, WCP/G1R, WCP/G2, WCP/G2R, DCP/G400, FCF/G6-0, FCFG101/0, FCFG102-0, FCFG201-0, FCFG202-0, FCFG10160H, FCFG102-0T...(Other models you can see in the webshop)		
spare parts for	100051		
	GEV No.	100907	Ref. No. 003609 0C0121 11061236
screw connection thread M10x1 Qty 1 pcs type SEF 1 ømm for thermocouple			
accessories for	100051		
	GEV No.	100000	Ref. No. —
pilot burner nozzle POLIDORO LPG code 22 bore ø 0.22mm Qty 1 pcs			
	GEV No.	100208	Ref. No. —
pilot burner nozzle POLIDORO LPG code 20 bore ø 0.2mm Qty 1 pcs			
	GEV No.	100209	Ref. No. —
pilot burner nozzle POLIDORO natural gas code 40 bore ø 0.4mm Qty 1 pcs			
	GEV No.	100701	Ref. No. 002564 004125 02B07 02E11 02I24 052610 056640 059380 059988 07714927 0915015 0915024 0A2473 0G2066 0G2265 0G2419 0H6628 0H6708 0H6802 0K4320 0KW911 0M0793 0M0823 1215009 19013340 727758 727820 72792 727920 M02E11
ignition electrode connection M4 Qty 1 pcs			















accessories for 100051			
	GEV No.	100906	Ref. No. 003610 056641 057960 0974037 0G2227 0K5791 11061230 19013341 727759
screw connection thread M10x1 for ignition electrode brass Qty 1 pcs WS 10			
	GEV No.	100907	Ref. No. 003609 0C0121 11061236
screw connection thread M10x1 Qty 1 pcs type SEF 1 ømm for thermocouple			
	GEV No.	100908	Ref. No. 046755 052125 0958013 0G2219 0K1348 0K5753 0KE882 0KL495 19012956 727742 727781
union screw thread M10x1 for pipe ø 4mm Qty 1 pcs			
	GEV No.	100909	Ref. No. 003859 057821
union screw thread M10x1 for pipe ø 6mm Qty 1 pcs			
	GEV No.	102110	Ref. No. 006249 054810 0C0152 0C0153 0C0626 517824900 517870202
pilot tube copper pipe ø 4mm thickness 1mm L 3000mm			
	GEV No.	102111	Ref. No. —
pilot tube copper pipe ø 6mm thickness 1mm L 3000mm			
	GEV No.	102508	Ref. No. —
union screw thread M10x1 for pipe ø 4mm Qty 5 pcs			
	GEV No.	102509	Ref. No. —
union screw thread M10x1 for pipe ø 6mm Qty 5 pcs			
	GEV No.	102699	Ref. No. 054037 054038
pilot burner nozzle POLIDORO natural gas code 25.2 bore ø 2x0.25mm Qty 1 pcs 2 bores			
	GEV No.	102795	Ref. No. —
olive for pipe ø 4mm Qty 1 pcs			
	GEV No.	102797	Ref. No. —
olive for pipe ø 6mm Qty 1 pcs			
	GEV No.	106703	Ref. No. —
pilot burner nozzle POLIDORO natural gas code 27.2 bore ø 2x0.27mm Qty 1 pcs			
	GEV No.	106704	Ref. No. —
pilot burner nozzle POLIDORO LPG code 16.2 bore ø 2x0.16mm Qty 1 pcs			
	GEV No.	106763	Ref. No. —
pilot burner nozzle POLIDORO natural gas code 27.2A bore ø 2x 0.27mm Qty 1 pcs			

Table continues overleaf



accessories for 100051	
	GEV No. 106859 Ref. No. 054286
pilot burner nozzle POLIDORO LPG code 24 bore ø 0.24mm Qty 1 pcs	

PRO-GAS

100 series

pilot burners



GEV No.	100071	Ref. No.	0H6338 100071 230626
----------------	--------	-----------------	----------------------------

description pilot burner type 100 series nozzle ø 0.2mm mushroom cap nozzle A

spare parts for 100071

	GEV No. 100086 Ref. No. —
pilot burner type 100 series nozzle ø 0.2mm nozzle A	

	GEV No. 100245 Ref. No.	003633 006188 056799 0977030 0G0082 0G2785 0G2786 0G5006 0K2946 0KD857 19012718 19022995
---	-------------------------	---

pilot burner nozzle LPG code 20 bore ø 0.2mm Qty 1 pcs thread M8x0.75

	GEV No. 100804 Ref. No. —
---	---------------------------

gasket for pilot burner

	GEV No. 100833 Ref. No.	0H6050 0KE589 100833
---	-------------------------	----------------------------

pilot burner cap SIT suitable for 100 series Hmm Lmm Qty 1 pcs

	GEV No. 100881 Ref. No. —
---	---------------------------

pilot burner bottom part PRO-GAS 100 series nozzle ø 0.2mm

	GEV No. 100885 Ref. No.	057251
---	-------------------------	--------

air mixing sleeve for pilot burner Qty 1 pcs

	GEV No. 100907 Ref. No.	003609 0C0121 11061236
---	-------------------------	------------------------------

screw connection thread M10x1 Qty 1 pcs type SEF 1 ømm for thermocouple

	GEV No. 100916 Ref. No. —
---	---------------------------

compression spring for pilot burner Qty 1 pcs

	GEV No. 100917 Ref. No. —
---	---------------------------

gasket for pilot burner Qty 1 pcs aluminium

	GEV No. 100918 Ref. No. —
---	---------------------------

screw for pilot burner

accessories for 100071		
	GEV No. 100246 Ref. No.	02137 056656 056797 0977031 0G0150 0G2787 0K1318 0K2895 0K3558 0K5866 0KW952 0M0833 19022988 19022989 M02137 MOL02137

pilot burner nozzle natural gas bore ø 0.35mm Qty 1 pcs thread M8x0.75

	GEV No. 100904 Ref. No.	052833 0K2497 100904 102504
---	-------------------------	--------------------------------------

locking screw M10x1 for pipe ø 4mm Qty 1 pcs

	GEV No. 100905 Ref. No.	052834 0958031
---	-------------------------	-------------------

locking screw M10x1 for pipe ø 6mm Qty 1 pcs

	GEV No. 102110 Ref. No.	006249 054810 0C0152 0C0153 0C0626 517824900 517870202
---	-------------------------	--

pilot tube copper pipe ø 4mm thickness 1mm L 3000mm

	GEV No. 102111 Ref. No. —
---	---------------------------

pilot tube copper pipe ø 6mm thickness 1mm L 3000mm

140 - 145 -150 series

pilot burners



GEV No.	100093	Ref. No.	0H6311
----------------	--------	-----------------	--------

description pilot burner type 150 series 1 flame with accessories

For models: 7550-2, 7551-2, 7552-2, 7553-2

spare parts for 100093















	GEV No. 100216 Ref. No. —
pilot burner nozzle SIT natural gas code 38 bore ø 0.45mm Qty 1 pcs suitable for SIT 150 series	

Table continues overleaf



spare parts for		100093	
	GEV No.	100701	Ref. No.
			002564 004125 02B07 02E11 02I24 052610 056640 059380 059988 07714927 0915015 0915024 0A2473 0G2066 0G2265 0G2419 0H6628 0H6708 0H6802 0K4320 0KW911 0M0793 0M0823 1215009 19013340 727758 727820 72792 727920 M02E11
	ignition electrode connection M4 Qty 1 pcs		
	GEV No.	100897	Ref. No.
			059161 0957009 0G2262 727799
	olive for pipe 4mm Qty 1 pcs for pilot burner		
	GEV No.	100906	Ref. No.
			003610 056641 057960 0974037 0G2227 0K5791 11061230 19013341 727759
	screw connection thread M10x1 for ignition electrode brass Qty 1 pcs WS 10		
	GEV No.	100907	Ref. No.
			003609 0C0121 11061236
	screw connection thread M10x1 Qty 1 pcs type SEF 1 0mm for thermocouple		
	GEV No.	100908	Ref. No.
			046755 052125 0958013 0G2219 0K1348 0K5753 0KE882 0KL495 19012956 727742 727781
	union screw thread M10x1 for pipe 4mm Qty 1 pcs		
accessories for		100093	
	GEV No.	100204	Ref. No.
			003792 004127 059216 07873 0977115 0C3214 0G2263 0G2415 0KT837 19013305 72780001 ADME01110
	pilot burner nozzle SIT LPG code 14 bore 0.18/0.20mm Qty 1 pcs suitable for 140 series		

accessories for		100093	
	GEV No.	100205	Ref. No.
			—
	pilot burner nozzle SIT LPG code 19 bore 0.23/0.26mm Qty 1 pcs suitable for SIT 150 series		
	GEV No.	100206	Ref. No.
			003626
	pilot burner nozzle SIT natural gas code 36 bore 0.60/0.55mm Qty 1 pcs suitable for SIT 150 series		
	GEV No.	100207	Ref. No.
			003784 003871 059215 0977113 0G2264 0G2416 19013306 72780002
	pilot burner nozzle SIT natural gas code 27 bore 0.40/0.38mm suitable for SIT 140 series		
	GEV No.	100803	Ref. No.
			—
	gasket for pilot burner Qty 1 pcs		
	GEV No.	100898	Ref. No.
			003863
	olive for pipe 6mm Qty 1 pcs for pilot burner		
	GEV No.	100909	Ref. No.
			003859 057821
	union screw thread M10x1 for pipe 6mm Qty 1 pcs		
	GEV No.	102110	Ref. No.
			006249 054810 0C0152 0C0153 0C0626 517824900 517870202
	pilot tube copper pipe 4mm thickness 1mm L 3000mm		
	GEV No.	102111	Ref. No.
			—
	pilot tube copper pipe 6mm thickness 1mm L 3000mm		

miscellaneous



1	GEV No.	101937	Ref. No.	0G2965 17012713
	description pilot burner			
	AGGRHFG000, AGGRHAG000, AGGRHBG000, AGGRABG000, AGGRHBG000, AGGWHFGBOO, AGGWHAGBOO, AGGWHBGBOM, AGGWABGBOO, AGGWHBGBOO, ALGWHFOOOO, ALGWHAOOOO, ALGWHCOOOO, AGGYIFGFCO, AGGYIAGFCO, AGGYIBGFCO, AGGRAAGOOM, AGGRAFGOOM, AGGWAAGBOM, AGGWAFGBOM, AGGYJAGFCM, AGGYJFGFCM, AGGYJBGFCM, AGGWDBGBOO, AGGWDFGBOO, AGGWDAGBOM, AGGWDFGBOM, AGGWDBGBO0, AGGYKFGFCO, AGGYKBGFCO, AGGYKAGFCM, AGGYKFGFCM, AGGYKBGFCM, AGPWACAGBOO, AGPWACAGBOM, AGPWCFGBOM, AGPWCBGBOM, AGGYLAGFCO, AGGYLFGFCO, AGGYLAGFCM, AGGYLFGFCM, AGGYLBGFCM, ALPWCAOOOO, ALGWDFOOOO, ALGWDCOOOO, AGGROIGOOO, AGGWOIGBOO, AGGYOIGFCO, AGGROIGOOM, AGGWOIGBOM... (Other models you can see in the webshop)			
	For models:			



electrodes



GEV No.	505279	Ref. No.	0C4104
description	gasket for ignition electrode L 65mm W 20mm		
For models:	FCZ061GAG, FCZ101GAG, FCZ102GAG, FCZ201GAG, FCZ202GAG, FCZ061GAD, FCZ101GAD, FCZ102GAD, FCZ201GAD, FCZ202GAD, FCZ101GTG, FCZ102GTG, FCZ201GTG, FCZ202GTG, FCZ101GTD, FCZ102GTD, FCZ201GTD, FCZ202GTD, FCZ061GBG, FCZ101GBG, FCZ102GBG, FCZ201GBG, FCZ202GBG, FCZ061GBD, FCZ101GBD, FCZ102GBD, FCZ201GBD, FCZ202GBD, FCZ061GBI, FCZ101GBI, FCZ201GBI, FCZ101GBG2, FCZ102GBG2, FCZ201GBG2, FCZ202GBG2, FCZ101GBD2, FCZ102GBD2, FCZ201GBD2, FCZ202GBD2, FCZ101GBI2, FCZ102GBI2, FCZ201GBI2, FCZ061GCG, FCZ101GCG, FCZ102GCG, FCZ201GCG, FCZ202GCG, FCZ061GCD, FCZ101GCD, FCZ102GCD... (Other models you can see in the webshop)		



GEV No.	102965	Ref. No.	OKI351 17012739
description	ignition electrode connection F 2.8x0.8mm		
For models:	ALGWHFOOOO, ALGWHAOOOO, ALGWHCOOOO, ALPWCAOOOO, ALGWDFOOOO, ALGWDCOOOO, ALGWOIOOOO, ALGWAASOOO, ALGWAFSOOO, ALGWASOOO, ALGWDFSOOO, ALPWCAOOOO, ALPWCFSOOO, ALGWOISOOO, ALGWABOOOO, ALGWHBOOOO, ALPWCBOOOO, ALGWDBOOOO, ALGWABSOOO, ALPWCBSOOO, ALGWDBSOOO, ALGWAFOOOO, ALGWAAOOOO, ALGWACOooo, ALGWDAOOOO, ALPWCCOOOO, ALPWCFOOOO		

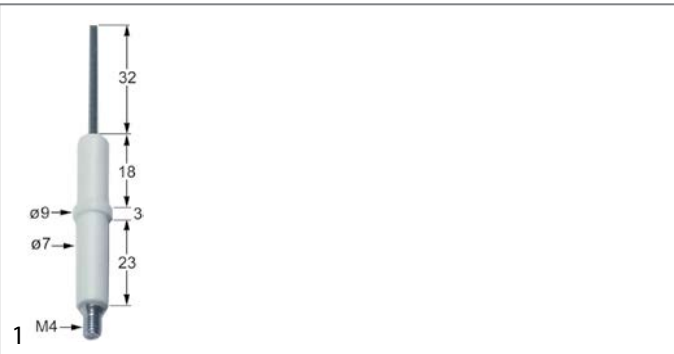

GEV No.	100701	Ref. No.	002564 004125 02B07 02E11 02I24 052610 056640 059380 059988 07714927 0915015 0915024 0A2473 0G2066 0G2265 0G2419 0H6628 0H6708 0H6802 0K4320 0KW911 0M0793 0M0823 1215009 19013340 727758 727820 72792 727920 M02E11
description	ignition electrode connection M4 Qty 1 pcs		
For models:	MCF/G1090, MCF/G1095, MCF/G995, MFR/G350, MFR/G700, MFR/G350D, MFR/G700D, MFR/G350F, MFR/G700F, MFR/G350E, MFR/G700E, MFR/G350NL, MFR/G700NL, MFR/G740, MFR/G380, MFR/G381, MFR/G350, MFR/G351, MFR/G700, MFR/G701, BCF/G2, BF/G1S07, BFR/G1S14, BR/G1FL, BR/G1FR, BR/G2FL, BR/G2FR, BCP/G1, MT/G350, MT/G352, MCP/G700, MCP/G701, MCP/G710, MCP/G711, MCP/G705, MCP/G706, RCF/G2, RCF/G3, RCF/G9, RBR/G2FM, RBR/G2IM, RBK/G2FM, RMV/G1C, RMV/G2C, RF/G1S07, RF/G2D07, RFR/G1S07, RFR/G2D07, RFR/G1S12, RFR/G2D12...(Other models you can see in the webshop)		
accessories for	100701		

description	ignition electrode connection M4 Qty 1 pcs		
For models:	MCF/G1090, MCF/G1095, MCF/G995, MFR/G350, MFR/G700, MFR/G350D, MFR/G700D, MFR/G350F, MFR/G700F, MFR/G350E, MFR/G700E, MFR/G350NL, MFR/G700NL, MFR/G740, MFR/G380, MFR/G381, MFR/G350, MFR/G351, MFR/G700, MFR/G701, BCF/G2, BF/G1S07, BFR/G1S14, BR/G1FL, BR/G1FR, BR/G2FL, BR/G2FR, BCP/G1, MT/G350, MT/G352, MCP/G700, MCP/G701, MCP/G710, MCP/G711, MCP/G705, MCP/G706, RCF/G2, RCF/G3, RCF/G9, RBR/G2FM, RBR/G2IM, RBK/G2FM, RMV/G1C, RMV/G2C, RF/G1S07, RF/G2D07, RFR/G1S07, RFR/G2D07, RFR/G1S12, RFR/G2D12...(Other models you can see in the webshop)		
accessories for	100701		

GEV No.	100906	Ref. No.	003610 056641 057960 0974037 0G2227 0K5791 11061230 19013341 727759
description	screw connection thread M10x1 for ignition electrode brass Qty 1 pcs WS 10		





		02B06 02E10 051565 051977 056754 058135 0915036 0915055 0C0488 0G0083 0H6630 0K5703 0K9080 0K1377 0KQ943 0M0792 19012724 6010046 752040111 M02E10	
GEV No.	100706	Ref. No.	
description	ignition electrode connection M4 Qty 1 pcs		
For models:	MCF/G705, MCF/G1055, MCF/G700, MCF/G1050, MCF/G705E, MCF/G1055E, MCF/G700D, MCF/G700, MCF/G705F, MCF/G1055F, MCF/G705NL, MCF/G1050D, MCFG1055NL, MCF/G702, MCF/G1052, MCF/G700, MCF/G1050, MR/G351, MR/G701, MR/G721, MR/G1071, MR/G350, MR/G350F, MR/G350NL, MR/G350E, MR/G360, MR/G360F, MR/G700, MR/G700F, MR/G700NL, MR/G700E, MR/G710, MR/G710F, MR/G1070, MR/G720, MR/G715, MR/G725, MR/G1075, MR/G361, MR/G711, MR/G716, MR/G726, MR/G1076, MBR/G710D, MBR/G700, MBR/G700F, MBR/G700UK, MBR/G701, MBR/G706, MBR/G701UK...(Other models you can see in the webshop)		

GEV No.	100718	Ref. No.	045821
description	ignition electrode D1 ø 10mm connection M5 D2 ø 14mm L1 55mm L2 10mm BL1 22mm BL2 22mm BL3 4mm to clip		

GEV No.	102354	Ref. No.	003471
description	ignition electrode D1 ø 32x13mm L1 57mm BL1 25mm connection F 4.8x0.8mm cable length 570mm		
For models:	ZMMDG4, ZMBDG8, ZMMDG6, ZMBDG12		

GEV No.	100738	Ref. No.	00368 004970 0K3534
description	ignition electrode D1 ø 6mm cable length 750mm D2 ø 10mm BL1 14mm BL2 2mm BL3 15mm to clip with spring and insulation connection ø 2.4mm		
For models:	SCG350, SCG700, SCG1050, SCG350, SCG700, SCG1050, PPL5GG, PPFL5GG		

GEV No.	100717	Ref. No.	054099
description	ignition electrode D1 ø 6mm connection F 2.8x0.8mm D2 ø 8.5mm BL1 18mm BL2 14mm BL3 21mm to clip		
For models:	RC/G320, RC/G330, RC/G320F, RC/G720, RC/G730, MCF/G705, MCF/G1055, MCF/G700, MCF/G1050, MCF/G705E, MCF/G1055E, MCF/G700D, MCF/G700, MCF/G705F, MCF/G1055F, MCF/G705NL, MCF/GE705, MCF/GE1055, MCF/GE700, MCFGE1050, MCF/GE700D, MCFGE1050D, MCF/G1050D, MCFG1055NL, MC/G355, MC/G350, MC/G355E, MC/G350D, MC/G355F, MC/G355NL, MC/G705, MC/G700, MC/G705E, MC/G700D, MC/G705NL, MC/G1055, MC/G1050, MC/G1050D, MC/G1055NL, MC/G705F, MCF/GE1055UK, MCF/G1090, MCF/G1095, MC/G352, MC/G702, MC/G1052, MCF/G702, MCF/GE702, MCF/G1052, MCFGE1052...(Other models you can see in the webshop)		

GEV No.	100707	Ref. No.	003272 054336 058385 0915037 0A2856 300903
description	ignition electrode D1 ø 7mm D2 ø 9mm connection ø2.4mm L1 14mm L2 6mm BL1 18mm BL2 3mm BL3 23mm to clip Qty 1 pcs		
For models:	HCPA/G1219, HCPA/G11219, HCPA/G121, HCPA/G121, NC4/FV, NC6/FVL, NC6/FV, NC6/2FV, NC8/2FV, NCG1V, NCG2V, NFG/20, NFG20+20, NFT/2GL, NFT/2GR, NFT/2GLC, 1TPG18F, 110FTL/N, 1104F/G, 1106F/2G, 1102FTL/N, 110FTR/N, 1102FTR/N, 1108F/2G, 110CP1, 110FR2, NC4/FV, NC6/FV, NC6/2FV, NC8/2FV, NC6/FVL, NFT/2GL, NFT/4GL, NFT/2GR, NFT/4GR, NFT/4GLR, NFT/4GLRC, NFT/2GLC, NFT/4GLC, NCG1V, NCG2V, NFG/20, NFG20+20, NTP/A, 090213, 090214, PCF/GG840, PCF/GG1260, PCF/GG1680, PTF/GG1835...(Other models you can see in the webshop)		

GEV No.	102330	Ref. No.	058337
description	ignition electrode D1 ø 7mm D2 ø 9mm L1 16mm BL1 18mm BL2 3mm BL3 23mm to clip connection ø 2.4mm		
For models:	ROCA/G500, ROCA/G1000, ROCF/G1000, ROTF/G1000, ROSD/G1000, ROSD/G1000, ROSS/G1000, ROSF/G1000, RORA/G500, RORA/G1000, ROC/G500, ROC/G1000, ROR/G500, ROR/G1000		

GEV No.	100724	Ref. No.	0H6257
description	ignition electrode D1 ø 8mm BL1 13mm BL2 28mm BL3 8mm connection F 2.8x0.8mm M10x0.75		
accessories for	100724		
	GEV No.	519546	Ref. No. —
	nut thread M10x0.75 H 3.45mm WS 14 brass Qty 1 pcs		

GEV No.	100703	Ref. No.	203190
description	ignition electrode D1 ø 9mm connection M4 D2 ø 11mm L1 8mm BL1 13mm BL2 4mm BL3 22mm to clip		

GEV No.	102170	Ref. No.	0774753 0A5169
description	ignition electrode flange length 24mm flange width 17mm D1 ø 10mm fixing dimensions ø4.5mm with flange		
For models:	HBR/G800, HBR/G805, HBR/G801, HBR/G806, HBR/G810, HBR/G815, HBR/G811, HBR/G816, HBR/G800D, HBR/G805D, HBR/G801D, HBR/G806D, HBR/G810D, HBR/G815D, HBR/G811D, HBR/G816D, HBR/G800NL, HBR/G805NL, HBR/G810NL, HBR/G800UK, ZBR/G800, ZBR/G805, ZBR/G801, ZBR/G806, ZBR/G810, ZBR/G815, ZBR/G811, ZBR/G816, ZBR/G800D, ZBR/G805D, ZBR/G801D, ZBR/G806D, ZBR/G810D, ZBR/G815D, ZBR/G811D, ZBR/G816D, ZBR/G800UK, ABR/G801, ABR/G806, ABR/G811, ABR/G816, ABR/G801D, ABR/G806D, ABR/G811D, ABR/G816D		

GEV No.	102361	Ref. No.	002637 0826212 60050311
description	ignition electrode flange length 24mm flange width 17mm D1 ø 9.5mm L1 20mm L2 20mm BL1 30mm BL2 28mm fixing dimensions ø4.5mm with flange connection ø 6mm		
For models:	BRN70G, BRN/70GZ, BR70GZ, BRNG70A, FCV/G10L3, FCVG10L3T, FCVG102L3, FCVG10L3J, FCVG102L3J, FCV/G10L6JAP, FCV/G102/1L-6JAP, FCV/G10L2, FCV/G6L4, FCV/G10L6, FCV/G102/1L6, 5711-2-6, 5711-2-7, 5711-2-8, 5711-2-10, 5711-2-8CH, 5711-2-10CH, 5711-2-6L, 5711-2-7L, 5711-2-8L, 5711-2-10L, 5712-2-10F, 5712-2-10S, 5714-2-10F, 5714-2-10S, ECV/G6T4, ECV/G10T4, ECVG102T4, ECV/G10T4J, ECV/G10T6, ECV/G102/1T6, HCPA/G1219, CPD42G-Z, CPD40GZ, RCV101G2, RCV101G4, ACV/G10C2, ACV/G10C4, ACVG102C4, ACV/G10C6, ACV/G102/1C6, NCV/G10L2, NCV/G10L4, NCV/G102/1, ZCV/G6T4, ZCV/G10T4...(Other models you can see in the webshop)		

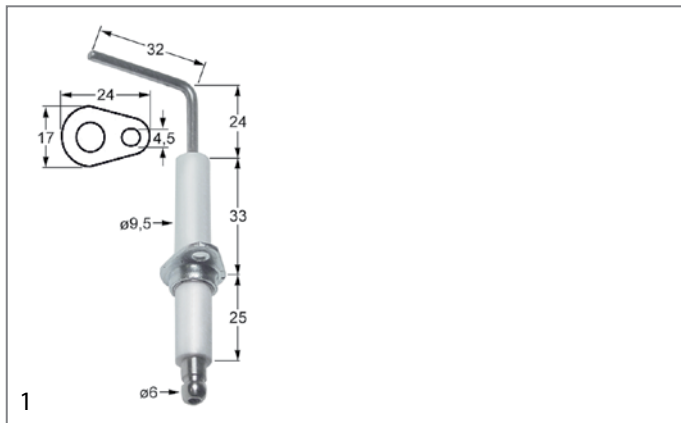

GEV No.	102360	Ref. No.	002344 0829267 60050361
description	ignition electrode flange length 24mm flange width 17mm D1 ø 9.5mm L1 24mm L2 32mm BL1 33mm BL2 25mm fixing dimensions ø4.5mm with flange connection ø 6mm		
For models:	FCV/G6L4, FCVMG62, 5711-2-6, 5711-2-7, 5711-2-8, 5711-2-10, 5711-2-8CH, 5711-2-10CH, 5711-2-6L, 5711-2-7L, 5711-2-8L, 5711-2-10L, ECV/G6T4, ZCV/G6T4		

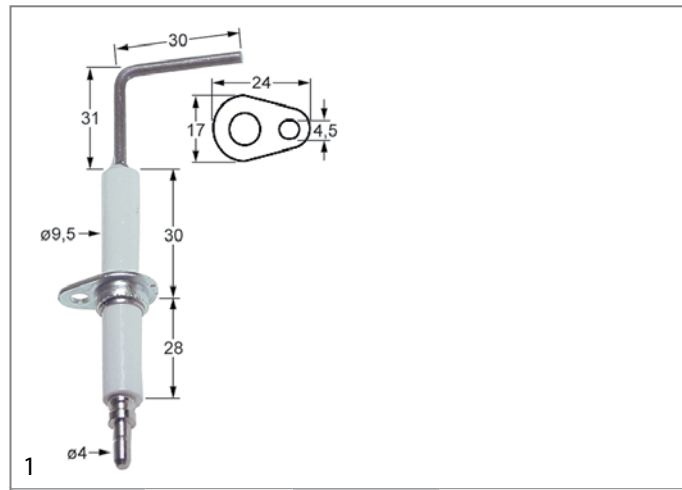

GEV No.	102175	Ref. No.	002638 60050310
description	ignition electrode flange length 24mm flange width 17mm D1 ø 9.5mm L1 31mm L2 30mm BL1 30mm BL2 28mm fixing dimensions ø4.5mm with flange connection ø 4mm		
For models:	FDV40G, FDV40GZ, FDV40GA, FDV20G, FDV20GZ, FDV20GA, BRN70G, BRN70E, BRN/70GZ, BRN/70EZ, BR70GZ, BR70EZ, BRNG70A, BRNE70A, FCV/G10L3, FCVG10L3T, FCVG102L3, FCV/G20L3, FCVG202L3, FCVG10L3J, FCVG102L3J, FCV/G10L6JAP, FCV/G102/1L6JAP, FCV/G10L2, FCV/G10L6, FCV/G102/1L6, FCV/G20L6, FCVG202L6, FCV/G101/1, FCV/G102/1, FCV/G201/1, FCV/G202/1, FCS101G2, FCS101G4, FCS101G4DT, FCS101GP9J, FCS101G49J, FCS101GP, FCS102G4, FCS102GA9J, FCS102G49J, FCS102GP, FCS201G4, FCS201GP, FCS202G4, FCS202GP, FCS101GX9J, FCS101GX, FCS102GX9J, FCS102GX...(Other models you can see in the webshop)		



GEV No.	100739	Ref. No.	003041
description	ignition electrode flange length 24mm flange width 17mm D1 ø 9.5mm L1 24mm L2 71mm L4 61mm L3 27mm BL1 24mm BL2 35mm fixing dimensions ø4.5mm with flange connection ø 4mm		
For models:	HI/G400, HI/G800, HI/G400N, HI/G800N		



GEV No.	102344	Ref. No.	0C1068
description	ignition electrode flange length 24mm flange width 17mm D1 ø 9.5mm L1 35mm L2 35mm BL2 58mm connection F 4.8x0.8mm cable length 850mm fixing dimensions ø4.5mm with flange		
For models:	AOS101GAEU, AOS102GAEU, AOS201GAEU, AOS202GAEU, AOS101GAAU, AOS102GAAU, AOS201GAAU, AOS202GAAU, AOS061GA, AOS061GB, AOS101GA, AOS101GB, AOS201GA, AOS201GB, AOS102GB, AOS102GA, AOS202GB, AOS202GA		

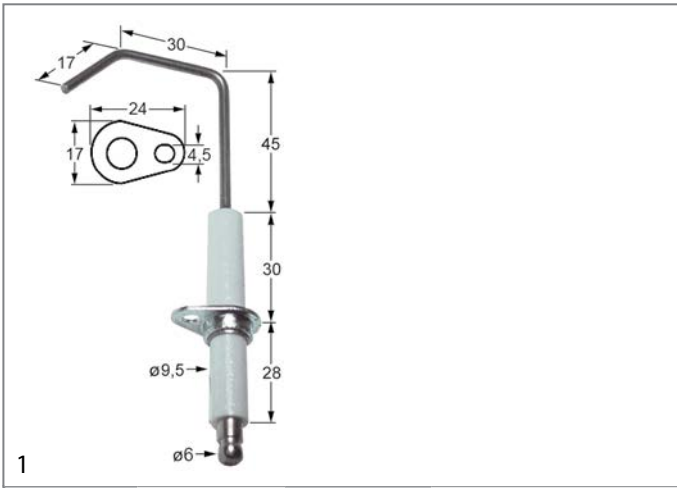

GEV No.	102169	Ref. No.	003556 0774752 0A5168
description	ignition electrode flange length 24mm flange width 17mm D1 ø 9.5mm L1 45mm L2 30mm L4 18mm L3 17mm BL1 30mm BL2 28mm fixing dimensions ø4.5mm with flange connection ø 6mm		
For models:	HBR/G800, HBR/G805, HBR/G801, HBR/G806, HBR/G810, HBR/G815, HBR/G811, HBR/G816, HBR/G800D, HBR/G805D, HBR/G801D, HBR/G806D, HBR/G810D, HBR/G815D, HBR/G811D, HBR/G816D, HBR/G800NL, HBR/G805NL, HBR/G810NL, HBR/G800UK, ZBR/G800, ZBR/G805, ZBR/G801, ZBR/G806, ZBR/G810, ZBR/G815, ZBR/G811, ZBR/G816, ZBR/G800D, ZBR/G805D, ZBR/G801D, ZBR/G806D, ZBR/G810D, ZBR/G815D, ZBR/G811D, ZBR/G816D, ZBR/G800UK, ABR/G800, ABR/G805, ABR/G801, ABR/G806, ABR/G810, ABR/G815, ABR/G811, ABR/G816, ABR/G800D, ABR/G805D, ABR/G801D, ABR/G806D, ABR/G810D...(Other models you can see in the webshop)		

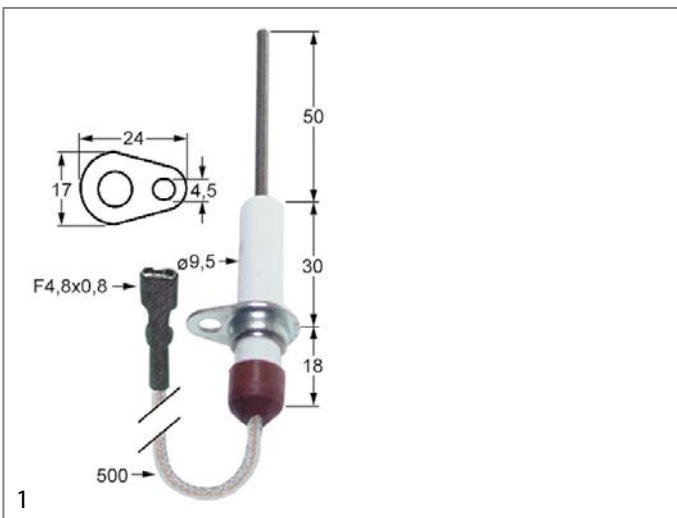

GEV No.	102345	Ref. No.	0C1049
description	ignition electrode flange length 24mm flange width 17mm D1 ø 9.5mm L1 50mm BL1 30mm BL2 18mm connection F 4.8x0.8mm cable length 500mm fixing dimensions ø4.5mm with flange		
For models:	AOS061GAEU, AOS101GAEU, AOS102GAEU, AOS201GAEU, AOS-202GAEU, AOS061GAAU, AOS101GAAU, AOS102GAAU, AOS201GAAU, AOS202GAAU, AOS061GA, AOS101GA, AOS101GB, AOS201GA, AOS201GB, AOS102GB, AOS102GA, AOS202GB, AOS202GA		



GEV No.	102359	Ref. No.	002343 60050360
description	ignition electrode flange length 24mm flange width 17mm D1 ø 9.5mm L1 60mm L2 12mm BL1 33mm BL2 25mm fixing dimensions ø4.5mm with flange connection ø 4mm		
For models:	FCV/G6L4, FCVMG62, 5711-2-6, 5711-2-7, 5711-2-8, 5711-2-10, 5711-2-8CH, 5711-2-10CH, 5711-2-6L, 5711-2-7L, 5711-2-8L, 5711-2-10L, ECV/G6T4, ZCV/G6T4		



GEV No.	107865	Ref. No.	0C7418 83089F401
description	ignition electrode flange length 38mm flange width 17mm D1 ø 9.4mm D2 ø 9.4mm L1 44.5mm L2 11mm BL1 27mm BL2 23mm connection male faston 4.8mm cable length 120mm mounting distance 28mm 2 hole flange connection ø 4mm		



GEV No.	106880	Ref. No.	0C5273
description	ignition electrode flange length 38mm flange width 17mm D1 ø 9.5mm D2 ø 8.5mm L1 10.5mm L2 42mm L3 9mm BL1 51mm BL2 40mm connection ø6 connection ø 6mm		

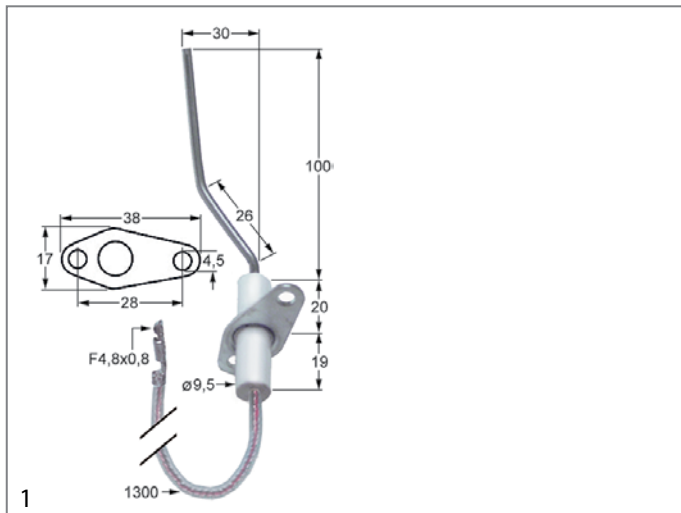

GEV No.	100780	Ref. No.	005886 OC5599
description	ignition electrode flange length 38mm flange width 17mm D1 ø 9.5mm L1 100mm L2 30mm L3 26mm BL1 20mm BL2 19mm connection F 4.8x0.8mm cable length 1300mm fixing dimensions ø4.5mm mounting distance 28mm with flange		
For models:	ZCBDG8, ZCBDG12, ZCBDG18		

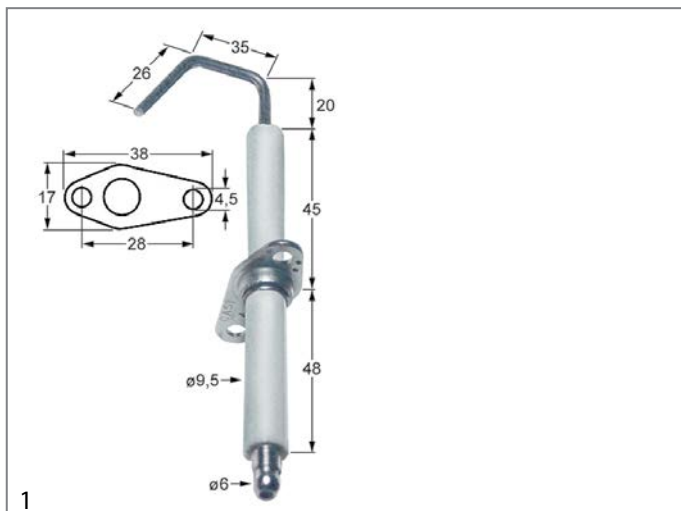

GEV No.	102351	Ref. No.	OC1137
description	ignition electrode flange length 38mm flange width 17mm D1 ø 9.5mm L1 20mm L2 35mm L3 26mm BL1 45mm BL2 48mm cable length 1180mm fixing dimensions ø4.5mm mounting distance 28mm with flange connection ø 6mm		
For models:	AOS201GAEU, AOS201GAAU, AOS061GA, AOS101GA, AOS201GA, AOS201GB		

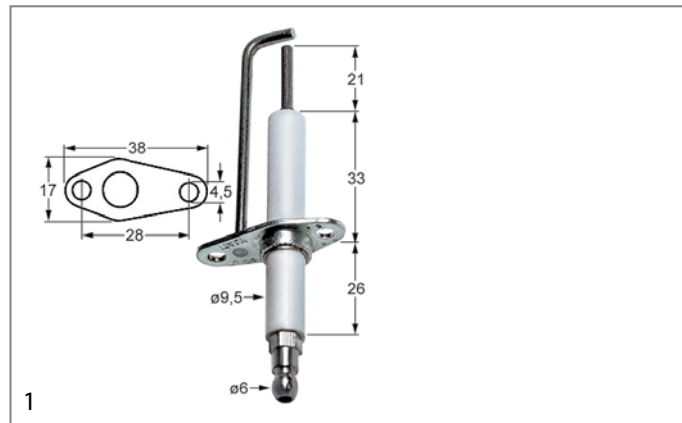

GEV No.	102362	Ref. No.	0H6803 OK2369 60050359
description	ignition electrode flange length 38mm flange width 17mm D1 ø 9.5mm L1 21mm BL1 33mm BL2 26mm fixing dimensions ø4.5mm mounting distance 28mm with flange with earthing contact connection ø 6mm		
For models:	FDV40G, FDV40GZ, FDV40GA, FDV20G, FDV20GZ, FDV20GA, FCV/G20L3, FCV/G20L3, FCV/G20L6, FCV/G20L6, FCV/G101/1, FCV/G102/1, FCV/G201/1, FCV/G202/1, FCS101G2, FCS101G4, FCS101G4DT, FCS101GP9J, FCS101G49J, FCS101GP, FCS102G4, FCS102GA9J, FCS102G49J, FCS102GP, FCS201G4, FCS201GP, FCS202G4, FCS202GP, FCS101GX9J, FCS101GX, FCS102GX9J, FCS102GX, FCS201GX, FCS202GX, 5712-2-6, 5712-2-7, 5712-2-8, 5712-2-10, 5714-2-6, 5714-2-7, 5714-2-8, 5714-2-10, 5717-2-6, 5714-2-7, 5714-2-8, 5714-2-10, 5712-2-6L, 5712-2-7L, 5712-2-8L, 5712-2-10L...(Other models you can see in the webshop)		

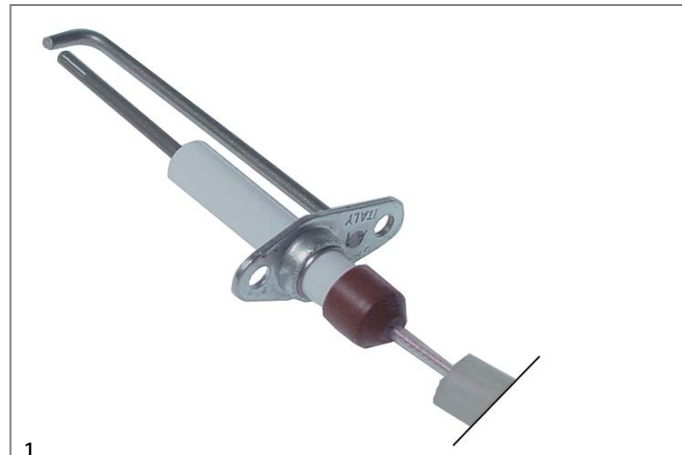

GEV No.	104374	Ref. No.	OC1771
description	ignition electrode flange length 38mm flange width 17mm D1 ø 9.5mm L1 35mm BL1 30mm BL2 18mm connection F 2.8x0.8mm cable length 450mm fixing dimensions 4.5mm mounting distance 28mm with flange with earthing contact		
For models:	AOS061GAEU, AOS101GAEU, AOS102GAEU, AOS061GAAU, AOS101GAAU, AOS102GAAU, AOS061GA, AOS061GB, AOS101GA, AOS101GB		

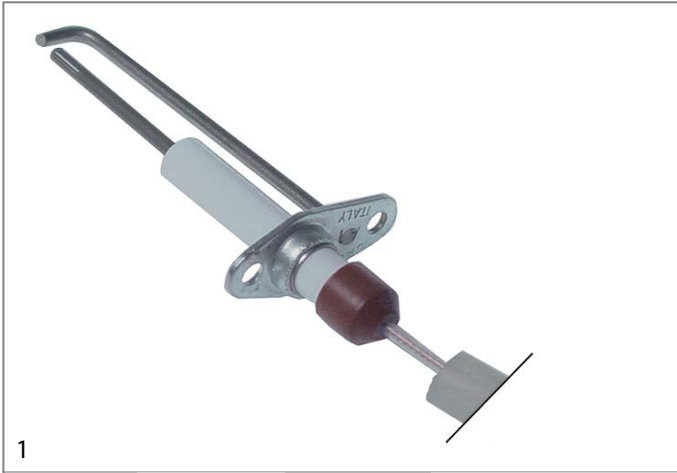

GEV No.	102352	Ref. No.	OC1134
description	ignition electrode flange length 38mm flange width 17mm D1 ø 9.5mm L1 35mm BL1 30mm BL2 18mm connection F 2.8x0.8mm cable length 600mm fixing dimensions ø4.5mm mounting distance 28mm with flange with earthing contact		
For models:	AOS201GAEU, AOS202GAEU, AOS201GAAU, AOS202GAAU, AOS-061GA, AOS101GA, AOS201GA, AOS201GB, AOS202GB, AOS202GA		

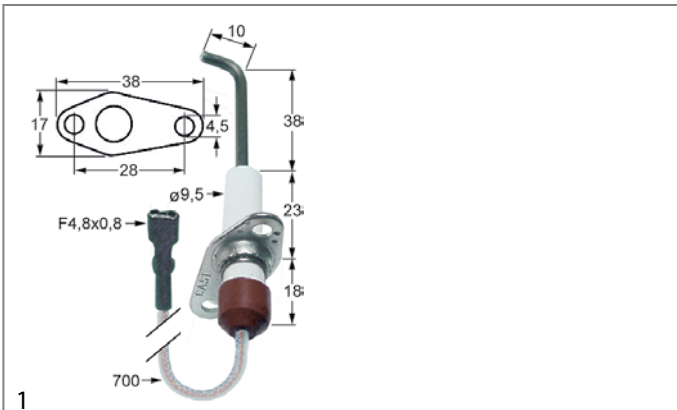

GEV No.	102349	Ref. No.	005920
description	ignition electrode flange length 38mm flange width 17mm D1 ø 9.5mm L1 38mm L2 10mm BL1 23mm BL2 18mm connection F 4.8x0.8mm cable length 700mm fixing dimensions ø4.5mm mounting distance 28mm with flange		
For models:	FCVG6L3CJ, FCV/G6L3C, FCV/G61/1, FCV/G61/1, FCV/G61/1, FCV/G61/1, FCVG6L3CT, FCVG6L3CJ, FCS061G48J, FCS061GP, FCS061G3DI, FCS061G4, FCS061G4DT, FCS061G49J, 5721-2-7, 5721-2-10, ECV/G6T4C, ECV/G61/1, ECV/G61/1, RCV061G2, ACV/G6C3C, ZCV/G6T4C, ZCV/G61/1		



GEV No.	104375	Ref. No.	005900 0C5598
description	ignition electrode flange length 38mm flange width 17mm D1 ø 9.5mm L1 8.5mm L2 20mm BL1 19mm BL2 21mm cable length 800mm		
For models:	ZCBDG8, ZCBDG12, ZCBDG18		



GEV No.	102350	Ref. No.	005911
description	ignition electrode flange length 51mm flange width 23mm D1 ø 9.5mm L1 33mm L2 11mm BL1 20mm BL2 15mm connection F 6.3x0.8/2.8x0.8mm cable length 450mm fixing dimensions ø5.5mm with flange		
For models:	FCV/G61/1, FCV/G61/1, FCV/G61/1, FCS061GP, FCS061G4, 5721-2-7, 5721-2-10, ECV/G61/1, ECV/G61/1, ZCV/G61/1		

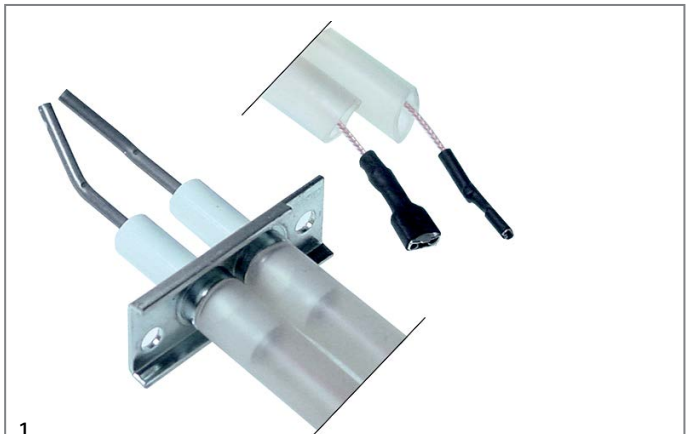

GEV No.	102348	Ref. No.	005910
description	ignition electrode flange length 51mm flange width 23mm D1 ø 9.5mm L1 33mm L2 11mm BL1 20mm BL2 15mm connection F 6.3x0.8/2.8x0.8mm cable length 650mm fixing dimensions ø5.5mm with flange		
For models:	FCVG6L3CJ, FCV/G6L3C, FCV/G61/1, FCV/G61/1, FCV/G61/1, FCV/G61/1, FCVG6L3CT, FCVG6L3CJ, FCS061G48J, FCS061GP, FCS061G3DI, FCS061G4, FCS061G4DT, FCS061G49J, 5721-2-7, 5721-2-10, ECV/G6T4C, ECV/G61/1, ECV/G61/1, RCV061G2, ACV/G6C3C, ZCV/G6T4C, ZCV/G61/1		



GEV No.	100742	Ref. No.	0H6313 61479
description	ignition electrode with earthing contact D1 ø 7mm L1 10mm L2 70mm BL1 16mm BL2 25mm connection F 6.3x0.8/2.8x0.8mm cable length 1550mm with flange		
For models:	7507-2, 7508-2, 7707-2, 9100-2, 9101-2, 9102-2, 9104-2, 9113-2, 9114-2, 9115-2, 9116-2		

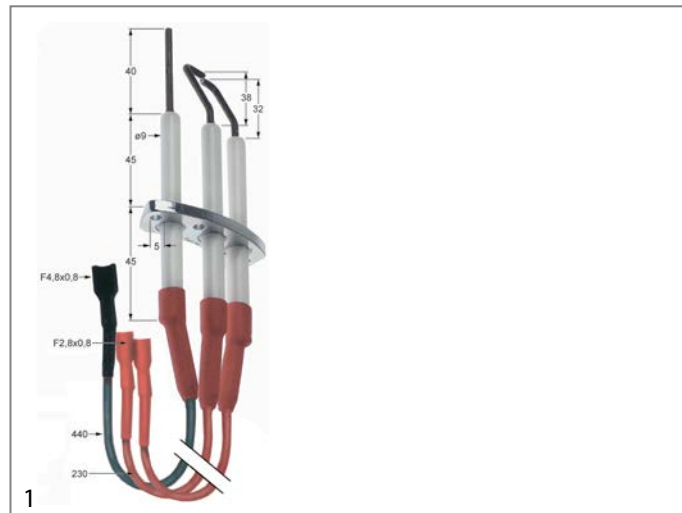

GEV No.	104535	Ref. No.	0C4461
description	monitoring and ignition electrodes group flange length 62mm flange width 20mm D1 ø 9mm L1 40/38/32mm BL1 45mm BL2 45mm connection F4.8x0.8/F2.8x0.8 cable length 440/230/230mm fixing dimensions ø5mm flange		
For models:	FCZ061GAG, FCZ101GAG, FCZ061GAD, FCZ101GAD, FCZ061GBG, FCZ101GBG, FCZ061GBD, FCZ101GBD, FCZ061GBI, FCZ101GBI, FCZ061GCG, FCZ101GCG, FCZ061GCD, FCZ101GCD, AOS061GAG1, AOS101GAG1, AOS061GAD1, AOS101GAD1, AOS061GAI1, AOS101GAI1, AOS101GAQ1, AOS061GAP1, AOS062GAP1, AOS101GAP1, AOS061GAU1, AOS101GAU1, AOS061GBG1, AOS101GBG1, AOS061GBD1, AOS101GBD1, AOS061GBI1, AOS101GBI1, AOS061GCG1, AOS101GCG1, AOS061GCD1, AOS101GCD1, AOS061GCP1, AOS062GCP1, AOS101GCP1, EJN061GAG, EJN101GAG, EJN061GAD, EJN10GAD, RDR061GAG, RDR101GAG, EJN061GBG, EJN101GBG, EJN061GBD, EJN101GBD, RDR061GBG...(Other models you can see in the webshop)		

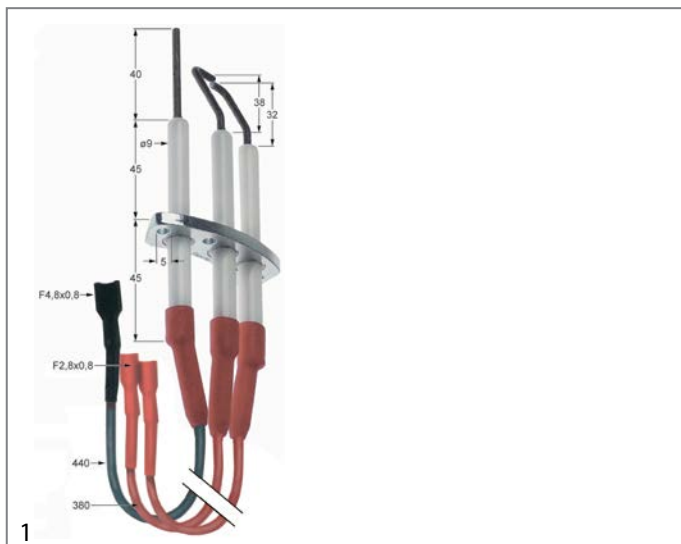

GEV No.	103225	Ref. No.	0C4259 0C4462
description	monitoring and ignition electrodes flange length 62mm flange width 20mm D1 ø 9mm L1 40/38/32mm L2 -/15/13mm L4 -/28/22mm L3 -/13/9mm BL1 45mm BL2 45mm connection F4.8x0.8/F2.8x0.8 cable length 440/380mm fixing dimensions ø5mm		
For models:	FCZ102GAG, FCZ201GAG, FCZ202GAG, FCZ102GAD, FCZ201GAD, FCZ202GAD, FCZ101GTG, FCZ102GTG, FCZ201GTG, FCZ202GTG, FCZ101GTD, FCZ102GTD, FCZ201GTD, FCZ202GTD, FCZ102GBG, FCZ201GBG, FCZ202GBG, FCZ102GBD, FCZ201GBD, FCZ202GBD, FCZ201GBI, FCZ101GBG2, FCZ102GBG2, FCZ201GBG2, FCZ202GBG2, FCZ101GBD2, FCZ102GBD2, FCZ201GBD2, FCZ202GBD2, FCZ101GBI2, FCZ102GBI2, FCZ201GBI2, FCZ102GCG, FCZ201GCG, FCZ202GCG, FCZ102GCD, FCZ201GCD, FCZ202GCD, FCZ101GCG2, FCZ102GCG2, FCZ201GCG2, FCZ202GCG2, FCZ101GCD2, FCZ102GCD2, FCZ201GCD2, FCZ202GCD2, AOS061GAGQ, AOS061GBGQ, AOS101GAGQ, AOS101GBGQ...(Other models you can see in the webshop)		



GEV No.	100906	Ref. No.	003610 056641 057960 0974037 0G2227 0K5791 11061230 19013341 727759
description	screw connection thread M10x1 for ignition electrode brass Qty 1 pcs WS 10		



ignition cables

pre-assembled cables

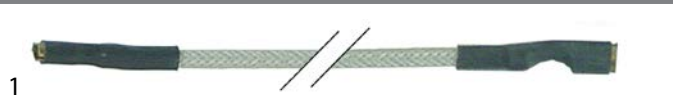

GEV No.	100176	Ref. No.	002544 059146
description	ignition cable cable length 1000mm connection ø2.4mm / ø4mm permanent temperature 200°C		
For models:	MR/G351, MR/G701, MR/G721, MR/G1071, MR/G350, MR/G350F, MR/G350NL, MR/G350E, MR/G360, MR/G360F, MR/G700, MR/G700F, MR/G700NL, MR/G700E, MR/G710, MR/G710F, MR/G1070, MR/G720, MR/G715, MR/G725, MR/G1075, MR/G361, MR/G711, MR/G716, MR/G726, MR/G1076, MFR/G740, MFR/G380, MFR/G381, MFR/G350, MFR/G351, MFR/G700, MFR/G701, MPN/GD761, MPN/GI761, MPN/GI760D, MPN/GD760, MPN/GD760F, MPN/GI760, MPN/GI760F, MT/G700D, MT/G700, MT/G350, MT/G352, MM/G351, MM/G701, MM/G350, MM/G700, MM/G350F, MM/G700F...(Other models you can see in the webshop)		

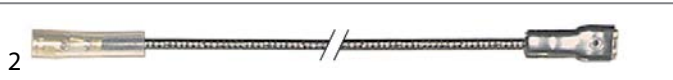

GEV No.	100026	Ref. No.	002578 0028398 054273 0K5687 0K1359 19012631
description	ignition cable cable length 1000mm connection ø4mm / F6.3mm		
For models:	MBR/G710D, MBR/G700, MBR/G700F, MBR/G700UK, MBR/G701, MBR/G706, MBR/G701UK, MBR/G751, MBR/G756, MFR/G350NL, MFR/G700NL, RBR/G710D, RBR/G700, RBR/G700F, 7BRG60, 7BRG60X, RBR/G701UK, RBR/G751, RBR/G756, XFR/G350NL, XFR/G700NL, XBR/G710D, XBR/G700, XBR/G710, XBR/G700F, XBR/G700UK, XBR/G701, M70GBP, XBR/G701UK, XBR/G751, XBR/G756, CBR/G700, RBR/G700, RBR/E700, RBR/G700, PTFG810, HMA/G800, HMA/G800D, HMA/G800NL, ZPTF/G1000, ZHMA/G80, CG148-001.A1AB, CG148-003.A2AB, CG248-201.A1ABBB, CG248-203.A1ABBB, CK248-209.D1ABBB, CK248-211.D1ABBB, LG159-703.A1BC, LG159-703.A2BC, LG159-704.A1BC...(Other models you can see in the webshop)		



GEV No.	106848	Ref. No.	0C5328
description	ignition cable cable length 1040mm connection F2.8/ø6mm		



GEV No.	102180	Ref. No.	005559
description	ignition cable cable length 1200mm connection ø2.4mm / ø2.4mm		
For models:	1TPG18F, 110FTL/N, 1102FTL/N, 110FTR/N, 1102FTR/N, 110CP1, NCG/2FV, NFT/2GL, NFT/4GL, NFT/2GR, NFT/4GR, NFT/4GLR, NFT/4GL-RC, NFT/2GLC, NFT/4GLC, NCG1V, NCG2V, NTP/A, 090213, 090214, PTF/GG1835, PRA/G420, PRA/G430, PRA/G440, PRA/G840, PRA/G850, PRA/G860, PCP/G840, 1TPG18F, 1FTGF4L, 1FTGF4R, 1FTGC4L, 1FTGF8L, 1FTGF8R, 1FTGC8L, 1CP/G08S		



GEV No.	103335	Ref. No.	0A5295
description	ignition cable cable length 1650mm connection ø2.4mm / ø4mm		
For models:	MCF/G995, RCF/G9, XCF/G9, MCF/G9, CCF/G710, CCF/G995, CCF/G996, PCF/G9, OCF/G840, OTF/G840, FCF/G6L3TOWNGAS, FCF/G6L3, FCF/G6L3JAP, FCF/G6-0, FCF/G6-1-JAP, ECF/G6/0, ACF/G6-0, JCF/G6-1, JCF/G6-2, RCF/G61G, ACV/G6C3, NCF/G6-0, NCV/G6L2, ZCF/G6-0		

GEV No.	102174	Ref. No.	0K0885 0K0886 0K0999 218597 220639
description	ignition cable cable length 2000mm connection ø4mm / F2.8mm		
For models:	7511-2, 7544-2, 7550-2, 7551-2, 7552-2, 7553-2, 7573-2, 7574-2, 7575-2, 7576-2, 7742-2, 7744-2, 7773-2, 7774-2, 7775-2, 7776-2		

GEV No.	106850	Ref. No.	0C5327
description	ignition cable cable length 580mm connection F2.8/ø6mm		

GEV No.	100018	Ref. No.	00123 0028521 004943 059578 0U3507
description	ignition cable cable length 600mm connection ø2.4mm / ø4mm permanent temperature 200°C		
For models:	MFR/G360, RFR/G360, T35GFR, HPN/GI815D, HPN/GI816, ZPN/GI816D, APN/GI816D, SFRG350, SFRG700, SCPG350, SFRG350, SFRG700, SRG350, SRG360, SRG700, SRG710, SMG350, SMG700, SCPG350		

GEV No.	100025	Ref. No.	0K0997 0K0998 0K9965
description	ignition cable cable length 600mm connection ø4mm / F6.3mm		
For models:	9030-2, 9031-2		



GEV No.	106849	Ref. No.	0C5329
description	ignition cable cable length 850mm connection F2.8/ø6mm		



GEV No.	100019	Ref. No.	003755 006514
description	ignition cable cable length 900mm connection ø2.4mm / ø4mm		
For models:	BF/G1S07, BG/G1, BG/G2, BCP/G1, RBR/G2FM, RBR/G2IM, RBK/G2FM, RFR/G2S40, RR/G1FL, RR/G1FR, RR/G1CL, RR/G2FL, RR/G2FM, RR/G2CL, RRV/G1FL, RRV/G1FR, RRV/G1CL, RRV/G2FL, RRV/G2FM, RRV/G2CL, RR/G2CM, RG/G1, RG/G2, RGV/G1, RGV/G2, RTV/G2, RTF/G2, RCP/G1S, RCP/G2D, RBV/G2, XFR/G1S14, XFR/G2D14, XR/G1FL, XR/G1FR, XR/G1CL, XR/G2FL, XR/G2FM, XR/G2CL, XRV/G1FL, XRV/G1FR, XRV/G1CL, XRV/G2FL, XRV/G2FM, XRV/G2CL, XR/G2CM, XG/G1, XG/G2, XGV/G1, XGV/G2, XTV/G2...(Other models you can see in the webshop)		

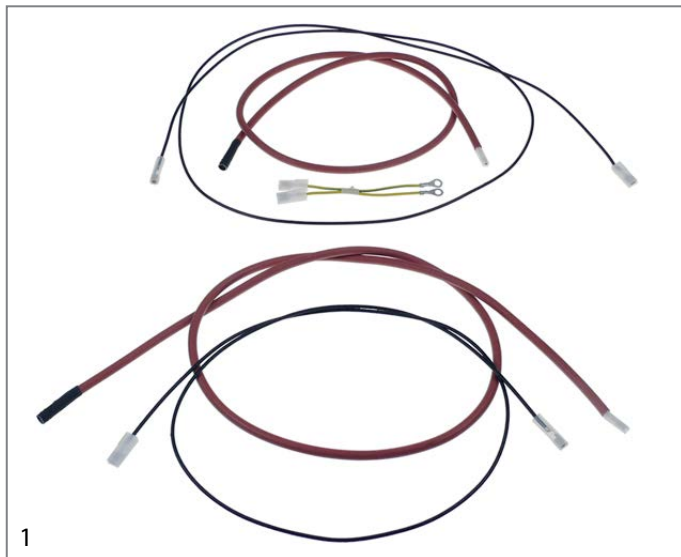

1

GEV No.	106851	Ref. No.	003083 006024
description	ignition cable set 1x6.3/ø4mm L:1100 1x6.3/ø4mm L:1500 1x2.8/ø6mm L:900 1x2.8/ø6mm L:1200 2x6.3/lug 5mm L:100		
For models:	FCV/G102/1L6JAP, FCV/G102/1L6, FCV/G102/1, FCS102G4, FCS102GP, FCS102GX, 5712-2-6, 5712-2-7, 5712-2-8, 5712-2-10, 5714-2-6, 5714-2-7, 5714-2-8, 5714-2-10, 5717-2-6, 5714-2-7, 5714-2-8, 5714-2-10, 5712-2-6L, 5712-2-7L, 5712-2-8L, 5712-2-10L, 5714-2-6L, 5714-2-7L, 5714-2-8L, 5714-2-10L, 5714-2-6L, 5714-2-7L, 5714-2-8L, 5714-2-10L, 5702-2-2, 5702-2-3, 5704-2-2, 5704-2-3, 5707-2-2, 57074-2-3, ECV/G102/1T6, ACV/G102/1C6, ZCV/G102/1T6		

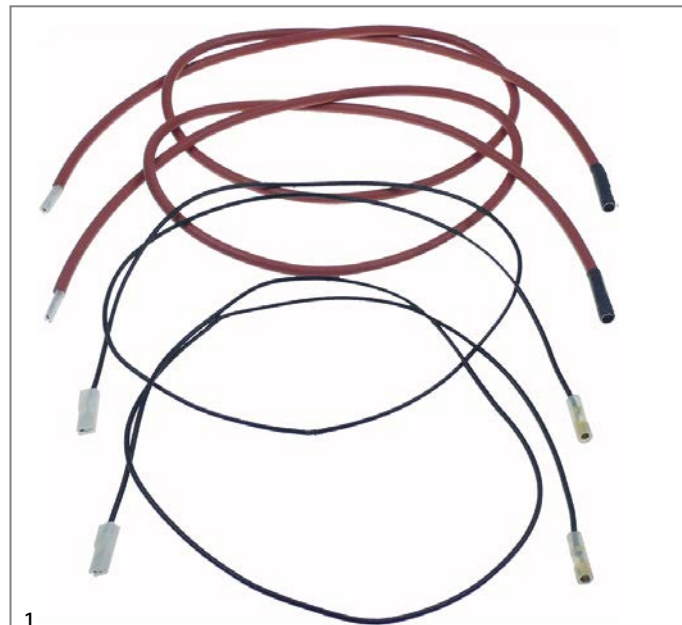

1

GEV No.	106879	Ref. No.	002953
description	ignition cable set 2x6.3/ø4mm L:1100 2x2.8/ø6mm L:1100		



1

GEV No.	106852	Ref. No.	006023
description	ignition cable set 1x6.3/ø4mm L:660 1x6.3/ø4mm L:1250 1x2.8/ø6mm L:700 1x2.8/ø6mm L:800 2x6.3/lug 5mm L:100		
For models:	FCV/G101/1, FCS101G4, FCS101G4DT, FCS101GP, FCS101GX		

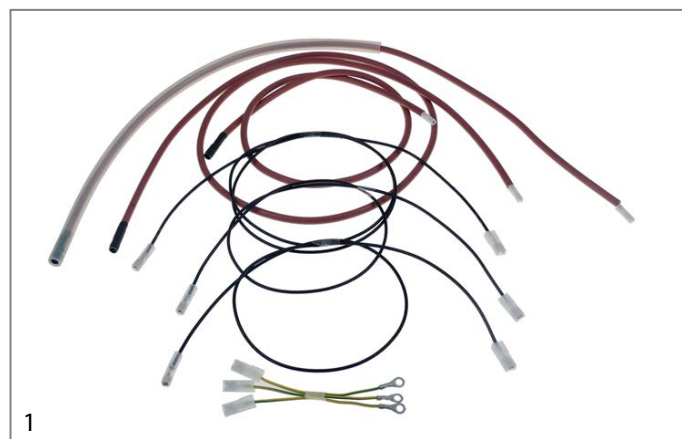

1

GEV No.	106853	Ref. No.	006397
description	ignition cable set 3x6.3/lug 5mm L:100 2x6.3/ø4mm L:800 1x6.3/ø4mm L:1350 2x2.8/ø6mm L:800 1x2.8/ø6mm L:1370		
For models:	FCV/G20L3, FCV/G20L6, 5714-2-7, 5714-2-8, 5714-2-10, 5714-2-7L, 5714-2-8L, 5714-2-10L, ECV/G20T4, ECV/G20T6, ACV/G20C4, ACV/G20C6, ZCV/G20T4, ZCV/G20T6		

piezoelectric igniters

mounting diameter 18mm



1

GEV No.	100012	Ref. No.	002605 0C9240 0K4313 0K5793 10041 19013347 727705
description	piezoelectric igniter body plastic blowing mounting ø 18mm connection ø2.4mm		
For models:	MCF/G995, MR/G351, MR/G701, MR/G721, MR/G1071, MR/G350, MR/G350F, MR/G350NL, MR/G350E, MR/G360, MR/G360F, MR/G700, MR/G700F, MR/G700NL, MR/G700E, MR/G710, MR/G710F, MR/G1070, MR/G720, MR/G715, MR/G725, MR/G1075, MR/G361, MR/G711, MR/G716, MR/G726, MR/G1076, MFR/G360, MFR/G740, MFR/G380, MFR/G381, MFR/G350, MFR/G351, MFR/G700, MFR/G701, MPN/GD761, MPN/GI761, MPN/GI760D, MPN/GD760, MPN/GD760F, MPN/GI760, MPN/GI760F, BF/G1507, MT/G700D, MT/G700, MT/G350, MT/G352, MM/G351, MM/G701, MM/G350...(Other models you can see in the webshop)		



1

GEV No.	100009	Ref. No.	003526 058593 059251 0A2127	
description	piezoelectric igniter body plastic blowing mounting ø 18mm connection ø2.4mm front measurements 26mm M18x1.5			
For models:	MR/G350F, MR/G350NL, MR/G350E, MR/G360F, MR/G700F, MR/G700NL, MR/G700E, MR/G710F, MFR/G360, MPN/GI760D, MPN/GD760F, MPN/GI760F, BF/G1507, BG/G1, BG/G2, BCP/G1, MM/G350F, MM/G700F, MM/G700E, MG/G350E, MG/G350F, MG/G350NL, MG/G700E, MG/G700F, MG/G700NL, MG/G1050F, RR/G350D, RR/G700D, RR/G720D, RR/G360F, RR/G710F, 7FTGC1L, RR/G1070D, RR/G350F, RR/G700F, RFR/G360, RPN/GD760F, RPN/GI760F, RM/G350D, RM/G700D, RM/G350F, RM/G700F, RG/G350D, RG/G700D, RG/G350F, 7GLG07, RG/G700F, 7GLG10, RG/G1050, T35GFR...(Other models you can see in the webshop)			
accessories for	100009			
	GEV No.	101339	Ref. No.	002816 0C9409
	cover cap for piezoelectric igniter			
	GEV No.	106869	Ref. No.	—
	cover cap for piezoelectric igniter ID ø 22mm ED ø 35mm H 25mm			
	GEV No.	107931	Ref. No.	—
	cover cap for piezoelectric igniter ID ø 21mm ED ø 36mm			

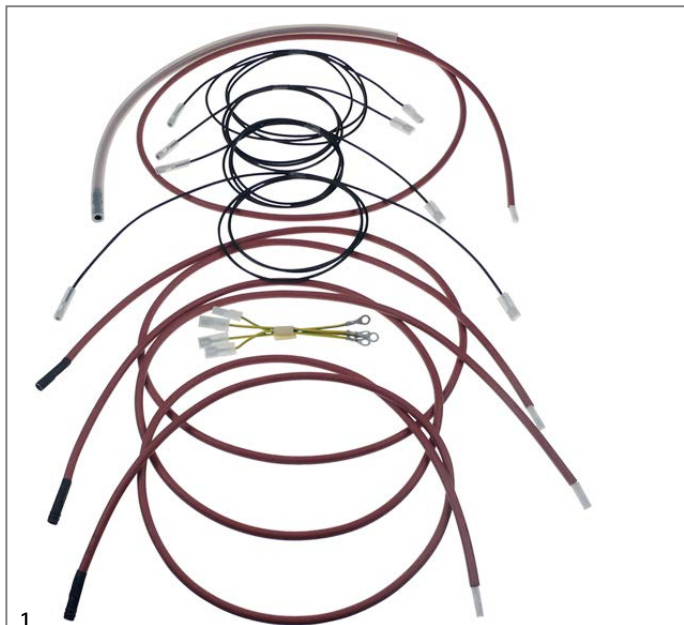

1

GEV No.	106854	Ref. No.	003082
description	ignition cable set 4x6.3/lug 5mm L:100 1x6.3/ø4mm L:1170 2x6.3/ø4mm L:1300 2x6.3/ø4mm L:1650 2x2.8/ø6mm L:1300 1x2.8/ø6mm L:1700		
For models:	FCVG202L3, FCVG202L6, 5714-2-7, 5714-2-8, 5714-2-10, 5714-2-7L, 5714-2-8L, 5714-2-10L, ECVG202T4, ECVG202T6, ACVG202C4, ACVG202C6, ZCV/G202/1, ZCV/G202/1		

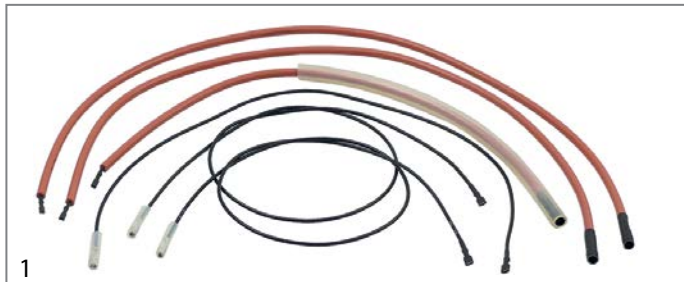

1

GEV No.	107872	Ref. No.	0C0759
description	ignition cable set 6-piece suitable for combi-steamer ELECTROLUX, ZANUSSI		
For models:	FCV/G201/1, FCS201G4, FCS201GP, FCS201GX		



mounting diameter 22mm



GEV No.	100013	Ref. No.	00128 004944 0073960 0K3510
description	piezoelectric igniter body plastic blowing mounting ø 22mm connection ø2.4mm cable lengthmm		
For models:	SCG350, SCG700, SCG1050, SFRG350, SFRG700, SCPG350, SCG350, SCG700, SCG1050, SFRG350, SFRG700, SRG350, SRG360, SRG700, SRG710, SMG350, SMG700, SCPG350, SGG350, SGG700, PPL5GG, PPFL5GG		
accessories for	100013		
	GEV No.	100023	Ref. No. —
	female bullet size 2.3mm 0.5-1.5mm ² CuZn t.max. 125°C Qty 20 pcs		



GEV No.	100005	Ref. No.	0073952 058497 0H6070 0K3450 0K9945
description	piezoelectric igniter body plastic blowing mounting ø 22mm connection ø2.4mm cable lengthmm SIT		
For models:	RF/G350D, RF/G700D, 7502-2, 7504-2, 7505-2-9, 7508-2, 7511-2, 7512-2, 7512-9, 7530-2, 7531-2, 7542-2, 7544-2, 7711-2, 7730-2, 7731-2, 7742-2, 7744-2, 9012-2, 9211-2-0		

miscellaneous



GEV No.	nla ¹	Ref. No.	052539 058225 059284 0K0210 0K2886 0K9955 0KB976 100007
description	piezoelectric igniter body metal connection F6.3x0.8 2 hole fixing ø 22mm		

¹no longer available



GEV No.	nla ¹	Ref. No.	002580 0G0078 0K4255 0K5693 0K5694 19012677 19012678 720125 752830006
description	piezoelectric igniter body metal connection F6.3x0.8 3 hole fixing ø 22mm		
For models:	CG148-001.A1AB, CG148-003.A2AB, CG248-201.A1ABBB, CG248-203.A1ABBB, CK248-209.D1ABBB, CK248-211.D1ABBB, LG159-703.A1BC, LG159-703.A2BC, LG159-704.A1BC, LG159-706.A1BC, LG259-711.A1ACC, LG259-712.A1ACC, LK259-707.D1ACC, LK259-708.D1ACC, LG259-739.A1ACC, LG259-740.A1ACC, CK248-205.D1ABBB, CK248-207.D1ABBB, LK159-707.D1BC, LK159-708.D1BC, LK259-727.D1ACC, LK259-728.D1ACC, LG159-704.A2BC, LK159-707.D2BC, LK159-708.D2BC, LG259-711.A2ACC, LG259-712.A2ACC, LK259-727.D2ACC, LK259-728.D2ACC, LK259-707.D2ACC, LK259-708.D2ACC, CK248-205.D2ABBB, CK248-207.D2ABBB, CK248-209.D2ABBB, CK248-211.D2ABBB, CG148-004.A1AB, CG148-005.A1AB, CG148-006.A1AB, CG248-240.A1ABBB, CG248-243.A1ABBB, CG248-244.A1ABBB, CG248-212.A1ABBB, CG248-213.A1ABBB, LG159-705.A1BC, LG159-753.A1BC, LG259-758.A1ACC, LG259-754.A1ACC, LG259-757.A1ACC, CG148-001.A3AB, CG148-003.A2AB...(Other models you can see in the webshop)		

¹no longer available



GEV No.	107564	Ref. No.	0C8450
description	piezoelectric igniter body plastic blowing connection F6.3x0.8 ø 22mm		
accessories for	107564		
	GEV No.	100025	Ref. No. 0K0997 0K0998 0K9965
	ignition cable cable length 600mm connection ø4mm / F6.3mm		

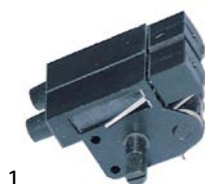





GEV No.	100114	Ref. No.	0K0300
description	piezoelectric igniter rotary		



			
1			
GEV No.	nla ¹	Ref. No.	002057 0073703 02112 02P01 0K5720 0M0843 19012784
description	piezoelectric igniter suitable for Minisit connection F6.3x0.8 ømm		
For models:	CR15G		

¹no longer available

			
1			
GEV No.	107517	Ref. No.	003271 0C8410
description	piezoelectric igniter suitable for Minisit connection F6.3x0.8 with cover cap ø 22mm		
spare parts for	107517		
	GEV No.	107564	Ref. No. 0C8450
	piezoelectric igniter body plastic blowing connection F6.3x0.8 ø 22mm		
accessories for	107517		
	GEV No.	100025	Ref. No. 0K0997 0K0998 0K9965
	ignition cable cable length 600mm connection ø4mm / F6.3mm		

			
1			
GEV No.	nla ¹	Ref. No.	003128 0073208 051567 054269 0H6049 0K5721 19012785 75800552
description	piezoelectric igniter suitable for Minisit with cover cap ømm connection F6.3x0.8		
For models:	MBR/G710D, MBR/G700, MBR/G700F, MBR/G700UK, MBR/G701, MBR/G706, MBR/G701UK, MBR/G751, MBR/G756, MFR/G350NL, MFR/G700NL, MFG1500Z, MFG2200Z, RBR/G710D, RBR/G700, RBR/G700F, 7BRG60, 7BRG60X, RBR/G701UK, RBR/G751, RBR/G756, XFR/G350NL, XFR/G700NL, XBR/G710D, XBR/G700, XBR/G710, XBR/G700F, XBR/G700UK, XBR/G701, M70GBP, XBR/G701UK, XBR/G751, XBR/G756, CBR/G700, RBR/G700, RBR/E700, RBR/G700, RFR/G300, RFR/G300, RFR/G300, PRFR/G300, PRFR/G300, RFR/G700, RFR/G700, RFR/G700, PRFR/G700, RFR/G700, PMG600, PMG600D, QFE300...(Other models you can see in the webshop)		
spare parts for	101136		
	GEV No.	100001	Ref. No. 002057 0073703 02112 02P01 0K5720 0M0843 19012784 73703
	piezoelectric igniter suitable for Minisit connection F6.3x0.8 ømm		

¹no longer available

			
1			
GEV No.	107822	Ref. No.	0G6821 0KI332/11151101
description	piezoelectric igniter switch knob connection ø2.4 shaft ø 6x5mm		

accessories

			
1			
GEV No.	101339	Ref. No.	002816 0C9409
description	cover cap for piezoelectric igniter		
For models:	MCF/G995, MR/G351, MR/G701, MR/G721, MR/G1071, MR/G350, MR/G360, MR/G700, MR/G710, MR/G1070, MR/G720, MR/G715, MR/G725, MR/G1075, MR/G361, MR/G711, MR/G716, MR/G726, MR/G1076, MFR/G740, MFR/G380, MFR/G381, MFR/G350, MFR/G351, MFR/G700, MFR/G701, MPN/GD761, MPN/GI761, MPN/GD760, MPN/GI760, BF/G1507, MT/G700D, MT/G700, MT/G350, MT/G352, MM/G351, MM/G701, MM/G350, MM/G700, MF/G700, MCP/G700, MCP/G701, MCP/G710, MCP/G711, MCP/G705, MCP/G706, MG/G350D, MG/G700D, MG/G350, MG/G700...(Other models you can see in the webshop)		



ignition units

			
1			
GEV No.	102485	Ref. No.	002297 003376 004240 03200241 051884 052577 053248 053647 057109 066868 069347 0A2073 0K2885 0M0475
description	ignition unit outputs 2 220-240VAC 0.6VA 50-60Hz		
For models:	MCF/G705, MCF/G1055, MCF/G700, MCF/G1050, MCF/G705E, MCF/G1055E, MCF/G700D, MCF/G700, MCF/G705F, MCF/G1055F, MCF/G705NL, MCF/G1050D, MCFG1055NL, MC/G355, MC/G350, MC/G355E, MC/G355F, MCF/G1090, MCF/G1095, MCF/G702, MCF/G1052, MCF/G700, MCF/G1050, MFR/G350, MFR/G700, MFR/G350D, MFR/G700D, MFR/G350F, MFR/G700F, MFR/G350E, MFR/G700E, MTF/GE1050, MT/G700F, MTF/G700F, MTF/G1055F, MTFGE1055F, MCP/G700, VO40G, RC/G1, XC/G1, JC/G1, MC/G1, RCF/G720, RCF/G1020, RCFG730, RCFG1030, RCF/G720F, RCF/G1020, RC/G350, RCF/G700... (Other models you can see in the webshop)		

			
1			
GEV No.	103334	Ref. No.	0C4105
description	ignition unit outputs 2 220-240VAC dimensions 83x42x32mm mounting distance 34mm inlet F2.8 outlet F2.8 type TSM 17VA 50/60Hz		
For models:	FCZ061GAG, FCZ101GAG, FCZ102GAG, FCZ201GAG, FCZ202GAG, FCZ061GAD, FCZ101GAD, FCZ102GAD, FCZ201GAD, FCZ202GAD, FCZ101GTG, FCZ102GTG, FCZ201GTG, FCZ202GTG, FCZ101GTD, FCZ102GTD, FCZ201GTD, FCZ202GTD, FCZ061GBG, FCZ101GBG, FCZ102GBG, FCZ201GBG, FCZ202GBG, FCZ061GBD, FCZ101GBD, FCZ102GBD, FCZ201GBD, FCZ202GBD, FCZ061GBI, FCZ101GBI, FCZ201GBI, FCZ101GBG2, FCZ102GBG2, FCZ201GBG2, FCZ202GBG2, FCZ101GBD2, FCZ102GBD2, FCZ201GBD2, FCZ202GBD2, FCZ101GBI2, FCZ102GBI2, FCZ201GBI2, FCZ061GCG, FCZ101GCG, FCZ102GCG, FCZ201GCG, FCZ202GCG, FCZ061GCD, FCZ101GCD, FCZ102GCD... (Other models you can see in the webshop)		

			
1			
GEV No.	101016	Ref. No.	0H6071 0K3019
description	ignition unit outputs 2 230VAC inlet F6.3x0.8 outlet F2.8x0.8 1.7VA 50Hz mounting ø 42mm		
For models:	7507-2, 7508-2, 7550-2, 7551-2, 7552-2, 7553-2, 7707-2		

			
1			
GEV No.	106571	Ref. No.	0K2374
description	ignition unit outputs 4		
For models:	7508-2		

			
1			
GEV No.	101015	Ref. No.	004248 01A26 054134 0A2097 0K9979 0KI131 0M0476 BF50046106
description	ignition unit outputs 4 230VAC 0.6VA 50Hz		
For models:	RC/G320, RC/G330, RC/G320F, RC/G720, RC/G730, MCF/G705, MCF/G700, MCF/G705E, MCF/G700D, MCF/G700, MCF/G705F, MCF/G705NL, MCF/GE705, MCF/GE700, MCF/GE700D, MC/G705, MC/G700, MC/G705E, MC/G705F, MTF/GE1050, MT/G700F, MTF/G700F, MTF/G1055F, MTFGE1055F, RCV/G320, RCV/G330, RCV/G320, RCV/G720, RCV/G730, RCV/G720, RCF/G720, RCFG730, RCF/G720F, RCF/GE720, RCF/GE730, RCF/GE720, RCF/GE720, RC/G700, RCF/G700, RCF/GE700D, RCF/G700D, RC/G700F, RCF/G700, RCF/GE700, RT/G700F, RTF/G700, RTF/G1050, T70GCK, M70GCK/G, XCF/GE700D... (Other models you can see in the webshop)		

			
1			
GEV No.	101003	Ref. No.	003214 0G0807
description	ignition unit outputs 4 230VAC 50Hz		
For models:	MCF/G702, MCF/G700, RCF/G702, 74FG07F, T70GCK, M70GCK/G, M70GCH/E, XTF/G1050D, M105GST/GA, XTF/G1050F		

			
1			
GEV No.	102388	Ref. No.	004248
description	ignition unit outputs 4 230VAC dimensions 111x23x34mm mounting distance 100mm inlet F6.3x0.8 outlet F2.8x0.8 type WAC-T4 0.6VA 50/60Hz		
For models:	RC/G2, RCV/G2, RCF/G3, RCF/M2, RSF/G2, RSV/G2, RSF/G3, MCF/G3A, XC/G2, XCV/G2, XCF/G3, XCF/M2, XSF/G2, XSV/G2, XSF/G3, JC/G2, JCV/G2, JCF/G3, JCF/M2, MC/G2, MCV/G2, MCF/G3, MCF/M2, MSF/G2, MSV/G2, MSF/G3		



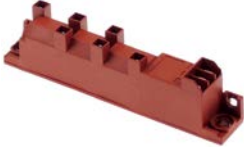

			
1			
GEV No.	102389	Ref. No.	004251
description	ignition unit outputs 6 230VAC dimensions 135x23x34mm mounting distance 123mm inlet F6.3x0.8 outlet F2.8x0.8 0.6VA 50/60Hz		
For models:	RCV/G3, RCF/G2, RCF/M3, MCF/G2A, XCV/G3, XCF/G2, XCFM3, JCV/G3, JCF/G2, JCFM3, MCV/G3, MCF/G2, MCF/M3		

			
1			
GEV No.	101004	Ref. No.	003552 054141 058826
description	ignition unit outputs 6 230VAC inlet F6.3x0.8 outlet F2.8x0.8 50Hz mounting ø 88mm		
For models:	MCF/G1055, MCF/G1050, MCF/G1055E, MCF/G1055F, MCF/GE1055, MCFGE1050, MCFGE1050D, MCF/G1050D, MCFG1055NL, MC/G1055, MC/G1050, MCF/GE1055UK, MCF/G1090, MCF/G1095, MCF/G1052, MCF/G1050, RCF/G1020, RCFG1030, RCF/G1020, RCF/G1050, RCF/G1050D, RCFGE1050D, MCF/G1050, RC/G1050, RCF/G1052, 76FG10F, XC/G1050, M105GCK/E, XC/1050D, XCF/G1050D, XCF/G1050F, XCFG1055NL, T105GCK, M105GCK/G, M105GCK/E, RCF/G1020, RCF/G1030		

ignition switches

			
1			
GEV No.	345038	Ref. No.	053978 058274 727946
description	momentary push switch mounting ø 25mm black 2NO 250V 16A connection male faston 6.3mm ambient temperature max. 85°C protection IP40		
For models:	RC/G320, RC/G330, RC/G320F, RC/G720, RC/G730, MCF/G705, MCF/G1055, MCF/G700, MCF/G1050, MCF/G705E, MCF/G1055E, MCF/G700D, MCF/G700, MCF/G705F, MCF/G1055F, MCF/G705NL, MCF/GE705, MCF/GE1055, MCF/GE700, MCFGE1050, MCF/GE700D, MCFGE1050D, MCF/G1050D, MCFG1055NL, MC/G355, MC/G350, MC/G355E, MC/G350D, MC/G355F, MC/G355NL, MC/G705, MC/G700, MC/G705E, MC/G700D, MC/G705NL, MC/G1055, MC/G1050, MC/G1050D, MC/G1055NL, MC/G705F, MCF/GE1055UK, MCF/G1090, MCF/G1095, MC/G352, MC/G702, MC/G1052, MCF/G702, MCF/GE702, MCF/G1052, MCFGE1052...(Other models you can see in the webshop)		

			
1			
GEV No.	301014	Ref. No.	0K6805 0KB556 201120021 301014 464129209 4641292091 990700
description	momentary rocker switch mounting measurements 30x11mm black 1NO 250V 16A connection male faston 6.3mm ambient temperature max. 85/125°C protection IP40 mounting ømm male faston 6.3mm		
For models:	D180, D180, D180, D180, D180		

			
1			
GEV No.	301207	Ref. No.	004241
description	microswitch operation switch mounting distance 24mm 250V 0.5A NO connection male faston 4.8mm type 209 actuating force: 400g		
For models:	RC/G1, RC/G2, RCV/G2, RCV/G3, RCF/G2, RCF/G3, RCF/M2, RCF/M3, RSF/G2, RSV/G2, RSF/G3, MCF/G2A, MCF/G3A, XC/G1, XC/G2, XCV/G2, XCV/G3, XCF/G2, XCF/G3, XCF/M2, XCFM3, XSF/G2, XSV/G2, XSF/G3, JC/G1, JC/G2, JCV/G2, JCV/G3, JCF/G2, JCF/G3, JCF/M2, JCFM3, MC/G1, MC/G2, MCV/G2, MCV/G3, MCF/G2, MCF/G3, MCF/M2, MCF/M3, MSF/G2, MSV/G2, MSF/G3		

thermocouples

thermocouple sets universal

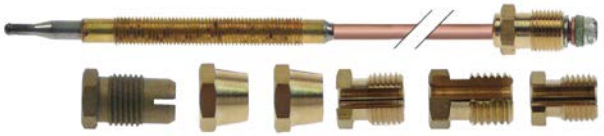
			
1			
GEV No.	103355	Ref. No.	0KB732 0KB972 0KC366 0KC368 0KF226 0KG315 0KG409 0S0056 G1724003
description	thermocouple set SIT 7-piece L 1200mm		

			
1			
GEV No.	103354	Ref. No.	0KB964 0KC254 0S0055 G1724002
description	thermocouple set SIT 7-piece L 900mm		



GEV No.	102003	Ref. No.	OU1115
description	thermocouple set 10-piece L 900mm		
For models:	GMG4-60, GMG4-60-AL, GMG4-60-ZO, GMG4-80, GMG4-80-AL, GMG4-80-ZO, SL/G460, SL/G480		

plug-in thermocouples

plug-in thermocouples standard

with barrel socket ø5mm - type Junkers with aluminised tip

GEV No.	102202	Ref. No.	0G2378 OKI386 OKJ690 102202 623568 72225601 726531
description	thermocouple M8x1 L 320mm plug connection ø5.0mm		
For models:	BE1-TA.3, BE1-W.3, BE1-WS-M.3, BE2-A-C.3, BE2-A-M.3, BE2-WS-C.3, BE2-WS-M.3, BE3-C.3, BE3-M.3, CE128-106, CE158-133.3.HV, CE158-244.3, CE158-246.3, CK248-209.D1ABBB, CK248-211.D1ABBB, HCE128-100, HCE128-104, HCE158-252W.3, HCE158-253.3, HLE129-100, HLE129-103, HLE129-104W, HLE159-252W.3.6, HLE159-328.3.HV, HLE159-351W.3.HV, HLE249-200.3, HLE249-208.3, HLE259-088.3.HV, HLE259-089.3.HV, HLE259-384W.3, LE129-101, LE159-261.3, LE159-281.3.6, LE159-318.3.HV, LE159-322.3.HV, LE159-330.3.HV, LE159-337.3.HV, LE159-344.3.MS92, LE159-347.3.HV, LE249-199.3, LE249-203.3, LE249-207.3, LE249-211.3, LE249-215.3, LE249-219.3, LE249-223.3, LE249-232.3, LE249-238.3, LE259-081.3.HV, LE259-082.3.HV...(Other models you can see in the webshop)		
accessories for	102202		
		GEV No.	101260 Ref. No. —
	thermocouple fitting thread M8x1 Qty 1 pcs		

GEV No.	102205	Ref. No.	0260138 054102 054103 054104 058332 0G0790 0G2417 0K2870 0KT836 19013307 727773
description	thermocouple M8x1 L 750mm plug connection ø5.0mm		
For models:	RC/G320, RC/G330, RC/G320F, RC/G720, RC/G730, MCF/G700, MCF/G1050, MCF/G700D, MCF/G700, MCF/G705NL, MCF/GE700, MCF-GE1050, MCF/GE700D, MCFGE1050D, MCF/G1050D, MCFG1055NL, MC/G350, MC/G350D, MC/G355NL, MC/G700, MC/G700D, MC/G705NL, MC/G1050, MC/G1050D, MC/G1055NL, MCF/G1090, MCF/G1095, MCF/G995, MC/G352, MC/G702, MC/G1052, MCF/G702, MCF/GE702, MCF/G1052, MCFGE1052, MC/G350, MC/G700, MC/G1050, MCF/G700, MCF/GE700, MCF/G1050, MCFGE1050, BC/G1, BCF/G2, MTF/G700D, MTF/G1050D, MTF/G700, MTF/G1050, MTF/GE1050, RC/G1...(Other models you can see in the webshop)		
accessories for	102205		
		GEV No.	101260 Ref. No. —
	thermocouple fitting thread M8x1 Qty 1 pcs		

GEV No.	102294	Ref. No.	OKI369 101.260 102205 726532
description	thermocouple M8x1 L 750mm plug connection ø5.0mm		
For models:	AGGRHFGOOO, AGGRHAGOOO, AGGRHBGOOM, AGGRABGOOO, AGGRHBGOOO, AGGWHFGBOO, AGGWHFGBOO, AGGWFBGOOM, AGGWABGOOO, AGGWFBGOOO, ALGWHF0000, ALGWHA0000, ALGWHC0000, AGGYIFGFCO, AGGYIAGFCO, AGGYIBGFCO, AGGRAAGOOM, AGGRAFGOOM, AGGWAAGBOM, AGGWAFGBOM, AGGYJAGFCM, AGGYJFGFCM, AGGYJBGFCM, AGGWDBGOOO, AGGWDFGBOO, AGGWDAAGBOM, AGGWDFGBOM, AGGWDBGBOM, AGGYKFGFCO, AGGYKBFGFCO, AGGYKAGFCM, AGGYKFGFCM, AGGYKBFGFCM, AGPWACAGBOO, AGPWACAGBOM, AGPWCFGBOM, AGPWCBGBOM, AGGYLAGFCO, AGGYLFGFCO, AGGYLAGFCM, AGGYLFGFCM, AGGYLBGF-CM, ALPWCA0000, ALGWDF0000, ALGWDC0000, AGGROIGOOO, AGGWOIGBOO, AGGYOIGFCO, AGGROIGOOM, AGGWOIGBOM...(Other models you can see in the webshop)		

with barrel socket ø6mm

type Junkers with aluminised tip

GEV No.	102229	Ref. No.	0H6174 OK9988 102032 102229 7749101167
description	thermocouple M10x1 L 1000mm plug connection ø6.0mm		



GEV No.	102231	Ref. No.	0K0656 0K0687 0K9989 102231 7749101169
description	thermocouple M10x1 L 1500mm plug connection ϕ 6.0mm		

GEV No.	102228	Ref. No.	0H6175 102031 102228
description	thermocouple M10x1 L 750mm plug connection ϕ 6.0mm		

GEV No.	102223	Ref. No.	0K0653 0K0654 0KB965 0KB967 102017 102018 102223
description	thermocouple M8x1 L 1200mm plug connection ϕ 6.0mm		

GEV No.	102218	Ref. No.	0K0682 0K0689 102019 102217 102218
description	thermocouple M8x1 L 320mm plug connection ϕ 6.0mm		

GEV No.	102221	Ref. No.	0K0683 0K0686 102219 102221
description	thermocouple M8x1 L 750mm plug connection ϕ 6.0mm		

with barrel socket ϕ 6(6.5)mm

thermocouples SIT

GEV No.	107626	Ref. No.	056715
description	thermocouple SIT ASA 11/32 L 1500mm plug connection ϕ 6.0(6.5)mm		
For models:	FZG18, FZ/G18		

GEV No.	107624	Ref. No.	057343
description	thermocouple SIT ASA 11/32 L 850mm plug connection ϕ 6.0(6.5)mm		

GEV No.	107619	Ref. No.	0290059 0290064 0A2161 0H6251 0H6253 0H6254 0KB968 215780
description	thermocouple SIT M10x1 L 1000mm plug connection ϕ 6.0(6.5)mm		
For models:	7500-2, 7501-2, 7502-2, 7502-9, 7503-2, 7504-2, 7504-9, 7505-2-9, 7505-9-9, 7508-2, 7511-2, 7512-2, 7512-9, 7530-2, 7531-2, 7550-2, 7551-2, 7552-2, 7553-2, 7700-2, 7701-2, 7703-2, 7711-2, 7730-2, 7731-2, 9000-2, 9001-2, 9002-2, 9004-2, 9006-9, 9012-2, 9030-2, 9031-2, 9201-2, 9203-2, 9211-2-0		



GEV No.	107621	Ref. No.	0290068 0H6248 0H6252 0KB970
description	thermocouple SIT M10x1 L 1500mm plug connection ø6.0(6.5)mm		
For models:	7542-2, 7544-2, 7742-2, 7744-2, 9042-2, 9044-2		

GEV No.	107601	Ref. No.	050856 0G1120 0K5729 0KI368 19012830
description	thermocouple SIT M8x1 L 600mm plug connection ø6.0(6.5)mm		
For models:	CG148-001.A1AB, CG148-003.A2AB, CG248-201.A1ABBB, CG248-203.A1ABBB, CK248-209.D1ABBB, CK248-211.D1ABBB, LG159-703.A1BC, LG159-703.A2BC, LG159-704.A1BC, LG159-706.A1BC, LG259-711.A1ACCB, LG259-712.A1ACCB, LK259-707.D1ACCB, LK259-708.D1ACCB, LG259-739.A1ACCB, LG259-740.A1ACCB, CK248-205.D1ABBB, CK248-207.D1ABBB, LK159-707.D1BC, LK159-708.D1BC, LK259-727.D1ACCB, LK259-728.D1ACCB, LG159-704.A2BC, LK159-707.D2BC, LK159-708.D2BC, LG259-711.A2ACCB, LG259-712.A2ACCB, LK259-727.D2ACCB, LK259-728.D2ACCB, LK259-707.D2ACCB, LK259-708.D2ACCB, CK248-205.D2ABBB, CK248-207.D2ABBB, CK248-209.D2ABBB, CK248-211.D2ABBB, CG148-004.A1AB, CG148-005.A1AB, CG148-006.A1AB, CG248-240.A1ABBB, CG248-243.A1ABBB, CG248-244.A1ABBB, CG248-212.A1ABBB, CG248-213.A1ABBB, LG159-705.A1BC, LG159-753.A1BC, LG259-758.A1ACCB, LG259-754.A1ACCB, LG259-757.A1ACCB, CG148-001.A3AB, CG148-003.A2AB...(Other models you can see in the webshop)		

GEV No.	107604	Ref. No.	002573 0200129 0K5730 19012831
description	thermocouple SIT M8x1 L 1200mm plug connection ø6.0(6.5)mm		
For models:	CG148-001.A1AB, CG148-003.A2AB, CG248-201.A1ABBB, CG248-203.A1ABBB, CK248-209.D1ABBB, CK248-211.D1ABBB, LG159-703.A1BC, LG159-703.A2BC, LG159-704.A1BC, LG159-706.A1BC, LG259-711.A1ACCB, LG259-712.A1ACCB, LK259-707.D1ACCB, LK259-708.D1ACCB, LG259-739.A1ACCB, LG259-740.A1ACCB, CK248-205.D1ABBB, CK248-207.D1ABBB, LK159-707.D1BC, LK159-708.D1BC, LK259-727.D1ACCB, LK259-728.D1ACCB, LG159-704.A2BC, LK159-707.D2BC, LK159-708.D2BC, LG259-711.A2ACCB, LG259-712.A2ACCB, LK259-727.D2ACCB, LK259-728.D2ACCB, LK259-707.D2ACCB, CK248-205.D2ABBB, CK248-207.D2ABBB, CK248-209.D2ABBB, CK248-211.D2ABBB, CG148-004.A1AB, CG148-005.A1AB, CG148-006.A1AB, CG248-240.A1ABBB, CG248-243.A1ABBB, CG248-244.A1ABBB, CG248-212.A1ABBB, CG248-213.A1ABBB, LG159-705.A1BC, LG159-753.A1BC, LG259-758.A1ACCB, LG259-754.A1ACCB, LG259-757.A1ACCB, CG148-001.A3AB, CG148-003.A2AB...(Other models you can see in the webshop)		

GEV No.	107602	Ref. No.	0290209 0C0202 0G2906 0G4070 11151701
description	thermocouple SIT M8x1 L 850mm plug connection ø6.0(6.5)mm		
For models:	ASG36, PC/G1, PC/G2, PCV/G2, PCV/G3, PCF/G2, PCF/G3, PCF/G9, PCF/M2, PCF/M3, PCF/M2E5, PTV/G2, PTF/G2, PSF/G2, PSV/G2, PSF/G3, PCV/G2N, PCF/G3N, PC/G2HV, PCV/G3N, PCF/G2N, PC/G1HV, PTV/G2N, PC/G1A, PC/G2A, PCV/G2A, PCV/G3A, PCF/G2A, PCF/G3A, PCF/M2A, PCF/M3A, OC/G1, OC/G2, OCV/G2, OCF/G2, OCF/G3, OCF/M2, OTV/G2, OTF/G2, OSF/G2, OSV/G2, TC/G1, TC/G2, TCV/G2, TCV/G3, TCF/G2, TCF/G3, TCF/M2, TCF/M3, TCF/M2E5...(Other models you can see in the webshop)		
accessories for	107602		
	GEV No.	100920	Ref. No. —
	thermocouple fitting thread M8x1 / M9x1 Qty 1 pcs		
	GEV No.	100922	Ref. No. —
	thermocouple fitting thread M10x1 / ASA 11/32 Qty 1 pcs		

GEV No.	107605	Ref. No.	0290171 051119 0G2023 0K2872 727828
description	thermocouple SIT M8x1 L 1500mm plug connection ø6.0(6.5)mm		
For models:	MCF/G705, MCF/G1055, MCF/G700, MCF/G1050, MCF/G705E, MCF/G1055E, MCF/G700D, MCF/G700, MCF/G705F, MCF/G1055F, MCF/G705NL, MCF/G1050D, MCFG1055NL, MCF/G702, MCF/G1052, MCF/G700, MCF/G1050, BCP/G1, MTF/G700D, MTF/G1050D, MTF/G700, MTF/G1050, MTF/GE1050, MT/G700F, MTF/G700F, MTF/G1055F, MTF/GE1055F, MF/G700, RCF/G2, RCF/G3, RCF/G9, RR/G1FL, RR/G1FR, RR/G2FL, RR/G2FM, RRV/G1FL, RRV/G1FR, RRV/G2FL, RRV/G2FM, RG/G1, RG/G2, RGV/G1, RGV/G2, RTV/G2, RTF/G2, RSF/G2, RSV/G2, RSF/G3, RBV/G2, MCF/G2A...(Other models you can see in the webshop)		



GEV No.	107612	Ref. No.	027350 0290089 0H6255
description	thermocouple SIT M9x1 L 1000mm plug connection ø6.0(6.5)mm		
For models:	CRN22G, CRN/20G, CRN30G, CRN15G, HCPA/G1219, HCPA/GI 1219, CR22G, CRN/22GZ, CRN20GZ, CRN30GZ, CRN15GZ, ZCPAG1219, ZCPA/GI 1219, CR22G, CRN20GA, CRN30GA, CRN15GA, CR42G, CR/40G, CR15G, CR/41G, CR42G, CR40G, ROCF/G1000, ROTA/G500, ROTA/G1000, ROTF/G1000, ROSD/G1000, ROSD/G1000, ROSS/G1000, ROSF/G1000, ROTF/E1000, RORA/G500, RORA/G1000, ROPN/G1000, ROPN/G1015, ROPN/G1020, ROT/G500, ROT/G1000, ROR/G500, ROR/G1000		

GEV No.	107613	Ref. No.	002579 003281 004123 020094 0290125 059816 0G2065 0G2382 0H6224 0K2943 0K3464 0K5728 10070 19012829 727757
description	thermocouple SIT M9x1 L 1200mm plug connection ø6.0(6.5)mm		
For models:	MCF/G1090, MCF/G1095, MCF/G995, MPN/GD761, MPN/GI761, MPN/GI760D, MPN/GD760, MPN/GD760F, MPN/GI760, MPN/GI760F, BCF/G2, RPD/G240, RPD/G260, XPD/G240, XPD/G260, JPD/G240, JPD/G260, MPD/G240, MPD/G260, RCF/G1095, 7PDG06, 7PIG06, RPN/GD760F, RPN/GI760F, CCF/G995, CCF/G996, XFR/G350NL, XFR/G700NL, XPN/GI760D, M70GDKE, M70GIKE, XPN/GD760F, XPN/GI760F, PCV/G2, PCV/G3, PCF/G2, PCF/G3, PCF/G9, PTF/G2, PSF/G2, PSF/G3, PCV/G2N, PCF/G3N, PCV/G3N, PCF/G2N, PCV/G2A, PCV/G3A, PCF/G2A, PCF/G3A, OCV/G2...(Other models you can see in the webshop)		

GEV No.	107614	Ref. No.	003280 006588 027036 0290022 02R19 02T01 053043 056631 056840 059064 059390 0C5899 0H6250 0K1129 0KL502 0KR014 0M0893 310401 4443105 444311500 727861 9BDSGS3890 M02T01 S444311800 SGT130
description	thermocouple SIT M9x1 L 1500mm plug connection ø6.0(6.5)mm		
spare parts for			
accessories for	undefined		

GEV No.	107608	Ref. No.	025204 027317 059282 059738 S444311600
description	thermocouple SIT M9x1 L 500mm plug connection ø6.0(6.5)mm		
For models:	RF/G300, HM/G800T, RF/G300		

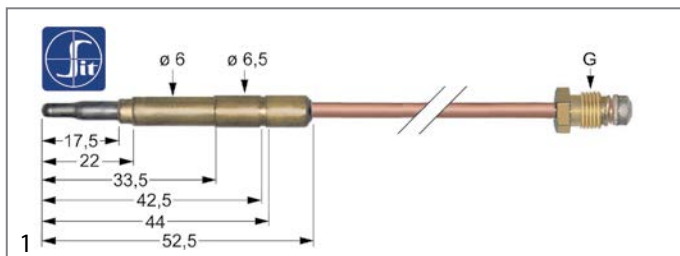

GEV No.	107609	Ref. No.	00118 004942 0200185 025031 0290015 0290016 053002 056639 057781 058133 059283 0K2918 0K3506 6010055
description	thermocouple SIT M9x1 L 600mm plug connection ø6.0(6.5)mm		
For models:	MFG1500Z, MFG2200Z, BR/G1FL, BR/G1FR, BR/G2FL, BR/G2FR, MM/G351, MM/G701, MM/G350, MM/G700, MM/G350F, MM/G700F, MM/G700E, MCP/G700, MCP/G701, MCP/G710, MCP/G711, MCP/G705, MCP/G706, VO40G, RCP/G1S, RCP/G2D, XCP/G1S, XCP/G2D, JCP/G1S, JCP/G2D, MCP/G1S, MCP/G2D, ARG12FL, ARG24FL, ARG36FL, ARG48FL, ARG12FR, ARG24FR, ARG36FR, ARG48FR, AGG12, AGG24, AGG36, AGG48, ARG12FLCE, ARG24FLCE, ARG36FLCE, ARG48FLCE, ARG12FRCE, ARG24FRCE, ARG36FRCE, ARG48FRCE, AGG12CE, AGG24CE...(Other models you can see in the webshop)		

plug-in thermocouples with interruption

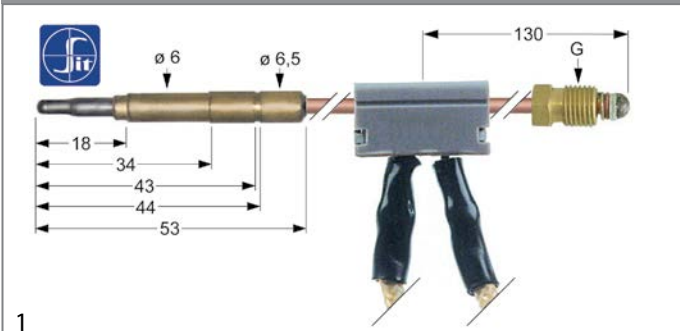

GEV No.	107863	Ref. No.	003528 0270426 051932 054055 056573 056914 058387 0C3162 0C3197 0K2898 0K2954 0K5790 0KG229 11151611 11151613 19013338 21635 727793 107869
description	thermocouple SIT with interrupter M9x1 L 1000mm plug connection ø6.0(6.5)mm cable 820mm		
For models:	MR/G721, MR/G1071, MR/G1070, MR/G720, MR/G725, MR/G1075, MR/G726, MR/G1076, MBR/G700UK, MBR/G701, MBR/G706, MBR/G701UK, MBR/G751, MBR/G756, MFR/G350, MFR/G700, MFR/G350D, MFR/G700D, MFR/G360, MFR/G350F, MFR/G700F, MFR/G350E, MFR/G700E, MFR/G740, MFR/G380, MFR/G381, MFR/G350, MFR/G351, MFR/G700, MFR/G701, BF/G1S07, BFR/G1S14, FG250D, FG250S, FGC/250D, FGC/250S, RBR/G2FM, RBR/G2IM, RBK/G2FM, RMV/G1C, RMV/G2C, RF/G1S07, RF/G2D07, RFR/G1S07, RFR/G2D07, RFR/G1S12, RFR/G2D12, RFR/G2S40, RFR/G1S14, RFR/G2D14...(Other models you can see in the webshop)		

plug-in thermocouples with aluminised tip

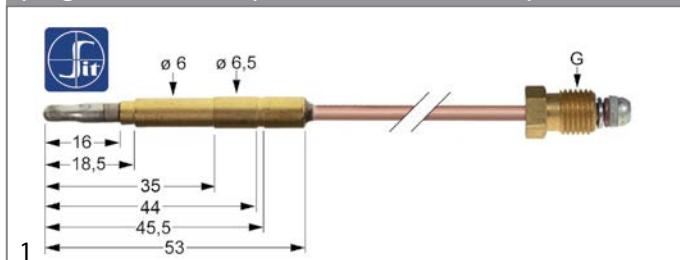

GEV No.	102681	Ref. No.	052814
description	thermocouple fast closing M9x1 L 850mm plug connection ø6.5mm		
For models:	MR/G351, MR/G701, MR/G350, MR/G350F, MR/G350NL, MR/G350E, MR/G360, MR/G360F, MR/G700, MR/G700F, MR/G700NL, MR/G700E, MR/G710, MR/G710F, MR/G715, MR/G361, MR/G711, MR/G716, MT/G700D, MTF/G700D, MTF/G1050D, MT/G700, MTF/G700, MTF/G1050, MTF/GE1050, MT/G700F, MTF/G700F, MTF/G1055F, MTFGE1055F, MT/G350, MT/G352, MG/G350D, MG/G700D, MG/G350, MG/G350E, MG/G350F, MG/G350NL, MG/G700, MG/G700E, MG/G700F, MG/G700NL, MG/G1050, MG/G1050F, MG/G1051, RR/G350D, RR/G700D, 7FTGF3L, 7FTGF3R, RR/G360F, 7FTGF7L...(Other models you can see in the webshop)		

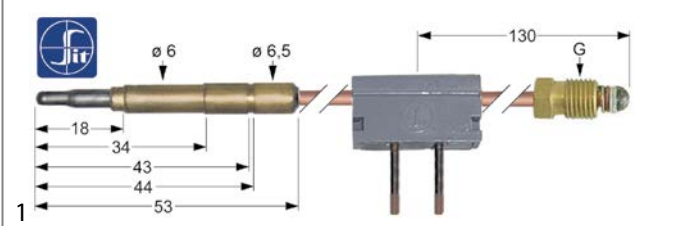

GEV No.	107164	Ref. No.	056574
description	thermocouple SIT with interrupter M9x1 L 1000mm plug connection ø6.0(6.5)mm soldering connection		

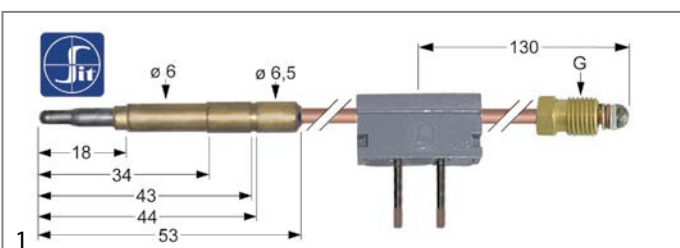

GEV No.	102068	Ref. No.	058503
description	thermocouple SIT with interrupter M9x1 L 320mm plug connection ø6.0mm soldering connection		
For models:	RF/G350D, RF/G700D		

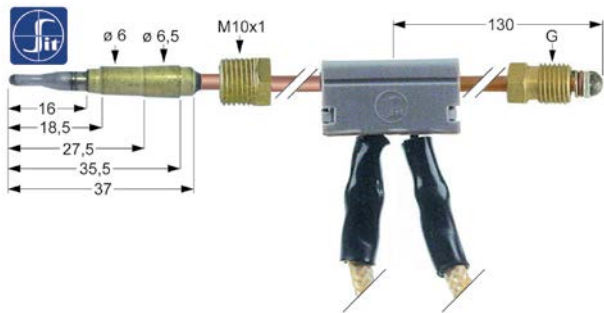

GEV No.	107148	Ref. No.	002784
description	thermocouple SIT with interrupter M9x1 L 600mm M10x1 F 6.3mm		
For models:	HBR/G800, HBR/G805, HBR/G810, HBR/G815, HBR/G811, HBR/G816, HBR/G800UK, ZBR/G800, ZBR/G805, ZBR/G810, ZBR/G815, ZBR/G811, ZBR/G816, ZBR/G800UK, ABR/G800, ABR/G805, ABR/G810, ABR/G815, ABR/G811, ABR/G816, OBR/G800UK		

threaded thermocouples

threaded thermocouples standard

with socket with thread M8x1

SIT

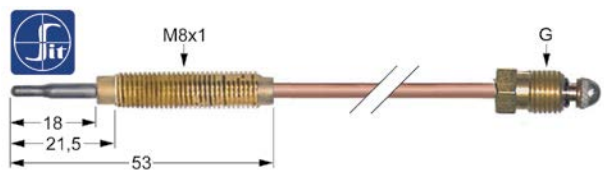

GEV No.	107643	Ref. No.	0H6256 OK0688
description	thermocouple SIT M10x1 L 600mm M8x1		
accessories for	107643		
	GEV No.	102067	Ref. No. 055033 0992014
nut thread M8x1 H 3mm brass Qty 1 pcs type SEF 1			

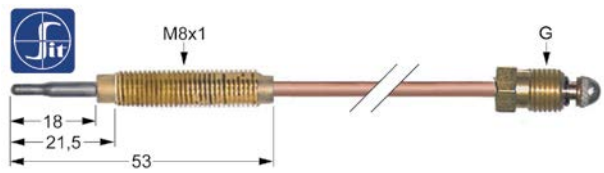

GEV No.	107634	Ref. No.	050235
description	thermocouple SIT M8x1 L 1500mm M8x1		
accessories for	107634		
	GEV No.	102067	Ref. No. 055033 0992014
nut thread M8x1 H 3mm brass Qty 1 pcs type SEF 1			

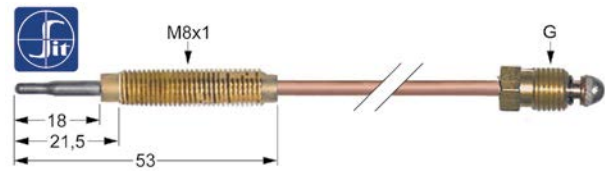

GEV No.	107630	Ref. No.	OK5688
description	thermocouple SIT M8x1 L 600mm M8x1		
For models:	CG148-001.A1AB, CG148-003.A2AB, CG248-201.A1ABBB, CG248-203.A1ABBB, CK248-209.D1ABBB, CK248-211.D1ABBB, LG159-703.A1BC, LG159-703.A2BC, LG159-704.A1BC, LG159-706.A1BC, LG259-711.A1A-CCB, LG259-712.A1ACCB, LK259-707.D1ACCB, LK259-708.D1ACCB, LG259-739.A1ACCB, LG259-740.A1ACCB, CK248-205.D1ABBB, CK248-207.D1ABBB, LK159-707.D1BC, LK159-708.D1BC, LK259-727.D1ACCB, LK259-728.D1ACCB, LG159-704.A2BC, LK159-707.D2BC, LK159-708.D2BC, LG259-711.A2ACCB, LG259-712.A2ACCB, LK259-727.D2ACCB, LK259-728.D2ACCB, LK259-707.D2ACCB, LK259-708.D2ACCB, CK248-205.D2ABBB, CK248-207.D2ABBB, CK248-209.D2ABBB, CK248-211.D2ABBB, CG148-004.A1AB, CG148-005.A1AB, CG148-006.A1AB, CG248-240.A1ABBB, CG248-243.A1ABBB, CG248-244.A1ABBB, CG248-212.A1ABBB, CG248-213.A1ABBB, LG159-705.A1BC, LG159-753.A1BC, LG259-758.A1ACCB, LG259-754.A1ACCB, LG259-757.A1ACCB, CG148-001.A3AB, CG148-003.A2AB...(Other models you can see in the webshop)		
accessories for	107630		
	GEV No.	102067	Ref. No. 055033 0992014
nut thread M8x1 H 3mm brass Qty 1 pcs type SEF 1			

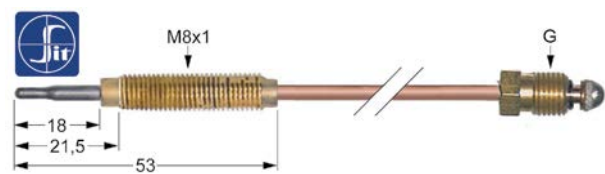

GEV No.	107631	Ref. No.	OK0652 OU2960
description	thermocouple SIT M8x1 L 850mm M8x1		
accessories for	107631		
	GEV No.	102067	Ref. No. 055033 0992014
nut thread M8x1 H 3mm brass Qty 1 pcs type SEF 1			

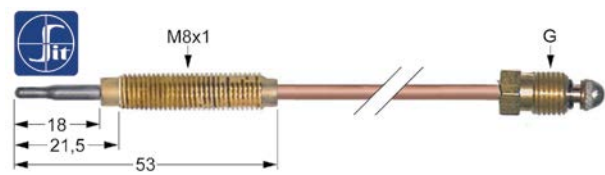

GEV No.	107640	Ref. No.	020756
description	thermocouple SIT M9x1 L 1500mm M8x1		

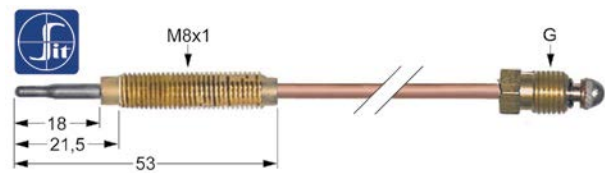

GEV No.	107636	Ref. No.	025677
description	thermocouple SIT M9x1 L 600mm M8x1		
accessories for	107636		
	GEV No.	102067	Ref. No. 055033 0992014
nut thread M8x1 H 3mm brass Qty 1 pcs type SEF 1			



accessories

nuts

			
1			
GEV No.	102067	Ref. No.	055033 0992014
description	nut thread M8x1 H 3mm brass Qty 1 pcs type SEF 1		
For models:	MBR/E710D, MBR/E700, MBR/E700UK, MBR/G701, MBR/G706, MBR/G701UK, MBR/G751, MBR/G756, MBR/E716, MBR/E706, 7BRE60XN, 7BRE60X, RBR/E700UK, 7BRG60, 7BRG60X, RBR/G701UK, RBR/G751, RBR/G756, RBR/E716, RBR/E706, XBR/E710D, M70EBP, XBR/E710, XBR/G701, M70GBP, XBR/G701UK, XBR/G751, XBR/G756, CBR/G700, CBR/E700, XBR/E716, XBR/E706, HR/G420D, HR/G820D, HR/G420, HR/G820, HR/G821, HBR/G800, HBR/G805, HBR/G801, HBR/G806, HBR/G810, HBR/G815, HBR/G811, HBR/G816, HBR/G800D, HBR/G805D, HBR/G801D, HBR/G806D, HBR/G810D...(Other models you can see in the webshop)		

screws

			
1			
GEV No.	106246	Ref. No.	0G0087 0K5713 19012767 745040613
description	screw thread M8x1 IT / M12x1 ET for thermocouple		
For models:	CG148-001.A1AB, CG148-003.A2AB, CG248-201.A1ABBB, CG248-203.A1ABBB, CK248-209.D1ABBB, CK248-211.D1ABBB, LG159-703.A1BC, LG159-703.A2BC, LG159-704.A1BC, LG159-706.A1BC, LG259-711.A1ACC, LG259-712.A1ACC, LK259-707.D1ACC, LK259-708.D1ACC, LG259-739.A1ACC, LG259-740.A1ACC, CK248-205.D1ABBB, CK248-207.D1ABBB, LK159-707.D1BC, LK159-708.D1BC, LK259-727.D1ACC, LK259-728.D1ACC, LG159-704.A2BC, LK159-707.D2BC, LK159-708.D2BC, LG259-711.A2ACC, LG259-712.A2ACC, LK259-727.D2ACC, LK259-728.D2ACC, LK259-707.D2ACC, LK259-708.D2ACC, CK248-205.D2ABBB, CK248-207.D2ABBB, CK248-209.D2ABBB, CK248-211.D2ABBB, CG148-004.A1AB, CG148-005.A1AB, CG148-006.A1AB, CG248-240.A1ABBB, CG248-243.A1ABBB, CG248-244.A1ABBB, CG248-212.A1ABBB, CG248-213.A1ABBB, LG159-705.A1BC, LG159-753.A1BC, LG259-758.A1ACC, LG259-754.A1ACC, LG259-757.A1ACC, CG148-001.A3AB, CG148-003.A2AB...(Other models you can see in the webshop)		

interrupters

			
1			
GEV No.	101258	Ref. No.	0974404 0H6263 0K3024
description	interrupter thread M10x1		
For models:	7550-2, 7551-2, 7552-2, 7553-2		

			
1			
GEV No.	101264	Ref. No.	00426 004982
description	interrupter thread M8x1		
For models:	SMG350, SMG700		

			
1			
GEV No.	101265	Ref. No.	00460 005687 0974402 0C0363 0K3564 301000 750G301000
description	interrupter thread M9x1		
For models:	SFRG350, SFRG700, SFRG350, SFRG700		

miscellaneous

			
1			
GEV No.	106245	Ref. No.	0G0241 0K5775 19013015 705040389
description	sleeve for thermocouple thread M12x1		
For models:	CG148-001.A1AB, CG148-003.A2AB, CG248-201.A1ABBB, CG248-203.A1ABBB, CK248-209.D1ABBB, CK248-211.D1ABBB, LG159-703.A1BC, LG159-703.A2BC, LG159-704.A1BC, LG159-706.A1BC, LG259-711.A1ACC, LG259-712.A1ACC, LK259-707.D1ACC, LK259-708.D1ACC, LG259-739.A1ACC, LG259-740.A1ACC, CK248-205.D1ABBB, CK248-207.D1ABBB, LK159-707.D1BC, LK159-708.D1BC, LK259-727.D1ACC, LK259-728.D1ACC, LG159-704.A2BC, LK159-707.D2BC, LK159-708.D2BC, LG259-711.A2ACC, LG259-712.A2ACC, LK259-727.D2ACC, LK259-728.D2ACC, LK259-707.D2ACC, LK259-708.D2ACC, CK248-205.D2ABBB, CK248-207.D2ABBB, CK248-209.D2ABBB, CK248-211.D2ABBB, CG148-004.A1AB, CG148-005.A1AB, CG148-006.A1AB, CG248-240.A1ABBB, CG248-243.A1ABBB, CG248-244.A1ABBB, CG248-212.A1ABBB, CG248-213.A1ABBB, LG159-705.A1BC, LG159-753.A1BC, LG259-758.A1ACC, LG259-754.A1ACC, LG259-757.A1ACC, CG148-001.A3AB, CG148-003.A2AB...(Other models you can see in the webshop)		



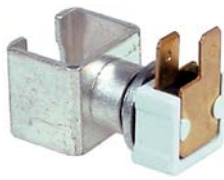



			
1			
GEV No.	102273	Ref. No.	0H6264 0TR930 215798 45002173001B
description	thermocouple junction		

gas burners

hob burners

universal hob burners

GEV

			
1			
GEV No.	103066	Ref. No.	055108
description	burner cap ø 80mm		
For models:	QCG300, QCG600		
accessories for	103066		
	GEV No.	103065	Ref. No. —
	burner ring for burner cap ø 80mm		
	GEV No.	104100	Ref. No. —
	burner head for burner cap ø 80mm		
	GEV No.	104101	Ref. No. —
	burner holder for burner cap ø 80mm with nozzle holder with mixing sleeve		

SABAF

1 series

			
1			
GEV No.	104288	Ref. No.	00375 004975 0K3537
description	burner cap 3.6kW ø 120mm		
For models:	SCG350, SCG700, SCG1050, SCG350, SCG700, SCG1050, PPL5GG, PPFL5GG		
accessories for	104288		
	GEV No.	104289	Ref. No. 00377 004977
	burner lower part 3/3.6kW for burner cap ø 90/120mm		
	GEV No.	105086	Ref. No. —
	burner ring 3.6kW for burner cap ø 120mm		
	GEV No.	105087	Ref. No. —
	burner head 3.6kW for burner cap ø 120mm		

			
1			
GEV No.	104286	Ref. No.	00373 004973
description	burner cap 3kW ø 90mm		
For models:	SCG350, SCG700, SCG1050, SCG350, SCG700, SCG1050, PPL5GG, PPFL5GG		
accessories for	104286		
	GEV No.	104289	Ref. No. 00377 004977
	burner lower part 3/3.6kW for burner cap ø 90/120mm		
	GEV No.	105089	Ref. No. —
	burner ring 3kW for burner cap ø 90mm		
	GEV No.	105090	Ref. No. —
	burner head 3kW for burner cap ø 90mm		

			
1			
GEV No.	104289	Ref. No.	00377 004977
description	burner lower part 3/3.6kW for burner cap ø 90/120mm		
For models:	SCG350, SCG700, SCG1050, SCG350, SCG700, SCG1050, PPL5GG		
accessories for	104289		
	GEV No.	104286	Ref. No. 00373 004973
	burner cap 3kW ø 90mm		
	GEV No.	104288	Ref. No. 00375 004975 0K3537
	burner cap 3.6kW ø 120mm		
	GEV No.	105086	Ref. No. —
	burner ring 3.6kW for burner cap ø 120mm		
	GEV No.	105087	Ref. No. —
	burner head 3.6kW for burner cap ø 120mm		
	GEV No.	105089	Ref. No. —
	burner ring 3kW for burner cap ø 90mm		
	GEV No.	105090	Ref. No. —
	burner head 3kW for burner cap ø 90mm		
	GEV No.	106482	Ref. No. —
	gas injector thread M6x0.75 WS 7 bore ø 1.1mm		
	GEV No.	106485	Ref. No. —
	gas injector thread M6x0.75 WS 7 bore ø 1.6mm		



accessories

reducers for pan supports



GEV No.	210014	Ref. No.	0H6047 0H6849 0K3423 1284491
description	reducer for pan support L 155mm W 140mm suitable for B burner		



GEV No.	210020	Ref. No.	0H6780
description	reducer for pan support L 186mm W 186mm		
For models:	7500-2, 7501-2, 7502-2, 7502-9, 7503-2, 7504-2, 7504-9, 7505-2-9, 7505-9-9, 7700-2, 7701-2, 7703-2, 9000-2, 9001-2, 9002-2, 9004-2, 9006-9, 9201-2, 9203-2		

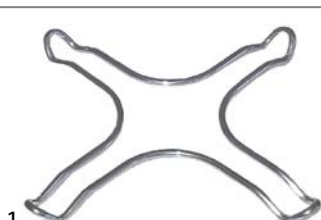

GEV No.	210001	Ref. No.	005962 025056 0G0214 340126 60021034
description	reducer for pan support L 265mm W 265mm SS suitable for universal		
For models:	RCF/E2MO, RCF/E2M4, RCVF/E3MO, RCVF/E3M4, FTG2, FT/G2, PCG810, PCG1210, PCG1610, PCG810F, PCG1210F, PCG1610F, PCG810D, PCG1210D, PCG1610D, PCG800NL, PCG1200NL, PCG1600NL, PCSG810, PCSG1210, PCSG1610, HCSG410, HCS/G410D, HCS/G400, PHCS/G400, HCS/G400F, HCF/G800F, PHCF/G800, HCS/G400NL, HCS/G400DK, HCSG810, HCS/G810D, HCS/G800, HCS/G800F, HCS/G800, HCS/G800NL, HCS/G800DK, HCFG810, HCF/G810D, HCF/GE81, HCF/GE81, HCF/GE81, HCF/G800, HCF/G800NL, HCF/G800DK, HCF/GE80, HCF/GE80, HCFG1210, HCF/G1210D, HCF/G1200...(Other models you can see in the webshop)		

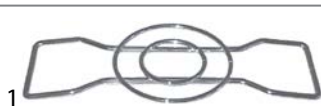

GEV No.	210002	Ref. No.	0A2000
description	reducer for pan support L 340mm W 100mm		

pan supports



GEV No.	210211	Ref. No.	0G2033 393010
description	pan support W 175mm L 360mm		
For models:	JCA/G800, JFC/GG800, JCF/GG1600, JCF/G1600, PZA/G800, PFZ/GG800, PCF/GG1600, PCF/G1600		

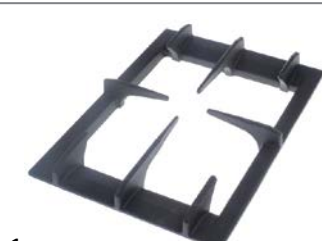

GEV No.	210027	Ref. No.	0C2526
description	pan support W 284mm L 386mm H 51mm suitable for ELECTROLUX, ZANUSSI		
For models:	PC/G1, PC/G2, PCV/G2, PCV/G3, PCF/G2, PCF/G3, PCF/M2, PCF/M3, PCF/M2E5, PSF/G2, PSV/G2, PSF/G3, PCV/G2N, PCF/G3N, PC/G2HV, PCV/G3N, PCF/G2N, PC/G1HV, PC/G1A, PC/G2A, PCV/G2A, PCV/G3A, PCF/G2A, PCF/G3A, PCF/M2A, PCF/M3A, OC/G1, OC/G2, OCV/G2, OCF/G2, OCF/G3, OCF/M2, OTV/G2, OTF/G2, OSF/G2, OSV/G2, TC/G1, TC/G2, TCV/G2, TCV/G3, TCF/G2, TCF/G3, TCF/M2, TCF/M3, TCF/M2E5, TSF/G2, TSV/G2, TSF/G3, TC/G1A, TC/G2A...(Other models you can see in the webshop)		



GEV No.	210138	Ref. No.	002436 055064 058532 058558 0HB084 5108061 510806102
description	pan support W 285mm L 345mm		
For models:	RC/G320, RC/G330, RC/G320F, RC/G720, RC/G730, MCF/G705, MCF/G1055, MCF/G700, MCF/G1050, MCF/G705E, MCF/G1055E, MCF/G705F, MCF/G1055F, MCF/GE705, MCF/GE1055, MCF/GE700, MCF-GE1050, MC/G355, MC/G350, MC/G355E, MC/G355F, MC/G705, MC/G700, MC/G705E, MC/G1055, MC/G1050, MC/G705F, MCF/GE1055UK, MCF/G1090, MCF/G1095, MCF/G700, MCF/G1050, MCF/G2A, MCF/G3A, XC/G1, XC/G2, XCV/G2, XCV/G3, XCF/G2, XCF/G3, XCF/M2, XCFM3, XSF/G2, XSV/G2, XSF/G3, MC/G1, MC/G2, MCV/G2, MCV/G3, MCF/G2...(Other models you can see in the webshop)		





			
1			
GEV No.	210155	Ref. No.	00376 004976 0K3538
description	pan support W 320mm L 530mm		
For models:	SCG350, SCG700, SCG1050, SCG350, SCG700, SCG1050, PPL5GG, PPFL5GG		

			
1			
GEV No.	210123	Ref. No.	OK1051 OKC891 291121700
description	pan support W 340mm L 730mm C-D burner		

			
1			
GEV No.	210058	Ref. No.	006086
description	pan support W 340mm L 340mm H 60mm		
For models:	ZC/G410, ZC/G810, ZCF/G810, ZC/G1210, ZCF/G1210, EC/G1610, ZCF/G1610, ZC/G410, ZC/G810, ZC/G1210, ZCF/G810, ZCF/G1210, ZCF/G1610, ZCF/G811, ZC/G411, ZC/G811, HC/G1211		

			
1			
GEV No.	210139	Ref. No.	053552 055754 056654 058179 059275
description	pan support W 345mm L 395mm		
For models:	HCSG410, HCS/G410D, HCS/G400, PHCS/G400, HCS/G400F, HCF/G800F, PHCF/G800, HCS/G400NL, HCS/G400DK, HCSG810, HCS/G810D, HCS/G800, HCS/G800F, HCS/G800, HCS/G800NL, HCS/G800DK, HCFG810, HCF/G810D, HCF/GE81, HCF/GE81, HCF/GE81, HCF/G800, HCF/G800NL, HCF/G800DK, HCF/GE80, HCF/GE80, HCFG1210, HCF/G1210D, HCF/G1200, HCF/G1200F, PHCF/G1200, HCF/G1200N, HCF/G1200D, HCFG1610, HCF/G1610D, HCF/G1600, HCF/G1600F, PHCF/G1600, HCF/G1600N, HCF/G1600D, HC/G410, HC/G810, ZPC/G1210, HCA/G410, HCA/G810, HCA/G810, HCF/G1210, ZHCF/G161, HCF/GE81, HCF/GE81...(Other models you can see in the webshop)		

			
1			
GEV No.	210148	Ref. No.	002446 054090 058169 058540 058575 0A2956
description	pan support W 340mm L 595mm		
For models:	MCF/G700D, MCF/G700, MCF/G705NL, MCF/GE700D, MCFGE1050D, MCF/G1050D, MCFG1055NL, RCF/GE700D, RCF/G1050D, RCF/G700D, RCFGE1050D, T35GCK, T70GCK, XC/G1050, M70GCK/G, M105GCK/E, XCF/GE700D, XC/G350D, XC/G700D, XC/1050D, XCF/G700D, XCF/G1050D, M70GCK/E, XC/G350F, XC/G700F, XCF/G700F, XCF/G1050F, XCF/G705NL, XCFG1055NL, CC/G710, CC/G1060, CCF/G710, T35GCK, T70GCK, T105GCK, M70GCK/G, M70GCH/E, M105GCK/G, M105GCK/E, XTF/G1050D, M105GST/GA, XTF/G1050F		

			
1			
GEV No.	210131	Ref. No.	OK1982 OK1983 GGB090
description	pan support W 345mm L 800mm C-C/C-D/D-E burner		
For models:	7500-2, 7501-2, 7502-2, 7502-9, 7503-2, 7504-2, 7504-9, 7505-2-9, 7505-9-9, 7508-2, 7700-2, 7701-2, 7703-2		

			
1			
GEV No.	210122	Ref. No.	OK1050 OKC890 291121600
description	pan support W 340mm L 730mm B-B burner		

			
1			
GEV No.	210126	Ref. No.	OK2329 OKD034
description	pan support W 345mm L 810mm C-C burner		
For models:	7501-2, 7502-2, 7502-9, 7503-2, 7504-2, 7504-9, 7505-2-9, 7505-9-9, 7701-2, 7703-2, 9001-2, 9002-2, 9004-2, 9006-9, 9201-2, 9203-2		



			
1			
GEV No.	210127	Ref. No.	OK2330 OKD062
description	pan support W 345mm L 810mm C-D burner		
For models:	7500-2, 7700-2, 9000-2		

			
1			
GEV No.	210130	Ref. No.	OK2331 OKD061
description	pan support W 345mm L 810mm D-E burner		
For models:	7501-2, 7502-2, 7502-9, 7503-2, 7504-2, 7504-9, 7505-2-9, 7505-9-9, 7701-2, 7703-2, 9001-2, 9002-2, 9004-2, 9006-9, 9201-2, 9203-2		

			
1			
GEV No.	210146	Ref. No.	002437 059208 0G2544 19013326
description	pan support W 350mm L 390mm		
For models:	HC/G410, HC/G810, HCF/G810, HC/G1210, HCF/G1210, EC/G1610, HCF/G1610, HC/G410, HC/G810, HC/G1210, HCF/G810, HCF/G1210, HCF/G1610, HCF/G811, HC/G411, HC/G811, HC/G1211, HC/G800U, HC/G1200U, HC/G1600U, HCF/G800U, HCF/G1200U, HCF/G1600U, HT/G800D, HTF/G1210		

			
1			
GEV No.	210208	Ref. No.	0C0132
description	pan support W 370mm L 380mm		
For models:	KC/G1, KC/G2, KCF/G2, KC/G3, KCF/G3, KCF/G4, KCF/M2, KC/T1, KC/T2, KC/T3, KCF/T2, KCF/T3, KCF/T4, KCF/G2H, KC/G1H, KC/G2H, KC/G3H, KC/T1H, KC/T2H, KC/T3H, KCF/G3A, KCF/W2, KCF/G3H, KCF/G2L, KCF/G3HA, KS/G2, KSF/G2, KSCF/G3, WC/G1, WC/G2, WCF/G2, WC/G3, WCF/G3, WCF/G4, WCF/M2, WCF/G2H, WC/G1H, WC/G2H, WC/G3H, WSCF/G3		

			
1			
GEV No.	210209	Ref. No.	0C0130
description	pan support W 370mm L 395mm		
For models:	KC/G1, KC/G2, KCF/G2, KC/G3, KCF/G3, KCF/G4, KCF/M2, KC/T1, KC/T2, KC/T3, KCF/T2, KCF/T3, KCF/T4, KCF/G2H, KC/G1H, KC/G2H, KC/G3H, KC/T1H, KC/T2H, KC/T3H, KCF/W2, KCF/G3H, KCF/G2L, KS/G2, KSF/G2, KSCF/G3, QC/G1, QC/G2, QC/G3, QC/T1, QC/T2, QC/T3, QC/G1H, QC/G2H, QC/G3H, QC/T1H, QC/T2H, QC/T3H		

spillage trays

			
1			
GEV No.	210205	Ref. No.	052102 055748
description	drain tray L 345mm W 360mm H 38mm ø 105mm PTFE coated steel		
For models:	PCG810, PCG1210, PCG1610, PCG810F, PCG1210F, PCG1610F, PCG810D, PCG1210D, PCG1610D, PCG800NL, PCG1200NL, PCG1600NL, PCSG810, PCSG1210, PCSG1610, HCSG410, HCS/G410D, HCS/G400, PHCS/G400, HCS/G400F, HCF/G800F, PHCF/G800, HCS/G400NL, HCS/G400DK, HCSG810, HCS/G810D, HCS/G800, HCS/G800F, HCS/G800, HCS/G800NL, HCS/G800DK, HCFG810, HCF/G810D, HCF/GE81, HCF/GE81, HCF/GE81, HCF/G800, HCF/G800NL, HCF/G800DK, HCF/GE80, HCF/GE80, HCFG1210, HCF/G1210D, HCF/G1200, HCF/G1200F, PHCF/G1200, HCF/G1200N, HCF/G1200D, HCFG1610, HCF/G1610D...(Other models you can see in the webshop)		

			
1			
GEV No.	210206	Ref. No.	052103 055749
description	drain tray L 360mm W 345mm ø 122mm		
For models:	PCG1210, PCG1210F, PCG1210D, PCG1200NL, PCSG810, PCSG1210, PCSG1610, HCSG410, HCS/G410D, HCS/G400, PHCS/G400, HCS/G400F, HCF/G800F, PHCF/G800, HCS/G400NL, HCS/G400DK, HCSG810, HCS/G810D, HCS/G800, HCS/G800F, HCS/G800, HCS/G800NL, HCS/G800DK, HCFG810, HCF/G810D, HCF/GE81, HCF/GE81, HCF/GE81, HCF/G800, HCF/G800NL, HCF/G800DK, HCF/GE80, HCF/GE80, HCFG1210, HCF/G1210D, HCF/G1200, HCF/G1200F, PHCF/G1200, HCF/G1200N, HCF/G1200D, HCFG1610, HCF/G1610D, HCF/G1600, HCF/G1600F, PHCF/G1600, HCF/G1600N, HCF/G1600D, HC/G410, HC/G810, ZPC/G1210...(Other models you can see in the webshop)		





			
1			
GEV No.	210207	Ref. No.	052104 055750
description	drain tray L 360mm W 345mm ø 145mm		
For models:	PCG1210, PCG1210F, PCG1210D, PCG1200NL, PCSG810, PCSG1210, PCSG1610, HCSG410, HCS/G410D, HCS/G400, PHCS/G400, HCS/G400F, HCF/G800F, PHCF/G800, HCS/G400NL, HCS/G400DK, HCSG810, HCS/G810D, HCS/G800, HCS/G800F, HCS/G800, HCS/G800NL, HCS/G800DK, HCFG810, HCF/G810D, HCF/GE81, HCF/GE81, HCF/G800, HCF/G800NL, HCF/G800DK, HCF/GE80, HCF/GE80, HCFG1210, HCF/G1210D, HCF/G1200, HCF/G1200F, PHCF/G1200, HCF/G1200N, HCF/G1200D, HCFG1610, HCF/G1610D, HCF/G1600, HCF/G1600F, PHCF/G1600, HCF/G1600N, HCF/G1600D, HC/G410, HC/G810, HTF/G1200...(Other models you can see in the webshop)		

air mixers			
			
1			
GEV No.	104569	Ref. No.	002527
description	air mixer		
For models:	MT/G350, MT/G352, RSF/G2, RSV/G2, XSF/G2, XSV/G2, MSF/G2, MSV/G2, RT/G352, RT/G351, XT/G352		

			
1			
GEV No.	112827	Ref. No.	054039
description	air mixer dimensions 8x5.5mm ø 40mm seat ø 10mm		
For models:	BFR/G1S14, BCP/G1, RFR/G1S14, RFR/G2D14, RPD/G240, RPD/G260, RPI/G260, RPI/G260P, RCP/G1S, RCP/G2D, XFR/G1S14, XFR/G2D14, XPD/G240, XPD/G260, XPI/G260, XPI/G260P, XCP/G1S, XCP/G2D, JFR/G1S14, JFR/G2D14, JPD/G240, JPD/G260, JPI/G260, JCP/G1S, JCP/G2D, MFR/G1S14, MFR/G2D14, MPD/G240, MPD/G260, MPI/G260, MPI/G260P, MCP/G1S, MCP/G2D, ACPG25, PFR/G1S14, PFR/G2D14, PPD/G260, PPI/G260P, PCP/G1S, PCP/G2D, PFRG2D14HV, PFRG1S14HV, OFR/G1S14, OFR/G2D14, OPD/G260, OPI/G260P, OCP/G1S, OCP/G2D, TFR/G1S14, TFR/G2D14...(Other models you can see in the webshop)		

			
1			
GEV No.	104372	Ref. No.	0G5199 0G6309 241804400
description	air mixing sleeve		
For models:	7502-2, 7504-2, 7508-2, 7512-2, 7530-2, 7531-2, 7730-2, 7731-2, 9002-2, 9004-2, 9012-2, 9030-2, 9031-2		

			
1			
GEV No.	105057	Ref. No.	026217 052511 215082800 215082814
description	air mixing tube		

			
1			
GEV No.	109181	Ref. No.	025009 052062 11161151
description	air mixing tube L 42mm D1 ø 18mm D2 ø 23mm ID ø 16mm brass		
For models:	BR/G1FL, BR/G1FR, BR/G2FL, BR/G2FR, RR/G1FL, RR/G1FR, RR/G1CL, RR/G2FL, RR/G2FM, RR/G2CL, RRV/G1FL, RRV/G1FR, RRV/G1CL, RRV/G2FL, RRV/G2FM, RRV/G2CL, RR/G2CM, XR/G1FL, XR/G1FR, XR/G1CL, XR/G2FL, XR/G2FM, XR/G2CL, XRV/G1FL, XRV/G1FR, XRV/G1CL, XRV/G2FL, XRV/G2FM, XRV/G2CL, XR/G2CM, JR/G1FL, JR/G1FR, JR/G1CL, JR/G2FL, JR/G2FM, JR/G2CL, JRV/G1FL, JRV/G1FR, JRV/G1CL, JRV/G2FL, JRV/G2FM, JRV/G2CL, MR/G1FL, MR/G1FR, MR/G1CL, MR/G2FL, MR/G2FM, MR/G2CL, MRV/G1FL, MRV/G1FR...(Other models you can see in the webshop)		

			
1			
GEV No.	104536	Ref. No.	051774 727869
description	air mixing tube L 42mm D1 ø 26mm D2 ø 32mm ID ø 23mm thickness 1mm brass		
For models:	MPN/GD761, MPN/GI761, MPN/GI760D, MPN/GD760, MPN/GD760F, MPN/GI760, MPN/GI760F, FDV40G, FDV40GZ, FDV40GA, FDV20G, FDV20GZ, FDV20GA, 7PDG06, 7PIG06, RPN/GD760F, RPN/GI760F, XPN/GI760D, M70GDKE, M70GIKE, XPN/GD760F, XPN/GI760F, RPN/G760, RPN/G760, PRPN/G760, RPN/GI760, RPN/GI760, RPN/GI760, PRPN/GI76, KS/G2, KSF/G2, KSCF/G3, HPN/GI806, HPN/GI805, HT/G800, HT/G800D, HTF/G810, HTF/G800D, HTF/G1210, HTF/G1210D, HT/G800NL, HTF/G800NL, HTFG1210NL, QS/G2, QSF/G2, QSCF/G3, ZPN/GI805, ZT/G800, ZT/G800D, ZTF/G810...(Other models you can see in the webshop)		

			
1			
GEV No.	106615	Ref. No.	051389
description	air mixing tube L 42mm ø 22mm		
For models:	MR/G721, MR/G1071, MR/G1070, MR/G720, MR/G725, MR/G1075, MR/G726, MR/G1076, MFR/G360, BG/G1, BG/G2, MG/G350E, MG/G350F, MG/G700E, MG/G700F, MG/G1050F, RBR/G2FM, RBR/G2IM, RBK/G2FM, RG/G1, RG/G2, RGV/G1, RGV/G2, XBR/G2FM, XBR/G2IM, XBK/G2FM, XG/G1, XG/G2, XGV/G1, XGV/G2, JBR/G2FM, JG/G1, JG/G2, JGV/G1, JGV/G2, MBR/G2FM, MBR/G2IM, MBK/G2FM, MG/G1, MG/G2, MG/G1, MG/G2, RR/G720D, 7FTGC7L, 7FTGC1L, RR/G1070D, 7FTGC7M, RR/G1076, RFR/G360, RG/G350D...(Other models you can see in the webshop)		

bar burners

bar burners

			
1			
GEV No.	105769	Ref. No.	003709
description	bar burner 1-row ø 50mm Wmm Hmm L 340mm flange width 57mm flange length 57mm convection oven		
For models:	FCFG101/0, FCFG102-0, FCFG201-0, FCFG10160H, FCFG102-0T, FCF/G101/1-1-JAP, FCF/G102/1-1-JAP, FCF/G101/1, ECFG101-0, ECFG102-0, ECFG201-0, ACFG101-0, ACFG102-0, ACFG201-0, ACFG10160H, JCF/G101/1-1, JCF/G102/1-1, JCF/G101/1-2, JCF/G102/1-2, RCF101G, NCF/G101/1, NCF/G102/1, ZCF/G101/1, ZCF/G102/1, ZCF/G201/1		

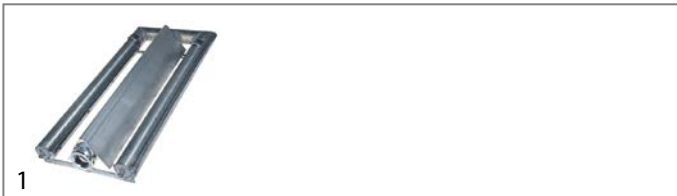

GEV No.	104128	Ref. No.	052855 OKE978
description	bar burner 2 row L 390mm W 180mm ømm H 45mm 6.4kW chargrill		
For models:	RG/G300, RG/G310D, RG/G300F, PRG/G300, RG/G300N, RG/G700, RG/G710D, RG/G700F, PRG/G700, RG/G700N, RGG1000, RG/G1000, PRG/G1000, RGV/G300, RGV/G310, RGV/G300, PRGV/G300, RGV/G300, RGV/G700, RGV/G701D, RGV/G700, PRGV/G700, RGV/G700, RGV/G1000, RGV/G1000, PRGV/G100, RG/G300, RG/G700, RG/G1000, RGV/G300, RGV/G700, RGV/G1000		

accessories for	104128		
------------------------	--------	--	--

	GEV No.	100562	Ref. No.	050591
gas injector bore ø 2.15mm				

	GEV No.	100574	Ref. No.	026786 0K2876
gas injector bore ø 1.4mm				

	GEV No.	100579	Ref. No.	026718
gas injector bore ø 1.3mm				

	GEV No.	101345	Ref. No.	020997 0F0146 727748
nut thread M15x1 H 3mm WS 19 brass Qty 1 pcs				

	GEV No.	101346	Ref. No.	025001 025902 0G0838 214110500
union nut nozzle holder				

	GEV No.	101347	Ref. No.	020988 051948 310056
nozzle holder angled				

	GEV No.	106615	Ref. No.	051389
air mixing tube L 42mm ø 22mm				



GEV No.	104573	Ref. No.	058979
description	bar burner 2 row L 400mm W 420mm ømm H 50mm oven		
For models:	MCF/G1090		



GEV No.	105642	Ref. No.	026864
description	bar burner 2 row L 420mm W 125mm ømm H 95mm fryer		
For models:	MFR/G360, RFR/G360, T35GFR, RF/G300, RF/G300		



GEV No.	104122	Ref. No.	056655
description	bar burner 2 row L 430mm W 205mm ømm H 45mm 6.95kW chargrill		
For models:	MG/G350D, MG/G700D, MG/G350, MG/G350E, MG/G350F, MG/G350NL, MG/G700, MG/G700E, MG/G700F, MG/G700NL, MG/G1050, MG/G1050F, MG/G1051, RG/G1, RG/G2, RGV/G1, RGV/G2, XG/G1, XG/G2, XGV/G1, XGV/G2, JG/G1, JG/G2, JGV/G1, JGV/G2, MG/G1, MG/G2, MG/G1, MG/G2, MG/G1, MG/G2, RG/G350D, RG/G700D, 7GLG03, RG/G350F, 7GLG07, RG/G700F, 7GLG10, RG/G1050, XG/G350D, XG/G700D, T35GCG, XG/G350E, XG/G350F, XG/G350NL, T70GCG, XG/G700E, XG/G700F, XG/G700NL, T105GCG, XG/G1050F, CG/G701...(Other models you can see in the webshop)		



GEV No.	105483	Ref. No.	00539 005656 0K3569
description	bar burner 2 row L 468mm W 200mm ømm H 45mm chargrill		
For models:	SGG350, SGG700		



GEV No.	104578	Ref. No.	004591
description	bar burner 2 row L 510mm W 190mm ømm H 40mm griddle		
For models:	BR/G1FL, BR/G1FR, BR/G2FL, BR/G2FR, RR/G1FL, RR/G1FR, RR/G1CL, RR/G2FL, RR/G2FM, RR/G2CL, RRV/G1FL, RRV/G1FR, RRV/G1CL, RRV/G2FL, RRV/G2FM, RRV/G2CL, RR/G2CM, XR/G1FL, XR/G1FR, XR/G1CL, XR/G2FL, XR/G2FM, XR/G2CL, XRV/G1FL, XRV/G1FR, XRV/G1CL, XRV/G2FL, XRV/G2FM, XRV/G2CL, XR/G2CM, JR/G1FL, JR/G1FR, JR/G1CL, JR/G2FL, JR/G2FM, JR/G2CL, JRV/G1FL, JRV/G1FR, JRV/G1CL, JRV/G2FL, JRV/G2FM, JRV/G2CL, MR/G1FL, MR/G1FR, MR/G1CL, MR/G2FL, MR/G2FM, MR/G2CL, MRV/G1FL, MRV/G1FR...(Other models you can see in the webshop)		



GEV No.	105637	Ref. No.	059523
description	bar burner 2 row L 520mm W 235mm ømm H 90mm pasta cooker		
For models:	MCP/G700, MCP/G701, MCP/G710, MCP/G711, MCP/G705, MCP/G706, 7CPG07P, RCP/G701, RCP/G706, M70GPC, M70GPC, XCP/G706, CCP/G700, HCP/G410D, HCP/G400, HCP/G410, HCP/G800, HCP/G810, HCPS/G400, ZCP/G400, ZCP/G410, ZCP/G800, ZCP/G810, ZCPS/G400, ACP/G400, ACP/G410, ACP/G800, ACP/G810, ACPS/G400, JCP/G800, PCP/G800		

1

GEV No.	105640	Ref. No.	056877
description	bar burner 2 row L 525mm W 210mm ømm H 90mm pasta cooker		
For models:	MCP/G700, 7CPG07P, M70GPC, RCP/G700, HCP/G800, HCP/G801, HCP/G400, HCP/G401, ZHCP/G400, ZHCP/G401, ZHCP/G800, ZHCP/G801, RCP/G700		



1

GEV No.	104584	Ref. No.	006462
description	bar burner 2 row L 545mm W 190mm ømm H 50mm multi purpose roasting pan		
For models:	RMV/G1C, XMV/G1C, MMV/G1C		



1

GEV No.	104581	Ref. No.	006650 0G4094 11085053
description	bar burner 2 row L 550mm W 190mm ømm H 50mm griddle		
For models:	KR/G1, KR/G2, KR/G1R, KR/G2R, KR/GT1, KR/GT2, KR/GT1R, KR/GT2R, KR/GT1C, KR/GT2C, KR/GT2CR, KR/GT1P, KR/GT2P, KR/GT1RP, KR/GT2RP, KR/GT1CP, KR/GT2CP, KR/GT2CRP, KRF/GT2RP, KT/G1, KT/G2, HR/G403W, HR/G803W, HR/G413W, HR/G813W, HR/G404W, HR/G804W, HR/G814W, QR/GT1, QR/GT2, QR/GT1R, QR/GT2R, QR/GT1C, QR/GT2C, QR/GT2CR, QR/GT1P, QR/GT2P, QR/GT1RP, QR/GT2RP, QR/GT1CP, QR/GT2CP, QR/GT2CRP, QRF/GT2RP, QT/G1, QT/G2, ZR/G403W, ZR/G803W, ZR/G413W, ZR/G813W, ZR/G404W...(Other models you can see in the webshop)		



1

GEV No.	104582	Ref. No.	002358
description	bar burner 2 row L 580mm W 225mm ømm H 45mm chargrill		
For models:	HG/G400, HG/G800, ZG/G400, ZG/G800, AG/G400, AG/G800		



1

GEV No.	104157	Ref. No.	051716
description	bar burner 3 row L 460mm W 355mm ømm Hmm kettle		
For models:	MPN/GD761, MPN/GI761, MPN/GI760D, MPN/GD760, MPN/GD760F, MPN/GI760, MPN/GI760F, 7PDG06, 7PIG06, RPN/GD760F, RPN/GI760F, XPN/GI760D, M70GDKE, M70GIKE, XPN/GD760F, XPN/GI760F, RPN/G760, RPN/G760, PRPN/G760, RPN/GI760, RPN/GI760, RPN/GI760, PRPN/GI76, HPN/GI806, HPN/GI805, ZPN/GI805, APN/GI805, RPN/G760, PRPN/GI76		



1

GEV No.	104583	Ref. No.	0C0490 0G2501 11061227 622502
description	bar burner 3 row L 640mm ømm H 265mm chargrill		
For models:	KGR/G1, KGR/G2, KGR/T1, KGR/T2, QGR/G1, QGR/G2, QGR/T1, QGR/T2, WGR/G1, WGR/G2, ADGRAAOOOO, ADGRHAOOOO, ADGRAFOOOO, ADGRHFOOOO, ADGUAAOOOO, ADGUHAOOOO, ADGUAFOOOO, ADGUHF0000, ADGROIOOOO, ADGUOIOOOO		



1

GEV No.	104580	Ref. No.	0A5124 0G2270 0G2630 727792
description	bar burner 3 row L 645mm W 190mm ømm H 45mm griddle		
For models:	HR/G400, HR/G800, HR/G410, HR/G811, HR/G403, HR/G803, HR/G413, HR/G814, HR/G403D, HR/G803D, HR/G814D, HR/G420D, HR/G820D, HR/G403NL, HR/G803NL, HR/G420, HR/G820, HR/G821, HR/G414D, HR/G400U, HR/G800U, HR/G410U, HR/G810U, HTR/G411, HTR/G811, HR/G400, HR/G800, HR/G410, HR/G811, ZR/G403, ZR/G803, ZR/G413, ZR/G814, ZR/G403D, ZR/G803D, ZR/G420, ZR/G820, ZR/G821, 2FTG-F4L, 2TFGF8L, AR/G400, AR/G800, AR/G410, AR/G811, AR/G403, AR/G803, AR/G403D, AR/G803D, AR/G403NL, AR/G803NL...(Other models you can see in the webshop)		





1

GEV No.	104585	Ref. No.	006471
description	bar burner 4 row L 415mm W 490mm ømm H 40mm multi purpose roasting pan		
For models:	RMV/G2C, XMV/G2C, MMV/G2C, KMV/G2C, QMV/G2C		

			
GEV No.	105647	Ref. No.	004353
description	bar burner 4 row L 450mm W 455mm ømm H 245mm tilting bratt pan		
For models:	RBR/G2FM, RBR/G2IM, RBK/G2FM, XBR/G2FM, XBR/G2IM, XBK/G2FM, JBR/G2FM, MBR/G2FM, MBR/G2IM, MBK/G2FM		

			
GEV No.	105648	Ref. No.	051296
description	bar burner 6 row L 595mm W 630mm ømm H 45mm tilting bratt pan		
For models:	HBR/G820, HBR/G825, HBR/G821UK, ZBR/G821, ZBR/G826, ABR/G820, ABR/G825, HBR/G803, HBR/G804, HBR/G803, HBR/G804, HBR/G803, HBR/G805, HBR/G803, HBR/G804, HBR/G803, HBR/G804		

			
GEV No.	105660	Ref. No.	059506
description	bar burner 4 row L 475mm W 470mm ømm kettle		
For models:	HPN/GI810, HPN/GI815, HPN/GI815D, HPN/GI816, HPN/GI816, HPN/GD811, HPN/GD816, HPA/GD825, HPA/GI825, HPNS/GI816, ZPN/GI810, 2PIG15, ZPN/GI816, ZPN/GI816D, ZPN/GD811, ZPN/GD816, 2PDAG15, 2PIAG15, ZPNS/GI816, APN/GI810, APN/GI815, APN/GI816, APN/GI816D, APN/GD811, APN/GD816, APNS/GI816, OPN/GI815		

			
GEV No.	105650	Ref. No.	0A5166
description	bar burner 6 row L 630mm W 550mm ømm tilting bratt pan		
For models:	HBR/G800D, HBR/G801D, HBR/G800, HBR/G805, HBR/G800UK, ZBR/G800, ZBR/G805, ZBR/G800UK, ABR/G800, ABR/G805, ABR/G801, ABR/G806, ABR/G800D, ABR/G805D, ABR/G801D, ABR/G806D, ABR/G805NL, ABR/G800, ABR/G805, OBR/G800UK		

			
GEV No.	105652	Ref. No.	0C0700
description	bar burner 4 row L 580mm W 545mm ømm H 30mm tilting bratt pan		
For models:	KBR/G2F, KBR/G2C, KBR/G2FH, KBR/G2CH, QBR/G2F, QBR/G2C, QBR/G2FH, QBR/G2CH, WBR/G2F, WBR/G2C, WBR/G2FH, WBR/G2CH		

			
GEV No.	105773	Ref. No.	0A2474
description	bar burner angled L 660mm W 205mm ømm Hmm oven		

			
GEV No.	104579	Ref. No.	056002
description	bar burner 4 row L 625mm W 330mm ømm H 85mm griddle		
For models:	HRS/G802, HRS/G802, HRS/G812, HRA/G802, HRA/G802, HR/G802T, ZHRAG802CR, HRA/G812, HRA/G812, ZHR/G802, ZHRA/G812, HRA/G802, ZHR/G802		

			
GEV No.	105061	Ref. No.	052067 052717 330111424
description	bar burner angled L 680mm W 260mm ømm Hmm oven		
For models:	HCF/G800F, PHCF/G800, HCFG810, HCF/G810D, HCF/G800, HCF/G800NL, HCF/G800DK, HCFG1210, HCF/G1210D, HCF/G1200, HCF/G1200F, PHCF/G1200, HCF/G1200N, HCF/G1200D, HCFG1610, HCF/G1610D, HCF/G1600, HCF/G1600F, PHCF/G1600, HCF/G1600N, HCF/G1600D, HTFG800, HTF/G800, HT/G800F, HTF/G800, HTF/G1210, HTF/G1210, HTF/G1200, HTF/G1200, HCA/G810, HCF/G1210, ZHCF/G161, ZHTF/G800, ZHTF/G121, HCA/G810, HCF/G1210, HCF/G1610, ZHTF/G800, HTF/G1210		

			
GEV No.	105651	Ref. No.	059624
description	bar burner 6 row L 550mm W 790mm ømm H 60mm frying pan		
For models:	HBR/G810, HBR/G815, HBR/G811, HBR/G816, ZBR/G810, ZBR/G815, ZBR/G811, ZBR/G816, ABR/G810, ABR/G815, ABR/G811, ABR/G816, ABR/G810D, ABR/G815D, ABR/G811D, ABR/G816D, ABR/G810, ABR/G815, ABR/G811, ABR/G816		

			
GEV No.	105653	Ref. No.	0C0701
description	bar burner L 700mm W 585mm ømm H 30mm tilting bratt pan		
For models:	KBR/G3F, KBR/G3FH, KBR/G3C, KBR/G3CH, QBR/G3F, QBR/G3FH, QBR/G3C, QBR/G3CH, WBR/G3F, WBR/G3FH, WBR/G3C, WBR/G3CH		



			
GEV No.	104291	Ref. No.	00420 004971
description	bar burner ø 26mm Wmm Hmm L 260mm bain marie		
For models:	SMG350, SMG700		

			
GEV No.	104589	Ref. No.	0A5447
description	bar burner ø 40mm Wmm Hmm L 550mm flange width 46mm bain marie flange ø 61mm		
For models:	RBV/G2, XBV/G2, JBV/G2, MBV/G2		

			
GEV No.	105643	Ref. No.	003326
description	bar burner ø 40mm Wmm Hmm L 380mm flange width 46mm fryer flange ø 61mm		
For models:	MFR/G380, MFR/G381, BF/G1S07, RF/G1S07, RF/G2D07, RFR/G1S07, RFR/G2D07, RF/G1S07, RF/G2D07, RFR/G1S07, RFR/G2D07, XFR/G1S07, XFR/G2D07, XFR/G1S07, XFR/G2D07, XF/G1S07, XF/G2D07, XFR/G1S07, XFR/G2D07, JF/G1S07, JF/G2D07, JFR/G1S07, JFR/G2D07, JF/G1S07, JF/G2D07, JFR/G2D07, JFR/G2D07, MF/G1S07, MF/G2D07, MFR/G1S07, MFR/G2D07, MF/G1S07, MF/G2D07, MFR/G1S07, MFR/G2D07, 7FRG03T, CFR/G381, T35GFR, PF/G1S07, PF/G2D07, PFR/G1S07, PFR/G2D07, OF/G1S07, OFR/G1S07, OFR/G2D07, TF/G1S07, TF/G2D07, TFR/G1S07, TFR/G2D07, JFR/G400...(Other models you can see in the webshop)		

			
GEV No.	104593	Ref. No.	059809
description	bar burner ø 40mm Wmm Hmm L 600mm flange width 46mm bain marie flange ø 61mm		
For models:	KB/G2, HM/G800, ZM/G800, WB/G2, AM/G800, AM/G800D, OM/G800		

			
GEV No.	104229	Ref. No.	054117
description	bar burner ø 40mm Wmm Hmm L 480mm flange width 46mm gas range flange ø 61mm		
For models:	MCF/G705, MCF/G1055, MCF/G700, MCF/G1050, MCF/G705E, MCF/G1055E, MCF/G700D, MCF/G700, MCF/G705F, MCF/G1055F, MCF/G705NL, MCF/G1050D, MCF/G1055NL, MCF/G702, MCF/G1052, MCF/G700, MCF/G1050, MTF/G700D, MTF/G1050D, MTF/G700, MTF/G1050, MTF/GE1050, MT/G700F, MTF/G700F, MTF/G1055F, MTFGE1055F, MF/G700, RCF/G720, RCF/G1020, RCFG730, RCFG1030, RCF/G720F, RCF/G1020, RCF/G700, RCF/G1050, RCF/G1050D, RCF/G700D, RCF/G700, MCF/G1050, RCF/G702, RCF/G1052, 74FG07F, 76FG10F, RTF/G700D, RTF/G1050D, 7TPG07F, 7TPG10F, RT/G700F, RTF/G700, RTF/G1050...(Other models you can see in the webshop)		

			
GEV No.	104223	Ref. No.	059221 0G2555 0KF068 727243 727743
description	bar burner ø 40mm Wmm Hmm L 620mm flange width 46mm gas range		
For models:	PCV/G2, PCV/G3, PCF/G2, PCF/G3, PTF/G2, PSF/G2, PSF/G3, PCV/G2N, PCF/G3N, PCV/G3N, PCF/G2N, PCV/G2A, PCV/G3A, PCF/G2A, PCF/G3A, OCV/G2, OCF/G2, OCF/G3, OTV/G2, OTF/G2, OSF/G2, OSV/G2, TCV/G2, TCV/G3, TCF/G2, TCF/G3, TTF/G2, TSF/G2, TSF/G3, TCV/G2A, TCV/G3A, TCF/G2A, TCF/G3A, HCF/G810, HCF/G810D, HCF/G1210D, HCF/G1610D, HCF/G810NL, HCF/G1210, HCF/G1610, HCF/G810, HCF/G1210, HCF/G1610, HCF/G811, HCF/G800U, HCF/G1200U, HCF/G1600U, KCF/G2, KCF/G3, KCF/G4...(Other models you can see in the webshop)		

			
GEV No.	104574	Ref. No.	004258
description	bar burner ø 40mm Wmm Hmm L 485mm oven flange ø 46mm		
For models:	RCF/G2, RCF/G3, RTF/G2, RSF/G2, RSV/G2, RSF/G3, MCF/G2A, MCF/G3A, XCF/G2, XCF/G3, XTF/G2, XSF/G2, XSV/G2, XSF/G3, JCF/G2, JCF/G3, JTF/G2, MCF/G2, MCF/G3, MTF/G2, MSF/G2, MSV/G2, MSF/G3		

			
GEV No.	105768	Ref. No.	003677
description	bar burner ø 50mm Wmm Hmm L 267mm flange width 57mm flange length 57mm convection oven		
For models:	FCF/G6-0, FCF/G6-1-JAP, ECF/G6/0, ACF/G6-0, JCF/G6-1, JCF/G6-2, RCF061G, NCF/G6-0, ZCF/G6-0		



			
GEV No.	105784	Ref. No.	056451
description	bar burner ø 50mm Wmm Hmm L 300mm flange width 57mm flange length 57mm convection oven		
For models:	FCV/G6L4, FCVG6-1, FCVG6-3, FCVG6-1UK, FCVG6-3UK, 5711-2-6, 5711-2-7, 5711-2-8, 5711-2-10, 5711-2-8CH, 5711-2-10CH, 5711-2-6L, 5711-2-7L, 5711-2-8L, 5711-2-10L, ECV/G6T4, FCV/G6-1, ZOFCV/G6-3, AFCV/G6-1, AFCV/G6-3, SCO/G6-3, ZCV/G6T4		

			
GEV No.	105638	Ref. No.	004726
description	bar burner ø 50mm Wmm Hmm L 340mm flange width 57mm flange length 57mm pasta cooker		
For models:	BCP/G1, RCP/G1S, RCP/G2D, XCP/G1S, XCP/G2D, JCP/G1S, JCP/G2D, MCP/G1S, MCP/G2D, PCP/G1S, PCP/G2D, OCP/G1S, OCP/G2D, TCP/G1S, TCP/G2D		

			
GEV No.	105407	Ref. No.	005794 00587
description	bar burner ø 50mm Wmm Hmm L 320mm flange width 72mm pasta cooker flange ø 75mm		
For models:	SCPG350, SCPG350		

			
GEV No.	105644	Ref. No.	005929 11061229
description	bar burner ø 50mm Wmm Hmm L 390mm flange width 57mm flange length 57mm fryer		
For models:	BFR/G1S14, RFR/G1S14, RFR/G2D14, XFR/G1S14, XFR/G2D14, JFR/G1S14, JFR/G2D14, MFR/G1S14, MFR/G2D14, PFR/G1S14, PFR/G2D14, PFRG2D14HV, PFRG1S14HV, OFR/G1S14, OFR/G2D14, TFR/G1S14, TFR/G2D14, KFR/G1A, KFR/G2B, QFR/G1A, QFR/G2B, WFR/G1A, WFR/G2B, AFGROAOOOO, AFGROFOOOO, AFGUOAOOOO, AFGUOFOOOO		

			
GEV No.	105661	Ref. No.	0C0743
description	bar burner ø 50mm Wmm Hmm L 330mm flange width 57mm flange length 57mm kettle		
For models:	KPI/G10, KPI/G15, KPD/G10, KPD/G15, KPD/G15A, KPI/G15A, KPI/G15H, KPI/G10H, QPI/G10, QPI/G15, QPD/G10, QPD/G15, QPI/G15H, QPI/G10H, WPI/G10, WPI/G15, WPD/G10, WPD/G15, WPD/G15A, WPI/G15A, WPI/G15H, WPI/G10H		

			
GEV No.	104290	Ref. No.	00366 004954
description	bar burner ø 50mm Wmm Hmm L 390mm tilting bratt pan		
For models:	SRG350, SRG360, SRG700, SRG710		

			
GEV No.	105641	Ref. No.	004847 11061203
description	bar burner ø 50mm Wmm Hmm L 330mm flange width 57mm flange length 57mm pasta cooker		
For models:	RPD/G240, RPD/G260, RPI/G260, RPI/G260P, XPD/G240, XPD/G260, XPI/G260, XPI/G260P, JPD/G240, JPD/G260, JPI/G260, MPD/G240, MPD/G260, MPI/G260, MPI/G260P, PPD/G260, PPI/G260P, OPD/G260, OPI/G260P, TPD/G260, TPI/G260P, KPI/G06, KCP/G1RU, KCP/G2RU, KCP/G1, KCP/G1R, KCP/G2, KCP/G2R, KCP/G1U, KCP/G2U, QPI/G06, QCP/G1, QCP/G1R, QCP/G2, QCP/G2R, WPI/G06, WCP/G1, WCP/G1R, WCP/G2, WCP/G2R, DCP/G400, AKGROAOOOO, AKGROFOOOO		

			
GEV No.	105645	Ref. No.	006127 11061201
description	bar burner ø 50mm Wmm Hmm L 408mm flange width 57mm flange length 57mm fryer		
For models:	KFR/G1E, KFR/G2F, KFH/G1, KFH/G1ELH, KFH/G1EH, HFH/G430, HFR/G430, HFR/G830, HFH/G400U, HFH/G401U, HFH/G435, HFRS/G430, QFR/G1E, QFR/G2F, QFH/G1, QFH/G1ELH, QFH/G1EH, ZFH/G430, ZFR/G430, ZFR/G830, ZFH/G435, ZFRS/G430, WFR/G1E, WFR/G2F, WFH/G1, WFH/G1ELH, WFH/G1EH, AFR/G430, AFR/G830, AFH/G435, AFRS/G430, AFGROAOOOO, AFGROFOOOO, AFGUOAOOOO, AFGUOFOOOO		





			
1			
GEV No.	104575	Ref. No.	002513
description	bar burner ø 50mm Wmm Hmm L 500mm flange width 57mm flange length 57mm oven		
For models:	MCF/G1095, MCF/G995, RCF/G9, XCF/G9, MCF/G9, RCF/G1095, CCF/G995, OCF/G9UK, TCF/G9, TCF/G9UK		

			
1			
GEV No.	104187	Ref. No.	OG4669 OK1207 11061245 7128D
description	bar burner ømm W 28mm H 49mm L 510mm flange width 35mm flange length 70mm tilting bratt pan		
For models:	APRPETOOB, APRBPEOOB, APRBPGTOOB, APRBPGOOB, APRB-PITOOB, APRBPIOOB, APRCPETOOB, APRCPPEOOB, APRCPGTOOB, APRCPGOOB, APRCPITOOB, APRCPIOOB, 7542-2, 7544-2, 9042-2, 9044-2		

			
1			
GEV No.	105766	Ref. No.	054028
description	bar burner ø 50mm Wmm Hmm L 525mm flange width 57mm flange length 57mm convection oven		
For models:	FCFG20, FCFG20D, FCFG20F, PFCFG20, FCFG20J, FCFG20J, FCFG20J, FCFG20J, FCFG201, FF/G20, COCO20G, ZOFCF/G20D		

			
1			
GEV No.	105970	Ref. No.	OKD090
description	bar burner ømm W 28mm H 49mm L 510mm flange width 35mm flange length 70mm tilting bratt pan		
For models:	7542-2, 7544-2, 7742-2, 7744-2, 9042-2, 9044-2		

			
1			
GEV No.	105639	Ref. No.	056638
description	bar burner ø 60mm Wmm Hmm L 390mm 1-row with bolt bolt ø 10x45mm flange width 67mm flange length 67mm pasta cooker		
For models:	HCP/G800, HCP/G400		

			
1			
GEV No.	104186	Ref. No.	0H6337 11061244 7128E
description	bar burner ømm W 28mm H 49mm L 510mm with ignition bridge 170mm flange width 35mm flange length 70mm tilting bratt pan		
For models:	APRPETOOB, APRBPEOOB, APRBPGTOOB, APRBPGOOB, APRB-PITOOB, APRBPIOOB, APRCPETOOB, APRCPPEOOB, APRCPGTOOB, APRCPGOOB, APRCPITOOB, APRCPIOOB, 7542-2, 7544-2, 9042-2, 9044-2		

			
1			
GEV No.	105770	Ref. No.	003992 004831
description	bar burner ø 60mm Wmm Hmm L 570mm flange width 61mm convection oven flange ø 79mm		
For models:	FCFG202-0, ECFG202-0, ACFG202-0, ZCF/G202/1		

			
1			
GEV No.	105971	Ref. No.	OKD091
description	bar burner ømm W 28mm H 49mm L 510mm with ignition bridge 170mm flange width 35mm flange length 70mm tilting bratt pan		
For models:	7542-2, 7544-2, 7742-2, 7744-2, 9042-2, 9044-2		





			
1			
GEV No.	104129	Ref. No.	052467 052912 330111700
description	bar burner ømm W 40mm H 31mm L 670mm griddle		
For models:	HRS/G401, HRS/G401, HRS/G401F, HRS/G411, HRS/G411, HRS/G411, HRS/G411, HRS/G801, HRS/G801, HRS/G801, HRS/G811, HRS/G811, HR/G401T, HR/G411T, HR/G801T, HR/G811T, ZHRS/G401, ZHRA/G411, ZHRA/G801, ZHRA/G811, HRA/G401D, HRA/G411D, HRA/G801D, HRA/G811D, ZHR/G401T, ZHR/G401T, ZHR/G801T, ZHR/G811T, FT/G2, ZHR/G801D		

			
1			
GEV No.	104185	Ref. No.	OK1193
description	bar burner ømm W 40mm H 53mm L 298mm kettle		
For models:	7511-2, 7512-2, 7512-9, 7550-2, 7711-2, 9012-2, 9211-2-0		

			
1			
GEV No.	104188	Ref. No.	0H6335
description	bar burner ømm W 40mm H 53mm L 400mm flange width 48mm flange length 83mm range/boiling pan		
For models:	7502-2, 7504-2, 7505-2-9, 7508-2, 7511-2, 7551-2, 7552-2, 7553-2, 7573-2, 7574-2, 7575-2, 7576-2, 7773-2, 7774-2, 7775-2, 7776-2, 9100-2, 9101-2, 9102-2, 9104-2, 9113-2, 9114-2, 9115-2, 9116-2		

			
1			
GEV No.	105999	Ref. No.	0G3823 19013016 722101
description	bar burner slotted ømm W 30mm H 55mm L 500mm gas range		
For models:	LG159-703.A1BC, LG159-703.A2BC, LG159-704.A1BC, LG159-706.A1BC, LG259-711.A1ACCB, LG259-712.A1ACCB, LK259-707.D1ACCB, LK259-708.D1ACCB, LG259-739.A1ACCB, LG259-740.A1ACCB, LK159-707.D1BC, LK159-708.D1BC, LK259-727.D1ACCB, LK259-728.D1ACCB, LG159-704.A2BC, LK159-707.D2BC, LK159-708.D2BC, LG259-711.A2ACCB, LG259-712.A2ACCB, LK259-727.D2ACCB, LK259-728.D2ACCB, LK259-707.D2ACCB, LK259-708.D2ACCB, LG159-705.A1BC, LG159-753.A1BC, LG259-758.A1ACCB, LG259-754.A1ACCB, LG259-757.A1ACCB, LG159-703.0.FF, LG159-703.0.GD, LG159-703.0.GK, LG159-703.0.ZS, LG159-703.0.SS, LG159-704.0.GD, LG159-704.0.SS, LG159-704.0.ZS, LK159-708.3.NS, LK159-708.3.SS, LK159-708.3.ZF, LG159-705.0.SS, LG159-706.0.NZ, LG159-706.0.ZN, LG159-753.0.ZZ, LG259-711.0.FF/ZZ, LG259-711.0.FN/NN, LG259-711.0.GL/GL, LG259-711.0.NS/NN, LG259-711.0.SS/SS, LG259-711.0.SZ/ZS, LG259-711.0.ZS/ZS...(Other models you can see in the webshop)		

			
1			
GEV No.	104590	Ref. No.	051974 0TR593
description	bar burner T-shape L 224mm ø 32mm bain marie		
For models:	HM/G800T		

			
1			
GEV No.	104588	Ref. No.	050918 058749
description	bar burner T-shape L 240mm ø 32mm bain marie		
For models:	MM/G350F, RM/G350D, RM/G350F, XM/G350D, T35GBM, XM/G350F		

			
1			
GEV No.	104587	Ref. No.	050919
description	bar burner T-shape L 585mm ø 32mm bain marie		
For models:	MM/G700F, MM/G700E, RM/G700D, RM/G700F, XM/G700D, T70GBM, XM/G700F, CM/G700		

			
1			
GEV No.	104591	Ref. No.	051975
description	bar burner T-shape L 630mm ø 32mm bain marie		
For models:	HM/G800T		

			
1			
GEV No.	105813	Ref. No.	002857
description	burner ømm W 185mm H 110mm L 560mm combi-steamer		
For models:	FCV/G6L4, 5711-2-6, 5711-2-7, 5711-2-8, 5711-2-10, 5711-2-8CH, 5711-2-10CH, 5711-2-6L, 5711-2-7L, 5711-2-8L, 5711-2-10L, ECV/G6T4, ZCV/G6T4		





			
1			
GEV No.	211041	Ref. No.	0C0424 11101352
description	chargrill grid L 175mm W 640mm H 50mm		
For models:	KGR/G2, KGR/E2, KGR/T2, QGR/G2, QGR/E2, QGR/T2, WGR/G2, WGR/E2, ADGRAA0000, ADGRHA0000, ADGRAFO000, ADGRHF0000, ADGUAA0000, ADGUHA0000, ADGUAF0000, ADGUHF0000, ADGROIO000, ADGUOIO000		

			
1			
GEV No.	211024	Ref. No.	004964 00543 0K3571
description	lava rock grid L 420mm W 268mm		
For models:	SGG350, SGG700		

			
1			
GEV No.	211034	Ref. No.	052849 053693 0C6879 0C8907 0C9059 0KE993 921643
description	chargrill grid L 340mm W 545mm		
For models:	MG/E350D, MG/E350UK, MG/E700D, MG/E700UK, MG/G350D, MG/G700D, MG/G350, MG/G350E, MG/G350F, MG/G350NL, MG/G700, MG/G700E, MG/G700F, MG/G700NL, MG/G1050, MG/G1050F, MG/E350, MG/E700, MG/G1051, RG/G1, RG/G2, RGV/G1, RGV/G2, XG/G1, XG/G2, XGV/G1, XGV/G2, JG/G1, JG/G2, JGV/G1, JGV/G2, MG/G1, MG/G2, MG/V/G1, MG/V/G2, RG/E350D, RG/E350UK, RG/E700D, RG/E700UK, RG/G350D, RG/G700D, 7GLG03, RG/G350F, 7GLG07, RG/G700F, 7GLG10, RG/G1050, 7GLE03T, 7GLE07T, XG/E350D...(Other models you can see in the webshop)		

			
1			
GEV No.	211006	Ref. No.	052762 052854 054711
description	lava rock grid L 440mm W 290mm		
For models:	RG/G300, RG/G310D, RG/G300F, PRG/G300, RG/G300N, RG/G700, RG/G710D, RG/G700F, PRG/G700, RG/G700N, RGG1000, RG/G1000, PRG/G1000, RGV/G300, RGV/G310, RGV/G300, PRGV/G300, RGV/G300, RGV/G700, RGV/G701D, RGV/G700, PRGV/G700, RGV/G700, RGV/G1000, RGV/G1000, PRGV/G100, RG/G300, RG/G700, RG/G1000, RGV/G300, RGV/G700, RGV/G1000		

			
1			
GEV No.	211025	Ref. No.	004963 00541 0K3570
description	chargrill grid L 480mm W 305mm H 14mm		
For models:	SGG350, SGG700		
accessories for	211025		
	GEV No.	211098	Ref. No. —
handle ø 28mm L 89mm thread M10x1 black			

			
1			
GEV No.	211051	Ref. No.	056657
description	lava rock grid L 440mm W 290mm		
For models:	MG/G350D, MG/G700D, MG/G350, MG/G350E, MG/G350F, MG/G350NL, MG/G700, MG/G700E, MG/G700F, MG/G700NL, MG/G1050, MG/G1050F, MG/G1051, RG/G350D, RG/G700D, 7GLG03, RG/G350F, 7GLG07, RG/G700F, 7GLG10, RG/G1050, XG/G350D, XG/G700D, T35GCC, XG/G350E, XG/G350F, XG/G350NL, T70GCC, XG/G700E, XG/G700F, XG/G700NL, T105GCC, XG/G1050F, CG/G701, RG/G300, RG/G300F, PRG/G300, RG/G700, RG/G700F, PRG/G700, RGG1000, RG/G1000, PRG/G1000, RGV/G300, RGV/G300, PRGV/G300, RGV/G700, RGV/G700, PRGV/G700, RGV/G1000...(Other models you can see in the webshop)		

			
1			
GEV No.	211087	Ref. No.	0C0450 11101351
description	chargrill grid L 640mm W 160mm		
For models:	KGR/G1, KGR/E1, KGR/T1, QGR/G1, QGR/E1, QGR/T1, WGR/G1, WGR/E1, ADGRAA0000, ADGRHA0000, ADGRAFO000, ADGRHF0000, ADGUAA0000, ADGUHA0000, ADGUAF0000, ADGUHF0000, ADGROIO000, ADGUOIO000		

			
1			
GEV No.	211035	Ref. No.	004801 006205
description	lava rock grid L 447mm W 285mm		
For models:	RG/G1, RGV/G1, XG/G1, XGV/G1, JG/G1, JGV/G1, MG/G1, MG/V/G1, PG/G1, PG/G1HV, OG/G1, TG/G1		

			
1			
GEV No.	211059	Ref. No.	002385
description	lava rock grid L 600mm W 345mm		
For models:	HG/G400, ZG/G400, AG/G400, AG/G800		





			
1			
GEV No.	211039	Ref. No.	0C0479
description	lava rock grid L 630mm W 340mm H 45mm		
For models:	KGR/G2, KGR/T2, WGR/G2		

			
1			
GEV No.	211036	Ref. No.	004806 006206
description	lava rock grid L 635mm W 445mm H 20mm		
For models:	RG/G2, RGV/G2, XG/G2, XGV/G2, JG/G2, JGV/G2, MG/G2, MG/G2, PG/G2, PG/G2HV, OG/G2, TG/G2		

			
1			
GEV No.	211037	Ref. No.	002395 0KE747
description	lava rock grid L 715mm W 595mm		
For models:	HG/G800, ZG/G800, AG/G400, AG/G800		

chargrill grids			
			
1			
GEV No.	211041	Ref. No.	0C0424 11101352
description	chargrill grid L 175mm W 640mm H 50mm		
For models:	KGR/G2, KGR/E2, KGR/T2, QGR/G2, QGR/E2, QGR/T2, WGR/G2, WGR/E2, ADGRAA0000, ADGRHA0000, ADGRAFO000, ADGRHF0000, ADGUA0000, ADGUHA0000, ADGUAFO000, ADGUHF0000, ADGROIO000, ADGUOIO000		

			
1			
GEV No.	211034	Ref. No.	052849 053693 0C6879 0C8907 0C9059 0KE993 921643
description	chargrill grid L 340mm W 545mm		
For models:	MG/E350D, MG/E350UK, MG/E700D, MG/E700UK, MG/G350D, MG/G700D, MG/G350, MG/G350E, MG/G350F, MG/G350NL, MG/G700, MG/G700E, MG/G700F, MG/G700NL, MG/G1050, MG/G1050F, MG/E350, MG/E700, MG/G1051, RG/G1, RG/G2, RGV/G1, RGV/G2, XG/G1, XG/G2, XGV/G1, XGV/G2, JG/G1, JG/G2, JGV/G1, JGV/G2, MG/G1, MG/G2, MG/G1, MG/G2, MG/G1, MG/G2, RG/E350D, RG/E350UK, RG/E700D, RG/E700UK, RG/G350D, RG/G700D, 7GLG03, RG/G350F, 7GLG07, RG/G700F, 7GLG10, RG/G1050, 7GLE03T, 7GLE07T, XG/E350D...(Other models you can see in the webshop)		

			
1			
GEV No.	211025	Ref. No.	004963 00541 0K3570
description	chargrill grid L 480mm W 305mm H 14mm		
For models:	SGG350, SGG700		
accessories for	211025		
	GEV No.	211098	Ref. No. —
	 handle ø 28mm L 89mm thread M10x1 black		

			
1			
GEV No.	211087	Ref. No.	0C0450 11101351
description	chargrill grid L 640mm W 160mm		
For models:	KGR/G1, KGR/E1, KGR/T1, QGR/G1, QGR/E1, QGR/T1, WGR/G1, WGR/E1, ADGRAA0000, ADGRHA0000, ADGRAFO000, ADGRHF0000, ADGUA0000, ADGUHA0000, ADGUAFO000, ADGUHF0000, ADGROIO000, ADGUOIO000		

lava rock grids			
			
1			
GEV No.	211024	Ref. No.	004964 00543 0K3571
description	lava rock grid L 420mm W 268mm		
For models:	SGG350, SGG700		



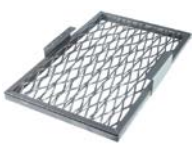

			
1			
GEV No.	211006	Ref. No.	052762 052854 054711
description	lava rock grid L 440mm W 290mm		
For models:	RG/G300, RG/G310D, RG/G300F, PRG/G300, RG/G300N, RG/G700, RG/G710D, RG/G700F, PRG/G700, RG/G700N, RGG1000, RG/G1000, PRG/G1000, RGV/G300, RGV/G310, RGV/G300, PRGV/G300, RGV/G300, RGV/G700, RGV/G701D, RGV/G700, PRGV/G700, RGV/G700, RGV/G1000, RGV/G1000, PRGV/G100, RG/G300, RG/G700, RG/G1000, RGV/G300, RGV/G700, RGV/G1000		

			
1			
GEV No.	211051	Ref. No.	056657
description	lava rock grid L 440mm W 290mm		
For models:	MG/G350D, MG/G700D, MG/G350, MG/G350E, MG/G350F, MG/G350NL, MG/G700, MG/G700E, MG/G700F, MG/G700NL, MG/G1050, MG/G1050F, MG/G1051, RG/G350D, RG/G700D, 7GLG03, RG/G350F, 7GLG07, RG/G700F, 7GLG10, RG/G1050, XG/G350D, XG/G700D, T35GCG, XG/G350E, XG/G350F, XG/G350NL, T70GCG, XG/G700E, XG/G700F, XG/G700NL, T105GCG, XG/G1050F, CG/G701, RG/G300, RG/G300F, PRG/G300, RG/G700, RG/G700F, PRG/G700, RG/G1000, RG/G1000, PRG/G1000, RGV/G300, RGV/G300, PRGV/G300, RGV/G700, RGV/G700, PRGV/G700, RGV/G1000...(Other models you can see in the webshop)		

			
1			
GEV No.	211035	Ref. No.	004801 006205
description	lava rock grid L 447mm W 285mm		
For models:	RG/G1, RGV/G1, XG/G1, XGV/G1, JG/G1, JGV/G1, MG/G1, MG/G1, PG/G1, PG/G1HV, OG/G1, TG/G1		

			
1			
GEV No.	211059	Ref. No.	002385
description	lava rock grid L 600mm W 345mm		
For models:	HG/G400, ZG/G400, AG/G400, AG/G800		



			
1			
GEV No.	211039	Ref. No.	0C0479
description	lava rock grid L 630mm W 340mm H 45mm		
For models:	KGR/G2, KGR/T2, WGR/G2		

			
1			
GEV No.	211036	Ref. No.	004806 006206
description	lava rock grid L 635mm W 445mm H 20mm		
For models:	RG/G2, RGV/G2, XG/G2, XGV/G2, JG/G2, JGV/G2, MG/G2, MG/G2, PG/G2, PG/G2HV, OG/G2, TG/G2		

			
1			
GEV No.	211037	Ref. No.	002395 0KE747
description	lava rock grid L 715mm W 595mm		
For models:	HG/G800, ZG/G800, AG/G400, AG/G800		

tube burners

			
1			
GEV No.	105071	Ref. No.	059297 0KW917 727883
description	tubular burner L 265mm W 50mm H 71mm for fryer oval suitable for 700/900 series		
For models:	MFR/G740, MFR/G350, MFR/G351, MFR/G700, MFR/G701, RFR/G1S12, RFR/G2D12, RFR/G2S40, XFR/G1S12, XFR/G2D12, XFR/G2S40, JFR/G1S12, JFR/G2D12, JFR/G2S40, MFR/G1S12, MFR/G2D12, MFR/G2S40, RFR/G741, 7FRG03S, 7FRG07S, CFR/G741, M35GFR, M70GFR, CFR/G351, CFR/G701, XFR/G700, PFR/G2S40, TFR/G2S40, KFR/G1T, HFR/G410, HFR/G810, HFR/G410D, HFR/G810D, HFR/G410NL, HFR/G810NL, HFR/G411, HFR/G412, FC1G, FC2G, QFR/G1T, ZFR/G410, ZFR/G810, ZFR/G410D, ZFR/G810D, ZFR/G411, ZFR/G412, RF/G1680, RF/G2480, WFR/G1T, AFR/G410...(Other models you can see in the webshop)		

			
1			
GEV No.	104568	Ref. No.	004287
description	tubular burner ø 74mm L 185mm H 60mm round solid top range		
For models:	RSF/G2, RSV/G2, XSF/G2, XSV/G2, MSF/G2, MSV/G2		
accessories for	104568		
	GEV No.	Ref. No.	002527
	 air mixer		





			
1			
GEV No.	104293	Ref. No.	00440 004945 OK3559
description	tubular burner ø 74mm L 200mm H 60mm round for fryer		
For models:	SFRG350, SFRG700, SFRG350, SFRG700		

ring burners

			
1			
GEV No.	105655	Ref. No.	051564
description	ring burner for kettle		
For models:	HQN/G1225, HQN/G1225, HQN/G1122, HQN/G1225, HQN/G1122		

			
1			
GEV No.	104196	Ref. No.	OKC724
description	ring burner L 290mm W 245mm for oven		

			
1			
GEV No.	104189	Ref. No.	OH7082
description	ring burner L 460mm W 245mm for oven		
For models:	7502-2, 7504-2, 9002-2, 9004-2		

			
1			
GEV No.	105654	Ref. No.	051563 S330216612
description	ring burner L 465mm W 233mm for kettle		
For models:	HQN/G1917, HQN/G1917, HQN/G1917		

forced air burners

			
1			
GEV No.	104692	Ref. No.	OC4125
description	mounting flange L 108mm W 83mm hole distance 21mm M4 thread L 15mm mounting distance 50mm		
For models:	FCZ101GAG, FCZ102GAG, FCZ201GAG, FCZ202GAG, FCZ101GAD, FCZ102GAD, FCZ201GAD, FCZ202GAD, FCZ101GTG, FCZ102GTG, FCZ201GTG, FCZ202GTG, FCZ101GTD, FCZ102GTD, FCZ201GTD, FCZ202GTD, FCZ101GBG, FCZ102GBG, FCZ201GBG, FCZ202GBG, FCZ101GBD, FCZ102GBD, FCZ201GBD, FCZ202GBD, FCZ101GBI, FCZ201GBI, FCZ101GBG2, FCZ102GBG2, FCZ201GBG2, FCZ202GBG2, FCZ101GBD2, FCZ102GBD2, FCZ201GBD2, FCZ202GBD2, FCZ101GBI2, FCZ102GBI2, FCZ201GBI2, FCZ101GCG, FCZ102GCG, FCZ201GCG, FCZ202GCG, FCZ101GCD, FCZ102GCD, FCZ201GCD, FCZ202GCD, FCZ101GCG2, FCZ102GCG2, FCZ201GCG2, FCZ202GCG2, FCZ101GCD2...(Other models you can see in the webshop)		

burners for convection ovens

			
1			
GEV No.	104622	Ref. No.	002636 OK1149
description	burner for convection oven ø 60mm L 220mm		
For models:	FDV40G, FDV40GZ, FDV40GA, FDV20G, FDV20GZ, FDV20GA, FCV/G10L3, FCVG10L3T, FCVG102L3, FCV/G20L3, FCVG202L3, FCVG10L3J, FCVG102L3J, FCV/G10L6JAP, FCV/G102/1L6JAP, FCV/G10L2, FCV/G10L6, FCV/G102/1L6, FCV/G20L6, FCVG202L6, FCV/G101/1, FCV/G102/1, FCV/G201/1, FCV/G202/1, FCS101G2, FCS101G4, FCS101G4DT, FCS101GP9J, FCS101G49J, FCS101GP, FCS102G4, FCS102GA9J, FCS102G49J, FCS102GP, FCS201G4, FCS201GP, FCS202G4, FCS202GP, FCS101GX9J, FCS101GX, FCS102GX9J, FCS102GX, FCS201GX, FCS202GX, 5712-2-6, 5712-2-7, 5712-2-8, 5712-2-10, 5714-2-6, 5714-2-7...(Other models you can see in the webshop)		

accessories

			
1			
GEV No.	104576	Ref. No.	059596
description	cover for gas burner		
For models:	HCF/G810, HCF/G1210, HCF/G1610, HCF/G810, HCF/G1210, HCF/G1610, HCF/G811, HCF/G800U, HCF/G1200U, HCF/G1600U, HTF/G810, HTF/G1210, HFS/G800, ACF/G810, ACF/G810D, ACF/G810NL, ACF/G1210, ACF/G1610, OCF/G840, OCF/G1610, OCF/G1210, ATF/G810, ATF/G800D, ATF/G1210, ATF/G1210D, ATF/G800NL, ATF-G1210NL, OTF/G840, OTF/G1210, AFS/G800		



			
GEV No.	104230	Ref. No.	054119
description	cover L 505mm W 200mm gas range suitable for 700 series		
For models:	MCF/G705, MCF/G1055, MCF/G700, MCF/G1050, MCF/G705E, MCF/G1055E, MCF/G700D, MCF/G700, MCF/G705F, MCF/G1055F, MCF/G705NL, MCF/G1050D, MCF/G1055NL, MCF/G702, MCF/G1052, MCF/G700, MCF/G1050, MTF/G700D, MTF/G1050D, MTF/G700, MTF/G1050, MTF/GE1050, MT/G700F, MTF/G700F, MTF/G1055F, MTFGE1055F, MF/G700, RCF/G2, RCF/G3, RTF/G2, RSF/G2, RSV/G2, RSF/G3, MCF/G2A, MCF/G3A, XCF/G2, XCF/G3, XTF/G2, XSF/G2, XSV/G2, XSF/G3, JCF/G2, JCF/G3, JTF/G2, MCF/G2, MCF/G3, MTF/G2, MSF/G2, MSV/G2, MSF/G3...(Other models you can see in the webshop)		

			
GEV No.	104577	Ref. No.	0C0175
description	cover L 690mm W 200mm gas range		
For models:	KCF/G2, KCF/G3, KCF/G4, KCF/T2, KCF/T3, KCF/T4, KCF/G2H, KCF/G3A, KCF/G3H, KCF/G2L, KCF/G3HA, KCF/G2G, KCF/G3G, KCF/G4G, KCF/G2HG, KCF/G3AG, KCF/G3HG, KCF/G2LG, KRF/GT2R, KRF/GT2RP, KS/G2, KSF/G2, KSCF/G3, QCF/G2, QCF/G3, QCF/G4, QCF/T2, QCF/T3, QCF/T4, QCF/G2H, QCF/G3A, QCF/G3H, QCF/G2L, QCF/G3HA, QRF/GT2R, QRF/GT2RP, QSF/G2, QSCF/G3, WCF/G2, WCF/G3, WCF/G4, WCF/G2H, WRF/GT2R, WRF/GT2RP, WSF/G2, WSCF/G3		

nozzle holders			
			
GEV No.	101344	Ref. No.	052387
description	nozzle holder		
For models:	MT/G700D, MTF/G700D, MTF/G1050D, MT/G700, MTF/G700, MTF/G1050, MTF/GE1050, MT/G700F, MTF/G700F, MTF/G1055F, MTF-GE1055F, RT/G700D, RTF/G700D, RTF/G1050D, 7TPG07T, 7TPG07F, 7TPG10F, RT/G700F, RTF/G700, RTF/G1050, XT/G700D, XTF/G700D, XTF/G1050D, T70GST, M70GST/G, M105GST/GA, XT/G700F, XTF/G700F, XTF/G1050F, CTFGA702, CT/G700, RTV/G720, RTV/G720, RTFG720, RTF/G720F, RTF/G1020, RTF/G1030, RTF/G1020F, PCG810, PCG1210, PCG1610, PCG810F, PCG1210F, PCG1610F, PCG810D, PCG1210D, PCG1610D, PCG800NL, PCG1200NL, PCG1600NL...(Other models you can see in the webshop)		

			
GEV No.	104753	Ref. No.	0G0081 0K5696 19012711 705040318
description	nozzle holder		
For models:	CG148-001.A1AB, CG148-003.A2AB, CG248-201.A1ABBB, CG248-203.A1ABBB, CK248-209.D1ABBB, CK248-211.D1ABBB, LG159-703.A1BC, LG159-703.A2BC, LG159-704.A1BC, LG159-706.A1BC, LG259-711.A1A-CCB, LG259-712.A1ACCB, LK259-707.D1ACCB, LK259-708.D1ACCB, LG259-739.A1ACCB, LG259-740.A1ACCB, CK248-205.D1ABBB, CK248-207.D1ABBB, LK159-707.D1BC, LK159-708.D1BC, LK259-727.D1ACCB, LK259-728.D1ACCB, LG159-704.A2BC, LK159-707.D2BC, LK159-708.D2BC, LG259-711.A2ACCB, LG259-712.A2ACCB, LK259-727.D2ACCB, LK259-728.D2ACCB, LK259-707.D2ACCB, LK259-708.D2ACCB, CK248-205.D2ABBB, CK248-207.D2ABBB, CK248-209.D2ABBB, CK248-211.D2ABBB, CG148-004.A1AB, CG148-005.A1AB, CG148-006.A1AB, CG248-240.A1ABBB, CG248-243.A1ABBB, CG248-244.A1ABBB, CG248-212.A1ABBB, CG248-213.A1ABBB, LG159-705.A1BC, LG159-753.A1BC, LG259-758.A1ACCB, LG259-754.A1ACCB, LG259-757.A1ACCB, CG148-001.A3AB, CG148-003.A2AB...(Other models you can see in the webshop)		

			
GEV No.	106580	Ref. No.	002187 727775
description	nozzle holder		
For models:	HC/G410, HC/G810, HCF/G810, HC/G410D, HC/G810D, HCF/G810D, HCF/G1210D, HCF/G1610D, HC/G410NL, HC/G810NL, HCF/G810NL, HC/G1210, HCF/G1210, EC/G1610, HCF/G1610, HCF/GE810, HC/G410, HC/G810, HC/G1210, HCF/G810, HCF/G1210, HCF/G1610, HCF/G811, HC/G411, HC/G811, HC/G1211, HC/G800U, HC/G1200U, HC/G1600U, HCF/G800U, HCF/G1200U, HCF/G1600U, HT/G800D, HTF/G810, HTF/G800D, HTF/G1210, HTF/G1210D, HT/G800NL, HTF/G800NL, HTF-G1210NL, HFS/G800, ZC/G410, ZC/G810, ZCF/G810, ZC/G410D, ZC/G810D, ZCF/G810D, ZCF/G1210D, ZHCFG1610D, ZC/G1210...(Other models you can see in the webshop)		

			
GEV No.	101347	Ref. No.	020988 051948 310056
description	nozzle holder angled		
For models:	MR/G351, MR/G701, MR/G721, MR/G1071, MR/G350, MR/G350F, MR/G350NL, MR/G350E, MR/G360, MR/G360F, MR/G700, MR/G700F, MR/G700NL, MR/G700E, MR/G710, MR/G710F, MR/G1070, MR/G720, MR/G715, MR/G725, MR/G1075, MR/G361, MR/G711, MR/G716, MR/G726, MR/G1076, MFR/G360, MPN/GD761, MPN/GI761, MPN/GI760D, MPN/GD760, MPN/GD760F, MPN/GI760, MPN/GI760F, MM/G700F, MM/G700E, MCP/G700, MG/G350D, MG/G700D, MG/G350, MG/G350E, MG/G350F, MG/G350NL, MG/G700, MG/G700E, MG/G700F, MG/G700NL, MG/G1050, MG/G1050F, MG/G1051...(Other models you can see in the webshop)		



			
1			
GEV No.	104522	Ref. No.	OKL493 104522 17012721
description	nozzle holder ID ø 10mm ET M17x1		
For models:	AGGRHFG000, AGGRHAG000, AGGRHBG00M, AGGRABG000, AGGRHBG000, AGGWHFGBOO, AGGWHAGBOO, AGGWHBG00M, AGGWABGBOO, AGGWHBGBOO, ALGWHFOOOO, ALGWHAOOOO, ALGWHCOOOO, AGGYIFGFCO, AGGYIAGFCO, AGGYIBGFCO, AGGRAAGOOM, AGGRAFGOOM, AGGWAAGBOM, AGGWAFGBOM, AGGYJAGFCM, AGGYJGFCM, AGGYJBGFCM, AGGWDBGBOO, AGGWDFGBOO, AGGWDAGBOM, AGGWDFGBOM, AGGWDBG00M, AGGYKFGFCO, AGGYKBF000, AGGYKAGFCM, AGGYKFGFCM, AGGYKBF000, AGPWCAGBOO, AGPWCAGBOM, AGPWCAGBOM, AGPWCAGBOM, AGGYLAGFCO, AGGYLFGFCO, AGGYLAGFCM, AGGYLFGFCM, AGGYLBF000, ALPWCAOOOO, ALGWDFOOOO, ALGWDCOOOO, AGGROIGOOO, AGGWOIGBOO, AGGYOIGFCO, AGGROIGOOM, AGGWOIGBOM... (Other models you can see in the webshop)		

			
1			
GEV No.	104537	Ref. No.	059375
description	nozzle holder L 39mm screw pipe fitting M16x1.5 ET M15x1 M10x1 tube ø 10mm		
For models:	BR/G1FL, BR/G1FR, BR/G2FL, BR/G2FR, BG/G1, BG/G2, MT/G350, MT/G352, MCP/G700, MCP/G701, MCP/G710, MCP/G711, MCP/G705, MCP/G706, RR/G1FL, RR/G1FR, RR/G1CL, RR/G2FL, RR/G2FM, RR/G2CL, RRV/G1FL, RRV/G1FR, RRV/G1CL, RRV/G2FL, RRV/G2FM, RRV/G2CL, RR/G2CM, RG/G1, RG/G2, RGV/G1, RGV/G2, RSF/G2, RSV/G2, XR/G1FL, XR/G1FR, XR/G1CL, XR/G2FL, XR/G2FM, XR/G2CL, XRV/G1FL, XRV/G1FR, XRV/G1CL, XRV/G2FL, XRV/G2FM, XRV/G2CL, XR/G2CM, XG/G1, XG/G2, XGV/G1, XGV/G2... (Other models you can see in the webshop)		

			
1			
GEV No.	106866	Ref. No.	059250
description	nozzle holder L 40mm M10x1		
For models:	MCF/G1095, MCF/G995, MFR/G380, MFR/G381, BCF/G2, BF/G1S07, BFR/G1S14, BCP/G1, RCF/G9, RF/G1S07, RF/G2D07, RFR/G1S07, RFR/G2D07, RPD/G240, RPD/G260, RPI/G260, RPI/G260P, RCP/G1S, RCP/G2D, RBV/G2, RF/G1S07, RF/G2D07, RFR/G1S07, RFR/G2D07, XCF/G9, XF/G1S07, XRF/G2D07, XFR/G1S07, XFR/G2D07, XPD/G240, XPD/G260, XPI/G260, XPI/G260P, XCP/G1S, XCP/G2D, XBV/G2, XF/G1S07, XF/G2D07, XFR/G1S07, XFR/G2D07, JF/G1S07, JF/G2D07, JFR/G1S07, JFR/G2D07, JPD/G240, JPD/G260, JPI/G260, JCP/G1S, JCP/G2D, JBV/G2... (Other models you can see in the webshop)		

			
1			
GEV No.	101152	Ref. No.	OC3158 101152
description	nozzle holder without internal nozzle, without external nozzle		

air slides

			
1			
GEV No.	104193	Ref. No.	0H6880 0K2558
description	air slide		

			
1			
GEV No.	104194	Ref. No.	0K2561
description	air slide		

miscellaneous

			
1			
GEV No.	104572	Ref. No.	052500 727873
description	bracket for gas burner		

For models:	KS/G2, KSF/G2, KSCF/G3, HT/G800, HT/G800D, HTF/G810, HTF/G800D, HTF/G1210, HTF/G1210D, HT/G800NL, HTF/G800NL, HTFG1210NL, QS/G2, QSF/G2, QSCF/G3, ZT/G800, ZT/G800D, ZTF/G810, ZTF/G800D, ZTF/G1210, ZTF/G1210D, WS/G2, WSF/G2, WSCF/G3, AT/G800, AT/G800D, ATF/G810, ATF/G800D, ATF/G1210, ATF/G1210D, AT/G800NL, ATF/G800NL, ATFG1210NL, OTF/G840, OT/G800, OTF/G1210, PTSG810, PTFG810, HTS/G800, HTS/G800, HTS/G800, HTS/G800NL, HTFG800, HTF/G800, HT/G800F, HTF/G800, HT/GE800, HTF/G1210, HTF/G1210, HTF/G1200... (Other models you can see in the webshop)		
--------------------	--	--	--

accessories for	104572	GEV No.	105024	Ref. No.	052376
------------------------	--------	----------------	--------	-----------------	--------

					
burner head for burner cap ø 180mm					

GEV No.	105025	Ref. No.	052374 0G2244 0KG213 727871
			
cover ø 80mm solid top range			

GEV No.	105026	Ref. No.	052377 0G2241 0KG211 727870
			
burner cap ø 180mm with central hole			



				
GEV No.	101947	Ref. No.	054101 056746 058331 0G0840	
description	bracket for igniter/thermocouple			
For models:	RC/G320, RC/G330, RC/G320F, RC/G720, RC/G730, MCF/G705, MCF/G1055, MCF/G700, MCF/G1050, MCF/G705E, MCF/G1055E, MCF/G700D, MCF/G700, MCF/G705F, MCF/G1055F, MCF/G705NL, MCF/GE705, MCF/GE1055, MCF/GE700, MCFGE1050, MCF/GE700D, MCFGE1050D, MCF/G1050D, MCFGE1055NL, MC/G355, MC/G350, MC/G355E, MC/G350D, MC/G355F, MC/G355NL, MC/G705, MC/G700, MC/G705E, MC/G700D, MC/G705NL, MC/G1055, MC/G1050, MC/G1050D, MC/G1055NL, MC/G705F, MCF/GE1055UK, MCF/G1090, MCF/G1095, MCF/G995, MC/G352, MC/G702, MC/G1052, MCF/G702, MCF/GE702, MCF/G1052...(Other models you can see in the webshop)			
accessories for	101947			
	GEV No.	105008	Ref. No.	054095 056747 0K2865
	burner ring for burner cap ø 70mm			
	GEV No.	105011	Ref. No.	054096 056748 0G0826 0K2867
	burner ring for burner cap ø 100mm			
	GEV No.	105012	Ref. No.	002443 054098 055562 058560 058576 0A2960 0G0822 0K2866
	burner cap ø 100mm			
	GEV No.	105056	Ref. No.	027433 053448 0KB777 S206991200
	air mixing sleeve L 43mm ED ø 43mm ID ø 40mm aluminium			
	GEV No.	105231	Ref. No.	054091 054164 0G0806
	burner head for burner cap ø 70mm with nozzle holder for plug-in nozzle			
	GEV No.	105232	Ref. No.	002442 054097 055563 058533 058559 0A2957 510812800
	burner cap ø 70mm			
	GEV No.	105233	Ref. No.	054092 054165 0G0828
	burner head for burner cap ø 100mm with nozzle holder for plug-in nozzle			
	GEV No.	105270	Ref. No.	054093
	gasket for burner cap ø 70mm			
	GEV No.	105271	Ref. No.	054094 0G0833
	gasket for burner cap ø 100mm			

			
GEV No.	112826	Ref. No.	006401
description	burner chamber for combi-steamer L 325mm SS W 100mm H 180mm		
For models:	FCV/G20L3, FCVG202L3, FCV/G20L6, FCVG202L6, FCV/G101/1, FCV/G102/1, FCV/G201/1, FCV/G202/1, FCS101GP9J, FCS101GP, FCS102G4, FCS102GA9J, FCS102G49J, FCS102GP, FCS201G4, FCS201GP, FCS202G4, FCS202GP, FCS101GX9J, FCS101GX, FCS102GX9J, FCS102GX, FCS201GX, FCS202GX, 5712-2-7, 5712-2-8, 5712-2-10, 5714-2-7, 5714-2-8, 5714-2-10, 5714-2-7, 5714-2-8, 5714-2-10, 5712-2-7L, 5712-2-8L, 5712-2-10L, 5714-2-7L, 5714-2-8L, 5714-2-10L, 5714-2-7L, 5714-2-8L, 5714-2-10L, ECV/G20T4, ECVG202T4, ECV/G20T4J, ECV/G20T6, ECVG202T6, ACV/G20C4, ACVG202C4, ACVG202C6...(Other models you can see in the webshop)		

			
GEV No.	416578	Ref. No.	057730 285490000
description	ceramic plate		
For models:	SL/G802, SLG802F, SLG802UK, SALG08		

			
GEV No.	105244	Ref. No.	002197 727789
description	spacer piece for Venturi		
For models:	HC/G410, HC/G810, HCF/G810, HC/G410D, HC/G810D, HCF/G810D, HCF/G1210D, HCF/G1610D, HC/G410NL, HC/G810NL, HCF/G810NL, HC/G1210, HCF/G1210, EC/G1610, HCF/G1610, HCF/GE810, HC/G410, HC/G810, HC/G1210, HCF/G810, HCF/G1210, HCF/G1610, HCF/G811, HC/G411, HC/G811, HC/G1211, HC/G800U, HC/G1200U, HC/G1600U, HCF/G800U, HCF/G1200U, HCF/G1600U, HT/G800D, HTF/G810, HTF/G800D, HTF/G1210, HTF/G1210D, HT/G800NL, HTF/G800NL, HTF-G1210NL, HFS/G800, ZC/G410, ZC/G810, ZCF/G810, ZC/G410D, ZC/G810D, ZCF/G810D, ZCF/G1210D, ZHCFG1610D, ZC/G1210...(Other models you can see in the webshop)		

accessories for 105244				
	GEV No.	105006	Ref. No.	002441 052121 058187 058253 059213 059253 0A5103 0KB788 19013325 727722
	burner cap ø 122mm with central hole			
	GEV No.	105055	Ref. No.	052116 19013303 727802
	air mixing sleeve L 40mm ED ø 43mm ID ø 40mm aluminium			
	GEV No.	105241	Ref. No.	002463 059212 19013322 727718
	burner head for burner cap ø 122mm			
	GEV No.	105243	Ref. No.	002460 059211
	venturi for burner cap ø 122mm			

gas nozzles

main nozzles

gas nozzles M7x1

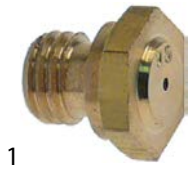

GEV No.	100522	Ref. No.	055113
description	gas injector thread M7x1 WS 10 bore ø 1.35mm		

gas nozzles M9x1



GEV No.	100511	Ref. No.	058375
description	gas injector thread M9x1 WS 10 bore ø 1.9mm		
For models:	MCP/G700, MCP/G701, MCP/G710, MCP/G711, MCP/G705, MCP/G706, RBR/G2FM, RBR/G2IM, RBK/G2FM, RMV/G1C, RMV/G2C, XBR/G2FM, XBR/G2IM, XBK/G2FM, XMV/G1C, XMV/G2C, JBR/G2FM, MBR/G2FM, MBR/G2IM, MBK/G2FM, MMV/G1C, MMV/G2C, 7CPG07P, RCP/G701, RCP/G706, M70GPC, M70GFC, XCP/G706, CCP/G700, PBR/G2FM, PBR/G2IM, PMV/G1C, PMV/G2C, OBR/G2FM, OBR/G2IM, OMV/G1C, OMV/G2C, TBR/G2FM, TBR/G2IM, TMV/G1C, TMV/G2C, KMV/G2C, HBR/G820, HBR/G825, HBR/G821UK, HPN/G1806, HPN/G1805, QMV/G2C, ZBR/G821, ZBR/G826...(Other models you can see in the webshop)		

gas nozzles M10x1



GEV No.	100638	Ref. No.	005935
description	gas injector thread M10x1 WS 11 bore ø 1.15mm inner peaked		
For models:	RFR/G1S14, RFR/G2D14, XFR/G1S14, XFR/G2D14, JFR/G1S14, JFR/G2D14, MFR/G1S14, MFR/G2D14, ADGRAA0000, ADGRHA0000, ADGRAFO000, ADGRHF0000, ADGUA00000, ADGUHA0000, ADGUAFO000, ADGUHF0000, AFGROA0000, AFGROFO000, AFGUA00000, AFGUOFO000, ADGROIO000, ADGUOIO000		



GEV No.	106291	Ref. No.	003514
description	gas injector thread M10x1 WS 11 bore ø 1.95mm inner peaked		
For models:	RFR/G1S14, RFR/G2D14, XFR/G1S14, XFR/G2D14, JFR/G1S14, JFR/G2D14, MFR/G1S14, MFR/G2D14, ACFG24, ACFG36, ACFG24T, ACFG36T, KB/G1, KB/G2, QB/G1, QB/G2, QB/E1, QB/E2, WB/G1, WB/G2, WB/E1, WB/E2		



GEV No.	102869	Ref. No.	006419
description	gas injector thread M10x1 WS 11 bore ø 2.9mm		
For models:	ACG12, ACG24, ACG36, ACG48, ACFG24, ACFG36, ACG12T, ACG24T, ACG36T, ACG48T, ACFG24T, ACFG36T, KPI/G10, KPI/G15, KPD/G10, KPD/G15, KPD/G15A, KPI/G15A, KPI/G06, KPI/G15H, KPI/G10H, KFR/G1E, KFR/G2F, KFH/G1, KFH/G1ELH, KFH/G1EH, HFH/G430, HFR/G430, HFR/G830, HFH/G435, HFRS/G430, QPI/G10, QPI/G15, QPD/G10, QPD/G15, QPI/G06, QPI/G15H, QPI/G10H, QFR/G1E, QFR/G2F, QFH/G1, QFH/G1ELH, QFH/G1EH, ZFH/G430, ZFR/G430, ZFR/G830, ZFH/G435, ZFRS/G430, WPI/G10, WPI/G15...(Other models you can see in the webshop)		



GEV No.	100150	Ref. No.	054630 0K2881
description	gas injector thread M10x1 bore ø 0.95mm L 30mm WS 12		
For models:	MCF/G1050D, MCF/G702, MCF/G1052, MCF/G700, MCF/G1050, MFR/G380, MFR/G381, BF/G1S07, MTF/G700D, MTF/G1050D, MTF/G700, MTF/G1050, MTF/GE1050, MF/G700, RF/G1S07, RF/G2D07, RFR/G1S07, RFR/G2D07, XF/G1S07, XF/G2D07, XFR/G1S07, XFR/G2D07, JF/G1S07, JF/G2D07, JFR/G2D07, JFR/G2D07, MF/G1S07, MF/G2D07, MFR/G1S07, MFR/G2D07, RCF/G702, RCF/G1052, 74FG07F, 76FG10F, 7FRG03T, RTF/G700D, RTF/G1050D, 7TPG07F, 7TPG10F, XCF/G700D, XCF/G1050D, M70GCK/G, M105GCK/G, CFR/G381, T35GFR, XTF/G700D, XTF/G1050D, M70GST/G, M105GST/GA, XTF/G700F...(Other models you can see in the webshop)		





GEV No.	100670	Ref. No.	002265 0G2231
description	gas injector thread M10x1 bore ø 0.9mm L 30mm WS 12		
For models:	BF/G1S07, RCF/G2, RCF/G3, RF/G1S07, RF/G2D07, RFR/G1S07, RFR/G2D07, RTV/G2, RTF/G2, RSF/G2, RSV/G2, RSF/G3, RBV/G2, MCF/G2A, MCF/G3A, XCF/G2, XCF/G3, XF/G1S07, XRF/G2D07, XFR/G1S07, XFR/G2D07, XTV/G2, XTF/G2, XSF/G2, XSV/G2, XSF/G3, XBV/G2, JCF/G2, JCF/G3, JF/G1S07, JF/G2D07, JFR/G1S07, JFR/G2D07, JTV/G2, JTF/G2, JBV/G2, MCF/G2, MCF/G3, MF/G1S07, MF/G2D07, MFR/G1S07, MFR/G2D07, MTV/G2, MTF/G2, MSF/G2, MSV/G2, MSF/G3, MBV/G2, PF/G1S07, PF/G2D07...(Other models you can see in the webshop)		





GEV No.	100154	Ref. No.	002906
description	gas injector thread M10x1 bore ø 1.05mm L 30mm WS 12		
For models:	MCF/G702, MCF/G1052, MCF/G700, MCF/G1050, MTF/G700D, MTF/G1050D, MTF/G700, MTF/G1050, MTF/GE1050, MF/G700, RCF/G2, RCF/G3, RTV/G2, RTF/G2, RSF/G2, RSV/G2, RSF/G3, RBV/G2, MCF/G2A, MCF/G3A, XCF/G2, XCF/G3, XTV/G2, XTF/G2, XSF/G2, XSV/G2, XSF/G3, XBV/G2, JCF/G2, JCF/G3, JTV/G2, JTF/G2, JBV/G2, MCF/G2, MCF/G3, MTV/G2, MTF/G2, MSF/G2, MSV/G2, MSF/G3, MBV/G2, RCF/G702, RCF/G1052, 74FG07F, 76FG10F, RTF/G700D, RTF/G1050D, 7TPG07F, 7TPG10F, M70GCK/G...(Other models you can see in the webshop)		





			
GEV No.	106400	Ref. No.	054082 72780305
description	gas injector thread M10x1 bore ø 1.1mm L 30mm WS 12		
For models:	MCF/G705, MCF/G1055, MCF/G700, MCF/G1050, MCF/G705E, MCF/G1055E, MCF/G705F, MCF/G1055F, BCF/G2, MTF/G1050, MTF/GE1050, MT/G700F, MTF/G700F, MTF/G1055F, MTFGE1055F, RCF/G720, RCF/G1020, RCFG730, RCFG1030, RCF/G720F, RCF/G1020, RCF/G700, RCF/G1050, RCF/G700, MCF/G1050, 7TPG10F, RT/G700F, RTF/G700, RTF/G1050, M70GCK/G, M105GCK/E, XCF/G700F, XCF/G1050F, CCF/G710, RTFG720, RTF/G720F, RTF/G1020, RTF/G1030, RTF/G1020F, PCV/G2, PCV/G3, PCF/G2, PCF/G3, PTV/G2, PTF/G2, PSF/G2, PSV/G2, PSF/G3, PCV/G2N, PCF/G3N...(Other models you can see in the webshop)		

			
GEV No.	100671	Ref. No.	059804
description	gas injector thread M10x1 bore ø 1.25mm L 30mm WS 12		
For models:	BCF/G2, PCV/G2, PCV/G3, PCF/G2, PCF/G3, PTV/G2, PTF/G2, PSF/G2, PSV/G2, PSF/G3, PCV/G2N, PCF/G3N, PCV/G3N, PCV/G2N, PTV/G2N, OCV/G2, OCF/G2, OCF/G3, OTV/G2, OTF/G2, OSF/G2, OSV/G2, TCV/G2, TCV/G3, TCF/G2, TCF/G3, TTV/G2, TTF/G2, TSF/G2, TSV/G2, TSF/G3, KB/G1, KB/G2, HM/G800, QB/G1, QB/G2, QB/E1, QB/E2, ZM/G800, WB/G1, WB/G2, WB/E1, WB/E2, AM/G800, AM/G800D, OM/G800, AFGROA-OOOO, AFGROFOOOO, AFGUOAOOOO, AFGUOFOOOO		

			
GEV No.	101974	Ref. No.	004732
description	gas injector thread M10x1 bore ø 1.35mm L 30mm WS 12		
For models:	BFR/G1S14, RCP/G1S, RCP/G2D, XCP/G1S, XCP/G2D, JCP/G1S, JCP/G2D, MCP/G1S, MCP/G2D, PFR/G1S14, PFR/G2D14, PFRG2D14HV, PFRG1S14HV, PCV/G2A, PCV/G3A, PCF/G2A, PCF/G3A, OCF/G9UK, OFR/G1S14, OFR/G2D14, TCF/G9, TCF/G9UK, TFR/G1S14, TFR/G2D14, TCV/G2A, TCV/G3A, TCF/G2A, TCF/G3A, KB/G1, KB/G2, KFR/G1A, KFR/G2B, QB/G1, QB/G2, QB/E1, QB/E2, QFR/G1A, QFR/G2B, WB/G1, WB/G2, WB/E1, WB/E2, WFR/G1A, WFR/G2B, AFGROA-OOOO, AFGROFOOOO, AFGUOAOOOO, AFGUOFOOOO		

			
GEV No.	100156	Ref. No.	059364 72780303
description	gas injector thread M10x1 bore ø 1.3mm L 30mm WS 12		
For models:	MCF/G1095, MCF/G995, BF/G1S07, RCF/G9, RFR/G1S14, RFR/G2D14, XCF/G9, XFR/G1S14, XFR/G2D14, JFR/G1S14, JFR/G2D14, MCF/G9, MFR/G1S14, MFR/G2D14, CCF/G995, PF/G1S07, PF/G2D07, PFR/G1S07, PFR/G2D07, OF/G1S07, OFR/G1S07, OFR/G2D07, TF/G1S07, TF/G2D07, TFR/G1S07, TFR/G2D07, HCF/G810, HCF/G810D, HCF/G1210D, HCF/G1610D, HCF/G810NL, HCF/G1210, HCF/G1610, HCF/G810, HCF/G1210, HCF/G1610, HCF/G811, HC/G411, HC/G811, HC/G1211, KCF/G2, KCF/G3, KCF/G4, KCF/T2, KCF/T3, KCF/T4, KCF/G2H, KCF/G3H, KCF/G2L, KCF/G2G...(Other models you can see in the webshop)		

			
GEV No.	100155	Ref. No.	056470 0G2229 0G2814 72780302
description	gas injector thread M10x1 bore ø 1.45mm L 30mm WS 12		
For models:	MCF/G1095, MCF/G995, MFR/G380, MFR/G381, BF/G1S07, RCF/G9, RF/G1S07, RF/G2D07, RFR/G1S07, RFR/G2D07, RF/G1S07, RF/G2D07, RFR/G1S07, RFR/G2D07, XCF/G9, XF/G1S07, XRF/G2D07, XFR/G1S07, XFR/G2D07, XF/G1S07, XF/G2D07, XFR/G1S07, XFR/G2D07, JF/G1S07, JF/G2D07, JFR/G1S07, JFR/G2D07, JF/G1S07, JF/G2D07, JFR/G2D07, JFR/G2D07, MCF/G9, MF/G1S07, MF/G2D07, MFR/G1S07, MFR/G2D07, MF/G1S07, MF/G2D07, MFR/G1S07, MFR/G2D07, RCF/G1095, 7FRG03T, CCF/G995, CFR/G381, T35GFR, PCF/G9, PF/G1S07, PF/G2D07, PFR/G1S07, PFR/G2D07...(Other models you can see in the webshop)		

			
GEV No.	101975	Ref. No.	003722 0G2230 0G2778 72780309
description	gas injector thread M10x1 bore ø 1.55mm L 30mm WS 12		
For models:	BF/G1S07, BCP/G1, RF/G1S07, RF/G2D07, RFR/G1S07, RFR/G2D07, RCP/G1S, RCP/G2D, XF/G1S07, XRF/G2D07, XFR/G1S07, XFR/G2D07, XCP/G1S, XCP/G2D, JF/G1S07, JF/G2D07, JFR/G1S07, JFR/G2D07, JCP/G1S, JCP/G2D, MF/G1S07, MF/G2D07, MFR/G1S07, MFR/G2D07, MCP/G1S, MCP/G2D, PF/G1S07, PF/G2D07, PFR/G1S07, PFR/G2D07, PCP/G1S, PCP/G2D, PBV/G2, OF/G1S07, OFR/G1S07, OFR/G2D07, OCP/G1S, OCP/G2D, TF/G1S07, TF/G2D07, TFR/G1S07, TFR/G2D07, TCP/G1S, TCP/G2D, TBV/G2, KPI/G10, KPI/G15, KPD/G10, KPD/G15, KPD/G15A...(Other models you can see in the webshop)		

			
GEV No.	100816	Ref. No.	002862
description	gas injector thread M10x1 bore ø 1.5mm WS 12		
For models:	BF/G1S07, RPD/G240, RF/G1S07, RF/G2D07, RFR/G1S07, RFR/G2D07, XPD/G240, XF/G1S07, XF/G2D07, XFR/G1S07, XFR/G2D07, JPD/G240, JF/G1S07, JF/G2D07, JFR/G2D07, JFR/G2D07, MPD/G240, MF/G1S07, MF/G2D07, MFR/G1S07, MFR/G2D07, PCF/G9, PF/G1S07, PF/G2D07, PFR/G1S07, PFR/G2D07, OCF/G9UK, OF/G1S07, OFR/G1S07, OFR/G2D07, TCF/G9, TCF/G9UK, TF/G1S07, TF/G2D07, TFR/G1S07, TFR/G2D07, KCF/G2, KCF/G3, KCF/G4, KCF/T2, KCF/T3, KCF/T4, KCF/G2H, KCF/G3A, KCF/G3H, KCF/G2L, KCF/G3HA, KCF/G2G, KCF/G3G, KCF/G4G...(Other models you can see in the webshop)		

			
GEV No.	100151	Ref. No.	054127 0K2882 72780310
description	gas injector thread M10x1 bore ø 1.65mm L 30mm WS 12		
For models:	MCF/G705, MCF/G1055, MCF/G700, MCF/G1050, MCF/G705E, MCF/G1055E, MCF/G705F, MCF/G1055F, MCF/G1050D, BF/G1S07, MTF/G1050, MTF/GE1050, MT/G700F, MTF/G700F, MTF/G1055F, MTF-GE1055F, RCF/G720, RCF/G1020, RCFG730, RCFG1030, RCF/G720F, RCF/G1020, RCF/G700, RCF/G1050, RCF/G700, MCF/G1050, 7TPG10F, RT/G700F, RTF/G700, RTF/G1050, M70GCK/G, M105GCK/E, XCF/G700D, XCF/G1050D, XCF/G700F, XCF/G1050F, CCF/G710, RTFG720, RTF/G720F, RTF/G1020, RTF/G1030, RTF/G1020F, PF/G1S07, PF/G2D07, PFR/G1S07, PFR/G2D07, PPD/G260, PPI/G260P, PBV/G2, OF/G1S07...(Other models you can see in the webshop)		

			
GEV No.	100153	Ref. No.	002905
description	gas injector thread M10x1 bore ø 1.6mm L 30mm WS 12		
For models:	MCF/G702, MCF/G1052, MCF/G700, MCF/G1050, MFR/G380, MFR/G381, BCP/G1, MTF/G700D, MTF/G1050D, MTF/G700, MTF/G1050, MTF/GE1050, MF/G700, RCF/G2, RCF/G3, RTV/G2, RTF/G2, RSF/G2, RSV/G2, RSF/G3, RPD/G260, RPI/G260, RPI/G260P, RBV/G2, RF/G1507, RF/G2D07, RFR/G1507, RFR/G2D07, MCF/G2A, MCF/G3A, XCF/G2, XCF/G3, XTV/G2, XTF/G2, XSF/G2, XSV/G2, XSF/G3, XPD/G260, XPI/G260, XPI/G260P, XBV/G2, XF/G1507, XF/G2D07, XFR/G1507, XFR/G2D07, JCF/G2, JCF/G3, JTV/G2, JTF/G2, JPD/G260...(Other models you can see in the webshop)		

			
GEV No.	103300	Ref. No.	055459
description	gas injector thread M10x1 bore ø 2.15mm L 30mm WS 12		
For models:	ACPG25, FCFG101/0, FCFG102-0, FCFG10160H, FCFG102-0T, FCF/G101/1-1-JAP, FCF/G101/1, FCVG10-2, FCVG10-4, FCVG10-5G, FCVG10-2UK, FCVG10-4UK, FCVG10-P, FCVG10PUK, ECFG101-0, ECFG102-0, ZOFCV/G102, ZOFCV/G104, ACFG101-0, ACFG102-0, ACFG10160H, JCF/G101/1-1, JCF/G101/1-2, RCF101G, AFCV/G101, AFCV/G103, SCO/G10-3, NCF/G101/1, NCF/G102/1, FCVG10-5G, ZCF/G101/1, ZCF/G102/1		

			
GEV No.	106402	Ref. No.	003723
description	gas injector thread M10x1 bore ø 1.75mm L 30mm WS 12		
For models:	BCF/G2, RBV/G2, XBV/G2, JBV/G2, MBV/G2, PCV/G2, PCV/G3, PCF/G2, PCF/G3, PTV/G2, PTF/G2, PSF/G2, PSV/G2, PSF/G3, PPD/G260, PPI/G260P, PBV/G2, PCV/G2N, PCF/G3N, PCV/G3N, PCF/G2N, PTV/G2N, OCV/G2, OCF/G2, OCF/G3, OTV/G2, OTF/G2, OSF/G2, OSV/G2, OPD/G260, OPI/G260P, TCV/G2, TCV/G3, TCF/G2, TCF/G3, TTV/G2, TTF/G2, TSF/G2, TSV/G2, TSF/G3, TPD/G260, TPI/G260P, TBV/G2, KCF/G3A, KCF/G3HA, KCF/G3AG, KB/G1, KB/G2, KPI/G10, KPI/G15...(Other models you can see in the webshop)		

			
GEV No.	102499	Ref. No.	056471 0KW910 727803 72780301
description	gas injector thread M10x1 bore ø 2.25mm L 30mm WS 12		
For models:	MCF/G1095, MCF/G995, RCF/G1095, CCF/G995, HCF/G810, HCF/G810D, HCF/G1210D, HCF/G1610D, HCF/G810NL, HCF/G1210, HCF/G1610, HCF/G810, HCF/G1210, HCF/G811, HC/G411, HC/G811, HC/G1211, KCF/G2, KCF/G3, KCF/G4, KCF/T2, KCF/T3, KCF/T4, KCF/G2H, KCF/G3H, KCF/G2L, KCF/G2G, KCF/G3G, KCF/G4G, KCF/G2HG, KCF/G3HG, KCF/G2LG, KRF/GT2R, KRF/GT2RP, KS/G2, KSF/G2, KSCF/G3, HTF/G810, HTF/G800D, HTF/G1210, HTF/G1210D, HTF/G800NL, HTF/G1210NL, HFS/G800, ZCF/G810, ZCF/G810D, ZCF/G1210D, ZHCFG1610D, ZCF/G1210...(Other models you can see in the webshop)		

			
GEV No.	100672	Ref. No.	054083
description	gas injector thread M10x1 bore ø 1.7mm L 30mm WS 12		
For models:	RPD/G240, XPD/G240, JPD/G240, MPD/G240, XCF/G705NL, XCF-G1055NL, FCFG20D, FCVG20-2, FCVG20-4D, FCVG20-4, FCVG20-4D, PMG600, JFC/GG800, JCF/GG1600, JPF/GG800, ZPM/G600, ZOFCF/G20D, PSZ/GG800, PFZ/GG800, PCF/GG1600		

			
GEV No.	101973	Ref. No.	002865 60050502
description	gas injector thread M10x1 bore ø 2.3mm L 30mm WS 12		
For models:	BCP/G1, RCF/G9, XCF/G9, MCF/G9, PCF/G9, PCP/G1S, PCP/G2D, OCF/G9UK, OCP/G1S, OCP/G2D, TCF/G9, TCF/G9UK, TCP/G1S, TCP/G2D, FCV/G6L4, 5711-2-6, 5711-2-7, 5711-2-8, 5711-2-10, 5711-2-8CH, 5711-2-10CH, 5711-2-6L, 5711-2-7L, 5711-2-8L, 5711-2-10L, ECV/G6T4, ZCV/G6T4		

			
GEV No.	100152	Ref. No.	054631
description	gas injector thread M10x1 bore ø 1.8mm L 30mm WS 12		
For models:	MCF/G1050D, MCF/G702, MCF/G1052, MCF/G700, MCF/G1050, MTF/G700D, MTF/G1050D, MTF/G700, MTF/G1050, MTF/GE1050, MF/G700, RCF/G2, RCF/G3, RTV/G2, RTF/G2, RSF/G2, RSV/G2, RSF/G3, RPD/G260, RPI/G260, RPI/G260P, MCF/G2A, MCF/G3A, XCF/G2, XCF/G3, XTV/G2, XTF/G2, XSF/G2, XSV/G2, XSF/G3, XPD/G260, XPI/G260, XPI/G260P, JCF/G2, JCF/G3, JTV/G2, JTF/G2, JPD/G260, JPI/G260, MCF/G2, MCF/G3, MTV/G2, MTF/G2, MSF/G2, MSV/G2, MSF/G3, MPD/G260, MPI/G260, MPI/G260P, RCF/G702...(Other models you can see in the webshop)		

			
GEV No.	103337	Ref. No.	002267
description	gas injector thread M10x1 bore ø 2.45mm L 30mm WS 12		
For models:	MCF/G1095, MCF/G995, BCP/G1, CCF/G995, PCP/G1S, PCP/G2D, OCF/G9UK, OCP/G1S, OCP/G2D, TCF/G9, TCF/G9UK, TCP/G1S, TCP/G2D, HCF/G810, HCF/G1210, HCF/G1610, HCF/G810, HCF/G1210, HCF/G1610, HCF/G811, HC/G411, HC/G811, HC/G1211, KCF/G2, KCF/G3, KCF/G4, KCF/T2, KCF/T3, KCF/T4, KCF/G2H, KCF/G3H, KCF/G2L, KCF/G2G, KCF/G3G, KCF/G4G, KCF/G2HG, KCF/G3HG, KCF/G2LG, KRF/GT2R, KRF/GT2RP, KS/G2, KSF/G2, KSCF/G3, HTF/G810, HTF/G1210, HFS/G800, ZCF/G810, ZCF/G1210, ZCF/G1610, ZCF/G810...(Other models you can see in the webshop)		

			
GEV No.	106403	Ref. No.	054033 0G2806 72780311
description	gas injector thread M10x1 bore ø 1.9mm L 30mm WS 12		
For models:	KCP/G1, KCP/G1R, KCP/G2, KCP/G2R, HM/G800, QCP/G1, QCP/G1R, QCP/G2, QCP/G2R, ZM/G800, WCP/G1, WCP/G1R, WCP/G2, WCP/G2R, AM/G800, AM/G800D, OM/G800, DCP/G400, FCFG101/0, FCFG102-0, FCFG10160H, FCFG102-0T, FCF/G101/1-1-JAP, FCF/G101/1, FCFG20, FCFG20F, PFCFG20, FCFG40D, FCFG20J, FCFG20J, FCFG20J, FCFG20J, FCVG10-2, FCVG10-4D, FCVG10-2, FCVG10-4, FCVG20-2, FCVG20-4, FCVG20-2UK, FCVG20-4UK, FCVG20-P, ECFG101-0, ECFG102-0, FCVG20PUK, FCFG201, ZOFCV/G202, ZOFCV/G204, AFGROAOOOO, AFGROFOOOO, AFGUOAOOOO...(Other models you can see in the webshop)		





			
1			
GEV No.	103336	Ref. No.	054128
description	gas injector thread M10x1 bore ø 3.4mm L 30mm WS 12		
For models:	MCF/G705, MCF/G1055, MCF/G700, MCF/G1050, MCF/G705F, MCF/G1055F, MCF/G1050D, BCF/G2, MTF/G1050, MTF/GE1050, MT/G700F, MTF/G700F, MTF/G1055F, MTFGE1055F, RCF/G720, RCF/G1020, RCF/G730, RCF/G1030, RCF/G720F, RCF/G1020, RCF/G700, RCF/G1050, RCF/G700, MCF/G1050, 7TPG10F, RT/G700F, RTF/G700, RTF/G1050, M70GCK/G, M105GCK/E, XCF/G700D, XCF/G1050D, XCF/G700F, XCF/G1050F, CCF/G710, RTFG720, RTF/G720F, RTF/G1020, RTF/G1030, RTF/G1020F, PCV/G2, PCV/G3, PCF/G2, PCF/G3, PTV/G2, PTF/G2, PSF/G2, PSV/G2, PSF/G3, PCV/G2N...(Other models you can see in the webshop)		

			
2			
GEV No.	106408	Ref. No.	054034
description	gas injector thread M10x1 bore ø 3mm L 30mm WS 12		
For models:	RC/T1, RC/T2, RCV/T2, RCV/T3, RCF/T2, RCF/T3, RCF/W2, RCF/W3, MC/T1, MC/T2, MCV/T2, MCV/T3, MCF/T2, MCF/T3, MCF/W2, MCF/W3, KPI/G10, KPI/G15, KPD/G10, KPD/G15, KPD/G15A, KPI/G15A, KPI/G06, KPI/G15H, KPI/G10H, QPI/G10, QPI/G15, QPD/G10, QPD/G15, QPI/G06, QPI/G15H, QPI/G10H, WPI/G10, WPI/G15, WPD/G10, WPD/G15, WPD/G15A, WPI/G15A, WPI/G06, WPI/G15H, WPI/G10H, FCFG101/0, FCFG102-0, FCFG102-0T, FCF/G102/1-1-JAP, FCFG20, FCFG20F, PFCFG20, FCFG20-2, FCFG20-4...(Other models you can see in the webshop)		

			
1			
GEV No.	106451	Ref. No.	0A2088 72780102
description	gas injector thread M10x1 WS 12 bore ø 0.9mm		
For models:	MFR/G350, MFR/G351, MFR/G700, MFR/G701, RC/G1, RC/G2, RCV/G2, RCV/G3, RCF/G2, RCF/G3, RCF/M2, RCF/M3, RSF/G2, RSV/G2, RSF/G3, MCF/G2A, MCF/G3A, XC/G1, XC/G2, XCV/G2, XCV/G3, XCF/G2, XCF/G3, XCF/M2, XCFM3, XSF/G2, XSV/G2, XSF/G3, JC/G1, JC/G2, JCV/G2, JCV/G3, JCF/G2, JCF/G3, JCF/M2, JCFM3, MC/G1, MC/G2, MCV/G2, MCV/G3, MCF/G2, MCF/G3, MCF/M2, MCF/M3, MSF/G2, MSV/G2, MSF/G3, 7FRG03S, 7FRG07S, M35GFR...(Other models you can see in the webshop)		

			
1			
GEV No.	106466	Ref. No.	059314 0A2300 72780127
description	gas injector thread M10x1 WS 12 bore ø 1.15mm		
For models:	BC/G1, BCF/G2, RR/G1FL, RR/G1FR, RR/G2FL, RR/G2FM, RRV/G1FL, RRV/G1FR, RRV/G2FL, RRV/G2FM, RG/G1, RG/G2, RGV/G1, RGV/G2, RTV/G2, RTF/G2, RSF/G3, XR/G1FL, XR/G1FR, XR/G2FL, XR/G2FM, XRV/G1FL, XRV/G1FR, XRV/G2FL, XRV/G2FM, XG/G1, XG/G2, XGV/G1, XGV/G2, XTV/G2, XTF/G2, XSF/G3, JR/G1FL, JR/G1FR, JR/G2FL, JR/G2FM, JRV/G1FL, JRV/G1FR, JRV/G2FL, JRV/G2FM, JG/G1, JG/G2, JGV/G1, JGV/G2, JTV/G2, JTF/G2, MR/G1FL, MR/G1FR, MR/G2FL, MR/G2FM...(Other models you can see in the webshop)		

			
1			
GEV No.	106611	Ref. No.	0A2101 19013333 72780114
description	gas injector thread M10x1 WS 12 bore ø 1.25mm		
For models:	PTV/G2, PTF/G2, PSF/G2, PSV/G2, PSF/G3, PGV/G1, PGV/G2, PMV/G1C, PMV/G2C, PGV/G1HV, PTV/G2N, PGV/G2HV, OTV/G2, OTF/G2, OSF/G2, OSV/G2, OGV/G1, OGV/G2, OMV/G1C, OMV/G2C, TTV/G2, TTF/G2, TSF/G2, TSV/G2, TSF/G3, TGV/G1, TGV/G2, TMV/G1C, TMV/G2C, HI/G400, HI/G800, HI/G400N, HI/G800N, KC/G1, KC/G2, KCF/G2, KC/G3, KCF/G3, KCF/G4, KCF/M2, KC/T1, KC/T2, KC/T3, KCF/T2, KCF/T3, KCF/T4, KCF/G2H, KC/G1H, KC/G2H, KC/G3H...(Other models you can see in the webshop)		

			
1			
GEV No.	106610	Ref. No.	0A2650
description	gas injector thread M10x1 WS 12 bore ø 1.2mm		
For models:	BR/G1FL, BR/G1FR, BR/G2FL, BR/G2FR, BG/G1, BG/G2, RC/G1, RC/G2, RCV/G2, RCV/G3, RCF/G2, RCF/G3, RCF/G9, RCF/M2, RCF/M3, RR/G1CL, RR/G2CL, RRV/G1CL, RRV/G2CL, RR/G2CM, RSF/G2, RSV/G2, RSF/G3, MCF/G2A, MCF/G3A, XC/G1, XC/G2, XCV/G2, XCV/G3, XCF/G2, XCF/G3, XCF/G9, XCF/M2, XCFM3, XR/G1CL, XR/G2CL, XRV/G1CL, XRV/G2CL, XR/G2CM, XSF/G2, XSV/G2, XSF/G3, JC/G1, JC/G2, JCV/G2, JCV/G3, JCF/G2, JCF/G3, JCF/M2, JCFM3...(Other models you can see in the webshop)		

			
1			
GEV No.	106452	Ref. No.	0A2533 72780128
description	gas injector thread M10x1 WS 12 bore ø 1.35mm		
For models:	BR/G1FL, BR/G1FR, BR/G2FL, BR/G2FR, BG/G1, BG/G2, RR/G1CL, RR/G2CL, RRV/G1CL, RRV/G2CL, RR/G2CM, RG/G1, RG/G2, RGV/G1, RGV/G2, RTV/G2, RTF/G2, RSF/G3, XR/G1CL, XR/G2CL, XRV/G1CL, XRV/G2CL, XR/G2CM, XG/G1, XG/G2, XGV/G1, XGV/G2, XTV/G2, XTF/G2, XSF/G3, JR/G1CL, JR/G2CL, JRV/G1CL, JRV/G2CL, JG/G1, JG/G2, JGV/G1, JGV/G2, JTV/G2, JTF/G2, MR/G1CL, MR/G2CL, MRV/G1CL, MRV/G2CL, MR/G2CM, MG/G1, MG/G2, MGV/G1, MGV/G2, MTV/G2...(Other models you can see in the webshop)		



1

GEV No.	106328	Ref. No.	002393 0G2261 19013330 72780110
description	gas injector thread M10x1 WS 12 bore ø 1.3mm		
For models:	BR/G1FL, BR/G1FR, BR/G2FL, BR/G2FR, BG/G1, BG/G2, MT/G350, MT/G352, RR/G1FL, RR/G1FR, RR/G2FL, RR/G2FM, RRV/G1FL, RRV/G1FR, RRV/G2FL, RRV/G2FM, RSF/G2, RSV/G2, XR/G1FL, XR/G1FR, XR/G2FL, XR/G2FM, XRV/G1FL, XRV/G1FR, XRV/G2FL, XRV/G2FM, XSF/G2, XSV/G2, JR/G1FL, JR/G1FR, JR/G2FL, JR/G2FM, JRV/G1FL, JRV/G1FR, JRV/G2FL, JRV/G2FM, MR/G1FL, MR/G1FR, MR/G2FL, MR/G2FM, MRV/G1FL, MRV/G1FR, MRV/G2FL, MRV/G2FM, MSF/G2, MSV/G2, RT/G352, RT/G351, CCF/G996, XT/G352...(Other models you can see in the webshop)		



1

GEV No.	106467	Ref. No.	0A2089 72780129
description	gas injector thread M10x1 WS 12 bore ø 1.6mm		
For models:	MFR/G740, MFR/G350, MFR/G351, MFR/G700, MFR/G701, RC/G1, RC/G2, RCV/G2, RCV/G3, RCF/G2, RCF/G3, RCF/M2, RCF/M3, RSF/G2, RSV/G2, RSF/G3, MCF/G2A, MCF/G3A, XC/G1, XC/G2, XCV/G2, XCV/G3, XCF/G2, XCF/G3, XCF/M2, XCFM3, XSF/G2, XSV/G2, XSF/G3, JC/G1, JC/G2, JCV/G2, JCV/G3, JCF/G2, JCF/G3, JCF/M2, JCFM3, MC/G1, MC/G2, MCV/G2, MCV/G3, MCF/G2, MCF/G3, MCF/M2, MCF/M3, MSF/G2, MSV/G2, MSF/G3, RFR/G741, 7FRG03S...(Other models you can see in the webshop)		



2

GEV No.	106453	Ref. No.	0A2082 19013332 72780113
description	gas injector thread M10x1 WS 12 bore ø 1.4mm		
For models:	PTV/G2, PTF/G2, PSF/G2, PSV/G2, PSF/G3, PGV/G1, PGV/G2, PFR/G2S40, PGV/G1HV, PTV/G2N, PGV/G2HV, OGV/G1, OGV/G2, TTV/G2, TTF/G2, TSF/G2, TSV/G2, TSF/G3, TGV/G1, TGV/G2, TFR/G2S40, HI/G400, HI/G800, HI/G400N, HI/G800N, KR/GT1, KR/GT2, KR/GT1R, KR/GT2R, KR/GT1C, KR/GT2C, KR/GT2CR, KR/GT1P, KR/GT2P, KR/GT1RP, KR/GT2RP, KR/GT1CP, KR/GT2CP, KR/GT2CRP, KS/G2, KSF/G2, KSCF/G3, QR/GT1, QR/GT2, QR/GT1R, QR/GT2R, QR/GT1C, QR/GT2C, QR/GT2CR, QR/GT1P...(Other models you can see in the webshop)		



1

GEV No.	106468	Ref. No.	059336 72780121
description	gas injector thread M10x1 WS 12 bore ø 1.7mm		
For models:	RFR/G1S12, RFR/G2D12, RFR/G2S40, XFR/G1S12, XFR/G2D12, XFR/G2S40, JFR/G1S12, JFR/G2D12, JFR/G2S40, MFR/G1S12, MFR/G2D12, MFR/G2S40, PTV/G2, PTF/G2, PSF/G2, PSV/G2, PSF/G3, PFR/G2S40, PTV/G2N, TTV/G2, TTF/G2, TSF/G2, TSV/G2, TSF/G3, TFR/G2S40, KP/G2, HFR/G410, HFR/G810, HFR/G410D, HFR/G810D, HFR/G410NL, HFR/G810NL, HFR/G411, HFR/G412, QP/G2, ZFR/G410, ZFR/G810, ZFR/G410D, ZFR/G810D, ZFR/G411, ZFR/G412, AFR/G410, AFR/G810, AFR/G410NL, M40GFR90, AFR/G411, AFR/G412, OFR/G810		



1

GEV No.	101961	Ref. No.	0A2103 72780104
description	gas injector thread M10x1 WS 12 bore ø 1.55mm		
For models:	MCF/G1090, MBR/G710D, MBR/G701, MBR/G706, MBR/G701UK, MBR/G751, MBR/G756, RFR/G1S12, RFR/G2D12, RFR/G2S40, XFR/G1S12, XFR/G2D12, XFR/G2S40, JFR/G1S12, JFR/G2D12, JFR/G2S40, MFR/G1S12, MFR/G2D12, MFR/G2S40, ARG12FL, ARG24FL, ARG36FL, ARG48FL, ARG12FR, ARG24FR, ARG36FR, ARG48FR, ARG12FLCE, ARG24FLCE, ARG36FLCE, ARG48FLCE, ARG12FRCE, ARG24FRCE, ARG36FRCE, ARG48FRCE, RBR/G710D, 7BRG60, 7BRG60X, RBR/G701UK, RBR/G751, RBR/G756, XBR/G701, M70GBP, XBR/G701UK, XBR/G751, XBR/G756, CBR/G700, PTV/G2, PTF/G2, PSF/G2...(Other models you can see in the webshop)		



1

GEV No.	106455	Ref. No.	0A2077 72780124
description	gas injector thread M10x1 WS 12 bore ø 1.85mm		
For models:	BR/G1FL, BR/G1FR, BR/G2FL, BR/G2FR, BG/G1, BG/G2, PR/G1FL, PR/G1FR, PR/G1CL, PR/G2FL, PR/G2FM, PR/G2CL, PRV/G1FL, PRV/G1FR, PRV/G1CL, PRV/G2FL, PRV/G2FM, PRV/G2CL, PR/G2CM, PTV/G2, PTF/G2, PSF/G2, PSV/G2, PSF/G3, PG/G1, PG/G2, PG/G1HV, PG/G2HV, PTV/G2N, PR/G1FLHV, PRV/G2FLHV, OR/G1FL, OR/G1FR, OR/G1CL, OR/G2FL, OR/G2CL, ORV/G1FL, ORV/G1FR, ORV/G2FL, OR/G2CM, OTV/G2, OTF/G2, OSF/G2, OSV/G2, OG/G1, OG/G2, TR/G1FL, TR/G1FR, TR/G1CL, TR/G2FL...(Other models you can see in the webshop)		



1

GEV No.	109115	Ref. No.	0C0141 62606003
description	gas injector thread M10x1 WS 12 bore ø 1.95mm		
For models:	KC/G1, KC/G2, KCF/G2, KC/G3, KCF/G3, KCF/G4, KCF/M2, KC/T1, KC/T2, KC/T3, KCF/T2, KCF/T3, KCF/T4, KCF/G2H, KC/G1H, KC/G2H, KC/G3H, KC/T1H, KC/T2H, KC/T3H, KCF/G3A, KCF/W2, KCF/G3H, KCF/G2L, KCF/G3HA, KC/G1G, KC/G2G, KCF/G2G, KC/G3G, KCF/G3G, KCF/G4G, KCF/M2G, KCF/G2HG, KC/G1H1G, KC/G2HG, KC/G3HG, KCF/G3AG, KCF/G3HG, KCF/M2E5G, KCF/G2LG, KS/G2, KSF/G2, KSCF/G3, QC/G1, QC/G2, QCF/G2, QC/G3, QCF/G3, QCF/G4, QCF/M2...(Other models you can see in the webshop)		



			
1			
GEV No.	106457	Ref. No.	0C0142
description	gas injector thread M10x1 WS 12 bore ø 2.05mm		
For models:	OCF/G9UK, TCF/G9, TCF/G9UK, KC/G1, KC/G2, KCF/G2, KC/G3, KCF/G3, KCF/G4, KCF/M2, KC/T1, KC/T2, KC/T3, KCF/T2, KCF/T3, KCF/T4, KCF/G2H, KC/G1H, KC/G2H, KC/G3H, KC/T1H, KC/T2H, KC/T3H, KCF/G3A, KCF/W2, KCF/G3H, KCF/G2L, KCF/G3HA, KC/G1G, KC/G2G, KCF/G2G, KC/G3G, KCF/G3G, KCF/G4G, KCF/M2G, KCF/G2HG, KC/G1H1G, KC/G2HG, KC/G3HG, KCF/G3AG, KCF/G3HG, KCF/M2E5G, KCF/G2LG, KS/G2, KSF/G2, KSCF/G3, QC/G1, QC/G2, QCF/G2, QC/G3...(Other models you can see in the webshop)		

			
1			
GEV No.	106469	Ref. No.	059382 0G2246 60050500 72780118
description	gas injector thread M10x1 WS 12 bore ø 2.5mm		
For models:	FDV40G, FDV40GZ, FDV40GA, FDV20G, FDV20GZ, FDV20GA, RC/T1, RC/T2, RCV/T2, RCV/T3, RCF/T2, RCF/T3, RCF/W2, RCF/W3, MC/T1, MC/T2, MCV/T2, MCV/T3, MCF/T2, MCF/T3, MCF/W2, MCF/W3, ARG12FL, ARG24FL, ARG36FL, ARG48FL, ARG12FR, ARG24FR, ARG36FR, ARG48FR, ARG12FLCE, ARG24FLCE, ARG36FLCE, ARG48FLCE, ARG12FRCE, ARG24FRCE, ARG36FRCE, ARG48FRCE, CCF/G996, HC/G410, HC/G810, HC/G1210, HCF/G810, HCF/G1210, HCF/G1610, KR/GT1, KR/GT2, KR/GT1R, KR/GT2R, KR/GT1C...(Other models you can see in the webshop)		

			
1			
GEV No.	104627	Ref. No.	0A2475
description	gas injector thread M10x1 WS 12 bore ø 2.25mm		
For models:	BG/G1, BG/G2, RR/G1CL, RR/G2CL, RRV/G1CL, RRV/G2CL, RR/G2CM, XR/G1CL, XR/G2CL, XRV/G1CL, XRV/G2CL, XR/G2CM, JR/G1CL, JR/G2CL, JRV/G1CL, JRV/G2CL, MR/G1CL, MR/G2CL, MRV/G1CL, MRV/G2CL, MR/G2CM, PC/G1, PC/G2, PCV/G2, PCV/G3, PCF/G2, PCF/G3, PCF/G9, PCF/M2, PCF/M3, PCF/M2E5, PTV/G2, PTF/G2, PSF/G2, PSV/G2, PSF/G3, PGV/G1, PGV/G2, PG/G1, PG/G2, PMV/G1C, PMV/G2C, PCV/G2N, PCF/G3N, PC/G2HV, PCV/G3N, PCF/G2N, PG/G1HV, PC/G1HV, PGV/G1HV...(Other models you can see in the webshop)		

			
1			
GEV No.	107866	Ref. No.	059358
description	gas injector thread M10x1 WS 12 bore ø 2.85mm		
For models:	MCP/G700, MCP/G701, MCP/G710, MCP/G711, MCP/G705, MCP/G706, 7CPG07P, RCP/G701, RCP/G706, M70GPC, M70GPC, XCP/G706, CCP/G700, PMV/G1C, PMV/G2C, OMV/G1C, OMV/G2C, TMV/G1C, TMV/G2C, HC/G410D, HC/G810D, HCF/G810D, HCF/G1210D, HCF/G1610D, HC/G410NL, HC/G810NL, HCF/G810NL, KR/GT1, KR/GT2, KR/GT1R, KR/GT2R, KR/GT1C, KR/GT2C, KR/GT2CR, KR/GT1P, KR/GT2P, KR/GT1RP, KR/GT2RP, KR/GT1CP, KR/GT2CP, KR/GT2CRP, KGR/G1, KGR/G2, KGR/E1, KGR/E2, KGR/T1, KGR/T2, HT/G800D, HTF/G800D, HTF/G1210D...(Other models you can see in the webshop)		

			
1			
GEV No.	106475	Ref. No.	0A2083 0C0143 0G2252 0G2887 0K0253 19013329 60050512 72780109
description	gas injector thread M10x1 WS 12 bore ø 2.2mm		
For models:	BR/G1FL, BR/G1FR, BR/G2FL, BR/G2FR, BG/G1, BG/G2, FDV40G, FDV40GZ, FDV40GA, FDV20G, FDV20GZ, FDV20GA, RR/G1FL, RR/G1FR, RR/G2FL, RR/G2FR, RRV/G1FL, RRV/G1FR, RRV/G2FL, RRV/G2FR, RG/G1, RG/G2, RGV/G1, RGV/G2, RTV/G2, RTF/G2, RSF/G3, XR/G1FL, XR/G1FR, XR/G2FL, XR/G2FR, XRV/G1FL, XRV/G1FR, XRV/G2FL, XRV/G2FR, XG/G1, XG/G2, XGV/G1, XGV/G2, XTV/G2, XTF/G2, XSF/G3, JR/G1FL, JR/G1FR, JR/G2FL, JR/G2FR, JRV/G1FL, JRV/G1FR, JRV/G2FL, JRV/G2FR...(Other models you can see in the webshop)		

			
1			
GEV No.	106461	Ref. No.	059383
description	gas injector thread M10x1 WS 12 bore ø 2.8mm		
For models:	RBR/G2FM, RBR/G2IM, RBK/G2FM, XBR/G2FM, XBR/G2IM, XBR/G2FM, JBR/G2FM, MBR/G2FM, MBR/G2IM, MBK/G2FM, PTV/G2, PTF/G2, PSF/G2, PSV/G2, PSF/G3, PBR/G2FM, PBR/G2IM, PMV/G1C, PMV/G2C, PTV/G2N, OBR/G2FM, OBR/G2IM, OMV/G1C, OMV/G2C, TTV/G2, TTF/G2, TSF/G2, TSV/G2, TSF/G3, TBR/G2FM, TBR/G2IM, TMV/G1C, TMV/G2C, KC/G1, KC/G2, KCF/G2, KC/G3, KCF/G3, KCF/G4, KCF/M2, KC/T1, KC/T2, KC/T3, KCF/T2, KCF/T3, KCF/T4, KCF/G2H, KC/G1H, KC/G2H, KC/G3H...(Other models you can see in the webshop)		



GEV No.	106474	Ref. No.	0A2102 0G2886 0K0281 72780108
description	gas injector thread M10x1 WS 12 bore ø 2mm		
For models:	BC/G1, BCF/G2, BR/G1FL, BR/G1FR, BR/G2FL, BR/G2FR, BG/G1, BG/G2, RMV/G1C, RR/G1FL, RR/G1FR, RR/G2FL, RR/G2FM, RRV/G1FL, RRV/G1FR, RRV/G2FL, RRV/G2FM, RG/G1, RG/G2, RGV/G1, RGV/G2, RTV/G2, RTF/G2, RSF/G3, XMV/G1C, XR/G1FL, XR/G1FR, XR/G2FL, XR/G2FM, XRV/G1FL, XRV/G1FR, XRV/G2FL, XRV/G2FM, XG/G1, XG/G2, XGV/G1, XGV/G2, XTV/G2, XTF/G2, XSF/G3, JR/G1FL, JR/G1FR, JR/G2FL, JR/G2FM, JRV/G1FL, JRV/G1FR, JRV/G2FL, JRV/G2FM, JG/G1, JG/G2... (Other models you can see in the webshop)		



GEV No.	107867	Ref. No.	002979
description	gas injector thread M10x1 WS 12 bore ø 3.8mm		
For models:	BR/G1FL, BR/G1FR, BR/G2FL, BR/G2FR, TR/G1FL, TR/G1FR, TR/G1CL, TR/G2FL, TR/G2FM, TR/G2CL, TRV/G1FL, TRV/G1FR, TRV/G1CL, TRV/G2FL, TRV/G2FM, TRV/G2CL, TR/G2CM, KBR/G2F, KBR/G2C, KBR/G3F, KBR/G3FH, KBR/G3C, KBR/G3CH, KBR/G2FH, KBR/G2CH, HPN/GI815, HPN/GI816, HPN/GD816, HPA/GD825, HPA/GI825, HPNS/GI816, QBR/G2F, QBR/G2C, QBR/G3F, QBR/G3FH, QBR/G3C, QBR/G3CH, QBR/G2FH, QBR/G2CH, 2PIG15, ZPN/GI816, ZPN/GD816, 2PDAG15, 2PIAG15, ZPNS/GI816, WBR/G2F, WBR/G2C, WBR/G3F, WBR/G3FH, WBR/G3C...(Other models you can see in the webshop)		



GEV No.	693314	Ref. No.	059528
description	gas injector thread M10x1 WS 12 bore ø 3.95mm		
For models:	FCV/G10L3, FCVG10L3T, FCVG102L3, FCVG10L3J, FCVG102L3J, FCV/G102/1L6JAP, FCV/G102/1L6, FCV/G102/1, FCS101G4, FCS101G4DT, FCS101GP9J, FCS101GP, FCS102GA9J, FCS102GP, ECVG102T4, ECV/G102/1T6, ACVG102C4, ACV/G102/1C6, NCV/G102/1, ZCV/G102/1, ZCV/G102/1T6		



GEV No.	106675	Ref. No.	002864
description	gas injector thread M10x1 WS 12 bore ø 4.5mm		
For models:	FDV40G, FDV40GZ, FDV40GA, FDV20G, FDV20GZ, FDV20GA, FCV/G10L3, FCVG10L3T, FCVG102L3, FCVG202L3, FCVG10L3J, FCVG102L3J, FCV/G102/1L6JAP, FCV/G102/1L6, FCVG202L6, FCV/G102/1, FCV/G202/1, FCS101GP9J, FCS101GP, FCS102G4, FCS-102GA9J, FCS102GA9J, FCS102GP, FCS201G4, FCS201GP, FCS202G4, FCS202GP, FCS202GX, 5717-2-6, 5714-2-7, 5714-2-8, 5714-2-10, 5714-2-6L, 5714-2-7L, 5714-2-8L, 5714-2-10L, 5707-2-2, 57074-2-3, ECVG102T4, ECVG202T4, ECV/G102/1T6, ECVG202T6, ACVG102C4, ACVG202C4, ACV/G102/1C6, ACVG202C6, NCV/G102/1, ZCV/G102/1, ZCV/G202/1, ZCV/G102/1T6...(Other models you can see in the webshop)		



GEV No.	107871	Ref. No.	0A2306
description	gas injector thread M10x1 WS 12 bore ø 4mm		
For models:	BG/G1, BG/G2, RG/T1, RG/T2, RGV/T1, RGV/T2, MG/T1, MG/T2, MG/T1, MG/T2, PG/G1, PG/G2, PG/G1HV, PG/G2HV, OG/G1, OG/G2, TR/G1FL, TR/G1FR, TR/G1CL, TR/G2FL, TR/G2FM, TR/G2CL, TRV/G1FL, TRV/G1FR, TRV/G1CL, TRV/G2FL, TRV/G2FM, TRV/G2CL, TR/G1, TG/G2, KRF/GT2R, KRF/GT2RP, KBR/G3F, KBR/G3FH, KBR/G3C, KBR/G3CH, HFR/G410, HFR/G810, HFR/G410D, HFR/G810D, HFR/G410NL, HFR/G810NL, HFR/G411, HFR/G412, HPN/GI815, HPN/GI816, HPN/GD816, HPA/GD825, HPA/GI825...(Other models you can see in the webshop)		





GEV No.	100381	Ref. No.	059357 0A2298 72780103
description	gas injector thread M10x1 WS 12 bore ø 0.85mm		
For models:	MT/G350, MT/G352, RC/G1, RC/G2, RCV/G2, RCV/G3, RCF/G2, RCF/G3, RCF/M2, RCF/M3, RSF/G2, RSV/G2, RSF/G3, MCF/G2A, MCF/G3A, XC/G1, XC/G2, XCV/G2, XCV/G3, XCF/G2, XCF/G3, XCF/M2, XCFM3, XSF/G2, XSV/G2, XSF/G3, JC/G1, JC/G2, JCV/G2, JCV/G3, JCF/G2, JCF/G3, JCF/M2, JCFM3, MC/G1, MC/G2, MCV/G2, MCV/G3, MCF/G2, MCF/G3, MCF/M2, MCF/M3, MSF/G2, MSV/G2, MSF/G3, RT/G352, RT/G351, XT/G352, PTV/G2, PTF/G2...(Other models you can see in the webshop)		





GEV No.	100382	Ref. No.	059328 0G2885 72780107
description	gas injector thread M10x1 WS 12 bore ø 1.05mm		
For models:	MFR/G740, MFR/G350, MFR/G351, MFR/G700, MFR/G701, RC/G1, RC/G2, RCV/G2, RCV/G3, RCF/G2, RCF/G3, RCF/G9, RCF/M2, RCF/M3, RSF/G2, RSV/G2, RSF/G3, MCF/G2A, MCF/G3A, XC/G1, XC/G2, XCV/G2, XCV/G3, XCF/G2, XCF/G3, XCF/G9, XCF/M2, XCFM3, XSF/G2, XSV/G2, XSF/G3, JC/G1, JC/G2, JCV/G2, JCV/G3, JCF/G2, JCF/G3, JCF/M2, JCFM3, MC/G1, MC/G2, MCV/G2, MCV/G3, MCF/G2, MCF/G3, MCF/M2, MCF/M3, MSF/G2, MSV/G2...(Other models you can see in the webshop)		





			
1			
GEV No.	100538	Ref. No.	0A2076 72780122
description	gas injector thread M10x1 WS 12 bore ø 1.1mm		
For models:	BC/G1, BCF/G2, PC/G1, PC/G2, PCV/G2, PCV/G3, PCF/G2, PCF/G3, PCF/G9, PCF/M2, PCF/M3, PCF/M2E5, PTV/G2, PTF/G2, PSF/G2, PSV/G2, PSF/G3, PCV/G2N, PCF/G3N, PC/G2HV, PCV/G3N, PCF/G2N, PC/G1HV, PTV/G2N, OC/G1, OC/G2, OCV/G2, OCF/G2, OCF/G3, OCF/M2, OCF/G9UK, OTV/G2, OTF/G2, OSF/G2, OSV/G2, TC/G1, TC/G2, TCV/G2, TCV/G3, TCF/G2, TCF/G3, TCF/G9, TCF/M2, TCF/M3, TCF/G9UK, TCF/M2E5, TTV/G2, TTF/G2, TSF/G2, TSV/G2...(Other models you can see in the webshop)		

			
1			
GEV No.	100477	Ref. No.	0A2141
description	gas injector thread M10x1 WS 12 bore ø 1.65mm		
For models:	MCP/G700, MCP/G701, MCP/G710, MCP/G711, MCP/G705, MCP/G706, RBR/G2FM, RBR/G2IM, RBK/G2FM, RMV/G1C, RMV/G2C, XBR/G2FM, XBR/G2IM, XBK/G2FM, XMV/G1C, XMV/G2C, JBR/G2FM, MBR/G2FM, MBR/G2IM, MBK/G2FM, MMV/G1C, MMV/G2C, ASG36, ARG-12FL, ARG24FL, ARG36FL, ARG48FL, ARG12FR, ARG24FR, ARG36FR, ARG48FR, AGG12, AGG24, AGG36, AGG48, ARG12FLCE, ARG24FLCE, ARG36FLCE, ARG48FLCE, ARG12FRCE, ARG24FRCE, ARG36FRCE, ARG48FRCE, AGG12CE, AGG24CE, AGG36CE, AGG48CE, 7CPG07P, RCP/G701, RCP/G706...(Other models you can see in the webshop)		

			
2			
GEV No.	100387	Ref. No.	0A2091 0G2249 19013328 60050501 72780101
description	gas injector thread M10x1 WS 12 bore ø 1.45mm		
For models:	MT/G350, MT/G352, RC/G1, RC/G2, RCV/G2, RCV/G3, RCF/G2, RCF/G3, RCF/M2, RCF/M3, RSF/G2, RSV/G2, RSF/G3, MCF/G2A, MCF/G3A, XC/G1, XC/G2, XCV/G2, XCV/G3, XCF/G2, XCF/G3, XCF/M2, XCFM3, XSF/G2, XSV/G2, XSF/G3, JC/G1, JC/G2, JCV/G2, JCV/G3, JCF/G2, JCF/G3, JCF/M2, JCFM3, MC/G1, MC/G2, MCV/G2, MCV/G3, MCF/G2, MCF/G3, MCF/M2, MCF/M3, MSF/G2, MSV/G2, MSF/G3, RT/G352, RT/G351, XT/G352, PTV/G2, PTF/G2...(Other models you can see in the webshop)		

			
1			
GEV No.	100447	Ref. No.	0A2081
description	gas injector thread M10x1 WS 12 bore ø 2.3mm		
For models:	ARG12FL, ARG24FL, ARG36FL, ARG48FL, ARG12FR, ARG24FR, ARG36FR, ARG48FR, ARG12FLCE, ARG24FLCE, ARG36FLCE, ARG48FLCE, ARG12FRCE, ARG24FRCE, ARG36FRCE, ARG48FRCE, CCF/G996, PR/G1FL, PR/G1FR, PR/G1CL, PR/G2FL, PR/G2FM, PR/G2CL, PRV/G1FL, PRV/G1FR, PRV/G1CL, PRV/G2FL, PRV/G2FM, PRV/G2CL, PR/G2CM, PRV/G1FLHV, PRV/G2FLHV, OR/G1FL, OR/G1FR, OR/G1CL, OR/G2FL, OR/G2CL, ORV/G1FL, ORV/G1FR, ORV/G2FL, OR/G2CM, TR/G1FL, TR/G1FR, TR/G1CL, TR/G2FL, TR/G2FM, TR/G2CL, TRV/G1FL, TRV/G1FR, TRV/G1CL...(Other models you can see in the webshop)		

			
1			
GEV No.	100384	Ref. No.	056793 72780105
description	gas injector thread M10x1 WS 12 bore ø 1.8mm		
For models:	MBR/G710D, MBR/G700, MBR/G700F, MBR/G700UK, RC/G1, RC/G2, RCV/G2, RCV/G3, RCF/G2, RCF/G3, RCF/G9, RCF/M2, RCF/M3, RSF/G2, RSV/G2, RSF/G3, MCF/G2A, MCF/G3A, XC/G1, XC/G2, XCV/G2, XCV/G3, XCF/G2, XCF/G3, XCF/G9, XCF/M2, XCFM3, XSF/G2, XSV/G2, XSF/G3, JC/G1, JC/G2, JCV/G2, JCV/G3, JCF/G2, JCF/G3, JCF/M2, JCFM3, MC/G1, MC/G2, MCV/G2, MCV/G3, MCF/G2, MCF/G3, MCF/G9, MCF/M2, MCF/M3, MSF/G2, MSV/G2, MSF/G3...(Other models you can see in the webshop)		

			
1			
GEV No.	100490	Ref. No.	056795
description	gas injector thread M10x1 WS 12 bore ø 2.7mm		
For models:	MBR/G710D, MBR/G700, MBR/G700F, MBR/G700UK, RBR/G710D, RBR/G700, RBR/G700F, XBR/G710D, XBR/G700, XBR/G700F, XBR/G700UK, CBR/G700, RBR/E700, RBR/G700, HC/G410D, HC/G810D, HCF/G810D, HCF/G1210D, HCF/G1610D, HC/G410NL, HC/G810NL, HCF/G810NL, KS/G2, KSF/G2, KSCF/G3, KMV/G2C, HT/G800, HT/G800D, HTF/G810, HTF/G800D, HTF/G1210, HTF/G1210D, HTF/G800NL, HTF/G800NL, HTFG1210NL, ZC/G410D, ZC/G810D, ZCF/G810D, ZCF/G1210D, ZHCFG1610D, QS/G2, QSF/G2, QSCF/G3, QMV/G2C, ZT/G800, ZT/G800D, ZTF/G810, ZTF/G800D...(Other models you can see in the webshop)		

			
1			
GEV No.	107874	Ref. No.	002917
description	gas injector thread M10x1 WS 12 bore ø 3.55mm		
For models:	HBR/G820, HBR/G825, HBR/G821UK, ZBR/G821, ZBR/G826, ABR/G820, ABR/G825		

gas nozzles M12x1

			
1			
GEV No.	100279	Ref. No.	OKW937 100279 518S0AD04 72506001
description	gas injector thread M12x1 WS 14 bore ø 0.82mm		
For models:	AGGRHFG000, AGGRHAG000, AGGRHBG000, AGGRABG000, AGGRHBG000, AGGWHFGBOO, AGGWHAGBOO, AGGWHBGBOM, AGGWABGBOO, AGGWHBGBOO, AGGYIFGFCO, AGGYIAGFCO, AGGYIBGFCO, AGGRAAGOOM, AGGRAFGOOM, AGGWAAGBOM, AGGWAFGBOM, AGGYJAGFCM, AGGYJFGFCM, AGGYJBGFCM, AGGWDBGBOO, AGGWDFGBOO, AGGWDAGBOM, AGGWDFGBOM, AGGWDBGBOM, AGGYKFGFCO, AGGYKGBFCO, AGGYKAGFCM, AGGYKFGFCM, AGGYKGBFCM, AGPWCAGBOO, AGPWCAGBOM, AGPWCFCBOM, AGPWCGBBOM, AGGYLAGFCO, AGGYLFGFCO, AGGYLAGFCM, AGGYLFGFCM, AGGYLBGFCM, AGGROIGOOO, AGGWOIGBOO, AGGYOIGFCO, AGGROIGOOM, AGGWOIGBOM, AGGYOIGFCM, AGGROIQOOO, AGGRAAQOOO, AGGRAQOOO, AGGWAQQOOO, AGGWAFQOOO... (Other models you can see in the webshop)		

			
2			
GEV No.	100283	Ref. No.	OK1241
description	gas injector thread M12x1 WS 14 bore ø 0.90mm		

			
1			
GEV No.	100280	Ref. No.	OG2773 100280 72506002
description	gas injector thread M12x1 WS 14 bore ø 0.93mm		
For models:	AGGRHFG000, AGGRHAG000, AGGRHBG000, AGGRABG000, AGGRHBG000, AGGWHFGBOO, AGGWHAGBOO, AGGWHBGBOM, AGGWABGBOO, AGGWHBGBOO, AGGYIFGFCO, AGGYIAGFCO, AGGYIBGFCO, AGGRAAGOOM, AGGRAFGOOM, AGGWAAGBOM, AGGWAFGBOM, AGGYJAGFCM, AGGYJFGFCM, AGGYJBGFCM, AGGWDBGBOO, AGGWDFGBOO, AGGWDAGBOM, AGGWDFGBOM, AGGWDBGBOM, AGGYKFGFCO, AGGYKGBFCO, AGGYKAGFCM, AGGYKFGFCM, AGGYKGBFCM, AGPWCAGBOO, AGPWCAGBOM, AGPWCFCBOM, AGPWCGBBOM, AGGYLAGFCO, AGGYLFGFCO, AGGYLAGFCM, AGGYLFGFCM, AGGYLBGFCM, AGGROIGOOO, AGGWOIGBOO, AGGYOIGFCO, AGGROIGOOM, AGGWOIGBOM, AGGYOIGFCM, AGGROIQOOO, AGGRAAQOOO, AGGRAQOOO, AGGWAQQOOO, AGGWAFQOOO... (Other models you can see in the webshop)		

			
1			
GEV No.	100282	Ref. No.	OKW934 100282 72506003
description	gas injector thread M12x1 WS 14 bore ø 0.95mm		
For models:	AGGRHFG000, AGGRHAG000, AGGRHBG000, AGGRABG000, AGGRHBG000, AGGWHFGBOO, AGGWHAGBOO, AGGWHBGBOM, AGGWABGBOO, AGGWHBGBOO, AGGYIFGFCO, AGGYIAGFCO, AGGYIBGFCO, AGGRAAGOOM, AGGRAFGOOM, AGGWAAGBOM, AGGWAFGBOM, AGGYJAGFCM, AGGYJFGFCM, AGGYJBGFCM, AGGWDBGBOO, AGGWDFGBOO, AGGWDAGBOM, AGGWDFGBOM, AGGWDBGBOM, AGGYKFGFCO, AGGYKGBFCO, AGGYKAGFCM, AGGYKFGFCM, AGGYKGBFCM, AGPWCAGBOO, AGPWCAGBOM, AGPWCFCBOM, AGPWCGBBOM, AGGYLAGFCO, AGGYLFGFCO, AGGYLAGFCM, AGGYLFGFCM, AGGYLBGFCM, AGGROIGOOO, AGGWOIGBOO, AGGYOIGFCO, AGGROIGOOM, AGGWOIGBOM, AGGYOIGFCM, AGGROIQOOO, AGGRAAQOOO, AGGRAQOOO, AGGWAQQOOO, AGGWAFQOOO... (Other models you can see in the webshop)		

			
1			
GEV No.	100284	Ref. No.	OK1245
description	gas injector thread M12x1 WS 14 bore ø 1.00mm		

			
1			
GEV No.	100662	Ref. No.	OG2031 OK1249
description	gas injector thread M12x1 WS 14 bore ø 1.05mm		
For models:	JCA/G800, JFC/GG800, JCF/GG1600, JCF/G1600, PZA/G800, PFZ/GG800, PCF/GG1600, PCF/G1600, 7500-2, 7501-2, 7502-2, 7502-9, 7503-2, 7504-2, 7504-9, 7505-2-9, 7505-9-9, 7700-2, 7701-2, 7703-2		

			
1			
GEV No.	100285	Ref. No.	OG2774 OK1240 100285 183326 72506004
description	gas injector thread M12x1 WS 14 bore ø 1.10mm		
For models:	AGGRHFG000, AGGRHAG000, AGGRHBG000, AGGRABG000, AGGRHBG000, AGGWHFGBOO, AGGWHAGBOO, AGGWHBGBOM, AGGWABGBOO, AGGWHBGBOO, AGGYIFGFCO, AGGYIAGFCO, AGGYIBGFCO, AGGRAAGOOM, AGGRAFGOOM, AGGWAAGBOM, AGGWAFGBOM, AGGYJAGFCM, AGGYJFGFCM, AGGYJBGFCM, AGGWDBGBOO, AGGWDFGBOO, AGGWDAGBOM, AGGWDFGBOM, AGGWDBGBOM, AGGYKFGFCO, AGGYKGBFCO, AGGYKAGFCM, AGGYKFGFCM, AGGYKGBFCM, AGPWCAGBOO, AGPWCAGBOM, AGPWCFCBOM, AGPWCGBBOM, AGGYLAGFCO, AGGYLFGFCO, AGGYLAGFCM, AGGYLFGFCM, AGGYLBGFCM, AGGROIGOOO, AGGWOIGBOO, AGGYOIGFCO, AGGROIGOOM, AGGWOIGBOM, AGGYOIGFCM, AGGROIQOOO, AGGRAAQOOO, AGGRAQOOO, AGGWAQQOOO, AGGWAFQOOO... (Other models you can see in the webshop)		





			
1			
GEV No.	100243	Ref. No.	0KW933 100243 72506005
description	gas injector thread M12x1 WS 14 bore ø 1.12mm		
For models:	AGGRHFG000, AGGRHAG000, AGGRHBG000, AGGRABG000, AGGRHBG000, AGGWHFGBOO, AGGWHAGBOO, AGGWHBGBOM, AGGWABGBOO, AGGWHBGBOO, ALGWHFOOOO, ALGWHAOOOO, ALGWHCOOOO, AGGYIFGFCO, AGGYIAGFCO, AGGYIBGFCO, AGGRAAGOOM, AGGRAFGOOM, AGGWAAGBOM, AGGWAFGBOM, AGGYJAGFCM, AGGYJFGFCM, AGGYJBGFCM, AGGWDBGBOO, AGGWDFGBOO, AGGWDAGBOM, AGGWDFGBOM, AGGWDBGBOM, AGGYKFGFCO, AGGYKBGFCO, AGGYKAGFCM, AGGYKFGFCM, AGGYKBGFCM, AGPYCAGBOO, AGPYCAGBOM, AGPYCAGBOM, AGPYCAGBOM, AGPYLAGFCO, AGPYLFGFCO, AGPYLAGFCM, AGPYLFGFCM, AGPYLBGFCM, ALPWCAOOOO, ALGWDFOOOO, ALGWDCOOOO, AGGROIGOOO, AGGWOIGBOO, AGGYOIGFCO, AGGROIGOOM, AGGWOIGBOM... (Other models you can see in the webshop)		

			
1			
GEV No.	100669	Ref. No.	0G2395 100669 72506007
description	gas injector thread M12x1 WS 14 bore ø 1.37mm		
For models:	AGGRHFG000, AGGRHAG000, AGGRHBG000, AGGRABG000, AGGRHBG000, AGGWHFGBOO, AGGWHAGBOO, AGGWHBGBOM, AGGWABGBOO, AGGWHBGBOO, AGGYIFGFCO, AGGYIAGFCO, AGGYIBGFCO, AGGRAAGOOM, AGGRAFGOOM, AGGWAAGBOM, AGGWAFGBOM, AGGYJAGFCM, AGGYJFGFCM, AGGYJBGFCM, AGGWDBGBOO, AGGWDFGBOO, AGGWDAGBOM, AGGWDFGBOM, AGGWDBGBOM, AGGYKFGFCO, AGGYKBGFCO, AGGYKAGFCM, AGGYKFGFCM, AGGYKBGFCM, AGPYCAGBOO, AGPYCAGBOM, AGPYCAGBOM, AGPYCAGBOM, AGPYLAGFCO, AGPYLFGFCO, AGPYLAGFCM, AGPYLFGFCM, AGPYLBGFCM, ALPWCAOOOO, ALGWDFOOOO, ALGWDCOOOO, AGGROIGOOO, AGGWOIGBOO, AGGYOIGFCM, AGGROIGOOM, AGGWOIGBOM... (Other models you can see in the webshop)		

			
1			
GEV No.	100306	Ref. No.	0G2027
description	gas injector thread M12x1 WS 14 bore ø 1.20mm		
For models:	JCA/G800, JFC/GG800, JCF/GG1600, JCF/G1600, PZA/G800, PFZ/GG800, PCF/GG1600, PCF/G1600, 7500-2, 7501-2, 7502-2, 7502-9, 7503-2, 7504-2, 7504-9, 7505-2-9, 7505-9-9, 7700-2, 7701-2, 7703-2		

			
1			
GEV No.	100307	Ref. No.	0E5323 0K1217 0K1224 0K1242 0K1250 0KV608 100307 72506021
description	gas injector thread M12x1 WS 14 bore ø 1.40mm		
For models:	7500-2, 7501-2, 7502-2, 7502-9, 7503-2, 7504-2, 7504-9, 7505-2-9, 7505-9-9, 7700-2, 7701-2, 7703-2		

			
1			
GEV No.	100286	Ref. No.	0G2775 0K1246 100286 72506006
description	gas injector thread M12x1 WS 14 bore ø 1.30mm		
For models:	AGGRHFG000, AGGRHAG000, AGGRHBG000, AGGRABG000, AGGRHBG000, AGGWHFGBOO, AGGWHAGBOO, AGGWHBGBOM, AGGWABGBOO, AGGWHBGBOO, ALGWHFOOOO, ALGWHAOOOO, ALGWHCOOOO, AGGYIFGFCO, AGGYIAGFCO, AGGYIBGFCO, AGGRAAGOOM, AGGRAFGOOM, AGGWAAGBOM, AGGWAFGBOM, AGGYJAGFCM, AGGYJFGFCM, AGGYJBGFCM, AGGWDBGBOO, AGGWDFGBOO, AGGWDAGBOM, AGGWDFGBOM, AGGWDBGBOM, AGGYKFGFCO, AGGYKBGFCO, AGGYKAGFCM, AGGYKFGFCM, AGGYKBGFCM, AGPYCAGBOO, AGPYCAGBOM, AGPYCAGBOM, AGPYCAGBOM, AGPYLAGFCO, AGPYLFGFCO, AGPYLAGFCM, AGPYLFGFCM, AGPYLBGFCM, ALPWCAOOOO, ALGWDFOOOO, ALGWDCOOOO, AGGROIGOOO, AGGWOIGBOO, AGGYOIGFCO, AGGROIGOOM, AGGWOIGBOM... (Other models you can see in the webshop)		

			
1			
GEV No.	100700	Ref. No.	0G3463 100700 72506008
description	gas injector thread M12x1 WS 14 bore ø 1.50mm		
For models:	AGGRHFG000, AGGRHAG000, AGGRHBG000, AGGRABG000, AGGRHBG000, AGGWHFGBOO, AGGWHAGBOO, AGGWHBGBOM, AGGWABGBOO, AGGWHBGBOO, AGGYIFGFCO, AGGYIAGFCO, AGGYIBGFCO, AGGRAAGOOM, AGGRAFGOOM, AGGWAAGBOM, AGGWAFGBOM, AGGYJAGFCM, AGGYJFGFCM, AGGYJBGFCM, AGGWDBGBOO, AGGWDFGBOO, AGGWDAGBOM, AGGWDFGBOM, AGGWDBGBOM, AGGYKFGFCO, AGGYKBGFCO, AGGYKAGFCM, AGGYKFGFCM, AGGYKBGFCM, AGPYCAGBOO, AGPYCAGBOM, AGPYCAGBOM, AGPYCAGBOM, AGPYLAGFCO, AGPYLFGFCO, AGPYLAGFCM, AGPYLFGFCM, AGPYLBGFCM, ALPWCAOOOO, AGGROIGOOO, AGGWOIGBOO, AGGYOIGFCO, AGGROIGOOM, AGGWOIGBOM, AGGYOIGFCM, AGGROIGOOM, AGGWOIGBOM... (Other models you can see in the webshop)		

			
1			
GEV No.	100300	Ref. No.	0G1792 100300
description	gas injector thread M12x1 WS 14 bore ø 1.35mm		
For models:	JCA/G800, JFC/GG800, JCF/GG1600, JCF/G1600, PZA/G800, PFZ/GG800, PCF/GG1600, PCF/G1600, 7501-2, 7502-2, 7502-9, 7503-2, 7504-2, 7504-9, 7505-2-9, 7505-9-9, 7701-2, 7703-2		



1

GEV No.	100301	Ref. No.	0G3804 100301 72506026
description	gas injector thread M12x1 WS 14 bore ø 1.55mm		
For models:	AGGRHFG000, AGGRHAG000, AGGRHBG00M, AGGRABG000, AGGRHBG000, AGGWHFGBOO, AGGWHAGBOO, AGGWHBG00M, AGGWABGBOO, AGGWHBGBOO, AGGYIFGFCO, AGGYIAGFCO, AGGYIBGFCO, AGGRAAGOOM, AGGRAFGOOM, AGGWAAGBOM, AGGWAFGBOM, AGGYJAGFCM, AGGYJFGFCM, AGGYJBGFCM, AGGWDBGBOO, AGGWDFGBOO, AGGWDAGBOM, AGGWDFGBOM, AGGWDBGBOM, AGGYKFGFCO, AGGYKBGFCO, AGGYKAGFCM, AGGYKFGFCM, AGGYKBGFCM, AGPWCAGBOO, AGPWCAGBOM, AGPWCFCGBOM, AGPWCGBBOM, AGGYLAGFCO, AGGYLFGFCO, AGGYLAGFCM, AGGYLFGFCM, AGGYLBGFCM, AGGROI000, AGGWOIGBOO, AGGYOIGFCO, AGGROI00M, AGGWOIGBOM, AGGYOIGFCM, AGGRAAQ000, AGGRAFQ000, AGGRABQ000, AGGWAAQ000, AGGWAFQ000... (Other models you can see in the webshop)		



1

GEV No.	100288	Ref. No.	0K1229 0KV607 100288 72506022
description	gas injector thread M12x1 WS 14 bore ø 1.70mm		
For models:	AGGRHFG000, AGGRHAG000, AGGRHBG00M, AGGRABG000, AGGRHBG000, AGGWHFGBOO, AGGWHAGBOO, AGGWHBG00M, AGGWABGBOO, AGGWHBGBOO, AGGYIFGFCO, AGGYIAGFCO, AGGYIBGFCO, AGGRAAGOOM, AGGRAFGOOM, AGGWAAGBOM, AGGWAFGBOM, AGGYJAGFCM, AGGYJFGFCM, AGGYJBGFCM, AGGWDBGBOO, AGGWDFGBOO, AGGWDAGBOM, AGGWDFGBOM, AGGWDBGBOM, AGGYKFGFCO, AGGYKBGFCO, AGGYKAGFCM, AGGYKFGFCM, AGGYKBGFCM, AGPWCAGBOO, AGPWCAGBOM, AGPWCFCGBOM, AGPWCGBBOM, AGGYLAGFCO, AGGYLFGFCO, AGGYLAGFCM, AGGYLFGFCM, AGGYLBGFCM, AGGROI000, AGGWOIGBOO, AGGYOIGFCO, AGGROI00M, AGGWOIGBOM, AGGYOIGFCM, AGGRAAQ000, AGGRAFQ000, AGGRABQ000, AGGWAAQ000, AGGWAFQ000... (Other models you can see in the webshop)		



1

GEV No.	100665	Ref. No.	0K1214
description	gas injector thread M12x1 WS 14 bore ø 1.60mm		
For models:	7500-2, 7501-2, 7502-2, 7502-9, 7503-2, 7504-2, 7504-9, 7505-2-9, 7505-9-9, 7700-2, 7701-2, 7703-2		



1

GEV No.	100289	Ref. No.	0G3001 100289 72506010
description	gas injector thread M12x1 WS 14 bore ø 1.80mm		
For models:	AGGRHFG000, AGGRHAG000, AGGRHBG00M, AGGRABG000, AGGRHBG000, AGGWHFGBOO, AGGWHAGBOO, AGGWHBG00M, AGGWABGBOO, AGGWHBGBOO, AGGYIFGFCO, AGGYIAGFCO, AGGYIBGFCO, AGGRAAGOOM, AGGRAFGOOM, AGGWAAGBOM, AGGWAFGBOM, AGGYJAGFCM, AGGYJFGFCM, AGGYJBGFCM, AGGWDBGBOO, AGGWDFGBOO, AGGWDAGBOM, AGGWDFGBOM, AGGWDBGBOM, AGGYKFGFCO, AGGYKBGFCO, AGGYKAGFCM, AGGYKFGFCM, AGGYKBGFCM, AGPWCAGBOO, AGPWCAGBOM, AGPWCFCGBOM, AGPWCGBBOM, AGGYLAGFCO, AGGYLFGFCO, AGGYLAGFCM, AGGYLFGFCM, AGGYLBGFCM, AGGROI000, AGGWOIGBOO, AGGYOIGFCO, AGGROI00M, AGGWOIGBOM, AGGYOIGFCM, AGGRAAQ000, AGGRAFQ000, AGGRABQ000, AGGWAAQ000, AGGWAFQ000... (Other models you can see in the webshop)		



1

GEV No.	100239	Ref. No.	0G2396 100239 72506009
description	gas injector thread M12x1 WS 14 bore ø 1.65mm		
For models:	AGGRHFG000, AGGRHAG000, AGGRHBG00M, AGGRABG000, AGGRHBG000, AGGWHFGBOO, AGGWHAGBOO, AGGWHBG00M, AGGWABGBOO, AGGWHBGBOO, AGGYIFGFCO, AGGYIAGFCO, AGGYIBGFCO, AGGRAAGOOM, AGGRAFGOOM, AGGWAAGBOM, AGGWAFGBOM, AGGYJAGFCM, AGGYJFGFCM, AGGYJBGFCM, AGGWDBGBOO, AGGWDFGBOO, AGGWDAGBOM, AGGWDFGBOM, AGGWDBGBOM, AGGYKFGFCO, AGGYKBGFCO, AGGYKAGFCM, AGGYKFGFCM, AGGYKBGFCM, AGPWCAGBOO, AGPWCAGBOM, AGPWCFCGBOM, AGPWCGBBOM, AGGYLAGFCO, AGGYLFGFCO, AGGYLAGFCM, AGGYLFGFCM, AGGYLBGFCM, AGGROI000, AGGWOIGBOO, AGGYOIGFCO, AGGROI00M, AGGWOIGBOM, AGGYOIGFCM, AGGRAAQ000, AGGRAFQ000, AGGRABQ000, AGGWAAQ000, AGGWAFQ000... (Other models you can see in the webshop)		



1

GEV No.	100302	Ref. No.	0H6355 100302
description	gas injector thread M12x1 WS 14 bore ø 1.85mm		
For models:	JCA/G800, JFC/GG800, JCF/GG1600, JCF/G1600, PZA/G800, PFZ/GG800, PCF/GG1600, PCF/G1600, 7500-2, 7501-2, 7502-2, 7502-9, 7503-2, 7504-2, 7504-9, 7505-2-9, 7505-9-9, 7700-2, 7701-2, 7703-2		





1

GEV No.	100290	Ref. No.	0K1215
description	gas injector thread M12x1 WS 14 bore ø 1.90mm		





			
1			
GEV No.	100740	Ref. No.	0C3656 0G2397 100740 72506011
description	gas injector thread M12x1 WS 14 bore ø 1.95mm		
For models:	AGGRHFG000, AGGRHAG000, AGGRHBG000, AGGRABG000, AGGRHBG000, AGGWHFG000, AGGWHAG000, AGGWHBG000, AGGWABG000, AGGWHBG000, ALGWHFO000, ALGWHAO000, ALGWHCO000, AGGYIFGFCO, AGGYIAGFCO, AGGYIBGFCO, AGGRAAG000, AGGRAFG000, AGGWAAGBOM, AGGWAFGBOM, AGGYJAGFCM, AGGYJFGFCM, AGGYJBGFCM, AGGWDBG000, AGGWDFG000, AGGWDAGBOM, AGGWDFGBOM, AGGWDBG00M, AGGYKFGFCO, AGGYKBFGFCO, AGGYKAGFCM, AGGYKFGFCM, AGGYKBFGFCM, AGPWCAGBOM, AGPWCAGBOM, AGPWCAGBOM, AGPWCAGBOM, AGPWCAGBOM, AGPWCAGBOM, AGPWCAGBOM, AGPWCAGBOM, AGPWCAGBOM, AGPWCAGBOM, ALPWCAO000, ALGWDFO000, ALGWDCO000, AGGROIGO00, AGGWOIGBOM, AGGYOIGFCO, AGGROIGO00M, AGGWOIGBOM... (Other models you can see in the webshop)		

			
1			
GEV No.	100292	Ref. No.	0G2030 100292
description	gas injector thread M12x1 WS 14 bore ø 2.10mm		
For models:	JCA/G800, JFC/GG800, JCF/GG1600, JCF/G1600, PZA/G800, PFZ/GG800, PCF/GG1600, PCF/G1600, 7501-2, 7502-2, 7502-9, 7503-2, 7504-2, 7504-9, 7505-2-9, 7505-9-9, 7701-2, 7703-2		

			
1			
GEV No.	100291	Ref. No.	0G2914 100291 72506023
description	gas injector thread M12x1 WS 14 bore ø 2.00mm		
For models:	AGGRHFG000, AGGRHAG000, AGGRHBG000, AGGRABG000, AGGRHBG000, AGGWHFG000, AGGWHAG000, AGGWHBG000, AGGWABG000, AGGWHBG000, ALGWHFO000, ALGWHAO000, ALGWHCO000, AGGYIFGFCO, AGGYIAGFCO, AGGYIBGFCO, AGGRAAG000, AGGRAFG000, AGGWAAGBOM, AGGWAFGBOM, AGGYJAGFCM, AGGYJFGFCM, AGGYJBGFCM, AGGWDBG000, AGGWDFG000, AGGWDAGBOM, AGGWDFGBOM, AGGWDBG00M, AGGYKFGFCO, AGGYKBFGFCO, AGGYKAGFCM, AGGYKFGFCM, AGGYKBFGFCM, AGPWCAGBOM, AGPWCAGBOM, AGPWCAGBOM, AGPWCAGBOM, AGPWCAGBOM, AGPWCAGBOM, AGPWCAGBOM, AGPWCAGBOM, AGPWCAGBOM, AGPWCAGBOM, ALPWCAO000, ALGWDFO000, ALGWDCO000, AGGROIGO00, AGGWOIGBOM, AGGYOIGFCO, AGGROIGO00M, AGGWOIGBOM... (Other models you can see in the webshop)		

			
1			
GEV No.	100744	Ref. No.	0G2915 100744 72506012
description	gas injector thread M12x1 WS 14 bore ø 2.12mm		
For models:	AGGRHFG000, AGGRHAG000, AGGRHBG000, AGGRABG000, AGGRHBG000, AGGWHFG000, AGGWHAG000, AGGWHBG000, AGGWABG000, AGGWHBG000, ALGWHFO000, ALGWHAO000, ALGWHCO000, AGGYIFGFCO, AGGYIAGFCO, AGGYIBGFCO, AGGRAAG000, AGGRAFG000, AGGWAAGBOM, AGGWAFGBOM, AGGYJAGFCM, AGGYJFGFCM, AGGYJBGFCM, AGGWDBG000, AGGWDFG000, AGGWDAGBOM, AGGWDFGBOM, AGGWDBG00M, AGGYKFGFCO, AGGYKBFGFCO, AGGYKAGFCM, AGGYKFGFCM, AGGYKBFGFCM, AGPWCAGBOM, AGPWCAGBOM, AGPWCAGBOM, AGPWCAGBOM, AGPWCAGBOM, AGPWCAGBOM, AGPWCAGBOM, AGPWCAGBOM, AGPWCAGBOM, AGPWCAGBOM, ALPWCAO000, ALGWDFO000, ALGWDCO000, AGGROIGO00, AGGWOIGBOM, AGGYOIGFCO, AGGROIGO00M, AGGWOIGBOM... (Other models you can see in the webshop)		

			
1			
GEV No.	100303	Ref. No.	0C3517 0G1794 100303 622582
description	gas injector thread M12x1 WS 14 bore ø 2.05mm		
For models:	JCA/G800, JFC/GG800, JCF/GG1600, JCF/G1600, DLP/SCE, DLP/SUK, ELP/SUSA, PZA/G800, PFZ/GG800, PCF/GG1600, PCF/G1600, 7500-2, 7501-2, 7502-2, 7502-9, 7503-2, 7504-2, 7504-9, 7505-2-9, 7505-9-9, 7700-2, 7701-2, 7703-2		

			
1			
GEV No.	100308	Ref. No.	0K1144
description	gas injector thread M12x1 WS 14 bore ø 2.15mm		

			
1			
GEV No.	100309	Ref. No.	0G2028 0G3802 0K1230 100309 72506027
description	gas injector thread M12x1 WS 14 bore ø 2.30mm		
For models:	JCA/G800, JFC/GG800, JCF/GG1600, JCF/G1600, AGGRHFG000, AGGRHAG000, AGGRHBG000, AGGRABG000, AGGRHBG000, AGGWHFG000, AGGWHAG000, AGGWHBG000, AGGWABG000, AGGWHBG000, AGGYIFGFCO, AGGYIAGFCO, AGGYIBGFCO, AGGRAAG000, AGGRAFG000, AGGWAAGBOM, AGGWAFGBOM, AGGYJAGFCM, AGGYJFGFCM, AGGYJBGFCM, AGGWDBG000, AGGWDFG000, AGGWDAGBOM, AGGWDFGBOM, AGGWDBG00M, AGGYKFGFCO, AGGYKBFGFCO, AGGYKAGFCM, AGGYKFGFCM, AGGYKBFGFCM, AGPWCAGBOM, AGPWCAGBOM, AGPWCAGBOM, AGPWCAGBOM, AGPWCAGBOM, AGPWCAGBOM, AGPWCAGBOM, AGPWCAGBOM, AGPWCAGBOM, AGPWCAGBOM, ALPWCAO000, ALGWDFO000, ALGWDCO000, AGGROIGO00, AGGWOIGBOM, AGGYOIGFCM, AGGROIGO00M, AGGWOIGBOM, AGGYOIGFCM, AGGROIGO00M... (Other models you can see in the webshop)		

			
1			
GEV No.	100294	Ref. No.	OG3803 100294 72506028
description	gas injector thread M12x1 WS 14 bore ø 2.40mm		
For models:	AGGRHFG000, AGGRHAG000, AGGRHBG00M, AGGRABG000, AGGRHBG000, AGGWHFGB00, AGGWHAGB00, AGGWHBG00M, AGGWABG000, AGGWHBGB00, AGGYIFGFCO, AGGYIAGFCO, AGGYIBGFCO, AGGRAAGOOM, AGGRAFGOOM, AGGWAAGBOM, AGGWAFGBOM, AGGYJAGFCM, AGGYJFGFCM, AGGYJBGFCM, AGGWDBGBOO, AGGWDFGBOO, AGGWADAGBOM, AGGWDFGBOM, AGGWDBGBOM, AGGYKFGFCO, AGGYKBFGBOM, AGGYKAGFCM, AGGYKFGFCM, AGGYKBFGBOM, AGPWCAGBOO, AGPWCAGBOM, AGPWCFCGBOM, AGPWCBBGOM, AGGYLAGFCO, AGGYLFGFCO, AGGYLAGFCM, AGGYLFGFCM, AGGYLBGFCM, AGGROIG000, AGGWOIGBOM, AGGYOIGFCO, AGGROIGOOM, AGGWOIGBOM, AGGYOIGFCM, AGGRAAQ000, AGGRAFQ000, AGGRABQ000, AGGWAAQ000, AGGWAFQ000... (Other models you can see in the webshop)		

			
1			
GEV No.	100304	Ref. No.	OG3891 100304 72506013
description	gas injector thread M12x1 WS 14 bore ø 2.60mm		

			
1			
GEV No.	100305	Ref. No.	OKL478 100305 72506016
description	gas injector thread M12x1 WS 14 bore ø 3.00mm		

			
1			
GEV No.	100749	Ref. No.	OKR077 100749 72506014
description	gas injector thread M12x1 WS 14 bore ø 2.45mm		

			
1			
GEV No.	100752	Ref. No.	OG2964 100752 72506015
description	gas injector thread M12x1 WS 14 bore ø 3.20mm		

			
1			
GEV No.	100326	Ref. No.	OU4101 230783
description	gas injector thread M12x1 WS 14 bore ø 2.50mm		

			
1			
GEV No.	100763	Ref. No.	OKR078 100763 72506018
description	gas injector thread M12x1 WS 14 bore ø 3.80mm		

			
1			
GEV No.	100416	Ref. No.	OG3511 100416 72506029
description	gas injector thread M12x1 WS 14 bore ø 2.55mm		
For models:	AGGRHFG000, AGGRHAG000, AGGRHBG00M, AGGRABG000, AGGRHBG000, AGGWHFGB00, AGGWHAGB00, AGGWHBG00M, AGGWABG000, AGGWHBGB00, AGGYIFGFCO, AGGYIAGFCO, AGGYIBGFCO, AGGRAAGOOM, AGGRAFGOOM, AGGWAAGBOM, AGGWAFGBOM, AGGYJAGFCM, AGGYJFGFCM, AGGYJBGFCM, AGGWDBGBOO, AGGWDFGBOO, AGGWADAGBOM, AGGWDFGBOM, AGGWDBGBOM, AGGYKFGFCO, AGGYKBFGBOM, AGGYKAGFCM, AGGYKFGFCM, AGGYKBFGBOM, AGPWCAGBOO, AGPWCAGBOM, AGPWCFCGBOM, AGPWCBBGOM, AGGYLAGFCO, AGGYLFGFCO, AGGYLAGFCM, AGGYLFGFCM, AGGYLBGFCM, AGGROIG000, AGGWOIGBOM, AGGYOIGFCO, AGGROIGOOM, AGGWOIGBOM, AGGYOIGFCM, AGGRAAQ000, AGGRAFQ000, AGGRABQ000, AGGWAAQ000, AGGWAFQ000... (Other models you can see in the webshop)		

			
1			
GEV No.	102794	Ref. No.	72506030
description	gas injector thread M12x1 WS 14 bore ø 3.85mm		

			
1			
GEV No.	100762	Ref. No.	OG3892 100762 72506017
description	gas injector thread M12x1 WS 14 bore ø 4.10mm		





gas nozzles M13x1			
			
1			
GEV No.	109108	Ref. No.	005652 50004
description	gas injector thread M13x1 bore ø 2.2mm WS 13		
For models:	SGG350, SGG700		

gas nozzles M15x1			
			
1			
GEV No.	100333	Ref. No.	230886
description	gas injector thread M15x1 bore ø 2.30mm WS 17		

			
1			
GEV No.	100331	Ref. No.	230887
description	gas injector thread M15x1 bore ø 2.70mm WS 17		

			
1			
GEV No.	100339	Ref. No.	230889
description	gas injector thread M15x1 bore ø 3.40mm WS 17		

			
1			
GEV No.	100334	Ref. No.	230888
description	gas injector thread M15x1 bore ø 3.50mm WS 17		

			
1			
GEV No.	100329	Ref. No.	230890
description	gas injector thread M15x1 bore ø 4.40mm WS 17		

gas nozzles (other)			
			
1			
GEV No.	106824	Ref. No.	050677
description	gas injector bore ø 0.4mm		
For models:	PCG1210D, PMG600D, HCF/G1210D, HCF/G1210		

			
1			
GEV No.	100588	Ref. No.	052528
description	gas injector bore ø 0.6mm		
For models:	HMA/G800D, ZHMA/G80		

			
1			
GEV No.	100586	Ref. No.	050679
description	gas injector bore ø 0.7mm		
For models:	PCG1210, PCG1210F, PCG1210D, PCG1200NL, PMG600, PMG600D, HCFG1210, HCF/G1210D, HCF/G1200, HCF/G1200F, PHCF/G1200, HCF/G1200N, HCF/G1200D, HMA/G800, HM/G800T, HTF/G1200, ZPC/G1210, ZPM/G600, HCF/G1210, ZHMA/G80, HCF/G1210		

			
1			
GEV No.	100567	Ref. No.	025983 0G0853 0K2875 214421020
description	gas injector bore ø 0.85mm		
For models:	MCF/GE700D, MCFGE1050D, MCF/G1050D, MCF/G1095, MC/G352, MC/G702, MC/G1052, MCF/G702, MCF/GE702, MCF/G1052, MCF-GE1052, MC/G350, MC/G700, MC/G1050, MCF/G700, MCF/GE700, MCF/G1050, MCFGE1050, MTF/G700D, MTF/G1050D, MTF/G700, MTF/G1050, MTF/GE1050, RCF/GE700D, RCFGE1050D, RC/G352, RC/G702, RC/G1052, RCF/G702, RCF/GE702, RCF/G1052, RCF/GE1052, 72FG03T, 74FG07T, 76FG10T, 74FG07F, 74FE07F, 76FG10F, RCF/GE1051, RTF/G700D, RTF/G1050D, 7TPG07F, 7TPG10F, XCF/GE700D, XC/G350D, XC/G700D, XC/1050D, XCF/G700D, XCF/G1050D, T105GCK...(Other models you can see in the webshop)		

			
1			
GEV No.	100577	Ref. No.	050675
description	gas injector bore ø 0.8mm		
For models:	PCG1210D, PMG600D, HCF/G1210D, HM/G800T, HCF/G1210		

			
GEV No.	100569	Ref. No.	026717 0K2927
description	gas injector bore ø 0.95mm		
For models:	RC/G320, RC/G330, RC/G320F, RC/G720, RC/G730, MCF/G705, MCF/G1055, MCF/G700, MCF/G1050, MCF/G705F, MCF/G1055F, MCF/GE705, MCF/GE1055, MCF/GE700, MCFGE1050, MC/G355, MC/G350, MC/G355F, MC/G705, MC/G700, MC/G1055, MC/G1050, MC/G705F, MCF/GE1055UK, MCF/G1090, MCF/G1095, MC/G352, MC/G702, MC/G1052, MCF/G702, MCF/GE702, MCF/G1052, MCFGE1052, MC/G350, MC/G700, MC/G1050, MCF/G700, MCF/GE700, MCF/G1050, MCFGE1050, MTF/G700D, MTF/G1050D, MTF/G700, MTF/G1050, MTF/GE1050, MT/G700F, MTF/G700F, MTF/G1055F, MTFGE1055F, RCV/G320...(Other models you can see in the webshop)		

			
GEV No.	100587	Ref. No.	025865 054365
description	gas injector bore ø 1.1mm		
For models:	RC/G320, RC/G330, RC/G320F, RC/G720, RC/G730, MCF/G705, MCF/G1055, MCF/G700, MCF/G1050, MCF/G705F, MCF/G1055F, MCF/GE705, MCF/GE1055, MCF/GE700, MCFGE1050, MC/G355, MC/G350, MC/G355F, MC/G705, MC/G700, MC/G1055, MC/G1050, MC/G705F, MCF/GE1055UK, MCF/G1090, MM/G350F, RCV/G320, RCV/G330, RCV/G320, RCV/G720, RCV/G730, RCV/G720, RCF/G720, RCF/G1020, RCF/G730, RCF/G1030, RCF/G720F, RCF/G1020, RCF/GE720, RCF/GE730, RCF/GE720, RCF/GE720, RC/G350, RC/G700, RCF/G700, RCF/G1050, RC/G350F, RC/G700F, RCF/G700, MCF/G1050...(Other models you can see in the webshop)		

			
GEV No.	100568	Ref. No.	051121
description	gas injector bore ø 0.9mm		
For models:	MFR/G350D, MFR/G700D, RFR/G350D, RFR/G700D, XFR/G700D, XFR/G700F, RFR/G700		

			
GEV No.	100580	Ref. No.	026788 0K2896
description	gas injector bore ø 1.25mm		
For models:	RG/G350D, RG/G700D, PCG1210, PCG1210F, PCG1210D, PMG600, PMG600D, HCFG1210, HCF/G1210D, HCF/G1200, HCF/G1200F, PHCF/G1200, HCF/G1200D, HM/G800T, HTF/G1210, HTF/G1200, ZPC/G1210, ZPM/G600, HCF/G1210, ZHTF/G121, HCF/G1210		

			
GEV No.	100565	Ref. No.	026212 050501 0G0856 0K2878
description	gas injector bore ø 1.05mm		
For models:	RC/G320, RC/G330, RC/G320F, RC/G720, RC/G730, MCF/G705, MCF/G1055, MCF/G700, MCF/G1050, MCF/G705E, MCF/G1055E, MCF/G705F, MCF/G1055F, MCF/GE705, MCF/GE1055, MCF/GE700, MCF-GE1050, MCF/GE700D, MCFGE1050D, MCF/G1050D, MC/G355, MC/G350, MC/G355E, MC/G355F, MC/G705, MC/G700, MC/G705E, MC/G1055, MC/G1050, MC/G705F, MCF/GE1055UK, MCF/G1090, MCF/G1095, MCF/G995, MC/G352, MC/G702, MC/G1052, MCF/G702, MCF/GE702, MCF/G1052, MCFGE1052, MC/G350, MC/G700, MC/G1050, MCF/G700, MCF/GE700, MCF/G1050, MCFGE1050, MR/G351, MR/G701...(Other models you can see in the webshop)		

			
GEV No.	100575	Ref. No.	026213 0K2923 0KE862
description	gas injector bore ø 1.2mm		
For models:	RC/G320, RC/G330, RC/G320F, RC/G720, RC/G730, MCF/G705, MCF/G1055, MCF/G700, MCF/G1050, MCF/G705E, MCF/G1055E, MCF/G705F, MCF/G1055F, MCF/GE705, MCF/GE1055, MCF/GE700, MCF-GE1050, MC/G355, MC/G350, MC/G355E, MC/G355F, MC/G705, MC/G700, MC/G705E, MC/G1055, MC/G1050, MC/G705F, MCF/GE1055UK, MCF/G1090, MCF/G1095, MCF/G995, MC/G352, MC/G702, MC/G1052, MCF/G702, MCF/GE702, MCF/GE702, MCF/G1052, MCFGE1052, MC/G350, MC/G700, MC/G1050, MCF/G700, MCF/GE700, MCF/G1050, MCFGE1050, MR/G351, MR/G701, MR/G721, MR/G1071, MR/G350...(Other models you can see in the webshop)		

			
GEV No.	100582	Ref. No.	026785
description	gas injector bore ø 1.15mm		
For models:	MT/G700D, MTF/G700D, MTF/G1050D, MT/G700, MTF/G700, MTF/G1050, MTF/GE1050, MT/G700F, MTF/G700F, MTF/G1055F, MTF-GE1055F, RT/G700D, RTF/G700D, RTF/G1050D, 7TPG07T, 7TPG07F, 7TPG10F, RT/G700F, RTF/G700, RTF/G1050, T70GCK, XC/G1050, M70GCK/E, XC/G700F, XCF/G700F, XCF/G1050F, CC/G710, CC/G1060, CCF/G710, XT/G700D, XTF/G700D, XTF/G1050D, T70GST, M70GST/G, M105GST/GA, XT/G700F, XTF/G700F, XTF/G1050F, CTFGA702, CT/G700, RTV/G720, RTV/G720, RTFG720, RTF/G720F, PCG810, PCG1210, PCG1610, PCG810F, PCG1210F, PCG1610F...(Other models you can see in the webshop)		

			
GEV No.	100583	Ref. No.	025866
description	gas injector bore ø 1.35mm		
For models:	MR/G721, MR/G1071, MR/G1070, MR/G720, MR/G725, MR/G1075, MR/G726, MR/G1076, MG/G350D, MG/G700D, MG/G350, MG/G700, MG/G1050, MG/G1051, 7FTGC7L, 7FTGC1L, 7FTGC7M, RR/G1076, 7GLG03, 7GLG07, 7GLG10, XR/G720D, XR/G1070D, T79GFT, T109GFT, XG/G350D, XG/G700D, T35GCG, XG/G350E, XG/G350F, XG/G350NL, T70GCG, XG/G700E, XG/G700F, XG/G700NL, T105GCG, XG/G1050F, CG/G701, FTG2, PCG810, PCG1210, PCG1610, PCG810F, PCG1210F, PCG1610F, PCG810D, PCG1610D, PCG800NL, PCG1200NL, PCG1600NL...(Other models you can see in the webshop)		



			
1			
GEV No.	100579	Ref. No.	026718
description	gas injector bore ø 1.3mm		
For models:	RG/G310D, RG/G710D, RGV/G310, RGV/G701D, FCFG6D, PCG810, PCG1610, PCG810F, PCG1610F, PCG810D, PCG1210D, PCG1610D, PCG800NL, PCG1600NL, ZPC/G810, ZPC/G1610		

			
1			
GEV No.	100564	Ref. No.	025954
description	gas injector bore ø 1.5mm		
For models:	RC/G320, RC/G330, RC/G320F, RC/G720, RC/G730, MCF/G705, MCF/G1055, MCF/G700, MCF/G1050, MCF/G705E, MCF/G1055E, MCF/G705F, MCF/G1055F, MCF/GE705, MCF/GE1055, MCF/GE700, MCF-GE1050, MC/G355, MC/G350, MC/G355E, MC/G355F, MC/G705, MC/G700, MC/G705E, MC/G1055, MC/G1050, MC/G705F, MCF/GE1055UK, MCF/G1090, RCV/G320, RCV/G330, RCV/G320, RCV/G720, RCV/G730, RCV/G720, RCF/G720, RCF/G1020, RCFG730, RCFG1030, RCF/G720F, RCF/G1020, RCF/GE720, RCF/GE730, RCF/GE720, RCF/GE720, RC/G350, RC/G700, RCF/G700, RCF/G1050, RC/G350F...(Other models you can see in the webshop)		

			
1			
GEV No.	100573	Ref. No.	045676 0G0797 0G0839
description	gas injector bore ø 1.45mm		
For models:	MCF/G1095, MC/G352, MC/G702, MC/G1052, MCF/G702, MCF/GE702, MCF/G1052, MCFGE1052, MC/G350, MC/G700, MC/G1050, MCF/G700, MCF/GE700, MCF/G1050, MCFGE1050, MTF/G700D, MTF/G1050D, MTF/G700, MTF/G1050, MTF/GE1050, RC/G352, RC/G702, RC/G1052, RCF/G702, RCF/GE702, RCF/G1052, RCF/GE1052, 72FG03T, 74FG07T, 76FG10T, 74FG07F, 74FE07F, 76FG10F, RCF/GE1051, RTF/G700D, RTF/G1050D, 7TPG07F, 7TPG10F, T35GCK, T70GCK, XC/G1050, M70GCK/E, XC/G350F, XC/G700F, XCF/G700F, XCF/G1050F, CC/G710, CC/G1060, CCF/G710, T105GCK...(Other models you can see in the webshop)		

			
1			
GEV No.	100581	Ref. No.	006222 026000 026622 0K2926 0K9210 0K9564
description	gas injector bore ø 1.65mm		
For models:	RC/G320, RC/G330, RC/G320F, RC/G720, RC/G730, MCF/G705, MCF/G1055, MCF/G700, MCF/G1050, MCF/G705F, MCF/G1055F, MCF/GE705, MCF/GE1055, MCF/GE700, MCFGE1050, MCF/GE700D, MCFGE1050D, MCF/G1050D, MC/G355, MC/G350, MC/G355F, MC/G705, MC/G700, MC/G1055, MC/G1050, MC/G705F, MCF/GE1055UK, MCF/G1090, MCF/G1095, MC/G352, MC/G702, MC/G1052, MCF/G702, MCF/GE702, MCF/G1052, MCFGE1052, MC/G350, MC/G700, MC/G1050, MCF/G700, MCF/GE700, MCF/G1050, MCFGE1050, MFR/G350, MFR/G700, MFR/G350F, MFR/G700F, MFR/G350E, MFR/G700E, MPN/GD761...(Other models you can see in the webshop)		

			
1			
GEV No.	100574	Ref. No.	026786 0K2876
description	gas injector bore ø 1.4mm		
For models:	RC/G320, RC/G330, RC/G320F, RC/G720, RC/G730, MCF/G705, MCF/G1055, MCF/G700, MCF/G1050, MCF/G700D, MCF/G705F, MCF/G1055F, MCF/G705NL, MCF/GE705, MCF/GE1055, MCF/GE700, MCFGE1050, MCF/GE700D, MCFGE1050D, MCF/G1050D, MCF-G1055NL, MC/G355, MC/G350, MC/G350D, MC/G355F, MC/G355NL, MC/G705, MC/G700, MC/G700D, MC/G705NL, MC/G1055, MC/G1050, MC/G1050D, MC/G1055NL, MC/G705F, MCF/GE1055UK, MCF/G1090, MFR/G360, MTF/G1050, MTF/GE1050, MT/G700F, MTF/G700F, MTF/G1055F, MTFGE1055F, MG/G350E, MG/G350F, MG/G700E, MG/G700F, MG/G1050F...(Other models you can see in the webshop)		

			
1			
GEV No.	100570	Ref. No.	026789
description	gas injector bore ø 1.75mm		
For models:	MFR/G350D, MFR/G700D, MTF/G1050, MTF/GE1050, MT/G700F, MTF/G700F, MTF/G1055F, MTFGE1055F, RFR/G350D, RFR/G700D, 7TPG10F, RT/G700F, RTF/G700, RTF/G1050, RM/G700D, XFR/G700D, XFR/G700F, XM/G700D, T70GBM, XM/G700F, CM/G700, RTV/G720, RTV/G720, RTF/G720, RTF/G720F, RTF/G1020, RTF/G1030, RTF/G1020F, HMA/G800D, RTV/G720, RTF/G720, RTF/G1020, RTF/G1030, ZHMA/G80		

			
1			
GEV No.	100578	Ref. No.	050515
description	gas injector bore ø 1.55mm		
For models:	MFR/G350D, MFR/G700D, RFR/G350D, RFR/G700D, XFR/G700D, XFR/G700F, PCG810, PCG1610, PCG810F, PCG1610F, PCG810D, PCG1210D, PCG1610D, PCG800NL, PCG1600NL, HCSG410, HCS/G410D, HCS/G400, PHCS/G400, HCS/G400F, HCF/G800F, PHCF/G800, HCS/G400NL, HCS/G400DK, HCSG810, HCS/G810D, HCS/G800, HCS/G800F, HCS/G800, HCS/G800NL, HCS/G800DK, HCFG810, HCF/G810D, HCF/GE81, HCF/GE81, HCF/G800, HCF/G800NL, HCF/G800DK, HCF/GE80, HCF/GE80, HCFG1210, HCF/G1210D, HCF/G1200, HCF/G1200F, PHCF/G1200, HCF/G1200N, HCF/G1200D, HCFG1610, HCF/G1610D, HCF/G1600...(Other models you can see in the webshop)		



1

GEV No.	100591	Ref. No.	026954
description	gas injector bore ø 1.7mm		
For models:	MT/G700D, MTF/G700D, MTF/G1050D, MT/G700, MTF/G700, MTF/G1050, MTF/GE1050, RT/G700D, RTF/G700D, RTF/G1050D, 7TPG07T, 7TPG07F, 7TPG10F, XCF/G705NL, XCFG1055NL, XT/G700D, XTF/G700D, XTF/G1050D, T70GST, M70GST/G, M105GST/GA, XT/G700F, XTF/G700F, XTF/G1050F, CTFGA702, CT/G700, PTFSG810, PTFG810, HM/G800T, HQN/G1917, HPN/G810, HPN/GI810, HTS/G800, HTF/G1200, ZPTF/G1000, ZPTS/G1000, HPN/G810, HPN/GI810, ZHTS/G800, ZHTF/G121, ZHT/G800		



1

GEV No.	100593	Ref. No.	025953
description	gas injector bore ø 1.9mm		
For models:	MFR/G350NL, MFR/G700NL, MPN/GD761, MPN/GI761, MPN/GD760, MPN/GD760F, MPN/GI760, MPN/GI760F, 7PDG06, 7PIG06, RPN/GD760F, RPN/GI760F, RM/G350D, XFR/G350NL, XFR/G700NL, XPN/GI760D, M70GDKE, M70GIKE, XPN/GD760F, XPN/GI760F, RPN/G760, RPN/G760, PRPN/G760, RPN/GI760, RPN/GI760, PRPN/GI76, FC1G, FC2G, RF/G1680, RF/G2480, HMA/G800D, HM/G800T, HFR/G420, HFR/G840, RPN/G760, PRPN/GI76, ZHMA/G80		



2

GEV No.	100572	Ref. No.	025868
description	gas injector bore ø 1.85mm		
For models:	RC/G320, RC/G330, RC/G320F, RC/G720, RC/G730, MCF/G705, MCF/G1055, MCF/G700, MCF/G1050, MCF/G705F, MCF/G1055F, MCF/GE705, MCF/GE1055, MCF/GE700, MCFGE1050, MC/G355, MC/G350, MC/G355F, MC/G705, MC/G700, MC/G1055, MC/G1050, MC/G705F, MCF/GE1055UK, MCF/G1090, MT/G700D, MTF/G700D, MTF/G1050D, MT/G700, MTF/G700, MTF/G1050, MTF/GE1050, MT/G700F, MTF/G700F, MTF/G1055F, MTFGE1055F, MCP/G700, RCV/G320, RCV/G330, RCV/G320, RCV/G720, RCV/G730, RCV/G720, RCF/G720, RCF/G1020, RCFG730, RCFG1030, RCF/G720F, RCF/G1020, RCF/GE720...(Other models you can see in the webshop)		



1

GEV No.	100595	Ref. No.	050750 0K2897
description	gas injector bore ø 2.05mm		
For models:	PCG1200NL, HCF/GE81, HCF/GE80, HCF/GE80, HMA/G800D, HCA/G410, HCA/G810, HCA/G810, HCF/GE81, HCA/G410D, HCA/G810, HCA/G810, HC/G400, HC/G800, HCA/G410, HCA/G810, HCF/GE81		



1

GEV No.	100571	Ref. No.	025867 051872 0G0795 0K2879
description	gas injector bore ø 1.8mm		
For models:	MCF/G705E, MCF/G1055E, MCF/GE700D, MCFGE1050D, MCF/G1050D, MC/G355E, MC/G705E, MCF/G1095, MCF/G995, MC/G352, MC/G702, MC/G1052, MCF/G702, MCF/GE702, MCF/G1052, MCFGE1052, MC/G350, MC/G700, MC/G1050, MCF/G700, MCF/GE700, MCF/G1050, MCFGE1050, MR/G351, MR/G701, MR/G350, MR/G350NL, MR/G360, MR/G700, MR/G710, MR/G715, MR/G361, MR/G711, MR/G716, MTF/G700D, MTF/G1050D, MTF/G700, MTF/G1050, MTF/GE1050, RCF/GE700D, RCFGE1050D, RC/G1050, RC/G352, RC/G702, RC/G1052, RCF/G702, RCF/GE702, RCF/G1052, RCF/GE1052, 72FG03...(Other models you can see in the webshop)		



1

GEV No.	100562	Ref. No.	050591
description	gas injector bore ø 2.15mm		
For models:	MFR/G360, MG/G350E, MG/G350F, MG/G350NL, MG/G700E, MG/G700F, MG/G700NL, MG/G1050F, RFR/G360, RG/G350F, 7GLG07, RG/G700F, 7GLG10, RG/G1050, T35GFR, RG/G300, RG/G310D, RG/G300F, PRG/G300, RG/G300N, RG/G700, RG/G710D, RG/G700F, PRG/G700, RG/G700N, RGG1000, RG/G1000, PRG/G1000, RF/G300, RGV/G300, RGV/G310, RGV/G300, PRGV/G300, RGV/G300, RGV/G700, RGV/G701D, RGV/G700, PRGV/G700, RGV/G700, RGV/G1000, RGV/G1000, PRGV/G100, PCG810, PCG1610, PCG810F, PCG1610F, PCG810D, PCG1210D, PCG1610D, PCG800NL...(Other models you can see in the webshop)		



1

GEV No.	102865	Ref. No.	0A2301
description	gas injector bore ø 1.95mm		
For models:	RC/G1, RC/G2, RCV/G2, RCV/G3, RCF/G2, RCF/G3, RCF/G9, RCF/M2, RCF/M3, RSF/G2, RSV/G2, RSF/G3, MCF/G2A, MCF/G3A, XC/G1, XC/G2, XCV/G2, XCV/G3, XCF/G2, XCF/G3, XCF/G9, XCF/M2, XCFM3, XSF/G2, XSV/G2, XSF/G3, JC/G1, JC/G2, JCV/G2, JCV/G3, JCF/G2, JCF/G3, JCF/M2, JCFM3, MC/G1, MC/G2, MCV/G2, MCV/G3, MCF/G2, MCF/G3, MCF/G9, MCF/M2, MCF/M3, MSF/G2, MSV/G2, MSF/G3, PTV/G2, PTF/G2, PSF/G2, PSV/G2...(Other models you can see in the webshop)		



1

GEV No.	100576	Ref. No.	026787 051530
description	gas injector bore ø 2.1mm		
For models:	MR/G721, MR/G1071, MR/G1070, MR/G720, MR/G725, MR/G1075, MR/G726, MR/G1076, 7FTGC7L, 7FTGC1L, 7FTGC7M, RR/G1076, RM/G350D, RG/G350D, RG/G700D, XR/G720D, XR/G1070D, T79GFT, T109GFT, FCFG10, FCFG10J, FCFG10J, FCFG10J, FCFG10J, PCG810, PCG1210, PCG1610, PCG810F, PCG1210F, PCG1610F, PCG810D, PCG1610D, PCG800NL, PCG1600NL, PCSG810, PCSG1210, PCSG1610, HCSG410, HCS/G410D, HCS/G400, PHCS/G400, HCS/G400F, HCF/G800F, PHCF/G800, HCS/G400NL, HCS/G400DK, HCSG810, HCS/G800, HCS/G800F, HCS/G800...(Other models you can see in the webshop)		





			
1			
GEV No.	100563	Ref. No.	026214
description	gas injector bore ø 2.2mm		
For models:	MG/G350D, MG/G700D, MG/G350, MG/G700, MG/G1050, MG/G1051, 7GLG03, 7GLG07, 7GLG10, XG/G350D, XG/G700D, T35GCG, XG/G350E, XG/G350F, XG/G350NL, T70GCG, XG/G700E, XG/G700F, XG/G700NL, T105GCG, XG/G1050F, CG/G701, FCFG6D, PCG810, PCG1610, PCG810F, PCG1610F, PCG810D, PCG1210D, PCG1610D, PCG800NL, PCG1600NL, HCSG410, HCS/G410D, HCS/G400, PHCS/G400, HCS/G400F, HCF/G800F, PHCF/G800, HCS/G400NL, HCS/G400DK, HCSG810, HCS/G810D, HCS/G800, HCS/G800F, HCS/G800, HCS/G800NL, HCS/G800DK, HCFG810, HCF/G810D...(Other models you can see in the webshop)		

			
1			
GEV No.	100561	Ref. No.	026720 0K2903
description	gas injector bore ø 2mm		
For models:	MCF/GE700D, MCFGE1050D, MCF/G1050D, MR/G351, MR/G701, MR/G350, MR/G360, MR/G700, MR/G710, MR/G715, MR/G361, MR/G711, MR/G716, MM/G350F, MG/G350D, MG/G700D, MG/G350, MG/G700, MG/G1050, MG/G1051, RCF/GE700D, RCFGE1050D, 7FTGF3L, 7FTGF3R, 7FTGF7L, RR/G710, RR/G716, RM/G350D, RM/G350F, 7GLG03, 7GLG07, 7GLG10, XCF/GE700D, XC/G350D, XC/G700D, XC/1050D, XCF/G700D, XCF/G1050D, XR/G350D, XR/G700D, T35GFT, XR/G350F, T36GFT, XR/G360F, T70GFT, XR/G700F, T70GFT, XR/G710F, XR/G350NL, XR/G700NL...(Other models you can see in the webshop)		

			
1			
GEV No.	100585	Ref. No.	050493 0K9209
description	gas injector bore ø 2.3mm		
For models:	HRS/G802, HRS/G802, HRS/G812, HRA/G802, HR/G802T, HM/G800T, ZHRAG802CR, HRA/G812, HRA/G812, ZHR/G802, ZHRA/G812, HRA/G802, ZHR/G802		

			
1			
GEV No.	100589	Ref. No.	057512
description	gas injector bore ø 3.2mm		
For models:	MFR/G350D, MFR/G700D, MTF/G1050, MTF/GE1050, MT/G700F, MTF/G700F, MTF/G1055F, MTFGE1055F, RFR/G350D, RFR/G700D, 7TPG10F, RT/G700F, RTF/G700, RTF/G1050, XFR/G700D, XFR/G700F, RTV/G720, RTV/G720, RTFG720, RTF/G720F, RTF/G1020, RTF/G1030, RTF/G1020F, RFR/G700, FCFG10NL, PCG810, PCG1610, PCG810F, PCG1610F, PCG810D, PCG1210D, PCG1610D, PCG800NL, PCG1600NL, HCSG410, HCS/G410D, HCS/G400, PHCS/G400, HCS/G400F, HCF/G800F, PHCF/G800, HCS/G400NL, HCS/G400DK, HCSG810, HCS/G810D, HCS/G800, HCS/G800F, HCS/G800, HCS/G800NL, HCS/G800DK...(Other models you can see in the webshop)		

			
1			
GEV No.	100596	Ref. No.	050807
description	gas injector bore ø 2.4mm		
For models:	RG/G310D, RG/G710D, RGV/G310, RGV/G701D, PCG810, PCG1610, PCG810F, PCG1610F, PCG810D, PCG1210D, PCG1610D, PCG800NL, PCG1600NL, HTF/G1210, ZPC/G810, ZPC/G1610		

			
1			
GEV No.	100590	Ref. No.	050571
description	gas injector bore ø 3.6mm		
For models:	FCFG10D, FTG2, FT/G2, FT/G2V, ZOFCF/G10D		

			
1			
GEV No.	100592	Ref. No.	051460 0K2877
description	gas injector bore ø 2.7mm		
For models:	MCF/GE700D, MCFGE1050D, MCF/G1050D, RCF/GE700D, RCF-GE1050D, T35GCK, T70GCK, XC/G1050, XCF/GE700D, XC/G350D, XC/G700D, XC/1050D, XCF/G700D, XCF/G1050D, M70GCK/E, XC/G350F, XC/G700F, XCF/G700F, XCF/G1050F, CC/G710, CC/G1060, CCF/G710, PCG810, PCG1610, PCG810F, PCG1610F, PCG810D, PCG1210D, PCG1610D, PCG800NL, PCG1600NL, HCSG410, HCS/G410D, HCS/G400, PHCS/G400, HCS/G400F, HCF/G800F, PHCF/G800, HCS/G400NL, HCS/G400DK, HCSG810, HCS/G810D, HCS/G800, HCS/G800F, HCS/G800, HCS/G800NL, HCS/G800DK, HCFG810, HCF/G810D, HCF/GE81...(Other models you can see in the webshop)		

			
1			
GEV No.	100584	Ref. No.	051874
description	gas injector bore ø 3.8mm		
For models:	HBR/G803, HBR/G804		

			
1			
GEV No.	107542	Ref. No.	053160
description	gas injector bore ø 5.5mm		
For models:	HPN/G810, HPN/G1810, HPN/G815, HPA/G815, HPN/G1815, HPA/G1815, HPN/G810, HPN/G815, HPA/G815, HPN/G1810, HPN/G1815, HPN/G1815		



pilot burner nozzles POLIDORO



GEV No.	106859	Ref. No.	054286
description	pilot burner nozzle POLIDORO LPG code 24 bore ø 0.24mm Qty 1 pcs		
For models:	BCP/G1, RCP/G1S, RCP/G2D, XCP/G1S, XCP/G2D, JCP/G1S, JCP/G2D, MCP/G1S, MCP/G2D, ACPG2S, PCP/G1S, PCP/G2D, OCP/G1S, OCP/G2D, TCP/G1S, TCP/G2D, KP/G2, KMV/G2C, KCP/G1RU, KCP/G2RU, KCP/G1, KCP/G1R, KCP/G2, KCP/G2R, KCP/G1U, KCP/G2U, QP/G2, QMV/G2C, QCP/G1, QCP/G1R, QCP/G2, QCP/G2R, WCP/G1, WCP/G1R, WCP/G2, WCP/G2R, DCP/G400, FCF/G6-0, FCFG101/0, FCFG102-0, FCFG201-0, FCFG202-0, FCFG10160H, FCFG102-0T, FCF/G6-1-JAP, FCF/G101/1-1-JAP, FCF/G102/1-1-JAP, FCF/G101/1, FCFG20, FCFG20D...(Other models you can see in the webshop)		



GEV No.	102699	Ref. No.	054037 054038
description	pilot burner nozzle POLIDORO natural gas code 25.2 bore ø 2x0.25mm Qty 1 pcs 2 bores		
For models:	BCP/G1, RMV/G1C, RMV/G2C, RCP/G1S, RCP/G2D, XMV/G1C, XMV/G2C, XCP/G1S, XCP/G2D, JCP/G1S, JCP/G2D, MMV/G1C, MMV/G2C, MCP/G1S, MCP/G2D, ARG12FL, ARG24FL, ARG36FL, ARG48FL, ARG12FR, ARG24FR, ARG36FR, ARG48FR, ACPG2S, ARG12FLCE, ARG24FLCE, ARG36FLCE, ARG48FLCE, ARG12FRCE, ARG24FRCE, ARG36FRCE, ARG48FRCE, PCP/G1S, PCP/G2D, OCP/G1S, OCP/G2D, TCP/G1S, TCP/G2D, KP/G2, KMV/G2C, KCP/G1RU, KCP/G2RU, KCP/G1, KCP/G1R, KCP/G2, KCP/G2R, KCP/G1U, KCP/G2U, QP/G2, QMV/G2C...(Other models you can see in the webshop)		

pilot burner nozzles SIT

100 series



GEV No.	100247	Ref. No.	056750
description	pilot burner nozzle LPG bore ø 0.2mm Qty 1 pcs suitable for SIT 100 series thread M8x0.75		
For models:	HCSG410, HCS/G410D, HCS/G400, PHCS/G400, HCS/G400F, HCF/G800F, PHCF/G800, HCS/G400NL, HCS/G400DK, HCSG810, HCS/G810D, HCS/G800, HCS/G800F, HCS/G800, HCS/G800NL, HCS/G800DK, HCFG810, HCF/G810D, HCF/GE81, HCF/GE81, HCF/G800, HCF/G800NL, HCF/G800DK, HCF/GE80, HCF/GE80, HCFG1210, HCF/G1210D, HCF/G1200, HCF/G1200F, PHCF/G1200, HCF/G1200NL, HCF/G1200D, HCFG1610, HCF/G1610D, HCF/G1600, HCF/G1600F, PHCF/G1600, HCF/G1600NL, HCF/G1600D, HC/G410, HC/G810, HTF/G1210, HTF/G1210, HTF/G1200, HTF/G1200, HCA/G410, HCA/G810, HCA/G810, HCF/G1210, ZHCF/G161...(Other models you can see in the webshop)		



GEV No.	100245	Ref. No.	003633 006188 056799 0977030 0G0082 0G2785 0G2786 0G5006 0K2946 0KD857 19012718 19022995
description	pilot burner nozzle LPG code 20 bore ø 0.2mm Qty 1 pcs thread M8x0.75		
For models:	MBR/G710D, MBR/G700, MBR/G700F, MBR/G700UK, MBR/G701, MBR/G706, MBR/G701UK, MBR/G751, MBR/G756, MFG1500Z, MFG2200Z, FG250D, FG250S, FGC/250D, FGC/250S, RBR/G710D, RBR/G700, RBR/G700F, 7BRG60, 7BRG60X, RBR/G701UK, RBR/G751, RBR/G756, XBR/G710D, XBR/G700, XBR/G710, XBR/G700F, XBR/G700UK, XBR/G701, M70GBP, XBR/G701UK, XBR/G751, XBR/G756, CBR/G700, RBR/G700, RBR/E700, RBR/G700, BR80GZ, PCG810, PCG1210, PCG1610, PCG810F, PCG1210F, PCG1610F, PCG810D, PCG1210D, PCG1610D, PCG800NL, PCG1200NL, PCG1600NL...(Other models you can see in the webshop)		





GEV No.	100246	Ref. No.	02137 056656 056797 0977031 0G0150 0G2787 0K1318 0K2895 0K3558 0K5866 0KW952 0M0833 19022988 19022989 M02137 MOL02137
description	pilot burner nozzle natural gas bore ø 0.35mm Qty 1 pcs thread M8x0.75		
For models:	MCF/G705, MCF/G1055, MCF/G700, MCF/G1050, MCF/G705E, MCF/G1055E, MCF/G700D, MCF/G700, MCF/G705F, MCF/G1055F, MCF/G705NL, MCF/G1050D, MCFG1055NL, MCF/G702, MCF/G1052, MCF/G700, MCF/G1050, MR/G351, MR/G701, MR/G721, MR/G1071, MR/G350, MR/G350F, MR/G350NL, MR/G350E, MR/G360, MR/G360F, MR/G700, MR/G700F, MR/G700NL, MR/G700E, MR/G710, MR/G710F, MR/G1070, MR/G720, MR/G715, MR/G725, MR/G1075, MR/G361, MR/G711, MR/G716, MR/G726, MR/G1076, MBR/G710D, MBR/G700, MBR/G700F, MBR/G700UK, MBR/G701, MBR/G706, MBR/G701UK...(Other models you can see in the webshop)		





GEV No.	100248	Ref. No.	056578
description	pilot burner nozzle natural gas bore ø 0.3mm Qty 1 pcs suitable for SIT 100 series		
For models:	PCG810, PCG1210, PCG1610, PCG810F, PCG1210F, PCG1610F, PCG810D, PCG1210D, PCG1610D, PCG800NL, PCG1200NL, PCG1600NL, HCSG410, HCS/G410D, HCS/G400, PHCS/G400, HCS/G400F, HCF/G800F, PHCF/G800, HCS/G400NL, HCS/G400DK, HCSG810, HCS/G810D, HCS/G800, HCS/G800F, HCS/G800, HCS/G800NL, HCS/G800DK, HCFG810, HCF/G810D, HCF/GE81, HCF/GE81, HCF/G800, HCF/G800NL, HCF/G800DK, HCF/GE80, HCF/GE80, HCFG1210, HCF/G1210D, HCF/G1200, HCF/G1200F, PHCF/G1200, HCF/G1200NL, HCF/G1200D, HCFG1610, HCF/G1610D, HCF/G1600, HCF/G1600F, PHCF/G1600, HCF/G1600NL...(Other models you can see in the webshop)		

			
GEV No.	102972	Ref. No.	003327 0K1319
description	pilot burner nozzle natural gas code 40 bore ø 0.4mm Qty 1 pcs		
For models:	MFR/G740, MFR/G380, MFR/G381, BF/G1S07, BFR/G1S14, RF/G1S07, RF/G2D07, RFR/G1S07, RFR/G2D07, RFR/G2S40, RFR/G1S14, RFR/G2D14, RF/G1S07, RF/G2D07, RFR/G1S07, RFR/G2D07, XF/G1S07, XRF/G2D07, XFR/G1S07, XFR/G2D07, XFR/G2S40, XFR/G1S14, XFR/G2D14, XF/G1S07, XF/G2D07, XFR/G1S07, XFR/G2D07, JF/G1S07, JF/G2D07, JFR/G1S07, JFR/G2D07, JFR/G2S40, JFR/G1S14, JFR/G2D14, JF/G1S07, JF/G2D07, JFR/G2D07, JFR/G2D07, MF/G1S07, MF/G2D07, MFR/G1S07, MFR/G2D07, MFR/G2S40, MFR/G1S14, MFR/G2D14, MF/G1S07, MF/G2D07, MFR/G1S07, MFR/G2D07, RFR/G741...(Other models you can see in the webshop)		

			
GEV No.	107170	Ref. No.	058525 0A2471 0G2805 0H6375 0KF051 727914 727915
description	pilot burner nozzle SIT natural gas bore ø 0.35mm Qty 1 pcs		
For models:	MFR/G350, MFR/G700, MFR/G350D, MFR/G700D, MFR/G350F, MFR/G700F, MFR/G350E, MFR/G700E, MFR/G740, MFR/G380, MFR/G381, MFR/G350, MFR/G351, MFR/G700, MFR/G701, BFR/G1S14, RF/G1S07, RF/G2D07, RFR/G1S07, RFR/G2D07, RFR/G1S12, RFR/G2D12, RFR/G2S40, RFR/G1S14, RFR/G2D14, XF/G1S07, XRF/G2D07, XFR/G1S07, XFR/G2D07, XFR/G1S12, XFR/G2D12, XFR/G2S40, XFR/G1S14, XFR/G2D14, JF/G1S07, JF/G2D07, JFR/G1S07, JFR/G2D07, JFR/G1S12, JFR/G2D12, JFR/G2S40, JFR/G1S14, JFR/G2D14, MF/G1S07, MF/G2D07, MFR/G1S07, MFR/G2D07, MFR/G1S12, MFR/G2D12, MFR/G2S40...(Other models you can see in the webshop)		

			
GEV No.	107171	Ref. No.	058330 058753 0977051 0G2234
description	pilot burner nozzle SIT natural/liquid gas bore ø 0.25mm Qty 1 pcs		
For models:	MCF/G705, MCF/G1055, MCF/G700, MCF/G1050, MCF/G705E, MCF/G1055E, MCF/G700D, MCF/G700, MCF/G705F, MCF/G1055F, MCF/G705NL, MCF/G1050D, MCF/G1055NL, MCF/G702, MCF/G1052, MCF/G700, MCF/G1050, MR/G351, MR/G701, MR/G721, MR/G1071, MR/G350, MR/G350F, MR/G350NL, MR/G350E, MR/G360, MR/G360F, MR/G700, MR/G700F, MR/G700NL, MR/G700E, MR/G710, MR/G710F, MR/G1070, MR/G720, MR/G715, MR/G725, MR/G1075, MR/G361, MR/G711, MR/G716, MR/G726, MR/G1076, MFR/G360, MPN/GD761, MPN/GI761, MPN/GI760D, MPN/GD760, MPN/GD760F, MPN/GI760...(Other models you can see in the webshop)		

140/150 series			
			
GEV No.	100204	Ref. No.	003792 004127 059216 07873 0977115 0C3214 0G2263 0G2415 0KT837 19013305 72780001 ADME01110
description	pilot burner nozzle SIT LPG code 14 bore ø 0.18/0.20mm Qty 1 pcs suitable for 140 series		
For models:	BR/G1FL, BR/G1FR, BR/G2FL, BR/G2FR, MT/G350, MT/G352, VO40G, RCF/G9, RBR/G2FM, RBR/G2IM, RBK/G2FM, RMV/G1C, RMV/G2C, RR/G1FL, RR/G1FR, RR/G1CL, RR/G2FL, RR/G2FM, RR/G2CL, RRV/G1FL, RRV/G1FR, RRV/G1CL, RRV/G2FL, RRV/G2FM, RRV/G2CL, RR/G2CM, RTV/G2, RTF/G2, RSF/G2, RSV/G2, RSF/G3, RBV/G2, XCF/G9, XBR/G2FM, XBR/G2IM, XBR/G2FM, XMV/G1C, XMV/G2C, XR/G1FL, XR/G1FR, XR/G1CL, XR/G2FL, XR/G2FM, XR/G2CL, XRV/G1FL, XRV/G1FR, XRV/G1CL, XRV/G2FL, XRV/G2FM, XRV/G2CL...(Other models you can see in the webshop)		

			
GEV No.	100207	Ref. No.	003784 003871 059215 0977113 0G2264 0G2416 19013306 72780002
description	pilot burner nozzle SIT natural gas code 27 bore ø 0.40/0.38mm suitable for SIT 140 series		
For models:	BR/G1FL, BR/G1FR, BR/G2FL, BR/G2FR, MT/G350, MT/G352, VO40G, RCF/G9, RBR/G2FM, RBR/G2IM, RBK/G2FM, RR/G1FL, RR/G1FR, RR/G1CL, RR/G2FL, RR/G2FM, RR/G2CL, RRV/G1FL, RRV/G1FR, RRV/G1CL, RRV/G2FL, RRV/G2FM, RRV/G2CL, RR/G2CM, RTV/G2, RTF/G2, RSF/G2, RSV/G2, RSF/G3, RBV/G2, XCF/G9, XBR/G2FM, XBR/G2IM, XBR/G2FM, XR/G1FL, XR/G1FR, XR/G1CL, XR/G2FL, XR/G2FM, XR/G2CL, XRV/G1FL, XRV/G1FR, XRV/G1CL, XRV/G2FL, XRV/G2FM, XRV/G2CL, XR/G2CM, XTV/G2, XTF/G2, XSF/G2...(Other models you can see in the webshop)		

			
GEV No.	100206	Ref. No.	003626
description	pilot burner nozzle SIT natural gas code 36 bore ø 0.60/0.55mm Qty 1 pcs suitable for SIT 150 series		
For models:	FG250D, FG250S, FGC/250D, FGC/250S, CRN22G, CRN/20G, CRN30G, CRN15G, CRN/22G, CRN20GZ, CRN30GZ, CRN15GZ, BR80GZ, CRN20GA, CRN30GA, CRN15GA, BR180GZ, BR100GZ, CR42G, CR/40G, CR15G, BR100G, BR80G, BR180G		



			
GEV No.	103288	Ref. No.	059356
description	pilot burner nozzle SIT natural gas code 50 bore ø 0.50mm suitable for 140 series		
For models:	BR/G1FL, BR/G1FR, BR/G2FL, BR/G2FR, PCV/G2, PCV/G3, PCF/G2, PCF/G3, PR/G1FL, PR/G1FR, PR/G1CL, PR/G2FL, PR/G2FM, PR/G2CL, PRV/G1FL, PRV/G1FR, PRV/G1CL, PRV/G2FL, PRV/G2FM, PRV/G2CL, PR/G2CM, PTV/G2, PTF/G2, PSF/G2, PSV/G2, PSF/G3, PBV/G2, PCV/G2N, PCF/G3N, PCV/G3N, PCF/G2N, PTV/G2N, PR/G1FLHV, PRV/G2FLHV, OCV/G2, OCF/G2, OCF/G3, OCF/G9UK, OR/G1FL, OR/G1FR, OR/G1CL, OR/G2FL, OR/G2CL, ORV/G1FL, ORV/G1FR, ORV/G2FL, OR/G2CM, OTV/G2, OTF/G2, OSF/G2...(Other models you can see in the webshop)		

160 series			
			
GEV No.	107172	Ref. No.	02136 054593 0977123 0A2540 0G2081 0KD989 0M0832 19022878 72015105 727755
description	pilot burner nozzle SIT LPG code 25 Qty 1 pcs		
For models:	MCF/G1090, MCF/G1095, MCF/G995, BCF/G2, MCP/G700, MCP/G701, MCP/G710, MCP/G711, MCP/G705, MCP/G706, RCF/G2, RCF/G3, RG/G1, RG/G2, RGV/G1, RGV/G2, RTV/G2, RTF/G2, RSF/G2, RSV/G2, RSF/G3, RPD/G240, RPD/G260, RPI/G260, RPI/G260P, MCF/G2A, MCF/G3A, XCF/G2, XCF/G3, XG/G1, XG/G2, XGV/G1, XGV/G2, XTV/G2, XTF/G2, XSF/G2, XSV/G2, XSF/G3, XPD/G240, XPD/G260, XPI/G260, XPI/G260P, JCF/G2, JCF/G3, JG/G1, JG/G2, JGV/G1, JGV/G2, JTV/G2, JTF/G2...(Other models you can see in the webshop)		

			
GEV No.	107650	Ref. No.	053667 057388
description	pilot burner nozzle SIT LPG code 30 Qty 1 pcs		
For models:	ACFG24, ACFG36, ACFG24T, ACFG36T, CCF/G996, PPD/G260, PPI/G260P, OPD/G260, OPI/G260P, TPD/G260, TPI/G260P, RF/G350D, RF/G700D, KPI/G10, KPI/G15, KPD/G10, KPD/G15, KPD/G15A, KPI/G15A, KPI/G15H, KPI/G10H, HBR/G800, HBR/G805, HBR/G810, HBR/G815, HBR/G811, HBR/G816, HBR/G800UK, QPI/G10, QPI/G15, QPD/G10, QPD/G15, QPI/G15H, QPI/G10H, ZBR/G800, ZBR/G805, ZBR/G810, ZBR/G815, ZBR/G811, ZBR/G816, ZBR/G800UK, WPI/G10, WPI/G15, WPD/G10, WPD/G15, WPD/G15A, WPI/G15A, WPI/G15H, WPI/G10H, ABR/G800...(Other models you can see in the webshop)		

			
GEV No.	107174	Ref. No.	02135 053670 056635 057389 0977118 0A2409 0G2062 0KT740 0M0831 727754
description	pilot burner nozzle SIT natural gas code 41 Qty 1 pcs		
For models:	MCF/G1090, MCF/G1095, MCF/G995, BCF/G2, MCP/G700, MCP/G701, MCP/G710, MCP/G711, MCP/G705, MCP/G706, RCF/G2, RCF/G3, RG/G1, RG/G2, RGV/G1, RGV/G2, RTV/G2, RTF/G2, RSF/G2, RSV/G2, RSF/G3, RPD/G240, RPD/G260, RPI/G260, RPI/G260P, MCF/G2A, MCF/G3A, XCF/G2, XCF/G3, XG/G1, XG/G2, XGV/G1, XGV/G2, XTV/G2, XTF/G2, XSF/G2, XSV/G2, XSF/G3, XPD/G240, XPD/G260, XPI/G260, XPI/G260P, JCF/G2, JCF/G3, JG/G1, JG/G2, JGV/G1, JGV/G2, JTV/G2, JTF/G2...(Other models you can see in the webshop)		

			
GEV No.	107175	Ref. No.	053668 057521 0977119 0H6361 11061249
description	pilot burner nozzle SIT natural gas code 51 Qty 1 pcs suitable for 160 series		
For models:	RF/G350D, RF/G700D, HBR/G800, HBR/G805, HBR/G810, HBR/G815, HBR/G811, HBR/G816, HBR/G800UK, ZBR/G800, ZBR/G805, ZBR/G810, ZBR/G815, ZBR/G811, ZBR/G816, ZBR/G800UK, ABR/G800, ABR/G805, ABR/G810, ABR/G815, ABR/G811, ABR/G816, OBR/G800UK, FCFG6D, FCFG10, FCFG10D, FCFG6, FCFG6F, PFCFG6, FCFG10J, FCFG10J, FCFG6J, FCFG6J, FCFG6J, FCFG6J, FCFG10J, FCFG10J, HBR/G803, HBR/G804, HBR/G803, HBR/G804, HBR/G803, HBR/G1003, HBR/G1003, HBR/G1004, HBR/G1013, FCF/G6, FCFG101, HBR/G803, HBR/G804...(Other models you can see in the webshop)		

bypass nozzles

bypass nozzles EGA

			
GEV No.	106825	Ref. No.	0K1226
description	bypass nozzle EGA bore ø 0.37mm		

			
GEV No.	100355	Ref. No.	0K1236
description	bypass nozzle EGA type 31248 series bore ø 0.52mm		

			
GEV No.	100356	Ref. No.	0H6068
description	bypass nozzle EGA type 31248 series bore ø 0.55mm total length 23mm ø 5mm thread M5x0.5		
For models:	7500-2, 7501-2, 7502-2, 7502-9, 7503-2, 7504-2, 7504-9, 7505-2-9, 7505-9-9, 7700-2, 7701-2, 7703-2		

			
GEV No.	100354	Ref. No.	0H6369
description	bypass nozzle EGA type 31248 series bore ø 0.5mm		
For models:	7500-2, 7501-2, 7502-2, 7502-9, 7503-2, 7504-2, 7504-9, 7505-2-9, 7505-9-9, 7700-2, 7701-2, 7703-2		

			
GEV No.	100361	Ref. No.	0H6370
description	bypass nozzle EGA type 31248 series bore ø 0.65mm		
For models:	7500-2, 7501-2, 7502-2, 7502-9, 7503-2, 7504-2, 7504-9, 7505-2-9, 7505-9-9, 7700-2, 7701-2, 7703-2		

			
GEV No.	100368	Ref. No.	0H6349
description	bypass nozzle EGA type 31248 series bore ø 0.6mm		
For models:	7512-2		

			
GEV No.	100358	Ref. No.	0H6347
description	bypass nozzle EGA type 31248 series bore ø 0.75mm		

			
GEV No.	100357	Ref. No.	0H6066
description	bypass nozzle EGA type 31248 series bore ø 0.7mm		
For models:	7501-2, 7502-2, 7502-9, 7503-2, 7504-2, 7504-9, 7505-2-9, 7505-9-9, 7701-2, 7703-2		

			
GEV No.	100346	Ref. No.	0K0241
description	bypass nozzle EGA type 31248 series bore ø 0.85mm		
For models:	7500-2, 7501-2, 7502-2, 7502-9, 7503-2, 7504-2, 7504-9, 7505-2-9, 7505-9-9, 7700-2, 7701-2, 7703-2		

			
GEV No.	100328	Ref. No.	0K0246
description	bypass nozzle EGA type 31248 series bore ø 0.8mm		

			
GEV No.	100347	Ref. No.	0K1213
description	bypass nozzle EGA type 31248 series bore ø 0.9mm		

			
GEV No.	100359	Ref. No.	0K1293
description	bypass nozzle EGA type 31248 series bore ø 1.2mm		

			
GEV No.	100363	Ref. No.	0K0261
description	bypass nozzle EGA type 31248 series bore ø 1.5mm		

bypass nozzles PEL20/21

			
GEV No.	100554	Ref. No.	002900 0KX139 19013314 72779003 835835900
description	bypass nozzle type PEL20/21 bore ø 0.45mm thread M5x0.5		
For models:	MCF/G1095, MC/G352, MC/G702, MC/G1052, MCF/G702, MCF/GE702, MCF/G1052, MCFGE1052, MC/G350, MC/G700, MC/G1050, MCF/G700, MCF/GE700, MCF/G1050, MCFGE1050, MTF/G700D, MTF/G1050D, MTF/G700, MTF/G1050, MTF/GE1050, RC/G1, RC/G2, RCV/G2, RCV/G3, RCF/G2, RCF/G3, RCF/M2, RCF/M3, RSF/G2, RSV/G2, RSF/G3, MCF/G2A, MCF/G3A, XC/G1, XC/G2, XCV/G2, XCV/G3, XCF/G2, XCF/G3, XCF/M2, XCFM3, XSF/G2, XSV/G2, XSF/G3, JC/G1, JC/G2, JCV/G2, JCV/G3, JCF/G2, JCF/G3...(Other models you can see in the webshop)		

			
GEV No.	100553	Ref. No.	002901 0G0855
description	bypass nozzle type PEL20/21 bore ø 0.4mm thread M5x0.5		
For models:	MCF/G1095, MC/G352, MC/G702, MC/G1052, MCF/G702, MCF/GE702, MCF/G1052, MCFGE1052, MC/G350, MC/G700, MC/G1050, MCF/G700, MCF/GE700, MCF/G1050, MCFGE1050, MTF/G700D, MTF/G1050D, MTF/G700, MTF/G1050, MTF/GE1050, RC/G1, RC/G2, RCV/G2, RCV/G3, RCF/G2, RCF/G3, RCF/M2, RCF/M3, RSF/G2, RSV/G2, RSF/G3, MCF/G2A, MCF/G3A, XC/G1, XC/G2, XCV/G2, XCV/G3, XCF/G2, XCF/G3, XCF/M2, XCFM3, XSF/G2, XSV/G2, XSF/G3, JC/G1, JC/G2, JCV/G2, JCV/G3, JCF/G2, JCF/G3...(Other models you can see in the webshop)		

			
GEV No.	100550	Ref. No.	002911 0G0857
description	bypass nozzle type PEL20/21 bore ø 0.55mm thread M5x0.5		
For models:	MCF/G1095, MCF/G995, MC/G352, MC/G702, MC/G1052, MCF/G702, MCF/GE702, MCF/G1052, MCFGE1052, MC/G350, MC/G700, MC/G1050, MCF/G700, MCF/GE700, MCF/G1050, MCFGE1050, BC/G1, MTF/G700D, MTF/G1050D, MTF/G700, MTF/G1050, MTF/GE1050, RC/G1, RC/G2, RCV/G2, RCV/G3, RCF/G2, RCF/G3, RCF/G9, RCF/M2, RCF/M3, RSF/G2, RSV/G2, RSF/G3, MCF/G2A, MCF/G3A, XC/G1, XC/G2, XCV/G2, XCV/G3, XCF/G2, XCF/G3, XCF/G9, XCF/M2, XCFM3, XSF/G2, XSV/G2, XSF/G3, JC/G1, JC/G2...(Other models you can see in the webshop)		





			
GEV No.	100526	Ref. No.	002925
description	bypass nozzle type PEL20/21 bore ø 0.5mm thread M5x0.5		
For models:	BC/G1, BCF/G2, PCV/G2, PCV/G3, PCF/G2, PCF/G3, PCF/G9, PCF/M2, PCF/M3, PCF/M2E5, PTV/G2, PTF/G2, PSF/G2, PSV/G2, PSF/G3, PCV/G2N, PCF/G3N, PCV/G3N, PCF/G2N, PTV/G2N, OC/G1, OC/G2, OCV/G2, OCF/G2, OCF/G3, OCF/M2, OCF/G9UK, OTV/G2, OTF/G2, OSF/G2, OSV/G2, TCV/G2, TCV/G3, TCF/G2, TCF/G3, TCF/G9, TCF/M2, TCF/M3, TCF/G9UK, TCF/M2E5, TTV/G2, TTF/G2, TSF/G2, TSV/G2, TSF/G3, HC/G410, HC/G810, HCF/G810, HC/G1210, HCF/G1210...(Other models you can see in the webshop)		

			
GEV No.	100552	Ref. No.	002908 72506105 72846605
description	bypass nozzle type PEL20/21 bore ø 0.7mm thread M5x0.5		
For models:	MCF/G1095, MC/G352, MC/G702, MC/G1052, MCF/G702, MCF/GE702, MCF/G1052, MCFGE1052, MC/G350, MC/G700, MC/G1050, MCF/G700, MCF/GE700, MCF/G1050, MCFGE1050, MTF/G700D, MTF/G1050D, MTF/G700, MTF/G1050, MTF/GE1050, RC/G1, RC/G2, RCV/G2, RCV/G3, RCF/G2, RCF/G3, RCF/M2, RCF/M3, RTV/G2, RTF/G2, RSF/G2, RSV/G2, RSF/G3, MCF/G2A, MCF/G3A, XC/G1, XC/G2, XCV/G2, XCV/G3, XCF/G2, XCF/G3, XCF/M2, XCFM3, XTV/G2, XTF/G2, XSF/G2, XSV/G2, XSF/G3, JC/G1, JC/G2...(Other models you can see in the webshop)		

			
GEV No.	100548	Ref. No.	002991 0KX137 19013312 72779001 835818500
description	bypass nozzle type PEL20/21 bore ø 0.65mm thread M5x0.5		
For models:	RSF/G2, RSV/G2, XSF/G2, XSV/G2, MSF/G2, MSV/G2, KC/G1, KC/G2, KCF/G2, KC/G3, KCF/G3, KCF/G4, KCF/M2, KC/T1, KC/T2, KC/T3, KCF/T2, KCF/T3, KCF/T4, KCF/G2H, KC/G1H, KC/G2H, KC/G3H, KC/T1H, KC/T2H, KC/T3H, KCF/G3A, KCF/W2, KCF/G3H, KCF/G2L, KCF/G3HA, KC/G1G, KC/G2G, KCF/G2G, KC/G3G, KCF/G3G, KCF/G4G, KCF/M2G, KCF/G2HG, KC/G1H1G, KC/G2HG, KC/G3HG, KCF/G3AG, KCF/G3HG, KCF/M2E5G, KCF/G2LG, KS/G2, KSF/G2, KSCF/G3, QC/G1...(Other models you can see in the webshop)		

			
GEV No.	100555	Ref. No.	002899
description	bypass nozzle type PEL20/21 bore ø 0.8mm thread M5x0.5		
For models:	MCF/G1095, MC/G352, MC/G702, MC/G1052, MCF/G702, MCF/GE702, MCF/G1052, MCFGE1052, MC/G350, MC/G700, MC/G1050, MCF/G700, MCF/GE700, MCF/G1050, MCFGE1050, BC/G1, BCF/G2, MTF/G700D, MTF/G1050D, MTF/G700, MTF/G1050, MTF/GE1050, RC/G1, RC/G2, RCV/G2, RCV/G3, RCF/G2, RCF/G3, RCF/M2, RCF/M3, RG/G1, RG/G2, RGV/G1, RGV/G2, RSF/G2, RSV/G2, RSF/G3, MCF/G2A, MCF/G3A, XC/G1, XC/G2, XCV/G2, XCV/G3, XCF/G2, XCF/G3, XCF/M2, XCFM3, XG/G1, XG/G2, XGV/G1...(Other models you can see in the webshop)		

			
GEV No.	100551	Ref. No.	002904
description	bypass nozzle type PEL20/21 bore ø 0.6mm thread M5x0.5		
For models:	MCF/G1095, MCF/G995, MC/G352, MC/G702, MC/G1052, MCF/G702, MCF/GE702, MCF/G1052, MCFGE1052, MC/G350, MC/G700, MC/G1050, MCF/G700, MCF/GE700, MCF/G1050, MCFGE1050, MTF/G700D, MTF/G1050D, MTF/G700, MTF/G1050, MTF/GE1050, RC/G1, RC/G2, RCV/G2, RCV/G3, RCF/G2, RCF/G3, RCF/G9, RCF/M2, RCF/M3, RSF/G2, RSV/G2, RSF/G3, MCF/G2A, MCF/G3A, XC/G1, XC/G2, XCV/G2, XCV/G3, XCF/G2, XCF/G3, XCF/G9, XCF/M2, XCFM3, XSF/G2, XSV/G2, XSF/G3, JC/G1, JC/G2, JCV/G2...(Other models you can see in the webshop)		

			
GEV No.	100556	Ref. No.	002909
description	bypass nozzle type PEL20/21 bore ø 0.95mm thread M5x0.5		
For models:	MCF/G1095, MCF/G995, MC/G352, MC/G702, MC/G1052, MCF/G702, MCF/GE702, MCF/G1052, MCFGE1052, MC/G350, MC/G700, MC/G1050, MCF/G700, MCF/GE700, MCF/G1050, MCFGE1050, MTF/G700D, MTF/G1050D, MTF/G700, MTF/G1050, MTF/GE1050, RC/G1, RC/G2, RCV/G2, RCV/G3, RCF/G2, RCF/G3, RCF/G9, RCF/M2, RCF/M3, RSF/G2, RSV/G2, RSF/G3, MCF/G2A, MCF/G3A, XC/G1, XC/G2, XCV/G2, XCV/G3, XCF/G2, XCF/G3, XCF/G9, XCF/M2, XCFM3, XSF/G2, XSV/G2, XSF/G3, JC/G1, JC/G2, JCV/G2...(Other models you can see in the webshop)		

			
GEV No.	100278	Ref. No.	002769
description	bypass nozzle type PEL20/21 bore ø 0.75mm thread M5x0.5		
For models:	BCP/G1, RSF/G2, RSV/G2, XSF/G2, XSV/G2, MSF/G2, MSV/G2, PCP/G1S, PCP/G2D, OCP/G1S, OCP/G2D, TCP/G1S, TCP/G2D, KC/G1, KC/G2, KCF/G2, KC/G3, KCF/G3, KCF/G4, KCF/M2, KC/T1, KC/T2, KC/T3, KCF/T2, KCF/T3, KCF/T4, KCF/G2H, KC/G1H, KC/G2H, KC/G3H, KC/T1H, KC/T2H, KC/T3H, KCF/G3A, KCF/W2, KCF/G3H, KCF/G2L, KCF/G3HA, KC/G1G, KC/G2G, KCF/G2G, KC/G3G, KCF/G3G, KCF/G4G, KCF/M2G, KCF/G2HG, KC/G1H1G, KC/G2HG, KC/G3HG, KCF/G3AG...(Other models you can see in the webshop)		

			
GEV No.	100528	Ref. No.	002926 0KX138 19013313 72779002 835827800
description	bypass nozzle type PEL20/21 bore ø 0.9mm thread M5x0.5		
For models:	RG/G1, RG/G2, RGV/G1, RGV/G2, XG/G1, XG/G2, XGV/G1, XGV/G2, JG/G1, JG/G2, JGV/G1, JGV/G2, MG/G1, MG/G2, MGV/G1, MGV/G2, PC/G1, PC/G2, PR/G1FL, PR/G1FR, PR/G1CL, PR/G2FL, PR/G2FM, PR/G2CL, PRV/G1FL, PRV/G1FR, PRV/G1CL, PRV/G2FL, PRV/G2FM, PRV/G2CL, PR/G2CM, PG/G1, PG/G2, PC/G2HV, PG/G1HV, PC/G1HV, PG/G2HV, PR/G1FLHV, PRV/G2FLHV, OR/G1FL, OR/G1FR, OR/G1CL, OR/G2FL, OR/G2CL, ORV/G1FL, ORV/G1FR, ORV/G2FL, OR/G2CM, OG/G1, OG/G2...(Other models you can see in the webshop)		

			
GEV No.	100557	Ref. No.	002902 72506108 72846608
description	bypass nozzle type PEL20/21 bore ø 1.05mm thread M5x0.5		
For models:	MCF/G1095, MCF/G995, MC/G352, MC/G702, MC/G1052, MCF/G702, MCF/GE702, MCF/G1052, MCFGE1052, MC/G350, MC/G700, MC/G1050, MCF/G700, MCF/GE700, MCF/G1050, MCFGE1050, MTF/G700D, MTF/G1050D, MTF/G700, MTF/G1050, MTF/GE1050, RC/G1, RC/G2, RC/G2, RC/G3, RCF/G2, RCF/G3, RCF/G9, RCF/M2, RCF/M3, RSF/G2, RSV/G2, RSF/G3, MCF/G2A, MCF/G3A, XC/G1, XC/G2, XCV/G2, XCV/G3, XCF/G2, XCF/G3, XCF/G9, XCF/M2, XCFM3, XSF/G2, XSV/G2, XSF/G3, JC/G1, JC/G2, JCV/G2...(Other models you can see in the webshop)		

			
GEV No.	100531	Ref. No.	002927
description	bypass nozzle type PEL20/21 bore ø 1.15mm thread M5x0.5		
For models:	RSF/G2, RSV/G2, XSF/G2, XSV/G2, MSF/G2, MSV/G2, HC/G410, HC/G810, HCF/G810, HC/G1210, HCF/G1210, EC/G1610, HCF/G1610, HCF/GE810, HC/G410, HC/G810, HC/G1210, HCF/G810, HCF/G1210, HCF/G1610, KP/G2, HFS/G800, ZC/G410, ZC/G810, ZCF/G810, ZC/G1210, ZCF/G1210, EC/G1610, ZCF/G1610, ZCF/GE810, ZC/G410, ZC/G810, ZC/G1210, ZCF/G810, ZCF/G1210, ZCF/G1610, QP/G2, ZFS/G800, AC/G410, AC/G810, ACF/G810, AC/G1210, ACF/G1210, AC/G1610, ACF/G1610, ACF/GE810, OCF/G840, OC/G810, OC/G1210, OCF/G1610...(Other models you can see in the webshop)		

			
GEV No.	100549	Ref. No.	002768
description	bypass nozzle type PEL20/21 bore ø 1.35mm thread M5x0.5		
For models:	RTV/G2, RTF/G2, RSF/G3, XTV/G2, XTF/G2, XSF/G3, JTV/G2, JTF/G2, MTV/G2, MTF/G2, MSF/G3, HR/G400, HR/G800, HR/G410, HR/G811, HR/G400, HR/G800, HR/G410, HR/G811, AR/G400, AR/G800, AR/G410, AR/G811, OR/G811		

			
GEV No.	100533	Ref. No.	002928
description	bypass nozzle type PEL20/21 bore ø 1.3mm thread M5x0.5		
For models:	HC/G410, HC/G810, HCF/G810, HC/G1210, HCF/G1210, EC/G1610, HCF/G1610, HCF/GE810, HC/G410, HC/G810, HC/G1210, HCF/G810, HCF/G1210, HCF/G1610, HCF/G811, HC/G411, HC/G1211, HTF/G810, HTF/G1210, HFS/G800, ZC/G410, ZC/G810, ZCF/G810, ZC/G1210, ZCF/G1210, EC/G1610, ZCF/G1610, ZCF/GE810, ZC/G410, ZC/G810, ZC/G1210, ZCF/G810, ZCF/G1210, ZCF/G1610, ZCF/G811, ZC/G411, ZC/G811, HC/G1211, ZTF/G810, ZTF/G1210, ZFS/G800, AC/G410, AC/G810, ACF/G810, AC/G1210, ACF/G1210, AC/G1610, ACF/G1610, ACF/GE810...(Other models you can see in the webshop)		

			
GEV No.	100534	Ref. No.	003182
description	bypass nozzle type PEL20/21 bore ø 1.4mm thread M5x0.5		
For models:	BCP/G1, RG/G1, RG/G2, RGV/G1, RGV/G2, XG/G1, XG/G2, XGV/G1, XGV/G2, JG/G1, JG/G2, JGV/G1, JGV/G2, MG/G1, MG/G2, MGV/G1, MGV/G2, PC/G1, PC/G2, PG/G1, PG/G2, PCP/G1S, PCP/G2D, PC/G2HV, PG/G1HV, PC/G1HV, PG/G2HV, PC/G1A, PC/G2A, PCF/M2A, PCF/M3A, OG/G1, OG/G2, OCP/G1S, OCP/G2D, TC/G1, TC/G2, TG/G1, TG/G2, TCP/G1S, TCP/G2D, TC/G1A, TC/G2A, TCF/M2A, TCF/M3A, HC/G410, HC/G810, HCF/G810, HC/G1210, HCF/G1210...(Other models you can see in the webshop)		

bypass nozzles PEL22			
			
GEV No.	100414	Ref. No.	004261 0KD856 19022856
description	bypass nozzle type PEL22 bore ø 0.45mm thread M6x0.5		
For models:	RCF/G2, RCF/G3, RTV/G2, RTF/G2, RSF/G2, RSV/G2, RSF/G3, MCF/G2A, MCF/G3A, XCF/G2, XCF/G3, XTV/G2, XTF/G2, XSF/G2, XSV/G2, XSF/G3, JCF/G2, JCF/G3, JTV/G2, JTF/G2, MCF/G2, MCF/G3, MTV/G2, MTF/G2, MSF/G2, MSV/G2, MSF/G3, CG148-001.A1ABB, CG148-003.A2AB, CG248-201.A1ABBB, CG248-203.A1ABBB, CK248-209.D1ABBB, CK248-211.D1ABBB, CK248-205.D1ABBB, CK248-207.D1ABBB, CK248-205.D2ABBB, CK248-207.D2ABBB, CK248-209.D2ABBB, CK248-211.D2ABBB, CG148-004.A1AB, CG148-005.A1AB, CG148-006.A1AB, CG248-240.A1ABBB, CG248-243.A1ABBB, CG248-244.A1ABBB, CG248-212.A1ABBB, CG248-213.A1ABBB, CG148-001.A3AB, CG148-003.A2AB, CG248-201.A3ABBB...(Other models you can see in the webshop)		

			
GEV No.	100391	Ref. No.	004260
description	bypass nozzle type PEL22 bore ø 0.55mm thread M6x0.5		
For models:	RCF/G2, RCF/G3, RTV/G2, RTF/G2, RSF/G2, RSV/G2, RSF/G3, MCF/G2A, MCF/G3A, XCF/G2, XCF/G3, XTV/G2, XTF/G2, XSF/G2, XSV/G2, XSF/G3, JCF/G2, JCF/G3, JTV/G2, JTF/G2, MCF/G2, MCF/G3, MTV/G2, MTF/G2, MSF/G2, MSV/G2, MSF/G3		

			
GEV No.	100392	Ref. No.	002948
description	bypass nozzle type PEL22 bore ø 0.6mm thread M6x0.5		
For models:	MR/G351, MR/G701, MR/G350, MR/G360, MR/G700, MR/G710, MR/G715, MR/G361, MR/G711, MR/G716, MT/G700D, MTF/G700D, MTF/G1050D, MT/G700, MTF/G700, MTF/G1050, MTF/GE1050, 7FTGF3L, 7FTGF3R, 7FTGF7L, RR/G710, RR/G716, RT/G700D, RTF/G700D, RTF/G1050D, 7TPG07T, 7TPG07F, 7TPG10F, XR/G350D, XR/G700D, T35GFT, XR/G350F, T36GFT, XR/G360F, T70GFT, XR/G700F, T70GFT, XR/G710F, XR/G350NL, XR/G700NL, CR/G720, XT/G700D, XTF/G700D, XTF/G1050D, T70GST, M70GST/G, M105GST/GA, XT/G700F, XTF/G700F, XTF/G1050F...(Other models you can see in the webshop)		

			
GEV No.	100409	Ref. No.	056743 0K2910
description	bypass nozzle type PEL22 bore ø 0.8mm thread M6x0.5		
For models:	RCF/G2, RCF/G3, RCF/G9, RG/G1, RG/G2, RGV/G1, RGV/G2, RTV/G2, RTF/G2, RSF/G2, RSV/G2, RSF/G3, MCF/G2A, MCF/G3A, XCF/G2, XCF/G3, XCF/G9, XTV/G2, XTF/G2, XSF/G2, XSV/G2, XSF/G3, JCF/G2, JCF/G3, JTV/G2, JTF/G2, MCF/G2, MCF/G3, MCF/G9, MG/G1, MG/G2, MGV/G1, MGV/G2, MTV/G2, MTF/G2, MSF/G2, MSV/G2, MSF/G3, RG/G350D, RG/G700D, RG/G310D, RG/G710D, RGV/G310, RGV/G701D		



			
GEV No.	106309	Ref. No.	003372
description	bypass nozzle type PEL22 bore ø 1.7mm thread M6x0.5		
For models:	PF/G1S07, PF/G2D07, PFR/G1S07, PFR/G2D07, OF/G1S07, OFR/G1S07, OFR/G2D07, TF/G1S07, TF/G2D07, TFR/G1S07, TFR/G2D07, KFR/G1A, KFR/G2B, HT/G800, HTF/G810, HTF/G1210, HCP/G410D, HCP/G400, HCP/G410, HCP/G800, HCP/G810, HCPS/G400, QFR/G1A, QFR/G2B, ZT/G800, ZTF/G810, ZTF/G1210, ZCP/G400, ZCP/G410, ZCP/G800, ZCP/G810, ZCPS/G400, WFR/G1A, WFR/G2B, AT/G800, ATF/G810, ATF/G1210, OTF/G840, OT/G800, OTF/G1210, ACP/G400, ACP/G410, ACP/G800, ACP/G810, ACPS/G400, JCP/G800, PCP/G800		

bypass nozzles PEL23/24

			
GEV No.	100674	Ref. No.	002976 003631
description	bypass nozzle type PEL23/24 bore ø 1.4mm thread M8x0.5		
For models:	HPN/GI810, HPN/GI815, HPN/GI816, HPN/GD811, HPN/GD816, HPA/GD825, HPA/GI825, HPNS/GI816, HCPA/G1219, HCPA/GI 1219, CR22G, ZPN/GI810, 2PIG15, ZPN/GI816, ZPN/GD811, ZPN/GD816, 2PDAG15, 2PIAG15, ZPNS/GI816, ZCPAG1219, ZCPA/GI 1219, CR22G, APN/GI810, APN/GI815, APN/GI816, APN/GD811, APN/GD816, APNS/GI816, OPN/GI815, CR15G, CR/41G, CR42G, CR40G		

			
GEV No.	100267	Ref. No.	056353
description	bypass nozzle type PEL23/24 bore ø 1.9mm thread M8x0.5		
For models:	MG/G350D, MG/G700D, MG/G350, MG/G350E, MG/G350F, MG/G700, MG/G700E, MG/G700F, MG/G1050, MG/G1050F, MG/G1051, RPD/G240, RPD/G260, RPI/G260, XPD/G240, XPD/G260, XPI/G260, JPD/G240, JPD/G260, JPI/G260, MPD/G240, MPD/G260, MPI/G260, 7GLG03, RG/G350F, 7GLG07, RG/G700F, 7GLG10, RG/G1050, XG/G350D, XG/G700D, T35GCG, XG/G350E, XG/G350F, XG/G350NL, T70GCG, XG/G700E, XG/G700F, XG/G700NL, T105GCG, XG/G1050F, CG/G701, RG/G300, RG/G300F, PRG/G300, RG/G700, RG/G700F, PRG/G700, RGG1000, RG/G1000...(Other models you can see in the webshop)		

internal nozzles

internal nozzles for EGA gas taps/nozzle holders

EGA 24197/24362

			
GEV No.	100341	Ref. No.	OK1129 OK1274
description	internal nozzle bore ø 1.15mm type EGA/PEL22		

			
GEV No.	100344	Ref. No.	OK1298
description	internal nozzle bore ø 1.2mm type EGA/PEL22		

			
GEV No.	100342	Ref. No.	230812
description	internal nozzle bore ø 1.4mm type EGA/PEL22		

			
GEV No.	100323	Ref. No.	OK1302
description	internal nozzle bore ø 1.85mm type EGA/PEL22		

			
GEV No.	100324	Ref. No.	230830
description	internal nozzle bore ø 2.1mm type PEL22		

			
GEV No.	100327	Ref. No.	230904
description	internal nozzle bore ø 2.35mm type EGA/PEL22		

EGA 26400/26440/23268

			
GEV No.	100310	Ref. No.	0H6356 100310
description	internal nozzle bore ø 0.66mm suitable for EGA26400/26440		

			
GEV No.	100319	Ref. No.	OK1282
description	internal nozzle bore ø 0.75mm suitable for EGA26400/26440		

			
GEV No.	100311	Ref. No.	0H6372
description	internal nozzle bore ø 0.80mm suitable for EGA26400/26440		

			
GEV No.	100321	Ref. No.	OK1283
description	internal nozzle bore ø 0.90mm suitable for EGA26400/26440		

			
GEV No.	100315	Ref. No.	OG1786
description	internal nozzle bore ø 0.95mm suitable for EGA26400/26440		

			
GEV No.	100312	Ref. No.	0H6357
description	internal nozzle bore ø 1.05mm suitable for EGA26400/26440		

			
GEV No.	100313	Ref. No.	OG1785 OK1252
description	internal nozzle bore ø 1.20mm suitable for EGA26400/26440		

1 			
GEV No.	100322	Ref. No.	OK1254 100322
description	internal nozzle bore ø 1.40mm suitable for EGA26400/26440		

1 			
GEV No.	100316	Ref. No.	OK1272
description	internal nozzle bore ø 1.70mm suitable for EGA26400/26440		

1 			
GEV No.	100314	Ref. No.	OG1791 100314
description	internal nozzle bore ø 1.90mm suitable for EGA26400/26440		

1 			
GEV No.	100317	Ref. No.	OK1232
description	internal nozzle bore ø 2.20mm suitable for EGA26400/26440		

chokes

throttle discs

1 			
GEV No.	107869	Ref. No.	OC2444
description	throttle disc for solenoid valve ED ø 18mm ID ø 7.5mm thickness 1mm SS for combi-steamer		
For models:	FCZ101GAG, FCZ102GAG, FCZ201GAG, FCZ202GAG, FCZ101GAD, FCZ102GAD, FCZ201GAD, FCZ202GAD, FCZ101GTG, FCZ102GTG, FCZ201GTG, FCZ202GTG, FCZ101GTD, FCZ102GTD, FCZ201GTD, FCZ202GTD, FCZ101GBG, FCZ102GBG, FCZ201GBG, FCZ202GBG, FCZ101GBD, FCZ102GBD, FCZ201GBD, FCZ202GBD, FCZ101GBI, FCZ201GBI, FCZ101GBG2, FCZ102GBG2, FCZ201GBG2, FCZ202GBG2, FCZ101GBD2, FCZ102GBD2, FCZ201GBD2, FCZ202GBD2, FCZ101GBI2, FCZ102GBI2, FCZ201GBI2, FCZ101GCG, FCZ102GCG, FCZ201GCG, FCZ202GCG, FCZ101GCD, FCZ102GCD, FCZ201GCD, FCZ202GCD, FCZ101GCG2, FCZ102GCG2, FCZ201GCG2, FCZ202GCG2, FCZ101GCD2...(Other models you can see in the webshop)		

1 			
GEV No.	107868	Ref. No.	OC1139
description	throttle disc for solenoid valve ED ø 18mm ID ø 7mm thickness 1mm for combi-steamer brass		
For models:	FCZ101GAG, FCZ201GAG, FCZ101GAD, FCZ201GAD, FCZ101GTG, FCZ201GTG, FCZ101GTD, FCZ201GTD, FCZ101GBG, FCZ201GBG, FCZ101GBD, FCZ201GBD, FCZ101GBI, FCZ201GBI, FCZ101GBG2, FCZ201GBG2, FCZ101GBD2, FCZ201GBD2, FCZ101GBI2, FCZ201GBI2, FCZ101GCG, FCZ201GCG, FCZ101GCD, FCZ201GCD, FCZ101GCG2, FCZ201GCG2, FCZ101GCD2, FCZ201GCD2, AOS101GAEU, AOS102GAEU, AOS201GAEU, AOS202GAEU, AOS101GAAU, AOS102GAAU, AOS201GAAU, AOS202GAAU, AOS101GA, AOS101GB, AOS201GA, AOS201GB, AOS102GB, AOS102GA, AOS202GB, AOS202GA, AOS101GAGQ, AOS101GBGQ, AOS201GAGQ, AOS201GBGQ, AOS101GADQ, AOS101GBDQ...(Other models you can see in the webshop)		

auxiliary gas parts

screw connections

adapters

1 			
GEV No.	106874	Ref. No.	056832
description	adapter thread 3/8" ET - M14x1.25 IT brass ID ø 8/10mm		
For models:	MBR/G710D, MBR/G700, MBR/G700F, MBR/G700UK, MBR/G701, MBR/G706, MBR/G701UK, MBR/G751, MBR/G756, RCP/G1S, RCP/G2D, RCP/E1S, RCP/E2D, XCP/G1S, XCP/G2D, XCP/E1S, XCP/E2D, JCP/G1S, JCP/G2D, JCP/E1S, JCP/E2D, MCP/G1S, MCP/G2D, MCP/E1S, MCP/E2D, RBR/G710D, RBR/G700, RBR/G700F, 7BRG60, 7BRG60X, RBR/G701UK, RBR/G751, RBR/G756, XBR/G710D, XBR/G700, XBR/G710, XBR/G700F, XBR/G700UK, XBR/G701, M70GBP, XBR/G701UK, XBR/G751, XBR/G756, CBR/G700, PCP/G1S, PCP/G2D, PCP/E1S, PCP/E2D, OCP/G1S, OCP/G2D...(Other models you can see in the webshop)		

1 			
GEV No.	103084	Ref. No.	069203
description	adapter thread M8x1 / M10x1 brass		
For models:	HBR/G820, HBR/G825, ABR/G820, ABR/G825		

double nipples

1 			
GEV No.	106518	Ref. No.	002716
description	double nipple T1: 1/2" T2: M24x1.5 tube ø 16mm		
For models:	FDV40G, FDV40GZ, FDV40GA, FDV20G, FDV20GZ, FDV20GA, HPN/GI810, HPN/GI815, HPN/GI816, HPN/GD811, HPN/GD816, HPA/GD825, HPA/GI825, HPNS/GI816, HPN/GI806, HPN/GI805, ZPN/GI810, 2PIG15, ZPN/GI816, ZPN/GD811, ZPN/GD816, 2PDAG15, 2PIAG15, ZPNS/GI816, ZPN/GI805, APN/GI810, APN/GI815, APN/GI816, APN/GD811, APN/GD816, APNS/GI816, OPN/GI815, APN/GI805, FCV/G10L3, FCV/G10L3T, FCV/G10L2L3, FCV/G20L3, FCV/G20L3L, FCV/G10L3J, FCV/G10L6, FCV/G10L6JAP, FCV/G102/1L6JAP, FCV/G10L2, FCV/G10L6, FCV/G102/1L6, FCV/G20L6, FCV/G20L6L, FCV/G101/1, FCV/G102/1, FCS101G2...(Other models you can see in the webshop)		



with rotating joint





1 			
GEV No.	102758	Ref. No.	OG3754 102758
description	rotating joint for ignition gas approval without DVGW complete		
For models:	7542-2, 7544-2, 7742-2, 7744-2, 9042-2, 9044-2		





			
1			
GEV No.	102748	Ref. No.	OK2578 OKE668 102748
description	rotating joint T1: M22 T2: 3/4" L 69mm W 57mm for main gas approval without DVGW complete		
For models:	7542-2, 7544-2, 7742-2, 7744-2, 9042-2, 9044-2		

olives			
			
Image not available			
1			
GEV No.	106426	Ref. No.	054979
description	olive		
For models:	MR/G351, MR/G701, MR/G350, MR/G350F, MR/G350NL, MR/G350E, MR/G360, MR/G360F, MR/G700, MR/G700F, MR/G700NL, MR/G700E, MR/G710, MR/G710F, MR/G715, MR/G361, MR/G711, MR/G716, MT/G700D, MTF/G700D, MTF/G1050D, MT/G700, MTF/G700, MTF/G1050, MTF/GE1050, MT/G700F, MTF/G700F, MTF/G1055F, MTF/GE1055F, MT/G350, MT/G352, MCP/G700, MCP/G701, MCP/G710, MCP/G711, MCP/G705, MCP/G706, MG/G350D, MG/G700D, MG/G350, MG/G350E, MG/G350F, MG/G350NL, MG/G700, MG/G700E, MG/G700F, MG/G700NL, MG/G1050, MG/G1050F, MG/G1051...(Other models you can see in the webshop)		



			
1			
GEV No.	101249	Ref. No.	052128
description	olive for pipe ø 10mm Qty 1 pcs		
For models:	MR/G351, MR/G701, MR/G350, MR/G350F, MR/G350NL, MR/G350E, MR/G360, MR/G360F, MR/G700, MR/G700F, MR/G700NL, MR/G700E, MR/G710, MR/G710F, MR/G715, MR/G361, MR/G711, MR/G716, MTF/G1050, MTF/GE1050, MT/G700F, MTF/G700F, MTF/G1055F, MTF/GE1055F, MCP/G700, MCP/G701, MCP/G710, MCP/G711, MCP/G705, MCP/G706, MG/G350E, MG/G350F, MG/G350NL, MG/G700E, MG/G700F, MG/G700NL, MG/G1050F, RR/G350D, RR/G700D, 7FTGF3L, 7FTGF3R, RR/G360F, 7FTGF7L, RR/G710, RR/G710F, RR/G350F, RR/G700F, RR/G716, 7TPG10F, RT/G700F...(Other models you can see in the webshop)		
accessories for	101249		
	GEV No.	101250	Ref. No. —
	union nut thread M20x1.5 for pipe ø 10mm		

			
1			
GEV No.	101278	Ref. No.	060325 OC0150 OG0794 OG1111 OG2610 OK1976 OKW924 OT1946 101278 17012732 17012758 19012727
description	olive for pipe ø 10mm Qty 1 pcs		
For models:	RC/G320, RC/G330, RC/G320F, RC/G720, RC/G730, MCF/G705, MCF/G1055, MCF/G700, MCF/G1050, MCF/G705E, MCF/G1055E, MCF/G700D, MCF/G700, MCF/G705F, MCF/G1055F, MCF/G705NL, MCF/GE705, MCF/GE1055, MCF/GE700, MCF/GE1050, MCF/GE700D, MCF/GE1050D, MCF/G1050D, MCF/G1055NL, MC/G355, MC/G350, MC/G355E, MC/G350D, MC/G355F, MC/G355NL, MC/G705, MC/G700, MC/G705E, MC/G700D, MC/G705NL, MC/G1055, MC/G1050, MC/G1050D, MC/G1055NL, MC/G705F, MCF/GE1055UK, MCF/G1090, MCF/G1095, MCF/G995, MC/G352, MC/G702, MC/G1052, MCF/G702, MCF/GE702, MCF/G1052...(Other models you can see in the webshop)		
accessories for	101278		
	GEV No.	100943	Ref. No. OKL494 100943 17012734
	union nut thread M17x1 tube ø 10mm		
	GEV No.	101300	Ref. No. 0A2125 0G2957
	union nut thread M16x1.5 tube ø 10mm		
	GEV No.	101478	Ref. No. —
	union nut thread 3/8" for pipe ø 10mm		



			
1			
GEV No.	101248	Ref. No.	004374 027478 050682 058370 0957007 0G2222 0K4315 214051400 727855
description	olive for pipe ø 12mm Qty 1 pcs suitable for PEL		
For models:	MCF/G1090, MCF/G1095, MFR/G350, MFR/G700, MFR/G350D, MFR/G700D, MFR/G350F, MFR/G700F, MFR/G350E, MFR/G700E, MFR/G380, MFR/G381, BCF/G2, BF/G1S07, BFR/G1S14, MM/G351, MM/G701, MM/G350, MM/G700, MM/G350F, MM/G700F, MM/G700E, MCP/E700, MCP/G700, MCP/E700D, MCP/G701, MCP/G710, MCP/G711, CPG2000Z, RMV/G1C, RMV/G2C, RF/G1S07, RF/G2D07, RFR/G1S07, RFR/G2D07, RFR/G1S14, RFR/G2D14, RF/G1S07, RF/G2D07, RFR/G1S07, RFR/G2D07, XMV/G1C, XMV/G2C, XF/G1S07, XRF/G2D07, XFR/G1S07, XFR/G2D07, XFR/G1S14, XFR/G2D14, XF/G1S07...(Other models you can see in the webshop)		
accessories for	101248		
	GEV No.	101251	Ref. No. —
	union nut thread M20x1.5 for pipe ø 12mm		







			
GEV No.	102517	Ref. No.	OK2859 293299
description	olive for pipe ø 15mm brass Qty 1 pcs		

			
GEV No.	101256	Ref. No.	052671 054817 059063 0960 0A2399
description	olive for pipe ø 16mm Qty 1 pcs		
For models:	MFR/G350, MFR/G700, MFR/G350D, MFR/G700D, MFR/G350F, MFR/G700F, MFR/G350E, MFR/G700E, MFR/G350NL, MFR/G700NL, MFR/G740, MFR/G350, MFR/G351, MPN/GD761, MPN/GI761, MPN/GI760D, MPN/GD760, MPN/GD760F, MPN/GI760, MPN/GI760F, FDV40G, FDV40GZ, FDV40GA, FDV20G, FDV20GZ, FDV20GA, RFR/G1S12, RFR/G2D12, RFR/G2S40, XFR/G1S12, XFR/G2D12, XFR/G2S40, JFR/G1S12, JFR/G2D12, JFR/G2S40, MFR/G1S12, MFR/G2D12, MFR/G2S40, RFR/G350, RFR/G700, RFR/G350D, RFR/G700D, RFR/G350F, RFR/G700F, RFR/G741, 7FRG03S, 7PDG06, 7PIG06, RPN/GD760F, RPN/GI760F... (Other models you can see in the webshop)		
accessories for	101256		
	GEV No.	101253	Ref. No. 054816
union nut thread M24x1.5 PEL for pipe ø 16mm			

			
GEV No.	101257	Ref. No.	052007 054815
description	olive for pipe ø 20mm Qty 1 pcs		
For models:	MPN/GD761, MPN/GI761, MPN/GI760D, MPN/GD760, MPN/GD760F, MPN/GI760, MPN/GI760F, 7PDG06, 7PIG06, RPN/GD760F, RPN/GI760F, XPN/GI760D, M70GDKE, M70GIKE, XPN/GD760F, XPN/GI760F, RPN/G760, RPN/G760, PRPN/G760, RPN/GI760, RPN/GI760, RPN/GI760, PRPN/GI76, HCF/G810, HC/G410D, HC/G810D, HCF/G810D, HCF/G1210D, HCF/G1610D, HC/G410NL, HC/G810NL, HCF/G810NL, HCF/G1210, HCF/G1610, HCF/GE810, HCF/G810, HCF/G1210, HCF/G1610, HCF/G811, HCF/G800U, HCF/G1200U, HCF/G1600U, HPN/GI810, HPN/GI815, HPN/GI815D, HPN/GI816, HPN/GI816, HPN/GD811, HPN/GD816, HPA/GD825... (Other models you can see in the webshop)		
accessories for	101257		
	GEV No.	101254	Ref. No. 054814 09074
union nut thread M28x1.5 tube ø 20mm			



			
GEV No.	101246	Ref. No.	052127 727782
description	olive for pipe ø 4mm Qty 1 pcs		
For models:	MR/G351, MR/G701, MR/G350, MR/G350F, MR/G350NL, MR/G350E, MR/G360, MR/G360F, MR/G700, MR/G700F, MR/G700NL, MR/G700E, MR/G710, MR/G710F, MR/G715, MR/G361, MR/G711, MR/G716, MPN/GD761, MPN/GI761, MPN/GI760D, MPN/GD760, MPN/GD760F, MPN/GI760, MPN/GI760F, BCF/G2, BF/G1S07, BR/G1FL, BR/G1FR, BR/G2FL, BR/G2FR, BCP/G1, MT/G700D, MTF/G700D, MTF/G1050D, MT/G700, MTF/G700, MTF/G1050, MTF/GE1050, MT/G700F, MTF/G700F, MTF/G1055F, MTFGE1055F, MT/G350, MT/G352, MCP/G700, MCP/G701, MCP/G710, MCP/G711, MCP/G705... (Other models you can see in the webshop)		
accessories for	101246		
	GEV No.	100908	Ref. No. 046755 052125 0958013 0G2219 0K1348 0K5753 0KE882 0KL495 19012956 727742 727781
union screw thread M10x1 for pipe ø 4mm Qty 1 pcs			



			
GEV No.	101284	Ref. No.	OK2491 OKC184 OKL219 101284 17012733
description	olive for pipe ø 4mm Qty 1 pcs		
For models:	ALGWHF0000, ALGWHA0000, ALGWHC0000, ALPWCA0000, ALGWDF0000, ALGWDC0000, ALGWOI0000, ALGWAAS000, ALGWAFS000, ALGWAS000, ALGWDF0000, ALPWCA0000, ALPWCFS000, ALGWOIS000, ALGWAB0000, ALGWHB0000, ALPWCBS000, ALGWDBS000, ALGWAB0000, ALGWAB0000, ALPWCBS000, ALGWDBS000, ALGWAF0000, ALGWAA0000, ALGWACO000, ALGWDA0000, ALPWCC0000, ALPWCF0000		
accessories for	101284		
	GEV No.	101259	Ref. No. —
union nut thread M8x1 for pipe ø 4mm			
	GEV No.	101285	Ref. No. 0K2490 OKC185 OKL220 101285 17012735
union screw thread M8x1 for pipe ø 4mm Qty 1 pcs JUNKERS			
	GEV No.	101294	Ref. No. —
union nut thread M10x1 for pipe ø 4mm WS 14 L 12mm Qty 1 pcs			





 <p>1</p>			
GEV No.	100897	Ref. No.	059161 0957009 0G2262 727799
description	olive for pipe ø 4mm Qty 1 pcs for pilot burner		
For models:	BCF/G2, BR/G1FL, BR/G1FR, BR/G2FL, BR/G2FR, MT/G350, MT/G352, RCF/G9, RBR/G2FM, RBR/G2IM, RBK/G2FM, RR/G1FL, RR/G1FR, RR/G1CL, RR/G2FL, RR/G2FM, RR/G2CL, RRV/G1FL, RRV/G1FR, RRV/G1CL, RRV/G2FL, RRV/G2FM, RRV/G2CL, RR/G2CM, RTV/G2, RTF/G2, RSF/G2, RSV/G2, RSF/G3, RBV/G2, XCF/G9, XBR/G2FM, XBR/G2IM, XBK/G2FM, XR/G1FL, XR/G1FR, XR/G1CL, XR/G2FL, XR/G2FM, XR/G2CL, XRV/G1FL, XRV/G1FR, XRV/G1CL, XRV/G2FL, XRV/G2FM, XRV/G2CL, XR/G2CM, XTV/G2, XTF/G2, XSF/G2...(Other models you can see in the webshop)		

 <p>1</p>			
GEV No.	100870	Ref. No.	053665 0957014 0G2291 727756
description	olive for pipe ø 4mm Qty 1 pcs suitable for 160 series for pilot burner		
For models:	MCF/G1090, MCF/G1095, MCF/G995, BCP/G1, MCP/G700, MCP/G701, MCP/G710, MCP/G711, MCP/G705, MCP/G706, RCF/G2, RCF/G3, RMV/G1C, RMV/G2C, RG/G1, RG/G2, RGV/G1, RGV/G2, RTF/G2, RSF/G2, RSV/G2, RSF/G3, RPD/G240, RPD/G260, RPI/G260, RPI/G260P, RCP/G1S, RCP/G2D, MCF/G2A, MCF/G3A, XCF/G2, XCF/G3, XG/G1, XG/G2, XGV/G1, XGV/G2, XTF/G2, XSF/G2, XSV/G2, XSF/G3, XPD/G240, XPD/G260, XPI/G260, XPI/G260P, XCP/G1S, XCP/G2D, JCF/G2, JCF/G3, JG/G1, JG/G2...(Other models you can see in the webshop)		

 <p>1</p>			
GEV No.	100898	Ref. No.	003863
description	olive for pipe ø 6mm Qty 1 pcs for pilot burner		
For models:	CRN22G, CRN/20G, CRN30G, CRN15G, HCPA/G1219, HCPA/GI 1219, CR22G, CRN/22GZ, CRN20GZ, CRN30GZ, CRN15GZ, ZCPAG1219, ZCPA/GI 1219, CR22G, CRN20GA, CRN30GA, CRN15GA, CR42G, CR/40G, CR15G, CR/41G, CR42G, CR40G		
accessories for	100898		
			
GEV No.	100909	Ref. No.	003859 057821
union screw thread M10x1 for pipe ø 6mm Qty 1 pcs			

 <p>1</p>			
GEV No.	101286	Ref. No.	020992 053666
description	olive ID ø 6mm Qty 1 pcs		
For models:	MTF/G1050, MTF/GE1050, MT/G700F, MTF/G700F, MTF/G1055F, MTF/GE1055F, RCF/G720, RCF/G1020, RCF/G730, RCF/G1030, RCF/G720F, RCF/G1020, 7TPG10F, RT/G700F, RTF/G700, RTF/G1050, CCF/G710, RTFG720, RTF/G720F, RTF/G1020, RTF/G1030, RTF/G1020F, HR/G403, HR/G803, HR/G413, HR/G814, HR/G403D, HR/G803D, HBR/G820, HBR/G825, HTR/G411, HTR/G811, ZR/G403, ZR/G803, ZR/G413, ZR/G814, ZR/G403D, ZR/G803D, 2FTGF4L, 2FTGF8L, AR/G403, AR/G803, AR/G403D, AR/G803D, ABR/G820, ABR/G825, ATR/G411, FCFG10, FCFG10D, FCFG10NL...(Other models you can see in the webshop)		
accessories for	101286		
			
GEV No.	100909	Ref. No.	003859 057821
union screw thread M10x1 for pipe ø 6mm Qty 1 pcs			

accessories for	101286		
			
GEV No.	101464	Ref. No.	—
union nut thread M12x1 for pipe ø 6mm			

 <p>1</p>			
GEV No.	102483	Ref. No.	0C3645 17012793
description	olive ID ø 7mm ED ø 9.5mm Qty 1 pcs brass L 7mm from serial no. 646		
For models:	PC/G1, PC/G2, PCV/G2, PCV/G3, PCF/G2, PCF/G3, PCF/G9, PCF/M2, PCF/M3, PCF/M2E5, PTV/G2, PTF/G2, PSF/G2, PSV/G2, PSF/G3, PCV/G2N, PCF/G3N, PC/G2HV, PCV/G3N, PCF/G2N, PC/G1HV, PTV/G2N, PC/G1A, PC/G2A, PCV/G2A, PCV/G3A, PCF/G2A, PCF/G3A, PCF/M2A, PCF/M3A, OCV/G2, OCF/G2, OCF/G3, OCF/M2, OTV/G2, OTF/G2, OSF/G2, OSV/G2, TC/G1, TC/G2, TCV/G2, TCV/G3, TCF/G2, TCF/G3, TCF/M2, TCF/M3, TCF/M2E5, TTV/G2, TTF/G2, TSF/G2...(Other models you can see in the webshop)		

union nuts

 <p>1</p>			
GEV No.	101346	Ref. No.	025001 025902 0G0838 214110500
description	union nut nozzle holder		
For models:	RC/G320, RC/G330, RC/G320F, RC/G720, RC/G730, MCF/G705, MCF/G1055, MCF/G700, MCF/G1050, MCF/G705E, MCF/G1055E, MCF/G700D, MCF/G700, MCF/G705F, MCF/G1055F, MCF/G705NL, MCF/GE705, MCF/GE1055, MCF/GE700, MCF/GE1050, MCF/GE700D, MCF/GE1050D, MCF/G1050D, MCF/G1055NL, MC/G355, MC/G350, MC/G355E, MC/G350D, MC/G355F, MC/G355NL, MC/G705, MC/G700, MC/G705E, MC/G700D, MC/G705NL, MC/G1055, MC/G1050, MC/G1050D, MC/G1055NL, MC/G705F, MCF/GE1055UK, MCF/G1090, MCF/G1095, MCF/G995, MC/G352, MC/G702, MC/G1052, MCF/G702, MCF/GE702, MCF/G1052...(Other models you can see in the webshop)		



1

GEV No.	101300	Ref. No.	0A2125 0G2957
description	union nut thread M16x1.5 tube ø 10mm		
For models:	MCF/G705, MCF/G1055, MCF/G700, MCF/G1050, MCF/G705E, MCF/G1055E, MCF/G700D, MCF/G700, MCF/G705F, MCF/G1055F, MCF/G705NL, MCF/GE705, MCF/GE1055, MCF/GE700, MCFGE1050, MCF/GE700D, MCFGE1050D, MCF/G1050D, MCFG1055NL, MC/G355, MC/G350, MC/G355E, MC/G350D, MC/G355F, MC/G355NL, MC/G705, MC/G700, MC/G705E, MC/G700D, MC/G705NL, MC/G1055, MC/G1050, MC/G1050D, MC/G1055NL, MC/G705F, MCF/GE1055UK, MCF/G1090, MCF/G1095, MCF/G995, MC/G352, MC/G702, MC/G1052, MCF/G702, MCF/GE702, MCF/G1052, MCFGE1052, MC/G350, MC/G700, MC/G1050, MCF/G700...(Other models you can see in the webshop)		
accessories for	101300		
	GEV No.	101278	Ref. No. 060325 0C0150 0G0794 0G1111 0G2610 0K1976 0KW924 0T1946 101278 17012732 17012758 19012727
olive for pipe ø 10mm Qty 1 pcs			

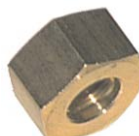

1

GEV No.	100943	Ref. No.	0KL494 100943 17012734
description	union nut thread M17x1 tube ø 10mm		
For models:	AGGRHFGOOO, AGGRHAGOOO, AGGRHBGOOM, AGGRABGOOO, AGGRHBGOOO, AGGWHFGBOO, AGGWHAGBOO, AGGWHBGBOM, AGGWABGBOO, AGGWHBGBOO, ALGWHFOOOO, ALGWHAOOOO, ALGWHCOOOO, AGGYIFGFCO, AGGYIAGFCO, AGGYIBGFCO, AGGRAAGOOM, AGGRAFGOOM, AGGWAAGBOM, AGGWAFGBOM, AGGYJAGFCM, AGGYJFGFCM, AGGYJBGFCM, AGGWDBGBOO, AGGWDFGBOO, AGGWDAGBOM, AGGWDFGBOM, AGGWDBGBOM, AGGYKFGFCO, AGGYKBGFCO, AGGYKAGFCM, AGGYKFGFCM, AGGYKBGFCM, AGPWCAGBOO, AGPWCAGBOM, AGPWCAGBOM, AGPWCAGBOM, AGGYLAGFCO, AGGYLFGFCO, AGGYLAGFCM, AGGYLFGFCM, AGGYLBGFCM, ALPWCAOOOO, ALGWDFOOOO, ALGWDCOOOO, AGGROIGOOO, AGGWOIGBOO, AGGYOIGFCO, AGGROIGOOM, AGGWOIGBOM...(Other models you can see in the webshop)		
accessories for	100943		
	GEV No.	101278	Ref. No. 060325 0C0150 0G0794 0G1111 0G2610 0K1976 0KW924 0T1946 101278 17012732 17012758 19012727
olive for pipe ø 10mm Qty 1 pcs			

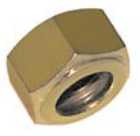

1

GEV No.	101253	Ref. No.	054816
description	union nut thread M24x1.5 PEL for pipe ø 16mm		
For models:	MPN/GD761, MPN/GI761, MPN/GI760D, MPN/GD760, MPN/GD760F, MPN/GI760, MPN/GI760F, FDV40GZ, FDV40GZ, FDV40GA, FDV20GZ, FDV20GA, 7PDG06, 7PIG06, RPN/GD760F, RPN/GI760F, XPN/GI760D, M70GDKE, M70GIKE, XPN/GD760F, XPN/GI760F, RPN/G760, RPN/G760, PRPN/G760, RPN/GI760, RPN/GI760, RPN/GI760, PRPN/GI76, HPN/GI810, HPN/GI815, HPN/GI815D, HPN/GI816, HPN/GI816, HPN/GD811, HPN/GD816, HPA/GD825, HPA/GI825, HPNS/GI816, HPN/GI806, HPN/GI805, ZPN/GI810, 2PIG15, ZPN/GI816, ZPN/GI816D, ZPN/GD811, ZPN/GD816, 2PDAG15, 2PIAG15, ZPNS/GI816...(Other models you can see in the webshop)		
accessories for	101253		
	GEV No.	101256	Ref. No. 052671 054817 059063 0960 0A2399
olive for pipe ø 16mm Qty 1 pcs			

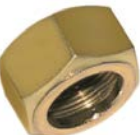

1

GEV No.	101254	Ref. No.	054814 09074
description	union nut thread M28x1.5 tube ø 20mm		
For models:	MPN/GD761, MPN/GI761, MPN/GI760D, MPN/GD760, MPN/GD760F, MPN/GI760, MPN/GI760F, 7PDG06, 7PIG06, RPN/GD760F, RPN/GI760F, XPN/GI760D, M70GDKE, M70GIKE, XPN/GD760F, XPN/GI760F, RPN/G760, RPN/G760, PRPN/G760, RPN/GI760, RPN/GI760, RPN/GI760, PRPN/GI76, HPN/GI810, HPN/GI815, HPN/GI815D, HPN/GI816, HPN/GI816, HPN/GD811, HPN/GD816, HPA/GD825, HPA/GI825, HPNS/GI816, HPN/GI806, HPN/GI805, HCPA/G1219, HCPA/GI 1219, ZPN/GI810, 2PIG15, ZPN/GI816, ZPN/GI816D, ZPN/GD811, ZPN/GD816, 2PDAG15, 2PIAG15, ZPNS/GI816, ZPN/GI805, ZCPAG1219, ZCPA/GI 1219, APN/GI810...(Other models you can see in the webshop)		
accessories for	101254		
	GEV No.	101257	Ref. No. 052007 054815
olive for pipe ø 20mm Qty 1 pcs			



union screws

1



GEV No.	100904	Ref. No.	052833 0K2497 100904 102504
description	locking screw M10x1 for pipe ø 4mm Qty 1 pcs		
For models:	MCF/G705, MCF/G1055, MCF/G700, MCF/G1050, MCF/G705E, MCF/G1055E, MCF/G700D, MCF/G700, MCF/G705F, MCF/G1055F, MCF/G705NL, MCF/G1050D, MCF/G1055NL, MCF/G1090, MCF/G1095, MCF/G995, MCF/G702, MCF/G1052, MCF/G700, MCF/G1050, MFR/G350, MFR/G700, MFR/G350D, MFR/G700D, MFR/G360, MFR/G350F, MFR/G700F, MFR/G350E, MFR/G700E, MFR/G350NL, MFR/G700NL, MTF/G700D, MTF/G1050D, MTF/G700, MTF/G1050, MTF/GE1050, MF/G700, MG/G350D, MG/G700D, MG/G350, MG/G350E, MG/G350F, MG/G350NL, MG/G700, MG/G700E, MG/G700F, MG/G700NL, MG/G1050, MG/G1050F, MG/G1051...(Other models you can see in the webshop)		

2



GEV No.	100905	Ref. No.	052834 0958031
description	locking screw M10x1 for pipe ø 6mm Qty 1 pcs		
For models:	MBR/G710D, MBR/G700, MBR/G700F, MBR/G700UK, MBR/G701, MBR/G706, MBR/G701UK, MBR/G751, MBR/G756, MM/G351, MM/G701, MM/G350, MM/G700, MM/G350F, MM/G700F, MM/G700E, RBR/G710D, RBR/G700, RBR/G700F, 7BRG60, 7BRG60X, RBR/G701UK, RBR/G751, RBR/G756, RM/G350D, RM/G700D, 7BMG03T, 7BMG07T, RM/G350F, RM/G700F, XBR/G710D, XBR/G700, XBR/G710, XBR/G700F, XBR/G700UK, XBR/G701, M70GBP, XBR/G701UK, XBR/G751, XBR/G756, CBR/G700, XM/G350D, XM/G700D, T35GBM, T70GBM, XM/G350F, XM/G700F, CM/G700, RMG300, RM/G300D...(Other models you can see in the webshop)		

1



GEV No.	100906	Ref. No.	003610 056641 057960 0974037 0G2227 0K5791 11061230 19013341 727759
description	screw connection thread M10x1 for ignition electrode brass Qty 1 pcs WS 10		

1



GEV No.	100907	Ref. No.	003609 0C0121 11061236
description	screw connection thread M10x1 Qty 1 pcs type SEF 1 ømm for thermocouple		
For models:	BCF/G2, VO40G, ACFG24, ACFG36, ASG36, ACFG24T, ACFG36T, PC/G1, PC/G2, PCV/G2, PCV/G3, PCF/G2, PCF/G3, PCF/G9, PCF/M2, PCF/M3, PCF/M2E5, PTV/G2, PTF/G2, PSF/G2, PSV/G2, PSF/G3, PGV/G1, PGV/G2, PCV/G2N, PCF/G3N, PC/G2HV, PCV/G3N, PCF/G2N, PC/G1HV, PGV/G1HV, PTV/G2N, PGV/G2HV, PC/G1A, PC/G2A, PCV/G2A, PCV/G3A, PCF/G2A, PCF/G3A, PCF/M2A, PCF/M3A, OC/G1, OC/G2, OCV/G2, OCF/G2, OCF/G3, OCF/M2, OCF/G9UK, OTV/G2, OTF/G2...(Other models you can see in the webshop)		

1











GEV No.	101275	Ref. No.	052668
description	union screw thread 1/2" for pipe ø 16mm Qty 1 pcs		
For models:	MFR/G350, MFR/G700, MFR/G350D, MFR/G700D, MFR/G350F, MFR/G700F, MFR/G350E, MFR/G700E, MFR/G350NL, MFR/G700NL, MFR/G740, MFR/G350, MFR/G351, RFR/G1S12, RFR/G2D12, RFR/G2S40, XFR/G1S12, XFR/G2D12, XFR/G2S40, JFR/G1S12, JFR/G2D12, JFR/G2S40, MFR/G1S12, MFR/G2D12, MFR/G2S40, RFR/G350, RFR/G700, RFR/G350D, RFR/G700D, RFR/G350F, RFR/G700F, RFR/G741, 7FRG03S, M35GFR, M70GFR, XFR/G350D, XFR/G700D, XFR/G350F, XFR/G700F, XFR/G350NL, XFR/G700NL, XFR/G351, CFR/G741, M35GFR, M70GFR, CFR/G351, CFR/G700, CFR/G351, CFR/G701, RFR/G300...(Other models you can see in the webshop)		
accessories for	101275		
	GEV No.	101274	Ref. No.
			—
description	olive for pipe ø 16mm Qty 1 pcs		

1



GEV No.	106873	Ref. No.	0G2223
description	union screw thread 3/8" L 20mm brass Qty 1 pcs WS 17		
For models:	JHR/G800, JHCR/G800, HRCR/G800, JHRR/G800, JFR/G400, PHR/G800, PHRC/G800, HRCR/G800, PHRR/G800, PFR/G400, 7502-2, 7504-2, 7505-2-9, 7511-2, 7530-2, 7531-2, 7542-2, 7544-2, 7730-2, 7731-2, 7742-2, 7744-2		

			
1			
GEV No.	100908	Ref. No.	046755 052125 0958013 0G2219 0K1348 0K5753 0KE882 0KL495 19012956 727742 727781
description	union screw thread M10x1 for pipe ø 4mm Qty 1 pcs		
For models:	MCF/G1090, MCF/G1095, MCF/G995, MR/G351, MR/G701, MR/G350, MR/G350F, MR/G350NL, MR/G350E, MR/G360, MR/G360F, MR/G700, MR/G700F, MR/G700NL, MR/G700E, MR/G710, MR/G710F, MR/G715, MR/G361, MR/G711, MR/G716, MPN/GD761, MPN/GI761, MPN/GI760D, MPN/GD760, MPN/GD760F, MPN/GI760, MPN/GI760F, BCF/G2, BF/G1507, BR/G1FL, BR/G1FR, BR/G2FL, BR/G2FR, BCP/G1, MT/G700D, MTF/G700D, MTF/G1050D, MT/G700, MTF/G700, MTF/G1050, MTF/GE1050, MT/G700F, MTF/G700F, MTF/G1055F, MTFGE1055F, MT/G350, MT/G352, MCP/G700, MCP/G701...(Other models you can see in the webshop)		
accessories for	100908		
	GEV No.	100897	Ref. No. 059161 0957009 0G2262 727799
olive for pipe ø 4mm Qty 1 pcs for pilot burner			
	GEV No.	101246	Ref. No. 052127 727782
olive for pipe ø 4mm Qty 1 pcs			
	GEV No.	101280	Ref. No. —
olive for pipe ø 4mm Qty 1 pcs			
	GEV No.	101282	Ref. No. —
olive for pipe ø 4mm L 7.4mm Qty 1 pcs			

			
1			
GEV No.	100909	Ref. No.	003859 057821
description	union screw thread M10x1 for pipe ø 6mm Qty 1 pcs		
For models:	CRN22G, CRN/20G, CRN30G, CRN15G, HCPA/G1219, HCPA/GI 1219, CR22G, CRN/22GZ, CRN20GZ, CRN30GZ, CRN15GZ, ZCPAG1219, ZCPA/GI 1219, CR22G, BR80GZ, CRN20GA, CRN30GA, CRN15GA, BR180GZ, BR100GZ, CR42G, CR/40G, CR15G, CR/41G, CR42G, CR40G, BR100G, BR80G, BR180G, ROCF/G1000, ROTF/G1000, ROSD/G1000, ROSF/G1000, RORA/G500, RORA/G1000, ROR/G500, ROR/G1000		
accessories for	100909		
	GEV No.	100898	Ref. No. 003863
olive for pipe ø 6mm Qty 1 pcs for pilot burner			
	GEV No.	101286	Ref. No. 020992 053666
olive ID ø 6mm Qty 1 pcs			
	GEV No.	101287	Ref. No. —
olive for pipe ø 6mm Qty 1 pcs			

accessories for	100909		
	GEV No.	101288	Ref. No. —
olive for pipe ø 6mm L 6mm aluminium Qty 1 pcs ED ø 8.5mm			



			
1			
GEV No.	102482	Ref. No.	0C3646 17012794
description	union screw thread M11x1 L 11mm Qty 1 pcs hole ø 7mm from serial no. 646		
For models:	PC/G1, PC/G2, PCV/G2, PCV/G3, PCF/G2, PCF/G3, PCF/G9, PCF/M2, PCF/M3, PCF/M2E5, PTV/G2, PTF/G2, PSF/G2, PSV/G2, PSF/G3, PCV/G2N, PCF/G3N, PC/G2HV, PCV/G3N, PCF/G2N, PC/G1HV, PTV/G2N, PC/G1A, PC/G2A, PCV/G2A, PCV/G3A, PCF/G2A, PCF/G3A, PCF/M2A, PCF/M3A, OCV/G2, OCF/G2, OCF/G3, OCF/M2, TC/G1, TC/G2, TCV/G2, TCV/G3, TCF/G2, TCF/G3, TCF/M2, TCF/M3, TCF/M2E5, TC/G1A, TC/G2A, TCV/G2A, TCV/G3A, TCF/G2A, TCF/G3A, TCF/M2A...(Other models you can see in the webshop)		

			
1			
GEV No.	101467	Ref. No.	051950
description	union screw thread M18x1.5 for pipe ø 12mm Qty 1 pcs		
For models:	MCF/G1090, MCF/G1095, MFR/G350, MFR/G700, MFR/G350D, MFR/G700D, MFR/G350F, MFR/G700F, MFR/G350E, MFR/G700E, MFR/G380, MFR/G381, BCF/G2, MM/G351, MM/G701, MM/G350, MM/G700, MM/G350F, MM/G700F, MM/G700E, RMV/G1C, RMV/G2C, RF/G1507, RF/G2D07, RFR/G1507, RFR/G2D07, RFR/G1514, RFR/G2D14, RF/G1507, RF/G2D07, RFR/G1507, RFR/G2D07, XBR/G2FM, XBR/G2IM, XBK/G2FM, XMV/G1C, XMV/G2C, XF/G1507, XRF/G2D07, XFR/G1507, XFR/G2D07, XFR/G1514, XFR/G2D14, XF/G1507, XF/G2D07, XFR/G1507, XFR/G2D07, JBR/G2FM, JF/G1507, JF/G2D07...(Other models you can see in the webshop)		

			
1			
GEV No.	101285	Ref. No.	0K2490 0KC185 0KL220 101285 17012735
description	union screw thread M8x1 for pipe ø 4mm Qty 1 pcs JUNKERS		
For models:	ALGWHFOOOO, ALGWHAOOO, ALGWHC0000, ALPWCAOOO, ALGWDF0000, ALGWDASOOO, ALGWOIOOOO, ALGWAASOOO, ALGWAFSOOO, ALGWDASOOO, ALGWDFOOOO, ALPWCAOOO, ALPWCFSOOO, ALGWOISOOO, ALGWABOOOO, ALGWHBOOOO, ALPWCB0000, ALGWDBOOOO, ALGWABSOOO, ALPWCB0000, ALGWDBSOOO, ALGWAFOOOO, ALGWA0000, ALGWACOOOO, ALGWDAOOOO, ALPWCCOOOO, ALPWCF0000		
accessories for	101285		
	GEV No.	101284	Ref. No. 0K2491 0KC184 0KL219 101284 17012733
olive for pipe ø 4mm Qty 1 pcs			



angle pieces

			
1			
GEV No.	102455	Ref. No.	0C3643 17012792
description	nozzle holder T1: M10x1 tube ø 7mm from serial no. 646		
For models:	PC/G1, PC/G2, PCV/G2, PCV/G3, PCF/G2, PCF/G3, PCF/G9, PCF/M2, PCF/M3, PCF/M2E5, PTV/G2, PTF/G2, PSF/G2, PSV/G2, PSF/G3, PCV/G2N, PCF/G3N, PC/G2HV, PCV/G3N, PCF/G2N, PC/G1HV, PTV/G2N, PC/G1A, PC/G2A, PCV/G2A, PCV/G3A, PCF/G2A, PCF/G3A, PCF/M2A, PCF/M3A, OCV/G2, OCF/G2, OCF/G3, OCF/M2, OTV/G2, OTF/G2, OSF/G2, OSV/G2, TC/G1, TG/G2, TCV/G2, TCV/G3, TCF/G2, TCF/G3, TCF/M2, TCF/M3, TCF/M2E5, TTV/G2, TTF/G2, TSF/G2...(Other models you can see in the webshop)		
accessories for	102455		
			
GEV No.	102482	Ref. No.	0C3646 17012794
description	union screw thread M11x1 L 11mm Qty 1 pcs hole ø 7mm from serial no. 646		
			
GEV No.	102483	Ref. No.	0C3645 17012793
description	olive ID ø 7mm ED ø 9.5mm Qty 1 pcs brass L 7mm from serial no. 646		

gas pressure regulators

Standard pressure according to country:
 Germany 50mbar
 France 37mbar
 Italy 30mbar
 Spain 37/50mbar
 UK 20mbar

			
1			
GEV No.	250126	Ref. No.	0C1074
description	gas pressure regulator RV48LM connection 3/4" - 3/4" output pressure 12.5-30mbar		
accessories for	250126		
			
GEV No.	542146	Ref. No.	—
description	reducer thread 1/2" ET - 3/4" ET SS total length 26mm WS 28 Qty 1 pcs		

gas ball valves

with DIN-DVGW approval

			
1			
GEV No.	520287	Ref. No.	006137 72010081
description	ball valve straight lever handle inlet 3/4" IT outlet 3/4" IT DN20 L 80mm approval DVGW gas technology operating p. 1bar		
For models:	ACG12, ACG24, ACG36, ACG48, ACFG24, ACFG36, ASG36, ARG12FL, ARG24FL, ARG36FL, ARG48FL, ARG12FR, ARG24FR, ARG36FR, ARG48FR, AGG12, AGG24, AGG36, AGG48, ACPG25, ACG12T, ACG24T, ACG36T, ACG48T, ACFG24T, ACFG36T, ARG12FLCE, ARG24FLCE, ARG36FLCE, ARG48FLCE, ARG12FRCE, ARG24FRCE, ARG36FRCE, ARG48FRCE, AGG12CE, AGG24CE, AGG36CE, AGG48CE, HC/G800U, HC/G1200U, HC/G1600U, HCF/G800U, HCF/G1200U, HCF/G1600U, KCP/G1RU, KCP/G2RU, KCP/G1U, KCP/G2U, HR/G400U, HR/G800U...(Other models you can see in the webshop)		

gas lines

main gas lines

universal

			
1			
GEV No.	107552	Ref. No.	0C0704
description	gas line connection ø10mm L 300mm ED ø 13mm SS flexible		
For models:	TMV/G1C, TMV/G2C, KBR/G2F, KBR/G2C, KBR/G3F, KBR/G3FH, KBR/G3C, KBR/G3CH, KBR/G2FH, KBR/G2CH, KCP/G1RU, KCP/G2RU, KCP/G1, KCP/G1R, KCP/G2, KCP/G2R, KCP/G1U, KCP/G2U, QBR/G2F, QBR/G2C, QBR/G3F, QBR/G3FH, QBR/G3C, QBR/G3CH, QBR/G2FH, QBR/G2CH, QCP/G1, QCP/G1R, QCP/G2, QCP/G2R, WBR/G2F, WBR/G2C, WBR/G3F, WBR/G3FH, WBR/G3C, WBR/G3CH, WBR/G2FH, WBR/G2CH, WCP/G1, WCP/G1R, WCP/G2, WCP/G2R, DCP/G400		

pilot tubes

producer-specific

			
1			
GEV No.	106519	Ref. No.	0C0802 517815902
description	gas line tube ø 16mm L 410mm W 80mm		
For models:	HPN/GD816, HPA/GD825, ZPN/GD816, 2PDAG15		



GEV No.	108096	Ref. No.	OKK124
description	pilot tube tube ø 10mm L 80mm W 75mm H 13mm copper connection 10mm soldering connection		
For models:	CG148-001.A1AB, CG148-003.A2AB, CG248-201.A1ABBB, CG248-203.A1ABBB, CK248-209.D1ABBB, CK248-211.D1ABBB, LG159-703.A1BC, LG159-703.A2BC, LG159-704.A1BC, LG159-706.A1BC, LG259-711.A1ACCB, LG259-712.A1ACCB, LK259-707.D1ACCB, LK259-708.D1ACCB, LG259-739.A1ACCB, LG259-740.A1ACCB, CK248-205.D1ABBB, CK248-207.D1ABBB, LK159-707.D1BC, LK159-708.D1BC, LK259-727.D1ACCB, LK259-728.D1ACCB, LG159-704.A2BC, LK159-707.D2BC, LK159-708.D2BC, LG259-711.A2ACCB, LG259-712.A2ACCB, LK259-727.D2ACCB, LK259-728.D2ACCB, LK259-707.D2ACCB, LK259-708.D2ACCB, CK248-205.D2ABBB, CK248-207.D2ABBB, CK248-209.D2ABBB, CK248-211.D2ABBB, CG148-004.A1AB, CG148-005.A1AB, CG148-006.A1AB, CG248-240.A1ABBB, CG248-243.A1ABBB, CG248-244.A1ABBB, CG248-212.A1ABBB, CG248-213.A1ABBB, LG159-705.A1BC, LG159-753.A1BC, LG259-758.A1ACCB, LG259-754.A1ACCB, LG259-757.A1ACCB, CG148-001.A3AB, CG148-003.A2AB...(Other models you can see in the webshop)		



GEV No.	107553	Ref. No.	OC0702
description	pilot tube tube ø 4mm L 130mm copper		
For models:	KBR/G2F, KBR/G2C, KBR/G3F, KBR/G3FH, KBR/G3C, KBR/G3CH, KBR/G2FH, KBR/G2CH, QBR/G2F, QBR/G2C, QBR/G3F, QBR/G3FH, QBR/G3C, QBR/G3CH, QBR/G2FH, QBR/G2CH, WBR/G2F, WBR/G2C, WBR/G3F, WBR/G3FH, WBR/G3C, WBR/G3CH, WBR/G2FH, WBR/G2CH		



GEV No.	107875	Ref. No.	OC0598
description	pilot tube tube ø 4mm L 160mm W 112mm H 55mm SS		
For models:	KR/GT1, KR/GT2, KR/GT1R, KR/GT2R, KR/GT1C, KR/GT2C, KR/GT2CR, KR/GT1P, KR/GT1RP, KR/GT1CP, QR/GT1, QR/GT2, QR/GT1R, QR/GT2R, QR/GT1C, QR/GT2C, QR/GT2CR, QR/GT1P, QR/GT1RP, QR/GT1CP, WR/GT1, WR/GT2, WR/GT1R, WR/GT2R, WR/GT1C, WR/GT2C, WR/GT2CR, WR/GT1P, WR/GT1RP, WR/GT1CP		

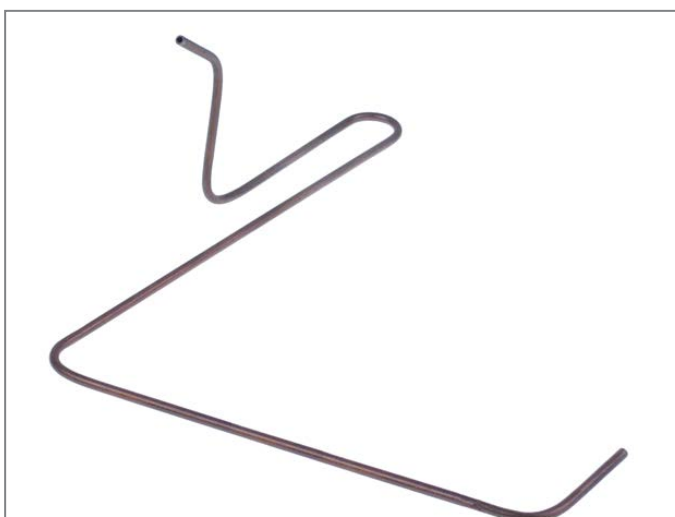

GEV No.	102488	Ref. No.	OC4192 OC9553
description	pilot tube tube ø 4mm L 230mm W 240mm H 90mm for N700 mounting pos. front		
For models:	PC/G1, PC/G2, PCV/G2, PCV/G3, PCF/G2, PCF/G3, PCF/G9, PCF/M2, PCF/M3, PCF/M2E5, PTV/G2, PTF/G2, PSF/G2, PSV/G2, PSF/G3, PCV/G2N, PCF/G3N, PC/G2HV, PCV/G3N, PCF/G2N, PC/G1HV, PTV/G2N, PC/G1A, PC/G2A, PCV/G2A, PCV/G3A, PCF/G2A, PCF/G3A, PCF/M2A, PCF/M3A, OCV/G2, OCF/G2, OCF/G3, OCF/M2, OTV/G2, OTF/G2, OSF/G2, OSV/G2, TC/G1, TC/G2, TCV/G2, TCV/G3, TCF/G2, TCF/G3, TCF/M2, TCF/M3, TCF/M2E5, TTV/G2, TTF/G2, TSF/G2...(Other models you can see in the webshop)		



1

GEV No.	102486	Ref. No.	0C3647
description	pilot tube tube ø 4mm L 310mm W 240mm H 90mm for N900 mounting pos. front		

1

GEV No.	102489	Ref. No.	0C4193 0C9552
description	pilot tube tube ø 4mm L 355mm W 160mm H 90mm for N700 mounting pos. rear		
For models:	PC/G1, PC/G2, PCV/G2, PCV/G3, PCF/G2, PCF/G3, PCF/G9, PCF/M2, PCF/M3, PCF/M2E5, PTV/G2, PTF/G2, PSF/G2, PSV/G2, PSF/G3, PCV/G2N, PCF/G2N, PCF/G3N, PC/G2HV, PCV/G3N, PCF/G2N, PC/G1HV, PTV/G2N, PC/G1A, PC/G2A, PCV/G2A, PCV/G3A, PCF/G2A, PCF/G3A, PCF/M2A, PCF/M3A, OCV/G2, OCF/G2, OCF/G3, OCF/M2, OTV/G2, OTF/G2, OSF/G2, OSV/G2, TC/G1, TC/G2, TCV/G2, TCV/G3, TCF/G2, TCF/G3, TCF/M2, TCF/M3, TCF/M2E5, TTV/G2, TTF/G2, TSF/G2...(Other models you can see in the webshop)		

1

GEV No.	102487	Ref. No.	0C3648
description	pilot tube tube ø 4mm L 530mm W 190mm H 90mm for N900 mounting pos. rear		

universal

1

GEV No.	102110	Ref. No.	006249 054810 0C0152 0C0153 0C0626 517824900 517870202
description	pilot tube copper pipe ø 4mm thickness 1mm L 3000mm		
For models:	PC/G1, PC/G2, PCV/G2, PCV/G3, PCF/G2, PCF/G3, PCF/M2, PCF/M3, PCF/M2E5, PTV/G2, PTF/G2, PSF/G2, PSV/G2, PSF/G3, PCV/G2N, PCF/G3N, PC/G2HV, PCV/G3N, PCF/G2N, PC/G1HV, PTV/G2N, PCV/G2A, PCV/G3A, PCF/G2A, PCF/G3A, OC/G1, OC/G2, OCV/G2, OCF/G2, OCF/G3, OCF/M2, OTV/G2, OTF/G2, OSF/G2, OSV/G2, TCV/G2, TCV/G3, TCF/G2, TCF/G3, TTF/G2, TSF/G2, TSF/G3, TCV/G2A, TCV/G3A, TCF/G2A, TCF/G3A, RPN/G760, RPN/G760, PRPN/G760, KC/G1...(Other models you can see in the webshop)		
accessories for	102110		
	GEV No.	100908	Ref. No.
			046755 052125 0958013 0G2219 0K1348 0K5753 0KE882 0KL495 19012956 727742 727781
	union screw thread M10x1 for pipe ø 4mm Qty 1 pcs		
	GEV No.	101246	Ref. No.
			052127 727782
	olive for pipe ø 4mm Qty 1 pcs		

gas hoses

CE approval to DIN 3383-1 EN 14800

1

GEV No.	250065	Ref. No.	0S1006
description	gas hose L 1000mm 1/2" IT - 1/2" ET braided EN 14800 DN12		

1

GEV No.	250067	Ref. No.	0S1007
description	gas hose L 1500mm 1/2" IT - 1/2" ET braided EN 14800 DN12		

1

GEV No.	250069	Ref. No.	0S1015
description	gas hose L 2000mm 1/2" IT - 1/2" ET braided EN 14800 DN12		



1	
GEV No.	250063
Ref. No.	051025
description	gas hose L 500mm 1/2" IT - 1/2" ET braided EN 14800 DN12

1	
GEV No.	250056
Ref. No.	051005
description	gas hose L 1000mm 1/2" IT - 1/2" IT braided EN 14800 DN12

1	
GEV No.	250057
Ref. No.	051008
description	gas hose L 1500mm 1/2" IT - 1/2" IT braided EN 14800 DN12

1	
GEV No.	250058
Ref. No.	051003
description	gas hose L 2000mm 1/2" IT - 1/2" IT braided EN 14800 DN12

1	
GEV No.	250059
Ref. No.	051026
description	gas hose L 500mm 1/2" IT - 1/2" IT braided EN 14800 DN12

UNI CIG 9891

1	
GEV No.	250037
Ref. No.	004019 051258
description	gas hose UNI CIG 9891 extendable L 450-1000mm 3/4" IT - 3/4" IT unbraided with SS connections

1	
GEV No.	520458
Ref. No.	051259
description	gas hose UNI CIG 9891 extendable L 900-2000mm 3/4" IT - 3/4" IT unbraided with SS connections

miscellaneous

1	
GEV No.	250000
Ref. No.	0H6831 OKI190 263346
description	gas hose L 790mm nominal-ø 12mm for tilting bratt pan SS
For models:	7542-2, 7544-2, 7742-2, 7744-2, 9042-2, 9044-2

pressure switches

1	
GEV No.	541182
Ref. No.	OK1397
description	pressure control
For models:	9100-2, 9101-2, 9102-2, 9104-2, 9113-2, 9114-2, 9115-2, 9116-2

1	
GEV No.	541073
Ref. No.	002635 0360001 OK2021 60050317
description	pressure control ø 45mm pressure range adjustable 5-20mbar pressure connection vertical gas technology connection 1/4" pressure connection ø 1/4"mm
For models:	FCV/G10L3, FCVG10L3T, FCVG102L3, FCVG10L3J, FCVG102L3J, FCV/G10L6JAP, FCV/G102/1L6JAP, FCVG6L3CJ, FCV/G10L2, FCV/G6L3C, FCV/G61/1, FCV/G61/1, FCV/G61/1, FCV/G61/1, FCVG6L3CT, FCVG6L3CJ, FCV/G6L4, FCV/G10L6, FCV/G102/1L6, FCV/G101/1, FCV/G102/1, FCS061G48J, FCS061GP, FCS061G3DI, FCS061G4, FCS061G4DT, FCS061G49J, FCS101G2, FCS101G4, FCS101G4DT, FCS101GP9J, FCS101G49J, FCS101GP, FCS102G4, FCS102GA9J, FCS102G49J, FCS102GP, FCS101GX9J, FCS101GX, FCS102GX9J, FCS102GX, 5721-2-7, 5721-2-10, ECV/G6T4, ECV/G10T4, ECVG102T4, ECV/G6T4C, ECV/G10T4J, ECV/G61/1, ECV/G61/1...(Other models you can see in the webshop)

1	
GEV No.	541867
Ref. No.	003772 60050313 C6065A1275 C6065A1275B
description	pressure control ø 80mm reset pressure 0.42bar triggering pressure 0.78mbar connection 7.5/10.5mm 250V voltage AC 1CO pressure connection ø 7.5-10.5mm
For models:	FDV40G, FDV40GZ, FDV40GA, FDV20G, FDV20GZ, FDV20GA, FCV/G10L3, FCVG10L3T, FCVG102L3, FCV/G20L3, FCVG202L3, FCVG10L3J, FCVG102L3J, FCV/G10L6JAP, FCV/G102/1L6JAP, FCV/G10L2, FCV/G10L6, FCV/G102/1L6, FCV/G20L6, FCVG202L6, FCV/G101/1, FCV/G102/1, FCS101G2, FCS101G4, FCS101G4DT, FCS101GP9J, FCS101G49J, FCS101GP, FCS102G4, FCS102GA9J, FCS102G49J, FCS102GP, FCS101GX9J, FCS101GX, FCS102GX9J, FCS102GX, 5712-2-6, 5712-2-7, 5712-2-8, 5712-2-10, 5714-2-6, 5714-2-7, 5714-2-8, 5714-2-10, 5717-2-6, 5714-2-7, 5714-2-8, 5714-2-10, 5712-2-6L, 5712-2-7L...(Other models you can see in the webshop)



 <p>1</p>			
GEV No.	541446	Ref. No.	005029 0360002
description	pressure control pressure range 10-50mbar connection 1/4"		
For models:	FDV40G, FDV40GZ, FDV40GA, FDV20G, FDV20GZ, FDV20GA, FCV/G20L3, FCVG202L3, FCV/G20L6, FCVG202L6, FCV/G201/1, FCV/G202/1, FCS201G4, FCS201GP, FCS202G4, FCS201GX, 5711-2-6, 5711-2-7, 5711-2-8, 5711-2-10, 5711-2-8CH, 5711-2-10CH, 5712-2-6, 5712-2-7, 5712-2-8, 5712-2-10, 5714-2-6, 5714-2-7, 5714-2-8, 5714-2-10, 5717-2-6, 5714-2-7, 5714-2-8, 5714-2-10, 5711-2-6L, 5711-2-7L, 5711-2-8L, 5711-2-10L, 5712-2-6L, 5712-2-7L, 5712-2-8L, 5712-2-10L, 5714-2-6L, 5714-2-7L, 5714-2-8L, 5714-2-10L, 5714-2-6L, 5714-2-7L, 5714-2-8L, 5714-2-10L...(Other models you can see in the webshop)		

 <p>1</p>			
GEV No.	541075	Ref. No.	002640 OK2020
description	pressure control pressure range adjustable 0.44-0.8mbar gas technology connection 6mm suitable for ZANUSSI		

 <p>1</p>			
GEV No.	541797	Ref. No.	006536
description	pressure control triggering pressure 0.5mbar pressure range 0.8/0.6mbar pressure connection horizontal gas technology connection 6mm 250V		
For models:	FCV/G20L3, FCVG202L3, FCV/G20L6, FCVG202L6, FCV/G201/1, FCV/G202/1, FCS201G4, FCS201GP, FCS202G4, FCS202GP, FCS201GX, FCS202GX, ECV/G20T4, ECVG202T4, ECV/G20T4J, ECV/G20T6, ECVG202T6, ACV/G20C4, ACVCG202C4, ACVCG202C6		

 <p>1</p>			
GEV No.	541352	Ref. No.	005746 0380072
description	pressure control triggering pressure 1.5mbar reset pressure 1.2mbar pressure range 1.5/1.2mbar pressure connection horizontal gas technology connection 6mm suitable for ZANUSSI		
For models:	FCVG6L3CJ, FCV/G6L3C, FCV/G61/1, FCV/G61/1, FCV/G61/1, FCV/G61/1, FCVG6L3CT, FCVG6L3CJ, FCS061G48J, FCS061GP, FCS061G3DI, FCS061G4, FCS061G4DT, FCS061G49J, 5721-2-7, 5721-2-10, ECV/G6T4C, ECV/G61/1, ECV/G61/1, RCV061G2, ACV/G6C3C, ZCV/G6T4C, ZCV/G61/1		

consumables

gas tap greases

 <p>1</p>			
GEV No.	890102	Ref. No.	050001 050002 050183 050245 167309285
description	gas tap grease FERMIT GLISSA tube 60g -20 up to +150°C approval DVGW		
description	Fermit GLISSA - tube 60g High-grade lubricant for gas valves and fittings and actuators in accordance with DIN EN 377 Glissa all gas valve grease is resistant to all gases and gas mixtures mentioned in DVGW worksheet G 260 and corresponds to DIN DVGW 96.01e1055 Synthetic, non-dropping, ductile Temperature range: up to +150°C		

lava rocks / ceramic briquettes

 <p>1</p>			
GEV No.	211008	Ref. No.	050859 OKA143 OKA145 OKA146
description	lava rocks size ca.20-70mm Qty 5kg		
For models:	MG/G350D, MG/G700D, MG/G350, MG/G350E, MG/G350F, MG/G350NL, MG/G700, MG/G700E, MG/G700F, MG/G700NL, MG/G1050, MG/G1050F, MG/G1051, RG/G1, RG/G2, RGV/G1, RGV/G2, XG/G1, XG/G2, XGV/G1, XGV/G2, JG/G1, JG/G2, JGV/G1, JGV/G2, MG/G1, MG/G2, MGV/G1, MGV/G2, RG/G350D, RG/G700D, 7GLG03, RG/G350F, 7GLG07, RG/G700F, 7GLG10, RG/G1050, XG/G350D, XG/G700D, T35GCG, XG/G350E, XG/G350F, XG/G350NL, T70GCG, XG/G700E, XG/G700F, XG/G700NL, T105GCG, XG/G1050F, CG/G701...(Other models you can see in the webshop)		



meters

leak detectors



1

GEV No.	802153	Ref. No.	052023
description	leak detector natural/liquid gas signal optic/acoustic incl. bag and battery display LED type SE151NM dimensions 90x160x30mm sensor external 275 + 1500mm cablemm		

for meat mincers

grinder plates

ENTERPRISE

with 2 notches

with hub



1

GEV No.	696112	Ref. No.	0KJ046
description	grinder plate type ENTERPRISE size 12 hole ø 3mm with hub grooves 2 stainless steel ø 70mm		
For models:	H70H, H70DS, HV82H, HV82H, H70DS, H70H		

equipment-specific units

for slicers

blades

standard



1

GEV No.	697399	Ref. No.	033743 0SI410 3026111 350GX
description	slicing machine blade ED ø 350mm seat ø 57mm 4 hole ID ø 280mm H 22.5mm C45 standard		
For models:	AG35, AV35, Europa350, Europa350, MAX350, LUX350, MEAT350, EUROPA350, AV35, MEET350		



1

GEV No.	696114	Ref. No.	0KJ047
description	grinder plate type ENTERPRISE size 12 hole ø 4.5mm with hub grooves 2 stainless steel ø 70mm		
For models:	H70H, H70DS, HV82H, HV82H, H70DS, H70H		

grindstones

grindstones cup form



1

GEV No.	697601	Ref. No.	0PR610
description	grindstone ø 45mm thickness 15mm bore ø 6mm grained coarse without bevel		
For models:	Europa350, EUROPA370		



1

GEV No.	696116	Ref. No.	0KJ048
description	grinder plate type ENTERPRISE size 12 hole ø 8mm with hub grooves 2 stainless steel ø 70mm		
For models:	H70H, H70DS, HV82H, HV82H, H70DS, H70H		



UNGER



1

GEV No.	696017	Ref. No.	OKQ566
description	grinder plate type Unger size 12 hole ø 3mm flat grooves 1 stainless steel ø 69.6mm		
For models:	H70H, H70DS, HV82H, HV82H, H70DS, H70H		



1

GEV No.	696018	Ref. No.	OKQ565
description	grinder plate type Unger size 12 hole ø 4.5mm flat grooves 1 stainless steel ø 69.6mm		
For models:	H70H, H70DS, HV82H, HV82H, H70DS, H70H		



1

GEV No.	696298	Ref. No.	OKQ564
description	grinder plate type Unger size 12 hole ø 8mm flat grooves 1 stainless steel ø 69.6mm		
For models:	H70H, H70DS, HV82H, HV82H, H70DS, H70H		

for cutters

lids



1

GEV No.	694584	Ref. No.	653512 8FRJ653512 9463
description	casing cover for cutter ø 208mm ID ø 200mm polycarbonate		
For models:	MVS-01, K25-01, K25-02, K25-03, MVS-02, K25-04, K25-05, K25-06, K25-09, K25-08, K25-07, DK25, DK25G, K25-10		

for vegetable slicers

lids



1

GEV No.	696465	Ref. No.	OKQ401 2881 DS02881
description	lid for vegetable slicer plastic ø 51mm		
For models:	CUTE0523, CUTE0538, KT055, KT056, K35-11, K55-01, K55E-01, K35-01, K55-02, K35-03, K35-03, K55E-05, K55-03, K35-04, K55-04, K35-05, K35-06, K55-05, K55E-02, K55E-03, K55-06, K35-07, K35-08, K55E-04, K55-07, K35-09, K55-08, K55E-12, K55E-07, K35-17, K35-15, K35-23, K55E-10, K35-13, K35-21, K55-12, K35-14, K35-16, K55E-09, K55E-08, K55E-13, K55E-06, K35-19, K35-22, K35-20, K35-12, K55-10, K35-24, K35-25, K35-06...(Other models you can see in the webshop)		

press levers



1

GEV No.	697898	Ref. No.	033638
description	lever for vegetable slicer L 94mm W 38mm H 38mm plastic TRS/3		
For models:	TRS-3-02, TRS-3-03, TRS-1-02, TRS-1-03, TRS-3-04, TRS-3-05, TRS-1-04, TRS-1-05, TRS-1-06, TRS-1-07, TRS-1-08, TRS-3-06, TRS-3-07, TRS-1-09, TRS-1-10, TRS-1-11, TR22-01, TR24, TRS-3-08, TRS-1-12, TRS-3-09, TRS-1-13, TR23-01, TR22-02, TR23-02, TRS-3-10, TR22-03, TR22-04, TR23-03, TR23-04, TR24-02, TRS-1-14, TRS-3-11, TRS-1-15, TRS-1-16, TRS-3-12, TRS-3-13, TRS-3-14, TRS-1-17, TRS-1-18, TRS-1-20, TRS-1-21, TRS-1-22, TRS-3-15, TRS-1-23, TRS-1-25, TRS-1-26, TRS-1-27, TRS-3-16, TRS-3-17...(Other models you can see in the webshop)		



1

GEV No.	699399	Ref. No.	032549 OKI992
description	plunger for vegetable slicer L 175mm plastic		
For models:	TGVE211, TGVE233, TV02, TV03, MULTI2-02, MULTI2-04, MULTI2-05, TRX-01, TRX-02, MULTI2-06, TRX-07, TRX-08, TRX-09, TRX-04, TRX-06, TRX-03		

ejector discs

			
1			
GEV No.	699131	Ref. No.	0KJ002 31003 4277 504277 DS04277 SPDS04277
description	ejector disc H 15mm ø 190mm seat ø 23/28mm		
For models:	MULTI2-01, TRS-3-02, TRS-3-03, TRS-1-02, TRS-1-03, MULTI2-02, TRS-3-04, TRS-3-05, TRS-1-04, TRS-1-05, TRS-1-06, MULTI2-03, TRS-1-07, TRS-1-08, TRS-3-06, TRS-3-07, TRS-1-09, MULTI2-04, MULTI2-05, TRX-01, TRX-02, TRS-1-10, TRS-1-11, TR22-01, TR24, TRS-3-08, TRS-1-12, TRS-3-09, TRS-1-13, MULTI2-06, TR23-01, TR22-02, TR23-02, TRS-3-10, TR200-07, TR22-03, TR22-04, TR23-03, TR23-04, TR24-02, TRS-1-14, TRS-3-11, TRS-1-15, TRS-1-16, TRS-3-12, TRS-3-13, TRS-3-14, TRX-07, TRX-08, TRX-09...(Other models you can see in the webshop)		

			
1			
GEV No.	699151	Ref. No.	OD5554
description	ejector disc H 25.5mm seat ø 23x28mm hole distance 42.5mm L 192mm		
For models:	TRS1V-01, TRS1V-02, TRS1V-03, TRS2V-01, TRK45VV-01, TRK55VV-01, TRK70VV-01, TRS1V-04, TRK55VV-02, TRK55VV-03, TRK70VV-03, TRS1V-05, TRS1V-06, TRS1V-07, TRS2V-02, TRK45VV-02, TRK70VV-02, TRK45VV-03, TRS1V-08, TRS1V-09, DTRK45VV, DTRK45VVG, DTRK55VV, DTRK55VVG, DTRK70VV, DTRK70VVG, TRS1V-02, TRS1V-01, TRS1V-03, TRS2V-01, TRSVV-01, TRS1V-07, TRS1V-10, TRSVV-01		

			
1			
GEV No.	699111	Ref. No.	0KI843 23038 9209 DS23038 DSM23038 SPDS09209
description	ejector disc H 30mm ø 179mm shaft diameter 14x11mm		
For models:	MINIG-01, MULTIG-01, MINIG-02, MULTIG-02, MULTIG-03, MULTIG-04, MINIG-03, MULTIG-05, MINIG-04, MULTIG-06, MULTIG-07, MIGHTY-01, MULTIG-08, MULTIG-22, MULTIG-10, MULTIG-17, MULTIG-19, MULTIG-16, MULTIG-15, MULTIG-14, MULTIG-21, MULTIG-20, MULTIG-13, MULTIG-18, MULTIG-12, MULTIG-04, MULTIG-05, MULTIG-06, DMIG4, DMIG, DMIG4G, DMIGG, CL17G, MULTIG-09		

miscellaneous

			
1			
GEV No.	110703	Ref. No.	004148
description	cylindrical handle thread M10 ø 28mm L 87mm		
For models:	ZCMME6, ZCBME12, ZCMME4, ZCBME8, ZCMME9, ZCBME18		

			
1			
GEV No.	696474	Ref. No.	033099 0KI095 4257 504257 70254257 DS04257
description	lever L 93mm ABS plastic for catch		
For models:	TGVE211, TGVE233, TV02, TV03, TRS-3-02, TRS-3-03, TRS-1-02, TRS-1-03, TRS-3-04, TRS-3-05, TRS-1-04, TRS-1-05, TRS-1-06, TRS-1-07, TRS-1-08, TRS-3-06, TRS-3-07, TRS-1-09, TRS-1-10, TRS-1-11, TR22-01, TR24, TRS-3-08, TRS-1-12, TRS-3-09, TRS-1-13, TR23-01, TR22-02, TR23-02, TRS-3-10, TR22-03, TR22-04, TR23-03, TR23-04, TR24-02, TRS-1-14, TRS-3-11, TRS-1-15, TRS-1-16, TRS-3-12, TRS-3-13, TRS-3-14, TRS-1-17, TRS-1-18, TRS-1-20, TRS-1-21, TRS-1-22, TRS-3-15, TRS-1-23, TRS-1-25...(Other models you can see in the webshop)		

for cheese graters

miscellaneous

			
1			
GEV No.	110703	Ref. No.	004148
description	cylindrical handle thread M10 ø 28mm L 87mm		
For models:	ZCMME6, ZCBME12, ZCMME4, ZCBME8, ZCMME9, ZCBME18		

for potato peelers

lids

			
1			
GEV No.	696727	Ref. No.	0KJ025
description	lid ø 310mm ID ø 275mm H 60mm mounting distance 90mm plastic		
For models:	T5, T5S-01, T5S-02, T5S-03, T5S-04, T5S-08, T5S-09, T5S-10, T5S-11, T5S-07, T5S-05, T5S-06, T5S-03, T5S-12, T5S-12		



abrasive side elements

inserts



1

GEV No.	696202	Ref. No.	037236 7ROGPL1003 PL100/3
description	abrasive band potato peeler ø 300mm L 205mm mounting distance 120mm PP4 Expo		
For models:	PP4, PL4T24V		

grinding discs



1

GEV No.	696377	Ref. No.	037546 9720625
description	grating disc ø 350mm for potato peeler device		
For models:	PP15, PL15T24V		

for dough mixers

chains

roller chains 08B-1 single



1

GEV No.	693275	Ref. No.	056862
description	roller chain DIN/ISO 08 B-1 splitting 1/2" / 12.7mm links 23 internal width 7.75mm rollerø 8.51mm single without connecting bow		
For models:	MBR/G710D, MBR/E710D, MBR/G700, MBR/G700F, MBR/E700, MBR/E700UK, MBR/G700UK, MBR/G701, MBR/G706, MBR/G701UK, MBR/G751, MBR/G756, MBR/E716, MBR/E706, RBR/G710D, 7BRE60XN, RBR/G700, RBR/G700F, 7BRE60X, RBR/E700UK, 7BRG60, 7BRG60X, RBR/G701UK, RBR/G751, RBR/G756, RBR/E716, RBR/E706, XBR/G710D, XBR/E710D, XBR/G700, XBR/G710, M70EBP, XBR/G700F, XBR/G700UK, XBR/E710, XBR/G701, M70GBP, XBR/G701UK, XBR/G751, XBR/G756, CBR/G700, CBR/E700, XBR/E716, XBR/E706, RBR/G700, RBR/E700, RBR/G700, RBR/E700, ZRBR/G700, ZRBR/G700D...(Other models you can see in the webshop)		

connectors



1

GEV No.	693276	Ref. No.	056863
description	connector single DIN/ISO 08 B-1 splitting 1/2" links 1 L 23mm internal width 11.8mm rollerø 4.3mm metal		
For models:	MBR/G710D, MBR/E710D, MBR/G700, MBR/G700F, MBR/E700, MBR/E700UK, MBR/G700UK, MBR/G701, MBR/G706, MBR/G701UK, MBR/G751, MBR/G756, MBR/E716, MBR/E706, RBR/G710D, 7BRE60XN, RBR/G700, RBR/G700F, 7BRE60X, RBR/E700UK, 7BRG60, 7BRG60X, RBR/G701UK, RBR/G751, RBR/G756, RBR/E716, RBR/E706, XBR/G710D, XBR/E710D, XBR/G700, XBR/G710, M70EBP, XBR/G700F, XBR/G700UK, XBR/E710, XBR/G701, M70GBP, XBR/G701UK, XBR/G751, XBR/G756, CBR/G700, CBR/E700, XBR/E716, XBR/E706, RBR/G700, RBR/E700, RBR/G700, RBR/E700, ZRBR/G700, ZRBR/G700D...(Other models you can see in the webshop)		

dough hooks

with mounting groove



1

GEV No.	697042	Ref. No.	0D3269
description	dough hook shaft ø 15mm usable height 279mm NT10		
For models:	PSN10-01, PSN20-01, PSN30-01, PSN30-02		



1

GEV No.	699397	Ref. No.	OKJ063 653161 8FRJ653161
description	dough hook shaft ø 24mm BM20/30 ELECTROLUX, ZANUSSI H 375mm		
For models:	BM20AS-01, BM20AS-02, BM20AS-03, BM20AS-04, BM30AS-01, BM30AS-02, BM20AS-05, BM30AS-03, BM20AS-06, BM30S-01, BM20AS-07, BM20AS-12, BM20S-01, BM20S-02, BM20S-03, BM30AS-04, BM30S-02, BM20AS-13, BM20AS-08, BM20S-04, BM30AS-05, BM20AS-09, BM20AS-10, BM30AS-06, BM20AS-11, EM20AS-01, EM20AS-02, EM30AS-01, BM20AS-14, BM20AS-15, BM20AS-16, BM20AS-17, BM20S-05, BM20AS-18, BM20AS-19, BM20AS-20, BM20AS-21, BM20S-06, BM20S-07, BM30AS-07, BM20AS-22, BM20S-08, BM20AS-23, BM30AS-08, BM30S-03, BM30S-04, BM30AS-11, BM30AS-09, BM30S-06, BM30AS-10...(Other models you can see in the webshop)		



miscellaneous



GEV No.	697296	Ref. No.	OD0669 21970
description	pin for spindle ø 3.3mm L 13mm Qty 10 pcs		
For models:	B2000K-01, B2000K-02, B2000K-03, B2000K-04, B2000T-01, B2000T-02, B2000T-03, B2000-4-01, B2000K-05, B2000MU-01, B2000-4-02, B2000-5-01, B2000-3-01, B2000MU-02, B2000K-06, B2000-4-03, B2000-5-02, B2000-6-01, B2000K-07, B2000-6-02, B2000-6-03, B2000-5-03, B2000-6-04, B2000K-08, B2000-4-04, B2000-5-04, B2000-5-05, B2000-6-05, B2000K-09, B2000-5-13, B2000-5-06, B2000-6-06, B2000-4-05, B2000-6-07, B2000K-10, B2000-4-06, B2000-5-07, B2000K-11, B2000-4-07, B2000-6-08, B2000K-12, B2000-5-08, B2000MU-03, B2000MU-04, B2000-5-09, B2000-6-13, B2000MU-05, B2000MU-06, B2000MU-07, B2000K-13...(Other models you can see in the webshop)		

for planetary mixers

dough hooks



GEV No.	698336	Ref. No.	29714 653523 8FRJ653523
description	dough hook shaft intake ø 24mm H 440mm flange ø 68.5mm		

miscellaneous



GEV No.	699257	Ref. No.	OD0955 7DSM24679
description	cotter pin set ø 8mm L 34mm		
For models:	BE12AS-01, BE20AS-01, BM20AS-01, BM20AS-02, BM20AS-03, BM20AS-04, BM30AS-01, BM30AS-02, BM20AS-05, BM30AS-03, BM20AS-06, BE20S-01, BE20AS-02, BM30S-01, BM20AS-07, BM20AS-12, BM20S-01, BM20S-02, BM20S-03, BM30AS-04, BM30S-02, BM20AS-13, BM20AS-08, BM20S-04, BM30AS-05, BE20S-02, BE20AS-03, XBM30AS-01, XBM30S-01, BM20AS-09, XBM30AS-02, BM20AS-10, BM30AS-06, BM20AS-11, XBM30AS-03, EM20AS-01, XBM20S-01, XBM20AS-01, XBM20S-02, XBM20AS-02, XBE20S-01, XBE20AS-01, XBE30S-01, XBE30AS-01, EM20AS-02, EM30AS-01, BE20S-03, BE20AS-04, BM20AS-14, BM20AS-15...(Other models you can see in the webshop)		

for dough roller

rollers

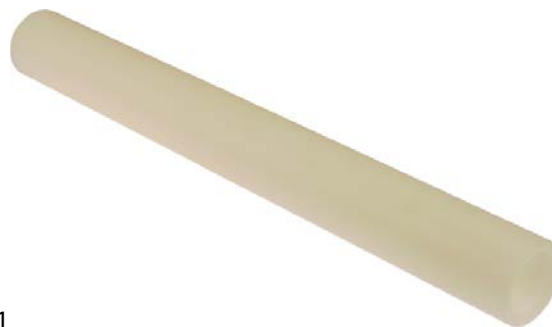

GEV No.	693912	Ref. No.	OPR019 3003950 7PIZ3003950
description	roller L 422mm ø 48mm mounting pos. bottom at the back		
For models:	ZFF40		

couplings



GEV No.	692011	Ref. No.	033750 4203200 4203250	
description	coupling ø 41.5mm ID ø 25mm H 12mm			
For models:	ZFF30, ZFF40			
accessories for	692011			
	GEV No.	692012	Ref. No.	—
	coupling ø 35mm ID ø 25mm H 14mm			



GEV No.	693919	Ref. No.	033740
description	mixer coupling		
For models:	BRN70G, BRN70E, BRN/70GZ, BRN/70EZ, BR70GZ, BR70EZ, BRNG70A, BRNE70A, HCPA/G1219, BR70E, CPD42G-Z, CPD40GZ, CPD42V-Z, CPD42E-Z, CPD40VZ, CPD40EZ		



pinions

rear mounting



1

GEV No.	697109	Ref. No.	034202 3203510 7PIZ3203510
description	pinion ø 47.5mm H 35mm mounting pos. rear ID ø 25mm for dough roller		
For models:	ZFF30, ZFF40		

front mounting



1

GEV No.	697108	Ref. No.	033747 3203410
description	pinion ø 47.5mm H 35mm mounting pos. front ID ø 14mm for dough roller		
For models:	ZFF30, ZFF40		

for hand blenders

spare parts and accessories



1

GEV No.	346885	Ref. No.	0D0723 22460 DS22460
description	actuator Qty 10 pcs		
For models:	B2000K-01, B2000K-02, B2000K-03, B2000K-04, B2000T-01, B2000T-02, B2000T-03, B2000-4-01, B2000K-05, B2000MU-01, B2000-4-02, B2000-5-01, B2000-3-01, B2000MU-02, B2000K-06, B2000-4-03, B2000-5-02, B2000-6-01, B2000K-07, B2000-6-02, B2000-6-03, B2000-5-03, B2000-6-04, B2000K-08, B2000-4-04, B2000-5-04, B2000-5-05, B2000-6-05, B2000K-09, B2000-5-13, B2000-5-06, B2000-6-06, B2000-4-05, B2000-6-07, B2000K-10, B2000-4-06, B2000-5-07, B2000K-11, B2000-4-07, B2000-6-08, B2000K-12, B2000-5-08, B2000MU-03, B2000MU-04, B2000-5-09, B2000-6-13, B2000MU-05, B2000MU-06, B2000MU-07, B2000K-13...(Other models you can see in the webshop)		



1

GEV No.	692578	Ref. No.	0D1035
description	bush thickness 20.5mm ID ø 25.6mm ext. ø 33 copper		
For models:	BE12AS-01, BE20AS-01, BM20AS-01, BM20AS-02, BM20AS-03, BM20AS-04, BM30AS-01, BM30AS-02, BM20AS-05, BM30AS-03, BM20AS-06, BE20S-01, BE20AS-02, BM30S-01, BM20AS-07, BM20AS-12, BM20S-01, BM20S-02, BM20S-03, BM30AS-04, BM30S-02, BM20AS-13, BM20AS-08, BM20S-04, BM30AS-05, BE20S-02, BE20AS-03, XBM30AS-01, XBM30S-01, BM20AS-09, XBM30AS-02, BM20AS-10, BM30AS-06, BM20AS-11, XBM30AS-03, EM20AS-01, XBM20S-01, XBM20AS-01, XBM20S-02, XBM20AS-02, XBE20S-01, XBE20AS-01, XBE30S-01, XBE30AS-01, EM20AS-02, EM30AS-01, BE20S-03, BE20AS-04, BM20AS-14, BM20AS-15...(Other models you can see in the webshop)		



1

GEV No.	651048	Ref. No.	OKJ066 15906 18622 702518622 DS18622
description	coupling D1 ø 16mm L 33mm Qty 5 pcs int. ø 1 7.4mm		
For models:	BERM-4-01, BERMK-01, BERM-3-01, BERM-MU-01, BERM-4-02, BERM-5-01, BERM-5-02, BERM-6-01, BERM-MU-02, BERM-MU-03, BERM-MU-04, BERMK-02, BERM-MU-05, BERMK-03		



1

GEV No.	699197	Ref. No.	0D5234
description	sealing ring ø 55mm H 5mm		
For models:	B3000-3-01, B3000-4-02, B3000-4-08, B3000-4-07, B3000-4-01, B3000-4-03, B3000-5-01, B3000-5-02, B3000-6-02, B3000-6-01, B3000-4-05, B3000-4-04, B3000-5-03, B3000-5-04, B3000-6-03, B3000-5-05, B3000-5-06, B3000-4-06, B3000-5-07, B3000-5-08, B3000-6-04, B3000-6-07, B3000-6-06, B3000-6-05, B3000MU-01, B3000MU-02, B3000MU-03, B3000MU-04, B3000MU-05, B3000MU-07, B3000MU-06, B3000-W-01, B3000K-02, B3000K-01, B3000K-08, B3000K-04, B3000K-03, B3000K-07, B3000K-06, B3000K-05, B3000MU-08, B3000MU-09, B3000MU-10, B3000MU-11, B3000MU-12, B3000K-09, DBM335, DBM345, DBM335G, DBM445...(Other models you can see in the webshop)		



1

GEV No.	697952	Ref. No.	OKQ655 12013 DS12013
description	spacer piece ID ø 39mm ext. ø 47 thickness 5.7mm		
For models:	MB40S-01, MB40S-02, EM40AS-01, MB40S-03, MB40S-04, XEM40S, MB40S-11, MBE40S-06, MBE40S-05, DMB40S3, MBE40S-05, MBE40S-06		

couplings



1

GEV No.	523549	Ref. No.	OD5260
description	bearing complete		
For models:	B3000-3-01, B3000-4-02, B3000-4-08, B3000-4-07, B3000-4-01, B3000-4-03, B3000-5-01, B3000-5-02, B3000-6-02, B3000-6-01, B3000-4-05, B3000-4-04, B3000-5-03, B3000-5-04, B3000-6-03, B3000-5-05, B3000-5-06, B3000-4-06, B3000-5-07, B3000-5-08, B3000-6-04, B3000-6-07, B3000-6-06, B3000-6-05, B3000MU-01, B3000MU-02, B3000MU-03, B3000MU-04, B3000MU-05, B3000MU-07, B3000MU-06, B3000-W-01, B3000K-02, B3000K-01, B3000K-08, B3000K-04, B3000K-03, B3000K-07, B3000K-06, B3000K-05, B3000MU-08, B3000MU-09, B3000MU-10, B3000MU-11, B3000MU-12, B3000K-09, DBM335, DBM345, DBM335G, DBM445...(Other models you can see in the webshop)		



1

GEV No.	697853	Ref. No.	OD5220
description	coupling set D1 ø 16mm D2 ø 20mm int. ø 17mm L 54mm teeth 8		
For models:	B3000-3-01, B3000-4-02, B3000-4-08, B3000-4-07, B3000-4-01, B3000-4-03, B3000-5-01, B3000-5-02, B3000-6-02, B3000-6-01, B3000-4-05, B3000-4-04, B3000-5-03, B3000-5-04, B3000-6-03, B3000-5-05, B3000-5-06, B3000-4-06, B3000-5-07, B3000-5-08, B3000-6-04, B3000-6-07, B3000-6-06, B3000-6-05, B3000MU-01, B3000MU-02, B3000MU-03, B3000MU-04, B3000MU-05, B3000MU-07, B3000MU-06, B3000-W-01, B3000K-02, B3000K-01, B3000K-08, B3000K-04, B3000K-03, B3000K-07, B3000K-06, B3000K-05, B3000MU-08, B3000MU-09, B3000MU-10, B3000MU-11, B3000MU-12, B3000K-09, DBM335, DBM345, DBM335G, DBM445...(Other models you can see in the webshop)		



1

GEV No.	696466	Ref. No.	OKR061 22308 23413 DS23413
description	coupling set D1 ø 23mm D2 ø 11mm int. ø 17/8mm L 44mm teeth 8		
For models:	B2000K-01, B2000K-02, B2000K-03, B2000K-04, B2000T-01, B2000T-02, B2000T-03, B2000-4-01, B2000K-05, B2000MU-01, B2000-4-02, B2000-5-01, B2000-3-01, B2000MU-02, B2000K-06, B2000-4-03, B2000-5-02, B2000-6-01, B2000K-07, B2000-6-02, B2000-6-03, B2000-5-03, B2000-6-04, B2000K-08, B2000-4-04, B2000-5-04, B2000-5-05, B2000-6-05, B2000K-09, B2000-5-13, B2000-5-06, B2000-6-06, B2000-4-05, B2000-6-07, B2000K-10, B2000-4-06, B2000-5-07, B2000K-11, B2000-4-07, B2000-6-08, B2000K-12, B2000-5-08, B2000MU-03, B2000MU-04, B2000-5-09, B2000-6-13, B2000MU-05, B2000MU-06, B2000MU-07, B2000K-13...(Other models you can see in the webshop)		

EQUIPMENT-SPECIFIC UNITS ELECTROLUX

blender sticks

spindles



1

GEV No.	697295	Ref. No.	OD0238 1487
description	drive shaft		
For models:	S4A3STD, S4A1STD, S8A3STD, S8A1STD		



1

GEV No.	698358	Ref. No.	OD3022 28213
description	spindle assembled D1 ø 13.8mm L 320mm aluminium		
For models:	B2000K-01, B2000K-02, B2000K-03, B2000K-04, B2000T-01, B2000T-02, B2000T-03, BERM-4-01, BERMK-01, BERM-3-01, B2000-4-01, B2000K-05, B2000MU-01, BERM-MU-01, B2000-4-02, B2000-5-01, BERM-4-02, BERM-5-01, BERM-5-02, BERM-6-01, B2000-3-01, BERM-MU-02, BERM-MU-03, BERM-MU-04, B2000MU-02, B2000K-06, B2000-4-03, B2000-5-02, B2000-6-01, B2000K-07, B2000-6-02, B2000-6-03, B2000-5-03, B2000-6-04, B2000K-08, B2000-4-04, B2000-5-04, B2000-5-05, B2000-6-05, B2000K-09, BERMK-02, BERM-MU-05, B2000-5-13, B2000-5-06, B2000-6-06, B2000-4-05, B2000-6-07, B2000K-10, B2000-4-06, B2000-5-07...(Other models you can see in the webshop)		

for fridges

spare parts and accessories



1

GEV No.	692229	Ref. No.	081823
description	drain fitting thread 1/2" ø 29mm L 75mm plastic		
For models:	ITP120UK, ITP120UK, AP20, ADN220ES, ADN110ESP, DUAL 2 DOORS, DUAL 2 DOORS, FV 1M, FV 1M, FV 2M, ALN110, ALN120, ADN111, AEN110, AEN120, AKN111, ADNN120, AENN120, ALN220, ALN240, ADN221, AEN220, AEN240, AEN221, ADNN220, ADN220, ADNN230, ADN230, AENN220, AENF220, AENN230, AENF230, ASN110, ASN111, ASN220, ASN221, AKN110UK, AKN220UK, ASN110UK, ASN220UK, ARDN110, ADN110E, ADN220E, 83012001, 83012033, ARDN220, ARDN221, 83012037, ASN110, ASF110...(Other models you can see in the webshop)		



			
1			
GEV No.	692230	Ref. No.	081797
description	opposite support thread 1/2" L 8mm for drain assembly plastic		
For models:	ITP120UK, ITP120UK, AP20, ADN220ES, ADN110ESP, FV 1M, FV 1M, FV 1M, FV 2M, FV 2M, FV 2M, FV 2M, FV 2M, DUAL 2 DOORS, DUAL 2 DOORS, FV 2M, FV 2M, FV 1M, FV 1M, FV 2M, ALN110, ALN120, ADN111, AEN110, AEN120, AKN111, ADNN120, AENN120, ALN220, ALN240, ADN221, AEN220, AEN240, AEN221, ADNN220, ADNF220, ADNN230, ADNF230, AENN220, AENF220, AENN230, AENF230, ASN110, ASN111, ASN220, ASN221, SM250, AKN110UK, AKN220UK, ASN110UK, ASN220UK... (Other models you can see in the webshop)		

			
2			
GEV No.	690632	Ref. No.	082757
description	pin refrigerated counter ø 5mm L 17mm		
For models:	AQC22U US, AQC119U US, , , , , BC44H, BCF44H, SM250, BC7, BCF7, BC56HA, BCF56HA, BC7, BCF7, BC10A, BLAST C/FREEZER, BCF7A, BLAST C/FREEZER, TRN1301, TRNA1301, TRNM1301, TRN1302, TRNA1302, TRNM1302, TRN1303, TRNA1303, TRNM1303, TRN1801, TRNA1801, TRNM1801, TRN1802, TRNA1802, TRNM1802, TRN1803, TRNA1803, TRNM1803, TRN2201, TRNA2201, TRNM2201, TRN2202, TRNA2202, TRNM2202, TRN2203, TRNA2203, TRNM2203, TRRN1301, TRRN1302, TRRN1303, TRRN1801... (Other models you can see in the webshop)		

housing and bezels

covers

			
1			
GEV No.	694337	Ref. No.	0A9666
description	bezel for lighting L 1375mm W 85mm H 18mm suitable for ELECTROLUX		
For models:	ADN111, AKN111, ADN221, AEN221, ASN111, ASN221, ARDN221, ADN111, ADN221, PR04R1GBR, PS04R1GM, 1-GL.DOOR REFRIG, PS04R1G, 1-GL.DOOR REFRIG, PS04R1GR, PR04R1G, PR04R1GR, MCD-6PGL, E06N0M1V, E06N1M1V, E06N0D1V, E06C0M1V, E06C1M1V, E06C0D1V, E14N0M2V, E14N1M2V, E14N0D2V, E14C0M2V, E14C1M2V, E14C0D2V, E05N0M1V, E05N1M1V, E12N0M2V, E12N1M2V, C06RD1G, C06RM1G, C06FD1G, C14RD2G, C14RM2G, C05RM1G, C12RM2G, RGD36, FGD36, RH06RD1G, C06FD1G, RH14RD2G, RS05RD1G, RS12RD2G, E06N0D1V, E06C0D1V... (Other models you can see in the webshop)		

control panel

			
1			
GEV No.	692285	Ref. No.	087796 087830 092129 0A9819
description	control panel		
For models:	83012001, 83012033, ARDNN120, 83012101, ARDN220, 83012037, ASN110, ASN220, ADN110, ADN120, ADNN120, ADNF120, ADN220, ADN240, ADNN220, ADNF220, ADNN230, ADNF230, ADN11060, ADN22060, TRN224C, TRN224D, TRN224E, TRN132A, TRN132B, TRN132C, TRNA132A, TRNA132B, TRNA132C, TRRN132A, TRRN132B, TRRN132C, TRN183A, TRN183B, TRN183C, TRN183D, TRNA183A, TRNA183B, TRNA183C, TRNA183D, TRRN183A, TRRN183B, TRRN183C, TRRN1842D, TRN224A, TRN224B, TRNA224A, TRNA224B, TRRN224A, TRRN224B... (Other models you can see in the webshop)		

for upright freezers

			
1			
GEV No.	699258	Ref. No.	092362
description	bezel for control part L 168mm W 38mm H 8mm		
For models:	ZPR04R1F, ZPR04F1F, PS04R1GM, PS06F1F6M, 1-DOOR REFRIG, PS04R1F, 1-DOOR REFRIG, PS04R1FR, 1-DOOR REFRIG, 2-DOOR REFRIG, PS04R2F, 1-GL.DOOR REFRIG, PS04R1G, 1-GL.DOOR REFRIG, PS04R1GR, PS06R1F, PS06R1FR, PS06R2F, PS06R2FR, 1-DOOR FREEZER, PS04F1F, 1-DOOR FREEZER, PS04F1FR, PS06F1F, PS06F1FR, PS06FE2F, PS04R1FM, PS04R1F6M, PS04R1F1M, PS04F1F6M, MCD650P, MCD650F, MCD650F2, MCD650FP2, MCD6PGL, MCD-65F2LR, RH06RD1F, RH06RD1FL, RH06RD1FR, RH06RD2F, RH06RD-2FR, RH06RD1G, RH06FD1F, RH06FD1FL, RH06FD1FR, RH06FD2F, RH06DD2F, RH06DD2FR, RH06DFD2F, RH14RD2F... (Other models you can see in the webshop)		

for refrigerated counters

spare parts and accessories



1

GEV No.	692229	Ref. No.	081823
description	drain fitting thread 1/2" ø 29mm L 75mm plastic		
For models:	ITP120UK, ITP120UK, AP20, ADN220ES, ADN110ESP, DUAL 2 DOORS, DUAL 2 DOORS, FV 1M, FV 1M, FV 2M, ALN110, ALN120, ADN111, AEN110, AEN120, AKN111, ADNN120, AENN120, ALN220, ALN240, ADN221, AEN220, AEN240, AEN221, ADNN220, ADNF220, ADNN230, ADNF230, AENN220, AENF220, AENN230, AENF230, ASN110, ASN111, ASN220, ASN221, AKN110UK, AKN220UK, ASN110UK, ASN220UK, ARDN110, ADN110E, ADN220E, 83012001, 83012033, ARDN220, ARDN221, 83012037, ASN110, ASF110...(Other models you can see in the webshop)		



2

GEV No.	692230	Ref. No.	081797
description	opposite support thread 1/2" L 8mm for drain assembly plastic		
For models:	ITP120UK, ITP120UK, AP20, ADN220ES, ADN110ESP, FV 1M, FV 1M, FV 1M, FV 2M, FV 2M, FV 2M, FV 2M, DUAL 2 DOORS, DUAL 2 DOORS, FV 2M, FV 2M, FV 1M, FV 1M, FV 2M, ALN110, ALN120, ADN111, AEN110, AEN120, AKN111, ADNN120, AENN120, ALN220, ALN240, ADN221, AEN220, AEN240, AEN221, ADNN220, ADNF220, ADNN230, ADNF230, AENN220, AENF220, AENN230, AENF230, ASN110, ASN111, ASN220, ASN221, SM250, AKN110UK, AKN220UK, ASN110UK, ASN220UK...(Other models you can see in the webshop)		



1

GEV No.	690632	Ref. No.	082757
description	pin refrigerated counter ø 5mm L 17mm		
For models:	AQC22U US, AQC119U US,,,,, BC44H, BCF44H, SM250, BC7, BCF7, BC56HA, BCF56HA, BC7, BCF7, BC10A, BLAST C/FREEZER, BCF7A, BLAST C/FREEZER, TRN1301, TRNA1301, TRNM1301, TRN1302, TRNA1302, TRNM1302, TRN1303, TRNA1303, TRNM1303, TRN1801, TRNA1801, TRNM1801, TRN1802, TRNA1802, TRNM1802, TRN1803, TRNA1803, TRNM1803, TRN2201, TRNA2201, TRNM2201, TRN2202, TRNA2202, TRNM2202, TRN2203, TRNA2203, TRNM2203, TRRN1301, TRRN1302, TRRN1303, TRRN1801...(Other models you can see in the webshop)		

for cold storage cells

pressure compensation valves



1

GEV No.	750332	Ref. No.	081971 646703100 780081971
description	pressure compensation valve mounting ø 61mm MiniElebar T.N. unheated for walk-in fridge +1 up to +10°C built-in depth 60mm mounting pos. horizontal		
For models:	ILP110, ILP110UK, ILN120, ILN110, ILN110UK, ILN120, ILF110, ILF110, IKNN220, IKNF120, ISPZ110, IKNF, FVNE051, IKNF220N, IKNN220, ZLP110, ZLN110, FVNE061, ZILN120, FVNE062		
spare parts for	750332		
		GEV No.	750335
		Ref. No.	—
	ventilation grille suitable for MiniElebar ø 86mm mounting distance 69.5mm H 14.5mm		

for ice-cube maker

drain systems

filters



1

GEV No.	695769	Ref. No.	086023
description	drain filter thread 7/8" ø 32mm H 10mm		

overflow pipes



1





GEV No.	695083	Ref. No.	085270
description	overflow pipe ID ø 22mm D1 ø 27mm D2 ø 19mm L 144mm		
For models:	FGC24AB, FGC24WB, FGC24ABS, FGC24WBAB, CB184A, FGC24AB, FGC24WB, C150W, C300A, C300W, CB1565W, CB246W, CB416W, CB955W, DSS42W, C80W, CB1565A, C80A, CB246A, CB416A, C150A, CB955A, FRESHMAKER, ICEWATER45, ICEWATER45, DSS42A		



1

GEV No.	695047	Ref. No.	086019
description	overflow pipe L 78mm straight		
For models:	CIM45A, CIM45W		



			
1			
GEV No.	695086	Ref. No.	087972
description	overflow pipe tube ø 20.5mm pipe length 88.6mm		
For models:	FGC33AS42, FGC46AS42, FGC65A42, MC140AB20, MC140WB20, MC200AB20, MC200WB20, FGC29AB, FGC29WB, FGC40A, FGC40W, FGC67AB, FGC67WB, FGC90A, FGC90W, FGC143AB, FGC143WB, FGC67A, FGC67B, FGC67C, FGC67D, FGC67E, FGC67F, FGC67G, FGC67H, FGC67I, FGC67J, FGC67K, FGC67L, FGC67M, FGC67N, FGC67O, FGC67P, FGC67Q, FGC67R, FGC67S, FGC67T, FGC67U, FGC67V, FGC67W, FGC67X, FGC67Y, FGC67Z, FGC67AA, FGC67AB, FGC67AC, FGC67AD, FGC67AE, FGC67AF, FGC67AG, FGC67AH, FGC67AI, FGC67AJ, FGC67AK, FGC67AL, FGC67AM, FGC67AN, FGC67AO, FGC67AP, FGC67AQ, FGC67AR, FGC67AS, FGC67AT, FGC67AU, FGC67AV, FGC67AW, FGC67AX, FGC67AY, FGC67AZ, FGC67BA, FGC67BB, FGC67BC, FGC67BD, FGC67BE, FGC67BF, FGC67BG, FGC67BH, FGC67BI, FGC67BJ, FGC67BK, FGC67BL, FGC67BM, FGC67BN, FGC67BO, FGC67BP, FGC67BQ, FGC67BR, FGC67BS, FGC67BT, FGC67BU, FGC67BV, FGC67BW, FGC67BX, FGC67BY, FGC67BZ, FGC67CA, FGC67CB, FGC67CC, FGC67CD, FGC67CE, FGC67CF, FGC67CG, FGC67CH, FGC67CI, FGC67CJ, FGC67CK, FGC67CL, FGC67CM, FGC67CN, FGC67CO, FGC67CP, FGC67CQ, FGC67CR, FGC67CS, FGC67CT, FGC67CU, FGC67CV, FGC67CW, FGC67CX, FGC67CY, FGC67CZ, FGC67DA, FGC67DB, FGC67DC, FGC67DD, FGC67DE, FGC67DF, FGC67DG, FGC67DH, FGC67DI, FGC67DJ, FGC67DK, FGC67DL, FGC67DM, FGC67DN, FGC67DO, FGC67DP, FGC67DQ, FGC67DR, FGC67DS, FGC67DT, FGC67DU, FGC67DV, FGC67DW, FGC67DX, FGC67DY, FGC67DZ, FGC67EA, FGC67EB, FGC67EC, FGC67ED, FGC67EE, FGC67EF, FGC67EG, FGC67EH, FGC67EI, FGC67EJ, FGC67EK, FGC67EL, FGC67EM, FGC67EN, FGC67EO, FGC67EP, FGC67EQ, FGC67ER, FGC67ES, FGC67ET, FGC67EU, FGC67EV, FGC67EW, FGC67EX, FGC67EY, FGC67EZ, FGC67FA, FGC67FB, FGC67FC, FGC67FD, FGC67FE, FGC67FF, FGC67FG, FGC67FH, FGC67FI, FGC67FJ, FGC67FK, FGC67FL, FGC67FM, FGC67FN, FGC67FO, FGC67FP, FGC67FQ, FGC67FR, FGC67FS, FGC67FT, FGC67FU, FGC67FV, FGC67FW, FGC67FX, FGC67FY, FGC67FZ, FGC67GA, FGC67GB, FGC67GC, FGC67GD, FGC67GE, FGC67GF, FGC67GG, FGC67GH, FGC67GI, FGC67GJ, FGC67GK, FGC67GL, FGC67GM, FGC67GN, FGC67GO, FGC67GP, FGC67GQ, FGC67GR, FGC67GS, FGC67GT, FGC67GU, FGC67GV, FGC67GW, FGC67GX, FGC67GY, FGC67GZ, FGC67HA, FGC67HB, FGC67HC, FGC67HD, FGC67HE, FGC67HF, FGC67HG, FGC67HH, FGC67HI, FGC67HJ, FGC67HK, FGC67HL, FGC67HM, FGC67HN, FGC67HO, FGC67HP, FGC67HQ, FGC67HR, FGC67HS, FGC67HT, FGC67HU, FGC67HV, FGC67HW, FGC67HX, FGC67HY, FGC67HZ, FGC67IA, FGC67IB, FGC67IC, FGC67ID, FGC67IE, FGC67IF, FGC67IG, FGC67IH, FGC67II, FGC67IJ, FGC67IK, FGC67IL, FGC67IM, FGC67IN, FGC67IO, FGC67IP, FGC67IQ, FGC67IR, FGC67IS, FGC67IT, FGC67IU, FGC67IV, FGC67IW, FGC67IX, FGC67IY, FGC67IZ, FGC67JA, FGC67JB, FGC67JC, FGC67JD, FGC67JE, FGC67JF, FGC67JG, FGC67JH, FGC67JI, FGC67JJ, FGC67JK, FGC67JL, FGC67JM, FGC67JN, FGC67JO, FGC67JP, FGC67JQ, FGC67JR, FGC67JS, FGC67JT, FGC67JU, FGC67JV, FGC67JW, FGC67JX, FGC67JY, FGC67JZ, FGC67KA, FGC67KB, FGC67KC, FGC67KD, FGC67KE, FGC67KF, FGC67KG, FGC67KH, FGC67KI, FGC67KJ, FGC67KK, FGC67KL, FGC67KM, FGC67KN, FGC67KO, FGC67KP, FGC67KQ, FGC67KR, FGC67KS, FGC67KT, FGC67KU, FGC67KV, FGC67KW, FGC67KX, FGC67KY, FGC67KZ, FGC67LA, FGC67LB, FGC67LC, FGC67LD, FGC67LE, FGC67LF, FGC67LG, FGC67LH, FGC67LI, FGC67LJ, FGC67LK, FGC67LL, FGC67LM, FGC67LN, FGC67LO, FGC67LP, FGC67LQ, FGC67LR, FGC67LS, FGC67LT, FGC67LU, FGC67LV, FGC67LW, FGC67LX, FGC67LY, FGC67LZ, FGC67MA, FGC67MB, FGC67MC, FGC67MD, FGC67ME, FGC67MF, FGC67MG, FGC67MH, FGC67MI, FGC67MJ, FGC67MK, FGC67ML, FGC67MN, FGC67MO, FGC67MP, FGC67MQ, FGC67MR, FGC67MS, FGC67MT, FGC67MU, FGC67MV, FGC67MW, FGC67MX, FGC67MY, FGC67MZ, FGC67NA, FGC67NB, FGC67NC, FGC67ND, FGC67NE, FGC67NF, FGC67NG, FGC67NH, FGC67NI, FGC67NJ, FGC67NK, FGC67NL, FGC67NM, FGC67NN, FGC67NO, FGC67NP, FGC67NQ, FGC67NR, FGC67NS, FGC67NT, FGC67NU, FGC67NV, FGC67NW, FGC67NX, FGC67NY, FGC67NZ, FGC67OA, FGC67OB, FGC67OC, FGC67OD, FGC67OE, FGC67OF, FGC67OG, FGC67OH, FGC67OI, FGC67OJ, FGC67OK, FGC67OL, FGC67OM, FGC67ON, FGC67OO, FGC67OP, FGC67OQ, FGC67OR, FGC67OS, FGC67OT, FGC67OU, FGC67OV, FGC67OW, FGC67OX, FGC67OY, FGC67OZ, FGC67PA, FGC67PB, FGC67PC, FGC67PD, FGC67PE, FGC67PF, FGC67PG, FGC67PH, FGC67PI, FGC67PJ, FGC67PK, FGC67PL, FGC67PM, FGC67PN, FGC67PO, FGC67PP, FGC67PQ, FGC67PR, FGC67PS, FGC67PT, FGC67PU, FGC67PV, FGC67PW, FGC67PX, FGC67PY, FGC67PZ, FGC67QA, FGC67QB, FGC67QC, FGC67QD, FGC67QE, FGC67QF, FGC67QG, FGC67QH, FGC67QI, FGC67QJ, FGC67QK, FGC67QL, FGC67QM, FGC67QN, FGC67QO, FGC67QP, FGC67QQ, FGC67QR, FGC67QS, FGC67QT, FGC67QU, FGC67QV, FGC67QW, FGC67QX, FGC67QY, FGC67QZ, FGC67RA, FGC67RB, FGC67RC, FGC67RD, FGC67RE, FGC67RF, FGC67RG, FGC67RH, FGC67RI, FGC67RJ, FGC67RK, FGC67RL, FGC67RM, FGC67RN, FGC67RO, FGC67RP, FGC67RQ, FGC67RR, FGC67RS, FGC67RT, FGC67RU, FGC67RV, FGC67RW, FGC67RX, FGC67RY, FGC67RZ, FGC67SA, FGC67SB, FGC67SC, FGC67SD, FGC67SE, FGC67SF, FGC67SG, FGC67SH, FGC67SI, FGC67SJ, FGC67SK, FGC67SL, FGC67SM, FGC67SN, FGC67SO, FGC67SP, FGC67SQ, FGC67SR, FGC67SS, FGC67ST, FGC67SU, FGC67SV, FGC67SW, FGC67SX, FGC67SY, FGC67SZ, FGC67TA, FGC67TB, FGC67TC, FGC67TD, FGC67TE, FGC67TF, FGC67TG, FGC67TH, FGC67TI, FGC67TJ, FGC67TK, FGC67TL, FGC67TM, FGC67TN, FGC67TO, FGC67TP, FGC67TQ, FGC67TR, FGC67TS, FGC67TT, FGC67TU, FGC67TV, FGC67TW, FGC67TX, FGC67TY, FGC67TZ, FGC67UA, FGC67UB, FGC67UC, FGC67UD, FGC67UE, FGC67UF, FGC67UG, FGC67UH, FGC67UI, FGC67UJ, FGC67UK, FGC67UL, FGC67UM, FGC67UN, FGC67UO, FGC67UP, FGC67UQ, FGC67UR, FGC67US, FGC67UT, FGC67UU, FGC67UV, FGC67UW, FGC67UX, FGC67UY, FGC67UZ, FGC67VA, FGC67VB, FGC67VC, FGC67VD, FGC67VE, FGC67VF, FGC67VG, FGC67VH, FGC67VI, FGC67VJ, FGC67VK, FGC67VL, FGC67VM, FGC67VN, FGC67VO, FGC67VP, FGC67VQ, FGC67VR, FGC67VS, FGC67VT, FGC67VU, FGC67VV, FGC67VW, FGC67VX, FGC67VY, FGC67VZ, FGC67WA, FGC67WB, FGC67WC, FGC67WD, FGC67WE, FGC67WF, FGC67WG, FGC67WH, FGC67WI, FGC67WJ, FGC67WK, FGC67WL, FGC67WM, FGC67WN, FGC67WO, FGC67WP, FGC67WQ, FGC67WR, FGC67WS, FGC67WT, FGC67WU, FGC67WV, FGC67WW, FGC67WX, FGC67WY, FGC67WZ, FGC67XA, FGC67XB, FGC67XC, FGC67XD, FGC67XE, FGC67XF, FGC67XG, FGC67XH, FGC67XI, FGC67XJ, FGC67XK, FGC67XL, FGC67XM, FGC67XN, FGC67XO, FGC67XP, FGC67XQ, FGC67XR, FGC67XS, FGC67XT, FGC67XU, FGC67XV, FGC67XW, FGC67XX, FGC67XY, FGC67XZ, FGC67YA, FGC67YB, FGC67YC, FGC67YD, FGC67YE, FGC67YF, FGC67YG, FGC67YH, FGC67YI, FGC67YJ, FGC67YK, FGC67YL, FGC67YM, FGC67YN, FGC67YO, FGC67YP, FGC67YQ, FGC67YR, FGC67YS, FGC67YT, FGC67YU, FGC67YV, FGC67YW, FGC67YX, FGC67YY, FGC67YZ, FGC67ZA, FGC67ZB, FGC67ZC, FGC67ZD, FGC67ZE, FGC67ZF, FGC67ZG, FGC67ZH, FGC67ZI, FGC67ZJ, FGC67ZK, FGC67ZL, FGC67ZM, FGC67ZN, FGC67ZO, FGC67ZP, FGC67ZQ, FGC67ZR, FGC67ZS, FGC67ZT, FGC67ZU, FGC67ZV, FGC67ZW, FGC67ZX, FGC67ZY, FGC67ZZ		
accessories for	695086		
	GEV No.	532517	Ref. No. —
	O-ring silicone thickness 1.78mm ID ø 17.17mm Qty 1 pcs		
	GEV No.	695059	Ref. No. —
	hose connector for ice-cube maker		
	GEV No.	695537	Ref. No. —
	gasket silicone ED ø 40mm ID ø 30mm thickness 2mm Qty 1 pcs		
	GEV No.	695622	Ref. No. —
	lid for overflow pipe tube ø 34mm		

ice chutes

slide grates

			
1			
GEV No.	694145	Ref. No.	OKM707
description	slide grate for ice-cube maker L 250mm W 170mm H 25mm		

spare parts and accessories

			
1			
GEV No.	696466	Ref. No.	OKR061 22308 23413 DS23413
description	coupling set D1 ø 23mm D2 ø 11mm int. ø 1 7/8mm L 44mm teeth 8		
For models:	B2000K-01, B2000K-02, B2000K-03, B2000K-04, B2000T-01, B2000T-02, B2000T-03, B2000-4-01, B2000K-05, B2000MU-01, B2000-4-02, B2000-5-01, B2000-3-01, B2000MU-02, B2000K-06, B2000-4-03, B2000-5-02, B2000-6-01, B2000K-07, B2000-6-02, B2000-6-03, B2000-5-03, B2000-6-04, B2000K-08, B2000-4-04, B2000-5-04, B2000-5-05, B2000-6-05, B2000K-09, B2000-5-13, B2000-5-06, B2000-6-06, B2000-4-05, B2000-6-07, B2000K-10, B2000-4-06, B2000-5-07, B2000K-11, B2000-4-07, B2000-6-08, B2000K-12, B2000-5-08, B2000MU-03, B2000MU-04, B2000-5-09, B2000-6-13, B2000MU-05, B2000MU-06, B2000MU-07, B2000K-13...(Other models you can see in the webshop)		

doors

bushes

			
1			
GEV No.	695782	Ref. No.	086006
description	bush for door ED ø 12.5mm ID ø 8.2mm L 10.8mm plastic		
For models:	CIM120AS, CIM120WS		

doors

			
1			
GEV No.	695743	Ref. No.	086565 OKM663 78135200 CM81460326
description	door for ice maker W 1080mm H 275mm thickness 16mm		

			
1			
GEV No.	695514	Ref. No.	099208
description	door for ice-cube maker W 447mm H 217mm thickness 22mm		
For models:	IMF35A, IMF35W, IMF58A, IMF58W, FGC33AS42, FGC46AS42, FGC40A, FGC40W, FGS94AB, FGS94WB, CIM38AB, CIM38WB, CIM50AB, FIM50WB, CIM38AB, CIM38WB, CIM50AB, FIM50WB, CB316A, CB425A, CIM38AB, CIM38WB, CIM50AB, FIM50WB		

			
1			
GEV No.	695457	Ref. No.	OKM641
description	door for ice-cube maker W 505mm H 270mm thickness 21mm		



1

GEV No.	695461	Ref. No.	086388 086488
description	door kit for ice-cube maker W 655mm H 260mm thickness 19mm		



1

GEV No.	696473	Ref. No.	0KM643
description	door W 600mm H 260mm thickness 17mm		



1

GEV No.	695460	Ref. No.	086480
description	door with door guide for ice-cube maker W 485mm H 260mm thickness 19mm		
For models:	CIM45A, CIM45W		

door guides



1

GEV No.	695448	Ref. No.	0KM683
description	door guides mounting pos. left L 215/240mm W 14mm		



1

GEV No.	695447	Ref. No.	0KM684
description	door guides mounting pos. right L 215/240mm W 14mm		

curtains

with holder



1

GEV No.	695506	Ref. No.	085320
description	curtain for ice maker W 328mm H 150mm with holder shaft length 325mm shaft ø 7.5mm		
For models:	FGC29AB, FGC29WB, FGCF25A, CB246W, FGC29AB, FGC29WB, CB249A, FGC29AB, FGC29WB, C150W, C300A, C300W, CB1565W, CB246W, CB416W, CB955W, DSS42W, C80W, CB1565A, C80A, CB246A, CB416A, C150A, CB955A, DSS42A		



1

GEV No.	695507	Ref. No.	085325 0KK207
description	curtain for ice maker W 433mm H 165mm with holder shaft length 438mm shaft ø 7.5mm		
For models:	FGC33AS42, FGC46AS42, FGC40A, FGC40W, CIM38AB, CIM38WB, CIM50AB, FIM50WB, CIM38AB, CIM38WB, CIM50AB, FIM50WB, CB316A, CB425A, CIM38AB, CIM38WB, CIM50AB, FIM50WB, C150W, C300A, C300W, CB1565W, CB246W, CB416W, CB955W, DSS42W, C80W, CB1565A, C80A, CB246A, CB416A, C150A, CB955A, FRESHMAKER, ICEWATER45, ICEWATER45, DSS42A		



1

GEV No.	696594	Ref. No.	N/A
description	curtain for ice-cube maker W 273mm H 160mm shaft length 280mm shaft ø 7.6mm holder length 316mm		

without holder



1

GEV No.	695076	Ref. No.	0KM655
description	curtain for ice maker W 284mm H 83mm		



1

GEV No.	695075	Ref. No.	086082
description	curtain for ice maker W 305mm H 115mm shaft length 323mm shaft ø 6mm		
For models:	ALLS521, ALLS520, ALS510		

1

GEV No.	695077	Ref. No.	086204
description	curtain for ice maker W 570mm H 115mm shaft length 610mm shaft ø 6mm		
For models:	CIM65A, CIM65W		

accessories

holders

1

GEV No.	695080	Ref. No.	086121
description	curtain holder for ice maker W 15mm H 80mm left		
For models:	CIM15A, CIM15W, CIM30A, CIM30W, CIM45A, CIM45W, CIM65A, CIM65W		

1

GEV No.	695079	Ref. No.	086122
description	curtain holder for ice maker W 15mm H 80mm right		
For models:	CIM15A, CIM15W, CIM30A, CIM30W, CIM45A, CIM45W, CIM65A, CIM65W		

lamellas

1

GEV No.	695082	Ref. No.	0U1257
description	lamella for curtain L 69mm W 23mm ID ø 8mm		
For models:	C150W, C300A, C300W, CB1565W, CB246W, CB416W, CB955W, DSS42W, C80W, CB1565A, C80A, CB246A, CB416A, C150A, CB955A, FRESHMAKER, ICEWATER45, ICEWATER45, DSS42A		

pan mechanics

sumps

1

GEV No.	695911	Ref. No.	086333
description	sump for spray system H 140mm ø 495mm		

spare parts and accessories

1

GEV No.	695013	Ref. No.	N/A
description	paddle with spindle		

1

GEV No.	695012	Ref. No.	N/A
description	paddle with spindle ø 95mm shaft ø 6mm shaft length 350mm		

gear wheels

1

GEV No.	691787	Ref. No.	0KM701
description	gear wheel ø 27/101mm shaft intake ø 13mm teeth 15/94		

suction system

intake filters

1

GEV No.	695532	Ref. No.	0KK231
description	round filters ø 28mm H 60mm		

drive technology

gear wheels



1

GEV No.	695582	Ref. No.	OKM702
description	gear wheel teeth 65 tooth width 14.5mm ED ø 74mm H 72mm shaft ø 12.7mm		

gaskets

shaft gaskets



1

GEV No.	695589	Ref. No.	086281
description	shaft sealing ED ø 48mm ID ø 25mm H 22mm suitable for augers		



1

GEV No.	695428	Ref. No.	OKM718 65040200
description	shaft sealing for auger ED ø 45mm ID ø 30mm		

housing and bezels



1

GEV No.	694326	Ref. No.	086566
description	frame for ice maker L 1080mm W 380mm H 71mm anthracite		

insulation



1

GEV No.	694112	Ref. No.	OKL155
description	insulation for discharge chute L 190mm W 200mm H 175mm		

mechanics for evaporators

screw conveyors



1

GEV No.	691789	Ref. No.	086287
description	screw conveyor ø 46mm L 330mm		

holders



1

GEV No.	694437	Ref. No.	OKM705
description	bearing block for evaporator kit with holder mounting pos. lower		

hoses

formed hoses

form L





1

GEV No.	695089	Ref. No.	OKM598
description	formed hose L-shape for ice-cube maker ID ø 12.5/22mm ED ø 18.5/27mm L 300mm W 30mm		



			
1			
GEV No.	695092	Ref. No.	OKM597
description	formed hose L-shape for ice-cube maker ID ø 13/21mm ED ø 18/27mm L 345mm W 80mm		

			
1			
GEV No.	695107	Ref. No.	OKV671
description	formed hose L-shape for ice-cube maker ID ø 17mm ED ø 23.5mm L 70mm W 50mm		
For models:	FGC33AS42, FGC46AS42, FGC65A42, MC140AB20, MC140WB20, MC200AB20, MC200WB20, FGC29AB, FGC29WB, FGC40A, FGC40W, FGC67AB, FGC67WB, FGC90A, FGC90W, FGCF25A, CB246W, CIM38AB, CIM38WB, CIM85AB, CIM15WB, CIM235AB, CIM235WB, CIM50AB, FIM50WB, FGC29AB, FGC29WB, CIM38AB, CIM38WB, CIM50AB, FIM50WB, CB249A, CB316A, CB425A, CB840A, FGC29AB, , FGC67AB, FGC67WB, CIM38AB, CIM38WB, CIM85AB, CIM15WB, CIM50AB, FIM50WB, VM500W+BI, VM500A+BI, VM350A+BI, VM350W+BI, FGC29WB...(Other models you can see in the webshop)		

			
1			
GEV No.	695091	Ref. No.	OU3302
description	formed hose L-shape for ice-cube maker ID ø 24mm ED ø 27mm L 130mm W 105mm		

form S			
			
1			
GEV No.	695090	Ref. No.	OKM593
description	formed hose S-shape for ice-cube maker ID ø 16/20mm ED ø 21/25mm L 110mm W 75mm		

			
1			
GEV No.	695093	Ref. No.	OKM594
description	formed hose S-shape for ice-cube maker ID ø 20/23mm ED ø 26/29mm L 115mm W 90mm		

hose connectors

with thread

			
1			
GEV No.	695045	Ref. No.	086013
description	hose connector 3-way ID ø 15mm ED ø 21mm L 91mm		
For models:	CIM30A, CIM30W, CIM45A, CIM45W, CIM65A, CIM65W, CIM120AS, CIM120WS		

			
1			
GEV No.	695096	Ref. No.	OKL201
description	hose connector for ice-cube maker		

without thread

			
1			
GEV No.	695058	Ref. No.	085275
description	hose connector 2-way for ice-cube maker		
For models:	IMF28A, IMF28W, IMF35A, IMF35W, IMF58A, IMF58W, IMF80A, IMF80W, FGC33AS42, FGC46AS42, FGC65A42, FGC24AB, FGC24WB, FGC29AB, FGC29WB, FGC40A, FGC40W, FGC67AB, FGC67WB, FGC90A, FGC90W, FGC143AB, FGC143WB, FGCF25A, CB246W, CIM38AB, CIM38WB, CIM85AB, CIM15WB, CIM50AB, FIM50WB, FGC24ABS, FGC24WBAB, FGC29AB, FGC29WB, CIM38AB, CIM38WB, CIM50AB, FIM50WB, FGC143AB, FGC143WB, CB184A, CB249A, CB316A, CB425A, CB840A, FGC24AB, FGC24WB, FGC29AB, ...(Other models you can see in the webshop)		

floats

float containers

			
1			
GEV No.	695037	Ref. No.	086264
description	float container for ice maker plastic		

			
1			
GEV No.	695072	Ref. No.	099434
description	float container for ice maker with microswitch plastic		
For models:	MF250WB20, FIM285ASB, FIM285WSB, VM250A+BI, VM250W+BI, G500A, GB1555W, GB1555A, G500W		



1

GEV No.	696755	Ref. No.	085600
description	float container for ice maker with microswitch plastic suitable for GB902		
spare parts for	696755		
	GEV No.	345105	Ref. No.
			0KI505
	microswitch with plunger 250V 16A 1CO connection male faston 6.3mm L 28mm ambient temperature max. 125°C mounting distance 22mm type SM-51 actuating force: 280g black		

miscellaneous



1

GEV No.	695630	Ref. No.	086445 OKM780
description	coupling set ø 37mm		



1

GEV No.	695744	Ref. No.	086584
description	insulation L 150mm W 100mm H 140mm ID ø 55mm		



1

GEV No.	695046	Ref. No.	086199
description	nut H 5mm thread M24x1.5 plastic		
For models:	CIM15A, CIM15W, CIM30A, CIM30W, CIM45A, CIM45W, CIM65A, CIM65W, CIM120AS, CIM120WS		



1

GEV No.	695587	Ref. No.	OKV758
description	repair kit for ice maker		
spare parts for	695587		
	GEV No.	695588	Ref. No.
			—
	bushing complete H 31.5mm ID ø 30mm ED ø 89mm mounting pos. lower		

valves

intake valves



1

GEV No.	695685	Ref. No.	086580
description	intake valve thread M11 L 130mm ø 37mm plastic		



1

GEV No.	695539	Ref. No.	087813
description	intake valve with float		
For models:	CIM235AB, CIM235WB, VM500W+BI, VM500A+BI, MUSTER350A, MUSTER800A, VB250A, VB250W, VM900A, VM900W		

valve inserts



1

GEV No.	695771	Ref. No.	086306 OKM720
description	valve bush thread 7/16" L 26mm ø 9.5mm brass WS 11		
For models:	CIM120AS, CIM120WS		

for espresso machines

brewing units

filter holder gaskets

O-rings



1

GEV No.	510409	Ref. No.	007029 047156 049909 0E5037 0K9011 543613600 740483105
description	O-ring EPDM thickness 5.34mm ID ø 56.52mm Qty 1 pcs		
For models:	EBS50, EBS50, EBS50, EBS50, EBV50, EBV50, EBV50, EBV50, EBV50, EBS50., EBS50H, EBS100., EBS100H, EBS150., EBS150H, EBS200., EBS200H, EBS300., EBS300H, EBV50., EBV50H, EBV100., EBV100H, EBV150, EBV150H, EBV200., EBV200H, EBV300., EBV300H, EBVC50, EBVC50H, EBVC100, EBVC100H, EBVC150, EBVC150H, EBVC200, EBVC200H, EBVC300, EBVC300H, EBP100., EBP100M, EBP150, EBP150M, EBP200., EBP200M, EBP300., EBP300M, EBPC100, EBPC100M, EBPC150...(Other models you can see in the webshop)		



brewing units manual

components

levers

lever handles



1

GEV No.	529902	Ref. No.	067411 075545
description	cylindrical handle thread M8 bore ø 8.5mm ø 21mm L 50mm plastic		
For models:	CL511, CL611, CL911, CL521, CL621, CL921, CL121, CL221, HQN/V917, HQN/V917, LO/E480, PLO480/E, LO480EUK, LO480E/63, LO480VAPO-RESTD, PLO480V, LO480V/63-60HZ, LO/E250, PLO250E, LO/E250UK, LO250E/63, LOPE25, LOPE48, LO480Z-VAPORE		

for pyroceram ranges

ceramic hobs

ceramic glass plates



1

GEV No.	692294	Ref. No.	059045
description	ceramic plate L 545mm W 290mm thickness 6mm		
For models:	MI/E350, MI/E350D, MI/E360, MI/E360D, RI/E1, MI/Z1, RI/Z1, XI/Z1, MI/Z2, RI/Z2, XI/Z2, MI/Z1U, MI/Z2U, XI/E1, JI/E1, MI/E1, PI/Z1, PI/Z2, PI/E1, PI/E2, PIF/E2, PIV/E2, PI/Z1E5, PI/Z2E5, PI/E1E5, PI/E2E5, PIF/E2E5, PI/Z2F, OI/Z1, OI/E1, OI/E2, OIF/E2, TI/Z1, TI/E1, TI/Z1E5, TI/E1E5, TI/Z2F		

for deep fryers

glass panels



1

GEV No.	693397	Ref. No.	057400 0C5340 0H6898 0K3033 12011870 275290025 727859
description	glass panel L 29mm W 29mm thickness 3.5mm square		
For models:	MFR/G360, MPN/GD761, MPN/GI761, MPN/GI760D, MPN/GD760, MPN/GD760F, MPN/GI760, MPN/GI760F, MM/G351, MM/G701, MM/G350, MM/G700, MM/G350F, MM/G700F, MM/G700E, MCP/G700, MCP/G701, MCP/G710, MCP/G711, MCP/G705, MCP/G706, FDV40G, FDV40GZ, FDV40GA, FDV20G, FDV20GZ, RBR/G2FM, RBR/G2IM, RBK/G2FM, RMV/G1C, RMV/G2C, RF/G1S07, RF/G2D07, RFR/G1S07, RFR/G2D07, RFR/G1S14, RFR/G2D14, RF/G1S07, RF/G2D07, RFR/G1S07, RFR/G2D07, XBR/G2FM, XBR/G2IM, XBK/G2FM, XMV/G1C, XMV/G2C, XF/G1S07, XRF/G2D07, XFR/G1S07...(Other models you can see in the webshop)		

for grills

spare parts and accessories



1

GEV No.	696732	Ref. No.	050670
description	union nut H 15mm M20x1.5 WS 24		
For models:	MR/G351, MR/G701, MR/G350, MR/G350F, MR/G350NL, MR/G350E, MR/G360, MR/G360F, MR/G700, MR/G700F, MR/G700NL, MR/G700E, MR/G710, MR/G710F, MR/G715, MR/G361, MR/G711, MR/G716, MT/G700D, MTF/G700D, MTF/G1050D, MT/G700, MTF/G700, MTF/G1050, MTF/GE1050, MT/G700F, MTF/G700F, MTF/G1055F, MTFGE1055F, MT/G350, MT/G352, MCP/E700, MCP/G700, MCP/E700D, MCP/G701, MCP/G710, MCP/G711, MCP/G705, MCP/G706, MG/G350D, MG/G700D, MG/G350, MG/G350E, MG/G350F, MG/G350NL, MG/G700, MG/G700E, MG/G700F, MG/G700NL, MG/G1050...(Other models you can see in the webshop)		

for convection ovens/combi-steamers

drain valves





1

GEV No.	698499	Ref. No.	006309
description	drain fitting ø 24.5mm H 60mm ED ø 59mm for pot		
For models:	FCZ201EAA, FCZ202EAA, FCZ201EAH, FCZ201EAN, FCZ201ETA, FCZ202ETA, FCZ201ETH, FCZ201ETN, FCZ201GAG, FCZ202GAG, FCZ201GAD, FCZ202GAD, FCZ201GTG, FCZ202GTG, FCZ201GTD, FCZ202GTD, FCZ201EBA, FCZ202EBA, FCZ201EBH, FCZ201EBN, FCZ201EBC, FCZ201EBA2, FCZ202EBA2, FCZ201EBH2, FCZ201EBN2, FCZ201EBC2, FCZ201GBG, FCZ202GBG, FCZ201GBD, FCZ202GBD, FCZ201GBI, FCZ201GBG2, FCZ202GBG2, FCZ201GBD2, FCZ202GBD2, FCZ201GBI2, FCZ201ECA, FCZ202ECA, FCZ201ECH, FCZ201ECN, FCZ201ECA2, FCZ202ECA2, FCZ201ECH2, FCZ201ECN2, FCZ201GCG, FCZ202GCG, FCZ201GCD, FCZ202GCD, FCZ201GCG2, FCZ202GCG2...(Other models you can see in the webshop)		

			
1			
GEV No.	699446	Ref. No.	0C4467
description	bushing ID ø 10mm ED ø 15mm L 14mm		
For models:	FCZ061EAA, FCZ101EAA, FCZ102EAA, FCZ061EAH, FCZ101EAH, FCZ061EAN, FCZ101EAN, FCZ061ETA, FCZ101ETA, FCZ102ETA, FCZ201ETA, FCZ202ETA, FCZ061ETH, FCZ101ETH, FCZ201ETH, FCZ061ETN, FCZ101ETN, FCZ201ETN, FCZ061GAG, FCZ061GAD, FCZ101GTG, FCZ102GTG, FCZ201GTG, FCZ202GTG, FCZ101GTD, FCZ102GTD, FCZ201GTD, FCZ202GTD, FCZ061EBA, FCZ101EBA, FCZ102EBA, FCZ061EBH, FCZ101EBH, FCZ061EBN, FCZ101EBN, FCZ061EBC, FCZ101EBC, FCZ201EBC, FCZ061EBA2, FCZ101EBA2, FCZ102EBA2, FCZ201EBA2, FCZ202EBA2, FCZ061EBH2, FCZ101EBH2, FCZ201EBH2, FCZ061EBN2, FCZ101EBN2, FCZ201EBN2, FCZ061EBC...(Other models you can see in the webshop)		

			
1			
GEV No.	692181	Ref. No.	053800
description	injection nozzle D1 ø 12.5mm D2 ø 15mm L 10mm brass		
For models:	FCFG6D, FCFE6D, FCFE6D, FCFG10, FCFG10D, FCFG10NL, FCFE10, FCFE10UK, FCFG20, FCFG20D, FCFG20F, PFCFG20, FCFE20, FCFE20UK, FCFG6, FCFG6F, PFCFG6, FCFE6, FCFE6UK, PFCFE6, FCF/G6, FCFG101, FCFG201, FCF/E6, FCF/E10, FCF/E20, FF/G6, FF/E10, FF/G10, FF/E20, FF/G20, COCO10G, COCO10E, COCO20G, COCO20E, COCO6G, COCO6E, COCVE423AF, FCFE061, FCFE101, FCFE201, ZOFCE/G10D, ZOFCE/G6D, ZOFCE/G20D		

			
2			
GEV No.	699447	Ref. No.	0C1560
description	guide bushing ID ø 15.5mm L 17.5mm WS 27		
For models:	FCS061GP, FCS061EP, FCS101EP4J, FCS101EP, FCS101GP9J, FCS102EP4J, FCS101GP, FCS102EP, FCS102GA9J, FCS201EP, FCS102GP, FCS202EP, FCS202GP, FCS061EXLN, FCS061EX, FCS101EX4J, FCS101EXLN, FCS101EX, FCS102EX4J, FCS102EX, FCS201EX, FCS201EXLN, FCS202EX, FCS101GX9J, FCS101GX, FCS102GX9J, FCS102GX, FCS201GX, FCS202GX		

			
1			
GEV No.	692772	Ref. No.	0C0443
description	injection pipe for combi-steamer curved ED ø 10mm ID ø 7mm L 375mm W 85mm copper suitable for ELECTROLUX, ZANUSSI		
For models:	FCF/G6-1-JAP, FCFE6-1J		

steam generators

steam generators

			
1			
GEV No.	694312	Ref. No.	005234 0K0680
description	steam generator L 615mm W 100mm H 425mm		
For models:	FDV40E, FDV40EL, FCV/E20L3, FCVE202L3, FCV/E20L6, FCVE202L6, FVC/E201/1, FVC/E202/1, FCS201E4, FCS201EP, FCS202E4, FCS202EP, FCS201EX, FCS201EXLN, FCS202EX, 5714-3-7, 5714-3-8, 5714-3-8E, 5714-3-10, 5717-3-7, 5717-3-8, 5717-3-8E, 5717-3-10, 5717-3-8M, 5717-3-8C, 5717-3-8M, 5714-3-10F, 5714-3-10S, ECV/E20T4, ECVE202T4, ECV/E20T6, ECVE202T6, ACV/E20C4, ACVE202C4, ACVE20C6, ACV/E202/1, ZCV/E20T4, ZCV/E202/1, ZCV/E20T6, ZCV/E202/1		

spare parts and accessories

			
1			
GEV No.	690869	Ref. No.	003825
description	bar L 440mm		
For models:	FDV40G, FDV40E, FDV40GZ, FDV40EL, FDV40GA, FDV20G, FDV20E, FDV20GZ, FDV20EL, FDV20GA, FCFG201-0, FCFG202-0, FCFE201-0, FCFE202-0, FCF201ENS, ECFG201-0, ECFG202-0, ECFE201-0, ECFE202-0, ECF201ENS, ACFG201-0, ACFG202-0, ACFE201-0, ACFE202-0, RCF201E, ZCF/G201/1, ZCF/G202/1, ZCF/E201/1-0, ZCF/E202/1-0		

			
1			
GEV No.	692775	Ref. No.	0KB717
description	steam generator with gasket L 250mm W 25mm H 25mm 230V connection F6.3x0.8		



			
1			
GEV No.	698497	Ref. No.	006976
description	bumper H 16mm ext. ø 25 suitable for ELECTROLUX		
For models:	FCZ061EAA, FCZ101EAA, FCZ102EAA, FCZ201EAA, FCZ202EAA, FCZ061EAH, FCZ101EAH, FCZ201EAH, FCZ061EAN, FCZ101EAN, FCZ201EAN, FCZ061ETA, FCZ101ETA, FCZ102ETA, FCZ201ETA, FCZ202ETA, FCZ061ETH, FCZ101ETH, FCZ201ETH, FCZ061ETN, FCZ101ETN, FCZ201ETN, FCZ061GAG, FCZ101GAG, FCZ102GAG, FCZ201GAG, FCZ202GAG, FCZ061GAD, FCZ101GAD, FCZ102GAD, FCZ201GAD, FCZ202GAD, FCZ101GTG, FCZ102GTG, FCZ201GTG, FCZ202GTG, FCZ101GTD, FCZ102GTD, FCZ201GTD, FCZ202GTD, FCZ061EBA, FCZ101EBA, FCZ102EBA, FCZ201EBA, FCZ202EBA, FCZ061EBH, FCZ101EBH, FCZ201EBH, FCZ061EBN, FCZ101EBN...(Other models you can see in the webshop)		

			
1			
GEV No.	551438	Ref. No.	0C1152
description	cap for water container 45 red suitable for combi-steamer		
For models:	FCZ061EAA, FCZ101EAA, FCZ102EAA, FCZ061EAH, FCZ101EAH, FCZ061EAN, FCZ101EAN, FCZ061ETA, FCZ101ETA, FCZ102ETA, FCZ061ETH, FCZ101ETH, FCZ061ETN, FCZ101ETN, FCZ061GAG, FCZ101GAG, FCZ102GAG, FCZ061GAD, FCZ101GAD, FCZ102GAD, FCZ101GTG, FCZ102GTG, FCZ101GTD, FCZ102GTD, FCZ061EBA, FCZ101EBA, FCZ102EBA, FCZ061EBH, FCZ101EBH, FCZ061EBN, FCZ101EBN, FCZ061EBC, FCZ101EBC, FCZ061EBA2, FCZ101EBA2, FCZ102EBA2, FCZ061EBH2, FCZ101EBH2, FCZ061EBN2, FCZ101EBN2, FCZ061EBC2, FCZ101EBC2, FCZ061GBI, FCZ101GBI, FCZ101GBG2, FCZ102GBG2, FCZ101GBD2, FCZ102GBD2, FCZ101GBI2, FCZ102GBI2...(Other models you can see in the webshop)		

			
2			
GEV No.	112826	Ref. No.	006401
description	burner chamber for combi-steamer L 325mm SS W 100mm H 180mm		
For models:	FCV/G20L3, FCVG20L3, FCV/G20L6, FCVG20L6, FCV/G101/1, FCV/G102/1, FCV/G201/1, FCV/G202/1, FCS101GP9J, FCS101GP, FCS102G4, FCS102GA9J, FCS102GA9J, FCS102GP, FCS201G4, FCS201GP, FCS202G4, FCS202GP, FCS101GX9J, FCS101GX, FCS102GX9J, FCS102GX, FCS201GX, FCS202GX, 5712-2-7, 5712-2-8, 5712-2-10, 5714-2-7, 5714-2-8, 5714-2-10, 5714-2-7, 5714-2-8, 5714-2-10, 5712-2-7L, 5712-2-8L, 5712-2-10L, 5714-2-7L, 5714-2-8L, 5714-2-10L, 5714-2-7L, 5714-2-8L, 5714-2-10L, ECV/G20T4, ECV/G20T4J, ECV/G20T6, ECV/G20T6, ACV/G20C4, ACVG20C4, ACVG20C6...(Other models you can see in the webshop)		

			
1			
GEV No.	551436	Ref. No.	0C2436
description	connecting piece for T-piece L 69mm ø 22/15mm brass		
For models:	FCZ201EAA, FCZ202EAA, FCZ201EAH, FCZ201EAN, FCZ201GAG, FCZ202GAG, FCZ201GAD, FCZ202GAD, FCZ201EBC, FCZ201GBI, FCZ201ECA, FCZ202ECA, FCZ201ECH, FCZ201ECN, FCZ201GCG, FCZ202GCG, FCZ201GCD, FCZ202GCD, AOS201GAEU, AOS202GAEU, AOS201GAU, AOS202GAU, AOS201EABU, AOS201EAFU, AOS202EA2N, AOS202EA, AOS201GA, AOS202GA, AOS201EAAQ, AOS202EAAQ, AOS201EANQ, AOS202EANQ, AOS201EACQ, AOS201EAHQ, AOS201GAGQ, AOS202GAGQ, AOS201GADQ, AOS202GADQ, AOS201GAIQ, AOS201GALQ, AOS201EAMQ, AOS201EABQ, AOS201GAPQ, AOS202GAPQ, AOS201EAA1, AOS202EAA1, AOS201EAH1, AOS201EAN1, AOS201EAC1, AOS201EAE1...(Other models you can see in the webshop)		

			
1			
GEV No.	700497	Ref. No.	054561
description	bush for door mechanism		
For models:	FCF02EV, FCF02EOM, FCF/E3, FCF/E2, FCF/E2D, FCF/E2UK, FCF/E2, FCF/E2, COCO6G, COCO6E, FCF/E2D		

			
1			
GEV No.	551399	Ref. No.	0KB684
description	cover for water tank L 353mm W 233mm H 7mm suitable for combi-steamer ELECTROLUX, ZANUSSI		
For models:	FCV31E3, 7CO30, CCO30G, ECO312CF, OTS100		

			
1			
GEV No.	551439	Ref. No.	0C1151
description	cap for water container 45 blue suitable for combi-steamer		
For models:	FCZ061EAA, FCZ101EAA, FCZ102EAA, FCZ061EAH, FCZ101EAH, FCZ061EAN, FCZ101EAN, FCZ061ETA, FCZ101ETA, FCZ102ETA, FCZ061ETH, FCZ101ETH, FCZ061ETN, FCZ101ETN, FCZ061GAG, FCZ101GAG, FCZ102GAG, FCZ061GAD, FCZ101GAD, FCZ102GAD, FCZ101GTG, FCZ102GTG, FCZ101GTD, FCZ102GTD, FCZ061EBA, FCZ101EBA, FCZ102EBA, FCZ061EBH, FCZ101EBH, FCZ061EBN, FCZ101EBN, FCZ061EBC, FCZ101EBC, FCZ061EBA2, FCZ101EBA2, FCZ102EBA2, FCZ061EBH2, FCZ101EBH2, FCZ061EBN2, FCZ101EBN2, FCZ061EBC2, FCZ101EBC2, FCZ061GBI, FCZ101GBI, FCZ101GBG2, FCZ102GBG2, FCZ101GBD2, FCZ102GBD2, FCZ101GBI2, FCZ102GBI2...(Other models you can see in the webshop)		

			
1			
GEV No.	551398	Ref. No.	0KB704
description	cover cap for water tank ø 34/51mm suitable for combi-steamer ELECTROLUX, ZANUSSI		
For models:	FCV31E3, 7CO30, CCO30G, ECO312CF, OTS100		

			
1			
GEV No.	550541	Ref. No.	002843
description	duct suitable for chip scuttle		
For models:	FCV/G6L3TOWNGAS, FCV/G6L3, FCV/G6L3JAP, ACV/G6C3, NCV/G6L2		

			
1			
GEV No.	550917	Ref. No.	0K2769
description	flange		
For models:	5611-3-10, 5611-3-8, 5612-3-10, 5612-3-8, 5614-3-10, 5614-3-8		

			
1			
GEV No.	550900	Ref. No.	0KD350
description	flange L 60mm W 40mm H 1mm		
For models:	5611-3-10, 5611-3-6, 5611-3-8, 5612-3-10, 5612-3-6, 5612-3-8, 5614-3-10, 5614-3-6, 5614-3-8		

			
1			
GEV No.	550899	Ref. No.	0KD286
description	flange L 60mm W 40mm H 2mm		
For models:	5611-3-10, 5611-3-6, 5611-3-8, 5612-3-10, 5612-3-6, 5612-3-8, 5614-3-10, 5614-3-6, 5614-3-8		

			
1			
GEV No.	551397	Ref. No.	0806857201 0C4244
description	mounting flange for lambda sensor L 70mm W 70mm H 40mm M12 ET		
For models:	FCZ061EAA, FCZ101EAA, FCZ102EAA, FCZ201EAA, FCZ202EAA, FCZ061EAH, FCZ101EAH, FCZ201EAH, FCZ061EAN, FCZ101EAN, FCZ201EAN, FCZ061ETA, FCZ101ETA, FCZ102ETA, FCZ201ETA, FCZ202ETA, FCZ061ETH, FCZ101ETH, FCZ201ETH, FCZ061ETN, FCZ101ETN, FCZ201ETN, FCZ061GAG, FCZ101GAG, FCZ102GAG, FCZ201GAG, FCZ202GAG, FCZ061GAD, FCZ101GAD, FCZ102GAD, FCZ201GAD, FCZ202GAD, FCZ101GTG, FCZ102GTG, FCZ201GTG, FCZ202GTG, FCZ101GTD, FCZ102GTD, FCZ201GTD, FCZ202GTD, FCZ061EBA, FCZ101EBA, FCZ102EBA, FCZ202EBA, FCZ061EBH, FCZ101EBH, FCZ061EBN, FCZ101EBN, FCZ061EBC, FCZ101EBC... (Other models you can see in the webshop)		

			
1			
GEV No.	699448	Ref. No.	0C4238 0CA756
description	nut L 22mm W 22mm H 6.5mm WS 22 M8		
For models:	FCZ061EAA, FCZ101EAA, FCZ102EAA, FCZ061EAH, FCZ101EAH, FCZ061EAN, FCZ101EAN, FCZ061ETA, FCZ101ETA, FCZ102ETA, FCZ061ETH, FCZ101ETH, FCZ061ETN, FCZ101ETN, FCZ061GAG, FCZ101GAG, FCZ102GAG, FCZ061GAD, FCZ101GAD, FCZ102GAD, FCZ101GTG, FCZ102GTG, FCZ101GTD, FCZ102GTD, FCZ061EBA, FCZ101EBA, FCZ102EBA, FCZ061EBH, FCZ101EBH, FCZ061EBN, FCZ101EBN, FCZ061EBC, FCZ101EBC, FCZ061EBA2, FCZ101EBA2, FCZ102EBA2, FCZ061EBH2, FCZ101EBH2, FCZ061EBN2, FCZ101EBN2, FCZ061EBC2, FCZ101EBC2, FCZ061GBG, FCZ101GBG, FCZ102GBG, FCZ061GBD, FCZ101GBD, FCZ102GBD, FCZ061GBI, FCZ101GBI... (Other models you can see in the webshop)		

			
1			
GEV No.	551442	Ref. No.	0C5201
description	pin for water container L 34mm		
For models:	TRV/G2CL		

			
1			
GEV No.	545179	Ref. No.	003701
description	spring for hose reel thickness 1mm for hose 6x12mm spring steel combi-steamer		
For models:	DCS		

			
1			
GEV No.	690878	Ref. No.	0K2793 0KC201 114114 754741
description	taper nut		





			
1			
GEV No.	530907	Ref. No.	0C1058
description	union nut thread 3/4" H 16mm WS 30 Qty 1 pcs		
For models:	FCZ061GAG, FCZ101GAG, FCZ102GAG, FCZ201GAG, FCZ202GAG, FCZ061GAD, FCZ101GAD, FCZ102GAD, FCZ201GAD, FCZ202GAD, FCZ101GTG, FCZ102GTG, FCZ201GTG, FCZ202GTG, FCZ101GTD, FCZ102GTD, FCZ201GTD, FCZ202GTD, FCZ061GBG, FCZ101GBG, FCZ102GBG, FCZ201GBG, FCZ202GBG, FCZ061GBD, FCZ101GBD, FCZ102GBD, FCZ201GBD, FCZ202GBD, FCZ061GBI, FCZ101GBI, FCZ201GBI, FCZ101GBG2, FCZ102GBG2, FCZ201GBG2, FCZ202GBG2, FCZ101GBD2, FCZ102GBD2, FCZ201GBD2, FCZ202GBD2, FCZ101GBI2, FCZ102GBI2, FCZ201GBI2, FCZ061GCG, FCZ101GCG, FCZ102GCG, FCZ201GCG, FCZ202GCG, FCZ061GCD, FCZ101GCD, FCZ102GCD... (Other models you can see in the webshop)		

<h3>filters</h3>			
			
1			
GEV No.	362014	Ref. No.	0C1155
description	container filter for combi-steamer SS hose ø 6mm		
For models:	FCZ061EAA, FCZ101EAA, FCZ102EAA, FCZ201EAA, FCZ202EAA, FCZ061EAH, FCZ101EAH, FCZ201EAH, FCZ061EAN, FCZ101EAN, FCZ201EAN, FCZ061ETA, FCZ101ETA, FCZ102ETA, FCZ061ETH, FCZ101ETH, FCZ061ETN, FCZ101ETN, FCZ061GAG, FCZ101GAG, FCZ102GAG, FCZ201GAG, FCZ061GAD, FCZ101GAD, FCZ102GAD, FCZ101GTG, FCZ102GTG, FCZ101GTD, FCZ102GTD, FCZ061EBA, FCZ101EBA, FCZ102EBA, FCZ201EBA, FCZ202EBA, FCZ061EBH, FCZ101EBH, FCZ201EBH, FCZ061EBN, FCZ101EBN, FCZ201EBN, FCZ061EBC, FCZ101EBC, FCZ201EBC, FCZ061EBA2, FCZ101EBA2, FCZ102EBA2, FCZ061EBH2, FCZ101EBH2, FCZ061EBN2, FCZ101EBN2... (Other models you can see in the webshop)		

			
1			
GEV No.	514377	Ref. No.	0H6299 0K1043
description	drain filter		
For models:	FDV40G, FDV40E, FDV40GZ, FDV40EL, FDV40GA, FDV20G, FDV20E, FDV20GZ, FDV20EL, FDV20GA, FCVG202L3, FCVE202L3, FCVG202L6, FCVE202L6, FCV/G202/1, FVC/E202/1, FCS202E4, FCS202G4, FCS202GP, FCS202GX, 5717-2-6, 5714-2-7, 5714-2-8, 5714-2-10, 5714-2-6L, 5714-2-7L, 5714-2-8L, 5714-2-10L, 5717-3-7, 5717-3-8, 5717-3-8E, 5717-3-10, 5717-3-8M, 5717-3-8C, 5717-3-8M, 5707-2-2, 57074-2-3, 5707-3-2, 5707-3-3, ECVG202T4, ECV202T4, ECVG202T6, ECV202T6, ACVG202C4, ACVE202C4, ACVG202C6, ACV/E202/1, ZCV/G202/1, ZCV/E202/1, ZCV/G202/1... (Other models you can see in the webshop)		

			
1			
GEV No.	514425	Ref. No.	005133 056444 0C1740 0F0073 0K8367 30001886
description	drain filter ø 102mm		
For models:	FCZ061EAA, FCZ101EAA, FCZ201EAA, FCZ061EAH, FCZ101EAH, FCZ201EAH, FCZ061EAN, FCZ101EAN, FCZ201EAN, FCZ061ETA, FCZ101ETA, FCZ201ETA, FCZ061ETH, FCZ101ETH, FCZ201ETH, FCZ061ETN, FCZ101ETN, FCZ201ETN, FCZ061GAG, FCZ101GAG, FCZ201GAG, FCZ061GAD, FCZ101GAD, FCZ201GAD, FCZ101GTG, FCZ102GTG, FCZ201GTG, FCZ101GTD, FCZ102GTD, FCZ201GTD, FCZ061EBA, FCZ101EBA, FCZ201EBA, FCZ061EBH, FCZ101EBH, FCZ201EBH, FCZ061EBN, FCZ101EBN, FCZ201EBN, FCZ061EBC, FCZ101EBC, FCZ201EBC, FCZ061EBA2, FCZ101EBA2, FCZ201EBA2, FCZ061EBH2, FCZ101EBH2, FCZ201EBH2, FCZ061EBN2, FCZ101EBN2... (Other models you can see in the webshop)		

<h3>housing and bezels</h3>			
			
1			
GEV No.	699198	Ref. No.	0C4138
description	flange bore ø 9mm ø 74mm H 5mm		
For models:	FCZ061EAA, FCZ101EAA, FCZ102EAA, FCZ201EAA, FCZ202EAA, FCZ061EAH, FCZ101EAH, FCZ201EAH, FCZ061EAN, FCZ101EAN, FCZ201EAN, FCZ061ETA, FCZ101ETA, FCZ102ETA, FCZ201ETA, FCZ202ETA, FCZ061ETH, FCZ101ETH, FCZ201ETH, FCZ061ETN, FCZ101ETN, FCZ201ETN, FCZ061GAG, FCZ101GAG, FCZ102GAG, FCZ201GAG, FCZ202GAG, FCZ061GAD, FCZ101GAD, FCZ102GAD, FCZ201GAD, FCZ202GAD, FCZ101GTG, FCZ102GTG, FCZ201GTG, FCZ202GTG, FCZ101GTD, FCZ102GTD, FCZ201GTD, FCZ202GTD, FCZ061EBA, FCZ101EBA, FCZ102EBA, FCZ201EBA, FCZ202EBA, FCZ061EBH, FCZ101EBH, FCZ201EBH, FCZ061EBN, FCZ101EBN... (Other models you can see in the webshop)		

			
1			
GEV No.	850115	Ref. No.	0C1590 0C4109
description	insulation set for boiler thickness 6mm plastic		
For models:	FCZ061EAA, FCZ101EAA, FCZ061EAH, FCZ101EAH, FCZ061EAN, FCZ101EAN, FCZ061EBA, FCZ101EBA, FCZ061EBH, FCZ101EBH, FCZ101EBN, AOW101EA, AOS061EABU, AOS101EABU, AOS061EAFU, AOS101EAFU, AOS101EA, AOS101EB, AOS101EA3J, AOS101EB3J, AOS101EA2N, AOS101EB2N, AOS101EA0H, AOS101EB0H, AOW101EABU, AOS061EAAQ, AOS061EBAQ, AOS101EAAQ, AOS101EBAQ, AOS061EANQ, AOS061EBNQ, AOS101EANQ, AOS101EBNQ, AOS061EACQ, AOS061EBCQ, AOS101EACQ, AOS101EBCQ, AOS061EAHQ, AOS061EBHQ, AOS101EAHQ, AOS101EBHQ, AOS101EBEQ, AOS061EAMQ, AOS101EAMQ, AOS061EABQ, AOS101EABQ, EJM061EAA, EJM101EAA, RDR061EAA, RDR101EAA... (Other models you can see in the webshop)		

glass panels



1				057400 0C5340 0H6898 0K3033 12011870 275290025 727859
GEV No.	693397	Ref. No.		
description	glass panel L 29mm W 29mm thickness 3.5mm square			
For models:	MFR/G360, MPN/GD761, MPN/GI761, MPN/GI760D, MPN/GD760, MPN/GD760F, MPN/GI760, MPN/GI760F, MM/G351, MM/G701, MM/G350, MM/G700, MM/G350F, MM/G700F, MM/G700E, MCP/G700, MCP/G701, MCP/G710, MCP/G711, MCP/G705, MCP/G706, FDV40G, FDV40GZ, FDV40GA, FDV20G, FDV20GZ, FDV20GA, RBR/G2FM, RBR/G2IM, RBK/G2FM, RMV/G1C, RMV/G2C, RF/G1S07, RF/G2D07, RFR/G1S07, RFR/G2D07, RFR/G1S14, RFR/G2D14, RF/G1S07, RF/G2D07, RFR/G1S07, RFR/G2D07, XBR/G2FM, XBR/G2IM, XBK/G2FM, XMV/G1C, XMV/G2C, XF/G1S07, XRF/G2D07, XFR/G1S07...(Other models you can see in the webshop)			

air filters



1				
GEV No.	970959	Ref. No.		0C4937
description	air filter L 415mm W 73mm H 15mm SS for combi-steamer ELECTROLUX, ZANUSSI			

frame



1				057382 0H6890 0K3035 0K541 12011869 727857
GEV No.	693398	Ref. No.		
description	frame for level glass			
For models:	MFR/G360, MPN/GD761, MPN/GI761, MPN/GI760D, MPN/GD760, MPN/GD760F, MPN/GI760, MPN/GI760F, MM/G351, MM/G701, MM/G350, MM/G700, MM/G350F, MM/G700F, MM/G700E, MCP/G700, MCP/G701, MCP/G710, MCP/G711, MCP/G705, MCP/G706, FDV40G, FDV40GZ, FDV40GA, FDV20G, FDV20GZ, FDV20GA, RBR/G2FM, RBR/G2IM, RBK/G2FM, RMV/G1C, RMV/G2C, RF/G1S07, RF/G2D07, RFR/G1S07, RFR/G2D07, RFR/G1S14, RFR/G2D14, RF/G1S07, RF/G2D07, RFR/G1S07, RFR/G2D07, XBR/G2FM, XBR/G2IM, XBK/G2FM, XMV/G1C, XMV/G2C, XF/G1S07, XRF/G2D07, XFR/G1S07...(Other models you can see in the webshop)			

cleaning system

nozzles



1				
GEV No.	510239	Ref. No.		0H6675
description	rinse jet for humidifier			

coupling bushings



1				0C4342 0C4680 0C6166 0C6167
GEV No.	694644	Ref. No.		
description	guide for washing arms			
For models:	FCS101EX4J, FCS101EXLN, FCS101EX, FCS102EX4J, FCS102EX, FCS201EX, FCS201EXLN, FCS202EX, FCS101GX9J, FCS101GX, FCS102GX9J, FCS102GX, FCS201GX, FCS202GX			

cleaning arms



1				007010 0C5503 0C8317
GEV No.	693408	Ref. No.		
description	cleaning arm			
For models:	FCZ061EAA, FCZ101EAA, FCZ102EAA, FCZ201EAA, FCZ202EAA, FCZ061EAH, FCZ101EAH, FCZ201EAH, FCZ061EAN, FCZ101EAN, FCZ201EAN, FCZ061ETA, FCZ101ETA, FCZ102ETA, FCZ201ETA, FCZ202ETA, FCZ061ETH, FCZ101ETH, FCZ201ETH, FCZ061ETN, FCZ101ETN, FCZ201ETN, FCZ061GAG, FCZ101GAG, FCZ102GAG, FCZ201GAG, FCZ202GAG, FCZ061GAD, FCZ101GAD, FCZ102GAD, FCZ201GAD, FCZ202GAD, FCZ101GTG, FCZ102GTG, FCZ201GTG, FCZ202GTG, FCZ101GTD, FCZ102GTD, FCZ201GTD, FCZ202GTD, FCZ061EBA, FCZ101EBA, FCZ102EBA, FCZ061EBH, FCZ101EBH, FCZ061EBN, FCZ101EBN, FCZ061EBC, FCZ101EBC, FCZ201EBC...(Other models you can see in the webshop)			
spare parts for	693408			
	GEV No.	693409	Ref. No.	007026
		retainer clip for wash arm		

hoses



1				
GEV No.	699394	Ref. No.		0C4294
description	collector ED ø 15mm ID ø 11mm for hose for cleaning system combi-steamer			
For models:	FCZ102EAA, FCZ102GAG, FCZ102GAD, FCZ102ECA, FCZ102GCG, FCZ102GCD, AOS102EAAQ, AOS102EANQ, AOS102GAGQ, AOS102GADQ, AOS102EAMQ, AOS102EABQ, AOS102GAPQ, AOS102EAC1, AOS102EAT1, AOS102GAG1, AOS102GAD1, AOS062GAP1, AOS102GAP1, AOS102GAU1, AOS102GCG1, AOS102GCD1, AOS062GCP1, AOS102GCP1, EJN102EAA, EJN102GAG, EJN102GAD, EJN102ECA, EJN102GCG, EJN102GCD			



screw connections



GEV No.	551437	Ref. No.	0C1170
description	T-piece for hose ø6mm plastic L 60mm		
For models:	AOS201GAEU, AOS202GAEU, AOS201GAU, AOS202GAU, AOS201EABU, AOS201EAFU, AOS201EA, AOS201EA3J, AOS201EA2N, AOS202EA2N, AOS201EA0H, AOS202EA, AOS201GA, AOS202GA		

pipes



GEV No.	699249	Ref. No.	0C0850
description	by-pass L 135mm W 40mm H 60mm ø 20mm flange 40x60mm		
For models:	FCV/G6L3TOWNGAS, FCV/G6L3, FCV/E101/1, FCV/E10L3JAP, FCV/E102/1L3JAP, FCV/E10L6JAP, FCV/E102/1L6JAP, FCV/G6L3JAP, FCV/G10L6JAP, FCV/G102/1L6JAP, FCV/E61/1, FCV/E61/1, FCV/E101/1, FCV/E101/1, FCV/E102/1, FCV/E61/1, FCV/E61/1, FCV/E101/1, FCV/E101/2, FCV/G61/1, FCV/G61/1, FCV/G61/1, FCV/E10L3, FCV/E102/1, FCV/E102/1L3, FCV/G6L4, FCV/E101/1, FCV/G10L6, FCV/E10L6, FCV/G102/1L6, FCV/E102/1L6, FCV/G20L6, FCV/G202L6, FCV/G101/1, FCV/E101/1, FCV/G102/1, FCV/E102/1, FCV/G201/1, FCV/E201/1, FCV/G202/1, FCV/E202/1, FCS061E44J, FCS061G48J, FCS061GP, FCS061EP, FCS061G3DI, FCS061E3CI, FCS061G4, FCS101E2, FCS061G4DT...(Other models you can see in the webshop)		



GEV No.	521190	Ref. No.	007012
description	water pipe L 205mm W 170mm ø 10mm for combi-steamer		
For models:	FCZ061EAA, FCZ101EAA, FCZ102EAA, FCZ061EAH, FCZ101EAH, FCZ061EAN, FCZ101EAN, FCZ061ETA, FCZ101ETA, FCZ061ETH, FCZ101ETH, FCZ061ETN, FCZ101ETN, FCZ061GAG, FCZ101GAG, FCZ061GAD, FCZ101GAD, FCZ061EBA, FCZ101EBA, FCZ102EBA, FCZ061EBH, FCZ101EBH, FCZ061EBN, FCZ101EBN, FCZ061EBC, FCZ101EBC, FCZ061EBA2, FCZ101EBA2, FCZ061EBH2, FCZ101EBH2, FCZ061EBN2, FCZ101EBN2, FCZ061EBC2, FCZ101EBC2, FCZ061GBG, FCZ101GBG, FCZ061GBD, FCZ101GBD, FCZ061GBI, FCZ101GBI, FCZ061ECA, FCZ101ECA, FCZ061ECH, FCZ101ECH, FCZ061ECN, FCZ101ECN, FCZ061ECA2, FCZ101ECA2, FCZ061ECH2, FCZ101ECH2...(Other models you can see in the webshop)		

level glasses



GEV No.	697987	Ref. No.	055343
description	level glass ø 54mm L 83mm thickness 3.5mm		
For models:	FCV/G6L4, FCVE6-1U, FCVE6-3U, FCVE6-1, FCVE6-3, FCVE6-1UK, FCVE6-3UK, FCVG6-1, FCVG6-3, FCVG6-1UK, FCVG6-3UK, FCVE10-2, FCVE10-4, FCVE10-2UK, FCVE10-4UK, FCVG10-2, FCVG10-4, FCVG10-2UK, FCVG10-4UK, FCVE20-2, FCVE20-4, FCVE20-2UK, FCVE20-4UK, FCVG20-2, FCVG20-4, FCVG20-2UK, FCVG20-4UK, ECV/G6T4, FCV/E6-1, FCV/E6-1, FCV/G6-1, ZOFV/G6-3, ZOFV/E102, ZOFV/E104, ZOFV/G102, ZOFV/G104, ZOFV/E202, ZOFV/E204, ZOFV/G202, ZOFV/G204, AFCV/G6-1, AFCV/G6-3, SCO/G6-3, ZCV/G6T4		

hoses



GEV No.	697979	Ref. No.	0C0874 0C0943 0C3307 0C3943 0C5122
description	hose ID ø 29mm ED ø 39mm L 340mm		
For models:	FCZ061EAA, FCZ061EAH, FCZ061EAN, FCZ061ETA, FCZ061ETH, FCZ061ETN, FCZ061EBA, FCZ061EBH, FCZ061EBN, FCZ061EBC, FCZ061EBA2, FCZ061EBH2, FCZ061EBN2, FCZ061EBC2, FCZ061ECA, FCZ061ECH, FCZ061ECN, FCZ061ECA2, FCZ061ECH2, FCZ061ECN2, FCV/G61/1, FCV/G61/1, FCV/G61/1, FCV/G202/1, FCS061GP, FCS061G4, 5714-2-7, 5714-2-8, 5714-2-10, 5721-2-7, 5721-2-10, 5714-2-7L, 5714-2-8L, 5714-2-10L, ECV/G61/1, ECV/G61/1, AOS061EAA1, AOS061EAH1, AOS061EAN1, AOS061EAC1, AOS061EAE1, AOS061EAF1, AOS061EAM1, AOS061EAB1, AOS061EAK1, AOS061EAT1, AOS061ETA1, AOS061ETH1, AOS061ETN1, AOS061ETC1...(Other models you can see in the webshop)		

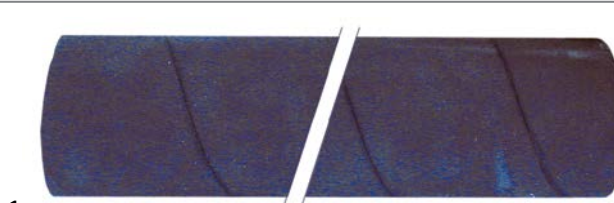

GEV No.	697981	Ref. No.	006113 006252 0C3322 0C5006
description	hose ID ø 29mm ED ø 39mm L 860mm		
For models:	FDV40G, FDV40E, FDV40GZ, FDV40EL, FDV40GA, FCV/E101/1, FCV/E101/1, FCV/E102/1, FCV/E101/1, FCV/E101/2, FCV/E102/1, FCV/E20L3, FCV/E20L6, FCV/G101/1, FCV/E101/1, FCV/G102/1, FCV/E102/1, FCV/E201/1, FCV/E202/1, FCS101E44J, FCS101EP4J, FCS101E4, FCS101G4, FCS101EP, FCS101G4DT, FCS102E44J, FCS101GP9J, FCS102EP4J, FCS101G49J, FCS102E4, FCS101GP, FCS102EP, FCS102G4, FCS102GA9J, FCS201EP, FCS102G49J, FCS202E4, FCS102GP, FCS202EP, FCS101EX4J, FCS101EXLN, FCS101EX, FCS102EX4J, FCS102EX, FCS201EX, FCS201EXLN, FCS202EX, FCS101GX9J, FCS101GX, FCS102GX9J...(Other models you can see in the webshop)		

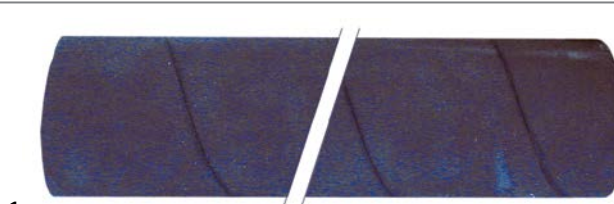

GEV No.	697982	Ref. No.	0C0869
description	hose ID ø 30mm ED ø 40mm L 1030mm		
For models:	FDV20G, FDV20E, FDV20GZ, FDV20EL, FDV20GA, FCV/G201/1, FCS201G4, FCS201GP, FCS202G4, FCS202GP, FCS201GX, FCS202GX, 5714-2-7, 5714-2-8, 5714-2-10, 5714-2-7L, 5714-2-8L, 5714-2-10L, 5714-2-10F, 5714-2-10S		



1

GEV No.	697980	Ref. No.	0C1223
description	hose ID ø 40mm ED ø 50mm L 450mm for combi-steamer		
For models:	FDV40G, FDV40GZ, FDV40GA, FCV/G202/1, FCS201EP, FCS202EP, FCS201GP, FCS202G4, FCS202GP, FCS201EX, FCS201EXLN, FCS202EX, 5714-2-7, 5714-2-8, 5714-2-10, 5714-2-7L, 5714-2-8L, 5714-2-10L		



1

GEV No.	697978	Ref. No.	0C1344
description	hose ID ø 40mm ED ø 50mm L 52mm		
For models:	FDV20G, FDV20GZ, FDV20GA, FCV/G61/1, FCV/G61/1, FCV/G61/1, FCV/G201/1, FVC/E201/1, FCS061G48J, FCS061GP, FCS061G3DI, FCS061G4, FCS061G4DT, FCS061G49J, FCS201E4, FCS201EP, FCS202E4, FCS201G4, FCS201GP, FCS202G4, FCS202GP, FCS201EX, FCS201GX, FCS202GX, 5714-2-7, 5714-2-8, 5714-2-10, 5721-2-7, 5721-2-10, 5714-2-7L, 5714-2-8L, 5714-2-10L, 5714-2-10F, 5714-2-10S, 5714-3-10F, 5714-3-10S, ECV/G61/1, ECV/G61/1, ZCV/G61/1		

service kits



1

GEV No.	542417	Ref. No.	0C9988
description	lever handle set for door combi-steamer bolt ø 19mm		
accessories for	542417		
	GEV No.	900272	Ref. No.
			003680
	window gasket profile 1830 L 1500mm Qty 1		

drip water trays



1

GEV No.	699201	Ref. No.	0C4242
description	drain tray to clip L 600mm W 77mm H 22mm		
For models:	FCZ061EAA, FCZ101EAA, FCZ061EAH, FCZ101EAH, FCZ061EAN, FCZ101EAN, FCZ061ETA, FCZ101ETA, FCZ061ETH, FCZ101ETH, FCZ061ETN, FCZ101ETN, FCZ061GAG, FCZ101GAG, FCZ061GAD, FCZ101GAD, FCZ101GTG, FCZ101GTD, FCZ061EBA, FCZ101EBA, FCZ061EBH, FCZ101EBH, FCZ061EBN, FCZ101EBN, FCZ061EBC, FCZ101EBC, FCZ061EBA2, FCZ101EBA2, FCZ061EBH2, FCZ101EBH2, FCZ061EBN2, FCZ101EBN2, FCZ061EBC2, FCZ101EBC2, FCZ061GBG, FCZ101GBG, FCZ061GBD, FCZ101GBD, FCZ061GBI, FCZ101GBI, FCZ101GBG2, FCZ101GBD2, FCZ101GBI2, FCZ061ECA, FCZ101ECA, FCZ061ECH, FCZ101ECH, FCZ061ECN, FCZ101ECN, FCZ061ECA2... (Other models you can see in the webshop)		

door mechanics

holders



1

GEV No.	692844	Ref. No.	006939
description	bracket for door mechanism combi-steamer L 264mm W 39mm H 34mm zinc-plated sheet steel		
For models:	FCF/E6-0, FCFE101-0, FCFE102-0, FCF061ELN, FCF101ELN, FCF6EHOR, FCFG10160H, FCF061ENS, FCF101ENS, FCF102ENS, FCFE6-1J, FCFE101-1J, FCFE102-1J, ECF/E6-0, ECFE101-0, ECFE102-0, ECF061ENS, ECF101ENS, ECF102ENS, ECF061E5M, ECF061ECV, ACF/E6-0, ACFE101-0, ACFE102-0, ACFG10160H, RCF061E, RCF101E		

miscellaneous



1

GEV No.	690631	Ref. No.	038023 081807
description	bush refrigerated counter		
For models:	AQCC22U US, , BC10A, BLAST C/FREEZER, BCF7A, BLAST C/FREEZER, TRN1301, TRNA1301, TRNM1301, TRN1302, TRNA1302, TRNM1302, TRN1303, TRNA1303, TRNM1303, TRN1801, TRNA1801, TRNM1801, TRN1802, TRNA1802, TRNM1802, TRN1803, TRNA1803, TRNM1803, TRN2201, TRNA2201, TRNM2201, TRN2202, TRNA2202, TRNM2202, TRN2203, TRNA2203, TRNM2203, TRRN1301, TRRN1302, TRRN1303, TRRN1801, TRRN1802, TRRN1803, TRRN2201, TRRN2202, TRRN2203, TRNP1802, STRP1101, TRRF130P, STRP1102, TRRF180P, STRP1601, TRRF220P... (Other models you can see in the webshop)		



door handles



GEV No.	696835	Ref. No.	0C4308 0C8719 0C9149
description	door handle L 180mm ø 46.5mm shaft L 40mm shaft diameter 8x8mm with bush		
For models:	FCZ201EAA, FCZ202EAA, FCZ201EAH, FCZ201EAN, FCZ201GAG, FCZ202GAG, FCZ201GAD, FCZ202GAD, FCZ201EBA, FCZ202EBA, FCZ201EBH, FCZ201EBN, FCZ201EBC, FCZ201GBG, FCZ202GBG, FCZ201GBD, FCZ202GBD, FCZ201GBI, FCZ201ECA, FCZ202ECA, FCZ201ECH, FCZ201ECN, FCZ201GCG, FCZ202GCG, FCZ201GCD, FCZ202GCD, AOS201EAAQ, AOS201EBAQ, AOS202EAAQ, AOS202EBAQ, AOS201EANQ, AOS201EBNQ, AOS202EANQ, AOS202EBNQ, AOS201EACQ, AOS201EBCQ, AOS201EAHQ, AOS201EBHQ, AOS201EBFQ, AOS201GAGQ, AOS201GBGQ, AOS202GAGQ, AOS202GBGQ, AOS201GADQ, AOS201GBDQ, AOS202GADQ, AOS202GBDQ, AOS201GAIQ, AOS201GALQ, AOS201EAMQ...(Other models you can see in the webshop)		



GEV No.	542415	Ref. No.	0C6569
description	lever handle plastic/SS shaft ø 11mm suitable for combi-steamer		
For models:	FCZ061ETA, FCZ101ETA, FCZ102ETA, FCZ061ETH, FCZ101ETH, FCZ061ETN, FCZ101ETN, FCZ102GTG, FCZ102GTD, FCZ061EBA2, FCZ101EBA2, FCZ102EBA2, FCZ061EBH2, FCZ101EBH2, FCZ061EBN2, FCZ101EBN2, FCZ061EBC2, FCZ101EBC2, FCZ102GBG2, FCZ102GBD2, FCZ102GBI2, FCZ061ECA2, FCZ101ECA2, FCZ102ECA2, FCZ061ECH2, FCZ101ECH2, FCZ061ECN2, FCZ101ECN2, FCZ102GCG2, FCZ102GCD2, AOS061ETA1, AOS101ETA1, AOS102ETA1, AOS061ETH1, AOS101ETH1, AOS061ETN1, AOS101ETN1, AOS061ETC1, AOS101ETC1, AOS061ETE1, AOS101ETE1, AOS061ETF1, AOS101ETF1, AOS061ETM1, AOS062ETM1, AOS101ETM1, AOS102ETM1, AOS061ETK1, AOS101ETK1, AOS102ETK1...(Other models you can see in the webshop)		



GEV No.	542417	Ref. No.	0C9988
description	lever handle set for door combi-steamer bolt ø 19mm		
accessories for	542417		
	GEV No.	900272	Ref. No. 003680
	window gasket profile 1830 L 1500mm Qty 1		

locking mechanism



GEV No.	692846	Ref. No.	0C4119
description	espagnolette lock L 1250mm complete ø 10mm for combi-steamer		
For models:	FCZ201EAA, FCZ202EAA, FCZ201EAH, FCZ201EAN, FCZ201GAG, FCZ202GAG, FCZ201GAD, FCZ202GAD, FCZ201EBA, FCZ202EBA, FCZ201EBH, FCZ201EBN, FCZ201EBC, FCZ202GBG, FCZ201GBD, FCZ202GBD, FCZ201ECA, FCZ202ECA, FCZ201ECH, FCZ201ECN, FCZ201GCG, FCZ202GCG, FCZ201GCD, FCZ202GCD, AOS201EAAQ, AOS201EBAQ, AOS202EAAQ, AOS202EBAQ, AOS201EANQ, AOS201EBNQ, AOS202EANQ, AOS202EBNQ, AOS201EACQ, AOS201EBCQ, AOS201EAHQ, AOS201EBHQ, AOS201GAGQ, AOS201GBGQ, AOS202GAGQ, AOS202GBGQ, AOS201GADQ, AOS202GADQ, AOS201GBDQ, AOS202GBDQ, AOS201GAIQ, AOS201GALQ, AOS201EAMQ, AOS201EABQ, AOS201GAPQ, AOS202GAPQ...(Other models you can see in the webshop)		

spare parts for	692846		
	GEV No.	690041	Ref. No. 003822 0H6727 0K2246 251425 751020943
	cam L 148mm mounting distance 32mm		
	GEV No.	692013	Ref. No. 052061 060920 0H6043 0K8575 60050373 727895
	roll pin ø 3mm L 16mm		
	GEV No.	694645	Ref. No. 0C4309
	bar for espagnolette lock ø 10mm L 345mm		
	GEV No.	698500	Ref. No. 0C4310
	bar L 435mm ø 9mm		
	GEV No.	700488	Ref. No. 003824 0K2718 0K8570 0K9189 751020941
	latch gear		

accessories



GEV No.	692851	Ref. No.	056552
description	connecting piece for door latch ø 10mm L 112mm		
For models:	FCVE10-2, FCVE10-4, FCVE103CE, FCVE10-2UK, FCVE10-4UK, FCVG10-2, FCVG10-4, FCVG10-1SG, FCVG10-2, FCVG10-4D, FCVG10-2UK, FCVG10-4UK, FCVG10-2, FCVG10-4, FCVE20-2, FCVE20-4, FCVE203CE, FCVE20/P-V, FCVE20-2UK, FCVE20-4UK, FCVG20-2, FCVG20-4, FCVG20-2, FCVG20-4D, FCVG20-2UK, FCVG20-4UK, FCVG20-4, FCVG20-4D, FCVE20-V, FCVE20VUK, FCVE10-P, FCVE10PUK, FCVG10-P, FCVG10PUK, FCVE20-P, FCVE20PUK, FCVG20-P, FCVG20PUK, HCF/G1210, ZHCF/G161, AFCV/G101, AFCV/G103, SCO/G10-3, AFCV/G201, AFCV/G203, SCO/G20-3, FCVG10-1SG, FCV/E20-V		



GEV No.	519624	Ref. No.	003991
description	door hinge for combi-steamer mounting pos. right bottom L 125mm W 50mm		
For models:	FCFG201-0, FCFG202-0, FCFE201-0, FCFE202-0, FCF201ENS, ECFG201-0, ECFG202-0, ECFE201-0, ECFE202-0, ECF201ENS, ACFG201-0, ACFG202-0, ACFE201-0, ACFE202-0, RCF201E, ZCF/G201/1, ZCF/G202/1, ZCF/E201/1-0, ZCF/E202/1-0		

vibration pumps



GEV No.	500566	Ref. No.	007018 0C2341
description	vibration pump 230V 32W 50Hz inlet ø 7 outlet ø 1/8" IT CEME type E512/A32		
For models:	FCZ061EAA, FCZ101EAA, FCZ102EAA, FCZ201EAA, FCZ202EAA, FCZ061EAH, FCZ101EAH, FCZ201EAH, FCZ061EAN, FCZ101EAN, FCZ201EAN, FCZ061ETA, FCZ101ETA, FCZ102ETA, FCZ201ETA, FCZ202ETA, FCZ061ETH, FCZ101ETH, FCZ201ETH, FCZ061ETN, FCZ101ETN, FCZ201ETN, FCZ061GAG, FCZ101GAG, FCZ102GAG, FCZ201GAG, FCZ202GAG, FCZ061GAD, FCZ101GAD, FCZ102GAD, FCZ201GAD, FCZ202GAD, FCZ101GTG, FCZ102GTG, FCZ201GTG, FCZ202GTG, FCZ101GTD, FCZ102GTD, FCZ201GTD, FCZ202GTD, FCZ061EBA, FCZ101EBA, FCZ102EBA, FCZ061EBH, FCZ101EBH, FCZ061EBN, FCZ101EBN, FCZ061EBC, FCZ101EBC, FCZ201EBC...(Other models you can see in the webshop)		
accessories for	500566		
	GEV No.	510303	Ref. No. 0C1935
	O-ring EPDM thickness 1.78mm ID ø 6.75mm Qty 1 pcs		
	GEV No.	520512	Ref. No. 0C1116
	reducer WS 17 IT 1/4" ET 1/8" total length 28mm		
	GEV No.	542346	Ref. No. 0C4198
	hose connector thread 1/4" with O-ring hose ø 5mm stainless steel Qty 1 pcs		



GEV No.	499060	Ref. No.	0C5371
description	vibration pump type E512 208/240V 60W 50-60Hz inlet ø 7 outlet ø 1/4" CEME L 150mm		
For models:	FCZ201ETA, FCZ202ETA, FCZ201ETH, FCZ201ETN, FCZ201GTG, FCZ201GTD, FCZ201EBA2, FCZ202EBA2, FCZ201EBH2, FCZ201EBN2, FCZ201EBC2, FCZ201GBG2, FCZ201GBD2, FCZ201GBI2, FCZ201ECA2, FCZ202ECA2, FCZ201ECH2, FCZ201ECN2, FCZ201GCG2, FCZ201GCD2, AOS201ETA1, AOS202ETA1, AOS201ETH1, AOS201ETN1, AOS201ETC1, AOS201ETE1, AOS201ETF1, AOS201ETM1, AOS202ETM1, AOS201ETK1, AOS202ETK1, AOS201GTG1, AOS201GTD1, AOS201GTP1, AOS201GTW1, AOS201EBA2, AOS202EBA2, AOS201EBH2, AOS201EBN2, AOS201EBC2, AOS201EBE2, AOS201EBF2, AOS201EBK2, AOS202EBK2, AOS201GBG2, AOS201GBD2, AOS201GBW2, AOS201ECA2, AOS202ECA2, AOS201ECH2...(Other models you can see in the webshop)		
spare parts for	499060		
	GEV No.	510303	Ref. No. 0C1935
	O-ring EPDM thickness 1.78mm ID ø 6.75mm Qty 1 pcs		
	GEV No.	520512	Ref. No. 0C1116
	reducer WS 17 IT 1/4" ET 1/8" total length 28mm		
accessories for	499060		
	GEV No.	542346	Ref. No. 0C4198
	hose connector thread 1/4" with O-ring hose ø 5mm stainless steel Qty 1 pcs		

heat exchangers



GEV No.	692323	Ref. No.	003881 215711
description	heat exchanger for convection oven		
For models:	FCV/G10L3, FCVG10L3T, FCV/G20L3, FCVG10L3J, FCV/G10L6JAP, FCV/G10L2, FCV/G10L6, FCV/G20L6, FCV/G101/1, FCV/G201/1, FCS101G2, FCS101G4, FCS101G4DT, FCS101GP9J, FCS101G49J, FCS101GP, FCS201G4, FCS201GP, FCS101GX9J, FCS101GX, FCS201GX, 5712-2-6, 5712-2-7, 5712-2-8, 5712-2-10, 5714-2-6, 5714-2-7, 5714-2-8, 5714-2-10, 5712-2-6L, 5712-2-7L, 5712-2-8L, 5712-2-10L, 5714-2-6L, 5714-2-7L, 5714-2-8L, 5714-2-10L, 5712-2-10F, 5712-2-10S, 5714-2-10F, 5714-2-10S, 5702-2-2, 5702-2-3, 5704-2-2, 5704-2-3, ECV/G10T4, ECV/G20T4, ECV/G10T4J, ECV/G20T4J, ECV/G10T6...(Other models you can see in the webshop)		



miscellaneous



1

GEV No.	698500	Ref. No.	0C4310
description	bar L 435mm ø 9mm		
For models:	FCZ201EAA, FCZ202EAA, FCZ201EAH, FCZ201EAN, FCZ201ETA, FCZ202ETA, FCZ201ETH, FCZ201ETN, FCZ201GAG, FCZ202GAG, FCZ201GAD, FCZ202GAD, FCZ201GTG, FCZ202GTG, FCZ201GTD, FCZ202GTD, FCZ201EBA, FCZ202EBA, FCZ201EBH, FCZ201EBN, FCZ201EBC, FCZ201EBA2, FCZ202EBA2, FCZ201EBH2, FCZ201EBN2, FCZ201EBC2, FCZ201GBG, FCZ202GBG, FCZ201GBD, FCZ202GBD, FCZ201GBI, FCZ201GBG2, FCZ202GBG2, FCZ201GBD2, FCZ202GBD2, FCZ201GBI2, FCZ201ECA, FCZ202ECA, FCZ201ECH, FCZ201ECN, FCZ201ECA2, FCZ202ECA2, FCZ201ECH2, FCZ201ECN2, FCZ201GCG, FCZ202GCG, FCZ201GCD, FCZ202GCD, FCZ201GCG2, FCZ202GCG2... (Other models you can see in the webshop)		



1

GEV No.	693429	Ref. No.	002662
description	bush		
For models:	FCZ061EAA, FCZ101EAA, FCZ102EAA, FCZ201EAA, FCZ202EAA, FCZ061EAH, FCZ101EAH, FCZ201EAH, FCZ061EAN, FCZ101EAN, FCZ201EAN, FCZ061ETA, FCZ101ETA, FCZ201ETA, FCZ202ETA, FCZ061ETH, FCZ101ETH, FCZ201ETH, FCZ061ETN, FCZ101ETN, FCZ201ETN, FCZ061GAG, FCZ101GAG, FCZ201GAG, FCZ202GAG, FCZ061GAD, FCZ101GAD, FCZ201GAD, FCZ202GAD, FCZ101GTG, FCZ201GTG, FCZ202GTG, FCZ101GTD, FCZ201GTD, FCZ202GTD, FCZ061EBA, FCZ101EBA, FCZ201EBA, FCZ202EBA, FCZ061EBH, FCZ101EBH, FCZ201EBH, FCZ202EBH... (Other models you can see in the webshop)		



1

GEV No.	550697	Ref. No.	003765 0K2358
description	bush for knob		
For models:	FCFE201-0, FCFE202-0, FCF201ENS, 5711-2-6, 5711-2-7, 5711-2-8, 5711-2-8CH, 5712-2-6, 5712-2-7, 5712-2-8, 5714-2-6, 5714-2-7, 5714-2-8, 5717-2-6, 5714-2-7, 5714-2-8, 5711-2-6L, 5711-2-7L, 5711-2-8L, 5712-2-6L, 5712-2-7L, 5712-2-8L, 5714-2-6L, 5714-2-7L, 5714-2-8L, 5714-2-6L, 5714-2-7L, 5714-2-8L, 5711-3-6, 5711-3-7, 5711-3-8, 5711-3-8CH, 5712-3-6, 5712-3-7, 5712-3-8, 5712-3-8E, 5712-3-8CH, 5714-3-6, 5714-3-7, 5714-3-8, 5714-3-8E, 5717-3-7, 5717-3-8, 5717-3-8E, 5717-3-8M, 5717-3-8C, 5717-3-8M, 5702-2-3, 5704-2-3, 57074-2-3... (Other models you can see in the webshop)		



1

GEV No.	696445	Ref. No.	0C6228
description	connecting fitting D1 ø 25mm D2 ø 11.5mm L 20mm WS 27 thread M18x1		
For models:	FCZ061EAA, FCZ101EAA, FCZ102EAA, FCZ061EAH, FCZ101EAH, FCZ061EAN, FCZ101EAN, FCZ061ETA, FCZ101ETA, FCZ102ETA, FCZ201ETA, FCZ202ETA, FCZ061ETH, FCZ101ETH, FCZ201ETH, FCZ061ETN, FCZ101ETN, FCZ201ETN, FCZ101GTG, FCZ102GTG, FCZ201GTG, FCZ202GTG, FCZ101GTD, FCZ102GTD, FCZ201GTD, FCZ202GTD, FCZ061EBA, FCZ101EBA, FCZ102EBA, FCZ061EBH, FCZ101EBH, FCZ061EBN, FCZ101EBN, FCZ061EBC, FCZ101EBC, FCZ061EBA2, FCZ101EBA2, FCZ102EBA2, FCZ201EBA2, FCZ202EBA2, FCZ061EBH2, FCZ101EBH2, FCZ201EBH2, FCZ061EBN2, FCZ101EBN2, FCZ201EBN2, FCZ061EBC2, FCZ101EBC2, FCZ201EBC2, FCZ101GBG2... (Other models you can see in the webshop)		



1

GEV No.	650218	Ref. No.	0C4292
description	drip tray horizontal L 755mm stainless steel W 20mm hole ø 9.6mm H 40mm		
For models:	FCZ102EAA, FCZ102ETA, FCZ102GAG, FCZ102GAD, FCZ102GTG, FCZ102GTD, FCZ102EBA, FCZ102EBA2, FCZ102GBG, FCZ102GBD, FCZ102GBG2, FCZ102GBD2, FCZ102GBI2, FCZ102ECA, FCZ102ECA2, FCZ102GCG, FCZ102GCD, FCZ102GCG2, FCZ102GCD2, AOS102EAAQ, AOS102EBAQ, AOS102EANQ, AOS102EBNQ, AOS102GAGQ, AOS102GBGQ, AOS102GADQ, AOS102GBDQ, AOS102EAMQ, AOS102EABQ, AOS102GAPQ, AOS102EAA1, AOS102EAC1, AOS102EAS1, AOS062EAM1, AOS102EAM1, AOS062EAB1, AOS102EAB1, AOS102EAK1, AOS102EAT1, AOS102ETA1, AOS062ETM1, AOS102ETM1, AOS102ETK1, AOS102GAG1, AOS102GAD1, AOS062GAP1, AOS102GAP1, AOS102GAU1, AOS102GTG1, AOS102GTD1... (Other models you can see in the webshop)		



1

GEV No.	650217	Ref. No.	0C4298
description	drip tray horizontal L 785mm plastic W 78mm H 12mm		
For models:	FCZ102EAA, FCZ102ETA, FCZ102GAG, FCZ102GAD, FCZ102GTG, FCZ102GTD, FCZ102EBA, FCZ102EBA2, FCZ102GBG, FCZ102GBD, FCZ102GBG2, FCZ102GBD2, FCZ102GBI2, FCZ102ECA, FCZ102ECA2, FCZ102GCG, FCZ102GCD, FCZ102GCG2, FCZ102GCD2, AOS102EAAQ, AOS102EBAQ, AOS102EANQ, AOS102EBNQ, AOS102GAGQ, AOS102GBGQ, AOS102GADQ, AOS102GBDQ, AOS102EAMQ, AOS102EABQ, AOS102GAPQ, AOS102EAA1, AOS102EAC1, AOS102EAS1, AOS062EAM1, AOS102EAM1, AOS062EAB1, AOS102EAB1, AOS102EAK1, AOS102EAT1, AOS102ETA1, AOS062ETM1, AOS102ETM1, AOS102ETK1, AOS102GAG1, AOS102GAD1, AOS062GAP1, AOS102GAP1, AOS102GAU1, AOS102GTG1, AOS102GTD1... (Other models you can see in the webshop)		



1

GEV No.	697983	Ref. No.	006670
description	flange bore \varnothing 9mm D1 \varnothing 74mm D2 \varnothing 22mm L 68mm thickness 1mm		
For models:	FCV/G6L3TOWNGAS, FCV/G6L3, FCV/E101/1, FCV/E10L3JAP, FCV/E102/1L3JAP, FCV/E10L6JAP, FCV/E102/1L6JAP, FCV/G6L3JAP, FCV/G10L6JAP, FCV/G102/1L6JAP, FCV/E61/1, FCV/E61/1, FCV/E101/1, FCV/E101/1, FCV/E102/1, FCV/E61/1, FCV/E61/1, FCV/E101/1, FCV/E101/2, FCV/G61/1, FCV/G61/1, FCV/G61/1, FCV/E10L3, FCV/E102/1, FCV/E102/1L3, FCV/G6L4, FCV/E101/1, FCV/G10L6, FCV/E10L6, FCV/G102/1L6, FCV/E102/1L6, FCV/G20L6, FCVG202L6, FCV/G101/1, FVC/E101/1, FCV/G102/1, FVC/E102/1, FCV/G201/1, FVC/E201/1, FCV/G202/1, FVC/E202/1, FCFG201-0, FCFG202-0, FCS061E44J, FCS061G48J, FCS061GP, FCS061EP, FCS061G3DI, FCS061E3CI, FCS061G4... (Other models you can see in the webshop)		



1

GEV No.	697985	Ref. No.	058730
description	flange for fan motor bore \varnothing 6.6mm \varnothing 230mm thickness 2.5mm		
For models:	FCFG20, FCFG20D, FCFG20F, PFCFG20, FCFE20, FCFE20UK, FCFG40, FCFG41, FCFG40D, FCFG40F, PFCFG40F, FCFE40, FCFE40D, FCFE40UK, PFCFE40F, FCFG20J, FCFG20J, FCFE20J, FCFE20J, FCFG40J, FCFG40J, FCFE40J, FCFE40J, FCFG20J, FCFG20J, FCFG41J, FCFG40J, FCVE20-2, FCVE20-4, FCVE203CE, FCVE20-2UK, FCVE20-4UK, FCVE20-P, FCVE20PUK, FCVG20-P, FCVG20PUK, FCFG201, FCFG202, FCFC202, FCFE202, ZOFCE/E202, ZOFCE/E204, FF/E40, AFCV/G201, AFCV/G203, SCO/G20-3, FF/E20, FF/G20, FF/G40, AFCF/E40... (Other models you can see in the webshop)		

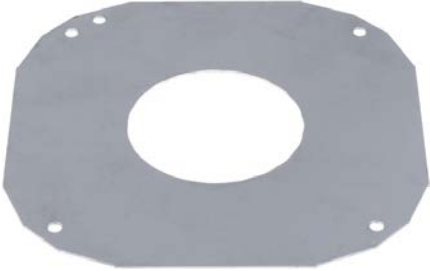

1

GEV No.	697984	Ref. No.	002872
description	flange for fan motor L 152mm W 152mm \varnothing 65mm thickness 1mm		
For models:	FCV/G10L3, FCVG10L3T, FCVG102L3, FCV/G20L3, FCVG202L3, FCVG10L3J, FCVG102L3J, FCV/G10L6JAP, FCV/G102/1L6JAP, FCV/G10L2, FCV/G10L6, FCV/G102/1L6, FCV/G20L6, FCVG202L6, FCV/G101/1, FCV/G102/1, FCV/G201/1, FCV/G202/1, FCS101G2, FCS101G4, FCS101G4DT, FCS101GP9J, FCS101G49J, FCS101GP, FCS102G4, FCS102GA9J, FCS102G49J, FCS102GP, FCS201G4, FCS201GP, FCS202G4, FCS202GP, FCS101GX9J, FCS101GX, FCS102GX9J, FCS102GX, FCS201GX, FCS202GX, 5712-2-6, 5712-2-7, 5712-2-8, 5712-2-10, 5714-2-6, 5714-2-7, 5714-2-8, 5714-2-10, 5717-2-6, 5714-2-7, 5714-2-8, 5714-2-10... (Other models you can see in the webshop)		



1

GEV No.	697986	Ref. No.	058958
description	flange \varnothing 269mm		
For models:	FCVE20-2, FCVE20-4, FCVE203CE, FCVE20-2UK, FCVE20-4UK, FCVE20-P, FCVE20PUK, FCVG20-P, FCVG20PUK, ZOFCE/E202, ZOFCE/E204, AFCV/G201, AFCV/G203, SCO/G20-3		



1

GEV No.	698582	Ref. No.	002634 0C7016
description	gasket conical D1 \varnothing 74mm D2 \varnothing 17mm thickness 11mm		
For models:	FCZ061EAA, FCZ101EAA, FCZ102EAA, FCZ201EAA, FCZ202EAA, FCZ061EAH, FCZ101EAH, FCZ201EAH, FCZ061EAN, FCZ101EAN, FCZ201EAN, FCZ061ETA, FCZ201ETA, FCZ202ETA, FCZ061ETH, FCZ201ETH, FCZ061ETN, FCZ201ETN, FCZ061GAG, FCZ101GAG, FCZ102GAG, FCZ201GAG, FCZ202GAG, FCZ061GAD, FCZ101GAD, FCZ102GAD, FCZ201GAD, FCZ202GAD, FCZ101GTG, FCZ102GTG, FCZ201GTG, FCZ202GTG, FCZ101GTD, FCZ102GTD, FCZ201GTD, FCZ202GTD, FCZ061EBA, FCZ101EBA, FCZ102EBA, FCZ201EBA, FCZ202EBA, FCZ061EBH, FCZ101EBH, FCZ201EBH, FCZ061EBN, FCZ101EBN, FCZ201EBN, FCZ061EBC, FCZ101EBC, FCZ201EBC... (Other models you can see in the webshop)		



1

GEV No.	694372	Ref. No.	0G3351 0KB679
description	gasket for hose for water inlet bore \varnothing 14mm L 33mm for hose 6mm hose length 260mm		
For models:	7C030, CCO30G, ECO312CF, OTS100		



1

GEV No.	693432	Ref. No.	002663 0F0082
description	gasket for knob		
For models:	EBS50, EBS50, EBS50, EBS50, EBV50, EBV50, EBV50, EBV50, EBV50, EBV50, EBS100, EBS100, EBS100, EBS100, EBV100, EBV100, EBV100, EBV100, EBV100, EBV100, EBV-C100, EBV-C100, EBV-C100, EBV-C100, EBV-C100, EBV200, EBV200, EBV200, EBV200, EBV200, EBV-C200, EBV-C200, EBV-C200, EBV-C200, EBV300, EBV300, EBV300, EBV300, EBV300, EBV300, EBV-C300, EBV-C300, EBV-C300, EBV-C300, EBV-C300, FCV/G10L3, FCV/G6L3TOWNGAS, FCV/G6L3, FCVG10L3T, FCVG102L3, FCV/G20L3, FCVG202L3... (Other models you can see in the webshop)		





			
1			
GEV No.	520938	Ref. No.	0C1168
description	gasket L 115mm rubber W 100mm thickness 3.5mm hole ø 7mm		
For models:	FCZ102EAA, FCZ201EAA, FCZ202EAA, FCZ201EAH, FCZ201EAN, FCZ102ETA, FCZ201ETA, FCZ202ETA, FCZ201ETH, FCZ201ETN, FCZ102GAG, FCZ201GAG, FCZ202GAG, FCZ102GAD, FCZ201GAD, FCZ202GAD, FCZ102GTG, FCZ201GTG, FCZ202GTG, FCZ102GTD, FCZ201GTD, FCZ202GTD, FCZ102EBA, FCZ201EBA, FCZ202EBA, FCZ201EBH, FCZ201EBN, FCZ201EBC, FCZ102EBA2, FCZ201EBA2, FCZ202EBA2, FCZ201EBH2, FCZ201EBN2, FCZ201EBC2, FCZ102GBG, FCZ201GBG, FCZ202GBG, FCZ102GBD, FCZ201GBD, FCZ202GBD, FCZ201GBI, FCZ102GBG2, FCZ201GBG2, FCZ202GBG2, FCZ102GBD2, FCZ201GBD2, FCZ202GBD2, FCZ102GBI2, FCZ201GBI2, FCZ102ECA... (Other models you can see in the webshop)		

			
1			
GEV No.	520866	Ref. No.	007117 516809501
description	hose connector brass straight thread 3/4" hose ø 30mm Qty 1 pcs		
For models:	FDV40G, FDV40GZ, FDV40GA, FDV20G, FDV20GZ, FDV20GA, FCZ061EAA, FCZ101EAA, FCZ102EAA, FCZ201EAA, FCZ202EAA, FCZ061EAH, FCZ101EAH, FCZ201EAH, FCZ061EAN, FCZ101EAN, FCZ201EAN, FCZ061ETA, FCZ101ETA, FCZ102ETA, FCZ201ETA, FCZ202ETA, FCZ061ETH, FCZ101ETH, FCZ201ETH, FCZ061ETN, FCZ101ETN, FCZ201ETN, FCZ201GAG, FCZ201GAD, FCZ201GTG, FCZ201GTD, FCZ061EBA, FCZ101EBA, FCZ102EBA, FCZ201EBA, FCZ202EBA, FCZ061EBH, FCZ101EBH, FCZ201EBH, FCZ061EBN, FCZ101EBN, FCZ201EBN, FCZ061EBC, FCZ101EBC, FCZ201EBC, FCZ061EBA2, FCZ101EBA2, FCZ102EBA2, FCZ201EBA2... (Other models you can see in the webshop)		

			
1			
GEV No.	696444	Ref. No.	0C4975
description	injection pipe L-shape for combi-steamer L 555mm WS 27 thread M18 ø 8mm		
For models:	FCZ101EAA, FCZ101EAH, FCZ101EAN, FCZ101ETA, FCZ201ETA, FCZ101ETH, FCZ201ETH, FCZ101ETN, FCZ201ETN, FCZ101GTG, FCZ201GTG, FCZ101GTD, FCZ201GTD, FCZ101EBA, FCZ101EBH, FCZ101EBN, FCZ101EBC, FCZ201EBC, FCZ101EBA2, FCZ201EBA2, FCZ101EBH2, FCZ201EBH2, FCZ101EBN2, FCZ201EBN2, FCZ101EBC2, FCZ201EBC2, FCZ101GBI, FCZ201GBI, FCZ101GBG2, FCZ201GBG2, FCZ101GBD2, FCZ201GBD2, FCZ101GBI2, FCZ201GBI2, FCZ101ECA, FCZ201ECA, FCZ101ECH, FCZ201ECH, FCZ101ECN, FCZ201ECN, FCZ101ECA2, FCZ201ECA2, FCZ101ECH2, FCZ201ECH2, FCZ101ECN2, FCZ201ECN2, FCZ201GCG, FCZ201GCD, FCZ101GCG2, FCZ201GCG2... (Other models you can see in the webshop)		

			
1			
GEV No.	601725	Ref. No.	0C3423
description	mounting clip		
For models:	FCZ061EAA, FCZ101EAA, FCZ102EAA, FCZ201EAA, FCZ202EAA, FCZ061EAH, FCZ101EAH, FCZ201EAH, FCZ061EAN, FCZ101EAN, FCZ201EAN, FCZ061ETA, FCZ101ETA, FCZ102ETA, FCZ061ETH, FCZ101ETH, FCZ061ETN, FCZ101ETN, FCZ061GAG, FCZ101GAG, FCZ102GAG, FCZ201GAG, FCZ202GAG, FCZ061GAD, FCZ101GAD, FCZ102GAD, FCZ201GAD, FCZ202GAD, FCZ061EBA, FCZ101EBA, FCZ102EBA, FCZ201EBA, FCZ202EBA, FCZ061EBH, FCZ101EBH, FCZ201EBH, FCZ061EBN, FCZ101EBN, FCZ201EBN, FCZ061EBC, FCZ101EBC, FCZ201EBC, FCZ061EBA2, FCZ101EBA2, FCZ102EBA2, FCZ201EBA2, FCZ102EBA2, FCZ061EBH2, FCZ101EBH2, FCZ061EBN2, FCZ101EBN2, FCZ061EBC2... (Other models you can see in the webshop)		

			
1			
GEV No.	543008	Ref. No.	0C1117
description	non-return valve plastic ø 10mm Qty 1 pcs total length 10mm		
For models:	FCZ061EAA, FCZ101EAA, FCZ102EAA, FCZ201EAA, FCZ202EAA, FCZ061EAH, FCZ101EAH, FCZ201EAH, FCZ061EAN, FCZ101EAN, FCZ201EAN, FCZ061ETA, FCZ101ETA, FCZ102ETA, FCZ201ETA, FCZ202ETA, FCZ061ETH, FCZ101ETH, FCZ201ETH, FCZ061ETN, FCZ101ETN, FCZ201ETN, FCZ061GAG, FCZ101GAG, FCZ102GAG, FCZ201GAG, FCZ202GAG, FCZ061GAD, FCZ101GAD, FCZ102GAD, FCZ201GAD, FCZ202GAD, FCZ101GTG, FCZ102GTG, FCZ201GTG, FCZ202GTG, FCZ101GTD, FCZ102GTD, FCZ201GTD, FCZ202GTD, FCZ061EBA, FCZ101EBA, FCZ102EBA, FCZ061EBH, FCZ101EBH, FCZ061EBN, FCZ101EBN, FCZ061EBC, FCZ101EBC, FCZ201EBC... (Other models you can see in the webshop)		

			
1			
GEV No.	693430	Ref. No.	051263 0F0147
description	nut thread M22x1.5 H 5mm WS 26 zinc-coated steel Qty 1 pcs		
For models:	FCZ061EAA, FCZ101EAA, FCZ102EAA, FCZ201EAA, FCZ202EAA, FCZ061EAH, FCZ101EAH, FCZ201EAH, FCZ061EAN, FCZ101EAN, FCZ201EAN, FCZ061ETA, FCZ101ETA, FCZ102ETA, FCZ201ETA, FCZ202ETA, FCZ061ETH, FCZ101ETH, FCZ201ETH, FCZ061ETN, FCZ101ETN, FCZ201ETN, FCZ061GAG, FCZ101GAG, FCZ102GAG, FCZ201GAG, FCZ202GAG, FCZ061GAD, FCZ101GAD, FCZ102GAD, FCZ201GAD, FCZ202GAD, FCZ101GTG, FCZ102GTG, FCZ201GTG, FCZ202GTG, FCZ101GTD, FCZ102GTD, FCZ201GTD, FCZ202GTD, FCZ061EBA, FCZ101EBA, FCZ102EBA, FCZ201EBA, FCZ202EBA, FCZ061EBH, FCZ101EBH, FCZ201EBH, FCZ061EBN, FCZ101EBN... (Other models you can see in the webshop)		

			
1			
GEV No.	693431	Ref. No.	002727
description	plain washer		
For models:	FCZ061EAA, FCZ101EAA, FCZ102EAA, FCZ201EAA, FCZ202EAA, FCZ061EAH, FCZ101EAH, FCZ201EAH, FCZ061EAN, FCZ101EAN, FCZ201EAN, FCZ061ETA, FCZ101ETA, FCZ102ETA, FCZ201ETA, FCZ202ETA, FCZ061ETH, FCZ101ETH, FCZ201ETH, FCZ061ETN, FCZ101ETN, FCZ201ETN, FCZ061GAG, FCZ101GAG, FCZ102GAG, FCZ201GAG, FCZ202GAG, FCZ061GAD, FCZ101GAD, FCZ102GAD, FCZ201GAD, FCZ202GAD, FCZ101GTG, FCZ102GTG, FCZ201GTG, FCZ202GTG, FCZ101GTD, FCZ102GTD, FCZ201GTD, FCZ202GTD, FCZ061EBA, FCZ101EBA, FCZ102EBA, FCZ201EBA, FCZ202EBA, FCZ061EBH, FCZ101EBH, FCZ201EBH, FCZ061EBN, FCZ101EBN...(Other models you can see in the webshop)		

			
2			
GEV No.	692446	Ref. No.	002091
description	reducer bore ø 0.6mm brass ø 12mm thickness 9mm code 6		
For models:	FCV/G6L3TOWNGAS, FCV/G6L3, FCV/E101/1, FCVE6L3J, FCV/G6L3JAP, FCV/G6L3CJ, FCV/E61/1, FCV/G10L2, FCV/E10L2, FCV/E61/1, FCV/G6L3C, FCV/G61/1, FCV/G6L3CT, FCV/G6L3CJ, FCV/E6L3, FCV/E101/1, FCF/G6-0, FCFG101/0, FCFG102-0, FCFG201-0, FCFG202-0, FCF/E6-0, FCFE101-0, FCFE102-0, FCFE201-0, FCFE202-0, FCF061ELN, FC-F101ELN, FCFG102-0T, FCF/G6-1-JAP, FCF/G101/1-1-JAP, FCF/G102/1-1-JAP, FCFE6-1J, FCFE101-1J, FCFE102-1J, FCF/G101/1, FCS061E44J, FCS061G48J, FCS061G3DI, FCS061E3CI, FCS101E2, FCS061G4DT, FCS061G49J, FCS101G2, FCVG10-1SG, 5702-2-2, 5702-2-3, 5702-3-2, 5702-3-3, ECF/G6/0...(Other models you can see in the webshop)		

			
1			
GEV No.	520512	Ref. No.	0C1116
description	reducer WS 17 IT 1/4" ET 1/8" total length 28mm		
For models:	FCZ061EAA, FCZ101EAA, FCZ102EAA, FCZ201EAA, FCZ202EAA, FCZ061EAH, FCZ101EAH, FCZ201EAH, FCZ061EAN, FCZ101EAN, FCZ201EAN, FCZ061ETA, FCZ101ETA, FCZ102ETA, FCZ201ETA, FCZ202ETA, FCZ061ETH, FCZ101ETH, FCZ201ETH, FCZ061ETN, FCZ101ETN, FCZ201ETN, FCZ061GAG, FCZ101GAG, FCZ102GAG, FCZ201GAG, FCZ202GAG, FCZ061GAD, FCZ101GAD, FCZ102GAD, FCZ201GAD, FCZ202GAD, FCZ101GTG, FCZ102GTG, FCZ201GTG, FCZ202GTG, FCZ101GTD, FCZ102GTD, FCZ201GTD, FCZ202GTD, FCZ061EBA, FCZ101EBA, FCZ102EBA, FCZ061EBH, FCZ101EBH, FCZ061EBN, FCZ101EBN, FCZ061EBC, FCZ101EBC, FCZ061EBA2...(Other models you can see in the webshop)		

			
1			
GEV No.	696399	Ref. No.	OKB722
description	water container for combi-steamer L 400mm plastic W 238mm		
For models:	FCV31E3, 7CO30, CCO30G, ECO312CF, OTS100		

for tilting bratt pans

spare parts and accessories

			
1			
GEV No.	693285	Ref. No.	051266
description	spigot		
For models:	HBR/G820, HBR/G825, HBR/E820, HBR/E825, HBR/G821UK, HCPA/G1219, HCPA/G1219, ZBR/E820, ZBR/E825, ZBR/G821, ZBR/G826, ZCPAG1219, ZCPA/G1219, ABR/G820, ABR/G825, ABR/E820, ABR/E825, HCPA/G1219, HCPA/G1219, HCPA/V1219, HCPA/EI1219, CR15G, CR/41G, CR42G, CR/41E, CR/41V, CR/42V, CR40G, CR40V, CR/40E, CR/42E, HQN/G1917, HQN/G1917, HQN/G1225, HQN/GI1225, HQN/EI917, HQN/GI122, HQN/V917, HPN/G810, HQN/EI1225, HPN/GI810, HPN/GI810, HPN/G815, HPA/G815, HPN/E810, HPN/GI815, HPA/GI815, HPN/EI810, HPA/GI815, HPN/E815...(Other models you can see in the webshop)		

gearboxes

			
1			
GEV No.	693270	Ref. No.	002795
description	gearbox		
For models:	KBR/G2FH, KBR/G2CH, KBR/E2FH, KBR/E2CH, HBR/G811, HBR/G816, HBR/E811, HBR/E816, QBR/G2FH, QBR/G2CH, QBR/E2FH, QBR/E2CH, ZBR/G811, ZBR/G816, ZBR/E811, ZBR/E816, WBR/G2FH, WBR/G2CH, WBR/E2FH, WBR/E2CH, ABR/G811, ABR/G816, ABR/E811, ABR/E816		



glass panels



GEV No.	693397	Ref. No.	057400 0C5340 0H6898 0K3033 12011870 275290025 727859
description	glass panel L 29mm W 29mm thickness 3.5mm square		
For models:	MFR/G360, MPN/GD761, MPN/GI761, MPN/GI760D, MPN/GD760, MPN/GD760F, MPN/GI760, MPN/GI760F, MM/G351, MM/G701, MM/G350, MM/G700, MM/G350F, MM/G700F, MM/G700E, MCP/G700, MCP/G701, MCP/G710, MCP/G711, MCP/G705, MCP/G706, FDV40G, FDV40GZ, FDV40GA, FDV20G, FDV20GZ, FDV20GA, RBR/G2FM, RBR/G2IM, RBR/G2FM, RMV/G1C, RMV/G2C, RF/G1S07, RF/G2D07, RFR/G1S07, RFR/G2D07, RFR/G1S14, RFR/G2D14, RF/G1S07, RF/G2D07, RFR/G1S07, RFR/G2D07, XBR/G2FM, XBR/G2IM, XBR/G2FM, XMV/G1C, XMV/G2C, XF/G1S07, XRF/G2D07, XFR/G1S07...(Other models you can see in the webshop)		

poly-V-belt pulleys



GEV No.	693264	Ref. No.	052783
description	V-belt pulley single disc ø 165mm shaft intake ø 20mm groove depth 10mm disc width 16mm groove width 4mm overall width 54mm aluminium		
For models:	HBR/G1013, HBR/E1013, HBR/G1013, HBR/E1013		



GEV No.	693261	Ref. No.	056976
description	V-belt pulley single disc ø 80mm shaft intake ø 15mm groove depth 9mm disc width 16mm groove width 4mm overall width 26mm steel shaft ø 25mm		
For models:	MBR/G710D, MBR/E710D, RBR/G710D, 7BRE60XN, XBR/E710D, XBR/G751, XBR/G756, XBR/E716, RBR/E700, ZRBR/G700D		



GEV No.	693268	Ref. No.	002147
description	V-ripped belt pulley grooves 6 disc ø 60mm shaft intake ø 15mm disc width 17mm groove depth 1.5mm groove width 1.5mm overall width 30mm		
For models:	HBR/G801, HBR/G806, HBR/G811, HBR/G816, HBR/G801D, HBR/G806D, HBR/G811D, HBR/G816D, HBR/E801, HBR/E806, HBR/E811, HBR/E816, ZBR/G801, ZBR/G806, ZBR/G811, ZBR/G816, ZBR/G801D, ZBR/G806D, ZBR/G811D, ZBR/G816D, ZR/G413, BR/E806, ZBR/E811, ZBR/E816, ABR/G801, ABR/G806, ABR/G811, ABR/G816, ABR/G801D, ABR/G806D, ABR/G811D, ABR/G816D, ABR/E801, ABR/E806, ABR/E811, ABR/E816		

spindles



GEV No.	693278	Ref. No.	056830
description	end piece DIN/ISO splitting links L 30mm internal width M8mm rollerø 4.5mm metal chrome-plated		
For models:	MBR/G710D, MBR/E710D, MBR/G700, MBR/G700F, MBR/E700, MBR/E700UK, MBR/G700UK, MBR/G701, MBR/G706, MBR/G701UK, MBR/G751, MBR/G756, MBR/E716, MBR/E706, RBR/G710D, 7BRE60XN, RBR/G700, RBR/G700F, 7BRE60X, RBR/E700UK, 7BRG60, 7BRG60X, RBR/G701UK, RBR/G751, RBR/G756, RBR/E716, RBR/E706, XBR/G710D, XBR/E710D, XBR/G700, XBR/G710, M70EBP, XBR/G700F, XBR/G700UK, XBR/E710, XBR/G701, M70GBP, XBR/G701UK, XBR/G751, XBR/G756, CBR/G700, CBR/E700, XBR/E716, XBR/E706, RBR/G700, RBR/E700, RBR/G700, RBR/E700, ZRBR/G700, ZRBR/G700D...(Other models you can see in the webshop)		



GEV No.	693277	Ref. No.	056827
description	end piece L 30mm internal width 8.5mm rollerø 4.5mm chrome-plated brass		
For models:	MBR/G710D, MBR/E710D, MBR/G700, MBR/G700F, MBR/E700, MBR/E700UK, MBR/G700UK, MBR/G701, MBR/G706, MBR/G701UK, MBR/G751, MBR/G756, MBR/E716, MBR/E706, RBR/G710D, 7BRE60XN, RBR/G700, RBR/G700F, 7BRE60X, RBR/E700UK, 7BRG60, 7BRG60X, RBR/G701UK, RBR/G751, RBR/G756, RBR/E716, RBR/E706, XBR/G710D, XBR/E710D, XBR/G700, XBR/G710, M70EBP, XBR/G700F, XBR/G700UK, XBR/E710, XBR/G701, M70GBP, XBR/G701UK, XBR/G751, XBR/G756, CBR/G700, CBR/E700, XBR/E716, XBR/E706, RBR/G700, RBR/E700, RBR/G700, RBR/E700, ZRBR/G700, ZRBR/G700D...(Other models you can see in the webshop)		



GEV No.	693267	Ref. No.	052803
description	threaded rod		
For models:	HBR/G1013, HBR/E1013, HBR/G1013, HBR/E1013		

1 

GEV No.	693271	Ref. No.	056823
description	threaded rod thread M6 L 500mm ø 21mm		
For models:	MBR/G710D, MBR/E710D, MBR/G700, MBR/G700F, MBR/E700, MBR/E700UK, MBR/G700UK, MBR/G701, MBR/G706, MBR/G701UK, MBR/G751, MBR/G756, MBR/E716, MBR/E706, RBR/G710D, 7BRE60XN, RBR/G700, RBR/G700F, 7BRE60X, RBR/E700UK, 7BRG60, 7BRG60X, RBR/G701UK, RBR/G751, RBR/G756, RBR/E716, RBR/E706, XBR/G710D, XBR/E710D, XBR/G700, XBR/G710, M70EBP, XBR/G700F, XBR/G700UK, XBR/E710, XBR/G701, M70GBP, XBR/G701UK, XBR/G751, XBR/G756, CBR/G700, CBR/E700, XBR/E716, XBR/E706, RBR/G700, RBR/E700, RBR/G700, RBR/E700, ZRBR/G700, ZRBR/G700D...(Other models you can see in the webshop)		

2 

GEV No.	693292	Ref. No.	0C0674
description	threaded rod thread TR20x4 L 525mm		
For models:	KBR/G2F, KBR/G2C, KBR/G3F, KBR/G3C, KBR/E2F, KBR/E2C, KBR/E3F, KBR/E3C, QBR/G2F, QBR/G2C, QBR/G3F, QBR/G3C, QBR/E2F, QBR/E2C, QBR/E3F, QBR/E3C, WBR/G2F, WBR/G2C, WBR/G3F, WBR/G3C, WBR/E2F, WBR/E2C, WBR/E3F, WBR/E3C		

1 

GEV No.	693283	Ref. No.	051336
description	threaded rod thread TR20x4 L 865mm		
For models:	HBR/G803, HBR/G804, HBR/G803, HBR/G804, HBR/G803, HBR/G805, HBR/G1003, HBR/G1003, HBR/G1004, HBR/E801, HBR/E803, HBR/E804, HBR/E805UK, HBR/E1003, HBR/G803, HBR/G804, HBR/G803, HBR/G804, HBR/G1003, HBR/E801, HBR/E803, HBR/E804, HBR/E1003, HBR/G1004		

miscellaneous

1 

GEV No.	693284	Ref. No.	051265
description	bracket		
For models:	HBR/G820, HBR/G825, HBR/E820, HBR/E825, HBR/G821UK, ZBR/E820, ZBR/E825, ZBR/G821, ZBR/G826, ABR/G820, ABR/G825, ABR/E820, ABR/E825, HBR/G803, HBR/G804, HBR/G803, HBR/G804, HBR/G803, HBR/G805, HBR/G1003, HBR/G1003, HBR/G1004, HBR/E801, HBR/E803, HBR/E804, HBR/E805UK, HBR/E1003, HBR/G803, HBR/G804, HBR/G1013, HBR/E1013, HBR/G803, HBR/G804, HBR/G1003, HBR/G1013, HBR/E801, HBR/E803, HBR/E804, HBR/E1003, HBR/E1013, HBR/G1004		

1 

GEV No.	693274	Ref. No.	056825
description	bush		
For models:	MBR/G710D, MBR/E710D, MBR/G700, MBR/G700F, MBR/E700, MBR/E700UK, MBR/G700UK, MBR/G701, MBR/G706, MBR/G701UK, MBR/G751, MBR/G756, MBR/E716, MBR/E706, RBR/G710D, 7BRE60XN, RBR/G700, RBR/G700F, 7BRE60X, RBR/E700UK, 7BRG60, 7BRG60X, RBR/G701UK, RBR/G751, RBR/G756, RBR/E716, RBR/E706, XBR/G710D, XBR/E710D, XBR/G700, XBR/G710, M70EBP, XBR/G700F, XBR/G700UK, XBR/E710, XBR/G701, M70GBP, XBR/G701UK, XBR/G751, XBR/G756, CBR/G700, CBR/E700, XBR/E716, XBR/E706, RBR/G700, RBR/E700, RBR/G700, RBR/E700, ZRBR/G700, ZRBR/G700D...(Other models you can see in the webshop)		

1 

GEV No.	693282	Ref. No.	051277
description	bush		
For models:	HBR/G820, HBR/G825, HBR/E820, HBR/E825, HBR/G821UK, ZBR/E820, ZBR/E825, ZBR/G821, ZBR/G826, ABR/G820, ABR/G825, ABR/E820, ABR/E825, HBR/G803, HBR/G804, HBR/G803, HBR/G804, HBR/G803, HBR/G805, HBR/G1003, HBR/G1003, HBR/G1004, HBR/E801, HBR/E803, HBR/E804, HBR/E805UK, HBR/E1003, HBR/G803, HBR/G804, HBR/G1013, HBR/E1013, HBR/G803, HBR/G804, HBR/G1003, HBR/G1013, HBR/E801, HBR/E803, HBR/E804, HBR/E1003, HBR/E1013, HBR/G1004		

1 

GEV No.	693902	Ref. No.	0C0651
description	bushing for tilting bratt pan		
For models:	KBR/G2F, KBR/G2C, KBR/G3F, KBR/G3FH, KBR/G3C, KBR/G3CH, KBR/E2F, KBR/E2C, KBR/E3F, KBR/E3FH, KBR/E3C, KBR/E3CH, KBR/G2FH, KBR/G2CH, KBR/E2FH, KBR/E2CH, QBR/G2F, QBR/G2C, QBR/G3F, QBR/G3FH, QBR/G3C, QBR/G3CH, QBR/E2F, QBR/E2C, QBR/E3F, QBR/E3FH, QBR/E3C, QBR/E3CH, QBR/G2FH, QBR/G2CH, QBR/E2FH, QBR/E2CH, WBR/G2F, WBR/G2C, WBR/G3F, WBR/G3FH, WBR/G3C, WBR/G3CH, WBR/E2F, WBR/E2C, WBR/E3F, WBR/E3FH, WBR/E3C, WBR/E3CH, WBR/G2FH, WBR/G2CH, WBR/E2FH, WBR/E2CH		



			
1			
GEV No.	523510	Ref. No.	045312 045726 056820 065048 072702 072751 0D0035 0H2689 OKT988 335601600 62022Z 62022ZRC3 6202Z 63646403 7SWE63646403
description	deep-groove ball bearing type 6202-2RS shaft ø 15mm ED ø 35mm W 11mm with sealing discs deep-groove ball bearing DIN 625-1		
For models:	MBR/G710D, MBR/E710D, MBR/G700, MBR/G700F, MBR/E700, MBR/E700UK, MBR/G700UK, MBR/G701, MBR/G706, MBR/G701UK, MBR/G751, MBR/G756, MBR/E716, MBR/E706, RBR/G2FM, RBR/G2IM, RBK/G2FM, RBR/E2FM, RBR/E2IM, RBK/E2FM, XBR/G2FM, XBR/G2IM, XBK/G2FM, XBR/E2FM, XBR/E2IM, XBK/E2FM, JBR/G2FM, JBR/E2FM, MBR/G2FM, MBR/G2IM, MBK/G2FM, MBR/E2FM, MBR/E2IM, MBK/E2FM, RBR/G710D, 7BRE60XN, RBR/G700, RBR/G700F, 7BRE60X, RBR/E700UK, 7BRG60, 7BRG60X, RBR/G701UK, RBR/G751, RBR/G756, RBR/E716, RBR/E706, XBR/G710D, XBR/E710D, XBR/G700...(Other models you can see in the webshop)		

			
1			
GEV No.	693279	Ref. No.	056852 056853
description	hauling cable for tilting bratt pan complete		
For models:	MBR/G710D, MBR/E710D, MBR/G700, MBR/G700F, MBR/E700, MBR/E700UK, MBR/G700UK, MBR/G701, MBR/G706, MBR/G701UK, MBR/G751, MBR/G756, MBR/E716, MBR/E706, RBR/G710D, 7BRE60XN, RBR/G700, RBR/G700F, 7BRE60X, RBR/E700UK, 7BRG60, 7BRG60X, RBR/G701UK, RBR/G751, RBR/G756, RBR/E716, RBR/E706, XBR/G710D, XBR/E710D, XBR/G700, XBR/G710, M70EBP, XBR/G700F, XBR/G700UK, XBR/E710, XBR/G701, M70GBP, XBR/G701UK, XBR/G751, XBR/G756, CBR/G700, CBR/E700, XBR/E716, XBR/E706, RBR/G700, RBR/E700, RBR/G700, RBR/E700, ZRBR/G700, ZRBR/G700D...(Other models you can see in the webshop)		

			
1			
GEV No.	698595	Ref. No.	051365
description	pin L 24.5mm for tilting bratt pan WS 19		
For models:	RBR/G2FM, RBR/G2IM, RBK/G2FM, RBR/E2FM, RBR/E2IM, RBK/E2FM, XBR/G2FM, XBR/G2IM, XBK/G2FM, XBR/E2FM, XBR/E2IM, XBK/E2FM, JBR/G2FM, JBR/E2FM, MBR/G2FM, MBR/G2IM, MBK/G2FM, MBR/E2FM, MBR/E2IM, MBK/E2FM, PBR/G2FM, PBR/G2IM, PBR/E2FM, PBR/E2IM, OBR/G2FM, OBR/G2IM, OBR/E2FM, OBR/E2IM, TBR/G2FM, TBR/G2IM, TBR/E2FM, TBR/E2IM, KBR/G2F, KBR/G2C, KBR/G3F, KBR/G3FH, KBR/G3C, KBR/G3CH, KBR/E2F, KBR/E2C, KBR/E3F, KBR/E3FH, KBR/E3C, KBR/E3CH, KBR/G2FH, KBR/G2CH, KBR/E2FH, KBR/E2CH, HBR/G820, HBR/G825...(Other models you can see in the webshop)		

			
1			
GEV No.	697947	Ref. No.	006554
description	plug L 50mm ø 39-42mm for tilting bratt pan PTFE		
For models:	KR/E1, KR/E2, HR/G403W, HR/G803W, HR/E403DW, HR/E803DW, HR/G413W, HR/G813W, HR/G404W, HR/G804W, HR/G814W, HR/E413W, HR/E813W, HR/E814W, HR/E433W, HR/E443W, HR/E833W, HR/E843W, HR/E844W, HR/E403W, HR/E803W, QR/GT1, QR/GT2, QR/E1, QR/E2, ZR/G403W, ZR/G803W, ZR/E403DW, ZR/E803DW, ZR/G413W, ZR/G813W, ZR/G404W, ZR/G804W, ZR/G814W, ZR/E413W, ZR/E813W, ZR/E814W, ZR/E433W, ZR/E443W, ZR/E833W, ZR/E843W, ZR/E844W, ZR/E403W, ZR/E803W, WR/GT1, WR/GT2, WR/E1, WR/E2, AR/E834W, AR/G403W...(Other models you can see in the webshop)		

			
1			
GEV No.	697992	Ref. No.	051276
description	retaining ring L 15mm ø 27mm thread M6		
For models:	HBR/G820, HBR/G825, HBR/E820, HBR/E825, HBR/G821UK, ZBR/E820, ZBR/E825, ZBR/G821, ZBR/G826, ABR/G820, ABR/G825, ABR/E820, ABR/E825, HBR/G803, HBR/G804, HBR/G803, HBR/G804, HBR/G803, HBR/G805, HBR/G1003, HBR/G1003, HBR/G1004, HBR/E801, HBR/E803, HBR/E804, HBR/E805UK, HBR/E1003, HBR/G803, HBR/G804, HBR/G803, HBR/G804, HBR/G1003, HBR/E801, HBR/E803, HBR/E804, HBR/E1003, HBR/G1004		

			
1			
GEV No.	693243	Ref. No.	OK1817
description	roller for cable		
For models:	7581-5.KK60, 7582-5.KK80, 7583-5.KK100, 7781-5.KK60, 7782-5.KK80, 7783-5.KK100, 7580-5.KK40, 7584-5.KK150, 7780-5.KK40, 7580-5/85.KK40.(N), 7581-5/85.KK60.(N), 7582-5/85.KK80.(N), 7583-5/85.KK100.(N), 7584-5-85.KK150.(N), 7580-5/90.KK40.(N), 7581-5/90.KK60.(N), 7582-5/90.KK80.(N), 7583-5/90.KK100.(N), 7584-5-90.KK150.(N), 7568-5-90.KK200.(N), 7542-2, 7542-3, 7544-2, 7544-3, 7546-3, 7548-3, 7568-3, 7568-5.KK200, 7568-5/85.KK200.(N), 7580-3, 7581-3, 7581-5, 7582-3, 7582-5, 7583-3, 7583-5, 7584-3, 7742-3, 7744-3, 7746-3, 7748-3, 7768-3, 7768-5.KK200, 7768-5/85.KK200.(N), 7768-5/90.KK200.(N), 7780-3, 7780-5/85.KK40.(N), 7780-5/90.KK40.(N), 7781-3, 7781-5...(Other models you can see in the webshop)		

			
1			
GEV No.	698588	Ref. No.	0c0673
description	sealing disc ø 20mm PTFE thickness 2mm ID ø 11mm		
For models:	RBR/G2FM, RBR/G2IM, RBK/G2FM, RBR/E2FM, RBR/E2IM, RBK/E2FM, XBR/G2FM, XBR/G2IM, XBK/G2FM, XBR/E2FM, XBR/E2IM, XBK/E2FM, JBR/G2FM, JBR/E2FM, MBR/G2FM, MBR/G2IM, MBK/G2FM, MBR/E2FM, MBR/E2IM, MBK/E2FM, PBR/G2FM, PBR/G2IM, PBR/E2FM, PBR/E2IM, OBR/G2FM, OBR/G2IM, OBR/E2FM, OBR/E2IM, TBR/G2FM, TBR/G2IM, TBR/E2FM, TBR/E2IM, KBR/G2F, KBR/G2C, KBR/G3F, KBR/G3FH, KBR/G3C, KBR/G3CH, KBR/E2F, KBR/E2C, KBR/E3F, KBR/E3FH, KBR/E3C, KBR/E3CH, KBR/G2FH, KBR/G2CH, KBR/E2FH, KBR/E2CH, QBR/G2F, QBR/G2C...(Other models you can see in the webshop)		

			
1			
GEV No.	505318	Ref. No.	002355
description	shaft L 120mm ø 20mm tilting bratt pan stainless steel D2 ø 16mmmm		
For models:	KBR/G2F, KBR/G2C, KBR/E2F, KBR/E2C, HBR/G800, HBR/G805, HBR/G810, HBR/G815, HBR/G800D, HBR/G805D, HBR/G810D, HBR/G815D, HBR/E800, HBR/E805, HBR/E810, HBR/E815, HBR/G800NL, HBR/G805NL, HBR/G810NL, HBR/G800UK, HBR/E800UK, HBR/G800, HBR/G805, HBR/G810, HBR/G815, HBR/E800, HBR/E805, HBR/E810, HBR/E815, HBR/G800UK, HBR/E800UK, QBR/G2F, QBR/G2C, QBR/E2F, QBR/E2C, ZBR/G800, ZBR/G805, ZBR/G810, ZBR/G815, ZBR/G800D, ZBR/G805D, ZBR/G810D, ZBR/G815D, HBR/E800, ZBR/E805, ZBR/E810, ZBR/E815, ZBR/G800UK, ZBR/E800UK, ZBR/G800...(Other models you can see in the webshop)		

			
Image not available			
1			
GEV No.	693281	Ref. No.	051326
description	spindle		

			
1			
GEV No.	693272	Ref. No.	056818
description	threaded bush		
For models:	MBR/G710D, MBR/E710D, MBR/G700, MBR/G700F, MBR/E700, MBR/E700UK, MBR/G700UK, MBR/G701, MBR/G706, MBR/G701UK, MBR/G751, MBR/G756, MBR/E716, MBR/E706, RBR/G710D, 7BRE60XN, RBR/G700, RBR/G700F, 7BRE60X, RBR/E700UK, 7BRG60, 7BRG60X, RBR/G701UK, RBR/G751, RBR/G756, RBR/E716, RBR/E706, XBR/G710D, XBR/E710D, XBR/G700, XBR/G710, M70EBP, XBR/G700F, XBR/G700UK, XBR/E710, XBR/G701, M70GBP, XBR/G701UK, XBR/G751, XBR/G756, CBR/G700, CBR/E700, XBR/E716, XBR/E706, RBR/G700, RBR/E700, RBR/G700, RBR/E700, ZRBR/G700, ZRBR/G700D...(Other models you can see in the webshop)		

			
1			
GEV No.	693291	Ref. No.	0C0675
description	threaded bush		
For models:	KBR/G2F, KBR/G2C, KBR/G3F, KBR/G3FH, KBR/G3C, KBR/G3CH, KBR/E2F, KBR/E2C, KBR/E3F, KBR/E3FH, KBR/E3C, KBR/E3CH, KBR/G2FH, KBR/G2CH, KBR/E2FH, KBR/E2CH, QBR/G2F, QBR/G2C, QBR/G3F, QBR/G3FH, QBR/G3C, QBR/G3CH, QBR/E2F, QBR/E2C, QBR/E3F, QBR/E3FH, QBR/E3C, QBR/E3CH, QBR/G2FH, QBR/G2CH, QBR/E2FH, QBR/E2CH, WBR/G2F, WBR/G2C, WBR/G3F, WBR/G3FH, WBR/G3C, WBR/G3CH, WBR/E2F, WBR/E2C, WBR/E3F, WBR/E3FH, WBR/E3C, WBR/E3CH, WBR/G2FH, WBR/G2CH, WBR/E2FH, WBR/E2CH		

			
1			
GEV No.	693266	Ref. No.	052800
description	threaded bush for tilting bratt pan		
For models:	HBR/G1013, HBR/E1013, HBR/G1013, HBR/E1013		

			
1			
GEV No.	693318	Ref. No.	051264
description	threaded bush for tilting bratt pan		
For models:	HBR/G820, HBR/G825, HBR/E820, HBR/E825, HBR/G821UK, ZBR/E820, ZBR/E825, ZBR/G821, ZBR/G826, ABR/G820, ABR/G825, ABR/E820, ABR/E825, HBR/G803, HBR/G804, HBR/G803, HBR/G804, HBR/G803, HBR/G805, HBR/G1003, HBR/G1003, HBR/G1004, HBR/E801, HBR/E803, HBR/E804, HBR/E805UK, HBR/E1003, HBR/G803, HBR/G804, HBR/G803, HBR/G804, HBR/G804, HBR/G1003, HBR/E801, HBR/E803, HBR/E804, HBR/E1003, HBR/G1004		



for boiling pans

spare parts and accessories

1



GEV No.	690869	Ref. No.	003825
description	bar L 440mm		
For models:	FDV40G, FDV40E, FDV40GZ, FDV40EL, FDV40GA, FDV20G, FDV20E, FDV20GZ, FDV20EL, FDV20GA, FCFG201-0, FCFG202-0, FCFE201-0, FCFE202-0, FCF201ENS, ECFG201-0, ECFG202-0, ECFE201-0, ECFE202-0, ECF201ENS, ACFG201-0, ACFG202-0, ACFE201-0, ACFE202-0, RCF201E, ZCF/G201/1, ZCF/G202/1, ZCF/E201/1-0, ZCF/E202/1-0		

1



GEV No.	111634	Ref. No.	058759
description	shaft extension		
For models:	MPN/V760, MPN/V760D, 7PEV06, M70VIKE		

1



GEV No.	693285	Ref. No.	051266
description	spigot		
For models:	HBR/G820, HBR/G825, HBR/E820, HBR/E825, HBR/G821UK, HCPA/G1219, HCPA/GI 1219, ZBR/E820, ZBR/E825, ZBR/G821, ZBR/G826, ZCPAG1219, ZCPA/GI 1219, ABR/G820, ABR/G825, ABR/E820, ABR/E825, HCPA/G1219, HCPA/GI1219, HCPA/V1219, HCPA/EI1219, CR15G, CR/41G, CR42G, CR/41E, CR/41V, CR/42V, CR40G, CR40V, CR/40E, CR/42E, HQN/G1917, HQN/G1917, HQN/G1225, HQN/GI1225, HQN/EI917, HQN/GI122, HQN/V917, HPN/G810, HQN/EI1225, HPN/GI810, HPN/GI810, HPN/G815, HPA/G815, HPN/E810, HPN/GI815, HPA/GI815, HPN/EI810, HPA/GI815, HPN/E815...(Other models you can see in the webshop)		

1



GEV No.	514515	Ref. No.	0K4996 763049
description	thermal fuse		
For models:	ACSGRT, GWACOEOORO, FWAAOMOORO, GWACOMOORO, IWKCOE-OOOO, HWAHOEOORO, GWAHOEOOOO, GWAHOEOORO, FWAHOEOORO, BEN150EW87, HWAJOEOORO, GWAJOEOORO, FWAJOEOORO, BEN200EW87, GWAJOMOORO, FWFJOEXOOO, FWFJOEXORO, BEN300E.S35.H97, GWAKOEOORO, FWAKOEOORO, IWAKOMOORO, GWAKOMOORO, FWFKOEXORO, FWKKOEOORO, IWALOEEOOOO, IWALOEORO, BEN400E.S35.H97, BEN400EF97, FWALOEORO, GWA-LOMOORO, IVAAOEOOOO, HVAAOEOORO, GVAAOEOOOO, GVAAOEOORO, FVAAOEOORO, IVKAOEOOOO, FVKAOEOORO, HVABOEOORO, GVABOEOOOO, GVABOEOORO, FVABOEOORO, FVFBEOEXORO, IVKBOE-OOOO, FVKBOEOORO, IVACOEOORO, BON080EF88, GVACOEOORO, FVACOEOORO, IVACOMOORO, GVACOMOORO...(Other models you can see in the webshop)		

filters

1



GEV No.	541370	Ref. No.	OG5198 OKC574 OKC990
description	drain filter		
For models:	7550-5.KES40, 7551-5.KES60, 7552-5.KES80, 7553-5.KES100, 7554-5.KES150, 7574-5.KES150, 7575-5.KES250, 7750-5.KES40, 7751-5.KES60, 7752-5.KES80, 7753-5.KES100, 7754-5.KES150, 7576-5.KES300, 7573-5.KES100, 7550-5/85.KES40.(N), 7551-5/85.KES60.(N), 7552-5/85.KES80.(N), 7553-5/85.KES100.(N), 7554-5/85.KES150.(N), 7550-5/90.KES40.(N), 7551-5/90.KES60.(N), 7552-5/90.KES80.(N), 7553-5/90.KES100.(N), 7554-5/90.KES150.(N), 7573-3/85.KES100.(N), 7574-3/85.KES150.(N), 7575-3/85.KES250.(N), 7576-3/85.KES300.(N), 7573-3/90.KES100.(N), 7574-3/90.KES150.(N), 7575-3/90.KES250.(N), 7576-3/90.KES300.(N), 7573-5/85.KES100.(N), 7574-5/85.KES150.(N), 7575-5/85.KES250.(N), 7576-5/85.KES300.(N), 7573-5/90.KES100.(N), 7574-5/90.KES150.(N), 7575-5/90.KES250.(N), 7576-5/90.KES300.(N), 7754-5/85.KES150, 7754-5/90.KES150, 7573-2, 7573-3, 7573-5, 7574-2, 7574-3, 7574-5, 7575-2, 7575-3...(Other models you can see in the webshop)		

1



GEV No.	514379	Ref. No.	010386 027114 0K2937 310191600
description	drain filter kettle		
For models:	MPN/GD761, MPN/GI761, MPN/GI760D, MPN/GD760, MPN/GD760F, MPN/GI760, MPN/GI760F, MPN/EI760, MPNEI760UK, MPN/V760, MPN/EI760D, MPN/V760D, RPD/G240, RPD/G260, RPI/G260, RPI/E240, RPI/E260, RPI/G260P, RPI/E260P, XPD/G240, XPD/G260, XPI/G260, XPI/E240, XPI/E260, XPI/G260P, XPI/E260P, JPD/G240, JPD/G260, JPI/G260, JPI/E240, JPI/E260, MPD/G240, MPD/G260, MPI/G260, MPI/E240, MPI/E260, MPI/G260P, MPI/E260P, 7PDG06, 7PIG06, 7PIE06, RPN/EI760UK, RPN/GD760F, RPN/GI760F, 7PEV06, RPN/EI760D, XPN/GI760D, M70GDKE, M70GIKE, M70EIKE...(Other models you can see in the webshop)		

gearboxes

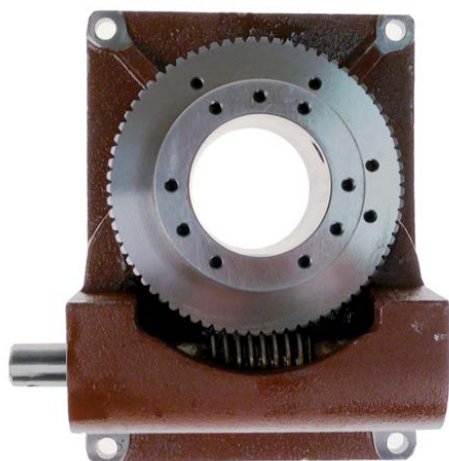

1

GEV No.	520400	Ref. No.	OG1613 0H6955 OK2752 280794 676SP1
description	auger gear		
For models:	7581-5.KK60, 7582-5.KK80, 7583-5.KK100, 7781-5.KK60, 7782-5.KK80, 7783-5.KK100, 7580-5.KK40, 7584-5.KK150, 7780-5.KK40, 7744-3/85.KB.(N), 7542-3/85., 7544-3/85.KB.(N), 7542-3/90.KB.(N), 7544-3/90.KB.(N), 7742-3/90.KB.(N), 7742-3/85.KB.(N), 7744-3/90.KB.(N), 7746-3/90.KB.(N), 7748-3/90.KB.(N), 7580-5/85.KK40.(N), 7581-5/85.KK60.(N), 7582-5/85.KK80.(N), 7583-5/85.KK100.(N), 7584-5-85.KK150.(N), 7580-5/90.KK40.(N), 7581-5/90.KK60.(N), 7582-5/90.KK80.(N), 7583-5/90.KK100.(N), 7584-5-90.KK150.(N), 7568-5-90.KK200.(N), 7541-3/85.KB.(N), 7546-3/85.KB.(N), 7548-3/85.KB.(N), 7546-3/90., 7548-3/90.KB.(N), 7746-3/85.KB.(N), 7748-3/85.KB.(N), 7542-3/85.KB.DWD, 7544-3/85.KB.220V3, 7742-3/85.KB.DWD.ETR, 7742-3/85.KB.DWD, 7748-3/85.KB.DWD.ETR, 7548-3/85.KB.DWD, 7542-2, 7542-3, 7544-2, 7544-3, 7546-3, 7548-3, 7568-3...(Other models you can see in the webshop)		

glass panels



1

GEV No.	693397	Ref. No.	057400 0C5340 0H6898 OK3033 12011870 275290025 727859
description	glass panel L 29mm W 29mm thickness 3.5mm square		
For models:	MFR/G360, MPN/GD761, MPN/GI761, MPN/GI760D, MPN/GD760, MPN/GD760F, MPN/GI760, MPN/GI760F, MM/G351, MM/G701, MM/G350, MM/G700, MM/G350F, MM/G700F, MM/G700E, MCP/G700, MCP/G701, MCP/G710, MCP/G711, MCP/G705, MCP/G706, FDV40G, FDV40GZ, FDV40GA, FDV20G, FDV20GZ, FDV20GA, RBR/G2FM, RBR/G2IM, RBK/G2FM, RMV/G1C, RMV/G2C, RF/G1S07, RF/G2D07, RFR/G1S07, RFR/G2D07, RFR/G1S14, RFR/G2D14, RF/G1S07, RF/G2D07, RFR/G1S07, RFR/G2D07, XBR/G2FM, XBR/G2IM, XBK/G2FM, XMV/G1C, XMV/G2C, XF/G1S07, XRF/G2D07, XFR/G1S07...(Other models you can see in the webshop)		

EQUIPMENT-SPECIFIC UNITS ELECTROLUX

level glasses

components

level glass pipes



1

GEV No.	697862	Ref. No.	059856 0C5352 OK3489 21567
description	level glass pipe ø 10mm L 167mm thickness 1.5mm with O-rings brown		
For models:	HPN/GI815, HPN/GI816, HPN/EI815D, HPN/EI815, HPA/GI825, HPA/EI825, HPN/GI855, HPN/GI1255, HPN/EI855, HPN/EI1255, HPNS/GI816, HPNS/EI815, HPNS/EI815D, 2PIAG15, ZPN/GI816, ZPN/EI815D, ZPN/EI815, 2PIAG15, ZPN/GI1255, ZPN/EI1255, ZPNS/GI816, ZPNS/EI815, ZPNS/EI815D, APN/GI810, APN/GI815, APN/GI816, APN/GI816D, APN/EI815D, APN/EI810, APN/EI815, APN/GD811, APN/GD816, APN/ED816, APNS/GI816, APNS/EI815, OPN/GI815		



1

GEV No.	697953	Ref. No.	002986
description	level glass pipe ø 10mm L 77mm thickness 1.6mm red		
For models:	RPI/G260, RPI/E240, RPI/E260, RPI/G260P, RPI/E260P, XPI/G260, XPI/E240, XPI/E260, XPI/G260P, XPI/E260P, JPI/G260, JPI/E240, JPI/E260, MPI/G260, MPI/E240, MPI/E260, MPI/G260P, MPI/E260P, PPI/G260P, PPI/E260P, OPI/G260P, OPI/E260P, TPI/G260P, TPI/E260P, HPN/GI810, HPN/EI810, HPN/GI806, HPN/EI806, HPN/GI805, HPN/EI805, ZPN/GI810, ZPN/EI810, ZPN/GI805, ZPN/EI805, APN/GI810, APN/GI815, APN/GI816, APN/EI815D, APN/EI810, APN/EI815, APN/GD811, APN/GD816, APN/ED816, APNS/GI816, APNS/EI815, OPN/GI815, APN/GI805, APN/EI805		

complete

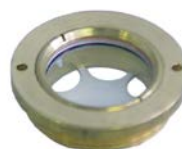

1

GEV No.	540200	Ref. No.	0H7003
description	level glass for kettle complete thread 1½"		

miscellaneous



1

GEV No.	691254	Ref. No.	OKJ532
description	lever for tilting kettle		
For models:	EBE40., EBE40, EBE40., EBE040, EBE60., EBE60., EBE60., EBE60., EBE60, EBE80., EBE80., EBE80., EBE80, EBE100., EBE100., EBE100., EBE100., EBE100, BASIC40, BASIC60, BASIC80., BASIC100, EBE40AWF, EBE60AWF, EBE80AWF, EBE100AWF		



1

GEV No.	540993	Ref. No.	01515000 051642 0TR591
description	support for manometer size 1/2"		
For models:	HCPA/GI 1219, CR20V, CR20EI, ZCPA/GI 1219, CR20V, CR20EI, HCPA/GI1219, HCPA/V1219, HCPA/EI1219, CR15V, CR15E, CR/41V, CR/42V, CR40V, HQN/G1917, HQN/G1917, HQN/GI1225, HQN/EI917, HQN/GI122, HQN/V917, HQN/EI1225, HPN/GI810, HPN/GI810, HPN/GI815, HPA/GI815, HPN/EI810, HPA/GI815, HPN/EI810, HPA/EI810, HPN/GI810, HPN/GI810, HPN/GI815, HPN/GI815, HPN/EI810, HPN/EI810, HPA/EI815, HQN/G1917, HQNEI817, HQN/V917, HQN/GI122, HQNEI122, HCPA/G121		

for contact grills

miscellaneous



1

GEV No.	694795	Ref. No.	653694 8FRJ653694
description	reusable backing sheets for Electrolux HSG L 400mm W 215mm H 0.2mm ømm Qty 24 pcs PTFE		

for pasta cookers

spare parts and accessories



1

GEV No.	693285	Ref. No.	051266
description	spigot		
For models:	HBR/G820, HBR/G825, HBR/E820, HBR/E825, HBR/G821UK, HCPA/G1219, HCPA/GI 1219, ZBR/E820, ZBR/E825, ZBR/G821, ZBR/G826, ZCPAG1219, ZCPA/GI 1219, ABR/G820, ABR/G825, ABR/E820, ABR/E825, HCPA/G1219, HCPA/GI1219, HCPA/V1219, HCPA/EI1219, CR15G, CR/41G, CR42G, CR/41E, CR/41V, CR/42V, CR40G, CR40V, CR/40E, CR/42E, HQN/G1917, HQN/G1917, HQN/G1225, HQN/GI1225, HQN/EI917, HQN/GI122, HQN/V917, HPN/G810, HQN/EI1225, HPN/GI810, HPN/GI810, HPN/G815, HPA/G815, HPN/E810, HPN/GI815, HPA/GI815, HPN/EI810, HPA/GI815, HPN/E815...(Other models you can see in the webshop)		

for pizza ovens

glass panels



1

GEV No.	700205	Ref. No.	004135
description	glass panel L 320mm W 100mm thickness 5mm rectangular		
For models:	ZCMDG6, ZCMDE6, ZCBDE12, ZCMME6, ZCBME12, ZCMDG4, ZCMDE4, ZCBDE8, ZCMME4, ZCBME8, ZCMDG9, ZCMDE9, ZCBDE18, ZCMME9, ZCBME18, ZCBDG8, ZCBDG12, ZCBDG18, FFPS16, FFPS32		

firebricks

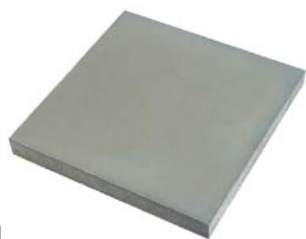

1			
GEV No.	850056	Ref. No.	005890 91610072 ADNM00011
description	firebrick L 330mm W 330mm H 30mm delivery freight forwarding company only		
For models:	ZCBDG8, ZCBDG12, ZCBDG18		



1			
GEV No.	850101	Ref. No.	0C2961
description	firebrick L 600mm W 300mm H 20mm grooved delivery freight forwarding company only		
For models:	PDE830, PDE1230, PDE12L30, PDE1830, PDE835, PDE1235, PDE12L35, PDE1835, PME430, PME630, PME6L30, PME930, PME435, PME635, PME6L35, PME935, PME830, PME1230, PME12L30, PME1830, PME835, PME1235, PME12L35, PME1835		



1			
GEV No.	850069	Ref. No.	003479
description	firebrick L 800mm W 425mm H 15mm delivery freight forwarding company only		
For models:	ZMMDG6, ZMBDG12		

for dishwashers

drain and intake components

ELECTROLUX/ZANUSSI

drain /intake bodies



1			
GEV No.	504771	Ref. No.	045464 047617
description	cap for drain unit		
For models:	LS500F, LS501F, LS540F, LS540DK, LS541F, LS540, LS500F, LS500UK, LS501, LS501UK, LS540D, LS540/63, LS541, LS500, LS501, LS540, ALS540		



1			
GEV No.	504773	Ref. No.	046596
description	cap for drain unit		
For models:	LS32, LS32/4.5, LS32UK/RP, LS32F, LV32F, C55, LV32/60, WT4, WT4B, WT4D, WT302, WT302/4.5, WT302UK/RP, WT302F, WT302/60, WT4DB, WT46, WT4DG, WT4WS1, LS33, LS33/4.5, LS33UK/RP, LS33F, LV33F, C55A, LS33/60, WT4BWS, WT4DWS1, WT4BDWS, WT303, WT303/4.5, WT303UK/RP, WT303F, WT303/60, NUC3DD, WT4D60, WT4DDG, EUC1, EUC1DP, EUC1WS, EUC1DPWS, EUC3, EUC3WS, EUC3DP, EUC3DPWS, EUC1G, EUC1DP60, EUC3DD, ZUCADDROW, ZUCADDROW6...(Other models you can see in the webshop)		
accessories for	504773		
	GEV No.	504776	Ref. No.
			049828 049848
description	gasket rubber ED ø 60mm ID ø 50mm thickness 1.5mm for intake body		



1			
GEV No.	504775	Ref. No.	048231 30000126
description	cap for drain unit		
For models:	LU7PDP, LU7ADP, LU7ADPWS, WTU40PDP, WTU40ADP, WTU40AD-PWS, WTU40ADPPD, LS10D, LS10, LS10UKRP, LC100, ECOTEMP12-, LS10/60, LS10/1, LS10/12KW, LS10F, LS10DEK, LS10/1UKRP, LS10SW, LS10/50J, LS10/60J, LS10DP, LS10/HD, SH55, LO10, LS10/UK1, LS10/UK3, LS12D, LS12, LS12UK/RP, LC120, LS12DP, LS12/60, LS12F, LS12DEK, LS12HD, WT60/GJ60, WT60/GJ50, PH10/12-RP, LS12/UK3, ECOTEMP12SW, ECOTEMP12INS, LS12MEX, LS10N, LS10, LS14EA, LS10UKDP, ET12E, LS10/60HZ, LS10CW...(Other models you can see in the webshop)		



1			
GEV No.	515138	Ref. No.	0S1319
description	connection thread 2"/1½" ED ø 70mm ID ø 50mm		

1

GEV No.	517482	Ref. No.	OE0141 OL1863
description	drain fitting complete ED ø 54mm H 30mm ID ø 29mm		
For models:	LN34, LN34, LN34, LN34, LN46, LN46, LN46, LN46, LN72, LN72, LN72, LN72, RT100ED, RT100ES, RT100SR, RT100SL, RT140ED, RT140ES, RT140SR, RT140SL, RT190ED, RT190ES, RT190SR, RT190SL, RT190HDED, RT190HDES, RT190HSR, RT190HSL, RT270ED, RT270ES, RT270SR, RT270SL, RT270HDED, RT270HDES, RT270HSR, RT270HSL, RT100ERF, RT100ELF, RT100VD, RT100VS, RT140ERF, RT140ELF, RT140VD, RT140VS, RT142ERF, RT142ELF, RT190ERF, RT190ELF, RT190VD, RT190VS...(Other models you can see in the webshop)		



2

GEV No.	507540	Ref. No.	069317 069654 051317
description	drain fitting complete thread 1½" ED ø 68mm ID ø 41mm		
For models:	TRNP1802, TLV1210TOP, TPLV1810TOP, TL1410DX, TL1410SX, TL1810DX, TL1810SX, TPLV1210, TPLV1810, TL1410DX, TL1410SX, TL1810DX, TL1810SX, LPS/75, LPS/75, LM55, LA1215D, LA1215S, LA1225, LA1825D, LA1825S, LA716, LA1416D, LA1416S, LA1426D, LA2116D, LA2116S, LA2426D, LA2826D, LA1215, LA1215S, LA1225, LA1825D, LA1825S, LA716, LA1416S, LA1416S, LA1426S, LA2126D, LA2126S, LA2426, LA2826, EDOIN28013, TRPE18V, LA, LA, LA, LA, LA, LA, LA...(Other models you can see in the webshop)		



1

GEV No.	524466	Ref. No.	047200
description	drain fitting ED ø 70mm L 50mm		
For models:	CT142DXE, CT142SXE, CT142DXEUK, CT142SXEUK, CT142DXV, CT142SXV, CT190DXE, CT190SXE, CT190DXEUK, CT190SXEUK, CT190DXV, CT190SXV, CT191DXE, CT191SXE, CT191DXEUK, CT191SXV, CT191DXV, CT191SXV, CT192DXE, CT192SXE, CT192DXEUK, CT192SXV, CT192DXV, CT192SXV, CT240DXE, CT240SXE, CT240DXEUK, CT240SXV, CT240DXV, CT240SXVUK, CT241DXE, CT241SXE, CT241DXEUK, CT241SXV, CT241SXV, CT241SXV, CT142DXEZ, CT142SXEZ, CT142DXVZ, CT142SXVZ, CT190DXEZ, CT190SXEZ, CT190DXV, CT190SXV, CT191DXE, CT191SXE, CT191DXV, CT191SXV, CT192DXE, CT192SXE...(Other models you can see in the webshop)		



1

GEV No.	540968	Ref. No.	050288
description	drain fitting ID ø 30mm ED ø 45mm for bain marie		
For models:	PMG600, PMG600D, HMS/E800, HMS/E400, HM/G800T, HM/E800T, ZPM/G600, DCBE21, DCB/E21U, DCBV40, SM08C, SM15C, SM15/CS, SM21C, ZSM08/C, ZSM15/C, ZSM15/CS, ZSM21/C		
accessories for	540968		
	GEV No.	514251	Ref. No. 050295
	gasket fibre ED ø 46mm ID ø 38mm thickness 2mm Qty 1 pcs		
	GEV No.	514252	Ref. No. 050287
	hexagonal nut		



1

GEV No.	504737	Ref. No.	075624 0E5647 22104958
description	drain fitting thread 1½" ED ø 55mm		
For models:	PW1SMG, PW1MG, PW1MUK, PW160HZ, PW1MHG, PW2MG, PW2MUK, PW2M60, WT830M, WT830MUK, WT830M60G, WT850M, WT850MUK, WT850M60G, WT830MHG, WT830M208U, WT830M240U, WT830H208U, WT830H240U, WT850M208U, WT850M240U, PW2SMG, ET830M, ET830MH, ET850M, PW1EAG, PW2EAG, WT830EA, WT850EA, WT830EAG, WT850EAG, WTC90ERB, WTC90ELB, WTC140ERA, WTC140ELA, WTC140ERB, WTC140ELB, WTC180ERA, WTC180ELA, WTC180ERB, WTC180ELB, WTC220ERA, WTC220ELA, WTC220ERB, WTC220ELB, WTC90ERBG, WTC90ELBG, WTC140ERAG, WTC140ELAG, WTC140ERBG...(Other models you can see in the webshop)		



1

GEV No.	515139	Ref. No.	051318
description	drain fitting thread 1½" ED ø 70mm H 60mm ID ø 50mm		

			
GEV No.	504303	Ref. No.	0E0113 OK7046 OL1862
description	drain fitting with gasket thread 1 1/2"		
For models:	FT36EDTS, FT36ESTS, FT36VDTS, FT36VSTS, FT36ED, FT36ES, FT36VD, FT36VS, FT50ED, FT50ES, FT50VD, FT50VS, FT72ED, FT72ES, FT72VD, FT72VS, FT36EDT, FT36EST, FT36VDT, FT36VST, FT50EDT, FT50EST, FT50VDT, FT50VST, FT72EDT, FT72EST, FT72VDT, FT72VST, FT36WED, FT36WES, FT36WVD, FT36WVS, FT50WED, FT50WES, FT50WVD, FT50WVS, FT72WED, FT72WES, FT72WVD, FT72WVS, FT36WEDT, FT36WEST, FT36WVDT, FT36WVST, FT50WEDT, FT50WEST, FT50WVDT, FT50WVST, FT72WEDT, FT72WEST...(Other models you can see in the webshop)		

			
GEV No.	504305	Ref. No.	048230 OTR553
description	gasket ED 74mm ID 50mm		
For models:	LU7PDP, LU7ADP, LU7ADPWS, WTU40PDP, WTU40ADP, WTU40ADPWS, WTU40ADPD, LS10D, LS10, LS10UKRP, LC100, ECOTEMP12-, LS10/60, LS10/1, LS10/12KW, LS10F, LS10DEK, LS10/1UKRP, LS10SW, LS10/50J, LS10/60J, LS10DP, LS10/HD, SH55, LO10, LS10/UK1, LS10/UK3, LS12D, LS12, LS12UK/RR, LC120, LS12DP, LS12/60, LS12F, LS12DEK, LS12HD, WT60/GJ60, WT60/GJ50, PH10/12-RP, LS12/UK3, ECOTEMP12SW, ECOTEMP12INS, LS12MEX, LS10N, LS10, LS14EA, LS10UKDP, ET12E, LS10/60HZ, LS10CW...(Other models you can see in the webshop)		

			
GEV No.	504777	Ref. No.	046594
description	end piece for intake body		
For models:	LS720F, LSE720DK, LSE720PH, LS860F, LS860DK, LS860PH, LS1080F, LS1080UK, LS1080PH, LSE721F, LS861F, LS1080M, LS1080, LS1080D, LS1080UK, LS1080/63, LSE721, LS720, LSE720UK, LS721UK, LSE720D, LS860, LS860, LS860D, LS860UK, LS861UK, LS860/63, LS861, 652120Z, LS860, LS1080, LS720N, LS860, DMAST2CUK, LSE720Z, LS860, LS1080, LS860, LS1080		

			
GEV No.	514251	Ref. No.	050295
description	gasket fibre ED 46mm ID 38mm thickness 2mm Qty 1 pcs		
For models:	PMG600, PMG600D, HMS/G400, HMS/G800, HMA/G800, HMS/E400, HMS/E800, HMA/E800, HMS/G400, HMS/G800D, HMA/G800D, HMS/E400, HMS/E800, HMA/E800, HMS/G400NL, HMS/G800, HMA/G800NL, HM/G400T, HM/G800T, HM/E400T, HM/E800T, ZPM/G600, ZHMA/G400, ZHMA/G80, ZHMA/G80, ZHMA/E400, ZHMA/801, ZHMA/E800, DCBE21, DCB/E21U, DCBV40, ZHMA/G40, ZHMA/G801D, ZHMA/G80, ZHMA/E400, ZHM/E800T, ZHM/G400, ZHM/G800, ZHM/G400, ZHM/G800		

			
GEV No.	504765	Ref. No.	066088
description	flat gasket FIBER ED 54mm ID 48mm thickness 2mm for thread 1 1/2" Qty 1 pcs		
For models:	CT92DXE, CT92SXE, CT92DXEUK, CT92SXEUK, CT92DXV, CT92SXV, CT92DXVUK, CT92SXVUK, CT140EDX, CT140ESX, CT140EDXUK, CT140SXEUK, CT140VDX, CT140VSX, CT141EDX, CT141ESX, CT141E-DUK, CT141ESUK, CT141VDX, CT141VSX, CT142DXE, CT142SXE, CT142DXEUK, CT142SXEUK, CT142DXV, CT142SXV, CT190DXE, CT190SXE, CT190DXEUK, CT190SXEUK, CT190DXV, CT190SXV, CT191DXE, CT191SXE, CT191DXE, CT191SXEUK, CT191DXV, CT191SXV, CT192DXE, CT192SXE, CT192DXEUK, CT192SXEUK, CT192DXV, CT192SXV, CT240DXE, CT240SXE, CT240DXEUK, CT240SX, CT240DXV, CT240SXVUK...(Other models you can see in the webshop)		

			
GEV No.	504770	Ref. No.	045461 046593 0KE876
description	gasket for intake body		
For models:	LS500F, LS501F, LS540F, LS540DK, LS541F, LS720F, LSE720DK, LSE720PH, LS860F, LS860DK, LS860PH, LS1080F, LS1080UK, LS1080PH, LSE721F, LS861F, LS540, LS1080M, LS1080, LS1080D, LS1080UK, LS1080/63, LS500F, LS500UK, LS501, LS501UK, LS540D, LS540/63, LSE721, LS720, LSE720UK, LS721UK, LSE720D, LS541, LS860, LS860, LS860D, LS860UK, LS861UK, LS860/63, LS861, LS500, LS501, LS540, 652120Z, LS860, LS1080, ALS540, LS720N, LS860...(Other models you can see in the webshop)		







			
GEV No.	504774	Ref. No.	046595
description	gasket rubber ED 58.5mm ID 47mm thickness 3mm Qty 1 pcs		
For models:	LS32, LS32/4.5, LS32UK/RR, LS32F, LV32F, C55, LV32/60, WT302, WT302/4.5, WT302UK/RR, WT302F, WT302/60, LS33, LS33/4.5, LS33UK/RR, LS33F, LV33F, C55A, LS33/60, WT303, WT303/4.5, WT303UK/RR, WT303F, WT303/60, LS720F, LSE720DK, LSE720PH, LS860F, LS860DK, LS860PH, LS1080F, LS1080UK, LS1080PH, LSE721F, LS861F, LS1080M, LS1080, LS1080D, LS1080UK, LS1080/63, LSE721, LS720, LSE720UK, LS721UK, LSE720D, LS860, LS860, LS860D, LS860UK, LS861UK...(Other models you can see in the webshop)		











			
1			
GEV No.	504776	Ref. No.	049828 049848
description	gasket rubber ED ø 60mm ID ø 50mm thickness 1.5mm for intake body		
For models:	WT4, WT4B, WT4D, WT4DB, WT46, WT4DG, WT4WS1, WT4BWS, WT4DWS1, WT4BDWS, NUC3DD, WT4D60, WT4DDG, EUC1, EUC1DP, EUC1WS, EUC1DPWS, EUC3, EUC3WS, EUC3DP, EUC3DPWS, EUC1G, EUC1DP60, EUC3DD, ZUCADDROW, ZUCADDROW6, LS5/1, LS5/1DP, LS5/1WS, LS5/1WSDP, LS5/3, LS5/3DP, LS5/3WS, LS5/3WSDP, FUCA3DD, LS5/3WSDPD, LB5DPG, LS5/1DP60, LS5/1DPAUS, LS5/1DPCS, KUC3, KUC3DP, NUC1, NUC1DP, NUC1WS, NUC1DPWS, NUC3, NUC3WS, NUC3DP, NUC3DPWS...(Other models you can see in the webshop)		

			
1			
GEV No.	514252	Ref. No.	050287
description	hexagonal nut		
For models:	PMG600, PMG600D, HMS/G400, HMS/G800, HMA/G800, HMS/E400, HMS/E800, HMA/E800, HMS/G400, HMS/G800D, HMA/G800D, HMS/E400, HMS/E800, HMA/E800, HMS/G400NL, HMS/G800, HMA/G800NL, HM/G400T, HM/G800T, HM/E400T, HM/E800T, ZPM/G600, ZHMA/G400, ZHMA/G80, ZHMA/G80, ZHMA/E400, ZHMA/801, ZHMA/E800, DCBE21, DCB/E21U, DCBV40, SM08C, SM15C, SM15/CS, SM21C, ZSM08/C, ZSM15/C, ZSM15/CS, ZSM21/C, ZHMA/G40, ZHMA/G801D, ZHMA/G80, ZHMA/E400, ZHM/E800T, ZHM/G400, ZHM/G800, ZHM/G400, ZHM/G800		

			
1			
GEV No.	520212	Ref. No.	066079
description	hexagonal nut thread 1½" brass WS 60 H 8mm		
For models:	CT92DXE, CT92SXE, CT92DXEUK, CT92SXEUK, CT92DXV, CT92SXV, CT92DXVUK, CT92SXVUK, CT140EDX, CT140ESX, CT140EDXUK, CT140SXEUK, CT140VDX, CT140VSX, CT141EDX, CT141ESX, CT141E-DUK, CT141ESUK, CT141VDX, CT141VSX, PW1SMG, PW1MG, PW-1MUK, PW160HZ, PW1MHG, PW2MG, PW2MUK, PW2M60, WT830M, WT830MUK, WT830M60G, WT850M, WT850MUK, WT850M60G, WT-830MHG, WT830M208U, WT830M240U, WT830H208U, WT830H240U, WT850M208U, WT850M240U, PW2SMG, ET830M, ET830MH, ET850M, CT142DXE, CT142SXE, CT142DXEUK, CT142SXEUK, PW1EAG...(Other models you can see in the webshop)		

			
1			
GEV No.	504594	Ref. No.	049035
description	intake body		
For models:	LB1, LB1WS, LB1WSDP, LB1/RBP, LB1/TOP, LB1/60, WT1WSDP, LB2D-PSAUS, LB1G, LB1WSG, WT2TOP60, WT2DPDI, WT2WSDPDI, LB1TOP, WT2TOPDI, LB2WS, LB2, LB2WSDP, LB2/TOP, LB2/RBP, LB2WS60, WT2WSDP, WT2WSDPD, LB2WSG, WT2WS, WT1, WT1WS, WT1TOP, WT2TOP, WT1/3DP, WT2/3DP, WT2DPAUS, WT2, LB2DPDI, LB2WSDPDI, LB2WSDPD, LB2TOP, LB2DP3, WT2DPD3, NGW, NGWDPDD, UC1, UC2WS, GW1, GW1WS, LV1WS, LV1WSDP, LV2WSDP, LV2WS, GW2D-PG...(Other models you can see in the webshop)		
accessories for	504594		
	GEV No.	504588	Ref. No. 049194
	overflow pipe L 187mm ø 24mm		
	GEV No.	504591	Ref. No. 049032
	round filters outflow		
	GEV No.	504592	Ref. No. 049034
	filter support		
	GEV No.	504594	Ref. No. 049035
	intake body		
	GEV No.	518610	Ref. No. 0L2757
	round filters ø 124mm H 115mm		
	GEV No.	532491	Ref. No. —
	O-ring EPDM thickness 3.53mm ID ø 120.2mm Qty 1 pcs		

			
1			
GEV No.	504605	Ref. No.	045458
description	intake body		
For models:	LS500F, LS501F, LS540F, LS540DK, LS541F, LS720F, LSE720DK, LSE720PH, LSE721F, LS540, LS500F, LS500UK, LS501, LS501UK, LS540D, LS540/63, LSE721, LS720, LSE720UK, LS721UK, LSE720D, LS541, LS500, LS501, LS540, 652120Z, ALS540, LS720N, LSE720Z		
accessories for	504605		
	GEV No.	504770	Ref. No. 045461 046593 0KE876
	gasket for intake body		
	GEV No.	504771	Ref. No. 045464 047617
	cap for drain unit		

			
1			
GEV No.	504606	Ref. No.	046525
description	intake body		
For models:	LS860F, LS860DK, LS860PH, LS1080F, LS1080UK, LS1080PH, LS861F, LS1080M, LS1080, LS1080D, LS1080UK, LS1080/63, LS860, LS860, LS860D, LS860UK, LS861UK, LS860/63, LS861, LS860, LS1080, LS860, DMAST2CUK, LS860, LS1080, LS860, LS1080		
accessories for	504606		
	GEV No.	504770	Ref. No. 045461 046593 0KE876
gasket for intake body			
	GEV No.	504773	Ref. No. 046596
cap for drain unit			
	GEV No.	504774	Ref. No. 046595
gasket rubber ED ø 58.5mm ID ø 47mm thickness 3mm Qty 1 pcs			
	GEV No.	504777	Ref. No. 046594
end piece for intake body			

			
1			
GEV No.	504610	Ref. No.	047457
description	intake body		

			
1			
GEV No.	504598	Ref. No.	048325 0L1629
description	intake body complete thread 2" ED ø 125mm ID ø 28mm hose ø 35/47mm		
For models:	LS32, LS32/4.5, LS32UK/RP, LS32F, LV32F, C55, LV32/60, WT4, WT4B, WT4D, WT302, WT302/4.5, WT302UK/RP, WT302F, WT302/60, WT4DB, WT46, WT4DG, WT4WS1, LS33, LS33/4.5, LS33UK/RP, LS33F, LV33F, C55A, LS33/60, WT4BWS, WT4DWS1, WT4BDWS, WT303, WT303/4.5, WT303UK/RP, WT303F, WT303/60, NUC3DD, WT4D60, WT4DDG, EUC1, EUC1DP, EUC1WS, EUC1DPWS, EUC3, EUC3WS, EUC3DP, EUC3DPWS, EUC1G, EUC1DP60, EUC3DD, ZUCADDROW, ZUCADDROW6...(Other models you can see in the webshop)		

			
1			
GEV No.	504601	Ref. No.	048430 049600 0L0081
description	intake body ED ø 104mm ID ø 25mm hose ø 35/41mm		
For models:	LU7PDP, LU7ADP, LU7ADPWS, WTU40PDP, WTU40ADP, WTU40ADPWS, WTU40ADPD, LS10D, LS10, LS10UKRP, LC100, ECOTEMP12-, LS10/60, LS10/1, LS10/12KW, LS10F, LS10DEK, LS10/1UKRP, LS10SW, LS10/50J, LS10/60J, LS10DP, LS10/HD, SH55, LO10, LS10/UK1, LS10/UK3, LS12D, LS12, LS12UK/RP, LC120, LS12DP, LS12/60, LS12F, LS12DEK, LS12HD, WT60/GJ60, WT60/GJ50, PH10/12-RP, LS12/UK3, ECOTEMP12SW, ECOTEMP12INS, LS12MEX, LS10N, LS10, LS14EA, LS10UKDP, ET12E, LS10/60HZ, LS10CW...(Other models you can see in the webshop)		
accessories for	504601		
	GEV No.	504775	Ref. No. 048231 30000126
cap for drain unit			
	GEV No.	504776	Ref. No. 049828 049848
gasket rubber ED ø 60mm ID ø 50mm thickness 1.5mm for intake body			
	GEV No.	508370	Ref. No. 048229
O-ring EPDM thickness 3.53mm ID ø 46.04mm Qty 1 pcs			

			
1			
GEV No.	504383	Ref. No.	0E5251 0K7225
description	intake body ED ø 118mm H 67mm ID ø 90mm		
For models:	TW1ERECO, TW1ELECO, TW1SRECO, TW1SLECO, RT100ED, RT100ES, RT100SR, RT100SL, RT140ED, RT140ES, RT140SR, RT140SL, RT190ED, RT190ES, RT190SR, RT190SL, RT190HDED, RT190HDES, RT190HSR, RT190HSL, RT270ED, RT270ES, RT270SR, RT270SL, RT270HDED, RT270HDES, RT270HSR, RT270HSL, RT100ERF, RT100ELF, RT100VD, RT100VS, RT140ERF, RT140ELF, RT140VD, RT140VS, RT142ERF, RT142ELF, RT190ERF, RT190ELF, RT190VD, RT190VS, RT190HERF, RT190HELF, RT190HDVDF, RT190HDVSF, RT270ERF, RT270ELF, RT270VDF, RT270VSF...(Other models you can see in the webshop)		

			
1			
GEV No.	504866	Ref. No.	0L2837
description	intake body ED ø 96mm H 200mm hose ø 62/34mm		

1

GEV No.	504861	Ref. No.	0L1638
description	intake body kit		
spare parts for	504861		
	GEV No.	504608	Ref. No. 047456 0A6113 0K8666 549609400
round filters ø 130mm H 100mm			



1

GEV No.	504772	Ref. No.	047554 0H2553 549607201
description	intake/drain body		
For models:	LSD55I, LSD55V, LS521, LS521D, LS521F, LS521M, LS521K, LS521, ZLS521, ALLS521, LS521ZD		



1

GEV No.	511339	Ref. No.	048327
description	O-ring EPDM thickness 3.53mm ID ø 110.7mm Qty 1 pcs		
For models:	LS32, LS32/4.5, LS32UK/RP, LS32F, LV32F, C55, LV32/60, WT302, WT302/4.5, WT302UK/RP, WT302F, WT302/60, LS33, LS33/4.5, LS33UK/RP, LS33F, LV33F, C55A, LS33/60, WT303, WT303/4.5, WT303UK/RP, WT303F, WT303/60, LS61, LS61/60, LS62, LS62D, LS62/UKRP, LS62F, LV62, LS62/60, ECOTEMP5, LS62/1P, LS62HD, LS65, LS62/UK, LS63, LS63D, LS63/UKRP, LS63F, LV63, LS63/60, LS63/1P, LS63/UK, LS64, LS64/UKRP, LV64, ECOTEMP5S, LS64/1P...(Other models you can see in the webshop)		



1

GEV No.	508370	Ref. No.	048229
description	O-ring EPDM thickness 3.53mm ID ø 46.04mm Qty 1 pcs		
For models:	LU7PDP, LU7ADP, LU7ADPWS, WTU40PDP, WTU40ADP, WTU40ADPWS, WTU40ADPD, LS10D, LS10, LS10UKRP, LC100, ECOTEMP12-, LS10/60, LS10/1, LS10/12KW, LS10F, LS10DEK, LS10/1UKRP, LS10SWS, LS10/50J, LS10/60J, LS10DP, LS10/HD, SH55, LO10, LS10/UK1, LS10/UK3, LS12D, LS12, LS12UK/RP, LC120, LS12DP, LS12/60, LS12F, LS12DEK, LS12HD, WT60/GJ60, WT60/GJ50, PH10/12-RP, LS12/UK3, ECOTEMP12SW, ECOTEMP12INS, LS12MEX, LS10N, LS10, LS14EA, LS10UKDP, ET12E, LS10/60HZ, LS10CW...(Other models you can see in the webshop)		



1

GEV No.	524493	Ref. No.	046875
description	overflow stock L 46mm seat ø 40mm for overflow pipe		
For models:	CT92DXE, CT92SX, CT92DXEUK, CT92SXEU, CT92DXV, CT92SXV, CT92DXVUK, CT92SXVUK, CT140EDX, CT140ESX, CT140EDXUK, CT140SXEU, CT140VDX, CT140VSX, CT141EDX, CT141ESX, CT141E-DUK, CT141ESUK, CT141VDX, CT141VSX, CT142DXE, CT142SX, CT142DXEUK, CT142SXEU, CT142DXV, CT142SXV, CT190DXE, CT190SX, CT190DXEUK, CT190SXEU, CT190DXV, CT190SXV, CT-191DXE, CT191SX, CT191DXEUK, CT191SXEU, CT191DXV, CT191SXV, CT192DXE, CT192SX, CT192DXEUK, CT192SXEU, CT192DXV, CT192SXV, CT240DXE, CT240SX, CT240DXEUK, CT240SX, CT240DXV, CT240SXVUK...(Other models you can see in the webshop)		

filters



1

GEV No.	524896	Ref. No.	070343 11409 9011409
description	bar L 42mm thread M6		
For models:	LB035C, LB035Q, LB040Q, LB040AUS, G350C, LBICEQ010, LBIOEQ010, G350, G350DP, LBIOEQ014, G400, G400DP		



1

GEV No.	504615	Ref. No.	047544 0A6158
description	flat filter		
For models:	LS520, LS520D, LS520M, LS520K, LS521, LS521D, LS521M, LS521K, LS521, ZLS510, ZLS520, ZLS521, ALLS521, ALLS520, ALS510, C52, LS520ZD, LS521ZD, LS510MZ, LS520MZ, LS521MZ		



1

GEV No.	504612	Ref. No.	049908
description	flat filter H 20mm L 480mm W 230mm		
For models:	EUC1, ZUCADDROW, ZUCADDROW6, EUCADDROW, EUCADDROW6, LS6EP, LS6EP/DD, LS6EADD, LS6EA/DPDD, WT38TDE, WT38M/50, LS6EADP3, LS6EADPWS, LS6EADPWSG, WT38WS, WT38WSG, WT38MEDWS, WT38PM50, WT37LEV/9, LS6EADPDWS, WT38DWS, LS-6SANA, EUCAI, EUCAIDP, EUCAI60, EUCAIWS, WT38M50/4, LS6EA/UK, LS6EA/DPUK, EUCAIG, EUCAIWSG, EUCAIML, EUCAIMLWS, EUCAIMLG, EUCAICL, EUCAICLG, EUCAIWL, LS6EA/60, EUCAICLW, EUCI, EUCIM, EUCIM60, EUCAIDPNW, ZUCI, ZUCID, ZUCAI, ZUCAIDP, ZUCAIDPWS, ZUCAIG, ZUCAIDDWS...(Other models you can see in the webshop)		

			
1			
GEV No.	504613	Ref. No.	048252 30000164
description	flat filter H 70mm L 235mm W 155mm		
For models:	LS10D, LS10, LS10UKRP, LC100, ECOTEMP12-, LS10/60, LS10/1, LS10/12KW, LS10F, LS10DEK, LS10/1UKRP, LS10SW, LS10/50J, LS10/60J, LS10DP, LS10/HD, SH55, LO10, LS10/UK1, LS10/UK3, LS12D, LS12, LS12UK/RP, LC120, LS12DP, LS12/60, LS12F, LS-12DEK, WT60/emF, WT60/12UK, WT60/9, WT60/12, WT60/12UKRP, WT60/9in, WT60/12in, LS12HD, PH10/12, LS12/UK3, ECOTEMP12SW, ECOTEMP12INS, LS12MEX, LS10N, LS10, LS14EA, LS10UKDP, ET12E, LS10/60HZ, LS10CW, LS10INS, HT1200INS... (Other models you can see in the webshop)		

			
1			
GEV No.	504611	Ref. No.	049051
description	flat filter L 415mm W 170mm		
For models:	LB1, LB1WS, LB1WSDP, LB1/RBP, LB1/TOP, LB1/60, WT1WSDP, LB2DPSAUS, LB1G, LB1WSG, WT2TOP60, WT2DPDI, WT2WSDPDI, LB1TOP, WT2TOPDI, LB2WS, LB2, LB2WSDP, LB2/TOP, LB2/RBP, LB2WS60, WT2WSDP, WT2WSDPD, LB2WSG, WT2WS, WT1, WT1WS, WT1TOP, WT2TOP, WT1/3DP, WT2/3DP, WT2DPAUS, WT2, LB2DPDI, LB2WSDPDI, LB2WSDPD, LB2TOP, LB2DP3, WT2DPD3, NGW, NGWDPDD, UC1, UC2WS, GW1, GW1WS, LV1WS, LV1WSDP, LV2WSDP, LV2WS, GW2DPG... (Other models you can see in the webshop)		

			
1			
GEV No.	504614	Ref. No.	048331 048332 048584 049537
description	flat filter L 495mm W 485mm		
For models:	LS32, LS32/4.5, LS32UK/RP, LS32F, LV32F, C55, LV32/60, WT302, WT302/4.5, WT302UK/RP, WT302F, WT302/60, LS33, LS33/4.5, LS33UK/RP, LS33F, LV33F, C55A, LS33/60, WT303, WT303/4.5, WT303UK/RP, WT303F, WT303/60, LS61, LS61/60, LS62, LS62D, LS62/UKRP, LS62F, LV62, LS62/60, ECOTEMP5, LS62/1P, LS62HD, LS65, LS62/UK, LS63, LS63D, LS63/UKRP, LS63F, LV63, LS63/60, LS63/1P, LS63/UK, LS64, LS64/UKRP, LV64, ECOTEMP5S, LS64/1P... (Other models you can see in the webshop)		

			
1			
GEV No.	504616	Ref. No.	048431 048515 049633 049647 049810
description	rectangular filter H 210mm L 195mm W 75mm		
For models:	LU7PDP, LU7ADP, LU7ADPWS, WTU40PDP, WTU40ADP, WTU40ADPWS, WTU40ADPD, LS10D, LS10, LS10UKRP, LC100, ECOTEMP12-, LS10/60, LS10/1, LS10/12KW, LS10F, LS10DEK, LS10/1UKRP, LS10SW, LS10/50J, LS10/60J, LS10DP, LS10/HD, SH55, LO10, LS10/UK1, LS10/UK3, LS12D, LS12, LS12UK/RP, LC120, LS12DP, LS12/60, LS12F, LS12DEK, LS12HD, WT60/GJ60, WT60/GJ50, PH10/12-RP, LS12/UK3, ECOTEMP12SW, ECOTEMP12INS, LS12MEX, LS10N, LS10, LS14EA, LS10UKDP, ET12E, LS10/60HZ, LS10CW... (Other models you can see in the webshop)		

			
1			
GEV No.	504693	Ref. No.	049022
description	round filters		
For models:	C55, WT4, WT4B, WT4D, WT302, WT302/4.5, WT302F, WT302/60, WT4DB, WT46, WT4WS1, C55A, WT4BWS, WT4DWS1, WT4BDWS, WT303, WT303/4.5, WT303F, WT303/60, WT4D60, WT4DDG, EU-C1WS, EUC1DPWS, EUC3WS, EUC3DPWS, LS5/1, LS5/1DP, LS5/1WS, LS5/1WSDP, LS5/3, LS5/3DP, LS5/3WS, LS5/3WSDP, LS5/3WSDPD, LS5/1DP60, LS5/1DPAUS, LS5/1DPCS, NUC1WS, NUC1DPWS, NUC3WS, NUC3DPWS, NUC3DDWS, LB1, LB1WS, LB1WSDP, WT1WSDP, LB2DPSAUS, LB1G, LB1WSG, LB2WS... (Other models you can see in the webshop)		

			
1			
GEV No.	518197	Ref. No.	069528
description	round filters		
For models:	LTB11, LTB12, LTB22, LTB11UK, LTB12UK, LTB22UK, LTB11, LTB22, 910-00-021, 910-00-023, 910-00-031, 910-00-033, 911-00-022, 911-00-024, 911-00-032, 911-00-034, CRYSTAL 11, CRYSTAL 22		





			
1			
GEV No.	504867	Ref. No.	0L2824 0L3586
description	round filters for intake body H 88mm with screw connection		

			
1			
GEV No.	524965	Ref. No.	0E5186
description	round filters ø 101mm H 125mm		
For models:	RT100ED, RT100ES, RT100SR, RT100SL, RT140ED, RT140ES, RT140SR, RT140SL, RT190ED, RT190ES, RT190SR, RT190SL, RT190HDED, RT190HDES, RT190HSR, RT190HSL, RT270ED, RT270ES, RT270SR, RT270SL, RT270HDED, RT270HDES, RT270HSR, RT270HSL, RT100ERF, RT100ELF, RT100VD, RT100VS, RT140ERF, RT140ELF, RT140VD, RT140VS, RT142ERF, RT142ELF, RT190ERF, RT190ELF, RT190VD, RT190VS, RT190HERF, RT190HELF, RT190HDVDF, RT190HDVSF, RT270ERF, RT270ELF, RT270VDF, RT270VSF, RT270HERF, RT270HELF, RT270HDVDF, RT270HDVSF...(Other models you can see in the webshop)		

			
1			
GEV No.	518610	Ref. No.	0L2757
description	round filters ø 124mm H 115mm		

			
1			
GEV No.	504608	Ref. No.	047456 0A6113 0K8666 549609400
description	round filters ø 130mm H 100mm		
For models:	LSDS5I, LSDS5V, LS510, LS520, LS520D, LS520F, LS520M, LS520K, LS521, LS521D, LS521F, LS521M, LS521K, LS521, LS4, ZLS510, ZLS520, ZLS521, ALLS521, ALLS520, ALS510, C51, C52, C50, LS520ZD, LS521ZD, CF314, LS510MZ, LS520MZ, LS521MZ		

			
1			
GEV No.	504595	Ref. No.	048324
description	round filters ø 130mm H 110mm		
For models:	LS32, LS32/4.5, LS32UK/RP, LS32F, LV32F, C55, LV32/60, WT4, WT4B, WT4D, WT302, WT302/4.5, WT302UK/RP, WT302F, WT302/60, WT4DB, WT46, WT4DG, WT4WS1, LS33, LS33/4.5, LS33UK/RP, LS33F, LV33F, C55A, LS33/60, WT4BWS, WT4DWS1, WT4BDWS, WT303, WT303/4.5, WT303UK/RP, WT303F, WT303/60, NUC3DD, WT4D60, WT4DDG, EUC1, EUC1DP, EUC1WS, EUC1DPWS, EUC3, EUC3WS, EUC3DP, EUC3DPWS, EUC1G, EUC1DP60, EUC3DD, ZUCADDROW, ZUCADDROW6...(Other models you can see in the webshop)		

			
1			
GEV No.	510041	Ref. No.	069529 0K3662 121016
description	round filters ø 136mm H 75mm		
For models:	LTB11, LTB12, LTB22, LTB11UK, LTB12UK, LTB22UK, LTB11, LTB22, 910-00-021, 910-00-023, 910-00-031, 910-00-033, 911-00-022, 911-00-024, 911-00-032, 911-00-034, CRYSTAL 11, CRYSTAL 22		

 <p style="text-align: center;">Image not available</p>			
1			
GEV No.	524038	Ref. No.	0E5376 0K7236 12711 468673001
description	round filters ø 147mm H 70mm		
For models:	A/TV8., A/TV11., A/TV16., A/TV8., A/TV11., A/TV16., A/TV8., A/TV8., A/TV11., A/TV11., A/TV16., A/TV16.		

			
1			
GEV No.	504591	Ref. No.	049032
description	round filters outflow		
For models:	LB1, LB1WS, LB1WSDP, LB1/RBP, LB1/TOP, LB1/60, WT1WSDP, LB2DPSAUS, LB1G, LB1WSG, WT2TOP60, WT2DPDI, WT2WSDPDI, LB1TOP, WT2TOPDI, LB2WS, LB2, LB2WSDP, LB2/TOP, LB2/RBP, LB2WS60, WT2WSDP, WT2WSDPD, LB2WSG, WT2WS, WT1, WT1WS, WT1TOP, WT2TOP, WT1/3DP, WT2/3DP, WT2DPAUS, WT2, LB2DPDI, LB2WSDPDI, LB2WSDPD, LB2TOP, LB2DP3, WT2DPD3, NGW, NGWDPDD, UC1, UC2WS, GW1, GW1WS, LV1WS, LV1WSDP, LV2WSDP, LV2WS, GW2DPG...(Other models you can see in the webshop)		

overflow pipes



GEV No.	504590	Ref. No.	047929 049036
description	O-ring EPDM thickness 2.62mm ID ø 18.72mm Qty 1 pcs		
For models:	LB1, LB1WS, LB1WSDP, LB1/RBP, LB1/TOP, LB1/60, WT1WSDP, LB2D-PSAUS, LB1G, LB1WSG, WT2TOP60, WT2DPDI, WT2WSDPDI, LB1TOP, WT2TOPDI, LB2WS, LB2, LB2WSDP, LB2/TOP, LB2/RBP, LB2WS60, WT2WSDP, WT2WSDPD, LB2WSG, WT2WS, WT1, WT1WS, WT1TOP, WT2TOP, WT1/3DP, WT2/3DP, WT2DPAUS, WT2, LB2DPDI, LB2WSDPDI, LB2WSDPD, LB2TOP, LB2DP3, WT2DPD3, NGW, NGWDPDD, LS540F, LS540DK, LS541F, LS720F, LSE720DK, LSE720PH, LS860F, LS860DK, LS860PH...(Other models you can see in the webshop)		



GEV No.	528919	Ref. No.	069527 456010
description	O-ring EPDM thickness 2.62mm ID ø 20.24mm Qty 1 pcs		
For models:	LTB11, LTB12, LTB22, LTB11UK, LTB12UK, LTB22UK, LTB11, LTB22, 910-00-021, 910-00-023, 910-00-031, 910-00-033, 911-00-022, 911-00-024, 911-00-032, 911-00-034, CRYSTAL 11, CRYSTAL 22		



GEV No.	510769	Ref. No.	046799 086280
description	O-ring EPDM thickness 2.62mm ID ø 25.07mm Qty 1 pcs		
For models:	LS32, LS32/4.5, LS32UK/RP, LS32F, LV32F, C55, LV32/60, WT4, WT4B, WT4D, WT302, WT302/4.5, WT302UK/RP, WT302F, WT302/60, WT4DB, WT46, WT4DG, WT4WS1, LS33, LS33/4.5, LS33UK/RP, LS33F, LV33F, C55A, LS33/60, WT4BWS, WT4DWS1, WT4BDWS, WT303, WT303/4.5, WT303UK/RP, WT303F, WT303/60, NUC3DD, WT4D60, WT4DDG, EUC1, EUC1DP, EUC1WS, EUC1DPWS, EUC3, EUC3WS, EUC3DP, EUC3DPWS, EUC1G, EUC1DP60, EUC3DD, ZUCADDROW, ZUCADDROW6...(Other models you can see in the webshop)		



GEV No.	504578	Ref. No.	045462 047458 0H2006 246180900 543616800
description	O-ring EPDM thickness 3.53mm ID ø 94.84mm Qty 1 pcs		
For models:	LS360F, LS360DK, LS365F, LS365, LS365PH, LS500F, LS501F, LS540F, LS540DK, LS541F, LS360D, LS365D, LS360, LS365, LS360/63, LS365/63, LS367, LS720F, LSE720DK, LSE720PH, LS860F, LS860DK, LS860PH, LS1080F, LS1080UK, LS1080PH, LSE721F, LS861F, LS540, LS1080M, LS1080, LS1080D, LS1080UK, LS1080/63, LSD551, LSD55V, LS500F, LS500UK, LS501, LS501UK, LS540D, LS540/63, LSE721, LS720, LSE720UK, LS721UK, LSE720D, LS541, LS860, LS860...(Other models you can see in the webshop)		



GEV No.	504602	Ref. No.	046635
description	overflow pipe		
For models:	LS365F, LS365, LS365PH, LS365D, LS365, LS365/63, LS367, LS365F		



GEV No.	504589	Ref. No.	049195
description	overflow pipe L 160mm ø 24mm		
For models:	LB1WSDP, LB1/TOP, WT1WSDP, LB2DPSAUS, WT2TOP60, WT2DPDI, WT2WSDPDI, LB1TOP, WT2TOPDI, LB2WSDP, LB2/TOP, WT2WSDP, WT2WSDPD, WT1TOP, WT2TOP, WT1/3DP, WT2/3DP, WT2DPAUS, LB2DPDI, LB2WSDPDI, LB2WSDPD, LB2TOP, LB2DP3, WT2DPD3, NGWDPDD, LV1WSDP, LV2WSDP, GW2DPG, GW2WSDPG		



GEV No.	504588	Ref. No.	049194
description	overflow pipe L 187mm ø 24mm		
For models:	LB1, LB1WS, LB1/RBP, LB1/60, WT1WSDP, LB1G, LB1WSG, LB2WS, LB2, LB2/RBP, LB2WS60, LB2WSG, WT2WS, WT1, WT1WS, WT2, NGW, UC1, UC2WS, GW1, GW1WS, LV1WS, LV1WSDP, LV2WSDP, LV2WS, GW2G, GW2WSG, GW2WS, GW2		



accessories for	504588	GEV No.	504590	Ref. No.	047929 049036
		O-ring EPDM thickness 2.62mm ID ø 18.72mm Qty 1 pcs			





GEV No.	510038	Ref. No.	069526 142008
description	overflow pipe L 190mm ø 25mm		
For models:	LTB11, LTB12, LTB22, LTB11UK, LTB12UK, LTB22UK, LTB11, LTB22, 910-00-021, 910-00-023, 910-00-031, 910-00-033, 911-00-022, 911-00-024, 911-00-032, 911-00-034, CRYSTAL 11, CRYSTAL 22		



accessories for	510038	GEV No.	528919	Ref. No.	069527 456010
		O-ring EPDM thickness 2.62mm ID ø 20.24mm Qty 1 pcs			



			
1			
GEV No.	504607	Ref. No.	047556 0H2555 549609600
description	overflow pipe L 200mm ø 29mm		
For models:	LSDS5I, LSDS5V, LS521, LS521D, LS521F, LS521M, LS521K, LS521, ZLS521, LS520ZD, LS521ZD, LS510MZ, LS520MZ, LS521MZ		
accessories for	504607		
			
GEV No.	510769	Ref. No.	046799 086280
O-ring EPDM thickness 2.62mm ID ø 25.07mm Qty 1 pcs			



			
1			
GEV No.	510768	Ref. No.	047460
description	overflow pipe L 210mm ø 30mm		
For models:	LS510, LS520, LS520D, LS520F, LS520M, LS520K, LS4, ZLS510, ZLS520, C51, C52, C50, CF314		

			
1			
GEV No.	510771	Ref. No.	048842
description	overflow pipe L 240mm ø 26mm		
For models:	WT4D, WT4DB, WT4DG, LS33, LS33/4.5, LS33UK/RP, LS33F, LV33F, C55A, LS33/60, WT4DWS1, WT4BDWS, WT303, WT303/4.5, WT303UK/RP, WT303F, WT303/60, NUC3DD, WT4D60, WT4DDG, EUC1, EUC1DP, EUC1DPWS, EUC3DP, EUC3DPWS, EUC1G, EUC1DP60, EUC3DD, ZUCADDROW, ZUCADDROW6, LS5/1DP, LS5/1WSDP, LS5/3DP, LS5/3WSDP, FUCA3DD, LS5/3WSDPD, LB5DPG, LS5/1DP60, LS5/1DPAUS, LS5/1DPCS, KUC3DP, NUC1DP, NUC1DPWS, NUC3DP, NUC3DPWS, NUC3DDWS, NUC1DP60, NUC1DPA, EUCADDROW, EUCADDROW6...(Other models you can see in the webshop)		
accessories for	510771		
			
GEV No.	510769	Ref. No.	046799 086280
O-ring EPDM thickness 2.62mm ID ø 25.07mm Qty 1 pcs			

			
1			
GEV No.	510770	Ref. No.	048323
description	overflow pipe L 260mm ø 26mm		
For models:	LS32, LS32/4.5, LS32UK/RP, LS32F, LV32F, C55, LV32/60, WT4, WT4B, WT302, WT302/4.5, WT302UK/RP, WT302F, WT302/60, WT46, WT4WS1, WT4BWS, EUC1, EUC1WS, EUC3, EUC3WS, LS5/1, LS5/1WS, LS5/3, LS5/3WS, KUC3, NUC1, NUC1WS, NUC3, NUC3WS, ZUCA1, ZUCA3, LS61, LS61/60, LS6EP, LS6EP/DD, LS6EADD, WT37LEV/9, EUCAI, LS6EA/UK, LS6EA/60, EUCAICLW, EUCI, ZUCI, ZUCID, ZUCAI, ZUCAID, ZUCA160, LS62, LS62D...(Other models you can see in the webshop)		
accessories for	510770		
			
GEV No.	510769	Ref. No.	046799 086280
O-ring EPDM thickness 2.62mm ID ø 25.07mm Qty 1 pcs			

			
1			
GEV No.	524492	Ref. No.	046876 047116
description	overflow pipe L 265mm ø 40mm		
For models:	CT92DXE, CT92SXE, CT92DXEUK, CT92SXEUK, CT92DXV, CT92SXV, CT92DXVUK, CT92SXVUK, CT140EDX, CT140ESX, CT140EDXUK, CT140SXUK, CT140VDX, CT140VSX, CT141EDX, CT141ESX, CT141E-DUK, CT141ESUK, CT141VDX, CT141VSX, CT142DXE, CT142SXE, CT142DXEUK, CT142SXEUK, CT142DXV, CT142SXV, CT190DXE, CT190SXE, CT190DXEUK, CT190SXEUK, CT190DXV, CT190SXV, CT191DXE, CT191SXE, CT191DXEUK, CT191SXEUK, CT191DXV, CT191SXV, CT192DXE, CT192SXE, CT192DXEUK, CT192SXEUK, CT192DXV, CT192SXV, CT240DXE, CT240SXE, CT240DXEUK, CT240SX, CT240DXV, CT240SXVUK...(Other models you can see in the webshop)		

			
1			
GEV No.	517480	Ref. No.	0L0908
description	overflow pipe L 355mm ø 40mm		
For models:	WTC90ERB, WTC90ELB, WTC140ERA, WTC140ELA, WTC140ERB, WTC140ELB, WTC180ERA, WTC180ELA, WTC180ERB, WTC180ELB, WTC220ERA, WTC220ELA, WTC220ERB, WTC220ELB, WTC90ERBG, WTC90ELBG, WTC140ERAG, WTC140ELAG, WTC140ERBG, WTC140ELBG, WTC180ERAG, WTC180ELAG, WTC180ERBG, WTC180ELBG, WTC220ERAG, WTC220ELAG, WTC220ERBG, WTC220ELBG, WTM140ERA, WTM140ELA, WTM140ERB, WTM140ELB, WTM165ERA, WTM165ELA, WTM165ERB, WTM165ELB, WTM200ERA, WTM200ELA, WTM200ERB, WTM200ELB, WTM250ERA, WTM250ELA, WTM250ERB, WTM250ELB, WTM300ERA, WTM300ELA, WTM300ERB, WTM300ELB, WTM180ERA, WTM180ELA...(Other models you can see in the webshop)		

			
1			
GEV No.	501557	Ref. No.	0L2829
description	overflow pipe L 385mm ø 39mm		
accessories for	501557		
	GEV No.	507314	Ref. No. 0L2359
	O-ring EPDM thickness 2.62mm ID ø 32.99mm		

			
1			
GEV No.	504599	Ref. No.	048250
description	overflow pipe L 415mm ø 39mm		
For models:	LS10D, LS10, LS10UKRP, LC100, ECOTEMP12-, LS10/60, LS10/1, LS10/12KW, LS10F, LS10DEK, LS10/1UKRP, LS10SW, LS10/50J, LS10/60J, LS10/HD, LS10/UK1, LS10/UK3, LS12D, LS12, LS12UK/RP, LC120, LS12/60, LS12F, LS12DEK, LS12HD, WT60/GJ60, WT60/GJ50, PH10/12-RP, LS12/UK3, ECOTEMP12SW, ECOTEMP12INS, LS12MEX, LS10N, LS10, LS14EA, LS10UKDP, ET12E, LS10/60HZ, LS10CW, LS10INS, HT1200INS, LS14EAI, LS10N, LS10DP, LS10HD, LS14EAI/AU, LS14EA/60, LS10UK/1, LS10UK/3, LS12INS...(Other models you can see in the webshop)		

			
1			
GEV No.	524489	Ref. No.	049140
description	overflow pipe L 420mm ø 40mm		
For models:	LU7PDP, LU7ADP, LU7ADPWS, WTU40PDP, WTU40ADP, WTU40ADPWS, WTU40ADPD, LS10DP, LO10, LS12DP, LS10UKDP, LS10/60HZ, LS10N, LS10DP, LS12DP, WT60DP, WT60UKDPCW, WT60NAUDP, LS12UKDPCW, WT65EBIDG, LS14EADP/G, LS14AH240U, WT65H208U, WT65H240U, LS12ASIA, LS14H208DU, LS14AH208U, LS14H240DU, LS14H208RU, LS14H240RU, WT65H208DU, WT65H240DU, WT65H-208RU, WT65H240RU, WT65M208U, WT65M240U, WT65M208DU, WT65M240DU, WT65M208RU, WT65M240RU, LS14EAWS, LS14ADPWSG, LS14EAIWS, WT65EBWS, WT65BIDWSG, WT65EBIWS, WT65MEDWS, WT65H208WS, WT65H240WS, ET12EWS...(Other models you can see in the webshop)		

			
1			
GEV No.	510434	Ref. No.	045476 068651 068713 315791300
description	overflow pipe L 426mm with filter ø 40mm		
For models:	LS360F, LS360DK, LS500F, LS501F, LS540F, LS540DK, LS541F, LS360D, LS360, LS360/63, LS720F, LSE720DK, LSE720PH, LS860F, LS860DK, LS860PH, LS1080F, LS1080UK, LS1080PH, LSE721F, LS861F, LS540, LS1080M, LS1080, LS1080D, LS1080UK, LS1080/63, LS500F, LS500UK, LS501, LS501UK, LS540D, LS540/63, LSE721, LS720, LSE720UK, LS721UK, LSE720D, LS541, LS860, LS860, LS860D, LS860UK, LS861UK, LS860/63, LS861, LS360, LS500, LS501, LS540...(Other models you can see in the webshop)		

			
1			
GEV No.	524490	Ref. No.	049675 0E5804 0K1122
description	overflow pipe L 450mm ø 40mm		
For models:	PW1EFL, PW1EFLF, PW1EFL/60HZ, PW1SMG, PW1MG, PW1MUK, PW160HZ, PW1MHG, PW2MG, PW2MUK, PW2M60, WT830M, WT830MUK, WT830M60G, WT850M, WT850MUK, WT850M60G, WT830MHG, WT830M208U, WT830M240U, WT830H208U, WT830H240U, WT850M208U, WT850M240U, PW2SMG, ET830M, ET830MH, ET850M, WT830EFL, WT830EFLF, WT830EFL/60HZ, PW1EAG, PW2EAG, WT830EA, WT850EA, WT830EAG, WT850EAG, PW100MG, PW100M, PW200M, PW100MHG, LV100M, LV200M, PW200MG, LO1EFL		

containers

container lids

			
1			
GEV No.	504298	Ref. No.	0L0272
description	cap ø 55mm for salt tank Qty 1 pcs		
For models:	WT4WS1, WT4BWS, WT4DWS1, WT4BDWS, EUC1WS, EUC1DPWS, EUC3WS, EUC3DPWS, LS5/1WS, LS5/1WSDP, LS5/3WS, LS5/3WSDP, LS5/3WSDPD, NUC1WS, NUC1DPWS, NUC3WS, NUC3DPWS, NUC3DDWS, LS6EADPWS, LS6EADPWSG, WT38WS, WT38WSG, WT38MEDWS, LS6EADPDWS, WT38DWS, EUCAIWS, EUCAIWSG, EUCAIMLWS, ZUCAIDPWS, ZUCAIDDWS, WT30H208U, WT30H240U, WT30H208DU, WT30H240DU, WT30H208RU, WT30H240RU, WT30M208U, WT30M240U, WT30M208DU, WT30M240DU, WT30M-208RU, WT30M240RU, WT30C208DU, WT30C240DU, WT30H208WS, WT30H240WS, LU7PDP, LU7ADP, LU7ADPWS, WTU40PDP...(Other models you can see in the webshop)		



1

GEV No.	504708	Ref. No.	047551
description	lid		
For models:	LS32, LS32/4.5, LS32F, LV32F, LV32/60, WT4, WT4B, WT4D, WT4DB, WT46, LS33, LS33/4.5, LS33F, LV33F, LS33/60, WT4D60, WT4DDG, LS5/1, LS5/1DP, LS5/3, LS5/3DP, LS5/1DP60, LS5/1DPAUS, LS5/1DPCS, LSD5S1, LSD5S5, LS520, LS520D, LS520F, LS520K, LS521, LS521D, LS521F, LS521M, LS521K, LS521, LS4, LS62, LS62D, LS62/UKRP, LS62F, LV62, LS62/60, LS62/1P, LS62HD, LS63, LS63D, LS63/UKRP, LS63F, LV63...(Other models you can see in the webshop)		



1

GEV No.	510109	Ref. No.	069472 480006
description	lid for salt tank		
For models:	LTB11, LTB11UK, LTB11, CRYSTAL 11		



1

GEV No.	510110	Ref. No.	069552 429012
description	lid for salt tank		
For models:	LTB11, LTB11UK, LTB11, CRYSTAL 11		



1

GEV No.	504701	Ref. No.	068644
description	screw cap		
For models:	LS360F, LS360DK, LS365F, LS365, LS365PH, LS360D, LS365D, LS360, LS365, LS360/63, LS365/63, LS367, WT32, WT32/4.5, WT32/UK, WT32/UKRP, WT32/F6, WT32/J60, WT32/J50, WT32/4.5N, WT33, WT33/4.5, WT33/UK, WT33/UKRP, WT33/F, WT33/60, WT33/4.5N, WT34, WT34/4.5, WT34/UKRP, WT34/4.5N, LS7D, LS7, LV70, LS7F, LS7DEK, LS7/9, LS7/DP, LS7/60, WT40/9, WT40/F, WT40/J50, WT40/J60, WT40UKRP, PH4/WT40, PH4RBP/WT40, LS10D, LS10, LS10UKRP, LC100...(Other models you can see in the webshop)		

dosing containers



1

GEV No.	504696	Ref. No.	049975
description	container		
For models:	WT4, WT4B, WT4D, WT4DB, WT46, WT4D60, WT4DDG, LS5/1, LS5/1DP, LS5/3, LS5/3DP, LS5/1DP60, LS5/1DPAUS, LS5/1DPCS, FL5, FL5DP, LV5, LV5DP, UC5DP, LD5DP, LD5, UC5/1, UC5/1DP, FL5DDG		



1

GEV No.	504700	Ref. No.	068630
description	container		
For models:	LS360F, LS360DK, LS365F, LS365, LS365PH, LS360D, LS365D, LS360, LS365, LS360/63, LS365/63, LS367, WT32, WT32/4.5, WT32/UK, WT32/UKRP, WT32/F6, WT32/J60, WT32/J50, WT32/4.5N, WT33, WT33/4.5, WT33/UK, WT33/UKRP, WT33/F, WT33/60, WT33/4.5N, WT34, WT34/4.5, WT34/UKRP, WT34/4.5N, LS7D, LS7, LV70, LS7F, LS7DEK, LS7/9, LS7/DP, LS7/60, WT40/9, WT40/F, WT40/J50, WT40/J60, WT40UKRP, PH4/WT40, PH4RBP/WT40, LS360, LS365F, ZLS520, ZLS521...(Other models you can see in the webshop)		



1

GEV No.	504690	Ref. No.	049024 049225
description	dosing container		
For models:	C55, WT302, WT302/4.5, WT302F, WT302/60, C55A, WT303, WT303/4.5, WT303F, WT303/60, LB1, LB1WS, LB1WSDP, WT1WSDP, LB2DPSAUS, LB1G, LB1WSG, LB2WS, LB2, LB2WSDP, LB2WS60, WT2WSDP, WT2WSDPD, LB2WSG, WT2WS, WT1, WT1WS, WT1TOP, WT2TOP, WT1/3DP, WT2/3DP, WT2DPAUS, LS6EP, LS6EP/DD, LS6EADD, LS6EA/DPDD, LS6EADP3, LS6EA/60, LS6EA, LS6EA/DP, LVA100B, LVA100Z, LVA100B, LVA100, LVA100-A, LVA/100-BU, FL32, FL32/4.5, FL33, FL33/4.5...(Other models you can see in the webshop)		
spare parts for	504690		
	GEV No.	504693	Ref. No. 049022
	round filters		



1

GEV No.	504707	Ref. No.	047549
description	rinse aid container		
For models:	LS32, LS32/4.5, LS32F, LV32F, LV32/60, LS33, LS33/4.5, LS33F, LV33F, LS33/60, LSD5S1, LSD5S5, LS520, LS520D, LS520F, LS520K, LS521, LS521D, LS521F, LS521M, LS521K, LS521, LS4, LS62, LS62D, LS62/UKRP, LS62F, LV62, LS62/60, LS62/1P, LS62HD, LS63, LS63D, LS63/UKRP, LS63F, LV63, LS63/60, LS63/1P, LS64, LS64/UKRP, LV64, LS64/1P, C52, C50		



1

GEV No.	511971	Ref. No.	048277
description	rinse aid container L 165mm W 86mm H 64mm		
For models:	LS10D, LS10, LS10UKRP, LC100, LS10/60, LS10/1, LS10/12KW, LS10F, LS10DEK, LS10SW, LS10/50J, LS10/60J, LS10DP, LS10/HD, LS12D, LS12, LC120, LS12DP, LS12/60, LS12F, LS12DEK, LS12HD, ECOTEMP12INS, LS12MEX, LS10N, LS8D, LS8, LC80, LS8F, LS8DEK, LS8/9, LS8/60, LS8/DP, WT50/9, WT50/UK9RF, WT50/F9, WT50/6, WT50/1UKRP, WT50/1, D800/9, D800/6, WT50/60, WT50/N, LS8/HD, WT50/J50, WT50/J60, LS8DEK, HT1200elm, HT1000elm, HYDRA1200...(Other models you can see in the webshop)		

salt tanks



1

GEV No.	524177	Ref. No.	069467 480005
description	lid ø 69mm H 20mm for salt tank ID ø 50mm		
For models:	LTB12, LTB22, LTB12UK, LTB22UK, LTB22, CRYSTAL 22		
accessories for	524177		
	GEV No.	524148	Ref. No. —
	O-ring EPDM thickness 3.53mm ID ø 40.86mm Qty 1 pcs		





1

GEV No.	510018	Ref. No.	069469 429011
description	nut ø 92mm H 10.5mm for salt tank ID ø 64mm		
For models:	LTB12, LTB22, LTB12UK, LTB22UK, LTB22, CRYSTAL 22		









1

GEV No.	504299	Ref. No.	0L0271
description	salt tank		
For models:	WT4WS1, WT4BWS, WT4DWS1, WT4BDWS, EUC1WS, EUC1DPWS, EUC3WS, EUC3DPWS, LS5/1WS, LS5/1WSDP, LS5/3WS, LS5/3WSDP, LS5/3WSDPD, NUC1WS, NUC1DPWS, NUC3WS, NUC3DPWS, NUC3DDWS, LV5/3WSDP, FL5/3WSDP, UC5WSDP		
accessories for	504299		
	GEV No.	504298	Ref. No. 0L0272
	cap ø 55mm for salt tank Qty 1 pcs		



1

GEV No.	510929	Ref. No.	010370 069471 069575 406001 406999
description	salt tank ø 120mm H 117mm hose ø 10mm mounting ø 70mm overall height 157mm		
For models:	LTB11, LTB12, LTB22, LTB11, LTB22, CRYSTAL 11, CRYSTAL 22		
spare parts for	510929		
	GEV No.	506015	Ref. No. 047192
	O-ring EPDM thickness 3.53mm ID ø 39.69mm Qty 1 pcs		
	GEV No.	510018	Ref. No. 069469 429011
	nut ø 92mm H 10.5mm for salt tank ID ø 64mm		
	GEV No.	524177	Ref. No. 069467 480005
	lid ø 69mm H 20mm for salt tank ID ø 50mm		
accessories for	510929		
	GEV No.	510071	Ref. No. 049244 069470 437034
	flat gasket rubber ED ø 81mm ID ø 68mm thickness 3mm for salt tank Qty 1 pcs		
	GEV No.	510654	Ref. No. —
	gasket H 6mm D1 ø 82mm D2 ø 68mm		

accessories for 510929

	GEV No.	510883	Ref. No.	—
	gasket rubber ED ø 86mm ID ø 66mm thickness 2mm for salt tank Qty 1 pcs			







1

GEV No.	504232	Ref. No.	049075
description	salt tank ø 120mm H 120mm		
For models:	LB1WS, LB1WSDP, LB1/TOP, WT1WSDP, LB2DPSAUS, LB1WSG, WT2TOP60, WT2WSDPDI, LB1TOP, WT2TOPDI, LB2WS, LB2WSDP, LB2/TOP, LB2/RBP, LB2WS60, WT2WSDP, WT2WSDPD, LB2WSG, WT2WS, WT1WS, WT1TOP, WT2TOP, LB2WSDPDI, LB2WSDPD, LB2TOP, UC2WS, GW1WS, LV1WS, LV1WSDP, LV2WSDP, LV2WS, GW2WSDPG, GW2WSG, GW2WS		



1

GEV No.	510032	Ref. No.	069680 406998
description	salt tank without gasket new model		
For models:	LTB11, LTB12, LTB22, LTB11UK, LTB12UK, LTB22UK, LTB11, LTB22, CRYSTAL 11, CRYSTAL 22		
spare parts for	510032		
	GEV No.	506015	Ref. No. 047192
	O-ring EPDM thickness 3.53mm ID ø 39.69mm Qty 1 pcs		
	GEV No.	510018	Ref. No. 069469 429011
	nut ø 92mm H 10.5mm for salt tank ID ø 64mm		
	GEV No.	510071	Ref. No. 049244 069470 437034
	flat gasket rubber ED ø 81mm ID ø 68mm thickness 3mm for salt tank Qty 1 pcs		
	GEV No.	524177	Ref. No. 069467 480005
	lid ø 69mm H 20mm for salt tank ID ø 50mm		

accessories



GEV No.	510071	Ref. No.	049244 069470 437034
description	flat gasket rubber ED ø 81mm ID ø 68mm thickness 3mm for salt tank Qty 1 pcs		
For models:	LB1, LB1WS, LB1WSDP, LB1/RBP, LB1/TOP, LB1/60, WT1WSDP, LB2D-PSAUS, LB1G, LB1WSG, WT2TOP60, WT2WSDPDI, LB1TOP, WT2TOPDI, LB2WS, LB2, LB2WSDP, LB2/TOP, LB2/RBP, LB2WS60, WT2WSDP, WT2WSDPD, LB2WSG, WT2WS, WT1WS, WT1TOP, WT2TOP, LB2WS-DPDI, LB2WSDPD, LB2TOP, LTB11, LTB12, LTB22, LTB11UK, LTB12UK, LTB22UK, LTB11, LTB22, UC1, UC2WS, 910-00-021, 910-00-023, 910-00-031, 910-00-033, 911-00-022, 911-00-024, 911-00-032, 911-00-034, GW1WS, LV1WS...(Other models you can see in the webshop)		



GEV No.	504712	Ref. No.	047548 049331
description	funnel		
For models:	LS32, LS32/4.5, LS32F, LV32F, LV32/60, LS33, LS33/4.5, LS33F, LV33F, LS33/60, LS520, LS520D, LS520F, LS520M, LS521, LS521D, LS521F, LS521M, LS521, LS4, LS62, LS62D, LS62/UKRP, LS62F, LV62, LS62/60, LS62/1P, LS62HD, LS63, LS63D, LS63/UKRP, LS63F, LV63, LS63/60, LS63/1P, LS64, LS64/UKRP, LV64, LS64/1P		



GEV No.	504327	Ref. No.	047604
description	funnel for salt tank D1 ø 96mm D2 ø 34mm		
For models:	WT4WS1, WT4BWS, WT4DWS1, WT4BDWS, EUC1WS, EUC1DPWS, EUC3WS, EUC3DPWS, LS5/1WS, LS5/1WSDP, LS5/3WS, LS5/3WSDP, LS5/3WSDPD, NUC1WS, NUC1DPWS, NUC3WS, NUC3DPWS, NUC3DDWS, LSD5S1, LSD5S5, LS6EADPWS, LS6EADPWSG, WT38WS, WT38WSG, WT38MEDWS, LS6EADPDWS, WT38DWS, EUCAIWS, EUCAIWSG, EUCAIMLWS, ZUCAIDPWS, ZUCAIDDWS, WT30H208WS, WT30H240WS, LU7ADPWS, WTU40ADPWS, LS14EAWS, LS14ADPWSG, LS14EAIWS, WT65EBWS, WT65BIDWSG, WT65EBIWS, WT65MEDWS, WT65H208WS, WT65H240WS, ET12EWS, WT65EBIWS, EHTAWS, EHTAIWS, EHTAIDWS...(Other models you can see in the webshop)		



GEV No.	504713	Ref. No.	047552
description	intake lance		
For models:	LS32, LS32/4.5, LS32F, LV32F, LV32/60, LS33, LS33/4.5, LS33F, LV33F, LS33/60, LSD5S1, LSD5S5, LS520, LS520D, LS520F, LS520K, LS521, LS521D, LS521F, LS521M, LS521K, LS521, LS4, LS62, LS62D, LS62/UKRP, LS62F, LV62, LS62/60, LS62/1P, LS62HD, LS63, LS63D, LS63/UKRP, LS63F, LV63, LS63/60, LS63/1P, LS64, LS64/UKRP, LV64, LS64/1P, C52, C50		



GEV No.	504703	Ref. No.	048434
description	lid suitable for ZANUSSI equiv. no. 048434 external height 20mm		
For models:	WT32, WT32/4.5, WT32/UK, WT32/UKRP, WT32/F6, WT32/J60, WT32/J50, WT32/4.5N, WT33, WT33/4.5, WT33/UK, WT33/UKRP, WT33/F, WT33/60, WT33/4.5N, WT34, WT34/4.5, WT34/UKRP, WT34/4.5N, LS7D, LS7, LV70, LS7F, LS7DEK, LS7/9, LS7/DP, LS7/60, WT40/9, WT40/F, WT40/J50, WT40/J60, WT40UKRP, PH4/WT40, PH4RBP/WT40, LS10D, LS10, LS10UKRP, LC100, LS10/60, LS10/1, LS10/12KW, LS10F, LS10DEK, LS10SW, LS10/50J, LS10/60J, LS10DP, LS10/HD, LS12D, LS12...(Other models you can see in the webshop)		



GEV No.	504710	Ref. No.	047550
description	nut		
For models:	LS32, LS32/4.5, LS32UK/RP, LS32F, LV32F, LV32/60, WT302UK/RP, LS33, LS33/4.5, LS33UK/RP, LS33F, LV33F, LS33/60, WT303UK/RP, LSD5S1, LSD5S5, LS520, LS520D, LS520F, LS520M, LS520K, LS521, LS521D, LS521F, LS521M, LS521K, LS521, LS4, LS62, LS62D, LS62/UKRP, LS62F, LV62, LS62/60, LS62/1P, LS62HD, LS65, LS62/UK, LS63, LS63D, LS63/UKRP, LS63F, LV63, LS63/60, LS63/1P, LS63/UK, LS64, LS64/UKRP, LV64, LS64/1P...(Other models you can see in the webshop)		



GEV No.	504704	Ref. No.	068627
description	thread bolt for dosing container		
For models:	LS365F, LS365, LS365PH, LS360D, LS365D, LS365, LS365/63, LS367, WT32, WT32/4.5, WT32/UK, WT32/UKRP, WT32/F6, WT32/J60, WT32/J50, WT32/4.5N, WT33, WT33/4.5, WT33/UK, WT33/UKRP, WT33/F, D500, WT33/60, WT33/4.5N, WT34, WT34/4.5, WT34/UKRP, D510, WT34/4.5N, LS7D, LS7, LV70, LS7F, LS7DEK, LS7/9, LS7/DP, LS7/60, WT40/9, WT40/F, WT40/J50, WT40/J60, WT40UKRP, PH4/WT40, PH4RBP/WT40, LS365F, ZLS520, ZLS521, ALLS521, ALLS520, FL620...(Other models you can see in the webshop)		



boilers

boilers for dishwashers

 <p>1</p>			
GEV No.	504740	Ref. No.	069453 982006
description	boiler		
For models:	LTB11, LTB12, LTB22, LTB11, LTB22, CRYSTAL 11, CRYSTAL 22		

 <p>1</p>			
GEV No.	504741	Ref. No.	046294 1130935
description	boiler		
For models:	LS360F, LS360DK, LS365F, LS365, LS365PH, LS500F, LS501F, LS360D, LS365D, LS360, LS365, LS360/63, LS365/63, LS367, LS500F, LS500UK, LS501, LS501UK, LS360, LS365F, LS500, LS501, ALS540, HB3PNT		

 <p>1</p>			
GEV No.	504744	Ref. No.	046521 046606 047947 047950 1130910
description	boiler		
For models:	LS720F, LSE720DK, LSE720PH, LS860F, LS860DK, LS860PH, LS1080F, LS1080UK, LS1080PH, LSE721F, LS861F, LS1080M, LS1080, LS1080D, LS1080UK, LS1080/63, LSE721, LS720, LSE720UK, LS721UK, LSE720D, LS860, LS860, LS860D, LS860UK, LS861UK, LS860/63, LS861, 652120Z, LS860, LS1080, LS720N, LS860, DMAST2CUK, LSE720Z, LS860, LS1080, LS860, LS1080		

 <p>1</p>			
GEV No.	504745	Ref. No.	049336 1130350
description	boiler		
For models:	LS32, LS32/4.5, LS32F, LV32F, C55, LV32/60, WT302, WT302/4.5, WT302F, WT302/60, LS33, LS33/4.5, LS33F, LV33F, C55A, LS33/60, WT303, WT303/4.5, WT303F, WT303/60, FL32, FL32/4.5, FL33, FL33/4.5, C32, C32/4.5, C33, C33/4.5, Z32, Z32/4.5, Z33, Z33/4.5		

 <p>1</p>			
GEV No.	504746	Ref. No.	048341 048548 1130150
description	boiler		
For models:	LS61, LS61/60, ECOTEMP5, ECOTEMP5S, WT32/4.5, WT32/UK, WT32/UKRP, WT32/J60, WT32/J50, WT32/4.5N, WT33/4.5, WT33/UK, WT33/UKRP, WT33/4.5N, WT34/4.5, WT34/UKRP, WT34/4.5N, LS7D, LS7, LS7UK/RP, LV70, LS7F, LS7DEK, LS7/1UK, LS7/DP, LS7/60, WT40/9, WT40/F, LS7HD, WT40/J50, WT40/J60, WT40UKRP, PH4/WT40, PH4RBP/WT40, LS10D, LS10, LS10UKRP, LC100, ECOTEMP12-, LS10/60, LS10/1, LS10F, LS10DEK, LS10/1UKRP, LS10DP, LS10/HD, SH55, LO10, LS12F, LS12DEK...(Other models you can see in the webshop)		

 <p>1</p>			
GEV No.	504747	Ref. No.	048283 048484 048727 0L1639 1130050 30000032
description	boiler		
For models:	LS62, LS62D, LS62/UKRP, LS62F, LV62, LS62/60, LS62/1P, LS62HD, LS63, LS63D, LS63/UKRP, LS63F, LV63, LS63/60, LS63/1P, LS64, LS64/UKRP, LV64, LS64/1P, ECOTEMP5SW, WT32, WT32/F6, WT33, WT33/F, D500, WT33/M50, WT33/M60, WT33/60, WT30U400, WT30U440, WT34, D510, LS7/9, LS10D, LS10, LS10UKRP, ECOTEMP12-, LS10/60, LS10/12KW, LS10DEK, LS10SW, LS10/50J, LS10/60J, LS12D, LS12, LS12UK/RP, LC120, LS12DP, LS12/60, LS12F...(Other models you can see in the webshop)		

 <p>1</p>			
GEV No.	504748	Ref. No.	049958 1130455
description	boiler		
For models:	WT4, WT4B, WT4D, WT4DB, WT46, WT4D60, WT4DDG, LS5/1, LS5/1DP, LS5/3, LS5/3DP, LS5/1DP60, LS5/1DPAUS, LS5/1DPCS, FL5, FL5DP, LV5, LV5DP, UC5DP, LD5DP, LD5, UC5/1, UC5/1DP, FL5DDG		

 <p>1</p>			
GEV No.	504749	Ref. No.	049902
description	boiler		
For models:	LS6EADD, LS6EA/DPDD, WT38TDE, WT38/M50, LS6EADP3, WT37LEV/9, LS6SANA, WT38M50/4, LS6EA/UK, LS6EA/DPUK, LS6EA/60, WT38D, WT37, WT38, WT37/4.5, WT38/4.5, WT37/UK, WT38C, WT38C60, WT38CUK, WT38/4.5NW, WT38UK, WT37J60, WT37J50, WT38/60, WT38/M60, WT38MED, WT38M60/4, WT38WL, LS6EA, LS6EA/DP, LS6EAH, LS6MCD, ET5EDG, H3300, ET5EDCW, H1310SANA, FL620EAG, FL620EA, FL620EADP, ET5E, ET5ED, FL620EA/DD, FL620EADP/, LV6EA, LV6EADP		

			
GEV No.	504751	Ref. No.	049632 0KG568 1130750
description	boiler		
For models:	LS10, LS10UKDP, ET12E, LS10/60HZ, LS10CW, LS10INS, HT1200INS, LS10N, LS10DP, LS10HD, LS10UK/1, LS10UK/3, LS12INS, LS12, LS12DP, LS12/60HZ, LS12CW, HT1200DEK, WT60DP, WT60, WT60CW, WT60UK-DPCW, WT60INS, WT60INSCW, WT60NAUCW, WT60NAU, WT60/60HZ, WT60/60HZC, WT60N, WT609NINS, LS12HD, WT60NAUDP, LS12UK/3CW, LS12NAU, LS12UKDPCW, ECOTEMP12S, WT60U40050, WT60U44060, WT60MX2206, LS12CWINS, LS12ASIA, WT60ASIA, HT1200, HT1000, HT1000INS, HT1200INS, HT1000DP, HT1200DP		

			
GEV No.	504759	Ref. No.	049987 0L0514
description	boiler kit		
For models:	LS14EA, ET12E, LS14EAI, LS14EAI/AU, LS14EA/60, LS14EAA-SIA, LS14EA/G, LS10EA, LS14EAI/DD, WT65E, WT65EB, WT65EI, ECOTEMP12S, WT65EBI, WT65EBIA, WT65EIA, WT65E60, WT65EB60, WT65EBIDG, WT65EBASIA, WT65EIM50, WT65EIM60, LS14EADP/G, WT65MED, WT65EJ50, WT65EJ60, WT65EBID, LS9AUK/3, WT55AUK/3, LS9ADG1, WT55ADG1, H3500, H1510SANA, HT900ADG1, HT-1200BIDG, HT1200, HT1000, HT1200INS, ET12EI, LV1000, LV1200INS		

			
GEV No.	504756	Ref. No.	0L0283 0L1906 171082670
description	boiler		
For models:	LS6EADD, LS6EA/DPDD, WT38TDE, WT38/M50, LS6EADP3, WT-37LEV/9, LS6SANA, EUCAI, EUCAIDP, EUCAI60, WT38M50/4, LS6EA/UK, LS6EA/DPUK, EUCAIG, EUCAIML, EUCAIMLG, EUCAICL, EUCAICLG, EUCAIWL, LS6EA/60, EUCAICLW, EUCAIDPNW, ZUCAI, ZUCAIDP, ZUCAIG, ZUCAID, ZUCAI60, EUCAIUSPH6, ZUCAIDD, EUCAIDD, EUCAIDPJ, EUCAIDPJ60, WT38D, WT37, WT38, WT37/4.5, WT38/4.5, WT37/UK, WT38C, WT38C60, WT38CUK, WT38/4.5NW, WT38UK, WT37J60, WT37J50, LS6AH240U, WT30H208U, WT30H240U, WT30H-208DU, WT30H240DU...(Other models you can see in the webshop)		

			
GEV No.	524960	Ref. No.	0E5954 0L1856
description	boiler kit ø 195mm L 480mm inlet ø 12mm		
For models:	TW1ERECO, TW1ELECO, TW1SRECO, TW1SLECO, RT100ED, RT100ES, RT140ED, RT140ES, RT190ED, RT190ES, RT190HDED, RT190HDES, RT270ED, RT270ES, RT270HDED, RT270HDES, RT100ERF, RT100ELF, RT140ERF, RT140ELF, RT142ERF, RT142ELF, RT190ERF, RT190ELF, RT190HERF, RT190HELF, RT270ERF, RT270ELF, RT270HERF, RT270HELF, RT100ERG, RT100ELG, RT140ERG, RT140ELG, RT190ERG, RT190ELG, RT190HERG, RT190HELG, RT270ERG, RT270ELG, RT270HERG, RT-270HELG, RT10ED, RT10ES, RT10SR, RT10SL, RT10ED/230, RT10ES/230, RT10ERF60, RT10ELF60...(Other models you can see in the webshop)		

			
GEV No.	524369	Ref. No.	0U1011
description	boiler		

			
GEV No.	504791	Ref. No.	002631 0C5335 0K0677 215723
description	boiler L 700mm W 290mm H 170mm		
For models:	FDV40G, FDV40GZ, FDV40GA, FDV20G, FDV20GZ, FDV20GA, FCV/G10L3, FCVG10L3T, FCVG10L3, FCV/G20L3, FCVG20L3, FCVG10L3J, FCVG10L3J, FCV/G10L6JAP, FCV/G102/1L6JAP, FCV/G10L6, FCV/G102/1L6, FCV/G20L6, FCVG20L6, FCV/G101/1, FCV/G102/1, FCV/G201/1, FCV/G202/1, FCS101G4, FCS101G4DT, FCS101GP9J, FCS-101G49J, FCS101GP, FCS102G4, FCS102GA9J, FCS102G49J, FCS102GP, FCS201G4, FCS201GP, FCS202G4, FCS202GP, FCS101GX9J, FCS101GX, FCS102GX9J, FCS102GX, FCS201GX, FCS202GX, 5712-2-6, 5712-2-7, 5712-2-8, 5712-2-10, 5714-2-6, 5714-2-7, 5714-2-8, 5714-2-10...(Other models you can see in the webshop)		



			
1			
GEV No.	504739	Ref. No.	049053 0L1953 0L2081 30001005
description	boiler ø 140mm L 325mm inlet ø 48mm		
For models:	LB1, LB1WS, LB1WSDP, LB1/RBP, LB1/TOP, LB1/60, WT1WSDP, LB2D-PSAUS, LB1G, LB1WSG, WT2TOP60, WT2DPDI, WT2WSDPDI, LB1TOP, WT2TOPDI, LB2WS, LB2, LB2WSDP, LB2/TOP, LB2/RBP, LB2WS60, WT2WSDP, WT2WSDPD, LB2WSG, WT2WS, WT1, WT1WS, WT1TOP, WT2TOP, WT1/3DP, WT2/3DP, WT2DPAUS, WT2, LB2DPDI, LB2WSDPDI, LB2WSDPD, LB2TOP, LB2DP3, WT2DPD3, NGW, NGWDPDD, UC1, UC2WS, GW1, GW1WS, LV1WS, LV1WSDP, LV2WSDP, LV2WS, GW2D-PG...(Other models you can see in the webshop)		

			
1			
GEV No.	524379	Ref. No.	0L0352
description	boiler ø 140mm L 400mm flange 3 hole flange inlet ø 12		
For models:	WT4, WT4B, WT4D, WT4DB, WT46, NUC3DD, WT4D60, WT4DDG, EUC1, EUC1DP, EUC3, EUC3DP, EUC1G, EUC1DP60, EUC3DD, LS5/1, LS5/1DP, LS5/3, LS5/3DP, LS5/1DP60, LS5/1DPAUS, LS5/1DPCS, KUC3, KUC3DP, NUC1, NUC1DP, NUC3, NUC3DP, NUC1DP60, NUC1DPA, FL5, FL5DP, LV5, LV5DP, UC5DP, LD5DP, LD5, UC5/1, UC5/1DP, FL5DDG, NUC1G		

			
1			
GEV No.	524961	Ref. No.	0L0346 0L1928 171082800
description	boiler ø 200mm L 375mm inlet ø 26		
For models:	LU7PDP, LU7ADP, LU7ADPWS, WTU40PDP, WTU40ADP, WTU40ADPWS, WTU40ADPD, LS14EA, ET12E, LS14EAI, LS14EAI/AU, LS14EA/60, LS14EAASIA, LS14EA/G, LS10EA, LS14EAI/DD, WT65E, WT65EB, WT65EI, ECOTEMP12S, WT65EBI, WT65EBIA, WT65EIA, WT65E60, WT65EB60, WT65EBIDG, WT65EBASIA, WT65EIM50, WT65EIM60, LS14EADP/G, WT65MED, WT65EJ50, WT65EJ60, LS14ROW, LS14SANA, WT65EBID, LS14ROW60, EHTA, EHTA60, EHTAI, EHTAID, EHTAIG, EHTAIAU, EHTAIMLAU, ZHTAID, ZHTAIAU, ZHTA, ZHTA60, ZHTAI, EHTAIUSPH5...(Other models you can see in the webshop)		

			
1			
GEV No.	525008	Ref. No.	0L0284 0L0734 0L1908 171071100
description	boiler ø 200mm L 415mm length external size 460mm		
For models:	LS6EP, LS6EP/DD, WT38PM50, EUCI, EUCIM, EUCIM60, ZUCI, ZUCID, WT38PM60, LU7PDP, LU7ADP, LU7ADPWS, WTU40PDP, WTU40ADP, WTU40ADPWS, WTU40ADPD, LS14EA, ET12E, LS14EAI, LS14EAI/AU, LS14EA/60, LS14EAASIA, LS14EA/G, LS10EA, LS14EAI/DD, ECOTEMP12S, LS14EADP/G, WT65ROW, LS14ROW, LS14SANA, LS14ROW60, WT65ROW60, LS9P, LS9PDD, LS9P60, WT55P, WT55P60, WT55PM50, WT55PM60, EHT, EHT60, EHTM, EHTM60, NHT, NHTD, NHT60, KHT, NHTM, NHTM60, FL620EP...(Other models you can see in the webshop)		

accessories

			
1			
GEV No.	511459	Ref. No.	069459 0H1288 468027
description	connecting fitting for boiler		
For models:	LTB11, LTB12, LTB22, LTB11, LTB22, CRYSTAL 11, CRYSTAL 22		

			
accessories for	511459		
GEV No.	511460	Ref. No.	069461 468003
description	connecting fitting for boiler		

			
1			
GEV No.	511460	Ref. No.	069461 468003
description	connecting fitting for boiler		
For models:	LTB11, LTB12, LTB22, LTB11, LTB22, CRYSTAL 11, CRYSTAL 22		

			
1			
GEV No.	517339	Ref. No.	005381 0K8372
description	flange ø 74mm ID ø 33mm thickness 1mm hole ø 9mm		
For models:	FCZ061EAA, FCZ201EAA, FCZ061EAH, FCZ201EAH, FCZ061EAN, FCZ201EAN, FCZ061EBA, FCZ201EBA, FCZ061EBH, FCZ201EBH, FCZ201EBN, FCZ201EBC, FCV/G10L3, FCVG10L3T, FCVG102L3, FCV/G20L3, FCVG202L3, FCV/E10L3JAP, FCV/E102/1L3JAP, FCV/E10L6JAP, FCV/E102/1L6JAP, FCV/G10L3J, FCVG102L3J, FCV/G10L6JAP, FCV/G102/1L6JAP, FCV/E61/1, FCV/E101/1, FCV/E101/1, FCV/E102/1, FCV/E61/1, FCV/E101/1, FCV/E101/2, FCV/E10L3, FCV/E102/1, FCV/E102/1L3, FCV/E20L3, FCV/E6L4, FCV/G10L6, FCV/E10L6, FCV/G102/1L6, FCV/E102/1L6, FCV/G20L6, FCV/E20L6, FCVG202L6, FCV/G101/1, FCV/E101/1, FCV/G102/1, FCV/E102/1, FCV/G201/1, FCV/E201/1...(Other models you can see in the webshop)		



			
GEV No.	504289	Ref. No.	0A8759 0A8881
description	bezel L 278mm W 48mm		
For models:	PTVN2719, PTVN2519, PTVN2724, PTVN2524, EMVN500, MVN-112V12C, EC4045GC, EP404VRC, EN404VAC, EC4045GC, DVP500V11C, DVP501V11C, MVP502V11C, DVN500V11C, DVN501V11C, DVP500V11V, DVP501V11V, MVP502V11V, EDVN500, DVN-501V11V, DVP600V11C, DVP601V11C, MVP602V11C, DVP600V12C, DVP601V12C, DVN600V11C, DVN601V11C, DVN600V12C, DVN-601V12C, DVP600V11V, DVP601V11V, EMVP602, DVN600V11V, EDVN601, DVP110V12C, DVP111V12C, MVP112V12C, DVN110V12C, DVN111V12C, DVP110V12V, DVP111V12V, MVP112V12V, EDVN1100, EDVN1101, DVP130V12C, DVP131V12C, MVP132V12C, DVN130V12C, DVN131V12C, DVP130V14C...(Other models you can see in the webshop)		

			
GEV No.	502289	Ref. No.	0L1999
description	control panel for dishwasher L 436mm W 32mm H 65mm		
For models:	LB1, LB1WS, LB1WSDP, WT1WSDP, WT2TOP60, WT2DPDI, WT2WSDPDI, LB1TOP, WT2TOPDI, LB2WS, LB2, LB2WSDP, WT2WSDP, WT2WSDPD, WT2WS, WT1, WT1WS, WT1TOP, WT2TOP, WT1/3DP, WT2/3DP, WT2, LB2DPDI, LB2WSDPDI, LB2WSDPD, LB2TOP, LB2DP3, WT2DPDP3, NGW, NGWDPDD, GW1, GW1WS, GW2DPG, GW2WSDPG, GW2G, GW2WSG, GW2WS, GW2		

trapdoors

			
GEV No.	504706	Ref. No.	047728 048465 800620900 S500690701
description	door		
For models:	WT32, WT32/4,5, WT32/UK, WT32/UKRP, WT32/F6, WT32/J60, WT32/J50, WT32/4,5N, WT33, WT33/4,5, WT33/UK, WT33/UKRP, WT33/F, D500, WT33/60, WT33/4,5N, WT34, WT34/4,5, WT34/UKRP, D510, WT34/4,5N, LS7D, LS7, LV70, LS7F, LS7DEK, LS7/9, LS7/DP, LS7/60, WT40/9, WT40/F, WT40/J50, WT40/J60, WT40UKRP, PH4/WT40, PH4R-BP/WT40, LS365F, ZLS520, ZLS521, ALLS521, ALLS520, FL620, FL630, FL700, LS520ZD, LS521ZD, CF314, LS520MZ, LS521MZ, Z62...(Other models you can see in the webshop)		

			
GEV No.	504698	Ref. No.	048363 049021
description	door for rinse aid container		
For models:	C55, WT4, WT4B, WT4D, WT302, WT302/4.5, WT302F, WT302/60, WT4DB, WT46, C55A, WT303, WT303/4.5, WT303F, WT303/60, WT4D60, WT4DDG, LS5/1, LS5/1DP, LS5/3, LS5/3DP, LS5/1DP60, LS5/1DPAUS, LS5/1DPCS, LB1, LB1WS, LB1WSDP, LB2DPSAUS, LB1G, LB1WSG, LB2WS, LB2, LB2WSDP, LB2WS60, LB2WSG, LS6EP, LS6EP/DD, LS6EADD, LS6EA/DPDD, LS6EADP3, LS6EA/60, LS6EA, LS6EA/DP, LS10D, LS10, LS10UKRP, LC100, LS10/60, LS10/1, LS10/12KW...(Other models you can see in the webshop)		

miscellaneous

			
GEV No.	504386	Ref. No.	049936 502664402
description	bridge for filter without hole L 555mm W 67mm H 14mm		
For models:	LS6EP, LS6EP/DD, LS6EADD, LS6EA/DPDD, WT38TDE, WT38/M50, LS6EADP3, LS6EADPWS, LS6EADPWSG, WT38WS, WT38WSG, WT38MEDWS, WT38PM50, WT37LEV/9, LS6EADPDWS, WT38DWS, LS-6SANA, EUCAI, EUCAIDP, EUCAI60, EUCAIWS, WT38M50/4, LS6EA/UK, LS6EA/DPUK, EUCAIG, EUCAIWSG, EUCAIML, EUCAIMLWS, EUCAIMLG, EUCAICL, EUCAICLG, EUCAIWL, LS6EA/60, EUCAICLW, EUCAI, EUCAIM, EUCAIM60, EUCAIDPNW, ZUCI, ZUCID, ZUCAI, ZUCAIDP, ZUCAIDPWS, ZUCAIG, ZUCAIDDWS, ZUCAID, ZUCAI60, EUCAIUSPH6, ZUCAIDD, EUCAIDD...(Other models you can see in the webshop)		



1

GEV No.	504288	Ref. No.	047453 047855 0K8659 30000003 541606300
description	spraying protection L 595mm		
For models:	LSDS51, LS510, LS520, LS520D, LS520F, LS520K, LS521, LS521D, LS521F, LS521M, LS521K, LS521, LS4, ZLS510, ZLS520, ZLS521, ALLS521, ALLS520, ALS510, LS520ZD, LS521ZD, CF314, LS510MZ, LS520MZ, LS521MZ		

hood mechanics for dishwashers

bolts



1

GEV No.	541992	Ref. No.	048652
description	bolt ED ø 8.5mm L 41mm thread M6 for hood mechanics		
For models:	LS8D, LS8, LS8UK/RP, LC80, LS8F, LS8DEK, LS8/9, LS8/60, LS8/1UKRP, LS8/DP, WT50/9, WT50/UK9RF, WT50/F9, WT50/6, WT50/1UKRP, WT50/1, D800/9, D800/6, WT50/60, WT50/N, LS8/HD, WT50/J50, WT50/J60, LS8/UK1, LS8UK3, WT50/UK1, WT50/UK3, LS8/9DD, LS8DEK, HT800, HYDRA800, Z80		



1

GEV No.	504679	Ref. No.	048349
description	screw bolt hood mechanics		
For models:	LS10SW, SH55, LO10, LS12D, LC120, LS12F, WT60/emF, WT60/12UK, WT60/9, WT60/12, WT60/12UKRP, WT60/9in, WT60/12in, PH10/12, ECOTEMP12SW, ECOTEMP12INS, ZHCP/G800, LSCE10, LSCE12		

bushes



1

GEV No.	541993	Ref. No.	048653
description	bush ED ø 23.8mm ID ø 8.7mm L 11mm for hood mechanics		
For models:	LS8D, LS8, LS8UK/RP, LC80, LS8F, LS8DEK, LS8/9, LS8/60, LS8/1UKRP, LS8/DP, WT50/9, WT50/UK9RF, WT50/F9, WT50/6, WT50/1UKRP, WT50/1, D800/9, D800/6, WT50/60, WT50/N, LS8/HD, WT50/J50, WT50/J60, LS8/UK1, LS8UK3, WT50/UK1, WT50/UK3, LS8/9DD, LS8DEK, HT800, HYDRA800, Z80		



1

GEV No.	504677	Ref. No.	046538
description	bush hood mechanics		
For models:	LSE720DK, LS720, LS720N		

spring holders



1

GEV No.	504337	Ref. No.	049594
description	spring holder dishwasher		
For models:	WT60/GJ60, WT60/GJ50, PH10/12-RP, LS10, LS14EA, LS10UKDP, ET12E, LS10/60HZ, LS10CW, LS10INS, HT1200INS, LS14EAI, LS10N, LS10DP, LS10HD, LS14EAI/AU, LS14EA/60, LS10UK/1, LS10UK/3, LS12INS, LS12, LS12DP, LS12/60HZ, LS12CW, HT1200DEK, LS14EAASIA, LS14EA/G, WT60DP, WT60, WT60CW, WT60UKDPCW, WT60INS, WT60INSCW, WT60NAUCW, WT60NAU, LS10EA, WT60/60HZ, WT60/60HZC, WT60N, WT609NINS, LS12HD, LS14EAI/DD, WT65E, WT65EB, WT65EI, WT60NAUDP, LS12UK/3CW, LS12NAU, LS12UKDPCW, ECOTEMP12S... (Other models you can see in the webshop)		

springs



1

GEV No.	511970	Ref. No.	0L0057
description	spring for hood mechanics L 765mm wire gauge ø 5mm ø 37mm		
For models:	WT60/GJ60, WT60/GJ50, PH10/12-RP, LS9P, LS9PDD, LS9AUK/3, LS9P60, EHTAO, WT55P, WT55P60, WT55AUK/3, LS9ADG1, WT55ADG1, LS9PAUS, WT55PM50, WT55PM60, EHT, EHT60, EHTG, EHTM, EHTM60, NHT, NHTD, NHT60, EHTAROW, EHTAROW60, ZHTAROW, ZHTAROW60, EHTAJ, EHTAJ60, EHTAO60, ZHTAO, ZHTAO60, KHT, NHTM, NHTM60, H2500, HT900, LV900P, LD900, HT900ADG1, OHTAROW, OHTAROW60, NHTG		



1

GEV No.	504290	Ref. No.	0L0722
description	tension spring for hood mechanics L 570mm wire gauge ø 1.8mm ø 13mm		
For models:	LU7PDP, LU7ADP, LU7ADPWS, WTU40PDP, WTU40ADP, WTU40ADPWS, WTU40ADPD, ET7ADP, LU700PDP, LU700ADP, LU700ADPWS		



guide bars

			
1			
GEV No.	524806	Ref. No.	0L0084
description	guide bar L 650mm for hood mechanics W 34mm H 30mm		
For models:	WT60/GJ60, WT60/GJ50, PH10/12-RP, LS9P, LS9PDD, LS9AUK/3, LS9P60, EHTAO, WT55P, WT55P60, WT55AUK/3, LS9ADG1, WT55ADG1, LS9PAUS, WT55PM50, WT55PM60, EHT, EHT60, EHTG, EHTM, EHTM60, NHT, NHTD, NHT60, EHTAROW, EHTAROW60, ZHTAROW, ZHTAROW60, EHTAJ, EHTAJ60, EHTAO60, ZHTAO, ZHTAO60, KHT, NHTM, NHTM60, H2500, HT900, LV900P, LD900, HT900ADG1, OHTAROW, OHTAROW60, NHTG		

hood handle supports

			
1			
GEV No.	504473	Ref. No.	048348
description	handle holder hood mechanics H 45mm ø 67mm		
For models:	LS10SW, SH55, LO10, LS12D, LC120, LS12F, WT60/emF, WT60/12UK, WT60/9, WT60/12, WT60/12UKRP, WT60/9in, WT60/12in, PH10/12, ECOTEMP12SW, ECOTEMP12INS, ZHCP/G800, LSCE10, LSCE12		

rollers

			
1			
GEV No.	504681	Ref. No.	049598
description	roller hood mechanics		
For models:	LS10, LS14EA, LS10UKDP, ET12E, LS10/60HZ, LS10CW, LS10INS, HT1200INS, LS14EAI, LS10N, LS10DP, LS10HD, LS14EAI/AU, LS14EA/60, LS10UK/1, LS10UK/3, LS12INS, LS12, LS12DP, LS12/60HZ, LS12CW, HT1200DEK, LS14EAASIA, LS14EA/G, WT60DP, WT60, WT60CW, WT60UKDPCW, WT60INS, WT60INSCW, WT60NAUCW, WT60NAU, LS10EA, WT60/60HZ, WT60/60HZC, WT60N, WT609NINS, LS12HD, LS14EAI/DD, WT65E, WT65EB, WT65EI, WT60NAUDP, LS12UK/3CW, LS12NAU, LS12UKDPCW, ECOTEMP12S, WT65EBI, WT65EBIA, WT65EIA...(Other models you can see in the webshop)		

			
1			
GEV No.	524964	Ref. No.	048657
description	roller ø 34.5mm H 26mm for hood mechanics plastic hole ø 10mm		
For models:	LS10, LS14EA, LS10UKDP, ET12E, LS10/60HZ, LS10CW, LS10INS, HT1200INS, LS14EAI, LS10N, LS10DP, LS10HD, LS14EAI/AU, LS14EA/60, LS10UK/1, LS10UK/3, LS12INS, LS12, LS12DP, LS12/60HZ, LS12CW, HT1200DEK, LS14EAASIA, LS14EA/G, WT60DP, WT60, WT60CW, WT60UKDPCW, WT60INS, WT60INSCW, WT60NAUCW, WT60NAU, LS10EA, WT60/60HZ, WT60/60HZC, WT60N, WT609NINS, LS12HD, LS14EAI/DD, WT65E, WT65EB, WT65EI, WT60NAUDP, LS12UK/3CW, LS12NAU, LS12UKDPCW, ECOTEMP12S, WT65EBI, WT65EBIA, WT65EIA...(Other models you can see in the webshop)		

			
1			
GEV No.	524963	Ref. No.	048260
description	roller ø 49mm H 21.5mm for hood mechanics plastic white hole ø 10mm		
For models:	LS10D, LS10, LS10UKRP, LC100, ECOTEMP12-, LS10/60, LS10/1, LS10/12KW, LS10F, LS10DEK, LS10/1UKRP, LS10SW, LS10/50J, LS10/60J, LS10DP, LS10/HD, SH55, LO10, LS10/UK1, LS10/UK3, LS12D, LS12, LS12UK/RP, LC120, LS12DP, LS12/60, LS12F, LS12DEK, WT60/emF, WT60/12UK, WT60/9, WT60/12, WT60/12UKRP, WT60/9in, WT60/12in, LS12HD, PH10/12, LS12/UK3, ECOTEMP12SW, ECOTEMP12INS, LS12MEX, LS10N, HT1200elm, HT1000elm, HYDRA1200, HYDRA1000, ZHCP/G800, LSCE10, LSCE12		

cable controls

			
1			
GEV No.	693244	Ref. No.	OK1802
description	hauling cable		
For models:	7581-5.KK60, 7582-5.KK80, 7583-5.KK100, 7781-5.KK60, 7782-5.KK80, 7783-5.KK100, 7580-5.KK40, 7584-5.KK150, 7780-5.KK40, 7580-5/85.KK40.(N), 7581-5/85.KK60.(N), 7582-5/85.KK80.(N), 7583-5/85.KK100.(N), 7584-5-85.KK150.(N), 7580-5/90.KK40.(N), 7581-5/90.KK60.(N), 7582-5/90.KK80.(N), 7583-5/90.KK100.(N), 7584-5-90.KK150.(N), 7568-5-90.KK200.(N), 7542-2, 7542-3, 7544-2, 7544-3, 7546-3, 7548-3, 7568-3, 7568-5.KK200, 7568-5/85.KK200.(N), 7580-3, 7581-3, 7581-5, 7582-3, 7582-5, 7583-3, 7583-5, 7584-3, 7742-3, 7744-3, 7746-3, 7748-3, 7768-3, 7768-5.KK200, 7768-5/85.KK200.(N), 7768-5/90.KK200.(N), 7780-3, 7780-5/85.KK40.(N), 7780-5/90.KK40.(N), 7781-3, 7781-5...(Other models you can see in the webshop)		

miscellaneous



GEV No.	523037	Ref. No.	047220
description	clamp L 73mm hood mechanics H 23mm W 26mm		
For models:	CT142DXE, CT142SXE, CT142DXEUK, CT142SXEU, CT142DXV, CT142SXV, CT190DXE, CT190SX, CT190DXEUK, CT190SXEU, CT190DXV, CT190SXV, CT191DXE, CT191SX, CT191DXEUK, CT191SXEU, CT191DXV, CT191SXV, CT192DXE, CT192SX, CT192DXEUK, CT192SXEU, CT192DXV, CT192SXV, CT240DXE, CT240SX, CT240DXEUK, CT240SXU, CT240DXV, CT240SXV, CT241DXE, CT241SX, CT241DXEUK, CT241SXU, CT241DXV, CT241SXV, CT142DXEZ, CT142SXEZ, CT142DXVZ, CT142SXVZ, CT190DXEZ, CT190SXEZ, CT190DXV, CT190SXV, CT191DXE, CT191SX, CT191DXV, CT191SXV, CT192DXE, CT192SX... (Other models you can see in the webshop)		

GEV No.	504680	Ref. No.	049597 0KB774
description	linkage guide hood mechanics		
For models:	LS10, LS14EA, LS10UKDP, ET12E, LS10/60HZ, LS10CW, LS10INS, HT1200INS, LS14EAI, LS10N, LS10DP, LS10HD, LS14EAI/AU, LS14EA/60, LS10UK/1, LS10UK/3, LS12INS, LS12, LS12DP, LS12/60HZ, LS12CW, HT1200DEK, LS14EAASIA, LS14EA/G, WT60DP, WT60, WT60CW, WT60UKDPCW, WT60INS, WT60INSCW, WT60NAUCW, WT60NAU, LS10EA, WT60/60HZ, WT60/60HZC, WT60N, WT609NINS, LS12HD, LS14EAI/DD, WT65E, WT65EB, WT65EI, WT60NAUDP, LS12UK/3CW, LS12NAU, LS12UKDPCW, ECOTEMP12S, WT65EBI, WT65EBIA, WT65EIA... (Other models you can see in the webshop)		

	Image not available		
GEV No.	504766	Ref. No.	048297
description	pin hood mechanics		
For models:	LS10D, LS10, LS10UKRP, LC100, ECOTEMP12-, LS10/60, LS10/1, LS10/12KW, LS10F, LS10DEK, LS10/1UKRP, LS10SW, LS10/50J, LS10/60J, LS10DP, LS10/HD, SH55, LO10, LS10/UK1, LS10/UK3, LS12D, LS12, LS12UK/RP, LC120, LS12DP, LS12/60, LS12F, LS12DEK, WT60/emF, WT60/12UK, WT60/9, WT60/12, WT60/12UKRP, WT60/9in, WT60/12in, LS12HD, PH10/12, LS12/UK3, ECOTEMP12SW, ECOTEMP12INS, LS12MEX, LS10N, LS8D, LS8, LS8UK/RP, LC80, LS8F, LS8DEK, LS8/9, LS8/60... (Other models you can see in the webshop)		

			
GEV No.	504678	Ref. No.	049430
description	screw connection hood mechanics		
For models:	SH55, LO10, LS12D, LC120, LS12F, WT60/emF, WT60/12UK, WT60/9, WT60/12, WT60/12UKRP, WT60/9in, WT60/12in, PH10/12, ECOTEMP12INS, LSCE10, LSCE12		

basket guides

actuators



GEV No.	699196	Ref. No.	0L1315
description	mixer coupling for rack conveyor dishwashing machine mounting pos. left L 55mm W 53mm H 9mm		
For models:	WTC90ERB, WTC90ELB, WTC140ERA, WTC140ELA, WTC140ERB, WTC140ELB, WTC180ERA, WTC180ELA, WTC180ERB, WTC180ELB, WTC220ERA, WTC220ELA, WTC220ERB, WTC220ELB, WTC90ERBG, WTC90ELBG, WTC140ERAG, WTC140ELAG, WTC140ERBG, WTC140ELBG, WTC180ERAG, WTC180ELAG, WTC180ERBG, WTC180ELBG, WTC220ERAG, WTC220ELAG, WTC220ERBG, WTC220ELBG, WT44BL208, WT44BR208, WT44BL240, WT44BR240, WT44CL208, WT44CR208, WT44CL240, WT44CR240, WT66BL208, WT66BR208, WT66BL240, WT66BR240, WT66CL208, WT66CR208, WT66CL240, WT66CR240, WTM140ERA, WTM140ELA, WTM140ERB, WTM140ELB, WTM165ERA, WTM165ELA... (Other models you can see in the webshop)		

			
GEV No.	699195	Ref. No.	0L1314
description	mixer coupling for rack conveyor dishwashing machine mounting pos. right L 55mm W 53mm H 9mm		
For models:	WTC90ERB, WTC90ELB, WTC140ERA, WTC140ELA, WTC140ERB, WTC140ELB, WTC180ERA, WTC180ELA, WTC180ERB, WTC180ELB, WTC220ERA, WTC220ELA, WTC220ERB, WTC220ELB, WTC90ERBG, WTC90ELBG, WTC140ERAG, WTC140ELAG, WTC140ERBG, WTC140ELBG, WTC180ERAG, WTC180ELAG, WTC180ERBG, WTC180ELBG, WTC220ERAG, WTC220ELAG, WTC220ERBG, WTC220ELBG, WT44BL208, WT44BR208, WT44BL240, WT44BR240, WT44CL208, WT44CR208, WT44CL240, WT44CR240, WT66BL208, WT66BR208, WT66BL240, WT66BR240, WT66CL208, WT66CR208, WT66CL240, WT66CR240, WTM140ERA, WTM140ELA, WTM140ERB, WTM140ELB, WTM165ERA, WTM165ELA... (Other models you can see in the webshop)		

miscellaneous









GEV No.	518624	Ref. No.	0K8636
description	screw bolt L 30mm thread M6 WS 13 ø 8mm		
For models:	A/CA, A/CMM90, ACMM180SS, 1/CMM180SD, HSSL, HSTT9UC, HSTT9UA, HSTT9LC, HSTT9LA, HSTT18UC, HSTT18UA, HSSAD3LR, HSSAD4LR, HSSAD5LR, HSSAD6LR, HSSAD3RL, HSSAD4RL, HSSAD5RL, HSSAD6RL		



			
GEV No.	524969	Ref. No.	0E5485
description	shaft for actuator SS L 58mm thread M5 ø 5mm		
For models:	RT100ED, RT100ES, RT100SR, RT100SL, RT140ED, RT140ES, RT140SR, RT140SL, RT190ED, RT190ES, RT190SR, RT190SL, RT190HDED, RT190HDES, RT190HSR, RT190HSL, RT270ED, RT270ES, RT270SR, RT270SL, RT270HDED, RT270HDES, RT270HSR, RT270HSL, RT100ERF, RT100ELF, RT100VD, RT100VS, RT140ERF, RT140ELF, RT140VD, RT140VS, RT142ERF, RT142ELF, RT190ERF, RT190ELF, RT190VD, RT190VS, RT190HERF, RT190HEL, RT190HDVDF, RT190HDVDF, RT270ERF, RT270ELF, RT270VDF, RT270VSF, RT270HERF, RT270HEL, RT270HDVDF, RT270HDVDF... (Other models you can see in the webshop)		





air traps





air traps			
			
GEV No.	504617	Ref. No.	048853
description	air trap		
For models:	LS32UK/RP, WT4, WT4B, WT4D, WT302UK/RP, WT4DB, WT46, WT4DG, WT4WS1, LS33, LS33/4.5, LS33UK/RP, LS33F, LV33F, C55A, LS33/60, WT4BWS, WT4DWS1, WT4BDWS, WT303, WT303/4.5, WT303UK/RP, WT303F, WT303/60, NUC3DD, WT4D60, WT4DDG, EUC1, EUC1DP, EUC1WS, EUC1DPWS, EUC3, EUC3WS, EUC3DP, EUC3DPWS, EUC1G, EUC1DP60, EUC3DD, ZUCADDROW, ZUCADDROW6, LS5/1, LS5/1DP, LS5/1WS, LS5/1WSDP, LS5/3, LS5/3DP, LS5/3WS, LS5/3WSDP, FUCA3DD, LS5/3WSDPD...(Other models you can see in the webshop)		
accessories for	504617		
	GEV No.	504618	Ref. No. 068642
	O-ring EPDM thickness 2.62mm ID ø 15.54mm Qty 1 pcs		
	GEV No.	504621	Ref. No. 049268
	nut		



			
GEV No.	504620	Ref. No.	048308 OK8750
description	air trap		
For models:	LS32, LS32/4.5, LS32UK/RP, LS32F, LV32F, C55, LV32/60, WT4, WT4B, WT4D, WT302, WT302/4.5, WT302UK/RP, WT302F, WT302/60, WT4DB, WT46, WT4DG, WT4WS1, LS33, LS33/4.5, LS33UK/RP, LS33F, LV33F, C55A, LS33/60, WT4BWS, WT4DWS1, WT4BDWS, WT303, WT303/4.5, WT303UK/RP, WT303F, WT303/60, NUC3DD, WT4D60, WT4DDG, EUC1, EUC1DP, EUC1WS, EUC1DPWS, EUC3, EUC3WS, EUC3DP, EUC3DPWS, EUC1G, EUC1DP60, EUC3DD, ZUCADDROW, ZUCADDROW6...(Other models you can see in the webshop)		
accessories for	504620		
	GEV No.	504618	Ref. No. 068642
	O-ring EPDM thickness 2.62mm ID ø 15.54mm Qty 1 pcs		
	GEV No.	504621	Ref. No. 049268
	nut		

			
GEV No.	504622	Ref. No.	046631 0H2542 0K8662 30000658 542601000 542601001 542601002
description	air trap		
For models:	LS360F, LS360DK, LS365F, LS365, LS365PH, LS360D, LS365D, LS360, LS365, LS360/63, LS365/63, LS367, LSDS51, LSDS5V, LS510, LS520, LS520D, LS520F, LS520M, LS520K, LS521, LS521D, LS521F, LS521M, LS521K, LS521, LS4, CT92DXE, CT92SXE, CT92DXEUK, CT92SXEUK, CT92DXV, CT92SXV, CT92DXVUK, CT92SXVUK, LS10D, LS10, LS10UKRP, LC100, ECOTEMP12-, LS10/60, LS10/1, LS10/12KW, LS10F, LS10DEK, LS10/1UKRP, LS10SW, LS10/50J, LS10/60J, LS10DP...(Other models you can see in the webshop)		
accessories for	504622		
	GEV No.	511452	Ref. No. 045507 046881 067930
	gasket for air trap		
	GEV No.	528487	Ref. No. 002923 068573 0E5488 0KF096 0KG547 246077000
	O-ring EPDM thickness 2.62mm ID ø 9.19mm Qty 1 pcs		

			
GEV No.	504624	Ref. No.	045351 045459
description	air trap		
For models:	LS500F, LS501F, LS540F, LS540DK, LS541F, LS720F, LSE720DK, LSE720PH, LS860F, LS860DK, LS860PH, LS1080F, LS1080UK, LS1080PH, LSE721F, LS861F, LS540, LS1080M, LS1080, LS1080D, LS1080UK, LS1080/63, LS500F, LS500UK, LS501, LS501UK, LS540D, LS540/63, LSE721, LS720, LSE720UK, LS721UK, LSE720D, LS541, LS860, LS860, LS860D, LS860UK, LS861UK, LS860/63, LS861, LO/E480, PLO480/E, LO480EUK, LO480E/63, LO480VAPORESTD, PLO480V, LO480V/63-60HZ, LO/E250, PLO250...(Other models you can see in the webshop)		
accessories for	504624		
	GEV No.	528487	Ref. No. 002923 068573 0E5488 0KF096 0KG547 246077000
	O-ring EPDM thickness 2.62mm ID ø 9.19mm Qty 1 pcs		



			
1			
GEV No.	511445	Ref. No.	049628 049776 0L0098
description	air trap L 230mm W 60mm hose ø 6mm		
For models:	LS32UK/RP, WT302UK/RP, WT4DG, WT4WS1, LS33UK/RP, WT4BWS, WT4DWS1, WT4BDWS, WT303UK/RP, EUC1WS, EUC1DPWS, EUC3WS, EUC3DPWS, ZUCADDROW, ZUCADDROW6, LS5/1WS, LS5/1WSDP, LS5/3WS, LS5/3WSDP, FUCA3DD, LS5/3WSDPD, LB5DPG, NUC1WS, NUC1DPWS, NUC3WS, NUC3DPWS, NUC3DDWS, ZUCA1, ZUCA3, EUCADDROW, EUCADDROW6, LS6EADD, LS6EA/DPDD, WT38TDE, WT38/M50, LS6EADP3, WT37LEV/9, LS6SANA, EUCAI, EUCAIDP, EUCAI60, WT38M50/4, LS6EA/UK, LS6EA/DPUK, EUCAIG, EUCAIML, EUCAIMLG, EUCAICL, EUCAICLG, EUCAIWL...(Other models you can see in the webshop)		

			
1			
GEV No.	510103	Ref. No.	069515 0H1289 0K4419 510103 984001
description	air trap L 85mm W 20mm H 80mm hose ø 6mm plastic		
For models:	LTB11, LTB12, LTB22, LTB11UK, LTB12UK, LTB22UK, LTB11, LTB22, 910-00-021, 910-00-023, 910-00-031, 910-00-033, 911-00-022, 911-00-024, 911-00-032, 911-00-034, CRYSTAL 11, CRYSTAL 22		
spare parts for	510103		
	GEV No.	505045	Ref. No. —
	GEV No.	505094	Ref. No. —
	GEV No.	510016	Ref. No. 069517 069646 486002
	GEV No.	510105	Ref. No. 069645 069670 0A6089 0K9317 468053

			
1			
GEV No.	524174	Ref. No.	070325
description	air trap L 87mm ø 50mm		
accessories for	524174		
	GEV No.	510893	Ref. No. —
	GEV No.	524176	Ref. No. —

air trap accessories			
			
1			
GEV No.	511452	Ref. No.	045507 046881 067930
description	gasket for air trap		
For models:	LS360F, LS360DK, LS365F, LS365, LS365PH, LS500F, LS501F, LS540F, LS540DK, LS541F, LS360D, LS365D, LS360, LS365, LS360/63, LS365/63, LS367, LS720F, LSE720DK, LSE720PH, LS860F, LS860DK, LS860PH, LS1080F, LS1080UK, LS1080PH, LSE721F, LS861F, LS540, LS1080M, LS1080, LS1080D, LS1080UK, LS1080/63, LSD55I, LSD55V, LS500F, LS500UK, LS501, LS501UK, LS540D, LS540/63, LSE721, LS720, LSE720UK, LS721UK, LSE720D, LS541, LS860, LS860...(Other models you can see in the webshop)		

			
1			
GEV No.	507586	Ref. No.	049904
description	hose for air trap L 600mm ø 8.5mm rubber		
For models:	WT4, WT4B, WT4D, WT4DB, WT46, WT4DG, WT4WS1, WT4BWS, WT4DWS1, WT4BDWS, NUC3DD, WT4D60, WT4DDG, EUC1, EUC1DP, EUC1WS, EUC1DPWS, EUC3, EUC3WS, EUC3DP, EUC3DPWS, EUC1G, EUC1DP60, EUC3DD, ZUCADDROW, ZUCADDROW6, LS5/1, LS5/1DP, LS5/1WS, LS5/1WSDP, LS5/3, LS5/3DP, LS5/3WS, LS5/3WSDP, FUCA3DD, LS5/3WSDPD, LB5DPG, LS5/1DP60, LS5/1DPAUS, LS5/1DPCS, KUC3, KUC3DP, NUC1, NUC1DP, NUC1WS, NUC1DPWS, NUC3, NUC3WS, NUC3DP, NUC3DPWS...(Other models you can see in the webshop)		

			
1			
GEV No.	510105	Ref. No.	069645 069670 0A6089 0K9317 468053
description	hose connector for air trap		
For models:	LTB11, LTB12, LTB22, LTB11UK, LTB12UK, LTB22UK, LTB11, LTB22, 910-00-021, 910-00-023, 910-00-031, 910-00-033, 911-00-022, 911-00-024, 911-00-032, 911-00-034, CRYSTAL 11, CRYSTAL 22		
spare parts for	510105		
	GEV No.	510017	Ref. No. 069987 0A6065 423011

			
1			
GEV No.	511643	Ref. No.	0S0675
description	hose connector L 42mm thread M12x1.75 hose ø 5mm plastic Qty 5 pcs		





			
1			
GEV No.	504621	Ref. No.	049268
description	nut		
For models:	LS32, LS32/4.5, LS32UK/RP, LS32F, LV32F, C55, LV32/60, WT4, WT4B, WT4D, WT302, WT302/4.5, WT302UK/RP, WT302F, WT302/60, WT4DB, WT46, WT4DG, WT4WS1, LS33, LS33/4.5, LS33UK/RP, LS33F, LV33F, C55A, LS33/60, WT4BWS, WT4DWS1, WT4BDWS, WT303, WT303/4.5, WT303UK/RP, WT303F, WT303/60, NUC3DD, WT4D60, WT4DDG, EUC1, EUC1DP, EUC1WS, EUC1DPWS, EUC3, EUC3WS, EUC3DP, EUC3DPWS, EUC1G, EUC1DP60, EUC3DD, ZUCADDROW, ZUCADDROW6...(Other models you can see in the webshop)		

			
1			
GEV No.	510598	Ref. No.	0E5006 0K8173 0KE503 812251
description	guide for spindle L 60mm W 40mm hole ø 21mm thickness 15mm		
For models:	PW1EFL, PW1EFLF, PW1EFL/60HZ, PW2EFL, PW2EFLF, PW2EFL/60HZ, PW2VFL, WT830EFL, WT830EFLF, WT830EFL/60HZ, WT850, WT850EFLF, WT850EFL/60HZ, WT850SFL, PW1EAG, PW2EAG, WT830EA, WT850EA, WT830EAG, WT850EAG, RT100ED, RT100ES, RT100SR, RT100SL, RT140ED, RT140ES, RT140SR, RT140SL, RT190ED, RT190ES, RT190SR, RT190SL, RT190HDED, RT190HDES, RT190HSR, RT190HSL, RT270ED, RT270ES, RT270SR, RT270SL, RT270HDED, RT270HDES, RT270HSR, RT270HSL, RT100ERF, RT100ELF, RT100VD, RT100VS, RT140ERF, RT140ELF...(Other models you can see in the webshop)		

mechanics for flight type dishwashers

			
1			
GEV No.	524500	Ref. No.	0E0114 0K7709
description	bearing for curtain ø 40mm hole ø 14.5mm thickness 20mm		
For models:	FT36EDTS, FT36ESTS, FT36VDTS, FT36VSTS, FT36ED, FT36ES, FT36VD, FT36VS, FT50ED, FT50ES, FT50VD, FT50VS, FT72ED, FT72ES, FT72VD, FT72VS, FT36EDT, FT36EST, FT36VDT, FT36VST, FT50EDT, FT50EST, FT50VDT, FT50VST, FT72EDT, FT72EST, FT72VDT, FT72VST, FT36WED, FT36WES, FT36WVD, FT36WVS, FT50WED, FT50WES, FT50WVD, FT50WVS, FT72WED, FT72WES, FT72WVD, FT72WVS, FT36WEDT, FT36WEST, FT36WVDT, FT36WVST, FT50WEDT, FT50WEST, FT50WVD, FT50WVST, FT72WEDT, FT72WEST...(Other models you can see in the webshop)		

			
1			
GEV No.	511483	Ref. No.	0E1607 0K8142
description	hook		
For models:	FT36EDTS, FT36ESTS, FT36VDTS, FT36VSTS, FT36ED, FT36ES, FT36VD, FT36VS, FT50ED, FT50ES, FT50VD, FT50VS, FT72ED, FT72ES, FT72VD, FT72VS, FT36EDT, FT36EST, FT36VDT, FT36VST, FT50EDT, FT50EST, FT50VDT, FT50VST, FT72EDT, FT72EST, FT72VDT, FT72VST, FT36WED, FT36WES, FT36WVD, FT36WVS, FT50WED, FT50WES, FT50WVD, FT50WVS, FT72WED, FT72WES, FT72WVD, FT72WVS, FT36WEDT, FT36WEST, FT36WVDT, FT36WVST, FT50WEDT, FT50WEST, FT50WVD, FT50WVST, FT72WEDT, FT72WEST...(Other models you can see in the webshop)		

			
1			
GEV No.	524503	Ref. No.	0E5321 0K8635
description	bearing for transport system		
For models:	A/CMM90., ACMM180SS, 1/CMM180SD, HSTT9UC, HSTT9UA, HSTT9LC, HSTT9LA, HSTT18UC, HSST18UA, HSCRDL, HSCRDR		

			
1			
GEV No.	504603	Ref. No.	0E5007 0K8166 11216
description	hook for dishwasher		
For models:	RT100ED, RT100ES, RT100SR, RT100SL, RT140ED, RT140ES, RT140SR, RT140SL, RT190ED, RT190ES, RT190SR, RT190SL, RT190HDED, RT190HDES, RT190HSR, RT190HSL, RT270ED, RT270ES, RT270SR, RT270SL, RT270HDED, RT270HDES, RT270HSR, RT270HSL, RT100ERF, RT100ELF, RT100VD, RT100VS, RT140ERF, RT140ELF, RT140VD, RT140VS, RT142ERF, RT142ELF, RT190ERF, RT190ELF, RT190VD, RT190VS, RT190HEREF, RT190HELFF, RT190HDVDF, RT190HDVDF, RT270ERF, RT270ELF, RT270VDF, RT270VSF, RT270HERF, RT270HELFF, RT270HDVDF, RT270HDVDF...(Other models you can see in the webshop)		

			
1			
GEV No.	524968	Ref. No.	0E3530 30001848
description	bracket for transport roller ø 30mm hole ø 8.4mm		
For models:	A/RF11, A/RF16., A/RF21., A/RF26., A/RF11-L, A/RF16-L, A/RF21-L, A/RF26-L, A/RF11-M., A/RF16., A/RF21, A/RF26, HSRC11, HSRC16, HSRC21, HSRC26, HSRC11LR, HSRC16LR, HCRC21LR, HSRC26LR, HSRC, HSRC11M, HSRC16M, HSRC21M, HSRC26M		

			
1			
GEV No.	524497	Ref. No.	0K7138
description	mixer coupling for transport system L 30mm W 12mm H 82mm		
For models:	D530ESD, D530ESD, D530ESD, D530ESD, D530ESD, D530ESD, D580+ESD, D580+ESD, D680+ESD, D680+ESD		

			
1			
GEV No.	510669	Ref. No.	0E5043 0K8236
description	bush for spindle L 40.5mm ø 25mm hole ø 20mm		
For models:	RT100ED, RT100ES, RT100SR, RT100SL, RT140ED, RT140ES, RT140SR, RT140SL, RT190ED, RT190ES, RT190SR, RT190SL, RT190HDED, RT190HDES, RT190HSR, RT190HSL, RT270ED, RT270ES, RT270SR, RT270SL, RT270HDED, RT270HDES, RT270HSR, RT270HSL, RT100ERF, RT100ELF, RT100VD, RT100VS, RT140ERF, RT140ELF, RT140VD, RT140VS, RT142ERF, RT142ELF, RT190ERF, RT190ELF, RT190VD, RT190VS, RT190HEREF, RT190HELFF, RT190HDVDF, RT190HDVDF, RT270ERF, RT270ELF, RT270VDF, RT270VSF, RT270HERF, RT270HELFF, RT270HDVDF, RT270HDVDF...(Other models you can see in the webshop)		

			
1			
GEV No.	524496	Ref. No.	046842 0E2896 0K8637
description	mixer coupling for warewashing basket L 71mm hole ø 8mm		
For models:	CT92DXE, CT92SXE, CT92DXEUK, CT92SXEUUK, CT92DXV, CT92SXV, CT92DXVUK, CT92SXVUK, CT140EDX, CT140ESX, CT140EDXUK, CT140SXEUUK, CT140VDX, CT140VSX, CT141EDX, CT141ESX, CT141E-DUK, CT141ESUK, CT141VDX, CT141VSX, CT142DXE, CT142SXE, CT142DXEUK, CT142SXEUUK, CT142DXV, CT142SXV, CT190DXE, CT190SXE, CT190DXEUK, CT190SXEUUK, CT190DXV, CT190SXV, CT-191DXE, CT191SXE, CT191DXEUK, CT191SXEUUK, CT191DXV, CT191SXV, CT192DXE, CT192SXE, CT192DXEUK, CT192SXEUUK, CT192DXV, CT192SXV, CT240DXE, CT240SXE, CT240DXEUK, CT240SX, CT240DXV, CT240SXVUK...(Other models you can see in the webshop)		

			
1			
GEV No.	510668	Ref. No.	002692 0F0186 0K8462
description	plug L 40mm ø 14mm hole ø 7mm		
For models:	FDV40G, FDV40E, FDV40GZ, FDV40EL, FDV40GA, FDV20G, FDV20E, FDV20GZ, FDV20EL, FDV20GA, FCZ061EAA, FCZ101EAA, FCZ102EAA, FCZ201EAA, FCZ202EAA, FCZ061EAH, FCZ101EAH, FCZ201EAH, FCZ061EAN, FCZ101EAN, FCZ201EAN, FCZ061ETA, FCZ101ETA, FCZ102ETA, FCZ201ETA, FCZ202ETA, FCZ061ETH, FCZ101ETH, FCZ201ETH, FCZ061ETN, FCZ101ETN, FCZ201ETN, FCZ061GAG, FCZ101GAG, FCZ102GAG, FCZ201GAG, FCZ202GAG, FCZ061GAD, FCZ101GAD, FCZ102GAD, FCZ201GAD, FCZ202GAD, FCZ101GTG, FCZ102GTG, FCZ201GTG, FCZ202GTG, FCZ101GTD, FCZ102GTD, FCZ-201GTD, FCZ202GTD...(Other models you can see in the webshop)		

			
1			
GEV No.	510674	Ref. No.	0E5046 0K7281 0K7307 0L2443 10067
description	roller for conrod L 16mm ø 39mm hole ø 15mm		
For models:	RT100ED, RT100ES, RT100SR, RT100SL, RT140ED, RT140ES, RT140SR, RT140SL, RT190ED, RT190ES, RT190SR, RT190SL, RT190HDED, RT190HDES, RT190HSR, RT190HSL, RT270ED, RT270ES, RT270SR, RT270SL, RT270HDED, RT270HDES, RT270HSR, RT270HSL, RT100ERF, RT100ELF, RT100VD, RT100VS, RT140ERF, RT140ELF, RT140VD, RT-140VS, RT142ERF, RT142ELF, RT190ERF, RT190ELF, RT190VD, RT190VS, RT190HERF, RT190HELF, RT190HDVDF, RT190HDVDF, RT270ERF, RT270ELF, RT270VDF, RT270VSF, RT270HERF, RT270HELF, RT270HD-VDF, RT270HDVDF...(Other models you can see in the webshop)		

			
1			
GEV No.	524499	Ref. No.	0E2193
description	roller for transport system ø 35mm hole ø 8.5mm		
For models:	FT36EDTS, FT36ESTS, FT36VDTS, FT36VSTS, FT36ED, FT36ES, FT36VD, FT36VS, FT50ED, FT50ES, FT50VD, FT50VS, FT72ED, FT72ES, FT72VD, FT72VS, FT36EDT, FT36EST, FT36VDT, FT36VST, FT50EDT, FT50EST, FT50VDT, FT50VST, FT72EDT, FT72EST, FT72VDT, FT72VST, FT36WED, FT36WES, FT36WVD, FT36WVS, FT50WED, FT50WES, FT50WVD, FT50WVS, FT72WED, FT72WES, FT72WVD, FT72WVS, FT36WEDT, FT36WEDT, FT36WVDT, FT36WVST, FT50WEDT, FT50WEST, FT50WVDT, FT50WVST, FT72WEDT, FT72WEST...(Other models you can see in the webshop)		

			
1			
GEV No.	694925 ¹	Ref. No.	0E3584
description	round belt ø 15mm Lmm Qty supplied by meter		
For models:	TW1ERECO, TW1ELECO, TW1SRECO, TW1SLECO, TL1, TL2, TL3, TC1, TC2, TC3, TC9, TC45, TTV, TTVS, TIV, TTR, CL1, CL2, CL3, CC1, CC2, CC3, C90, C45, CTV, CTVS, CIV, CCR, HSCCB5, HSCCB10, HSCCB20, HSC- CB25, HSCCB90C, HSCCB45C, HSCCBR, HSCCBDLF, HSCCBDRF, HSC- CBCLF, HSCCBDRF, HSSA3LR, HSSA4LR, HSSA5LR, HSSA6LR, HSSA3RL, HSSA4RL, HSSA5RL, HSSA6RL, HSCCT10, HSCCT20, HSCCT30...(Other models you can see in the webshop)		

			
1			
GEV No.	524495	Ref. No.	0E0207 0K7704 0KG781
description	shaft bearing for transport system L 80mm W 35mm H 35mm hole ø 20mm		
For models:	FT36EDTS, FT36ESTS, FT36VDTS, FT36VSTS, FT36ED, FT36ES, FT36VD, FT36VS, FT50ED, FT50ES, FT50VD, FT50VS, FT72ED, FT72ES, FT72VD, FT72VS, FT36EDT, FT36EST, FT36VDT, FT36VST, FT50EDT, FT50EST, FT50VDT, FT50VST, FT72EDT, FT72EST, FT72VDT, FT72VST, FT36WED, FT36WES, FT36WVD, FT36WVS, FT50WED, FT50WES, FT50WVD, FT50WVS, FT72WED, FT72WES, FT72WVD, FT72WVS, FT36WEDT, FT36WEDT, FT36WVDT, FT36WVST, FT50WEDT, FT50WEST, FT50WVDT, FT50WVST, FT72WEDT, FT72WEST...(Other models you can see in the webshop)		

			
1			
GEV No.	541995	Ref. No.	048576
description	sliding rail door mechanism L 897mm W 16mm H 41mm		
For models:	LO/E480, PLO480/E, LO480EUK, LO480E/63, LO480VAPORESTD, PLO480V, LO480V/63-60HZ, LO/E250, PLO250E, LO/E250UK, LO250E/63, LOPE25, LOPE48, LO480Z-VAPORE		

			
1			
GEV No.	511644	Ref. No.	0K6667
description	spacer for transport system L 112mm W 12mm hole ø 8mm		



1

GEV No.	530895	Ref. No.	OKZ168
description	spindle for tappet L 785mm ø 8mm suitable for ELECTROLUX, ZANUSSI		
For models:	FT36WED, FT36WES, FT36WVD, FT36WVS, FT50WED, FT50WES, FT50WVD, FT50WVS, FT72WED, FT72WES, FT72WVD, FT72WVS, FT36WEDT, FT36WEST, FT36WVDT, FT36WVST, FT50WEDT, FT50WEST, FT50WVDT, FT50WVST, FT72WEDT, FT72WEST, FT72WVDT, FT72WVST, WTF2WERC, WTF2WELC, WTF2WSRC, WTF2WSLC, WTF2WHERC, WTF2WHEL, WTF2WHSRC, WTF2WHSRC, WTF3WERC, WTF3WELC, WTF3WSRC, WTF3WSLC, WTF3WHERC, WTF3WHEL, WTF3WHSRC, WTF3WHSLC, WTF2WERB, WTF2WELB, WTF2WSRB, WTF2WSLB, WTF2WHERB, WTF2WHEL, WTF2WHSRB, WTF2WHSRB, WTF3WELB, WTF3WELB...(Other models you can see in the webshop)		

2

GEV No.	510667	Ref. No.	OE2196 OK8238 30001732
description	tappet for dishwasher L 138mm W 86mm		
For models:	FT36EDTS, FT36ESTS, FT36VDTS, FT36VSTS, FT36ED, FT36ES, FT36VD, FT36VS, FT50ED, FT50ES, FT50VD, FT50VS, FT72ED, FT72ES, FT72VD, FT72VS, FT36EDT, FT36EST, FT36VDT, FT36VST, FT50EDT, FT50EST, FT50VDT, FT50VST, FT72EDT, FT72EST, FT72VDT, FT72VST, FT36WED, FT36WES, FT36WVD, FT36WVS, FT50WED, FT50WES, FT50WVD, FT50WVS, FT72WED, FT72WES, FT72WVD, FT72WVS, FT36WEDT, FT36WEST, FT36WVDT, FT36WVST, FT50WEDT, FT50WEST, FT50WVDT, FT50WVST, FT72WEDT, FT72WEST...(Other models you can see in the webshop)		

1

GEV No.	511597	Ref. No.	OKU566 428083300
description	tappet for dishwasher L 140mm W 45mm H 68mm hole ø 8.4mm		
For models:	FT36EDTS, FT36ESTS, FT36VDTS, FT36VSTS, FT36ED, FT36ES, FT36VD, FT36VS, FT50ED, FT50ES, FT50VD, FT50VS, FT72ED, FT72ES, FT72VD, FT72VS, FT36EDT, FT36EST, FT36VDT, FT36VST, FT50EDT, FT50EST, FT50VDT, FT50VST, FT72EDT, FT72EST, FT72VDT, FT72VST, FT36WED, FT36WES, FT36WVD, FT36WVS, FT50WED, FT50WES, FT50WVD, FT50WVS, FT72WED, FT72WES, FT72WVD, FT72WVS, FT36WEDT, FT36WEST, FT36WVDT, FT36WVST, FT50WEDT, FT50WEST, FT50WVDT, FT50WVST, FT72WEDT, FT72WEST...(Other models you can see in the webshop)		

1

GEV No.	524498	Ref. No.	OE0023 OK7067 OK7068 OKE350
description	tappet for transport system		
For models:	LN34, LN34, LN34, LN34, LN46, LN46, LN46, LN46, LN72, LN72, LN72, LN72, LN34, LN34, LN34, LN34, LN46, LN46, LN46, LN46, LN72, LN72, LN72, LN72		

pipes

1

GEV No.	504284	Ref. No.	032238
description	pipe S-shape tube ø 25mm L 480mm		
For models:	DL07/C, DL14/C, DL14/CP, DL21/C, DL21/CP		

backflow preventers

backflow preventers

1

GEV No.	510789	Ref. No.	048191 0H2565
description	backflow preventer		
For models:	LS520D, LS520K, LS521D, LS521K, LS521, LS61, LS61/60, LS62, LS62D, LS62/UKRP, LS62F, LV62, LS62/60, ECOTEMP5, LS62/1P, LS62HD, LS63, LS63D, LS63/UKRP, LS63F, LV63, LS63/60, LS63/1P, LS64, LS64/UKRP, LV64, ECOTEMP5S, LS64/1P, ECOTEMP5SW, WT32, WT32/4,5, WT32/UK, WT32/UKRP, WT32/F6, WT32/J60, WT32/J50, WT32/4,5N, WT33, WT33/4,5, WT33/UK, WT33/UKRP, WT33/F, D500, WT33/M50, WT33/M60, WT33/60, WT33/4,5N, WT30U400, WT30U440, WT34...(Other models you can see in the webshop)		

1

GEV No.	512403	Ref. No.	0L3240
description	backflow preventer		



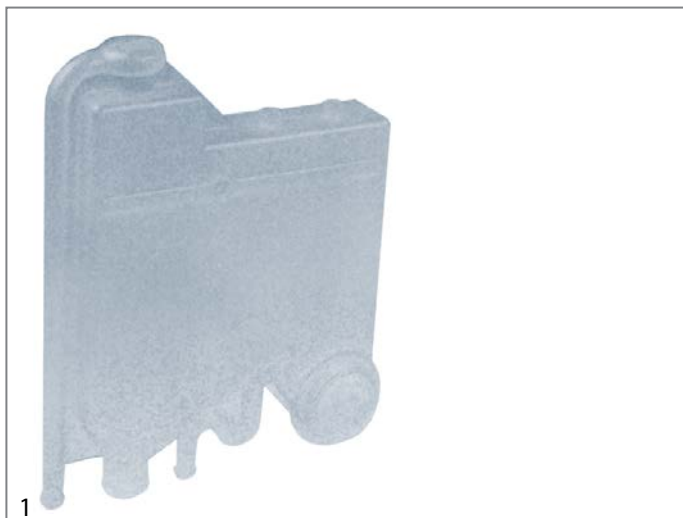

1

GEV No.	524491	Ref. No.	049481 0L2435
description	backflow preventer		
For models:	LS32UK/RP, WT302UK/RP, WT4DG, LS33UK/RP, WT303UK/RP, LB5DPG, WT38TDE, LS6EA/UK, LS6EA/DPUK, EUCAIG, EUCAIMLG, EUCAICLG, ZUCAIG, EUCAIUSPH6, WT38D, WT37/UK, WT38CUK, WT38UK, LS10/UK1, LS10/UK3, LS12/UK3, LS10UKDP, LS10UK/1, LS10UK/3, LS14EA/G, WT60UKDPCW, LS12UK/3CW, LS12UKDPCW, WT65E-BIDG, LS14EADP/G, EHTAIG, EHTAIUSPH5, EHTAIUSPH6, LS8/UK1, LS8UK3, WT50/UK1, WT50/UK3, LS9AUK/3, WT55AUK/3, LS9ADG1, WT55ADG1, EHTG, PW1SMG, PW1MG, PW1MUK, PW1MHG, PW2MG, PW2MUK, WT830MUK, WT830M60G...(Other models you can see in the webshop)		



1

GEV No.	511446	Ref. No.	049459 0KB770
description	backflow preventer dimensions 200x260mm		
For models:	ZUCADDROW, ZUCADDROW6, FUCA3DD, ZUCA1, ZUCA3, EUCADDROW, EUCADDROW6, LS6EADD, LS6EA/DPDD, WT38/M50, LS6EADP3, WT37LEV/9, LS6SANA, EUCAI, EUCAIDP, EUCAI60, WT38M50/4, EUCAIML, EUCAICL, EUCAIWL, LS6EA/60, EUCAICLW, EUCAIDPNW, ZUCAI, ZUCAIDP, ZUCAID, ZUCAI60, ZUCAIDD, EUCAIDD, EUCAIDPJ, EUCAIDPJ60, WT38D, WT37, WT38, WT37/4.5, WT38/4.5, WT38C, WT38C60, WT38/4.5NW, WT37J60, WT37J50, LS6AH240U, WT30H208U, WT30H240U, WT30H208DU, WT30H240DU, WT30H208RU, WT30H240RU, LS6AH208DU, LS6AH208U...(Other models you can see in the webshop)		
accessories for	511446		
	GEV No.	511448	Ref. No. 049480 0KB772
	lid for back flow restrictor		
	GEV No.	512175	Ref. No. 049460 0KB771
	O-ring EPDM thickness 2.62mm ID ø 53.65mm Qty 1 pcs		



1

GEV No.	516101	Ref. No.	005762 007008 049332 0E5648 0L1892
description	backflow preventer dishwasher hose ø 12mm		
For models:	FCV/G61/1, FCV/G61/1, FCV/G61/1, FCV/G202/1, 5712-2-7, 5712-2-8, 5712-2-10, 5714-2-7, 5714-2-8, 5714-2-10, 5714-2-7, 5714-2-8, 5714-2-10L, 5714-2-10, 5721-2-7, 5721-2-10, 5712-2-7L, 5712-2-8L, 5712-2-10L, 5714-2-7L, 5714-2-8L, 5714-2-10L, 5714-2-7L, 5714-2-8L, 5714-2-10L, 5712-3-7, 5712-3-8, 5712-3-8E, 5712-3-10, 5714-3-7, 5714-3-8, 5714-3-8E, 5714-3-10, 5717-3-7, 5717-3-8, 5717-3-8E, 5717-3-10, 5717-3-8M, 5717-3-8M, AOS061EA, AOS061EB, AOS101EA, AOS101EB, AOS201EA, AOS201EB, AOS061EA3J, AOS061EB3J, AOS101EA3J, AOS101EB3J, AOS201EA3J, AOS201EB3J...(Other models you can see in the webshop)		
spare parts for	516101		
	GEV No.	506367	Ref. No. —
	flat gasket rubber ED ø 40mm ID ø 28mm thickness 1.8mm Qty 1 pcs		



1

GEV No.	520273	Ref. No.	048414 049851 153328
description	non-return valve brass connection 1/2" IT - 1/2" IT total length 60mm DN15		
For models:	LS32F, LV32F, WT302F, LS33F, LV33F, WT303F, LS62F, LV62, LS63F, LV63, LS64, LV64, LS64/1P, WT32/F6, WT33/F, WT33/M50, WT33/M60, WT30U400, WT30U440, WT34, LV70, LS7F, WT40/9, WT40/F, LS10D, LC100, LS10F, LC120, LS12F, LC80, LS8F, WT50/F9, HT1000elm		



accessories



1			
GEV No.	511448	Ref. No.	049480 OKB772
description	lid for back flow restrictor		
For models:	LS32UK/RP, WT302UK/RP, WT4DG, WT4WS1, LS33UK/RP, WT4BWS, WT4DWS1, WT4BDWS, WT303UK/RP, EUC1WS, EUC1DPWS, EUC3WS, EUC3DPWS, ZUCADDROW, ZUCADDROW6, LS5/1WS, LS5/1WSDP, LS5/3WS, LS5/3WSDP, FUCA3DD, LS5/3WSDPD, LB5DPG, NUC1WS, NUC1DPWS, NUC3WS, NUC3DPWS, NUC3DDWS, ZUCA1, ZUCA3, EUCADDROW, EUCADDROW6, LS6EADD, LS6EA/DPDD, WT38TDE, WT38/M50, LS6EADP3, WT37LEV/9, LS6SANA, EUCAI, EUCAIDP, EUCAI60, WT38M50/4, LS6EA/UK, LS6EA/DPUK, EUCAIG, EUCAIML, EUCAIMLG, EUCAICL, EUCAICLG, EUCAIWL...(Other models you can see in the webshop)		

miscellaneous



1			
GEV No.	701305	Ref. No.	045836
description	gasket for dishwasher plastic L 70mm W 15mm H 70mm		
For models:	LS500F, LS501F, LS540F, LS540DK, LS541F, LS540, LS500F, LS500UK, LS501, LS501UK, LS540D, LS540/63, LS541, LS500, LS501, LS540, ALS540		



1			
GEV No.	506160	Ref. No.	OKM405
description	plain washer ID ø 8.6mm ED ø 16mm thickness 1.5mm SS Qty 1 pcs		
For models:	AG25, AG30, AG35, AG37, AV25, AV30, AV35, AV37, AG30, Europa350, Europa350, EUROPA370, MAX300, MAX350, MAX300, LUX350, LUX370, MEAT350, MAX300, MXMATIC300, AG25, AG30, EUROPA350, AV30, AV35, AV37, ECO300, MEET350, MEET370, MEET300		



1			
GEV No.	524046	Ref. No.	OKI589
description	vibration damper L 40mm W 25mm H 25mm for pump		
For models:	K35, K35, PSR100A-01, PSR100M-01, PSR100M-04, DPSR100		

door mechanics

bolts



1			
GEV No.	504658	Ref. No.	047478 514650502
description	bolt for hinge		
For models:	LSDS51, LSDS5V, LS510, LS520, LS520D, LS520F, LS520M, LS520K, LS521, LS521D, LS521F, LS521M, LS521K, LS521, LS4, ZLS510, ZLS520, ZLS521, C51, C52, C50, LS520ZD, LS521ZD, CF314, LS510MZ, LS520MZ, LS521MZ		



1			
GEV No.	517704	Ref. No.	049283
description	bolt L 15mm thread M5/M6 for door hinge		
For models:	LS32, LS32/4.5, LS32UK/RP, LS32F, LV32F, C55, LV32/60, WT4, WT4B, WT4D, WT302, WT302/4.5, WT302UK/RP, WT302F, WT302/60, WT4DB, WT46, WT4DG, WT4WS1, LS33, LS33/4.5, LS33UK/RP, LS33F, LV33F, C55A, LS33/60, WT4BWS, WT4DWS1, WT4BDWS, WT303, WT303/4.5, WT303UK/RP, WT303F, WT303/60, NUC3DD, WT4D60, WT4DDG, EUC1, EUC1DP, EUC1WS, EUC1DPWS, EUC3, EUC3WS, EUC3DP, EUC3DPWS, EUC1G, EUC1DP60, EUC3DD, ZUCADDROW, ZUCADDROW6...(Other models you can see in the webshop)		



1			
GEV No.	698502	Ref. No.	OC6008
description	pin ø 7mm total length 45mm WS 13		

springs

roller springs



1			
GEV No.	519449	Ref. No.	0E5002 0E5158 0K8168
description	roller spring W 25mm ID ø 32mm lug lengthmm		
For models:	WTF2ERC, WTF2ELC, WTF2SRC, WTF2SLC, WTF2HERC, WTF2HEL, WTF2HSRC, WTF2HSLC, WTF3ERC, WTF3ELC, WTF3SRC, WTF3SLC, WTF3HERC, WTF3HELC, WTF3HSRC., WTF3HSLC, WTF2ERB., WTF2ELB, WTF2SRB, WTF2SLB, WTF2HERB, WTF2HELB, WTF2HSRB, WTF2HSLB, WTF3ERB, WTF3ELB, WTF3SRB, WTF3SLB, WTF3HERB, WTF3HELB, WTF3HSRB, WTF3HSLB, WTF4HERB, WTF4HELB, WTF4HSRB, WTF4HSLB, WTF2ERA, WTF2ELA, WTF2SRA, WTF2SLA, WTF2HERA, WTF2HELA, WTF2HSRA, WTF2HSLA, WTF3ERA, WTF3ELA, WTF3SRA, WTF3SLA, WTF3HERA, WTF3HELA...(Other models you can see in the webshop)		

linkage



GEV No.	699139	Ref. No.	049731
description	door guides L 138mm H 30mm W 5mm		
For models:	PW1MHG, WT830MHG, WT830H208U, WT830H240U, ET830MH, PW100MHG		



GEV No.	504643	Ref. No.	049282
description	door pin		
For models:	LS32, LS32/4.5, LS32UK/RP, LS32F, LV32F, C55, LV32/60, WT4, WT4B, WT4D, WT302, WT302/4.5, WT302UK/RP, WT302F, WT302/60, WT4DB, WT46, WT4DG, WT4WS1, LS33, LS33/4.5, LS33UK/RP, LS33F, LV33F, C55A, LS33/60, WT4BWS, WT4DWS1, WT4BDWS, WT303, WT303/4.5, WT303UK/RP, WT303F, WT303/60, NUC3DD, WT4D60, WT4DDG, EUC1, EUC1DP, EUC1WS, EUC1DPWS, EUC3, EUC3WS, EUC3DP, EUC3DPWS, EUC1G, EUC1DP60, EUC3DD, ZUCADDROW, ZUCADDROW6...(Other models you can see in the webshop)		



GEV No.	504654	Ref. No.	048581
description	door pin spring linkage		
For models:	LS7D, LS7, LS7UK/RP, LV70, LS7F, LS7DEK, LS7/1UK, LS7/9, LS7/DP, LS7/60, WT40/9, WT40/F, LS7HD, WT40/J50, WT40/J60, WT40UKRP, PH4/WT40, PH4RBP/WT40, FL700, HYDRA700, Z70		



GEV No.	507413	Ref. No.	049687 0L0034
description	linkage guide L 220mm H 5mm W 30mm		
For models:	PW1SMG, PW1MG, PW1MUK, PW160HZ, PW2MG, PW2MUK, PW2M60, WT830M, WT830MUK, WT830M60G, WT850M, WT850MUK, WT850M60G, WT830M208U, WT830M240U, WT850M208U, WT850M240U, PW2SMG, ET830M, ET850M, PW100MG, PW100M, PW200M, LV100M, LV200M		

sliding plates



GEV No.	504645	Ref. No.	049285
description	sliding plate sliding plate		
For models:	LS32, LS32/4.5, LS32UK/RP, LS32F, LV32F, C55, LV32/60, WT4, WT4B, WT4D, WT302, WT302/4.5, WT302UK/RP, WT302F, WT302/60, WT4DB, WT46, WT4DG, WT4WS1, LS33, LS33/4.5, LS33UK/RP, LS33F, LV33F, C55A, LS33/60, WT4BWS, WT4DWS1, WT4BDWS, WT303, WT303/4.5, WT303UK/RP, WT303F, WT303/60, NUC3DD, WT4D60, WT4DDG, EUC1, EUC1DP, EUC1WS, EUC1DPWS, EUC3, EUC3WS, EUC3DP, EUC3DPWS, EUC1G, EUC1DP60, EUC3DD, ZUCADDROW, ZUCADDROW6...(Other models you can see in the webshop)		

rollers



GEV No.	694643	Ref. No.	0E5001 0K8167
description	roller ø 30mm W 58mm ID ø 11mm		
For models:	WTF2ERC, WTF2ELC, WTF2SRC, WTF2SLC, WTF2HERC, WTF2HEL, WTF2HSRC, WTF2HSLC, WTF3ERC, WTF3ELC, WTF3SRC, WTF3SLC, WTF3HERC, WTF3HEL, WTF3HSRC., WTF3HSLC, WTF2ERB., WTF2ELB, WTF2SRB, WTF2SLB, WTF2HERB, WTF2HELB, WTF2HSRB, WTF2HSLB, WTF3ERB, WTF3ELB, WTF3SRB, WTF3SLB, WTF3HERB, WTF3HELB, WTF3HSRB, WTF3HSLB, WTF4HERB, WTF4HELB, WTF4HSRB, WTF4HSLB, WTF2ERA, WTF2ELA, WTF2SRA, WTF2SLA, WTF2HERA, WTF2HELA, WTF2HSRA, WTF2HSLA, WTF3ERA, WTF3ELA, WTF3SRA, WTF3SLA, WTF3HERA, WTF3HELA...(Other models you can see in the webshop)		

hinges



GEV No.	504651	Ref. No.	048317 048582
description	door hinge hinge left mounting pos. left		
For models:	LS7D, LS7, LS7UK/RP, LV70, LS7F, LS7DEK, LS7/1UK, LS7/9, LS7/DP, LS7/60, WT40/9, WT40/F, LS7HD, WT40/J50, WT40/J60, WT40UKRP, PH4/WT40, PH4RBP/WT40, FL700, HYDRA700, Z70		





GEV No.	504647	Ref. No.	048814 0L0718
description	door hinge hinge lever left mounting pos. left		
For models:	LS61, LS61/60, LS6EP, LS6EP/DD, LS6EADD, LS6EA/DPDD, WT38T-DE, WT38/M50, LS6EADP3, LS6EADPWS, LS6EADPWSG, WT38WS, WT38WSG, WT38MEDWS, WT38PM50, WT37LEV/9, LS6EADPDWS, WT38DWS, LS6SANA, EUCAI, EUCAIDP, EUCAI60, EUCAIWS, WT38M50/4, LS6EA/UK, LS6EA/DPUK, EUCAIG, EUCAIWSG, EUCAIML, EUCAIMLWS, EUCAIMLG, EUCAICL, EUCAICLG, EUCAIWL, LS6EA/60, EUCAICLW, EUCI, EUCIM, EUCIM60, EUCAIDPNW, ZUCI, ZUCID, ZUCAI, ZUCAIDP, ZUCAIDPWS, ZUCAIG, ZUCAIDDWS, ZUCAID, ZUCAI60, EUCAIUSPH6...(Other models you can see in the webshop)		



			
1			
GEV No.	504646	Ref. No.	048813 0L0717
description	door hinge hinge lever right mounting pos. right		
For models:	LS61, LS61/60, LS6EP, LS6EP/DD, LS6EADD, LS6EA/DPDD, WT38T-DE, WT38/M50, LS6EADP3, LS6EADPWS, LS6EADPWG, WT38WS, WT38WSG, WT38MEDWS, WT38PM50, WT37LEV/9, LS6EADPDWS, WT38DWS, LS6SANA, EUCAI, EUCAIDP, EUCAI60, EUCAIWS, WT38M50/4, LS6EA/UK, LS6EA/DPUK, EUCAIG, EUCAIWSG, EUCAIML, EUCAIMLWS, EUCAIMLG, EUCAICL, EUCAICLG, EUCAIWL, LS6EA/60, EUCAICLW, EUCI, EUCIM, EUCIM60, EUCAIDPNW, ZUCI, ZUCID, ZUCAI, ZUCAIDP, ZUCAIDPWS, ZUCAIG, ZUCAIDDWS, ZUCAID, ZUCAI60, EUCAIUSPH6...(Other models you can see in the webshop)		

			
1			
GEV No.	518547	Ref. No.	069513
description	door hinge hinge mounting pos. left		
For models:	LTB11, LTB12, LTB22, LTB11UK, LTB12UK, LTB22UK, LTB11, LTB22, 910-00-021, 910-00-023, 910-00-031, 910-00-033, 911-00-022, 911-00-024, 911-00-032, 911-00-034, CRYSTAL 11, CRYSTAL 22		

			
1			
GEV No.	518253	Ref. No.	0A6146
description	door hinge hinge mounting pos. right		
For models:	LTB11, LTB12, LTB22, LTB11UK, LTB12UK, LTB22UK, LTB11, LTB22, 910-00-021, 910-00-023, 910-00-031, 910-00-033, 911-00-022, 911-00-024, 911-00-032, 911-00-034, CRYSTAL 11, CRYSTAL 22		

			
1			
GEV No.	504650	Ref. No.	048318 048583
description	door hinge hinge right mounting pos. right		
For models:	LS7D, LS7, LS7UK/RP, LV70, LS7F, LS7DEK, LS7/1UK, LS7/9, LS7/DP, LS7/60, WT40/9, WT40/F, LS7HD, WT40/J50, WT40/J60, WT40UKRP, PH4/WT40, PH4RBP/WT40, FL700, HYDRA700, Z70		

hinge pins			
			
1			
GEV No.	504642	Ref. No.	049281
description	hinge pin hinge pin		
For models:	LS32, LS32/4.5, LS32UK/RP, LS32F, LV32F, C55, LV32/60, WT4, WT4B, WT4D, WT302, WT302/4.5, WT302UK/RP, WT302F, WT302/60, WT4DB, WT46, WT4DG, WT4WS1, LS33, LS33/4.5, LS33UK/RP, LS33F, LV33F, C55A, LS33/60, WT4BWS, WT4DWS1, WT4BDWS, WT303, WT303/4.5, WT303UK/RP, WT303F, WT303/60, NUC3DD, WT4D60, WT4DDG, EUC1, EUC1DP, EUC1WS, EUC1DPWS, EUC3, EUC3WS, EUC3DP, EUC3DPWS, EUC1G, EUC1DP60, EUC3DD, ZUCADDROW, ZUCADDROW6...(Other models you can see in the webshop)		

			
1			
GEV No.	518097	Ref. No.	049685
description	hinge pin ø 25mm D1 ø 16mm L 34mm thread M8 stainless steel		
For models:	PW1SMG, PW1MG, PW1MUK, PW160HZ, PW1MHG, PW2MG, PW2MUK, PW2M60, WT830M, WT830MUK, WT830M60G, WT850M, WT850MUK, WT850M60G, WT830MHG, WT830M208U, WT830M240U, WT830H208U, WT830H240U, WT850M208U, WT850M240U, PW2SMG, ET830M, ET830MH, ET850M, PW100MG, PW100M, PW200M, PW100MHG, LV100M, LV200M, PW200MG		

door frames			
			
1			
GEV No.	504665	Ref. No.	047483
description	door frame door frame		
For models:	LSDS5I, LSDS5V, LS510, LS520, LS520D, LS520F, LS520M, LS520K, LS521, LS521D, LS521F, LS521M, LS521K, LS521, LS4, ZLS510, ZLS520, ZLS521, C51, C52, C50, LS520ZD, LS521ZD, LS510MZ, LS520MZ, LS521MZ		

door bumpers



1

GEV No.	700998	Ref. No.	049711
description	bracket L 72mm mounting pos. left ø 8mm hole distance 15mm hole ø 5mm		
For models:	PW1SMG, PW1MG, PW1MUK, PW160HZ, PW1MHG, PW2MG, PW2MUK, PW2M60, WT830M, WT830MUK, WT830M60G, WT850M, WT850MUK, WT850M60G, WT830MHG, WT830M208U, WT830M240U, WT830H208U, WT830H240U, WT850M208U, WT850M240U, PW2SMG, ET830M, ET830MH, ET850M, PW100MG, PW100M, PW200M, PW100MHG, LV100M, LV200M, PW200MG		



1

GEV No.	700996	Ref. No.	049693
description	bracket L 72mm mounting pos. right ø 8mm hole distance 15mm hole ø 5mm		
For models:	PW1SMG, PW1MG, PW1MUK, PW160HZ, PW1MHG, PW2MG, PW2MUK, PW2M60, WT830M, WT830MUK, WT830M60G, WT850M, WT850MUK, WT850M60G, WT830MHG, WT830M208U, WT830M240U, WT830H208U, WT830H240U, WT850M208U, WT850M240U, PW2SMG, ET830M, ET830MH, ET850M, PW100MG, PW100M, PW200M, PW100MHG, LV100M, LV200M, PW200MG		



1

GEV No.	504644	Ref. No.	049286
description	door bumper end stop		
For models:	LS32, LS32/4.5, LS32UK/RP, LS32F, LV32F, C55, LV32/60, WT4, WT4B, WT4D, WT302, WT302/4.5, WT302UK/RP, WT302F, WT302/60, WT4DB, WT46, WT4DG, WT4WS1, LS33, LS33/4.5, LS33UK/RP, LS33F, LV33F, C55A, LS33/60, WT4BWS, WT4DWS1, WT4BDWS, WT303, WT303/4.5, WT303UK/RP, WT303F, WT303/60, NUC3DD, WT4D60, WT4DDG, EUC1, EUC1DP, EUC1WS, EUC1DPWS, EUC3, EUC3WS, EUC3DP, EUC3DPWS, EUC1G, EUC1DP60, EUC3DD, ZUCADDROW, ZUCADDROW6...(Other models you can see in the webshop)		

EQUIPMENT-SPECIFIC UNITS ELECTROLUX



1

GEV No.	524870	Ref. No.	0L0595
description	door bumper mounting pos. left for dishwasher		
For models:	PW1SMG, PW1MG, PW1MUK, PW1MHG, PW2MG, PW2MUK, WT830M, WT830MUK, WT830M60G, WT850M, WT850MUK, WT850M60G, WT830MHG, WT830M208U, WT830M240U, WT830H208U, WT830H240U, WT850M208U, WT850M240U, PW2SMG, ET830M, ET830MH, ET850M, PW100MG, PW100M, PW200M, PW100MHG, LV100M, LV200M, PW200MG		



1

GEV No.	524869	Ref. No.	0L0594
description	door bumper mounting pos. right for dishwasher		
For models:	PW1SMG, PW1MG, PW1MUK, PW1MHG, PW2MG, PW2MUK, WT830M, WT830MUK, WT830M60G, WT850M, WT850MUK, WT850M60G, WT830MHG, WT830M208U, WT830M240U, WT830H208U, WT830H240U, WT850M208U, WT850M240U, PW2SMG, ET830M, ET830MH, ET850M, PW100MG, PW100M, PW200M, PW100MHG, LV100M, LV200M, PW200MG		

locks



1

GEV No.	504663	Ref. No.	049536
description	door catch L 35mm W 12mm H 28mm mounting distance 28mm		
For models:	LS32, LS32/4.5, LS32UK/RP, LS32F, LV32F, C55, LV32/60, WT4, WT4B, WT4D, WT302, WT302/4.5, WT302UK/RP, WT302F, WT302/60, WT4DB, WT46, WT4DG, WT4WS1, LS33, LS33/4.5, LS33UK/RP, LS33F, LV33F, C55A, LS33/60, WT4BWS, WT4DWS1, WT4BDWS, WT303, WT303/4.5, WT303UK/RP, WT303F, WT303/60, NUC3DD, WT4D60, WT4DDG, EUC1, EUC1DP, EUC1WS, EUC1DPWS, EUC3, EUC3WS, EUC3DP, EUC3DPWS, EUC1G, EUC1DP60, EUC3DD, ZUCADDROW, ZUCADDROW6...(Other models you can see in the webshop)		



			
1			
GEV No.	504659	Ref. No.	047491 0A6111 0H2557 0K8667 549610000
description	door catch L 84mm W 19mm H 31mm mounting distance 64mm catch housing		
For models:	LSD551, LSD55V, LS510, LS520, LS520D, LS520F, LS520M, LS520K, LS521, LS521D, LS521F, LS521M, LS521K, LS521, LS4, ZLS510, ZLS520, ZLS521, ALLS521, ALLS520, ALS510, C51, C52, C50, LS520ZD, LS521ZD, CF314, LS510MZ, LS520MZ, LS521MZ		

			
1			
GEV No.	518081	Ref. No.	075598 0L0608 330280800
description	handle rail set 3-piece L 550mm		
For models:	SL/E851, SL/E901, CT140EDX, CT140ESX, CT140EDXUK, CT140SXEUK, CT140VDX, CT140VSX, CT141EDX, CT141ESX, CT141EDUK, CT141E-SUK, CT141VDX, CT141VSX, CT142DXE, CT142SXE, CT142DXEUK, CT142SXEUK, CT142DXV, CT142SXV, CT190DXE, CT190SXE, CT190DXEUK, CT190SXEUK, CT190DXV, CT190SXV, CT191DXE, CT191SXE, CT191DXEUK, CT191DXV, CT191SXV, CT192DXE, CT192SXE, CT192DXEUK, CT192SXEUK, CT192DXV, CT192SXV, CT240DXE, CT240SXE, CT240DXEUK, CT240SX, CT240DXV, CT240SXVUK, CT241DXE, CT241SXE, CT241DXEUK, CT241SXEUK, CT241DXV, CT241SXV...(Other models you can see in the webshop)		

miscellaneous			
			
1			
GEV No.	504482	Ref. No.	0L0366
description	bracket H 19mm L 70mm W 35mm		
For models:	WT4, WT4B, WT4D, WT4DB, WT46, WT4DG, WT4WS1, WT4BWS, WT4DWS1, WT4BDWS, NUC3DD, WT4D60, WT4DDG, EUC1, EUC1DP, EUC1WS, EUC1DPWS, EUC3, EUC3WS, EUC3DP, EUC3DPWS, EUC1G, EUC1DP60, EUC3DD, ZUCADDROW, ZUCADDROW6, LS5/1, LS5/1DP, LS5/1WS, LS5/1WSDP, LS5/3, LS5/3DP, LS5/3WS, LS5/3WSDP, FUCA3DD, LS5/3WSDPD, LB5DPG, LS5/1DP60, LS5/1DPAUS, LS5/1D-PCS, KUC3, KUC3DP, NUC1, NUC1DP, NUC1WS, NUC1DPWS, NUC3, NUC3WS, NUC3DP, NUC3DPWS...(Other models you can see in the webshop)		

			
1			
GEV No.	504657	Ref. No.	047476 047841 048161 345008
description	hinge hinge		
For models:	LSD551, LSD55V, LS510, LS520, LS520D, LS520F, LS520M, LS520K, LS521, LS521D, LS521F, LS521M, LS521K, LS521, LS4, ZLS510, ZLS520, ZLS521, ALLS521, ALLS520, ALS510, C51, C52, C50, LS520ZD, LS521ZD, CF314, LS510MZ, LS520MZ, LS521MZ		

			
1			
GEV No.	504648	Ref. No.	048812
description	bush bush		
For models:	LS61, LS61/60, LS6EP, LS6EP/DD, LS6EADD, LS6EA/DPDD, WT38T-DE, WT38/M50, LS6EADP3, LS6EADPWS, LS6EADPWSG, WT38WS, WT38WSG, WT38MEDWS, WT38PM50, WT37LEV/9, LS6EADPDWS, WT38DWS, LS6SANA, EUCAI, EUCAIDP, EUCAI60, EUCAIWS, WT38M50/4, LS6EA/UK, LS6EA/DPUK, EUCAIG, EUCAIWSG, EUCAIML, EUCAIMLWS, EUCAIMLG, EUCAICL, EUCAICLG, EUCAIWL, LS6EA/60, EUCAICLW, EUCI, EUCIM, EUCIM60, EUCAIDPNW, ZUCI, ZUCID, ZUCAI, ZUCAIDP, ZUCAIDPWS, ZUCAIG, ZUCAIDDWS, ZUCAID, ZUCAI60, EUCAIUSPH6...(Other models you can see in the webshop)		

			
1			
GEV No.	504641	Ref. No.	049280
description	hinge mounting pos. left hinge		
For models:	LS32, LS32/4.5, LS32UK/RP, LS32F, LV32F, C55, LV32/60, WT4, WT4B, WT4D, WT302, WT302/4.5, WT302UK/RP, WT302F, WT302/60, WT4DB, WT46, WT4DG, WT4WS1, LS33, LS33/4.5, LS33UK/RP, LS33F, LV33F, C55A, LS33/60, WT4BWS, WT4DWS1, WT4BDWS, WT303, WT303/4.5, WT303UK/RP, WT303F, WT303/60, NUC3DD, WT4D60, WT4DDG, EUC1, EUC1DP, EUC1WS, EUC1DPWS, EUC3, EUC3WS, EUC3DP, EUC3DPWS, EUC1G, EUC1DP60, EUC3DD, ZUCADDROW, ZUCADDROW6...(Other models you can see in the webshop)		



1

GEV No.	504656	Ref. No.	046291
description	hinge mounting pos. left hinge		
For models:	LS360F, LS360DK, LS365F, LS365, LS365PH, LS500F, LS501F, LS540F, LS540DK, LS541F, LS360D, LS365D, LS360, LS365, LS360/63, LS365/63, LS367, LS540, LS500F, LS500UK, LS501, LS501UK, LS540D, LS540/63, LS541, LS360, LS365F, LS500, LS501, LS540, ALS540, HBP3PNT		



1

GEV No.	504640	Ref. No.	049279
description	hinge mounting pos. right hinge		
For models:	LS32, LS32/4.5, LS32UK/RP, LS32F, LV32F, C55, LV32/60, WT4, WT4B, WT4D, WT302, WT302/4.5, WT302UK/RP, WT302F, WT302/60, WT4DB, WT46, WT4DG, WT4WS1, LS33, LS33/4.5, LS33UK/RP, LS33F, LV33F, C55A, LS33/60, WT4BWS, WT4DWS1, WT4BDWS, WT303, WT303/4.5, WT303UK/RP, WT303F, WT303/60, NUC3DD, WT4D60, WT4DDG, EUC1, EUC1DP, EUC1WS, EUC1DPWS, EUC3, EUC3WS, EUC3DP, EUC3DPWS, EUC1G, EUC1DP60, EUC3DD, ZUCADDROW, ZUCADDROW6...(Other models you can see in the webshop)		



1

GEV No.	504655	Ref. No.	046292
description	hinge mounting pos. right hinge		
For models:	LS360F, LS360DK, LS365F, LS365, LS365PH, LS500F, LS501F, LS540F, LS540DK, LS541F, LS360D, LS365D, LS360, LS365, LS360/63, LS365/63, LS367, LS540, LS500F, LS500UK, LS501, LS501UK, LS540D, LS540/63, LS541, LS360, LS365F, LS500, LS501, LS540, ALS540, HBP3PNT		



1

GEV No.	504636	Ref. No.	049192 049246
description	plate plastic plastic plate		
For models:	LB1, LB1WS, LB1WSDP, LB1/RBP, LB1/TOP, LB1/60, WT1WSDP, LB2D-PSAUS, LB1G, LB1WSG, WT2TOP60, WT2DPDI, WT2WSDPDI, LB1TOP, WT2TOPDI, LB2WS, LB2, LB2WSDP, LB2/TOP, LB2/RBP, LB2WS60, WT2WSDP, WT2WSDPD, LB2WSG, WT2WS, WT1, WT1WS, WT1TOP, WT2TOP, WT1/3DP, WT2/3DP, WT2DPAUS, WT2, LB2DPDI, LB2WSDPDI, LB2WSDPD, LB2TOP, LB2DP3, WT2DPD3, NGW, NGWDPDD, UC1, UC2WS, GW1, GW1WS, LV1WS, LV1WSDP, LV2WSDP, LV2WS, GW2D-PG...(Other models you can see in the webshop)		



1

GEV No.	541996	Ref. No.	081727
description	plug for door handle H 14.1mm D1 ø 18.8mm D2 ø 27mm green		
For models:	LS360F, LS360DK, LS365F, LS365, LS500F, LS501F, LS540F, LS540DK, LS541F, LS360D, LS365D, LS360, LS365, LS360/63, LS365/63, LS367, LS540, LS500F, LS500UK, LS501, LS501UK, LS540D, LS540/63, LS541, CT140EDX, CT140ESX, CT140EDXUK, CT140SXEU, CT140VDX, CT140VSX, CT141EDX, CT141ESX, CT141EDUK, CT141ESUK, CT141VDX, CT141VSX, CT142DXE, CT142SX, CT142DXEUK, CT142SXEU, CT142DXV, CT142SXV, CT190DXE, CT190SX, CT190DXEUK, CT190SXEU, CT190DXV, CT190SXV, CT191DXE, CT191SX...(Other models you can see in the webshop)		



1

GEV No.	524501	Ref. No.	0E5022 0E5157 0K8296
description	spring for door latch L 85mm W 20mm		
For models:	RT100ED, RT100ES, RT100SR, RT100SL, RT140ED, RT140ES, RT140SR, RT140SL, RT190ED, RT190ES, RT190SR, RT190SL, RT190HDED, RT190HDES, RT190HSR, RT190HSL, RT270ED, RT270ES, RT270SR, RT270SL, RT270HDED, RT270HDES, RT270HSR, RT270HSL, RT100ERF, RT100ELF, RT100VD, RT100VS, RT140ERF, RT140ELF, RT140VD, RT140VS, RT142ERF, RT142ELF, RT190ERF, RT190ELF, RT190VD, RT190VS, RT190HERF, RT190HEL, RT190HDVDF, RT190HDVSF, RT270ERF, RT270ELF, RT270VDF, RT270VSF, RT270HERF, RT270HEL, RT270HDVDF, RT270HDVSF...(Other models you can see in the webshop)		



1

GEV No.	541994	Ref. No.	0E2898
description	spring holder H 25mm L 70mm W 20mm for dishwasher		
For models:	RT100ED, RT100ES, RT100SR, RT100SL, RT140ED, RT140ES, RT140SR, RT140SL, RT190ED, RT190ES, RT190SR, RT190SL, RT190HDED, RT190HDES, RT190HSR, RT190HSL, RT270ED, RT270ES, RT270SR, RT270SL, RT270HDED, RT270HDES, RT270HSR, RT270HSL, RT100ERF, RT100ELF, RT100VD, RT100VS, RT140ERF, RT140ELF, RT140VD, RT140VS, RT142ERF, RT142ELF, RT190ERF, RT190ELF, RT190VD, RT190VS, RT190HERF, RT190HEL, RT190HDVDF, RT190HDVSF, RT270ERF, RT270ELF, RT270VDF, RT270VSF, RT270HERF, RT270HEL, RT270HDVDF, RT270HDVSF...(Other models you can see in the webshop)		



			
GEV No.	504637	Ref. No.	049030 049802
description	spring jack spring jack		
For models:	LB1, LB1WS, LB1WSDP, LB1/RBP, LB1/TOP, LB1/60, WT1WSDP, LB2D-PSAUS, LB1G, LB1WSG, WT2TOP60, WT2DPDI, WT2WSDPDI, LB1TOP, WT2TOPDI, LB2WS, LB2, LB2WSDP, LB2/TOP, LB2/RBP, LB2WS60, WT2WSDP, WT2WSDPD, LB2WSG, WT2WS, WT1, WT1WS, WT1TOP, WT2TOP, WT1/3DP, WT2/3DP, WT2DPAUS, WT2, LB2DPDI, LB2WSDPDI, LB2WSDPD, LB2TOP, LB2DP3, WT2DPD3, NGW, NGWDPDD, UC1, UC2WS, GW1, GW1WS, LV1WS, LV1WSDP, LV2WSDP, LV2WS, GW2D-PG...(Other models you can see in the webshop)		

			
GEV No.	533004	Ref. No.	0E5038 0KJ660
description	curtain W 550mm H 355mm		
For models:	RT100ED, RT100ES, RT100SR, RT100SL, RT140ED, RT140ES, RT140SR, RT140SL, RT190ED, RT190ES, RT190SR, RT190SL, RT190HDED, RT190HDES, RT190HSR, RT190HSL, RT270ED, RT270ES, RT270SR, RT270SL, RT270HDED, RT270HDES, RT270HSR, RT270HSL, RT100ERF, RT100ELF, RT100VD, RT100VS, RT140ERF, RT140ELF, RT140VD, RT140VS, RT142ERF, RT142ELF, RT190ERF, RT190ELF, RT190VD, RT190VS, RT190HERF, RT190HELF, RT190HDVDF, RT190HDVSF, RT270ERF, RT270ELF, RT270VDF, RT270VSF, RT270HERF, RT270HELF, RT270HDVDF, RT270HDVSF...(Other models you can see in the webshop)		

curtains

curtains

			
GEV No.	533110	Ref. No.	046883
description	curtain W 530mm H 350mm warewashing		
For models:	CT92DXE, CT92SXE, CT92DXEUK, CT92SXEUK, CT92DXV, CT92SXV, CT92DXVUK, CT92SXVUK, CT140EDX, CT140ESX, CT140EDXUK, CT140SXEUK, CT140VDX, CT140VSX, CT141EDX, CT141ESX, CT141E-DUK, CT141ESUK, CT141VDX, CT141VSX, CT142DXE, CT142SXE, CT142DXEUK, CT142SXEUK, CT142DXV, CT142SXV, CT190DXE, CT190SXE, CT190DXEUK, CT190SXEUK, CT190DXV, CT190SXV, CT-191DXE, CT191SXE, CT191DXEUK, CT191SXEUK, CT191DXV, CT191SXV, CT192DXE, CT192SXE, CT192DXEUK, CT192SXEUK, CT192DXV, CT192SXV, CT240DXE, CT240SXE, CT240DXEUK, CT240SX, CT240DXV, CT240SXVUK...(Other models you can see in the webshop)		

			
GEV No.	698597	Ref. No.	0E2728 0E5486 0K8514
description	curtain W 550mm H 458mm		
For models:	RT100ED, RT100ES, RT100SR, RT100SL, RT140ED, RT140ES, RT140SR, RT140SL, RT190ED, RT190ES, RT190SR, RT190SL, RT190HDED, RT190HDES, RT190HSR, RT190HSL, RT270ED, RT270ES, RT270SR, RT270SL, RT270HDED, RT270HDES, RT270HSR, RT270HSL, RT100ERF, RT100ELF, RT100VD, RT100VS, RT140ERF, RT140ELF, RT140VD, RT-140VS, RT142ERF, RT142ELF, RT190ERF, RT190ELF, RT190VD, RT190VS, RT190HERF, RT190HELF, RT190HDVDF, RT190HDVSF, RT270ERF, RT270ELF, RT270VDF, RT270VSF, RT270HERF, RT270HELF, RT270HDVDF, RT270HDVSF...(Other models you can see in the webshop)		

			
GEV No.	533109	Ref. No.	0E5029 0E5268 0E5277 0H2508
description	curtain W 545mm H 445mm warewashing		
For models:	RT100ED, RT100ES, RT100SR, RT100SL, RT140ED, RT140ES, RT140SR, RT140SL, RT190ED, RT190ES, RT190SR, RT190SL, RT190HDED, RT190HDES, RT190HSR, RT190HSL, RT270ED, RT270ES, RT270SR, RT270SL, RT270HDED, RT270HDES, RT270HSR, RT270HSL, RT100ERF, RT100ELF, RT100VD, RT100VS, RT140ERF, RT140ELF, RT140VD, RT-140VS, RT142ERF, RT142ELF, RT190ERF, RT190ELF, RT190VD, RT190VS, RT190HERF, RT190HELF, RT190HDVDF, RT190HDVSF, RT270ERF, RT270ELF, RT270VDF, RT270VSF, RT270HERF, RT270HELF, RT270HDVDF, RT270HDVSF...(Other models you can see in the webshop)		

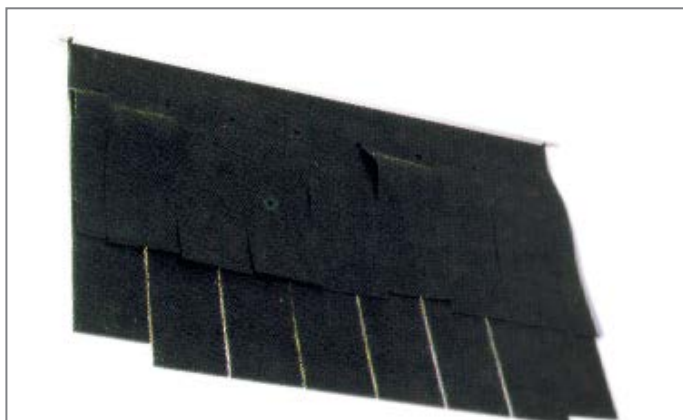

1			
GEV No.	533105	Ref. No.	046882
description	curtain W 575mm H 420mm warewashing		
For models:	CT92DXE, CT92SXE, CT92DXEUK, CT92SXEUK, CT92DXV, CT92SXV, CT92DXVUK, CT92SXVUK, CT140EDX, CT140ESX, CT140EDXUK, CT140SXUK, CT140VDX, CT140VSX, CT141EDX, CT141ESX, CT141E-DUK, CT141ESUK, CT141VDX, CT141VSX, CT142DXE, CT142SXE, CT142DXEUK, CT142SXUK, CT142DXV, CT142SXV, CT190DXE, CT190SXE, CT190DXEUK, CT190SXUK, CT190DXV, CT190SXV, CT191DXE, CT191SXE, CT191DXEUK, CT191SXUK, CT191DXV, CT191SXV, CT192DXE, CT192SXE, CT192DXEUK, CT192SXUK, CT192DXV, CT192SXV, CT240DXE, CT240SXE, CT240DXEUK, CT240SX, CT240DXV, CT240SXVUK...(Other models you can see in the webshop)		



2			
GEV No.	504287	Ref. No.	0E5828 0E5966 0E6006 0K8592
description	curtain W 580mm H 480mm		
For models:	TW1ERECO, TW1ELECO, TW1SRECO, TW1SLECO, RT190ED, RT190ES, RT190SR, RT190SL, RT190HDED, RT190HDES, RT190HSR, RT190HSL, RT270ED, RT270ES, RT270SR, RT270SL, RT270HDED, RT270HDES, RT270HSR, RT270HSL, RT142ERF, RT142ELF, RT190ERF, RT190ELF, RT190VD, RT190VS, RT190HEREF, RT190HEL, RT190HDVDF, RT190HDVSF, RT270ERF, RT270ELF, RT270VDF, RT270VSF, RT270HEREF, RT270HEL, RT270HDVDF, RT270HDVSF, RT190ERG, RT190ELG, RT190VDU, RT190VSU, RT190HERG, RT190HEL, RT190HDVDU, RT190HDVSU, RT270ERG, RT270ELG, RT270VDU, RT270VSU...(Other models you can see in the webshop)		



1			
GEV No.	533106	Ref. No.	048042
description	curtain W 640mm H 430mm warewashing		
For models:	CT92DXE, CT92SXE, CT92DXEUK, CT92SXEUK, CT92DXV, CT92SXV, CT92DXVUK, CT92SXVUK, CT140EDX, CT140ESX, CT140EDXUK, CT140SXUK, CT140VDX, CT140VSX, CT141EDX, CT141ESX, CT141E-DUK, CT141ESUK, CT141VDX, CT141VSX, CT142DXE, CT142SXE, CT142DXEUK, CT142SXUK, CT142DXV, CT142SXV, CT190DXE, CT190SXE, CT190DXEUK, CT190SXUK, CT190DXV, CT190SXV, CT191DXE, CT191SXE, CT191DXEUK, CT191SXUK, CT191DXV, CT191SXV, CT192DXE, CT192SXE, CT192DXEUK, CT192SXUK, CT192DXV, CT192SXV, CT240DXE, CT240SXE, CT240DXEUK, CT240SX, CT240DXV, CT240SXVUK...(Other models you can see in the webshop)		

washing and rinsing systems



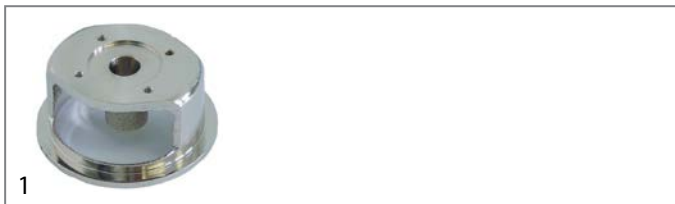

1			
GEV No.	504529	Ref. No.	048246 048401
description	bush		
For models:	LS61, LS61/60, LS6EP, LS6EP/DD, LS6EADD, LS6EA/DPDD, WT38T-DE, WT38/M50, LS6EADP3, LS6EADPWS, LS6EADPWG, WT38WS, WT38WSG, WT38MEDWS, WT38PM50, WT37LEV/9, LS6EADPDWS, WT38DWS, LS6SANA, EUCAI, EUCAIDP, EUCAI60, EUCAIWS, WT38M50/4, LS6EA/UK, LS6EA/DPUK, EUCAIG, EUCAIWSG, EUCAIML, EUCAIMLWS, EUCAIMLG, EUCAICL, EUCAICLG, EUCAIWL, LS6EA/60, EUCAICLW, EUCAI, EUCAIM, EUCAIM60, EUCAIDPNW, ZUCI, ZUCID, ZUCAI, ZUCAIDP, ZUCAIDPWS, ZUCAIG, ZUCAIDDWS, ZUCAID, ZUCAI60, EUCAIUSPH6...(Other models you can see in the webshop)		





1			
GEV No.	504550	Ref. No.	046362
description	bush		
For models:	LS360F, LS360DK, LS365F, LS365, LS365PH, LS540F, LS540DK, LS541F, LS360D, LS365D, LS360, LS365, LS360/63, LS365/63, LS367, LS720F, LSE720DK, LSE720PH, LS860F, LS860DK, LS860PH, LS1080F, LS1080UK, LS1080PH, LSE721F, LS861F, LS540, LS1080M, LS1080, LS1080D, LS1080UK, LS1080/63, LS540D, LS540/63, LSE721, LS720, LSE720UK, LS721UK, LSE720D, LS541, LS860, LS860, LS860D, LS860UK, LS861UK, LS860/63, LS861, LS360, LS365F, LS540...(Other models you can see in the webshop)		



			
1			
GEV No.	693407	Ref. No.	007024 0C5103
description	bush for wash arm		
For models:	FCZ061EAA, FCZ101EAA, FCZ102EAA, FCZ201EAA, FCZ202EAA, FCZ061EAH, FCZ101EAH, FCZ201EAH, FCZ061EAN, FCZ101EAN, FCZ201EAN, FCZ101GAG, FCZ102GAG, FCZ201GAG, FCZ202GAG, FCZ101GAD, FCZ102GAD, FCZ201GAD, FCZ202GAD, FCZ061ECA, FCZ101ECA, FCZ102ECA, FCZ201ECA, FCZ202ECA, FCZ061ECH, FCZ101ECH, FCZ201ECH, FCZ061ECN, FCZ101ECN, FCZ201ECN, FCZ101GCG, FCZ102GCG, FCZ201GCG, FCZ202GCG, FCZ101GCD, FCZ102GCD, FCZ201GCD, FCZ202GCD, AOS061GAEU, AOS101GAEU, AOS102GAEU, AOS201GAEU, AOS202GAEU, AOS061GAAU, AOS101GAAU, AOS102GAAU, AOS201GAAU, AOS202GAAU, AOW101EA, AOS061EABU...(Other models you can see in the webshop)		

			
1			
GEV No.	504542	Ref. No.	047991 549611100
description	connector holder		
For models:	LS510, LS520, LS520D, LS520F, LS520M, LS520K, LS521, LS521D, LS521F, LS521M, LS521K, LS521, C51, C52		

			
1			
GEV No.	518623	Ref. No.	065507
description	bush ø 42.5mm W 59mm H 24.7mm ID ø 15.5mm		
For models:	LS500F, LS501F, LS500F, LS500UK, LS501, LS501UK, LS500, LS501		

			
1			
GEV No.	510016	Ref. No.	069517 069646 486002
description	eye bolt for rinse aid container connection		
For models:	LTB11, LTB12, LTB22, LTB11UK, LTB12UK, LTB22UK, LTB11, LTB22, 910-00-021, 910-00-023, 910-00-031, 910-00-033, 911-00-022, 911-00-024, 911-00-032, 911-00-034, CRYSTAL 11, CRYSTAL 22		

			
1			
GEV No.	504504	Ref. No.	049042
description	bush wash arm		
For models:	LB1, LB1WS, LB1WSDP, LB1/RBP, LB1/TOP, LB1/60, WT1WSDP, LB2D-PSAUS, LB1G, LB1WSG, WT2TOP60, WT2DPDI, WT2WSDPDI, LB1TOP, WT2TOPDI, LB2WS, LB2, LB2WSDP, LB2/TOP, LB2/RBP, LB2WS60, WT2WSDP, WT2WSDPD, LB2WSG, WT2WS, WT1, WT1WS, WT1TOP, WT2TOP, WT1/3DP, WT2/3DP, WT2DPAUS, WT2, LB2DPDI, LB2WSDPDI, LB2WSDPDI, LB2TOP, LB2DP3, WT2DPD3, NGW, NGWDPDD, UC1, UC2WS, GW1, GW1WS, LV1WS, LV1WSDP, LV2WSDP, LV2WS, GW2D-PG...(Other models you can see in the webshop)		

			
1			
GEV No.	504331	Ref. No.	0E6005
description	gasket for wash arm rubber ø 78mm ID ø 50mm		
For models:	RT190ED, RT190ES, RT190SR, RT190SL, RT190HDED, RT190HDES, RT190HSR, RT190HSL, RT270ED, RT270ES, RT270SR, RT270SL, RT270HDED, RT270HDES, RT270HSR, RT270HSL, RT142ERF, RT142ELF, RT190ERF, RT190ELF, RT190VD, RT190VS, RT190HERF, RT190HELF, RT190HDVDF, RT190HDVSF, RT270ERF, RT270ELF, RT270VDF, RT270VSF, RT270HERF, RT270HELF, RT270HDVDF, RT270HDVSF, RT190ERG, RT190ELG, RT190VDU, RT190VSU, RT190HERG, RT190HELG, RT190HDVDU, RT190HDVSU, RT270ERG, RT270ELG, RT270VDU, RT270VSU, RT270HERG, RT270HELG, RT270HDVDU, RT270HDVSU...(Other models you can see in the webshop)		

			
1			
GEV No.	504515	Ref. No.	049294
description	connector holder		
For models:	LS32, LS32/4.5, LS32UK/RP, LS32F, LV32F, C55, LV32/60, WT4, WT4B, WT4D, WT302, WT302/4.5, WT302UK/RP, WT302F, WT302/60, WT4DB, WT46, WT4DG, WT4WS1, LS33, LS33/4.5, LS33UK/RP, LS33F, LV33F, C55A, LS33/60, WT4BWS, WT4DWS1, WT4BDWS, WT303, WT303/4.5, WT303UK/RP, WT303F, WT303/60, NUC3DD, WT4D60, WT4DDG, EUC1, EUC1DP, EUC1WS, EUC1DPWS, EUC3, EUC3WS, EUC3DP, EUC3DPWS, EUC1G, EUC1DP60, EUC3DD, ZUCADDROW, ZUCADDROW6...(Other models you can see in the webshop)		

			
1			
GEV No.	504308	Ref. No.	0L0110
description	gasket with notch rubber ø 120mm ID ø 88mm thickness 1mm		
For models:	WT4, WT4B, WT4D, WT4DB, WT46, WT4DG, WT4WS1, WT4BWS, WT4DWS1, WT4BDWS, NUC3DD, WT4D60, WT4DDG, EUC1, EUC1DP, EUC1WS, EUC1DPWS, EUC3, EUC3WS, EUC3DP, EUC3DPWS, EUC1G, EUC1DP60, EUC3DD, ZUCADDROW, ZUCADDROW6, LS5/1, LS5/1DP, LS5/1WS, LS5/1WSDP, LS5/3, LS5/3DP, LS5/3WS, LS5/3WSDP, FUCA3DD, LS5/3WSDPD, LB5DPG, LS5/1DP60, LS5/1DPAUS, LS5/1DPCS, KUC3, KUC3DP, NUC1, NUC1DP, NUC1WS, NUC1DPWS, NUC3, NUC3WS, NUC3DP, NUC3DPWS...(Other models you can see in the webshop)		

			
1			
GEV No.	698501	Ref. No.	0C4681
description	hexagonal screw thread M22 L 12mm WS 36		
For models:	FCS101EX4J, FCS101EXLN, FCS101EX, FCS102EX4J, FCS102EX, FCS201EX, FCS201EXLN, FCS202EX, FCS101GX9J, FCS101GX, FCS102GX9J, FCS102GX, FCS201GX, FCS202GX		

			
1			
GEV No.	504261	Ref. No.	0L0077
description	hose ø 63/53mm L 230mm L-shape		
For models:	RT100ED, RT100ES, RT100SR, RT100SL, RT140ED, RT140ES, RT140SR, RT140SL, RT190ED, RT190ES, RT190SR, RT190SL, RT190HDED, RT190HDES, RT190HSR, RT190HSL, RT270ED, RT270ES, RT270SR, RT270SL, RT270HDED, RT270HDES, RT270HSR, RT270HSL, RT100ERF, RT100ELF, RT100VD, RT100VS, RT140ERF, RT140ELF, RT140VD, RT140VS, RT142ERF, RT142ELF, RT190ERF, RT190ELF, RT190VD, RT190VS, RT190HERF, RT190HELF, RT190HDVDF, RT190HDVSF, RT270ERF, RT270ELF, RT270VDF, RT270VSF, RT270HERF, RT270HELF, RT270HDVDF, RT270HDVSF...(Other models you can see in the webshop)		

			
1			
GEV No.	504503	Ref. No.	049047
description	knurled nut thread M10x1 ø 30mm H 4mm SS		
For models:	LB1, LB1WS, LB1WSDP, LB1/RBP, LB1/TOP, LB1/60, WT1WSDP, LB2DPSAUS, LB1G, LB1WSG, WT2TOP60, WT2DPDI, WT2WSDPDI, LB1TOP, WT2TOPDI, LB2WS, LB2, LB2WSDP, LB2/TOP, LB2/RBP, LB2WS60, WT2WSDP, WT2WSDPD, LB2WSG, WT2WS, WT1, WT1WS, WT1TOP, WT2TOP, WT1/3DP, WT2/3DP, WT2DPAUS, WT2, LB2DPDI, LB2WSDPDI, LB2WSDPD, LB2TOP, LB2DP3, WT2DPD3, NGW, NGWDPDD, UC1, UC2WS, GW1, GW1WS, LV1WS, LV1WSDP, LV2WSDP, LV2WS, GW2DPG...(Other models you can see in the webshop)		

			
1			
GEV No.	504528	Ref. No.	048632 0E5638
description	knurled nut thread M12x1 ø 35mm H 6mm SS		
For models:	LS61, LS61/60, LS6EP, LS6EP/DD, LS6EADD, LS6EA/DPDD, WT38TDE, WT38/M50, LS6EADP3, LS6EADPWS, LS6EADPWSG, WT38WS, WT38WSG, WT38MEDWS, WT38PM50, WT37LEV/9, LS6EADPDWS, WT38DWS, LS6SANA, EUCAI, EUCAIDP, EUCAI60, EUCAIWS, WT38M50/4, LS6EA/UK, LS6EA/DPUK, EUCAIG, EUCAIWSG, EUCAIML, EUCAIMLWS, EUCAIMLG, EUCAICL, EUCAICLG, EUCAIWL, LS6EA/60, EUCAICLW, EUCI, EUCIM, EUCIM60, EUCAIDPNW, ZUCI, ZUCID, ZUCAI, ZUCAIDP, ZUCAIDPWS, ZUCAIG, ZUCAIDDWS, ZUCAID, ZUCAI60, EUCAIUSPH6...(Other models you can see in the webshop)		

			
1			
GEV No.	504516	Ref. No.	046364 047282 089817
description	knurled nut thread M8x1 ø 25mm H 6mm SS		
For models:	LS32, LS32/4.5, LS32UK/RP, LS32F, LV32F, C55, LV32/60, WT4, WT4B, WT4D, WT302, WT302/4.5, WT302UK/RP, WT302F, WT302/60, WT4DB, WT46, WT4DG, WT4WS1, LS33, LS33/4.5, LS33UK/RP, LS33F, LV33F, C55A, LS33/60, WT4BWS, WT4DWS1, WT4BDWS, WT303, WT303/4.5, WT303UK/RP, WT303F, WT303/60, NUC3DD, WT4D60, WT4DDG, EUC1, EUC1DP, EUC1WS, EUC1DPWS, EUC3, EUC3WS, EUC3DP, EUC3DPWS, EUC1G, EUC1DP60, EUC3DD, ZUCADDROW, ZUCADDROW6...(Other models you can see in the webshop)		

			
1			
GEV No.	504547	Ref. No.	046365 047283 0TR534
description	knurled nut thread M8x1 ø 25mm H 6mm SS		
For models:	LS360F, LS360DK, LS365F, LS365, LS365PH, LS540F, LS540DK, LS541F, LS360D, LS365D, LS360, LS365, LS360/63, LS365/63, LS367, LS720F, LSE720DK, LSE720PH, LS860F, LS860DK, LS860PH, LS1080F, LS1080UK, LS1080PH, LSE721F, LS861F, LS540, LS1080M, LS1080, LS1080D, LS1080UK, LS1080/63, LS540D, LS540/63, LSE721, LS720, LSE720UK, LS721UK, LSE720D, LS541, LS860, LS860, LS860D, LS860UK, LS861UK, LS860/63, LS861, WT40/9, WT40/F, LS10D...(Other models you can see in the webshop)		

			
1			
GEV No.	504339	Ref. No.	0E5423 0K8724
description	manifold L 77mm grommet ø 13.5mm grommet length 30mm		
For models:	PW2MUK, WT850MUK, FT36EDTS, FT36ESTS, FT36VDTS, FT36VSTS, FT36ED, FT36ES, FT36VD, FT36VS, FT50ED, FT50ES, FT50VD, FT50VS, FT72ED, FT72ES, FT72VD, FT72VS, FT36EDT, FT36EST, FT36VDT, FT36VST, FT50EDT, FT50EST, FT50VDT, FT50VST, FT72EDT, FT72EST, FT72VDT, FT72VST, FT36WED, FT36WES, FT36WVD, FT36WVS, FT50WED, FT50WES, FT50WVD, FT50WVS, FT72WED, FT72WES, FT72WVD, FT72WVS, FT36WEDT, FT36WEST, FT36WVDT, FT36WVST, FT50WEDT, FT50WEST, FT50WVDT, FT50WVST...(Other models you can see in the webshop)		



			
1			
GEV No.	504272	Ref. No.	049596 OL0557
description	nut		
For models:	WT60/GJ60, WT60/GJ50, PH10/12-RP, LS10, LS14EA, LS10UKDP, ET12E, LS10/60HZ, LS10CW, LS10INS, HT1200INS, LS14EAI, LS10N, LS10DP, LS10HD, LS14EAI/AU, LS14EA/60, LS10UK/1, LS10UK/3, LS12INS, LS12, LS12DP, LS12/60HZ, LS12CW, HT1200DEK, LS14EAASIA, LS14EA/G, WT60DP, WT60, WT60CW, WT60UKDPCW, WT60INS, WT60INSCW, WT60NAUCW, WT60NAU, LS10EA, WT60/60HZ, WT60/60HZC, WT60N, WT609NINS, LS12HD, LS14EAI/DD, WT65E, WT65EB, WT65EI, WT60NAUDP, LS12UK/3CW, LS12NAU, LS12UKDPCW, ECOTEMP12S... (Other models you can see in the webshop)		

			
1			
GEV No.	504523	Ref. No.	048824
description	nut for wash arm support		
For models:	LS32, LS32/4.5, LS32UK/RP, LS32F, LV32F, C55, LV32/60, WT4, WT4B, WT4D, WT302, WT302/4.5, WT302UK/RP, WT302F, WT302/60, WT4DB, WT46, WT4DG, WT4WS1, LS33, LS33/4.5, LS33UK/RP, LS33F, LV33F, C55A, LS33/60, WT4BWS, WT4DWS1, WT4BDWS, WT303, WT303/4.5, WT303UK/RP, WT303F, WT303/60, NUC3DD, WT4D60, WT4DDG, EUC1, EUC1DP, EUC1WS, EUC1DPWS, EUC3, EUC3WS, EUC3DP, EUC3DPWS, EUC1G, EUC1DP60, EUC3DD, ZUCADDROW, ZUCADDROW6... (Other models you can see in the webshop)		

			
2			
GEV No.	504555	Ref. No.	047891
description	nut		
For models:	LS540F, LS540DK, LS541F, LS720F, LSE720DK, LSE720PH, LS860F, LS860DK, LS860PH, LS1080F, LS1080UK, LS1080PH, LSE721F, LS861F, LS540, LS1080M, LS1080, LS1080D, LS1080UK, LS1080/63, LS540D, LS540/63, LSE721, LS720, LSE720UK, LS721UK, LSE720D, LS541, LS860, LS860, LS860D, LS860UK, LS861UK, LS860/63, LS861, LS540, 652120Z, LS860, LS1080, ALS540, LS720N, LS860, DMAST2CUK, LSE720Z, LS860, LS1080, LS860, LS1080		

			
1			
GEV No.	504536	Ref. No.	048237 0KE908
description	nut for wash arm support		
For models:	LU7PDP, LU7ADP, LU7ADPWS, WTU40PDP, WTU40ADP, WTU40ADPWS, WTU40ADPD, LS10D, LS10, LS10UKRP, LC100, LS10/60, LS10/1, LS10/12KW, LS10F, LS10DEK, LS10/1UKRP, LS10SW, LS10/50J, LS10/60J, LS10DP, LS10/HD, SH55, LO10, LS10/UK1, LS10/UK3, LS12D, LS12, LS12UK/RP, LC120, LS12DP, LS12/60, LS12F, LS12DEK, LS12HD, WT60/GJ60, WT60/GJ50, PH10/12-RP, LS12/UK3, ECOTEMP12INS, LS12MEX, LS10N, LS10, LS14EA, LS10UKDP, ET12E, LS10/60HZ, LS10CW, LS10INS, HT1200INS... (Other models you can see in the webshop)		

			
1			
GEV No.	504506	Ref. No.	049039
description	nut for wash arm support		
For models:	LB1, LB1WS, LB1WSDP, LB1/RBP, LB1/TOP, LB1/60, WT1WSDP, LB2D-PSAUS, LB1G, LB1WSG, WT2TOP60, WT2DPDI, WT2WSDPDI, LB1TOP, WT2TOPDI, LB2WS, LB2, LB2WSDP, LB2/TOP, LB2/RBP, LB2WS60, WT2WSDP, WT2WSDPD, LB2WSG, WT2WS, WT1, WT1WS, WT1TOP, WT2TOP, WT1/3DP, WT2/3DP, WT2DPAUS, WT2, LB2DPDI, LB2WSDPDI, LB2WSDPD, LB2TOP, LB2DP3, WT2DPD3, NGW, NGWDPDD, UC1, UC2WS, GW1, GW1WS, LV1WS, LV1WSDP, LV2WSDP, LV2WS, GW2DPG... (Other models you can see in the webshop)		

			
1			
GEV No.	504505	Ref. No.	049043
description	nut wash arm		
For models:	LB1, LB1WS, LB1WSDP, LB1/RBP, LB1/TOP, LB1/60, WT1WSDP, LB2D-PSAUS, LB1G, LB1WSG, WT2TOP60, WT2DPDI, WT2WSDPDI, LB1TOP, WT2TOPDI, LB2WS, LB2, LB2WSDP, LB2/TOP, LB2/RBP, LB2WS60, WT2WSDP, WT2WSDPD, LB2WSG, WT2WS, WT1, WT1WS, WT1TOP, WT2TOP, WT1/3DP, WT2/3DP, WT2DPAUS, WT2, LB2DPDI, LB2WSDPDI, LB2WSDPD, LB2TOP, LB2DP3, WT2DPD3, NGW, NGWDPDD, UC1, UC2WS, GW1, GW1WS, LV1WS, LV1WSDP, LV2WSDP, LV2WS, GW2DPG... (Other models you can see in the webshop)		

			
1			
GEV No.	504517	Ref. No.	048330
description	nut for wash arm support		
For models:	LS32, LS32/4.5, LS32UK/RP, LS32F, LV32F, C55, LV32/60, WT4, WT4B, WT4D, WT302, WT302/4.5, WT302UK/RP, WT302F, WT302/60, WT4DB, WT46, WT4DG, WT4WS1, LS33, LS33/4.5, LS33UK/RP, LS33F, LV33F, C55A, LS33/60, WT4BWS, WT4DWS1, WT4BDWS, WT303, WT303/4.5, WT303UK/RP, WT303F, WT303/60, NUC3DD, WT4D60, WT4DDG, EUC1, EUC1DP, EUC1WS, EUC1DPWS, EUC3, EUC3WS, EUC3DP, EUC3DPWS, EUC1G, EUC1DP60, EUC3DD, ZUCADDROW, ZUCADDROW6... (Other models you can see in the webshop)		

			
1			
GEV No.	693409	Ref. No.	007026
description	retainer clip for wash arm		
For models:	FCZ061EAA, FCZ101EAA, FCZ102EAA, FCZ201EAA, FCZ202EAA, FCZ061EAH, FCZ101EAH, FCZ201EAH, FCZ061EAN, FCZ101EAN, FCZ201EAN, FCZ061ETA, FCZ101ETA, FCZ201ETA, FCZ201ETA, FCZ202ETA, FCZ061ETH, FCZ101ETH, FCZ201ETH, FCZ061ETN, FCZ101ETN, FCZ201ETN, FCZ061GAG, FCZ101GAG, FCZ102GAG, FCZ201GAG, FCZ202GAG, FCZ061GAD, FCZ101GAD, FCZ102GAD, FCZ201GAD, FCZ202GAD, FCZ101GTG, FCZ102GTG, FCZ201GTG, FCZ202GTG, FCZ101GTD, FCZ102GTD, FCZ201GTD, FCZ202GTD, FCZ061EBA, FCZ101EBA, FCZ102EBA, FCZ061EBH, FCZ101EBH, FCZ061EBN, FCZ101EBN, FCZ061EBC, FCZ101EBC, FCZ201EBC... (Other models you can see in the webshop)		



1

GEV No.	518003	Ref. No.	069444 447128
description	screw cap		
For models:	LTB11, LTB12, LTB22, LTB11UK, LTB12UK, LTB22UK, LTB11, LTB22, CRYSTAL 11, CRYSTAL 22		



1

GEV No.	510011	Ref. No.	069497 429008
description	screw connection plastic		
For models:	LTB11, LTB12, LTB22, LTB11UK, LTB12UK, LTB22UK, LTB11, LTB22, CRYSTAL 11, CRYSTAL 22		



1

GEV No.	504520	Ref. No.	048820 0KE924
description	throttle disc		
For models:	LS32, LS32/4.5, LS32UK/RP, LS32F, LV32F, C55, LV32/60, WT4, WT4B, WT4D, WT302, WT302/4.5, WT302UK/RP, WT302F, WT302/60, WT4DB, WT46, WT4DG, WT4WS1, LS33, LS33/4.5, LS33UK/RP, LS33F, LV33F, C55A, LS33/60, WT4BWS, WT4DWS1, WT4BDWS, WT303, WT303/4.5, WT303UK/RP, WT303F, WT303/60, NUC3DD, WT4D60, WT4DDG, EUC1, EUC1DP, EUC1WS, EUC1DPWS, EUC3, EUC3WS, EUC3DP, EUC3DPWS, EUC1G, EUC1DP60, EUC3DD, ZUCADDROW, ZUCADDROW6...(Other models you can see in the webshop)		



1

GEV No.	504530	Ref. No.	048238 048645 048931
description	throttle disc		
For models:	LS7D, LS7, LS7UK/RP, LV70, LS7F, LS7DEK, LS7/1UK, LS7/60, WT40/9, WT40/F, LS10D, LS10, LS10UKRP, LC100, LS10/60, LS10/1, LS10/12KW, LS10F, LS10DEK, LS10/1UKRP, LS10SW, LS10DP, LS10/HD, LS10/UK1, LS10/UK3, LS12D, LS12, LS12UK/RP, LC120, LS12DP, LS12/60, LS12F, LS12DEK, LS12HD, LS12/UK3, ECOTEMP12INS, LS12MEX, LS10N, LS10, LS14EA, LS10UKDP, ET12E, LS10/60HZ, LS10CW, LS10INS, HT1200INS, LS14EAI, LS10N, LS10DP, LS10HD...(Other models you can see in the webshop)		



1

GEV No.	518243	Ref. No.	047275
description	throttle disc for wash arm ED ø 48mm ID ø 30mm thickness 1mm		
For models:	CT92DXE, CT92SXE, CT92DXEUK, CT92SXEUK, CT92DXV, CT92SXV, CT92DXVUK, CT92SXVUK, CT140EDX, CT140ESX, CT140EDXUK, CT140SXUK, CT140VDS, CT140VDSX, CT141EDX, CT141ESX, CT141E-DUK, CT141ESUK, CT141VDS, CT141VDSX, CT142DXE, CT142SXE, CT142DXEUK, CT142SXEUK, CT142DXV, CT142SXV, CT190DXE, CT190SXE, CT190DXEUK, CT190SXEUK, CT190DXV, CT190SXV, CT191DXE, CT191SXE, CT191DXEUK, CT191SXEUK, CT191DXV, CT191SXV, CT192DXE, CT192SXE, CT192DXEUK, CT192SXEUK, CT192DXV, CT192SXV, CT240DXE, CT240SXE, CT240DXEUK, CT240SX, CT240DXV, CT240SXVUK...(Other models you can see in the webshop)		



1

GEV No.	510112	Ref. No.	069440 454002
description	Thumb screw thread M10 thread L 10mm ø 22mm H 4.5mm SS		
For models:	LTB11, LTB12, LTB22, LTB11UK, LTB12UK, LTB22UK, LTB11, LTB22, CRYSTAL 11, CRYSTAL 22		



1

GEV No.	524502	Ref. No.	0H2292 0K7334 0K7455 0K7572
description	wash arm bearing mounting pos. lower ø 20mm D2 ø 16.5mm H 10mm		
For models:	D480, D480, D180, D180, D180, D180, D180, D180, D180, D180, D180, D180, D180, D180, D180, D180, D180		



1

GEV No.	503170	Ref. No.	048239
description	wash arm bearing ø 14mm D2 ø 12.2mm thread M16 WS 19		
For models:	LS7D, LS7, LS7UK/RP, LV70, LS7F, LS7DEK, LS7/1UK, LS7/60, WT40/9, WT40/F, LC100, LS10F, LS8D, LS8, LS8UK/RP, LC80, LS8F, LS8DEK, LS8/9, LS8/60, LS8/1UKRP, WT50/9, WT50/UK9RF, WT50/F9, WT50/6, WT50/1UKRP, WT50/1, FL700, HT800, HYDRA700, HYDRA800, Z70, Z80		





			
GEV No.	693405	Ref. No.	007009
description	wash arm support		
For models:	FCZ061EAA, FCZ101EAA, FCZ102EAA, FCZ061EAH, FCZ101EAH, FCZ061EAN, FCZ101EAN, FCZ061GAG, FCZ101GAG, FCZ102GAG, FCZ061GAD, FCZ101GAD, FCZ102GAD, FCZ061ECA, FCZ101ECA, FCZ102ECA, FCZ061ECH, FCZ101ECH, FCZ061ECN, FCZ101ECN, FCZ-061GCG, FCZ101GCG, FCZ102GCG, FCZ061GCD, FCZ101GCD, FCZ-102GCD, AOS061GAEU, AOS101GAEU, AOS061GAU, AOS101GAU, AOW101EA, AOS061EA, AOS101EA, AOS201EA, AOS061EA3J, AOS101EA3J, AOS201EA3J, AOS061EA2N, AOS101EA2N, AOS201EA2N, AOS061EA0H, AOS101EA0H, AOS201EA0H, AOS-061GA, AOS101GA, AOW101EABU, AOS061EAAQ, AOS101EAAQ, AOS102EAAQ, AOS061EANQ...(Other models you can see in the webshop)		

			
GEV No.	693406	Ref. No.	007025 0C4197 0C5293
description	wash arm support		
For models:	FCZ061EAA, FCZ101EAA, FCZ102EAA, FCZ201EAA, FCZ202EAA, FCZ061EAH, FCZ101EAH, FCZ201EAH, FCZ061EAN, FCZ101EAN, FCZ201EAN, FCZ061GAG, FCZ101GAG, FCZ102GAG, FCZ201GAG, FCZ202GAG, FCZ061GAD, FCZ101GAD, FCZ102GAD, FCZ201GAD, FCZ202GAD, FCZ061ECA, FCZ101ECA, FCZ102ECA, FCZ201ECA, FCZ202ECA, FCZ061ECH, FCZ101ECH, FCZ201ECH, FCZ061ECN, FCZ101ECN, FCZ201ECN, FCZ061GCG, FCZ101GCG, FCZ102GCG, FCZ201GCG, FCZ202GCG, FCZ061GCD, FCZ101GCD, FCZ102GCD, FCZ201GCD, FCZ202GCD, AOS061GAEU, AOS101GAEU, AOS-102GAEU, AOS201GAEU, AOS202GAEU, AOS061GAU, AOS101GAU, AOS102GAU...(Other models you can see in the webshop)		

			
GEV No.	507411	Ref. No.	046860
description	wash jet		
For models:	CT92DXE, CT92SXE, CT92DXEUK, CT92SXEUK, CT92DXV, CT92SXV, CT92DXVUK, CT92SXVUK, CT140EDX, CT140ESX, CT140EDXUK, CT140SXEUK, CT140VDX, CT140VSX, CT141EDX, CT141ESX, CT141E- DUK, CT141ESUK, CT141VDX, CT141VSX, CT142DXE, CT142SXE, CT142DXEUK, CT142SXEUK, CT142DXV, CT142SXV, CT190DXE, CT190SXE, CT190DXEUK, CT190SXEUK, CT190DXV, CT190SXV, CT-191DXE, CT191SXE, CT191DXEUK, CT191SXEUK, CT191DXV, CT191SXV, CT192DXE, CT192SXE, CT192DXEUK, CT192SXEUK, CT192DXV, CT192SXV, CT240DXE, CT240SXE, CT240DXEUK, CT240SX, CT240DXV, CT240SXVUK...(Other models you can see in the webshop)		

			
GEV No.	504312	Ref. No.	049291 0L0125
description	wash pipe		
For models:	LS32, LS32/4.5, LS32UK/RP, LS32F, LV32F, C55, LV32/60, WT4, WT4B, WT4D, WT302, WT302/4.5, WT302UK/RP, WT302F, WT302/60, WT4DB, WT46, WT4DG, WT4WS1, LS33, LS33/4.5, LS33UK/RP, LS33F, LV33F, C55A, LS33/60, WT4BWS, WT4DWS1, WT4BDWS, WT303, WT303/4.5, WT303UK/RP, WT303F, WT303/60, NUC3DD, WT4D60, WT4DDG, EUC1, EUC1DP, EUC1WS, EUC1DPWS, EUC3, EUC3WS, EUC3DP, EUC3DPWS, EUC1G, EUC1DP60, EUC3DD, ZUCADDROW, ZUCADDROW6...(Other models you can see in the webshop)		

			
GEV No.	504560	Ref. No.	046400
description	wash pipe		
For models:	LS360F, LS360DK, LS365F, LS365, LS365PH, LS360D, LS365D, LS360, LS365, LS360/63, LS365/63, LS367, LS360, LS365F, HB3PNT		

			
GEV No.	524808	Ref. No.	049946
description	wash pipe L 510mm plastic suitable for ELECTROLUX with wash arm support		
For models:	WT1WSDP, WT2TOP60, WT2DPDI, WT2WSDPDI, WT2TOPDI, LB2WS, LB2, LB2WSDP, WT2WSDP, WT2WSDPD, WT2WS, WT2TOP, WT2/3DP, WT2DPAUS, WT2, LB2DPDI, LB2WSDPDI, LB2WSDPD, LB2TOP, LB2DP3, WT2DPD3, NGW, NGWDPDD, GW2DPG, GW2WSDPG, GW2G, GW2WSG, GW2WS, GW2		

			
GEV No.	518102	Ref. No.	048822 0L0095 830623602
description	wash pipe L 700mm with rinse arm shaft		
For models:	LS61, LS61/60, LS6EP, LS6EP/DD, LS6EADD, LS6EA/DPDD, WT38TDE, WT38/M50, LS6EADP3, WT38PM50, WT37LEV/9, LS6SANA, EUCAI, EUCAIDP, EUCAI60, WT38M50/4, LS6EA/UK, LS6EA/DPUK, EUCAIG, EUCAIML, EUCAIMLG, EUCAICL, EUCAICLG, EUCAIWL, LS6EA/60, EUCAICLW, EUCI, EUCIM, EUCIM60, EUCAIDPNW, ZUCI, ZUCID, ZUCAI, ZUCAIDP, ZUCAIG, ZUCAID, ZUCAI60, EUCAIUSPH6, ZUCAIDD, EUCAIDD, EUCAIDPJ, EUCAIDPJ60, LS62, LS62D, LS62/UKRP, LS62F, LV62, LS62/60, ECOTEMP5, LS62/1P...(Other models you can see in the webshop)		

			
GEV No.	504334	Ref. No.	049595 0I0556 0L0556
description	wash pipe L 985mm plastic		
For models:	WT60/GJ60, WT60/GJ50, PH10/12-RP, LS10, LS14EA, LS10UKDP, ET12E, LS10/60HZ, LS10CW, LS10INS, HT1200INS, LS14EAI, LS10N, LS10DP, LS10HD, LS14EAI/AU, LS14EA/60, LS10UK/1, LS10UK/3, LS12INS, LS12, LS12DP, LS12/60HZ, LS12CW, HT1200DEK, LS14EAASIA, LS14EA/G, WT60DP, WT60, WT60CW, WT60UKDPCW, WT60INS, WT60INSCW, WT60NAUCW, WT60NAU, LS10EA, WT60/60HZ, WT60/60HZC, WT60N, WT609NINS, LS12HD, LS14EAI/DD, WT65E, WT65EB, WT65EI, WT60NAUDP, LS12UK/3CW, LS12NAU, LS12UKDPCW, ECOTEMP12S...(Other models you can see in the webshop)		



GEV No.	524021	Ref. No.	0HA121
description	wash pipe mounting pos. upper/lower		



GEV No.	519577	Ref. No.	049945
description	wash pipe ø 24mm L 430mm plastic suitable for ELECTROLUX		
For models:	LB1, LB1WS, LB1WSDP, WT1WSDP, LB1TOP, WT1, WT1WS, WT1TOP, WT1/3DP, GW1, GW1WS		



GEV No.	504634	Ref. No.	046542
description	wash pipe ø 60mm L 400mm		
For models:	LS860F, LS860DK, LS860PH, LS1080F, LS1080UK, LS1080PH, LS861F, LS1080M, LS1080, LS1080D, LS1080UK, LS1080/63, LS860, LS860, LS860D, LS860UK, LS861UK, LS860/63, LS861, LS860, LS1080, LS860, DMAST2CUK, LS860, LS1080, LS860, LS1080		



GEV No.	504258	Ref. No.	0E2969 OK8394 30200010
description	wash pipe ø 63mm L 185mm L-shape		
For models:	FT36EDTS, FT36ESTS, FT36VDTs, FT36VSTs, FT36ED, FT36ES, FT36VD, FT36VS, FT50ED, FT50ES, FT50VD, FT50VS, FT72ED, FT72ES, FT72VD, FT72VS, FT36EDT, FT36EST, FT36VDT, FT36VST, FT50EDT, FT50EST, FT50VDT, FT50VST, FT72EDT, FT72EST, FT72VDT, FT72VST, WTF2ERC, WTF2ELC, WTF2SRC, WTF2SLC, WTF2HERC, WTF2HEL, WTF2HSRC, WTF2HSLC, WTF3ERC, WTF3ELC, WTF3SRC, WTF3SLC, WTF3HERC, WTF3HEL, WTF3HSRC, WTF3HSLC, WTF2ERB., WTF2ELB, WTF2SRB, WTF2SLB, WTF2HERB, WTF2HELB...(Other models you can see in the webshop)		

washing and rinsing systems (sorted by producer)

ELECTROLUX

rinse jets



GEV No.	519573	Ref. No.	045753
description	rinse jet thr.ø 9.6mm WS 13 ID ø 2.8mm		
For models:	LO/E480, PLO480/E, LO480EUK, LO480E/63, LO480VAPORESTD, PLO480V, LO480V/63-60HZ, LO/E250, PLO250E, LO/E250UK, LO250E/63, LOPE25, LOPE48, LO480Z-VAPORE		

wash arm fixings



GEV No.	519574	Ref. No.	075627
description	retaining ring ED ø 50.1mm ID ø 18.5mm thickness 10mm		
For models:	LO/E480, PLO480/E, LO480EUK, LO480E/63, LO480VAPORESTD, PLO480V, LO480V/63-60HZ, LO/E250, PLO250E, LO/E250UK, LO250E/63, LOPE25, LOPE48, LO480Z-VAPORE		



GEV No.	519570	Ref. No.	065502
description	wash arm support ø 43.5mm ED ø 76.4mm ID ø 37.5mm thickness 3mm L 190mm		
For models:	LS500F, LS501F, LS500F, LS500UK, LS501, LS501UK, LS500, LS501		

wash pipes



















GEV No.	699255	Ref. No.	0C4322 0C5369
description	service kit wash pipe		
For models:	FCZ202EAA, FCZ202ECA, AOS202EAAQ, AOS202EANQ, AOS202EAA1, AOS202EAM1, AOS202EAB1, AOS202EAK1, AOS202ECA1, EJN202EAA, EJN202ECA		







GEV No.	504858	Ref. No.	0L2821 0L3470
description	wash pipe L 840mm suitable for ELECTROLUX		





ZANUSSI			
 <p>1</p>			
GEV No.	510119	Ref. No.	069576 0H1291 990008
description	wash and rinse arm wash arm L 410mm rinse arm L 410mm w. jets 7 r. jets 5 mounting ø 16.5mm mounting pos. lower		
For models:	LTB11, LTB12, LTB22, LTB11UK, LTB12UK, LTB22UK, LTB11, LTB22, CRYSTAL 11, CRYSTAL 22		
spare parts for	510119		
	GEV No.	510010	Ref. No. 069452 129039
wash arm boss L1 64mm L2 60mm mounting ø 16.5mm			
	GEV No.	510130	Ref. No. 069450 0H1283 0H3806 429006
union nut for rinse jet			
	GEV No.	510131	Ref. No. 069448 0H1284 0H3804 0K3818 429007
union nut for wash jet			
	GEV No.	510138	Ref. No. 0T4075 140013
wash jet fine groove			
	GEV No.	510139	Ref. No. 069451 0K3717 140007
rinse jet			
	GEV No.	518004	Ref. No. 069449 0H1268 0H3805 0K3718 140008
wash jet			
	GEV No.	518382	Ref. No. —
wash arm mounting pos. right L 175mm mounting ø 24mm nozzles 4			
	GEV No.	518383	Ref. No. —
rinse arm mounting pos. left L 175mm mounting ø 13mm nozzles 2			
	GEV No.	518384	Ref. No. —
rinse arm mounting pos. right L 175mm mounting ø 13mm nozzles 3			
	GEV No.	518631	Ref. No. —
wash arm mounting pos. left L 170mm nozzles mounting ø 24mm			
accessories for	510119		
	GEV No.	510108	Ref. No. 069445 327006
rinse arm shaft			
	GEV No.	510112	Ref. No. 069440 454002
Thumb screw thread M10 thread L 10mm ø 22mm H 4.5mm S5			
	GEV No.	518003	Ref. No. 069444 447128
screw cap			

accessories for 510119			
	GEV No.	518008	Ref. No. —
gasket D1 ø 43mm D2 ø 78mm thickness 2mm with 6 holes wash arm support			
	GEV No.	518036	Ref. No. 069442 127012
formed hose angled warewashing			

 <p>1</p>			
GEV No.	510139	Ref. No.	069451 0K3717 140007
description	rinse jet		
For models:	LTB11, LTB12, LTB22, LTB11UK, LTB12UK, LTB22UK, LTB11, LTB22, 911-00-022, 911-00-024, 911-00-032, 911-00-034, CRYSTAL 11, CRYSTAL 22		
accessories for	510139		
	GEV No.	510130	Ref. No. 069450 0H1283 0H3806 429006
union nut for rinse jet			

 <p>1</p>			
GEV No.	510130	Ref. No.	069450 0H1283 0H3806 429006
description	union nut for rinse jet		
For models:	LTB11, LTB12, LTB22, LTB11UK, LTB12UK, LTB22UK, LTB11, LTB22, 911-00-022, 911-00-024, 911-00-032, 911-00-034, CRYSTAL 11, CRYSTAL 22		
accessories for	510130		
	GEV No.	510139	Ref. No. 069451 0K3717 140007
rinse jet			



 <p>1</p>			
GEV No.	510131	Ref. No.	069448 0H1284 0H3804 0K3818 429007
description	union nut for wash jet		
For models:	LTB11, LTB12, LTB22, LTB11UK, LTB12UK, LTB22UK, LTB11, LTB22, 911-00-022, 911-00-024, 911-00-032, 911-00-034, CRYSTAL 11, CRYSTAL 22		
accessories for	510131		
	GEV No.	510138	Ref. No. 0T4075 140013
wash jet fine groove			



			
1			
GEV No.	510010	Ref. No.	069452 129039
description	wash arm boss L1 64mm L2 60mm mounting ø 16.5mm		
For models:	LTB11, LTB12, LTB22, LTB11UK, LTB12UK, LTB22UK, LTB11, LTB22, CRYSTAL 11, CRYSTAL 22		

			
1			
GEV No.	518004	Ref. No.	069449 0H1268 0H3805 0K3718 140008
description	wash jet		
For models:	LTB11, LTB12, LTB22, LTB11UK, LTB12UK, LTB22UK, LTB11, LTB22, 911-00-022, 911-00-024, 911-00-032, 911-00-034, CRYSTAL 11, CRYSTAL 22		

			
1			
GEV No.	510118	Ref. No.	069577 0A6075 0H1292 993031
description	wash arm L 245mm nozzles 4 mounting ø 12mm mounting pos. upper		
For models:	LTB11, LTB12, LTB22, LTB11UK, LTB12UK, LTB22UK, LTB11, LTB22, CRYSTAL 11, CRYSTAL 22		
spare parts for	510118		
	GEV No.	510011	Ref. No.
			069497 429008
screw connection plastic			
	GEV No.	510012	Ref. No.
			069643 437008
flat gasket PTFE ED ø 16.5mm ID ø 12.5mm thickness 1.5mm Qty 1 pcs equiv. no. 437008			
	GEV No.	510013	Ref. No.
			069498 0KR324 325001 7BAI325001
rinse arm shaft			
	GEV No.	510130	Ref. No.
			069450 0H1283 0H3806 429006
union nut for rinse jet			
	GEV No.	510139	Ref. No.
			069451 0K3717 140007
rinse jet			
	GEV No.	518326	Ref. No.
			—
rinse arm boss			
	GEV No.	518328	Ref. No.
			—
rinse arm mounting pos. right L 110mm mounting ø 13mm nozzles 2			

spare parts for	510118		
	GEV No.	518329	Ref. No.
			—
rinse arm mounting pos. left L 110mm mounting ø 13mm nozzles 2			

			
1			
GEV No.	510139	Ref. No.	069451 0K3717 140007
description	rinse jet		
For models:	LTB11, LTB12, LTB22, LTB11UK, LTB12UK, LTB22UK, LTB11, LTB22, 911-00-022, 911-00-024, 911-00-032, 911-00-034, CRYSTAL 11, CRYSTAL 22		
accessories for	510139		
	GEV No.	510130	Ref. No.
			069450 0H1283 0H3806 429006
union nut for rinse jet			





			
1			
GEV No.	510130	Ref. No.	069450 0H1283 0H3806 429006
description	union nut for rinse jet		
For models:	LTB11, LTB12, LTB22, LTB11UK, LTB12UK, LTB22UK, LTB11, LTB22, 911-00-022, 911-00-024, 911-00-032, 911-00-034, CRYSTAL 11, CRYSTAL 22		
accessories for	510130		
	GEV No.	510139	Ref. No.
			069451 0K3717 140007
rinse jet			





			
1			
GEV No.	504513	Ref. No.	047471 049296 0A6109 0H2540 0K8660 541607200 5416072006
description	end cap		
For models:	LS32, LS32/4.5, LS32UK/RP, LS32F, LV32F, C55, LV32/60, WT4, WT4B, WT4D, WT302, WT302/4.5, WT302UK/RP, WT302F, WT302/60, WT4DB, WT46, WT4DG, WT4WS1, LS33, LS33/4.5, LS33UK/RP, LS33F, LV33F, C55A, LS33/60, WT4BWS, WT4DWS1, WT4BDWS, WT303, WT303/4.5, WT303UK/RP, WT303F, WT303/60, NUC3DD, WT4D60, WT4DDG, EUC1, EUC1DP, EUC1WS, EUC1DPWS, EUC3, EUC3WS, EUC3DP, EUC3DPWS, EUC1G, EUC1DP60, EUC3DD, ZUCADDROW, ZUCADDROW6...(Other models you can see in the webshop)		





			
1			
GEV No.	504514	Ref. No.	049299 0K8661 541607300 5416073004
description	end cap		
For models:	LS32, LS32/4.5, LS32UK/RP, LS32F, LV32F, C55, LV32/60, WT4, WT4B, WT4D, WT302, WT302/4.5, WT302UK/RP, WT302F, WT302/60, WT4DB, WT46, WT4DG, WT4WS1, LS33, LS33/4.5, LS33UK/RP, LS33F, LV33F, C55A, LS33/60, WT4BWS, WT4DWS1, WT4BDWS, WT303, WT303/4.5, WT303UK/RP, WT303F, WT303/60, NUC3DD, WT4D60, WT4DDG, EUC1, EUC1DP, EUC1WS, EUC1DPWS, EUC3, EUC3WS, EUC3DP, EUC3DPWS, EUC1G, EUC1DP60, EUC3DD, ZUCADDROW, ZUCADDROW6...(Other models you can see in the webshop)		

			
2			
GEV No.	504512	Ref. No.	047473 0H2549 543617000
description	O-ring EPDM thickness 1.78mm ID ø 14mm Qty 1 pcs		
For models:	LS32, LS32/4.5, LS32UK/RP, LS32F, LV32F, C55, LV32/60, WT4, WT4B, WT4D, WT302, WT302/4.5, WT302UK/RP, WT302F, WT302/60, WT4DB, WT46, WT4DG, WT4WS1, LS33, LS33/4.5, LS33UK/RP, LS33F, LV33F, C55A, LS33/60, WT4BWS, WT4DWS1, WT4BDWS, WT303, WT303/4.5, WT303UK/RP, WT303F, WT303/60, NUC3DD, WT4D60, WT4DDG, EUC1, EUC1DP, EUC1WS, EUC1DPWS, EUC3, EUC3WS, EUC3DP, EUC3DPWS, EUC1G, EUC1DP60, EUC3DD, ZUCADDROW, ZUCADDROW6...(Other models you can see in the webshop)		

			
1			
GEV No.	504510	Ref. No.	047989 049297
description	rinse arm		
For models:	LS32, LS32/4.5, LS32UK/RP, LS32F, LV32F, C55, LV32/60, WT4, WT4B, WT4D, WT302, WT302/4.5, WT302UK/RP, WT302F, WT302/60, WT4DB, WT46, WT4DG, WT4WS1, LS33, LS33/4.5, LS33UK/RP, LS33F, LV33F, C55A, LS33/60, WT4BWS, WT4DWS1, WT4BDWS, WT303, WT303/4.5, WT303UK/RP, WT303F, WT303/60, NUC3DD, WT4D60, WT4DDG, EUC1, EUC1DP, EUC1WS, EUC1DPWS, EUC3, EUC3WS, EUC3DP, EUC3DPWS, EUC1G, EUC1DP60, EUC3DD, ZUCADDROW, ZUCADDROW6...(Other models you can see in the webshop)		
spare parts for	504510		
	GEV No.	504512	Ref. No. 047473 0H2549 543617000
	O-ring EPDM thickness 1.78mm ID ø 14mm Qty 1 pcs		
	GEV No.	504565	Ref. No. 047468 047469 047990 0A6108 0H2649 0K1124 835612501 S549607002
	wash arm boss		
	GEV No.	504570	Ref. No. 047475 0A6160 0H2541
	end cap		
	GEV No.	504572	Ref. No. 047474 047927 0A6110 0H2556 549609900
	rinse jet		



			
1			
GEV No.	504511	Ref. No.	047472 047926 047988 048142 049298 0A6159 0TR547 549609801
description	rinse arm L 208mm nozzles 3		
For models:	LS32, LS32/4.5, LS32UK/RP, LS32F, LV32F, C55, LV32/60, WT4, WT4B, WT4D, WT302, WT302/4.5, WT302UK/RP, WT302F, WT302/60, WT4DB, WT46, WT4DG, WT4WS1, LS33, LS33/4.5, LS33UK/RP, LS33F, LV33F, C55A, LS33/60, WT4BWS, WT4DWS1, WT4BDWS, WT303, WT303/4.5, WT303UK/RP, WT303F, WT303/60, NUC3DD, WT4D60, WT4DDG, EUC1, EUC1DP, EUC1WS, EUC1DPWS, EUC3, EUC3WS, EUC3DP, EUC3DPWS, EUC1G, EUC1DP60, EUC3DD, ZUCADDROW, ZUCADDROW6...(Other models you can see in the webshop)		
spare parts for	504511		
	GEV No.	504512	Ref. No. 047473 0H2549 543617000
	O-ring EPDM thickness 1.78mm ID ø 14mm Qty 1 pcs		
	GEV No.	504570	Ref. No. 047475 0A6160 0H2541
	end cap		
	GEV No.	504572	Ref. No. 047474 047927 0A6110 0H2556 549609900
	rinse jet		

			
1			
GEV No.	504509	Ref. No.	049295
description	wash arm		
For models:	LS32, LS32/4.5, LS32UK/RP, LS32F, LV32F, C55, LV32/60, WT4, WT4B, WT4D, WT302, WT302/4.5, WT302UK/RP, WT302F, WT302/60, WT4DB, WT46, WT4DG, WT4WS1, LS33, LS33/4.5, LS33UK/RP, LS33F, LV33F, C55A, LS33/60, WT4BWS, WT4DWS1, WT4BDWS, WT303, WT303/4.5, WT303UK/RP, WT303F, WT303/60, NUC3DD, WT4D60, WT4DDG, EUC1, EUC1DP, EUC1WS, EUC1DPWS, EUC3, EUC3WS, EUC3DP, EUC3DPWS, EUC1G, EUC1DP60, EUC3DD, ZUCADDROW, ZUCADDROW6...(Other models you can see in the webshop)		
spare parts for	504509		
	GEV No.	504513	Ref. No. 047471 049296 0A6109 0H2540 0K8660 541607200 5416072006
	end cap		

			
1			
GEV No.	504508	Ref. No.	049293
description	wash arm boss		
For models:	LS32, LS32/4.5, LS32UK/RP, LS32F, LV32F, C55, LV32/60, WT4, WT4B, WT4D, WT302, WT302/4.5, WT302UK/RP, WT302F, WT302/60, WT4DB, WT46, WT4DG, WT4WS1, LS33, LS33/4.5, LS33UK/RP, LS33F, LV33F, C55A, LS33/60, WT4BWS, WT4DWS1, WT4BDWS, WT303, WT303/4.5, WT303UK/RP, WT303F, WT303/60, NUC3DD, WT4D60, WT4DDG, EUC1, EUC1DP, EUC1WS, EUC1DPWS, EUC3, EUC3WS, EUC3DP, EUC3DPWS, EUC1G, EUC1DP60, EUC3DD, ZUCADDROW, ZUCADDROW6...(Other models you can see in the webshop)		





			
1			
GEV No.	504570	Ref. No.	047475 0A6160 0H2541
description	end cap		
For models:	LSDS51, LSDS5V, LS510, LS520, LS520D, LS520F, LS520M, LS520K, LS521, LS521D, LS521F, LS521M, LS521K, LS521, ZLS510, ZLS520, ZLS521, ALLS521, ALLS520, ALS510, C51, C52, LS520ZD, LS521ZD, LS510MZ, LS520MZ, LS521MZ		

			
1			
GEV No.	504512	Ref. No.	047473 0H2549 543617000
description	O-ring EPDM thickness 1.78mm ID ø 14mm Qty 1 pcs		
For models:	LS32, LS32/4.5, LS32UK/RP, LS32F, LV32F, C55, LV32/60, WT4, WT4B, WT4D, WT302, WT302/4.5, WT302UK/RP, WT302F, WT302/60, WT4DB, WT46, WT4DG, WT4WS1, LS33, LS33/4.5, LS33UK/RP, LS33F, LV33F, C55A, LS33/60, WT4BWS, WT4DWS1, WT4BDWS, WT303, WT303/4.5, WT303UK/RP, WT303F, WT303/60, NUC3DD, WT4D60, WT4DDG, EUC1, EUC1DP, EUC1WS, EUC1DPWS, EUC3, EUC3WS, EUC3DP, EUC3DPWS, EUC1G, EUC1DP60, EUC3DD, ZUCADDROW, ZUCADDROW6...(Other models you can see in the webshop)		

			
1			
GEV No.	504566	Ref. No.	047470 0A6115 0H2648 0K9153 835612401
description	wash arm		
For models:	LSDS51, LSDS5V, LS510, LS520, LS520D, LS520F, LS520M, LS520K, LS521, LS521D, LS521F, LS521M, LS521K, LS521, ZLS510, ZLS520, ZLS521, ALLS521, ALLS520, ALS510, C51, C52, LS520ZD, LS521ZD, LS510MZ, LS520MZ, LS521MZ		
spare parts for	504566		
	GEV No.	504513	Ref. No. 047471 049296 0A6109 0H2540 0K8660 541607200 5416072006
end cap			

spare parts for	504566		
	GEV No.	504565	Ref. No. 047468 047469 047990 0A6108 0H2649 0K1124 835612501 5549607002
wash arm boss			



			
1			
GEV No.	504565	Ref. No.	047468 047469 047990 0A6108 0H2649 0K1124 835612501 5549607002
description	wash arm boss		
For models:	LSDS51, LSDS5V, LS510, LS520, LS520D, LS520F, LS520M, LS520K, LS521, LS521D, LS521F, LS521M, LS521K, LS521, ZLS510, ZLS520, ZLS521, ALLS521, ALLS520, ALS510, C51, C52, LS520ZD, LS521ZD, LS510MZ, LS520MZ, LS521MZ		

			
1			
GEV No.	504501	Ref. No.	049049 0L2096
description	rinse arm L 400mm nozzles 7 mounting ø 12mm mounting pos. upper/lower		
For models:	LB1, LB1WS, LB1WSDP, LB1/RBP, LB1/TOP, LB1/60, WT1WSDP, LB2D-PSAUS, LB1G, LB1WSG, WT2TOP60, WT2DPDI, WT2WSDPDI, LB1TOP, WT2TOPDI, LB2WS, LB2, LB2WSDP, LB2/TOP, LB2/RBP, LB2WS60, WT2WSDP, WT2WSDPD, LB2WSG, WT2WS, WT1, WT1WS, WT1TOP, WT2TOP, WT1/3DP, WT2/3DP, WT2DPAUS, WT2, LB2DPDI, LB2WSDPDI, LB2WSDPD, LB2TOP, LB2DP3, WT2DPD3, NGW, NGWDPDD, UC1, UC2WS, GW1, GW1WS, LV1WS, LV1WSDP, LV2WSDP, LV2WS, GW2D-PG...(Other models you can see in the webshop)		
spare parts for	504501		
	GEV No.	504502	Ref. No. 049046
rinse arm shaft			
	GEV No.	504503	Ref. No. 049047
knurled nut thread M10x1 ø 30mm H 4mm SS			
	GEV No.	504504	Ref. No. 049042
bush wash arm			
	GEV No.	504761	Ref. No. 048714
end cap for rinse arm			



1



GEV No.	504526	Ref. No.	048248 048337 048542 048716 0L2095 0T0325	
description	rinse arm L 469mm nozzles 7 mounting ø 12mm mounting pos. upper/lower			
For models:	LS61, LS61/60, LS6EP, LS6EP/DD, LS6EADD, LS6EA/DPDD, WT38T-DE, WT38/M50, LS6EADP3, LS6EADPWS, LS6EADPWSG, WT38WS, WT38WSG, WT38MEDWS, WT38PM50, WT37LEV/9, LS6EADPDWS, WT38DWS, LS6SANA, EUCAI, EUCAIDP, EUCAI60, EUCAIWS, WT38M50/4, LS6EA/UK, LS6EA/DPUK, EUCAIG, EUCAIWSG, EUCAIML, EUCAIMLWS, EUCAIMLG, EUCAICL, EUCAICLG, EUCAIWL, LS6EA/60, EUCAICLW, EUCI, EUCIM, EUCIM60, EUCAIDPNW, ZUCI, ZUCID, ZUCAI, ZUCAIDP, ZUCAIDPWS, ZUCAIG, ZUCAIDDWS, ZUCAID, ZUCAI60, EUCAIUSPH6...(Other models you can see in the webshop)			
spare parts for	504526			
	GEV No.	504527	Ref. No.	048290 0E5641 0T2704
	rinse arm shaft			
	GEV No.	504528	Ref. No.	048632 0E5638
	knurled nut thread M12x1 ø 35mm H 6mm SS			
	GEV No.	504761	Ref. No.	048714
	end cap for rinse arm			

1



GEV No.	519572	Ref. No.	049152
description	rinse arm L 670mm nozzles 10 mounting ø 12mm mounting pos. upper/lower stainless steel		
For models:	LS62HD, LS7HD, LS10UKRP, LS10/HD, SH55, LO10, LS12HD, LS8/HD		

1



GEV No.	504500	Ref. No.	049044
description	wash arm L 410mm nozzles 8 mounting ø 35.4mm mounting pos. upper/lower		
For models:	LB1, LB1WS, LB1WSDP, LB1/RBP, LB1/TOP, LB1/60, WT1WSDP, LB2D-PSAUS, LB1G, LB1WSG, WT2TOP60, WT2DPDI, WT2WSDPDI, LB1TOP, WT2TOPDI, LB2WS, LB2, LB2WSDP, LB2/TOP, LB2/RBP, LB2WS60, WT2WSDP, WT2WSDPD, LB2WSG, WT2WS, WT1, WT1WS, WT1TOP, WT2TOP, WT1/3DP, WT2/3DP, WT2DPAUS, WT2, LB2DPDI, LB2WSDPDI, LB2WSDPD, LB2TOP, LB2DP3, WT2DPD3, NGW, NGWDPDD, UC1, UC2WS, GW1, GW1WS, LV1WS, LV1WSDP, LV2WSDP, LV2WS, GW2D-PG...(Other models you can see in the webshop)		



1





GEV No.	504535	Ref. No.	048247 0L0597	
description	wash arm L 480mm nozzles 12 mounting ø 14/63mm mounting pos. lower			
For models:	LS10D, LS10, LS10UKRP, LC100, ECOTEMP12-, LS10/60, LS10/1, LS10/12KW, LS10F, LS10DEK, LS10/1UKRP, LS10SW, LS10DP, LS10/HD, LS10/UK1, LS10/UK3, LS12D, LS12, LS12UK/RP, LC120, LS12DP, LS12/60, LS12F, LS12DEK, LS12HD, LS12/UK3, ECOTEMP12SW, ECOTEMP12INS, LS12MEX, LS10N, LS10, LS14EA, LS10UKDP, ET12E, LS10/60HZ, LS10CW, LS10INS, HT1200INS, LS14EAI, LS10N, LS10DP, LS10HD, LS14EAI/AU, LS14EA/60, LS10UK/1, LS10UK/3, LS12INS, LS12, LS12DP, LS12/60HZ...(Other models you can see in the webshop)			
spare parts for	504535			
	GEV No.	504528	Ref. No.	048632 0E5638
	knurled nut thread M12x1 ø 35mm H 6mm SS			
	GEV No.	504529	Ref. No.	048246 048401
	bush			

1





GEV No.	504525	Ref. No.	048336 048821 0KE914 0L0598	
description	wash arm L 485mm nozzles 12 mounting ø 14/63mm mounting pos. upper/lower			
For models:	LS61, LS61/60, LS6EP, LS6EP/DD, LS6EADD, LS6EA/DPDD, WT38T-DE, WT38/M50, LS6EADP3, LS6EADPWS, LS6EADPWSG, WT38WS, WT38WSG, WT38MEDWS, WT38PM50, WT37LEV/9, LS6EADPDWS, WT38DWS, LS6SANA, EUCAI, EUCAIDP, EUCAI60, EUCAIWS, WT38M50/4, LS6EA/UK, LS6EA/DPUK, EUCAIG, EUCAIWSG, EUCAIML, EUCAIMLWS, EUCAIMLG, EUCAICL, EUCAICLG, EUCAIWL, LS6EA/60, EUCAICLW, EUCI, EUCIM, EUCIM60, EUCAIDPNW, ZUCI, ZUCID, ZUCAI, ZUCAIDP, ZUCAIDPWS, ZUCAIG, ZUCAIDDWS, ZUCAID, ZUCAI60, EUCAIUSPH6...(Other models you can see in the webshop)			
spare parts for	504525			
	GEV No.	504528	Ref. No.	048632 0E5638
	knurled nut thread M12x1 ø 35mm H 6mm SS			
	GEV No.	504529	Ref. No.	048246 048401
	bush			

			
GEV No.	504761	Ref. No.	048714
description	end cap for rinse arm		
For models:	LB1, LB1WS, LB1WSDP, LB1/RBP, LB1/TOP, LB1/60, WT1WSDP, LB2D-PSAUS, LB1G, LB1WSG, WT2TOP60, WT2DPDI, WT2WSDPDI, LB1TOP, WT2TOPDI, LB2WS, LB2, LB2WSDP, LB2/TOP, LB2/RBP, LB2WS60, WT2WSDP, WT2WSDPD, LB2WSG, WT2WS, WT1, WT1WS, WT1TOP, WT2TOP, WT1/3DP, WT2/3DP, WT2DPAUS, WT2, LB2DPDI, LB2WSDPDI, LB2WSDPD, LB2TOP, LB2DP3, WT2DPD3, NGW, NGWDPDD, LS61, LS61/60, LS6EP, LS6EP/DD, LS6EADD, LS6EA/DPDD, WT38TDE, WT38/M50, LS6EADP3...(Other models you can see in the webshop)		



			
GEV No.	504283	Ref. No.	048289
description	end cap for wash arm ø 16mm H 7mm		
For models:	LS7D, LS7, LS7UK/RP, LV70, LS7F, LS7DEK, LS7/1UK, LS7/60, WT40/9, WT40/F, LS10D, LS10, LS10UKRP, LC100, LS10F, LS12D, LS12, LS12UK/RP, LC120, LS12F, LS8D, LS8, LS8UK/RP, LC80, LS8F, LS8DEK, LS8/9, LS8/60, LS8/1UKRP, WT50/9, WT50/UK9RF, WT50/F9, WT50/6, WT50/1UKRP, WT50/1, FL700, HT1200elm, HT1000elm, HT800, HYDRA700, HYDRA1200, HYDRA1000, HYDRA800, Z70, LSCE10, LSCE12, Z80		

			
GEV No.	504752	Ref. No.	049048
description	end cap old edition		
For models:	WT1WSDP, WT2WSDP, WT2WSDPD, WT2WS, WT1, WT1WS, WT1TOP, WT2TOP, WT1/3DP, WT2/3DP, WT2DPAUS, Z1, Z1/WS, Z1TOP, Z2, Z2TOP		

			
GEV No.	504546	Ref. No.	046266
description	end cap		
For models:	LS360F, LS360DK, LS365F, LS365, LS365PH, LS500F, LS501F, LS540F, LS540DK, LS541F, LS360D, LS365D, LS360, LS365, LS360/63, LS365/63, LS367, LS720F, LSE720DK, LSE720PH, LS860F, LS860DK, LS860PH, LS1080F, LS1080UK, LS1080PH, LSE721F, LS861F, LS540, LS1080M, LS1080, LS1080D, LS1080UK, LS1080/63, LS500F, LS500UK, LS501, LS501UK, LS540D, LS540/63, LSE721, LS720, LSE720UK, LS721UK, LSE720D, LS541, LS860, LS860, LS860D, LS860UK...(Other models you can see in the webshop)		

			
GEV No.	504545	Ref. No.	046273
description	opposite support		
For models:	LS360F, LS360DK, LS365F, LS365, LS365PH, LS500F, LS501F, LS540F, LS540DK, LS541F, LS360D, LS365D, LS360, LS365, LS360/63, LS365/63, LS367, LS720F, LSE720DK, LSE720PH, LS860F, LS860DK, LS860PH, LS1080F, LS1080UK, LS1080PH, LSE721F, LS861F, LS540, LS1080M, LS1080, LS1080D, LS1080UK, LS1080/63, LS500F, LS500UK, LS501, LS501UK, LS540D, LS540/63, LSE721, LS720, LSE720UK, LS721UK, LSE720D, LS541, LS860, LS860, LS860D, LS860UK...(Other models you can see in the webshop)		

			
GEV No.	528485	Ref. No.	067898 070339 086109 0H2570 0KK903 530501200 60074
description	O-ring EPDM thickness 1.78mm ID ø 6.07mm Qty 1 pcs		
For models:	MCP/E700, MCP/G700, MCP/E700D, MCP/G701, MCP/G710, MCP/G711, RCP/E2S, MCP/E2S, 7CPE07P, 7CPG07P, RCP/G701, M70EPC, M70GPC, M70GPC, CCP/G700, CCP/E700, PCP/E2SHP, OCP/E2S, TCP/E2S, RCP/G700, RCPE700, HCP/G410D, HCP/G410, HCP/G810, HCP/E410, HCP/E810, HCPS/E410, ZCP/G410, ZCP/G810, ZCP/E410, ZCP/E810, ZCPS/E410, ACP/G400, ACP/G410, ACP/G800, ACP/G810, ACP/E400, ACP/E410, ACP/E800, ACP/E810, ACP/G400, ACP/G400, ACP/E400, ACP/E410, LS32, LS32/4.5, LS32UK/RP, LS32F, LV32F, C55, LV32/60...(Other models you can see in the webshop)		

			
GEV No.	504543	Ref. No.	046272 048036
description	rinse jet H 15mm		
For models:	LS360F, LS360DK, LS365F, LS365, LS365PH, LS540F, LS540DK, LS541F, LS360D, LS365D, LS360, LS365, LS360/63, LS365/63, LS367, LS720F, LSE720DK, LSE720PH, LS860F, LS860DK, LS860PH, LS1080F, LS1080UK, LS1080PH, LSE721F, LS861F, LS540, LS1080M, LS1080, LS1080D, LS1080UK, LS1080/63, LS540D, LS540/63, LSE721, LS720, LSE720UK, LS721UK, LSE720D, LS541, LS860, LS860, LS860D, LS860UK, LS861UK, LS860/63, LS861, CT92DXE, CT92SXE, CT92DXEUK...(Other models you can see in the webshop)		
accessories for	504543		
	GEV No.	504545	Ref. No. 046273
	 opposite support		

			
GEV No.	517479	Ref. No.	0E5521
description	rinse arm mounting pos. upper/lower L 538mm nozzles 4		
For models:	RT100ED, RT100ES, RT100SR, RT100SL, RT140ED, RT140ES, RT140SR, RT140SL, RT190ED, RT190ES, RT190SR, RT190SL, RT190HDED, RT190HDES, RT190HSR, RT190HSL, RT270ED, RT270ES, RT270SR, RT270SL, RT270HDED, RT270HDES, RT270HSR, RT270HSL, RT100ERF, RT100ELF, RT100VD, RT100VS, RT140ERF, RT140ELF, RT140VD, RT140VS, RT142ERF, RT142ELF, RT190ERF, RT190ELF, RT190VD, RT190VS, RT190HERF, RT190HELF, RT190HDVDF, RT190HDVDF, RT270ERF, RT270ELF, RT270VDF, RT270VSF, RT270HERF, RT270HELF, RT270HDVDF, RT270HDVSF...(Other models you can see in the webshop)		





			
GEV No.	524962	Ref. No.	OE5148
description	rinse jet H 5mm thread 1/8" ET WS 13 code 9504		
For models:	RT100ED, RT100ES, RT100SR, RT100SL, RT140ED, RT140ES, RT140SR, RT140SL, RT190ED, RT190ES, RT190SR, RT190SL, RT190HDED, RT190HDES, RT190HSR, RT190HSL, RT270ED, RT270ES, RT270SR, RT270SL, RT270HDED, RT270HDES, RT270HSR, RT270HSL, RT100ERF, RT100ELF, RT100VD, RT100VS, RT140ERF, RT140ELF, RT140VD, RT140VS, RT142ERF, RT142ELF, RT190ERF, RT190ELF, RT190VD, RT190VS, RT190HERF, RT190HELF, RT190HDVDF, RT190HDVSF, RT270ERF, RT270ELF, RT270VDF, RT270VSF, RT270HERF, RT270HELF, RT270HDVDF, RT270HDVSF...(Other models you can see in the webshop)		



			
GEV No.	517478	Ref. No.	OE5465 OE5995
description	wash arm mounting pos. lower L 595mm W 515mm nozzles 28		
For models:	RT100ED, RT100ES, RT100SR, RT100SL, RT140ED, RT140ES, RT140SR, RT140SL, RT190ED, RT190ES, RT190SR, RT190SL, RT190HDED, RT190HDES, RT190HSR, RT190HSL, RT270ED, RT270ES, RT270SR, RT270SL, RT270HDED, RT270HDES, RT270HSR, RT270HSL, RT100ERF, RT100ELF, RT100VD, RT100VS, RT140ERF, RT140ELF, RT140VD, RT140VS, RT142ERF, RT142ELF, RT190ERF, RT190ELF, RT190VD, RT190VS, RT190HERF, RT190HELF, RT190HDVDF, RT190HDVSF, RT270ERF, RT270ELF, RT270VDF, RT270VSF, RT270HERF, RT270HELF, RT270HDVDF, RT270HDVSF...(Other models you can see in the webshop)		

			
GEV No.	517477	Ref. No.	OE5467 OE5994 OE6024
description	wash arm mounting pos. upper L 595mm W 515mm nozzles 30		
For models:	RT100ED, RT100ES, RT100SR, RT100SL, RT140ED, RT140ES, RT140SR, RT140SL, RT190ED, RT190ES, RT190SR, RT190SL, RT190HDED, RT190HDES, RT190HSR, RT190HSL, RT270ED, RT270ES, RT270SR, RT270SL, RT270HDED, RT270HDES, RT270HSR, RT270HSL, RT100ERF, RT100ELF, RT100VD, RT100VS, RT140ERF, RT140ELF, RT140VD, RT140VS, RT142ERF, RT142ELF, RT190ERF, RT190ELF, RT190VD, RT190VS, RT190HERF, RT190HELF, RT190HDVDF, RT190HDVSF, RT270ERF, RT270ELF, RT270VDF, RT270VSF, RT270HERF, RT270HELF, RT270HDVDF, RT270HDVSF...(Other models you can see in the webshop)		



			
GEV No.	517703	Ref. No.	OE5016 741611624
description	end cap for wash arm mounting pos. upper/lower H 17mm thread 12 WS 38		
For models:	FT36EDTS, FT36ESTS, FT36VDTS, FT36VSTS, FT36ED, FT36ES, FT36VD, FT36VS, FT50ED, FT50ES, FT50VD, FT50VS, FT72ED, FT72ES, FT72VD, FT72VS, FT36EDT, FT36EST, FT36VDT, FT36VST, FT50EDT, FT50EST, FT50VDT, FT50VST, FT72EDT, FT72EST, FT72VDT, FT72VST, FT36WED, FT36WES, FT36WVD, FT36WVS, FT50WED, FT50WES, FT50WVD, FT50WVS, FT72WED, FT72WES, FT72WVD, FT72WVS, FT36WEDT, FT36WEST, FT36WVDT, FT36WVST, FT50WEDT, FT50WEST, FT50WVDT, FT50WVST, FT72WEDT, FT72WEST...(Other models you can see in the webshop)		

			
GEV No.	519580	Ref. No.	OE5997
description	end cap for wash arm mounting pos. upper/lower ø 50mm L 40mm		
For models:	RT100ED, RT100ES, RT100SR, RT100SL, RT140ED, RT140ES, RT140SR, RT140SL, RT190ED, RT190ES, RT190SR, RT190SL, RT190HDED, RT190HDES, RT190HSR, RT190HSL, RT270ED, RT270ES, RT270SR, RT270SL, RT270HDED, RT270HDES, RT270HSR, RT270HSL, RT100ERF, RT100ELF, RT100VD, RT100VS, RT140ERF, RT140ELF, RT140VD, RT140VS, RT142ERF, RT142ELF, RT190ERF, RT190ELF, RT190VD, RT190VS, RT190HERF, RT190HELF, RT190HDVDF, RT190HDVSF, RT270ERF, RT270ELF, RT270VDF, RT270VSF, RT270HERF, RT270HELF, RT270HDVDF, RT270HDVSF...(Other models you can see in the webshop)		



			
GEV No.	524004	Ref. No.	070329
description	wash arm L 190mm nozzles 4 mounting pos. lower		
For models:	LB040R, LBIOET014		





			
GEV No.	524003	Ref. No.	OHA146
description	wash arm L 230mm H 110mm nozzles 3 mounting pos. upper		
For models:	LB040R, LBIOET014		
spare parts for	524003		
	GEV No.	507134	Ref. No.
			OHA102
swirl H 5mm ø 14.5mm 5.5mm			





			
1			
GEV No.	524050	Ref. No.	OHA002 10383 9010383
description	wash jet thread 3/8" H 20mm		

			
1			
GEV No.	524007	Ref. No.	OHA043
description	rinse arm L 205mm H 380mm nozzles 5		
accessories for	524007		
	GEV No.	524051	Ref. No. OHA129
			rinse jet

			
1			
GEV No.	524053	Ref. No.	OHA077 60002 9060002
description	flat gasket rubber D1 ø 18mm D2 ø 13mm thickness 1mm for nozzle Qty 1 pcs		
For models:	LB035R, LB040R, LBIOET010, LBIOET014		

			
1			
GEV No.	524051	Ref. No.	OHA129
description	rinse jet		
For models:	LB035R, LB040R, LBIOET010, LBIOET014		
accessories for	524051		
	GEV No.	524052	Ref. No. —
			swirl for rinse jet H1 5mm ø 10mm H 16mm 2mm

			
1			
GEV No.	524011	Ref. No.	070349
description	wash and rinse arm wash arm L 380mm rinse arm L 380mm w. jets 6 r. jets 6 mounting ø 12/45mm		
spare parts for	524011		
	GEV No.	524057	Ref. No. —
			end cap for wash arm
	GEV No.	524061	Ref. No. —
			rinse jet thread 1/4" WS 18 hole ø 1.5mm
	GEV No.	524062	Ref. No. —
			end cap for rinse arm

spare parts for	524011		
	GEV No.	524081	Ref. No. —
			bush for rinse arm
	GEV No.	524095	Ref. No. —
			knurled nut thread M8 ø 24mm H 6mm SS
	GEV No.	524131	Ref. No. —
			wash arm boss mounting pos. lower
	GEV No.	528243	Ref. No. —
			O-ring EPDM thickness 1.78mm ID ø 15.6mm Qty 1 pcs

			
1			
GEV No.	361304	Ref. No.	0E2836 0E5360 0K8992
description	O-ring EPDM ID ø 11.11mm thickness 1.78mm Qty 1 pcs for type DIB3E/DIB5E		
For models:	W3400H06, W3130H, W3130H, W3240H., W3240H, W3400H, W3400H, W3130H, W3180H, W3180H, W3180H, W3180H, W3240H_EL, W3240H_CLA, W3180H, W3130H, W3180H, W3130H, W3180H, W3180H, W3300H, W3300H, LC12EC, CLC12EC, CLC22VC, FT36EDTS, FT36ESTS, FT36VDTS, FT36VSTS, FT36ED, FT36ES, FT36VD, FT36VS, FT50ED, FT50ES, FT50VD, FT50VS, FT72ED, FT72ES, FT72VD, FT72VS, FT36EDT, FT36EST, FT36VDT, FT36VST, FT50EDT, FT50EST, FT50VDT, FT50VST, FT72EDT, FT72EST...(Other models you can see in the webshop)		

			
1			
GEV No.	524832	Ref. No.	0E5640
description	rinse arm mounting pos. upper/lower L 600mm nozzles 7 mounting ø 12mm		
For models:	PW1EFL, PW1EFLF, PW1EFL/60HZ, PW2EFL, PW2EFLF, PW2EFL/60HZ, PW2VFL, PW1SMG, PW1MG, PW1MUK, PW160HZ, PW1MHG, PW2MG, PW2MUK, PW2M60, WT830M, WT830MUK, WT830M60G, WT850M, WT850MUK, WT850M60G, WT830MHG, WT830M208U, WT830M240U, WT830H208U, WT830H240U, WT850M208U, WT850M240U, PW2SMG, ET830M, ET830MH, ET850M, WT830EFL, WT830EFLF, WT830EFL/60HZ, WT850, WT850EFLF, WT850EFL/60HZ, WT850SFL, PW1EAG, PW2EAG, WT830EA, WT850EA, WT830EAG, WT850EAG, PW100MG, PW100M, PW200M, PW100MHG, LV100M...(Other models you can see in the webshop)		



GEV No.	504579	Ref. No.	047461 0H2551 549605903
description	opposite support mounting pos. lower		
For models:	LSD551, LSD55V, LS510, LS520, LS520D, LS520F, LS520M, LS520K, LS521, LS521D, LS521F, LS521M, LS521K, LS521, ZLS510, ZLS520, ZLS521, ALLS521, ALLS520, ALS510, C51, C52, LS520ZD, LS521ZD, LS510MZ, LS520MZ, LS521MZ		



GEV No.	504521	Ref. No.	049290
description	wash arm support mounting pos. lower		
For models:	LS32, LS32/4.5, LS32UK/RP, LS32F, LV32F, C55, LV32/60, WT4, WT4B, WT4D, WT302, WT302/4.5, WT302UK/RP, WT302F, WT302/60, WT4DB, WT46, WT4DG, WT4WS1, LS33, LS33/4.5, LS33UK/RP, LS33F, LV33F, C55A, LS33/60, WT4BWS, WT4DWS1, WT4BDWS, WT303, WT303/4.5, WT303UK/RP, WT303F, WT303/60, NUC3DD, WT4D60, WT4DDG, EUC1, EUC1DP, EUC1WS, EUC1DPWS, EUC3, EUC3WS, EUC3DP, EUC3DPWS, EUC1G, EUC1DP60, EUC3DD, ZUCADDROW, ZUCADDROW6...(Other models you can see in the webshop)		



GEV No.	504531	Ref. No.	048329 048819 0L1628
description	wash arm support mounting pos. lower		
For models:	LS61, LS61/60, LS6EP, LS6EP/DD, LS6EADD, LS6EA/DPDD, WT38T-DE, WT38/M50, LS6EADP3, LS6EADPWS, LS6EADPWSG, WT38WS, WT38WSG, WT38MEDWS, WT38PM50, WT37LEV/9, LS6EADPDWS, WT38DWS, LS6SANA, EUCAI, EUCAIDP, EUCAI60, EUCAIWS, WT38M50/4, LS6EA/UK, LS6EA/DPUK, EUCAIG, EUCAIWSG, EUCAIML, EUCAIMLWS, EUCAIMLG, EUCAICL, EUCAICLG, EUCAIWL, LS6EA/60, EUCAICLW, EUCI, EUCIM, EUCIM60, EUCAIDPNW, ZUCI, ZUCID, ZUCAI, ZUCAIDP, ZUCAIDPWS, ZUCAIG, ZUCAIDDWS, ZUCAID, ZUCAI60, EUCAIUSPH6...(Other models you can see in the webshop)		



GEV No.	504539	Ref. No.	048235
description	wash arm support mounting pos. lower		
For models:	LU7PDP, LU7ADP, LU7ADPWS, WTU40PDP, WTU40ADP, WTU40ADPWS, WTU40ADPD, LS10D, LS10, LS10UKRP, LC100, LS10/60, LS10/1, LS10/12KW, LS10F, LS10DEK, LS10/1UKRP, LS10SW, LS10/50J, LS10/60J, LS10DP, LS10/HD, SH55, LO10, LS10/UK1, LS10/UK3, LS12D, LS12, LS12UK/RP, LC120, LS12DP, LS12/60, LS12F, LS12DEK, LS12HD, WT60/GJ60, WT60/GJ50, PH10/12-RP, LS12/UK3, ECOTEMP12INS, LS12MEX, LS10N, LS10, LS14EA, LS10UKDP, ET12E, LS10/60HZ, LS10CW, LS10INS, HT1200INS...(Other models you can see in the webshop)		





GEV No.	504557	Ref. No.	047893
description	wash arm support mounting pos. lower		
For models:	LS540F, LS540DK, LS541F, LS540, LS540D, LS540/63, LS541, LS540, ALS540		





GEV No.	504554	Ref. No.	046547
description	wash arm support mounting pos. upper		
For models:	LS860F, LS860DK, LS860PH, LS1080F, LS1080UK, LS1080PH, LS861F, LS1080M, LS1080, LS1080D, LS1080UK, LS1080/63, LS860, LS860, LS860D, LS860UK, LS861UK, LS860/63, LS861, LS860, LS1080, LS860, DMAST2CUK, LS860, LS1080, LS860, LS1080		





GEV No.	504754	Ref. No.	0L0695
description	wash arm support mounting pos. upper		
For models:	LU7PDP, LU7ADP, LU7ADPWS, WTU40PDP, WTU40ADP, WTU40ADPWS, WTU40ADPD, PW1SMG, PW1MG, PW1MUK, PW1MHG, PW2MG, PW2MUK, WT830M, WT830MUK, WT830M60G, WT850M, WT850MUK, WT850M60G, WT830MHG, WT830M208U, WT830M240U, WT830H208U, WT830H240U, WT850M208U, WT850M240U, PW2SMG, ET830M, ET830MH, ET850M, ET7ADP, LU700PDP, LU700ADP, LU700ADPWS, PW100MG, PW100M, PW200M, PW100MHG, LV100M, LV200M, PW200MG		
accessories for	504754		
	GEV No.	504574	Ref. No. 046376
			
	GEV No.	504580	Ref. No. 046366 3000221 543605100
			



GEV No.	504755	Ref. No.	0L0901
description	wash arm support mounting pos. upper		
accessories for	504755		
	GEV No.	504532	Ref. No. 048333 30001789 5514663403
			
	GEV No.	504574	Ref. No. 046376
			



			
1			
GEV No.	510676	Ref. No.	0L0051
description	wash arm support mounting pos. upper H 130mm L1 345mm		
For models:	WT60/GJ60, WT60/GJ50, PH10/12-RP, LS14EA, ET12E, LS14EAI, LS14EAI/AU, LS14EA/60, LS14EAASIA, LS14EA/G, LS10EA, LS14EAI/DD, WT65E, WT65EB, WT65EI, ECOTEMP12S, WT65EBI, WT65EBIA, WT65EIA, WT65E60, WT65EB60, WT65EBIDG, WT65EBASIA, WT65EIM50, WT65EIM60, LS14EADP/G, WT65MED, WT65EJ50, WT65EJ60, LS14EAWS, LS14ADPWSG, LS14EAIWS, WT65EBWS, WT65BIDWSG, WT65EBIWS, ET12EWS, WT65ROW, LS14ROW, LS14SANA, WT65EBID, LS14ROW60, WT65ROW60, EHTA, EHTA60, EHTAWS, EHTAI, EHTAID, EHTAIWS, EHTAIDWS, EHTAIG...(Other models you can see in the webshop)		

			
1			
GEV No.	519570	Ref. No.	065502
description	wash arm support ø 43.5mm ED ø 76.4mm ID ø 37.5mm thickness 3mm L 190mm		
For models:	LS500F, LS501F, LS500F, LS500UK, LS501, LS501UK, LS500, LS501		

rinse arm shafts

			
1			
GEV No.	504502	Ref. No.	049046
description	rinse arm shaft		
For models:	LB1, LB1WS, LB1WSDP, LB1/RBP, LB1/TOP, LB1/60, WT1WSDP, LB2D-PSAUS, LB1G, LB1WSG, WT2TOP60, WT2DPDI, WT2WSDPDI, LB1TOP, WT2TOPDI, LB2WS, LB2, LB2WSDP, LB2/TOP, LB2/RBP, LB2WS60, WT2WSDP, WT2WSDPD, LB2WSG, WT2WS, WT1, WT1WS, WT1TOP, WT2TOP, WT1/3DP, WT2/3DP, WT2DPAUS, WT2, LB2DPDI, LB2WSDPDI, LB2WSDPD, LB2TOP, LB2DP3, WT2DPD3, NGW, NGWDPDD, UC1, UC2WS, GW1, GW1WS, LV1WS, LV1WSDP, LV2WSDP, LV2WS, GW2D-PG...(Other models you can see in the webshop)		

			
1			
GEV No.	504522	Ref. No.	049292
description	rinse arm shaft		
For models:	LS32, LS32/4.5, LS32UK/RP, LS32F, LV32F, C55, LV32/60, WT4, WT4B, WT4D, WT302, WT302/4.5, WT302UK/RP, WT302F, WT302/60, WT4DB, WT46, WT4DG, WT4WS1, LS33, LS33/4.5, LS33UK/RP, LS33F, LV33F, C55A, LS33/60, WT4BWS, WT4DWS1, WT4BDWS, WT303, WT303/4.5, WT303UK/RP, WT303F, WT303/60, NUC3DD, WT4D60, WT4DDG, EUC1, EUC1DP, EUC1WS, EUC1DPWS, EUC3, EUC3WS, EUC3DP, EUC3DPWS, EUC1G, EUC1DP60, EUC3DD, ZUCADDROW, ZUCADDROW6...(Other models you can see in the webshop)		

			
1			
GEV No.	504527	Ref. No.	048290 0E5641 0T2704
description	rinse arm shaft		
For models:	LS61, LS61/60, LS6EP, LS6EP/DD, LS6EADD, LS6EA/DPDD, WT38T-DE, WT38/M50, LS6EADP3, LS6EADPWS, LS6EADPWSG, WT38WS, WT38WSG, WT38MEDWS, WT38PM50, WT37LEV/9, LS6EADPDWS, WT38DWS, LS6SANA, EUCAI, EUCAIDP, EUCAI60, EUCAIWS, WT38M50/4, LS6EA/UK, LS6EA/DPUK, EUCAIG, EUCAIWSG, EUCAIML, EUCAIMLWS, EUCAIMLG, EUCAICL, EUCAICLG, EUCAIWL, LS6EA/60, EUCAICLW, EUCI, EUCIM, EUCIM60, EUCAIDPNW, ZUCI, ZUCID, ZUCAI, ZUCAIDP, ZUCAIDPWS, ZUCAIG, ZUCAIDDWS, ZUCAID, ZUCAI60, EUCAIUSPH6...(Other models you can see in the webshop)		

			
1			
GEV No.	504532	Ref. No.	048333 30001789 S514663403
description	rinse arm shaft		
For models:	LS7D, LS7, LS7UK/RP, LV70, LS7F, LS7DEK, LS7/1UK, LS7/9, LS7/DP, LS7/60, WT40/9, WT40/F, LS7HD, WT40/J50, WT40/J60, WT40UKRP, PH4/WT40, PH4RBP/WT40, LS10D, LS10, LS10UKRP, LC100, LS10F, LS12D, LS12, LS12UK/RP, LC120, LS12F, LS8D, LS8, LS8UK/RP, LC80, LS8F, LS8DEK, LS8/9, LS8/60, LS8/1UKRP, LS8/DP, WT50/9, WT50/UK9RF, WT50/F9, WT50/6, WT50/1UKRP, WT50/1, D800/9, D800/6, WT50/60, WT50/N, LS8/HD, WT50/J50...(Other models you can see in the webshop)		

			
1			
GEV No.	504549	Ref. No.	046363
description	rinse arm shaft		
For models:	LS360F, LS360DK, LS365F, LS365, LS365PH, LS540F, LS540DK, LS541F, LS360D, LS365D, LS360, LS365, LS360/63, LS365/63, LS367, LS720F, LSE720DK, LSE720PH, LS860F, LS860DK, LS860PH, LS1080F, LS1080UK, LS1080PH, LSE721F, LS861F, LS540, LS1080M, LS1080, LS1080D, LS1080UK, LS1080/63, LS540D, LS540/63, LSE721, LS720, LSE720UK, LS721UK, LSE720D, LS541, LS860, LS860, LS860D, LS860UK, LS861UK, LS860/63, LS861, LS360, LS365F, LS540...(Other models you can see in the webshop)		

			
1			
GEV No.	504573	Ref. No.	047464 514650602
description	rinse arm shaft		
For models:	LSDS51, LSDS5V, LS510, LS520, LS520D, LS520F, LS520M, LS520K, LS521, LS521D, LS521F, LS521M, LS521K, LS521, ZLS510, ZLS520, ZLS521, ALLS521, ALLS520, ALS510, C51, C52, LS520ZD, LS521ZD, LS510MZ, LS520MZ, LS521MZ		

			
1			
GEV No.	510013	Ref. No.	069498 OKR324 325001 7BAI325001
description	rinse arm shaft		
For models:	LTB11, LTB12, LTB22, LTB11UK, LTB12UK, LTB22UK, LTB11, LTB22, CRYSTAL 11, CRYSTAL 22		



1

GEV No.	510108	Ref. No.	069445 327006
description	rinse arm shaft		
For models:	LTB11, LTB12, LTB22, LTB11UK, LTB12UK, LTB22UK, LTB11, LTB22, CRYSTAL 11, CRYSTAL 22		

for vacuum packers

PTFE tapes



1

GEV No.	692155	Ref. No.	033195 033769 034083 KR991001 KR991006
description	PTFE tape W 50mm Qty 1m		
For models:	CSV10B, CSV20B, CSV25C, CSV40C, CSV21B, CSV26C, CSV41C, MVS50D		

knobs

universal knobs



1

GEV No.	110232	Ref. No.	0112134
description	knob switch 4-position t.max. °C °C ø 50mm shaft ø 6x4.6mm shaft flat upper black		



1

GEV No.	110234	Ref. No.	0112138
description	knob switch 7-position t.max. °C °C ø 50mm shaft ø 6x4.6mm shaft flat upper black		



1

GEV No.	110253	Ref. No.	0A2207 0A2269 8335612010
description	knob switch zero mark t.max. °C °C ø 50mm shaft ø 6x4.6mm shaft flat upper black		
For models:	HGRV, 710-00-115, 710-00-115, 711-00-115, 711-00-115, 710-00-122, 710-00-122, 711-00-122, 711-00-122, 0WC142, 655-00-106, 655-00-107, 655-00-110, 656-00-106, KITCALDO		

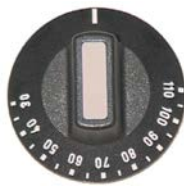

1

GEV No.	110241	Ref. No.	0102025
description	knob thermostat t.max. 110°C ø 50mm shaft ø 6x4.6mm shaft flat upper black temperature range 30-110°C		



1

GEV No.	110242	Ref. No.	0K4433 0K9909 110242
description	knob thermostat t.max. 180°C ø 50mm shaft ø 6x4.6mm shaft flat upper black temperature range 100-180°C		



1

GEV No.	110245	Ref. No.	0102024 0112024
description	knob thermostat t.max. 300°C ø 50mm shaft ø 6x4.6mm shaft flat upper black temperature range 50-300°C		





			
1			
GEV No.	110932	Ref. No.	0E3019
description	knob switch zero mark t.max.°C ø 42mm shaft ø 6x4.6mm shaft flat upper black		
For models:	TW1ERECO, TW1ELECO, TW1SRECO, TW1SLECO, RT10ED, RT10ES, RT10SR, RT10SL, RT10ED/230, RT10ES/230, RT10ERF60, RT10ELF60, RT10ERF, RT10ELF, RT10ERBF60, RT10ELBF60, RT10ERG, RT10ELG, RT10EDH, RT10ESH, RT10SRB, RT10SLB, RT10ED/230H, RT10ES/230H, RT10ERBF, RT10ELBF, RT10ERBG, RT10ELBG, RT10EDECO, RT10ESECO, RT10SRC, RT10SLC, RT10ED/230E, RT10ES/230E, RT10ERCF, RT10ELCF, RT10ERCG, RT10ELCG, RT10EDHE, RT10ESHE, RT10SRCB, RT10SLCB, RT10ED/230HE, RT10ES/230HE, RT10ERCBF, RT10ELCBF, RT10ERCBG, RT10ELCBG, RT10ERASIA, RT10ELASIA...(Other models you can see in the webshop)		

			
1			
GEV No.	111927	Ref. No.	0K5807
description	knob shaft flat upper black shaft ø 6x4.6 external size 32mm H 29mm		
For models:	CEB068, CEB069, UEB068, UEB069, CGB068, CGB069, UGB068, UGB069, VSE-S.3, VSE-S.4.MARINE, VSE-S.3.JUNO, VSE-W.3, VSE-W.4.MARINE, VSE-W.3.JUNO		

miscellaneous

			
1			
GEV No.	112105	Ref. No.	0H9730 128288
description	knob ø 21mm shaft ø 6mm		
For models:	VARIOSTEAM/S-33.3/F		

			
1			
GEV No.	111797	Ref. No.	0C0966
description	knob without symbol ø 54mm shaft ø 6x4.6mm shaft flat lower silver H 23mm		
For models:	FCS061GP, FCS061EP, FCS101E2, FCS101EP4J, FCS101EP, FCS101G-P9J, FCS102EP4J, FCS101GP, FCS102EP, FCS102GA9J, FCS201EP, FCS102GP, FCS202EP, FCS201GP, FCS202GP, FCS061EXLN, FCS061EX, FCS101EX4J, FCS101EXLN, FCS101EX, FCS102EX4J, FCS102EX, FCS201EX, FCS201EXLN, FCS202EX, FCS101GX9J, FCS101GX, FCS-102GX9J, FCS102GX, FCS201GX, FCS202GX		

			
1			
GEV No.	112911	Ref. No.	0D0718 22452 DS22452
description	knob ø 75mm shaft ø 6x4.6mm		
For models:	B2000K-01, B2000K-02, B2000K-03, B2000K-04, B2000T-01, B2000T-02, B2000T-03, B2000-4-01, B2000K-05, B2000MU-01, B2000-4-02, B2000-5-01, B2000-3-01, B2000MU-02, B2000K-06, B2000-4-03, B2000-5-02, B2000-6-01, B2000K-07, B2000-6-02, B2000-6-03, B2000-5-03, B2000-6-04, B2000K-08, B2000-4-04, B2000-5-04, B2000-5-05, B2000-6-05, B2000K-09, B2000-5-13, B2000-5-06, B2000-6-06, B2000-4-05, B2000-6-07, B2000K-10, B2000-4-06, B2000-5-07, B2000K-11, B2000-4-07, B2000-6-08, B2000K-12, B2000-5-08, B2000MU-03, B2000MU-04, B2000-5-09, B2000-6-13, B2000MU-05, B2000MU-06, B2000MU-07, B2000K-13...(Other models you can see in the webshop)		

accessories

button springs

			
1			
GEV No.	550132	Ref. No.	025245 058445 0M2312 0U0825 0U1421 214590700 214590701 51610700 BR83006
description	knob spring ø 6x4.6mm Qty 10 pcs		
For models:	TC1000, 134TCA0, TCD1000, TC1400, TCD1400, 4061410, TC1600, TC1610, TCD1600, TC2000, TCD2000, TC2010, LPS/75, LPS/75, RC/E320, RC/E320U, RC/E720, RC/E720, MCF/GE705, MCF/GE1055, MCF/GE700, MCFGE1050, MCF/GE700D, MCFGE1050D, MCF/E700D, MCF/E700, MCF/E700UK, MCF/E1050D, MCF/E1050, MC/E350D, MC/E350UK, MC/E700D, MC/E700UK, MC/E1050D, MCF/GE1055UK, MC/E350, MC/E700, MC/E1050, MI/E350, MI/E700, MIF/E700, MI/E350D, MI/E700D, MIF/E700D, MI/E360, MI/E710, MIF/E710, MI/E360D, MI/E710D, MIF/E710D...(Other models you can see in the webshop)		

covers

			
1			
GEV No.	110288	Ref. No.	025255 025256 054367
description	cover cap knob white		
For models:	MFR/G350, MFR/G351, RCV/G2, RCV/G3, RCV/E2, RCV/E3, RRV/G1FL, RRV/G1FR, RRV/G2FL, RRV/G2FM, RRV/E1FL, RRV/E1FR, RRV/E2FL, RRV/E2FM, RG/G1, RG/G2, RGV/G1, RGV/G2, RGV/E1, RGV/E2, RTV/G2, RSV/G2, RIV/E2, RBV/G2, RBV/E2, XCV/G2, XCV/G3, XCV/E2, XCV/E3, XRV/G1FL, XRV/G1FR, XRV/G2FL, XRV/G2FM, XRV/E1FL, XRV/E1FR, XRV/E1CL, XRV/E2FL, XRV/E2FM, XRV/E2CL, XGV/G1, XGV/G2, XGV/E1, XGV/E2, XTV/G2, XSV/G2, XIV/E2, XBV/G2, XBV/E2, JCV/G2, JCV/G3... (Other models you can see in the webshop)		

			
1			
GEV No.	112107	Ref. No.	OG3399 128290
description	lid knob		
For models:	VARIOSTEAM/S-33.3/F		

fascias

			
1			
GEV No.	111766	Ref. No.	055454
description	bezel		
For models:	FCVG6-1, FCVG6-3, FCVG6-1UK, FCVG6-3UK, FCVG10-2, FCVG10-4, FCVG10-1SG, FCVG10-2, FCVG10-4D, FCVG10-2UK, FCVG10-4UK, FCVG10-2, FCVG10-4, FCVG20-2, FCVG20-4, FCVG20-2, FCVG20-4D, FCVG20-2UK, FCVG20-4UK, FCVG20-4, FCVG20-4D		

			
1			
GEV No.	111661	Ref. No.	0C0623
description	bezel gas regulator t.max. 190°C 120-190°C		
For models:	PF/G1S07, PF/G2D07, PFR/G1S07, PFR/G2D07, PFR/G1S14, PFR/G2D14, PFRG2D14HV, PFRG1S14HV, OF/G1S07, OFR/G1S07, OFR/G2D07, OFR/G1S14, OFR/G2D14, KFR/G1A, KFR/G2B, KFR/G1E, KFR/G2F, KFR/G1T, WFR/G1A, WFR/G2B, WFR/G1E, WFR/G2F, WFR/G1T		

			
1			
GEV No.	111613	Ref. No.	0C0194
description	bezel gas regulator t.max. 270°C 110-270°C		
For models:	PCV/G2, PCV/G3, PCF/G2, PCF/G3, PTF/G2, PSF/G2, PSV/G2, PSF/G3, PCV/G2N, PCF/G3N, PCV/G3N, PCF/G2N, PCV/G2A, PCV/G3A, PCF/G2A, PCF/G3A, OCV/G2, OCF/G2, OCF/G3, OCF/G9UK, OTV/G2, OTF/G2, OSF/G2, OSV/G2, KCF/G2, KCF/G3, KCF/G4, KCF/T2, KCF/T3, KCF/T4, KCF/G2H, KCF/G3A, KCF/G3H, KCF/G2L, KCF/G3HA, KCF/G2G, KCF/G3G, KCF/G4G, KCF/G2HG, KCF/G3AG, KCF/G3HG, KCF/G2LG, KRF/GT2R, KRF/GT2RP, KS/G2, KSF/G2, KSCF/G3, WCF/G2, WCF/G3, WCF/G4... (Other models you can see in the webshop)		

			
1			
GEV No.	111626	Ref. No.	0C0597
description	bezel gas regulator t.max. 270°C 110-270°C		
For models:	OMV/G1C, OMV/G2C, KR/GT1, KR/GT2, KR/GT1R, KR/GT2R, KR/GT1C, KR/GT2C, KR/GT2CR, KRF/GT2R, KR/GT1P, KR/GT2P, KR/GT1RP, KR/GT2RP, KR/GT1CP, KR/GT2CP, KR/GT2CRP, KRF/GT2RP, KMV/G2C, WR/GT1, WR/GT2, WR/GT1R, WR/GT2R, WR/GT1C, WR/GT2C, WR/GT2CR, WRF/GT2R, WRF/GT2RP		

			
1			
GEV No.	111650	Ref. No.	0C0503
description	bezel gas regulator t.max. 90°C 30-90°C		
For models:	PBV/G2, KB/G1, KB/G2, WB/G1, WB/G2		

			
1			
GEV No.	111632	Ref. No.	0C0192
description	bezel gas tap with ignition flame t.max. °C for front hob		
For models:	PC/G1, PC/G2, PCV/G2, PCV/G3, PCF/G2, PCF/G3, PCF/M2, PCF/M3, PCF/M2E5, PTV/G2, PTF/G2, PSF/G2, PSV/G2, PSF/G3, PGV/G1, PGV/G2, PCV/G2N, PCF/G3N, PC/G2HV, PCV/G3N, PCF/G2N, PC/G1HV, PGV/G1HV, PTV/G2N, PGV/G2HV, PC/G1A, PC/G2A, PCV/G2A, PCV/G3A, PCF/G2A, PCF/G3A, OC/G1, OC/G2, OCV/G2, OCF/G2, OCF/G3, OTV/G2, OTF/G2, OSF/G2, OSV/G2, OGV/G1, OGV/G2, KC/G1, KC/G2, KCF/G2, KC/G3, KCF/G3, KCF/G4, KCF/M2, KC/T1... (Other models you can see in the webshop)		

			
1			
GEV No.	111633	Ref. No.	0C0193
description	bezel gas tap with ignition flame t.max. °C for rear hob		
For models:	PC/G1, PC/G2, PCV/G2, PCV/G3, PCF/G2, PCF/G3, PCF/M2, PCF/M3, PCF/M2E5, PR/G1FL, PR/G1FR, PR/G2FL, PR/G2FM, PRV/G1FL, PRV/G1FR, PRV/G2FL, PRV/G2FM, PTV/G2, PTF/G2, PSF/G2, PSV/G2, PSF/G3, PG/G1, PG/G2, PCP/G1S, PCP/G2D, PCV/G2N, PCF/G3N, PC/G2HV, PCV/G3N, PCF/G2N, PG/G1HV, PC/G1HV, PG/G2HV, PTV/G2N, PR/G1FLHV, PRV/G2FLHV, PC/G1A, PC/G2A, PCV/G2A, PCV/G3A, PCF/G2A, PCF/G3A, OC/G1, OC/G2, OCV/G2, OCF/G2, OCF/G3, OR/G1FL, OR/G1FR... (Other models you can see in the webshop)		

			
1			
GEV No.	112807	Ref. No.	0C2017
description	bezel no to be sold in France for knob dimensions 70x86.5mm		
For models:	TCF/M2, TCF/M3, TC/E1, TC/E2, TCV/E2, TCV/E3, TCF/E2, TC/E2Q, TCF/E2Q, TCV/E2Q, TI/Z1, TI/Z2, TI/E1, TI/E2, TIF/E2, TIV/E2, TC/E2QE5, TCF/E2QE5, TI/Z1E5, TI/Z2E5, TI/E1E5, TI/E2E5, TIF/E2E5, TC/E1E5, TC/E2E5, TCF/E2E5, TCF/M2E5, TI/Z2F, TG/E1, TG/E2, TG/E1E5, TG/E2E5, TF/E1D05, TF/E1S07, TF/E2D07, TFR/E1S07, TFR/E2D07, TF/E1S12, TF/E2D12, TFR/E1S12, TFR/E2D12, TFR/E1S14, TFR/E2D14, TF/E1D05E5, TF/E1S12E5, TF/E2D12E5, TF/E1S07E5, TFR/E2D07E5, TFR/E2D12E5, TCP/E1S... (Other models you can see in the webshop)		



			
1			
GEV No.	111621	Ref. No.	0C0259
description	bezel oven TH/BH/TH+BH		
For models:	PCF/M2, PCF/M3, PCV/E2, PCV/E3, PCF/E2, PC/E2Q, PCF/E2Q, PCV/E2Q, PI/E1, PI/E2, PIF/E2, PIV/E2, PC/E2QE5, PCF/E2QE5, PI/E1E5, PI/E2E5, PIF/E2E5, PCF/E2E5, PCF/M2E5, PCF/M2A, PCF/M3A, OCF/M2, OCV/E3, OCF/E2, OC/E2Q, OCF/E2Q, OI/E1, OI/E2, OIF/E2, KCF/M2, KC/E1, KC/E2, KCF/E2, KC/E1E5, KC/E2E5, KCF/E2E5, KCF/W2, KCF/M2G, KCF/M2E5G, KRF/E2R, KRF/E2RP, WCF/M2, WC/E1, WC/E2, WCF/E2, WC/E1E5, WC/E2E5, WCF/E2E5, WRF/E2R, WRF/E2RP		

			
1			
GEV No.	111818	Ref. No.	0C2006
description	bezel t.max.°C gas thermostat Mertik		
For models:	PCF/G9, TCV/G2, TCV/G3, TCF/G2, TCF/G3, TCF/G9, TCF/G9UK, TTF/G2, TSF/G2, TSV/G2, TSF/G3, TMV/G1C, TMV/G2C, TFR/G1S14, TFR/G2D14, TBV/G2, TCV/G2A, TCV/G3A, TCF/G2A, TCF/G3A, QCF/G2, QCF/G3, QCF/G4, QCF/T2, QCF/T3, QCF/T4, QCF/G2H, QCF/G3A, QCF/G3H, QCF/G2L, QCF/G3HA, QR/GT1, QR/GT2, QR/GT1R, QR/GT2R, QR/GT1C, QR/GT2C, QR/GT2CR, QRF/GT2R, QR/GT1P, QR/GT2P, QR/GT1RP, QR/GT2RP, QR/GT1CP, QR/GT2CP, QR/GT2CRP, QRF/GT2RP, QSF/G2, QSCF/G3, QB/G1...(Other models you can see in the webshop)		

			
1			
GEV No.	111654	Ref. No.	0C0518
description	bezel switch 0-1-0-1		
For models:	PW/E1, PB/E2, PBV/E2, PB/E2E5, OW/E1, OB/E1, OB/E2, KB/E2, KW/E1, WB/E2, WW/E1		

			
1			
GEV No.	111608	Ref. No.	0C0317
description	bezel thermostat 1-8 for front hob		
For models:	PI/E1, PI/E2, PIF/E2, PIV/E2, PI/E1E5, PI/E2E5, PIF/E2E5, PCP/E2SH, PCP/E1SH, PCP/E2SH, PCP/E2SH3B, OI/E1, OI/E2, OIF/E2, OCP/E2S, OCP/E1SH, OCP/E2SH, KI/E1, KI/E2, KI/E2E5, KT/E1, KT/E2, KPI/G10, KPI/G15, KPI/E10, KPI/E15, KPI/G15A, KPI/E15A, KPI/G06, KPI/E06, KPI/E15H, KPI/E10H, WI/E1, WI/E2, WI/E2E5, WT/E1, WT/E2, WPI/G10, WPI/G15, WPI/E10, WPI/E15, WPI/G15A, WPI/E15A, WPI/G06, WPI/E06, WPI/E15H, WPI/E10H		

			
1			
GEV No.	111635	Ref. No.	0C0560
description	bezel switch 4-position		
For models:	PCP/E2SH, PCP/E1SH, PCP/E2SH, PCP/E2SH3B, OCP/E2S, OCP/E1SH, OCP/E2SH, KCP/G1RU, KCP/G2RU, KCP/E1RU, KCP/E2RU, KCP/G1, KCP/G1R, KCP/G2, KCP/G2R, KCP/E1, KCP/E1R, KCP/E2, KCP/E2R, KCP/G1U, KCP/G2U, KCP/E1U, KCP/E2U, WCP/G1, WCP/G1R, WCP/G2, WCP/G2R, WCP/E1, WCP/E1R, WCP/E2, WCP/E2R, DCP/G400		

			
1			
GEV No.	111609	Ref. No.	0C0318
description	bezel thermostat 1-8 for rear hob		
For models:	PI/E1, PI/E2, PIF/E2, PIV/E2, PI/E1E5, PI/E2E5, PIF/E2E5, PMV/E1C, PMV/E2C, PPD/G260, PPI/G260P, PPI/E260P, OI/E1, OI/E2, OIF/E2, OMV/E1C, OMV/E2C, OPD/G260, OPI/G260P, OPI/E260P, KI/E1, KI/E2, KI/E2E5, KT/E1, KT/E2, KPD/G10, KPD/G15, KPD/G15A, KPI/E25, KPI/G15H, KPI/G10H, KBR/G2F, KBR/G2C, KBR/G3F, KBR/G3FH, KBR/G3C, KBR/G3CH, KBR/E2F, KBR/E2C, KBR/E3F, KBR/E3FH, KBR/E3C, KBR/E3CH, KMW/E2C, KBR/G2FH, KBR/G2CH, KBR/E2FH, KBR/E2CH, KCP/G1RU, KCP/G2RU...(Other models you can see in the webshop)		

			
1			
GEV No.	111605	Ref. No.	0C0304
description	bezel switch 7-position for front hob		
For models:	PC/E1, PC/E2, PCV/E2, PCV/E3, PCF/E2, PC/E2Q, PCF/E2Q, PCV/E2Q, PC/E2QE5, PCF/E2QE5, PC/E1E5, PC/E2E5, PCF/E2E5, OC/E1, OC/E2, OCV/E3, OCF/E2, OC/E2Q, OCF/E2Q, KC/E1, KC/E2, KCF/E2, KC/E1E5, KC/E2E5, KCF/E2E5, WC/E1, WC/E2, WCF/E2, WC/E1E5, WC/E2E5, WCF/E2E5		

			
1			
GEV No.	111665	Ref. No.	0C0615
description	bezel thermostat t.max. 185°C 105-185°C		
For models:	PFR/G2S40, PF/E1D05, PF/E1S07, PF/E2D07, PFR/E1S07, PFR/E2D07, PF/E1S12, PF/E2D12, PFR/E1S12, PFR/E2D12, PFR/E1S14, PFR/E2D14, PF/E1D05E5, PF/E1S12E5, PF/E2D12E5, PF/E1S07E5, PFRE2D07E5, PFR/E2D12E5, OF/E1S07, OFR/E1S07, OFR/E2D07, OF/E1S12, OF/E2D12, OFR/E1S12, OFR/E2D12, TFR/G2S40, KFR/E1A, KFR/E2B, KFR/E1E, KFR/E2F, KFR/E1C, KFR/E2D, KFR/E1CE5, KFR/E2DE5, WFR/E1A, WFR/E2B, WFR/E1E, WFR/E2F, WFR/E1C, WFR/E2D		

			
1			
GEV No.	111606	Ref. No.	0C0307
description	bezel switch 7-position for rear hob		
For models:	PC/E1, PC/E2, PCV/E2, PCV/E3, PCF/E2, PC/E2Q, PCF/E2Q, PCV/E2Q, PC/E2QE5, PCF/E2QE5, PC/E1E5, PC/E2E5, PCF/E2E5, PCP/E1S, PCP/E2D, OC/E1, OC/E2, OCV/E3, OCF/E2, OC/E2Q, OCF/E2Q, OCP/E1S, OCP/E2D, KC/E1, KC/E2, KCF/E2, KC/E1E5, KC/E2E5, KCF/E2E5, WC/E1, WC/E2, WCF/E2, WC/E1E5, WC/E2E5, WCF/E2E5		

			
GEV No.	111628	Ref. No.	0C0466
description	bezel thermostat t.max. 280°C 120-280°C		
For models:	PR/E1FL, PR/E1FR, PR/E1CL, PR/E2FL, PR/E2FM, PR/E2CL, PRV/E1FL, PRV/E1FR, PRV/E1CL, PRV/E2FL, PRV/E2FM, PRV/E2CL, PR/E2CM, PR/E1FLO, PR/E1FLE5, PR/E1FRE5, PR/E2FLE5, PR/E2CME5, PR/E2FME5, PGV/E1, PGV/E2, PG/E1, PG/E2, PMV/E1C, PMV/E2C, PG/E1E5, PG/E2E5, OR/E1FL, OR/E1FR, OR/E1CL, OR/E2FL, OR/E2FM, OR/E2CL, OR/E2CM, OR/E1FLO, OMV/E1C, OMV/E2C, KR/E1, KR/E2, KR/E1R, KR/E2R, KR/E1C, KR/E2C, KR/E2CR, KR/E1E5, KR/E1RE5, KR/E2E5, KR/E2RE5, KR/E1CE5, KR/E2CE5...(Other models you can see in the webshop)		

			
GEV No.	111620	Ref. No.	0C0258
description	bezel thermostat t.max. 300°C 100-300°C		
For models:	PCF/M2, PCF/M3, PCV/E2, PCV/E3, PCF/E2, PC/E2Q, PCF/E2Q, PCV/E2Q, PI/E1, PI/E2, PIF/E2, PIV/E2, PC/E2QE5, PCF/E2QE5, PI/E1E5, PI/E2E5, PIF/E2E5, PCF/E2E5, PCF/M2E5, PBR/E2FM, PBR/E2IM, PCF/M2A, PCF/M3A, OCF/M2, OCV/E3, OCF/E2, OC/E2Q, OCF/E2Q, OI/E1, OI/E2, OIF/E2, OBR/E2FM, OBR/E2IM, KCF/M2, KC/E1, KC/E2, KCF/E2, KC/E1E5, KC/E2E5, KCF/E2E5, KCF/W2, KCF/M2G, KCF/M2E5G, KRF/E2R, KRF/E2RP, KBR/G2F, KBR/G2C, KBR/G3F, KBR/G3FH, KBR/G3C...(Other models you can see in the webshop)		

			
GEV No.	111653	Ref. No.	0C0515
description	bezel thermostat t.max. 90°C 30-90°C		
For models:	PB/E1, PB/E2, PBV/E2, PB/E2E5, OB/E1, OB/E2, KB/E1, KB/E2, WB/E1, WB/E2		

			
GEV No.	111675	Ref. No.	0C0711
description	bezel water hot/cold		
For models:	PPD/G260, PPI/G260P, PPI/E260P, OPD/G260, OPI/G260P, OPI/E260P, KPI/G10, KPI/G15, KPI/E10, KPI/E15, KPD/G10, KPD/G15, KPD/G15A, KPI/G15A, KPI/E15A, KPI/G06, KPI/E06, KPI/E25, KPI/G15H, KPI/E15H, KPI/G10H, KPI/E10H, WPI/G10, WPI/G15, WPI/E10, WPI/E15, WPD/G10, WPD/G15, WPD/G15A, WPI/G15A, WPI/E15A, WPI/G06, WPI/E06, WPI/E25, WPI/G15H, WPI/E15H, WPI/G10H, WPI/E10H		

			
GEV No.	112106	Ref. No.	0G1890 0K5794 0K5814 0KG945 128289 19016028 19016059
description	bezel zero mark		
For models:	VARIOSTEAM/S-33.3/F		

gaskets			
			
GEV No.	110300	Ref. No.	059326
description	gasket		
For models:	HBR/G800, HBR/G805, HBR/G810, HBR/G815, HBR/G811, HBR/G816, HBR/G800UK, ZBR/G800, ZBR/G805, ZBR/G810, ZBR/G815, ZBR/G811, ZBR/G816, ZBR/G800UK, ABR/G800, ABR/G805, ABR/G810, ABR/G815, ABR/G811, ABR/G816, OBR/G800UK		

			
GEV No.	550679	Ref. No.	006465
description	gasket for knob		
For models:	RMV/G1C, RMV/G2C, XMV/G1C, XMV/G2C, MMV/G1C, MMV/G2C, HR/G403W, HR/G803W, HR/G413W, HR/G813W, HR/G404W, HR/G804W, HR/G814W, HFR/G430, HFR/G830, HFRS/G430, ZR/G403W, ZR/G803W, ZR/G413W, ZR/G813W, ZR/G404W, ZR/G804W, ZR/G814W, ZFR/G430, ZFR/G830, ZFRS/G430, AR/G403W, AR/G803W, AR/G413W, AR/G813W, AR/G404W, AR/G804W, AR/G814W, AFR/G430, AFR/G830, AFRS/G430		

			
GEV No.	693432	Ref. No.	002663 0F0082
description	gasket for knob		
For models:	EBS50, EBS50, EBS50, EBS50, EBV50, EBV50, EBV50, EBV50, EBV50, EBS100, EBS100, EBS100, EBS100, EBV100, EBV100, EBV100, EBV100, EBV100, EBV-C100, EBV-C100, EBV-C100, EBV-C100, EBV-C100, EBV-C100, EBV200, EBV200, EBV200, EBV200, EBV-C200, EBV-C200, EBV-C200, EBV-C200, EBV300, EBV300, EBV300, EBV300, EBV300, EBV-C300, EBV-C300, EBV-C300, EBV-C300, EBV-C300, FCV/G10L3, FCV/G6L3TOWNGAS, FCV/G6L3, FCVG10L3T, FCVG102L3, FCV/G20L3, FCVG202L3...(Other models you can see in the webshop)		

			
GEV No.	697975	Ref. No.	003955 0C3796
description	gasket for knob ED ø 16mm Qty 50 pcs		
For models:	FDV40G, FDV40E, FDV40GZ, FDV40EL, FDV40GA, FDV20G, FDV20E, FDV20GZ, FDV20EL, FDV20GA, FCF02EV, FCF02EOEM, FCV/G10L3, FCV/G6L3TOWNGAS, FCV/G6L3, FCVG10L3T, FCVG102L3, FCV/G20L3, FCVG202L3, FCVE6L3J, FCV/E10L3JAP, FCV/E102/1L3JAP, FCV/G6L3JAP, FCVG10L3J, FCVG102L3J, FCVG6L3CJ, FCV/E61/1, FCV/G10L2, FCV/E101/1, FCV/E10L2, FCV/E61/1, FCV/E101/2, FCV/G6L3C, FCV/G61/1, FCVG6L3CT, FCVG6L3CJ, FCV/E10L3, FCV/E102/1, FCV/E6L3, FCV/E102/1L3, FCV/E20L3, FCVE202L3, FCV/G6L4, FCV/E6L4, FCV/E101/1, FCV/G101/1, FVC/E101/1, FVC/G102/1, FVC/E102/1, FCV/G201/1...(Other models you can see in the webshop)		



			
GEV No.	111607	Ref. No.	053816 0KE998
description	gasket knob D1 ø 14mm D2 ø 4mm thickness 3mm equiv. no. 53816 suitable for JUNO, ZANUSSI		
For models:	RC/E320, RC/E320U, RC/E720, RC/E720, MCF/GE705, MCF/GE1055, MCF/GE700, MCFGE1050, MCF/GE700D, MCFGE1050D, MCF/E700D, MCF/E700, MCF/E700UK, MCF/E1050D, MCF/E1050, MC/E350D, MC/E350UK, MC/E700D, MC/E700UK, MC/E1050D, MCF/GE1055UK, MC/E350, MC/E700, MC/E1050, MI/E350, MI/E700, MIF/E700, MI/E350D, MI/E700D, MIF/E700D, MI/E360, MI/E710, MIF/E710, MI/E360D, MI/E710D, MIF/E710D, MCF/GE702, MCFGE1052, MCF/GE700, MCF-GE1050, MBR/G710D, MBR/E710D, MBR/E700, MBR/E700UK, MBR/E716, MBR/E706, MFR/G350, MFR/G700, MFR/E350, MFR/E700...(Other models you can see in the webshop)		

			
GEV No.	111762	Ref. No.	056500
description	gasket knob hole distance 24mm D1 ø 40mm D2 ø 14mm equiv. no. 56500 suitable for ZANUSSI		
For models:	FCVE6-3CE, FCVE103CE, FCVE203CE		

			
GEV No.	110202	Ref. No.	0H6984
description	gasket switch shaft		
For models:	7508-2		

			
GEV No.	110271	Ref. No.	0H6667 18005609
description	gasket switch shaft		
For models:	SLE159-170, SLE159-180, 7561-3.KES60.RW, 7562-3.KES80.RW, 7563-3.KES100.RW, 7564-3.KES150.RW, 7720-3/90.WB.GN1/1., 7520-3/85.WB.GN1/1., 7731-3/85.GRPL.VCHR, 7701-3/85, 7721-3/85.WB.GN2/1, 7751-3/85.KES60, 7744-3/85.KB.(N), 7501-3/85., 7531-3/85., 7501-3/90.HE.4PL.(N), 7531-3/90.GRPL.(N), 7508-3/85., 7502-3/85., 7520-3/90.WB.GN1/1., 7720-3/85.WB.GN1/1., 7542-3/85., 7544-3/85.KB.(N), 7542-3/90.KB.(N), 7544-3/90.KB.(N), 7742-3/90.KB.(N), 7742-3/85.KB.(N), 7744-3/90.KB.(N), 7746-3/90.KB.(N), 7748-3/90.KB.(N), 7747-3/90.KB.(N), 7550-3/85.KES40.(N), 7551-3/85.KES60, 7552-3/85.KES80.(N), 7553-3/85.KES100.(N), 7554-3/85.KES150.(N), 7550-3/90.KES40.(N), 7551-3/90.KES60, 7552-3/90.KES80.(N), 7553-3/90.KES100.(N), 7554-3/90.KES150.(N), 7561-3/85.KES60.RW, 7562-3/85.KES80.RW, 7563-3/85.KES100.RW, 7564-3/85.KES150.RW, 7561-3/90.KES60.RW, 7562-3/90.KES80.RW, 7563-3/90.KES100.RW, 7564-3/90.KES150.RW, 7573-3/85.KES100.(N)...(Other models you can see in the webshop)		

knob adaptors

			
GEV No.	102478	Ref. No.	005913
description	knob adaptor		
For models:	HCPA/G1219, HCPA/GI 1219, CR20V, CR20EI, CR22G, ZCPAG1219, ZCPA/GI 1219, CR20V, CR20EI, CR22G, CR15G, CR15V, CR15E		

			
GEV No.	102479	Ref. No.	002300
description	knob adaptor		
For models:	HCPA/G1219, HCPA/GI 1219, CR20V, CR20EI, CR22G, ZCPAG1219, ZCPA/GI 1219, CR20V, CR20EI, CR22G, CR15G, CR15V, CR15E		

miscellaneous

			
GEV No.	693429	Ref. No.	002662
description	bush		
For models:	FCZ061EAA, FCZ101EAA, FCZ102EAA, FCZ201EAA, FCZ202EAA, FCZ061EAH, FCZ101EAH, FCZ201EAH, FCZ061EAN, FCZ101EAN, FCZ201EAN, FCZ061ETA, FCZ101ETA, FCZ102ETA, FCZ201ETA, FCZ202ETA, FCZ061ETH, FCZ101ETH, FCZ201ETH, FCZ061ETN, FCZ101ETN, FCZ201ETN, FCZ061GAG, FCZ101GAG, FCZ102GAG, FCZ201GAG, FCZ202GAG, FCZ061GAD, FCZ101GAD, FCZ102GAD, FCZ201GAD, FCZ202GAD, FCZ101GTG, FCZ102GTG, FCZ201GTG, FCZ202GTG, FCZ101GTD, FCZ102GTD, FCZ201GTD, FCZ202GTD, FCZ061EBA, FCZ101EBA, FCZ102EBA, FCZ201EBA, FCZ202EBA, FCZ061EBH, FCZ101EBH, FCZ201EBH, FCZ061EBN, FCZ101EBN...(Other models you can see in the webshop)		

			
GEV No.	550697	Ref. No.	003765 0K2358
description	bush for knob		
For models:	FCFE201-0, FCFE202-0, FCF201ENS, 5711-2-6, 5711-2-7, 5711-2-8, 5711-2-8CH, 5712-2-6, 5712-2-7, 5712-2-8, 5714-2-6, 5714-2-7, 5714-2-8, 5717-2-6, 5714-2-7, 5714-2-8, 5711-2-6L, 5711-2-7L, 5711-2-8L, 5712-2-6L, 5712-2-7L, 5712-2-8L, 5714-2-6L, 5714-2-7L, 5714-2-8L, 5714-2-6L, 5714-2-7L, 5714-2-8L, 5711-3-6, 5711-3-7, 5711-3-8, 5711-3-8CH, 5712-3-6, 5712-3-7, 5712-3-8, 5712-3-8E, 5712-3-8CH, 5714-3-6, 5714-3-7, 5714-3-8, 5714-3-8E, 5717-3-7, 5717-3-8, 5717-3-8E, 5717-3-8M, 5717-3-8C, 5717-3-8M, 5702-2-3, 5704-2-3, 57074-2-3...(Other models you can see in the webshop)		

			
GEV No.	693430	Ref. No.	051263 0F0147
description	nut thread M22x1.5 H 5mm WS 26 zinc-coated steel Qty 1 pcs		
For models:	FCZ061EAA, FCZ101EAA, FCZ102EAA, FCZ201EAA, FCZ202EAA, FCZ061EAH, FCZ101EAH, FCZ201EAH, FCZ061EAN, FCZ101EAN, FCZ201EAN, FCZ061ETA, FCZ101ETA, FCZ102ETA, FCZ201ETA, FCZ202ETA, FCZ061ETH, FCZ101ETH, FCZ201ETH, FCZ061ETN, FCZ101ETN, FCZ201ETN, FCZ061GAG, FCZ101GAG, FCZ102GAG, FCZ201GAG, FCZ202GAG, FCZ061GAD, FCZ101GAD, FCZ102GAD, FCZ201GAD, FCZ202GAD, FCZ101GTG, FCZ102GTG, FCZ201GTG, FCZ202GTG, FCZ101GTD, FCZ102GTD, FCZ201GTD, FCZ202GTD, FCZ061EBA, FCZ101EBA, FCZ102EBA, FCZ201EBA, FCZ202EBA, FCZ061EBH, FCZ101EBH, FCZ201EBH, FCZ061EBN, FCZ101EBN...(Other models you can see in the webshop)		

			
1			
GEV No.	693431	Ref. No.	002727
description	plain washer		
For models:	FCZ061EAA, FCZ101EAA, FCZ102EAA, FCZ201EAA, FCZ202EAA, FCZ061EAH, FCZ101EAH, FCZ201EAH, FCZ061EAN, FCZ101EAN, FCZ201EAN, FCZ061ETA, FCZ101ETA, FCZ102ETA, FCZ201ETA, FCZ202ETA, FCZ061ETH, FCZ101ETH, FCZ201ETH, FCZ061ETN, FCZ101ETN, FCZ201ETN, FCZ061GAG, FCZ101GAG, FCZ102GAG, FCZ201GAG, FCZ202GAG, FCZ061GAD, FCZ101GAD, FCZ102GAD, FCZ201GAD, FCZ202GAD, FCZ101GTG, FCZ102GTG, FCZ201GTG, FCZ202GTG, FCZ101GTD, FCZ102GTD, FCZ201GTD, FCZ202GTD, FCZ061EBA, FCZ101EBA, FCZ102EBA, FCZ201EBA, FCZ202EBA, FCZ061EBH, FCZ101EBH, FCZ201EBH, FCZ061EBN, FCZ101EBN...(Other models you can see in the webshop)		

			
1			
GEV No.	691974	Ref. No.	051259 052392
description	hand wheel ø 175mm D1 ø 40mm bore ø 20mm depth of bore 35mm thread M8 hole distance 8mm L2 155mm without handle		
For models:	HBR/G803, HBR/G804, HBR/G803, HBR/G804, HBR/G803, HBR/G805, HBR/G1003, HBR/G1003, HBR/G1004, HBR/E801, HBR/E803, HBR/E804, HBR/E805UK, HBR/E1003, HBR/G803, HBR/G804, HBR/G1013, HBR/E1013, HBR/G803, HBR/G804, HBR/G1003, HBR/G1013, HBR/E801, HBR/E803, HBR/E804, HBR/E1003, HBR/E1013, HBR/G1004		
accessories for	691974		
	GEV No.	690859	Ref. No.
			051299 052393 0KE974 28201
folding handle ø 28mm total length 110mm seat ø 26mm shaft ømm thread M6 with pin L 110mm			

handles and hand wheels

hand wheels

hand wheels

			
1			
GEV No.	693399	Ref. No.	0A5164
description	hand wheel ø 160mm D1 ø 40mm bore ø 16mm hole ø 4mm thread hole distance 4mm groove widthmm L1 22mm L2 50mm handle length 75mm with folding handle		
For models:	RBR/G2FM, RBR/G2IM, RBK/G2FM, RBR/E2FM, RBR/E2IM, RBK/E2FM, XBR/G2FM, XBR/G2IM, XBK/G2FM, XBR/E2FM, XBR/E2IM, XBK/E2FM, JBR/G2FM, JBR/E2FM, MBR/G2FM, MBR/G2IM, MBK/G2FM, MBR/E2FM, MBR/E2IM, MBK/E2FM, PBR/G2FM, PBR/G2IM, PBR/E2FM, PBR/E2IM, OBR/G2FM, OBR/G2IM, OBR/E2FM, OBR/E2IM, TBR/G2FM, TBR/G2IM, TBR/E2FM, TBR/E2IM, KBR/G2F, KBR/G2C, KBR/G3F, KBR/G3FH, KBR/G3C, KBR/G3CH, KBR/E2F, KBR/E2C, KBR/E3F, KBR/E3FH, KBR/E3C, KBR/E3CH, KBR/G2FH, KBR/G2CH, KBR/E2FH, KBR/E2CH, HBR/G800, HBR/G805...(Other models you can see in the webshop)		

			
1			
GEV No.	693317	Ref. No.	0H6470
description	hand wheel ø 160mm D1 ø 40mm bore ø 20mm L1 30mm L2 50mm without handle aluminium		
accessories for	693317		
	GEV No.	514256	Ref. No.
			0K2472
cone handle ø 26mm total length 97mm thread M10 aluminium L1 82mm L2 15mm L 82mm			



GEV No.	690085	Ref. No.	OG0008 OG0010 OG0255 OG2237 OH6471 OK1715 OK1716 OK5530 OK5532 19006140 19006145 19006146 234850 707045032
----------------	--------	-----------------	---

description hand wheel ø 200mm D1 ø 48mm bore ø 20mm thread groove widthmm L1 30mm L2 60mm handle length 82mm with folding handle

For models: ACSGRT, BOT080S.MH25.W94, BOT080S.MS25.W94, BOT100E.MS35.H97, BOT150S.MH25.F98, BOT150S.MH25.W94, BOT200S.MH25.F18, BOT200S.MH25.W14, BOT400E.MS35.W14, BOT400S.MH25.F18, CEB068, FET060E.MS35P.F88, FET060E.MS35P.W84, FET060E.MS35S.F88, FET080E.MS35P.F88, FET080E.MS35P.W84, FET080E.MS35S.W84, FET100E.MS35P.F88, FET100E.MS35P.W84, BOT150E.MS35.H97, FET100E.MS35S.F97, FET060E.MS35S.W84, FET080E.MS35S.F88, FET100E.MS35S.F88, FET100E.MS35S.W84, BOT040E.MS35.F88, BOT040S.MH25.F98, BOT040E.MS35.W84, BOT040S.MH25.W94, BOT060E.MS35.F88, BOT060S.MH25.F98, BOT060E.MS35.W84, BOT060S.MH25.W94, BOT080E.MS35.F88, BOT080S.MH25.F98, BOT080E.MS35.W84, BOT100S.MH25.F98, BOT100S.MH25.W94, BOT300S.MH25.F18, BOT300S.MH25.W14, BOT400E.MS35.F18, BOT400S.MS25.F18, BOT400S.MH25.W14, BOT400S.MS25.W14, BOT040E.MS35.F98, BOT040E.MS35.W94, BOT060E.MS35.F98, BOT060E.MS35.W94, BOT080E.MS35.F98, BOT080E.MS35.W94...(Other models you can see in the webshop)

spare parts for 690085

	GEV No.	514255	Ref. No.	OC3800 OK2348 SN1402791
---	----------------	--------	-----------------	-------------------------------

folding handle ø 26mm total length 85mm seat ø 20mm shaft ømm thread M6 with pin L 85mm



GEV No.	690551	Ref. No.	OH6472 OKE626
----------------	--------	-----------------	------------------

description hand wheel ø 200mm D1 ø 48mm bore ø 20mm thread M8 groove widthmm L1 30mm L2 60mm handle length 80mm no fold-away handle

For models: 7744-3/85.KB.(N), 7542-3/85., 7544-3/85.KB.(N), 7542-3/90.KB.(N), 7544-3/90.KB.(N), 7742-3/90.KB.(N), 7742-3/85.KB.(N), 7744-3/90.KB.(N), 7541-3/85.KB.(N), 7542-3/85.KB.DWD, 7544-3/85.KB.220V3, 7742-3/85.KB.DWD.ETR, 7742-3/85.KB.DWD, 7542-2, 7542-3, 7544-2, 7544-3, 7546-3, 7548-3, 7581-5, 7582-5, 7583-5, 7742-3, 7744-3, 7746-3, 7748-3, 7781-5, 7782-5, 7783-5

spare parts and accessories



GEV No.	514254	Ref. No.	OH6791 256612 5983KU26
----------------	--------	-----------------	------------------------------

description folding handle ø 26mm total length 102mm seat ø 20mm shaft ømm thread M6 L 102mm

For models: 7581-5.KK60, 7582-5.KK80, 7583-5.KK100, 7781-5.KK60, 7782-5.KK80, 7783-5.KK100, 7580-5.KK40, 7584-5.KK150, 7780-5.KK40, 7580-5/85.KK40.(N), 7581-5/85.KK60.(N), 7582-5/85.KK80.(N), 7583-5/85.KK100.(N), 7584-5-85.KK150.(N), 7580-5/90.KK40.(N), 7581-5/90.KK60.(N), 7582-5/90.KK80.(N), 7583-5/90.KK100.(N), 7584-5-90.KK150.(N), 7568-5-90.KK200.(N), 7568-3, 7568-5.KK200, 7568-5/85.KK200.(N), 7580-3, 7581-3, 7582-3, 7583-3, 7584-3, 7768-3, 7768-5.KK200, 7768-5/85.KK200.(N), 7768-5/90.KK200.(N), 7780-3, 7780-5/85.KK40.(N), 7780-5/90.KK40.(N), 7781-3, 7781-5/85.KK60.(N), 7781-5/90.KK60.(N), 7782-3, 7782-5/85.KK80.(N), 7782-5/90.KK80.(N), 7783-3, 7783-5/85.KK100.(N), 7783-5/90.KK100.(N), 7784-3, 7784-5.KK150, 7784-5/85.KK150.(N), 7784-5/90.KK150.(N), 9042-2, 9042-3...(Other models you can see in the webshop)



GEV No.	514255	Ref. No.	OC3800 OK2348 SN1402791
----------------	--------	-----------------	-------------------------------

description folding handle ø 26mm total length 85mm seat ø 20mm shaft ømm thread M6 with pin L 85mm

For models: KBR/E2F, KBR/E2C, KBR/E3F, KBR/E3FH, KBR/E3C, KBR/E3CH, KBR/E2FH, KBR/E2CH, 7581-5.KK60, 7582-5.KK80, 7583-5.KK100, 7781-5.KK60, 7782-5.KK80, 7783-5.KK100, 7580-5.KK40, 7584-5.KK150, 7780-5.KK40, 7580-5/85.KK40.(N), 7581-5/85.KK60.(N), 7582-5/85.KK80.(N), 7583-5/85.KK100.(N), 7584-5-85.KK150.(N), 7580-5/90.KK40.(N), 7581-5/90.KK60.(N), 7582-5/90.KK80.(N), 7583-5/90.KK100.(N), 7584-5-90.KK150.(N), 7568-5-90.KK200.(N), 7542-2, 7542-3, 7544-2, 7544-3, 7546-3, 7548-3, 7568-3, 7568-5.KK200, 7568-5/85.KK200.(N), 7580-3, 7581-3, 7581-5, 7582-3, 7582-5, 7583-3, 7583-5, 7584-3, 7742-2, 7742-3, 7744-2, 7744-3, 7746-3...(Other models you can see in the webshop)



GEV No.	690859	Ref. No.	051299 052393 OKE974 28201
----------------	--------	-----------------	-------------------------------------

description folding handle ø 28mm total length 110mm seat ø 26mm shaft ømm thread M6 with pin L 110mm

For models: HBR/G803, HBR/G804, HBR/G803, HBR/G804, HBR/G803, HBR/G805, HBR/G1003, HBR/G1003, HBR/G1004, HBR/E801, HBR/E803, HBR/E804, HBR/E805UK, HBR/E1003, HBR/G803, HBR/G804, HBR/G1013, HBR/E1013, HBR/G803, HBR/G804, HBR/G1003, HBR/G1013, HBR/E801, HBR/E803, HBR/E804, HBR/E1003, HBR/E1013, HBR/G1004

			
1			
GEV No.	540246	Ref. No.	0K5514
description	cylindrical handle thread M8 ø 23mm L 65mm rotary		
For models:	CEB068, CEB069, UEB068, UEB069, CGB068, CGB069, UGB068, UGB069		

			
1			
GEV No.	514256	Ref. No.	0K2472
description	cone handle ø 26mm total length 97mm thread M10 aluminium L1 82mm L2 15mm L3 82mm		

cylindrical handles

rotary

			
1			
GEV No.	540246	Ref. No.	0K5514
description	cylindrical handle thread M8 ø 23mm L 65mm rotary		
For models:	CEB068, CEB069, UEB068, UEB069, CGB068, CGB069, UGB068, UGB069		

fixed

			
1			
GEV No.	110703	Ref. No.	004148
description	cylindrical handle thread M10 ø 28mm L 87mm		
For models:	ZCMME6, ZCBME12, ZCMME4, ZCBME8, ZCMME9, ZCBME18		

			
1			
GEV No.	697977	Ref. No.	004107
description	cylindrical handle thread M12 ø 29mm L 112mm plastic		
For models:	ZCMDG6, ZCMDE6, ZCBDE12, ZCMDG4, ZCMDE4, ZCBDE8, ZCMDG9, ZCMDE9, ZCBDE18, ZCBDG8, ZCBDG12, ZCBDG18, FFPS16, FFPS32		

			
1			
GEV No.	529902	Ref. No.	067411 075545
description	cylindrical handle thread M8 bore ø 8.5mm ø 21mm L 50mm plastic		
For models:	CL511, CL611, CL911, CL521, CL621, CL921, CL121, CL221, HQN/V917, HQN/V917, LO/E480, PLO480/E, LO480EUK, LO480E/63, LO480VAPORESTD, PLO480V, LO480V/63-60HZ, LO/E250, PLO250E, LO/E250UK, LO250E/63, LOPE25, LOPE48, LO480Z-VAPORE		

			
1			
GEV No.	540713	Ref. No.	058111 5900235
description	cylindrical handle thread M8 ø 17mm L 38mm		
For models:	QME300A, QME600, QFE300, QFE302, QFE600, QFE602, QFG300, QFG600		

			
1			
GEV No.	691314	Ref. No.	057728
description	cylindrical handle thread M8 ø 28mm L 86mm		
For models:	MCP/E700, MCP/G700, MCP/E700D, MCP/G701, MCP/G710, MCP/G711, MCP/G705, MCP/G706, MG/E350D, MG/E350UK, MG/E700D, MG/E700UK, MG/G350D, MG/G700D, MG/G350, MG/G350E, MG/G350F, MG/G350NL, MG/G700, MG/G700E, MG/G700F, MG/G700NL, MG/G1050, MG/G1050F, MG/E350, MG/E700, MG/G1051, CPG2000Z, RG/G1, RG/G2, RGV/G1, RGV/G2, RG/E1, RG/E2, RGV/E1, RGV/E2, XG/G1, XG/G2, XGV/G1, XGV/G2, XG/E1, XG/E2, XGV/E1, XGV/E2, JG/G1, JG/G2, JGV/G1, JGV/G2, JG/E1, JG/E2...(Other models you can see in the webshop)		

cone handles

			
1			
GEV No.	110704	Ref. No.	00329 004906 0K3527
description	cone handle thread M6 ø 16mm L 25mm plastic black		
For models:	SFRE700, SME350, SME700, SGE350, SFRG350, SFRG700, SFRE350, SFRE700, SME350, SME700, SGE350, SFRG350, SFRG700, SMG350, SMG700, BM35E6U, SFRE350, SFRE351, SFRE700, SFRE701, GR35E6U		



			
1			
GEV No.	514256	Ref. No.	OK2472
description	cone handle ø 26mm total length 97mm thread M10 aluminium L1 82mm L2 15mm L 82mm		

			
1			
GEV No.	514322	Ref. No.	026822 029898
description	cone handle thread M6 ø 20mm L 26mm plastic black		
For models:	HFH/G430, HFH/E430, HFH/G401U, HFH/G435, HFH/G435, ZFH/G430, ZFH/E430, ZFH/G435, ZFH/G435, AFH/G435, AFH/E435, FCV/G10L3, FCV/G6L3TOWNGAS, FCV/G6L3, FCVG10L3T, FCVG102L3, FCV/G20L3, FCVG202L3, FCVE6L3J, FCV/E10L3JAP, FCV/E102/1L3JAP, FCV/G6L3JAP, FCVG10L3J, FCVG102L3J, FCVG6L3CJ, FCV/E61/1, FCV/G10L2, FCV/E101/1, FCV/E10L2, FCV/E61/1, FCV/E101/2, FCV/G6L3C, FCV/G61/1, FCV/G61/1, FCV/G61/1, FCVG6L3CT, FCVG6L3CJ, FCV/E10L3, FCV/E102/1, FCV/E6L3, FCV/E102/1L3, FCV/E20L3, FCVE202L3, FCV/G6L4, FCV/E6L4, FCV/E101/1, FCV/G101/1, FVC/E101/1, FCV/G102/1, FVC/E102/1...(Other models you can see in the webshop)		

			
1			
GEV No.	111666	Ref. No.	010142 728005
description	star handle shaft 7x7mm ø 68mm L 22mm black thermoplastic		
For models:	KPD/G15A, KPI/G15A, KPI/E15A, HFR/E410, HFR/E810, HFR/E411, HFR/E412, HFR/G412, HFR/E418, HFR/E818, HPA/GD825, HPA/GI825, HPA/ED825, HPA/EI825, ZFR/E410, ZFR/E810, ZFR/E411, ZFR/E412, ZFR/G412, ZFR/E418, ZFR/E818, 2PDAG15, 2PIAG15, WPD/G15A, WPI/G15A, WPI/E15A, AFR/E410, AFR/E810, AFR/E411, AFR/E412, AFR/G412, OFR/E810, HPA/G815, HPA/GI815, HPA/EI810, HPA/G815, HPN/GI815, HPA/EI815		

			
1			
GEV No.	540228	Ref. No.	OK1704
description	star handle shaft 8x8mm ø 80mm		
For models:	7550-5.KES40, 7551-5.KES60, 7552-5.KES80, 7553-5.KES100, 7554-5.KES150, 7574-5.KES150, 7750-5.KES40, 7751-5.KES60, 7752-5.KES80, 7753-5.KES100, 7754-5.KES150, 7573-5.KES100, 7550-5/85.KES40.(N), 7551-5/85.KES60.(N), 7552-5/85.KES80.(N), 7553-5/85.KES100.(N), 7554-5/85.KES150.(N), 7550-5/90.KES40.(N), 7551-5/90.KES60.(N), 7552-5/90.KES80.(N), 7553-5/90.KES100.(N), 7554-5/90.KES150.(N), 7573-5/85.KES100.(N), 7574-5/85.KES150.(N), 7573-5/90.KES100.(N), 7574-5/90.KES150.(N), 7754-5/85.KES150, 7754-5/90.KES150, 7550-5, 7551-5, 7552-5, 7553-5, 7554-5, 7573-5, 7574-5, 7575-5, 7576-5, 7750-5, 7750-5/85.KES40.(N), 7750-5/90.KES40.(N), 7751-5, 7751-5/85.KES60, 7751-5/90.KES60, 7752-5, 7752-5/85.KES80, 7752-5/90.KES80, 7753-5, 7753-5/85.KES100, 7753-5/90.KES100, 7754-5...(Other models you can see in the webshop)		

star handles

			
1			
GEV No.	541361	Ref. No.	0H6469
description	star handle shaft 10x10mm ø 100mm L 28mm black thermoplastic		
For models:	7575-5.KES250, 7576-5.KES300, 7573-5.KES100, 7573-5/85.KES100.(N), 7575-5/85.KES250.(N), 7576-5/85.KES300.(N), 7573-5/90.KES100.(N), 7575-5/90.KES250.(N), 7576-5/90.KES300.(N), 7775-5, 7775-5/85.KES250.(N), 7775-5/90.KES250.(N), 7776-5, 7776-5/85.KES300.(N), 7776-5/90.KES300.(N)		

			
1			
GEV No.	540365	Ref. No.	0H6468
description	star handle shaft 6x6mm ø 50mm L 18mm black thermoplastic		

handle bars

handle bars

			
1			
GEV No.	692527	Ref. No.	081726 081728
description	handle rail tube ø 24mm L 203mm for fridge brown		



handle rails

ZANUSSI



GEV No.	518081	Ref. No.	075598 0L0608 330280800
description	handle rail set 3-piece L 550mm		
For models:	SL/E851, SL/E901, CT140EDX, CT140ESX, CT140EDXUK, CT140SXEU, CT140VDX, CT140VSX, CT141EDX, CT141ESX, CT141EDUK, CT141ESUK, CT141VDX, CT141VSX, CT142DXE, CT142SXE, CT142DXEUK, CT142SXEU, CT142DXV, CT142SXV, CT190DXE, CT190SX, CT190DXEUK, CT190SXEU, CT190DXV, CT190SXV, CT191DXE, CT191SX, CT191DXEUK, CT191DXV, CT191SXV, CT192DXE, CT192SX, CT192DXEUK, CT192SXEU, CT192DXV, CT192SXV, CT240DXE, CT240SX, CT240DXEUK, CT240SX, CT240DXV, CT240SXVUK, CT241DXE, CT241SX, CT241DXEUK, CT241SXEU, CT241DXV, CT241SXV...(Other models you can see in the webshop)		



GEV No.	692528	Ref. No.	082726
description	handle rail W 43mm L 426mm dark grey		
For models:	TRN1301, TRNA1301, TRNM1301, TRN1302, TRNA1302, TRNM1302, TRN1303, TRNA1303, TRNM1303, TRN1801, TRNA1801, TRNM1801, TRN1802, TRNA1802, TRNM1802, TRN1803, TRNA1803, TRNM1803, TRN2201, TRNA2201, TRNM2201, TRN2202, TRNA2202, TRNM2202, TRN2203, TRNA2203, TRNM2203, TRRN1301, TRRN1302, TRRN1303, TRRN1801, TRRN1802, TRRN1803, TRRN2201, TRRN2202, TRRN2203, TRNP1802, TRRF130P, TRRF180P, TRRF220P, TRF1301, TRRF1301, TRF1801, TRRF1801, TRF2201, TRRF2201, TRN1301, TRNA1301, TRNM1301, TRRF1301...(Other models you can see in the webshop)		
accessories for	692528		
	GEV No.	692529	Ref. No. 082727
	console for handle rod mounting pos. right		
	GEV No.	692530	Ref. No. 082728
	console for handle rod mounting pos. left		

handle rails

GEV No.	694830	Ref. No.	0A8899
description	cover L 445mm W 18mm Qty 1 pcs		
For models:	EDOIN28013, EDOIN28013, EDON420121B, EDON280120, EDON280112, EDON280111, EDON280104, EDON280103, EDON280102, EDON280113, EDON280105, EDON420130, EDON420122, EDON420121, EDON420114, EDON420105, EDON420106, EDON420123, EDON420115, EDON570140, EDON570132, EDON570131, EDON570124, EDON570122, EDON570108, EDON570133, EDON570125, EDON720150, EDON720142, EDON720133, EDON720134, EDON720132, EDON720126, EDON720143, EDON720135, EDORN28120, EDORN28112, EDORN28111, EDORN28104, EDORN28103, EDORN28113, EDORN28105, EDORN28130, EDORN42122, EDORN42114, EDORN42106, EDORN42123, EDORN42115, EDORN57140, EDORN57132...(Other models you can see in the webshop)		

GEV No.	694331	Ref. No.	0A8898
description	handle rail L 450mm W 53mm H 40mm gold-coloured		
For models:	EDOIN28013, EDOIN28013, EDON420121B, EDON280120, EDON280112, EDON280111, EDON280104, EDON280103, EDON280102, EDON280113, EDON280105, EDON420130, EDON420122, EDON420121, EDON420114, EDON420105, EDON420106, EDON420123, EDON420115, EDON570140, EDON570132, EDON570131, EDON570124, EDON570122, EDON570108, EDON570133, EDON570125, EDON720150, EDON720142, EDON720133, EDON720134, EDON720132, EDON720126, EDON720143, EDON720135, EDORN28120, EDORN28112, EDORN28111, EDORN28104, EDORN28103, EDORN28113, EDORN28105, EDORN28130, EDORN42122, EDORN42114, EDORN42106, EDORN42123, EDORN42115, EDORN57140, EDORN57132...(Other models you can see in the webshop)		

GEV No.	518081	Ref. No.	075598 0L0608 330280800
description	handle rail set 3-piece L 550mm		
For models:	SL/E851, SL/E901, CT140EDX, CT140ESX, CT140EDXUK, CT140SXEU, CT140VDX, CT140VSX, CT141EDX, CT141ESX, CT141EDUK, CT141ESUK, CT141VDX, CT141VSX, CT142DXE, CT142SXE, CT142DXEUK, CT142SXEU, CT142DXV, CT142SXV, CT190DXE, CT190SX, CT190DXEUK, CT190SXEU, CT190DXV, CT190SXV, CT191DXE, CT191SX, CT191DXEUK, CT191DXV, CT191SXV, CT192DXE, CT192SX, CT192DXEUK, CT192SXEU, CT192DXV, CT192SXV, CT240DXE, CT240SX, CT240DXEUK, CT240SX, CT240DXV, CT240SXVUK, CT241DXE, CT241SX, CT241DXEUK, CT241SXEU, CT241DXV, CT241SXV...(Other models you can see in the webshop)		

end caps

GEV No.	692530	Ref. No.	082728
description	console for handle rod mounting pos. left		
For models:	TRN1301, TRNA1301, TRNM1301, TRN1302, TRNA1302, TRNM1302, TRN1303, TRNA1303, TRNM1303, TRN1801, TRNA1801, TRNM1801, TRN1802, TRNA1802, TRNM1802, TRN1803, TRNA1803, TRNM1803, TRN2201, TRNA2201, TRNM2201, TRN2202, TRNA2202, TRNM2202, TRN2203, TRNA2203, TRNM2203, TRRN1301, TRRN1302, TRRN1303, TRRN1801, TRRN1802, TRRN1803, TRRN2201, TRRN2202, TRRN2203, TRNP1802, TRRF130P, TRRF180P, TRRF220P, TRF1301, TRRF1301, TRF1801, TRRF1801, TRF2201, TRRF2201, TRN1301, TRNA1301, TRNM1301, TRRF1301...(Other models you can see in the webshop)		



			
1			
GEV No.	692529	Ref. No.	082727
description	console for handle rod mounting pos. right		
For models:	TRN1301, TRNA1301, TRNM1301, TRN1302, TRNA1302, TRNM1302, TRN1303, TRNA1303, TRNM1303, TRN1801, TRNA1801, TRNM1801, TRN1802, TRNA1802, TRNM1802, TRN1803, TRNA1803, TRNM1803, TRN2201, TRNA2201, TRNM2201, TRN2202, TRNA2202, TRNM2202, TRN2203, TRNA2203, TRNM2203, TRRN1301, TRRN1302, TRRN1303, TRRN1801, TRRN1802, TRRN1803, TRRN2201, TRRN2202, TRRN2203, TRNP1802, TRRF130P, TRRF180P, TRRF220P, TRF1301, TRRF1301, TRF1801, TRRF1801, TRF2201, TRRF2201, TRN1301, TRNA1301, TRNM1301, TRRF1301...(Other models you can see in the webshop)		

			
1			
GEV No.	690448	Ref. No.	081906 0HA081 511700500 60001 9060001
description	pull handle L 402mm H 42mm mounting distance 375mm		
For models:	ALP111, ALP221, ALN111, ALN221, ILP111, ILP221, ILN111, ILN221, ALP111, ALP221, ALN111, ALN221, AKP111, AKP221, AKN111, AKN221, AKP111, AKP221, AKN111, AKP221, CA21ALHG, CA45ALHG, CA21ALCG, CA21SSCG, CA21SSHG, CA45SSHG, CA45ALCG, CA45SSCG, CA18ALHG, CA18SSHG, CA18ALCG, CA18SSCG, CA38ALHG, CA38SSHG, CA38ALCG, CA38SSCG, CA18ALMG, CA21ALMG, CA45ALMG, CA21SSMG, CA45SSMG, CA38ALMG, CA18SSMG, CA38SSMG, CA21SSMG, CA45SSMG, CA18SSMG, CA38SSMG, CA21ALLG, CA21SSLG...(Other models you can see in the webshop)		

bracket handles

			
1			
GEV No.	530490	Ref. No.	0D5436 0D5496
description	handle L 140mm H 55mm mounting distance 112mm hole ø 5mm for mixer		
For models:	K451V-01, K452V-01, K552V-01, K702V-01, K45VV-01, K55VV-01, K70VV-01, TRK45VV-01, TRK55VV-01, TRK70VV-01, TRK55VV-02, TRK55VV-03, TRK70VV-03, K452V-02, K552V-02, K702V-02, K45VV-02, K55VV-02, K70VV-02, K45VV-03, K55VV-03, K70VV-03, TRK45VV-02, TRK70VV-02, TRK45VV-03, K552V-03, K552V-04, K55VV-04, DTRK45VV, DTRK45VVG, DTRK55VV, DTRK55VVG, DTRK70VV, DTRK70VVG, DK451V, DK452V, DK45VV, DK45VVG, DK552V38, DK552VS38, DK55VV, DK55VVG, DK702V, DK70VV, DK70VVG, K451V-02, K451V-03		

lever handles

			
1			
GEV No.	542415	Ref. No.	0C6569
description	lever handle plastic/SS shaft ø 11mm suitable for combi-steamer		
For models:	FCZ061ETA, FCZ101ETA, FCZ102ETA, FCZ061ETH, FCZ101ETH, FCZ061ETN, FCZ101ETN, FCZ102GTG, FCZ102GTD, FCZ061EBA2, FCZ101EBA2, FCZ102EBA2, FCZ061EBH2, FCZ101EBH2, FCZ061EBN2, FCZ101EBN2, FCZ061EBC2, FCZ101EBC2, FCZ102GBG2, FCZ102GBD2, FCZ102GBI2, FCZ061ECA2, FCZ101ECA2, FCZ102ECA2, FCZ061ECH2, FCZ101ECH2, FCZ061ECN2, FCZ101ECN2, FCZ102GCG2, FCZ102GCD2, AOS061ETA1, AOS101ETA1, AOS102ETA1, AOS061ETH1, AOS101ETH1, AOS061ETN1, AOS101ETN1, AOS061ETC1, AOS101ETC1, AOS061ETE1, AOS101ETE1, AOS061ETF1, AOS101ETF1, AOS061ETM1, AOS062ETM1, AOS101ETM1, AOS102ETM1, AOS061ETK1, AOS101ETK1, AOS102ETK1...(Other models you can see in the webshop)		

			
1			
GEV No.	690449	Ref. No.	081838 081846
description	pull handle L 252mm H 40mm mounting distance 232mm		
For models:	IKN111, IKN221, ISP111N, ISP221N, IKNF220N, IKNSO120, IKNN220		

			
1			
GEV No.	701417	Ref. No.	031529
description	pull handle L 280mm mounting distance 227mm hole ø 5.5mm for fridge		
For models:	WMMHPLUK, CMS, CMSEL/SOL		



1

GEV No.	542417	Ref. No.	0C9988
description	lever handle set for door combi-steamer bolt ø 19mm		
accessories for	542417		
GEV No.	900272	Ref. No.	003680
	window gasket profile 1830 L 1500mm Qty 1		



1

GEV No.	504780	Ref. No.	047481 047584 047606 069505 069510 0K3911
description	handle		
For models:	LSDS5I, LSDS5V, LS510, LS520, LS520D, LS520F, LS520M, LS521, LS521D, LS521F, LS521M, LS521, LS4, LTB11, LTB12, LTB22, LTB11UK, LTB12UK, LTB22UK, CRYSTAL 11, CRYSTAL 22, C51, C52, C50, CF314		



1

GEV No.	540929	Ref. No.	056887 0K4293 723461
description	lever handle suitable for outlet tap shaft 8x8mm L 90mm		
For models:	MCP/E700, MCP/G700, MCP/E700D, MCP/G701, MCP/G710, MCP/G711, MCP/G705, MCP/G706, RCP/E2S, MCP/E1SH, MCP/E1SUH, MCP/E2SUHS, MCP/E2S, MCP/E2SH, MCP/E2SUH, MCP/E2SUT, MCP/E2SHB, 7CPE07P, 7CPG07P, RCP/G701, RCP/G706, M70EPC, M70GPC, M70GPC, XCP/G706, CCP/G700, CCP/E700, ECP/E1ELHU, PCP/E2SHP, PCP/E1SH, PCP/E2SH, PCP/E2SH3B, PCP/E1ELH, OCP/E2S, OCP/E1SH, OCP/E2SH, TCP/E1ELHU, TCP/E2S, TCP/E2SH, TCP/E1ELH, RCP/G700, RCPE700, KCP/G1RU, KCP/G2RU, KCP/E1RU, KCP/E2RU, KCP/G1, KCP/G1R, KCP/G2, KCP/G2R...(Other models you can see in the webshop)		

door handles

door handles



1

GEV No.	694918	Ref. No.	032933 037804
description	door handle L 198mm W 70mm H 15mm grey		
For models:	TF1400, TF1410, TF2000, TF2010, TN1000, TN1010, TN1200, TN1210, TN1400, TN1410, TN1600, TN1610, TN1800, TN1810, TN2000, TN2010, TND1000, TND1200S, TND1400, TND1600, TND1800, TND2000, LA716, LA1225, LA1216D, LA1216S, LA1426, LA1416D, LA1416S, LA1826D, LA1826S, LA2126D, LA2126S, LA2426, LA2826, AS1400, AS2000, PA600, PA800, PA1000, PA1200, PA1400, PA1600, PA1800, PB600, PB800, PB1200, PS1000, PS1200, PS1400...(Other models you can see in the webshop)		

recessed handles



1

GEV No.	694429	Ref. No.	054261
description	grip shell L 309mm W 170mm H 62mm plastic		



1

GEV No.	694378	Ref. No.	0E3709 0KB730
description	door handle L 54mm W 25mm H 40mm black hole ø 4mm		
For models:	FCV31E3, 7CO30, CCO30G, ECO312CF, OTS100		



hand cranks



1

GEV No.	514250	Ref. No.	002276 44221 SP44200EC952
description	hand crank bore ø 10mm L 80mm with folding handle		
For models:	KBR/G2F, KBR/G2C, KBR/G3F, KBR/G3FH, KBR/G3C, KBR/G3CH, KBR/E2F, KBR/E2C, KBR/E3F, KBR/E3FH, KBR/E3C, KBR/E3CH, KBR/G2FH, KBR/G2CH, KBR/E2FH, KBR/E2CH, HBR/G800, HBR/G805, HBR/G801, HBR/G806, HBR/G810, HBR/G815, HBR/G811, HBR/G816, HBR/G800D, HBR/G805D, HBR/G801D, HBR/G806D, HBR/G810D, HBR/G815D, HBR/G811D, HBR/G816D, HBR/E800, HBR/E805, HBR/E801, HBR/E806, HBR/E810, HBR/E815, HBR/E811, HBR/E816, HBR/G800NL, HBR/G805NL, HBR/G810NL, HBR/G800UK, HBR/E800UK, HBR/G800, HBR/G805, HBR/G810, HBR/G815, HBR/G811...(Other models you can see in the webshop)		



1

GEV No.	700449	Ref. No.	054059 066847
description	handle		



1

GEV No.	694553	Ref. No.	0kq367
description	handle H 30mm ø 60mm vegetable slicers ELECTROLUX		
For models:	K35, CUTE0523, CUTE0538, K35, KT055, KT056, K35-11, K55-01, K55E-01, K35-01, K55-02, K35-02, K35-03, K55E-05, K55-03, K35-04, K55-04, K35-05, K35-06, K55-05, K55E-02, K55E-03, K55-06, K35-07, K35-08, K55E-04, K55-07, K35-09, K55-08, K55E-12, K55E-07, K35-17, K35-15, K35-23, K55E-10, K35-13, K35-21, K55-12, K35-14, K35-16, K55E-09, K55E-08, K55E-13, K55E-06, K35-19, K35-22, K35-20, K35-12, K55-10, K35-24...(Other models you can see in the webshop)		

miscellaneous



1

GEV No.	690453	Ref. No.	083420
description	handle		
For models:	ITP120UK, ITP120UK, DOC121V11C, DOP121V11C, DOP120V11C, DOC121V11C, DOP121V11C, DOP120V11C		



1

GEV No.	696532	Ref. No.	054196
description	handle L 100mm W 28mm hole distance 79mm Qty 1 pcs thread M4		
For models:	MFR/G360, RTV/G720, RTV/G720, RTFG720, RTF/G720F, RTF/G1020, RTF/G1030, RTF/G1020F, RR/E300, RRE702, RR/E300UK, RR/E311, RR/E700, RR/E700UK, RR/E711, RFRE305, RFRE315, RRV/G300D, RRV/E300, RRV/E300, RRV/E311, RRV/E700, RRV/E700, RRV/E711, QR/E300, QR/E600, QR/E605, QR/E605, QR/E601, QRG300, QR/G600, QRG601, QFE300, QFE302, QFE600, QFE602, QFG300, QFG600, FCF/E2		



1

GEV No.	700443	Ref. No.	025083
description	handle		
For models:	FCF/E3, FCF/E2, FCF/E2D, FCF/E2UK		
accessories for	700443		
GEV No.	700452	Ref. No.	054854
	door catch with spigot		

accessories

covers



1

GEV No.	530894	Ref. No.	003749
description	cover for door handle L 148mm rubber black		
For models:	FCFG101/0, FCFG102-0, FCFG102-0T, ECFG101-0, ECFG102-0, ACF/G6-0, ACFG101-0, ACFG102-0, ACF/E6-0, ACFE101-0, ACFE102-0, RCF061G, RCF061E, RCF101G, RCF101E, NCF/G6-0, NCF/G101/1, NCF/G102/1, NCF/E6-0, NCF/E101/1, NCF/E102/1, ZCF/G101/1, ZCF/G102/1		

end caps



1

GEV No.	518664	Ref. No.	0C4091
description	end cap for handle ø 32.5mm		
For models:	FCZ061EAA, FCZ101EAA, FCZ102EAA, FCZ061EAH, FCZ101EAH, FCZ061EAN, FCZ101EAN, FCZ061ETA, FCZ101ETA, FCZ102ETA, FCZ061ETH, FCZ101ETH, FCZ061ETN, FCZ101ETN, FCZ061GAG, FCZ101GAG, FCZ102GAG, FCZ061GAD, FCZ101GAD, FCZ102GAD, FCZ101GTG, FCZ102GTG, FCZ101GTD, FCZ102GTD, FCZ061EBA, FCZ101EBA, FCZ102EBA, FCZ061EBH, FCZ101EBH, FCZ061EBN, FCZ101EBN, FCZ061EBC, FCZ101EBC, FCZ061EBA2, FCZ101EBA2, FCZ102EBA2, FCZ061EBH2, FCZ101EBH2, FCZ061EBN2, FCZ101EBN2, FCZ061EBC2, FCZ101EBC2, FCZ061GBG, FCZ101GBG, FCZ102GBG, FCZ061GBD, FCZ101GBD, FCZ102GBD, FCZ061GBI, FCZ101GBI... (Other models you can see in the webshop)		

extensions



1

GEV No.	540928	Ref. No.	056985
description	extension handle		
For models:	MCP/E700, MCP/G700, MCP/E700D, MCP/G705, MCP/G706, 7CPE07P, 7CPG07P, RCP/G706, M70EPC, M70GPC, M70GPC, XCP/G706, CCP/G700, CCP/E700, RCP/G700, RCPE700, RCP/G700, RCP/E700		

miscellaneous



1

GEV No.	690026	Ref. No.	004195
description	hand protection for door handle ED ø 36mm ID ø 12.3mm D1 ø 22.6-23.5mm		
For models:	ZCMDE6, ZCBDE12, ZCMDE4, ZCBDE8, ZCMDE9, ZCBDE18, ZCBDG8, ZCBDG12, ZCBDG18, FFPS16, FFPS32		



locks

locking devices

producer-specific

ELECTROLUX



GEV No.	690461	Ref. No.	087175 0A8053
description	key cylinder straight thread M19x1 rotation 90° cam length 54mm cam width 16mm		
For models:	ITP120UK, ITP120UK, ALP120, ALP220, ALP240, ALN120, ALN220, ALN240, ALNN120, ALNN230, ALNSO120, ALF220UK, ALF120, ALF220, ALF240, ALNF120, ALNF230, ADN220ES, ADF110ES, ADF220ES, ADN110ESP, ADF110ESP, ILNSO120, ILN120, ILNN230, ILNF120, ILNF230, ALP120, ALP220, ALP240, ALN120, ALN220, ALN240, ALF120, ALF220, ALF240, ALNN120, ALNF120, ALNN230, ALNF230, ALNSO120, ALN110, ALN120, ADN111, AEN110, AEN120, AKN111, ADF110, ALF110, ADF120...(Other models you can see in the web-shop)		



GEV No.	690641	Ref. No.	0A8655 0KE836
description	key cylinder thread M15x1 rotation 90° L 20mm		
For models:	ICF110, ICP110, ICP111, ICP130, ICP112, ICF110, ICN110UK, ICF110, APP113, APP114, APF113, APF114, APP223, APP224, APP114/60, APP224/60, APP224/60, APP11B, APP113V, APF114, APP22B, APP224V, APF223, APF224, APF22B, APP223OS, ICF110, ICP112, ICP130, ESMLR60W, ESMLF60W, ESMLR60S, ESMLF60S, RS24, FS24, RFS24, NEPV40, NICP40, NEPEV40, NICF40, NEPV40, NEPA40, NEPEV40, 400LTPVN, KZ1502, KE1502GT, TE1502, TZ1502, EP406VRPUK, E04P6VRVUK...(Other models you can see in the webshop)		



GEV No.	690637	Ref. No.	081694 OKM805
description	key cylinder with slide latch ø 23mm thread M19x1 mounting measurements 16.5x19mm hub 38-45mm shaft ø 11mm thread L 24mm		
For models:	ALP110, ALP120, ALP111, ALP220, ALP240, ALP221, ALN110, ALN120, ALN111, ALN220, ALN240, ALN221, ALNN120, ALNN220, ALNN230, ALNSO120, ALP110UK, ALN110UK, ALNN220UK, ALF110, ALF220UK, ALNF220, ALF110, ALF120, ALF220, ALF240, ALNF120, ALNF220, ALNF230, ILP110, ILP110UK, ILN120, ILP111, ILP220, ILP220UK, ILP240, ILP221, ILN110, ILN110UK, ILN120, ILN111, ILN220, ILN220UK, ILN240, ILNSO120, ILN221, ILNN120, ILNN220, ILNN220UK, ILNN230...(Other models you can see in the webshop)		

face mounted latches

RAHRBACH

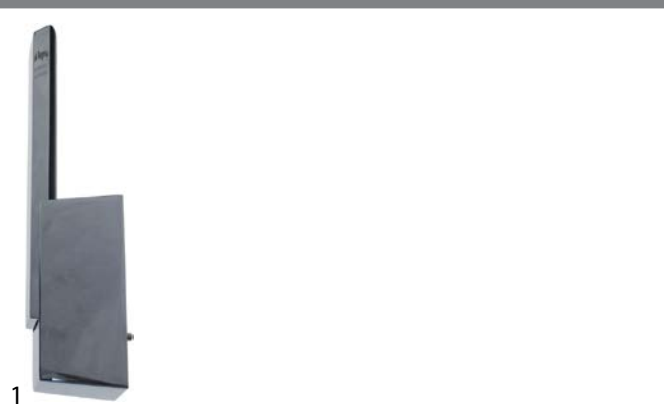

GEV No.	694369	Ref. No.	0H2207 0K7348 6183020179
description	catch series 6183 hinging left/right non lockable H 40mm W 35mm total length 190mm with door catch overall height 43mm		
spare parts for	694369		
	GEV No.	700773	Ref. No. —
	door catch H 19mm adjustable L 38mm W 26mm mounting distance 20mm		



GEV No.	694390	Ref. No.	OK6864 OKJ423 466015400 6183020180
description	catch with door catch H 40mm W 35mm lockable total length 190mm		

turning lever locks

universal

RAHRBACH

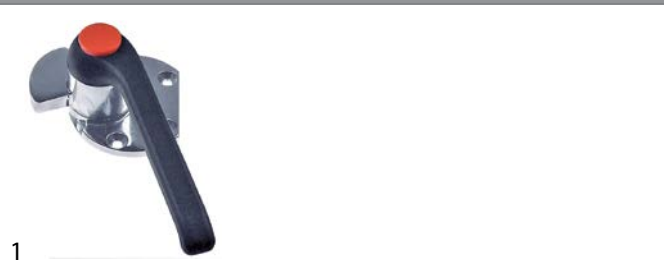



GEV No.	690044	Ref. No.	OK8322 0T4381 80700439
description	handle latch right L 185mm H 59mm handle material plastic type 6300 series		
accessories for	690044		
	GEV No.	690136	Ref. No. —
	sliding plate mounting pos. right L 28mm H 3mm W 21mm H2 12.5mm		

Table continues overleaf





accessories for	690044		
	GEV No.	700091	Ref. No. —
	door catch mounting pos. right off-set 20mm L 110mm H 56mm W 33mm mounting distance 68/68mm zinc die cast series 6300		
	GEV No.	700098	Ref. No. —
	door catch mounting pos. right off-set 38mm L 110mm H 74mm W 33mm mounting distance 68/68mm series 1750		

edgemoat latches

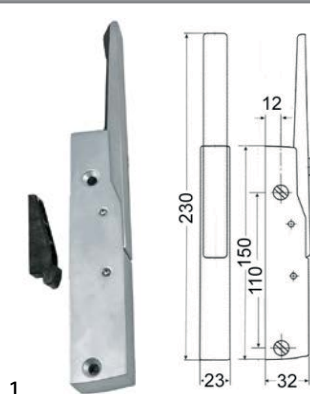
handle latches

CAFF/FERMOD





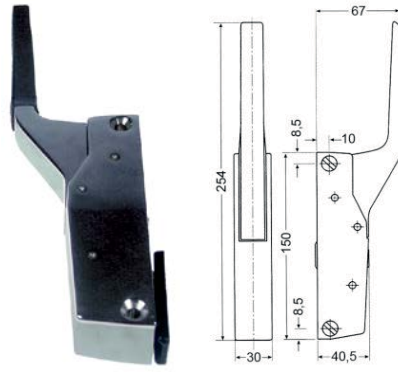

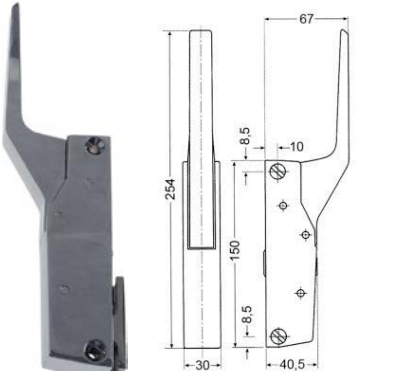



GEV No.	690455	Ref. No.	032156
description	handle latch L 150mm mounting distance 110mm matt chrome-plated non lockable refrigeration units 570 R-L complete with door catch		
For models:	WMIB3EC, DT/V12, DT/V20, DT/V24, DT/V30, DT/V36, CCB10, CCB20, DT/V12T, DT/V20T, DT/V24T, DT/V30T, DT/V36T, DT/V, DT/SV		
spare parts for	690455		
	GEV No.	690429	Ref. No. —
	door catch CT 25.5mm		
accessories for	690455		
	GEV No.	690428	Ref. No. —
	door catch H 51mm W 13.9mm mounting distance 30mm plastic CT 16.5mm		
	GEV No.	690445	Ref. No. —
	base plate H 2mm		
	GEV No.	690446	Ref. No. —
	base plate H 5mm L 56mm W 18mm		

	GEV No.	700631	Ref. No.	OK3058
	description	catch complete with door catch		

	GEV No.	694365	Ref. No.	OK7679
	description	handle latch L 150mm mounting distance 133mm complete with door catch for headed units H 40.5mm W 30mm type 791 total length 254mm overall height 67mm		
	For models:	AR170, AR170, AR170, AR170, AR170, AR170, AR170, AR170, AR170, AR170S, AR170S, AR170S, AR170S, AR170S, AR170S, AR170S, AR170S, AR170S, AR170S, AR170S, AR340, AR340, AR340, AR340, AR340, AR340, AR340, AR340, AR340S, AR340S, AR340S, AR340S, AR340S, AR340S, AR340S, AR340S, AR340S		



producer-specific			
INOXTREND			
			
1			
GEV No.	690146	Ref. No.	005107 0H6459 OK1669 234663 60050345 6200020900
description	handle latch L 172mm mounting distance 134mm non lockable heated units 6200 H 65mm type DUPLO total length 248mm		
For models:	5711-2-6, 5711-2-7, 5711-2-8, 5711-2-10, 5711-2-8CH, 5711-2-10CH, 5712-2-6, 5712-2-7, 5712-2-8, 5712-2-10, 5711-2-6L, 5711-2-7L, 5711-2-8L, 5711-2-10L, 5721-2-7, 5721-2-10, 5712-2-6L, 5712-2-7L, 5712-2-8L, 5712-2-10L, 5711-3-6, 5711-3-7, 5711-3-8, 5711-3-10, 5711-3-8CH, 5711-3-10CH, 5712-3-6, 5712-3-7, 5712-3-8, 5712-3-8E, 5712-3-10, 5712-3-8CH, 5712-3-10C, 5712-2-10F, 5712-2-10S, 5711-3-10F, 5711-3-10S, 5712-3-10F, 5712-3-10S, 5702-2-2, 5702-2-3, 5701-3-2, 5701-3-3, 5702-3-2, 5702-3-3, 5611-3-10, 5611-3-6, 5611-3-8, 5612-3-10, 5612-3-6...(Other models you can see in the webshop)		
accessories for	690146		
	GEV No.	690123	Ref. No. OK8039 OK8574 6200020921
door catch with roller			
	GEV No.	693777	Ref. No. 0H6797 OK2347 60050346 60050493
gasket H 6.6mm L 105mm W 45mm L1 78mm W1 25mm for handle			
	GEV No.	693778	Ref. No. 005176 0H6568 OK1952 242818
door catch			

MODULAR			
			
1			
GEV No.	690146	Ref. No.	005107 0H6459 OK1669 234663 60050345 6200020900
description	handle latch L 172mm mounting distance 134mm non lockable heated units 6200 H 65mm type DUPLO total length 248mm		
For models:	5711-2-6, 5711-2-7, 5711-2-8, 5711-2-10, 5711-2-8CH, 5711-2-10CH, 5712-2-6, 5712-2-7, 5712-2-8, 5712-2-10, 5711-2-6L, 5711-2-7L, 5711-2-8L, 5711-2-10L, 5721-2-7, 5721-2-10, 5712-2-6L, 5712-2-7L, 5712-2-8L, 5712-2-10L, 5711-3-6, 5711-3-7, 5711-3-8, 5711-3-10, 5711-3-8CH, 5711-3-10CH, 5712-3-6, 5712-3-7, 5712-3-8, 5712-3-8E, 5712-3-10, 5712-3-8CH, 5712-3-10C, 5712-2-10F, 5712-2-10S, 5711-3-10F, 5711-3-10S, 5712-3-10F, 5712-3-10S, 5702-2-2, 5702-2-3, 5701-3-2, 5701-3-3, 5702-3-2, 5702-3-3, 5611-3-10, 5611-3-6, 5611-3-8, 5612-3-10, 5612-3-6...(Other models you can see in the webshop)		
accessories for	690146		
	GEV No.	690123	Ref. No. OK8039 OK8574 6200020921
door catch with roller			
	GEV No.	693777	Ref. No. 0H6797 OK2347 60050346 60050493
gasket H 6.6mm L 105mm W 45mm L1 78mm W1 25mm for handle			
	GEV No.	693778	Ref. No. 005176 0H6568 OK1952 242818
door catch			

ZANUSSI

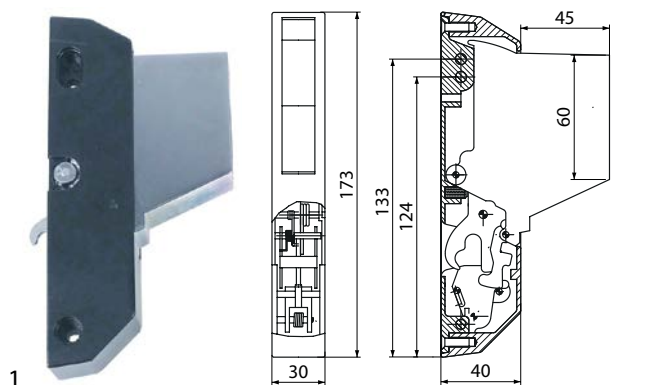

GEV No.	700467	Ref. No.	002647 0F0175 0K1663 0K8474 0KC474 0KZ752 1520148 60050284 6200020920 7TMB1520148
description	catch L 173mm H 40mm mounting distance 133/124mm W 30mm non lockable 6200 total length 170mm overall height 85mm		
For models:	FCV/G10L3, FCV/G6L3TOWNGAS, FCV/G6L3, FCVG10L3T, FCVG102L3, FCV/E101/1, FCVE6L3J, FCV/E10L3JAP, FCV/E102/1L3JAP, FCV/E10L6JAP, FCV/E102/1L6JAP, FCV/G6L3JAP, FCVG10L3J, FCVG102L3J, FCV/G10L6JAP, FCV/G102/1L6JAP, FCVG6L3CJ, FCV/E61/1, FCV/G10L2, FCV/E61/1, FCV/E101/1, FCV/E101/1, FCV/E101/1, FCV/E10L2, FCV/E102/1, FCV/E61/1, FCV/E61/1, FCV/E101/1, FCV/E101/2, FCV/G6L3C, FCV/G61/1, FCV/G61/1, FCV/G61/1, FCV/G61/1, FCV/G6L3CT, FCVG6L3CJ, FCV/E10L3, FCV/E102/1, FCV/E6L3, FCV/E102/1L3, FCV/G6L4, FCV/E6L4, FCV/E101/1, FCV/G10L6, FCV/E10L6, FCV/G102/1L6, FCV/E102/1L6, FCV/E101/1, FCV/G101/1, FCV/E101/1, FCV/G102/1...(Other models you can see in the webshop)		
accessories for	700467		

	GEV No.	693937	Ref. No.	002717 002722 003090 003091 03303203 03304194 0A5320 0A5365 0F0029 0K1684 0K1685 0K8473 0K9180 0K9181 0K9340 0KE759 234705 60050286
	door handle H 44mm L 220mm W 50mm plastic black			

	GEV No.	700468	Ref. No.	002650 0F0173 0KL740 1520893 51520893 7TMB1520893
	door catch with roller			

	GEV No.	701412	Ref. No.	—
	cover cap plastic round ø 11mm black for catch thickness 8mm			

RAHRBACH

6188 ERGO series

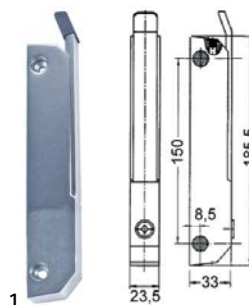

GEV No.	690808	Ref. No.	002278
description	handle latch L 185mm mounting distance 150mm chrome-plated non lockable for headed units 6188 type ERGO		
For models:	FVE3, FVE3, VAPE3		
accessories for	690808		
	GEV No.	690110	Ref. No. —
	base plate H 1mm L 38mm W 11mm mounting distance 26mm plastic		
	GEV No.	690111	Ref. No. —
	base plate H 2mm L 38mm W 11mm mounting distance 26mm plastic		
	GEV No.	690114	Ref. No. —
	base plate H 3.5mm L 185mm W 30mm mounting distance 150mm with inclination thread M5		
	GEV No.	700082	Ref. No. 056464 056581
	door catch L 38mm W 18mm mounting distance 26mm		

STUV

3.30.05xx.x series

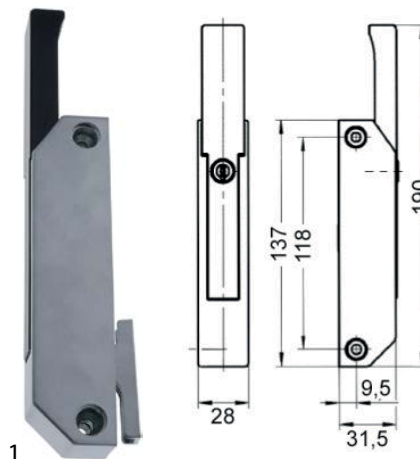

GEV No.	694368	Ref. No.	078011 0K7566 0KB600 33005010
description	handle latch L 137mm mounting distance 118mm refrigeration units 3.30.500.0.003.3		
For models:	HC-AR, AR85, AR85, AR85, AR85, AR85, AR85, AR85, HC-CS		
spare parts for	694368		
	GEV No.	700078	Ref. No. —
	door catch L 47mm W 14mm H 29mm mounting distance 21-33mm zinc die cast adjustable		



door catches



GEV No.	693778	Ref. No.	005176 0H6568 0K1952 242818
description	door catch		
For models:	5711-2-6, 5711-2-7, 5711-2-8, 5711-2-10, 5711-2-8CH, 5711-2-10CH, 5712-2-6, 5712-2-7, 5712-2-8, 5712-2-10, 5711-2-6L, 5711-2-7L, 5711-2-8L, 5711-2-10L, 5721-2-7, 5721-2-10, 5712-2-6L, 5712-2-7L, 5712-2-8L, 5712-2-10L, 5711-3-6, 5711-3-7, 5711-3-8, 5711-3-10, 5711-3-8CH, 5711-3-10CH, 5712-3-6, 5712-3-7, 5712-3-8, 5712-3-8E, 5712-3-10, 5712-3-8CH, 5712-3-10C, 5712-2-10F, 5712-2-10S, 5711-3-10F, 5711-3-10S, 5712-3-10F, 5712-3-10S, 5702-2-2, 5702-2-3, 5701-3-2, 5701-3-3, 5702-3-2, 5702-3-3, 5611-3-10, 5611-3-6, 5611-3-8, 5612-3-10, 5612-3-6...(Other models you can see in the webshop)		



GEV No.	700461	Ref. No.	002086 0KE741
description	door catch L 22mm thread M5 ø 9mm with spigot total length 45mm thread L 23mm		
For models:	FCFG6D, FCFE6D, FCFE6D, FCFG6, FCFG6F, PFCFG6, FCFE6, FCFE6UK, PFCFE6, FCFE6J50, FCFE6J60, FCFG6J, FCFG6J, FCFG6J, FCFG6J, FCFE6-1U, FCFE6-3U, FCFE6-1, FCFE6-3, FCFE6-1UK, FCFE6-3UK, FCFG6-1, FCFG6-3, FCFG6-1UK, FCFG6-3UK, FCF/G6, FCF/E6, FCF/E6-1, FCF/E6-1, FCF/G6-1, ZOF6V/G6-3, AFCV/G6-1, AFCV/G6-3, SCO/G6-3, AFCF/E6, FF/G6, COCVE423AF, FCFE061, ZOF6F/G6D		



GEV No.	700082	Ref. No.	056464 056581
description	door catch L 38mm W 18mm mounting distance 26mm		
For models:	FCFG6D, FCFE6D, FCFE6D, FCFG6, FCFG6F, PFCFG6, FCFE6, FCFE6UK, PFCFE6, FCFE6-1U, FCFE6-3U, FCFE6-1, FCFE6-3, FCFE6-3CE, FCFE6-1UK, FCFE6-3UK, FCFG6-1, FCFG6-3, FCFG6-1UK, FCFG6-3UK, FCF/G6, FCF/E6, FCF/E6-1, FCF/E6-1, FCF/G6-1, ZOF6V/G6-3, AFCV/G6-1, AFCV/G6-3, AFCF/E6, FF/G6, COCVE423AF, FCFE061, ZOF6F/G6D		



GEV No.	690123	Ref. No.	0K8039 0K8574 6200020921
description	door catch with roller		



GEV No.	700468	Ref. No.	002650 0F0173 0KL740 1520893 51520893 7TMB1520893
description	door catch with roller		
For models:	FCV/G10L3, FCV/G6L3TOWNGAS, FCV/G6L3, FCVG10L3T, FCVG102L3, FCV/E101/1, FCFE6L3J, FCV/E10L3JAP, FCV/E102/1L3JAP, FCV/E10L-6JAP, FCV/E102/1L6JAP, FCV/G6L3JAP, FCVG10L3J, FCVG102L3J, FCV/G10L6JAP, FCV/G102/1L6JAP, FCVG6L3CJ, FCV/E61/1, FCV/G10L2, FCV/E61/1, FCV/E101/1, FCV/E101/1, FCV/E10L2, FCV/E102/1, FCV/E61/1, FCV/E61/1, FCV/E101/1, FCV/E101/2, FCV/G6L3C, FCV/G61/1, FCV/G61/1, FCV/G61/1, FCV/G61/1, FCVG6L3CT, FCVG6L3CJ, FCV/E10L3, FCV/E102/1, FCV/E6L3, FCV/E102/1L3, FCV/G6L4, FCV/E6L4, FCV/E101/1, FCV/G10L6, FCV/E10L6, FCV/G102/1L6, FCV/E102/1L6, FCV/E101/1, FCV/G101/1, FCV/E101/1, FCV/G102/1...(Other models you can see in the webshop)		





GEV No.	700451	Ref. No.	054562
description	door catch with spigot		
For models:	FCFE6UK, COCO6G, COCO6E		

walk-in fridge catches

CAFF/FERMOD

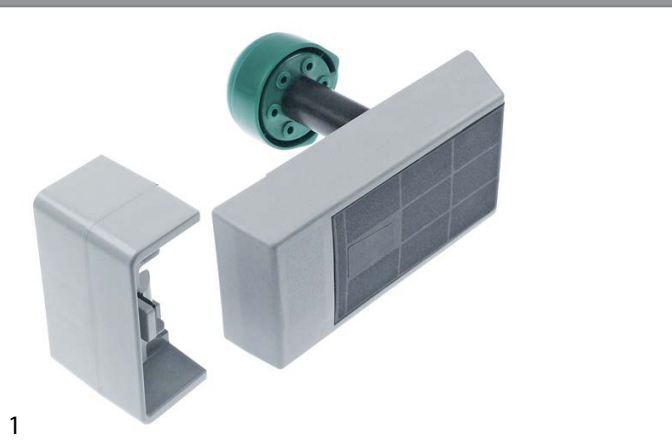
920/921 series





GEV No.	701295	Ref. No.	084893
description	walk-in fridge catch L 245mm W 108mm H 52.5mm for door thickness 52-72mm		
For models:	BC100A, BC100DA, BC100RA, BC100RDA, BC180A, BC180DA, BC180RA, BC180RDA, BC180RPA, BCF100A, BCF100DA, BCF100RA, BCF100RDA, BCF180A, BCF180DA, BCF180RA, BCF180RDA, BCF180RPA, BC120A, BC120RA, BCF120A, BCF120RA, BLAST C/FREEZER, BLAST C/FREEZER, BLAST C/FREEZER, BLAST C/FREEZER, BLAST C/FREEZER, BLAST C/FREEZER, BC0144, BC072, ESBC72R, ESBC144R, ESBF70, ESBF70R, ESBF144, ESBF144R, AOCP2028R, AOCP2028RD, AOCP2028RT, AOFP2028R, AOFP2028RD, AOFP2028RT, AOFP2028RU, BLAST C/FREEZER, BLAST C/FREEZER, BLAST C/FREEZER, BLAST C/FREEZER, BLAST C/FREEZER, BLAST C/FREEZER, AOFP2028RU4...(Other models you can see in the webshop)		
spare parts for	701295		
	GEV No.	700573	Ref. No. —
	walk-in fridge catch door thickness 100mm type 920HP L 245mm W 108mm H 52.5mm H1 220mm		
	GEV No.	700579	Ref. No. —
	door catch for off-set 52-72mm W 54mm H 82mm L 135mm type 920/921/920HP/921HP		

snap locks

universal

			
GEV No.	690596	Ref. No.	057414 100906
description	snap lock L 60mm W 15mm H 36mm mounting distance 48/28mm spring thickness 1.5mm complete with door catch zamak		
For models:	BCFCV101/1, BCFCV102/1, BCFCV101/1, BCFCV102/1		

			
GEV No.	504662	Ref. No.	049271
description	snap lock L 70mm W 12mm H 16mm mounting distance 58mm without door catch stainless steel		
For models:	LS32, LS32/4.5, LS32UK/RP, LS32F, LV32F, C55, LV32/60, WT4, WT4B, WT4D, WT302, WT302/4.5, WT302UK/RP, WT302F, WT302/60, WT4DB, WT46, WT4DG, WT4WS1, LS33, LS33/4.5, LS33UK/RP, LS33F, LV33F, C55A, LS33/60, WT4BWS, WT4DWS1, WT4BDWS, WT303, WT303/4.5, WT303UK/RP, WT303F, WT303/60, NUC3DD, WT4D60, WT4DDG, EUC1, EUC1DP, EUC1WS, EUC1DPWS, EUC3, EUC3WS, EUC3DP, EUC3DPWS, EUC1G, EUC1DP60, EUC3DD, ZUCADDROW, ZUCADDROW6...(Other models you can see in the webshop)		
accessories for	504662		
	GEV No.	504663	Ref. No. 049536
	door catch L 35mm W 12mm H 28mm mounting distance 28mm		

producer-specific



ZANUSSI

			
GEV No.	504663	Ref. No.	049536
description	door catch L 35mm W 12mm H 28mm mounting distance 28mm		
For models:	LS32, LS32/4.5, LS32UK/RP, LS32F, LV32F, C55, LV32/60, WT4, WT4B, WT4D, WT302, WT302/4.5, WT302UK/RP, WT302F, WT302/60, WT4DB, WT46, WT4DG, WT4WS1, LS33, LS33/4.5, LS33UK/RP, LS33F, LV33F, C55A, LS33/60, WT4BWS, WT4DWS1, WT4BDWS, WT303, WT303/4.5, WT303UK/RP, WT303F, WT303/60, NUC3DD, WT4D60, WT4DDG, EUC1, EUC1DP, EUC1WS, EUC1DPWS, EUC3, EUC3WS, EUC3DP, EUC3DPWS, EUC1G, EUC1DP60, EUC3DD, ZUCADDROW, ZUCADDROW6...(Other models you can see in the webshop)		

			
GEV No.	504659	Ref. No.	047491 0A6111 0H2557 0K8667 549610000
description	door catch L 84mm W 19mm H 31mm mounting distance 64mm catch housing		
For models:	LSD55I, LSD55V, LS510, LS520, LS520D, LS520F, LS520M, LS520K, LS521, LS521D, LS521F, LS521M, LS521K, LS521, LS4, ZLS510, ZLS520, ZLS521, ALLS521, ALLS520, ALS510, C51, C52, C50, LS520ZD, LS521ZD, CF314, LS510MZ, LS520MZ, LS521MZ		





			
GEV No.	701291	Ref. No.	058989
description	snap lock for oven L 160mm W 16mm mounting distance 144mm		
For models:	MCF/G1090, MCF/G1095, MCF/G995, RCF/G9, XCF/G9, MCF/G9, RCF/G1095, CCF/G995, CCF/G996		

			
GEV No.	504662	Ref. No.	049271
description	snap lock L 70mm W 12mm H 16mm mounting distance 58mm without door catch stainless steel		
For models:	LS32, LS32/4.5, LS32UK/RP, LS32F, LV32F, C55, LV32/60, WT4, WT4B, WT4D, WT302, WT302/4.5, WT302UK/RP, WT302F, WT302/60, WT4DB, WT46, WT4DG, WT4WS1, LS33, LS33/4.5, LS33UK/RP, LS33F, LV33F, C55A, LS33/60, WT4BWS, WT4DWS1, WT4BDWS, WT303, WT303/4.5, WT303UK/RP, WT303F, WT303/60, NUC3DD, WT4D60, WT4DDG, EUC1, EUC1DP, EUC1WS, EUC1DPWS, EUC3, EUC3WS, EUC3DP, EUC3DPWS, EUC1G, EUC1DP60, EUC3DD, ZUCADDROW, ZUCADDROW6...(Other models you can see in the webshop)		
accessories for	504662		
		GEV No.	504663
		Ref. No.	049536
	door catch L 35mm W 12mm H 28mm mounting distance 28mm		

españolette locks

universal

			
GEV No.	690837	Ref. No.	056551 0K2871 0KJ908 5401030 753020379
description	bolt piece L 75mm W 29mm H 28mm cam length 17.5mm cam width 10mm mounting distance 20/40mm		
For models:	FCVE10-2, FCVE10-4, FCVE103CE, FCVE10-2UK, FCVE10-4UK, FCVG10-2, FCVG10-4, FCVG10-1SG, FCVG10-2, FCVG10-4D, FCVG10-2UK, FCVG10-4UK, FCVG10-2, FCVG10-4, FCVE20-2, FCVE20-4, FCVE203CE, FCVE20/P-V, FCVE20-2UK, FCVE20-4UK, FCVG20-2, FCVG20-4, FCVG20-2, FCVG20-4D, FCVG20-2UK, FCVG20-4UK, FCVG20-4, FCVG20-4D, FCVE20-V, FCVE20VUK, FCVE10-P, FCVE10PUK, FCVG10-P, FCVG10PUK, FCVE20-P, FCVE20PUK, C204200-3, C20230-3, C204400-3N, C206400-3N, C20T4/400-, C20P4200-3, C20P4230-3, C20P44003N, C20P64003N, C20PT4/400, FCVG20-P, FCVG20PUK, AFCV/G101, AFCV/G103...(Other models you can see in the webshop)		

			
GEV No.	690041	Ref. No.	003822 0H6727 0K2246 251425 751020943
description	cam L 148mm mounting distance 32mm		
For models:	FDV40G, FDV40E, FDV40GZ, FDV40EL, FDV40GA, FDV20G, FDV20E, FDV20GZ, FDV20EL, FDV20GA, FCZ201EAA, FCZ202EAA, FCZ201E-AH, FCZ201EAN, FCZ201ETA, FCZ202ETA, FCZ201ETH, FCZ201ETN, FCZ201GAG, FCZ202GAG, FCZ201GAD, FCZ202GAD, FCZ201GTG, FCZ202GTG, FCZ201GTD, FCZ202GTD, FCZ201EBA, FCZ202EBA, FCZ201EBH, FCZ201EBN, FCZ201EBC, FCZ201EBA2, FCZ202EBA2, FCZ201EBH2, FCZ201EBN2, FCZ201EBC2, FCZ201GBG, FCZ202GBG, FCZ201GBD, FCZ202GBD, FCZ201GBI, FCZ201GBG2, FCZ202GBG2, FCZ201GBD2, FCZ202GBD2, FCZ201GBI2, FCZ201ECA, FCZ202ECA, FCZ201ECH, FCZ201ECN...(Other models you can see in the webshop)		

			
GEV No.	693797	Ref. No.	004104 0G1982 234701
description	console upper/lower for cam		
For models:	FDV40G, FDV40E, FDV40GZ, FDV40EL, FDV40GA, FDV20G, FDV20E, FDV20GZ, FDV20EL, FDV20GA, FCV/G20L3, FCVG202L3, FCV/E20L3, FCVE202L3, FCV/G20L6, FCV/E20L6, FCVG202L6, FCVE202L6, FCV/G201/1, FVC/E201/1, FCV/G202/1, FVC/E202/1, FCFG201-0, FCFG202-0, FCFE201-0, FCFE202-0, FCF201ENS, FCS201E4, FCS201EP, FCS202E4, FCS202EP, FCS201G4, FCS201GP, FCS202G4, FCS202GP, FCS201EX, FCS201EXLN, FCS202EX, FCS201GX, FCS202GX, 5714-2-6, 5714-2-7, 5714-2-8, 5714-2-10, 5717-2-6, 5714-2-7, 5714-2-8, 5714-2-10, 5714-2-6L, 5714-2-7L...(Other models you can see in the webshop)		

			
GEV No.	690040	Ref. No.	OKS854 1951149 1951151
description	door catch with roller H 42mm L 40mm W 40mm zinc die cast mounting distance 26mm type 0751 series		

			
GEV No.	690838	Ref. No.	056571 0K2873 5401029
description	door catch with roller H 48mm L 50mm W 26mm mounting distance 28mm rollerø 10mm		
For models:	FCVE10-2, FCVE10-4, FCVE103CE, FCVE10-2UK, FCVE10-4UK, FCVG10-2, FCVG10-4, FCVG10-1SG, FCVG10-2, FCVG10-4D, FCVG10-2UK, FCVG10-4UK, FCVG10-2, FCVG10-4, FCVE20-2, FCVE20-4, FCVE203CE, FCVE20/P-V, FCVE20-2UK, FCVE20-4UK, FCVG20-2, FCVG20-4, FCVG20-2, FCVG20-4D, FCVG20-2UK, FCVG20-4UK, FCVG20-4, FCVG20-4D, FCVE20-V, FCVE20VUK, FCVE10-P, FCVE10PUK, FCVG10-P, FCVG10PUK, FCVE20-P, FCVE20PUK, FCVG20-P, FCVG20PUK, AFCV/G101, AFCV/G103, SCO/G10-3, AFCV/G201, AFCV/G203, SCO/G20-3, FCVG10-1SG, FCV/E20-V		





			
GEV No.	690836	Ref. No.	056550 OK3031 5401028
description	latch gear L 17mm W 26mm H 1.5mm mounting distance 42mm shaft diameter 7x7mm		
For models:	FCVE10-2, FCVE10-4, FCVE103CE, FCVE10-2UK, FCVE10-4UK, FCVG10-2, FCVG10-4, FCVG10-1SG, FCVG10-2, FCVG10-4D, FCVG10-2UK, FCVG10-4UK, FCVG10-2, FCVG10-4, FCVE20-2, FCVE20-4, FCVE203CE, FCVE20/P-V, FCVE20-2UK, FCVE20-4UK, FCVG20-2, FCVG20-4, FCVG20-2, FCVG20-4D, FCVG20-2UK, FCVG20-4UK, FCVG20-4, FCVG20-4D, FCVE20-V, FCVE20VUK, FCVE10-P, FCVE10PUK, FCVG10-P, FCVG10PUK, FCVE20-P, FCVE20PUK, FCVG20-P, FCVG20PUK, AFCV/G101, AFCV/G103, SCO/G10-3, AFCV/G201, AFCV/G203, SCO/G20-3, FCVG10-1SG, FCV/E20-V		

producer-specific

ELECTROLUX

			
GEV No.	700490	Ref. No.	005519 0H6728 OK1951 OK2247 0KE636 242817 60050439 72005302
description	door catch with roller		
For models:	FDV40G, FDV40E, FDV40GZ, FDV40EL, FDV40GA, FDV20G, FDV20E, FDV20GZ, FDV20EL, FDV20GA, FCV/G20L3, FCVG202L3, FCV/E20L3, FCVE202L3, FCV/G20L6, FCV/E20L6, FCVG202L6, FCVE202L6, FCV/G201/1, FVC/E201/1, FCV/G202/1, FVC/E202/1, FCFG201-0, FCFG202-0, FCFE201-0, FCFE202-0, FCF201ENS, 5714-2-6, 5714-2-7, 5714-2-8, 5714-2-10, 5717-2-6, 5714-2-7, 5714-2-8, 5714-2-10, 5714-2-6L, 5714-2-7L, 5714-2-8L, 5714-2-10L, 5714-2-6L, 5714-2-7L, 5714-2-8L, 5714-2-10L, 5714-3-6, 5714-3-7, 5714-3-8, 5714-3-8E, 5714-3-10, 5717-3-6, 5717-3-7...(Other models you can see in the webshop)		

			
GEV No.	693752	Ref. No.	0H6729 251427 60050440 750010188
description	door handle black plastic		

			
GEV No.	690042	Ref. No.	0H6928 OK2719 OKS851 280156 5401006 60050454 751020942
description	latch gear opening to the right shaft intake ø 8x8mm L 170mm W 40mm H 40mm		
For models:	5714-2-6, 5714-2-7, 5714-2-8, 5714-2-10, 5717-2-6, 5714-2-7, 5714-2-8, 5714-2-10, 5714-2-6L, 5714-2-7L, 5714-2-8L, 5714-2-10L, 5714-2-6L, 5714-2-7L, 5714-2-8L, 5714-2-10L, 5714-3-6, 5714-3-7, 5714-3-8, 5714-3-8E, 5714-3-10, 5717-3-6, 5717-3-7, 5717-3-8, 5717-3-8E, 5717-3-10, 5717-3-8M, 5717-3-8C, 5717-3-8M, 5714-2-10F, 5714-2-10S, 5714-3-10F, 5714-3-10S, 5704-2-2, 5704-2-3, 5707-2-2, 57074-2-3, 5704-3-2, 5704-3-3, 5707-3-2, 5707-3-3, 5614-3-10, 5614-3-6, 5614-3-8		
accessories for	690042		
			
GEV No.	690040	Ref. No.	OKS854 1951149 1951151
description	door catch with roller H 42mm L 40mm W 40mm zinc die cast mounting distance 26mm type 0751 series		
			
GEV No.	690041	Ref. No.	003822 0H6727 OK2246 251425 751020943
description	cam L 148mm mounting distance 32mm		
			
GEV No.	691050	Ref. No.	—
description	bar ø 10mm for door latch L 113.5mm		

			
GEV No.	700471	Ref. No.	003994 0G2001 0H6996
description	bushing for door handle		
For models:	FDV40G, FDV40E, FDV40GZ, FDV40EL, FDV40GA, FDV20G, FDV20E, FDV20GZ, FDV20EL, FDV20GA, FCV/G20L3, FCVG202L3, FCV/E20L3, FCVE202L3, FCV/G20L6, FCV/E20L6, FCVG202L6, FCVE202L6, FCV/G201/1, FVC/E201/1, FCV/G202/1, FVC/E202/1, FCFG201-0, FCFG202-0, FCFE201-0, FCFE202-0, FCF201ENS, 5714-2-6, 5714-2-7, 5714-2-8, 5714-2-10, 5717-2-6, 5714-2-7, 5714-2-8, 5714-2-10, 5714-2-6L, 5714-2-7L, 5714-2-8L, 5714-2-10L, 5714-2-6L, 5714-2-7L, 5714-2-8L, 5714-2-10L, 5714-3-6, 5714-3-7, 5714-3-8, 5714-3-8E, 5714-3-10, 5717-3-6, 5717-3-7...(Other models you can see in the webshop)		







			
1			
GEV No.	693797	Ref. No.	004104 0G1982 234701
description	console upper/lower for cam		
For models:	FDV40G, FDV40E, FDV40GZ, FDV40EL, FDV40GA, FDV20G, FDV20E, FDV20GZ, FDV20EL, FDV20GA, FCV/G20L3, FCVG202L3, FCV/E20L3, FCVE202L3, FCV/G20L6, FCV/E20L6, FCVG202L6, FCVE202L6, FCV/G201/1, FVC/E201/1, FCV/G202/1, FVC/E202/1, FCFG201-0, FCFG202-0, FCFE201-0, FCFE202-0, FCF201ENS, FCS201E4, FCS201EP, FCS202E4, FCS202EP, FCS201G4, FCS201GP, FCS202G4, FCS202GP, FCS201EX, FCS201EXLN, FCS202EX, FCS201GX, FCS202GX, 5714-2-6, 5714-2-7, 5714-2-8, 5714-2-10, 5717-2-6, 5714-2-7, 5714-2-8, 5714-2-10, 5714-2-6L, 5714-2-7L...(Other models you can see in the webshop)		

			
2			
GEV No.	700490	Ref. No.	005519 0H6728 0K1951 0K2247 0KE636 242817 60050439 72005302
description	door catch with roller		
For models:	FDV40G, FDV40E, FDV40GZ, FDV40EL, FDV40GA, FDV20G, FDV20E, FDV20GZ, FDV20EL, FDV20GA, FCV/G20L3, FCVG202L3, FCV/E20L3, FCVE202L3, FCV/G20L6, FCV/E20L6, FCVG202L6, FCVE202L6, FCV/G201/1, FVC/E201/1, FCV/G202/1, FVC/E202/1, FCFG201-0, FCFG202-0, FCFE201-0, FCFE202-0, FCF201ENS, 5714-2-6, 5714-2-7, 5714-2-8, 5714-2-10, 5717-2-6, 5714-2-7, 5714-2-8, 5714-2-10, 5714-2-6L, 5714-2-7L, 5714-2-8L, 5714-2-10L, 5714-2-6L, 5714-2-7L, 5714-2-8L, 5714-2-10L, 5714-2-6L, 5714-2-7L, 5714-2-8L, 5714-2-10L, 5714-3-6, 5714-3-7, 5714-3-8, 5714-3-8E, 5714-3-10, 5717-3-6, 5717-3-7, 5717-3-8, 5717-3-8E, 5717-3-10, 5717-3-8M, 5717-3-8C, 5717-3-8M, 5714-2-10F, 5714-2-10S, 5714-3-10F, 5714-3-10S, 5704-2-2, 5704-2-3, 5707-2-2, 57074-2-3, 5704-3-2, 5704-3-3, 5707-3-2, 5707-3-3, 5614-3-10, 5614-3-6, 5614-3-8		





			
1			
GEV No.	694366	Ref. No.	0J0006 0K1618 0K1619 H23398500
description	flange for door handle brass L 95mm W 40mm H 28.5mm hole ø 14mm		
For models:	5714-2-6, 5714-2-7, 5714-2-8, 5714-2-10, 5717-2-6, 5714-2-7, 5714-2-8, 5714-2-10, 5714-2-6L, 5714-2-7L, 5714-2-8L, 5714-2-10L, 5714-2-6L, 5714-2-7L, 5714-2-8L, 5714-2-10L, 5714-3-6, 5714-3-7, 5714-3-8, 5714-3-8E, 5714-3-10, 5717-3-6, 5717-3-7, 5717-3-8, 5717-3-8E, 5717-3-10, 5717-3-8M, 5717-3-8C, 5717-3-8M, 5714-2-10F, 5714-2-10S, 5714-3-10F, 5714-3-10S, 5704-2-2, 5704-2-3, 5707-2-2, 57074-2-3, 5704-3-2, 5704-3-3, 5707-3-2, 5707-3-3, 5614-3-10, 5614-3-6, 5614-3-8		







			
1			
GEV No.	700491	Ref. No.	003990
description	gasket suitable for JUNO equiv. no. 03990 L 40mm W 35mm door catch thickness 1mm		
For models:	FDV40G, FDV40E, FDV40GZ, FDV40EL, FDV40GA, FDV20G, FDV20E, FDV20GZ, FDV20EL, FDV20GA, FCFG201-0, FCFG202-0, FCFE201-0, FCFE202-0, FCF201ENS, 5714-2-6, 5714-2-7, 5714-2-8, 5714-2-10, 5717-2-6, 5714-2-7, 5714-2-8, 5714-2-10, 5714-2-6L, 5714-2-7L, 5714-2-8L, 5714-2-10L, 5714-2-6L, 5714-2-7L, 5714-2-8L, 5714-2-10L, 5714-3-6, 5714-3-7, 5714-3-8, 5714-3-8E, 5714-3-10, 5717-3-6, 5717-3-7, 5717-3-8, 5717-3-8E, 5717-3-10, 5717-3-8M, 5717-3-8C, 5717-3-8M, 5704-2-2, 5704-2-3, 5707-2-2, 57074-2-3, 5704-3-2, 5704-3-3...(Other models you can see in the webshop)		

							
1							
GEV No.	690042	Ref. No.	0H6928 0K2719 0KS851 280156 5401006 60050454 751020942				
description	latch gear opening to the right shaft intake ø 8x8mm L 170mm W 40mm H 40mm						
For models:	5714-2-6, 5714-2-7, 5714-2-8, 5714-2-10, 5717-2-6, 5714-2-7, 5714-2-8, 5714-2-10, 5714-2-6L, 5714-2-7L, 5714-2-8L, 5714-2-10L, 5714-2-6L, 5714-2-7L, 5714-2-8L, 5714-2-10L, 5714-3-6, 5714-3-7, 5714-3-8, 5714-3-8E, 5714-3-10, 5717-3-6, 5717-3-7, 5717-3-8, 5717-3-8E, 5717-3-10, 5717-3-8M, 5717-3-8C, 5717-3-8M, 5714-2-10F, 5714-2-10S, 5714-3-10F, 5714-3-10S, 5704-2-2, 5704-2-3, 5707-2-2, 57074-2-3, 5704-3-2, 5704-3-3, 5707-3-2, 5707-3-3, 5614-3-10, 5614-3-6, 5614-3-8						
accessories for	690042						
		<table border="1"> <tr> <td>GEV No.</td> <td>690040</td> <td>Ref. No.</td> <td>0KS854 1951149 1951151</td> </tr> </table>	GEV No.	690040	Ref. No.	0KS854 1951149 1951151	door catch with roller H 42mm L 40mm W 40mm zinc die cast mounting distance 26mm type 0751 series
GEV No.	690040	Ref. No.	0KS854 1951149 1951151				
		<table border="1"> <tr> <td>GEV No.</td> <td>690041</td> <td>Ref. No.</td> <td>003822 0H6727 0K2246 251425 751020943</td> </tr> </table>	GEV No.	690041	Ref. No.	003822 0H6727 0K2246 251425 751020943	cam L 148mm mounting distance 32mm
GEV No.	690041	Ref. No.	003822 0H6727 0K2246 251425 751020943				
		<table border="1"> <tr> <td>GEV No.</td> <td>691050</td> <td>Ref. No.</td> <td>—</td> </tr> </table>	GEV No.	691050	Ref. No.	—	bar ø 10mm for door latch L 113.5mm
GEV No.	691050	Ref. No.	—				

			
1			
GEV No.	690041	Ref. No.	003822 0H6727 0K2246 251425 751020943
description	cam L 148mm mounting distance 32mm		
For models:	FDV40G, FDV40E, FDV40GZ, FDV40EL, FDV40GA, FDV20G, FDV20E, FDV20GZ, FDV20EL, FDV20GA, FCZ201EAA, FCZ202EAA, FCZ201E-AH, FCZ201EAN, FCZ201ETA, FCZ202ETA, FCZ201ETH, FCZ201ETN, FCZ201GAG, FCZ202GAG, FCZ201GAD, FCZ202GAD, FCZ201GTG, FCZ202GTG, FCZ201GTD, FCZ202GTD, FCZ201EBA, FCZ202EBA, FCZ201EBH, FCZ201EBN, FCZ201EBC, FCZ201EBA2, FCZ202EBA2, FCZ201EBH2, FCZ201EBN2, FCZ201EBC2, FCZ201GBG, FCZ202GBG, FCZ201GBD, FCZ202GBD, FCZ201GBI, FCZ201GBG2, FCZ202GBG2, FCZ201GBD2, FCZ202GBD2, FCZ201GBI2, FCZ201ECA, FCZ202ECA, FCZ201ECH, FCZ201ECN...(Other models you can see in the webshop)		





			
2			
GEV No.	693797	Ref. No.	004104 0G1982 234701
description	console upper/lower for cam		
For models:	FDV40G, FDV40E, FDV40GZ, FDV40EL, FDV40GA, FDV20G, FDV20E, FDV20GZ, FDV20EL, FDV20GA, FCV/G20L3, FCVG202L3, FCV/E20L3, FCVE202L3, FCV/G20L6, FCV/E20L6, FCVG202L6, FCVE202L6, FCV/G201/1, FVC/E201/1, FCV/G202/1, FVC/E202/1, FCFG201-0, FCFG202-0, FCFE201-0, FCFE202-0, ECFG201ENS, FCS201E4, FCS201EP, FCS202E4, FCS202EP, FCS201G4, FCS201GP, FCS202G4, FCS202GP, FCS201EX, FCS201EXLN, FCS202EX, FCS201GX, FCS202GX, 5714-2-6, 5714-2-7, 5714-2-8, 5714-2-10, 5717-2-6, 5714-2-7, 5714-2-8, 5714-2-10, 5714-2-6L, 5714-2-7L...(Other models you can see in the webshop)		

			
1			
GEV No.	694382	Ref. No.	004099
description	espagnolette lock complete with flange L 1265mm		
For models:	FDV40G, FDV40E, FDV40GZ, FDV40EL, FDV40GA, FDV20G, FDV20E, FDV20GZ, FDV20EL, FDV20GA, FCFG201-0, FCFG202-0, FCFE201-0, FCFE202-0, FCF201ENS, ECFG201-0, ECFG202-0, ECFE201-0, ECFE202-0, ECF201ENS, ACFG201-0, ACFG202-0, ACFE201-0, ACFE202-0, RCF201E, ZCF/G201/1, ZCF/G202/1, ZCF/E201/1-0, ZCF/E202/1-0		
spare parts for	694382		
	GEV No.	690041	Ref. No.
			003822 0H6727 0K2246 251425 751020943
	cam L 148mm mounting distance 32mm		
	GEV No.	690042	Ref. No.
			0H6928 0K2719 0K5851 280156 5401006 60050454 751020942
	latch gear opening to the right shaft intake ø 8x8mm L 170mm W 40mm H 40mm		
	GEV No.	693797	Ref. No.
			004104 0G1982 234701
	console upper/lower for cam		
	GEV No.	700472	Ref. No.
			004098
	flange for door handle brass L 95mm W 40mm H 15mm hole ø 14mm		

			
1			
GEV No.	692846	Ref. No.	0C4119
description	espagnolette lock L 1250mm complete ø 10mm for combi-steamer		
For models:	FCZ201EAA, FCZ202EAA, FCZ201EAH, FCZ201EAN, FCZ201GAG, FCZ202GAG, FCZ201GAD, FCZ202GAD, FCZ201EBA, FCZ202EBA, FCZ201EBH, FCZ201EBN, FCZ201GBG, FCZ202GBG, FCZ201GBD, FCZ202GBD, FCZ201ECA, FCZ202ECA, FCZ201ECH, FCZ201ECN, FCZ201GCG, FCZ202GCG, FCZ201GCD, FCZ202GCD, AOS201EAAQ, AOS201EBAQ, AOS202EAAQ, AOS202EBAQ, AOS201EANQ, AOS201EB-NQ, AOS202EANQ, AOS202EBNQ, AOS201EACQ, AOS201EBCQ, AOS201EAHQ, AOS201EBHQ, AOS201GAGQ, AOS201GBGQ, AOS202GAGQ, AOS202GBGQ, AOS201GADQ, AOS201GBDQ, AOS-202GADQ, AOS202GBDQ, AOS201GAIQ, AOS201GALQ, AOS201EAMQ, AOS201EABQ, AOS201GAPQ, AOS202GAPQ...(Other models you can see in the webshop)		
spare parts for	692846		
	GEV No.	690041	Ref. No.
			003822 0H6727 0K2246 251425 751020943
	cam L 148mm mounting distance 32mm		
	GEV No.	692013	Ref. No.
			052061 060920 0H6043 0K8575 60050373 727895
	roll pin ø 3mm L 16mm		
	GEV No.	694645	Ref. No.
			0C4309
	bar for espagnolette lock ø 10mm L 345mm		
	GEV No.	698500	Ref. No.
			0C4310
	bar L 435mm ø 9mm		
	GEV No.	700488	Ref. No.
			003824 0K2718 0K8570 0K9189 751020941
	latch gear		

			
1			
GEV No.	700472	Ref. No.	004098
description	flange for door handle brass L 95mm W 40mm H 15mm hole ø 14mm		
For models:	FDV40G, FDV40E, FDV40GZ, FDV40EL, FDV40GA, FDV20G, FDV20E, FDV20GZ, FDV20EL, FDV20GA, FCV/G20L3, FCVG202L3, FCV/E20L3, FCVE202L3, FCV/G20L6, FCV/E20L6, FCVG202L6, FCVE202L6, FCV/G201/1, FVC/E201/1, FCV/G202/1, FVC/E202/1, FCFG201-0, FCFG202-0, FCFE201-0, FCFE202-0, FCF201ENS, ECFG201-0, ECFG202-0, ECFE201-0, ECFE202-0, ECF201ENS, ACFG201-0, ACFG202-0, ACFE201-0, ACFE202-0, RCF201E, ACV/G20C4, ACVG202C4, ACV/E20C4, ACVE202C4...(Other models you can see in the webshop)		





 <p>1</p>			
GEV No.	690042	Ref. No.	OH6928 OK2719 OKS851 280156 5401006 60050454 751020942
description	latch gear opening to the right shaft intake ø 8x8mm L 170mm W 40mm H 40mm		
For models:	5714-2-6, 5714-2-7, 5714-2-8, 5714-2-10, 5717-2-6, 5714-2-7, 5714-2-8, 5714-2-10, 5714-2-6L, 5714-2-7L, 5714-2-8L, 5714-2-10L, 5714-2-6L, 5714-2-7L, 5714-2-8L, 5714-2-10L, 5714-3-6, 5714-3-7, 5714-3-8, 5714-3-8E, 5714-3-10, 5717-3-6, 5717-3-7, 5717-3-8, 5717-3-8E, 5717-3-10, 5717-3-8M, 5717-3-8C, 5717-3-8M, 5714-2-10F, 5714-2-10S, 5714-3-10F, 5714-3-10S, 5704-2-2, 5704-2-3, 5707-2-2, 57074-2-3, 5704-3-2, 5704-3-3, 5707-3-2, 5707-3-3, 5614-3-10, 5614-3-6, 5614-3-8		
accessories for	690042		
	GEV No.	690040	Ref. No.
			OKS854 1951149 1951151
	door catch with roller H 42mm L 40mm W 40mm zinc die cast mounting distance 26mm type 0751 series		
	GEV No.	690041	Ref. No.
			003822 OH6727 OK2246 251425 751020943
	cam L 148mm mounting distance 32mm		
	GEV No.	691050	Ref. No.
			—
	bar ø 10mm for door latch L 113.5mm		

 <p>1</p>			
GEV No.	692013	Ref. No.	052061 060920 OH6043 OK8575 60050373 727895
description	roll pin ø 3mm L 16mm		
For models:	MCF/G1090, MCF/G1095, MCF/G995, MR/G721, MR/G1071, MR/G1070, MR/G720, MR/G725, MR/G1075, MR/G726, MR/G1076, MFR/G350, MFR/G700, MFR/G350D, MFR/G700D, MFR/G350F, MFR/G700F, MFR/G350E, MFR/G700E, MFR/E355, MFR/E355UK, MFR/E355D, MFR/E705, MFR/E705UK, MFR/E705D, MFR/G740, MFR/E740, MFR/G350, MFR/G351, MFR/G700, MFR/G701, FDV40G, FDV40E, FDV40GZ, FDV40EL, FDV40GA, FDV20G, FDV20E, FDV20GZ, FDV20EL, FDV20GA, RCF/G1095, RR/G720D, 7FTGC7L, 7FTGC1L, RR/G1070D, 7FTGC7M, RR/G1076, RFR/G350, RFR/G700...(Other models you can see in the webshop)		

 <p>1</p>			
GEV No.	694407	Ref. No.	OK8572
description	bar for catch straight ø 10mm L 65mm		
For models:	C204200-3, C20230-3, C204400-3N, C206400-3N, C20T4/400-, C20P4200-3, C20P4230-3, C20P44003N, C20P64003N, C20PT4/400		

 <p>1</p>			
GEV No.	700489	Ref. No.	005037
description	bar for door latch ø 10mm L 465mm		
For models:	FCV/G20L3, FCV/G202L3, FCV/E20L3, FCVE202L3, FCV/G20L6, FCV/E20L6, FCV/G202L6, FCVE202L6, FCV/G201/1, FVC/E201/1, FCV/G202/1, FVC/E202/1, FCS201E4, FCS201EP, FCS202E4, FCS202EP, FCS201G4, FCS201GP, FCS202G4, FCS202GP, FCS201EX, FCS201EXLN, FCS202EX, FCS201GX, FCS202GX, ECV/G20T4, ECV/E20T4, ECVG202T4, ECVE202T4, ECV/G20T4J, ECV/G20T6, ECV/E20T6, ECVG202T6, ECVE202T6, ACV/G20C4, ACV/G202C4, ACV/E20C4, ACVE202C4, ACV/G20C6, ACV/G202C6, ACVE202C6, ACV/E202/1, ZCV/G20T4, ZCV/E20T4, ZCV/G202/1, ZCV/E202/1, ZCV/G20T6, ZCV/E20T6, ZCV/G202/1, ZCV/E202/1		

 <p>1</p>			
GEV No.	690837	Ref. No.	056551 OK2871 OKJ908 5401030 753020379
description	bolt piece L 75mm W 29mm H 28mm cam length 17.5mm cam width 10mm mounting distance 20/40mm		
For models:	FCVE10-2, FCVE10-4, FCVE103CE, FCVE10-2UK, FCVE10-4UK, FCV/G10-2, FCV/G10-4, FCV/G10-4, FCVE20-2, FCVE20-4, FCVE203CE, FCVE20/P-V, FCVE20-2UK, FCVE20-4UK, FCV/G20-2, FCV/G20-4, FCV/G20-2, FCV/G20-4D, FCV/G20-2UK, FCV/G20-4UK, FCV/G20-4, FCV/G20-4D, FCVE20-V, FCVE20VUK, FCVE10-P, FCVE10PUK, FCV/G10-P, FCV/G10PUK, FCVE20-P, FCVE20PUK, C204200-3, C20230-3, C204400-3N, C206400-3N, C20T4/400-, C20P4200-3, C20P4230-3, C20P44003N, C20P64003N, C20PT4/400, FCV/G20-P, FCV/G20PUK, AFCV/G101, AFCV/G103...(Other models you can see in the webshop)		

 <p>1</p>			
GEV No.	694413	Ref. No.	0F0145
description	espagnolette lock complete L 1010mm		
For models:	CS20ME4/200-3, CS20ME4/230-3, CS20ME6/230-3, CS20ME4/400-3N, CS20ME6/400-3N, CS20ME4/400-3NE, CS20ME4/400-3, CS-20ME4/440-3, CS20MT4/400-3N, CS20MT6/400-3N, CS20GE4/200-3, CS20GE4/230-3, CS20GE6/230-3, CS20GE4/400-3N, CS20GE6/400-3N, CS20GE4/400-3NE, CS20GE4/400-3, CS20GE4/440-3, CS-20GT4/400-3N, CS20GT6/400-3N, CS20LCE4/200-3, CS20LCE4/230-3, CS20LCE6/230-3, CS20LCE4/400-3N, CS20LCE6/400-3N, CS20LCE4/400-3N, CS20LCE4/440-3, CS20LCT4/400-3N, CS20LCT6/400-3N, C204200-3, C20230-3, C204400-3N, C206400-3N, C20T4/400-, C20P4200-3, C20P4230-3, C20P44003N, C20P64003N, C20PT4/400		

 <p>1</p>			
GEV No.	692013	Ref. No.	052061 060920 OH6043 OK8575 60050373 727895
description	roll pin ø 3mm L 16mm		
For models:	MCF/G1090, MCF/G1095, MCF/G995, MR/G721, MR/G1071, MR/G1070, MR/G720, MR/G725, MR/G1075, MR/G726, MR/G1076, MFR/G350, MFR/G700, MFR/G350D, MFR/G700D, MFR/G350F, MFR/G700F, MFR/G350E, MFR/G700E, MFR/E355, MFR/E355UK, MFR/E355D, MFR/E705, MFR/E705UK, MFR/E705D, MFR/G740, MFR/E740, MFR/G350, MFR/G351, MFR/G700, MFR/G701, FDV40G, FDV40E, FDV40GZ, FDV40EL, FDV40GA, FDV20G, FDV20E, FDV20GZ, FDV20EL, FDV20GA, RCF/G1095, RR/G720D, 7FTGC7L, 7FTGC1L, RR/G1070D, 7FTGC7M, RR/G1076, RFR/G350, RFR/G700...(Other models you can see in the webshop)		

			
GEV No.	690041	Ref. No.	003822 0H6727 0K2246 251425 751020943
description	cam L 148mm mounting distance 32mm		
For models:	FDV40G, FDV40E, FDV40GZ, FDV40EL, FDV40GA, FDV20G, FDV20E, FDV20GZ, FDV20EL, FDV20GA, FCZ201EAA, FCZ202EAA, FCZ201E-AH, FCZ201EAN, FCZ201ETA, FCZ202ETA, FCZ201ETH, FCZ201ETN, FCZ201GAG, FCZ202GAG, FCZ201GAD, FCZ202GAD, FCZ201GTG, FCZ202GTG, FCZ201GTD, FCZ202GTD, FCZ201EBA, FCZ202EBA, FCZ201EBH, FCZ201EBN, FCZ201EBC, FCZ201EBA2, FCZ202EBA2, FCZ201EBH2, FCZ201EBN2, FCZ201EBC2, FCZ201GBG, FCZ202GBG, FCZ201GBD, FCZ202GBD, FCZ201GBI, FCZ201GBG2, FCZ202GBG2, FCZ201GBD2, FCZ202GBD2, FCZ201GBI2, FCZ201ECA, FCZ202ECA, FCZ201ECH, FCZ201ECN...(Other models you can see in the webshop)		

			
GEV No.	694366	Ref. No.	0J0006 0K1618 0K1619 H23398500
description	flange for door handle brass L 95mm W 40mm H 28.5mm hole ø 14mm		
For models:	5714-2-6, 5714-2-7, 5714-2-8, 5714-2-10, 5717-2-6, 5714-2-7, 5714-2-8, 5714-2-10, 5714-2-6L, 5714-2-7L, 5714-2-8L, 5714-2-10L, 5714-2-6L, 5714-2-7L, 5714-2-8L, 5714-2-10L, 5714-3-6, 5714-3-7, 5714-3-8, 5714-3-8E, 5714-3-10, 5717-3-6, 5717-3-7, 5717-3-8, 5717-3-8E, 5717-3-10, 5717-3-8M, 5717-3-8C, 5717-3-8M, 5714-2-10F, 5714-2-10S, 5714-3-10F, 5714-3-10S, 5704-2-2, 5704-2-3, 5707-2-2, 57074-2-3, 5704-3-2, 5704-3-3, 5707-3-2, 5707-3-3, 5614-3-10, 5614-3-6, 5614-3-8		

			
GEV No.	693797	Ref. No.	004104 0G1982 234701
description	console upper/lower for cam		
For models:	FDV40G, FDV40E, FDV40GZ, FDV40EL, FDV40GA, FDV20G, FDV20E, FDV20GZ, FDV20EL, FDV20GA, FCV/G20L3, FCVG202L3, FCV/E20L3, FCVE202L3, FCV/G20L6, FCV/E20L6, FCVG202L6, FCVE202L6, FCV/G201/1, FVC/E201/1, FCV/G202/1, FVC/E202/1, FCFG201-0, FCFG202-0, FCFE201-0, FCFE202-0, FCF201ENS, FCS201E4, FCS201EP, FCS202E4, FCS202EP, FCS201G4, FCS201GP, FCS202G4, FCS202GP, FCS201EX, FCS201EXLN, FCS202EX, FCS201GX, FCS202GX, 5714-2-6, 5714-2-7, 5714-2-8, 5714-2-10, 5717-2-6, 5714-2-7, 5714-2-8, 5714-2-10, 5714-2-6L, 5714-2-7L...(Other models you can see in the webshop)		

			
GEV No.	692013	Ref. No.	052061 060920 0H6043 0K8575 60050373 727895
description	roll pin ø 3mm L 16mm		
For models:	MCF/G1090, MCF/G1095, MCF/G995, MR/G721, MR/G1071, MR/G1070, MR/G720, MR/G725, MR/G1075, MR/G726, MR/G1076, MFR/G350, MFR/G700, MFR/G350D, MFR/G700D, MFR/G350F, MFR/G700F, MFR/G350E, MFR/G700E, MFR/E355, MFR/E355UK, MFR/E355D, MFR/E705, MFR/E705UK, MFR/E705D, MFR/G740, MFR/E740, MFR/G350, MFR/G351, MFR/G700, MFR/G701, FDV40G, FDV40E, FDV40GZ, FDV40EL, FDV40GA, FDV20G, FDV20E, FDV20GZ, FDV20EL, FDV20GA, RCF/G1095, RR/G720D, 7FTGC7L, 7FTGC1L, RR/G1070D, 7FTGC7M, RR/G1076, RFR/G350, RFR/G700...(Other models you can see in the webshop)		

			
GEV No.	694381	Ref. No.	006246 88390400
description	espagnolette lock complete with flange L 1135mm		
For models:	5714-2-7, 5714-2-8, 5714-2-10, 5714-2-7, 5714-2-8, 5714-2-10, 5714-2-7L, 5714-2-8L, 5714-2-10L, 5714-2-7L, 5714-2-8L, 5714-2-10L, 5714-3-7, 5714-3-8, 5714-3-8E, 5714-3-10, 5717-3-7, 5717-3-8, 5717-3-8E, 5717-3-10, 5717-3-8M, 5717-3-8M		

			
GEV No.	700489	Ref. No.	005037
description	bar for door latch ø 10mm L 465mm		
For models:	FCV/G20L3, FCVG202L3, FCV/E20L3, FCVE202L3, FCV/G20L6, FCV/E20L6, FCVG202L6, FCVE202L6, FCV/G201/1, FVC/E201/1, FCV/G202/1, FVC/E202/1, FCS201E4, FCS201EP, FCS202E4, FCS202EP, FCS201G4, FCS201GP, FCS202G4, FCS202GP, FCS201EX, FCS201EXLN, FCS202EX, FCS201GX, FCS202GX, ECV/G20T4, ECV/E20T4, ECVG202T4, ECVE202T4, ECV/G20T4J, ECV/G20T6, ECV/E20T6, ECVG202T6, ECVE202T6, ACV/G20C4, ACVG202C4, ACV/E20C4, ACVE202C4, ACV/G20C6, ACVG202C6, ACVE20C6, ACV/E20/1, ZCV/G20T4, ZCV/E20T4, ZCV/G202/1, ZCV/E202/1, ZCV/G20T6, ZCV/E20T6, ZCV/G202/1, ZCV/E202/1		

spare parts for 694381			
	GEV No.	690041	Ref. No. 003822 0H6727 0K2246 251425 751020943
cam L 148mm mounting distance 32mm			

	GEV No.	690042	Ref. No. 0H6928 0K2719 0K5851 280156 5401006 60050454 751020942
latch gear opening to the right shaft intake ø 8x8mm L 170mm W 40mm H 40mm			



	GEV No.	693797	Ref. No. 004104 0G1982 234701
console upper/lower for cam			

	GEV No.	694366	Ref. No. 0J0006 0K1618 0K1619 H23398500
flange for door handle brass L 95mm W 40mm H 28.5mm hole ø 14mm			

			
1			
GEV No.	691768	Ref. No.	005038
description	bar L 420mm ID ø 8mm ext. ø 10		
For models:	FCV/G20L3, FCVG202L3, FVC/E20L3, FCVE202L3, FCV/G20L6, FCV/E20L6, FCVG202L6, FCVE202L6, FCV/G201/1, FVC/E201/1, FCV/G202/1, FVC/E202/1, FCS201E4, FCS201EP, FCS202E4, FCS202EP, FCS201G4, FCS201GP, FCS202G4, FCS202GP, FCS201EX, FCS201EXLN, FCS202EX, FCS201GX, FCS202GX, ECV/G20T4, ECV/E20T4, ECVG202T4, ECVE202T4, ECV/G20T4J, ECV/G20T6, ECV/E20T6, ECVG202T6, ECVE202T6, ACV/G20C4, ACVG202C4, ACV/E20C4, ACVE202C4, ACV/G20C6, ACVG202C6, ACVE20C6, ACV/E202/1, ZCV/G20T4, ZCV/E20T4, ZCV/G202/1, ZCV/E202/1, ZCV/G20T6, ZCV/E20T6, ZCV/G202/1, ZCV/E202/1		

			
2			
GEV No.	690041	Ref. No.	003822 0H6727 0K2246 251425 751020943
description	cam L 148mm mounting distance 32mm		
For models:	FDV40G, FDV40E, FDV40GZ, FDV40EL, FDV40GA, FDV20G, FDV20E, FDV20GZ, FDV20EL, FDV20GA, FCZ201EAA, FCZ202EAA, FCZ201EAH, FCZ201EAN, FCZ201ETA, FCZ202ETA, FCZ201ETH, FCZ201ETN, FCZ201GAG, FCZ202GAG, FCZ201GAD, FCZ202GAD, FCZ201GTG, FCZ202GTG, FCZ201GTD, FCZ202GTD, FCZ201EBA, FCZ202EBA, FCZ201EBH, FCZ201EBN, FCZ201EBC, FCZ201EBA2, FCZ202EBA2, FCZ201EBH2, FCZ201EBN2, FCZ201EBC2, FCZ201GBG, FCZ202GBG, FCZ201GBD, FCZ202GBD, FCZ201GBI, FCZ201GBG2, FCZ202GBG2, FCZ201GBD2, FCZ202GBD2, FCZ201GBI2, FCZ201ECA, FCZ202ECA, FCZ201ECH, FCZ201ECN...(Other models you can see in the webshop)		

			
1			
GEV No.	693797	Ref. No.	004104 0G1982 234701
description	console upper/lower for cam		
For models:	FDV40G, FDV40E, FDV40GZ, FDV40EL, FDV40GA, FDV20G, FDV20E, FDV20GZ, FDV20EL, FDV20GA, FVC/G20L3, FCVG202L3, FCV/E20L3, FCVE202L3, FCV/G20L6, FVC/E20L6, FCVG202L6, FCVE202L6, FCV/G201/1, FVC/E201/1, FCV/G202/1, FVC/E202/1, FCFG201-0, FCFG202-0, FCFE201-0, FCFE202-0, FCF201ENS, FCS201E4, FCS201EP, FCS202E4, FCS202EP, FCS201G4, FCS201GP, FCS202G4, FCS202GP, FCS201EX, FCS201EXLN, FCS202EX, FCS201GX, FCS202GX, 5714-2-6, 5714-2-7, 5714-2-8, 5714-2-10, 5717-2-6, 5714-2-7, 5714-2-8, 5714-2-10, 5714-2-6L, 5714-2-7L...(Other models you can see in the webshop)		

			
1			
GEV No.	694414	Ref. No.	005342
description	espagnolette lock complete with flange L 1310mm		
For models:	FCV/G20L3, FCVG202L3, FVC/E20L3, FCVE202L3, FCV/G20L6, FCV/E20L6, FCVG202L6, FCVE202L6, FCV/G201/1, FVC/E201/1, FCV/G202/1, FVC/E202/1, ECV/G20T4, ECV/E20T4, ECVG202T4, ECVE202T4, ECV/G20T4J, ECV/G20T6, ECV/E20T6, ECVG202T6, ECVE202T6, ACV/G20C4, ACVG202C4, ACV/E20C4, ACVE202C4, ACV/G20C6, ACVG202C6, ACVE20C6, ACV/E202/1, ZCV/G20T4, ZCV/E20T4, ZCV/G202/1, ZCV/E202/1, ZCV/G20T6, ZCV/E20T6, ZCV/G202/1, ZCV/E202/1		
accessories for	694414		
	GEV No.	700490	Ref. No. 005519 0H6728 0K1951 0K2247 0KE636 242817 60050439 72005302
door catch with roller			

			
1			
GEV No.	700472	Ref. No.	004098
description	flange for door handle brass L 95mm W 40mm H 15mm hole ø 14mm		
For models:	FDV40G, FDV40E, FDV40GZ, FDV40EL, FDV40GA, FDV20G, FDV20E, FDV20GZ, FDV20EL, FDV20GA, FVC/G20L3, FCVG202L3, FCV/E20L3, FCVE202L3, FCV/G20L6, FVC/E20L6, FCVG202L6, FCVE202L6, FCV/G201/1, FVC/E201/1, FCV/G202/1, FVC/E202/1, FCFG201-0, FCFG202-0, FCFE201-0, FCFE202-0, FCF201ENS, ECVG20T4, ECV/E20T4, ECVG202T4, ECVE202T4, ECV/G20T4J, ECV/G20T6, ECV/E20T6, ECVG202T6, ECVE202T6, ACFG201-0, ACFG202-0, ACVE201-0, ACVE202-0, RCF201E, ACV/G20C4, ACVG202C4, ACV/E20C4, ACVE202C4...(Other models you can see in the webshop)		

			
1			
GEV No.	692013	Ref. No.	052061 060920 0H6043 0K8575 60050373 727895
description	roll pin ø 3mm L 16mm		
For models:	MCF/G1090, MCF/G1095, MCF/G995, MR/G721, MR/G1071, MR/G1070, MR/G720, MR/G725, MR/G1075, MR/G726, MR/G1076, MFR/G350, MFR/G700, MFR/G350D, MFR/G700D, MFR/G350F, MFR/G700F, MFR/G350E, MFR/G700E, MFR/E355, MFR/E355UK, MFR/E355D, MFR/E705, MFR/E705UK, MFR/E705D, MFR/G740, MFR/E740, MFR/G350, MFR/G351, MFR/G700, MFR/G701, FDV40G, FDV40E, FDV40GZ, FDV40EL, FDV40GA, FDV20G, FDV20E, FDV20GZ, FDV20EL, FDV20GA, RCF/G1095, RR/G720D, 7FTGC7L, 7FTGC1L, RR/G1070D, 7FTGC7M, RR/G1076, RFR/G350, RFR/G700...(Other models you can see in the webshop)		

miscellaneous

			
1			
GEV No.	700440	Ref. No.	003682
description	bolt for catch		
For models:	JCF/G6-1, JCF/G101/1-1, JCF/G102/1-1, JCF/E6-1, JCF/E101/1-1, JCF/E102/1-1, JCF/G6-2, JCF/G101/1-2, JCF/G102/1-2, JCF/E6-2, JCF/E101/1-2, JCF/E102/1-2		

			
1			
GEV No.	693771	Ref. No.	0H6770 0K2290 253429
description	bolt piece		

			
1			
GEV No.	693772	Ref. No.	0H6566
description	door catch		

			
1			
GEV No.	700452	Ref. No.	054854
description	door catch with spigot		
For models:	FCF02EV, FCF02EOEM, FCF/E3, FCF/E2, FCF/E2D, FCF/E2UK, FCF/E2, FCF/E2, FCF/E2D		

			
1			
GEV No.	694374	Ref. No.	0A2413
description	guide ϕ 32/46mm ID ϕ 22.5/26mm L 40mm		
For models:	FF/E40, FF/E10, FF/G10, FF/E20, FF/G20, FF/G40, AFCF/E40		

			
1			
GEV No.	693749	Ref. No.	0K2697 279789
description	spring for snap lock		

hinges

piano hinges

producer-specific

ELECTROLUX/JUNO

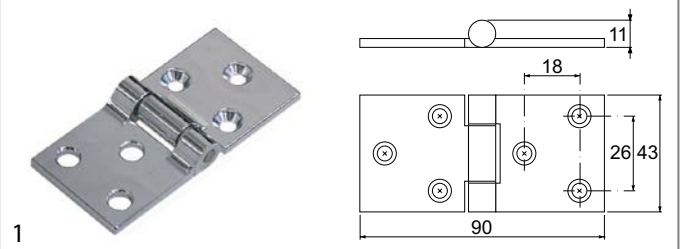

GEV No.	690025	Ref. No.	0H6454
description	hinge L 90mm W 43mm H 11mm mounting distance 26mm mounting distance 1 18mm hole ϕ 5,5/8mm thickness 3.5mm Zamak VC		

edgmount hinges

CAFF/FERMOD

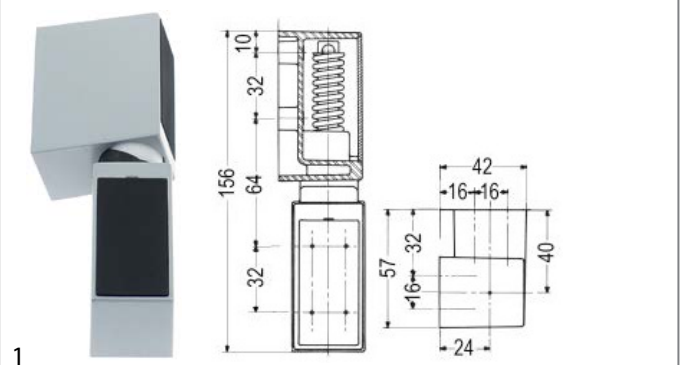

GEV No.	690642	Ref. No.	0A8414 0A9531
description	edgmount hinge L 156mm mounting distance 64/32mm hinging right with gradient and spring series G 466		
For models:	MRF4808660, MRF6018660, MRF401/86, MRF601/86, MRF240/86, MRF480/86, RI16R1FR, RI016RE1F, RI16RE1FR, RI17RE1FU, MFR24040, MRF480/40, RI16R1F, RI16R2FT, RI16R2FGT, MRF601/86, RI16H1F, RI16H2FT, RI16R1G, EWE601, EWZ601, EWDE602, EWDZ602, RI17RE1FRU, RI17R1FRPU, RI17RE1FPU, EDVP20VR1G, EDVP10VR1, EDVP20VR1, EDVP10VR1, EDVP20VR1, EDVP10VR1, EDVP10VR1, EDVP20VR14V, RI12H1F, RI27H2F, RI12H2FT, 12800100.1, 12800110.1, 12800110.1, 12800100.1, RI27H4FT, EDVP20VR12V, KUMAC		

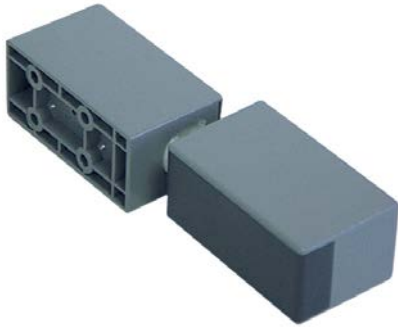

1

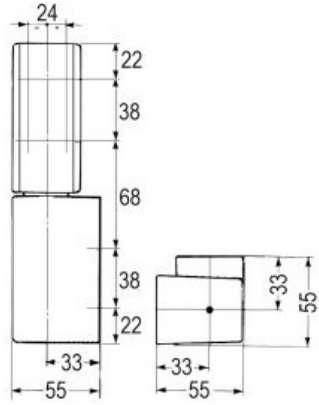

GEV No.	690805	Ref. No.	084892
description	edgemoat hinge L 188mm mounting distance 38mm hinging left/right with gradient and spring series G 920		
For models:	BC100A, BC100DA, BC100RA, BC100RDA, BC180A, BC180DA, BC180RA, BC180RDA, BC180RPA, BCF100A, BCF100DA, BCF100RA, BCF100RDA, BCF180A, BCF180DA, BCF180RA, BCF180RDA, BCF180RPA, BC120A, BC120RA, BCF120A, BCF120RA, BLAST C/FREEZER, BLAST C/FREEZER, BLAST C/FREEZER, BLAST C/FREEZER, BLAST C/FREEZER, BLAST C/FREEZER, BC0144, BC072, ESBC72R, ESBC144R, ESBF70, ESBF70R, ESBF144, ESBF144R, AOCP2028R, AOCP2028RD, AOCP2028RT, AOFP2028R, AOFP2028RD, AOFP2028RT, AOFP2028RU, BLAST C/FREEZER, BLAST C/FREEZER, BLAST C/FREEZER, BLAST C/FREEZER, BLAST C/FREEZER, BLAST C/FREEZER, AOFP202RU4...(Other models you can see in the webshop)		
accessories for	690805		
		GEV No.	691642
		Ref. No.	—
	base plate thickness 5mm plastic L 98mm W 49mm		

spring assisted hinges

universal
INTERKLIMAT
hinges



1

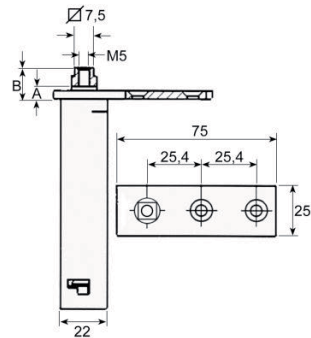

GEV No.	690622	Ref. No.	081653 082079 082219
description	spring assisted hinge series 28L mounting pos. left/right L 75mm W 25mm H 103mm A 13mm B 18mm mounting measurements 22x22mm intake 7.5x7.5 refrigeration units		
For models:	AP20, BC11, BC22, BC44, BC44H, BCF11, BCF22, BCF44, ALP110, ALP120, ALP220, ALP240, ALN110, ALN120, ALN220, ALN240, ALNN120, ALNN220, ALNN230, ALNSO120, ALP110UK, ALN110UK, ALNN220UK, ALF110, ALF220UK, ALNF220, ALF110, ALF120, ALF220, ALF240, ALNF120, ALNF220, ALNF230, BC44, BCF44, ADN220ES, ADF110ES, ADF220ES, ADN110ESP, ADF110ESP, ILP110, ILP110UK, ILN120, FV 1M, FV 1M, FV 1M, FV 1M, FV 1M, FV 1M, FV 1M, FV Dual...(Other models you can see in the webshop)		

accessories



1

GEV No.	690757	Ref. No.	081654
description	bush for door hinge ID \varnothing 7.5mm L 25.5mm W 25.5mm black H 4.5mm		
For models:	AP20, BC11, BC22, BC44, BC44H, BCF11, BCF22, BCF44, BCW061, BCW101, BCW102, BCFW061, BCFW101, ALP110, ALP120, ALP220, ALP240, ALN110, ALN120, ALN220, ALN240, ALNN220, ALNN230, ALP110UK, ALN110UK, ALNN220UK, ALF110, ALF220UK, ALNF220, ALF110, ALF120, ALF220, ALF240, ALNF220, ALNF230, BC44, BCF44, ADN220ES, ADF110ES, ADF220ES, ADN110ESP, ADF110ESP, BCWS061T, BCFW102, ILP110, ILP110UK, ILN120, FV 1M, FV 1M, FV 2M...(Other models you can see in the webshop)		



1

GEV No.	690747	Ref. No.	0A8856
description	bush for hinge ID ø 7.5mm L 25.5mm W 25.5mm white mounting measurements 22x22mm H 4.5mm		
For models:	BCW201R, BCFW201R, ALP120, ALP220, ALP240, ALN120, ALN220, ALN240, ALNN120, ALNN230, ALNSO120, ALF220UK, ALF120, ALF220, ALF240, ALNF120, ALNF230, ILNSO120, ILNN120, ILNN230, ILNF120, ILNF230, ALP120, ALP220, ALP240, ALN120, ALN220, ALN240, ALF120, ALF220, ALF240, ALNN120, ALNF120, ALNN230, ALNF230, ALNSO120, ALN120, AEN120, ADF120, ALF120, AEF120, ADNN120, ADN120, AENN120, AENF120, ALN240, AEN240, ADF240, AEF240, ADNN230...(Other models you can see in the webshop)		

producer-specific

ELECTROLUX/ZANUSSI



1

GEV No.	690757	Ref. No.	081654
description	bush for door hinge ID ø 7.5mm L 25.5mm W 25.5mm black H 4.5mm		
For models:	AP20, BC11, BC22, BC44, BC44H, BCF11, BCF22, BCF44, BCW061, BCW101, BCW102, BCFW061, BCFW101, ALP110, ALP120, ALP220, ALP240, ALN110, ALN120, ALN220, ALN240, ALNN220, ALNN230, ALP110UK, ALN110UK, ALNN220UK, ALF110, ALF220UK, ALNF220, ALF110, ALF120, ALF220, ALNF220, ALNF230, BC44, BCF44, ADN220ES, ADF110ES, ADF220ES, ADN110ESP, ADF110ESP, BCWS061T, BCFW102, ILP110, ILP110UK, ILN120, FV 1M, FV 2M...(Other models you can see in the webshop)		



1

GEV No.	690747	Ref. No.	0A8856
description	bush for hinge ID ø 7.5mm L 25.5mm W 25.5mm white mounting measurements 22x22mm H 4.5mm		
For models:	BCW201R, BCFW201R, ALP120, ALP220, ALP240, ALN120, ALN220, ALN240, ALNN120, ALNN230, ALNSO120, ALF220UK, ALF120, ALF220, ALF240, ALNF120, ALNF230, ILNSO120, ILNN120, ILNN230, ILNF120, ILNF230, ALP120, ALP220, ALP240, ALN120, ALN220, ALN240, ALF120, ALF220, ALF240, ALNN120, ALNF120, ALNN230, ALNF230, ALNSO120, ALN120, AEN120, ADF120, ALF120, AEF120, ADNN120, ADN120, AENN120, AENF120, ALN240, AEN240, ADF240, AEF240, ADNN230...(Other models you can see in the webshop)		



1

GEV No.	690620	Ref. No.	0A8372
description	spring assisted hinge		



1

GEV No.	701028	Ref. No.	083876
description	spring assisted hinge L 75mm W 25mm H 102.5mm mounting distance 25.5mm		
For models:	BC11, BC22, BC44H, BCF11, BCF22, BCF44H, AQC31U US, AQC60U, AQC119U US, , BC28A6, Crosswise, , BCF15A6, , BCW061, BCW101, BCW201R, BCW102, BCFW061, BCFW101, BCFW201R, BC11, BC22, BC44H, BCF11, BCF22, BCF44H, BCWS061T, BCFW102, BC11, BC22, BC44H, BCF11, BCF22, BCF44H, BCFWS102, BCFWS101, BC15A, Crosswise, BC28A, Crosswise, BC56HA, BCF15A, Crosswise, BCF28A, Crosswise, BCF56HA, BCFWS061...(Other models you can see in the webshop)		





1

GEV No.	690621	Ref. No.	0A8371 10251068
description	spring assisted hinge left		



1

GEV No.	690633	Ref. No.	082502 082587	
description	spring assisted hinge refrigerator			
For models:	ALP111, ALP221, ALN111, ALN221, ILP111, ILP221, ILN111, ILN221, ALP111, ALP221, ALN111, ALN221, ADN221, AKP111, AKP221, AKN111, AKN221, AKP111, AKP221, AKN111, AKP221, ESR142GR, ESR142G, ESR41GR, ESR41G, ESR61GR, ESR61G, EUKR61G, ESR41G60HZ, ESR61G60, ESR142G60HZ, ESF61G60, ESF41G, ESF41GR, ESF41G60HZ, ESF61GR, ESF61GR, TZ751GT, TE1502GT, IKN111, IKN221, ISP111N, ISP221N, ETZ601GT, ETE601GT, TE751GT, TZ1502GT, KE1502GT, KZ751GT, KZ1502GT...(Other models you can see in the webshop)			
accessories for	690633			
	GEV No.	690634	Ref. No.	082501 087135
	hinge bearing mounting pos. lower with bolt refrigerator			
	GEV No.	690635	Ref. No.	081900 082499
	hinge bearing mounting pos. upper with bolt refrigerator			



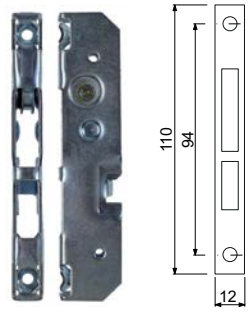

SAGI			
 <p>1</p>			
GEV No.	690747	Ref. No.	0A8856
description	bush for hinge ID \varnothing 7.5mm L 25.5mm W 25.5mm white mounting measurements 22x22mm H 4.5mm		
For models:	BCW201R, BCFW201R, ALP120, ALP220, ALP240, ALN120, ALN220, ALN240, ALNN120, ALNN230, ALNSO120, ALF220UK, ALF120, ALF220, ALF240, ALNF120, ALNF230, ILNSO120, ILNN120, ILNN230, ILNF120, ILNF230, ALP120, ALP220, ALP240, ALN120, ALN220, ALN240, ALF120, ALF220, ALF240, ALNN120, ALNF120, ALNN230, ALNF230, ALNSO120, ALN120, AEN120, ADF120, ALF120, AEF120, ADNN120, ADN120, AENN120, AENF120, ALN240, AEN240, ADF240, AEF240, ADNN230...(Other models you can see in the webshop)		

 <p>1</p>			
GEV No.	700003	Ref. No.	006091 0K3591
description	opposite support L 110mm W 12mm mounting distance 94mm		

oven hinges

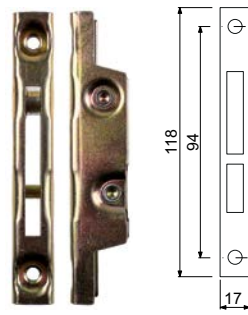
 <p>1</p>			
GEV No.	691939	Ref. No.	052049 052725 205075400
description	cover mounting distance 94mm L 122mm W 20mm oven hinge		
For models:	MCF/G705, MCF/G1055, MCF/G700, MCF/G1050, MCF/G705E, MCF/G1055E, MCF/G700D, MCF/G700, MCF/G705F, MCF/G1055F, MCF/G705NL, MCF/GE705, MCF/GE1055, MCF/GE700, MCFGE1050, MCF/GE700D, MCFGE1050D, MCF/G1050D, MCFG1055NL, MCF/E700D, MCF/E700, MCF/E700UK, MCF/E1050D, MCF/E1050, MCF/GE1055UK, MIF/E700, MIF/E700D, MIF/E710, MIF/E710D, MCF/G702, MCF/GE702, MCF/G1052, MCFGE1052, MCF/G700, MCF/GE700, MCF/G1050, MCFGE1050, MTF/G700D, MTF/G1050D, MTF/G700, MTF/G1050, MTF/GE1050, MT/G700F, MTF/G700F, MTF/G1055F, MTFGE1055F, MF/G700, MF/E700, RCF/G2, RCF/G3...(Other models you can see in the webshop)		

 <p>1</p>			
GEV No.	700001	Ref. No.	053096
description	opposite support L 118mm W 17mm mounting distance 94mm		

 <p>1</p>			
GEV No.	690031	Ref. No.	037595
description	opposite support oven hinge		
For models:	PPL5GG, PPFL5GG		

 <p>1</p>			
GEV No.	700436	Ref. No.	0KC554
description	hook for hinge		

 <p>1</p>			
GEV No.	700457	Ref. No.	056439 058934
description	opposite support oven hinge		
For models:	FCF/E4-OLD, FCF/E4D, FCFE4PH, FCF/E4OLD3, FCF/E4OLD4, FCF/E4OLD2, FCF/E4OLD1, FCF/E4D		



1

GEV No.	700456	Ref. No.	056339
description	oven hinge		
For models:	FCF/E4OLD4		
accessories for	700456		
	GEV No.	700457	Ref. No. 056439 058934
	opposite support oven hinge		



1

GEV No.	701118	Ref. No.	006087
description	oven hinge lever length 126mm mounting ear position left L 155mm W 20mm Qty 1 pcs		
For models:	PPL5GG, PPFL5GG		



1

GEV No.	701018	Ref. No.	006090
description	oven hinge lever length 126mm mounting ear position right L 155mm W 20mm Qty 1 pcs		
For models:	PPL5GG, PPFL5GG		



1

GEV No.	701015	Ref. No.	005186
description	oven hinge lever length 22mm L 209mm W 20mm Qty 1 pcs		
For models:	FCF/E4, FCF/E4-3KW, JCF/E4, JCF/E4, ECF/E4, ECF/E4-3KW, ACF/E4, ACF/E4-3KW, NCF/E4, ZCF/E4, ZCF/E4		

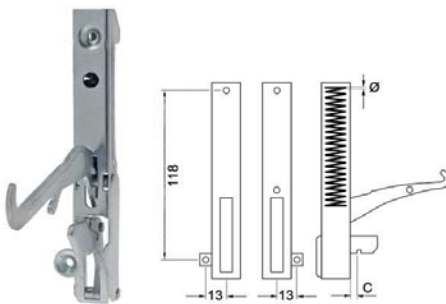

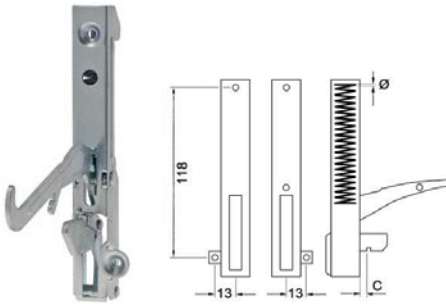

1

GEV No.	700013	Ref. No.	OK3593
description	oven hinge mounting distance 118mm lug mounting 13mm lever length 119mm groove distance 13mm spring thickness 3.5mm mounting ear position left spring length 60mm L 154mm		
accessories for	700013		
	GEV No.	700003	Ref. No. 006091 OK3591
	opposite support L 110mm W 12mm mounting distance 94mm		



1

GEV No.	700014	Ref. No.	OK3592
description	oven hinge mounting distance 118mm mounting distance 2mm lug mounting 13mm lever length 119mm groove distance 13mm spring thickness 3.5mm mounting ear position right spring length 60mm L 154mm		
accessories for	700014		
	GEV No.	700003	Ref. No. 006091 OK3591
	opposite support L 110mm W 12mm mounting distance 94mm		







1

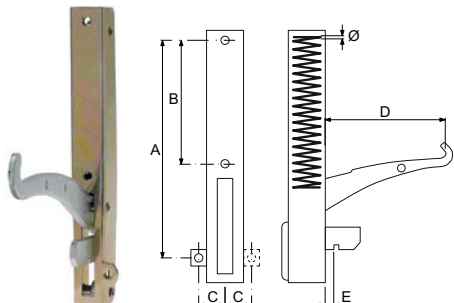

GEV No.	701014	Ref. No.	058933
description	oven hinge mounting distance 155mm lever length 130mm groove distance 9mm spring thickness 3.5mm spring length 67mm W 20mm Qty 2 pcs		
For models:	FCF/E4-OLD, FCF/E4D, FCFE4PH, FCF/E4OLD3, FCF/E4OLD4, FCF/E4OLD2, FCF/E4OLD1, FCF/E4D		



			
GEV No.	701596	Ref. No.	059227
description	oven hinge mounting distance 173mm mounting distance 2 105mm lug mounting 14mm lever length 117mm groove distance 10mm spring thickness 3mm mounting ear position left/right spring length 112mm W 25mm		
For models:	BCF/G2, BCF/E2, HCF/G810, HC/E400, HC/E800, HCF/E800, HCF/G810D, HCF/G1210D, HCF/G1610D, HCF/G810NL, HCF/G1210, HCF/G1610, HCF/GE810, HC/E410, HC/E810, HCF/E810, HCF/G810, HCF/G1210, HCF/G1610, HCF/G811, HCF/G800U, HCF/G1200U, HCF/G1600U, HTF/G810, HTF/G800D, HTF/G1210, HTF/G1210D, HTF/G800NL, HTFG1210NL, HFS/G800, HFS/E800, ZCF/G810, ZC/E400, ZC/E800, ZCF/E800, ZCF/G810D, ZCF/G1210D, ZHCFG1610D, ZCF/G1210, ZCF/G1610, ZCF/GE810, ZC/E410, ZC/E810, ZCF/E810, ZCF/G810, ZCF/G1210, ZCF/G1610, ZCF/G811, ZTF/G810, ZTF/G800D...(Other models you can see in the webshop)		

			
GEV No.	700007	Ref. No.	0A2004 0A2877 45011662
description	oven hinge mounting distance 173mm mounting distance 2 105mm lug mounting 14mm lever length 120mm groove distance 11mm spring thickness 3.5mm mounting ear position right spring length 112mm W 25mm		
accessories for	700007		
	GEV No.	700001	Ref. No. 053096
opposite support L 118mm W 17mm mounting distance 94mm			

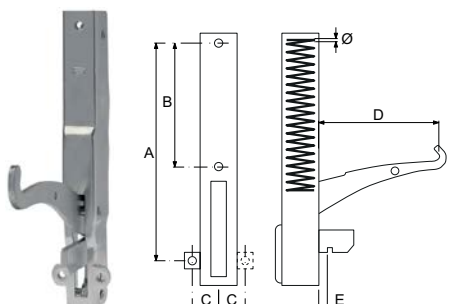
			
GEV No.	700006	Ref. No.	0A2005 0A2876
description	oven hinge mounting distance 173mm mounting distance 2 105mm lug mounting 14mm lever length 120mm groove distance 11mm spring thickness 3.5mm mounting ear position left spring length 112mm W 25mm		
accessories for	700006		
	GEV No.	700001	Ref. No. 053096
opposite support L 118mm W 17mm mounting distance 94mm			
	GEV No.	700007	Ref. No. 0A2004 0A2877 45011662
oven hinge mounting distance 173mm mounting distance 2 105mm lug mounting 14mm lever length 120mm groove distance 11mm spring thickness 3.5mm mounting ear position right spring length 112mm W 25mm			

			
GEV No.	701009 ¹	Ref. No.	026529 052092 0C0203 0K2884 335250752 335253212 728058-a
description	oven hinge mounting distance 173mm mounting distance 2mm lug mounting 14mm lever length 112mm groove distance 10mm spring thickness 3mm mounting ear position left/right spring length 111mm L 205mm W 25mm		
For models:	PCV/G2, PCV/G3, PCF/G2, PCF/G3, PCF/M2, PCF/M3, PCV/E2, PCV/E3, PCF/E2, PC/E2Q, PCF/E2Q, PCV/E2Q, PI/E1, PI/E2, PIF/E2, PIV/E2, PC/E2QE5, PCF/E2QE5, PI/E1E5, PI/E2E5, PIF/E2E5, PCF/E2E5, PCF/M2E5, PTF/G2, PSF/G2, PSV/G2, PSF/G3, PCV/G2N, PCF/G3N, PCV/G3N, PCF/G2N, PCV/G2A, PCV/G3A, PCF/G2A, PCF/G3A, PCF/M2A, PCF/M3A, OCV/G2, OCF/G2, OCF/G3, OCF/M2, OCV/E3, OCF/E2, OC/E2Q, OCF/E2Q, OI/E1, OI/E2, OIF/E2, OTV/G2, OTF/G2...(Other models you can see in the webshop)		
accessories for	701009		
	GEV No.	691939	Ref. No. 052049 052725 205075400
cover mounting distance 94mm L 122mm W 20mm oven hinge			
	GEV No.	700001	Ref. No. 053096
opposite support L 118mm W 17mm mounting distance 94mm			

¹with opposite support



1

GEV No.	701561	Ref. No.	050766
description	oven hinge mounting distance 173mm mounting distance 2mm lug mounting 14mm lever length 112mm groove distance 10mm spring thickness 3mm mounting ear position left/right spring length 111mm L 205mm W 25mm with opposite support		
For models:	MCF/G705, MCF/G1055, MCF/G700, MCF/G1050, MCF/G705E, MCF/G1055E, MCF/G700D, MCF/G700, MCF/G705F, MCF/G1055F, MCF/G705NL, MCF/GE705, MCF/GE1055, MCF/GE700, MCFGE1050, MCF/GE700D, MCFGE1050D, MCF/G1050D, MCFG1055NL, MCF/E700D, MCF/E700, MCF/E700UK, MCF/E1050D, MCF/E1050, MCF/GE1055UK, MIF/E700, MIF/E700D, MIF/E710, MIF/E710D, MCF/G702, MCF/GE702, MCF/G1052, MCFGE1052, MCF/G700, MCF/GE700, MCF/G1050, MCFGE1050, MTF/G700D, MTF/G1050D, MTF/G700, MTF/G1050, MTF/GE1050, MTF/G700F, MTF/G700F, MTF/G1055F, MTFGE1055F, MTF/G700, MTF/E700, RCF/G2, RCF/G3...(Other models you can see in the webshop)		

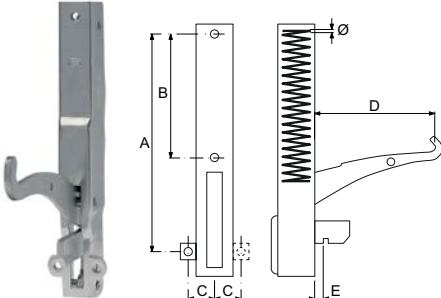

1

GEV No.	701414	Ref. No.	0C3129
description	oven hinge mounting distance 173mm mounting distance 2mm lug mounting 14mm lever length 113mm groove distance 10mm spring thickness 4mm mounting ear position left/right spring length 111mm L 205mm W 25mm with opposite support		
For models:	KCF/G3AG, QCF/G3A, QCF/G3HA		



1

GEV No.	701627	Ref. No.	003687
description	oven hinge mounting distance 29mm mounting distance 2 32mm L 115mm mounting pos. lower W 50mm bolt ϕ 7.8mm bolt 14mm		
For models:	FCF/G6-0, FCF/E6-0, FCF061ELN, FCF6EHOR, FCF061ENS, FCF/G6-1-JAP, FCFE6-1J, ECF/G6/0, ECF/E6-0, ECF061ENS, ECF061ESM, ECF061ECV, ACF/G6-0, ACF/E6-0, JCF/G6-1, JCF/E6-1, JCF/G6-2, JCF/E6-2, RCF061G, RCF061E, NCF/G6-0, NCF/E6-0, ZCF/G6-0, ZCF/E6-0		



1

GEV No.	700892	Ref. No.	0C3026 3581914540
description	oven hinge Qty 2 pcs		
For models:	FCF/E4, FCF/E4-3KW, FCF4E, FCF4E-3KW, ECF4E, ECF4E3KW, ECF/E4, ECF/E4-3KW, ACF/E4, ACF/E4-3KW, ACF4E, ACF4E3KW		

door bearing



1

GEV No.	700080	Ref. No.	0A8689
description	bolt for hinge		
For models:	ZBRAV806, ZBRAV805, ZBRAVV805, DLP14/F, DLP21/F, DL14/F, DL21/F, DL14/F, DL21/F, DLP14/F, DLP21/F, DL14/F, DL21/F, DLP14/F, DLP21/F, MLP2V2, MLP2V12, MLP3V3, MLP3V22, MLP3V14, MLP4V4, MLP4V32, MLP4V24, PTVN2719, PTVN2519, PTVN2724, PTVN2524, EDOIN28013, EDOIN28013, EDON420121B, EDON280120, EDON280112, EDON280111, EDON280104, EDON280103, EDON280102, EDON280113, EDON280105, EDON420130, EDON420122, EDON420121, EDON420114, EDON420105, EDON420106, EDON420123, EDON420115, EDON570140, EDON570132, EDON570131, EDON570124...(Other models you can see in the webshop)		



1

GEV No.	700464	Ref. No.	054256 055318
description	bolt for hinge		
For models:	FCVE10, FCVE20, FCVE6-1U, FCVE6-3U, FCVE6-1, FCVE6-3, FCVE6-1UK, FCVE6-3UK, FCVG6-1, FCVG6-3, FCVG6-1UK, FCVG6-3UK, FCVE10-2, FCVE10-4, FCVE10-2UK, FCVE10-4UK, FCVG10-2, FCVG10-4, FCVG10-2, FCVG10-4D, FCVG10-2UK, FCVG10-4UK, FCVG10-2, FCVG10-4, FCVE20-2, FCVE20-4, FCVE203CE, FCVE20/P-V, FCVE20-2UK, FCVE20-4UK, FCVG20-2, FCVG20-4, FCVG20-2, FCVG20-4D, FCVG20-2UK, FCVG20-4UK, FCVG20-4, FCVG20-4D, FCVE20-V, FCVE20VUK, FCF/E6-1, FCF/E6-1, FCFV/G6-1, ZOFVCV/G6-3, ZOFVCV/E102, ZOFVCV/E104, ZOFVCV/G102, ZOFVCV/G104, ZOFVCV/E202, ZOFVCV/E204...(Other models you can see in the webshop)		



			
1			
GEV No.	700466	Ref. No.	059083
description	bolt for hinge		
For models:	FCVE6-1U, FCVE6-3U, FCVE6-1, FCVE6-3, FCVE6-3CE, FCVE6-1UK, FCVE6-3UK, FCGV6-1, FCGV6-3, FCGV6-1UK, FCGV6-3UK, FCVE10-2, FCVE10-4, FCVE103CE, FCVE10-2UK, FCVE10-4UK, FCGV10-ISG, FCVE10-P, FCVE10PUK, FCGV10-P, FCGV10PUK, FCVE20-P, FCVE20PUK, FCGV20-P, FCGV20PUK, FCV/E6-1, FCV/E6-1, FCV/G6-1, ZOFVCV/G6-3, ZOFVCV/E102, ZOFVCV/E104, AFCV/G6-1, AFCV/G6-3, SCO/G6-3, AFCV/G101, AFCV/G103, SCO/G10-3, FCGV10-ISG		

			
2			
GEV No.	690645	Ref. No.	0A9096
description	bush for door hinge		
For models:	APP22B, ESMLR60W, ESMLF60W, ESMLR60S, ESMLF60S, RS24, FS24, RFS24, KZ1502, KE1502GT, TE1502, TZ1502, RI75RE1F, RI075RE1FR, RI093RE1F, RI093RE1FR, RI093RE1FU, EP406VRPUK, E04C6SCGUK, WDE752, WE751F, WZ751, WE751, WDE752, WDE752, RI075R1F, RI075R1FR, RI075R2FGT, WZ751, RI93RE1FEU, WDE752GT, WZ751, WZ751, WZ751, RI93R1FERU, E070R1P, E070R1P1, RW24, R04PVF4M, R04FSF4M, R04NVF4, R04NVF4F, R04PVFWG, R04FSFWG, R04PVF4, R04FSF4, R04PVG4, R04PVGW, R04FSFW...(Other models you can see in the webshop)		

			
1			
GEV No.	691310	Ref. No.	083875
description	bush L 23mm W 23mm ID ø 7mm for hinge		
For models:	BC11, BC22, BC44H, BCF11, BCF22, BCF44H, AQC31U US, AQC60U, AQC119U US, , BC28A6, Crosswise, , BCF15A6, , BC11, BC22, BC44H, BCF11, BCF22, BCF44H, BC11, BC22, BC44H, BCF11, BCF22, BCF44H, BC15A, Crosswise, BC28A, Crosswise, BC56HA, BCF15A, Crosswise, BCF28A, Crosswise, BCF56HA, ESBF10, ESB10, ESB10R, ESB10C, ESB10R, ESB10C, ESBF20, RBC102, ESK40H, ESF40H, EABP31, EABP51, EABC501...(Other models you can see in the webshop)		

			
1			
GEV No.	690696	Ref. No.	084528
description	bush mounting pos. lower for door hinge		
For models:	RI75RE1F, RI075RE1FR, RI093RE1F, RI093RE1FR, RI093RE1FU, WDE752, WE751F, WZ751, WE751G, WE751, WDE752, WDE752, RI075R1F, RI075R1FR, RI075R1G, RI075R2FGT, WZ751, RI93RE1FEU, WE751G, WDE752GT, WZ751, WZ751, WZ751, RI93R1FERU, E070R1P, E070R1P1, E070R1P1		

			
1			
GEV No.	690695	Ref. No.	084521
description	bush mounting pos. upper for door hinge		
For models:	RI75RE1F, RI075RE1FR, RI093RE1F, RI093RE1FR, RI093RE1FU, WDE752, WE751F, WZ751, WE751G, WE751, WDE752, WDE752, RI075R1F, RI075R1FR, RI075R1G, RI075R2FGT, WZ751, RI93RE1FEU, WE751G, WDE752GT, WZ751, WZ751, WZ751, RI93R1FERU, E070R1P, E070R1P1, E070R1P1		

			
1			
GEV No.	690631	Ref. No.	038023 081807
description	bush refrigerated counter		
For models:	AQC22U US, , BC10A, BLAST C/FREEZER, BCF7A, BLAST C/FREEZER, TRN1301, TRNA1301, TRNM1301, TRN1302, TRNA1302, TRNM1302, TRN1303, TRNA1303, TRNM1303, TRN1801, TRNA1801, TRNM1801, TRN1802, TRNA1802, TRNM1802, TRN1803, TRNA1803, TRNM1803, TRN2201, TRNA2201, TRNM2201, TRN2202, TRNA2202, TRNM2202, TRN2203, TRNA2203, TRNM2203, TRRN1301, TRRN1302, TRRN1303, TRRN1801, TRRN1802, TRRN1803, TRRN2201, TRRN2202, TRRN2203, TRRN2203, TRNP1802, STRP1101, TRRF130P, STRP1102, TRRF180P, STRP1601, TRRF220P...(Other models you can see in the webshop)		

			
1			
GEV No.	700083	Ref. No.	0A8072
description	hinge		
For models:	MVR/E1400, MVR/E1050, MVR/E1060, 7BAE10C, 7BAE14S, 7BAE10S, B105RC, B140RC, ZBRAV806, ZBRAV805, ZBRAVV805, DLP14/F, DLP21/F, DL14/F, DL21/F, DL14/F, DL21/F, DLP14/F, DLP21/F, DL14/F, DL21/F, DLP14/F, DLP21/F, ES2M, ES3M, PTVN2719, PTVN2519, PTVN2724, PTVN2524, 721-00-115, 721-00-116, 721-00-122, 721-00-123, EDON28013, EDON28013, 23000150.1, 23000151.1, 23100150.1, 23100151.1, EDON420121B, 15600116.1, 15600120.1, EDON280120, EDON280112, EDON280111, EDON280104, EDON280103, EDON280102, EDON280113, EDON280105...(Other models you can see in the webshop)		

			
1			
GEV No.	701165	Ref. No.	003686
description	hinge L 49mm W 50mm H 74mm mounting pos. upper right Qty 1 pcs		
For models:	FCF/G6-0, FCF/E6-0, FCF061ELN, FCF6EHOR, FCF061ENS, FCF/G6-1-JAP, FCFE6-1J, ECF/G6/0, ECF/E6-0, ECF061ENS, ECF061E5M, ECF061ECV, ACF/G6-0, ACF/E6-0, JCF/G6-1, JCF/E6-1, JCF/G6-2, JCF/E6-2, RCF061G, RCF061E, NCF/G6-0, NCF/E6-0, ZCF/G6-0, ZCF/E6-0		



1

GEV No.	690660	Ref. No.	082756
description	hinge L 50mm W 42mm H 25mm hole distance 28/25mm lower		
For models:	TRN1301, TRNA1301, TRNM1301, TRN1302, TRNA1302, TRNM1302, TRN1303, TRNA1303, TRNM1303, TRN1801, TRNA1801, TRNM1801, TRN1802, TRNA1802, TRNM1802, TRN1803, TRNA1803, TRNM1803, TRN2201, TRNA2201, TRNM2201, TRN2202, TRNA2202, TRNM2202, TRN2203, TRNA2203, TRNM2203, TRRN1301, TRRN1302, TRRN1303, TRRN1801, TRRN1802, TRRN1803, TRRN2201, TRRN2202, TRRN2203, TRRF130P, TRRF180P, TRRF220P, TRF1301, TRRF1301, TRF1801, TRRF1801, TRF2201, TRRF2201, TRN1301, TRNA1301, TRNM1301, TRRN1301, TRF1301...(Other models you can see in the webshop)		



1

GEV No.	697999	Ref. No.	087822
description	hinge L 55mm W 20mm H 71mm mounting pos. upper bolt 45mm bolt ø 7mm suitable for refrigerator		
For models:	WE751F, WZ751, WDE752, WDE752, RI075R2FGT, WZ751, E070RI1P, E070RI1P1		



1

GEV No.	701016	Ref. No.	003720
description	hinge L 61.5mm W 49mm H 74mm mounting pos. upper right		
For models:	FCFG101/0, FCFG102-0, FCFG201-0, FCFG202-0, FCFE101-0, FCFE102-0, FCFE201-0, FCFE202-0, FCF101ELN, FCFG10160H, FCF101ENS, FCF102ENS, FCF201ENS, FCFG102-0T, FCF/G101/1-1-JAP, FCF/G102/1-1-JAP, FCFE101-1J, FCFE102-1J, FCF/G101/1, ECFG101-0, ECFG102-0, ECFG201-0, ECFG202-0, ECFE101-0, ECFE102-0, ECFE201-0, ECFE202-0, ECF101ENS, ECF102ENS, ECF201ENS, ACFG101-0, ACFG102-0, ACFG201-0, ACFG202-0, ACFE101-0, ACFE102-0, ACFE201-0, ACFE202-0, ACFG10160H, JCF/G101/1-1, JCF/G102/1-1, JCF/E101/1-1, JCF/E102/1-1, JCF/G101/1-2, JCF/G102/1-2, JCF/E101/1-2, JCF/E102/1-2, RCF101G, RCF101E, RCF201E...(Other models you can see in the webshop)		



1

GEV No.	701017	Ref. No.	0F0026
description	hinge L 68mm W 50mm H 72mm mounting pos. bottom right		
For models:	CS7ME4/200-3, CS7ME4/230-3, CS7ME4/400-3N, CS7ME6/400-3N, CS7ME4/400-3N/EO, CS7ME4/400-3/50HZ/MA, CS7ME4/440-3/60HZ/MA, CS7MT4/400-3N, CS7GE4/200-3, CS7GE4/230-3, CS7GE4/400-3N, CS7GE6/400-3N, CS7GE4/400-3N/EO, CS7GE4/400-3/50HZ/MA, CS7GE4/440-3/60HZ/MA, CS7GT4/400-3N, CS7LCE4/200-3, CS7LCE4/230-3, CS7LCE4/400-3N, CS7LCE6/400-3N, CS7LCE4/400-3N/EO, CS7LCE4/400-3/50HZ/M, CS7LCE4/440-3/60HZ/M, CS7LCT4/400-3N, CS10ME4/200-3, CS10ME4/230-3, CS10ME6/230-3, CS10ME4/400-3N, CS10ME6/400-3N, CS10ME4/400-3N/EO, CS10ME4/400-3/50HZ/M, CS10ME4/440-3/60HZ/M, CS10MT4/400-3N, CS10MT6/400-3N, CS10GE4/200-3, CS10GE4/230-3, CS10GE6/230-3, CS10GE4/400-3N, CS10GE6/400-3N, CS10GE4/400-3N/EO, CS10GE4/400-3/50HZ/M, CS10GE4/440-3/60HZ/M, CS10GT4/400-3N, CS10GT6/400-3N, CS10LCE4/200-3, CS10LCE4/230-3, CS10LCE6/230-3, CS10LCE4/400-3N, CS10LCE6/400-3N, CS10LCE4/400-3N/EO...(Other models you can see in the webshop)		



1

GEV No.	693775	Ref. No.	0H7181
description	hinge L 70mm W 45mm H 60mm mounting pos. lower		
For models:	5611-3-10, 5611-3-6, 5611-3-8, 5612-3-10, 5612-3-6, 5612-3-8, 5614-3-10, 5614-3-6, 5614-3-8		



1

GEV No.	693774	Ref. No.	0H7182
description	hinge L 70mm W 45mm H 60mm mounting pos. upper		
For models:	5611-3-10, 5611-3-6, 5611-3-8, 5612-3-10, 5612-3-6, 5612-3-8, 5614-3-10, 5614-3-6, 5614-3-8		





1

GEV No.	690994	Ref. No.	0C0139
description	hinge mounting pos. bottom left/upper right for pasta cooker		
For models:	ACPG25, PCV/G2, PCV/G3, PCF/G2, PCF/G3, PCF/M2, PCF/M3, PCF/M2E5, PSF/G3, PF/G1S07, PF/G2D07, PFR/G1S07, PFR/G2D07, PFR/G1S14, PFR/G2D14, PFR/G2S40, PFR/E1S07, PFR/E2D07, PFR/E1S12, PFR/E2D12, PFR/E1S14, PFR/E2D14, PFR/E2D07E5, PFR/E2D12E5, PCP/G1S, PCP/G2D, PCP/E1S, PCP/E2D, PCP/E2SH, PCP/E1SH, PCP/E2SH, PCP/E2SH3B, PCV/G2N, PFRG2D14HV, PCF/G3N, PCV/G3N, PCF/G2N, PFRG1S14HV, PCV/G2A, PCV/G3A, PCF/G2A, PCF/G3A, PCF/M2A, PCF/M3A, OCV/G2, OCF/G2, OCF/G3, OF/G1S07, OFR/G1S07, OFR/G2D07...(Other models you can see in the webshop)		





 <p>1</p>			
GEV No.	693776	Ref. No.	005241 005395 0K1659
description	hinge mounting pos. bottom right		
For models:	5714-2-6, 5714-2-7, 5714-2-8, 5714-2-10, 5717-2-6, 5714-2-7, 5714-2-8, 5714-2-10, 5714-2-6L, 5714-2-7L, 5714-2-8L, 5714-2-10L, 5714-3-6, 5714-3-7, 5714-3-8, 5714-3-8E, 5714-3-10, 5717-3-6, 5717-3-7, 5717-3-8, 5717-3-8E, 5717-3-10, 5717-3-8M, 5717-3-8C, 5704-2-2, 5704-2-3, 5707-2-2, 57074-2-3, 5704-3-2, 5704-3-3, 5707-3-2, 5707-3-3		

 <p>1</p>			
GEV No.	693783	Ref. No.	005112 0K1661
description	hinge mounting pos. bottom right		
For models:	5721-2-7, 5721-2-10, 5711-3-7, 5711-3-8, 5711-3-10, 5711-3-10F, 5711-3-10S, 5701-3-2, 5701-3-3		

 <p>1</p>			
GEV No.	693756	Ref. No.	0H7063 0KQ899
description	hinge mounting pos. left		

 <p>1</p>			
GEV No.	693754	Ref. No.	0G5216
description	hinge mounting pos. lower		

 <p>1</p>			
GEV No.	693767	Ref. No.	005110 0K1657
description	hinge mounting pos. lower		
For models:	5711-2-6, 5711-2-7, 5711-2-8, 5711-2-10, 5711-2-8CH, 5711-2-10CH, 5712-2-6, 5712-2-7, 5712-2-8, 5712-2-10, 5711-2-6L, 5711-2-7L, 5711-2-8L, 5711-2-10L, 5712-2-6L, 5712-2-7L, 5712-2-8L, 5712-2-10L, 5711-3-6, 5711-3-7, 5711-3-8, 5711-3-10, 5711-3-8CH, 5711-3-10CH, 5712-3-6, 5712-3-7, 5712-3-8, 5712-3-8E, 5712-3-10, 5712-3-8CH, 5712-3-10C, 5712-2-10F, 5712-2-10S, 5712-3-10F, 5712-3-10S, 5702-2-2, 5702-2-3, 5702-3-2, 5702-3-3		

 <p>1</p>			
GEV No.	693768	Ref. No.	0KC901
description	hinge mounting pos. lower		

 <p>1</p>			
GEV No.	693769	Ref. No.	0H7112
description	hinge mounting pos. lower		

 <p>1</p>			
GEV No.	693755	Ref. No.	0H7064 0KQ898
description	hinge mounting pos. right		

 <p>1</p>			
GEV No.	700029	Ref. No.	0G5222
description	hinge mounting pos. right		

 <p>1</p>			
GEV No.	693765	Ref. No.	005111 0K1655
description	hinge mounting pos. upper		
For models:	5711-2-6, 5711-2-7, 5711-2-8, 5711-2-10, 5711-2-8CH, 5711-2-10CH, 5712-2-6, 5712-2-7, 5712-2-8, 5712-2-10, 5711-2-6L, 5711-2-7L, 5711-2-8L, 5711-2-10L, 5721-2-7, 5721-2-10, 5712-2-6L, 5712-2-7L, 5712-2-8L, 5712-2-10L, 5711-3-6, 5711-3-7, 5711-3-8, 5711-3-10, 5711-3-8CH, 5711-3-10CH, 5712-3-6, 5712-3-7, 5712-3-8, 5712-3-8E, 5712-3-10, 5712-3-8CH, 5712-3-10C, 5712-2-10F, 5712-2-10S, 5711-3-10F, 5711-3-10S, 5712-3-10F, 5712-3-10S, 5702-2-2, 5702-2-3, 5701-3-2, 5701-3-3, 5702-3-2, 5702-3-3		

			
1			
GEV No.	693766	Ref. No.	0KC899
description	hinge mounting pos. upper		

			
1			
GEV No.	693770	Ref. No.	0H7114
description	hinge mounting pos. upper		

			
1			
GEV No.	690996	Ref. No.	0C0138
description	hinge mounting pos. upper left/bottom right for pasta cooker		
For models:	ACPG25, PCV/G2, PCV/G3, PCF/G2, PCF/G3, PCF/M2, PCF/M3, PCF/M2E5, PSF/G3, PF/G1S07, PF/G2D07, PFR/G1S07, PFR/G2D07, PFR/G1S14, PFR/G2D14, PFR/G2S40, PFR/E1S07, PFR/E2D07, PFR/E1S12, PFR/E2D12, PFR/E1S14, PFR/E2D14, PFRE2D07E5, PFRE2D12E5, PCP/G1S, PCP/G2D, PCP/E1S, PCP/E2D, PCP/E2SH, PCP/E1SH, PCP/E2SH, PCP/E2SH3B, PCV/G2N, PFRG2D14HV, PCF/G3N, PCV/G3N, PCF/G2N, PFRG1S14HV, PCV/G2A, PCV/G3A, PCF/G2A, PCF/G3A, PCF/M2A, PCF/M3A, OCV/G2, OCF/G2, OCF/G3, OF/G1S07, OFR/G1S07, OFR/G2D07... (Other models you can see in the webshop)		

			
1			
GEV No.	693782	Ref. No.	005242 0K1658
description	hinge mounting pos. upper right		
For models:	5714-2-6, 5714-2-7, 5714-2-8, 5714-2-10, 5717-2-6, 5714-2-7, 5714-2-8, 5714-2-10, 5714-2-6L, 5714-2-7L, 5714-2-8L, 5714-2-10L, 5714-2-6L, 5714-2-7L, 5714-2-8L, 5714-2-10L, 5714-3-6, 5714-3-7, 5714-3-8, 5714-3-8E, 5714-3-10, 5717-3-6, 5717-3-7, 5717-3-8, 5717-3-8E, 5717-3-10, 5717-3-8M, 5717-3-8C, 5714-2-10F, 5714-2-10S, 5714-3-10F, 5714-3-10S, 5704-2-2, 5704-2-3, 5707-2-2, 5707-2-3, 5704-3-2, 5704-3-3, 5707-3-2, 5707-3-3		

			
1			
GEV No.	700021	Ref. No.	045480 045483
description	hinge SS left		

			
1			
GEV No.	700020	Ref. No.	045481
description	hinge SS right		

			
1			
GEV No.	700475	Ref. No.	002652 003721
description	hinge bearing L 125mm W 50mm H 18mm mounting pos. bottom right with bolt		
For models:	FCV/G10L3, FCV/G6L3TOWNGAS, FCV/G6L3, FCVG10L3T, FCVG102L3, FCV/E101/1, FCVE6L3J, FCV/E10L3JAP, FCV/E102/1L3JAP, FCV/E10L-6JAP, FCV/E102/1L6JAP, FCV/G6L3JAP, FCVG10L3J, FCVG102L3J, FCV/G10L6JAP, FCV/G102/1L6JAP, FCVG6L3CJ, FCV/E61/1, FCV/G10L2, FCV/E61/1, FCV/E101/1, FCV/E101/1, FCV/E102, FCV/E102/1, FCV/E61/1, FCV/E61/1, FCV/E101/1, FCV/E101/2, FCV/G6L3C, FCV/G61/1, FCV/G61/1, FCV/G61/1, FCV/G61/1, FCVG6L3CT, FCVG6L3CJ, FCV/E10L3, FCV/E102/1, FCV/E6L3, FCV/E102/1L3, FCV/G6L4, FCV/E6L4, FCV/E101/1, FCV/G10L6, FCV/E10L6, FCV/G102/1L6, FCV/E102/1L6, FCV/E101/1, FCV/G101/1, FVC/E101/1, FCV/G102/1...(Other models you can see in the webshop)		

			
1			
GEV No.	690630	Ref. No.	081808 084037
description	hinge bearing mounting pos. bottom left with bolt refrigerated counter		
For models:	TR1202, TR1221, TR1603, TR1622, TR1641, TR2004, TR2023, TR2042, TR1202, TR1221, TR1603, TR1622, TR1641, TR2004, TR2023, TR2042		

			
1			
GEV No.	700476	Ref. No.	005694
description	hinge bearing mounting pos. bottom right with bolt		
For models:	FDV40G, FDV40E, FDV40GZ, FDV40EL, FDV40GA, FDV20G, FDV20E, FDV20GZ, FDV20EL, FDV20GA, FCV/G20L3, FCVG202L3, FCV/E20L3, FCVE202L3, FCV/G20L6, FCV/E20L6, FCVG202L6, FCVE202L6, FCV/G201/1, FVC/E201/1, FCV/G202/1, FVC/E202/1, FCS201E4, FCS201EP, FCS202E4, FCS202EP, FCS201G4, FCS201GP, FCS202G4, FCS202GP, FCS201EX, FCS201EXLN, FCS202EX, FCS201GX, FCS202GX, ECV/G20T4, ECV/E20T4, ECVG202T4, ECVE202T4, ECV/G20T4J, ECV/G20T6, ECV/E20T6, ECVG202T6, ECVE202T6, ACV/G20C4, ACVG202C4, ACV/E20C4, ACVE202C4, ACV/G20C6, ACVG202C6...(Other models you can see in the webshop)		





			
1			
GEV No.	700511	Ref. No.	007091
description	hinge bearing mounting pos. bottom right with bolt		
For models:	CL221, AOS202EA2N, AOS202EB2N, AOS202EA, AOS202EB, AOS-201GA, AOS201GB, AOS202GB, AOS202GA		

			
1			
GEV No.	690625	Ref. No.	081660 082374
description	hinge bearing mounting pos. centre with bolt refrigerator		
For models:	ALP120, ALP220, ALP240, ALN120, ALN220, ALN240, ALNN120, ALNN230, ALNSO120, ALF220UK, ALF120, ALF220, ALF240, ALNF120, ALNF230, ILP110, ILP110UK, ILN120, ILN110, ILN110UK, ILN120, ILNSO120, ILNN120, ILNN230, ILF110, ILF110, ILF120, ILNF120, ILNF230, ALP120, ALP220, ALP240, ALN120, ALN220, ALN240, ALF120, ALF220, ALF240, ALNN120, ALNF120, ALNN230, ALNF230, ALNSO120, ALNN1203, AKP110, AKS110, AKP120, AKP230, AKP220, AKS220... (Other models you can see in the webshop)		

			
1			
GEV No.	690699	Ref. No.	082754
description	hinge bearing mounting pos. centre without bolt		
For models:	TRN1301, TRNA1301, TRNM1301, TRN1302, TRNA1302, TRNM1302, TRN1303, TRNA1303, TRNM1303, TRN1801, TRNA1801, TRNM1801, TRN1802, TRNA1802, TRNM1802, TRN1803, TRNA1803, TRNM1803, TRN2201, TRNA2201, TRNM2201, TRN2202, TRNA2202, TRNM2202, TRN2203, TRNA2203, TRNM2203, TRRN1301, TRRN1302, TRRN1303, TRRN1801, TRRN1802, TRRN1803, TRRN2201, TRRN2202, TRRN2203, TRNP1802, TRRF130P, TRRF180P, TRRF220P, TRF1301, TRRF1301, TRF1801, TRRF1801, TRF2201, TRRF2201, TRN1301, TRNA1301, TRNM1301, TRRN1301... (Other models you can see in the webshop)		

			
1			
GEV No.	690624	Ref. No.	081656
description	hinge bearing mounting pos. left without bolt		

			
1			
GEV No.	690656	Ref. No.	082722
description	hinge bearing mounting pos. left without bolt		
For models:	TRN1301, TRNA1301, TRNM1301, TRN1302, TRNA1302, TRNM1302, TRN1303, TRNA1303, TRNM1303, TRN1801, TRNA1801, TRNM1801, TRN1802, TRNA1802, TRNM1802, TRN1803, TRNA1803, TRNM1803, TRN2201, TRNA2201, TRNM2201, TRN2202, TRNA2202, TRNM2202, TRN2203, TRNA2203, TRNM2203, TRRN1301, TRRN1302, TRRN1303, TRRN1801, TRRN1802, TRRN1803, TRRN2201, TRRN2202, TRRN2203, TRNP1802, TRRF130P, TRRF180P, TRRF220P, TRF1301, TRRF1301, TRF1801, TRRF1801, TRF2201, TRRF2201, TRN1301, TRNA1301, TRNM1301, TRRN1301... (Other models you can see in the webshop)		

			
1			
GEV No.	690694	Ref. No.	084519
description	hinge bearing mounting pos. lower with bolt		
For models:	WDE752, WDE752GT, WZ751, WZ752, WE751		

			
1			
GEV No.	690785	Ref. No.	084534
description	hinge bearing mounting pos. lower with bolt		
For models:	RI75RE1F, RI075RE1FR, RI093RE1F, RI093RE1FR, RI093RE1FU, WE751G, WE751, WDE752, WDE752, RI075R1F, RI075R1FR, RI075R1G, RI075R2FGT, RI93RE1FEU, WE751G, WDE752GT, RI93R1FERU, E070RI1V, E070RI1P1		

			
1			
GEV No.	700480	Ref. No.	002875 0F0151 0KE542 0KI114 22200855
description	hinge bearing mounting pos. lower with bolt		
For models:	FCV/G10L3, FCV/G6L3TOWNGAS, FCV/G6L3, FCVG10L3T, FCVG102L3, FCV/E101/1, FCV/G20L3, FCVG202L3, FCVE6L3J, FCV/E10L3JAP, FCV/E102/1L3JAP, FCV/E10L6JAP, FCV/E102/1L6JAP, FCV/G6L-3JAP, FCVG10L3J, FCVG102L3J, FCV/G10L6JAP, FCV/G102/1L6JAP, FCVG6L3CJ, FCV/E61/1, FCV/G10L2, FCV/E61/1, FCV/E101/1, FCV/E101/1, FCV/E10L2, FCV/E102/1, FCV/E61/1, FCV/E61/1, FCV/E101/1, FCV/E101/2, FCV/G6L3C, FCV/G61/1, FCV/G61/1, FCV/G61/1, FCV/G61/1, FCV/G6L3CT, FCVG6L3CJ, FCV/E10L3, FCV/E102/1, FCV/E6L3, FCV/E102/1L3, FCV/E20L3, FCVE202L3, FCV/G6L4, FCV/E6L4, FCV/E101/1, FCV/G10L6, FCV/E10L6, FCV/G102/1L6, FCV/E102/1L6... (Other models you can see in the webshop)		



GEV No.	690634	Ref. No.	082501 087135
description	hinge bearing mounting pos. lower with bolt refrigerator		
For models:	ALP221, ALN221, ILP221, ILN221, ALP221, ALN221, ADN111, AKN111, ADN221, AEN221, ASN111, ASN221, ARDN221, ADN111, ADN221, AKP221, AKN221, AKP221, AKP221, PR04R1G, 1-GL.DOOR REFRIG, PS04R1G, 1-GL.DOOR REFRIG, PS04R1GR, PR04R1G, PR04R1GR, IKN221, ISP221N, MCD6PGL, E06N0M1V, E06N1M1V, E06N0D1V, E06C0M1V, E06C1M1V, E06COD1V, E14N0M2V, E14N1M2V, E14N0D2V, E14C0M2V, E14C1M2V, E14C0D2V, E05N0M1V, E05N1M1V, E12N0M2V, E12N1M2V, C06RD1G, C06RM1G, C06FD1G, C14RD2G, C14RM2G...(Other models you can see in the webshop)		



GEV No.	690627	Ref. No.	081657 082256
description	hinge bearing mounting pos. right/left with bolt refrigerator		
For models:	BC44, BCF44, ALP110, ALP220, ALP240, ALN110, ALN220, ALN240, ALNN220, ALNN230, ALP110UK, ALN110UK, ALNN220UK, ALF110, ALF220UK, ALNF220, ALF110, ALF220, ALF240, ALNF220, ALNF230, BC44, BCF44, ILNN220, ILNN220UK, ILNN230, ALP110UK, ALN110UK, ALNN220UK, ALF110UK, ALNF220UK, ILNF220, ILNF220UK, ILNF230, ALP110, ALP220, ALP240, ALN110, ALN220, ALN240, ALF110, ALF220, ALF240, ALNN220, ALNF220, ALNN230, ALNF230, AZP1103, AZF1103, AZP2203...(Other models you can see in the webshop)		



GEV No.	690665	Ref. No.	0A8973
description	hinge bearing mounting pos. right with bolt		
For models:	133-01-110, 133-01-111, 133-06-110, 133-06-111		



GEV No.	690628	Ref. No.	082350
description	hinge bearing mounting pos. right/left without bolt		
For models:	ALP120, ALP240, ALN120, ALN240, ALNN120, ALNN230, ALNSO120, ALF120, ALF240, ALNF120, ALNF230, ILNSO120, ILNN120, ILNN230, ILNF120, ILNF230, ALP120, ALP220, ALP240, ALN120, ALN220, ALN240, ALF120, ALF220, ALF240, ALNN120, ALNF120, ALNN230, ALNF230, ALNSO120, ALNN1203, AKP110, AKS110, AKP120, AKP230, AKP240, AKN110, AKN120, AKN230, AKN240, AKNN120, AKNN230, AKNSO120, AKP110UK, AKN110UK, AKF240, AKNF120, AKNF230, AKF110UK, AKF110...(Other models you can see in the webshop)		



GEV No.	690623	Ref. No.	081655
description	hinge bearing mounting pos. right without bolt		





GEV No.	690649	Ref. No.	0A9174
description	hinge bearing mounting pos. right/left without bolt		
For models:	MLP609V11V, MLP139V12V, MLP602V11V, MLP132V12V, MLC601V11V, MLC602V11V, MLP609V11V, MLP602V11V, MLP139V12V, MLP132V12V		





GEV No.	690655	Ref. No.	082721
description	hinge bearing mounting pos. right without bolt		
For models:	TRN1301, TRNA1301, TRNM1301, TRN1302, TRNA1302, TRNM1302, TRN1303, TRNA1303, TRNM1303, TRN1801, TRNA1801, TRNM1801, TRN1802, TRNA1802, TRNM1802, TRN1803, TRNA1803, TRNM1803, TRN2201, TRNA2201, TRNM2201, TRN2202, TRNA2202, TRNM2202, TRN2203, TRNA2203, TRNM2203, TRRN1301, TRRN1302, TRRN1303, TRRN1801, TRRN1802, TRRN1803, TRRN2201, TRRN2202, TRRN2203, TRNP1802, TRRF130P, TRRF180P, TRRF220P, TRF1301, TRRF1301, TRF1801, TRRF1801, TRF2201, TRRF2201, TRN1301, TRNA1301, TRNM1301, TRRN1301...(Other models you can see in the webshop)		





 <p>1</p>			
GEV No.	690673	Ref. No.	0A8688
description	hinge bearing mounting pos. right/left without bolt		
For models:	DLP21/F, DL21/F, DL21/F, DLP21/F, DL21/F, DLP21/F, EDON420121B, EDON280120, EDON280112, EDON280111, EDON280104, EDON280103, EDON280102, EDON280113, EDON280105, EDON420130, EDON420122, EDON420121, EDON420114, EDON420105, EDON420106, EDON420123, EDON420115, EDON570140, EDON570132, EDON570131, EDON570124, EDON570122, EDON570108, EDON570133, EDON570125, EDON720150, EDON720142, EDON720133, EDON720134, EDON720132, EDON720126, EDON720143, EDON720135, EDORN28120, EDORN28112, EDORN28111, EDORN28104, EDORN28103, EDORN28113, EDORN28105, EDORN28130, EDORN42122, EDORN42114, EDORN42106...(Other models you can see in the webshop)		

 <p>1</p>			
GEV No.	700463	Ref. No.	053763 055130 055316
description	hinge bearing mounting pos. upper right with bolt		
For models:	FCFG6D, FCVE6D, FCVE6D, FCFG10, FCFG10D, FCFG10NL, FCVE10, FCVE10UK, FCFG20, FCFG20D, FCFG20F, PFCFG20, FCVE20, FCVE20UK, FCFG40, FCFG41, FCFG40D, FCFG40F, PFCFG40F, FCVE40, FCVE40D, FCVE40UK, PFCFE40F, FCFG6, FCFG6F, PFCFG6, FCVE6, FCVE6UK, PFCFE6, FCVE10, FCVE20, FCVE6J50, FCVE6J60, FCFG10J, FCFG10J, FCVE10J, FCVE10J, FCFG20J, FCFG20J, FCVE20J, FCVE20J, FCFG40J, FCFG40J, FCVE40J, FCFG6J, FCFG6J, FCFG6J, FCFG6J, FCFG6J, FCFG10J...(Other models you can see in the webshop)		

 <p>2</p>			
GEV No.	690679	Ref. No.	0A8974
description	hinge bearing mounting pos. upper left with bolt		
For models:	133-01-110, 133-01-111, 133-06-110, 133-06-111		

 <p>1</p>			
GEV No.	700473	Ref. No.	002651
description	hinge bearing mounting pos. upper right with bolt		
For models:	FCV/G10L3, FCV/G6L3TOWNGAS, FCV/G6L3, FCFV10L3T, FCFV102L3, FCVE101/1, FCVE6L3J, FCVE10L3JAP, FCVE102/1L3JAP, FCVE10L6JAP, FCVE102/1L6JAP, FCV/G6L3JAP, FCFV10L3J, FCFV102L3J, FCFV10L6JAP, FCFV102/1L6JAP, FCFV6L3CJ, FCVE61/1, FCFV10L2, FCVE61/1, FCVE101/1, FCVE101/1, FCVE10L2, FCVE102/1, FCVE61/1, FCVE61/1, FCVE101/1, FCVE101/2, FCV/G6L3C, FCV/G61/1, FCV/G61/1, FCV/G61/1, FCV/G61/1, FCFV6L3CT, FCFV6L3CJ, FCVE10L3, FCVE102/1, FCVE6L3, FCVE102/1L3, FCFV6L4, FCVE6L4, FCVE101/1, FCFV10L6, FCVE10L6, FCFV102/1L6, FCVE102/1L6, FCVE101/1, FCFV101/1, FCFV101/1, FCFV102/1...(Other models you can see in the webshop)		

 <p>1</p>			
GEV No.	690698	Ref. No.	084535
description	hinge bearing mounting pos. upper left with bolt		
For models:	WE751G, WDE752GT		

 <p>1</p>			
GEV No.	690693	Ref. No.	084520
description	hinge bearing mounting pos. upper with bolt		
For models:	WDE752, WDE752GT, WZ751, WZ752, WE751		

 <p>1</p>			
GEV No.	700462	Ref. No.	055415
description	hinge bearing mounting pos. upper right with bolt		
For models:	FCVE6-1U, FCVE6-3U, FCVE6-1, FCVE6-3, FCVE6-3CE, FCVE6-1UK, FCVE6-3UK, FCFV6-1, FCFV6-3, FCFV6-1UK, FCFV6-3UK, FCVE6-1, FCVE6-1, FCVE6-1, ZOFV6-3, AFCV6-1, AFCV6-3, SCO6-3		

			
1			
GEV No.	700477	Ref. No.	002876 0F0152 0KE543 0T3934 22200891
description	hinge bearing mounting pos. upper with bolt		
For models:	FCV/G10L3, FCV/G6L3TOWNGAS, FCV/G6L3, FCVG10L3T, FCVG102L3, FCV/E101/1, FCV/G20L3, FCVG202L3, FCVE6L3J, FCV/E10L3JAP, FCV/E102/1L3JAP, FCV/E10L6JAP, FCV/E102/1L6JAP, FCV/G6L-3JAP, FCVG10L3J, FCVG102L3J, FCV/G10L6JAP, FCV/G102/1L6JAP, FCVG6L3CJ, FCV/E61/1, FCV/G10L2, FCV/E61/1, FCV/E101/1, FCV/E101/1, FCV/E10L2, FCV/E102/1, FCV/E61/1, FCV/E61/1, FCV/E101/1, FCV/E101/2, FCV/G6L3C, FCV/G61/1, FCV/G61/1, FCV/G61/1, FCV/G61/1, FCVG6L3CT, FCVG6L3CJ, FCV/E10L3, FCV/E102/1, FCV/E6L3, FCV/E102/1L3, FCV/E20L3, FCVE202L3, FCV/G6L4, FCV/E6L4, FCV/E101/1, FCV/G10L6, FCV/E10L6, FCV/G102/1L6, FCV/E102/1L6...(Other models you can see in the webshop)		

			
2			
GEV No.	690635	Ref. No.	081900 082499
description	hinge bearing mounting pos. upper with bolt refrigerator		
For models:	ALP111, ALP221, ALN111, ALN221, ILP111, ILP221, ILN111, ILN221, ALP111, ALP221, ALN111, ALN221, AKP111, AKP221, AKN111, AKN221, AKP111, AKP221, AKN111, AKP221, IKN111, IKN221, ISP111N, ISP221N, ETZ601GT, ETE601GT, EKZ601GT, ETZ601GT, EKE601GT, ETE601GT, DVP500V11V, DVP501V11V, MVP502V11V, EDVN500, DVN501V11V, DVP600V11V, DVP601V11V, EMVP602, EVN600V11V, EEVN601, DVN600V11V, EDVN601, DVP110V12V, DVP111V12V, MVP112V12V, EDVN1100, EDVN1101, DVP130V12V, DVP131V12V, EEVNI1301...(Other models you can see in the webshop)		

			
1			
GEV No.	690644	Ref. No.	0A9266
description	hinge bearing with bolt		
For models:	APP22B, ESMLR60W, ESMLF60W, ESMLR60S, ESMLF60S, RS24, FS24, RFIS24, KZ1502, KE1502GT, TE1502, TZ1502, R04PVF4M, R04FSF4M, R04NVF4, R04NVF4F, R04PVF4, R04FSF4, C04PVF4D, C04NVF4D, C04FSF4D, C04FISHD, MLC600V11C, MLC130V12C, MLP609V11C, MLP602V11C, MLP139V12C, MLP132V12C, MLP600V11C, MLP130V12C, E04P4VRC, E04N4VAC, E04C4SGC, E04N4VAC, MLC609V11C, MLC139V12C, MLC602V11C, MLC132V12C, MLP609V11, MLP139V12C, MLP602V11C, MLP132V12C, MLP600V11C, MLP130V12C, MLC600V11C, MLC130V12C, MLC601V11C, MLC139V12C, MLC602V11C, MLC132V12C		

			
1			
GEV No.	690650	Ref. No.	0A9173
description	hinge bearing with bolt		
For models:	MLP609V11V, MLP139V12V, MLP602V11V, MLP132V12V, MLC601V11V, MLC602V11V, MLP609V11V, MLP602V11V, MLP139V12V, MLP132V12V, MLC601V11C, MLC602V11C		

			
1			
GEV No.	690652	Ref. No.	083751
description	hinge bearing with bolt		
For models:	ESR142GR, ESR142G, ESR41GR, ESR41G, ESR61GR, ESR61G, EUKR61G, ESR41G60HZ, ESR61G60, ESR142G60HZ, ESF61G60, ESF41G, ESF41GR, ESF41G60HZ, ESF61GR, ESF61GR, ESR41G, ESMR41G, ESR41GR, ESM41G		

			
1			
GEV No.	690664	Ref. No.	0A8455
description	hinge bearing with bolt		
For models:	133-01-110, 133-01-111, 133-06-110, 133-06-111		

			
1			
GEV No.	690668	Ref. No.	0A8470
description	hinge bearing with bolt		
For models:	ES2M, ES3M, 23000150.1, 23000151.1, 23100150.1, 23100151.1		

			
1			
GEV No.	690670	Ref. No.	0A8505
description	hinge bearing with bolt		
For models:	ES3M, 23100150.1, 23100151.1		



			
1			
GEV No.	690866	Ref. No.	006972
description	hinge bearing with bolt		
For models:	AOS061EABU, AOS061EAFU, AOS061EA, AOS061EB, AOS061EA3J, AOS061EB3J, AOS061EA2N, AOS061EB2N, AOS061EB5M, AOS101EB5M, AOS061EB6M, AOS101EB6M, AOS061EA0H, AOS061EB0H, AOS061GA, AOS101GA		

			
1			
GEV No.	690867	Ref. No.	006980
description	hinge bearing with bolt		
For models:	AOS061GAEU, AOS101GAEU, AOS061GAAU, AOS101GAAU, AOS061EABU, AOS101EABU, AOS061EAFU, AOS101EAFU, AOS061EA, AOS061EB, AOS101EA, AOS101EB, AOS061EA3J, AOS061EB3J, AOS101EA3J, AOS101EB3J, AOS061EA2N, AOS061EB2N, AOS101EA2N, AOS101EB2N, AOS061EB5M, AOS101EB5M, AOS061EB6M, AOS101EB6M, AOS061EA0H, AOS061EB0H, AOS101EA0H, AOS101EB0H, AOS061GA, AOS061GB, AOS101GA, AOS101GB		

			
1			
GEV No.	690868	Ref. No.	007086
description	hinge bearing with bolt		
For models:	FCZ201EAA, FCZ202EAA, FCZ201EAH, FCZ201EAN, FCZ201ETA, FCZ202ETA, FCZ201ETH, FCZ201ETN, FCZ201GAG, FCZ202GAG, FCZ201GAD, FCZ202GAD, FCZ201GTG, FCZ202GTG, FCZ201GTD, FCZ202GTD, FCZ201EBA, FCZ202EBA, FCZ201EBH, FCZ201EBN, FCZ201EBC, FCZ201EBA2, FCZ202EBA2, FCZ201EBH2, FCZ201EBN2, FCZ201EBC2, FCZ201GBG, FCZ202GBG, FCZ201GBD, FCZ202GBD, FCZ201GBI, FCZ201GBG2, FCZ202GBG2, FCZ201GBD2, FCZ202GBD2, FCZ201GBI2, FCZ201ECA, FCZ202ECA, FCZ201ECH, FCZ201ECN, FCZ201ECA2, FCZ202ECA2, FCZ201ECH2, FCZ201ECN2, FCZ201GCG, FCZ202GCG, FCZ201GCD, FCZ202GCD, FCZ201GCG2, FCZ202GCG2... (Other models you can see in the webshop)		

			
1			
GEV No.	700484	Ref. No.	007007
description	hinge bearing with bolt		
For models:	FCZ061EAA, FCZ101EAA, FCZ102EAA, FCZ201EAA, FCZ202EAA, FCZ061EAH, FCZ101EAH, FCZ201EAH, FCZ061EAN, FCZ101EAN, FCZ201EAN, FCZ061ETA, FCZ101ETA, FCZ102ETA, FCZ201ETA, FCZ202ETA, FCZ061ETH, FCZ101ETH, FCZ201ETH, FCZ061ETN, FCZ101ETN, FCZ201ETN, FCZ061GAG, FCZ101GAG, FCZ102GAG, FCZ201GAG, FCZ202GAG, FCZ061GAD, FCZ101GAD, FCZ102GAD, FCZ201GAD, FCZ202GAD, FCZ101GTG, FCZ102GTG, FCZ201GTG, FCZ202GTG, FCZ101GTD, FCZ102GTD, FCZ201GTD, FCZ202GTD, FCZ061EBA, FCZ101EBA, FCZ102EBA, FCZ201EBA, FCZ202EBA, FCZ061EBH, FCZ101EBH, FCZ201EBH, FCZ061EBN, FCZ101EBN... (Other models you can see in the webshop)		

			
1			
GEV No.	690638	Ref. No.	081901 082500
description	hinge bearing without bolt		
For models:	ALP111, ALP221, ALN111, ALN221, ILP111, ILP221, ILN111, ILN221, ALP111, ALP221, ALN111, ALN221, AKP111, AKP221, AKN111, AKN221, AKP111, AKP221, AKN111, AKP221, ESR142GR, ESR142G, ESR41GR, ESR41G, ESR61GR, ESR61G, EUKR61G, ESR41G60HZ, ESR61G60, ESR142G60HZ, ESF61G60, ESF41G, ESF41GR, ESF41G60HZ, ESF61GR, ESF61G, ESR41G, ESMR41G, ESR41GR, ESM41G, TZ751GT, TE1502GT, IKN111, IKN221, ISP111N, ISP221N, ETZ601GT, ETE601GT, TE751GT, TZ1502GT... (Other models you can see in the webshop)		

			
1			
GEV No.	690639	Ref. No.	082257
description	hinge bearing without bolt		
For models:	AP20, BC44, BCF44, ALP110, ALP120, ALP220, ALP240, ALN110, ALN120, ALN220, ALN240, ALNN120, ALNN220, ALNN230, ALNSO120, ALP110UK, ALN110UK, ALNN220UK, ALF110, ALF220UK, ALNF220, ALF110, ALF120, ALF220, ALF240, ALNF120, ALNF220, ALNF230, BC44, BCF44, ILP110, ILP110UK, ILN120, FV 1M, FV 1M, FV 1M, FV 1M, FV Dual, FV Dual, FV 2M, FV 2M, FV 2M, DUAL 2 DOORS, DUAL 2 DOORS, FV 2M, FV 2M, ILP220, ILP220UK, ILP240, FV 1M... (Other models you can see in the webshop)		

			
1			
GEV No.	690643	Ref. No.	0A9097
description	hinge bearing without bolt		
For models:	ESMLR60W, ESMLF60W, ESMLR60S, ESMLF60S, KZ1502, KE1502GT, TE1502, TZ1502, MLP609V11C, MLP139V12C, MLP602V11C, MLP132V12C, MLP600V11C, MLP130V12C, MLC600V11C, MLC130V12C, MLP609V11C, MLP602V11C, MLP139V12C, MLP132V12C, MLP600V11C, MLP130V12C, MLC609V11C, MLC139V12C, MLC602V11C, MLC132V12C, MLP609V11, MLP139V12C, MLP602V11C, MLP132V12C, MLP600V11C, MLP130V12C		

			
1			
GEV No.	690651	Ref. No.	083716
description	hinge bearing without bolt		
For models:	ESR14412FR, ESR141212FR, ESR142FR, ESR141212F, ESR142F, ESR14412F, ESF142FR, ESR4212FR, ESR4212F, ESR41FR, ESF41FR, ESR41F, ESR61F, ESF621/2F, ESR621/2F, ESR621/2F, ESR61FR, ESF61FR, ESF621/2FR, ESQC41F, ESQC41FR, ESQF41F, ESQF41FR, , EUKR61/N, EUKR142N, , EUKR61F, EUKR621/2F, EUKR142F, EUKR141212, EUKR14412F, , ESR41F60HZ, ESR422F60HZ, ESR61F60, ESR622F60, ESR142F60, ESR1412F60HZ, ESR1442F60HZ, ESF142F60, ESMF41F, ESF142F, ESF621/2F, ESF61F, EUKF61F, EUKF621/2F, EUKF142F, ESF41F60HZ, GSF61F60...(Other models you can see in the webshop)		

			
2			
GEV No.	690871	Ref. No.	005041
description	hinge bearing without bolt		
For models:	FCV/G20L3, FCVG20L3, FCV/E20L3, FCVE20L3, FCV/G20L6, FCV/E20L6, FCVG20L6, FCVE20L6, FCV/G201/1, FVC/E201/1, FCV/G202/1, FVC/E202/1, FCS201E4, FCS201EP, FCS202E4, FCS202EP, FCS201G4, FCS201GP, FCS202G4, FCS202GP, FCS201EX, FCS201EXLN, FCS202EX, FCS201GX, FCS202GX, ECV/G20T4J, ACV/G20C4, ACVG202C4, ACV/E20C4, ACVE202C4, ACV/G20C6, ACVG202C6, ACVE20C6, ACV/E202/1		

			
1			
GEV No.	693288	Ref. No.	002107 051260
description	hinge bearing without bolt		
For models:	HBR/G820, HBR/G825, HBR/E820, HBR/E825, HBR/G821UK, HCPA/G1219, HCPA/GI 1219, ZBR/E820, ZBR/E825, ZBR/G821, ZBR/G826, ZCPAG1219, ZCPA/GI 1219, ABR/G820, ABR/G825, ABR/E820, ABR/E825, HCPA/G1219, HCPA/GI1219, HCPA/V1219, HCPA/EI1219, HQN/G1917, HQN/G1917, HQN/G1225, HQN/GI1225, HQN/EI917, HQN/GI122, HQN/V917, HPN/G810, HQN/EI1225, HPN/GI810, HPN/GI810, HPN/G815, HPA/G815, HPN/E810, HPN/GI815, HPA/GI815, HPN/EI810, HPA/GI815, HPN/E815, HPN/EI810, HPA/EI810, HPN/GI810, HBR/G803, HBR/G804, HBR/G803, HBR/G804, HBR/G803, HBR/G805, HBR/G1003...(Other models you can see in the webshop)		

			
1			
GEV No.	700079	Ref. No.	0A8687
description	hinge bearing without bolt		
For models:	ZBRAV806, ZBRAV805, ZBRAVV805, ZBRAV706, ZBRAV705, ZBRAVV705, DLP14/F, DLP21/F, DL14/F, DL21/F, DL14/F, DL21/F, DLP14/F, DLP21/F, DL14/F, DL21/F, DLP14/F, DLP21/F, PTVN2719, PTVN2519, PTVN2724, PTVN2524, EDOIN28013, EDOIN28013, EDON420121B, EDON280120, EDON280112, EDON280111, EDON280104, EDON280103, EDON280102, EDON280113, EDON280105, EDON420130, EDON420122, EDON420121, EDON420114, EDON420105, EDON420106, EDON420123, EDON420115, EDON570140, EDON570132, EDON570131, EDON570124, EDON570122, EDON570108, EDON570133, EDON570125, EDON720150...(Other models you can see in the webshop)		

			
1			
GEV No.	694510	Ref. No.	0A9740
description	hinge camp mounting pos. right/left L 123mm W 64mm stainless steel		
For models:	ALN120, AEN120, ADF120, ALF120, AEF120, ADNN120, ADNF120, AENN120, AENF120, ALN240, AEN240, ADF240, AEF240, ADNN230, ADNF230, AENN230, AENF230, ARDF120, ARDNN120, 83012101, ADN120, ADF120, ADNN120, ADNF120, ADN240, ADF240, ADNN220, ADNF220, ADNN230, ADNF230, PR06R2FBR, PS06F1F6M, 2-DOOR REFRIG, PS04R2F, PS06R1F, PS06R1FR, PS06R2F, PS06R2FR, PS06F1F, PS06F1FR, PS06FE2F, PR04R2F, PR06R2F, PR06R2FR, PR06FE2F, MP602, MP602/60, MCD650F2, MP1200, MP1200...(Other models you can see in the webshop)		

			
1			
GEV No.	694508	Ref. No.	087128
description	hinge camp mounting pos. right/left L 146mm W 40mm H 5mm stainless steel shaft diameter 7.5x7.5mm		
For models:	ADN220ES, ADF110ES, ADF220ES, ADN110ESP, ADF110ESP, ALN110, ALN120, AEN110, AEN120, ADF110, ALF110, ADF120, ALF120, AEF110, AEF120, ADNN120, ADNF120, AENN120, AENF120, ALN220, ALN240, AEN220, AEN240, ADF220, ADF240, AEF220, AEF240, ADNN220, ADNF220, ADNN230, ADNF230, AENN220, AENF220, AENN230, AENF230, ASN110, ASF110, ASN220, ASF220, AKN110UK, AKF110UK, AKN220UK, AKF220UK, ASN110UK, ASF110UK, ASN220UK, ASF220UK, ARDN110, ADN110E, ADF110E...(Other models you can see in the webshop)		

			
1			
GEV No.	694509	Ref. No.	0A9739
description	hinge camp mounting pos. right/left L 186mm W 30mm H 9.5mm stainless steel shaft diameter 7.5x7.5mm		
For models:	ALN120, AEN120, ADF120, ALF120, AEF110, AEF120, ADNN120, ADNF120, AENN120, AENF120, ALN240, AEN240, ADF240, AEF240, ADNN230, ADNF230, AENN230, AENF230, ASF110, ARDF120, ARDNN120, 83012101, ADN120, ADF120, ADNN120, ADNF120, ADN240, ADF240, ADNN220, ADNF220, ADNN230, ADNF230, PR06R2FBR, PS06F1F6M, 2-DOOR REFRIG, PS04R2F, PS06R1F, PS06R1FR, PS06R2F, PS06R2FR, PS06F1F, PS06F1FR, PS06FE2F, PR04R2F, PR06R2F, PR06R2FR, PR06FE2F, MR600DOOR, RH06DD2U, RH06DFD2U...(Other models you can see in the webshop)		



			
1			
GEV No.	690667	Ref. No.	0A8073
description	hinge pin		
For models:	ES2M, ES3M, 721-00-115, 721-00-116, 721-00-122, 721-00-123, 23000150.1, 23000151.1, 23100150.1, 23100151.1, GF4060, 721-00-116, 721-00-122, 721-00-123		

			
1			
GEV No.	692501	Ref. No.	0A9124
description	hinge pine L 29mm thread M5 ø 7mm for blast chiller Qty 1 pcs		
For models:	ITP120UK, ITP120UK, BC11, BC22, BC44H, BCF11, BCF22, BCF44H, AQC31U US, AQC60U, AQC119U US, , BC28A6, Crosswise, , BCF15A6, , BC11, BC22, BC44H, BCF11, BCF22, BCF44H, BC11, BC22, BC44H, BCF11, BCF22, BCF44H, BC15A, Crosswise, BC28A, Crosswise, BC56HA, BCF15A, Crosswise, BCF28A, Crosswise, BCF56HA, ESBF10, ESBC10, ESBC10R, ESBC20, ESBC20R, ESBF20, RBC102, ESK40H, ESF40H, RBF611560...(Other models you can see in the webshop)		

miscellaneous

			
1			
GEV No.	519624	Ref. No.	003991
description	door hinge for combi-steamer mounting pos. right bottom L 125mm W 50mm		
For models:	FCFG201-0, FCFG202-0, FCFE201-0, FCFE202-0, FCF201ENS, ECFG201-0, ECFG202-0, ECFE201-0, ECFE202-0, ECF201ENS, ACFG201-0, ACFG202-0, ACFE201-0, ACFE202-0, RCF201E, ZCF/G201/1, ZCF/G202/1, ZCF/E201/1-0, ZCF/E202/1-0		

			
1			
GEV No.	701020	Ref. No.	0C5463 ODF006
description	hinge for combi-steamer mounting pos. left		
For models:	FCV31E3, 7CO30, CCO30G, ECO312CF, OTS100		

			
1			
GEV No.	701019	Ref. No.	0C5462 OKB714
description	hinge for combi-steamer mounting pos. right		
For models:	FCV31E3, 7CO30, CCO30G, ECO312CF, OTS100		

accessories

shafts

			
1			
GEV No.	700028	Ref. No.	OK1653
description	hinge pin		
For models:	7502-2, 7502-3, 7502-9, 7504-2, 7504-3, 7508-2, 7508-3, 7512-3, 9000-3, 9002-2, 9002-3, 9004-2, 9004-3, 9012-2, 9012-3, 9015-3, 9203-3-0, 9203-3-8		

			
1			
GEV No.	693742	Ref. No.	0H6456 234613
description	shaft for hinge mounting pos. right/left		

base plate

			
1			
GEV No.	700479	Ref. No.	002877 0F0149 0KE574 0KI115 30000692
description	base plate for door hinge mounting pos. upper left		
For models:	FCV/G10L3, FCV/G6L3TOWNGAS, FCV/G6L3, FCVG10L3T, FCVG102L3, FCV/E101/1, FCV/G20L3, FCVG202L3, FCVE6L3J, FCV/E10L3JAP, FCV/E102/1L3JAP, FCV/E10L6JAP, FCV/E102/1L6JAP, FCV/G6L-3JAP, FCVG10L3J, FCVG102L3J, FCV/G10L6JAP, FCV/G102/1L6JAP, FCVG6L3CJ, FCV/E61/1, FCV/G10L2, FCV/E61/1, FCV/E101/1, FCV/E101/1, FCV/E10L2, FCV/E102/1, FCV/E61/1, FCV/E61/1, FCV/E101/1, FCV/E101/2, FCV/G6L3C, FCV/G61/1, FCV/G61/1, FCV/G61/1, FCV/G61/1, FCV/G61/1, FCV/G6L3CT, FCV/G6L3CJ, FCV/E10L3, FCV/E102/1, FCV/E6L3, FCV/E102/1L3, FCV/E20L3, FCVE202L3, FCV/G6L4, FCV/E6L4, FCV/E101/1, FCV/G10L6, FCV/E10L6, FCV/G102/1L6, FCV/E102/1L6...(Other models you can see in the webshop)		

miscellaneous

			
1			
GEV No.	690666	Ref. No.	0A8074
description	bush conical ID ø 6mm ED ø 8.2mm L 15mm brass		
For models:	ES2M, ES3M, 721-00-115, 721-00-116, 721-00-122, 721-00-123, 23000150.1, 23000151.1, 23100150.1, 23100151.1, 15600116.1, 15600120.1, 133-01-110, 133-01-111, 133-06-110, 133-06-111, GF4060, 721-00-116, 721-00-122, 721-00-123		

			
1			
GEV No.	690647	Ref. No.	082964
description	bush refrigerator		
For models:	ITP120UK, ITP120UK, APP113V, APP22B, APP224V, ESMLR60W, ESMLF60W, ESMLR60S, ESMLF60S, RS24, FS24, RFIS24, KZ1502, KE1502GT, TE1502, TZ1502, MRL402, EP406VRPUK, E04P6VRVUK, E04P8SRVUK, E04C6SCGUK, MP402C, MP40060, MP402, MP40260, M06P9M1V, M06C9M1V, M13P9M2V, RW24, R04PVF4M, R04FSF4M, R04NVF4, R04NVF4F, R04PVFWG, R04FSFWG, R04PVF4, R04FSF4, R04PVG4, R04PVFW, R04PVGW, R04FSFW, C04NVFWD, C04NVGWD, C04PVF4D, C04NVF4D, C04FSF4D, C04PVG4D, C04FISHD, R04P6SRGB, MLP609V11C...(Other models you can see in the webshop)		

			
1			
GEV No.	690646	Ref. No.	0A9092
description	bush refrigerator ID ø 7mm		
For models:	ITP120UK, ITP120UK, APP22B, ESMLR60W, ESMLF60W, ESMLR60S, ESMLF60S, RS24, FS24, RFIS24, KZ1502, KE1502GT, TE1502, TZ1502, EP406VRPUK, E04C6SCGUK, RW24, R04PVF4M, R04FSF4M, R04NVF4, R04NVF4F, R04PVFWG, R04FSFWG, R04PVF4, R04FSF4, R04PVFW, R04FSFW, C04NVFWD, C04NVGWD, C04PVF4D, C04NVF4D, C04FSF4D, C04FISHD, MLP609V11C, MLP609V11V, MLP139V12C, MLP139V12V, MLP602V11C, MLP602V11V, MLP132V12C, MLP132V12V, MLP600V11C, MLP130V12C, MLC600V11C, MLC130V12C, MLC601V11V, MLC602V11V, MLP609V11C, MLP609V11V, MLP602V11C...(Other models you can see in the webshop)		

			
1			
GEV No.	700474	Ref. No.	002653 0F0153 0G1988 0K8484 0KE546 273804
description	disc for hinge corrugated		
For models:	FDV40G, FDV40E, FDV40GZ, FDV40EL, FDV40GA, FDV20G, FDV20E, FDV20GZ, FDV20EL, FDV20GA, FCZ201EAA, FCZ202EAA, FCZ201E-AH, FCZ201EAN, FCZ201ETA, FCZ202ETA, FCZ201ETH, FCZ201ETN, FCZ201GAG, FCZ202GAG, FCZ201GAD, FCZ202GAD, FCZ201GTG, FCZ202GTG, FCZ201GTD, FCZ202GTD, FCZ201EBA, FCZ202EBA, FCZ201EBH, FCZ201EBN, FCZ201EBC, FCZ201EBA2, FCZ202EBA2, FCZ201EBH2, FCZ201EBN2, FCZ201EBC2, FCZ201GBG, FCZ202GBG, FCZ201GBD, FCZ202GBD, FCZ201GBI, FCZ201GBG2, FCZ202GBG2, FCZ201GBD2, FCZ202GBD2, FCZ201GBI2, FCZ201ECA, FCZ202ECA, FCZ201ECH, FCZ201ECN...(Other models you can see in the webshop)		

			
1			
GEV No.	690648	Ref. No.	082962
description	pressure pin refrigerator		
For models:	ITP120UK, ITP120UK, BC44, BCF44, BC56VA, Crosswise 20, BCF64A, Crosswise 20, APP113V, APP22B, APP224V, ESMLR60W, ESMLF60W, ESMLR60S, ESMLF60S, RS24, FS24, RFIS24, KZ1502, KE1502GT, TE1502, TZ1502, MRL402, EP406VRPUK, E04P6VRVUK, E04P8SRVUK, E04C6SCGUK, MP402C, MP40060, MP402, MP40260, Crosswise 20, RBC20.1-56, Crosswise 20, RBF20.1-64, BLAST C/F, Crosswise 20, RBF2016, EEVA40/1, EEVAC40/1, ESK40V, ESBC40, ESBF40, ESF40V, ESF40VR, BE431, BFE431, ESK40VZ, M06P9M1V, M06C9M1V...(Other models you can see in the webshop)		

			
1			
GEV No.	700478	Ref. No.	002645 0F0166 0K2944 0K8509 0K8738 0KE548 30000731
description	protector for glass door for hinge		
For models:	FCV/G10L3, FCV/G6L3TOWNGAS, FCV/G6L3, FCVG10L3T, FCVG102L3, FCV/E101/1, FCV/G20L3, FCVG202L3, FCVE6L3J, FCV/E10L3JAP, FCV/E102/1L3JAP, FCV/E10L6JAP, FCV/E102/1L6JAP, FCV/G6L-3JAP, FCVG10L3J, FCVG102L3J, FCV/G10L6JAP, FCV/G102/1L6JAP, FCVG6L3CJ, FCV/E61/1, FCV/G10L2, FCV/E61/1, FCV/E101/1, FCV/E101/1, FCV/E10L2, FCV/E102/1, FCV/E61/1, FCV/E61/1, FCV/E101/1, FCV/E101/2, FCV/G6L3C, FCV/G61/1, FCV/G61/1, FCV/G61/1, FCV/G61/1, FCV/G6L3CT, FCV/G6L3CJ, FCV/E10L3, FCV/E102/1, FCV/E6L3, FCV/E102/1L3, FCV/E20L3, FCVE202L3, FCV/G6L4, FCV/E6L4, FCV/E101/1, FCV/G10L6, FCV/E10L6, FCV/G102/1L6, FCV/E102/1L6...(Other models you can see in the webshop)		



pullouts

drawer slides

producer-specific

			
1			
GEV No.	690677	Ref. No.	082742
description	drawer rail L 620mm pull-out lengthmm Qty 1 piece W 11mm H 29mm mounting pos. left		
For models:	TRN1301, TRNA1301, TRNM1301, TRN1302, TRNA1302, TRNM1302, TRN1303, TRNA1303, TRNM1303, TRN1801, TRNA1801, TRNM1801, TRN1802, TRNA1802, TRNM1802, TRN1803, TRNA1803, TRNM1803, TRN2201, TRNA2201, TRNM2201, TRN2202, TRNA2202, TRNM2202, TRN2203, TRNA2203, TRNM2203, TRNP1802, TRN1301, TRNA1301, TRNM1301, TRN1302, TRNA1302, TRNM1302, TRN1303, TRNA1303, TRNM1303, TRN1801, TRNA1801, ARNM1801, TRN1802, TRNA1802, TRNM1802, TRN1803, TRNA1803, TRNM1803, TRN2201, TRNA2201, TRNM2201, TRN2202...(Other models you can see in the webshop)		



							
GEV No.	690676	Ref. No.	082743				
description	drawer rail L 620mm pull-out length Qty 1 piece W 11mm H 29mm mounting pos. right						
For models:	TRN1301, TRNA1301, TRNM1301, TRN1302, TRNA1302, TRNM1302, TRN1303, TRNA1303, TRNM1303, TRN1801, TRNA1801, TRNM1801, TRN1802, TRNA1802, TRNM1802, TRN1803, TRNA1803, TRNM1803, TRN2201, TRNA2201, TRNM2201, TRN2202, TRNA2202, TRNM2202, TRN2203, TRNA2203, TRNM2203, TRNP1802, TRN1301, TRNA1301, TRNM1301, TRN1302, TRNA1302, TRNM1302, TRN1303, TRNA1303, TRNM1303, TRN1801, TRNA1801, ARNM1801, TRN1802, TRNA1802, TRNM1802, TRN1803, TRNA1803, TRNM1803, TRN2201, TRNA2201, TRNM2201, TRN2202...(Other models you can see in the webshop)						
spare parts for	690676						
		<table border="1"> <tr> <td>GEV No.</td> <td>690680</td> <td>Ref. No.</td> <td>0A8292</td> </tr> </table>	GEV No.	690680	Ref. No.	0A8292	roller rollerø 24mm B1 6mm overall width 9mm A 24mm B 6mm C 9mm D 6mm E 10mm ceramic bearing ball bearing
GEV No.	690680	Ref. No.	0A8292				

			
GEV No.	690773	Ref. No.	084437
description	drawer slide L 580mm pull-out length 520mm Qty 1 piece W 17mm H 60mm mounting pos. right		
For models:	TRN1301, TRNA1301, TRNM1301, TRN1302, TRNA1302, TRNM1302, TRN1303, TRNA1303, TRNM1303, TRN1801, TRNA1801, TRNM1801, TRN1802, TRNA1802, TRNM1802, TRN1803, TRNA1803, TRNM1803, TRN2201, TRNA2201, TRNM2201, TRN2202, TRNA2202, TRNM2202, TRN2203, TRNA2203, TRNM2203, KT2T, KT3T, KT4T, NTRRN1301, NTRRN1302, NTRRN1801, NTRRN1802, NTRRN2201, NTRRN2202, NTRNA1301, NTRNA1302, NTRNA1801, NTRNA1802, NTRNA2201, NTRNA2202, NTRN130P, NTRN130C, NTRN180P, NTRN180C, NTRN220P, NTRN220C, NTRRN1301, TRRN1302...(Other models you can see in the webshop)		

			
GEV No.	690654	Ref. No.	082761
description	drawer slide L 580mm pull-out length 550mm Qty 1 piece W 18mm H 62mm mounting pos. left		
For models:	TRRN1301, TRRN1302, TRRN1303, TRRN1801, TRRN1802, TRRN1803, TRRN2201, TRRN2202, TRRN2203, TRN1302, TRNA1302, TRNM1302, TRN1303, TRNA1303, TRNM1303, TRN1802, TRNA1802, TRNM1802, TRN1803, TRNA1803, TRNM1803, TRN2202, TRNA2202, TRNM2202, TRN2203, TRNA2203, TRNM2203, EDON420121B, EDON280120, EDON280112, EDON280111, EDON280104, EDON280103, EDON280102, EDON280113, EDON280105, EDON420130, EDON420122, EDON420121, EDON420114, EDON420105, EDON420106, EDON420123, EDON420115, EDON570140, EDON570132, EDON570131, EDON570124, EDON570122, EDON570108...(Other models you can see in the webshop)		

							
GEV No.	690653	Ref. No.	082760				
description	drawer slide L 580mm pull-out length 550mm Qty 1 piece W 18mm H 62mm mounting pos. right						
For models:	TRRN1301, TRRN1302, TRRN1303, TRRN1801, TRRN1802, TRRN1803, TRRN2201, TRRN2202, TRRN2203, TRN1302, TRNA1302, TRNM1302, TRN1303, TRNA1303, TRNM1303, TRN1802, TRNA1802, TRNM1802, TRN1803, TRNA1803, TRNM1803, TRN2202, TRNA2202, TRNM2202, TRN2203, TRNA2203, TRNM2203, EDON420121B, EDON280120, EDON280112, EDON280111, EDON280104, EDON280103, EDON280102, EDON280113, EDON280105, EDON420130, EDON420122, EDON420121, EDON420114, EDON420105, EDON420106, EDON420123, EDON420115, EDON570140, EDON570132, EDON570131, EDON570124, EDON570122, EDON570108...(Other models you can see in the webshop)						
spare parts for	690653						
		<table border="1"> <tr> <td>GEV No.</td> <td>690750</td> <td>Ref. No.</td> <td>089159 0A8370</td> </tr> </table>	GEV No.	690750	Ref. No.	089159 0A8370	stop fortelescopico rail L 20mm plastic H 12mm D 9mm
GEV No.	690750	Ref. No.	089159 0A8370				

accessories

			
GEV No.	690750	Ref. No.	089159 0A8370
description	stop fortelescopico rail L 20mm plastic H 12mm D 9mm		
For models:	STRP1102, STRP1602, STRP1603, STRP2202, STRP2203, STRP1602R, STRP1603R, STRP2202R, STRP2203R, STRP1102R, RCSN2M2, RCSN2M12, RCSN3M3, RCSN3M22, RCSN3M14, RCSN4M4, RCSN4M32, RCSN4M24, RCSN2M2U, RCSN3M3U, RCSN4M4U, RCSN2M2R, RCSN2M12R, RCSN3M3R, RCSN3M22R, RCSN3M14R, RCSN4M4R, RCSN4M32R, RCSN4M24R, RCSN2M2T, RCSN3M3T, RCSN4M4T, RCSN2M24, RCSN3M34, RCSN4M44, RCSF2M24, RCSF3M34, HB2PA60, HB4CA60, HB2PUA60, HB4CUA60, HB3PA60, HB6CA60, HB3PUA60, HB6CUA60, HB6C3A, HB9CA, HB6C3UA, HB9CUA, RCSN3M06...(Other models you can see in the webshop)		

			
GEV No.	696333	Ref. No.	089157
description	stop fortelescopico rail L 20mm plastic H 15mm D 8mm		
For models:	STRP1102, STRP1602, STRP1603, STRP2202, STRP2203, STRP1602R, STRP1603R, STRP2202R, STRP2203R, STRP1102R, RCSN2M2, RCSN2M12, RCSN3M3, RCSN3M22, RCSN3M14, RCSN4M4, RCSN4M32, RCSN4M24, RCSN2M2U, RCSN3M3U, RCSN4M4U, RCSN2M2R, RCSN2M12R, RCSN3M3R, RCSN3M22R, RCSN3M14R, RCSN4M4R, RCSN4M32R, RCSN4M24R, RCSN2M2T, RCSN3M3T, RCSN4M4T, RCSN2M24, RCSN3M34, RCSN4M44, RCSF2M24, RCSF3M34, HB2PA60, HB4CA60, HB2PUA60, HB4CUA60, HB3PA60, HB6CA60, HB3PUA60, HB6CUA60, HB6C3A, HB9CA, HB6C3UA, HB9CUA, RCSN3M06...(Other models you can see in the webshop)		

rollers

rollers

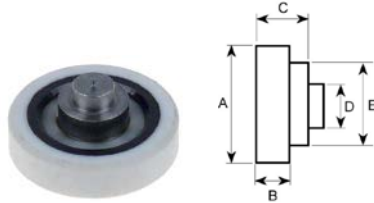

1

GEV No.	690680	Ref. No.	0A8292
description	roller rollerø 24mm B1 6mm overall width 9mm A 24mm B 6mm C 9mm D 6mm E 10mm ceramic bearing ball bearing		
For models:	TRN1301, TRNA1301, TRNM1301, TRN1302, TRNA1302, TRNM1302, TRN1303, TRNA1303, TRNM1303, TRN1801, TRNA1801, TRNM1801, TRN1802, TRNA1802, TRNM1802, TRN1803, TRNA1803, TRNM1803, TRN2201, TRNA2201, TRNM2201, TRN2202, TRNA2202, TRNM2202, TRN2203, TRNA2203, TRNM2203, TRNP1802, TRN1301, TRNA1301, TRNM1301, TRN1302, TRNA1302, TRNM1302, TRN1303, TRNA1303, TRNM1303, TRN1801, TRNA1801, ARNM1801, TRN1802, TRNA1802, TRNM1802, TRN1803, TRNA1803, TRNM1803, TRN2201, TRNA2201, TRNM2201, TRN2202...(Other models you can see in the webshop)		



1

GEV No.	692324	Ref. No.	0PE017
description	roller rollerø 19mm B1 6mm overall width 8mm A 19mm B 6mm C 8mm ø 9mm plastic bore ø 6mm		
For models:	NFS15C, FS15C2, FSV11C3CX, FSV15C4CX, FSV11C3CC, FSV15C4CC		

accessories



1

GEV No.	560133	Ref. No.	0D0503 0U0336 3653
description	hexagonal nut thread M6 H 5mm WS 10 SS DIN/ISO DIN 934 / ISO 4032/8673 Qty 20 pcs		
For models:	K35, CUTE0523, CUTE0538, VARIO-G, K35, KT055, KT056, MC40AS-01, K35-11, K55-01, TR260-01, TR260-02, TR260-03, TR260-04, K55E-01, EL65, XBE10AS-01, BM20AS-01, MC40AS-02, K35-01, K55-02, XBE10AS-02, K35-02, PL15-01, XBE10AS-03, BM20AS-02, K35-03, XBE10S-1, K55E-05, PL15-02, PL15-03, XBE10S-02, XBE10AS-04, BM20AS-03, BM20AS-04, BM30AS-01, BM30AS-02, MC40AS-03, BMX60AS-01, K55-03, XBE10S-03, XBE10S-04, BM20AS-05, BM30AS-03, BMX60AS-02, BM20AS-06, BMX60AS-03, K35-04, K55-04, K35-05...(Other models you can see in the webshop)		

roller with holder



1

GEV No.	690567	Ref. No.	032935 033885
description	roller rollerø 22mm B1 6mm with holder SS/Nylon mounting pos. left door bearing ball bearing Qty 1 pcs H 12mm L 64mm mounting distance 38/50mm		
For models:	TC1200TOP, TC1210TOP, TC1400TOP, TC1410TOP, TC1600TOP, TC1610TOP, TC1800TOP, TC1810TOP, TC2000TOP, TC2010TOP, TCD1200TOP, TCD1400TOP, TCD1600TOP, TCD1800TOP, TCD2000TOP, TF1400, TF1410, TF2000, TF2010, TN1000, TN1010, TN1200, TN1210, TN1400, TN1410, TN1600, TN1610, TN1800, TN1810, TN2000, TN2010, TND1000, TND1200S, TND1400, TND1600, TND1800, TND2000, TC1000, TC1010, TC1200, TC1210, TC1400, TC1410, TC1600, TC1610, TC1800, TC1810, TC2000, TC2010, TCD1000...(Other models you can see in the webshop)		



1

GEV No.	690711	Ref. No.	032932 033886
description	roller rollerø 22mm B1 6mm with holder SS/Nylon mounting pos. right door (left) bearing ball bearing Qty 1 pcs H 11mm L 63mm mounting distance 38/50mm		
For models:	TC1200TOP, TC1210TOP, TC1400TOP, TC1410TOP, TC1600TOP, TC1610TOP, TC1800TOP, TC1810TOP, TC2000TOP, TC2010TOP, TCD1200TOP, TCD1400TOP, TCD1600TOP, TCD1800TOP, TCD2000TOP, TF1400, TF1410, TF2000, TF2010, TN1000, TN1010, TN1200, TN1210, TN1400, TN1410, TN1600, TN1610, TN1800, TN1810, TN2000, TN2010, TND1000, TND1200S, TND1400, TND1600, TND1800, TND2000, TC1000, TC1010, TC1200, TC1210, TC1400, TC1410, TC1600, TC1610, TC1800, TC1810, TC2000, TC2010, TCD1000...(Other models you can see in the webshop)		

accessories



1

GEV No.	692727	Ref. No.	037462
description	door guides L 42mm thickness 8.5mm for sliding door		
For models:	TA1600DX, TA1600SX, TA2000DX, TA2000SX, TA1610DX, TN1000, TN1010, TN1200, TN1210, TN1400, TN1410, TN1600, TN1610, TN1800, TN1810, TN2000, TN2010, TND1000, TND1200, TND1400, TND1600, TND1800, TND2000, AS1400S, AS2000S, TA1610SX, TA2010DX, TA2010SX, TA2000, TA2010, TN1000, TN1010, TN1200, TN1210, TN1400, TN1410, TN1600, TN1610, TN1800, TN1810, TN2000, TN2010, TND1000, TND1200, TND1400, TND1600, TND1800, TND2000, TC1200, TC1210...(Other models you can see in the webshop)		



fittings for catering equipment

outlet taps

universal

GEV No.	540747	Ref. No.	0C2670
description	outlet tap chrome-plated brass angled W 30mm H 40mm thread 1/2" IT		
For models:	BB/E1, PF/E1D05, PF/E1D05E5, PBV/G2, PB/E1, PB/E2, PBV/E2, PB/E2E5, OB/E1, OB/E2, TF/E1D05, TF/E1D05E5, TBV/G2, TB/E1, TB/E2, TBV/E2, TB/E2E5		

GEV No.	540699	Ref. No.	0C2669
description	outlet tap W 35mm H 35mm thread 3/4" IT		
For models:	BF/G1S07, BF/E1S12, PF/G1S07, PF/G2D07, PFR/G1S07, PFR/G2D07, PF/E1S07, PF/E2D07, PF/E1S12, PF/E2D12, PF/E1S12E5, PF/E2D12E5, PF/E1S07E5, OF/G1S07, OFR/G1S07, OFR/G2D07, OF/E1S07, OF/E1S12, OF/E2D12, TF/G1S07, TF/G2D07, TFR/G1S07, TFR/G2D07, TF/E1S07, TF/E2D07, TF/E1S12, TF/E2D12, TF/E1S12E5, TF/E2D12E5, TF/E1S07E5		

producer-specific

ELECTROLUX

GEV No.	540658	Ref. No.	053108 OK7222 700610
description	ball valve connection 3/4" IT - 3/4" IT DN20 total length 69mm		
For models:	MFR/G350, MFR/G700, MFR/G350D, MFR/G700D, MFR/G350F, MFR/G700F, MFR/G350E, MFR/G700E, MFR/E355, MFR/E355UK, MFR/E355D, MFR/E705, MFR/E705UK, MFR/E705D, RFR/E1S12, RFR/E2D12, XFR/E1S12, XFR/E2D12, JFR/E1S12, JFR/E2D12, MFR/E1S12, MFR/E2D12, RFR/G350, RFR/G700, RFR/G350D, RFR/G700D, RFR/G350F, RFR/G700F, M35GFR, M70GFR, XFR/G350D, XFR/G700D, XFR/G350F, XFR/G700F, XFR/G351, CFR/G351, CFR/G700, RFR/G301, RFR/G300, RFR/G301, RFR/G701, RFR/G701F, HFR/G420, HFR/G420, HFR/G840, HFR/G840, HFR/E420, HFR/E420UK, HFR/E840...(Other models you can see in the webshop)		

GEV No.	540978	Ref. No.	003378 728055
description	bracket		
For models:	MFR/E355, MFR/E355UK, MFR/E355D, MFR/E705, MFR/E705UK, MFR/E705D, MFR/G740, MFR/E740, MFR/G350, MFR/G351, MFR/G700, MFR/G701, RFR/G1S12, RFR/G2D12, RCP/E2S, XFR/G1S12, XFR/G2D12, JFR/G1S12, JFR/G2D12, MCP/E1SH, MCP/E1SUH, MCP/E2SUHS, MFR/G1S12, MFR/G2D12, MCP/E2S, MCP/E2SH, MCP/E2SUH, MCP/E2SUT, MCP/E2SHB, RFR/E356, RFR/E741, RFR/E701, RFR/G741, 7FRG03S, 7FRG07S, CFR/G741, CFR/E702, M35GFR, M70GFR, CFR/G351, CFR/G701, HFR/G410, HFR/G810, HFR/E410, HFR/E810, HFR/G411, HFR/E411, HFR/E412, HFR/E418, HFR/E818...(Other models you can see in the webshop)		

GEV No.	110704	Ref. No.	00329 004906 0K3527
description	cone handle thread M6 ø 16mm L 25mm plastic black		
For models:	SFRE700, SME350, SME700, SGE350, SFRG350, SFRG700, SFRE350, SFRE700, SME350, SME700, SGE350, SFRG350, SFRG700, SMG350, SMG700, BM35E6U, SFRE350, SFRE351, SFRE700, SFRE701, GR35E6U		

GEV No.	514006	Ref. No.	00079 005411 005678 00800 058114 0K3501 7060060
description	drain pipe L 200mm thread ø 22mm		
For models:	QME300A, QME600, QFE300, QFE302, QFE600, QFE602, QFG300, QFG600, SFRE700, SME350, SME700, SGE350, SFRG350, SFRG700, SFRE350, SFRE700, SME350, SME700, SGE350, SFRG350, SFRG700, SMG350, SMG700, BM35E6U, SFRE350, SFRE351, SFRE700, SFRE701, GR35E6U		

mechanical components, equipment accessories

			
1			
GEV No.	540965	Ref. No.	002384 002457
description	drain pipe thread		
For models:	MFR/E350, MFR/E700, MFR/E370, MFR/E350UK, MFR/E700UK, MFR/E370UK, MFR/E370D, MFR/E350D, MFR/E700D, MFR/G380, MFR/G381, MM/G351, MM/G701, MM/E350, MM/E700, MM/E350UK, MM/E700UK, MM/G350, MM/G700, MM/G350F, MM/G700F, MM/G700E, MM/E350D, MM/E700D, RF/G1S07, RF/G2D07, RF/E1D05, RF/E1S08, RF/E2D08, RF/E1S12, RF/E2D12, RBV/G2, RB/E1, RB/E2, RBV/E2, XF/G1S07, XRF/G2D07, XF/E1D05, XF/E1S08, XF/E2D08, XF/E1S12, XF/E2D12, XBV/G2, XB/E1, XB/E2, XBV/E2, JF/G1S07, JF/G2D07, JF/E1D05, JF/E1S08...(Other models you can see in the webshop)		

			
2			
GEV No.	514109	Ref. No.	002117 003830 728004
description	extension thread		
For models:	HFR/E410, HFR/E810, HFR/E411, HFR/E412, HFR/E418, HFR/E818, ZFR/E410, ZFR/E810, ZFR/E411, ZFR/E412, ZFR/E418, ZFR/E818, AFR/E410, AFR/E810, AFR/E411, AFR/E412, OFR/E810		









			
1			
GEV No.	540677	Ref. No.	006877
description	guide for outlet tap for handle thread		
For models:	KFR/G1E, KFR/G2F, KFR/E1E, KFR/E2F, KFH/G1, KFH/E1, KFH/G1ELH, KFH/E1ELH, KFH/G1EH, KFH/E1EH, KFR/G1T, QFR/G1E, QFR/G2F, QFR/E1E, QFR/E2F, QFH/G1, QFH/E1, QFH/G1ELH, QFH/E1ELH, QFH/G1EH, QFH/E1H, QFR/G1T, WFR/G1E, WFR/G2F, WFR/E1E, WFR/E2F, WFH/G1, WFH/E1, WFH/G1ELH, WFH/E1ELH, WFH/G1EH, WFH/E1EH, WFR/G1T		

			
1			
GEV No.	540678	Ref. No.	006689
description	handle for outlet tap		
For models:	HFH/G430, HFH/E430, HFH/G435, HFH/E435, ZFH/G430, ZFH/E430, ZFH/G435, ZFH/E435, AFH/G435, AFH/E435		

			
1			
GEV No.	540987	Ref. No.	006142
description	handle for outlet tap		
For models:	HFR/G430, HFR/G830, HFR/E430, HFR/E830, HFH/G400U, HFH/G401U, HFRS/G430, HFRS/E430, ZFR/G430, ZFR/G830, ZFR/E430, ZFR/E830, ZFRS/G430, ZFRS/E430, AFR/G430, AFR/G830, AFR/E430, AFR/E830, AFRS/G430, AFRS/E430		

			
1			
GEV No.	540979	Ref. No.	003377 727891
description	handle rod L 200mm for outlet tap		
For models:	MFR/E355, MFR/E355UK, MFR/E355D, MFR/E705, MFR/E705UK, MFR/E705D, MFR/G740, MFR/E740, MFR/G350, MFR/G351, MFR/G700, MFR/G701, RFR/G1S12, RFR/G2D12, XFR/G1S12, XFR/G2D12, JFR/G1S12, JFR/G2D12, MFR/G1S12, MFR/G2D12, RFR/E356, RFR/E741, RFR/E701, RFR/G741, 7FRG03S, 7FRG07S, CFR/G741, CFR/E702, M35GFR, M70GFR, CFR/G351, CFR/G701, HFR/G410, HFR/G810, HFR/G410D, HFR/G810D, HFR/G410NL, HFR/G810NL, HFR/G411, ZFR/G410, ZFR/G810, ZFR/G410D, ZFR/G810D, ZFR/G411, AFR/G410, AFR/G810, M40GFR90, AFR/G411, AFR/G412, OFR/G810		

			
1			
GEV No.	691355	Ref. No.	00336 0K3530
description	lever L 64mm for outlet tap thread M6 ET - M6 ET		
For models:	SME350, SME700, SGE350, SFRG350, SFRG700, SME350, SME700, SGE350, SFRG350, SFRG700, SMG350, SMG700, BM35E6U, GR35E6U		



				
1				
GEV No.	540776	Ref. No.	058113 7060030	
description	outlet tap L 83mm without handle thread 3/4" IT shaft L 9mm shaft ø 10x7.3mm handle M6			
For models:	QME300A, QME600, QFE300, QFE302, QFE600, QFE602, QFG300, QFG600			
spare parts for	540776			
	GEV No.	532453	Ref. No.	—
				
accessories for	540776			
	GEV No.	110734	Ref. No.	—
				
	GEV No.	514006	Ref. No.	00079 005411 005678 00800 058114 0K3501 7060060
				
	GEV No.	514217	Ref. No.	—
				
	GEV No.	540651	Ref. No.	—
				
	GEV No.	540734	Ref. No.	—
				
	GEV No.	693082	Ref. No.	—
				



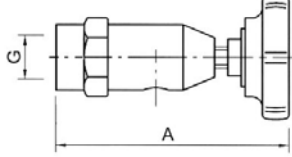

			
GEV No.	540259	Ref. No.	005667 00742
description	outlet tap without handle thread 3/4" IT		
For models:	SFRE700, SME350, SME700, SGE350, SFRG350, SFRG700, SFRE350, SFRE700, SME350, SME700, SGE350, SFRG350, SFRG700, SMG350, SMG700, BM35E6U, SFRE350, SFRE351, SFRE700, SFRE701, GR35E6U		
accessories for	540259		
	GEV No.	514006	Ref. No. 00079 005411 005678 00800 058114 0K3501 7060060
drain pipe L 200mm thread ø 22mm			
	GEV No.	540748	Ref. No. —
lever L 70mm for outlet tap thread M6 ET - M6 ET thread L 28/11mm			
	GEV No.	540749	Ref. No. —
cone handle plastic black for outlet tap			
	GEV No.	540755	Ref. No. —
lever for outlet tap			
	GEV No.	691355	Ref. No. 00336 0K3530
lever L 64mm for outlet tap thread M6 ET - M6 ET			

aerators and air bleeders

			
GEV No.	540014	Ref. No.	0K5787
description	aerator and air bleeder thread 1/2" ET chrome-plated L 78mm		
spare parts for	540014		
	GEV No.	112777	Ref. No. —
star handle shaft 6x6mm ø 50mm L 18mm black plastic			
	GEV No.	540365	Ref. No. 0H6468
star handle shaft 6x6mm ø 50mm L 18mm black thermoplastic			

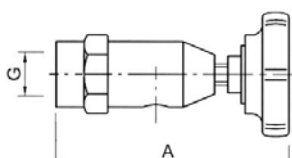
 			
GEV No.	540016	Ref. No.	0H6418 0K1865 0KV408 176017 240061 7KUE176017
description	aerator and air bleeder thread 1/2" IT chrome-plated L 78mm		
spare parts for	540016		
	GEV No.	112777	Ref. No. —
star handle shaft 6x6mm ø 50mm L 18mm black plastic			
	GEV No.	540365	Ref. No. 0H6468
star handle shaft 6x6mm ø 50mm L 18mm black thermoplastic			

 			
GEV No.	540013	Ref. No.	0G3246 0H6419 0H9962 0K1435 0K5382 0KL215 19003288 670300 762184
description	aerator and air bleeder thread 3/8" ET WS 27 chrome-plated L 86mm		
For models:	ACSGRT, BOT080S.MH25.W94, BOT080S.MS25.W94, BOT100E.MS35.H97, BOT150S.MH25.F98, BOT150S.MH25.W94, BOT200S.MH25.F18, BOT200S.MH25.W14, BOT400E.MS35.W14, BOT400S.MH25.F18, BOT150E.MS35.H97, BOT040E.MS35.F88, BOT040S.MH25.F98, BOT040E.MS35.W84, BOT040S.MH25.W94, BOT060E.MS35.F88, BOT060S.MH25.F98, BOT060E.MS35.W84, BOT060S.MH25.W94, BOT080E.MS35.F88, BOT080S.MH25.F98, BOT080E.MS35.W84, BOT100S.MH25.F98, BOT100S.MH25.W94, BOT300S.MH25.F18, BOT300S.MH25.W14, BOT400E.MS35.F18, BOT400S.MS25.F18, BOT400S.MH25.W14, BOT400S.MS25.W14, BOT040E.MS35.F98, BOT040E.MS35.W94, BOT060E.MS35.F98, BOT060E.MS35.W94, BOT100E.MS35.F98, BOT100E.MS35.W94, BOT150E.MS35.F98, BOT150E.MS35.W94, BOT200E.MS35.F18, BOT200E.MS35.W14, BOT300E.MS35.F18, BOT300E.MS35.W14, BOT060S.MS35.F98, BOT060S.MS35.W94, BOT080S.MS35.F98, BOT080S.MS35.W94, BOT100S.MS35.F98, BOT100S.MS35.W94... (Other models you can see in the webshop)		
spare parts for	540013		
	GEV No.	112777	Ref. No. —
star handle shaft 6x6mm ø 50mm L 18mm black plastic			
	GEV No.	540365	Ref. No. 0H6468
star handle shaft 6x6mm ø 50mm L 18mm black thermoplastic			

spare parts



1			
GEV No.	540365	Ref. No.	0H6468
description	star handle shaft 6x6mm ø 50mm L 18mm black thermoplastic		



1			
GEV No.	540949	Ref. No.	0H6420 0H9729 0H9963 0K2998 0K5385 0KG799 127296 19003294 670420
description	aerator and air bleeder thread 1/2" ET chrome-plated with O-ring L 15mm ø 25mm		

For models: ACSGR7, GWACOE00RO, FWAAMO00RO, GWACOMO00RO, IWKCOE0000, HWAHOE00RO, GWAHOE0000, GWAHOE00RO, FWAHOE00RO, BEN150EW87, HWAJOE00RO, GWAJOE00RO, FWAJOE00RO, BEN200EW87, GWAJOM00RO, FWFJOEX000, FWFJOEX0RO, BEN300E.S35.H97, GWAKOE00RO, FWAKOE00RO, IWAKOMO00RO, GWAKOMO00RO, FWFKOEX0RO, FWKKOE00RO, IWALOE0000, IWALOE00RO, BEN400E.S35.H97, BEN400EF97, FWALOE00RO, GWALOMO00RO, IVAAOE0000, HVAAOE00RO, GVAAOE0000, GVAAOE00RO, FVAAOE00RO, IVKAOE0000, FVKAOE00RO, HVABOE00RO, GVABOE0000, GVABOE00RO, FVABOE00RO, FVFB0EX0RO, IVKBOE0000, FVKBOE00RO, IVACOE00RO, BON080EF88, GVACOE00RO, FVACOE00RO, IVACOMO00RO, GVACOMO00RO...(Other models you can see in the webshop)



1			
GEV No.	540826	Ref. No.	059664 0K1458 0K1463 0K1464 0K1466 0KC081 670020
description	aerator and air bleeder thread 1/2" ET WS 24 chrome-plated brass L 30mm		
For models:	XPN/EI760D, HPN/EI815D, HPNS/EI815D, ZPN/EI815D, ZPNS/EI815D, APN/EI815D, APN/EI810, APN/EI815, APN/ED816, APNS/EI815		



1			
GEV No.	541407	Ref. No.	0G3877 185021
description	aerator and air bleeder thread 1/2" IT chrome-plated		



1			
GEV No.	540827	Ref. No.	010023 01509004 0S0140 335234113
description	aerator and air bleeder thread 3/4" ET chrome-plated L 45mm ø 36mm		
For models:	PV101, PV201, PV301, PV501, PVA101, PVA201, PVA301, PVA501, PV101, PV201, PV301, PV501, PVA101, PVA201, PVA301, PVA501		





1			
GEV No.	540825	Ref. No.	003536 008021 008098 01509002 051556 051566 10178 14945 21566
description	aerator and air bleeder thread 3/8" ET WS 24 chrome-plated L 37mm		
For models:	MPN/GI761, MPN/GI760D, MPN/GI760, MPN/GI760F, MPN/EI760, MPNEI760UK, MPN/V760, MPN/V760D, RPI/G260, RPI/E240, RPI/E260, RPI/G260P, RPI/E260P, XPI/G260, XPI/E240, XPI/E260, XPI/G260P, XPI/E260P, JPI/G260, JPI/E240, JPI/E260, MPI/G260, MPI/E240, MPI/E260, MPI/G260P, MPI/E260P, 7PIG06, 7PIE06, RPN/EI760UK, RPN/GI760F, 7PEV06, XPN/GI760D, M70GIKE, M70EIKE, XPN/EI760UK, M70VIKE, XPN/GI760F, PPI/G260P, PPI/E260P, OPI/G260P, OPI/E260P, TPI/G260P, TPI/E260P, RPNV740, RPN/GI760, RPN/GI760, RPN/GI760, PRPN/GI76, RPN/EI760, RPN/EI760...(Other models you can see in the webshop)		



steam valves

 <p>1</p>			
GEV No.	541542	Ref. No.	OKD952 686240502
description	steam valve straight connection 1" IT total length 90mm H 140mm brass		
spare parts for	541542		
	GEV No.	540229	Ref. No. —
star handle shaft 9x9mm ø 80mm L 23mm black thermoplastic			
	GEV No.	541546	Ref. No. —
screw chrome-plated brass thread M5 thread L 10mm			
	GEV No.	541548	Ref. No. —
gasket PTFE ID ø 15mm H 7mm for thread 1 1/4" ED ø 35mm			
	GEV No.	541554	Ref. No. —
gasket copper ext. ø 49 ID ø 42mm H 2mm for thread 1 1/4"			
	GEV No.	541557	Ref. No. —
tap head chrome-plated thread 1 1/4" for steam tap 1"			

 <p>1</p>			
GEV No.	541455	Ref. No.	01510005 038020 0S0142
description	steam tap angled connection 1" ET total length 40mm H 150mm brass		
For models:	FSV11FD3X, FSV15FD4X, FSV15FDC4X, FSV11FD3C, FSV15FD4C, FSV15FDC4C		
spare parts for	541455		
	GEV No.	541563	Ref. No. —
star handle shaft 7x7mm ø 72mm L 24mm black plastic			
	GEV No.	541565	Ref. No. —
tap head for steam tap 1" shaft 7x7mm			



 <p>1</p>			
GEV No.	520000	Ref. No.	01512006 0S0143
description	steam valve angled connection 1 1/4" IT total length 52mm H 190mm brass		
spare parts for	520000		
	GEV No.	541566	Ref. No. —
tap head for steam tap 1 1/4" shaft 9x9mm			
	GEV No.	541567	Ref. No. —
star handle shaft 9x9mm ø 74mm L 24mm black plastic			

lid hinges

type ECHTERMANN

10 series

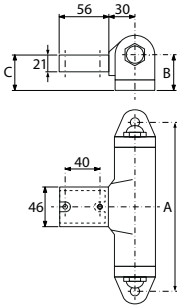
10.61

  <p>1</p>			
GEV No.	693241	Ref. No.	OK2589 69106135360
description	lid hinge type 6910.61 level of centre of rotation 35mm load capacity 20-30NM opening angle 60° closing angle 10° mounting distance 198mm square pipe 50x25x2mm		
For models:	7581-5.KK60, 7582-5.KK80, 7583-5.KK100, 7781-5.KK60, 7782-5.KK80, 7783-5.KK100, 7580-5.KK40, 7780-5.KK40, 7580-5/85.KK40.(N), 7581-5/85.KK60.(N), 7582-5/85.KK80.(N), 7583-5/85.KK100.(N), 7580-5/90.KK40.(N), 7581-5/90.KK60.(N), 7582-5/90.KK80.(N), 7583-5/90.KK100.(N), 7585-3/85.KK40.MOTK., 7586-3/85.KK60.MOTK., 7587-3/85.KK80.MOTK., 7588-3/85.KK100.MOTK, 7585-3/90.KK40.MOTK., 7586-3/90.KK60.MOTL, 7587-3/90.KK80.MOTK., 7588-3/90.KK100.MOTK, 7585-5/85.KK40.MOTK., 7586-5/85.KK60.MOTK., 7587-5/85.KK80.MOTK., 7588-5/85.KK100.MOTK, 7585-5/90.KK40.MOTK., 7586-5/90.KK60.MOTK., 7587-5/90.KK80.MOTK., 7588-5/90.KK100.MOTK, 7580-3, 7581-3, 7581-5, 7582-3, 7582-5, 7583-3, 7780-3, 7780-5/85.KK40.(N), 7780-5/90.KK40.(N), 7781-3, 7781-5, 7781-5/85.KK60.(N), 7781-5/90.KK60.(N), 7782-3, 7782-5, 7782-5/85.KK80.(N), 7782-5/90.KK80.(N), 7783-3...(Other models you can see in the webshop)		
spare parts for	693241		
	GEV No.	691612	Ref. No. —
repair kit for lid hinge load capacity 20-30NM			

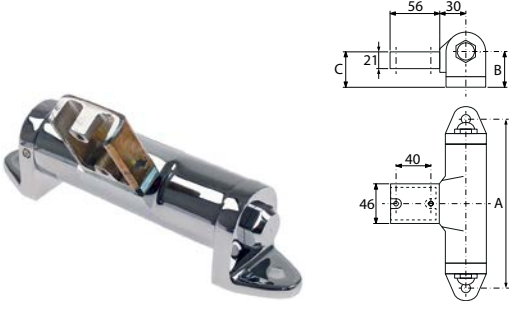

1

GEV No.	693242	Ref. No.	OK2590 69106135560
description	lid hinge type 6910.61 level of centre of rotation 35mm load capacity 30-50NM opening angle 60° closing angle 10° mounting distance 198mm bore ø 11mm chrome-plated square pipe 50x25x2mm		
For models:	7581-5.KK60, 7582-5.KK80, 7781-5.KK60, 7584-5.KK150, 7780-5.KK40, 7581-5/85.KK60.(N), 7582-5/85.KK80.(N), 7584-5-85.KK150.(N), 7581-5/90.KK60.(N), 7582-5/90.KK80.(N), 7584-5-90.KK150.(N), 7568-5-90.KK200.(N), 7585-3/85.KK40.MOTK., 7585-3/90.KK40.MOTK., 7585-5/85.KK40.MOTK., 7589-5/85.KK150.MOTK, 7585-5/90.KK40.MOTK., 7589-5-90.KK150.MOTK, 7569-5/90.KK200.MOTK, 7568-3, 7568-5.KK200, 7568-5/85.KK200.(N), 7569-3/85.KK200.MOTK, 7569-3/90.KK200.MOTK, 7569-5/85.KK200.MOTK, 7581-3, 7582-3, 7583-3, 7583-5, 7584-3, 7589-3/85.KK150.MOTK, 7589-3/90.KK150.MOTK, 7768-3, 7768-5.KK200, 7768-5/85.KK200.(N), 7768-5/90.KK200.(N), 7769-3/85.KK200.MOTK, 7769-3/90.KK200.MOTK, 7769-5/85.KK200.MOTK, 7769-5/90.KK200.MOTK, 7780-5/85.KK40.(N), 7780-5/90.KK40.(N), 7781-3, 7781-5/85.KK60.(N), 7781-5/90.KK60.(N), 7782-3, 7783-3, 7783-5, 7784-3, 7784-5.KK150...(Other models you can see in the webshop)		
spare parts for	693242		
	GEV No.	691613	Ref. No. —
	repair kit for lid hinge load capacity 30-50NM		

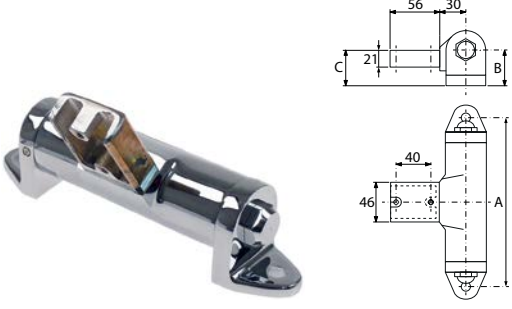

1

GEV No.	691265	Ref. No.	OK2571 69106135655
description	lid hinge type 6910.61 level of centre of rotation 35mm load capacity 50-60NM opening angle 55° mounting distance 198mm chrome-plated square pipe 50x25x2mm		
spare parts for	691265		
	GEV No.	691614	Ref. No. —
	repair kit for lid hinge load capacity 50-60NM		

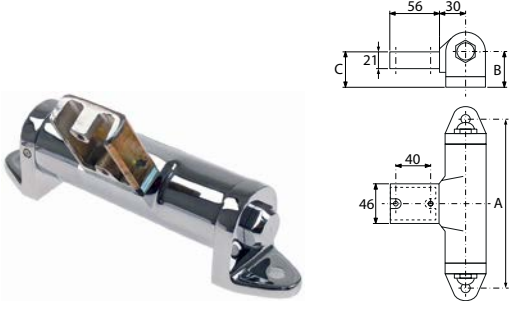

1

GEV No.	693246	Ref. No.	OK2591 69106135660
description	lid hinge type 6910.61 level of centre of rotation 35mm load capacity 50-60NM opening angle 60° closing angle 10° mounting distance 198mm bore ø 11mm square pipe 50x25x2mm		
For models:	7584-3, 9174-3, 9174-5, 9175-3, 9175-5, 9176-3, 9176-5, 9185-3, 9185-5, 9186-5, 9373-5-8, 9374-3-0, 9374-3-8, 9374-5-0, 9374-5-8, 9375-3-0, 9375-3-8, 9375-5-0, 9375-5-8, 9376-3-0, 9376-3-8, 9376-5-0, 9385-3-0, 9385-3-8, 9385-5-0, 9385-5-8, 9386-3-0		
spare parts for	693246		
	GEV No.	691614	Ref. No. —
	repair kit for lid hinge load capacity 50-60NM		

10.62

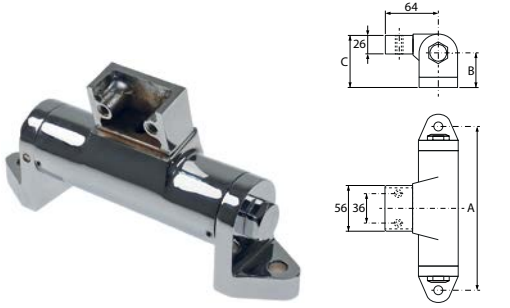

1

GEV No.	693245	Ref. No.	OK2593 6910.62/45-6 69106245675
description	lid hinge type 10.62 level of centre of rotation 45mm load capacity 50-60NM opening angle 75° mounting distance 198mm bore ø 11mm chrome-plated		
For models:	9116-2, 9116-3, 9116-5, 9316-3-0, 9316-3-8, 9316-5-0, 9316-5-8, 9411-3, 9413-3, 9414-3, 9415-3, 9416-3, 9416-5		
spare parts for	693245		
	GEV No.	691614	Ref. No. —
	repair kit for lid hinge load capacity 50-60NM		



GEV No.	693234	Ref. No.	OK2587 69106245275
description	lid hinge type 1062 level of centre of rotation 45mm load capacity 10-20NM opening angle 75° closing angle 10° mounting distance 198mm bore ø 11mm MD lid 36mm chrome-plated brass		
For models:	7550-5.KES40, 7551-5.KES60, 7561-3.KES60.RW, 7750-5.KES40, 7751-5.KES60, 7751-3/85.KES60, 7550-3/85.KES40.(N), 7551-3/85.KES60, 7550-3/90.KES40.(N), 7551-3/90.KES60, 7550-5/85.KES40.(N), 7551-5/85.KES60.(N), 7550-5/90.KES40.(N), 7551-5/90.KES60.(N), 7561-3/85.KES60.RW., 7561-3/90.KES60.RW., 7550-2, 7550-3, 7550-5, 7551-2, 7551-3, 7551-5, 7560-3, 7561-3, 7750-3, 7750-3/85.KES40, 7750-3/90.KES40, 7750-5, 7750-5/85.KES40.(N), 7750-5/90.KES40.(N), 7751-3, 7751-3/90.KES60, 7751-5, 7751-5/85.KES60, 7751-5/90.KES60		

GEV No.	693237	Ref. No.	OK2588 69106245575
description	lid hinge type 1062 level of centre of rotation 45mm load capacity 30-50NM opening angle 75° closing angle 10° mounting distance 198mm bore ø 11mm MD lid 36mm chrome-plated brass		
For models:	7551-5.KES60, 7554-5.KES150, 7564-3.KES150.RW, 7750-5.KES40, 7754-5.KES150, 7554-3/85.KES150.(N), 7554-3/90.KES150.(N), 7551-5/85.KES60.(N), 7554-5/85.KES150.(N), 7551-5/90.KES60.(N), 7554-5/90.KES150.(N), 7564-3/85.KES150.RW., 7564-3/90.KES150.RW., 7754-5/85.KES150, 7754-5/90.KES150, 7554-3, 7554-5, 7564-2, 7750-5/85.KES40.(N), 7750-5/90.KES40.(N), 7754-3, 7754-3/85.KES150, 7754-3/90.KES150, 7754-5, 9114-2, 9114-3, 9114-5, 9115-2, 9115-3, 9115-5, 9314-3-0, 9314-3-8, 9314-5-0, 9314-5-8, 9315-3-0, 9315-3-8, 9315-5-0, 9315-5-8, 9411-3, 9413-3, 9414-3, 9414-5, 9415-3, 9415-5, 9416-3		
spare parts for	693237		
	GEV No.	691613	Ref. No.
	repair kit for lid hinge load capacity 30-50NM		

GEV No.	693235	Ref. No.	0H6887 69106245375
description	lid hinge type 1062 level of centre of rotation 45mm load capacity 20-30NM opening angle 75° closing angle 10° mounting distance 198mm bore ø 11mm MD lid 36mm chrome-plated brass		
For models:	7550-5.KES40, 7552-5.KES80, 7553-5.KES100, 7562-3.KES80.RW, 7563-3.KES100.RW, 7752-5.KES80, 7753-5.KES100, 7552-3/85.KES80.(N), 7553-3/85.KES100.(N), 7552-3/90.KES80.(N), 7553-3/90.KES100.(N), 7550-5/85.KES40.(N), 7552-5/85.KES80.(N), 7553-5/85.KES100.(N), 7550-5/90.KES40.(N), 7552-5/90.KES80.(N), 7553-5/90.KES100.(N), 7562-3/85.KES80.RW., 7563-3/85.KES100.RW., 7562-3/90.KES80.RW., 7563-3/90.KES100.RW., 7552-2, 7552-3, 7552-5, 7553-2, 7553-3, 7553-5, 7562-3, 7563-3, 7752-3, 7752-3/85.KES80, 7752-3/90.KES80, 7752-5, 7752-5/85.KES80, 7752-5/90.KES80, 7753-3, 7753-3/85.KES100, 7753-3/90.KES100, 7753-5, 7753-5/85.KES100, 7753-5/90.KES100, 9111-3, 9111-5, 9113-2, 9113-3, 9113-5, 9311-3-0, 9311-3-8, 9311-5-0, 9311-5-8...(Other models you can see in the webshop)		
spare parts for	693235		
	GEV No.	691612	Ref. No.
	repair kit for lid hinge load capacity 20-30NM		

GEV No.	693240	Ref. No.	OK2586
description	lid hinge type 1062 level of centre of rotation 45mm load capacity up to 10NM opening angle 75° MT lid M8mm chrome-plated square pipe 60x30x2mm hole distance 198mm		
spare parts for	693240		
	GEV No.	691610	Ref. No.
	repair kit for lid hinge load capacity 10NM		

10.81

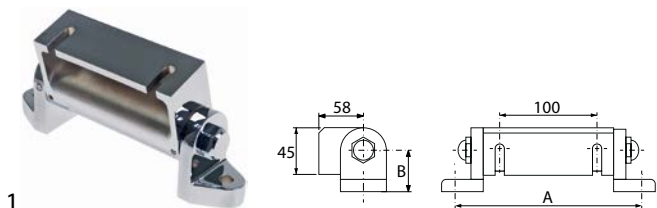

GEV No.	692648	Ref. No.	OK5245
description	lid hinge type 1081 level of centre of rotation 35mm load capacity 10-20NM opening angle 75° closing angle 10° mounting distance 198mm bore ø 11mm MD lid 100mm chrome-plated brass		
For models:	IVAAOEOOOO, HVAEOEOORO, GVAEOEOOOO, GVAEOEOORO, FVAEOEOORO, IVKAOEOOOO, FVKAEOOORO, HVABOEOORO, GVABOEOOOO, GVABOEOORO, FVABOEOORO, FVFBEOEXORO, IVKBOEOOOO, FVKBOEOORO, IVACOEOORO, BON080EF88, GVACOEOORO, FVACOEOORO, IVACOMOORO, GVACOMOORO, GVFCOEXOOO, GVFCOEXORO, FVFCOEXORO, FVKCOEOORO, IVAEOEOOOO, IVAEOEOORO, HVAEOEOORO, GVAEOEOORO, FVAEOEOORO, IVAEOMOORO, GVAEOMOORO, FVOEOEXOOO, FVFEEOEXORO, HVKEOEOORO, GVKOEOOORO, FVKEOEOORO, GVAHOEOOOO, GVAHOEOORO, FVAHOEOORO, GVAHOMOORO, FVFOEXORO, BON150SF98, FVOAEOXOOO, HVFAEOXOOO, GVOAOMXOOO, IVFAOMXOOO, FVOBOEXOOO, HVFBEOXOOO, GVOBOMXOOO, IVFBOMXOOO...(Other models you can see in the webshop)		

2

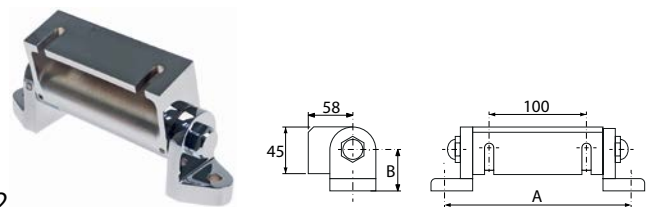

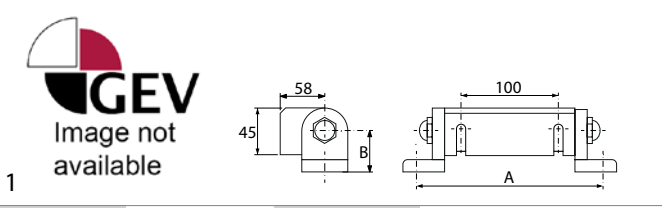

GEV No.	691203	Ref. No.	OG2126 OK5247 19000771 69108145675
description	lid hinge type 1081 level of centre of rotation 45mm load capacity 50-60NM opening angle 75° closing angle 10° mounting distance 198mm bore ø 11mm MD lid 100mm chrome-plated brass		
For models:	FET060E.MS35P.F88, FET060E.MS35P.W84, FET060E.MS35S.F88, FET080E.MS35P.F88, FET080E.MS35P.W84, FET080E.MS35S.W84, FET100E.MS35P.F88, FET100E.MS35P.W84, FET100E.MS35S.F97, FET060E.MS35S.W84, FET080E.MS35S.F88, FET100E.MS35S.F88, FET100E.MS35S.W84, APABPETOOC, APABPGTOOC, APACPITOOC, APACPGTOOC, APABPIOOC, APABPITOOC, APACPPIOOC, APACPI TOOC, GPWBOEOOBO, GPXBOEOOBO, GPYBOEOOBO, GPWCOEOO BO, GPXCOEOOBO, GPYCOEOOBO, GPWEOEOOBO, GPXEOEOOBO, GPYEOEOOBO, FET060E.MS35S.F98, FET060E.MS35S.W94, FET080E.MS35S.F98, FET080E.MS35S.W94, FET100E.MS35S.F98, FET100E.MS35S.W94, FET060E.MS35P.F98, FET060E.MS35P.W94, FET080E.MS35P.F98, FET080E.MS35P.W94, FET100E.MS35P.F98, FET100E.MS35P.W94, FET060E.MS35S.F97, FET080E.MS35S.F97, FET060E.MS35P.F97, FET060E.MS35P.H97, FET080E.MS35P.F97, FET080E.MS35P.H97, FET100E.MS35P.F97, FET100E.MS35P.H97...(Other models you can see in the webshop)		
spare parts for	691203		
	GEV No.	691614	Ref. No. —
repair kit for lid hinge load capacity 50-60NM			

10.82



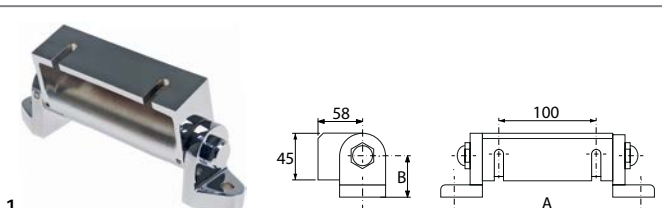

GEV No.	692652	Ref. No.	OG3736
description	lid hinge type 1082 level of centre of rotation 35mm load capacity 70-100NM opening angle 72° closing angle 10° mounting distance 220mm bore ø 11mm MD lid 100mm chrome-plated brass		
For models:	BOT060G.MS25.H97, KU5HOEOOOO, BOT060G.MS25.F98, BOT060G.MS25.W94, BOT080G.MS25.F98, BOT080G.MS25.W94, BOT100G.MS25.F98, BOT100G.MS25.W94, BOT150G.MS25.F18, BOT150G.MS25.W14, BOT060G.MS25.F97, BOT100G.MS25.F97, BOT150G.MS25.F17		

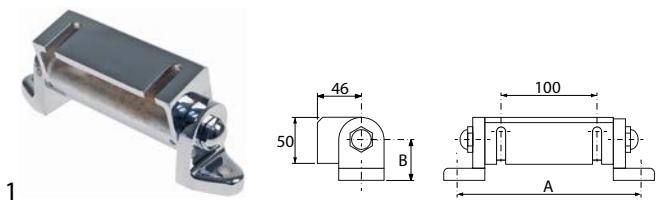

GEV No.	691204	Ref. No.	OH9913 OK5248 OK8861 16045137 19000772 69108245775
description	lid hinge type 1082 level of centre of rotation 35mm load capacity 70-100NM opening angle 75° closing angle 10° mounting distance 220mm bore ø 11mm MD lid 100mm chrome-plated brass		
For models:	FET060E.MS35P.F88, FET060E.MS35P.W84, FET060E.MS35S.F88, FET080E.MS35P.F88, FET080E.MS35P.W84, FET080E.MS35S.W84, FET100E.MS35P.F88, FET100E.MS35P.W84, FET100E.MS35S.F97, FET060E.MS35S.W84, FET080E.MS35S.F88, FET100E.MS35S.F88, FET100E.MS35S.W84, GPWBOEOOBO, GPXBOEOOBO, GPYBOEOO BO, GPWCOEOOBO, GPXCOEOOBO, GPYCOEOOBO, GPWEOEOOBO, GPXEOEOOBO, GPYEOEOOBO, FET060E.MS35S.F98, FET060E.MS35S.W94, FET080E.MS35S.F98, FET080E.MS35S.W94, FET100E.MS35S.F98, FET100E.MS35S.W94, FET060E.MS35P.F98, FET060E.MS35P.W94, FET080E.MS35P.F98, FET080E.MS35P.W94, FET100E.MS35P.F98, FET100E.MS35P.W94, FET060E.MS35S.F97, FET080E.MS35S.F97, FET060E.MS35P.F97, FET060E.MS35P.H97, FET080E.MS35P.F97, FET080E.MS35P.H97, FET100E.MS35P.F97, FET100E.MS35P.H97		
spare parts for	691204		
	GEV No.	691615	Ref. No. —
repair kit for lid hinge load capacity 70-100NM			

10.86



GEV No.	693236	Ref. No.	OK2585 69108640375
description	lid hinge type 6910.86 level of centre of rotation 40mm load capacity 20-30NM opening angle 75° closing angle 10° mounting distance 198mm bore ø 11mm MD lid 100mm chrome-plated brass		
spare parts for	693236		
	GEV No.	691612	Ref. No. —
repair kit for lid hinge load capacity 20-30NM			



GEV No.	693238	Ref. No.	0K2594 69108665375
description	lid hinge type 6910.86 level of centre of rotation 65mm load capacity 20-30NM opening angle 75° closing angle 10° mounting distance 198mm bore ø 11mm MD lid 100mm chrome-plated brass		
For models:	7575-5.KES250, 7576-5.KES300, 7573-5.KES100, 7573-3/85.KES100.(N), 7574-3/85.KES150.(N), 7575-3/85.KES250.(N), 7576-3/85.KES300.(N), 7573-3/90.KES100.(N), 7574-3/90.KES150.(N), 7575-3/90.KES250.(N), 7576-3/90.KES300.(N), 7573-5/85.KES100.(N), 7575-5/85.KES250.(N), 7576-5/85.KES300.(N), 7573-3/85.KES100.(N), 7574-3/85.KES150.(N), 7575-3/85.KES250.(N), 7576-3/85.KES300.(N), 7573-2, 7574-2, 7575-2, 7576-2, 7573-3, 7574-3, 7575-3, 7576-3, 7573-5, 7574-5, 7575-5, 7576-5, 7573-3/90.KES100.(N), 7574-3/90.KES150.(N), 7575-3/90.KES250.(N), 7576-3/90.KES300.(N), 7773-2, 7774-2, 7775-2, 7776-2, 7773-3, 7774-3, 7775-3, 7776-3, 7773-5, 7774-5, 7775-5, 7776-5, 7773-3/85.KES100, 7773-3/90.KES100, 7773-5, 7773-5/85.KES100.(N), 7774-2, 7774-3, 7774-3/85.KES150, 7774-3/90.KES150, 7775-2, 7775-3, 7775-3/85.KES250, 7775-3/90.KES250, 7775-5, 7775-5/85.KES250.(N), 7775-5/90.KES250.(N), 7776-2, 7776-3, 7776-3/85.KES300, 7776-3/90.KES300...(Other models you can see in the webshop)		
spare parts for	693238		
	GEV No.	691612	Ref. No. —
repair kit for lid hinge load capacity 20-30NM			

GEV No.	693239	Ref. No.	0K2595 69108665575
description	lid hinge type 6910.86 level of centre of rotation 65mm load capacity 30-50NM opening angle 75° closing angle 10° mounting distance 198mm bore ø 11mm MD lid 100mm chrome-plated brass		
For models:	7574-5.KES150, 7576-5.KES300, 7573-5.KES100, 7576-3/85.KES300.(N), 7576-3/90.KES300.(N), 7573-5/85.KES100.(N), 7574-5/85.KES150.(N), 7576-5/85.KES300.(N), 7573-5/90.KES100.(N), 7574-5/90.KES150.(N), 7576-5/90.KES300.(N), 7573-2, 7574-5, 7575-2, 7576-2, 7576-3, 7576-5, 7577-3, 7773-2, 7774-5, 7774-5/85.KES150.(N), 7774-5/90.KES150.(N), 7775-2, 7776-2, 7776-3, 7776-3/85.KES300, 7776-3/90.KES300, 7776-5, 7776-5/85.KES300.(N), 7776-5/90.KES300.(N)		
spare parts for	693239		
	GEV No.	691613	Ref. No. —
repair kit for lid hinge load capacity 30-50NM			

ELECTROLUX

spare parts

GEV No.	693310	Ref. No.	059865
description	adjusting bush		
For models:	KPI/G10, KPI/G15, KPI/E10, KPI/E15, HPN/GI810, HPN/GI815, HPN/GI815D, HPN/GI816, HPN/GI816, HPN/EI815D, HPN/EI810, HPN/EI815, HPN/GD811, HPN/GD816, HPN/ED811, HPN/ED816, HPNS/GI816, HPNS/EI815, HPNS/EI815D, HPN/GI806, HPN/EI806, HPN/GI805, HPN/EI805, QPI/G10, QPI/G10H, ZPN/GI816D, HPN/ED825, HPN/EI825, ZPN/GI805, ZPN/EI805, WPI/G10, WPI/E10, WPI/E15, APN/GI810, APN/GI815, APN/GI816, APN/GI816D, APN/EI815D, APN/EI810, APN/EI815, APN/GD811, APN/GD816, APN/ED816, APNS/GI816, APNS/EI815, OPN/GI815, APN/GI805, APN/EI805		

GEV No.	701215	Ref. No.	002983
description	adjusting bush D1 ø 47mm D2 ø 45mm L 77mm		
For models:	KPD/G10, KPD/G15, KPD/G15A, KPI/G15A, KPI/E15A, KPI/G06, KPI/E06, KPI/G15H, KPI/E15H, KPI/E10H, HPA/GD825, HPA/GI825, HPA/ED825, HPA/EI825, QPI/G15, QPI/E10, QPI/E15, QPD/G10, QPD/G15, QPI/G06, QPI/E06, QPI/G15H, QPI/E15H, QPI/E10H, ZPN/GI810, 2PIG15, ZPN/GI816, ZPN/EI815D, ZPN/EI810, ZPN/EI815, ZPN/GD811, ZPN/GD816, ZPN/ED811, ZPN/ED816, 2PDAG15, 2PIAG15, ZPNS/GI816, ZPNS/EI815, ZPNS/EI815D, WPI/G15, WPD/G10, WPD/G15, WPD/G15A, WPI/G15A, WPI/E15A, WPI/G06, WPI/E06, WPI/G15H, WPI/E15H, WPI/E10H		



1

GEV No.	701216	Ref. No.	002982
description	adjusting bush ø 47mm L 40mm		
For models:	KPD/G10, KPD/G15, KPD/G15A, KPI/G15A, KPI/E15A, KPI/G06, KPI/E06, KPI/G15H, KPI/E15H, KPI/E10H, HPA/GD825, HPA/GI825, HPA/ED825, HPA/EI825, QPI/G15, QPI/E10, QPI/E15, QPD/G10, QPD/G15, QPI/G06, QPI/E06, QPI/G15H, QPI/E15H, QPI/E10H, ZPN/GI810, 2PIG15, ZPN/GI816, ZPN/EI815D, ZPN/EI810, ZPN/EI815, ZPN/GD811, ZPN/GD816, ZPN/ED811, ZPN/ED816, 2PDAG15, 2PIAG15, ZPNS/GI816, ZPNS/EI815, ZPNS/EI815D, WPI/G15, WPD/G10, WPD/G15, WPD/G15A, WPI/G15A, WPI/E15A, WPI/G06, WPI/E06, WPI/G15H, WPI/E15H, WPI/E10H		



1

GEV No.	693298	Ref. No.	052892
description	bracket left		
For models:	MPN/GD761, MPN/GI761, MPN/GI760D, MPN/GD760, MPN/GD760F, MPN/GI760, MPN/GI760F, MPN/EI760, MPNEI760UK, MPN/V760, MPN/EI760D, MPN/V760D, 7PDG06, 7PIG06, 7PIE06, RPN/EI760UK, RPN/GD760F, RPN/GI760F, 7PEV06, RPN/EI760D, M70GDKE, M70EIKE, XPN/EI760UK, M70VIKE, XPN/GD760F, XPN/EI760D, RPNV740, RPN/G760, RPN/G760, PRPN/G760, RPN/GI760, RPN/GI760, RPN/GI760, PRPN/GI76, RPN/EI760, RPN/EI760, RPNV760, RPN/G760, PRPN/GI76, RPN/EI760, RPN/V740, RPN/V760		



2

GEV No.	693302	Ref. No.	004849
description	bracket		
For models:	RPD/G240, RPD/G260, RPI/G260, RPI/E240, RPI/E260, RPI/G260P, RPI/E260P, XPD/G240, XPD/G260, XPI/G260, XPI/E240, XPI/E260, XPI/G260P, XPI/E260P, JPD/G240, JPD/G260, JPI/G260, JPI/E240, JPI/E260, MPD/G240, MPD/G260, MPI/G260, MPI/E240, MPI/E260, MPI/G260P, MPI/E260P		



1

GEV No.	693301	Ref. No.	052891
description	bracket right		
For models:	MPN/GD761, MPN/GI761, MPN/GI760D, MPN/GD760, MPN/GD760F, MPN/GI760, MPN/GI760F, MPN/EI760, MPNEI760UK, MPN/V760, MPN/EI760D, MPN/V760D, 7PDG06, 7PIG06, 7PIE06, RPN/EI760UK, RPN/GD760F, RPN/GI760F, 7PEV06, RPN/EI760D, XPN/GI760D, M70GDKE, M70GIKE, M70EIKE, XPN/EI760UK, M70VIKE, XPN/GD760F, XPN/GI760F, XPN/EI760D, RPNV740, RPN/G760, RPN/G760, PRPN/G760, RPN/GI760, RPN/GI760, RPN/GI760, PRPN/GI76, RPN/EI760, RPN/EI760, RPN/V760, RPN/G760, PRPN/GI76, RPN/EI760, RPN/V740, RPN/V760		



1

GEV No.	693307	Ref. No.	002944
description	bracket for kettle type series 900		
For models:	KPI/G10, KPI/G15, KPI/E10, KPI/E15, KPD/G10, KPD/G15, KPD/G15A, KPI/G15A, KPI/E15A, KPI/G15H, KPI/E15H, KPI/G10H, KPI/E10H, HPN/GI810, HPN/GI815, HPN/GI816, HPN/EI815D, HPN/EI810, HPN/EI815, HPN/GD811, HPN/GD816, HPN/ED811, HPN/ED816, HPA/GD825, HPA/GI825, HPA/ED825, HPA/EI825, HPNS/GI816, HPNS/EI815, HPNS/EI815D, QPI/G10, QPI/G15, QPI/E10, QPI/E15, QPD/G10, QPD/G15, QPI/G15H, QPI/E15H, QPI/G10H, QPI/E10H, ZPN/GI810, 2PIG15, ZPN/GI816, ZPN/EI815D, ZPN/EI810, ZPN/EI815, ZPN/GD811, ZPN/GD816, ZPN/ED811, ZPN/ED816...(Other models you can see in the webshop)		



1

GEV No.	693306	Ref. No.	002106 051288
description	bracket right		
For models:	HBR/G820, HBR/G825, HBR/E820, HBR/E825, HBR/G821UK, HCPA/G1219, HCPA/GI1219, ZBR/E820, ZBR/E825, ZBR/G821, ZBR/G826, ZCPAG1219, ZCPA/GI1219, ABR/G820, ABR/G825, ABR/E820, ABR/E825, HCPA/G1219, HCPA/GI1219, HCPA/V1219, HCPA/EI1219, HQN/G1917, HQN/GI917, HQN/G1225, HQN/GI1225, HQN/EI917, HQN/GI122, HQN/V917, HPN/G810, HQN/EI1225, HPN/GI810, HPN/GI810, HPN/G815, HPA/G815, HPN/E810, HPN/GI815, HPA/GI815, HPN/EI810, HPA/GI815, HPN/E815, HPN/EI810, HPA/EI810, HPN/GI810, HBR/G803, HBR/G804, HBR/G803, HBR/G804, HBR/G803, HBR/G805, HBR/G1003...(Other models you can see in the webshop)		



			
1			
GEV No.	693309	Ref. No.	059863
description	brake		
For models:	KPI/G10, KPI/G15, KPI/E10, KPI/E15, HPN/GI810, HPN/GI815, HPN/GI815D, HPN/GI816, HPN/GI816, HPN/EI815D, HPN/EI810, HPN/EI815, HPN/GD811, HPN/GD816, HPN/ED811, HPN/ED816, HPNS/GI816, HPNS/EI815, HPNS/EI815D, HPN/GI806, HPN/EI806, HPN/GI805, HPN/EI805, QPI/G10, QPI/G10H, ZPN/GI816D, HPN/ED825, HPN/EI825, ZPN/GI805, ZPN/EI805, WPI/G10, WPI/E10, WPI/E15, APN/GI810, APN/GI815, APN/GI816, APN/GI816D, APN/EI815D, APN/EI810, APN/EI815, APN/GD811, APN/GD816, APN/ED816, APNS/GI816, APNS/EI815, OPN/GI815, APN/GI805, APN/EI805		

			
1			
GEV No.	693300	Ref. No.	052897
description	bush		
For models:	MPN/GD761, MPN/GI761, MPN/GI760D, MPN/GD760, MPN/GD760F, MPN/GI760, MPN/GI760F, MPN/EI760, MPNEI760UK, MPN/V760, MPN/EI760D, MPN/V760D, 7PDG06, 7PIG06, 7PIE06, RPN/EI760UK, RPN/GD760F, RPN/GI760F, 7PEV06, RPN/EI760D, XPN/GI760D, M70GDKE, M70GIKE, M70EIKE, XPN/EI760UK, M70VIKE, XPN/GD760F, XPN/GI760F, XPN/EI760D, RPNV740, RPN/G760, RPN/G760, PRPN/G760, RPN/GI760, RPN/GI760, PRPN/GI76, RPN/EI760, RPN/EI760, RPNV760, RPN/G760, PRPN/GI76, RPN/EI760, RPN/V740, RPN/V760		

			
1			
GEV No.	693308	Ref. No.	059864
description	bush		
For models:	KPI/G10, KPI/G15, KPI/E10, KPI/E15, KPD/G10, KPD/G15, KPD/G15A, KPI/G15A, KPI/E15A, KPI/G06, KPI/E06, KPI/G15H, KPI/E15H, KPI/G10H, KPI/E10H, HPN/GI810, HPN/GI815, HPN/GI815D, HPN/GI816, HPN/GI816, HPN/EI815D, HPN/EI810, HPN/EI815, HPN/GD811, HPN/GD816, HPN/ED811, HPN/ED816, HPA/GD825, HPA/GI825, HPA/ED825, HPA/EI825, HPNS/GI816, HPNS/EI815, HPNS/EI815D, HPN/GI806, HPN/EI806, HPN/GI805, HPN/EI805, QPI/G10, QPI/G15, QPI/E10, QPI/E15, QPD/G10, QPD/G15, QPI/G06, QPI/E06, QPI/G15H, QPI/E15H, QPI/G10H, QPI/E10H...(Other models you can see in the webshop)		

			
1			
GEV No.	693312	Ref. No.	059859
description	countersunk screw thread M6		
For models:	KPI/G10, KPI/G15, KPI/E10, KPI/E15, KPD/G10, KPD/G15, KPD/G15A, KPI/G15A, KPI/E15A, KPI/G06, KPI/E06, KPI/G15H, KPI/E15H, KPI/G10H, KPI/E10H, HPN/GI810, HPN/GI815, HPN/GI815D, HPN/GI816, HPN/GI816, HPN/EI815D, HPN/EI810, HPN/EI815, HPN/GD811, HPN/GD816, HPN/ED811, HPN/ED816, HPA/GD825, HPA/GI825, HPA/ED825, HPA/EI825, HPNS/GI816, HPNS/EI815, HPNS/EI815D, HPN/GI806, HPN/EI806, HPN/GI805, HPN/EI805, QPI/G10, QPI/G15, QPI/E10, QPI/E15, QPD/G10, QPD/G15, QPI/G06, QPI/E06, QPI/G15H, QPI/E15H, QPI/G10H, QPI/E10H...(Other models you can see in the webshop)		

			
1			
GEV No.	693311	Ref. No.	059860
description	cylinder head bolt thread M6 thread L 15mm SS Qty 1 pcs intake slotted		
For models:	KPI/G10, KPI/G15, KPI/E10, KPI/E15, KPD/G10, KPD/G15, KPD/G15A, KPI/G15A, KPI/E15A, KPI/G06, KPI/E06, KPI/G15H, KPI/E15H, KPI/G10H, KPI/E10H, HPN/GI810, HPN/GI815, HPN/GI815D, HPN/GI816, HPN/GI816, HPN/EI815D, HPN/EI810, HPN/EI815, HPN/GD811, HPN/GD816, HPN/ED811, HPN/ED816, HPA/GD825, HPA/GI825, HPA/ED825, HPA/EI825, HPNS/GI816, HPNS/EI815, HPNS/EI815D, HPN/GI806, HPN/EI806, HPN/GI805, HPN/EI805, QPI/G10, QPI/G15, QPI/E10, QPI/E15, QPD/G10, QPD/G15, QPI/G06, QPI/E06, QPI/G15H, QPI/E15H, QPI/G10H, QPI/E10H...(Other models you can see in the webshop)		

			
1			
GEV No.	693305	Ref. No.	034209 0A2612 728035
description	spanner		
For models:	RPD/G240, RPD/G260, RPI/G260, RPI/E240, RPI/E260, RPI/G260P, RPI/E260P, XPD/G240, XPD/G260, XPI/G260, XPI/E240, XPI/E260, XPI/G260P, XPI/E260P, JPD/G240, JPD/G260, JPI/G260, JPI/E240, JPI/E260, MPD/G240, MPD/G260, MPI/G260, MPI/E240, MPI/E260, MPI/G260P, MPI/E260P, PPD/G260, PPI/G260P, PPI/E260P, OPD/G260, OPI/G260P, OPI/E260P, TPD/G260, TPI/G260P, TPI/E260P, HFR/G410, HFR/G810, HFR/G410D, HFR/G810D, HFR/G410NL, HFR/G810NL, HFR/E410, HFR/E810, HFR/G411, HFR/E411, HFR/E412, HFR/G412, HFR/E418, HFR/E818, ZFR/G410...(Other models you can see in the webshop)		



GEV No.	693299	Ref. No.	052894 0K2934
description	torsion spring ø 28.6mm L2 103mm wire gauge ø 3.6mm L1 45mm		
For models:	MPN/GD761, MPN/GI761, MPN/GI760D, MPN/GD760, MPN/GD760F, MPN/GI760, MPN/GI760F, MPN/EI760, MPNEI760UK, MPN/V760, MPN/EI760D, MPN/V760D, 7PDG06, 7PIG06, 7PIE06, RPN/EI760UK, RPN/GD760F, RPN/GI760F, 7PEV06, RPN/EI760D, XPN/GI760D, M70GDKE, M70GIKE, M70EIKE, XPN/EI760UK, M70VIKE, XPN/GD760F, XPN/GI760F, XPN/EI760D, RPNV740, RPN/G760, RPN/G760, PRPN/G760, RPN/GI760, RPN/GI760, RPN/GI760, PRPN/GI76, RPN/EI760, RPN/EI760, RPNV760, RPN/G760, PRPN/GI76, RPN/EI760, RPN/V740, RPN/V760		



GEV No.	693313	Ref. No.	051527
description	torsion spring ø 38.1mm wire gauge ø 6.2mm L1 19mm L2 212mm L3 19mm		
For models:	HPN/G810, HPN/GI810, HPN/GI810, HPN/G815, HPA/G815, HPN/E810, HPN/GI815, HPA/GI815, HPN/EI810, HPA/GI815, HPN/E815, HPN/EI810, HPA/EI810, HPN/GI810, HPN/G810, HPN/G815, HPA/G815, HPN/GI810, HPN/GI815, HPN/GI815, HPN/E810, HPN/E815, HPN/EI810, HPN/EI810, HPA/EI815		



GEV No.	693316	Ref. No.	059518
description	torsion spring ø 38.2mm wire gauge ø 6.2mm L1 33mm L2 320mm L3 24mm		
For models:	KPI/G10, KPI/G15, KPI/E10, KPI/E15, KPD/G10, KPD/G15, KPI/G06, KPI/E06, KPI/G15H, KPI/E15H, KPI/G10H, KPI/E10H, HPN/GI810, HPN/GI815, HPN/GI815D, HPN/GI816, HPN/GI816, HPN/EI815D, HPN/EI810, HPN/EI815, HPN/GD811, HPN/GD816, HPN/ED811, HPN/ED816, HPNS/GI816, HPNS/EI815, HPNS/EI815D, HPN/GI806, HPN/EI806, HPN/GI805, HPN/EI805, QPI/G10, QPI/G15, QPI/E10, QPI/E15, QPD/G10, QPD/G15, QPI/G06, QPI/E06, QPI/G15H, QPI/E15H, QPI/G10H, QPI/E10H, ZPN/GI816D, HPN/ED825, HPN/EI825, ZPN/GI805, ZPN/EI805, WPI/G10, WPI/G15...(Other models you can see in the webshop)		



GEV No.	693315	Ref. No.	002981 003643
description	torsion spring ø 39mm wire gauge ø 7.1mm L1 31mm L2 322mm L3 23mm		
For models:	KPD/G15A, KPI/G15A, KPI/E15A, BRN70G, BRN70E, CRN22G, CRN/20G, CRN30G, CRN15G, CRN15V, CRN15E, HPA/GD825, HPA/GI825, HPA/ED825, HPA/EI825, HCPA/G1219, HCPA/GI 1219, CR20V, CR20EI, CR22G, BRN/70GZ, BRN/70EZ, CRN/22GZ, CRN20GZ, CRN30GZ, CRN15GZ, CRN15V-Z, CRN15EZ, ZPN/GI810, 2PIG15, ZPN/GI816, ZPN/EI815D, ZPN/EI810, ZPN/EI815, ZPN/GD811, ZPN/GD816, ZPN/ED811, ZPN/ED816, 2PDAG15, 2PIAG15, ZPNS/GI816, ZPNS/EI815, ZPNS/EI815D, ZCPAG1219, ZCPA/GI 1219, CR20V, CR20EI, CR22G, BR80GZ, BR80EZ...(Other models you can see in the webshop)		



GEV No.	693304	Ref. No.	004850
description	torsion spring wire gauge ø 4mm L1 7mm L2 101mm L3 7mm ø 28.6mm		
For models:	RPD/G240, RPD/G260, RPI/G260, RPI/E240, RPI/E260, RPI/G260P, RPI/E260P, XPD/G240, XPD/G260, XPI/G260, XPI/E240, XPI/E260, XPI/G260P, XPI/E260P, JPD/G240, JPD/G260, JPI/G260, JPI/E240, JPI/E260, MPD/G240, MPD/G260, MPI/G260, MPI/E240, MPI/E260, MPI/G260P, MPI/E260P, PPD/G260, PPI/G260P, PPI/E260P, OPD/G260, OPI/G260P, OPI/E260P, TPD/G260, TPI/G260P, TPI/E260P, LVA100B, LVA100Z, LVA100B, LVA100, LVA100-A, LVA/100-BU		

ICOS



GEV No.	514129	Ref. No.	008017 008071
description	adjusting bush L 100mm ø 70/60mm		
For models:	PV101, PV201, PV301, PV501, PVA101, PVA201, PVA301, PVA501, PV101, PV201, PV301, PV501, PVA101, PVA201, PVA301, PVA501		

miscellaneous

spare parts



Image not available

GEV No.	693233	Ref. No.	0K2584
description	lid hinge		



drain taps

brass

drain taps



GEV No.	548001	Ref. No.	002520 01303008 01312007 0G3669 0S0107 0S1037 11171264
description	drain tap 1 1/2" IT O-ring seal kettle connection with union nut A 80mm B1 68mm B2 132mm		
For models:	MPN/GD761, MPN/GI761, MPN/GD760, MPN/GI760, MPN/EI760, MPN-EI760UK, MPN/EI760D, RPD/G240, RPD/G260, RPI/G260, RPI/E240, RPI/E260, RPI/G260P, RPI/E260P, XPD/G240, XPD/G260, XPI/G260, XPI/E240, XPI/E260, XPI/G260P, XPI/E260P, JPD/G240, JPD/G260, JPI/G260, JPI/E240, JPI/E260, MPD/G240, MPD/G260, MPI/G260, MPI/E240, MPI/E260, MPI/G260P, MPI/E260P, 7PDG06, 7PIG06, 7PIE06, RPN/EI760UK, RPN/EI760D, XPN/GI760D, M70GDKE, M70GIKE, M70EIKE, XPN/EI760UK, XPN/GD760F, XPN/GI760F, XPN/EI760D, PPD/G260, PPI/G260P, PPI/E260P, OPD/G260...(Other models you can see in the webshop)		
spare parts for	548001		
	GEV No.	505092	Ref. No. 0C3142 34044796
	O-ring EPDM thickness 5.34mm ID ø 43.82mm Qty 1 pcs		
	GEV No.	540213	Ref. No. —
	handle ID ø 5mm L 117mm		



GEV No.	541673	Ref. No.	01332007
description	drain tap 1 1/2" IT with union nut conical seal		
spare parts for	541673		
	GEV No.	540213	Ref. No. —
	handle ID ø 5mm L 117mm		
	GEV No.	540956	Ref. No. —
	gasket for drain tap hose ext. ø 46mm ID ø 38mm H 2mm		

accessories for	541673		
	GEV No.	510404	Ref. No. 0E2240 0H2578 0H2612 0K6137 0K8703 0KG502 3427TJ1,5
	flat gasket fibre ED ø 44mm ID ø 34mm thickness 2mm Qty 1 pcs		
	GEV No.	890116	Ref. No. 0G1994 0KK505 0S0353 0S1145 11019107 400191 743000111 7CAR16925 7KLU1019700
	fitting grease FERMIT GLISSA tube 60g -20 up to +140°C approval complies with KTW recommendation		
	GEV No.	890118	Ref. No. 001019 0S0004 36200410
	fitting grease FERMIT GLISSA can 1000g -20 up to +140°C approval complies with KTW recommendation		
	GEV No.	890119	Ref. No. —
	fitting grease FERMIT GLISSA tube 30g -20 up to +140°C approval complies with KTW recommendation		



GEV No.	540275	Ref. No.	008027 01301009 01301109 01321009 053229 058362 0C4850 0KK154 0S0135 0S0285 0U1426 11171258 52005050
description	drain tap 2" IT with union nut A 90mm B 151mm B1 80mm chrome-plated brass		
For models:	KPI/G10, KPI/G15, KPI/E10, KPI/E15, KPD/G10, KPD/G15, KPD/G15A, KPI/G15A, KPI/E15A, KPI/G15H, KPI/E15H, KPI/G10H, KPI/E10H, CRN22G, CRN/20G, CRN30G, CRN15G, CRN15V, CRN15E, HPN/GI810, HPN/GI815, HPN/GI816, HPN/EI815D, HPN/EI810, HPN/EI815, HPN/GD811, HPN/GD816, HPN/ED811, HPN/ED816, HPA/GD825, HPA/GI825, HPA/ED825, HPA/EI825, HPNS/GI816, HPNS/EI815, HPNS/EI815D, HCPA/G1219, HCPA/GI 1219, CR20V, CR20EI, CR22G, QPI/G10, QPI/G15, QPI/E10, QPI/E15, QPD/G10, QPD/G15, QPI/G15H, QPI/E15H, QPI/G10H...(Other models you can see in the webshop)		
spare parts for	540275		
	GEV No.	540214	Ref. No. 054000 0S0287 34003012
	handle ID ø 6mm L 145mm		
accessories for	540275		
	GEV No.	529484	Ref. No. —
	flat gasket fibre ED ø 58mm ID ø 50mm thickness 2mm Qty 1 pcs		

Table continues overleaf

accessories for 540275			
	GEV No.	542448	Ref. No. —
gasket silicone 60x49x2 for drain tap 2"			





GEV No.	541860	Ref. No.	01302008 01322009 052882 050111 050950
----------------	--------	-----------------	--

description drain tap 2" IT with union nut conical seal A 95mm B1 75mm B2 155mm

For models: MPN/GI760D, RPN/GI760, APN/GI816D, HPN/GI810, HPA/GI815

spare parts for 541860

	GEV No.	540214	Ref. No.	054000 050287 34003012
handle ID ø 6mm L 145mm				

	GEV No.	540959	Ref. No.	—
gasket for drain tap hose ext. ø 60mm ID ø 50mm H 2mm				

accessories for 541860

	GEV No.	529484	Ref. No.	—
flat gasket fibre ED ø 58mm ID ø 50mm thickness 2mm Qty 1 pcs				



GEV No.	540296	Ref. No.	01304602 017215 050112 335104600
----------------	--------	-----------------	---

description drain tap ET M60x2mm chrome-plated brass

spare parts for 540296

	GEV No.	505092	Ref. No.	0C3142 34044796
O-ring EPDM thickness 5.34mm ID ø 43.82mm Qty 1 pcs				

	GEV No.	540213	Ref. No.	—
handle ID ø 5mm L 117mm				



GEV No.	540157	Ref. No.	01304783 01304785 052632 053159 057333 0K3445 0K3476 0S0138 10027 21159
----------------	--------	-----------------	--

description drain tap ET M78x3mm chrome-plated brass

For models: KPI/G18, KPI/G25, KPI/E25, HPN/GI855, HPN/GI1255, HPN/EI855, HPN/EI1255, QPI/G18, QPI/G25, QPI/E25, ZPN/GI1255, ZPN/EI1255, WPI/E25, HQN/G1917, HQN/G1917, HQN/G1225, HQN/GI1225, HQN/EI917, HQN/GI122, HQN/V917, HPN/G810, HQN/EI1225, HPN/GI810, HPN/G815, HPA/G815, HPN/E810, HPN/GI815, HPN/EI810, HPA/GI815, HPN/E815, HPN/EI810, HPA/EI810, HPN/GI810, HPN/G810, HPN/G815, HPA/G815, HPN/GI810, HPN/GI815, HPN/GI815, HPN/E810, HPN/E815, HPN/EI810, HPN/EI810, HPA/EI815, HQN/G1917, HQNEI817, HQN/V917, HQN/G1225, HQN/GI122, HQNEI122...(Other models you can see in the webshop)

spare parts for 540157

	GEV No.	540214	Ref. No.	054000 050287 34003012
handle ID ø 6mm L 145mm				

accessories

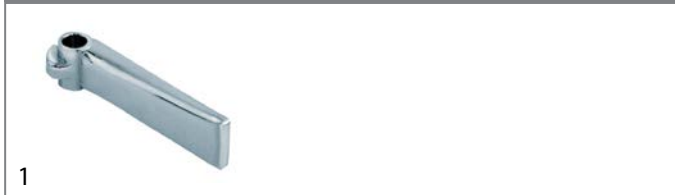

GEV No.	540082	Ref. No.	0K0311 0K1869 0K2137
----------------	--------	-----------------	----------------------------

description handle for drain tap L 110mm

For models: 7550-3, 7550-5, 7551-3, 7551-5, 7552-3, 7552-5, 7553-3, 7553-5, 7554-3, 7554-5, 7573-2, 7573-3, 7573-5, 7574-2, 7574-3, 7574-5, 7575-2, 7575-3, 7575-5, 7576-2, 7576-3, 7576-5, 7577-3, 7750-3, 7750-5, 7751-3, 7751-5, 7752-3, 7752-5, 7753-3, 7753-5, 7754-3, 7754-5, 7773-2, 7773-3, 7773-5, 7774-2, 7774-3, 7774-5, 7775-2, 7775-3, 7775-5, 7776-2, 7776-3, 7776-5, 9100-3, 9101-3, 9102-3, 9104-3, 9106-3...(Other models you can see in the webshop)



			
1			
GEV No.	540214	Ref. No.	054000 050287 34003012
description	handle ID ø 6mm L 145mm		
For models:	HCPA/G1219, HCPA/GI 1219, ZCPAG1219, ZCPA/GI 1219, HCPA/G1219, HCPA/GI1219, HCPA/V1219, HCPA/EI1219, CR15G, HFR/G1680, HFR/E1680, HFR/G2480, HFR/E2480, HCPA/G121, HCPA/G121		

			
1			
GEV No.	540119	Ref. No.	OK2487 OK3046
description	O-ring EPDM thickness 2.5mm ID ø 59mm Qty 1 pcs		
For models:	7574-5.KES150, 7575-5.KES250, 7576-5.KES300, 7573-5.KES100, 7573-3/85.KES100.(N), 7574-3/85.KES150.(N), 7575-3/85.KES250.(N), 7576-3/85.KES300.(N), 7573-3/90.KES100.(N), 7574-3/90.KES150.(N), 7575-3/90.KES250.(N), 7576-3/90.KES300.(N), 7573-5/85.KES100.(N), 7574-5/85.KES150.(N), 7575-5/85.KES250.(N), 7576-5/85.KES300.(N), 7573-5/90.KES100.(N), 7574-5/90.KES150.(N), 7575-5/90.KES250.(N), 7576-5/90.KES300.(N), 7773-3/85.KES100, 7773-3/90.KES100, 7773-5, 7773-5/85.KES100.(N), 7773-5/90.KES100.(N), 7774-3/85.KES150, 7774-3/90.KES150, 7774-5, 7774-5/85.KES150.(N), 7774-5/90.KES150.(N), 7775-3/85.KES250, 7775-3/90.KES250, 7775-5, 7775-5/85.KES250.(N), 7775-5/90.KES250.(N), 7776-3/85.KES300, 7776-3/90.KES300, 7776-5, 7776-5/85.KES300.(N), 7776-5/90.KES300.(N)		

			
1			
GEV No.	540222	Ref. No.	053809 OH6848 OK2958 OK3045 OTR613 68226012
description	O-ring EPDM thickness 2.62mm ID ø 47.3mm Qty 1 pcs		
For models:	FCFG101/0, FCFG102-0, FCFG201-0, FCFG202-0, FCFE101-0, FCFE102-0, FCFE201-0, FCFE202-0, FCF101ELN, FCFG10160H, FCF201ENS, FCFG102-0T, FCF/G101/1-1-JAP, FCF/G102/1-1-JAP, FCFE101-1J, FCFE102-1J, FCF/G101/1, FCFG6D, FCFE6D, FCFE6D, FCFG10, FCFG10D, FCFG10NL, FCFE10, FCFE10UK, FCFG20, FCFG20D, FCFG20F, PFCFG20, FCFE20, FCFE20UK, FCFG40, FCFG41, FCFG40D, FCFG40F, PFCFG40F, FCFE40, FCFE40D, FCFE40UK, PFCFE40F, FCFG6, FCFG6F, PFCFG6, FCFE6, FCFE6UK, PFCFE6, FCVE10, FCVE20, FCFE6J50, FCFE6J60... (Other models you can see in the webshop)		

			
1			
GEV No.	540083	Ref. No.	OK1469 OK1496 OK1500 OK3837 OK3839 OK5399 OKC410 OKF290 19003359 629140502 6722001
description	pressure bolt for drain tap		
For models:	7550-5.KES40, 7551-5.KES60, 7552-5.KES80, 7553-5.KES100, 7554-5.KES150, 7561-3.KES60.RW, 7562-3.KES80.RW, 7563-3.KES100.RW, 7564-3.KES150.RW, 7581-5.KK60, 7582-5.KK80, 7583-5.KK100, 7574-5.KES150, 7575-5.KES250, 7750-5.KES40, 7751-5.KES60, 7752-5.KES80, 7753-5.KES100, 7754-5.KES150, 7781-5.KK60, 7782-5.KK80, 7783-5.KK100, 7576-5.KES300, 7573-5.KES100, 7580-5.KK40, 7584-5.KK150, 7780-5.KK40, 7751-3/85.KES60, 7550-3/85.KES40.(N), 7551-3/85.KES60, 7552-3/85.KES80.(N), 7553-3/85.KES100.(N), 7554-3/85.KES150.(N), 7550-3/90.KES40.(N), 7551-3/90.KES60, 7552-3/90.KES80.(N), 7553-3/90.KES100.(N), 7554-3/90.KES150.(N), 7550-5/85.KES40.(N), 7551-5/85.KES60.(N), 7552-5/85.KES80.(N), 7553-5/85.KES100.(N), 7554-5/85.KES150.(N), 7550-5/90.KES40.(N), 7551-5/90.KES60.(N), 7552-5/90.KES80.(N), 7553-5/90.KES100.(N), 7554-5/90.KES150.(N), 7561-3/85.KES60.RW., 7562-3/85.KES80.RW...(Other models you can see in the webshop)		

steam traps

steam traps

			
1			
GEV No.	541356	Ref. No.	OH6413 1730015000 173015
description	thermostatic steam trap thread 1/2" 60-100°C type ST 1730		

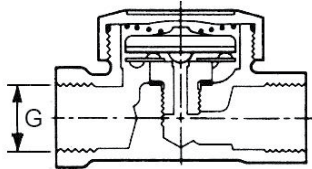

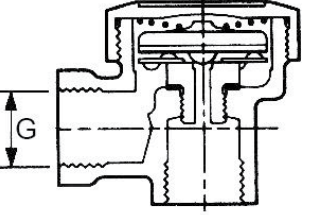

1

GEV No.	541461	Ref. No.	0H9965 0K5388 129487 19003297 3007500
description	thermostatic steam trap thread 1/2" type BPT13S brass		
For models:	ACSGRT, BOT080S.MH25.W94, BOT080S.MS25.W94, BOT100E.MS35.H97, BOT150S.MH25.F98, BOT150S.MH25.W94, BOT200S.MH25.F18, BOT200S.MH25.W14, BOT400E.MS35.W14, BOT400S.MH25.F18, BOT150E.MS35.H97, BOT040E.MS35.F88, BOT040S.MH25.F98, BOT040E.MS35.W84, BOT040S.MH25.W94, BOT060E.MS35.F88, BOT060S.MH25.F98, BOT060E.MS35.W84, BOT060S.MH25.W94, BOT080E.MS35.F88, BOT080S.MH25.F98, BOT080E.MS35.W84, BOT100S.MH25.F98, BOT100S.MH25.W94, BOT300S.MH25.F18, BOT300S.MH25.W14, BOT400E.MS35.F18, BOT400S.MS25.F18, BOT400S.MH25.W14, BOT400S.MS25.W14, BOT040E.MS35.F98, BOT040E.MS35.W94, BOT060E.MS35.F98, BOT060E.MS35.W94, BOT080E.MS35.F98, BOT080E.MS35.W94, BOT100E.MS35.F98, BOT100E.MS35.W94, BOT150E.MS35.F98, BOT150E.MS35.W94, BOT200E.MS35.F18, BOT200E.MS35.W14, BOT300E.MS35.F18, BOT300E.MS35.W14, BOT060S.MS35.F98, BOT060S.MS35.W94, BOT080S.MS35.F98, BOT080S.MS35.W94, BOT100S.MS35.F98, BOT100S.MS35.W94...(Other models you can see in the webshop)		

2

GEV No.	540994	Ref. No.	0H6537 1231220200 1231320200
description	thermostatic steam trap thread 3/4" type BPT13A brass		
For models:	7550-5.KES40, 7551-5.KES60, 7552-5.KES80, 7553-5.KES100, 7554-5.KES150, 7561-3.KES60.RW, 7562-3.KES80.RW, 7563-3.KES100.RW, 7564-3.KES150.RW, 7581-5.KK60, 7582-5.KK80, 7583-5.KK100, 7574-5.KES150, 7575-5.KES250, 7750-5.KES40, 7751-5.KES60, 7752-5.KES80, 7753-5.KES100, 7754-5.KES150, 7781-5.KK60, 7782-5.KK80, 7783-5.KK100, 7576-5.KES300, 7573-5.KES100, 7580-5.KK40, 7584-5.KK150, 7780-5.KK40, 7751-3/85.KES60, 7550-3/85.KES40.(N), 7551-3/85.KES60, 7552-3/85.KES80.(N), 7553-3/85.KES100.(N), 7554-3/85.KES150.(N), 7550-3/90.KES40.(N), 7551-3/90.KES60, 7552-3/90.KES80.(N), 7553-3/90.KES100.(N), 7554-3/90.KES150.(N), 7550-5/85.KES40.(N), 7551-5/85.KES60.(N), 7552-5/85.KES80.(N), 7553-5/85.KES100.(N), 7554-5/85.KES150.(N), 7550-5/90.KES40.(N), 7551-5/90.KES60.(N), 7552-5/90.KES80.(N), 7553-5/90.KES100.(N), 7554-5/90.KES150.(N), 7561-3/85.KES60.RW., 7562-3/85.KES80.RW...(Other models you can see in the webshop)		
spare parts for	540994		
	GEV No.	540219	Ref. No. —
	repair kit thread 1/2" -3/4" type BPT13		

safety fittings

safety fittings



1

GEV No.	514304	Ref. No.	059663 69354200
description	safety fitting thread 1" 0.5bar 140kg/h thread size manometer 1/2" chrome-plated H 188mm		
For models:	XPN/EI760D, HPN/EI815D, HPNS/EI815D, ZPN/EI815D, ZPNS/EI815D, APN/EI815D, APN/EI810, APN/EI815, APN/ED816, APNS/EI815		
spare parts for	514304		
	GEV No.	540322	Ref. No. —
	ball handle thread M8 ø 32mm with metal bush		



1







GEV No.	514381	Ref. No.	008019 01505006
description	safety fitting thread 1 1/4" 0.5bar angled 3kg		
For models:	PV101, PV201, PV301, PV501, PVA101, PVA201, PVA301, PVA501, PV101, PV201, PV301, PV501, PVA101, PVA201, PVA301, PVA501		
spare parts for	514381		
	GEV No.	514121	Ref. No. —
	safety valve triggering pressure 0.5bar with CE approval M88 thread 1 1/4"		
	GEV No.	540820	Ref. No. 010348 22805060
	fitting support thread 1 1/4" W 165mm		
	GEV No.	540827	Ref. No. 010023 01509004 050140 335234113
	aerator and air bleeder thread 3/4" ET chrome-plated L 45mm ø 36mm		
	GEV No.	540829	Ref. No. —
	manometer siphon thread 1/2"		
	GEV No.	540830	Ref. No. —
	pressure gauge tap IT 1/4" ET 1/4"		



Table continues overleaf



spare parts for		514381	
	GEV No.	541062	Ref. No.
			0H6487 0KC083 236116 9151915
manometer ø 63mm pressure range 0 up to 1bar connection marking adjustable kettle thread 1/4"			

accessories			
	1		
GEV No.	540820	Ref. No.	010348 22805060
description fitting support thread 1 1/4" W 165mm			

	1		
GEV No.	540822	Ref. No.	054808 0A2392 22805062
description fitting support thread 3/4"			
For models: MPN/GI761, MPN/GI760D, MPN/GI760, MPN/GI760F, MPN/EI760, MP-NEI760UK, MPN/V760, MPN/EI760D, MPN/V760D, RPI/G260, RPI/E240, RPI/E260, RPI/G260P, RPI/E260P, XPI/G260, XPI/E240, XPI/E260, XPI/G260P, XPI/E260P, JPI/G260, JPI/E240, JPI/E260, MPI/G260, MPI/E240, MPI/E260, MPI/G260P, MPI/E260P, 7PIG06, 7PIE06, RPN/EI760UK, RPN/GI760F, 7PEV06, RPN/EI760D, XPN/GI760D, M70GIKE, M70EIKE, XPN/EI760UK, M70VIKE, XPN/GI760F, XPN/EI760D, PPI/G260P, PPI/E260P, OPI/G260P, OPI/E260P, TPI/G260P, TPI/E260P, RPNV740, RPN/GI760, RPN/GI760, RPN/GI760...(Other models you can see in the webshop)			

	1		
GEV No.	540835	Ref. No.	027297 22906410
description screw cap thread 3/4"			
For models: MPN/GI761, MPN/GI760D, MPN/GI760, MPN/GI760F, MPN/EI760, MP-NEI760UK, MPN/V760, MPN/EI760D, MPN/V760D, RPI/G260, RPI/E240, RPI/E260, RPI/G260P, RPI/E260P, XPI/G260, XPI/E240, XPI/E260, XPI/G260P, XPI/E260P, JPI/G260, JPI/E240, JPI/E260, MPI/G260, MPI/E240, MPI/E260, MPI/G260P, MPI/E260P, 7PIG06, 7PIE06, RPN/EI760UK, RPN/GI760F, 7PEV06, RPN/EI760D, XPN/GI760D, M70GIKE, M70EIKE, XPN/EI760UK, M70VIKE, XPN/GI760F, XPN/EI760D, PPI/G260P, PPI/E260P, OPI/G260P, OPI/E260P, TPI/G260P, TPI/E260P, RPNV740, RPN/GI760, RPN/GI760, RPN/GI760...(Other models you can see in the webshop)			
spare parts for 540835			
	GEV No.	513016	Ref. No.
			027300 0L1277
O-ring EPDM thickness 3.53mm ID ø 26.58mm Qty 1 pcs			
accessories for 540835			
	GEV No.	513016	Ref. No.
			027300 0L1277
O-ring EPDM thickness 3.53mm ID ø 26.58mm Qty 1 pcs			

	1		
GEV No.	540828	Ref. No.	008023 0K3444 10023
description manometer siphon thread 3/8"			
For models: PV101, PV201, PV301, PV501, PVA101, PVA201, PVA301, PVA501, PV101, PV201, PV301, PV501, PVA101, PVA201, PVA301, PVA501, C150W, C300A, C300W, CB1565W, CB246W, CB416W, CB955W, DSS42W, C80W, CB1565A, C80A, CB246A, CB416A, C150A, CB955A, FRESHMAKER, ICEWATER45, ICEWATER45, DSS42A			

safety valves			
	1		
GEV No.	540721	Ref. No.	002312 003524 008020 056691 057493 0K3441 10020
description safety valve triggering pressure 0.5bar M88 thread 1 1/4"			
For models: KPI/G10, KPI/G15, KPI/E10, KPI/E15, KPI/G15A, KPI/E15A, KPI/G15H, KPI/E15H, KPI/G10H, KPI/E10H, CRN15V, HPN/GI810, HPN/GI815, HPN/GI816, HPN/EI810, HPN/EI815, HPA/GI825, HPA/EI825, HPN/GI855, HPN/GI1255, HPN/EI855, HPN/EI1255, HPNS/GI816, HPNS/EI815, HCPA/GI 1219, CR20V, CR20EI, QPI/G10, QPI/G15, QPI/E10, QPI/E15, QPI/G15H, QPI/E15H, QPI/G10H, QPI/E10H, CRN15V-Z, ZPN/GI810, 2PIG15, ZPN/GI816, ZPN/EI810, ZPN/EI815, 2PIAG15, ZPN/GI1255, ZPN/EI1255, ZPNS/GI816, ZPNS/EI815, ZCPA/GI 1219, CR20V, CR20EI, WPI/G10...(Other models you can see in the webshop)			
accessories for 540721			
	GEV No.	541501	Ref. No.
			—
reducer for safety fitting IT 1 1/4" ET 3/4"			

	1		
GEV No.	540722	Ref. No.	01506007 052623
description safety valve with outlet for lid			
For models: KPD/G15A, KPI/G15A, KPI/E15A, HPA/GD825, HPA/GI825, HPA/ED825, HPA/EI825, 2PDAG15, 2PIAG15, WPD/G15A, WPI/G15A, WPI/E15A, HPA/G815, HPA/GI815, HPA/EI810, HPA/G815, HPN/GI815, HPA/EI815			

			
1			
GEV No.	541357	Ref. No.	0H6302 851BG1/2
description	safety valve		

			
1			
GEV No.	541458	Ref. No.	OG0122 OK2987 OK5784 OK5785 19013244 19013245 610515106 75701101
description	safety valve T1: 1/2" T2: 1/2" triggering pressure 1.3bar		
For models:	VARIOTEAM/S-33.3/F, STEAM-O-MAT		

			
1			
GEV No.	514509	Ref. No.	077019013246 OG5631 OK5786
description	safety valve T1: 1/2" T2: 1/2" triggering pressure 1.7bar for kettle		
For models:	ACSGRT, GWACOE00RO, FWAAMO00RO, GWACOMO0RO, IWKCOE0000, HWAHOE00RO, GWAHOE0000, GWAHOE00RO, FWAHOE00RO, BEN150EW87, HWAJOE00RO, GWAJOE00RO, FWAJOE00RO, BEN200EW87, GWAJOMO0RO, FWFJOEX000, FWFJOEX0RO, BEN300E.S35.H97, GWAKOE00RO, FWAKOE00RO, IWAKOMO0RO, GWAKOMO0RO, FWFKOEX0RO, FWKKOE00RO, IWALOE0000, IWALOE00RO, BEN400E.S35.H97, BEN400EF97, FWALOE00RO, GWALOMO0RO, IVAAOE0000, HVAAOE00RO, GVAAOE0000, GVAAOE00RO, FVAAOE00RO, IVKAOE0000, FVKAOE00RO, HVABOE00RO, GVABOE0000, GVABOE00RO, FVABOE00RO, FVFB0EX0RO, IVKBOE0000, FVKBOE00RO, IVACOE00RO, BON080EF88, GVACOE00RO, FVACOE00RO, IVACOMO0RO, GVACOMO0RO...(Other models you can see in the webshop)		

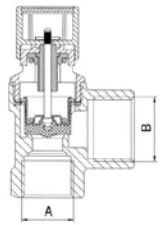
 			
1			
GEV No.	540915	Ref. No.	0H6534 610420001
description	safety valve T1: 3/4" T2: 1" triggering pressure 1.1bar 6104 R		
For models:	7561-3.KES60.RW, 7562-3.KES80.RW, 7563-3.KES100.RW, 7564-3.KES150.RW, 7751-3/85.KES60, 7550-3/85.KES40.(N), 7551-3/85.KES60, 7552-3/85.KES80.(N), 7553-3/85.KES100.(N), 7554-3/85.KES150.(N), 7550-3/90.KES40.(N), 7551-3/90.KES60, 7552-3/90.KES80.(N), 7553-3/90.KES100.(N), 7554-3/90.KES150.(N), 7561-3/85.KES60.RW, 7562-3/85.KES80.RW, 7563-3/85.KES100.RW, 7564-3/85.KES150.RW, 7561-3/90.KES60.RW, 7562-3/90.KES80.RW, 7563-3/90.KES100.RW, 7564-3/90.KES150.RW, 7573-3/85.KES100.(N), 7574-3/85.KES150.(N), 7575-3/85.KES250.(N), 7576-3/85.KES300.(N), 7573-3/90.KES100.(N), 7574-3/90.KES150.(N), 7575-3/90.KES250.(N), 7576-3/90.KES300.(N), 7585-3/85.KK40.MOTK., 7586-3/85.KK60.MOTK., 7587-3/85.KK80.MOTK., 7588-3/85.KK100.MOTK, 7585-3/90.KK40.MOTK., 7586-3/90.KK60.MOTL., 7587-3/90.KK80.MOTK., 7588-3/90.KK100.MOTK, 7550-2, 7550-3, 7551-2, 7551-3, 7552-2, 7552-3, 7553-2, 7553-3, 7554-3, 7560-3, 7561-3...(Other models you can see in the webshop)		

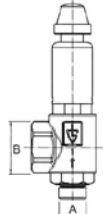
 			
1			
GEV No.	101977	Ref. No.	OG3876 185053
description	safety valve T1: 3/4" T2: 3/4" triggering pressure 0.65bar		

			
1			
GEV No.	514376	Ref. No.	0H6434 45037803
description	safety valve triggering pressure 1bar thread 1"-3/4"		

filters

grease filters

			
1			
GEV No.	970601	Ref. No.	0S0052
description	grease filter W 250mm H 400mm thickness 20mm SS outer grids 2 inner grids 3 for range hoods		



			
1			
GEV No.	970104	Ref. No.	0S0050
description	grease filter W 400mm H 400mm thickness 20mm SS layers 7 outer grids 2 inner grids 5 for range hoods		

			
1			
GEV No.	970100	Ref. No.	032271 0S0049 640060
description	grease filter W 500mm H 400mm thickness 20mm SS outer grids 2 inner grids 5 for range hoods		



			
1			
GEV No.	970602	Ref. No.	0H7138
description	grease filter W 520mm H 465mm thickness 20mm SS outer grids 2 inner grids 3 for range hoods		

air filters

			
1			
GEV No.	694183	Ref. No.	086562
description	air filter L 500mm W 500mm H 20mm		

accessories

fastening material

			
1			
GEV No.	693914	Ref. No.	054905 0F0156
description	spring clip for drain filter		
For models:	MCP/E700, MCP/G700, MCP/E700D, MCP/G701, MCP/G710, MCP/G711, MCP/G705, MCP/G706, RCP/G1S, RCP/G2D, RCP/E1S, RCP/E2D, RCP/E2S, XCP/G1S, XCP/G2D, XCP/E1S, XCP/E2D, JCP/G1S, JCP/G2D, JCP/E1S, JCP/E2D, MCP/E1SH, MCP/E1SUH, MCP/E2SUHS, MCP/G1S, MCP/G2D, MCP/E1S, MCP/E2D, MCP/E2S, MCP/E2SH, MCP/E2SUH, MCP/E2SUT, MCP/E2SHB, ACPG2S, 7CPE07P, 7CPG07P, RCP/G701, RCP/G706, M70EPC, M70GPC, M70GPC, XCP/G706, CCP/G700, CCP/E700, ECP/E1ELHU, PCP/G1S, PCP/G2D, PCP/E1S, PCP/E2D, PCP/E2SHP...(Other models you can see in the webshop)		
accessories for	693914		
	GEV No.	694000	Ref. No. 004836 11101347
	filter		

equipment feet and end caps

equipment feet

with screw mounting

			
1			
GEV No.	701012	Ref. No.	0H2317
description	equipment foot tube ø 50mm H 95-165mm plastic Qty 1 pcs WS 45		
For models:	CS7ME4/200-3, CS7ME4/230-3, CS7ME4/400-3N, CS7ME6/400-3N, CS7ME4/400-3N/EO, CS7ME4/400-3/50HZ/MA, CS7ME4/440-3/60HZ/MA, CS7MT4/400-3N, CS7GE4/200-3, CS7GE4/230-3, CS7GE4/400-3N, CS7GE6/400-3N, CS7GE4/400-3N/EO, CS7GE4/400-3/50HZ/MA, CS7GE4/440-3/60HZ/MA, CS7GT4/400-3N, CS7LCE4/200-3, CS7LCE4/230-3, CS7LCE4/400-3N, CS7LCE6/400-3N, CS7LCE4/400-3N/EO, CS7LCE4/400-3/50HZ/M, CS7LCE4/440-3/60HZ/M, CS7LCT4/400-3N, C7E4/200-3, C7E4/230-3, C7E4/400-3N, C7E6/400-3N, C7PE4/200-3, C7PE4/230-3, C7PE4/400-3N, C7PT4/400-3N, AR85, AR85, AR85, AR85, AR85, AR85, AR85, AR85, AR6ES, AR6ES, AR6ES, AR6ES, AR6ES, AR6ES, AR6ES, AR6ES, AR6ES, AR6ES, AR6ES...(Other models you can see in the webshop)		

components



1

GEV No.	700103	Ref. No.	053792
description	equipment foot tube ø 56mm plate size mm hole distance mm H 130mm SS size 2" Qty 1 pcs		
For models:	ICF110, ICP110, ICP111, ICP130, ICP112, ICF110, ICN110UK, ICF110, AP20, ILP111, ILP221, ILN111, ILNSO120, ILN221, ILNN120, ILNF120, TRN1301, TRNA1301, TRNM1301, TRRN1301, TRF1301, TRN1302, TRNA1302, TRNM1302, TRRN1302, TRN1303, TRNA1303, TRNM1303, TRRN1303, TRN1801, TRNA1801, ARNM1801, TRRN1801, TRF1801, TRN1802, TRNA1802, TRNM1802, TRRN1802, TRN1803, TRNA1803, TRNM1803, TRRN1803, TRN2201, TRNA2201, TRNM2201, TRRN2201, TRF2201, TRN2202, TRNA2202, TRNM2202...(Other models you can see in the webshop)		

with fixing plate



1

GEV No.	701618	Ref. No.	048579
description	equipment foot tube ø 64mm plate size 74x74mm hole distance 58mm H 153mm SS		
For models:	BC11, BC22, BC44H, BCF11, BCF22, BCF44H, AQC31U US, AQC60U, AQC119U US, BC28A6, Crosswise, BCF15A6, BCW061, BCW101, BCW102, BCFW061, BCFW101, BC11, BC22, BC44H, BCF11, BCF22, BCF44H, BCWS061T, BCFW102, BC11, BC22, BC44H, BCF11, BCF22, BCF44H, BCFWS102, BCFWS101, BC15A, Crosswise, BC28A, Crosswise, BC56VA, Crosswise 20, BC56HA, BCF15A, Crosswise, BCF28A, Crosswise, BCF64A, Crosswise 20...(Other models you can see in the webshop)		



1

GEV No.	701620	Ref. No.	0c4824
description	equipment foot tube ø 64mm plate size 74x74mm hole distance 58mm H 190-250mm SS		
For models:	FCZ201EAA, FCZ202EAA, FCZ201EAH, FCZ201EAN, FCZ201ETA, FCZ202ETA, FCZ201ETH, FCZ201ETN, FCZ201GAG, FCZ202GAG, FCZ201GAD, FCZ202GAD, FCZ201GTG, FCZ202GTG, FCZ201GTD, FCZ202GTD, FCZ201EBA, FCZ202EBA, FCZ201EBH, FCZ201EBN, FCZ201EBC, FCZ201EBA2, FCZ202EBA2, FCZ201EBH2, FCZ201EBN2, FCZ201EBC2, FCZ201GBG, FCZ202GBG, FCZ201GBD, FCZ202GBD, FCZ201GBI, FCZ201GBG2, FCZ202GBG2, FCZ201GBD2, FCZ202GBD2, FCZ201GBI2, FCZ201ECA, FCZ202ECA, FCZ201ECH, FCZ201ECN, FCZ201ECA2, FCZ202ECA2, FCZ201ECH2, FCZ201ECN2, FCZ201GCG, FCZ202GCG, FCZ201GCD, FCZ202GCD, FCZ201GCG2, FCZ202GCG2...(Other models you can see in the webshop)		



1

GEV No.	701106	Ref. No.	0A9138
description	equipment foot tube ø 64mm plate size 90x130mm H 130-230mm SS size 2" Qty 1 pcs		
For models:	BC44, BCF44, ALP110, ALP120, ALP111, ALP220, ALP240, ALP221, ALN110, ALN120, ALN111, ALN220, ALN240, ALN221, ALNN120, ALNN220, ALNN230, ALNSO120, ALP110UK, ALN110UK, ALNN220UK, ALF110, ALF220UK, ALNF220, ALF110, ALF120, ALF220, ALF240, ALNF120, ALNF220, ALNF230, ADN220ES, ADF110ES, ADF220ES, ADN110ESP, ADF110ESP, ILP110, ILP110UK, ILN120, ILP220, ILP220UK, ILP240, ILN110, ILN110UK, ILN120, ILN220, ILN220UK, ILN240, ILNN220, ILNN220UK...(Other models you can see in the webshop)		

components



1

GEV No.	700103	Ref. No.	053792
description	equipment foot tube ø 56mm plate size mm hole distance mm H 130mm SS size 2" Qty 1 pcs		
For models:	ICF110, ICP110, ICP111, ICP130, ICP112, ICF110, ICN110UK, ICF110, AP20, ILP111, ILP221, ILN111, ILNSO120, ILN221, ILNN120, ILNF120, TRN1301, TRNA1301, TRNM1301, TRRN1301, TRF1301, TRN1302, TRNA1302, TRNM1302, TRRN1302, TRN1303, TRNA1303, TRNM1303, TRRN1303, TRN1801, TRNA1801, ARNM1801, TRRN1801, TRF1801, TRN1802, TRNA1802, TRNM1802, TRRN1802, TRN1803, TRNA1803, TRNM1803, TRRN1803, TRN2201, TRNA2201, TRNM2201, TRRN2201, TRF2201, TRN2202, TRNA2202, TRNM2202...(Other models you can see in the webshop)		



bullet feet

zamak/SS



1

GEV No.	700112	Ref. No.	031921 032550 069311 069754 069815 0A3103
description	equipment foot pipe type 40x40 thickness 1mm H 33-60mm Zamak/SS Qty 1 pcs		
For models:	TG1000, TG1010, TG1200, TG1210, TG1400, TG1410, TG1600, TG1610, TG1800, TG1810, TG2000, TG2010, TG1000, TG1100, TG1200, TG1300, TG1400, TG1500, TG1600, TG1700, TG1800, TG1900, TG2000, TG1010, TG1110, TG1210, TG1310, TG1410, TG1510, TG1610, TG1710, TG1810, TG1910, TG2010, TLC1200S, TLC1210, TLC1800S, TL1410DX, TL1410SX, TL1810DX, TL1810SX, TLC1810, TLV1210, TLV1810, LG716, LG1225, LG1216DX, LG1216SX, LG1426, LG1416DX...(Other models you can see in the webshop)		

screw-in feet



1

GEV No.	694831	Ref. No.	0A8640
description	equipment foot thread M10 thread L 26mm ø 40mm H 13mm		
For models:	NEPV40, NICF40, NEPV40, NEPA40, NEPEV40, 400LTPVN, MRL402, E04P6VRVUK, E04P8SRVUK, MP402C, MP40060, NEPV40, NEPA40, NEPEV40, 400LTPVN, MP402, MP40260, NEPV40, EKE421S, EK401U, EK401UGT, EKE421GTS, ET401S, ET401SGT, RW24, EC406SGC, EC406SGV, 120.06.402, EP406SRC, EP406SRV, EP406VRC, EP406VRV, EN406VAC, EC406SGC, EC406SGV, EP406VAV, R04P6SRGB, 12006402.1, EP406SRC, EP406SRV, EP406VRC, EP406VRV, EN406VAC, EP406VAV, R04P6SRB, R04P6SWB, E04P6SRC, E04P6SRV, EP406VRC, E04P6VRV...(Other models you can see in the webshop)		



1

GEV No.	699395	Ref. No.	026806
description	equipment foot thread M6 thread L 17mm ø 18mm H 20mm		
For models:	RC/G320, RC/G330, RC/G320F, RC/G720, RC/G730, RC/E320, RC/E320U, RC/E720, RC/E720, MC/G355, MC/G350, MC/G355E, MC/G350D, MC/G355F, MC/G355NL, MC/G705, MC/G700, MC/G705E, MC/G700D, MC/G705NL, MC/G1055, MC/G1050, MC/E350D, MC/E350UK, MC/E700D, MC/E700UK, MC/E1050D, MC/G1050D, MC/G1055NL, MC/G705F, MC/E350, MC/E700, MC/E1050, MI/E350, MI/E700, MI/E350D, MI/E700D, MI/E360, MI/E710, MI/E360D, MI/E710D, MC/G352, MC/G702, MC/G1052, MC/G350, MC/G700, MC/G1050, MR/E350D, MR/E350UK, MR/E360...(Other models you can see in the webshop)		

end caps and plugs

for square pipes

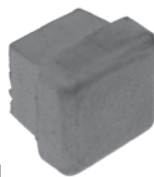

1

GEV No.	695068	Ref. No.	0U3305
description	end cap for ice maker insertion size 13x13mm		

DERBY RUOTE

with fixing plate

chrome-plated steel



1

GEV No.	701287	Ref. No.	0C2216
description	swivel castor ø 125mm plate fixing housing chrome-plated sheet steel plate size 95x70mm hole distance 70x50mm capacity 100kg bearing cup-and-cone bearing wheel body polypropylene tread TPE tyres H 162mm wheel width 30mm Qty 1 pcs		
For models:	FCZ202EAA, FCZ202ETA, FCZ202GAG, FCZ202GAD, FCZ202GTG, FCZ202GTD, FCZ202EBA, FCZ202EBA2, FCZ202GBG, FCZ202GBD, FCZ202GBG2, FCZ202GBD2, FCZ202ECA, FCZ202ECA2, FCZ202GCG, FCZ202GCD, FCZ202GCG2, FCZ202GCD2, AOS202GAEU, AOS202GAAU, AOS202EA2N, AOS202EB2N, AOS202EA, AOS202EB, AOS202GB, AOS202GA, AOS202EAAQ, AOS202EBAQ, AOS202EANQ, AOS202EBNQ, AOS202GAGQ, AOS202GBGQ, AOS202GADQ, AOS202GBDQ, AOS202GAPQ, AOS202EAA1, AOS202EAM1, AOS202EAB1, AOS202EAK1, AOS202EAT1, AOS202ETA1, AOS202ETM1, AOS202ETK1, AOS202GAG1, AOS202GAD1, AOS202GAP1, AOS202GAU1, AOS202GTG1, AOS202GTD1, AOS202GTP1...(Other models you can see in the webshop)		
accessories for	701287		
	GEV No.	701286	Ref. No.
			—
	description	swivel castor with swivel brake ø 125mm plate fixing housing chrome-plated sheet steel plate size 95x70mm hole distance 70x50mm capacity 100kg bearing cup-and-cone bearing wheel body polypropylene tread TPE tyres H 162mm wheel width 30mm Qty 1 pcs	



with bolt hole

chrome-plated steel



GEV No.	700200	Ref. No.	033657 F145D210023E
----------------	--------	-----------------	------------------------

description swivel castor ø 100mm bolt hole bolt hole ø 12mm housing chrome-plated sheet steel capacity 80kg bearing ball bearing wheel body polypropylene tread TPE tyres H 132mm wheel width 30mm Qty 1 pcs

For models: TG1000RL, TG1100RL, TG1200RL, TG1300RL, TG1400RL, TG1500RL, TG1600RL, TG1700RL, TG1800RL, TG1900RL, TG2000RL, TG1010RL, TG1110RL, TG1210RL, TG1210RL, TG1410RL, TG1510RL, TG1610RL, TG1710RL, TG1810RL, TG1910RL, TG2010RL, TG1000R, TG1100R, TG1200R, TG1300R, TG1400R, TG1500R, TG1600R, TG1700R, TG1800R, TG1900R, TG2000R, TG1010R, TG1110R, TG1210R, TG1310R, TG1410R, TG1510R, TG1610R, TG1710R, TG1810R, TG1910R, TG2010R, TLC1210H, TLC1810H, TLV1210, TLV1810H, TG1000P, TG1100...(Other models you can see in the webshop)



GEV No.	700207	Ref. No.	0E5373 OKB549 461208700 F135D7125.12
----------------	--------	-----------------	---

description swivel castor ø 125mm bolt hole bolt hole ø 12mm housing chrome-plated sheet steel capacity 100kg bearing ball bearing wheel body polypropylene tread TPE tyres H 159mm wheel width 30mm Qty 1 pcs

For models: CS10ME4/200-3, CS10ME4/230-3, CS10ME6/230-3, CS10ME4/400-3N, CS10ME6/400-3N, CS10ME4/400-3N/EO, CS10ME4/400-3/50HZ/M, CS10ME4/440-3/60HZ/M, CS10MT4/400-3N, CS10MT6/400-3N, CS10GE4/200-3, CS10GE4/230-3, CS10GE6/230-3, CS10GE4/400-3N, CS10GE6/400-3N, CS10GE4/400-3N/EO, CS10GE4/400-3/50HZ/M, CS10GE4/440-3/60HZ/M, CS10GT4/400-3N, CS10GT6/400-3N, CS10LCE4/200-3, CS10LCE4/230-3, CS10LCE6/230-3, CS10LCE4/400-3N, CS10LCE6/400-3N, CS10LCE4/400-3N/EO, CS10LCE4/400-3/50HZ/, CS10LCE4/440-3/60HZ/, CS10LCT4/400-3N, CS10LCT6/400-3N, CS20ME4/200-3, CS20ME4/230-3, CS20ME6/230-3, CS20ME4/400-3N, CS20ME6/400-3N, CS20ME4/400-3NE, CS20ME4/400-3, CS20ME4/440-3, CS20MT4/400-3N, CS20MT6/400-3N, CS20GE4/200-3, CS20GE4/230-3, CS20GE6/230-3, CS20GE4/400-3N, CS20GE6/400-3N, CS20GE4/400-3NE, CS20GE4/400-3, CS20GE4/440-3, CS20GT4/400-3N, CS20GT6/400-3N...(Other models you can see in the webshop)

stainless steel

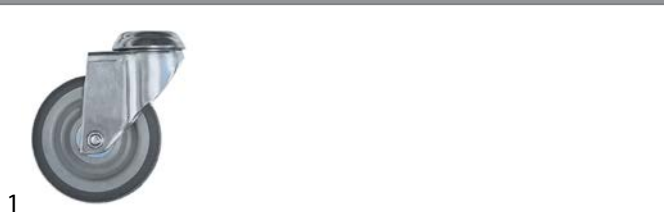

GEV No.	700222	Ref. No.	0S1427
----------------	--------	-----------------	--------

description swivel castor ø 125mm bolt hole bolt hole ø 12mm housing SS capacity 100kg bearing ball bearing wheel body polypropylene tread TPE tyres H 159mm wheel width 30mm Qty 1 pcs

with thread

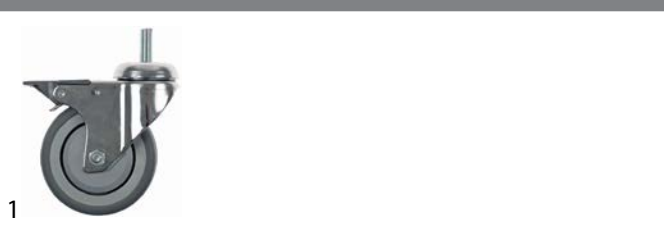

GEV No.	710012 ¹	Ref. No.	0C1631
----------------	---------------------	-----------------	--------

description swivel castor with swivel brake ø 100mm thread housing chrome-plated steel capacity 80kg spigot high 30mm spigot-ø M12mm bearing ball bearing wheel body polypropylene tread TPE tyres H 132mm wheel width 30mm -20 up to +60°C Qty 1 pcs

For models: FCZ201EAA, FCZ202EAA, FCZ201EAH, FCZ201EAN, FCZ201ETA, FCZ202ETA, FCZ201ETH, FCZ201ETN, FCZ201GAG, FCZ202GAG, FCZ201GAD, FCZ202GAD, FCZ201GTG, FCZ202GTG, FCZ201GTD, FCZ202GTD, FCZ201EBA, FCZ202EBA, FCZ201EBH, FCZ201EBN, FCZ201EBC, FCZ201EBA2, FCZ202EBA2, FCZ201EBH2, FCZ201EBN2, FCZ201EBC2, FCZ201GBG, FCZ202GBG, FCZ201GBD, FCZ202GBD, FCZ201GBI, FCZ201GBG2, FCZ202GBG2, FCZ201GBD2, FCZ202GBD2, FCZ201GBI2, FCZ201ECA, FCZ202ECA, FCZ201ECH, FCZ201ECN, FCZ201ECA2, FCZ202ECA2, FCZ201ECH2, FCZ201ECN2, FCZ201GCG, FCZ202GCG, FCZ201GCD, FCZ202GCD, FCZ201GCG2, FCZ202GCG2...(Other models you can see in the webshop)

¹with swivel brake



GEV No.	710025	Ref. No.	007107 0C1632
----------------	--------	-----------------	------------------

description swivel castor without brake ø 100mm thread housing chrome-plated steel capacity 80kg spigot high 30mm spigot-ø M12mm bearing ball bearing wheel body polypropylene tread TPE tyres H 132mm wheel width 30mm -20 up to +60°C Qty 1 pcs

For models: FCZ201EAA, FCZ201EAH, FCZ201EAN, FCZ201ETA, FCZ201ETH, FCZ201ETN, FCZ201GAG, FCZ201GAD, FCZ201GTG, FCZ201GTD, FCZ201EBA, FCZ201EBH, FCZ201EBN, FCZ201EBC, FCZ201EBA2, FCZ201EBH2, FCZ201EBN2, FCZ201EBC2, FCZ201GBG, FCZ201GBD, FCZ201GBI, FCZ201GBG2, FCZ201GBD2, FCZ201GBI2, FCZ201ECA, FCZ201ECH, FCZ201ECN, FCZ201ECA2, FCZ201ECH2, FCZ201ECN2, FCZ201GCG, FCZ201GCD, FCZ201GCG2, FCZ201GCD2, CL221, AOS201GAEU, AOS201GAU, AOS201EABU, AOS201EAFU, AOS201EA, AOS201EB, AOS201EA3J, AOS201EB3J, AOS201EA2N, AOS201EB2N, AOS201EB5M, AOS201EB6M, AOS201EA0H, AOS201EB0H, AOS201GA...(Other models you can see in the webshop)



miscellaneous

with bolt hole

ø125mm



1

GEV No.	710005	Ref. No.	OK6717 461208704
description	swivel castor with swivel brake ø 125mm bolt hole ø10.5/13mm housing zinc-plated sheet steel capacity 100kg wheel width 30mm MANNER		
For models:	HCCS20W, HCCS20W, LOR, LOT440, LOT470, BUF8W, BUF12W, BUF81W, BUF121W, BUF8S, BUF12S, BUF8L, BUF12L, BUF8BM, BUF12BM, BUF8ROT, BUF12WOT, BUF81WOT, BUF121WOT, BUF8BMOT, BUF12BMOT, BUF2BMOT, BUF3BMOT, BUF2BM, BUF3BM, LOT385, AR170, AR170, AR170, AR170, AR170, AR170, AR170, AR170, AR170, AR170, AR170, AR170S, AR170S, AR170S, AR170S, AR170S, AR170S, AR170S, AR170S, AR170S, AR170S, AR170S, AR170S, AR340, AR340...(Other models you can see in the webshop)		

baskets

crumb screens



1

GEV No.	970524	Ref. No.	006130 17012749 830884701
description	crumb screen L 295mm W 385mm suitable for fryer		
For models:	KFR/G1E, KFR/G2F, KFR/E1E, KFR/E2F, KFH/G1, KFH/E1, KFH/G1ELH, KFH/E1ELH, KFH/G1EH, KFH/E1EH, HFH/G430, HFH/E430, HFR/G430, HFR/G830, HFR/E430, HFR/E830, HFH/G400U, HFH/G401U, HFH/G435, HFH/G435, HFRS/G430, HFRS/E430, QFR/G1E, QFR/G2F, QFR/E1E, QFR/E2F, QFH/G1, QFH/E1, QFH/G1ELH, QFH/E1ELH, QFH/G1EH, QFH/E1H, ZFH/G430, ZFH/E430, ZFR/G430, ZFR/G830, ZFR/E430, ZFR/E830, ZFH/G435, ZFH/E435, ZFRS/G430, ZFRS/E430, WFR/G1E, WFR/G2F, WFR/E1E, WFR/E2F, WFH/G1, WFH/E1, WFH/G1ELH, WFH/E1ELH...(Other models you can see in the webshop)		



1

GEV No.	970779	Ref. No.	OC1743
description	crumb screen L 389mm W 319mm H 5mm chrome-plated steel for fryer		
For models:	PFR/G2S40, TFR/G2S40, KFR/G1T, QFR/G1T, WFR/G1T		

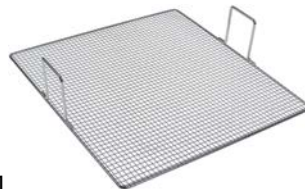

1

GEV No.	504335	Ref. No.	054505
description	crumb screen L 400mm W 345mm H 85mm chrome-plated steel		
For models:	HFR/G410, HFR/G810, HFR/G410D, HFR/G810D, HFR/G410NL, HFR/G810NL, HFR/G411, HFR/G412, ZFR/G410, ZFR/G810, ZFR/G410D, ZFR/G810D, ZFR/G411, ZFR/G412, AFR/G410, AFR/G810, AFR/G410D, AFR/G810D, AFR/G410NL, M40GFR90, AFR/G411, AFR/G412, OFR/G810, HFR/G421, ZHFRG421		



1

GEV No.	970728	Ref. No.	0H6552 490222
description	crumb screen L 338mm W 194mm H 180mm suitable for ELECTROLUX for fryer		
For models:	7536-3, 7537-3, 7736-3, 7737-3		



1

GEV No.	970804	Ref. No.	OK9836 OKZM63 79001060011
description	crumb screen L 245mm W 245mm H 210mm stainless steel		



1

GEV No.	970805	Ref. No.	OK9919 OKZM53
description	crumb screen L 330mm W 230mm H 210mm stainless steel		

warewashing baskets

steel wire baskets round

mix baskets

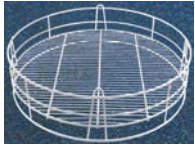

GEV No.	970494	Ref. No.	045098 865566
description	mix basket ED ø 520mm H 155mm usable height 85mm		
For models:	LS500F, LS500UK, LS501, LS501UK		

plate baskets



GEV No.	970561	Ref. No.	065565 865565
description	plate basket ED ø 520mm		
For models:	LS500F, LS500UK, LS501, LS501UK		

steel wire baskets square

mix baskets



GEV No.	971006 ¹	Ref. No.	0HA029 30087 860138 9030087
description	mix basket L 345mm W 345mm H 120mm mesh type wide-meshed		

¹wide-meshed



GEV No.	971015 ¹	Ref. No.	069564 983001
description	mix basket L 382mm W 382mm H 200mm mesh type wide-meshed		
For models:	LTB11, LTB12, LTB22, LTB11UK, LTB12UK, LTB22UK, LTB11, LTB22, 910-00-021, 910-00-023, 910-00-031, 910-00-033, CRYSTAL 11, CRYSTAL 22		

¹wide-meshed



GEV No.	971013 ¹	Ref. No.	069563
description	mix basket L 382mm W 382mm H 90mm mesh type wide-meshed		
For models:	LTB11, LTB12, LTB22, LTB11UK, LTB12UK, LTB22UK, LTB11, LTB22, 910-00-021, 910-00-023, 910-00-031, 910-00-033, CRYSTAL 11, CRYSTAL 22		

¹wide-meshed



GEV No.	971023 ¹	Ref. No.	0U1033
description	mix basket L 400mm W 400mm H 130mm mesh type close-meshed		

¹fine-meshed



GEV No.	970074 ¹	Ref. No.	050058 CRP001
description	mix basket L 500mm W 500mm H 130mm mesh type close-meshed		

¹fine-meshed

plate baskets



GEV No.	971043	Ref. No.	050057
description	plate basket L 500mm W 500mm H 130mm plates 20 plate ø 240mm		

plastic baskets square

mix baskets



GEV No.	971078	Ref. No.	051130 2146
description	mix basket L 400mm W 400mm H 150mm		

accessories

cutlery inserts

			
1			
GEV No.	976013	Ref. No.	069561
description	cutlery insert L 105mm W 105mm ømm H 140mm		
For models:	LTB11, LTB12, LTB22, LTB11UK, LTB12UK, LTB22UK, LTB11, LTB22, 910-00-021, 910-00-023, 910-00-031, 910-00-033, 911-00-022, 911-00-024, 911-00-032, 911-00-034, CRYSTAL 11, CRYSTAL 22		

			
1			
GEV No.	976016	Ref. No.	049070 069956 0L1813 865574 867059
description	cutlery insert L 110mm W 110mm ømm H 130mm		
For models:	DLT, DLP		

section inserts for glasses



			
1			
GEV No.	970302	Ref. No.	069572 960455
description	section insert for glasses L 400mm W 400mm H 105mm 10-piece		
For models:	LTB11, LTB12, LTB22, LTB11UK, LTB12UK, LTB22UK, LTB11, LTB22, 910-00-021, 910-00-023, 910-00-031, 910-00-033, 911-00-022, 911-00-024, 911-00-032, 911-00-034, CRYSTAL 11, CRYSTAL 22		

plate inserts

			
1			
GEV No.	970517	Ref. No.	069562
description	plate insert L 320mm W 80mm plates 12		
For models:	LTB11, LTB12, LTB22, LTB11UK, LTB12UK, LTB22UK, LTB11, LTB22, 910-00-021, 910-00-023, 910-00-031, 910-00-033, 911-00-022, 911-00-024, 911-00-032, 911-00-034, CRYSTAL 11, CRYSTAL 22		

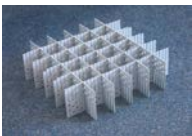

shelves and shelf rails

grates

universal

without upstand

			
1			
GEV No.	970120	Ref. No.	057468 GOC155 X330266113
description	grate W 325mm D 530mm GN 1/1 chrome-plated steel wire gauge frame 7mm lengthwise wires gauge 4mm crossing wires 1		
For models:	FCFG6D, FCFE6D, FCFE6D, FCFG6, FCFG6F, PFCFG6, FCFE6, FCFE6UK, PFCFE6, FCFE6J50, FCFE6J60, FCFG6J, FCFG6J, FCFG6J, FCFG6J, FCF/G6, FCF/E6, AFCF/E6, FF/G6, COCO6G, COCO6E, COCCE423AF, FCFE061, ZOFCF/G6D		

accessories for	970120		
	GEV No.	690330	Ref. No. —
		rack L 1000mm W 22mm H 4mm aperture 3x8mm hole distance 12.5mm stainless steel	
	GEV No.	694700	Ref. No. —
		shelf support L 31/28mm W 22mm H 18mm SS Qty 12 pcs	
	GEV No.	694701	Ref. No. —
		shelf support L 31/28mm W 22mm H 17mm SS with hook Qty 12 pcs	

			
1			
GEV No.	970125	Ref. No.	082729 0A8069 881061
description	grate W 325mm D 530mm GN 1/1 plastic-coated steel crossing wires 1 white suitable for refrigerator		
For models:	TRN1301, TRNA1301, TRNM1301, TRN1302, TRNA1302, TRNM1302, TRN1303, TRNA1303, TRNM1303, TRN1801, TRNA1801, TRNM1801, TRN1802, TRNA1802, TRNM1802, TRN1803, TRNA1803, TRNM1803, TRN2201, TRNA2201, TRNM2201, TRN2202, TRNA2202, TRNM2202, TRN2203, TRNA2203, TRNM2203, TRRN1301, TRRN1302, TRRN1303, TRRN1801, TRRN1802, TRRN1803, TRRN2201, TRRN2202, TRRN2203, TRRF130P, TRRF180P, TRRF220P, TRF1301, TRRF1301, TRF1801, TRRF1801, TRF2201, TRRF2201, TRN1301, TRNA1301, TRNM1301, TRF1301, TRRF1301...(Other models you can see in the webshop)		







accessories for	970125		
	GEV No.	690330	Ref. No. —
		rack L 1000mm W 22mm H 4mm aperture 3x8mm hole distance 12.5mm stainless steel	

Table continues overleaf

accessories for 970125			
	GEV No.	694700	Ref. No. —
shelf support L 31/28mm W 22mm H 18mm SS Qty 12 pcs			
	GEV No.	694701	Ref. No. —
shelf support L 31/28mm W 22mm H 17mm SS with hook Qty 12 pcs			

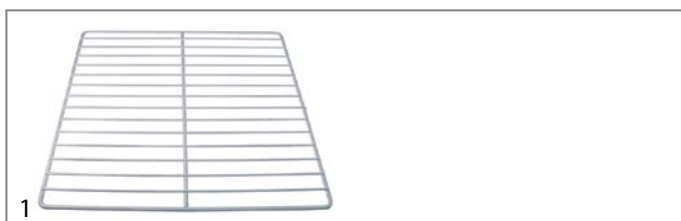



GEV No.	970084	Ref. No.	082904
description	grate W 530mm D 530mm plastic-coated steel crossing wires 1		
For models:	ASP110, ASS110, ASP220, ASS220, ASN110, ASN220, ASP110UK, ASP220UK, ASN110UK, ASN220UK, ASF110, ASF110, ASF220, ASP110UK, ASP220UK, ASN110UK, ASN220UK, ASF110UK, ASF220UK, ISP110, ISN110, ISS110, ISF110, ASP110, ASS110, ASP220, ASS220, ASN110, ASN220, ASF110, ASF220, ISP111N, ISP221N, ISP110N, ISN110N, ISF110N, ISS110, DVP500V11V, DVP501V11V, MVP502V11V, EDVN500, DVN501V11V, DVP110V12C, DVP111V12C, MVP112V12C, DVN110V12C, DVN111V12C, DVP110V12V, DVP111V12V, MVP112V12V... (Other models you can see in the webshop)		

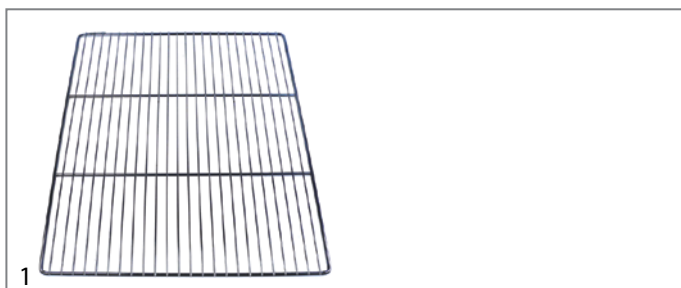

accessories for 970084			
	GEV No.	690330	Ref. No. —
rack L 1000mm W 22mm H 4mm aperture 3x8mm hole distance 12.5mm stainless steel			
	GEV No.	694700	Ref. No. —
shelf support L 31/28mm W 22mm H 18mm SS Qty 12 pcs			
	GEV No.	694701	Ref. No. —
shelf support L 31/28mm W 22mm H 17mm SS with hook Qty 12 pcs			

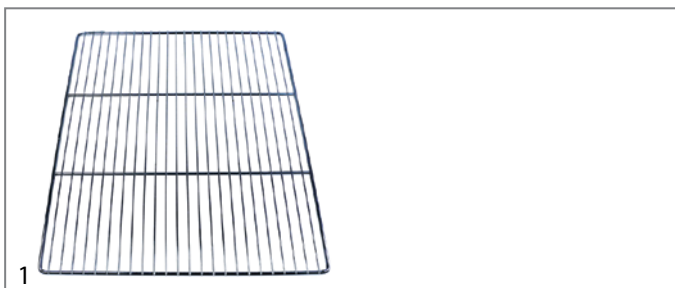

GEV No.	970121	Ref. No.	054115 082122 164250 727751
----------------	--------	-----------------	--------------------------------------

description	grate W 650mm D 530mm GN 2/1 chrome-plated steel crossing wires 2		
accessories for 970121			
	GEV No.	690330	Ref. No. —
rack L 1000mm W 22mm H 4mm aperture 3x8mm hole distance 12.5mm stainless steel			
	GEV No.	694700	Ref. No. —
shelf support L 31/28mm W 22mm H 18mm SS Qty 12 pcs			
	GEV No.	694701	Ref. No. —
shelf support L 31/28mm W 22mm H 17mm SS with hook Qty 12 pcs			



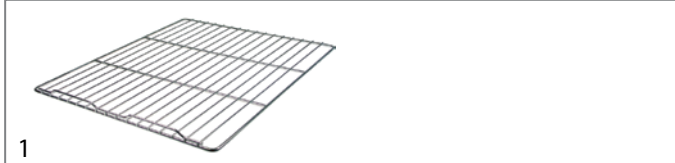

GEV No.	970123	Ref. No.	003189
description	grate W 650mm D 530mm GN 2/1 stainless steel wire gauge frame 7.8mm lengthwise wires gauge 3.8mm crossing wires 2 suitable for refrigerator		
For models:	FCV/E102/1, FCV/E102/1		
accessories for 970123			
	GEV No.	690330	Ref. No. —
rack L 1000mm W 22mm H 4mm aperture 3x8mm hole distance 12.5mm stainless steel			
	GEV No.	694700	Ref. No. —
shelf support L 31/28mm W 22mm H 18mm SS Qty 12 pcs			
	GEV No.	694701	Ref. No. —
shelf support L 31/28mm W 22mm H 17mm SS with hook Qty 12 pcs			

with upstand









GEV No.	970527	Ref. No.	025020 081883
----------------	--------	-----------------	------------------

description	grate W 530mm D 650mm GN 2/1 chrome-plated steel with hinge camp crossing wires 2 suitable for refrigerator		
For models:	ALP110, ALP120, ALP111, ALP220, ALP240, ALP221, ALN110, ALN120, ALN111, ALN220, ALN240, ALN221, ALNN220, ALP110UK, ALN110UK, ALNN220UK, ALF110, ALF220UK, ALNF220, ALF110, ALF120, ALF220, ALF240, ALNF220, ILP110, ILP110UK, ILN120, ILP111, ILP220, ILP220UK, ILP240, ILP221, ILN110, ILN110UK, ILN120, ILN111, ILN220, ILN220UK, ILN240, ILN221, ILNN220, ILNN220UK, ALP110UK, ALN110UK, ALNN220UK, ALF110UK, ALNF220UK, ILF110, ILF110, ILF120...(Other models you can see in the webshop)		

accessories for 970527			
	GEV No.	690330	Ref. No. —
rack L 1000mm W 22mm H 4mm aperture 3x8mm hole distance 12.5mm stainless steel			
	GEV No.	694700	Ref. No. —
shelf support L 31/28mm W 22mm H 18mm SS Qty 12 pcs			
	GEV No.	694701	Ref. No. —
shelf support L 31/28mm W 22mm H 17mm SS with hook Qty 12 pcs			



			
1			
GEV No.	970556	Ref. No.	081735 081903 082885 083635 880720
description	grate W 530mm D 650mm GN 2/1 plastic-coated steel with hinge camp wire gauge frame 9mm lengthwise wires gauge 5mm crossing wires 2 white suitable for refrigerator		
For models:	ALNN120, ALNN230, ALNSO120, ALNF120, ALNF230, ADN220ES, ADF110ES, ADF220ES, ADN110ESP, ADF110ESP, ILNSO120, ILNN230, ILNF230, ALNN120, ALNF120, ALNN230, ALNF230, ALNSO120, ALN110, ALN120, ADN111, AEN110, AEN120, AKN111, ADF110, ALF110, ADF120, ALF120, AEF110, AEF120, ADNN120, ADNF120, AENN120, AENF120, ALN220, ALN240, ADN221, AEN220, AEN240, AEN221, ADF220, ADF240, AEF220, AEF240, ADNN220, ADNF220, ADNN230, ADNF230, AENN220, AENF220...(Other models you can see in the webshop)		
accessories for	970556		
	GEV No.	690330	Ref. No. —
	rack L 1000mm W 22mm H 4mm aperture 3x8mm hole distance 12.5mm stainless steel		
	GEV No.	690332	Ref. No. —
	shelf support L 31/28mm W 22mm H 17mm SS with hook Qty 1 pcs		
	GEV No.	694700	Ref. No. —
	shelf support L 31/28mm W 22mm H 18mm SS Qty 12 pcs		
	GEV No.	694701	Ref. No. —
	shelf support L 31/28mm W 22mm H 17mm SS with hook Qty 12 pcs		

			
1			
GEV No.	970528	Ref. No.	087343
description	grate W 650mm D 530mm GN 2/1 stainless steel with hinge camp crossing wires 2 suitable for refrigerator		

producer-specific

			
1			
GEV No.	970891	Ref. No.	093252
description	grate GN 2/1 W 530mm D 650mm H 40mm plastic-coated steel crossing wires 2		
For models:	FV 1M, FV 1M, FV 1M, FV 1M, FV 1M, FV 1M, FV Dual, FV Dual, FV 2M, FV 2M, FV 2M, FV 2M, DUAL 2 DOORS, DUAL 2 DOORS, FV 2M, FV 2M, FV 1M, FV 1M, FV 1M, FV 1M, FV 2M, FV 2M, FV 1M, FV 1M, FV 1M, FV 1M, FV Dual, FV Dual, FV 2M, FV 2M, FV 2M, FV 2M, DUAL 2 DOORS, DUAL 2 DOORS, FV 2M, FV 2M, FV 1M, FV 1M, FV 1M, FV 1M, FV, FV, FV 2M, FV 2M, FV 2M...(Other models you can see in the webshop)		

			
1			
GEV No.	970019	Ref. No.	006029 059246
description	ventilation grille W 395mm D 75mm steel chrome-plated suitable for refrigerator for bottom heaters		
For models:	HR/E400D, HR/E800D, HR/E410, HR/E811, HR/E420, HR/E820, HR/E821, HR/E400, HR/E800, HBR/G821UK, HPN/GI810, HPN/GI815, HPN/GI816, HPN/GD811, HPN/GD816, HPA/EI825, HPN/GI855, HPN/GI1255, HPNS/GI816, HPN/GI806, HPN/GI805, HTR/E410, HTR/E810, HG/E400, HG/E800, ZC/G410, ZC/G810, ZCF/G810, ZC/E400, ZC/E800, ZCF/E800, ZC/G1210, ZCF/G1210, EC/G1610, ZCF/G1610, ZI/E400, ZI/E800, ZC/E410, ZC/E810, ZCF/E810, ZC/G410, ZC/G810, ZC/G1210, ZCF/G810, ZCF/G1210, ZCF/G1610, ZCF/G811, ZC/G411, ZC/G811, HC/G1211...(Other models you can see in the webshop)		

grates

			
1			
GEV No.	691972	Ref. No.	002307 002438 006580 059209
description	chimney grate L 396mm W 70mm H 25mm cast iron		
For models:	HC/G410, HC/G810, HCF/G810, HC/E400, HC/E800, HCF/E800, HC/G1210, HCF/G1210, EC/G1610, HCF/G1610, HI/E400, HI/E800, HC/E410, HC/E810, HCF/E810, HI/G400, HI/G800, HI/G400N, HI/G800N, HC/G410, HC/G810, HC/G1210, HCF/G810, HCF/G1210, HCF/G1610, HCF/G811, HC/G411, HC/G811, HC/G1211, HC/G800U, HC/G1200U, HC/G1600U, HCF/G800U, HCF/G1200U, HCF/G1600U, HR/E400D, HR/E800D, HR/E410, HR/E811, HR/E420, HR/E820, HR/E821, HR/G420D, HR/G820D, HR/G420, HR/G820, HR/G821, HR/E400, HR/E800, HR/G400U...(Other models you can see in the webshop)		

grid attachments

			
1			
GEV No.	690806	Ref. No.	082317
description	rack support L 540mm H 26mm W 17.5mm plastic suitable for ELECTROLUX, ZANUSSI		
For models:	ASP110, ASS110, ASP220, ASS220, ASN110, ASN220, ASP110UK, ASP220UK, ASN110UK, ASN220UK, ASF110, ASF110, ASF220, ASP110UK, ASP220UK, ASN110UK, ASN220UK, ASF110UK, ASF220UK, ISP110, ISP220, ISN110, ISN220, ISS110, ISS220, ISF110, ISF220, ASP110, ASS110, ASP220, ASS220, ASN110, ASN220, ASF110, ASF220, ISP111N, ISP221N, ISP110N, ISN110N, ISF110N, ISS110, ISP220N, ISN220N, ISF220N, ISS220, MVP602V11C, EMVP602, DVP110V12C, DVP111V12C, MVP112V12C...(Other models you can see in the webshop)		



GEV No.	690807	Ref. No.	082316
description	rack support L 720mm H 26mm W 27mm plastic		
For models:	ASP110, ASS110, ASP220, ASS220, ASN110, ASN220, ASP110UK, ASP220UK, ASN110UK, ASN220UK, ASF110, ASF110, ASF220, ASP110UK, ASP220UK, ASN110UK, ASN220UK, ASF110UK, ASF220UK, ISP110, ISP220, ISN110, ISN220, ISS110, ISS220, ISF110, ISF220, ASP110, ASS110, ASP220, ASS220, ASN110, ASN220, ASF110, ASF220, ISP111N, ISP221N, ISP110N, ISN110N, ISF110N, ISS110, ISP220N, ISN220N, ISF220N, ISS220, MVP602V11C, EMVP602, DVP110V12C, DVP111V12C, MVP112V12C...(Other models you can see in the webshop)		

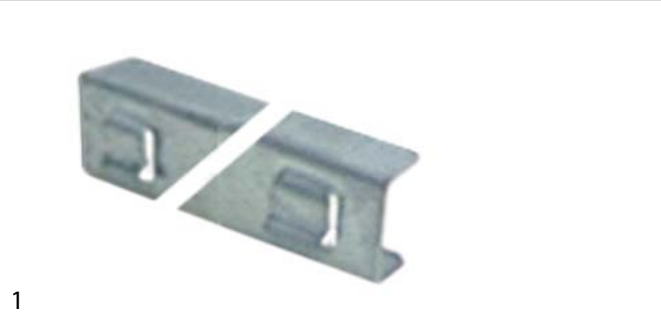

GEV No.	690778	Ref. No.	082304 093853 880558
description	guide U-shape L 466mm W 14mm H 20mm mounting pos. left/right		
For models:	ZPR04R1F, ZPR04F1F, ZPR06R1F, ZPR06F1F, ESR14412FR, ESR-141212FR, ESR142FR, ESR141212F, ESR142F, ESR14412F, ESF142FR, ESR4212FR, ESR4212F, ESR41GR, ESR41FR, ESR41G, ESF41FR, ESR41F, ESR61F, ESF621/2F, ESR61GR, ESR621/2F, ESR621/2F, ESR61FR, ESF61FR, ESF621/2FR, ESR61G, ESQC41F, ESQC41FR, ESQF41F, ESQF41FR, , EUKR61/N, EUKR142N, , EUKR61F, EUKR621/2F, EUKR61G, EUKR142F, EUKR141212, EUKR14412F, , ESR41F60HZ, ESR422F60HZ, ESR41G60HZ, ESR61F60, ESR622F60, ESR61G60, ESR142F60, ESR1412F60HZ...(Other models you can see in the webshop)		

shelf rails and supports

producer-specific



GEV No.	690739	Ref. No.	0A8164 SA00766302
description	guide L-shape L 445mm W 20mm H 22mm mounting pos. left		
For models:	133-01-110, 133-01-111, 133-06-110, 133-06-111		



GEV No.	690777	Ref. No.	082286
description	guide U-shape L 467mm W 15mm H 18mm mounting pos. left/right		
For models:	ISPZ110, ISNZ110, ISSZ110, ISPZ220, ISNZ220, ISSZ220, FVNE051, FVNE11E, CA38ALHG, CA38SSHG, CA38ALCG, CA38SSCG, CA38ALMG, CA38SSMG, CA21SSMG, CA45SSMG, CA18SSMG, CA38SSMG, CA38ALLG, CA38SSLG, CA38SSLG		



GEV No.	690784	Ref. No.	0A8163 SA00766202
description	guide L-shape L 445mm W 20mm H 22mm mounting pos. right		
For models:	133-01-110, 133-01-111, 133-06-110, 133-06-111		



GEV No.	690781	Ref. No.	0A8153
description	guide U-shape L 495mm W 15mm H 20mm mounting pos. left		
For models:	SAL250, ES950, 130-00-130.1, KTSM100, KKSM100, KTP100, 13000130.1, KTP100, KTSM100, KKSM100, 130-00-131-1, 13000132.1, 13000131.1, 13000132.1		





1

GEV No.	690779	Ref. No.	082719
description	guide U-shape L 565mm W 14mm H 20mm mounting pos. left		
For models:	TRN1301, TRNA1301, TRNM1301, TRN1302, TRNA1302, TRNM1302, TRN1303, TRNA1303, TRNM1303, TRN1801, TRNA1801, TRNM1801, TRN1802, TRNA1802, TRNM1802, TRN1803, TRNA1803, TRNM1803, TRN2201, TRNA2201, TRNM2201, TRN2202, TRNA2202, TRNM2202, TRN2203, TRNA2203, TRNM2203, TRRN1301, TRRN1302, TRRN1303, TRRN1801, TRRN1802, TRRN1803, TRRN2201, TRRN2202, TRRN2203, TRNP1802, TRRF130P, TRRF180P, TRRF220P, TRF1301, TRRF1301, TRF1801, TRRF1801, TRF2201, TRRF2201, TRN1301, TRNA1301, TRNM1301, TRRN1301...(Other models you can see in the webshop)		



2

GEV No.	690780	Ref. No.	082720
description	guide U-shape L 565mm W 14mm H 20mm mounting pos. right		
For models:	TRN1301, TRNA1301, TRNM1301, TRN1302, TRNA1302, TRNM1302, TRN1303, TRNA1303, TRNM1303, TRN1801, TRNA1801, TRNM1801, TRN1802, TRNA1802, TRNM1802, TRN1803, TRNA1803, TRNM1803, TRN2201, TRNA2201, TRNM2201, TRN2202, TRNA2202, TRNM2202, TRN2203, TRNA2203, TRNM2203, TRRN1301, TRRN1302, TRRN1303, TRRN1801, TRRN1802, TRRN1803, TRRN2201, TRRN2202, TRRN2203, TRNP1802, TRRF130P, TRRF180P, TRRF220P, TRF1301, TRRF1301, TRF1801, TRRF1801, TRF2201, TRRF2201, TRN1301, TRNA1301, TRNM1301, TRRN1301...(Other models you can see in the webshop)		



1

GEV No.	690776	Ref. No.	082206 082263 083263 880557
description	guide U-shape L 580mm W 21mm mounting pos. left/right		
For models:	ALP110, ALP120, ALP111, ALP220, ALP240, ALP221, ALN110, ALN120, ALN111, ALN220, ALN240, ALN221, ALNN120, ALNN220, ALNN230, ALNSO120, ALP110UK, ALN110UK, ALNN220UK, ALF110, ALF220UK, ALNF220, ALF110, ALF120, ALF220, ALF240, ALNF120, ALNF220, ALNF230, ILP110, ILP110UK, ILN120, ILP111, ILP220, ILP220UK, ILP240, ILP221, ILN110, ILN110UK, ILN120, ILN111, ILN220, ILN220UK, ILN240, ILNSO120, ILN221, ILNN120, ILNN220, ILNN220UK, ILNN230...(Other models you can see in the webshop)		





1

GEV No.	690659	Ref. No.	0A8260 SA00888800	
description	guide U-shape L 582mm W 15mm H 19mm mounting pos. left			
For models:	ES2M, ES3M, 23000150.1, 23000151.1, 23100150.1, 23100151.1			
accessories for	690659			
	GEV No.	690783	Ref. No.	0A8259 SA00888900
	guide U-shape L 582mm W 15mm H 19mm mounting pos. right			



1

GEV No.	690783	Ref. No.	0A8259 SA00888900	
description	guide U-shape L 582mm W 15mm H 19mm mounting pos. right			
For models:	RH14RE4HU, RH14FE4HU, ES2M, ES3M, RH14RE4HRU, RH14FE4HRU, 23000150.1, 23000151.1, 23100150.1, 23100151.1			
accessories for	690783			
	GEV No.	690659	Ref. No.	0A8260 SA00888800
	guide U-shape L 582mm W 15mm H 19mm mounting pos. left			



1

GEV No.	692226	Ref. No.	0A9680
description	guide U-shape L 620mm W 14mm mounting pos. left/right inner height 18.5mm		
For models:	ADN220ES, ADF110ES, ADF220ES, ADN110ESP, ADF110ESP, ALN110, ALN120, ADN111, AEN110, AEN120, ADF110, ALF110, ADF120, ALF120, AEF110, AEF120, ADNN120, ADN120, ALN220, ALN240, ADN221, AEN220, AEN240, ADF220, ADF240, AEF220, AEF240, ADNN220, ADN220, ADNN230, ADN230, ASN110, ASF110, ASN220, ASF220, ARDN110, ADN110E, ADF110E, ADN220E, ADF220E, 83012001, 83012033, 83012201, ARDF110L, ARDF120, ARDNN120, 83012101, ARDN220, ARDN221, ARDN220...(Other models you can see in the webshop)		



1

GEV No.	692654	Ref. No.	093251
description	guide U-shape L 650mm W 15mm H 21mm mounting pos. right		
For models:	FV 1M, FV 1M, FV 1M, FV 1M, FV 1M, FV, FV, FV 2M, FV 2M, FV 2M, FV 2M, FV 2M, FV 2M, FV 1M, FV 1M, FV 2M, FV 2M, FV 2M, FV 1M, FV 2M, FV 1M, FV 1M, FV 1M, FV, FV, FV 2M, FV 2M, FV 2M, FV 2M, FV 1M, FV 1M, FV 1M, FV, FV 2M, FV 2M, FV 2M, FV 1M, FV 1M, FV 1M, FV Dual 1/2 doors, FV Dual 1/2 doors, FV 2M, FV 2M, FV 2M...(Other models you can see in the webshop)		

			
GEV No.	692653	Ref. No.	093250
description	guide U-shape L 650mm W 21mm mounting pos. left		
For models:	FV 1M, FV 1M, FV 1M, FV 1M, FV 1M, FV, FV, FV 2M, FV 2M, FV 2M, FV 2M, FV 2M, FV 2M, DUAL 2 DOORS, DUAL 2 DOORS, FV 1M, FV 1M, FV 2M, FV 2M, FV 1M, FV 2M, FV 1M, FV 1M, FV 1M, FV 1M, FV 1M, FV, FV, FV 2M, FV 2M, FV 2M, FV 2M, DUAL 2 DOORS, DUAL 2 DOORS, FV 1M, FV 1M, FV 1M, FV, FV 2M, FV 2M, FV 2M, FV 2M, DUAL 2 DOORS, DUAL 2 DOORS, FV 1M, FV 1M, FV 1M, FV 1M... (Other models you can see in the webshop)		

			
GEV No.	701109	Ref. No.	090214
description	hook for setting bar L 12mm W 14mm bore ø 4.5mm		
For models:	ADN220ES, ADF110ES, ADF220ES, ADN110ESP, ADF110ESP, ADN110E, 83012001, 83012033, ARDNN120, 83012101, 83012037, ASN110, ASF110, ASN220, ASF220, ADN110, ADN120, ADN111, ADF110, ADF120, ADNN120, ADNF120, ADN220, ADN240, ADN221, ADF220, ADNN220, ADNF220, ADNN230, ADNF230, ADN11060, ADF11060, ADN22060, ADF2206, AZP1103, AZP110360, ALN1103, AZP6430, ALN11033, IKNF220N, RS06PX1F6M, FULL DOOR FREEZER, IKNN220, RS06RX1F, FULL DOOR FREEZER, RS06FX1F, RS06DX2F, RS13RX2F, RS13FX2F, RS13DX2F... (Other models you can see in the webshop)		

			
GEV No.	701107	Ref. No.	083838
description	hook for setting bar L 31mm W 14mm bore ø 4.5mm Qty 1 pcs		
For models:	BC44, BCF44, BC44, BCF44, ADN220ES, ADF110ES, ADF220ES, BC44, BCF44, ALN110, ALN120, ADN111, AEN110, AEN120, AKN111, ADF110, ALF110, ADF120, ALF120, AEF110, AEF120, ADNN120, ADNF120, AENN120, AENF120, ALN220, ALN240, ADN221, AEN220, AEN240, AEN221, ADF220, ADF240, AEF220, AEF240, ADNN220, ADNF220, ADNN230, ADNF230, AENN220, AENF220, AENN230, AENF230, ASN110, ASN111, ASF110, ASN220, ASN221, ASF220, AKN110UK... (Other models you can see in the webshop)		

			
GEV No.	701108	Ref. No.	090210
description	hook for setting bar L 32mm W 14mm bore ø 4.5mm		
For models:	ADN220ES, ADF110ES, ADF220ES, ADN110ESP, ADF110ESP, ADN110E, 83012001, 83012033, ARDNN120, 83012101, 83012037, ASN110, ASF110, ASN220, ASF220, ADN110, ADN120, ADN111, ADF110, ADF120, ADNN120, ADNF120, ADN220, ADN240, ADN221, ADF220, ADNN220, ADNF220, ADNN230, ADNF230, ADN11060, ADF11060, ADN22060, ADF2206, AZP1103, AZP110360, ALN1103, AZP6430, ALN11033, IKNF220N, RS06PX1F6M, FULL DOOR FREEZER, IKNN220, RS06RX1F, FULL DOOR FREEZER, RS06FX1F, RS06DX2F, RS13RX2F, RS13FX2F, RS13DX2F... (Other models you can see in the webshop)		

			
GEV No.	692531	Ref. No.	093850
description	pair of setting bar U-shape L 581mm W 20mm H 14mm mounting pos. left/right		

			
GEV No.	700911	Ref. No.	OTT840 881456
description	pair of setting bar U-shape L 620mm W 14.4mm inner height 19mm		

			
GEV No.	692342	Ref. No.	093851
description	pair of setting bar U-shape L 620mm W 14mm H 20mm mounting pos. left/right		

			
GEV No.	701105	Ref. No.	091630
description	rack L 1270mm W 32mm aperture 16x22mm		
For models:	ADN220ES, ADF110ES, ADF220ES, ADN110ESP, ADF110ESP, ADN110E, ADN220E, ADF220E, 83012001, 83012033, 83012201, ARDF110L, ARDN220, ARDNF220, 83012037, ASN110, ASF110, ASN220, ASF220, ADN110, ADN120, ADN111, ADF110, ADF120, ADN220, ADN240, ADN221, ADF220, ADNN220, ADNF220, ADNN230, ADNF230, ADN11060, ADF11060, ADN22060, ADF2206, AZP1103, AZP110360, ALN1103, AZP6430, ALN11033, IKNF220N, RS06PX1F6M, FULL DOOR FREEZER, IKNN220, RS06RX1F, FULL DOOR FREEZER, RS06FX1F, RS13RX2F, RS13FX2F, RS13DX2F, RH14RE2FUS, RH14FE2FUS, RS06PX1F, RS06PX1F6, RS06R41F, RS06NX1F... (Other models you can see in the webshop)		

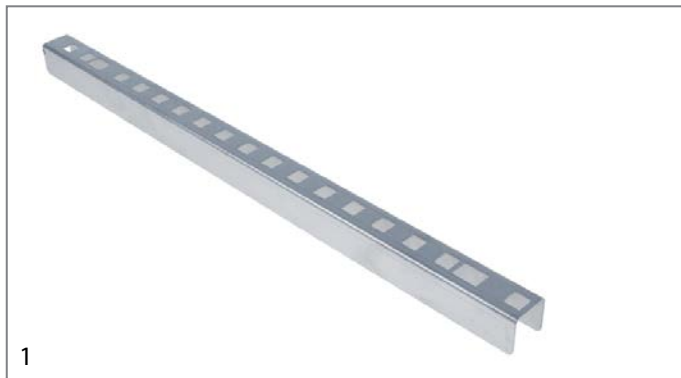

GEV No.	692227	Ref. No.	085988
description	rack L 580mm W 32mm H 32mm hole distance 30mm aperture 13x13mm		
For models:	ALN120, AEN120, ADF120, ALF120, AEF120, ADNN120, ADNF120, ALN240, ADF240, AEF240, ADNN230, ADNF230, ARDF120, ARDNN120, 83012101, ADN120, ADF120, ADNN120, ADNF120, ADN240, ADNN220, ADNF220, ADNN230, ADNF230, ALNN1203, AZP1103, AZP110360, ALN1103, AZP6430, ALN11033, ALNN1203, IKNF220N, IKNN220, RS06RX1F, RS06DX2F, RS06PX1F, RS06PX1F6, RS06R41F, RS06NX1F, RS06DFX2F, RS06PW1F, RH06DD2U, RH06DFD2U, RH14D-D3U, RH14DFD3U, MCD650F2, RH06RE2HU, RH06FE2HU, RH14RE4HU, RH14FE4HU...(Other models you can see in the webshop)		

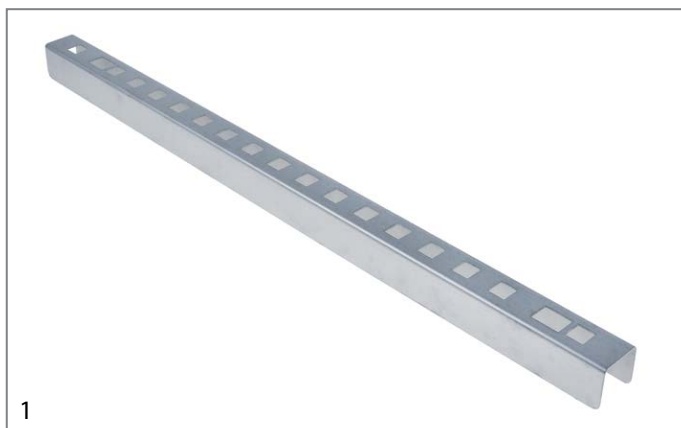

GEV No.	692228	Ref. No.	085985
description	rack L 600mm W 33mm hole distance 30mm aperture 13x13mm		
For models:	ALN120, AEN120, ADF120, ALF120, AEF120, ADNN120, ADNF120, ALN240, AEN240, ADF240, AEF240, ADNN230, ADNF230, ARDF120, ARDNN120, 83012101, ADN120, ADF120, ADNN120, ADNF120, ADN240, ADF240, ADNN220, ADNF220, ADNN230, ADNF230, RH06D-D2U, RH06DFD2U, RH14DD3U, RH14DFD3U, MCD650F2, RH06RE2HU, RH06FE2HU, RH14RE4HU, RH14FE4HU, RH06REHRU, RH06FE2HRU, RH14RE4HRU, RH14FE4HRU, MCD650FP2, MCD65F2LR, E06N0M2C, E06N1M2C, E06NOD2C, E06COM2C, E06C1M2C, E06COD2C, E06COD2C, E06N0M2C, E06N0M2C...(Other models you can see in the webshop)		



GEV No.	690626	Ref. No.	031970
description	shelf support L 32mm W 14mm H 20mm		
For models:	TC1200TOP, TC1210TOP, TC1400TOP, TC1410TOP, TC1600TOP, TC1610TOP, TC1800TOP, TC1810TOP, TC2000TOP, TC2010TOP, TCD1200TOP, TCD1400TOP, TCD1600TOP, TCD1800TOP, TCD2000TOP, TF1400, TF1410, TF2000, TF2010, TN1000, TN1010, TN1200, TN1210, TN1400, TN1410, TN1600, TN1610, TN1800, TN1810, TN2000, TN2010, TND1000, TND1200S, TND1400, TND1600, TND1800, TND2000, TC1000, TC1010, TC1200, TC1210, TC1400, TC1410, TC1600, TC1610, TC1800, TC1810, TC2000, TC2010, TCD1000...(Other models you can see in the webshop)		

gaskets

refrigeration gaskets

plug-in gaskets

profile 9048

We offer custom-made gaskets for this profile

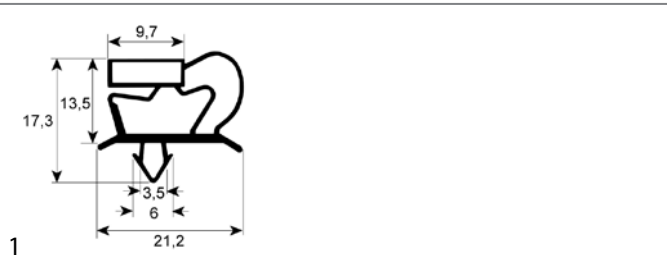

GEV No.	900021	Ref. No.	031694 12381
description	refrigeration gasket profile 9048 W 142mm L 372mm plug size drawer refrigeration size 2/5 suitable for ELECTROLUX, ZANUSSI		
For models:	TRN1301, TRNA1301, TRNM1301, TRN1302, TRNA1302, TRNM1302, TRN1303, TRNA1303, TRNM1303, TRN1801, TRNA1801, TRNM1801, TRN1802, TRNA1802, TRNM1802, TRN1803, TRNA1803, TRNM1803, TRN2201, TRNA2201, TRNM2201, TRN2202, TRNA2202, TRNM2202, TRN2203, TRNA2203, TRNM2203, TRRN1301, TRRN1302, TRRN1303, TRRN1801, TRRN1802, TRRN1803, TRRN2201, TRRN2202, TRRN2203, TRN1303, TRNA1303, TRNM1303, TRN1803, TRNA1803, TRNM1803, TRN2203, TRNA2203, TRNM2203, KT2T, KT3T, KT4T, EDON420121B, EDON280120...(Other models you can see in the webshop)		

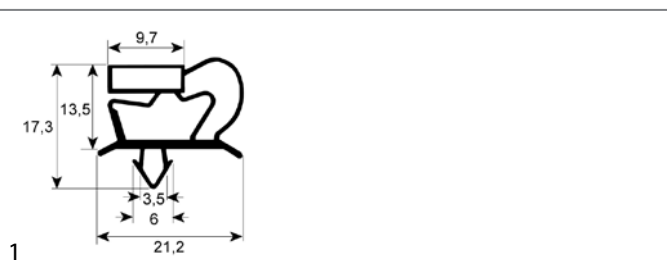

GEV No.	900302	Ref. No.	082740 12382
description	refrigeration gasket profile 9048 W 157mm L 312mm plug size refrigeration		
For models:	TRN1301, TRNA1301, TRNM1301, TRN1302, TRNA1302, TRNM1302, TRN1303, TRNA1303, TRNM1303, TRN1801, TRNA1801, TRNM1801, TRN1802, TRNA1802, TRNM1802, TRN1803, TRNA1803, TRNM1803, TRN2201, TRNA2201, TRNM2201, TRN2202, TRNA2202, TRNM2202, TRN2203, TRNA2203, TRNM2203, TRNP1802, TRN1301, TRNA1301, TRNM1301, TRN1302, TRNA1302, TRNM1302, TRN1303, TRNA1303, TRNM1303, TRN1801, TRNA1801, TRNM1801, TRN1802, TRNA1802, TRNM1802, TRN1803, TRNA1803, TRNM1803, TRN2201, TRNA2201, TRNM2201, TRN2202...(Other models you can see in the webshop)		

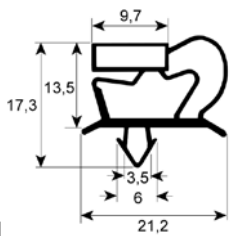

GEV No.	900372	Ref. No.	0A8752 12387
description	refrigeration gasket profile 9048 W 157mm L 372mm plug size drawer size 1/3		
For models:	EDON420121B, EDON280120, EDON280112, EDON280111, EDON280104, EDON280103, EDON280102, EDON280113, EDON280105, EDON420130, EDON420122, EDON420121, EDON420114, EDON420105, EDON420106, EDON420123, EDON420115, EDON570140, EDON570132, EDON570131, EDON570124, EDON570122, EDON570108, EDON570133, EDON570125, EDON720150, EDON720142, EDON720133, EDON720134, EDON720132, EDON720126, EDON720143, EDON720135, EDORN28120, EDORN28112, EDORN28111, EDORN28104, EDORN28103, EDORN28113, EDORN28105, EDORN28130, EDORN42122, EDORN42114, EDORN42106, EDORN42123, EDORN42115, EDORN57140, EDORN57132, EDOR570131, EDORN57124...(Other models you can see in the webshop)		

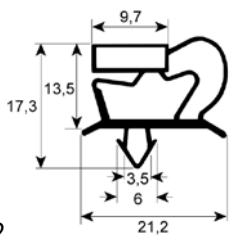

GEV No.	900303	Ref. No.	081772 12937
description	refrigeration gasket profile 9048 W 195mm L 372mm plug size drawer refrigeration size 1/3 suitable for ELECTROLUX, ZANUSSI		
For models:	TR1202, TR1221, TR1603, TR1622, TR1641, TR2004, TR2023, TR2042, TR1202, TR1221, TR1603, TR1622, TR1641, TR2004, TR2023, TR2042		

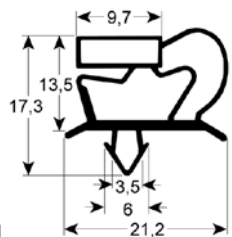

GEV No.	900373	Ref. No.	0A9222 0A9289 12456
description	refrigeration gasket profile 9048 W 212mm L 417mm plug size drawer		
For models:	KTSM102, KKSM100, KKSM102, KTSM104, SAL25T12, SAL25N12, SAL25N04, SAL25T04, KTSM100, KKSM100, 13000131.1, 13000132.1		

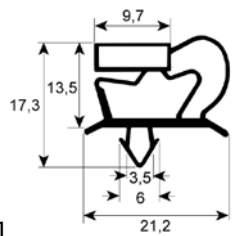

GEV No.	900019	Ref. No.	082759 12051
description	refrigeration gasket profile 9048 W 262mm L 372mm plug size drawer size 1/2		
For models:	TRN1301, TRNA1301, TRNM1301, TRN1302, TRNA1302, TRNM1302, TRN1303, TRNA1303, TRNM1303, TRN1801, TRNA1801, TRNM1801, TRN1802, TRNA1802, TRNM1802, TRN1803, TRNA1803, TRNM1803, TRN2201, TRNA2201, TRNM2201, TRN2202, TRNA2202, TRNM2202, TRN2203, TRNA2203, TRNM2203, TRRN1301, TRRN1302, TRRN1303, TRRN1801, TRRN1802, TRRN1803, TRRN2201, TRRN2202, TRRN2203, TRN1302, TRNA1302, TRNM1302, TRN1802, TRNA1802, TRNM1802, TRN2202, TRNA2202, TRNM2202, KT2T, KT3T, KT4T, NTRRN1301, NTRRN1302...(Other models you can see in the webshop)		

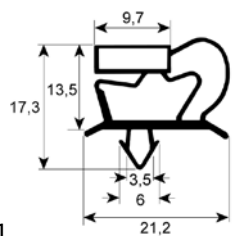

GEV No.	900305	Ref. No.	081815 12919
description	refrigeration gasket profile 9048 W 322mm L 372mm plug size drawer size 1/2		
For models:	TR1202, TR1221, TR1603, TR1622, TR1641, TR2004, TR2023, TR2042, TR1202, TR1221, TR1603, TR1622, TR1641, TR2004, TR2023, TR2042		

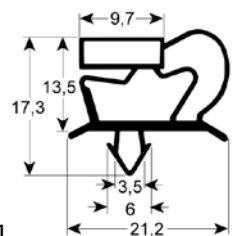

GEV No.	902098	Ref. No.	088028
description	refrigeration gasket profile 9048 W 352mm L 362mm plug size		
For models:	SSODWC12, SSODWC16, SSWC12, SSWC16, SSWC20, SSBMHC12HD, SSBMHC16HD, SSBMHC20H, SSODWCS12, SSODWCS16, SSODWC20, DVRVAF12, DVRVAF16, DRVAF12, DRVAF16, DRVAF20, ZLRW12C, ZLRW16C, ZLRW20C, ZLRDW12C, ZLRDW16C, ZLRDD12C, ZLRDD16C, ZLB12HHD, ZLB16HHD, ZLB20HHD, ZLRDW12S, ZLRDW16S, ZLRD-W20C		



GEV No.	901776	Ref. No.	088055
description	refrigeration gasket profile 9048 W 355mm L 430mm plug size		
For models:	SSODDPC12, SSODDPC16, SSDPC12, SSDPC16, SSDPC16, SSOD-DPC20, DVRPAF12, DVRPAF16, DRPAF12, DRPAF16, DRPAF20, ZLR-P12C, ZLRP16C, ZLRP20C, ZLRDD12C, ZLRDD16C, ZLRDD20C		

GEV No.	900304	Ref. No.	081805 12918
description	refrigeration gasket profile 9048 W 372mm L 587mm plug size door refrigeration size 1/1		
For models:	TR1202, TR1221, TR1603, TR1622, TR1641, TR2004, TR2023, TR2042, TR1202, TR1221, TR1603, TR1622, TR1641, TR2004, TR2023, TR2042		

GEV No.	900020	Ref. No.	031693 12045
description	refrigeration gasket profile 9048 W 372mm L 385mm plug size drawer refrigeration size 3/5 suitable for ELECTROLUX, ZANUSSI		
For models:	TRN1301, TRNA1301, TRNM1301, TRN1302, TRNA1302, TRNM1302, TRN1303, TRNA1303, TRNM1303, TRN1801, TRNA1801, TRNM1801, TRN1802, TRNA1802, TRNM1802, TRN1803, TRNA1803, TRNM1803, TRN2201, TRNA2201, TRNM2201, TRN2202, TRNA2202, TRNM2202, TRN2203, TRNA2203, TRNM2203, TRRN1301, TRRN1302, TRRN1303, TRRN1801, TRRN1802, TRRN1803, TRRN2201, TRRN2202, TRRN2203, TRN1303, TRNA1303, TRNM1303, TRN1803, TRNA1803, TRNM1803, TRN2203, TRNA2203, TRNM2203, KT2T, KT3T, KT4T, MVR/E1400, MVR/E1050...(Other models you can see in the webshop)		

GEV No.	900029	Ref. No.	0A9150 0KE849 13196
description	refrigeration gasket profile 9048 W 417mm L 502mm plug size door refrigeration		
For models:	SAL250, ES950, 130-00-130.1, KTSM100, KKSMM100, KTP100, 13000130.1, KTP100, KTSM100, KKSMM100, 130-00-131-1, 13000132.1		

GEV No.	900018	Ref. No.	082725 12047
description	refrigeration gasket profile 9048 W 372mm L 572mm plug size door size 1/1		
For models:	TRN1301, TRNA1301, TRNM1301, TRN1302, TRNA1302, TRNM1302, TRN1303, TRNA1303, TRNM1303, TRN1801, TRNA1801, TRNM1801, TRN1802, TRNA1802, TRNM1802, TRN1803, TRNA1803, TRNM1803, TRN2201, TRNA2201, TRNM2201, TRN2202, TRNA2202, TRNM2202, TRN2203, TRNA2203, TRNM2203, TRRN1301, TRRN1302, TRRN1303, TRRN1801, TRRN1802, TRRN1803, TRRN2201, TRRN2202, TRRN2203, TRNP1802, TRRF130P, TRRF180P, TRRF220P, TRF1301, TRRF1301, TRF1801, TRRF1801, TRF2201, TRRF2201, TRN1301, TRNA1301, TRNM1301, TRRN1301...(Other models you can see in the webshop)		

GEV No.	901295	Ref. No.	0A9647 11372
description	refrigeration gasket profile 9048 W 418mm L 495mm plug size plug-in gasket		
For models:	SM250, SAL25L2C94, SM100, PT100, KTSM102, KKSMM100, KTM100, ESM100, EKTMM100, EKKM100, SAL25L2C9, PTR259, SAL25T12, SAL25N12, SAL25T20, SAL25N20		

GEV No.	900986	Ref. No.	0A8992 13694
description	refrigeration gasket profile 9048 W 450mm L 578mm plug size		
For models:	ZBRAV806, ZBRAV805, ZBRAVV805, PTVN2719, PTVN2519, PTVN2724, PTVN2524, EDON400120, EDON600130, EDON800140, EDORN400120, EDORN600130, EDORN800140, EDONM400120, EDONM600130, EDONM800140, EDORNM400120, EDORNM600130, EDORN800140, EDOB40012, EDOB60013, EDOB80014		

GEV No.	901391	Ref. No.	081216
description	refrigeration gasket profile 9048 W 450mm L 648mm plug size plug-in gasket		
For models:	DCBR40, DCB/R40F, DCB/R40U, DCB/R40/61, DCBR41, DCB/R41F, DCB/R41U, DCB/R41-6, DCBR60, DCB/R60F, DCB/R60U, DCBR61, DCB/R61U, DCB/R61-6		

GEV No.	901779	Ref. No.	083851
description	refrigeration gasket profile 9048 W 625mm L 1535mm plug size		
For models:	TE751L, TZ751L, TZ751GT, TE751R, TZ751R, TE1502, TZ1502, TE751GT, KE751L, KZ751GT, TE751L, TZ751L, TZ751GT, KE751R, KZ751R, KE1502, KZ1502, KE751GT, TE752R, TE1502, TE751GT, CE752, KZ751L		

GEV No.	900384	Ref. No.	083742 14158
description	refrigeration gasket profile 9048 W 502mm L 1502mm plug size		
For models:	ZPR04R1F, ZPR04F1F, ESR4212FR, ESR4212F, ESR41FR, ESF41FR, ESR41F, ESF621/2F, ESR621/2F, ESR621/2F, ESF621/2FR, ESQC41F, ESQC41FR, ESQF41F, ESQF41FR, EUKR621/2F, ESR41F60HZ, ESR422F60HZ, ESR622F60, ESMF41F, PR04R1FBR, ESF41F60HZ, ESF41F, EUKF41F, PR04F1FBR, PS04RE1F, PS04FE1F, 1-DOOR REFRIG, PS04R1F, 1-DOOR REFRIG, PS04R1FR, 1-DOOR REFRIG, 1-DOOR FREEZER, PS04F1F, 1-DOOR FREEZER, PS04F1FR, PS04R1FM, PS04R1F6M, PR04R1F4, PR04F1F4, PS04R1F1M, PS04F1F6M, ESR41FR, ESR41F, ESR41F60, ESF41FR, ESMR41F, PR04R1F...(Other models you can see in the webshop)		

GEV No.	900389	Ref. No.	083664 13235
description	refrigeration gasket profile 9048 W 637mm L 1512mm plug size door refrigeration suitable for ELECTROLUX, ZANUSSI		
For models:	ETZ601, ETZ1402, ETE601, ETE1402, ETE601L, ETZ601L, EKZ601, EKZ1402, ETZ601, ETZ1402, EKE601, EKE1402, ETE601, ETE1402, EKE601L, EKZ601L, ETZ601L		

GEV No.	900383	Ref. No.	083675 14161
description	refrigeration gasket profile 9048 W 502mm L 717mm plug size		
For models:	ESR4212FR, ESR4212F, ESR422F60HZ, 2-DOOR REFRIG, PS04R2F, ESR421/2F, ESR422F60, PR04R2F, 2 1/2 -DOORS REFRIG, PDVN501V12C, PDVN507V11C, PDVC501V12C, PDVC507V12C		

GEV No.	900388	Ref. No.	083662 12748
description	refrigeration gasket profile 9048 W 637mm L 717mm plug size 1/2 door refrigeration		
For models:	ECZ602, ETZ602, ETZ1404, ETE602, ETE1404, ECE602, EKZ602, EKZ1404, ETZ602, ETZ1404, EGE602, EGE602, ECE602, ECZ602, EKE602, EKE1404, ETE602, ETE1404		

GEV No.	900380	Ref. No.	0A9195 10880
description	refrigeration gasket profile 9048 W 597mm L 1677mm plug size		
For models:	MLP609V11V, MLP139V12V, MLP602V11V, MLP132V12V, MLC601V11V, MLC602V11V, MLP609V11V, MLP602V11V, MLP139V12V, MLP132V12V, MLC601V11C, MLC602V11C		



GEV No.	900023	Ref. No.	082218 082375 11098
description	refrigeration gasket profile 9048 W 647mm L 1517mm plug size door refrigeration suitable for ELECTROLUX, ZANUSSI		
For models:	ALP110, ALP220, ALN110, ALN220, ALNN220, ALNN230, ALP110UK, ALN110UK, ALNN220UK, ALF110, ALNF220, ALF110, ALF220, ALNF220, ALNF230, ILP110, ILP110UK, ILN120, ILN110, ILN110UK, ILN120, ILNN220, ILNN220UK, ALP110UK, ALN110UK, ALNN220UK, ALF110UK, ALNF220UK, ILF110, ILF110, ILF120, ILNF220, ILNF220UK, ALP110, ALP220, ALP240, ALN110, ALN220, ALN240, ALF110, ALF220, ALF240, ALNN220, ALNF220, ALNN230, ALNF230, AZP1103, AZF1103, AZP2203, AZF2203...(Other models you can see in the webshop)		

GEV No.	900377	Ref. No.	084529 12105 462000
description	refrigeration gasket profile 9048 W 647mm L 1792mm plug size		
For models:	WDE752, WDE752GT, WZ751, WZ752, WE751		

GEV No.	900035	Ref. No.	082311 082424 11097
description	refrigeration gasket profile 9048 W 648mm L 725mm plug size 1/2 door refrigeration suitable for ELECTROLUX, ZANUSSI		
For models:	ALP120, ALP240, ALN120, ALN240, ALNN120, ALNN230, ALNSO120, ALF120, ALF240, ALNF120, ALNF230, ILP110, ILP110UK, ILN120, ILN110, ILN110UK, ILN120, ILNSO120, ILNN120, ILNN230, ILF110, ILF110, ILF120, ILNF120, ILNF230, ALP120, ALP220, ALP240, ALN120, ALN220, ALN240, ALF120, ALF220, ALF240, ALNN120, ALNF120, ALNN230, ALNF230, ALNSO120, ALNN1203, AKP110, AKS110, AKP120, AKP230, AKP240, AKN110, AKN120, AKN230, AKN240, AKNN120...(Other models you can see in the webshop)		

GEV No.	901308	Ref. No.	087824 10531
description	refrigeration gasket profile 9048 W 650mm L 1700mm plug size		
For models:	RI75RE1F, RI075RE1FR, RI093RE1F, RI093RE1FR, RI093RE1FU, WE751F, WZ751, WDE752, WDE752, RI075R1F, RI075R1FR, RI075R2FGT, WZ751, RI93RE1FEU, RI93R1FERU, E070R1P, E070R11P1		

GEV No.	900301	Ref. No.	080959 11146
description	refrigeration gasket profile 9048 W 660mm L 1565mm plug size door refrigeration		

GEV No.	901235	Ref. No.	083461 11055
description	refrigeration gasket profile 9048 W 706mm L 1506mm plug size for blast chiller suitable for ELECTROLUX, ZANUSSI		
For models:	BC44, BCF44, BC44, BCF44, BC44, BCF44, ESBC40, ESBC40R, ESBF40, EEVA40/1, EEVAC40/1, ESK40V, ESBC40, ESBF40, ESF40V, ESF-40VR, BE431, BFE431, ESK40VZ, EEVA40/1, EEVAC40/1, EEVA40/1, EEVAC40/1, ATPE201, AF430, AB430, AF430, ATPE201, AF430		

GEV No.	900385	Ref. No.	083749 14162
description	refrigeration gasket profile 9048 W 707mm L 797mm plug size 1/2 door refrigeration		
For models:	ESR14412FR, ESR141212FR, ESR141212F, ESR14412F, ESR621/2F, ESR621/2F, ESF621/2FR, EUKR621/2F, EUKR141212, EUKR14412F, ESR622F60, ESR1412F60HZ, ESR1442F60HZ, ESF621/2F, EUKF621/2F, ESF6212F6, PR06R2FBR, PS06F1F6M, PS06R1F, PS06R1FR, PS06R2F, PS06R2FR, PS06F1F, PS06F1FR, PS06FE2F, PR06R2F, PR06R2FR, PR06FE2F, ICF6212F, ICF6212F, 2 1/2 -DOORS REFRIG, 2 1/2 -DOORS REFRIG, 2 1/2-DOORS FREEZER		

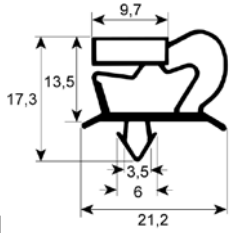

GEV No.	900375	Ref. No.	0A9180 11584
description	refrigeration gasket profile 9048 W 740mm L 1810mm plug size		
For models:	EWE601, EWZ601, EWDE602, EWDZ602, 12800100.1, 12800110.1, 12800110.1, 12800100.1		

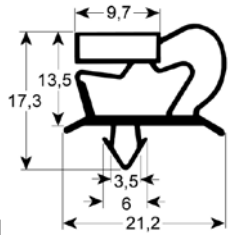

GEV No.	902099	Ref. No.	0A9522
description	refrigeration gasket profile 9048 W 775mm L 1827mm plug-in gasket		
For models:	EDVP10VR1, EDVP20VR1, EDVP10VR1, EDVP20VR1, EDVP10VR1, EDVP20VR14V, RI12H1F, RI27H2F, RI12H2FT, RI27H4FT, KUMAC		

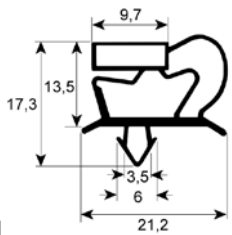

GEV No.	900386	Ref. No.	083722 14159 16038
description	refrigeration gasket profile 9048 W 797mm L 1492mm plug size door refrigeration suitable for ELECTROLUX, ZANUSSI		
For models:	ZPR06R1F, ZPR06F1F, ESR14412FR, ESR141212FR, ESR142FR, ESR141212F, ESR142F, ESR14412F, ESF142FR, ESR61F, ESR61FR, ESF61FR, EUKR61/N, EUKR142N, EUKR61F, EUKR142F, EUKR141212, EUKR14412F, ESR61F60, ESR142F60, ESR1412F60HZ, ESR1442F-60HZ, ESF142F60, ESF142F, ESF61F, EUKF61F, EUKF142F, GSF61F60, PR06R1FBR, PR06R2FBR, PR06F1FBR, PS06F1F6M, PS06RE1F, PS06FE1F, PS06R1F, PS06R1FR, PS06R2F, PS06R2FR, PS06F1F, PS06F1FR, PS06FE2F, PR06R1F4, PR06F1F4, PR06R1F, PR06R1FR, PR06R2F, PR06R2FR, PR06F1F, PR06F1FR, PR06FE2F...(Other models you can see in the webshop)		

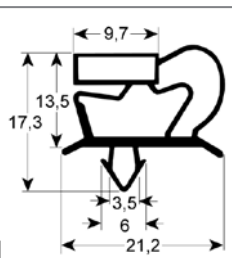

GEV No.	902258	Ref. No.	N/A
description	refrigeration gasket profile 9048 W 2500mm		

profile 9773

We offer custom-made gaskets for this profile

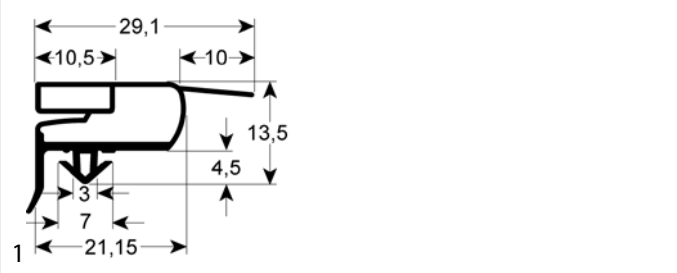

GEV No.	901389	Ref. No.	089148
description	refrigeration gasket profile 9773 W 276mm L 404mm external size W1 263mm L1 391mm plug size suitable for ELECTROLUX, ZANUSSI		
For models:	STRP1102, STRP1602, STRP1603, STRP2202, STRP2203, STRP1602R, STRP2202R, STRP2203R, STRP1102R, GDE900S, GDE900K, GDE900F, RCSN2M12, RCSN3M22, RCSN3M14, RCSN4M32, RCSN4M24, RCSN2M12R, RCSN3M22R, RCSN3M14R, RCSN4M32R, RCSN4M24R, RCSN3M06, SO2P120I, SO4P300I, SO4P220I, SO4P140I, SO5P320I, SO5P240I, RCSF3M3, RCSF2M12, SO4P220R, SO4P140R, SO5P320R, SO5P240R, SO2P120R		

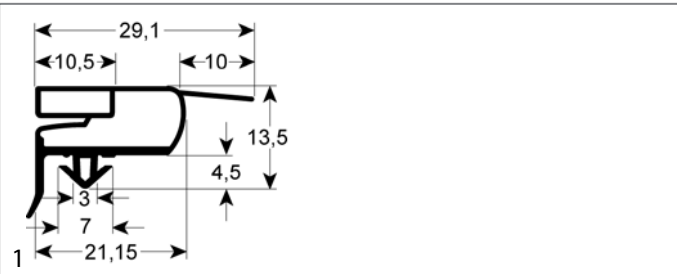

GEV No.	901388	Ref. No.	0A9595
description	refrigeration gasket profile 9773 W 285mm L 395mm external size W1 272mm L1 382mm plug size suitable for ELECTROLUX, ZANUSSI		
For models:	MLP2V2, MLP2V12, MLP3V3, MLP3V22, MLP3V14, MLP4V4, MLP4V32, MLP4V24		

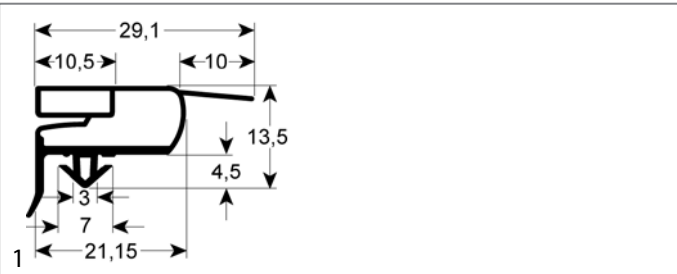

GEV No.	901392	Ref. No.	0A9565
description	refrigeration gasket profile 9773 W 395mm L 595mm external size W1 382mm L1 582mm plug size suitable for ELECTROLUX, ZANUSSI		
For models:	MLP2V2, MLP2V12, MLP3V3, MLP3V22, MLP3V14, MLP4V4, MLP4V32, MLP4V24		



GEV No.	901154	Ref. No.	089183 14725
description	refrigeration gasket profile 9773 W 407mm L 580mm external size W1 394mm L1 567mm plug size suitable for ELECTROLUX, ZANUSSI		
For models:	STRP1101, STRP1102, STRP1601, STRP1602, STRP1603, STRP2201, STRP2202, STRP2203, STRP1101S, STRP1601S, STRP2201S, STRP1602R, STRP1603R, STRP2201R, STRP2202R, STRP2203R, STRP1101R, STRP1102R, STRP1601R, RCSN2M2, RCSN2M12, RCSN3M3, RCSN3M22, RCSN3M14, RCSN4M4, RCSN4M32, RCSN4M24, RCSN2M2U, RCSN3M3U, RCSN4M4U, RCSN2M2R, RCSN2M12R, RCSN3M3R, RCSN3M22R, RCSN3M14R, RCSN4M4R, RCSN4M32R, RCSN4M24R, RCSN2M2T, RCSN3M3T, RCSN4M4T, RCSN2M24, RCSN3M34, RCSN4M44, RCSF2M24, RCSF3M34, RCSN3M06, SO2P200I, SO2P120I, SO4P300I...(Other models you can see in the webshop)		

GEV No.	900379	Ref. No.	088076 0A9099 0KE847 12901 15235
description	refrigeration gasket profile 9773 W 620mm L 1700mm external size W1 607mm L1 1687mm plug size suitable for ELECTROLUX, ZANUSSI		
For models:	APP113, APP114, APP114/60, APP224/60, APP11B, APP22B, APF223, APF224, APF22B, ESMLR60W, ESMLF60W, ESMLR60S, ESMLF60S, KZ1502, KE1502GT, TE1502, TZ1502, M06P0M1C, M06P9M1C, M06P2M1C, M13COM2C, M13C9M2C, M13C2M2C, CM06RF3M, CM06RF4M, CM06RFWM, CM13FF3M, CM13FF4M, CM13FFWM, CM06RF3M, CM13FF3M, MLP609V11C, MLP139V12C, MLP602V11C, MLP132V12C, MLP600V11C, MLP130V12C, MLC600V11C, MLC130V12C, MLP609V11C, MLP602V11C, MLP139V12C, MLP132V12C, MLP600V11C, MLP130V12C, MLC609V11C, MLC139V12C, MLC602V11C, MLC132V12C, MLP609V11...(Other models you can see in the webshop)		

GEV No.	900957	Ref. No.	087451 12938
description	refrigeration gasket profile 9773 W 590mm L 685mm external size W1 577mm L1 672mm plug size		
For models:	PFF119		

GEV No.	900984	Ref. No.	0A8230 13875
description	refrigeration gasket profile 9773 W 664mm L 762mm external size W1 651mm L1 749mm plug size suitable for ELECTROLUX, ZANUSSI		

GEV No.	900985	Ref. No.	087357 13295
description	refrigeration gasket profile 9773 W 598mm L 1690mm external size W1 585mm L1 1677mm plug size suitable for ELECTROLUX, ZANUSSI		
For models:	APF113, APF114, APP223, APP224, APP224/60, APF114, APP224V, M06C0M1C, M06C9M1C, M06C2M1C, M13P0M2C, M13P9M2C, M13P2M2C, M13P9M2V, CM06FF3M, CM06FF4M, CM06FFWM, CM13RF3M, CM13RF4M, CM13RFWM, CM06FF3M, CM13RF3M		

GEV No.	900983	Ref. No.	0A8225 13876
description	refrigeration gasket profile 9773 W 665mm L 1570mm external size W1 652mm L1 1557mm plug size suitable for ELECTROLUX, ZANUSSI		

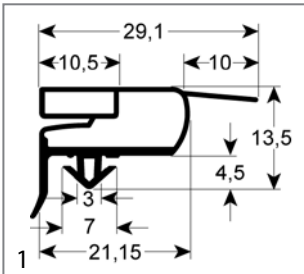

GEV No.	900254	Ref. No.	085696 085719 10604
description	refrigeration gasket profile 9773 W 682mm L 1531mm external size W1 669mm L1 1518mm plug size suitable for ELECTROLUX, ZANUSSI		
For models:	RS24, FS24, RFIS24, MRL402, EP406VRPUK, E04C6SCGUK, RW24, R04PVF4M, R04FSF4M, R04NVF4, R04NVF4F, R04PVFWG, R04FSFWG, R04PVF4, R04FSF4, R04PVG4, R04PVF4, R04PVGW, R04FSFW, C04NVFWD, C04PVF4D, C04NVF4D, C04FSF4D, C04FISHD, E04P6SRC, EP406VRC, E04N6VAC, E04C6SGC, E04P4VRC, E04N4VAC, E04C4SGC, E04N4VAC		

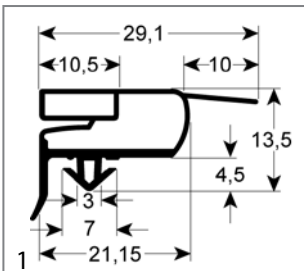

GEV No.	900381	Ref. No.	0A8647 12376
description	refrigeration gasket profile 9773 W 685mm L 1518mm external size W1 672mm L1 1505mm plug size suitable for ELECTROLUX, ZANUSSI		
For models:	ICF110, ICP110, ICP130, ICF110, ICN110UK, ICF110, ICP110, ICF110, ICP130, NEPV40, NICP40, NICF40, NEPV40, NEPA40, NEPV40, NEPA40, NEPV40, NICP40, EKE421S, EK401U, ET401S, EKE411UF, EK401UCS, ET401SCS, 12001720, EC406SGC, EC404SGC, 120.06.402, EP406SRC, EP406VRC, EN406VAC, EN404VAC, EC406SGC, EP404VRC, EN404VAC, EC404SGC, 12006402.1, EP406SRC, EP406VRC, EN406VAC, EP404VRC, EN404VAC, RVPE041, RVNE041, RVNE04P, ZEEP40, ZICP40, ZICF40, ZICF40		

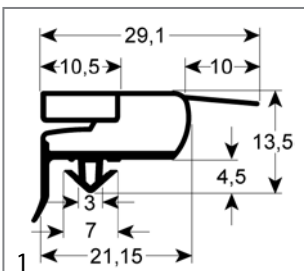

GEV No.	902305	Ref. No.	N/A
description	refrigeration gasket profile 9773 Wmm L 2500mm		

profile 9704

We offer custom-made gaskets for this profile

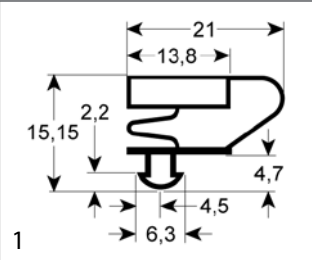

GEV No.	900374	Ref. No.	082505 082586 417603
description	refrigeration gasket profile 9704 W 665mm L 1535mm plug size glass door refrigeration suitable for ELECTROLUX, ZANUSSI		
For models:	ALP111, ALP221, ALN111, ALN221, ILP111, ILP221, ILN111, ILN221, ALP111, ALP221, ALN111, ALN221, AKP111, AKP221, AKN111, AKN221, AKP111, AKP221, AKN111, AKP221, ESR142GR, ESR142G, ESR142G60HZ, TE1502GT, IKN111, IKN221, ISP111N, ISP221N, ETZ601GT, ETE601GT, TZ1502GT, KE1502GT, KZ1502GT, EKZ601GT, ETZ601GT, EKE601GT, ETE601GT, DVP500V11V, DVP501V11V, MVP502V11V, EDVN500, DVN501V11V, DVP600V11V, DVP601V11V, EMVP602, EVN600V11V, EEVN601, DVN600V11V, EDVN601, DVP110V12V...(Other models you can see in the webshop)		

GEV No.	902299	Ref. No.	N/A
description	refrigeration gasket profile 9704 Wmm L 2500mm		

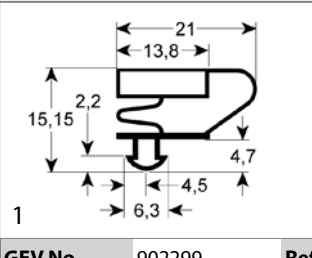

GEV No.	902299	Ref. No.	N/A
description	refrigeration gasket profile 9704 Wmm L 2500mm		

profile 9753

We offer custom-made gaskets for this profile

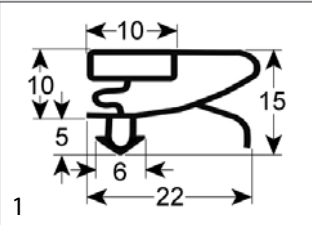

GEV No.	900875	Ref. No.	N/a
description	refrigeration gasket profile 9753 Wmm L 2500mm		

GEV No.	900875	Ref. No.	N/a
description	refrigeration gasket profile 9753 Wmm L 2500mm		

profile 9180

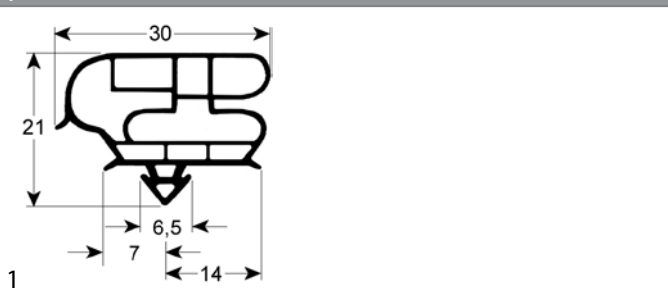

GEV No.	902128	Ref. No.	093257 094152 548R06801 548R06802
description	gasket profile 9180 W 580mm L 1580mm plug size		
For models:	FV 1M, FV 1M, FV 1M, FV 1M, FV 2M, FV 2M, DUAL 2 DOORS, DUAL 2 DOORS, FV 2M, FV 2M, FV 1M, FV 1M, FV 2M, FV 2M, FV 1M, FV 1M, FV 1M, FV 1M, FV 1M, FV 1M, FV 2M, FV 2M, DUAL 2 DOORS, DUAL 2 DOORS, FV 2M, FV 2M, FV 1M, FV 1M, FV 1M, FV 1M, FV 2M, FV 2M, FV 2M, FV 2M, DUAL 2 DOORS, DUAL 2 DOORS, FV 1M, FV 1M, FV 2M, FV 2M, FV 1M, FV 1M, FV 1M, FV 1M... (Other models you can see in the webshop)		

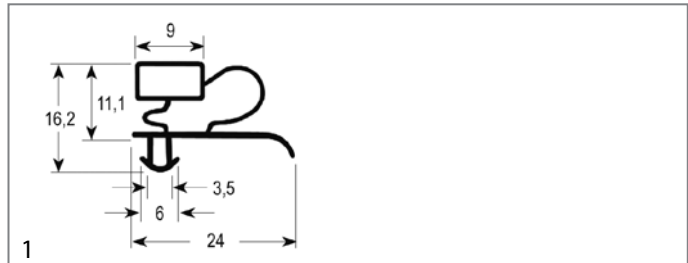

GEV No.	900989	Ref. No.	0A8365 A02048500
description	refrigeration gasket profile 9333 W 670mm L 1460mm plug size		

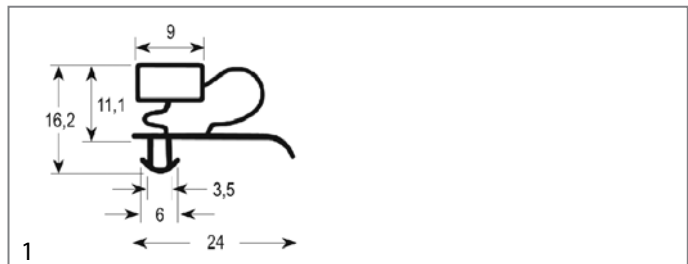

GEV No.	900382	Ref. No.	0A8648
description	refrigeration gasket profile 9333 W 685mm L 1515mm plug size glass door refrigeration		
For models:	ICP111, ICP112, ICP111, ICP112, NEPEV40, NEPEV40, 400LTPVN, NEPEV40, 400LTPVN, EK401UGT, EKE421GTS, ET401SGT, MRP402, EC406SGV, EP406SRV, EP406VRV, EC406SGV, EP406VAV, EP408SRV, EP406SRV, EP406VRV, EP406VAV, EP408SRV, RVPE04V, RVPE04W, ZICP110, ZICV40, ZICFV40, ZICFV40		

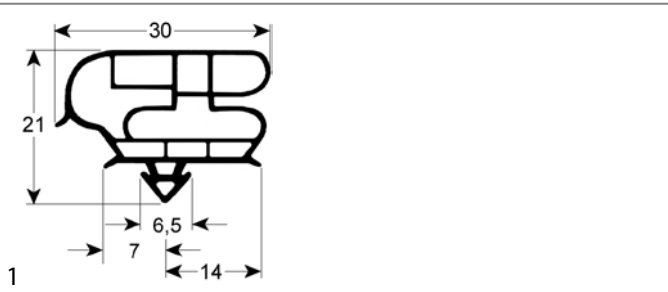

GEV No.	901909	Ref. No.	093273 094153
description	refrigeration gasket profile 9180 W 610mm L 765mm plug size L1 738mm W1 584mm external size		
For models:	FV 1M, FV 1M, FV Dual, FV Dual, FV 2M, FV 2M, FV 2M, FV 1M, FV 1M, FV 1M, FV 1M, FV Dual, FV Dual, FV 2M, FV 2M, FV 1M, FV, FV, FV 2M, FV 1M, FV 1M, FV Dual, FV Dual, FV 2M, FV 2M, FV 2M, FV 2M, FV 1M, ESP72HFG, FV 1M, FV Dual, FV Dual, FV 1M, FV, FV, FV 1M, FV, FV 1M, FV 1M, FV Dual, FV Dual, FV 1M, FV 1M, FV Dual 1/2 doors, FV Dual 1/2 doors, FV 1M, FV 1M, FV Dual 1/2 doors, FV 1M... (Other models you can see in the webshop)		

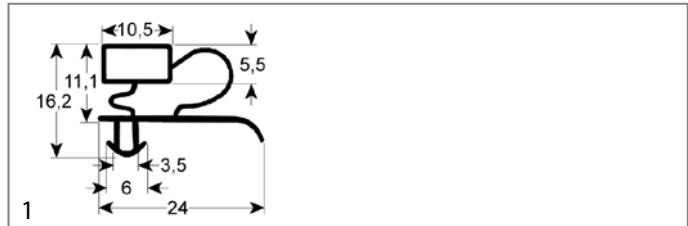

GEV No.	902167	Ref. No.	N/A
description	refrigeration gasket profile 9333 Wmm L 2500mm		

profile 9333

We offer custom-made gaskets for this profile



GEV No.	900387	Ref. No.	083791 421140A
description	refrigeration gasket profile 9333 W 520mm L 1515mm plug size glass door refrigeration		
For models:	ESR41GR, ESR41G, ESR41G60HZ, ESF41G, ESF41GR, ESF41G60HZ, ESR41G, ESMR41G, ESR41GR, ESM41G		

profile 9237

We offer custom-made gaskets for this profile

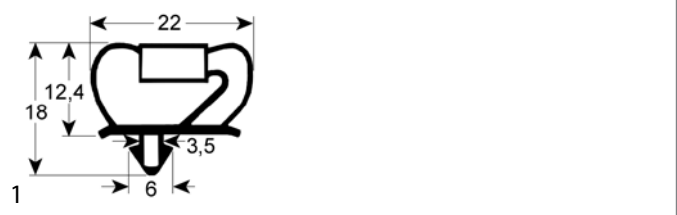

GEV No.	900012	Ref. No.	081943 13213
description	refrigeration gasket profile 9237 W 645mm L 1535mm plug size door refrigeration		

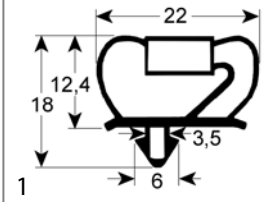

GEV No.	901343	Ref. No.	0A9559 10628
description	refrigeration gasket profile 9237 W 661mm L 1512mm plug size		
For models:	E04P6VRVUK, E04P8SRVUK, C04NVGWD, C04PVG4D, R04P6SRGB, R04P6SRB, R04P6SWB, E04P6SRV, E04P6VRV, E04P8SRV, E04C6SGV, E04P4VRV, E04C4SGV		

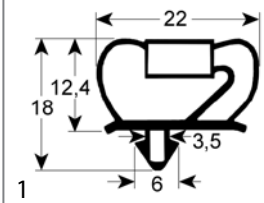

GEV No.	900013	Ref. No.	081725 12754
description	refrigeration gasket profile 9237 W 690mm L 710mm plug size 1/2 door refrigeration		

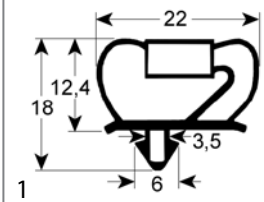

GEV No.	900015	Ref. No.	081724 12753
description	refrigeration gasket profile 9237 W 710mm L 1500mm plug size door refrigeration		

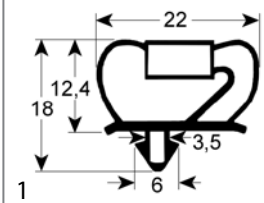

GEV No.	900097	Ref. No.	N/A
description	refrigeration gasket profile 9237 Wmm L 2000mm		

profile 9251

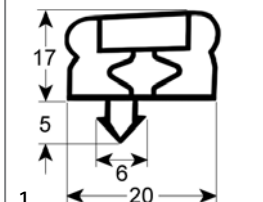

GEV No.	902129	Ref. No.	085218
description	gasket profile 9251 W 760mm L 2050mm plug size 3-sided		
For models:	MN0316T, MN0516T, MN0616T, MN0716T, MN0420T, MN0620T, MN0820T, MN0920T, MN0724T, MN0924T, MN0928T, MN1128T, 20-16FB13, MF0316T, MF0516T, MF0616T, MF0716T, MF0420T, MF0620T, MF0820T, MF0920T, MF0724T, MF0924T, MF0928T, MF1128T, MN-0316RT, MN0516RT, MN0616RT, MN0716RT, MN0420RT, MN0620RT, MN0820RT, MN0920RT, MN0724RT, MN0924RT, MN0928RT, MN-1128RT, 20-16MSG1, MF0316RT, MF0516RT, MF0616RT, MF0716RT, MF0420RT, MF0620RT, MF0820RT, MF0920RT, MF0724RT, MF0924RT, MF0928RT, MF1128RT...(Other models you can see in the webshop)		

profile 9794

We offer custom-made gaskets for this profile

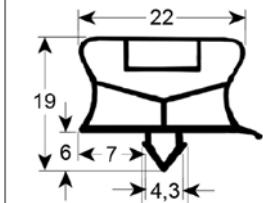

GEV No.	901390	Ref. No.	088484
description	refrigeration gasket profile 9794 W 150mm L 380mm plug size plug-in gasket		
For models:	TRN224C, TRN224D, TRN224E, TRN132A, TRN132B, TRN132C, TRNA132A, TRNA132B, TRNA132C, TRRN132A, TRRN132B, TRRN132C, TRN183A, TRN183B, TRN183C, TRN183D, TRNA183A, TRNA183B, TRNA183C, TRNA183D, TRRN183A, TRRN183B, TRRN183C, TRRN1842D, TRN224A, TRN224B, TRNA224A, TRNA224B, TRRN224A, TRRN224B, TRF132A, TRFA132A, TRRF132A, TRF183A, TRFA183A, TRRF183A, TRN132AE, TRN183AE, TRN224AE, TRF132AE, TRF183AE, RCDR4M24, RCDR4M16, RCDR4M08, RCDR2M20, RCDR2M12, RCDR-2M20U, RCDR2M12U, RCDR2M04R, RCDR3M22...(Other models you can see in the webshop)		

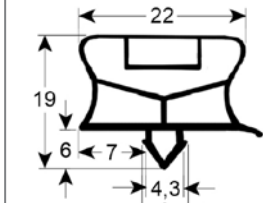

GEV No.	901414	Ref. No.	099572
description	refrigeration gasket profile 9794 W 150mm L 384mm plug size		
For models:	TRGS/1V7T, TRGS/2VT, TRGS/3V7T, TRGS/1VC27, TRGS/1VC37, TRGS/2V2C7, TCGS/1V7T, TCGS/2V7T, TCGS/1VC27, TCGS/2V2C7, TRGRS/1V7T, TRGRS/2V7T, TRGRS/3V7T, TRGRS/1VC2, TRGRS/1VC3, TRGRS/2V2C, TCGRS/1V7T, TCGRS/2V7T, TCGRS/1VC2, TCGRS/2V2, TRGS2VC27T, TRGS2VC2CB, TCGS2VC27T		



GEV No.	900987	Ref. No.	087691 12817
description	refrigeration gasket profile 9794 W 254mm L 387mm plug size		
For models:	TRN224C, TRN224D, TRN224E, TRN132A, TRN132B, TRN132C, TRNA132A, TRNA132B, TRNA132C, TRRN132A, TRRN132B, TRRN132C, TRN183A, TRN183B, TRN183C, TRN183D, TRNA183A, TRNA183B, TRNA183C, TRNA183D, TRRN183A, TRRN183B, TRRN183C, TRRN1842D, TRN224A, TRN224B, TRNA224A, TRNA224B, TRRN224A, TRRN224B, TRF132A, TRFA132A, TRRF132A, TRF183A, TRFA183A, TRRF183A, TRN132AE, TRN183AE, TRN224AE, TRF132AE, TRF183AE, RCDR4M24, RCDR4M16, RCDR4M08, RCDR2M20, RCDR2M12, RCDR2M20U, RCDR2M12U, RCDR2M04R, RCDR3M22...(Other models you can see in the webshop)		

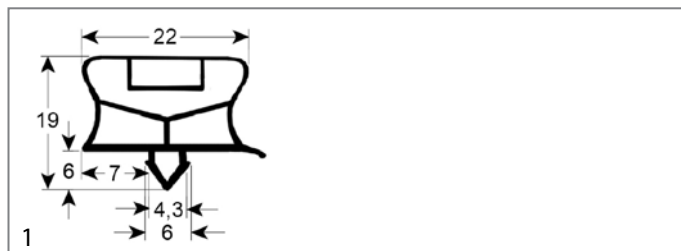

GEV No.	900890	Ref. No.	087664 12659
description	refrigeration gasket profile 9794 W 390mm L 555mm plug size		
For models:	TRN224C, TRN224D, TRN224E, TRN132A, TRN132B, TRN132C, TRNA132A, TRNA132B, TRNA132C, TRRN132A, TRRN132B, TRRN132C, TRN183A, TRN183B, TRN183C, TRN183D, TRNA183A, TRNA183B, TRNA183C, TRNA183D, TRRN183A, TRRN183B, TRRN183C, TRRN1842D, TRN224A, TRN224B, TRNA224A, TRNA224B, TRRN224A, TRRN224B, TRF132A, TRFA132A, TRRF132A, TRF183A, TRFA183A, TRRF183A, TRN132AE, TRN183AE, TRN224AE, TRF132AE, TRF183AE, TRN132AS, TRN183AS, RCDR4M24, RCDR4M16, RCDR4M08, RCDR2M20, RCDR2M12, RCDR2M20U, RCDR2M12U...(Other models you can see in the webshop)		

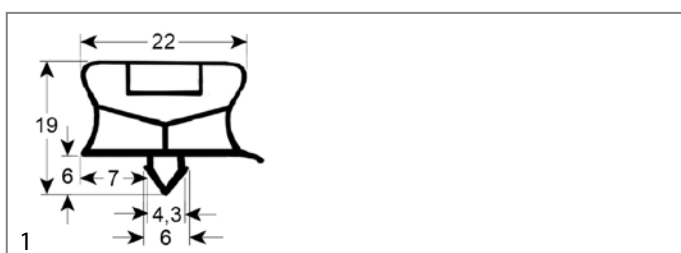

GEV No.	902325	Ref. No.	099538
description	refrigeration gasket profile 9794 W 260mm L 395mm plug size Qty 1		
For models:	RCSN2M12, RCSN3M22, RCSN3M14, RCSN2M12R, RCSN3M22R, RCSN3M14R, RCSN4M32R, RCSN4M24R, HB4CA60, HB4CUA60, HB6CA60, HB6CUA60, HB2PNT, HB2PA, HB4CA, HB6CA, HB2PUA, HB4CUA, HB6CUA, RCSN3M06, HB1P2CA, HB1P2CAU, HB2P2C12A, HB2P2C12UA, HB1P4C12A, HB1P4C12UA, HB1P5CA, HB1P5CUA, HB2P, HB1P2C12, HB4C, HB2P2C, HB1P4C, HB6C, HB3P2C, HB2P4C, HB8C, HB1P2CR, HB4CR, HB2P2CR, HB1P4CR, HB6CR, HB3P2CR, HB2P4CR, HB8CR, RCHBF1P2C, RCHBF2P2C, HB1P2C12U, HB4CU, HB2P2CU...(Other models you can see in the webshop)		

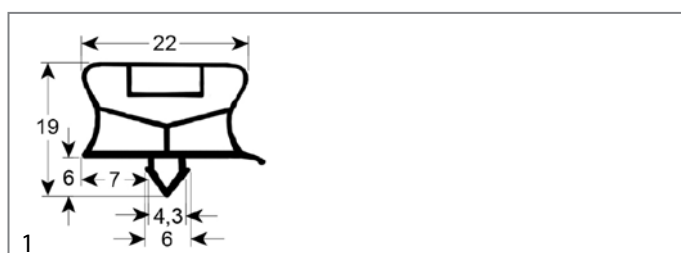

GEV No.	901369	Ref. No.	099531
description	refrigeration gasket profile 9794 W 390mm L 560mm plug size		
For models:	RCSN2M2, RCSN2M12, RCSN3M3, RCSN3M22, RCSN3M14, RCSN4M4, RCSN4M32, RCSN4M24, RCSN2M2U, RCSN3M3U, RCSN4M4U, RCSN2M2R, RCSN2M12R, RCSN3M3R, RCSN3M22R, RCSN3M14R, RCSN4M4R, RCSN4M32R, RCSN4M24R, RCSN2M2T, RCSN3M3T, RCSN4M4T, RCSN2M24, RCSN3M34, RCSN4M44, RCSF2M24, RCSF3M34, HB2PA60, HB2PUA60, HB3PA60, HB3PUA60, HB2PNT, HB3PNT, HB4PNT, HB2PNTR, HB3PNTR, HB4PNTR, RCSH2D6W, RCSH2D12W, RCSH3D, HB2PA, HB3PA, HB2PUA, HB3PUA, RCSN3M06, HB2PANT, HB1P2CA, HB1P2CAU, HB1P3C3A, HB1P3C3AU...(Other models you can see in the webshop)		



GEV No.	901482	Ref. No.	099571 K0003700
description	refrigeration gasket profile 9794 W 295mm L 385mm plug size		
For models:	TRGS/1V7T, TRGS/2V7T, TRGS/3V7T, TRGS/1VC27, TRGS/1VC37, TRGS/2V2C7, TCGS/1V7T, TCGS/2V7T, TCGS/1VC27, TCGS/2V2C7, TRGRS/1V7T, TRGRS/2V7T, TRGRS/3V7T, TRGRS/1VC2, TRGRS/1VC3, TRGRS/2V2C, TCGRS/1V7T, TCGRS/2V7T, TCGRS/1VC2, TCGRS/2V2, TRGS2VC27T, TRGS2VC2CB, TCGS2VC27T		

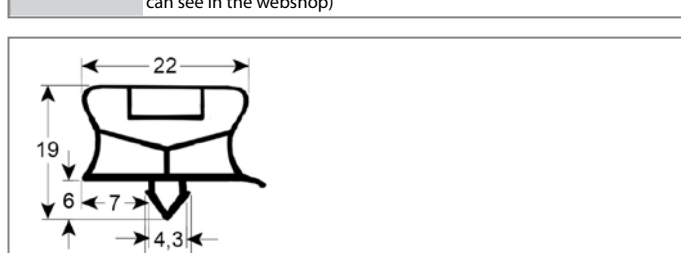

GEV No.	901559	Ref. No.	088331 14171
description	refrigeration gasket profile 9794 W 502mm L 925mm plug size		
For models:	BCW101, BCFW101, BCFWS101, EABP51, EABC501, AOFF101U, AOFFS101C, AOFFS101CR, AOF5101CR, AOF5101CU, AOFF10160, AOC101, AOC101R, AOC101CR, AOF101.1-, AOFF101U4, AOC101C, AOC101CR, AOFF101C, AOFF101CR, AOF101CJ, AOFF101CU, AOF101CU4, AOFFS101CT, EABP51C, EABC51C, EABC551C, HORBCF50, EBC551CR		

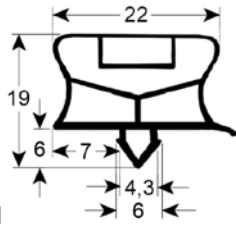

GEV No.	901528	Ref. No.	089663
description	refrigeration gasket profile 9794 W 553mm L 1385mm plug size		
For models:	BCW201R, BCFW201R, EABPR101, EABC101R, AOPFS201CR, AOF201RCU, EABPR101, EABPR101CR, EABC101R, AOCPP201CRR, AOPF201CRR, AOPF201RRU, AOF201RRU4		



GEV No.	902546	Ref. No.	091143 092689
description	refrigeration gasket profile 9794 W 561mm L 685mm plug size		
For models:	RCUR16X1, RUCR16W1V, RUCR16W1, RUCR16X1V, RUCR16X1VV, RUCR16X1, RUCR16G1V, RUCR16W1, RUCR16W1V, RUCR16X1G, RUCR16W1G, RUCR16X1G, RUCR16W1G, Counter 160, Counter 160, RUCR16, RUCR16L, Counter 160		

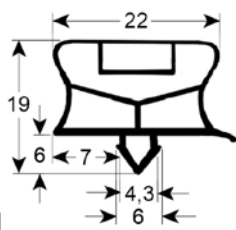

GEV No.	901153	Ref. No.	089735 14246
description	refrigeration gasket profile 9794 W 622mm L 1495mm plug size		
For models:	AZP1103, AZF1103, AZP2203, AZF2203, AZP1103, AZP2203, ALN1103, ALN2203, ALNN2203, AZP6430, ALF1104, AZP13430, AZF13430, ALN11033, ALF11033, AZP1103, AZP110360, ALN1103, AZP6430, ALN11033, AZF1103, ALF1104, ALF11033, AZP2203, AZP220360, ALN2203, AZP13430, AZF2203, AZF13430, ALNN2203, ISS110N, ISS220N, RS06PX1F6M, FULL DOOR FREEZER, ISP110N, ISN110N, ISP220N, ISN220N, RS06RX1F, FULL DOOR FREEZER, RS06FX1F, RS13RX2F, RS13FX2F, RS13DX2F, RS06PX1F, RS06PX1F6, RS06R41F, RS06NX1F, RS06F41F, FULL DOOR FREEZER...(Other models you can see in the webshop)		

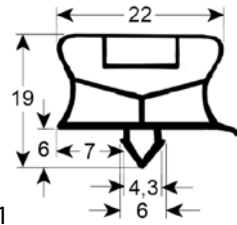

GEV No.	900981	Ref. No.	087129 12409
description	refrigeration gasket profile 9794 W 626mm L 1467mm plug size		
For models:	ADN220ES, ADF110ES, ADF220ES, ADN110ESP, ADF110ESP, ALN110, AEN110, ADF110, ALF110, AEF110, ALN220, AEN220, ADF220, AEF220, ADNN220, ADNF220, ADNN230, ADNF230, AENN220, AENF220, AENN230, AENF230, ASN110, ASF110, ASN220, ASF220, AKN110UK, AKF110UK, AKN220UK, AKF220UK, ASN110UK, ASF110UK, ASN220UK, ASF220UK, ARDN110, ADN110E, ADF110E, ADN220E, ADF220E, 83012001, 83012033, 83012201, ARDF110L, ARDN220, ARDNF220, 83012037, ASN110, ASF110, ASN220, ASF220...(Other models you can see in the webshop)		

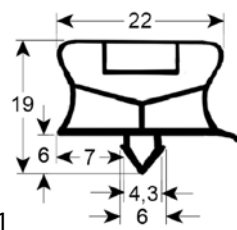

GEV No.	900988	Ref. No.	099866 0A9741 12410
description	refrigeration gasket profile 9794 W 691mm L 626mm plug size		
For models:	ALN120, AEN120, ADF120, ALF120, AEF120, ADNN120, ADNF120, AENN120, AENF120, ALN240, AEN240, ADF240, AEF240, ADNN230, ADNF230, AENN230, AENF230, ARDF120, ARDNN120, 83012101, ADN120, ADF120, ADNN120, ADNF120, ADN240, ADF240, ADNN220, ADNF220, ADNN230, ADNF230, ALNN1203, AZP1103, AZP110360, ALN1103, AZP6430, ALN11033, ALNN1203, IKNF220N, IKNN220, RS06RX1F, RS06DX2F, RS06PX1F, RS06PX1F6, RS06R41F, RS06NX1F, RS06DFX2F, RS06PW1F, RH06DD2U, RH06DFD2U, RH14DD3U...(Other models you can see in the webshop)		

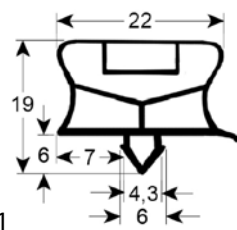

GEV No.	901672	Ref. No.	099637
description	refrigeration gasket profile 9794 W 696mm L 1496mm plug size with magnet		
For models:	BC56VA, Crosswise 20, BCF64A, Crosswise 20, Crosswise 20, RBC20.1-56, Crosswise 20, RBF20.1-64, BLAST C/F, Crosswise 20, RBF2016, Crosswise 20, EEVA561, Crosswise 20, EEVAC641		

profile 9373

We offer custom-made gaskets for this profile



GEV No.	902163	Ref. No.	N/A
description	refrigeration gasket profile 9373 Wmm L 2500mm plug size		

screw-in gaskets

profile 9663

We offer custom-made gaskets for this profile

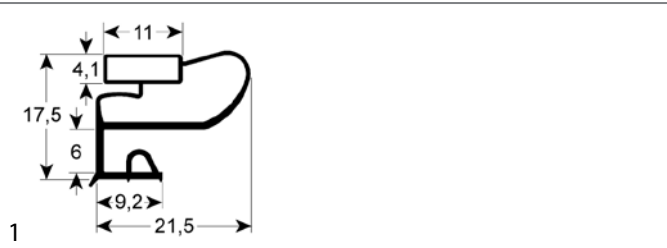

GEV No.	902295	Ref. No.	N/A
description	refrigeration gasket profile 9663 Wmm L 2500mm		

profile 9030

We offer custom-made gaskets for this profile

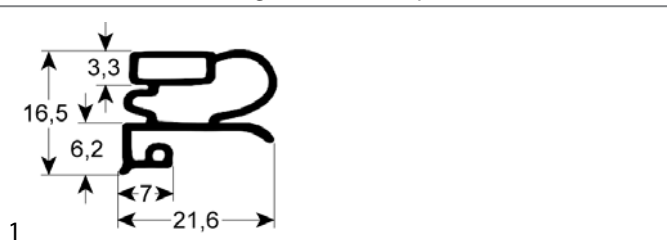

GEV No.	900001	Ref. No.	0A8083 11577
description	refrigeration gasket profile 9030 W 185mm L 390mm external size		



GEV No.	900034	Ref. No.	0A8379 12598
description	refrigeration gasket profile 9030 W 200mm L 392mm external size refrigeration		



GEV No.	900002	Ref. No.	0A8079 11581
description	refrigeration gasket profile 9030 W 310mm L 390mm external size drawer for refrigerated counter refrigeration size 1/2		

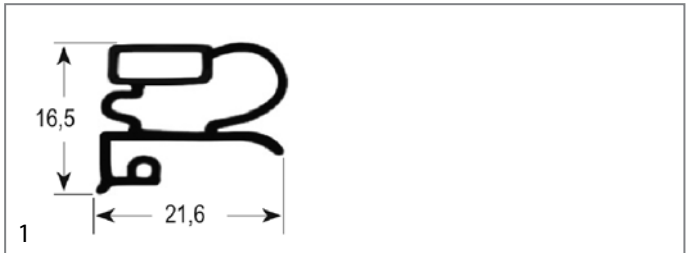

GEV No.	900309	Ref. No.	0K9330
description	refrigeration gasket profile 9030 W 330mm L 380mm external size drawer for refrigerated counter refrigeration size 1/2		

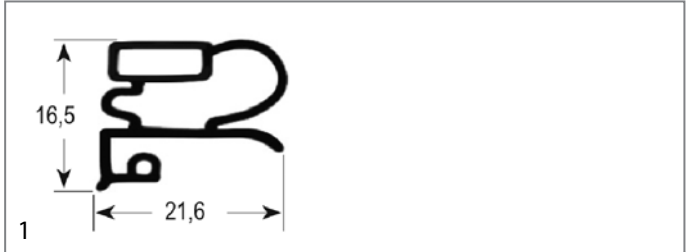

GEV No.	900308	Ref. No.	0K9331
description	refrigeration gasket profile 9030 W 380mm L 585mm external size drawer for refrigerated counter refrigeration size 1/1		



GEV No.	900003	Ref. No.	0A8081
description	refrigeration gasket profile 9030 W 390mm L 435mm external size drawer for refrigerated counter refrigeration size 3/5		



GEV No.	900004	Ref. No.	0A8075 0KE819 11579
description	refrigeration gasket profile 9030 W 391mm L 640mm external size door for refrigerated counter refrigeration size 1/1		
For models:	ES2M, ES3M, 23000150.1, 23000151.1, 23100150.1, 23100151.1		



GEV No.	900007	Ref. No.	0A8144 13487
description	refrigeration gasket profile 9030 W 446mm L 540mm external size refrigeration size 1/1		

GEV No.	900014	Ref. No.	0A8159 13486
description	refrigeration gasket profile 9030 W 540mm L 670mm external size refrigeration size 1/1		
For models:	133-01-110, 133-01-111, 133-06-110, 133-06-111		

GEV No.	900006	Ref. No.	081293 0A8048 11445
description	refrigeration gasket profile 9030 W 670mm L 1570mm external size door refrigeration suitable for ELECTROLUX, ZANUSSI		

GEV No.	900005	Ref. No.	081294 0A8049 11446
description	refrigeration gasket profile 9030 W 675mm L 770mm external size 1/2 door refrigeration suitable for ELECTROLUX, ZANUSSI		

gaskets for heated units

window seals

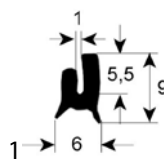

GEV No.	900270	Ref. No.	053754 054460 057397 057529 057655 057866 0C1325
description	window gasket profile 1510 Qty 5m		
For models:	HBR/G800, HBR/G805, HBR/G801, HBR/G806, HBR/G810, HBR/G815, HBR/G811, HBR/G816, HBR/G800D, HBR/G805D, HBR/G801D, HBR/G806D, HBR/G810D, HBR/G815D, HBR/G811D, HBR/G816D, HBR/E800, HBR/E805, HBR/E801, HBR/E806, HBR/E810, HBR/E815, HBR/E811, HBR/E816, HBR/G800NL, HBR/G805NL, HBR/G810NL, HBR/G800UK, HBR/E800UK, HBR/G800, HBR/G805, HBR/G810, HBR/G815, HBR/G811, HBR/G816, HBR/E800, HBR/E805, HBR/E810, HBR/E815, HBR/E811, HBR/E816, HBR/G800UK, HBR/E800UK, ZBR/G800, ZBR/G805, ZBR/G801, ZBR/G806, ZBR/G810, ZBR/G815, ZBR/G811...(Other models you can see in the webshop)		

GEV No.	900752	Ref. No.	0K2281 H25326900
description	window gasket profile 1550 Qty 3m		
For models:	5714-2-6, 5714-2-7, 5714-2-8, 5714-2-10, 5717-2-6, 5714-2-7, 5714-2-8, 5714-2-10, 5714-2-6L, 5714-2-7L, 5714-2-8L, 5714-2-10L, 5714-2-6L, 5714-2-7L, 5714-2-8L, 5714-2-10L, 5714-3-6, 5714-3-7, 5714-3-8, 5714-3-8E, 5714-3-10, 5717-3-6, 5717-3-7, 5717-3-8, 5717-3-8E, 5717-3-10, 5717-3-8M, 5717-3-8C, 5714-2-10F, 5714-2-10S, 5714-3-10F, 5714-3-10S, 5704-2-2, 5704-2-3, 5707-2-2, 5707-2-3, 5704-3-2, 5704-3-3, 5707-3-2, 5707-3-3		

GEV No.	900591	Ref. No.	005109 0H6761 0K2280
description	window gasket profile 1550 Wmm L 3000mm		
For models:	5711-2-6, 5711-2-7, 5711-2-8, 5711-2-10, 5711-2-8CH, 5711-2-10CH, 5712-2-6, 5712-2-7, 5712-2-8, 5712-2-10, 5711-2-6L, 5711-2-7L, 5711-2-8L, 5711-2-10L, 5721-2-7, 5721-2-10, 5712-2-6L, 5712-2-7L, 5712-2-8L, 5712-2-10L, 5711-3-6, 5711-3-7, 5711-3-8, 5711-3-10, 5711-3-8CH, 5711-3-10CH, 5712-3-6, 5712-3-7, 5712-3-8, 5712-3-8E, 5712-3-10, 5712-3-8CH, 5712-3-10C, 5712-2-10F, 5712-2-10S, 5711-3-10F, 5711-3-10S, 5712-3-10F, 5712-3-10S, 5702-2-2, 5702-2-3, 5701-3-2, 5701-3-3, 5702-3-2, 5702-3-3		

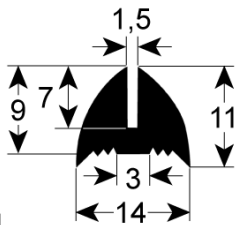

GEV No.	901356	Ref. No.	0H2421 OK8006
description	window gasket profile 1653 L 1685mm Qty 1		
For models:	AR170, AR170, AR170, AR170, AR170, AR170, AR170, AR170, AR170, AR170S, AR170S, AR170S, AR170S, AR170S, AR170S, AR170S, AR170S, AR170S, AR340S, AR340S, AR340S, AR340S, AR340S, AR340S, AR340S, AR10ES, AR10ES, AR10ES, AR10ES, AR10ES, AR10ES, AR10ES, AR10ESP, AR10ESP, AR10ESP, AR10ESP, AR10ESP, AR10ES, AR10ES, AR10ES, AR10ES...(Other models you can see in the webshop)		

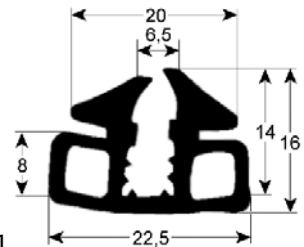

GEV No.	900191	Ref. No.	055314
description	window gasket profile 1820 perimeter 2200mm Qty 1		
For models:	FCVE10-2, FCVE10-4, FCVE103CE, FCVE10-2UK, FCVE10-4UK, FCVG10-2, FCVG10-4, FCVG10-4, FCVG10-4D, FCVG10-2UK, FCVG10-4UK, FCVG10-2, FCVG10-4, FCVE20/P-V, FCVE20-V, FCVE20VUK, FCVE10-P, FCVE10PUK, FCVG10-P, FCVG10PUK, ZOFCV/E102, ZOFCV/E104, ZOFCV/G102, ZOFCV/G104, AFCV/G101, AFCV/G103, SCO/G10-3, FCVG10-4, FCV/E20-V		

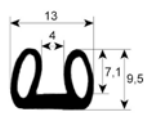

GEV No.	900144	Ref. No.	0H6828
description	window gasket profile 1790 Qty supplied by meter		

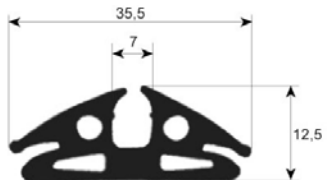

GEV No.	900272	Ref. No.	003680
description	window gasket profile 1830 L 1500mm Qty 1		
For models:	FCF/G6-0, FCF/E6-0, FCF061ELN, FCF6EHOR, FCF061ENS, FCF/G6-1-JAP, FCFE6-1J, ECF/G6/0, ECF/E6-0, ECF061ENS, ECF061E5M, ECF061ECV, ACF/G6-0, ACF/E6-0, JCF/G6-1, JCF/G6-2, RCF061G, RCF061E, NCF/G6-0, NCF/E6-0, ZCF/G6-0, ZCF/E6-0		

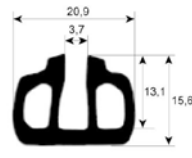

GEV No.	900036	Ref. No.	0H6663 60050435
description	window gasket profile 1800 Qty supplied by meter		

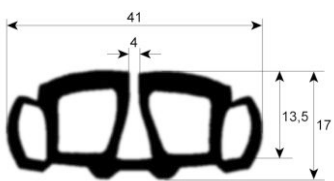

GEV No.	900154	Ref. No.	OK2079 OK2086 246160
description	window gasket profile 1840 perimeter 1700mm Qty 1		
For models:	5611-3-6		

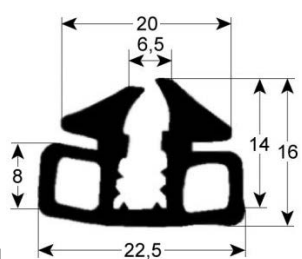

GEV No.	900190	Ref. No.	054557 055412
description	window gasket profile 1820 perimeter 1400mm Qty 1		
For models:	FCFG6D, FCFE6D, FCFE6D, FCFG6, FCFG6F, PFCFG6, FCFE6, FCFE6UK, PFCFE6, FCFE6J50, FCFE6J60, FCFG6J, FCFG6J, FCFG6J, FCFG6J, FCFE6-1U, FCFE6-3U, FCFE6-1, FCFE6-3, FCFE6-3CE, FCFE6-1UK, FCFE6-3UK, FCFG6-1, FCFG6-3, FCFG6-1UK, FCFG6-3UK, FCF/G6, FCF/E6, FCF/E6-1, FCF/E6-1, FCF/G6-1, ZOFCV/G6-3, AFCV/G6-1, AFCV/G6-3, SCO/G6-3, AFCF/E6, FF/G6, COCO6G, COCO6E, COCVE423AF, FCFE061, ZOFCF/G6D		

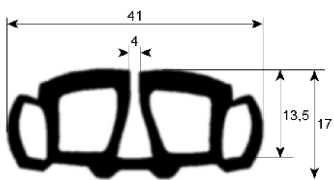

GEV No.	900176	Ref. No.	OK2081 OK2085
description	window gasket profile 1840 perimeter 2000mm Qty 1		
For models:	5614-3-6		



GEV No.	900175	Ref. No.	OK2080 OK2084
description	window gasket profile 1840 perimeter 2100mm Qty 1		
For models:	5612-3-6		

GEV No.	900155	Ref. No.	OK2082
description	window gasket profile 1841 perimeter 1700mm Qty 1		
For models:	5611-3-10, 5611-3-8		

GEV No.	900181	Ref. No.	OH6637 OH6639
description	window gasket profile 1841 perimeter 2000mm Qty 1		
For models:	5614-3-10, 5614-3-8		

GEV No.	900180	Ref. No.	OH6636 246164
description	window gasket profile 1841 perimeter 2200mm Qty 1		
For models:	5612-3-10, 5612-3-8		

GEV No.	900269	Ref. No.	003739
description	window gasket profile 1874 perimeter 2060mm Qty 1		
For models:	FCFG101/0, FCFG102-0, FCFG201-0, FCFG202-0, FCFE101-0, FCFE102-0, FCFE201-0, FCFE202-0, FCF101ELN, FCFG10160H, FCF101ENS, FCF102ENS, FCF201ENS, FCFG102-0T, FCF/G101/1-1-JAP, FCF/G102/1-1-JAP, FCFE101-1J, FCFE102-1J, FCF/G101/1, ECFG101-0, ECFG102-0, ECFG201-0, ECFG202-0, ECFE101-0, ECFE102-0, ECFE201-0, ECFE202-0, ECF101ENS, ECF102ENS, ECF201ENS, ACFG101-0, ACFG102-0, ACFG201-0, ACFG202-0, ACFE101-0, ACFE102-0, ACFE201-0, ACFE202-0, ACFG10160H, JCF/G101/1-1, JCF/G102/1-1, JCF/E101/1-1, JCF/E102/1-1, JCF/G101/1-2, JCF/G102/1-2, JCF/E101/1-2, JCF/E102/1-2, RCF101G, RCF101E, RCF201E...(Other models you can see in the webshop)		

GEV No.	900185	Ref. No.	002837
description	window gasket profile 1875 perimeter 1500mm Qty 1		
For models:	FCV/G6L3TOWNGAS, FCV/G6L3, FCVE6L3J, FCV/G6L3JAP, FCVG6L3CJ, FCV/E61/1, FCV/E61/1, FCV/E61/1, FCV/E61/1, FCV/G6L3C, FCV/G61/1, FCV/G61/1, FCV/G61/1, FCV/G61/1, FCV/G61/1, FCV/G6L3CT, FCVG6L3CJ, FCV/E6L3, FCV/G6L4, FCV/E6L4, ECV/G6T4, ECV/E6T4, ECV/G6T4C, ECV/G61/1, ECV/G61/1, RCV061G2, RCV061E2, RCV061E4, ACV/G6C3, ACV/G6C3C, ACV/E6C3, NCV/G6L2, NCV/E6L2, ZCV/G6T4C, ZCV/G61/1, ZCV/G6T4, ZCV/E6T4		

GEV No.	900186	Ref. No.	002878 OK2279 253249
description	window gasket profile 1875 perimeter 2000mm Qty 1		
For models:	FCV/G10L3, FCVG10L3T, FCVG102L3, FCFE101/1, FCFE201L3, FCFE202L3, FCFE101L3JAP, FCFE102/1L3JAP, FCFE101L6JAP, FCFE102/1L6JAP, FCFE101L3J, FCFE102L3J, FCFE101L6JAP, FCFE102/1L6JAP, FCFE101L2, FCFE101/1, FCFE101/1, FCFE101/1, FCFE101/1, FCFE101/1, FCFE101/2, FCFE101L3, FCFE102/1, FCFE102/1L3, FCFE201L3, FCFE202L3, FCFE101/1, FCFE101L6, FCFE101L6, FCFE102/1L6, FCFE102/1L6, FCFE201L6, FCFE202L6, FCFE202L6, FCFE202L6, FCFE101/1, FCFE101/1, FCFE101/1, FCFE101/1, FCFE102/1, FCFE102/1, FCFE201/1, FCFE201/1, FCFE202/1, FCFE202/1, FCFE101/0, FCFE102-0, FCFE201-0, FCFE202-0, FCFE101-0, FCFE102-0...(Other models you can see in the webshop)		

door seals



1			0H6854 268187 410015 E862074
GEV No.	900499	Ref. No.	
description	door seal		

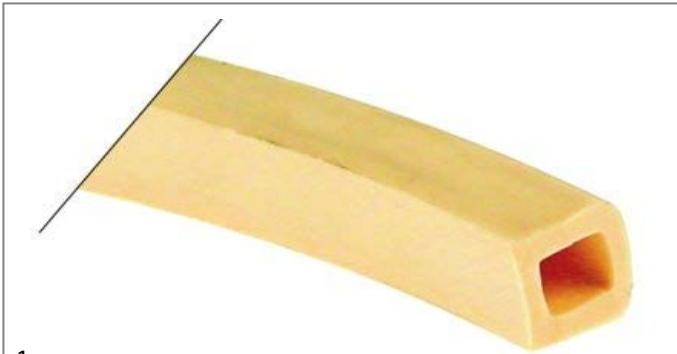

1			0H7007
GEV No.	900593	Ref. No.	
description	door seal L 1000mm		



1			0H6855
GEV No.	900582	Ref. No.	
description	door seal L 495mm		

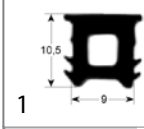

1			0LX024
GEV No.	900142	Ref. No.	
description	door seal profile 2010 Qty supplied by meter		

1			0H6976 284133
GEV No.	900037	Ref. No.	
description	door seal profile 2020 Qty supplied by meter		

1			0H6655 60050433
GEV No.	900044	Ref. No.	
description	door seal profile 2030 W 414mm L 620mm external size Qty 1		

1			0H6653
GEV No.	900042 ¹	Ref. No.	
description	door seal profile 2030 W 414mm L 620mm external size Qty 1 long side open		

¹3-sided (long side open)

1			0H6973 284122 60050459
GEV No.	900588	Ref. No.	
description	door seal profile 2030 W 428mm L 431mm external size Qty 1		

1			0H6656 0KC477 246257 60050434
GEV No.	900045	Ref. No.	
description	door seal profile 2030 W 620mm L 699mm external size Qty 1		



1

GEV No.	900041 ¹	Ref. No.	0H6654
description	door seal profile 2030 W 620mm L 699mm external size Qty 1 short side open		

¹3-sided (short side open)

1

GEV No.	902466	Ref. No.	0F0054 OK8585 490172202 4901722027
description	door seal profile 2100 L 1600mm suitable for ELECTROLUX, ZANUSSI combi-steamer		
For models:	CS20ME4/200-3, CS20ME4/230-3, CS20ME6/230-3, CS20ME4/400-3N, CS20ME6/400-3N, CS20ME4/400-3NE, CS20ME4/400-3, CS20ME4/440-3, CS20MT4/400-3N, CS20MT6/400-3N, CS20GE4/200-3, CS20GE4/230-3, CS20GE6/230-3, CS20GE4/400-3N, CS20GE6/400-3N, CS20GE4/400-3NE, CS20GE4/400-3, CS20GE4/440-3, CS20GT4/400-3N, CS20GT6/400-3N, CS20LCE4/200-3, CS20LCE4/230-3, CS20LCE6/230-3, CS20LCE4/400-3N, CS20LCE6/400-3N, CS20LCE4/400-3N, CS20LCE4/440-3, CS20LCT4/400-3N, CS20LCT6/400-3N, C204200-3, C20230-3, C204400-3N, C206400-3N, C20T4/400-, C20P4200-3, C20P4230-3, C20P44003N, C20P64003N, C20PT4/400		

1

GEV No.	900152	Ref. No.	0H6668 OK2083 246166 60050424
description	door seal profile 2445 W 430mm L 630mm external size Qty 1		
For models:	5611-3-10, 5611-3-6, 5611-3-8		

1

GEV No.	900586 ¹	Ref. No.	OK1832
description	door seal profile 2445 W 445mm L 630mm external size Qty 1		

¹3-sided (long side open)

1

GEV No.	900587 ¹	Ref. No.	OK1833
description	door seal profile 2445 W 620mm L 715mm external size Qty 1		

¹3-sided (short side open)

1

GEV No.	900189	Ref. No.	053751
description	door seal profile 2260 W 645mm L 715mm external size Qty 1 10 x 2/1		
For models:	FCFG20, FCFG20D, FCFG20F, PFCFG20, FCFE20, FCFE20UK, FCFG201, FCF/E20, COCO20G, COCO20E, FCFE201, ZOFCE/G20D		

1

GEV No.	900153	Ref. No.	OG2086 0H6669 246167 60050426
description	door seal profile 2445 W 630mm L 735mm external size Qty 1		
For models:	5612-3-10, 5612-3-6, 5612-3-8		

1

GEV No.	900763	Ref. No.	0H2653 OK9170 1008202020 877921855 8779218554
description	door seal profile 2276 Qty supplied by meter		

1

GEV No.	900170	Ref. No.	0H6641 246176
description	door seal profile 2445 W 650mm L 1350mm external size Qty 1		
For models:	5614-3-10, 5614-3-6, 5614-3-8		



GEV No.	900188	Ref. No.	055315 0K2968
description	door seal profile 2450 W 640mm H 720mm external size Qty 1 suitable for ELECTROLUX 640x720		
For models:	FCFG10, FCFG10D, FCFG10NL, FCFE10, FCFE10UK, FCFG20, FCFG20D, FCFG20F, PFCFG20, FCFE20, FCFE20UK, FCVE10, FCFG10J, FCFG10J, FCFE10J, FCFE10J, FCFG20J, FCFG20J, FCFE20J, FCFE20J, FCFG10J, FCFG10J, FCFG20J, FCFG20J, FCVE10-2, FCVE10-4, FCVE103CE, FCVE10-2UK, FCVE10-4UK, FCFG10-2, FCFG10-4, FCFG10-ISG, FCFG10-2, FCFG10-4D, FCFG10-2UK, FCFG10-4UK, FCFG10-2, FCFG10-4, FCVE20-2, FCVE20-4, FCVE203CE, FCVE20-2UK, FCVE20-4UK, FCFG20-2, FCFG20-4, FCFG20-2, FCFG20-4D, FCFG20-2UK, FCFG20-4UK, FCFG20-4...(Other models you can see in the webshop)		

GEV No.	900275	Ref. No.	054986
description	door seal profile 2450 W 645mm H 1380mm external size Qty 1 suitable for ELECTROLUX 640x1380		
For models:	FCFG40, FCFG41, FCFG40D, FCFG40F, PFCFG40F, FCFE40, FCFE40D, FCFE40UK, PFCFE40F, FCFG40J, FCFG40J, FCFE40J, FCFE40J, FCFG41J, FCFG40J, FCVE20/P-V, FCVE20-V, FCVE20VUK, FCFG202, FCF202, FCFE202, FF/E40, FF/G40, AFCF/E40, 4236N, 4238N, FCV/E20-V		

GEV No.	900162	Ref. No.	005102 005707 0K1843 237390 60050351
description	door seal profile 2520 W 430mm L 610mm external size Qty 1 suitable for ELECTROLUX 610x430		
For models:	FCVG6L3CJ, FCV/G6L3C, FCV/G61/1, FCV/G61/1, FCV/G61/1, FCV/G61/1, FCV/G61/1, FCV/G6L3CT, FCV/G6L3CJ, FCS061G48J, FCS061GP, FCS061G3DI, FCS061G4, FCS061G4DT, FCS061G49J, 5711-2-6, 5711-2-7, 5711-2-8, 5711-2-10, 5711-2-8CH, 5711-2-10CH, 5711-2-6L, 5711-2-7L, 5711-2-8L, 5711-2-10L, 5721-2-7, 5721-2-10, 5711-3-6, 5711-3-7, 5711-3-8, 5711-3-10, 5711-3-8CH, 5711-3-10CH, 5711-3-10F, 5711-3-10S, 5701-3-2, 5701-3-3, ECV/G6T4C, ECV/G61/1, ECV/G61/1, RCV061G2, ACV/G6C3C, ZCV/G6T4C, ZCV/G61/1		

GEV No.	900433	Ref. No.	002828 004226 005713 0KE761 60050309
description	door seal profile 2520 W 430mm L 635mm external size Qty 1 suitable for ELECTROLUX, JUNO, ZANUSSI 635x430		
For models:	FCV/G6L3TOWNGAS, FCV/G6L3, FCVE6L3J, FCV/G6L3JAP, FCV/E61/1, FCV/E61/1, FCV/E61/1, FCV/E61/1, FCV/E6L3, FCV/G6L4, FCV/E6L4, FCF/G6-0, FCF/E6-0, FCF061ELN, FCF6EHOR, FCF061ENS, FCF/G6-1-JAP, FCVE6-1J, FCS061E44J, FCS061EP, FCS061E3CI, FCS061E4, FCS061EXLN, FCS061EX, ECF/G6/0, ECF/E6-0, ECF061ENS, ECF061E5M, ECF061ECV, ECV/G6T4, ECV/E6T4, ACF/G6-0, ACF/E6-0, JCF/G6-1, JCF/E6-1, JCF/G6-2, JCF/E6-2, RCV061E2, RCV061E4, RCF061G, RCF061E, ACV/G6C3, ACV/E6C3, NCF/G6-0, NCF/E6-0, NCV/G6L2, NCV/E6L2, ZCV/G6T4, ZCV/E6T4, ZCF/G6-0...(Other models you can see in the webshop)		

GEV No.	900579	Ref. No.	005708 0F0046 0K8380 0KE536 30000734
description	door seal profile 2520 W 450mm L 1490mm external size Qty 1 suitable for ELECTROLUX 450x1490		
For models:	CS20ME4/200-3, CS20ME4/230-3, CS20ME6/230-3, CS20ME4/400-3N, CS20ME6/400-3N, CS20ME4/400-3NE, CS20ME4/400-3, CS20ME4/440-3, CS20MT4/400-3N, CS20MT6/400-3N, CS20GE4/200-3, CS20GE4/230-3, CS20GE6/230-3, CS20GE4/400-3N, CS20GE6/400-3N, CS20GE4/400-3NE, CS20GE4/400-3, CS20GE4/440-3, CS20GT4/400-3N, CS20GT6/400-3N, CS20LCE4/200-3, CS20LCE4/230-3, CS20LCE6/230-3, CS20LCE4/400-3N, CS20LCE6/400-3N, CS20LCE4/400-3N, CS20LCE4/440-3, CS20LCT4/400-3N, CS20LCT6/400-3N, C204200-3, C20230-3, C204400-3N, C206400-3N, C20T4/400-, C20P4200-3, C20P4230-3, C20P44003N, C20P64003N, C20PT4/400		

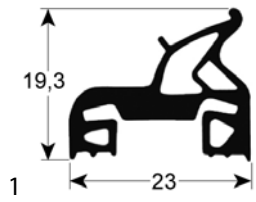

GEV No.	900577	Ref. No.	005710 0F0002 0K8378 0KB642
description	door seal profile 2520 W 450mm L 550mm external size Qty 1 suitable for ELECTROLUX 450x550		
For models:	CS7ME4/200-3, CS7ME4/230-3, CS7ME4/400-3N, CS7ME6/400-3N, CS7ME4/400-3N/EO, CS7ME4/400-3/50HZ/MA, CS7ME4/440-3/60HZ/MA, CS7MT4/400-3N, CS7GE4/200-3, CS7GE4/230-3, CS7GE4/400-3N, CS7GE6/400-3N, CS7GE4/400-3N/EO, CS7GE4/400-3/50HZ/MA, CS7GE4/440-3/60HZ/MA, CS7GT4/400-3N, CS7LCE4/200-3, CS7LCE4/230-3, CS7LCE4/400-3N, CS7LCE6/400-3N, CS7LCE4/400-3N/EO, CS7LCE4/400-3/50HZ/M, CS7LCE4/440-3/60HZ/M, CS7LCT4/400-3N, C7E4/200-3, C7E4/230-3, C7E4/400-3N, C7E6/400-3N, C7PE4/200-3, C7PE4/230-3, C7PE4/400-3N, C7PT4/400-3N		

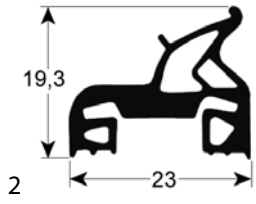

GEV No.	900578	Ref. No.	005709 0F0069 0K8379
description	door seal profile 2520 W 450mm L 770mm external size Qty 1 suitable for ELECTROLUX 450x770		
For models:	CS10ME4/200-3, CS10ME4/230-3, CS10ME6/230-3, CS10ME4/400-3N, CS10ME6/400-3N, CS10ME4/400-3N/EO, CS10ME4/400-3/50HZ/M, CS10ME4/440-3/60HZ/M, CS10MT4/400-3N, CS10MT6/400-3N, CS10GE4/200-3, CS10GE4/230-3, CS10GE6/230-3, CS10GE4/400-3N, CS10GE6/400-3N, CS10GE4/400-3N/EO, CS10GE4/400-3/50HZ/M, CS10GE4/440-3/60HZ/M, CS10GT4/400-3N, CS10GT6/400-3N, CS10LCE4/200-3, CS10LCE4/230-3, CS10LCE6/230-3, CS10LCE4/400-3N, CS10LCE6/400-3N, CS10LCE4/400-3N/EO, CS10LCE4/400-3/50HZ/M, CS10LCE4/440-3/60HZ/M, CS10LCT4/400-3N, CS10LCT6/400-3N, C104200-3, C104230-3, C104400-3N, C106400-3N, C10T4/400-3, C10P4200-3, C10P4230-3, C10P44003N, C10P64003N, C10PT4/400		

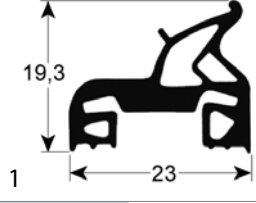

GEV No.	900161	Ref. No.	003088 005705 0K1842 237389
description	door seal profile 2520 W 640mm L 1400mm external size Qty 1 suitable for ELECTROLUX 640x1400		
For models:	5714-2-6, 5714-2-7, 5714-2-8, 5714-2-10, 5717-2-6, 5714-2-7, 5714-2-8, 5714-2-10, 5714-2-6L, 5714-2-7L, 5714-2-8L, 5714-2-10L, 5714-2-6L, 5714-2-7L, 5714-2-8L, 5714-2-10L, 5714-3-6, 5714-3-7, 5714-3-8, 5714-3-8E, 5714-3-10, 5717-3-6, 5717-3-7, 5717-3-8, 5717-3-8E, 5717-3-10, 5717-3-8M, 5717-3-8C, 5714-2-10F, 5714-2-10S, 5714-3-10F, 5714-3-10S, 5704-2-2, 5704-2-3, 5707-2-2, 57074-2-3, 5704-3-2, 5704-3-3, 5707-3-2, 5707-3-3		

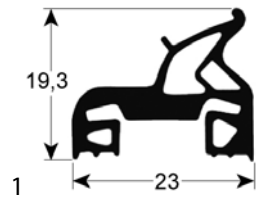

GEV No.	900590	Ref. No.	005706 0H6521 60050350
description	door seal profile 2520 W 640mm L 730mm external size Qty 1 suitable for ELECTROLUX 640x730		
For models:	5712-2-6, 5712-2-7, 5712-2-8, 5712-2-10, 5712-2-6L, 5712-2-7L, 5712-2-8L, 5712-2-10L, 5712-3-6, 5712-3-7, 5712-3-8, 5712-3-8E, 5712-3-10, 5712-3-8CH, 5712-3-10C, 5712-2-10F, 5712-2-10S, 5712-3-10F, 5712-3-10S, 5702-2-2, 5702-2-3, 5702-3-2, 5702-3-3		

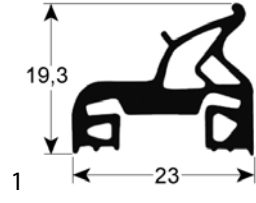

GEV No.	900434	Ref. No.	003995 005711
description	door seal profile 2520 W 655mm L 1400mm external size Qty 1 suitable for ELECTROLUX 660x1400		
For models:	FDV40G, FDV40E, FDV40GZ, FDV40EL, FDV40GA, FDV20G, FDV20E, FDV20GZ, FDV20EL, FDV20GA, FCV/G20L3, FCVG20L3, FCV/E20L3, FCFE20L3, FCV/G20L6, FCV/E20L6, FCVG20L6, FCFE20L6, FCV/G201/1, FVC/E201/1, FCV/G202/1, FVC/E202/1, FCFG201-0, FCFG202-0, FCFE201-0, FCFE202-0, FCF201ENS, FCS201E4, FCS201EP, FCS202E4, FCS202EP, FCS201G4, FCS201GP, FCS202G4, FCS202GP, FCS201EX, FCS201EXLN, FCS202EX, FCS201GX, FCS202GX, 5714-2-7, 5714-2-8, 5714-2-10, 5714-2-7, 5714-2-8, 5714-2-10, 5714-2-7L, 5714-2-8L, 5714-2-10L, 5714-2-7L...(Other models you can see in the webshop)		

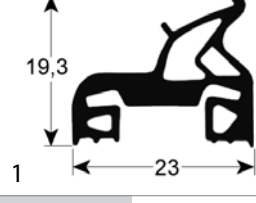

GEV No.	900160	Ref. No.	002654 004227 005712 0K1840 0K476 0KE753 237387 543817600 60050293
description	door seal profile 2520 W 655mm L 725mm external size Qty 1 suitable for ELECTROLUX		
For models:	FCV/G10L3, FCVG10L3T, FCVG102L3, FCV/E101/1, FCV/E10L3JAP, FCV/E102/1L3JAP, FCV/E10L6JAP, FCV/E102/1L6JAP, FCVG10L3J, FCVG102L3J, FCV/G10L6JAP, FCV/G102/1L6JAP, FCV/G10L2, FCV/E101/1, FCV/E101/1, FCV/E10L2, FCV/E101/1, FCV/E101/2, FCV/E10L3, FCV/E102/1L3, FCV/E101/1, FCV/G10L6, FCV/E10L6, FCV/G102/1L6, FCV/E102/1L6, FCV/E101/1, FCV/G101/1, FVC/E101/1, FCV/G102/1, FVC/E102/1, FCFG101/0, FCFG102-0, FCFE101-0, FCFE102-0, FCF101ELN, FCFG10160H, FCF101ENS, FCF102ENS, FCFG102-0T, FCF/G101/1-1-JAP, FCF/G102/1-1-JAP, FCFE101-1J, FCFE102-1J, FCF/G101/1, FCS101E2, FCS101E4J, FCS101EP4J, FCS101G2, FCS101E4, FCS101G4...(Other models you can see in the webshop)		



GEV No.	900369	Ref. No.	ORT059
description	door seal profile 2715 W 465mm H 510mm outer plug size Qty 1		

GEV No.	900930	Ref. No.	ORT058
description	door seal profile 2715 W 465mm H 775mm outer plug size Qty 1		

GEV No.	900276	Ref. No.	OC0881 OC1473
description	door seal profile 2760 W 480mm L 1460mm outer plug size Qty 1 suitable for ELECTROLUX 1438x450		
For models:	FCZ201EAA, FCZ201EAH, FCZ201EAN, FCZ201ETA, FCZ201ETH, FCZ201ETN, FCZ201GAG, FCZ201GAD, FCZ201GTG, FCZ201GTD, FCZ201EBA, FCZ201EBH, FCZ201EBN, FCZ201EBC, FCZ201EBA2, FCZ201EBH2, FCZ201EBN2, FCZ201EBC2, FCZ201GBG, FCZ201GBD, FCZ201GBI, FCZ201GBG2, FCZ201GBD2, FCZ201GBI2, FCZ201ECA, FCZ201ECH, FCZ201ECN, FCZ201ECA2, FCZ201ECH2, FCZ201ECN2, FCZ201GCG, FCZ201GCD, FCZ201GCG2, FCZ201GCD2, AOS201GAEU, AOS201GAAU, AOS201EABU, AOS201EAFU, AOS201EA, AOS201EB, AOS201EA3J, AOS201EB3J, AOS201EA2N, AOS201EB2N, AOS201EB5M, AOS201EB6M, AOS201EA0H, AOS201EB0H, AOS201GA, AOS201GB...(Other models you can see in the webshop)		

GEV No.	900278	Ref. No.	006992 OC1496
description	door seal profile 2760 W 480mm L 505mm outer plug size Qty 1 suitable for ELECTROLUX 475x450		
For models:	FCZ061EAA, FCZ061EAH, FCZ061EAN, FCZ061ETA, FCZ061ETH, FCZ061ETN, FCZ061GAG, FCZ061GAD, FCZ061EBA, FCZ061EBH, FCZ061EBN, FCZ061EBC, FCZ061EBA2, FCZ061EBH2, FCZ061EBN2, FCZ061EBC2, FCZ061GBG, FCZ061GBD, FCZ061GBI, FCZ061ECA, FCZ061ECH, FCZ061ECN, FCZ061ECA2, FCZ061ECH2, FCZ061ECN2, FCZ061GCG, FCZ061GCD, AOS061GAEU, AOS061GAAU, AOS061EABU, AOS061EAFU, AOS061EA, AOS061EB, AOS061EA3J, AOS061EB3J, AOS061EA2N, AOS061EB2N, AOS061EB5M, AOS061EB6M, AOS061EA0H, AOS061EB0H, AOS061GA, AOS061GB, AOS061EAAQ, AOS061EBAQ, AOS061EANQ, AOS061EBNQ, AOS061EACQ, AOS061EBCQ, AOS061EAHQ...(Other models you can see in the webshop)		

GEV No.	900268	Ref. No.	007069 OC1477
description	door seal profile 2760 W 480mm L 755mm outer plug size Qty 1 suitable for ELECTROLUX 450x725		
For models:	FCZ101EAA, FCZ101EAH, FCZ101EAN, FCZ101ETA, FCZ101ETH, FCZ101ETN, FCZ101GAG, FCZ101GAD, FCZ101GTG, FCZ101GTD, FCZ101EBA, FCZ101EBH, FCZ101EBN, FCZ101EBC, FCZ101EBA2, FCZ101EBH2, FCZ101EBN2, FCZ101EBC2, FCZ101GBG, FCZ101GBD, FCZ101GBI, FCZ101GBG2, FCZ101GBD2, FCZ101GBI2, FCZ101ECA, FCZ101ECH, FCZ101ECN, FCZ101ECA2, FCZ101ECH2, FCZ101ECN2, FCZ101GCG, FCZ101GCD, FCZ101GCG2, FCZ101GCD2, AOS101GAEU, AOS101GAAU, AOS101EABU, AOS101EAFU, AOS101EA, AOS101EB, AOS101EA3J, AOS101EB3J, AOS101EA2N, AOS101EB2N, AOS101EB5M, AOS101EB6M, AOS101EA0H, AOS101EB0H, AOS101GA, AOS101GB...(Other models you can see in the webshop)		

GEV No.	900267	Ref. No.	OC1195 OC1889
description	door seal profile 2760 W 660mm L 1460mm outer plug size Qty 1 suitable for ELECTROLUX 1438x630		
For models:	AOS202GAEU, AOS202GAAU, AOS202EA2N, AOS202EB2N, AOS202EA, AOS202EB, AOS202GB, AOS202GA, AOS202EAAQ, AOS202EBAQ, AOS202EANQ, AOS202EBNQ, AOS202GAGQ, AOS202GBGQ, AOS202GADQ, AOS202GBDQ, AOS202GAPQ		

GEV No.	900038	Ref. No.	0H6986 1501791
description	door seal profile 2945 W 605mm L 1310mm external size Qty 1		

GEV No.	900051	Ref. No.	0G1819 0H6767
description	door seal profile 2955 Qty supplied by meter		

GEV No.	900149	Ref. No.	0H6865
description	door seal profile 2945 W 905mm L 1370mm external size Qty 1		

GEV No.	900273	Ref. No.	054850
description	door seal profile 2970 L 1133mm Qty 1		
For models:	FCF02EV, FCF02EOEM, FCF/E3, FCF/E2, FCF/E2D, FCF/E2UK, FCF/E2, FCF/E2, FCF/E2D		

GEV No.	900306	Ref. No.	057396 057528 057656
description	door seal profile 2947 Qty supplied by meter		

GEV No.	900583	Ref. No.	0H6975
description	door seal W 435mm L 660mm		

GEV No.	900147	Ref. No.	0H6760
description	door seal profile 2950 Qty supplied by meter		

GEV No.	900624	Ref. No.	054111 054112 OKF002
description	door seal profile 2953 Qty supplied by meter		
For models:	MCF/G705, MCF/G1055, MCF/G700, MCF/G1050, MCF/G705E, MCF/G1055E, MCF/G700D, MCF/G700, MCF/G705F, MCF/G1055F, MCF/G705NL, MCF/GE705, MCF/GE1055, MCF/GE700, MCFGE1050, MCF/GE700D, MCFGE1050D, MCF/G1050D, MCFG1055NL, MCF/E700D, MCF/E700, MCF/E700UK, MCF/E1050D, MCF/E1050, MCF/GE1055UK, MIF/E700, MIF/E700D, MIF/E710, MIF/E710D, MCF/G702, MCF/GE702, MCF/G1052, MCFGE1052, MCF/G700, MCF/GE700, MCF/G1050, MCFGE1050, MTF/G700D, MTF/G1050D, MTF/G700, MTF/G1050, MTF/GE1050, MT/G700F, MTF/G700F, MTF/G1055F, MTFGE1055F, MF/G700, MF/E700, RCF/G2, RCF/G3...(Other models you can see in the webshop)		

door seals with fixing hook

GEV No.	900027	Ref. No.	0E3680
description	door seal L 290mm W 260mm external size		
For models:	FCV31E3, 7CO30, CCO30G, ECO312CF, OTS100		



GEV No.	900401	Ref. No.	006801
description	door seal L 600mm W 300mm 3-sided long side open with 5 mounting clips		
For models:	PPL5GG, PPFL5GG		

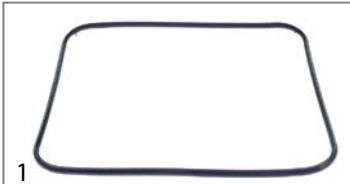

GEV No.	901699	Ref. No.	QC4159 3577252020
description	door seal W 410mm with 4 mounting clips H 340mm		
For models:	FCF/E4, FCF/E4-3KW, FCF4E, FCF4E-3KW, ECF4E, ECF4E3KW, ECF/E4, ECF/E4-3KW, ACF/E4, ACF/E4-3KW, ACF4E, ACF4E3KW		

door gaskets (wire reinforced)

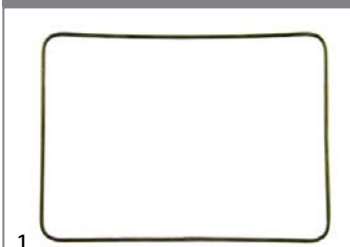

GEV No.	900279	Ref. No.	005194 3565015041
description	oven gasket wire reinforced L 395mm W 285mm		

door seals with tension springs

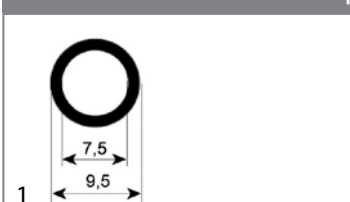

GEV No.	900046	Ref. No.	0H6762
description	oven gasket profile 2958 L 290mm Qty 1 mounting pos. lateral		
For models:	7508-3/85., 7502-3/85., 7500-3/85.HE.2PL.(N), 7504-3/85.HE.6PL.BO, 7505-3/85, 7512-3/85.KF.BO.(N), 7502-3/90.HE.4PL.BO., 7504-3/90.HE.6PL.BO., 7505-3/90.HE.6PL.BO., 7508-3/90.HE.CER.BO., 7512-3/90.KF.BO.(N), 7700-3/85, 7700-3/90.HE.2PL.(N), 7502-3/85.HE.4PL.BO., 7508-3/85.HE.CER.BO., 7505-3/85.HE.6PL.BO., 7508-3/85.HE.CER.BO., 7506-3/85.HE.CER.2KZ, 7508-3/85.HE.CER.BO., 7506-3/85.HE.CER.2KZ, 7510-3/85.HE.CER.6KZ, 7504-3/90.HE.6PL.BO., 7502-2, 7502-3, 7502-9, 7504-2, 7504-3, 7504-9, 7505-2-9, 7505-3, 7505-9-9, 7508-2, 7508-3, 7510-3/90.HE.CER.6KZ, 7511-2, 7512-3, 7512-9, 9000-3, 9002-2, 9002-3, 9004-2, 9004-3, 9006-9, 9012-2, 9012-3, 9015-3, 9203-3-0, 9203-3-8		

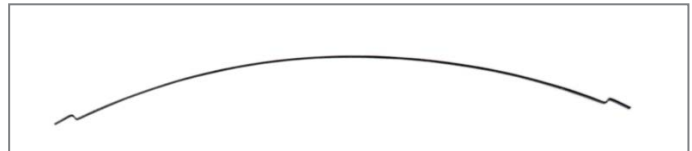

GEV No.	690003	Ref. No.	0H6606 0H6917 840258212193
description	spring L 310mm for gasket mounting pos. lateral		
For models:	7508-3/85., 7502-3/85., 7500-3/85.HE.2PL.(N), 7504-3/85.HE.6PL.BO, 7505-3/85, 7512-3/85.KF.BO.(N), 7502-3/90.HE.4PL.BO., 7504-3/90.HE.6PL.BO., 7505-3/90.HE.6PL.BO., 7508-3/90.HE.CER.BO., 7512-3/90.KF.BO.(N), 7700-3/85, 7700-3/90.HE.2PL.(N), 7502-3/85.HE.4PL.BO., 7508-3/85.HE.CER.BO., 7505-3/85.HE.6PL.BO., 7508-3/85.HE.CER.BO., 7506-3/85.HE.CER.2KZ, 7508-3/85.HE.CER.BO., 7506-3/85.HE.CER.2KZ, 7510-3/85.HE.CER.6KZ, 7504-3/90.HE.6PL.BO., 7502-2, 7502-3, 7502-9, 7504-2, 7504-3, 7505-3, 7508-2, 7508-3, 7510-3/90.HE.CER.6KZ, 7511-2, 7512-3, 7512-9, 9000-3, 9002-2, 9002-3, 9004-2, 9004-3, 9012-2, 9012-3, 9015-3, 9203-3-0, 9203-3-8		

gaskets for tray rack trolleys

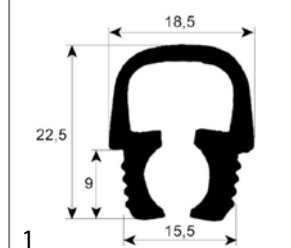

GEV No.	900150	Ref. No.	0H6661 246281
description	tray rack trolley gasket profile 4040 L 510mm Qty 1		
For models:	5614-3-10, 5614-3-6, 5614-3-8		

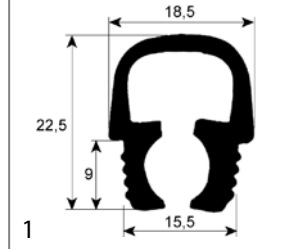

GEV No.	900592	Ref. No.	0H6662 0K2102
description	tray rack trolley gasket profile 4040 L 658mm Qty 1		
For models:	5714-3-6, 5714-3-7, 5714-3-8, 5714-3-8E, 5714-3-10, 5717-3-6, 5717-3-7, 5717-3-8, 5717-3-8E, 5717-3-10, 5717-3-8M, 5717-3-8C, 5714-2-10F, 5714-2-10S, 5714-3-10F, 5714-3-10S, 5704-2-2, 5704-2-3, 5707-2-2, 57074-2-3, 5704-3-2, 5704-3-3, 5707-3-2, 5707-3-3		



GEV No.	900495	Ref. No.	0H6985
description	tray rack trolley gasket profile 4045 L 460mm Qty 1		



GEV No.	900584	Ref. No.	0H6866
description	tray rack trolley gasket profile 4045 L 900mm Qty 1		

GEV No.	900580	Ref. No.	006176
description	tray rack trolley gasket profile 4055 L 660mm Qty 1		
For models:	5714-2-7, 5714-2-8, 5714-2-10, 5714-2-7, 5714-2-8, 5714-2-10, 5714-2-7L, 5714-2-8L, 5714-2-10L, 5714-2-7L, 5714-2-8L, 5714-2-10L, 5714-3-7, 5714-3-8, 5714-3-8E, 5714-3-10, 5717-3-7, 5717-3-8, 5717-3-8E, 5717-3-10, 5717-3-8M, 5717-3-8M		

GEV No.	900295	Ref. No.	0C0899 0C1484
description	tray rack trolley gasket profile 4100 L 610mm Qty 1		
For models:	AOS201GAEU, AOS201GAU, AOS201EABU, AOS201EAFU, AOS201EA, AOS201EB, AOS201EA3J, AOS201EB3J, AOS201EA2N, AOS201EB2N, AOS201EB5M, AOS201EB6M, AOS201EA0H, AOS201EB0H, AOS201GA, AOS201GB		

GEV No.	901631	Ref. No.	0C4121
description	tray rack trolley gasket profile 4100 L 660mm		
For models:	FCZ201EAA, FCZ201EAH, FCZ201EAN, FCZ201ETA, FCZ201ETH, FCZ201ETN, FCZ201GAG, FCZ201GAD, FCZ201GTG, FCZ201GTD, FCZ201EBA, FCZ201EBH, FCZ201EBN, FCZ201EBC, FCZ201EBA2, FCZ201EBH2, FCZ201EBN2, FCZ201EBC2, FCZ201GBG, FCZ201GBD, FCZ201GBI, FCZ201GBG2, FCZ201GBD2, FCZ201GBI2, FCZ201ECA, FCZ201ECH, FCZ201ECN, FCZ201ECA2, FCZ201ECH2, FCZ201ECN2, FCZ201GCG, FCZ201GCD, FCZ201GCG2, FCZ201GCD2, AOS201EAAQ, AOS201EBAQ, AOS201EANQ, AOS201EBN2, AOS201EACQ, AOS201EBCQ, AOS201EAHQ, AOS201EBHQ, AOS201EBFQ, AOS201GAGQ, AOS201GBGQ, AOS201GADQ, AOS201GBDQ, AOS201GAIQ, AOS201GALQ, AOS201EAMQ...(Other models you can see in the webshop)		

GEV No.	900274	Ref. No.	0C1196 0C1890
description	tray rack trolley gasket profile 4100 L 745mm Qty 1		
For models:	AOS202GAEU, AOS202GAU, AOS202EA2N, AOS202EB2N, AOS202EA, AOS202EB, AOS202GB, AOS202GA		

GEV No.	901630	Ref. No.	0C4131
description	tray rack trolley gasket profile 4100 L 810mm		
For models:	FCZ202EAA, FCZ202ETA, FCZ202GAG, FCZ202GAD, FCZ202GTG, FCZ202GTD, FCZ202EBA, FCZ202EBA2, FCZ202GBG, FCZ202GBD, FCZ202GBG2, FCZ202GBD2, FCZ202ECA, FCZ202ECA2, FCZ202GCG, FCZ202GCD, FCZ202GCG2, FCZ202GCD2, AOS202EAAQ, AOS202EBAQ, AOS202EANQ, AOS202EBN2, AOS202GAGQ, AOS202GBGQ, AOS202GADQ, AOS202GBDQ, AOS202GAPQ, AOS202EAA1, AOS202EAM1, AOS202EAB1, AOS202EAK1, AOS202EAT1, AOS202ETA1, AOS202ETM1, AOS202ETK1, AOS202GAG1, AOS202GAD1, AOS202GAP1, AOS202GAU1, AOS202GTG1, AOS202GTD1, AOS202GTP1, AOS202GTW1, AOS202EBA1, AOS202EBK1, AOS202EBA2, AOS202EBK2, AOS202GBG1, AOS202GBD1, AOS202GBG2...(Other models you can see in the webshop)		

boiling pan gaskets

GEV No.	900755	Ref. No.	002175 0G0022 0K5567 0K5571 0KF622 19006882 19006887 2003401
description	boiling pan gasket profile 3030 L 1130mm W 655mm		
For models:	GWACOEOORO, FWAAMOORO, GWACOMOORO, IWKCOEOOOO, HWAHOEOORO, GWAHOEOOOO, GWAHOEOORO, FWAHOEOORO, BEN150EW87, HWAJOEOORO, GWAJOEOORO, FWAJOEOORO, BEN200EW87, GWAJOMOORO, FWFJOEXOOO, FWFJOEXORO, BEN300E.S35.H97, GWAKOEOORO, FWAKOEOORO, IWAKOMOORO, GWAKOMOORO, FWFKOEXORO, FWKKEOORO, IVALOEOOOO, IVALOEOORO, BEN400E.S35.H97, BEN400EF97, FVALOEOORO, GWALOMOORO, ISACOEOORO, HSACOEOORO, ISACOMOORO, ISAHOEOOOO, FSAHOMOOO, FSAHOEOORO, GSAHOMOORO, FSKHOEOOOO, ISAJOE-OOOO, ISAJOEORO, HSAJOEOORO, PEN200E.S35.H97, FSAJOEOORO, ISAJOMOORO, GSAJOMOORO, FSKJOEOORO, FSAKOEORO, ISAKOMOORO, UET060E.MS35.F88, UET090E.MS35.F88, UET090E.MS35.W84...(Other models you can see in the webshop)		

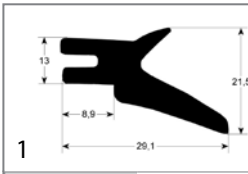

GEV No.	693249	Ref. No.	0H6980
description	boiling pan gasket profile 3030 L 770mm W 690mm suitable for JUNO		
For models:	9190-3, 9191-3, 9193-3, 9195-3, 9390-3, 9391-3, 9393-3, 9395-3		

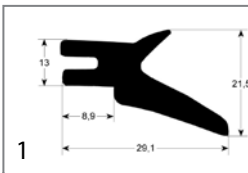

GEV No.	693248	Ref. No.	0K2806
description	boiling pan gasket profile 3030 suitable for JUNO		
For models:	9190-3, 9191-3, 9193-3, 9195-3, 9390-3, 9391-3, 9393-3, 9395-3		

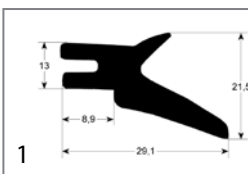

GEV No.	693251	Ref. No.	0H6982
description	boiling pan gasket profile 3030 suitable for JUNO		
For models:	9190-3, 9191-3, 9193-3, 9195-3, 9390-3, 9391-3, 9393-3, 9395-3		

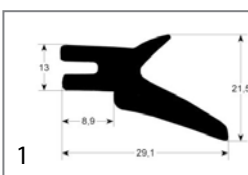

GEV No.	900609	Ref. No.	0G0024 0K5574 19006893 740402
description	door seal profile 3030 ø 430mm		
For models:	VARIOSTEAM/S-33.3/F, STEAM-O-MAT		

O-rings

EPDM



GEV No.	361304	Ref. No.	0E2836 0E5360 0K8992
description	O-ring EPDM ID ø 11.11mm thickness 1.78mm Qty 1 pcs for type DIB3E/DIB5E		
For models:	W3400H06, W3130H, W3130H, W3240H., W3240H, W3400H, W3400H, W3130H, W3180H, W3180H, W3180H, W3180H, W3240H_EL, W3240H_CLA, W3180H, W3130H, W3180H, W3130H, W3180H, W3300H, W3300H, LC12EC, CLC12EC, CLC22VC, FT36EDTS, FT36ESTS, FT36VDT, FT36VST, FT36ED, FT36ES, FT36VD, FT36VS, FT50ED, FT50ES, FT50VD, FT50VS, FT72ED, FT72ES, FT72VD, FT72VS, FT36EDT, FT36EST, FT36VDT, FT36VST, FT50EDT, FT50EST, FT50VDT, FT50VST, FT72EDT, FT72EST...(Other models you can see in the webshop)		



GEV No.	510302	Ref. No.	047986 0H2550 0Q0014 543619100
description	O-ring EPDM ID ø 12.42mm thickness 1.78mm Qty 1 pcs		
For models:	WT4, WT4B, WT4D, WT4DB, WT46, WT4DG, WT4WS1, WT4BWS, WT4DWS1, WT4BDWS, NUC3DD, WT4D60, WT4DDG, EUC1, EUC1DP, EUC1WS, EUC1DPWS, EUC3, EUC3WS, EUC3DP, EUC3DPWS, EUC1G, EUC1DP60, EUC3DD, ZUCADDROW, ZUCADDROW6, LS5/1, LS5/1DP, LS5/1WS, LS5/1WSDP, LS5/3, LS5/3DP, LS5/3WS, LS5/3WSDP, FUCA3DD, LS5/3WSDPD, LB5DPG, LS5/1DP60, LS5/1DPAUS, LS5/1D-PCS, KUC3, KUC3DP, NUC1, NUC1DP, NUC1WS, NUC1DPWS, NUC3, NUC3WS, NUC3DP, NUC3DPWS...(Other models you can see in the webshop)		

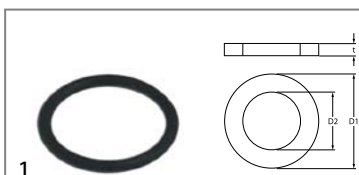

GEV No.	504512	Ref. No.	047473 0H2549 543617000
description	O-ring EPDM thickness 1.78mm ID ø 14mm Qty 1 pcs		
For models:	LS32, LS32/4.5, LS32UK/RP, LS32F, LV32F, C55, LV32/60, WT4, WT4B, WT4D, WT302, WT302/4.5, WT302UK/RP, WT302F, WT302/60, WT4DB, WT46, WT4DG, WT4WS1, LS33, LS33/4.5, LS33UK/RP, LS33F, LV33F, C55A, LS33/60, WT4BWS, WT4DWS1, WT4BDWS, WT303, WT303/4.5, WT303UK/RP, WT303F, WT303/60, NUC3DD, WT4D60, WT4DDG, EUC1, EUC1DP, EUC1WS, EUC1DPWS, EUC3, EUC3WS, EUC3DP, EUC3DPWS, EUC1G, EUC1DP60, EUC3DD, ZUCADDROW, ZUCADDROW6...(Other models you can see in the webshop)		

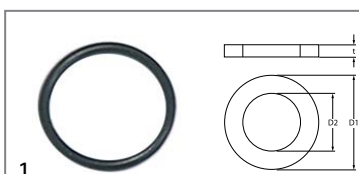

GEV No.	510322	Ref. No.	047987 543810600
description	O-ring EPDM thickness 1.78mm ID ø 17.17mm Qty 1 pcs		
For models:	LS510, LS520, LS520D, LS520F, LS520M, LS520K, LS521, LS521D, LS521F, LS521M, LS521K, LS521, ZLS510, ZLS520, ZLS521, ALLS521, ALLS520, ALS510, C51, C52, LS520ZD, LS521ZD, LS510MZ, LS520MZ, LS521MZ		



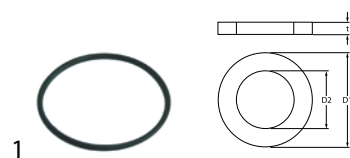

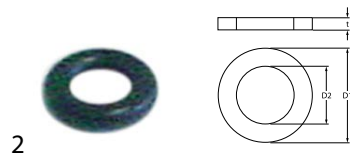
			
GEV No.	510824	Ref. No.	052779
description	O-ring EPDM thickness 1.78mm ID ø 20.35mm Qty 1 pcs		
For models:	BF/E1S12, MCP/E700, MCP/G700, MCP/E700D, MCP/G701, MCP/G710, MCP/G711, MCP/G705, MCP/G706, RCP/E2S, MCP/E1SH, MCP/E1SUH, MCP/E2SUHS, MCP/E2S, MCP/E2SH, MCP/E2SUH, MCP/E2SUT, MCP/E2SHB, 7CPE07P, 7CPG07P, RCP/G701, RCP/G706, M70EPC, M70GPC, M70GPC, XCP/G706, CCP/G700, CCP/E700, RCP/G700, RCPE700, KPI/G10, KPI/G15, KPI/E10, KPI/E15, KPD/G10, KPD/G15, KPD/G15A, KPI/G15A, KPI/E15A, KPI/G15H, KPI/E15H, KPI/G10H, KPI/E10H, HPN/G1810, HPN/G1815, HPN/G1815D, HPN/G1816, HPN/G1816, HPN/E1815D, HPN/E1810...(Other models you can see in the webshop)		

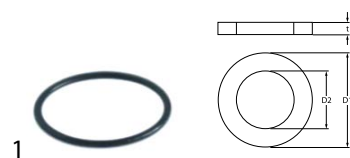
			
GEV No.	532003	Ref. No.	059293 0K4317 12012059 727879
description	O-ring EPDM thickness 1.78mm ID ø 3.69mm Qty 10 pcs		
For models:	MFR/G740, MFR/G350, MFR/G351, MFR/G700, MFR/G701, BF/G1S07, BFR/G1S14, BFR/E1S14, RFR/G1S12, RFR/G2D12, RFR/G2S40, XFR/G1S12, XFR/G2D12, XFR/G2S40, JFR/G1S12, JFR/G2D12, JFR/G2S40, MCP/E1SH, MCP/E1SUH, MCP/E2SUHS, MFR/G1S12, MFR/G2D12, MFR/G2S40, MCP/E2SH, MCP/E2SUH, MCP/E2SUT, MCP/E2SHB, ASG36, ARG24FL, ARG36FL, ARG48FL, ARG24FR, ARG36FR, ARG48FR, ARG24FLCE, ARG36FLCE, ARG48FLCE, ARG24FRCE, ARG36FRCE, ARG48FRCE, RFR/G741, 7FRG03S, 7FRG07S, CFR/G741, M35GFR, M70GFR, CFR/G351, CFR/G701, PCV/G2, PCV/G3...(Other models you can see in the webshop)		

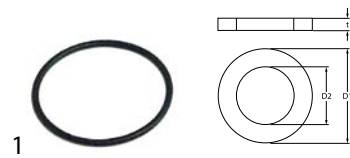
			
GEV No.	530296	Ref. No.	046861
description	O-ring EPDM thickness 1.78mm ID ø 31.47mm Qty 1 pcs		
For models:	LS365F, LS365, LS365PH, LS365D, LS365, LS365/63, LS367, LSDS51, LSDS5V, LS521, LS521D, LS521F, LS521M, LS521K, LS521, CT140EDX, CT140ESX, CT140EDXUK, CT140SXEU, CT140VDX, CT140VSX, CT141EDX, CT141ESX, CT141EDUK, CT141ESUK, CT141VDX, CT141VSX, CT142DXE, CT142SXE, CT142DXEUK, CT142SXEU, CT142DXV, CT142SXV, CT190DXE, CT190SXE, CT190DXEUK, CT190SXEU, CT190DXV, CT190SXV, CT191DXE, CT191SXE, CT191DXEUK, CT191SXEU, CT191DXV, CT191SXV, CT192DXE, CT192SXE, CT192DXEUK, CT192SXEU, CT192DXV...(Other models you can see in the webshop)		

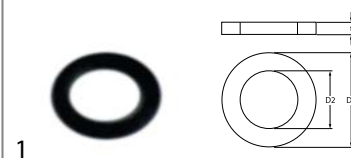
			
GEV No.	532616	Ref. No.	046868 0KN637
description	O-ring EPDM thickness 1.78mm ID ø 34.65mm Qty 1 pcs		
For models:	CT142DXE, CT142SXE, CT142DXEUK, CT142SXEU, CT142DXV, CT142SXV, CT190DXE, CT190SXE, CT190DXEUK, CT190SXEU, CT190DXV, CT190SXV, CT191DXE, CT191SXE, CT191DXEUK, CT191SXEU, CT191DXV, CT191SXV, CT142DXEZ, CT142SXEZ, CT142DXVZ, CT142SXVZ, CT190DXEZ, CT190SXEZ, CT190DXV, CT190SXV, CT191DXE, CT191SXE, CT191DXV, CT191SXV		

			
GEV No.	528485	Ref. No.	067898 070339 086109 0H2570 0KK903 530501200 60074
description	O-ring EPDM thickness 1.78mm ID ø 6.07mm Qty 1 pcs		
For models:	MCP/E700, MCP/G700, MCP/E700D, MCP/G701, MCP/G710, MCP/G711, RCP/E2S, MCP/E2S, 7CPE07P, 7CPG07P, RCP/G701, M70EPC, M70GPC, M70GPC, CCP/G700, CCP/E700, PCP/E2SHP, OCP/E2S, TCP/E2S, RCP/G700, RCPE700, HCP/G410D, HCP/G410, HCP/G810, HCP/E410, HCP/E810, HCPS/E410, ZCP/G410, ZCP/G810, ZCP/E410, ZCP/E810, ZCPS/E410, ACP/G400, ACP/G410, ACP/G800, ACP/G810, ACP/E400, ACP/E410, ACP/E800, ACP/E810, ACPS/G400, ACPS/E400, ACPS/E410, LS32, LS32/4.5, LS32UK/RP, LS32F, LV32F, C55, LV32/60...(Other models you can see in the webshop)		

			
GEV No.	510303	Ref. No.	0C1935
description	O-ring EPDM thickness 1.78mm ID ø 6.75mm Qty 1 pcs		
For models:	FCZ061EAA, FCZ101EAA, FCZ102EAA, FCZ201EAA, FCZ202EAA, FCZ061EAH, FCZ101EAH, FCZ201EAH, FCZ061EAN, FCZ101EAN, FCZ201EAN, FCZ061ETA, FCZ101ETA, FCZ102ETA, FCZ201ETA, FCZ202ETA, FCZ061ETH, FCZ101ETH, FCZ201ETH, FCZ061ETN, FCZ101ETN, FCZ201ETN, FCZ061GAG, FCZ101GAG, FCZ102GAG, FCZ201GAG, FCZ202GAG, FCZ061GAD, FCZ101GAD, FCZ102GAD, FCZ201GAD, FCZ202GAD, FCZ101GTG, FCZ102GTG, FCZ201GTG, FCZ202GTG, FCZ101GTD, FCZ102GTD, FCZ201GTD, FCZ202GTD, FCZ061EBA, FCZ101EBA, FCZ102EBA, FCZ061EBH, FCZ101EBH, FCZ061EBN, FCZ101EBN, FCZ061EBC, FCZ101EBC, FCZ201EBC...(Other models you can see in the webshop)		

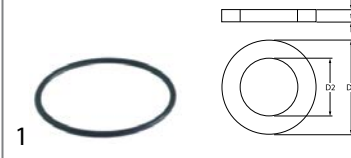
			
GEV No.	530293	Ref. No.	003173 0H2543 0L0555 543605900 K10014B
description	O-ring EPDM thickness 1.78mm ID ø 8.73mm Qty 1 pcs		

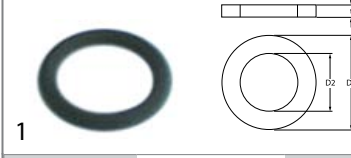
			
GEV No.	532006	Ref. No.	0L2341 0Q0002
description	O-ring EPDM thickness 1.78mm ID ø 8.73mm Qty 10 pcs		



GEV No.	504574	Ref. No.	046376
description	O-ring EPDM thickness 1.78mm ID ø 9.25mm Qty 1 pcs		
For models:	WT4, WT4B, WT4D, WT4DB, WT46, WT4DG, WT4WS1, WT4BWS, WT4DWS1, WT4BDWS, NUC3DD, WT4D60, WT4DDG, EUC1, EUC1DP, EUC1WS, EUC1DPWS, EUC3, EUC3WS, EUC3DP, EUC3DPWS, EUC1G, EUC1DP60, EUC3DD, ZUCADDRROW, ZUCADDRROW6, LS5/1, LS5/1DP, LS5/1WS, LS5/1WSDP, LS5/3, LS5/3DP, LS5/3WS, LS5/3WSDP, FUCA3DD, LS5/3WSDPD, LB5DPG, LS5/1DP60, LS5/1DPAUS, LS5/1DPCS, KUC3, KUC3DP, NUC1, NUC1DP, NUC1WS, NUC1DPWS, NUC3, NUC3WS, NUC3DP, NUC3DPWS...(Other models you can see in the webshop)		



GEV No.	532581	Ref. No.	0E5118 OK9002 OKC484 OKM727 OKQ575 740431514 7404315140
description	O-ring EPDM thickness 2.3mm ID ø 17.2mm Qty 1 pcs		
For models:	FT36EDTS, FT36ESTS, FT36VDTS, FT36VSTS, FT36ED, FT36ES, FT36VD, FT36VS, FT50ED, FT50ES, FT50VD, FT50VS, FT72ED, FT72ES, FT72VD, FT72VS, FT36EDT, FT36EST, FT36VDT, FT36VST, FT50EDT, FT50EST, FT50VDT, FT50VST, FT72EDT, FT72EST, FT72VDT, FT72VST, FT36WED, FT36WES, FT36WVD, FT36WVS, FT50WED, FT50WES, FT50WVD, FT50WVS, FT72WED, FT72WES, FT72WVD, FT72WVS, FT36WEDT, FT36WEST, FT36WVDT, FT36WVST, FT50WEDT, FT50WEST, FT50WVDT, FT50WVST, FT72WEDT, FT72WEST...(Other models you can see in the webshop)		

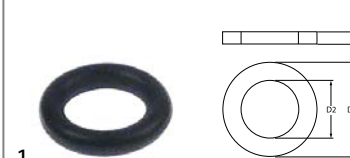

GEV No.	524494	Ref. No.	0E5034 OK8996
description	O-ring EPDM thickness 2.4mm ID ø 5.3mm Qty 1 pcs		
For models:	PW1EFL, PW1EFLF, PW1EFL/60HZ, PW2EFL, PW2EFLF, PW2EFL/60HZ, PW2VFL, WT830EFL, WT830EFLF, WT830EFL/60HZ, WT850, WT850EFLF, WT850EFL/60HZ, WT850SFL, FT36EDTS, FT36ESTS, FT36VDTS, FT36VSTS, FT36ED, FT36ES, FT36VD, FT36VS, FT50ED, FT50ES, FT50VD, FT50VS, FT72ED, FT72ES, FT72VD, FT72VS, FT36EDT, FT36EST, FT36VDT, FT36VST, FT50EDT, FT50EST, FT50VDT, FT50VST, FT72EDT, FT72EST, FT72VDT, FT72VST, WTF2ERC, WTF2ELC, WTF2SRC, WTF2SLC, WTF2HERC, WTF2HEL, WTF2HSRC, WTF2HSLC...(Other models you can see in the webshop)		



GEV No.	528883	Ref. No.	OK8997 370082024 740430614 7404306149
description	O-ring EPDM thickness 2.4mm ID ø 8.5mm Qty 1 pcs		
For models:	D480, D480, D180, D180, D180, D180, D180, D180, D180, D180, D180, D180, D180, D180, D180, D180, D180		

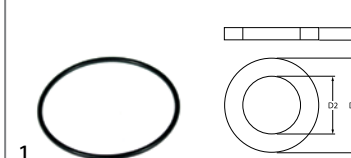

GEV No.	540119	Ref. No.	OK2487 OK3046
description	O-ring EPDM thickness 2.5mm ID ø 59mm Qty 1 pcs		
For models:	7574-5.KES150, 7575-5.KES250, 7576-5.KES300, 7573-5.KES100, 7573-3/85.KES100.(N), 7574-3/85.KES150.(N), 7575-3/85.KES250.(N), 7576-3/85.KES300.(N), 7573-3/90.KES100.(N), 7574-3/90.KES150.(N), 7575-3/90.KES250.(N), 7576-3/90.KES300.(N), 7573-5/85.KES100.(N), 7574-5/85.KES150.(N), 7575-5/85.KES250.(N), 7576-5/85.KES300.(N), 7573-5/90.KES100.(N), 7574-5/90.KES150.(N), 7575-5/90.KES250.(N), 7576-5/90.KES300.(N), 7773-3/85.KES100, 7773-3/90.KES100, 7773-5, 7773-5/85.KES100.(N), 7773-5/90.KES100.(N), 7774-3/85.KES150, 7774-3/90.KES150, 7774-5, 7774-5/85.KES150.(N), 7774-5/90.KES150.(N), 7775-3/85.KES250, 7775-3/90.KES250, 7775-5, 7775-5/85.KES250.(N), 7775-5/90.KES250.(N), 7776-3/85.KES300, 7776-3/90.KES300, 7776-5, 7776-5/85.KES300.(N), 7776-5/90.KES300.(N)		

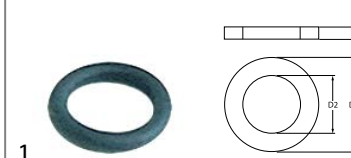

GEV No.	529412	Ref. No.	069518 069519 069644 069976 OH3772 456006 H139321178
description	O-ring EPDM thickness 2.62mm ID ø 10.78mm Qty 1 pcs		
For models:	LTB11, LTB12, LTB22, LTB11UK, LTB12UK, LTB22UK, LTB11, LTB22, 910-00-021, 910-00-023, 910-00-031, 910-00-033, 911-00-022, 911-00-024, 911-00-032, 911-00-034, CRYSTAL 11, CRYSTAL 22		



GEV No.	528223	Ref. No.	067292 0G1952 FAR0630340
description	O-ring EPDM thickness 2.62mm ID ø 11.91mm Qty 1 pcs		
For models:	C55, WT4, WT4B, WT4D, WT302, WT302/4.5, WT302F, WT302/60, WT4DB, WT46, C55A, WT303, WT303/4.5, WT303F, WT303/60, WT4D60, WT4DDG, LS5/1, LS5/1DP, LS5/3, LS5/3DP, LS5/1DP60, LS5/1DPAUS, LS5/1DPCS, WT1WSDP, WT2WSDP, WT2WSDPD, WT2WS, WT1, WT1WS, WT1TOP, WT2TOP, WT1/3DP, WT2/3DP, WT2DPAUS, CT92DXE, CT92SXE, CT92DXEUK, CT92SXEUK, CT92DXV, CT92SXV, CT92DXVUK, CT92SXVUK, CT140EDX, CT140ESX, CT140EDXUK, CT140SXEU, CT140VDX, CT140VSX, CT141EDX...(Other models you can see in the webshop)		

GEV No.	528919	Ref. No.	069527 456010
description	O-ring EPDM thickness 2.62mm ID ø 20.24mm Qty 1 pcs		
For models:	LTB11, LTB12, LTB22, LTB11UK, LTB12UK, LTB22UK, LTB11, LTB22, 910-00-021, 910-00-023, 910-00-031, 910-00-033, 911-00-022, 911-00-024, 911-00-032, 911-00-034, CRYSTAL 11, CRYSTAL 22		

GEV No.	507313	Ref. No.	046223 070346
description	O-ring EPDM thickness 2.62mm ID ø 13.95mm Qty 1 pcs		
For models:	LB035C, LB035Q, LB040Q, LB040AUS, LS360F, LS360DK, LS365F, LS365, LS365PH, LS500F, LS501F, LS540F, LS540DK, LS541F, LS360D, LS365D, LS360, LS365, LS360/63, LS365/63, LS367, LS720F, LSE720DK, LSE720PH, LS860F, LS860DK, LS860PH, LS1080F, LS1080UK, LS1080PH, LSE721F, LS861F, LS540, LS1080M, LS1080, LS1080D, LS1080UK, LS1080/63, LSD551, LSD55V, LS500F, LS500UK, LS501, LS501UK, LS540D, LS540/63, LSE721, LS720, LSE720UK, LS721UK...(Other models you can see in the webshop)		

GEV No.	510769	Ref. No.	046799 086280
description	O-ring EPDM thickness 2.62mm ID ø 25.07mm Qty 1 pcs		
For models:	LS32, LS32/4.5, LS32UK/RP, LS32F, LV32F, C55, LV32/60, WT4, WT4B, WT4D, WT302, WT302/4.5, WT302UK/RP, WT302F, WT302/60, WT4DB, WT46, WT4DG, WT4WS1, LS33, LS33/4.5, LS33UK/RP, LS33F, LV33F, C55A, LS33/60, WT4BWS, WT4DWS1, WT4BDWS, WT303, WT303/4.5, WT303UK/RP, WT303F, WT303/60, NUC3DD, WT4D60, WT4DDG, EUC1, EUC1DP, EUC1WS, EUC1DPWS, EUC3, EUC3WS, EUC3DP, EUC3DPWS, EUC1G, EUC1DP60, EUC3DD, ZUCADDROW, ZUCADDROW6...(Other models you can see in the webshop)		

GEV No.	504618	Ref. No.	068642
description	O-ring EPDM thickness 2.62mm ID ø 15.54mm Qty 1 pcs		
For models:	LS32, LS32/4.5, LS32UK/RP, LS32F, LV32F, C55, LV32/60, WT4, WT4B, WT4D, WT302, WT302/4.5, WT302UK/RP, WT302F, WT302/60, WT4DB, WT46, WT4DG, WT4WS1, LS33, LS33/4.5, LS33UK/RP, LS33F, LV33F, C55A, LS33/60, WT4BWS, WT4DWS1, WT4BDWS, WT303, WT303/4.5, WT303UK/RP, WT303F, WT303/60, NUC3DD, WT4D60, WT4DDG, EUC1, EUC1DP, EUC1WS, EUC1DPWS, EUC3, EUC3WS, EUC3DP, EUC3DPWS, EUC1G, EUC1DP60, EUC3DD, ZUCADDROW, ZUCADDROW6...(Other models you can see in the webshop)		

GEV No.	532611	Ref. No.	0L0922
description	O-ring EPDM thickness 2.62mm ID ø 26.65mm Qty 1 pcs		
For models:	WTC90ERB, WTC90ELB, WTC140ERA, WTC140ELA, WTC140ERB, WTC140ELB, WTC180ERA, WTC180ELA, WTC180ERB, WTC180ELB, WTC220ERA, WTC220ELA, WTC220ERB, WTC220ELB, WTC90ERBG, WTC90ELBG, WTC140ERAG, WTC140ELAG, WTC140ERBG, WTC140ELBG, WTC180ERAG, WTC180ELAG, WTC180ERBG, WTC180ELBG, WTC220ERAG, WTC220ELAG, WTC220ERBG, WTC220ELBG, WT44BL208, WT44BR208, WT44BL240, WT44BR240, WT44CL208, WT44CR208, WT44CL240, WT44CR240, WT66BL208, WT66BR208, WT66BL240, WT66BR240, WT66CL208, WT66CR208, WT66CL240, WT66CR240, WTM140ERA, WTM140ELA, WTM140ERB, WTM140ELB, WTM165ERA, WTM165ELA...(Other models you can see in the webshop)		

GEV No.	504590	Ref. No.	047929 049036
description	O-ring EPDM thickness 2.62mm ID ø 18.72mm Qty 1 pcs		
For models:	LB1, LB1WS, LB1WSDP, LB1/RBP, LB1/TOP, LB1/60, WT1WSDP, LB2D-PSAUS, LB1G, LB1WSG, WT2TOP60, WT2DPDI, WT2WSDPDI, LB1TOP, WT2TOPDI, LB2WS, LB2, LB2WSDP, LB2/TOP, LB2/RBP, LB2WS60, WT2WSDP, WT2WSDPD, LB2WSG, WT2WS, WT1, WT1WS, WT1TOP, WT2TOP, WT1/3DP, WT2/3DP, WT2DPAUS, WT2, LB2DPDI, LB2WSDPDI, LB2WSDPD, LB2TOP, LB2DP3, WT2DP3, NGW, NGWDPDD, LS540F, LS540DK, LS541F, LS720F, LSE720DK, LSE720PH, LS860F, LS860DK, LS860PH...(Other models you can see in the webshop)		

GEV No.	504561	Ref. No.	067768
description	O-ring EPDM thickness 2.62mm ID ø 29.82mm Qty 1 pcs		
For models:	LS360F, LS360DK, LS365F, LS365, LS365PH, LS360D, LS365D, LS360, LS365, LS360/63, LS365/63, LS367, LS360, LS365F, HB3PNT		

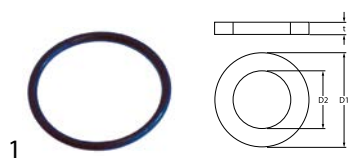

GEV No.	507314	Ref. No.	0L2359
description	O-ring EPDM thickness 2.62mm ID ø 32.99mm		
For models:	WTM140ERA, WTM140ELA, WTM140ERB, WTM140ELB, WTM165ERA, WTM165ELA, WTM165ERB, WTM165ELB, WTM200ERA, WTM200ELA, WTM200ERB, WTM200ELB, WTM250ERA, WTM250ELA, WTM250ERB, WTM250ELB, WTM300ERA, WTM300ELA, WTM300ERB, WTM300ELB, WTM180ERA, WTM180ELA, WTM180ERB, WTM180ELB, WTM140SRA, WTM140SLA, WTM165SRA, WTM165SLA, WTM180SRA, WTM180SLA, WTM200SRA, WTM200SLA, WTM250SRA, WTM250SLA, WTM300SRA, WTM300SLA, RTM140ERA, RTM140ELA, RTM140ERB, RTM140ELB, RTM165ERA, RTM165ELA, RTM165ERB, RTM165ELB, RTM180ERA, RTM180ELA, RTM180ERB, RTM180ELB, RTM200ERA, RTM200ELA... (Other models you can see in the webshop)		
accessories for	507314		
	GEV No.	507314	Ref. No. 0L2359
	O-ring EPDM thickness 2.62mm ID ø 32.99mm		

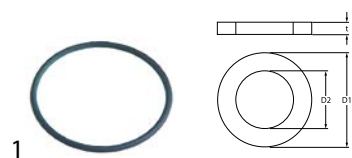

GEV No.	532546	Ref. No.	052206
description	O-ring EPDM thickness 2.62mm ID ø 52.07mm Qty 1 pcs		
For models:	HQN/G1917, HQN/G1917, HQN/G1225, HQN/G11225, HQN/EI917, HQN/GI122, HQN/V917, HPN/G810, HQN/EI1225, HPN/GI810, HPN/GI810, HPN/G815, HPA/G815, HPN/E810, HPN/GI815, HPA/GI815, HPN/EI810, HPA/GI815, HPN/E815, HPN/EI810, HPA/EI810, HPN/GI810, HPN/G810, HPN/G815, HPA/G815, HPN/GI810, HPN/GI815, HPN/GI815, HPN/E810, HPN/E815, HPN/EI810, HPN/EI810, HPA/EI815, HQN/G1917, HQNEI817, HQN/V917, HQN/G1225, HQN/GI122, HQNEI122		

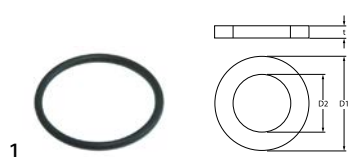

GEV No.	517004	Ref. No.	089919
description	O-ring EPDM thickness 2.62mm ID ø 34.6mm Qty 1 pcs		
For models:	FGS94AB, FGS94WB, FGS140A, FIM150ASB, FIM150WSB, G500A, GB1555W, GB1555A, G500W		

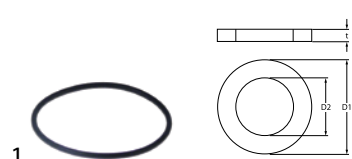

GEV No.	512175	Ref. No.	049460 0KB771
description	O-ring EPDM thickness 2.62mm ID ø 53.65mm Qty 1 pcs		
For models:	LS32UK/RP, WT302UK/RP, WT4DG, WT4WS1, LS33UK/RP, WT4BWS, WT4DWS1, WT4BDWS, WT303UK/RP, EUC1WS, EUC1DPWS, EUC3WS, EUC3DPWS, ZUCADDROW, ZUCADDROW6, LS5/1WS, LS5/1WSDP, LS5/3WS, LS5/3WSDP, FUCA3DD, LS5/3WSDPD, LB5DPG, NUC1WS, NUC1DPWS, NUC3WS, NUC3DPWS, NUC3DDWS, ZUCA1, ZUCA3, EUCADDROW, EUCADDROW6, LS6EADD, LS6EA/DPDD, WT38TDE, WT38/M50, LS6EADP3, WT37LEV/9, LS6SANA, EUCAI, EUCAIDP, EUCAI60, WT38M50/4, LS6EA/UK, LS6EA/DPUK, EUCAIG, EUCAIML, EUCAIMLG, EUCAICL, EUCAICLG, EUCAIWL... (Other models you can see in the webshop)		



GEV No.	540222	Ref. No.	053809 0H6848 0K2958 0K3045 0TR613 68226012
description	O-ring EPDM thickness 2.62mm ID ø 47.3mm Qty 1 pcs		
For models:	FCFG101/0, FCFG102-0, FCFG201-0, FCFG202-0, FCFE101-0, FCFE102-0, FCFE201-0, FCFE202-0, FCF101ELN, FCFG10160H, FCF201ENS, FCFG102-0T, FCF/G101/1-1-JAP, FCF/G102/1-1-JAP, FCFE101-1J, FCFE102-1J, FCF/G101/1, FCFG6D, FCFE6D, FCFE6D, FCFG10, FCFG10D, FCFG10NL, FCFE10, FCFE10UK, FCFG20, FCFG20D, FCFG20F, PFCFG20, FCFE20, FCFE20UK, FCFG40, FCFG41, FCFG40D, FCFG40F, PFCFG40F, FCFE40, FCFE40D, FCFE40UK, PFCFE40F, FCFG6, FCFG6F, PFCFG6, FCFE6, FCFE6UK, PFCFE6, FCVE10, FCVE20, FCFE6J50, FCFE6J60... (Other models you can see in the webshop)		



GEV No.	504577	Ref. No.	047462 0H2548 543616900
description	O-ring EPDM thickness 2.62mm ID ø 60mm Qty 1 pcs		
For models:	LSDS5I, LSDS5V, LS510, LS520, LS520D, LS520F, LS520M, LS520K, LS521, LS521D, LS521F, LS521M, LS521K, LS521, ZLS510, ZLS520, ZLS521, ALLS521, ALLS520, ALS510, C51, C52, LS520ZD, LS521ZD, LS510MZ, LS520MZ, LS521MZ		



GEV No.	511395	Ref. No.	0KM818
description	O-ring EPDM thickness 2.62mm ID ø 71.12mm Qty 1 pcs		

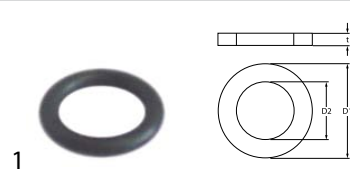

			
GEV No.	528487	Ref. No.	002923 068573 0E5488 0KF096 0KG547 246077000
description	O-ring EPDM thickness 2.62mm ID ø 9.19mm Qty 1 pcs		
For models:	RPI/G260, RPI/E240, RPI/E260, RPI/G260P, RPI/E260P, XPI/G260, XPI/E240, XPI/E260, XPI/G260P, XPI/E260P, JPI/G260, JPI/E240, JPI/E260, MPI/G260, MPI/E240, MPI/E260, MPI/G260P, MPI/E260P, PPI/G260P, PPI/E260P, OPI/G260P, OPI/E260P, TPI/G260P, TPI/E260P, HPN/GI810, HPN/GI815, HPN/GI816, HPN/EI815D, HPN/EI810, HPN/EI815, HPA/GI825, HPA/EI825, HPNS/GI816, HPNS/EI815, HPNS/EI815D, HPN/GI806, HPN/EI806, HPN/GI805, HPN/EI805, ZPN/GI810, 2PIG15, ZPN/GI816, ZPN/EI815D, ZPN/EI810, ZPN/EI815, 2PIAG15, ZPNS/GI816, ZPNS/EI815, ZPNS/EI815D, ZPN/GI805...(Other models you can see in the webshop)		

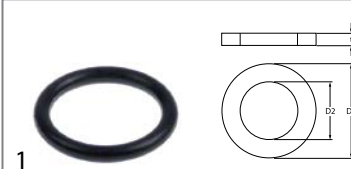
			
GEV No.	511322	Ref. No.	0A5182
description	O-ring EPDM thickness 3.53mm ID ø 20.22mm Qty 1 pcs		
For models:	PI/Z2F, TI/Z2F, KB/G1, KB/G2, KB/E1, KB/E2, HM/G400, HM/G800, HM/E400, HM/E800, QB/G1, QB/G2, QB/E1, QB/E2, ZM/G400, ZM/G800, ZM/E400, ZM/E800, WB/G1, WB/G2, WB/E1, WB/E2, AM/G800, AM/G800D, AM/E400, AM/E800, OM/G800, OM/E800		

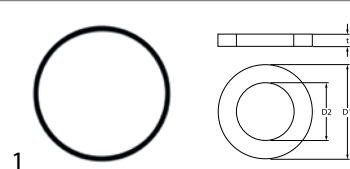
			
GEV No.	510009	Ref. No.	069531 0K3982 456001
description	O-ring EPDM thickness 3.53mm ID ø 101.2mm Qty 1 pcs		
For models:	LTB11, LTB12, LTB22, LTB11UK, LTB12UK, LTB22UK, LTB11, LTB22, 910-00-021, 910-00-023, 910-00-031, 910-00-033, 911-00-022, 911-00-024, 911-00-032, 911-00-034, CRYSTAL 11, CRYSTAL 22		

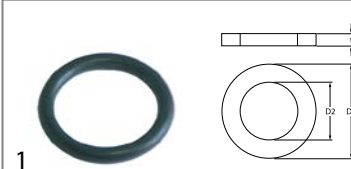
			
GEV No.	511517	Ref. No.	059475
description	O-ring EPDM thickness 3.53mm ID ø 21.82mm Qty 10 pcs		
For models:	HBR/G800, HBR/G805, HBR/G801, HBR/G806, HBR/G810, HBR/G815, HBR/G811, HBR/G816, HBR/G800D, HBR/G805D, HBR/G801D, HBR/G806D, HBR/G810D, HBR/G815D, HBR/G811D, HBR/G816D, HBR/G800NL, HBR/G805NL, HBR/G810NL, HBR/G800UK, HBR/G800, HBR/G805, HBR/G810, HBR/G815, HBR/G811, HBR/G816, HBR/G800UK, ZBR/G800, ZBR/G805, ZBR/G801, ZBR/G806, ZBR/G810, ZBR/G815, ZBR/G811, ZBR/G816, ZBR/G800D, ZBR/G805D, ZBR/G801D, ZBR/G806D, ZBR/G810D, ZBR/G815D, ZBR/G811D, ZBR/G816D, ZBR/G800UK, ZBR/G800, ZBR/G805, ZBR/G810, ZBR/G815, ZBR/G811, ZBR/G816...(Other models you can see in the webshop)		

			
GEV No.	511339	Ref. No.	048327
description	O-ring EPDM thickness 3.53mm ID ø 110.7mm Qty 1 pcs		
For models:	LS32, LS32/4.5, LS32UK/RP, LS32F, LV32F, C55, LV32/60, WT302, WT302/4.5, WT302UK/RP, WT302F, WT302/60, LS33, LS33/4.5, LS33UK/RP, LS33F, LV33F, C55A, LS33/60, WT303, WT303/4.5, WT303UK/RP, WT303F, WT303/60, LS61, LS61/60, LS62, LS62D, LS62/UKRP, LS62F, LV62, LS62/60, ECOTEMP5, LS62/1P, LS62HD, LS65, LS62/UK, LS63, LS63D, LS63/UKRP, LS63F, LV63, LS63/60, LS63/1P, LS63/UK, LS64, LS64/UKRP, LV64, ECOTEMP5S, LS64/1P...(Other models you can see in the webshop)		

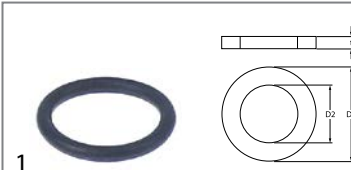
			
GEV No.	517087	Ref. No.	050292 086551 0A2366
description	O-ring EPDM thickness 3.53mm ID ø 23.4mm Qty 1 pcs		
For models:	PMG600, PMG600D, HMS/G400, HMS/G800, HMA/G800, HMS/E400, HMS/E800, HMA/E800, HMS/G400, HMS/G800D, HMA/G800D, HMS/E400, HMS/E800, HMA/E800, HMS/G400NL, HMS/G800, HMA/G800NL, HM/G400T, HM/G800T, HM/E400T, HM/E800T, ZPM/G600, ZHMA/G400, ZHMA/G80, ZHMA/G80, ZHMA/E400, ZHMA/801, ZHMA/E800, DCBE21, DCB/E21U, DCB/V40, SM08C, SM15C, SM15/CS, SM21C, ZSM08/C, ZSM15/C, ZSM15/CS, ZSM21/C, ZHMA/G40, ZHMA/G801D, ZHMA/G80, ZHMA/E400, ZHM/E800T, ZHM/G400, ZHM/G800, ZHM/G400, ZHM/G800		

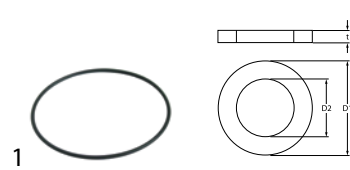
			
GEV No.	504593	Ref. No.	049033
description	O-ring EPDM thickness 3.53mm ID ø 123.4mm Qty 1 pcs		
For models:	LB1, LB1WS, LB1WSDP, LB1/RBP, LB1/TOP, LB1/60, WT1WSDP, LB2D-PSAUS, LB1G, LB1WSG, WT2TOP60, WT2DPDI, WT2WSDPDI, LB1TOP, WT2TOPDI, LB2WS, LB2, LB2WSDP, LB2/TOP, LB2/RBP, LB2WS60, WT2WSDP, WT2WSDPD, LB2WSG, WT2WS, WT1, WT1WS, WT1TOP, WT2TOP, WT1/3DP, WT2/3DP, WT2DPAUS, WT2, LB2DPDI, LB2WSDPDI, LB2WSDPD, LB2TOP, LB2DP3, WT2DPD3, NGW, NGWDPDD, UC1, UC2WS, GW1, GW1WS, LV1WS, LV1WSDP, LV2WSDP, LV2WS, GW2D-PG...(Other models you can see in the webshop)		

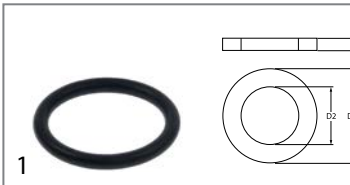

GEV No.	513016	Ref. No.	027300 0L1277
description	O-ring EPDM thickness 3.53mm ID ø 26.58mm Qty 1 pcs		
For models:	MPN/GI761, MPN/GI760D, MPN/GI760, MPN/GI760F, MPN/EI760, MPNEI760UK, MPN/V760, MPN/EI760D, MPN/V760D, RFR/G2S40, RFR/E2S40, RPI/G260, RPI/E240, RPI/E260, RPI/G260P, RPI/E260P, XFR/G2S40, XFR/E2S40, XPI/G260, XPI/E240, XPI/E260, XPI/G260P, XPI/E260P, JFR/G2S40, JFR/E2S40, JPI/G260, JPI/E240, JPI/E260, MFR/G2S40, MFR/E2S40, MPI/G260, MPI/E240, MPI/E260, MPI/G260P, MPI/E260P, 7PIE06, 7PIE06, RPN/EI760UK, RPN/GI760F, 7PEV06, RPN/EI760D, XPN/GI760D, M70GIKE, M70EIKE, XPN/EI760UK, M70VIKE, XPN/GI760F, XPN/EI760D, PPI/G260P, PPI/E260P...(Other models you can see in the webshop)		



GEV No.	508061	Ref. No.	065506
description	O-ring EPDM thickness 3.53mm ID ø 42.86mm Qty 1 pcs		
For models:	LS32UK/RP, WT302UK/RP, LS33UK/RP, WT303UK/RP, LS500F, LS501F, LS540F, LS540DK, LS541F, LS720F, LSE720DK, LSE720PH, LS1080F, LS1080UK, LS1080PH, LSE721F, LS540, LS1080M, LS1080, LS1080D, LS1080UK, LS1080/63, LS500F, LS500UK, LS501, LS501UK, LS540D, LS540/63, LSE721, LS720, LSE720UK, LS721UK, LSE720D, LS541, LS520D, LS520K, LS521D, LS521K, LS521, LS4, LS61, LS61/60, LS62, LS62D, LS62/UKRP, LS62F, LV62, LS62/60, ECOTEMPS, LS62/1P...(Other models you can see in the webshop)		

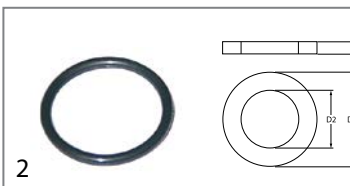

GEV No.	510072	Ref. No.	049245 069468 456016
description	O-ring EPDM thickness 3.53mm ID ø 32.93mm Qty 1 pcs		
For models:	LB1, LB1WS, LB1WSDP, LB1/RBP, LB1/TOP, LB1/60, WT1WSDP, LB2DPSAUS, LB1G, LB1WSG, WT2TOP60, WT2WSDPDI, LB1TOP, WT2TOPDI, LB2WS, LB2, LB2WSDP, LB2/TOP, LB2/RBP, LB2WS60, WT2WSDP, WT2WSDPD, LB2WSG, WT2WS, WT1WS, WT1TOP, WT2TOP, LB2WSDPDI, LB2WSDPD, LB2TOP, LTB12, LTB22, LTB12UK, LTB22UK, LTB22, UC1, UC2WS, GW1WS, LV1WS, LV1WSDP, LV2WSDP, LV2WS, GW2WSDPG, GW2WSG, GW2WS, CRYSTAL 22		

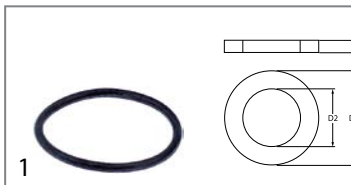

GEV No.	508370	Ref. No.	048229
description	O-ring EPDM thickness 3.53mm ID ø 46.04mm Qty 1 pcs		
For models:	LU7PDP, LU7ADP, LU7ADPWS, WTU40PDP, WTU40ADP, WTU40ADPWS, WTU40ADPD, LS10D, LS10, LS10UKRP, LC100, ECOTEMP12-, LS10/60, LS10/1, LS10/12KW, LS10F, LS10DEK, LS10/1UKRP, LS10SW, LS10/50J, LS10/60J, LS10DP, LS10/HD, SH55, LO10, LS10/UK1, LS10/UK3, LS12D, LS12, LS12UK/RP, LC120, LS12DP, LS12/60, LS12F, LS12DEK, LS12HD, WT60/GJ60, WT60/GJ50, PH10/12-RP, LS12/UK3, ECOTEMP12SW, ECOTEMP12INS, LS12MEX, LS10N, LS10, LS14EA, LS10UKDP, ET12E, LS10/60HZ, LS10CW...(Other models you can see in the webshop)		

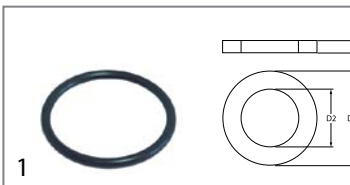

GEV No.	510895	Ref. No.	027301 OKM725
description	O-ring EPDM thickness 3.53mm ID ø 34.52mm Qty 1 pcs		
For models:	LS360F, LS360DK, LS365F, LS365, LS365PH, LS540F, LS540DK, LS541F, LS360D, LS365D, LS360, LS365, LS360/63, LS365/63, LS367, LS720F, LSE720DK, LSE720PH, LS860F, LS860DK, LS860PH, LS1080F, LS1080UK, LS1080PH, LSE721F, LS861F, LS540, LS1080M, LS1080, LS1080D, LS1080UK, LS1080/63, LS540D, LS540/63, LSE721, LS720, LSE720UK, LS721UK, LSE720D, LS541, LS860, LS860, LS860D, LS860UK, LS861UK, LS860/63, LS861, LS360, LS365F, LS540...(Other models you can see in the webshop)		

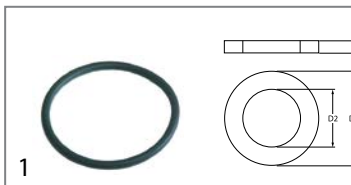

GEV No.	505180	Ref. No.	0HA075
description	O-ring EPDM thickness 3.53mm ID ø 47.22mm Qty 1 pcs		
For models:	LB035C, LB035Q, LB040Q, LB040AUS, G350C, LBICEQ010, LBIOEQ010, G350, G350DP, LBIOEQ014, G400, G400DP, LCFBE003		

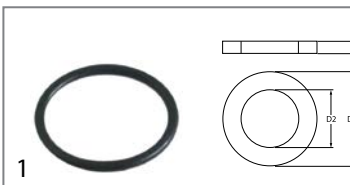

GEV No.	506015	Ref. No.	047192
description	O-ring EPDM thickness 3.53mm ID ø 39.69mm Qty 1 pcs		
For models:	PW1SMG, PW1MG, PW1MUK, PW160HZ, PW1MHG, PW2MG, PW2MUK, PW2M60, WT830M, WT830MUK, WT830M60G, WT850M, WT850MUK, WT850M60G, WT830MHG, WT830M208U, WT830M240U, WT830H208U, WT830H240U, WT850M208U, WT850M240U, PW2SMG, ET830M, ET830MH, ET850M, CT142DXE, CT142SXE, CT142DXEUK, CT142SXEUK, CT142DXV, CT142SXV, CT190DXE, CT190SXE, CT190DXEUK, CT190SXEUK, CT190DXV, CT190SXV, CT191DXE, CT191SXE, CT191DXE, CT191SXEUK, CT191DXV, CT191SXV, CT192DXE, CT192SXE, CT192DXEUK, CT192SXEUK, CT192DXV, CT192SXV, CT240DXE...(Other models you can see in the webshop)		

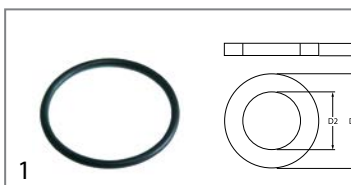

GEV No.	532619	Ref. No.	075647
description	O-ring EPDM thickness 3.53mm ID ø 50.8mm Qty 1 pcs		
For models:	CT92DXE, CT92SXE, CT92DXEUK, CT92SXEUK, CT92DXV, CT92SXV, CT92DXVUK, CT92SXVUK, CT140EDX, CT140ESX, CT140EDXUK, CT140SXEUK, CT140VDX, CT140VSX, CT141EDX, CT141ESX, CT141EDUK, CT141ESUK, CT141VDX, CT141VSX, CT142DXE, CT142SXE, CT142DXEUK, CT142SXEUK, CT142DXV, CT142SXV, CT190DXE, CT190SXE, CT190DXEUK, CT190SXEUK, CT190DXV, CT190SXV, CT191DXE, CT191SXE, CT191DXE, CT191SXEUK, CT191DXV, CT191SXV, CT192DXE, CT192SXE, CT192DXEUK, CT192SXEUK, CT192DXV, CT192SXV, CT240DXE, CT240SXE, CT240DXEUK, CT240SX, CT240DXV, CT240SXVUK...(Other models you can see in the webshop)		

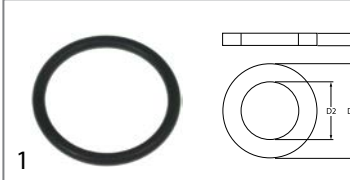

GEV No.	524479	Ref. No.	0E0142 0E5021
description	O-ring EPDM thickness 3mm ID ø 29mm Qty 1 pcs		
For models:	FT36WED, FT36WES, FT36WVD, FT36WVS, FT50WED, FT50WES, FT50WVD, FT50WVS, FT72WED, FT72WES, FT72WVD, FT72WVS, FT36WEDT, FT36WEST, FT36WVDT, FT36WVST, FT50WEDT, FT50WEST, FT50WVDT, FT50WVST, FT72WEDT, FT72WEST, FT72WVDT, FT72WVST, WTF2ERC, WTF2ELC, WTF2SRC, WTF2SLC, WTF2HERC, WTF2HEL, WTF2HSRC, WTF2HSLC, WTF3ERC, WTF3ELC, WTF3SRC, WTF3SLC, WTF3HERC, WTF3HEL, WTF3HSRC, WTF3HSLC, WTF2ERB, WTF2ELB, WTF2SRB, WTF2SLB, WTF2HERB, WTF2HELB, WTF2HSRB, WTF2HSLB, WTF3ERB, WTF3ELB...(Other models you can see in the webshop)		

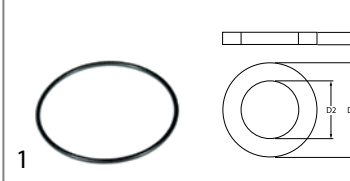

GEV No.	502203	Ref. No.	0KQ652 12099 DS12099
description	O-ring EPDM thickness 3mm ID ø 51mm Qty 1 pcs		
For models:	T15S-01, T10S-01, T15S-02, T10S-02, T10S-03, T15S-03, T10S-07, T10S-04, T15S-06, T15S-04, T10S-05, T10S-08, T15S-07, T15S-05, T10S-06, T15S-08, T10S-09, T15S-09, T10S-17, T10S-18, T10S-19, T10S-20, T15S-20, T15S-11, T10S-10, T10S-15, T15S-10, T15S-15, T10S-16, T10S-13, T10S-11, T15S-17, T15S-14, T15S-12, T15S-16, T15S-22, T10S-14, T15S-13, T15S-19		



GEV No.	528192	Ref. No.	0D3539
description	O-ring EPDM thickness 3mm ID ø 56mm Qty 1 pcs		
For models:	BE12AS-01, BE20AS-01, MVS-01, BM20AS-01, K120-01, BM20AS-02, BM20AS-03, BM20AS-04, BM30AS-01, BM30AS-02, K120-02, BM20AS-05, BM30AS-03, BM20AS-06, BE20S-01, BE20AS-02, BM30S-01, BM20AS-07, BM20AS-12, BM20S-01, BM20S-02, MVS-02, BM20S-03, BM30AS-04, BM30S-02, K120-03, K180-01, KE120-01, KE180-01, BM20AS-13, BM20AS-08, BM20S-04, BM30AS-05, BE20S-02, BE20AS-03, BM20AS-09, BM20AS-10, BM30AS-06, BM20AS-11, KE120-02, EM20AS-01, K120-04, K180-02, EM20AS-02, EM30AS-01, EM40AS-01, BE20S-03, BE20AS-04, BM20AS-14, BM20AS-15...(Other models you can see in the webshop)		

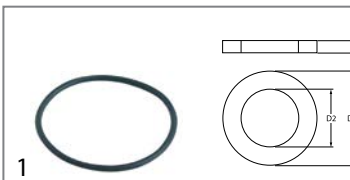

GEV No.	501008	Ref. No.	046865
description	O-ring EPDM thickness 3mm ID ø 64mm Qty 1 pcs		
For models:	CT92DXE, CT92SXE, CT92DXEUK, CT92SXEUK, CT92DXV, CT92SXV, CT92DXVUK, CT92SXVUK, CT140EDX, CT140ESX, CT140EDXUK, CT140SXUK, CT140VDX, CT140VSX, CT141EDX, CT141ESX, CT141EDUK, CT141ESUK, CT141VDX, CT141VSX, CT142DXE, CT142SXE, CT142DXEUK, CT142SXEUK, CT142DXV, CT142SXV, CT190DXE, CT190SXE, CT190DXEUK, CT190SXEUK, CT190DXV, CT190SXV, CT191DXE, CT191SXE, CT191DXEUK, CT191SXEUK, CT191DXV, CT191SXV, CT192DXE, CT192SXE, CT192DXEUK, CT192SXEUK, CT192DXV, CT192SXV, CT240DXE, CT240SXE, CT240DXEUK, CT240SX, CT240DXV, CT240SXVUK...(Other models you can see in the webshop)		

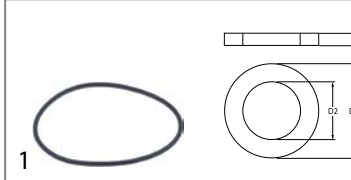

GEV No.	524483	Ref. No.	049894
description	O-ring EPDM thickness 4mm ID ø 110mm Qty 1 pcs		
For models:	WT4, WT4B, WT4D, WT4DB, WT46, WT4DG, WT4WS1, WT4BWS, WT4DWS1, WT4BDWS, NUC3DD, WT4D60, WT4DDG, EUC1, EUC1DP, EUC1WS, EUC1DPWS, EUC3, EUC3WS, EUC3DP, EUC3DPWS, EUC1G, EUC1DP60, EUC3DD, ZUCADDROW, ZUCADDROW6, LS5/1, LS5/1DP, LS5/1WS, LS5/1WSDP, LS5/3, LS5/3DP, LS5/3WS, LS5/3WSDP, FUCA3DD, LS5/3WSDPD, LB5DPG, LS5/1DP60, LS5/1DPAUS, LS5/1DPCS, KUC3, KUC3DP, NUC1, NUC1DP, NUC1WS, NUC1DPWS, NUC3, NUC3WS, NUC3DP, NUC3DPWS...(Other models you can see in the webshop)		

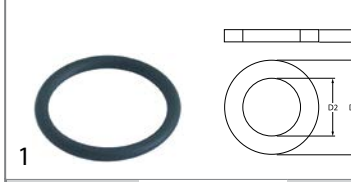

GEV No.	505092	Ref. No.	0C3142 34044796
description	O-ring EPDM thickness 5.34mm ID ø 43.82mm Qty 1 pcs		

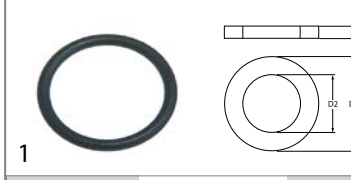

GEV No.	510408	Ref. No.	046213 055533 067620 0H2559 0L2765 19006668 19006946
description	O-ring EPDM thickness 5.34mm ID ø 47mm Qty 1 pcs		
For models:	MPN/EI760, MPNEI760UK, MPN/EI760D, MCP/E700, MCP/G700, MCP/E700D, MCP/G701, MCP/G710, MCP/G711, FDV40E, FDV40EL, FDV20E, FDV20EL, RPI/E240, RPI/E260, RPI/E260P, RCP/E2S, XPI/E240, XPI/E260, XPI/E260P, JPI/E240, JPI/E260, MPI/E240, MPI/E260, MPI/E260P, MCP/E2S, 7PIE06, RPN/EI760UK, RPN/EI760D, 7CPE07P, 7CPG07P, RCP/G701, M70EIKE, XPN/EI760UK, XPN/EI760D, M70EPC, M70GPC, M70GPC, CCP/G700, CCP/E700, XFV/E700, PPI/E260P, ECP/E1ELHU, PCP/E2SHP, PCP/E1ELH, OPI/E260P, OCP/E2S, TPI/E260P, TCP/E1ELHU, TCP/E2S...(Other models you can see in the webshop)		

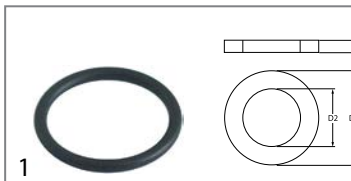

GEV No.	505175	Ref. No.	003928
description	O-ring EPDM thickness 5.34mm ID ø 50.16mm Qty 1 pcs		
For models:	BRN70G, BRN70E, BRN/70GZ, BRN/70EZ, BR70GZ, BR70EZ, BRNG70A, BRNE70A, FV4E, HCPA/G1219, BR70E, CR15V, CR15E, FV4E		

			
GEV No.	510409	Ref. No.	007029 047156 049909 0E5037 OK9011 543613600 740483105
description	O-ring EPDM thickness 5.34mm ID ø 56.52mm Qty 1 pcs		
For models:	EBS50, EBS50, EBS50, EBS50, EBV50, EBV50, EBV50, EBV50, EBV50, EBS50., EBS50H, EBS100., EBS100H, EBS150., EBS150H, EBS200., EBS200H, EBS300., EBS300H, EBV50., EBV50H, EBV100., EBV100H, EBV150, EBV150H, EBV200., EBV200H, EBV300., EBV300H, EBVC50, EBVC50H, EBVC100, EBVC100H, EBVC150, EBVC150H, EBVC200, EBVC200H, EBVC300, EBVC300H, EBP100., EBP100M, EBP150, EBP150M, EBP200., EBP200M, EBP300., EBP300M, EBPC100, EBPC100M, EBPC150...(Other models you can see in the webshop)		

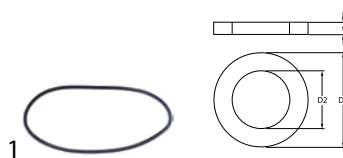
			
GEV No.	510551	Ref. No.	0049 0L0338
description	pump cover gasket ID ø 158.3mm pump type 1214/1293/1225/2243/1226/1204/3473/1241 thickness 3.53mm EPDM Qty 1 pcs		

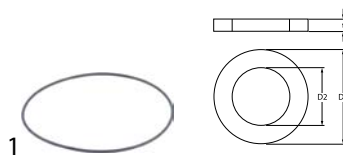
			
GEV No.	504320	Ref. No.	049172
description	pump cover gasket ID ø 160.75mm thickness 3.53mm EPDM Qty 1 pcs		

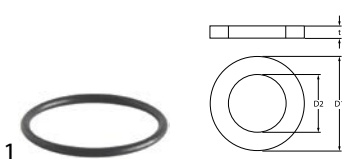
			
GEV No.	532613	Ref. No.	049593
description	O-ring EPDM thickness 5.34mm ID ø 72.39mm Qty 1 pcs		
For models:	WT60/GJ60, WT60/GJ50, PH10/12-RP, LS10, LS14EA, LS10UKDP, ET12E, LS10/60HZ, LS10CW, LS10INS, HT1200INS, LS14EA, LS10N, LS10DP, LS10HD, LS14EA/AU, LS14EA/60, LS10UK/1, LS10UK/3, LS12INS, LS12, LS12DP, LS12/60HZ, LS12CW, HT1200DEK, LS14EAASIA, LS14EA/G, WT60DP, WT60, WT60CW, WT60UKDPCW, WT60INS, WT60INSCW, WT60NAUCW, WT60NAU, LS10EA, WT60/60HZ, WT60/60HZC, WT60N, WT609NINS, LS12HD, LS14EA/ID, WT65E, WT65EB, WT65EI, WT60NAUDP, LS12UK/3CW, LS12NAU, LS12UKDPCW, ECOTEMP12S...(Other models you can see in the webshop)		

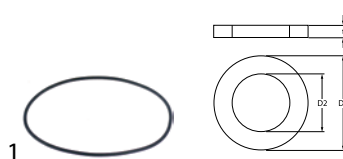
			
GEV No.	503147	Ref. No.	048984
description	pump cover gasket thickness 3.53mm ID ø 148.8mm Qty 1 pcs		

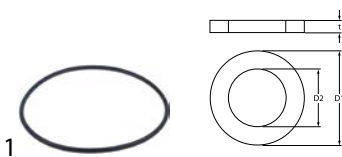
			
GEV No.	532615	Ref. No.	061413
description	O-ring EPDM thickness 7.6mm ID ø 226mm Qty 1 pcs		
For models:	LB8G, LB8G/63, LB8GF, LB8GPH, LB8G, LB8GPHm, LB8G		

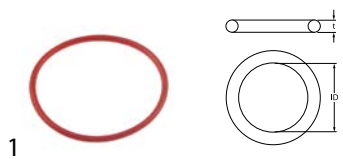
			
silicone			
GEV No.	532505	Ref. No.	0C0188
description	O-ring silicone thickness 1.78mm ID ø 33.05mm Qty 1 pcs		
For models:	PC/G1, PC/G2, PC/G2HV, PC/G1HV, PC/G1A, PC/G2A, OC/G1, OC/G2, TC/G1, TC/G2, TC/G1A, TC/G2A, KC/G1, KC/G2, KCF/G2, KC/G3, KCF/G3, KCF/G4, KCF/M2, KC/T1, KC/T2, KC/T3, KCF/T2, KCF/T3, KCF/T4, KCF/G2H, KC/G1H, KC/G2H, KC/G3H, KC/T1H, KC/T2H, KC/T3H, KCF/W2, KCF/G3H, KCF/G2L, KC/G1G, KC/G2G, KCF/G2G, KC/G3G, KCF/G3G, KCF/G4G, KCF/M2G, KCF/G2HG, KC/G1H1G, KC/G2HG, KC/G3HG, KCF/G3HG, KCF/M2E5G, KCF/G2LG, KS/G2...(Other models you can see in the webshop)		

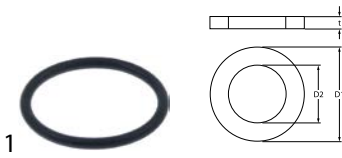
			
GEV No.	524145	Ref. No.	070315 0HB200
description	O-ring ID ø 32mm thickness 3mm Qty 1 pcs		
For models:	LB035C, LB035R, LB035Q, LB040R, LB040Q, LB040AUS, G350C, LBICEQ010, LBIOET010, LBIOET014, LBIOEQ010, G350, G350DP, LBIOEQ014, G400, G400DP		

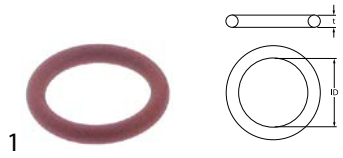
			
GEV No.	525388	Ref. No.	0L2303
description	O-ring silicone thickness 1.78mm ID ø 9.25mm Qty 1 pcs		
For models:	LWC44AR208, LWC44AL208, LWC44AR240, LWC44AL240, LWC66AR208, LWC66AL208, LWC66AR240, LWC66AL240		

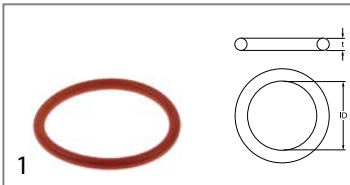

GEV No.	532685	Ref. No.	0L2304
description	O-ring silicone thickness 3.34mm ID ø 56.52mm Qty 1 pcs		
For models:	LWC44AR208, LWC44AL208, LWC44AR240, LWC44AL240, LWC66AR208, LWC66AL208, LWC66AR240, LWC66AL240		

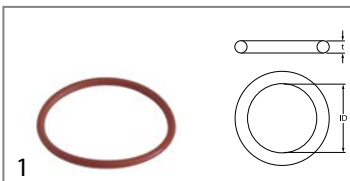

GEV No.	528948	Ref. No.	006406
description	O-ring silicone thickness 3.53mm ID ø 50.39mm Qty 1 pcs		
For models:	RMV/E1C, RMV/E2C, RMV/G1C, RMV/G2C, XMV/E1C, XMV/E2C, XMV/G1C, XMV/G2C, JMV/E1C, JMV/E2C, MMV/E1C, MMV/E2C, MMV/G1C, MMV/G2C, PMV/G1C, PMV/E1C, PMV/E2C, OMV/G1C, OMV/G2C, OMV/E1C, OMV/E2C, TMV/G1C, TMV/G2C, TMV/E1C, TMV/E2C, KMV/G2C, KMV/E2C, QMV/G2C, QMV/E2C		

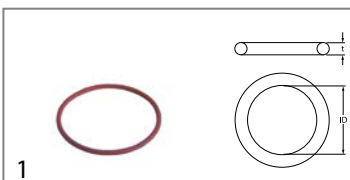

GEV No.	510561	Ref. No.	0H7021 60050466
description	O-ring silicone thickness 3mm ID ø 55mm Qty 1 pcs		
For models:	5611-3-10, 5611-3-6, 5611-3-8, 5612-3-10, 5612-3-6, 5612-3-8, 5614-3-10, 5614-3-6, 5614-3-8		

Viton

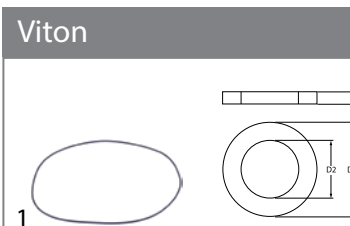

GEV No.	532686	Ref. No.	0KV753
description	O-ring EPDM thickness 1.78mm ID ø 216.1mm Qty 1 pcs		



GEV No.	532610	Ref. No.	052903
description	O-ring EPDM thickness 2.62mm ID ø 44.12mm Qty 1 pcs		
For models:	MPN/GD761, MPN/GI761, MPN/GI760D, MPN/GD760, MPN/GD760F, MPN/GI760, MPN/GI760F, MPN/EI760, MPNEI760UK, MPN/V760, MPN/EI760D, MPN/V760D, RPD/G240, RPD/G260, RPI/G260, RPI/E240, RPI/E260, RPI/G260P, RPI/E260P, XPD/G240, XPD/G260, XPI/G260, XPI/E240, XPI/E260, XPI/G260P, XPI/E260P, JPD/G240, JPD/G260, JPI/G260, JPI/E240, JPI/E260, MPD/G240, MPD/G260, MPI/G260, MPI/E240, MPI/E260, MPI/G260P, MPI/E260P, 7PDG06, 7PIG06, 7PIE06, RPN/EI760UK, RPN/GD760F, RPN/GI760F, 7PEV06, RPN/EI760D, XPN/GI760D, M70GDKE, M70GIKE, M70EIKE...(Other models you can see in the webshop)		

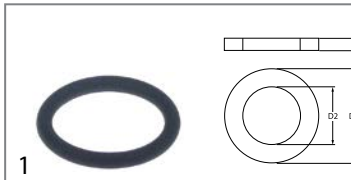

GEV No.	524482	Ref. No.	0KJ544
description	O-ring Viton thickness 2.5mm ID ø 16.5mm Qty 1 pcs		
For models:	EBV50, EBV50, EBV50, EBV50, EBV50, EBV100, EBV100, EBV100, EBV100, EBV100, EBV-C100, EBV-C100, EBV-C100, EBV-C100, EBV-C100, EBV200, EBV200, EBV200, EBV200, EBV200, EBV-C200, EBV-C200, EBV-C200, EBV-C200, EBV300, EBV300, EBV300, EBV300, EBV300, EBV-C300, EBV-C300, EBV-C300, EBV-C300, EBV-C300, EBS50, EBS50H, EBS100, EBS100H, EBS150, EBS150H, EBS200, EBS200H, EBS300, EBS300H, EBV50, EBV50H, EBV100, EBV100H, EBV150...(Other models you can see in the webshop)		

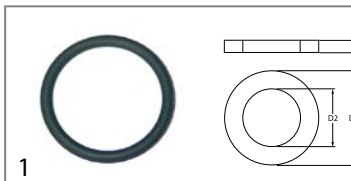

GEV No.	511300	Ref. No.	002873 0F0199 0G0014 0K2486 0K5556 0K8687 0K8840 1140203517 12044490 19006832 60050274
description	O-ring Viton thickness 3.53mm ID ø 28.17mm for 57 series for motor shaft		
For models:	FCZ061EAA, FCZ101EAA, FCZ102EAA, FCZ201EAA, FCZ202EAA, FCZ061EAH, FCZ101EAH, FCZ201EAH, FCZ061EAN, FCZ101EAN, FCZ201EAN, FCZ061ETA, FCZ101ETA, FCZ102ETA, FCZ201ETA, FCZ202ETA, FCZ061ETH, FCZ101ETH, FCZ201ETH, FCZ061ETN, FCZ101ETN, FCZ201ETN, FCZ061GAG, FCZ101GAG, FCZ102GAG, FCZ201GAG, FCZ202GAG, FCZ061GAD, FCZ101GAD, FCZ102GAD, FCZ201GAD, FCZ202GAD, FCZ101GTG, FCZ102GTG, FCZ201GTG, FCZ202GTG, FCZ101GTD, FCZ102GTD, FCZ201GTD, FCZ202GTD, FCZ061EBA, FCZ101EBA, FCZ102EBA, FCZ201EBA, FCZ061EBH, FCZ101EBH, FCZ201EBH, FCZ061EBN, FCZ101EBN...(Other models you can see in the webshop)		

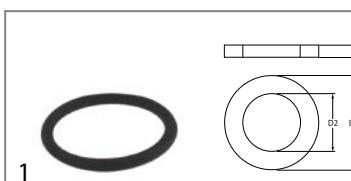



GEV No.	532506	Ref. No.	007074
description	O-ring Viton thickness 3.53mm ID ø 29.75mm Qty 1 pcs		
For models:	FCZ061EAA, FCZ101EAA, FCZ102EAA, FCZ201EAA, FCZ202EAA, FCZ061EAH, FCZ101EAH, FCZ201EAH, FCZ061EAN, FCZ101EAN, FCZ201EAN, FCZ061GAG, FCZ101GAG, FCZ102GAG, FCZ201GAG, FCZ202GAG, FCZ061GAD, FCZ101GAD, FCZ102GAD, FCZ201GAD, FCZ202GAD, FCZ061ECA, FCZ101ECA, FCZ102ECA, FCZ201ECA, FCZ202ECA, FCZ061ECH, FCZ101ECH, FCZ201ECH, FCZ061ECN, FCZ101ECN, FCZ201ECN, FCZ061GCG, FCZ101GCG, FCZ102GCG, FCZ201GCG, FCZ202GCG, FCZ061GCD, FCZ101GCD, FCZ102GCD, FCZ201GCD, FCZ202GCD, AOS061GAEU, AOS101GAEU, AOS102GAEU, AOS201GAEU, AOS202GAEU, AOS061GAU, AOS101GAU, AOS102GAU...(Other models you can see in the webshop)		

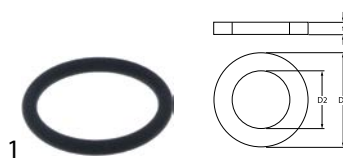

			
GEV No.	528412	Ref. No.	002874 0F0200 0K2485 0K8686 60050326
description	O-ring Viton thickness 3.53mm ID ø 31.34mm Qty 1 pcs		
For models:	FDV40G, FDV40GZ, FDV40GA, FDV20G, FDV20GZ, FDV20GA, FCZ061EAA, FCZ101EAA, FCZ102EAA, FCZ201EAA, FCZ202EAA, FCZ061EAH, FCZ101EAH, FCZ201EAH, FCZ061EAN, FCZ101EAN, FCZ201EAN, FCZ061ETA, FCZ101ETA, FCZ102ETA, FCZ201ETA, FCZ061ETH, FCZ101ETH, FCZ201ETH, FCZ061ETN, FCZ101ETN, FCZ201ETN, FCZ061GAG, FCZ101GAG, FCZ102GAG, FCZ202GAG, FCZ061GAD, FCZ101GAD, FCZ102GAD, FCZ202GAD, FCZ101GTG, FCZ102GTG, FCZ202GTG, FCZ101GTD, FCZ102GTD, FCZ202GTD, FCZ061EBA, FCZ101EBA, FCZ102EBA, FCZ201EBA, FCZ202EBA, FCZ061EBH, FCZ101EBH, FCZ201EBH, FCZ061EBN...(Other models you can see in the webshop)		

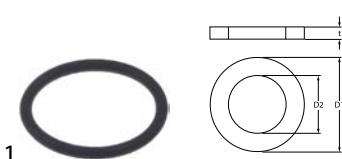
			
GEV No.	524478	Ref. No.	0E0010 0HB234 0K7084 0KP724
description	O-ring Viton thickness 5.7mm ID ø 44.2mm Qty 1 pcs		
For models:	WTF2ERC, WTF2ELC, WTF2SRC, WTF2SLC, WTF2HERC, WTF2HEL, WTF2HSRC, WTF2HSLC, WTF3ERC, WTF3ELC, WTF3SRC, WTF3SLC, WTF3HERC, WTF3HEL, WTF3HSRC, WTF3HSLC, WTF2ERB, WTF2ELB, WTF2SRB, WTF2SLB, WTF2HERB, WTF2HELB, WTF2HSRB, WTF2HSLB, WTF3ERB, WTF3ELB, WTF3SRB, WTF3SLB, WTF3HERB, WTF3HELB, WTF3HSRB, WTF3HSLB, WTF4HERB, WTF4HELB, WTF4HSRB, WTF4HSLB, WTF2ERA, WTF2ELA, WTF2SRA, WTF2SLA, WTF2HERA, WTF2HELA, WTF2HSRA, WTF2HSLA, WTF3ERA, WTF3ELA, WTF3SRA, WTF3SLA, WTF3HERA, WTF3HELA...(Other models you can see in the webshop)		

			
GEV No.	550529	Ref. No.	055349
description	O-ring Viton thickness 3.53mm ID ø 34.52mm Qty 1 pcs		
For models:	FCV/G61/1, FCV/G61/1, FCV/G61/1, FCV/G6L4, FCS061GP, FCS061G4, FCVE6-1U, FCVE6-3U, FCVE6-1, FCVE6-3, FCVE6-1UK, FCVE6-3UK, FCVG6-1, FCVG6-3, FCVG6-1UK, FCVG6-3UK, FCVE10-2, FCVE10-4, FCVE103CE, FCVE10-2UK, FCVE10-4UK, FCVG10-2, FCVG10-4, FCVG10-1SG, FCVG10-2, FCVG10-4D, FCVG10-2UK, FCVG10-4UK, FCVG10-2, FCVG10-4, FCVE20-2, FCVE20-4, FCVE203CE, FCVE20/P-V, FCVE20-2UK, FCVE20-4UK, FCVG20-2, FCVG20-4, FCVG20-2, FCVG20-4D, FCVG20-2UK, FCVG20-4UK, FCVG20-4, FCVG20-4D, FCVE20-V, FCVE20VUK, FCVE10-P, FCVE10PUK, FCVG10-P, FCVG10PUK...(Other models you can see in the webshop)		

			
GEV No.	103007	Ref. No.	0H6863
description	O-ring Viton thickness 5mm ID ø 42.5mm Qty 1 pcs		
For models:	7500-2, 7501-2, 7502-2, 7502-9, 7503-2, 7504-2, 7504-9, 7505-2-9, 7505-9-9, 7508-2, 7700-2, 7701-2, 7703-2, 9000-2, 9001-2, 9002-2, 9004-2, 9006-9, 9201-2, 9203-2		

miscellaneous

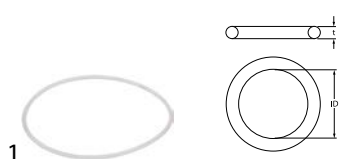
			
GEV No.	694432	Ref. No.	086549
description	O-ring thickness 2mm ID ø 70mm Qty 1 pcs		

sealing washers

fibre gaskets

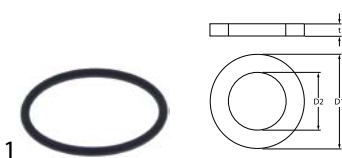
			
GEV No.	530887	Ref. No.	0C3128
description	O-ring Viton thickness 3.53mm ID ø 49.2mm Qty 1 pcs		
For models:	FCZ202ETA, FCZ202EBA2, FCZ202ECA2, AOS202EA2N, AOS202EB2N, AOS202EA, AOS202EB, AOS202ETA1, AOS202ETM1, AOS202ETK1, AOS202EBA2, AOS202EBK2, AOS202ECA2		

			
GEV No.	540071	Ref. No.	0K5555
description	flat gasket FIBER ED ø 18mm ID ø 10mm thickness 2mm Qty 1 pcs		
For models:	ACSGRT, GWACOE00RO, FWAAMO00RO, GWACOMO00RO, IWKCOE0000, HWAHOE00RO, GWAHOE0000, GWAHOE00RO, FWAHOE00RO, BEN150EW87, HWAJOE00RO, GWAJOE00RO, FWAJOE00RO, BEN200EW87, GWAJOMO00RO, FWFJOEX000, FWFJOEX00RO, BEN300E.S35.H97, GWAKOE00RO, FWAKOE00RO, IWAKOMO00RO, GWAKOMO00RO, FWFKOE00RO, FWFKOE00RO, IWALOE0000, IWALOE00RO, BEN400E.S35.H97, BEN400EF97, FWALOE00RO, GWALOMO00RO, IVAAOE0000, HVAAOE00RO, GVAAOE0000, GVAAOE00RO, FVAAOE00RO, IVKAOE0000, FVKAOE00RO, HVABOE00RO, GVABOE0000, GVABOE00RO, FVABOE00RO, FVFB0EX00RO, IVKBOE0000, FVKBOE00RO, IVACOEO0RO, BON080EF88, GVACOE00RO, FVACOE00RO, IVACOMO00RO, GVACOMO00RO...(Other models you can see in the webshop)		

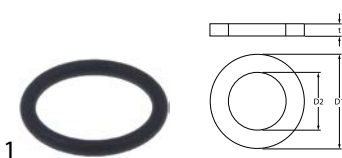
			
GEV No.	550530	Ref. No.	055323
description	O-ring Viton thickness 5.34mm ID ø 37.8mm Qty 1 pcs		
For models:	FDV20G, FDV20GZ, FDV20GA, 7CPE07P, 7CPG07P, M70EPC, M70GPC, FCV/G10L3, FCV/G6L3TOWNGAS, FCV/G6L3, FCVG10L3T, FCVG10L3J, FCV/E101/1, FCV/G20L3, FCVE6L3J, FCV/E10L3JAP, FCV/E102/1L-3JAP, FCV/E10L6JAP, FCV/E102/1L6JAP, FCV/G6L3JAP, FCVG10L3J, FCVG10L3J, FCV/G10L6JAP, FCV/G102/1L6JAP, FCVG6L3CJ, FCV/E61/1, FCV/G10L2, FCV/E61/1, FCV/E101/1, FCV/E101/1, FCV/E10L2, FCV/E102/1, FCV/E61/1, FCV/E61/1, FCV/E101/1, FCV/E101/2, FCV/G6L3C, FCV/G61/1, FCV/G61/1, FCV/G61/1, FCV/G61/1, FCV/G61/1, FCV/G6L3CT, FCVG6L3CJ, FCV/E10L3, FCV/E102/1, FCV/E6L3, FCV/E102/1L3, FCV/E20L3, FCV/G6L4, FCV/E6L4...(Other models you can see in the webshop)		



GEV No.	524967	Ref. No.	067935
description	flat gasket FIBER ED ø 24.5mm ID ø 16.7mm thickness 2mm Qty 1 pcs		
For models:	DCBE21, DCB/E21U, DCBV40, CT92DXE, CT92SXE, CT92DXEUK, CT92SXEUUK, CT92DXV, CT92SXV, CT92DXVUK, CT92SXVUK, LS10D, CT140EDX, CT140ESX, CT140EDXUK, CT140SXEUUK, CT140VDX, CT140VSX, CT141EDX, CT141ESX, CT141EDUK, CT141ESUK, CT141VDX, CT141VSX, CT142DXE, CT142SXE, CT142DXEUK, CT142SXEUUK, CT142DXV, CT142SXV, CT190DXE, CT190SXE, CT190DXEUK, CT190SXEUUK, CT190DXV, CT190SXV, CT191DXE, CT191SXE, CT191DXEUK, CT191SXEUUK, CT191DXV, CT191SXV, CT192DXE, CT192SXE, CT192DXEUK, CT192SXEUUK, CT192DXV, CT192SXV, CT240DXE, CT240SXE...(Other models you can see in the webshop)		



GEV No.	518393	Ref. No.	0K5559
description	flat gasket FIBER ED ø 24mm ID ø 17mm thickness 2mm Qty 1 pcs		
For models:	GWACOEOORO, FWAAMOORO, GWACOMOORO, IWKCOEOOOO, HWAHOEOORO, GWAHOEOOOO, GWAHOEOORO, FWAHOEOORO, BEN150EW87, HWAJOEOORO, GWAJOEOORO, FWAJOEOORO, BEN200EW87, GWAJOMOORO, FWFJOEXOOO, FWFJOEXORO, BEN300E.S35.H97, GWAKOEOORO, FWAKOEOORO, IWAKOMOORO, GWAKOMOORO, FWFKOEXORO, FWKKOEOORO, IVALOEOOOO, IVALOEOORO, BEN400E.S35.H97, BEN400EF97, FVALOEOORO, GWALOMOORO, IVAAOEOOOO, HVAAOEOORO, GVAAOEOOOO, GVAAOEOORO, FVAAOEOORO, IVKAOEOOOO, FVKAEOEOORO, HVABOEOORO, GVABOEOOOO, GVABOEOORO, FVABOEOORO, FVBOEXORO, IVKBOEOOOO, FVKBOEOORO, IVACOEOORO, BON080EF88, GVACOEOORO, FVACOEOORO, IVACOMOORO, GVACOMOORO, GVFCOEXOOO...(Other models you can see in the webshop)		



GEV No.	504765	Ref. No.	066088
description	flat gasket FIBER ED ø 54mm ID ø 48mm thickness 2mm for thread 1½" Qty 1 pcs		
For models:	CT92DXE, CT92SXE, CT92DXEUK, CT92SXEUUK, CT92DXV, CT92SXV, CT92DXVUK, CT92SXVUK, CT140EDX, CT140ESX, CT140EDXUK, CT140SXEUUK, CT140VDX, CT140VSX, CT141EDX, CT141ESX, CT141EDUK, CT141ESUK, CT141VDX, CT141VSX, CT142DXE, CT142SXE, CT142DXEUK, CT142SXEUUK, CT142DXV, CT142SXV, CT190DXE, CT190SXE, CT190DXEUK, CT190SXEUUK, CT190DXV, CT190SXV, CT191DXE, CT191SXE, CT191DXEUK, CT191SXEUUK, CT191DXV, CT191SXV, CT192DXE, CT192SXE, CT192DXEUK, CT192SXEUUK, CT192DXV, CT192SXV, CT240DXE, CT240SXE, CT240DXEUK, CT240SX, CT240DXV, CT240SXVUK...(Other models you can see in the webshop)		



GEV No.	510417	Ref. No.	0K6103 0K6660 0K8701
description	flat gasket fibre ED ø 20mm ID ø 14mm thickness 2mm Qty 1 pcs		
For models:	D180, D180, D180, D180, D180, D180, D180, D180, D180, D180, D180, D180, D180, D180, D820, D820, D820, D820, D530ESD, D530ESD, D530ESD, D530ESD, D530ESD, D580+ESD, D580+ESD, D680+ESD, D680+ESD, AR170, AR170, AR170, AR170, AR170, AR170, AR170, AR170S, AR170S, AR170S, AR170S, AR170S, AR170S, AR170S, AR170S, AR170S...(Other models you can see in the webshop)		



GEV No.	524477	Ref. No.	0E5122 0K8702 0L1487 0L2402
description	flat gasket fibre ED ø 29mm ID ø 21mm thickness 1.5mm Qty 1 pcs		
For models:	PW1EFL, PW1EFL, PW1EFL/60HZ, PW2EFL, PW2EFL, PW2EFL/60HZ, PW2VFL, WT830EFL, WT830EFL, WT830EFL/60HZ, WT850, WT850EFL, WT850EFL/60HZ, WT850SFL, FT36EDTS, FT36ESTS, FT36VDT, FT36VST, FT36ED, FT36ES, FT36VD, FT36VS, FT50ED, FT50ES, FT50VD, FT50VS, FT72ED, FT72ES, FT72VD, FT72VS, FT36EDT, FT36EST, FT36VDT, FT36VST, FT50EDT, FT50EST, FT50VDT, FT50VST, FT72EDT, FT72EST, FT72VDT, FT72VST, WTF2ERC, WTF2ELC, WTF2SRC, WTF2SLC, WTF2HERC, WTF2HEL, WTF2HSRC, WTF2HSLC...(Other models you can see in the webshop)		



GEV No.	510597	Ref. No.	050296
description	flat gasket fibre ED ø 34mm ID ø 24mm thickness 2mm Qty 1 pcs		
For models:	PMG600, PMG600D, HMS/E400, HM/G800T, ZPM/G600, DL14/C, DL14/CP, DL21/C, DL21/CP, SM08C., SM15CP, SM15C., SM15/CS., SM21/CP, SM21C., SSBMHC12, SSBMHC16, SSBMHC20, SSBMB12, SSBMB16, SSBMHB20, SSBMB8, SSBMHC8, DBMAC12, DBMAC16, DBMAC20, DBMP12, DBMP16, DBMP20, ZLB12H, ZLB16H, ZLB20H, ZLB12B, ZLB16B, ZLB20B, ZLB08B, ZLB08H, DI-WHW2, DI-WHW3, DI-WHW4, DI-WHW5, DI-WHW6, DI12HWW, DI14HWW, DI2BM, DI3BM, DI4BM, DI2BMO, DI3BMO, DI4BMO...(Other models you can see in the webshop)		





GEV No.	506072	Ref. No.	0G0018
description	flat gasket fibre ED ø 38mm ID ø 27mm thickness 2mm outflow for thread 1¼" Qty 1 pcs		
For models:	CG148-001.A1AB, CG148-003.A2AB, CG248-201.A1ABBB, CG248-203.A1ABBB, CK248-209.D1ABBB, CK248-211.D1ABBB, LG159-703.A1BC, LG159-703.A2BC, LG159-704.A1BC, LG159-706.A1BC, LG259-711.A1ACCB, LG259-712.A1ACCB, LK259-707.D1ACCB, LK259-708.D1ACCB, LG259-739.A1ACCB, LG259-740.A1ACCB, CK248-205.D1ABBB, CK248-207.D1ABBB, LK159-707.D1BC, LK159-708.D1BC, LK259-727.D1ACCB, LK259-728.D1ACCB, LG159-704.A2BC, LK159-707.D2BC, LK159-708.D2BC, LG259-711.A2ACCB, LG259-712.A2ACCB, LK259-727.D2ACCB, LK259-728.D2ACCB, LK259-707.D2ACCB, LK259-708.D2ACCB, CK248-205.D2ABBB, CK248-207.D2ABBB, CK248-209.D2ABBB, CK248-211.D2ABBB, CG148-004.A1AB, CG148-005.A1AB, CG148-006.A1AB, CG248-240.A1ABBB, CG248-243.A1ABBB, CG248-244.A1ABBB, CG248-212.A1ABBB, CG248-213.A1ABBB, LG159-705.A1BC, LG159-753.A1BC, LG259-758.A1ACCB, LG259-754.A1ACCB, LG259-757.A1ACCB, CG148-001.A3AB, CG148-003.A2AB...(Other models you can see in the webshop)		



			
GEV No.	510404	Ref. No.	0E2240 0H2578 0H2612 0K6137 0K8703 0KG502 3427TJ1,5
description	flat gasket fibre ED ø 44mm ID ø 34mm thickness 2mm Qty 1 pcs		
For models:	EBS50, EBS50, EBS50, EBS50, EBV50, EBV50, EBV50, EBV50, EBV50, EBS100, EBS100, EBS100, EBS100, EBV100, EBV100, EBV100, EBV100, EBV100, EBV-C100, EBV-C100, EBV-C100, EBV-C100, EBV-C100, EBV-C100, EBS200, EBS200, EBS200, EBS200, EBV200, EBV200, EBV200, EBV200, EBV200, EBV-C200, EBV-C200, EBV-C200, EBV-C200, EBS300, EBS300, EBS300, EBS300, EBV300, EBV300, EBV300, EBV300, EBV300, EBV-C300, EBV-C300, EBV-C300, EBV-C300...(Other models you can see in the webshop)		

			
GEV No.	504306	Ref. No.	069438 075646 0E5524 0KK028
description	gasket fibre ED ø 16mm ID ø 10mm thickness 2mm Qty 1 pcs		
For models:	CT92DXE, CT92SXE, CT92DXEUK, CT92SXEUK, CT92DXV, CT92SXV, CT92DXVUK, CT92SXVUK, CT140EDX, CT140ESX, CT140EDXUK, CT140SXEU, CT140VDX, CT140VXS, CT141EDX, CT141ESX, CT141EDUK, CT141ESUK, CT141VXS, PW1EFL, PW1EFLF, PW1EFL/60HZ, PW2EFL, PW2EFLF, PW2EFL/60HZ, PW2VFL, CT142DXE, CT142SXE, CT142DXEUK, CT142SXEU, WT830EFL, WT830EFLF, WT830EFL/60HZ, WT850, WT850EFL, WT850EFL/60HZ, WT850SFL, CT142DXV, CT142SXV, CT190DXE, CT190SXE, CT190DXEUK, CT190SXEU, CT190DXV, CT190SXV, CT191DXE, CT191SXE, CT191DXEUK, CT191SXEU...(Other models you can see in the webshop)		

			
GEV No.	517823	Ref. No.	059675
description	flat gasket fibre ED ø 65mm ID ø 50mm thickness 2mm Qty 1 pcs		
For models:	HPN/GI810, HPN/GI815, HPN/GI815D, HPN/GI816, HPN/GI816, HPN/GI815D, HPN/GI810, HPN/GI815, HPN/GD811, HPN/GD816, HPN/ED811, HPN/ED816, HPA/GD825, HPA/GI825, HPA/ED825, HPA/EI825, HPNS/GI816, HPNS/EI815, HPNS/EI815D, ZPN/GI810, 2PIG15, ZPN/GI816, ZPN/GI816D, ZPN/EI815D, ZPN/EI810, ZPN/EI815, ZPN/GD811, ZPN/GD816, ZPN/ED811, ZPN/ED816, 2PDAG15, 2PIAG15, HPN/ED825, HPN/EI825, ZPNS/GI816, ZPNS/EI815, ZPNS/EI815D, APN/GI810, APN/GI815, APN/GI816, APN/GI816D, APN/EI815D, APN/EI810, APN/EI815, APN/GD811, APN/GD816, APN/ED816, APNS/GI816, APNS/EI815, OPN/GI815		

			
GEV No.	514251	Ref. No.	050295
description	gasket fibre ED ø 46mm ID ø 38mm thickness 2mm Qty 1 pcs		
For models:	PMG600, PMG600D, HMS/G400, HMS/G800, HMA/G800, HMS/E400, HMS/E800, HMA/E800, HMS/G400, HMS/G800D, HMA/G800D, HMS/E400, HMS/E800, HMA/E800, HMS/G400NL, HMS/G800, HMA/G800NL, HM/G400T, HM/G800T, HM/E400T, HM/E800T, ZPM/G600, ZHMA/G400, ZHMA/G80, ZHMA/G80, ZHMA/E400, ZHMA/801, ZHMA/E800, DCBE21, DCB/E21U, DCBV40, ZHMA/G40, ZHMA/G801D, ZHMA/G80, ZHMA/E400, ZHM/E800T, ZHM/G400, ZHM/G800, ZHM/G400, ZHM/G800		

			
GEV No.	531298	Ref. No.	054100 0780054100
description	gasket FIBER ED ø 9.5mm ID ø 5.5mm thickness 1mm		
For models:	RC/G320, RC/G330, RC/G320F, RC/G720, RC/G730, MCF/G705, MCF/G1055, MCF/G700, MCF/G1050, MCF/G705E, MCF/G1055E, MCF/G700D, MCF/G700, MCF/G705F, MCF/G1055F, MCF/G705NL, MCF/GE705, MCF/GE1055, MCF/GE700, MCFGE1050, MCF/GE700D, MCFGE1050D, MCF/G1050D, MCFG1055NL, MC/G355, MC/G350, MC/G355E, MC/G350D, MC/G355F, MC/G355NL, MC/G705, MC/G700, MC/G705E, MC/G700D, MC/G705NL, MC/G1055, MC/G1050, MC/G1050D, MC/G1055NL, MC/G705F, MCF/GE1055UK, MCF/G1090, MCF/G1095, MC/G352, MC/G702, MC/G1052, MCF/G702, MCF/GE702, MCF/G1052, MCFGE1052...(Other models you can see in the webshop)		

			
GEV No.	540796	Ref. No.	004986 008028 020279 026229 054795 050289 11012191 34012781
description	gasket fibre ED ø 60mm ID ø 50mm thickness 2mm for outlet tap Qty 1 pcs		
For models:	KPI/G10, KPI/G15, KPI/E10, KPI/E15, KPD/G10, KPD/G15, KPD/G15A, KPI/G15A, KPI/E15A, KPI/G15H, KPI/E15H, KPI/G10H, KPI/E10H, HPN/GI810, HPN/GI815, HPN/GI815D, HPN/GI816, HPN/GI816, HPN/EI815D, HPN/EI810, HPN/EI815, HPN/GD811, HPN/GD816, HPN/ED811, HPN/ED816, HPA/GD825, HPA/GI825, HPA/ED825, HPA/EI825, HPNS/GI816, HPNS/EI815, HPNS/EI815D, CR22G, QPI/G10, QPI/G15, QPI/E10, QPI/E15, QPD/G10, QPD/G15, QPI/G15H, QPI/E15H, QPI/G10H, QPI/E10H, ZPN/GI810, 2PIG15, ZPN/GI816, ZPN/GI816D, ZPN/EI815D, ZPN/EI810, ZPN/EI815...(Other models you can see in the webshop)		



GEV No.	504295	Ref. No.	047201
description	gasket fibre ED ø 69mm ID ø 62mm thickness 2mm Qty 1 pcs		
For models:	CT142DXE, CT142SX, CT142DXEUK, CT142SXUK, CT142DXV, CT142SXV, CT190DXE, CT190SX, CT190DXEUK, CT190SXUK, CT190DXV, CT190SXV, CT191DXE, CT191SX, CT191DXEUK, CT191SXUK, CT191DXV, CT191SXV, CT192DXE, CT192SX, CT192DXEUK, CT192SXUK, CT192DXV, CT192SXV, CT240DXE, CT240SX, CT240DXEUK, CT240SXUK, CT240DXV, CT240SXV, CT241DXE, CT241SX, CT241DXEUK, CT241SXUK, CT241DXV, CT241SXV, CT142DXEZ, CT142SXEZ, CT142DXVZ, CT142SXVZ, CT190DXEZ, CT190SXEZ, CT190DXV, CT190SXV, CT191DXE, CT191SX, CT191DXV, CT191SXV, CT192DXE, CT192SX... (Other models you can see in the webshop)		

rubber gaskets



GEV No.	505398	Ref. No.	032460
description	flat gasket ED ø 45mm ID ø 37mm thickness 2.5mm for display refrigerator Qty 1 pcs		
For models:	FS07C, FS11C, FS11C2, NFS15C, FS15C2, FSV07C2X, FSV11C3X, FSV15C4X, FSV07C2C, FSV11C3C, FSV15C4C, FSV11C3CX, FSV15C4CX, FSV11C3CC, FSV15C4CC, SSBMHC12, SSBMHC16, SSBMHC20, SSBMB12, SSBMB16, SSBMB20, SSBMHC12HD, SSBMHC16HD, SSBMHC20H, SSBMB8, SSBMHC8, DBMAC12, DBMAC16, DBMAC20, DBMP12, DBMP16, DBMP20, ZLB12H, ZLB16H, ZLB20H, ZLB12B, ZLB16B, ZLB20B, ZLB12HHD, ZLB16HHD, ZLB20HHD, ZLB08B, ZLB08H, DI-WHW2, DI-WHW3, DI-WHW4, DI-WHW5, DI-WHW6, DI12HWW, DI14HWW... (Other models you can see in the webshop)		



GEV No.	504524	Ref. No.	048823
description	flat gasket rubber ED ø 121mm ID ø 85mm thickness 1mm Qty 1 pcs		
For models:	LS32, LS32/4.5, LS32UK/RP, LS32F, LV32F, C55, LV32/60, WT4, WT4B, WT4D, WT302, WT302/4.5, WT302UK/RP, WT302F, WT302/60, WT4DB, WT46, LS33, LS33/4.5, LS33UK/RP, LS33F, LV33F, C55A, LS33/60, WT303, WT303/4.5, WT303UK/RP, WT303F, WT303/60, WT4D60, WT4DDG, LS5/1, LS5/1DP, LS5/3, LS5/3DP, LS5/1DP60, LS5/1DPAUS, LS5/1DPCS, LS61, LS61/60, LS6EP, LS6EP/DD, LS6EADD, LS6EA/DPPD, WT38TDE, WT38/M50, LS6EADP3, WT38PM50, WT37LEV/9, LS6SANA... (Other models you can see in the webshop)		



GEV No.	504319	Ref. No.	046584
description	flat gasket rubber ED ø 14mm ID ø 12mm thickness 1mm Qty 1 pcs		
For models:	LS32, LS32/4.5, LS32UK/RP, LS32F, LV32F, C55, LV32/60, WT302, WT302/4.5, WT302UK/RP, WT302F, WT302/60, LS33, LS33/4.5, LS33UK/RP, LS33F, LV33F, C55A, LS33/60, WT303, WT303/4.5, WT303UK/RP, WT303F, WT303/60, LS360F, LS360DK, LS365F, LS365, LS365PH, LS500F, LS501F, LS540F, LS540DK, LS541F, LS360D, LS365D, LS360, LS365, LS360/63, LS365/63, LS367, LS720F, LSE720DK, LSE720PH, LS860F, LS860DK, LS860PH, LS1080F, LS1080UK, LS1080PH... (Other models you can see in the webshop)		



GEV No.	526631	Ref. No.	049201
description	flat gasket rubber ED ø 24mm ID ø 15mm thickness 3mm Qty 1 pcs		
For models:	LS32, LS32/4.5, LS32UK/RP, LS32F, LV32F, C55, LV32/60, WT302, WT302/4.5, WT302UK/RP, WT302F, WT302/60, WT4DG, WT4WS1, LS33, LS33/4.5, LS33UK/RP, LS33F, LV33F, C55A, LS33/60, WT4BWS, WT4DWS1, WT4BDWS, WT303, WT303/4.5, WT303UK/RP, WT303F, WT303/60, LS5/1WS, LS5/1WSDP, LS5/3WS, LS5/3WSDP, LS5/3WSDPD, LB5DPG, LB1, LB1WS, LB1WSDP, LB1/RBP, LB1/TOP, LB1/60, WT1WSDP, LB2DPSAUS, LB1G, LB1WSG, LB2WS, LB2, LB2WSDP, LB2/TOP, LB2/RBP... (Other models you can see in the webshop)		



GEV No.	511908	Ref. No.	005921
description	flat gasket rubber ED ø 30mm ID ø 20.5mm thickness 2mm Qty 1 pcs		
For models:	ECP/E1ELHU, PCP/E1S, PCP/E2D, PCP/E2SHP, PCP/E1ELH, OCP/E1S, OCP/E2D, OCP/E2S, TCP/E1ELHU, TCP/E1S, TCP/E2D, TCP/E2S, TCP/E1ELH, KCP/G1RU, KCP/G2RU, KCP/E1RU, KCP/E2RU, KCP/G1, KCP/G1R, KCP/G2, KCP/G2R, KCP/E1, KCP/E1R, KCP/E2, KCP/E2R, KCP/G1U, KCP/G2U, KCP/E1U, KCP/E2U, QCP/G1, QCP/G1R, QCP/G2, QCP/G2R, QCP/E1, QCP/E1R, QCP/E2, QCP/E2R, WCP/G1, WCP/G1R, WCP/G2, WCP/G2R, WCP/E1, WCP/E1R, WCP/E2, WCP/E2R, DCP/G400		





GEV No.	504507	Ref. No.	049038
description	flat gasket rubber ED ø 49.5mm ID ø 39mm thickness 2mm Qty 1 pcs equiv. no. 049038 suitable for ZANUSSI		
For models:	LB1, LB1WS, LB1WSDP, LB1/RBP, LB1/TOP, LB1/60, WT1WSDP, LB2DPSAUS, LB1G, LB1WSG, WT2TOP60, WT2DPDI, WT2WSDPDI, LB1TOP, WT2TOPDI, LB2WS, LB2, LB2WSDP, LB2/TOP, LB2/RBP, LB2WS60, WT2WSDP, WT2WSDPD, LB2WSG, WT2WS, WT1, WT1WS, WT1TOP, WT2TOP, WT1/3DP, WT2/3DP, WT2DPAUS, WT2, LB2DPDI, LB2WSDPDI, LB2WSDPD, LB2TOP, LB2DP3, WT2DPD3, NGW, NGWDPDD, UC1, UC2WS, GW1, GW1WS, LV1WS, LV1WSDP, LV2WSDP, LV2WS, GW2DPG... (Other models you can see in the webshop)		



GEV No.	521124	Ref. No.	060009 070308
description	flat gasket rubber ED ø 52mm ID ø 42mm thickness 6mm Qty 1 pcs		
For models:	LB035C, LB035R, LB035Q, LB040R, LB040Q, LB040AUS, G350C, LBICEQ010, LBIOET010, LBIOET014, LBIOEQ010, G350, G350DP, LBIOEQ014, G400, G400DP, LCFBE003		



			
GEV No.	504711	Ref. No.	030186 246008800
description	flat gasket rubber ED ø 55mm ID ø 42mm thickness 3mm Qty 1 pcs		
For models:	LS32, LS32/4.5, LS32F, LV32F, LV32/60, LS33, LS33/4.5, LS33F, LV33F, LS33/60, LSD55I, LSD55V, LS520, LS520D, LS520F, LS520M, LS520K, LS521, LS521D, LS521F, LS521M, LS521K, LS521, LS4, LS62, LS62D, LS62/UKRP, LS62F, LV62, LS62/60, LS62/1P, LS62HD, LS63, LS63D, LS63/UKRP, LS63F, LV63, LS63/60, LS63/1P, LS64, LS64/UKRP, LV64, LS64/1P, C52, C50		

			
GEV No.	504323	Ref. No.	060716
description	gasket rubber ED ø 48.5mm ID ø 42.5mm thickness 5mm Qty 1 pcs		

			
GEV No.	504774	Ref. No.	046595
description	gasket rubber ED ø 58.5mm ID ø 47mm thickness 3mm Qty 1 pcs		
For models:	LS32, LS32/4.5, LS32UK/RP, LS32F, LV32F, C55, LV32/60, WT302, WT302/4.5, WT302UK/RP, WT302F, WT302/60, LS33, LS33/4.5, LS33UK/RP, LS33F, LV33F, C55A, LS33/60, WT303, WT303/4.5, WT303UK/RP, WT303F, WT303/60, LS720F, LSE720DK, LSE720PH, LS860F, LS860DK, LS860PH, LS1080F, LS1080UK, LS1080PH, LSE721F, LS861F, LS1080M, LS1080, LS1080D, LS1080UK, LS1080/63, LSE721, LS720, LSE720UK, LS721UK, LSE720D, LS860, LS860, LS860D, LS860UK, LS861UK...(Other models you can see in the webshop)		

			
GEV No.	693757	Ref. No.	0H6852
description	flat gasket rubber ED ø 60mm ID ø 17mm thickness 1.5mm Qty 1 pcs		

			
GEV No.	504776	Ref. No.	049828 049848
description	gasket rubber ED ø 60mm ID ø 50mm thickness 1.5mm for intake body		
For models:	WT4, WT4B, WT4D, WT4DB, WT46, WT4DG, WT4WS1, WT4BWS, WT4DWS1, WT4BDWS, NUC3DD, WT4D60, WT4DDG, EUC1, EUC1DP, EUC1WS, EUC1DPWS, EUC3, EUC3WS, EUC3DP, EUC3DPWS, EUC1G, EUC1DP60, EUC3DD, ZUCADDROW, ZUCADDROW6, LS5/1, LS5/1DP, LS5/1WS, LS5/1WSDP, LS5/3, LS5/3DP, LS5/3WS, LS5/3WSDP, FUCA3DD, LS5/3WSDPD, LB5DPG, LS5/1DP60, LS5/1DPAUS, LS5/1D-PCS, KUC3, KUC3DP, NUC1, NUC1DP, NUC1WS, NUC1DPWS, NUC3, NUC3WS, NUC3DP, NUC3DPWS...(Other models you can see in the webshop)		

			
GEV No.	510071	Ref. No.	049244 069470 437034
description	flat gasket rubber ED ø 81mm ID ø 68mm thickness 3mm for salt tank Qty 1 pcs		
For models:	LB1, LB1WS, LB1WSDP, LB1/RBP, LB1/TOP, LB1/60, WT1WSDP, LB2D-PSAUS, LB1G, LB1WSG, WT2TOP60, WT2WSDPDI, LB1TOP, WT2TOPDI, LB2WS, LB2, LB2WSDP, LB2/TOP, LB2/RBP, LB2WS60, WT2WSDP, WT2WSDPD, LB2WSG, WT2WS, WT1WS, WT1TOP, WT2TOP, LB2WSDPDI, LB2WSDPD, LB2TOP, LTB11, LTB12, LTB22, LTB11UK, LTB12UK, LTB22UK, LTB11, LTB22, UC1, UC2WS, 910-00-021, 910-00-023, 910-00-031, 910-00-033, 911-00-022, 911-00-024, 911-00-032, 911-00-034, GW1WS, LV1WS...(Other models you can see in the webshop)		

			
GEV No.	504307	Ref. No.	0K7355
description	gasket rubber ED ø 22mm ID ø 7mm thickness 2mm Qty 1 pcs		
For models:	D530ESD, D530ESD, D530ESD, D530ESD, D530ESD, D530ESD, D580+ESD, D580+ESD, D680+ESD, D680+ESD		

<p>copper gaskets</p> <p>DIN-7603-A</p> 			
GEV No.	528660	Ref. No.	0C4201
description	flat gasket copper ED ø 21mm ID ø 17mm thickness 1.5mm suitable for 3/8"		
For models:	FCZ061EAA, FCZ101EAA, FCZ102EAA, FCZ061EAH, FCZ101EAH, FCZ061EAN, FCZ101EAN, FCZ061ETA, FCZ101ETA, FCZ102ETA, FCZ201ETA, FCZ202ETA, FCZ061ETH, FCZ101ETH, FCZ201ETH, FCZ061ETN, FCZ101ETN, FCZ201ETN, FCZ061GAG, FCZ061GAD, FCZ101GTG, FCZ102GTG, FCZ201GTG, FCZ202GTG, FCZ101GTD, FCZ102GTD, FCZ201GTD, FCZ202GTD, FCZ061EBA, FCZ101EBA, FCZ102EBA, FCZ061EBH, FCZ101EBH, FCZ061EBN, FCZ101EBN, FCZ061EBC, FCZ101EBC, FCZ201EBC, FCZ061EBA2, FCZ101EBA2, FCZ102EBA2, FCZ201EBA2, FCZ202EBA2, FCZ061EBH2, FCZ101EBH2, FCZ201EBH2, FCZ061EBN2, FCZ101EBN2, FCZ201EBN2, FCZ061EBC2...(Other models you can see in the webshop)		

			
GEV No.	510878	Ref. No.	046925 061488
description	gasket rubber ED ø 23.5mm ID ø 14mm thickness 2.3mm Qty 1 pcs size 3/4"		
For models:	MCP/E700, MCP/G700, MCP/E700D, MCP/G701, MCP/G710, MCP/G711, FDV40G, FDV40E, FDV40GZ, FDV40EL, FDV40GA, FDV20G, FDV20E, FDV20GZ, FDV20EL, FDV20GA, 7CPE07P, 7CPG07P, RCP/G701, M70EPC, M70GPC, M70GPC, CCP/G700, CCP/E700, RCP/G700, RCPE700, FCZ202GAG, FCZ202GAD, FCZ202GBG, FCZ202GBD, FCZ202GCG, FCZ202GCD, FCV/G10L3, FCV/G6L3TOWNGAS, FCV/G6L3, FCVG10L3T, FCVG10L3L, FCV/E101/1, FCV/G20L3, FCVG20L3, FCVE6L3J, FCV/E10L3JAP, FCV/E102/1L3JAP, FCV/E10L6JAP, FCV/E102/1L6JAP, FCV/G6L3JAP, FCVG10L3J, FCVG10L3L, FCV/G10L6JAP, FCV/G102/1L6JAP...(Other models you can see in the webshop)		

PTFE gaskets

			
1			
GEV No.	510012	Ref. No.	069643 437008
description	flat gasket PTFE ED ø 16.5mm ID ø 12.5mm thickness 1.5mm Qty 1 pcs equiv. no. 437008		
For models:	LTB11, LTB12, LTB22, LTB11UK, LTB12UK, LTB22UK, LTB11, LTB22, CRYSTAL 11, CRYSTAL 22		

			
1			
GEV No.	524054	Ref. No.	0HA079 60004 9060004
description	gasket PTFE ED ø 15mm ID ø 10mm thickness 2mm Qty 1 pcs		
For models:	LB035C, LB035R, LB035Q, LB040R, LB040Q, LB040AUS, G350C, LBICEQ010, LBIOET010, LBIOET014, LBIOEQ010, G350, G350DP, LBIOEQ014, G400, G400DP, LCFBE003		

			
1			
GEV No.	693745	Ref. No.	002624 0C3641 0F0165 237382
description	gasket PTFE ED ø 20mm ID ø 15mm thickness 1mm Qty 1 pcs		
For models:	FCZ061EAA, FCZ101EAA, FCZ102EAA, FCZ201EAA, FCZ202EAA, FCZ061EAH, FCZ101EAH, FCZ201EAH, FCZ061EAN, FCZ101EAN, FCZ201EAN, FCZ061ETA, FCZ101ETA, FCZ102ETA, FCZ201ETA, FCZ061ETH, FCZ101ETH, FCZ201ETH, FCZ061ETN, FCZ101ETN, FCZ201ETN, FCZ061GAG, FCZ101GAG, FCZ102GAG, FCZ201GAG, FCZ202GAG, FCZ061GAD, FCZ101GAD, FCZ102GAD, FCZ201GAD, FCZ202GAD, FCZ101GTG, FCZ102GTG, FCZ201GTG, FCZ202GTG, FCZ101GTD, FCZ102GTD, FCZ201GTD, FCZ202GTD, FCZ061EBA, FCZ101EBA, FCZ102EBA, FCZ201EBA, FCZ202EBA, FCZ061EBH, FCZ101EBH, FCZ201EBH, FCZ061EBN, FCZ101EBN, FCZ201EBN...(Other models you can see in the webshop)		

foam rubber gaskets

			
1			
GEV No.	504669	Ref. No.	046583
description	foam rubber gasket W 10mm thickness 2mm self-adhesive Qty 5m		
For models:	LS32, LS32/4.5, LS32UK/RP, LS32F, LV32F, C55, LV32/60, WT4, WT4B, WT4D, WT302UK/RP, WT4DB, WT46, WT4DG, WT4WS1, LS33, LS33/4.5, LS33UK/RP, LS33F, LV33F, C55A, LS33/60, WT4BWS, WT4DWS1, WT4BDWS, WT303UK/RP, NUC3DD, WT4D60, WT4DDG, EUC1, EUC1DP, EUC1WS, EUC1DPWS, EUC3, EUC3WS, EUC3DP, EUC3DPWS, EUC1G, EUC1DP60, EUC3DD, ZUCADDROW, ZUCADDROW6, LS5/1, LS5/1DP, LS5/1WS, LS5/1WSDP, LS5/3, LS5/3DP, LS5/3WS, LS5/3WSDP...(Other models you can see in the webshop)		

			
1			
GEV No.	505301	Ref. No.	0E5225 873303240
description	foam rubber gasket W 20mm thickness 4mm self-adhesive Qty 1m		
For models:	FT36EDTS, FT36ESTS, FT36VDTs, FT36VSTs, FT36ED, FT36ES, FT36VD, FT36VS, FT50ED, FT50ES, FT50VD, FT50VS, FT72ED, FT72ES, FT72VD, FT72VS, FT36EDT, FT36EST, FT36VDT, FT36VST, FT50EDT, FT50EST, FT50VDT, FT50VST, FT72EDT, FT72EST, FT72VDT, FT72VST, WT730ER, WT730EL, WT730SR, WT730SL, WT760ER, WT760EL, WT760SR, WT760SL, WT790ER, WT790EL, WT790SR, WT790SL, WT730ERTS, WT730ERT, WT730SRTS, WT730SRT, WT760ERT, WT760SRT, WT790ERT, WT790SRT, WT730ELTS, WT730ELT...(Other models you can see in the webshop)		

			
1			
GEV No.	511391	Ref. No.	0k9154
description	foam rubber gasket W 24mm thickness 4mm self-adhesive Qty 1m suitable for COMENDA		

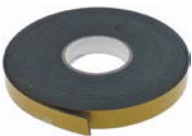
			
1			
GEV No.	505395	Ref. No.	094649
description	foam rubber gasket W 25mm thickness 3mm self-adhesive		

			
1			
GEV No.	508418	Ref. No.	0T4515
description	foam rubber gasket W 15mm thickness 8mm self-adhesive Qty 1m		

			
1			
GEV No.	901292	Ref. No.	086670
description	foam rubber gasket W 15mm thickness 8mm self-adhesive Qty supplied by meter		



GEV No.	512510	Ref. No.	088581 0E5245 0L0113 0L3189
description	foam rubber gasket self-adhesive Qty supplied by meter W 8mm		
For models:	BC100A, BC100DA, BC100RA, BC100RDA, BC180A, BC180DA, BC180RA, BC180RDA, BC180RPA, BCF100A, BCF100DA, BCF100RA, BCF100RDA, BCF180A, BCF180DA, BCF180RA, BCF180RDA, BCF180RPA, AQC22U US, AQC31U US, AQC60U, AQC119U US, , , BC28A6, Crosswise, , , BCF15A6, , , BCW061, BCW101, BCW102, BCFW061, BCFW101, BC120A, BC120RA, BCF120A, BCF120RA, ADN220ES, ADF110ES, ADF220ES, ADN110ESP, ADF110ESP, BCWS061T, BCFW102, BLAST C/FREEZER, BLAST C/FREEZER, BLAST C/FREEZER...(Other models you can see in the webshop)		

GEV No.	901478	Ref. No.	089613 569701800
description	foam rubber gasket ø 12.5mm L 156mm foam rubber		
For models:	ADF110ES, ADN110ESP, ADF110ESP, ALN110, ALN120, AEN110, AEN120, AEF110, AEF120, ADNN120, ADNF120, AENN120, AENF120, ADNN220, ADNF220, ADNN230, ADNF230, AENF220, AENN230, AENF230, ASN110, ASF110, AKN110UK, ASN110UK, ARDN110, ADN110E, ADF110E, 83012001, 83012033, 83012201, ARDF110L, ARDF120, ARDN120, 83012101, 83012037, ASN110, ASF110, ADN110, ADN120, ADN111, ADF110, ADF120, ADNN120, ADNF120, ADNN220, ADNF220, ADNN230, ADNF230, ADN11060, ADF11060... (Other models you can see in the webshop)		

GEV No.	901678	Ref. No.	0K7496 1179 12111 23534 501179 70251179 DS01179
description	foam rubber gasket Qty 1200mm incl. adhesive for lid		
For models:	GDE900S, GDE900K, GDE900F, T15S-01, T10S-01, T15S-02, T10S-02, T10S-03, T15S-03, T10S-07, T10S-04, T15S-06, T15S-04, T10S-05, T10S-08, T15S-07, T15S-05, T10S-06, T15S-08, T10S-09, T15S-09, T10S-17, T10S-18, T10S-19, T10S-20, T15S-20, T15S-11, T10S-10, T10S-15, T15S-10, T15S-15, T10S-16, T10S-13, T10S-11, T15S-17, T15S-14, T15S-12, T15S-16, T15S-22, T10S-14, T15S-13, T15S-19		

sealing cords

square

GEV No.	693739	Ref. No.	058404 0A2027 0A2213 0A2214 0A2640 0G2279 727731
description	sealing cord square size 12x12mm t.max. 550°C braided L 5m		
For models:	MBR/G710D, MBR/E710D, MBR/G700, MBR/G700F, MBR/E700, MBR/E700UK, MBR/G700UK, MBR/G701, MBR/G706, MBR/G701UK, MBR/G751, MBR/G756, MBR/E716, MBR/E706, RBR/G710D, 7BRE60XN, RBR/G700, RBR/G700F, 7BRE60X, RBR/E700UK, 7BRG60, 7BRG60X, RBR/G701UK, RBR/G751, RBR/G756, RBR/E716, RBR/E706, XBR/G710D, XBR/E710D, XBR/G700, XBR/G710, M70EBP, XBR/G700F, XBR/G700UK, XBR/E710, XBR/G701, M70GBP, XBR/G701UK, XBR/G751, XBR/G756, CBR/G700, CBR/E700, XBR/E716, XBR/E706, KR/G1, KR/G2, KR/G1R, KR/G2R, KT/G1, KT/G2...(Other models you can see in the webshop)		

round

GEV No.	691362	Ref. No.	0K3197
description	sealing cord round ø 6mm t.max. 550°C braided L 5m Qty 1		
For models:	7511-3/85.KF.(N), 7512-3/85.KF.BO.(N), 7511-3/90.KF.(N), 7512-3/90.KF.BO.(N), 7711-3/85.KF.(N), 7711-3/90.KF.(N), 7511-2, 7511-3, 7512-2, 7512-3, 7512-9, 7711-2, 7711-3, 9013-3, 9015-3, 9213-3-0, 9213-3-8		

door seal rails

GEV No.	900376	Ref. No.	084530 0A8409
description	bottom gasket W 37mm W2 15mm L 1000mm self-adhesive		
For models:	WDE752, WE751G, WDE752GT, WZ751, WDZ752, EWE601, EWZ601, EWDE602, EWDZ602, WE751, 12800100.1, 12800110.1, 12800110.1, 12800100.1		

shaft gaskets

shaft gaskets

GEV No.	698239	Ref. No.	086273
description	shaft seal ID ø 11.91mm ED ø 18.24mm thickness 5mm		

			
1			
GEV No.	511532	Ref. No.	OKV751
description	shaft seal ID ø 15mm ED ø 25.5mm thickness 6.5mm for ice-cube maker		

			
1			
GEV No.	511534	Ref. No.	086274
description	shaft seal ID ø 22mm ED ø 32mm thickness 5.5mm		

			
1			
GEV No.	511533	Ref. No.	OKM798
description	shaft seal ID ø 25mm ED ø 34mm thickness 5mm for ice maker		

			
1			
GEV No.	512424	Ref. No.	OKQ342
description	shaft seal ID ø 30mm ED ø 42mm thickness 7mm		

			
1			
GEV No.	693747	Ref. No.	0H6857
description	shaft sealing		

			
1			
GEV No.	511645	Ref. No.	046056 046057
description	shaft sealing ID ø 64mm ED ø 80mm thickness 8mm		

			
1			
GEV No.	697988	Ref. No.	047303
description	shaft sealing ID ø 75mm ED ø 110mm thickness 12/9.5mm for washing machine		
For models:	LB120EPH, LB120E, LB160EPH, LB160E, LB160V, CLB160E, CLB160V, LB110E, LB120E, LB160EZ, LB160V, CLB160E, CLB160V, EWM120, EWM160		

miscellaneous			
			
1			
GEV No.	511301	Ref. No.	002699 0F0096 OK0447 0KE120 0KE540 60050273
description	shaft seal ID ø 16mm ED ø 38mm thickness 18mm		
For models:	FCZ061EAA, FCZ101EAA, FCZ102EAA, FCZ201EAA, FCZ202EAA, FCZ061EAH, FCZ101EAH, FCZ201EAH, FCZ061EAN, FCZ101EAN, FCZ201EAN, FCZ061ETA, FCZ101ETA, FCZ102ETA, FCZ201ETA, FCZ202ETA, FCZ061ETH, FCZ101ETH, FCZ201ETH, FCZ061ETN, FCZ101ETN, FCZ201ETN, FCZ061GAG, FCZ101GAG, FCZ102GAG, FCZ201GAG, FCZ202GAG, FCZ061GAD, FCZ101GAD, FCZ102GAD, FCZ201GAD, FCZ202GAD, FCZ101GTG, FCZ102GTG, FCZ201GTG, FCZ202GTG, FCZ101GTD, FCZ102GTD, FCZ201GTD, FCZ202GTD, FCZ061EBA, FCZ101EBA, FCZ102EBA, FCZ201EBA, FCZ202EBA, FCZ061EBH, FCZ101EBH, FCZ201EBH, FCZ061EBN, FCZ101EBN...(Other models you can see in the webshop)		

			
1			
GEV No.	511905	Ref. No.	0H6853 268134 268134E
description	shaft seal ID ø 23mm ED ø 58mm thickness 22mm		

special gaskets			
for combi-steamers			
			
1			
GEV No.	699813	Ref. No.	OC4101
description	gasket for burner L 130mm W 104mm graphite thickness 3.5mm hole distance 82mm		
For models:	FCZ061GAG, FCZ101GAG, FCZ102GAG, FCZ201GAG, FCZ202GAG, FCZ061GAD, FCZ101GAD, FCZ102GAD, FCZ201GAD, FCZ202GAD, FCZ101GTG, FCZ102GTG, FCZ201GTG, FCZ202GTG, FCZ101GTD, FCZ102GTD, FCZ201GTD, FCZ202GTD, FCZ061GBG, FCZ101GBG, FCZ102GBG, FCZ201GBG, FCZ202GBG, FCZ061GBD, FCZ101GBD, FCZ102GBD, FCZ201GBD, FCZ202GBD, FCZ061GBI, FCZ101GBI, FCZ201GBI, FCZ101GBG2, FCZ102GBG2, FCZ201GBG2, FCZ202GBG2, FCZ101GBD2, FCZ102GBD2, FCZ201GBD2, FCZ202GBD2, FCZ101GBI2, FCZ102GBI2, FCZ201GBI2, FCZ061GCG, FCZ101GCG, FCZ102GCG, FCZ201GCG, FCZ202GCG, FCZ061GCD, FCZ101GCD, FCZ102GCD...(Other models you can see in the webshop)		



			
GEV No.	699203	Ref. No.	002614
description	gasket L 60mm W 40mm thickness 2mm hole distance 45mm		
For models:	FCV/G10L3, FCV/G6L3TOWNGAS, FCV/G6L3, FCVG10L3T, FCVG102L3, FCV/E101/1, FCV/G20L3, FCVG202L3, FCVE6L3J, FCV/E10L3JAP, FCV/E102/1L3JAP, FCV/E10L6JAP, FCV/E102/1L6JAP, FCV/G6L3JAP, FCVG10L3J, FCVG102L3J, FCV/G10L6JAP, FCV/G102/1L6JAP, FCVG6L3CJ, FCV/E61/1, FCV/G10L2, FCV/E61/1, FCV/E101/1, FCV/E101/1, FCV/E10L2, FCV/E102/1, FCV/E61/1, FCV/E61/1, FCV/E101/1, FCV/E101/2, FCV/G6L3C, FCV/G61/1, FCV/G61/1, FCV/G61/1, FCV/G61/1, FCVG6L3CT, FCVG6L3CJ, FCV/E10L3, FCV/E102/1, FCV/E6L3, FCV/E102/1L3, FCV/E20L3, FCVE202L3, FCV/G6L4, FCV/E6L4, FCV/E101/1, FCV/G10L6, FCV/E10L6, FCV/G102/1L6, FCV/E102/1L6...(Other models you can see in the webshop)		

			
GEV No.	699199	Ref. No.	0C4093
description	gasket L 70mm W 70mm thickness 3mm		
For models:	FCZ061EAA, FCZ101EAA, FCZ102EAA, FCZ201EAA, FCZ202EAA, FCZ061EAH, FCZ101EAH, FCZ201EAH, FCZ061EAN, FCZ101EAN, FCZ201EAN, FCZ061ETA, FCZ101ETA, FCZ102ETA, FCZ201ETA, FCZ202ETA, FCZ061ETH, FCZ101ETH, FCZ201ETH, FCZ061ETN, FCZ101ETN, FCZ201ETN, FCZ061GAG, FCZ101GAG, FCZ102GAG, FCZ201GAG, FCZ202GAG, FCZ061GAD, FCZ101GAD, FCZ102GAD, FCZ201GAD, FCZ202GAD, FCZ101GTG, FCZ102GTG, FCZ201GTG, FCZ202GTG, FCZ101GTD, FCZ102GTD, FCZ201GTD, FCZ202GTD, FCZ061EBA, FCZ101EBA, FCZ102EBA, FCZ201EBA, FCZ202EBA, FCZ061EBH, FCZ101EBH, FCZ201EBH, FCZ061EBN, FCZ101EBN...(Other models you can see in the webshop)		

			
GEV No.	699200	Ref. No.	0C4088
description	gasket L 71mm W 27mm thickness 9.5mm hole distance 50mm		
For models:	FCZ061EAA, FCZ101EAA, FCZ102EAA, FCZ201EAA, FCZ202EAA, FCZ061EAH, FCZ101EAH, FCZ201EAH, FCZ061EAN, FCZ101EAN, FCZ201EAN, FCZ061ETA, FCZ101ETA, FCZ102ETA, FCZ201ETA, FCZ202ETA, FCZ061ETH, FCZ101ETH, FCZ201ETH, FCZ061ETN, FCZ101ETN, FCZ201ETN, FCZ061GAG, FCZ101GAG, FCZ102GAG, FCZ201GAG, FCZ202GAG, FCZ061GAD, FCZ101GAD, FCZ102GAD, FCZ201GAD, FCZ202GAD, FCZ101GTG, FCZ102GTG, FCZ201GTG, FCZ202GTG, FCZ101GTD, FCZ102GTD, FCZ201GTD, FCZ202GTD, FCZ061EBA, FCZ101EBA, FCZ102EBA, FCZ201EBA, FCZ202EBA, FCZ061EBH, FCZ101EBH, FCZ201EBH, FCZ061EBN, FCZ101EBN...(Other models you can see in the webshop)		

			
GEV No.	560642	Ref. No.	0C4133 0CA402
description	gasket suitable for ELECTROLUX, ZANUSSI combi-steamer L 115mm W 70mm foam thickness 4mm hole distance 95mm		
For models:	FCZ202EAA, FCZ201ETA, FCZ202ETA, FCZ201ETH, FCZ201ETN, FCZ202GAG, FCZ202GAD, FCZ201GTG, FCZ202GTG, FCZ201GTD, FCZ202GTD, FCZ202EBA, FCZ201EBA2, FCZ202EBA2, FCZ201EBH2, FCZ201EBN2, FCZ201EBC2, FCZ201GBG2, FCZ202GBG2, FCZ201GBD2, FCZ202GBD2, FCZ201GBI2, FCZ202ECA, FCZ201ECA2, FCZ202ECA2, FCZ201ECH2, FCZ201ECN2, FCZ201GCG2, FCZ202GCG2, FCZ201GCD2, FCZ202GCD2, AOS202EA2N, AOS202EB2N, AOS202EA, AOS202EB, AOS202GB, AOS202GA, AOS202EAAQ, AOS202EBAQ, AOS202EANQ, AOS202EBNQ, AOS202GAGQ, AOS202GBGQ, AOS202GADQ, AOS202GBDQ, AOS202GAPQ, AOS202EAA1, AOS202EAM1, AOS202EAB1, AOS202EAK1...(Other models you can see in the webshop)		

			
GEV No.	560638	Ref. No.	053829 0780053829
description	gasket suitable for ELECTROLUX, ZANUSSI for combi-steamer ED ø 85mm ID ø 60mm rubber thickness 7mm		
For models:	RMV/E1C, RMV/E2C, XMV/E1C, XMV/E2C, JMV/E1C, JMV/E2C, MMV/E1C, MMV/E2C, FCV/G10L3, FCV/G6L3TOWNGAS, FCV/G6L3, FCVG10L3T, FCVG102L3, FCV/E101/1, FCV/G20L3, FCVG202L3, FCVE6L3J, FCV/E10L3JAP, FCV/E102/1L3JAP, FCV/E10L6JAP, FCV/E102/1L6JAP, FCV/G6L3JAP, FCVG10L3J, FCVG102L3J, FCV/G10L6JAP, FCV/G102/1L6JAP, FCVG6L3CJ, FCV/E61/1, FCV/G10L2, FCV/E61/1, FCV/E101/1, FCV/E101/1, FCV/E102/1, FCV/E61/1, FCV/E61/1, FCV/E101/1, FCV/E101/2, FCV/G6L3C, FCV/G61/1, FCV/G61/1, FCV/G61/1, FCV/G61/1, FCVG6L3CT, FCVG6L3CJ, FCV/E10L3, FCV/E102/1, FCV/E6L3, FCV/E102/1L3, FCV/E20L3, FCVE202L3...(Other models you can see in the webshop)		

			
GEV No.	560641	Ref. No.	ODF005
description	gasket suitable for ELECTROLUX, ZANUSSI for combi-steamer L 38mm W 16mm for steam generator thickness 5mm hole distance 24mm		
For models:	FCV31E3, 7CO30, CCO30G, ECO312CF, OTS100		

			
1			
GEV No.	560639	Ref. No.	002612
description	gasket suitable for ELECTROLUX, ZANUSSI for combi-steamer L 60mm W 46mm silicone thickness 2mm hole distance 50mm		
For models:	FDV40G, FDV40E, FDV40GZ, FDV40EL, FDV40GA, FDV20G, FDV20E, FDV20GZ, FDV20EL, FDV20GA, FCV/G10L3, FCV/G6L3TOWNGAS, FCV/G6L3, FCVG10L3T, FCVG10L3, FCV/E101/1, FCV/G20L3, FCVG20L3, FCV/E6L3J, FCV/E10L3JAP, FCV/E102/1L3JAP, FCV/E10L6JAP, FCV/E102/1L6JAP, FCV/G6L3JAP, FCVG10L3J, FCVG10L3J, FCV/G10L6JAP, FCV/G102/1L6JAP, FCVG6L3CJ, FCV/E61/1, FCV/G10L2, FCV/E61/1, FCV/E101/1, FCV/E101/1, FCV/E10L2, FCV/E102/1, FCV/E61/1, FCV/E61/1, FCV/E101/1, FCV/E101/2, FCV/G6L3C, FCV/G61/1, FCV/G61/1, FCV/G61/1, FCV/G61/1, FCVG6L3CT, FCVG6L3CJ, FCV/E10L3, FCV/E102/1, FCV/E6L3...(Other models you can see in the webshop)		

			
2			
GEV No.	560640	Ref. No.	005760
description	gasket suitable for ELECTROLUX, ZANUSSI for combi-steamer L 74mm W 74mm for heat exchanger graphite thickness 2mm hole distance 60mm		
For models:	FCVG6L3CJ, FCV/G6L3C, FCV/G61/1, FCV/G61/1, FCV/G61/1, FCV/G61/1, FCVG6L3CT, FCVG6L3CJ, FCS061G48J, FCS061GP, FCS061G3DI, FCS061G4, FCS061G4DT, FCS061G49J, 5721-2-7, 5721-2-10, ECV/G6T4C, ECV/G61/1, ECV/G61/1, RCV061G2, ACV/G6C3C, ZCV/G6T4C, ZCV/G61/1		

			
1			
GEV No.	560637	Ref. No.	007005
description	gasket suitable for ELECTROLUX, ZANUSSI for combi-steamer L 94mm W 84mm		
For models:	FCZ061EAA, FCZ101EAA, FCZ061EAH, FCZ101EAH, FCZ061EAN, FCZ101EAN, FCZ061ETA, FCZ101ETA, FCZ061ETH, FCZ101ETH, FCZ061ETN, FCZ101ETN, FCZ061GAG, FCZ101GAG, FCZ102GAG, FCZ201GAG, FCZ061GAD, FCZ101GAD, FCZ102GAD, FCZ201GAD, FCZ101GTG, FCZ102GTG, FCZ101GTD, FCZ102GTD, FCZ061EBA, FCZ101EBA, FCZ061EBH, FCZ101EBH, FCZ061EBN, FCZ101EBN, FCZ061EBC, FCZ101EBC, FCZ061EBA2, FCZ101EBA2, FCZ061EBH2, FCZ101EBH2, FCZ061EBN2, FCZ101EBN2, FCZ061EBC2, FCZ101EBC2, FCZ061GBG, FCZ101GBG, FCZ102GBG, FCZ201GBG, FCZ061GBD, FCZ101GBD, FCZ102GBD, FCZ201GBD, FCZ061GBI, FCZ101GBI...(Other models you can see in the webshop)		

door seals for dishwashers

			
1			
GEV No.	504675	Ref. No.	047455 0T3882 543616101
description	door seal L 315mm W 255mm mounting pos. left H 15mm door suitable for ZANUSSI equiv. no. 047455		
For models:	LSDS5I, LSDS5V, LS510, LS520, LS520D, LS520F, LS520M, LS520K, LS521, LS521D, LS521F, LS521M, LS521K, LS521, LS4, ZLS510, ZLS520, ZLS521, ALLS521, ALLS520, ALS510, C51, C52, C50, LS520ZD, LS521ZD, CF314, LS510MZ, LS520MZ, LS521MZ		

			
1			
GEV No.	504674	Ref. No.	047454 543616001
description	door seal L 315mm W 255mm mounting pos. right H 15mm door suitable for ZANUSSI equiv. no. 047454		
For models:	LSDS5I, LSDS5V, LS510, LS520, LS520D, LS520F, LS520M, LS520K, LS521, LS521D, LS521F, LS521M, LS521K, LS521, LS4, ZLS510, ZLS520, ZLS521, ALLS521, ALLS520, ALS510, C51, C52, C50, LS520ZD, LS521ZD, LS510MZ, LS520MZ, LS521MZ		

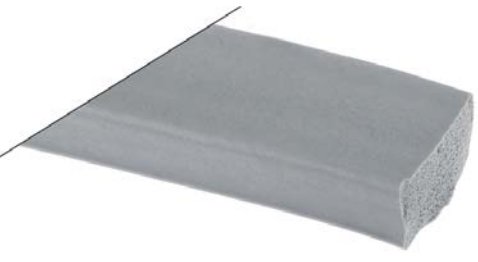
			
1			
GEV No.	504466	Ref. No.	0W02T5 75011088350
description	door seal L 3500mm W 25mm thickness 15mm		

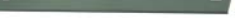
			
1			
GEV No.	504667	Ref. No.	049017
description	door seal L 440mm mounting pos. upper door suitable for ZANUSSI equiv. no. 049017		
For models:	LB1, LB1WS, LB1WSDP, LB1/RBP, LB1/TOP, LB1/60, WT1WSDP, LB2D-PSAUS, LB1G, LB1WSG, WT2TOP60, WT2DPDI, WT2WSDPDI, LB1TOP, WT2TOPDI, LB2WS, LB2, LB2WSDP, LB2/TOP, LB2/RBP, LB2WS60, WT2WSDP, WT2WSDPD, LB2WSG, WT2WS, WT1, WT1WS, WT1TOP, WT2TOP, WT1/3DP, WT2/3DP, WT2DPAUS, WT2, LB2DPDI, LB2WSDPDI, LB2WSDPD, LB2TOP, LB2DP3, WT2DPD3, NGW, NGWDPDD, UC1, UC2WS, GW1, GW1WS, LV1WS, LV1WSDP, LV2WSDP, LV2WS, GW2D-PG...(Other models you can see in the webshop)		



GEV No.	504758	Ref. No.	048306 048849 049248 049892 049932
description	door seal L 560mm mounting pos. upper		
For models:	LS61, LS61/60, LS6EP, LS6EP/DD, LS6EADD, LS6EA/DPDD, WT38/M50, LS6EADP3, LS6EADPWS, LS6EADPWSG, WT38WS, WT38WSG, WT38MEDWS, WT38PM50, WT37LEV/9, LS6EADPDWS, WT38DWS, LS6SANA, EUCAI, EUCAIDP, EUCAI60, EUCAIWS, WT38M50/4, LS6EA/UK, LS6EA/DPUK, EUCAIG, EUCAIWSG, EUCAIML, EUCAIMLWS, EUCAICL, EUCAICLG, EUCAIWL, LS6EA/60, EUCAICLW, EUCI, EUCIM, EUCIM60, EUCAIDPNW, ZUCI, ZUCID, ZUCAI, ZUCAIDP, ZUCAIDPWS, ZUCAIG, ZUCAIDDWS, ZUCAID, ZUCAI60, EUCAIUSPH6, ZUCAIDD, EUCAIDD... (Other models you can see in the webshop)		

GEV No.	504372	Ref. No.	048306 049892 0L2561
description	door seal W 560mm H 310mm		

GEV No.	504326	Ref. No.	0L0021
description	door seal L 595mm W 24mm H 4.5mm Qty 1		
For models:	WT4, WT4B, WT4D, WT4DB, WT46, WT4DG, WT4WS1, WT4BWS, WT4DWS1, WT4BDWS, NUC3DD, WT4D60, WT4DDG, EUC1, EUC1DP, EUC1WS, EUC1DPWS, EUC3, EUC3WS, EUC3DP, EUC3DPWS, EUC1G, EUC1DP60, EUC3DD, ZUCADDROW, ZUCADDROW6, LS5/1, LS5/1DP, LS5/1WS, LS5/1WSDP, LS5/3, LS5/3DP, LS5/3WS, LS5/3WSDP, FUCA3DD, LS5/3WSDPD, LB5DPG, LS5/1DP60, LS5/1DPAUS, LS5/1DPCS, KUC3, KUC3DP, NUC1, NUC1DP, NUC1WS, NUC1DPWS, NUC3, NUC3WS, NUC3DP, NUC3DPWS... (Other models you can see in the webshop)		

GEV No.	504669	Ref. No.	046583
description	foam rubber gasket W 10mm thickness 2mm self-adhesive Qty 5m		
For models:	LS32, LS32/4.5, LS32UK/RP, LS32F, LV32F, C55, LV32/60, WT4, WT4B, WT4D, WT302UK/RP, WT4DB, WT46, WT4DG, WT4WS1, LS33, LS33/4.5, LS33UK/RP, LS33F, LV33F, C55A, LS33/60, WT4BWS, WT4DWS1, WT4BDWS, WT303UK/RP, NUC3DD, WT4D60, WT4DDG, EUC1, EUC1DP, EUC1WS, EUC1DPWS, EUC3, EUC3WS, EUC3DP, EUC3DPWS, EUC1G, EUC1DP60, EUC3DD, ZUCADDROW, ZUCADDROW6, LS5/1, LS5/1DP, LS5/1WS, LS5/1WSDP, LS5/3, LS5/3DP, LS5/3WS, LS5/3WSDP... (Other models you can see in the webshop)		

GEV No.	504673	Ref. No.	046394
description	door seal L 600mm mounting pos. upper door suitable for ZANUSSI equiv. no. 046394		
For models:	LS360F, LS360DK, LS365F, LS365, LS365PH, LS360D, LS365D, LS360, LS365, LS360/63, LS365/63, LS367, LS360, LS365F, HB3PNT		

GEV No.	511391	Ref. No.	0k9154
description	foam rubber gasket W 24mm thickness 4mm self-adhesive Qty 1m suitable for COMENDA		

GEV No.	504668	Ref. No.	049016
description	door seal mounting pos. lower door suitable for ZANUSSI equiv. no. 049016		
For models:	LB1, LB1WS, LB1WSDP, LB1/RBP, LB1/TOP, LB1/60, WT1WSDP, LB2D-PSAUS, LB1G, LB1WSG, WT2TOP60, WT2DPDI, WT2WSDPDI, LB1TOP, WT2TOPDI, LB2WS, LB2, LB2WSDP, LB2/TOP, LB2/RBP, LB2WS60, WT2WSDP, WT2WSDPD, LB2WSG, WT2WS, WT1, WT1WS, WT1TOP, WT2TOP, WT1/3DP, WT2/3DP, WT2DPAUS, WT2, LB2DPDI, LB2WSDPDI, LB2WSDPD, LB2TOP, LB2DP3, WT2DPD3, NGW, NGWDPDD, UC1, UC2WS, GW1, GW1WS, LV1WS, LV1WSDP, LV2WSDP, LV2WS, GW2D-PG... (Other models you can see in the webshop)		

<h3 style="background-color: #808080; color: white; padding: 5px;">miscellaneous</h3>			
GEV No.	693402	Ref. No.	002706 0K1836
description	boiler gasket		
For models:	FDV40G, FDV40GZ, FDV40GA, FDV20G, FDV20GZ, FDV20GA, FCV/G10L3, FCV/G10L3T, FCV/G102L3, FCV/G20L3, FCV/G20L3J, FCV/G102L3J, FCV/G10L6JAP, FCV/G102/1L6JAP, FCV/G10L6, FCV/G102/1L6, FCV/G20L6, FCV/G20L6, FCV/G201/1, FCV/G202/1, FCS101G4, FCS101G4DT, FCS101GP9J, FCS101G49J, FCS101GP, FCS102G4, FCS102GA9J, FCS102G49J, FCS102GP, FCS201G4, FCS201GP, FCS202G4, FCS202GP, FCS101GX9J, FCS101GX, FCS102GX9J, FCS102GX, FCS201GX, FCS202GX, 5712-2-6, 5712-2-7, 5712-2-8, 5712-2-10, 5714-2-6, 5714-2-7, 5714-2-8, 5714-2-10, 5717-2-6, 5714-2-7... (Other models you can see in the webshop)		



1

GEV No.	901629	Ref. No.	OC5834
description	flange gasket L 101mm W 83mm hole ø 6mm hole distance 7 holes thickness 5mm for heating element		
For models:	FCZ061EAA, FCZ101EAA, FCZ102EAA, FCZ061EAH, FCZ101EAH, FCZ061EAN, FCZ101EAN, FCZ061ETA, FCZ101ETA, FCZ102ETA, FCZ201ETA, FCZ202ETA, FCZ061ETH, FCZ101ETH, FCZ201ETH, FCZ061ETN, FCZ101ETN, FCZ201ETN, FCZ061EBA, FCZ101EBA, FCZ102EBA, FCZ061EBH, FCZ101EBH, FCZ061EBN, FCZ101EBN, FCZ061EBC, FCZ101EBC, FCZ201EBC, FCZ061EBA2, FCZ101EBA2, FCZ102EBA2, FCZ201EBA2, FCZ202EBA2, FCZ061EBH2, FCZ101EBH2, FCZ201EBH2, FCZ061EBN2, FCZ101EBN2, FCZ201EBN2, FCZ061EBC2, FCZ101EBC2, FCZ201EBC2, FCZ061ECA, FCZ101ECA, FCZ102ECA, FCZ061ECH, FCZ101ECH, FCZ061ECN, FCZ101ECN, FCZ061ECA2... (Other models you can see in the webshop)		
accessories for	901629		
	GEV No.	420284	Ref. No.
			OC5841
description	heating element 24000W 400V heating circuits 6 L 535mm W 60mm H 75mm 7 hole fixing connection male faston 6.3mm flange length 105mm flange width 87mm tube ø 8.4mm immersion heater number of thermostat sleeves 1 length thermostat sleeves 120mm thermostat sleeve eccentric, clinging thermostat sleeves ø 4.7mm		



1

GEV No.	901678	Ref. No.	OK7496 1179 12111 23534 501179 70251179 DS01179
description	foam rubber gasket Qty 1200mm incl. adhesive for lid		
For models:	GDE900S, GDE900K, GDE900F, T15S-01, T10S-01, T15S-02, T10S-02, T10S-03, T15S-03, T10S-07, T10S-04, T15S-06, T15S-04, T10S-05, T10S-08, T15S-07, T15S-05, T10S-06, T15S-08, T10S-09, T15S-09, T10S-17, T10S-18, T10S-19, T10S-20, T15S-20, T15S-11, T10S-10, T10S-15, T15S-10, T15S-15, T10S-16, T10S-13, T10S-11, T15S-17, T15S-14, T15S-12, T15S-16, T15S-22, T10S-14, T15S-13, T15S-19		



1

GEV No.	550916	Ref. No.	0H6666 60050437
description	gasket		
For models:	5611-3-10, 5611-3-6, 5611-3-8, 5612-3-10, 5612-3-6, 5612-3-8, 5614-3-10, 5614-3-6, 5614-3-8		



1

GEV No.	504304	Ref. No.	OE0112 OK7352
description	gasket ED ø 103mm ID ø 66mm rubber thickness 2mm hole distance 65mm		
For models:	FT36EDTS, FT36ESTS, FT36VDT5, FT36VSTS, FT36ED, FT36ES, FT36VD, FT36VS, FT50ED, FT50ES, FT50VD, FT50VS, FT72ED, FT72ES, FT72VD, FT72VS, FT36EDT, FT36EST, FT36VDT, FT36VST, FT50EDT, FT50EST, FT50VDT, FT50VST, FT72EDT, FT72EST, FT72VDT, FT72VST, FT36WED, FT36WES, FT36WVD, FT36WVS, FT50WED, FT50WES, FT50WVD, FT50WVS, FT72WED, FT72WES, FT72WVD, FT72WVS, FT36WEDT, FT36WEST, FT36WVDT, FT36WVST, FT50WEDT, FT50WEST, FT50WVDT, FT50WVST, FT72WEDT, FT72WEST...(Other models you can see in the webshop)		



1

GEV No.	504332	Ref. No.	046058
description	gasket ED ø 105mm ID ø 75mm thickness 3mm hole distance 36mm		



1

GEV No.	697971	Ref. No.	OC1048
description	gasket ED ø 148mm graphite thickness 3mm		
For models:	AOS102GAEU, AOS201GAEU, AOS202GAEU, AOS102GAAU, AOS201GAAU, AOS202GAAU, AOS101GA, AOS101GB, AOS201GA, AOS201GB, AOS102GB, AOS102GA, AOS202GB, AOS202GA		



1

GEV No.	504328	Ref. No.	075648
description	gasket ED ø 50mm ID ø 13mm		
For models:	LO/E480, PLO480/E, LO480EUK, LO480E/63, LO480VAPORESTD, PLO480V, LO480V/63-60HZ, LO/E250, PLO250E, LO/E250UK, LO250E/63, LOPE25, LOPE48, LO480Z-VAPORE		



1

GEV No.	697969	Ref. No.	OC1111
description	gasket ED ø 84mm thickness 3mm hole distance 50mm		
For models:	AOS102GAEU, AOS201GAEU, AOS202GAEU, AOS102GAAU, AOS201GAAU, AOS202GAAU, AOS201GA, AOS201GB, AOS102GB, AOS102GA, AOS202GB, AOS202GA		



1

GEV No.	697960	Ref. No.	OC1077
description	gasket ED ø 87mm ID ø 43mm graphite thickness 3mm		
For models:	AOS061GAEU, AOS061GAAU, AOS061GA, AOS061GB, AOS101GA, AOS061GAGQ, AOS061GBGQ, AOS061GADQ, AOS061GBDQ, AOS061GAIQ, AOS061GALQ, AOS061GAPQ		



1

GEV No.	697966	Ref. No.	OK2100
description	gasket ED ø 88mm ID ø 68mm rubber thickness 3mm hole distance 39mm		
For models:	FDV40G, FDV40GZ, FDV40GA, FDV20G, FDV20GZ, FDV20GA, FCVG202L3, FCVE202L3, FCVG202L6, FCVE202L6, FCV/G202/1, FVC/E202/1, FCS202E4, FCS201G4, FCS202G4, 5714-2-7, 5714-2-8, 5714-2-10, 5714-2-7L, 5714-2-8L, 5714-2-10L, ECVG202T4, ECVE202T4, ECVG202T6, ECVE202T6, ACVG202C4, ACVE202C4, ACVG202C6, ACV/E202/1, ZCV/G202/1, ZCV/E202/1, ZCV/E202/1		



1

GEV No.	517456	Ref. No.	OC3442 OC7033
description	gasket for boiler ED ø 107mm thickness 5.5mm		
For models:	FCZ061EAA, FCZ101EAA, FCZ102EAA, FCZ201EAA, FCZ202EAA, FCZ061EAH, FCZ101EAH, FCZ201EAH, FCZ061EAN, FCZ101EAN, FCZ201EAN, FCZ061ETA, FCZ101ETA, FCZ102ETA, FCZ201ETA, FCZ202ETA, FCZ061ETH, FCZ101ETH, FCZ201ETH, FCZ061ETN, FCZ101ETN, FCZ201ETN, FCZ061GAG, FCZ101GAG, FCZ102GAG, FCZ201GAG, FCZ202GAG, FCZ061GAD, FCZ101GAD, FCZ102GAD, FCZ201GAD, FCZ202GAD, FCZ101GTG, FCZ102GTG, FCZ201GTG, FCZ202GTG, FCZ101GTD, FCZ102GTD, FCZ201GTD, FCZ202GTD, FCZ061EBA, FCZ101EBA, FCZ102EBA, FCZ061EBH, FCZ101EBH, FCZ061EBN, FCZ101EBN, FCZ061EBC, FCZ101EBC, FCZ201EBC...(Other models you can see in the webshop)		

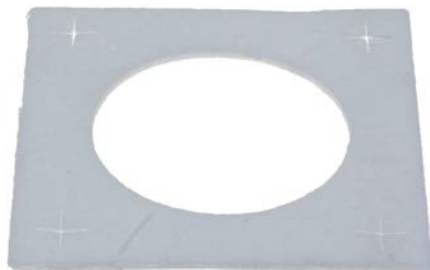

1

GEV No.	697956	Ref. No.	003875
description	gasket for heat exchanger ID ø 70mm ceramic fibre thickness 3mm hole distance 85mm		
For models:	FCV/G10L3, FCVG10L3T, FCVG102L3, FCV/G20L3, FCVG202L3, FCVG10L3J, FCVG102L3J, FCV/G10L6JAP, FCV/G102/1L6JAP, FCV/G10L2, FCV/G10L6, FCV/G102/1L6, FCV/G20L6, FCVG202L6, FCV/G101/1, FCV/G102/1, FCV/G201/1, FCV/G202/1, FCS101G2, FCS101G4, FCS101G4DT, FCS101GP9J, FCS101G49J, FCS101GP, FCS102G4, FCS102GA9J, FCS102G49J, FCS102GP, FCS201G4, FCS201GP, FCS202G4, FCS202GP, FCS101GX9J, FCS101GX, FCS102GX9J, FCS102GX, FCS201GX, FCS202GX, 5712-2-6, 5712-2-7, 5712-2-8, 5712-2-10, 5714-2-6, 5714-2-7, 5714-2-8, 5714-2-10, 5717-2-6, 5714-2-7, 5714-2-8, 5714-2-10...(Other models you can see in the webshop)		



1

GEV No.	697957	Ref. No.	002704
description	gasket for heat exchanger L 100mm W 100mm ID ø 55mm ceramic fibre thickness 3mm hole distance 78mm		
For models:	FCV/G10L3, FCVG10L3T, FCV/G20L3, FCVG10L3J, FCV/G10L6JAP, FCV/G10L2, FCV/G10L6, FCV/G20L6, ECV/G10T4, ECV/G20T4, ECV/G10T4J, ECV/G10T6, ECV/G20T6, RCV101G2, ACV/G10C2, ACV/G10C4, ACV/G20C4, ACV/G10C6, ACV/G20C6, NCV/G10L2, NCV/G10L4, ZCV/G10T4, ZCV/G20T4, ZCV/G10T6, ZCV/G20T6		



1

GEV No.	697967	Ref. No.	002629
description	gasket for heat exchanger L 100mm W 100mm ID ø 76mm thickness 2.5mm		
For models:	FCV/G10L3, FCVG10L3T, FCV/G20L3, FCVG10L3J, FCV/G10L6JAP, FCV/G10L2, FCV/G10L6, FCV/G20L6, ECV/G10T4, ECV/G20T4, ECV/G10T4J, ECV/G10T6, ECV/G20T6, RCV101G2, ACV/G10C2, ACV/G10C4, ACV/G20C4, ACV/G10C6, ACV/G20C6, NCV/G10L2, NCV/G10L4, ZCV/G10T4, ZCV/G20T4, ZCV/G10T6, ZCV/G20T6		



GEV No.	697964	Ref. No.	003873 0G5209
description	gasket for heat exchanger L 100mm W 100mm ID ø 77mm thickness 5mm		
For models:	FCV/G10L3, FCV/G10L3T, FCV/G20L3, FCV/G10L3J, FCV/G10L6JAP, FCV/G10L2, FCV/G10L6, FCV/G20L6, FCV/G101/1, FCV/G201/1, FCS101G2, FCS101G4, FCS101G4DT, FCS101GP9J, FCS101G49J, FCS101GP, FCS201G4, FCS201GP, FCS101GX9J, FCS101GX, FCS201GX, 5712-2-6, 5712-2-7, 5712-2-8, 5712-2-10, 5714-2-6, 5714-2-7, 5714-2-8, 5714-2-10, 5712-2-6L, 5712-2-7L, 5712-2-8L, 5712-2-10L, 5714-2-6L, 5714-2-7L, 5714-2-8L, 5714-2-10L, 5712-2-10F, 5712-2-10S, 5714-2-10F, 5714-2-10S, 5702-2-2, 5702-2-3, 5704-2-2, 5704-2-3, ECV/G10T4, ECV/G20T4, ECV/G10T4J, ECV/G20T4J, ECV/G10T6...(Other models you can see in the webshop)		



GEV No.	550924	Ref. No.	002075 0K4316 17012751 727878
description	gasket for probe ID ø 6mm EPDM		
For models:	MFR/G740, MFR/G350, MFR/G351, MFR/G700, MFR/G701, RFR/G1S12, RFR/G2D12, RFR/G2S40, XFR/G1S12, XFR/G2D12, XFR/G2S40, JFR/G1S12, JFR/G2D12, JFR/G2S40, MFR/G1S12, MFR/G2D12, MFR/G2S40, RFR/G741, 7FRG03S, 7FRG07S, CFR/G741, M35GFR, M70GFR, CFR/G351, CFR/G701, XFR/G700, PFR/G2S40, TFR/G2S40, KFR/G1E, KFR/G2F, KFR/E1E, KFR/E2F, KFH/G1, KFH/E1, KFH/G1ELH, KFH/E1ELH, KFH/G1EH, KFH/E1EH, HFR/G410, HFR/G810, HFR/G410D, HFR/G810D, HFR/G410NL, HFR/G810NL, HFR/G411, HFR/G412, FC1G, HFR/E1680, FC2G, HFR/E2480...(Other models you can see in the webshop)		



GEV No.	697958	Ref. No.	0C2569
description	gasket ID ø 66.5mm ceramic fibre thickness 5mm		



GEV No.	900775	Ref. No.	0G4250 0H9716 0H9871 0K5103 12011444 18025483 3077580024
description	gasket L 1000mm size 10x2mm self-adhesive silicone		
For models:	CE128-106, CE158-133.3.HV, CE158-244.3, CE158-246.3, CK248-209, D1ABBB, CK248-211.D1ABBB, HCE128-100, HCE128-104, HCE158-252W.3, HCE158-253.3, HLE129-100, HLE129-103, HLE129-104W, HLE159-252W.3.6, HLE159-328.3.HV, HLE159-351W.3.HV, HLE249-200.3, HLE249-208.3, HLE259-088.3.HV, HLE259-089.3.HV, HLE259-384W.3, HLI159-371W.3, HLI159-373.3, HLI259-390W.3, LE129-101, LE159-261.3, LE159-281.3.6, LE159-318.3.HV, LE159-322.3.HV, LE159-330.3.HV, LE159-337.3.HV, LE159-344.3.MS92, LE159-347.3.HV, LE249-199.3, LE249-203.3, LE249-207.3, LE249-211.3, LE249-215.3, LE249-219.3, LE249-223.3, LE249-232.3, LE249-238.3, LE259-081.3.HV, LE259-082.3.HV, LE259-083.3.HV, LE259-094.3.HV, LE259-099.3.HV, LE259-382.3, LI159-375.3, LI159-376.3...(Other models you can see in the webshop)		



GEV No.	520938	Ref. No.	0C1168
description	gasket L 115mm rubber W 100mm thickness 3.5mm hole ø 7mm		
For models:	FCZ102EAA, FCZ201EAA, FCZ202EAA, FCZ201EAH, FCZ201EAN, FCZ102ETA, FCZ201ETA, FCZ202ETA, FCZ201ETH, FCZ201ETN, FCZ102GAG, FCZ201GAG, FCZ202GAG, FCZ102GAD, FCZ201GAD, FCZ202GAD, FCZ102GTG, FCZ201GTG, FCZ202GTG, FCZ102GTD, FCZ201GTD, FCZ202GTD, FCZ102EBA, FCZ201EBA, FCZ202EBA, FCZ201EBH, FCZ201EBN, FCZ201EBC, FCZ102EBA2, FCZ201EBA2, FCZ202EBA2, FCZ201EBH2, FCZ201EBN2, FCZ201EBC2, FCZ102GBG, FCZ201GBG, FCZ202GBG, FCZ102GBD, FCZ201GBD, FCZ202GBD, FCZ201GBI, FCZ102GBG2, FCZ201GBG2, FCZ202GBG2, FCZ102GBD2, FCZ201GBD2, FCZ202GBD2, FCZ102GBI2, FCZ201GBI2, FCZ102ECA...(Other models you can see in the webshop)		



GEV No.	697962	Ref. No.	0C1628
description	gasket L 130mm W 125mm ID ø 106mm rubber		
For models:	AOS102GB, AOS102GA		



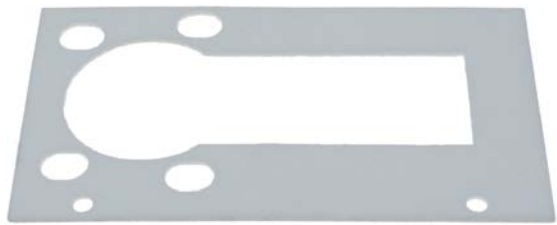

1

GEV No.	697963	Ref. No.	003882
description	gasket L 139mm W 134mm rubber thickness 4mm		
For models:	FCVG102L3, FCVG202L3, FCVG102L3J, FCV/G102/1L6JAP, FCV/G102/1L6, FCVG202L6, FCV/G102/1, FCV/G202/1, FCS102G4, FCS102GA9J, FCS102G49J, FCS102GP, FCS202G4, FCS202GP, FCS102GX9J, FCS102GX, FCS202GX, 5717-2-6, 5714-2-7, 5714-2-8, 5714-2-10, 5714-2-6L, 5714-2-7L, 5714-2-8L, 5714-2-10L, 5707-2-2, 57074-2-3, ECVG102T4, ECVG202T4, ECV/G102/1T6, ECVG202T6, ACVG102C4, ACVG202C4, ACV/G102/1C6, ACVG202C6, NCV/G102/1, ZCV/G102/1, ZCV/G202/1, ZCV/G102/1T6, ZCV/G202/1		



1

GEV No.	697955	Ref. No.	003883
description	gasket L 275mm W 155mm thickness 3mm		
For models:	FCVG102L3, FCVG202L3, FCVG102L3J, FCV/G102/1L6JAP, FCV/G102/1L6, FCVG202L6, FCV/G102/1, FCV/G202/1, FCS102G4, FCS102GA9J, FCS102G49J, FCS102GP, FCS201G4, FCS202G4, FCS202GP, FCS102GX9J, FCS102GX, FCS202GX, 5717-2-6, 5714-2-7, 5714-2-8, 5714-2-10, 5714-2-6L, 5714-2-7L, 5714-2-8L, 5714-2-10L, 5707-2-2, 57074-2-3, ECVG102T4, ECVG202T4, ECV/G102/1T6, ECVG202T6, ACVG102C4, ACVG202C4, ACVG202C6, ZCV/G102/1, ZCV/G202/1, ZCV/G102/1T6, ZCV/G202/1		



1

GEV No.	504322	Ref. No.	060717
description	gasket L 14mm W 14mm external height 4mm ID ø 8mm		



1

GEV No.	697973	Ref. No.	005769
description	gasket L 280mm W 115mm ceramic fibre with aluminium foil thickness 2.5mm		
For models:	FCV/G61/1, FCV/G61/1, FCV/G61/1, FCS061GP, FCS061G4, 5721-2-7, 5721-2-10, ECV/G61/1, ECV/G61/1, ZCV/G61/1		

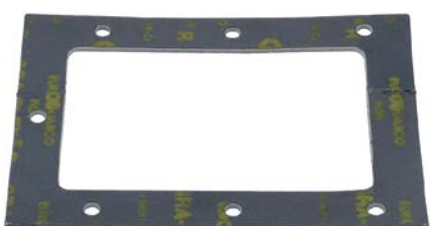

1

GEV No.	697959	Ref. No.	005768
description	gasket L 163mm W 120mm graphite thickness 2mm		
For models:	FCV/G61/1, FCV/G61/1, FCV/G61/1, FCS061GP, FCS061G4, 5721-2-7, 5721-2-10, ECV/G61/1, ECV/G61/1, ZCV/G61/1		



1

GEV No.	697954	Ref. No.	OK8134 30000200
description	gasket L 38mm W 17mm thickness 1.5mm hole distance 26mm		
For models:	AR10ES, AR10ES, AR10ES, AR10ES, AR10ES, AR10ES, AR10ES, AR10ES, AR10ESP, AR10ESP, AR10ESP, AR10ESP, AR10ESP, AR10ESP, AR10ES, AR10ES, AR10ES, AR10ES, AR10ES, AR10ES, AR10ESP, AR10ESP, AR10ESP, AR10ESP, AR10ESP, AR10ESP, AR10ESP, AR10ESP, AR10ESP, AR10ESP, AR20ES, AR20ES, AR20ES, AR20ES, AR20ES, AR20ESP, AR20ESP, AR20ESP, AR20ESP, AR20ESP, AR20ESP... (Other models you can see in the webshop)		



1

GEV No.	697972	Ref. No.	0C3777
description	gasket L 230mm W 140mm ID ø 70mm ceramic fibre with aluminium foil thickness 5mm		
For models:	AOS202GAEU, AOS202GAAU, AOS202GB, AOS202GA		



1

GEV No.	697968	Ref. No.	0C1050
description	gasket L 68mm W 68mm thickness 3mm hole distance 50mm		
For models:	AOS061GAEU, AOS101GAEU, AOS201GAEU, AOS061GAAU, AOS101GAAU, AOS201GAAU, AOS061GA, AOS061GB, AOS101GA, AOS101GB, AOS201GA, AOS201GB		

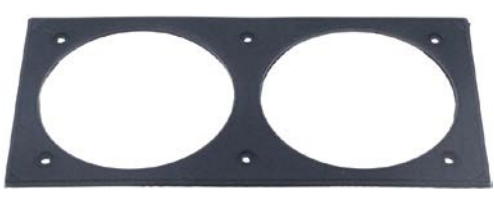

1

GEV No.	697961	Ref. No.	0C2812
description	gasket L 250mm W 125mm ID ø 107mm thickness 5mm hole distance 90mm		
For models:	AOS202GAEU, AOS202GAAU		



GEV No.	697965	Ref. No.	005754
description	gasket L 85mm W 80mm ID ø 51mm rubber thickness 4mm		
For models:	FCVG6L3CJ, FCV/G6L3C, FCV/G61/1, FCV/G61/1, FCV/G61/1, FCV/G61/1, FCV/G61/1, FCV/G61/1, FCV/G61/1, FCV/G61/1, FCS061G48J, FCS061GP, FCS061G3D1, FCS061G4, FCS061G4DT, FCS061G49J, 5721-2-7, 5721-2-10, ECV/G6T4C, ECV/G61/1, ECV/G61/1, RCV061G2, ACV/G6C3C, ZCV/G6T4C, ZCV/G61/1		



GEV No.	901527	Ref. No.	OKZB29 18070
description	gasket L 950mm W 135mm Qty 1m thickness 3mm hole distance 93mm		



GEV No.	693396	Ref. No.	057402 0H6716 OK3034 12011871 250617 727858
description	gasket level glass L 30mm W 30mm thickness 0.8mm equiv. no. 250617 suitable for JUNO		
For models:	MFR/G360, MPN/GD761, MPN/GI761, MPN/GI760D, MPN/GD760, MPN/GD760F, MPN/GI760, MPN/GI760F, MM/G351, MM/G701, MM/G350, MM/G700, MM/G350F, MM/G700F, MM/G700E, MCP/G700, MCP/G701, MCP/G710, MCP/G711, MCP/G705, MCP/G706, FDV40G, FDV40GZ, FDV40GA, FDV20G, FDV20GZ, FDV20GA, RBR/G2FM, RBR/G2IM, RBK/G2FM, RMV/G1C, RMV/G2C, RF/G1S07, RF/G2D07, RFR/G1S07, RFR/G2D07, RFR/G1S14, RFR/G2D14, RF/G1S07, RF/G2D07, RFR/G1S07, RFR/G2D07, XBR/G2FM, XBR/G2IM, XBK/G2FM, XMV/G1C, XMV/G2C, XF/G1S07, XRF/G2D07, XFR/G1S07...(Other models you can see in the webshop)		
accessories for	693396		
	GEV No.	693398	Ref. No.
			057382 0H6890 OK3035 OKC541 12011869 727857
frame for level glass			

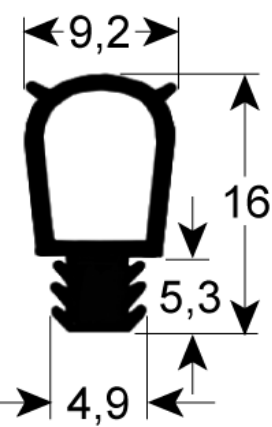

GEV No.	902067	Ref. No.	088264
description	gasket mounting pos. control panel		
For models:	BCW101, BCW102, BCFW101, BCFW102, BCFWS102, BCFWS101, SSODWC12, SSODDPC12, SSODWC16, SSODDPC16, SSODWB12, SSODDPB12, SSODWB16, SSODDPD16, SSODWCS12, SSODWCS16, SSODWC20, SSODDPC20, DVRVAF12, DVRPAF12, DVRVAF16, DVRPAF16, DVRVP12, DVRPP12, DVRVP16, DVRPP16, ZLRDW12C, ZLRDW16C, ZLRDW12B, ZLRDW16B, ZLRDD12C, ZLRDD16C, ZLRDD12B, ZLRDD16B, ZLRDW12S, ZLRDW16S, ZLRDW20C, ZLRDD20C, AOFPS102C, AOFPS102CR, AOFPS102CR, AOFPS101U, AOFPS101U, AOFPS102U, AOFPS101C, AOFPS101CR, AOFPS101CR, AOC102, AOC102CR, AOC102CR, AOC102CR...		



GEV No.	691252	Ref. No.	OK5262 OKF635 1152060040 19000804 70081901 V40AFPM
description	gasket profile V ED ø 46mm ID ø 36mm		

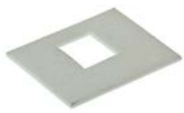

GEV No.	510014	Ref. No.	069525 437036
description	gasket suitable for HOBART equiv. no. 139321-155 L 84mm W 40mm thickness 2.5mm		
For models:	LTB11, LTB12, LTB22, LTB11UK, LTB12UK, LTB22UK, LTB11, LTB22, 910-00-021, 910-00-023, 910-00-031, 910-00-033, 911-00-022, 911-00-024, 911-00-032, 911-00-034, CRYSTAL 11, CRYSTAL 22		

1

GEV No.	700491	Ref. No.	003990
description	gasket suitable for JUNO equiv. no. 03990 L 40mm W 35mm door catch thickness 1mm		
For models:	FDV40G, FDV40E, FDV40GZ, FDV40EL, FDV40GA, FDV20G, FDV20E, FDV20GZ, FDV20EL, FDV20GA, FCFG201-0, FCFG202-0, FCFE201-0, FCFE202-0, FCF201ENS, 5714-2-6, 5714-2-7, 5714-2-8, 5714-2-10, 5717-2-6, 5714-2-7, 5714-2-8, 5714-2-10, 5714-2-6L, 5714-2-7L, 5714-2-8L, 5714-2-10L, 5714-2-6L, 5714-2-7L, 5714-2-8L, 5714-2-10L, 5714-3-6, 5714-3-7, 5714-3-8, 5714-3-8E, 5714-3-10, 5717-3-6, 5717-3-7, 5717-3-8, 5717-3-8E, 5717-3-10, 5717-3-8M, 5717-3-8C, 5717-3-8M, 5704-2-2, 5704-2-3, 5707-2-2, 57074-2-3, 5704-3-2, 5704-3-3...(Other models you can see in the webshop)		



2

GEV No.	504732	Ref. No.	046360
description	gasket suitable for ZANUSSI equiv. no. 046360 L 47mm W 18.5mm thickness 3mm		
For models:	LS360DK, LS365F, LS365, LS365PH, LS500F, LS501F, LS540F, LS540DK, LS541F, LS360D, LS365D, LS360, LS365, LS360/63, LS365/63, LS367, LS720F, LSE720DK, LSE720PH, LS860F, LS860DK, LS860PH, LS1080F, LS1080UK, LS1080PH, LSE721F, LS861F, LS540, LS1080M, LS1080, LS1080D, LS1080UK, LS1080/63, LS500F, LS500UK, LS501, LS501UK, LS540D, LS540/63, LSE721, LS720, LSE720UK, LS721UK, LSE720D, LS541, LS860, LS860, LS860D, LS860UK, LS861UK...(Other models you can see in the webshop)		

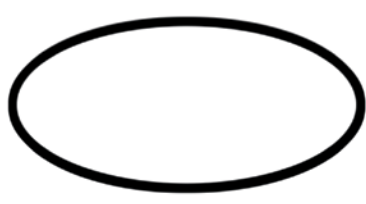

1

GEV No.	693404	Ref. No.	054260 055371 OKF018
description	gasket suitable for ZANUSSI equiv. no. 55371 fanwheel ED ø 800mm		
For models:	FCVE10, FCVE20, FCVE6-1U, FCVE6-3U, FCVE6-1, FCVE6-3, FCVE6-3CE, FCVE6-1UK, FCVE6-3UK, FCGV6-1, FCGV6-3, FCGV6-1UK, FCGV6-3UK, FCVE10-2, FCVE10-4, FCVE103CE, FCVE10-2UK, FCVE10-4UK, FCGV10-2, FCGV10-4, FCGV10-ISG, FCGV10-2, FCGV10-4D, FCGV10-2UK, FCGV10-4UK, FCGV10-2, FCGV10-4, FCVE20-2, FCVE20-4, FCVE203CE, FCVE20/P-V, FCVE20-2UK, FCVE20-4UK, FCGV20-2, FCGV20-4, FCGV20-2, FCGV20-4D, FCGV20-2UK, FCGV20-4UK, FCGV20-4, FCGV20-4D, FCVE20-V, FCVE20VUK, FCVE10-P, FCVE10PUK, FCGV10-P, FCGV10PUK, FCVE20-P, FCVE20PUK, FCGV20-P...(Other models you can see in the webshop)		



1

GEV No.	693403	Ref. No.	003874 237394
description	gasket suitable for ZANUSSI hot air		
For models:	FCV/G10L3, FCGV10L3T, FCV/G20L3, FCGV10L3J, FCV/G10L6JAP, FCV/G10L2, FCV/G10L6, FCGV20L6, FCV/G101/1, FCV/G201/1, FCS101G2, FCS101G4, FCS101G4DT, FCS101GP9J, FCS101G49J, FCS101GP, FCS201GP, FCS101GX9J, FCS101GX, FCS201GX, 5712-2-6, 5712-2-7, 5712-2-8, 5712-2-10, 5714-2-6, 5714-2-7, 5714-2-8, 5714-2-10, 5712-2-6L, 5712-2-7L, 5712-2-8L, 5712-2-10L, 5714-2-6L, 5714-2-7L, 5714-2-8L, 5714-2-10L, 5712-2-10F, 5712-2-10S, 5714-2-10F, 5714-2-10S, 5702-2-2, 5702-2-3, 5704-2-2, 5704-2-3, ECV/G10T4, ECV/G20T4, ECV/G10T4J, ECV/G20T4J, ECV/G10T6, ECV/G20T6...(Other models you can see in the webshop)		



1

GEV No.	697974	Ref. No.	003700
description	gasket U-shape ED ø 22.5mm ID ø 14.5mm		
For models:	DCS		

thermostat gaskets



1

GEV No.	510167	Ref. No.	066717
description	gasket for thermostat ED ø 41mm ID ø 18mm Qty ANGELO PO/ ZANUSSI pcs equiv. no. 3150270/66717		
For models:	LB8G, LB8G/63, LB8GF, LB8GPH, LB8G, LB8GPHm, LB8G		

gaskets for wash arm support



1

GEV No.	504537	Ref. No.	048236
description	gasket D1 ø 100mm D2 ø 70mm thickness 7.5mm wash arm support equiv. no. 048236 suitable for ZANUSSI		
For models:	LS32, LS32/4.5, LS32UK/RP, LS32F, LV32F, C55, LV32/60, WT4, WT4B, WT4D, WT302, WT302/4.5, WT302UK/RP, WT302F, WT302/60, WT4DB, WT46, WT4DG, WT4WS1, LS33, LS33/4.5, LS33UK/RP, LS33F, LV33F, C55A, LS33/60, WT4BWS, WT4DWS1, WT4BDWS, WT303, WT303/4.5, WT303UK/RP, WT303F, WT303/60, NUC3DD, WT4D60, WT4DDG, EUC1, EUC1DP, EUC1WS, EUC1DPWS, EUC3, EUC3WS, EUC3DP, EUC3DPWS, EUC1G, EUC1DP60, EUC3DD, ZUCADDROW, ZUCADDROW6...(Other models you can see in the webshop)		

			
1			
GEV No.	504559	Ref. No.	047928
description	gasket D1 ø 26mm D2 ø 70mm thickness 2mm rubber with 3 screw holes wash arm support equiv. no. 047928 suitable for ZANUSSI		
For models:	LS540F, LS540DK, LS541F, LS720F, LSE720DK, LSE720PH, LS860F, LS860DK, LS860PH, LS1080F, LS1080UK, LS1080PH, LSE721F, LS861F, LS540, LS1080M, LS1080, LS1080D, LS1080UK, LS1080/63, LS540D, LS540/63, LSE721, LS720, LSE720UK, LS721UK, LSE720D, LS541, LS860, LS860, LS860D, LS860UK, LS861UK, LS860/63, LS861, LS540, 652120Z, LS860, LS1080, ALS540, LS720N, LS860, DMAST2CUK, LSE720Z, LS860, LS1080, LS860, LS1080		

miscellaneous

			
1			
GEV No.	900757	Ref. No.	0H6888 0K2603 275960 60050451
description	strengthening for gasket		
For models:	5611-3-10, 5611-3-6, 5611-3-8, 5612-3-10, 5612-3-6, 5612-3-8		

refrigeration cycle components
cooling water regulators

			
1			
GEV No.	541483	Ref. No.	086246
description	cooling water regulator 3/8" type V46AA-9950 connection 6mm soldering connection pressure range 5-18bar water pressure max. 10bar water temperature max. 90°C capillary pipe 750mm L 160mm 0.9kg		

valves

			
1			
GEV No.	750016	Ref. No.	087333
description	expansion valve DANFOSS type TUB coolant R134a angled 90° thermostatically controlled inlet 6mm ODF outlet 12mm ODF p max 34bar -40 up to +10°C capillary pipe 800mm		
For models:	FV 2M, 83012037, ADN220, TRRN132A, TRRN132B, TRRN132C, TRRN183A, TRRN183B, TRRN183C, TRRN1842D, TRRN224A, TRRN224B, SSODWC12, SSODDPC12, SSODWC16, SSODDPC16, SSODPC12, SSODPC16, SSODPC16, SSODWC20, SSODDPC20, DVRVAF12, DVRPAF12, DVRVAF16, DVRPAF16, DRPAF12, DRPAF16, DRPAF20, ZLRP12C, ZLRP16C, ZLRP20C, ZLRDW12C, ZLRDW16C, ZLRDD12C, ZLRDD16C, ZLRDW20C, ZLRDD20C, ESR621/2F, ESR61FR, ESR41FR, ESR41GR, RI16R1FR, RI075RE1FR, RI093RE1FR, RI16RE1FR, RCDR2M20R, RCDR2M12R, RCDR2M04R, RCDR3M30R, RCDR3M22R...(Other models you can see in the webshop)		



Schrader valves

Schrader valves (complete)



1

GEV No.	750340	Ref. No.	0A8171
description	Schrader valve complete connection soldering connection ø 6mm pipe length 100mm		
For models:	ICF110, ICP110, ICP111, ICP130, ICP112, ITP120UK, ICF110, ICN110UK, ICF110, ITP120UK, BC22, BCF22, ALP110, ALP120, ALP111, ALP220, ALP240, ALP221, ALN110, ALN120, ALN111, ALN220, ALN240, ALN221, ALNN120, ALNN220, ALNN230, ALNSO120, ALP110UK, ALN110UK, ALNN220UK, ALF110, ALNF220, ALF110, ALF120, ALNF120, ALNF220, ALNF230, ADN220ES, ADF110ES, ADF220ES, ADN110ESP, ADF110ESP, ILP110, ILP110UK, ILN120, FV 1M, FV 1M, FV 1M, FV 1M...(Other models you can see in the webshop)		
accessories for	750340		
	GEV No.	750479	Ref. No. —
	screw cap CASTEL 8392/A size 1/4" SAE for Schrader valve connection 1/4" Qty 1		

valve bodies



1

GEV No.	750097	Ref. No.	085292
description	valve body for Schrader valve thread 1/4" SAE connection 6mm soldering connection		
For models:	IMF28A, IMF28W, IMF35A, IMF35W, IMF58A, IMF58W, IMF80A, IMF80W, FGC33A542, FGC46A542, FGC65A42, MF250WB20, MC140AB20, MC140WB20, MC200AB20, MC200WB20, FGS500A, FGS500W, FGC24AB, FGC24WB, FGC29AB, FGC29WB, FGC40A, FGC40W, FGC67AB, FGC67WB, FGC90A, FGC90W, FGC143AB, FGC143WB, FGS94AB, FGS94WB, FGS140A, FGC25A, CB246W, CIM38AB, CIM38WB, CIM85AB, CIM15WB, CIM235AB, CIM235WB, FIM150ASB, FIM150WSB, FIM285ASB, FIM285WSB, CIM50AB, FIM50WB, FGC24ABS, FGC24WBAB, FGC29AB...(Other models you can see in the webshop)		

valve inserts



1

GEV No.	750098	Ref. No.	085290
description	Schrader valve CASTEL 8394/B R22		
For models:	IMF58A, IMF58W, IMF80A, IMF80W, FGS500A, FGS500W, FGC40A, FGC40W, FGC90A, FGC90W, FGC143AB, FGC143WB, FGS94AB, FGS94WB, FGS140A, FGC25A, CB246W, CIM235AB, CIM235WB, FIM150ASB, FIM150WSB, FIM285ASB, FIM285WSB, FGC143AB, FGC143WB, FGC143AB, FGC143WB, VM500W+BI, VM500A+BI, VM250A+BI, VM250W+BI, VM350A+BI, VM350W+BI, C150W, C300A, C300W, CB1565W, CB246W, CB416W, CB955W, DSS42W, C80W, CB1565A, C80A, CB246A, CB416A, C150A, CB955A, FRESHMAKER, ICEWATER45...(Other models you can see in the webshop)		

spare parts and accessories



1

GEV No.	371310	Ref. No.	089614
description	insulating cover		
For models:	FV 2M, ADN220, TRRN132A, TRRN132B, TRRN132C, TRRN183A, TRRN183B, TRRN183C, TRRN1842D, TRRN224A, TRRN224B, TRRF132A, TRRF183A, PS06F1F6M, PS04R1FR, PS04R1GR, PS06R1F, PS06R1FR, PS06R2F, PS06R2FR, PS04F1FR, PS06F1F, PS06F1FR, PS06FE2F, PS04R1FR, PS04R1FLR, PS06R1FR, PS06R1FRL, PS04F1FR, PS04F1FRL, PS09F1FR, RI16R1FR, RI16RE1FR, RCDR2M20R, RCDR2M12R, RCDR2M04R, RCDR3M30R, RCDR3M22R, RCDR3M14R, RCDR3M06R, RCDR4M40R, RCDR4M32R, RCDF2M20R, RCDF3M30R, RI17RE1FRU, RI17R1FRPU, RS06RX1FR, FULL DOOR FREEZER, RS06FX1FR, HB2PN-TR...(Other models you can see in the webshop)		

filter driers

CASTEL

STANDARD series

suitable for refrigerants R12, R22, R134a, R404A, R407C, R410A, R502, R507



1

GEV No.	750041	Ref. No.	086312
description	dryer type 4305/2 connection 7/16" UNF (1/4" SAE) 80cm ³ p max 45bar -40 up to +80°C 275g total length 119mm		
For models:	CIM120AS, CIM120WS		

miscellaneous



1

GEV No.	750314	Ref. No.	081716
description	dryer ø 17.4mm L 123mm connection 5.3/8mm		
For models:	ICF110, ITP120UK, ITP120UK, ILP110, ILP110UK, ILN120, ILP111, ILP220, ILP220UK, ILP240, ILP221, ILN110, ILN110UK, ILN120, ILN111, ILN220, ILN220UK, ILN240, ILNSO120, ILN221, ILNN120, ILNN220, ILNN220UK, ILNN230, ALP110UK, ALN110UK, ALNN220UK, ALNF220UK, ILNF120, ILNF220, ILNF220UK, ILNF230, ALP110, ALP120, ALP111, ALP220, ALP240, ALP221, ALN110, ALN120, ALN111, ALN220, ALN240, ALN221, ALNN120, ALNF120, ALNN220, ALNF220, ALNN230, ALNF230...(Other models you can see in the webshop)		

			
1			
GEV No.	750244	Ref. No.	50289076007
description	dryer size 15g ø 19mm L 117mm connection 3,2/6,2mm		

			
1			
GEV No.	750276	Ref. No.	0A9410
description	dryer size 30g ø 24mm L 147mm connection 6,5/6,5mm		
For models:	AQC22U US, , , FV Dual, BC10A, BLAST C/FREEZER, BCF7A, BLAST C/FREEZER, SSODWC12, SSODDPC12, SSODWC16, SSODDPC16, SSODWB12, SSODDPB12, SSODWB16, SSODDPD16, SSWB12, SSWB16, SSWB20, SSDPC12, SSDPC16, SSDPC16, SSDPD12, SSDPD16, SSDPD20, DVRVAF12, DVRPAF12, DVRVAF16, DVRPAF16, DVRVP12, DVRPP12, DVRVP16, DVRPP16, DRVP12, DRVP16, DRVP20, DRPAF12, DRPAF16, DRPAF20, DRPP12, DRPP16, DRPP20, ZLRW12B, ZLRW16B, ZLRW20B, ZLRP12C, ZLRP16C, ZLRP20C, ZLRP12B, ZLRP16B...(Other models you can see in the webshop)		

			
1			
GEV No.	750231	Ref. No.	084078
description	dryer size 40g ø 24mm L 164mm connection 3,2/6,2mm		
For models:	ADN220ES, ADF110ES, ADF220ES, ADN110ESP, ADF110ESP, FV 1M, FV 1M, FV 1M, FV 2M, FV 2M, FV 2M, FV 2M, FV 2M, FV 2M, FV 2M, FV 2M, FV 2M, FV 1M, ALN110, ALN120, ADN111, AEN110, AEN120, AKN111, ADF110, ALF110, ADF120, ALF120, AEF110, AEF120, ADNN120, ADN120, AENN120, AENF120, ADN221, ADNN220, ADN220, ADN230, ADN230, AENN220, AENF220, AENN230, AENF230, ASN110, ASN111, ASF110, SM250, AKN110UK, AKF110UK, ASN110UK...(Other models you can see in the webshop)		

			
1			
GEV No.	750313	Ref. No.	083719 083854
description	dryer ø 24mm L 143mm connection 5/7.6mm		
For models:	ICP110, ICP111, ICP130, ICP112, ITP120UK, ICF110, ICN110UK, ICF110, ITP120UK, ALP110, ALP120, ALP111, ALP220, ALP240, ALP221, ALN110, ALN120, ALN111, ALN220, ALN240, ALN221, ALNN120, ALNN220, ALNN230, ALNSO120, ALP110UK, ALN110UK, ALNN220UK, ALNF120, ALNF230, ADF110ES, ALN220, ALN240, AEN220, AEN240, AEN221, ADF220, ADF240, AEF220, AEF240, ASN220, ASN221, ASF220, AKN220UK, AKF220UK, ASN220UK, ASF220UK, ADN110E, ADF110E, APP114/60...(Other models you can see in the webshop)		

			
1			
GEV No.	750048	Ref. No.	0A9371
description	dryer size 40g ø 24mm L 175mm connection 6,5/6,5mm type D90,Q130		
For models:	ALF110, ALF220UK, ALNF220, ALF110, ALF120, ALF220, ALF240, ALNF120, ALNF220, ALNF230, ADN220ES, ADF220ES, FV 2M, FV 2M, FV 2M, FV 2M, APF113, APF114, BC7, BCF7, ADF220E, APP224/60, AZF2203, ARDNF220, BC7, BCF7, ASF220, ADF220, ADF240, ADF2206, AKP110, AKS110, AKP120, AKN110, AKN120, AKP110UK, AKN110UK, AKF240, AKNF120, AKNF220, AKNF230, AKF110UK, AKF110, AKF120, AKF230, AKF220, ASF110, ASF110, ASF220, TRF1301...(Other models you can see in the webshop)		

refrigeration pipes

copper pipes uninsulated

			
1			
GEV No.	694252	Ref. No.	091724
description	T-piece ED ø 6mm copper		



evaporators

for fridges

producer-specific



GEV No.	750356	Ref. No.	088017
description	evaporator L 1065mm W 105mm H 245mm		
For models:	SSODWC12, SSODDPC12, SSODWB12, SSODDPB12, SSDPC12, SSDPD12, SSODWCS12, DVRVAF12, DVRPAF12, DVRVP12, DVRPP12, DRPAF12, DRPP12, ZLRP12C, ZLRP12B, ZLRDW12C, ZLRDW12B, ZLRDD12C, ZLRDD12B, ZLRDW12S, DI4RWV, DI4RWVVR, DI4RWVO, DI4RWVOR, DI4ROD, DI4ROPR, DIVRW4R, DIVRW4R, DIVRW4R		



GEV No.	750364	Ref. No.	092270
description	evaporator L 265mm W 165mm H 255mm		
For models:	TRN132A, TRN132B, TRN132C, TRNA132A, TRNA132B, TRNA132C, TRN183A, TRN183B, TRN183C, TRN183D, TRNA183A, TRNA183B, TRNA183C, TRNA183D, TRN132AE, TRN183AE, TRN132AS, TRN183AS, RCDR2M20, RCDR2M12, RCDR2M04, RCDR2M20U, RCDR2M12U, RCDR2M04U, RCDR3M30, RCDR3M22, RCDR3M14, RCDR3M06, RCDR3M0U, RCDR3M22U, RCDR3M14U, RCDR3M06U, RCSER2M2, RCSER3M3, RCDRS2M20, RCDR3M30H, RCSER2M2U, RCSER3M3U, RCEF2M2U, RCEF3M3U, RCDR2M20T, RCDR2M13T, RCDR2M13U, RCDR3M30T, RCDR3M23T, RCDR3M23U, RCDR3M16T, RCDR3M09U		



GEV No.	750312	Ref. No.	087708 092271
description	evaporator L 310mm W 255mm H 150mm refrigerators and refrigerator-freezers suitable for ELECTROLUX, ZANUSSI		
For models:	TRN224C, TRN224D, TRN224E, TRN132B, TRN183A, TRN183B, TRN183C, TRN183D, TRNA183A, TRNA183B, TRNA183D, TRN224A, TRN224B, TRNA224A, TRNA224B, TRF132A, TRFA132A, TRF183A, TRFA183A, TRN224AE, TRF132AE, TRF183AE, RCDR4M24, RCDR4M16, RCDR4M08, RCD4M40, RCDR4M32, RCDR4M40U, RCDR4M32U, RCDFM20UX, RCDF3M30U, RCER4M4, RCEF2M2X, RCEF3M3, RCDR4M40, RCDR4M32, RCDR4M40U, RCDR4M32U, RCDF2M20, RCDFM20U, RCDF3M30, RCDF3M30U, RCSER4M4, RCEF2M2, RCEF3M3, RCSER4M4U, RCEF2M2U, RCEF3M3U, RCDR4M40T, RCDR4M33T...(Other models you can see in the webshop)		



GEV No.	750251	Ref. No.	082231
description	evaporator L 315mm W 105mm H 690mm overall height 125mm refrigerators and refrigerator-freezers suitable for ELECTROLUX, ZANUSSI		
For models:	ALP220, ALP240, ALN220, ALN240, ILP220, ILP220UK, ILP240, ILN220, ILN220UK, ILN240, ALP220, ALP240, ALN220, ALN240, AKP230, AKP220, AKP240, AKN230, AKN220, AKN240, AKP220UK, AKN220UK, IKP220, IKN220, AKP230, AKP220, AKP240, AKN230, AKN220, AKN240, AKP220UK, AKN220UK, ASP220, ASN220, ASP220UK, ASN220UK, ASP220UK, ASN220UK, ISP220, ISN220, ASP220, ASN220, IKP220, IKP2240, IKN220, IKN240, ISP220, ISN220, ESR141212F, ESR142F...(Other models you can see in the webshop)		



GEV No.	750150	Ref. No.	082211 0K9702
description	evaporator L 315mm W 125mm H 105mm refrigerators and refrigerator-freezers suitable for ELECTROLUX, ZANUSSI		
For models:	ALP110, ALP120, ALN110, ALN120, ALNN120, ALNN220, ALNN230, ALP110UK, ALN110UK, ALNN220UK, ALNF120, ILP110, ILP110UK, ILN120, ILN110, ILN110UK, ILN120, ILNN120, ILNN220, ILNN220UK, ILNN230, ALP110UK, ALN110UK, ALNN220UK, ALNF220UK, ILNF120, ILNF220, ILNF220UK, ALP110, ALP120, ALN110, ALN120, ALNN120, ALNF120, ALNN220, ALNF220, ALNN230, ALNF230, AKP110, AKS110, AKP120, AKN110, AKN120, AKNN120, AKNN220, AKNN230, IKP110, AKP110UK, AKN110UK, AKNF120...(Other models you can see in the webshop)		



GEV No.	750303	Ref. No.	091587
description	evaporator L 370mm W 150mm H 110mm		
For models:	FULL DOOR FREEZER, FULL DOOR FREEZER, RS06FX1F, FULL DOOR FREEZER, RS06FX1F4, RS13DFX2F, FULL DOOR FREEZER, RS06FW1F, FULL DOOR FREEZER, RS06FX1F6, FULL DOOR FREEZER, RS06FX2H, FULL DOOR FREEZER, RS06FX1FG, FULL DOOR FREEZER, RS06FX1FR, FULL DOOR FREEZER, RS06F41FS, FULL DOOR FREEZER, RS06FX1A, FULL DOOR FREEZER, RS06FX1FD, FULL DOOR FREEZER, RS06F41FS, FULL DOOR FREEZER, RD06FX1F		

mechanical components, equipment accessories



1

GEV No.	750250	Ref. No.	082732 OKF157
description	evaporator L 395mm W 100mm H 250mm refrigerator suitable for ELECTROLUX, ZANUSSI		
For models:	TRN1301, TRNA1301, TRNM1301, TRN1302, TRNA1302, TRNM1302, TRN1303, TRNA1303, TRNM1303, TRN1801, TRNA1801, TRNM1801, TRN1802, TRNA1802, TRNM1802, TRN1803, TRNA1803, TRNM1803, TRN2201, TRNA2201, TRNM2201, TRN2202, TRNA2202, TRNM2202, TRN2203, TRNA2203, TRNM2203, TRRN1301, TRRN1302, TRRN1303, TRRN1801, TRRN1802, TRRN1803, TRRN2201, TRRN2202, TRRN2203, TRNP1802, TRN1301, TRNA1301, TRNM1301, TRRN1301, TRN1302, TRNA1302, TRNM1302, TRRN1302, TRN1303, TRNA1303, TRNM1303, TRRN1303, TRN1801...(Other models you can see in the webshop)		



1

GEV No.	750343	Ref. No.	0A9672
description	evaporator L 460mm W 205mm H 210mm refrigerator suitable for ELECTROLUX, ZANUSSI		
For models:	ADN220ES, ADF220ES, ALN220, ALN240, ADN221, AEN220, AEN240, AEN221, ADF220, ADF240, AEF220, AEF240, ASN220, ASN221, ASF220, AKN220UK, AKF220UK, ASN220UK, ASF220UK, ADN220E, ADF220E, ARDN220, ARDN221, ASN220, ADN220, ADN240, ADN221, ADN22060, ADF2206, RH14RE2FUS, RH14FE2FUS, RI016RE1F, RI17RE1FU, RH14RE2FS, RH14FE2FS, RI16R1F, RI16R2FT, RI16R2FGT, MP1200, MP1200, RH14RE2F, RH14FE2F, RH14RE2FEU, RH14FE2FEU, RH14RE4HU, RH14FE4HU, RI16R1G, RH14R2FERU, RH14F2FERU, RH14RE4HRU...(Other models you can see in the webshop)		



1

GEV No.	750302	Ref. No.	087402 0A9681
description	evaporator L 410mm W 128mm H 227mm refrigerators and refrigerator-freezers suitable for ELECTROLUX, ZANUSSI		
For models:	ADF110ES, ALN110, ALN120, ADN111, AEN110, AEN120, AKN111, ADF110, ALF110, ADF120, ALF120, AEF110, AEF120, ADNN120, ADNF120, AENN120, AENF120, ADNN220, ADNF220, ADNN230, ADNF230, AENN220, AENF220, AENN230, AENF230, ASN110, ASN111, ASF110, AKN110UK, AKF110UK, ASN110UK, ASF110UK, ARDN110, ADN110E, ADF110E, 83012001, 83012033, 83012201, ARDF110L, ARDF120, ARDN120, 83012101, ASN110, ASF110, ADN110, ADN120, ADN111, ADF110, ADF120, ADNN120...(Other models you can see in the webshop)		



1

GEV No.	750669	Ref. No.	0A9550
description	evaporator ZANUSSI L 895mm W 520mm		
For models:	RS24, MRL402, EP406VRPUK, E04P6VRVUK, E04P8SRVUK, MP402C, MP40060, MP402, MP40260, RW24, R04PVF4M, R04PVFWG, R04PVF4, R04PVG4, R04PVFW, R04PVGW, C04PVF4D, C04PVG4D, R04P6SRGB, R04P6SRB, R04P6SWB, E04P6SRC, E04P6SRV, EP406VRC, E04P6VRV, E04P4VRC, E04P8SRV, E04P4VRV		



1

GEV No.	750009	Ref. No.	0A9212 0KE850 D81111
description	evaporator L 445mm W 95mm H 110mm		
For models:	ESMLF60W, ESMLF60S, KE1502GT, TZ1502, MLC600V11C, MLC601V11V, MLC602V11V, MLC609V11C, MLC602V11C, MLP609V11, MLP602V11C, MLP600V11C		

for ice-cube maker

for ice cube maker



1

GEV No.	750201	Ref. No.	0U1252
description	evaporator for ice-cube maker 36 cubes L 440mm W 190mm H 40mm		
For models:	FGC33AS42, FGC46AS42, FGC40A, FGC40W, CIM38AB, CIM38WB, CIM50AB, FIM50WB, CIM38AB, CIM38WB, CIM50AB, FIM50WB, CB316A, CB425A, CIM38AB, CIM38WB, CIM50AB, FIM50WB, C150W, C300A, C300W, CB1565W, CB246W, CB416W, CB955W, DSS42W, C80W, CB1565A, C80A, CB246A, CB416A, C150A, CB955A, FRESHMAKER, ICEWATER45, ICEWATER45, DSS42A		



condensers

condensers

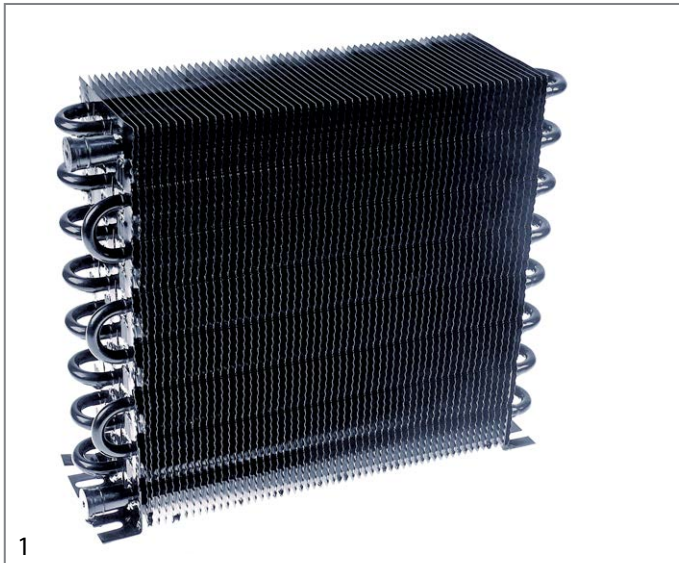

GEV No.	750249	Ref. No.	081773 081826 082229
description	condenser refrigerator W 300mm D 90mm H 250mm suitable for ELECTROLUX, ZANUSSI		
For models:	ALP110, ALP120, ALP111, ALN110, ALN120, ALN111, ALNN120, ALNN220, ALNN230, ALNSO120, ALP110UK, ALN110UK, ALNN220UK, ALNF120, ILP110, ILP110UK, ILN120, ILP111, ILP220, ILP220UK, ILP240, ILN110, ILN110UK, ILN120, ILN111, ILN220, ILN220UK, ILN240, ILNSO120, ILNN120, ILNN220, ILNN220UK, ILNN230, ALP110UK, ALN110UK, ALNN220UK, ALNF220UK, ILNF120, ILNF220, ILNF220UK, ILNF230, ALP110, ALP120, ALP111, ALN110, ALN120, ALN111, ALNN120, ALNF120, ALNN220...(Other models you can see in the webshop)		

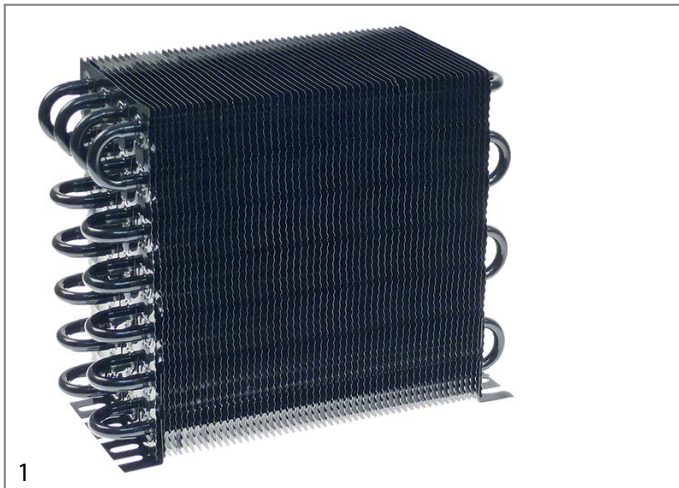

GEV No.	750661	Ref. No.	085613
description	condenser W 215mm D 270mm H 117mm Qty 1 pcs		
For models:	IMF58A, IMF58W, FGC40A, FGC40W, FGS140A, C150W, C300A, C300W, CB1565W, CB246W, CB416W, CB955W, DSS42W, C80W, CB1565A, C80A, CB246A, CB416A, C150A, CB955A, FRESHMAKER, ICEWATER45, ICEWATER45, IF29W, IF55W, IF75W, IF30W, IF29A, IF30A, IF55A, IF75A, DSS42A		



GEV No.	750341	Ref. No.	085981
description	condenser W 260mm D 110mm H 285mm		
For models:	ADF110ES, ADN110ESP, ADF110ESP, ADF110, ALF110, ADF120, ALF120, AEF110, AEF120, ADNF220, ADNN230, ADNF230, AENF220, AENN230, AENF230, ASF110, AKF110UK, ASF110UK, APP223, APP224, ADN110E, ADF110E, APP224/60, 83012201, ARDF110L, ARDF120, ASF110, ADF110, ADF120, ADNN220, ADNF220, ADNN230, ADNF230, ADF11060, ZPR06F1F, APP22B, APP224V, APP223OS, DI2RDP, DI3RDP, DI4RDP, DI2RDPO, DI3RDPO, DI4RDPO, PS06F1F6M, PS06FE1F, PS06F1F, PS06FE2F, PR06F1F4, PR06F1F...(Other models you can see in the webshop)		

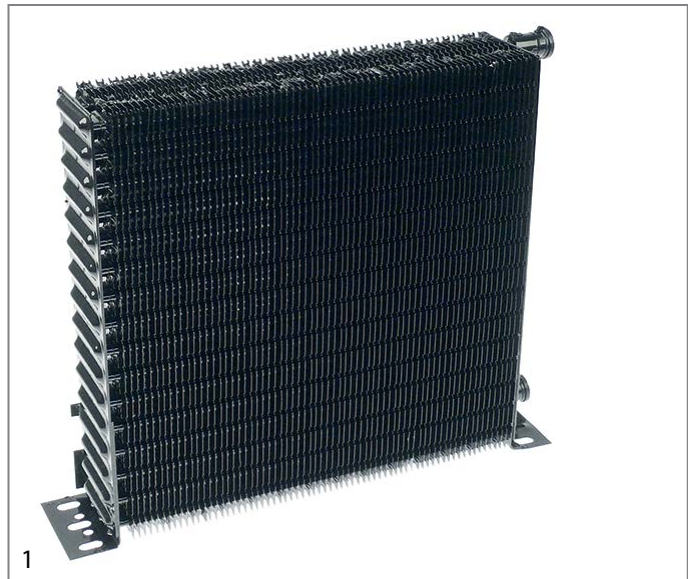

GEV No.	750409	Ref. No.	088661
description	condenser W 260mm D 60mm H 250mm mounting distance 275mm connection ø 8mm		

condensers water-cooled



GEV No.	695827	Ref. No.	OKM751
description	condenser tube ø 25mm ø 155mm H 300mm mounting distance 85mm water-cooled for ice maker connection 14mm		

evaporation and condensing trays

evaporation trays



GEV No.	750298	Ref. No.	080803 084029
description	evaporation tray L 530mm W 325mm H 43mm		
For models:	BC11, BC22, BC44, BC44H, BCF11, BCF22, BCF44, BCF44H, AQC31U US, AQC60U, AQC119U US, BC28A6, Crosswise, BCF15A6, BCW061, BCW101, BCW102, BCFW061, BCFW101, ALP110, ALP120, ALP111, ALP220, ALP240, ALP221, ALN110, ALN120, ALN111, ALN220, ALN240, ALN221, ALNN120, ALNN220, ALNN230, ALNSO120, ALP110UK, ALN110UK, ALNN220UK, ALF110, ALF220UK, ALNF220, ALF110, ALF120, ALF220, ALF240, ALNF120...(Other models you can see in the webshop)		

unheated condensing trays



GEV No.	750316	Ref. No.	089615
description	condensing tray L 160mm W 80mm H 85mm		
For models:	FGS500A, FGS500W, G500A, GB1555W, GB1555A, G500W		



GEV No.	750706	Ref. No.	091600
description	condensing tray L 582mm W 584mm H 148mm plastic for evaporator		
For models:	RS06PX1F6M, FULL DOOR FREEZER, RS06RX1F, FULL DOOR FREEZER, RS06FX1F, RS06DX2F, RS13DX2F, RS06PX1F, RS06PX1F6, RS06R41F, RS06NX1F, FULL DOOR FREEZER, RS06FX1F4, RS06DFX2F, RS13DFX2F, RS06PW1F, FULL DOOR FREEZER, RS06FW1F, FULL DOOR FREEZER, RS06FX1F6, RS06RXH, FULL DOOR FREEZER, RS06FX2H, RS06RX1FG, FULL DOOR FREEZER, RS06FX1FG, RS06RX1FR, FULL DOOR FREEZER, RS06FX1FR, RS06N41F, FULL DOOR FREEZER, RS06F41FS, RS06RXHA, FULL DOOR FREEZER, RS06FX1A, RS0PX1FD, FULL DOOR FREEZER, RS06FX1FD, FULL DOOR FREEZER, RS06F41FS, RS06N41F, RD06PX1F, FULL DOOR FREEZER, RD06FX1F		

transmission technology and ball bearings

drive belts

V-belts

profile Z/10



GEV No.	693262	Ref. No.	052804
description	V-belt belt width 10mm L 560mm H 6mm CODE Z22 profile Z/10		
For models:	MBR/G710D, MBR/E710D, RBR/G710D, 7BRE60XN, XBR/E710D, XBR/G751, XBR/G756, XBR/E716, RBR/E700, HBR/G1013, HBR/E1013, HBR/G1013, HBR/E1013, ZRBR/G700D		

toothed belts





GEV No.	699398	Ref. No.	0KQ691 10675
description	toothed belt L 609.6mm belt width 12.7mm H 2.3mm teeth 120 CODE 240XL050		
For models:	BE5-01, BE5-02, BE5-03, BE5-04, BE5A-01, BE5-05, BE5A-02, EL5N-01, EL5N-02, DM55-01, BE5A-03, BE5A-04, BE5-06, BE5-07, BE5A-05, BE5-09, BE5-12, BE5-11, BE5-13, BE5-14, BE5-08, BE5-05, BE5A-02		





GEV No.	692780	Ref. No.	0KJ735
description	toothed belt profile 150XL075 L 380mm belt width 19mm teeth 75		
For models:	T5, T5S-01, T5S-02, T5S-03, T5S-04, T5S-08, T5S-09, T5S-10, T5S-11, T5S-07, T5S-05, T5S-06, T5S-03, T5S-12, T5S-12		





			
GEV No.	699205	Ref. No.	0D2720
description	toothed belt profile 296NV L 1000mm belt width 25mm H 10.5mm CODE 1000W25-24518 W 25mm		
For models:	XBM30AS-01, XBM30S-01, XBM30AS-02, XBM30AS-03, XBM20S-01, XBM20AS-01, XBM20S-02, XBM20AS-02, XBM20AS-03, XBM20S-03, XBM20AS-04, XBM20S-04, XBM30AS-04, XBM40S-01, XBM20S-27, XBM30S-02, XBM40AS-01, XBM20AS-24, XBM20S-28, XBM30AS-19, XBM30S-14, XBM20AS-05, XBM20S-05, XBM20AS-09, XBM20S-12, XBM20AS-10, XBM20S-13, XBM20AS-07, XBM20AS-08, XBM20S-11, XBM20S-10, XBM30AS-06, XBM30S-07, XBM30AS-07, XBM30S-08, XBM40AS-05, XBM40S-06, XBM20S-08, XBM20S-14, XBM20S-15, XBM20S-24, XBM20S-25, XBM20AS-11, XBM20AS-12, XBM20AS-17, XBM20AS-18, XBM20S-18, XBM20S-19, XBM20S-26, XBM20S-21... (Other models you can see in the webshop)		

			
GEV No.	504778	Ref. No.	OE5050 OE5188 OH2514 OK8235 OKE514
description	toothed belt profile T10 L 610mm H 4mm teeth 61 rubber with textile insertion CODE 354T1 W 16mm		
For models:	RT100ED, RT100ES, RT100SR, RT100SL, RT140ED, RT140ES, RT140SR, RT140SL, RT190ED, RT190ES, RT190SR, RT190SL, RT190HDED, RT190HDES, RT190HSR, RT190HSL, RT270ED, RT270ES, RT270SR, RT270SL, RT270HDED, RT270HDES, RT270HSR, RT270HSL, RT100ERF, RT100ELF, RT100VD, RT100VS, RT140ERF, RT140ELF, RT140VD, RT140VS, RT142ERF, RT142ELF, RT190ERF, RT190ELF, RT190VD, RT190VS, RT190HERF, RT190HELF, RT190HDVDF, RT190HDVSF, RT270ERF, RT270ELF, RT270VDF, RT270VSF, RT270HERF, RT270HELF, RT270HDVDF, RT270HDVSF...(Other models you can see in the webshop)		

			
GEV No.	698653	Ref. No.	OKJ039
description	toothed belt profile V L 1000mm CODE 4668 W 31.5mm		
For models:	MC40AS-01, MC40AS-02, MC40AS-03, MC40S-01, MC40AS-04, MC40AS-05, MC40S-02, EM40AS-01, MC40AS-12, MC40S-13, MC40AS-14, MC40AS-11, MC40S-04, MC40S-03, MC40AS-06, MC40AS-08, MC40S-06, MC40S-07, MC40AS-09, MC40S-09, MC40S-08		

			
GEV No.	698408	Ref. No.	OKJ740
description	V-belt profile V L 875mm H 13mm teeth 121 splitting 4-3 rubber with textile insertion CODE 3024R W 39mm 414NV		
For models:	BMX60AS-01, BMX60AS-02, BMX60AS-03, BMX60S-01, BMXE60S-01, BMX60AS-04, BMXE60AS-1, BMXE80S-01, BMXE80AS-1, BMX60ASC-1, BMXE60ASC1, BMX60AS-05, BMXE80AS-2, BMX60S-02, BMXE80S-02, BMXE60S-02, EMXE80AS-1, EM60AS-01, EM60AS-02, EM80AS-01, BMXE60AS-2, BMXE60S-03, BMXE80AS-3, BMX60AS-09, BMX60AS-07, BMX60AS-08, BMX60S-05, BMX60S-07, BMXE60S-04, BMXE60SC-1, BMXE80AS-4, BMXE80S-04, BMX60S-09, BMX60S-08, BMX60S-03, BMX60S-12, BMXE80S-03, BMX60AS-06, BMX60S-04, BMX60AS-11, DBMX60S, DBMX60SX, DBMX60AS, DBMX60ASX, DBMX60S, DBMXE80S, DBMXE80AS		

poly-v belts			
			
GEV No.	693140	Ref. No.	0KQ225 7361 DS07361
description	poly-v belt grooves 14 W 30mm L 1168mm profile J		
For models:	MB40S-01, MB40S-02, MBE40S-01, MBE40S-02, MB40S-03, MB40S-04, MBE40S-03, XEM40S, MB40S-11, MBE40S-06, MBE40S-05, DMB40S3, MBE40S-05, MBE40S-06		

			
GEV No.	692098	Ref. No.	033583 6001900
description	poly-v belt grooves 16 W 37mm L 508mm profile J		

			
GEV No.	693269	Ref. No.	002148
description	poly-v belt grooves 6 W 14mm L 355mm profile J		
For models:	KBR/G2FH, KBR/G2CH, KBR/E2FH, KBR/E2CH, HBR/G801, HBR/G806, HBR/G811, HBR/G816, HBR/G801D, HBR/G806D, HBR/G811D, HBR/G816D, HBR/E801, HBR/E806, HBR/E811, HBR/E816, QBR/G2FH, QBR/G2CH, QBR/E2FH, QBR/E2CH, ZBR/G801, ZBR/G806, ZBR/G811, ZBR/G816, ZBR/G801D, ZBR/G806D, ZBR/G811D, ZBR/G816D, ZR/G413, BR/E806, ZBR/E811, ZBR/E816, WBR/G2FH, WBR/G2CH, WBR/E2FH, WBR/E2CH, ABR/G801, ABR/G806, ABR/G811, ABR/G816, ABR/G801D, ABR/G806D, ABR/G811D, ABR/G816D, ABR/E801, ABR/E806, ABR/E811, ABR/E816		

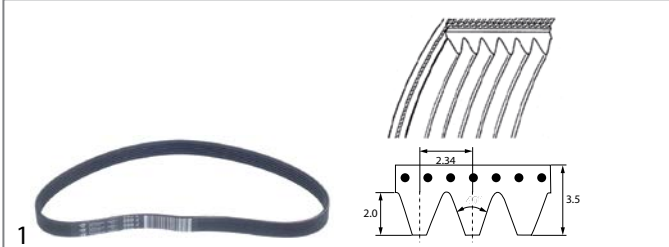

GEV No.	698409	Ref. No.	033106 1060 501060 DS01060
description	poly-v belt grooves 6 W 14mm L 559mm profile J		
For models:	TGVE211, TGVE233, TV02, TV03, K35-11, K35-01, K35-02, PL15-01, K35-03, PL15-02, PL15-03, BMX60AS-01, BMX60AS-02, BMX60AS-03, K35-04, K35-05, EL40-01, BMX60S-01, BMX60S-01, BMX60AS-04, BMXE60AS-1, BMXE80S-01, BMXE80AS-1, K35-06, BMX60ASC-1, BMXE60ASC1, PL15-06, PL15-05, BMX60AS-05, BMXE80AS-2, BMX60S-02, BMXE80S-02, BMXE60S-02, XBE60S-01, XBE60AS-01, XBE80S-01, XBE80AS-01, K35-07, K35-08, EMXE80AS-1, K35-09, PL15-04, BMXE60AS-2, XBE60S-02, XBE80S-02, BMXE60S-03, XBE80AS-02, BMXE80AS-3, BMX60AS-09, BMX60AS-07...(Other models you can see in the webshop)		



GEV No.	695278	Ref. No.	0C2953
description	round belt ø 6mm L 850mm		
For models:	FCZ101GTG, FCZ102GTG, FCZ201GTG, FCZ202GTG, FCZ101GTD, FCZ102GTD, FCZ201GTD, FCZ202GTD, FCZ061GBI, FCZ101GBI, FCZ101GBG2, FCZ102GBG2, FCZ201GBG2, FCZ202GBG2, FCZ101GBD2, FCZ102GBD2, FCZ201GBD2, FCZ202GBD2, FCZ101GBI2, FCZ102GBI2, FCZ201GBI2, FCZ101GCG2, FCZ102GCG2, FCZ201GCG2, FCZ202GCG2, FCZ101GCD2, FCZ102GCD2, FCZ201GCD2, FCZ202GCD2, AOS061GAEU, AOS101GAEU, AOS101GAAU, AOW101EA, AOW101EABU, AOS061GAPQ, AOS101GAPQ, AOS102GAPQ, AOS201GAPQ, AOS202GAPQ, AOS101GAQ1, AOS061GAP1, AOS062GAP1, AOS101GAP1, AOS102GAP1, AOS201GAP1, AOS101GTG1, AOS102GTG1, AOS201GTG1, AOS202GTG1, AOS101GTD1...(Other models you can see in the webshop)		

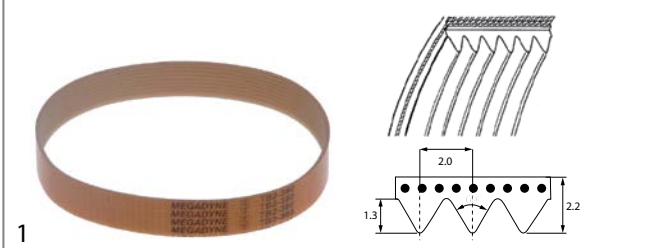

GEV No.	697896	Ref. No.	033722 3030126
description	poly-v belt grooves 12 W 24mm L 430mm profile TB2		
For models:	AV30, AV35, AV37, LUX350, LUX370		



GEV No.	694415	Ref. No.	0KJ812
description	round belt ø 8mm L 820mm		

chains

roller chains 08B-1 single



GEV No.	693275	Ref. No.	056862
description	roller chain DIN/ISO 08 B-1 splitting 1/2" / 12.7mm links 23 internal width 7.75mm rollerø 8.51mm single without connecting bow		
For models:	MBR/G710D, MBR/E710D, MBR/G700, MBR/G700F, MBR/E700, MBR/E700UK, MBR/G700UK, MBR/G701, MBR/G706, MBR/G701UK, MBR/G751, MBR/G756, MBR/E716, MBR/E706, RBR/G710D, 7BRE60XN, RBR/G700, RBR/G700F, 7BRE60X, RBR/E700UK, 7BRG60, 7BRG60X, RBR/G701UK, RBR/G751, RBR/G756, RBR/E716, RBR/E706, XBR/G710D, XBR/E710D, XBR/G700, XBR/G710, M70EBP, XBR/G700F, XBR/G700UK, XBR/E710, XBR/G701, M70GBP, XBR/G701UK, XBR/G751, XBR/G756, CBR/G700, CBR/E700, XBR/E716, XBR/E706, RBR/G700, RBR/E700, RBR/G700, RBR/E700, ZRBR/G700, ZRBR/G700D...(Other models you can see in the webshop)		

round belts



GEV No.	694925 ¹	Ref. No.	0E3584
description	round belt ø 15mm Lmm Qty supplied by meter		
For models:	TW1ERECO, TW1ELECO, TW1SRECO, TW1SLECO, TL1, TL2, TL3, TC1, TC2, TC3, TC9, TC45, TTV, TTVS, TIV, TTR, CL1, CL2, CL3, CC1, CC2, CC3, C90., C45., CTV, CTVS, CIV, CCR, HSCCB5, HSCCB10, HSCCB20, HSCCB25, HSCCB90C, HSCCB45C, HSCCBR, HSCCBDLF, HSCCBDRF, HSCBCLF, HSCCBCRF, HSSA3LR, HSSA4LR, HSSA5LR, HSSA6LR, HSSA3RL, HSSA4RL, HSSA5RL, HSSA6RL, HSCCT10, HSCCT20, HSCCT30...(Other models you can see in the webshop)		

¹by the meter



connectors



GEV No.	693276	Ref. No.	056863
description	connector single DIN/ISO 08 B-1 splitting 1/2" links 1 L 23mm internal width 11.8mm rollerø 4.3mm metal		
For models:	MBR/G710D, MBR/E710D, MBR/G700, MBR/G700F, MBR/E700, MBR/E700UK, MBR/G700UK, MBR/G701, MBR/G706, MBR/G701UK, MBR/G751, MBR/G756, MBR/E716, MBR/E706, RBR/G710D, 7BRE60XN, RBR/G700, RBR/G700F, 7BRE60X, RBR/E700UK, 7BRG60, 7BRG60X, RBR/G701UK, RBR/G751, RBR/G756, RBR/E716, RBR/E706, XBR/G710D, XBR/E710D, XBR/G700, XBR/G710, M70EBP, XBR/G700F, XBR/G700UK, XBR/E710, XBR/G701, M70GBP, XBR/G701UK, XBR/G751, XBR/G756, CBR/G700, CBR/E700, XBR/E716, XBR/E706, RBR/G700, RBR/E700, RBR/G700, RBR/E700, ZRBR/G700, ZRBR/G700D...(Other models you can see in the webshop)		

GEV No.	700487	Ref. No.	054560
description	torsion spring ø 10.8mm L2 5mm wire gauge ø 2.2mm L1 86mm L3 86mm		
For models:	COCO6G, COCO6E		

GEV No.	700426	Ref. No.	0H6915 279830
description	torsion spring ø 12.9mm L2 64mm wire gauge ø 2.6mm mounting pos. right L1 100mm L3 11mm		

springs

torsion springs



GEV No.	699156	Ref. No.	092759
description	spring ø 26mm L2 35mm L1 25mm L3 20mm		

GEV No.	700450	Ref. No.	054282
description	torsion spring ø 13mm L2 177mm wire gauge ø 2.5mm L1 10mm L3 177mm Qty 1 pcs		
For models:	FCF/G6-0, FCFG101/0, FCFG102-0, FCF/E6-0, FCFE101-0, FCFE102-0, FCF061ELN, FCF101ELN, FCF6EHOR, FCFG10160H, FCF061ENS, FCF101ENS, FCF102ENS, FCFG102-0T, FCF/G6-1-JAP, FCF/G101/1-1-JAP, FCF/G102/1-1-JAP, FCFE6-1J, FCFE101-1J, FCFE102-1J, FCF/G101/1, FCFG10, FCFG10D, FCFG10NL, FCFE10, FCFE10UK, FCFG20, FCFG20D, FCFG20F, PFCFG20, FCFE20, FCFE20UK, FCFG40, FCFG41, FCFG40D, FCFG40F, PFCFG40F, FCFE40, FCFE40D, FCFE40UK, PFCFE40F, FCVE10, FCVE20, FCFG10J, FCFG10J, FCFE10J, FCFE10J, FCFG20J, FCFG20J, FCFE20J...(Other models you can see in the webshop)		

GEV No.	700427	Ref. No.	0H6914 279829
description	torsion spring ø 13mm L2 64mm wire gauge ø 2.7mm mounting pos. left L1 101mm L3 9mm		

GEV No.	504653	Ref. No.	046268
description	torsion spring mounting pos. left		
For models:	WT302, WT302/4.5, WT302F, WT302/60, WT303, WT303/4.5, WT303F, WT303/60, LS360F, LS360DK, LS365F, LS365, LS365PH, LS500F, LS501F, LS540F, LS540DK, LS541F, LS360D, LS365D, LS360, LS365, LS360/63, LS365/63, LS367, LS540, LS500F, LS500UK, LS501, LS501UK, LS540D, LS540/63, LS541, LS7D, LS7, LS7UK/RP, LV70, LS7F, LS7DEK, LS7/1UK, LS7/9, LS7/DP, LS7/60, WT40/9, WT40/F, LS7HD, WT40/J50, WT40/J60, WT40UKRP, PH4/WT40...(Other models you can see in the webshop)		

GEV No.	690683	Ref. No.	082178
description	torsion spring ø 14.5mm wire gauge ø 2.5mm L1 86mm L2 30mm L3 16mm refrigerator		

GEV No.	504652	Ref. No.	046269
description	torsion spring mounting pos. right		
For models:	LS360F, LS360DK, LS365F, LS365, LS365PH, LS500F, LS501F, LS540F, LS540DK, LS541F, LS360D, LS365D, LS360, LS365, LS360/63, LS365/63, LS367, LS540, LS500F, LS500UK, LS501, LS501UK, LS540D, LS540/63, LS541, LS7D, LS7, LS7UK/RP, LV70, LS7F, LS7DEK, LS7/1UK, LS7/9, LS7/DP, LS7/60, WT40/9, WT40/F, LS7HD, WT40/J50, WT40/J60, WT40UKRP, PH4/WT40, PH4RBP/WT40, LS360, LS365F, LS500, LS501, LS540, ALS540, FL700...(Other models you can see in the webshop)		

GEV No.	700087	Ref. No.	082179
description	torsion spring ø 14.5mm wire gauge ø 2.7mm L1 86mm L2 30mm L3 16mm refrigerator		



GEV No.	700023	Ref. No.	0H6608
description	torsion spring \varnothing 18.2mm L2 150mm wire gauge \varnothing 3.2mm mounting pos. left L1 100mm L3 24mm		



GEV No.	700022	Ref. No.	0H6607
description	torsion spring \varnothing 18.6mm L2 93mm wire gauge \varnothing 3.4mm mounting pos. right L1 133mm L3 24mm		



GEV No.	700027	Ref. No.	OK2680
description	torsion spring \varnothing 19.2mm L2 86mm wire gauge \varnothing 3.8mm mounting pos. left L1 131mm L3 26mm		
For models:	7502-2, 7502-3, 7502-9, 7504-2, 7504-3, 7508-2, 7508-3, 7512-3, 9000-3, 9002-2, 9002-3, 9004-2, 9004-3, 9012-2, 9012-3, 9015-3, 9203-3-0, 9203-3-8		

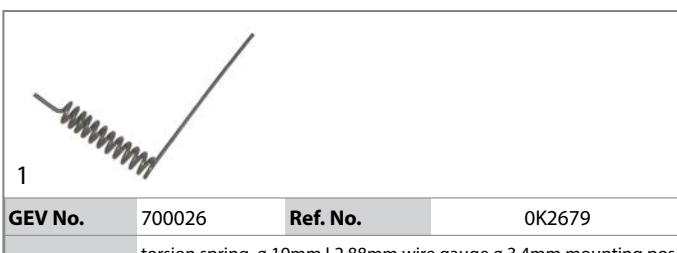

GEV No.	700026	Ref. No.	OK2679
description	torsion spring \varnothing 19mm L2 88mm wire gauge \varnothing 3.4mm mounting pos. right L1 132mm L3 26mm		
For models:	7502-2, 7502-3, 7502-9, 7504-2, 7504-3, 7508-2, 7508-3, 7512-3, 9000-3, 9002-2, 9002-3, 9004-2, 9004-3, 9012-2, 9012-3, 9015-3, 9203-3-0, 9203-3-8		

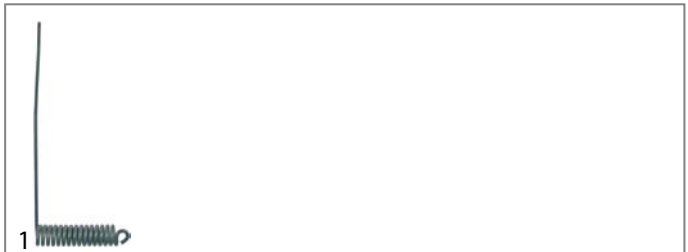

GEV No.	690880	Ref. No.	OK2829 OKL682 193604
description	torsion spring \varnothing 20.9mm L2 75mm wire gauge \varnothing 3.7mm L1 200mm L3 20mm		

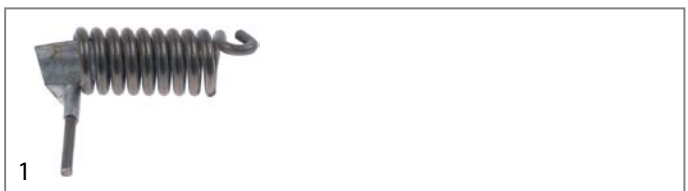

GEV No.	692666	Ref. No.	OPRF26
description	torsion spring \varnothing 23mm L2 16mm wire gauge \varnothing 4mm L1 52mm L3 52mm Qty 1 pcs		



GEV No.	693299	Ref. No.	052894 OK2934
description	torsion spring \varnothing 28.6mm L2 103mm wire gauge \varnothing 3.6mm L1 45mm		
For models:	MPN/GD761, MPN/GI761, MPN/GI760D, MPN/GD760, MPN/GD760F, MPN/GI760, MPN/GI760F, MPN/EI760, MPNEI760UK, MPN/V760, MPN/EI760D, MPN/V760D, 7PDG06, 7PIG06, 7PIE06, RPN/EI760UK, RPN/GD760F, RPN/GI760F, 7PEV06, RPN/EI760D, XPN/GI760D, M70GDKE, M70GIKE, M70EIKE, XPN/EI760UK, M70VIKE, XPN/GD760F, XPN/GI760F, XPN/EI760D, RPNV740, RPN/G760, RPN/G760, PRPN/G760, RPN/GI760, RPN/GI760, RPN/GI760, PRPN/GI76, RPN/EI760, RPN/EI760, RPNV760, RPN/G760, PRPN/GI76, RPN/EI760, RPN/V740, RPN/V760		





GEV No.	693313	Ref. No.	051527
description	torsion spring \varnothing 38.1mm wire gauge \varnothing 6.2mm L1 19mm L2 212mm L3 19mm		
For models:	HPN/G810, HPN/GI810, HPN/GI810, HPN/G815, HPA/G815, HPN/E810, HPN/GI815, HPA/GI815, HPN/EI810, HPA/GI815, HPN/E815, HPN/EI810, HPA/EI810, HPN/GI810, HPN/G810, HPN/G815, HPA/G815, HPN/GI810, HPN/GI815, HPN/GI815, HPN/E810, HPN/E815, HPN/EI810, HPN/EI810, HPA/EI815		





GEV No.	693316	Ref. No.	059518
description	torsion spring \varnothing 38.2mm wire gauge \varnothing 6.2mm L1 33mm L2 320mm L3 24mm		
For models:	KPI/G10, KPI/G15, KPI/E10, KPI/E15, KPD/G10, KPD/G15, KPI/G06, KPI/E06, KPI/G15H, KPI/E15H, KPI/G10H, KPI/E10H, HPN/GI810, HPN/GI815, HPN/GI815D, HPN/GI816, HPN/GI816, HPN/EI815D, HPN/EI810, HPN/EI815, HPN/GD811, HPN/GD816, HPN/ED811, HPN/ED816, HPNS/GI816, HPNS/EI815, HPNS/EI815D, HPN/GI806, HPN/EI806, HPN/GI805, HPN/EI805, QPI/G10, QPI/G15, QPI/E10, QPI/E15, QPD/G10, QPD/G15, QPI/G06, QPI/E06, QPI/G15H, QPI/E15H, QPI/G10H, QPI/E10H, ZPN/GI816D, HPN/ED825, HPN/EI825, ZPN/GI805, ZPN/EI805, WPI/G10, WPI/G15...(Other models you can see in the webshop)		



			
GEV No.	693286	Ref. No.	051268
description	torsion spring \varnothing 39.2mm wire gauge \varnothing 7.2mm L1 308mm L2 19mm L3 19mm for kettle type series 900		
For models:	HBR/G820, HBR/G825, HBR/E820, HBR/E825, HBR/G821UK, HCPA/G1219, HCPA/GI 1219, ZBR/E820, ZBR/E825, ZBR/G821, ZBR/G826, ZCPAG1219, ZCPA/GI 1219, ABR/G820, ABR/G825, ABR/E820, ABR/E825, HCPA/G1219, HCPA/GI1219, HCPA/V1219, HCPA/EI1219, CR42G, CR42V, CR42E, CR/40G, CR/40V, CR40E, CR15G, CR/41G, CR42G, CR/41E, CR/41V, CR/42V, CR40G, CR40V, CR/40E, CR/42E, HQN/G1917, HQN/G1917, HQN/G1225, HQN/GI1225, HQN/EI917, HQN/GI122, HQN/V917, HQN/EI1225, HBR/G803, HBR/G804, HBR/G803, HBR/G804, HBR/G803...(Other models you can see in the webshop)		

			
GEV No.	693315	Ref. No.	002981 003643
description	torsion spring \varnothing 39mm wire gauge \varnothing 7.1mm L1 31mm L2 322mm L3 23mm		
For models:	KPD/G15A, KPI/G15A, KPI/E15A, BRN70G, BRN70E, CRN22G, CRN/20G, CRN30G, CRN15G, CRN15V, CRN15E, HPA/GD825, HPA/GI825, HPA/ED825, HPA/EI825, HCPA/G1219, HCPA/GI 1219, CR20V, CR20EI, CR22G, BRN/70GZ, BRN/70EZ, CRN/22GZ, CRN20GZ, CRN30GZ, CRN15GZ, CRN15V-Z, CRN15EZ, ZPN/GI810, 2PIG15, ZPN/GI816, ZPN/EI815D, ZPN/EI810, ZPN/EI815, ZPN/GD811, ZPN/GD816, ZPN/ED811, ZPN/ED816, 2PDAG15, 2PIAG15, ZPNS/GI816, ZPNS/EI815, ZPNS/EI815D, ZCPAG1219, ZCPA/GI 1219, CR20V, CR20EI, CR22G, BR80GZ, BR80EZ...(Other models you can see in the webshop)		

			
GEV No.	690879	Ref. No.	0K2675
description	torsion spring \varnothing 43mm L2 117mm wire gauge \varnothing 7.2mm L1 80mm L3 18mm		

			
GEV No.	504697	Ref. No.	048279
description	torsion spring \varnothing 6mm L2 6mm wire gauge \varnothing 1.2mm L1 67mm L3 29mm		
For models:	WT4, WT4B, WT4D, WT4DB, WT46, WT4D60, WT4DDG, LS5/1, LS5/1DP, LS5/3, LS5/3DP, LS5/1DP60, LS5/1DPAUS, LS5/1DPCS, LB1, LB1WS, LB1WSDP, WT1WSDP, LB2DPSAUS, LB1G, LB1WSG, LB2WS, LB2, LB2WSDP, LB2WS60, WT2WSDP, WT2WSDPD, LB2WSG, WT2WS, WT1, WT1WS, WT1TOP, WT2TOP, WT1/3DP, WT2/3DP, WT2DPAUS, LS6EP, LS6EP/DD, LS6EADD, LS6EA/DPDD, LS6EADP3, LS6EA/60, LS6EA, LS6EA/DP, LS10D, LS10, LS10UKRP, LC100, LS10/60, LS10/1...(Other models you can see in the webshop)		

			
GEV No.	504705	Ref. No.	068645
description	torsion spring \varnothing 7mm L2 5mm wire gauge \varnothing 1mm L1 50mm L3 29mm		
For models:	LS365F, LS365, LS365PH, LS360D, LS365D, LS365, LS365/63, LS367, WT32, WT32/4,5, WT32/UK, WT32/UKRP, WT32/F6, WT32/J60, WT32/J50, WT32/4,5N, WT33, WT33/4,5, WT33/UK, WT33/UKRP, WT33/F, D500, WT33/60, WT33/4,5N, WT34, WT34/4,5, WT34/UKRP, D510, WT34/4,5N, LS7D, LS7, LV70, LS7F, LS7DEK, LS7/9, LS7/DP, LS7/60, WT40/9, WT40/F, WT40/J50, WT40/J60, WT40UKRP, PH4/WT40, PH4BP/WT40, LS365F, ZLS520, ZLS521, ALLS521, ALLS520, FL620...(Other models you can see in the webshop)		

compression springs

			
GEV No.	301209	Ref. No.	004243
description	compression spring \varnothing 10mm L 15mm wire gauge \varnothing 0.9mm		
For models:	RC/G1, RC/G2, RCV/G2, RCV/G3, RCF/G2, RCF/G3, RCF/M2, RCF/M3, RSF/G2, RSV/G2, RSF/G3, MCF/G2A, MCF/G3A, XC/G1, XC/G2, XCV/G2, XCV/G3, XCF/G2, XCF/G3, XCF/M2, XCFM3, XSF/G2, XSV/G2, XSF/G3, JC/G1, JC/G2, JCV/G2, JCV/G3, JCF/G2, JCF/G3, JCF/M2, JCFM3, MC/G1, MC/G2, MCV/G2, MCV/G3, MCF/G2, MCF/G3, MCF/M2, MCF/M3, MSF/G2, MSV/G2, MSF/G3		

			
GEV No.	700422	Ref. No.	052789
description	compression spring \varnothing 14.8mm L 70mm wire gauge \varnothing 1.7mm		
For models:	HBR/G1013, HBR/E1013, HBR/G1013, HBR/E1013		

			
GEV No.	700445	Ref. No.	053757 0F0155
description	compression spring \varnothing 21.7mm L 29mm wire gauge \varnothing 1.5mm		
For models:	HCCS20W, HCCS20W, FCF/G6-0, FCFG101/0, FCFG102-0, FCF/E6-0, FCFE101-0, FCFE102-0, FCF061ELN, FCF101ELN, FCF6EHOR, FCFG10160H, FCF061ENS, FCF101ENS, FCF102ENS, FCFG102-0T, FCF/G6-1-JAP, FCF/G101/1-1-JAP, FCF/G102/1-1-JAP, FCFE6-1J, FCFE101-1J, FCFE102-1J, FCF/G101/1, FCFG10, FCFG10D, FCFG10NL, FCFE10, FCFE10UK, FCFG20, FCFG20D, FCFG20F, PFCFG20, FCFE20, FCFE20UK, FCFG40, FCFG41, FCFG40D, FCFG40F, PFCFG40F, FCFE40, FCFE40D, FCFE40UK, PFCFE40F, FCVE10, FCVE20, FCFG10J, FCFG10J, FCFE10J, FCFE10J, FCFG20J...(Other models you can see in the webshop)		

			
GEV No.	700424	Ref. No.	056846
description	compression spring \varnothing 26mm L 220mm wire gauge \varnothing 4.2mm		
For models:	MBR/G710D, MBR/E710D, MBR/G700, MBR/G700F, MBR/E700, MBR/E700UK, MBR/G700UK, MBR/G701, MBR/G706, MBR/G701UK, MBR/G751, MBR/G756, MBR/E716, MBR/E706, RBR/G710D, 7BRE60XN, RBR/G700, RBR/G700F, 7BRE60X, RBR/E700UK, 7BRG60, 7BRG60X, RBR/G701UK, RBR/G751, RBR/G756, RBR/E716, RBR/E706, XBR/G710D, XBR/E710D, XBR/G700, XBR/G710, M70EBP, XBR/G700F, XBR/G700UK, XBR/E710, XBR/G701, M70GBP, XBR/G701UK, XBR/G751, XBR/G756, CBR/G700, CBR/E700, XBR/E716, XBR/E706, RBR/G700, RBR/E700, RBR/G700, RBR/E700, ZRBR/G700, ZRBR/G700D...(Other models you can see in the webshop)		

			
GEV No.	504660	Ref. No.	047492 0K8620 514650801
description	compression spring \varnothing 8.9mm L 37.5mm wire gauge \varnothing 1.15mm		
For models:	LSDS51, LSDS5V, LS510, LS520, LS520D, LS520F, LS520M, LS520K, LS521, LS521D, LS521F, LS521M, LS521K, LS521, LS4, ZLS510, ZLS520, ZLS521, ALLS521, ALLS520, ALS510, C51, C52, C50, LS520ZD, LS521ZD, CF314, LS510MZ, LS520MZ, LS521MZ		



GEV No.	519544	Ref. No.	047489 30213076 514650700
description	compression spring \varnothing 9.1mm L 28mm wire gauge \varnothing 0.8mm		
For models:	LSD55I, LSD55V, LS510, LS520, LS520D, LS520F, LS520M, LS520K, LS521, LS521D, LS521F, LS521M, LS521K, LS521, LS4, ZLS510, ZLS520, ZLS521, ALLS521, ALLS520, ALS510, C51, C52, C50, LS520ZD, LS521ZD, CF314, LS510MZ, LS520MZ, LS521MZ		

spring compressors



GEV No.	504688	Ref. No.	046539 049886 075767 VVG212
description	spring compressor		
For models:	SPE100/20, SPE100/20UK, LS720F, LSE720DK, LSE720PH, LS860F, LS860DK, LS860PH, LS1080F, LS1080UK, LS1080PH, LSE721F, LS861F, LS1080M, LS1080, LS1080D, LS1080UK, LS1080/63, LSE721, LS720, LSE720UK, LS721UK, LSE720D, LS860, LS860, LS860D, LS860UK, LS861UK, LS860/63, LS861, LS10D, LS10, LS10UKRP, LC100, ECOTEMP12-, LS10/60, LS10/1, LS10/12KW, LS10F, LS10DEK, LS10/1U-KRP, LS10SW, LS10/50J, LS10/60J, LS10DP, LS10/HD, SH55, LO10, LS10/UK1, LS10/UK3...(Other models you can see in the webshop)		



GEV No.	504689	Ref. No.	049583
description	spring compressor		
For models:	WT60/GJ60, WT60/GJ50, PH10/12-RP, LS10, LS14EA, LS10UKDP, ET12E, LS10/60HZ, LS10CW, LS10INS, HT1200INS, LS14EA1, LS10N, LS10DP, LS10HD, LS14EA1/AU, LS14EA/60, LS10UK/1, LS10UK/3, LS12INS, LS12, LS12DP, LS12/60HZ, LS12CW, HT1200DEK, LS14EAASIA, LS14EA/G, WT60DP, WT60, WT60CW, WT60UKDPCW, WT60INS, WT60INSCW, WT60NAUCW, WT60NAU, LS10EA, WT60/60HZ, WT60/60HZC, WT60N, WT609NINS, LS12HD, LS14EA1/DD, WT65E, WT65EB, WT65EI, WT60NAUDP, LS12UK/3CW, LS12NAU, LS12UKDPCW, ECOTEMP125...(Other models you can see in the webshop)		



GEV No.	693287	Ref. No.	051267
description	spring compressor		
For models:	HBR/G820, HBR/G825, HBR/E820, HBR/E825, HBR/G821UK, HCPA/G1219, HCPA/GI 1219, ZBR/E820, ZBR/E825, ZBR/G821, ZBR/G826, ZCPAG1219, ZCPA/GI 1219, ABR/G820, ABR/G825, ABR/E820, ABR/E825, HCPA/G1219, HCPA/GI1219, HCPA/V1219, HCPA/EI1219, CR15G, CR41G, CR42G, CR41E, CR41V, CR42V, CR40G, CR40V, CR40E, CR42E, HQN/G1917, HQN/G1917, HQN/G1225, HQN/GI1225, HQN/EI917, HQN/GI122, HQN/V917, HPN/G810, HQN/EI1225, HPN/GI810, HPN/GI810, HPN/G815, HPA/G815, HPN/E810, HPN/GI815, HPA/GI815, HPN/EI810, HPA/GI815, HPN/E815...(Other models you can see in the webshop)		



GEV No.	693290	Ref. No.	0A2551
description	spring compressor		
For models:	RBR/G2FM, RBR/G2IM, RBK/G2FM, RBR/E2FM, RBR/E2IM, RBK/E2FM, XBR/G2FM, XBR/G2IM, XBK/G2FM, XBR/E2FM, XBR/E2IM, XBK/E2FM, JBR/G2FM, JBR/E2FM, MBR/G2FM, MBR/G2IM, MBK/G2FM, MBR/E2FM, MBR/E2IM, MBK/E2FM, PBR/G2FM, PBR/G2IM, PBR/E2FM, PBR/E2IM, OBR/G2FM, OBR/G2IM, OBR/E2FM, OBR/E2IM, TBR/G2FM, TBR/G2IM, TBR/E2FM, TBR/E2IM, KBR/G2F, KBR/G2C, KBR/G3F, KBR/G3FH, KBR/G3C, KBR/G3CH, KBR/E2F, KBR/E2C, KBR/E3F, KBR/E3FH, KBR/E3C, KBR/E3CH, KBR/G2FH, KBR/G2CH, KBR/E2FH, KBR/E2CH, HBR/G800, HBR/G805...(Other models you can see in the webshop)		

gas tension springs



GEV No.	692685	Ref. No.	033241
description	gas tension spring 150N hub 100mm D1 \varnothing 6mm D2 \varnothing 15mm hole distance 260mm hole \varnothing 6mm L 275mm		
For models:	CSV20B, CSV25C, CSV21B, CSV26C		

roller springs



GEV No.	519449	Ref. No.	0E5002 0E5158 0K8168
description	roller spring W 25mm ID \varnothing 32mm lug lengthmm		
For models:	WTF2ERC, WTF2ELC, WTF2SRC, WTF2SLC, WTF2HERC, WTF2HEL, WTF2HSRC, WTF2HSLC, WTF3ERC, WTF3ELC, WTF3SRC, WTF3SLC, WTF3HERC, WTF3HELC, WTF3HSRC., WTF3HSLC, WTF2ERB., WTF2ELB, WTF2SRB, WTF2SLB, WTF2HERB, WTF2HELB, WTF2HSRB, WTF2HSLB, WTF3ERB, WTF3ELB, WTF3SRB, WTF3SLB, WTF3HERB, WTF3HELB, WTF3HSRB, WTF3HSLB, WTF4HERB, WTF4HELB, WTF4HSRB, WTF4HSLB, WTF2ERA, WTF2ELA, WTF2SRA, WTF2SLA, WTF2HERA, WTF2HELA, WTF2HSRA, WTF2HSLA, WTF3ERA, WTF3ELA, WTF3SRA, WTF3SLA, WTF3HERA, WTF3HELA...(Other models you can see in the webshop)		



			
1			
GEV No.	504518	Ref. No.	0E5167 OK8169
description	roller spring W 39mm ID ø 32mm lug lengthmm		
For models:	TW1ERECO, TW1ELECO, TW1SRECO, TW1SLECO, RT100ED, RT100ES, RT100SR, RT100SL, RT140ED, RT140ES, RT140SR, RT140SL, RT190ED, RT190ES, RT190SR, RT190SL, RT190HDED, RT190HDES, RT190HSR, RT190HSL, RT270ED, RT270ES, RT270SR, RT270SL, RT270HDED, RT270HDES, RT270HSR, RT270HSL, RT100ERF, RT100ELF, RT100VD, RT100VS, RT140ERF, RT140ELF, RT140VD, RT140VS, RT142ERF, RT142ELF, RT190ERF, RT190ELF, RT190VD, RT190VS, RT190HERF, RT190HEL, RT190HDVDF, RT190HDVSF, RT270ERF, RT270ELF, RT270VDF, RT270VSF...(Other models you can see in the webshop)		

			
1			
GEV No.	691220	Ref. No.	053342 058444 0G2210
description	spring clip shaft diameter 6mm ømm L 17mm W 14mm H 5mm wire gauge ø 1.5mm		
For models:	ICP111, ICF110, ICF110, AP20, BC100A, BC100DA, BC100RA, BC100RDA, BC180A, BC180DA, BC180RA, BC180RDA, BC180RPA, BC11, BC22, BC44, BC44H, BCF11, BCF22, BCF44, BCF44H, BCF100A, BCF100DA, BCF100RA, BCF100RDA, BCF180A, BCF180DA, BCF180RA, BCF180RDA, BCF180RPA, AQC22U US, AQC31U US, AQC60U, AQC119U US, , , BC28A6, Crosswise, , , BCF15A6, , , ALP110, ALP120, ALP111, ALP220, ALP240, ALP221, ALN110...(Other models you can see in the webshop)		

accessories

rollers

			
1			
GEV No.	694643	Ref. No.	0E5001 OK8167
description	roller ø 30mm W 58mm ID ø 11mm		
For models:	WTF2ERC, WTF2ELC, WTF2SRC, WTF2SLC, WTF2HERC, WTF2HELC, WTF2HSRC, WTF2HSLC, WTF3ERC, WTF3ELC, WTF3SRC, WTF3SLC, WTF3HERC, WTF3HELC, WTF3HSRC, WTF3HSLC, WTF2ERB, WTF2ELB, WTF2SRB, WTF2SLB, WTF2HERB, WTF2HELB, WTF2HSRB, WTF2HSLB, WTF3ERB, WTF3ELB, WTF3SRB, WTF3SLB, WTF3HERB, WTF3HELB, WTF3HSRB, WTF3HSLB, WTF4HERB, WTF4HELB, WTF4HSRB, WTF4HSLB, WTF2ERA, WTF2ELA, WTF2SRA, WTF2SLA, WTF2HERA, WTF2HELA, WTF2HSRA, WTF2HSLA, WTF3ERA, WTF3ELA, WTF3SRA, WTF3SLA, WTF3HERA, WTF3HELA...(Other models you can see in the webshop)		

tension springs

			
1			
GEV No.	504687	Ref. No.	049947
description	tension spring		
For models:	LS14EAI/AU, WT65EBIA, WT65EIA, WT65MED, WT65MEDWS, EHTAIAU, EHTAIMLAU, ZHTAIAU, H1510SANA		

			
1			
GEV No.	540916	Ref. No.	OKI647 NZ9205959267
description	tension spring		
For models:	7581-5, 7781-5, 9172-3, 9172-5, 9372-3-0, 9372-3-8, 9372-5-0, 9372-5-8		

miscellaneous

			
1			
GEV No.	700455	Ref. No.	055558
description	spring		
For models:	FCF02EV, FCF02EOEM, FCF/E3, FCF/E2, FCF/E2D, FCF/E2UK, FCF/E2, FCF/E2, FCF/E2, FCF/E2D		

			
1			
GEV No.	540918	Ref. No.	OK2685
description	tension spring		
For models:	7582-5.KK80, 7781-5.KK60, 7582-5/85.KK80.(N), 7582-5/90.KK80.(N), 7568-5-90.KK200.(N), 7568-3, 7568-5.KK200, 7568-5/85.KK200.(N), 7768-3, 7768-5.KK200, 7768-5/85.KK200.(N), 7768-5/90.KK200.(N), 7781-5/85.KK60.(N), 7781-5/90.KK60.(N), 9175-3, 9175-5, 9375-3-0, 9375-3-8, 9375-5-0, 9375-5-8		

 <p>Image not available</p>			
GEV No.	540919	Ref. No.	OK2686
description	tension spring		
For models:	9176-3, 9176-5, 9376-3-0, 9376-3-8, 9376-5-0		

			
GEV No.	700418	Ref. No.	OG1777 279268
description	tension spring for double-wall lid		
For models:	7576-3, 7776-3, 9041-3, 9042-3, 9045-3, 9046-3, 9101-2, 9101-3, 9101-5, 9104-2, 9104-3, 9104-5, 9113-3, 9113-5, 9241-3-0, 9241-3-8, 9242-3-0, 9242-3-8, 9245-3-0, 9245-3-8, 9246-3-0, 9246-3-8, 9301-3-0, 9301-3-8, 9301-5-0, 9301-5-8, 9304-3-0, 9304-3-8, 9304-5-0, 9304-5-8, 9313-3-0, 9313-3-8, 9313-5-0, 9313-5-8		

			
GEV No.	700419	Ref. No.	OG1778 279258
description	tension spring for double-wall lid		
For models:	7573-3, 7574-3, 7574-5, 7773-3, 7774-3, 7774-5, 9047-3, 9048-3, 9102-2, 9102-3, 9102-5, 9104-2, 9104-3, 9104-5, 9111-3, 9111-5, 9113-3, 9113-5, 9247-3-0, 9247-3-8, 9248-3-0, 9248-3-8, 9302-3-0, 9302-3-8, 9302-5-0, 9302-5-8, 9304-3-0, 9304-3-8, 9304-5-0, 9304-5-8, 9311-3-0, 9311-3-8, 9311-5-0, 9311-5-8, 9313-3-0, 9313-3-8, 9313-5-0, 9313-5-8		

			
GEV No.	700414	Ref. No.	OK2703 RZ20714310
description	tension spring for single-wall lid		
For models:	7744-3/85.KB.(N), 7544-3/85.KB.(N), 7544-3/90.KB.(N), 7744-3/90.KB.(N), 7748-3/90.KB.(N), 7747-3/90.KB.(N), 7541-3/85.KB.(N), 7543-3/85.KB.(N), 7543-3/90.KB.(N), 7547-3/85.KB.(N), 7548-3/85.KB.(N), 7547-3/90.KB.(N), 7548-3/90.KB.(N), 7743-3/85.KB.(N), 7743-3/90.KB.(N), 7747-3/85.KB.(N), 7748-3/85.KB.(N), 7544-3/85.KB.220V3, 7543-3/90.KB.EO.ETRO, 7748-3/85.KB.DWD.ETR, 7548-3/85.KB.DWD, 7544-2, 7544-3, 7548-3, 7744-2, 7744-3, 7748-3		

			
GEV No.	700415	Ref. No.	0H6903
description	tension spring for single-wall lid		
For models:	9041-3, 9042-2, 9042-3, 9043-3, 9044-3, 9241-3-0, 9241-3-8, 9242-3-0, 9242-3-8, 9243-3-0, 9243-3-8, 9244-3-0, 9244-3-8		

 <p>Image not available</p>			
GEV No.	700416	Ref. No.	OG1779
description	tension spring for single-wall lid		
For models:	7575-3, 7575-5, 7775-3, 7775-5, 9043-3, 9044-2, 9044-3, 9045-3, 9046-3, 9047-3, 9048-3, 9100-2, 9100-3, 9100-5, 9102-2, 9102-3, 9102-5, 9111-3, 9111-5, 9243-3-0, 9243-3-8, 9244-3-0, 9244-3-8, 9245-3-0, 9245-3-8, 9246-3-0, 9246-3-8, 9247-3-0, 9247-3-8, 9248-3-0, 9248-3-8, 9300-3-0, 9300-3-8, 9300-5-0, 9300-5-8, 9302-3-0, 9302-3-8, 9302-5-0, 9302-5-8, 9311-3-0, 9311-3-8, 9311-5-0, 9311-5-8		

			
GEV No.	700417	Ref. No.	0H6918
description	tension spring for single-wall lid		
For models:	9047-3, 9048-3, 9247-3-0, 9247-3-8, 9248-3-0, 9248-3-8		

			
GEV No.	504649	Ref. No.	048815
description	tension spring ø 10.5mm total length 274mm wire gauge ø 1.8mm		
For models:	LS61, LS61/60, LS6EP, LS6EP/DD, LS6EADD, LS6EA/DPDD, WT38T-DE, WT38/M50, LS6EADP3, LS6EADPWS, LS6EADPWSG, WT38WS, WT38WSG, WT38MEDWS, WT38PM50, WT37LEV/9, LS6EADPDWS, WT38DWS, LS6SANA, EUCAI, EUCAIDP, EUCAI60, EUCAIWS, WT38M50/4, LS6EA/UK, LS6EA/DPUK, EUCAIG, EUCAIWSG, EUCAIML, EUCAIMLWS, EUCAIMLG, EUCAICL, EUCAICLG, EUCAIWL, LS6EA/60, EUCAICLW, EUCI, EUCIM, EUCIM60, EUCAIDPNW, ZUCI, ZUCID, ZUCAI, ZUCAIDP, ZUCAIDPWS, ZUCAIG, ZUCAIDDWS, ZUCAID, ZUCAI60, EUCAIUSPH6...(Other models you can see in the webshop)		

			
GEV No.	695544	Ref. No.	085308
description	tension spring ø 10.5mm total length 42mm wire gauge ø 1.5mm		
For models:	IF29W, IF55W, IF75W, IF30W, IF29A, IF30A, IF55A, IF75A		

			
GEV No.	504639	Ref. No.	049086
description	tension spring ø 15.5mm total length 198mm wire gauge ø 1.5mm		
For models:	WT1WSDP, WT2TOP60, WT2DPDI, WT2WSDPDI, WT2TOPDI, LB2WS, LB2, LB2WSDP, WT2WSDP, WT2WSDPD, WT2WS, WT2TOP, WT2/3DP, WT2DPAUS, WT2, LB2DPDI, LB2WSDPDI, LB2WSDPD, LB2TOP, LB2DP3, WT2DPD3, NGW, NGWDPDD, GW2DPG, GW2WSDPG, GW2G, GW2WSG, GW2WS, GW2		

			
GEV No.	504638	Ref. No.	049200
description	tension spring ø 15mm total length 185mm wire gauge ø 1.5mm		
For models:	LB1, LB1WS, LB1WSDP, WT1WSDP, LB1TOP, WT1, WT1WS, WT1TOP, WT1/3DP, GW1, GW1WS		

			
GEV No.	700420	Ref. No.	056975
description	tension spring ø 20mm total length 60mm wire gauge ø 2.6mm		
For models:	MBR/G710D, MBR/E710D, RBR/G710D, 7BRE60XN, XBR/E710D, XBR/G751, XBR/G756, XBR/E716, RBR/E700, ZRBR/G700D		

			
GEV No.	540859	Ref. No.	OK2682
description	tension spring ø 25mm total length 274mm wire gauge ø 4.1mm		
For models:	7580-5.KK40, 7780-5.KK40, 7746-3/90.KB.(N), 7580-5/85.KK40.(N), 7580-5/90.KK40.(N), 7546-3/85.KB.(N), 7546-3/90., 7746-3/85.KB.(N), 7542-2, 7580-3, 7742-2, 7780-3, 7780-5/85.KK40.(N), 7780-5/90.KK40.(N), 9171-3, 9171-5, 9371-3-0, 9371-3-8, 9371-5-0, 9371-5-8		



GEV No.	693295	Ref. No.	0C0666
description	tension spring ø 29.5mm total length 310mm wire gauge ø 4.6mm		
For models:	KBR/G2F, KBR/G2C, KBR/G3F, KBR/G3FH, KBR/G3C, KBR/G3CH, KBR/E2F, KBR/E2C, KBR/E3F, KBR/E3FH, KBR/E3C, KBR/E3CH, KBR/G2FH, KBR/G2CH, KBR/E2FH, KBR/E2CH, QBR/G2F, QBR/G2C, QBR/G3F, QBR/G3FH, QBR/G3C, QBR/G3CH, QBR/E2F, QBR/E2C, QBR/E3F, QBR/E3FH, QBR/E3C, QBR/E3CH, QBR/G2FH, QBR/G2CH, QBR/E2FH, QBR/E2CH, WBR/G2F, WBR/G2C, WBR/G3F, WBR/G3FH, WBR/G3C, WBR/G3CH, WBR/E2F, WBR/E2C, WBR/E3F, WBR/E3FH, WBR/E3C, WBR/E3CH, WBR/G2FH, WBR/G2CH, WBR/E2FH, WBR/E2CH		



GEV No.	504684	Ref. No.	048655
description	tension spring ø 40mm total length 365mm wire gauge ø 4mm		
For models:	LS8D, LS8, LS8UK/RP, LC80, LS8F, LS8DEK, LS8/9, LS8/60, LS8/1UKRP, LS8/DP, WT50/9, WT50/UK9RF, WT50/F9, WT50/6, WT50/1UKRP, WT50/1, D800/9, D800/6, WT50/60, WT50/N, LS8/HD, WT50/J50, WT50/J60, LS8/UK1, LS8UK3, WT50/UK1, WT50/UK3, LS8/9DD, LS8DEK, HT800, HYDRA800, Z80		



GEV No.	700413	Ref. No.	0K2039
description	tension spring ø 29mm total length 210mm wire gauge ø 4.1mm		
For models:	7542-3/85., 7542-3/90.KB.(N), 7742-3/90.KB.(N), 7742-3/85.KB.(N), 7746-3/90.KB.(N), 7541-3/85.KB.(N), 7541-3/90.KB.(N), 7545-3/85.KB.(N), 7546-3/85.KB.(N), 7545-3/90.KB.(N), 7546-3/90., 7741-3/85.KB.(N), 7741-3/90.KB.(N), 7745-3/90.KB.(N), 7745-3/85.KB.(N), 7746-3/85.KB.(N), 7542-3/85.KB.DWD, 7545-3/85.KB.DWD, 7742-3/85.KB.DWD.ETR, 7541-3/90.KB.EO.ETRO, 7742-3/85.KB.DWD, 7542-2, 7542-3, 7546-3, 7742-2, 7742-3, 7746-3		



GEV No.	504685	Ref. No.	049582
description	tension spring ø 40mm total length 750mm wire gauge ø 5.5mm		
For models:	LS10, LS14EA, LS10UKDP, ET12E, LS10/60HZ, LS10CW, LS10INS, HT1200INS, LS14EA, LS10N, LS10DP, LS10HD, LS14EA/60, LS10UK/1, LS10UK/3, LS12INS, LS12, LS12DP, LS12/60HZ, LS12CW, HT1200DEK, LS14EAASIA, LS14EA/G, WT60DP, WT60, WT60CW, WT60UKD-PCW, WT60INS, WT60INSCW, WT60NAUCW, WT60NAU, LS10EA, WT60/60HZ, WT60/60HZC, WT60N, WT609NINS, LS12HD, LS14EAI/DD, WT65E, WT65EB, WT65EI, WT60NAUDP, LS12UK/3CW, LS12NAU, LS12UKDPCW, ECOTEMP12S, WT65EBI, WT65E60, WT65EB60, WT60U40050...(Other models you can see in the webshop)		



GEV No.	540858	Ref. No.	0K2683
description	tension spring ø 34.4mm total length 285mm wire gauge ø 5.3mm		
For models:	7581-5.KK60, 7582-5.KK80, 7583-5.KK100, 7781-5.KK60, 7782-5.KK80, 7783-5.KK100, 7580-5.KK40, 7584-5.KK150, 7780-5.KK40, 7580-5/85.KK40.(N), 7581-5/85.KK60.(N), 7582-5/85.KK80.(N), 7583-5/85.KK100.(N), 7584-5-85.KK150.(N), 7580-5/90.KK40.(N), 7581-5/90.KK60.(N), 7582-5/90.KK80.(N), 7583-5/90.KK100.(N), 7584-5-90.KK150.(N), 7580-3, 7581-3, 7582-3, 7582-5, 7583-3, 7584-3, 7780-3, 7780-5/85.KK40.(N), 7780-5/90.KK40.(N), 7781-3, 7781-5/85.KK60.(N), 7781-5/90.KK60.(N), 7782-3, 7782-5, 7782-5/85.KK80.(N), 7782-5/90.KK80.(N), 7783-3, 7783-5/85.KK100.(N), 7783-5/90.KK100.(N), 7784-3, 7784-5.KK150, 7784-5/85.KK150.(N), 7784-5/90.KK150.(N), 9173-3, 9173-5, 9373-3-0, 9373-3-8, 9373-5-0, 9373-5-8		



GEV No.	504682	Ref. No.	046615
description	tension spring ø 50mm total length 290mm L2 165mm		
For models:	LS720F, LSE720DK, LSE720PH, LSE721F, LSE721, LS720, LSE720UK, LS721UK, LSE720D, 652120Z, LS720N, LSE720Z		



GEV No.	693289	Ref. No.	0A5150
description	tension spring ø 36.5mm total length 240mm wire gauge ø 6.9mm		
For models:	HBR/G800, HBR/G805, HBR/G801, HBR/G806, HBR/G810, HBR/G815, HBR/G811, HBR/G816, HBR/G800D, HBR/G805D, HBR/G801D, HBR/G806D, HBR/G810D, HBR/G815D, HBR/G811D, HBR/G816D, HBR/E800, HBR/E805, HBR/E801, HBR/E806, HBR/E810, HBR/E815, HBR/E811, HBR/E816, HBR/G800NL, HBR/G805NL, HBR/G810NL, HBR/G800UK, HBR/E800UK, HBR/G800, HBR/G805, HBR/G810, HBR/G815, HBR/G811, HBR/G816, HBR/E800, HBR/E805, HBR/E810, HBR/E815, HBR/E811, HBR/E816, HBR/G800UK, HBR/E800UK, ZBR/G800, ZBR/G805, ZBR/G801, ZBR/G806, ZBR/G810, ZBR/G815, ZBR/G811...(Other models you can see in the webshop)		



GEV No.	695108	Ref. No.	085301
description	tension spring ø 6.3mm total length 21mm wire gauge ø 0.5mm		
For models:	IF29W, IF55W, IF75W, IF30W, IF29A, IF30A, IF55A, IF75A		



GEV No.	504686	Ref. No.	048258
description	tension spring ø 39.3mm total length 493mm wire gauge ø 4.1mm		
For models:	LS10D, LS10, LS10UKRP, LC100, ECOTEMP12-, LS10/60, LS10/1, LS10/12KW, LS10F, LS10DEK, LS10/1UKRP, LS10SW, LS10/50J, LS10/60J, LS10DP, LS10/HD, SH55, LO10, LS10/UK1, LS10/UK3, LS12D, LS12, LS12UK/RP, LC120, LS12DP, LS12/60, LS12F, LS12DEK, LS12HD, LS12/UK3, LS12MEX, LS10N, HT1200elm, HT1000elm, HYDRA1200, HYDRA1000, LSCE12		



GEV No.	693294	Ref. No.	0C0671
description	tension spring ø 70mm total length 355mm wire gauge ø 10mm		
For models:	KBR/G2F, KBR/G2C, KBR/G3F, KBR/G3FH, KBR/G3C, KBR/G3CH, KBR/E2F, KBR/E2C, KBR/E3F, KBR/E3FH, KBR/E3C, KBR/E3CH, KBR/G2FH, KBR/G2CH, KBR/E2FH, KBR/E2CH, QBR/G2F, QBR/G2C, QBR/G3F, QBR/G3FH, QBR/G3C, QBR/G3CH, QBR/E2F, QBR/E2C, QBR/E3F, QBR/E3FH, QBR/E3C, QBR/E3CH, QBR/G2FH, QBR/G2CH, QBR/E2FH, QBR/E2CH, WBR/G2F, WBR/G2C, WBR/G3F, WBR/G3FH, WBR/G3C, WBR/G3CH, WBR/E2F, WBR/E2C, WBR/E3F, WBR/E3FH, WBR/E3C, WBR/E3CH, WBR/G2FH, WBR/G2CH, WBR/E2FH, WBR/E2CH		



GEV No.	695435	Ref. No.	085300
description	tension spring ø 9.2mm total length 24mm wire gauge ø 1.6mm		
For models:	IF29W, IF55W, IF75W, IF30W, IF29A, IF30A, IF55A, IF75A		



1

GEV No.	517425	Ref. No.	075633 30213075
description	tension spring ø 9mm total length 22mm wire gauge ø 0.7mm Qty 1 pcs		
For models:	CT92DXE, CT92SX, CT92DXEUK, CT92SXEU, CT92DXV, CT92SXV, CT92DXVUK, CT92SXVUK, CT140EDX, CT140ESX, CT140EDXUK, CT140SXEU, CT140VDX, CT140VSX, CT141EDX, CT141ESX, CT141EDXUK, CT141ESUK, CT141VDX, CT141VSX, CT142DXE, CT142SX, CT142DXEUK, CT142SXEU, CT142DXV, CT142SXV, CT190DXE, CT190SX, CT190DXEUK, CT190SXEU, CT190DXV, CT190SXV, CT191DXE, CT191SX, CT191DXEUK, CT191SXEU, CT191DXV, CT191SXV, CT192DXE, CT192SX, CT192DXEUK, CT192SXEU, CT192DXV, CT192SXV, CT240DXE, CT240SX, CT240DXEUK, CT240SXV, CT240SXVUK...(Other models you can see in the webshop)		

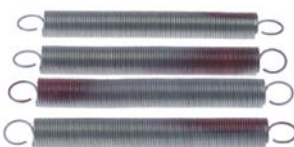

1

GEV No.	701164	Ref. No.	031370
description	tension spring set 4-piece ø 17mm total length 165mm wire gauge ø 1.5mm for plate dispensers		
For models:	WMMHPLUK, SM15/CS., CMS, CS3, DI-TBLI, DI-TBL2, DI-DL260, DI-DL310, DS/PCC2, DS/PCC4, SM08C, SM15C, SM15/CS, SM21C, CMSEL/SOL, ZSM08/C, ZSM15/C, ZSM15/CS, ZSM21/C		

SS 18/10 - perforated



1

GEV No.	993292	Ref. No.	050899
description	GN container SS size GN 1/1 perforated D 65mm		

baking sheets



1

GEV No.	694965	Ref. No.	0KI553
description	baking sheet W 265mm L 325mm H 40mm SS GN 1/2 perforated inner edges rounded suitable for combi-steamer		
For models:	7CO30, CCO30G, ECO312CF, OTS100		

manometers



1

GEV No.	541365	Ref. No.	0H6500 8536317
description	manometer ø 100mm pressure range 0 up to 1.6bar thread 1/2" marking 0.40 bar		



1

GEV No.	541579	Ref. No.	003535 008022 017055 0K3443 0U1434 10022 36303604 36303605 52027020
description	manometer ø 52mm pressure range 0 up to 1bar connection marking 0.5 thread 1/4"		
For models:	KPI/G18, KPI/G25, KPI/E25, CRN15V, HPN/GI855, HPN/GI1255, HPN/EI855, HPN/EI1255, HCPA/GI 1219, CR20V, CR20EI, QPI/G18, QPI/G25, QPI/E25, CRN15V-Z, ZPN/GI1255, ZPN/EI1255, ZCPA/GI 1219, CR20V, CR20EI, WPI/E25, CRN15VA, PV101, PV201, PV301, PV501, PVA101, PVA201, PVA301, PVA501, HCPA/GI1219, HCPA/V1219, HCPA/EI1219, CPD42V-Z, CR42V, CR/40V, CR15V, CR15E, CPD40VZ, CR/41V, CR/42V, CR40V, HQN/G1917, HQN/G1917, HQN/GI1225, HQN/EI917, HQN/GI122, HQN/V917, HQN/EI1225, HPN/GI810...(Other models you can see in the webshop)		

kitchen accessories

gastronorm

GN containers

SS 18/10 - standard



1

GEV No.	993020	Ref. No.	050871	
description	GN container SS 18/10 size GN 1/1 D 40mm			
accessories for	993020			
	GEV No.	993074	Ref. No.	—
lid SS 18/10 size GN 1/1 for GN container				





			
1			
GEV No.	541798	Ref. No.	058941
description	manometer ø 52mm pressure range 0-6bar connection lower thread 1/4"		
For models:	FCV/G6L3TOWNGAS, FCV/G6L3, FCV/E101/1, FCVE6L3J, FCV/G6L3JAP, FCVG6L3CJ, FCV/E61/1, FCV/G10L2, FCV/E10L2, FCV/E61/1, FCV/G6L3C, FCV/G61/1, FCVG6L3CT, FCVG6L3CJ, FCV/E6L3, FCV/E101/1, FCS061E44J, FCS061G48J, FCS061G3DI, FCS061E3CI, FCS101E2, FCS061G4DT, FCS061G49J, FCS101G2, FCVG10-ISG, FCVMG62, ECV/G6T4C, ECV/E101GP, RCV061G2, RCV061E2, RCV101G2, RCV101E2, ACV/G10C2, ACV/E10C2, ACV/G6C3, ACV/G6C3C, ACV/E6C3, NCV/G6L2, NCV/G10L2, NCV/E6L2, NCV/E10L2, FCVG10-ISG, ZCV/G6T4C		

			
1			
GEV No.	541339	Ref. No.	0C0712
description	manometer ø 62.4mm pressure range 0 up to 1bar thread 1/8" marking connection		
For models:	KPI/G10, KPI/G15, KPI/E10, KPI/E15, KPI/G15A, KPI/E15A, KPI/G06, KPI/E06, KPI/G15H, KPI/E15H, KPI/G10H, KPI/E10H, QPI/G10, QPI/G15, QPI/E10, QPI/E15, QPI/G06, QPI/E06, QPI/G15H, QPI/E15H, QPI/G10H, QPI/E10H, WPI/G10, WPI/G15, WPI/E10, WPI/E15, WPI/G15A, WPI/E15A, WPI/G06, WPI/E06, WPI/G15H, WPI/E15H, WPI/G10H, WPI/E10H		

			
1			
GEV No.	541334	Ref. No.	059515
description	manometer ø 60mm pressure range 0 up to 1bar thread 1/8" marking 0.5 kettle connection on the backside		
For models:	HPN/GI810, HPN/GI815, HPN/GI816, HPN/EI815D, HPN/EI810, HPN/EI815, HPA/GI825, HPA/EI825, HPNS/GI816, HPNS/EI815, HPNS/EI815D, HPN/GI806, HPN/EI806, HPN/GI805, HPN/EI805, ZPN/GI810, 2PIG15, ZPN/GI816, ZPN/EI815D, ZPN/EI810, ZPN/EI815, 2PIAG15, ZPNS/GI816, ZPNS/EI815, ZPNS/EI815D, ZPN/GI805, ZPN/EI805, APN/GI810, APN/GI815, APN/GI816, APN/GI816D, APN/EI815D, APN/EI810, APN/EI815, APN/GD811, APN/GD816, APN/ED816, APNS/GI816, APNS/EI815, OPN/GI815, APN/GI805, APN/EI805		

			
1			
GEV No.	541355	Ref. No.	0H6486
description	manometer ø 63mm pressure range 0 up to 1.6bar connection on the backside marking 1 thread 1/4"		

			
1			
GEV No.	541337	Ref. No.	0H6495 0KE628
description	manometer ø 60mm pressure range -1.5 up to +1.5bar connection on the backside marking 1.1 thread 1/4"		
For models:	7561-3.KES60.RW, 7562-3.KES80.RW, 7563-3.KES100.RW, 7564-3.KES150.RW, 7751-3/85.KES60, 7550-3/85.KES40.(N), 7551-3/85.KES60, 7552-3/85.KES80.(N), 7553-3/85.KES100.(N), 7554-3/85.KES150.(N), 7550-3/90.KES40.(N), 7551-3/90.KES60, 7552-3/90.KES80.(N), 7553-3/90.KES100.(N), 7554-3/90.KES150.(N), 7561-3/85.KES60.RW., 7562-3/85.KES80.RW., 7563-3/85.KES100.RW., 7564-3/85.KES150.RW., 7561-3/90.KES60.RW., 7562-3/90.KES80.RW., 7563-3/90.KES100.RW., 7564-3/90.KES150.RW., 7573-3/85.KES100.(N), 7574-3/85.KES150.(N), 7575-3/85.KES250.(N), 7576-3/85.KES300.(N), 7573-3/90.KES100.(N), 7574-3/90.KES150.(N), 7575-3/90.KES250.(N), 7576-3/90.KES300.(N), 7585-3/85.KK40.MOTK., 7586-3/85.KK60.MOTK., 7587-3/85.KK80.MOTK., 7588-3/85.KK100.MOTK., 7585-3/90.KK40.MOTK., 7586-3/90.KK60.MOTL., 7587-3/90.KK80.MOTK., 7588-3/90.KK100.MOTK., 7550-2, 7550-3, 7551-2, 7551-3, 7552-2, 7552-3, 7553-2, 7553-3, 7554-3, 7560-3, 7561-3...(Other models you can see in the webshop)		

			
1			
GEV No.	541062	Ref. No.	0H6487 0KC083 236116 9151915
description	manometer ø 63mm pressure range 0 up to 1bar connection marking adjustable kettle thread 1/4"		
spare parts for	541062		
	GEV No.	541130	Ref. No.
			—
	 glass panel ø 58mm thickness 2mm		

			
1			
GEV No.	541336	Ref. No.	OK1796 236110
description	manometer ø 63mm pressure range 0 up to 1bar thread 1/4"		



1

GEV No.	541460	Ref. No.	0H9970 0K2991 0K5402 129648 19003764 9877132KL16
description	manometer pressure range 0 up to 2.5bar marking 1.3		
For models:	VARIOSTEAM/S-33.3/F, STEAM-O-MAT		



1

GEV No.	548455	Ref. No.	0L0454 0L0677 4PP1840000
description	spray gun for appliances 3/8" IT		

hose reels and spray guns

spray guns



1

GEV No.	542964	Ref. No.	00920003 050323 7RBF920003
description	spray gun for appliances 1/2" ET L 135mm		



1

GEV No.	542038	Ref. No.	003175 0K1055 903030 9030302
description	spray gun for appliances 3/8" IT L 135mm		
For models:	DCS		



1

GEV No.	549332	Ref. No.	003167 7I003167 9030100
description	spray gun for appliances 1/2" IT L 215mm type ZANUSSI		
accessories for	549332		
	GEV No.	520168	Ref. No. —
	double nipple nickel-plated brass thread 1/2" - 1/2" Qty 1 pcs		



1

GEV No.	542395	Ref. No.	0S0662
description	spray gun for appliances set 1/2" IT type KLARCO		





1

GEV No.	520532	Ref. No.	003170
description	shower hose connections 3/8" L 1600mm EPDM t.max. 110°C burst p. 10bar for combi-steamer		
For models:	DCS		



			
1			
GEV No.	540675	Ref. No.	003164
description	shower head		

			
1			
GEV No.	542966	Ref. No.	003513 4PP040000 9030070
description	wall holder for hand spray		

			
1			
GEV No.	545800	Ref. No.	0C1128 873835800
description	hose reel complete with spray gun hose length 1.6m		
For models:	AOS201EB, AOS201EB3J, AOS201EB2N, AOS202EB2N, AOS201EB0H, AOS202EB, AOS201GB, AOS202GB, AOS201EBAQ, AOS202EBAQ, AOS201EBNQ, AOS202EBNQ, AOS201EBCQ, AOS201EBHQ, AOS201EBFQ, AOS201GBGQ, AOS202GBGQ, AOS201GBDQ, AOS202GBDQ		

hose reels

appliance hose reels

			
1			
GEV No.	542357	Ref. No.	0C4248
description	hose reel complete hose length 1.3m connection 1/8" hose ø 13mm		
For models:	FCZ061EAA, FCZ101EAA, FCZ102EAA, FCZ061EAH, FCZ101EAH, FCZ061EAN, FCZ101EAN, FCZ061ETA, FCZ101ETA, FCZ102ETA, FCZ061ETH, FCZ101ETH, FCZ061ETN, FCZ101ETN, FCZ061GAG, FCZ101GAG, FCZ102GAG, FCZ061GAD, FCZ101GAD, FCZ102GAD, FCZ101GTG, FCZ102GTG, FCZ101GTD, FCZ102GTD, FCZ061EBA, FCZ101EBA, FCZ102EBA, FCZ061EBH, FCZ101EBH, FCZ061EBN, FCZ101EBN, FCZ061EBC, FCZ101EBC, FCZ061EBA2, FCZ101EBA2, FCZ102EBA2, FCZ061EBH2, FCZ101EBH2, FCZ061EBN2, FCZ101EBN2, FCZ061EBC2, FCZ101EBC2, FCZ061GBI, FCZ101GBI, FCZ101GBG2, FCZ102GBG2, FCZ101GBD2, FCZ102GBD2, FCZ101GBI2, FCZ102GBI2...(Other models you can see in the webshop)		

			
1			
GEV No.	545178	Ref. No.	007039 0C1156
description	hose reel for combi-steamer complete with spray gun hose length 1.6m connection 1/2" IT hose ø 12mm hose type EPDM		
For models:	AOS061EA, AOS061EB, AOS101EA, AOS101EB, AOS061EA3J, AOS061EB3J, AOS101EA3J, AOS101EB3J, AOS061EA2N, AOS061EB2N, AOS101EA2N, AOS101EB2N, AOS061EA0H, AOS061EB0H, AOS101EA0H, AOS101EB0H, AOS061GA, AOS101GA		

spare parts and accessories

miscellaneous

			
1			
GEV No.	545179	Ref. No.	003701
description	spring for hose reel thickness 1mm for hose 6x12mm spring steel combi-steamer		
For models:	DCS		

			
1			
GEV No.	542397	Ref. No.	0C2218
description	hose reel complete with spray gun hose length 1.4m hose ø 6.3x13.2mm hose type silicone SS		
For models:	AOS061GAEU, AOS101GAEU, AOS061GAAU, AOS101GAAU, AOS061EABU, AOS101EABU, AOS061EAFU, AOS101EAFU, AOS061EA, AOS061EB, AOS101EA, AOS101EB, AOS061EA3J, AOS061EB3J, AOS101EA3J, AOS101EB3J, AOS061EA2N, AOS061EB2N, AOS101EA2N, AOS101EB2N, AOS061EA0H, AOS061EB0H, AOS101EA0H, AOS101EB0H, AOS101GA, AOS101GB		

dosing pumps

peristaltic dosing pumps





GERMAC

built-in version

with frequency control



1

GEV No.	361267	Ref. No.	0U1032 20128 20588
description	dosing pump GERMAC frequency control 2l/h 230VAC detergent hose ø 4x6mm hose thermoplastic type G202 4W built-in version peristaltic pump dimensions 62x70x93mm		
For models:	LBIOEQ010, G350, G350DP, LBIOEQ014, G400, G400DP		
spare parts for	361267		
	GEV No.	361263	Ref. No. —
	roller assembly GERMAC suitable for G80/82/150/152/200/202/250/252/600		
	GEV No.	361554	Ref. No. —
	pump hose GERMAC detergent hose type thermoplastic hose ø 5x8mm for model G200/G250/G252		
	GEV No.	361556	Ref. No. —
	control PCB type G82/G152/G202/G252 GERMAC		
accessories for	361267		
	GEV No.	361106	Ref. No. —
	container filter with weight and non-return valve SS hose ø 4x6mm ø 21mm L 51mm non return valve lip valve		
	GEV No.	520090	Ref. No. —
	PVC hose ID ø 4mm ED ø 6mm L 2m thickness 1mm t.max. 60°C transparent		
	GEV No.	520091	Ref. No. —
	nylon hose ID ø 4mm ED ø 6mm L 2m thickness 1mm operating p. 10bar burst p. 50bar t.max. 100°C transparent		





SEKO

wall-mounted version

with speed control



1

GEV No.	361163 ¹	Ref. No.	0S0671 3090304 PPR0301A2000
description	dosing pump SEKO speed control 0.15-1l/h 230VAC rinse aid hose ø 4x6mm hose type D hose Sekobril suction level 1.5m type PR counter pressure 3bar dimensions 103x82x92mm		
spare parts for	361163		
	GEV No.	361135	Ref. No. 049418 9900090098
	pump hose SEKO rinse aid hose ø 3x8mm hose ø 4x6mm hose type D hose Sekobril		
	GEV No.	361136	Ref. No. —
	roller assembly for dosing pump hole ø 4.8x4mm		
accessories for	361163		
	GEV No.	361144	Ref. No. —
	mounting set rinse aid hose type 4x6mm hose length 2m PVC/nylon hose container filter/non-return valve transparent		
	GEV No.	520090	Ref. No. —
	PVC hose ID ø 4mm ED ø 6mm L 2m thickness 1mm t.max. 60°C transparent		
	GEV No.	520091	Ref. No. —
	nylon hose ID ø 4mm ED ø 6mm L 2m thickness 1mm operating p. 10bar burst p. 50bar t.max. 100°C transparent		

¹with accessories







1

GEV No.	361156 ¹	Ref. No.	0S0669 3090303 PPR0004A1000
description	dosing pump SEKO speed control 0.6-4l/h 230VAC detergent hose ø 4x6mm hose type K hose Santoprene suction level 1.5m type PR wall-mounted version dimensions 103x82x92mm		
spare parts for	361156		
	GEV No.	361136	Ref. No. —
	roller assembly for dosing pump hole ø 4.8x4mm		

¹with accessories

Table continues overleaf









spare parts for 361156				
	GEV No.	361815	Ref. No.	049419 050678 3090351 9900090057
pump hose detergent hose ø 6x10mm hose ø 4x6mm hose type K hose Santoprene type SEKO				
accessories for 361156				
	GEV No.	361142	Ref. No.	—
mounting set detergent hose type 4x6mm hose length 2m PVC 2x hose/container filter/tank intake transparent				
	GEV No.	361891	Ref. No.	—
mounting set detergent hose type 4x6mm hose length 2m PVC 2x hose/container filter/tank intake transparent				
	GEV No.	520090	Ref. No.	—
PVC hose ID ø 4mm ED ø 6mm L 2m thickness 1mm t.max. 60°C transparent				
	GEV No.	520091	Ref. No.	—
nylon hose ID ø 4mm ED ø 6mm L 2m thickness 1mm operating p. 10bar burst p. 50bar t.max. 100°C transparent				

built-in version

with frequency control







GEV No.	361215	Ref. No.	049469 050707 051710 NBR003A1032 PBR0003A1016	
description	dosing pump SEKO frequency control 0.3-3.0l/h 230VAC detergent hose ø 4x6mm hose type K hose Santoprene suction level 1.5m type PBR protection IP55 dimensions 100x67x68mm power input 3.5W			
For models:	WT1WSDP, WT2DPDI, WT2WSDPDI, WT2TOPDI, WT2WSDP, WT2WSDPD, LB2DPDI, LB2WSDPDI, LB2WSDPD, WT2DPD3, NGWDPDD, LS8DEK			
spare parts for 361215				
	GEV No.	361136	Ref. No.	—
roller assembly for dosing pump hole ø 4.8x4mm				
	GEV No.	361226	Ref. No.	—
PCB L 59mm W 26mm electronic control				
	GEV No.	361815	Ref. No.	049419 050678 3090351 9900090057
pump hose detergent hose ø 6x10mm hose ø 4x6mm hose type K hose Santoprene type SEKO				
accessories for 361215				
	GEV No.	361142	Ref. No.	—
mounting set detergent hose type 4x6mm hose length 2m PVC 2x hose/container filter/tank intake transparent				
	GEV No.	520090	Ref. No.	—
PVC hose ID ø 4mm ED ø 6mm L 2m thickness 1mm t.max. 60°C transparent				

accessories for 361215				
	GEV No.	520091	Ref. No.	—
nylon hose ID ø 4mm ED ø 6mm L 2m thickness 1mm operating p. 10bar burst p. 50bar t.max. 100°C transparent				







with time control









GEV No.	361211 ¹	Ref. No.	050706 PBM030HA2000	
description	dosing pump SEKO with single time control 0.4l/h 230VAC rinse aid hose ø 4x6mm hose type D hose Sekobril suction level 1.5m type PBM built-in version dosing time 1-20s			
spare parts for 361211				
	GEV No.	361135	Ref. No.	049418 9900090098
pump hose SEKO rinse aid hose ø 3x8mm hose ø 4x6mm hose type D hose Sekobril				
	GEV No.	361136	Ref. No.	—
roller assembly for dosing pump hole ø 4.8x4mm				
accessories for 361211				
	GEV No.	361144	Ref. No.	—
mounting set rinse aid hose type 4x6mm hose length 2m PVC/nylon hose container filter/non-return valve transparent				
	GEV No.	520090	Ref. No.	—
PVC hose ID ø 4mm ED ø 6mm L 2m thickness 1mm t.max. 60°C transparent				
	GEV No.	520091	Ref. No.	—
nylon hose ID ø 4mm ED ø 6mm L 2m thickness 1mm operating p. 10bar burst p. 50bar t.max. 100°C transparent				

¹with accessories



without control			
			
1			
GEV No.	361150 ¹	Ref. No.	049311 049416 049625 0KE953 0L0506 0L0697 0S0704 NPG030HA2022 PPG030HA2015 PPG030HA2018
description	dosing pump SEKO without control 0.4l/h 230VAC rinse aid hose ø 4x6mm hose type D hose Sekobril suction level 1.5m horizontal/vertical type PG dimensions 67x95x52mm		
For models:	LS32UK/RP, WT302UK/RP, WT4DG, WT4WS1, LS33UK/RP, WT4BWS, WT4DWS1, WT4BDWS, WT303UK/RP, EUC1WS, EUC1DPWS, EUC3WS, EUC3DPWS, ZUCADDROW, ZUCADDROW6, LS5/1WS, LS5/1WSDP, LS5/3WS, LS5/3WSDP, FUCA3DD, LS5/3WSDPD, LB5DPG, NUC1WS, NUC1DPWS, NUC3WS, NUC3DPWS, NUC3DDWS, ZUCA1, ZUCA3, EUCADDROW, EUCADDROW6, LS6EADD, LS6EA/DPDD, WT38TDE, WT38/M50, LS6EADP3, LS6EADPWS, LS6EADPWSG, WT38WS, WT38WSG, WT38MEDWS, WT37LEV/9, LS6EADPDWS, WT38DWS, LS6SANA, EUCAI, EUCAIDP, EUCAI60, EUCAIWS, WT38M50/4...(Other models you can see in the webshop)		
spare parts for	361150		
	GEV No.	361135	Ref. No. 049418 9900090098
	pump hose SEKO rinse aid hose ø 3x8mm hose ø 4x6mm hose type D hose Sekobril		
	GEV No.	361136	Ref. No. —
	roller assembly for dosing pump hole ø 4.8x4mm		
	GEV No.	361562	Ref. No. —
	pump cover for dosing pump yellow		
accessories for	361150		
	GEV No.	361144	Ref. No. —
	mounting set rinse aid hose type 4x6mm hose length 2m PVC/nylon hose container filter/non-return valve transparent		
	GEV No.	570123	Ref. No. —
	PVC hose ID ø 4mm ED ø 6mm L 3.5m thickness 1mm t.max. 60°C transparent		



¹with accessories

			
1			
GEV No.	361152 ¹	Ref. No.	049312 049624 0KE952 0L0696 0S0705 NPG0003A1027 PPG0003A1021 PPG0003A1022
description	dosing pump SEKO without control 3l/h 230VAC detergent hose ø 4x6mm hose type K hose Santoprene suction level 1.5m horizontal/vertical type PG built-in version dimensions 67x95x52mm		
For models:	LS32, LS32/4.5, LS32UK/RP, LS32F, LV32F, C55, LV32/60, WT302UK/RP, WT4DG, LS33, LS33/4.5, LS33UK/RP, LS33F, LV33F, C55A, LS33/60, WT303UK/RP, NUC3DD, WT4DDG, EUC1G, EUC3DD, ZUCADDROW, ZUCADDROW6, FUCA3DD, LS5/3WSDPD, LB5DPG, NUC3DDWS, EUCADDROW, EUCADDROW6, LS6EP, LS6EP/DD, LS6EADD, LS6EA/DPDD, WT38TDE, WT38/M50, LS6EADP3, LS6EADPWSG, WT38WSG, WT38PM50, LS6EADPDWS, WT38DWS, LS6SANA, WT38M50/4, LS6EA/UK, LS6EA/DPUK, EUCAIG, EUCAIWSG, EUCAIMLG, EUCAICL, EUCAICLG...(Other models you can see in the webshop)		
spare parts for	361152		
	GEV No.	361136	Ref. No. —
	roller assembly for dosing pump hole ø 4.8x4mm		
	GEV No.	361562	Ref. No. —
	pump cover for dosing pump yellow		
	GEV No.	361815	Ref. No. 049419 0S0678 3090351 9900090057
	pump hose detergent hose ø 6x10mm hose ø 4x6mm hose type K hose Santoprene type SEKO		
accessories for	361152		
	GEV No.	361142	Ref. No. —
	mounting set detergent hose type 4x6mm hose length 2m PVC 2x hose/container filter/tank intake transparent		
	GEV No.	520090	Ref. No. —
	PVC hose ID ø 4mm ED ø 6mm L 2m thickness 1mm t.max. 60°C transparent		
	GEV No.	520091	Ref. No. —
	nylon hose ID ø 4mm ED ø 6mm L 2m thickness 1mm operating p. 10bar burst p. 50bar t.max. 100°C transparent		

¹with accessories



spare parts			
			
GEV No.	361815	Ref. No.	049419 050678 3090351 9900090057
description	pump hose detergent hose ø 6x10mm hose ø 4x6mm hose type K hose Santoprene type SEKO		
For models:	WT4DG, WT4WS1, WT4BWS, WT4DWS1, WT4BDWS, EUC1WS, EUC1DPWS, EUC3WS, EUC3DPWS, ZUCADDROW, ZUCADDROW6, LS5/1WS, LS5/1WSDP, LS5/3WS, LS5/3WSDP, FUCA3DD, LS5/3WSDPD, LB5DPG, NUC1WS, NUC1DPWS, NUC3WS, NUC3DPWS, NUC3DDWS, ZUCA1, ZUCA3, EUCADDROW, EUCADDROW6, LS6EP, LS6EP/DD, LS6EADD, LS6EA/DPDD, WT38TDE, WT38/M50, LS6EADP3, LS6EAD-PWS, LS6EADPWSG, WT38WS, WT38WSG, WT38MEDWS, WT38PM50, WT37LEV/9, LS6EADPDWS, WT38DWS, LS6SANA, EUCAI, EUCAIDP, EUCAI60, EUCAIWS, WT38M50/4, LS6EA/UK...(Other models you can see in the webshop)		









			
GEV No.	361135	Ref. No.	049418 9900090098
description	pump hose SEKO rinse aid hose ø 3x8mm hose ø 4x6mm hose type D hose Sekobril		
For models:	WT4DG, WT4WS1, WT4BWS, WT4DWS1, WT4BDWS, EUC1WS, EUC1DPWS, EUC3WS, EUC3DPWS, ZUCADDROW, ZUCADDROW6, LS5/1WS, LS5/1WSDP, LS5/3WS, LS5/3WSDP, FUCA3DD, LS5/3WSDPD, LB5DPG, NUC1WS, NUC1DPWS, NUC3WS, NUC3DPWS, NUC3DDWS, ZUCA1, ZUCA3, EUCADDROW, EUCADDROW6, LS6EADD, LS6EA/DPDD, WT38TDE, WT38/M50, LS6EADP3, LS6EADPWS, LS6EAD-PWSG, WT38WS, WT38WSG, WT38MEDWS, WT37LEV/9, LS6EAD-PDWS, WT38DWS, LS6SANA, EUCAI, EUCAIDP, EUCAI60, EUCAIWS, WT38M50/4, LS6EA/UK, LS6EA/DPUK, EUCAIG, EUCAIWSG...(Other models you can see in the webshop)		
spare parts for	361135		
			
GEV No.	361866	Ref. No.	—
union nut for hose connector ø 17mm			

piston pumps			
with solenoid coil			
			
GEV No.	361740	Ref. No.	048580
description	dosing pump inlet 4x6mm outlet 5mm 230V rinse aid duty cycle 25% type EKP-M 50Hz impulse 3imp/s		
For models:	WT40/9, WT40/F, LS8D, LS8, LS8UK/RP, LC80, LS8F, LS8DEK, LS8/9, LS8/60, LS8/1UKRP, WT50/9, WT50/UK9RF, WT50/F9, WT50/6, WT50/1UKRP, WT50/1, HT800, Z80		
spare parts for	361740		
			
GEV No.	361811	Ref. No.	—
hose connector for dosing pump hose ø 6.3mm T1: M12x1.5 chrome-plated brass			

accessories for	361740		
			
GEV No.	361505	Ref. No.	—
screw pipe fitting straight nickel-plated brass thread 3/8" IT hose ø 6x8mm			



spare parts			
			
GEV No.	361113	Ref. No.	069479 201002 30003481
description	solenoid coil 230VAC for type DB2		
For models:	LTB11, LTB12, LTB22, LTB11UK, LTB12UK, LTB22UK, LTB11, LTB22, 910-00-021, 910-00-023, 910-00-031, 910-00-033, 911-00-022, 911-00-024, 911-00-032, 911-00-034, CRYSTAL 11, CRYSTAL 22		



membrane dosing pumps

self-priming			
LANG			
			
GEV No.	361008 ¹	Ref. No.	045478
description	dosing pump type N6 with special hose set rinse aid pressure connection ø angled, 4x6mm suction connection ø straight, 4x6mm suction connection straight, M10x1		
For models:	LS360F, LS365F, LS365PH, LS500F, LS501F, LS540F, LS540DK, LS541F, LS360D, LS365D, LS360, LS365, LS360/63, LS365/63, LS367, LS720F, LSE720DK, LSE720PH, LS860F, LS860DK, LS860PH, LS1080F, LS1080UK, LS1080PH, LSE721F, LS861F, LS540, LS1080M, LS1080, LS1080D, LS1080UK, LS1080/63, LSDS51, LSDS5V, LS500F, LS500UK, LS501, LS501UK, LS540D, LS540/63, LSE721, LS720, LSE720UK, LS721UK, LSE720D, LS541, LS860, LS860, LS860D, LS860UK...(Other models you can see in the webshop)		
spare parts for	361008		
			
GEV No.	361079	Ref. No.	—
spring for type N5/N6 for ball			
			
GEV No.	361080	Ref. No.	—
O-ring EPDM thickness 2mm ID ø 16mm Qty 1 pcs			
			
GEV No.	361085	Ref. No.	—
O-ring EPDM thickness 2mm ID ø 8mm Qty 1 pcs			
			
GEV No.	361309	Ref. No.	—
ball for type N5/N6			
			
GEV No.	361310	Ref. No.	—
bracket for type N6 ball guide			
			
GEV No.	361311	Ref. No.	—
O-ring EPDM thickness 2mm ID ø 6mm Qty 1 pcs for type N6			
			
GEV No.	361314	Ref. No.	—
valve ring for type N6 holder for O-ring			

¹with accessories
Table continues overleaf



spare parts for 361008				
	GEV No.	361317	Ref. No.	—
sealing disc for type N6				
	GEV No.	361886	Ref. No.	—
non-return valve inletmm outletmm outlet ø 12.4mm L 12.7mm				

accessories				
				
1				
GEV No.	101286	Ref. No.	020992 053666	
description olive ID ø 6mm Qty 1 pcs				
For models: MTF/G1050, MTF/GE1050, MT/G700F, MTF/G700F, MTF/G1055F, MTF/GE1055F, RCF/G720, RCF/G1020, RCF/G730, RCF/G1030, RCF/G720F, RCF/G1020, 7TPG10F, RT/G700F, RTF/G700, RTF/G1050, CCF/G710, RTFG720, RTF/G720F, RTF/G1020, RTF/G1030, RTF/G1020F, HR/G403, HR/G803, HR/G413, HR/G814, HR/G403D, HR/G803D, HBR/G820, HBR/G825, HTR/G411, HTR/G811, ZR/G403, ZR/G803, ZR/G413, ZR/G814, ZR/G403D, ZR/G803D, 2FTGF4L, 2FTGF8L, AR/G403, AR/G803, AR/G403D, AR/G803D, ABR/G820, ABR/G825, ATR/G411, FCFG10, FCFG10D, FCFG10NL...(Other models you can see in the webshop)				
accessories for 101286				
	GEV No.	100909	Ref. No.	003859 057821
union screw thread M10x1 for pipe ø 6mm Qty 1 pcs				
	GEV No.	101464	Ref. No.	—
union nut thread M12x1 for pipe ø 6mm				

SEKO				
spare parts				
				
1				
GEV No.	361304	Ref. No.	0E2836 0E5360 0K8992	
description O-ring EPDM ID ø 11.11mm thickness 1.78mm Qty 1 pcs for type DIB3E/DIB5E				
For models: W3400H06, W3130H, W3130H, W3240H., W3240H, W3400H, W3400H, W3130H, W3180H, W3180H, W3180H, W3180H, W3240H_EL, W3240H_CLA, W3180H, W3130H, W3180H, W3130H, W3180H, W3300H, W3300H, LC12EC, CLC12EC, CLC22VC, FT36EDTS, FT36ESTS, FT36VDTS, FT36VSTS, FT36ED, FT36ES, FT36VD, FT36VS, FT50ED, FT50ES, FT50VD, FT50VS, FT72ED, FT72ES, FT72VD, FT72VS, FT36EDT, FT36EST, FT36VDT, FT36VST, FT50EDT, FT50EST, FT50VDT, FT50VST, FT72EDT, FT72EST...(Other models you can see in the webshop)				







various			
			
1			
GEV No.	361900 ¹	Ref. No.	0L0094 0L3182
description dosing pump kit rinse aid inlet 4x6mm outlet 4x6mm pressure connection ø 4x6mm suction connection ø 4x6mm incl. accessories			
For models: WT4, WT4B, WT4D, WT4DB, WT46, NUC3DD, WT4D60, WT4DDG, EUC1, EUC1DP, EUC3, EUC3DP, EUC1G, EUC1DP60, EUC3DD, LS5/1, LS5/1DP, LS5/3, LS5/3DP, LS5/1DP60, LS5/1DPAUS, LS5/1DPCS, KUC3, KUC3DP, NUC1, NUC1DP, NUC3, NUC3DP, NUC1DP60, NUC1DPA, LB1, LB1WS, LB1WSDP, WT1WSDP, LB2DPSAUS, LB1G, LB1WSG, WT2TOP60, WT2DPDI, WT2WSDPDI, LB1TOP, WT2TOPDI, LB2WS, LB2, LB2WSDP, LB2WS60, WT2WSDP, WT2WSDPD, LB2WSG, WT2WS... (Other models you can see in the webshop)			







¹with accessories

				
1				
GEV No.	361015	Ref. No.	0HA056 20199 6104007 9020199	
description dosing pump membrane dosing pump rinse aid inlet 6x8mm outlet 4x6mm pressure connection ø 4x6mm suction connection ø 6x8mm				
For models: LB035C, LB035Q, LB040Q, LB040AUS, G350C, LBICEQ010, LBIOET010, LBIOET014, LBIOEQ010, G350, G350DP, LBIOEQ014, G400, G400DP, LCFBE003				
spare parts for 361015				
	GEV No.	361132	Ref. No.	—
membrane dosing pump				
	GEV No.	510298	Ref. No.	—
lip valve dosing pump suitable for DB2/DS5				



 <p>2x</p> <p>1</p>			
GEV No.	361370	Ref. No.	047447 048223 048496 048498 048715 049484 0L3200 Z048498B
description	dosing pump type model 2 rinse aid inlet 4x6mm outlet 4x6mm pressure connection ø 4x6mm suction connection ø 4x6mm		
For models:	LS32, LS32/4.5, LS32F, LV32F, C55, LV32/60, WT4, WT4B, WT4D, WT302, WT302/4.5, WT302F, WT302/60, WT4DB, WT46, LS33, LS33/4.5, LS33F, LV33F, C55A, LS33/60, WT303, WT303/4.5, WT303F, WT303/60, WT4D60, WT4DDG, LS5/1, LS5/1DP, LS5/3, LS5/3DP, LS5/1DP60, LS5/1DPAUS, LS5/1DP3C, LB1, LB1WS, LB1WSDP, WT1WSDP, LB2D-PSAUS, LB1G, LB1WSG, LB2WS, LB2, LB2WSDP, LB2WS60, WT2WSDP, WT2WSDPD, LB2WSG, WT2WS, WT1...(Other models you can see in the webshop)		
spare parts for	361370		
		GEV No.	361307 Ref. No. —
	membrane dosing pump ø 68mm hole ø 6mm for type DIB3P/DIB5P		

accessories for	361519		
		GEV No.	361553 Ref. No. —
	membrane EPDM		
		GEV No.	361700 Ref. No. —
	hose connector rotary hose ø 4x6mm plastic connection M10x1		
		GEV No.	361702 Ref. No. —
	hose connector brass hose ø 4x6mm		
		GEV No.	361704 Ref. No. —
	hose connector brass straight thread M12x1 hose ø 11mm Qty 1 pcs		
		GEV No.	510296 Ref. No. —
	membrane silicone		
		GEV No.	520090 Ref. No. —
	PVC hose ID ø 4mm ED ø 6mm L 2m thickness 1mm t.max. 60°C transparent		
		GEV No.	520091 Ref. No. —
	nylon hose ID ø 4mm ED ø 6mm L 2m thickness 1mm operating p. 10bar burst p. 50bar t.max. 100°C transparent		

self-priming with supporting pressure			
GERMAC			
type 1000			
 <p>1</p>			
GEV No.	361519	Ref. No.	OHA055
description	dosing pump type 1000 rinse aid inlet 4x6mm outlet M10x1 pressure connection ø M10x1 IT for pipes ø 6mm suction connection ø PVC 4x6mm supporting pressure 11mm rebound ball PTFE 1mm GERMAC CODE VNR/A3		
spare parts for	361519		
		GEV No.	361550 Ref. No. —
	hose connector hose ø 4x6mm		
		GEV No.	361551 Ref. No. —
	compression spring wire gauge ø 1mm		
		GEV No.	361703 Ref. No. —
	hose connector thread M10x1 brass pipe connection ø 4x6mmmm		
		GEV No.	361705 Ref. No. —
	gasket for hose connector M12x1		
		GEV No.	510298 Ref. No. —
	lip valve dosing pump suitable for DB2/DS5		

SEKO			
 <p>1</p>			
GEV No.	361304	Ref. No.	0E2836 0E5360 0K8992
description	O-ring EPDM ID ø 11.11mm thickness 1.78mm Qty 1 pcs for type DIB3E/DIB5E		
For models:	W3400H06, W3130H, W3130H, W3240H., W3240H, W3400H, W3400H, W3130H, W3180H, W3180H, W3180H, W3180H, W3240H_EL, W3240H_CLA, W3180H, W3130H, W3180H, W3130H, W3180H, W3300H, W3300H, LC12EC, CLC12EC, CLC22VC, FT36EDTS, FT36ESTS, FT36VDTs, FT36VSTs, FT36ED, FT36ES, FT36VD, FT36VS, FT50ED, FT50ES, FT50VD, FT50VS, FT72ED, FT72ES, FT72VD, FT72VS, FT36EDT, FT36EST, FT36VDT, FT36VST, FT50EDT, FT50EST, FT50VDT, FT50VST, FT72EDT, FT72EST...(Other models you can see in the webshop)		

accessories			
container filters			
 <p>1</p>			
GEV No.	362014	Ref. No.	0C1155
description	container filter for combi-steamer SS hose ø 6mm		
For models:	FCZ061EAA, FCZ101EAA, FCZ102EAA, FCZ201EAA, FCZ202EAA, FCZ061EAH, FCZ101EAH, FCZ201EAH, FCZ061EAN, FCZ101EAN, FCZ201EAN, FCZ061ETA, FCZ101ETA, FCZ102ETA, FCZ061ETH, FCZ101ETH, FCZ061ETN, FCZ101ETN, FCZ061GAG, FCZ101GAG, FCZ102GAG, FCZ201GAG, FCZ061GAD, FCZ101GAD, FCZ102GAD, FCZ101GTG, FCZ102GTG, FCZ101GTD, FCZ102GTD, FCZ061EBA, FCZ101EBA, FCZ102EBA, FCZ201EBA, FCZ202EBA, FCZ061EBH, FCZ101EBH, FCZ201EBH, FCZ061EBN, FCZ101EBN, FCZ201EBN, FCZ061EBC, FCZ101EBC, FCZ201EBC, FCZ061EBA2, FCZ101EBA2, FCZ102EBA2, FCZ061EBH2, FCZ101EBH2, FCZ061EBN2, FCZ101EBN2...(Other models you can see in the webshop)		



GEV No.	361462	Ref. No.	049356 051028 9900106162 9900106836
description	container filter with weight SS hose ø 4x6mm		
For models:	LS32UK/RP, C55, WT302UK/RP, LS33UK/RP, C55A, WT303UK/RP, LS65, LS62/UK, LS63/UK, LS64/UK, WT35, WT32/UK, WT33/UK, WT34/UK, LS10/UK1, LS10/UK3, LS12/UK3, LS10, LS14EA, LS10UKDP, ET12E, LS10/60HZ, LS10CW, LS10INS, HT1200INS, LS14EA1, LS10N, LS10DP, LS10HD, LS14EA1/AU, LS14EA/60, LS10UK/1, LS10UK/3, LS12INS, LS12, LS12DP, LS12/60HZ, LS12CW, HT1200DEK, LS14EAASIA, LS14EA/G, WT60DP, WT60, WT60CW, WT60UKDPCW, WT60INS, WT60INSCW, WT60NAUCW, WT60NAU, LS10EA...(Other models you can see in the webshop)		

non-return valves



GEV No.	361147	Ref. No.	049358 071033 9900071033 9900071034 9900071055
description	non-return valve inlet 4x6mm outlet 1/8" L 50mm Qty 1 pcs		
For models:	LS32UK/RP, WT302UK/RP, LS33UK/RP, WT303UK/RP, LS65, LS62/UK, LS63/UK, LS64/UK, WT35, WT32/UK, WT33/UK, WT34/UK, LS10/UK1, LS10/UK3, LS12/UK3, LS8/UK1, LS8UK3, WT50/UK1, WT50/UK3, ET5AIT		

tank inlets



GEV No.	361270	Ref. No.	049557 049801 0KA991
description	tank inlet SS M12 hose ø 4mm		
For models:	LS32UK/RP, WT302UK/RP, WT4DG, LS33UK/RP, WT303UK/RP, NUC3DD, WT4DDG, EUC1G, EUC3DD, ZUCADDROW, ZUCADDROW6, FUCA3DD, LS5/3WSDPD, LB5DPG, NUC3DDWS, EUCADDROW, EUCADDROW6, WT2DPDI, WT2WSDPDI, WT2TOPDI, WT2WSDP, WT2WSDPD, LB2DPDI, LB2WSDPDI, LB2WSDPD, WT2DPD3, LS6EP, LS6EP/DD, LS6EADD, LS6EA/DPDD, WT38TDE, WT38/M50, LS6EADP3, LS6EADPWSG, WT38WS, WT38WSG, WT38MEDWS, WT38PM50, WT37LEV/9, LS6EADPDWS, WT38DWS, LS6SANA, EUCAIWS, WT38M50/4, LS6EA/UK, LS6EA/DPUK, EUCAIG, EUCAIWSG, EUCAIMLWS, EUCAIMLG...(Other models you can see in the webshop)		



GEV No.	361841	Ref. No.	050674
description	tank inlet stainless steel M10x1.5 hose ø 4mm		

mounting sets



GEV No.	361942	Ref. No.	0C1127
description	hose set detergent/rinse aid hose type 6x9mm hose length 2x2m PVC incl. container filter and screw connection		
For models:	FCZ201EAA, FCZ202EAA, FCZ201EAH, FCZ201EAN, FCZ201ETA, FCZ202ETA, FCZ201ETH, FCZ201ETN, FCZ201GAG, FCZ202GAG, FCZ201GAD, FCZ202GAD, FCZ201GTG, FCZ202GTG, FCZ201GTD, FCZ202GTD, FCZ201EBC, FCZ201EBA2, FCZ202EBA2, FCZ201EBH2, FCZ201EBN2, FCZ201EBC2, FCZ201GBI, FCZ201GBG2, FCZ202GBG2, FCZ201GBD2, FCZ202GBD2, FCZ201GBI2, FCZ201ECA, FCZ202ECA, FCZ201ECH, FCZ201ECN, FCZ201ECA2, FCZ202ECA2, FCZ201ECH2, FCZ201ECN2, FCZ201GCG, FCZ202GCG, FCZ201GCD, FCZ202GCD, FCZ201GCG2, FCZ202GCG2, FCZ201GCD2, FCZ202GCD2, AOS-201GAEU, AOS202GAEU, AOS201GAAU, AOS202GAAU, AOS201EABU, AOS201EAFU...(Other models you can see in the webshop)		

hoses

supply hoses

stainless steel flexi hoses

universal hoses

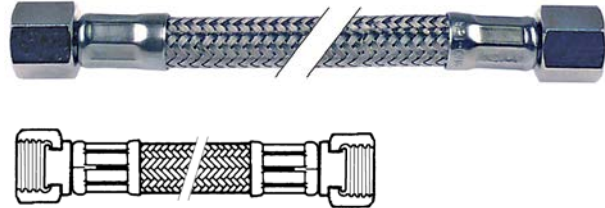

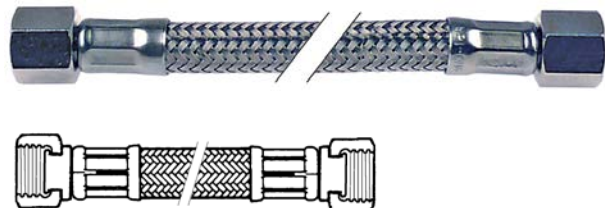

GEV No.	520612	Ref. No.	0D2999
description	flex hose SS braid straight-straight DN10 connections 1/2" L 1000mm approval DVGW operating p. 10bar test pressure 32bar burst p. 95bar		
For models:	T5E-04, T5E-01, T5M-01, T5E-02, T5E-03, T8E-01, T8E-02, T8M-01, T8E-03, T5E-05, T5E-06, T5E-05, T5E-04, T5E-01, T5M-01, T5E-02, T8E-01, T8E-02, T8M-01, T8E-03		



GEV No.	520613	Ref. No.	050348
description	flex hose SS braid straight-straight DN10 connections 1/2" L 1500mm approval DVGW operating p. 10bar test pressure 32bar burst p. 95bar		

accessories for	520010		
	GEV No.	520054	Ref. No. —
	flat gasket rubber ED ø 23.5mm ID ø 14mm thickness 2.3mm Qty 10 pcs		

	1		
GEV No.	520011	Ref. No.	047605 048816 049378 0K1135 0L1031 0L1887 0S0153 830607400
description	supply hose PVC straight-curved DN13 connections 3/4" L 2000mm operating p. 10bar burst p. 32bar t.max. 90°C approval VDE flat seal		
For models:	LS32, LS32/4.5, LS32UK/RP, LS32F, LV32F, C55, LV32/60, WT4, WT4B, WT4D, WT302, WT302/4.5, WT302UK/RP, WT302F, WT302/60, WT4DB, WT46, WT4DG, WT4WS1, LS33, LS33/4.5, LS33UK/RP, LS33F, LV33F, C55A, LS33/60, WT4BWS, WT4DWS1, WT4BDWS, WT303, WT303/4.5, WT303UK/RP, WT303F, WT303/60, NUC3DD, WT4D60, WT4DDG, EUC1, EUC1DP, EUC1WS, EUC1DPWS, EUC3, EUC3WS, EUC3DP, EUC3DPWS, EUC1G, EUC1DP60, EUC3DD, ZUCADDROW, ZUCADDROW6...(Other models you can see in the webshop)		

	1		
GEV No.	520888	Ref. No.	060933 0S0152
description	supply hose PVC straight-straight DN14 connections 3/4" L 1500mm operating p. 10bar burst p. 32bar t.max. 90°C grey approval VDE flat seal		
For models:	LB8G, LB8G/63, LB8GF, LB8GPH, LB8G, LB8GPHm, LB80EPH, LB80E, LB120EPH, LB120E, LB160EPH, LB160E, LB160V, CLB160E, CLB160V, LB70E, LB110E, LB80E, LB8G, LB70E, LB120E, LB160EZ, LB160V, CLB160E, CLB160V, EWM120, EWM160		

	1		
GEV No.	520537	Ref. No.	048909
description	supply hose PVC L 1500mm thread 3/4" D1 ø 13mm Qty 1 ext. ø 19		
For models:	LS32, LS32/4.5, LS32F, LV32F, C55, LV32/60, WT302, WT302/4.5, WT302F, WT302/60, LS33, LS33/4.5, LS33F, LV33F, C55A, LS33/60, WT303, WT303/4.5, WT303F, WT303/60, LB1/RBP, LB1/TOP, WT1WSDP, WT2TOP60, LB1TOP, WT2TOPDI, LB2/TOP, LB2/RBP, WT2WSDP, WT2WSDPD, WT2WS, WT1, WT1WS, WT1TOP, WT2TOP, WT1/3DP, WT2/3DP, WT2DPAUS, LB2TOP, LS62/UKRP, ECOTEMP5, LS62HD, LS63/UKRP, LS64/UKRP, ECOTEMP5S, WT32/UKRP, WT32/J60, WT32/J50, WT33/UKRP, WT34/UKRP...(Other models you can see in the webshop)		

pre-rinse hoses

stainless steel flexi hoses

	1		
GEV No.	542858	Ref. No.	069568 0L0644 0S1094
description	shower hose connections 1/2" L 1200mm SS operating p. 10bar burst p. 90bar t.max. 90°C for pre-rinse units suitable for drinking water rotary with flexible fabric		

stainless steel spiral tubes with bend relief

	1		
GEV No.	540066 ¹	Ref. No.	0K3922 0KC217 0L0641
description	shower hose connections 1/2" L 1000mm SS operating p. 10bar burst p. 40bar t.max. 90°C approval KTW with integrated gasket DN 8mm		
spare parts for	540066		
	GEV No.	504209	Ref. No. —
	flat gasket FIBER ED ø 18.5mm ID ø 11mm thickness 2mm Qty 1 pcs		

¹brass bush



PVC braided hoses

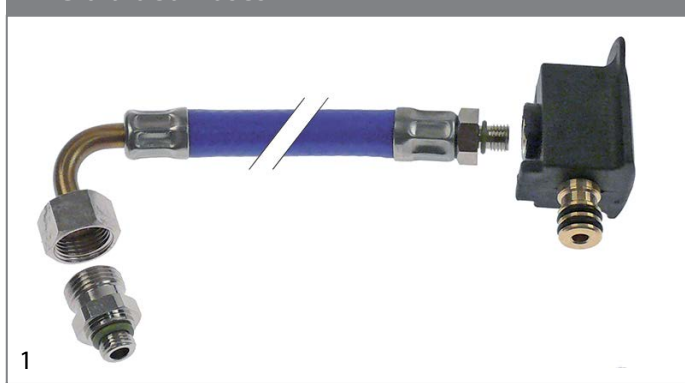

GEV No.	520531	Ref. No.	OC4539 OC4541 OL0674 OL0675 OL1161 OS1262
description	shower hose L 1400mm silicone FDA-BGA compliant		

drain hoses

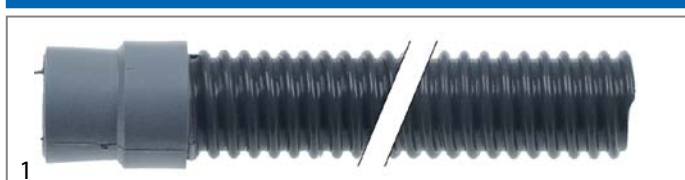

GEV No.	524488	Ref. No.	047459
description	drain hose DN34 L 1000mm straight ϕ inside 36mm straight ext. ϕ 42mm inner hose ϕ 35mm outer hose ϕ 42mm		
For models:	ALLS520, ALS510		

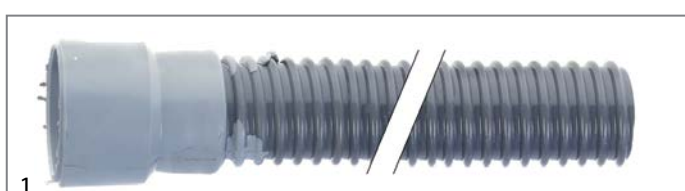

GEV No.	530615	Ref. No.	030440 030442 047894 050148
description	drain hose DN40 L 1000mm straight ϕ inside 58mm straight ext. ϕ 65mm outer hose ϕ 47mm temp.-resist. 90°C		
For models:	LS500F, LS501F, LS540F, LS540DK, LS541F, LS720F, LSE720DK, LSE720PH, LS860F, LS860DK, LS860PH, LS1080F, LS1080UK, LS1080PH, LSE721F, LS861F, LS540, LS1080M, LS1080, LS1080D, LS1080UK, LS1080/63, LS500F, LS500UK, LS501, LS501UK, LS540D, LS540/63, LSE721, LS720, LSE720UK, LS721UK, LSE720D, LS541, LS860, LS860, LS860D, LS860UK, LS861UK, LS860/63, LS861, LS500, LS501, LS540, 652120Z, LS860, LS1080, ALS540, LS720N, LS860... (Other models you can see in the webshop)		

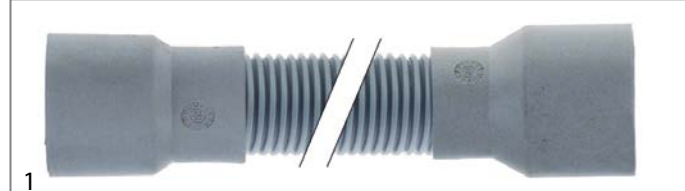

GEV No.	504253	Ref. No.	049856
description	drain hose DN21 L 1600mm A int. ϕ 35mm A ext. ϕ 40mm B int. ϕ 40mm B ext. ϕ 46mm outer hose ϕ 29mm		
For models:	WT4, WT4B, WT46, WT4WS1, WT4BWS, EUC1, EUC1WS, EUC3, EUC3WS, LS5/1, LS5/1WS, LS5/3, LS5/3WS, KUC3, NUC1, NUC1WS, NUC3, NUC3WS, ZUCA1, ZUCA3, LS6EP, LS6EP/DD, LS6EADD, WT37LEV/9, EUCAI, LS6EA/UK, LS6EA/60, EUCAICLW, EUCI, ZUCI, ZUCID, ZUCAI, ZUCAID, ZUCAI60, WT37, WT37/4.5, WT37/UK, WT37J60, WT37J50, LS6EA, FL5, LV5, LD5, UC5/1, FL620EP, LV6EP, FL620EA, ET5E, FL620EP/DD, FL620EA/DD...(Other models you can see in the webshop)		

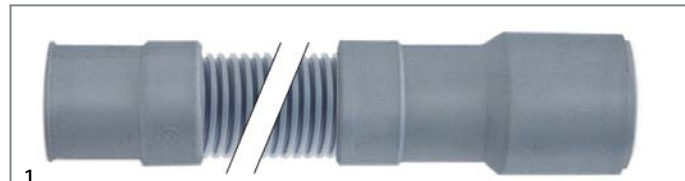

GEV No.	530570	Ref. No.	049052 049748 OKB776
description	drain hose DN21 L 2000mm A int. ϕ 21mm A ext. ϕ 25mm B int. ϕ 20/29mm B ext. ϕ 27/35mm outer hose ϕ 25mm		
For models:	LB1, LB1WS, LB1/RBP, LB1/60, WT1WSDP, LB1G, LB1WSG, LB2WS, LB2, LB2/RBP, LB2WS60, LB2WSG, WT2WS, WT1, WT1WS, WT1TOP, WT2, NGW, UC1, UC2WS, GW1, GW1WS, LV1WS, LV1WSDP, LV2WSDP, LV2WS, GW2G, GW2WSG, GW2WS, GW2		

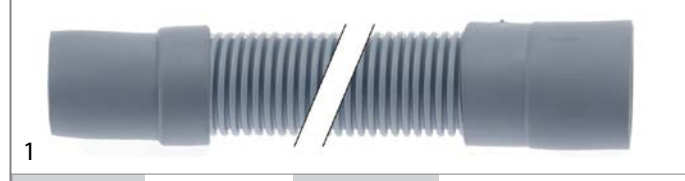

GEV No.	530575	Ref. No.	047465 050149
description	drain hose DN31 L 1000mm A int. ϕ 36mm A ext. ϕ 40mm B int. ϕ 40mm B ext. ϕ 46mm outer hose ϕ 41mm		
For models:	LSD55I, LSD55V, LS510, LS520, LS520D, LS520F, LS520M, LS520K, LS4, ZLS510, ZLS520, ET12AI, ET12AIT, C51, C52, C50, LS520ZD, CF314		



GEV No.	504254	Ref. No.	048818
description	drain hose DN35 L 1600mm A int. ϕ 35mm A ext. ϕ 41mm B int. ϕ 41mm B ext. ϕ 49mm outer hose ϕ 42mm		
For models:	LS32, LS32/4.5, LS32UK/RP, LS32F, LV32F, C55, LV32/60, WT302, WT302/4.5, WT302UK/RP, WT302F, WT302/60, LS61, LS61/60, LS62, LS62D, LS62/UKRP, LS62F, LV62, LS62/60, ECOTEMP5, LS62/1P, LS62HD, LS62/UK, WT32, WT32/4.5, WT32/UK, WT32/UKRP, WT32/F6, WT32/J60, WT32/J50, WT32/4.5N, WT32/UK, FL32, FL32/4.5, FL610, FL620, C32, C32/4.5, Z32, Z32/4.5, Z62, Z63, Z64		



1

GEV No.	504252	Ref. No.	047558
description	drain hose DN1.5 L 2150mm straight \varnothing inside 18mm straight ext. \varnothing 24mm elbow \varnothing inside 28mm elbow ext. \varnothing 34mm outer hose \varnothing 24mm		
For models:	LSD55I, LSD55V, LS521, LS521D, LS521F, LS521M, LS521K, LS521, ZLS510, ZLS520, ZLS521, ALL521, LS520ZD, LS521ZD, LS510MZ, LS520MZ, LS521MZ		



1

GEV No.	524807	Ref. No.	048845
description	drain hose DN19 L 1800mm straight \varnothing inside 19mm straight ext. \varnothing 25mm elbow \varnothing inside 29mm elbow ext. \varnothing 37mm outer hose \varnothing 24mm with piggyback plastic warewashing		
For models:	LS33, LS33/4.5, LS33UK/RP, LS33F, LV33F, C55A, LS33/60, WT303, WT303/4.5, WT303UK/RP, WT303F, WT303/60, LB1WSDP, LB1/TOP, WT1WSDP, LB2DPSAUS, LB2WSDP, LB2/TOP, WT2WSDP, WT2WSDPD, WT2TOP, WT1/3DP, WT2/3DP, WT2DPAUS, LS65, LS63, LS63D, LS63/UKRP, LS63F, LV63, LS63/60, LS63/1P, LS63/UK, LS64, LS64/UKRP, LV64, ECOTEMP5S, LS64/1P, LS64/UK, WT35, WT33, WT33/4.5, WT33/UK, WT33/UKRP, WT33/F, D500, WT33/M50, WT33/M60, WT33/60, WT33/4,5N...(Other models you can see in the webshop)		



1

GEV No.	504291	Ref. No.	049831 049878
description	drain hose DN20 L 2200/800mm straight \varnothing inside 20mm straight ext. \varnothing 27mm elbow \varnothing inside 29mm elbow ext. \varnothing 36mm outer hose \varnothing 27mm with elbow piggyback		
For models:	WT4D, WT4DB, WT4DG, WT4DWS1, WT4BDWS, NUC3DD, WT4D60, WT4DDG, EUC1, EUC1DP, EUC1DPWS, EUC3DP, EUC3DPWS, EUC1G, EUC1DP60, EUC3DD, ZUCADDROW, ZUCADDROW6, LS5/1DP, LS5/1WSDP, LS5/3DP, LS5/3WSDP, FUCA3DD, LS5/3WSDPD, LB5DPG, LS5/1DP60, LS5/1DPAUS, LS5/1DPCS, KUC3DP, NUC1DP, NUC1DPWS, NUC3DP, NUC3DPWS, NUC3DDWS, NUC1DP60, NUC1DPA, EUCADDROW, EUCADDROW6, LS6EP, LS6EA/DPDD, WT38TDE, LS6EADP3, WT38PM50, LS6SANA, EUCAIDP, EUCAI60, LS6EA/DPUK, EUCAIG, EUCAIML, EUCAIMLG...(Other models you can see in the webshop)		



1

GEV No.	504343	Ref. No.	0L0806
description	drain hose DN21 L 2200/800mm straight \varnothing inside 29mm straight ext. \varnothing 21mm elbow \varnothing inside 29mm elbow ext. \varnothing 35mm outer hose \varnothing 27mm with staight piggyback		
For models:	WT65H208U, WT65H240U, WT65H208DU, WT65H240DU, WT65H-208RU, WT65H240RU, WT65M208U, WT65M240U, WT65M208DU, WT65M240DU, WT65M208RU, WT65M240RU, LS14EAWS, LS14ADPWSG, LS14EAIWS, WT65EBWS, WT65BIDWSG, WT65EBIWS, WT65MEDWS, WT65H208WS, WT65H240WS, ET12EWS, WT65EBIWS, EHTAWS, EHTAIWS, EHTAIDWS, EHTAIWSG, ZHTAWS, ZHTAIWS, HT1200WS, HT1200IWS, LV1200IWS, HT1200BIDW, ET12EWS, AHTAWS, AHTAIWS, AHTAIWSG		



industrial hoses

Niplaflex hoses

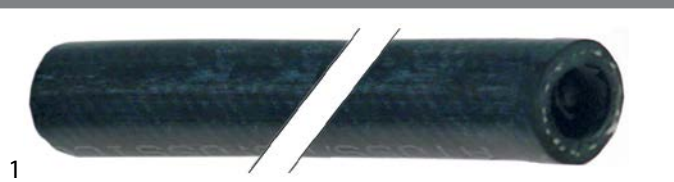

GEV No.	530719	Ref. No.	055345 055445
description	hose ID ø 11mm ED ø 18mm L 0.4m operating p. 10bar burst p. 30bar t.max. 110°C		
For models:	MBR/G710D, MBR/E710D, MBR/G700, MBR/G700F, MBR/E700, MBR/E700UK, MBR/G700UK, MBR/G701, MBR/G706, MBR/G701UK, MBR/G751, MBR/G756, MBR/E716, MBR/E706, MCP/E700, MCP/G700, MCP/E700D, MCP/G701, MCP/G710, MCP/G711, RCP/E2S, MCP/E1SH, MCP/E1SUH, MCP/E2SUHS, MCP/E2S, MCP/E2SH, MCP/E2SUH, MCP/E2SUT, MCP/E2SHB, RBR/G710D, 7BRE60XN, RBR/G700, RBR/G700F, 7BRE60X, RBR/E700UK, 7BRG60, 7BRG60X, RBR/G701UK, RBR/G751, RBR/G756, RBR/E716, RBR/E706, 7CPE07P, 7CPG07P, RCP/G701, XBR/G710D, XBR/E710D, XBR/G700, XBR/G710, M70EBP...(Other models you can see in the webshop)		



GEV No.	530561	Ref. No.	002707 086085 0C3165 0C4158 0F0092 OK2439 OK8058 OK8734 11D027 263246 28190001 60050353
description	pressure hose ID ø 10mm ED ø 17mm L 5m thickness 3.5mm operating p. 10bar burst p. 30bar t.max. 110°C		
For models:	FDV40G, FDV40E, FDV40GZ, FDV40EL, FDV40GA, FDV20G, FDV20E, FDV20GZ, FDV20EL, FDV20GA, RPD/G240, RPD/G260, RPI/G260, RPI/E240, RPI/E260, RPI/G260P, RPI/E260P, RBV/G2, RBV/E2, XPD/G240, XPD/G260, XPI/G260, XPI/E240, XPI/E260, XPI/G260P, XPI/E260P, XBV/G2, XBV/E2, JPD/G240, JPD/G260, JPI/G260, JPI/E240, JPI/E260, JBV/G2, JBV/E2, MPD/G240, MPD/G260, MPI/G260, MPI/E240, MPI/E260, MPI/G260P, MPI/E260P, MBV/G2, MBV/E2, PPD/G260, PPI/G260P, PPI/E260P, PBV/G2, PB/E1, PB/E2...(Other models you can see in the webshop)		



GEV No.	530562	Ref. No.	045451 045807 045808 045942 045943 048531 057763 057791 065535 065536 066081 066082 069091 0E5121
description	pressure hose ID ø 13mm ED ø 21mm L 5m operating p. 10bar burst p. 30bar t.max. 110°C		
For models:	LV4800HERC, WT40/J50, FL5DP, LS8, H3300, WT200ELP, Z480PE-SECO, WTC5250ELA, LB2DP3, DTVSX, H512LVELEPL, H512LVELP, WT150HELG, WT60/60HZC, LS5/1WS, LV33F, WT150ELEPL+RBP, RT10ERCBF, WT140ELP, WT302/4.5, H522VELECO, CT1915XE, WT100EL, FCFG20F, H522LVERC, WT65EB60, ZLB20B, ZLB16HHD, RT140ERCF, LS64/UKRP, LS33F, WT200HERC, RT190ELG, WT95SERF, RT34HDEDEP, LS8/9DD, WTC140ELBG, RTCS140ELA, C32, ZUCADDROW, WT65EIA, PW1MHG, LB1WS, DI4BMO, CT191DXE, CT190SXV, A/DTEX, RTC220ELA, LV4800ELC, LS12ASIA...(Other models you can see in the webshop)		

nylon hoses



GEV No.	520032	Ref. No.	0L0481
description	nylon hose ID ø 4mm ED ø 6mm L 5m thickness 1mm operating p. 10bar burst p. 50bar t.max. 100°C blue		
For models:	LB1, LB1WS, LB1WSDP, WT1WSDP, WT2TOP60, WT2DPDI, WT2WSDPDI, LB1TOP, WT2TOPDI, LB2WS, LB2, LB2WSDP, WT2WSDP, WT2WSDPD, WT2WS, WT1, WT1WS, WT1TOP, WT2TOP, WT1/3DP, WT2/3DP, WT2, LB2DPDI, LB2WSDPDI, LB2WSDPD, LB2TOP, LB2DP3, WT2DPD3, NGW, NGWDPDD, WT38TDE, WT38/M50, LS6EADPWS, LS6EADPWSG, WT38WS, WT38WSG, WT38MEDWS, WT37LEV/9, LS6EADPDWS, WT38DWS, EUCAI, EUCAIDP, EUCAI60, EUCAIWS, WT38M50/4, EUCAIG, EUCAIWSG, EUCAIML, EUCAIMLWS, EUCAIMLG...(Other models you can see in the webshop)		



GEV No.	520031	Ref. No.	049360 049905 0L1163
description	nylon hose ID ø 4mm ED ø 6mm L 5m thickness 1mm operating p. 10bar burst p. 50bar t.max. 100°C transparent		
For models:	LS32UK/RP, C55, WT302UK/RP, LS33UK/RP, C55A, WT303UK/RP, ZUCADDROW, ZUCADDROW6, FUCA3DD, ZUCA1, ZUCA3, EUCADDROW, EUCADDROW6, WT2DPDI, WT2WSDPDI, WT2TOPDI, WT2WSDPD, WT2WSDPD, LB2DPDI, LB2WSDPDI, LB2WSDPD, WT2DPD3, LS6EP, LS6EP/DD, LS6EADD, LS6EA/DPDD, WT38TDE, WT38/M50, LS6EADP3, LS6EADPWSG, WT38WSG, WT38PM50, WT37LEV/9, LS6SANA, EUCAI, EUCAIDP, EUCAI60, WT38M50/4, LS6EA/UK, LS6EA/DPUK, EUCAIG, EUCAIWSG, EUCAIML, EUCAIMLG, EUCAICL, EUCAICLG, EUCAIWL, LS6EA/60, EUCAICLW, EUCL...(Other models you can see in the webshop)		

pressure control hoses



GEV No.	530560	Ref. No.	048168 048225 048226 048883 060055 068638 068792 068793 068794 0H2567 244001300 244001400 244001500
description	pressure control hose ID \varnothing 5mm ED \varnothing 9mm L 5m operating p. 30bar burst p. 90bar temp.-resist. 60°C		
For models:	LS32, LS32/4.5, LS32UK/RP, LS32F, LV32F, C55, LV32/60, WT4, WT4B, WT4D, WT302, WT302/4.5, WT302UK/RP, WT302F, WT302/60, WT4DB, WT46, LS33, LS33/4.5, LS33UK/RP, LS33F, LV33F, C55A, LS33/60, WT303, WT303/4.5, WT303UK/RP, WT303F, WT303/60, NUC3DD, WT4D60, WT4DDG, EUC1, EUC1DP, EUC3, EUC3DP, EUC1G, EUC1DP60, EUC3DD, LS5/1, LS5/1DP, LS5/3, LS5/3DP, LS5/1DP60, LS5/1DPAUS, LS5/1DPCS, KUC3, KUC3DP, NUC1, NUC1DP...(Other models you can see in the webshop)		



GEV No.	530367	Ref. No.	072393
description	pressure hose ID \varnothing 4mm ED \varnothing 7mm thickness 1.5mm warewashing black Qty 5m		
For models:	LS32UK/RP, WT302UK/RP, WT4DG, WT4WS1, LS33UK/RP, WT4BWS, WT4DWS1, WT4BDWS, WT303UK/RP, EUC1WS, EUC1DPWS, EUC3WS, EUC3DPWS, ZUCADDROW, ZUCADDROW6, LS5/1WS, LS5/1WSDP, LS5/3WS, LS5/3WSDP, FUCA3DD, LS5/3WSDPD, LB5DPG, NUC1WS, NUC1DPWS, NUC3WS, NUC3DPWS, NUC3DDWS, ZUCA1, ZUCA3, EUCADDROW, EUCADDROW6, WT1WSDP, NGW, NGWDPDD, LS6EADD, LS6EA/DPDD, WT38TDE, WT38/M50, LS6EADP3, LS6EADPWS, LS6EADPWSG, WT38WS, WT38WSG, WT38MEDWS, WT37LEV/9, LS6EADPDWS, WT38DWS, LS6SANA, EUCAI, EUCAIDP...(Other models you can see in the webshop)		

PVC hoses

PVC hoses without fabric



GEV No.	520384	Ref. No.	049359 9900090006 99090006
description	PVC hose ID \varnothing 4mm ED \varnothing 6mm L 10m thickness 1mm t.max. 60°C blue		
For models:	LS32UK/RP, C55, WT302UK/RP, LS33UK/RP, C55A, WT303UK/RP, LS65, LS62/UK, LS63/UK, LS64/UK, WT35, WT32/UK, WT33/UK, WT34/UK, LS10/UK1, LS10/UK3, LS12/UK3, LS10, LS14EA, LS10UKDP, ET12E, LS10/60HZ, LS10CW, LS10INS, HT1200INS, LS14EA, LS10N, LS10DP, LS10HD, LS14EAI/AU, LS14EA/60, LS10UK/1, LS10UK/3, LS12INS, LS12, LS12DP, LS12/60HZ, LS12CW, HT1200DEK, LS14EAASIA, LS14EA/G, WT60DP, WT60, WT60CW, WT60UKDP, WT60INS, WT60INSCW, WT60NAUCW, WT60NAU, LS10EA...(Other models you can see in the webshop)		
accessories for	520384		
	GEV No.	361058	Ref. No. —
	container filter with non-return valve SS hose \varnothing 4x6mm \varnothing 20mm L 56mm		
	GEV No.	361066	Ref. No. —
	container filter straight SS hose \varnothing 4x6mm L 37mm non return valve ball valve		
	GEV No.	361106	Ref. No. —
	container filter with weight and non-return valve SS hose \varnothing 4x6mm \varnothing 21mm L 51mm non return valve lip valve		
	GEV No.	361141	Ref. No. —
	container filter with weight ceramic hose \varnothing 4mm		
	GEV No.	361230	Ref. No. —
	container filter with weight stainless steel hose \varnothing 4x6mm		
	GEV No.	361462	Ref. No. 049356 051028 9900106162 9900106836
	container filter with weight SS hose \varnothing 4x6mm		
	GEV No.	361728	Ref. No. —
	container filter with 4m 4x6 hose SS hose \varnothing 4x6mm hose length 4000mm		



GEV No.	520027	Ref. No.	069480
description	PVC hose ID \varnothing 4mm ED \varnothing 7mm L 10m thickness 1.5mm t.max. 60°C transparent		
For models:	LTB11, LTB12, LTB22, LTB11UK, LTB12UK, LTB22UK, LTB11, LTB22, 910-00-021, 910-00-023, 910-00-031, 910-00-033, 911-00-022, 911-00-024, 911-00-032, 911-00-034, CRYSTAL 11, CRYSTAL 22		





GEV No.	520029	Ref. No.	0C2309
description	PVC hose ID ø 6mm ED ø 9mm L 10m thickness 1.5mm t.max. 60°C transparent		
For models:	FCZ061ETA, FCZ061ETH, FCZ061ETN, FCZ061EBA2, FCZ061EBH2, FCZ061EBN2, FCZ061EBC2, FCZ061ECA2, FCZ061ECH2, FCZ061ECN2, AOW101EA, AOS061GA, AOS101GA, AOW101EABU, AOS062EAM1, AOS062EAB1, AOS061ETA1, AOS061ETH1, AOS061ETN1, AOS061ETC1, AOS061ETE1, AOS061ETF1, AOS061ETM1, AOS062ETM1, AOS061ETK1, AOS061EBA2, AOS061EBH2, AOS061EBN2, AOS061EBC2, AOS061EBE2, AOS061EBF2, AOS061EBK2, AOS062ECM1, AOS062ECB1, AOS061ECA2, AOS061ECH2, AOS061ECN2, AOS062ECM2		

extraction and pressure hoses

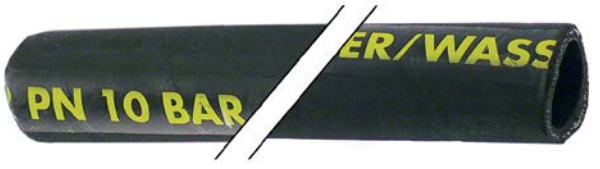

GEV No.	530442	Ref. No.	004730 059543
description	universal hose ID ø 32mm ED ø 40mm L 1m operating p. 10bar burst p. 30bar temp.-resist. -30 up to +80°C		
For models:	RCP/G1S, RCP/G2D, RCP/E1S, RCP/E2D, XCP/G1S, XCP/G2D, XCP/E1S, XCP/E2D, JCP/G1S, JCP/G2D, JCP/E1S, JCP/E2D, MCP/E1SH, MCP/E1SUH, MCP/E2SUHS, MCP/G1S, MCP/G2D, MCP/E1S, MCP/E2D, MCP/E2SH, MCP/E2SUH, MCP/E2SUT, MCP/E2SHB, ACPG25, ECP/E1ELHU, PCP/G1S, PCP/G2D, PCP/E1SH, PCP/E2SH, PCP/E1ELH, OCP/G1S, OCP/G2D, OCP/E1SH, OCP/E2SH, TCP/E1ELHU, TCP/G1S, TCP/G2D, TCP/E2SH, TCP/E1ELH, HCP/G410D, HCP/G400, HCP/G410, HCP/G800, HCP/G810, HCP/E400, HCP/E410, HCP/E800, HCP/E810, HCP5/G400, HCP5/E400...(Other models you can see in the webshop)		



GEV No.	530342	Ref. No.	006703 0K8736 0KE156
description	universal hose ID ø 32mm ED ø 43mm L 0.5m operating p. 10bar burst p. 30bar temp.-resist. -30 up to +80°C		

silicone hoses

without fabric

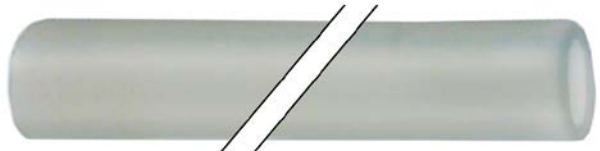

GEV No.	570121 ¹	Ref. No.	006248 11151417
description	silicone hose ID ø 20mm ED ø 26mm Lm t.max. 200°C		
For models:	FDV40G, FDV40GZ, FDV40GA, FDV20G, FDV20GZ, FDV20GA, FCV/E101/1, FCV/G20L3, FCVG202L3, FCV/E61/1, FCV/E61/1, FCV/E101/1, FCV/E101/1, FCV/E102/1, FCV/E61/1, FCV/E61/1, FCV/E101/1, FCV/E101/2, FCV/G61/1, FCV/G61/1, FCV/G61/1, FCV/E102/1, FCV/E101/1, FCV/G20L6, FCVG202L6, FCV/G101/1, FCV/E101/1, FCV/G102/1, FVC/E102/1, FCV/G201/1, FVC/E201/1, FCV/G202/1, FVC/E202/1, FCS061E44J, FCS061G48J, FCS061EP, FCS061G3DI, FCS061E3CI, FCS101E2, FCS061G4DT, FCS061G49J, FCS101EP4J, FCS101EP, FCS102EP4J, FCS102EP, FCS201E4, FCS201EP, FCS202E4, FCS202EP, FCS201GP...(Other models you can see in the webshop)		

¹by the meter

pressure hoses (other)



GEV No.	530601	Ref. No.	0K2454 30001740
description	pressure hose ID ø 40mm ED ø 52mm thickness 6mm L 80mm		
For models:	5611-3-10, 5611-3-6, 5611-3-8, 5612-3-10, 5612-3-6, 5612-3-8		

formed hoses

straight



GEV No.	504627	Ref. No.	046257 065531
description	formed hose D1 ø 42mm D2 ø 52mm L 430mm dishwasher straight		
For models:	LS32, LS32/4.5, LS32UK/RP, LS32F, LV32F, C55, LV32/60, WT4, WT4B, WT4D, WT302, WT302/4.5, WT302UK/RP, WT302F, WT302/60, WT4DB, WT46, LS33, LS33/4.5, LS33UK/RP, LS33F, LV33F, C55A, LS33/60, WT303, WT303/4.5, WT303UK/RP, WT303F, WT303/60, NUC3DD, WT4D60, WT4DDG, EUC1, EUC1DP, EUC3, EUC3DP, EUC1G, EUC1DP60, EUC3DD, ZUCADDROW, ZUCADDROW6, LS5/1, LS5/1DP, LS5/3, LS5/3DP, FUCA3DD, LS5/1DP60, LS5/1DPAUS, LS5/1DPCS, KUC3...(Other models you can see in the webshop)		

			
GEV No.	504626	Ref. No.	045457 045768 045806 068640
description	formed hose D1 ø 55mm D2 ø 45mm L 300mm dishwasher straight		
For models:	LS32, LS32/4.5, LS32UK/RP, LS32F, LV32F, C55, LV32/60, WT302, WT302/4.5, WT302UK/RP, WT302F, WT302/60, WT4DG, WT4WS1, LS33, LS33/4.5, LS33UK/RP, LS33F, LV33F, C55A, LS33/60, WT4BWS, WT4DWS1, WT4BDWS, WT303, WT303/4.5, WT303UK/RP, WT303F, WT303/60, EUC1WS, EUC1DPWS, EUC3WS, EUC3DPWS, LS5/1WS, LS5/1WSDP, LS5/3WS, LS5/3WSDP, LS5/3WSDPD, LB5DPG, NUC1WS, NUC1DPWS, NUC3WS, NUC3DPWS, NUC3DDWS, LS360F, LS360DK, LS365F, LS365, LS365PH, LS500F...(Other models you can see in the webshop)		

			
GEV No.	504631	Ref. No.	045456 0L0613
description	formed hose dishwasher straight equiv. no. 045456		
For models:	LS500F, LS501F, LS540F, LS540DK, LS541F, LS720F, LSE720DK, LSE720PH, LS1080F, LS1080UK, LS1080PH, LSE721F, LS540, LS1080, LS1080D, LS1080UK, LS1080/63, LS500F, LS500UK, LS501, LS501UK, LS540D, LS540/63, LSE721, LS720, LSE720UK, LS721UK, LSE720D, LS541, LS10, LS14EA, LS10UKDP, ET12E, LS10/60HZ, LS10CW, LS10INS, HT1200INS, LS14EAI, LS10N, LS10DP, LS10HD, LS14EAI/AU, LS14EA/60, LS10UK/1, LS10UK/3, LS12INS, LS12, LS12DP, LS12/60HZ, LS12CW...(Other models you can see in the webshop)		

			
GEV No.	504633	Ref. No.	046565
description	formed hose dishwasher straight equiv. no. 046565		
For models:	LS860F, LS860DK, LS860PH, LS1080F, LS1080UK, LS1080PH, LS861F, LS1080M, LS1080, LS1080D, LS1080UK, LS1080/63, LS860, LS860, LS860D, LS860UK, LS861UK, LS860/63, LS861, CT92DXE, CT92SXE, CT92DXEUK, CT92SXEUK, CT92DXV, CT92SXV, CT92DXVUK, CT92SXVUK, CT140EDX, CT140ESX, CT140EDXUK, CT140SXEU, CT140VDX, CT140VSX, CT141EDX, CT141ESX, CT141EDUK, CT141ESUK, CT141VDX, CT141VSX, PW1SMG, PW1MG, PW1MUK, PW1MHG, PW2MG, PW2MUK, WT830M, WT830MUK, WT830M60G, WT850M, WT850MUK...(Other models you can see in the webshop)		

			
GEV No.	504285	Ref. No.	049287
description	formed hose hose ext. ø 30mm hose int. ø 25mm L 430mm black Qty 1		
For models:	LS32UK/RP, WT302UK/RP, WT4DG, WT4WS1, LS33UK/RP, WT4BWS, WT4DWS1, WT4BDWS, WT303UK/RP, EUC1WS, EUC1DPWS, EUC3WS, EUC3DPWS, LS5/1WS, LS5/1WSDP, LS5/3WS, LS5/3WSDP, LS5/3WSDPD, LB5DPG, NUC1WS, NUC1DPWS, NUC3WS, NUC3DPWS, NUC3DDWS, LS6EADD, LS6EA/DPDD, WT38TDE, WT38/M50, LS6EADP3, LS6EADPWS, LS6EADPWSG, WT38WS, WT38WSG, WT38MEDWS, WT37LEV/9, LS6EADPDWS, WT38DWS, LS6SANA, EUCAI, EUCAIDP, EUCAI60, EUCAIWS, WT38M50/4, LS6EA/UK, LS6EA/DPUK, EUCAIG, EUCAIWSG, EUCAIML, EUCAIMLWS, EUCAIMLG...(Other models you can see in the webshop)		

			
GEV No.	503169	Ref. No.	0L0935
description	formed hose hose ext. ø 65mm hose int. ø 56mm L 82mm Qty 1 equiv. no. 0L0935		
For models:	WTC90ERB, WTC90ELB, WTC140ERA, WTC140ELA, WTC140ERB, WTC140ELB, WTC180ERA, WTC180ELA, WTC180ERB, WTC180ELB, WTC220ERA, WTC220ELA, WTC220ERB, WTC220ELB, WTC90ERBG, WTC90ELBG, WTC140ERAG, WTC140ELAG, WTC140ERBG, WTC140ELBG, WTC180ERAG, WTC180ELAG, WTC180ERBG, WTC180ELBG, WTC220ERAG, WTC220ELAG, WTC220ERBG, WTC220ELBG, WT44BL208, WT44BR208, WT44BL240, WT44BR240, WT44CL208, WT44CR208, WT44CL240, WT44CR240, WT66BL208, WT66BR208, WT66BL240, WT66BR240, WT66CL208, WT66CR208, WT66CL240, WT66CR240, WTM140ERA, WTM140ELA, WTM140ERB, WTM140ELB, WTM165ERA, WTM165ELA...(Other models you can see in the webshop)		



1

GEV No.	504286	Ref. No.	048242
description	formed hose hose ext. ø 80mm hose int. ø 70mm L 50mm black Qty 1		
For models:	LS10D, LS10, LS10UKRP, LC100, ECOTEMP12-, LS10/60, LS10/1, LS10/12KW, LS10F, LS10DEK, LS10/1UKRP, LS10SW, LS10/50J, LS10/60J, LS10DP, LS10/HD, SH55, LO10, LS10/UK1, LS10/UK3, LS12D, LS12, LS12UK/RP, LC120, LS12DP, LS12/60, LS12F, LS12DEK, LS12HD, LS12/UK3, ECOTEMP12SW, ECOTEMP12INS, LS12MEX, LS10N, LS10, LS14EA, LS10UKDP, ET12E, LS10/60HZ, LS10CW, LS10INS, HT1200INS, LS14EAI, LS10N, LS10DP, LS10HD, LS14EAI/AU, LS14EA/60, LS10UK/1, LS10UK/3...(Other models you can see in the webshop)		

form L



1

GEV No.	524487	Ref. No.	0E0134 0E5166 0H1998 0K4558 0K8297
description	formed hose end piece A ext. ø 30mm end piece A int. ø 24mm AD2 ø 30mm ø end piece B 24mm L 125mm Qty 1 L-shape		
For models:	LN34, LN34, LN34, LN34, LN46, LN46, LN46, LN46, LN72, LN72, LN72, RT100ED, RT100ES, RT100SR, RT100SL, RT140ED, RT140ES, RT140SR, RT140SL, RT190ED, RT190ES, RT190SR, RT190SL, RT190H-DED, RT190HDES, RT190HSR, RT190HSL, RT270ED, RT270ES, RT270SR, RT270SL, RT270HDED, RT270HDES, RT270HSR, RT270HSL, RT100ERF, RT100ELF, RT100VD, RT100VS, RT140ERF, RT140ELF, RT140VD, RT140VS, RT190ERF, RT190ELF, RT190VD, RT190VS, RT190HERF, RT190HELFL...(Other models you can see in the webshop)		



1

GEV No.	504263	Ref. No.	0L0038
description	hose D1 ø 73mm D2 ø 63mm L 90mm rubber		
For models:	RT100ED, RT100ES, RT100SR, RT100SL, RT140ED, RT140ES, RT140SR, RT140SL, RT190ED, RT190ES, RT190SR, RT190SL, RT190HDED, RT190HDES, RT190HSR, RT190HSL, RT270ED, RT270ES, RT270SR, RT270SL, RT270HDED, RT270HDES, RT270HSR, RT270HSL, RT100ERF, RT100ELF, RT100VD, RT100VS, RT140ERF, RT140ELF, RT140VD, RT140VS, RT142ERF, RT142ELF, RT190ERF, RT190ELF, RT190VD, RT190VS, RT190HERF, RT190HELFL, RT190HDVDF, RT190HDVSF, RT270ERF, RT270ELF, RT270VDF, RT270VSF, RT270HERF, RT270HELFL, RT270HDVDF, RT270HDVSF...(Other models you can see in the webshop)		



1

GEV No.	517702	Ref. No.	0E2970 0H2516 0KE518 0KI410
description	formed hose end piece A ext. ø 64mm end piece A int. ø 54mm AD2 ø 66mm ø end piece B 54mm L 190mm L-shape		
For models:	PW1EFL, PW1EFL, PW1EFL/60HZ, PW2EFL, PW2EFL, PW2EFL/60HZ, PW2VFL, WT830EFL, WT830EFL, WT830EFL/60HZ, WT850, WT850EFL, WT850EFL/60HZ, WT850SFL, FT36EDTS, FT36ESTS, FT36VDT, FT36VDT, FT36ED, FT36ES, FT36VD, FT36VS, FT50ED, FT50ES, FT50VD, FT50VS, FT72ED, FT72ES, FT72VD, FT72VS, FT36EDT, FT36EST, FT36VDT, FT36VST, FT50EDT, FT50EST, FT50VDT, FT50VST, FT72EDT, FT72EST, FT72VDT, FT72VST, FT36WED, FT36WES, FT36WVD, FT36WVS, FT50WED, FT50WES, FT50WVD, FT50WVS...(Other models you can see in the webshop)		



1

GEV No.	530720	Ref. No.	056888
description	steam hose ID ø 30mm ED ø 41mm L 700mm Qty 1 for combi-steamer		
For models:	MCP/E700, MCP/G700, MCP/E700D, MCP/G701, MCP/G710, MCP/G711, MCP/G705, MCP/G706, RCP/E2S, MCP/E1SH, MCP/E1SUH, MCP/E2SUHS, MCP/E2S, MCP/E2SH, MCP/E2SUH, MCP/E2SUT, MCP/E2SHB, 7CPE07P, 7CPG07P, RCP/G701, RCP/G706, M70EPC, M70GPC, M70GPC, XCP/G706, CCP/G700, CCP/E700, PCP/E2SHP, PCP/E2SH3B, OCP/E2S, TCP/E2S, RCP/G700, RCPE700, KCP/G1RU, KCP/G2RU, KCP/E1RU, KCP/E2RU, KCP/G1, KCP/G1R, KCP/G2, KCP/G2R, KCP/E1, KCP/E1R, KCP/E2, KCP/E2R, KCP/G1U, KCP/G2U, KCP/E1U, KCP/E2U, QCP/G1...(Other models you can see in the webshop)		



1

GEV No.	504629	Ref. No.	046398 092303
description	formed hose warewashing L-shape equiv. no. 046398		
For models:	LS360F, LS360DK, LS365F, LS365, LS365PH, LS360D, LS365D, LS360, LS365, LS360/63, LS365/63, LS367, LS360, LS365F, HB3PNT		

1

GEV No.	504625	Ref. No.	049041
description	formed hose warewashing L-shape equiv. no. 049041		
For models:	LB1, LB1WS, LB1WSDP, LB1/RBP, LB1/TOP, LB1/60, WT1WSDP, LB2D-PSAUS, LB1G, LB1WSG, LB2WS, LB2, LB2WSDP, LB2/TOP, LB2/RBP, LB2WS60, WT2WSDP, WT2WSDPD, LB2WSG, WT2WS, WT1, WT1WS, WT1TOP, WT2TOP, WT1/3DP, WT2/3DP, WT2DPAUS, UC1, UC2WS, GW1, GW1WS, LV1WS, LV1WSDP, LV2WSDP, LV2WS, GW2WS, GW2, Z1, Z1/WS, Z1TOP, Z2, Z2TOP		



1

GEV No.	504630	Ref. No.	048241
description	formed hose warewashing equiv. no. 048241 with piggyback, old		
For models:	LS10D, LS10, LS10UKRP, LC100, ECOTEMP12-, LS10/60, LS10/1, LS10/12KW, LS10F, LS10DEK, LS10/1UKRP, LS10SW, LS10/50J, LS10/60J, LS10DP, LS10/HD, SH55, LO10, LS10/UK1, LS10/UK3, LS12D, LS12, LS12UK/RP, LC120, LS12DP, LS12/60, LS12F, LS12DEK, LS12HD, LS12/UK3, ECOTEMP12SW, ECOTEMP12INS, LS12MEX, LS10N, HT1200elm, HT1000elm, HYDRA1200, HYDRA1000, LSCE10, LSCE12		



1

GEV No.	518216	Ref. No.	069535 069536 0A6119 0T4098 127001
description	formed hose warewashing L-shape equiv. no. 127001 mounting pos. upper		
For models:	LTB11, LTB12, LTB22, LTB11UK, LTB12UK, LTB22UK, LTB11, LTB22, 910-00-021, 910-00-023, 910-00-031, 910-00-033, 911-00-022, 911-00-024, 911-00-032, 911-00-034, CRYSTAL 11, CRYSTAL 22		

form S



1

GEV No.	504632	Ref. No.	046372 046616
description	formed hose S-shape warewashing equiv. no. 046372		
For models:	LS540F, LS540DK, LS541F, LS720F, LSE720DK, LSE720PH, LSE721F, LS540, LS540D, LS540/63, LSE721, LS720, LSE720UK, LS721UK, LSE720D, LS541, LS540, 652120Z, ALS540, LS720N, LSE720Z		

with branch



1

GEV No.	512495	Ref. No.	0L2825
description	formed hose ID ø 50mm int. ø 1 50mm int. ø 2 45mm for dishwasher		

miscellaneous



1

GEV No.	518036	Ref. No.	069442 127012
description	formed hose angled warewashing		
For models:	LTB11, LTB12, LTB22, LTB11UK, LTB12UK, LTB22UK, LTB11, LTB22, 910-00-021, 910-00-023, 910-00-031, 910-00-033, 911-00-022, 911-00-024, 911-00-032, 911-00-034, CRYSTAL 11, CRYSTAL 22		



for dishwashers

pressure hoses



GEV No.	513319	Ref. No.	049773
description	hose ext. ø 36 ID ø 25mm L 1000mm black		
For models:	LS32UK/RP, WT302UK/RP, WT4DG, WT4WS1, LS33UK/RP, WT4BWS, WT4DWS1, WT4BDWS, WT303UK/RP, EUC1WS, EUC1DPWS, EUC3WS, EUC3DPWS, ZUCADDROW, ZUCADDROW6, LS5/1WS, LS5/1WSDP, LS5/3WS, LS5/3WSDP, FUCA3DD, LS5/3WSDPD, LB5DPG, NUC1WS, NUC1DPWS, NUC3WS, NUC3DPWS, NUC3DDWS, ZUCA1, ZUCA3, EUCADDROW, EUCADDROW6, LS6EAD, LS6EA/DPDD, WT38TDE, WT38/M50, LS6EADP3, WT37LEV/9, LS6SANA, WT38M50/4, LS6EA/UK, LS6EA/DPUK, LS6EA/60, WT38D, WT37, WT38, LS65, LS62/UK, WT37/4.5, WT38/4.5, WT37/UK...(Other models you can see in the webshop)		



GEV No.	513320	Ref. No.	049599
description	hose ext. ø 36 ID ø 27mm black		
For models:	LU7PDP, LU7ADP, LU7ADPWS, WTU40PDP, WTU40ADP, WTU40ADPWS, WTU40ADPD, WT60/GJ60, WT60/GJ50, PH10/12-RP, LS10, LS14EA, LS10UKDP, ET12E, LS10/60HZ, LS10CW, LS10INS, HT1200INS, LS14EAI, LS10N, LS10DP, LS10HD, LS14EAI/AU, LS14EA/60, LS10UK/1, LS10UK/3, LS12INS, LS12, LS12DP, LS12/60HZ, LS12CW, HT1200DEK, LS14EAASIA, LS14EA/G, WT60DP, WT60, WT60CW, WT60UKDPCW, WT60INS, WT60INSCW, WT60NAUCW, WT60NAU, LS10EA, WT60/60HZ, WT60/60HZC, WT60N, WT609NINS, LS12HD, LS14EAI/DD, WT65E...(Other models you can see in the webshop)		



GEV No.	699202	Ref. No.	0L0612
description	sleeve ext. ø 52 ID ø 42mm L 109mm		
For models:	LU7PDP, LU7ADP, LU7ADPWS, WTU40PDP, WTU40ADP, WTU40ADPWS, WTU40ADPD, WT60/GJ60, WT60/GJ50, PH10/12-RP, LS14EA, ET12E, LS14EAI, LS14EAI/AU, LS14EA/60, LS14EAASIA, LS14EA/G, LS10EA, LS14EAI/DD, WT65E, WT65EB, WT65EI, ECOTEMP12S, WT65E-BI, WT65EBIA, WT65EIA, WT65E60, WT65EB60, WT65EBIDG, WT65E-BASIA, WT65EIM50, WT65EIM60, LS14EADP/G, WT65MED, WT65EJ50, WT65EJ60, LS14AH240U, WT65H208U, WT65H240U, LS14H208DU, LS14AH208U, LS14H240DU, LS14H208RU, LS14H240RU, WT65H-208DU, WT65H240DU, WT65H208RU, WT65H240RU, WT65M208U, WT65M240U...(Other models you can see in the webshop)		

miscellaneous



GEV No.	698596	Ref. No.	0C6203
description	collector ED ø 15mm ID ø 11mm for dishwasher		
For models:	FCZ102EAA, FCZ102ETA, FCZ102EBA, FCZ102EBA2, FCZ102ECA, FCZ102ECA2, AOS102EAA1, AOS102EAC1, AOS102EAS1, AOS062EAM1, AOS102EAM1, AOS062EAB1, AOS102EAB1, AOS102E-AK1, AOS102EAT1, AOS102ETA1, AOS062ETM1, AOS102ETM1, AOS102ETK1, AOS102EBA1, AOS102EBC1, AOS102EBK1, AOS102E-BA2, AOS102EBK2, AOS102ECA1, AOS062ECM1, AOS102ECM1, AOS062ECB1, AOS102ECB1, AOS102ECA2, AOS062ECM2, AOS102ECM2, EJV102EAA, EJV102EBA, EJV102ECA		



GEV No.	699193	Ref. No.	0L0068
description	formed hose ED ø 72mm ID ø 60mm D1 ø 58mm D2 ø 46.5mm L 90mm		
For models:	LU7PDP, LU7ADP, LU7ADPWS, WTU40PDP, WTU40ADP, WTU40ADP-PWS, WTU40ADPD, WT60/GJ60, WT60/GJ50, PH10/12-RP, LS14EA, ET12E, LS14EAI, LS14EAI/AU, LS14EA/60, LS14EAASIA, LS14EA/G, LS10EA, LS14EAI/DD, ECOTEMP12S, LS14EADP/G, WT65ROW, LS14ROW, LS14SANA, LS14ROW60, WT65ROW60, EHTA, EHTA60, EHTAWS, EHTAI, EHTAID, EHTAIWS, EHTAIDWS, EHTAIG, EHTAIWSG, EHTAIAU, EHTAIMLAU, ZHTAWS, ZHTAID, ZHTAIWS, ZHTAIAU, ZHTA, ZHTA60, ZHTAI, EHTAIUSPH5, EHTAIUSPH6, LS9P, LS9PDD, LS9AUK/3, LS9P60...(Other models you can see in the webshop)		



fittings, hose and pipe connectors

hose connectors

without screw connection



1

GEV No.	501210	Ref. No.	047431 OKW990
description	Y-piece plastic hose ø 10-10-10mm		
For models:	FDV40G, FDV40E, FDV40GZ, FDV40EL, FDV40GA, FDV20G, FDV20E, FDV20GZ, FDV20EL, FDV20GA, RPI/E240, RPI/E260, RPI/G260P, RPI/E260P, RCP/E2S, XPI/E240, XPI/E260, XPI/G260P, XPI/E260P, JPI/E240, JPI/E260, MCP/E1SH, MCP/E1SUH, MCP/E2SUHS, MPI/E240, MPI/E260, MPI/G260P, MPI/E260P, MCP/E2S, MCP/E2SH, MCP/E2SUH, MCP/E2SUT, MCP/E2SHB, PPD/G260, PPI/G260P, PPI/E260P, OPD/G260, OPI/G260P, OPI/E260P, TPD/G260, TPI/G260P, TPI/E260P, KPI/G10, KPI/G15, KPI/E10, KPI/E15, KPD/G10, KPD/G15, KPD/G15A, KPI/G15A...(Other models you can see in the webshop)		



2

GEV No.	504583	Ref. No.	048195
description	Y-piece plastic hose ø 12-12-12mm		
For models:	LS32, LS32/4.5, LS32F, LV32F, C55, LV32/60, WT4, WT4B, WT4D, WT302, WT302/4.5, WT302F, WT302/60, WT4DB, WT46, WT4WS1, LS33, LS33/4.5, LS33F, LV33F, C55A, LS33/60, WT4BWS, WT4DWS1, WT4BDWS, WT303, WT303/4.5, WT303F, WT303/60, NUC3DD, WT4D60, WT4DDG, EUC1, EUC1DP, EUC1WS, EUC1DPWS, EUC3, EUC3WS, EUC3DP, EUC3DPWS, EUC1G, EUC1DP60, EUC3DD, LS5/1, LS5/1DP, LS5/1WS, LS5/1WSDP, LS5/3, LS5/3DP, LS5/3WS...(Other models you can see in the webshop)		



1

GEV No.	541109	Ref. No.	069195
description	Y-piece plastic hose ø 8-6-8mm for pressure switch		
For models:	LB8G, LB8G/63, LB8GF, LB8GPH, LB8G, LB8GPHm, LB8G		



1

GEV No.	504302	Ref. No.	0L0275
description	T-piece plastic hose ø 10-6-10mm ID ø 5/7.5mm L 62mm W 34mm		
For models:	WT4WS1, WT4BWS, WT4DWS1, WT4BDWS, EUC1WS, EUC1DPWS, EUC3WS, EUC3DPWS, LS5/1WS, LS5/1WSDP, LS5/3WS, LS5/3WSDP, LS5/3WSDPD, NUC1WS, NUC1DPWS, NUC3WS, NUC3DPWS, NUC3DDWS, LV5/3WSDP, FL5/3WSDP, UC5WSDP		



1

GEV No.	504582	Ref. No.	049073 049554 0L0353
description	cross fitting SS hose ø 11-11-11-11mm 4-way		
For models:	LB1, LB1WS, LB1WSDP, LB1/RBP, LB1/TOP, LB1/60, WT1WSDP, LB2DPSAUS, LB1G, LB1WSG, WT2TOP60, WT2DPDI, WT2WSDPDI, LB1TOP, WT2TOPDI, LB2WS, LB2, LB2WSDP, LB2/TOP, LB2/RBP, LB2WS60, WT2WSDP, WT2WSDPD, LB2WSG, WT2WS, WT1, WT1WS, WT1TOP, WT2TOP, WT1/3DP, WT2/3DP, WT2DPAUS, WT2, LB2DPDI, LB2WSDPDI, LB2WSDPD, LB2TOP, LB2DP3, WT2DPD3, UC1, UC2WS, GW1, GW1WS, LV1WS, LV1WSDP, LV2WSDP, LV2WS, GW2DPG, GW2WSDPG, GW2G...(Other models you can see in the webshop)		



miscellaneous



1			
GEV No.	501421	Ref. No.	056884
description	Y-piece ø 30mm L 79mm with holder for pasta cooker		
For models:	MCP/E700, MCP/G700, MCP/E700D, MCP/G701, MCP/G710, MCP/G711, MCP/G705, MCP/G706, 7CPE07P, 7CPG07P, RCP/G701, RCP/G706, M70EPC, M70GPC, M70GPC, XCP/G706, CCP/G700, CCP/E700, RCP/G700, RCPE700, HCP/G800, HCP/G801, HCP/G400, HCP/G401, HCP/E800, HCP/E801, HCP/E400, HCP/E401, ZHCP/E800, ZHCP/G400, ZHCP/G401, ZHCP/G800, ZHCP/G801, ZHCP/E400, ZHCP/E401, HCP/E800, ZHCP/E801, RCP/G700, RCP/E700		

fittings

double nipples



1			
GEV No.	520163	Ref. No.	006350
description	double nipple nickel-plated brass thread 1/4" - 1/4" Qty 1 pcs		
For models:	BR80GZ, BR80EZ, BR180GZ, BR180Z, BR100GZ, BR100Z, CR42G, CR40G, BR100G, BR100E, BR180E, BR80G, BR80E, BR180G		



1			
GEV No.	520887	Ref. No.	0E0446 0W3306 74131 1522
description	double nipple SS thread 3/4" - 3/4" L1 20mm L2 20mm		
For models:	W3400H06, W3400H, W3400H, CLC35E, CLC40V, WTF2ERC, WTF2ELC, WTF2SRC, WTF2SLC, WTF2HERC, WTF2HELX, WTF2HSRC, WTF2HSLC, WTF3ERC, WTF3ELC, WTF3SRC, WTF3SLC, WTF3HERC, WTF3HELX, WTF3HSRC., WTF3HSLC, WTF2ERB., WTF2ELB, WTF2SRB, WTF2SLB, WTF2HERB, WTF2HELB, WTF2HSRB, WTF2HSLB, WTF3ERB, WTF3ELB, WTF3SRB, WTF3SLB, WTF3HERB, WTF3HELX, WTF3HSRB, WTF3HSLB, WTF4HERB, WTF4HELB, WTF4HSRB, WTF4HSLB, WTF2ERA, WTF2ELA, WTF2SRA, WTF2SLA, WTF2HERA, WTF2HELA, WTF2HSRA, WTF2HSLA, WTF3ERA...(Other models you can see in the webshop)		



1			
GEV No.	520657	Ref. No.	0E5431
description	double nipple brass thread 1/2" - 3/4"		
For models:	ECP/E1ELHU, PCP/E2SHP, PCP/E1ELH, OCP/E2S, TCP/E1ELHU, TCP/E2S, TCP/E2SH, TCP/E1ELH, KCP/G1RU, KCP/G2RU, KCP/E1RU, KCP/E2RU, KCP/G1, KCP/G1R, KCP/G2, KCP/G2R, KCP/E1, KCP/E1R, KCP/E2, KCP/E2R, KCP/G1U, KCP/G2U, KCP/E1U, KCP/E2U, QCP/G1, QCP/G1R, QCP/G2, QCP/G2R, QCP/E1, QCP/E1R, QCP/E2, QCP/E2R, WCP/G1, WCP/G1R, WCP/G2, WCP/G2R, WCP/E1, WCP/E1R, WCP/E2, WCP/E2R, DCP/G400, RT100ED, RT100ES, RT100SR, RT100SL, RT140ED, RT140ES, RT140SR, RT140SL, RT190ED...(Other models you can see in the webshop)		

angle pieces



1			
GEV No.	541924	Ref. No.	0C4080
description	angle piece thread 1/2" IT - 1/2" IT brass		

hose connectors

brass



1			
GEV No.	504316	Ref. No.	0E2895
description	hose connector brass straight thread 1/2" hose ø 15mm Qty 1 pcs		
For models:	RT100ED, RT100ES, RT100SR, RT100SL, RT140ED, RT140ES, RT140SR, RT140SL, RT190ED, RT190ES, RT190SR, RT190SL, RT190HDED, RT190HDES, RT190HSR, RT190HSL, RT270ED, RT270ES, RT270SR, RT270SL, RT270HDED, RT270HDES, RT270HSR, RT270HSL, RT100ERF, RT100ELF, RT100VD, RT100VS, RT140ERF, RT140ELF, RT140VD, RT140VS, RT142ERF, RT142ELF, RT190ERF, RT190ELF, RT190VD, RT190VS, RT190HERF, RT190HELF, RT190HDVDF, RT190HDVSF, RT270ERF, RT270ELF, RT270VDF, RT270VSF, RT270HERF, RT270HELF, RT270HDVDF, RT270HDVSF...(Other models you can see in the webshop)		



GEV No.	520866	Ref. No.	007117 516809501
description	hose connector brass straight thread 3/4" hose ø 30mm Qty 1 pcs		
For models:	FDV40G, FDV40GZ, FDV40GA, FDV20G, FDV20GZ, FDV20GA, FCZ061EAA, FCZ101EAA, FCZ102EAA, FCZ201EAA, FCZ202EAA, FCZ061EAH, FCZ101EAH, FCZ201EAH, FCZ061EAN, FCZ101EAN, FCZ201EAN, FCZ061ETA, FCZ101ETA, FCZ102ETA, FCZ201ETA, FCZ202ETA, FCZ061ETH, FCZ101ETH, FCZ201ETH, FCZ061ETN, FCZ101ETN, FCZ201ETN, FCZ201GAG, FCZ201GAD, FCZ201GTG, FCZ201GTD, FCZ061EBA, FCZ101EBA, FCZ102EBA, FCZ201EBA, FCZ202EBA, FCZ061EBH, FCZ101EBH, FCZ201EBH, FCZ061EBN, FCZ101EBN, FCZ201EBN, FCZ061EBC, FCZ101EBC, FCZ201EBC, FCZ061EBA2, FCZ101EBA2, FCZ102EBA2, FCZ201EBA2...(Other models you can see in the webshop)		

stainless steel



GEV No.	542346	Ref. No.	0C4198
description	hose connector thread 1/4" with O-ring hose ø 5mm stainless steel Qty 1 pcs		
For models:	FCZ061EAA, FCZ101EAA, FCZ102EAA, FCZ201EAA, FCZ202EAA, FCZ061EAH, FCZ101EAH, FCZ201EAH, FCZ061EAN, FCZ101EAN, FCZ201EAN, FCZ061ETA, FCZ101ETA, FCZ102ETA, FCZ201ETA, FCZ202ETA, FCZ061ETH, FCZ101ETH, FCZ201ETH, FCZ061ETN, FCZ101ETN, FCZ201ETN, FCZ061GAG, FCZ101GAG, FCZ102GAG, FCZ201GAG, FCZ202GAG, FCZ061GAD, FCZ101GAD, FCZ102GAD, FCZ201GAD, FCZ202GAD, FCZ101GTG, FCZ102GTG, FCZ201GTG, FCZ202GTG, FCZ101GTD, FCZ102GTD, FCZ201GTD, FCZ202GTD, FCZ061EBA, FCZ101EBA, FCZ102EBA, FCZ061EBH, FCZ101EBH, FCZ061EBN, FCZ101EBN, FCZ061EBC, FCZ101EBC, FCZ201EBC...(Other models you can see in the webshop)		

nickel-plated brass



GEV No.	520203	Ref. No.	0E5529 0K8725 0L0040
description	hose connector nickel-plated brass straight thread 1/2" hose ø 12mm Qty 1 pcs		
For models:	FT36EDTS, FT36ESTS, FT36VDTS, FT36VSTS, FT36ED, FT36ES, FT36VD, FT36VS, FT50ED, FT50ES, FT50VD, FT50VS, FT72ED, FT72ES, FT72VD, FT72VS, FT36EDT, FT36EST, FT36VDT, FT36VST, FT50EDT, FT50EST, FT50VDT, FT50VST, FT72EDT, FT72EST, FT72VDT, FT72VST, WTF2ERC, WTF2ELC, WTF2SRC, WTF2SLC, WTF2HERC, WTF2HELC, WTF2HSRC, WTF2HSLC, WTF3ERC, WTF3ELC, WTF3SRC, WTF3SLC, WTF3HERC, WTF3HELC, WTF3HSRC., WTF3HSLC, WTF2ERB., WTF2ELB, WTF2SRB, WTF2SLB, WTF2HERB, WTF2HELB...(Other models you can see in the webshop)		

producer-specific



GEV No.	501021	Ref. No.	0620342
description	hose connector		





GEV No.	520201	Ref. No.	0C1626
description	hose connector nickel-plated brass straight thread 1/4" hose ø 12mm Qty 1 pcs		
For models:	ECP/E1ELHU, PCP/E2SHP, PCP/E1SH, PCP/E2SH, PCP/E2SH3B, PCP/E1ELH, OCP/E2S, OCP/E1SH, OCP/E2SH, TCP/E1ELHU, TCP/E2S, TCP/E2SH, TCP/E1ELH, KCP/G1RU, KCP/G2RU, KCP/E1RU, KCP/E2RU, KCP/G1, KCP/G1R, KCP/G2, KCP/G2R, KCP/E1, KCP/E1R, KCP/E2, KCP/E2R, KCP/G1U, KCP/G2U, KCP/E1U, KCP/E2U, QCP/G1, QCP/G1R, QCP/G2, QCP/G2R, QCP/E1, QCP/E1R, QCP/E2, QCP/E2R, WCP/G1, WCP/G1R, WCP/G2, WCP/G2R, WCP/E1, WCP/E1R, WCP/E2, WCP/E2R, DCP/G400, FCZ061EAA, FCZ101EAA, FCZ102EAA, FCZ201EAA...(Other models you can see in the webshop)		



GEV No.	504584	Ref. No.	049289 0L0365 EZ3823
description	hose connector metal L 56mm D1 ø 29mm D2 ø 14mm D3 ø 14mm		
For models:	LS32UK/RP, WT302UK/RP, WT4DG, WT4WS1, LS33UK/RP, WT4BWS, WT4DWS1, WT4BDWS, WT303UK/RP, EUC1WS, EUC1DPWS, EUC3WS, EUC3DPWS, ZUCADDROW, ZUCADDROW6, LS5/1WS, LS5/1WSDP, LS5/3WS, LS5/3WSDP, FUCA3DD, LS5/3WSDPD, LB5DPG, NUC1WS, NUC1DPWS, NUC3WS, NUC3DPWS, NUC3DDWS, ZUCA1, ZUCA3, EUCADDROW, EUCADDROW6, LS6EADD, LS6EA/DPDD, WT38TDE, WT38/M50, LS6EADP3, WT37LEV/9, LS6SANA, EUCAI, EUCAIDP, EUCAI60, WT38M50/4, LS6EA/UK, LS6EA/DPUK, EUCAIG, EUCAIML, EUCAIMLG, EUCAICL, EUCAICLG, EUCAIWL...(Other models you can see in the webshop)		



			
1			
GEV No.	504321	Ref. No.	0E5489 0E5510 0K8721 0K8723 0L0653 552217100 552217300
description	hose connector thread 1/2" grommet ø 15mm grommet length 20mm WS 24 total length 50mm thread L 14mm brass		
For models:	PW1EFL, PW1EFLF, PW1EFL/60HZ, PW2EFL, PW2EFLF, PW2EFL/60HZ, PW2VFL, WT830EFL, WT830EFLF, WT830EFL/60HZ, WT850, WT850EFLF, WT850EFL/60HZ, WT850SFL, FT36EDTS, FT36ESTS, FT36VDTs, FT36VSTs, FT36ED, FT36ES, FT36VD, FT36VS, FT50ED, FT50ES, FT50VD, FT50VS, FT72ED, FT72ES, FT72VD, FT72VS, FT36EDT, FT36EST, FT36VDT, FT36VST, FT50EDT, FT50EST, FT50VDT, FT50VST, FT72EDT, FT72EST, FT72VDT, FT72VST, FT36WED, FT36WES, FT36WVD, FT36WVS, FT50WED, FT50WES, FT50WVD, FT50WVS...(Other models you can see in the webshop)		

			
2			
GEV No.	504314	Ref. No.	0E3080
description	hose connector thread 1/8" IT grommet ø 13.5mm grommet length 28.5mm total length 58mm brass		
For models:	FT36EDTS, FT36ESTS, FT36VDTs, FT36VSTs, FT36ED, FT36ES, FT36VD, FT36VS, FT50ED, FT50ES, FT50VD, FT50VS, FT72ED, FT72ES, FT72VD, FT72VS, FT36EDT, FT36EST, FT36VDT, FT36VST, FT50EDT, FT50EST, FT50VDT, FT50VST, FT72EDT, FT72EST, FT72VDT, FT72VST, FT36WED, FT36WES, FT36WVD, FT36WVS, FT50WED, FT50WES, FT50WVD, FT50WVS, FT72WED, FT72WES, FT72WVD, FT72WVS, FT36WEDT, FT36WEST, FT36WVDT, FT36WVST, FT50WEDT, FT50WEST, FT50WVDT, FT50WVST, FT72WEDT, FT72WEST...(Other models you can see in the webshop)		

			
1			
GEV No.	504313	Ref. No.	049561 0KB773
description	hose connector thread M12x1.75 grommet ø 11.3mm grommet length 23mm WS 17 total length 43mm thread L 15mm stainless steel IT M8x1.25		
For models:	LS14AH240U, WT65H208U, WT65H240U, LS14H208DU, LS14AH208U, LS14H240DU, LS14H208RU, LS14H240RU, WT65H208DU, WT65H240DU, WT65H208RU, WT65M208U, WT65M240U, WT65M208DU, WT65M240DU, WT65M208RU, WT65M240RU, WT65H208WS, WT65H240WS		

<p>push-in fittings</p> <p>JOHN GUEST</p> 			
1			
GEV No.	440033	Ref. No.	0c1124
description	push-in fitting John Guest T-piece pipe connection ø15mm - ø15mm - ø15mm		
For models:	FCZ061EAA, FCZ101EAA, FCZ102EAA, FCZ201EAA, FCZ202EAA, FCZ061EAH, FCZ101EAH, FCZ201EAH, FCZ061EAN, FCZ101EAN, FCZ201EAN, FCZ061GAG, FCZ101GAG, FCZ102GAG, FCZ201GAG, FCZ202GAG, FCZ061GAD, FCZ101GAD, FCZ102GAD, FCZ201GAD, FCZ202GAD, FCZ061EBC, FCZ101EBC, FCZ201EBC, FCZ061GBI, FCZ101GBI, FCZ201GBI, FCZ061ECA, FCZ101ECA, FCZ102ECA, FCZ201ECA, FCZ202ECA, FCZ061ECH, FCZ101ECH, FCZ201ECH, FCZ061ECN, FCZ101ECN, FCZ201ECN, FCZ061GCG, FCZ101GCG, FCZ102GCG, FCZ201GCG, FCZ202GCG, FCZ061GCD, FCZ101GCD, FCZ102GCD, FCZ201GCD, FCZ202GCD, FCS061EXLN, FCS061EX...(Other models you can see in the webshop)		

			
1			
GEV No.	440032	Ref. No.	0C1123
description	push-in fitting John Guest T-piece pipe connection ø22mm - ø15mm - ø22mm		
For models:	FCZ201EAA, FCZ202EAA, FCZ201EAH, FCZ201EAN, FCZ201GAG, FCZ202GAG, FCZ201GAD, FCZ202GAD, FCZ201EBC, FCZ201GBI, FCZ201ECA, FCZ202ECA, FCZ201ECH, FCZ201ECN, FCZ201GCG, FCZ202GCG, FCZ201GCD, FCZ202GCD, AOS201GAEU, AOS202GAEU, AOS201GAUU, AOS202GAUU, AOS201EABU, AOS201EAFU, AOS201EA, AOS201EA3J, AOS201EA2N, AOS202EA2N, AOS201EA0H, AOS202EA, AOS201GA, AOS202GA, AOS201EAAQ, AOS202EAAQ, AOS201EANQ, AOS202EANQ, AOS201EACQ, AOS201EAHQ, AOS201GAGQ, AOS202GAGQ, AOS201GADQ, AOS202GADQ, AOS201GAIQ, AOS201GALQ, AOS201EAMQ, AOS201EABQ, AOS201GAPQ, AOS202GAPQ, AOS201EAA1, AOS202EAA1...(Other models you can see in the webshop)		

			
1			
GEV No.	440030	Ref. No.	0C1149
description	push-in fitting John Guest straight thread 1/2" BSP stub ø 15		
For models:	FCZ061EAA, FCZ101EAA, FCZ102EAA, FCZ061EAH, FCZ101EAH, FCZ061EAN, FCZ101EAN, FCZ061GAG, FCZ101GAG, FCZ102GAG, FCZ061GAD, FCZ101GAD, FCZ102GAD, FCZ061EBC, FCZ101EBC, FCZ061GBI, FCZ101GBI, FCZ061ECA, FCZ101ECA, FCZ102ECA, FCZ061ECH, FCZ101ECH, FCZ061ECN, FCZ101ECN, FCZ061GCG, FCZ101GCG, FCZ102GCG, FCZ061GCD, FCZ101GCD, FCZ102GCD, FCS061EXLN, FCS061EX, FCS101EX4J, FCS101EXLN, FCS101EX, FCS102EX4J, FCS102EX, FCS201EX, FCS201EXLN, FCS202EX, FCS101GX9J, FCS101GX, FCS102GX9J, FCS102GX, FCS201GX, FCS202GX, AOS061GAEU, AOS101GAEU, AOS102GAEU, AOS061GAUU...(Other models you can see in the webshop)		



1

GEV No.	440029	Ref. No.	0C1122
description	push-in fitting John Guest straight thread 3/4" BSP stub ø 22		
For models:	FCZ201EAA, FCZ202EAA, FCZ201EAH, FCZ201EAN, FCZ201GAG, FCZ202GAG, FCZ201GAD, FCZ202GAD, FCZ201EBC, FCZ201GBI, FCZ201ECA, FCZ202ECA, FCZ201ECH, FCZ201ECN, FCZ201GCG, FCZ202GCG, FCZ201GCD, FCZ202GCD, AOS201GAEU, AOS202GAEU, AOS201GAUU, AOS202GAUU, AOS201EABU, AOS201EAFU, AOS201EA, AOS201EA3J, AOS201EA2N, AOS202EA2N, AOS201EA0H, AOS202EA, AOS201GA, AOS202GA, AOS201EAAQ, AOS202EAAQ, AOS201EANQ, AOS202EANQ, AOS201EACQ, AOS201EAHQ, AOS-201GAGQ, AOS202GAGQ, AOS201GADQ, AOS202GADQ, AOS-201GAIQ, AOS201GALQ, AOS201EAMQ, AOS201EABQ, AOS201GAPQ, AOS202GAPQ, AOS201EAA1, AOS202EAA1...(Other models you can see in the webshop)		





1

GEV No.	520726	Ref. No.	OK1391 637961 BNR637961
description	ball valve connection 1/2" IT - 1/2" ET DN15 total length 56mm		



1

GEV No.	540937	Ref. No.	005919
description	ball valve connection 3/4" IT - 1" IT DN20 total length 80mm		
For models:	ECP/E1ELHU, PCP/G1S, PCP/G2D, PCP/E1S, PCP/E2D, PCP/E2SH, PCP/E1SH, PCP/E2SH, PCP/E2SH3B, PCP/E1ELH, OCP/G1S, OCP/G2D, OCP/E1S, OCP/E2D, OCP/E2S, OCP/E1SH, OCP/E2SH, TCP/E1ELHU, TCP/E2S, TCP/E2SH, TCP/E1ELH, KCP/G1RU, KCP/G2RU, KCP/E1RU, KCP/E2RU, KCP/G1, KCP/G1R, KCP/G2, KCP/G2R, KCP/E1, KCP/E1R, KCP/E2, KCP/E2R, KCP/G1U, KCP/G2U, KCP/E1U, KCP/E2U, QCP/G1, QCP/G1R, QCP/G2, QCP/G2R, QCP/E1, QCP/E1R, QCP/E2, QCP/E2R, WCP/G1, WCP/G1R, WCP/G2, WCP/G2R, WCP/E1...(Other models you can see in the webshop)		
accessories for	540937		
		GEV No.	540938
		Ref. No.	0C0563
	description	extension for ball valve	
		GEV No.	540939
		Ref. No.	—
	description	lever handle suitable for outlet tap shaft 8x8mm	



1

GEV No.	540982	Ref. No.	005927 OKI534 11171256
description	ball valve connection 3/4" IT - 3/4" ET DN20 total length 69mm shaft ø 8x5mm		
For models:	BFR/G1S14, BFR/E1S14, RFR/G1S14, RFR/G2D14, RFR/E1S14, RFR/E2D14, RFR/G1S07, RFR/G2D07, RFR/E1S07, RFR/E2D07, RFR/E1S12, RFR/E2D12, XFR/G1S14, XFR/G2D14, XFR/E1S14, XFR/E2D14, XFR/G1S07, XFR/G2D07, XFR/E1S07, XFR/E2D07, XFR/E1S12, XFR/E2D12, JFR/G1S14, JFR/G2D14, JFR/E1S14, JFR/E2D14, JFR/G2D07, JFR/G2D07, JFR/E1S07, JFR/E2D07, MFR/G1S14, MFR/G2D14, MFR/E1S14, MFR/E2D14, MFR/G1S07, MFR/G2D07, MFR/E1S07, MFR/E2D07, MFR/E1S12, MFR/E2D12, PF/G1S07, PF/G2D07, PFR/G1S07, PFR/G2D07, PFR/G1S14, PFR/G2D14, PFR/E1S07, PFR/E2D07, PFR/E1S12, PFR/E2D12...(Other models you can see in the webshop)		

valves and tank inlets

ball valves

universal

mini ball valves



1

GEV No.	520296	Ref. No.	0H6056 0H6384 500125 60050399
description	ball valve connection 1/2" IT - 1/2" IT DN10 total length 47mm chrome-plated brass		
For models:	5614-3-10, 5614-3-6, 5614-3-8		
accessories for	520296		
		GEV No.	515040
		Ref. No.	—
	description	drain fitting size 1/2" usable heightmm overall height 16mm ED ø 28mm chrome-plated brass	

ball valves with butterfly handle



1

GEV No.	540983	Ref. No.	0A5439
description	ball valve connection 1" IT - 1" ET DN25 total length 79mm		
For models:	RFR/G2S40, RFR/E2S40, XFR/G2S40, XFR/E2S40, JFR/G2S40, JFR/E2S40, MFR/G2S40, MFR/E2S40, PFR/G2S40, KFR/G1A, KFR/G2B, KFR/E1C, KFR/E2D, KFR/E1CE5, KFR/E2DE5, HFR/E431, HFR/E831, QFR/G1A, QFR/G2B, QFR/E1C, QFR/E2D, ZFR/E431, ZFR/E831, WFR/E1C, WFR/E2D, AFR/E431, AFR/E831		



			
1			
GEV No.	540658	Ref. No.	053108 OK7222 700610
description	ball valve connection 3/4" IT - 3/4" IT DN20 total length 69mm		
For models:	MFR/G350, MFR/G700, MFR/G350D, MFR/G700D, MFR/G350F, MFR/G700F, MFR/G350E, MFR/G700E, MFR/E355, MFR/E355UK, MFR/E355D, MFR/E705, MFR/E705UK, MFR/E705D, RFR/E1S12, RFR/E2D12, XFR/E1S12, XFR/E2D12, JFR/E1S12, JFR/E2D12, MFR/E1S12, MFR/E2D12, RFR/G350, RFR/G700, RFR/G350D, RFR/G700D, RFR/G350F, RFR/G700F, M35GFR, M70GFR, XFR/G350D, XFR/G700D, XFR/G350F, XFR/G700F, XFR/G351, CFR/G351, CFR/G700, RFR/G301, RFR/G300, RFR/G301, RFR/G701, RFR/G701F, HFR/G420, HFR/G420, HFR/G840, HFR/G840, HFR/E420, HFR/E420UK, HFR/E840...(Other models you can see in the webshop)		

			
1			
GEV No.	542287	Ref. No.	005902
description	ball valve connection 3/8" IT - 3/8" IT DN10 total length 42mm		
For models:	BCP/G1, ACPG25, ECP/E1ELHU, PCP/G1S, PCP/G2D, PCP/E1S, PCP/E2D, PCP/E1ELH, PBV/G2, PBV/E2, OCP/G1S, OCP/G2D, OCP/E1S, OCP/E2D, TCP/E1ELHU, TCP/G1S, TCP/G2D, TCP/E1S, TCP/E2D, TCP/E1ELH, TBV/G2, TBV/E2, KCP/G1RU, KCP/G2RU, KCP/E1RU, KCP/E2RU, KCP/G1, KCP/G1R, KCP/G2, KCP/G2R, KCP/E1, KCP/E1R, KCP/E2, KCP/E2R, KCP/G1U, KCP/G2U, KCP/E1U, KCP/E2U, QCP/G1, QCP/G1R, QCP/G2, QCP/G2R, QCP/E1, QCP/E1R, QCP/E2, QCP/E2R, WCP/G1, WCP/G1R, WCP/G2, WCP/G2R...(Other models you can see in the webshop)		

ball valves with lever handle

			
1			
GEV No.	540931	Ref. No.	056843 OKF043 700607
description	ball valve connection 3/8" IT - 3/8" IT DN10 total length 42mm		
For models:	MBR/G700, MBR/G700F, RBR/G2FM, RBR/G2IM, RBR/E2FM, RBR/E2IM, RCP/G1S, RCP/G2D, RCP/E1S, RCP/E2D, RBV/G2, RBV/E2, XBR/G2FM, XBR/G2IM, XBR/E2FM, XBR/E2IM, XCP/G1S, XCP/G2D, XCP/E1S, XCP/E2D, XBV/G2, XBV/E2, JBR/G2FM, JBR/E2FM, JCP/G1S, JCP/G2D, JCP/E1S, JCP/E2D, JBV/G2, JBV/E2, MBR/G2FM, MBR/G2IM, MBR/E2FM, MBR/E2IM, MCP/G1S, MCP/G2D, MCP/E1S, MCP/E2D, MBV/G2, MBV/E2, RBR/G700, RBR/G700F, XBR/G701, M70GBP, PBR/G2FM, PBR/G2IM, PBR/E2FM, PBR/E2IM, OBR/G2FM, OBR/G2IM...(Other models you can see in the webshop)		
accessories for	540931		
	GEV No.	111643	Ref. No. 004465 004483
knob water t.max.°C temperature range°C ø 70mm shaft ø 10x8mm shaft flat upper black			
	GEV No.	301208	Ref. No. 004242
disc			
	GEV No.	540932	Ref. No. 0A2563 1594
adapter for ball valve			
	GEV No.	540933	Ref. No. 0A2135
extension IT for ball valve ET M6 shaft ø 10x8mm			

			
1			
GEV No.	520282	Ref. No.	004729 033143 0G2292 0KC087
description	ball valve connection 1" IT - 1" IT DN25 total length 67mm with lever handle		
For models:	RCP/G1S, RCP/G2D, RCP/E1S, RCP/E2D, XCP/G1S, XCP/G2D, XCP/E1S, XCP/E2D, JCP/G1S, JCP/G2D, JCP/E1S, JCP/E2D, MCP/G1S, MCP/G2D, MCP/E1S, MCP/E2D, JCP/G800, JFM/G400, 7720-3/90.WB.GN1/1., 7520-3/85.WB.GN1/1., 7721-3/85.WB.GN2/1, 7520-3/90.WB.GN1/1., 7720-3/85.WB.GN1/1., 7521-3/85., 7521-3/90.WB.GN2/1., 7721-3/90.WB.GN2/1., 7521-3/85.WB.GN2/1.W, 198N, 265N, PCP/G800, PFM/G400, 7520-3, 7521-3, 7720-3, 7721-3, 9020-3, 9220-3-0, 9220-3-8		

			
1			
GEV No.	514325	Ref. No.	0A2071
description	ball valve connection 1" IT - 1" IT DN25 total length 83mm with lever handle		

			
1			
GEV No.	520280	Ref. No.	010369 0901/2 098215 0H6385 OKF802 OT3680 231205 430033 500305 60050400
description	ball valve connection 1/2" IT - 1/2" IT DN15 total length 50mm with lever handle handle length 85mm		
For models:	RPNV740, RPNV760, RPN/V740, RPN/V760, 5611-3-10, 5611-3-6, 5611-3-8, 5612-3-10, 5612-3-6, 5612-3-8, 5614-3-10, 5614-3-6, 5614-3-8		

			
1			
GEV No.	540981 ¹	Ref. No.	004486
description	ball valve connection 1/2" IT - tube ø16mm total length 69mm handle length 95mm		
For models:	RFR/G1S07, RFR/G2D07, RFR/E1S08, RFR/E2D08, XFR/G1S07, XFR/G2D07, XFR/E1S08, XFR/E2D08, JFR/G1S07, JFR/G2D07, JFR/E1S08, JFR/E2D08, MFR/G1S07, MFR/G2D07, MFR/E1S08, MFR/E2D08, JFR/G400, PFR/G400		

¹pipe connection ø16mm

			
1			
GEV No.	540991	Ref. No.	0A5258 700075
description	ball valve connection 3/8" IT - 3/8" ET DN10 total length 62mm with lever handle handle length 95mm		
For models:	RPD/G240, RPD/G260, RPI/G260, XPD/G240, XPD/G260, XPI/G260, JPD/G240, JPD/G260, JPI/G260, MPD/G240, MPD/G260, MPI/G260, APN/GI810, APN/GI815, APN/GI816, APN/EI815D, APN/EI810, APN/EI815, APN/GD811, APN/GD816, APN/ED816, APNS/GI816, APNS/EI815, OPN/GI815, APN/GI805, APN/EI805		

ball valves electric			
			
1			
GEV No.	401140	Ref. No.	005026 0K1518 60050497
description	ball valve inlet 1" IT outlet 1" IT with plug 230V L 152mm 50/60Hz closed off-current mode of operation electric connection cable 200mm size DN25		
For models:	FCVG202L3, FCV/G20L6, FCV/E20L6, FCVG202L6, FCVE202L6, FCV/G201/1, FVC/E201/1, FVC/E202/1, 5712-2-7, 5712-2-8, 5712-2-10, 5714-2-7, 5714-2-8, 5714-2-10, 5717-2-6, 5714-2-7, 5714-2-8, 5714-2-10, 5712-2-7L, 5712-2-8L, 5712-2-10L, 5714-2-7L, 5714-2-8L, 5714-2-10L, 5714-2-6L, 5714-2-7L, 5714-2-8L, 5714-2-10L, 5711-3-7, 5711-3-8, 5711-3-10, 5711-3-8CH, 5711-3-10CH, 5712-3-7, 5712-3-8, 5712-3-8E, 5712-3-10, 5712-3-8CH, 5712-3-10C, 5714-3-7, 5714-3-8, 5714-3-8E, 5714-3-10, 5717-3-6, 5717-3-7, 5717-3-8, 5717-3-8E, 5717-3-10, 5717-3-8M, 5717-3-8C...(Other models you can see in the webshop)		

			
1			
GEV No.	400001	Ref. No.	201915
description	ball valve inlet 1/2" IT outlet 1/2" IT with manual unlocking 230V L 58mm 50Hz closed off-current mode of operation electric connection plug		



			
1			
GEV No.	400293	Ref. No.	059004 0L0949
description	ball valve inlet 3/4" IT outlet 3/4" IT electric 24V 50/60Hz cable length 250mm		
For models:	FCVE10-P, FCVE10PUK, FCVG10-P, FCVG10PUK, FCVE20-P, FCVE20PUK, FCVG20-P, FCVG20PUK, WTM140ERA, WTM140ELA, WTM140ERB, WTM140ELB, WTM165ERA, WTM165ELA, WTM165ERB, WTM165ELB, WTM200ERA, WTM200ELA, WTM200ERB, WTM200ELB, WTM250ERA, WTM250ELA, WTM250ERB, WTM250ELB, WTM300ERA, WTM300ELA, WTM300ERB, WTM300ELB, WTM180ERA, WTM180ELA, WTM180ERB, WTM180ELB, WTM140SRA, WTM140SLA, WTM165SRA, WTM165SLA, WTM180SRA, WTM180SLA, WTM200SRA, WTM200SLA, WTM250SRA, WTM250SLA, WTM300SRA, WTM300SLA, RTM140ERA, RTM140ELA, RTM140ERB, RTM140ELB, RTM165ERA, RTM165ELA...(Other models you can see in the webshop)		



			
GEV No.	401139	Ref. No.	002713 0C0882 0F0171 0K1526 0K8453 0K9349 2255318 60050290 696804201 867016 8670160
description	ball valve inlet 3/4" IT outlet 3/4" IT with plug 230V L 65mm 50/60Hz closed off-current mode of operation electric connection cable 200mm		
For models:	FCZ061EAA, FCZ101EAA, FCZ102EAA, FCZ201EAA, FCZ202EAA, FCZ061EAH, FCZ101EAH, FCZ201EAH, FCZ061EAN, FCZ101EAN, FCZ201EAN, FCZ061ETA, FCZ101ETA, FCZ102ETA, FCZ201ETA, FCZ202ETA, FCZ061ETH, FCZ101ETH, FCZ201ETH, FCZ061ETN, FCZ101ETN, FCZ201ETN, FCZ061GAG, FCZ101GAG, FCZ102GAG, FCZ201GAG, FCZ202GAG, FCZ061GAD, FCZ101GAD, FCZ102GAD, FCZ201GAD, FCZ202GAD, FCZ101GTD, FCZ102GTD, FCZ201GTD, FCZ202GTD, FCZ061EBA, FCZ101EBA, FCZ102EBA, FCZ201EBA, FCZ202EBA, FCZ061EBH, FCZ101EBH, FCZ201EBH, FCZ061EBN, FCZ101EBN...(Other models you can see in the webshop)		

shut-off valves

universal

			
GEV No.	540935	Ref. No.	056616 110120
description	shut-off valve connection tube ø 10mm total length 110mm shaft 7x7mm		
For models:	HCP/G800, HCP/G400, HCP/E800, HCP/E400		
accessories for	540935		
	GEV No.	110287	Ref. No. 025260 054254
knob water t.max.°C temperature range°C ø 50mm shaft ø 7x7mm shaft flat black			

producer-specific			
ZANUSSI			
			
GEV No.	111642	Ref. No.	051694 058632
description	knob water cold ø 70mm shaft ø 10x8mm shaft flat upper black H 39mm		
For models:	MBR/G700, MBR/G700F, MPN/GI760D, MPN/GD760F, MPN/GI760F, MPN/EI760, MPNEI760UK, RPNV740, RPN/G760, RPN/G760, PRPN/G760, RPN/GI760, RPN/GI760, RPN/GI760, PRPN/GI76, RPN/EI760, RPN/EI760, RPNV760		







			
GEV No.	541848	Ref. No.	002922
description	shut-off valve connection 1/2" 1/2" total length 48mm mounting pos. right shaft ø 8x10mm shaft L 75mm rosette thread G2 27x19G		
For models:	HBR/G821UK, ZBR/G821, ZBR/G826		
spare parts for	541848		
	GEV No.	111642	Ref. No. 051694 058632
knob water cold ø 70mm shaft ø 10x8mm shaft flat upper black H 39mm			
	GEV No.	514083	Ref. No. —
rosette connection 27x19G chrome-plated total lengthmm mounting pos.			
	GEV No.	514084	Ref. No. —
nut thread 27x19G WS 34			

			
GEV No.	111642	Ref. No.	051694 058632
description	knob water cold ø 70mm shaft ø 10x8mm shaft flat upper black H 39mm		
For models:	MBR/G700, MBR/G700F, MPN/GI760D, MPN/GD760F, MPN/GI760F, MPN/EI760, MPNEI760UK, RPNV740, RPN/G760, RPN/G760, PRPN/G760, RPN/GI760, RPN/GI760, RPN/GI760, PRPN/GI76, RPN/EI760, RPN/EI760, RPNV760		







			
1			
GEV No.	111644	Ref. No.	059531
description	knob water cold t.max.°C temperature range°C ø 70mm shaft ø 10x8mm shaft flat upper black H 25mm		
For models:	HPN/GI810, HPN/GI815, HPN/GI816, HPN/EI815D, HPN/EI810, HPN/EI815, HPN/GD811, HPN/GD816, HPN/ED811, HPN/ED816, HPA/GD825, HPA/GI825, HPA/ED825, HPA/EI825, HPN/GI855, HPN/GI1255, HPN/EI855, HPN/EI1255, HPNS/GI816, HPNS/EI815, HPNS/EI815D, HPN/GI806, HPN/EI806, HPN/GI805, HPN/EI805, HCP/G400, HCP/G800, HCP/E400, HCP/E800, HCPS/G400, HCPS/E400, HCP/G400U, HCP/G800U, ZPN/GI1255, ZPN/EI1255, ZPN/GI805, JCP/G800, JFM/G400		

			
1			
GEV No.	111678	Ref. No.	051695 058708
description	knob water hot ø 70mm shaft ø 10x8mm shaft flat upper black/red H 29mm		
For models:	MPN/GI760D, MPN/GD760F, MPN/GI760F, MPN/EI760, MPNEI760UK, RPNV740, RPN/G760, RPN/G760, PRPN/G760, RPN/GI760, RPN/GI760, RPN/GI760, PRPN/GI76, RPN/EI760, RPN/EI760, RPNV760, RBR/G700, RBR/G700		

			
1			
GEV No.	111680	Ref. No.	059516
description	knob water hot ø 70mm shaft ø 10x8mm shaft flat upper black/red H 39mm		
For models:	HPN/GI810, HPN/GI815, HPN/GI816, HPN/EI815D, HPN/EI810, HPN/EI815, HPN/GD811, HPN/GD816, HPN/ED811, HPN/ED816, HPA/GD825, HPA/GI825, HPA/ED825, HPA/EI825, HPN/GI855, HPN/GI1255, HPN/EI855, HPN/EI1255, HPNS/GI816, HPNS/EI815, HPNS/EI815D, HPN/GI806, HPN/EI806, HPN/GI805, HPN/EI805, ZPN/GI1255, ZPN/EI1255, ZPN/GI805		

			
1			
GEV No.	540930	Ref. No.	003517 02312123
description	shut-off valve connection 1/2" 1/2" total length 48mm mounting pos. left shaft ø 8x10mm shaft L 61mm marking S rosette thread G2 27x19G		
For models:	MPN/GD761, MPN/GI761, MPN/GI760D, MPN/GD760, MPN/GD760F, MPN/GI760, MPN/GI760F, MPN/EI760, MPNEI760UK, MPN/V760, MPN/EI760D, MPN/V760D, MCP/G705, MCP/G706, 7PDG06, 7PIG06, 7PIE06, RPN/EI760UK, RPN/GD760F, RPN/GI760F, 7PEV06, RPN/EI760D, RCP/G706, XPN/GI760D, M70GDKE, M70GIKE, M70EIKE, XPN/EI760UK, XPN/GD760F, XPN/GI760F, XPN/EI760D, XCP/G706, HPN/GI810, HPN/GI815, HPN/GI816, HPN/EI815D, HPN/EI810, HPN/EI815, HPN/GD811, HPN/GD816, HPN/ED811, HPN/ED816, HPA/GD825, HPA/GI825, HPA/ED825, HPA/EI825, HPNS/GI816, HPNS/EI815, HPNS/EI815D, HPN/GI806...(Other models you can see in the webshop)		
spare parts for	540930		
	GEV No.	111642	Ref. No.
			051694 058632
	knob water cold ø 70mm shaft ø 10x8mm shaft flat upper black H 39mm		
	GEV No.	111678	Ref. No.
			051695 058708
	knob water hot ø 70mm shaft ø 10x8mm shaft flat upper black/red H 29mm		
	GEV No.	514061	Ref. No.
			—
	knob water cold t.max.°C°C ø 67mm shaft ø 10x8mm shaft flat variable		
	GEV No.	514083	Ref. No.
			—
	rosette connection 27x19G chrome-plated total lengthmm mounting pos.		
	GEV No.	514084	Ref. No.
			—
	nut thread 27x19G WS 34		



			
1			
GEV No.	540971	Ref. No.	003516 02311123 0K1534
description	shut-off valve connection 1/2" 1/2" total length 48mm mounting pos. right shaft L 61mm marking D rosette thread G2 27x19G shaft ø 8x10mm		
For models:	MPN/GD761, MPN/GI761, MPN/GI760D, MPN/GD760, MPN/GD760F, MPN/GI760, MPN/GI760F, MPN/EI760, MPNEI760UK, MPN/V760, MPN/EI760D, MPN/V760D, 7PDG06, 7PIG06, 7PIE06, RPN/EI760UK, RPN/GD760F, RPN/GI760F, 7PEV06, RPN/EI760D, XPN/GI760D, M70GDKE, M70GIKE, M70EIKE, XPN/EI760UK, XPN/GD760F, XPN/GI760F, XPN/EI760D, HPN/GI810, HPN/GI815, HPN/GI816, HPN/EI815D, HPN/EI810, HPN/EI815, HPN/GD811, HPN/GD816, HPN/ED811, HPN/ED816, HPA/GD825, HPA/GI825, HPA/ED825, HPA/EI825, HPNS/GI816, HPNS/EI815, HPNS/EI815D, HPN/GI806, HPN/EI806, HPN/GI805, HPN/EI805, HCP/G400...(Other models you can see in the webshop)		
spare parts for	540971		
	GEV No.	111642	Ref. No. 051694 058632
	knob water cold ø 70mm shaft ø 10x8mm shaft flat upper black H 39mm		
	GEV No.	111644	Ref. No. 059531
	knob water cold t.max.°C temperature range°C ø 70mm shaft ø 10x8mm shaft flat upper black H 25mm		
	GEV No.	111678	Ref. No. 051695 058708
	knob water hot ø 70mm shaft ø 10x8mm shaft flat upper black/red H 29mm		
	GEV No.	111680	Ref. No. 059516
	knob water hot ø 70mm shaft ø 10x8mm shaft flat upper black/red H 39mm		
	GEV No.	514083	Ref. No. —
	rosette connection 27x19G chrome-plated total lengthmm mounting pos.		

			
1			
GEV No.	110288	Ref. No.	025255 025256 054367
description	cover cap knob white		
For models:	MFR/G350, MFR/G351, RCV/G2, RCV/G3, RCV/E2, RCV/E3, RRV/G1FL, RRV/G1FR, RRV/G2FL, RRV/G2FM, RRV/E1FL, RRV/E1FR, RRV/E2FL, RRV/E2FM, RG/G1, RG/G2, RGV/G1, RGV/G2, RGV/E1, RGV/E2, RTV/G2, RSV/G2, RIV/E2, RBV/G2, RBV/E2, XCV/G2, XCV/G3, XCV/E2, XCV/E3, XRV/G1FL, XRV/G1FR, XRV/G2FL, XRV/G2FM, XRV/E1FL, XRV/E1FR, XRV/E1CL, XRV/E2FL, XRV/E2FM, XRV/E2CL, XGV/G1, XGV/G2, XGV/E1, XGV/E2, XTV/G2, XSV/G2, XIV/E2, XBV/G2, XBV/E2, JCV/G2, JCV/G3...(Other models you can see in the webshop)		

			
1			
GEV No.	110287	Ref. No.	025260 054254
description	knob water t.max.°C temperature range°C ø 50mm shaft ø 7x7mm shaft flat black		
For models:	HCP/G800, HCP/G400, HMS/E800, HMS/E400, HM/G800T, HM/E800T, HQN/G1917, HQN/G1917, HQN/G1225, HQN/GI1225, HQN/EI917, HQN/GI122, HQN/V917, HPN/G810, HQN/EI1225, HPN/GI810, HPN/GI810, HPN/G815, HPA/G815, HPN/E810, HPN/GI815, HPA/GI815, HPN/EI810, HPA/GI815, HPN/E815, HPN/EI810, HPA/EI810, HPN/GI810, HBR/G803, HBR/G804, HBR/G803, HBR/G804, HBR/G803, HBR/G805, HBR/G1003, HBR/G1003, HBR/G1004, HBR/E801, HBR/E803, HBR/E804, HBR/E805UK, HBR/E1003, HBR/G803, HBR/G804, HBR/G1013, HBR/E1013, HCP/E800, HCP/E400		
accessories for	110287		
	GEV No.	110288	Ref. No. 025255 025256 054367
	cover cap knob white		







			
1			
GEV No.	540773	Ref. No.	02310933 026537 0K2933
description	shut-off valve connection 1/2" 1/2" left total length 34mm mounting pos. left angled shaft intake ø M5x0.8mm rosette thread G2 27x19G		
For models:	M70EIKE, XPN/EI760UK, M70VIKE, RPNV740, RPN/G760, RPN/G760, PRPN/G760, RPN/GI760, RPN/GI760, RPN/GI760, PRPN/GI76, RPN/EI760, RPN/EI760, RPNV760, HPN/GI815D, HPN/GI816, ZPN/GI816D, HPN/ED825, HPN/EI825, HQN/G1917, HQN/G1917, HQN/G1225, HQN/GI1225, HQN/EI917, HQN/GI122, HQN/V917, HPN/G810, HQN/EI1225, HPN/GI810, HPN/GI810, HPN/G815, HPA/G815, HPN/E810, HPN/GI815, HPA/GI815, HPN/EI810, HPA/GI815, HPN/E815, HPN/EI810, HPA/EI810, HPN/GI810, HPN/G810, HPN/G815, HPA/G815, HPN/GI810, HPN/GI815, HPN/GI815, HPN/E810, HPN/E815, HPN/EI810...(Other models you can see in the webshop)		
spare parts for	540773		
	GEV No.	110287	Ref. No. 025260 054254
	knob water t.max.°C temperature range°C ø 50mm shaft ø 7x7mm shaft flat black		
	GEV No.	110288	Ref. No. 025255 025256 054367
	cover cap knob white		
	GEV No.	514083	Ref. No. —
	rosette connection 27x19G chrome-plated total lengthmm mounting pos.		
	GEV No.	514084	Ref. No. —
	nut thread 27x19G WS 34		
	GEV No.	540414	Ref. No. —
	star handle connection hot total lengthmm mounting pos. shaft diameter 7x7mm ø 55mm 35 built-in depth 22mm		

Table continues overleaf

spare parts for 540773			
	GEV No.	540415	Ref. No. —
star handle connection cold total lengthmm mounting pos. shaft diameter 7x7mm ø 55mm 35 built-in depth 22mm			





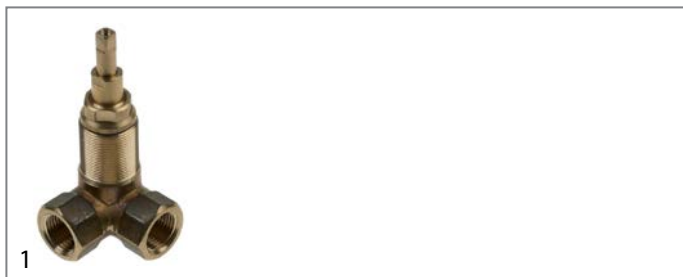

GEV No.	540771	Ref. No.	02309933 02314933 025733 053703
description	shut-off valve connection 1/2" 1/2" right total length 34mm mounting pos. right angled shaft intake ø M5x0.8mm rosette thread G2 27x19G		
For models:	M70EIKE, XPN/EI760UK, M70VIKE, RPNV740, RPN/G760, RPN/G760, PRPN/G760, RPN/GI760, RPN/GI760, RPN/GI760, PRPN/GI76, RPN/EI760, RPN/EI760, RPNV760, HPN/GI815D, HPN/GI816, ZPN/GI816D, HPN/ED825, HPN/EI825, HMS/G400, HMS/G800, HMA/G800, HMS/E400, HMS/E800, HMA/E800, HMS/G400, HMS/G800D, HMA/G800D, HMS/E400, HMS/E800, HMA/E800, HMS/G400NL, HMS/G800, HMA/G800NL, HM/G400T, HM/G800T, HM/E400T, HM/E800T, HQN/G1917, HQN/G1917, HQN/G1225, HQN/G1225, HQN/EI917, HQN/GI122, HQN/V917, HPN/G810, HQN/EI1225, HPN/GI810, HPN/GI810, HPN/G815...(Other models you can see in the webshop)		



spare parts for 540771			
	GEV No.	110287	Ref. No. 025260 054254
knob water t.max.°C temperature range°C ø 50mm shaft ø 7x7mm shaft flat black			
	GEV No.	110288	Ref. No. 025255 025256 054367
cover cap knob white			
	GEV No.	111642	Ref. No. 051694 058632
knob water cold ø 70mm shaft ø 10x8mm shaft flat upper black H 39mm			
	GEV No.	111644	Ref. No. 059531
knob water cold t.max.°C temperature range°C ø 70mm shaft ø 10x8mm shaft flat upper black H 25mm			
	GEV No.	111678	Ref. No. 051695 058708
knob water hot ø 70mm shaft ø 10x8mm shaft flat upper black/red H 29mm			
	GEV No.	111680	Ref. No. 059516
knob water hot ø 70mm shaft ø 10x8mm shaft flat upper black/red H 39mm			
	GEV No.	514083	Ref. No. —
rosette connection 27x19G chrome-plated total lengthmm mounting pos.			
	GEV No.	514084	Ref. No. —
nut thread 27x19G WS 34			
	GEV No.	540414	Ref. No. —
star handle connection hot total lengthmm mounting pos. shaft diameter 7x7mm ø 55mm 35 built-in depth 22mm			
	GEV No.	540415	Ref. No. —
star handle connection cold total lengthmm mounting pos. shaft diameter 7x7mm ø 55mm 35 built-in depth 22mm			

steam valves



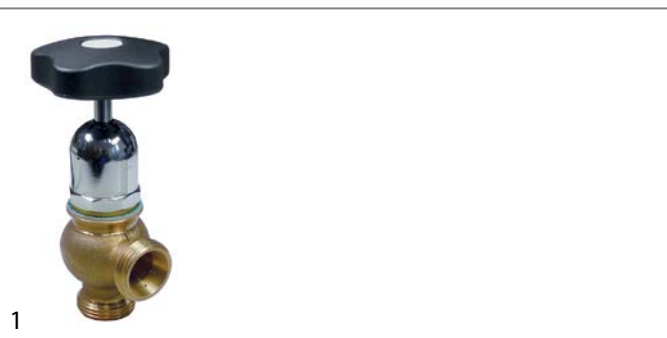

GEV No.	541542	Ref. No.	0KD952 686240502
description	steam valve straight connection 1" IT total length 90mm H 140mm brass		
spare parts for 541542			
	GEV No.	540229	Ref. No. —
star handle shaft 9x9mm ø 80mm L 23mm black thermoplastic			
	GEV No.	541546	Ref. No. —
screw chrome-plated brass thread M5 thread L 10mm			
	GEV No.	541548	Ref. No. —
gasket PTFE ID ø 15mm H 7mm for thread 1¼" ED ø 35mm			
	GEV No.	541554	Ref. No. —
gasket copper ext. ø 49 ID ø 42mm H 2mm for thread 1¼"			
	GEV No.	541557	Ref. No. —
tap head chrome-plated thread 1¼" for steam tap 1"			



GEV No.	541455	Ref. No.	01510005 038020 0S0142
description	steam tap angled connection 1" ET total length 40mm H 150mm brass		
For models:	FSV11FD3X, FSV15FD4X, FSV15FDC4X, FSV11FD3C, FSV15FD4C, FSV15FDC4C		
spare parts for 541455			
	GEV No.	541563	Ref. No. —
star handle shaft 7x7mm ø 72mm L 24mm black plastic			
	GEV No.	541565	Ref. No. —
tap head for steam tap 1" shaft 7x7mm			



1

GEV No.	520000	Ref. No.	01512006 0S0143	
description	steam valve angled connection 1 1/4" IT total length 52mm H 190mm brass			
spare parts for	520000			
	GEV No.	541566	Ref. No.	—
	tap head for steam tap 1 1/4" shaft 9x9mm			
	GEV No.	541567	Ref. No.	—
	star handle shaft 9x9mm ø 74mm L 24mm black plastic			



1

GEV No.	540989	Ref. No.	0C0689
description	inlet spout		
For models:	KBR/G2F, KBR/G2C, KBR/G3F, KBR/G3FH, KBR/G3C, KBR/G3CH, KBR/E2F, KBR/E2C, KBR/E3F, KBR/E3FH, KBR/E3C, KBR/E3CH, KBR/G2FH, KBR/G2CH, KBR/E2FH, KBR/E2CH, WBR/G2F, WBR/G2C, WBR/G3F, WBR/G3FH, WBR/G3C, WBR/G3CH, WBR/E2F, WBR/E2C, WBR/E3F, WBR/E3FH, WBR/E3C, WBR/E3CH, WBR/G2FH, WBR/G2CH, WBR/E2FH, WBR/E2CH		



1

GEV No.	540990	Ref. No.	051672 22801919
description	inlet spout connection 1/2" ET projection 120mm spout height 55mm		
For models:	MPN/GD761, MPN/GI761, MPN/GI760D, MPN/GD760, MPN/GD760F, MPN/GI760, MPN/GI760F, MPN/EI760, MPNEI760UK, MPN/V760, MPN/EI760D, MPN/V760D, 7PDG06, 7PIG06, 7PIE06, RPN/EI760UK, RPN/GD760F, RPN/GI760F, 7PEV06, RPN/EI760D, XPN/GI760D, M70GDKE, M70GIKE, M70EIKE, XPN/EI760UK, M70VIKE, XPN/GD760F, XPN/GI760F, XPN/EI760D, RPNV740, RPN/G760, RPN/G760, PRPN/G760, RPN/GI760, RPN/GI760, RPN/GI760, PRPN/GI76, RPN/EI760, RPN/EI760, RPNV760, KPI/G06, HPN/GI806, HPN/EI806, HPN/GI805, HPN/EI805, QPI/E06, ZPN/GI805, ZPN/EI805, APN/GI805, APN/EI805...(Other models you can see in the webshop)		

inlet taps



1

GEV No.	540799	Ref. No.	002322 00502173 0K9286	
description	inlet tap connection 1/2" projection 130mm with swivel spout			
For models:	HBR/G800, HBR/G805, HBR/G801, HBR/G806, HBR/G810, HBR/G815, HBR/G811, HBR/G816, HBR/G800D, HBR/G805D, HBR/G801D, HBR/G806D, HBR/G810D, HBR/G815D, HBR/G811D, HBR/G816D, HBR/E800, HBR/E805, HBR/E801, HBR/E806, HBR/E810, HBR/E815, HBR/E811, HBR/E816, HBR/G800NL, HBR/G805NL, HBR/G810NL, HBR/G800UK, HBR/E800UK, HBR/G800, HBR/G805, HBR/G810, HBR/G815, HBR/G811, HBR/G816, HBR/E800, HBR/E805, HBR/E810, HBR/E815, HBR/G800UK, ZBR/G800, ZBR/G805, ZBR/G801, ZBR/G806, ZBR/G810, ZBR/G815, ZBR/G811, ZBR/G816, ZBR/G800D, ZBR/G805D...(Other models you can see in the webshop)			
spare parts for	540799			
	GEV No.	548176	Ref. No.	—
	tap head without plunger bush bearing thread 1/2" T2: M24x1 D1 ø 18mm D2 ø 24mm H1 18-24mm H2 29mm H3 10mm shaft intake ø 8mm suitable for RUBINETTERIE DEL FRIULI			
	GEV No.	551335	Ref. No.	—
	star handle shaft intake ø 8mm shaft length H1 12mm H2 22mm D1 ø 32mm suitable for RUBINETTERIE DEL FRIULI marking blue			



1

GEV No.	541895	Ref. No.	0C4146
description	inlet spout connection 1/2" ET tube ø 16mm projection 50mm overall height 70mm spout height 50mm rotation°		
For models:	PPD/G260, PPI/G260P, PPI/E260P, OPI/E260P, TPD/G260, TPI/G260P, TPI/E260P, KPI/E06, QPI/G06, WPI/G06, WPI/E06		



1

GEV No.	514075	Ref. No.	0C0721
description	inlet spout for pasta cooker		
For models:	PCP/E25HP, PCP/E15H, PCP/E25H, PCP/E25H3B, OCP/E25, OCP/E15H, OCP/E25H, TCP/E25, TCP/E25H, KCP/G1RU, KCP/G2RU, KCP/E1RU, KCP/E2RU, KCP/G1, KCP/G1R, KCP/G2, KCP/G2R, KCP/E1, KCP/E1R, KCP/E2, KCP/E2R, KCP/G1U, KCP/G2U, KCP/E1U, KCP/E2U, QCP/G1, QCP/G1R, QCP/G2, QCP/G2R, QCP/E1, QCP/E1R, QCP/E2, QCP/E2R, WCP/G1, WCP/G1R, WCP/G2, WCP/G2R, WCP/E1, WCP/E1R, WCP/E2, WCP/E2R, DCP/G400		



2

GEV No.	540966	Ref. No.	004537
description	inlet spout for pasta cooker		
For models:	RPD/G240, RPD/G260, RPI/G260, RPI/E240, RPI/E260, RPI/G260P, RPI/E260P, RCP/G1S, RCP/G2D, RCP/E1S, RCP/E2D, RBV/G2, RBV/E2, XPD/G240, XPD/G260, XPI/G260, XPI/E240, XPI/E260, XPI/G260P, XPI/E260P, XCP/G1S, XCP/G2D, XCP/E1S, XCP/E2D, XBV/G2, XBV/E2, JPD/G240, JPD/G260, JPI/G260, JPI/E240, JPI/E260, JCP/G1S, JCP/G2D, JCP/E1S, JCP/E2D, JBV/G2, JBV/E2, MPD/G240, MPD/G260, MPI/G260, MPI/E240, MPI/E260, MPI/G260P, MPI/E260P, MCP/G1S, MCP/G2D, MCP/E1S, MCP/E2D, MBV/G2, MBV/E2...(Other models you can see in the webshop)		



1

GEV No.	540992	Ref. No.	051521 22801909 22801910
description	inlet tap connection 1/2" IT projection 23mm spout height 23mm		
For models:	KPI/G10, KPI/G15, KPI/E10, KPI/E15, KPD/G10, KPD/G15, KPD/G15A, KPI/G15A, KPI/E15A, KPI/G15H, KPI/E15H, KPI/G10H, KPI/E10H, HPN/GI810, HPN/GI815, HPN/GI815D, HPN/GI816, HPN/GI816, HPN/EI815D, HPN/EI810, HPN/EI815, HPN/GD811, HPN/GD816, HPN/ED811, HPN/ED816, HPA/GD825, HPA/GI825, HPA/ED825, HPA/EI825, HPNS/GI816, HPNS/EI815, HPNS/EI815D, HCPA/G1219, HCPA/GI1219, QPI/G10, QPI/G15, QPI/E10, QPI/E15, QPD/G10, QPD/G15, QPI/G15H, QPI/E15H, QPI/G10H, QPI/E10H, ZPN/GI810, 2PIG15, ZPN/GI816, ZPN/GI816D, ZPN/EI815D, ZPN/EI810...(Other models you can see in the webshop)		

water softeners

manual softener





1

GEV No.	530123	Ref. No.	0S0579	
description	softener manual with bypass valve container capacity 12l amount of resin 8.4l salt amount/regeneration 1.5kg capacity at 16°d-H/20°e/29°FH 1680l ø 190mm W 255mm H 500mm connection 3/8" operation pressure 1-8bar water temperature 4-25°C flow rate 900l/h type DVA BP			
spare parts for	530123			
	GEV No.	520130	Ref. No.	—
lid type DVA BP complete for softener				
	GEV No.	520131	Ref. No.	—
O-ring ID ø 77mm thickness 6.5mm suitable for type LT/BP				
	GEV No.	520137	Ref. No.	—
valve type DVA BP tap head				
	GEV No.	520142	Ref. No.	—
filter mounting pos. lower type DVA BP 12l				
	GEV No.	520269	Ref. No.	—
filter mounting pos. upper type DVA BP				
	GEV No.	530128	Ref. No.	—
base suitable for type LT/BP				
	GEV No.	530803	Ref. No.	—
lid handle				
	GEV No.	530807	Ref. No.	—
container lid suitable for type LT/BP				
accessories for	530123			
	GEV No.	520136	Ref. No.	0S0333
ion-exchange resin type Dowex HCR-S/S 25l 20.5kg				
	GEV No.	530182	Ref. No.	—
pre-filter connection 3/8" ø 180mm L 180.5mm				
	GEV No.	530186	Ref. No.	—
filter ø 58mm L 125mm				
	GEV No.	530187	Ref. No.	—
mounting wrench				

Table continues overleaf



accessories for		530123	
	GEV No.	530238	Ref. No. —
regenerant salt type BROXETTEN content 25kg format tablets			
	GEV No.	530240	Ref. No. —
ion-exchange resin PURE type PC002 25l 20.5kg			

spare parts for		530843	
	GEV No.	520524	Ref. No. —
spring for cam shaft suitable for GIX 5/8/12			
	GEV No.	520525	Ref. No. —
sensor optic for softener suitable for GIX 5/8/12			
	GEV No.	520526	Ref. No. —
connection cable for sensor suitable for GIX 5/8/12			
	GEV No.	520527	Ref. No. —
O-ring EPDM thickness 5.34mm ID ø 24.77mm Qty 1 pcs			
	GEV No.	520528	Ref. No. —
valve set for softener suitable for GIX 5/8/12			
	GEV No.	520529	Ref. No. —
lid for softener suitable for GIX 5/8 + ISI 5/8			
	GEV No.	520530	Ref. No. —
O-ring EPDM thickness 3.53mm ID ø 36.1mm Qty 1 pcs			
	GEV No.	530037	Ref. No. —
O-ring set suitable for CABLT/MINI/MAXI			
	GEV No.	530041	Ref. No. —
power supply unit 6W primary 230V 50Hz secondary 12VACV 0.5A suitable for Autotrol 255/440 255/460			
	GEV No.	530216	Ref. No. —
gear motor 4W 11V 50/60Hz for softener suitable for GIX 5/8/12 0.8/1rpm			
	GEV No.	530238	Ref. No. —
regenerant salt type BROXETTEN content 25kg format tablets			
	GEV No.	530240	Ref. No. —
ion-exchange resin PURE type PC002 25l 20.5kg			
	GEV No.	530273	Ref. No. —
ion-exchange resin type Dowex HCR-S/S 6l 5kg			
	GEV No.	530274	Ref. No. —
ion-exchange resin type Dowex HCR-S/S 9l 7.5kg			
	GEV No.	530275	Ref. No. —
container L 435mm W 240mm H 320mm for GIX8			
	GEV No.	530312	Ref. No. —
filter type CABLT/MINI/MAXI			
	GEV No.	530316	Ref. No. —
ball type CABLT/MINI/MAXI			
	GEV No.	530402	Ref. No. —
bracket holding fork type CABLT/MINI/MAXI			
	GEV No.	530831	Ref. No. —
cover salt tank suitable for GIX 8/ISI 8			

automatic softeners

with Autotrol control Logix 255/740 (timer)



1

















GEV No.	530843	Ref. No.	0S0716 0S1079 AA05 AAX05
description	softener automatic type GIX8 container capacity 8l amount of resin 5.6l salt amount/regeneration 1kg capacity at 16°dH/20°e/29°fH 1120l W 250mm L 480mm H 540mm connection 3/4" operation pressure 2-8bar water temperature 6-25°C flow rate 1500l/h with control Autotrol 255/740 (timer) supply 230VAC with timer		
spare parts for	530843		
	GEV No.	402775	Ref. No. —
PCB with timer type 740 LOGIX suitable for GIX8			
	GEV No.	520136	Ref. No. 0S0333
ion-exchange resin type Dowex HCR-S/S 25l 20.5kg			
	GEV No.	520306	Ref. No. —
overflow stock type CABLT/MINI/MAXI			
	GEV No.	520309	Ref. No. —
container SS connection 2½" 8l			
	GEV No.	520318	Ref. No. —
gasket set suitable for CABLT/MINI/MAXI			
	GEV No.	520322	Ref. No. —
O-ring			
	GEV No.	520521	Ref. No. —
control head complete for softener suitable for GIX 5/8/12			
	GEV No.	520522	Ref. No. —
cover for control head suitable for GIX 5/8/12			
	GEV No.	520523	Ref. No. —
camshaft for softener suitable for GIX 5/8/12			

Table continues overleaf



accessories for 530843			
	GEV No.	510836	Ref. No. —
supply filter thread 3/4" ET - 3/4" IT total length 76mm plastic			
	GEV No.	515143	Ref. No. —
hose nipple suitable for high temperature pipe DN50 for hose ID 8/10/13/19/25mm straight polypropylene			
	GEV No.	515144	Ref. No. —
hose nipple suitable for high temperature pipe DN40 for hose ID 8/10/13/19/25mm straight polypropylene			
	GEV No.	520007	Ref. No. 048621 049540
flex hose SS braid straight-curved DN15 connection 1: 3/4" connection 2: 3/4" L 2500mm approval operating p. 10bar test pressure 32bar burst p. 95bar			
	GEV No.	520169	Ref. No. —
double nipple brass thread 3/4" - 3/4" Qty 1 pcs			
	GEV No.	530238	Ref. No. —
regenerant salt type BROXETTEN content 25kg format tablets			
	GEV No.	530628	Ref. No. —
water shock arrestor connection 3/4" - 3/4" operating p. up to 10bar water hammer max. 50bar t.max. 90°C damping range 3-50bar brass			
	GEV No.	530844	Ref. No. —
Chlorine generator for softener for Autotrol 255/740 255/760			
	GEV No.	540039	Ref. No. —
pipe aerator inlet 3/4" outlet 3/4" approval DVGW			

accessories			
	1		
GEV No.	530296	Ref. No.	046861
description O-ring EPDM thickness 1.78mm ID ø 31.47mm Qty 1 pcs			
For models:	LS365F, LS365, LS365PH, LS365D, LS365, LS365/63, LS367, LSDS5I, LSDS5V, LS521, LS521D, LS521F, LS521M, LS521K, LS521, CT140EDX, CT140ESX, CT140EDXUK, CT140SXEU, CT140VDX, CT140VSX, CT141EDX, CT141ESX, CT141EDUK, CT141ESUK, CT141VDX, CT141VSX, CT142DXE, CT142SX, CT142DXEUK, CT142SXEU, CT142DXV, CT142SXV, CT190DXE, CT190SX, CT190DXEUK, CT190SXEU, CT190DXV, CT190SXV, CT191DXE, CT191SX, CT191DXEUK, CT191SXEU, CT191DXV, CT191SXV, CT192DXE, CT192SX, CT192DXEUK, CT192SXEU... (Other models you can see in the webshop)		

substitute resins

			
1			
GEV No.	520136	Ref. No.	050333
description ion-exchange resin type Dowex HCR-S/S 25I 20.5kg			

water filters

BRITA

water filters







PURITY C Quell ST

carbonate hardness reduction specifically for coffee and vending machines

			
1			
GEV No.	530835	Ref. No.	051056
description water filter BRITA type PURITY C500 Quell ST capacity 4125-6800l flow rate 100l/h operation p max 8.6bar water temperature +4 up to +30°C filter power 10µm decarbonisation			
accessories for 530835			
	GEV No.	520540	Ref. No. —
flex hose connections 3/8" L 1500mm SS braid straight-straight with ball valve DN8			
	GEV No.	520541	Ref. No. —
flex hose SS braid straight-curved DN8 connection 1: 3/4" connection 2: 3/8" L 1500mm approval DVGW operating p. 10bar test pressure 32bar burst p. 95bar			
	GEV No.	520542	Ref. No. —
reducer IT 3/8" ET 3/4" plastic total length 30mm WS 22 with gasket Qty 1 pcs			
	GEV No.	530055	Ref. No. —
flow meter with digital display connection 3/8" IT - 3/8" ET total length 81mm flow rate 10-100l/h operation p max 8bar water temperature 4-30°C ambient temperature max. 0-60°C cable length 1500mm display 6 digits			
	GEV No.	530836	Ref. No. —
filter head BRITA connection 3/8" type PURITY C blend 30% water temperature +4 up to +30°C decarbonisation for coffee machine/combi-steamer			

Table continues overleaf



accessories for 530835			
	GEV No.	530837	Ref. No. —
filter head connection 3/8" type PURITY C blend 0-70% decarbonisation for coffee machine/combi-steamer			
	GEV No.	530838	Ref. No. —
filter head connection John Guest 8mm type PURITY C blend 0-70% universal with wall holder			
	GEV No.	530840	Ref. No. —
wall holder suitable for PURITY C Qty 1 pcs			
	GEV No.	530841	Ref. No. —
cover suitable for PURITY C Qty 1 pcs			
	GEV No.	543007	Ref. No. —
backflow preventer plastic thread 3/8" IT - 3/8" ET total length 46mm Qty 1 pcs			
	GEV No.	800031	Ref. No. —
measuring device carbonate hardness			

PURITY Clean

partial desalination for dishwashers

			
1			
GEV No.	530379	Ref. No.	050682 050801
description	water filter BRITA type Purity 1200 Clean capacity 12000l flow rate 600l/h operation p max 6bar water temperature +4 up to +60°C ø 288mm H 550mm partial desalination for dishwashers flow rate 5l/min		
spare parts for	530379		
	GEV No.	530378	Ref. No. —
filter cartridge BRITA type Purity 1200 Clean capacity 12000l flow rate 600l/h operation p max 6bar water temperature +4 up to +60°C ø 550mm H 288mm partial desalination for dishwashers			
accessories for	530379		
	GEV No.	520584	Ref. No. —
flex hose SS straight-curved DN12 connection 1: 3/4" connection 2: 3/4" L 2000mm approval DVGW operating p. 10bar test pressure 32bar burst p. 95bar			

PURITY Quell ST









partial desalination specifically for big coffee makers and combi-steamers
With or without MAE (electronic display)

			
1			
GEV No.	530846	Ref. No.	050683 0T0725
description	water filter BRITA type PURITY 1200 Quell ST capacity 7253-13187l flow rate 120l/h operation p max 6.9bar water temperature +4 up to +30°C ø 205mm H 425mm decarbonisation for coffee machine/combi-steamer		

drain systems and wash basins

drain fittings

universal

			
1			
GEV No.	515042	Ref. No.	051310
description	drain fitting size 1½" usable heightmm overall height 32mm ED ø 69mm chrome-plated brass		
accessories for	515042		
	GEV No.	515051	Ref. No. —
standpipe size 1½" usable height 170mm overall height 185mm ED ø 40mm SS			
	GEV No.	515052	Ref. No. —
standpipe size 1½" usable height 220mm overall height 235mm ED ø 40mm SS			
	GEV No.	515053	Ref. No. —
standpipe size 1½" usable height 260mm overall height 275mm ED ø 40mm SS			
	GEV No.	515054	Ref. No. —
standpipe size 1½" usable height 310mm overall height 325mm ED ø 40mm SS			
	GEV No.	515062	Ref. No. —
standpipe size 1½" usable height 190mm overall height 200mm ED ø 46mm chrome-plated brass with filter			
	GEV No.	515063	Ref. No. —
standpipe size 1½" usable height 230mm overall height 240mm ED ø 46mm chrome-plated brass with filter			
	GEV No.	515064	Ref. No. —
standpipe size 1½" usable height 280mm overall height 290mm ED ø 46mm chrome-plated brass with filter			

standpipes

1 1/4"



GEV No.	515042	Ref. No.	0S1310
description	drain fitting size 1 1/2" usable heightmm overall height 32mm ED ø 69mm chrome-plated brass		
accessories for	515042		
	GEV No.	515051	Ref. No. —
	standpipe size 1 1/2" usable height 170mm overall height 185mm ED ø 40mm SS		
	GEV No.	515052	Ref. No. —
	standpipe size 1 1/2" usable height 220mm overall height 235mm ED ø 40mm SS		
	GEV No.	515053	Ref. No. —
	standpipe size 1 1/2" usable height 260mm overall height 275mm ED ø 40mm SS		
	GEV No.	515054	Ref. No. —
	standpipe size 1 1/2" usable height 310mm overall height 325mm ED ø 40mm SS		
	GEV No.	515062	Ref. No. —
	standpipe size 1 1/2" usable height 190mm overall height 200mm ED ø 46mm chrome-plated brass with filter		
	GEV No.	515063	Ref. No. —
	standpipe size 1 1/2" usable height 230mm overall height 240mm ED ø 46mm chrome-plated brass with filter		
	GEV No.	515064	Ref. No. —
	standpipe size 1 1/2" usable height 280mm overall height 290mm ED ø 46mm chrome-plated brass with filter		

1 1/2"



GEV No.	515042	Ref. No.	0S1310
description	drain fitting size 1 1/2" usable heightmm overall height 32mm ED ø 69mm chrome-plated brass		
accessories for	515042		
	GEV No.	515051	Ref. No. —
	standpipe size 1 1/2" usable height 170mm overall height 185mm ED ø 40mm SS		
	GEV No.	515052	Ref. No. —
	standpipe size 1 1/2" usable height 220mm overall height 235mm ED ø 40mm SS		
	GEV No.	515053	Ref. No. —
	standpipe size 1 1/2" usable height 260mm overall height 275mm ED ø 40mm SS		
	GEV No.	515054	Ref. No. —
	standpipe size 1 1/2" usable height 310mm overall height 325mm ED ø 40mm SS		
	GEV No.	515062	Ref. No. —
	standpipe size 1 1/2" usable height 190mm overall height 200mm ED ø 46mm chrome-plated brass with filter		
	GEV No.	515063	Ref. No. —
	standpipe size 1 1/2" usable height 230mm overall height 240mm ED ø 46mm chrome-plated brass with filter		

accessories for	515042		
	GEV No.	515064	Ref. No. —
	standpipe size 1 1/2" usable height 280mm overall height 290mm ED ø 46mm chrome-plated brass with filter		

GEV No.	515042	Ref. No.	0S1310
description	drain fitting size 1 1/2" usable heightmm overall height 32mm ED ø 69mm chrome-plated brass		
accessories for	515042		
	GEV No.	515051	Ref. No. —
	standpipe size 1 1/2" usable height 170mm overall height 185mm ED ø 40mm SS		
	GEV No.	515052	Ref. No. —
	standpipe size 1 1/2" usable height 220mm overall height 235mm ED ø 40mm SS		
	GEV No.	515053	Ref. No. —
	standpipe size 1 1/2" usable height 260mm overall height 275mm ED ø 40mm SS		
	GEV No.	515054	Ref. No. —
	standpipe size 1 1/2" usable height 310mm overall height 325mm ED ø 40mm SS		
	GEV No.	515062	Ref. No. —
	standpipe size 1 1/2" usable height 190mm overall height 200mm ED ø 46mm chrome-plated brass with filter		
	GEV No.	515063	Ref. No. —
	standpipe size 1 1/2" usable height 230mm overall height 240mm ED ø 46mm chrome-plated brass with filter		
	GEV No.	515064	Ref. No. —
	standpipe size 1 1/2" usable height 280mm overall height 290mm ED ø 46mm chrome-plated brass with filter		







GEV No.	515042	Ref. No.	0S1310
description	drain fitting size 1 1/2" usable heightmm overall height 32mm ED ø 69mm chrome-plated brass		
accessories for	515042		
	GEV No.	515051	Ref. No. —
	standpipe size 1 1/2" usable height 170mm overall height 185mm ED ø 40mm SS		
	GEV No.	515052	Ref. No. —
	standpipe size 1 1/2" usable height 220mm overall height 235mm ED ø 40mm SS		
	GEV No.	515053	Ref. No. —
	standpipe size 1 1/2" usable height 260mm overall height 275mm ED ø 40mm SS		
	GEV No.	515054	Ref. No. —
	standpipe size 1 1/2" usable height 310mm overall height 325mm ED ø 40mm SS		
	GEV No.	515062	Ref. No. —
	standpipe size 1 1/2" usable height 190mm overall height 200mm ED ø 46mm chrome-plated brass with filter		
	GEV No.	515063	Ref. No. —
	standpipe size 1 1/2" usable height 230mm overall height 240mm ED ø 46mm chrome-plated brass with filter		

Table continues overleaf





accessories for 515042			
	GEV No.	515064	Ref. No. —
standpipe size 1½" usable height 280mm overall height 290mm ED ø 46mm chrome-plated brass with filter			

	GEV No.	515042	Ref. No.	0S1310
description drain fitting size 1½" usable heightmm overall height 32mm ED ø 69mm chrome-plated brass				

accessories for 515042				
	GEV No.	515051	Ref. No.	—
standpipe size 1½" usable height 170mm overall height 185mm ED ø 40mm SS				
	GEV No.	515052	Ref. No.	—
standpipe size 1½" usable height 220mm overall height 235mm ED ø 40mm SS				
	GEV No.	515053	Ref. No.	—
standpipe size 1½" usable height 260mm overall height 275mm ED ø 40mm SS				
	GEV No.	515054	Ref. No.	—
standpipe size 1½" usable height 310mm overall height 325mm ED ø 40mm SS				
	GEV No.	515062	Ref. No.	—
standpipe size 1½" usable height 190mm overall height 200mm ED ø 46mm chrome-plated brass with filter				
	GEV No.	515063	Ref. No.	—
standpipe size 1½" usable height 230mm overall height 240mm ED ø 46mm chrome-plated brass with filter				
	GEV No.	515064	Ref. No.	—
standpipe size 1½" usable height 280mm overall height 290mm ED ø 46mm chrome-plated brass with filter				

producer-specific				
ELECTROLUX				
	GEV No.	501354	Ref. No.	032244 0K9621 22104957
description drain fitting thread M35x2 brass ø 45mm H 25mm ID ø 30mm				
For models: DL07/C, DL14/C, DL14/CP, DL21/C, DL21/CP, SM08C., SM15CP, SM15C., SM15/CS., SM21/CP, SM21C., FS07C, FS11C, FS11C2, NFS15C, FS15C2, FSV07C2X, FSV11C3X, FSV15C4X, FSV07C2C, FSV11C3C, FSV15C4C, FSV11C3CX, FSV15C4CX, FSV11C3CC, FSV15C4CC, SSBMHC12, SSBMHC16, SSBMHC20, SSBMB12, SSBMB16, SSBMHB20, SSBMHC12HD, SSBMHC16HD, SSBMHC20H, SSBMB8, SSBMHC8, DBMAC12, DBMAC16, DBMAC20, DBMP12, DBMP16, DBMP20, ZLB12H, ZLB16H, ZLB20H, ZLB12B, ZLB16B, ZLB20B, ZLB12HHD...(Other models you can see in the webshop)				

	GEV No.	510597	Ref. No.	050296
description flat gasket fibre ED ø 34mm ID ø 24mm thickness 2mm Qty 1 pcs				
For models: PMG600, PMG600D, HMS/E400, HM/G800T, ZPM/G600, DL14/C, DL14/CP, DL21/C, DL21/CP, SM08C., SM15CP, SM15C., SM15/CS., SM21/CP, SM21C., SSBMHC12, SSBMHC16, SSBMHC20, SSBMB12, SSBMB16, SSBMHB20, SSBMB8, SSBMHC8, DBMAC12, DBMAC16, DBMAC20, DBMP12, DBMP16, DBMP20, ZLB12H, ZLB16H, ZLB20H, ZLB12B, ZLB16B, ZLB20B, ZLB08B, ZLB08H, DI-WHW2, DI-WHW3, DI-WHW4, DI-WHW5, DI-WHW6, DI12HWWW, DI14HWWW, DI2BM, DI3BM, DI4BM, DI2BMO, DI3BMO, DI4BMO...(Other models you can see in the webshop)				

	GEV No.	501355	Ref. No.	032245 30001215
description nut thread M35x2 H 8mm WS 41 steel				
For models: DL07/C, DL14/C, DL14/CP, DL21/C, DL21/CP, SM08C., SM15CP, SM15C., SM15/CS., SM21/CP, SM21C., FS07C, FS11C, FS11C2, NFS15C, FS15C2, FSV07C2X, FSV11C3X, FSV15C4X, FSV07C2C, FSV11C3C, FSV15C4C, FSV11C3CX, FSV15C4CX, FSV11C3CC, FSV15C4CC, SSBMHC12, SSBMHC16, SSBMHC20, SSBMB12, SSBMB16, SSBMHB20, SSBMHC12HD, SSBMHC16HD, SSBMHC20H, SSBMB8, SSBMHC8, DBMAC12, DBMAC16, DBMAC20, DBMP12, DBMP16, DBMP20, ZLB12H, ZLB16H, ZLB20H, ZLB12B, ZLB16B, ZLB20B, ZLB12HHD...(Other models you can see in the webshop)				

	GEV No.	540969	Ref. No.	0A5181
description overflow pipe L 85mm ø 20mm				
For models: KB/G1, KB/G2, KB/E1, KB/E2, HM/G400, HM/G800, HM/E400, HM/E800, QB/G1, QB/G2, QB/E1, QB/E2, ZM/G400, ZM/G800, ZM/E400, ZM/E800, WB/G1, WB/G2, WB/E1, WB/E2, AM/G800, AM/G800D, AM/E400, AM/E800, OM/G800, OM/E800				
accessories for 540969				
	GEV No.	511516	Ref. No.	—
O-ring EPDM thickness 3.53mm ID ø 20.22mm Qty 10 pcs				

HT drain pipes

rubber sleeves

	GEV No.	515085	Ref. No.	0H6650 246238
description rubber sleeve suitable for high temperature pipe ED ø 40mm ID ø 20-32mm				
For models: 5611-3-10, 5611-3-6, 5611-3-8, 5612-3-10, 5612-3-6, 5612-3-8, 5614-3-10, 5614-3-6, 5614-3-8				

U-bends



GEV No.	515137	Ref. No.	051335
description	U-bend thread 1 1/2" ø 40mm outflow distance max. 330mm		

connection fittings

pipe aerators



GEV No.	540073	Ref. No.	0E5530 0K8532
description	pipe aerator inlet 1/2" outlet 1/2" approval DVGW		
For models:	FT36EDTS, FT36ESTS, FT36VDTs, FT36VSTs, FT36ED, FT36ES, FT36VD, FT36VS, FT50ED, FT50ES, FT50VD, FT50VS, FT72ED, FT72ES, FT72VD, FT72VS, FT36EDT, FT36EST, FT36VDT, FT36VST, FT50EDT, FT50EST, FT50VDT, FT50VST, FT72EDT, FT72EST, FT72VDT, FT72VST, FT36WED, FT36WES, FT36WVD, FT36WVS, FT50WED, FT50WES, FT50WVD, FT50WVS, FT72WED, FT72WES, FT72WVD, FT72WVS, FT36WEDT, FT36WEST, FT36WVDT, FT36WVST, FT50WEDT, FT50WEST, FT50WVDT, FT50WVST, FT72WEDT, FT72WEST...(Other models you can see in the webshop)		

screw pipe fittings



GEV No.	540052	Ref. No.	002188 0A2159
description	elbow screw joint thread 3/8" tube ø 10mm chrome-plated brass		
For models:	RPI/G260, RPI/E240, RPI/E260, RPI/G260P, RPI/E260P, XPI/G260, XPI/E240, XPI/E260, XPI/G260P, XPI/E260P, JPI/G260, JPI/E240, JPI/E260, MPI/G260, MPI/E240, MPI/E260, MPI/G260P, MPI/E260P, PPI/G260P, PPI/E260P, OPI/G260P, OPI/E260P, TPI/G260P, TPI/E260P, HPN/GI810, HPN/GI815, HPN/GI816, HPN/EI815D, HPN/EI810, HPN/EI815, HPA/GI825, HPA/EI825, HPNS/GI816, HPNS/EI815, HPNS/EI815D, HPN/GI806, HPN/EI806, HPN/GI805, HPN/EI805, ZPN/GI810, 2PIG15, ZPN/GI816, ZPN/EI815D, ZPN/EI810, ZPN/EI815, 2PIAG15, ZPNS/GI816, ZPNS/EI815, ZPNS/EI815D, ZPN/GI805...(Other models you can see in the webshop)		

water cycle components

pressure reduction valves

pressure reduction valves

universal



GEV No.	520543	Ref. No.	002678
description	pressure reduction valve connection 1/2" setting range 1-4bar p max 15bar		
For models:	MCP/E15H, MCP/E1SUH, MCP/E2SUHS, MCP/E2SH, MCP/E2SUH, MCP/E2SUT, MCP/E2SHB, ECP/E1ELHU, PCP/E2SHP, PCP/E15H, PCP/E2SH, PCP/E2SH3B, PCP/E1ELH, OCP/E2S, OCP/E15H, OCP/E2SH, TCP/E1ELHU, TCP/E2S, TCP/E2SH, TCP/E1ELH, FCV/G6L3TOWNGAS, FCV/G6L3, FCV/E101/1, FCVE6L3J, FCV/G6L3JAP, FCVG6L3CJ, FCV/E61/1, FCV/G10L2, FCV/E10L2, FCV/E61/1, FCV/G6L3C, FCV/G61/1, FCVG6L3CT, FCVG6L3CJ, FCV/E6L3, FCV/E101/1, FCS061E44J, FCS061G48J, FCS061G3DI, FCS061E3CI, FCS101E2, FCS061G4DT, FCS061G49J, FCS101G2, ECV/G6T4C, ECV/E10IGP, RCV061G2, RCV061E2, RCV101G2, RCV101E2...(Other models you can see in the webshop)		

supply filters



GEV No.	520261	Ref. No.	053037 054450 067392 46202
description	supply filter thread 1/2" IT - 1/2" IT total length 58mm red brass mesh opening 0.4mm		
For models:	FCV/G6L3TOWNGAS, FCV/G6L3, FCV/E101/1, FCVE6L3J, FCV/G6L3JAP, FCVG6L3CJ, FCV/E61/1, FCV/G10L2, FCV/E10L2, FCV/E61/1, FCV/G6L3C, FCV/G61/1, FCVG6L3CT, FCVG6L3CJ, FCV/E6L3, FCV/E101/1, FCS061E44J, FCS061G48J, FCS061G3DI, FCS061E3CI, FCS101E2, FCS061G4DT, FCS061G49J, FCS101G2, FVGC4, FV4G, FV4E, FCVG10-1SG, FCVMG62, ECV/G6T4C, ECV/E10IGP, CR15G, CR15V, CR15E, CR/41G, CR42G, CR/41E, CR/41V, CR/42V, CR40G, CR40V, CR/40E, CR/42E, FV4G, FV4E, FVAC041, LS365F, LS365, LS365PH, LS365D...(Other models you can see in the webshop)		





1

GEV No.	520262	Ref. No.	068121
description	supply filter thread 3/4" IT - 3/4" IT total length 70mm red brass DN20 mesh opening 0.4mm		
For models:	CLB160V, LS500F, LS501F, LS540F, LS540DK, LS541F, LS720F, LSE720DK, LSE720PH, LS860F, LS860DK, LS860PH, LS1080F, LS1080UK, LS1080PH, LSE721F, LS861F, LS540, LS1080M, LS1080, LS1080D, LS1080UK, LS1080/63, LS500F, LS500UK, LS501, LS501UK, LS540D, LS540/63, LSE721, LS720, LSE720UK, LS721UK, LSE720D, LS541, LS860, LS860, LS860D, LS860UK, LS861UK, LS860/63, LS861, WT38/M50, WT38M50/4, EUCAIDPJ, EUCAIDPJ60, WT37J60, WT37J50, LS6AH240U, WT30H208U...(Other models you can see in the web-shop)		



1

GEV No.	695531	Ref. No.	085279
description	supply filter thread 1" total length 100mm plastic with metal filter ø 18mm		
For models:	MC140AB20, MC140WB20, MC200AB20, MC200WB20, FGC24AB, FGC24WB, CIM235AB, CIM235WB, FGC24ABS, FGC24WBAB, CB184A, FGC24AB, FGC24WB, VM500W+BI, VM500A+BI, VM350A+BI, VM350W+BI, C150W, C300A, C300W, CB1565W, CB246W, CB416W, CB955W, DSS42W, C80W, CB1565A, C80A, CB246A, CB416A, C150A, CB955A, FRESHMAKER, ICEWATER45, ICEWATER45, DSS42A, VB250A, VB250W, VM900A, VM900W		



1

GEV No.	504586	Ref. No.	048834
description	supply filter thread 3/4" ET - 3/4" IT total length 108mm plastic		
For models:	LS32, LS32/4.5, LS32UK/RP, LS32F, LV32F, C55, LV32/60, WT4, WT4B, WT4D, WT302, WT302/4.5, WT302UK/RP, WT302F, WT302/60, WT4DB, WT46, WT4DG, WT4WS1, LS33, LS33/4.5, LS33UK/RP, LS33F, LV33F, C55A, LS33/60, WT4BWS, WT4DWS1, WT4BDWS, WT303, WT303/4.5, WT303UK/RP, WT303F, WT303/60, NUC3DD, WT4D60, WT4DDG, EUC1, EUC1DP, EUC1WS, EUC1DPWS, EUC3, EUC3WS, EUC3DP, EUC3DPWS, EUC1G, EUC1DP60, EUC3DD, ZUCADDROW, ZUCADDROW6...(Other models you can see in the webshop)		



1

GEV No.	504585	Ref. No.	048746
description	supply filter thread 3/4" ET - 3/4" IT total length 122mm plastic DN19		
For models:	LS7D, LS7, LS7UK/RP, LV70, LS7F, LS7DEK, LS7/1UK, LS7/9, LS7/DP, LS7/60, WT40/9, WT40/F, WT40/J50, WT40/J60, WT40UKRP, PH4/WT40, PH4RBP/WT40, LS10D, LS10, LS10UKRP, LC100, ECOTEMP12-, LS10/60, LS10/1, LS10/12KW, LS10F, LS10DEK, LS10/1UKRP, LS10SW, LS10/50J, LS10/60J, LS10DP, LS10/HD, SH55, LO10, LS10/UK1, LS10/UK3, LS12D, LS12, LS12UK/RP, LC120, LS12DP, LS12/60, LS12F, LS12DEK, LS12HD, WT60/GJ60, WT60/GJ50, PH10/12-RP, LS12/UK3...(Other models you can see in the webshop)		

non-return valves



1

GEV No.	520273	Ref. No.	048414 049851 153328
description	non-return valve brass connection 1/2" IT - 1/2" IT total length 60mm DN15		
For models:	LS32F, LV32F, WT302F, LS33F, LV33F, WT303F, LS62F, LV62, LS63F, LV63, LS64, LV64, LS64/1P, WT32/F6, WT33/F, WT33/M50, WT33/M60, WT30U400, WT30U440, WT34, LV70, LS7F, WT40/9, WT40/F, LS10D, LC100, LS10F, LC120, LS12F, LC80, LS8F, WT50/F9, HT1000elm		



1

GEV No.	543034	Ref. No.	0C2312
description	non-return valve plastic total length 22mm Qty 1 pcs ø 19.5mm		
For models:	FCZ061EAA, FCZ101EAA, FCZ102EAA, FCZ201EAA, FCZ202EAA, FCZ061EAH, FCZ101EAH, FCZ201EAH, FCZ061EAN, FCZ101EAN, FCZ201EAN, FCZ061ETA, FCZ101ETA, FCZ102ETA, FCZ201ETA, FCZ202ETA, FCZ061ETH, FCZ101ETH, FCZ201ETH, FCZ061ETN, FCZ101ETN, FCZ201ETN, FCZ061GAG, FCZ101GAG, FCZ102GAG, FCZ201GAG, FCZ202GAG, FCZ061GAD, FCZ101GAD, FCZ102GAD, FCZ201GAD, FCZ202GAD, FCZ101GTG, FCZ102GTG, FCZ201GTG, FCZ202GTG, FCZ101GTD, FCZ102GTD, FCZ201GTD, FCZ202GTD, FCZ061EBA, FCZ101EBA, FCZ102EBA, FCZ201EBA, FCZ202EBA, FCZ061EBH, FCZ101EBH, FCZ201EBH, FCZ061EBN, FCZ101EBN...(Other models you can see in the webshop)		

ancillary products

fitting greases



1

GEV No.	890118	Ref. No.	001019 050004 36200410
description	fitting grease FERMIT GLISSA can 1000g -20 up to +140°C approval complies with KTW recommendation		
description	<p>Fermit GLISSA - can 1000g</p> <p>Non-dripping lubricating grease for hot and cold water valves and fittings</p> <p>Ductile, smooth, non-dripping lubricating grease for valves and fittings, that with regard to food law is beyond reproach and is therefore also suitable for drinking water pipes. Can also be used for machines and equipment where Glissa valve and fitting grease comes into contact with food or drinking water.</p> <p>Temperature range: -20°C to +140°C</p> <p>Approved by NSF-H 1 and DIN 51502</p>		



2

GEV No.	890116	Ref. No.	OG1994 OKK505 OS0353 OS1145 11019107 400191 743000111 7CAR16925 7KLU1019700
description	fitting grease FERMIT GLISSA tube 60g -20 up to +140°C approval complies with KTW recommendation		
description	<p>Fermit GLISSA - tube 60g</p> <p>Non-dripping lubricating grease for hot and cold water valves and fittings</p> <p>Ductile, smooth, non-dripping lubricating grease for valves and fittings, that with regard to food law is beyond reproach and is therefore also suitable for drinking water pipes. Can also be used for machines and equipment where Glissa valve and fitting grease comes into contact with food or drinking water.</p> <p>Temperature range: -20°C to +140°C</p> <p>Approved by NSF-H 1 and DIN 51502</p>		
For models:	5611-3-10, 5611-3-6, 5611-3-8, 5612-3-10, 5612-3-6, 5612-3-8, 5614-3-10, 5614-3-6, 5614-3-8		

clamps

hose clamps

DIN 3017 - W2



1

GEV No.	520111	Ref. No.	0L0266
description	hose clamp ø 10-16mm width 9mm Qty 10 pcs DIN 3017		
For models:	WT4WS1, WT4BWS, WT4DWS1, WT4BDWS, EUC1WS, EUC1DPWS, EUC3WS, EUC3DPWS, LS5/1WS, LS5/1WSDP, LS5/3WS, LS5/3WSDP, LS5/3WSDPD, NUC1WS, NUC1DPWS, NUC3WS, NUC3DPWS, NUC3DDWS, LV5/3WSDP, FL5/3WSDP, UC5WSDP		



1

GEV No.	520112	Ref. No.	007019 046797 048126 057545 065121 0G2046 0K2123 0KX145 12011873 158CS 19006947
description	hose clamp ø 12-20mm width 9mm Qty 10 pcs DIN 3017		
For models:	ACPG25, PPD/G260, PPI/G260P, PPI/E260P, OPD/G260, OPI/G260P, OPI/E260P, TPD/G260, TPI/G260P, TPI/E260P, KPI/E10, KPI/E15, KPD/G10, KPD/G15, KPD/G15A, KPI/E15A, KPI/G06, KPI/E06, KPI/G15H, KPI/E15H, KPI/G10H, KPI/E10H, KBR/G2F, KBR/G2C, KBR/G3F, KBR/G3FH, KBR/G3C, KBR/G3CH, KBR/E2F, KBR/E2C, KBR/E3F, KBR/E3FH, KBR/E3C, KBR/E3CH, KBR/G2FH, KBR/G2CH, KBR/E2FH, KBR/E2CH, KCP/G1RU, KCP/G2RU, KCP/E1RU, KCP/E2RU, KCP/G1, KCP/G1R, KCP/G2, KCP/G2R, KCP/E1, KCP/E1R, KCP/E2, KCP/E2R...(Other models you can see in the webshop)		





1

GEV No.	520113	Ref. No.	0E5120 0E900
description	hose clamp ø 16-27mm width 9mm Qty 10 pcs DIN 3017		
For models:	W365H, W375H5, W3105H, W3130H, W3130H, W3240H, W3240H, W3130H, W3180H, W3180H, W3180H, W3180H, W3240H_EL, W3240H_CLA, W3180H, W3130H, W3180H, W3105H, W3105H, W3105H, W375H, W3105H, W3130H, W3180H, W375N, W375N, W375N, W3105N, W3105N, W3105N, W3130N, W3130N, W3130N, W3130N, W3130N, W3130N, W3130N, W3180N, W3180N, W3180N, W3180N, W3180N, W3180N, W3180N, WT730WSRTS, WT730WSLTS, WT760S-RTM, WT760WSLTM, WT790WSRTM, WT790WSLTM, WT100SRM...(Other models you can see in the webshop)		





			
1			
GEV No.	520114	Ref. No.	OE1166 OKB299
description	hose clamp ø 20-32mm width 9mm Qty 10 pcs DIN 3017		
For models:	W3400H06, W355HE, W365H, W375H5, W3105H, W3130H, W3130H, W3240H., W3240H, W3400H, W3400H, W355HQSR, W3130H, W3180H, W3180H, W3180H, W3240H_EL, W3240H_CLA, W3180H, W3130H, W3180H, W3105H, W3105H, W3105H, W355H, W375H, W3105H, W3130H, W3180H, W3300H, W3300H, W355H, W455H04, W455HQSR, WE66MP, WE66MP, WE106MP, LC12EC, CLC12EC, CLC22, LACE22M, CLC22V, LACV22M/V, CLC22VC, LB81E, LB81BP, LB81COP, W375N, W375N...(Other models you can see in the webshop)		

			
1			
GEV No.	520118	Ref. No.	046855 065537 072582 0E1358 0K8983 736284051
description	hose clamp ø 50-70mm width 9mm Qty 5 pcs DIN 3017		
For models:	LS32, LS32/4.5, LS32UK/RP, LS32F, LV32F, C55, LV32/60, WT4, WT4B, WT4D, WT302, WT302/4.5, WT302UK/RP, WT302F, WT302/60, WT4DB, WT46, WT4DG, WT4WS1, LS33, LS33/4.5, LS33UK/RP, LS33F, LV33F, C55A, LS33/60, WT4BWS, WT4DWS1, WT4BDWS, WT303, WT303/4.5, WT303UK/RP, WT303F, WT303/60, NUC3DD, WT4D60, WT4DDG, EUC1, EUC1DP, EUC1WS, EUC1DPWS, EUC3, EUC3WS, EUC3DP, EUC3DPWS, EUC1G, EUC1DP60, EUC3DD, ZUCADDROW, ZUCADDROW6...(Other models you can see in the webshop)		

			
1			
GEV No.	520115	Ref. No.	047578 049446 0K0198 0L0367
description	hose clamp ø 25-40mm width 9mm Qty 10 pcs DIN 3017		
For models:	EBS50., EBS50H, EBS100., EBS100H, EBS150., EBS150H, EBS200., EBS200H, EBS300., EBS300H, EBV50., EBV50H, EBV100., EBV100H, EBV150, EBV150H, EBV200., EBV200H, EBV300., EBV300H, EBVC50, EBVC50H, EBVC100, EBVC100H, EBVC150, EBVC150H, EBVC200, EBVC200H, EBVC300, EBVC300H, EBP100., EBP100M, EBP150, EBP150M, EBP200., EBP200M, EBP300., EBP300M, EBPC100, EBPC100M, EBPC150, EBPC150M, EBPC200, EBPC200M, EBPC300, EBPC300M, MED50H, MED100H, MED150H, MED200H...(Other models you can see in the webshop)		

			
1			
GEV No.	520119	Ref. No.	046478 046853 065047 0E0992
description	hose clamp ø 60-80mm width 9mm Qty 5 pcs DIN 3017		
For models:	LB8G, LB8G/63, LB8GF, LB8GPH, LB8G, LB8GPHm, LB80EPH, LB80E, LB120EPH, LB120E, LB160EPH, LB160E, LB160V, CLB160E, CLB160V, LB70E, LB110E, SPE144/23, SPE144/23U, SPE144/23, LS500F, LS501F, LS540F, LS540DK, LS541F, LS720F, LSE720DK, LSE720PH, LS860F, LS860DK, LS860PH, LS1080F, LS1080UK, LS1080PH, LSE721F, LS861F, LS540, LS1080M, LS1080, LS1080D, LS1080UK, LS1080/63, LS500F, LS500UK, LS501, LS501UK, LS540D, LS540/63, LSE721, LS720...(Other models you can see in the webshop)		

			
1			
GEV No.	520116	Ref. No.	046566 046878 060407 066056 0E2686 0K8981 736283451
description	hose clamp ø 32-50mm width 9mm Qty 5 pcs DIN 3017		
For models:	LS32, LS32/4.5, LS32UK/RP, LS32F, LV32F, C55, LV32/60, WT4, WT4B, WT4D, WT302, WT302/4.5, WT302UK/RP, WT302F, WT302/60, WT4DB, WT46, WT4DG, WT4WS1, LS33, LS33/4.5, LS33UK/RP, LS33F, LV33F, C55A, LS33/60, WT4BWS, WT4DWS1, WT4BDWS, WT303, WT303/4.5, WT303UK/RP, WT303F, WT303/60, NUC3DD, WT4D60, WT4DDG, EUC1, EUC1DP, EUC1WS, EUC1DPWS, EUC3, EUC3WS, EUC3DP, EUC3DPWS, EUC1G, EUC1DP60, EUC3DD, ZUCADDROW, ZUCADDROW6...(Other models you can see in the webshop)		

			
1			
GEV No.	520110	Ref. No.	046946 048224 0539812 0H2566 0KB296 211003001008
description	hose clamp ø 8-12mm width 9mm Qty 10 pcs DIN 3017		
For models:	LS32, LS32/4.5, LS32UK/RP, LS32F, LV32F, C55, LV32/60, WT4, WT4B, WT4D, WT302, WT302/4.5, WT302UK/RP, WT302F, WT302/60, WT4DB, WT46, WT4DG, LS33, LS33/4.5, LS33UK/RP, LS33F, LV33F, C55A, LS33/60, WT4DWS1, WT4BDWS, WT303, WT303/4.5, WT303UK/RP, WT303F, WT303/60, NUC3DD, WT4D60, WT4DDG, EUC1, EUC1DP, EUC1DPWS, EUC3, EUC3DP, EUC3DPWS, EUC1G, EUC1DP60, EUC3DD, ZUCADDROW, ZUCADDROW6, LS5/1, LS5/1DP, LS5/1WSPD, LS5/3...(Other models you can see in the webshop)		

			
GEV No.	520117	Ref. No.	OL0193
description	hose clamp stainless steel ø 40-60mm width 9mm Qty 5 pcs DIN 3017		
For models:	LU7PDP, LU7ADP, LU7ADPWS, WTU40PDP, WTU40ADP, WTU40ADPWS, WTU40ADPD, WT60/GJ60, WT60/GJ50, PH10/12-RP, LS14EA, ET12E, LS14EAI, LS14EAI/AU, LS14EA/60, LS14EAASIA, LS14EA/G, LS10EA, LS14EAI/DD, WT65E, WT65EB, WT65EI, ECOTEMP12S, WT65E-BI, WT65EBIA, WT65EIA, WT65E60, WT65EB60, WT65EBIDG, WT65E-BASIA, WT65EIM50, WT65EIM60, LS14EADP/G, WT65MED, WT65EJ50, WT65EJ60, LS14AH240U, WT65H208U, WT65H240U, LS14H208DU, LS14AH208U, LS14H240DU, LS14H208RU, LS14H240RU, WT65H-208DU, WT65H240DU, WT65H208RU, WT65H240RU, WT65M208U, WT65M240U...(Other models you can see in the webshop)		

DIN 3017 - W4			
			
GEV No.	520120	Ref. No.	049888 OU1043
description	hose clamp SS W4 ø 12-20mm width 9mm Qty 1 pcs DIN 3017		
For models:	LB035C, LB035R, LB035Q, LB040R, LB040Q, LB040AUS, WT60/GJ60, WT60/GJ50, PH10/12-RP, LS14EA, ET12E, LS14EAI, LS14EAI/AU, LS14EA/60, LS14EAASIA, LS14EA/G, LS10EA, LS14EAI/DD, WT65E, WT65EB, WT65EI, ECOTEMP12S, WT65EBI, WT65EBIA, WT65EIA, WT65E60, WT65EB60, WT65EBIDG, WT65EBASIA, WT65EIM50, WT65EIM60, LS14EADP/G, WT65MED, WT65EJ50, WT65EJ60, LS14AH240U, WT65H208U, WT65H240U, LS14H208DU, LS14AH208U, LS14H240DU, LS14H208RU, WT65H208DU, WT65H-240DU, WT65H208RU, WT65H240RU, WT65M208U, WT65M240U, WT65M208DU...(Other models you can see in the webshop)		

			
GEV No.	520121	Ref. No.	0G2823
description	hose clamp SS W4 ø 16-27mm width 9mm Qty 1 pcs DIN 3017		
For models:	CE128-106, CE158-133.3.HV, CE158-244.3, CE158-246.3, CK248-209.D1ABBB, CK248-211.D1ABBB, HCE128-100, HCE128-104, HCE158-252W.3, HCE158-253.3, HLE129-100, HLE129-103, HLE129-104W, HLE159-252W.3.6, HLE159-328.3.HV, HLE159-351W.3.HV, HLE249-200.3, HLE249-208.3, HLE259-088.3.HV, HLE259-089.3.HV, HLE259-384W.3, LE129-101, LE159-261.3, LE159-281.3.6, LE159-318.3.HV, LE159-322.3.HV, LE159-330.3.HV, LE159-337.3.HV, LE159-344.3.MS92, LE159-347.3.HV, LE249-199.3, LE249-203.3, LE249-207.3, LE249-211.3, LE249-215.3, LE249-219.3, LE249-223.3, LE249-232.3, LE249-238.3, LE259-081.3.HV, LE259-082.3.HV, LE259-083.3.HV, LE259-094.3.HV, LE259-099.3.HV, LE259-382.3, LK259-707.D1ACCB, LK259-708.D1ACCB, CK248-205.D1ABBB, CK248-207.D1ABBB, LK159-707.D1BC...(Other models you can see in the webshop)		

pipes



miscellaneous



			
GEV No.	695617	Ref. No.	056810
description	water pipe		
For models:	MBR/G710D, MBR/E710D, MBR/G700, MBR/G700F, MBR/E700, MBR/E700UK, MBR/G700UK, MBR/G701, MBR/G706, MBR/G701UK, MBR/G751, MBR/G756, MBR/E716, MBR/E706, RBR/G710D, 7BRE60XN, RBR/G700, RBR/G700F, 7BRE60X, RBR/E700UK, 7BRG60, 7BRG60X, RBR/G701UK, RBR/G751, RBR/G756, RBR/E716, RBR/E706, XBR/G710D, XBR/G700, XBR/G710, XBR/G700F, XBR/G700UK, XBR/G701, M70GBP, XBR/G751, XBR/G756, CBR/G700, RBR/G700, RBR/E700, RBR/G700, ZRBR/G700, ZRBR/G700D, RBR/G700		

tools

cleaning tools

scrapers

			
GEV No.	890049	Ref. No.	0S1606
description	scraper for ceramic hobs		
spare parts for	890049		
	GEV No.	Ref. No.	—
		890052	—
	spare blades for scraper Qty 10 pcs		

			
GEV No.	890240	Ref. No.	059048
description	scraper for ceramic hobs		
For models:	MI/E350, MI/E700, MIF/E700, MI/E350D, MI/E700D, MIF/E700D, MI/E360, MI/E710, MIF/E710, MI/E360D, MI/E710D, MIF/E710D, RI/E1, RI/E2, RIF/E2, RIV/E2, XI/E1, XI/E2, XIF/E2, XIV/E2, JI/E1, JI/E2, JIF/E2, JIV/E2, MI/E1, MI/E2, MIF/E2, MIV/E2, XMI/E360, XMI/E710, XMIF/E710, CI/E710, CIF/E710, PI/E1, PI/E2, PIF/E2, PIV/E2, PI/E1E5, PI/E2E5, PIF/E2E5, OI/E1, OI/E2, OIF/E2, TI/E1, TI/E2, TIF/E2, TIV/E2, TI/E1E5, TI/E2E5, TIF/E2E5...(Other models you can see in the webshop)		
spare parts for	890240		
	GEV No.	Ref. No.	—
		890241	—
	spare blades for scraper Qty 5 pcs		



			
1			
GEV No.	705020	Ref. No.	OC0474 OC9974
description	scraper for charrill		
For models:	PGV/G1, PGV/G2, PGV/E1, PGV/E2, PGV/G1HV, PGV/G2HV, OGV/G1, OGV/G2, TGV/G1, TGV/G2, TGV/E1, TGV/E2, KGR/G1, KGR/G2, KGR/E1, KGR/E2, KGR/T1, KGR/T2, QGR/G1, QGR/G2, QGR/E1, QGR/E2, QGR/T1, QGR/T2, WGR/G1, WGR/G2, WGR/E1, WGR/E2		

			
1			
GEV No.	705022	Ref. No.	056940 164257 VVG153RI
description	scraper for charrill		
For models:	RR/G2CM, RR/E2CM, XR/G2CM, MR/G2CM, MR/E2CM, PR/G1FL, PR/G1FR, PR/G1CL, PR/G2FL, PR/G2FM, PR/G2CL, PRV/G1FL, PRV/G1FR, PRV/G1CL, PRV/G2FL, PRV/G2FM, PRV/G2CL, PR/G2CM, PR/E1FL, PR/E1FR, PR/E1CL, PR/E2FL, PR/E2FM, PR/E2CL, PRV/E1FL, PRV/E1FR, PRV/E1CL, PRV/E2FL, PRV/E2FM, PRV/E2CL, PR/E2CM, PR/E1FLE5, PR/E1FRE5, PR/E2FLE5, PR/E2CME5, PR/E2FME5, PR/G1FLHV, PRV/G2FLHV, OR/G1FL, OR/G1FR, OR/G1CL, OR/G2FL, OR/G2CL, ORV/G1FL, ORV/G1FR, ORV/G2FL, ORV/G2CM, OR/E1FR, OR/E2FM, OR/E2CM... (Other models you can see in the webshop)		

			
1			
GEV No.	705008	Ref. No.	055995 OG1958 OK5309
description	scraper for griddle		
For models:	MR/E720, MR/G721, MR/G1071, MR/G1070, MR/G720, MR/G725, MR/G1075, MR/E725, MR/E720D, MR/G726, MR/G1076, RMV/E1C, RMV/E2C, RMV/G1C, RMV/G2C, RR/G1CL, RR/G2CL, RRV/G1CL, RRV/G2CL, RR/E1CL, RR/E2CL, RRV/E1CL, RRV/E2CL, RR/G2CM, RR/E2CM, XMV/E1C, XMV/E2C, XMV/G1C, XMV/G2C, XR/G1CL, XR/G2CL, XRV/G1CL, XRV/G2CL, XR/E1CL, XR/E2CL, XRV/E1CL, XRV/E2CL, XR/G2CM, JMV/E1C, JMV/E2C, JR/G1CL, JR/G2CL, JRV/G1CL, JRV/G2CL, JR/E1CL, JR/E2CL, JRV/E1CL, JRV/E2CL, MMV/E1C, MMV/E2C... (Other models you can see in the webshop)		
spare parts for	705008		
			
GEV No.	705021	Ref. No.	056347 05L01 OC2519 OC6241 OM1325 54172
spare blades for scraper Qty 10 pcs			

			
1			
GEV No.	705021	Ref. No.	056347 05L01 OC2519 OC6241 OM1325 54172
description	spare blades for scraper Qty 10 pcs		
For models:	MR/E720, MR/G721, MR/G1071, MR/G1070, MR/G720, MR/G725, MR/G1075, MR/E725, MR/E720D, MR/G726, MR/G1076, RMV/E1C, RMV/E2C, RMV/G1C, RMV/G2C, RR/G1CL, RR/G2CL, RRV/G1CL, RRV/G2CL, RR/E1CL, RR/E2CL, RRV/E1CL, RRV/E2CL, RR/G2CM, RR/E2CM, XMV/E1C, XMV/E2C, XMV/G1C, XMV/G2C, XR/G1CL, XR/G2CL, XRV/G1CL, XRV/G2CL, XR/E1CL, XR/E2CL, XRV/E1CL, XRV/E2CL, XR/G2CM, JMV/E1C, JMV/E2C, JR/G1CL, JR/G2CL, JRV/G1CL, JRV/G2CL, JR/E1CL, JR/E2CL, JRV/E1CL, JRV/E2CL, MMV/E1C, MMV/E2C... (Other models you can see in the webshop)		

measuring equipment

meters

leak detectors

for natural and liquid gas

			
1			
GEV No.	802153	Ref. No.	0S2023
description	leak detector natural/liquid gas signal optic/acoustic incl. bag and battery display LED type SE151NM dimensions 90x160x30mm sensor external 275 + 1500mm cablemm		

thermometers

built-in thermometers

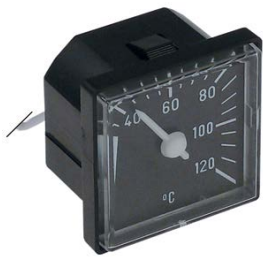

GEV No.	541522	Ref. No.	048525 0E5545 0E5675 0K7789 0K7790 0KB617
description	thermometer mounting measurements 45x45mm +40 up to +120°C capillary pipe 5000mm probe ø 6mm probe L 36mm front measurements 48x48mm		
For models:	WT35, WT34, WT34/4,5, WT34/UKRP, D510, WT34/4,5N, WT34/UK, WT50/9, WT50/UK9RF, WT50/F9, WT50/6, WT50/1 UKRP, WT50/1, D800/9, D800/6, WT50/60, WT50/N, WT50/J50, WT50/J60, WT50/UK1, WT50/UK3, PW1EFL, PW1EFLF, PW1EFL/60HZ, PW2EFL, PW2EFLF, PW2EFL/60HZ, PW2VFL, WT830EFL, WT830EFL/60HZ, WT850, WT850EFLF, WT850EFL/60HZ, WT850SFL, TW1ERECO, TW1E-LECO, TW1SRECO, TW1SLECO, RT100ED, RT100ES, RT100SR, RT100SL, RT140ED, RT140ES, RT140SR, RT140SL, RT190ED, RT190ES, RT190SR... (Other models you can see in the webshop)		



GEV No.	541095	Ref. No.	048544 0E5478
description	thermometer mounting measurements 58x25.5mm 0 up to +120°C capillary pipe 3000mm probe ø 6.5mm probe L 20mm		
For models:	ECOTEMP5, LS65, LS64, LS64/UKRP, LV64, ECOTEMP5S, LS64/1P, LS64/UK, ECOTEMP5SW, LS10D, LS10, LS10UKRP, LC100, ECOTEMP12-, LS10/60, LS10/1, LS10/12KW, LS10F, LS10DEK, LS10/1UKRP, LS10SW, LS10/50J, LS10/60J, LS10DP, LS10/HD, SH55, LO10, LS10/UK1, LS10/UK3, LS12D, LS12, LS12UK/RP, LC120, LS12DP, LS12/60, LS12F, LS12DEK, LS12HD, LS12/UK3, ECOTEMP12SW, ECOTEMP12INS, LS12MEX, LS10N, LS8D, LS8, LS8UK/RP, LC80, LS8F, LS8DEK, LS8/9... (Other models you can see in the webshop)		

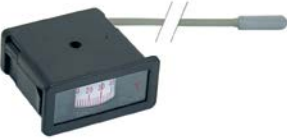

GEV No.	541080	Ref. No.	081730 082613 083101 0A9687 0A9689
description	thermometer mounting measurements 58x25.5mm -40 up to +40°C capillary pipe 2500mm probe ø 6mm probe L 30mm		
For models:	ICP110, ICP111, ICP112, ICF110, AEN110, AEN120, AKN111, AEF110, AEF120, AENN120, AENF120, AENN220, AENF220, AENN230, AENF230, ASN110, ASN111, ASF110, IKP110, IKP220, IKN110, IKN220, IKNSO120, IKNN120, IKNN220, IKNN230, IKS110, IKS220, IKF110, IKF220, IKNF120, IKNF120, IKNF230, ISP220, ISN110, ISN220, ISS110, ISS220, ISF110, ISF220, TRN1301, TRNA1301, TRNM1301, TRN1302, TRNA1302, TRNM1302, TRN1303, TRNA1303, TRNM1303, TRN1801... (Other models you can see in the webshop)		



GEV No.	541841	Ref. No.	087164
description	thermometer mounting measurements 58x25.5mm -40 up to +40°C capillary pipe 3200mm probe ø 6mm probe L 30mm		
For models:	AEN220, AEN240, AEN221, ASN220, ASN221, E14N0M2C, E14N-1M2C, E14N0M4C, E14N1M4C, E14N0M2V, E14N1M2V, E12N0M2C, E12N1M2C, E12N0M2V, E12N1M2V, C14RM2F, C14RM4F, C14RM2G, C12RM2F, C12RM2G, RVNM142, RVNM142, RMNE14V, RVNM122, RMNE12V		

ø52mm



GEV No.	541521	Ref. No.	032863 034075
description	thermometer mounting ø 52mm t.max. 120°C 0 up to +120°C probe ø 8.5mm probe L 33mm capillary pipe 1000mm		
For models:	TC1200, TC1210, TC1400, TC1410, TC1600, TC1610, TC1800, TC1810, TC2000, TC2010, TCD1200, TCD1400, TCD1600, TCD1800, TCD2000, LPS/75, LPS/75, DI-HTGW1, DI-HTGW2, DI-HTGW3, DI-HTGW4, CCB10, CCB20, SC		



GEV No.	541840	Ref. No.	048564 0PE178
description	thermometer mounting ø 52mm t.max. 120°C 0-120°C probe ø 6mm probe L 38mm capillary pipe 2500mm		
For models:	Z64, Z70, Z80		



GEV No.	541582	Ref. No.	056383
description	thermometer mounting ø 52mm t.max. 350°C +50 up to +350°C probe ø 6mm probe L 17mm capillary pipe 1700mm		
For models:	FCFG101/0, FCFG102-0, FCFG201-0, FCFG202-0, FCFE101-0, FCFE102-0, FCFE201-0, FCFE202-0, FCF101ELN, FCFG10160H, FCF201ENS, FCFG102-0T, FCF/G101/1-1-JAP, FCF/G102/1-1-JAP, FCFE101-1J, FCFE102-1J, FCF/G101/1, FCFE6J50, FCFE6J60, FCFG10J, FCFG10J, FCFE10J, FCFE10J, FCFG20J, FCFG20J, FCFE20J, FCFE20J, FCFG40J, FCFG40J, FCFE40J, FCFE40J, FCFG6J, FCFG6J, FCFG6J, FCFG6J, FCFG10J, FCFG10J, FCFG20J, FCFG20J, FCFG41J, FCFG40J, ECFG101-0, ECFG102-0, ECFG201-0, ECFG202-0, ECFE101-0, ECFE102-0, ECFE201-0, ECFE202-0, ECF201ENS...(Other models you can see in the webshop)		



GEV No.	541090	Ref. No.	053808
description	thermometer mounting ø 52mm t.max. 350°C 0 up to +350°C probe ø 6.5mm probe L 22mm capillary pipe 1450mm		
For models:	FC1G, FC2G, RF/G1680, RF/G2480, FCFG6D, FCFE6D, FCFE6D, FCFG10, FCFG10D, FCFG10NL, FCFE10, FCFE10UK, FCFG20, FCFG20D, FCFG20F, PFCFG20, FCFE20, FCFE20UK, FCFG40, FCFG41, FCFG40D, FCFG40F, PFCFG40F, FCFE40, FCFE40D, FCFE40UK, PFCFE40F, FCFG6, FCFG6F, PFCFG6, FCFE6, FCFE6UK, PFCFE6, FCVE10, FCVE20, FCVE6-1U, FCVE6-3U, FCVE6-1, FCVE6-3, FCVE6-1UK, FCVE6-3UK, FCVG6-1, FCVG6-3, FCVG6-1UK, FCVG6-3UK, FCVE10-2, FCVE10-4, FCVE10-2UK, FCVE10-4UK, FCVG10-2...(Other models you can see in the webshop)		



GEV No.	541083	Ref. No.	081792 084034
description	thermometer mounting ø 52mm t.max. 40°C -40 up to +40°C probe ø 6mm probe L 30mm capillary pipe 1500mm		
For models:	AP20, DLP14/F, DLP21/F, DL14/F, DL21/F, DL14/F, DL21/F, DLP14/F, DLP21/F, DL14/F, DL21/F, DLP14/F, DLP21/F		

ø60mm			
GEV No.	379593	Ref. No.	057622 058081
description	thermometer mounting ø 60mm t.max. 300°C 50-300°C probe ø 4mm probe L 135mm capillary pipe 1050mm		
For models:	M70EIKE, XPN/EI760UK		



GEV No.	541082	Ref. No.	081512 177541238808
description	thermometer mounting ø 60mm t.max. 40°C -40 up to +40°C probe ø 6mm probe L 135mm capillary pipe 2000mm		
For models:	DCBR40, DCB/R40F, DCB/R40U, DCB/R40/61, DCBR41, DCB/R41F, DCB/R41U, DCB/R41-6, DCBR60, DCB/R60F, DCB/R60U, DCBR61, DCB/R61U, DCB/R61-6, 23000150.1, 23000151.1, 23100150.1, 23100151.1, 15600116.1, 15600120.1		



GEV No.	541054	Ref. No.	004162
description	thermometer mounting ø 60mm t.max. 500°C 0 up to +500°C probe ø 10mm probe L 80mm capillary pipe 700mm		
For models:	ZCMME6, ZCBME12, ZCMME4, ZCBME8, ZCMME9, ZCBME18		

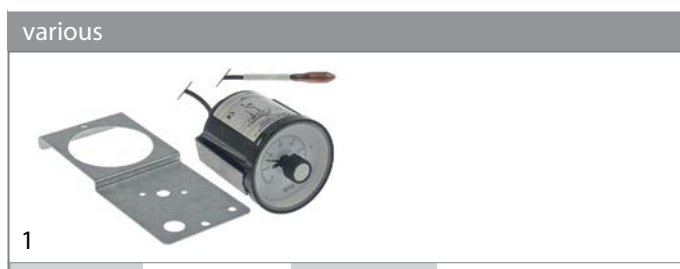

various			
GEV No.	381358	Ref. No.	OKU570 OKZQ05
description	thermostat t.max. 120°C temperature range 0-120°C 1-pole 1CO probe ø 8.5mm probe L 32mm capillary pipe 1600mm mounting ø 60mm		
For models:	HCCS20W, HCCS20W, A-O-H/S, A-O-H/W, A-O-H/PT, A-O-H/M50, A-O-H/M60, HC-CS, HC-CS		

fastening material

screws

countersunk screws



1

GEV No.	501370	Ref. No.	OK8911
description	countersunk screw thread M6 L 50mm SS DIN 963/ISO 2009 Qty 1 pcs intake slotted head ø 11mm		
For models:	CS7ME4/200-3, CS7ME4/230-3, CS7ME4/400-3N, CS7ME6/400-3N, CS7ME4/400-3N/EO, CS7ME4/400-3/50HZ/MA, CS7ME4/440-3/60HZ/MA, CS7MT4/400-3N, CS7GE4/200-3, CS7GE4/230-3, CS7GE4/400-3N, CS7GE6/400-3N, CS7GE4/400-3N/EO, CS7GE4/400-3/50HZ/MA, CS7GE4/440-3/60HZ/MA, CS7GT4/400-3N, CS7LCE4/200-3, CS7LCE4/230-3, CS7LCE4/400-3N, CS7LCE6/400-3N, CS7LCE4/400-3N/EO, CS7LCE4/400-3/50HZ/M, CS7LCE4/440-3/60HZ/M, CS7LCT4/400-3N, CS10ME4/200-3, CS10ME4/230-3, CS10ME6/230-3, CS10ME4/400-3N, CS10ME6/400-3N, CS10ME4/400-3N/EO, CS10ME4/400-3/50HZ/M, CS10ME4/440-3/60HZ/M, CS10MT4/400-3N, CS10MT6/400-3N, CS10GE4/200-3, CS10GE4/230-3, CS10GE6/230-3, CS10GE4/400-3N, CS10GE6/400-3N, CS10GE4/400-3N/EO, CS10GE4/400-3/50HZ/M, CS10GE4/440-3/60HZ/M, CS10GT4/400-3N, CS10GT6/400-3N, CS10LCE4/200-3, CS10LCE4/230-3, CS10LCE6/230-3, CS10LCE4/400-3N, CS10LCE6/400-3N, CS10LCE4/400-3N/EO...(Other models you can see in the webshop)		

oval head screws



1

GEV No.	560057	Ref. No.	0C3539
description	oval head screw thread M5 L 13mm stainless steel intake Phillips Qty 10 pcs		

hexagonal screws



1

GEV No.	560464	Ref. No.	OKE147 725244740
description	hexagonal screw thread M8 thread L 12mm SS WS 13 Qty 1 pcs head thickness 5mm DIN 933 / ISO 4017		
For models:	A/RF11, A/RF16., A/RF21., A/RF26., A/CA, A/CMM90., A/TSADX., A/TSASX., A/RF11-L, A/RF16-L, A/RF21-L, A/RF26-L, A/RF11-M., A/RF16., A/RF21, A/RF26, A/TS5SX., A/TS5DX., A/TS6SX., A/TS7DX., A/TS7SX., A/TS7DX., A/TS8SX., A/TS8DX., A/TSADX, A/TSASX, HSCCB5, HSCCB10, HSCCB20, HSCCB25, HSCCB90C, HSCCB45C, HSCCBR, HSCCBDLF, HSCCBDRF, HSCCBCLF, HSCCBCRF, HSSA3LR, HSSA4LR, HSSA5LR, HSSA6LR, HSSA3RL, HSSA4RL, HSSA5RL, HSSA6RL, HSCCT10, HSCCT20, HSCCT30, HSCCTL10, HSCCTL20...(Other models you can see in the webshop)		

cylinder head bolts

miscellaneous



1

GEV No.	693311	Ref. No.	059860
description	cylinder head bolt thread M6 thread L 15mm SS Qty 1 pcs intake slotted		
For models:	KPI/G10, KPI/G15, KPI/E10, KPI/E15, KPD/G10, KPD/G15, KPD/G15A, KPI/G15A, KPI/E15A, KPI/G06, KPI/E06, KPI/G15H, KPI/E15H, KPI/G10H, KPI/E10H, HPN/GI810, HPN/GI815, HPN/GI815D, HPN/GI816, HPN/GI816, HPN/EI815D, HPN/EI810, HPN/EI815, HPN/GD811, HPN/GD816, HPN/ED811, HPN/ED816, HPA/GD825, HPA/GI825, HPA/ED825, HPA/EI825, HPNS/GI816, HPNS/EI815, HPNS/EI815D, HPN/GI806, HPN/EI806, HPN/GI805, HPN/EI805, QPI/G10, QPI/G15, QPI/E10, QPI/E15, QPD/G10, QPD/G15, QPI/G06, QPI/E06, QPI/G15H, QPI/E15H, QPI/G10H, QPI/E10H...(Other models you can see in the webshop)		



1

GEV No.	550843	Ref. No.	051675
description	screw		
For models:	RPNV740, RPN/G760, RPN/G760, PRPN/G760, RPN/GI760, RPN/GI760, RPN/GI760, PRPN/GI76, RPN/EI760, RPN/EI760, RPNV760		

grub screws

DIN 913/ISO 4026





1

GEV No.	504733	Ref. No.	047846 0H2563
description	grub screw thread M4 L 5mm stainless steel DIN 913 intake internal hexagon WS 2 Qty 1 pcs		
For models:	LS860F, LS860DK, LS860PH, LS1080F, LS1080UK, LS1080PH, LS861F, LS1080M, LS1080, LS1080D, LS1080UK, LS1080/63, LS860, LS860, LS860D, LS860UK, LS861UK, LS860/63, LS861, LS510, LS520, LS520D, LS520F, LS520M, LS520K, LS521, LS521D, LS521F, LS521M, LS521K, LS521, LS4, LS61, LS61/60, LS62, LS62D, LS62/UKRP, LS62F, LV62, LS62/60, ECOTEMP5, LS62/1P, LS62HD, LS65, LS62/UK, LS63, LS63D, LS63/UKRP, LS63F, LV63...(Other models you can see in the webshop)		





DIN 916/ISO 4029			
			
1			
GEV No.	504734	Ref. No.	046258
description	grub screw thread M4 L 6mm black DIN 916 intake internal hexagon WS 2 Qty 1 pcs		
For models:	RTV/G720, RTV/G720, RTFG720, RTF/G720F, RTF/G1020, RTF/G1030, RTF/G1020F, KPI/G15H, KPI/G10H, QPI/G15H, QPI/G10H, WPI/G15H, WPI/G10H, FCV/E101/1, FCV/E10L6JAP, FCV/E102/1L6JAP, FCV/G10L6JAP, FCV/G102/1L6JAP, FCV/E61/1, FCV/E101/1, FCV/E102/1, FCV/E61/1, FCV/E101/1, FCV/G61/1, FCV/G10L6, FCV/E10L6, FCV/G102/1L6, FCV/E102/1L6, FCV/G20L6, FCV/E20L6, FCV/G202L6, FCVE202L6, FCS061GP, FCS101EP4J, FCS101EP, FCS101GP9J, FCS102EP4J, FCS101GP, FCS102EP, FCS102GA9J, FCS201EP, FCS102GP, FCS202EP, FCS201GP, FCS202GP, FCS061E4, FCS101EX4J, FCS101EXLN, FCS101EX, FCS102EX4J...(Other models you can see in the webshop)		

knurled screws			
			
1			
GEV No.	510112	Ref. No.	069440 454002
description	Thumb screw thread M10 thread L 10mm ø 22mm H 4.5mm SS		
For models:	LTB11, LTB12, LTB22, LTB11UK, LTB12UK, LTB22UK, LTB11, LTB22, CRYSTAL 11, CRYSTAL 22		

miscellaneous			
			
1			
GEV No.	700442	Ref. No.	025033 052220 0G6450 727728
description	thread bolt thread M6 L 32mm thread L 13mm head ø 8mm for rail		
For models:	MCF/G705, MCF/G1055, MCF/G700, MCF/G1050, MCF/G705E, MCF/G1055E, MCF/G700D, MCF/G700, MCF/G705F, MCF/G1055F, MCF/G705NL, MCF/GE705, MCF/GE1055, MCF/GE700, MCFGE1050, MCF/GE700D, MCFGE1050D, MCF/G1050D, MCFG1055NL, MCF/E700D, MCF/E700, MCF/E700UK, MCF/E1050D, MCF/E1050, MCF/GE1055UK, MI/E350, MI/E700, MIF/E700, MI/E350D, MI/E700D, MIF/E700D, MI/E360, MI/E710, MIF/E710, MI/E360D, MI/E710D, MIF/E710D, MCF/G995, MCF/G702, MCF/GE702, MCF/G1052, MCFGE1052, MCF/G700, MCF/GE700, MCF/G1050, MCFGE1050, MR/E350D, MR/E350UK, MR/E360, MR/E700D...(Other models you can see in the webshop)		

nuts			
			
1			
GEV No.	504503	Ref. No.	049047
description	knurled nut thread M10x1 ø 30mm H 4mm SS		
For models:	LB1, LB1WS, LB1WSDP, LB1/RBP, LB1/TOP, LB1/60, WT1WSDP, LB2D-PSAUS, LB1G, LB1WSG, WT2TOP60, WT2DPDI, WT2WSDPDI, LB1TOP, WT2TOPDI, LB2WS, LB2, LB2WSDP, LB2/TOP, LB2/RBP, LB2WS60, WT2WSDP, WT2WSDPD, LB2WSG, WT2WS, WT1, WT1WS, WT1TOP, WT2TOP, WT1/3DP, WT2/3DP, WT2DPAUS, WT2, LB2DPDI, LB2WSDPDI, LB2WSDPD, LB2TOP, LB2DP3, WT2DPD3, NGW, NGWDPDD, UC1, UC2WS, GW1, GW1WS, LV1WS, LV1WSDP, LV2WSDP, LV2WS, GW2D-PG...(Other models you can see in the webshop)		

			
1			
GEV No.	504528	Ref. No.	048632 0E5638
description	knurled nut thread M12x1 ø 35mm H 6mm SS		
For models:	LS61, LS61/60, LS6EP, LS6EP/DD, LS6EADD, LS6EA/DPDD, WT38T-DE, WT38/M50, LS6EADP3, LS6EADPWS, LS6EADPWSG, WT38WS, WT38WSG, WT38MEDWS, WT38PM50, WT37LEV/9, LS6EADPDWS, WT38DWS, LS6SANA, EUCAI, EUCAIDP, EUCAI60, EUCAIWS, WT38M50/4, LS6EA/UK, LS6EA/DPUK, EUCAIG, EUCAIWSG, EUCAIML, EUCAIMLWS, EUCAIMLG, EUCAICL, EUCAICLG, EUCAIWL, LS6EA/60, EUCAICLW, EUCI, EUCIM, EUCIM60, EUCAIDPNW, ZUCI, ZUCID, ZUCAI, ZUCAIDP, ZUCAIDPWS, ZUCAIG, ZUCAIDDWS, ZUCAID, ZUCAI60, EUCAIUSPH6...(Other models you can see in the webshop)		

			
1			
GEV No.	697970	Ref. No.	056150
description	knurled nut thread M6 ø 20mm H 7.7mm SS		
For models:	FCV/G6L3TOWNGAS, FCV/G6L3, FCVE6L3J, FCV/G6L3JAP, FCV/G6L3CJ, FCV/E61/1, FCV/E61/1, FCV/E61/1, FCV/E61/1, FCV/G6L3C, FCV/G61/1, FCV/G61/1, FCV/G61/1, FCV/G61/1, FCV/G6L3CT, FCV/G6L3CJ, FCV/E6L3, FCV/G6L4, FCV/E6L4, FCF6EHOR, FCS061E44J, FCS-061G48J, FCS061GP, FCS061EP, FCS061G3DI, FCS061E3CI, FCS061G4, FCS061G4DT, FCS061G49J, FCS061E4, FCS061EXLN, FCS061EX, FCFE6J50, FCFE6J60, FCFG6J, FCFG6J, FCFG6J, FCFG6J, FCFE6-1U, FCFE6-3U, FCFE6-1, FCFE6-3, FCFE6-3CE, FCFE6-1UK, FCFE6-3UK, FCFVG6-1, FCFVG6-3, FCFVG6-1UK, FCFVG6-3UK, 5711-2-6...(Other models you can see in the webshop)		

			
1			
GEV No.	504516	Ref. No.	046364 047282 089817
description	knurled nut thread M8x1 ø 25mm H 6mm SS		
For models:	LS32, LS32/4.5, LS32UK/RP, LS32F, LV32F, C55, LV32/60, WT4, WT4B, WT4D, WT302, WT302/4.5, WT302UK/RP, WT302F, WT302/60, WT4DB, WT46, WT4DG, WT4WS1, LS33, LS33/4.5, LS33UK/RP, LS33F, LV33F, C55A, LS33/60, WT4BWS, WT4DWS1, WT4BDWS, WT303, WT303/4.5, WT303UK/RP, WT303F, WT303/60, NUC3DD, WT4D60, WT4DDG, EUC1, EUC1DP, EUC1WS, EUC1DPWS, EUC3, EUC3WS, EUC3DP, EUC3DPWS, EUC1G, EUC1DP60, EUC3DD, ZUCADDROW, ZUCADDROW6...(Other models you can see in the webshop)		

			
2			
GEV No.	504547	Ref. No.	046365 047283 0TR534
description	knurled nut thread M8x1 ø 25mm H 6mm SS		
For models:	LS360F, LS360DK, LS365F, LS365, LS365PH, LS540F, LS540DK, LS541F, LS360D, LS365D, LS360, LS365, LS360/63, LS365/63, LS367, LS720F, LSE720DK, LSE720PH, LS860F, LS860DK, LS860PH, LS1080F, LS1080UK, LS1080PH, LSE721F, LS861F, LS540, LS1080M, LS1080, LS1080D, LS1080UK, LS1080/63, LS540D, LS540/63, LSE721, LS720, LSE720UK, LS721UK, LSE720D, LS541, LS860, LS860, LS860D, LS860UK, LS861UK, LS860/63, LS861, WT40/9, WT40/F, LS10D...(Other models you can see in the webshop)		

hexagonal nuts
DIN 934 / ISO 4032/8673

			
1			
GEV No.	560223	Ref. No.	0U0182
description	hexagonal nut thread M3 H 2.4mm WS 5.5 SS DIN/ISO DIN 934 / ISO 4032/8673 Qty 1 pcs		
For models:	AIARHFFOBB, AIARHAF00B, AIARHBFO0B, AIAWHFFFOB, AIAWHAF00B, AIAWHBFF0B, ADGRAAO000, ADGRHA0000, ADGRAFO000, ADGRHF0000, ADGUA00000, ADGUHA0000, ADGUAFO000, ADGUHF0000, AKGROA0000, AKGROFO000, ADGROIO000, ADGUOIO000, AIAROI000B, AIAWOIFF0B, AIAWA0000, AIAWABK00B, AIAWAFK00B, AIAROI000B, AIARA000B, AIARABK00B, AIARAFK00B, AIAWOIK00B, AIARA000B, AIARABQ00B, AIARAFQ00B, AIAROIQ00B, AIAWAQ00B, AIAWABQ00B, AIAWAFQ00B, AIAWOIQ00B, SLE159-170, SLE159-180, AIARAF00B, AIARA00B, AIARABFO0B, AIAWAFF00B, AIAWAFF00B, AIAWABFF0B		

			
1			
GEV No.	511212	Ref. No.	0K4516
description	hexagonal nut thread M6 H 5mm WS 10 SS DIN/ISO DIN 934 / ISO 4032/8673 Qty 1 pcs		
For models:	HLE159-241W.3.6, FSAKOE00RO, HWAKOE00RO, GSACOE000, BEN300E.S35.H97, LK259-728.D1ACCB, BOT150G.MS25.F17, GU3E-OEW00Z, LG259-711.0.SS/SS, GWKJOM0000, LG159-753.A1BC, LG159-703.0.FF, BEN200EW87, ISKJOM0000, LE159-231.3, HCE158-131W.3.HV, LE159-316.3.HV, ISKJOM00RO, HCE158-122W.3.HV, LE159-343.3.MS92, GWFHOEXORO, GWKCOEOORO, GSKCOEO000, LG159-706.0.ZN, GSKCOMOORO, HLE259-089.3.HV, LE159-307.3.HV, IWFKOMXORO, HLE249-228.3, IWAJOM0000, LE249-207.3, GSKCOEOORO, GWFCOEX000, HSKCOEOORO, CE158-252.3, LG159-704.0.ZS, IWFJOMXORO, CG248-240.0.NN/ZZ, CE158-142.3.MS82, LE259-954.3.MS92, ALAWCBSOOC, HWALOE00RO, GWKKOMOORO, HCE158-231W.3, GPWCOEOO0B, AGGWHBGBOO, GPXCOEOO0B, AGGYOIGFCO, GWACOM0000, KUYJOEWO00...(Other models you can see in the webshop)		

			
1			
GEV No.	560133	Ref. No.	0D0503 0U0336 3653
description	hexagonal nut thread M6 H 5mm WS 10 SS DIN/ISO DIN 934 / ISO 4032/8673 Qty 20 pcs		
For models:	K35, CUTE0523, CUTE0538, VARIO-G, K35, KT055, KT056, MC40AS-01, K35-11, K55-01, TR260-01, TR260-02, TR260-03, TR260-04, K55E-01, EL65, XBE10AS-01, BM20AS-01, MC40AS-02, K35-01, K55-02, XBE10AS-02, K35-02, PL15-01, XBE10AS-03, BM20AS-02, K35-03, XBE10S-1, K55E-05, PL15-02, PL15-03, XBE10S-02, XBE10AS-04, BM20AS-03, BM20AS-04, BM30AS-01, BM30AS-02, MC40AS-03, BMX60AS-01, K55-03, XBE10S-03, XBE10S-04, BM20AS-05, BM30AS-03, BMX60AS-02, BM20AS-06, BMX60AS-03, K35-04, K55-04, K35-05...(Other models you can see in the webshop)		

<p>DIN 985</p> 			
1			
GEV No.	560142	Ref. No.	049372
description	hexagonal nut thread M6 H 6mm SS WS 10 Qty 20 pcs DIN/ISO DIN 985 self-locking		
For models:	LS32, LS32/4.5, LS32UK/RP, LS32F, LV32F, C55, LV32/60, WT4, WT4B, WT4D, WT302, WT302/4.5, WT302UK/RP, WT302F, WT302/60, WT4DB, WT46, WT4DG, WT4WS1, LS33, LS33/4.5, LS33UK/RP, LS33F, LV33F, C55A, LS33/60, WT4BWS, WT4DWS1, WT4BDWS, WT303, WT303/4.5, WT303UK/RP, WT303F, WT303/60, NUC3DD, WT4D60, WT4DDG, EUC1, EUC1DP, EUC1WS, EUC1DPWS, EUC3, EUC3WS, EUC3DP, EUC3DPWS, EUC1G, EUC1DP60, EUC3DD, ZUCADDROW, ZUCADDROW6...(Other models you can see in the webshop)		





DIN 6923 / ISO 4161			
			
GEV No.	504315	Ref. No.	091346 0A9554 0E5372 0KG221 0L2469 0Q0011
description	nut thread M5 H 5mm WS 8 Qty 10 pcs		
For models:	APP113V, APP224V, EBS50., EBS50H, EBS100., EBS100H, EBS150., EBS150H, EBS200., EBS200H, EBS300., EBS300H, EBV50., EBV50H, EBV100., EBV100H, EBV150, EBV150H, EBV200., EBV200H, EBV300., EBV300H, EBVC50, EBVC50H, EBVC100, EBVC100H, EBVC150, EBVC150H, EBVC200, EBVC200H, EBVC300, EBVC300H, EBP100., EBP100M, EBP150, EBP150M, EBP200., EBP200M, EBP300., EBP300M, EBPC100, EBPC100M, EBPC150, EBPC150M, EBPC200, EBPC200M, EBPC300, EBPC300M, MED50H, MED100H...(Other models you can see in the webshop)		

			
GEV No.	550261	Ref. No.	006245 0K9627 514875601
description	nut thread M14x1 H 4mm WS 19 SS Qty 1 pcs		
For models:	FCV/G6L3TOWNGAS, FCV/G6L3, FCV/E101/1, FCV/G20L3, FCV/G20L3, FCV/E10L6JAP, FCV/E102/1L6JAP, FCV/G6L3JAP, FCV/G10L6JAP, FCV/G102/1L6JAP, FCV/E61/1, FCV/E61/1, FCV/E101/1, FCV/E101/1, FCV/E102/1, FCV/E61/1, FCV/E61/1, FCV/E101/1, FCV/G61/1, FCV/G61/1, FCV/E102/1, FCV/G6L4, FCV/E101/1, FCV/G10L6, FCV/E10L6, FCV/G102/1L6, FCV/E102/1L6, FCV/G101/1, FVC/E101/1, FCV/G102/1, FVC/E102/1, FCV/G201/1, FVC/E201/1, FCV/G202/1, FVC/E202/1, FCF/G6-0, FCFG101/0, FCFG102-0, FCFG201-0, FCFG202-0, FCF/E6-0, FCFE101-0, FCFE102-0, FCF061ELN, FCF101ELN, FCF6EHOR, FCFG10160H, FCF061ENS, FCF101ENS...(Other models you can see in the webshop)		

			
GEV No.	507448	Ref. No.	0E5063 0K8708
description	nut thread M8 H 8mm SS WS 13 Qty 1 pcs		
For models:	RT100ED, RT100ES, RT100SR, RT100SL, RT140ED, RT140ES, RT140SR, RT140SL, RT190ED, RT190ES, RT190SR, RT190SL, RT190HDED, RT190HDES, RT190HSR, RT190HSL, RT270ED, RT270ES, RT270SR, RT270SL, RT270HDED, RT270HDES, RT270HSR, RT270HSL, RT100ERF, RT100ELF, RT100VD, RT100VS, RT140ERF, RT140ELF, RT140VD, RT140VS, RT142ERF, RT142ELF, RT190ERF, RT190ELF, RT190VD, RT190VS, RT190HERF, RT190HELF, RT190HDVDF, RT190HDVSF, RT270ERF, RT270ELF, RT270VDF, RT270VSF, RT270HERF, RT270HELF, RT270HDVDF, RT270HDVSF...(Other models you can see in the webshop)		

			
GEV No.	101345	Ref. No.	020997 0F0146 727748
description	nut thread M15x1 H 3mm WS 19 brass Qty 1 pcs		
For models:	MCF/G705, MCF/G1055, MCF/G700, MCF/G1050, MCF/G705E, MCF/G1055E, MCF/G700D, MCF/G700, MCF/G705F, MCF/G1055F, MCF/G705NL, MCF/G1050D, MCF/G1055NL, MCF/G1095, MCF/G995, MCF/G702, MCF/G1052, MCF/G700, MCF/G1050, MR/G351, MR/G701, MR/G721, MR/G1071, MR/G350, MR/G350F, MR/G350NL, MR/G350E, MR/G360, MR/G360F, MR/G700, MR/G700F, MR/G700NL, MR/G700E, MR/G710, MR/G710F, MR/G1070, MR/G720, MR/G715, MR/G725, MR/G1075, MR/G361, MR/G711, MR/G716, MR/G726, MR/G1076, MFR/G350, MFR/G700, MFR/G350D, MFR/G700D, MFR/G360...(Other models you can see in the webshop)		

hexagonal nuts metric (without norm)			
			
GEV No.	514252	Ref. No.	050287
description	hexagonal nut		
For models:	PMG600, PMG600D, HMS/G400, HMS/G800, HMA/G800, HMS/E400, HMS/E800, HMA/E800, HMS/G400, HMS/G800D, HMA/G800D, HMS/E400, HMS/E800, HMA/E800, HMS/G400NL, HMS/G800, HMA/G800NL, HM/G400T, HM/G800T, HM/E400T, HM/E800T, ZPM/G600, ZHMA/G400, ZHMA/G80, ZHMA/G80, ZHMA/E400, ZHMA/801, ZHMA/E800, DCBE21, DCB/E21U, DCBV40, SM08C, SM15C, SM15/CS, SM21C, ZSM08/C, ZSM15/C, ZSM15/CS, ZSM21/C, ZHMA/G40, ZHMA/G801D, ZHMA/G80, ZHMA/E400, ZHM/E800T, ZHM/G400, ZHM/G800, ZHM/G400, ZHM/G800		

			
GEV No.	693430	Ref. No.	051263 0F0147
description	nut thread M22x1.5 H 5mm WS 26 zinc-coated steel Qty 1 pcs		
For models:	FCZ061EAA, FCZ101EAA, FCZ102EAA, FCZ201EAA, FCZ202EAA, FCZ061EAH, FCZ101EAH, FCZ201EAH, FCZ061EAN, FCZ101EAN, FCZ201EAN, FCZ061ETA, FCZ101ETA, FCZ102ETA, FCZ201ETA, FCZ202ETA, FCZ061ETH, FCZ101ETH, FCZ201ETH, FCZ061ETN, FCZ101ETN, FCZ201ETN, FCZ061GAG, FCZ101GAG, FCZ102GAG, FCZ201GAG, FCZ202GAG, FCZ061GAD, FCZ101GAD, FCZ102GAD, FCZ201GAD, FCZ202GAD, FCZ101GTG, FCZ102GTG, FCZ201GTG, FCZ202GTG, FCZ101GTD, FCZ102GTD, FCZ201GTD, FCZ202GTD, FCZ061EBA, FCZ101EBA, FCZ102EBA, FCZ201EBA, FCZ202EBA, FCZ061EBH, FCZ101EBH, FCZ201EBH, FCZ061EBN, FCZ101EBN...(Other models you can see in the webshop)		

			
GEV No.	690842	Ref. No.	056409
description	nut		
For models:	FCVE10-2, FCVE10-4, FCVE103CE, FCVE10-2UK, FCVE10-4UK, FCVG10-2, FCVG10-4, FCVG10-4-4, FCVG10-4-4D, FCVG10-2UK, FCVG10-4UK, FCVG10-2, FCVG10-4, FCVE20-2, FCVE20-4, FCVE203CE, FCVE20/P-V, FCVE20-2UK, FCVE20-4UK, FCVG20-2, FCVG20-4, FCVG20-2, FCVG20-4D, FCVG20-2UK, FCVG20-4UK, FCVG20-4, FCVG20-4D, FCVE20-V, FCVE20VUK, FCVE10-P, FCVE10PUK, FCVG10-P, FCVG10PUK, FCVE20-P, FCVE20PUK, FCVG20-P, FCVG20PUK, AFCV/G101, AFCV/G103, SCO/G10-3, AFCV/G201, AFCV/G203, SCO/G20-3, FCVG10-4, FCV/E20-V		

			
1			
GEV No.	102067	Ref. No.	055033 0992014
description	nut thread M8x1 H 3mm brass Qty 1 pcs type SEF 1		
For models:	MBR/E710D, MBR/E700, MBR/E700UK, MBR/G701, MBR/G706, MBR/G701UK, MBR/G751, MBR/G756, MBR/E716, MBR/E706, 7BRE60XN, 7BRE60X, RBR/E700UK, 7BRG60, 7BRG60X, RBR/G701UK, RBR/G751, RBR/G756, RBR/E716, RBR/E706, XBR/E710D, M70EBP, XBR/E710, XBR/G701, M70GBP, XBR/G701UK, XBR/G751, XBR/G756, CBR/G700, CBR/E700, XBR/E716, XBR/E706, HR/G420D, HR/G820D, HR/G420, HR/G820, HR/G821, HBR/G800, HBR/G805, HBR/G801, HBR/G806, HBR/G810, HBR/G815, HBR/G811, HBR/G816, HBR/G800D, HBR/G805D, HBR/G801D, HBR/G806D, HBR/G810D...(Other models you can see in the webshop)		

hexagonal nuts inch thread			
			
1			
GEV No.	503155	Ref. No.	003035
description	nut thread 1/2" H 7mm WS 25 brass Qty 1 pcs		
For models:	CR15V, CR15E, LVS3, LVS2, LVS1, LVS15, LVS20, LVS30		

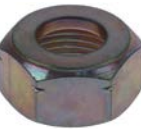
union nuts			
			
1			
GEV No.	530907	Ref. No.	0C1058
description	union nut thread 3/4" H 16mm WS 30 Qty 1 pcs		
For models:	FCZ061GAG, FCZ101GAG, FCZ102GAG, FCZ201GAG, FCZ202GAG, FCZ061GAD, FCZ101GAD, FCZ102GAD, FCZ201GAD, FCZ202GAD, FCZ101GTG, FCZ102GTG, FCZ201GTG, FCZ202GTG, FCZ101GTD, FCZ102GTD, FCZ201GTD, FCZ202GTD, FCZ061GBG, FCZ101GBG, FCZ102GBG, FCZ201GBG, FCZ202GBG, FCZ061GBD, FCZ101GBD, FCZ102GBD, FCZ201GBD, FCZ202GBD, FCZ061GBI, FCZ101GBI, FCZ201GBI, FCZ101GBG2, FCZ102GBG2, FCZ201GBG2, FCZ202GBG2, FCZ101GBD2, FCZ102GBD2, FCZ201GBD2, FCZ202GBD2, FCZ101GBI2, FCZ102GBI2, FCZ201GBI2, FCZ061GCG, FCZ101GCG, FCZ102GCG, FCZ201GCG, FCZ202GCG, FCZ061GCD, FCZ101GCD, FCZ102GCD...(Other models you can see in the webshop)		

washers			
spring washers			
			
1			
GEV No.	104284	Ref. No.	069567 0C6288 0W3291 735583001
description	clamping washer nominal-ø 4mm ED ø 10mm steel thickness 0.7mm Qty 10 pcs		
For models:	ACG12, ACG24, ACG36, ACG48, ACFG24, ACFG36, AIZ16, ASG36, ARG12FL, ARG24FL, ARG36FL, ARG48FL, ARG12FR, ARG24FR, ARG36FR, ARG48FR, AGG12, AGG24, AGG36, AGG48, ACPG25, ACG12T, ACG24T, ACG36T, ACG48T, ACFG24T, ACFG36T, ARG12FLCE, ARG24FLCE, ARG36FLCE, ARG48FLCE, ARG12FRCE, ARG24FRCE, ARG36FRCE, ARG48FRCE, AGG12CE, AGG24CE, AGG36CE, AGG48CE, PC/G1, PC/G2, PCV/G2, PCV/G3, PCF/G2, PCF/G3, PCF/G9, PCF/M2, PCF/M3, PC/E1, PC/E2...(Other models you can see in the webshop)		

washers			
DIN 125A			
			
1			
GEV No.	560312	Ref. No.	0D0622
description	plain washer ID ø 10.5mm ED ø 20mm thickness 2mm SS Qty 1 pcs DIN 125A for thread M10		
For models:	MVS-01, BM20AS-01, BM20AS-02, BM20AS-03, BM20AS-04, BM30AS-01, BM30AS-02, BMX60AS-01, BM20AS-05, BM30AS-03, BMX60AS-02, BM20AS-06, BMX60AS-03, BM10S-01, BMX60S-01, BMXE60S-01, BMX60AS-04, BMXE60AS-1, BMXE80S-01, BMXE80AS-1, BMX60ASC-1, BMXE60ASC1, BMX60AS-05, BMXE80AS-2, BM30S-01, BM20AS-07, BM20AS-12, TI25-01, BM20S-01, BMX60S-02, BM20S-02, MVS-02, BMXE80S-02, BM20S-03, BMXE60S-02, BM30AS-04, BM30S-02, BM20AS-13, BM20AS-08, BM20S-04, BM30AS-05, XBE60S-01, XBE60AS-01, XBE80S-01, XBE80AS-01, BM20AS-09, BM20AS-10, BM30AS-06, BM20AS-11, EM20AS-01...(Other models you can see in the webshop)		

			
1			
GEV No.	560112	Ref. No.	0E1119
description	plain washer ID ø 5.3mm ED ø 10mm thickness 1mm SS Qty 20 pcs DIN 125A for thread M5		
For models:	W3400H06, W355HE, W3400H, W3400H, W355HQSR, W355H, W355H, LC12E, LC12EC, CLC12, CLC12EC, CLC22, CLC22VC, C240, C260, WE55QSR_EL, LC12E, 82RV10E, CLC22E, A/CMA90CD, A/CMA90CS, A/CMA90SD, A/CMA90SS, W3400H01, W3400H02, W3400H03, W3400H04, C24001, C240R01, C26001, C260R01, C290R01, C260R02, C240R02, D480, D48, D48, D48, D48, D480, D480, D48, D48, D48, D48, D48, D48, D48, D480, D480...(Other models you can see in the webshop)		





			
1			
GEV No.	520114	Ref. No.	OE1166 OKB299
description	hose clamp ø 20-32mm width 9mm Qty 10 pcs DIN 3017		
For models:	W3400H06, W355HE, W365H, W375H5, W3105H, W3130H, W3130H, W3240H., W3240H, W3400H, W3400H, W355HQSR, W3130H, W3180H, W3180H, W3180H, W3240H_EL, W3240H_CLA, W3180H, W3130H, W3180H, W3105H, W3105H, W3105H, W355H, W375H, W3105H, W3130H, W3180H, W3300H, W3300H, W355H, W455H04, W455HQSR, WE66MP, WE66MP, WE106MP, LC12EC, CLC12EC, CLC22, LACE22M, CLC22V, LACV22M/V, CLC22VC, LB81E, LB81BP, LB81COP, W375N, W375N...(Other models you can see in the webshop)		

			
1			
GEV No.	520118	Ref. No.	046855 065537 072582 0E1358 0K8983 736284051
description	hose clamp ø 50-70mm width 9mm Qty 5 pcs DIN 3017		
For models:	LS32, LS32/4.5, LS32UK/RP, LS32F, LV32F, C55, LV32/60, WT4, WT4B, WT4D, WT302, WT302/4.5, WT302UK/RP, WT302F, WT302/60, WT4DB, WT46, WT4DG, WT4WS1, LS33, LS33/4.5, LS33UK/RP, LS33F, LV33F, C55A, LS33/60, WT4BWS, WT4DWS1, WT4BDWS, WT303, WT303/4.5, WT303UK/RP, WT303F, WT303/60, NUC3DD, WT4D60, WT4DDG, EUC1, EUC1DP, EUC1WS, EUC1DPWS, EUC3, EUC3WS, EUC3DP, EUC3DPWS, EUC1G, EUC1DP60, EUC3DD, ZUCADDROW, ZUCADDROW6...(Other models you can see in the webshop)		

			
1			
GEV No.	520115	Ref. No.	047578 049446 0K0198 0L0367
description	hose clamp ø 25-40mm width 9mm Qty 10 pcs DIN 3017		
For models:	EBS50., EBS50H, EBS100., EBS100H, EBS150., EBS150H, EBS200., EBS200H, EBS300., EBS300H, EBV50., EBV50H, EBV100., EBV100H, EBV150, EBV150H, EBV200., EBV200H, EBV300., EBV300H, EBVC50, EBVC50H, EBVC100, EBVC100H, EBVC150, EBVC150H, EBVC200, EBVC200H, EBVC300, EBVC300H, EBP100., EBP100M, EBP150, EBP150M, EBP200., EBP200M, EBP300., EBP300M, EBPC100, EBPC100M, EBPC150, EBPC150M, EBPC200, EBPC200M, EBPC300, EBPC300M, MED50H, MED100H, MED150H, MED200H...(Other models you can see in the webshop)		

			
1			
GEV No.	520119	Ref. No.	046478 046853 065047 0E0992
description	hose clamp ø 60-80mm width 9mm Qty 5 pcs DIN 3017		
For models:	LB8G, LB8G/63, LB8GF, LB8GPH, LB8G, LB8GPHm, LB80EPH, LB80E, LB120EPH, LB120E, LB160EPH, LB160E, LB160V, CLB160E, CLB160V, LB70E, LB110E, SPE144/23, SPE144/23U, SPE144/23, LS500F, LS501F, LS540F, LS540DK, LS541F, LS720F, LSE720DK, LSE720PH, LS860F, LS860DK, LS860PH, LS1080F, LS1080UK, LS1080PH, LSE721F, LS861F, LS540, LS1080M, LS1080, LS1080D, LS1080UK, LS1080/63, LS500F, LS500UK, LS501, LS501UK, LS540D, LS540/63, LSE721, LS720...(Other models you can see in the webshop)		

			
1			
GEV No.	520116	Ref. No.	046566 046878 060407 066056 0E2686 0K8981 736283451
description	hose clamp ø 32-50mm width 9mm Qty 5 pcs DIN 3017		
For models:	LS32, LS32/4.5, LS32UK/RP, LS32F, LV32F, C55, LV32/60, WT4, WT4B, WT4D, WT302, WT302/4.5, WT302UK/RP, WT302F, WT302/60, WT4DB, WT46, WT4DG, WT4WS1, LS33, LS33/4.5, LS33UK/RP, LS33F, LV33F, C55A, LS33/60, WT4BWS, WT4DWS1, WT4BDWS, WT303, WT303/4.5, WT303UK/RP, WT303F, WT303/60, NUC3DD, WT4D60, WT4DDG, EUC1, EUC1DP, EUC1WS, EUC1DPWS, EUC3, EUC3WS, EUC3DP, EUC3DPWS, EUC1G, EUC1DP60, EUC3DD, ZUCADDROW, ZUCADDROW6...(Other models you can see in the webshop)		

			
1			
GEV No.	520110	Ref. No.	046946 048224 0539812 0H2566 0KB296 211003001008
description	hose clamp ø 8-12mm width 9mm Qty 10 pcs DIN 3017		
For models:	LS32, LS32/4.5, LS32UK/RP, LS32F, LV32F, C55, LV32/60, WT4, WT4B, WT4D, WT302, WT302/4.5, WT302UK/RP, WT302F, WT302/60, WT4DB, WT46, WT4DG, LS33, LS33/4.5, LS33UK/RP, LS33F, LV33F, C55A, LS33/60, WT4DWS1, WT4BDWS, WT303, WT303/4.5, WT303UK/RP, WT303F, WT303/60, NUC3DD, WT4D60, WT4DDG, EUC1, EUC1DP, EUC1DPWS, EUC3, EUC3DP, EUC3DPWS, EUC1G, EUC1DP60, EUC3DD, ZUCADDROW, ZUCADDROW6, LS5/1, LS5/1DP, LS5/1WSPD, LS5/3...(Other models you can see in the webshop)		

			
GEV No.	520117	Ref. No.	OL0193
description	hose clamp stainless steel ϕ 40-60mm width 9mm Qty 5 pcs DIN 3017		
For models:	LU7PDP, LU7ADP, LU7ADPWS, WTU40PDP, WTU40ADP, WTU40ADPWS, WTU40ADPD, WT60/GJ60, WT60/GJ50, PH10/12-RP, LS14EA, ET12E, LS14EAI, LS14EAI/AU, LS14EA/60, LS14EAASIA, LS14EA/G, LS10EA, LS14EAI/DD, WT65E, WT65EB, WT65EI, ECOTEMP12S, WT65E-BI, WT65EBIA, WT65EIA, WT65E60, WT65EB60, WT65EBIDG, WT65E-BASIA, WT65EIM50, WT65EIM60, LS14EADP/G, WT65MED, WT65EJ50, WT65EJ60, LS14AH240U, WT65H208U, WT65H240U, LS14H208DU, LS14AH208U, LS14H240DU, LS14H208RU, LS14H240RU, WT65H-208DU, WT65H240DU, WT65H208RU, WT65H240RU, WT65M208U, WT65M240U...(Other models you can see in the webshop)		

DIN 3017 - W4

			
GEV No.	520120	Ref. No.	049888 0U1043
description	hose clamp SS W4 ϕ 12-20mm width 9mm Qty 1 pcs DIN 3017		
For models:	LB035C, LB035R, LB035Q, LB040R, LB040Q, LB040AUS, WT60/GJ60, WT60/GJ50, PH10/12-RP, LS14EA, ET12E, LS14EAI, LS14EAI/AU, LS14EA/60, LS14EAASIA, LS14EA/G, LS10EA, LS14EAI/DD, WT65E, WT65EB, WT65EI, ECOTEMP12S, WT65EBI, WT65EBIA, WT65EIA, WT65E60, WT65EB60, WT65EBIDG, WT65EBASIA, WT65EIM50, WT65EIM60, LS14EADP/G, WT65MED, WT65EJ50, WT65EJ60, LS14AH240U, WT65H208U, WT65H240U, LS14H208DU, LS14AH208U, LS14H240DU, LS14H208RU, WT65H208DU, WT65H-240DU, WT65H208RU, WT65H240RU, WT65M208U, WT65M240U, WT65M208DU...(Other models you can see in the webshop)		

			
GEV No.	520121	Ref. No.	0G2823
description	hose clamp SS W4 ϕ 16-27mm width 9mm Qty 1 pcs DIN 3017		
For models:	CE128-106, CE158-133.3.HV, CE158-244.3, CE158-246.3, CK248-209, D1ABBB, CK248-211.D1ABBB, HCE128-100, HCE128-104, HCE158-252W.3, HCE158-253.3, HLE129-100, HLE129-103, HLE129-104W, HLE159-252W.3.6, HLE159-328.3.HV, HLE159-351W.3.HV, HLE249-200.3, HLE249-208.3, HLE259-088.3.HV, HLE259-089.3.HV, HLE259-384W.3, LE129-101, LE159-261.3, LE159-281.3.6, LE159-318.3.HV, LE159-322.3.HV, LE159-330.3.HV, LE159-337.3.HV, LE159-344.3.MS92, LE159-347.3.HV, LE249-199.3, LE249-203.3, LE249-207.3, LE249-211.3, LE249-215.3, LE249-219.3, LE249-223.3, LE249-232.3, LE249-238.3, LE259-081.3.HV, LE259-082.3.HV, LE259-083.3.HV, LE259-094.3.HV, LE259-099.3.HV, LE259-382.3, LK259-707.D1ACCB, LK259-708.D1ACCB, CK248-205.D1ABBB, CK248-207.D1ABBB, LK159-707.D1BC...(Other models you can see in the webshop)		

one ear clamps

			
GEV No.	520991	Ref. No.	0C5385
description	one ear clamp ϕ 16mm width 8mm SS		
For models:	BCP/G1, BCP/E1, ACPG25, ECP/E1ELHU, PCP/E1ELH, TCP/E1ELHU, TCP/E1ELH, FCZ061EAA, FCZ061EAH, FCZ061EAN, FCZ061ETA, FCZ061ETH, FCZ061ETN, FCZ061EBA, FCZ061EBH, FCZ061EBN, FCZ061EBC, FCZ061EBA2, FCZ061EBH2, FCZ061EBN2, FCZ061EBC2, FCZ061ECA, FCZ061ECH, FCZ061ECN, FCZ061ECA2, FCZ061ECH2, FCZ061ECN2, AOW101EA, AOW101EABU, AOS061EAA1, AOS061EAH1, AOS061EAN1, AOS061EAC1, AOS061EAE1, AOS061EAF1, AOS061EAM1, AOS061EAB1, AOS061EAK1, AOS061EAT1, AOS061ETA1, AOS061ETH1, AOS061ETN1, AOS061ETC1, AOS061ETE1, AOS061ETF1, AOS061ETM1, AOS061ETK1, AOS061EBA1, AOS061EBH1, AOS061EBN1...(Other models you can see in the webshop)		

cable clamps

			
GEV No.	693247	Ref. No.	0K0194 190435
description	cable clamp wire gauge ϕ 5mm		
For models:	7581-5.KK60, 7582-5.KK80, 7583-5.KK100, 7781-5.KK60, 7782-5.KK80, 7783-5.KK100, 7580-5.KK40, 7584-5.KK150, 7780-5.KK40, 7580-5/85.KK40.(N), 7581-5/85.KK60.(N), 7582-5/85.KK80.(N), 7583-5/85.KK100.(N), 7584-5-85.KK150.(N), 7580-5/90.KK40.(N), 7581-5/90.KK60.(N), 7582-5/90.KK80.(N), 7583-5/90.KK100.(N), 7584-5-90.KK150.(N), 7568-5-90.KK200.(N), 7542-2, 7542-3, 7544-2, 7544-3, 7546-3, 7548-3, 7568-3, 7568-5.KK200, 7568-5/85.KK200.(N), 7580-3, 7581-3, 7581-5, 7582-3, 7582-5, 7583-3, 7583-5, 7584-3, 7742-3, 7744-3, 7746-3, 7748-3, 7768-3, 7768-5.KK200, 7768-5/85.KK200.(N), 7768-5/90.KK200.(N), 7780-3, 7780-5/85.KK40.(N), 7780-5/90.KK40.(N), 7781-3, 7781-5...(Other models you can see in the webshop)		

retaining rings

<p>DIN 471</p> 			
GEV No.	512260	Ref. No.	0KQ557
description	retaining ring shaft ϕ 14mm thickness 1.2mm steel DIN 471		
For models:	T5S-01, T5S-02, BMX60AS-01, BMX60AS-02, BMX60AS-03, BMX60S-01, BMXE60S-01, BMX60AS-04, BMXE60AS-1, BMXE80S-01, BMXE80AS-1, BMX60ASC-1, BMXE60ASC1, BMX60AS-05, BMXE80AS-2, T5S-03, BMX60S-02, BMXE80S-02, BMXE60S-02, XBE60S-01, XBE60AS-01, XBE80S-01, XBE80AS-01, EMXE80AS-1, EM60AS-01, EM60AS-02, EM80AS-01, BMXE60AS-2, T5S-04, XBE60S-02, XBE80S-02, BMXE60S-03, XBE80AS-02, BMXE80AS-3, BMX60AS-09, BMX60AS-07, BMX60AS-08, BMX60S-05, BMX60S-07, BMXE60S-04, BMXE60S-1, BMXE80AS-4, BMXE80S-04, T5S-08, T5S-09, BMX60S-09, T5S-10, T5S-11, BMX60S-08, BMX60S-03...(Other models you can see in the webshop)		





			
1			
GEV No.	504519	Ref. No.	048979
description	retaining ring shaft ø 17mm thickness 1mm SS DIN 471		
For models:	LS32, LS32/4.5, LS32UK/RP, LS32F, LV32F, C55, LV32/60, WT4, WT4B, WT4D, WT302, WT302/4.5, WT302UK/RP, WT302F, WT302/60, WT4DB, WT46, WT4DG, WT4WS1, LS33, LS33/4.5, LS33UK/RP, LS33F, LV33F, C55A, LS33/60, WT4BWS, WT4DWS1, WT4BDWS, WT303, WT303/4.5, WT303UK/RP, WT303F, WT303/60, NUC3DD, WT4D60, WT4DDG, EUC1, EUC1DP, EUC1WS, EUC1DPWS, EUC3, EUC3WS, EUC3DP, EUC3DPWS, EUC1G, EUC1DP60, EUC3DD, ZUCADDROW, ZUCADDROW6...(Other models you can see in the webshop)		

			
1			
GEV No.	698591	Ref. No.	0E5152 0K8970 735313007
description	retaining ring shaft ø 28mm thickness 1.5mm SS DIN 471		
For models:	EBV100, EBV100, EBV100, EBV100, EBV100, EBV-C100, EBV-C100, EBV-C100, EBV-C100, EBV200, EBV200, EBV200, EBV200, EBV200, EBV-C200, EBV-C200, EBV-C200, EBV-C200, EBV-C200, EBV300, EBV300, EBV300, EBV300, EBV300, EBV-C300, EBV-C300, EBV-C300, EBV-C300, EBS50, EBS50H, EBS100, EBS100H, EBS150, EBS150H, EBS200, EBS200H, EBS300, EBS300H, EBV50, EBV50H, EBV100, EBV100H, EBV150, EBV150H, EBV200, EBV200H, EBV300, EBV300H...(Other models you can see in the webshop)		

DIN 472			
			
1			
GEV No.	698003	Ref. No.	0A2592
description	retaining ring bore ø 35mm thickness 1.5mm steel DIN 472		
For models:	MBR/G710D, MBR/E710D, MBR/G700, MBR/G700F, MBR/E700, MBR/E700UK, MBR/G700UK, MBR/G701, MBR/G706, MBR/G701UK, MBR/G751, MBR/G756, MBR/E716, MBR/E706, RBR/E2FM, RBR/E2IM, RBR/E2FM, XBR/G2FM, XBR/G2IM, XBR/G2FM, XBR/E2FM, XBR/E2IM, XBR/E2FM, JBR/G2FM, JBR/E2FM, MBK/G2FM, MBR/E2FM, MBR/E2IM, MBK/E2FM, RBR/G710D, 7BRE60XN, RBR/G700, RBR/G700F, 7BRE60X, RBR/E700UK, 7BRG60, 7BRG60X, RBR/G701UK, RBR/G751, RBR/G756, RBR/E716, RBR/E706, XBR/G710D, XBR/E710D, XBR/G700, XBR/G710, M70EBP, XBR/G700F, XBR/G700UK, XBR/E710...(Other models you can see in the webshop)		

			
1			
GEV No.	523102	Ref. No.	0D0656 0KQ392 21930 3074
description	retaining ring bore ø 47mm thickness 1.8mm steel DIN 472		
For models:	MC40AS-01, TR260-01, TR260-02, TR260-03, TR260-04, MC40AS-02, MC40AS-03, MC40S-01, MC40AS-04, MC40AS-05, MC40S-02, TR260-05, TR260-06, PSN10-01, XBM30AS-01, PSN20-01, PSN30-01, PSN30-02, XBM30S-01, PSN40-01, PSN60-01, PSN80-01, XBM30AS-02, XBM30AS-03, XBM20S-01, XBM20AS-01, XBM20S-02, XBM20AS-02, TR260-07, EM40AS-01, TR260-08, XBM20AS-03, XBM20S-03, XBM20AS-04, XBM20S-04, XBM30AS-04, XBM40S-01, XBM20S-27, XBM30S-02, XBM40AS-01, XBM20AS-24, XBM20S-28, XBM30AS-19, XBM30S-14, XBM20AS-05, XBM20S-05, TR260-09, TR260-15, TR260-16, XBM20AS-09...(Other models you can see in the webshop)		

			
1			
GEV No.	523101	Ref. No.	03078 0U0717 23838 DS23838
description	retaining ring bore ø 62mm thickness 2mm steel DIN 472		
For models:	T25E-01, T25E-02, BMX60AS-01, T25E-03, BMX60AS-02, BMX60AS-03, BMX60S-01, BMXE60S-01, BMX60AS-04, BMXE60AS-1, BMXE80S-01, BMXE80AS-1, BMX60ASC-1, BMXE60ASC1, BMX60AS-05, BMXE80AS-2, TI25-01, BMX60S-02, BMXE80S-02, BMXE60S-02, T25E-04, T25E-06, ELX65-01, ELX65-02, PSN10-01, PSN20-01, PSN30-01, PSN30-02, PSN40-01, PSN60-01, PSN80-01, EMXE80AS-1, T25E-05, EM60AS-01, EM60AS-02, EM80AS-01, ELX65-03, ELX65-04, ELX65-05, ELX65-06, BMXE60AS-2, ELX65-07, TI25-02, BMXE60S-03, BMXE80AS-3, BMX60AS-09, BMX60AS-07, BMX60AS-08, BMX60S-05, BMX60S-07...(Other models you can see in the webshop)		

DIN 6799			
			
1			
GEV No.	529724	Ref. No.	049284
description	retaining ring E D1 ø 4mm D2 ø 9mm SS DIN 6799 thickness 0.7mm for shaft ø 4-5mm		
For models:	LS32, LS32/4.5, LS32UK/RP, LS32F, LV32F, C55, LV32/60, WT4, WT4B, WT4D, WT302, WT302/4.5, WT302UK/RP, WT302F, WT302/60, WT4DB, WT46, WT4DG, WT4WS1, LS33, LS33/4.5, LS33UK/RP, LS33F, LV33F, C55A, LS33/60, WT4BWS, WT4DWS1, WT4BDWS, WT303, WT303/4.5, WT303UK/RP, WT303F, WT303/60, NUC3DD, WT4D60, WT4DDG, EUC1, EUC1DP, EUC1WS, EUC1DPWS, EUC3, EUC3WS, EUC3DP, EUC3DPWS, EUC1G, EUC1DP60, EUC3DD, ZUCADDROW, ZUCADDROW6...(Other models you can see in the webshop)		

			
1			
GEV No.	507015	Ref. No.	068293 0C6421 0H6035 117584
description	retaining ring E D1 ø 7mm D2 ø 14mm SS DIN 6799 thickness 0.9mm for shaft ø 8-11mm		
For models:	FCZ061EAA, FCZ101EAA, FCZ102EAA, FCZ061EAH, FCZ101EAH, FCZ061EAN, FCZ101EAN, FCZ061ETA, FCZ101ETA, FCZ102ETA, FCZ201ETA, FCZ202ETA, FCZ061ETH, FCZ101ETH, FCZ201ETH, FCZ061ETN, FCZ101ETN, FCZ201ETN, FCZ101GTG, FCZ102GTG, FCZ201GTG, FCZ202GTG, FCZ101GTD, FCZ102GTD, FCZ201GTD, FCZ202GTD, FCZ061EBA, FCZ101EBA, FCZ102EBA, FCZ061EBH, FCZ101EBH, FCZ061EBN, FCZ101EBN, FCZ061EBC, FCZ101EBC, FCZ061EBA2, FCZ101EBA2, FCZ102EBA2, FCZ201EBA2, FCZ202EBA2, FCZ061EBH2, FCZ101EBH2, FCZ201EBH2, FCZ061EBN2, FCZ101EBN2, FCZ201EBN2, FCZ061EBC2, FCZ101EBC2, FCZ201EBC2, FCZ101GBG2...(Other models you can see in the webshop)		

roll pins



1

GEV No.	692013	Ref. No.	052061 060920 0H6043 OK8575 60050373 727895
description	roll pin ø 3mm L 16mm		
For models:	MCF/G1090, MCF/G1095, MCF/G995, MR/G721, MR/G1071, MR/G1070, MR/G720, MR/G725, MR/G1075, MR/G726, MR/G1076, MFR/G350, MFR/G700, MFR/G350D, MFR/G700D, MFR/G350F, MFR/G700F, MFR/G350E, MFR/G700E, MFR/E355, MFR/E355UK, MFR/E355D, MFR/E705, MFR/E705UK, MFR/E705D, MFR/G740, MFR/E740, MFR/G350, MFR/G351, MFR/G700, MFR/G701, FDV40G, FDV40E, FDV40GZ, FDV40EL, FDV40GA, FDV20G, FDV20E, FDV20GZ, FDV20EL, FDV20GA, RCF/G1095, RR/G720D, 7FTGC7L, 7FTGC1L, RR/G1070D, 7FTGC7M, RR/G1076, RFR/G350, RFR/G700...(Other models you can see in the webshop)		



1

GEV No.	560462	Ref. No.	0C2170
description	roll pin ø 4.5mm L 36mm nominal-ø 4mm		
For models:	KBR/G2F, KBR/G2C, KBR/G3F, KBR/G3FH, KBR/G3C, KBR/G3CH, KBR/E2F, KBR/E2C, KBR/E3F, KBR/E3FH, KBR/E3C, KBR/E3CH, KBR/G2FH, KBR/G2CH, KBR/E2FH, KBR/E2CH, QBR/G2F, QBR/G2C, QBR/G3F, QBR/G3FH, QBR/G3C, QBR/G3CH, QBR/E2F, QBR/E2C, QBR/E3F, QBR/E3FH, QBR/E3C, QBR/E3CH, QBR/G2FH, QBR/G2CH, QBR/E2FH, QBR/E2CH, WBR/G2F, WBR/G2C, WBR/G3F, WBR/G3FH, WBR/G3C, WBR/G3CH, WBR/E2F, WBR/E2C, WBR/E3F, WBR/E3FH, WBR/E3C, WBR/E3CH, WBR/G2FH, WBR/G2CH, WBR/E2FH, WBR/E2CH		



1

GEV No.	692464	Ref. No.	006841 0Q0013
description	roll pin ø 4mm L 24mm Qty 25 pcs		
For models:	PBR/G2FM, PBR/G2IM, PBR/E2FM, PBR/E2IM, OBR/G2FM, OBR/G2IM, OBR/E2FM, OBR/E2IM, TBR/G2FM, TBR/G2IM, TBR/E2FM, TBR/E2IM, KBR/G2F, KBR/G2C, KBR/G3F, KBR/G3FH, KBR/G3C, KBR/G3CH, KBR/E2F, KBR/E2C, KBR/E3F, KBR/E3FH, KBR/E3C, KBR/E3CH, KBR/G2FH, KBR/G2CH, KBR/E2FH, KBR/E2CH, HBR/G800, HBR/G805, HBR/G810, HBR/G815, HBR/G811, HBR/G816, HBR/E800, HBR/E805, HBR/E810, HBR/E815, HBR/E811, HBR/E816, HBR/G800UK, HBR/E800UK, QBR/G2F, QBR/G2C, QBR/G3F, QBR/G3FH, QBR/G3C, QBR/G3CH, QBR/E2F, QBR/E2C...(Other models you can see in the webshop)		



1

GEV No.	691397	Ref. No.	045446
description	roll pin ø 4mm L 26mm		
For models:	HBR/G1013, HBR/E1013, HBR/G1013, HBR/E1013, LS360F, LS360DK, LS365F, LS365, LS365PH, LS540F, LS540DK, LS541F, LS360D, LS365D, LS360, LS365, LS360/63, LS365/63, LS367, LS540, LS540D, LS540/63, LS541, LS7D, LS7, LS7UK/RP, LV70, LS7F, LS7DEK, LS7/1UK, LS7/9, LS7/DP, LS7/60, WT40/9, WT40/F, LS7HD, WT40/J50, WT40/J60, WT40UKRP, PH4/WT40, PH4RBP/WT40, LS360, LS365F, LS540, ALS540, FL700, HYDRA700, HB3PNT, Z70		

cotter pins



1

GEV No.	695209	Ref. No.	OK8898 721615040
description	cotter pin ø 2mm L 20mm SS		
For models:	FT36EDTS, FT36ESTS, FT36VDTs, FT36VSTs, FT36ED, FT36ES, FT36VD, FT36VS, FT50ED, FT50ES, FT50VD, FT50VS, FT72ED, FT72ES, FT72VD, FT72VS, FT36EDT, FT36EST, FT36VDT, FT36VST, FT50EDT, FT50EST, FT50VDT, FT50VST, FT72EDT, FT72EST, FT72VDT, FT72VST, FT36VED, FT36WES, FT36WVD, FT36WVS, FT50WED, FT50WES, FT50WVD, FT50WVS, FT72WED, FT72WES, FT72WVD, FT72WVS, FT36WEDT, FT36WEST, FT36WVDT, FT36WVST, FT50WEDT, FT50WEST, FT50WVDT, FT50WVST, FT72WEDT, FT72WEST...(Other models you can see in the webshop)		

pins



1

GEV No.	551400	Ref. No.	002958
description	threaded shaft L 43mm M6 WS 10		
For models:	FCV/G6L3TOWNGAS, FCV/G6L3, FCVE6L3J, FCV/G6L3JAP, FCVG6L3CJ, FCV/E61/1, FCV/E61/1, FCV/E61/1, FCV/E61/1, FCV/G6L3C, FCV/G61/1, FCV/G61/1, FCV/G61/1, FCV/G61/1, FCVG6L3CT, FCVG6L3CJ, FCV/E6L3, FCV/G6L4, FCV/E6L4, FCF/G6-0, FCF/E6-0, FCF061ELN, FCF6EHOR, FCF061ENS, FCF/G6-1-JAP, FCFE6-1J, FCS061E44J, FCS061G48J, FCS061GP, FCS061EP, FCS061G3DI, FCS061E3CI, FCS061G4, FCS061G4DT, FCS061G49J, FCS061E4, FCS061EXLN, FCS061EX, 5711-2-6, 5711-2-7, 5711-2-8, 5711-2-10, 5711-2-8CH, 5711-2-10CH, 5711-2-6L, 5711-2-7L, 5711-2-8L, 5711-2-10L, 5721-2-7, 5721-2-10...(Other models you can see in the webshop)		



consumables

sealants and adhesives

high temperature silicone



1

GEV No.	890060	Ref. No.	OC0074 OG1878 HT6076
description	adhesive PACTAN 6076 310ml 250°C anthracite		
description	PACTAN 6076 - cartridge 310ml - anthracite 1-component silicone-based product for specific gluing and sealing purposes that require a high temperature resistance. The material is used for bonding and sealing of parts with high temperature load e.g. inner door of oven as well as for other bonding and sealing purposes especially on ovens and ranges. The product is fast to light, resistant to ageing and ozone and reveals a very good chemical resistance. Temperature resistance up to 250°C		
For models:	TIW/Z1, KI/Z1A, KI/Z2A, KI/Z1E5A, KI/Z2E5A, WI/Z1A, WI/Z2A, WI/Z1E5A, WI/Z2E5A, 7508-3/85., 7506-3/85.HE.CER.2KZ, 7507-3/85., 7514-3/85.HE.2KF.IND, 7515-3/85.HE.4KF.IND, 7506-3/90.HE.CER.2KZ, 7507-3/90.HE.CER.4KZ, 7508-3/90.HE.CER.BO., 7514-3/90.HE.2KF.IND, 7515-3/90.HE.4KF.IND, 7706-3/85.HE.CER.2KZ, 7707-3/85.HE.4KF.CER, 7714-3/85.HE.2KF.IND, 7706-3/90.HE.CER.2KZ, 7707-3/90.HE.4KF.CER, 7714-3/90.HE.2KF.IND, 7715-3/90.HE.4KF.IND, 7508-3/85.HE.CER.BO., 7508-3/85.HE.CER.BO., 7506-3/85.HE.CER.2KZ, 7506-3/85.HE.CER.2KZ, 7508-3/85.HE.CER.BO., 7507-3/85.HE.CER.4KZ, 7506-3/85.HE.CER.2KZ, 7510-3/85.HE.CER.6KZ, 7507-3/85.HE.CER.4KZ, 7507-3/85.HE.CER.4KZ, 7506-3, 7507-2, 7507-3, 7508-2, 7508-3, 7510-3/90.HE.CER.6KZ, 7514-3, 7515-3, 7706-3, 7707-2, 7707-3, 7714-3, 7715-3, 7715-3/85.HE.4KF.IND...(Other models you can see in the webshop)		



1

GEV No.	890059	Ref. No.	00004106 OG1997 OH7008 422779
description	high temperature silicone FERMITOPP 300 neutral curing -40 up to +265°C black cartridge 310ml		
description	Fermitopp HN 300 - cartridge 310ml - black Is used for sealing expansion joints on heating flues, ovens, reactors, chimneys, stacks, etc. The sealant is neutrally cross-linking, reacts with the moisture in the air and is characterised by extremely good hot air-resistance. The adhesive surfaces must be dry, clean and free of loose parts and in the case of porous substrates they should, if necessary, be given a first coat of primer. Post-smoothing e.g. with soap solution must take place before skinning. Highly refractory, odourless, UV/water/colour/hot-air resistant Temperature range -50°C to +250°C		



1

GEV No.	890050	Ref. No.	OD6223 OH9711 OH9717 OK3948 OK4520 OKG971 OKI337 11018918 12011792 12011948 7076467
description	high temperature silicone NOVASIL S76 acetoxy-curing -40 up to +265°C t.max. 280°C anthracite cartridge 310ml		
description	Novasil S56 - cartridge 310ml - anthracite - Developed for applications in the home appliance industry: - Gluing of oven door seals - Gluing of mounting brackets for cooker fascias, oven door seals and handles - Attachment of elastic seals, e.g. to oven doors Temperature resistance: -40°C to +265°C		
For models:	CE128-106, CE158-133.3.HV, CE158-244.3, CE158-246.3, CK248-209, D1ABBB, CK248-211.D1ABBB, HCE128-100, HCE128-104, HCE158-252W.3, HCE158-253.3, HLE129-100, HLE129-103, HLE129-104W, HLE159-252W.3.6, HLE159-328.3.HV, HLE159-351W.3.HV, HLE249-200.3, HLE249-208.3, HLE259-088.3.HV, HLE259-089.3.HV, HLE259-384W.3, HLI159-371W.3, HLI159-373.3, HLI259-390W.3, LE129-101, LE159-261.3, LE159-281.3.6, LE159-318.3.HV, LE159-322.3.HV, LE159-330.3.HV, LE159-337.3.HV, LE159-344.3.MS92, LE159-347.3.HV, LE249-199.3, LE249-203.3, LE249-207.3, LE249-211.3, LE249-215.3, LE249-219.3, LE249-223.3, LE249-232.3, LE249-238.3, LE259-081.3.HV, LE259-082.3.HV, LE259-083.3.HV, LE259-094.3.HV, LE259-099.3.HV, LE259-382.3, LI159-375.3, LI159-376.3...(Other models you can see in the webshop)		



1

GEV No.	890035	Ref. No.	OH7009
description	high temperature silicone SIL-BOND RTV4500 -52 up to +204°C white cartridge 305ml		
description	Sil-Bond RTV 4500 - cartridge 305ml - white One component room temperature vulcanizing RTV acetoxy cure silicone sealant and adhesive that has been chemically formulated for high strength adhesion. When fully cured, this unique VOC compliant formula offers UV stability and excellent adhesion to form waterproof and airtight bonds to metal, steel, tile, fiberglass, ceramic, glass, aluminum, painted surfaces, wood, plywood, marble, plus many other common substrates. This product is specifically formulated to offer all weather performance. Temperature range: -52°C to +204°C NTF approved		
For models:	5611-3-10, 5611-3-6, 5611-3-8, 5612-3-10, 5612-3-6, 5612-3-8, 5614-3-10, 5614-3-6, 5614-3-8		

			
1			
GEV No.	890258	Ref. No.	059611
description	high temperature silicone TOMABOND TB77 -40 up to +250°C t.max. 300°C anthracite cartridge 310ml		
description	<p>Tomabond TB 77 - cartridge 310ml - anthracite</p> <p>Special neutral adhesive sealant with extraordinary quality and workability characteristics. Suitable for producing bonds and seals with high thermal loads in numerous materials such as ABS, PA, PC, PMMA, Al (including anodised), stainless steel, zinc sheet, glass, ceramic, natural stone counters and many composite materials.</p> <p>Non-corrosive to metal or electronic parts, good grease resistance, high adhesion (1.1 N/mm²)</p> <p>Temperature-resistant from -40 °C to +250 °C (short-term to +300 °C)</p>		
For models:	V350, V700, V1050, V1400		

lubricants

fitting greases

			
1			
GEV No.	890118	Ref. No.	001019 050004 36200410
description	fitting grease FERMIT GLISSA can 1000g -20 up to +140°C approval complies with KTW recommendation		
description	<p>Fermit GLISSA - can 1000g</p> <p>Non-dripping lubricating grease for hot and cold water valves and fittings</p> <p>Ductile, smooth, non-dripping lubricating grease for valves and fittings, that with regard to food law is beyond reproach and is therefore also suitable for drinking water pipes. Can also be used for machines and equipment where Glissa valve and fitting grease comes into contact with food or drinking water.</p> <p>Temperature range: -20°C to +140°C</p> <p>Approved by NSF-H 1 and DIN 51502</p>		

			
1			
GEV No.	890116	Ref. No.	0G1994 0KK505 0S0353 0S1145 11019107 400191 743000111 7CAR16925 7KLU1019700
description	fitting grease FERMIT GLISSA tube 60g -20 up to +140°C approval complies with KTW recommendation		
description	<p>Fermit GLISSA - tube 60g</p> <p>Non-dripping lubricating grease for hot and cold water valves and fittings</p> <p>Ductile, smooth, non-dripping lubricating grease for valves and fittings, that with regard to food law is beyond reproach and is therefore also suitable for drinking water pipes. Can also be used for machines and equipment where Glissa valve and fitting grease comes into contact with food or drinking water.</p> <p>Temperature range: -20°C to +140°C</p> <p>Approved by NSF-H 1 and DIN 51502</p>		
For models:	5611-3-10, 5611-3-6, 5611-3-8, 5612-3-10, 5612-3-6, 5612-3-8, 5614-3-10, 5614-3-6, 5614-3-8		

gas tap greases

			
1			
GEV No.	890102	Ref. No.	0S0001 0S0002 0S0183 0S0245 167309285
description	gas tap grease FERMIT GLISSA tube 60g -20 up to +150°C approval DVGW		
description	<p>Fermit GLISSA - tube 60g</p> <p>High-grade lubricant for gas valves and fittings and actuators in accordance with DIN EN 377</p> <p>Glissa all gas valve grease is resistant to all gases and gas mixtures mentioned in DVGW worksheet G 260 and corresponds to DIN DVGW 96.01e1055</p> <p>Synthetic, non-dripping, ductile</p> <p>Temperature range: up to +150°C</p>		



silicone fats

 <p>1</p>			
GEV No.	890101	Ref. No.	022102 0G3153 0G3685 0H7004 12011924 7CGH12011924 A7610556 DEB22102
description	silicone grease FERMIT GLISSA tube 60g -40 to +200°C approval		
description	<p>Fermit GLISSA - tube 60g</p> <p>Non-drip lubricating grease for drinking water valves and fittings Glissa silicone grease is suitable as a lubricant and sealant for drinking water valves and fittings (e.g. cartridges of single-lever mixers, switching valves and swivel spouts). Water-repellent, physiologically safe, sealing and has a high temperature resistance up to 200°C. Complies with the guidelines of the UBA for sanitary lubricants, tested by TZW for suitability for drinking water and approved in accordance with DIN ISO 21469. Temperature range: -40°C to +200°C</p>		
For models:	<p>ACSGRT, BOT080S.MH25.W94, BOT080S.MS25.W94, BOT100E.MS35.H97, BOT150S.MH25.F98, BOT150S.MH25.W94, BOT200S.MH25.F18, BOT200S.MH25.W14, BOT400E.MS35.W14, BOT400S.MH25.F18, UET060E.MS35.F88, UET090E.MS35.F88, UET090E.MS35.W84, UET100E.MS35.F88, UET100E.MS35.W84, UET150E.MS35.F88, BOT150E.MS35.H97, UET060E.MS35.W84, UET150E.MS35.W84, BOT040E.MS35.F88, BOT040S.MH25.F98, BOT040E.MS35.W84, BOT040S.MH25.W94, BOT060E.MS35.F88, BOT060S.MH25.F98, BOT060E.MS35.W84, BOT060S.MH25.W94, BOT080E.MS35.F88, BOT080S.MH25.F98, BOT080E.MS35.W84, BOT100S.MH25.F98, BOT100S.MH25.W94, BOT300S.MH25.F18, BOT300S.MH25.W14, BOT400E.MS35.F18, BOT400S.MS25.F18, BOT400S.MH25.W14, BOT400S.MS25.W14, BOT040E.MS35.F98, BOT040E.MS35.W94, BOT060E.MS35.F98, BOT060E.MS35.W94, BOT080E.MS35.F98, BOT080E.MS35.W94, BOT100E.MS35.F98, BOT100E.MS35.W94, BOT150E.MS35.F98, BOT150E.MS35.W94, BOT200E.MS35.F18, BOT200E.MS35.W14...(Other models you can see in the webshop)</p>		

machine lubricants

 <p>1</p>			
GEV No.	890029	Ref. No.	OKL180
description	machine lubricant Mobilux EP004 can 500g for gearbox -25 up to +120°C		
description	<p>Mobilux EP004 - can 500g</p> <p>Suitable for lubricating enclosed gears and bearings in poorly sealed gear cases with the exception of electric motor bearings. Can also be used for many other industrial applications, e.g. gear cases and chains, in which conventional gear oils would escape due to leaks caused by worn or missing seals. Meets requirements of SEW 1008 hour gear test, DR.EM.2003 mod. Temperature resistance: -25°C to +120°C</p>		

cleaning agents

degreasers

 <p>1</p>			
GEV No.	802212	Ref. No.	0S1195
description	degreaser for grills		

substitute resins

 <p>1</p>			
GEV No.	520136	Ref. No.	0S0333
description	ion-exchange resin type Dowex HCR-S/S 25l 20.5kg		

lava rocks / ceramic briquettes

 <p>1</p>			
GEV No.	211008	Ref. No.	050859 OKA143 OKA145 OKA146
description	lava rocks size ca.20-70mm Qty 5kg		
For models:	<p>MG/G350D, MG/G700D, MG/G350, MG/G350E, MG/G350F, MG/G350NL, MG/G700, MG/G700E, MG/G700F, MG/G700NL, MG/G1050, MG/G1050F, MG/G1051, RG/G1, RG/G2, RGV/G1, RGV/G2, XG/G1, XG/G2, XGV/G1, XGV/G2, JG/G1, JG/G2, JGV/G1, JGV/G2, MG/G1, MG/G2, MG/G1, MG/G2, RG/G350D, RG/G700D, 7GLG03, RG/G350F, 7GLG07, RG/G700F, 7GLG10, RG/G1050, XG/G350D, XG/G700D, T35GCG, XG/G350E, XG/G350F, XG/G350NL, T70GCG, XG/G700E, XG/G700F, XG/G700NL, T105GCG, XG/G1050F, CG/G701...(Other models you can see in the webshop)</p>		



			
1			
GEV No.	358533	Ref. No.	002348 005077 053534 058871 068914 072068 083499 0C1480 0C2237 0F0187 0H7033 0K8698 11019129 60050255 CF00023
description	fine fuse size ø5x20mm 6.3A fast-acting rated 250V Qty 10 pcs		
For models:	BC44, BC44H, BCW101, BCW102, BCFW101, BC44, BC44H, BCFW102, BC44, BC44H, BCFWS102, BCFWS101, STRP1101, STRP1102, STRP1601, STRP1602, STRP1603, STRP2201, STRP2202, STRP2203, STRP1101S, STRP1601S, STRP2201S, STRP1602R, STRP1603R, STRP2201R, STRP2202R, STRP2203R, STRP1101R, STRP1102R, STRP1601R, FDV40G, FDV40E, FDV40GZ, FDV40EL, FDV40GA, FDV20G, FDV20E, FDV20GZ, FDV20EL, FDV20GA, MCP/E1SH, MCP/E1SUH, MCP/E2SUHS, MCP/E2SH, MCP/E2SUH, MCP/E2SUT, MCP/E2SHB, ECP/E1ELHU, PCP/E1SH...(Other models you can see in the webshop)		

			
1			
GEV No.	358695	Ref. No.	005032 0H9825 0K3350 0K4542 0K4994 11019096 18013703 4005032
description	fine fuse size ø5x20mm 3.15A medium lag rated 250V Qty 10 pcs		
For models:	FCV/G20L3, FCVG202L3, FCV/E20L3, FCVE202L3, FCV/G20L6, FCV/E20L6, FCVG202L6, FCVE202L6, FCV/G201/1, FVC/E201/1, FVC/E202/1, 5714-2-7, 5714-2-8, 5714-2-10, 5714-2-7, 5714-2-8, 5714-2-10, 5714-2-7L, 5714-2-8L, 5714-2-10L, 5714-2-7L, 5714-2-8L, 5714-2-10L, 5714-3-7, 5714-3-8, 5714-3-8E, 5714-3-10, 5717-3-7, 5717-3-8, 5717-3-8E, 5717-3-10, 5717-3-8M, 5717-3-8M, ECV/G20T4, ECV/E20T4, ECVG202T4, ECVE202T4, ECV/G20T4J, ECV/G20T6, ECV/E20T6, ECVG202T6, ECVE202T6, CE128-106, CE158-133.3.HV, CE158-244.3, CE158-246.3, CEB068, CK248-209.D1ABBB, CK248-211.D1ABBB, HCE128-100...(Other models you can see in the webshop)		

			
1			
GEV No.	358594	Ref. No.	002820 0F0189 0H7031 11019111
description	fine fuse size ø5x20mm 0.16A slow-acting rated 250V Qty 10 pcs		
For models:	FCV/G10L3, FCV/G6L3TOWNGAS, FCV/G6L3, FCVG10L3T, FCVG102L3, FCV/E101/1, FCV/G20L3, FCVG202L3, FCVE6L3J, FCV/E10L3JAP, FCV/E102/1L3JAP, FCV/E10L6JAP, FCV/E102/1L6JAP, FCV/G6L-3JAP, FCVG10L3J, FCVG102L3J, FCV/G10L6JAP, FCV/G102/1L6JAP, FCVG6L3CJ, FCV/E61/1, FCV/G10L2, FCV/E61/1, FCV/E101/1, FCV/E101/1, FCV/E10L2, FCV/E102/1, FCV/E61/1, FCV/E61/1, FCV/E101/1, FCV/E101/2, FCV/G6L3C, FCV/G61/1, FCV/G61/1, FCV/G61/1, FCV/G61/1, FCV/G61/1, FCV/G6L3CT, FCV/G6L3CJ, FCV/E10L3, FCV/E102/1, FCV/E6L3, FCV/E102/1L3, FCV/E20L3, FCVE202L3, FCV/G6L4, FCV/E6L4, FCV/E101/1, FCV/G10L6, FCV/E10L6, FCV/G102/1L6, FCV/E102/1L6...(Other models you can see in the webshop)		

			
1			
GEV No.	358592	Ref. No.	086338 3049003
description	fine fuse size ø5x20mm 0.1A slow-acting rated 250V Qty 10 pcs		
For models:	CIM120AS, CIM120WS		

			
1			
GEV No.	358596	Ref. No.	002920
description	fine fuse size ø5x20mm 0.25A slow-acting rated 250V Qty 10 pcs		
For models:	FCV/G10L3, FCV/G6L3TOWNGAS, FCV/G6L3, FCVG10L3T, FCVE6L3J, FCV/E10L3JAP, FCV/E10L6JAP, FCV/G6L3JAP, FCVG10L3J, FCV/G10L6JAP, FCVG6L3CJ, FCV/E61/1, FCV/G10L2, FCV/E61/1, FCV/E10L2, FCV/E61/1, FCV/E61/1, FCV/G6L3C, FCV/G61/1, FCV/G61/1, FCV/G61/1, FCV/G61/1, FCV/G61/1, FCV/G6L3CT, FCV/G6L3CJ, FCV/E10L3, FCV/E6L3, FCV/G6L4, FCV/E6L4, FCV/G10L6, FCV/E10L6, FCV/E101/1, FCV/G101/1, FVC/E101/1, FCS061G48J, FCS061GP, FCS061G3DI, FCS061E-3CI, FCS061G4, FCS101E2, FCS061G4DT, FCS101E44J, FCS061G49J, FCS101G2, FCS101E4, FCS101G4, FCS101G4DT, FCS101G49J, AOW101EA, 5711-2-8CH, 5711-2-10CH...(Other models you can see in the webshop)		



ø10x38mm 500V



1

GEV No.	358020	Ref. No.	048995
description	fine fuse size ø10x38mm 1A rated 500V type Gg fast-acting Qty 1 pcs		
For models:	WT33/M50, WT33/M60, WT30U400, WT30U440		



1

GEV No.	358032	Ref. No.	047131
description	fine fuse size ø10x38mm 25A rated 500V type Gg fast-acting Qty 1 pcs		
For models:	LS7/9, CT92DXE, CT92SXE, CT92DXEUK, CT92SXEU, CT92DXV, CT92SXV, CT92DXVUK, CT92SXVUK, CT140EDX, CT140ESX, CT140EDXUK, CT140SXEU, CT140VDX, CT140VSX, CT141EDX, CT141ESX, CT141EDUK, CT141ESUK, CT141VDX, CT141VSX, CT142DXE, CT142SXE, CT142DXEUK, CT142SXEU, CT142DXV, CT142SXV, CT190DXE, CT190SXE, CT190DXEUK, CT190SXEU, CT190DXV, CT190SXV, CT191DXE, CT191SXE, CT191DXEUK, CT191SXEU, CT191DXV, CT191SXV, CT192DXE, CT192SXE, CT192DXEUK, CT192SXEU, CT192DXV, CT192SXV, CT240DXE, CT240SXE, CT240DXEUK, CT240SXV...(Other models you can see in the webshop)		



1

GEV No.	358397	Ref. No.	0H9861 0K5074 0M2131 14R15 15F01 18025434 2600102 721730 ET25
description	fuse size 76mm 25A rated 690V Qty 1 pcs		
For models:	CE128-106, CE158-133.3.HV, CE158-244.3, CE158-246.3, CK248-209, D1ABBB, CK248-211.D1ABBB, HCE128-100, HCE128-104, HCE158-252W.3, HCE158-253.3, HLE129-100, HLE129-103, HLE129-104W, HLE159-252W.3.6, HLE159-328.3.HV, HLE159-351W.3.HV, HLE249-200.3, HLE249-208.3, HLE259-088.3.HV, HLE259-089.3.HV, HLE259-384W.3, LE129-101, LE159-261.3, LE159-281.3.6, LE159-318.3.HV, LE159-322.3.HV, LE159-330.3.HV, LE159-337.3.HV, LE159-344.3.MS92, LE159-347.3.HV, LE249-199.3, LE249-203.3, LE249-207.3, LE249-211.3, LE249-215.3, LE249-219.3, LE249-223.3, LE249-232.3, LE249-238.3, LE259-081.3.HV, LE259-082.3.HV, LE259-083.3.HV, LE259-094.3.HV, LE259-099.3.HV, LE259-382.3, LK259-707.D1ACCB, LK259-708.D1ACCB, CK248-205.D1ABBB, CK248-207.D1ABBB, LK159-707.D1BC...(Other models you can see in the webshop)		

fine fuse holders



1

GEV No.	358394	Ref. No.	0H6523 60050414
description	fuse holder suitable fuse ø5x30mm mounting ø 18.3mm 6.3A rated 500V connection F2.8		



1

GEV No.	358395	Ref. No.	0H6526
description	screw cap suitable fuse ø 14.5mm mounting ømm thread M9x1 6.3A rated 250V connection suitable for fuse holder		

A

alarm devices	189
angle pieces	832
appliance hose reels	795
audible timers	188
automatic softeners	827
axial fans	314

B

ball valves	818
ball valves electric	291, 820
bar burners	499
bi-metal thermostats	72, 73
boiling pan gaskets	747
booster pumps I	358
booster pumps II	359
bullet connectors	374

C

cable clamps	848
cables	373
cam switches	132
capillary tube clips	112
castors and bumper angles	711
ceramic heaters	31
clamps	111, 834, 846
cleaning agents	853
cleaning tools	836
cold air circulating fans (complete)	322
compressors	303
condensators & interference suppression filters	364
condensing trays heated	314
connection cables	373
connection fittings	832
consumables	851
contactors	190
container filters	801
control equipment	151
control thermostats	75, 103
cooling water regulators	776
copper pipes uninsulated	778
copper wire	373
cotter pins	850
countersunk screws	840
cross flow fans	324
cylinder head bolts	840

D

defrost timers	188
degreasers	853
door catches	661
door gaskets (wire reinforced)	746

door seal rails	765
door seals	738
door seals for dishwashers	768
door seals with fixing hook	745
door seals with tension springs	746
dosing pumps	796
double nipples	815
drain fittings	829
drain hoses	805
drain pumps	358
drain systems and wash basins	829

E

edgemount hinges	670
edgemount latches	658
electric accessories	373
electric timers	186
electrodes	300
electronic controllers	210
electronic magnets	377
end caps and plugs	711
energy regulators	72
espagnolette locks	663
evaporators	779
expansion valves	776
extraction and pressure hoses	809
extractor fans	340

F

fans	314
fasteners	846
fastening material	840
female fastons	374
ferrite rings	367
filter driers	777
filters	367
fine fuses	854
fitting greases	834, 852
fittings	815
float switches	131
foam rubber gaskets	764
foil heating elements	66
forced air burners	510
formed hoses	809
fridge lamps	172
fuses	368, 854

G

gas ball valves	547
gas burners	495
gas control valves	425
gas hoses	549
gas lines	547

gas nozzles	514
gas pressure regulators	547
gas solenoid valves	438
gas tap greases	551, 852
gas taps	378
gas thermostats	403
gaskets for heated units	735
gaskets for tray rack trolleys	746
gaskets for wash arm support	775
gastronorm	792
grates	715
grub screws	840

H

Hall sensors	239
halogen lamp	171
handle latches	658
heater battery	30
heating cables	30
heating cartridges	30
heating elements	3, 29
heating elements for bain maries	5
heating elements for chargrills	26
heating elements for condensate evaporation	20
heating elements for contact grills	23
heating elements for convection	57
heating elements for defrosting	19
heating elements for fryers	9
heating elements for frying pans	8
heating elements for griddles	14
heating elements for heated trolleys	29
heating elements for large hobs	16
heating elements for ovens	3
heating elements for pasta cookers	23
heating elements for pizza ovens	24
heating elements for refrigeration	19
heating elements for salamanders/toasters	27
heating elements for tilting bratt pan	21
heating rods	31
hexagonal nuts	842
hexagonal screws	840
high temperature silicone	851
hob burners	495
hose clamps	834, 846
hose connectors	814, 815
hose reels	795
hoses	802
hot air fans	337
hot air motors	327
hot plates	66
HT drain pipes	831

I

ignition boxes	435
ignition cables	480
ignition switches	486
ignition units	485
immersion heating elements	32
indicator lights	159
indicator lights (complete)	163
induction coils	3
industrial hoses	807
infrared lamps	172
inlet spouts	825
inlet taps	825

K

knurled nuts	841
knurled screws	841

L

lamp accessories	180
lamps	159
lava rocks / ceramic briquetts	551, 853
leak detectors	552, 837
level probes	224
light bulbs	170
linear lamps	171
lubricants	852

M

machine lubricants	853
magnetic switches	146
manual softener	826
measuring equipment	837
mechanical timers	186
meters	837
microswitches	120
motors	341

N

neon light bulbs	162, 169
Niplaflex hoses	807
non-return valves	802, 833
nuts	841
nylon hoses	807

O

one ear clamps	848
operating capacitors	365
O-rings	748
oval head screws	840
oven hinges	673
oven lamps	172

P			
piano hinges	670	screw-in gaskets	734
piezoelectric igniters	482	screws	840
pilot burners	438	sealants and adhesives	851
pilot heating elements	32	sealing cords	765
pins	850	sealing washers	759
pipe aerators	832	shaft gaskets	765
plug connectors	374	shelves and shelf rails	715
plug-in gaskets	721	shut-off valves	821
position switches	125	silicone	851
power supply cables	373	silicone fats	853
pre-rinse hoses	804	silicone hoses	809
pressure control hoses	808	slot nuts	846
pressure hoses	813	snap locks	662
pressure reduction valves	832, 832	solenoid valves	265
pressure switches	292, 550	solid state relays	200
probe clips	111	speed controllers	341
probes	224	spray guns	794
programme timers	180	spray guns with external thread	794
pumps	344	spring assisted hinges	671
pumps for ice machines	361	spring clips	111
push/momentary push switches	117	spring washers	844
push-in fittings	817	stainless steel flexi hoses	802, 804
PVC braided hoses	805	standpipes	830
PVC hoses	808	starting capacitors	364
PVC supply hoses	803	steam valves	824
		substitute resins	828, 853
		supply filters	832, 832
		supply hoses	802
		switches and momentary switches	113
		system switches (ROLD)	126
R			
radial fans	339	T	
radiation heaters	64	tank inlets	802
refrigeration cycle components	776	temperature probes	224
refrigeration fans	316	terminal boxes	377
refrigeration gaskets	721	terminals	374
refrigeration motors universal	316	terminals and connectors	373
refrigeration pipes	778	thermocouples	486
refrigeration thermostats	105	thermostat gaskets	775
relays	200	thermostats	72
residual heat indicators	180	time relays	207
retaining rings	848	timers	180
ring burners	510	tools	836
ring terminals	373	tooth lock washers	846
rocker/momentary rocker switches	113	touch sensitive light switches	146
roll pins	850	transformers	208
rotary switches	145	tube burners	509
rubber sleeves	831	turning lever locks	657
		U	
safety bi-metal thermostats	72	U-bends	832
safety thermostats	88, 104	union nuts	844
safety valves	437		
Schrader valves	777		
screw pipe fittings	832		

universal hoses	802
universal probes	224

V

valves and tank inlets	818
vibration pumps	360

W

walk-in fridge catches	662
wash and rinse pumps	344
washers	844
water cycle components	832
water filters	828
water softeners	826
window seals	735
wire end ferrules	374