



**GAS COMPONENTS**



**ELECTRIC COMPONENTS**



**WATER TECHNOLOGY**



**MECHANICAL COMPONENTS**



**TOOLS**

Spare parts suitable for

**ELETTROBAR**

Find the complete and up-to-date range of products in our GEV Webshop



# Manufacturer catalogue

The most important spare parts and accessories arranged clearly for every manufacturer

- ✓ Complete product range and all appliance data always up to date in the GEV Webshop
- ✓ Alphabetical Index at the end of the catalogue

## GEV Webshop

[www.gev-online.co.uk](http://www.gev-online.co.uk)

[www.gev-online.com](http://www.gev-online.com)



- 🔍 Add to Favourites
- 🔍 Sign In with email address and usual password
- 🔍 Easy-order – place several items in your basket at the same time
- 🔍 Quick Item search – no login needed



## heating elements

### heating elements for fryers

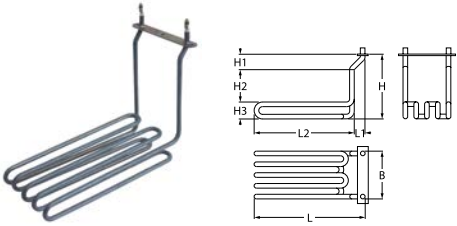

1

<b>GEV No.</b>	416504	<b>Ref. No.</b>	230070
<b>description</b>	heating element 3300W 230V heating circuits 1 L 320mm W 131mm H 220mm rectangular flange connection M4 immersion heater L1 14mm L2 306mm H1 25mm H2 130mm H3 45mm windings 5 hole distance 72mm hole ø 6mm flange length 160mm flange width 22mm tube ø 8.5mm connection length 42mm		
<b>For models:</b>	FRI12, FRI12+12, FRI6, FRI6+6, FRI9, FRI9+9		

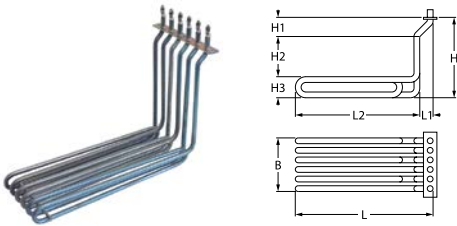

1

<b>GEV No.</b>	416506	<b>Ref. No.</b>	230072
<b>description</b>	heating element 6600W 230/400V heating circuits 3 L 342mm W 127mm H 230mm rectangular flange connection M4 fryer heaters L1 15mm L2 327mm H1 25mm H2 167mm H3 38mm windings 6 hole distance 72mm hole ø 6mm flange length 160mm flange width 22mm tube ø 8.5mm		
<b>For models:</b>	FRI12, FRI12+12, FRI15, FRI15M, FRI6, FRI6+6, FRI9, FRI9+9		

### heating elements for contact grills

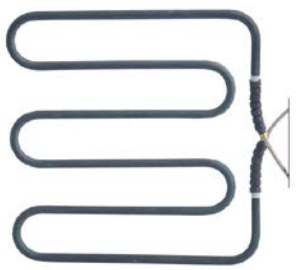

1

<b>GEV No.</b>	416497	<b>Ref. No.</b>	921008
<b>description</b>	heating element 1000W 230V L 180mm W 185mm H 15mm W1 45mm W2 97mm connection length 48mm tube ø 6.3mm windings 3 cable length 755mm dry heating element		
<b>For models:</b>	433, 434, 436, 437, 438, 439, G33, G34, G37, G38, G39		

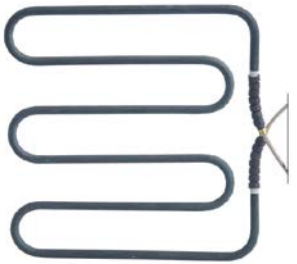

1

<b>GEV No.</b>	416496	<b>Ref. No.</b>	921017
<b>description</b>	heating element 700W 230V L 176mm W 190mm H 17mm W1 40mm W2 110mm connection length 50mm tube ø 6.3mm windings 3 cable length 700mm dry heating element		
<b>For models:</b>	433, 434, 436, 437, 438, 439, G33, G34, G37, G38, G39		

### contact heaters



1

<b>GEV No.</b>	416237	<b>Ref. No.</b>	230104 999206
<b>description</b>	contact heater 1400W 230V heating circuits 1 L 133mm W 120mm H 10mm dishwasher connection soldering connection connection distance 76mm connection length 37mm heat-conducting paste included hole ø 7mm dry heating element		
<b>For models:</b>	2312-007, 2312-009-CRP, 914100, 914101, 914339, 914342, 914343, 914624, 914625, 914626, 914627, 914628, 914850, 914851, 914854, 914944, PS-60, RIVER-48, RIVER-50, RIVER-50-CRP, RIVER-50-CRP-SP, RIVER-54, RIVER-54CRP, River-54-CRP-s.p., RIVER-54-CRP-SP, RIVER-61		

### quartz heating elements



1

<b>GEV No.</b>	416494	<b>Ref. No.</b>	230031
<b>description</b>	heating coil 500W 115V for quartz tube L1 240mm L2 185mm ø 6mm connection eye		
<b>For models:</b>	406		



1

<b>GEV No.</b>	415311	<b>Ref. No.</b>	923003
<b>description</b>	quartz heating element L 410mm ø 11mm 1000W 230V W 130mm connection eye double inner length 390mm		
<b>For models:</b>	412		



1

<b>GEV No.</b>	416493	<b>Ref. No.</b>	484001
<b>description</b>	quartz tube WW L 390mm ID ø 8.5mm ED ø 11mm		
<b>For models:</b>	406		



## coil heating elements



<b>GEV No.</b>	420330	<b>Ref. No.</b>	927132 DRE2
<b>description</b>	heating element 2000W 240V L 454mm W 210mm ø 27.5mm thread M14x1 connection M4 for drying warewashing heating circuits 1 2 hole fixing		
<b>For models:</b>	161, 221, 271, 272, 362, A3EBDAKRKYK, A3EBSAKRK, A4EBDAKEYK, A4EBDAKRK, A4EBDAKWK, A4EBDAKZK, A4EBDBKRK, A4EBSAK, A4EBSAKCK, A4EBSAKEKYK, A4EBSAKRKP, A4EBTSAK, A5EBDAKYK, A5EBSAKRK, A5EBSAKRKYK, A5EBSAKWK, A5EBSAKWKYK, A5EBSBKRKP, A5EBSBKWK, CLEAN-161, CLEAN-221, CLEAN-271, CLEAN-272, CLEAN-361, CLEAN-361P, CLEAN-362, CLEAN-471, CLEAN-471P, GL280EB23DAR, GL280EBDARY, GL280EBDAW, GL280EBDAY, GL280EBDB, GL280EBDBR, GL280EBSA, GL280EBSAE, GL280EBSAEW, GL280EBSAEWY, GL280EBSAR, GL280EBSARY, GL280EBSAW, GL280EBSAWY, GL280EBSAY, GL280EBSB, GL282EB93DA...(Other models you can see in the webshop)		



<b>GEV No.</b>	417640	<b>Ref. No.</b>	927245
<b>description</b>	heating element 3000W 230V L 455mm W 212mm ø 28mm thread M15x1 heating circuits 1 screw		
<b>For models:</b>	CLEAN-160, CLEAN-220, CLEAN-270, CLEAN-271, CLEAN-361, CLEAN-361P, CLEAN-471, CLEAN-471P		



<b>GEV No.</b>	417526	<b>Ref. No.</b>	DRE1
<b>description</b>	heating element 4000W 220V L 475mm W 350mm ø 28mm thread M15x1 connection M4 connection length 33mm dry heating element heating circuits 1 2 hole fixing		

## immersion heating elements

### 3 hole flange ø38.5mm

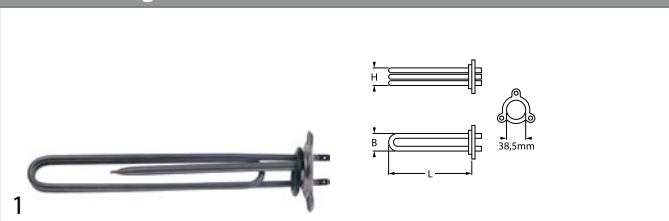





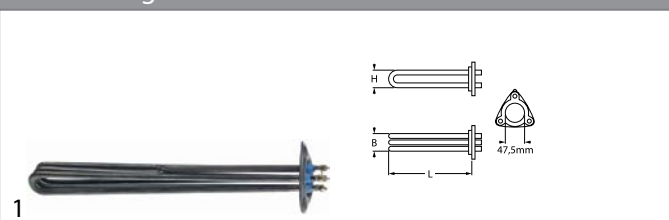

<b>GEV No.</b>	418642	<b>Ref. No.</b>	230113
<b>description</b>	heating element 2600W 230V mounting ø 38.5mm heating circuits 1 L 260mm W 33mm H 24mm number of thermostat sleeves 1 thermostat sleeves ø 7mm length thermostat sleeves 175mm thermostat sleeve eccentric, non clinging tube ø 6.5mm hole distance 57mm 3 hole flange connection male faston 6.3mm immersion heater		
<b>For models:</b>	913289, 913290, 913291, 913292, 913356, 913357, 913363, 913364, 913372, 913373, 913374, 913375, 913376, 913377, 913416, 913418, 913435, 913544, 913545, 913665, 913666, 913667, 913668, 913685, 913771, 913772, 913773, 913774, 913832, 913837, 913911, 913912, 913948, 913950, 913977, 913984, 913990, 914165, 914166, 914167, 914168, 914206, 914214, 914316, 914317, 914355, 914386, 914387, 914388, 914389...(Other models you can see in the webshop)		
<b>accessories for</b>	418642		
		<b>GEV No.</b>	532577
		<b>Ref. No.</b>	—
	O-ring EPDM thickness 5.34mm ID ø 40.65mm Qty 1 pcs		

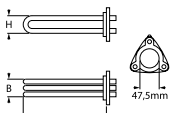

### 3 hole flange ø47.5mm





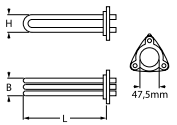

<b>GEV No.</b>	420545	<b>Ref. No.</b>	80397
<b>description</b>	heating element 10500W 230V heating circuits 3 L 354mm W 35mm H 75mm number of thermostat sleeves 1 length thermostat sleeves 180mm thermostat sleeve right tube ø 8.5mm hole ø 60mm threaded		
<b>For models:</b>	FAST-60, FAST-73, PV280FAST, PV280FASTCH		





 			
<b>GEV No.</b>	415001	<b>Ref. No.</b>	230013 230014 230034 230081
<b>description</b>	heating element 4500W 230V mounting $\varnothing$ 47.5mm heating circuits 3 L 316mm W 35mm H 34mm number of thermostat sleeves 1 thermostat sleeves $\varnothing$ 7mm length thermostat sleeves 180mm thermostat sleeve eccentric, non clinging tube $\varnothing$ 6.3mm hole distance 62mm hole $\varnothing$ 8mm connection M4 3 hole flange immersion heater		
<b>For models:</b>	10, 12, 14, 22F, 22R, 40F, 44F, 510F, 510FD, 66, 913297, 913298, 913299, 913300, 913360, 913361, 913391, 913392, 913546, 913547, 913578, 913611, 913684, 913932, 913933, 914318, 914319, 914326, 914331, 914338, 914406, 914431, 914517, 914545, 914688, 914979, 915140, 915248, CLEAN-100, CLEAN-120, CLEAN-3, E.50, E.51, E.52, E.55, E1, E10, E100, E110...(Other models you can see in the webshop)		
<b>spare parts for</b>	415001		
	<b>GEV No.</b>	510408	<b>Ref. No.</b> 456002 456079
	O-ring EPDM thickness 5.34mm ID $\varnothing$ 47mm Qty 1 pcs		
<b>accessories for</b>	415001		
	<b>GEV No.</b>	510562	<b>Ref. No.</b> —
	O-ring silicone thickness 5.34mm ID $\varnothing$ 47mm Qty 1 pcs		
	<b>GEV No.</b>	521103	<b>Ref. No.</b> —
	nut thread M4 H 3mm WS 7 brass Qty 20 pcs		
	<b>GEV No.</b>	521104	<b>Ref. No.</b> —
	washer ID $\varnothing$ 4.3mm ED $\varnothing$ 8mm thickness 0.5mm brass Qty 20 pcs for thread M4		
	<b>GEV No.</b>	560111	<b>Ref. No.</b> —
	plain washer ID $\varnothing$ 4.3mm ED $\varnothing$ 9mm thickness 0.8mm SS Qty 20 pcs DIN 125A for thread M4		
	<b>GEV No.</b>	560131	<b>Ref. No.</b> —
	hexagonal nut thread M4 H 3.2mm WS 7 SS DIN/ISO DIN 934 / ISO 4032/8673 Qty 20 pcs		

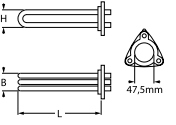

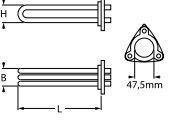

 			
<b>GEV No.</b>	417440	<b>Ref. No.</b>	230111
<b>description</b>	heating element 4900W 230V mounting $\varnothing$ 47.5mm heating circuits 3 L 330mm W 32mm H 34mm number of thermostat sleeves 1 thermostat sleeves $\varnothing$ 7mm length thermostat sleeves 177mm thermostat sleeve not clinging tube $\varnothing$ 6.5mm hole distance 62mm hole $\varnothing$ 8mm connection M4 3 hole flange immersion heater		
<b>For models:</b>	913913, 913914, 914284, 914356, 914400, 914401, 914402, 914403, 914404, 914405, 914449, 914642, 914909, 915136, 915137, 915150, 915151, 915152, 915154, 915155, 915160, 915161, 915162, 915166, 915167, 915168, 915175, 915176, 915177, 915319, 915338, 915341, 915348, 915418, 915419, 915420, 915421, 915479, 915483, 915484, 915492, 915493, 915528, 915537, 915538, 915539, 915540, 915547, 915558, 915635...(Other models you can see in the webshop)		
<b>accessories for</b>	417440		
	<b>GEV No.</b>	510408	<b>Ref. No.</b> 456002 456079
	O-ring EPDM thickness 5.34mm ID $\varnothing$ 47mm Qty 1 pcs		

<b>accessories for</b>	417440		
	<b>GEV No.</b>	510562	<b>Ref. No.</b> —
	O-ring silicone thickness 5.34mm ID $\varnothing$ 47mm Qty 1 pcs		

 			
<b>GEV No.</b>	416240	<b>Ref. No.</b>	230083 230083C
<b>description</b>	heating element 6545W 230/400V mounting $\varnothing$ 48mm heating circuits 3 L 355mm W 31mm H 37mm number of thermostat sleeves 1 thermostat sleeves $\varnothing$ 7mm length thermostat sleeves 175mm thermostat sleeve upper centre not clinging tube $\varnothing$ 6.5mm hole distance 63mm hole $\varnothing$ 10mm connection M4 3 hole flange immersion heater		
<b>For models:</b>	80, 914380, 914436, 915747, 915817, 916045, A3EB, A3EBD, A3EBDA-KRKYK, A3EBDAKWK, A3EBDBKWK, A3EBDRKYK, A3EBDWK, A3EBDYK, A3EBSAK, A3EBSAKRK, A3EBSAKWK, A3EBSBKWKYK, A3EBSEKWK, A3EBSWK, A4EBT, A4EBTSAK, CE78HZ23, E.60, E78, E78HP, F85, F85P, FAST-161+PA-220-60-1, Fast161+PA-220-60-1, GL280EB, GL280EB23, GL280EB23DAR, GL280EB23HZ, GL280EB23HZDY, GL280EBD, GL280EBDA, GL280EBDAE, GL280EBDAR, GL280EBDARY, GL280EBDAW, GL280EBDAWY, GL280EBDAY, GL280EBDB, GL280EBDBR, GL280EBDBW, GL280EBDWY, GL280EBDY, GL280EBS, GL280EBSA...(Other models you can see in the webshop)		
<b>accessories for</b>	416240		
	<b>GEV No.</b>	510408	<b>Ref. No.</b> 456002 456079
	O-ring EPDM thickness 5.34mm ID $\varnothing$ 47mm Qty 1 pcs		
	<b>GEV No.</b>	510562	<b>Ref. No.</b> —
	O-ring silicone thickness 5.34mm ID $\varnothing$ 47mm Qty 1 pcs		

 			
<b>GEV No.</b>	419043	<b>Ref. No.</b>	230117
<b>description</b>	heating element 7600W 400V mounting $\varnothing$ 47.5mm heating circuits 3 L 330mm W 40mm H 35mm number of thermostat sleeves 1 thermostat sleeves $\varnothing$ 7.5mm length thermostat sleeves 180mm thermostat sleeve eccentric, non clinging tube $\varnothing$ 8.5mm hole distance 63mm hole $\varnothing$ 10mm connection length 25mm connection M4 3 hole flange immersion heater		
<b>For models:</b>	915157, 915158, 915166, 915167, 915168, 915172, 915173, 915285, 915348, 915420, 915421, 915422, 915479, 915494, 915495, 915496, 915497, 915547, 915558, 915635, 915747, 916054, 916067, 916068, 916069, 916079, 916080, 916209, 916367, 916368, 916417, 916420, 916421, 916422, 916423, 916424, 916686, 916760, 916802, 916885, NG281, NG281CDD, NG281HZ23, NG281HZ23DD, NG38123, NG38123TERMO, NG381DDHZ23, NG381DDPSHZ23, Niagara-261, Niagara-271-2...(Other models you can see in the webshop)		
<b>accessories for</b>	419043		
	<b>GEV No.</b>	510408	<b>Ref. No.</b> 456002 456079
	O-ring EPDM thickness 5.34mm ID $\varnothing$ 47mm Qty 1 pcs		







<b>GEV No.</b>	416241	<b>Ref. No.</b>	230020 230020C 230095 REB230020C
<b>description</b>	heating element 8000W 230V mounting $\varnothing$ 47.5mm heating circuits 3 L 355mm W 35mm H 35mm number of thermostat sleeves 1 thermostat sleeves $\varnothing$ 7.5mm length thermostat sleeves 185mm thermostat sleeve not clinging tube $\varnothing$ 6.3mm hole distance 64mm hole $\varnothing$ 8mm connection M4 3 hole flange immersion heater		
<b>For models:</b>	81, 914380, 914436, 915729, 915747, A3EB, A3EBD, A3EBDAKRKYK, A3EBDAKWK, A3EBDBKWK, A3EBDRKYK, A3EBDVK, A3EBDYK, A3EBSAK, A3EBSAKRK, A3EBSAKWK, A3EBSBKWKYK, A3EBSEKWK, A3EBSWK, A4EB, A4EBD, A4EBDAKEKYK, A4EBDAKRK, A4EBDAKWK, A4EBDAKZK, A4EBDBKRK, A4EBDPKWYK, A4EBDRK, A4EBS, A4EBSAK, A4EBSAKCK, A4EBSAKEKYK, A4EBSAKRK, A4EBSAKRKP, A4EBSAKYK, A4EBSCK, A4EBT, A4EBTSAK, CLEAN-110, E.65, E110, E12, E120, E14, Fast180, Fast180-230V-3Ph-60Hz, Fast181, FAST-181, FAST-200, FAST-63...(Other models you can see in the webshop)		
<b>spare parts for</b>	416241		
	<b>GEV No.</b>	510408	<b>Ref. No.</b> 456002 456079
	O-ring EPDM thickness 5.34mm ID $\varnothing$ 47mm Qty 1 pcs		
<b>accessories for</b>	416241		
	<b>GEV No.</b>	510093	<b>Ref. No.</b> 467002 69870
	protection cap		
	<b>GEV No.</b>	510408	<b>Ref. No.</b> 456002 456079
	O-ring EPDM thickness 5.34mm ID $\varnothing$ 47mm Qty 1 pcs		
	<b>GEV No.</b>	510562	<b>Ref. No.</b> —
	O-ring silicone thickness 5.34mm ID $\varnothing$ 47mm Qty 1 pcs		





<b>GEV No.</b>	416242	<b>Ref. No.</b>	80398 80398C
<b>description</b>	heating element 9500W 230V mounting $\varnothing$ 47.5mm heating circuits 3 L 330mm W 35mm H 35mm number of thermostat sleeves 1 thermostat sleeves $\varnothing$ 7mm length thermostat sleeves 175mm thermostat sleeve eccentric, non clinging tube $\varnothing$ 8.5mm hole distance 72mm hole $\varnothing$ 8/10mm connection M4 3 hole flange immersion heater		
<b>For models:</b>	80, 82, 914380, 914436, 915747, A5EB, A5EBD, A5EBDAKPKWK, A5EBDAKWK, A5EBDAKYK, A5EBDRK, A5EBS, A5EBSAKPKWK, A5EBSAKRK, A5EBSAKRKYK, A5EBSAKWK, A5EBSAKWKYK, A5EBSBKRPK, A5EBSBKWK, A5EBSRK, A5EBSYK, CGL74CABT, CNT800CH, Fast200, FAST-200, Fast93, GL280EB, GL280EB23, GL280EB23DAR, GL280EB23HZ, GL280EB23HZDY, GL280EBD, GL280EBDA, GL280EBDAE, GL280EBDAR, GL280EBDARY, GL280EBDAW, GL280EBDAWY, GL280EBDAY, GL280EBDB, GL280EBDBR, GL280EBDBW, GL280EBDWY, GL280EBDY, GL280EBS, GL280EBSA, GL280EBSAE, GL280EBSAEW, GL280EBSAEWY, GL280EBSAR...(Other models you can see in the webshop)		
<b>spare parts for</b>	416242		
	<b>GEV No.</b>	510408	<b>Ref. No.</b> 456002 456079
	O-ring EPDM thickness 5.34mm ID $\varnothing$ 47mm Qty 1 pcs		















<b>GEV No.</b>	415668	<b>Ref. No.</b>	230023 230090
<b>description</b>	heating element 2625W 230V mounting $\varnothing$ 47.5mm heating circuits 1 L 190mm W 41mm H 54mm number of thermostat sleeves 1 thermostat sleeves $\varnothing$ 7mm length thermostat sleeves 170mm thermostat sleeve eccentric, non clinging tube $\varnothing$ 6.3mm hole distance 62mm hole $\varnothing$ 8mm connection M4 3 hole flange immersion heater		
<b>For models:</b>	21F, 21FD, 21R, 21RD, 25F, 25FD, 25R, 25RD, 30F, 30FD, 30R, 30RD, 31F, 31FD, 31R, 31RD, RIVER-40, S621, S623, S624, S626, S631, S633, S634, S636		
<b>spare parts for</b>	415668		
	<b>GEV No.</b>	510408	<b>Ref. No.</b> 456002 456079
	O-ring EPDM thickness 5.34mm ID $\varnothing$ 47mm Qty 1 pcs		
<b>accessories for</b>	415668		
	<b>GEV No.</b>	510562	<b>Ref. No.</b> —
	O-ring silicone thickness 5.34mm ID $\varnothing$ 47mm Qty 1 pcs		





<b>GEV No.</b>	416280	<b>Ref. No.</b>	230091
<b>description</b>	heating element 2700W 230V heating circuits 1 number of thermostat sleeves 1 thermostat sleeve eccentric, non clinging 3 hole flange immersion heater		
<b>For models:</b>	913992, 913993, 914592, 914612, 914613, CLEAN-3, River-40, RIVER-43, RIVER-44		
<b>accessories for</b>	416280		
	<b>GEV No.</b>	510408	<b>Ref. No.</b> 456002 456079
	O-ring EPDM thickness 5.34mm ID $\varnothing$ 47mm Qty 1 pcs		
	<b>GEV No.</b>	510562	<b>Ref. No.</b> —
	O-ring silicone thickness 5.34mm ID $\varnothing$ 47mm Qty 1 pcs		





			
<b>GEV No.</b>	415002	<b>Ref. No.</b>	230012
<b>description</b>	heating element 3000W 230V mounting ø 47.5mm heating circuits 1 L 198mm W 35mm H 44mm number of thermostat sleeves 1 thermostat sleeves ø 7mm length thermostat sleeves 175mm thermostat sleeve not clinging tube ø 6.3mm hole distance 64mm hole ø 8mm connection M4 3 hole flange immersion heater		
<b>For models:</b>	21F, 21FD, 21R, 21RD, 22F, 22R, 25F, 25FD, 25R, 25RD, 30F, 30FD, 30R, 30RD, 31F, 31FD, 31R, 31RD, 40F, 44F, S621, S623, S624, S626, S631, S633, S634, S636		
<b>accessories for</b>	415002		
	<b>GEV No.</b>	510408	<b>Ref. No.</b> 456002 456079
	O-ring EPDM thickness 5.34mm ID ø 47mm Qty 1 pcs		
	<b>GEV No.</b>	510562	<b>Ref. No.</b> —
	O-ring silicone thickness 5.34mm ID ø 47mm Qty 1 pcs		
	<b>GEV No.</b>	521103	<b>Ref. No.</b> —
	nut thread M4 H 3mm WS 7 brass Qty 20 pcs		
	<b>GEV No.</b>	521104	<b>Ref. No.</b> —
	washer ID ø 4.3mm ED ø 8mm thickness 0.5mm brass Qty 20 pcs for thread M4		
	<b>GEV No.</b>	560111	<b>Ref. No.</b> —
	plain washer ID ø 4.3mm ED ø 9mm thickness 0.8mm SS Qty 20 pcs DIN 125A for thread M4		
	<b>GEV No.</b>	560131	<b>Ref. No.</b> —
	hexagonal nut thread M4 H 3.2mm WS 7 SS DIN/ISO DIN 934 / ISO 4032/8673 Qty 20 pcs		

			
<b>GEV No.</b>	415039	<b>Ref. No.</b>	927066 927280 DRB81C
<b>description</b>	heating element 8000W 230V mounting ø 57.5mm heating circuits 3 L 375mm W 41mm H 42mm number of thermostat sleeves 1 thermostat sleeves ø 7mm length thermostat sleeves 230mm thermostat sleeve upper centre not clinging tube ø 6mm hole distance 73mm hole ø 10mm connection length 30mm connection M4 3 hole flange immersion heater		
<b>For models:</b>	161, 221, 271, 272, 362, CLEAN-160, CLEAN-161, CLEAN-220, CLEAN-221, CLEAN-270, CLEAN-271, CLEAN-272, CLEAN-362		
<b>spare parts for</b>	415039		
	<b>GEV No.</b>	510409	<b>Ref. No.</b> 929046
	O-ring EPDM thickness 5.34mm ID ø 56.52mm Qty 1 pcs		
<b>accessories for</b>	415039		
	<b>GEV No.</b>	521103	<b>Ref. No.</b> —
	nut thread M4 H 3mm WS 7 brass Qty 20 pcs		
	<b>GEV No.</b>	521104	<b>Ref. No.</b> —
	washer ID ø 4.3mm ED ø 8mm thickness 0.5mm brass Qty 20 pcs for thread M4		
	<b>GEV No.</b>	560111	<b>Ref. No.</b> —
	plain washer ID ø 4.3mm ED ø 9mm thickness 0.8mm SS Qty 20 pcs DIN 125A for thread M4		
	<b>GEV No.</b>	560131	<b>Ref. No.</b> —
	hexagonal nut thread M4 H 3.2mm WS 7 SS DIN/ISO DIN 934 / ISO 4032/8673 Qty 20 pcs		

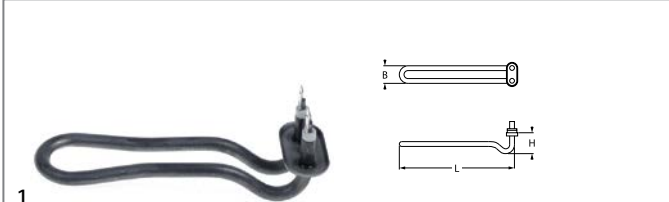

<p>3 hole flange ø57.5mm</p> 			
<b>GEV No.</b>	418871	<b>Ref. No.</b>	927026 927276
<b>description</b>	heating element 10000W 230V mounting ø 57.5mm heating circuits 3 L 375mm W 40mm H 33mm number of thermostat sleeves 1 thermostat sleeves ø 7mm length thermostat sleeves 225mm thermostat sleeve upper centre not clinging tube ø 6.3mm hole distance 73mm hole ø 8mm connection length 24mm		
<b>For models:</b>	161, 221, 271, 272, 362, CLEAN-160, CLEAN-161, CLEAN-220, CLEAN-221, CLEAN-270, CLEAN-271, CLEAN-272, CLEAN-361, CLEAN-361P, CLEAN-362, CLEAN-471, CLEAN-471P		
<b>accessories for</b>	418871		
	<b>GEV No.</b>	510409	<b>Ref. No.</b> 929046
	O-ring EPDM thickness 5.34mm ID ø 56.52mm Qty 1 pcs		

<p>with compression flange 50 x 26mm</p> 			
<b>GEV No.</b>	420332	<b>Ref. No.</b>	230107
<b>description</b>	heating element 600W 230V heating circuits 1 flange 50x26mm L 125mm W 48mm H 70mm tube ø 8.4mm connection male faston 6.3mm immersion heater compression flange		
<b>For models:</b>	913992, 913993, 914583, 914592, 914612, 914613, 915143, RIVER-40, RIVER-40-CRP, RIVER-44, RIVER-44-CRP, RIVER-44-CRP-ST, RIVER-44CRP-ST		
<b>spare parts for</b>	420332		
	<b>GEV No.</b>	510387	<b>Ref. No.</b> 437086
	gasket L 46mm W 22mm ømm EPDM for heating element for flange 50x26mm		
	<b>GEV No.</b>	510388	<b>Ref. No.</b> —
	counterflange ømm hole distancemm perforation ømm L 43mm W 21mm SS for heating element for flange 50x26mm		



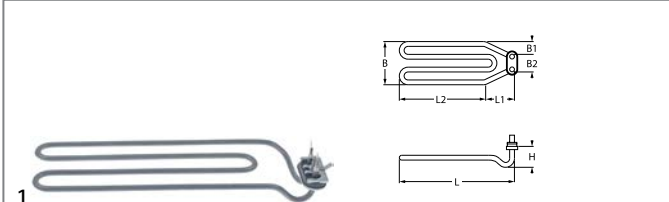

<b>GEV No.</b>	416234	<b>Ref. No.</b>	230098
<b>description</b>	heating element 600W 230V heating circuits 1 flange 50x26mm L 160mm W 45mm H 27mm tube ø 8.8mm connection male faston 6.3mm connection length 40mm immersion heater compression flange		
<b>For models:</b>	913289, 913290, 913291, 913292, 913356, 913357, 913372, 913373, 913374, 913375, 913416, 913435, 913544, 913545, 913665, 913666, 913667, 913668, 913685, 913771, 913772, 913773, 913774, 913832, 913837, 913911, 913912, 913948, 913950, 913977, 913984, 913990, 914165, 914166, 914206, 914214, 914316, 914317, 914355, 914386, 914387, 914388, 914389, 914390, 914391, 914392, 914393, 914394, 914395, 914396...(Other models you can see in the webshop)		
<b>accessories for</b>	416234		
	<b>GEV No.</b>	510387	<b>Ref. No.</b> 437086
	gasket L 46mm W 22mm ømm EPDM for heating element for flange 50x26mm		
	<b>GEV No.</b>	510388	<b>Ref. No.</b> —
	counterflange ømm hole distancemm perforation ømm L 43mm W 21mm SS for heating element for flange 50x26mm		



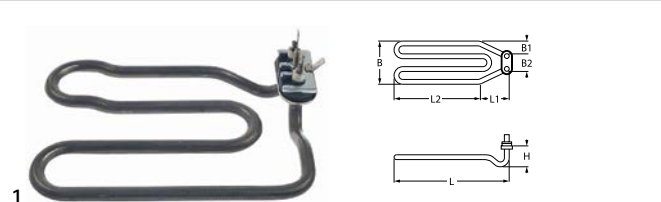

<b>GEV No.</b>	420333	<b>Ref. No.</b>	230103
<b>description</b>	heating element 2450W 220/240V heating circuits 1 compression flange flange 50x26mm L 295mm W 89mm H 27mm L1 35mm L2 260mm W1 59mm W2 30mm connection male faston 6.3mm tube ø 6.2mm immersion heater for tank		
<b>spare parts for</b>	420333		
	<b>GEV No.</b>	510387	<b>Ref. No.</b> 437086
	gasket L 46mm W 22mm ømm EPDM for heating element for flange 50x26mm		
	<b>GEV No.</b>	510388	<b>Ref. No.</b> —
	counterflange ømm hole distancemm perforation ømm L 43mm W 21mm SS for heating element for flange 50x26mm		



<b>GEV No.</b>	420464	<b>Ref. No.</b>	73069
<b>description</b>	heating element 2500W 230V heating circuits 1 screw flange 50x26mm L 170mm W 120mm H 30mm L1 50mm L2 120mm tube ø 8.5mm warewashing		
<b>For models:</b>	NG381, NG38123, NG38123TERMO, NG381C, NG381CDD, NG381CFUR, NG381DDHZ23, NG381DDPS, NG381DDPSHZ23, NG381HPDD, NG381TERMO, NG381TXCDD, Niagara-381, Niagara-381-230V-3Ph-50Hz, Niagara-381-230V-3Ph-60Hz, Niagara-381DP, Niagara-381HPD, River-282-2, River-282S-2TDE, River-285, River-382, River-382-230V-3Ph-50Hz, River-382H, River-382NRG, River-382NRG-230-3Ph-50Hz, River-382TDE, RV382, RV38223TERMO, RV382AHP, RV-382FUR, RV382R, RV382R23TERMO, RV382RFUR, RV382S, RV382SFUR, RV382TERMO, RV382TX, RV382TXR		
<b>spare parts for</b>	420464		
	<b>GEV No.</b>	510387	<b>Ref. No.</b> 437086
	gasket L 46mm W 22mm ømm EPDM for heating element for flange 50x26mm		



<b>GEV No.</b>	420331	<b>Ref. No.</b>	230112
<b>description</b>	heating element 1400W 230V compression flange flange 50x26mm L 160mm heating circuits 1 H 29mm W 190mm connection male faston 6.3mm immersion heater tube ø 8.4mm		
<b>For models:</b>	915150, 915151, 915152, 915154, 915155, 915160, 915161, 915162, 915166, 915167, 915168, 915172, 915173, 915175, 915176, 915177, 915285, 915319, 915338, 915341, 915348, 915418, 915419, 915420, 915421, 915422, 915479, 915492, 915493, 915496, 915497, 915547, 915558, 915635, 915663, 915747, 916054, CNT800CH, FAST-73, NG281, NG281HP, NIAGARA-251, Niagara-261, NIAGARA-281, NIAGARA-281HP, PLUVIA-260, Pluvia-270, PLUVIA-280, Pluvia280-230V-3PH-60HZ, PV280...(Other models you can see in the webshop)		
<b>spare parts for</b>	420331		
	<b>GEV No.</b>	510387	<b>Ref. No.</b> 437086
	gasket L 46mm W 22mm ømm EPDM for heating element for flange 50x26mm		
	<b>GEV No.</b>	510388	<b>Ref. No.</b> —
	counterflange ømm hole distancemm perforation ømm L 43mm W 21mm SS for heating element for flange 50x26mm		





## with compression flange 70 x 26mm

<b>GEV No.</b>	415009	<b>Ref. No.</b>	230057 230058 230087
<b>description</b>	heating element 2500W 230V heating circuits 1 flange 70x26mm L 280mm W 51mm H mm tube ø 6.3mm connection M4 immersion heater compression flange		
<b>For models:</b>	11F, 11FD, 11F-DVGV, 11R, 11RD, 350F, 350FD, 350R, 350RD, 35-ELECTRONIC, 35F, 35FD, 35R, 35RD, 400F, 400FD, 400R, 400RD, 40-ELECTRONIC, 40F, 40FD, 40R, 40RD, 45, 450, 67F, 67R, E.35, E.40, E.41, E.42, E.45		
<b>accessories for</b>	415009		
	<b>GEV No.</b>	521128	<b>Ref. No.</b> 437048
	gasket L 66mm W 21mm ømm for heating element suitable for ELETTROBAR, WOLK		

<b>GEV No.</b>	415000	<b>Ref. No.</b>	230075 230076 230088
<b>description</b>	heating element 2900W 230V heating circuits 1 flange 70x26mm L 272mm W 51mm H mm tube ø 6.3mm connection M4 immersion heater compression flange		
<b>For models:</b>	050F, 050FP, 46, 460, 500F, 500FD, 50-ELECTRONIC, 50F, 50FD, 510F, 510FD, 913297, 913298, 913299, 913300, 913360, 913361, 913391, 913392, 913546, 913547, 913578, 913611, 913684, 913932, 913933, 914331, 914517, 914545, 914688, 914979, 915140, 915248, E.46, E.50, E.51, GSP50, GSP50P, LF50, LF55, MCS01E, MCS01EP, MCS01S, MCS01SP, P500		
<b>spare parts for</b>	415000		
	<b>GEV No.</b>	521128	<b>Ref. No.</b> 437048
	gasket L 66mm W 21mm ømm for heating element suitable for ELETTROBAR, WOLK		
<b>accessories for</b>	415000		
	<b>GEV No.</b>	521128	<b>Ref. No.</b> 437048
	gasket L 66mm W 21mm ømm for heating element suitable for ELETTROBAR, WOLK		

## with expansion flange 70 x 18mm

<b>GEV No.</b>	416239	<b>Ref. No.</b>	230100
<b>description</b>	heating element 2600W 230V heating circuits 1 flange 70x18mm L 270mm W 65mm connection male faston 6.3mm tube ø 8.5mm immersion heater expansion flange		
<b>For models:</b>	913289, 913290, 913771, 913772, 913832, 914386, 914387, 914388, 914390, 914391, 914692, 914693, 914694, 914703, 914870, E.35, E.35H, E.40, E.40H, E.45, MC201CL, MINIBAR, MISTRAL-40, NIAGARA-35, NIAGARA-40, NIAGARA-45, S280		

<b>GEV No.</b>	420550	<b>Ref. No.</b>	230109
<b>description</b>	heating element 4600W 230V heating circuits 3 flange 70x18mm L 360mm W 60mm L1 45mm H 55mm L2 45mm connection F 6.3mm L3 290mm immersion heater expansion flange for dishwashers tube ø 6.5mm		
<b>For models:</b>	914583, 915143, RIVER-40-CRP, RIVER-44-CRP, River-44-CRP-ST, RIVER-44CRP-ST		

<b>GEV No.</b>	419042	<b>Ref. No.</b>	230108
<b>description</b>	heating element 7000W 230V heating circuits 3 flange 70x18mm L 415mm W 64mm H 52mm L1 40mm L2 25mm L3 350mm tube ø 6.3mm connection male faston 6.3mm immersion heater expansion flange for dishwasher		
<b>For models:</b>	2312-009-CRP, 914628, 914944, RIVER-50-CRP, RIVER-50-CRP-SP, RIVER-54CRP, River-54-CRP-s.p., RIVER-54-CRP-SP		

<b>GEV No.</b>	416243	<b>Ref. No.</b>	230106
<b>description</b>	heating element 7600W 230V heating circuits 3 flange 70x18mm L 390mm W 60mm H 13mm connection male faston 6.3mm tube ø 6.3mm immersion heater expansion flange INCOLOY-800		
<b>For models:</b>	2312-007, 914100, 914101, 914339, 914342, 914343, 914624, 914625, 914626, 914627, 914850, 914851, 914854, RIVER-48, RIVER-50, RIVER-54, RIVER-61		

## with round flange ø47.5mm

<b>GEV No.</b>	420057	<b>Ref. No.</b>	230116
<b>description</b>	heating element 3000W 230V heating circuits 1 mounting ø 47.5mm L 330mm W 33mm H 19mm tube ø 8.4mm thermostat sleeves ø 7.4mm number of thermostat sleeves 1 length thermostat sleeves 170mm		
<b>For models:</b>	914400, 914401, 914402, 914403, 914404, 914405, 914449, 914568, 915483, 915484, 915537, 915538, 915539, 915540, 915664, 915697, 915698, 915699, 915700, 915701, 915702, 915756, 915799, 915800, 915809, 915830, 916020, 916024, 916026, 916030, 916247, 916248, 916249, 916382, 916452, 916584, 916654, 916670, 916688, 916763, 916812, 916813, E.50, E.50D.PA, E.51, Fast160, FAST-160, Fast160-2, FAST-160-230-50-1N, Fast160-230-50-1N...(Other models you can see in the webshop)		
<b>spare parts for</b>	420057		
	<b>GEV No.</b>	510408	<b>Ref. No.</b> 456002 456079
	O-ring EPDM thickness 5.34mm ID ø 47mm Qty 1 pcs		



with round flange ø57.5mm



<b>GEV No.</b>	415034	<b>Ref. No.</b>	DRB23
<b>description</b>	heating element 2600W 230V heating circuits 1 mounting ø 57.5mm L 180mm W 37mm H 27mm round flange connection male faston 6.3mm immersion heater tube ø 8.5mm		
<b>accessories for</b>	415034		
	<b>GEV No.</b>	550002	<b>Ref. No.</b> —
	tension strap H 10mm L 21mm W 10mm hole ø 6.5mm for heating element		



<b>GEV No.</b>	415038	<b>Ref. No.</b>	929040
<b>description</b>	heating element 5000W 230V heating circuits 3 mounting ø 57.5mm L 373mm W 44mm H 40mm round flange connection M4 immersion heater tube ø 6.3mm connection length 19mm thermostat sleeves ø 7mm number of thermostat sleeves 1 length thermostat sleeves 328mm thermostat sleeve not clinging		
<b>For models:</b>	55		
<b>spare parts for</b>	415038		
	<b>GEV No.</b>	510409	<b>Ref. No.</b> 929046
	O-ring EPDM thickness 5.34mm ID ø 56.52mm Qty 1 pcs		
<b>accessories for</b>	415038		
	<b>GEV No.</b>	521103	<b>Ref. No.</b> —
	nut thread M4 H 3mm WS 7 brass Qty 20 pcs		
	<b>GEV No.</b>	521104	<b>Ref. No.</b> —
	washer ID ø 4.3mm ED ø 8mm thickness 0.5mm brass Qty 20 pcs for thread M4		
	<b>GEV No.</b>	550002	<b>Ref. No.</b> —
	tension strap H 10mm L 21mm W 10mm hole ø 6.5mm for heating element		
	<b>GEV No.</b>	560111	<b>Ref. No.</b> —
	plain washer ID ø 4.3mm ED ø 9mm thickness 0.8mm SS Qty 20 pcs DIN 125A for thread M4		
	<b>GEV No.</b>	560131	<b>Ref. No.</b> —
	hexagonal nut thread M4 H 3.2mm WS 7 SS DIN/ISO DIN 934 / ISO 4032/8673 Qty 20 pcs		

miscellaneous



<b>GEV No.</b>	417575	<b>Ref. No.</b>	230118
<b>description</b>	heating element 2100W 230V W 165mm H 25mm L 270mm format angled		
<b>For models:</b>	915157, 915158, 915160, 915161, 915162, 915175, 915319, 915494, 915495, 915663, 916020, 916021, 916024, 916025, 916026, 916027, 916030, 916031, 916045, 916067, 916068, 916069, 916079, 916080, 916201, 916202, 916203, 916204, 916205, 916206, 916207, 916208, 916209, 916247, 916248, 916249, 916250, 916251, 916252, 916365, 916366, 916367, 916368, 916382, 916383, 916411, 916412, 916413, 916414, 916415...(Other models you can see in the webshop)		

1 1/4"



<b>GEV No.</b>	415005	<b>Ref. No.</b>	230002
<b>description</b>	heating element 2000W 230V heating circuits 1 thread 1 1/4" L 170mm W 32mm H 22mm tube ø 6.2mm connection M4		
<b>For models:</b>	R497, R499, R501, R503, R505, R507, S641, S643		
<b>accessories for</b>	415005		
	<b>GEV No.</b>	510405	<b>Ref. No.</b> 437028
	flat gasket fibre ED ø 56mm ID ø 42mm thickness 2mm for thread 1 1/4" Qty 1 pcs		
	<b>GEV No.</b>	520232	<b>Ref. No.</b> —
	nut thread 1 1/4" H 5mm nickel-plated brass WS 47 Qty 1 pcs		
	<b>GEV No.</b>	521103	<b>Ref. No.</b> —
	nut thread M4 H 3mm WS 7 brass Qty 20 pcs		
	<b>GEV No.</b>	521104	<b>Ref. No.</b> —
	washer ID ø 4.3mm ED ø 8mm thickness 0.5mm brass Qty 20 pcs for thread M4		
	<b>GEV No.</b>	528021	<b>Ref. No.</b> —
	flat gasket PTFE ED ø 53mm ID ø 42.5mm thickness 3mm Qty 1 pcs equiv. no. 12001/02286 suitable for Astoria/Aurora/Brasilia/Wega		
	<b>GEV No.</b>	560111	<b>Ref. No.</b> —
	plain washer ID ø 4.3mm ED ø 9mm thickness 0.8mm SS Qty 20 pcs DIN 125A for thread M4		
	<b>GEV No.</b>	560131	<b>Ref. No.</b> —
	hexagonal nut thread M4 H 3.2mm WS 7 SS DIN/ISO DIN 934 / ISO 4032/8673 Qty 20 pcs		







<b>GEV No.</b>	415042	<b>Ref. No.</b>	230003
<b>description</b>	heating element 2200W 230V heating circuits 1 thread 1 1/4" L 165mm W 35mm H 26mm tube ø 6.3mm connection M4 immersion heater flange with thread		
<b>spare parts for</b>	415042		
	<b>GEV No.</b>	510405	<b>Ref. No.</b> 437028
	flat gasket fibre ED ø 56mm ID ø 42mm thickness 2mm for thread 1 1/4" Qty 1 pcs		
<b>accessories for</b>	415042		
	<b>GEV No.</b>	520232	<b>Ref. No.</b> —
	nut thread 1 1/4" H 5mm nickel-plated brass WS 47 Qty 1 pcs		
	<b>GEV No.</b>	521103	<b>Ref. No.</b> —
	nut thread M4 H 3mm WS 7 brass Qty 20 pcs		
	<b>GEV No.</b>	521104	<b>Ref. No.</b> —
	washer ID ø 4.3mm ED ø 8mm thickness 0.5mm brass Qty 20 pcs for thread M4		
	<b>GEV No.</b>	528021	<b>Ref. No.</b> —
	flat gasket PTFE ED ø 53mm ID ø 42.5mm thickness 3mm Qty 1 pcs equiv. no. 12001/02286 suitable for Astoria/Aurora/Brasilia/Wega		
	<b>GEV No.</b>	560111	<b>Ref. No.</b> —
	plain washer ID ø 4.3mm ED ø 9mm thickness 0.8mm SS Qty 20 pcs DIN 125A for thread M4		

Table continues overleaf











<b>accessories for</b>	415042		
	GEV No.	560131	Ref. No. —
	hexagonal nut thread M4 H 3.2mm WS 7 SS DIN/ISO DIN 934 / ISO 4032/8673 Qty 20 pcs		

<b>accessories for</b>	415004		
	GEV No.	560131	Ref. No. —
	hexagonal nut thread M4 H 3.2mm WS 7 SS DIN/ISO DIN 934 / ISO 4032/8673 Qty 20 pcs		







			
<b>GEV No.</b>	415011	<b>Ref. No.</b>	230007 230021
<b>description</b>	heating element 3000W 230V heating circuits 1 thread 1/4" L 285mm W 24mm H 20mm tube ø 6.5mm connection M4 immersion heater connection length 26mm flange with thread WS 54		
<b>For models:</b>	35F, 35FD, 35R, 35RD, R509, R511, R704		
<b>accessories for</b>	415011		
	GEV No.	510405	Ref. No. 437028
	flat gasket fibre ED ø 56mm ID ø 42mm thickness 2mm for thread 1/4" Qty 1 pcs		
	GEV No.	520232	Ref. No. —
	nut thread 1/4" H 5mm nickel-plated brass WS 47 Qty 1 pcs		
	GEV No.	528021	Ref. No. —
	flat gasket PTFE ED ø 53mm ID ø 42.5mm thickness 3mm Qty 1 pcs equiv. no. 12001/02286 suitable for Astoria/Aurora/Brasilia/Wega		





			
<b>GEV No.</b>	415666	<b>Ref. No.</b>	230077
<b>description</b>	heating element 1100W 230V heating circuits 1 L 151mm W 56mm Hmm thread 1/8" mounting distance 50mm tube ø 6.3mm 2 hole fixing immersion heater connection male faston 6.3mm		
<b>For models:</b>	350F, 350FD, 350R, 350RD, 400F, 400FD, 400R, 400RD, 40F, 40FD, 40R, 40RD		

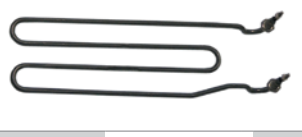

			
<b>GEV No.</b>	415008	<b>Ref. No.</b>	230016
<b>description</b>	heating element 2000W 230V heating circuits 1 L 140mm W 173mm H 35mm thread M14x1.5 mounting distance 33mm tube ø 4.2mm 2 hole fixing connection length 15mm immersion heater L1 14mm L2 118mm W1 128mm W2 45mm		
<b>For models:</b>	R495		
<b>accessories for</b>	415008		
	GEV No.	510417	Ref. No. 437002 437024
	flat gasket fibre ED ø 20mm ID ø 14mm thickness 2mm Qty 1 pcs		
	GEV No.	520228	Ref. No. —
	tooth lock washer ID ø 15.3mm ED ø 24mm steel Qty 1 pcs for thread M14		
	GEV No.	520230	Ref. No. —
	nut thread M14x1.5 H 5mm WS 19 zinc-coated steel Qty 1 pcs		
	GEV No.	521101	Ref. No. —
	nut thread M14x1.5 H 5mm WS 19 SS Qty 1 pcs		
	GEV No.	550262	Ref. No. —
	flat gasket copper ED ø 20mm ID ø 14mm thickness 2mm		

			
<b>GEV No.</b>	415004	<b>Ref. No.</b>	230008 230026
<b>description</b>	heating element 3000W 230/380V heating circuits 3 thread 1/2" L 300mm W 32mm H 34mm tube ø 6.3mm connection M4 immersion heater connection length 20mm flange with thread		
<b>For models:</b>	R708, S870		
<b>accessories for</b>	415004		
	GEV No.	510406	Ref. No. —
	flat gasket fibre ED ø 60mm ID ø 48mm thickness 3mm for thread 1/2" Qty 1 pcs		
	GEV No.	510424	Ref. No. —
	gasket copper ED ø 55mm ID ø 48mm thickness 2.2mm Centellen for thread 1/2"		
	GEV No.	520211	Ref. No. —
	reducer thread 2" ET - 1/2" IT brass		
	GEV No.	520212	Ref. No. —
	hexagonal nut thread 1/2" brass WS 60 H 8mm		
	GEV No.	521103	Ref. No. —
	nut thread M4 H 3mm WS 7 brass Qty 20 pcs		
	GEV No.	521104	Ref. No. —
	washer ID ø 4.3mm ED ø 8mm thickness 0.5mm brass Qty 20 pcs for thread M4		
	GEV No.	550361	Ref. No. —
	blind flange ø 58mm thread 1/2"		
	GEV No.	560111	Ref. No. —
	plain washer ID ø 4.3mm ED ø 9mm thickness 0.8mm SS Qty 20 pcs DIN 125A for thread M4		









			
1			
<b>GEV No.</b>	415010	<b>Ref. No.</b>	230009 230017 230044
<b>description</b>	heating element 2000W 230V heating circuits 1 L 260mm W 125mm H 20mm L1 110mm L2 150mm W1 42mm W2 83mm thread M10x1 mounting distance 70mm tube ø 6.5mm connection M4 immersion heater 2 hole fixing		
<b>For models:</b>	11F, 11FD, 11F-DVGW, 11R, 11RD, 21F, 21FD, 21R, 21RD, 22F, 22R, 25F, 25FD, 25R, 25RD, 30F, 30FD, 30R, 30RD, 31F, 31FD, 31R, 31RD, 40F, 440F, 44F, S621, S623, S624, S626, S631, S633, S634, S636		
<b>accessories for</b>	415010		
	GEV No.	504306	Ref. No. —
gasket fibre ED ø 16mm ID ø 10mm thickness 2mm Qty 1 pcs			
	GEV No.	510893	Ref. No. 456015
O-ring EPDM thickness 2.62mm ID ø 9.92mm Qty 1 pcs			
	GEV No.	520231	Ref. No. —
nut thread M10x1 H 6mm WS 14 zinc-coated steel Qty 1 pcs			
	GEV No.	521103	Ref. No. —
nut thread M4 H 3mm WS 7 brass Qty 20 pcs			
	GEV No.	521104	Ref. No. —
washer ID ø 4.3mm ED ø 8mm thickness 0.5mm brass Qty 20 pcs for thread M4			
	GEV No.	521129	Ref. No. —
nut thread M10 H 6mm SS WS 17 Qty 1 pcs DIN/ISO DIN 439			
	GEV No.	560111	Ref. No. —
plain washer ID ø 4.3mm ED ø 9mm thickness 0.8mm SS Qty 20 pcs DIN 125A for thread M4			
	GEV No.	560131	Ref. No. —
hexagonal nut thread M4 H 3.2mm WS 7 SS DIN/ISO DIN 934 / ISO 4032/8673 Qty 20 pcs			

			
1			
<b>GEV No.</b>	415664	<b>Ref. No.</b>	230006 230085
<b>description</b>	heating element 2250W 230V heating circuits 1 L 300mm W 90mm H 25mm thread 1/8" mounting distance 64mm tube ø 6.3mm connection M4 immersion heater 2 hole fixing		
<b>For models:</b>	11F, 11FD, 11R, 11RD, 31F, 31FD, 31R, 31RD, 67F, 67R, 913363, 913364, 913376, 913377, 913418, 914167, 914168, 914398, 914399, 914443, 914943, 915695, 915696, 915819, E.41, E.42, E.45, E41, Fast145, FAST-145, Fast145D, FAST-145D, NIAGARA-45		
<b>accessories for</b>	415664		
	GEV No.	510893	Ref. No. 456015
O-ring EPDM thickness 2.62mm ID ø 9.92mm Qty 1 pcs			
	GEV No.	521103	Ref. No. —
nut thread M4 H 3mm WS 7 brass Qty 20 pcs			
	GEV No.	521104	Ref. No. —
washer ID ø 4.3mm ED ø 8mm thickness 0.5mm brass Qty 20 pcs for thread M4			

<b>accessories for</b>	415664		
	GEV No.	521129	Ref. No. —
nut thread M10 H 6mm SS WS 17 Qty 1 pcs DIN/ISO DIN 439			
	GEV No.	560111	Ref. No. —
plain washer ID ø 4.3mm ED ø 9mm thickness 0.8mm SS Qty 20 pcs DIN 125A for thread M4			
	GEV No.	560131	Ref. No. —
hexagonal nut thread M4 H 3.2mm WS 7 SS DIN/ISO DIN 934 / ISO 4032/8673 Qty 20 pcs			

			
1			
<b>GEV No.</b>	415665	<b>Ref. No.</b>	230060 230061 230086
<b>description</b>	heating element 2750/3250W 220/240V heating circuits 1 L 380mm W 110mm H 30mm thread M10x1 mounting distance 75mm tube ø 6.5mm connection M4 immersion heater 2 hole fixing		
<b>For models:</b>	050F, 050FP, 10, 12, 14, 22F, 22R, 2312-001, 2312-002, 40F, 440F, 44F, 46, 460, 500F, 500FD, 50F, 50FD, 510F, 510FD, 913297, 913298, 913299, 913300, 913360, 913361, 913391, 913392, 913546, 913547, 913578, 913611, 913684, 913913, 913914, 913932, 913933, 914284, 914318, 914319, 914326, 914331, 914338, 914356, 914400, 914401, 914402, 914403, 914404, 914405...(Other models you can see in the webshop)		
<b>spare parts for</b>	415665		
	GEV No.	510893	Ref. No. 456015
O-ring EPDM thickness 2.62mm ID ø 9.92mm Qty 1 pcs			
<b>accessories for</b>	415665		
	GEV No.	510416	Ref. No. 437022
flat gasket fibre ED ø 19mm ID ø 10.5mm thickness 1.5mm for thread M10 Qty 1 pcs			
	GEV No.	520231	Ref. No. —
nut thread M10x1 H 6mm WS 14 zinc-coated steel Qty 1 pcs			
	GEV No.	520876	Ref. No. 463007
protection cap for heating element ø 11.5mm H 32mm W 25mm plastic			
	GEV No.	521103	Ref. No. —
nut thread M4 H 3mm WS 7 brass Qty 20 pcs			
	GEV No.	521104	Ref. No. —
washer ID ø 4.3mm ED ø 8mm thickness 0.5mm brass Qty 20 pcs for thread M4			
	GEV No.	521129	Ref. No. —
nut thread M10 H 6mm SS WS 17 Qty 1 pcs DIN/ISO DIN 439			
	GEV No.	560111	Ref. No. —
plain washer ID ø 4.3mm ED ø 9mm thickness 0.8mm SS Qty 20 pcs DIN 125A for thread M4			
	GEV No.	560131	Ref. No. —
hexagonal nut thread M4 H 3.2mm WS 7 SS DIN/ISO DIN 934 / ISO 4032/8673 Qty 20 pcs			



			
1			
<b>GEV No.</b>	416235	<b>Ref. No.</b>	70562 80360 80677
<b>description</b>	heating element 3000W 230V heating circuits 1 L 320mm W 50mm H 40mm thread M10x1 mounting distance 44mm tube ø 6.3mm connection male faston 6.3mm 2 hole fixing L1 32mm L2 288mm		
<b>For models:</b>	80, 81, 82, CE78HZ23, CGL74CABT, E78, E78HP, Fast181, Fast181-230V-3Ph-60Hz, Fast181-400V-3NPh-60Hz, HM1, KLP105EB, LP105DDDTEB, LP105DDDTEBN, LP105EB, LP60, NG292HZ, NG381L, NG381LC, NG381LCFUR, NG381LDDPS, NIAGARA-271, Niagara-283A, Niagara-283L-2, Niagara-292-400V-3Ph-60Hz, Niagara-381L, Niagara-381LC, RIVER-282, River-282L-2, River-282LS-2TDE, River-285, River-295P, River-296P, River-382L, River-382L-230V-3Ph-50Hz, River-382LNRG, River-382LTDE, River-482, RIVER-71, RIVER-78, RIVER-80, River-81, River-81CRP, RIVER-81-CRP, RIVER-82, River-82CRP, RIVER-82-CRP, RIVER-E78, RIVER-HL-81, RIVER-HL-82...(Other models you can see in the webshop)		
<b>spare parts for</b>	416235		
	<b>GEV No.</b>	510893	<b>Ref. No.</b> 456015
	O-ring EPDM thickness 2.62mm ID ø 9.92mm Qty 1 pcs		
<b>accessories for</b>	416235		
	<b>GEV No.</b>	510416	<b>Ref. No.</b> 437022
	flat gasket fibre ED ø 19mm ID ø 10.5mm thickness 1.5mm for thread M10 Qty 1 pcs		
	<b>GEV No.</b>	510893	<b>Ref. No.</b> 456015
	O-ring EPDM thickness 2.62mm ID ø 9.92mm Qty 1 pcs		
	<b>GEV No.</b>	521129	<b>Ref. No.</b> —
	nut thread M10 H 6mm SS WS 17 Qty 1 pcs DIN/ISO DIN 439		
	<b>GEV No.</b>	560192	<b>Ref. No.</b> —
	tooth lock washer ID ø 10.4mm ED ø 18mm SS DIN/ISO DIN 6798A Qty 1 pcs for thread M10		

			
1			
<b>GEV No.</b>	420334	<b>Ref. No.</b>	41211 C.41211
<b>description</b>	heating element 3000W 230V heating circuits 1 L 380mm W 87mm H 26mm thread M10x1 mounting distance 81mm tube ø 6.3mm connection M4 immersion heater 2 hole fixing		
<b>For models:</b>	U61, U61E, U61H, U61HE		

foil heating elements

			
1			
<b>GEV No.</b>	416236	<b>Ref. No.</b>	230080.AG
<b>description</b>	foil heating element L 130mm W 84mm 130W 230V t.max. 175°C without temperature limiter silicone cable length 200mm thickness 1mm		
<b>For models:</b>	CLEAN-3, RIVER-43		

accessories

various			
			
1			
<b>GEV No.</b>	550057	<b>Ref. No.</b>	999006
<b>description</b>	screw connection set for heating element		
<b>For models:</b>	404, 406, 412		

sealing washers

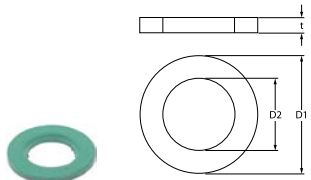
fibre gaskets			
			
1			
<b>GEV No.</b>	510416	<b>Ref. No.</b>	437022
<b>description</b>	flat gasket fibre ED ø 19mm ID ø 10.5mm thickness 1.5mm for thread M10 Qty 1 pcs		
<b>For models:</b>	S621, S623, S624, S626, S631, S633, S634, S636		

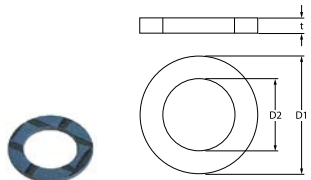
			
1			
<b>GEV No.</b>	510417	<b>Ref. No.</b>	437002 437024
<b>description</b>	flat gasket fibre ED ø 20mm ID ø 14mm thickness 2mm Qty 1 pcs		
<b>For models:</b>	11F, 11FD, 11F-DVGW, 11R, 11RD, 12, 14, 21F, 21FD, 21R, 21RD, 22F, 22R, 25F, 25FD, 25R, 25RD, 30F, 30FD, 30R, 30RD, 31F, 31FD, 31R, 31RD, 40F, 440F, 44F, 450, 46, 460, 500F, 500FD, 50F, 50FD, 510F, 510FD, CLEAN-100, CLEAN-110, CLEAN-120, E.45, E.46, E.50, E.51, E.52, E1, E10, E100, E110, E12...(Other models you can see in the webshop)		

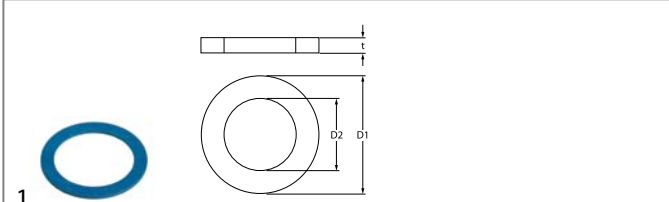

<b>GEV No.</b>	510405	<b>Ref. No.</b>	437028
<b>description</b>	flat gasket fibre ED $\phi$ 56mm ID $\phi$ 42mm thickness 2mm for thread 1 1/4" Qty 1 pcs		
<b>For models:</b>	R497, R499, R501, R503, R505, R507, R509, R511, R704, S641, S643		

O-rings

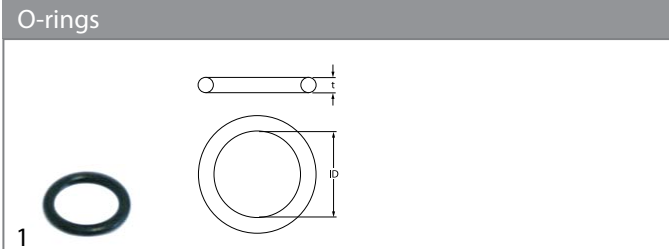

<b>GEV No.</b>	510893	<b>Ref. No.</b>	456015
<b>description</b>	O-ring EPDM thickness 2.62mm ID $\phi$ 9.92mm Qty 1 pcs		
<b>For models:</b>	050F, 050FP, 2312-001, 2312-002, 31F, 31FD, 31R, 31RD, 500F, 500FD, 50F, 50FD, 510F, 510FD, 67F, 67R, 913297, 913298, 913299, 913300, 913360, 913361, 913363, 913364, 913376, 913377, 913391, 913392, 913418, 913546, 913547, 913578, 913611, 913684, 913913, 913914, 913932, 913933, 914167, 914168, 914284, 914318, 914319, 914326, 914331, 914338, 914356, 914398, 914399, 914400...(Other models you can see in the webshop)		

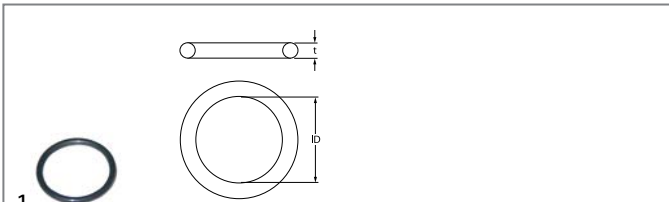

<b>GEV No.</b>	510072	<b>Ref. No.</b>	456016
<b>description</b>	O-ring EPDM thickness 3.53mm ID $\phi$ 32.93mm Qty 1 pcs		
<b>For models:</b>	050F, 050FP, 10, 11F, 11FD, 11F-DVGW, 11R, 11RD, 21F, 21FD, 21R, 21RD, 22F, 22R, 25F, 25FD, 25R, 25RD, 30F, 30FD, 30R, 30RD, 31F, 31FD, 31R, 31RD, 350F, 350FD, 350R, 350RD, 35-ELECTRONIC, 35F, 35FD, 35R, 35RD, 400F, 400FD, 400R, 400RD, 40-ELECTRONIC, 40F, 40FD, 40R, 40RD, 440F, 44F, 45, 450, 46, 460...(Other models you can see in the webshop)		

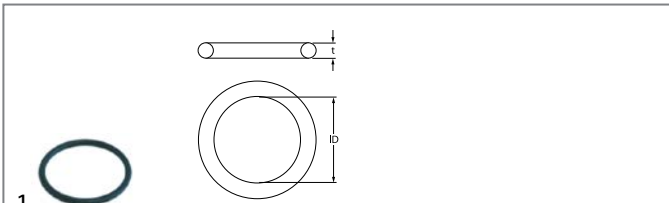

<b>GEV No.</b>	521120	<b>Ref. No.</b>	456075
<b>description</b>	O-ring EPDM thickness 5.34mm ID $\phi$ 37.47mm Qty 1 pcs		
<b>For models:</b>	913289, 913290, 913291, 913292, 913356, 913357, 913363, 913364, 913372, 913373, 913374, 913375, 913376, 913377, 913416, 913418, 913435, 913544, 913545, 913665, 913666, 913667, 913668, 913685, 913771, 913772, 913773, 913774, 913832, 913837, 913911, 913912, 913948, 913950, 913977, 913984, 913990, 914165, 914166, 914167, 914168, 914206, 914214, 914316, 914317, 914355, 914386, 914387, 914388, 914389...(Other models you can see in the webshop)		

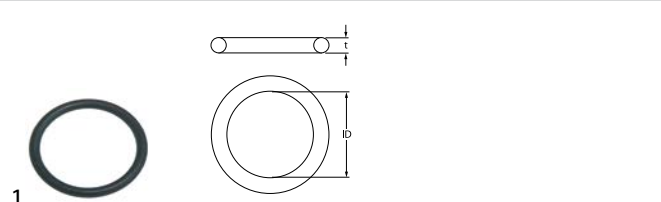

<b>GEV No.</b>	510408	<b>Ref. No.</b>	456002 456079
<b>description</b>	O-ring EPDM thickness 5.34mm ID $\phi$ 47mm Qty 1 pcs		
<b>For models:</b>	10, 12, 14, 21F, 21FD, 21R, 21RD, 22F, 22R, 25F, 25FD, 25R, 25RD, 30F, 30FD, 30R, 30RD, 31F, 31FD, 31R, 31RD, 40F, 440F, 44F, 50F, 50FD, 510F, 510FD, 66, 80, 81, 82, 913297, 913298, 913299, 913300, 913360, 913361, 913391, 913392, 913546, 913547, 913578, 913611, 913684, 913913, 913914, 913932, 913933, 913992...(Other models you can see in the webshop)		

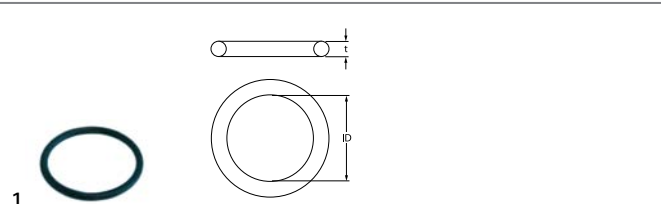

<b>GEV No.</b>	510409	<b>Ref. No.</b>	929046
<b>description</b>	O-ring EPDM thickness 5.34mm ID $\phi$ 56.52mm Qty 1 pcs		
<b>For models:</b>	161, 221, 271, 272, 362, 55, CLEAN-160, CLEAN-161, CLEAN-220, CLEAN-221, CLEAN-270, CLEAN-271, CLEAN-272, CLEAN-361, CLEAN-361P, CLEAN-362, CLEAN-471, CLEAN-471P		

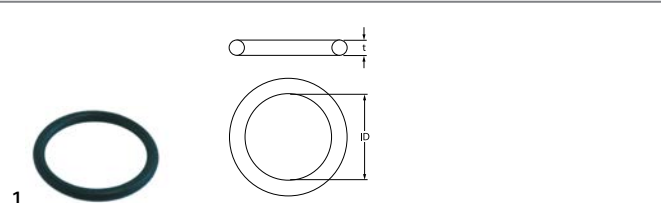

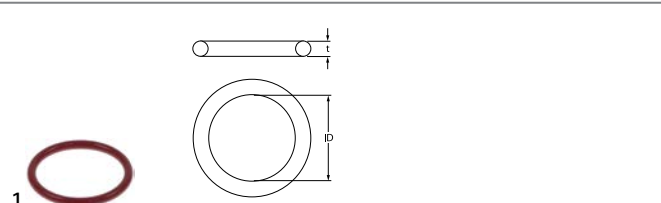

<b>GEV No.</b>	510410	<b>Ref. No.</b>	456008
<b>description</b>	O-ring EPDM thickness 5.34mm ID $\phi$ 75.57mm Qty 1 pcs		
<b>For models:</b>	66, S651, S651P, S653, S654, S655, S810, S815, S830, S835, S850, SR651		





<b>GEV No.</b>	514017	<b>Ref. No.</b>	927010
<b>description</b>	O-ring silicone thickness 3.53mm ID $\phi$ 32.93mm Qty 1 pcs		
<b>For models:</b>	CLEAN-160, CLEAN-220, CLEAN-270, CLEAN-271, CLEAN-361, CLEAN-361P, CLEAN-471, CLEAN-471P		





flange gaskets			
			
1			
<b>GEV No.</b>	510387	<b>Ref. No.</b>	437086
<b>description</b>	gasket L 46mm W 22mm ømm EPDM for heating element for flange 50x26mm		
<b>For models:</b>	913289, 913290, 913291, 913292, 913356, 913357, 913372, 913373, 913374, 913375, 913416, 913435, 913544, 913545, 913665, 913666, 913667, 913668, 913685, 913771, 913772, 913773, 913774, 913832, 913837, 913911, 913912, 913948, 913950, 913977, 913984, 913990, 913992, 913993, 914165, 914166, 914206, 914214, 914316, 914317, 914355, 914386, 914387, 914388, 914389, 914390, 914391, 914392, 914393, 914394...(Other models you can see in the webshop)		
<b>accessories for</b>	510387		
		<b>GEV No.</b>	510388
		<b>Ref. No.</b>	—
	counterflange ømm hole distancemm perforation ømm L 43mm W 21mm SS for heating element for flange 50x26mm		

			
1			
<b>GEV No.</b>	521128	<b>Ref. No.</b>	437048
<b>description</b>	gasket L 66mm W 21mm ømm for heating element suitable for ELETTROBAR, WOLK		
<b>For models:</b>	050F, 050FP, 11F, 11FD, 11F-DVGW, 11R, 11RD, 2312-001, 2312-002, 350F, 350FD, 350R, 350RD, 35-ELECTRONIC, 35F, 35FD, 35R, 35RD, 400F, 400FD, 400R, 400RD, 40-ELECTRONIC, 40F, 40FD, 40R, 40RD, 46, 460, 500F, 500FD, 50-ELECTRONIC, 50F, 50FD, 510F, 510FD, 67F, 67R, 913297, 913298, 913299, 913300, 913360, 913361, 913391, 913392, 913546, 913547, 913578, 913611...(Other models you can see in the webshop)		

protection caps			
			
1			
<b>GEV No.</b>	510084	<b>Ref. No.</b>	467001
<b>description</b>	protection cap		
<b>For models:</b>	66, S651, S651P, S653, S654, S655, S810, S815, S830, S835, S850, SR651		

			
1			
<b>GEV No.</b>	510093	<b>Ref. No.</b>	467002 69870
<b>description</b>	protection cap		
<b>For models:</b>	10, 12, 14, 21F, 21FD, 21R, 21RD, 22F, 22R, 25F, 25FD, 25R, 25RD, 30F, 30FD, 30R, 30RD, 31F, 31FD, 31R, 31RD, 40F, 440F, 44F, 510F, 510FD, 66, 913297, 913298, 913299, 913300, 913360, 913361, 913391, 913392, 913546, 913547, 913578, 913611, 913684, 913913, 913914, 913932, 913933, 913992, 913993, 914284, 914318, 914319, 914326...(Other models you can see in the webshop)		



			
1			
<b>GEV No.</b>	510094	<b>Ref. No.</b>	415001
<b>description</b>	protection cap		
<b>For models:</b>	R509, R511, R704, R706, R708, S641, S643, S870		

			
1			
<b>GEV No.</b>	520876	<b>Ref. No.</b>	463007
<b>description</b>	protection cap for heating element ø 11.5mm H 32mm W 25mm plastic		
<b>For models:</b>	050F, 050FP, 10, 11F, 11FD, 11F-DVGW, 11R, 11RD, 12, 14, 22F, 22R, 2312-001, 2312-002, 31F, 31FD, 31R, 31RD, 350F, 350FD, 350R, 350RD, 35-ELECTRONIC, 35F, 35FD, 35R, 35RD, 400F, 400FD, 400R, 400RD, 40-ELECTRONIC, 40F, 40FD, 40R, 40RD, 440F, 44F, 45, 450, 46, 460, 500F, 500FD, 50-ELECTRONIC, 50F, 50FD, 510F, 510FD, 67F...(Other models you can see in the webshop)		

## thermostats

### bi-metal thermostats

#### safety bi-metal thermostats

			
1			
<b>GEV No.</b>	390233	<b>Ref. No.</b>	236039 926189
<b>description</b>	bi-metal safety thermostat hole distance 24mm switch-off temp. 110°C 1NC 1-pole 16A connection F6.3 2 hole fixing without holder		
<b>For models:</b>	050F, 050FP, 10, 11F, 11FD, 11R, 11RD, 12, 14, 22F, 2312-001, 2312-002, 2312-007, 31F, 31FD, 31R, 31RD, 350F, 350FD, 350R, 350RD, 35F, 35FD, 35R, 35RD, 400F, 400FD, 400R, 400RD, 40F, 40FD, 40R, 40RD, 440F, 44F, 45, 450, 46, 460, 500F, 500FD, 50F, 50FD, 510F, 510FD, 80, 81, 82, 913289, 913290...(Other models you can see in the webshop)		
<b>accessories for</b>	390233		
		<b>GEV No.</b>	504736
		<b>Ref. No.</b>	—
	bracket for contact thermostat		
		<b>GEV No.</b>	550388
		<b>Ref. No.</b>	431006
	bracket for contact thermostat mounting distance 24.5mm mounting ø 3.8		

			
1			
<b>GEV No.</b>	390459	<b>Ref. No.</b>	236053
<b>description</b>	bi-metal safety thermostat hole distancemm switch-off temp. 200°C 1NC 1-pole 16A connection F6.3 M4		
<b>For models:</b>	2312-007, 2312-009-CRP, 67F, 67R, 914100, 914101, 914339, 914342, 914343, 914624, 914625, 914626, 914627, 914628, 914850, 914851, 914854, 914944, E.35, PS-60, RIVER-48, RIVER-50, RIVER-50-CRP, RIVER-50-CRP-SP, RIVER-54, RIVER-54CRP, River-54-CRP-s.p., RIVER-54-CRP-SP, RIVER-61		





			
1			
<b>GEV No.</b>	390318	<b>Ref. No.</b>	236047
<b>description</b>	bi-metal safety thermostat switch-off temp. 95°C 1-pole 2 hole fixing		
<b>For models:</b>	2312-009-CRP, 913289, 913290, 913291, 913292, 913356, 913357, 913363, 913364, 913372, 913373, 913374, 913375, 913376, 913377, 913416, 913435, 913544, 913545, 913665, 913666, 913667, 913668, 913685, 913771, 913772, 913773, 913774, 913832, 913837, 913911, 913912, 913913, 913948, 913950, 913977, 913984, 913990, 913992, 913993, 914165, 914166, 914206, 914214, 914284, 914316, 914317, 914355, 914386, 914387...(Other models you can see in the webshop)		

bi-metal thermostats

			
1			
<b>GEV No.</b>	390301	<b>Ref. No.</b>	236035
<b>description</b>	bi-metal thermostat hole distance 23.8mm switch-off temp. 60°C 1NC 1-pole 16A connection F6.3 2 hole fixing		
<b>For models:</b>	350F, 350FD, 350R, 350RD, 400F, 400FD, 400R, 400RD, 913289, 913290, 913291, 913292, 913356, 913357, 913363, 913364, 913372, 913373, 913374, 913375, 913376, 913377, 913416, 913435, 913544, 913545, 913665, 913666, 913667, 913668, 913685, 913771, 913772, 913773, 913774, 913832, 913837, 913948, 914386, 914387, 914388, 914389, 914390, 914391, 914392, 914393, 914394, 914395, 914396, 914397...(Other models you can see in the webshop)		

			
1			
<b>GEV No.</b>	390319	<b>Ref. No.</b>	236048
<b>description</b>	bi-metal thermostat hole distance 23.8mm switch-off temp. 80°C 1NC 1-pole 16A connection F6.3 2 hole fixing		
<b>For models:</b>	913289, 913290, 913291, 913292, 913356, 913357, 913372, 913373, 913374, 913375, 913416, 913435, 913544, 913545, 913665, 913666, 913667, 913668, 913685, 913771, 913772, 913773, 913774, 913832, 913837, 913948, 914386, 914387, 914388, 914389, 914390, 914391, 914392, 914393, 914394, 914395, 914396, 914397, 914441, 914442, 914515, 914537, 914547, 914683, 914689, 914692, 914693, 914694, 914703, 914863...(Other models you can see in the webshop)		

			
1			
<b>GEV No.</b>	390504	<b>Ref. No.</b>	236052
<b>description</b>	bi-metal thermostat hole distance 23.8mm switch-off temp. 90°C 1NO 1-pole 16A 250V connection F6.3 2 hole fixing probe ø 16mm		
<b>For models:</b>	915150, 915151, 915152, 915154, 915155, 915160, 915161, 915162, 915166, 915167, 915168, 915172, 915173, 915175, 915319, 915348, 915418, 915419, 915420, 915421, 915422, 915479, 915492, 915493, 915496, 915497, 915547, 915558, 915635, 915663, 915747, 916020, 916021, 916024, 916025, 916026, 916027, 916030, 916031, 916045, 916054, 916068, 916069, 916080, 916201, 916202, 916203, 916204, 916205, 916206...(Other models you can see in the webshop)		

			
1			
<b>GEV No.</b>	390129	<b>Ref. No.</b>	236056
<b>description</b>	bi-metal thermostat hole distance mm switch-off temp. 125°C 1NC 1-pole 16A connection F6.3 M4		
<b>For models:</b>	2312-007, 914100, 914101, 914339, 914342, 914343, 914624, 914625, 914626, 914627, 914628, 914850, 914851, 914854, 914944, PS-60, RIVER-48, RIVER-54, RIVER-54CRP, River-54-CRP-s.p.		

control and safety thermostats

EGO

control thermostats

51.\_ series

			
1			
<b>GEV No.</b>	390306	<b>Ref. No.</b>	236022
<b>description</b>	thermostat t.max. 85°C temperature range fixed 85°C 1-pole gland nut		
<b>For models:</b>	11F, 11FD, 11F-DVGW, 11R, 11RD, 21F, 21FD, 21R, 21RD, 22F, 22R, 25F, 25FD, 25R, 25RD, 30F, 30FD, 30R, 30RD, 31F, 31FD, 31R, 31RD, 350F, 350FD, 350R, 350RD, 500F, 500FD, 66		

55.10/19\_ series

			
1			
<b>GEV No.</b>	390003	<b>Ref. No.</b>	236002 236007 236008
<b>description</b>	thermostat t.max. 90°C temperature range 30-90°C 1-pole 1CO 16A probe ø 15mm probe L 22.5mm capillary pipe 1700mm capillary pipe isolatedmm gland nut shaft ø 6x4.6mm shaft L 16mm shaft position upper° shaft position rotation 270° with knob probe		
<b>For models:</b>	R495, R497, R499, R708, S641, S643		
<b>accessories for</b>	390003		
	<b>GEV No.</b>	510165	<b>Ref. No.</b> —
gasket for thermostat ED ø 27mm ID ø 11mm thickness 8.5mm			





55.13\_series



<b>GEV No.</b>	375006	<b>Ref. No.</b>	236004 236027 236041 236046
<b>description</b>	thermostat t.max. 85°C temperature range 30-85°C 1-pole 1CO 16A probe ø 6mm probe L 92mm capillary pipe 3150mm capillary pipe isolated 300mm gland nut shaft L 23mm shaft position upper rotation 270° probe material SS		
<b>For models:</b>	10, 11F, 11FD, 11R, 11RD, 12, 14, 350F, 350FD, 350R, 350RD, 400F, 400FD, 400R, 400RD, 500F, 500FD, CLEAN-3, S621, S623, S624, S626, S631, S633, S634, S636, S651, S651P, S653, S654, S655, S810, S815, S830, S835, S850, S870, S950, SR651		

55.14\_series



<b>GEV No.</b>	390316	<b>Ref. No.</b>	236024
<b>description</b>	thermostat t.max. 53°C temperature range fixed 53°C 1-pole 1NC 16A probe ø 6mm probe L 116mm capillary pipe 600mm capillary pipe isolated 600mm gland nut shaft Lmm shaft position° shaft position		
<b>For models:</b>	350F, 350FD, 350R, 350RD, 400F, 400FD, 400R, 400RD, 66		

55.17\_series

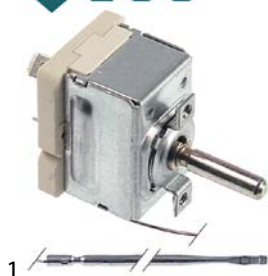

<b>GEV No.</b>	375672	<b>Ref. No.</b>	927312
<b>description</b>	thermostat t.max. 320°C temperature range 50-320°C 1-pole 1NO 16A probe ø 3.03mm probe L 178mm capillary pipe 840mm capillary pipe isolatedmm gland nut shaft ø 6x4.6mm shaft L 23mm shaft position upper rotation 270°		

safety thermostats

55.10/19\_series



<b>GEV No.</b>	375200	<b>Ref. No.</b>	236029
<b>description</b>	safety thermostat capillary pipe 900mm probe ø 6mm 1-pole probe L 130mm 0.5A capillary pipe isolatedmm gland nut switch-off temp. 235°C probe		

55.32\_series

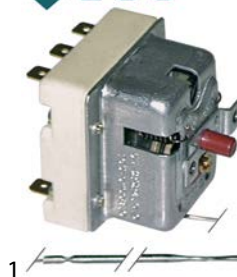

<b>GEV No.</b>	375139	<b>Ref. No.</b>	236032
<b>description</b>	safety thermostat switch-off temp. 108°C 3-pole 20A probe ø 3mm probe L 190mm capillary pipe 600mm capillary pipe isolated 600mm gland nut probe SS		
<b>For models:</b>	40F		

56.\_series



<b>GEV No.</b>	390851	<b>Ref. No.</b>	236015
<b>description</b>	safety thermostat set switch-off temp. 225°C 1-pole NC 0.5A probe ø 6mm probe L 80mm capillary pipe 900mm capillary pipe isolated 450mm gland nut M10x1		



IMIT / TEMPOMATIC / ARTERMO

control thermostats



<b>GEV No.</b>	390314	<b>Ref. No.</b>	929106
<b>description</b>	thermostat t.max. 60°C temperature range fixed 60°C-pole 1CO 15A probe ø 6.5mm probe L 95mm capillary pipe 2000mm capillary pipe isolated 1950mm gland nut shaft ømm shaft Lmm shaft position rotation° probe material copper		
<b>For models:</b>	55, CLEAN-161, CLEAN-221, CLEAN-271, CLEAN-272, CLEAN-362, U132, U70		



<b>GEV No.</b>	390421	<b>Ref. No.</b>	929107
<b>description</b>	thermostat t.max. 85°C temperature range 0-90°C 1-pole 1CO 16A probe ø 6.5mm probe L 95mm capillary pipe 1500mm capillary pipe isolated 1450mm gland nut shaft ømm shaft Lmm shaft position rotation 270° probe material copper		
<b>For models:</b>	161, 221, 271, 272, 362, 55, CE78HZ23, CLEAN-160, CLEAN-161, CLEAN-220, CLEAN-221, CLEAN-270, CLEAN-271, CLEAN-272, CLEAN-361, CLEAN-361P, CLEAN-362, CLEAN-471, CLEAN-471P, E.60, E.65, E1, E10, E100, E110, E12, E120, E14, E140, E78, E78HP, GL280EB-23DAR, GL280EBDARY, GL280EBDAW, GL280EBDAY, GL280EBDB, GL280EBDBR, GL280EBSA, GL280EBSAE, GL280EBSAEW, GL280EBSAEWY, GL280EBSAR, GL280EBSARY, GL280EBSAW, GL280EBSAWY, GL280EBSAY, GL280EBSB, GL282EB93DA, GL282EBDA, GL282EB-DARW...(Other models you can see in the webshop)		



<b>GEV No.</b>	390005	<b>Ref. No.</b>	236003 236014 926196
<b>description</b>	thermostat t.max. 85°C temperature range 25-85°C 1-pole 1CO 15A probe ø 11mm probe L 35mm capillary pipe 600mm capillary pipe isolated 600mm gland nut shaft ø 6x4.6mm shaft L 8mm shaft position upper° rotation 270° screw-in probe		
<b>For models:</b>	11F, 11FD, 11R, 11RD, E.60, E.65, E1, E10, E100, E110, E12, E120, E14, E140, E78, RIVER-78, RIVER-E78, S621, S623, S624, S626, S631, S633, S634, S636, U61, U61H		
<b>accessories for</b>	390005		
	<b>GEV No.</b>	510417	<b>Ref. No.</b> 437002 437024
	flat gasket fibre ED ø 20mm ID ø 14mm thickness 2mm Qty 1 pcs		
	<b>GEV No.</b>	550261	<b>Ref. No.</b> —
	nut thread M14x1 H 4mm WS 19 SS Qty 1 pcs		



<b>GEV No.</b>	390310	<b>Ref. No.</b>	236028
<b>description</b>	thermostat t.max. 85°C temperature range fixed 55°C 1-pole 1CO 16A probe ø 9.5mm probe L 37mm capillary pipe 600mm capillary pipe isolated 540mm gland nut shaft ømm shaft Lmm shaft position rotation° screw-in probe probe thread 3/8" probe material SS		
<b>For models:</b>	500F, 500FD		
<b>accessories for</b>	390310		
	<b>GEV No.</b>	506024	<b>Ref. No.</b> —
	nut thread 3/8" H 6mm SS WS 22 Qty 1 pcs		
	<b>GEV No.</b>	529349	<b>Ref. No.</b> 437030
	flat gasket FIBER ED ø 22mm ID ø 16.5mm thickness 2mm for thread 3/8" Qty 1 pcs		



<b>GEV No.</b>	390425	<b>Ref. No.</b>	926259 DRT141C
<b>description</b>	thermostat t.max. 85°C temperature range fixed 60°C 1-pole 1CO 16A probe ø 9.5mm probe L 37mm capillary pipe 600mm capillary pipe isolated 600mm gland nut shaft ømm shaft Lmm shaft position rotation° screw-in probe probe thread M14x1 probe material SS		
<b>For models:</b>	E78		
<b>accessories for</b>	390425		
	<b>GEV No.</b>	510417	<b>Ref. No.</b> 437002 437024
	flat gasket fibre ED ø 20mm ID ø 14mm thickness 2mm Qty 1 pcs		
	<b>GEV No.</b>	511472	<b>Ref. No.</b> —
	nut thread 3/8" H 4mm brass WS 21 Qty 1 pcs		

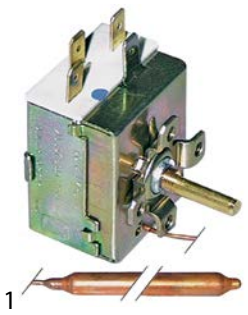

			
<b>GEV No.</b>	390006	<b>Ref. No.</b>	929044 DRT13L
<b>description</b>	thermostat t.max. 86°C temperature range 0-86°C 1-pole 1CO 16A probe ø 6.5mm probe L 95mm capillary pipe 1500mm capillary pipe isolatedmm gland nut shaft ø 6x4.6mm shaft L 19mm rotation 270°		
<b>For models:</b>	161, 221, 271, 272, 362, CLEAN-160, CLEAN-161, CLEAN-220, CLEAN-221, CLEAN-270, CLEAN-271, CLEAN-272, CLEAN-361, CLEAN-361P, CLEAN-362, CLEAN-471, CLEAN-471P, RIVER-150		
<b>accessories for</b>	390006		
	 GEV No. 110100 Ref. No. 929042 knob thermostat t.max. 90°C 0-90°C ø 42mm shaft ø 6x4.6mm shaft flat -135° black		
	 GEV No. 110105 Ref. No. — rosette knob ø 42mm ø 56mm zero mark		

control thermostats with operation switch

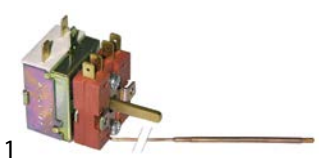

			
<b>GEV No.</b>	390139	<b>Ref. No.</b>	921014 921046
<b>description</b>	thermostat t.max. 270°C temperature range 63-270°C 1-pole 1CO 15A probe ø 3.5mm probe L 195mm capillary pipe 1000mm capillary pipe isolatedmm gland nut shaft ø 6x4.6mm shaft L 17mm shaft position upper° rotation 270°		
<b>For models:</b>	433, 434, 436, 437, 438, 439, G33, G34, G35, G36, G37, G38, G39, GV45L, GV45R, GV62L, GV62R		

safety thermostats

			
<b>GEV No.</b>	390770	<b>Ref. No.</b>	927057
<b>description</b>	safety thermostat switch-off temp. 90-110°C 1-pole 1CO 16/0.5A probe ø 6.5mm probe L 90mm capillary pipe 2000mm capillary pipe isolated 1950mm gland nut probe		
<b>For models:</b>	161, 221, 271, 272, 362, 914380, 914436, A3EB, A3EBD, A3EBDAKRYK, A3EBDAKWK, A3EBDBKWK, A3EBDRKYK, A3EBDWK, A3EBDYK, A3EBS-AK, A3EBSAKRK, A3EBSAKWK, A3EBSBKWKYK, A3EBSEKWK, A3EBS-WK, A4EB, A4EBD, A4EBDAKEYK, A4EBDAKWK, A4EBDAKWK, A4EB-DAKZK, A4EBDBKRK, A4EBDPKWYK, A4EBDRK, A4EBS, A4EBSAK, A4EBSAKCK, A4EBSAKEYK, A4EBSAKRK, A4EBSAKRKP, A4EBSAKYK, A4EBSCK, A4EBT, A4EBTSAK, A5EB, A5EBD, A5EBDAKPKWK, A5EBDAK-WK, A5EBDAKYK, A5EBDRK, A5EBS, A5EBSAKPKWK, A5EBSAKRK, A5EBSAKRKYK...(Other models you can see in the webshop)		

CAEM

control thermostats

			
<b>GEV No.</b>	390672	<b>Ref. No.</b>	236023 236042
<b>description</b>	thermostat t.max. 53°C temperature range fixed 53°C 1-pole 1CO 16A probe ø 9.5mm probe L 30mm capillary pipe 600mm capillary pipe isolated 540mm gland nut shaft Lmm screw-in probe probe thread M14x1		
<b>For models:</b>	2312-001, 2312-002, 31F, 31FD, 31R, 31RD, 440F, 450, 460, 500F, 500FD, 50F, 50FD, 510F, 510FD, 67F, 67R, 913297, 913298, 913299, 913300, 913360, 913361, 913391, 913392, 913418, 913546, 913547, 913578, 913611, 913684, 913932, 913933, 914326, 914331, 914398, 914399, 914400, 914401, 914402, 914403, 914404, 914405, 914406, 914443, 914449, 914517, 914545, 914568, 914688...(Other models you can see in the webshop)		
<b>spare parts for</b>	390672		
	 GEV No. 510417 Ref. No. 437002 flat gasket fibre ED ø 20mm ID ø 14mm thickness 2mm Qty 1 pcs		
	 GEV No. 550261 Ref. No. — nut thread M14x1 H 4mm WS 19 SS Qty 1 pcs		

			
<b>GEV No.</b>	390686	<b>Ref. No.</b>	236043
<b>description</b>	thermostat t.max. 83°C temperature range°C 1-pole 1CO 20A probe ø 6mm probe L 90mm capillary pipe 630mm capillary pipe isolated 550mm gland nut shaft ømm shaft Lmm shaft position rotation 270° probe material copper		
<b>For models:</b>	2312-001, 2312-002, 31F, 31FD, 31R, 31RD, 350F, 350FD, 350R, 350RD, 400F, 400FD, 400R, 400RD, 440F, 450, 460, 50F, 50FD, 510F, 510FD, 67F, 67R, 913297, 913298, 913299, 913300, 913360, 913361, 913363, 913364, 913376, 913377, 913391, 913392, 913418, 913546, 913547, 913578, 913611, 913684, 913932, 913933, 914326, 914331, 914398, 914399, 914400, 914401, 914402...(Other models you can see in the webshop)		



TECASA

safety thermostats



<b>GEV No.</b>	390028	<b>Ref. No.</b>	236034 236045
<b>description</b>	safety thermostat switch-off temp. 230°C 1-pole 16A probe ø 3mm probe L 155mm capillary pipe 890mm capillary pipe isolated 600mm gland nut probe SS		
<b>For models:</b>	FRI12, FRI12+12, FRI15, FRI15M, FRI6, FRI6+6, FRI9, FRI9+9, ME15, ME20, ME30, ME40		

PRODIGY / FIRT

safety thermostats



<b>GEV No.</b>	375478	<b>Ref. No.</b>	927106 DRT25
<b>description</b>	safety thermostat switch-off temp. 200°C temperature range°C 1-pole 1CO 20A probe ø 3.3mm probe L 190mm capillary pipe 2150mm capillary pipe isolatedmm gland nut probe SS		
<b>For models:</b>	161, 221, 271, 272, 362, A3EBDAKRKYK, A3EBSAKRK, A4EBDAKEKYK, A4EBDAKRK, A4EBDAKWK, A4EBDAKZK, A4EBDBKRK, A4EBSAK, A4EBSAKCK, A4EBSAKEKYK, A4EBSAKRKP, A4EBTSAK, A5EBDAKYK, A5EBSAKRK, A5EBSAKRKYK, A5EBSAKWK, A5EBSAKWKYK, A5EBSBKRKPK, A5EBSBKWK, CLEAN-160, CLEAN-161, CLEAN-220, CLEAN-221, CLEAN-270, CLEAN-271, CLEAN-272, CLEAN-361, CLEAN-361P, CLEAN-362, CLEAN-471, CLEAN-471P, GL280EB23DAR, GL280EBDARY, GL280EBDAW, GL280EBDAY, GL280EBDB, GL280EBDBR, GL280EB-SA, GL280EBSAE, GL280EBSAEW, GL280EBSAEWY, GL280EBSAR, GL280EBSARY, GL280EBSAW, GL280EBSAWY...(Other models you can see in the webshop)		

accessories

fitting parts



<b>GEV No.</b>	550388	<b>Ref. No.</b>	431006
<b>description</b>	bracket for contact thermostat mounting distance 24.5mm mounting ø 3.8		
<b>For models:</b>	10, 11F, 11FD, 11R, 11RD, 12, 14, 22F, 31F, 31FD, 31R, 31RD, 350F, 350FD, 350R, 350RD, 35F, 35FD, 35R, 35RD, 400F, 400FD, 400R, 400RD, 40F, 40FD, 40R, 40RD, 440F, 44F, 45, 450, 46, 460, 500F, 500FD, 50F, 50FD, 510F, 510FD, CLEAN-100, CLEAN-110, CLEAN-120, CLEAN-3, E.35, E.40, E.41, E.42, E.45, E.46...(Other models you can see in the webshop)		

plunger sockets



<b>GEV No.</b>	513031	<b>Ref. No.</b>	929038 DZP22
<b>description</b>	thermowell L 125mm SS single		
<b>For models:</b>	55, A3EB, A3EBD, A3EBDAKRKYK, A3EBDAKWK, A3EBDBKWK, A3EBDRKYK, A3EBDVK, A3EBDYK, A3EBSAK, A3EBSAKRK, A3EBSAKWK, A3EBSBKWKYK, A3EBSEKWK, A3EBSWK, A4EB, A4EBD, A4EBDAKEKYK, A4EBDAKRK, A4EBDAKWK, A4EBDAKZK, A4EBDBKRK, A4EBDPKWKYK, A4EBDRK, A4EBS, A4EBSAK, A4EBSAKCK, A4EBSAKEKYK, A4EBSAKRK, A4EBSAKRKP, A4EBSAKYK, A4EBSCK, A4EBT, A4EBTSAK, A5EB, A5EBD, A5EBDAKPKWK, A5EBDAKWK, A5EBDAKYK, A5EBDRK, A5EBS, A5EBSAKPKWK, A5EBSAKRK, A5EBSAKRKYK, A5EBSAKWK, A5EBSAKWKYK, A5EBSBKRKPK, A5EBSBKWK, A5EBSRK, A5EBSYK...(Other models you can see in the webshop)		



<b>GEV No.</b>	550995	<b>Ref. No.</b>	999160
<b>description</b>	thermowell thread M14x1 ID ø 5mm L 40mm SS ø 9mm		
<b>For models:</b>	050F, 050FP, 913913, 913914, 914167, 914168, 914284, 914318, 914319, 914338, 914356, 914431, 914642, 914909, 914943, 915136, 915137, F85, F85P, Mistral51, MISTRAL-51, NIAGARA-45, Niagara-51		

switches and momentary switches

rocker/momentary rocker switches

27.8x25mm



<b>GEV No.</b>	345002	<b>Ref. No.</b>	208009
<b>description</b>	rocker switch mounting measurements 27.8x25mm black 2CO 250V 16A connection male faston 6.3mm ambient temperature max. 85°C protection IP40		



<b>GEV No.</b>	345003 <sup>1</sup>	<b>Ref. No.</b>	213007
<b>description</b>	rocker switch mounting measurements 27.8x25mm green 2NO 250V 16A illuminated connection male faston 6.3mm ambient temperature max. 85°C protection IP40		

<sup>1</sup>illuminated



push/momentary push switches

28.5x77.5mm



1

<b>GEV No.</b>	345625	<b>Ref. No.</b>	926190 DEP61
<b>description</b>	switch combination latching mounting measurements 28.5x77.5mm black 2CO/2NO/2NO 250V 16A connection male faston 6.3mm ambient temperature max. 85°C protection IP40		

30x22mm



1

<b>GEV No.</b>	301047 <sup>1</sup>	<b>Ref. No.</b>	226059
<b>description</b>	push switch mounting measurements 30x22mm green 2NO 250V 16A illuminated connection male faston 6.3mm ambient temperature max. 85°C protection IP40 latching		
<b>For models:</b>	11F, 11FD, 11F-DVGW, 11R, 11RD		

<sup>1</sup>illuminated

ø25mm



1

<b>GEV No.</b>	345961	<b>Ref. No.</b>	999107
<b>description</b>	momentary push switch mounting ø 25mm orange 1NO/indicator light 250V 16A connection male faston 6.3mm ambient temperature max. 85°C protection IP40		
<b>For models:</b>	CLEAN-3		

1

<b>GEV No.</b>	345001	<b>Ref. No.</b>	999070
<b>description</b>	momentary push switch mounting ø 25mm yellow 1NO/indicator light 250V 16A cover connection male faston 6.3mm ambient temperature max. 85°C protection IP65		
<b>For models:</b>	11F, 11FD, 11R, 11RD		

**accessories for** 345001



<b>GEV No.</b>	345039	<b>Ref. No.</b>	410005
<b>description</b>	protective cover round ED ø 33mm external size 23mm internal size 21mm H 12mm clear mounting ø 25mm		



1

<b>GEV No.</b>	345039	<b>Ref. No.</b>	410005
<b>description</b>	protective cover round ED ø 33mm external size 23mm internal size 21mm H 12mm clear mounting ø 25mm		
<b>For models:</b>	11F, 11FD, 11F-DVGW, 11R, 11RD, 14		

**accessories for** 345039



<b>GEV No.</b>	345001	<b>Ref. No.</b>	999070
<b>description</b>	momentary push switch mounting ø 25mm yellow 1NO/indicator light 250V 16A cover connection male faston 6.3mm ambient temperature max. 85°C protection IP65		

ø30mm



1

<b>GEV No.</b>	345956	<b>Ref. No.</b>	226004
<b>description</b>	momentary push switch mounting ø 30mm multicolour 1NO 300V incl. several button connection screw ambient temperature max. 85°C protection IP40		
<b>For models:</b>	S850, S870, S950		

accessories

element holders



1

<b>GEV No.</b>	348215	<b>Ref. No.</b>	226126
<b>description</b>	element holder dimensions 25x25mm ID ø 21.4mm grey		
<b>For models:</b>	917042, 917043, 917044, 917049, Clean140, Clean140S, Clean161		



## microswitches

## universal



1				
<b>GEV No.</b>	345042	<b>Ref. No.</b>	218009	
<b>description</b>	microswitch with plunger 250V 16A 1CO connection male faston 6.3mm L 28mm ambient temperature max. 125°C mounting distance 22mm type EF83161.3 actuating force: 75g blue/black			
<b>For models:</b>	11F, 11FD, 11R, 11RD, R495, R497, R499, R501, R503, R505, R507, R509, R511, R704, R706, R708, S621, S623, S624, S626, S631, S633, S634, S636, S641, S643, S651, S651P, S653, S654, S655, S810, S815, S830, S835, S850, S870, S950, SR651			
<b>accessories for</b>	345042			
	<b>GEV No.</b>	345043	<b>Ref. No.</b>	—
	lever set 5-piece			

## lever actuated



1				
<b>GEV No.</b>	345257	<b>Ref. No.</b>	218002	
<b>description</b>	microswitch with lever 250V 16A 1CO connection male faston 6.3mm L 29mm L1 33mm ambient temperature max. 120°C mounting distance 22mm actuating force: 130g lever length 31.5mm			



1				
<b>GEV No.</b>	345125	<b>Ref. No.</b>	927246	
<b>description</b>	microswitch with lever 250V 16A 1CO connection male faston 6.3mm ambient temperature max. 85°C mounting distance 25mm type C99ZP3 actuating force: 25g lever length 63.5mm			
<b>For models:</b>	161, 221, 271, 272, 362, 914380, 914436, 915773, A3EB, A3EBD, A3EBDAKRKYK, A3EBDAKWK, A3EBDBKWK, A3EBDRKYK, A3EBDWK, A3EBDYK, A3EBSAK, A3EBSAKRK, A3EBSAKWK, A3EBSBKWKYK, A3EBSEKWK, A3EBSWK, A4EB, A4EBD, A4EBDAKEKYK, A4EBDAKRK, A4EBDAKWK, A4EBDAKZK, A4EBDBKWK, A4EBDPKWKYK, A4EBDRK, A4EBS, A4EBSAK, A4EBSAKCK, A4EBSAKEKYK, A4EBSAKRK, A4EBSAKRKP, A4EBSAKYK, A4EBSCK, A4EBT, A4EBTSAK, A5EB, A5EBD, A5EBDAKPWK, A5EBDAKWK, A5EBDAKYK, A5EBDRK, A5EBS, A5EBSAKPKWK, A5EBSAKRK...(Other models you can see in the webshop)			



1				
<b>GEV No.</b>	345311	<b>Ref. No.</b>	DEM14	
<b>description</b>	microswitch with lever 250V 16A 1NO connection male faston 6.3mm ambient temperature max. 85°C type TYFE22 lever length 41mm			

## pin-plunger actuated



1				
<b>GEV No.</b>	345042	<b>Ref. No.</b>	218009	
<b>description</b>	microswitch with plunger 250V 16A 1CO connection male faston 6.3mm L 28mm ambient temperature max. 125°C mounting distance 22mm type EF83161.3 actuating force: 75g blue/black			
<b>For models:</b>	11F, 11FD, 11R, 11RD, R495, R497, R499, R501, R503, R505, R507, R509, R511, R704, R706, R708, S621, S623, S624, S626, S631, S633, S634, S636, S641, S643, S651, S651P, S653, S654, S655, S810, S815, S830, S835, S850, S870, S950, SR651			
<b>accessories for</b>	345042			
	<b>GEV No.</b>	345043	<b>Ref. No.</b>	—
	lever set 5-piece			

## accessories



1				
<b>GEV No.</b>	518000	<b>Ref. No.</b>	486160	
<b>description</b>	adjusting screw for pressure pin			
<b>For models:</b>	21F, 21FD, 21R, 21RD, 25F, 25FD, 25R, 25RD, 30F, 30FD, 30R, 30RD, 31F, 31FD, 31R, 31RD, 440F, 44F			



1				
<b>GEV No.</b>	518041	<b>Ref. No.</b>	462005	
<b>description</b>	pressure pin for microswitch L 25.4mm ø 4.7mm			
<b>For models:</b>	21F, 21FD, 21R, 21RD, 25F, 25FD, 25R, 25RD, 30F, 30FD, 30R, 30RD, 31F, 31FD, 31R, 31RD, 440F, 44F			

## position switches

## HIGHLY





1				
<b>GEV No.</b>	347877	<b>Ref. No.</b>	927304	
<b>description</b>	position switch 2NC 250V L 56mm W 21mm H 25mm 5A			





system switches (ROLD)

			
1			
<b>GEV No.</b>	345612	<b>Ref. No.</b>	480059
<b>description</b>	blank size 23x23mm black		
<b>For models:</b>	350F, 350FD, 350R, 350RD, 35-ELECTRONIC, 35F, 35FD, 35R, 35RD, 400F, 400FD, 400R, 400RD, 40-ELECTRONIC, 40F, 40FD, 40R, 40RD, 45, 450, 46, 500F, 500FD, 50-ELECTRONIC, 50F, 50FD, 510F, 510FD, P500		

			
2			
<b>GEV No.</b>	345721	<b>Ref. No.</b>	226102
<b>description</b>	blank cap holder		
<b>For models:</b>	Fast180, Fast180-230V-3Ph-60Hz, FAST-60, FAST-73, PLUVIA-280, Pluvia280-230V-3Ph-60Hz, PV280, PV280FAST, PV280FAST2, PV280FAST-2BIO, PV280FAST2HZ23, PV280FASTCH, PV280FASTHB, PV280HZ23		

			
1			
<b>GEV No.</b>	346848	<b>Ref. No.</b>	226111
<b>description</b>	element holder dimensions 25x25mm ID ø 21.4mm grey		

			
1			
<b>GEV No.</b>	345602	<b>Ref. No.</b>	226073
<b>description</b>	element holder double mounting measurements 28.5x52.6mm black for push buttons 23x23mm		
<b>For models:</b>	350F, 350FD, 350R, 350RD, 35-ELECTRONIC, 35F, 35FD, 35R, 35RD, 400F, 400FD, 400R, 400RD, 40-ELECTRONIC, 40F, 40FD, 40R, 40RD		

				
1				
<b>GEV No.</b>	345577	<b>Ref. No.</b>	226122	
<b>description</b>	element holder mounting measurements 19.3x12.9mm black arched for push buttons 11x15.8			
<b>For models:</b>	GLS40H, GLS40HP, GSP50, GSP50P, HM1			
<b>accessories for</b>	345577			
	<b>GEV No.</b>	345578	<b>Ref. No.</b>	227078
	 push button mounting measurements 11x15.8mm orange for Element carrier			

			
1			
<b>GEV No.</b>	345627	<b>Ref. No.</b>	226101
<b>description</b>	element holder mounting measurements 20.6x16.4mm black arched for push buttons 13x17mm		

			
1			
<b>GEV No.</b>	346846	<b>Ref. No.</b>	226112
<b>description</b>	element holder mounting measurements 20.6x16.4mm blue arched for push buttons 13x17mm		
<b>For models:</b>	2312-001, 2312-002		

			
1			
<b>GEV No.</b>	345537	<b>Ref. No.</b>	226114
<b>description</b>	element holder mounting measurements 20.6x16.4mm grey arched for push buttons 13x17mm		
<b>For models:</b>	Fast181, ST70FASTHZ23		

			
1			
<b>GEV No.</b>	347150	<b>Ref. No.</b>	226113
<b>description</b>	element holder mounting measurements 23.6x14.6mm grey arched for push buttons 11x21mm		
<b>For models:</b>	913289, 913290, 913291, 913292, 913297, 913298, 913299, 913300, 913356, 913357, 913360, 913361, 913363, 913364, 913372, 913373, 913374, 913375, 913376, 913377, 913391, 913392, 913416, 913418, 913435, 913544, 913545, 913546, 913547, 913578, 913611, 913665, 913666, 913667, 913668, 913684, 913685, 913771, 913772, 913773, 913774, 913832, 913837, 913932, 913933, 913948, 914326, 914331, 914386, 914387...(Other models you can see in the webshop)		

			
1			
<b>GEV No.</b>	347151	<b>Ref. No.</b>	226121
<b>description</b>	element holder mounting measurements 23.6x14.6mm white arched for push buttons 11x21mm		
<b>For models:</b>	915160, 915161, 915162, 915175, 915176, 915177, 915319, 915338, 915341, 915418, 915419, 915611, 915612, 915613, 915663, 915670, 915686, 915687, 915688, 915689, 915690, 915691, 915692, 915693, 915694, 915695, 915696, 915697, 915698, 915699, 915700, 915701, 915702, 915729, 915756, 915799, 915800, 915816, 915817, 915818, 915819, 915830, 915842, 916162, FAST-135, Fast135CT, FAST-135CT, Fast135D, FAST-135D, Fast135H...(Other models you can see in the webshop)		



1

<b>GEV No.</b>	346201	<b>Ref. No.</b>	226080
<b>description</b>	element holder mounting measurements 28.5x77.5mm grey three-fold element holder		
<b>For models:</b>	LF50, LF55, PS-60		



1

<b>GEV No.</b>	345536	<b>Ref. No.</b>	226096
<b>description</b>	element holder mounting ø 16mm flat black		
<b>For models:</b>	MC201CL, MC501E, MC501EP, MC501S, MC501SP		



1

<b>GEV No.</b>	345603	<b>Ref. No.</b>	226074
<b>description</b>	element holder triple mounting measurements 28.5x77.5mm black for push buttons 23x23mm		
<b>For models:</b>	35-ELECTRONIC, 35F, 35FD, 35R, 35RD, 40-ELECTRONIC, 40F, 40FD, 40R, 40RD, 45, 450, 46, 460, 500F, 500FD, 50-ELECTRONIC, 50F, 50FD, 510F, 510FD, P500		



1

<b>GEV No.</b>	345601	<b>Ref. No.</b>	299035
<b>description</b>	indicator lamp holder V ø 11mm		
<b>For models:</b>	350F, 350FD, 350R, 350RD, 35-ELECTRONIC, 35F, 35FD, 35R, 35RD, 400F, 400FD, 400R, 400RD, 40-ELECTRONIC, 40F, 40FD, 40R, 40RD, 45, 450, 46, 460, 500F, 500FD, 50-ELECTRONIC, 50F, 50FD, 510F, 510FD, 67F, 67R, 915695, 915696, 915819, Fast145, FAST-145, Fast145D, FAST-145D, LF50, LF55, P500		



1

<b>GEV No.</b>	346241	<b>Ref. No.</b>	207011
<b>description</b>	indicator light lens ø 23.3mm yellow		
<b>For models:</b>	LF50, LF55		



1

<b>GEV No.</b>	345606	<b>Ref. No.</b>	226071
<b>description</b>	momentary switch unit 2CO 250V 16A connection male faston 6.3mm		
<b>For models:</b>	350F, 350FD, 350R, 350RD, 35-ELECTRONIC, 35F, 35FD, 35R, 35RD, 400F, 400FD, 400R, 400RD, 40-ELECTRONIC, 40F, 40FD, 40R, 40RD, 45, 450, 46, 460, 500F, 500FD, 50-ELECTRONIC, 50F, 50FD, 510F, 510FD, 67F, 67R, 915160, 915161, 915162, 915175, 915176, 915177, 915319, 915338, 915341, 915418, 915419, 915611, 915612, 915613, 915663, 915670, 915686, 915687, 915688...(Other models you can see in the webshop)		



1

<b>GEV No.</b>	345650	<b>Ref. No.</b>	226093 226095
<b>description</b>	momentary switch unit 2CO 250V 16A connection male faston 6.3mm		
<b>For models:</b>	2312-001, 2312-002, 913289, 913290, 913291, 913292, 913297, 913298, 913299, 913300, 913356, 913357, 913360, 913361, 913363, 913364, 913372, 913373, 913374, 913375, 913376, 913377, 913391, 913392, 913416, 913418, 913435, 913544, 913545, 913546, 913547, 913578, 913611, 913665, 913666, 913667, 913668, 913684, 913685, 913771, 913772, 913773, 913774, 913832, 913837, 913932, 913933, 913948, 914326, 914331...(Other models you can see in the webshop)		



1

<b>GEV No.</b>	345578	<b>Ref. No.</b>	227078
<b>description</b>	push button mounting measurements 11x15.8mm orange for Element carrier		
<b>For models:</b>	GLS40H, GLS40HP, GSP50, GSP50P, HM1		
<b>accessories for</b>	345578		
	<b>GEV No.</b>	345577	<b>Ref. No.</b>
			226122
	element holder mounting measurements 19.3x12.9mm black arched for push buttons 11x15.8		





1

<b>GEV No.</b>	346816	<b>Ref. No.</b>	227035
<b>description</b>	push button ø 23mm black		
<b>For models:</b>	PS-60		







			
1			
<b>GEV No.</b>	347152	<b>Ref. No.</b>	227067
<b>description</b>	push button size 11x21mm blue		
<b>For models:</b>	913289, 913290, 913291, 913292, 913297, 913298, 913299, 913300, 913356, 913357, 913360, 913361, 913363, 913364, 913372, 913373, 913374, 913375, 913376, 913377, 913391, 913392, 913416, 913418, 913435, 913544, 913545, 913546, 913547, 913578, 913611, 913665, 913666, 913667, 913668, 913684, 913685, 913771, 913772, 913773, 913774, 913832, 913837, 913932, 913933, 913948, 914326, 914331, 914386, 914387...(Other models you can see in the webshop)		

			
1			
<b>GEV No.</b>	347922	<b>Ref. No.</b>	227077
<b>description</b>	push button size 11x21mm silver		

			
1			
<b>GEV No.</b>	345621	<b>Ref. No.</b>	227056
<b>description</b>	push button size 17x13mm black		

			
1			
<b>GEV No.</b>	345539	<b>Ref. No.</b>	227068
<b>description</b>	push button size 17x13mm grey		
<b>For models:</b>	2312-001, 2312-002		

			
1			
<b>GEV No.</b>	346035	<b>Ref. No.</b>	227062
<b>description</b>	push button size 17x13mm silver		

			
1			
<b>GEV No.</b>	345613	<b>Ref. No.</b>	227030
<b>description</b>	push button size 23x23mm black drain pump		
<b>For models:</b>	45, 450, 46, 460, 500F, 500FD, 50-ELECTRONIC, 50F, 50FD, 510F, 510FD, P500		

			
1			
<b>GEV No.</b>	345660	<b>Ref. No.</b>	227031
<b>description</b>	push button size 23x23mm black flash with lens		
<b>For models:</b>	P500		

			
1			
<b>GEV No.</b>	345607	<b>Ref. No.</b>	207025 227025
<b>description</b>	push button size 23x23mm black main switch with lens		
<b>For models:</b>	350F, 350FD, 350R, 350RD, 35-ELECTRONIC, 35F, 35FD, 35R, 35RD, 400F, 400FD, 400R, 400RD, 40-ELECTRONIC, 40F, 40FD, 40R, 40RD, 45, 450, 46, 460, 500F, 500FD, 50-ELECTRONIC, 50F, 50FD, 510F, 510FD		

			
1			
<b>GEV No.</b>	345615	<b>Ref. No.</b>	227033
<b>description</b>	push button size 23x23mm black programme		
<b>For models:</b>	46, 460, 500F, 500FD, 50-ELECTRONIC, 50F, 50FD, 510F, 510FD, P500		

			
1			
<b>GEV No.</b>	345611	<b>Ref. No.</b>	227029
<b>description</b>	push button size 23x23mm black rinsing		
<b>For models:</b>	350F, 350FD, 350R, 350RD, 35-ELECTRONIC, 35F, 35FD, 35R, 35RD, 400F, 400FD, 400R, 400RD, 40-ELECTRONIC, 40F, 40FD, 40R, 40RD, 45, 450, 46, 460, 500F, 500FD, 50F, 50FD, 510F, 510FD		

			
1			
<b>GEV No.</b>	345609	<b>Ref. No.</b>	227027
<b>description</b>	push button size 23x23mm black START		
<b>For models:</b>	350F, 350FD, 350R, 350RD, 35-ELECTRONIC, 35F, 35FD, 35R, 35RD, 400F, 400FD, 400R, 400RD, 40-ELECTRONIC, 40F, 40FD, 40R, 40RD, 45, 450, 46, 460, 500F, 500FD, 50-ELECTRONIC, 50F, 50FD, 510F, 510FD		



1

<b>GEV No.</b>	345661	<b>Ref. No.</b>	227032
<b>description</b>	push button size 23x23mm black timer		
<b>For models:</b>	P500		



1

<b>GEV No.</b>	347878	<b>Ref. No.</b>	227072
<b>description</b>	push button size 23x23mm grey with lens		



1

<b>GEV No.</b>	346847	<b>Ref. No.</b>	409003
<b>description</b>	rotary disc green/black disc ø 18.7mm		



1

<b>GEV No.</b>	345608	<b>Ref. No.</b>	409001
<b>description</b>	rotary disc green/black disc ø 20.6mm		
<b>For models:</b>	350F, 350FD, 350R, 350RD, 35-ELECTRONIC, 35F, 35FD, 35R, 35RD, 400F, 400FD, 400R, 400RD, 40-ELECTRONIC, 40F, 40FD, 40R, 40RD, 45, 450, 46, 460, 500F, 500FD, 50-ELECTRONIC, 50F, 50FD, 510F, 510FD, 67F, 67R, LF50, LF55, P500		



1

<b>GEV No.</b>	345605	<b>Ref. No.</b>	208010
<b>description</b>	switch 2CO 250V 16A connection male faston 6.3mm		
<b>For models:</b>	350F, 350FD, 350R, 350RD, 35-ELECTRONIC, 35F, 35FD, 35R, 35RD, 400F, 400FD, 400R, 400RD, 40-ELECTRONIC, 40F, 40FD, 40R, 40RD, 45, 450, 46, 460, 500F, 500FD, 50-ELECTRONIC, 50F, 50FD, 510F, 510FD, 67F, 67R, 915160, 915161, 915162, 915175, 915176, 915177, 915319, 915338, 915341, 915418, 915419, 915611, 915612, 915613, 915663, 915670, 915686, 915687, 915688...(Other models you can see in the webshop)		



1

<b>GEV No.</b>	345651	<b>Ref. No.</b>	208011
<b>description</b>	switch 2CO 250V 16A connection male faston 6.3mm		
<b>For models:</b>	2312-001, 2312-002, 913289, 913290, 913291, 913292, 913297, 913298, 913299, 913300, 913356, 913357, 913360, 913361, 913363, 913364, 913372, 913373, 913374, 913375, 913376, 913377, 913391, 913392, 913416, 913418, 913435, 913544, 913545, 913546, 913547, 913578, 913611, 913665, 913666, 913667, 913668, 913684, 913685, 913771, 913772, 913773, 913774, 913832, 913837, 913932, 913933, 913948, 914326, 914331...(Other models you can see in the webshop)		



1

<b>GEV No.</b>	346851	<b>Ref. No.</b>	80804
<b>description</b>	switch 2CO 250V 16A connection male faston 6.3mm		
<b>For models:</b>	CE78HZ23, E78, E78HP, Fast181, FAST-181, Fast181-230V-3Ph-60Hz, Fast181-400V-3NPh-60Hz, FAST-60, FAST-73, HM1, PLUVIA-280, Pluvia280-230V-3PH-60HZ, PS-60, PV280, PV280FAST, PV280FASTCH, PV280FASTHB, PV280HZ23, RIVER-78, RIVER-E78, ST70FAST, ST-70FASTHB, ST70FASTHB400, ST70FASTHZ23		

## system switches

## ELETTROBAR

## fascias



1

<b>GEV No.</b>	345655	<b>Ref. No.</b>	480096
<b>description</b>	blank grey format rectangular mounting measurements 24x34mm		
<b>For models:</b>	E.35, E.35H, E.40, E.40H, E.41, E.42, E.45, E.46, E.50, E.51, E.52		



1

<b>GEV No.</b>	345652	<b>Ref. No.</b>	480095
<b>description</b>	blank grey format square mounting measurements 25x25mm		
<b>For models:</b>	E.35, E.35H, E.40, E.41, E.42, E.45, E.46, E.50, E.51, E.52		



push buttons

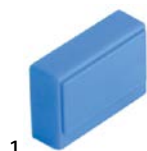

1

<b>GEV No.</b>	345658	<b>Ref. No.</b>	227052
<b>description</b>	push button		
<b>For models:</b>	E.35, E.35H, E.40, E.40H, E.41, E.42, E.45, E.46, E.50, E.51, E.52, E.60, E.65, E1, E10, E100, E110, E12, E120, E14, E140		



1

<b>GEV No.</b>	345659	<b>Ref. No.</b>	227051
<b>description</b>	push button		
<b>For models:</b>	E.35, E.35H, E.40, E.40H, E.41, E.42, E.45, E.46, E.50, E.51, E.52, E.60, E.65, E1, E10, E100, E110, E12, E120, E14, E140, RIVER-78, U132, U61, U61H, U70		



1

<b>GEV No.</b>	347523	<b>Ref. No.</b>	227050
<b>description</b>	push button black ø 12mm H 7mm		
<b>For models:</b>	MC201CL, MC501E, MC501EP, MC501S, MC501SP, TF-503		



1

<b>GEV No.</b>	347522	<b>Ref. No.</b>	226092
<b>description</b>	push button green ø 20mm H 11mm		
<b>For models:</b>	CLEAN-3		



1

<b>GEV No.</b>	347922	<b>Ref. No.</b>	227077
<b>description</b>	push button size 11x21mm silver		

element holders



1

<b>GEV No.</b>	345653	<b>Ref. No.</b>	226098
<b>description</b>	element holder grey format square illuminable L.26 suitable for E35/4 E46/E50/E51		
<b>For models:</b>	E.35, E.35H, E.40, E.40H, E.41, E.42, E.45, E.46, E.50, E.51, E.52		

cam switches

3 operating positions



1

<b>GEV No.</b>	345670	<b>Ref. No.</b>	923011
<b>description</b>	cam switch 3 operating positions 1CO sequence 1-0-2 16A shaft ø 6x4.6mm shaft L 23mm connection male faston 6.3mm		
<b>For models:</b>	412		

rotary switches

BREMAS

A1200 series



1

<b>GEV No.</b>	345547	<b>Ref. No.</b>	213001
<b>description</b>	rotary switch sets of contacts 1 2 0-1 type CA0120001 380V 12A shaft ø 5x5mm shaft L 23mm shaft square connection screw		
<b>For models:</b>	337, 338, 343, 344, 404, 406, ME15, ME20, ME30, ME40		



1

<b>GEV No.</b>	345274	<b>Ref. No.</b>	213003
<b>description</b>	rotary switch sets of contacts 4 2 0-1 type CA0120004 380V 12A shaft ø 5x5mm shaft L 23mm shaft square connection screw		
<b>For models:</b>	22F, 22R, 40F, R708		



1

<b>GEV No.</b>	300326	<b>Ref. No.</b>	927034
<b>description</b>	rotary switch sets of contacts 6 0-1-2-3 type CS012015B 400V 12A shaft $\varnothing$ 5x5mm shaft L 18mm		
<b>For models:</b>	161, 221, 271, 272, 362, CLEAN-160, CLEAN-161, CLEAN-220, CLEAN-221, CLEAN-270, CLEAN-271, CLEAN-272, CLEAN-362		



1

<b>GEV No.</b>	345916	<b>Ref. No.</b>	926182
<b>description</b>	rotary switch sets of contacts 6 6 1-2-3-4-5-6 type CS0128618 600V 12A shaft $\varnothing$ 5x5mm shaft L 15mm shaft square connection screw		
<b>For models:</b>	E.60, E.65, E1, E10, E100, E110, E12, E120, E14, E140		

## A1600 series



1

<b>GEV No.</b>	347401	<b>Ref. No.</b>	205004
<b>description</b>	rotary switch 4 momentary switch-0-1-momentary switch sets of contacts 8 type CS0077762 600V 16A shaft $\varnothing$ 5x5mm shaft L 22mm shaft square connection screw		
<b>For models:</b>	22F, 22R, 40F, PS-60		

## VM



1

<b>GEV No.</b>	345619	<b>Ref. No.</b>	205010
<b>description</b>	rotary switch 5 1-2-3-4-5 sets of contacts 15 type P302255 400V 16A shaft $\varnothing$ 4x5mm shaft L 15mm shaft square connection screw		
<b>For models:</b>	CLEAN-3		

## miscellaneous



1

<b>GEV No.</b>	347689	<b>Ref. No.</b>	213002
<b>description</b>	rotary switch sets of contacts 2 2 0-1 type CS20-00063 690V 25A shaft $\varnothing$ 5x5mm shaft L 22mm shaft square connection male faston 6.3mm		
<b>For models:</b>	10, 12, 66, CLEAN-100, CLEAN-110, CLEAN-120, R495, R499, R501, R503, R505, R507, R509, R511, R704, R706, S641, S643, S870		

## magnetic switches

## 36x13mm



1

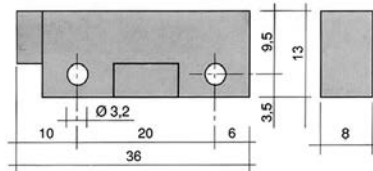

<b>GEV No.</b>	345118 <sup>1</sup>	<b>Ref. No.</b>	211002 211002AG 80871
<b>description</b>	magnetic switch L 36mm W 13mm 1NO 250V 1A P max. 50W connection cable cable length 980mm		
<b>For models:</b>	050F, 050FP, 21F, 21FD, 21R, 21RD, 2312-001, 2312-002, 2312-007, 2312-009-CRP, 25F, 25FD, 25R, 25RD, 30F, 30FD, 30R, 30RD, 31F, 31FD, 31R, 31RD, 350F, 350FD, 350R, 350RD, 35-ELECTRONIC, 35F, 35FD, 35R, 35RD, 400F, 400FD, 400R, 400RD, 40-ELECTRONIC, 40F, 40FD, 40R, 40RD, 440F, 44F, 45, 450, 46, 460, 500F, 500FD, 50-ELECTRONIC, 50F... (Other models you can see in the webshop)		
<b>accessories for</b>	345118		
	<b>GEV No.</b>	345399	<b>Ref. No.</b> 927088 CWM7
	magnet $\varnothing$ 3.3mm L 40mm H 8mm W 13mm hole distance 30mm M3		

<sup>1</sup>with coded connector

## 65x20mm



1

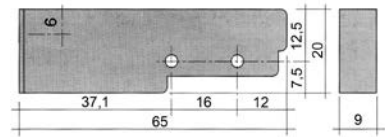

<b>GEV No.</b>	347876	<b>Ref. No.</b>	927056
<b>description</b>	magnetic switch L 65mm W 20mm 1NC 24V 4A P max. 100W connection cable cable length 1940mm		
<b>For models:</b>	161, 221, 271, 272, 362, CLEAN-160, CLEAN-161, CLEAN-220, CLEAN-221, CLEAN-270, CLEAN-271, CLEAN-272, CLEAN-362		

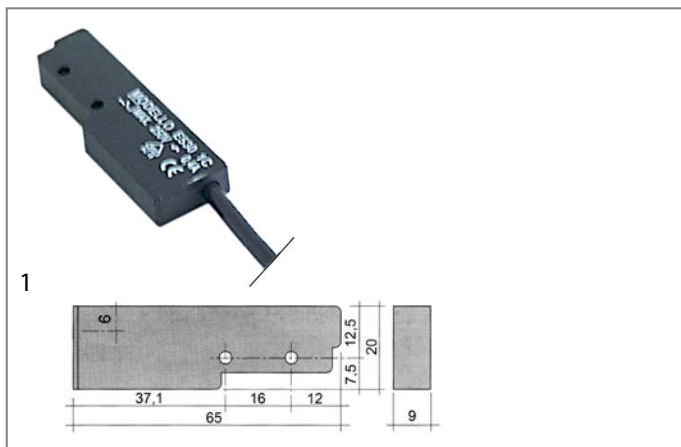

<b>GEV No.</b>	345116	<b>Ref. No.</b>	927017
<b>description</b>	magnetic switch L 65mm W 20mm 1NO 250V 0.4A P max. 100W connection cable length 3000mm		
<b>For models:</b>	161, 221, 271, 272, 362, CLEAN-160, CLEAN-161, CLEAN-220, CLEAN-221, CLEAN-270, CLEAN-271, CLEAN-272, CLEAN-361, CLEAN-361P, CLEAN-362, CLEAN-471, CLEAN-471P, RIVER-150, RV150, U132, U132E, U61, U61E, U61H, U61HE, U70, U70E		
<b>accessories for</b>	345116		
	<b>GEV No.</b>	345399	<b>Ref. No.</b> 927088 CWM7
	magnet ø 3.3mm L 40mm H 8mm W 13mm hole distance 30mm M3		



<b>GEV No.</b>	345202	<b>Ref. No.</b>	DEM2038
<b>description</b>	magnetic switch 250V 0.04A P max. 10W probe L 29mm 1NO connection plug cable length 1400mm		



<b>GEV No.</b>	345630	<b>Ref. No.</b>	926195
<b>description</b>	magnetic switch 250V 0.04A P max. 10W probe L 29mm 1NO connection plug cable length 350mm		
<b>For models:</b>	E.60, E.65, E100, E110, E120, E140		
<b>accessories for</b>	345630		
	<b>GEV No.</b>	345336	<b>Ref. No.</b> 926014
	magnet ø 4.8mm L 63mm H 11mm W 18.8mm hole distance 51mm M4		



<b>GEV No.</b>	345146	<b>Ref. No.</b>	211001
<b>description</b>	magnetic switch 250V 1A P max. 50W probe L 29mm 1NO connection plug cable length 980mm		
<b>For models:</b>	10, 11F, 11FD, 11F-DVGW, 11R, 11RD, 12, 14, 22F, 22R, 2312-007, 2312-009-CRP, 40F, 914100, 914101, 914339, 914342, 914343, 914624, 914625, 914626, 914627, 914628, 914850, 914851, 914854, 914944, CLEAN-100, CLEAN-110, CLEAN-120, E1, E10, E100, E110, E12, E120, E14, E140, RIVER-48, RIVER-50, RIVER-50-CRP, RIVER-50-CRP-SP, River-54, RIVER-54CRP, River-54-CRP-s.p., RIVER-54-CRP-SP, RIVER-61		

accessories

magnets

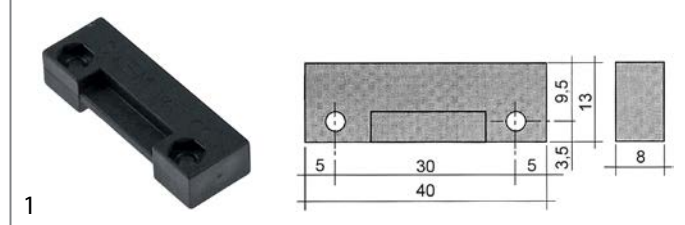

<b>GEV No.</b>	345399	<b>Ref. No.</b>	927088 CWM7
<b>description</b>	magnet ø 3.3mm L 40mm H 8mm W 13mm hole distance 30mm M3		
<b>For models:</b>	161, 221, 271, 272, 362, 80, 81, 82, 914380, 914436, A3EB, A3EBD, A3EBDAKRKYK, A3EBDAKWK, A3EBDBKWK, A3EBDRKYK, A3EBDWK, A3EBDYK, A3EBSAK, A3EBSAKRK, A3EBSAKWK, A3EBSBKWKYK, A3EBSEKWK, A3EBSWK, A4EB, A4EBD, A4EBDAKEKYK, A4EBDAKRK, A4EBDAKWK, A4EBDAKZK, A4EBDBKRK, A4EBDPKWKYK, A4EBDRK, A4EBS, A4EBSAK, A4EBSAKCK, A4EBSAKEKYK, A4EBSAKRK, A4EBSAKRKP, A4EBSAKYK, A4EBSCK, A4EBT, A4EBTSAK, A5EB, A5EBD, A5EBDAKPKWK, A5EBDAKWK, A5EBDAKYK, A5EBDRK, A5EBS...(Other models you can see in the webshop)		

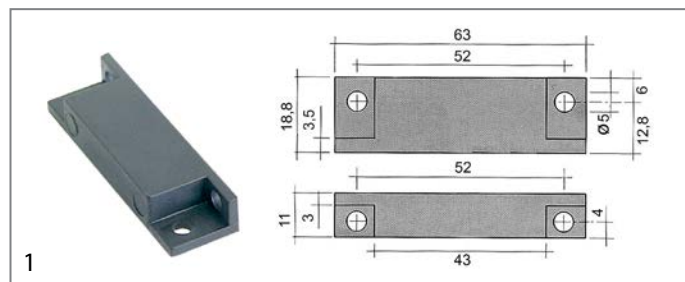

<b>GEV No.</b>	345336	<b>Ref. No.</b>	926014
<b>description</b>	magnet ø 4.8mm L 63mm H 11mm W 18.8mm hole distance 51mm M4		
<b>For models:</b>	10, 12, 161, 221, 271, 272, 362, 914380, 914436, A3EB, A3EBD, A3EBDAKRKYK, A3EBDAKWK, A3EBDBKWK, A3EBDRKYK, A3EBDWK, A3EBDYK, A3EBSAK, A3EBSAKRK, A3EBSAKWK, A3EBSBKWKYK, A3EBSEKWK, A3EBSWK, A4EB, A4EBD, A4EBDAKEKYK, A4EBDAKRK, A4EBDAKWK, A4EBDAKZK, A4EBDBKRK, A4EBDPKWKYK, A4EBDRK, A4EBS, A4EBSAK, A4EBSAKCK, A4EBSAKEKYK, A4EBSAKRK, A4EBSAKRKP, A4EBSAKYK, A4EBSCK, A4EBT, A4EBTSAK, A5EB, A5EBD, A5EBDAKPKWK, A5EBDAKWK, A5EBDAKYK, A5EBDRK, A5EBS, A5EBSAKPKWK...(Other models you can see in the webshop)		



1

<b>GEV No.</b>	346953	<b>Ref. No.</b>	999108
<b>description</b>	magnet ømm L 23mm H 17mm W 18mm M6 hole ø 6.5mm		
<b>For models:</b>	050F, 050FP, 11F, 11FD, 11R, 11RD, 2312-001, 2312-002, 45, 450, 46, 460, 500F, 500FD, 510F, 510FD, 913297, 913298, 913299, 913300, 913360, 913361, 913391, 913392, 913418, 913546, 913547, 913578, 913611, 913684, 913913, 913914, 913932, 913933, 914167, 914168, 914284, 914318, 914319, 914326, 914331, 914338, 914356, 914398, 914399, 914400, 914401, 914402, 914403, 914404...(Other models you can see in the webshop)		



1

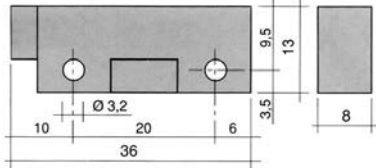

<b>GEV No.</b>	345398	<b>Ref. No.</b>	217003
<b>description</b>	magnet ømm L 36mm H 8mm W 13mm hole distance 20mm M3 hole ø 3mm		
<b>For models:</b>	2312-007, 2312-009-CRP, 914100, 914101, 914214, 914316, 914317, 914339, 914342, 914343, 914624, 914625, 914626, 914627, 914628, 914850, 914851, 914854, 914874, 914944, Mistral40, MISTRAL-40, PS-60, RIVER-48, RIVER-50, RIVER-50-CRP, RIVER-50-CRP-SP, River-54, RIVER-54CRP, River-54-CRP-s.p., RIVER-54-CRP-SP, RIVER-61		

## control equipment

### GENERAL ELECTRIC (AEG)

#### push buttons



1

<b>GEV No.</b>	347486	<b>Ref. No.</b>	927308
<b>description</b>	push button mounting measurements ø22mm round red		
<b>For models:</b>	CLEAN-161, CLEAN-221, CLEAN-271, CLEAN-272, CLEAN-362		



1

<b>GEV No.</b>	345779	<b>Ref. No.</b>	927035 927036
<b>description</b>	contact block GENERAL ELECTRIC P9B10VN 1NO max 400V 10A brown		
<b>For models:</b>	161, 221, 271, 272, 362, CLEAN-160, CLEAN-161, CLEAN-220, CLEAN-221, CLEAN-270, CLEAN-271, CLEAN-272, CLEAN-361, CLEAN-361P, CLEAN-362, CLEAN-471, CLEAN-471P, RIVER-HL-82		

## lamps

### indicator lights

#### indicator lights 2-piece (lens and indicator lamp)

##### indicator light lenses

ø12mm (type SDY-3)



1

<b>GEV No.</b>	359262	<b>Ref. No.</b>	926114
<b>description</b>	indicator light housings mounting measurements ø12mm green round Qty 1 pcs		



1

<b>GEV No.</b>	359260	<b>Ref. No.</b>	926115
<b>description</b>	indicator light housings mounting measurements ø12mm yellow round Qty 1 pcs		
<b>For models:</b>	161, 221, 271, 272, 362, CLEAN-161, CLEAN-221, CLEAN-271, CLEAN-272, CLEAN-362, E.60, E.65, E1, E10, E100, E110, E12, E120, E14, E140		

#### indicator lamps for socket type SRZ / SDK / SDY / SFK



1

<b>GEV No.</b>	359130	<b>Ref. No.</b>	216006 926113
<b>description</b>	indicator lamp 230V clear connection male faston 6.3mm ø 8mm		
<b>For models:</b>	350F, 350FD, 350R, 350RD, 35-ELECTRONIC, 35F, 35FD, 35R, 35RD, 400F, 400FD, 400R, 400RD, 40-ELECTRONIC, 40F, 40FD, 40R, 40RD, 45, 450, 46, 460, 500F, 500FD, 50-ELECTRONIC, 50F, 50FD, 510F, 510FD, 67F, 67R, LF50, LF55, P500		



1

<b>GEV No.</b>	359129	<b>Ref. No.</b>	927334
<b>description</b>	indicator lamp 24V clear connection male faston 6.3mm		
<b>For models:</b>	161, 221, 271, 272, 362, CLEAN-161, CLEAN-221, CLEAN-271, CLEAN-272, CLEAN-362		

#### indicator lights 3-piece (housing, lens and bulb)

##### lamps

##### neon light bulbs





1

<b>GEV No.</b>	345958	<b>Ref. No.</b>	216011
<b>description</b>	neon light bulb socket Ba9s 230V ø 10mm L 28mm		
<b>For models:</b>	S850, S870, S950		

indicator lights (complete)

ø 6mm

			
1			
<b>GEV No.</b>	359005	<b>Ref. No.</b>	216003 216025
<b>description</b>	indicator light ø 6mm 230V yellow cable length 400mm		
<b>For models:</b>	11F, 11FD, 11F-DVGW, 11R, 11RD, 2312-001, 2312-002, 913289, 913290, 913291, 913292, 913297, 913298, 913299, 913300, 913356, 913357, 913360, 913361, 913363, 913364, 913372, 913373, 913374, 913375, 913376, 913377, 913391, 913392, 913416, 913418, 913435, 913544, 913545, 913546, 913547, 913578, 913611, 913665, 913666, 913667, 913668, 913684, 913685, 913771, 913772, 913773, 913774, 913832, 913837...(Other models you can see in the webshop)		

			
1			
<b>GEV No.</b>	360735	<b>Ref. No.</b>	216032
<b>description</b>	indicator light ø 6mm yellow 12V cable length 280mm		
<b>For models:</b>	915160, 915161, 915162, 915175, 915319, 915611, 915612, 915613, 915663, 915670, 916247, 916248, 916249, 916250, 916251, 916252, 916365, 916366, 916382, 916383, 916452, 916504, 916584, 916670, 916688, 916763, 917044, 917049, Clean161, Fast160-2, Fast161-2, Fast170, Fast170S, Pluvia-240, Pluvia-260, Pluvia-270		

			
1			
<b>GEV No.</b>	345960	<b>Ref. No.</b>	216022
<b>description</b>	indicator light ø 6mm 230V green		
<b>For models:</b>	CLEAN-3		

			
1			
<b>GEV No.</b>	359031	<b>Ref. No.</b>	926286 DEL15
<b>description</b>	indicator light ø 6mm 230V green		
<b>For models:</b>	CE78HZ23, E78, E78HP, RIVER-78, RIVER-E78		

			
1			
<b>GEV No.</b>	359032	<b>Ref. No.</b>	DEL13
<b>description</b>	indicator light ø 6mm 230V yellow		

ø10mm

with plug-in socket

			
1			
<b>GEV No.</b>	359140	<b>Ref. No.</b>	216018
<b>description</b>	indicator light ø 10mm yellow 230V connection male faston 6.3mm Qty 1 pcs		
<b>For models:</b>	10, 12, 14, 22F, 22R, 40F, 66, CLEAN-100, CLEAN-110, CLEAN-120		

ø12mm

with plug-in socket

			
1			
<b>GEV No.</b>	359044	<b>Ref. No.</b>	216020
<b>description</b>	indicator light ø 12mm clear 230V connection male faston 6.3mm temp.-resist. 120°C Qty 1 pcs		
<b>For models:</b>	22F, 22R, 40F, 66		

			
1			
<b>GEV No.</b>	359041	<b>Ref. No.</b>	216019
<b>description</b>	indicator light ø 12mm green 230V connection male faston 6.3mm temp.-resist. 120°C Qty 1 pcs		
<b>For models:</b>	22F, 22R, 40F, 66		

			
1			
<b>GEV No.</b>	359042	<b>Ref. No.</b>	216012 216016
<b>description</b>	indicator light ø 12mm yellow 230V connection male faston 6.3mm temp.-resist. 120°C Qty 1 pcs		
<b>For models:</b>	305, 305S, 306, 306S, 307, 307S, 308, 308S, 313, 313S, 314, 314S, 319, 319S, 320, 320S, 337, 338, 343, 344, 433, 434, 436, 437, 438, 439, FRI12, FRI12+12, FRI15, FRI15M, FRI6, FRI6+6, FRI9, FRI9+9, G33, G34, G37, G38, G39, ME15, ME20, ME30, ME40		

28.5x28.5mm

			
1			
<b>GEV No.</b>	345610	<b>Ref. No.</b>	207007
<b>description</b>	indicator light lens 23x23 orange operating		
<b>For models:</b>	350F, 350FD, 350R, 350RD, 35-ELECTRONIC, 35F, 35FD, 35R, 35RD, 400F, 400FD, 400R, 400RD, 40-ELECTRONIC, 40F, 40FD, 40R, 40RD, 45, 450, 46, 460, 500F, 500FD, 50-ELECTRONIC, 50F, 50FD, 510F, 510FD, P500		

			
1			
<b>GEV No.</b>	345616	<b>Ref. No.</b>	207010
<b>description</b>	indicator light lens 23x23 orange Sinus		

			
1			
<b>GEV No.</b>	345614	<b>Ref. No.</b>	410008
<b>description</b>	indicator light lens orange heating		
<b>For models:</b>	450, 46, 460, 500F, 500FD, 50F, 50FD, 510F, 510FD		



1

<b>GEV No.</b>	345617	<b>Ref. No.</b>	207009
<b>description</b>	indicator light lens orange thermometer		
<b>For models:</b>	P500		

## miscellaneous



1

<b>GEV No.</b>	359006	<b>Ref. No.</b>	226006
<b>description</b>	indicator light white 230V		
<b>For models:</b>	31F, 31FD, 31R, 31RD, 440F, 44F, S621, S623, S624, S626, S631, S633, S634, S636, S641, S643, S651, S651P, S653, S654, S655, S810, S815, S830, S835, S850, S870, S950, SR651		

## LED

## indicator lamps

## mounting diameter 6mm



1

<b>GEV No.</b>	359404	<b>Ref. No.</b>	216028
<b>description</b>	indicator light LED mounting ø 6mm 5VDC green connection cable 200mm 2mA		
<b>For models:</b>	CE78HZ23, E.35H, E.40H, E78, E78HP, Fast181, FAST-181, Fast181-230V-3Ph-60Hz, Fast181-400V-3NPh-60Hz, HM1, PS-60, RIVER-E78, ST70FAST, ST70FASTHB, ST70FASTHB400, ST70FASTHZ23		



1

<b>GEV No.</b>	358098	<b>Ref. No.</b>	216029
<b>description</b>	indicator light LED mounting ø 6mm 5VDC yellow connection cable 200mm 2mA		
<b>For models:</b>	CE78HZ23, E.35H, E.40H, E78, E78HP, Fast180, Fast180-230V-3Ph-60Hz, Fast181, FAST-181, Fast181-230V-3Ph-60Hz, Fast181-400V-3NPh-60Hz, FAST-60, FAST-73, HM1, PLUVIA-280, Pluvia280-230V-3Ph-60Hz, PS-60, PV280, PV280FAST, PV280FAST2, PV280FAST2BIO, PV280FAST2HZ23, PV280FASTCH, PV280FASTHB, PV280HZ23, RIVER-E78, ST70FAST, ST70FASTHB, ST70FASTHB400, ST70FASTHZ23		

## screw-on/push-on fit

## neon light bulbs



1

<b>GEV No.</b>	345958	<b>Ref. No.</b>	216011
<b>description</b>	neon light bulb socket Ba9s 230V ø 10mm L 28mm		
<b>For models:</b>	S850, S870, S950		

## timers

## programme timers



1

<b>GEV No.</b>	360005	<b>Ref. No.</b>	238011 238052
<b>description</b>	timer BIGATTI D94 engines 1 chambers 1 operation time 20min 230V shaft ømm shaft Lmm manif. no. WE006 motor type 82354021L		
<b>For models:</b>	11F, 11FD, 11R, 11RD, 21F, 21FD, 21R, 21RD, 25F, 25FD, 25R, 25RD, 30F, 30FD, 30R, 30RD, 31F, 31FD, 31R, 31RD, 350F, 350FD, 350R, 350RD, 35-ELECTRONIC, 35F, 35FD, 35R, 35RD, 400F, 400FD, 400R, 400RD, 40-ELECTRONIC, 40F, 40FD, 40R, 40RD, 45, 450, 50-ELECTRONIC, 50F, 50FD, 67F, 67R, 913289, 913290, 913291, 913292, 913356...(Other models you can see in the webshop)		



1

<b>GEV No.</b>	360260	<b>Ref. No.</b>	DTP31
<b>description</b>	timer BIGATTI D94 engines 1 chambers 3 operation time 18min 230V shaft ømm shaft Lmm manif. no. COL001 motor type 82394831		



1

<b>GEV No.</b>	360004	<b>Ref. No.</b>	238003
<b>description</b>	timer BIGATTI D94 engines 2 chambers 4 operation time 108s/168s 220-240V shaft ømm shaft Lmm manif. no. SER009 / 238003 motor type 82354018R / 82354017L		
<b>For models:</b>	S651P, S810, S815, S830, S835		







1

<b>GEV No.</b>	360298	<b>Ref. No.</b>	238030
<b>description</b>	timer BIGATTI D94 engines 2 chambers 4 operation time 3min/6min/9min 230V shaft ømm shaft Lmm manif. no. WE004 motor type UDS40NE1LK operation time 3/6/9min		
<b>For models:</b>	S950		



1

<b>GEV No.</b>	360349	<b>Ref. No.</b>	238046 238046.AG 238053 REB238046 REB238053
<b>description</b>	timer CDC 11803 engines 1 chambers 3 operation time 150s 230V shaft ømm shaft Lmm manif. no. 11803F1BEE000.0010 motor type M48R ATS type 11803F1 / 238046		
<b>For models:</b>	11F, 11FD, 11R, 11RD, 21F, 21FD, 21R, 21RD, 25F, 25FD, 25R, 25RD, 30F, 30FD, 30R, 30RD, 31F, 31FD, 31R, 31RD, 350F, 350FD, 350R, 350RD, 400F, 400FD, 400R, 400RD, 450, 913289, 913290, 913291, 913292, 913356, 913357, 913363, 913364, 913372, 913373, 913374, 913375, 913376, 913377, 913416, 913418, 913435, 913544, 913545, 913665, 913666...(Other models you can see in the webshop)		
<b>spare parts for</b>	360349		
	<b>GEV No.</b>	360673	<b>Ref. No.</b> —
	motor kit pinion ø 6.8mm teeth 15 230V voltage AC 50/60Hz turn direction clockwise motor ø 48mm H 18.5mm motor type UDS-40NE1RNZ165 cable length 150mm with holder		







1

<b>GEV No.</b>	360723	<b>Ref. No.</b>	RTFOC00030
<b>description</b>	timer CDC 11903F3 engines 1 chambers 3 operation time 80min 230V shaft ø 6x4.6mm shaft L 18mm manif. no. 11903F3EVE000.0000		



1



<b>GEV No.</b>	360025	<b>Ref. No.</b>	238049 238050 238050.AG
<b>description</b>	timer CDC 7003F engines 1 chambers 3 operation time 360s 230V 50Hz shaft ø 6x7mm shaft L 26mm manif. no. 7003F3 / 360025 motor type M37LN		
<b>For models:</b>	10, 12, 22F, 22R, 40F, 66, CLEAN-100, CLEAN-110, CLEAN-120		
<b>spare parts for</b>	360025		
	<b>GEV No.</b>	360131	<b>Ref. No.</b> —
	motor CDC pinion ø 5.4mm teeth 12 230V turn direction left motor ø 37mm motor type M37LN for timer		
<b>accessories for</b>	360025		
	<b>GEV No.</b>	110085	<b>Ref. No.</b> 226051
	push button t.max.°C°C ø 36mm shaft ømm shaft flat grey for knob		
	<b>GEV No.</b>	110086	<b>Ref. No.</b> 447089
	knob switch zero mark t.max.°C°C ø 45mm shaft ømm shaft flat special black		
	<b>GEV No.</b>	110087	<b>Ref. No.</b> 499066
	retaining ring shaft ø 8mm DIN 471		





1

<b>GEV No.</b>	360132	<b>Ref. No.</b>	238060
<b>description</b>	timer CDC 7801 engines 1 chambers 1 operation time 20min 230V shaft ømm shaft Lmm manif. no. 7801F1 / 360132 motor type M37RN		
<b>For models:</b>	46, 500F, 500FD, 50F, 50FD, 510F, 510FD		
<b>spare parts for</b>	360132		
	<b>GEV No.</b>	360119	<b>Ref. No.</b> —
	motor CDC pinion ø 5.4mm teeth 12 230V turn direction right motor ø 37mm motor type M37RN for timer		



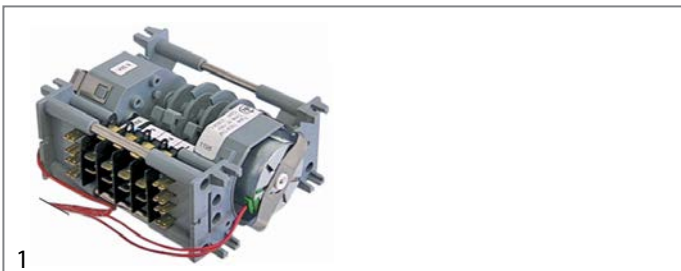

<b>GEV No.</b>	360133	<b>Ref. No.</b>	238066
<b>description</b>	timer CDC 7804DV engines 2 chambers 4 operation time 60s / 20min 230V shaft ømm shaft Lmm manif. no. 7804DV / 360133 motor type M37RN/M37LN		
<b>For models:</b>	2312-001, 2312-002, 460, 500F, 500FD, 510F, 510FD, 913297, 913298, 913299, 913300, 913360, 913361, 913391, 913392, 913546, 913547, 913578, 913611, 913684, 913932, 913933, 914331, 914400, 914401, 914402, 914403, 914404, 914405, 914449, 914517, 914545, 914568, 914688, 914979, 915140, 915248, E.46, E.50, E.50D.PA, E.51, E.52, GSP50, GSP50P, GSP51, GSP51P, LF50, LF55, MC501E, MC501EP... (Other models you can see in the webshop)		
<b>spare parts for</b>	360133		
	<b>GEV No.</b>	360119	<b>Ref. No.</b> —
	motor CDC pinion ø 5.4mm teeth 12 230V turn direction right motor ø 37mm motor type M37RN for timer		
	<b>GEV No.</b>	360131	<b>Ref. No.</b> —
	motor CDC pinion ø 5.4mm teeth 12 230V turn direction left motor ø 37mm motor type M37LN for timer		



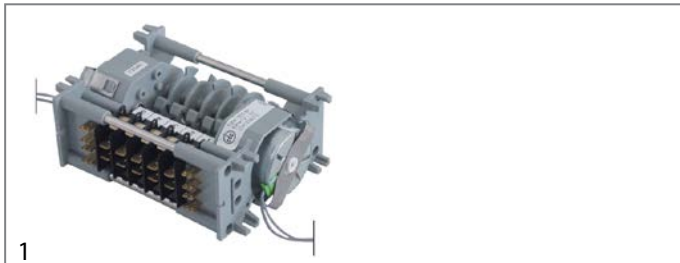

<b>GEV No.</b>	360134	<b>Ref. No.</b>	238061
<b>description</b>	timer CDC 7804DV engines 2 chambers 4 operation time 6s / 3min 230V shaft ømm shaft Lmm manif. no. 7804DV / 360134 motor type M37RN/M37LN		
<b>For models:</b>	500F, 500FD, 50F, 50FD, 510F, 510FD		
<b>spare parts for</b>	360134		
	<b>GEV No.</b>	360119	<b>Ref. No.</b> —
	motor CDC pinion ø 5.4mm teeth 12 230V turn direction right motor ø 37mm motor type M37RN for timer		
	<b>GEV No.</b>	360131	<b>Ref. No.</b> —
	motor CDC pinion ø 5.4mm teeth 12 230V turn direction left motor ø 37mm motor type M37LN for timer		



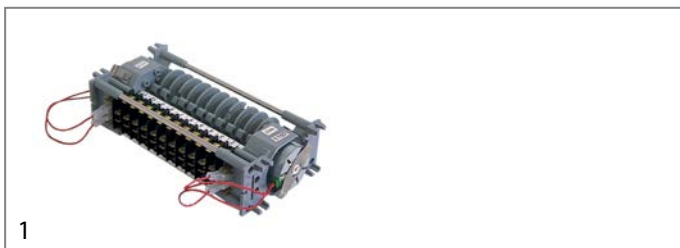

<b>GEV No.</b>	360264	<b>Ref. No.</b>	238073
<b>description</b>	timer CDC 7805DV engines 2 chambers 5 operation time 72s/20min 230V shaft ømm shaft Lmm manif. no. 7805DV / 238073 motor type M37RN/M37LN		
<b>For models:</b>	914326, 914406, E.55		
<b>spare parts for</b>	360264		
	<b>GEV No.</b>	360119	<b>Ref. No.</b> —
	motor CDC pinion ø 5.4mm teeth 12 230V turn direction right motor ø 37mm motor type M37RN for timer		
	<b>GEV No.</b>	360131	<b>Ref. No.</b> —
	motor CDC pinion ø 5.4mm teeth 12 230V turn direction left motor ø 37mm motor type M37LN for timer		

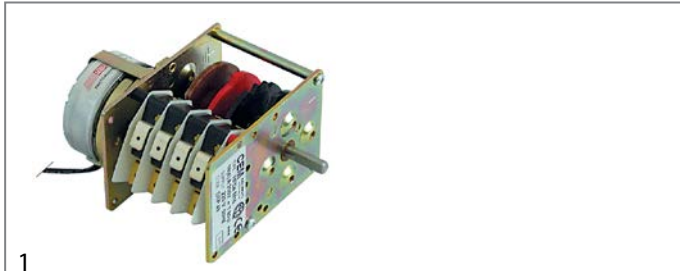

<b>GEV No.</b>	360124	<b>Ref. No.</b>	238067
<b>description</b>	timer CDC 7811DV engines 2 chambers 11 operation time 90s / 20min 230V shaft ømm shaft Lmm manif. no. 7811DV / 238067 motor type M37RN/M37LN		
<b>For models:</b>	CLEAN-3		
<b>spare parts for</b>	360124		
	<b>GEV No.</b>	360119	<b>Ref. No.</b> —
	motor CDC pinion ø 5.4mm teeth 12 230V turn direction right motor ø 37mm motor type M37RN for timer		
	<b>GEV No.</b>	360131	<b>Ref. No.</b> —
	motor CDC pinion ø 5.4mm teeth 12 230V turn direction left motor ø 37mm motor type M37LN for timer		



<b>GEV No.</b>	360089	<b>Ref. No.</b>	926122 DTP49
<b>description</b>	timer CEM HFD4M16 engines 1 chambers 4 operation time 180s 230V shaft ø 6x4.6mm shaft L 17mm manif. no. HFD4M16 / DTP49 motor type UDS11NE1RH		
<b>spare parts for</b>	360089		
	<b>GEV No.</b>	360112	<b>Ref. No.</b> —
	motor SAIA pinion ø 4mm teeth 12 230V turn direction right motor ø 48mm motor type UDS11NE1RHZ for timer		





1

<b>GEV No.</b>	360019	<b>Ref. No.</b>	DTP14
<b>description</b>	timer CEM HFD4M16 engines 1 chambers 4 operation time 255s 230V shaft $\varnothing$ 6x4.6mm shaft L 17mm manuf. no. HFD4M16 / DTP14 motor type UDS11NE1RH		
<b>spare parts for</b>	360019		
	<b>GEV No.</b>	360112	<b>Ref. No.</b> —
	motor SAIA pinion $\varnothing$ 4mm teeth 12 230V turn direction right motor $\varnothing$ 48mm motor type UDS11NE1RHZ for timer		





1

<b>GEV No.</b>	360028	<b>Ref. No.</b>	DTP15
<b>description</b>	timer CEM HFD4M16 engines 1 chambers 4 operation time 270s 230V shaft $\varnothing$ 6x4.6mm shaft L 17mm manuf. no. HFD4M16 / DTP15 motor type UDS11NE1RH		
<b>spare parts for</b>	360028		
	<b>GEV No.</b>	360112	<b>Ref. No.</b> —
	motor SAIA pinion $\varnothing$ 4mm teeth 12 230V turn direction right motor $\varnothing$ 48mm motor type UDS11NE1RHZ for timer		



1

<b>GEV No.</b>	360030	<b>Ref. No.</b>	DTP21
<b>description</b>	timer CEM HL6M16 engines 2 chambers 6 operation time 60s/120s 230V shaft $\varnothing$ 6mm shaft Lmm manuf. no. HL6M16 / DTP21 motor type UDS11NE1RH / UDS11NE1LH		
<b>spare parts for</b>	360030		
	<b>GEV No.</b>	360112	<b>Ref. No.</b> —
	motor SAIA pinion $\varnothing$ 4mm teeth 12 230V turn direction right motor $\varnothing$ 48mm motor type UDS11NE1RHZ for timer		
	<b>GEV No.</b>	360113	<b>Ref. No.</b> —
	motor SAIA pinion $\varnothing$ 4mm teeth 12 230V turn direction left motor $\varnothing$ 48mm motor type UDS40NE1RNZ165 for timer		



1

<b>GEV No.</b>	360125	<b>Ref. No.</b>	238069
<b>description</b>	timer FIBER P25 engines 1 chambers 1 operation time 15s-14.4min 230V shaft $\varnothing$ 6mm shaft Lmm manuf. no. P255JC11JK7 motor type M51BJOR6400		
<b>For models:</b>	CLEAN-3		
<b>spare parts for</b>	360125		
	<b>GEV No.</b>	360673	<b>Ref. No.</b> —
	motor kit pinion $\varnothing$ 6.8mm teeth 15 230V voltage AC 50/60Hz turn direction clockwise motor $\varnothing$ 48mm H 18.5mm motor type UDS-40NE1RNZ165 cable length 150mm with holder		

mechanical timers



1

<b>GEV No.</b>	350028	<b>Ref. No.</b>	222001 923012
<b>description</b>	timer G 2-pole operation time 15min impulse mechanical 2NO at 250V 16A permanent position no shaft $\varnothing$ 3.5 x 3.5mm shaft 3.5x3.5mm shaft L 17mm mounting distance 28mm mounting thread M8 connection lateral		
<b>For models:</b>	404, 406, 412		
<b>accessories for</b>	350028		
	<b>GEV No.</b>	110365	<b>Ref. No.</b> —
	knob switch zero mark t.max.°C $\varnothing$ 44mm shaft $\varnothing$ 3.5x3.5mm shaft flat black		
	<b>GEV No.</b>	110371	<b>Ref. No.</b> —
	dial plate graduation 15min permanent position no rotation 30-330° $\varnothing$ 60mm timers knob $\varnothing$ 45mm		



# contactors

## LS Industrial Systems

### power contactors



1

<b>GEV No.</b>	381167	<b>Ref. No.</b>	229042 H.775599-001
<b>description</b>	power contactor resistive load 20A 230VAC (AC3/400V) 9A/4kW main contacts 4NO auxiliary contacts connection screw connection type GMC-9M/4		
<b>For models:</b>	913913, 913914, 914284, 914318, 914319, 914338, 914356, 914431, 914642, 914909, 915136, 915137, 915150, 915151, 915152, 915154, 915155, 915157, 915158, 915160, 915161, 915162, 915166, 915167, 915168, 915172, 915173, 915175, 915285, 915319, 915348, 915420, 915421, 915422, 915479, 915492, 915493, 915494, 915495, 915496, 915497, 915547, 915558, 915635, 915663, 915729, 915747, 916021, 916025, 916027...(Other models you can see in the webshop)		

## GENERAL ELECTRIC (AEG)

### power contactors



1

<b>GEV No.</b>	380231	<b>Ref. No.</b>	926147
<b>description</b>	power contactor resistive load 16A 230VAC (AC3/400V) 6A/3kW main contacts 3NO auxiliary contacts 1NC connection screw connection type AEG LS0701A		
<b>For models:</b>	CLEAN-110, CLEAN-120, E.65, E110, E12, E120, E14, E140, River-285, RV282R, U132, U61, U61H, U70		



1

<b>GEV No.</b>	380239	<b>Ref. No.</b>	926040
<b>description</b>	power contactor resistive load 20A 230VAC (AC3/400V) 8.4A/4kW main contacts 3NO auxiliary contacts 1NC connection screw connection type LS05 01A type AEG LS05 01A type GE MC1A 301A		
<b>For models:</b>	12, 14		



1

<b>GEV No.</b>	380238	<b>Ref. No.</b>	229032
<b>description</b>	power contactor resistive load 20A 230VAC (AC3/400V) 8.4A/4kW main contacts 3NO auxiliary contacts 1NO connection screw connection type LS0510A type AEG LS0510A type GE MC1A 310A		
<b>For models:</b>	050F, 050FP, 12, 22F, 440F, 44F, F85, F85P, FRI12, FRI12+12, FRI15, FRI15M, FRI6, FRI6+6, FRI9, FRI9+9, MISTRAL-51, NIAGARA-51, S950, U132, U61, U61H, U70		



1

<b>GEV No.</b>	380245	<b>Ref. No.</b>	229010 229011 229019 929122
<b>description</b>	power contactor resistive load 25A 230VAC (AC3/400V) 9A/4kW main contacts 3NO auxiliary contacts 1NC connection screw connection type AEG LS4K 01A type GE CL00A 301 H 85mm		
<b>For models:</b>	500F, 500FD, 66, E.65, E110, E12, E120, E14, E140, FRI12, FRI12+12, FRI15, FRI15M, FRI6, FRI6+6, FRI9, FRI9+9, S651, S651P, S653, S654, S655, S810, S815, S830, S835, S850, S870, S950, SR651		



1

<b>GEV No.</b>	381191	<b>Ref. No.</b>	926282 DTC112NO
<b>description</b>	power contactor resistive load 25A 400VAC (AC3/400V) 12A/5.5kW main contacts 3NO auxiliary contacts 1NO connection screw connection type AEG type GE CL01A310T6		
<b>For models:</b>	80, 81, 82, CGL74CABT, KLP105EB, KLP201DDDDTEB, KLP201EB, KLP301, KLP301DDDDTEB, LP105DDDDTEB, LP105DDDDTEBN, LP105EB, LP201DDDDTEB, LP201EB, LP301, LP301EB, Niagara-283A, River-285, River-81CRP, RIVER-81-CRP, RIVER-82, River-82CRP, RIVER-82-CRP, RIVER-HL-82, RV282R, RV81CCRP, RV81CRP, RV82, RV8223, RV82C, RV82CCRP, RV82CRP, SevenL, SV72AEB, U132e, U61E, U61HE, U70e		



ISKRA (FANAL)

power contactors



1

<b>GEV No.</b>	380423	<b>Ref. No.</b>	229016
<b>description</b>	power contactor resistive load 35A 230VAC (AC3/400V) 25A/11kW main contacts 3NO auxiliary contacts connection screw connection type Fanal DSL22 type ISKRA KNL22		
<b>For models:</b>	337, 338, 343, 344, 440F, 44F, ME15, ME20, ME30, ME40, S950		

SIEMENS

power contactors



1

<b>GEV No.</b>	381387	<b>Ref. No.</b>	73350
<b>description</b>	power contactor resistive load 22A 230VAC (AC3/400V) 4kW main contacts 3NO auxiliary contacts 1NO connection screw connection type 3RT2016-1AP01		
<b>For models:</b>	CNT800CH, Fast180, Fast180-230V-3Ph-60Hz, Fast181, Fast200, Fast93, GL280EB, GL280EB23, GL280EB23DAR, GL280EB23HZ, GL280EB23HZDY, GL280EBDARY, GL280EBDAW, GL280EBDAY, GL280EBDB, GL280EBDBR, GL280EBDWY, GL280EBSA, GL280EBSAE, GL280EBSAEW, GL280EBSAEWY, GL280EBSAR, GL280EBSARY, GL280EBSAW, GL280EBSAWY, GL280EBSAY, GL280EBSB, GL280EBSR, GL280EBSWY, GL282EB, GL282EB93, GL282EB93DA, GL282EB-93HZ23, GL282EBCH, GL282EBDA, GL282EBDARW, GL282EBDAWY, GL282EBDBW, GL282EBDCWY, GL282EBHZ23, GL282EBHZ23DY, GL282EBHZ23SY, GL282EBSA, GL282EBSAEW, GL282EBSAEWY, GL282EBAP, GL282EBSAR, GL282EBSAW, GL282EBSBR, GL282EBSY... (Other models you can see in the webshop)		



1

<b>GEV No.</b>	380389	<b>Ref. No.</b>	229037 80350
<b>description</b>	power contactor resistive load 22A 230VAC (AC3/400V) 9A/4kW main contacts 3NO auxiliary contacts 1NO connection screw connection type 3RT10-16-1AP01		
<b>For models:</b>	2312-007, 2312-009-CRP, 80, 81, 82, 914100, 914101, 914339, 914342, 914343, 914624, 914625, 914626, 914627, 914628, 914850, 914851, 914854, 914944, CE78HZ23, CGL74CABT, E78, E78HP, HM1, KLP105EB, KLP201DDDTTEB, KLP201EB, KLP301, KLP301DDDTTEB, LP105DDDTTEB, LP105DDDTTEBN, LP105EB, LP201DDDTTEB, LP201EB, LP301, LP301EB, LP60, NIAGARA-271, RIVER-150, RIVER-48, RIVER-50, RIVER-50-CRP, RIVER-50-CRP-SP, RIVER-54, RIVER-54CRP, River-54-CRP-s.p., RIVER-54-CRP-SP, RIVER-61, RIVER-71, RIVER-78...(Other models you can see in the webshop)		



1

<b>GEV No.</b>	380957	<b>Ref. No.</b>	927051 927160
<b>description</b>	power contactor resistive load 22A 24VAC (AC3/400V) 12A/5.5kW main contacts 3NO auxiliary contacts 1NO connection screw connection type 3RT10-17-1AB01 50/60Hz		
<b>For models:</b>	A3EBD, A3EBDAKWK, A3EBDBKWK, A3EBDWK, A3EBDYK, A3ESBAK, A3ESBAKWK, A3ESBKWKYK, A3ESBWK, A4EBD, A4EBS, A4ESAKRK, A4ESAKYK, A4EBSCK, A5EBD, A5EBDAKPKWK, A5EBDAKWK, A5EBS, A5ESBAKPKWK, A5ESBYK, CLEAN-361, CLEAN-361P, CLEAN-471, CLEAN-471P, RIVER-MULTI-2252, RIVER-MULTI-2256, RIVER-MULTI-2258		



1

<b>GEV No.</b>	381393	<b>Ref. No.</b>	73351
<b>description</b>	power contactor resistive load 40A 230VAC (AC3/400V) 12A/5.5kW main contacts 3NO auxiliary contacts 1NC/1NO connection screw type 3RT2024-1AL20		
<b>For models:</b>	Fast200, Fast93, GL280EB, GL280EB23, GL280EB23DAR, GL280EB-23HZ, GL280EB23HZDY, GL280EBDARY, GL280EBDAW, GL280EBDAY, GL280EBDB, GL280EBDBR, GL280EBDWY, GL280EBSA, GL280EBSAE, GL280EBSAEW, GL280EBSAEWY, GL280EBSAR, GL280EBSARY, GL280EBSAW, GL280EBSAWY, GL280EBSAY, GL280EBSB, GL280EBSR, GL280EBSWY, GL282EB, GL282EB93, GL282EB93DA, GL282EB-93HZ23, GL282EBCH, GL282EBDA, GL282EBDARW, GL282EBDAWY, GL282EBDBW, GL282EBDCWY, GL282EBHZ23, GL282EBHZ23DY, GL282EBHZ23SY, GL282EBSA, GL282EBSAEW, GL282EBSAEWY, GL282EBAP, GL282EBSAR, GL282EBSAW, GL282EBSBR, GL282EBSY, GL284EB, GL284EBDA, GL284EBDAEW, GL284EBDPWY...(Other models you can see in the webshop)		



1

<b>GEV No.</b>	380390	<b>Ref. No.</b>	80351
<b>description</b>	power contactor resistive load 40A 230VAC (AC3/400V) 12A/5.5kW main contacts 3NO auxiliary contacts connection screw connection type 3RT10-24-1AL20 50/60Hz		
<b>For models:</b>	914380, 914436, FAST-181, Fast181-230V-3Ph-60Hz, Fast181-400V-3NPh-60Hz, FAST-200, GL280EB, GL280EBD, GL280EBDA, GL280EBDAE, GL280EBDAR, GL280EBDAWY, GL280EBDBW, GL280EBDY, GL280EBS, GL280EBSY, GL282EB, GL282EBCH, GL282EBCHD, GL282EBD, GL282EBDAE, GL282EBDAR, GL284EBD, GL284EBDAWY, GL284EBS, GL284EBSAR, GL286EBD, GL286EBDARY, GL286EBS, GL286EBSAW, NIAGARA-2150, NIAGARA-2152, NIAGARA-2154, NIAGARA-2156, RIVER-150, RIVER-152, RIVER-154, RIVER-298, RIVER-80, RIVER-81, RIVER-82, RV150, RV15023, RV15023DA, RV150D, RV150DA, RV150DAR, RV150DARY, RV150DAW, RV150DAWY...(Other models you can see in the webshop)		



1

<b>GEV No.</b>	381190	<b>Ref. No.</b>	DEI395
<b>description</b>	motor protection circuit breaker type 3RV1021-4AA10 setting range 11-16A contacts 3NO connection screw		

relays

power relays

with DIN rail mounting

lateral



1

<b>GEV No.</b>	380313	<b>Ref. No.</b>	229036
<b>description</b>	power relays FINDER 230VAC 16A 3CO connection male faston DIN rail manuf. no. 62.83.8.230.0008		
<b>For models:</b>	050F, 050FP, CE78HZ23, E.51, E.55, E78, E78HP, F85, F85P, LF55, MC501E, MC501EP, MISTRAL-51, NIAGARA-51, PS-60, RIVER-152, RIVER-43, RIVER-78, RIVER-E78		

with flange mounting



1

<b>GEV No.</b>	380131	<b>Ref. No.</b>	2290009
<b>description</b>	power relays Italiana Relè 230VAC 16A 3CO connection male faston 6.3mm screw mounting manuf. no. B2-3-230AC		

auxiliary contacts



1

<b>GEV No.</b>	381389	<b>Ref. No.</b>	DEI4
<b>description</b>	auxiliary contact contacts 1NO/1NC AC15 6A for contactors 3RT1 connection screw AC1 10A type 3RH1921-1DA11		
<b>For models:</b>	FAST-181, Fast181-230V-3Ph-60Hz, Fast181-400V-3NPh-60Hz, RIVER-282L-2, RIVER-282LS-2TDE, RIVER-298, RIVER-382L, RIVER-382L-230V-3Ph-50Hz, RIVER-382LNRG, RIVER-382LTDE, RIVER-482, RV298, RV298HZ, RV382L, RV382L23TERMO, RV382LFUR, RV382LR, RV382LS, RV382LSFUR, RV382LTX, RV382LTXR, RV482, ST70FASTHB, ST70FASTHB400		

motor protection circuit breakers





1

<b>GEV No.</b>	380541	<b>Ref. No.</b>	927368 DEI35
<b>description</b>	motor protection circuit breaker type 3RV1011-0JA10 setting range 0.7-1A (AC3/400V) 0.25kW		
<b>For models:</b>	914380, 914436, 915819, A3EBD, A3EBDAKRKYK, A3EBDAKWK, A3EBDBKWK, A3EBDRKYK, A3EBDWK, A3EBDYK, A3EBSAK, A3EBSAKRK, A3EBSAKWK, A3EBSBKWKYK, A3EBSKWK, A3EBSWK, A4EBD, A4EBDAKEYK, A4EBDAKRK, A4EBDBKRK, A4EBDRK, A4EBS, A4EBSAKCK, A4EBSAKEKYK, A4EBSAKRK, A4EBSAKRKPK, A4EBSAKYK, A4EBSCK, A5EBD, A5EBDAKPKWK, A5EBDAKWK, A5EBDRK, A5EBS, A5EBSAKPKWK, A5EBSAKRK, A5EBSAKRKYK, A5EBSBKRPK, A5EBSBKWK, A5EBSRK, A5EBSYK, CLEAN-161, CLEAN-221, CLEAN-271, CLEAN-272, CLEAN-362, FAST-200, GL280EB, GL280EB23DAR, GL280EBD, GL280EBDA...(Other models you can see in the webshop)		





			
1			
<b>GEV No.</b>	380130	<b>Ref. No.</b>	229008
<b>description</b>	power relays Italiana Relè 230VAC 16A 3NO connection male faston 6.3mm screw mounting manuf. no. B1-3-230AC		

			
1			
<b>GEV No.</b>	380702	<b>Ref. No.</b>	229039 229040
<b>description</b>	power relays FINDER 230VAC 16A 3NO connection male faston 6.3mm flange dimensions 36x38x68mm manuf. no. 62.83.8.230.0300 230V		
<b>For models:</b>	913297, 913298, 913299, 913300, 913360, 913361, 913391, 913392, 913418, 913546, 913547, 913578, 913611, 913684, 913911, 913912, 913913, 913914, 913932, 913933, 913950, 913977, 913984, 913990, 913992, 913993, 914165, 914166, 914167, 914168, 914206, 914214, 914284, 914316, 914317, 914318, 914319, 914326, 914331, 914338, 914355, 914356, 914398, 914399, 914400, 914401, 914402, 914403, 914404, 914405...(Other models you can see in the webshop)		

with bracket mounting			
			
1			
<b>GEV No.</b>	380312	<b>Ref. No.</b>	229023 229024
<b>description</b>	power relays FINDER 230VAC 10A 3CO connection male faston 4.8mm bracket mounting dimensions 52x32.2x36.5mm manuf. no. 60.63.8.230.0000		
<b>For models:</b>	10, 12, 14, 21F, 21FD, 21R, 21RD, 22F, 22R, 2312-001, 2312-002, 25F, 25FD, 25R, 25RD, 30F, 30FD, 30R, 30RD, 31F, 31FD, 31R, 31RD, 40F, 440F, 460, 500F, 500FD, 510F, 510FD, 66, 913289, 913290, 913291, 913292, 913297, 913298, 913299, 913300, 913356, 913357, 913360, 913361, 913363, 913364, 913372, 913373, 913374, 913375, 913376...(Other models you can see in the webshop)		

			
1			
<b>GEV No.</b>	380311	<b>Ref. No.</b>	229030
<b>description</b>	power relays Italiana Relè 230VAC 20A 1NC/1NO connection F6.3 bracket mounting manuf. no. A1B-230AC-FA		
<b>For models:</b>	11F, 11FD, 11F-DVGW, 11R, 11RD, 21F, 21FD, 21R, 21RD, 22F, 25F, 25FD, 25R, 25RD, 30F, 30FD, 30R, 30RD, 31F, 31FD, 31R, 31RD, 350F, 350FD, 350R, 350RD, 400F, 400FD, 400R, 400RD, 440F, 44F, 450, 460, 500F, 500FD, 50F, 50FD, 510F, 510FD, CLEAN-3, E.45, E.46, E.50, E.51, E.52, TF-503, TF-513, TF-515		

			
1			
<b>GEV No.</b>	380139	<b>Ref. No.</b>	926021 929115
<b>description</b>	power relays FINDER 230VAC 16A 2CO connection F6.3 bracket mounting dimensions 68x38.2x35.8mm manuf. no. 62.82.8.230.0000		
<b>For models:</b>	10, 2312-001, 2312-002, 80, 81, 82, 914380, 914436, 915747, CE78HZ23, CGL74CABT, CLEAN-100, E.50, E.51, E.60, E.65, E1, E10, E100, E110, E12, E120, E14, E140, E78, E78HP, Fast181, FAST-181, Fast181-230V-3Ph-60Hz, Fast181-400V-3NPh-60Hz, Fast200, FAST-200, Fast93, GL280EB, GL280EB23, GL280EB23DAR, GL280EB23HZ, GL280EB23HZDY, GL280EBD, GL280EBDA, GL280EBDAE, GL280EBDAR, GL280EBDARY, GL280EBDAW, GL280EBDAWY, GL280EBDAY, GL280EBDB, GL280EBDBR, GL280EBDBW, GL280EBDWY...(Other models you can see in the webshop)		



			
1			
<b>GEV No.</b>	380185	<b>Ref. No.</b>	229025 229029 DER111
<b>description</b>	power relays Italiana Relè 230VAC 30A 1NO connection F6.3 bracket mounting dimensions 36.5x32.2x51.8mm manuf. no. A10-230AC-FA		
<b>For models:</b>	050F, 050FP, 10, 22F, 22R, 2312-007, 2312-009-CRP, 440F, 44F, 46, 500F, 500FD, 50-ELECTRONIC, 50F, 50FD, 510F, 510FD, 80, 81, 913297, 913298, 913299, 913300, 913360, 913361, 913391, 913392, 913546, 913547, 913578, 913611, 913684, 913913, 913914, 913932, 913933, 914100, 914101, 914284, 914318, 914319, 914326, 914331, 914338, 914339, 914342, 914343, 914356, 914400, 914401...(Other models you can see in the webshop)		



with male contacts

bullet connectors, 8 contacts



<b>GEV No.</b>	380135	<b>Ref. No.</b>	927044
<b>description</b>	power relays FINDER 24VAC 10A 2CO connection plug-in connection round 8-pole manif. no. 60.12.8.024.0040 90.26/ZVE8 250V 8-pole		
<b>For models:</b>	161, 221, 271, 272, 362, CLEAN-160, CLEAN-161, CLEAN-220, CLEAN-221, CLEAN-270, CLEAN-271, CLEAN-272, CLEAN-361, CLEAN-361P, CLEAN-362, CLEAN-471, CLEAN-471P		
<b>accessories for</b>	380135		
	<b>GEV No.</b>	380137	<b>Ref. No.</b> 927045
	relay socket 8-pole connection plug-in connection round 8-pole dimensions 65x28x40mm 380V voltage AC 10A Italiana Relè manuf. no. ZVE8		
	<b>GEV No.</b>	380638	<b>Ref. No.</b> —
	relay socket 8-pole dimensions 51x41x23mm 250V 10A FINDER manuf. no. 90.26		

relay sockets



<b>GEV No.</b>	380137	<b>Ref. No.</b>	927045
<b>description</b>	relay socket 8-pole connection plug-in connection round 8-pole dimensions 65x28x40mm 380V voltage AC 10A Italiana Relè manuf. no. ZVE8		
<b>For models:</b>	161, 221, 271, 272, 362, CLEAN-160, CLEAN-161, CLEAN-220, CLEAN-221, CLEAN-270, CLEAN-271, CLEAN-272, CLEAN-361, CLEAN-361P, CLEAN-362, CLEAN-471, CLEAN-471P		
<b>accessories for</b>	380137		
	<b>GEV No.</b>	380805	<b>Ref. No.</b> —
	support bracket		

time relays

time relays



<b>GEV No.</b>	380611	<b>Ref. No.</b>	929113
<b>description</b>	time relay FINDER 81.01.0.230 time range 0.1s-10h 12-230V AC/DC 16A mounting measurements DIN railmm 1CO connection grip connection		
<b>For models:</b>	161, 221, 271, 272, 362, CLEAN-161, CLEAN-221, CLEAN-271, CLEAN-272, CLEAN-362, E.60, E.65, E1, E10, E100, E110, E12, E120, E14, E140		

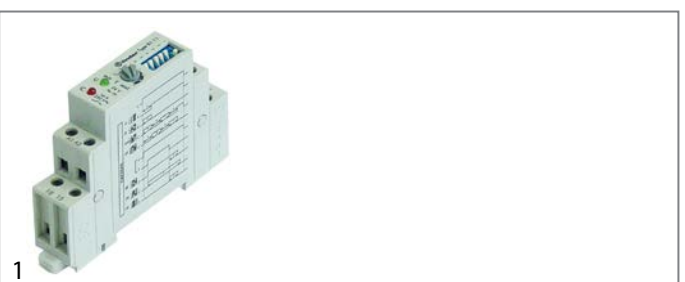

<b>GEV No.</b>	380612	<b>Ref. No.</b>	DET237BT
<b>description</b>	time relay FINDER 81.11.0.024.0000 12-240V AC/DC 16A 1CO connection grip connection		
<b>For models:</b>	River-285, RV282R		

transformers

open transformers

with clamp terminal

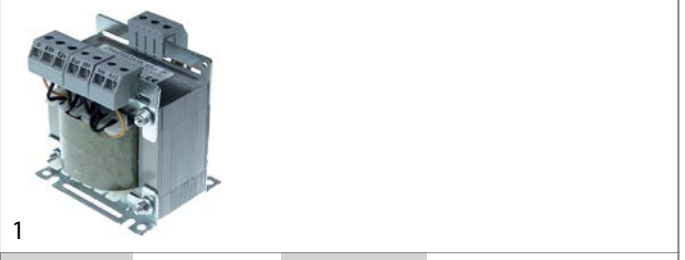

<b>GEV No.</b>	401604	<b>Ref. No.</b>	DET313
<b>description</b>	transformer primary 230/400VAC secondary 12VAC 160VA		





## electronic controllers

### LAE

#### universal controllers

#### built-in version



1

<b>GEV No.</b>	378340	<b>Ref. No.</b>	927289
<b>description</b>	electronic controller LAE type AC1-5PS1RD mounting measurements 71x29mm 12V voltage AC/DC Pt100 relay outputs 1 CO-12A(4) Pt100 built-in depth 70mm protection IP54 built-in version defr. funct. -100 up to +850°C display 3 digits		

### miscellaneous

#### electronic thermometers



1

<b>GEV No.</b>	402047	<b>Ref. No.</b>	DET164
<b>description</b>	thermometer 14V voltage AC/DC display 2 digit PTC temperature restriction 0-60°C incl. probe		



1

<b>GEV No.</b>	403327	<b>Ref. No.</b>	927333
<b>description</b>	thermometer ARTERMO type ROF-DIG/12 mounting measurements 58x26mm 12V voltage AC -30 jusqu'à +110°C measuring input NTC display 3 digits front measurements 64x31mm		
<b>For models:</b>	161, 221, 271, 272, 362, CLEAN-161, CLEAN-221, CLEAN-271, CLEAN-272, CLEAN-362		

## probes

### universal probes

#### temperature probes



1

<b>GEV No.</b>	379142	<b>Ref. No.</b>	927335
<b>description</b>	temperature probe PTC 1kOhm cable PVC probe -50 up to +150°C cable -10 up to 100°C probe ø6x30mm cable length 1.5m without screw connection 2-wire		
<b>For models:</b>	161, 221, 271, 272, 362, CLEAN-161, CLEAN-221, CLEAN-271, CLEAN-272, CLEAN-362		

## producer-specific probes

### probes



1

<b>GEV No.</b>	403942	<b>Ref. No.</b>	231016
<b>description</b>	temperature probe		
<b>For models:</b>	913911, 913912, 913913, 913914, 913950, 913977, 913990, 914167, 914168, 914284, 914516, 914543, 914612, 915138, 915143, 915150, 915151, 915152, 915154, 915155, 915157, 915158, 915160, 915161, 915162, 915166, 915167, 915168, 915172, 915173, 915175, 915319, 915348, 915420, 915421, 915422, 915479, 915492, 915493, 915494, 915495, 915496, 915497, 915547, 915558, 915611, 915612, 915613, 915614, 915615...(Other models you can see in the webshop)		



1

<b>GEV No.</b>	379101	<b>Ref. No.</b>	231006
<b>description</b>	temperature probe NTC 10kOhm cable PVC probe -40 up to +110°C cable -10 up to 100°C connection plug thread probe ø4.5x30mm cable length 0.35m		
<b>For models:</b>	35-ELECTRONIC, 35F, 35FD, 35R, 35RD, 40-ELECTRONIC, 40F, 40FD, 40R, 40RD, 44F, 45, 46, 50-ELECTRONIC, 50F, 50FD		



1

<b>GEV No.</b>	400910	<b>Ref. No.</b>	231014
<b>description</b>	temperature probe NTC 10kOhm cable silicone probe -40 up to +110°C cable -50 up to +180°C connection coded plug thread probe ø4.5x30mm cable length 0.35m		
<b>For models:</b>	050F, 050FP, 2312-007, 2312-009-CRP, 80, 81, 82, 913977, 913984, 913992, 913993, 914100, 914101, 914165, 914166, 914206, 914214, 914316, 914317, 914318, 914319, 914338, 914339, 914342, 914343, 914355, 914356, 914380, 914431, 914436, 914516, 914543, 914583, 914592, 914613, 914624, 914625, 914626, 914627, 914628, 914642, 914684, 914850, 914851, 914854, 914874, 914909, 914943, 914944, 915136...(Other models you can see in the webshop)		



1

<b>GEV No.</b>	403103	<b>Ref. No.</b>	927172
<b>description</b>	temperature probe Pt100 cable PTFE probe -100 up to 450°C cable -40 up to +250°C connection 3-wire thread probe ø6x70mm cable length 10m		

### accessories

#### miscellaneous



1

<b>GEV No.</b>	379905	<b>Ref. No.</b>	231008
<b>description</b>	extension		
<b>For models:</b>	46, 50-ELECTRONIC, 50F, 50FD		

electric components



## electronics

## electronics accessories



1			
<b>GEV No.</b>	699373	<b>Ref. No.</b>	419040
<b>description</b>	spacer piece for PCB thread M3 L 19.5mm H 10mm plastic black		
<b>For models:</b>	915160, 915161, 915162, 915175, 915319, 915611, 915612, 915613, 915663, 915670, 916247, 916248, 916249, 916250, 916251, 916252, 916365, 916366, 916382, 916383, 916452, 916504, 916584, 916670, 916688, 916763, 917044, 917049, Clean161, Fast160-2, Fast161-2, Fast170, Fast170S, Pluvia-240, Pluvia-260, Pluvia-270		

## EPROMS



1			
<b>GEV No.</b>	400900	<b>Ref. No.</b>	225029
<b>description</b>	EPROM CODE 225029-3		
<b>For models:</b>	MISTRAL-40, MISTRAL-51, NIAGARA-35, NIAGARA-40, NIAGARA-51, RIVER-40, RIVER-50, RIVER-61		



1			
<b>GEV No.</b>	401917	<b>Ref. No.</b>	225034
<b>description</b>	EPROM CODE 225034		
<b>For models:</b>	2312-009-CRP, RIVER-40-CRP, RIVER-50-CRP		



1			
<b>GEV No.</b>	401558	<b>Ref. No.</b>	81000 81010
<b>description</b>	EPROM CODE 81000-1		
<b>For models:</b>	80, 81, CGL74CABT, LP60, RIVER-71, RIVER-80, River-81, RIVER-82, RV71, RV80, RV8023, RV8023HZ, RV80C, RV80HZ, RV81, RV8123, RV81A, RV81C, RV81HZ, RV81HZ23, RV81PAP, RV82, RV8223, RV82C, SevenL, U60E		



1			
<b>GEV No.</b>	401559	<b>Ref. No.</b>	81021
<b>description</b>	EPROM CODE 81000-1		
<b>For models:</b>	CE78HZ23, E78, E78HP, FAST-181, HM1, RIVER-E78, ST70FAST		

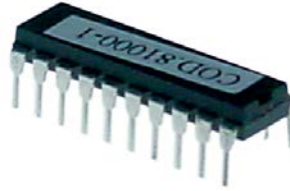

1			
<b>GEV No.</b>	401557	<b>Ref. No.</b>	225028-4
<b>description</b>	EPROM for dishwasher CODE 225028-4		



1			
<b>GEV No.</b>	403247	<b>Ref. No.</b>	225031
<b>description</b>	EPROM for dishwasher CODE 225031-5		
<b>For models:</b>	050F, 050FP, 913911, 913912, 913913, 913914, 913950, 913977, 913984, 913990, 914165, 914166, 914206, 914214, 914284, 914316, 914317, 914318, 914319, 914338, 914355, 914356, 914431, 914516, 914543, 914642, 914684, 914874, 914909, 915136, 915137, 915138, F85, F85P, MINIBAR, Mistral40, MISTRAL-40, Mistral51, MISTRAL-51, NIAGARA-35, Niagara-40, NIAGARA-51, River-39, S280		



1			
<b>GEV No.</b>	403245	<b>Ref. No.</b>	225032
<b>description</b>	EPROM for dishwasher CODE 225032-2		
<b>For models:</b>	914167, 914168, 914943, NIAGARA-45		

1

<b>GEV No.</b>	403248	<b>Ref. No.</b>	225033
<b>description</b>	EPROM for dishwasher CODE 225033-1 unsuitable for Maidaid		
<b>For models:</b>	NIAGARA-45		



1

<b>GEV No.</b>	403241	<b>Ref. No.</b>	81001
<b>description</b>	EPROM type U61E for dishwasher CODE 81001-3		
<b>For models:</b>	KLP105EB, KLP201DDDTEB, KLP201EB, KLP301, KLP301DDDTEB, LP105DDDTEB, LP105DDDTEBN, LP105EB, LP201DDDTEB, LP201EB, LP301, LP301EB, River-81CRP, RIVER-81-CRP, River-82CRP, RIVER-82-CRP, RV81CCRP, RV81CRP, RV82CCRP, RV82CRP, U132E, U61E, U61HE, U70e		



1

<b>GEV No.</b>	403249	<b>Ref. No.</b>	225044
<b>description</b>	EPROM for dishwasher CODE 225044-2		
<b>For models:</b>	2312-007, 914624, 914625, 914627, 914850, 914851, 914854		

PCBs



1

<b>GEV No.</b>	404015	<b>Ref. No.</b>	215034-1
<b>description</b>	control PCB dishwasher 230V 50Hz		
<b>For models:</b>	916020, 916021, 916024, 916025, 916026, 916027, 916030, 916031, 916181, 916183, 916184, 916185, 916196, 916197, 916198, 916199, 916200, 916201, 916202, 916203, 916204, 916205, 916206, 916207, 916208, 916209, 916367, 916409, 916410, 916411, 916412, 916413, 916414, 916415, 916416, 916417, 916591, 916592, 916593, 916684, 916685, 916751, 916761, 916762, 916802, 916812, 916813, 916877, 916878, 916885...(Other models you can see in the webshop)		



1

<b>GEV No.</b>	403246	<b>Ref. No.</b>	81006
<b>description</b>	EPROM for dishwasher CODE 81006-5		
<b>For models:</b>	PS-60		



1

<b>GEV No.</b>	404017	<b>Ref. No.</b>	80944
<b>description</b>	control PCB dishwasher Niagara 381 suitable for ELETTROBAR		
<b>For models:</b>	916020, 916021, 916024, 916025, 916026, 916027, 916030, 916031, 916045, 916181, 916183, 916184, 916185, 916196, 916197, 916198, 916199, 916200, 916201, 916202, 916203, 916204, 916205, 916206, 916207, 916208, 916209, 916367, 916409, 916410, 916411, 916412, 916413, 916414, 916415, 916416, 916417, 916591, 916592, 916593, 916654, 916684, 916685, 916751, 916761, 916762, 916802, 916812, 916813, 916877...(Other models you can see in the webshop)		





1

<b>GEV No.</b>	403244	<b>Ref. No.</b>	81008
<b>description</b>	EPROM for dishwasher CODE 81008		
<b>For models:</b>	RIVER-152, River-154, RV152, RV152D, RV152DA, RV152DARY, RV152DAY, RV152DW, RV152S, RV152SA, RV152SAW, RV152SE, RV152SW, RV152SY, RV154, RV154BT, RV154BTSAE, RV154D, RV154DA, RV154DARY, RV154DAW, RV154DAY, RV154DY, RV154S, RV154SA, RV154SAW, RV154SAY, RV154SC, RV154SY		



1

<b>GEV No.</b>	404016	<b>Ref. No.</b>	215032-4
<b>description</b>	control PCB warewashing Toptech 24-20GT 230V 50Hz		
<b>For models:</b>	916045, 916066, 916067, 916068, 916069, 916077, 916078, 916079, 916080, 916368, 916418, 916419, 916420, 916421, 916422, 916423, 916424, 916594, 916595, 916654, 916686, 916760, Fast160C, Ocean360-UK, River-242-2, River-242-2T, River-252-2, River-252-2T, River-262-2, River-262-2T, River-272, River-282-2, River-282L-2, River-282LS-2TDE, River-282S-2TDE, River-285, River-342C, River-342T, River-352C, River-352T, River-362C, River-362C-230V-3Ph-50Hz, River-362T, River-362T-230V-3Ph-50Hz, River-372, River-382, River-382-230V-3Ph-50Hz, River-382H, River-382L, River-382L-230V-3Ph-50Hz... (Other models you can see in the webshop)		
<b>accessories for</b>	404016		
	<b>GEV No.</b>	<b>Ref. No.</b>	—
	programmer KIT BOOT-LOADER suitable for EUROTEC GROUP		



1

<b>GEV No.</b>	403102	<b>Ref. No.</b>	227074
<b>description</b>	keypad PCB dishwasher L 170mm W 35mm with display buttons 3		
<b>For models:</b>	915150, 915151, 915152, 915166, 915167, 915168, 915348, 915420, 915421, 915479, 915547, 915558, 915614, 915615, 915616, 915635, 915671, 915747, 915959, NG271, NG281, NG281CDD, NG281HP, NG281HPDD, NG281HZ23, NG281HZ23DD, NG291, NG292, NG292HZ, NG293, NIAGARA-241, Niagara-251, NIAGARA-261, NIAGARA-271, NIAGARA-281, Niagara-281HP, NIAGARA-291, NIAGARA-292, Niagara-292-400V-3Ph-60Hz, NIAGARA-293		



1

<b>GEV No.</b>	404018	<b>Ref. No.</b>	80943
<b>description</b>	control PCB warewashing Toptech 24-20GT suitable for ELETTRORBAR 50Hz 230V		
<b>For models:</b>	916066, 916067, 916068, 916069, 916077, 916078, 916079, 916080, 916368, 916418, 916419, 916420, 916421, 916422, 916423, 916424, 916594, 916595, 916686, 916760, River-242-2, River-242-2T, River-252-2, River-252-2T, River-262-2, River-262-2T, River-272, River-282-2, River-282L-2, River-282LS-2TDE, River-282S-2TDE, River-285, River-342C, River-342T, River-352C, River-352T, River-362C, River-362C-230V-3Ph-50Hz, River-362T, River-362T-230V-3Ph-50Hz, River-372, River-382, River-382-230V-3Ph-50Hz, River-382H, River-382L, River-382L-230V-3Ph-50Hz, River-382LNRG, River-382LTDE, River-382NRG, River-382NRG-230-3Ph-50Hz... (Other models you can see in the webshop)		



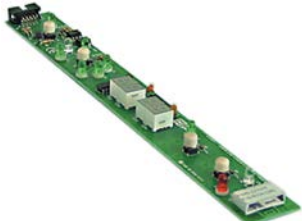

1

<b>GEV No.</b>	402319	<b>Ref. No.</b>	41600
<b>description</b>	keypad PCB dishwasher LP10/20/30		
<b>For models:</b>	914380, 914436, KLP105EB, KLP201DDDTEB, KLP201EB, KLP301DDDTEB, LP105DDDTEB, LP105DDDTEBN, LP105EB, LP201DDDTEB, LP201EB, LP301EB, RIVER-150, River-152, RIVER-154, RV150, RV15023, RV15023DA, RV150D, RV150DA, RV150DAR, RV150DARY, RV150DAW, RV150DAWY, RV150DAY, RV150DE, RV150DRW, RV150DW, RV150DWY, RV150DY, RV150HZ23, RV150S, RV150SA, RV150SAC, RV150SAEW, RV150SAR, RV150SAW, RV150SAWY, RV150SAY, RV150SB, RV150SE, RV150SW, RV150SWY, RV150SY, RV152, RV152D, RV152DA, RV152DARY, RV152DAY, RV152DW... (Other models you can see in the webshop)		



1

<b>GEV No.</b>	400897	<b>Ref. No.</b>	227059 227084
<b>description</b>	display PCB dishwasher GS 60		
<b>For models:</b>	050F, 050FP, 2312-007, 2312-009-CRP, 80, 81, 82, 913911, 913912, 913913, 913914, 913950, 913977, 913984, 913990, 913992, 913993, 914100, 914101, 914165, 914166, 914167, 914168, 914206, 914214, 914284, 914316, 914317, 914318, 914319, 914338, 914339, 914342, 914343, 914355, 914356, 914431, 914516, 914543, 914583, 914592, 914612, 914613, 914624, 914625, 914626, 914627, 914628, 914642, 914684... (Other models you can see in the webshop)		
<b>accessories for</b>	400897		
	<b>GEV No.</b>	<b>Ref. No.</b>	80933 926272
	ribbon cable 10-pole L 3000mm plug type coded 2 row plug: number of poles 10		





1

<b>GEV No.</b>	400898	<b>Ref. No.</b>	80889 80899 80900
<b>description</b>	keypad PCB dishwasher LP10/20/30 with display		
<b>For models:</b>	CGL74CABT, CNT800CH, KLP301, LP301, River-295P, River-296P, RIVER-HL-82, RV295PS, RV296PS, SevenE, SevenL		
<b>accessories for</b>	400898		
	<b>GEV No.</b>	<b>Ref. No.</b>	41523
	ribbon cable 10-pole L 1200mm plug type 2 row coded Qty 1m		

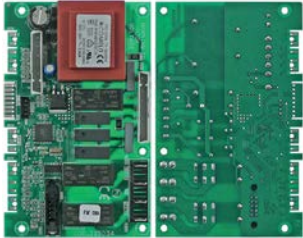

			
<b>GEV No.</b>	403270	<b>Ref. No.</b>	227083 80929
<b>description</b>	keypad PCB for dishwasher River 252/262 L 220mm W 40mm with display buttons 3		
<b>For models:</b>	915154, 915155, 915157, 915158, 915172, 915173, 915285, 915422, 915492, 915493, 915494, 915495, 915496, 915497, 915617, 915618, 915672, 915747, 915773, 915774, 916054, Fast200, FAST-200, Fast93, GL280EB, GL280EB23, GL280EB23DAR, GL280EB23HZ, GL280EB23HZDY, GL280EBD, GL280EBDA, GL280EBDAE, GL280EBDAR, GL280EBDARY, GL280EBDAW, GL280EBDAWY, GL280EBDAY, GL280EBDB, GL280EBDBR, GL280EBDBW, GL280EBDWY, GL280EBDY, GL280EBS, GL280EBSA, GL280EBSAE, GL280EBSAEW, GL280EBSAEWY, GL280EBSAR, GL280EBSARY, GL280EBSAW...(Other models you can see in the webshop)		

			
<b>GEV No.</b>	403780	<b>Ref. No.</b>	215034-6
<b>description</b>	main PCB dishwasher ELETTOBAR / COLGED L 136mm W 85mm		
<b>For models:</b>	916237, 916238, 916239, 916240, 916241, 916242, 916243, 916244, 916245, 916246, 916401, 916402, 916403, 916404, 916405, 916406, 916407, 916408, 916451, 916583, 916687, 916787, 916921, 916922, 916991, 916992, 916993, 917042, 917043, Clean140, Clean140S, Fast130, Fast135-2, Fast135-2S, Fast135H-2, Fast135H-2S, Fast139-2, Fast139-2S, Fast139H-2, Fast139H-2S, Fast140, Fast145-2, Fast150		

 Image not available			
<b>GEV No.</b>	400290	<b>Ref. No.</b>	215011 215998
<b>description</b>	PCB		

			
<b>GEV No.</b>	400949	<b>Ref. No.</b>	215018
<b>description</b>	PCB		
<b>For models:</b>	E.35H, E.40H		

			
<b>GEV No.</b>	361366	<b>Ref. No.</b>	215001
<b>description</b>	PCB dishwasher 11F suitable for DB2 type DB2/EV1/EKP-M		
<b>For models:</b>	10, 11F, 11FD, 11F-DVGW, 11R, 11RD, 12, 14, 21F, 21FD, 21R, 21RD, 22F, 22R, 25F, 25FD, 25R, 25RD, 30F, 30FD, 30R, 30RD, 31F, 31FD, 31R, 31RD, 40F, 440F, 46, 460, 66, CLEAN-100, CLEAN-110, CLEAN-120, CLEAN-3, E.45, E.46		

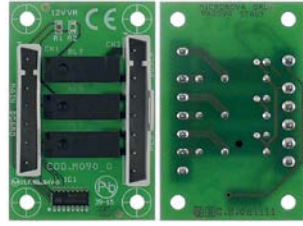
			
<b>GEV No.</b>	403621	<b>Ref. No.</b>	215036
<b>description</b>	PCB dishwasher 25/26/27-05 26/27-20 L 60mm W 40mm		
<b>For models:</b>	915160, 915161, 915162, 915175, 915319, 915611, 915612, 915613, 915663, 915670, 916020, 916021, 916024, 916025, 916026, 916027, 916030, 916031, 916181, 916183, 916184, 916185, 916196, 916197, 916198, 916199, 916200, 916201, 916202, 916203, 916204, 916205, 916206, 916207, 916208, 916209, 916237, 916238, 916239, 916240, 916241, 916242, 916243, 916244, 916245, 916246, 916247, 916248, 916249, 916250...(Other models you can see in the webshop)		

			
<b>GEV No.</b>	403622	<b>Ref. No.</b>	215039
<b>description</b>	PCB dishwasher 25/26/27-05 26/27-20 L 90mm W 50mm starting relay		
<b>For models:</b>	915160, 915161, 915162, 915175, 915319, 915496, 915663, 916067, 916068, 916069, 916079, 916080, 916201, 916202, 916203, 916204, 916205, 916206, 916207, 916208, 916209, 916365, 916366, 916367, 916368, 916411, 916412, 916413, 916414, 916415, 916416, 916417, 916420, 916421, 916422, 916423, 916424, 916684, 916685, 916686, 916760, 916761, 916762, 916802, 916812, 916813, 916878, 916885, Fast170, Fast170S...(Other models you can see in the webshop)		

1

<b>GEV No.</b>	400157	<b>Ref. No.</b>	215009 215013
<b>description</b>	PCB dishwasher 35/40/50/350		
<b>For models:</b>	35-ELECTRONIC, 35F, 35FD, 35R, 35RD, 40-ELECTRONIC, 40F, 40FD, 40R, 40RD, 45, 46, 50-ELECTRONIC, 50F, 50FD		

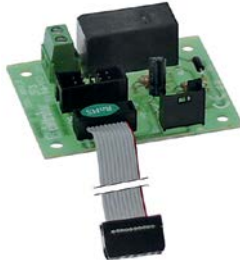

1

<b>GEV No.</b>	401049	<b>Ref. No.</b>	215022
<b>description</b>	PCB dishwasher LP10/20/30		
<b>For models:</b>	2312-009-CRP, 914380, 914436, 914583, 914628, 914944, 915143, KLP105EB, KLP201DDDTTEB, KLP201EB, KLP301, KLP301DDDTTEB, LP105DDDTTEB, LP105DDDTTEBN, LP105EB, LP201DDDTTEB, LP201EB, LP301, LP301EB, RIVER-150, River-152, RIVER-154, RIVER-40-CRP, RIVER-44-CRP, RIVER-44-CRP-ST, RIVER-44CRP-ST, RIVER-50-CRP, RIVER-50-CRP-SP, RIVER-54CRP, River-54-CRP-s.p., RIVER-54-CRP-SP, River-81CRP, RIVER-81-CRP, River-82CRP, RIVER-82-CRP, RIVER-HL-81, RIVER-HL-82, RV150, RV15023, RV15023DA, RV150D, RV150DA, RV-150DAR, RV150DARY, RV150DAW, RV150DAWY, RV150DAY, RV150DE, RV150DRW, RV150DW...(Other models you can see in the webshop)		



1

<b>GEV No.</b>	403734	<b>Ref. No.</b>	215034-3
<b>description</b>	PCB dishwasher COLGED L 135mm W 85mm		
<b>For models:</b>	915160, 915161, 915162, 915175, 915319, 915611, 915612, 915613, 915663, 915670, 916247, 916248, 916249, 916250, 916251, 916252, 916365, 916366, 916382, 916383, 916452, 916504, 916584, 916670, 916688, 916763, 917044, 917049, Clean161, Fast160-2, Fast161-2, Fast170, Fast170S, Pluvia-240, Pluvia-260, Pluvia-270		



1

<b>GEV No.</b>	403572	<b>Ref. No.</b>	215032-1
<b>description</b>	PCB dishwasher Protech 1113/611 TR10 L 178mm W 125mm		
<b>For models:</b>	915157, 915158, 915494, 915495, 915617, 915618, 915672, 915773, 915774, Fast200, Fast93, GL280EB, GL280EB23, GL280EB23DAR, GL280EB23HZ, GL280EB23HZDY, GL280EBDARY, GL280EBDAW, GL280EBDAY, GL280EBDB, GL280EBDBR, GL280EBDWY, GL280EB-SA, GL280ESAE, GL280ESAEW, GL280ESAEWY, GL280ES-AR, GL280ESARY, GL280ESAW, GL280ESAWY, GL280ESAY, GL280ESB, GL280ESR, GL280ESWY, GL282EB, GL282EB93, GL282EB93DA, GL282EB93HZ23, GL282EBCH, GL282EBDA, GL282EB-DARW, GL282EBDAWY, GL282EBDBW, GL282EBDCWY, GL282EBHZ23, GL282EBHZ23DY, GL282EBHZ23SY, GL282EBSA, GL282ESAEW, GL282ESAEWY...(Other models you can see in the webshop)		

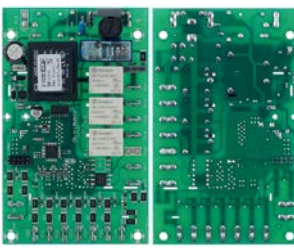

1

<b>GEV No.</b>	403093	<b>Ref. No.</b>	215033 215038
<b>description</b>	PCB dishwasher L 135mm W 82mm		
<b>For models:</b>	913363, 913364, 915611, 915612, 915613, 915670, 915686, 915687, 915689, 915690, 915691, 915692, 915693, 915694, 915695, 915696, 915819, 916162, 916788, E.41, Fast135CT, Fast135D, Fast135H, Fast135HCT, Fast135HD, Fast139, Fast139CT, Fast139D, Fast140, Fast145, Fast145D, PLUVIA-240		



1

<b>GEV No.</b>	403518	<b>Ref. No.</b>	215034-5
<b>description</b>	PCB dishwasher R4258E1120T7S L 136mm W 85.5mm 230V		
<b>For models:</b>	Fast180, Fast180-230V-3Ph-60Hz, Fast181, PV280FAST2, PV280FAST-2BIO, PV280FAST2HZ23, ST70FASTHZ23		



1

<b>GEV No.</b>	402880	<b>Ref. No.</b>	215027
<b>description</b>	PCB dishwasher L 152mm W 80mm		
<b>For models:</b>	915150, 915151, 915152, 915166, 915167, 915168, 915348, 915420, 915421, 915479, 915547, 915558, 915614, 915615, 915616, 915635, 915671, 915747, 915959, NG271, NG281, NG281CDD, NG281HP, NG281HPDD, NG281HZ23, NG281HZ23DD, NG291, NG292, NG292HZ, NG293, NIAGARA-241, Niagara-251, NIAGARA-261, NIAGARA-271, NIAGARA-281, Niagara-281HP, NIAGARA-291, NIAGARA-292, Niagara-292-400V-3Ph-60Hz, NIAGARA-293		

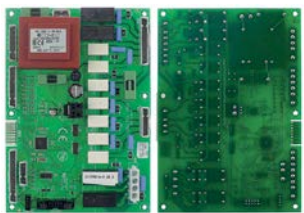

1

<b>GEV No.</b>	404027	<b>Ref. No.</b>	215032-5
<b>description</b>	PCB dishwasher TOPTECH 921-924 L 178mm W 130mm		
<b>For models:</b>	River-295P, River-296P, RV295PS, RV296PS		

1

<b>GEV No.</b>	401900	<b>Ref. No.</b>	215029
<b>description</b>	PCB L 120mm W 80mm		
<b>For models:</b>	915160, 915161, 915162, 915175, 915176, 915177, 915319, 915338, 915341, 915418, 915419, 915483, 915484, 915527, 915528, 915537, 915538, 915539, 915540, 915663, 915664, 915686, 915687, 915688, 915689, 915690, 915691, 915692, 915693, 915694, 915695, 915696, 915697, 915698, 915699, 915700, 915701, 915702, 915729, 915756, 915799, 915800, 915809, 915816, 915817, 915818, 915819, 915830, 915842, FAST-135...(Other models you can see in the webshop)		



1

<b>GEV No.</b>	403045	<b>Ref. No.</b>	215032
<b>description</b>	PCB suitable for ELETTROBAR		
<b>For models:</b>	915154, 915155, 915172, 915173, 915285, 915422, 915492, 915493, 915496, 915497, 915617, 915618, 915672, 915773, 915774, 916054, FAST-200, GL280EB, GL280EBD, GL280EBDA, GL280EBDAE, GL280EBDAR, GL280EBDAWY, GL280EBDBW, GL280EBDY, GL280EBS, GL280EBSY, GL282EB, GL282EBCH, GL282EBCHD, GL282EBD, GL282EBDAE, GL282EBDAR, GL284EBD, GL284EBDAWY, GL284EBS, GL284EBSAR, GL286EBD, GL286EBDARY, GL286EBS, GL286EBSAW, NIAGARA-2150, NIAGARA-2152, NIAGARA-2154, NIAGARA-2156, RIVER-242, RIVER-252, River-262, RIVER-282, RIVER-294...(Other models you can see in the webshop)		



1

<b>GEV No.</b>	403784	<b>Ref. No.</b>	215037
<b>description</b>	PCB warewashing ELETTROBAR / COLGED L 60mm W 30mm		
<b>For models:</b>	915160, 915161, 915162, 915175, 915319, 915611, 915612, 915613, 915663, 915670, 916247, 916248, 916249, 916250, 916251, 916252, 916365, 916366, 916382, 916383, 916452, 916504, 916584, 916670, 916688, 916763, 917044, 917049, Clean161, Fast160-2, Fast161-2, Fast170, Fast170S, Fast180, Fast180-230V-3Ph-60Hz, Fast181, Pluvia-240, Pluvia-260, Pluvia-270, PV280FAST2, PV280FAST2BIO, PV280FAST2HZ23, ST70FASTHZ23		





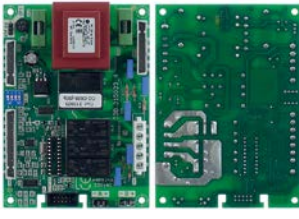

1

<b>GEV No.</b>	403509	<b>Ref. No.</b>	999298
<b>description</b>	PCB warewashing NIAGARA/SILVER		
<b>For models:</b>	CNT800CH, NIAGARA-283, Niagara-283A, SevenE, SV72AEB, SV72EB		



1

<b>GEV No.</b>	400899	<b>Ref. No.</b>	215023
<b>description</b>	power PCB dishwasher LP10/20/30 without EPROM		
<b>For models:</b>	050F, 050FP, 2312-007, 2312-009-CRP, 80, 81, 82, 913911, 913912, 913913, 913914, 913950, 913977, 913984, 913990, 913992, 913993, 914100, 914101, 914165, 914166, 914167, 914168, 914206, 914214, 914284, 914316, 914317, 914318, 914319, 914338, 914339, 914342, 914343, 914355, 914356, 914380, 914431, 914436, 914516, 914543, 914583, 914592, 914612, 914613, 914624, 914625, 914626, 914627, 914628...(Other models you can see in the webshop)		
<b>accessories for</b>	400899		
	<b>GEV No.</b>	400761	<b>Ref. No.</b> CN5
<b>description</b>	plug connector 5-pole		
	<b>GEV No.</b>	400900	<b>Ref. No.</b> 225029
<b>description</b>	EPROM CODE 225029-3		
	<b>GEV No.</b>	401558	<b>Ref. No.</b> 81000 81010
<b>description</b>	EPROM CODE 81000-1		
	<b>GEV No.</b>	403241	<b>Ref. No.</b> 81001
<b>description</b>	EPROM type U61E for dishwasher CODE 81001-3		
	<b>GEV No.</b>	550048	<b>Ref. No.</b> —
<b>description</b>	female bullet		

## keypads

### front foils



1

<b>GEV No.</b>	402166	<b>Ref. No.</b>	025635
<b>description</b>	front foil dishwasher E.50-51 L 420mm W 35mm		
<b>For models:</b>	913297, 913298, 913299, 913300, 913360, 913361, 913391, 913392, 913546, 913547, 913578, 913611, 913684, 913932, 913933, 914331, 914400, 914401, 914402, 914403, 914404, 914405, 914449, 914517, 914545, 914568, 914688, 914979, 915140, 915248, E.50, E.50D.PA, E.51		



1

<b>GEV No.</b>	403782	<b>Ref. No.</b>	70704 70727
<b>description</b>	front foil dishwasher ELETTROBAR / NIAGARA L 258mm W 36mm		
<b>For models:</b>	916196, 916197, 916198, 916199, 916200, 916201, 916202, 916203, 916204, 916205, 916206, 916207, 916208, 916209, 916367, 916409, 916410, 916411, 916412, 916413, 916414, 916415, 916416, 916417, 916591, 916592, 916593, 916684, 916685, 916761, 916762, 916802, 916812, 916813, 916877, 916878, 916885, NG381, NG38123, NG-38123TERMO, NG381C, NG381CDD, NG381CFUR, NG381DDHZ23, NG381DDPS, NG381DDPSHZ23, NG381HPDD, NG381L, NG381LC, NG381LCFUR...(Other models you can see in the webshop)		



electric components

1			
<b>GEV No.</b>	401948	<b>Ref. No.</b>	025982
<b>description</b>	front foil dishwasher GS40		
<b>For models:</b>	GLS40H, GLS40HP		

1			
<b>GEV No.</b>	401947	<b>Ref. No.</b>	025983
<b>description</b>	front foil dishwasher GS50/GS51		
<b>For models:</b>	GSP50, GSP50P		

1			
<b>GEV No.</b>	401963	<b>Ref. No.</b>	80856
<b>description</b>	front foil dishwasher HM		
<b>For models:</b>	HM1		

1			
<b>GEV No.</b>	403243	<b>Ref. No.</b>	025898
<b>description</b>	front foil dishwasher Niagara 261 blue L 448mm W 53mm		
<b>For models:</b>	915166, 915167, 915168, 915348, 915420, 915421, 915479, 915547, 915558, 915635, 915747, NIAGARA-261		

1			
<b>GEV No.</b>	518568	<b>Ref. No.</b>	025473
<b>description</b>	keypad foil		
<b>For models:</b>	F85, F85P		

1			
<b>GEV No.</b>	518566	<b>Ref. No.</b>	025471
<b>description</b>	keypad foil dishwasher 050FP		
<b>For models:</b>	050F, 050FP		

1			
<b>GEV No.</b>	401596	<b>Ref. No.</b>	36782
<b>description</b>	keypad foil dishwasher L20		

1			
<b>GEV No.</b>	505276	<b>Ref. No.</b>	36784
<b>description</b>	keypad foil dishwasher L25 L 494mm W 84mm buttons 4		

1			
<b>GEV No.</b>	518567	<b>Ref. No.</b>	025472
<b>description</b>	keypad foil warewashing F85		
<b>For models:</b>	F85		

## membrane keypads

1			
<b>GEV No.</b>	403631	<b>Ref. No.</b>	75948
<b>description</b>	membrane keypad for dishwasher L 230mm W 65mm		
<b>For models:</b>	915747		

## accessories

1			
<b>GEV No.</b>	346850	<b>Ref. No.</b>	80883
<b>description</b>	push button no lens blue ø 21mm		

1			
<b>GEV No.</b>	346849	<b>Ref. No.</b>	80884
<b>description</b>	push button with lens blue ø 21mm		





## solenoid valves

### solenoid valves (water)

ELBI

straight



<b>GEV No.</b>	373017	<b>Ref. No.</b>	240016 240021
<b>description</b>	solenoid valve single straight 230VAC inlet 3/4" outlet 11.5mm DN10 ELBI		
<b>For models:</b>	80, 81, 82, 915150, 915151, 915152, 915154, 915155, 915157, 915158, 915160, 915161, 915162, 915166, 915167, 915168, 915172, 915173, 915175, 915176, 915177, 915319, 915338, 915341, 915348, 915418, 915419, 915420, 915421, 915422, 915479, 915483, 915484, 915492, 915493, 915494, 915495, 915496, 915497, 915537, 915538, 915539, 915540, 915547, 915558, 915611, 915612, 915613, 915614, 915615... (Other models you can see in the webshop)		



<b>GEV No.</b>	370243	<b>Ref. No.</b>	240012
<b>description</b>	solenoid valve single straight 230VAC inlet 3/4" outlet 11.5mm input 5.5l/min t.max. 90°C ELBI plastic flow regulating valve inlet black		
<b>For models:</b>	CLEAN-3, RIVER-43		



<b>GEV No.</b>	370315	<b>Ref. No.</b>	929172
<b>description</b>	solenoid valve double straight 230VAC inlet 3/4" outlet 11.5mm input 16l/min t.max. 90°C ELBI plastic flow regulating valve inlet black		
<b>For models:</b>	914380, 914436, Fast200, FAST-200, Fast93, GL280EB, GL280EB23, GL280EB23DAR, GL280EB23HZ, GL280EB23HZDY, GL280EBD, GL280EBDA, GL280EBDAE, GL280EBDAR, GL280EBDARY, GL280EBDAW, GL280EBDAWY, GL280EBDAY, GL280EBDB, GL280EBDBR, GL280EBDBW, GL280EBDWY, GL280EBDY, GL280EBS, GL280EBSA, GL280EBSAE, GL280EBSAEW, GL280EBSAEWY, GL280EBSAR, GL280EBSARY, GL280EBSAW, GL280EBSAWY, GL280EBSAY, GL280EBSB, GL280EBSR, GL280EBSWY, GL280EBSY, GL282EB, GL282EB93, GL282EB93DA, GL282EB93HZ23, GL282EBCH, GL282EBCHD, GL282EBD, GL282EBDA, GL282EBDAE, GL282EBDAR, GL282EBDARW, GL282EBDAWY, GL282EBDBW... (Other models you can see in the webshop)		



<b>GEV No.</b>	370246	<b>Ref. No.</b>	240010
<b>description</b>	solenoid valve double straight 230VAC inlet 3/4" outlet 11.5mm t.max. 90°C ELBI plastic output B 0.5l/min flow regulating valve outlet B red		
<b>For models:</b>	050F, 050FP, 11F, 11FD, 11R, 11RD, 2312-001, 2312-002, 2312-007, 31F, 31FD, 31R, 31RD, 350F, 350FD, 350R, 350RD, 35-ELECTRONIC, 35F, 35FD, 35R, 35RD, 400F, 400FD, 400R, 400RD, 40-ELECTRONIC, 40F, 40FD, 40R, 40RD, 46, 460, 500F, 500FD, 50-ELECTRONIC, 50F, 50FD, 510F, 510FD, 913289, 913290, 913291, 913292, 913297, 913298, 913299, 913300, 913356, 913357... (Other models you can see in the webshop)		



<b>GEV No.</b>	370247	<b>Ref. No.</b>	240002
<b>description</b>	solenoid valve triple straight 230VAC inlet 3/4" outlet 11.5mm t.max. 90°C ELBI plastic flow regulating valve inlet orange output B 0.5l/min flow regulating valve outlet B red		
<b>For models:</b>	11F, 11FD, 11F-DVGW, 11R, 11RD, 21F, 21FD, 21R, 21RD, 25F, 25FD, 25R, 25RD, 30F, 30FD, 30R, 30RD, 31F, 31FD, 31R, 31RD, 350F, 350FD, 350R, 350RD, 35-ELECTRONIC, 35F, 35FD, 35R, 35RD, 400F, 400FD, 400R, 400RD, 40-ELECTRONIC, 40F, 40FD, 40R, 40RD, 45, 450, 46, 460, 50F, 50FD, 510F, 510FD, 55, 67F, 67R... (Other models you can see in the webshop)		

#### spare parts and accessories

#### reducers

#### inlet side



<b>GEV No.</b>	371326	<b>Ref. No.</b>	75976
<b>description</b>	reducer ELBI ø 16mm white		
<b>For models:</b>	915747		

#### RPE







<b>GEV No.</b>	374063	<b>Ref. No.</b>	5200152
<b>description</b>	solenoid valve single straight 230VAC inlet 3/8" IT outlet 3/8" IT input/output/min DN11 t.max. 25/60/90°C duty cycle 100% RPE R Mini 410 plastic		

1 electric components



TP			
			
1			
<b>GEV No.</b>	370021	<b>Ref. No.</b>	240003
<b>description</b>	solenoid valve double straight 230VAC inlet 3/4" outlet 11.5mm DN10 TP flow regulating valve inlet white		
<b>For models:</b>	11F, 11FD, 11F-DVGW, 11R, 11RD, 21F, 21FD, 21R, 21RD, 22F, 22R, 25F, 25FD, 25R, 25RD, 30F, 30FD, 30R, 30RD, 31F, 31FD, 31R, 31RD, 350F, 350FD, 350R, 350RD, 400F, 400FD, 400R, 400RD, 40-ELECTRONIC, 40F, 40FD, 40R, 40RD, 44F, 46, 460, 50F, 50FD, 510F, 510FD, 55, 66, 67F, 67R, 913363, 913364, 913376...(Other models you can see in the webshop)		
<b>spare parts for</b>	370021		
	<b>GEV No.</b>	371013	<b>Ref. No.</b> —
solenoid coil TP 230VAC 50/60Hz			
<b>accessories for</b>	370021		
	<b>GEV No.</b>	371220	<b>Ref. No.</b> —
reducer TP flow rate 3l/min red tolerance ±15%			
	<b>GEV No.</b>	371221	<b>Ref. No.</b> —
reducer TP flow rate 5.5l/min yellow tolerance ±15%			
	<b>GEV No.</b>	371222	<b>Ref. No.</b> —
reducer TP flow rate 6l/min grey tolerance ±15%			
	<b>GEV No.</b>	371223	<b>Ref. No.</b> —
reducer TP flow rate 10l/min white tolerance ±15%			
	<b>GEV No.</b>	371224	<b>Ref. No.</b> —
reducer TP flow rate 12l/min bronze tolerance ±15%			
	<b>GEV No.</b>	371225	<b>Ref. No.</b> —
reducer TP flow rate 16l/min light brown tolerance ±15%			
	<b>GEV No.</b>	371226	<b>Ref. No.</b> —
reducer TP flow rate 20l/min red tolerance ±15%			
	<b>GEV No.</b>	371230	<b>Ref. No.</b> —
reducer TP flow rate 0.25l/min red tolerance ±25%			
	<b>GEV No.</b>	371231	<b>Ref. No.</b> —
reducer TP flow rate 0.35l/min violet tolerance ±25%			
	<b>GEV No.</b>	371232	<b>Ref. No.</b> —
reducer TP flow rate 0.5l/min orange tolerance ±25%			
	<b>GEV No.</b>	371233	<b>Ref. No.</b> —
reducer TP flow rate 0.8l/min white tolerance ±25%			
	<b>GEV No.</b>	371234	<b>Ref. No.</b> —
reducer TP flow rate 1l/min light blue tolerance ±25%			
	<b>GEV No.</b>	371235	<b>Ref. No.</b> —
reducer TP flow rate 1.2l/min brown tolerance ±25%			

accessories for 370021			
	<b>GEV No.</b>	371236	<b>Ref. No.</b> —
reducer TP flow rate 1.5l/min light brown tolerance ±25%			
	<b>GEV No.</b>	371237	<b>Ref. No.</b> —
reducer TP flow rate 2.5l/min yellow tolerance ±25%			
	<b>GEV No.</b>	371238	<b>Ref. No.</b> —
reducer TP flow rate 3.4l/min dark green tolerance ±25%			
	<b>GEV No.</b>	371239	<b>Ref. No.</b> —
reducer TP flow rate 5l/min black tolerance ±25%			
	<b>GEV No.</b>	371240	<b>Ref. No.</b> —
reducer TP flow rate 8l/min blue tolerance ±20%			













1			
			
1			
<b>GEV No.</b>	370111	<b>Ref. No.</b>	927001
<b>description</b>	solenoid valve double straight 24VAC inlet 3/4" outlet 11.5mm DN10 TP		
<b>For models:</b>	161, 221, 271, 272, 362, CLEAN-160, CLEAN-161, CLEAN-220, CLEAN-221, CLEAN-270, CLEAN-271, CLEAN-272, CLEAN-362		
<b>spare parts for</b>	370111		
	<b>GEV No.</b>	371035	<b>Ref. No.</b> —
solenoid coil 24VAC			
<b>accessories for</b>	370111		
	<b>GEV No.</b>	371220	<b>Ref. No.</b> —
reducer TP flow rate 3l/min red tolerance ±15%			
	<b>GEV No.</b>	371221	<b>Ref. No.</b> —
reducer TP flow rate 5.5l/min yellow tolerance ±15%			
	<b>GEV No.</b>	371222	<b>Ref. No.</b> —
reducer TP flow rate 6l/min grey tolerance ±15%			
	<b>GEV No.</b>	371223	<b>Ref. No.</b> —
reducer TP flow rate 10l/min white tolerance ±15%			
	<b>GEV No.</b>	371224	<b>Ref. No.</b> —
reducer TP flow rate 12l/min bronze tolerance ±15%			
	<b>GEV No.</b>	371225	<b>Ref. No.</b> —
reducer TP flow rate 16l/min light brown tolerance ±15%			
	<b>GEV No.</b>	371226	<b>Ref. No.</b> —
reducer TP flow rate 20l/min red tolerance ±15%			
	<b>GEV No.</b>	371230	<b>Ref. No.</b> —
reducer TP flow rate 0.25l/min red tolerance ±25%			
	<b>GEV No.</b>	371231	<b>Ref. No.</b> —
reducer TP flow rate 0.35l/min violet tolerance ±25%			

Table continues overleaf



accessories for		370111		
GEV No.	Ref. No.	Ref. No.	Ref. No.	—
	371232	Ref. No.	—	reducer TP flow rate 0.5l/min orange tolerance ±25%
	371233	Ref. No.	—	reducer TP flow rate 0.8l/min white tolerance ±25%
	371234	Ref. No.	—	reducer TP flow rate 1l/min light blue tolerance ±25%
	371235	Ref. No.	—	reducer TP flow rate 1.2l/min brown tolerance ±25%
	371236	Ref. No.	—	reducer TP flow rate 1.5l/min light brown tolerance ±25%
	371237	Ref. No.	—	reducer TP flow rate 2.5l/min yellow tolerance ±25%
	371238	Ref. No.	—	reducer TP flow rate 3.4l/min dark green tolerance ±25%
	371239	Ref. No.	—	reducer TP flow rate 5l/min black tolerance ±25%
	371240	Ref. No.	—	reducer TP flow rate 8l/min blue tolerance ±20%

  <p>1</p>				
GEV No.	370017	Ref. No.	240005 240011 240018	
description	solenoid valve single straight 230VAC inlet 3/4" outlet 11.5mm DN10 TP p max 10bar			
For models:	050F, 050FP, 10, 11F, 11FD, 11F-DVGW, 11R, 11RD, 12, 14, 21F, 21FD, 21R, 21RD, 22F, 2312-001, 2312-002, 2312-007, 2312-009-CRP, 25F, 25FD, 25R, 25RD, 30F, 30FD, 30R, 30RD, 31F, 31FD, 31R, 31RD, 350F, 350FD, 350R, 350RD, 35-ELECTRONIC, 35F, 35FD, 35R, 35RD, 400F, 400FD, 400R, 400RD, 40-ELECTRONIC, 40F, 40FD, 40R, 40RD, 440F... (Other models you can see in the webshop)			
spare parts for	370017			
	GEV No.	371013	Ref. No.	—
solenoid coil TP 230VAC 50/60Hz				
accessories for	370017			
	GEV No.	371220	Ref. No.	—
reducer TP flow rate 3l/min red tolerance ±15%				
	GEV No.	371221	Ref. No.	—
reducer TP flow rate 5.5l/min yellow tolerance ±15%				
	GEV No.	371222	Ref. No.	—
reducer TP flow rate 6l/min grey tolerance ±15%				
	GEV No.	371223	Ref. No.	—
reducer TP flow rate 10l/min white tolerance ±15%				

accessories for		370017		
GEV No.	Ref. No.	Ref. No.	Ref. No.	—
	371224	Ref. No.	—	reducer TP flow rate 12l/min bronze tolerance ±15%
	371225	Ref. No.	—	reducer TP flow rate 16l/min light brown tolerance ±15%
	371226	Ref. No.	—	reducer TP flow rate 20l/min red tolerance ±15%
	371230	Ref. No.	—	reducer TP flow rate 0.25l/min red tolerance ±25%
	371231	Ref. No.	—	reducer TP flow rate 0.35l/min violet tolerance ±25%
	371232	Ref. No.	—	reducer TP flow rate 0.5l/min orange tolerance ±25%
	371233	Ref. No.	—	reducer TP flow rate 0.8l/min white tolerance ±25%
	371234	Ref. No.	—	reducer TP flow rate 1l/min light blue tolerance ±25%
	371235	Ref. No.	—	reducer TP flow rate 1.2l/min brown tolerance ±25%
	371236	Ref. No.	—	reducer TP flow rate 1.5l/min light brown tolerance ±25%
	371237	Ref. No.	—	reducer TP flow rate 2.5l/min yellow tolerance ±25%
	371238	Ref. No.	—	reducer TP flow rate 3.4l/min dark green tolerance ±25%
	371239	Ref. No.	—	reducer TP flow rate 5l/min black tolerance ±25%
	371240	Ref. No.	—	reducer TP flow rate 8l/min blue tolerance ±20%



  <p>1</p>				
GEV No.	370015	Ref. No.	240006	
description	solenoid valve single angled 230VAC inlet 3/4" outlet 11.5mm DN10 TP			
accessories for	370015			
	GEV No.	371220	Ref. No.	—
reducer TP flow rate 3l/min red tolerance ±15%				

Table continues overleaf



accessories for		370015	
GEV No.	371221	Ref. No.	—
	reducer TP flow rate 5.5l/min yellow tolerance ±15%		
	reducer TP flow rate 6l/min grey tolerance ±15%		
	reducer TP flow rate 10l/min white tolerance ±15%		
	reducer TP flow rate 12l/min bronze tolerance ±15%		
	reducer TP flow rate 16l/min light brown tolerance ±15%		
	reducer TP flow rate 20l/min red tolerance ±15%		
	reducer TP flow rate 0.25l/min red tolerance ±25%		
	reducer TP flow rate 0.35l/min violet tolerance ±25%		
	reducer TP flow rate 0.5l/min orange tolerance ±25%		
	reducer TP flow rate 0.8l/min white tolerance ±25%		
	reducer TP flow rate 1l/min light blue tolerance ±25%		
	reducer TP flow rate 1.2l/min brown tolerance ±25%		
	reducer TP flow rate 1.5l/min light brown tolerance ±25%		
	reducer TP flow rate 2.5l/min yellow tolerance ±25%		
	reducer TP flow rate 3.4l/min dark green tolerance ±25%		
	reducer TP flow rate 5l/min black tolerance ±25%		
	reducer TP flow rate 8l/min blue tolerance ±20%		

solenoid valves with reducers

1			
<b>GEV No.</b>	370245	<b>Ref. No.</b>	927242 DEV34516 LF-3120530
<b>description</b>	solenoid valve single straight 24VAC inlet 3/4" outlet 11.5mm input 16l/min t.max. 90°C TP plastic flow regulating valve inlet light brown		
<b>For models:</b>	161, 221, 271, 272, 362, A4EBSAKCK, CLEAN-160, CLEAN-161, CLEAN-220, CLEAN-221, CLEAN-270, CLEAN-271, CLEAN-272, CLEAN-361, CLEAN-361P, CLEAN-362, CLEAN-471, CLEAN-471P		

various

1			
<b>GEV No.</b>	370726	<b>Ref. No.</b>	999288
<b>description</b>	solenoid valve double straight 220-240VAC inlet 11mm outlet 11mm MILANO plastic output B red		
<b>For models:</b>	913364, 915150, 915151, 915152, 915154, 915155, 915157, 915158, 915160, 915161, 915162, 915166, 915167, 915168, 915172, 915173, 915175, 915285, 915319, 915348, 915418, 915419, 915420, 915421, 915422, 915479, 915483, 915484, 915492, 915493, 915494, 915495, 915496, 915497, 915537, 915538, 915539, 915540, 915547, 915558, 915611, 915612, 915613, 915614, 915615, 915616, 915617, 915618, 915635, 915663...(Other models you can see in the webshop)		

1			
<b>GEV No.</b>	370636	<b>Ref. No.</b>	240020
<b>description</b>	solenoid valve single CO 230VAC outlet 10.5mm MILANO 00168401 plastic 3-ways inlet 10.5mm 50/60Hz male faston 6.3mm		
<b>For models:</b>	915154, 915155, 915157, 915158, 915166, 915167, 915168, 915172, 915173, 915175, 915176, 915177, 915285, 915338, 915341, 915348, 915420, 915421, 915422, 915492, 915493, 915494, 915495, 915496, 915497, 915547, 915558, 915617, 915618, 915663, 915672, 915747, 915773, 915774, 916054, 916066, 916067, 916068, 916069, 916077, 916078, 916079, 916080, 916368, 916418, 916419, 916420, 916421, 916422, 916423...(Other models you can see in the webshop)		
<b>accessories for</b>	370636		
	<b>GEV No.</b>	371142	<b>Ref. No.</b>
			133009
	reducer for solenoid valve ø 8.2mm		



metal

ASCO

solenoid valves steam (water)

2-way



1

<b>GEV No.</b>	370728	<b>Ref. No.</b>	927148
<b>description</b>	solenoid valve 2-ways 24VAC inlet 1/2" IT outlet 1/2" IT connection 1/2" L 62mm DN 12mm t.max. 85°C slide-on receptacle DIN -10 up to +85°C Asco type series E238C coil type 43005421 membranes NBR p max 10bar p min 0.3bar 50/60Hz brass		
<b>For models:</b>	CLEAN-361, CLEAN-361P, CLEAN-471, CLEAN-471P		

PARKER

2-way

VE-123 series



1

<b>GEV No.</b>	370727	<b>Ref. No.</b>	927142
<b>description</b>	solenoid valve brass 2-ways 24VAC inlet 1/2" IT outlet 1/2" IT connection 1/2" L 72mm DN 13mm t.max. 140°C -10 up to 140°C PARKER type series VE123 coil type ZB09 membranes Viton p max 5bar 50/60Hz 24V voltage AC		
<b>For models:</b>	272, 362, CLEAN-161, CLEAN-221, CLEAN-271, CLEAN-272, CLEAN-361, CLEAN-361P, CLEAN-362, CLEAN-471, CLEAN-471P		

Solenoid valve - accessories



1

<b>GEV No.</b>	371142	<b>Ref. No.</b>	133009
<b>description</b>	reducer for solenoid valve ø 8.2mm		
<b>For models:</b>	915166, 915167, 915168, 915175, 915176, 915177, 915338, 915341, 915348, 915420, 915421, 915547, 915558, 915663, 915747, NIAGARA-251, NIAGARA-261, PLUVIA-260, Pluvia-270		

pressure switches

for warewashing

ø 58mm with male faston 6.3mm

with connection horizontal



1

<b>GEV No.</b>	541002	<b>Ref. No.</b>	224002
<b>description</b>	pressure control pressure range 110/60mbar connection 6mm ø 58mm pressure connection horizontal warewashing pressure connection ø 6mm		
<b>For models:</b>	66, 80, 81, 82, CE78HZ23, E78, E78HP, HM1, LP60, NG381L, NG381LC, NG381LCFUR, NG381LDDPS, Niagara-283L-2, Niagara-381L, Niagara-381LC, R495, R499, R501, R503, R505, R507, R509, R511, R704, R706, R708, RIVER-282, River-282-2, River-282L-2, River-282LS-2TDE, River-282S-2TDE, River-285, RIVER-294, RIVER-295, River-295P, RIVER-296, River-296P, RIVER-297, RIVER-298, River-382, River-382-230V-3Ph-50Hz, River-382H, River-382L, River-382L-230V-3Ph-50Hz, River-382LNRG, River-382LTDE, River-382NRG, River-382NRG-230-3Ph-50Hz, River-382TDE...(Other models you can see in the webshop)		



1

<b>GEV No.</b>	541011	<b>Ref. No.</b>	224010
<b>description</b>	pressure control pressure range 110/70mbar connection 6mm ø 58mm pressure connection horizontal warewashing		
<b>For models:</b>	2312-002, 913297, 913298, 913299, 913300, 913360, 913361, 913391, 913392, 913546, 913547, 913578, 913611, 913684, 913913, 913914, 913932, 913933, 914284, 914318, 914319, 914331, 914338, 914356, 914400, 914401, 914402, 914403, 914404, 914405, 914431, 914449, 914517, 914545, 914568, 914642, 914688, 914909, 914979, 915136, 915137, 915140, 915248, 915483, 915484, 915528, 915537, 915538, 915539, 915540...(Other models you can see in the webshop)		



1

<b>GEV No.</b>	541102	<b>Ref. No.</b>	224006
<b>description</b>	pressure control pressure range 115/15mbar connection 6mm ø 58mm pressure connection horizontal warewashing		
<b>For models:</b>	915747, A4EBT, A4EBTSAK, CLEAN-3, River-multi-2256		



1

<b>GEV No.</b>	541647	<b>Ref. No.</b>	224011
<b>description</b>	pressure control pressure range 115/85mbar connection 6mm ø 58mm pressure connection ø 6mm		
<b>For models:</b>	914326, 914406, 915729, E.55, FAST-63, RIVER-43		



1

<b>GEV No.</b>	543025	<b>Ref. No.</b>	224027
<b>description</b>	pressure control pressure range 155/130mbar connection F6.3 ø 5.5mm		
<b>For models:</b>	915611, 915612, 915613, 915614, 915615, 915616, 915670, 915671, 915959, 916196, 916197, 916198, 916199, 916200, 916409, 916410, 916591, 916592, 916593, 916877, Niagara-241, Niagara-241-2, Niagara-341, Pluvia-240		



1

<b>GEV No.</b>	543024	<b>Ref. No.</b>	224026
<b>description</b>	pressure control pressure range 120/95mbar connection F6.3 ø 5.5mm		
<b>For models:</b>	915611, 915612, 915613, 915614, 915615, 915616, 915670, 915671, 915959, 916196, 916197, 916198, 916199, 916200, 916409, 916410, 916591, 916592, 916593, 916877, NIAGARA-241, Niagara-241-2, Niagara-341, Pluvia-240		



1

<b>GEV No.</b>	541644	<b>Ref. No.</b>	224014
<b>description</b>	pressure control pressure range 160/125mbar connection 6mm ø 58mm pressure connection ø 6mm		
<b>For models:</b>	RIVER-43		



1

<b>GEV No.</b>	541899	<b>Ref. No.</b>	224022 224025
<b>description</b>	pressure control pressure range 125/105mbar connection 6mm ø 58mm pressure connection horizontal warewashing pressure connection ø 6mm		
<b>For models:</b>	915150, 915151, 915152, 915154, 915155, 915157, 915158, 915160, 915161, 915162, 915166, 915167, 915168, 915175, 915176, 915177, 915319, 915338, 915341, 915348, 915418, 915419, 915420, 915421, 915479, 915492, 915493, 915494, 915495, 915547, 915558, 915635, 915663, 915747, 916201, 916202, 916203, 916204, 916205, 916206, 916207, 916208, 916209, 916365, 916366, 916367, 916411, 916412, 916413, 916414...(Other models you can see in the webshop)		



1

<b>GEV No.</b>	541898	<b>Ref. No.</b>	224023
<b>description</b>	pressure control pressure range 165/140mbar connection 6mm ø 58mm pressure connection horizontal warewashing pressure connection ø 6mm		
<b>For models:</b>	915150, 915151, 915152, 915154, 915155, 915160, 915161, 915162, 915166, 915167, 915168, 915175, 915176, 915177, 915319, 915338, 915341, 915348, 915418, 915419, 915420, 915421, 915479, 915492, 915493, 915547, 915558, 915635, 915663, 915747, 916201, 916202, 916203, 916204, 916205, 916206, 916207, 916208, 916209, 916365, 916366, 916367, 916411, 916412, 916413, 916414, 916415, 916416, 916417, 916684...(Other models you can see in the webshop)		



1

<b>GEV No.</b>	541166	<b>Ref. No.</b>	224008
<b>description</b>	pressure control pressure range 140/110mbar connection 6mm ø 58mm pressure connection horizontal warewashing		
<b>For models:</b>	2312-009-CRP, PS-60, RIVER-40, RIVER-44, RIVER-44-CRP, RIVER-48, RIVER-50, RIVER-50-CRP, RIVER-61		



1

<b>GEV No.</b>	541103	<b>Ref. No.</b>	224007
<b>description</b>	pressure control pressure range 170/140mbar connection 6mm ø 58mm pressure connection horizontal warewashing		
<b>For models:</b>	CLEAN-3		





			
1			
<b>GEV No.</b>	541105	<b>Ref. No.</b>	926049
<b>description</b>	pressure control pressure range 180/70mbar connection 6mm ø 58mm pressure connection horizontal warewashing		
<b>For models:</b>	12, 14, 161, 221, 271, 272, 362, 80, 81, 82, 914380, 914436, 915747, 915773, A3EB, A3EBD, A3EBDAKRKYK, A3EBDAKWK, A3EBDBKWK, A3EBDRKYK, A3EBDWK, A3EBDYK, A3EBSAK, A3EBSAKRK, A3EBSAKWK, A3EBSBKWKYK, A3EBSEKWK, A3EBSWK, A4EB, A4EBD, A4EBDAKEYK, A4EBDAKRK, A4EBDAKWK, A4EBDAKZK, A4EBDBKRRK, A4EBDPKWYK, A4EBDRK, A4EBS, A4EBSAK, A4EBSAKCK, A4EBSAKKEYK, A4EBSAKRK, A4EBSAKRKP, A4EBSAKYK, A4EBSCK, A4EBT, A4EBTSAK, A5EB, A5EBD, A5EBDAKPKWK...(Other models you can see in the webshop)		

			
1			
<b>GEV No.</b>	541778	<b>Ref. No.</b>	224009
<b>description</b>	pressure control pressure range 208/178mbar connection 6mm ø 58mm pressure connection horizontal warewashing pressure connection ø 6mm		
<b>For models:</b>	2312-009-CRP, RIVER-48, RIVER-50, RIVER-50-CRP, RIVER-61		

			
1			
<b>GEV No.</b>	541001	<b>Ref. No.</b>	224004
<b>description</b>	pressure control pressure range 35/17mbar connection 6mm ø 58mm pressure connection horizontal warewashing		
<b>For models:</b>	11F, 11FD, 11F-DVGW, 11R, 11RD, 2312-009-CRP, 350F, 350FD, 350R, 350RD, 35-ELECTRONIC, 35F, 35FD, 35R, 35RD, 400F, 400FD, 400R, 400RD, 40-ELECTRONIC, 40F, 40FD, 40R, 40RD, 440F, 44F, 67F, 67R, 913289, 913290, 913291, 913292, 913356, 913357, 913363, 913364, 913372, 913373, 913374, 913375, 913376, 913377, 913416, 913435, 913544, 913545, 913665, 913666, 913667, 913668...(Other models you can see in the webshop)		

			
1			
<b>GEV No.</b>	543014	<b>Ref. No.</b>	224024
<b>description</b>	pressure control pressure range 35/22mbar connection 6mm suitable for COLGED		
<b>For models:</b>	915154, 915155, 915157, 915158, 915172, 915173, 915285, 915422, 915492, 915493, 915494, 915495, 915496, 915497, 916045, 916054, 916067, 916068, 916069, 916079, 916080, 916368, 916420, 916421, 916422, 916423, 916424, 916654, 916686, 916760, Fast160C, Ocean360-UK, River-252, River-252-2, River-252-2T, River-253, RIVER-262, River-262-2, River-262-2T, River-272, River-352C, River-352T, River-362C, River-362C-230V-3Ph-50Hz, River-362T, River-362T-230V-3Ph-50Hz, River-372		

			
1			
<b>GEV No.</b>	541132	<b>Ref. No.</b>	224015
<b>description</b>	pressure control pressure range 40/18mbar connection 6mm ø 58mm pressure connection horizontal warewashing		
<b>For models:</b>	2312-007, 914100, 914101, 914339, 914342, 914343, 914624, 914625, 914626, 914627, 914850, 914851, 914854, PS-60, RIVER-48, River-54		

			
1			
<b>GEV No.</b>	541010	<b>Ref. No.</b>	224028
<b>description</b>	pressure control pressure range 50/30mbar connection 6mm ø 58mm pressure connection horizontal warewashing		
<b>For models:</b>	915617, 915618, 915672, 915773, 915774, 916066, 916077, 916078, 916418, 916419, 916594, 916595, RIVER-242, River-242-2, River-242-2T, River-342C, River-342T		

			
1			
<b>GEV No.</b>	541013	<b>Ref. No.</b>	929039
<b>description</b>	pressure control pressure range 55/25mbar connection 6mm ø 58mm pressure connection horizontal warewashing		
<b>For models:</b>	10, 55, CLEAN-100, CLEAN-110, E.60, E.65, E1, E10, E100, E110		

			
1			
<b>GEV No.</b>	541003	<b>Ref. No.</b>	224003
<b>description</b>	pressure control pressure range 55/35mbar connection 6mm ø 58mm pressure connection horizontal warewashing pressure connection ø 6mm		
<b>For models:</b>	050F, 050FP, 21F, 21FD, 21R, 21RD, 22F, 22R, 2312-001, 2312-002, 25F, 25FD, 25R, 25RD, 30F, 30FD, 30R, 30RD, 31F, 31FD, 31R, 31RD, 40F, 440F, 44F, 45, 450, 46, 460, 500F, 500FD, 50-ELECTRONIC, 50F, 50FD, 510F, 510FD, 913297, 913298, 913299, 913300, 913360, 913361, 913391, 913392, 913418, 913546, 913547, 913578, 913611, 913684...(Other models you can see in the webshop)		





			
<b>GEV No.</b>	541106	<b>Ref. No.</b>	224005
<b>description</b>	pressure control pressure range 90/56mbar connection 6mm ø 58mm pressure connection horizontal warewashing pressure connection ø 6mm		
<b>For models:</b>	050F, 050FP, 22F, 22R, 40F, 440F, 45, 450, 460, 500F, 500FD, 510F, 510FD, E.46, E.50, E.51, E.52, F85, F85P, LF50, LF55, MC501E, MC501EP, MC501S, MC501SP, NIAGARA-51, RIVER-40, RIVER-40-CRP, RIVER-44, RIVER-44-CRP, TF-503		

			
<b>GEV No.</b>	541951	<b>Ref. No.</b>	224029
<b>description</b>	pressure control pressure range 90/60mbar connection 6mm ø 58mm pressure connection horizontal warewashing pressure connection ø 6mm		
<b>For models:</b>	916020, 916021, 916024, 916025, 916026, 916027, 916030, 916031, 916045, 916247, 916248, 916249, 916250, 916251, 916252, 916382, 916383, 916452, 916504, 916584, 916654, 916670, 916688, 916763, 916921, 916922, 916992, 916993, 917044, 917049, Clean161, Fast145-2, Fast150, Fast160-2, Fast160C, Fast161-2, Ocean360, Ocean360M, Ocean360-UK		

			
<b>GEV No.</b>	541866	<b>Ref. No.</b>	224016
<b>description</b>	pressure control pressure range 90/75mbar connection 6mm ø 58mm pressure connection horizontal warewashing pressure connection ø 6mm		
<b>For models:</b>	2312-007, 913992, 913993, 914100, 914101, 914339, 914342, 914343, 914583, 914592, 914612, 914613, 914624, 914625, 914626, 914627, 914850, 914851, 914854, 915143, RIVER-44, RIVER-44-CRP-ST, RIVER-44CRP-ST, RIVER-48, RIVER-54		

			
<b>GEV No.</b>	541017	<b>Ref. No.</b>	69850
<b>description</b>	pressure control with mounting strap pressure range 40/20mbar connection 6mm ø 58mm pressure connection horizontal warewashing		
<b>For models:</b>	Fast181, FAST-181, Fast181-230V-3Ph-60Hz, Fast181-400V-3NPh-60Hz, NG271, NG291, NG381, NG38123, NG38123TERMO, NG381C, NG381CDD, NG381CFUR, NG381DDHZ23, NG381DDPS, NG381D-DPSHZ23, NG381HPDD, NG381TERMO, NG381TXCDD, NIAGARA-271, NIAGARA-283, Niagara-283A, NIAGARA-291, Niagara-381, Niagara-381-230V-3Ph-50Hz, Niagara-381-230V-3Ph-60Hz, Niagara-381DP, Niagara-381HPD, RIVER-294, RV294, ST70FAST, ST70FASTHB, ST70FASTHB400, ST70FASTHZ23, SV72AEB, SV72EB		

<p>miscellaneous</p> 			
<b>GEV No.</b>	541950	<b>Ref. No.</b>	224018 999328
<b>description</b>	pressure control kit pressure range 0-30mbar connection 6mm warewashing		
<b>For models:</b>	915172, 915173, 915285, 915422, 915496, 915497, 915617, 915618, 915672, 915773, 915774, 916054, RIVER-242, RIVER-262, RIVER-282, RV282, RV282DD		

			
<b>GEV No.</b>	543015	<b>Ref. No.</b>	70561
<b>description</b>	pressure control pressure range 0-30mbar connection 6mm rectangular pressure monitoring		
<b>For models:</b>	915496, 915617, 915618, 915672, 915773, 915774, 916066, 916067, 916068, 916069, 916077, 916078, 916079, 916080, 916368, 916418, 916419, 916420, 916421, 916422, 916423, 916424, 916594, 916595, 916686, 916760, RIVER-242, RIVER-242-2, RIVER-242-2T, RIVER-252-2, RIVER-252-2T, RIVER-262, RIVER-262-2, RIVER-262-2T, RIVER-272, RIVER-282-2, RIVER-282L-2, RIVER-282LS-2TDE, RIVER-282S-2TDE, RIVER-285, RIVER-342C, RIVER-342T, RIVER-352C, RIVER-352T, RIVER-362C, RIVER-362C-230V-3Ph-50Hz, RIVER-362T, RIVER-362T-230V-3Ph-50Hz, RIVER-372, RIVER-382...(Other models you can see in the webshop)		

<p>accessories</p> 			
<b>GEV No.</b>	518367	<b>Ref. No.</b>	468098
<b>description</b>	screw connection		
<b>For models:</b>	11F, 11FD, 11R, 11RD, 350F, 350FD, 350R, 350RD, 400F, 400FD, 400R, 400RD, 500F, 500FD		





			
1			
<b>GEV No.</b>	541109	<b>Ref. No.</b>	035031
<b>description</b>	Y-piece plastic hose ø 8-6-8mm for pressure switch		
<b>For models:</b>	050F, 050FP, 22F, 22R, 2312-002, 2312-007, 2312-009-CRP, 40F, 440F, 45, 450, 460, 500F, 500FD, 510F, 510FD, 913297, 913298, 913299, 913300, 913360, 913361, 913391, 913392, 913546, 913547, 913578, 913611, 913684, 913913, 913914, 913932, 913933, 913992, 913993, 914100, 914101, 914284, 914318, 914319, 914326, 914331, 914338, 914339, 914342, 914343, 914356, 914400, 914401, 914402...(Other models you can see in the webshop)		

## flow meters and flow sensors

### flow meters

#### miscellaneous

			
1			
<b>GEV No.</b>	402680	<b>Ref. No.</b>	240017 240998
<b>description</b>	flow meter pressure range 0.2-10bar connection 10mm L 69mm		
<b>For models:</b>	80, 81, 82, MISTRAL-40, MISTRAL-51, NIAGARA-35, NIAGARA-40, NIAGARA-45, NIAGARA-51, RIVER-40, RIVER-43, RIVER-44, RIVER-48, RIVER-50, RIVER-54, RIVER-61, RIVER-80, RIVER-81, RIVER-82		

## motors

### gear motors

#### for dishwashers

			
1			
<b>GEV No.</b>	601861	<b>Ref. No.</b>	927105
<b>description</b>	gear motor FIR type 71-B5 180W 400V voltage AC 50/60Hz 3 phase 900/1100rpm shaft ø 14mm L 227mm for transport system without gearbox		
<b>For models:</b>	221, 271, 272, 362, A3EB, A3EBD, A3EBDAKRKYK, A3EBDAKWK, A3EBDBKWK, A3EBDRKYK, A3EBDVK, A3EBDYK, A3EBSAK, A3EBSAKRK, A3EBSAKWK, A3EBSBKWKYK, A3EBSEKWK, A3EBSWK, A4EB, A4EBD, A4EBDAKEKYK, A4EBDAKRK, A4EBDAKWK, A4EBDAKZK, A4EBDBKRK, A4EBDPKWKYK, A4EBDRK, A4EBS, A4EBSAK, A4EBSAKCK, A4EBSAKEKYK, A4EBSAKRK, A4EBSAKRKP, A4EBSAKYK, A4EBSCK, A4EBT, A4EBTSAK, A5EB, A5EBD, A5EBDAKPKWK, A5EBDAKWK, A5EBDAKYK, A5EBDRK, A5EBS, A5EBSAKPKWK, A5EBSAKRK, A5EBSAKRKYK, A5EBSAKWK, A5EBSAKWKYK, A5EBSBKRKP...(Other models you can see in the webshop)		

### accessories

#### fan wheels

			
1			
<b>GEV No.</b>	601677	<b>Ref. No.</b>	927108
<b>description</b>	fan wheel motor type 63B14 ø 220mm shaft intake ø 11mm H 65mm		
<b>For models:</b>	161, 221, 271, 272, 362, A3EBDAKRKYK, A3EBDRKYK, A3EBSAKRK, A3EBSEKWK, A4EBDAKEKYK, A4EBDAKRK, A4EBDBKRK, A4EBDRK, A4EBSAKCK, A4EBSAKEKYK, A4EBSAKRKP, A5EBDRK, A5EBSAKRK, A5EBSAKRKYK, A5EBSBKRKP, A5EBSRK, CLEAN-161, CLEAN-221, CLEAN-271, CLEAN-272, CLEAN-362, GL280EB23DAR, GL280EBDARY, GL280EBDBR, GL280EBSAE, GL280EBSAEW, GL280EBSAEWY, GL280EBSAR, GL280EBSARY, GL280EBSR, GL282EBDARW, GL282EBDCWY, GL282EBSAEW, GL282EBSAEWY, GL282EBSAR, GL282EBSBR, GL284EBDAEW, GL284EBDR, GL284EBSAE, GL286EBDAR, GL286EBSAPE, RV150DAR, RV150DRW, RV150SAC, RV150SAR...(Other models you can see in the webshop)		



# pumps

## wash and rinse pumps

FIR

pumps



<b>GEV No.</b>	500541	<b>Ref. No.</b>	130107
<b>description</b>	pump		
<b>For models:</b>	350F, 350FD, 350R, 350RD, 35F, 35FD, 35R, 35RD		



2



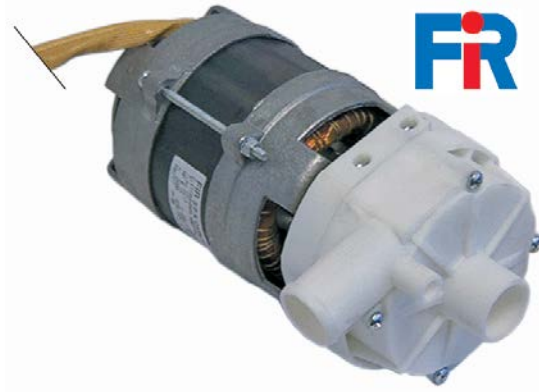

<b>GEV No.</b>	500545	<b>Ref. No.</b>	926079 926148
<b>description</b>	pump		
<b>For models:</b>	12, 14, CLEAN-120, E12, E120, E14, E140		



1

<b>GEV No.</b>	500037	<b>Ref. No.</b>	929167
<b>description</b>	pump inlet ø 28mm outlet ø 26mm type 2211.1410 230V 50Hz 1 phase 0.074kW 0.1HP L 190mm rotation direction left capacitor 5µF FIR		
<b>For models:</b>	915747, KLP105EB, KLP301, KLP301DDDTBE, LP105DDDTBE, LP105DDDTBE, LP105EB, LP301, LP301EB, LP60, River-81CRP, RIVER-81-CRP, River-82CRP, RIVER-82-CRP, RV81CCRP, RV81CRP, RV82CCRP, RV82CRP, U132E, U60E, U61, U61E, U61H, U61He		

**spare parts for** 500037

	<b>GEV No.</b>	365017	<b>Ref. No.</b>	206008 206010
	operating capacitor capacity 5µF 450V tolerance 5% 50/60Hz ambient temperature max. -25 to +85°C ø 28mm L 54mm M8 plastic connection male faston 6.3mm 16.10.08 protection			
	<b>GEV No.</b>	510384	<b>Ref. No.</b>	116020 929182
	pump cover inlet ø 28mm outlet ø 26mm ø 100mm ID ø 76mm			
	<b>GEV No.</b>	510695	<b>Ref. No.</b>	927190 RAT123
	mechanical shaft seal height counter ring 5.5mm ID ø 11mm			
	<b>GEV No.</b>	521203	<b>Ref. No.</b>	124034 929173
	impellor ø 72mm H 18mm thread M7 shaft ø 11mm shaft length 32mm blades 3			



1









<b>GEV No.</b>	499227	<b>Ref. No.</b>	130108	
<b>description</b>	pump inlet ø 28mm outlet ø 26mm type B236.1400 220-240V 50Hz 1 phase 0.14kW 0.2HP L 200mm rotation direction left capacitor 6.3µF FIR			
<b>For models:</b>	400F, 400FD, 400R, 400RD, 40F, 40FD, 40R, 40RD, TF-503			
<b>spare parts for</b>	499227			
	<b>GEV No.</b>	365012	<b>Ref. No.</b>	206009
	operating capacitor capacity 6.3µF 450V tolerance 5% 50Hz ambient temperature max. -25 to +85°C ø 30mm L 61mm M8 plastic connection male faston 6.3mm protection			

Table continues overleaf



<b>spare parts for</b> 499227				
	GEV No.	510384	Ref. No.	116020 929182
pump cover inlet ø 28mm outlet ø 26mm ø 100mm ID ø 76mm				
	GEV No.	510695	Ref. No.	927190 RAT123
mechanical shaft seal height counter ring 5.5mm ID ø 11mm				
	GEV No.	521203	Ref. No.	124034 929173
impellor ø 72mm H 18mm thread M7 shaft ø 11mm shaft length 32mm blades 3				
	GEV No.	521703	Ref. No.	456038 456063
pump cover gasket EPDM thickness 2.5mm ID ø 75mm Qty 1 pcs				



<b>1</b>				
<b>GEV No.</b>	499279	<b>Ref. No.</b>	927137	
<b>description</b>	pump inlet ø 28mm outlet ø 26mm type B246.2520 230/400V 50Hz 3 phase 0.18kW 0.25HP L 265mm rotation direction right FIR			
<b>For models:</b>	272, 362, CLEAN-161, CLEAN-221, CLEAN-271, CLEAN-272, CLEAN-361, CLEAN-361P, CLEAN-362, CLEAN-471, CLEAN-471P			
<b>spare parts for</b> 499279				
	GEV No.	510510	Ref. No.	—
pump cover pump type 2212/2228/2229/2211				
	GEV No.	510532	Ref. No.	80813
impellor ø 72mm H 22mm shaft ø 11mm shaft length 32mm blades 3				
	GEV No.	510695	Ref. No.	927190 RAT123
mechanical shaft seal height counter ring 5.5mm ID ø 11mm				
	GEV No.	521703	Ref. No.	456038 456063
pump cover gasket EPDM thickness 2.5mm ID ø 75mm Qty 1 pcs				



<b>1</b>				
<b>GEV No.</b>	502287	<b>Ref. No.</b>	77047	
<b>description</b>	pump inlet ø 30mm outlet ø 26mm type 5213.4050 230/400V 50Hz 3 phase 0.11kW 0.15HP L 200mm rotation direction left			
<b>For models:</b>	A3EB, A3EBD, A3EBDAKRKYK, A3EBDAKWK, A3EBDBKWK, A3EBDRKYK, A3EBDVK, A3EBDYK, A3EBSAK, A3EBSAKRK, A3EBSAKWK, A3EBSBKWKYK, A3EBSEKWK, A3EBSWK, A4EB, A4EBD, A4EBDAKEYK, A4EBDAKRK, A4EBDAKWK, A4EBDAKZK, A4EBDBKRK, A4EBDPKWKYK, A4EBDRK, A4EBS, A4EBSAK, A4EBSAKCK, A4EBSAKEKYK, A4EBSAKRK, A4EBSAKRKP, A4EBSAKYK, A4EBSCK, A4EBT, A4EBTSAK, A5EB, A5EBD, A5EBDAKPKWK, A5EBDAKWK, A5EBDAKYK, A5EBDRK, A5EBS, A5EBSAKPKWK, A5EBSAKRK, A5EBSAKRKYK, A5EBSAKWK, A5EBSAKWKYK, A5EBSBKRPK, A5EBSBKWK, A5EBSRK, A5EBSYK, RIVER-MULTI-2252...(Other models you can see in the webshop)			
<b>spare parts for</b> 502287				
	GEV No.	699372	Ref. No.	80814
flange for pump with cover type 5213 L 103mm W 103mm H 69mm				











<b>1</b>				
<b>GEV No.</b>	500544	<b>Ref. No.</b>	926151	
<b>description</b>	pump inlet ø 60mm outlet ø 50mm type 4223.1900 230V 50Hz 1 phase 0.73kW 1HP L 225mm rotation direction right capacitor 16µF FIR			
<b>For models:</b>	CLEAN-100, E.60, E100			
<b>spare parts for</b> 500544				
	GEV No.	365021	Ref. No.	206004
operating capacitor capacity 16µF 425V tolerance 5% 50/60Hz ambient temperature max. -25 to +85°C ø 35mm L 73mm single M8 plastic connection male faston 6.3mm 416.10.99 protection				
	GEV No.	510552	Ref. No.	437049
pump cover gasket pump type 1292-2/3942/3981/3911/3983				
	GEV No.	510693	Ref. No.	141002 70942 80121 RAT72
mechanical shaft seal for shaft ø 12mm slide ring ext. ø 24mm slide ring H 15.5mm slide ring int. ø 11mm counter ring mounting ø 24mm height counter ring 8mm counter ring int. ø 13.5mm				

Table continues overleaf





<b>spare parts for</b> 500544			
	GEV No.	518067	Ref. No. 926152
impellor ø 103mm H 29mm M7L			
	GEV No.	521512	Ref. No. 116015
pump cover FIR inlet ø 60mm outlet ø 50mm			



<b>1</b>			
<b>GEV No.</b>	499281	<b>Ref. No.</b>	80134
<b>description</b>	pump inlet ø 60mm outlet ø 50mm type 4298.1404 230V 50Hz 1 phase 1.1kW L 210mm rotation direction right capacitor 12.5µF FIR		
<b>For models:</b>	Niagara-283A, RIVER-282, River-285, RV282DD, RV282R, SV72AEB		
<b>spare parts for</b>	499281		
	GEV No.	365014	Ref. No. 80191
operating capacitor capacity 12.5µF 450V tolerance 5%Hz ambient temperature max. -25 to +85°C ø 35mm L 70mm M8 plastic connection male faston 6.3mm 455.C3DS.12.5 protection			
	GEV No.	510600	Ref. No. 80197
impellor ø 102mm H 29mm shaft intake ø 9/8mm rotation direction right blades 6			
	GEV No.	510692	Ref. No. 80193 RAT19
mechanical shaft seal for shaft ø 11mm slide ring ext. ø 24mm slide ring H 13mm counter ring mounting ø 26mm height counter ring 8mm counter ring int. ø 14mm			
	GEV No.	521702	Ref. No. —
pump cover gasket thickness 3.5x4.5mm Qty 1 pcs			



<b>1</b>			
<b>GEV No.</b>	499336	<b>Ref. No.</b>	929175
<b>description</b>	pump inlet ø 62 outlet ø 62 type 2250.2732 230/400V 50Hz 2.95kW 4HP		
<b>For models:</b>	KLP301, KLP301DDDTEB, LP301, LP301EB, RIVER-298, RV298, U132, U132e, U70, U70E		
<b>spare parts for</b>	499336		
	GEV No.	510687	Ref. No. 929179
mechanical shaft seal for shaft ø 18mm height counter ring 8mm ID ø 17mm ED ø 39mm H 15mm mounting ø 42mm int. ø 1 21mm			
	GEV No.	521026	Ref. No. —
pump cover gasket ID ø 182.5mm thickness 5x4.5mm			
	GEV No.	521028	Ref. No. —
pump cover FIR inlet ø 62mm outlet ø 62mm turn direction right ø 215mm ID ø 175mm inner height 40mm			











<b>1</b>			
<b>GEV No.</b>	499334	<b>Ref. No.</b>	929174
<b>description</b>	pump inlet ø 62mm outlet ø 62mm type 2250.2731 230/400V 50Hz 1 phase 3kW FIR		
<b>For models:</b>	KLP201DDDTEB, KLP201EB, KLP301, KLP301DDDTEB, LP201DDDTEB, LP201EB, LP301, LP301EB, RIVER-297, RIVER-298, RV297, RV298, U132, U132e, U70, U70e		
<b>spare parts for</b>	499334		
	GEV No.	510687	Ref. No. 929179
mechanical shaft seal for shaft ø 18mm height counter ring 8mm ID ø 17mm ED ø 39mm H 15mm mounting ø 42mm int. ø 1 21mm			
	GEV No.	512455	Ref. No. 929189
fan wheel ø 155mm H 18mm shaft intake ø 18mm plastic blades 12			

Table continues overleaf







<b>spare parts for</b> 499334				
	GEV No.	521026	Ref. No.	—
pump cover gasket ID ø 182.5mm thickness 5x4.5mm				
	GEV No.	521028	Ref. No.	—
pump cover FIR inlet ø 62mm outlet ø 62mm turn direction right ø 215mm ID ø 175mm inner height 40mm				
	GEV No.	521277	Ref. No.	929181
impellor ø 135mm H 39mm pump type Fir 2275 - 3.6HP thread M14L				







<b>GEV No.</b>	501487	<b>Ref. No.</b>	70100
<b>description</b>	pump inlet ø 63mm outlet ø 40mm type 4267.5050 230/400V 50Hz 3 phase 1.5kW L 300mm rotation direction right FIR		
<b>For models:</b>	NG381L, NG381LC, NG381LCFUR, NG381LDDPS, Niagara-283L-2, Niagara-381L, Niagara-381LC, River-282L-2, River-282LS-2TDE, River-382L, River-382L-230V-3Ph-50Hz, River-382LNRG, River-382LTDE, River-482, RV382L, RV382L23TERMO, RV382LFUR, RV382LR, RV382LS, RV382LSFUR, RV382LTX, RV382LTXR, RV482		
<b>spare parts for</b>	501487		
	GEV No.	502273	Ref. No. 70945
pump cover FIR inlet ø 63mm outlet ø 2x40mm pump type 4267.5050 turn direction right			
	GEV No.	510602	Ref. No. 124002 927186
impellor ø 110mm H 34mm rotation direction right thread M8L shaft ø 28mm seat ø 12.2mm blades 6			
	GEV No.	510693	Ref. No. 141002 70942 80121 RAT72
mechanical shaft seal for shaft ø 12mm slide ring ext. ø 24mm slide ring H 15.5mm slide ring int. ø 11mm counter ring mounting ø 24mm height counter ring 8mm counter ring int. ø 13.5mm			
	GEV No.	524416	Ref. No. 70943 80120
pump cover gasket thickness 4x4mm Qty 1 pcs			

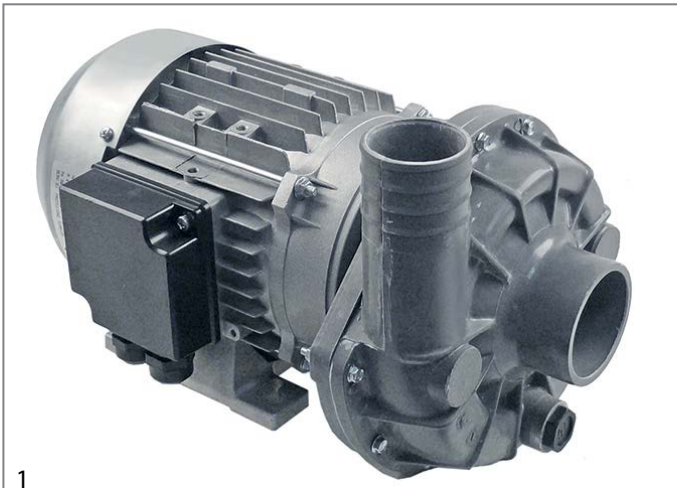

<b>GEV No.</b>	500155	<b>Ref. No.</b>	130039
<b>description</b>	pump inlet ø 63mm outlet ø 47mm type 1225 230V 50Hz 1 phase 1.1kW 1.5HP L 335mm rotation direction right capacitor 31.5µF FIR		
<b>For models:</b>	66, S850		
<b>spare parts for</b>	500155		
	GEV No.	365016	Ref. No. 206006
operating capacitor capacity 31.5µF 400V tolerance 5%Hz ambient temperature max. -25 to +85°C ø 45mm L 95mm M8 plastic connection male faston 6.3mm protection			
	GEV No.	510602	Ref. No. 124002 927186
impellor ø 110mm H 34mm rotation direction right thread M8L shaft ø 28mm seat ø 12.2mm blades 6			
	GEV No.	510693	Ref. No. 141002 70942 80121 RAT72
mechanical shaft seal for shaft ø 12mm slide ring ext. ø 24mm slide ring H 15.5mm slide ring int. ø 11mm counter ring mounting ø 24mm height counter ring 8mm counter ring int. ø 13.5mm			
	GEV No.	521513	Ref. No. 116002 80118
pump cover FIR inlet ø 63mm outlet ø 47mm turn direction right ID ø 150mm inner height 32mm			
	GEV No.	524416	Ref. No. 70943 80120
pump cover gasket thickness 4x4mm Qty 1 pcs			







1

<b>GEV No.</b>	500023	<b>Ref. No.</b>	130025
<b>description</b>	pump inlet ø 63mm outlet ø 47mm type 1225.2725 230/400V 50Hz 3 phase 1.1kW 1.5HP L 335mm rotation direction right FIR		
<b>For models:</b>	66, S850		
<b>spare parts for</b>	500023		
	<b>GEV No.</b>	510602	<b>Ref. No.</b> 124002 927186
	impellor ø 110mm H 34mm rotation direction right thread M8L shaft ø 28mm seat ø 12.2mm blades 6		
	<b>GEV No.</b>	510693	<b>Ref. No.</b> 141002 70942 80121 RAT72
	mechanical shaft seal for shaft ø 12mm slide ring ext. ø 24mm slide ring H 15.5mm slide ring int. ø 11mm counter ring mounting ø 24mm height counter ring 8mm counter ring int. ø 13.5mm		
	<b>GEV No.</b>	521513	<b>Ref. No.</b> 116002 80118
	pump cover FIR inlet ø 63mm outlet ø 47mm turn direction right ID ø 150mm inner height 32mm		
	<b>GEV No.</b>	524416	<b>Ref. No.</b> 70943 80120
	pump cover gasket thickness 4x4mm Qty 1 pcs		



1

<b>GEV No.</b>	501513	<b>Ref. No.</b>	41990
<b>description</b>	pump inlet ø 63mm outlet ø 47mm type 1227.2711M10 230/400V 50Hz 3 phase 1.7kW L 340mm rotation direction right FIR		
<b>For models:</b>	NG293, NIAGARA-293, RIVER-296, River-296P, RV296, RV296PS		
<b>spare parts for</b>	501513		
	<b>GEV No.</b>	510693	<b>Ref. No.</b> 141002 70942 80121 RAT72
	mechanical shaft seal for shaft ø 12mm slide ring ext. ø 24mm slide ring H 15.5mm slide ring int. ø 11mm counter ring mounting ø 24mm height counter ring 8mm counter ring int. ø 13.5mm		
	<b>GEV No.</b>	511667	<b>Ref. No.</b> 70939
	fan wheel ø 123mm H 17mm shaft intake ø 15mm		
	<b>GEV No.</b>	521513	<b>Ref. No.</b> 116002 80118
	pump cover FIR inlet ø 63mm outlet ø 47mm turn direction right ID ø 150mm inner height 32mm		
	<b>GEV No.</b>	524416	<b>Ref. No.</b> 70943 80120
	pump cover gasket thickness 4x4mm Qty 1 pcs		
	<b>GEV No.</b>	698772	<b>Ref. No.</b> 41991
	impellor ø 113mm H 34mm M10L pump type 1227.2711M10 rotation direction right suitable for FIR blades 6		



1

<b>GEV No.</b>	500117	<b>Ref. No.</b>	919223 926150 929201
<b>description</b>	pump inlet ø 63mm outlet ø 47mm type 4225.22725 230/400V 50Hz 3 phase 1.4kW 2HP L 280mm rotation direction right FIR		
<b>For models:</b>	A3EB, A3EBD, A3EBDAKRKYK, A3EBDAKWK, A3EBDBKWK, A3EB-DRKYK, A3EBDWK, A3EBDYK, A3EBSAK, A3EBSAKRK, A3EBSAKWK, A3EBSBKWKYK, A3EBSEKWK, A3EBSWK, A4EB, A4EBD, A4EBDAKEKYK, A4EBDAKRK, A4EBDAKWK, A4EBDAKZK, A4EBDBKRK, A4EBDPKWKYK, A4EBDRK, A4EBS, A4EBSAK, A4EBSAKCK, A4EBSAKEKYK, A4EBSA-KRK, A4EBSAKRKP, A4EBSAKYK, A4EBSCK, E.65, E14, E140, Fast200, FAST-200, Fast93, GL282EB93, GL282EB93DA, GL282EB93HZ23, GL282EBCH, GL282EBCHD, GL286EB, GL286EBD, GL286EBDA, GL286EBDAR, GL286EBDARY, GL286EBDAW, GL286EBDAY, GL286EBD-WY...(Other models you can see in the webshop)		
<b>spare parts for</b>	500117		
	<b>GEV No.</b>	510602	<b>Ref. No.</b> 124002 927186
	impellor ø 110mm H 34mm rotation direction right thread M8L shaft ø 28mm seat ø 12.2mm blades 6		
	<b>GEV No.</b>	510693	<b>Ref. No.</b> 141002 70942 80121 RAT72
	mechanical shaft seal for shaft ø 12mm slide ring ext. ø 24mm slide ring H 15.5mm slide ring int. ø 11mm counter ring mounting ø 24mm height counter ring 8mm counter ring int. ø 13.5mm		
	<b>GEV No.</b>	521513	<b>Ref. No.</b> 116002 80118
	pump cover FIR inlet ø 63mm outlet ø 47mm turn direction right ID ø 150mm inner height 32mm		
	<b>GEV No.</b>	524416	<b>Ref. No.</b> 70943 80120
	pump cover gasket thickness 4x4mm Qty 1 pcs		



1

<b>GEV No.</b>	500570	<b>Ref. No.</b>	75175
<b>description</b>	pump inlet ø 63mm outlet ø 47mm type 422512725 230/400V 50Hz 3 phase 1.1kW 1.5HP L 285mm rotation direction right FIR		
<b>For models:</b>	914380, 914436, 915747, GL280EB, GL280EB23, GL280EB23DAR, GL280EBD, GL280EBDA, GL280EBDAE, GL280EBDAR, GL280EBDARY, GL280EBDAW, GL280EBDAWY, GL280EBDAY, GL280EBDB, GL280EBD-BR, GL280EBDBW, GL280EBDWY, GL280EBDY, GL280EBS, GL280EB-SA, GL280EBSAE, GL280EBSAEW, GL280EBSAEWY, GL280EBSAR, GL280EBSARY, GL280EBSAW, GL280EBSAWY, GL280EBSAY, GL280EBSB, GL280EBSR, GL280EBSWY, GL280EBSY, GL282EB, GL282EBD, GL282EBDA, GL282EBDAE, GL282EBDAR, GL282EB-DARW, GL282EBDAWY, GL282EBDBW, GL282EBDCWY, GL282EB-SA, GL282EBSAEW, GL282EBSAEWY, GL282EBSAP, GL282EBSAR, GL282EBSAW, GL282EBSBR, GL282EBSY...(Other models you can see in the webshop)		
<b>spare parts for</b>	500570		
	<b>GEV No.</b>	510693	<b>Ref. No.</b> 141002 70942 80121 RAT72
	mechanical shaft seal for shaft ø 12mm slide ring ext. ø 24mm slide ring H 15.5mm slide ring int. ø 11mm counter ring mounting ø 24mm height counter ring 8mm counter ring int. ø 13.5mm		
	<b>GEV No.</b>	521082	<b>Ref. No.</b> 80881
	impellor ø 96mm H 32mm rotation direction right thread M8L		
	<b>GEV No.</b>	521513	<b>Ref. No.</b> 116002 80118
	pump cover FIR inlet ø 63mm outlet ø 47mm turn direction right ID ø 150mm inner height 32mm		
	<b>GEV No.</b>	524416	<b>Ref. No.</b> 70943 80120
	pump cover gasket thickness 4x4mm Qty 1 pcs		



1			
<b>GEV No.</b>	499283	<b>Ref. No.</b>	75175HZ
<b>description</b>	pump inlet ø 63mm outlet ø 47mm type 422512760 230/400V 60Hz 3 phase 1.1kW L 290mm rotation direction right FIR		
<b>For models:</b>	GL280EB23HZ, GL280EB23HZDY, GL282EBHZ23, GL282EBHZ23DY, GL282EBHZ23SY, GL284EBHZ23, GL284EBHZ23DBHZY, GL284EBHZ23DBWY, GL284EBHZ23DBY, GL284EBHZ23DY, GL284EBHZ23SAP, Niagara-2150-230V-3Ph-60hz, Niagara-2154-230-3Ph-60Hz		



1			
<b>GEV No.</b>	501540	<b>Ref. No.</b>	929123
<b>description</b>	pump inlet ø 63mm outlet ø 47mm type 422522726 230/400V 50Hz 3 phase 1.4kW 2HP L 280mm rotation direction right FIR		
<b>For models:</b>	E.65, U61, U61E, U61HE		
<b>spare parts for</b>	501540		
	<b>GEV No.</b>	510602	<b>Ref. No.</b> 124002 927186
	impellor ø 110mm H 34mm rotation direction right thread M8L shaft ø 28mm seat ø 12.2mm blades 6		
	<b>GEV No.</b>	510693	<b>Ref. No.</b> 141002 70942 80121 RAT72
	mechanical shaft seal for shaft ø 12mm slide ring ext. ø 24mm slide ring H 15.5mm slide ring int. ø 11mm counter ring mounting ø 24mm height counter ring 8mm counter ring int. ø 13.5mm		
	<b>GEV No.</b>	521513	<b>Ref. No.</b> 116002 80118
	pump cover FIR inlet ø 63mm outlet ø 47mm turn direction right ID ø 150mm inner height 32mm		

<b>spare parts for</b>	501540		
	<b>GEV No.</b>	524416	<b>Ref. No.</b> 70943 80120
	pump cover gasket thickness 4x4mm Qty 1 pcs		







1			
<b>GEV No.</b>	499280	<b>Ref. No.</b>	80115
<b>description</b>	pump inlet ø 63mm outlet ø 47mm type 5295.5050 230/400V 50Hz 3 phase 1.5kW L 300mm rotation direction right FIR		
<b>For models:</b>	80, 82, CGL74CABT, NG292, NIAGARA-292, RIVER-295, River-295P, River-81CRP, RIVER-81-CRP, RIVER-82, River-82CRP, RIVER-82-CRP, RIVER-HL-82, RV295, RV295PS, RV81CCRP, RV81CRP, RV82, RV8223, RV82C, RV82CCRP, RV82CRP, SevenL		

<b>spare parts for</b>	499280		
	<b>GEV No.</b>	502277	<b>Ref. No.</b> 70944 80119
	impellor ø 111mm H 31mm thread M8L		
	<b>GEV No.</b>	510693	<b>Ref. No.</b> 141002 70942 80121 RAT72
	mechanical shaft seal for shaft ø 12mm slide ring ext. ø 24mm slide ring H 15.5mm slide ring int. ø 11mm counter ring mounting ø 24mm height counter ring 8mm counter ring int. ø 13.5mm		
	<b>GEV No.</b>	521022	<b>Ref. No.</b> —
	fanwheel cover ID ø 137mm ED ø 142mm H 70mm for wash pump		
	<b>GEV No.</b>	524416	<b>Ref. No.</b> 70943 80120
	pump cover gasket thickness 4x4mm Qty 1 pcs		
	<b>GEV No.</b>	698773	<b>Ref. No.</b> —
	pump cover inlet ø 63mm outlet ø 47mm turn direction right ø 194mm ID ø 158mm		







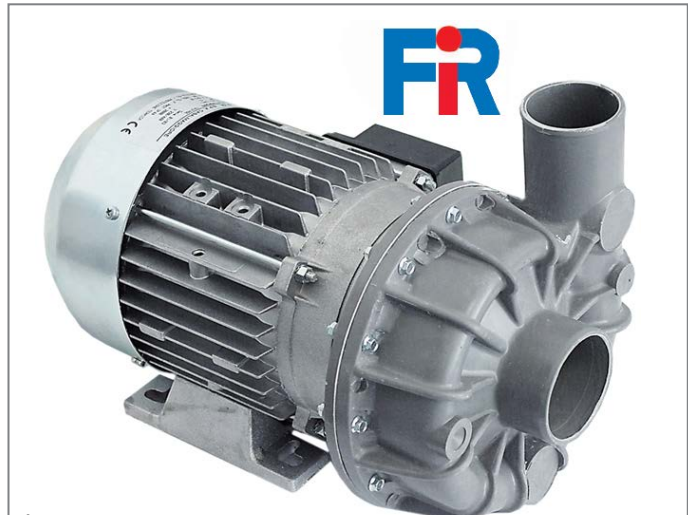

1

<b>GEV No.</b>	500119	<b>Ref. No.</b>	130038
<b>description</b>	pump inlet ø 63mm outlet ø 53mm type 1241.1402 230V 50Hz 1 phase 1.1kW 1.5HP L 330mm rotation direction left capacitor 31.5µF FIR		
<b>For models:</b>	S870		
<b>spare parts for</b>	500119		
	<b>GEV No.</b>	365016	<b>Ref. No.</b> 206006
	operating capacitor capacity 31.5µF 400V tolerance 5%Hz ambient temperature max. -25 to +85°C ø 45mm L 95mm M8 plastic connection male faston 6.3mm protection		
	<b>GEV No.</b>	510531	<b>Ref. No.</b> 1165005
	pump cover FIR inlet ø 63mm outlet ø 53mm auxiliary pressure connection M16x1.5mm supporting pressure open turn direction left ø 185mm ID ø 150mm inner high 37mm		
	<b>GEV No.</b>	510612	<b>Ref. No.</b> 927227 RAG19
	impellor ø 110mm H 34mm M8R		
	<b>GEV No.</b>	510693	<b>Ref. No.</b> 141002 70942 80121 RAT72
	mechanical shaft seal for shaft ø 12mm slide ring ext. ø 24mm slide ring H 15.5mm slide ring int. ø 11mm counter ring mounting ø 24mm height counter ring 8mm counter ring int. ø 13.5mm		
	<b>GEV No.</b>	524416	<b>Ref. No.</b> 70943 80120
	pump cover gasket thickness 4x4mm Qty 1 pcs		



1

<b>GEV No.</b>	500111	<b>Ref. No.</b>	130002
<b>description</b>	pump inlet ø 63mm outlet ø 53mm type 1241.2500 230/400V 50Hz 3 phase 1.1kW 1.5HP L 330mm rotation direction left FIR		
<b>For models:</b>	55, S870		
<b>spare parts for</b>	500111		
	<b>GEV No.</b>	510531	<b>Ref. No.</b> 1165005
	pump cover FIR inlet ø 63mm outlet ø 53mm auxiliary pressure connection M16x1.5mm supporting pressure open turn direction left ø 185mm ID ø 150mm inner high 37mm		
	<b>GEV No.</b>	510612	<b>Ref. No.</b> 927227 RAG19
	impellor ø 110mm H 34mm M8R		
	<b>GEV No.</b>	510693	<b>Ref. No.</b> 141002 70942 80121 RAT72
	mechanical shaft seal for shaft ø 12mm slide ring ext. ø 24mm slide ring H 15.5mm slide ring int. ø 11mm counter ring mounting ø 24mm height counter ring 8mm counter ring int. ø 13.5mm		
	<b>GEV No.</b>	524416	<b>Ref. No.</b> 70943 80120
	pump cover gasket thickness 4x4mm Qty 1 pcs		



1





<b>GEV No.</b>	500324	<b>Ref. No.</b>	130005
<b>description</b>	pump inlet ø 63mm outlet ø 53mm type 1243.2591 230/400V 50Hz 3 phase 2.35kW 3.2HP L 365mm rotation direction left FIR		
<b>For models:</b>	S950		
<b>spare parts for</b>	500324		
	<b>GEV No.</b>	510357	<b>Ref. No.</b> 124014
	impellor ø 124mm H 34/16mm thread M8R blades 6		

Table continues overleaf







<b>spare parts for</b> 500324									
	<table border="1"> <tr> <th>GEV No.</th> <th>510531</th> <th>Ref. No.</th> <th>1165005</th> </tr> <tr> <td colspan="4">pump cover FIR inlet ø 63mm outlet ø 53mm auxiliary pressure connection M16x1.5mm supporting pressure open turn direction left ø 185mm ID ø 150mm inner height 37mm</td> </tr> </table>	GEV No.	510531	Ref. No.	1165005	pump cover FIR inlet ø 63mm outlet ø 53mm auxiliary pressure connection M16x1.5mm supporting pressure open turn direction left ø 185mm ID ø 150mm inner height 37mm			
GEV No.	510531	Ref. No.	1165005						
pump cover FIR inlet ø 63mm outlet ø 53mm auxiliary pressure connection M16x1.5mm supporting pressure open turn direction left ø 185mm ID ø 150mm inner height 37mm									
	<table border="1"> <tr> <th>GEV No.</th> <th>510693</th> <th>Ref. No.</th> <th>141002 70942 80121 RAT72</th> </tr> <tr> <td colspan="4">mechanical shaft seal for shaft ø 12mm slide ring ext. ø 24mm slide ring H 15.5mm slide ring int. ø 11mm counter ring mounting ø 24mm height counter ring 8mm counter ring int. ø 13.5mm</td> </tr> </table>	GEV No.	510693	Ref. No.	141002 70942 80121 RAT72	mechanical shaft seal for shaft ø 12mm slide ring ext. ø 24mm slide ring H 15.5mm slide ring int. ø 11mm counter ring mounting ø 24mm height counter ring 8mm counter ring int. ø 13.5mm			
GEV No.	510693	Ref. No.	141002 70942 80121 RAT72						
mechanical shaft seal for shaft ø 12mm slide ring ext. ø 24mm slide ring H 15.5mm slide ring int. ø 11mm counter ring mounting ø 24mm height counter ring 8mm counter ring int. ø 13.5mm									
	<table border="1"> <tr> <th>GEV No.</th> <th>524416</th> <th>Ref. No.</th> <th>70943 80120</th> </tr> <tr> <td colspan="4">pump cover gasket thickness 4x4mm Qty 1 pcs</td> </tr> </table>	GEV No.	524416	Ref. No.	70943 80120	pump cover gasket thickness 4x4mm Qty 1 pcs			
GEV No.	524416	Ref. No.	70943 80120						
pump cover gasket thickness 4x4mm Qty 1 pcs									

LGB





									
1									
<b>GEV No.</b>	500154	<b>Ref. No.</b>	130135						
<b>description</b>	pump 230V 50Hz 1 phase 0.18kW LGB								
<b>For models:</b>	E.35								
<b>spare parts for</b> 500154									
	<table border="1"> <tr> <th>GEV No.</th> <th>521221</th> <th>Ref. No.</th> <th>124048</th> </tr> <tr> <td colspan="4">impellor ø 67mm H 16mm rotation direction right thread M7L shaft ø 13mm shaft length 12mm blades 8</td> </tr> </table>	GEV No.	521221	Ref. No.	124048	impellor ø 67mm H 16mm rotation direction right thread M7L shaft ø 13mm shaft length 12mm blades 8			
GEV No.	521221	Ref. No.	124048						
impellor ø 67mm H 16mm rotation direction right thread M7L shaft ø 13mm shaft length 12mm blades 8									

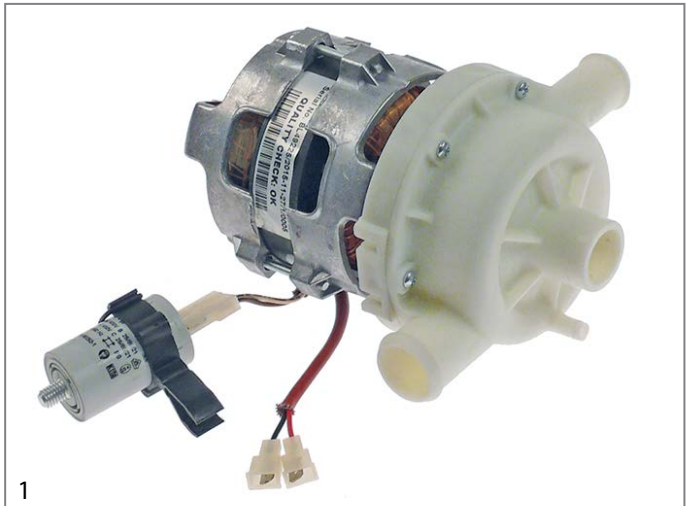

1									
<b>GEV No.</b>	501503	<b>Ref. No.</b>	130166						
<b>description</b>	pump inlet ø 28mm outlet ø 22/27mm type CF 2745 230V 50Hz 1 phase 0.19kW L 175mm rotation direction right capacitor 4µF LGB with capacitor								
<b>For models:</b>	915611, 915612, 915613, 915614, 915615, 915616, 915617, 915618, 915670, 915671, 915672, 915773, 915774, 915959, 916066, 916077, 916078, 916196, 916197, 916198, 916199, 916200, 916409, 916410, 916418, 916419, 916591, 916592, 916593, 916594, 916595, 916877, 916921, 916922, 916992, 916993, Fast145-2, Fast150, Niagara-241, Niagara-241-2, Niagara-341, Pluvia-240, RIVER-242, River-242-2, River-242-2T, River-342C, River-342T								
<b>spare parts for</b> 501503									
	<table border="1"> <tr> <th>GEV No.</th> <th>365031</th> <th>Ref. No.</th> <th>206013</th> </tr> <tr> <td colspan="4">operating capacitor capacity 4µF 450V tolerance 5% 50/60Hz ambient temperature max. -25 to +85°C ø 31mm L 58mm M8 plastic connection male faston 6.3mm protection</td> </tr> </table>	GEV No.	365031	Ref. No.	206013	operating capacitor capacity 4µF 450V tolerance 5% 50/60Hz ambient temperature max. -25 to +85°C ø 31mm L 58mm M8 plastic connection male faston 6.3mm protection			
GEV No.	365031	Ref. No.	206013						
operating capacitor capacity 4µF 450V tolerance 5% 50/60Hz ambient temperature max. -25 to +85°C ø 31mm L 58mm M8 plastic connection male faston 6.3mm protection									
	<table border="1"> <tr> <th>GEV No.</th> <th>509002</th> <th>Ref. No.</th> <th>456083 456084</th> </tr> <tr> <td colspan="4">O-ring EPDM thickness 2.62mm ID ø 82.22mm Qty 1 pcs</td> </tr> </table>	GEV No.	509002	Ref. No.	456083 456084	O-ring EPDM thickness 2.62mm ID ø 82.22mm Qty 1 pcs			
GEV No.	509002	Ref. No.	456083 456084						
O-ring EPDM thickness 2.62mm ID ø 82.22mm Qty 1 pcs									





<b>spare parts for</b> 501503									
	<table border="1"> <tr> <th>GEV No.</th> <th>510703</th> <th>Ref. No.</th> <th>141007 80843</th> </tr> <tr> <td colspan="4">mechanical shaft seal for shaft ø 13mm slide ring H 13mm height counter ring 5.5mm ED ø 26mm</td> </tr> </table>	GEV No.	510703	Ref. No.	141007 80843	mechanical shaft seal for shaft ø 13mm slide ring H 13mm height counter ring 5.5mm ED ø 26mm			
GEV No.	510703	Ref. No.	141007 80843						
mechanical shaft seal for shaft ø 13mm slide ring H 13mm height counter ring 5.5mm ED ø 26mm									
	<table border="1"> <tr> <th>GEV No.</th> <th>698765</th> <th>Ref. No.</th> <th>124063</th> </tr> <tr> <td colspan="4">impellor ø 70mm H 21mm rotation direction right thread M7L suitable for LGB shaft ø 13mm shaft length 20mm blades 4</td> </tr> </table>	GEV No.	698765	Ref. No.	124063	impellor ø 70mm H 21mm rotation direction right thread M7L suitable for LGB shaft ø 13mm shaft length 20mm blades 4			
GEV No.	698765	Ref. No.	124063						
impellor ø 70mm H 21mm rotation direction right thread M7L suitable for LGB shaft ø 13mm shaft length 20mm blades 4									
	<table border="1"> <tr> <th>GEV No.</th> <th>698770</th> <th>Ref. No.</th> <th>116035</th> </tr> <tr> <td colspan="4">pump cover LGB inlet ø 28mm outlet ø 22/28mm ø 108mm ID ø 84mm</td> </tr> </table>	GEV No.	698770	Ref. No.	116035	pump cover LGB inlet ø 28mm outlet ø 22/28mm ø 108mm ID ø 84mm			
GEV No.	698770	Ref. No.	116035						
pump cover LGB inlet ø 28mm outlet ø 22/28mm ø 108mm ID ø 84mm									



1									
<b>GEV No.</b>	501525	<b>Ref. No.</b>	130168						
<b>description</b>	pump inlet ø 28mm outlet ø 22/27mm type CF 3091 230V 60Hz 1 phase 0.2kW L 175mm rotation direction right capacitor 4µF LGB with capacitor								
<b>For models:</b>	915611, 915612, 915613, 915614, 915615, 915616, 915617, 915618, 915670, 915671, 915672, 915773, 915774, 915959, 916066, 916077, 916078, 916196, 916197, 916198, 916199, 916200, 916409, 916410, 916418, 916419, 916591, 916592, 916593, 916594, 916595, 916877, Niagara-241, Niagara-241-2, Niagara-341, Pluvia-240, River-242, River-242-2, River-242-2T, River-342C, River-342T								
<b>spare parts for</b> 501525									
	<table border="1"> <tr> <th>GEV No.</th> <th>365031</th> <th>Ref. No.</th> <th>206013</th> </tr> <tr> <td colspan="4">operating capacitor capacity 4µF 450V tolerance 5% 50/60Hz ambient temperature max. -25 to +85°C ø 31mm L 58mm M8 plastic connection male faston 6.3mm protection</td> </tr> </table>	GEV No.	365031	Ref. No.	206013	operating capacitor capacity 4µF 450V tolerance 5% 50/60Hz ambient temperature max. -25 to +85°C ø 31mm L 58mm M8 plastic connection male faston 6.3mm protection			
GEV No.	365031	Ref. No.	206013						
operating capacitor capacity 4µF 450V tolerance 5% 50/60Hz ambient temperature max. -25 to +85°C ø 31mm L 58mm M8 plastic connection male faston 6.3mm protection									
	<table border="1"> <tr> <th>GEV No.</th> <th>509002</th> <th>Ref. No.</th> <th>456083 456084</th> </tr> <tr> <td colspan="4">O-ring EPDM thickness 2.62mm ID ø 82.22mm Qty 1 pcs</td> </tr> </table>	GEV No.	509002	Ref. No.	456083 456084	O-ring EPDM thickness 2.62mm ID ø 82.22mm Qty 1 pcs			
GEV No.	509002	Ref. No.	456083 456084						
O-ring EPDM thickness 2.62mm ID ø 82.22mm Qty 1 pcs									
	<table border="1"> <tr> <th>GEV No.</th> <th>510703</th> <th>Ref. No.</th> <th>141007 80843</th> </tr> <tr> <td colspan="4">mechanical shaft seal for shaft ø 13mm slide ring H 13mm height counter ring 5.5mm ED ø 26mm</td> </tr> </table>	GEV No.	510703	Ref. No.	141007 80843	mechanical shaft seal for shaft ø 13mm slide ring H 13mm height counter ring 5.5mm ED ø 26mm			
GEV No.	510703	Ref. No.	141007 80843						
mechanical shaft seal for shaft ø 13mm slide ring H 13mm height counter ring 5.5mm ED ø 26mm									
	<table border="1"> <tr> <th>GEV No.</th> <th>698765</th> <th>Ref. No.</th> <th>124063</th> </tr> <tr> <td colspan="4">impellor ø 70mm H 21mm rotation direction right thread M7L suitable for LGB shaft ø 13mm shaft length 20mm blades 4</td> </tr> </table>	GEV No.	698765	Ref. No.	124063	impellor ø 70mm H 21mm rotation direction right thread M7L suitable for LGB shaft ø 13mm shaft length 20mm blades 4			
GEV No.	698765	Ref. No.	124063						
impellor ø 70mm H 21mm rotation direction right thread M7L suitable for LGB shaft ø 13mm shaft length 20mm blades 4									
	<table border="1"> <tr> <th>GEV No.</th> <th>698770</th> <th>Ref. No.</th> <th>116035</th> </tr> <tr> <td colspan="4">pump cover LGB inlet ø 28mm outlet ø 22/28mm ø 108mm ID ø 84mm</td> </tr> </table>	GEV No.	698770	Ref. No.	116035	pump cover LGB inlet ø 28mm outlet ø 22/28mm ø 108mm ID ø 84mm			
GEV No.	698770	Ref. No.	116035						
pump cover LGB inlet ø 28mm outlet ø 22/28mm ø 108mm ID ø 84mm									



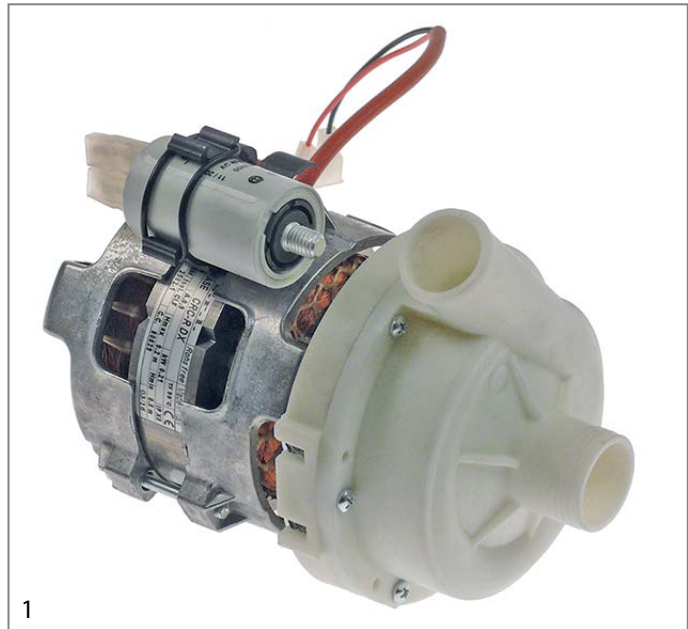

1

<b>GEV No.</b>	499099	<b>Ref. No.</b>	130163 80627
<b>description</b>	pump inlet ø 28mm outlet ø 26mm type CRC-R DX 230V 50Hz 1 phase 0.2kW L 175mm rotation direction left capacitor 4µF LGB		
<b>For models:</b>	915154, 915155, 915157, 915158, 915172, 915173, 915285, 915422, 915492, 915493, 915494, 915495, 915496, 915497, 915617, 915618, 915672, 915773, 915774, 916045, 916054, 916066, 916067, 916068, 916069, 916077, 916078, 916079, 916080, 916368, 916418, 916419, 916420, 916421, 916422, 916423, 916424, 916594, 916595, 916654, 916686, 916760, Fast160C, Ocean360-UK, River-242, River-242-2, River-242-2T, RIVER-252, River-252-2, River-252-2T...(Other models you can see in the webshop)		
<b>spare parts for</b>	499099		
	<b>GEV No.</b>	365031	<b>Ref. No.</b> 206013
	operating capacitor capacity 4µF 450V tolerance 5% 50/60Hz ambient temperature max. -25 to +85°C ø 31mm L 58mm M8 plastic connection male faston 6.3mm protection		
	<b>GEV No.</b>	509002	<b>Ref. No.</b> 456083 456084
	O-ring EPDM thickness 2.62mm ID ø 82.22mm Qty 1 pcs		
	<b>GEV No.</b>	510703	<b>Ref. No.</b> 141007 80843
	mechanical shaft seal for shaft ø 13mm slide ring H 13mm height counter ring 5.5mm ED ø 26mm		
	<b>GEV No.</b>	521091	<b>Ref. No.</b> 116040
	pump cover LGB inlet ø 28mm outlet ø 26mm pump type CRC-R DX		
	<b>GEV No.</b>	521092	<b>Ref. No.</b> 124070
	impellor ø 80mm H 25mm pump type CRC-R DX thread M6R shaft ø 13mm shaft length 20mm		







1

<b>GEV No.</b>	501526	<b>Ref. No.</b>	80629
<b>description</b>	pump inlet ø 28mm outlet ø 26mm type CRC-R DX 230V 60Hz 1 phase 0.21kW L 175mm rotation direction left capacitor 4µF LGB		
<b>For models:</b>	915154, 915155, 915157, 915158, 915172, 915173, 915285, 915422, 915492, 915493, 915494, 915495, 915496, 915497, 915617, 915618, 915672, 915773, 915774, 916045, 916054, 916066, 916067, 916068, 916069, 916077, 916078, 916079, 916080, 916368, 916418, 916419, 916420, 916421, 916422, 916423, 916424, 916594, 916595, 916654, 916686, 916760, Fast160C, Ocean360-UK, River-242, River-242-2, River-242-2T, RIVER-252, River-252-2, River-252-2T...(Other models you can see in the webshop)		
<b>spare parts for</b>	501526		
	<b>GEV No.</b>	365031	<b>Ref. No.</b> 206013
	operating capacitor capacity 4µF 450V tolerance 5% 50/60Hz ambient temperature max. -25 to +85°C ø 31mm L 58mm M8 plastic connection male faston 6.3mm protection		
	<b>GEV No.</b>	509002	<b>Ref. No.</b> 456083 456084
	O-ring EPDM thickness 2.62mm ID ø 82.22mm Qty 1 pcs		
	<b>GEV No.</b>	510703	<b>Ref. No.</b> 141007 80843
	mechanical shaft seal for shaft ø 13mm slide ring H 13mm height counter ring 5.5mm ED ø 26mm		
	<b>GEV No.</b>	521091	<b>Ref. No.</b> 116040
	pump cover LGB inlet ø 28mm outlet ø 26mm pump type CRC-R DX		
	<b>GEV No.</b>	521092	<b>Ref. No.</b> 124070
	impellor ø 80mm H 25mm pump type CRC-R DX thread M6R shaft ø 13mm shaft length 20mm		







1

<b>GEV No.</b>	500542	<b>Ref. No.</b>	130097
<b>description</b>	pump inlet $\varnothing$ 28mm outlet $\varnothing$ 26mm type ZF130DX 230V 50Hz 1 phase 0.3kW 0.41HP L 190mm rotation direction left capacitor 6.3 $\mu$ F LGB		
<b>For models:</b>	400F, 400FD, 400R, 400RD, 40-ELECTRONIC, 40F, 40FD, 40R, 40RD		
<b>spare parts for</b>	500542		
	GEV No.	365012	Ref. No. 206009
	operating capacitor capacity 6.3 $\mu$ F 450V tolerance 5% 50Hz ambient temperature max. -25 to +85°C $\varnothing$ 30mm L 61mm M8 plastic connection male faston 6.3mm protection		
	GEV No.	510703	Ref. No. 141007 80843
	mechanical shaft seal for shaft $\varnothing$ 13mm slide ring H 13mm height counter ring 5.5mm ED $\varnothing$ 26mm		
	GEV No.	521107	Ref. No. —
	pump cover LGB inlet $\varnothing$ 28mm outlet $\varnothing$ 26mm auxiliary pressure connection 12mm ID $\varnothing$ 77mm		
	GEV No.	521228	Ref. No. 124032
	impellor $\varnothing$ 72mm H 17mm rotation direction left thread M7R shaft $\varnothing$ 13mm shaft length 12mm blades 3		
	GEV No.	528800	Ref. No. —
	O-ring EPDM thickness 2.62mm ID $\varnothing$ 75.87mm Qty 1 pcs		



1

<b>GEV No.</b>	500094	<b>Ref. No.</b>	130099
<b>description</b>	pump inlet $\varnothing$ 28mm outlet $\varnothing$ 26mm type ZF131SX 230V 50Hz 1 phase 0.2kW 0.15HP L 195mm rotation direction left capacitor 6.3 $\mu$ F LGB		
<b>For models:</b>	350F, 350FD, 350R, 350RD, 35-ELECTRONIC		
<b>spare parts for</b>	500094		
	GEV No.	365012	Ref. No. 206009
	operating capacitor capacity 6.3 $\mu$ F 450V tolerance 5% 50Hz ambient temperature max. -25 to +85°C $\varnothing$ 30mm L 61mm M8 plastic connection male faston 6.3mm protection		

<b>spare parts for</b>	500094		
	GEV No.	502266	Ref. No. —
	pump cover inlet $\varnothing$ 28mm outlet $\varnothing$ 26mm		
	GEV No.	510703	Ref. No. 141007 80843
	mechanical shaft seal for shaft $\varnothing$ 13mm slide ring H 13mm height counter ring 5.5mm ED $\varnothing$ 26mm		
	GEV No.	521085	Ref. No. —
	impellor $\varnothing$ 72mm H 17mm thread M7L shaft $\varnothing$ 13mm shaft length 12mm blades 3		
	GEV No.	528800	Ref. No. —
	O-ring EPDM thickness 2.62mm ID $\varnothing$ 75.87mm Qty 1 pcs		









1

<b>GEV No.</b>	500979	<b>Ref. No.</b>	130148
<b>description</b>	pump inlet $\varnothing$ 28mm outlet $\varnothing$ 26mm type ZFC1121DX 230V 50Hz 1 phase 0.25kW L 198mm rotation direction left capacitor 6.3 $\mu$ F LGB		
<b>For models:</b>	2312-009-CRP, 914628, 914944, RIVER-40-CRP, RIVER-44-CRP, RIVER-44-CRP-ST, RIVER-50-CRP, RIVER-50-CRP-SP, RIVER-54CRP, RIVER-54-CRP-s.p., RIVER-54-CRP-SP		
<b>spare parts for</b>	500979		
	GEV No.	365012	Ref. No. 206009
	operating capacitor capacity 6.3 $\mu$ F 450V tolerance 5% 50Hz ambient temperature max. -25 to +85°C $\varnothing$ 30mm L 61mm M8 plastic connection male faston 6.3mm protection		
	GEV No.	510703	Ref. No. 141007 80843
	mechanical shaft seal for shaft $\varnothing$ 13mm slide ring H 13mm height counter ring 5.5mm ED $\varnothing$ 26mm		
	GEV No.	521098	Ref. No. —
	pump cover LGB inlet $\varnothing$ 28mm outlet $\varnothing$ 26mm auxiliary pressure connection 12mm ID $\varnothing$ 77mm		
	GEV No.	521099	Ref. No. —
	impellor $\varnothing$ 72mm H 17mm thread M7R shaft $\varnothing$ 13mm shaft length 12mm		
	GEV No.	528800	Ref. No. —
	O-ring EPDM thickness 2.62mm ID $\varnothing$ 75.87mm Qty 1 pcs		



1

<b>GEV No.</b>	500351	<b>Ref. No.</b>	130994
<b>description</b>	pump inlet $\varnothing$ 29mm outlet $\varnothing$ 39mm type X5SX 230V 50Hz 1 phase 0.8kW 1.09HP L 210mm rotation direction right capacitor 16 $\mu$ F LGB		
<b>For models:</b>	2312-009-CRP, RIVER-48, RIVER-50, RIVER-50-CRP, RIVER-50-CRP-SP, RIVER-54, RIVER-54-CRP-SP, RIVER-61		
<b>spare parts for</b>	500351		
	<b>GEV No.</b>	365021	<b>Ref. No.</b> 206004
	operating capacitor capacity 16 $\mu$ F 425V tolerance 5% 50/60Hz ambient temperature max. -25 to +85°C $\varnothing$ 35mm L 73mm single M8 plastic connection male faston 6.3mm 416.10.99 protection		
	<b>GEV No.</b>	510703	<b>Ref. No.</b> 141007 80843
	mechanical shaft seal for shaft $\varnothing$ 13mm slide ring H 13mm height counter ring 5.5mm ED $\varnothing$ 26mm		
	<b>GEV No.</b>	518294	<b>Ref. No.</b> 437087
	flat gasket rubber ED $\varnothing$ 85mm ID $\varnothing$ 71mm thickness 2mm Qty 1 pcs		
	<b>GEV No.</b>	521234	<b>Ref. No.</b> 124052
	impellor thread M8L ED $\varnothing$ 93mm W 16mm		
	<b>GEV No.</b>	523509	<b>Ref. No.</b> 314001
	deep-groove ball bearing type 6201-2RS shaft $\varnothing$ 12mm ED $\varnothing$ 32mm W 10mm with sealing discs deep-groove ball bearing DIN 625-1		
	<b>GEV No.</b>	532537	<b>Ref. No.</b> 456067
	O-ring EPDM thickness 3.53mm ID $\varnothing$ 113.9mm Qty 1 pcs		



1

<b>GEV No.</b>	499138	<b>Ref. No.</b>	130993 999241
<b>description</b>	pump inlet $\varnothing$ 33mm outlet $\varnothing$ 26mm type X3SX 230V 50Hz 1 phase 0.26kW L 300mm rotation direction right capacitor 6.3 $\mu$ F LGB		
<b>For models:</b>	913992, 913993, 914583, 914592, 914612, 914613, 915143, RIVER-40, RIVER-40-CRP, RIVER-44, RIVER-44-CRP, RIVER-44-CRP-ST, RIVER-44CRP-ST		
<b>spare parts for</b>	499138		
	<b>GEV No.</b>	365012	<b>Ref. No.</b> 206009
	operating capacitor capacity 6.3 $\mu$ F 450V tolerance 5% 50Hz ambient temperature max. -25 to +85°C $\varnothing$ 30mm L 61mm M8 plastic connection male faston 6.3mm protection		
	<b>GEV No.</b>	509004	<b>Ref. No.</b> 124049
	impellor $\varnothing$ 71mm H 16mm M7L rotation direction right shaft $\varnothing$ 13mm shaft length 13mm blades 8		
	<b>GEV No.</b>	510703	<b>Ref. No.</b> 141007 80843
	mechanical shaft seal for shaft $\varnothing$ 13mm slide ring H 13mm height counter ring 5.5mm ED $\varnothing$ 26mm		
	<b>GEV No.</b>	521088	<b>Ref. No.</b> 116030
	pump cover LGB inlet $\varnothing$ 33mm outlet $\varnothing$ 26mm		
	<b>GEV No.</b>	521147	<b>Ref. No.</b> 315024
	flange		
	<b>GEV No.</b>	521703	<b>Ref. No.</b> 456038 456063
	pump cover gasket EPDM thickness 2.5mm ID $\varnothing$ 75mm Qty 1 pcs		
	<b>GEV No.</b>	523501	<b>Ref. No.</b> 314009
	deep-groove ball bearing type 608-2RS shaft $\varnothing$ 8mm ED $\varnothing$ 22mm W 7mm with sealing discs deep-groove ball bearing DIN 625-1		









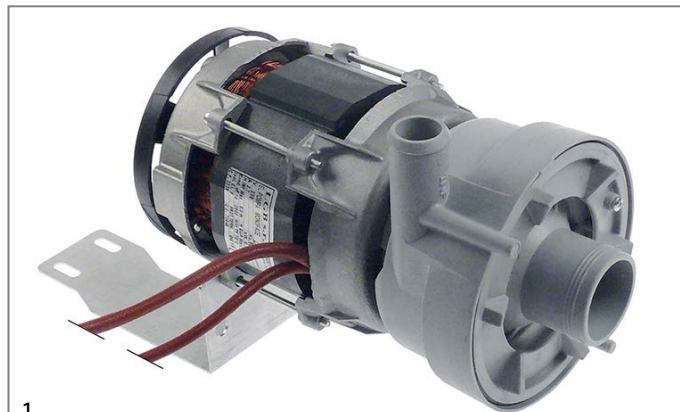

1			
<b>GEV No.</b>	499100	<b>Ref. No.</b>	130161 130982
<b>description</b>	pump inlet ø 42mm outlet ø 24/37mm type LA50 230V 50Hz 1 phase 0.47kW L 220mm rotation direction right capacitor 10µF LGB with flange and hoses		
<b>For models:</b>	915150, 915151, 915152, 915154, 915155, 915157, 915158, 915160, 915161, 915162, 915166, 915167, 915168, 915172, 915173, 915175, 915176, 915177, 915285, 915319, 915338, 915341, 915348, 915418, 915419, 915420, 915421, 915422, 915479, 915492, 915493, 915494, 915495, 915496, 915497, 915547, 915558, 915635, 915663, 915747, 916054, Niagara-251, NIAGARA-261, Pluvia-260, PLUVIA-270, River-252, RIVER-253, River-262		
<b>spare parts for</b>	499100		
	<b>GEV No.</b>	365015	<b>Ref. No.</b> 206002
	operating capacitor capacity 10µF 400V tolerance 5%Hz ambient temperature max. -25 to +85°C ø 35.5mm L 59mm M8 plastic connection male faston 6.3mm protection		
	<b>GEV No.</b>	510702	<b>Ref. No.</b> —
	mechanical shaft seal height counter ring 5.5mm ID ø 12mm		
	<b>GEV No.</b>	521024	<b>Ref. No.</b> 124057 73053
	impeller ø 88mm H 30mm rotation direction right thread M7L shaft ø 12mm blades 6		
	<b>GEV No.</b>	698767	<b>Ref. No.</b> 335015
	fan blade ø 110mm H 18mm shaft intake ø 12mm plastic blades 6		
	<b>GEV No.</b>	698768	<b>Ref. No.</b> 480148
	pump cover LGB inlet ø 42mm pump type LA50 AP ø 115mm ID ø 36mm		
	<b>GEV No.</b>	698810	<b>Ref. No.</b> 456078
	O-ring EPDM thickness 3.56mm ID ø 112mm Qty 1 pcs		
	<b>GEV No.</b>	698827	<b>Ref. No.</b> 429074
	threaded ring LGB pump type LA50 ø 120mm ID ø 70mm		











1			
<b>GEV No.</b>	499190	<b>Ref. No.</b>	69120
<b>description</b>	pump inlet ø 42mm outlet ø 24/37mm type LA50 230V 50Hz 1 phase 0.47kW L 225mm rotation direction right capacitor 10µF LGB		
<b>For models:</b>	FAST-60, FAST-73, NG281, NG281HP, NIAGARA-281, NIAGARA-281HP, PLUVIA-280, PV280, PV280FAST, PV280FASTCH		
<b>spare parts for</b>	499190		
	<b>GEV No.</b>	365015	<b>Ref. No.</b> 206002
	operating capacitor capacity 10µF 400V tolerance 5%Hz ambient temperature max. -25 to +85°C ø 35.5mm L 59mm M8 plastic connection male faston 6.3mm protection		
	<b>GEV No.</b>	510702	<b>Ref. No.</b> —
	mechanical shaft seal height counter ring 5.5mm ID ø 12mm		
	<b>GEV No.</b>	521024	<b>Ref. No.</b> 124057 73053
	impeller ø 88mm H 30mm rotation direction right thread M7L shaft ø 12mm blades 6		
	<b>GEV No.</b>	698767	<b>Ref. No.</b> 335015
	fan blade ø 110mm H 18mm shaft intake ø 12mm plastic blades 6		
	<b>GEV No.</b>	698768	<b>Ref. No.</b> 480148
	pump cover LGB inlet ø 42mm pump type LA50 AP ø 115mm ID ø 36mm		
	<b>GEV No.</b>	698793	<b>Ref. No.</b> 73052
	pump cover outlet ø 24/36mm pump type LGB		
	<b>GEV No.</b>	698810	<b>Ref. No.</b> 456078
	O-ring EPDM thickness 3.56mm ID ø 112mm Qty 1 pcs		
	<b>GEV No.</b>	698827	<b>Ref. No.</b> 429074
	threaded ring LGB pump type LA50 ø 120mm ID ø 70mm		



1







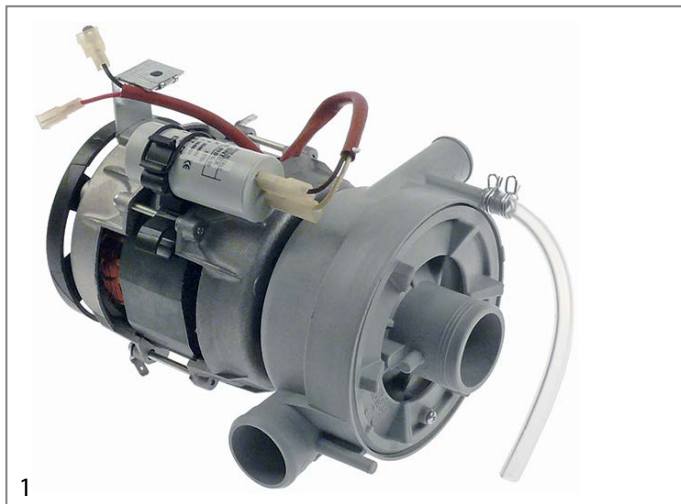

<b>GEV No.</b>	501484	<b>Ref. No.</b>	69122
<b>description</b>	pump inlet ø 42mm outlet ø 37/24mm type LA50 230V 50Hz 1 phase 0.47kW L 220mm rotation direction right capacitor 10µF auxiliary pressure connection 8mm LGB		
<b>For models:</b>	CNT800CH, Fast180, NG281CDD, NG281HPDD, NG281HZ23, NG281HZ23DD, Niagara-281, Niagara-281-2, Niagara-281HP, OC380, OC380FUR, Ocean380, PV280FAST2, PV280FAST2BIO, SevenE		
<b>spare parts for</b>	501484		
	<b>GEV No.</b>	365015	<b>Ref. No.</b> 206002
	operating capacitor capacity 10µF 400V tolerance 5%Hz ambient temperature max. -25 to +85°C ø 35.5mm L 59mm M8 plastic connection male faston 6.3mm protection		
	<b>GEV No.</b>	510702	<b>Ref. No.</b> —
	mechanical shaft seal height counter ring 5.5mm ID ø 12mm		
	<b>GEV No.</b>	521024	<b>Ref. No.</b> 124057 73053
	impellor ø 88mm H 30mm rotation direction right thread M7L shaft ø 12mm blades 6		
	<b>GEV No.</b>	698767	<b>Ref. No.</b> 335015
	fan blade ø 110mm H 18mm shaft intake ø 12mm plastic blades 6		
	<b>GEV No.</b>	698768	<b>Ref. No.</b> 480148
	pump cover LGB inlet ø 42mm pump type LA50 AP ø 115mm ID ø 36mm		
	<b>GEV No.</b>	698769	<b>Ref. No.</b> 116032
	pump casing ø 125mm outlet ø 24/37mm		
	<b>GEV No.</b>	698810	<b>Ref. No.</b> 456078
	O-ring EPDM thickness 3.56mm ID ø 112mm Qty 1 pcs		
	<b>GEV No.</b>	698827	<b>Ref. No.</b> 429074
	threaded ring LGB pump type LA50 ø 120mm ID ø 70mm		

1

<b>GEV No.</b>	501486	<b>Ref. No.</b>	73048
<b>description</b>	pump inlet ø 42mm outlet ø 37mm type LA50 AP 230V 50Hz 1 phase 0.7kW L 220mm rotation direction right capacitor 14µF auxiliary pressure connection 8mm LGB		
<b>For models:</b>	NG381, NG38123, NG38123TERMO, NG381C, NG381CDD, NG381CFUR, NG381DDPS, NG381HPDD, NG381TERMO, NG381TXCDD, Niagara-381, Niagara-381-230V-3Ph-50Hz, Niagara-381DP, Niagara-381HPD, River-282-2, River-282S-2TDE, River-285, River-382, River-382-230V-3Ph-50Hz, River-382H, River-382NRG, River-382NRG-230-3Ph-50Hz, River-382TDE, RV382, RV38223TERMO, RV382AHP, RV382FUR, RV382R, RV382R23TERMO, RV382RFUR, RV382S, RV382SFUR, RV382TERMO, RV382TX, RV382TXR		
<b>spare parts for</b>	501486		
	<b>GEV No.</b>	365020	<b>Ref. No.</b> 73055
	operating capacitor capacity 14µF 400V tolerance 5%Hz ambient temperature max. -25 to +85°C ø 35mm L 70mm M8 plastic connection male faston 6.3mm protection		
	<b>GEV No.</b>	510702	<b>Ref. No.</b> —
	mechanical shaft seal height counter ring 5.5mm ID ø 12mm		
	<b>GEV No.</b>	521024	<b>Ref. No.</b> 124057 73053
	impellor ø 88mm H 30mm rotation direction right thread M7L shaft ø 12mm blades 6		
	<b>GEV No.</b>	698767	<b>Ref. No.</b> 335015
	fan blade ø 110mm H 18mm shaft intake ø 12mm plastic blades 6		
	<b>GEV No.</b>	698768	<b>Ref. No.</b> 480148
	pump cover LGB inlet ø 42mm pump type LA50 AP ø 115mm ID ø 36mm		
	<b>GEV No.</b>	698793	<b>Ref. No.</b> 73052
	pump cover outlet ø 24/36mm pump type LGB		
	<b>GEV No.</b>	698810	<b>Ref. No.</b> 456078
	O-ring EPDM thickness 3.56mm ID ø 112mm Qty 1 pcs		
	<b>GEV No.</b>	698827	<b>Ref. No.</b> 429074
	threaded ring LGB pump type LA50 ø 120mm ID ø 70mm		











1

<b>GEV No.</b>	501485	<b>Ref. No.</b>	130977
<b>description</b>	pump inlet ø 42mm outlet ø 37mm type LA500 230V 50Hz 1 phase 0.47kW L 220mm rotation direction right capacitor 10µF auxiliary pressure connection 8mm LGB		
<b>For models:</b>	915160, 915161, 915162, 915175, 915319, 915496, 915663, 916020, 916021, 916024, 916025, 916026, 916027, 916030, 916031, 916045, 916067, 916068, 916069, 916079, 916080, 916201, 916202, 916203, 916204, 916205, 916206, 916207, 916208, 916209, 916247, 916248, 916249, 916250, 916251, 916252, 916365, 916366, 916367, 916368, 916382, 916383, 916411, 916412, 916413, 916414, 916415, 916416, 916417, 916420...(Other models you can see in the webshop)		
<b>spare parts for</b>	501485		
	<b>GEV No.</b>	365015	<b>Ref. No.</b> 206002
	operating capacitor capacity 10µF 400V tolerance 5%Hz ambient temperature max. -25 to +85°C ø 35.5mm L 59mm M8 plastic connection male faston 6.3mm protection		
	<b>GEV No.</b>	510702	<b>Ref. No.</b> —
	mechanical shaft seal height counter ring 5.5mm ID ø 12mm		
	<b>GEV No.</b>	521024	<b>Ref. No.</b> 124057 73053
	impellor ø 88mm H 30mm rotation direction right thread M7L shaft ø 12mm blades 6		
	<b>GEV No.</b>	698767	<b>Ref. No.</b> 335015
	fan blade ø 110mm H 18mm shaft intake ø 12mm plastic blades 6		
	<b>GEV No.</b>	698768	<b>Ref. No.</b> 480148
	pump cover LGB inlet ø 42mm pump type LA50 AP ø 115mm ID ø 36mm		
	<b>GEV No.</b>	698769	<b>Ref. No.</b> 116032
	pump casing ø 125mm outlet ø 24/37mm		
	<b>GEV No.</b>	698810	<b>Ref. No.</b> 456078
	O-ring EPDM thickness 3.56mm ID ø 112mm Qty 1 pcs		
	<b>GEV No.</b>	698827	<b>Ref. No.</b> 429074
	threaded ring LGB pump type LA50 ø 120mm ID ø 70mm		











1

<b>GEV No.</b>	501528	<b>Ref. No.</b>	130976
<b>description</b>	pump inlet ø 42mm outlet ø 37mm type LA500 230V 60Hz 1 phase 0.46kW L 220mm rotation direction right capacitor 10µF auxiliary pressure connection 8mm LGB		
<b>For models:</b>	915160, 915161, 915162, 915175, 915319, 915496, 915663, 916020, 916021, 916024, 916025, 916026, 916027, 916030, 916031, 916067, 916068, 916069, 916079, 916080, 916201, 916202, 916203, 916204, 916205, 916206, 916207, 916208, 916209, 916247, 916248, 916249, 916250, 916251, 916252, 916365, 916366, 916367, 916368, 916382, 916383, 916411, 916412, 916413, 916414, 916415, 916416, 916417, 916420, 916421...(Other models you can see in the webshop)		
<b>spare parts for</b>	501528		
	<b>GEV No.</b>	365015	<b>Ref. No.</b> 206002
	operating capacitor capacity 10µF 400V tolerance 5%Hz ambient temperature max. -25 to +85°C ø 35.5mm L 59mm M8 plastic connection male faston 6.3mm protection		
	<b>GEV No.</b>	510702	<b>Ref. No.</b> —
	mechanical shaft seal height counter ring 5.5mm ID ø 12mm		
	<b>GEV No.</b>	521024	<b>Ref. No.</b> 124057 73053
	impellor ø 88mm H 30mm rotation direction right thread M7L shaft ø 12mm blades 6		
	<b>GEV No.</b>	698767	<b>Ref. No.</b> 335015
	fan blade ø 110mm H 18mm shaft intake ø 12mm plastic blades 6		
	<b>GEV No.</b>	698768	<b>Ref. No.</b> 480148
	pump cover LGB inlet ø 42mm pump type LA50 AP ø 115mm ID ø 36mm		
	<b>GEV No.</b>	698769	<b>Ref. No.</b> 116032
	pump casing ø 125mm outlet ø 24/37mm		
	<b>GEV No.</b>	698810	<b>Ref. No.</b> 456078
	O-ring EPDM thickness 3.56mm ID ø 112mm Qty 1 pcs		
	<b>GEV No.</b>	698827	<b>Ref. No.</b> 429074
	threaded ring LGB pump type LA50 ø 120mm ID ø 70mm		





1







<b>GEV No.</b>	500156	<b>Ref. No.</b>	130098 130109
<b>description</b>	pump inlet ø 50mm outlet ø 50mm type ZF400SX 230V 50Hz 1 phase 0.6kW 0.8HP L 210mm rotation direction right capacitor 16µF LGB		
<b>For models:</b>	050F, 050FP, 2312-001, 2312-002, 46, 460, 500F, 500FD, 50-ELECTRONIC, 50F, 50FD, 913297, 913298, 913299, 913300, 913360, 913361, 913391, 913392, 913546, 913547, 913578, 913611, 913684, 913913, 913914, 913932, 913933, 914284, 914331, 914356, 914400, 914401, 914402, 914403, 914404, 914405, 914449, 914517, 914545, 914568, 914642, 914688, 914909, 914979, 915136, 915137, 915140, 915248, 915483...(Other models you can see in the webshop)		
<b>spare parts for</b>	500156		
	<b>GEV No.</b>	509020	<b>Ref. No.</b> 124031
	impellor ø 104mm H 25mm M8L		
	<b>GEV No.</b>	510703	<b>Ref. No.</b> 141007 80843
	mechanical shaft seal for shaft ø 13mm slide ring H 13mm height counter ring 5.5mm ED ø 26mm		
	<b>GEV No.</b>	513713	<b>Ref. No.</b> 315017
	pump cover bottom part		
	<b>GEV No.</b>	521548	<b>Ref. No.</b> 116019
	pump cover LGB inlet ø 50mm outlet ø 50mm		
	<b>GEV No.</b>	521562	<b>Ref. No.</b> 116021
	pump cover		
	<b>GEV No.</b>	521734	<b>Ref. No.</b> 315022
	pump cover bottom part		
	<b>GEV No.</b>	523509	<b>Ref. No.</b> 314001
	deep-groove ball bearing type 6201-2RS shaft ø 12mm ED ø 32mm W 10mm with sealing discs deep-groove ball bearing DIN 625-1		
	<b>GEV No.</b>	532623	<b>Ref. No.</b> 80844
	O-ring EPDM thickness 2.62mm ID ø 120.32mm Qty 1 pcs		
<b>accessories for</b>	500156		
	<b>GEV No.</b>	365021	<b>Ref. No.</b> 206004
	operating capacitor capacity 16µF 425V tolerance 5% 50/60Hz ambient temperature max. -25 to +85°C ø 35mm L 73mm single M8 plastic connection male faston 6.3mm 416.10.99 protection		







1

<b>GEV No.</b>	500543	<b>Ref. No.</b>	130126
<b>description</b>	pump inlet ø 50mm outlet ø 50mm type ZF400VSX 230V 50Hz 1 phase 0.85kW 1.2HP L 245mm rotation direction right capacitor 16µF LGB		
<b>For models:</b>	510F, 510FD, 913297, 913298, 913299, 913300, 913360, 913361, 913391, 913392, 913546, 913547, 913578, 913611, 913684, 913932, 913933, 914318, 914319, 914331, 914338, 914431, 914517, 914545, 914688, 914979, 915140, 915248, E.50, E.51, F85, F85P, GSP51, GSP51P, LF55, MC501E, MC501EP, Mistral51, MISTRAL-51, NIAGARA-51, TF-513, TF-515		
<b>spare parts for</b>	500543		
	<b>GEV No.</b>	365021	<b>Ref. No.</b> 206004
	operating capacitor capacity 16µF 425V tolerance 5% 50/60Hz ambient temperature max. -25 to +85°C ø 35mm L 73mm single M8 plastic connection male faston 6.3mm 416.10.99 protection		
	<b>GEV No.</b>	509020	<b>Ref. No.</b> 124031
	impellor ø 104mm H 25mm M8L		
	<b>GEV No.</b>	510703	<b>Ref. No.</b> 141007 80843
	mechanical shaft seal for shaft ø 13mm slide ring H 13mm height counter ring 5.5mm ED ø 26mm		
	<b>GEV No.</b>	521548	<b>Ref. No.</b> 116019
	pump cover LGB inlet ø 50mm outlet ø 50mm		
	<b>GEV No.</b>	521734	<b>Ref. No.</b> 315022
	pump cover bottom part		
	<b>GEV No.</b>	532623	<b>Ref. No.</b> 80844
	O-ring EPDM thickness 2.62mm ID ø 120.32mm Qty 1 pcs		



<b>1</b>				
<b>GEV No.</b>	500361	<b>Ref. No.</b>	80112 926078	
<b>description</b>	pump inlet ø 60mm outlet ø 49mm type ZF400SX 230V 50Hz 1 phase 0.8kW 1HP L 210mm rotation direction right capacitor 16µF LGB			
<b>For models:</b>	10, 80, 81, CE78HZ23, CLEAN-100, E100, E78, E78HP, FAST-181, HM1, NG271, NG291, NIAGARA-271, NIAGARA-291, RIVER-294, RIVER-78, RIVER-80, RIVER-81, RIVER-E78, RV294, RV80, RV8023, RV8023HZ, RV80C, RV80HZ, ST70FAST			
<b>spare parts for</b>	500361			
	<b>GEV No.</b>	365021	<b>Ref. No.</b>	206004
		operating capacitor capacity 16µF 425V tolerance 5% 50/60Hz ambient temperature max. -25 to +85°C ø 35mm L 73mm single M8 plastic connection male faston 6.3mm 416.10.99 protection		
	<b>GEV No.</b>	509020	<b>Ref. No.</b>	124031
		impellor ø 104mm H 25mm M8L		
	<b>GEV No.</b>	510703	<b>Ref. No.</b>	141007 80843
		mechanical shaft seal for shaft ø 13mm slide ring H 13mm height counter ring 5.5mm ED ø 26mm		
	<b>GEV No.</b>	521547	<b>Ref. No.</b>	116013
		pump cover LGB inlet ø 60mm outlet ø 50mm supporting pressure M8 turn direction right ø 160mm ID ø 127mm inner height 36mm		
	<b>GEV No.</b>	521736	<b>Ref. No.</b>	315011
		pump cover bottom part bottom part		
	<b>GEV No.</b>	532623	<b>Ref. No.</b>	80844
		O-ring EPDM thickness 2.62mm ID ø 120.32mm Qty 1 pcs		
<b>accessories for</b>	500361			
	<b>GEV No.</b>	513264	<b>Ref. No.</b>	80545
		fastening angle for wash pump		



<b>1</b>				
<b>GEV No.</b>	501527	<b>Ref. No.</b>	80113HZ	
<b>description</b>	pump inlet ø 60mm outlet ø 49mm type ZF400SX 230V 60Hz 1 phase 0.77kW 1HP L 210mm rotation direction right capacitor 16µF LGB			
<b>For models:</b>	Fast181, Fast181-230V-3Ph-60Hz, Fast181-400V-3NPh-60Hz, NIAGARA-283, RIVER-282, RV282, ST70FASTHB400, ST70FASTHZ23, SV72EB			
<b>spare parts for</b>	501527			
	<b>GEV No.</b>	365021	<b>Ref. No.</b>	206004
		operating capacitor capacity 16µF 425V tolerance 5% 50/60Hz ambient temperature max. -25 to +85°C ø 35mm L 73mm single M8 plastic connection male faston 6.3mm 416.10.99 protection		
	<b>GEV No.</b>	509020	<b>Ref. No.</b>	124031
		impellor ø 104mm H 25mm M8L		
	<b>GEV No.</b>	510703	<b>Ref. No.</b>	141007 80843
		mechanical shaft seal for shaft ø 13mm slide ring H 13mm height counter ring 5.5mm ED ø 26mm		
	<b>GEV No.</b>	521547	<b>Ref. No.</b>	116013
		pump cover LGB inlet ø 60mm outlet ø 50mm supporting pressure M8 turn direction right ø 160mm ID ø 127mm inner height 36mm		
	<b>GEV No.</b>	532623	<b>Ref. No.</b>	80844
		O-ring EPDM thickness 2.62mm ID ø 120.32mm Qty 1 pcs		







1

<b>GEV No.</b>	499282	<b>Ref. No.</b>	77553
<b>description</b>	pump inlet ø 60mm outlet ø 49mm type ZF400VSX 220-230/380-400V 50Hz 3 phase 0.7kW L 270mm rotation direction right LGB		
<b>For models:</b>	915747, A4EB, A4EBD, A4EBDAKEKYK, A4EBDAKRK, A4EBDAKWK, A4EBDAKZK, A4EBDBKRK, A4EBDPKWYK, A4EBDRK, A4EBS, A4EBSAK, A4EBSAKCK, A4EBSAKEKYK, A4EBSAKRK, A4EBSAKRKP, A4EBSAKYK, A4EBSCK, A4EBT, A4EBTSAK, A5EB, A5EBD, A5EBDAKPKWK, A5EBDAKWK, A5EBDAKYK, A5EBDRK, A5EBS, A5EBSAKPKWK, A5EBSAKRK, A5EBSAKRKYK, A5EBSAKWK, A5EBSAKWKYK, A5EBSBKRPK, A5EBSBKWK, A5EBSRK, A5EBSYK, GL284EB, GL284EBD, GL284EBDA, GL284EBDAEW, GL284EBDAWY, GL284EBDPWY, GL284EBDR, GL284EBDY, GL284EBS, GL284EBSA, GL284EBSAE, GL284EBSAP, GL284EBSAR, GL284EBSAWY...(Other models you can see in the webshop)		
<b>spare parts for</b>	499282		
	<b>GEV No.</b>	502279	<b>Ref. No.</b> —
	impellor H 31mm ED ø 100mm blades 6		
	<b>GEV No.</b>	510702	<b>Ref. No.</b> —
	mechanical shaft seal height counter ring 5.5mm ID ø 12mm		
	<b>GEV No.</b>	510709	<b>Ref. No.</b> 926255
	mechanical shaft seal		
	<b>GEV No.</b>	521058	<b>Ref. No.</b> —
	fanwheel cover suitable for LGB ID ø 138mm ED ø 142mm H 59mm plastic		
	<b>GEV No.</b>	521547	<b>Ref. No.</b> 116013
	pump cover LGB inlet ø 60mm outlet ø 50mm supporting pressure M8 turn direction right ø 160mm ID ø 127mm inner height 36mm		







1

<b>GEV No.</b>	500001	<b>Ref. No.</b>	130020
<b>description</b>	pump inlet ø 60mm outlet ø 50mm type T150SX 230/400V 50Hz 3 phase 0.9kW 1.2HP L 290mm rotation direction right LGB		
<b>For models:</b>	S651, S651P, S653, S654, S655, S830, S835, SR651		
<b>spare parts for</b>	500001		
	<b>GEV No.</b>	509020	<b>Ref. No.</b> 124031
	impellor ø 104mm H 25mm M8L		
	<b>GEV No.</b>	510703	<b>Ref. No.</b> 141007 80843
	mechanical shaft seal for shaft ø 13mm slide ring H 13mm height counter ring 5.5mm ED ø 26mm		
	<b>GEV No.</b>	521547	<b>Ref. No.</b> 116013
	pump cover LGB inlet ø 60mm outlet ø 50mm supporting pressure M8 turn direction right ø 160mm ID ø 127mm inner height 36mm		
	<b>GEV No.</b>	532623	<b>Ref. No.</b> 80844
	O-ring EPDM thickness 2.62mm ID ø 120.32mm Qty 1 pcs		







1

<b>GEV No.</b>	500148	<b>Ref. No.</b>	130042 130045 130059
<b>description</b>	pump inlet ø 60mm outlet ø 50mm type ZA160SX 230V 50Hz 1 phase 1.1kW 1.5HP L 310mm rotation direction right capacitor 25µF LGB		
<b>For models:</b>	S651, S654, S810, S815, S830, S835		
<b>spare parts for</b>	500148		
	<b>GEV No.</b>	365109	<b>Ref. No.</b> —
	operating capacitor capacity 25µF 400V tolerance 5%Hz ambient temperature max. -25 to +85°C ø 44mm L 70mm M8 plastic connection male faston 6.3mm protection		
	<b>GEV No.</b>	510616	<b>Ref. No.</b> 124012
	impellor ø 104mm H 25mm shaft intake ø 10mm		
	<b>GEV No.</b>	510703	<b>Ref. No.</b> 141007 80843
	mechanical shaft seal for shaft ø 13mm slide ring H 13mm height counter ring 5.5mm ED ø 26mm		
	<b>GEV No.</b>	521547	<b>Ref. No.</b> 116013
	pump cover LGB inlet ø 60mm outlet ø 50mm supporting pressure M8 turn direction right ø 160mm ID ø 127mm inner height 36mm		
	<b>GEV No.</b>	532623	<b>Ref. No.</b> 80844
	O-ring EPDM thickness 2.62mm ID ø 120.32mm Qty 1 pcs		







1

<b>GEV No.</b>	500002	<b>Ref. No.</b>	130017 130018 130068 130069 130079 130080
<b>description</b>	pump inlet ø 60mm outlet ø 50mm type ZA400SX 230V 50Hz 1 phase 0.9kW 1.2HP L 300mm rotation direction right capacitor 20µF LGB		
<b>For models:</b>	22F, 40F, 440F, 44F, E.52, S651, S651P, S653, S654, S655, S830, S835, SR651		
<b>spare parts for</b>	500002		
	<b>GEV No.</b>	365019	<b>Ref. No.</b> 206005
	operating capacitor capacity 20µF 400V tolerance 5% 50/60Hz ambient temperature max. -25 to +85°C ø 39.5mm L 70mm M8 plastic connection male faston 6.3mm 16.10.25. protection		
	<b>GEV No.</b>	509020	<b>Ref. No.</b> 124031
	impellor ø 104mm H 25mm M8L		
	<b>GEV No.</b>	510703	<b>Ref. No.</b> 141007 80843
	mechanical shaft seal for shaft ø 13mm slide ring H 13mm height counter ring 5.5mm ED ø 26mm		
	<b>GEV No.</b>	521547	<b>Ref. No.</b> 116013
	pump cover LGB inlet ø 60mm outlet ø 50mm supporting pressure M8 turn direction right ø 160mm ID ø 127mm inner height 36mm		
	<b>GEV No.</b>	532623	<b>Ref. No.</b> 80844
	O-ring EPDM thickness 2.62mm ID ø 120.32mm Qty 1 pcs		







1

<b>GEV No.</b>	499126	<b>Ref. No.</b>	80113
<b>description</b>	pump inlet ø 60mm outlet ø 50mm type ZF400SX 230V 50Hz 1 phase 1.1kW L 215mm rotation direction right capacitor 16µF LGB		
<b>For models:</b>	NIAGARA-283, RIVER-282, RIVER-81, River-81CRP, RIVER-81-CRP, River-82CRP, RIVER-82-CRP, RV282, RV81, RV8123, RV81A, RV81C, RV81CCRP, RV81CRP, RV81HZ, RV81HZ23, RV81PAP, RV82CCRP, RV82CRP, SV72EB		
<b>spare parts for</b>	499126		
	<b>GEV No.</b>	<b>Ref. No.</b>	206004
	365021		
	operating capacitor capacity 16µF 425V tolerance 5% 50/60Hz ambient temperature max. -25 to +85°C ø 35mm L 73mm single M8 plastic connection male faston 6.3mm 416.10.99 protection		
	<b>GEV No.</b>	<b>Ref. No.</b>	141007 80843
	510703		
	mechanical shaft seal for shaft ø 13mm slide ring H 13mm height counter ring 5.5mm ED ø 26mm		
	<b>GEV No.</b>	<b>Ref. No.</b>	80845
	521090		
	impellor ø 101mm H 32mm thread M8L shaft ø 13mm shaft length 12mm		
	<b>GEV No.</b>	<b>Ref. No.</b>	116013
	521547		
	pump cover LGB inlet ø 60mm outlet ø 50mm supporting pressure M8 turn direction right ø 160mm ID ø 127mm inner height 36mm		
	<b>GEV No.</b>	<b>Ref. No.</b>	80844
	532623		
	O-ring EPDM thickness 2.62mm ID ø 120.32mm Qty 1 pcs		





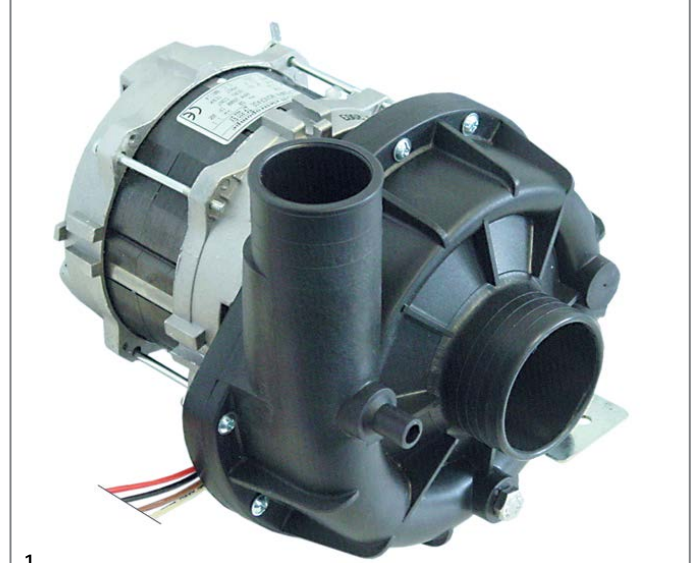

1

<b>GEV No.</b>	500362	<b>Ref. No.</b>	926146
<b>description</b>	pump inlet ø 62mm outlet ø 50mm type CE150SX 230/400V 50Hz 3 phase 1.1kW 1.5HP L 280mm rotation direction right LGB		
<b>For models:</b>	CLEAN-110, E1, E110		
<b>spare parts for</b>	500362		
	<b>GEV No.</b>	<b>Ref. No.</b>	456023 926084
	510551		
	pump cover gasket ID ø 158.3mm pump type 1214/1293/1225/2243/1226/1204/3473/1241 thickness 3.53mm EPDM Qty 1 pcs		

<b>spare parts for</b>	500362		
	<b>GEV No.</b>	<b>Ref. No.</b>	141002 70942 80121 RAT72
	510693		
	mechanical shaft seal for shaft ø 12mm slide ring ext. ø 24mm slide ring H 15.5mm slide ring int. ø 11mm counter ring mounting ø 24mm height counter ring 8mm counter ring int. ø 13.5mm		
	<b>GEV No.</b>	<b>Ref. No.</b>	926085
	521240		
	impellor ø 110mm H 32mm rotation direction left thread M8L shaft ø 20mm shaft length 10mm seat ø 8.2mm blades 6		
	<b>GEV No.</b>	<b>Ref. No.</b>	926086
	521536		
	pump cover ALBA / LGB inlet ø 62mm outlet ø 50mm auxiliary pressure connection 12mm supporting pressure closed turn direction right ø 180mm ID ø 150mm inner height 38mm		
	<b>GEV No.</b>	<b>Ref. No.</b>	—
	602013		
	fan wheel ø 100mm H 28mm shaft intake ø 17.5mm plastic		





1

<b>GEV No.</b>	500360	<b>Ref. No.</b>	80114
<b>description</b>	pump inlet ø 62mm outlet ø 50mm type ZF522SX 230V 50Hz 1 phase 1.1kW 1.5HP L 220mm rotation direction right capacitor 16µF LGB		
<b>For models:</b>	80, 81, LP60, RIVER-71, RIVER-80, RIVER-81, RIVER-81-CRP, RIVER-HL-81, RV71, RV81, RV8123, RV81A, RV81C, RV81HZ, RV81HZ23, RV81PAP, U60E		
<b>spare parts for</b>	500360		
	<b>GEV No.</b>	<b>Ref. No.</b>	206004
	365021		
	operating capacitor capacity 16µF 425V tolerance 5% 50/60Hz ambient temperature max. -25 to +85°C ø 35mm L 73mm single M8 plastic connection male faston 6.3mm 416.10.99 protection		
	<b>GEV No.</b>	<b>Ref. No.</b>	456023 926084
	510551		
	pump cover gasket ID ø 158.3mm pump type 1214/1293/1225/2243/1226/1204/3473/1241 thickness 3.53mm EPDM Qty 1 pcs		
	<b>GEV No.</b>	<b>Ref. No.</b>	141002 70942 80121 RAT72
	510693		
	mechanical shaft seal for shaft ø 12mm slide ring ext. ø 24mm slide ring H 15.5mm slide ring int. ø 11mm counter ring mounting ø 24mm height counter ring 8mm counter ring int. ø 13.5mm		
	<b>GEV No.</b>	<b>Ref. No.</b>	—
	521280		
	impellor ø 107mm H 26mm thread M8L shaft ø 20mm shaft length 15mm seat ø 8.2mm blades 6		
	<b>GEV No.</b>	<b>Ref. No.</b>	926086
	521536		
	pump cover ALBA / LGB inlet ø 62mm outlet ø 50mm auxiliary pressure connection 12mm supporting pressure closed turn direction right ø 180mm ID ø 150mm inner height 38mm		





1



<b>GEV No.</b>	501363	<b>Ref. No.</b>	927022
<b>description</b>	pump inlet ø 62mm outlet ø 52mm type AM5226 230/400V 50Hz 0.65kW L 295mm rotation direction left LGB		
<b>For models:</b>	161, 221, 271, 362, CLEAN-160, CLEAN-161, CLEAN-220, CLEAN-221, CLEAN-270, CLEAN-271, CLEAN-272, CLEAN-361, CLEAN-361P, CLEAN-362, CLEAN-471, CLEAN-471P		
<b>spare parts for</b>	501363		
	<b>GEV No.</b>	510551	<b>Ref. No.</b> 456023 926084
	pump cover gasket ID ø 158.3mm pump type 1214/1293/1225/2243/1226/1204/3473/1241 thickness 3.53mm EPDM Qty 1 pcs		
	<b>GEV No.</b>	510694	<b>Ref. No.</b> 926274
	mechanical shaft seal for shaft ø 13mm height counter ring 8mm ID ø 11.5mm H 16mm mounting ø 24/26mm int. ø 1 14mm		
	<b>GEV No.</b>	521141	<b>Ref. No.</b> —
	impeller ø 70mm H 32mm thread M8R shaft ø 20mm shaft length 9mm		
	<b>GEV No.</b>	521516	<b>Ref. No.</b> —
	pump cover LGB inlet ø 62mm outlet ø 52mm auxiliary pressure connection 12mm supporting pressure closed turn direction left ø 190mm ID ø 150mm inner height 40mm		



1

<b>GEV No.</b>	499299	<b>Ref. No.</b>	DPE1906
<b>description</b>	pump inlet ø 62mm outlet ø 52mm type AM5226DX 220-240/380-415V 60Hz 3 phase 0.55kW L 293mm rotation direction left LGB		
<b>spare parts for</b>	499299		
	<b>GEV No.</b>	510551	<b>Ref. No.</b> 456023 926084
	pump cover gasket ID ø 158.3mm pump type 1214/1293/1225/2243/1226/1204/3473/1241 thickness 3.53mm EPDM Qty 1 pcs		
	<b>GEV No.</b>	510694	<b>Ref. No.</b> 926274
	mechanical shaft seal for shaft ø 13mm height counter ring 8mm ID ø 11.5mm H 16mm mounting ø 24/26mm int. ø 1 14mm		

**spare parts for** 499299

	<b>GEV No.</b>	521141	<b>Ref. No.</b>	—
	impeller ø 70mm H 32mm thread M8R shaft ø 20mm shaft length 9mm			
	<b>GEV No.</b>	521516	<b>Ref. No.</b>	—
	pump cover LGB inlet ø 62mm outlet ø 52mm auxiliary pressure connection 12mm supporting pressure closed turn direction left ø 190mm ID ø 150mm inner height 40mm			



1

<b>GEV No.</b>	501584	<b>Ref. No.</b>	65600
<b>description</b>	pump inlet ø 63mm outlet ø 44mm type PSA 230/400V 50Hz 3 phase 2.5kW L 340mm rotation direction right LGB		









1

<b>GEV No.</b>	500733	<b>Ref. No.</b>	80116
<b>description</b>	pump inlet ø 63mm outlet ø 48mm type AM5225SX 230/400V 50Hz 3 phase 0.9kW 1.2HP L 300mm rotation direction right LGB		
<b>For models:</b>	80, 81, 82, RIVER-82, RIVER-82-CRP, RIVER-HL-82		



1

<b>GEV No.</b>	499101	<b>Ref. No.</b>	79056
<b>description</b>	pump inlet ø outlet ø 38mm type C600 230V 50Hz 1 phase 0.8kW L 220mm rotation direction right capacitor 16µF LGB with drain and flange		
<b>For models:</b>	PS-60		
<b>spare parts for</b>	499101		
	<b>GEV No.</b>	365021	<b>Ref. No.</b> 206004
	operating capacitor capacity 16µF 425V tolerance 5% 50/60Hz ambient temperature max. -25 to +85°C ø 35mm L 73mm single M8 plastic connection male faston 6.3mm 416.10.99 protection		
	<b>GEV No.</b>	502280	<b>Ref. No.</b> 111034
	pump sump LGB auxiliary pressure connection 7mm supporting pressure closed pump type RV54		
	<b>GEV No.</b>	510703	<b>Ref. No.</b> 141007 80843
	mechanical shaft seal for shaft ø 13mm slide ring H 13mm height counter ring 5.5mm ED ø 26mm		
	<b>GEV No.</b>	521234	<b>Ref. No.</b> 124052
	impellor thread M8L ED ø 93mm W 16mm		
	<b>GEV No.</b>	523509	<b>Ref. No.</b> 314001
	deep-groove ball bearing type 6201-2RS shaft ø 12mm ED ø 32mm W 10mm with sealing discs deep-groove ball bearing DIN 625-1		
	<b>GEV No.</b>	532537	<b>Ref. No.</b> 456067
	O-ring EPDM thickness 3.53mm ID ø 113.9mm Qty 1 pcs		



1

<b>GEV No.</b>	499119	<b>Ref. No.</b>	130987
<b>description</b>	pump inlet ø outlet ø 38mm type RV54 230V 50Hz 1 phase 0.8kW L 380mm rotation direction right capacitor 16µF LGB with holder		
<b>For models:</b>	2312-007, 914100, 914101, 914339, 914342, 914343, 914624, 914625, 914626, 914627, 914628, 914850, 914851, 914854, 914944, RIVER-48, RIVER-54, RIVER-54CRP, River-54-CRP-s.p.		
<b>spare parts for</b>	499119		
	<b>GEV No.</b>	365021	<b>Ref. No.</b> 206004
	operating capacitor capacity 16µF 425V tolerance 5% 50/60Hz ambient temperature max. -25 to +85°C ø 35mm L 73mm single M8 plastic connection male faston 6.3mm 416.10.99 protection		
	<b>GEV No.</b>	502280	<b>Ref. No.</b> 111034
	pump sump LGB auxiliary pressure connection 7mm supporting pressure closed pump type RV54		
	<b>GEV No.</b>	510703	<b>Ref. No.</b> 141007 80843
	mechanical shaft seal for shaft ø 13mm slide ring H 13mm height counter ring 5.5mm ED ø 26mm		
	<b>GEV No.</b>	521234	<b>Ref. No.</b> 124052
	impellor thread M8L ED ø 93mm W 16mm		
	<b>GEV No.</b>	523509	<b>Ref. No.</b> 314001
	deep-groove ball bearing type 6201-2RS shaft ø 12mm ED ø 32mm W 10mm with sealing discs deep-groove ball bearing DIN 625-1		
	<b>GEV No.</b>	532537	<b>Ref. No.</b> 456067
	O-ring EPDM thickness 3.53mm ID ø 113.9mm Qty 1 pcs		



1

<b>GEV No.</b>	500153	<b>Ref. No.</b>	130139 999134
<b>description</b>	pump inlet ø outlet ø type W180SX 230V 50Hz 1 phase 0.19kW 0.26HP L 220mm rotation direction right capacitor 5µF LGB		
<b>For models:</b>	913289, 913290, 913356, 913372, 913373, 913544, 913665, 913667, 913771, 913772, 913832, 913837, 914165, 914166, 914206, 914355, 914386, 914387, 914388, 914389, 914390, 914391, 914692, 914693, 914694, 914703, 914870, 915686, 915687, 915688, 915689, 915690, 915691, 916237, 916238, 916239, 916240, 916241, 916401, 916402, 916403, 916404, 916787, E.35, E.35-Elettrobar, E.35H, E.35H-Elettrobar, Fast130, FAST-135, Fast135-2...(Other models you can see in the webshop)		
<b>spare parts for</b>	500153		
	<b>GEV No.</b>	365017	<b>Ref. No.</b> 206008 206010
	operating capacitor capacity 5µF 450V tolerance 5% 50/60Hz ambient temperature max. -25 to +85°C ø 28mm L 54mm M8 plastic connection male faston 6.3mm 16.10.08 protection		
	<b>GEV No.</b>	510703	<b>Ref. No.</b> 141007 80843
	mechanical shaft seal for shaft ø 13mm slide ring H 13mm height counter ring 5.5mm ED ø 26mm		
	<b>GEV No.</b>	513267	<b>Ref. No.</b> 480054
	end cap for wash pump suitable for pump casing		
	<b>GEV No.</b>	513283	<b>Ref. No.</b> 437082
	gasket		
	<b>GEV No.</b>	518177	<b>Ref. No.</b> 111023 116023
	drain unit thread 3/4" ID ø 35mm hose ø 24mm		
	<b>GEV No.</b>	518204	<b>Ref. No.</b> 429065
	screw connection for filter ø 67mm		
	<b>GEV No.</b>	518205	<b>Ref. No.</b> 437079 80182 reb437079
	flat gasket rubber ED ø 61mm ID ø 47mm thickness 2mm Qty 1 pcs		
	<b>GEV No.</b>	521147	<b>Ref. No.</b> 315024
	flange		
	<b>GEV No.</b>	521221	<b>Ref. No.</b> 124048
	impellor ø 67mm H 16mm rotation direction right thread M7L shaft ø 13mm shaft length 12mm blades 8		
	<b>GEV No.</b>	528800	<b>Ref. No.</b> —
	O-ring EPDM thickness 2.62mm ID ø 75.87mm Qty 1 pcs		



1

<b>GEV No.</b>	500150	<b>Ref. No.</b>	130136 999135
<b>description</b>	pump inlet ø outlet ø type W210SX 230V 50Hz 1 phase 0.24kW 0.33HP L 230mm rotation direction right capacitor 6.3µF LGB		
<b>For models:</b>	913291, 913292, 913357, 913374, 913375, 913416, 913435, 913545, 913666, 913668, 913685, 913773, 913774, 913911, 913912, 913948, 913950, 913977, 913984, 913990, 914214, 914316, 914317, 914392, 914393, 914394, 914395, 914396, 914397, 914441, 914442, 914515, 914516, 914537, 914543, 914547, 914683, 914684, 914689, 914863, 914874, 915138, 915139, 915527, 915692, 915693, 915694, 916162, 916181, 916183...(Other models you can see in the webshop)		
<b>spare parts for</b>	500150		
	<b>GEV No.</b>	365012	<b>Ref. No.</b> 206009
	operating capacitor capacity 6.3µF 450V tolerance 5% 50Hz ambient temperature max. -25 to +85°C ø 30mm L 61mm M8 plastic connection male faston 6.3mm protection		
	<b>GEV No.</b>	509004	<b>Ref. No.</b> 124049
	impellor ø 71mm H 16mm M7L rotation direction right shaft ø 13mm shaft length 13mm blades 8		
	<b>GEV No.</b>	510703	<b>Ref. No.</b> 141007 80843
	mechanical shaft seal for shaft ø 13mm slide ring H 13mm height counter ring 5.5mm ED ø 26mm		
	<b>GEV No.</b>	513267	<b>Ref. No.</b> 480054
	end cap for wash pump suitable for pump casing		
	<b>GEV No.</b>	513275	<b>Ref. No.</b> 456074
	O-ring EPDM thickness 1.78mm ID ø 82.27mm Qty 1 pcs		
	<b>GEV No.</b>	518177	<b>Ref. No.</b> 111023 116023
	drain unit thread 3/4" ID ø 35mm hose ø 24mm		
	<b>GEV No.</b>	518204	<b>Ref. No.</b> 429065
	screw connection for filter ø 67mm		
	<b>GEV No.</b>	518205	<b>Ref. No.</b> 437079 80182 reb437079
	flat gasket rubber ED ø 61mm ID ø 47mm thickness 2mm Qty 1 pcs		
	<b>GEV No.</b>	521147	<b>Ref. No.</b> 315024
	flange		





OLYMPIA

pumps

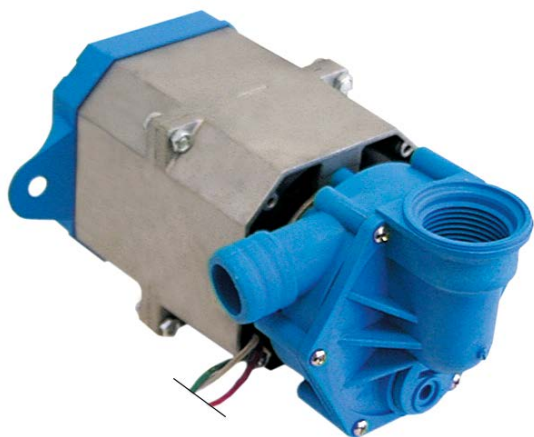

1

<b>GEV No.</b>	500005	<b>Ref. No.</b>	130050 130085 130086 130087
<b>description</b>	pump inlet ø 1" IT outlet ø 28mm type T60 230V 50Hz 1 phase 0.19kW 0.26HP L 210mm rotation direction left capacitor 5µF OLYMPIA		
<b>For models:</b>	11F, 11FD, 11F-DVGW, 11R, 11RD, 913363, 913364, 913376, 913377, E.41, E.42, E41		
<b>spare parts for</b>	500005		
	<b>GEV No.</b>	365017	<b>Ref. No.</b> 206008 206010
	operating capacitor capacity 5µF 450V tolerance 5% 50/60Hz ambient temperature max. -25 to +85°C ø 28mm L 54mm M8 plastic connection male faston 6.3mm 16.10.08 protection		
	<b>GEV No.</b>	509001	<b>Ref. No.</b> 124028
	impellor ø 75mm H 15mm pump type type C rotation direction left thread M6R shaft ø 11/12mm shaft length 25mm blades 4		
	<b>GEV No.</b>	509003	<b>Ref. No.</b> 315013 999175
	pump cover OLYMPIA inlet 1" outlet ø 28mm pump type T60		
	<b>GEV No.</b>	510693	<b>Ref. No.</b> 141002 70942 80121 RAT72
	mechanical shaft seal for shaft ø 12mm slide ring ext. ø 24mm slide ring H 15.5mm slide ring int. ø 11mm counter ring mounting ø 24mm height counter ring 8mm counter ring int. ø 13.5mm		
	<b>GEV No.</b>	528800	<b>Ref. No.</b> —
	O-ring EPDM thickness 2.62mm ID ø 75.87mm Qty 1 pcs		







1

<b>GEV No.</b>	500199	<b>Ref. No.</b>	130115 130116
<b>description</b>	pump inlet ø 32mm outlet ø 30/24mm type T80 230V 50Hz 1 phase 0.25kW 0.34HP L 205mm rotation direction left capacitor 5µF OLYMPIA		
<b>For models:</b>	67F, 67R		
<b>spare parts for</b>	500199		
	<b>GEV No.</b>	365017	<b>Ref. No.</b> 206008 206010
	operating capacitor capacity 5µF 450V tolerance 5% 50/60Hz ambient temperature max. -25 to +85°C ø 28mm L 54mm M8 plastic connection male faston 6.3mm 16.10.08 protection		
	<b>GEV No.</b>	510693	<b>Ref. No.</b> 141002 70942 80121 RAT72
	mechanical shaft seal for shaft ø 12mm slide ring ext. ø 24mm slide ring H 15.5mm slide ring int. ø 11mm counter ring mounting ø 24mm height counter ring 8mm counter ring int. ø 13.5mm		
	<b>GEV No.</b>	521151	<b>Ref. No.</b> 124040
	impellor ø 71mm H 19mm pump type OLYMPIA thread M10R shaft ø 12mm shaft length 8mm		
	<b>GEV No.</b>	521178	<b>Ref. No.</b> 315018
	pump casing OLYMPIA outlet ø 30/24mm pump type T80		
	<b>GEV No.</b>	521552	<b>Ref. No.</b> 116022
	pump cover OLYMPIA inlet ø 32mm outlet ø 30/24mm ø 103mm ID ø 93mm		
	<b>GEV No.</b>	521703	<b>Ref. No.</b> 456038 456063
	pump cover gasket EPDM thickness 2.5mm ID ø 75mm Qty 1 pcs		







1

<b>GEV No.</b>	500152	<b>Ref. No.</b>	130122
<b>description</b>	pump inlet $\varnothing$ 44mm outlet $\varnothing$ 30mm type T90 230V 50Hz 1 phase 0.33kW 0.45HP L 220mm rotation direction left capacitor 8 $\mu$ F OLYMPIA		
<b>For models:</b>	45, 450, 913418, 914167, 914168, 914398, 914399, 914443, 914943, 915695, 915696, 915819, E.45, Fast145, FAST-145, Fast145D, FAST-145D, Niagara-45		
<b>spare parts for</b>	500152		
	<b>GEV No.</b>	365013	<b>Ref. No.</b> 206001
	operating capacitor capacity 8 $\mu$ F 400V tolerance 5%Hz ambient temperature max. -25 to +85°C $\varnothing$ 31.5mm L 55mm M8 plastic connection male faston 6.3mm protection		
	<b>GEV No.</b>	509007	<b>Ref. No.</b> 124043
	impellor $\varnothing$ 85mm H 20mm rotation direction left thread M10R shaft $\varnothing$ 12mm shaft length 7.5mm blades 12		
	<b>GEV No.</b>	510693	<b>Ref. No.</b> 141002 70942 80121 RAT72
	mechanical shaft seal for shaft $\varnothing$ 12mm slide ring ext. $\varnothing$ 24mm slide ring H 15.5mm slide ring int. $\varnothing$ 11mm counter ring mounting $\varnothing$ 24mm height counter ring 8mm counter ring int. $\varnothing$ 13.5mm		
	<b>GEV No.</b>	521703	<b>Ref. No.</b> 456038 456063
	pump cover gasket EPDM thickness 2.5mm ID $\varnothing$ 75mm Qty 1 pcs		



1

<b>GEV No.</b>	500003	<b>Ref. No.</b>	130008
<b>description</b>	pump inlet $\varnothing$ 45mm outlet $\varnothing$ 32mm type T30 230V 50Hz 1 phase 0.29kW 0.39HP L 190mm rotation direction right capacitor 8 $\mu$ F OLYMPIA		
<b>For models:</b>	S621, S623, S624, S626, S631, S633, S634, S636		
<b>spare parts for</b>	500003		
	<b>GEV No.</b>	365013	<b>Ref. No.</b> 206001
	operating capacitor capacity 8 $\mu$ F 400V tolerance 5%Hz ambient temperature max. -25 to +85°C $\varnothing$ 31.5mm L 55mm M8 plastic connection male faston 6.3mm protection		
	<b>GEV No.</b>	510512	<b>Ref. No.</b> 116008
	pump cover OLYMPIA inlet $\varnothing$ 45mm outlet $\varnothing$ 31mm outlet 2 $\varnothing$ 24 turn direction right $\varnothing$ 130mm ID $\varnothing$ 124mm inner height 20mm		
	<b>GEV No.</b>	510554	<b>Ref. No.</b> 456024
	O-ring EPDM thickness 2mm ID $\varnothing$ 120mm Qty 1 pcs		
	<b>GEV No.</b>	510615	<b>Ref. No.</b> 124006 REB124006
	impellor $\varnothing$ 90mm H 22mm rotation direction right thread M10L blades 4		
	<b>GEV No.</b>	510693	<b>Ref. No.</b> 141002 70942 80121 RAT72
	mechanical shaft seal for shaft $\varnothing$ 12mm slide ring ext. $\varnothing$ 24mm slide ring H 15.5mm slide ring int. $\varnothing$ 11mm counter ring mounting $\varnothing$ 24mm height counter ring 8mm counter ring int. $\varnothing$ 13.5mm		



1

<b>GEV No.</b>	500535	<b>Ref. No.</b>	130117
<b>description</b>	pump inlet $\varnothing$ outlet $\varnothing$ 27mm type T70 230V 50Hz 1 phase 0.3kW 0.4HP L 130mm rotation direction right capacitor 6.3 $\mu$ F OLYMPIA		
<b>For models:</b>	CLEAN-3, RIVER-43		
<b>spare parts for</b>	500535		
	<b>GEV No.</b>	365012	<b>Ref. No.</b> 206009
	operating capacitor capacity 6.3 $\mu$ F 450V tolerance 5% 50Hz ambient temperature max. -25 to +85°C $\varnothing$ 30mm L 61mm M8 plastic connection male faston 6.3mm protection		
	<b>GEV No.</b>	510556	<b>Ref. No.</b> 456022
	O-ring EPDM thickness 1.78mm ID $\varnothing$ 94.97mm Qty 1 pcs pump type T110		
	<b>GEV No.</b>	510693	<b>Ref. No.</b> 141002 70942 80121 RAT72
	mechanical shaft seal for shaft $\varnothing$ 12mm slide ring ext. $\varnothing$ 24mm slide ring H 15.5mm slide ring int. $\varnothing$ 11mm counter ring mounting $\varnothing$ 24mm height counter ring 8mm counter ring int. $\varnothing$ 13.5mm		
	<b>GEV No.</b>	521254	<b>Ref. No.</b> 124022 124042
	impellor $\varnothing$ 81mm H 11mm thread M8L shaft $\varnothing$ 12mm shaft length 28mm blades 6		

booster pumps I





1

<b>GEV No.</b>	500060	<b>Ref. No.</b>	130013 130049 130052
<b>description</b>	pump inlet $\varnothing$ 1" outlet $\varnothing$ 1" type PQM60 230V 50Hz 1 phase 0.37kW PEDRELLLO		
<b>For models:</b>	R495, R497, R499, R501, R503, R505, R507, R509, R511, R704, R706, R708, S621, S623, S624, S626, S631, S633, S634, S636, S641, S643, S651, S651P, S653, S654, S655, S810, S815, S830, S835, S850, S870, S950, SR651		
<b>accessories for</b>	500060		
	<b>GEV No.</b>	365015	<b>Ref. No.</b> 206002
	operating capacitor capacity 10 $\mu$ F 400V tolerance 5%Hz ambient temperature max. -25 to +85°C $\varnothing$ 35.5mm L 59mm M8 plastic connection male faston 6.3mm protection		



1

<b>GEV No.</b>	500359	<b>Ref. No.</b>	130143 DPE127
<b>description</b>	pump inlet $\varnothing$ 12 outlet $\varnothing$ 12 type PPL46DX 230V 50Hz 0.33kW capacitor 10 $\mu$ F LGB		
<b>For models:</b>	80, 81, 82, 914568, 915756, CE78HZ23, CGL74CABT, E.50D.PA, E78, E78HP, FAST-160D-PA, FAST-181, HM1, NIAGARA-283, Niagara-283A, RIVER-71, RIVER-78, RIVER-80, River-81, RIVER-82, RIVER-E78, RV71, RV80, RV8023, RV8023HZ, RV80C, RV80HZ, RV81, RV8123, RV81A, RV81C, RV81HZ, RV81HZ23, RV81PAP, RV82, RV8223, RV82C, SevenL, ST70FAST, SV72AEB, SV72EB		
<b>spare parts for</b>	500359		
	<b>GEV No.</b>	698663	<b>Ref. No.</b> —
	impellor $\varnothing$ 60mm H 12mm with flute shaft intake $\varnothing$ 12mm W 60mm suitable for LGB		
<b>accessories for</b>	500359		
	<b>GEV No.</b>	365015	<b>Ref. No.</b> 206002
	operating capacitor capacity 10 $\mu$ F 400V tolerance 5%Hz ambient temperature max. -25 to +85°C $\varnothing$ 35.5mm L 59mm M8 plastic connection male faston 6.3mm protection		



1



<b>GEV No.</b>	500358	<b>Ref. No.</b>	130102 130120
<b>description</b>	pump inlet $\varnothing$ 3/8" outlet $\varnothing$ 3/8" type PS46 230V 50Hz 0.45kW $\varnothing$ 100mm L 200mm capacitor 10 $\mu$ F LGB		
<b>For models:</b>	45, 450, 46, 460, 500F, 500FD, 50F, 50FD, 510F, 510FD, 913297, 913298, 913299, 913300, 913360, 913361, 913391, 913392, 913546, 913547, 913578, 913611, 913684, 913913, 913914, 913932, 913933, 914284, 914326, 914331, 914356, 914400, 914401, 914402, 914403, 914404, 914405, 914406, 914449, 914517, 914545, 914642, 914688, 914909, 914979, 915136, 915137, 915140, 915248, CLEAN-3...(Other models you can see in the webshop)		
<b>spare parts for</b>	500358		
	<b>GEV No.</b>	510713	<b>Ref. No.</b> 141009
	slide ring for shaft $\varnothing$ 12mm ED $\varnothing$ 24mm H 16mm		
	<b>GEV No.</b>	510723	<b>Ref. No.</b> —
	counter ring H 8mm ED $\varnothing$ 26mm ID $\varnothing$ 13.5mm for mechanical shaft seal		
	<b>GEV No.</b>	698400	<b>Ref. No.</b> —
	pump cover gasket pump type PS46 thickness 2mm ID $\varnothing$ 66mm Qty 1 pcs		
<b>accessories for</b>	500358		
	<b>GEV No.</b>	365015	<b>Ref. No.</b> 206002
	operating capacitor capacity 10 $\mu$ F 400V tolerance 5%Hz ambient temperature max. -25 to +85°C $\varnothing$ 35.5mm L 59mm M8 plastic connection male faston 6.3mm protection		
	<b>GEV No.</b>	511279	<b>Ref. No.</b> —
	hose connector brass straight thread 3/8" hose $\varnothing$ 12mm Qty 1 pcs		

Table continues overleaf

<b>accessories for</b>	500358		
	<b>GEV No.</b>	520202	<b>Ref. No.</b> 927015
	hose connector nickel-plated brass straight thread 3/8" hose ø 12mm Qty 1 pcs		
	<b>GEV No.</b>	520677	<b>Ref. No.</b> —
	hose connector brass straight thread 3/8" hose ø 13mm Qty 1 pcs		

## drain pumps

### ASKOLL



<b>GEV No.</b>	500210	<b>Ref. No.</b>	130123
<b>description</b>	drain pump 230V 40W		
<b>For models:</b>	2312-007, 2312-009-CRP, 45, 450, 913289, 913290, 913291, 913292, 913356, 913357, 913363, 913364, 913372, 913373, 913374, 913375, 913376, 913377, 913416, 913418, 913435, 913544, 913545, 913665, 913666, 913667, 913668, 913685, 913771, 913772, 913773, 913774, 913832, 913837, 913911, 913912, 913948, 913950, 913977, 913984, 913990, 914100, 914101, 914165, 914166, 914167, 914168, 914206, 914214, 914316...(Other models you can see in the webshop)		



<b>GEV No.</b>	499343	<b>Ref. No.</b>	130182
<b>description</b>	drain pump 32W 220V 60Hz ASKOLL type R26		
<b>For models:</b>	916452, 916688		



<b>GEV No.</b>	499333	<b>Ref. No.</b>	130181 80117UL
<b>description</b>	drain pump 32W 220V inlet ø 30mm outlet ø 22mm 60Hz ASKOLL type R26 complete		
<b>For models:</b>	915150, 915151, 915152, 915154, 915155, 915157, 915158, 915160, 915161, 915162, 915166, 915167, 915168, 915172, 915173, 915175, 915319, 915348, 915418, 915419, 915420, 915421, 915422, 915479, 915492, 915493, 915494, 915495, 915496, 915497, 915547, 915558, 915611, 915612, 915613, 915614, 915615, 915616, 915617, 915618, 915635, 915663, 915670, 915671, 915672, 915747, 915773, 915774, 915959, 916054...(Other models you can see in the webshop)		



<b>GEV No.</b>	501514	<b>Ref. No.</b>	130175
<b>description</b>	drain pump 40W 220-240V inlet ø 30mm outlet ø 22mm 50Hz ASKOLL type M231 XP		
<b>For models:</b>	916020, 916021, 916024, 916025, 916026, 916027, 916030, 916031, 916045, 916247, 916248, 916249, 916250, 916251, 916252, 916382, 916383, 916504, 916584, 916654, 916670, 916763, 916921, 916922, 916992, 916993, 917044, 917049, Clean161, Fast145-2, Fast150, Fast160-2, Fast160C, Fast161-2, Ocean360, Ocean360M, Ocean360-UK		



<b>GEV No.</b>	501541	<b>Ref. No.</b>	130177
<b>description</b>	drain pump 40W 220-240V inlet ø 30mm outlet ø 22mm 50Hz ASKOLL type M231 XP		
<b>For models:</b>	915150, 915151, 915152, 915154, 915155, 915157, 915158, 915160, 915161, 915162, 915166, 915167, 915168, 915172, 915173, 915175, 915319, 915348, 915418, 915419, 915420, 915421, 915422, 915479, 915492, 915493, 915494, 915495, 915496, 915497, 915547, 915558, 915611, 915612, 915613, 915617, 915618, 915635, 915663, 915670, 915672, 915747, 915773, 915774, 915959, 916054, 916066, 916067, 916068, 916069...(Other models you can see in the webshop)		



1

<b>GEV No.</b>	499310	<b>Ref. No.</b>	130146
<b>description</b>	drain pump 40W 220V inlet ø 24mm outlet ø 22mm 50Hz ASKOLL type M231 XP complete		
<b>For models:</b>	913992, 913993, 914583, 914592, 914612, 914613, 915143, RIVER-40, RIVER-40-CRP, RIVER-44, RIVER-44-CRP, RIVER-44-CRP-ST, RIVER-44CRP-ST		



1

<b>GEV No.</b>	499102	<b>Ref. No.</b>	999161
<b>description</b>	drain pump inlet ø 24mm outlet ø 22mm 230-240V 25W 50Hz ASKOLL type R113 retrofit kit		
<b>For models:</b>	913297, 913298, 913299, 913300, 913360, 913361, 913391, 913392, 913546, 913547, 913578, 913611, 913684, 913932, 913933, 914318, 914319, 914331, 914338, 914400, 914401, 914402, 914403, 914404, 914405, 914431, 914449, 914517, 914545, 914688, 914979, 915140, 915248, E.50, E.51, Mistral51, MISTRAL-51, NIAGARA-51		



1

<b>GEV No.</b>	499315	<b>Ref. No.</b>	130178
<b>description</b>	drain pump inlet ø 24/30/35/39mm outlet ø 22/31mm 230V 40W 50Hz ASKOLL type M231 XP kit		
<b>For models:</b>	915686, 915687, 915689, 915690, 915691, 915692, 915693, 915694, 916162, 916181, 916183, 916184, 916185, 916237, 916238, 916239, 916240, 916241, 916242, 916243, 916244, 916245, 916246, 916401, 916402, 916403, 916404, 916405, 916406, 916407, 916408, 916583, 916751, 916787, 916788, 916991, 917042, 917043, Clean140, Clean140S, Fast130, Fast135-2, Fast135-2S, Fast135CT, Fast135D, Fast135H, Fast135H-2, Fast135H-2S, Fast135HCT, Fast135HD...(Other models you can see in the webshop)		



1

<b>GEV No.</b>	499244	<b>Ref. No.</b>	999150
<b>description</b>	drain pump inlet ø 30mm outlet ø 22mm 220-240V 40W 50Hz ASKOLL type M231 XP kit		
<b>spare parts for</b>	499244		
	<b>GEV No.</b>	<b>Ref. No.</b>	—
	drain pump inlet ømm outlet ømm 230V 40W 50Hz ASKOLL type M231 XP without lid		



1

<b>GEV No.</b>	499245	<b>Ref. No.</b>	999162
<b>description</b>	drain pump inlet ø 24mm outlet ø 22mm 220-240V 40W 50Hz ASKOLL type M231 XP kit		
<b>spare parts for</b>	499245		
	<b>GEV No.</b>	<b>Ref. No.</b>	—
	drain pump inlet ømm outlet ømm 230V 40W 50Hz ASKOLL type M231 XP without lid		

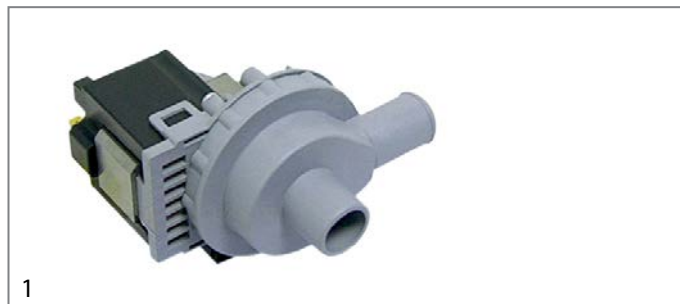

1

<b>GEV No.</b>	500214	<b>Ref. No.</b>	130105 130176
<b>description</b>	drain pump inlet ø 30mm outlet ø 22mm 230/240V 30W 50Hz ASKOLL type R113		
<b>For models:</b>	050F, 050FP, 2312-001, 2312-002, 46, 460, 500F, 500FD, 50F, 50FD, 510F, 510FD, 913297, 913298, 913299, 913300, 913360, 913361, 913391, 913392, 913546, 913547, 913578, 913611, 913684, 913913, 913914, 913932, 913933, 914284, 914318, 914319, 914331, 914338, 914356, 914400, 914401, 914402, 914403, 914404, 914405, 914431, 914449, 914517, 914545, 914568, 914642, 914688, 914909, 914979...(Other models you can see in the webshop)		









<b>GEV No.</b>	501364	<b>Ref. No.</b>	999234
<b>description</b>	drain pump inlet ø 30mm outlet ø 22mm 230V 25W 50Hz ASKOLL type R113 conversion kit		
<b>For models:</b>	914100, 914101, 914339, 914342, 914343, 914624, 914625, 914626, 914627, 914850, 914851, 914854, River-48, River-54		
<b>spare parts for</b>	501364		
	<b>GEV No.</b>	517572	<b>Ref. No.</b> 144992
	backflow preventer for drain hose ø 31/21mm		



<b>GEV No.</b>	500215	<b>Ref. No.</b>	130138
<b>description</b>	drain pump inlet ø 30mm outlet ø 22mm 230V 40W 50Hz ASKOLL type M231 XP with holder		
<b>For models:</b>	E.35, E.40		



<b>GEV No.</b>	500209	<b>Ref. No.</b>	130156
<b>description</b>	drain pump inlet ømm outlet ømm 230V 40W 50Hz ASKOLL type M231 XP with holder		
<b>For models:</b>	914326, 914406, E.55		
<b>spare parts for</b>	500209		
	<b>GEV No.</b>	512175	<b>Ref. No.</b> —
	O-ring EPDM thickness 2.62mm ID ø 53.65mm Qty 1 pcs		
<b>accessories for</b>	500209		
	<b>GEV No.</b>	500197	<b>Ref. No.</b> —
	body drain pump		
	<b>GEV No.</b>	500300	<b>Ref. No.</b> —
	pump cover inlet ø 39mm outlet ø 31 mm		
	<b>GEV No.</b>	500301	<b>Ref. No.</b> —
	pump cover inlet ø 35mm outlet ø 31 mm		
	<b>GEV No.</b>	500303	<b>Ref. No.</b> —
	body inlet ø 24mm outlet ø 22mm suitable for drain pump		

<b>accessories for</b>	500209		
	<b>GEV No.</b>	500304	<b>Ref. No.</b> —
	pump cover inlet ø 30mm outlet ø 22mm ø 78mm		
	<b>GEV No.</b>	500305	<b>Ref. No.</b> —
	pump cover inlet ø 30mm outlet ø 22mm		
	<b>GEV No.</b>	560483	<b>Ref. No.</b> —
	screw ø 3.7mm L 20mm SS Qty 1 pcs head ø 7mm		

**GRE**





<b>GEV No.</b>	500057	<b>Ref. No.</b>	130021 130022
<b>description</b>	drain pump inlet ø 22/30mm outlet ø 22mm 100W 230V 50Hz GRE		
<b>For models:</b>	R505, S621, S624, S631, S634, S651, S651P, S654, S655, S810, S815, S830, S835, SR651		



<b>GEV No.</b>	500087	<b>Ref. No.</b>	130070 130083
<b>description</b>	drain pump inlet ø 25mm outlet ø 21mm 100W 230V 50Hz GRE with temperature protection		
<b>For models:</b>	21F, 21FD, 21R, 21RD, 25F, 25FD, 25R, 25RD, 30F, 30FD, 30R, 30RD, 31F, 31FD, 31R, 31RD, S621, S623, S624, S626, S631, S633, S634, S636		



<b>GEV No.</b>	500213	<b>Ref. No.</b>	130071 130084
<b>description</b>	drain pump inlet ø 30mm outlet ø 22mm 100W 230V 50Hz GRE		
<b>For models:</b>	22F, 22R		
<b>spare parts for</b>	500213		
	<b>GEV No.</b>	500307	<b>Ref. No.</b> 121053
	filter		
	<b>GEV No.</b>	500899	<b>Ref. No.</b> —
	pump cover inlet ø 30mm outlet ø 22mm pump type 500.213		

1

<b>GEV No.</b>	500546	<b>Ref. No.</b>	130094
<b>description</b>	drain pump inlet $\varnothing$ 30mm outlet $\varnothing$ 23mm 100W 230V 50Hz GRE		
<b>For models:</b>	22F, 40F, 440F, 44F, E.52		



1

<b>GEV No.</b>	500247	<b>Ref. No.</b>	926103
<b>description</b>	drain pump inlet $\varnothing$ 34mm outlet $\varnothing$ 29mm 100W 230V 50Hz GRE		
<b>For models:</b>	E1, E10, E100, E110		



1

<b>GEV No.</b>	500350	<b>Ref. No.</b>	929114
<b>description</b>	drain pump inlet $\varnothing$ 34mm outlet $\varnothing$ 29mm 100W 230V 50Hz GRE		
<b>For models:</b>	E.60, E.65, E120, E140		



1

<b>GEV No.</b>	500212	<b>Ref. No.</b>	130112
<b>description</b>	drain pump inlet $\varnothing$ mm outlet $\varnothing$ mm 100W 230V 50Hz GRE without lid		
<b>For models:</b>	CLEAN-3, RIVER-43		

### HANNING



1

<b>GEV No.</b>	500363	<b>Ref. No.</b>	80117
<b>description</b>	drain pump 40W 230V		
<b>For models:</b>	80, 81, 82, 915150, 915151, 915152, 915154, 915155, 915157, 915158, 915160, 915161, 915162, 915166, 915167, 915168, 915172, 915173, 915175, 915176, 915177, 915285, 915319, 915338, 915341, 915348, 915418, 915419, 915420, 915421, 915422, 915479, 915492, 915493, 915494, 915495, 915496, 915497, 915547, 915558, 915611, 915612, 915613, 915614, 915615, 915616, 915617, 915618, 915635, 915663... (Other models you can see in the webshop)		

### accessories

#### holders



1

<b>GEV No.</b>	513717	<b>Ref. No.</b>	035064
<b>description</b>	fastening angle for drain pump		
<b>For models:</b>	050F, 050FP, 2312-002, 913297, 913298, 913299, 913300, 913360, 913361, 913391, 913392, 913546, 913547, 913578, 913611, 913684, 913913, 913914, 913932, 913933, 914284, 914318, 914319, 914331, 914338, 914356, 914400, 914401, 914402, 914403, 914404, 914405, 914431, 914449, 914517, 914545, 914568, 914642, 914688, 914909, 914979, 915136, 915137, 915140, 915248, 915483, 915484, 915528, 915537, 915538...(Other models you can see in the webshop)		
<b>accessories for</b>	513717		
	<b>GEV No.</b>	<b>Ref. No.</b>	111019 111030 111999
opposite support mounting pos. lower for wash arm support			



booster pumps II

accessories



1			
<b>GEV No.</b>	365015	<b>Ref. No.</b>	206002
<b>description</b>	operating capacitor capacity 10µF 400V tolerance 5%Hz ambient temperature max. -25 to +85°C ø 35.5mm L 59mm M8 plastic connection male faston 6.3mm protection		
<b>For models:</b>	500F, 500FD, 50F, 50FD, 510F, 510FD, 913297, 913298, 913299, 913300, 913360, 913361, 913391, 913392, 913546, 913547, 913578, 913611, 913684, 913913, 913914, 913932, 913933, 913992, 913993, 914100, 914101, 914284, 914326, 914331, 914339, 914342, 914343, 914356, 914400, 914401, 914402, 914403, 914404, 914405, 914406, 914449, 914517, 914545, 914568, 914624, 914625, 914626, 914627, 914642...(Other models you can see in the webshop)		



2			
<b>GEV No.</b>	365017	<b>Ref. No.</b>	206008 206010
<b>description</b>	operating capacitor capacity 5µF 450V tolerance 5% 50/60Hz ambient temperature max. -25 to +85°C ø 28mm L 54mm M8 plastic connection male faston 6.3mm 16.10.08 protection		
<b>For models:</b>	11F, 11FD, 11F-DVGW, 11R, 11RD, 350F, 350FD, 350R, 350RD, 35-ELECTRONIC, 35F, 35FD, 35R, 35RD, 67F, 67R, 913289, 913290, 913356, 913363, 913364, 913372, 913373, 913376, 913377, 913544, 913665, 913667, 913771, 913772, 913832, 913837, 914165, 914166, 914206, 914355, 914386, 914387, 914388, 914389, 914390, 914391, 914692, 914693, 914694, 914703, 914870, 915686, 915687, 915688...(Other models you can see in the webshop)		



1			
<b>GEV No.</b>	365012	<b>Ref. No.</b>	206009
<b>description</b>	operating capacitor capacity 6.3µF 450V tolerance 5% 50Hz ambient temperature max. -25 to +85°C ø 30mm L 61mm M8 plastic connection male faston 6.3mm protection		
<b>For models:</b>	400F, 400FD, 400R, 400RD, 40-ELECTRONIC, 40F, 40FD, 40R, 40RD, 913291, 913292, 913357, 913374, 913375, 913416, 913435, 913545, 913666, 913668, 913685, 913773, 913774, 913911, 913912, 913948, 913950, 913977, 913984, 913990, 913992, 913993, 914214, 914316, 914317, 914392, 914393, 914394, 914395, 914396, 914397, 914441, 914442, 914515, 914516, 914537, 914543, 914547, 914583, 914592, 914612...(Other models you can see in the webshop)		

accessories

pump covers



1			
<b>GEV No.</b>	521563	<b>Ref. No.</b>	929191
<b>description</b>	pump cover		
<b>For models:</b>	KLP201DDDTTEB, KLP201EB, KLP301, KLP301DDDTTEB, LP201DDDTTEB, LP201EB, LP301, LP301EB, U132, U132E, U70, U70e		



1			
<b>GEV No.</b>	510516	<b>Ref. No.</b>	116004
<b>description</b>	pump cover pump type 1295		
<b>For models:</b>	R706, R708		



1			
<b>GEV No.</b>	510514	<b>Ref. No.</b>	116009
<b>description</b>	pump cover pump type T110		

pump cover gaskets





1			
<b>GEV No.</b>	513283	<b>Ref. No.</b>	437082
<b>description</b>	gasket		
<b>For models:</b>	913289, 913290, 913356, 913372, 913373, 913544, 913665, 913667, 913771, 913772, 913832, 913837, 914165, 914166, 914206, 914355, 914386, 914387, 914388, 914389, 914390, 914391, 914692, 914693, 914694, 914703, 914870, 915686, 915687, 915688, 915689, 915690, 915691, 916237, 916238, 916239, 916240, 916241, 916401, 916402, 916403, 916404, 916787, E.35, E.35-Elettrobar, E.35H, E.35H-Elettrobar, Fast130, FAST-135, Fast135-2...(Other models you can see in the webshop)		



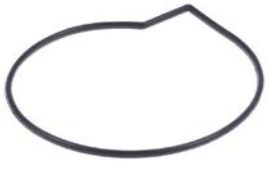

			
1			
<b>GEV No.</b>	524535	<b>Ref. No.</b>	929180
<b>description</b>	pump cover gasket thickness 4.5x4.5mm ID ø 182mm Qty 1 pcs		
<b>For models:</b>	KLP201DDDTEB, KLP201EB, KLP301, KLP301DDDTEB, LP201DDDTEB, LP201EB, LP301, LP301EB, RIVER-297, RIVER-298, RV297, RV298, RV298HZ, U132, U132E, U70, U70e		

			
1			
<b>GEV No.</b>	521081	<b>Ref. No.</b>	80199
<b>description</b>	pump cover gasket thickness 4mm Qty 1 pcs		
<b>For models:</b>	Niagara-283A, River-285, RV282R, SV72AEB		
<b>spare parts for</b>	521081		
	<b>GEV No.</b>	499281	<b>Ref. No.</b> 80134
	pump inlet ø 60mm outlet ø 50mm type 4298.1404 230V 50Hz 1 phase 1.1kW L 210mm rotation direction right capacitor 12.5µF FIR		

			
1			
<b>GEV No.</b>	365014	<b>Ref. No.</b>	80191
<b>description</b>	operating capacitor capacity 12.5µF 450V tolerance 5%Hz ambient temperature max. -25 to +85°C ø 35mm L 70mm M8 plastic connection male faston 6.3mm 45S.C3DS.12.5 protection		
<b>For models:</b>	Niagara-283A, RIVER-282, River-285, RV282DD, RV282R, SV72AEB		

			
1			
<b>GEV No.</b>	365020	<b>Ref. No.</b>	73055
<b>description</b>	operating capacitor capacity 14µF 400V tolerance 5%Hz ambient temperature max. -25 to +85°C ø 35mm L 70mm M8 plastic connection male faston 6.3mm protection		
<b>For models:</b>	NG381DDPS, NG381DDPSHZ23, Niagara-381-230V-3Ph-60Hz, Niagara-381DP, River-282-2, River-285, River-382, River-382-230V-3Ph-50Hz, River-382H, River-382NRG, River-382NRG-230-3Ph-50Hz, RV382, RV38223TERMO, RV382AHP, RV382FUR, RV382R, RV382R23TERMO, RV382RFUR, RV382TERMO, RV382TX, RV382TXR		

## condensators & interference suppression filters

### operating capacitors

#### plastic

			
1			
<b>GEV No.</b>	365209	<b>Ref. No.</b>	70536
<b>description</b>	operating capacitor capacity 1.5µF 420V ø 25mm L 70mm M8 connection F6.3		
<b>For models:</b>	River-285, River-382LNRG, River-382NRG, River-382NRG-230-3Ph-50Hz, RV282R, RV382LR, RV382LTXR, RV382R, RV382R23TERMO, RV382RFUR, RV382TXR		

			
1			
<b>GEV No.</b>	365021	<b>Ref. No.</b>	206004
<b>description</b>	operating capacitor capacity 16µF 425V tolerance 5% 50/60Hz ambient temperature max. -25 to +85°C ø 35mm L 73mm single M8 plastic connection male faston 6.3mm 416.10.99 protection		
<b>For models:</b>	050F, 050FP, 22F, 2312-001, 2312-002, 2312-007, 2312-009-CRP, 40F, 440F, 44F, 46, 460, 500F, 500FD, 50F, 50FD, 510F, 510FD, 913297, 913298, 913299, 913300, 913360, 913361, 913391, 913392, 913546, 913547, 913578, 913611, 913684, 913913, 913914, 913932, 913933, 914100, 914101, 914284, 914318, 914319, 914331, 914338, 914339, 914342, 914343, 914356, 914400, 914401, 914402, 914403...(Other models you can see in the webshop)		

			
1			
<b>GEV No.</b>	365015	<b>Ref. No.</b>	206002
<b>description</b>	operating capacitor capacity 10µF 400V tolerance 5%Hz ambient temperature max. -25 to +85°C ø 35.5mm L 59mm M8 plastic connection male faston 6.3mm protection		
<b>For models:</b>	500F, 500FD, 50F, 50FD, 510F, 510FD, 913297, 913298, 913299, 913300, 913360, 913361, 913391, 913392, 913546, 913547, 913578, 913611, 913684, 913913, 913914, 913932, 913933, 913992, 913993, 914100, 914101, 914284, 914326, 914331, 914339, 914342, 914343, 914356, 914400, 914401, 914402, 914403, 914404, 914405, 914406, 914449, 914517, 914545, 914568, 914624, 914625, 914626, 914627, 914642...(Other models you can see in the webshop)		

			
1			
<b>GEV No.</b>	365019	<b>Ref. No.</b>	206005
<b>description</b>	operating capacitor capacity 20µF 400V tolerance 5% 50/60Hz ambient temperature max. -25 to +85°C ø 39.5mm L 70mm M8 plastic connection male faston 6.3mm 16.10.25. protection		
<b>For models:</b>	10, 440F, 44F, 80, 81, 82, 914326, 914406, 915729, CE78HZ23, CLEAN-100, E.52, E.55, E100, E78, E78HP, Fast181, FAST-181, Fast181-230V-3Ph-60Hz, Fast181-400V-3NPh-60Hz, FAST-63, HM1, LP60, NG271, NG291, NIAGARA-271, NIAGARA-283, NIAGARA-291, R706, R708, RIVER-282, RIVER-294, RIVER-71, RIVER-78, RIVER-80, RIVER-81, RIVER-81-CRP, RIVER-82-CRP, RIVER-E78, RIVER-HL-81, RIVER-HL-82, RV282, RV294, RV71, RV80, RV8023, RV8023HZ, RV80C, RV80HZ, RV81...(Other models you can see in the webshop)		



			
1			
<b>GEV No.</b>	365016	<b>Ref. No.</b>	206006
<b>description</b>	operating capacitor capacity 31.5µF 400V tolerance 5%Hz ambient temperature max. -25 to +85°C ø 45mm L 95mm M8 plastic connection male faston 6.3mm protection		
<b>For models:</b>	66, S850, S870		

			
1			
<b>GEV No.</b>	365031	<b>Ref. No.</b>	206013
<b>description</b>	operating capacitor capacity 4µF 450V tolerance 5% 50/60Hz ambient temperature max. -25 to +85°C ø 31mm L 58mm M8 plastic connection male faston 6.3mm protection		
<b>For models:</b>	915611, 915612, 915613, 915614, 915615, 915616, 915617, 915618, 915670, 915671, 915672, 915773, 915774, 915959, 916045, 916066, 916077, 916078, 916196, 916197, 916198, 916199, 916200, 916409, 916410, 916418, 916419, 916591, 916592, 916593, 916594, 916595, 916654, 916877, 916921, 916922, 916992, 916993, Fast145-2, Fast150, Fast160C, Niagara-241, Niagara-241-2, Niagara-341, Ocean360-UK, Pluvia-240, RIVER-242, River-242-2, River-242-2T, River-342C...(Other models you can see in the webshop)		

			
1			
<b>GEV No.</b>	365017	<b>Ref. No.</b>	206008 206010
<b>description</b>	operating capacitor capacity 5µF 450V tolerance 5% 50/60Hz ambient temperature max. -25 to +85°C ø 28mm L 54mm M8 plastic connection male faston 6.3mm 16.10.08 protection		
<b>For models:</b>	11F, 11FD, 11F-DVGW, 11R, 11RD, 350F, 350FD, 350R, 350RD, 35-ELECTRONIC, 35F, 35FD, 35R, 35RD, 67F, 67R, 913289, 913290, 913356, 913363, 913364, 913372, 913373, 913376, 913377, 913544, 913665, 913667, 913771, 913772, 913832, 913837, 914165, 914166, 914206, 914355, 914386, 914387, 914388, 914389, 914390, 914391, 914692, 914693, 914694, 914703, 914870, 915686, 915687, 915688...(Other models you can see in the webshop)		

			
1			
<b>GEV No.</b>	365012	<b>Ref. No.</b>	206009
<b>description</b>	operating capacitor capacity 6.3µF 450V tolerance 5% 50Hz ambient temperature max. -25 to +85°C ø 30mm L 61mm M8 plastic connection male faston 6.3mm protection		
<b>For models:</b>	400F, 400FD, 400R, 400RD, 40-ELECTRONIC, 40F, 40FD, 40R, 40RD, 913291, 913292, 913357, 913374, 913375, 913416, 913435, 913545, 913666, 913668, 913685, 913773, 913774, 913911, 913912, 913948, 913950, 913977, 913984, 913990, 913992, 913993, 914214, 914316, 914317, 914392, 914393, 914394, 914395, 914396, 914397, 914441, 914442, 914515, 914516, 914537, 914543, 914547, 914583, 914592, 914612...(Other models you can see in the webshop)		

			
1			
<b>GEV No.</b>	365013	<b>Ref. No.</b>	206001
<b>description</b>	operating capacitor capacity 8µF 400V tolerance 5%Hz ambient temperature max. -25 to +85°C ø 31.5mm L 55mm M8 plastic connection male faston 6.3mm protection		
<b>For models:</b>	21F, 21FD, 21R, 21RD, 25F, 25FD, 25R, 25RD, 30F, 30FD, 30R, 30RD, 31F, 31FD, 31R, 31RD, 45, 450, 913418, 914167, 914168, 914398, 914399, 914443, 914943, 915695, 915696, 915819, CLEAN-3, E.45, Fast145, FAST-145, Fast145D, FAST-145D, NIAGARA-45, R495, R497, R499, R501, R503, R505, R507, R509, R511, R704, R706, R708, S621, S623, S624...(Other models you can see in the webshop)		

## filters

## interference suppression filters

			
1			
<b>GEV No.</b>	365047	<b>Ref. No.</b>	926144
<b>description</b>	interference suppression filter capacity 0.33µF(X2)+2x0.015µF		
<b>For models:</b>	913363, 913364, 913376, 913377, CLEAN-100, CLEAN-110, CLEAN-120, CLEAN-160, CLEAN-220, CLEAN-270, CLEAN-271, CLEAN-361, CLEAN-361P, CLEAN-471, CLEAN-471P, E.35, E.35H, E.40, E.40H, E.41, E.42, E.60, E.65, E1, E10, E100, E110, E12, E120, E14, E140, E41, MC-201CL, MINIBAR, NIAGARA-35, NIAGARA-40, RIVER-50, RIVER-61, S280, U132, U61, U61H, U70		

			
1			
<b>GEV No.</b>	365048	<b>Ref. No.</b>	212001
<b>description</b>	interference suppression filter type KPB7028 275V 50/60Hz conductor 2 with E connection male faston 6.3mm L 50mm ø 38mm Hmm Wmm M8 aluminium Qty 1 pcs		
<b>For models:</b>	050F, 050FP, 11F, 11FD, 11F-DVGW, 11R, 11RD, 21F, 21FD, 21R, 21RD, 22F, 22R, 25F, 25FD, 25R, 25RD, 30F, 30FD, 30R, 30RD, 31F, 31FD, 31R, 31RD, 350F, 350FD, 350R, 350RD, 35-ELECTRONIC, 35F, 35FD, 35R, 35RD, 400F, 400FD, 400R, 400RD, 40-ELECTRONIC, 40F, 40FD, 40R, 40RD, 440F, 44F, 45, 450, 46, 460, 500F...(Other models you can see in the webshop)		





fuses

fine fuses

 <p>1</p>			
<b>GEV No.</b>	358530	<b>Ref. No.</b>	926284
<b>description</b>	fine fuse size $\varnothing$ 5x20mm 0.8A fast-acting rated 250V Qty 10 pcs		
<b>For models:</b>	80, 81, 914380, 914436, CE78HZ23, CGL74CABT, E78, E78HP, FAST-181, HM1, KLP105EB, KLP201DDDTEB, KLP201EB, KLP301, KLP301DDDTEB, LP105DDDTEB, LP105DDDTEBN, LP105EB, LP201DDDTEB, LP201EB, LP301, LP301EB, LP60, PS-60, RIVER-150, River-152, RIVER-154, RIVER-71, RIVER-80, River-81, River-81CRP, RIVER-81-CRP, RIVER-82, River-82CRP, RIVER-82-CRP, RIVER-E78, RIVER-HL-81, RV150, RV15023, RV15023DA, RV150D, RV150DA, RV150DAR, RV150DARY, RV150DAW, RV150DAWY, RV150DAY, RV150DE, RV150DRW, RV150DW...(Other models you can see in the webshop)		

 <p>2</p>			
<b>GEV No.</b>	358677	<b>Ref. No.</b>	228004 228010
<b>description</b>	fine fuse size $\varnothing$ 5x20mm 4A fast-acting rated 250V Qty 10 pcs		
<b>For models:</b>	2312-007, 2312-009-CRP, 80, 81, 82, 913363, 913364, 913911, 913912, 913913, 913914, 913950, 913977, 913984, 913990, 913992, 913993, 914100, 914101, 914165, 914166, 914167, 914168, 914206, 914214, 914284, 914316, 914317, 914318, 914319, 914338, 914339, 914342, 914343, 914355, 914356, 914380, 914431, 914436, 914516, 914543, 914583, 914592, 914612, 914613, 914624, 914625, 914626, 914627, 914628...(Other models you can see in the webshop)		

 <p>1</p>			
<b>GEV No.</b>	358693	<b>Ref. No.</b>	80874
<b>description</b>	fine fuse size $\varnothing$ 5x20mm 2A medium lag rated 250V Qty 10 pcs		
<b>For models:</b>	RIVER-298, RV298, RV298HZ		

 <p>1</p>			
<b>GEV No.</b>	358594	<b>Ref. No.</b>	228012
<b>description</b>	fine fuse size $\varnothing$ 5x20mm 0.16A slow-acting rated 250V Qty 10 pcs		
<b>For models:</b>	915154, 915155, 915157, 915158, 915172, 915173, 915285, 915422, 915492, 915493, 915494, 915495, 915496, 915497, 915747, 916045, 916054, 916067, 916068, 916069, 916079, 916080, 916368, 916420, 916421, 916422, 916423, 916424, 916654, 916686, 916760, Fast160C, Fast200, FAST-200, Fast93, GL280EB, GL280EB23, GL280EB23DAR, GL280EB23HZ, GL280EB23HZDY, GL280EBD, GL280EBDA, GL280EBDAE, GL280EBDAR, GL280EBDARY, GL280EBDAW, GL280EBDAWY, GL280EBDAY, GL280EBDB, GL280EBDBR...(Other models you can see in the webshop)		

 <p>1</p>			
<b>GEV No.</b>	358603	<b>Ref. No.</b>	228011
<b>description</b>	fine fuse size $\varnothing$ 5x20mm 2A slow-acting rated 250V Qty 10 pcs		
<b>For models:</b>	915154, 915155, 915157, 915158, 915172, 915173, 915285, 915422, 915492, 915493, 915494, 915495, 915496, 915497, 915747, 916045, 916054, 916067, 916068, 916069, 916079, 916080, 916368, 916420, 916421, 916422, 916423, 916424, 916654, 916686, 916760, Fast160C, Fast200, FAST-200, Fast93, GL280EB, GL280EB23, GL280EB23DAR, GL280EB23HZ, GL280EB23HZDY, GL280EBD, GL280EBDA, GL280EBDAE, GL280EBDAR, GL280EBDARY, GL280EBDAW, GL280EBDAWY, GL280EBDAY, GL280EBDB, GL280EBDBR...(Other models you can see in the webshop)		

 <p>1</p>			
<b>GEV No.</b>	358606	<b>Ref. No.</b>	228014
<b>description</b>	fine fuse size $\varnothing$ 5x20mm 4A slow-acting rated 250V Qty 10 pcs		
<b>For models:</b>	916237, 916238, 916239, 916240, 916241, 916242, 916243, 916244, 916245, 916246, 916401, 916402, 916403, 916404, 916405, 916406, 916407, 916408, 916451, 916583, 916687, 916787, 916991, 917042, 917043, Clean140, Clean140S, Fast130, Fast135-2, Fast135-2S, Fast135H-2, Fast135H-2S, Fast139-2, Fast139-2S, Fast139H-2, Fast139H-2S, Fast140		

 <p>1</p>			
<b>GEV No.</b>	358760	<b>Ref. No.</b>	926283
<b>description</b>	fine fuse size $\varnothing$ 6.3x32mm 0.315A medium lag rated 250V Qty 10 pcs		
<b>For models:</b>	80, 81, 914380, 914436, CE78HZ23, CGL74CABT, E78, E78HP, FAST-181, HM1, KLP105EB, KLP201DDDTEB, KLP201EB, KLP301, KLP301DDDTEB, LP105DDDTEB, LP105DDDTEBN, LP105EB, LP201DDDTEB, LP201EB, LP301, LP301EB, LP60, PS-60, RIVER-150, River-152, RIVER-154, RIVER-71, RIVER-80, River-81, River-81CRP, RIVER-81-CRP, RIVER-82, River-82CRP, RIVER-82-CRP, RIVER-E78, RIVER-HL-81, RV150, RV15023, RV15023DA, RV150D, RV150DA, RV150DAR, RV150DARY, RV150DAW, RV150DAWY, RV150DAY, RV150DE, RV150DRW, RV150DW...(Other models you can see in the webshop)		

fine fuse holders

 <p>1</p>			
<b>GEV No.</b>	551234	<b>Ref. No.</b>	210010
<b>description</b>	fuse holder suitable fuse $\varnothing$ 5x20mm 1-pole 6.3A rated 600V L 52mm W 8mm H 51mm connection screw clamp cross section 4mm <sup>2</sup>		
<b>For models:</b>	913913, 913914, 913992, 913993, 914100, 914101, 914167, 914168, 914284, 914318, 914319, 914338, 914356, 914431, 914583, 914592, 914612, 914613, 914624, 914625, 914627, 914628, 914642, 914850, 914851, 914854, 914909, 914943, 914944, 915136, 915137, 915143, 915150, 915151, 915152, 915160, 915161, 915162, 915166, 915167, 915168, 915175, 915176, 915177, 915319, 915338, 915341, 915348, 915418, 915419...(Other models you can see in the webshop)		

→ electric components





			
<b>GEV No.</b>	550499	<b>Ref. No.</b>	H.228047
<b>description</b>	fuse holder suitable fuse ø5x20mm 6.3A rated 500V		
<b>For models:</b>	2312-007, 2312-009-CRP, 80, 81, 82, 913911, 913912, 913950, 913977, 913984, 913990, 914165, 914166, 914206, 914214, 914316, 914317, 914339, 914342, 914343, 914355, 914380, 914436, 914516, 914543, 914626, 914684, 914874, 915138, A3EB, A3EBD, A3EBDAKRKYK, A3EB-DAKWK, A3EBDBKWK, A3EBDRKYK, A3EBDWK, A3EBDYK, A3EBSAK, A3EBSAKRK, A3EBSAKWK, A3EBSBKWKYK, A3EBSEKWK, A3EBSWK, A4EB, A4EBD, A4EBDAKEKYK, A4EBDAKRK, A4EBDAKWK, A4EBDAKZK, A4EBDBKRK...(Other models you can see in the webshop)		

			
<b>GEV No.</b>	550519	<b>Ref. No.</b>	H.228048
<b>description</b>	cover plate suitable fuseA ratedV connection for fuse holder		
<b>For models:</b>	2312-007, 2312-009-CRP, 80, 81, 82, 913911, 913912, 913950, 913977, 913984, 913990, 914165, 914166, 914206, 914214, 914316, 914317, 914339, 914342, 914343, 914355, 914380, 914436, 914516, 914543, 914626, 914684, 914874, 915138, CE78HZ23, CGL74CABT, CNT800CH, E78, E78HP, Fast180, Fast180-230V-3Ph-60Hz, Fast181, FAST-181, Fast181-230V-3Ph-60Hz, Fast181-400V-3NPh-60Hz, Fast200, FAST-200, FAST-60, FAST-73, Fast93, GL280EB, GL280EB23, GL280EB23DAR, GL280EB23HZ, GL280EB23HZDY...(Other models you can see in the webshop)		

			
<b>GEV No.</b>	403250	<b>Ref. No.</b>	80933 926272
<b>description</b>	ribbon cable 10-pole L 3000mm plug type coded 2 row plug: number of poles 10		
<b>For models:</b>	80, 81, 82, 914380, 914436, KLP105EB, KLP201DDDTTEB, KLP201EB, KLP301DDDTTEB, LP105DDDTTEB, LP105DDDTTEBN, LP105EB, LP201DDDTTEB, LP201EB, LP301EB, LP60, NG271, NG281, NG281CDD, NG281HP, NG281HPDD, NG281HZ23, NG281HZ23DD, NG291, NG381, NG38123, NG38123TERMO, NG381C, NG381CDD, NG381CFUR, NG381DDHZ23, NG381DDPS, NG381DDPSHZ23, NG381HPDD, NG381L, NG381LC, NG381LCFUR, NG381LDDPS, NG381TERMO, NG381TXCDD, NIAGARA-271, NIAGARA-281, Niagara-281-2, Niagara-281HP, NIAGARA-283, Niagara-283A, Niagara-283L-2, NIAGARA-291, Niagara-381, Niagara-381-230V-3Ph-50Hz...(Other models you can see in the webshop)		

			
<b>GEV No.</b>	402927	<b>Ref. No.</b>	211011
<b>description</b>	ribbon cable 10-pole L 500mm plug type FC-10P raster size 2.54mm		
<b>For models:</b>	913992, 913993, 914583, 914592, 914612, 914613, 915143, RIVER-40, RIVER-40-CRP, RIVER-43, RIVER-44, RIVER-44-CRP, River-44-CRP-ST, RIVER-44CRP-ST		

			
<b>GEV No.</b>	400902	<b>Ref. No.</b>	80934 926281 DWS90
<b>description</b>	ribbon cable 10-pole L 750mm plug type FC-10P raster size 2.54mm		
<b>For models:</b>	915747, CNT800CH, Fast180, Fast180-230V-3Ph-60Hz, Fast181, Fast200, FAST-200, Fast93, GL280EB, GL280EB23, GL280EB23DAR, GL280EB23HZ, GL280EB23HZDY, GL280EBD, GL280EBDA, GL280EB-DAE, GL280EBDAR, GL280EBDARY, GL280EBDAW, GL280EBDAWY, GL280EBDAY, GL280EBDB, GL280EBDBR, GL280EBDBW, GL280EBDWY, GL280EBDY, GL280EBS, GL280EBSA, GL280EBSAE, GL280EBSAEW, GL280EBSAEWY, GL280EBSAR, GL280EBSARY, GL280EBSAW, GL280EBSAWY, GL280EBSAY, GL280EBSB, GL280EBSR, GL280EBSWY, GL280EBSY, GL282EB, GL282EB93, GL282EB93DA, GL282EB93HZ23, GL282EBCH, GL282EBCHD, GL282EBD, GL282EBDA, GL282EBDAE, GL282EBDAR...(Other models you can see in the webshop)		

			
<b>GEV No.</b>	403451	<b>Ref. No.</b>	211017
<b>description</b>	ribbon cable L 2100mm Qty 1m		
<b>For models:</b>	915611, 915612, 915613, 915614, 915615, 915616, 915617, 915618, 915670, 915671, 915672, 915673, 915674, 915695, 916066, 916077, 916078, 916181, 916183, 916184, 916185, 916196, 916197, 916198, 916199, 916200, 916409, 916410, 916418, 916419, 916591, 916592, 916593, 916594, 916595, 916751, 916877, NIAGARA-241, Niagara-241-2, Niagara-341, Ocean340, Pluvia-240, River-242, River-242-2, River-242-2T, River-342C, River-342T		

### electric accessories

#### cables

#### ribbon cables

#### group 1

			
<b>GEV No.</b>	402970	<b>Ref. No.</b>	41523
<b>description</b>	ribbon cable 10-pole L 1200mm plug type 2 row coded Qty 1m		
<b>For models:</b>	KLP301, LP301		

			
<b>GEV No.</b>	400903	<b>Ref. No.</b>	211009
<b>description</b>	ribbon cable 10-pole L 2290mm plug type FC-10P raster size 2.54mm		
<b>For models:</b>	050F, 050FP, 2312-007, 2312-009-CRP, 913911, 913912, 913913, 913914, 913950, 913977, 913984, 913990, 914100, 914101, 914165, 914166, 914167, 914168, 914206, 914214, 914284, 914316, 914317, 914318, 914319, 914338, 914339, 914342, 914343, 914355, 914356, 914431, 914516, 914543, 914624, 914625, 914626, 914627, 914628, 914642, 914684, 914850, 914851, 914854, 914874, 914909, 914943, 914944, 915136, 915137...(Other models you can see in the webshop)		

			
<b>GEV No.</b>	403450	<b>Ref. No.</b>	211013
<b>description</b>	ribbon cable 10-pole L 2300mm warewashing Qty 1 pcs		
<b>For models:</b>	915150, 915151, 915152, 915154, 915155, 915158, 915160, 915161, 915162, 915166, 915167, 915168, 915172, 915173, 915175, 915285, 915319, 915348, 915420, 915421, 915422, 915479, 915492, 915493, 915496, 915497, 915547, 915548, 915558, 915635, 915663, 915747, 916020, 916021, 916024, 916025, 916026, 916027, 916030, 916031, 916045, 916054, 916068, 916069, 916080, 916201, 916202, 916203, 916204, 916205, 916206...(Other models you can see in the webshop)		





plug connectors

			
<b>GEV No.</b>	551395	<b>Ref. No.</b>	CN6
<b>description</b>	female bullet ø 2.5mm CuZn gal Sn Qty 1 pcs suitable for CN2, CN3, CN4		
<b>For models:</b>	2312-007, 913911, 913912, 913913, 913914, 913950, 913977, 913984, 913990, 913992, 913993, 914100, 914101, 914165, 914166, 914167, 914168, 914206, 914214, 914284, 914316, 914317, 914318, 914319, 914338, 914339, 914342, 914343, 914355, 914356, 914431, 914516, 914543, 914583, 914592, 914612, 914613, 914624, 914625, 914626, 914627, 914628, 914642, 914684, 914850, 914851, 914854, 914874, 914909, 914943...(Other models you can see in the webshop)		

			
<b>GEV No.</b>	551394	<b>Ref. No.</b>	CN7
<b>description</b>	female bullet ø 2.8mm CuZn gal Sn Qty 1 pcs suitable for CN5		
<b>For models:</b>	2312-007, 913911, 913912, 913913, 913914, 913950, 913977, 913984, 913990, 913992, 913993, 914100, 914101, 914165, 914166, 914167, 914168, 914206, 914214, 914284, 914316, 914317, 914318, 914319, 914338, 914339, 914342, 914343, 914355, 914356, 914431, 914516, 914543, 914583, 914592, 914612, 914613, 914624, 914625, 914626, 914627, 914628, 914642, 914684, 914850, 914851, 914854, 914874, 914909, 914943...(Other models you can see in the webshop)		

			
<b>GEV No.</b>	400761	<b>Ref. No.</b>	CN5
<b>description</b>	plug connector 5-pole		
<b>For models:</b>	2312-007, 913911, 913912, 913913, 913914, 913950, 913977, 913984, 913990, 913992, 913993, 914100, 914101, 914165, 914166, 914167, 914168, 914206, 914214, 914284, 914316, 914317, 914318, 914319, 914338, 914339, 914342, 914343, 914355, 914356, 914431, 914516, 914543, 914583, 914592, 914612, 914613, 914624, 914625, 914626, 914627, 914628, 914642, 914684, 914850, 914851, 914854, 914874, 914909, 914943...(Other models you can see in the webshop)		
<b>accessories for</b>	400761		
	<b>GEV No.</b>	550048	<b>Ref. No.</b> —
	female bullet		
	<b>GEV No.</b>	551394	<b>Ref. No.</b> CN7
	female bullet ø 2.8mm CuZn gal Sn Qty 1 pcs suitable for CN5		

			
<b>GEV No.</b>	403854	<b>Ref. No.</b>	CN3
<b>description</b>	plug connector 5-pole raster size 5mm		
<b>For models:</b>	2312-007, 913911, 913912, 913913, 913914, 913950, 913977, 913984, 913990, 913992, 913993, 914100, 914101, 914165, 914166, 914167, 914168, 914206, 914214, 914284, 914316, 914317, 914318, 914319, 914338, 914339, 914342, 914343, 914355, 914356, 914431, 914516, 914543, 914583, 914592, 914612, 914613, 914624, 914625, 914626, 914627, 914628, 914642, 914684, 914850, 914851, 914854, 914874, 914909, 914943...(Other models you can see in the webshop)		
<b>accessories for</b>	403854		
	<b>GEV No.</b>	551395	<b>Ref. No.</b> CN6
	female bullet ø 2.5mm CuZn gal Sn Qty 1 pcs suitable for CN2, CN3, CN4		

			
<b>GEV No.</b>	403853	<b>Ref. No.</b>	CN4
<b>description</b>	plug connector 6-pole raster size 5mm		
<b>For models:</b>	2312-007, 913911, 913912, 913913, 913914, 913950, 913977, 913984, 913990, 913992, 913993, 914100, 914101, 914165, 914166, 914167, 914168, 914206, 914214, 914284, 914316, 914317, 914318, 914319, 914338, 914339, 914342, 914343, 914355, 914356, 914431, 914516, 914543, 914583, 914592, 914612, 914613, 914624, 914625, 914626, 914627, 914628, 914642, 914684, 914850, 914851, 914854, 914874, 914909, 914943...(Other models you can see in the webshop)		
<b>accessories for</b>	403853		
	<b>GEV No.</b>	551395	<b>Ref. No.</b> CN6
	female bullet ø 2.5mm CuZn gal Sn Qty 1 pcs suitable for CN2, CN3, CN4		

			
<b>GEV No.</b>	403852	<b>Ref. No.</b>	CN2
<b>description</b>	plug connector 8-pole raster size 5mm		
<b>For models:</b>	2312-007, 913911, 913912, 913913, 913914, 913950, 913977, 913984, 913990, 913992, 913993, 914100, 914101, 914165, 914166, 914167, 914168, 914206, 914214, 914284, 914316, 914317, 914318, 914319, 914338, 914339, 914342, 914343, 914355, 914356, 914431, 914516, 914543, 914583, 914592, 914612, 914613, 914624, 914625, 914626, 914627, 914628, 914642, 914684, 914850, 914851, 914854, 914874, 914909, 914943...(Other models you can see in the webshop)		
<b>accessories for</b>	403852		
	<b>GEV No.</b>	551395	<b>Ref. No.</b> CN6
	female bullet ø 2.5mm CuZn gal Sn Qty 1 pcs suitable for CN2, CN3, CN4		

terminals

connection terminals with screw/faston connections

			
<b>GEV No.</b>	550278	<b>Ref. No.</b>	921044
<b>description</b>	power terminal block 3-pole max. 40A max 400V connection ø6mm <sup>2</sup> / F6.3 temp.-resist. 150°C cross section 6mm <sup>2</sup>		

			
<b>GEV No.</b>	550349	<b>Ref. No.</b>	220010
<b>description</b>	power terminal block 4-pole max. 40A max 400V connection ø6mm <sup>2</sup> / F6.3 temp.-resist. 150°C cross section 6mm <sup>2</sup>		
<b>For models:</b>	11F, 11FD, 11R, 11RD, 350F, 350FD, 350R, 350RD, 35F, 35FD, 35R, 35RD, 400F, 400FD, 400R, 400RD, 40F, 40FD, 40R, 40RD, 45, 450, 500F, 500FD, 50-ELECTRONIC, 50F, 50FD, 67F, 67R, 913418, 913992, 913993, 914167, 914168, 914398, 914399, 914443, 914583, 914592, 914612, 914613, 914943, 915143, 915611, 915612, 915613, 915614, 915615, 915616, 915617...(Other models you can see in the webshop)		



			
1			
<b>GEV No.</b>	550411	<b>Ref. No.</b>	220011 921057
<b>description</b>	power terminal block 6-pole max. 40A max 450V connection $\phi 6\text{mm}^2$ / F6.3 temp.-resist. 150°C cross section $6\text{mm}^2$		
<b>For models:</b>	050F, 050FP, 10, 12, 14, 22F, 2312-001, 2312-002, 2312-007, 2312-009-CRP, 440F, 44F, 46, 460, 500F, 500FD, 50-ELECTRONIC, 50F, 50FD, 510F, 510FD, 80, 81, 82, 913297, 913298, 913299, 913300, 913360, 913361, 913391, 913392, 913546, 913547, 913578, 913611, 913684, 913913, 913914, 913932, 913933, 914100, 914101, 914284, 914318, 914319, 914326, 914331, 914338, 914339...(Other models you can see in the webshop)		

## connection boxes

			
1			
<b>GEV No.</b>	550300	<b>Ref. No.</b>	459018
<b>description</b>	power terminal block 3-pole contacts P+N+E		
<b>For models:</b>	913289, 913290, 913291, 913292, 913356, 913357, 913363, 913364, 913372, 913373, 913374, 913375, 913376, 913377, 913416, 913435, 913544, 913545, 913665, 913666, 913667, 913668, 913685, 913771, 913772, 913773, 913774, 913832, 913837, 913911, 913912, 913948, 913950, 913977, 913984, 913990, 914165, 914166, 914206, 914214, 914316, 914317, 914355, 914386, 914387, 914388, 914389, 914390, 914391, 914392...(Other models you can see in the webshop)		

## rail-mounted terminals

## miscellaneous

			
1			
<b>GEV No.</b>	551234	<b>Ref. No.</b>	210010
<b>description</b>	fuse holder suitable fuse $\phi 5 \times 20\text{mm}$ 1-pole 6.3A rated 600V L 52mm W 8mm H 51mm connection screw clamp cross section $4\text{mm}^2$		
<b>For models:</b>	913913, 913914, 913992, 913993, 914100, 914101, 914167, 914168, 914284, 914318, 914319, 914338, 914356, 914431, 914583, 914592, 914612, 914613, 914624, 914625, 914627, 914628, 914642, 914850, 914851, 914854, 914909, 914943, 914944, 915136, 915137, 915143, 915150, 915151, 915152, 915160, 915161, 915162, 915166, 915167, 915168, 915175, 915176, 915177, 915319, 915338, 915341, 915348, 915418, 915419...(Other models you can see in the webshop)		

			
1			
<b>GEV No.</b>	550996	<b>Ref. No.</b>	927115
<b>description</b>	rail-mounted terminal 0.5-4mm <sup>2</sup> green/yellow for TS 35 (plastic)		
<b>For models:</b>	161, 221, 271, 272, 362, A3EB, A3EBD, A3EBDAKRRKYK, A3EBDAK-WK, A3EBDBKWK, A3EBDRKYK, A3EBDVK, A3EBDYK, A3EBSAK, A3EBSAKRK, A3EBSAKWK, A3EBSBKWKYK, A3EBSEKWK, A3EBSWK, A4EB, A4EBD, A4EBDAKEKYK, A4EBDAKRRK, A4EBDAKWK, A4EBD-AKZK, A4EBDBKRRK, A4EBDPKWKYK, A4EBDRK, A4EBS, A4EBSAK, A4EBSAKCK, A4EBSAKEKYK, A4EBSAKRK, A4EBSAKRKP, A4EBSAKYK, A4EBSCK, A4EBT, A4EBTSAK, A5EB, A5EBD, A5EBDAKPKWK, A5EBDAK-WK, A5EBDAKYK, A5EBDRK, A5EBS, A5EBSAKPKWK, A5EBSAKRK, A5EBSAKRKYK, A5EBSAKWK, A5EBSAKWKYK...(Other models you can see in the webshop)		

## gas thermostats

## SIT

## 710 Minisit series









			
1			
<b>GEV No.</b>	101131	<b>Ref. No.</b>	611001
<b>description</b>	gas thermostat without cap, button and angle SIT type MINISIT 710 t.max. 190°C 50-190°C gas inlet 1/2" gas outlet 3/8" thermocouple connection M9x1 pilot connection M10x1 probe $\phi 5\text{mm}$ probe L 98mm capillary pipe 1200mm probe type type A2 pressure controller no pressure regulator mbar gland nut		
<b>For models:</b>	367, 368, 373, 374, MG15, MG20, MG30, MG40		
<b>spare parts for</b>	101131		
	<b>GEV No.</b>	101053	<b>Ref. No.</b>
			—
			magnet unit T1: M9x1 T2: M24x1 L 45mm $\phi 17\text{mm}$ suitable for Minisit
	<b>GEV No.</b>	102103	<b>Ref. No.</b>
			—
			probe 60-200°C probe $\phi 5\text{mm}$ probe L 98mm capillary pipe 1050mm t.max. 200°C fryer probe type type A2 suitable for MINISIT 710
<b>accessories for</b>	101131		
	<b>GEV No.</b>	100809	<b>Ref. No.</b>
			—
			O-ring EPDM thickness 2mm ID $\phi 21\text{mm}$ Qty 1 pcs
	<b>GEV No.</b>	100820	<b>Ref. No.</b>
			—
			gland duct ET M14x1.5 IT M10x0.75 probe $\phi$ max. 6.5mm WS 22
	<b>GEV No.</b>	100904	<b>Ref. No.</b>
			—
			locking screw M10x1 for pipe $\phi 4\text{mm}$ Qty 1 pcs
	<b>GEV No.</b>	100905	<b>Ref. No.</b>
			—
			locking screw M10x1 for pipe $\phi 6\text{mm}$ Qty 1 pcs
	<b>GEV No.</b>	101054	<b>Ref. No.</b>
			—
			magnet unit T1: M10x1 T2: M24x1 L 45mm $\phi 17\text{mm}$ suitable for Minisit

Table continues overleaf



accessories for		101131	
	GEV No.	101136	Ref. No. 611002
piezoelectric igniter suitable for Minisit with cover cap ømm connection F6.3x0.8			
	GEV No.	101137	Ref. No. —
cover cap without piezoelectric igniter			
	GEV No.	101267	Ref. No. —
reducer IT 3/8" ET 1/2" L 21mm			
	GEV No.	101268	Ref. No. —
gas connection thread 3/8" angled with O-ring MINISIT 710			
	GEV No.	101269	Ref. No. —
gas connection thread 1/2" angled with O-ring MINISIT 710			
	GEV No.	101270	Ref. No. —
screw connection IT 3/8" ET 3/8" L 28mm			
	GEV No.	101272	Ref. No. —
screw connection IT 1/2" ET 3/8" L 57mm			
	GEV No.	101273	Ref. No. —
olive for pipe ø 12mm L 9.5mm brass Qty 1 pcs suitable for universal			
	GEV No.	101274	Ref. No. —
olive for pipe ø 16mm Qty 1 pcs			
	GEV No.	101275	Ref. No. —
union screw thread 1/2" for pipe ø 16mm Qty 1 pcs			
	GEV No.	101276	Ref. No. —
union screw thread 3/8" tube ø 12mm Qty 1 pcs			
	GEV No.	110068	Ref. No. 447060
knob suitable for Minisit ø 37mm			

accessories

probes



<b>GEV No.</b>	102118	<b>Ref. No.</b>	RIC0001008
<b>description</b>	probe 110-190°C probe ø 6mm probe L 102mm capillary pipe 1050mm t.max. 190°C fryer probe type type A3 suitable for MINISIT 710		
<b>For models:</b>	MG15, MG20		
<b>accessories for</b>	102118		
	GEV No.	100820	Ref. No. —
gland duct ET M14x1.5 IT M10x0.75 probe ø max. 6.5mm WS 22			

ignition parts

pilot burners

producer-specific pilot burners

ELETTROBAR



<b>GEV No.</b>	100192	<b>Ref. No.</b>	611003
<b>description</b>	pilot burner SIT type 160 series 2 flames nozzle ømm gas connectionmm without nozzle		
<b>For models:</b>	367, 368, 373, 374, MG15, MG20, MG30, MG40		

electrodes



<b>GEV No.</b>	100701	<b>Ref. No.</b>	611006
<b>description</b>	ignition electrode connection M4 Qty 1 pcs		
<b>For models:</b>	367, 368, 373, 374, MG15, MG20, MG30, MG40		
<b>accessories for</b>	100701		
	GEV No.	100906	Ref. No. —
screw connection thread M10x1 for ignition electrode brass Qty 1 pcs WS 10			

ignition cables

pre-assembled cables



<b>GEV No.</b>	100026	<b>Ref. No.</b>	611007
<b>description</b>	ignition cable cable length 1000mm connection ø4mm / F6.3mm		
<b>For models:</b>	367, 368, 373, 374, MG15, MG20, MG30, MG40		

piezoelectric igniters

miscellaneous



<b>GEV No.</b>	nla <sup>1</sup>	<b>Ref. No.</b>	611002
<b>description</b>	piezoelectric igniter suitable for Minisit with cover cap ømm connection F6.3x0.8		
<b>For models:</b>	367, 368, 373, 374, MG15, MG20, MG30, MG40		
<b>spare parts for</b>	101136		
	<b>GEV No.</b>	100001	<b>Ref. No.</b> —
	piezoelectric igniter suitable for Minisit connection F6.3x0.8 ømm		

<sup>1</sup>no longer available

thermocouples

plug-in thermocouples

plug-in thermocouples with interruption

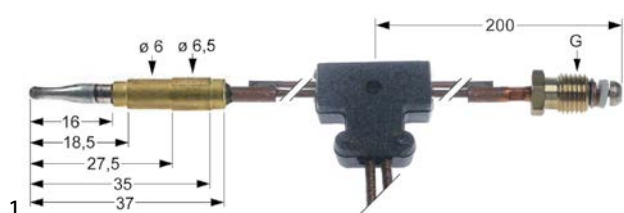

<b>GEV No.</b>	102925	<b>Ref. No.</b>	611005
<b>description</b>	thermocouple with interrupter M9x1 L 750mm plug connection ø6.0(6.5)mm F 6.3mm		
<b>For models:</b>	367, 368, 373, 374, MG15, MG20, MG30, MG40		

accessories

interrupters



<b>GEV No.</b>	101265	<b>Ref. No.</b>	468068
<b>description</b>	interrupter thread M9x1		
<b>For models:</b>	367, 368, 373, 374, MG15, MG20, MG30, MG40		

gas nozzles

main nozzles

gas nozzles M10x0.75



<b>GEV No.</b>	106796	<b>Ref. No.</b>	611026
<b>description</b>	gas injector thread M10x0.75 WS 10 bore ø 1.75mm		
<b>For models:</b>	367, 368, 373, 374, MG15, MG20, MG30, MG40		

pilot burner nozzles

pilot burner nozzles SIT

160 series



<b>GEV No.</b>	107650	<b>Ref. No.</b>	611008
<b>description</b>	pilot burner nozzle SIT LPG code 30 Qty 1 pcs		
<b>For models:</b>	367, 368, 373, 374, MG15, MG20, MG30, MG40		



auxiliary gas parts

screw connections

olives



<b>GEV No.</b>	101278	<b>Ref. No.</b>	RTCU900012
<b>description</b>	olive for pipe ø 10mm Qty 1 pcs		
<b>For models:</b>	MG15, MG20		

<b>accessories for</b>	101278		
	<b>GEV No.</b>	100943	<b>Ref. No.</b> —
	union nut thread M17x1 tube ø 10mm		
	<b>GEV No.</b>	101300	<b>Ref. No.</b> —
	union nut thread M16x1.5 tube ø 10mm		
	<b>GEV No.</b>	101478	<b>Ref. No.</b> RTCU900013
	union nut thread 3/8" for pipe ø 10mm		





union nuts

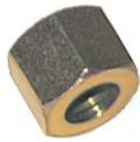

1			
<b>GEV No.</b>	101478	<b>Ref. No.</b>	RTCU900013
<b>description</b>	union nut thread 3/8" for pipe ø 10mm		
<b>For models:</b>	MG15, MG20		

pipes

union nuts

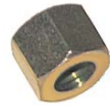

1			
<b>GEV No.</b>	101478	<b>Ref. No.</b>	RTCU900013
<b>description</b>	union nut thread 3/8" for pipe ø 10mm		
<b>For models:</b>	MG15, MG20		

equipment-specific units

for vegetable slicers

miscellaneous



1			
<b>GEV No.</b>	699128	<b>Ref. No.</b>	927095
<b>description</b>	shaft sealing ED ø 40mm ID ø 30mm H 7mm plastic for vegetable slicer		
<b>For models:</b>	161, 221, 271, 272, 362, CLEAN-160, CLEAN-161, CLEAN-220, CLEAN-221, CLEAN-270, CLEAN-271, CLEAN-272, CLEAN-361, CLEAN-361P, CLEAN-362, CLEAN-471, CLEAN-471P		

for dishwashers

containers

container lids



1			
<b>GEV No.</b>	518073	<b>Ref. No.</b>	480023
<b>description</b>	container lid		
<b>For models:</b>	11F, 11FD, 11F-DVGW, 11R, 11RD, 22F, 22R, 40F, 440F, 44F, 913992, 913993, CLEAN-3, E.52, RIVER-40, RIVER-43, S651, S654, S810, S815, S830, S835		

for espresso machines

brewing units

filter holder gaskets

O-rings



1			
<b>GEV No.</b>	510409	<b>Ref. No.</b>	929046
<b>description</b>	O-ring EPDM thickness 5.34mm ID ø 56.52mm Qty 1 pcs		
<b>For models:</b>	161, 221, 271, 272, 362, 55, CLEAN-160, CLEAN-161, CLEAN-220, CLEAN-221, CLEAN-270, CLEAN-271, CLEAN-272, CLEAN-361, CLEAN-361P, CLEAN-362, CLEAN-471, CLEAN-471P		



1			
<b>GEV No.</b>	510109	<b>Ref. No.</b>	480006
<b>description</b>	lid for salt tank		
<b>For models:</b>	11F, 11FD, 11R, 11RD, 21F, 21FD, 21R, 21RD, 2312-007, 2312-009-CRP, 25F, 25FD, 25R, 25RD, 30F, 30FD, 30R, 30RD, 31F, 31FD, 31R, 31RD, 913363, 913364, 913376, 913377, 913992, 913993, 914100, 914101, 914339, 914342, 914343, 914583, 914592, 914612, 914613, 914624, 914625, 914626, 914627, 914628, 914850, 914851, 914854, 914944, 915143, E.41, E.42, E41...(Other models you can see in the webshop)		

steam/water taps

steam/water pipes

accessories

gaskets



1			
<b>GEV No.</b>	510893	<b>Ref. No.</b>	456015
<b>description</b>	O-ring EPDM thickness 2.62mm ID ø 9.92mm Qty 1 pcs		
<b>For models:</b>	050F, 050FP, 2312-001, 2312-002, 31F, 31FD, 31R, 31RD, 500F, 500FD, 50F, 50FD, 510F, 510FD, 67F, 67R, 913297, 913298, 913299, 913300, 913360, 913361, 913363, 913364, 913376, 913377, 913391, 913392, 913418, 913546, 913547, 913578, 913611, 913684, 913913, 913914, 913932, 913933, 914167, 914168, 914284, 914318, 914319, 914326, 914331, 914338, 914356, 914398, 914399, 914400...(Other models you can see in the webshop)		



1			
<b>GEV No.</b>	510110	<b>Ref. No.</b>	429012
<b>description</b>	lid for salt tank		
<b>For models:</b>	11F, 11FD, 11R, 11RD, 21F, 21FD, 2312-007, 2312-009-CRP, 25F, 25FD, 30F, 30FD, 31F, 31FD, 31R, 31RD, 913363, 913364, 913376, 913377, 913992, 913993, 914100, 914101, 914339, 914342, 914343, 914583, 914592, 914612, 914613, 914624, 914625, 914626, 914627, 914628, 914850, 914851, 914854, 914944, 915143, E.41, E.42, E41, R501, R503, R505, R507, R509, R511...(Other models you can see in the webshop)		

dosing containers



<b>GEV No.</b>	510019	<b>Ref. No.</b>	114997
<b>description</b>	rinse aid container		
<b>For models:</b>	22F, 22R, 40F, 440F, 44F, E.52, S651, S654, S810, S815, S830, S835		
<b>spare parts for</b>	510019		
	<b>GEV No.</b>	518073	<b>Ref. No.</b> 480023
	container lid		

salt tanks













<b>GEV No.</b>	524177	<b>Ref. No.</b>	480005
<b>description</b>	lid ø 69mm H 20mm for salt tank ID ø 50mm		
<b>For models:</b>	050F, 050FP, 11F, 11FD, 11R, 11RD, 21F, 21FD, 21R, 21RD, 2312-001, 2312-002, 2312-007, 25F, 25FD, 25R, 25RD, 30F, 30FD, 30R, 30RD, 31F, 31FD, 31R, 31RD, 350R, 350RD, 35-ELECTRONIC, 35R, 35RD, 400F, 400FD, 400R, 400RD, 40-ELECTRONIC, 40F, 40FD, 40R, 40RD, 45, 450, 46, 460, 500F, 500FD, 50-ELECTRONIC, 50F, 50FD, 510F, 510FD...(Other models you can see in the webshop)		
<b>accessories for</b>	524177		
	<b>GEV No.</b>	524148	<b>Ref. No.</b> —
	O-ring EPDM thickness 3.53mm ID ø 40.86mm Qty 1 pcs		



<b>GEV No.</b>	510018	<b>Ref. No.</b>	429011
<b>description</b>	nut ø 92mm H 10.5mm for salt tank ID ø 64mm		
<b>For models:</b>	050F, 050FP, 11F, 11FD, 21F, 21FD, 21R, 21RD, 2312-001, 2312-002, 2312-007, 25F, 25FD, 25R, 25RD, 30F, 30FD, 30R, 30RD, 31F, 31FD, 31R, 31RD, 350F, 350FD, 350R, 350RD, 35-ELECTRONIC, 35F, 35FD, 35R, 35RD, 400F, 400FD, 400R, 400RD, 40-ELECTRONIC, 40F, 40FD, 40R, 40RD, 45, 450, 46, 460, 500F, 500FD, 50-ELECTRONIC, 50F, 50FD...(Other models you can see in the webshop)		



<b>GEV No.</b>	510929	<b>Ref. No.</b>	406999
<b>description</b>	salt tank ø 120mm H 117mm hose ø 10mm mounting ø 70mm overall height 157mm		
<b>For models:</b>	R495, R497, R499, R501, R503, R505, R507, R509, R511, R704, R706, R708, S621, S623, S624, S626, S631, S633, S634, S636, S641, S643, S651, S651P, S653, S654, S655, S810, S815, S830, S835, S850, S870, S950, SR651		
<b>spare parts for</b>	510929		
	<b>GEV No.</b>	506015	<b>Ref. No.</b> 456052
	O-ring EPDM thickness 3.53mm ID ø 39.69mm Qty 1 pcs		
	<b>GEV No.</b>	510018	<b>Ref. No.</b> 429011
	nut ø 92mm H 10.5mm for salt tank ID ø 64mm		
	<b>GEV No.</b>	524177	<b>Ref. No.</b> 480005
	lid ø 69mm H 20mm for salt tank ID ø 50mm		
<b>accessories for</b>	510929		
	<b>GEV No.</b>	510071	<b>Ref. No.</b> 437034
	flat gasket rubber ED ø 81mm ID ø 68mm thickness 3mm for salt tank Qty 1 pcs		
	<b>GEV No.</b>	510654	<b>Ref. No.</b> —
	gasket H 6mm D1 ø 82mm D2 ø 68mm		
	<b>GEV No.</b>	510883	<b>Ref. No.</b> —
	gasket rubber ED ø 86mm ID ø 66mm thickness 2mm for salt tank Qty 1 pcs		

 <p>1</p>			
<b>GEV No.</b>	510032	<b>Ref. No.</b>	406998
<b>description</b>	salt tank without gasket new model		
<b>For models:</b>	050F, 050FP, 11F, 11FD, 11R, 11RD, 21F, 21FD, 2312-001, 2312-002, 2312-007, 25F, 25FD, 30F, 30FD, 31F, 31FD, 31R, 31RD, 350F, 350FD, 35-ELECTRONIC, 35F, 35FD, 400F, 400FD, 400R, 400RD, 40-ELECTRONIC, 40F, 40FD, 40R, 40RD, 45, 450, 46, 460, 500F, 500FD, 50-ELECTRONIC, 50F, 50FD, 510F, 510FD, 67F, 67R, 913289, 913290, 913291, 913292...(Other models you can see in the webshop)		
<b>spare parts for</b>	510032		
	<b>GEV No.</b>	<b>Ref. No.</b>	456052
	506015		
	O-ring EPDM thickness 3.53mm ID ø 39.69mm Qty 1 pcs		
	<b>GEV No.</b>	<b>Ref. No.</b>	429011
	510018		
	nut ø 92mm H 10.5mm for salt tank ID ø 64mm		
	<b>GEV No.</b>	<b>Ref. No.</b>	437034
	510071		
	flat gasket rubber ED ø 81mm ID ø 68mm thickness 3mm for salt tank Qty 1 pcs		

accessories

 <p>1</p>			
<b>GEV No.</b>	699250	<b>Ref. No.</b>	73337
<b>description</b>	extension for salt tank ø 52mm Qty 1 pcs L 140mm		
<b>For models:</b>	River-282S-2TDE, River-382TDE, RV382S, RV382SFUR		

 <p>1</p>			
<b>GEV No.</b>	517802	<b>Ref. No.</b>	466008
<b>description</b>	extension for salt tank Qty 1 pcs L 78mm ID ø 38mm		
<b>For models:</b>	915617, 915618, 915672, 915773, 915774, 916066, 916077, 916078, 916418, 916419, 916594, 916595, River-242, River-242-2, River-242-2T, River-342C, River-342T		

 <p>1</p>			
<b>GEV No.</b>	504793	<b>Ref. No.</b>	466006
<b>description</b>	extension for salt tank Qty 1 pcs L 94mm ID ø 38mm		
<b>For models:</b>	915154, 915155, 915157, 915158, 915172, 915173, 915285, 915422, 915492, 915493, 915494, 915495, 915496, 915497, 916054, 916067, 916068, 916069, 916079, 916080, 916368, 916420, 916421, 916422, 916423, 916424, 916686, 916760, RIVER-252, River-252-2, River-252-2T, River-253, RIVER-262, River-262-2, River-262-2T, River-272, River-282LS-2TDE, River-352C, River-352T, River-362C, River-362C-230V-3Ph-50Hz, River-362T, River-362T-230V-3Ph-50Hz, River-372, River-382LTDE, RV382LS, RV382LSFUR		

 <p>1</p>			
<b>GEV No.</b>	510071	<b>Ref. No.</b>	437034
<b>description</b>	flat gasket rubber ED ø 81mm ID ø 68mm thickness 3mm for salt tank Qty 1 pcs		
<b>For models:</b>	050F, 050FP, 11F, 11FD, 11R, 11RD, 2312-001, 2312-002, 2312-007, 2312-009-CRP, 31F, 31FD, 31R, 31RD, 350F, 350FD, 35-ELECTRONIC, 35F, 35FD, 400F, 400FD, 400R, 400RD, 40-ELECTRONIC, 40F, 40FD, 40R, 40RD, 45, 450, 46, 460, 500F, 500FD, 50-ELECTRONIC, 50F, 50FD, 510F, 510FD, 67F, 67R, 913289, 913290, 913291, 913292, 913297, 913298, 913299, 913300, 913356...(Other models you can see in the webshop)		

 <p>1</p>			
<b>GEV No.</b>	511457	<b>Ref. No.</b>	799002
<b>description</b>	funnel for salt		

boilers

boilers for dishwashers



<b>GEV No.</b>	510029	<b>Ref. No.</b>	104019 104023
<b>description</b>	boiler		
<b>For models:</b>	11F, 11FD, 11F-DVGW, 11R, 11RD		



<b>GEV No.</b>	513241	<b>Ref. No.</b>	926026
<b>description</b>	boiler		
<b>For models:</b>	10, CLEAN-100, CLEAN-110, E.60, E1, E10, E100, E110, E140		



<b>GEV No.</b>	513242	<b>Ref. No.</b>	926055
<b>description</b>	boiler		
<b>For models:</b>	12, 14, CLEAN-120, E.60, E.65, E12, E120, E14, E140		



<b>GEV No.</b>	513243	<b>Ref. No.</b>	80389
<b>description</b>	boiler		
<b>For models:</b>	80, 81, 82, CE78HZ23, CGL74CABT, E78, E78HP, Fast181, FAST-181, Fast181-230V-3Ph-60Hz, Fast181-400V-3NPh-60Hz, HM1, NG292, NG293, NIAGARA-283, Niagara-283A, NIAGARA-292, NIAGARA-293, RIVER-71, RIVER-78, RIVER-80, River-81, RIVER-82, RIVER-E78, RIVER-HL-81, RIVER-HL-82, RV71, RV80, RV8023, RV8023HZ, RV80C, RV80HZ, RV81, RV8123, RV81A, RV81C, RV81HZ, RV81HZ23, RV81PAP, RV82, RV8223, RV82C, SevenL, ST70FAST, ST70FASTHB, ST70FASTHB400, ST70FASTHZ23, SV72AEB, SV72EB		



<b>GEV No.</b>	518373	<b>Ref. No.</b>	104025 104027
<b>description</b>	boiler		
<b>For models:</b>	11R, 11RD, 350F, 350FD, 350R, 350RD, 35-ELECTRONIC, 35F, 35FD, 35R, 35RD, 400F, 400FD, 400R, 400RD, 40-ELECTRONIC, 40F, 40FD, 40R, 40RD, 45, 450, 67F, 67R, E.41, E.42, E.45		



<b>GEV No.</b>	518375	<b>Ref. No.</b>	104033
<b>description</b>	boiler		
<b>For models:</b>	913992, 913993, 914592, 914612, 914613, CLEAN-3, E.35, RIVER-40, RIVER-43, RIVER-44		



<b>GEV No.</b>	518376	<b>Ref. No.</b>	104047.SO
<b>description</b>	boiler		
<b>For models:</b>	E.45		



<b>GEV No.</b>	518378	<b>Ref. No.</b>	104030
<b>description</b>	boiler		
<b>For models:</b>	22F, 500F, 500FD, 50F, 50FD, 510F, 510FD, 914326, 914406, E.50, E.51, E.52, E.55, TF-503, TF-513, TF-515		



<b>GEV No.</b>	518574	<b>Ref. No.</b>	104020
<b>description</b>	boiler		
<b>For models:</b>	22F, 22R, 40F, 44F		



<b>GEV No.</b>	518576	<b>Ref. No.</b>	104050
<b>description</b>	boiler		
<b>For models:</b>	913297, 913298, 913299, 913300, 913360, 913361, 913391, 913392, 913546, 913547, 913578, 913611, 913684, 913932, 913933, 914318, 914319, 914331, 914338, 914431, 914517, 914545, 914688, 914979, 915140, 915248, E.50, E.51, F85, F85P, GSP51, GSP51P, LF55, MC501E, MC501EP, Mistral51, MISTRAL-51, NIAGARA-271, NIAGARA-51, PS-60		



<b>GEV No.</b>	513709	<b>Ref. No.</b>	104056
<b>description</b>	boiler ø 110mm L 295mm		
<b>For models:</b>	913291, 913292, 913357, 913374, 913375, 913416, 913435, 913545, 913666, 913668, 913685, 913773, 913774, 913911, 913912, 913948, 913950, 913977, 913984, 913990, 914165, 914166, 914206, 914214, 914316, 914317, 914355, 914392, 914393, 914394, 914395, 914396, 914397, 914441, 914442, 914515, 914516, 914537, 914543, 914547, 914683, 914684, 914689, 914863, 914874, 915138, 915139, 915527, 915611, 915612...(Other models you can see in the webshop)		



			
1			
<b>GEV No.</b>	501512	<b>Ref. No.</b>	104063
<b>description</b>	boiler ø 110mm L 300mm hose ø 6/11mm		
<b>For models:</b>	915617, 915618, 915672, 915773, 915774, 916066, 916077, 916078, 916418, 916419, 916594, 916595, River-242, River-242-2, River-242-2T, River-342C, River-342T		

			
1			
<b>GEV No.</b>	518235	<b>Ref. No.</b>	104060
<b>description</b>	boiler ø 145mm L 405mm flange 3 hole flange		
<b>For models:</b>	913913, 913914, 914284, 914356, 914400, 914401, 914402, 914403, 914404, 914405, 914449, 914568, 914642, 914909, 915136, 915137, 915150, 915151, 915152, 915160, 915161, 915162, 915166, 915167, 915168, 915175, 915176, 915177, 915319, 915338, 915341, 915348, 915418, 915419, 915420, 915421, 915479, 915483, 915484, 915528, 915537, 915538, 915539, 915540, 915547, 915558, 915635, 915663, 915664, 915697...(Other models you can see in the webshop)		

			
1			
<b>GEV No.</b>	501511	<b>Ref. No.</b>	104061
<b>description</b>	boiler ø 145mm L 420mm hose ø 18/27mm		
<b>For models:</b>	915154, 915155, 915157, 915158, 915172, 915173, 915285, 915422, 915492, 915493, 915494, 915495, 915496, 915497, 916045, 916054, 916067, 916068, 916069, 916079, 916080, 916368, 916420, 916421, 916422, 916423, 916424, 916654, 916686, 916760, Fast160C, Ocean360-UK, River-252, River-252-2, River-252-2T, River-253, RIVER-262, River-262-2, River-262-2T, River-272, RIVER-282, River-282-2, River-282L-2, River-282LS-2TDE, River-282S-2TDE, River-285, RIVER-294, RIVER-295, River-295P, RIVER-296...(Other models you can see in the webshop)		

			
1			
<b>GEV No.</b>	518377	<b>Ref. No.</b>	104026
<b>description</b>	boiler ø 150mm L 360mm		
<b>For models:</b>	050F, 050FP, 2312-001, 2312-002, 46, 460, 500F, 500FD, 50-ELECTRONIC, 50F, 50FD, 510F, 510FD, 913297, 913298, 913299, 913300, 913360, 913361, 913391, 913392, 913546, 913547, 913578, 913611, 913684, 913932, 913933, 914331, 914517, 914545, 914688, 914979, 915140, 915248, E.46, E.50, E.51, F85, F85P, GSP50, GSP50P, GSP51, GSP51P, LF50, LF55, MC501E, MC501EP, MC501S, MC501SP...(Other models you can see in the webshop)		





			
1			
<b>GEV No.</b>	517447	<b>Ref. No.</b>	982019
<b>description</b>	boiler ø 155mm L 405mm inlet ø 11		
<b>For models:</b>	2312-009-CRP, 914628, 914944, RIVER-50-CRP, RIVER-50-CRP-SP, RIVER-54CRP, River-54-CRP-s.p., RIVER-54-CRP-SP		

			
1			
<b>GEV No.</b>	518111	<b>Ref. No.</b>	80582
<b>description</b>	boiler ø 190mm L 425mm		



			
1			
<b>GEV No.</b>	517455	<b>Ref. No.</b>	41230
<b>description</b>	boiler ø 210mm L 405mm		
<b>For models:</b>	U132E, U70E		

			
1			
<b>GEV No.</b>	698808	<b>Ref. No.</b>	43550
<b>description</b>	boiler ø 210mm L 500mm		
<b>For models:</b>	RIVER-298, RV298, RV298HZ		

			
1			
<b>GEV No.</b>	518588	<b>Ref. No.</b>	104039 999244
<b>description</b>	boiler with heating element 2600W 230V ø 110mm L 295mm		
<b>For models:</b>	E.35, E.40		
<b>spare parts for</b>	518588		
	<b>GEV No.</b>	513709	<b>Ref. No.</b>
			104056
	boiler ø 110mm L 295mm		

			
1			
<b>GEV No.</b>	518098	<b>Ref. No.</b>	104043.SO 104044.SO 104906
<b>description</b>	boiler with safety thermostat 2600W 230V ø 110mm L 295mm W 110mm H 115mm connection 11mm hose ø 6mm with thermostat inlet ø 11mm		
<b>For models:</b>	913289, 913290, 913356, 913372, 913373, 913544, 913665, 913667, 913771, 913772, 913832, 913837, 914386, 914387, 914388, 914389, 914390, 914391, 914692, 914693, 914694, 914703, 914870, E.35, E.35-Elettrobar, E.35H, E.35H-Elettrobar, E.40, E.40H, MC201CL, MINIBAR, MISTRAL-40, NIAGARA-35, NIAGARA-40, S280		
<b>spare parts for</b>	518098		
	<b>GEV No.</b>	390233	<b>Ref. No.</b> 236039 926189
	bi-metal safety thermostat hole distance 24mm switch-off temp. 110°C 1NC 1-pole 16A connection F6.3 2 hole fixing without holder		
	<b>GEV No.</b>	390319	<b>Ref. No.</b> 236048
	bi-metal thermostat hole distance 23.8mm switch-off temp. 80°C 1NC 1-pole 16A connection F6.3 2 hole fixing		
	<b>GEV No.</b>	418642	<b>Ref. No.</b> 230113
	heating element 2600W 230V mounting ø 38.5mm heating circuits 1 L 260mm W 33mm H 24mm number of thermostat sleeves 1 thermostat sleeves ø 7mm length thermostat sleeves 175mm thermostat sleeve eccentric, non clinging tube ø 6.5mm hole distance 57mm 3 hole flange connection male faston 6.3mm immersion heater		
	<b>GEV No.</b>	521120	<b>Ref. No.</b> 456075
	O-ring EPDM thickness 5.34mm ID ø 37.47mm Qty 1 pcs		

accessories

			
1			
<b>GEV No.</b>	511459	<b>Ref. No.</b>	468027
<b>description</b>	connecting fitting for boiler		
<b>For models:</b>	S621, S623, S624, S626, S631, S633, S634, S636		
<b>accessories for</b>	511459		
	<b>GEV No.</b>	511460	<b>Ref. No.</b> 468003
	connecting fitting for boiler		

			
1			
<b>GEV No.</b>	511460	<b>Ref. No.</b>	468003
<b>description</b>	connecting fitting for boiler		

			
1			
<b>GEV No.</b>	518348	<b>Ref. No.</b>	468117
<b>description</b>	hose connector		
<b>For models:</b>	050F, 050FP, 10, 12, 14, 21F, 21FD, 21R, 21RD, 22F, 22R, 25F, 25FD, 25R, 25RD, 30F, 30FD, 30R, 30RD, 31F, 31FD, 31R, 31RD, 40F, 44F, 46, 460, 500F, 500FD, 50-ELECTRONIC, 50F, 50FD, 510F, 510FD, 66, CLEAN-100, CLEAN-110, CLEAN-3, E.46, E.50, E.51, E.52, E.60, E.65, E1, E10, E100, E110, E12...(Other models you can see in the webshop)		

			
1			
<b>GEV No.</b>	507451	<b>Ref. No.</b>	926027
<b>description</b>	insulating mat for boiler L 455mm W 405mm thickness 6mm		
<b>For models:</b>	10, CLEAN-100, CLEAN-110, E.60, E1, E10, E100, E110		

			
1			
<b>GEV No.</b>	517799	<b>Ref. No.</b>	143228
<b>description</b>	pipe for boiler ø 9mm L 245mm		
<b>For models:</b>	913289, 913290, 913291, 913292, 913356, 913357, 913363, 913364, 913372, 913373, 913374, 913375, 913376, 913377, 913416, 913418, 913435, 913544, 913545, 913665, 913666, 913667, 913668, 913685, 913771, 913772, 913773, 913774, 913832, 913837, 913911, 913912, 913948, 913950, 913977, 913984, 913990, 914165, 914166, 914167, 914168, 914206, 914214, 914316, 914317, 914355, 914386, 914387, 914388, 914389...(Other models you can see in the webshop)		

gaskets

			
1			
<b>GEV No.</b>	698804	<b>Ref. No.</b>	70540
<b>description</b>	gasket L 534mm W 108mm thickness 2.5mm		
<b>For models:</b>	River-285, River-382LNRG, River-382NRG, River-382NRG-230-3Ph-50Hz, RV282R, RV382LR, RV382LTXR, RV382R, RV382R23TERMO, RV382RFUR, RV382TXR		

			
1			
<b>GEV No.</b>	698802	<b>Ref. No.</b>	35510
<b>description</b>	gasket L 65mm W 10mm H 4mm thickness 4mm		
<b>For models:</b>	LP60, NG271, NG291, NIAGARA-271, NIAGARA-291, RIVER-294, RIVER-71, RV294, RV71, U60E		

rotation plates

			
1			
<b>GEV No.</b>	516264	<b>Ref. No.</b>	319003
<b>description</b>	rotation plate ø 350mm grey seat ø 21.7mm		
<b>For models:</b>	350R, 350RD, 35-ELECTRONIC, 35R, 35RD		



rotation plate bearings



<b>GEV No.</b>	519423	<b>Ref. No.</b>	322004
<b>description</b>	spindle for rotation plate		
<b>For models:</b>	21R, 21RD, 25R, 25RD, 30R, 30RD, 31R, 31RD, S624, S626, S634, S636		



<b>GEV No.</b>	519425	<b>Ref. No.</b>	322005
<b>description</b>	spindle for rotation plate		
<b>For models:</b>	22R, S651, S654, S655, S815, S835		



<b>GEV No.</b>	519426	<b>Ref. No.</b>	322006
<b>description</b>	spindle for rotation plate		
<b>For models:</b>	11R, 11RD		



<b>GEV No.</b>	519427	<b>Ref. No.</b>	322007
<b>description</b>	spindle for rotation plate		
<b>For models:</b>	350R, 350RD, 35-ELECTRONIC, 35R, 35RD, 400R, 400RD, 40-ELECTRONIC, 40R, 40RD, 67R, E.42		

softener cartridges  
softening columns



<b>GEV No.</b>	530000	<b>Ref. No.</b>	117001
<b>description</b>	softener 4-fold L 380mm W 180mm		



<b>GEV No.</b>	530395	<b>Ref. No.</b>	117007
<b>description</b>	softener 4-fold L 380mm W 180mm		
<b>For models:</b>	915150, 915151, 915152, 915160, 915161, 915162, 915166, 915167, 915168, 915175, 915319, 915348, 915418, 915419, 915420, 915421, 915479, 915483, 915484, 915537, 915538, 915539, 915540, 915547, 915558, 915611, 915612, 915613, 915614, 915615, 915616, 915635, 915663, 915664, 915670, 915671, 915686, 915687, 915688, 915689, 915690, 915691, 915692, 915693, 915694, 915695, 915696, 915697, 915698, 915699...(Other models you can see in the webshop)		



<b>GEV No.</b>	524534	<b>Ref. No.</b>	117006
<b>description</b>	softener 6-fold L 380mm W 260mm		
<b>For models:</b>	915150, 915151, 915152, 915160, 915161, 915162, 915166, 915167, 915168, 915175, 915176, 915177, 915319, 915338, 915341, 915348, 915418, 915419, 915420, 915421, 915479, 915547, 915558, 915635, 915663, 915747, NIAGARA-251, NIAGARA-261, PLUVIA-260, Pluvia-270		

complete



<b>GEV No.</b>	518640	<b>Ref. No.</b>	117008
<b>description</b>	softener type Eledro 425		
<b>For models:</b>	915154, 915155, 915157, 915158, 915172, 915173, 915422, 915492, 915493, 915494, 915495, 915496, 915497, 915617, 915618, 916054, 916066, 916067, 916068, 916069, 916077, 916078, 916079, 916080, 916368, 916418, 916419, 916420, 916421, 916422, 916423, 916424, 916594, 916595, 916686, 916760, River-242, River-242-2, River-242-2T, River-252, River-252-2, River-252-2T, River-253, River-262, River-262-2, River-262-2T, River-272, River-282LS-2TDE, River-282S-2TDE, River-342C...(Other models you can see in the webshop)		

spare parts and accessories



<b>GEV No.</b>	699348	<b>Ref. No.</b>	480084
<b>description</b>	plug rubber D1 ø 35mm mounting ø 23.5mm		
<b>For models:</b>	913418, 914167, 914168, 914398, 914399, 914443, 914943, E.45, NIAGARA-45		

## housing and bezels

### fascias



1

<b>GEV No.</b>	518581	<b>Ref. No.</b>	480099
<b>description</b>	end cap for control panel mounting pos. left		
<b>For models:</b>	2312-001, 2312-002, E.46, E.50, E.51, E.52, MISTRAL-51, NIAGARA-51		



1

<b>GEV No.</b>	518582	<b>Ref. No.</b>	480100
<b>description</b>	end cap for control panel mounting pos. right		
<b>For models:</b>	2312-001, 2312-002, E.46, E.50, E.51, E.52, MISTRAL-51, NIAGARA-51		

### flanges



1

<b>GEV No.</b>	699252	<b>Ref. No.</b>	75057
<b>description</b>	flange H 40mm ø 130mm mounting pos. lower		
<b>For models:</b>	914380, 914436, A3EBD, A3EBDAKWK, A3EBDBKWK, A3EBDVK, A3EBDYK, A3EBSAK, A3EBSAKWK, A3EBSBKWKYK, A3EBSWK, A4EBD, A4EBS, A4EBSAKRK, A4EBSAKYK, A4EBSCK, A5EBD, A5EBDAKPKWK, A5EBDAKWK, A5EBS, A5EBSAKPKWK, A5EBSYK, FAST-200, GL280EB, GL280EBD, GL280EBDA, GL280EBDAE, GL280EBDAR, GL280EBDAWY, GL280EBDBW, GL280EBDY, GL280EBS, GL280EBSY, GL282EB, GL282EBCH, GL282EBCHD, GL282EBD, GL282EBDAE, GL282EBDAR, GL284EBD, GL284EBDAWY, GL284EBS, GL284EBSAR, GL286EBD, GL286EBDARY, GL286EBS, GL286EBSAW, NIAGARA-2150, NIAGARA-2152, NIAGARA-2154...(Other models you can see in the webshop)		



1

<b>GEV No.</b>	699251	<b>Ref. No.</b>	75141
<b>description</b>	flange H 65mm ø 130mm mounting pos. upper		
<b>For models:</b>	914380, 914436, A3EBD, A3EBDAKWK, A3EBDBKWK, A3EBDVK, A3EBDYK, A3EBSAK, A3EBSAKWK, A3EBSBKWKYK, A3EBSWK, A4EBD, A4EBS, A4EBSAKRK, A4EBSAKYK, A4EBSCK, A5EBD, A5EBDAKPKWK, A5EBDAKWK, A5EBS, A5EBSAKPKWK, A5EBSYK, FAST-200, GL280EB, GL280EBD, GL280EBDA, GL280EBDAE, GL280EBDAR, GL280EBDAWY, GL280EBDBW, GL280EBDY, GL280EBS, GL280EBSY, GL282EB, GL282EBCH, GL282EBCHD, GL282EBD, GL282EBDAE, GL282EBDAR, GL284EBD, GL284EBDAWY, GL284EBS, GL284EBSAR, GL286EBD, GL286EBDARY, GL286EBS, GL286EBSAW, NIAGARA-2150, NIAGARA-2152, NIAGARA-2154...(Other models you can see in the webshop)		



1

<b>GEV No.</b>	699345	<b>Ref. No.</b>	K75057
<b>description</b>	flange with ring gasket H 35mm ø 130mm		
<b>For models:</b>	A3EB, A3EBDAKRYK, A3EBDRKYK, A3EBSAKRK, A3EBSEKWK, A4EB, A4EBDAKEKYK, A4EBDAKWK, A4EBDAKZK, A4EBDBKWK, A4EBDPKWKYK, A4EBDRK, A4EBSAK, A4EBSAKCK, A4EBSAKEKYK, A4EBSAKRKPK, A4EBT, A4EBTSK, A5EB, A5EBDAKYK, A5EBDRK, A5EBSAKRK, A5EBSAKRYK, A5EBSAKWK, A5EBSAKWKYK, A5EBSBKRPK, A5EBSBKWK, A5EBSRK, Fast200, Fast93, GL280EB, GL280EB23, GL280EB23DAR, GL280EB23HZ, GL280EB23HZDY, GL280EBDARY, GL280EBDAW, GL280EBDAY, GL280EBDB, GL280EBDBR, GL280EBDWY, GL280EBSA, GL280EBSAE, GL280EBSAEW, GL280EBSAEWY, GL280EBSAR, GL280EBSARY, GL280EBSAW, GL280EBSAWY...(Other models you can see in the webshop)		



1

<b>GEV No.</b>	699346	<b>Ref. No.</b>	K75141
<b>description</b>	flange with ring gasket H 35mm ø 130mm mounting pos. upper M6		
<b>For models:</b>	A3EB, A3EBDAKRYK, A3EBDRKYK, A3EBSAKRK, A3EBSEKWK, A4EB, A4EBDAKEKYK, A4EBDAKWK, A4EBDAKZK, A4EBDBKWK, A4EBDPKWKYK, A4EBDRK, A4EBSAK, A4EBSAKCK, A4EBSAKEKYK, A4EBSAKRKPK, A4EBT, A4EBTSK, A5EB, A5EBDAKYK, A5EBDRK, A5EBSAKRK, A5EBSAKRYK, A5EBSAKWK, A5EBSAKWKYK, A5EBSBKRPK, A5EBSBKWK, A5EBSRK, Fast200, Fast93, GL280EB, GL280EB23, GL280EB23DAR, GL280EB23HZ, GL280EB23HZDY, GL280EBDARY, GL280EBDAW, GL280EBDAY, GL280EBDB, GL280EBDBR, GL280EBDWY, GL280EBSA, GL280EBSAE, GL280EBSAEW, GL280EBSAEWY, GL280EBSAR, GL280EBSARY, GL280EBSAW, GL280EBSAWY...(Other models you can see in the webshop)		





trapdoors



1

<b>GEV No.</b>	518542	<b>Ref. No.</b>	029096
<b>description</b>	door		
<b>For models:</b>	11F, 11FD, 11F-DVGW, 11R, 11RD, 913363, 913364, 913376, 913377, 913992, 913993, CLEAN-3, E.41, E.42, E41, RIVER-40, RIVER-43		



1

<b>GEV No.</b>	518543	<b>Ref. No.</b>	029032
<b>description</b>	door		
<b>For models:</b>	22F, 22R, 40F, 440F, 44F, E.52, S651, S654, S810, S815, S830, S835		

miscellaneous



1

<b>GEV No.</b>	513304	<b>Ref. No.</b>	70549
<b>description</b>	duct ID ø 17mm ED ø 24mm		
<b>For models:</b>	River-285, River-382LNRG, River-382NRG, River-382NRG-230-3Ph-50Hz, RV282R, RV382LR, RV382LTXR, RV382R, RV382R23TERMO, RV382RFUR, RV382TXR		



1

<b>GEV No.</b>	513000	<b>Ref. No.</b>	480057
<b>description</b>	lid rubber ED ø 27mm		
<b>For models:</b>	050F, 050FP, 11F, 11FD, 11R, 11RD, 12, 14, 22F, 22R, 2312-001, 2312-002, 350F, 350FD, 350R, 350RD, 35F, 35FD, 35R, 35RD, 400F, 400FD, 400R, 400RD, 40F, 40FD, 40R, 40RD, 440F, 44F, 500F, 500FD, 50F, 50FD, 510F, 510FD, 913297, 913298, 913299, 913300, 913360, 913361, 913391, 913392, 913418, 913546, 913547, 913578, 913611, 913684... (Other models you can see in the webshop)		



1

<b>GEV No.</b>	513708	<b>Ref. No.</b>	480058
<b>description</b>	lid rubber ø 17mm mounting ø 17mm		
<b>For models:</b>	11F, 11FD, 11R, 11RD, 22F, 2312-001, 2312-002, 350F, 350FD, 350R, 350RD, 35F, 35FD, 35R, 35RD, 400F, 400FD, 400R, 400RD, 40F, 40FD, 40R, 40RD, 440F, 44F, 45, 450, 46, 460, 500F, 500FD, 50F, 50FD, 510F, 510FD, 66, 913297, 913298, 913299, 913300, 913360, 913361, 913391, 913392, 913546, 913547, 913578, 913611, 913684, 913913... (Other models you can see in the webshop)		

gearboxes



1

<b>GEV No.</b>	518634	<b>Ref. No.</b>	927102
<b>description</b>	gearbox motor shaft ø 14mm flange ø 160mm drive shaft ø 25mm type VF49A60		
<b>For models:</b>	161, 221, 271, 914380, 914436, CLEAN-160, CLEAN-161, CLEAN-220, CLEAN-221, GL280EB, GL280EB23, GL280EB23DAR, GL280EB23HZ, GL280EB23HZDY, GL280EBD, GL280EBDA, GL280EBDAE, GL280EBDAR, GL280EBDARY, GL280EBDAW, GL280EBDAWY, GL280EBDAY, GL280EBDB, GL280EBDBR, GL280EBDBW, GL280EBDWY, GL280EBDY, GL280EBS, GL280EBSA, GL280EBSAE, GL280EBSAEW, GL280EBSAEWY, GL280EBSAR, GL280EBSARY, GL280EBSAW, GL280EBSAWY, GL280EBSAY, GL280EBSB, GL280EBSR, GL280EBSWY, GL280EBSY, GL282EB, GL282EBD, GL282EBDA, GL282EBDAE, GL282EBDAR, GL282EBDARW, GL282EBDAWY, GL282EBDBW, GL282EBDCWY... (Other models you can see in the webshop)		



1

<b>GEV No.</b>	699357	<b>Ref. No.</b>	65921
<b>description</b>	gearbox motor shaft ø 14mm flange ø 160mm transmission 1/30 drive shaft ø 25mm type SW 050		

hood mechanics for dishwashers

bolts



1			
<b>GEV No.</b>	513200	<b>Ref. No.</b>	80131
<b>description</b>	screw bolt hood mechanics		
<b>For models:</b>	80, 81, 82, CGL74CABT, River-80, RIVER-81, River-81CRP, RIVER-81-CRP, RIVER-82, River-82CRP, RIVER-82-CRP, RIVER-HL-81, RIVER-HL-82, RV80, RV8023, RV8023HZ, RV80C, RV80HZ, RV81, RV8123, RV81A, RV81C, RV81CCRP, RV81CRP, RV81HZ, RV81HZ23, RV81PAP, RV82, RV8223, RV82C, RV82CCRP, RV82CRP, SevenL		

spring holders



1			
<b>GEV No.</b>	513117	<b>Ref. No.</b>	DAG31
<b>description</b>	spring holder		



1			
<b>GEV No.</b>	513205	<b>Ref. No.</b>	926004
<b>description</b>	spring holder hood mechanics		
<b>For models:</b>	10, 12, 14, CLEAN-100, CLEAN-110, CLEAN-120, E1, E10, E100, E110, E12, E120, E14, E140		

springs



1			
<b>GEV No.</b>	513118	<b>Ref. No.</b>	CMT520
<b>description</b>	spring		



1			
<b>GEV No.</b>	517448	<b>Ref. No.</b>	926108
<b>description</b>	tension spring $\phi$ 30mm total length 505mm wire gauge $\phi$ 5.5mm for hood mechanics Qty 1 pcs		
<b>For models:</b>	80, 81, 82, CGL74CABT, NG281, NG281CDD, NG281HP, NG281HPDD, NG281HZ23, NG281HZ23DD, NG381, NG38123, NG38123TERMO, NG381C, NG381CDD, NG381CFUR, NG381DDHZ23, NG381DDPS, NG381DDPSHZ23, NG381HPDD, NG381L, NG381LC, NG381LCFUR, NG381LDDPS, NG381TERMO, NG381TXCDD, NIAGARA-281, Niagara-281-2, Niagara-281HP, NIAGARA-283, Niagara-283L-2, Niagara-381, Niagara-381-230V-3Ph-50Hz, Niagara-381-230V-3Ph-60Hz, Niagara-381DP, Niagara-381HPD, Niagara-381L, Niagara-381LC, OC380, OC380FUR, OC380HZ23, Ocean380, RIVER-282, River-282-2, River-282L-2, River-282LS-2TDE, River-282S-2TDE, River-285, River-382, River-382-230V-3Ph-50Hz...(Other models you can see in the webshop)		

guide bars



1			
<b>GEV No.</b>	513724	<b>Ref. No.</b>	80068 80069
<b>description</b>	guide bar L 590mm hood mechanics		
<b>For models:</b>	80, 81, 82, CE78HZ23, CGL74CABT, CNT800CH, E78, E78HP, Fast180, Fast180-230V-3Ph-60Hz, Fast181, FAST-181, Fast181-230V-3Ph-60Hz, Fast181-400V-3NPh-60Hz, FAST-60, FAST-73, HM1, NG281, NG281CDD, NG281HP, NG281HPDD, NG281HZ23, NG281HZ23DD, Niagara-281, Niagara-281-2, Niagara-281HP, NIAGARA-283, Niagara-283A, OC380, OC380FUR, OC380HZ23, Ocean380, PLUVIA-280, Pluvia280-230V-3Ph-60Hz, PS-60, PV280, PV280FAST, PV280FAST2, PV280FAST2BIO, PV280FAST2HZ23, PV280FASTCH, PV280FASTHB, PV280HZ23, RIVER-282, River-285, RIVER-78, RIVER-80, RIVER-81, River-81CRP, RIVER-81-CRP...(Other models you can see in the webshop)		



1			
<b>GEV No.</b>	698740	<b>Ref. No.</b>	K70365
<b>description</b>	guide bar L 685mm W 28mm H 28mm with sealing strip		
<b>For models:</b>	NG381, NG38123, NG38123TERMO, NG381C, NG381CDD, NG381CFUR, NG381DDHZ23, NG381DDPS, NG381DDPSHZ23, NG381HPDD, NG381L, NG381LC, NG381LCFUR, NG381LDDPS, NG381TERMO, NG381TXCDD, Niagara-283L-2, Niagara-381, Niagara-381-230V-3Ph-50Hz, Niagara-381-230V-3Ph-60Hz, Niagara-381DP, Niagara-381HPD, Niagara-381L, Niagara-381LC, River-282-2, River-282L-2, River-282LS-2TDE, River-282S-2TDE, River-285, River-382, River-382-230V-3Ph-50Hz, River-382H, River-382L, River-382L-230V-3Ph-50Hz, River-382LNRG, River-382LTDE, River-382NRG, River-382NRG-230-3Ph-50Hz, River-382TDE, RV382, RV38223TERMO, RV382AHP, RV382FUR, RV382L, RV382L23TERMO, RV382LFUR, RV382LR, RV382LS, RV382LSFUR, RV382LTX...(Other models you can see in the webshop)		



1			
<b>GEV No.</b>	698739	<b>Ref. No.</b>	70065
<b>description</b>	guide bar L 685mm W 28mm H 28mm without gasket		
<b>For models:</b>	River-482, RV482		



1			
<b>GEV No.</b>	698803	<b>Ref. No.</b>	41038
<b>description</b>	sliding rail L 458mm mounting pos. rear W 21mm H 20mm		
<b>For models:</b>	KLP105EB, KLP201DDDTBE, KLP201EB, KLP301, KLP301DDDTBE, LP105DDDTBE, LP105DDDTBE, LP105EB, LP201DDDTBE, LP201EB, LP301, LP301EB, NG292, NG292HZ, NG293, NIAGARA-292, Niagara-292-400V-3Ph-60Hz, NIAGARA-293, RIVER-295, River-295P, RV295, RV295PS, U132e, U61E, U61HE, U70e		



## hood handles

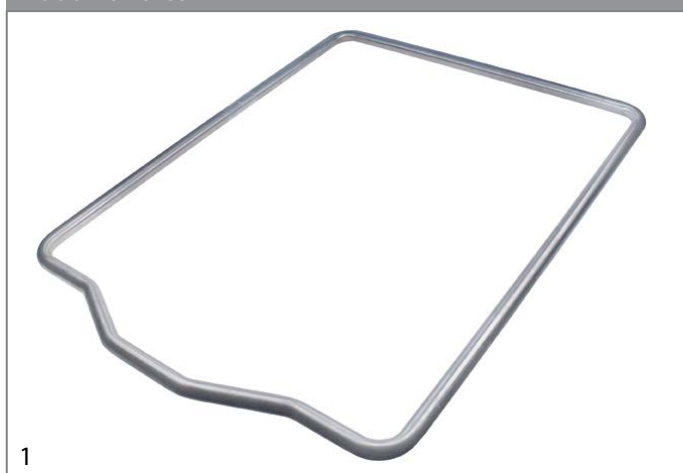

1	<b>GEV No.</b>	513719	<b>Ref. No.</b>	80027
<b>description</b> hood handle				
<b>For models:</b> 80, 81, 82, CE78HZ23, CGL74CABT, CNT800CH, E78, E78HP, Fast180, Fast180-230V-3Ph-60Hz, Fast181, FAST-181, Fast181-230V-3Ph-60Hz, Fast181-400V-3NPh-60Hz, FAST-60, FAST-73, HM1, NG281, NG281HP, NG281HPDD, NG281HZ23, NG281HZ23DD, NIAGARA-281, Niagara-281-2, Niagara-281HP, Niagara-283A, OC380, OC380FUR, OC380HZ23, Ocean380, PLUVIA-280, Pluvia280-230V-3PH-60HZ, PS-60, PV280, PV280FAST, PV280FAST2, PV280FAST2BIO, PV-280FAST2HZ23, PV280FASTCH, PV280FASTHB, PV280HZ23, RIVER-78, RIVER-80, River-81, River-81CRP, RIVER-81-CRP, RIVER-82, River-82CRP, RIVER-82-CRP, RIVER-E78...(Other models you can see in the webshop)				

## hood handle supports



1	<b>GEV No.</b>	513202	<b>Ref. No.</b>	80190
<b>description</b> bearing for hood handle plastic				
<b>For models:</b> 80, 81, 82, CE78HZ23, CGL74CABT, CNT800CH, E78, E78HP, Fast180, Fast180-230V-3Ph-60Hz, Fast181, FAST-181, Fast181-230V-3Ph-60Hz, Fast181-400V-3NPh-60Hz, FAST-60, FAST-73, HM1, NG281, NG281CDD, NG281HP, NG281HPDD, NG281HZ23, NG281HZ23DD, Niagara-281, Niagara-281-2, Niagara-281HP, NIAGARA-283, Niagara-283A, OC380, OC380FUR, OC380HZ23, Ocean380, PLUVIA-280, Pluvia280-230V-3PH-60HZ, PS-60, PV280, PV280FAST, PV280FAST2, PV280FAST2BIO, PV280FAST2HZ23, PV280FASTCH, PV280FASTHB, PV280HZ23, RIVER-282, River-285, RIVER-78, RIVER-80, River-81, River-81CRP, RIVER-81-CRP...(Other models you can see in the webshop)				



1	<b>GEV No.</b>	698795	<b>Ref. No.</b>	70192
<b>description</b> guide for hood mechanics mounting pos. rear L 66mm W 38mm H 20mm				
<b>For models:</b> NG381, NG38123, NG38123TERMO, NG381C, NG381CDD, NG381CFUR, NG381DDHZ23, NG381DDPS, NG381DDPSHZ23, NG381HPDD, NG381L, NG381LC, NG381LCFUR, NG381LDDPS, NG381TERMO, NG381TXCDD, Niagara-283L-2, Niagara-381, Niagara-381-230V-3Ph-50Hz, Niagara-381-230V-3Ph-60Hz, Niagara-381DP, Niagara-381HPD, Niagara-381L, Niagara-381LC, River-282-2, River-282L-2, River-282LS-2TDE, River-282S-2TDE, River-285, River-382, River-382-230V-3Ph-50Hz, River-382H, River-382L, River-382L-230V-3Ph-50Hz, River-382LNRG, River-382LTDE, River-382NRG, River-382NRG-230-3Ph-50Hz, River-382TDE, River-482, RV382, RV38223TERMO, RV382AHP, RV382FUR, RV382L, RV382L23TERMO, RV382LFUR, RV382LR, RV382LS, RV382LSFUR...(Other models you can see in the webshop)				



1	<b>GEV No.</b>	513192	<b>Ref. No.</b>	926243
<b>description</b> guide for hood handle				
<b>For models:</b> CE78HZ23, E78, E78HP, HM1, PS-60, RIVER-78, RIVER-E78				



1	<b>GEV No.</b>	513116	<b>Ref. No.</b>	DWD2X
<b>description</b> connecting piece hood mechanics				

## rollers

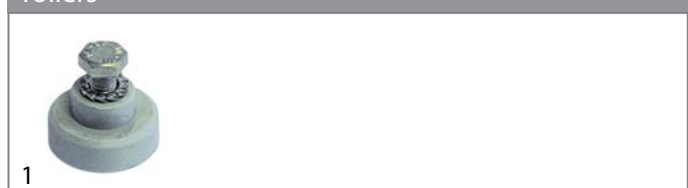

1	<b>GEV No.</b>	510067	<b>Ref. No.</b>	999073
<b>description</b> roller				



1	<b>GEV No.</b>	518539	<b>Ref. No.</b>	926006
<b>description</b> roller hood mechanics complete				
<b>For models:</b> 10, CLEAN-100, CLEAN-110, CLEAN-120, E1, E10, E100, E110, E12, E120, E14, E140				



1	<b>GEV No.</b>	698741	<b>Ref. No.</b>	499098
<b>description</b> roller ø 34.7mm H 5mm for cable				
<b>For models:</b> 915617, 915618, 915672, 915773, 915774, 916066, 916077, 916078, 916418, 916419, 916594, 916595, River-242, River-242-2, River-242-2T, River-342C, River-342T				



1	<b>GEV No.</b>	513201	<b>Ref. No.</b>	80132
<b>description</b> roller ø 36/42mm H 34mm hood mechanics plastic grey hole ø 12mm				
<b>For models:</b> CGL74CABT, SevenL				



1

<b>GEV No.</b>	501335	<b>Ref. No.</b>	80132B
<b>description</b>	roller $\phi$ 42mm H 35mm for hood handle blue		
<b>For models:</b>	80, 81, 82, RIVER-80, River-81, RIVER-81-CRP, RIVER-82, RIVER-82-CRP, RIVER-HL-81, RIVER-HL-82, RV80, RV8023, RV8023HZ, RV80C, RV80HZ, RV81, RV8123, RV81A, RV81C, RV81HZ, RV81HZ23, RV81PAP, RV82, RV8223, RV82C		

screws for spring compressor



1

<b>GEV No.</b>	518540	<b>Ref. No.</b>	927273
<b>description</b>	screw for spring compressor hood mechanics		
<b>For models:</b>	CLEAN-161, CLEAN-221, CLEAN-271, CLEAN-272, CLEAN-362, E100, E110, E120, E140		

cable controls



1

<b>GEV No.</b>	698742	<b>Ref. No.</b>	399020
<b>description</b>	cable control L 60.5mm wire gauge $\phi$ 1.6mm for cover		
<b>For models:</b>	915617, 915618, 915672, 915773, 915774, 916066, 916077, 916078, 916418, 916419, 916594, 916595, River-242, River-242-2, River-242-2T, River-342C, River-342T		

miscellaneous



1

<b>GEV No.</b>	501336	<b>Ref. No.</b>	80130B
<b>description</b>	base for hood rod blue		
<b>For models:</b>	80, 81, 82, RIVER-80, River-81, River-81CRP, RIVER-81-CRP, RIVER-82, River-82CRP, RIVER-82-CRP, RIVER-HL-81, RIVER-HL-82, RV80, RV8023, RV8023HZ, RV80C, RV80HZ, RV81, RV8123, RV81A, RV81C, RV81CCRP, RV81CRP, RV81HZ, RV81HZ23, RV81PAP, RV82, RV8223, RV82C, RV82CCRP, RV82CRP		



1

<b>GEV No.</b>	513198	<b>Ref. No.</b>	80130
<b>description</b>	base for roller ED $\phi$ 64mm ID $\phi$ 8.5mm hood mechanics grey		
<b>For models:</b>	CGL74CABT, SevenL		



1

<b>GEV No.</b>	698811	<b>Ref. No.</b>	41100
<b>description</b>	door bumper ED $\phi$ 20mm H 20mm		
<b>For models:</b>	NG292HZ, Niagara-292-400V-3Ph-60Hz, River-295P, River-296P, RV295PS, RV296PS		



1

<b>GEV No.</b>	508375	<b>Ref. No.</b>	80105
<b>description</b>	fixing support		
<b>For models:</b>	80, 81, 82, CE78HZ23, CGL74CABT, CNT800CH, E78, E78HP, Fast180, Fast180-230V-3Ph-60Hz, Fast181, FAST-181, Fast181-230V-3Ph-60Hz, Fast181-400V-3NPh-60Hz, FAST-60, FAST-73, HM1, LP60, NG271, NG281, NG281CDD, NG281HP, NG281HPDD, NG281HZ23, NG281HZ23DD, NG291, NIAGARA-271, NIAGARA-281, Niagara-281-2, Niagara-281HP, NIAGARA-283, Niagara-283A, NIAGARA-291, OC380, OC380FUR, OC380HZ23, Ocean380, PLUVIA-280, Pluvia280-230V-3Ph-60Hz, PS-60, PV280, PV280FAST, PV280FAST2, PV280FAST2BIO, PV280FAST2HZ23, PV280FASTCH, PV280FASTHB, PV280HZ23, RIVER-282, River-285...(Other models you can see in the webshop)		



1

<b>GEV No.</b>	518537	<b>Ref. No.</b>	926003
<b>description</b>	handle holder hood mechanics		
<b>For models:</b>	10, 12, 14, CLEAN-100, CLEAN-110, CLEAN-120, E1, E10, E100, E110, E12, E120, E14, E140		



			
1			
<b>GEV No.</b>	513274	<b>Ref. No.</b>	80998
<b>description</b>	hexagonal screw thread M4 plastic WS 7 thread L 6mm		
<b>For models:</b>	80, 81, 82, CE78HZ23, CGL74CABT, CNT800CH, E78, E78HP, Fast180, Fast180-230V-3Ph-60Hz, Fast181, FAST-181, Fast181-230V-3Ph-60Hz, Fast181-400V-3NPh-60Hz, FAST-60, FAST-73, HM1, NG281, NG281CDD, NG281HP, NG281HPDD, NG281HZ23, NG281HZ23DD, Niagara-281, Niagara-281-2, Niagara-281HP, NIAGARA-283, Niagara-283A, OC380, OC380FUR, OC380HZ23, Ocean380, PLUVIA-280, Pluvia280-230V-3PH-60HZ, PS-60, PV280, PV280FAST, PV280FAST2, PV280FAST2BIO, PV280FAST2HZ23, PV280FASTCH, PV280FASTHB, PV280HZ23, RIVER-282, River-285, RIVER-78, RIVER-80, River-81, River-81CRP, RIVER-81-CRP...(Other models you can see in the webshop)		

			
1			
<b>GEV No.</b>	518538	<b>Ref. No.</b>	926002
<b>description</b>	opposite support hood mechanics		
<b>For models:</b>	10, 12, 14, CLEAN-100, CLEAN-110, CLEAN-120, E1, E10, E100, E110, E12, E120, E14, E140		

## basket guides

### guide bars

			
1			
<b>GEV No.</b>	530558	<b>Ref. No.</b>	015039
<b>description</b>	guide bar mounting pos. left L 422mm W 43mm H 39mm		
<b>For models:</b>	400F, 400FD, 400R, 400RD, 40F, 40FD, 40R, 40RD, 67F, 67R, 913291, 913292, 913357, 913374, 913375, 913416, 913435, 913545, 913666, 913668, 913685, 913773, 913774, 913911, 913912, 913948, 913950, 913977, 913984, 913990, 914214, 914316, 914317, 914392, 914393, 914394, 914395, 914396, 914397, 914441, 914442, 914515, 914516, 914537, 914543, 914547, 914683, 914684, 914689, 914863...(Other models you can see in the webshop)		

## basket holders

			
1			
<b>GEV No.</b>	699347	<b>Ref. No.</b>	75076
<b>description</b>	buffer for basket transport L 25m ø 17.5mm		
<b>For models:</b>	914380, 914436, A3EB, A3EBD, A3EBDAKRKYK, A3EBDAKWK, A3EBDBKWK, A3EBDRKYK, A3EBDVK, A3EBDYK, A3EBSAK, A3EBSAKRK, A3EBSAKWK, A3EBSBKWKYK, A3EBSEKWK, A3EBSWK, A4EB, A4EBD, A4EBDAKEKYK, A4EBDAKRK, A4EBDAKWK, A4EBDAKZK, A4EBDBKRK, A4EBDPKWKYK, A4EBDRK, A4EBS, A4EBSAK, A4EBSAKCK, A4EBSAKEKYK, A4EBSAKRK, A4EBSAKRKP, A4EBSAKYK, A4EBSCK, A4EBT, A4EBTSAK, A5EB, A5EBD, A5EBDAKPKWK, A5EBDAKWK, A5EBDAKYK, A5EBDRK, A5EBS, A5EBSAKPKWK, A5EBSAKRK, A5EBSAKRKYK, A5EBSAKWK, A5EBSAKWKYK, A5EBSBKRKP, A5EBSBKWK, A5EBSRK...(Other models you can see in the webshop)		





			
1			
<b>GEV No.</b>	699344	<b>Ref. No.</b>	75058
<b>description</b>	roller for basket H 35mm ø 45mm		
<b>For models:</b>	914380, 914436, A3EB, A3EBD, A3EBDAKRKYK, A3EBDAKWK, A3EBDBKWK, A3EBDRKYK, A3EBDVK, A3EBDYK, A3EBSAK, A3EBSAKRK, A3EBSAKWK, A3EBSBKWKYK, A3EBSEKWK, A3EBSWK, A4EB, A4EBD, A4EBDAKEKYK, A4EBDAKRK, A4EBDAKWK, A4EBDAKZK, A4EBDBKRK, A4EBDPKWKYK, A4EBDRK, A4EBS, A4EBSAK, A4EBSAKCK, A4EBSAKEKYK, A4EBSAKRK, A4EBSAKRKP, A4EBSAKYK, A4EBSCK, A4EBT, A4EBTSAK, A5EB, A5EBD, A5EBDAKPKWK, A5EBDAKWK, A5EBDAKYK, A5EBDRK, A5EBS, A5EBSAKPKWK, A5EBSAKRK, A5EBSAKRKYK, A5EBSAKWK, A5EBSAKWKYK, A5EBSBKRKP, A5EBSBKWK, A5EBSRK...(Other models you can see in the webshop)		

## air traps

### air traps



			
1			
<b>GEV No.</b>	518229	<b>Ref. No.</b>	984006
<b>description</b>	air trap		





			
1			
<b>GEV No.</b>	518232	<b>Ref. No.</b>	107006
<b>description</b>	air trap		
<b>For models:</b>	CLEAN-3, RIVER-43		

			
1			
<b>GEV No.</b>	518487	<b>Ref. No.</b>	107002
<b>description</b>	air trap		
<b>For models:</b>	050F, 050FP, 31F, 31FD, 31R, 31RD, 500F, 500FD, 50F, 50FD, 510F, 510FD, E.52, F85, F85P		
<b>accessories for</b>	518487		
	<b>GEV No.</b>	505045	<b>Ref. No.</b> 456009
	O-ring EPDM thickness 1.78mm ID ø 5.28mm Qty 1 pcs		
	<b>GEV No.</b>	510016	<b>Ref. No.</b> 486002
	eye bolt for rinse aid container connection		
	<b>GEV No.</b>	510105	<b>Ref. No.</b> 468053
	hose connector for air trap		

			
1			
<b>GEV No.</b>	518488	<b>Ref. No.</b>	107005
<b>description</b>	air trap		
<b>For models:</b>	2312-001, 2312-002, 350F, 350FD, 350R, 350RD, 35F, 35FD, 35R, 35RD, 40F, 40FD, 40R, 40RD, 67F, 67R, 913289, 913290, 913291, 913292, 913297, 913298, 913299, 913300, 913356, 913357, 913360, 913361, 913363, 913364, 913372, 913373, 913374, 913375, 913376, 913377, 913391, 913392, 913416, 913418, 913435, 913544, 913545, 913546, 913547, 913578, 913611, 913665, 913666, 913667...(Other models you can see in the webshop)		
<b>accessories for</b>	518488		
	<b>GEV No.</b>	504618	<b>Ref. No.</b> 456026
	O-ring EPDM thickness 2.62mm ID ø 15.54mm Qty 1 pcs		
	<b>GEV No.</b>	510075	<b>Ref. No.</b> 437019
	flat gasket rubber ED ø 22mm ID ø 13mm thickness 1.5mm Qty 1 pcs		
	<b>GEV No.</b>	510106	<b>Ref. No.</b> 468029
	hose connector for air trap		

			
1			
<b>GEV No.</b>	518641	<b>Ref. No.</b>	984007
<b>description</b>	air trap complete ø 34mm H 70mm hose ø 6mm		
<b>For models:</b>	916020, 916021, 916024, 916025, 916026, 916027, 916030, 916031, 916045, 916247, 916248, 916249, 916250, 916251, 916252, 916382, 916383, 916452, 916504, 916584, 916654, 916670, 916688, 916763, 916921, 916922, 916992, 916993, 917044, 917049, Clean161, Fast145-2, Fast150, Fast160-2, Fast160C, Fast161-2, Ocean360, Ocean360M, Ocean360-UK		

			
1			
<b>GEV No.</b>	519499	<b>Ref. No.</b>	107012
<b>description</b>	air trap L 46mm W 35mm H 72mm thread 3/4" hose ø 5.5mm plastic		
<b>For models:</b>	2312-007, 913992, 913993, 914100, 914101, 914339, 914342, 914343, 914583, 914592, 914612, 914613, 914624, 914625, 914626, 914627, 914628, 914850, 914851, 914854, 914944, 915143, Fast181, FAST-181, Fast181-230V-3Ph-60Hz, Fast181-400V-3NPh-60Hz, NG271, NG291, NG292, NG292HZ, NG293, NG381, NG38123, NG38123TERMO, NG381C, NG381CDD, NG381CFUR, NG381DDHZ23, NG381DDPS, NG381DDPSHZ23, NG381HPDD, NG381L, NG381LC, NG381LCFUR, NG381LDDPS, NG381TERMO, NG381TXCDD, NIAGARA-271, NIAGARA-283, Niagara-283A...(Other models you can see in the webshop)		
<b>accessories for</b>	519499		
	<b>GEV No.</b>	516261	<b>Ref. No.</b> 437098
	flat gasket rubber ED ø 33mm ID ø 25mm thickness 2.5mm for air trap Qty 1 pcs		
	<b>GEV No.</b>	519498	<b>Ref. No.</b> 417120
	nut thread 3/4" H 10mm WS 30 plastic Qty 1 pcs		

			
1			
<b>GEV No.</b>	510103	<b>Ref. No.</b>	984001
<b>description</b>	air trap L 85mm W 20mm H 80mm hose ø 6mm plastic		
<b>For models:</b>	050F, 050FP, 11F, 11FD, 11F-DVGW, 11R, 11RD, 21F, 21FD, 21R, 21RD, 22F, 22R, 25F, 25FD, 25R, 25RD, 30F, 30FD, 30R, 30RD, 31F, 31FD, 31R, 31RD, 40F, 440F, 44F, 500F, 500FD, 50-ELECTRONIC, 50F, 50FD, 510F, 510FD, 66, E.52, F85, F85P, S621, S623, S624, S626, S631, S633, S634, S636, S651, S651P, S653...(Other models you can see in the webshop)		
<b>spare parts for</b>	510103		
	<b>GEV No.</b>	505045	<b>Ref. No.</b> 456009
	O-ring EPDM thickness 1.78mm ID ø 5.28mm Qty 1 pcs		
	<b>GEV No.</b>	505094	<b>Ref. No.</b> —
	air trap		
	<b>GEV No.</b>	510016	<b>Ref. No.</b> 486002
	eye bolt for rinse aid container connection		
	<b>GEV No.</b>	510105	<b>Ref. No.</b> 468053
	hose connector for air trap		





			
1			
<b>GEV No.</b>	510111	<b>Ref. No.</b>	984002
<b>description</b>	air trap ø 34mm H 130mm hose ø 6mm plastic		
<b>For models:</b>	R495, R499, R501, R503, R505, R507, R509, R511, R704, R706, R708, S641, S643, S870, S950		
<b>spare parts for</b>	510111		
	<b>GEV No.</b>	504618	<b>Ref. No.</b> 456026
	O-ring EPDM thickness 2.62mm ID ø 15.54mm Qty 1 pcs		



Table continues overleaf



<b>spare parts for</b> 510111			
	<b>GEV No.</b>	510075	<b>Ref. No.</b> 437019
flat gasket rubber ED ø 22mm ID ø 13mm thickness 1.5mm Qty 1 pcs			
	<b>GEV No.</b>	510106	<b>Ref. No.</b> 468029
hose connector for air trap			



<b>GEV No.</b>	518200	<b>Ref. No.</b>	984005
<b>description</b>	air trap ø 34mm H 78mm hose ø 6mm plastic		
<b>For models:</b>	10, 12, 14, 161, 221, 2312-001, 2312-002, 271, 272, 350F, 350FD, 350R, 350RD, 35-ELECTRONIC, 35F, 35FD, 35R, 35RD, 362, 400F, 400FD, 400R, 400RD, 40-ELECTRONIC, 40F, 40FD, 40R, 40RD, 45, 450, 46, 460, 67F, 67R, 80, 81, 82, 913289, 913290, 913291, 913292, 913297, 913298, 913299, 913300, 913356, 913357, 913360, 913361, 913363...(Other models you can see in the webshop)		

<b>spare parts for</b> 518200			
	<b>GEV No.</b>	504618	<b>Ref. No.</b> 456026
O-ring EPDM thickness 2.62mm ID ø 15.54mm Qty 1 pcs			
	<b>GEV No.</b>	510075	<b>Ref. No.</b> 437019
flat gasket rubber ED ø 22mm ID ø 13mm thickness 1.5mm Qty 1 pcs			
	<b>GEV No.</b>	510106	<b>Ref. No.</b> 468029
hose connector for air trap			



<b>GEV No.</b>	511959	<b>Ref. No.</b>	107014
<b>description</b>	air trap ø 42mm hose ø 6mm plastic		
<b>For models:</b>	915150, 915151, 915152, 915154, 915155, 915160, 915161, 915162, 915166, 915167, 915168, 915175, 915176, 915177, 915319, 915338, 915341, 915348, 915418, 915419, 915420, 915421, 915479, 915492, 915493, 915547, 915558, 915611, 915612, 915613, 915614, 915615, 915616, 915635, 915663, 915670, 915671, 915747, 915959, 916196, 916197, 916198, 916199, 916200, 916201, 916202, 916203, 916204, 916205, 916206...(Other models you can see in the webshop)		



<b>GEV No.</b>	511993	<b>Ref. No.</b>	107013
<b>description</b>	air trap ø 43mm H 33mm hose ø 6mm plastic		
<b>For models:</b>	915150, 915151, 915152, 915154, 915155, 915157, 915158, 915160, 915161, 915162, 915166, 915167, 915168, 915172, 915173, 915175, 915176, 915177, 915285, 915319, 915338, 915341, 915348, 915418, 915419, 915420, 915421, 915422, 915479, 915492, 915493, 915494, 915495, 915496, 915497, 915547, 915558, 915611, 915612, 915613, 915614, 915615, 915616, 915617, 915618, 915635, 915663, 915670, 915671, 915672...(Other models you can see in the webshop)		



<b>GEV No.</b>	524810	<b>Ref. No.</b>	144027 144032
<b>description</b>	air trap W 95mm H 150mm hose ø 6/8mm plastic		
<b>For models:</b>	915154, 915155, 915157, 915158, 915172, 915173, 915285, 915422, 915492, 915493, 915494, 915495, 915496, 915497, 915617, 915618, 915672, 915773, 915774, 916045, 916054, 916066, 916067, 916068, 916069, 916077, 916078, 916079, 916080, 916368, 916418, 916419, 916420, 916421, 916422, 916423, 916424, 916594, 916595, 916654, 916686, 916760, Fast160C, Ocean360-UK, River-242, River-242-2, River-242-2T, River-252, River-252-2, River-252-2T...(Other models you can see in the webshop)		

### air trap accessories



<b>GEV No.</b>	510075	<b>Ref. No.</b>	437019
<b>description</b>	flat gasket rubber ED ø 22mm ID ø 13mm thickness 1.5mm Qty 1 pcs		
<b>For models:</b>	10, 12, 14, 22F, 22R, 2312-001, 2312-002, 350F, 350FD, 350R, 350RD, 35-ELECTRONIC, 35F, 35FD, 35R, 35RD, 400F, 400FD, 400R, 400RD, 40-ELECTRONIC, 40F, 40FD, 40R, 40RD, 44F, 45, 450, 46, 460, 67F, 67R, 913289, 913290, 913291, 913292, 913297, 913298, 913299, 913300, 913356, 913357, 913360, 913361, 913363, 913364, 913372, 913373, 913374, 913375...(Other models you can see in the webshop)		



<b>GEV No.</b>	510105	<b>Ref. No.</b>	468053
<b>description</b>	hose connector for air trap		
<b>For models:</b>	050F, 050FP, 11F, 11FD, 11F-DVGW, 21F, 21FD, 21R, 21RD, 22F, 22R, 25F, 25FD, 25R, 25RD, 30F, 30FD, 30R, 30RD, 31F, 31FD, 31R, 31RD, 40F, 440F, 44F, 500F, 500FD, 50-ELECTRONIC, 50F, 50FD, 510F, 510FD, 66, E.52, F85, F85P, S621, S623, S624, S626, S631, S633, S634, S636, S651, S654, S810, S815, S830...(Other models you can see in the webshop)		

<b>spare parts for</b> 510105			
	<b>GEV No.</b>	510017	<b>Ref. No.</b> 468007
union screw			



<b>GEV No.</b>	510106	<b>Ref. No.</b>	468029
<b>description</b>	hose connector for air trap		
<b>For models:</b>	10, 12, 14, 22F, 22R, 2312-001, 2312-002, 350F, 350FD, 350R, 350RD, 40-ELECTRONIC, 40F, 40FD, 40R, 40RD, 44F, 913289, 913290, 913291, 913292, 913297, 913298, 913299, 913300, 913356, 913357, 913360, 913361, 913363, 913364, 913372, 913373, 913374, 913375, 913376, 913377, 913391, 913392, 913416, 913418, 913435, 913544, 913545, 913546, 913547, 913578, 913611, 913665, 913666...(Other models you can see in the webshop)		

## mechanics for flight type dishwashers



<b>GEV No.</b>	699351	<b>Ref. No.</b>	75231 K75649
<b>description</b>	cover for eccentrics plastic D1 ø 147mm D2 ø 32.6mm		
<b>For models:</b>	914380, 914436, A3EB, A3EBD, A3EBDAKRKYK, A3EBDAKWK, A3EBDBKWK, A3EBDRKYK, A3EBDWK, A3EBDYK, A3EBSAK, A3EBSAKRK, A3EBSAKWK, A3EBSBKWKYK, A3EBSEKWK, A3EBSWK, A4EB, A4EBD, A4EBDAKEKYK, A4EBDAKRK, A4EBDAKWK, A4EBDAKZK, A4EBDBKRK, A4EBDPKWKYK, A4EBDRK, A4EBS, A4EBSAK, A4EBSAKCK, A4EBSAKKEYK, A4EBSAKRK, A4EBSAKRKP, A4EBSAKYK, A4EBSCK, A4EBT, A4EBTSAK, A5EB, A5EBD, A5EBDAKPKWK, A5EBDAKWK, A5EBDAKYK, A5EBDRK, A5EBS, A5EBSAKPKWK, A5EBSAKRK, A5EBSAKRKYK, A5EBSAKWK, A5EBSAKWKYK, A5EBSBKRPK, A5EBSBKWK, A5EBSRK...(Other models you can see in the webshop)		



<b>GEV No.</b>	504423	<b>Ref. No.</b>	927048
<b>description</b>	protector L 230mm W 95mm H 16mm hole ø 25x7mm thickness 4mm		
<b>For models:</b>	161, 221, 271, 272, 362, A3EB, A3EBD, A3EBDAKRKYK, A3EBDAKWK, A3EBDBKWK, A3EBDRKYK, A3EBDWK, A3EBDYK, A3EBSAK, A3EBSAKRK, A3EBSAKWK, A3EBSBKWKYK, A3EBSEKWK, A3EBSWK, A4EB, A4EBD, A4EBDAKEKYK, A4EBDAKRK, A4EBDAKWK, A4EBDAKZK, A4EBDBKRK, A4EBDPKWKYK, A4EBDRK, A4EBS, A4EBSAK, A4EBSAKCK, A4EBSAKKEYK, A4EBSAKRK, A4EBSAKRKP, A4EBSAKYK, A4EBSCK, A4EBT, A4EBTSAK, A5EB, A5EBD, A5EBDAKPKWK, A5EBDAKWK, A5EBDAKYK, A5EBDRK, A5EBS, A5EBSAKPKWK, A5EBSAKRK, A5EBSAKRKYK, A5EBSAKWK, A5EBSAKWKYK...(Other models you can see in the webshop)		



<b>GEV No.</b>	504389	<b>Ref. No.</b>	927092
<b>description</b>	roller for transport system L 30mm ID ø 16mm ED ø 30mm		
<b>For models:</b>	161, 221, 271, 272, 362, CLEAN-160, CLEAN-161, CLEAN-220, CLEAN-221, CLEAN-270, CLEAN-271, CLEAN-272, CLEAN-361, CLEAN-361P, CLEAN-362, CLEAN-471, CLEAN-471P		



<b>GEV No.</b>	524511	<b>Ref. No.</b>	927082
<b>description</b>	roller for transport system W 20mm ED ø 24.5mm hole ø 8mm		
<b>For models:</b>	161, 221, 271, 272, 362, CLEAN-160, CLEAN-161, CLEAN-220, CLEAN-221, CLEAN-270, CLEAN-271, CLEAN-272, CLEAN-361, CLEAN-361P, CLEAN-362, CLEAN-471, CLEAN-471P		



<b>GEV No.</b>	505305	<b>Ref. No.</b>	DND29
<b>description</b>	spacer bush for transport system L 28.5mm ø 13.5mm ID ø 8mm		

## EQUIPMENT-SPECIFIC UNITS ELETTROBAR



<b>GEV No.</b>	504422	<b>Ref. No.</b>	DNS18
<b>description</b>	tappet for dishwasher L 84mm W 29.5mm H 26mm ø 14mm hole ø 9/10mm		



<b>GEV No.</b>	511994	<b>Ref. No.</b>	927288
<b>description</b>	tappet for dishwasher L 84mm W 30mm H 98mm		



<b>GEV No.</b>	511996	<b>Ref. No.</b>	927083
<b>description</b>	tappet for dishwasher right L 62mm W 52mm H 19mm hole ø 12mm		
<b>For models:</b>	161, 221, 271, 272, 362, CLEAN-160, CLEAN-161, CLEAN-220, CLEAN-221, CLEAN-270, CLEAN-271, CLEAN-272, CLEAN-361, CLEAN-361P, CLEAN-362, CLEAN-471, CLEAN-471P		

## pipes



<b>GEV No.</b>	698771	<b>Ref. No.</b>	42028
<b>description</b>	aspiration tube tube ø 60.5mm L 87mm ID ø 57mm		
<b>For models:</b>	915747, A3EB, A3EBD, A3EBDAKRKYK, A3EBDAKWK, A3EBDBKWK, A3EBDRKYK, A3EBDWK, A3EBDYK, A3EBSAK, A3EBSAKRK, A3EBSAKWK, A3EBSBKWKYK, A3EBSEKWK, A3EBSWK, A4EB, A4EBD, A4EBDAKEKYK, A4EBDAKRK, A4EBDAKWK, A4EBDAKZK, A4EBDBKRK, A4EBDPKWKYK, A4EBDRK, A4EBS, A4EBSAK, A4EBSAKCK, A4EBSAKKEYK, A4EBSAKRK, A4EBSAKRKP, A4EBSAKYK, A4EBSCK, A4EBT, A4EBTSAK, A5EB, A5EBD, A5EBDAKPKWK, A5EBDAKWK, A5EBDAKYK, A5EBDRK, A5EBS, A5EBSAKPKWK, A5EBSAKRK, A5EBSAKRKYK, A5EBSAKWK, A5EBSAKWKYK, A5EBSBKRPK, A5EBSBKWK, A5EBSRK, A5EBSYK...(Other models you can see in the webshop)		



1

<b>GEV No.</b>	698806	<b>Ref. No.</b>	70167
<b>description</b>	connecting fitting tube ø 30/32mm L 50mm plastic		
<b>For models:</b>	NG381, NG38123, NG38123TERMO, NG381C, NG381CDD, NG381CFUR, NG381DDHZ23, NG381DDPS, NG381DDPSHZ23, NG381HPDD, NG381L, NG381LC, NG381LCFUR, NG381LDDPS, NG381TERMO, NG381TXCDD, Niagara-283L-2, Niagara-381, Niagara-381-230V-3Ph-50Hz, Niagara-381-230V-3Ph-60Hz, Niagara-381DP, Niagara-381HPD, Niagara-381L, Niagara-381LC, River-282-2, River-282L-2, River-282LS-2TDE, River-282S-2TDE, River-285, River-295P, River-296P, River-382, River-382-230V-3Ph-50Hz, River-382H, River-382L, River-382L-230V-3Ph-50Hz, River-382LNRG, River-382LTDE, River-382NRG, River-382NRG-230-3Ph-50Hz, River-382TDE, River-482, RV295PS, RV296PS, RV382, RV38223TERMO, RV382AHP, RV382FUR, RV382L, RV382L23TERMO...(Other models you can see in the webshop)		



2

<b>GEV No.</b>	698749	<b>Ref. No.</b>	70094
<b>description</b>	pipe L 594mm tube ø 25mm		
<b>For models:</b>	NG381, NG38123, NG38123TERMO, NG381C, NG381CDD, NG381CFUR, NG381DDHZ23, NG381DDPS, NG381DDPSHZ23, NG381HPDD, NG381L, NG381LC, NG381LCFUR, NG381LDDPS, NG381TERMO, NG381TXCDD, Niagara-283L-2, Niagara-381, Niagara-381-230V-3Ph-50Hz, Niagara-381-230V-3Ph-60Hz, Niagara-381DP, Niagara-381HPD, Niagara-381L, Niagara-381LC, River-282-2, River-282L-2, River-282LS-2TDE, River-282S-2TDE, River-285, River-382, River-382-230V-3Ph-50Hz, River-382H, River-382L, River-382L-230V-3Ph-50Hz, River-382LNRG, River-382LTDE, River-382NRG, River-382NRG-230-3Ph-50Hz, River-382TDE, River-482, RV382, RV38223TERMO, RV382AHP, RV382FUR, RV382L, RV382L23TERMO, RV382LRFUR, RV382LR, RV382LS, RV382LSFUR...(Other models you can see in the webshop)		



1

<b>GEV No.</b>	698805	<b>Ref. No.</b>	43560
<b>description</b>	T-piece for dishwasher tube ø 27mm L 115mm		
<b>For models:</b>	RIVER-298, RV298, RV298HZ		

backflow preventers

backflow preventers



1

<b>GEV No.</b>	698704	<b>Ref. No.</b>	144993
<b>description</b>	air valve for drain hose D1 ø 21mm D2 ø 10.5mm		
<b>For models:</b>	915154, 915155, 915157, 915158, 915172, 915173, 915285, 915422, 915492, 915493, 915494, 915495, 915496, 915497, 915617, 915618, 915672, 915773, 915774, 916054, 916066, 916067, 916068, 916069, 916077, 916078, 916079, 916080, 916368, 916418, 916419, 916420, 916421, 916422, 916423, 916424, 916594, 916595, 916686, 916760, RIVER-242, River-242-2, River-242-2T, River-252, River-252-2, River-252-2T, River-253, RIVER-262, River-262-2, River-262-2T...(Other models you can see in the webshop)		



1

<b>GEV No.</b>	698703	<b>Ref. No.</b>	144995
<b>description</b>	air valve for drain hose D1 ø 21mm D2 ø 6mm ID ø 17mm		
<b>For models:</b>	915150, 915151, 915152, 915154, 915155, 915157, 915158, 915160, 915161, 915162, 915166, 915167, 915168, 915172, 915173, 915175, 915176, 915177, 915285, 915319, 915338, 915341, 915348, 915418, 915419, 915420, 915421, 915422, 915479, 915492, 915493, 915494, 915495, 915496, 915497, 915547, 915558, 915635, 915663, 915747, FAST-60, FAST-73, NG281, NG281HP, NIAGARA-251, NIAGARA-261, NIAGARA-281, NIAGARA-281HP, PLUVIA-260, Pluvia-270...(Other models you can see in the webshop)		



1

<b>GEV No.</b>	698737	<b>Ref. No.</b>	144993B
<b>description</b>	air valve total length 78mm hose ø 11mm		
<b>For models:</b>	River-282LS-2TDE, River-282S-2TDE, River-382LTDE, River-382TDE, RV382LS, RV382LSFUR, RV382S, RV382SFUR		



1

<b>GEV No.</b>	512447	<b>Ref. No.</b>	144022
<b>description</b>	backflow preventer		
<b>For models:</b>	River-282-2, River-282L-2, River-285, River-382, River-382-230V-3Ph-50Hz, River-382H, River-382L, River-382L-230V-3Ph-50Hz, River-382LNRG, River-382NRG, River-382NRG-230-3Ph-50Hz, River-482, RV382, RV38223TERMO, RV382AHP, RV382FUR, RV382L, RV382L23TERMO, RV382LFUR, RV382LR, RV382LTX, RV382LTXR, RV382R, RV382R23TERMO, RV382RFUR, RV382TERMO, RV382TX, RV382TXR, RV482		



1

<b>GEV No.</b>	518237	<b>Ref. No.</b>	144004
<b>description</b>	backflow preventer		
<b>For models:</b>	11F, 11FD, 11F-DVGW, 11R, 11RD, 22F, 350F, 350FD, 350R, 350RD, 35-ELECTRONIC, 35F, 35FD, 35R, 35RD, 400F, 400FD, 400R, 400RD, 40-ELECTRONIC, 40F, 40FD, 40R, 40RD, 440F, 44F, 45, 450, 46, 460, 500F, 500FD, 50-ELECTRONIC, 50F, 50FD, 510F, 510FD, CLEAN-3		



1

<b>GEV No.</b>	518297	<b>Ref. No.</b>	144011
<b>description</b>	backflow preventer		
<b>For models:</b>	050F, 050FP, 2312-001, 2312-002, 913297, 913298, 913299, 913300, 913360, 913361, 913391, 913392, 913546, 913547, 913578, 913611, 913684, 913913, 913914, 913932, 913933, 913992, 913993, 914284, 914318, 914319, 914331, 914338, 914356, 914400, 914401, 914402, 914403, 914404, 914405, 914431, 914449, 914517, 914545, 914592, 914612, 914613, 914642, 914688, 914909, 914979, 915136, 915137, 915140, 915248...(Other models you can see in the webshop)		



1

<b>GEV No.</b>	518486	<b>Ref. No.</b>	144010 144010NT
<b>description</b>	backflow preventer connection 1/2" dishwasher hose ø 12mm		
<b>For models:</b>	161, 221, 2312-007, 271, 272, 31F, 31FD, 31R, 31RD, 362, 80, 81, 82, 913289, 913290, 913291, 913292, 913356, 913357, 913372, 913373, 913374, 913375, 913416, 913418, 913435, 913544, 913545, 913665, 913666, 913667, 913668, 913685, 913771, 913772, 913773, 913774, 913832, 913837, 913911, 913912, 913948, 913950, 913977, 913984, 913990, 914100, 914101, 914165, 914166...(Other models you can see in the webshop)		



1

<b>GEV No.</b>	517572	<b>Ref. No.</b>	144992
<b>description</b>	backflow preventer for drain hose ø 31/21mm		
<b>For models:</b>	915611, 915612, 915613, 915614, 915615, 915616, 915617, 915618, 915670, 915671, 915672, 915773, 915774, 915959, 916020, 916021, 916024, 916025, 916026, 916027, 916030, 916031, 916045, 916066, 916077, 916078, 916196, 916197, 916198, 916199, 916200, 916247, 916248, 916249, 916250, 916251, 916252, 916382, 916383, 916409, 916410, 916418, 916419, 916452, 916504, 916584, 916591, 916592, 916593, 916594...(Other models you can see in the webshop)		



1

<b>GEV No.</b>	512445	<b>Ref. No.</b>	144991B
<b>description</b>	backflow preventer hose ø 11mm		
<b>For models:</b>	River-282-2, River-282L-2, River-282LS-2TDE, River-282S-2TDE, River-285, River-382, River-382-230V-3Ph-50Hz, River-382H, River-382L, River-382L-230V-3Ph-50Hz, River-382LNRG, River-382LTDE, River-382NRG, River-382NRG-230-3Ph-50Hz, River-382TDE, River-482, RV382, RV38223TERMO, RV382AHP, RV382FUR, RV382L, RV382L-23TERMO, RV382LFUR, RV382LR, RV382LS, RV382LSFUR, RV382LTX, RV382LTXR, RV382R, RV382R23TERMO, RV382RFUR, RV382S, RV382S-FUR, RV382TERMO, RV382TX, RV382TXR, RV482		



1

<b>GEV No.</b>	512446	<b>Ref. No.</b>	144991
<b>description</b>	backflow preventer hose ø 11mm		
<b>For models:</b>	915150, 915151, 915152, 915154, 915155, 915157, 915158, 915160, 915161, 915162, 915166, 915167, 915168, 915172, 915173, 915175, 915319, 915348, 915418, 915419, 915420, 915421, 915422, 915479, 915492, 915493, 915494, 915495, 915496, 915497, 915547, 915558, 915635, 915663, 915747, 916054, 916067, 916068, 916069, 916079, 916080, 916201, 916202, 916203, 916204, 916205, 916206, 916207, 916208, 916209...(Other models you can see in the webshop)		



			
1			
<b>GEV No.</b>	524882	<b>Ref. No.</b>	H.324091
<b>description</b>	backflow preventer hose ø 12mm		
<b>For models:</b>	915150, 915151, 915152, 915154, 915155, 915157, 915158, 915160, 915161, 915162, 915166, 915167, 915168, 915172, 915173, 915175, 915176, 915177, 915285, 915319, 915338, 915341, 915348, 915418, 915419, 915420, 915421, 915422, 915479, 915492, 915493, 915494, 915495, 915496, 915497, 915547, 915558, 915635, 915663, 915747, NIAGARA-251, NIAGARA-261, PLUVIA-260, Pluvia-270, RIVER-252, RIVER-253, RIVER-262, River-282LS-2TDE, River-282S-2TDE, River-382LTDE...(Other models you can see in the webshop)		

			
2			
<b>GEV No.</b>	514502	<b>Ref. No.</b>	144030
<b>description</b>	backflow preventer plastic hose ø 11mm		
<b>For models:</b>	915150, 915151, 915152, 915154, 915155, 915157, 915158, 915160, 915161, 915162, 915166, 915167, 915168, 915172, 915173, 915175, 915319, 915348, 915418, 915419, 915420, 915421, 915422, 915479, 915492, 915493, 915494, 915495, 915496, 915497, 915547, 915558, 915611, 915612, 915613, 915614, 915615, 915616, 915617, 915618, 915635, 915663, 915670, 915671, 915672, 915686, 915694, 915695, 915696, 915747...(Other models you can see in the webshop)		

## accessories

			
1			
<b>GEV No.</b>	511997	<b>Ref. No.</b>	476008
<b>description</b>	ball for back flow restrictor ø 8mm plastic		
<b>For models:</b>	913992, 913993, 914583, 914592, 914612, 914613, 914628, 914944, 915143, 915150, 915151, 915152, 915154, 915155, 915157, 915158, 915160, 915161, 915162, 915166, 915167, 915168, 915172, 915173, 915175, 915176, 915177, 915285, 915319, 915338, 915341, 915348, 915418, 915419, 915420, 915421, 915422, 915479, 915492, 915493, 915494, 915495, 915496, 915497, 915547, 915558, 915611, 915612, 915613, 915614...(Other models you can see in the webshop)		

## miscellaneous

			
Image not available			
1			
<b>GEV No.</b>	513115	<b>Ref. No.</b>	DWR15
<b>description</b>	bush		

			
1			
<b>GEV No.</b>	513139	<b>Ref. No.</b>	DWP725
<b>description</b>	connecting fitting		

			
1			
<b>GEV No.</b>	518241	<b>Ref. No.</b>	480087
<b>description</b>	cover		
<b>For models:</b>	913291, 913292, 913357, 913374, 913375, 913416, 913435, 913545, 913666, 913668, 913685, 913773, 913774, 913911, 913912, 913948, 913950, 913977, 913984, 913990, 913992, 913993, 914214, 914316, 914317, 914392, 914393, 914394, 914395, 914396, 914397, 914441, 914442, 914515, 914516, 914537, 914543, 914547, 914583, 914592, 914612, 914613, 914683, 914684, 914689, 914863, 914874, 915138, 915139, 915143...(Other models you can see in the webshop)		

			
Image not available			
1			
<b>GEV No.</b>	518184	<b>Ref. No.</b>	325047
<b>description</b>	extension		
<b>For models:</b>	913992, 913993, 914583, 914592, 914612, 914613, 915143, CLEAN-3, RIVER-40, RIVER-40-CRP, RIVER-43, RIVER-44, RIVER-44-CRP, River-44-CRP-ST, RIVER-44CRP-ST		

			
1			
<b>GEV No.</b>	519481	<b>Ref. No.</b>	927110
<b>description</b>	heater battery L 440mm W 260mm H 195mm		
<b>For models:</b>	161, 221, 271, 272, 362, CLEAN-160, CLEAN-161, CLEAN-220, CLEAN-221, CLEAN-270, CLEAN-271, CLEAN-272, CLEAN-361, CLEAN-361P, CLEAN-362, CLEAN-471, CLEAN-471P, RIVER-150, RV150		



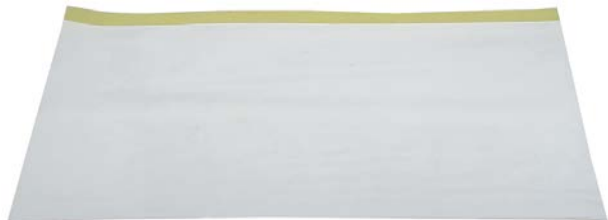

			
1			
<b>GEV No.</b>	698872	<b>Ref. No.</b>	480153
<b>description</b>	lid for housing H 8mm D1 ø 27mm D2 ø 17mm		
<b>For models:</b>	915611, 915612, 915613, 915614, 915615, 915616, 915670, 915671, 915959, 916196, 916197, 916198, 916199, 916200, 916409, 916410, 916591, 916592, 916593, 916877, Niagara-241, Niagara-241-2, Niagara-341, Pluvia-240		

			
1			
<b>GEV No.</b>	698716	<b>Ref. No.</b>	CWP2
<b>description</b>	PCB support L 34mm		
<b>For models:</b>	CNT800CH, Fast180, Fast180-230V-3Ph-60Hz, Fast181, FAST-60, FAST-73, NG271, NG281, NG281CDD, NG281HP, NG281HPDD, NG281HZ23, NG281HZ23DD, NG291, NG292, NG292HZ, NG293, NG381, NG38123, NG38123TERMO, NG381C, NG381CDD, NG381CFUR, NG381DDHZ23, NG381DDPS, NG381DDPSHZ23, NG381HPDD, NG381L, NG381LC, NG381LCFUR, NG381LDDPS, NG381TERMO, NG381TXCDD, NIAGARA-271, NIAGARA-281, Niagara-281-2, Niagara-281HP, NIAGARA-283, Niagara-283A, Niagara-283L-2, NIAGARA-291, NIAGARA-292, Niagara-292-400V-3Ph-60Hz, NIAGARA-293, Niagara-381, Niagara-381-230V-3Ph-50Hz, Niagara-381-230V-3Ph-60Hz, Niagara-381DP, Niagara-381HPD, Niagara-381L...(Other models you can see in the webshop)		

			
1			
<b>GEV No.</b>	343006	<b>Ref. No.</b>	214086
<b>description</b>	protective film for dishwasher self-adhesive L 485mm W 360mm Qty 1 pcs		
<b>For models:</b>	2312-001, 2312-002, 2312-007, 2312-009-CRP, 46, 460, 913297, 913298, 913299, 913300, 913360, 913361, 913391, 913392, 913546, 913547, 913578, 913611, 913684, 913932, 913933, 913992, 913993, 914100, 914101, 914326, 914331, 914339, 914342, 914343, 914400, 914401, 914402, 914403, 914404, 914405, 914406, 914449, 914517, 914545, 914583, 914592, 914612, 914613, 914624, 914625, 914626, 914627, 914628, 914688...(Other models you can see in the webshop)		

			
1			
<b>GEV No.</b>	698871	<b>Ref. No.</b>	419036
<b>description</b>	spacer for PCB L 18mm W 6mm D1 ø 6mm D2 ø 3mm		
<b>For models:</b>	2312-007, 2312-009-CRP, 913911, 913912, 913913, 913914, 913950, 913977, 913984, 913990, 913992, 913993, 914100, 914101, 914165, 914166, 914167, 914168, 914206, 914214, 914284, 914316, 914317, 914318, 914319, 914338, 914339, 914342, 914343, 914355, 914356, 914431, 914516, 914543, 914583, 914592, 914612, 914613, 914624, 914625, 914626, 914627, 914628, 914642, 914684, 914850, 914851, 914854, 914874, 914909...(Other models you can see in the webshop)		

			
1			
<b>GEV No.</b>	698875	<b>Ref. No.</b>	461028
<b>description</b>	spacer for PCB L 19mm D1 ø 10mm		
<b>For models:</b>	915160, 915161, 915162, 915175, 915319, 915496, 915663, 916067, 916068, 916069, 916079, 916080, 916181, 916183, 916184, 916185, 916201, 916202, 916203, 916204, 916205, 916206, 916207, 916208, 916209, 916237, 916238, 916239, 916240, 916241, 916242, 916243, 916244, 916245, 916246, 916365, 916366, 916367, 916368, 916401, 916402, 916403, 916404, 916405, 916406, 916407, 916408, 916411, 916412, 916413...(Other models you can see in the webshop)		

			
1			
<b>GEV No.</b>	511995	<b>Ref. No.</b>	927146
<b>description</b>	water distributor for cold water brass L 170mm W 30mm H 30mm thread 1/2" IT		
<b>For models:</b>	CLEAN-361, CLEAN-361P, CLEAN-471, CLEAN-471P, RIVER-150, RV150		

door mechanics  
spare parts and accessories

			
1			
<b>GEV No.</b>	507579	<b>Ref. No.</b>	75064
<b>description</b>	catch hook for door		
<b>For models:</b>	A3EB, A3EBD, A3EBDAKRKYK, A3EBDAKWK, A3EBDBKWK, A3EBDRKYK, A3EBDWK, A3EBDYK, A3EBSAK, A3EBSAKRK, A3EBSAKWK, A3EBSBKWKYK, A3EBSEKWK, A3EBSWK, A4EB, A4EBD, A4EBDAKEKYK, A4EBDAKRK, A4EBDAKWK, A4EBDAKZK, A4EBDBKRK, A4EBDPKWKYK, A4EBDRK, A4EBS, A4EBSAK, A4EBSAKCK, A4EBSAKEKYK, A4EBSAKRK, A4EBSAKRKP, A4EBSAKYK, A4EBSCK, A4EBT, A4EBTSAK, A5EB, A5EBD, A5EBDAKPKWK, A5EBDAKWK, A5EBDAKYK, A5EBDRK, A5EBS, A5EBSAKPKWK, A5EBSAKRK, A5EBSAKRKYK, A5EBSAKWK, A5EBSAKWKYK, A5EBSBKRPK, A5EBSBKWK, A5EBSRK, A5EBSYK, GL284EB...(Other models you can see in the webshop)		



			
1			
<b>GEV No.</b>	507580	<b>Ref. No.</b>	75226
<b>description</b>	catch hook for door		
<b>For models:</b>	914380, 914436, A3EB, A3EBD, A3EBDAKRKYK, A3EBDAKWK, A3EBDBKWK, A3EBDRKYK, A3EBDVK, A3EBDYK, A3EBSAK, A3EBSAKRK, A3EBSAKWK, A3EBSBKWKYK, A3EBSEKWK, A3EBSWK, A4EB, A4EBD, A4EBDAKEKYK, A4EBDAKRK, A4EBDAKWK, A4EBDAKZK, A4EBDBKRK, A4EBDPKWKYK, A4EBDRK, A4EBS, A4EBSAK, A4EBSAKCK, A4EBSAKEKYK, A4EBSAKRK, A4EBSAKRKP, A4EBSAKYK, A4EBSCK, A4EBT, A4EBTSAK, A5EB, A5EBD, A5EBDAKPKWK, A5EBDAKWK, A5EBDAKYK, A5EBDRK, A5EBS, A5EBSAKPKWK, A5EBSAKRK, A5EBSAKRKYK, A5EBSAKWK, A5EBSAKWKYK, A5EBSBKRPK, A5EBSBKWK, A5EBSRK...(Other models you can see in the webshop)		

## spring holders

			
1			
<b>GEV No.</b>	551324	<b>Ref. No.</b>	307014
<b>description</b>	spring holder H 16mm L 17mm W 20mm		
<b>For models:</b>	915150, 915151, 915152, 915154, 915155, 915157, 915158, 915160, 915161, 915162, 915166, 915167, 915168, 915172, 915173, 915175, 915176, 915177, 915285, 915319, 915338, 915341, 915348, 915418, 915419, 915420, 915421, 915422, 915479, 915492, 915493, 915494, 915495, 915496, 915497, 915547, 915558, 915635, 915663, 915747, 916054, 916067, 916068, 916069, 916079, 916080, 916201, 916202, 916203, 916204...(Other models you can see in the webshop)		

## springs

### miscellaneous

			
1			
<b>GEV No.</b>	698809	<b>Ref. No.</b>	449058
<b>description</b>	spring L 170mm W 75mm		
<b>For models:</b>	915150, 915151, 915152, 915154, 915155, 915157, 915158, 915160, 915161, 915162, 915166, 915167, 915168, 915172, 915173, 915175, 915176, 915177, 915285, 915319, 915338, 915341, 915348, 915418, 915419, 915420, 915421, 915422, 915479, 915492, 915493, 915494, 915495, 915496, 915497, 915547, 915558, 915635, 915663, 915747, 916054, 916067, 916068, 916069, 916079, 916080, 916201, 916202, 916203, 916204...(Other models you can see in the webshop)		

### tension springs

			
1			
<b>GEV No.</b>	701154	<b>Ref. No.</b>	449059 449063
<b>description</b>	tension spring $\varnothing$ 10.5mm total length 200mm wire gauge $\varnothing$ 1.3mm for door mechanism		
<b>For models:</b>	915160, 915161, 915162, 915166, 915167, 915168, 915172, 915173, 915175, 915176, 915177, 915285, 915319, 915338, 915341, 915348, 915418, 915419, 915420, 915421, 915422, 915479, 915496, 915497, 915547, 915558, 915635, 915663, 915747, 916054, 916068, 916069, 916080, 916205, 916206, 916207, 916208, 916209, 916365, 916366, 916367, 916368, 916414, 916415, 916416, 916417, 916422, 916423, 916424, 916684...(Other models you can see in the webshop)		

			
1			
<b>GEV No.</b>	701227	<b>Ref. No.</b>	449057 H.227855 H.231937
<b>description</b>	tension spring $\varnothing$ 10mm total length 155mm wire gauge $\varnothing$ 1.1mm L1 60mm L2 11mm for door mechanism		
<b>For models:</b>	2312-007, 2312-009-CRP, 914100, 914101, 914339, 914342, 914343, 914624, 914625, 914626, 914627, 914628, 914850, 914851, 914854, 914944, RIVER-48, RIVER-50, RIVER-50-CRP, RIVER-50-CRP-SP, RIVER-54, RIVER-54CRP, RIVER-54-CRP-s.p., RIVER-54-CRP-SP, RIVER-61		

			
1			
<b>GEV No.</b>	519604	<b>Ref. No.</b>	449064
<b>description</b>	tension spring $\varnothing$ 21mm L1 58mm wire gauge $\varnothing$ 2mm L2 13mm L3 13mm total length 84mm		
<b>For models:</b>	915617, 915618, 915672, 915773, 915774, 916066, 916077, 916078, 916418, 916419, 916594, 916595, RIVER-242, RIVER-242-2, RIVER-242-2T, RIVER-342C, RIVER-342T		

### linkage

			
1			
<b>GEV No.</b>	698800	<b>Ref. No.</b>	44593
<b>description</b>	bar L 670mm thread M6/M10 $\varnothing$ 10mm		
<b>For models:</b>	NG293, NIAGARA-293, RIVER-296, RIVER-296P, RIVER-297, RIVER-298, RV296, RV296PS, RV297, RV298, RV298HZ		

			
1			
<b>GEV No.</b>	518558	<b>Ref. No.</b>	929016 999229 DAT43
<b>description</b>	door pin complete with threaded shaft tie bar		
<b>For models:</b>	55, E.65		

			
1			
<b>GEV No.</b>	518362	<b>Ref. No.</b>	304024
<b>description</b>	door pin door pin		
<b>For models:</b>	2312-007, 2312-009-CRP, 914100, 914101, 914339, 914342, 914343, 914624, 914625, 914626, 914627, 914628, 914850, 914851, 914854, 914944, RIVER-48, RIVER-50, RIVER-50-CRP, RIVER-50-CRP-SP, RIVER-54, RIVER-54CRP, RIVER-54-CRP-s.p., RIVER-54-CRP-SP, RIVER-61		



			
1			
<b>GEV No.</b>	518355	<b>Ref. No.</b>	304021
<b>description</b>	door pin stop rod		
<b>For models:</b>	050F, 050FP, 2312-001, 2312-002, 45, 450, 46, 460, 500F, 500FD, 50F, 50FD, 510F, 510FD, 913297, 913298, 913299, 913300, 913360, 913361, 913391, 913392, 913418, 913546, 913547, 913578, 913611, 913684, 913913, 913914, 913932, 913933, 914167, 914168, 914284, 914318, 914319, 914326, 914331, 914338, 914356, 914398, 914399, 914400, 914401, 914402, 914403, 914404, 914405, 914406...(Other models you can see in the webshop)		





 <p>Image not available</p>			
<b>GEV No.</b>	519418	<b>Ref. No.</b>	41093 C.41093
<b>description</b>	tie bar L 560mm ø 10mm		
<b>For models:</b>	KLP105EB, LP105DDDTBE, LP105DDDTBE, LP105EB, U132, U61, U61E, U61HE, U70		

threaded shafts

			
<b>GEV No.</b>	698798	<b>Ref. No.</b>	304028
<b>description</b>	thread bolt ø 7mm L 30.2mm thread M5		
<b>For models:</b>	915160, 915161, 915162, 915175, 915319, 915663, 916067, 916068, 916069, 916079, 916080, 916201, 916202, 916203, 916204, 916205, 916206, 916207, 916208, 916209, 916365, 916366, 916367, 916368, 916411, 916412, 916413, 916414, 916415, 916416, 916417, 916420, 916421, 916422, 916423, 916424, 916684, 916685, 916686, 916760, 916761, 916762, 916802, 916812, 916813, 916878, 916885, Fast170, Fast170S, Niagara-251-2...(Other models you can see in the webshop)		

			
<b>GEV No.</b>	518559	<b>Ref. No.</b>	929015 DWP380
<b>description</b>	threaded shaft		
<b>For models:</b>	55, E.65		
<b>accessories for</b>	518559		
			
<b>GEV No.</b>	518560	<b>Ref. No.</b>	—
<b>description</b>	retaining ring E D1 ø 7mm D2 ø 14mm DIN 6799		

sliding plates

			
<b>GEV No.</b>	519407	<b>Ref. No.</b>	929210
<b>description</b>	sliding plate dimensions 60x15mm		
<b>accessories for</b>	519407		
			
<b>GEV No.</b>	519406	<b>Ref. No.</b>	929209
<b>description</b>	gasket for sliding plate dimensions 69x16mm		

			
<b>GEV No.</b>	517801	<b>Ref. No.</b>	307012
<b>description</b>	sliding plate L 75mm W 12mm H 10mm		
<b>For models:</b>	2312-007, 2312-009-CRP, 914100, 914101, 914339, 914342, 914343, 914624, 914625, 914626, 914627, 914628, 914850, 914851, 914854, 914944, LP60, NG271, NG291, NIAGARA-271, NIAGARA-291, RIVER-294, RIVER-48, RIVER-50, RIVER-50-CRP, RIVER-50-CRP-SP, RIVER-54, RIVER-54CRP, RIVER-54-CRP-s.p., RIVER-54-CRP-SP, RIVER-61, RIVER-71, RV294, RV71, U60E		

			
<b>GEV No.</b>	518356	<b>Ref. No.</b>	307003
<b>description</b>	sliding plate sliding plate		
<b>For models:</b>	050F, 050FP, 22F, 22R, 2312-001, 2312-002, 40F, 440F, 44F, 45, 450, 46, 460, 500F, 500FD, 50F, 50FD, 510F, 510FD, 913297, 913298, 913299, 913300, 913360, 913361, 913391, 913392, 913418, 913546, 913547, 913578, 913611, 913684, 913913, 913914, 913932, 913933, 914167, 914168, 914284, 914318, 914319, 914326, 914331, 914338, 914356, 914398, 914399, 914400, 914401...(Other models you can see in the webshop)		

			
<b>GEV No.</b>	518353	<b>Ref. No.</b>	307005
<b>description</b>	stop plastic for door L 60mm W 12.5mm H 10mm		
<b>For models:</b>	400F, 400FD, 400R, 400RD, 40-ELECTRONIC, 40F, 40FD, 40R, 40RD, 67F, 67R, 913291, 913292, 913357, 913374, 913375, 913416, 913435, 913545, 913666, 913668, 913685, 913773, 913774, 913911, 913912, 913948, 913950, 913977, 913984, 913990, 914214, 914316, 914317, 914392, 914393, 914394, 914395, 914396, 914397, 914441, 914442, 914515, 914516, 914537, 914543, 914547, 914683, 914684, 914689...(Other models you can see in the webshop)		

hinges

			
<b>GEV No.</b>	518547	<b>Ref. No.</b>	311002.CR
<b>description</b>	door hinge hinge mounting pos. left		
<b>For models:</b>	31F, 31FD, 31R, 31RD		

			
<b>GEV No.</b>	518551	<b>Ref. No.</b>	311005.CR
<b>description</b>	door hinge hinge mounting pos. left		
<b>For models:</b>	913363, 913364, 913376, 913377, E.41, E.42, E.52, E41		





			
1			
<b>GEV No.</b>	518253	<b>Ref. No.</b>	311001.CR
<b>description</b>	door hinge hinge mounting pos. right		
<b>For models:</b>	31F, 31FD, 31R, 31RD		

			
1			
<b>GEV No.</b>	518550	<b>Ref. No.</b>	311006.CR
<b>description</b>	door hinge hinge mounting pos. right		
<b>For models:</b>	913363, 913364, 913376, 913377, E.41, E.42, E.52, E41		

			
1			
<b>GEV No.</b>	504797	<b>Ref. No.</b>	35060
<b>description</b>	door hinge mounting pos. left ø 10mm L 70mm		
<b>For models:</b>	LP60, NG271, NG291, NIAGARA-271, NIAGARA-291, RIVER-294, RIVER-71, RV294, RV71, U60E		

			
1			
<b>GEV No.</b>	518301	<b>Ref. No.</b>	311019
<b>description</b>	door hinge mounting pos. left/right		
<b>For models:</b>	913297, 913298, 913299, 913300, 913360, 913361, 913391, 913392, 913418, 913546, 913547, 913578, 913611, 913684, 913913, 913914, 913932, 913933, 914167, 914168, 914284, 914326, 914331, 914356, 914398, 914399, 914400, 914401, 914402, 914403, 914404, 914405, 914406, 914443, 914449, 914517, 914545, 914568, 914642, 914688, 914909, 914943, 914979, 915136, 915137, 915140, 915248, 915483, 915484, 915528...(Other models you can see in the webshop)		

			
1			
<b>GEV No.</b>	518122	<b>Ref. No.</b>	030157
<b>description</b>	hinge complete for dishwasher L 588mm		
<b>For models:</b>	2312-007, 2312-009-CRP		

 <p>Image not available</p>			
1			
<b>GEV No.</b>	518265	<b>Ref. No.</b>	311010
<b>description</b>	hinge mounting pos. right		
<b>For models:</b>	45, 450, 46, 460, 500F, 500FD, 50F, 50FD, 510F, 510FD		

			
1			
<b>GEV No.</b>	510090	<b>Ref. No.</b>	449036
<b>description</b>	spring door lock spring mounting pos. door lock		
<b>For models:</b>	11F, 11FD, 11F-DVGW, 11R, 11RD, 350F, 350FD, 350R, 350RD, 35-ELECTRONIC, 35F, 35FD, 35R, 35RD, 400F, 400FD, 400R, 400RD, 40-ELECTRONIC, 40F, 40FD, 40R, 40RD, 46, 500F, 500FD, 50-ELECTRONIC, 50F, 50FD, 510F, 510FD, 67F, 67R, 913289, 913290, 913291, 913292, 913356, 913357, 913363, 913364, 913372, 913373, 913374, 913375, 913376, 913377, 913416, 913435, 913544...(Other models you can see in the webshop)		

<h3>hinge camps</h3>			
			
1			
<b>GEV No.</b>	518257	<b>Ref. No.</b>	307002 307002.CR
<b>description</b>	hinge camp mounting pos. left		
<b>For models:</b>	21F, 21FD, 21R, 21RD, 25F, 25FD, 25R, 25RD, 30F, 30FD, 30R, 30RD, 31F, 31FD, 31R, 31RD, 440F, 44F, S621, S623, S624, S626, S631, S633, S634, S636, S651, S651P, S653, S654, S655, S810, S815, S830, S835, SR651		

			
1			
<b>GEV No.</b>	518262	<b>Ref. No.</b>	311009
<b>description</b>	hinge camp mounting pos. left		
<b>For models:</b>	350F, 350FD, 350R, 350RD, 35-ELECTRONIC, 35F, 35FD, 35R, 35RD, 400F, 400FD, 400R, 400RD, 40-ELECTRONIC, 40F, 40FD, 40R, 40RD, 67F, 67R, 913289, 913290, 913291, 913292, 913356, 913357, 913372, 913373, 913374, 913375, 913416, 913435, 913544, 913545, 913665, 913666, 913667, 913668, 913685, 913771, 913772, 913773, 913774, 913832, 913837, 913911, 913912, 913948, 913950, 913977...(Other models you can see in the webshop)		

			
1			
<b>GEV No.</b>	518553	<b>Ref. No.</b>	307008
<b>description</b>	hinge camp mounting pos. left		
<b>For models:</b>	11F, 11FD, 11F-DVGW, 11R, 11RD, 22F, 22R, 40F, 913363, 913364, 913376, 913377, E.41, E.42, E.52, E41		



<b>GEV No.</b>	518261	<b>Ref. No.</b>	311008
<b>description</b>	hinge camp mounting pos. right		
<b>For models:</b>	67F, 67R, 913289, 913290, 913291, 913292, 913356, 913357, 913372, 913373, 913374, 913375, 913416, 913435, 913544, 913545, 913665, 913666, 913667, 913668, 913685, 913771, 913772, 913773, 913774, 913832, 913837, 913911, 913912, 913948, 913950, 913977, 913984, 913990, 914165, 914166, 914206, 914214, 914316, 914317, 914355, 914386, 914387, 914388, 914389, 914390, 914391, 914392, 914393, 914394... (Other models you can see in the webshop)		



<b>GEV No.</b>	518552	<b>Ref. No.</b>	307009
<b>description</b>	hinge camp mounting pos. right		
<b>For models:</b>	11F, 11FD, 11F-DVGW, 11R, 11RD, 22F, 22R, 40F, 913363, 913364, 913376, 913377, E.41, E.42, E.52, E41		

hinge pins



<b>GEV No.</b>	518264	<b>Ref. No.</b>	325034
<b>description</b>	hinge pin hinge pin		
<b>For models:</b>	400F, 400FD, 400R, 400RD, 40-ELECTRONIC, 40F, 40FD, 40R, 40RD, 67F, 67R, 913291, 913292, 913357, 913374, 913375, 913416, 913435, 913545, 913666, 913668, 913685, 913773, 913774, 913911, 913912, 913948, 913950, 913977, 913984, 913990, 914214, 914316, 914317, 914392, 914393, 914394, 914395, 914396, 914397, 914441, 914442, 914515, 914516, 914537, 914543, 914547, 914683, 914684, 914689... (Other models you can see in the webshop)		



<b>GEV No.</b>	518267	<b>Ref. No.</b>	325036
<b>description</b>	hinge pin hinge pin		
<b>For models:</b>	050F, 050FP, 2312-001, 2312-002, 45, 450, 46, 460, 500F, 500FD, 50-ELECTRONIC, 50F, 50FD, 510F, 510FD, 913297, 913298, 913299, 913300, 913360, 913361, 913391, 913392, 913418, 913546, 913547, 913578, 913611, 913684, 913913, 913914, 913932, 913933, 914167, 914168, 914284, 914318, 914319, 914326, 914331, 914338, 914356, 914398, 914399, 914400, 914401, 914402, 914403, 914404, 914405... (Other models you can see in the webshop)		



<b>GEV No.</b>	518555	<b>Ref. No.</b>	325033
<b>description</b>	hinge pin hinge pin		
<b>For models:</b>	11F, 11FD, 11F-DVGW, 11R, 11RD, 22F, 913363, 913364, 913376, 913377, E.41, E.42, E.52, E41		

door seals

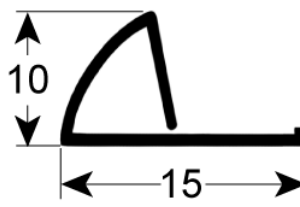

<b>GEV No.</b>	512461	<b>Ref. No.</b>	437109
<b>description</b>	door seal L 450mm W 17mm		
<b>For models:</b>	915611, 915612, 915613, 915614, 915615, 915616, 915670, 915671, 915959, 916196, 916197, 916198, 916199, 916200, 916409, 916410, 916591, 916592, 916593, 916877, Niagara-241, Niagara-241-2, Niagara-341, Pluvia-240		

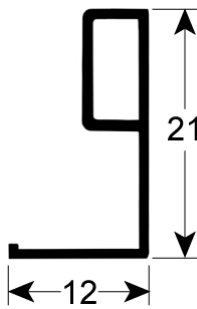

<b>GEV No.</b>	512462	<b>Ref. No.</b>	437110
<b>description</b>	door seal L 450mm W 21mm		
<b>For models:</b>	915617, 915618, 915672, 915773, 915774, 916066, 916077, 916078, 916418, 916419, 916594, 916595, River-242, River-242-2, River-242-2T, River-342C, River-342T		

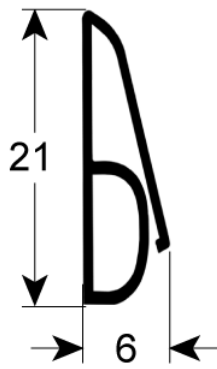

<b>GEV No.</b>	512472	<b>Ref. No.</b>	35017
<b>description</b>	door seal L 625mm W 21mm		
<b>For models:</b>	NG271, NG291, NIAGARA-271, NIAGARA-291, RIVER-294, RV294		

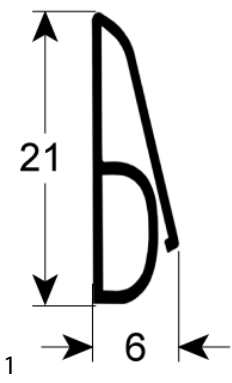

<b>GEV No.</b>	512471	<b>Ref. No.</b>	41583
<b>description</b>	door seal L 740mm W 21mm		
<b>For models:</b>	NG292HZ, Niagara-292-400V-3Ph-60Hz, River-295P, River-296P, RV295PS, RV296PS		

**door guides**



<b>GEV No.</b>	698744	<b>Ref. No.</b>	307015
<b>description</b>	door guides L 109mm W 24.5mm H 18mm mounting pos. left/right		
<b>For models:</b>	915150, 915151, 915152, 915154, 915155, 915157, 915158, 915160, 915161, 915162, 915166, 915167, 915168, 915172, 915173, 915175, 915176, 915177, 915285, 915319, 915338, 915341, 915348, 915418, 915419, 915420, 915421, 915422, 915479, 915492, 915493, 915494, 915495, 915496, 915497, 915547, 915558, 915635, 915663, 915747, 916054, 916067, 916068, 916069, 916079, 916080, 916201, 916202, 916203, 916204...(Other models you can see in the webshop)		



<b>GEV No.</b>	698743	<b>Ref. No.</b>	307016
<b>description</b>	door guides L 88.5mm W 14mm H 6.3mm		
<b>For models:</b>	915611, 915612, 915613, 915614, 915615, 915616, 915617, 915618, 915670, 915671, 915672, 915773, 915774, 915959, 916066, 916077, 916078, 916196, 916197, 916198, 916199, 916200, 916409, 916410, 916418, 916419, 916591, 916592, 916593, 916594, 916595, 916877, NIAGARA-241, Niagara-241-2, Niagara-341, Pluvia-240, RIVER-242, River-242-2, River-242-2T, River-342C, River-342T		



<b>GEV No.</b>	698797	<b>Ref. No.</b>	310013
<b>description</b>	guide L 30mm W 17mm H 17mm mounting pos. right/left		
<b>For models:</b>	915150, 915151, 915152, 915154, 915155, 915157, 915158, 915160, 915161, 915162, 915166, 915167, 915168, 915172, 915173, 915175, 915176, 915177, 915285, 915319, 915338, 915341, 915348, 915418, 915419, 915420, 915421, 915422, 915479, 915492, 915493, 915494, 915495, 915496, 915497, 915547, 915558, 915635, 915663, 915747, 916054, 916067, 916068, 916069, 916079, 916080, 916201, 916202, 916203, 916204...(Other models you can see in the webshop)		

**door frames**



<b>GEV No.</b>	901694	<b>Ref. No.</b>	41197
<b>description</b>	frame for door mounting pos. upper W 34mm L 595mm SS mounting distance 225mm		
<b>For models:</b>	KLP105EB, LP105DDDTEB, LP105DDDTEBN, LP105EB, NG292, NG293, NIAGARA-292, NIAGARA-293, RIVER-295, RIVER-296, RV295, RV296, U61E, U61HE		

**door bumpers**



<b>GEV No.</b>	518066	<b>Ref. No.</b>	417041
<b>description</b>	door bumper end stop		
<b>For models:</b>	050F, 050FP, 22F, 22R, 2312-001, 2312-002, 40F, 440F, 44F, 45, 450, 46, 460, 500F, 500FD, 50F, 50FD, 510F, 510FD, 913297, 913298, 913299, 913300, 913360, 913361, 913391, 913392, 913418, 913546, 913547, 913578, 913611, 913684, 913913, 913914, 913932, 913933, 914167, 914168, 914284, 914318, 914319, 914326, 914331, 914338, 914356, 914398, 914399, 914400, 914401...(Other models you can see in the webshop)		



<b>GEV No.</b>	518354	<b>Ref. No.</b>	028078
<b>description</b>	door bumper slotted hole disc		
<b>For models:</b>	400F, 400FD, 400R, 400RD, 40-ELECTRONIC, 40F, 40FD, 40R, 40RD, 67F, 67R, 913291, 913292, 913357, 913374, 913375, 913416, 913435, 913545, 913666, 913668, 913685, 913773, 913774, 913911, 913912, 913948, 913950, 913977, 913984, 913990, 914100, 914101, 914214, 914316, 914317, 914392, 914393, 914394, 914395, 914396, 914397, 914441, 914442, 914515, 914516, 914537, 914543, 914547, 914624...(Other models you can see in the webshop)		

**door shafts**







Image not available

<b>GEV No.</b>	513106	<b>Ref. No.</b>	DWP35
<b>description</b>	door shaft		

1 			
<b>GEV No.</b>	518263	<b>Ref. No.</b>	304017
<b>description</b>	door shaft		
<b>For models:</b>	350F, 350FD, 350R, 350RD, 35-ELECTRONIC, 35F, 35FD, 35R, 35RD, 913289, 913290, 913356, 913372, 913373, 913544, 913665, 913667, 913771, 913772, 913832, 913837, 914165, 914166, 914206, 914355, 914386, 914387, 914388, 914389, 914390, 914391, 914692, 914693, 914694, 914703, 914870, 915686, 915687, 915688, 915689, 915690, 915691, 916237, 916238, 916239, 916240, 916241, 916401, 916402, 916403...(Other models you can see in the webshop)		

2 			
<b>GEV No.</b>	518556	<b>Ref. No.</b>	929018
<b>description</b>	door shaft		
<b>For models:</b>	55, E.65		
<b>accessories for</b>	518556		
	<b>GEV No.</b>	518557	<b>Ref. No.</b> 929017
retaining ring E D1 ø 5mm D2 ø 11mm SS DIN 6799 thickness 0.7mm			

locks

1 			
<b>GEV No.</b>	518242	<b>Ref. No.</b>	329012
<b>description</b>	door catch		
<b>For models:</b>	11F, 11FD, 11F-DVGW, 11R, 11RD, 350F, 350FD, 350R, 350RD, 35-ELECTRONIC, 35F, 35FD, 35R, 35RD, 400F, 400FD, 400R, 400RD, 40-ELECTRONIC, 40F, 40FD, 40R, 40RD, 67F, 67R, 913289, 913290, 913291, 913292, 913356, 913357, 913363, 913364, 913372, 913373, 913374, 913375, 913376, 913377, 913416, 913435, 913544, 913545, 913665, 913666, 913667, 913668, 913685, 913771, 913772...(Other models you can see in the webshop)		

1 			
<b>GEV No.</b>	518244	<b>Ref. No.</b>	994011 REB994011
<b>description</b>	door catch catch		
<b>For models:</b>	050F, 050FP, 22F, 22R, 40F, 440F, 44F, 45, 450, 46, 460, 55, F85, F85P		

1 			
<b>GEV No.</b>	510091	<b>Ref. No.</b>	329009
<b>description</b>	door catch tongue		
<b>For models:</b>	11F, 11FD, 11R, 11RD		

1 			
<b>GEV No.</b>	513138	<b>Ref. No.</b>	994012
<b>description</b>	door catch with nut door locking catch		
<b>For models:</b>	2312-001, 2312-002, 500F, 500FD, 50F, 50FD, 510F, 510FD, 913297, 913298, 913299, 913300, 913360, 913361, 913391, 913392, 913418, 913546, 913547, 913578, 913611, 913684, 913913, 913914, 913932, 913933, 914167, 914168, 914284, 914326, 914331, 914356, 914398, 914399, 914400, 914401, 914402, 914403, 914404, 914405, 914406, 914443, 914449, 914517, 914545, 914568, 914642, 914688, 914909, 914943...(Other models you can see in the webshop)		

1 			
<b>GEV No.</b>	519575	<b>Ref. No.</b>	927278
<b>description</b>	snap lock mounting pos. upper L 53mm W 14mm H 14mm thread M12		

1 			
<b>GEV No.</b>	518245	<b>Ref. No.</b>	325030
<b>description</b>	spigot door catch		
<b>For models:</b>	22F, 22R, 2312-001, 2312-002, 40F, 440F, 44F, 45, 450, 46, 460, 500F, 500FD, 50F, 50FD, 510F, 510FD, 913297, 913298, 913299, 913300, 913360, 913361, 913391, 913392, 913418, 913546, 913547, 913578, 913611, 913684, 913913, 913914, 913932, 913933, 914167, 914168, 914284, 914326, 914331, 914356, 914398, 914399, 914400, 914401, 914402, 914403, 914404, 914405, 914406...(Other models you can see in the webshop)		

1 			
<b>GEV No.</b>	518298	<b>Ref. No.</b>	325066
<b>description</b>	spigot door catch		
<b>For models:</b>	050F, 050FP, 915729, 916020, 916021, 916024, 916025, 916026, 916027, 916030, 916031, 916045, 916247, 916248, 916249, 916250, 916251, 916252, 916382, 916383, 916452, 916504, 916584, 916654, 916670, 916688, 916763, 916921, 916922, 916992, 916993, 917044, 917049, Clean161, F85, F85P, Fast145-2, Fast150, Fast160-2, Fast160C, Fast161-2, FAST-63, GSP50, GSP50P, GSP51, GSP51P, Ocean360, Ocean360M, Ocean360-UK		

miscellaneous



1

<b>GEV No.</b>	518527	<b>Ref. No.</b>	447116
<b>description</b>	bracket door handle door handle support		
<b>For models:</b>	21F, 21FD, 21R, 21RD, 25F, 25FD, 25R, 25RD, 30F, 30FD, 30R, 30RD, 31F, 31FD, 31R, 31RD, 440F, 44F, 55, E.65, ME15, ME20, ME30, ME40, MG15, MG20, MG30, MG40		



2

<b>GEV No.</b>	513203	<b>Ref. No.</b>	80277
<b>description</b>	bracket for lever		
<b>For models:</b>	80, 81, 82, CE78HZ23, CGL74CABT, CNT800CH, E78, E78HP, Fast180, Fast180-230V-3Ph-60Hz, Fast181, FAST-181, Fast181-230V-3Ph-60Hz, Fast181-400V-3NPh-60Hz, FAST-60, FAST-73, HM1, NG281, NG281CDD, NG281HP, NG281HPDD, NG281HZ23, NG281HZ23DD, Niagara-281, Niagara-281-2, Niagara-281HP, NIAGARA-283, Niagara-283A, OC380, OC380FUR, OC380HZ23, Ocean380, PLUVIA-280, Pluvia280-230V-3PH-60HZ, PS-60, PV280, PV280FAST, PV280FAST2, PV280FAST2BIO, PV280FAST2HZ23, PV280FASTCH, PV280FASTHB, PV280HZ23, RIVER-282, River-285, RIVER-78, RIVER-80, River-81, River-81CRP, RIVER-81-CRP...(Other models you can see in the webshop)		

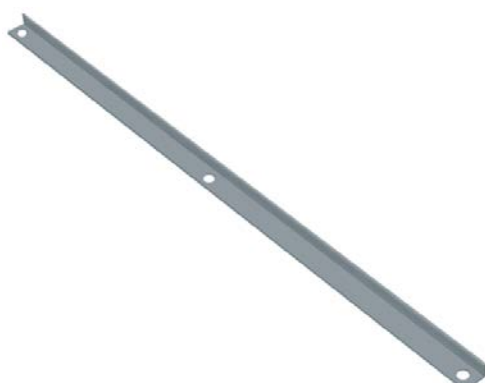

1

<b>GEV No.</b>	518247	<b>Ref. No.</b>	033291
<b>description</b>	fastening angle for door seal		
<b>For models:</b>	350F, 350FD, 350R, 350RD, 35-ELECTRONIC, 35F, 35FD, 35R, 35RD, 913289, 913290, 913356, 913372, 913373, 913544, 913665, 913667, 913771, 913772, 913832, 913837, 914165, 914166, 914206, 914355, 914386, 914387, 914388, 914389, 914390, 914391, 914692, 914693, 914694, 914703, 914870, 915686, 915687, 915688, 915689, 915690, 915691, 916237, 916238, 916239, 916240, 916241, 916401, 916402, 916403...(Other models you can see in the webshop)		



1

<b>GEV No.</b>	518249	<b>Ref. No.</b>	033294
<b>description</b>	fastening angle for door seal		
<b>For models:</b>	400F, 400FD, 400R, 400RD, 40-ELECTRONIC, 40F, 40FD, 40R, 40RD, 67F, 67R, 913291, 913292, 913357, 913374, 913375, 913416, 913435, 913545, 913666, 913668, 913685, 913773, 913774, 913911, 913912, 913948, 913950, 913977, 913984, 913990, 914392, 914393, 914394, 914395, 914396, 914397, 914441, 914442, 914515, 914516, 914537, 914543, 914547, 914683, 914684, 914689, 914863, 915138, 915139...(Other models you can see in the webshop)		



1

<b>GEV No.</b>	519406	<b>Ref. No.</b>	929209
<b>description</b>	gasket for sliding plate dimensions 69x16mm		



1

<b>GEV No.</b>	518526	<b>Ref. No.</b>	447137
<b>description</b>	grip shell		
<b>For models:</b>	CLEAN-3		



1

<b>GEV No.</b>	518522	<b>Ref. No.</b>	311013
<b>description</b>	hinge hinge		
<b>For models:</b>	913992, 913993, 914583, 914592, 914612, 914613, 915143, CLEAN-3, RIVER-40, RIVER-40-CRP, RIVER-43, RIVER-44, RIVER-44-CRP, River-44-CRP-ST, RIVER-44CRP-ST		



1

<b>GEV No.</b>	513204	<b>Ref. No.</b>	80275
<b>description</b>	opposite support for spring $\varnothing$ 28mm L 100mm		
<b>For models:</b>	80, 81, 82, CE78HZ23, CGL74CABT, CNT800CH, E78, E78HP, Fast180, Fast180-230V-3Ph-60Hz, Fast181, FAST-181, Fast181-230V-3Ph-60Hz, Fast181-400V-3NPh-60Hz, FAST-60, FAST-73, HM1, NG281, NG281CDD, NG281HP, NG281HPDD, NG281HZ23, NG281HZ23DD, Niagara-281, Niagara-281-2, Niagara-281HP, NIAGARA-283, Niagara-283A, OC380, OC380FUR, OC380HZ23, Ocean380, PLUVIA-280, Pluvia280-230V-3PH-60HZ, PS-60, PV280, PV280FAST, PV280FAST2, PV280FAST2BIO, PV280FAST2HZ23, PV280FASTCH, PV280FASTHB, PV280HZ23, RIVER-282, River-285, RIVER-78, RIVER-80, River-81, River-81CRP, RIVER-81-CRP...(Other models you can see in the webshop)		



1

<b>GEV No.</b>	698708	<b>Ref. No.</b>	486224
<b>description</b>	screw ED $\varnothing$ 8.5mm ID $\varnothing$ 4.8mm L 12mm thread M5		
<b>For models:</b>	2312-007, 2312-009-CRP, 914100, 914101, 914624, 914625, 914627, 914628, 914850, 914851, 914854, 914944, RIVER-50, RIVER-50-CRP, RIVER-50-CRP-SP, RIVER-54, RIVER-54CRP, River-54-CRP-s.p., RIVER-54-CRP-SP, RIVER-61		



1

<b>GEV No.</b>	698748	<b>Ref. No.</b>	35013
<b>description</b>	side panel for door L 235mm W 100mm thickness 2mm		
<b>For models:</b>	LP60, NG271, NG291, NIAGARA-271, NIAGARA-291, RIVER-294, RIVER-71, RV294, RV71, U60E		



1

<b>GEV No.</b>	513288	<b>Ref. No.</b>	307018
<b>description</b>	spring holder for door spring		
<b>For models:</b>	915617, 915618, 915672, 915773, 915774, 916066, 916077, 916078, 916418, 916419, 916594, 916595, River-242, River-242-2, River-242-2T, River-342C, River-342T		

screw connections



1

<b>GEV No.</b>	518508	<b>Ref. No.</b>	926222
<b>description</b>	nut thread 1/4" H 7mm WS 50 brass Qty 1 pcs		
<b>For models:</b>	E12, E120, E14, E140		



1

<b>GEV No.</b>	519498	<b>Ref. No.</b>	417120
<b>description</b>	nut thread 3/4" H 10mm WS 30 plastic Qty 1 pcs		
<b>For models:</b>	2312-007, 913992, 913993, 914100, 914101, 914339, 914342, 914343, 914583, 914592, 914612, 914613, 914624, 914625, 914626, 914627, 914628, 914850, 914851, 914854, 914944, 915143, Fast181, FAST-181, Fast181-230V-3Ph-60Hz, Fast181-400V-3NPh-60Hz, NG271, NG291, NG292, NG292HZ, NG293, NG381, NG38123, NG38123TERMO, NG381C, NG381CDD, NG381CFUR, NG381DDHZ23, NG381DDPS, NG381DDPSHZ23, NG381HPDD, NG381L, NG381LC, NG381LCFUR, NG381LDDPS, NG381TERMO, NG381TXCDD, NIAGARA-271, NIAGARA-283, Niagara-283A...(Other models you can see in the webshop)		



1

<b>GEV No.</b>	698874	<b>Ref. No.</b>	417119
<b>description</b>	nut thread M3 H 3.5mm plastic Qty 1 pcs for PCB		
<b>For models:</b>	2312-007, 2312-009-CRP, 913911, 913912, 913913, 913914, 913950, 913977, 913984, 913990, 913992, 913993, 914100, 914101, 914165, 914166, 914167, 914168, 914206, 914214, 914284, 914316, 914317, 914318, 914319, 914338, 914339, 914342, 914343, 914355, 914356, 914431, 914516, 914543, 914583, 914592, 914612, 914613, 914624, 914625, 914626, 914627, 914628, 914642, 914684, 914850, 914851, 914854, 914874, 914909...(Other models you can see in the webshop)		



1

<b>GEV No.</b>	698705	<b>Ref. No.</b>	429075
<b>description</b>	screw H 14mm WS 22 Qty 1 pcs plastic for air valve		
<b>For models:</b>	915150, 915151, 915152, 915154, 915155, 915157, 915158, 915160, 915161, 915162, 915166, 915167, 915168, 915172, 915173, 915175, 915176, 915177, 915285, 915319, 915338, 915341, 915348, 915418, 915419, 915420, 915421, 915422, 915479, 915492, 915493, 915494, 915495, 915496, 915497, 915547, 915558, 915635, 915663, 915747, 916054, 916067, 916068, 916069, 916079, 916080, 916201, 916202, 916203, 916204...(Other models you can see in the webshop)		



1

<b>GEV No.</b>	698876	<b>Ref. No.</b>	486078
<b>description</b>	screw thread M6x30mm Qty 1 pcs SS		
<b>For models:</b>	914380, 914436, A3EB, A3EBD, A3EBDAKRYK, A3EBDAKWK, A3EBDBKWK, A3EBDRKYK, A3EBDVK, A3EBDYK, A3EBSAK, A3EBSAKRK, A3EBSAKWK, A3EBSBKWKYK, A3EBSEKWK, A3EBSWK, A4EB, A4EBD, A4EBDAKEKYK, A4EBDAKRK, A4EBDAKWK, A4EBDAKZK, A4EBDBKRR, A4EBDPKWKYK, A4EBDRK, A4EBS, A4EBSAK, A4EBSAKCK, A4EBSAKEKYK, A4EBSAKRK, A4EBSAKRKP, A4EBSAKYK, A4EBSCK, A4EBT, A4EBTSAK, A5EB, A5EBD, A5EBDAKPKWK, A5EBDAKWK, A5EBDAKYK, A5EBDRK, A5EBS, A5EBSAKPKWK, A5EBSAKRK, A5EBSAKRKYK, A5EBSAKWK, A5EBSAKWKYK, A5EBSBKRPK, A5EBSBKWK, A5EBSRK...(Other models you can see in the webshop)		



curtains

curtains



1

<b>GEV No.</b>	533008	<b>Ref. No.</b>	75120
<b>description</b>	curtain W 540mm H 405mm plastic thickness 1.3mm		
<b>For models:</b>	914380, 914436, A3EB, A3EBD, A3EBDAKRKYK, A3EBDAKWK, A3EBDBKWK, A3EBDRKYK, A3EBDVK, A3EBDYK, A3EBSAK, A3EBSAKRK, A3EBSAKWK, A3EBSBKWKYK, A3EBSEKWK, A3EBSWK, A4EB, A4EBD, A4EBDAKEYK, A4EBDAKRK, A4EBDAKWK, A4EBDAKZK, A4EBDBKRW, A4EBDPKWKYK, A4EBDRK, A4EBS, A4EBSAK, A4EBSAKCK, A4EBSAKKEYK, A4EBSAKRK, A4EBSAKRKP, A4EBSAKYK, A4EBSCK, A4EBT, A4EBTSAK, A5EB, A5EBD, A5EBDAKPKWK, A5EBDAKWK, A5EBDAKYK, A5EBDRK, A5EBS, A5EBSAKPKWK, A5EBSAKRK, A5EBSAKRKYK, A5EBSAKWK, A5EBSAKWKYK, A5EBSBKRPK, A5EBSBKWK, A5EBSRK...(Other models you can see in the webshop)		
<b>accessories for</b>	533008		
	<b>GEV No.</b>	<b>Ref. No.</b>	
	533009	75121	
	curtain rod L 545mm ø 8mm		



1

<b>GEV No.</b>	533018	<b>Ref. No.</b>	77120
<b>description</b>	curtain W 585mm H 400mm		
<b>For models:</b>	A4EB, A4EBD, A4EBDAKEYK, A4EBDAKRK, A4EBDAKWK, A4EBDAKZK, A4EBDBKRW, A4EBDPKWKYK, A4EBDRK, A4EBS, A4EBSAK, A4EBSAKCK, A4EBSAKKEYK, A4EBSAKRK, A4EBSAKRKP, A4EBSAKYK, A4EBSCK, A4EBT, A4EBTSAK, A5EB, A5EBD, A5EBDAKPKWK, A5EBDAKWK, A5EBDAKYK, A5EBDRK, A5EBS, A5EBSAKPKWK, A5EBSAKRK, A5EBSAKRKYK, A5EBSAKWK, A5EBSAKWKYK, A5EBSBKRPK, A5EBSBKWK, A5EBSRK, A5EBSYK, GL284EB, GL284EBD, GL284EBDA, GL284EBDAEW, GL284EBDAWY, GL284EBDPWY, GL284EBDR, GL284EBDY, GL284EBHZ23, GL284EBHZ23DBHZY, GL284EBHZ23DBWY, GL284EBHZ23DBY, GL284EBHZ23DY, GL284EBHZ23SAP, GL284EBS...(Other models you can see in the webshop)		



1

<b>GEV No.</b>	533007	<b>Ref. No.</b>	75123
<b>description</b>	curtain W 620mm H 250mm thickness 1.4mm		
<b>For models:</b>	914380, 914436, A3EB, A3EBD, A3EBDAKRKYK, A3EBDAKWK, A3EBDBKWK, A3EBDRKYK, A3EBDVK, A3EBDYK, A3EBSAK, A3EBSAKRK, A3EBSAKWK, A3EBSBKWKYK, A3EBSEKWK, A3EBSWK, A4EB, A4EBD, A4EBDAKEYK, A4EBDAKRK, A4EBDAKWK, A4EBDAKZK, A4EBDBKRW, A4EBDPKWKYK, A4EBDRK, A4EBS, A4EBSAK, A4EBSAKCK, A4EBSAKKEYK, A4EBSAKRK, A4EBSAKRKP, A4EBSAKYK, A4EBSCK, A4EBT, A4EBTSAK, A5EB, A5EBD, A5EBDAKPKWK, A5EBDAKWK, A5EBDAKYK, A5EBDRK, A5EBS, A5EBSAKPKWK, A5EBSAKRK, A5EBSAKRKYK, A5EBSAKWK, A5EBSAKWKYK, A5EBSBKRPK, A5EBSBKWK, A5EBSRK...(Other models you can see in the webshop)		

curtain rods



1

<b>GEV No.</b>	533009	<b>Ref. No.</b>	75121
<b>description</b>	curtain rod L 545mm ø 8mm		
<b>For models:</b>	914380, 914436, A3EB, A3EBD, A3EBDAKRKYK, A3EBDAKWK, A3EBDBKWK, A3EBDRKYK, A3EBDVK, A3EBDYK, A3EBSAK, A3EBSAKRK, A3EBSAKWK, A3EBSBKWKYK, A3EBSEKWK, A3EBSWK, A4EB, A4EBD, A4EBDAKEYK, A4EBDAKRK, A4EBDAKWK, A4EBDAKZK, A4EBDBKRW, A4EBDPKWKYK, A4EBDRK, A4EBS, A4EBSAK, A4EBSAKCK, A4EBSAKKEYK, A4EBSAKRK, A4EBSAKRKP, A4EBSAKYK, A4EBSCK, A4EBT, A4EBTSAK, A5EB, A5EBD, A5EBDAKPKWK, A5EBDAKWK, A5EBDAKYK, A5EBDRK, A5EBS, A5EBSAKPKWK, A5EBSAKRK, A5EBSAKRKYK, A5EBSAKWK, A5EBSAKWKYK, A5EBSBKRPK, A5EBSBKWK, A5EBSRK...(Other models you can see in the webshop)		



1





<b>GEV No.</b>	533019	<b>Ref. No.</b>	75124
<b>description</b>	curtain rod L 620mm ø 8mm		
<b>For models:</b>	914380, 914436, A3EB, A3EBD, A3EBDAKRKYK, A3EBDAKWK, A3EBDBKWK, A3EBDRKYK, A3EBDVK, A3EBDYK, A3EBSAK, A3EBSAKRK, A3EBSAKWK, A3EBSBKWKYK, A3EBSEKWK, A3EBSWK, A4EB, A4EBD, A4EBDAKEYK, A4EBDAKRK, A4EBDAKWK, A4EBDAKZK, A4EBDBKRW, A4EBDPKWKYK, A4EBDRK, A4EBS, A4EBSAK, A4EBSAKCK, A4EBSAKKEYK, A4EBSAKRK, A4EBSAKRKP, A4EBSAKYK, A4EBSCK, A4EBT, A4EBTSAK, A5EB, A5EBD, A5EBDAKPKWK, A5EBDAKWK, A5EBDAKYK, A5EBDRK, A5EBS, A5EBSAKPKWK, A5EBSAKRK, A5EBSAKRKYK, A5EBSAKWK, A5EBSAKWKYK, A5EBSBKRPK, A5EBSBKWK, A5EBSRK...(Other models you can see in the webshop)		





washing and rinsing systems





1

<b>GEV No.</b>	513271	<b>Ref. No.</b>	412028
<b>description</b>	connector holder grey		
<b>For models:</b>	2312-001, 2312-002, E.35, E.35H, E.40, E.40H, E.50, E.51, GLS40H, GLS40HP, MC201CL, MISTRAL-40, MISTRAL-51, NIAGARA-35, NIAGARA-40, NIAGARA-51		

			
<b>1</b>			
<b>GEV No.</b>	517568	<b>Ref. No.</b>	41064
<b>description</b>	counterflange for wash arm support $\phi$ 69mm ID $\phi$ 63mm H 35mm mounting distance 64mm hole $\phi$ 7mm		
<b>For models:</b>	KLP105EB, KLP201DDDTEB, KLP201EB, KLP301, KLP301DDDTEB, LP105DDDTEB, LP105DDDTEBN, LP105EB, LP201DDDTEB, LP201EB, LP301, LP301EB, NG292, NG292HZ, NG293, NIAGARA-292, Niagara-292-400V-3Ph-60Hz, NIAGARA-293, RIVER-295, River-295P, RIVER-296, River-296P, RIVER-297, RIVER-298, RV295, RV295PS, RV296, RV296PS, RV297, RV298, RV298HZ, U132E, U61E, U61HE, U70e		
<b>accessories for</b>	517568		
	<b>GEV No.</b>	531605	<b>Ref. No.</b> 42053
	extension for rinsing shaft $\phi$ 16mm H 122mm thread L 12mm WS 19		
	<b>GEV No.</b>	532603	<b>Ref. No.</b> 926252
	O-ring EPDM thickness 3.53mm ID $\phi$ 69.85mm Qty 1 pcs		
	<b>GEV No.</b>	698750	<b>Ref. No.</b> 41185
	throttle disc $\phi$ 71.5mm hole $\phi$ 17/22mm		

			
<b>1</b>			
<b>GEV No.</b>	517441	<b>Ref. No.</b>	41064CP C.41064CP
<b>description</b>	counterflange for wash arm support with throttle disc $\phi$ 70mm ID $\phi$ 63mm L 110mm W 89mm H 35mm		
<b>For models:</b>	KLP105EB, KLP201DDDTEB, KLP201EB, KLP301, KLP301DDDTEB, LP105DDDTEB, LP105DDDTEBN, LP105EB, LP201DDDTEB, LP201EB, LP301, LP301EB, NG292, NG292HZ, NG293, NIAGARA-292, Niagara-292-400V-3Ph-60Hz, NIAGARA-293, RIVER-295, River-295P, RIVER-296, River-296P, RIVER-297, RIVER-298, RV295, RV295PS, RV296, RV296PS, RV297, RV298, RV298HZ, U132, U132E, U61, U61E, U61H, U61HE, U70, U70e		
<b>spare parts for</b>	517441		
	<b>GEV No.</b>	698750	<b>Ref. No.</b> 41185
	throttle disc $\phi$ 71.5mm hole $\phi$ 17/22mm		
<b>accessories for</b>	517441		
	<b>GEV No.</b>	531605	<b>Ref. No.</b> 42053
	extension for rinsing shaft $\phi$ 16mm H 122mm thread L 12mm WS 19		
	<b>GEV No.</b>	532603	<b>Ref. No.</b> 926252
	O-ring EPDM thickness 3.53mm ID $\phi$ 69.85mm Qty 1 pcs		

			
<b>1</b>			
<b>GEV No.</b>	518473	<b>Ref. No.</b>	927084
<b>description</b>	disc ID $\phi$ 12.2mm ED $\phi$ 19.3mm thickness 1.3mm		
<b>For models:</b>	161, 221, 271, 272, 362, CLEAN-160, CLEAN-161, CLEAN-220, CLEAN-221, CLEAN-270, CLEAN-271, CLEAN-272, CLEAN-361, CLEAN-361P, CLEAN-362, CLEAN-471, CLEAN-471P, E.60, E.65		

			
<b>1</b>			
<b>GEV No.</b>	510016	<b>Ref. No.</b>	486002
<b>description</b>	eye bolt for rinse aid container connection		
<b>For models:</b>	050F, 050FP, 11F, 11FD, 11F-DVGW, 11R, 11RD, 21F, 21FD, 21R, 21RD, 22F, 22R, 25F, 25FD, 25R, 25RD, 30F, 30FD, 30R, 30RD, 31F, 31FD, 31R, 31RD, 40F, 440F, 44F, 500F, 500FD, 50-ELECTRONIC, 50F, 50FD, 510F, 510FD, 66, E.52, F85, F85P, S621, S623, S624, S626, S631, S633, S634, S636, S651, S651P, S653...(Other models you can see in the webshop)		

			
<b>1</b>			
<b>GEV No.</b>	518461	<b>Ref. No.</b>	303029
<b>description</b>	flange for wash arm support		
<b>For models:</b>	050F, 050FP, 2312-001, 2312-002, 913297, 913298, 913299, 913300, 913360, 913361, 913391, 913392, 913546, 913547, 913578, 913611, 913684, 913913, 913914, 913932, 913933, 914284, 914318, 914319, 914331, 914338, 914356, 914400, 914401, 914402, 914403, 914404, 914405, 914431, 914449, 914517, 914545, 914568, 914642, 914688, 914909, 914979, 915136, 915137, 915140, 915248, 915483, 915484, 915528, 915537...(Other models you can see in the webshop)		

			
<b>1</b>			
<b>GEV No.</b>	507545	<b>Ref. No.</b>	437091
<b>description</b>	flat gasket PTFE ED $\phi$ 13mm ID $\phi$ 7mm thickness 0.65mm Qty 1 pcs		
<b>For models:</b>	2312-007, 2312-009-CRP, 913992, 913993, 914100, 914101, 914339, 914342, 914343, 914583, 914592, 914612, 914613, 914624, 914625, 914626, 914627, 914628, 914850, 914851, 914854, 914944, 915143, E.55, RIVER-40, RIVER-40-CRP, RIVER-43, RIVER-44, RIVER-44-CRP, RIVER-44-CRP-ST, RIVER-44CRP-ST, RIVER-48, RIVER-50, RIVER-50-CRP, RIVER-50-CRP-SP, RIVER-54, RIVER-54CRP, RIVER-54-CRP-s.p., RIVER-54-CRP-SP, RIVER-61		

			
<b>1</b>			
<b>GEV No.</b>	518240	<b>Ref. No.</b>	437078
<b>description</b>	flat gasket rubber ED $\phi$ 33mm ID $\phi$ 17mm thickness 1.5mm Qty 1 pcs		
<b>For models:</b>	2312-009-CRP, 67R, 913289, 913290, 913291, 913292, 913356, 913357, 913363, 913364, 913372, 913373, 913374, 913375, 913376, 913377, 913416, 913435, 913544, 913545, 913665, 913666, 913667, 913668, 913685, 913771, 913772, 913773, 913774, 913832, 913837, 913911, 913912, 913948, 913950, 913977, 913984, 913990, 913992, 913993, 914165, 914166, 914206, 914214, 914316, 914317, 914355, 914386, 914387, 914388...(Other models you can see in the webshop)		



			
1			
<b>GEV No.</b>	507541	<b>Ref. No.</b>	437102
<b>description</b>	flat gasket rubber ED ø 74mm ID ø 57mm thickness 2mm Qty 1 pcs		
<b>For models:</b>	915150, 915151, 915152, 915154, 915155, 915157, 915158, 915160, 915161, 915162, 915166, 915167, 915168, 915172, 915173, 915175, 915176, 915177, 915285, 915319, 915338, 915341, 915348, 915418, 915419, 915420, 915421, 915422, 915479, 915492, 915493, 915494, 915495, 915496, 915497, 915547, 915558, 915617, 915618, 915635, 915663, 915672, 915747, 915773, 915774, 916020, 916021, 916024, 916025, 916026...(Other models you can see in the webshop)		

			
1			
<b>GEV No.</b>	518444	<b>Ref. No.</b>	199051 480008
<b>description</b>	flow control valve for wash arm ø 16mm H 20mm		
<b>For models:</b>	67R, 913291, 913292, 913357, 913374, 913375, 913416, 913435, 913545, 913666, 913668, 913685, 913773, 913774, 913911, 913912, 913948, 913950, 913977, 913984, 913990, 914214, 914316, 914317, 914392, 914393, 914394, 914395, 914396, 914397, 914441, 914442, 914515, 914516, 914537, 914543, 914547, 914683, 914684, 914689, 914863, 914874, 915138, 915139, 915527, 915692, 915693, 915694, 915816, 916162...(Other models you can see in the webshop)		

			
1			
<b>GEV No.</b>	513228	<b>Ref. No.</b>	926035
<b>description</b>	gasket		
<b>For models:</b>	10, 12, 14, CLEAN-100, CLEAN-110, CLEAN-120, E1, E10, E100, E110, E12, E120, E14, E140		

			
1			
<b>GEV No.</b>	513277	<b>Ref. No.</b>	437080
<b>description</b>	gasket		
<b>For models:</b>	67F, 67R, 913291, 913292, 913357, 913363, 913364, 913374, 913375, 913376, 913377, 913416, 913435, 913545, 913666, 913668, 913685, 913773, 913774, 913911, 913912, 913948, 913950, 913977, 913984, 913990, 914214, 914316, 914317, 914392, 914393, 914394, 914395, 914396, 914397, 914441, 914442, 914515, 914516, 914537, 914543, 914547, 914683, 914689, 914863, 914874, 915138, 915139, 915150, 915151...(Other models you can see in the webshop)		

			
1			
<b>GEV No.</b>	518594	<b>Ref. No.</b>	437037
<b>description</b>	gasket for rinse connection		
<b>For models:</b>	21F, 21FD, 21R, 21RD, 25F, 25FD, 25R, 25RD, 30F, 30FD, 30R, 30RD, 31F, 31FD, 31R, 31RD, 45, 450, 913418, 914167, 914168, 914398, 914399, 914443, 914943, 915695, 915696, 915819, E.45, Fast145, FAST-145, Fast145D, FAST-145D, Niagara-45, S621, S623, S624, S626, S631, S633, S634, S636		

			
1			
<b>GEV No.</b>	518071	<b>Ref. No.</b>	80178
<b>description</b>	gasket for wash arm support L 109mm W 68mm		
<b>For models:</b>	80, 81, 82, CE78HZ23, CGL74CABT, CNT800CH, E78, E78HP, Fast180, Fast180-230V-3Ph-60Hz, Fast181, FAST-181, Fast181-230V-3Ph-60Hz, Fast181-400V-3NPh-60Hz, FAST-60, FAST-73, HM1, NG281, NG281CDD, NG281HP, NG281HPDD, NG281HZ23, NG281HZ23DD, NG381, NG38123, NG38123TERMO, NG381C, NG381CDD, NG381CFUR, NG381DDHZ23, NG381DDPS, NG381DDPSHZ23, NG381HPDD, NG381L, NG381LC, NG381LCFUR, NG381LDDPS, NG381TERMO, NG381TXCDD, Niagara-281, Niagara-281-2, Niagara-281HP, NIAGARA-283, Niagara-283A, Niagara-283L-2, Niagara-381, Niagara-381-230V-3Ph-50Hz, Niagara-381-230V-3Ph-60Hz, Niagara-381DP, Niagara-381HPD...(Other models you can see in the webshop)		

			
1			
<b>GEV No.</b>	518116	<b>Ref. No.</b>	H.17298619
<b>description</b>	gasket for wash arm support rubber ø 60mm ID ø 47mm thickness 1mm		
<b>For models:</b>	2312-007, 2312-009-CRP, 914326, E.55, NIAGARA-251, NIAGARA-261, PLUVIA-260, RIVER-48, RIVER-50, RIVER-50-CRP, RIVER-50-CRP-SP, RIVER-54, RIVER-54-CRP-SP, RIVER-61		

			
1			
<b>GEV No.</b>	518595	<b>Ref. No.</b>	111001
<b>description</b>	hose connector double		
<b>For models:</b>	21F, 21FD, 21R, 21RD, 25F, 25FD, 25R, 25RD, 30F, 30FD, 30R, 30RD, 31F, 31FD, 31R, 31RD, 45, 450, 913418, 914167, 914168, 914398, 914399, 914443, 914943, 915695, 915696, 915819, E.45, Fast145, FAST-145, Fast145D, FAST-145D, Niagara-45, S621, S623, S624, S626, S631, S633, S634, S636		

			
1			
<b>GEV No.</b>	513158	<b>Ref. No.</b>	80365
<b>description</b>	knurled nut		
<b>For models:</b>	Fast181, FAST-181, KLP105EB, KLP201DDDTTEB, KLP201EB, KLP301, KLP301DDDTTEB, LP105DDDTTEB, LP105DDDTTEBN, LP105EB, LP201DDDTTEB, LP201EB, LP301, LP301EB, NG271, NG291, NG292, NG293, NG381, NG38123, NG38123TERMO, NG381C, NG381CDD, NG381CFUR, NG381DDHZ23, NG381DDPS, NG381DDPSHZ23, NG381HPDD, NG381TERMO, NG381TXCDD, NIAGARA-271, NIAGARA-283, Niagara-283A, NIAGARA-291, NIAGARA-292, NIAGARA-293, Niagara-381, Niagara-381-230V-3Ph-50Hz, Niagara-381-230V-3Ph-60Hz, Niagara-381DP, Niagara-381HPD, RIVER-282, RIVER-282-2, RIVER-2825-2TDE, RIVER-285, RIVER-294, RIVER-295, RIVER-296, RIVER-297, RIVER-298...(Other models you can see in the webshop)		

			
1			
<b>GEV No.</b>	518286	<b>Ref. No.</b>	472068
<b>description</b>	knurled nut		
<b>For models:</b>	2312-007, 2312-009-CRP, 914100, 914101, 914339, 914342, 914343, 914624, 914625, 914626, 914627, 914628, 914850, 914851, 914854, 914944, E.55, RIVER-48, RIVER-50, RIVER-50-CRP, RIVER-50-CRP-SP, River-54, RIVER-54CRP, River-54-CRP-s.p., RIVER-54-CRP-SP, RIVER-61		

			
1			
<b>GEV No.</b>	518665	<b>Ref. No.</b>	454006
<b>description</b>	knurled nut mounting pos. upper/lateral ø 19.65mm H 4mm thread M5		
<b>For models:</b>	913289, 913290, 913291, 913292, 913297, 913298, 913299, 913300, 913356, 913357, 913360, 913361, 913372, 913373, 913374, 913375, 913391, 913392, 913416, 913418, 913435, 913544, 913545, 913546, 913547, 913578, 913611, 913665, 913666, 913667, 913668, 913684, 913685, 913771, 913772, 913773, 913774, 913832, 913837, 913911, 913912, 913913, 913914, 913932, 913933, 913948, 913950, 913977, 913984, 913990...(Other models you can see in the webshop)		

			
1			
<b>GEV No.</b>	517444	<b>Ref. No.</b>	80697
<b>description</b>	knurled nut thread M10x1 ø 25mm H 4mm SS		
<b>For models:</b>	915830, Fast160DP		

			
1			
<b>GEV No.</b>	518238	<b>Ref. No.</b>	143173 143268
<b>description</b>	manifold ø 12mm L 98mm		
<b>For models:</b>	050F, 050FP, 10, 12, 14, 2312-001, 2312-002, 2312-009-CRP, 31F, 31FD, 31R, 31RD, 350F, 350FD, 350R, 350RD, 35-ELECTRONIC, 35F, 35FD, 35R, 35RD, 400F, 400FD, 400R, 400RD, 40-ELECTRONIC, 40F, 40FD, 40R, 40RD, 45, 450, 46, 460, 500F, 500FD, 50-ELECTRONIC, 50F, 50FD, 510F, 510FD, 67F, 67R, 80, 81, 82, 913418, 913992, 913993, 914167...(Other models you can see in the webshop)		

			
1			
<b>GEV No.</b>	510104	<b>Ref. No.</b>	991002
<b>description</b>	mixer for rinse aid		
<b>For models:</b>	R499, R501, R503, R505, R507, S641, S643, S950		

			
1			
<b>GEV No.</b>	518181	<b>Ref. No.</b>	429053
<b>description</b>	nut		
<b>For models:</b>	913992, 913993, 914583, 914592, 914612, 914613, 915143, CLEAN-3, RIVER-40, RIVER-40-CRP, RIVER-43, RIVER-44, RIVER-44-CRP, River-44-CRP-ST, RIVER-44CRP-ST		

			
1			
<b>GEV No.</b>	518593	<b>Ref. No.</b>	417039
<b>description</b>	nut for rinse pipe		
<b>For models:</b>	21F, 21FD, 21R, 21RD, 25F, 25FD, 25R, 25RD, 30F, 30FD, 30R, 30RD, 31F, 31FD, 31R, 31RD, 45, 450, 913418, 914167, 914168, 914398, 914399, 914443, 914943, 915695, 915696, 915819, E.45, Fast145, FAST-145, Fast145D, FAST-145D, Niagara-45, S621, S623, S624, S626, S631, S633, S634, S636		

			
1			
<b>GEV No.</b>	517454	<b>Ref. No.</b>	308031
<b>description</b>	nut for wash arm ED ø 35mm thickness 11mm plastic		
<b>For models:</b>	2312-007, 914100, 914101, 914339, 914342, 914343, 914568, 914624, 914625, 914626, 914627, 914628, 914850, 914851, 914854, 914944, 915830, E.50D.PA, Fast160DP, FAST-160DP, RIVER-48, RIVER-54, RIVER-54CRP, River-54-CRP-s.p.		

			
1			
<b>GEV No.</b>	518637	<b>Ref. No.</b>	429073
<b>description</b>	nut for wash arm support thread M56x2		
<b>For models:</b>	915150, 915151, 915152, 915154, 915155, 915157, 915158, 915160, 915161, 915162, 915166, 915167, 915168, 915172, 915173, 915175, 915176, 915177, 915285, 915319, 915338, 915341, 915348, 915418, 915419, 915420, 915421, 915422, 915479, 915492, 915493, 915494, 915495, 915496, 915497, 915547, 915558, 915617, 915618, 915635, 915663, 915672, 915747, 915773, 915774, 916020, 916021, 916024, 916025, 916026...(Other models you can see in the webshop)		







			
1			
<b>GEV No.</b>	518596	<b>Ref. No.</b>	417038
<b>description</b>	nut wash pipe		
<b>For models:</b>	21F, 21FD, 21R, 21RD, 25F, 25FD, 25R, 25RD, 30F, 30FD, 30R, 30RD, 31F, 31FD, 31R, 31RD, 45, 450, 67F, 67R, 913291, 913292, 913357, 913363, 913364, 913374, 913375, 913376, 913377, 913416, 913418, 913435, 913545, 913666, 913668, 913685, 913773, 913774, 913911, 913912, 913948, 913950, 913977, 913984, 913990, 914167, 914168, 914214, 914316, 914317...(Other models you can see in the webshop)		

			
2			
<b>GEV No.</b>	518086	<b>Ref. No.</b>	80174
<b>description</b>	opposite support		
<b>For models:</b>	CGL74CABT, CNT800CH, Fast180, Fast180-230V-3Ph-60Hz, FAST-60, FAST-73, NG281, NG281CDD, NG281HP, NG281HPDD, NG281HZ23, NG281HZ23DD, NG381, NG38123, NG38123TERMO, NG381C, NG381CDD, NG381CFUR, NG381DDHZ23, NG381DDPS, NG381D-DPSHZ23, NG381HPDD, NG381L, NG381LC, NG381LCFUR, NG381LD-DPS, NG381TERMO, NG381TXCDD, NIAGARA-281, Niagara-281-2, Niagara-281HP, NIAGARA-283, Niagara-283A, Niagara-283L-2, Niagara-381, Niagara-381-230V-3Ph-50Hz, Niagara-381-230V-3Ph-60Hz, Niagara-381DP, Niagara-381HPD, Niagara-381L, Niagara-381LC, OC380, OC380FUR, OC380HZ23, Ocean380, PLUVIA-280, Pluvia280-230V-3PH-60HZ, PS-60, PV280, PV280FAST...(Other models you can see in the webshop)		

			
1			
<b>GEV No.</b>	518091	<b>Ref. No.</b>	80181
<b>description</b>	opposite support		
<b>For models:</b>	RIVER-71		

			
1			
<b>GEV No.</b>	518089	<b>Ref. No.</b>	80184
<b>description</b>	retaining ring for wash arm ID ø 40mm ED ø 44mm thickness 3mm		
<b>For models:</b>	Fast180, Fast180-230V-3Ph-60Hz, Fast181, FAST-181, Fast181-230V-3Ph-60Hz, Fast181-400V-3NPh-60Hz, LP60, NG291, NG381, NG38123, NG38123TERMO, NG381C, NG381CDD, NG381CFUR, NG381DDHZ23, NG381DDPS, NG381DDPSHZ23, NG381HPDD, NG381L, NG381LC, NG381LCFUR, NG381LDDPS, NG381TERMO, NG381TXCDD, Niagara-281-2, Niagara-283L-2, NIAGARA-291, Niagara-381, Niagara-381-230V-3Ph-50Hz, Niagara-381-230V-3Ph-60Hz, Niagara-381DP, Niagara-381HPD, Niagara-381L, Niagara-381LC, OC380, OC380FUR, OC380HZ23, Ocean380, PS-60, PV280FAST2, PV280FAST2BIO, PV280FAST2HZ23, River-282-2, River-282L-2, River-282LS-2TDE, River-282S-2TDE, River-285, RIVER-294, River-382, River-382-230V-3Ph-50Hz...(Other models you can see in the webshop)		

			
1			
<b>GEV No.</b>	524811	<b>Ref. No.</b>	303037
<b>description</b>	ring for wash arm ID ø 41mm ED ø 45mm thickness 3mm plastic		
<b>For models:</b>	914326, 914406, 915150, 915151, 915152, 915154, 915155, 915157, 915158, 915160, 915161, 915162, 915166, 915167, 915168, 915172, 915173, 915175, 915176, 915177, 915285, 915319, 915338, 915341, 915348, 915418, 915419, 915420, 915421, 915422, 915479, 915492, 915493, 915494, 915495, 915496, 915497, 915547, 915558, 915635, 915663, 915729, 915747, 916054, CE78HZ23, CNT800CH, E.55, E78, E78HP, FAST-181...(Other models you can see in the webshop)		

			
1			
<b>GEV No.</b>	698715	<b>Ref. No.</b>	80622
<b>description</b>	ring for wash arm ø 22mm ID ø 11.5mm thickness 1mm		

			
1	Image not available		
<b>GEV No.</b>	518389	<b>Ref. No.</b>	325046
<b>description</b>	rinse arm shaft		
<b>For models:</b>	CLEAN-3		

			
1			
<b>GEV No.</b>	513259	<b>Ref. No.</b>	111026
<b>description</b>	rinse arm support mounting pos. upper		
<b>For models:</b>	67F, 67R, 913291, 913292, 913357, 913363, 913364, 913374, 913375, 913376, 913377, 913416, 913435, 913545, 913666, 913668, 913685, 913773, 913774, 913911, 913912, 913948, 913950, 913977, 913984, 913990, 914214, 914316, 914317, 914392, 914393, 914394, 914395, 914396, 914397, 914441, 914442, 914515, 914516, 914537, 914543, 914547, 914683, 914684, 914689, 914863, 914874, 915138, 915139, 915527...(Other models you can see in the webshop)		

			
1			
<b>GEV No.</b>	518434	<b>Ref. No.</b>	429050
<b>description</b>	rinse arm support mounting pos. upper		
<b>For models:</b>	22F, 2312-009-CRP, 350F, 350FD, 350R, 350RD, 35-ELECTRONIC, 35F, 35FD, 35R, 35RD, 400F, 400FD, 400R, 400RD, 40-ELECTRONIC, 40F, 40FD, 40R, 40RD, 67R, 913289, 913290, 913291, 913292, 913356, 913357, 913363, 913364, 913372, 913373, 913374, 913375, 913376, 913377, 913416, 913435, 913544, 913545, 913665, 913666, 913667, 913668, 913685, 913771, 913772, 913773, 913774, 913832, 913837...(Other models you can see in the webshop)		

			
1			
<b>GEV No.</b>	518443	<b>Ref. No.</b>	468165
<b>description</b>	rinse arm support mounting pos. upper		
<b>For models:</b>	2312-009-CRP, 67R, 913289, 913290, 913291, 913292, 913356, 913357, 913363, 913364, 913372, 913373, 913374, 913375, 913376, 913377, 913416, 913435, 913544, 913545, 913665, 913666, 913667, 913668, 913685, 913771, 913772, 913773, 913774, 913832, 913837, 913911, 913912, 913948, 913950, 913977, 913984, 913990, 914165, 914166, 914206, 914214, 914316, 914317, 914355, 914386, 914387, 914388, 914389, 914390...(Other models you can see in the webshop)		

			
1			
<b>GEV No.</b>	518125	<b>Ref. No.</b>	143240
<b>description</b>	rinse hose ø 17.5mm		
<b>For models:</b>	913297, 913298, 913299, 913300, 913360, 913361, 913391, 913392, 913546, 913547, 913578, 913611, 913684, 913913, 913914, 913932, 913933, 914284, 914318, 914319, 914331, 914338, 914356, 914400, 914401, 914402, 914403, 914404, 914405, 914431, 914449, 914517, 914545, 914568, 914642, 914688, 914909, 914979, 915136, 915137, 915140, 915248, 915483, 915484, 915528, 915537, 915538, 915539, 915540, 915664...(Other models you can see in the webshop)		

			
1			
<b>GEV No.</b>	518471	<b>Ref. No.</b>	926065
<b>description</b>	rinse pipe		
<b>For models:</b>	12, 14, CLEAN-120, E12, E120, E14, E140		

			
1			
<b>GEV No.</b>	518003	<b>Ref. No.</b>	447030 447128
<b>description</b>	screw cap		
<b>For models:</b>	050F, 050FP, 11F, 11FD, 11F-DVGW, 21F, 21FD, 2312-001, 2312-002, 25F, 25FD, 30F, 30FD, 31F, 31FD, 400F, 400FD, 40-ELECTRONIC, 40F, 40FD, 45, 450, 46, 460, 500F, 500FD, 50F, 50FD, 510F, 510FD, 67R, 913363, 913364, 913376, 913377, 914568, 915830, E.41, E.42, E.45, E.46, E.50, E.50D.PA, E.51, E.41, F.85, F.85P, FAST-160DP, GSP50, GSP50P...(Other models you can see in the webshop)		

			
1			
<b>GEV No.</b>	513127	<b>Ref. No.</b>	80285
<b>description</b>	screw connection		
<b>For models:</b>	Fast181, ST70FASTHZ23		

			
1			
<b>GEV No.</b>	513286	<b>Ref. No.</b>	80281
<b>description</b>	screw connection		
<b>For models:</b>	80, 81, 82, CE78HZ23, CGL74CABT, E78, E78HP, FAST-181, Fast181-230V-3Ph-60Hz, Fast181-400V-3NPh-60Hz, HM1, NG271, NG291, NIAGARA-271, NIAGARA-283, Niagara-283A, NIAGARA-291, PS-60, RIVER-282, River-285, RIVER-294, RIVER-78, RIVER-80, River-81, River-81CRP, RIVER-81-CRP, RIVER-82, River-82CRP, RIVER-82-CRP, RIVER-E78, RIVER-HL-81, RIVER-HL-82, RV282, RV282DD, RV282R, RV294, RV71, RV80, RV8023, RV8023HZ, RV80C, RV80HZ, RV81, RV8123, RV81A, RV81C, RV81CCRP, RV81CRP, RV81HZ, RV81HZ23...(Other models you can see in the webshop)		

			
1			
<b>GEV No.</b>	518288	<b>Ref. No.</b>	429069
<b>description</b>	screw connection		
<b>For models:</b>	2312-007, 2312-009-CRP, 80, 81, 82, 914100, 914101, 914326, 914339, 914342, 914343, 914406, 914624, 914625, 914626, 914627, 914628, 914850, 914851, 914854, 914944, 915150, 915151, 915152, 915154, 915155, 915157, 915158, 915160, 915161, 915162, 915166, 915167, 915168, 915172, 915173, 915175, 915176, 915177, 915285, 915319, 915338, 915341, 915348, 915418, 915419, 915420, 915421, 915422, 915479...(Other models you can see in the webshop)		

			
1			
<b>GEV No.</b>	510011	<b>Ref. No.</b>	429008
<b>description</b>	screw connection plastic		
<b>For models:</b>	11F, 11FD, 11F-DVGW, 21F, 21FD, 25F, 25FD, 30F, 30FD, 31F, 31FD, 350F, 350FD, 35-ELECTRONIC, 35F, 35FD, 400F, 400FD, 40-ELECTRONIC, 40F, 40FD, 45, 450, 913289, 913290, 913291, 913292, 913356, 913357, 913363, 913364, 913372, 913373, 913374, 913375, 913376, 913377, 913416, 913418, 913435, 913544, 913545, 913665, 913666, 913667, 913668, 913685, 913771, 913772, 913773...(Other models you can see in the webshop)		

			
1			
<b>GEV No.</b>	518012	<b>Ref. No.</b>	308015
<b>description</b>	slide ring ED ø 65mm ID ø 50mm thickness 1.8mm		
<b>For models:</b>	S651, S654, S810, S815, S830, S835		





			
1			
<b>GEV No.</b>	517443	<b>Ref. No.</b>	437117 80623
<b>description</b>	slide ring for rinse arm mounting pos. upper/lower PTFE ED ø 22mm ID ø 9.5mm thickness 1mm		
<b>For models:</b>	915160, 915161, 915162, 915175, 915319, 915611, 915612, 915613, 915663, 915670, 915830, 916020, 916021, 916024, 916025, 916026, 916027, 916030, 916031, 916045, 916066, 916067, 916068, 916069, 916077, 916078, 916079, 916080, 916181, 916183, 916184, 916185, 916196, 916197, 916198, 916199, 916200, 916201, 916202, 916203, 916204, 916205, 916206, 916207, 916208, 916209, 916237, 916238, 916239, 916240...(Other models you can see in the webshop)		

			
1			
<b>GEV No.</b>	518485	<b>Ref. No.</b>	419030
<b>description</b>	spacer rod		
<b>For models:</b>	45, 450, 913418, 914167, 914168, 914398, 914399, 914443, 914943, 915695, 915696, 915819, E.45, Fast145, FAST-145, Fast145D, FAST-145D, Niagara-45		

			
1			
<b>GEV No.</b>	510058	<b>Ref. No.</b>	199018
<b>description</b>	throttle disc		
<b>For models:</b>	11F, 11FD, 11F-DVGW, 66, 67R, 913363, 913364, 913376, 913377, E.41, E.42, E41		

			
1			
<b>GEV No.</b>	513270	<b>Ref. No.</b>	80316
<b>description</b>	throttle disc		
<b>For models:</b>	80, 81, 82, CE78HZ23, CGL74CABT, E78, E78HP, Fast181, FAST-181, Fast181-230V-3Ph-60Hz, Fast181-400V-3NPh-60Hz, HM1, LP60, NG271, NG291, NIAGARA-271, NIAGARA-283, Niagara-283A, NIAGARA-291, RIVER-282, River-285, RIVER-294, RIVER-71, RIVER-78, RIVER-80, River-81, River-81CRP, RIVER-81-CRP, RIVER-82, River-82CRP, RIVER-82-CRP, RIVER-E78, RIVER-HL-81, RIVER-HL-82, RV282, RV282DD, RV282R, RV294, RV71, RV80, RV8023, RV8023HZ, RV80C, RV80HZ, RV81, RV8123, RV81A, RV81C, RV81CCR, RV81CRP...(Other models you can see in the webshop)		

			
1			
<b>GEV No.</b>	518015	<b>Ref. No.</b>	199001
<b>description</b>	throttle disc		
<b>For models:</b>	S651, S654, S810, S815, S830, S835		

			
1			
<b>GEV No.</b>	518284	<b>Ref. No.</b>	199053
<b>description</b>	throttle disc		
<b>For models:</b>	2312-007, 2312-009-CRP, 914100, 914101, 914339, 914342, 914343, 914624, 914625, 914626, 914627, 914628, 914850, 914851, 914854, 914944, PS-60, RIVER-48, RIVER-50, RIVER-50-CRP, RIVER-50-CRP-SP, River-54, RIVER-54CRP, River-54-CRP-s.p., RIVER-54-CRP-SP, RIVER-61		

			
1			
<b>GEV No.</b>	518337	<b>Ref. No.</b>	199039
<b>description</b>	throttle disc		
<b>For models:</b>	46, 460, E.46, GSP50, GSP50P, GSP51, GSP51P, P500, TF-503, TF-513, TF-515		

			
1			
<b>GEV No.</b>	518458	<b>Ref. No.</b>	199045
<b>description</b>	throttle disc		
<b>For models:</b>	2312-001, 2312-002, 500F, 500FD, 50F, 50FD, 510F, 510FD, E.50, E.51, E.52, E.60, E.65, E1, E110, LF50, LF55, MC501E, MC501EP, MC501S, MC501SP, MISTRAL-51, NIAGARA-51		

			
1			
<b>GEV No.</b>	518459	<b>Ref. No.</b>	199043 3243693
<b>description</b>	throttle disc		
<b>For models:</b>	2312-001, 2312-002, 500F, 500FD, 50F, 50FD, 510F, 510FD, CLEAN-100, CLEAN-110, CLEAN-120, E.50, E.51, E.52, E.60, E.65, E1, E10, E100, E110, E12, E120, E14, E140, LF50, LF55, MC501E, MC501EP, MC501S, MC501SP, MISTRAL-51, NIAGARA-51		

			
1			
<b>GEV No.</b>	518032	<b>Ref. No.</b>	199027
<b>description</b>	throttle disc ED ø 34mm ID ø 13.2mm thickness 1mm		
<b>For models:</b>	050F, 050FP, 22F, 40F, 440F, 44F, 500F, 500FD, 50F, 50FD, 510F, 510FD, F85, F85P		

			
1			
<b>GEV No.</b>	510112	<b>Ref. No.</b>	454002
<b>description</b>	Thumb screw thread M10 thread L 10mm ø 22mm H 4.5mm SS		
<b>For models:</b>	050F, 050FP, 11F, 11FD, 11F-DVGW, 21F, 21FD, 2312-001, 2312-002, 25F, 25FD, 30F, 30FD, 31F, 31FD, 400F, 400FD, 40-ELECTRONIC, 40F, 40FD, 45, 450, 46, 460, 500F, 500FD, 50F, 50FD, 510F, 510FD, 67R, 913363, 913364, 913376, 913377, 914568, 915830, E.41, E.42, E.45, E.46, E.50, E.50D.PA, E.51, E.41, F85, F85P, FAST-160DP, GSP50, GSP50P... (Other models you can see in the webshop)		

			
1			
<b>GEV No.</b>	518484	<b>Ref. No.</b>	449045
<b>description</b>	wash arm support for stationary arms mounting pos. upper		
<b>For models:</b>	21F, 21FD, 25F, 25FD, 30F, 30FD, 31F, 31FD, 31R, 31RD, 350R, 350RD, 35-ELECTRONIC, 35R, 35RD, 400F, 400FD, 400R, 400RD, 40-ELECTRONIC, 40F, 40FD, 40R, 40RD, 45, 450, 67R, 913291, 913292, 913357, 913363, 913364, 913374, 913375, 913376, 913377, 913416, 913418, 913435, 913545, 913666, 913668, 913685, 913773, 913774, 913911, 913912, 913948, 913950, 913977...(Other models you can see in the webshop)		

			
1			
<b>GEV No.</b>	513229	<b>Ref. No.</b>	926036
<b>description</b>	wash arm support mounting pos. upper		
<b>For models:</b>	10, 12, 14, CLEAN-100, CLEAN-110, CLEAN-120, E1, E10, E100, E110, E12, E120, E14, E140		



			
1			
<b>GEV No.</b>	518483	<b>Ref. No.</b>	449041
<b>description</b>	wash arm support mounting pos. upper		
<b>For models:</b>	22F, 22R, 40F, 440F, 44F, E.52		

			
1			
<b>GEV No.</b>	518580	<b>Ref. No.</b>	115129
<b>description</b>	wash arm support mounting pos. upper		
<b>For models:</b>	914326, 914406, 915729, E.55, FAST-63		

			
1			
<b>GEV No.</b>	518400	<b>Ref. No.</b>	127029
<b>description</b>	wash arm support mounting pos. upper coupling left		
<b>For models:</b>	22F, 22R, 40F, 440F, 44F, E.52		

			
1			
<b>GEV No.</b>	518469	<b>Ref. No.</b>	127051
<b>description</b>	wash arm support mounting pos. upper coupling left		
<b>For models:</b>	E.52		

			
1			
<b>GEV No.</b>	518468	<b>Ref. No.</b>	127030 127030.FR
<b>description</b>	wash arm support mounting pos. upper coupling right		
<b>For models:</b>	22F, 40F, 440F, 44F, E.52, TF-503, TF-513, TF-515		

			
1			
<b>GEV No.</b>	513714	<b>Ref. No.</b>	80237
<b>description</b>	wash pipe		
<b>For models:</b>	80, 81, 82, CE78HZ23, CGL74CABT, E78, E78HP, Fast181, FAST-181, Fast181-230V-3Ph-60Hz, Fast181-400V-3NPh-60Hz, HM1, NIAGARA-283, Niagara-283A, RIVER-282, River-285, RIVER-78, RIVER-80, River-81, River-81CRP, RIVER-81-CRP, RIVER-82, River-82CRP, RIVER-82-CRP, RIVER-E78, RIVER-HL-81, RIVER-HL-82, RV282, RV282DD, RV282R, RV80, RV8023, RV8023HZ, RV80C, RV80HZ, RV81, RV8123, RV81A, RV81C, RV81CCRP, RV81CRP, RV81HZ, RV81HZ23, RV81PAP, RV82, RV8223, RV82C, RV82CCRP, RV82CRP, SevenL...(Other models you can see in the webshop)		
<b>spare parts for</b>	513714		
	<b>GEV No.</b>	518141	<b>Ref. No.</b> 80179
	wash arm support thread M46x2 ø 44mm ID ø 39mm L 112.5mm W 86mm hole ø 12mm		



			
1			
<b>GEV No.</b>	518633	<b>Ref. No.</b>	115128 115139
<b>description</b>	wash pipe		
<b>For models:</b>	2312-007, 2312-009-CRP, 914100, 914101, 914339, 914342, 914343, 914624, 914625, 914626, 914627, 914628, 914850, 914851, 914854, 914944, RIVER-48, RIVER-50, RIVER-50-CRP, RIVER-50-CRP-SP, RIVER-54, RIVER-54CRP, River-54-CRP-s.p., RIVER-54-CRP-SP, RIVER-61		

			
1			
<b>GEV No.</b>	518645	<b>Ref. No.</b>	115140
<b>description</b>	wash pipe L 690mm		
<b>For models:</b>	915160, 915161, 915162, 915166, 915167, 915168, 915172, 915173, 915175, 915176, 915177, 915285, 915319, 915338, 915341, 915348, 915418, 915419, 915420, 915421, 915422, 915479, 915496, 915497, 915547, 915558, 915635, 915663, 915747, 916054, 916068, 916069, 916080, 916205, 916206, 916207, 916208, 916209, 916365, 916366, 916367, 916368, 916414, 916415, 916416, 916417, 916422, 916423, 916424, 916684...(Other models you can see in the webshop)		

			
1			
<b>GEV No.</b>	698718	<b>Ref. No.</b>	69017
<b>description</b>	wash pipe mounting pos. upper ø 72x120mm L 310mm plastic thread M6		
<b>For models:</b>	Fast180, Fast180-230V-3Ph-60Hz, Fast181, NG381, NG38123, NG38123TERMO, NG381C, NG381CDD, NG381CFUR, NG381DDHZ23, NG381DDPS, NG381DDPSHZ23, NG381HPDD, NG381L, NG381LC, NG381LCFUR, NG381LDDPS, NG381TERMO, NG381TXCDD, Niagara-281-2, Niagara-283L-2, Niagara-381, Niagara-381-230V-3Ph-50Hz, Niagara-381-230V-3Ph-60Hz, Niagara-381DP, Niagara-381HPD, Niagara-381L, Niagara-381LC, OC380, OC380FUR, OC380HZ23, Ocean380, PV280FAST2, PV280FAST2BIO, PV280FAST2HZ23, River-282-2, River-282L-2, River-282LS-2TDE, River-282S-2TDE, River-285, River-382, River-382-230V-3Ph-50Hz, River-382H, River-382L, River-382L-230V-3Ph-50Hz, River-382LNRG, River-382LTDE, River-382NRG, River-382NRG-230-3Ph-50Hz, River-382TDE...(Other models you can see in the webshop)		

			
1			
<b>GEV No.</b>	519493	<b>Ref. No.</b>	75165
<b>description</b>	wash pipe ø 48mm L 617mm plastic		
<b>For models:</b>	914380, 914436, 915747, A4EB, A4EBD, A4EBDAKEYK, A4EBDAKRK, A4EBDAKWK, A4EBDAKZK, A4EBDBKRK, A4EBDPKWKYK, A4EBDRK, A4EBS, A4EBSAK, A4EBSACKK, A4EBSAKEKYK, A4EBSAKRK, A4EBSAKRKP, A4EBSAKYK, A4EBSCK, A4EBT, A4EBTSAK, A5EB, A5EBD, A5EBDAKPKWK, A5EBDAKWK, A5EBDAKYK, A5EBDRK, A5EBS, A5EBSAKPKWK, A5EBSAKRK, A5EBSAKRKYK, A5EBSAKWK, A5EBSAKWKYK, A5EBSBKRKP, A5EBSBKWK, A5EBSRK, A5EBSYK, Fast200, FAST-200, Fast93, GL280EB, GL280EB23, GL280EB23DAR, GL280EB23HZ, GL280EB23HZDY, GL280EBD, GL280EBDA, GL280EBDAE, GL280EBDAR...(Other models you can see in the webshop)		

## washing and rinsing systems (sorted by producer)

### ELETTROBAR



			
1			
<b>GEV No.</b>	518269	<b>Ref. No.</b>	990061 990108
<b>description</b>	wash and rinse arm wash arm L 495mm rinse arm L 490mm w. jets 9 r. jets 5 mounting ø 16.5mm mounting pos. upper		
<b>For models:</b>	050F, 050FP, 2312-001, 2312-002, 914568, 915830, E.50, E.50D.PA, E.51, F85, F85P, FAST-160DP, GSP50, GSP50P, GSP51, GSP51P, LF50, LF55, MC501E, MC501EP, MC501S, MC501SP, MISTRAL-51, NIAGARA-51, P500, RIVER-E78		
<b>spare parts for</b>	518269		
	<b>GEV No.</b>	510010	<b>Ref. No.</b> 129003 129039
	wash arm boss L1 64mm L2 60mm mounting ø 16.5mm		
	<b>GEV No.</b>	510139	<b>Ref. No.</b> 140007
	rinse jet		
	<b>GEV No.</b>	513262	<b>Ref. No.</b> 499009
	blank nozzle		
	<b>GEV No.</b>	518004	<b>Ref. No.</b> 140008
	wash jet		
	<b>GEV No.</b>	518053	<b>Ref. No.</b> 429006.TN 429039
	union nut for rinse jet		
	<b>GEV No.</b>	518272	<b>Ref. No.</b> 429040
	union nut for wash jet		
	<b>GEV No.</b>	518332	<b>Ref. No.</b> 106008
	wash arm mounting pos. right L 220mm mounting ø 24mm nozzles 5		
	<b>GEV No.</b>	518333	<b>Ref. No.</b> 106006
	wash arm mounting pos. left L 220mm mounting ø 24mm nozzles 4		
	<b>GEV No.</b>	518334	<b>Ref. No.</b> 106007
	rinse arm mounting pos. right L 220mm mounting ø 13mm nozzles 3		
	<b>GEV No.</b>	518335	<b>Ref. No.</b> 106005
	rinse arm mounting pos. left L 220mm mounting ø 13mm nozzles 3		

			
1			
<b>GEV No.</b>	518465	<b>Ref. No.</b>	106072.CR
<b>description</b>	rinse arm mounting pos. left		
<b>For models:</b>	500F, 500FD, 50F, 50FD, 510F, 510FD, E.50, E.51		

			
1			
<b>GEV No.</b>	518335	<b>Ref. No.</b>	106005
<b>description</b>	rinse arm mounting pos. left L 220mm mounting ø 13mm nozzles 3		
<b>For models:</b>	050F, 050FP, 2312-001, 2312-002, 914568, 915830, E.50, E.50D.PA, E.51, F85, F85P, FAST-160DP, GSP50, GSP50P, GSP51, GSP51P, LF50, LF55, MC501E, MC501EP, MC501S, MC501SP, MISTRAL-51, NIAGARA-51, P500, PS-60, S651, S651P, S653, S654, S655, S830, S835, S850, SR651, TF-503, TF-513, TF-515		

			
Image not available			
1			
<b>GEV No.</b>	518464	<b>Ref. No.</b>	106073.CR
<b>description</b>	rinse arm mounting pos. right		
<b>For models:</b>	500F, 500FD, 50F, 50FD, 510F, 510FD, E.50, E.51		

			
1			
<b>GEV No.</b>	518334	<b>Ref. No.</b>	106007
<b>description</b>	rinse arm mounting pos. right L 220mm mounting ø 13mm nozzles 3		
<b>For models:</b>	050F, 050FP, 2312-001, 2312-002, 914568, 915830, E.50, E.50D.PA, E.51, F85, F85P, FAST-160DP, GSP50, GSP50P, GSP51, GSP51P, LF50, LF55, MC501E, MC501EP, MC501S, MC501SP, MISTRAL-51, NIAGARA-51, P500, PS-60, S651, S651P, S653, S654, S655, S830, S835, S850, SR651		

			
1			
<b>GEV No.</b>	510139	<b>Ref. No.</b>	140007
<b>description</b>	rinse jet		
<b>For models:</b>	050F, 050FP, 10, 11F, 11FD, 11F-DVGW, 11R, 11RD, 12, 21F, 21FD, 21R, 21RD, 22F, 2312-001, 2312-002, 25F, 25FD, 25R, 25RD, 30F, 30FD, 30R, 30RD, 31F, 31FD, 31R, 31RD, 350F, 350FD, 350R, 350RD, 35-ELECTRONIC, 35F, 35FD, 35R, 35RD, 400F, 400FD, 400R, 400RD, 40-ELECTRONIC, 40F, 40FD, 40R, 40RD, 440F, 44F, 45, 450...(Other models you can see in the webshop)		
<b>accessories for</b>	510139		
	<b>GEV No.</b>	510130	<b>Ref. No.</b> 429006
	union nut for rinse jet		

			
1			
<b>GEV No.</b>	518053	<b>Ref. No.</b>	429006.TN 429039
<b>description</b>	union nut for rinse jet		
<b>For models:</b>	050F, 050FP, 45, 450, 46, 460, 67R, 914684, E.50, E.51, F85, F85P, LF50, LF55, MC501E, MC501EP, MC501S, MC501SP, MISTRAL-51, NIAGARA-51, RIVER-39, TF-503, TF-513, TF-515		

			
1			
<b>GEV No.</b>	518272	<b>Ref. No.</b>	429040
<b>description</b>	union nut for wash jet		
<b>For models:</b>	050F, 050FP, 45, 450, 46, 460, 67R, 914684, E.50, E.51, F85, F85P, LF50, LF55, MC501E, MC501EP, MC501S, MC501SP, MISTRAL-51, NIAGARA-51, RIVER-39, TF-503, TF-513, TF-515		



			
1			
<b>GEV No.</b>	518333	<b>Ref. No.</b>	106006
<b>description</b>	wash arm mounting pos. left L 220mm mounting ø 24mm nozzles 4		
<b>For models:</b>	050F, 050FP, 2312-001, 2312-002, 914568, 915830, E.50, E.50D.PA, E.51, F85, F85P, FAST-160DP, GSP50, GSP50P, GSP51, GSP51P, LF50, LF55, MC501E, MC501EP, MC501S, MC501SP, MISTRAL-51, NIAGARA-51, P500, PS-60, S651, S651P, S653, S654, S655, S830, S835, S850, SR651, TF-503, TF-513, TF-515		
<b>accessories for</b>	518333		
	<b>GEV No.</b>	518004	<b>Ref. No.</b> 140008
	wash jet		
	<b>GEV No.</b>	518272	<b>Ref. No.</b> 429040
	union nut for wash jet		

			
1			
<b>GEV No.</b>	518332	<b>Ref. No.</b>	106008
<b>description</b>	wash arm mounting pos. right L 220mm mounting ø 24mm nozzles 5		
<b>For models:</b>	050F, 050FP, 2312-001, 2312-002, 914568, 915830, E.50, E.50D.PA, E.51, F85, F85P, FAST-160DP, GSP50, GSP50P, GSP51, GSP51P, LF50, LF55, MC501E, MC501EP, MC501S, MC501SP, MISTRAL-51, NIAGARA-51, P500, PS-60, S651, S651P, S653, S654, S655, S830, S835, S850, SR651		
<b>accessories for</b>	518332		
	<b>GEV No.</b>	518004	<b>Ref. No.</b> 140008
	wash jet		
	<b>GEV No.</b>	518272	<b>Ref. No.</b> 429040
	union nut for wash jet		

			
1			
<b>GEV No.</b>	510010	<b>Ref. No.</b>	129003 129039
<b>description</b>	wash arm boss L1 64mm L2 60mm mounting ø 16.5mm		
<b>For models:</b>	050F, 050FP, 11F, 11FD, 11F-DVGW, 21F, 21FD, 2312-001, 2312-002, 25F, 25FD, 30F, 30FD, 31F, 31FD, 400F, 400FD, 40-ELECTRONIC, 40F, 40FD, 45, 450, 46, 460, 500F, 500FD, 50F, 50FD, 510F, 510FD, 67R, 913363, 913364, 913376, 913377, 914568, 915830, E.41, E.42, E.45, E.46, E.50, E.50D.PA, E.51, E.41, F85, F85P, FAST-160DP, GSP50, GSP50P...(Other models you can see in the webshop)		







			
<b>1</b>			
<b>GEV No.</b>	518004	<b>Ref. No.</b>	140008
<b>description</b>	wash jet		
<b>For models:</b>	050F, 050FP, 11R, 11RD, 21F, 21FD, 21R, 21RD, 2312-001, 2312-002, 25F, 25FD, 25R, 25RD, 30F, 30FD, 30R, 30RD, 31F, 31FD, 31R, 31RD, 500F, 500FD, 50F, 50FD, 510F, 510FD, 67R, 914568, 915830, E.42, E.50, E.50D.PA, E.51, F85, F85P, FAST-160DP, GSP50, GSP50P, GSP51, GSP51P, LF50, LF55, MC501E, MC501EP, MC501S, MC501SP, MISTRAL-51, NIAGARA-51...(Other models you can see in the webshop)		



<b>accessories for</b>	510119		
	<b>GEV No.</b>	518003	<b>Ref. No.</b>
			447030 447128
	screw cap		
	<b>GEV No.</b>	518008	<b>Ref. No.</b>
			437016
	gasket D1 ø 43mm D2 ø 78mm thickness 2mm with 6 holes wash arm support		
	<b>GEV No.</b>	518036	<b>Ref. No.</b>
			127012
	formed hose angled warewashing		

			
<b>1</b>			
<b>GEV No.</b>	510119	<b>Ref. No.</b>	990008
<b>description</b>	wash and rinse arm wash arm L 410mm rinse arm L 410mm w. jets 7 r. jets 5 mounting ø 16.5mm mounting pos. lower		
<b>For models:</b>	21F, 21FD, 25F, 25FD, 30F, 30FD, 31F, 31FD, S621, S623, S624, S626, S631, S633, S634, S636		

			
<b>1</b>			
<b>GEV No.</b>	518383	<b>Ref. No.</b>	106010
<b>description</b>	rinse arm mounting pos. left L 175mm mounting ø 13mm nozzles 2		
<b>For models:</b>	11F, 11FD, 11F-DVGW, 21F, 21FD, 25F, 25FD, 30F, 30FD, 31F, 31FD, 400F, 400FD, 40-ELECTRONIC, 40F, 40FD, 913363, 913364, 913376, 913377, E.41, E.42, E.46, E41, S621, S623, S624, S626, S631, S633, S634, S636		

<b>spare parts for</b>	510119		
	<b>GEV No.</b>	510010	<b>Ref. No.</b>
			129003 129039
	wash arm boss L1 64mm L2 60mm mounting ø 16.5mm		
	<b>GEV No.</b>	510130	<b>Ref. No.</b>
			429006
	union nut for rinse jet		
	<b>GEV No.</b>	510131	<b>Ref. No.</b>
			429007
	union nut for wash jet		





			
<b>1</b>			
<b>GEV No.</b>	518384	<b>Ref. No.</b>	106011
<b>description</b>	rinse arm mounting pos. right L 175mm mounting ø 13mm nozzles 3		
<b>For models:</b>	11F, 11FD, 11F-DVGW, 21F, 21FD, 25F, 25FD, 30F, 30FD, 31F, 31FD, 400F, 400FD, 40-ELECTRONIC, 40F, 40FD, 913363, 913364, 913376, 913377, E.41, E.42, E.46, E41, S621, S623, S624, S626, S631, S633, S634, S636		

	<b>GEV No.</b>	510138	<b>Ref. No.</b>
			114013 140013 140020
	wash jet fine groove		
	<b>GEV No.</b>	510139	<b>Ref. No.</b>
			140007
	rinse jet		
	<b>GEV No.</b>	518004	<b>Ref. No.</b>
			140008
	wash jet		



			
<b>1</b>			
<b>GEV No.</b>	510139	<b>Ref. No.</b>	140007
<b>description</b>	rinse jet		
<b>For models:</b>	050F, 050FP, 10, 11F, 11FD, 11F-DVGW, 11R, 11RD, 12, 21F, 21FD, 21R, 21RD, 22F, 2312-001, 2312-002, 25F, 25FD, 25R, 25RD, 30F, 30FD, 30R, 30RD, 31F, 31FD, 31R, 31RD, 350F, 350FD, 350R, 350RD, 35-ELECTRONIC, 35F, 35FD, 35R, 35RD, 400F, 400FD, 400R, 400RD, 40-ELECTRONIC, 40F, 40FD, 40R, 40RD, 440F, 44F, 45, 450...(Other models you can see in the webshop)		

<b>accessories for</b>	510139		
	<b>GEV No.</b>	510130	<b>Ref. No.</b>
			429006
	union nut for rinse jet		



			
<b>1</b>			
<b>GEV No.</b>	510130	<b>Ref. No.</b>	429006
<b>description</b>	union nut for rinse jet		

	<b>GEV No.</b>	518382	<b>Ref. No.</b>
			106009
	wash arm mounting pos. right L 175mm mounting ø 24mm nozzles 4		
	<b>GEV No.</b>	518383	<b>Ref. No.</b>
			106010
	rinse arm mounting pos. left L 175mm mounting ø 13mm nozzles 2		
	<b>GEV No.</b>	518384	<b>Ref. No.</b>
			106011
	rinse arm mounting pos. right L 175mm mounting ø 13mm nozzles 3		
	<b>GEV No.</b>	518631	<b>Ref. No.</b>
			106012
	wash arm mounting pos. left L 170mm nozzles mounting ø 24mm		

			
<b>1</b>			
<b>GEV No.</b>	510130	<b>Ref. No.</b>	429006
<b>description</b>	union nut for rinse jet		
<b>For models:</b>	10, 11F, 11FD, 11F-DVGW, 11R, 11RD, 12, 21F, 21FD, 21R, 21RD, 22F, 2312-001, 2312-002, 25F, 25FD, 25R, 25RD, 30F, 30FD, 30R, 30RD, 31F, 31FD, 31R, 31RD, 350F, 350FD, 350R, 350RD, 35-ELECTRONIC, 35F, 35FD, 35R, 35RD, 400F, 400FD, 400R, 400RD, 40-ELECTRONIC, 40F, 40FD, 40R, 40RD, 440F, 44F, 500F, 500FD, 50-ELECTRONIC, 50F...(Other models you can see in the webshop)		

<b>accessories for</b>	510119		
	<b>GEV No.</b>	510108	<b>Ref. No.</b>
			327006
	rinse arm shaft		
	<b>GEV No.</b>	510112	<b>Ref. No.</b>
			454002
	Thumb screw thread M10 thread L 10mm ø 22mm H 4.5mm SS		

<b>accessories for</b>	510130		
	<b>GEV No.</b>	510139	<b>Ref. No.</b>
			140007
	rinse jet		







			
1			
<b>GEV No.</b>	510131	<b>Ref. No.</b>	429007
<b>description</b>	union nut for wash jet		
<b>For models:</b>	11F, 11FD, 11F-DVGW, 11R, 11RD, 21F, 21FD, 21R, 21RD, 2312-001, 2312-002, 25F, 25FD, 25R, 25RD, 30F, 30FD, 30R, 30RD, 31F, 31FD, 31R, 31RD, 350F, 350FD, 350R, 350RD, 35-ELECTRONIC, 35F, 35FD, 35R, 35RD, 400F, 400FD, 40-ELECTRONIC, 40F, 40FD, 500F, 500FD, 50F, 50FD, 510F, 510FD, 913363, 913364, 913376, 913377, 914568, 915830, E.35...(Other models you can see in the webshop)		
<b>accessories for</b>	510131		
	<b>GEV No.</b>	510138	<b>Ref. No.</b>
			114013 140013 140020
	wash jet fine groove		

			
1			
<b>GEV No.</b>	518631	<b>Ref. No.</b>	106012
<b>description</b>	wash arm mounting pos. left L 170mm nozzles mounting ø 24mm		
<b>For models:</b>	11F, 11FD, 11F-DVGW, 21F, 21FD, 25F, 25FD, 30F, 30FD, 31F, 31FD, 400F, 400FD, 40-ELECTRONIC, 40F, 40FD, 913363, 913364, 913376, 913377, E.41, E.42, E.46, E.41, S621, S623, S624, S626, S631, S633, S634, S636		

			
1			
<b>GEV No.</b>	518382	<b>Ref. No.</b>	106009
<b>description</b>	wash arm mounting pos. right L 175mm mounting ø 24mm nozzles 4		
<b>For models:</b>	11F, 11FD, 11F-DVGW, 21F, 21FD, 25F, 25FD, 30F, 30FD, 31F, 31FD, 400F, 400FD, 40-ELECTRONIC, 40F, 40FD, 913363, 913364, 913376, 913377, E.41, E.42, E.45, E.46, E.41, NIAGARA-45, S621, S623, S624, S626, S631, S633, S634, S636		

			
1			
<b>GEV No.</b>	510010	<b>Ref. No.</b>	129003 129039
<b>description</b>	wash arm boss L1 64mm L2 60mm mounting ø 16.5mm		
<b>For models:</b>	050F, 050FP, 11F, 11FD, 11F-DVGW, 21F, 21FD, 2312-001, 2312-002, 25F, 25FD, 30F, 30FD, 31F, 31FD, 400F, 400FD, 40-ELECTRONIC, 40F, 40FD, 45, 450, 46, 460, 500F, 500FD, 50F, 50FD, 510F, 510FD, 67R, 913363, 913364, 913376, 913377, 914568, 915830, E.41, E.42, E.45, E.46, E.50, E.50D.PA, E.51, E.41, F85, F85P, FAST-160DP, GSP50, GSP50P... (Other models you can see in the webshop)		

			
1			
<b>GEV No.</b>	518004	<b>Ref. No.</b>	140008
<b>description</b>	wash jet		
<b>For models:</b>	050F, 050FP, 11R, 11RD, 21F, 21FD, 21R, 21RD, 2312-001, 2312-002, 25F, 25FD, 25R, 25RD, 30F, 30FD, 30R, 30RD, 31F, 31FD, 31R, 31RD, 500F, 500FD, 50F, 50FD, 510F, 510FD, 67R, 914568, 915830, E.42, E.50, E.50D.PA, E.51, F85, F85P, FAST-160DP, GSP50, GSP50P, GSP51, GSP51P, LF50, LF55, MC501E, MC501EP, MC501S, MC501SP, MISTRAL-51, NIAGARA-51...(Other models you can see in the webshop)		



			
1			
<b>GEV No.</b>	518411	<b>Ref. No.</b>	990077
<b>description</b>	wash and rinse arm wash arm L 410mm rinse arm L 415mm w. jets 7 r. jets 5 mounting ø 17/52mm mounting pos. upper		
<b>For models:</b>	46, 460, TF-503, TF-513, TF-515		
<b>spare parts for</b>	518411		
	<b>GEV No.</b>	510138	<b>Ref. No.</b>
			114013 140013 140020
	wash jet fine groove		
	<b>GEV No.</b>	510139	<b>Ref. No.</b>
			140007
	rinse jet		
	<b>GEV No.</b>	518053	<b>Ref. No.</b>
			429006.TN 429039
	union nut for rinse jet		
	<b>GEV No.</b>	518272	<b>Ref. No.</b>
			429040
	union nut for wash jet		
<b>accessories for</b>	518411		
	<b>GEV No.</b>	510112	<b>Ref. No.</b>
			454002
	Thumb screw thread M10 thread L 10mm ø 22mm H 4.5mm SS		
	<b>GEV No.</b>	518003	<b>Ref. No.</b>
			447030 447128
	screw cap		

			
1			
<b>GEV No.</b>	518415	<b>Ref. No.</b>	106047
<b>description</b>	rinse arm mounting pos. left mounting ø 19mm nozzles 2		
<b>For models:</b>	46, 460, TF-503, TF-513, TF-515		

			
1			
<b>GEV No.</b>	518414	<b>Ref. No.</b>	106048
<b>description</b>	rinse arm mounting pos. right mounting ø 19mm nozzles 3		
<b>For models:</b>	46, 460, 67R, TF-503, TF-513, TF-515		







			
<b>GEV No.</b>	510139	<b>Ref. No.</b>	140007
<b>description</b>	rinse jet		
<b>For models:</b>	050F, 050FP, 10, 11F, 11FD, 11F-DVGW, 11R, 11RD, 12, 21F, 21FD, 21R, 21RD, 22F, 2312-001, 2312-002, 25F, 25FD, 25R, 25RD, 30F, 30FD, 30R, 30RD, 31F, 31FD, 31R, 31RD, 350F, 350FD, 350R, 350RD, 35-ELECTRONIC, 35F, 35FD, 35R, 35RD, 400F, 400FD, 400R, 400RD, 40-ELECTRONIC, 40F, 40FD, 40R, 40RD, 440F, 44F, 45, 450...(Other models you can see in the webshop)		
<b>accessories for</b>	510139		
			
<b>GEV No.</b>	510130	<b>Ref. No.</b>	429006
<b>description</b>	union nut for rinse jet		



			
<b>GEV No.</b>	518053	<b>Ref. No.</b>	429006.TN 429039
<b>description</b>	union nut for rinse jet		
<b>For models:</b>	050F, 050FP, 45, 450, 46, 460, 67R, 914684, E.50, E.51, F85, F85P, LF50, LF55, MC501E, MC501EP, MC501S, MC501SP, MISTRAL-51, NIAGARA-51, RIVER-39, TF-503, TF-513, TF-515		

			
<b>GEV No.</b>	518272	<b>Ref. No.</b>	429040
<b>description</b>	union nut for wash jet		
<b>For models:</b>	050F, 050FP, 45, 450, 46, 460, 67R, 914684, E.50, E.51, F85, F85P, LF50, LF55, MC501E, MC501EP, MC501S, MC501SP, MISTRAL-51, NIAGARA-51, RIVER-39, TF-503, TF-513, TF-515		

			
<b>GEV No.</b>	518413	<b>Ref. No.</b>	106091
<b>description</b>	wash arm mounting pos. left mounting ø 24mm nozzles 3		
<b>For models:</b>	46, 460		



			
<b>GEV No.</b>	518412	<b>Ref. No.</b>	106090
<b>description</b>	wash arm mounting pos. right mounting ø 24mm nozzles 4		
<b>For models:</b>	46, 460		

			
<b>GEV No.</b>	510010	<b>Ref. No.</b>	129003 129039
<b>description</b>	wash arm boss L1 64mm L2 60mm mounting ø 16.5mm		
<b>For models:</b>	050F, 050FP, 11F, 11FD, 11F-DVGW, 21F, 21FD, 2312-001, 2312-002, 25F, 25FD, 30F, 30FD, 31F, 31FD, 400F, 400FD, 40-ELECTRONIC, 40F, 40FD, 45, 450, 46, 460, 500F, 500FD, 50F, 50FD, 510F, 510FD, 67R, 913363, 913364, 913376, 913377, 914568, 915830, E.41, E.42, E.45, E.46, E.50, E.50D.PA, E.51, E41, F85, F85P, FAST-160DP, GSP50, GSP50P...(Other models you can see in the webshop)		

			
<b>GEV No.</b>	510138	<b>Ref. No.</b>	114013 140013 140020
<b>description</b>	wash jet fine groove		
<b>For models:</b>	11F, 11FD, 11F-DVGW, 350F, 350FD, 350R, 350RD, 35-ELECTRONIC, 35F, 35FD, 35R, 35RD, 400F, 400FD, 40-ELECTRONIC, 40F, 40FD, 45, 450, 46, 460, 67R, 913363, 913364, 913376, 913377, E.35, E.35H, E.40, E.40H, E.41, E.42, E.45, E.46, E41, GLS40H, GLS40HP, GSP50, GSP50P, GSP51, GSP51P, MC201CL, MISTRAL-40, NIAGARA-35, NIAGARA-40, NIAGARA-45, P500, PS-60, TF-503, TF-513...(Other models you can see in the webshop)		
<b>accessories for</b>	510138		
			
<b>GEV No.</b>	510131	<b>Ref. No.</b>	429007
<b>description</b>	union nut for wash jet		



			
<b>GEV No.</b>	518449	<b>Ref. No.</b>	990078 990097
<b>description</b>	wash and rinse arm wash arm L 435mm rinse arm L 445mm w. jets 8 r. jets 5 mounting ø 16.5mm mounting pos. lower		
<b>For models:</b>	45, 450, 46, 460, E.45, E.46, NIAGARA-45		
<b>spare parts for</b>	518449		
			
<b>GEV No.</b>	510010	<b>Ref. No.</b>	129003 129039
<b>description</b>	wash arm boss L1 64mm L2 60mm mounting ø 16.5mm		
			
<b>GEV No.</b>	510130	<b>Ref. No.</b>	429006
<b>description</b>	union nut for rinse jet		
			
<b>GEV No.</b>	510131	<b>Ref. No.</b>	429007
<b>description</b>	union nut for wash jet		
			
<b>GEV No.</b>	510138	<b>Ref. No.</b>	114013 140013 140020
<b>description</b>	wash jet fine groove		
			
<b>GEV No.</b>	510139	<b>Ref. No.</b>	140007
<b>description</b>	rinse jet		



Table continues overleaf



<b>spare parts for</b> 518449			
	GEV No.	513262	Ref. No. 499009
blank nozzle			
	GEV No.	518382	Ref. No. 106009
wash arm mounting pos. right L 175mm mounting ø 24mm nozzles 4			
	GEV No.	518451	Ref. No. 106107
rinse arm mounting pos. right L 200mm mounting ø 13mm nozzles 3			

			
1	GEV No.	518452	Ref. No. 106108
<b>description</b> rinse arm mounting pos. left L 185mm mounting ø 13mm nozzles 4			
<b>For models:</b> E.45, E.46			

			
1	GEV No.	518451	Ref. No. 106107
<b>description</b> rinse arm mounting pos. right L 200mm mounting ø 13mm nozzles 3			
<b>For models:</b> E.45, E.46, NIAGARA-45			

			
1	GEV No.	510139	Ref. No. 140007
<b>description</b> rinse jet			
<b>For models:</b> 050F, 050FP, 10, 11F, 11FD, 11F-DVGW, 11R, 11RD, 12, 21F, 21FD, 21R, 21RD, 22F, 2312-001, 2312-002, 25F, 25FD, 25R, 25RD, 30F, 30FD, 30R, 30RD, 31F, 31FD, 31R, 31RD, 350F, 350FD, 350R, 350RD, 35-ELECTRONIC, 35F, 35FD, 35R, 35RD, 400F, 400FD, 400R, 400RD, 40-ELECTRONIC, 40F, 40FD, 40R, 40RD, 440F, 44F, 45, 450...(Other models you can see in the webshop)			
<b>accessories for</b> 510139			
	GEV No.	510130	Ref. No. 429006
union nut for rinse jet			

			
1	GEV No.	510130	Ref. No. 429006
<b>description</b> union nut for rinse jet			
<b>For models:</b> 10, 11F, 11FD, 11F-DVGW, 11R, 11RD, 12, 21F, 21FD, 21R, 21RD, 22F, 2312-001, 2312-002, 25F, 25FD, 25R, 25RD, 30F, 30FD, 30R, 30RD, 31F, 31FD, 31R, 31RD, 350F, 350FD, 350R, 350RD, 35-ELECTRONIC, 35F, 35FD, 35R, 35RD, 400F, 400FD, 400R, 400RD, 40-ELECTRONIC, 40F, 40FD, 40R, 40RD, 440F, 44F, 500F, 500FD, 50-ELECTRONIC, 50F...(Other models you can see in the webshop)			
<b>accessories for</b> 510130			
	GEV No.	510139	Ref. No. 140007
rinse jet			



			
1	GEV No.	510131	Ref. No. 429007
<b>description</b> union nut for wash jet			
<b>For models:</b> 11F, 11FD, 11F-DVGW, 11R, 11RD, 21F, 21FD, 21R, 21RD, 2312-001, 2312-002, 25F, 25FD, 25R, 25RD, 30F, 30FD, 30R, 30RD, 31F, 31FD, 31R, 31RD, 350F, 350FD, 350R, 350RD, 35-ELECTRONIC, 35F, 35FD, 35R, 35RD, 400F, 400FD, 40-ELECTRONIC, 40F, 40FD, 500F, 500FD, 50F, 50FD, 510F, 510FD, 913363, 913364, 913376, 913377, 914568, 915830, E.35...(Other models you can see in the webshop)			
<b>accessories for</b> 510131			
	GEV No.	510138	Ref. No. 114013 140013 140020
wash jet fine groove			

			
1	GEV No.	518450	Ref. No. 106106
<b>description</b> wash arm mounting pos. left L 175mm mounting ø 24mm nozzles 4			
<b>For models:</b> E.45, E.46, NIAGARA-45			

			
1	GEV No.	518382	Ref. No. 106009
<b>description</b> wash arm mounting pos. right L 175mm mounting ø 24mm nozzles 4			
<b>For models:</b> 11F, 11FD, 11F-DVGW, 21F, 21FD, 25F, 25FD, 30F, 30FD, 31F, 31FD, 400F, 400FD, 40-ELECTRONIC, 40F, 40FD, 913363, 913364, 913376, 913377, E.41, E.42, E.45, E.46, E41, NIAGARA-45, S621, S623, S624, S626, S631, S633, S634, S636			

			
1	GEV No.	510010	Ref. No. 129003 129039
<b>description</b> wash arm boss L1 64mm L2 60mm mounting ø 16.5mm			
<b>For models:</b> 050F, 050FP, 11F, 11FD, 11F-DVGW, 21F, 21FD, 2312-001, 2312-002, 25F, 25FD, 30F, 30FD, 31F, 31FD, 400F, 400FD, 40-ELECTRONIC, 40F, 40FD, 45, 450, 46, 460, 500F, 500FD, 50F, 50FD, 510F, 510FD, 67R, 913363, 913364, 913376, 913377, 914568, 915830, E.41, E.42, E.45, E.46, E.50, E.50D.PA, E.51, E41, F85, F85P, FAST-160DP, GSP50, GSP50P...(Other models you can see in the webshop)			





			
<b>GEV No.</b>	510138	<b>Ref. No.</b>	114013 140013 140020
<b>description</b>	wash jet fine groove		
<b>For models:</b>	11F, 11FD, 11F-DVGW, 350F, 350FD, 350R, 350RD, 35-ELECTRONIC, 35F, 35FD, 35R, 35RD, 400F, 400FD, 40-ELECTRONIC, 40F, 40FD, 45, 450, 46, 460, 67R, 913363, 913364, 913376, 913377, E.35, E.35H, E.40, E.40H, E.41, E.42, E.45, E.46, E.41, GLS40H, GLS40HP, GSP50, GSP50P, GSP51, GSP51P, MC201CL, MISTRAL-40, NIAGARA-35, NIAGARA-40, NIAGARA-45, P500, PS-60, TF-503, TF-513...(Other models you can see in the webshop)		
<b>accessories for</b>	510138		
		<b>GEV No.</b>	510131 <b>Ref. No.</b> 429007
	union nut for wash jet		



			
<b>GEV No.</b>	513711	<b>Ref. No.</b>	990075
<b>description</b>	wash and rinse arm wash arm L 495mm rinse arm L 460mm w. jets 9 r. jets 5 mounting ø 16.5mm mounting pos. lower		
<b>For models:</b>	GSP50, GSP50P, GSP51, GSP51P, P500, TF-503, TF-513, TF-515		
<b>spare parts for</b>	513711		
		<b>GEV No.</b>	510010 <b>Ref. No.</b> 129003 129039
	wash arm boss L1 64mm L2 60mm mounting ø 16.5mm		
		<b>GEV No.</b>	510138 <b>Ref. No.</b> 114013 140013 140020
	wash jet fine groove		
		<b>GEV No.</b>	510139 <b>Ref. No.</b> 140007
	rinse jet		
		<b>GEV No.</b>	513262 <b>Ref. No.</b> 499009
	blank nozzle		
		<b>GEV No.</b>	518053 <b>Ref. No.</b> 429006.TN 429039
	union nut for rinse jet		
		<b>GEV No.</b>	518272 <b>Ref. No.</b> 429040
	union nut for wash jet		
		<b>GEV No.</b>	518332 <b>Ref. No.</b> 106008
	wash arm mounting pos. right L 220mm mounting ø 24mm nozzles 5		
		<b>GEV No.</b>	518333 <b>Ref. No.</b> 106006
	wash arm mounting pos. left L 220mm mounting ø 24mm nozzles 4		
		<b>GEV No.</b>	518334 <b>Ref. No.</b> 106007
	rinse arm mounting pos. right L 220mm mounting ø 13mm nozzles 3		



			
<b>GEV No.</b>	518409	<b>Ref. No.</b>	106094
<b>description</b>	rinse arm mounting pos. left L 190mm mounting ø 19mm nozzles 3		
<b>For models:</b>	45, 450, 46, 460, GSP50, GSP50P, GSP51, GSP51P, NIAGARA-45, P500		

 <p>Image not available</p>			
<b>GEV No.</b>	518464	<b>Ref. No.</b>	106073.CR
<b>description</b>	rinse arm mounting pos. right		
<b>For models:</b>	500F, 500FD, 50F, 50FD, 510F, 510FD, E.50, E.51		

			
<b>GEV No.</b>	518334	<b>Ref. No.</b>	106007
<b>description</b>	rinse arm mounting pos. right L 220mm mounting ø 13mm nozzles 3		
<b>For models:</b>	050F, 050FP, 2312-001, 2312-002, 914568, 915830, E.50, E.50D.PA, E.51, F85, F85P, FAST-160DP, GSP50, GSP50P, GSP51, GSP51P, LF50, LF55, MC501E, MC501EP, MC501S, MC501SP, MISTRAL-51, NIAGARA-51, P500, PS-60, S651, S651P, S653, S654, S655, S830, S835, S850, SR651		

			
<b>GEV No.</b>	510139	<b>Ref. No.</b>	140007
<b>description</b>	rinse jet		
<b>For models:</b>	050F, 050FP, 10, 11F, 11FD, 11F-DVGW, 11R, 11RD, 12, 21F, 21FD, 21R, 21RD, 22F, 2312-001, 2312-002, 25F, 25FD, 25R, 25RD, 30F, 30FD, 30R, 30RD, 31F, 31FD, 31R, 31RD, 350F, 350FD, 350R, 350RD, 35-ELECTRONIC, 35F, 35FD, 35R, 35RD, 400F, 400FD, 400R, 400RD, 40-ELECTRONIC, 40F, 40FD, 40R, 40RD, 440F, 44F, 45, 450...(Other models you can see in the webshop)		
<b>accessories for</b>	510139		
		<b>GEV No.</b>	510130 <b>Ref. No.</b> 429006
	union nut for rinse jet		



			
<b>GEV No.</b>	510130	<b>Ref. No.</b>	429006
<b>description</b>	union nut for rinse jet		
<b>For models:</b>	10, 11F, 11FD, 11F-DVGW, 11R, 11RD, 12, 21F, 21FD, 21R, 21RD, 22F, 2312-001, 2312-002, 25F, 25FD, 25R, 25RD, 30F, 30FD, 30R, 30RD, 31F, 31FD, 31R, 31RD, 350F, 350FD, 350R, 350RD, 35-ELECTRONIC, 35F, 35FD, 35R, 35RD, 400F, 400FD, 400R, 400RD, 40-ELECTRONIC, 40F, 40FD, 40R, 40RD, 440F, 44F, 500F, 500FD, 50-ELECTRONIC, 50F...(Other models you can see in the webshop)		
<b>accessories for</b>	510130		
		<b>GEV No.</b>	510139 <b>Ref. No.</b> 140007
	rinse jet		

	
<b>GEV No.</b>	510131
<b>Ref. No.</b>	429007
<b>description</b>	union nut for wash jet
<b>For models:</b>	11F, 11FD, 11F-DVGW, 11R, 11RD, 21F, 21FD, 21R, 21RD, 2312-001, 2312-002, 25F, 25FD, 25R, 25RD, 30F, 30FD, 30R, 30RD, 31F, 31FD, 31R, 31RD, 350F, 350FD, 350R, 350RD, 35-ELECTRONIC, 35F, 35FD, 35R, 35RD, 400F, 400FD, 40-ELECTRONIC, 40F, 40FD, 500F, 500FD, 50F, 50FD, 510F, 510FD, 913363, 913364, 913376, 913377, 914568, 915830, E.35...(Other models you can see in the webshop)
<b>accessories for</b>	510131
	GEV No. 510138 Ref. No. 114013 140013 140020
	wash jet fine groove

	
<b>GEV No.</b>	518333
<b>Ref. No.</b>	106006
<b>description</b>	wash arm mounting pos. left L 220mm mounting ø 24mm nozzles 4
<b>For models:</b>	050F, 050FP, 2312-001, 2312-002, 914568, 915830, E.50, E.50D.PA, E.51, F85, F85P, FAST-160DP, GSP50, GSP50P, GSP51, GSP51P, LF50, LF55, MC501E, MC501EP, MC501S, MC501SP, MISTRAL-51, NIAGARA-51, P500, PS-60, S651, S651P, S653, S654, S655, S830, S835, S850, SR651, TF-503, TF-513, TF-515
<b>accessories for</b>	518333
	GEV No. 518004 Ref. No. 140008
	wash jet
	GEV No. 518272 Ref. No. 429040
	union nut for wash jet

	
<b>GEV No.</b>	518332
<b>Ref. No.</b>	106008
<b>description</b>	wash arm mounting pos. right L 220mm mounting ø 24mm nozzles 5
<b>For models:</b>	050F, 050FP, 2312-001, 2312-002, 914568, 915830, E.50, E.50D.PA, E.51, F85, F85P, FAST-160DP, GSP50, GSP50P, GSP51, GSP51P, LF50, LF55, MC501E, MC501EP, MC501S, MC501SP, MISTRAL-51, NIAGARA-51, P500, PS-60, S651, S651P, S653, S654, S655, S830, S835, S850, SR651
<b>accessories for</b>	518332
	GEV No. 518004 Ref. No. 140008
	wash jet
	GEV No. 518272 Ref. No. 429040
	union nut for wash jet

	
<b>GEV No.</b>	510010
<b>Ref. No.</b>	129003 129039
<b>description</b>	wash arm boss L1 64mm L2 60mm mounting ø 16.5mm
<b>For models:</b>	050F, 050FP, 11F, 11FD, 11F-DVGW, 21F, 21FD, 2312-001, 2312-002, 25F, 25FD, 30F, 30FD, 31F, 31FD, 400F, 400FD, 40-ELECTRONIC, 40F, 40FD, 45, 450, 46, 460, 500F, 500FD, 50F, 50FD, 510F, 510FD, 67R, 913363, 913364, 913376, 913377, 914568, 915830, E.41, E.42, E.45, E.46, E.50, E.50D.PA, E.51, E41, F85, F85P, FAST-160DP, GSP50, GSP50P...(Other models you can see in the webshop)

	
<b>GEV No.</b>	510138
<b>Ref. No.</b>	114013 140013 140020
<b>description</b>	wash jet fine groove
<b>For models:</b>	11F, 11FD, 11F-DVGW, 350F, 350FD, 350R, 350RD, 35-ELECTRONIC, 35F, 35FD, 35R, 35RD, 400F, 400FD, 40-ELECTRONIC, 40F, 40FD, 45, 450, 46, 460, 67R, 913363, 913364, 913376, 913377, E.35, E.35H, E.40, E.40H, E.41, E.42, E.45, E.46, E41, GLS40H, GLS40HP, GSP50, GSP50P, GSP51, GSP51P, MC201CL, MISTRAL-40, NIAGARA-35, NIAGARA-40, NIAGARA-45, P500, PS-60, TF-503, TF-513...(Other models you can see in the webshop)
<b>accessories for</b>	510138
	GEV No. 510131 Ref. No. 429007
	union nut for wash jet









	
<b>GEV No.</b>	518001
<b>Ref. No.</b>	990046
<b>description</b>	wash and rinse arm wash arm L 410mm rinse arm L 410mm w. jets 7 r. jets 5 mounting ø 16.5mm mounting pos. lower
<b>For models:</b>	11F, 11FD, 11F-DVGW, 400F, 400FD, 40-ELECTRONIC, 40F, 40FD, 913363, 913364, 913376, 913377, E.41, E.42, E.46, E41
<b>spare parts for</b>	518001
	GEV No. 510010 Ref. No. 129003 129039
	wash arm boss L1 64mm L2 60mm mounting ø 16.5mm
	GEV No. 510130 Ref. No. 429006
	union nut for rinse jet
	GEV No. 510131 Ref. No. 429007
	union nut for wash jet
	GEV No. 510138 Ref. No. 114013 140013 140020
	wash jet fine groove
	GEV No. 510139 Ref. No. 140007
	rinse jet
	GEV No. 518382 Ref. No. 106009
	wash arm mounting pos. right L 175mm mounting ø 24mm nozzles 4



Table continues overleaf







spare parts for		518001	
	GEV No.	518383	Ref. No. 106010
	rinse arm mounting pos. left L 175mm mounting ø 13mm nozzles 2		
	GEV No.	518384	Ref. No. 106011
	rinse arm mounting pos. right L 175mm mounting ø 13mm nozzles 3		
	GEV No.	518631	Ref. No. 106012
	wash arm mounting pos. left L 170mm nozzles mounting ø 24mm		
accessories for		518001	
	GEV No.	510037	Ref. No. 115035
	wash arm support		
	GEV No.	510054	Ref. No. 437046
	gasket D1 ø 65mm D2 ø 35.5mm thickness 2.5mm with 5 holes wash arm support		
	GEV No.	510056	Ref. No. 325025
	rinse arm shaft		
	GEV No.	510057	Ref. No. 111009
	opposite support for wash arm support mounting pos. lower Mod. 111009 suitable for 11R		
	GEV No.	510058	Ref. No. 199018
	throttle disc		
	GEV No.	510108	Ref. No. 327006
	rinse arm shaft		
	GEV No.	518003	Ref. No. 447030 447128
	screw cap		
	GEV No.	518421	Ref. No. 111015
	opposite support for wash arm support mounting pos. lower Mod. 111015		

	1		
GEV No.	518383	Ref. No.	106010
description	rinse arm mounting pos. left L 175mm mounting ø 13mm nozzles 2		
For models:	11F, 11FD, 11F-DVGW, 21F, 21FD, 25F, 25FD, 30F, 30FD, 31F, 31FD, 400F, 400FD, 40-ELECTRONIC, 40F, 40FD, 913363, 913364, 913376, 913377, E.41, E.42, E.46, E41, S621, S623, S624, S626, S631, S633, S634, S636		

	1		
GEV No.	518384	Ref. No.	106011
description	rinse arm mounting pos. right L 175mm mounting ø 13mm nozzles 3		
For models:	11F, 11FD, 11F-DVGW, 21F, 21FD, 25F, 25FD, 30F, 30FD, 31F, 31FD, 400F, 400FD, 40-ELECTRONIC, 40F, 40FD, 913363, 913364, 913376, 913377, E.41, E.42, E.46, E41, S621, S623, S624, S626, S631, S633, S634, S636		

	1		
GEV No.	510139	Ref. No.	140007
description	rinse jet		
For models:	050F, 050FP, 10, 11F, 11FD, 11F-DVGW, 11R, 11RD, 12, 21F, 21FD, 21R, 21RD, 22F, 2312-001, 2312-002, 25F, 25FD, 25R, 25RD, 30F, 30FD, 30R, 30RD, 31F, 31FD, 31R, 31RD, 350F, 350FD, 350R, 350RD, 35-ELECTRONIC, 35F, 35FD, 35R, 35RD, 400F, 400FD, 400R, 400RD, 40-ELECTRONIC, 40F, 40FD, 40R, 40RD, 440F, 44F, 45, 450...(Other models you can see in the webshop)		
accessories for	510139		
	GEV No.	510130	Ref. No. 429006
	union nut for rinse jet		



	1		
GEV No.	510130	Ref. No.	429006
description	union nut for rinse jet		
For models:	10, 11F, 11FD, 11F-DVGW, 11R, 11RD, 12, 21F, 21FD, 21R, 21RD, 22F, 2312-001, 2312-002, 25F, 25FD, 25R, 25RD, 30F, 30FD, 30R, 30RD, 31F, 31FD, 31R, 31RD, 350F, 350FD, 350R, 350RD, 35-ELECTRONIC, 35F, 35FD, 35R, 35RD, 400F, 400FD, 400R, 400RD, 40-ELECTRONIC, 40F, 40FD, 40R, 40RD, 440F, 44F, 500F, 500FD, 50-ELECTRONIC, 50F...(Other models you can see in the webshop)		
accessories for	510130		
	GEV No.	510139	Ref. No. 140007
	rinse jet		

	1		
GEV No.	510131	Ref. No.	429007
description	union nut for wash jet		
For models:	11F, 11FD, 11F-DVGW, 11R, 11RD, 21F, 21FD, 21R, 21RD, 2312-001, 2312-002, 25F, 25FD, 25R, 25RD, 30F, 30FD, 30R, 30RD, 31F, 31FD, 31R, 31RD, 350F, 350FD, 350R, 350RD, 35-ELECTRONIC, 35F, 35FD, 35R, 35RD, 400F, 400FD, 40-ELECTRONIC, 40F, 40FD, 500F, 500FD, 50F, 50FD, 510F, 510FD, 913363, 913364, 913376, 913377, 914568, 915830, E.35...(Other models you can see in the webshop)		
accessories for	510131		
	GEV No.	510138	Ref. No. 114013 140013 140020
	wash jet fine groove		

	1		
GEV No.	518631	Ref. No.	106012
description	wash arm mounting pos. left L 170mm nozzles mounting ø 24mm		
For models:	11F, 11FD, 11F-DVGW, 21F, 21FD, 25F, 25FD, 30F, 30FD, 31F, 31FD, 400F, 400FD, 40-ELECTRONIC, 40F, 40FD, 913363, 913364, 913376, 913377, E.41, E.42, E.46, E41, S621, S623, S624, S626, S631, S633, S634, S636		

			
1			
<b>GEV No.</b>	518382	<b>Ref. No.</b>	106009
<b>description</b>	wash arm mounting pos. right L 175mm mounting ø 24mm nozzles 4		
<b>For models:</b>	11F, 11FD, 11F-DVGW, 21F, 21FD, 25F, 25FD, 30F, 30FD, 31F, 31FD, 400F, 400FD, 40-ELECTRONIC, 40F, 40FD, 913363, 913364, 913376, 913377, E.41, E.42, E.45, E.46, E41, NIAGARA-45, S621, S623, S624, S626, S631, S633, S634, S636		

			
1			
<b>GEV No.</b>	510010	<b>Ref. No.</b>	129003 129039
<b>description</b>	wash arm boss L1 64mm L2 60mm mounting ø 16.5mm		
<b>For models:</b>	050F, 050FP, 11F, 11FD, 11F-DVGW, 21F, 21FD, 2312-001, 2312-002, 25F, 25FD, 30F, 30FD, 31F, 31FD, 400F, 400FD, 40-ELECTRONIC, 40F, 40FD, 45, 450, 46, 460, 500F, 500FD, 50F, 50FD, 510F, 510FD, 67R, 913363, 913364, 913376, 913377, 914568, 915830, E.41, E.42, E.45, E.46, E.50, E.50D.PA, E.51, E41, F85, F85P, FAST-160DP, GSP50, GSP50P... (Other models you can see in the webshop)		

			
1			
<b>GEV No.</b>	510138	<b>Ref. No.</b>	114013 140013 140020
<b>description</b>	wash jet fine groove		
<b>For models:</b>	11F, 11FD, 11F-DVGW, 350F, 350FD, 350R, 350RD, 35-ELECTRONIC, 35F, 35FD, 35R, 35RD, 400F, 400FD, 40-ELECTRONIC, 40F, 40FD, 45, 450, 46, 460, 67R, 913363, 913364, 913376, 913377, E.35, E.35H, E.40, E.40H, E.41, E.42, E.45, E.46, E41, GLS40H, GLS40HP, GSP50, GSP50P, GSP51, GSP51P, MC201CL, MISTRAL-40, NIAGARA-35, NIAGARA-40, NIAGARA-45, P500, PS-60, TF-503, TF-513...(Other models you can see in the webshop)		
<b>accessories for</b>	510138		
	<b>GEV No.</b>	510131	<b>Ref. No.</b> 429007
union nut for wash jet			



			
1			
<b>GEV No.</b>	518005	<b>Ref. No.</b>	990009
<b>description</b>	wash and rinse arm 2 wash arms/ 2 rinse arms		
<b>For models:</b>	S651, S651P, S653, S654, S655, S830, S835, S850, SR651		

			
1			
<b>GEV No.</b>	518465	<b>Ref. No.</b>	106072.CR
<b>description</b>	rinse arm mounting pos. left		
<b>For models:</b>	500F, 500FD, 50F, 50FD, 510F, 510FD, E.50, E.51		



			
1			
<b>GEV No.</b>	518335	<b>Ref. No.</b>	106005
<b>description</b>	rinse arm mounting pos. left L 220mm mounting ø 13mm nozzles 3		
<b>For models:</b>	050F, 050FP, 2312-001, 2312-002, 914568, 915830, E.50, E.50D.PA, E.51, F85, F85P, FAST-160DP, GSP50, GSP50P, GSP51, GSP51P, LF50, LF55, MC501E, MC501EP, MC501S, MC501SP, MISTRAL-51, NIAGARA-51, P500, PS-60, S651, S651P, S653, S654, S655, S830, S835, S850, SR651, TF-503, TF-513, TF-515		



			
Image not available			
1			
<b>GEV No.</b>	518464	<b>Ref. No.</b>	106073.CR
<b>description</b>	rinse arm mounting pos. right		
<b>For models:</b>	500F, 500FD, 50F, 50FD, 510F, 510FD, E.50, E.51		

			
1			
<b>GEV No.</b>	518334	<b>Ref. No.</b>	106007
<b>description</b>	rinse arm mounting pos. right L 220mm mounting ø 13mm nozzles 3		
<b>For models:</b>	050F, 050FP, 2312-001, 2312-002, 914568, 915830, E.50, E.50D.PA, E.51, F85, F85P, FAST-160DP, GSP50, GSP50P, GSP51, GSP51P, LF50, LF55, MC501E, MC501EP, MC501S, MC501SP, MISTRAL-51, NIAGARA-51, P500, PS-60, S651, S651P, S653, S654, S655, S830, S835, S850, SR651		

			
1			
<b>GEV No.</b>	510139	<b>Ref. No.</b>	140007
<b>description</b>	rinse jet		
<b>For models:</b>	050F, 050FP, 10, 11F, 11FD, 11F-DVGW, 11R, 11RD, 12, 21F, 21FD, 21R, 21RD, 22F, 2312-001, 2312-002, 25F, 25FD, 25R, 25RD, 30F, 30FD, 30R, 30RD, 31F, 31FD, 31R, 31RD, 350F, 350FD, 350R, 350RD, 35-ELECTRONIC, 35F, 35FD, 35R, 35RD, 400F, 400FD, 400R, 400RD, 40-ELECTRONIC, 40F, 40FD, 40R, 40RD, 440F, 44F, 45, 450...(Other models you can see in the webshop)		
<b>accessories for</b>	510139		
	<b>GEV No.</b>	510130	<b>Ref. No.</b> 429006
union nut for rinse jet			





			
<b>GEV No.</b>	510130	<b>Ref. No.</b>	429006
<b>description</b>	union nut for rinse jet		
<b>For models:</b>	10, 11F, 11FD, 11F-DVGW, 11R, 11RD, 12, 21F, 21FD, 21R, 21RD, 22F, 2312-001, 2312-002, 25F, 25FD, 25R, 25RD, 30F, 30FD, 30R, 30RD, 31F, 31FD, 31R, 31RD, 350F, 350FD, 350R, 350RD, 35-ELECTRONIC, 35F, 35FD, 35R, 35RD, 400F, 400FD, 400R, 400RD, 40-ELECTRONIC, 40F, 40FD, 40R, 40RD, 440F, 44F, 500F, 500FD, 50-ELECTRONIC, 50F...(Other models you can see in the webshop)		
<b>accessories for</b>	510130		
		<b>GEV No.</b>	510139
	rinse jet	<b>Ref. No.</b>	140007

			
<b>GEV No.</b>	510131	<b>Ref. No.</b>	429007
<b>description</b>	union nut for wash jet		
<b>For models:</b>	11F, 11FD, 11F-DVGW, 11R, 11RD, 21F, 21FD, 21R, 21RD, 2312-001, 2312-002, 25F, 25FD, 25R, 25RD, 30F, 30FD, 30R, 30RD, 31F, 31FD, 31R, 31RD, 350F, 350FD, 350R, 350RD, 35-ELECTRONIC, 35F, 35FD, 35R, 35RD, 400F, 400FD, 40-ELECTRONIC, 40F, 40FD, 500F, 500FD, 50F, 50FD, 510F, 510FD, 913363, 913364, 913376, 913377, 914568, 915830, E.35...(Other models you can see in the webshop)		
<b>accessories for</b>	510131		
		<b>GEV No.</b>	510138
	wash jet fine groove	<b>Ref. No.</b>	114013 140013 140020

			
<b>GEV No.</b>	518333	<b>Ref. No.</b>	106006
<b>description</b>	wash arm mounting pos. left L 220mm mounting ø 24mm nozzles 4		
<b>For models:</b>	050F, 050FP, 2312-001, 2312-002, 914568, 915830, E.50, E.50D.PA, E.51, F85, F85P, FAST-160DP, GSP50, GSP50P, GSP51, GSP51P, LF50, LF55, MC501E, MC501EP, MC501S, MC501SP, MISTRAL-51, NIAGARA-51, P500, PS-60, S651, S651P, S653, S654, S655, S830, S835, S850, SR651, TF-503, TF-513, TF-515		
<b>accessories for</b>	518333		
		<b>GEV No.</b>	518004
	wash jet	<b>Ref. No.</b>	140008
		<b>GEV No.</b>	518272
	union nut for wash jet	<b>Ref. No.</b>	429040

			
<b>GEV No.</b>	518332	<b>Ref. No.</b>	106008
<b>description</b>	wash arm mounting pos. right L 220mm mounting ø 24mm nozzles 5		
<b>For models:</b>	050F, 050FP, 2312-001, 2312-002, 914568, 915830, E.50, E.50D.PA, E.51, F85, F85P, FAST-160DP, GSP50, GSP50P, GSP51, GSP51P, LF50, LF55, MC501E, MC501EP, MC501S, MC501SP, MISTRAL-51, NIAGARA-51, P500, PS-60, S651, S651P, S653, S654, S655, S830, S835, S850, SR651		
<b>accessories for</b>	518332		
		<b>GEV No.</b>	518004
	wash jet	<b>Ref. No.</b>	140008
		<b>GEV No.</b>	518272
	union nut for wash jet	<b>Ref. No.</b>	429040

			
<b>GEV No.</b>	510010	<b>Ref. No.</b>	129003 129039
<b>description</b>	wash arm boss L1 64mm L2 60mm mounting ø 16.5mm		
<b>For models:</b>	050F, 050FP, 11F, 11FD, 11F-DVGW, 21F, 21FD, 2312-001, 2312-002, 25F, 25FD, 30F, 30FD, 31F, 31FD, 400F, 400FD, 40-ELECTRONIC, 40F, 40FD, 45, 450, 46, 460, 500F, 500FD, 50F, 50FD, 510F, 510FD, 67R, 913363, 913364, 913376, 913377, 914568, 915830, E.41, E.42, E.45, E.46, E.50, E.50D.PA, E.51, E.41, F85, F85P, FAST-160DP, GSP50, GSP50P...(Other models you can see in the webshop)		

			
<b>GEV No.</b>	518004	<b>Ref. No.</b>	140008
<b>description</b>	wash jet		
<b>For models:</b>	050F, 050FP, 11R, 11RD, 21F, 21FD, 21R, 21RD, 2312-001, 2312-002, 25F, 25FD, 25R, 25RD, 30F, 30FD, 30R, 30RD, 31F, 31FD, 31R, 31RD, 350F, 350FD, 350R, 350RD, 35-ELECTRONIC, 35F, 35FD, 35R, 35RD, 400F, 400FD, 40-ELECTRONIC, 40F, 40FD, 500F, 500FD, 50F, 50FD, 510F, 510FD, 67R, 914568, 915830, E.42, E.50, E.50D.PA, E.51, F85, F85P, FAST-160DP, GSP50, GSP50P, GSP51, GSP51P, LF50, LF55, MC501E, MC501EP, MC501S, MC501SP, MISTRAL-51, NIAGARA-51...(Other models you can see in the webshop)		



			
<b>GEV No.</b>	524077	<b>Ref. No.</b>	79040
<b>description</b>	wash and rinse arm wash arm L 490mm rinse arm L 495mm w. jets 8 r. jets 6 mounting ø 16.5mm mounting pos. upper/lower		
<b>For models:</b>	PS-60		
<b>spare parts for</b>	524077		
		<b>GEV No.</b>	510139
	rinse jet	<b>Ref. No.</b>	140007
		<b>GEV No.</b>	518004
	wash jet	<b>Ref. No.</b>	140008

Table continues overleaf



<b>spare parts for</b> 524077	
	GEV No. 518053 Ref. No. 429006.TN 429039
union nut for rinse jet	
	GEV No. 518272 Ref. No. 429040
union nut for wash jet	
	GEV No. 518332 Ref. No. 106008
wash arm mounting pos. right L 220mm mounting ø 24mm nozzles 5	
	GEV No. 518333 Ref. No. 106006
wash arm mounting pos. left L 220mm mounting ø 24mm nozzles 4	
	GEV No. 518334 Ref. No. 106007
rinse arm mounting pos. right L 220mm mounting ø 13mm nozzles 3	
	GEV No. 518335 Ref. No. 106005
rinse arm mounting pos. left L 220mm mounting ø 13mm nozzles 3	



	1
<b>GEV No.</b> 518465	<b>Ref. No.</b> 106072.CR
<b>description</b> rinse arm mounting pos. left	
<b>For models:</b> 500F, 500FD, 50F, 50FD, 510F, 510FD, E.50, E.51	



	1
<b>GEV No.</b> 518335	<b>Ref. No.</b> 106005
<b>description</b> rinse arm mounting pos. left L 220mm mounting ø 13mm nozzles 3	
<b>For models:</b> 050F, 050FP, 2312-001, 2312-002, 914568, 915830, E.50, E.50D.PA, E.51, F85, F85P, FAST-160DP, GSP50, GSP50P, GSP51, GSP51P, LF50, LF55, MC501E, MC501EP, MC501S, MC501SP, MISTRAL-51, NIAGARA-51, P500, PS-60, S651, S651P, S653, S654, S655, S830, S835, S850, SR651, TF-503, TF-513, TF-515	

 Image not available	
	1
<b>GEV No.</b> 518464	<b>Ref. No.</b> 106073.CR
<b>description</b> rinse arm mounting pos. right	
<b>For models:</b> 500F, 500FD, 50F, 50FD, 510F, 510FD, E.50, E.51	

	1
<b>GEV No.</b> 518334	<b>Ref. No.</b> 106007
<b>description</b> rinse arm mounting pos. right L 220mm mounting ø 13mm nozzles 3	
<b>For models:</b> 050F, 050FP, 2312-001, 2312-002, 914568, 915830, E.50, E.50D.PA, E.51, F85, F85P, FAST-160DP, GSP50, GSP50P, GSP51, GSP51P, LF50, LF55, MC501E, MC501EP, MC501S, MC501SP, MISTRAL-51, NIAGARA-51, P500, PS-60, S651, S651P, S653, S654, S655, S830, S835, S850, SR651	

	1
<b>GEV No.</b> 510139	<b>Ref. No.</b> 140007
<b>description</b> rinse jet	
<b>For models:</b> 050F, 050FP, 10, 11F, 11FD, 11F-DVGW, 11R, 11RD, 12, 21F, 21FD, 21R, 21RD, 22F, 2312-001, 2312-002, 25F, 25FD, 25R, 25RD, 30F, 30FD, 30R, 30RD, 31F, 31FD, 31R, 31RD, 350F, 350FD, 350R, 350RD, 35-ELECTRONIC, 35F, 35FD, 35R, 35RD, 400F, 400FD, 400R, 400RD, 40-ELECTRONIC, 40F, 40FD, 40R, 40RD, 440F, 44F, 45, 450...(Other models you can see in the webshop)	
<b>accessories for</b> 510139	
	GEV No. 510130 Ref. No. 429006
union nut for rinse jet	

	1
<b>GEV No.</b> 510130	<b>Ref. No.</b> 429006
<b>description</b> union nut for rinse jet	
<b>For models:</b> 10, 11F, 11FD, 11F-DVGW, 11R, 11RD, 12, 21F, 21FD, 21R, 21RD, 22F, 2312-001, 2312-002, 25F, 25FD, 25R, 25RD, 30F, 30FD, 30R, 30RD, 31F, 31FD, 31R, 31RD, 350F, 350FD, 350R, 350RD, 35-ELECTRONIC, 35F, 35FD, 35R, 35RD, 400F, 400FD, 400R, 400RD, 40-ELECTRONIC, 40F, 40FD, 40R, 40RD, 440F, 44F, 500F, 500FD, 50-ELECTRONIC, 50F...(Other models you can see in the webshop)	
<b>accessories for</b> 510130	
	GEV No. 510139 Ref. No. 140007
rinse jet	

	1
<b>GEV No.</b> 510131	<b>Ref. No.</b> 429007
<b>description</b> union nut for wash jet	
<b>For models:</b> 11F, 11FD, 11F-DVGW, 11R, 11RD, 21F, 21FD, 21R, 21RD, 2312-001, 2312-002, 25F, 25FD, 25R, 25RD, 30F, 30FD, 30R, 30RD, 31F, 31FD, 31R, 31RD, 350F, 350FD, 350R, 350RD, 35-ELECTRONIC, 35F, 35FD, 35R, 35RD, 400F, 400FD, 40-ELECTRONIC, 40F, 40FD, 500F, 500FD, 50F, 50FD, 510F, 510FD, 913363, 913364, 913376, 913377, 914568, 915830, E.35...(Other models you can see in the webshop)	
<b>accessories for</b> 510131	
	GEV No. 510138 Ref. No. 114013 140013 140020
wash jet fine groove	



	1
<b>GEV No.</b> 518333	<b>Ref. No.</b> 106006
<b>description</b> wash arm mounting pos. left L 220mm mounting ø 24mm nozzles 4	
<b>For models:</b> 050F, 050FP, 2312-001, 2312-002, 914568, 915830, E.50, E.50D.PA, E.51, F85, F85P, FAST-160DP, GSP50, GSP50P, GSP51, GSP51P, LF50, LF55, MC501E, MC501EP, MC501S, MC501SP, MISTRAL-51, NIAGARA-51, P500, PS-60, S651, S651P, S653, S654, S655, S830, S835, S850, SR651, TF-503, TF-513, TF-515	
<b>accessories for</b> 518333	
	GEV No. 518004 Ref. No. 140008
wash jet	



Table continues overleaf









<b>accessories for</b>	518333		
	<b>GEV No.</b>	518272	<b>Ref. No.</b> 429040
	union nut for wash jet		

	1		
<b>GEV No.</b>	518332	<b>Ref. No.</b>	106008
<b>description</b>	wash arm mounting pos. right L 220mm mounting ø 24mm nozzles 5		
<b>For models:</b>	050F, 050FP, 2312-001, 2312-002, 914568, 915830, E.50, E.50D.PA, E.51, F85, F85P, FAST-160DP, GSP50, GSP50P, GSP51, GSP51P, LF50, LF55, MC501E, MC501EP, MC501S, MC501SP, MISTRAL-51, NIAGARA-51, P500, PS-60, S651, S651P, S653, S654, S655, S830, S835, S850, SR651		

<b>accessories for</b>	518332		
	<b>GEV No.</b>	518004	<b>Ref. No.</b> 140008
	wash jet		
	<b>GEV No.</b>	518272	<b>Ref. No.</b> 429040
	union nut for wash jet		

	1		
<b>GEV No.</b>	510010	<b>Ref. No.</b>	129003 129039
<b>description</b>	wash arm boss L1 64mm L2 60mm mounting ø 16.5mm		
<b>For models:</b>	050F, 050FP, 11F, 11FD, 11F-DVGW, 21F, 21FD, 2312-001, 2312-002, 25F, 25FD, 30F, 30FD, 31F, 31FD, 400F, 400FD, 40-ELECTRONIC, 40F, 40FD, 45, 450, 46, 460, 500F, 500FD, 50F, 50FD, 510F, 510FD, 67R, 913363, 913364, 913376, 913377, 914568, 915830, E.41, E.42, E.45, E.46, E.50, E.50D.PA, E.51, E41, F85, F85P, FAST-160DP, GSP50, GSP50P... (Other models you can see in the webshop)		

	1		
<b>GEV No.</b>	517561	<b>Ref. No.</b>	79021
<b>description</b>	wash arm boss mounting pos. upper/lower mounting ø 45mm L 84mm W 75mm H 50mm		
<b>For models:</b>	PS-60		

	1		
<b>GEV No.</b>	510138	<b>Ref. No.</b>	114013 140013 140020
<b>description</b>	wash jet fine groove		
<b>For models:</b>	11F, 11FD, 11F-DVGW, 350F, 350FD, 350R, 350RD, 35-ELECTRONIC, 35F, 35FD, 35R, 35RD, 400F, 400FD, 40-ELECTRONIC, 40F, 40FD, 45, 450, 46, 460, 67R, 913363, 913364, 913376, 913377, E.35, E.35H, E.40, E.40H, E.41, E.42, E.45, E.46, E41, GLS40H, GLS40HP, GSP50, GSP50P, GSP51, GSP51P, MC201CL, MISTRAL-40, NIAGARA-35, NIAGARA-40, NIAGARA-45, P500, PS-60, TF-503, TF-513...(Other models you can see in the webshop)		
<b>accessories for</b>	510138		
	<b>GEV No.</b>	510131	<b>Ref. No.</b> 429007
	union nut for wash jet		

	1		
<b>GEV No.</b>	518040	<b>Ref. No.</b>	990064 990079
<b>description</b>	wash and rinse arm 2 wash arms/ 2 rinse arms		
<b>For models:</b>	350F, 350FD, 350R, 350RD, 35-ELECTRONIC, 35F, 35FD, 35R, 35RD		

	1		
<b>GEV No.</b>	518426	<b>Ref. No.</b>	990096
<b>description</b>	wash and rinse arm wash arm L 350mm rinse arm L 350mm w. jets 6 r. jets 4 mounting ø 14/37mm mounting pos. lower		
<b>For models:</b>	E.35		

<b>spare parts for</b>	518426		
	<b>GEV No.</b>	510130	<b>Ref. No.</b> 429006
	union nut for rinse jet		
	<b>GEV No.</b>	510131	<b>Ref. No.</b> 429007
	union nut for wash jet		
	<b>GEV No.</b>	510138	<b>Ref. No.</b> 114013 140013 140020
	wash jet fine groove		
	<b>GEV No.</b>	510139	<b>Ref. No.</b> 140007
	rinse jet		
	<b>GEV No.</b>	513271	<b>Ref. No.</b> 412028
	connector holder grey		
	<b>GEV No.</b>	518028	<b>Ref. No.</b> 454004
	knurled nut thread M5 ø 25mm H 4mm SS		
	<b>GEV No.</b>	518428	<b>Ref. No.</b> 106095
	wash arm mounting pos. right L 160mm mounting ø 19mm nozzles 3		
	<b>GEV No.</b>	518429	<b>Ref. No.</b> 106096
	wash arm mounting pos. left L 155mm mounting ø 15mm nozzles 3		
	<b>GEV No.</b>	518430	<b>Ref. No.</b> 106098
	rinse arm mounting pos. right L 165mm mounting ø 14mm nozzles 2		
	<b>GEV No.</b>	518431	<b>Ref. No.</b> 106097
	rinse arm mounting pos. left L 165mm mounting ø 14mm nozzles 2		



<b>GEV No.</b>	513712	<b>Ref. No.</b>	990103
<b>description</b>	wash and rinse arm wash arm L 350mm rinse arm L 350mm w. jets 6 r. jets 4 mounting ø 14/41mm mounting pos. lower		
<b>For models:</b>	E.35, E.35H, MC201CL, NIAGARA-35		

**spare parts for** 513712

	<b>GEV No.</b>	510130	<b>Ref. No.</b>	429006
	<b>description</b>	union nut for rinse jet		

	<b>GEV No.</b>	510131	<b>Ref. No.</b>	429007
	<b>description</b>	union nut for wash jet		

	<b>GEV No.</b>	510138	<b>Ref. No.</b>	114013 140013 140020
	<b>description</b>	wash jet fine groove		

	<b>GEV No.</b>	510139	<b>Ref. No.</b>	140007
	<b>description</b>	rinse jet		

	<b>GEV No.</b>	513261	<b>Ref. No.</b>	129056
	<b>description</b>	wash arm boss		

	<b>GEV No.</b>	513271	<b>Ref. No.</b>	412028
	<b>description</b>	connector holder grey		

	<b>GEV No.</b>	518028	<b>Ref. No.</b>	454004
	<b>description</b>	knurled nut thread M5 ø 25mm H 4mm SS		

	<b>GEV No.</b>	518428	<b>Ref. No.</b>	106095
	<b>description</b>	wash arm mounting pos. right L 160mm mounting ø 19mm nozzles 3		

	<b>GEV No.</b>	518429	<b>Ref. No.</b>	106096
	<b>description</b>	wash arm mounting pos. left L 155mm mounting ø 15mm nozzles 3		

	<b>GEV No.</b>	518430	<b>Ref. No.</b>	106098
	<b>description</b>	rinse arm mounting pos. right L 165mm mounting ø 14mm nozzles 2		

	<b>GEV No.</b>	518431	<b>Ref. No.</b>	106097
	<b>description</b>	rinse arm mounting pos. left L 165mm mounting ø 14mm nozzles 2		



<b>GEV No.</b>	518431	<b>Ref. No.</b>	106097
<b>description</b>	rinse arm mounting pos. left L 165mm mounting ø 14mm nozzles 2		
<b>For models:</b>	350F, 350FD, 350R, 350RD, 35F, 35FD, 35R, 35RD, E.35, E.35H, MC-201CL, NIAGARA-35		



<b>GEV No.</b>	518430	<b>Ref. No.</b>	106098
<b>description</b>	rinse arm mounting pos. right L 165mm mounting ø 14mm nozzles 2		
<b>For models:</b>	E.35, E.35H, MC201CL, NIAGARA-35		



<b>GEV No.</b>	510139	<b>Ref. No.</b>	140007
<b>description</b>	rinse jet		
<b>For models:</b>	050F, 050FP, 10, 11F, 11FD, 11F-DVGW, 11R, 11RD, 12, 21F, 21FD, 21R, 21RD, 22F, 2312-001, 2312-002, 25F, 25FD, 25R, 25RD, 30F, 30FD, 30R, 30RD, 31F, 31FD, 31R, 31RD, 350F, 350FD, 350R, 350RD, 35-ELECTRONIC, 35F, 35FD, 35R, 35RD, 400F, 400FD, 400R, 400RD, 40-ELECTRONIC, 40F, 40FD, 40R, 40RD, 440F, 44F, 45, 450...(Other models you can see in the webshop)		

<b>accessories for</b>	510139			
	<b>GEV No.</b>	510130	<b>Ref. No.</b>	429006
	<b>description</b>	union nut for rinse jet		



<b>GEV No.</b>	510130	<b>Ref. No.</b>	429006
<b>description</b>	union nut for rinse jet		
<b>For models:</b>	10, 11F, 11FD, 11F-DVGW, 11R, 11RD, 12, 21F, 21FD, 21R, 21RD, 22F, 2312-001, 2312-002, 25F, 25FD, 25R, 25RD, 30F, 30FD, 30R, 30RD, 31F, 31FD, 31R, 31RD, 350F, 350FD, 350R, 350RD, 35-ELECTRONIC, 35F, 35FD, 35R, 35RD, 400F, 400FD, 400R, 400RD, 40-ELECTRONIC, 40F, 40FD, 40R, 40RD, 440F, 44F, 500F, 500FD, 50-ELECTRONIC, 50F...(Other models you can see in the webshop)		

<b>accessories for</b>	510130			
	<b>GEV No.</b>	510139	<b>Ref. No.</b>	140007
	<b>description</b>	rinse jet		





<b>GEV No.</b>	510131	<b>Ref. No.</b>	429007
<b>description</b>	union nut for wash jet		
<b>For models:</b>	11F, 11FD, 11F-DVGW, 11R, 11RD, 21F, 21FD, 21R, 21RD, 2312-001, 2312-002, 25F, 25FD, 25R, 25RD, 30F, 30FD, 30R, 30RD, 31F, 31FD, 31R, 31RD, 350F, 350FD, 350R, 350RD, 35-ELECTRONIC, 35F, 35FD, 35R, 35RD, 400F, 400FD, 40-ELECTRONIC, 40F, 40FD, 500F, 500FD, 50F, 50FD, 510F, 510FD, 913363, 913364, 913376, 913377, 914568, 915830, E.35...(Other models you can see in the webshop)		



<b>accessories for</b>	510131			
	<b>GEV No.</b>	510138	<b>Ref. No.</b>	114013 140013 140020
	<b>description</b>	wash jet fine groove		















			
1			
<b>GEV No.</b>	518429	<b>Ref. No.</b>	106096
<b>description</b>	wash arm mounting pos. left L 155mm mounting ø 15mm nozzles 3		
<b>For models:</b>	350F, 350FD, 350R, 350RD, 35F, 35FD, 35R, 35RD, E.35, E.35H, MC-201CL, NIAGARA-35		

			
1			
<b>GEV No.</b>	518428	<b>Ref. No.</b>	106095
<b>description</b>	wash arm mounting pos. right L 160mm mounting ø 19mm nozzles 3		
<b>For models:</b>	350F, 350FD, 350R, 350RD, 35F, 35FD, 35R, 35RD, E.35, E.35H, MC-201CL, NIAGARA-35		

			
1			
<b>GEV No.</b>	518438	<b>Ref. No.</b>	129050
<b>description</b>	wash arm boss L 64mm mounting ø 14/37mm H 38mm W 60mm		
<b>For models:</b>	E.35, E.40		



			
1			
<b>GEV No.</b>	510138	<b>Ref. No.</b>	114013 140013 140020
<b>description</b>	wash jet fine groove		
<b>For models:</b>	11F, 11FD, 11F-DVGW, 350F, 350FD, 350R, 350RD, 35-ELECTRONIC, 35F, 35FD, 35R, 35RD, 400F, 400FD, 40-ELECTRONIC, 40F, 40FD, 45, 450, 46, 460, 67R, 913363, 913364, 913376, 913377, E.35, E.35H, E.40, E.40H, E.41, E.42, E.45, E.46, E41, GLS40H, GLS40HP, GSP50, GSP50P, GSP51, GSP51P, MC201CL, MISTRAL-40, NIAGARA-35, NIAGARA-40, NIAGARA-45, P500, PS-60, TF-503, TF-513...(Other models you can see in the webshop)		
<b>accessories for</b>	510138		
	<b>GEV No.</b>	510131	<b>Ref. No.</b> 429007
union nut for wash jet			

			
1			
<b>GEV No.</b>	518437	<b>Ref. No.</b>	990094 990104
<b>description</b>	wash and rinse arm wash arm L 400mm rinse arm L 400mm w. jets 7 r. jets 5 mounting ø 14/41mm mounting pos. lower		
<b>For models:</b>	E.40, E.40H, GLS40H, GLS40HP, MISTRAL-40, NIAGARA-40		
<b>spare parts for</b>	518437		
	<b>GEV No.</b>	510130	<b>Ref. No.</b> 429006
union nut for rinse jet			

<b>spare parts for</b>	518437		
	<b>GEV No.</b>	510131	<b>Ref. No.</b> 429007
union nut for wash jet			
	<b>GEV No.</b>	510138	<b>Ref. No.</b> 114013 140013 140020
wash jet fine groove			
	<b>GEV No.</b>	510139	<b>Ref. No.</b> 140007
rinse jet			
	<b>GEV No.</b>	513261	<b>Ref. No.</b> 129056
wash arm boss			
	<b>GEV No.</b>	513271	<b>Ref. No.</b> 412028
connector holder grey			
	<b>GEV No.</b>	518028	<b>Ref. No.</b> 454004
knurled nut thread M5 ø 25mm H 4mm SS			
	<b>GEV No.</b>	518439	<b>Ref. No.</b> 106111
wash arm mounting pos. left L 180mm mounting ø 19mm nozzles 3			
	<b>GEV No.</b>	518440	<b>Ref. No.</b> 106112
wash arm mounting pos. right L 180mm mounting ø 19mm nozzles 4			
	<b>GEV No.</b>	518441	<b>Ref. No.</b> 106113
rinse arm mounting pos. left L 190mm mounting ø 14mm nozzles 3 type A			
	<b>GEV No.</b>	518442	<b>Ref. No.</b> 106114
rinse arm mounting pos. right L 190mm mounting ø 14mm nozzles 2 type B			



			
1			
<b>GEV No.</b>	518441	<b>Ref. No.</b>	106113
<b>description</b>	rinse arm mounting pos. left L 190mm mounting ø 14mm nozzles 3 type A		
<b>For models:</b>	E.40, E.40H, GLS40H, GLS40HP, MISTRAL-40, NIAGARA-40		

			
1			
<b>GEV No.</b>	518442	<b>Ref. No.</b>	106114
<b>description</b>	rinse arm mounting pos. right L 190mm mounting ø 14mm nozzles 2 type B		
<b>For models:</b>	E.40, E.40H, GLS40H, GLS40HP, MISTRAL-40, NIAGARA-40		



			
<b>1</b>			
<b>GEV No.</b>	510139	<b>Ref. No.</b>	140007
<b>description</b>	rinse jet		
<b>For models:</b>	050F, 050FP, 10, 11F, 11FD, 11F-DVGW, 11R, 11RD, 12, 21F, 21FD, 21R, 21RD, 22F, 2312-001, 2312-002, 25F, 25FD, 25R, 25RD, 30F, 30FD, 30R, 30RD, 31F, 31FD, 31R, 31RD, 350F, 350FD, 350R, 350RD, 35-ELECTRONIC, 35F, 35FD, 35R, 35RD, 400F, 400FD, 400R, 400RD, 40-ELECTRONIC, 40F, 40FD, 40R, 40RD, 440F, 44F, 45, 450...(Other models you can see in the webshop)		
<b>accessories for</b>	510139		
	<b>GEV No.</b>	510130	<b>Ref. No.</b> 429006
union nut for rinse jet			



			
<b>1</b>			
<b>GEV No.</b>	518440	<b>Ref. No.</b>	106112
<b>description</b>	wash arm mounting pos. right L 180mm mounting ø 19mm nozzles 4		
<b>For models:</b>	E.40, E.40H, GLS40H, GLS40HP, MISTRAL-40, NIAGARA-40		

			
<b>1</b>			
<b>GEV No.</b>	513261	<b>Ref. No.</b>	129056
<b>description</b>	wash arm boss		
<b>For models:</b>	E.35, E.35H, E.40, E.40H, GLS40H, GLS40HP, MC201CL, MISTRAL-40, NIAGARA-35, NIAGARA-40		

			
<b>1</b>			
<b>GEV No.</b>	510138	<b>Ref. No.</b>	114013 140013 140020
<b>description</b>	wash jet fine groove		
<b>For models:</b>	11F, 11FD, 11F-DVGW, 350F, 350FD, 350R, 350RD, 35-ELECTRONIC, 35F, 35FD, 35R, 35RD, 400F, 400FD, 40-ELECTRONIC, 40F, 40FD, 45, 450, 46, 460, 67R, 913363, 913364, 913376, 913377, E.35, E.35H, E.40, E.40H, E.41, E.42, E.45, E.46, E41, GLS40H, GLS40HP, GSP50, GSP50P, GSP51, GSP51P, MC201CL, MISTRAL-40, NIAGARA-35, NIAGARA-40, NIAGARA-45, P500, PS-60, TF-503, TF-513...(Other models you can see in the webshop)		
<b>accessories for</b>	510138		
	<b>GEV No.</b>	510131	<b>Ref. No.</b> 429007
union nut for wash jet			









			
<b>1</b>			
<b>GEV No.</b>	518317	<b>Ref. No.</b>	993032 993036
<b>description</b>	rinse arm L 245mm nozzles 4 mounting ø 17.2/M20mm mounting pos. upper		
<b>For models:</b>	45, 450, 67R, 914684, River-39		

			
<b>1</b>			
<b>GEV No.</b>	510130	<b>Ref. No.</b>	429006
<b>description</b>	union nut for rinse jet		
<b>For models:</b>	10, 11F, 11FD, 11F-DVGW, 11R, 11RD, 12, 21F, 21FD, 21R, 21RD, 22F, 2312-001, 2312-002, 25F, 25FD, 25R, 25RD, 30F, 30FD, 30R, 30RD, 31F, 31FD, 31R, 31RD, 350F, 350FD, 350R, 350RD, 35-ELECTRONIC, 35F, 35FD, 35R, 35RD, 400F, 400FD, 400R, 400RD, 40-ELECTRONIC, 40F, 40FD, 40R, 40RD, 440F, 44F, 500F, 500FD, 50-ELECTRONIC, 50F...(Other models you can see in the webshop)		
<b>accessories for</b>	510130		
	<b>GEV No.</b>	510139	<b>Ref. No.</b> 140007
rinse jet			

			
<b>1</b>			
<b>GEV No.</b>	510131	<b>Ref. No.</b>	429007
<b>description</b>	union nut for wash jet		
<b>For models:</b>	11F, 11FD, 11F-DVGW, 11R, 11RD, 21F, 21FD, 21R, 21RD, 2312-001, 2312-002, 25F, 25FD, 25R, 25RD, 30F, 30FD, 30R, 30RD, 31F, 31FD, 31R, 31RD, 350F, 350FD, 350R, 350RD, 35-ELECTRONIC, 35F, 35FD, 35R, 35RD, 400F, 400FD, 40-ELECTRONIC, 40F, 40FD, 500F, 500FD, 50F, 50FD, 510F, 510FD, 913363, 913364, 913376, 913377, 914568, 915830, E.35...(Other models you can see in the webshop)		
<b>accessories for</b>	510131		
	<b>GEV No.</b>	510138	<b>Ref. No.</b> 114013 140013 140020
wash jet fine groove			

			
<b>1</b>			
<b>GEV No.</b>	518439	<b>Ref. No.</b>	106111
<b>description</b>	wash arm mounting pos. left L 180mm mounting ø 19mm nozzles 3		
<b>For models:</b>	E.40, E.40H, GLS40H, GLS40HP, MISTRAL-40, NIAGARA-40		





			
1			
<b>GEV No.</b>	510118	<b>Ref. No.</b>	993031
<b>description</b>	wash arm L 245mm nozzles 4 mounting ø 12mm mounting pos. upper		
<b>For models:</b>	11F, 11FD, 11F-DVGW, 21F, 21FD, 22F, 25F, 25FD, 30F, 30FD, 31F, 31FD, 350F, 350FD, 35-ELECTRONIC, 35F, 35FD, 400F, 400FD, 40-ELECTRONIC, 40F, 40FD, 913289, 913290, 913291, 913292, 913356, 913357, 913363, 913364, 913372, 913373, 913374, 913375, 913376, 913377, 913416, 913418, 913435, 913544, 913545, 913665, 913666, 913667, 913668, 913685, 913771, 913772, 913773, 913774...(Other models you can see in the webshop)		
<b>spare parts for</b>	510118		
	<b>GEV No.</b>	510011	<b>Ref. No.</b> 429008
	screw connection plastic		
	<b>GEV No.</b>	510012	<b>Ref. No.</b> 437008
	flat gasket PTFE ED ø 16.5mm ID ø 12.5mm thickness 1.5mm Qty 1 pcs equiv. no. 437008		
	<b>GEV No.</b>	510013	<b>Ref. No.</b> 325001
	rinse arm shaft		
	<b>GEV No.</b>	510130	<b>Ref. No.</b> 429006
	union nut for rinse jet		
	<b>GEV No.</b>	510139	<b>Ref. No.</b> 140007
	rinse jet		
	<b>GEV No.</b>	518326	<b>Ref. No.</b> 129002
	rinse arm boss		
	<b>GEV No.</b>	518328	<b>Ref. No.</b> 106036
	rinse arm mounting pos. right L 110mm mounting ø 13mm nozzles 2		
	<b>GEV No.</b>	518329	<b>Ref. No.</b> 106035
	rinse arm mounting pos. left L 110mm mounting ø 13mm nozzles 2		



			
1			
<b>GEV No.</b>	518331	<b>Ref. No.</b>	106049
<b>description</b>	rinse arm L 110mm nozzles 2 mounting ø 13mm mounting pos. left		
<b>For models:</b>	45, 450, 914684, RIVER-39		



			
1			
<b>GEV No.</b>	518329	<b>Ref. No.</b>	106035
<b>description</b>	rinse arm mounting pos. left L 110mm mounting ø 13mm nozzles 2		
<b>For models:</b>	11F, 11FD, 11F-DVGW, 21F, 21FD, 25F, 25FD, 30F, 30FD, 31F, 31FD, 400F, 400FD, 40-ELECTRONIC, 40F, 40FD, 913289, 913290, 913291, 913292, 913356, 913357, 913363, 913364, 913372, 913373, 913374, 913375, 913376, 913377, 913416, 913418, 913435, 913544, 913545, 913665, 913666, 913667, 913668, 913685, 913771, 913772, 913773, 913774, 913832, 913837, 913911, 913912, 913948, 913950...(Other models you can see in the webshop)		

			
1			
<b>GEV No.</b>	518330	<b>Ref. No.</b>	106050
<b>description</b>	rinse arm mounting pos. right		
<b>For models:</b>	45, 450, 67R, 914684, RIVER-39		



			
1			
<b>GEV No.</b>	518328	<b>Ref. No.</b>	106036
<b>description</b>	rinse arm mounting pos. right L 110mm mounting ø 13mm nozzles 2		
<b>For models:</b>	11F, 11FD, 11F-DVGW, 21F, 21FD, 25F, 25FD, 30F, 30FD, 31F, 31FD, 350F, 350FD, 35-ELECTRONIC, 35F, 35FD, 400F, 400FD, 40-ELECTRONIC, 40F, 40FD, 913289, 913290, 913291, 913292, 913356, 913357, 913363, 913364, 913372, 913373, 913374, 913375, 913376, 913377, 913416, 913418, 913435, 913544, 913545, 913665, 913666, 913667, 913668, 913685, 913771, 913772, 913773, 913774, 913832...(Other models you can see in the webshop)		

			
1			
<b>GEV No.</b>	518326	<b>Ref. No.</b>	129002
<b>description</b>	rinse arm boss		
<b>For models:</b>	11F, 11FD, 11F-DVGW, 31F, 31FD, 350F, 350FD, 35-ELECTRONIC, 35F, 35FD, 400F, 400FD, 40-ELECTRONIC, 40F, 40FD, 45, 450, 67R, 913289, 913290, 913291, 913292, 913356, 913357, 913363, 913364, 913372, 913373, 913374, 913375, 913376, 913377, 913416, 913418, 913435, 913544, 913545, 913665, 913666, 913667, 913668, 913685, 913771, 913772, 913773, 913774, 913832, 913837, 913911, 913912...(Other models you can see in the webshop)		

			
1			
<b>GEV No.</b>	510139	<b>Ref. No.</b>	140007
<b>description</b>	rinse jet		
<b>For models:</b>	050F, 050FP, 10, 11F, 11FD, 11F-DVGW, 11R, 11RD, 12, 21F, 21FD, 21R, 21RD, 22F, 2312-001, 2312-002, 25F, 25FD, 25R, 25RD, 30F, 30FD, 30R, 30RD, 31F, 31FD, 31R, 31RD, 350F, 350FD, 350R, 350RD, 35-ELECTRONIC, 35F, 35FD, 35R, 35RD, 400F, 400FD, 400R, 400RD, 40-ELECTRONIC, 40F, 40FD, 40R, 40RD, 440F, 44F, 45, 450...(Other models you can see in the webshop)		
<b>accessories for</b>	510139		
	<b>GEV No.</b>	510130	<b>Ref. No.</b> 429006
	union nut for rinse jet		



			
1			
<b>GEV No.</b>	510130	<b>Ref. No.</b>	429006
<b>description</b>	union nut for rinse jet		
<b>For models:</b>	10, 11F, 11FD, 11F-DVGW, 11R, 11RD, 12, 21F, 21FD, 21R, 21RD, 22F, 2312-001, 2312-002, 25F, 25FD, 25R, 25RD, 30F, 30FD, 30R, 30RD, 31F, 31FD, 31R, 31RD, 350F, 350FD, 350R, 350RD, 35-ELECTRONIC, 35F, 35FD, 35R, 35RD, 400F, 400FD, 400R, 400RD, 40-ELECTRONIC, 40F, 40FD, 40R, 40RD, 440F, 44F, 500F, 500FD, 50-ELECTRONIC, 50F...(Other models you can see in the webshop)		
<b>accessories for</b>	510130		
	<b>GEV No.</b>	510139	<b>Ref. No.</b> 140007
rinse jet			

			
1			
<b>GEV No.</b>	518053	<b>Ref. No.</b>	429006.TN 429039
<b>description</b>	union nut for rinse jet		
<b>For models:</b>	050F, 050FP, 45, 450, 46, 460, 67R, 914684, E.50, E.51, F85, F85P, LF50, LF55, MC501E, MC501EP, MC501S, MC501SP, MISTRAL-51, NIAGARA-51, RIVER-39, TF-503, TF-513, TF-515		

			
1			
<b>GEV No.</b>	518142	<b>Ref. No.</b>	990113
<b>description</b>	wash arm wash arm L 490mm rinse arm L 490mm w. jets 10 r. jets 5 mounting ø 14/44mm mounting pos. upper/lower Mod. E50/503 & 91-series		
<b>For models:</b>	913297, 913298, 913299, 913300, 913360, 913361, 913391, 913392, 913546, 913547, 913578, 913611, 913684, 913913, 913914, 913932, 913933, 914284, 914318, 914319, 914326, 914331, 914338, 914356, 914400, 914401, 914402, 914403, 914404, 914405, 914406, 914431, 914449, 914517, 914545, 914642, 914688, 914909, 914979, 915136, 915137, 915140, 915150, 915151, 915152, 915154, 915155, 915157, 915158, 915160...(Other models you can see in the webshop)		
<b>spare parts for</b>	518142		
	<b>GEV No.</b>	511510	<b>Ref. No.</b> 456070
O-ring EPDM thickness 2.62mm ID ø 15.54mm Qty 10 pcs			





			
1			
<b>GEV No.</b>	511510	<b>Ref. No.</b>	456070
<b>description</b>	O-ring EPDM thickness 2.62mm ID ø 15.54mm Qty 10 pcs		
<b>For models:</b>	913289, 913290, 913291, 913292, 913297, 913298, 913299, 913300, 913356, 913357, 913360, 913361, 913372, 913373, 913374, 913375, 913391, 913392, 913416, 913418, 913435, 913544, 913545, 913546, 913547, 913578, 913611, 913665, 913666, 913667, 913668, 913684, 913685, 913771, 913772, 913773, 913774, 913832, 913837, 913911, 913912, 913913, 913914, 913932, 913933, 913948, 913950, 913977, 913984, 913990...(Other models you can see in the webshop)		



			
1			
<b>GEV No.</b>	532058	<b>Ref. No.</b>	456071
<b>description</b>	O-ring EPDM thickness 2.62mm ID ø 23.81mm Qty 10 pcs		
<b>For models:</b>	913289, 913290, 913291, 913292, 913297, 913298, 913299, 913300, 913356, 913357, 913360, 913361, 913372, 913373, 913374, 913375, 913391, 913392, 913416, 913418, 913435, 913544, 913545, 913546, 913547, 913578, 913611, 913665, 913666, 913667, 913668, 913684, 913685, 913771, 913772, 913773, 913774, 913832, 913837, 913911, 913912, 913913, 913914, 913932, 913933, 913948, 913950, 913977, 913984, 913990...(Other models you can see in the webshop)		

			
1			
<b>GEV No.</b>	517438	<b>Ref. No.</b>	106153
<b>description</b>	wash arm mounting pos. upper left/bottom left wash arm L 230mm rinse arm L 230mm w. jets 5 r. jets 3 mounting ø 12/27mm		
<b>For models:</b>	913297, 913298, 913299, 913300, 913360, 913361, 913391, 913392, 913546, 913547, 913578, 913611, 913684, 913913, 913914, 913932, 913933, 914284, 914318, 914319, 914326, 914331, 914338, 914356, 914400, 914401, 914402, 914403, 914404, 914405, 914406, 914431, 914449, 914517, 914545, 914642, 914688, 914909, 914979, 915136, 915137, 915140, 915150, 915151, 915152, 915154, 915155, 915157, 915158, 915160...(Other models you can see in the webshop)		
<b>accessories for</b>	517438		
	<b>GEV No.</b>	517440	<b>Ref. No.</b> 129068
wash arm boss mounting pos. upper/lower L 88mm W 63mm H 69mm			

			
1			
<b>GEV No.</b>	517567	<b>Ref. No.</b>	69316
<b>description</b>	wash arm mounting pos. upper/lower left wash arm L 210mm rinse arm L 210mm w. jets 5 r. jets 3 mounting ø 27/17mm		
<b>For models:</b>	CNT800CH, Fast180, Fast180-230V-3Ph-60Hz, FAST-60, FAST-73, NG281, NG281CDD, NG281HP, NG281HPDD, NG281HZ23, NG281H-Z23DD, NIAGARA-281, Niagara-281-2, Niagara-281HP, OC380, OC380FUR, OC380HZ23, Ocean380, PLUVIA-280, Pluvia280-230V-3PH-60HZ, PV280, PV280FAST, PV280FAST2, PV280FAST2BIO, PV280FAST2HZ23, PV280FASTCH, PV280FASTHB, PV280HZ23, SevenE		

			
1			
<b>GEV No.</b>	517562	<b>Ref. No.</b>	69314
<b>description</b>	wash arm mounting pos. upper/lower right wash arm L 210mm rinse arm L 210mm w. jets 4 r. jets 2 mounting ø 27/17mm		
<b>For models:</b>	CNT800CH, Fast180, Fast180-230V-3Ph-60Hz, FAST-60, FAST-73, NG281, NG281CDD, NG281HP, NG281HPDD, NG281HZ23, NG281H-Z23DD, NIAGARA-281, Niagara-281-2, Niagara-281HP, OC380, OC380FUR, OC380HZ23, Ocean380, PLUVIA-280, Pluvia280-230V-3PH-60HZ, PV280, PV280FAST, PV280FAST2, PV280FAST2BIO, PV280FAST2HZ23, PV280FASTCH, PV280FASTHB, PV280HZ23, SevenE		

			
1			
<b>GEV No.</b>	517563	<b>Ref. No.</b>	106152
<b>description</b>	wash arm mounting pos. upper/lower right wash arm L 230mm rinse arm L 230mm w. jets 5 r. jets 2 mounting ø 27/17mm		
<b>For models:</b>	913297, 913298, 913299, 913300, 913360, 913361, 913391, 913392, 913546, 913547, 913578, 913611, 913684, 913913, 913914, 913932, 913933, 914284, 914318, 914319, 914326, 914331, 914338, 914356, 914400, 914401, 914402, 914403, 914404, 914405, 914406, 914431, 914449, 914517, 914545, 914642, 914688, 914909, 914979, 915136, 915137, 915140, 915150, 915151, 915152, 915154, 915155, 915157, 915158, 915160...(Other models you can see in the webshop)		
<b>accessories for</b>	517563		
	<b>GEV No.</b>	504618	<b>Ref. No.</b> 456026
	O-ring EPDM thickness 2.62mm ID ø 15.54mm Qty 1 pcs		
	<b>GEV No.</b>	513725	<b>Ref. No.</b> 437100
	flat gasket PTFE ED ø 21.2mm ID ø 19mm thickness 0.5mm Qty 1 pcs		
	<b>GEV No.</b>	532058	<b>Ref. No.</b> 456071
	O-ring EPDM thickness 2.62mm ID ø 23.81mm Qty 10 pcs		

			
1			
<b>GEV No.</b>	517440	<b>Ref. No.</b>	129068
<b>description</b>	wash arm boss mounting pos. upper/lower L 88mm W 63mm H 69mm		
<b>For models:</b>	913297, 913298, 913299, 913300, 913360, 913361, 913391, 913392, 913418, 913546, 913547, 913578, 913611, 913684, 913913, 913914, 913932, 913933, 914167, 914168, 914284, 914318, 914319, 914326, 914331, 914338, 914356, 914398, 914399, 914400, 914401, 914402, 914403, 914404, 914405, 914406, 914431, 914443, 914449, 914517, 914545, 914642, 914688, 914909, 914943, 914979, 915136, 915137, 915140, 915150...(Other models you can see in the webshop)		
<b>accessories for</b>	517440		
	<b>GEV No.</b>	517438	<b>Ref. No.</b> 106153
	wash arm mounting pos. upper left/bottom left wash arm L 230mm rinse arm L 230mm w. jets 5 r. jets 3 mounting ø 12/27mm		
	<b>GEV No.</b>	517563	<b>Ref. No.</b> 106152
	wash arm mounting pos. upper/lower right wash arm L 230mm rinse arm L 230mm w. jets 5 r. jets 2 mounting ø 27/17mm		



			
1			
<b>GEV No.</b>	531272	<b>Ref. No.</b>	990110
<b>description</b>	wash arm wash arm L 405mm rinse arm L 405mm w. jets 8 r. jets 5 mounting ø 14mm mounting pos. upper/lower complete HOBART/EUROTEC warewashing E40		
<b>For models:</b>	913291, 913292, 913357, 913374, 913375, 913416, 913435, 913545, 913666, 913668, 913685, 913773, 913774, 913911, 913912, 913948, 913950, 913977, 913984, 913990, 914214, 914316, 914317, 914392, 914393, 914394, 914395, 914396, 914397, 914441, 914442, 914515, 914516, 914537, 914543, 914547, 914683, 914689, 914863, 914874, 915138, 915139, 915527, 915611, 915612, 915613, 915614, 915615, 915616, 915617...(Other models you can see in the webshop)		





			
1			
<b>GEV No.</b>	518666	<b>Ref. No.</b>	990118
<b>description</b>	wash arm wash arm L 455mm w. jets 9 r. jets 5		
<b>For models:</b>	CE78HZ23, E78, E78HP, Fast181, FAST-181, NG271, NG381, NG38123, NG38123TERMO, NG381C, NG381CDD, NG381CFUR, NG381DDHZ23, NG381DDPS, NG381DDPSHZ23, NG381HPDD, NG381TERMO, NG381TXCDD, NIAGARA-271, NIAGARA-283, Niagara-283A, Niagara-381, Niagara-381-230V-3Ph-50Hz, Niagara-381-230V-3Ph-60Hz, Niagara-381DP, Niagara-381HPD, RIVER-282, River-282-2, River-282S-2TDE, River-285, River-382, River-382-230V-3Ph-50Hz, River-382H, River-382NRG, River-382NRG-230-3Ph-50Hz, River-382TDE, RIVER-E78, RV282, RV282DD, RV282R, RV382, RV38223TERMO, RV382AHP, RV-382FUR, RV382R, RV382R23TERMO, RV382RFUR, RV382S, RV382SFUR, RV382TERMO...(Other models you can see in the webshop)		

			
1			
<b>GEV No.</b>	511510	<b>Ref. No.</b>	456070
<b>description</b>	O-ring EPDM thickness 2.62mm ID ø 15.54mm Qty 10 pcs		
<b>For models:</b>	913289, 913290, 913291, 913292, 913297, 913298, 913299, 913300, 913356, 913357, 913360, 913361, 913372, 913373, 913374, 913375, 913391, 913392, 913416, 913418, 913435, 913544, 913545, 913546, 913547, 913578, 913611, 913665, 913666, 913667, 913668, 913684, 913685, 913771, 913772, 913773, 913774, 913832, 913837, 913911, 913912, 913913, 913914, 913932, 913933, 913948, 913950, 913977, 913984, 913990...(Other models you can see in the webshop)		

			
1			
<b>GEV No.</b>	532058	<b>Ref. No.</b>	456071
<b>description</b>	O-ring EPDM thickness 2.62mm ID ø 23.81mm Qty 10 pcs		
<b>For models:</b>	913289, 913290, 913291, 913292, 913297, 913298, 913299, 913300, 913356, 913357, 913360, 913361, 913372, 913373, 913374, 913375, 913391, 913392, 913416, 913418, 913435, 913544, 913545, 913546, 913547, 913578, 913611, 913665, 913666, 913667, 913668, 913684, 913685, 913771, 913772, 913773, 913774, 913832, 913837, 913911, 913912, 913913, 913914, 913932, 913933, 913948, 913950, 913977, 913984, 913990...(Other models you can see in the webshop)		

			
1			
<b>GEV No.</b>	517565	<b>Ref. No.</b>	106148
<b>description</b>	wash arm mounting pos. upper/lower left wash arm L 185mm rinse arm L 185mm w. jets 4 r. jets 2 mounting ø 27/17mm		
<b>For models:</b>	913291, 913292, 913357, 913374, 913375, 913416, 913435, 913545, 913666, 913668, 913685, 913773, 913774, 913911, 913912, 913948, 913950, 913977, 913984, 913990, 914214, 914316, 914317, 914392, 914393, 914394, 914395, 914396, 914397, 914441, 914442, 914515, 914516, 914537, 914543, 914547, 914683, 914689, 914863, 914874, 915138, 915139, 915527, 915611, 915612, 915613, 915614, 915615, 915616, 915617...(Other models you can see in the webshop)		

			
<b>GEV No.</b>	517564	<b>Ref. No.</b>	106149
<b>description</b>	wash arm mounting pos. upper/lower right wash arm L 185mm rinse arm L 185mm w. jets 4 r. jets 3 mounting ø 27/17mm		
<b>For models:</b>	913291, 913292, 913357, 913374, 913375, 913416, 913435, 913545, 913666, 913668, 913685, 913773, 913774, 913911, 913912, 913948, 913950, 913977, 913984, 913990, 914214, 914316, 914317, 914392, 914393, 914394, 914395, 914396, 914397, 914441, 914442, 914515, 914516, 914537, 914543, 914547, 914683, 914689, 914863, 914874, 915138, 915139, 915527, 915611, 915612, 915613, 915614, 915615, 915616, 915617...(Other models you can see in the webshop)		
<b>accessories for</b>	517564		
	<b>GEV No.</b>	511510	<b>Ref. No.</b> 456070
	O-ring EPDM thickness 2.62mm ID ø 15.54mm Qty 10 pcs		
	<b>GEV No.</b>	532058	<b>Ref. No.</b> 456071
	O-ring EPDM thickness 2.62mm ID ø 23.81mm Qty 10 pcs		

			
<b>GEV No.</b>	524809	<b>Ref. No.</b>	990111
<b>description</b>	wash and rinse arm wash arm L 340mm rinse arm L 340mm w. jets 7 r. jets 4 mounting ø 14/41mm mounting pos. lower		
<b>For models:</b>	913289, 913290, 913356, 913372, 913373, 913544, 913665, 913667, 913771, 913772, 913832, 913837, 914165, 914166, 914206, 914355, 914386, 914387, 914388, 914389, 914390, 914391, 914692, 914693, 914694, 914703, 914870, 915686, 915687, 915688, 915689, 915690, 915691, E.35, E.35-Elettrobar, E.35H, E.35H-Elettrobar, FAST-135, Fast135CT, FAST-135CT, Fast135D, FAST-135D, Fast135H, FAST-135H, Fast135HCT, FAST-135HCT, Fast135HD, FAST-135HD, NIAGARA-35		
<b>spare parts for</b>	524809		
	<b>GEV No.</b>	511510	<b>Ref. No.</b> 456070
	O-ring EPDM thickness 2.62mm ID ø 15.54mm Qty 10 pcs		
	<b>GEV No.</b>	517566	<b>Ref. No.</b> 106146
	wash arm mounting pos. bottom right wash arm L 155mm rinse arm L 155mm w. jets 3 r. jets 2 mounting ø 27/17mm		
	<b>GEV No.</b>	517821	<b>Ref. No.</b> 106147
	wash and rinse arm wash arm L 155mm rinse arm L 155mm w. jets 4 r. jets 3 mounting ø 17/22mm		
	<b>GEV No.</b>	532058	<b>Ref. No.</b> 456071
	O-ring EPDM thickness 2.62mm ID ø 23.81mm Qty 10 pcs		

			
<b>GEV No.</b>	517822	<b>Ref. No.</b>	69312
<b>description</b>	wash and rinse arm wash arm L 458mm rinse arm L 458mm w. jets 9 r. jets 5 mounting ø 14/44mm		
<b>For models:</b>	CNT800CH, Fast180, Fast180-230V-3Ph-60Hz, FAST-60, FAST-73, NG281, NG281CDD, NG281HP, NG281HPDD, NG281HZ23, NG281HZ23DD, NIAGARA-281, Niagara-281-2, Niagara-281HP, OC380, OC380FUR, OC380HZ23, Ocean380, PLUVIA-280, Pluvia280-230V-3PH-60Hz, PV280, PV280FAST, PV280FAST2, PV280FAST2BIO, PV280FAST2HZ23, PV280FASTCH, PV280FASTHB, PV280HZ23, SevenE		

			
<b>GEV No.</b>	511510	<b>Ref. No.</b>	456070
<b>description</b>	O-ring EPDM thickness 2.62mm ID ø 15.54mm Qty 10 pcs		
<b>For models:</b>	913289, 913290, 913291, 913292, 913297, 913298, 913299, 913300, 913356, 913357, 913360, 913361, 913372, 913373, 913374, 913375, 913391, 913392, 913416, 913418, 913435, 913544, 913545, 913546, 913547, 913578, 913611, 913665, 913666, 913667, 913668, 913684, 913685, 913771, 913772, 913773, 913774, 913832, 913837, 913911, 913912, 913913, 913914, 913932, 913933, 913948, 913950, 913977, 913984, 913990...(Other models you can see in the webshop)		

			
<b>GEV No.</b>	532058	<b>Ref. No.</b>	456071
<b>description</b>	O-ring EPDM thickness 2.62mm ID ø 23.81mm Qty 10 pcs		
<b>For models:</b>	913289, 913290, 913291, 913292, 913297, 913298, 913299, 913300, 913356, 913357, 913360, 913361, 913372, 913373, 913374, 913375, 913391, 913392, 913416, 913418, 913435, 913544, 913545, 913546, 913547, 913578, 913611, 913665, 913666, 913667, 913668, 913684, 913685, 913771, 913772, 913773, 913774, 913832, 913837, 913911, 913912, 913913, 913914, 913932, 913933, 913948, 913950, 913977, 913984, 913990...(Other models you can see in the webshop)		

			
<b>GEV No.</b>	517821	<b>Ref. No.</b>	106147
<b>description</b>	wash and rinse arm wash arm L 155mm rinse arm L 155mm w. jets 4 r. jets 3 mounting ø 17/22mm		
<b>For models:</b>	913289, 913290, 913356, 913372, 913373, 913544, 913665, 913667, 913771, 913772, 913832, 913837, 914165, 914166, 914206, 914355, 914386, 914387, 914388, 914389, 914390, 914391, 914692, 914693, 914694, 914703, 914870, 915686, 915687, 915688, 915689, 915690, 915691, E.35, E.35-Elettrobar, E.35H, E.35H-Elettrobar, FAST-135, Fast135CT, FAST-135CT, Fast135D, FAST-135D, Fast135H, FAST-135H, Fast135HCT, FAST-135HCT, Fast135HD, FAST-135HD, NIAGARA-35		







			
1			
<b>GEV No.</b>	517566	<b>Ref. No.</b>	106146
<b>description</b>	wash arm mounting pos. bottom right wash arm L 155mm rinse arm L 155mm w. jets 3 r. jets 2 mounting ø 27/17mm		
<b>For models:</b>	913289, 913290, 913356, 913372, 913373, 913544, 913665, 913667, 913771, 913772, 913832, 913837, 914165, 914166, 914206, 914355, 914386, 914387, 914388, 914389, 914390, 914391, 914692, 914693, 914694, 914703, 914870, 915686, 915687, 915688, 915689, 915690, 915691, E.35, E.35-Elettrobar, E.35H, E.35H-Elettrobar, FAST-135, Fast135CT, FAST-135CT, Fast135D, FAST-135D, Fast135H, FAST-135H, Fast135HCT, FAST-135HCT, Fast135HD, FAST-135HD, NIAGARA-35		

			
1			
<b>GEV No.</b>	518314	<b>Ref. No.</b>	990082
<b>description</b>	wash arm H 470mm L 425mm nozzles 6 mounting pos. upper		
<b>For models:</b>	45, 450, 913418, 914167, 914168, 914398, 914399, 914443, 914943, 915695, 915696, 915819, E.45, Fast145, FAST-145, Fast145D, FAST-145D, NIAGARA-45		

			
1			
<b>GEV No.</b>	518626	<b>Ref. No.</b>	990015
<b>description</b>	wash arm H 470mm L 325mm nozzles 6 mounting ø 25mm		
<b>For models:</b>	R497, R499, R501, R503		

			
1			
<b>GEV No.</b>	518453	<b>Ref. No.</b>	990092
<b>description</b>	wash arm H 470mm L 425mm nozzles 6 mounting pos. upper		
<b>For models:</b>	E.45		

			
1			
<b>GEV No.</b>	510143	<b>Ref. No.</b>	140003
<b>description</b>	wash jet		
<b>For models:</b>	R495, R497, R499, R501, R503, R509, R511, R704, R706, R708, S651, S651P, S653, S654, S655, S830, S835, SR651		

			
1			
<b>GEV No.</b>	518312	<b>Ref. No.</b>	990095PL
<b>description</b>	wash arm mounting pos. lower		
<b>For models:</b>	E.40H		

			
1			
<b>GEV No.</b>	518448	<b>Ref. No.</b>	129051 990099
<b>description</b>	wash arm		
<b>For models:</b>	913363, 913364, 913376, 913377, E.41, E.42, E41		

			
1			
<b>GEV No.</b>	518410	<b>Ref. No.</b>	441010
<b>description</b>	end cap		
<b>For models:</b>	21F, 21FD, 21R, 21RD, 25F, 25FD, 25R, 25RD, 30F, 30FD, 30R, 30RD, 31F, 31FD, 31R, 31RD, 45, 450, 67R, 913291, 913292, 913357, 913363, 913364, 913374, 913375, 913376, 913377, 913416, 913418, 913435, 913545, 913666, 913668, 913685, 913773, 913774, 913911, 913912, 913948, 913950, 913977, 913984, 913990, 914167, 914168, 914214, 914316, 914317, 914392...(Other models you can see in the webshop)		

			
1			
<b>GEV No.</b>	518386	<b>Ref. No.</b>	990056
<b>description</b>	wash arm H 395mm L 385mm nozzles 6 mounting pos. upper		
<b>For models:</b>	21F, 21FD, 25F, 25FD, 30F, 30FD, 31F, 31FD		



			
1			
<b>GEV No.</b>	510135	<b>Ref. No.</b>	110001
<b>description</b>	nozzle holder		
<b>For models:</b>	11F, 11FD, 11F-DVGW, 21F, 21FD, 25F, 25FD, 30F, 30FD, 31F, 31FD, 400F, 400FD, 40-ELECTRONIC, 40F, 40FD, E.40, E.40H, E.41, E.42, E.45, NIAGARA-40, S621, S623, S624, S626, S631, S633, S634, S636, S651, S655, S835		

			
<b>GEV No.</b>	510146	<b>Ref. No.</b>	119003
<b>description</b>	swirl ø 18.5mm H 7mm hole ø 2mm		
<b>For models:</b>	11F, 11FD, 11F-DVGW, 21F, 21FD, 25F, 25FD, 30F, 30FD, 31F, 31FD, 400F, 400FD, 40-ELECTRONIC, 40F, 40FD, 45, 450, 67R, 913291, 913292, 913357, 913363, 913364, 913374, 913375, 913376, 913377, 913416, 913418, 913435, 913545, 913666, 913668, 913685, 913773, 913774, 913911, 913912, 913948, 913950, 913977, 913984, 913990, 914167, 914168, 914214, 914316, 914317, 914392...(Other models you can see in the webshop)		

			
<b>GEV No.</b>	510144	<b>Ref. No.</b>	140010
<b>description</b>	union nut for wash jet		
<b>For models:</b>	11F, 11FD, 11F-DVGW, 31F, 31FD, 400F, 400FD, 40-ELECTRONIC, 40F, 40FD, 45, 450, 67R, 913291, 913292, 913357, 913363, 913364, 913374, 913375, 913376, 913377, 913416, 913418, 913435, 913545, 913666, 913668, 913685, 913773, 913774, 913911, 913912, 913948, 913950, 913977, 913984, 913990, 914167, 914168, 914214, 914316, 914317, 914392, 914393, 914394, 914395, 914396, 914397, 914398...(Other models you can see in the webshop)		





			
<b>GEV No.</b>	518159	<b>Ref. No.</b>	110010
<b>description</b>	wash jet holder		
<b>For models:</b>	21F, 21FD, 25F, 25FD, 30F, 30FD, 31F, 31FD, 45, 450, 67R, 913418, 914167, 914168, 914398, 914399, 914443, 914943, 915695, 915696, 915819, E.45, Fast145, FAST-145, Fast145D, FAST-145D, NIAGARA-45		

			
<b>GEV No.</b>	518480	<b>Ref. No.</b>	929195
<b>description</b>	wash arm		
<b>For models:</b>	KLP105EB, LP105DDDTEB, LP105DDDEBN, LP105EB, NG292, NG292HZ, NG293, NIAGARA-292, Niagara-292-400V-3Ph-60Hz, NIAGARA-293, RIVER-295, River-295P, RIVER-296, River-296P, RV295, RV295PS, RV296, RV296PS, U61, U61E, U61H, U61HE		

			
<b>GEV No.</b>	518481	<b>Ref. No.</b>	929196
<b>description</b>	wash arm L 335mm nozzles 12 mounting ø 16mm mounting pos. upper and bottom		
<b>For models:</b>	KLP201DDDTEB, KLP201EB, KLP301, KLP301DDDTEB, LP201DDDEBN, LP201EB, LP301, LP301EB, RIVER-297, RIVER-298, RV297, RV298, RV298HZ, U132, U132E, U70, U70e		
<b>accessories for</b>	518481		
	<b>GEV No.</b>	513123	<b>Ref. No.</b>
			626129 926129
	wash arm bearing mounting pos. upper/lower		
	<b>GEV No.</b>	513124	<b>Ref. No.</b>
			80314 926128
	nut M24x1.5		

			
<b>GEV No.</b>	518316	<b>Ref. No.</b>	129036
<b>description</b>	wash arm L 385mm nozzles 4 mounting ø 20mm mounting pos. upper		
<b>For models:</b>	913992, 913993, 914583, 914592, 914612, 914613, 915143, CLEAN-3, RIVER-40, RIVER-40-CRP, RIVER-43, RIVER-44, RIVER-44-CRP, River-44-CRP-ST, RIVER-44CRP-ST		

			
<b>GEV No.</b>	518455	<b>Ref. No.</b>	990087
<b>description</b>	wash arm L 490mm nozzles 8 mounting ø 50mm mounting pos. lower		
<b>For models:</b>	2312-001, 2312-002, 500F, 500FD, 50F, 50FD, 510F, 510FD, CLEAN-100, CLEAN-110, CLEAN-120, E.50, E.51, E.52, E.60, E.65, E1, E10, E100, E110, E12, E120, E14, E140, LF50, LF55, MC501E, MC501EP, MC501S, MC501SP, MISTRAL-51, NIAGARA-51		

			
<b>GEV No.</b>	518019	<b>Ref. No.</b>	990055
<b>description</b>	wash arm L 490mm nozzles 8 mounting ø 50mm mounting pos. upper and bottom		
<b>For models:</b>	10, 12, 14, 22F, 40F, 44F, 500F, 500FD, 50F, 50FD, 510F, 510FD, 55, 66, CLEAN-110, S651, S810, S830		
<b>accessories for</b>	518019		
	<b>GEV No.</b>	511143	<b>Ref. No.</b>
			303009
	bush for wash arm mounting pos. upper and bottom H 10mm D1 ø 65mm D2 ø 54mm ID ø 50mm type 22/66		
	<b>GEV No.</b>	518014	<b>Ref. No.</b>
			325011
	rinse arm shaft		
	<b>GEV No.</b>	518032	<b>Ref. No.</b>
			199027
	throttle disc ED ø 34mm ID ø 13.2mm thickness 1mm		





			
1			
<b>GEV No.</b>	518270	<b>Ref. No.</b>	129046 DLL160
<b>description</b>	wash arm L 510mm nozzles 10 mounting ø 16mm mounting pos. lower		
<b>For models:</b>	050F, 050FP, F85, F85P		

			
1			
<b>GEV No.</b>	518273	<b>Ref. No.</b>	990107
<b>description</b>	wash arm L 510mm nozzles 8 mounting ø 15mm mounting pos. upper and bottom		
<b>For models:</b>	2312-007, 2312-009-CRP, 914100, 914101, 914339, 914342, 914343, 914624, 914625, 914626, 914627, 914628, 914850, 914851, 914854, 914944, E.55, RIVER-48, RIVER-50, RIVER-50-CRP, RIVER-50-CRP-SP, River-54, RIVER-54CRP, River-54-CRP-s.p., RIVER-54-CRP-SP, RIVER-61		

			
1			
<b>GEV No.</b>	511143	<b>Ref. No.</b>	303009
<b>description</b>	bush for wash arm mounting pos. upper and bottom H 10mm D1 ø 65mm D2 ø 54mm ID ø 50mm type 22/66		
<b>For models:</b>	10, 12, 14, 22F, 2312-001, 2312-002, 40F, 440F, 44F, 500F, 500FD, 50-ELECTRONIC, 50F, 50FD, 510F, 510FD, 55, 66, CLEAN-100, CLEAN-110, CLEAN-120, E.50, E.51, E.52, E.60, E.65, E1, E10, E100, E110, E12, E120, E14, E140, LF50, LF55, MC501E, MC501EP, MC501S, MC501SP, MISTRAL-51, NIAGARA-51, S651, S810, S830		

			
1			
<b>GEV No.</b>	518236	<b>Ref. No.</b>	303040
<b>description</b>	sealing ring for wash arm support ED ø 44mm ID ø 42mm plastic		
<b>For models:</b>	915154, 915155, 915160, 915161, 915162, 915168, 915175, 915319, 915479, 915492, 915493, 915496, 915663, 916020, 916021, 916024, 916025, 916026, 916027, 916030, 916031, 916045, 916067, 916068, 916069, 916079, 916080, 916201, 916202, 916203, 916204, 916205, 916206, 916207, 916208, 916209, 916247, 916248, 916249, 916250, 916251, 916252, 916365, 916366, 916367, 916368, 916382, 916383, 916411, 916412...(Other models you can see in the webshop)		

			
1			
<b>GEV No.</b>	518282	<b>Ref. No.</b>	303032
<b>description</b>	sealing ring for wash arm support stainless steel		
<b>For models:</b>	2312-007, 2312-009-CRP, 80, 81, 82, 914100, 914101, 914339, 914342, 914343, 914568, 914624, 914625, 914626, 914627, 914628, 914850, 914851, 914854, 914944, 915830, CE78HZ23, CGL74CABT, E.50D.PA, E.55, E78, E78HP, Fast160DP, FAST-160DP, Fast181, FAST-181, HM1, LP60, RIVER-48, RIVER-50, RIVER-50-CRP, RIVER-50-CRP-SP, RIVER-54, RIVER-54CRP, River-54-CRP-s.p., RIVER-54-CRP-SP, RIVER-61, RIVER-71, RIVER-78, RIVER-80, River-81, River-81CRP, RIVER-81-CRP, RIVER-82, River-82CRP...(Other models you can see in the webshop)		

			
1			
<b>GEV No.</b>	518007	<b>Ref. No.</b>	993030
<b>description</b>	rinse arm		
<b>For models:</b>	S651, S654, S810, S815, S830, S835		

			
1			
<b>GEV No.</b>	518392	<b>Ref. No.</b>	993041
<b>description</b>	rinse arm L 325mm nozzles 3 mounting ø 14mm mounting pos. upper		
<b>For models:</b>	440F, 44F		

			
1			
<b>GEV No.</b>	510159	<b>Ref. No.</b>	145003
<b>description</b>	end cap		
<b>For models:</b>	10, 12, 22F, 2312-001, 2312-002, 40F, 440F, 44F, 500F, 500FD, 50-ELECTRONIC, 50F, 50FD, 510F, 510FD, 55, 66, CLEAN-100, CLEAN-110, CLEAN-120, E.50, E.51, E.52, E.60, E1, E10, E100, E110, E12, E120, LF50, LF55, MC501E, MC501EP, MC501S, MC501SP, MISTRAL-51, NIAGARA-51		

			
1			
<b>GEV No.</b>	518016	<b>Ref. No.</b>	145001
<b>description</b>	end cap		
<b>For models:</b>	10, S651, S654, S810, S815, S830, S835, S950		

			
1			
<b>GEV No.</b>	518017	<b>Ref. No.</b>	145002
<b>description</b>	end cap		
<b>For models:</b>	S651, S654, S810, S815, S830, S835, S950		

			
1			
<b>GEV No.</b>	518035	<b>Ref. No.</b>	145004
<b>description</b>	end cap without holder for rinse arm		
<b>For models:</b>	10, 12, 22F, 2312-001, 2312-002, 40F, 440F, 44F, 500F, 500FD, 50-ELECTRONIC, 50F, 50FD, 510F, 510FD, 55, 66, CLEAN-100, CLEAN-110, CLEAN-120, E.50, E.51, E.52, E.60, E1, E10, E100, E110, E12, E120, LF50, LF55, MC501E, MC501EP, MC501S, MC501SP, MISTRAL-51, NIAGARA-51		

			
1			
<b>GEV No.</b>	510134	<b>Ref. No.</b>	468055
<b>description</b>	nozzle holder for rinse jet		
<b>For models:</b>	S651, S654, S810, S815, S830, S835, S950		

			
1			
<b>GEV No.</b>	511150	<b>Ref. No.</b>	468125
<b>description</b>	nozzle holder for rinse jet left		
<b>For models:</b>	10, 12, 22F, 2312-001, 2312-002, 40F, 440F, 44F, 500F, 500FD, 50-ELECTRONIC, 50F, 50FD, 510F, 510FD, 55, 66, CLEAN-100, CLEAN-110, CLEAN-120, E.50, E.51, E.52, E.60, E1, E10, E100, E110, E12, E120, LF50, LF55, MC501E, MC501EP, MC501S, MC501SP, MISTRAL-51, NIAGARA-51		

			
1			
<b>GEV No.</b>	511149	<b>Ref. No.</b>	468124
<b>description</b>	nozzle holder for rinse jet right		
<b>For models:</b>	10, 12, 22F, 2312-001, 2312-002, 40F, 440F, 44F, 500F, 500FD, 50-ELECTRONIC, 50F, 50FD, 510F, 510FD, 55, 66, CLEAN-100, CLEAN-110, CLEAN-120, E.50, E.51, E.52, E.60, E1, E10, E100, E110, E12, E120, LF50, LF55, MC501E, MC501EP, MC501S, MC501SP, MISTRAL-51, NIAGARA-51		

			
1			
<b>GEV No.</b>	510113	<b>Ref. No.</b>	449029
<b>description</b>	opposite support for rinse jet		
<b>For models:</b>	10, 12, 22F, 2312-001, 2312-002, 40F, 440F, 44F, 500F, 500FD, 50-ELECTRONIC, 50F, 50FD, 510F, 510FD, 55, 66, CLEAN-100, CLEAN-110, CLEAN-120, E.50, E.51, E.52, E.60, E1, E10, E100, E110, E12, E120, LF50, LF55, MC501E, MC501EP, MC501S, MC501SP, MISTRAL-51, NIAGARA-51, S651, S654, S810, S815, S830, S835, S950		

			
1			
<b>GEV No.</b>	518425	<b>Ref. No.</b>	106054.CR
<b>description</b>	rinse arm mounting pos. bottom left L 200mm mounting ø 14mm nozzles 2		
<b>For models:</b>	2312-001, 2312-002, 500F, 500FD, 50F, 50FD, 510F, 510FD, CLEAN-100, CLEAN-110, CLEAN-120, E.50, E.51, E.52, E1, E10, E100, E110, E12, E120, LF50, LF55, MC501E, MC501EP, MC501S, MC501SP, MISTRAL-51, NIAGARA-51		



			
1			
<b>GEV No.</b>	518424	<b>Ref. No.</b>	106053.CR
<b>description</b>	rinse arm mounting pos. bottom right L 200mm mounting ø 14mm nozzles 1		
<b>For models:</b>	2312-001, 2312-002, 500F, 500FD, 50F, 50FD, 510F, 510FD, CLEAN-100, CLEAN-110, CLEAN-120, E.50, E.51, E.52, E1, E10, E100, E110, E12, E120, LF50, LF55, MC501E, MC501EP, MC501S, MC501SP, MISTRAL-51, NIAGARA-51		

			
1			
<b>GEV No.</b>	518423	<b>Ref. No.</b>	106056.CR
<b>description</b>	rinse arm mounting pos. upper left L 185mm mounting ø 14mm nozzles 1		
<b>For models:</b>	E.52		

			
1			
<b>GEV No.</b>	518422	<b>Ref. No.</b>	106055.CR
<b>description</b>	rinse arm mounting pos. upper right L 185mm mounting ø 14mm nozzles 1		
<b>For models:</b>	E.52		



			
1			
<b>GEV No.</b>	513219	<b>Ref. No.</b>	129019 DAS265
<b>description</b>	rinse arm boss		
<b>For models:</b>	050F, 050FP, 10, 12, 14, 22F, 2312-001, 2312-002, 40F, 440F, 44F, 500F, 500FD, 50F, 50FD, 510F, 510FD, 55, 66, CLEAN-100, CLEAN-110, CLEAN-120, E.50, E.51, E.52, E.60, E.65, E1, E10, E100, E110, E12, E120, E14, E140, F85, F85P, LF50, LF55, MC501E, MC501EP, MC501S, MC501SP, MISTRAL-51, NIAGARA-51, S651, S654, S810, S815, S830...(Other models you can see in the webshop)		



			
<b>GEV No.</b>	510139	<b>Ref. No.</b>	140007
<b>description</b>	rinse jet		
<b>For models:</b>	050F, 050FP, 10, 11F, 11FD, 11F-DVGW, 11R, 11RD, 12, 21F, 21FD, 21R, 21RD, 22F, 2312-001, 2312-002, 25F, 25FD, 25R, 25RD, 30F, 30FD, 30R, 30RD, 31F, 31FD, 31R, 31RD, 350F, 350FD, 350R, 350RD, 35-ELECTRONIC, 35F, 35FD, 35R, 35RD, 400F, 400FD, 400R, 400RD, 40-ELECTRONIC, 40F, 40FD, 40R, 40RD, 440F, 44F, 45, 450...(Other models you can see in the webshop)		
<b>accessories for</b>	510139		
			
<b>GEV No.</b>	510130	<b>Ref. No.</b>	429006
	union nut for rinse jet		



			
<b>GEV No.</b>	510140	<b>Ref. No.</b>	140006
<b>description</b>	rinse jet		
<b>For models:</b>	22R, R495, R497, R499, R501, R503, R505, R507, R509, R511, R704, R706, R708, S651, S651P, S653, S654, S655, S810, S815, S830, S835, S870, S950, SR651		



			
<b>GEV No.</b>	510137	<b>Ref. No.</b>	138001
<b>description</b>	swirl		
<b>For models:</b>	22R, R495, R497, R499, R501, R503, R509, R511, R704, R706, R708, S651, S651P, S653, S654, S655, S810, S815, S830, S835, S870, SR651		



			
<b>GEV No.</b>	510130	<b>Ref. No.</b>	429006
<b>description</b>	union nut for rinse jet		
<b>For models:</b>	10, 11F, 11FD, 11F-DVGW, 11R, 11RD, 12, 21F, 21FD, 21R, 21RD, 22F, 2312-001, 2312-002, 25F, 25FD, 25R, 25RD, 30F, 30FD, 30R, 30RD, 31F, 31FD, 31R, 31RD, 350F, 350FD, 350R, 350RD, 35-ELECTRONIC, 35F, 35FD, 35R, 35RD, 400F, 400FD, 400R, 400RD, 40-ELECTRONIC, 40F, 40FD, 40R, 40RD, 440F, 44F, 500F, 500FD, 50-ELECTRONIC, 50F...(Other models you can see in the webshop)		
<b>accessories for</b>	510130		
			
<b>GEV No.</b>	510139	<b>Ref. No.</b>	140007
	rinse jet		

			
<b>GEV No.</b>	518470	<b>Ref. No.</b>	929126
<b>description</b>	rinse arm L 500mm nozzles 7 mounting ø 14mm mounting pos. upper and bottom		
<b>For models:</b>	E.65		



			
<b>GEV No.</b>	518478	<b>Ref. No.</b>	422051
<b>description</b>	rinse arm L 640mm nozzles 8 mounting ø 14mm mounting pos. upper and bottom complete		
<b>For models:</b>	U132E, U70E		
<b>spare parts for</b>	518478		
			
<b>GEV No.</b>	510895	<b>Ref. No.</b>	456043
	O-ring EPDM thickness 3.53mm ID ø 34.52mm Qty 1 pcs		
			
<b>GEV No.</b>	513055	<b>Ref. No.</b>	926133 CSP2502
	rinse jet		
			
<b>GEV No.</b>	513271	<b>Ref. No.</b>	412028
	connector holder grey		
			
<b>GEV No.</b>	518028	<b>Ref. No.</b>	454004
	knurled nut thread M5 ø 25mm H 4mm SS		
			
<b>GEV No.</b>	518416	<b>Ref. No.</b>	926131
	opposite support for rinse jet		
			
<b>GEV No.</b>	518419	<b>Ref. No.</b>	926132
	end cap for rinse arm		

			
<b>GEV No.</b>	518417	<b>Ref. No.</b>	926168
<b>description</b>	blank nozzle for rinse arm		
<b>For models:</b>	050F, 050FP, F85, F85P, MINIBAR, S280		
<b>accessories for</b>	518417		
			
<b>GEV No.</b>	560062	<b>Ref. No.</b>	—
	flat-headed bolt thread M4 thread L 10mm SS DIN 7985/ISO 7045 Qty 20 pcs intake Phillips head ø 8mm head thickness 2mm		
			
<b>GEV No.</b>	560131	<b>Ref. No.</b>	—
	hexagonal nut thread M4 H 3.2mm WS 7 SS DIN/ISO DIN 934 / ISO 4032/8673 Qty 20 pcs		

			
<b>GEV No.</b>	518419	<b>Ref. No.</b>	926132
<b>description</b>	end cap for rinse arm		
<b>For models:</b>	050F, 050FP, 2312-007, 2312-009-CRP, 80, 81, 82, 913992, 913993, 914100, 914101, 914339, 914342, 914343, 914583, 914592, 914612, 914613, 914624, 914625, 914626, 914627, 914628, 914850, 914851, 914854, 914944, 915143, 915830, CGL74CABT, E.65, E78, F85, F85P, Fast160DP, FAST-181, Fast181-230V-3Ph-60Hz, Fast181-400V-3NPh-60Hz, HM1, KLP105EB, KLP201DDDTTEB, KLP201EB, KLP301, KLP301DDDTTEB, LP105DDDTTEB, LP105DDDTTEBN, LP105EB, LP201DDDTTEB, LP201EB, LP301...(Other models you can see in the webshop)		
<b>accessories for</b>	518419		
	<b>GEV No.</b>	528485	<b>Ref. No.</b> 456060
O-ring EPDM thickness 1.78mm ID ø 6.07mm Qty 1 pcs			

			
<b>GEV No.</b>	513055	<b>Ref. No.</b>	926133 CSP2502
<b>description</b>	rinse jet		
<b>For models:</b>	050F, 050FP, E.65, F85, F85P, MINIBAR, S280, U132, U132E, U61, U61E, U61H, U61HE, U70, U70E		
<b>accessories for</b>	513055		
	<b>GEV No.</b>	560062	<b>Ref. No.</b> —
flat-headed bolt thread M4 thread L 10mm SS DIN 7985/ISO 7045 Qty 20 pcs intake Phillips head ø 8mm head thickness 2mm			
	<b>GEV No.</b>	560131	<b>Ref. No.</b> —
hexagonal nut thread M4 H 3.2mm WS 7 SS DIN/ISO DIN 934 / ISO 4032/8673 Qty 20 pcs			

			
<b>GEV No.</b>	518320	<b>Ref. No.</b>	993048
<b>description</b>	rinse arm L 460mm nozzles 5 mounting ø 14mm mounting pos. lower		
<b>For models:</b>	914568, 915830, E.50D.PA, E.55, FAST-160DP, RIVER-50, RIVER-50-CRP, RIVER-61		
<b>spare parts for</b>	518320		
	<b>GEV No.</b>	510303	<b>Ref. No.</b> 456030 CGR106
O-ring EPDM thickness 1.78mm ID ø 6.75mm Qty 1 pcs			
	<b>GEV No.</b>	518276	<b>Ref. No.</b> 140025 80373
rinse jet			
	<b>GEV No.</b>	518277	<b>Ref. No.</b> 140026
rinse jet			
	<b>GEV No.</b>	518278	<b>Ref. No.</b> 480086
end cap			
	<b>GEV No.</b>	518280	<b>Ref. No.</b> 412029
connector holder for knurled nut			
	<b>GEV No.</b>	518281	<b>Ref. No.</b> 454005
knurled nut thread M6 SS ø 20mm H 4mm			
	<b>GEV No.</b>	518327	<b>Ref. No.</b> 129054
rinse arm boss			

			
<b>GEV No.</b>	518416	<b>Ref. No.</b>	926131
<b>description</b>	opposite support for rinse jet		
<b>For models:</b>	050F, 050FP, E.65, F85, F85P, MINIBAR, S280, U132, U132E, U61, U61E, U61H, U61HE, U70, U70E		
<b>accessories for</b>	518416		
	<b>GEV No.</b>	560062	<b>Ref. No.</b> —
flat-headed bolt thread M4 thread L 10mm SS DIN 7985/ISO 7045 Qty 20 pcs intake Phillips head ø 8mm head thickness 2mm			
	<b>GEV No.</b>	560131	<b>Ref. No.</b> —
hexagonal nut thread M4 H 3.2mm WS 7 SS DIN/ISO DIN 934 / ISO 4032/8673 Qty 20 pcs			

			
<b>GEV No.</b>	510303	<b>Ref. No.</b>	456030 CGR106
<b>description</b>	O-ring EPDM thickness 1.78mm ID ø 6.75mm Qty 1 pcs		
<b>For models:</b>	050F, 050FP, 914568, 915830, E.50D.PA, E.55, E.65, F85, F85P, FAST-160DP, Fast181-230V-3Ph-60Hz, Fast181-400V-3NPh-60Hz, MINIBAR, NG292HZ, Niagara-292-400V-3Ph-60Hz, River-295P, River-296P, RIVER-40, RIVER-43, RIVER-50, RIVER-50-CRP, RIVER-61, RIVER-80, RIVER-81, RIVER-82, RV295PS, RV296PS, S280, ST70FASTHB400, U132, U61, U61E, U61H, U61HE, U70		

			
<b>GEV No.</b>	513219	<b>Ref. No.</b>	129019 DAS265
<b>description</b>	rinse arm boss		
<b>For models:</b>	050F, 050FP, 10, 12, 14, 22F, 2312-001, 2312-002, 40F, 440F, 44F, 500F, 500FD, 50F, 50FD, 510F, 510FD, 55, 66, CLEAN-100, CLEAN-110, CLEAN-120, E.50, E.51, E.52, E.60, E.65, E1, E10, E100, E110, E12, E120, E14, E140, F85, F85P, LF50, LF55, MCS01E, MCS01EP, MCS01S, MCS01SP, MISTRAL-51, NIAGARA-51, S651, S654, S810, S815, S830...(Other models you can see in the webshop)		







			
1			
<b>GEV No.</b>	518274	<b>Ref. No.</b>	993047
<b>description</b>	rinse arm L 475mm nozzles 7 mounting ø 14mm mounting pos. upper		
<b>For models:</b>	E.55, RIVER-50, RIVER-50-CRP, RIVER-61		



			
1			
<b>GEV No.</b>	518280	<b>Ref. No.</b>	412029
<b>description</b>	connector holder for knurled nut		
<b>For models:</b>	2312-007, 2312-009-CRP, 913992, 913993, 914100, 914101, 914339, 914342, 914343, 914568, 914583, 914592, 914612, 914613, 914624, 914625, 914626, 914627, 914628, 914850, 914851, 914854, 914944, 915143, 915830, E.50D.PA, E.55, FAST-160DP, RIVER-40, RIVER-40-CRP, RIVER-43, RIVER-44, RIVER-44-CRP, RIVER-44-CRP-ST, RIVER-44CRP-ST, RIVER-48, RIVER-50, RIVER-50-CRP, RIVER-50-CRP-SP, RIVER-54, RIVER-54CRP, RIVER-54-CRP-s.p., RIVER-54-CRP-SP, RIVER-61		



			
1			
<b>GEV No.</b>	518278	<b>Ref. No.</b>	480086
<b>description</b>	end cap		
<b>For models:</b>	914568, 915830, E.50D.PA, E.55, FAST-160DP, RIVER-40, RIVER-43, RIVER-50, RIVER-50-CRP, RIVER-61		

			
1			
<b>GEV No.</b>	518281	<b>Ref. No.</b>	454005
<b>description</b>	knurled nut thread M6 SS ø 20mm H 4mm		
<b>For models:</b>	2312-007, 2312-009-CRP, 80, 81, 82, 913992, 913993, 914100, 914101, 914339, 914342, 914343, 914568, 914583, 914592, 914612, 914613, 914624, 914625, 914626, 914627, 914628, 914850, 914851, 914854, 914944, 915143, 915830, CE78HZ23, CGL74CABT, E.50D.PA, E.55, E78, E78HP, FAST-160DP, HM1, LP60, NIAGARA-271, RIVER-282, RIVER-40, RIVER-40-CRP, RIVER-43, RIVER-44, RIVER-44-CRP, RIVER-44-CRP-ST, RIVER-44CRP-ST, RIVER-48, RIVER-50, RIVER-50-CRP, RIVER-50-CRP-SP... (Other models you can see in the webshop)		



			
1			
<b>GEV No.</b>	510303	<b>Ref. No.</b>	456030 CGR106
<b>description</b>	O-ring EPDM thickness 1.78mm ID ø 6.75mm Qty 1 pcs		
<b>For models:</b>	050F, 050FP, 914568, 915830, E.50D.PA, E.55, E.65, F85, F85P, FAST-160DP, Fast181-230V-3Ph-60Hz, Fast181-400V-3NPh-60Hz, MINIBAR, NG292HZ, Niagara-292-400V-3Ph-60Hz, River-295P, River-296P, RIVER-40, RIVER-43, RIVER-50, RIVER-50-CRP, RIVER-61, RIVER-80, RIVER-81, RIVER-82, RV295PS, RV296PS, S280, ST70FASTHB400, U132, U61, U61E, U61H, U61HE, U70		

			
1			
<b>GEV No.</b>	518327	<b>Ref. No.</b>	129054
<b>description</b>	rinse arm boss		
<b>For models:</b>	2312-007, 2312-009-CRP, 913992, 913993, 914100, 914101, 914339, 914342, 914343, 914568, 914583, 914592, 914612, 914613, 914624, 914625, 914626, 914627, 914628, 914850, 914851, 914854, 914944, 915143, 915830, E.50D.PA, E.55, FAST-160DP, RIVER-40, RIVER-40-CRP, RIVER-43, RIVER-44, RIVER-44-CRP, RIVER-44-CRP-ST, RIVER-44CRP-ST, RIVER-48, RIVER-50, RIVER-50-CRP, RIVER-50-CRP-SP, RIVER-54, RIVER-54CRP, RIVER-54-CRP-s.p., RIVER-54-CRP-SP, RIVER-61		
<b>accessories for</b>	518327		
			
<b>GEV No.</b>	513157	<b>Ref. No.</b>	412030 80374
<b>description</b> connector holder			
			
<b>GEV No.</b>	518281	<b>Ref. No.</b>	454005
<b>description</b> knurled nut thread M6 SS ø 20mm H 4mm			

			
1			
<b>GEV No.</b>	518276	<b>Ref. No.</b>	140025 80373
<b>description</b>	rinse jet		
<b>For models:</b>	914568, 915830, E.50D.PA, E.55, FAST-160DP, FAST-181, KLP105EB, KLP201DDDTEB, KLP201EB, KLP301, KLP301DDDTEB, LP105DDDTEB, LP105DDDTEBN, LP105EB, LP201DDDTEB, LP201EB, LP301, LP301EB, NG291, NG292, NG293, NIAGARA-291, NIAGARA-292, NIAGARA-293, RIVER-294, RIVER-295, RIVER-296, RIVER-297, RIVER-298, RIVER-40, RIVER-43, RIVER-50, RIVER-50-CRP, RIVER-61, RV294, RV295, RV296, RV297, RV298, RV298HZ, ST70FASTHB, U132E, U61He, U70E		
<b>accessories for</b>	518276		
			
<b>GEV No.</b>	510303	<b>Ref. No.</b>	456030 CGR106
<b>description</b> O-ring EPDM thickness 1.78mm ID ø 6.75mm Qty 1 pcs			









			
1			
<b>GEV No.</b>	518277	<b>Ref. No.</b>	140026
<b>description</b>	rinse jet		
<b>For models:</b>	E.55, RIVER-50, RIVER-50-CRP, RIVER-61		
<b>accessories for</b>	518277		
			
<b>GEV No.</b>	528485	<b>Ref. No.</b>	456060
<b>description</b> O-ring EPDM thickness 1.78mm ID ø 6.07mm Qty 1 pcs			

			
1			
<b>GEV No.</b>	518388	<b>Ref. No.</b>	993043
<b>description</b>	rinse arm complete		
<b>For models:</b>	CLEAN-3		

			
1			
<b>GEV No.</b>	518162	<b>Ref. No.</b>	113992
<b>description</b>	rinse arm L 370mm nozzles 4 mounting ø 13.5mm mounting pos. upper and bottom		
<b>For models:</b>	CLEAN-3		
<b>spare parts for</b>	518162		
	<b>GEV No.</b>	518164	<b>Ref. No.</b> 140019
	rinse jet		
	<b>GEV No.</b>	518391	<b>Ref. No.</b> 480065
	end cap for rinse arm		

			
1			
<b>GEV No.</b>	518391	<b>Ref. No.</b>	480065
<b>description</b>	end cap for rinse arm		
<b>For models:</b>	CLEAN-3		

			
1			
<b>GEV No.</b>	518164	<b>Ref. No.</b>	140019
<b>description</b>	rinse jet		
<b>For models:</b>	2312-007, 2312-009-CRP, 913992, 913993, 914100, 914101, 914339, 914342, 914343, 914583, 914592, 914612, 914613, 914624, 914625, 914626, 914627, 914628, 914850, 914851, 914854, 914944, 915143, CLEAN-3, RIVER-40, RIVER-40-CRP, RIVER-43, RIVER-44, RIVER-44-CRP, RIVER-44-CRP-ST, RIVER-44CRP-ST, RIVER-48, RIVER-50, RIVER-50-CRP, RIVER-50-CRP-SP, RIVER-54, RIVER-54CRP, River-54-CRP-s.p., RIVER-54-CRP-SP, RIVER-61		

			
1			
<b>GEV No.</b>	513148	<b>Ref. No.</b>	926057
<b>description</b>	rinse arm L 505mm nozzles 6 mounting ø 14mm mounting pos. upper and bottom		
<b>For models:</b>	14, E14, E140		
<b>spare parts for</b>	513148		
	<b>GEV No.</b>	513152	<b>Ref. No.</b> 926061
	nozzle for rinse arm		
	<b>GEV No.</b>	513219	<b>Ref. No.</b> 129019 DAS265
	rinse arm boss		
	<b>GEV No.</b>	513220	<b>Ref. No.</b> 926063 926093
	bush for rinse arm		
	<b>GEV No.</b>	513271	<b>Ref. No.</b> 412028
	connector holder grey		
	<b>GEV No.</b>	518021	<b>Ref. No.</b> 926059
	rinse arm mounting pos. upper/lower nozzles 3		
	<b>GEV No.</b>	518028	<b>Ref. No.</b> 454004
	knurled nut thread M5 ø 25mm H 4mm SS		
	<b>GEV No.</b>	518037	<b>Ref. No.</b> 926062
	end cap for rinse arm		

			
1			
<b>GEV No.</b>	513220	<b>Ref. No.</b>	926063 926093
<b>description</b>	bush for rinse arm		
<b>For models:</b>	050F, 050FP, 14, E.65, E14, E140, F85, F85P, U132, U132E, U61, U61E, U61H, U61HE, U70, U70E		

			
1			
<b>GEV No.</b>	518037	<b>Ref. No.</b>	926062
<b>description</b>	end cap for rinse arm		
<b>For models:</b>	14, E14, E140		

			
1			
<b>GEV No.</b>	518038	<b>Ref. No.</b>	926058
<b>description</b>	flat gasket rubber ED ø 12mm thickness 2mm Qty 1 pcs		
<b>For models:</b>	14, E14, E140		







			
1			
<b>GEV No.</b>	513152	<b>Ref. No.</b>	926061
<b>description</b>	nozzle for rinse arm		
<b>For models:</b>	14, E1, E14, E140		

			
1			
<b>GEV No.</b>	518021	<b>Ref. No.</b>	926059
<b>description</b>	rinse arm mounting pos. upper/lower nozzles 3		
<b>For models:</b>	14, E14, E140		

			
1			
<b>GEV No.</b>	518397	<b>Ref. No.</b>	106043 106043.FR
<b>description</b>	wash arm L 445mm nozzles 10 mounting pos. left		
<b>For models:</b>	22F, 40F, 440F, 44F, E.52		

			
1			
<b>GEV No.</b>	518396	<b>Ref. No.</b>	106044 106044.FR
<b>description</b>	wash arm L 445mm nozzles 10 mounting pos. right		
<b>For models:</b>	22F, 40F, 440F, 44F, E.52		

			
1			
<b>GEV No.</b>	518039	<b>Ref. No.</b>	480045
<b>description</b>	end cap ø 22mm mounting pos. right for wash arm		
<b>For models:</b>	22F, 40F, 440F, 44F, E.52		

			
1			
<b>GEV No.</b>	510147	<b>Ref. No.</b>	119004
<b>description</b>	swirl ø 27mm H 12mm		
<b>For models:</b>	22F, 22R, 400R, 400RD, 40-ELECTRONIC, 40F, 40R, 40RD, 440F, 44F, E.52, S651, S654, S810, S815, S830, S835		

			
1			
<b>GEV No.</b>	510007	<b>Ref. No.</b>	140014
<b>description</b>	union nut for wash jet		
<b>For models:</b>	22F, 22R, 400R, 400RD, 40-ELECTRONIC, 40F, 40R, 40RD, 440F, 44F, E.52		

			
1			
<b>GEV No.</b>	517552	<b>Ref. No.</b>	927011
<b>description</b>	wash arm mounting pos. upper/lower L 495mm nozzles 5		
<b>For models:</b>	161, 221, 271, 272, 362, CLEAN-160, CLEAN-161, CLEAN-220, CLEAN-221, CLEAN-270, CLEAN-271, CLEAN-272, CLEAN-361, CLEAN-361P, CLEAN-362, CLEAN-471, CLEAN-471P		

			
1			
<b>GEV No.</b>	524812	<b>Ref. No.</b>	927012
<b>description</b>	end cap for wash arm mounting pos. upper/lower ø 45mm H 28mm		
<b>For models:</b>	161, 221, 271, 272, 362, CLEAN-160, CLEAN-161, CLEAN-220, CLEAN-221, CLEAN-270, CLEAN-271, CLEAN-272, CLEAN-361, CLEAN-361P, CLEAN-362, CLEAN-471, CLEAN-471P		

			
1			
<b>GEV No.</b>	528155	<b>Ref. No.</b>	927337 CGR4131NT
<b>description</b>	O-ring Viton thickness 3.53mm ID ø 32.93mm Qty 1 pcs		
<b>For models:</b>	161, 221, 271, 272, 362, 915747, 915773, A3EB, A3EBDAKRKYK, A3EBDRKYK, A3EBSAKRK, A3EBSEKWK, A4EB, A4EBDAKEKYK, A4EBDAKRK, A4EBDAKWK, A4EBDAKZK, A4EBDBKRK, A4EBDPKWKYK, A4EBDRK, A4EBSAK, A4EBSAKCK, A4EBSAKEKYK, A4EBSAKRKP, A4EBT, A4EBTSAK, A5EB, A5EBDAKYK, A5EBDRK, A5EBSAKRK, A5EBSAKRKYK, A5EBSAKWK, A5EBSAKWKYK, A5EBSBKRKP, A5EBSBKWK, A5EBSRK, CLEAN-161, CLEAN-221, CLEAN-271, CLEAN-272, CLEAN-362, Fast181, FAST-181, Fast181-230V-3Ph-60Hz, Fast181-400V-3NPh-60Hz, Fast200, Fast93, GL280EB, GL280EB23, GL280EB23DAR... (Other models you can see in the webshop)		



			
1			
<b>GEV No.</b>	517434	<b>Ref. No.</b>	75125
<b>description</b>	rinse arm mounting pos. lower L 565mm W 20mm H 40mm nozzles 4		
<b>For models:</b>	914380, 914436, 915747, A3EB, A3EBD, A3EBDAKRKYK, A3EBDAKWK, A3EBDBKWK, A3EBDRKYK, A3EBDVK, A3EBDYK, A3EBSAK, A3EBSAKRK, A3EBSAKWK, A3EBSBKWKYK, A3EBSEKWK, A3EBSWK, A4EB, A4EBD, A4EBDAKEKYK, A4EBDAKRK, A4EBDAKWK, A4EBDAKZK, A4EBDBKRK, A4EBDPKWKYK, A4EBDRK, A4EBS, A4EBSAK, A4EBSAKCK, A4EBSAKEKYK, A4EBSAKRK, A4EBSAKRKP, A4EBSAKYK, A4EBSCK, A4EBT, A4EBTSAK, A5EB, A5EBD, A5EBDAKPKWK, A5EBDAKWK, A5EBDAKYK, A5EBDRK, A5EBS, A5EBSAKPKWK, A5EBSAKRK, A5EBSAKRKYK, A5EBSAKWK, A5EBSAKWKYK, A5EBSBKRKPK, A5EBSBKWK... (Other models you can see in the webshop)		

			
2			
<b>GEV No.</b>	517436	<b>Ref. No.</b>	927069
<b>description</b>	rinse arm mounting pos. upper/lower L 545mm W 20mm H 40mm nozzles 4 without nozzles		
<b>For models:</b>	161, 221, 271, 272, 362, CLEAN-160, CLEAN-161, CLEAN-220, CLEAN-221, CLEAN-270, CLEAN-271, CLEAN-272, CLEAN-361, CLEAN-361P, CLEAN-362, CLEAN-471, CLEAN-471P		

			
1			
<b>GEV No.</b>	524536	<b>Ref. No.</b>	75133
<b>description</b>	rinse jet thread M5 ø 8.5mm H 12mm WS 7		
<b>For models:</b>	914380, 914436, 915747, A3EB, A3EBD, A3EBDAKRKYK, A3EBDAKWK, A3EBDBKWK, A3EBDRKYK, A3EBDVK, A3EBDYK, A3EBSAK, A3EBSAKRK, A3EBSAKWK, A3EBSBKWKYK, A3EBSEKWK, A3EBSWK, A4EB, A4EBD, A4EBDAKEKYK, A4EBDAKRK, A4EBDAKWK, A4EBDAKZK, A4EBDBKRK, A4EBDPKWKYK, A4EBDRK, A4EBS, A4EBSAK, A4EBSAKCK, A4EBSAKEKYK, A4EBSAKRK, A4EBSAKRKP, A4EBSAKYK, A4EBSCK, A4EBT, A4EBTSAK, A5EB, A5EBD, A5EBDAKPKWK, A5EBDAKWK, A5EBDAKYK, A5EBDRK, A5EBS, A5EBSAKPKWK, A5EBSAKRK, A5EBSAKRKYK, A5EBSAKWK, A5EBSAKWKYK, A5EBSBKRKPK, A5EBSBKWK... (Other models you can see in the webshop)		

miscellaneous

			
1			
<b>GEV No.</b>	518044	<b>Ref. No.</b>	110003
<b>description</b>	nozzle holder		
<b>For models:</b>	11R, 11RD, 21R, 21RD, 25R, 25RD, 30R, 30RD, 31R, 31RD, 350F, 350FD, 35-ELECTRONIC, 35F, 35FD, E.42		

			
1			
<b>GEV No.</b>	510132	<b>Ref. No.</b>	110002
<b>description</b>	nozzle holder for rinse jet		
<b>For models:</b>	22R, R495, R497, R499, R501, R503, R505, R507, R509, R511, R704, R706, R708, S651, S651P, S653, S654, S655, S815, S830, S835, S870, SR651		
<b>accessories for</b>	510132		
	<b>GEV No.</b>	510113	<b>Ref. No.</b>
			449029
	 opposite support for rinse jet		

			
1			
<b>GEV No.</b>	513038	<b>Ref. No.</b>	929074
<b>description</b>	rinse jet		
<b>For models:</b>	55		

			
1			
<b>GEV No.</b>	513255	<b>Ref. No.</b>	929075
<b>description</b>	rinse jet		
<b>For models:</b>	55		



			
1			
<b>GEV No.</b>	510141	<b>Ref. No.</b>	140004
<b>description</b>	wash jet		
<b>For models:</b>	R505, R507		

			
1			
<b>GEV No.</b>	518018	<b>Ref. No.</b>	110004
<b>description</b>	wash jet holder		
<b>For models:</b>	22R, 400R, 400RD, 40-ELECTRONIC, 40R, 40RD, R497, R499, R501, R503, R505, R507, S651, S651P, S653, S654, S655, S810, S815, S830, S835, S870, S950, SR651		

wash arm supports



			
1			
<b>GEV No.</b>	518474	<b>Ref. No.</b>	929116
<b>description</b>	opposite support		
<b>For models:</b>	E.60, E.65		





 <p>1</p>									
<b>GEV No.</b>	518289	<b>Ref. No.</b>	115117						
<b>description</b>	opposite support for wash arm								
<b>For models:</b>	2312-007, 2312-009-CRP, 914339, 914342, 914343, 914626, PS-60, RIVER-48, RIVER-50, RIVER-50-CRP, RIVER-50-CRP-SP, RIVER-54, RIVER-54-CRP-SP, RIVER-61								
<b>accessories for</b>	518289								
 <table border="1"> <tr> <td><b>GEV No.</b></td> <td>518205</td> <td><b>Ref. No.</b></td> <td colspan="2">437079 80182 reb437079</td> </tr> </table> <p>flat gasket rubber ED ø 61mm ID ø 47mm thickness 2mm Qty 1 pcs</p>					<b>GEV No.</b>	518205	<b>Ref. No.</b>	437079 80182 reb437079	
<b>GEV No.</b>	518205	<b>Ref. No.</b>	437079 80182 reb437079						

 <p>1</p>			
<b>GEV No.</b>	518183	<b>Ref. No.</b>	115088
<b>description</b>	opposite support mounting pos. lower		
<b>For models:</b>	913992, 913993, 914583, 914592, 914612, 914613, 915143, CLEAN-3, RIVER-40, RIVER-40-CRP, RIVER-43, RIVER-44, RIVER-44-CRP, River-44-CRP-ST, RIVER-44CRP-ST		

 <p>1</p>			
<b>GEV No.</b>	518108	<b>Ref. No.</b>	115102
<b>description</b>	opposite support for wash arm support		
<b>For models:</b>	67R		

 <p>1</p>							
<b>GEV No.</b>	518171	<b>Ref. No.</b>	111019 111030 111999				
<b>description</b>	opposite support mounting pos. lower for wash arm support						
<b>For models:</b>	10, 22F, 46, 460, 500F, 500FD, 50-ELECTRONIC, 50F, 50FD, 510F, 510FD, 913297, 913298, 913299, 913300, 913360, 913361, 913391, 913392, 913546, 913547, 913578, 913611, 913684, 913913, 913914, 913932, 913933, 914284, 914318, 914319, 914326, 914331, 914338, 914356, 914400, 914401, 914402, 914403, 914404, 914405, 914406, 914431, 914449, 914517, 914545, 914568, 914642, 914688, 914909...(Other models you can see in the webshop)						
<b>accessories for</b>	518171						
 <table border="1"> <tr> <td><b>GEV No.</b></td> <td>513717</td> <td><b>Ref. No.</b></td> <td colspan="1">035064</td> </tr> </table> <p>fastening angle for drain pump</p>				<b>GEV No.</b>	513717	<b>Ref. No.</b>	035064
<b>GEV No.</b>	513717	<b>Ref. No.</b>	035064				



 <p>1</p>			
<b>GEV No.</b>	510057	<b>Ref. No.</b>	111009
<b>description</b>	opposite support for wash arm support mounting pos. lower Mod. 111009 suitable for 11R		
<b>For models:</b>	11F, 11FD, 11R, 11RD, 67F, 67R		

 <p>1</p>			
<b>GEV No.</b>	518343	<b>Ref. No.</b>	111031
<b>description</b>	opposite support mounting pos. lower for wash arm support		
<b>For models:</b>	050F, 050FP, 2312-001, 2312-002, E.50, E.51, E.55, F85, F85P, LF50, LF55, MC501E, MC501EP, MC501S, MC501SP, MISTRAL-51, NIAGARA-51, P500		



 <p>1</p>			
<b>GEV No.</b>	518421	<b>Ref. No.</b>	111015
<b>description</b>	opposite support for wash arm support mounting pos. lower Mod. 111015		
<b>For models:</b>	11F, 11FD, 11F-DVGW		

 <p>1</p>			
<b>GEV No.</b>	518427	<b>Ref. No.</b>	115087
<b>description</b>	opposite support mounting pos. lower for wash arm support		
<b>For models:</b>	350F, 350FD, 350R, 350RD, 35-ELECTRONIC, 35F, 35FD, 35R, 35RD, 400F, 400FD, 400R, 400RD, 40-ELECTRONIC, 40F, 40FD, 40R, 40RD		



 <p>1</p>			
<b>GEV No.</b>	518447	<b>Ref. No.</b>	111025
<b>description</b>	opposite support for wash arm support mounting pos. lower Mod. 111025 11NM suitable for E41 C		
<b>For models:</b>	913363, 913364, 913376, 913377, E.41, E.42, E41		

			
1			
<b>GEV No.</b>	513102	<b>Ref. No.</b>	926052
<b>description</b>	opposite support mounting pos. upper		
<b>For models:</b>	12, 14, 45, 450, 915695, 915696, 915819, CLEAN-120, E.45, E12, E120, E14, E140, Fast145, Fast145D		
<b>accessories for</b>	513102		
	<b>GEV No.</b>	518025	<b>Ref. No.</b> 437014
	gasket D1 ø 50mm D2 ø 82mm thickness 2mm with 6 holes wash arm support equiv. no. 437014 suitable for COLGED		
	<b>GEV No.</b>	518471	<b>Ref. No.</b> 926065
	rinse pipe		

			
1			
<b>GEV No.</b>	510037	<b>Ref. No.</b>	115035
<b>description</b>	wash arm support		
<b>For models:</b>	11F, 11FD, 11F-DVGW		



			
1			
<b>GEV No.</b>	518069	<b>Ref. No.</b>	80177
<b>description</b>	wash arm support		
<b>For models:</b>	80, 81, 82, CE78HZ23, CGL74CABT, CNT800CH, E78, E78HP, FAST-181, Fast181-230V-3Ph-60Hz, Fast181-400V-3NPh-60Hz, FAST-60, FAST-73, HM1, NG281, NG281CDD, NG281HP, NG281HPDD, NG281HZ23, NG281HZ23DD, NG291, NIAGARA-281, Niagara-281HP, NIAGARA-283, Niagara-283A, NIAGARA-291, PLUVIA-280, Pluvia280-230V-3PH-60HZ, PS-60, PV280, PV280FAST, PV280FASTCH, PV280FASTHB, PV280HZ23, RIVER-282, River-285, RIVER-294, River-482, RIVER-71, RIVER-78, RIVER-80, River-81, River-81CRP, RIVER-81-CRP, RIVER-82, River-82CRP, RIVER-82-CRP, RIVER-E78, RIVER-HL-81, RIVER-HL-82...(Other models you can see in the webshop)		
<b>accessories for</b>	518069		
	<b>GEV No.</b>	518071	<b>Ref. No.</b> 80178
	gasket for wash arm support L 109mm W 68mm		

			
1			
<b>GEV No.</b>	518096	<b>Ref. No.</b>	4206301
<b>description</b>	wash arm support mounting pos. lower		
<b>For models:</b>	KLP105EB, KLP201DDDTEB, KLP201EB, KLP301, KLP301DDDTEB, LP105DDDTEB, LP105DDDTEBN, LP105EB, LP201DDDTEB, LP201EB, LP301, LP301EB, NG292, NG292HZ, NG293, NIAGARA-292, Niagara-292-400V-3Ph-60Hz, NIAGARA-293, RIVER-295, River-295P, RIVER-296, River-296P, RIVER-297, RIVER-298, RV295, RV295PS, RV296, RV296PS, RV297, RV298, RV298HZ, U132E, U61E, U61HE, U70e		

			
1			
<b>GEV No.</b>	518168	<b>Ref. No.</b>	115094
<b>description</b>	wash arm support mounting pos. lower		
<b>For models:</b>	45, 450, E.45, NIAGARA-45		
<b>accessories for</b>	518168		
	<b>GEV No.</b>	518025	<b>Ref. No.</b> 437014
	gasket D1 ø 50mm D2 ø 82mm thickness 2mm with 6 holes wash arm support equiv. no. 437014 suitable for COLGED		

			
1			
<b>GEV No.</b>	518173	<b>Ref. No.</b>	115106
<b>description</b>	wash arm support mounting pos. lower		
<b>For models:</b>	E.35, E.40		

			
1			
<b>GEV No.</b>	518445	<b>Ref. No.</b>	115107
<b>description</b>	wash arm support mounting pos. lower		
<b>For models:</b>	913363, 913364, 913376, 913377, E.41, E.42, E41		

			
1			
<b>GEV No.</b>	518636	<b>Ref. No.</b>	115143
<b>description</b>	wash arm support mounting pos. lower		
<b>For models:</b>	915150, 915151, 915152, 915154, 915155, 915157, 915158, 915160, 915161, 915162, 915166, 915167, 915168, 915172, 915173, 915175, 915176, 915177, 915285, 915319, 915338, 915341, 915348, 915418, 915419, 915420, 915421, 915422, 915479, 915492, 915493, 915494, 915495, 915496, 915497, 915547, 915558, 915635, 915663, 915747, 916020, 916021, 916024, 916025, 916026, 916027, 916030, 916031, 916045, 916054...(Other models you can see in the webshop)		
<b>accessories for</b>	518636		
	<b>GEV No.</b>	518637	<b>Ref. No.</b> 429073
	nut for wash arm support thread M56x2		





			
1			
<b>GEV No.</b>	518174	<b>Ref. No.</b>	115110
<b>description</b>	wash arm support mounting pos. lower D1 ø 38mm D2 ø 59mm H 69mm ID ø 13mm		
<b>For models:</b>	913289, 913290, 913291, 913292, 913356, 913357, 913372, 913373, 913374, 913375, 913416, 913435, 913544, 913545, 913665, 913666, 913667, 913668, 913685, 913771, 913772, 913773, 913774, 913832, 913837, 913911, 913912, 913948, 913950, 913977, 913984, 913990, 914165, 914166, 914206, 914214, 914316, 914317, 914355, 914386, 914387, 914388, 914389, 914390, 914391, 914392, 914393, 914394, 914395, 914396...(Other models you can see in the webshop)		

			
1			
<b>GEV No.</b>	518031	<b>Ref. No.</b>	115075
<b>description</b>	wash arm support mounting pos. lower H 108mm		
<b>For models:</b>	12, 14, 22F, 2312-001, 2312-002, 440F, 44F, 500F, 500FD, 50-ELECTRONIC, 50F, 50FD, 510F, 510FD, 913297, 913298, 913299, 913300, 913360, 913361, 913391, 913392, 913546, 913547, 913578, 913611, 913684, 913913, 913914, 913932, 913933, 914284, 914318, 914319, 914326, 914331, 914338, 914356, 914400, 914401, 914402, 914403, 914404, 914405, 914406, 914431, 914449, 914517, 914545, 914568...(Other models you can see in the webshop)		

			
1			
<b>GEV No.</b>	518024	<b>Ref. No.</b>	115076 DAS2596
<b>description</b>	wash arm support mounting pos. lower H 126.5mm		
<b>For models:</b>	050F, 050FP, 10, 46, 460, CLEAN-100, CLEAN-110, CLEAN-120, E.46, E.60, E.65, E1, E10, E100, E110, E12, E120, F85, F85P, GSP50, GSP50P, GSP51, GSP51P, P500		

			
1			
<b>GEV No.</b>	513167	<b>Ref. No.</b>	115144
<b>description</b>	wash arm support mounting pos. lower H 145mm ID ø 24mm		
<b>For models:</b>	915611, 915612, 915613, 915614, 915615, 915616, 915617, 915618, 915670, 915671, 915672, 915773, 915774, 915959, 916066, 916077, 916078, 916196, 916197, 916198, 916199, 916200, 916409, 916410, 916418, 916419, 916591, 916592, 916593, 916594, 916595, 916877, 916921, 916922, 916992, 916993, Fast145-2, Fast150, Niagara-241, Niagara-241-2, Niagara-341, Pluvia-240, RIVER-242, River-242-2, River-242-2T, River-342C, River-342T		

			
1			
<b>GEV No.</b>	517570	<b>Ref. No.</b>	75171
<b>description</b>	wash arm support mounting pos. lower ø 40mm L1 62mm ID ø 28mm		
<b>For models:</b>	914380, 914436, A3EBD, A3EBDAKWK, A3EBDBKWK, A3EBDVK, A3EBDYK, A3EBSAK, A3EBSAKWK, A3EBSBKWKYK, A3EBSWK, A4EBD, A4EBS, A4EBSAKRK, A4EBSAKYK, A4EBSCK, A5EBD, A5EBDAKPKWK, A5EBDAKWK, A5EBS, A5EBSAKPKWK, A5EBSYK, FAST-200, GL280EB, GL280EBD, GL280EBDA, GL280EBDAE, GL280EBDAR, GL280EBDAWY, GL280EBDBW, GL280EBDY, GL280EBS, GL280EBSY, GL282EB, GL282EBCH, GL282EBCHD, GL282EBD, GL282EBDAE, GL282EBDAR, GL284EBD, GL284EBDAWY, GL284EBS, GL284EBSAR, GL286EBD, GL286EBDARY, GL286EBS, GL286EBSAW, NIAGARA-2150, NIAGARA-2152, NIAGARA-2154...(Other models you can see in the webshop)		

			
1			
<b>GEV No.</b>	517793	<b>Ref. No.</b>	75648
<b>description</b>	wash arm support mounting pos. lower ø 40mm L1 62mm ID ø 28mm		
<b>For models:</b>	915747, A3EB, A3EBDAKRKYK, A3EBDRKYK, A3EBSAKRK, A3EBSEKWK, A4EB, A4EBDAKEKYK, A4EBDAKRK, A4EBDAKWK, A4EBDAKZK, A4EBDBKRK, A4EBDPKWKYK, A4EBDRK, A4EBSAK, A4EBSAKCK, A4EBSAKEKYK, A4EBSAKRKP, A4EBT, A4EBTSAK, A5EB, A5EBDAKYK, A5EBDRK, A5EBSAKRK, A5EBSAKRKYK, A5EBSAKWK, A5EBSAKWKYK, A5EBSBKRPK, A5EBSBKWK, A5EBSRK, Fast200, Fast93, GL280EB, GL280EB23, GL280EB23DAR, GL280EB23HZ, GL280EB23HZDY, GL280EBDARY, GL280EBDAW, GL280EBDAY, GL280EBDB, GL280EBDBR, GL280EBDWY, GL280EBSA, GL280EBSAE, GL280EBSAEW, GL280EBSAEWY, GL280EBSAR, GL280EBSARY, GL280EBSAW...(Other models you can see in the webshop)		
<b>accessories for</b>	517793		
	<b>GEV No.</b>	528155	<b>Ref. No.</b> 927337 CGR4131NT

			
1			
<b>GEV No.</b>	518030	<b>Ref. No.</b>	926029
<b>description</b>	wash arm support mounting pos. upper		
<b>For models:</b>	10, 12, 14, CLEAN-110		

			
1			
<b>GEV No.</b>	518401	<b>Ref. No.</b>	108007
<b>description</b>	wash arm support mounting pos. upper		
<b>For models:</b>	22F, 22R, 40F, 440F, 44F, E.52, TF-503, TF-513, TF-515		



<b>GEV No.</b>	518403	<b>Ref. No.</b>	127028
<b>description</b>	wash arm support mounting pos. upper		
<b>For models:</b>	22F, 22R, 40F, 440F, 44F, E.52		



<b>GEV No.</b>	517569	<b>Ref. No.</b>	75144 75169 75645
<b>description</b>	wash arm support mounting pos. upper ø 40mm L1 62mm ID ø 28mm		
<b>For models:</b>	914380, 914436, 915747, A3EB, A3EBD, A3EBDAKRKYK, A3EBDAKWK, A3EBDBKWK, A3EBDRKYK, A3EBDVK, A3EBDYK, A3EBSAK, A3EBSAKRK, A3EBSAKWK, A3EBSBKWKYK, A3EBSEKWK, A3EBSWK, A4EB, A4EBD, A4EBDAKEYK, A4EBDAKRK, A4EBDAKWK, A4EBDAKZK, A4EBDBKRK, A4EBDPKWKYK, A4EBDRK, A4EBS, A4EBSAK, A4EBSAKCK, A4EBSAKEKYK, A4EBSAKRK, A4EBSAKRKP, A4EBSAKYK, A4EBSCK, A4EBT, A4EBTSAK, A5EB, A5EBD, A5EBDAKPKWK, A5EBDAKWK, A5EBDAKYK, A5EBDRK, A5EBS, A5EBSAKPKWK, A5EBSAKRK, A5EBSAKRKYK, A5EBSAKWK, A5EBSAKWKYK, A5EBSBKRPK, A5EBSBKWK... (Other models you can see in the webshop)		



<b>GEV No.</b>	518338	<b>Ref. No.</b>	115074 41550
<b>description</b>	wash arm support mounting pos. upper ø 49mm		
<b>For models:</b>	46, 460, 500F, 500FD, 50F, 50FD, 510F, 510FD, E.46, E.50, E.51, E.60, E.65, TF-503, TF-513, TF-515, U61, U61E		



<b>GEV No.</b>	524079	<b>Ref. No.</b>	4205901
<b>description</b>	wash arm support mounting pos. upper ø 69mm H 79mm		
<b>For models:</b>	KLP105EB, KLP201DDTEB, KLP201EB, KLP301, KLP301DDTEB, LP105DDTEB, LP105DDTEBN, LP105EB, LP201DDTEB, LP201EB, LP301, LP301EB, RIVER-297, RIVER-298, RV297, RV298, RV298HZ, U132E, U61He, U70E		



<b>GEV No.</b>	520646	<b>Ref. No.</b>	75155
<b>description</b>	wash arm support ø 33mm hose ø 35mm		
<b>For models:</b>	914380, 914436, 915747, A3EB, A3EBD, A3EBDAKRKYK, A3EBDAKWK, A3EBDBKWK, A3EBDRKYK, A3EBDVK, A3EBDYK, A3EBSAK, A3EBSAKRK, A3EBSAKWK, A3EBSBKWKYK, A3EBSEKWK, A3EBSWK, A4EB, A4EBD, A4EBDAKEYK, A4EBDAKRK, A4EBDAKWK, A4EBDAKZK, A4EBDBKRK, A4EBDPKWKYK, A4EBDRK, A4EBS, A4EBSAK, A4EBSAKCK, A4EBSAKEKYK, A4EBSAKRK, A4EBSAKRKP, A4EBSAKYK, A4EBSCK, A4EBT, A4EBTSAK, A5EB, A5EBD, A5EBDAKPKWK, A5EBDAKWK, A5EBDAKYK, A5EBDRK, A5EBS, A5EBSAKPKWK, A5EBSAKRK, A5EBSAKRKYK, A5EBSAKWK, A5EBSAKWKYK, A5EBSBKRPK, A5EBSBKWK... (Other models you can see in the webshop)		



<b>GEV No.</b>	501450	<b>Ref. No.</b>	111024
<b>description</b>	wash arm support thread M12 L 100mm mounting ø 70mm ID ø 35mm		
<b>For models:</b>	913363, 913364, 913376, 913377, E.41, E.42, E41		





<b>GEV No.</b>	518141	<b>Ref. No.</b>	80179
<b>description</b>	wash arm support thread M46x2 ø 44mm ID ø 39mm L 112.5mm W 86mm hole ø 12mm		
<b>For models:</b>	CGL74CABT, NG271, NG291, NIAGARA-271, NIAGARA-283, Niagara-283A, NIAGARA-291, RIVER-282, River-285, RIVER-294, RIVER-80, River-81, RV282, RV282DD, RV282R, RV294, RV80, RV8023, RV8023HZ, RV80C, RV80HZ, RV81, RV8123, RV81A, RV81C, RV81HZ, RV81HZ23, RV81PAP, SevenL, SV72AEB, SV72EB		
<b>accessories for</b>	518141		
	<b>GEV No.</b>	513286	<b>Ref. No.</b> 80281
	<b>GEV No.</b>	518205	<b>Ref. No.</b> 437079 80182 reb437079
	flat gasket rubber ED ø 61mm ID ø 47mm thickness 2mm Qty 1 pcs		





<b>GEV No.</b>	513124	<b>Ref. No.</b>	80314 926128
<b>description</b>	nut M24x1.5		
<b>For models:</b>	2312-001, 2312-002, 2312-009-CRP, 80, 81, 82, 914583, 914628, 914944, 915143, CGL74CABT, E.50, E.51, E78, FAST-181, Fast181-230V-3Ph-60Hz, Fast181-400V-3NPh-60Hz, HM1, LP60, MISTRAL-51, NG291, NG292, NG292HZ, NG293, NIAGARA-291, NIAGARA-292, Niagara-292-400V-3Ph-60Hz, NIAGARA-293, NIAGARA-51, RIVER-294, RIVER-295, River-295P, RIVER-296, River-296P, RIVER-40-CRP, RIVER-44-CRP, RIVER-44-CRP-ST, RIVER-44CRP-ST, RIVER-50-CRP, RIVER-50-CRP-SP, RIVER-54CRP, River-54-CRP-s.p., RIVER-54-CRP-SP, RIVER-71, RIVER-78, RIVER-80, River-81, River-81CRP, RIVER-81-CRP, RIVER-82... (Other models you can see in the webshop)		
<b>accessories for</b>	513124		
	<b>GEV No.</b>	513123	<b>Ref. No.</b> 626129 926129
	wash arm bearing mounting pos. upper/lower		



			
1			
<b>GEV No.</b>	518090	<b>Ref. No.</b>	417111
<b>description</b>	wash arm bearing		
<b>For models:</b>	2312-007, 914100, 914101, 914339, 914342, 914343, 914568, 914624, 914625, 914626, 914627, 914628, 914850, 914851, 914854, 914944, 915830, E.50D.PA, Fast160DP, FAST-160DP, RIVER-48, RIVER-54, RIVER-54CRP, River-54-CRP-s.p.		

			
1			
<b>GEV No.</b>	518178	<b>Ref. No.</b>	429052
<b>description</b>	wash arm bearing mounting pos. lower		
<b>For models:</b>	913992, 913993, 914583, 914592, 914612, 914613, 915143, CLEAN-3, RIVER-40, RIVER-40-CRP, RIVER-43, RIVER-44, RIVER-44-CRP, River-44-CRP-ST, RIVER-44CRP-ST		

			
1			
<b>GEV No.</b>	513161	<b>Ref. No.</b>	80310
<b>description</b>	wash arm bearing mounting pos. upper		
<b>For models:</b>	80, 81, 82, CGL74CABT, E78, FAST-181, Fast181-230V-3Ph-60Hz, Fast181-400V-3NPh-60Hz, HM1, LP60, NG291, NG292, NG292HZ, NG293, NIAGARA-291, NIAGARA-292, Niagara-292-400V-3Ph-60Hz, NIAGARA-293, RIVER-294, RIVER-295, River-295P, RIVER-296, River-296P, RIVER-71, RIVER-78, RIVER-80, River-81, River-81CRP, RIVER-81-CRP, RIVER-82, River-82CRP, RIVER-82-CRP, RIVER-E78, RIVER-HL-81, RIVER-HL-82, RV294, RV295, RV295PS, RV296, RV296PS, RV71, RV80, RV8023, RV8023HZ, RV80C, RV80HZ, RV81, RV8123, RV81A, RV81C... (Other models you can see in the webshop)		
<b>accessories for</b>	513161		
	<b>GEV No.</b>	513124	<b>Ref. No.</b> 80314 926128
	nut M24x1.5		

			
1			
<b>GEV No.</b>	518179	<b>Ref. No.</b>	429055
<b>description</b>	wash arm bearing mounting pos. upper		
<b>For models:</b>	913992, 913993, 914583, 914592, 914612, 914613, 915143, CLEAN-3, RIVER-40, RIVER-40-CRP, RIVER-43, RIVER-44, RIVER-44-CRP, River-44-CRP-ST, RIVER-44CRP-ST		

			
1			
<b>GEV No.</b>	513123	<b>Ref. No.</b>	626129 926129
<b>description</b>	wash arm bearing mounting pos. upper/lower		
<b>For models:</b>	2312-001, 2312-002, 2312-009-CRP, 914583, 914628, 914944, 915143, E.50, E.51, LP60, MISTRAL-51, NG292HZ, Niagara-292-400V-3Ph-60Hz, NIAGARA-51, River-295P, River-296P, RIVER-40-CRP, RIVER-44-CRP, RIVER-44-CRP-ST, RIVER-44CRP-ST, RIVER-50-CRP, RIVER-50-CRP-SP, RIVER-54CRP, River-54-CRP-s.p., RIVER-54-CRP-SP, River-81CRP, RIVER-81-CRP, River-82CRP, RIVER-82-CRP, RV295PS, RV296PS, RV81CCRP, RV81CRP, RV82CCRP, RV82CRP, U132, U132E, U60E, U61, U61E, U61H, U61HE, U70, U70E		
<b>accessories for</b>	513123		
	<b>GEV No.</b>	513124	<b>Ref. No.</b> 80314 926128
	nut M24x1.5		

## rinse arm shafts

			
1			
<b>GEV No.</b>	518048	<b>Ref. No.</b>	325039
<b>description</b>	extension for rinse arm shaft		
<b>For models:</b>	400F, 400FD, 40-ELECTRONIC, 40F, 40FD		

			
1			
<b>GEV No.</b>	518170	<b>Ref. No.</b>	143174
<b>description</b>	extension for rinse arm shaft		
<b>For models:</b>	050F, 050FP, 22F, 2312-001, 2312-002, 440F, 44F, 46, 460, 500F, 500FD, 50F, 50FD, 510F, 510FD, 913297, 913298, 913299, 913300, 913360, 913361, 913391, 913392, 913546, 913547, 913578, 913611, 913684, 913913, 913914, 913932, 913933, 914284, 914318, 914319, 914326, 914331, 914338, 914356, 914400, 914401, 914402, 914403, 914404, 914405, 914406, 914431, 914449, 914517, 914545...(Other models you can see in the webshop)		

			
1			
<b>GEV No.</b>	510013	<b>Ref. No.</b>	325001
<b>description</b>	rinse arm shaft		
<b>For models:</b>	11F, 11FD, 11F-DVGW, 21F, 21FD, 25F, 25FD, 30F, 30FD, 31F, 31FD, 350F, 350FD, 35-ELECTRONIC, 35F, 35FD, 400F, 400FD, 40-ELECTRONIC, 40F, 40FD, 45, 450, 67R, 913289, 913290, 913291, 913292, 913356, 913357, 913363, 913364, 913372, 913373, 913374, 913375, 913376, 913377, 913416, 913418, 913435, 913544, 913545, 913665, 913666, 913667, 913668, 913685, 913771, 913772...(Other models you can see in the webshop)		

			
1			
<b>GEV No.</b>	510056	<b>Ref. No.</b>	325025
<b>description</b>	rinse arm shaft		
<b>For models:</b>	11F, 11FD, 11F-DVGW, 11R, 11RD, 67F, 67R, 913363, 913364, 913376, 913377, E.41, E.42, E.41		

			
1			
<b>GEV No.</b>	510108	<b>Ref. No.</b>	327006
<b>description</b>	rinse arm shaft		
<b>For models:</b>	050F, 050FP, 11F, 11FD, 11F-DVGW, 21F, 21FD, 2312-001, 2312-002, 25F, 25FD, 30F, 30FD, 31F, 31FD, 400F, 400FD, 40-ELECTRONIC, 40F, 40FD, 45, 450, 46, 460, 500F, 500FD, 50-ELECTRONIC, 50F, 50FD, 510F, 510FD, 67R, 913363, 913364, 913376, 913377, 914568, 915830, E.41, E.42, E.45, E.46, E.50, E.50D.PA, E.51, E.41, F85, F85P, FAST-160DP, GSP50...(Other models you can see in the webshop)		

			
1			
<b>GEV No.</b>	511141	<b>Ref. No.</b>	926037
<b>description</b>	rinse arm shaft		
<b>For models:</b>	10, 12, 14		

			
1			
<b>GEV No.</b>	513101	<b>Ref. No.</b>	DLP940
<b>description</b>	rinse arm shaft		

			
1			
<b>GEV No.</b>	513122	<b>Ref. No.</b>	926130 DLP52
<b>description</b>	rinse arm shaft		
<b>For models:</b>	050F, 050FP, CLEAN-100, CLEAN-110, CLEAN-120, E.60, E.65, E1, E10, E100, E110, E12, E120, E14, E140, F85, F85P, U132, U132E, U61, U61E, U61H, U61HE, U70, U70E		

			
1			
<b>GEV No.</b>	513159	<b>Ref. No.</b>	80380
<b>description</b>	rinse arm shaft		
<b>For models:</b>	80, 81, 82, CGL74CABT, E78, FAST-181, HM1, KLP105EB, KL-P201DDDTBE, KLP201EB, KLP301, KLP301DDDTBE, LP105DDDTBE, LP105DDDTBE, LP105EB, LP201DDDTBE, LP201EB, LP301, LP301EB, LP60, NG291, NG292, NG293, NIAGARA-291, NIAGARA-292, NIAGARA-293, RIVER-294, RIVER-295, RIVER-296, RIVER-297, RIVER-298, RIVER-71, RIVER-78, RIVER-80, RIVER-81, River-81CRP, RIVER-81-CRP, RIVER-82, River-82CRP, RIVER-82-CRP, RIVER-E78, RIVER-HL-81, RIVER-HL-82, RV294, RV295, RV296, RV297, RV298, RV298HZ, RV71...(Other models you can see in the webshop)		

			
1			
<b>GEV No.</b>	513160	<b>Ref. No.</b>	80282
<b>description</b>	rinse arm shaft		
<b>For models:</b>	80, 81, 82, CE78HZ23, CGL74CABT, E78, E78HP, FAST-181, Fast181-230V-3Ph-60Hz, Fast181-400V-3NPh-60Hz, HM1, NG291, NG292, NG292HZ, NG293, NIAGARA-291, NIAGARA-292, Niagara-292-400V-3Ph-60Hz, NIAGARA-293, RIVER-294, RIVER-295, River-295P, RIVER-296, River-296P, RIVER-71, RIVER-78, RIVER-80, RIVER-81, River-81CRP, RIVER-81-CRP, RIVER-82, River-82CRP, RIVER-82-CRP, RIVER-E78, RIVER-HL-81, RIVER-HL-82, RV294, RV295, RV295PS, RV296, RV296PS, RV71, RV80, RV8023, RV8023HZ, RV80C, RV80HZ, RV81, RV8123, RV81A...(Other models you can see in the webshop)		

			
1			
<b>GEV No.</b>	518014	<b>Ref. No.</b>	325011
<b>description</b>	rinse arm shaft		
<b>For models:</b>	12, 14, 22F, 350R, 350RD, 35-ELECTRONIC, 35R, 35RD, 40F, 440F, 44F, 500F, 500FD, 50F, 50FD, 510F, 510FD, 66, S651, S654, S810, S815, S830, S835		

			
1			
<b>GEV No.</b>	518023	<b>Ref. No.</b>	926038
<b>description</b>	rinse arm shaft		
<b>For models:</b>	10, CLEAN-110		

			
1			
<b>GEV No.</b>	518034	<b>Ref. No.</b>	325031
<b>description</b>	rinse arm shaft		
<b>For models:</b>	22F, 40F, 44F, E.52		

			
1			
<b>GEV No.</b>	518042	<b>Ref. No.</b>	325043
<b>description</b>	rinse arm shaft		
<b>For models:</b>	350F, 350FD, 35-ELECTRONIC, 35F, 35FD		

			
1			
<b>GEV No.</b>	518172	<b>Ref. No.</b>	325064
<b>description</b>	rinse arm shaft		
<b>For models:</b>	914684, E.35, E.35H, E.40, E.40H, GLS40H, GLS40HP, MC201CL, MINIBAR, MISTRAL-40, NIAGARA-35, NIAGARA-40, RIVER-39, S280		







			
<b>GEV No.</b>	518185	<b>Ref. No.</b>	325048
<b>description</b>	rinse arm shaft		
<b>For models:</b>	913992, 913993, 914583, 914592, 914612, 914613, 915143, CLEAN-3, RIVER-40, RIVER-40-CRP, RIVER-43, RIVER-44, RIVER-44-CRP, River-44-CRP-ST, RIVER-44CRP-ST		

			
<b>GEV No.</b>	517571	<b>Ref. No.</b>	325078
<b>description</b>	rinse arm shaft H 67mm thread M5 thread L 4.5mm		
<b>For models:</b>	913289, 913290, 913291, 913292, 913356, 913357, 913372, 913373, 913374, 913375, 913416, 913435, 913544, 913545, 913665, 913666, 913667, 913668, 913685, 913771, 913772, 913773, 913774, 913832, 913837, 913911, 913912, 913948, 913950, 913977, 913984, 913990, 914165, 914166, 914206, 914214, 914316, 914317, 914355, 914386, 914387, 914388, 914389, 914390, 914391, 914392, 914393, 914394, 914395, 914396...(Other models you can see in the webshop)		

			
<b>GEV No.</b>	518283	<b>Ref. No.</b>	325069
<b>description</b>	rinse arm shaft		
<b>For models:</b>	2312-007, 2312-009-CRP, 914100, 914101, 914339, 914342, 914343, 914624, 914625, 914626, 914627, 914628, 914850, 914851, 914854, 914944, RIVER-48, RIVER-50, RIVER-50-CRP, RIVER-50-CRP-SP, River-54, RIVER-54CRP, River-54-CRP-s.p., RIVER-54-CRP-SP, RIVER-61		

			
<b>GEV No.</b>	518405	<b>Ref. No.</b>	325045
<b>description</b>	rinse arm shaft mounting pos. lower		
<b>For models:</b>	46, 460, E.46, GSP50, GSP50P, GSP51, GSP51P, P500, RIVER-40		

			
<b>GEV No.</b>	518285	<b>Ref. No.</b>	325071
<b>description</b>	rinse arm shaft		
<b>For models:</b>	2312-007, 2312-009-CRP, 913992, 913993, 914100, 914101, 914339, 914342, 914343, 914583, 914592, 914612, 914613, 914624, 914625, 914626, 914627, 914628, 914850, 914851, 914854, 914944, 915143, E.55, RIVER-40, RIVER-40-CRP, RIVER-43, RIVER-44, RIVER-44-CRP, RIVER-44-CRP-ST, RIVER-44CRP-ST, RIVER-48, RIVER-50, RIVER-50-CRP, RIVER-50-CRP-SP, RIVER-54, RIVER-54CRP, River-54-CRP-s.p., RIVER-54-CRP-SP, RIVER-61		

			
<b>GEV No.</b>	524096	<b>Ref. No.</b>	80283
<b>description</b>	rinse arm shaft mounting pos. lower ø 16mm H 38mm thread M12x1.75		
<b>For models:</b>	80, 81, 82, CE78HZ23, CGL74CABT, E78, E78HP, Fast181, FAST-181, Fast181-230V-3Ph-60Hz, Fast181-400V-3NPh-60Hz, HM1, NG291, NIAGARA-291, RIVER-294, RIVER-78, RIVER-80, River-81, River-81CRP, RIVER-81-CRP, RIVER-82, River-82CRP, RIVER-82-CRP, RIVER-E78, RIVER-HL-81, RIVER-HL-82, RV294, RV71, RV80, RV8023, RV8023HZ, RV80C, RV80HZ, RV81, RV8123, RV81A, RV81C, RV81CCRP, RV81CRP, RV81HZ, RV81HZ23, RV81PAP, RV82, RV8223, RV82C, RV82CCRP, RV82CRP, SevenL, ST70FAST, ST70FASTHB...(Other models you can see in the webshop)		

			
<b>GEV No.</b>	518287	<b>Ref. No.</b>	325070
<b>description</b>	rinse arm shaft		
<b>For models:</b>	2312-007, 2312-009-CRP, 914100, 914101, 914339, 914342, 914343, 914624, 914625, 914626, 914627, 914628, 914850, 914851, 914854, 914944, E.55, RIVER-48, RIVER-50, RIVER-50-CRP, RIVER-50-CRP-SP, River-54, RIVER-54CRP, River-54-CRP-s.p., RIVER-54-CRP-SP, RIVER-61		

			
<b>GEV No.</b>	513224	<b>Ref. No.</b>	926127
<b>description</b>	rinse arm shaft mounting pos. upper		
<b>For models:</b>	CLEAN-100, CLEAN-110, CLEAN-120, E1, E10, E100, E110, E12, E120, E14, E140		

			
<b>GEV No.</b>	518420	<b>Ref. No.</b>	926154
<b>description</b>	rinse arm shaft		
<b>For models:</b>	050F, 050FP, CLEAN-100, CLEAN-110, CLEAN-120, E.60, E.65, E1, E10, E100, E110, E12, E120, E14, E140, F85, F85P		

			
<b>GEV No.</b>	517445	<b>Ref. No.</b>	80700
<b>description</b>	rinse arm shaft mounting pos. upper/lower H 36mm thread M10x1 thread L 9mm		
<b>For models:</b>	915830, Fast160DP		

			
<b>GEV No.</b>	518456	<b>Ref. No.</b>	325063
<b>description</b>	rinse arm shaft		
<b>For models:</b>	2312-001, 2312-002, 500F, 500FD, 50F, 50FD, 510F, 510FD, E.50, E.51, E.52, LF50, LF55, MCS01E, MCS01EP, MCS01S, MCS01SP, MISTRAL-51, NIAGARA-51		

			
<b>GEV No.</b>	518151	<b>Ref. No.</b>	143199
<b>description</b>	rinse pipe		
<b>For models:</b>	913418, 914167, 914168, 914398, 914399, 914443, 914943, 915695, 915696, 915819, E.45, Fast145, FAST-145, Fast145D, FAST-145D, NIAGARA-45		

## for toasters

pliers

pliers



1

<b>GEV No.</b>	690010	<b>Ref. No.</b>	433004
<b>description</b>	plier for toaster H 180mm total length 100mm		
<b>For models:</b>	404, 406, 412		

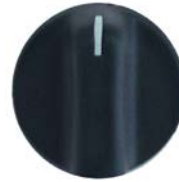

1

<b>GEV No.</b>	110339	<b>Ref. No.</b>	447059 447147
<b>description</b>	knob switch zero mark ø 40mm shaft ø 6x4.6mm shaft flat lower black		
<b>For models:</b>	337, 338, 343, 344, FRI12, FRI12+12, FRI6, FRI6+6, FRI9, FRI9+9, ME15, ME20, ME30, ME40		



1

<b>GEV No.</b>	110354	<b>Ref. No.</b>	921002
<b>description</b>	knob switch zero mark ø 47mm shaft ø 6x4.6mm shaft flat lower black		
<b>For models:</b>	305, 305S, 306, 306S, 307, 307S, 308, 308S, 313, 313S, 314, 314S, 319, 319S, 320, 320S, 337, 338, 343, 344, 433, 434, 436, 437, 438, 439, FRI12, FRI12+12, FRI15, FRI15M, FRI6, FRI6+6, FRI9, FRI9+9, ME15, ME20, ME30, ME40		



1

<b>GEV No.</b>	110285	<b>Ref. No.</b>	921039
<b>description</b>	knob switch zero mark t.max.°C ø 40mm shaft ø 6x4.6mm shaft flat upper black		
<b>For models:</b>	G33, G34, G37, G38, G39		



1

<b>GEV No.</b>	110086	<b>Ref. No.</b>	447089
<b>description</b>	knob switch zero mark t.max.°C ø 45mm shaft ømm shaft flat special black		
<b>For models:</b>	10, 12, 22F, 22R, 40F, 66, CLEAN-100, CLEAN-110, CLEAN-120		
<b>accessories for</b>	110086		



<b>GEV No.</b>	110085	<b>Ref. No.</b>	226051
<b>description</b>	push button t.max.°C ø 36mm shaft ømm shaft flat grey for knob		

## knobs

## producer-specific knobs

## ELETTROBAR



1

<b>GEV No.</b>	510096	<b>Ref. No.</b>	447007
<b>description</b>	knob		
<b>For models:</b>	R495, R497, R499, R501, R503, R505, R507, R509, R511, R704, R706, R708, S641, S643, S870		



1

<b>GEV No.</b>	110004	<b>Ref. No.</b>	999044
<b>description</b>	knob switch zero mark ø 38mm shaft ø 4x4mm black		
<b>For models:</b>	404, 406, 412		





1

<b>GEV No.</b>	110326	<b>Ref. No.</b>	999081
<b>description</b>	knob switch zero mark ø 38mm shaft ø 6x4.6mm shaft flat lower brown		
<b>For models:</b>	412		



			
1			
<b>GEV No.</b>	111434	<b>Ref. No.</b>	447148 999045
<b>description</b>	knob switch zero mark t.max.°C ø 46mm shaft ø 5x5mm shaft flat horizontal black		
<b>For models:</b>	404, 406, ME15, ME20, ME30, ME40		

			
1			
<b>GEV No.</b>	110900	<b>Ref. No.</b>	999125
<b>description</b>	knob zero mark ø 39mm shaft ø 6x4.6mm shaft flat left black		

			
1			
<b>GEV No.</b>	110085	<b>Ref. No.</b>	226051
<b>description</b>	push button t.max.°C ø 36mm shaft ømm shaft flat grey for knob		
<b>For models:</b>	10, 12, 22F, 22R, 40F, 66, CLEAN-100, CLEAN-110, CLEAN-120		

			
1			
<b>GEV No.</b>	518532	<b>Ref. No.</b>	480091 480127
<b>description</b>	end cap mounting pos. left		
<b>For models:</b>	913289, 913290, 913291, 913292, 913356, 913357, 913363, 913364, 913372, 913373, 913374, 913375, 913376, 913377, 913416, 913418, 913435, 913544, 913545, 913665, 913666, 913667, 913668, 913685, 913771, 913772, 913773, 913774, 913832, 913837, 913911, 913912, 913948, 913950, 913977, 913984, 913990, 913992, 913993, 914165, 914166, 914167, 914168, 914206, 914355, 914386, 914387, 914388, 914389, 914390...(Other models you can see in the webshop)		

			
1			
<b>GEV No.</b>	518534	<b>Ref. No.</b>	480097
<b>description</b>	end cap mounting pos. left		
<b>For models:</b>	E.46, E.50, E.51, E.52, KLP105EB, KLP201DDDTEB, KLP201EB, KLP301DDDTEB, LP105DDDTEB, LP105DDDTEBN, LP105EB, LP201DDDTEB, LP201EB, LP301EB, NIAGARA-51, U132, U132e, U61, U61E, U61H, U61He, U70, U70e		

## handles and hand wheels

### handle rails

#### end caps

			
1			
<b>GEV No.</b>	518530	<b>Ref. No.</b>	480043
<b>description</b>	end cap mounting pos. left		
<b>For models:</b>	2312-001, 2312-002, 45, 450, 46, 460, 915695, 915696, 915819, FAST-145, Fast145D, FAST-145D		

			
1			
<b>GEV No.</b>	518529	<b>Ref. No.</b>	480042
<b>description</b>	end cap mounting pos. right		
<b>For models:</b>	2312-001, 2312-002, 45, 450, 46, 460, 915695, 915696, 915819, FAST-145, Fast145D, FAST-145D, TF-503, TF-513, TF-515		

			
1			
<b>GEV No.</b>	518531	<b>Ref. No.</b>	480092 480128
<b>description</b>	end cap mounting pos. right		
<b>For models:</b>	913289, 913290, 913291, 913292, 913356, 913357, 913363, 913364, 913372, 913373, 913374, 913375, 913376, 913377, 913416, 913418, 913435, 913544, 913545, 913665, 913666, 913667, 913668, 913685, 913771, 913772, 913773, 913774, 913832, 913837, 913911, 913912, 913948, 913950, 913977, 913984, 913990, 913992, 913993, 914165, 914166, 914167, 914168, 914206, 914355, 914386, 914387, 914388, 914389, 914390...(Other models you can see in the webshop)		



## miscellaneous



1

<b>GEV No.</b>	513094	<b>Ref. No.</b>	DWM78
----------------	--------	-----------------	-------

<b>description</b>	door handle
--------------------	-------------



1

<b>GEV No.</b>	513095	<b>Ref. No.</b>	DWM69
----------------	--------	-----------------	-------

<b>description</b>	door handle
--------------------	-------------



1

<b>GEV No.</b>	513108	<b>Ref. No.</b>	DWM61
----------------	--------	-----------------	-------

<b>description</b>	handle
--------------------	--------

## accessories

## miscellaneous



1

<b>GEV No.</b>	513098	<b>Ref. No.</b>	DWP296
----------------	--------	-----------------	--------

<b>description</b>	screw for door handle
--------------------	-----------------------

## pullouts

## rollers

## rollers



1

<b>GEV No.</b>	518363	<b>Ref. No.</b>	499078
----------------	--------	-----------------	--------

<b>description</b>	roller rollers 36mm B1 10mm overall width 22mm A 36mm B 10mm C 22mm ø 20.5mm plastic tread plastic
--------------------	--

<b>For models:</b>	2312-007, 2312-009-CRP, 913992, 913993, 914100, 914101, 914339, 914342, 914343, 914583, 914592, 914612, 914613, 914624, 914625, 914626, 914627, 914628, 914850, 914851, 914854, 914944, 915143, CLEAN-3, RIVER-40, RIVER-40-CRP, RIVER-43, RIVER-44, RIVER-44-CRP, RIVER-44-CRP-ST, RIVER-44CRP-ST, RIVER-48, RIVER-50, RIVER-50-CRP, RIVER-50-CRP-SP, RIVER-54, RIVER-54CRP, River-54-CRP-s.p., RIVER-54-CRP-SP, RIVER-61
--------------------	--

## fittings for catering equipment

## outlet taps

## universal



1

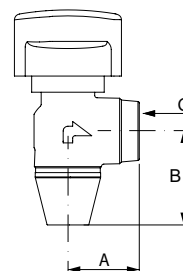

<b>GEV No.</b>	540699	<b>Ref. No.</b>	720008
----------------	--------	-----------------	--------

<b>description</b>	outlet tap W 35mm H 35mm thread 3/4" IT
--------------------	---

<b>For models:</b>	FRI12, FRI12+12, FRI6, FRI6+6, FRI9, FRI9+9
--------------------	---



## equipment feet and end caps

### equipment feet

with screw mounting

universal



1

<b>GEV No.</b>	700868	<b>Ref. No.</b>	73100
<b>description</b>	equipment foot tube ø 64mm thread M12 thread L 25mm H 155-235mm SS size 2 1/2" Qty 1 pcs		
<b>For models:</b>	A3EB, A3EBDAKRKYK, A3EBDRKYK, A3EBSAKRK, A3EBSEKWK, A4EB, A4EBDAKEKYK, A4EBDAKRK, A4EBDAKWK, A4EBDAKZK, A4EBDBKRK, A4EBDPKWYK, A4EBDRK, A4EBSAK, A4EBSAKCK, A4EBSAKEKYK, A4EBSAKRKP, A4EBT, A4EBTSAK, A5EB, A5EBDAKYK, A5EBDRK, A5EBSAKRK, A5EBSAKRKYK, A5EBSAKWK, A5EBSAKWKYK, A5EBSBKRKP, A5EBSBKWK, A5EBSRK, CNT800CH, Fast180, Fast180-230V-3Ph-60Hz, Fast181, Fast181-230V-3Ph-60Hz, Fast181-400V-3NPh-60Hz, Fast200, Fast93, GL280EB, GL280EB23, GL280EB23DAR, GL280EB23HZ, GL280EB23HZDY, GL280EBDARY, GL280EBDAW, GL280EBDAY, GL280EBDB, GL280EBDBR, GL280EBDWY, GL280EBSA, GL280EBSAE...(Other models you can see in the webshop)		



1

<b>GEV No.</b>	513287	<b>Ref. No.</b>	79028 926117
<b>description</b>	equipment foot tube ø 60mm thread M12 thread L 33mm H 155-235mm SS size 2" Qty 1 pcs		
<b>For models:</b>	80, 81, 82, 914100, 914101, 914326, 914380, 914406, 914436, 914624, 914625, 914627, 914628, 914850, 914851, 914854, 914944, 915175, 915176, 915177, 915663, 915729, A3EBD, A3EBDAKWK, A3EBDBKWK, A3EBDWK, A3EBDYK, A3EBSAK, A3EBSAKWK, A3EBSBKWKYK, A3EBSWK, A4EBD, A4EBS, A4EBSAKRK, A4EBSAKYK, A4EBSCK, A5EBD, A5EBDAKPKWK, A5EBDAKWK, A5EBS, A5EBSAKPKWK, A5EBSYK, CE78HZ23, CGL74CABT, E.55, E78, E78HP, FAST-181, FAST-200, FAST-60...(Other models you can see in the webshop)		

### screw-in feet



1

<b>GEV No.</b>	695601	<b>Ref. No.</b>	461010
<b>description</b>	equipment foot thread M17 thread L 23mm ø 24mm H 11mm plastic WS 24 Qty 1 pcs		
<b>For models:</b>	11F, 11FD, 11F-DVGW, 11R, 11RD, 21F, 21FD, 21R, 21RD, 25F, 25FD, 25R, 25RD, 30F, 30FD, 30R, 30RD, 31F, 31FD, 31R, 31RD, 350F, 350FD, 350R, 350RD, 35-ELECTRONIC, 35F, 35FD, 35R, 35RD, 67F, 67R, 913289, 913290, 913291, 913292, 913356, 913357, 913363, 913364, 913372, 913373, 913374, 913375, 913376, 913377, 913416, 913435, 913544, 913545...(Other models you can see in the webshop)		



1

<b>GEV No.</b>	513284	<b>Ref. No.</b>	461019
<b>description</b>	equipment foot thread M8 thread L 20mm ø 30mm H 12mm Qty 1 pcs		
<b>For models:</b>	050F, 050FP, 2312-001, 2312-002, 2312-007, 2312-009-CRP, 45, 450, 46, 460, 500F, 500FD, 50F, 50FD, 510F, 510FD, 913297, 913298, 913299, 913300, 913360, 913361, 913391, 913392, 913418, 913546, 913547, 913578, 913611, 913684, 913913, 913914, 913932, 913933, 913992, 913993, 914100, 914101, 914167, 914168, 914284, 914318, 914319, 914331, 914338, 914339, 914342, 914343, 914356, 914398...(Other models you can see in the webshop)		

## baskets

### fryer baskets

ELETTROBAR



1

<b>GEV No.</b>	970295	<b>Ref. No.</b>	706089
<b>description</b>	fryer basket L1 295mm W1 200mm H1 110mm chrome-plated steel		
<b>For models:</b>	FRI12, FRI12+12, FRI6, FRI6+6, FRI9, FRI9+9		



1

<b>GEV No.</b>	970298	<b>Ref. No.</b>	706092
<b>description</b>	fryer basket L1 300mm W1 225mm H1 120mm		
<b>For models:</b>	ME15, ME20, ME30, ME40, MG15, MG20, MG30, MG40		



1

<b>GEV No.</b>	970296	<b>Ref. No.</b>	706090
<b>description</b>	fryer basket L1 325mm W1 220mm H1 110mm		
<b>For models:</b>	FRI12, FRI12+12, FRI15, FRI15M, FRI6, FRI6+6, FRI9, FRI9+9		



1

<b>GEV No.</b>	970300	<b>Ref. No.</b>	706093
<b>description</b>	fryer basket L1 390mm W1 235mm H1 120mm L2 560mm H3 300mm chrome-plated steel		

## warewashing baskets

### steel wire baskets round

#### mix baskets

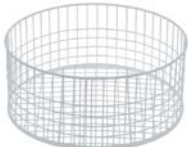

1

<b>GEV No.</b>	970320	<b>Ref. No.</b>	983015 988015
<b>description</b>	mix basket ED ø 370mm H 170mm seat ømm		



1

<b>GEV No.</b>	970321	<b>Ref. No.</b>	983026
<b>description</b>	mix basket ED ø 370mm H 195mm seat ømm		



1

<b>GEV No.</b>	970322	<b>Ref. No.</b>	983025
<b>description</b>	mix basket ED ø 400mm H 190mm seat ø 375mm		

### steel wire baskets octagonal

#### mix baskets

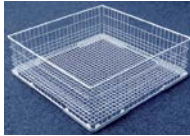

1

<b>GEV No.</b>	971016 <sup>1</sup>	<b>Ref. No.</b>	983036
<b>description</b>	mix basket L 382mm W 382mm H 130mm mesh type close-meshed		

<sup>1</sup>fine-meshed



1

<b>GEV No.</b>	971015 <sup>1</sup>	<b>Ref. No.</b>	983001
<b>description</b>	mix basket L 382mm W 382mm H 200mm mesh type wide-meshed		

<sup>1</sup>wide-meshed



1

<b>GEV No.</b>	971013 <sup>1</sup>	<b>Ref. No.</b>	938055 983039 983055
<b>description</b>	mix basket L 382mm W 382mm H 90mm mesh type wide-meshed		

<sup>1</sup>wide-meshed



1

<b>GEV No.</b>	970072 <sup>1</sup>	<b>Ref. No.</b>	983032
<b>description</b>	mix basket L 500mm W 500mm H 100mm mesh type wide-meshed		

<sup>1</sup>wide-meshed



1

<b>GEV No.</b>	970074 <sup>1</sup>	<b>Ref. No.</b>	983033
<b>description</b>	mix basket L 500mm W 500mm H 130mm mesh type close-meshed		

<sup>1</sup>fine-meshed

 <p>1</p>			
<b>GEV No.</b>	971089 <sup>1</sup>	<b>Ref. No.</b>	41301 706125
<b>description</b>	mix basket L 610mm W 550mm H 175mm		

<sup>1</sup>wide-meshed

## plate baskets

 <p>1</p>			
<b>GEV No.</b>	970071	<b>Ref. No.</b>	983031
<b>description</b>	plate basket L 500mm W 500mm H 100mm plates 18 plate ø 250mm		

 <p>1</p>			
<b>GEV No.</b>	971127	<b>Ref. No.</b>	983027
<b>description</b>	plate basket L 500mm W 500mm H 105mm plates 16 plate ø 240mm		

 <p>1</p>			
<b>GEV No.</b>	971053	<b>Ref. No.</b>	983030
<b>description</b>	plate basket L 540mm W 540mm H 100mm plates 22 plate ø 270mm		

## glass basket

 <p>1</p>			
<b>GEV No.</b>	971017	<b>Ref. No.</b>	983041 988041
<b>description</b>	glass basket L 382mm W 382mm H 170mm number of rows 3 rows spacing 120mm		
<b>spare parts for</b>	971017		
	<b>GEV No.</b>	970001	<b>Ref. No.</b> —
	sliding corner wire gauge ø 5mm L 120mm W 120mm H 12mm L-shape		

 <p>1</p>			
<b>GEV No.</b>	971018	<b>Ref. No.</b>	938038 983038
<b>description</b>	glass basket L 382mm W 382mm H 170mm number of rows 4 rows spacing 85mm inclined bottom		

## plastic baskets octagonal

### tray baskets

 <p>1</p>			
<b>GEV No.</b>	970829	<b>Ref. No.</b>	780106
<b>description</b>	tray rack L 500mm W 500mm H 110mm mesh type wide-meshed for 8 trays for size 530x370		

## accessories

### cutlery inserts

 <p>1</p>			
<b>GEV No.</b>	976013	<b>Ref. No.</b>	712001 712003 712019
<b>description</b>	cutlery insert L 105mm W 105mm ømm H 140mm		

 <p>1</p>			
<b>GEV No.</b>	976016	<b>Ref. No.</b>	780068
<b>description</b>	cutlery insert L 110mm W 110mm ømm H 130mm		

## section inserts for glasses

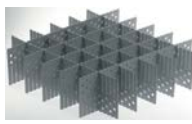
 <p>1</p>			
<b>GEV No.</b>	970302	<b>Ref. No.</b>	712006
<b>description</b>	section insert for glasses L 400mm W 400mm H 105mm 10-piece		

sliding corners



<b>GEV No.</b>	970830	<b>Ref. No.</b>	461003
<b>description</b>	sliding corner L 120mm W 120mm L-shape for 970829		
<b>For models:</b>	S621, S623, S631, S633, S641, S643, S651, S651P, S653, S810, S830, S850, S870		



<b>GEV No.</b>	970820	<b>Ref. No.</b>	75075
<b>description</b>	sliding corner L 44mm W 44mm H 17mm		
<b>For models:</b>	914380, 914436, A3EB, A3EBD, A3EBDAKRKYK, A3EBDAKWK, A3EBDBKWK, A3EBDRKYK, A3EBDWK, A3EBDYK, A3EBSAK, A3EBSAKRK, A3EBSAKWK, A3EBSBKWKYK, A3EBSEKWK, A3EBSWK, A4EB, A4EBD, A4EBDAKEKYK, A4EBDAKRK, A4EBDAKWK, A4EBDAKZK, A4EBDBKRK, A4EBDPKWKYK, A4EBDRK, A4EBS, A4EBSAK, A4EBSAKCK, A4EBSAKKEYK, A4EBSAKRK, A4EBSAKRKPK, A4EBSAKYK, A4EBSCK, A4EBT, A4EBTSAK, A5EB, A5EBD, A5EBDAKPKWK, A5EBDAKWK, A5EBDAKYK, A5EBDRK, A5EBS, A5EBSAKPKWK, A5EBSAKRK, A5EBSAKRKYK, A5EBSAKWK, A5EBSAKWKYK, A5EBSBKRPK, A5EBSBKWK, A5EBSRK...(Other models you can see in the webshop)		

plate inserts



<b>GEV No.</b>	970517	<b>Ref. No.</b>	712004
<b>description</b>	plate insert L 320mm W 80mm plates 12		

**gaskets**

refrigeration gaskets

screw-in gaskets

profile 9663

We offer custom-made gaskets for this profile

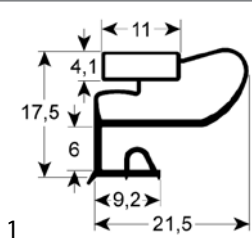

<b>GEV No.</b>	901980	<b>Ref. No.</b>	025698-00R
<b>description</b>	refrigeration gasket profile 9663 W 302mm L 424mm external size		

O-rings

EPDM



<b>GEV No.</b>	361304	<b>Ref. No.</b>	456042
<b>description</b>	O-ring EPDM ID $\phi$ 11.11mm thickness 1.78mm Qty 1 pcs for type DIB3E/DIB5E		
<b>For models:</b>	350R, 350RD, 35-ELECTRONIC, 35R, 35RD, 67R, E.42, MINIBAR, S280		

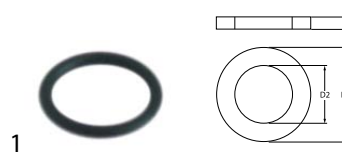

<b>GEV No.</b>	529545	<b>Ref. No.</b>	456051
<b>description</b>	O-ring EPDM thickness 1.78mm ID $\phi$ 10.82mm Qty 1 pcs		
<b>For models:</b>	67F, 67R, 913363, 913364, 913376, 913377, E.41, E.42, E41		

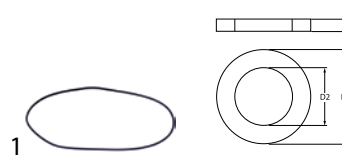

<b>GEV No.</b>	521717	<b>Ref. No.</b>	456031
<b>description</b>	O-ring EPDM thickness 1.78mm ID $\phi$ 120.37mm Qty 1 pcs		

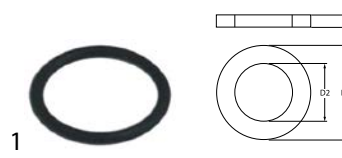

<b>GEV No.</b>	504512	<b>Ref. No.</b>	456017
<b>description</b>	O-ring EPDM thickness 1.78mm ID $\phi$ 14mm Qty 1 pcs		
<b>For models:</b>	66, R495, R497, R499, R501, R503, R505, R507, R509, R511, R704, R706, R708, S621, S623, S624, S626, S631, S633, S634, S636, S641, S643, S651, S651P, S653, S654, S655, S810, S815, S830, S835, S850, S870, S950, SR651		

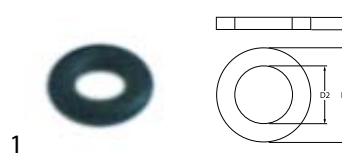

<b>GEV No.</b>	511500	<b>Ref. No.</b>	456014
<b>description</b>	O-ring EPDM thickness 1.78mm ID $\phi$ 2.9mm Qty 10 pcs		
<b>For models:</b>	21F, 21FD, 21R, 21RD, 25F, 25FD, 25R, 25RD, 30F, 30FD, 30R, 30RD, 31F, 31FD, 31R, 31RD, 44F		





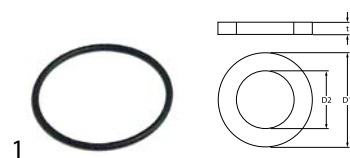

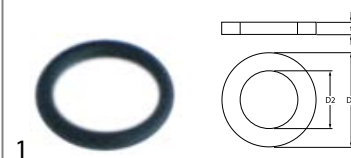
			
<b>GEV No.</b>	513057	<b>Ref. No.</b>	927094
<b>description</b>	O-ring EPDM thickness 1.78mm ID $\phi$ 28.3mm Qty 1 pcs		
<b>For models:</b>	161, 221, 271, 272, 362, CLEAN-160, CLEAN-161, CLEAN-220, CLEAN-221, CLEAN-270, CLEAN-271, CLEAN-272, CLEAN-361, CLEAN-361P, CLEAN-362, CLEAN-471, CLEAN-471P		

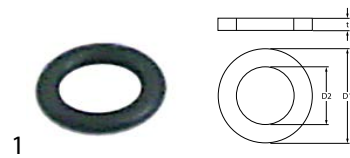
			
<b>GEV No.</b>	510177	<b>Ref. No.</b>	456018 CGR2031
<b>description</b>	O-ring EPDM thickness 1.78mm ID $\phi$ 7.66mm Qty 1 pcs		
<b>For models:</b>	10, 11F, 11FD, 11F-DVGW, 11R, 11RD, 12, 14, 161, 21F, 21FD, 21R, 21RD, 221, 22R, 25F, 25FD, 25R, 25RD, 271, 272, 30F, 30FD, 30R, 30RD, 31F, 31FD, 31R, 31RD, 362, 440F, 44F, 46, 460, 500F, 500FD, 50F, 50FD, 510F, 510FD, A4EBT, A4EBTSAK, C13, CLEAN-100, CLEAN-110, CLEAN-120, CLEAN-160, CLEAN-161, CLEAN-220, CLEAN-221...(Other models you can see in the webshop)		

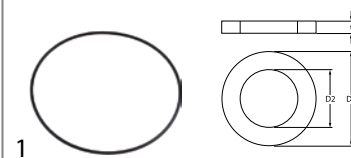
			
<b>GEV No.</b>	505045	<b>Ref. No.</b>	456009
<b>description</b>	O-ring EPDM thickness 1.78mm ID $\phi$ 5.28mm Qty 1 pcs		
<b>For models:</b>	11F, 11FD, 11F-DVGW, 11R, 11RD, 350F, 350FD, 350R, 350RD, 35-ELECTRONIC, 35F, 35FD, 35R, 35RD, 400F, 400FD, 400R, 400RD, 40-ELECTRONIC, 40F, 40FD, 40R, 40RD, 500F, 500FD, E.35, E.40, MC201CL		

			
<b>GEV No.</b>	513275	<b>Ref. No.</b>	456074
<b>description</b>	O-ring EPDM thickness 1.78mm ID $\phi$ 82.27mm Qty 1 pcs		
<b>For models:</b>	913289, 913290, 913291, 913292, 913356, 913357, 913372, 913373, 913374, 913375, 913416, 913435, 913544, 913545, 913665, 913666, 913667, 913668, 913685, 913771, 913772, 913773, 913774, 913832, 913837, 913911, 913912, 913948, 913950, 913977, 913984, 913990, 914165, 914166, 914206, 914214, 914316, 914317, 914355, 914386, 914387, 914388, 914389, 914390, 914391, 914392, 914393, 914394, 914395, 914396...(Other models you can see in the webshop)		

			
<b>GEV No.</b>	528485	<b>Ref. No.</b>	456060
<b>description</b>	O-ring EPDM thickness 1.78mm ID $\phi$ 6.07mm Qty 1 pcs		
<b>For models:</b>	2312-007, 2312-009-CRP, 80, 81, 82, 913992, 913993, 914100, 914101, 914339, 914342, 914343, 914583, 914592, 914612, 914613, 914624, 914625, 914626, 914627, 914628, 914850, 914851, 914854, 914944, 915143, 915830, E78, Fast160DP, FAST-181, HM1, KLP105EB, KLP201DDDTTEB, KLP201EB, KLP301, KLP301DDDTTEB, LP105DDDTTEB, LP105DDDTTEBN, LP105EB, LP201DDDTTEB, LP201EB, LP301, LP301EB, NG291, NG292, NG293, NIAGARA-291, NIAGARA-292, NIAGARA-293, RIVER-294...(Other models you can see in the webshop)		

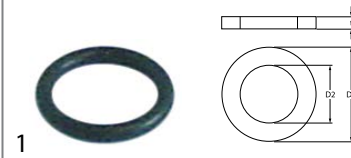
			
<b>GEV No.</b>	504574	<b>Ref. No.</b>	456019
<b>description</b>	O-ring EPDM thickness 1.78mm ID $\phi$ 9.25mm Qty 1 pcs		
<b>For models:</b>	11F, 11FD, 11F-DVGW, 11R, 11RD, 44F, 913289, 913290, 913291, 913292, 913356, 913357, 913372, 913373, 913374, 913375, 913416, 913435, 913544, 913545, 913665, 913666, 913667, 913668, 913685, 913771, 913772, 913773, 913774, 913832, 913837, 913911, 913912, 913948, 913950, 913977, 913984, 913990, 914165, 914166, 914206, 914214, 914316, 914317, 914355, 914386, 914387, 914388, 914389, 914390...(Other models you can see in the webshop)		

			
<b>GEV No.</b>	510303	<b>Ref. No.</b>	456030 CGR106
<b>description</b>	O-ring EPDM thickness 1.78mm ID $\phi$ 6.75mm Qty 1 pcs		
<b>For models:</b>	050F, 050FP, 914568, 915830, E.50D.PA, E.55, E.65, F85, F85P, FAST-160DP, Fast181-230V-3Ph-60Hz, Fast181-400V-3NPh-60Hz, MINIBAR, NG292HZ, Niagara-292-400V-3Ph-60Hz, River-295P, River-296P, RIVER-40, RIVER-43, RIVER-50, RIVER-50-CRP, RIVER-61, RIVER-80, RIVER-81, RIVER-82, RV295PS, RV296PS, S280, ST70FASTHB400, U132, U61, U61E, U61H, U61HE, U70		

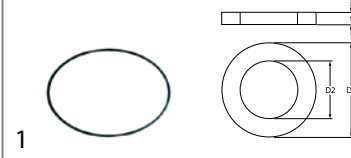
			
<b>GEV No.</b>	510556	<b>Ref. No.</b>	456022
<b>description</b>	O-ring EPDM thickness 1.78mm ID $\phi$ 94.97mm Qty 1 pcs pump type T110		
<b>For models:</b>	CLEAN-3, RIVER-43, S651, S651P, S653, S654, S655, S830, S835, SR651		

<b>GEV No.</b>	529412	<b>Ref. No.</b>	456006 456048
<b>description</b>	O-ring EPDM thickness 2.62mm ID $\varnothing$ 10.78mm Qty 1 pcs		
<b>For models:</b>	050F, 050FP, 11F, 11FD, 11F-DVGW, 11R, 11RD, 21F, 21FD, 21R, 21RD, 22F, 22R, 25F, 25FD, 25R, 25RD, 30F, 30FD, 30R, 30RD, 31F, 31FD, 31R, 31RD, 40F, 440F, 44F, 500F, 500FD, 50-ELECTRONIC, 50F, 50FD, 510F, 510FD, 55, 66, 913289, 913290, 913291, 913292, 913356, 913357, 913372, 913373, 913374, 913375, 913416, 913435, 913544...(Other models you can see in the webshop)		

<b>GEV No.</b>	511510	<b>Ref. No.</b>	456070
<b>description</b>	O-ring EPDM thickness 2.62mm ID $\varnothing$ 15.54mm Qty 10 pcs		
<b>For models:</b>	913289, 913290, 913291, 913292, 913297, 913298, 913299, 913300, 913356, 913357, 913360, 913361, 913372, 913373, 913374, 913375, 913391, 913392, 913416, 913418, 913435, 913544, 913545, 913546, 913547, 913578, 913611, 913665, 913666, 913667, 913668, 913684, 913685, 913771, 913772, 913773, 913774, 913832, 913837, 913911, 913912, 913913, 913914, 913932, 913933, 913948, 913950, 913977, 913984, 913990...(Other models you can see in the webshop)		

<b>GEV No.</b>	518227	<b>Ref. No.</b>	456020
<b>description</b>	O-ring EPDM thickness 2.62mm ID $\varnothing$ 12.37mm Qty 1 pcs		
<b>For models:</b>	10, 12, 14, 22F, 22R, 2312-001, 2312-002, 350F, 350FD, 350R, 350RD, 35-ELECTRONIC, 35F, 35FD, 35R, 35RD, 400F, 400FD, 400R, 400RD, 40-ELECTRONIC, 40F, 40FD, 40R, 40RD, 44F, 45, 450, 46, 460, 913289, 913290, 913291, 913292, 913297, 913298, 913299, 913300, 913356, 913357, 913360, 913361, 913363, 913364, 913372, 913373, 913374, 913375, 913376, 913377...(Other models you can see in the webshop)		

<b>GEV No.</b>	528919	<b>Ref. No.</b>	456010
<b>description</b>	O-ring EPDM thickness 2.62mm ID $\varnothing$ 20.24mm Qty 1 pcs		
<b>For models:</b>	11F, 11FD, 11R, 11RD, 21F, 21FD, 21R, 21RD, 25F, 25FD, 25R, 25RD, 30F, 30FD, 30R, 30RD, 31F, 31FD, 31R, 31RD, S621, S623, S624, S626, S631, S633, S634, S636, S870		

<b>GEV No.</b>	532623	<b>Ref. No.</b>	80844
<b>description</b>	O-ring EPDM thickness 2.62mm ID $\varnothing$ 120.32mm Qty 1 pcs		
<b>For models:</b>	Fast181, FAST-181, Fast181-230V-3Ph-60Hz, Fast181-400V-3NPh-60Hz, NG271, NG291, NIAGARA-271, NIAGARA-283, NIAGARA-291, RIVER-282, RIVER-294, RIVER-81, River-81CRP, RIVER-81-CRP, River-82CRP, RIVER-82-CRP, RV282, RV294, RV81, RV8123, RV81A, RV81C, RV81CCRP, RV81CRP, RV81HZ, RV81HZ23, RV81PAP, RV82CCRP, RV82CRP, ST70FAST, ST70FASTHB, ST70FASTHB400, ST70FASTHZ23, SV72EB		

<b>GEV No.</b>	532058	<b>Ref. No.</b>	456071
<b>description</b>	O-ring EPDM thickness 2.62mm ID $\varnothing$ 23.81mm Qty 10 pcs		
<b>For models:</b>	913289, 913290, 913291, 913292, 913297, 913298, 913299, 913300, 913356, 913357, 913360, 913361, 913372, 913373, 913374, 913375, 913391, 913392, 913416, 913418, 913435, 913544, 913545, 913546, 913547, 913578, 913611, 913665, 913666, 913667, 913668, 913684, 913685, 913771, 913772, 913773, 913774, 913832, 913837, 913911, 913912, 913913, 913914, 913932, 913933, 913948, 913950, 913977, 913984, 913990...(Other models you can see in the webshop)		

<b>GEV No.</b>	504618	<b>Ref. No.</b>	456026
<b>description</b>	O-ring EPDM thickness 2.62mm ID $\varnothing$ 15.54mm Qty 1 pcs		
<b>For models:</b>	10, 12, 14, C15, CLEAN-100, CLEAN-110, CLEAN-120		

<b>GEV No.</b>	510769	<b>Ref. No.</b>	456046
<b>description</b>	O-ring EPDM thickness 2.62mm ID $\varnothing$ 25.07mm Qty 1 pcs		
<b>For models:</b>	10, 12, 14, 22F, 22R, 40F, 440F, 44F, 55, CLEAN-100, CLEAN-110, CLEAN-120, E.52		



<b>GEV No.</b>	504561	<b>Ref. No.</b>	456073
<b>description</b>	O-ring EPDM thickness 2.62mm ID $\varnothing$ 29.82mm Qty 1 pcs		
<b>For models:</b>	915150, 915151, 915152, 915154, 915155, 915157, 915158, 915160, 915161, 915162, 915166, 915167, 915168, 915172, 915173, 915175, 915176, 915177, 915285, 915319, 915338, 915341, 915348, 915418, 915419, 915420, 915421, 915422, 915479, 915492, 915493, 915494, 915495, 915496, 915497, 915547, 915558, 915611, 915612, 915613, 915614, 915615, 915616, 915617, 915618, 915635, 915663, 915670, 915671, 915672...(Other models you can see in the webshop)		

<b>GEV No.</b>	528487	<b>Ref. No.</b>	CGR3037
<b>description</b>	O-ring EPDM thickness 2.62mm ID $\varnothing$ 9.19mm Qty 1 pcs		
<b>For models:</b>	NG381, NG38123, NG38123TERMO, NG381C, NG381CDD, NG381CFUR, NG381DDHZ23, NG381DDPS, NG381DDPSHZ23, NG381HPDD, NG381L, NG381LC, NG381LCFUR, NG381LDDPS, NG381TERMO, NG381TXCDD, Niagara-283L-2, Niagara-381, Niagara-381-230V-3Ph-50Hz, Niagara-381-230V-3Ph-60Hz, Niagara-381DP, Niagara-381HPD, Niagara-381L, Niagara-381LC, River-282-2, River-282L-2, River-282LS-2TDE, River-282S-2TDE, River-285, River-382, River-382-230V-3Ph-50Hz, River-382H, River-382L, River-382L-230V-3Ph-50Hz, River-382LNRG, River-382LTDE, River-382NRG, River-382NRG-230-3Ph-50Hz, River-382TDE, RV382, RV38223TERMO, RV382AHP, RV382FUR, RV382L, RV382L23TERMO, RV382LFUR, RV382LR, RV382LS, RV382LSFUR, RV382LTX...(Other models you can see in the webshop)		

<b>GEV No.</b>	512056	<b>Ref. No.</b>	929061
<b>description</b>	O-ring EPDM thickness 2.62mm ID $\varnothing$ 50.47mm Qty 1 pcs		
<b>For models:</b>	10, 12, 14, 55, CLEAN-100, CLEAN-110, CLEAN-120, E1, E10, E100, E110, E12, E120, E14, E140		

<b>GEV No.</b>	510893	<b>Ref. No.</b>	456015
<b>description</b>	O-ring EPDM thickness 2.62mm ID $\varnothing$ 9.92mm Qty 1 pcs		
<b>For models:</b>	050F, 050FP, 2312-001, 2312-002, 31F, 31FD, 31R, 31RD, 500F, 500FD, 50F, 50FD, 510F, 510FD, 67F, 67R, 913297, 913298, 913299, 913300, 913360, 913361, 913363, 913364, 913376, 913377, 913391, 913392, 913418, 913546, 913547, 913578, 913611, 913684, 913913, 913914, 913932, 913933, 914167, 914168, 914284, 914318, 914319, 914326, 914331, 914338, 914356, 914398, 914399, 914400...(Other models you can see in the webshop)		

<b>GEV No.</b>	518275	<b>Ref. No.</b>	456066
<b>description</b>	O-ring EPDM thickness 2.62mm ID $\varnothing$ 6.02mm Qty 1 pcs		

<b>GEV No.</b>	510554	<b>Ref. No.</b>	456024
<b>description</b>	O-ring EPDM thickness 2mm ID $\varnothing$ 120mm Qty 1 pcs		
<b>For models:</b>	440F, 44F, 46, 460, 500F, 500FD, 50-ELECTRONIC, 50F, 50FD, E.46, E.50, E.52, R497, R499, R501, R503, R505, R507, R509, R511, R704, R706, R708, S641, S643		

<b>GEV No.</b>	509002	<b>Ref. No.</b>	456083 456084
<b>description</b>	O-ring EPDM thickness 2.62mm ID $\varnothing$ 82.22mm Qty 1 pcs		
<b>For models:</b>	915611, 915612, 915613, 915614, 915615, 915616, 915617, 915618, 915670, 915671, 915672, 915773, 915774, 915959, 916066, 916077, 916078, 916196, 916197, 916198, 916199, 916200, 916409, 916410, 916418, 916419, 916591, 916592, 916593, 916594, 916595, 916877, 916921, 916922, 916992, 916993, Fast145-2, Fast150, NIAGARA-241, Niagara-241-2, Niagara-341, Pluvia-240, RIVER-242, River-242-2, River-242-2T, River-342C, River-342T		

<b>GEV No.</b>	510009	<b>Ref. No.</b>	456001
<b>description</b>	O-ring EPDM thickness 3.53mm ID $\varnothing$ 101.2mm Qty 1 pcs		
<b>For models:</b>	21F, 21FD, 21R, 21RD, 25F, 25FD, 25R, 25RD, 30F, 30FD, 30R, 30RD, 31F, 31FD, 31R, 31RD, 913418, 914398, 914399, 914443, E.45, S621, S623, S624, S626, S631, S633, S634, S636		

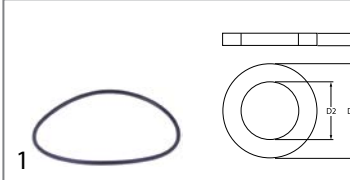

<b>GEV No.</b>	532537	<b>Ref. No.</b>	456067
<b>description</b>	O-ring EPDM thickness 3.53mm ID ø 113.9mm Qty 1 pcs		
<b>For models:</b>	2312-007, 2312-009-CRP, 914100, 914101, 914339, 914342, 914343, 914624, 914625, 914626, 914627, 914628, 914850, 914851, 914854, 914944, PS-60, RIVER-48, RIVER-50, RIVER-50-CRP, RIVER-50-CRP-SP, RIVER-54, RIVER-54CRP, River-54-CRP-s.p., RIVER-54-CRP-SP, RIVER-61		

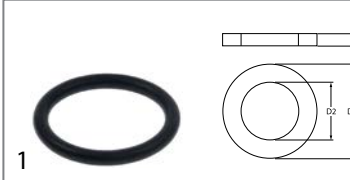

<b>GEV No.</b>	513016	<b>Ref. No.</b>	929050
<b>description</b>	O-ring EPDM thickness 3.53mm ID ø 26.58mm Qty 1 pcs		
<b>For models:</b>	55		

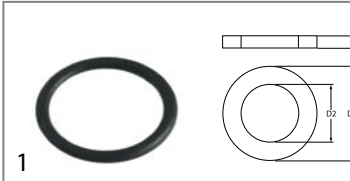

<b>GEV No.</b>	505152	<b>Ref. No.</b>	70135
<b>description</b>	O-ring EPDM thickness 3.53mm ID ø 29mm Qty 1 pcs		
<b>For models:</b>	NG381, NG38123, NG38123TERMO, NG381C, NG381CDD, NG381CFUR, NG381DDHZ23, NG381DDPS, NG381DDPSHZ23, NG381HPDD, NG381L, NG381LC, NG381LCFUR, NG381LDDPS, NG381TERMO, NG381TXCDD, Niagara-283L-2, Niagara-381, Niagara-381-230V-3Ph-50Hz, Niagara-381-230V-3Ph-60Hz, Niagara-381DP, Niagara-381HPD, Niagara-381L, Niagara-381LC		

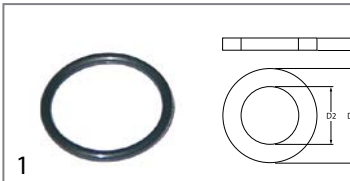

<b>GEV No.</b>	510072	<b>Ref. No.</b>	456016
<b>description</b>	O-ring EPDM thickness 3.53mm ID ø 32.93mm Qty 1 pcs		
<b>For models:</b>	050F, 050FP, 10, 11F, 11FD, 11F-DVGW, 11R, 11RD, 21F, 21FD, 21R, 21RD, 22F, 22R, 25F, 25FD, 25R, 25RD, 30F, 30FD, 30R, 30RD, 31F, 31FD, 31R, 31RD, 350F, 350FD, 350R, 350RD, 35-ELECTRONIC, 35F, 35FD, 35R, 35RD, 400F, 400FD, 400R, 400RD, 40-ELECTRONIC, 40F, 40FD, 40R, 40RD, 440F, 44F, 45, 450, 46, 460...(Other models you can see in the webshop)		

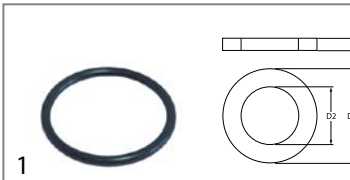

<b>GEV No.</b>	510895	<b>Ref. No.</b>	456043
<b>description</b>	O-ring EPDM thickness 3.53mm ID ø 34.52mm Qty 1 pcs		

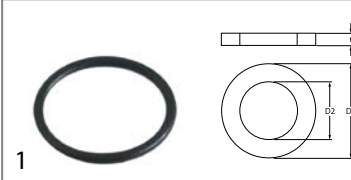

<b>GEV No.</b>	506015	<b>Ref. No.</b>	456052
<b>description</b>	O-ring EPDM thickness 3.53mm ID ø 39.69mm Qty 1 pcs		
<b>For models:</b>	2312-001, 2312-002, 2312-007, 350F, 350FD, 350R, 350RD, 35-ELECTRONIC, 35F, 35FD, 35R, 35RD, 400F, 400FD, 400R, 400RD, 40-ELECTRONIC, 40F, 40FD, 40R, 40RD, 55, 913289, 913290, 913291, 913292, 913297, 913298, 913299, 913300, 913356, 913357, 913360, 913361, 913363, 913364, 913372, 913373, 913374, 913375, 913376, 913377, 913391, 913392, 913416, 913418, 913435, 913544, 913545, 913546...(Other models you can see in the webshop)		

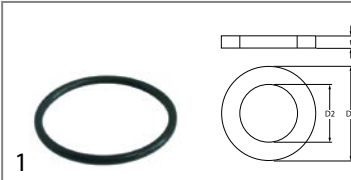

<b>GEV No.</b>	528315	<b>Ref. No.</b>	456044
<b>description</b>	O-ring EPDM thickness 3.53mm ID ø 47.63mm Qty 1 pcs		
<b>For models:</b>	CLEAN-3, RIVER-43		

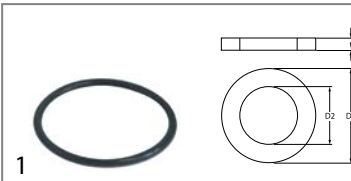

<b>GEV No.</b>	518175	<b>Ref. No.</b>	456061 REB456061
<b>description</b>	O-ring EPDM thickness 3.53mm ID ø 49.21mm Qty 1 pcs		
<b>For models:</b>	913289, 913290, 913291, 913292, 913356, 913357, 913372, 913373, 913374, 913375, 913416, 913435, 913435, 913544, 913545, 913665, 913666, 913667, 913668, 913685, 913771, 913772, 913773, 913774, 913832, 913837, 913911, 913912, 913948, 913950, 913977, 913984, 913990, 914165, 914166, 914206, 914214, 914316, 914317, 914355, 914386, 914387, 914388, 914389, 914390, 914391, 914392, 914393, 914394, 914395, 914396...(Other models you can see in the webshop)		

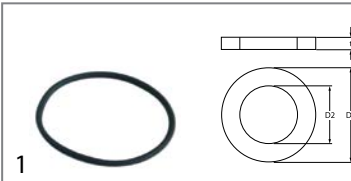

<b>GEV No.</b>	532603	<b>Ref. No.</b>	926252
<b>description</b>	O-ring EPDM thickness 3.53mm ID ø 69.85mm Qty 1 pcs		
<b>For models:</b>	KLP105EB, KLP201DDTEB, KLP201EB, KLP301, KLP301DDTEB, LP105DDTEB, LP105DDTEBN, LP105EB, LP201DDTEB, LP201EB, LP301, LP301EB, NG292, NG292HZ, NG293, NIAGARA-292, Niagara-292-400V-3Ph-60Hz, NIAGARA-293, RIVER-295, River-295P, RIVER-296, River-296P, RIVER-297, RIVER-298, RV295, RV295PS, RV296, RV296PS, RV297, RV298, RV298HZ, U132E, U61E, U61HE, U70e		



<b>GEV No.</b>	532498	<b>Ref. No.</b>	456047
<b>description</b>	O-ring EPDM thickness 3.53mm ID ø 9.12mm Qty 1 pcs		
<b>For models:</b>	22F, 440F, 44F, 500F, 500FD, 50F, 50FD, 66, CLEAN-100, CLEAN-120, E.46, E100		

<b>GEV No.</b>	521120	<b>Ref. No.</b>	456075
<b>description</b>	O-ring EPDM thickness 5.34mm ID ø 37.47mm Qty 1 pcs		
<b>For models:</b>	913289, 913290, 913291, 913292, 913356, 913357, 913363, 913364, 913372, 913373, 913374, 913375, 913376, 913377, 913416, 913418, 913435, 913544, 913545, 913665, 913666, 913667, 913668, 913685, 913771, 913772, 913773, 913774, 913832, 913837, 913911, 913912, 913948, 913950, 913977, 913984, 913990, 914165, 914166, 914167, 914168, 914206, 914214, 914316, 914317, 914355, 914386, 914387, 914388, 914389...(Other models you can see in the webshop)		

<b>GEV No.</b>	698810	<b>Ref. No.</b>	456078
<b>description</b>	O-ring EPDM thickness 3.56mm ID ø 112mm Qty 1 pcs		
<b>For models:</b>	915150, 915151, 915152, 915154, 915155, 915157, 915158, 915160, 915161, 915162, 915166, 915167, 915168, 915172, 915173, 915175, 915176, 915177, 915285, 915319, 915338, 915341, 915348, 915418, 915419, 915420, 915421, 915422, 915479, 915492, 915493, 915494, 915495, 915496, 915497, 915547, 915558, 915635, 915663, 915747, 916020, 916021, 916024, 916025, 916026, 916027, 916030, 916031, 916045, 916054...(Other models you can see in the webshop)		

<b>GEV No.</b>	510408	<b>Ref. No.</b>	456002 456079
<b>description</b>	O-ring EPDM thickness 5.34mm ID ø 47mm Qty 1 pcs		
<b>For models:</b>	10, 12, 14, 21F, 21FD, 21R, 21RD, 22F, 22R, 25F, 25FD, 25R, 25RD, 30F, 30FD, 30R, 30RD, 31F, 31FD, 31R, 31RD, 40F, 440F, 44F, 50F, 50FD, 510F, 510FD, 66, 80, 81, 82, 913297, 913298, 913299, 913300, 913360, 913361, 913391, 913392, 913546, 913547, 913578, 913611, 913684, 913913, 913914, 913932, 913933, 913992...(Other models you can see in the webshop)		

<b>GEV No.</b>	532718	<b>Ref. No.</b>	80816
<b>description</b>	O-ring EPDM thickness 4mm ID ø 80mm Qty 1 pcs		
<b>For models:</b>	A3EB, A3EBD, A3EBDAKRRKYK, A3EBDAKWK, A3EBDBKWK, A3EBDRKYY, A3EBDWK, A3EBDYK, A3EBSAK, A3EBSAKRK, A3EBSAKWK, A3EBSBKWKYYK, A3EBSEKWK, A3EBSWK, A4EB, A4EBD, A4EBDAKEKYK, A4EBDAKRR, A4EBDAKWK, A4EBDAKZK, A4EBDBKRR, A4EBDPKWKYYK, A4EBDRK, A4EBS, A4EBSAK, A4EBSAKCK, A4EBSAKEKYK, A4EBSAKRK, A4EBSAKRKP, A4EBSAKYK, A4EBSCK, A4EBT, A4EBTSAK, A5EB, A5EBD, A5EBDAKPKWK, A5EBDAKWK, A5EBDAKYK, A5EBDRK, A5EBS, A5EBSAKPKWK, A5EBSAKRK, A5EBSAKRRKYK, A5EBSAKWK, A5EBSAKWKYYK, A5EBSBKRRKP, A5EBSBKWK, A5EBSRK, A5EBSYK, KLP105EB...(Other models you can see in the webshop)		

<b>GEV No.</b>	510409	<b>Ref. No.</b>	929046
<b>description</b>	O-ring EPDM thickness 5.34mm ID ø 56.52mm Qty 1 pcs		
<b>For models:</b>	161, 221, 271, 272, 362, 55, CLEAN-160, CLEAN-161, CLEAN-220, CLEAN-221, CLEAN-270, CLEAN-271, CLEAN-272, CLEAN-361, CLEAN-361P, CLEAN-362, CLEAN-471, CLEAN-471P		

<b>GEV No.</b>	532543	<b>Ref. No.</b>	456076
<b>description</b>	O-ring EPDM thickness 5.34mm ID ø 136.5mm Qty 1 pcs		
<b>For models:</b>	915150, 915151, 915152, 915154, 915155, 915157, 915158, 915160, 915161, 915162, 915166, 915167, 915168, 915172, 915173, 915175, 915176, 915177, 915285, 915319, 915338, 915341, 915348, 915418, 915419, 915420, 915421, 915422, 915479, 915492, 915493, 915494, 915495, 915496, 915497, 915547, 915558, 915635, 915663, 915747, 916020, 916021, 916024, 916025, 916026, 916027, 916030, 916031, 916045, 916054...(Other models you can see in the webshop)		

<b>GEV No.</b>	510410	<b>Ref. No.</b>	456008
<b>description</b>	O-ring EPDM thickness 5.34mm ID ø 75.57mm Qty 1 pcs		
<b>For models:</b>	66, S651, S651P, S653, S654, S655, S810, S815, S830, S835, S850, SR651		

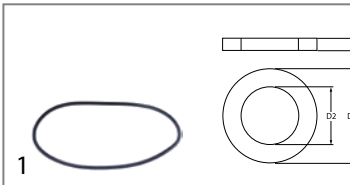

<b>GEV No.</b>	510551	<b>Ref. No.</b>	456023 926084
<b>description</b>	pump cover gasket ID ø 158.3mm pump type 1214/1293/1225/2243/1226/1204/3473/1241 thickness 3.53mm EPDM Qty 1 pcs		
<b>For models:</b>	12, 14, 161, 221, 271, 272, 362, 55, 66, 80, 81, 82, 914380, 914436, 915747, A3EB, A3EBD, A3EBDAKRKYK, A3EBDAKWK, A3EBDBKWK, A3EBDRKYK, A3EBDWK, A3EBDYK, A3EBSAK, A3EBSAKRK, A3EBSAKWK, A3EBSBKWKYK, A3EBSEKWK, A3EBSWK, A4EB, A4EBD, A4EBDAKEKYK, A4EBDAKRK, A4EBDAKWK, A4EBDAKZK, A4EBDBKRK, A4EBDPKWKYK, A4EBDRK, A4EBS, A4EBSAK, A4EBSAKCK, A4EBSAKEKYK, A4EBSAKRK, A4EBSAKRKP, A4EBSAKYK, A4EBSCK, A4EBT, A4EBTSAK, A5EB, A5EBD...(Other models you can see in the webshop)		

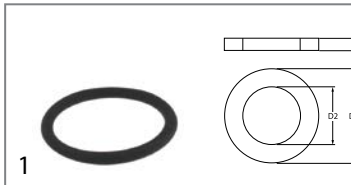

<b>GEV No.</b>	528155	<b>Ref. No.</b>	927337 CGR4131NT
<b>description</b>	O-ring Viton thickness 3.53mm ID ø 32.93mm Qty 1 pcs		
<b>For models:</b>	161, 221, 271, 272, 362, 915747, 915773, A3EB, A3EBDAKRKYK, A3EBDRKYK, A3EBSAKRK, A3EBSEKWK, A4EB, A4EBDAKEKYK, A4EBDAKRK, A4EBDAKWK, A4EBDAKZK, A4EBDBKRK, A4EBDPKWKYK, A4EBDRK, A4EBSAK, A4EBSAKCK, A4EBSAKEKYK, A4EBSAKRKP, A4EBT, A4EBTSAK, A5EB, A5EBDAKYK, A5EBDRK, A5EBSAKRK, A5EBSAKRKYK, A5EBSAKWK, A5EBSAKWKYK, A5EBSBKRPK, A5EBSBKWK, A5EBSRK, CLEAN-161, CLEAN-221, CLEAN-271, CLEAN-272, CLEAN-362, Fast181, FAST-181, Fast181-230V-3Ph-60Hz, Fast181-400V-3NPh-60Hz, Fast200, Fast93, GL280EB, GL280EB23, GL280EB23DAR...(Other models you can see in the webshop)		

**silicone**

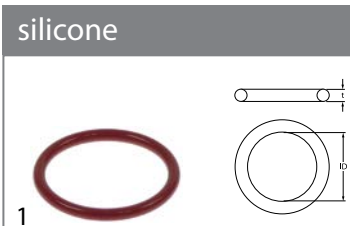

<b>GEV No.</b>	514017	<b>Ref. No.</b>	927010
<b>description</b>	O-ring silicone thickness 3.53mm ID ø 32.93mm Qty 1 pcs		
<b>For models:</b>	CLEAN-160, CLEAN-220, CLEAN-270, CLEAN-271, CLEAN-361, CLEAN-361P, CLEAN-471, CLEAN-471P		

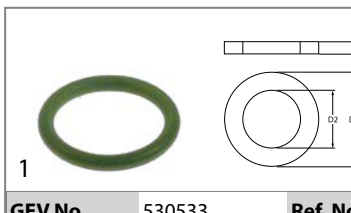

<b>GEV No.</b>	530533	<b>Ref. No.</b>	456080
<b>description</b>	O-ring Viton thickness 3mm ID ø 20mm Qty 1 pcs		
<b>For models:</b>	915611, 915612, 915613, 915614, 915615, 915616, 915670, 915671, 915959, 916196, 916197, 916198, 916199, 916200, 916409, 916410, 916591, 916592, 916593, 916877, 916921, 916922, 916992, 916993, Fast145-2, Fast150, Niagara-241, Niagara-241-2, Niagara-341, Pluvia-240		

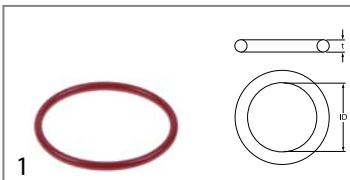

<b>GEV No.</b>	532594	<b>Ref. No.</b>	927097
<b>description</b>	O-ring silicone thickness 3.53mm ID ø 50.8mm Qty 1 pcs		
<b>For models:</b>	161, 221, 271, 272, 362, CLEAN-160, CLEAN-161, CLEAN-220, CLEAN-221, CLEAN-270, CLEAN-271, CLEAN-272, CLEAN-361, CLEAN-361P, CLEAN-362, CLEAN-471, CLEAN-471P		

**miscellaneous**



<b>GEV No.</b>	513099	<b>Ref. No.</b>	CGR108
<b>description</b>	O-ring		

**Viton**

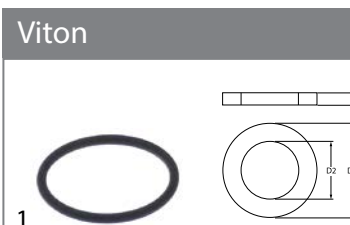

<b>GEV No.</b>	532625	<b>Ref. No.</b>	456081 5037072
<b>description</b>	O-ring Viton thickness 2.62mm ID ø 28.25mm Qty 1 pcs		
<b>For models:</b>	915150, 915151, 915152, 915154, 915155, 915160, 915161, 915162, 915166, 915167, 915168, 915175, 915176, 915177, 915319, 915338, 915341, 915348, 915418, 915419, 915420, 915421, 915479, 915492, 915493, 915547, 915558, 915635, 915663, 915747, 916020, 916021, 916024, 916025, 916026, 916027, 916030, 916031, 916045, 916201, 916202, 916203, 916204, 916205, 916206, 916207, 916208, 916209, 916247, 916248...(Other models you can see in the webshop)		

**sealing washers**

**fibre gaskets**





<b>GEV No.</b>	518541	<b>Ref. No.</b>	437021
<b>description</b>	flat gasket FIBER ED ø 12mm ID ø 8mm thickness 1.5mm Qty 1 pcs		
<b>For models:</b>	050F, 050FP, 11R, 11RD, 12, 14, 21F, 21FD, 21R, 21RD, 22F, 22R, 25F, 25FD, 25R, 25RD, 30F, 30FD, 30R, 30RD, 31F, 31FD, 31R, 31RD, 40F, 440F, 44F, 46, 460, 500F, 500FD, 50-ELECTRONIC, 50F, 50FD, 510F, 510FD, 66, CLEAN-100, CLEAN-110, CLEAN-120, CLEAN-3, E.46, E.50, E.51, E.52, E.60, E.65, E1, E10, E100...(Other models you can see in the webshop)		





			
1			
<b>GEV No.</b>	529349	<b>Ref. No.</b>	437030
<b>description</b>	flat gasket FIBER ED ø 22mm ID ø 16.5mm thickness 2mm for thread 3/8" Qty 1 pcs		
<b>For models:</b>	11F, 11FD, 11R, 11RD, 2312-001, 2312-002, 55, 67F, 67R, 913297, 913298, 913299, 913300, 913360, 913361, 913391, 913392, 913418, 913546, 913547, 913578, 913611, 913684, 913932, 913933, 914326, 914331, 914398, 914399, 914400, 914401, 914402, 914403, 914404, 914405, 914406, 914443, 914449, 914517, 914545, 914568, 914688, 914979, 915140, 915248, 915483, 915484, 915528, 915537, 915538... (Other models you can see in the webshop)		

			
1			
<b>GEV No.</b>	506241	<b>Ref. No.</b>	CGF17
<b>description</b>	flat gasket FIBER ED ø 24mm ID ø 16mm thickness 2mm Qty 1 pcs		
<b>For models:</b>	A3EB, A3EBD, A3EBDAKRKYK, A3EBDAKWK, A3EBDBKWK, A3EBDRKYK, A3EBDVK, A3EBDYK, A3EBSAK, A3EBSAKRK, A3EBSAKWK, A3EBSBKWKYK, A3EBSEKWK, A3EBSWK, A4EB, A4EBD, A4EBDAKEKYK, A4EBDAKRK, A4EBDAKWK, A4EBDAKZK, A4EBDBKRK, A4EBDPKWKYK, A4EBDRK, A4EBS, A4EBSAK, A4EBSAKCK, A4EBSAKEKYK, A4EBSAKRK, A4EBSAKRKP, A4EBSAKYK, A4EBSCK, A4EBT, A4EBTSAK, A5EB, A5EBD, A5EBDAKPKWK, A5EBDAKWK, A5EBDAKYK, A5EBDRK, A5EBS, A5EBSAKPKWK, A5EBSAKRK, A5EBSAKRKYK, A5EBSAKWK, A5EBSAKWKYK, A5EBSBKRPK, A5EBSBKWK, A5EBSRK, A5EBSYK, River-multi-2252... (Other models you can see in the webshop)		

			
1			
<b>GEV No.</b>	518393	<b>Ref. No.</b>	437042
<b>description</b>	flat gasket FIBER ED ø 24mm ID ø 17mm thickness 2mm Qty 1 pcs		
<b>For models:</b>	10, 11F, 11FD, 11R, 11RD, 12, 14, 21F, 21FD, 21R, 21RD, 22F, 22R, 25F, 25FD, 25R, 25RD, 30F, 30FD, 30R, 30RD, 31F, 31FD, 31R, 31RD, 40F, 440F, 44F, 500F, 500FD, 50-ELECTRONIC, 50F, 50FD, 510F, 510FD, 55, 913297, 913298, 913299, 913300, 913360, 913361, 913391, 913392, 913546, 913547, 913578, 913611, 913684, 913913... (Other models you can see in the webshop)		

			
1			
<b>GEV No.</b>	510076	<b>Ref. No.</b>	437031
<b>description</b>	flat gasket FIBER ED ø 33mm ID ø 21mm thickness 1.5mm Qty 1 pcs		
<b>For models:</b>	350R, 350RD, 35-ELECTRONIC, 35R, 35RD, 368, 374, 66, MG30, MG40, R495, R497, R499, R501, R503, R505, R507, R509, R511, R704, R706, R708, S641, S643, S870		

			
1			
<b>GEV No.</b>	510074	<b>Ref. No.</b>	437025
<b>description</b>	flat gasket FIBER ED ø 35mm ID ø 27mm thickness 1.5mm Qty 1 pcs		
<b>For models:</b>	11F, 11FD, 11F-DVGW, 11R, 11RD, 2312-009-CRP, 350F, 350FD, 35-ELECTRONIC, 35F, 35FD, 400F, 400FD, 400R, 400RD, 40-ELECTRONIC, 40F, 40FD, 40R, 40RD, 67F, 67R, 913363, 913364, 913376, 913377, 913992, 913993, 914100, 914101, 914339, 914342, 914343, 914583, 914624, 914625, 914626, 914627, 914628, 914850, 914851, 914854, 914944, 915143, 915747, A4EBT, A4EBTSAK, CLEAN-3, E.41, E.42... (Other models you can see in the webshop)		

			
1			
<b>GEV No.</b>	510416	<b>Ref. No.</b>	437022
<b>description</b>	flat gasket fibre ED ø 19mm ID ø 10.5mm thickness 1.5mm for thread M10 Qty 1 pcs		
<b>For models:</b>	S621, S623, S624, S626, S631, S633, S634, S636		

			
1			
<b>GEV No.</b>	510417	<b>Ref. No.</b>	437002 437024
<b>description</b>	flat gasket fibre ED ø 20mm ID ø 14mm thickness 2mm Qty 1 pcs		
<b>For models:</b>	11F, 11FD, 11F-DVGW, 11R, 11RD, 12, 14, 21F, 21FD, 21R, 21RD, 22F, 22R, 25F, 25FD, 25R, 25RD, 30F, 30FD, 30R, 30RD, 31F, 31FD, 31R, 31RD, 40F, 440F, 44F, 450, 46, 460, 500F, 500FD, 50F, 50FD, 510F, 510FD, CLEAN-100, CLEAN-110, CLEAN-120, E.45, E.46, E.50, E.51, E.52, E1, E10, E100, E110, E12... (Other models you can see in the webshop)		

			
1			
<b>GEV No.</b>	510080	<b>Ref. No.</b>	437027
<b>description</b>	flat gasket fibre ED ø 44.5mm ID ø 33mm thickness 2mm Qty 1 pcs		
<b>For models:</b>	11F, 11FD, 11F-DVGW, 11R, 11RD, 66, 67F, 67R, 913363, 913364, 913376, 913377, E.41, E.42, E.41, R495, R497, R499, R501, R503, R505, R507, R509, R511, R704, R706, R708, S651, S654, S810, S815, S830, S835, S870, S950		

			
1			
<b>GEV No.</b>	510405	<b>Ref. No.</b>	437028
<b>description</b>	flat gasket fibre ED ø 56mm ID ø 42mm thickness 2mm for thread 1 1/4" Qty 1 pcs		
<b>For models:</b>	R497, R499, R501, R503, R505, R507, R509, R511, R704, S641, S643		

			
1			
<b>GEV No.</b>	510081	<b>Ref. No.</b>	437029
<b>description</b>	sealing ring fibre ED ø 60mm ID ø 48mm thickness 1.5mm Qty 1 pcs		
<b>For models:</b>	R706, R708, S870		

## rubber gaskets



<b>GEV No.</b>	505396	<b>Ref. No.</b>	437107
<b>description</b>	flat gasket rubber ED ø 109mm ID ø 86mm thickness 2.5mm Qty 1 pcs		
<b>For models:</b>	915611, 915612, 915613, 915614, 915615, 915616, 915617, 915618, 915670, 915671, 915672, 915773, 915774, 915959, 916066, 916077, 916078, 916196, 916197, 916198, 916199, 916200, 916409, 916410, 916418, 916419, 916591, 916592, 916593, 916594, 916595, 916877, 916921, 916922, 916992, 916993, Fast145-2, Fast150, Niagara-241, Niagara-241-2, Niagara-341, Pluvia-240, River-242, River-242-2, River-242-2T, River-342C, River-342T		



<b>GEV No.</b>	519547	<b>Ref. No.</b>	437041
<b>description</b>	flat gasket rubber ED ø 14.4mm ID ø 15.5mm thickness 2mm Qty 1 pcs size 3/4"		
<b>For models:</b>	050F, 050FP, 10, 11F, 11FD, 11F-DVGW, 11R, 11RD, 12, 14, 21F, 21FD, 21R, 21RD, 22F, 22R, 2312-001, 2312-002, 2312-007, 2312-009-CRP, 25F, 25FD, 25R, 25RD, 30F, 30FD, 30R, 30RD, 31F, 31FD, 31R, 31RD, 350F, 350FD, 350R, 350RD, 35-ELECTRONIC, 35F, 35FD, 35R, 35RD, 400F, 400FD, 400R, 400RD, 40-ELECTRONIC, 40F, 40FD, 40R, 40RD...		



<b>GEV No.</b>	510075	<b>Ref. No.</b>	437019
<b>description</b>	flat gasket rubber ED ø 22mm ID ø 13mm thickness 1.5mm Qty 1 pcs		
<b>For models:</b>	10, 12, 14, 22F, 22R, 2312-001, 2312-002, 350F, 350FD, 350R, 350RD, 35-ELECTRONIC, 35F, 35FD, 35R, 35RD, 400F, 400FD, 400R, 400RD, 40-ELECTRONIC, 40F, 40FD, 40R, 40RD, 44F, 45, 450, 46, 460, 67F, 67R, 913289, 913290, 913291, 913292, 913297, 913298, 913299, 913300, 913356, 913357, 913360, 913361, 913363, 913364, 913372, 913373, 913374, 913375...(Other models you can see in the webshop)		



<b>GEV No.</b>	507544	<b>Ref. No.</b>	75402
<b>description</b>	flat gasket rubber ED ø 29mm ID ø 17mm thickness 1mm Qty 1 pcs		
<b>For models:</b>	RIVER-282, River-282-2, River-282L-2, River-282LS-2TDE, River-282S-2TDE, River-285, River-382, River-382-230V-3Ph-50Hz, River-382H, River-382L, River-382L-230V-3Ph-50Hz, River-382LNRG, River-382LTDE, River-382NRG, River-382NRG-230-3Ph-50Hz, River-382TDE, River-482, RV282DD, RV282R, RV382, RV38223TERMO, RV382AHP, RV382FUR, RV382L, RV382L23TERMO, RV382LFUR, RV382LR, RV382LS, RV382LSFUR, RV382LTX, RV382LTXR, RV382R, RV382R23TERMO, RV382RFUR, RV382S, RV382SFUR, RV382TERMO, RV382TX, RV382TXR, RV482		



<b>GEV No.</b>	505397	<b>Ref. No.</b>	437083
<b>description</b>	flat gasket rubber ED ø 32mm ID ø 19.5mm thickness 1.5mm Qty 1 pcs		
<b>For models:</b>	913992, 913993, 914583, 914592, 914612, 914613, 914628, 914944, 915143, 915150, 915151, 915152, 915154, 915155, 915157, 915158, 915160, 915161, 915162, 915166, 915167, 915168, 915172, 915173, 915175, 915176, 915177, 915285, 915319, 915338, 915341, 915348, 915418, 915419, 915420, 915421, 915422, 915479, 915492, 915493, 915494, 915495, 915496, 915497, 915547, 915558, 915611, 915612, 915613, 915614...(Other models you can see in the webshop)		



<b>GEV No.</b>	518240	<b>Ref. No.</b>	437078
<b>description</b>	flat gasket rubber ED ø 33mm ID ø 17mm thickness 1.5mm Qty 1 pcs		
<b>For models:</b>	2312-009-CRP, 67R, 913289, 913290, 913291, 913292, 913356, 913357, 913363, 913364, 913372, 913373, 913374, 913375, 913376, 913377, 913416, 913435, 913544, 913545, 913665, 913666, 913667, 913668, 913685, 913771, 913772, 913773, 913774, 913832, 913837, 913911, 913912, 913948, 913950, 913977, 913984, 913990, 913992, 913993, 914165, 914166, 914206, 914214, 914316, 914317, 914355, 914386, 914387, 914388...(Other models you can see in the webshop)		



<b>GEV No.</b>	516261	<b>Ref. No.</b>	437098
<b>description</b>	flat gasket rubber ED ø 33mm ID ø 25mm thickness 2.5mm for air trap Qty 1 pcs		
<b>For models:</b>	2312-007, 913992, 913993, 914100, 914101, 914339, 914342, 914343, 914583, 914592, 914612, 914613, 914624, 914625, 914626, 914627, 914628, 914850, 914851, 914854, 914944, 915143, Fast181, FAST-181, Fast181-230V-3Ph-60Hz, Fast181-400V-3NPh-60Hz, NG271, NG291, NG292, NG292HZ, NG293, NG381, NG38123, NG38123TERMO, NG381C, NG381CDD, NG381CFUR, NG381DDHZ23, NG381DDPS, NG381DDPSHZ23, NG381HPDD, NG381L, NG381LC, NG381LCFUR, NG381LDDPS, NG381TERMO, NG381TXCDD, NIAGARA-271, NIAGARA-283, Niagara-283A...(Other models you can see in the webshop)		





<b>GEV No.</b>	510876	<b>Ref. No.</b>	437104
<b>description</b>	flat gasket rubber ED ø 45mm ID ø 33mm thickness 3mm Qty 1 pcs		
<b>For models:</b>	915154, 915155, 915157, 915158, 915172, 915173, 915285, 915422, 915492, 915493, 915494, 915495, 915496, 915497, 915617, 915618, 915672, 915773, 915774, 916045, 916054, 916066, 916067, 916068, 916069, 916077, 916078, 916079, 916080, 916368, 916418, 916419, 916420, 916421, 916422, 916423, 916424, 916594, 916595, 916654, 916686, 916760, Fast160C, Ocean360-UK, River-242, River-242-2, River-242-2T, River-252, River-252-2, River-252-2T...(Other models you can see in the webshop)		







			
<b>GEV No.</b>	513059	<b>Ref. No.</b>	437063
<b>description</b>	flat gasket rubber ED ø 52mm ID ø 40mm thickness 3mm Qty 1 pcs		
<b>For models:</b>	050F, 050FP, 12, 14, 161, 221, 2312-001, 2312-002, 271, 272, 362, 45, 450, 46, 460, 500F, 500FD, 50-ELECTRONIC, 50F, 50FD, 510F, 510FD, 55, 913297, 913298, 913299, 913300, 913360, 913361, 913391, 913392, 913418, 913546, 913547, 913578, 913611, 913684, 913913, 913914, 913932, 913933, 914167, 914168, 914284, 914318, 914319, 914331, 914338, 914356, 914398...(Other models you can see in the webshop)		

			
<b>GEV No.</b>	510070	<b>Ref. No.</b>	437038
<b>description</b>	flat gasket rubber ED ø 61mm ID ø 41.5mm thickness 3mm Qty 1 pcs		
<b>For models:</b>	350F, 350FD, 350R, 350RD, 35-ELECTRONIC, 35F, 35FD, 35R, 35RD, 400F, 400FD, 400R, 400RD, 40-ELECTRONIC, 40F, 40FD, 40R, 40RD, 66, R497, R499, R501, R503, R505, R507, R509, R511, R704, R706, R708, S641, S643, S651, S651P, S653, S654, S655, S810, S815, S830, S835, S850, S870, S950, SR651		

			
<b>GEV No.</b>	518205	<b>Ref. No.</b>	437079 80182 reb437079
<b>description</b>	flat gasket rubber ED ø 61mm ID ø 47mm thickness 2mm Qty 1 pcs		
<b>For models:</b>	2312-007, 2312-009-CRP, 80, 81, 82, 913289, 913290, 913291, 913292, 913356, 913357, 913372, 913373, 913374, 913375, 913416, 913435, 913544, 913545, 913665, 913666, 913667, 913668, 913685, 913771, 913772, 913773, 913774, 913832, 913837, 913911, 913912, 913948, 913950, 913977, 913984, 913990, 913992, 913993, 914100, 914101, 914165, 914166, 914206, 914214, 914316, 914317, 914339, 914342, 914343...(Other models you can see in the webshop)		

			
<b>GEV No.</b>	518501	<b>Ref. No.</b>	437033
<b>description</b>	flat gasket rubber ED ø 68mm ID ø 41.5mm thickness 8mm Qty 1 pcs		
<b>For models:</b>	66, R704, R706, R708, S651, S651P, S653, S654, S655, S810, S815, S830, S835, S850, S870, S950, SR651		

			
<b>GEV No.</b>	507541	<b>Ref. No.</b>	437102
<b>description</b>	flat gasket rubber ED ø 74mm ID ø 57mm thickness 2mm Qty 1 pcs		
<b>For models:</b>	915150, 915151, 915152, 915154, 915155, 915157, 915158, 915160, 915161, 915162, 915166, 915167, 915168, 915172, 915173, 915175, 915176, 915177, 915285, 915319, 915338, 915341, 915348, 915418, 915419, 915420, 915421, 915422, 915479, 915492, 915493, 915494, 915495, 915496, 915497, 915547, 915558, 915617, 915618, 915635, 915663, 915672, 915747, 915773, 915774, 916020, 916021, 916024, 916025, 916026...(Other models you can see in the webshop)		

			
<b>GEV No.</b>	510071	<b>Ref. No.</b>	437034
<b>description</b>	flat gasket rubber ED ø 81mm ID ø 68mm thickness 3mm for salt tank Qty 1 pcs		
<b>For models:</b>	050F, 050FP, 11F, 11FD, 11R, 11RD, 2312-001, 2312-002, 2312-007, 2312-009-CRP, 31F, 31FD, 31R, 31RD, 350F, 350FD, 35-ELECTRONIC, 35F, 35FD, 400F, 400FD, 400R, 400RD, 40-ELECTRONIC, 40F, 40FD, 40R, 40RD, 45, 450, 46, 460, 500F, 500FD, 50-ELECTRONIC, 50F, 50FD, 510F, 510FD, 67F, 67R, 913289, 913290, 913291, 913292, 913297, 913298, 913299, 913300, 913356...(Other models you can see in the webshop)		

			
<b>GEV No.</b>	518294	<b>Ref. No.</b>	437087
<b>description</b>	flat gasket rubber ED ø 85mm ID ø 71mm thickness 2mm Qty 1 pcs		
<b>For models:</b>	2312-007, 2312-009-CRP, 914100, 914101, 914339, 914342, 914343, 914624, 914625, 914626, 914627, 914628, 914850, 914851, 914854, 914944, PS-60, RIVER-48, RIVER-50, RIVER-50-CRP, RIVER-50-CRP-SP, RIVER-54, RIVER-54CRP, River-54-CRP-s.p., RIVER-54-CRP-SP, RIVER-61		

			
<b>GEV No.</b>	518060	<b>Ref. No.</b>	456040
<b>description</b>	gasket rubber ED ø 132mm ID ø 122mm thickness 5mm		
<b>For models:</b>	10, 22F, 22R, 40F, 44F, 80, 81, 82, 914326, 914406, 915729, CE78HZ23, CGL74CABT, CLEAN-100, CLEAN-110, E.52, E.55, E.60, E.65, E1, E10, E100, E110, E78, E78HP, Fast181, FAST-181, Fast181-230V-3Ph-60Hz, Fast181-400V-3NPh-60Hz, FAST-63, HM1, KLP105EB, LP105DDDTEB, LP105DDDTEBN, LP105EB, LP60, NG271, NG291, NG292, NG292HZ, NG293, NIAGARA-271, NIAGARA-283, Niagara-283A, NIAGARA-291, NIAGARA-292, Niagara-292-400V-3Ph-60Hz, NIAGARA-293, RIVER-282, River-285...(Other models you can see in the webshop)		

## PTFE gaskets

			
<b>GEV No.</b>	507545	<b>Ref. No.</b>	437091
<b>description</b>	flat gasket PTFE ED ø 13mm ID ø 7mm thickness 0.65mm Qty 1 pcs		
<b>For models:</b>	2312-007, 2312-009-CRP, 913992, 913993, 914100, 914101, 914339, 914342, 914343, 914583, 914592, 914612, 914613, 914624, 914625, 914626, 914627, 914628, 914850, 914851, 914854, 914944, 915143, E.55, RIVER-40, RIVER-40-CRP, RIVER-43, RIVER-44, RIVER-44-CRP, RIVER-44-CRP-ST, RIVER-44CRP-ST, RIVER-48, RIVER-50, RIVER-50-CRP, RIVER-50-CRP-SP, RIVER-54, RIVER-54CRP, River-54-CRP-s.p., RIVER-54-CRP-SP, RIVER-61		

			
1			
<b>GEV No.</b>	510012	<b>Ref. No.</b>	437008
<b>description</b>	flat gasket PTFE ED ø 16.5mm ID ø 12.5mm thickness 1.5mm Qty 1 pcs equiv. no. 437008		
<b>For models:</b>	11F, 11FD, 11F-DVGW, 21F, 21FD, 25F, 25FD, 30F, 30FD, 31F, 31FD, 350F, 350FD, 35-ELECTRONIC, 35F, 35FD, 400F, 400FD, 40-ELECTRONIC, 40F, 40FD, 45, 450, 67R, 913289, 913290, 913291, 913292, 913356, 913357, 913363, 913364, 913372, 913373, 913374, 913375, 913376, 913377, 913416, 913418, 913435, 913544, 913545, 913665, 913666, 913667, 913668, 913685, 913771, 913772...(Other models you can see in the webshop)		

			
2			
<b>GEV No.</b>	513725	<b>Ref. No.</b>	437100
<b>description</b>	flat gasket PTFE ED ø 21.2mm ID ø 19mm thickness 0.5mm Qty 1 pcs		
<b>For models:</b>	913297, 913298, 913299, 913300, 913360, 913361, 913391, 913392, 913546, 913547, 913578, 913611, 913684, 913913, 913914, 913932, 913933, 914284, 914318, 914319, 914326, 914331, 914338, 914356, 914400, 914401, 914402, 914403, 914404, 914405, 914406, 914431, 914449, 914517, 914545, 914568, 914642, 914688, 914909, 914979, 915136, 915137, 915140, 915150, 915151, 915152, 915154, 915155, 915157, 915158...(Other models you can see in the webshop)		

			
1			
<b>GEV No.</b>	518346	<b>Ref. No.</b>	437090
<b>description</b>	flat gasket PTFE ED ø 22mm ID ø 9.2mm thickness 1mm Qty 1 pcs equiv. no. 437090 suitable for COLGED		
<b>For models:</b>	2312-007, 2312-009-CRP, 913992, 913993, 914100, 914101, 914339, 914342, 914343, 914583, 914592, 914612, 914613, 914624, 914625, 914626, 914627, 914628, 914850, 914851, 914854, 914944, 915143, E.55, RIVER-40, RIVER-40-CRP, RIVER-43, RIVER-44, RIVER-44-CRP, RIVER-44-CRP-ST, RIVER-44CRP-ST, RIVER-48, RIVER-50, RIVER-50-CRP, RIVER-50-CRP-SP, RIVER-54, RIVER-54CRP, RIVER-54-CRP-s.p., RIVER-54-CRP-SP, RIVER-61		

			
1			
<b>GEV No.</b>	518180	<b>Ref. No.</b>	303018
<b>description</b>	flat gasket PTFE ED ø 40mm ID ø 35mm thickness 3mm Qty 1 pcs equiv. no. 303018/371450-166 suitable for COLGED, HOBART		
<b>For models:</b>	913289, 913290, 913291, 913292, 913356, 913357, 913372, 913373, 913374, 913375, 913416, 913435, 913544, 913545, 913665, 913666, 913667, 913668, 913685, 913771, 913772, 913773, 913774, 913832, 913837, 913911, 913912, 913948, 913950, 913977, 913984, 913990, 913992, 913993, 914165, 914166, 914206, 914214, 914316, 914317, 914355, 914386, 914387, 914388, 914389, 914390, 914391, 914392, 914393, 914394...(Other models you can see in the webshop)		



shaft gaskets

v-rings

			
1			
<b>GEV No.</b>	696554	<b>Ref. No.</b>	499018
<b>description</b>	V-ring for shaft ø 18mm ID ø 16.5mm ED ø 22mm thickness 7.5mm		
<b>For models:</b>	11R, 11RD, 21R, 21RD, 22R, 25R, 25RD, 30R, 30RD, 31R, 31RD, 67R, E.42, R495, R497, R499, R501, R503, R505, R507, S624, S626, S634, S636, S651, S654, S655, S815, S835		

shaft gaskets

			
1			
<b>GEV No.</b>	699128	<b>Ref. No.</b>	927095
<b>description</b>	shaft sealing ED ø 40mm ID ø 30mm H 7mm plastic for vegetable slicer		
<b>For models:</b>	161, 221, 271, 272, 362, CLEAN-160, CLEAN-161, CLEAN-220, CLEAN-221, CLEAN-270, CLEAN-271, CLEAN-272, CLEAN-361, CLEAN-361P, CLEAN-362, CLEAN-471, CLEAN-471P		

			
1			
<b>GEV No.</b>	698755	<b>Ref. No.</b>	314011
<b>description</b>	shaft sealing ID ø 9mm ED ø 10mm for wash pump		
<b>For models:</b>	915611, 915612, 915613, 915614, 915615, 915616, 915617, 915618, 915670, 915671, 915672, 915773, 915774, 915959, 916066, 916077, 916078, 916196, 916197, 916198, 916199, 916200, 916409, 916410, 916418, 916419, 916591, 916592, 916593, 916594, 916595, 916877, 916921, 916922, 916992, 916993, Fast145-2, Fast150, Niagara-241, Niagara-241-2, Niagara-341, Pluvia-240, River-242, River-242-2, River-242-2T, River-342C, River-342T		
<b>spare parts for</b>	698755		
	<b>GEV No.</b>	501503	<b>Ref. No.</b> 130166
	pump inlet ø 28mm outlet ø 22/27mm type CF 2745 230V 50Hz 1 phase 0.19kW L 175mm rotation direction right capacitor 4µF LGB with capacitor		

special gaskets

door seals for dishwashers

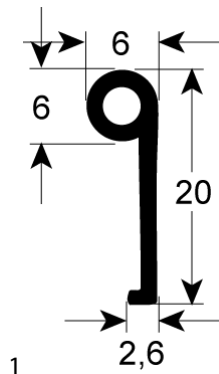

<b>GEV No.</b>	518123	<b>Ref. No.</b>	41247
<b>description</b>	door seal L 1050mm W 6mm H 20mm Qty 1		
<b>For models:</b>	KLP105EB, KLP201DDDTEB, KLP201EB, KLP301, KLP301DDDTEB, LP105DDDTEB, LP105DDDTEBN, LP105EB, LP201DDDTEB, LP201EB, LP301, LP301EB, NG292, NG293, NIAGARA-292, NIAGARA-293, RIVER-295, RIVER-296, RIVER-297, RIVER-298, RV295, RV296, RV297, RV298, RV298HZ, U132E, U61E, U61HE, U70e		

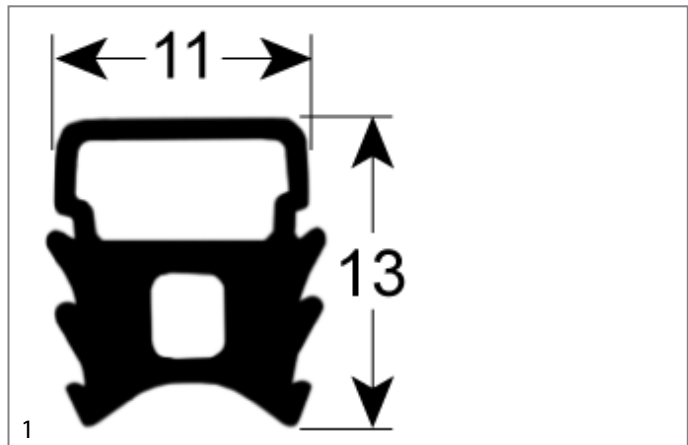

<b>GEV No.</b>	518088	<b>Ref. No.</b>	437088 437097
<b>description</b>	door seal L 1370mm		
<b>For models:</b>	2312-007, 2312-009-CRP, 914100, 914101, 914339, 914342, 914343, 914624, 914625, 914626, 914627, 914628, 914850, 914851, 914854, 914944, RIVER-48, RIVER-50, RIVER-50-CRP, RIVER-50-CRP-SP, RIVER-54, RIVER-54CRP, RIVER-54-CRP-s.p., RIVER-54-CRP-SP, RIVER-61		

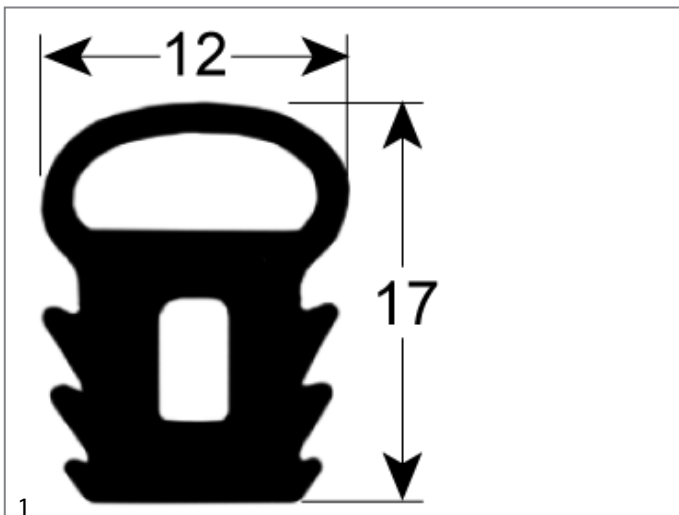

<b>GEV No.</b>	518252	<b>Ref. No.</b>	437071
<b>description</b>	door seal L 1165mm dishwasher		
<b>For models:</b>	913992, 913993, 914583, 914592, 914612, 914613, 915143, CLEAN-3, RIVER-40, RIVER-40-CRP, RIVER-43, RIVER-44, RIVER-44-CRP, RIVER-44-CRP-ST, RIVER-44CRP-ST		

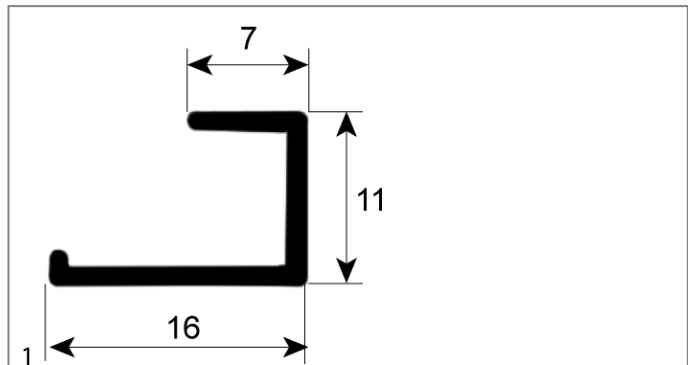

<b>GEV No.</b>	518246	<b>Ref. No.</b>	437057
<b>description</b>	door seal L 395mm dishwasher suitable for ELETTROBAR, WOLK equiv. no. 437057		
<b>For models:</b>	350F, 350FD, 350R, 350RD, 35-ELECTRONIC, 35F, 35FD, 35R, 35RD, 913289, 913290, 913356, 913372, 913373, 913544, 913665, 913667, 913771, 913772, 913832, 913837, 914165, 914166, 914206, 914355, 914386, 914387, 914388, 914389, 914390, 914391, 914692, 914693, 914694, 914703, 914870, 915686, 915687, 915688, 915689, 915690, 915691, 916237, 916238, 916239, 916240, 916241, 916401, 916402, 916403...(Other models you can see in the webshop)		

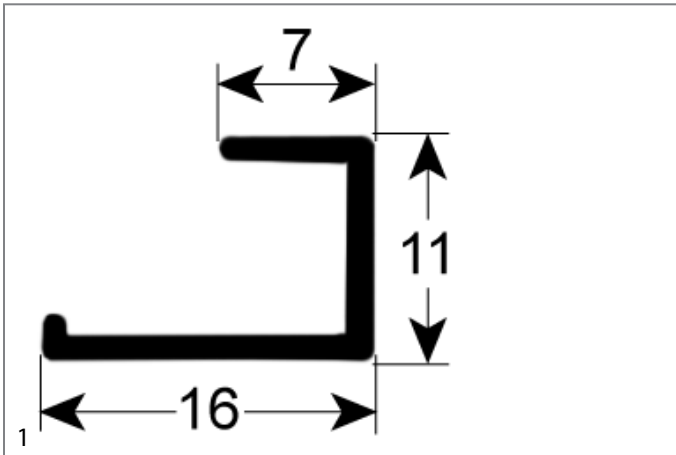

<b>GEV No.</b>	518248	<b>Ref. No.</b>	437058
<b>description</b>	door seal L 430mm dishwasher suitable for ELETTROBAR, WOLK equiv. no. 437058		
<b>For models:</b>	400F, 400FD, 400R, 400RD, 40-ELECTRONIC, 40F, 40FD, 40R, 40RD, 67F, 67R, 913291, 913292, 913357, 913374, 913375, 913416, 913435, 913545, 913666, 913668, 913685, 913773, 913774, 913911, 913912, 913948, 913950, 913977, 913984, 913990, 914392, 914393, 914394, 914395, 914396, 914397, 914441, 914442, 914515, 914516, 914537, 914543, 914547, 914683, 914684, 914689, 914863, 915138, 915139... (Other models you can see in the webshop)		

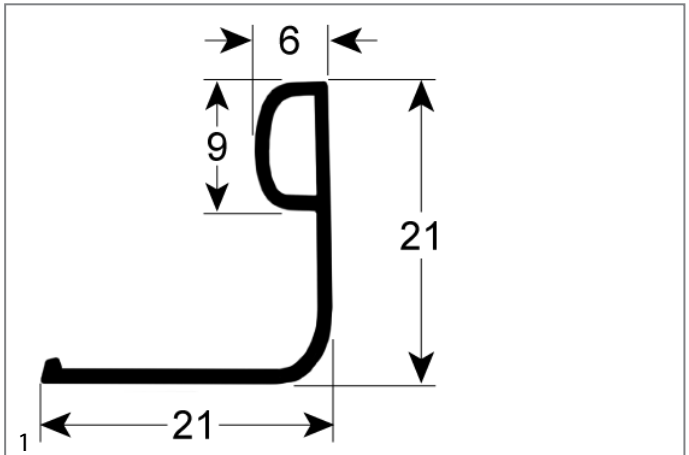

<b>GEV No.</b>	518300	<b>Ref. No.</b>	437075
<b>description</b>	door seal L 590mm dishwasher suitable for ELETTROBAR, WOLK equiv. no. 437075		
<b>For models:</b>	E.65		

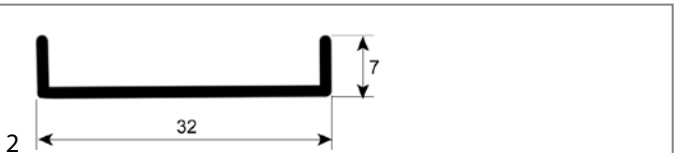

<b>GEV No.</b>	518535	<b>Ref. No.</b>	437051
<b>description</b>	door seal L 450mm dishwasher suitable for ELETTROBAR, WOLK equiv. no. 437051		
<b>For models:</b>	11F, 11FD, 11F-DVGW, 11R, 11RD, 913363, 913364, 913376, 913377, E.41, E.42, E.41		

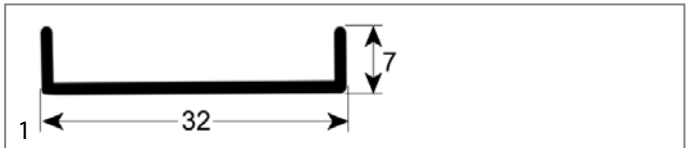

<b>GEV No.</b>	518536	<b>Ref. No.</b>	437052 437081
<b>description</b>	door seal L 590mm W 32mm dishwasher suitable for ELETTROBAR, WOLK equiv. no. 437052		
<b>For models:</b>	050F, 050FP, 22F, 22R, 2312-001, 2312-002, 40F, 913297, 913298, 913299, 913300, 913360, 913361, 913391, 913392, 913546, 913547, 913578, 913611, 913684, 913913, 913914, 913932, 913933, 914284, 914326, 914331, 914356, 914400, 914401, 914402, 914403, 914404, 914405, 914406, 914449, 914517, 914545, 914568, 914642, 914688, 914909, 914979, 915136, 915137, 915140, 915248, 915483, 915484, 915528...(Other models you can see in the webshop)		

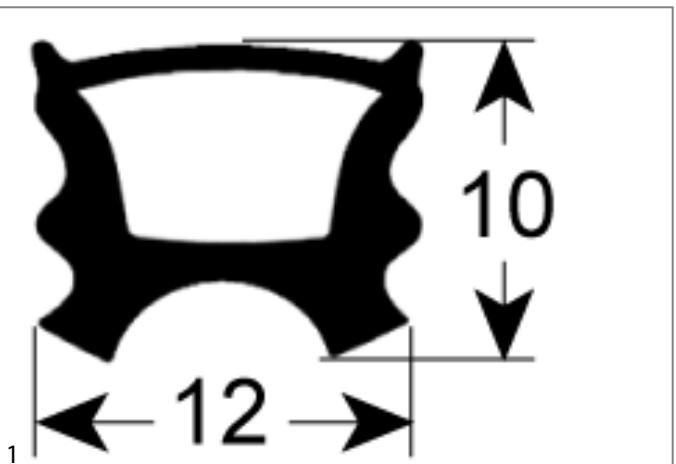

<b>GEV No.</b>	518613	<b>Ref. No.</b>	437103
<b>description</b>	door seal L 555mm W 395mm for dishwasher 3-sided		
<b>For models:</b>	915150, 915151, 915152, 915154, 915155, 915157, 915158, 915160, 915161, 915162, 915166, 915167, 915168, 915172, 915173, 915175, 915176, 915177, 915285, 915319, 915338, 915341, 915348, 915418, 915419, 915420, 915421, 915422, 915479, 915492, 915493, 915494, 915495, 915496, 915497, 915547, 915558, 915635, 915663, 915747, 916054, 916067, 916068, 916069, 916079, 916080, 916201, 916202, 916203, 916204...(Other models you can see in the webshop)		

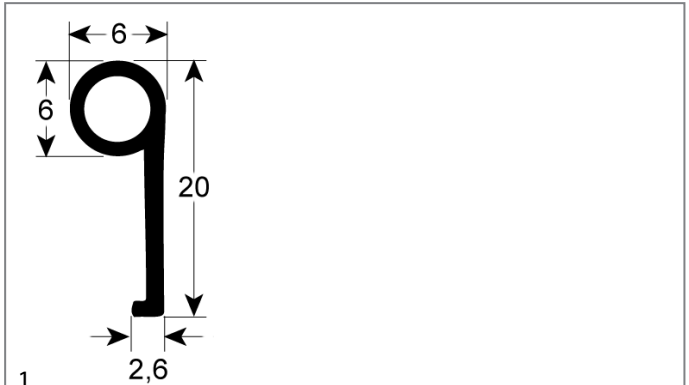

<b>GEV No.</b>	902025	<b>Ref. No.</b>	41247MT
<b>description</b>	door seal W 6mm H 20mm		



## miscellaneous



1			
<b>GEV No.</b>	510066	<b>Ref. No.</b>	437053
<b>description</b>	gasket for filter		
<b>For models:</b>	22F, 22R, 31F, 31FD, 31R, 31RD		



1			
<b>GEV No.</b>	511999	<b>Ref. No.</b>	75168
<b>description</b>	gasket for flange ED $\varnothing$ 123mm ID $\varnothing$ 46mm rubber thickness 3mm hole distance 53mm		
<b>For models:</b>	914380, 914436, A3EB, A3EBD, A3EBDAKRKYK, A3EBDAKWK, A3EBDBKWK, A3EBDRKYK, A3EBDVK, A3EBDYK, A3EBSAK, A3EBSAKRK, A3EBSAKWK, A3EBSBKWKYK, A3EBSEKWK, A3EBSWK, A4EB, A4EBD, A4EBDAKEYK, A4EBDAKRK, A4EBDAKWK, A4EBDAKZK, A4EBDBKRK, A4EBDPKWKYK, A4EBDRK, A4EBS, A4EBSAK, A4EBSAKCK, A4EBSAKKEYK, A4EBSAKRK, A4EBSAKRKP, A4EBSAKYK, A4EBSCK, A4EBT, A4EBTSAK, A5EB, A5EBD, A5EBDAKPKWK, A5EBDAKWK, A5EBDAKYK, A5EBDRK, A5EBS, A5EBSAKPKWK, A5EBSAKRK, A5EBSAKRKYK, A5EBSAKWK, A5EBSAKWKYK, A5EBSBKRPK, A5EBSBKWK, A5EBSRK...(Other models you can see in the webshop)		



1			
<b>GEV No.</b>	518221	<b>Ref. No.</b>	437072
<b>description</b>	gasket for lid		
<b>For models:</b>	CLEAN-3, RIVER-43		



1			
<b>GEV No.</b>	519406	<b>Ref. No.</b>	929209
<b>description</b>	gasket for sliding plate dimensions 69x16mm		



1			
<b>GEV No.</b>	510014	<b>Ref. No.</b>	437036
<b>description</b>	gasket suitable for HOBART equiv. no. 139321-155 L 84mm W 40mm thickness 2.5mm		
<b>For models:</b>	21F, 21FD, 21R, 21RD, 25F, 25FD, 25R, 25RD, 30F, 30FD, 30R, 30RD, 31F, 31FD, 31R, 31RD, S621, S623, S624, S626, S631, S633, S634, S636, S651, S651P, S653, S654, S655, S830, S835, SR651		

## gaskets for wash arm support



1			
<b>GEV No.</b>	518008	<b>Ref. No.</b>	437016
<b>description</b>	gasket D1 $\varnothing$ 43mm D2 $\varnothing$ 78mm thickness 2mm with 6 holes wash arm support		
<b>For models:</b>	66, S651, S651P, S653, S654, S655, S810, S815, S830, S835, S850, SR651		



1			
<b>GEV No.</b>	518025	<b>Ref. No.</b>	437014
<b>description</b>	gasket D1 $\varnothing$ 50mm D2 $\varnothing$ 82mm thickness 2mm with 6 holes wash arm support equiv. no. 437014 suitable for COLGED		
<b>For models:</b>	050F, 050FP, 10, 12, 14, 22F, 22R, 2312-001, 2312-002, 40F, 440F, 44F, 45, 450, 46, 460, 500F, 500FD, 50F, 50FD, 510F, 510FD, 66, 913297, 913298, 913299, 913300, 913360, 913361, 913391, 913392, 913418, 913546, 913547, 913578, 913611, 913684, 913913, 913914, 913932, 913933, 914167, 914168, 914284, 914318, 914319, 914326, 914331, 914338, 914356...(Other models you can see in the webshop)		



1			
<b>GEV No.</b>	518649	<b>Ref. No.</b>	437108
<b>description</b>	gasket D1 $\varnothing$ 64mm D2 $\varnothing$ 49mm thickness 2mm wash arm support		
<b>For models:</b>	915611, 915612, 915613, 915614, 915615, 915616, 915617, 915618, 915670, 915671, 915672, 915773, 915774, 915959, 916066, 916077, 916078, 916196, 916197, 916198, 916199, 916200, 916409, 916410, 916418, 916419, 916591, 916592, 916593, 916594, 916595, 916877, 916921, 916922, 916992, 916993, Fast145-2, Fast150, Niagara-241, Niagara-241-2, Niagara-341, Pluvia-240, RIVER-242, River-242-2, River-242-2T, River-342C, River-342T		



1			
<b>GEV No.</b>	510054	<b>Ref. No.</b>	437046
<b>description</b>	gasket D1 $\varnothing$ 65mm D2 $\varnothing$ 35.5mm thickness 2.5mm with 5 holes wash arm support		
<b>For models:</b>	11F, 11FD, 11F-DVGW, 11R, 11RD, 67F, 67R, 913363, 913364, 913376, 913377, E.41, E.42, E41		



1

<b>GEV No.</b>	518656	<b>Ref. No.</b>	70476
<b>description</b>	gasket D1 ø 90mm D2 ø 70mm thickness 1.5mm wash arm support		
<b>For models:</b>	NG381L, NG381LC, NG381LCFUR, NG381LDDPS, Niagara-283L-2, Niagara-381L, Niagara-381LC, River-282L-2, River-282LS-2TDE, River-382L, River-382L-230V-3Ph-50Hz, River-382LNRG, River-382LTDE, River-482, RV382L, RV382L23TERMO, RV382LFUR, RV382LR, RV382LS, RV382LSFUR, RV382LTX, RV382LTXR, RV482		



1

<b>GEV No.</b>	518339	<b>Ref. No.</b>	437064
<b>description</b>	gasket D2 ø 50mm thickness 2mm with 3 screw holes wash arm support equiv. no. 437064 suitable for COLGED hole ø 50mm hole distance 67mm		
<b>For models:</b>	050F, 050FP, 2312-001, 2312-002, 46, 460, 500F, 500FD, 50F, 50FD, 510F, 510FD, 913297, 913298, 913299, 913300, 913360, 913361, 913391, 913392, 913546, 913547, 913578, 913611, 913684, 913913, 913914, 913932, 913933, 914284, 914318, 914319, 914331, 914338, 914356, 914400, 914401, 914402, 914403, 914404, 914405, 914431, 914449, 914517, 914545, 914568, 914642, 914688, 914909, 914979... (Other models you can see in the webshop)		



1

<b>GEV No.</b>	518402	<b>Ref. No.</b>	437050
<b>description</b>	gasket with 3 screw holes wash arm support hole distance 61mm D2 ø 34mm thickness 2.5mm hole ø 34mm		
<b>For models:</b>	22F, 22R, 40F, 440F, 44F, 914380, 914436, 915747, A3EB, A3EBD, A3EBDAKRKYK, A3EBDAKWK, A3EBDBKWK, A3EBDRKYK, A3EBDWK, A3EBDYK, A3EBSAK, A3EBSAKRK, A3EBSAKWK, A3EBSBKWKYK, A3EBSEKWK, A3EBSWK, A4EB, A4EBD, A4EBDAKEYK, A4EBDAKRK, A4EBDAKWK, A4EBDAKZK, A4EBDBKRK, A4EBDPKWKYK, A4EBDRK, A4EBS, A4EBSAK, A4EBSAKCK, A4EBSAKEKYK, A4EBSAKRK, A4EBSAKRKP, A4EBSAKYK, A4EBSCK, A4EBT, A4EBTSAK, A5EB, A5EBD, A5EBDAKP-KWK, A5EBDAKWK, A5EBDAKYK, A5EBDRK, A5EBS, A5EBSAKPKWK, A5EBSAKRK... (Other models you can see in the webshop)		

## transmission technology and ball bearings

### ball bearings

#### deep-groove ball bearings 2RS



1

<b>GEV No.</b>	523501	<b>Ref. No.</b>	314009
<b>description</b>	deep-groove ball bearing type 608-2RS shaft ø 8mm ED ø 22mm W 7mm with sealing discs deep-groove ball bearing DIN 625-1		
<b>For models:</b>	350F, 350FD, 350R, 350RD, 35-ELECTRONIC, 35F, 35FD, 35R, 35RD, 400F, 400FD, 400R, 400RD, 40-ELECTRONIC, 40F, 40FD, 40R, 40RD, 913289, 913290, 913291, 913292, 913356, 913357, 913372, 913373, 913374, 913375, 913416, 913435, 913544, 913545, 913665, 913666, 913667, 913668, 913685, 913771, 913772, 913773, 913774, 913832, 913837, 913911, 913912, 913948, 913950, 913977, 913984, 913990... (Other models you can see in the webshop)		



1

<b>GEV No.</b>	523509	<b>Ref. No.</b>	314001
<b>description</b>	deep-groove ball bearing type 6201-2RS shaft ø 12mm ED ø 32mm W 10mm with sealing discs deep-groove ball bearing DIN 625-1		
<b>For models:</b>	050F, 050FP, 10, 11F, 11FD, 11F-DVGW, 11R, 11RD, 21F, 21FD, 21R, 21RD, 2312-001, 2312-002, 2312-007, 2312-009-CRP, 25F, 25FD, 25R, 25RD, 30F, 30FD, 30R, 30RD, 31F, 31FD, 31R, 31RD, 45, 450, 46, 460, 500F, 500FD, 50-ELECTRONIC, 50F, 50FD, 510F, 510FD, 67F, 67R, 913297, 913298, 913299, 913300, 913360, 913361, 913363, 913364, 913376... (Other models you can see in the webshop)		



1

<b>GEV No.</b>	523511	<b>Ref. No.</b>	314003
<b>description</b>	deep-groove ball bearing type 6203-2RS shaft ø 17mm ED ø 40mm W 12mm with sealing discs deep-groove ball bearing DIN 625-1		
<b>For models:</b>	22F, 40F, 440F, 44F, 55, 66, CLEAN-120, E.52, E12, E120, E14, E140, S651, S654, S810, S815, S830, S835, S850, S870		



deep-groove ball bearings 2Z



<b>GEV No.</b>	523539	<b>Ref. No.</b>	314005
<b>description</b>	deep-groove ball bearing shaft $\varnothing$ 20mm ED $\varnothing$ 47mm W 14mm type 6204-2Z DIN 625-1		

springs

compression springs



<b>GEV No.</b>	696750	<b>Ref. No.</b>	927244 CMT13
<b>description</b>	compression spring $\varnothing$ 20mm L 89.5mm wire gauge $\varnothing$ 2mm windings 14 zinc-coated steel		
<b>For models:</b>	161, 221, 271, 272, 362, 914380, 914436, 915773, A3EB, A3EBD, A3EBDAKRKYK, A3EBDAKWK, A3EBDBKWK, A3EBDRKYK, A3EBDVK, A3EBDYK, A3EBSAK, A3EBSAKRK, A3EBSAKWK, A3EBSBKWKYK, A3EBSEKWK, A3EBSWK, A4EB, A4EBD, A4EBDAKEKYK, A4EBDAKRK, A4EBDAKWK, A4EBDAKZK, A4EBDBKRK, A4EBDPKWKYK, A4EBDRK, A4EBS, A4EBSAK, A4EBSAKCK, A4EBSAKEKYK, A4EBSAKRK, A4EBSAKRKP, A4EBSAKYK, A4EBSCK, A4EBT, A4EBTSAK, A5EB, A5EBD, A5EBDAKPWK, A5EBDAKWK, A5EBDAKYK, A5EBDRK, A5EBS, A5EBSAKPKWK, A5EBSAKRK...(Other models you can see in the webshop)		

spring compressors



<b>GEV No.</b>	513119	<b>Ref. No.</b>	926009
<b>description</b>	spring compressor		
<b>For models:</b>	10, 12, 14, 80, 81, 82, CE78HZ23, CGL74CABT, CNT800CH, E100, E110, E120, E140, E78, E78HP, Fast180, Fast180-230V-3Ph-60Hz, Fast181, FAST-181, Fast181-230V-3Ph-60Hz, Fast181-400V-3NPh-60Hz, FAST-60, FAST-73, HM1, NG281, NG281CDD, NG281HP, NG281HPDD, NG281HZ23, NG281HZ23DD, NG381, NG38123, NG38123TERMO, NG381C, NG381CDD, NG381CFUR, NG381DDHZ23, NG381DDPS, NG381DDPSHZ23, NG381HPDD, NG381L, NG381LC, NG381LCFUR, NG381LDDPS, NG381TERMO, NG381TXCDD, Niagara-281, Niagara-281-2, Niagara-281HP, NIAGARA-283...(Other models you can see in the webshop)		

gas tension springs

gas tension springs



<b>GEV No.</b>	701299	<b>Ref. No.</b>	35070
<b>description</b>	gas tension spring 50N hub 150mm D1 $\varnothing$ 15mm D2 $\varnothing$ 6mm hole distance 365.5mm hole $\varnothing$ 6.5mm L 380mm		
<b>For models:</b>	914214, 914316, 914317, 914318, 914319, 914338, 914431, 914874, LP60, Mistral40, MISTRAL-40, Mistral51, MISTRAL-51, NG271, NG291, NIAGARA-271, NIAGARA-291, RIVER-294, RIVER-71, RV294, RV71, U60E		

roller springs

roller springs



<b>GEV No.</b>	511910	<b>Ref. No.</b>	927267
<b>description</b>	roller spring complete incl. holder W 39mm ID $\varnothing$ mm lug length 67mm		
<b>For models:</b>	161, 221, 271, 272, 362, CLEAN-160, CLEAN-161, CLEAN-220, CLEAN-221, CLEAN-270, CLEAN-271, CLEAN-272, CLEAN-361, CLEAN-361P, CLEAN-362, CLEAN-471, CLEAN-471P		



<b>GEV No.</b>	518029	<b>Ref. No.</b>	927268 927269
<b>description</b>	roller spring complete incl. holder W 50mm ID $\varnothing$ mm lug length 68mm		
<b>For models:</b>	271, 362, CLEAN-161, CLEAN-221, CLEAN-270, CLEAN-271, CLEAN-272, CLEAN-361, CLEAN-362, CLEAN-471		



<b>GEV No.</b>	517449	<b>Ref. No.</b>	75271
<b>description</b>	roller spring L 95mm W 66mm		
<b>For models:</b>	914380, 914436, A3EB, A3EBD, A3EBDAKRKYK, A3EBDAKWK, A3EBDBKWK, A3EBDRKYK, A3EBDVK, A3EBDYK, A3EBSAK, A3EBSAKRK, A3EBSAKWK, A3EBSBKWKYK, A3EBSEKWK, A3EBSWK, A4EB, A4EBD, A4EBDAKEKYK, A4EBDAKRK, A4EBDAKWK, A4EBDAKZK, A4EBDBKRK, A4EBDPKWKYK, A4EBDRK, A4EBS, A4EBSAK, A4EBSAKCK, A4EBSAKEKYK, A4EBSAKRK, A4EBSAKRKP, A4EBSAKYK, A4EBSCK, A4EBT, A4EBTSAK, A5EB, A5EBD, A5EBDAKPWK, A5EBDAKWK, A5EBDAKYK, A5EBDRK, A5EBS, A5EBSAKPKWK, A5EBSAKRK, A5EBSAKRKYK, A5EBSAKWK, A5EBSAKWKYK, A5EBSBKWK, A5EBSRK...(Other models you can see in the webshop)		





<b>GEV No.</b>	517452	<b>Ref. No.</b>	927020
<b>description</b>	roller spring W 38.5mm ID $\varnothing$ 24mm lug lengthmm mounting distance 22mm		
<b>For models:</b>	CLEAN-160, CLEAN-220, CLEAN-270, CLEAN-271, CLEAN-361, CLEAN-361P, CLEAN-471, CLEAN-471P		

			
1			
<b>GEV No.</b>	517453	<b>Ref. No.</b>	927310
<b>description</b>	roller spring W 51mm ID ø 28mm lug lengthmm mounting distance 22mm		

			
1			
<b>GEV No.</b>	517450	<b>Ref. No.</b>	77560
<b>description</b>	roller spring W 51mm ID ø 31mm lug length 90mm		
<b>For models:</b>	A4EB, A4EBD, A4EBDAKEKYK, A4EBDAKRK, A4EBDAKWK, A4EBDAKZK, A4EBDBKRK, A4EBDPKWYK, A4EBDRK, A4EBS, A4EBSAK, A4EBSAKCK, A4EBSAKEKYK, A4EBSAKRK, A4EBSAKRKP, A4EBSAKYK, A4EBSCK, A4EBT, A4EBTSAK, A5EB, A5EBD, A5EBDAKPKWK, A5EBDAKWK, A5EBDAKYK, A5EBDRK, A5EBS, A5EBSAKPKWK, A5EBSAKRK, A5EBSAKRKYK, A5EBSAKWK, A5EBSAKWKYK, A5EBSBKRKP, A5EBSBKWK, A5EBSRK, A5EBSYK, GL284EB, GL284EBD, GL284EBDA, GL284EBDAEW, GL284EBDAWY, GL284EBDPWY, GL284EBDR, GL284EBDY, GL284EBHZ23, GL284EBHZ23DBHZY, GL284EBHZ23DBWY, GL284EBHZ23DBY, GL284EBHZ23DY, GL284EBHZ23SAP, GL284EBS...(Other models you can see in the webshop)		

tension springs

			
1			
<b>GEV No.</b>	701154	<b>Ref. No.</b>	449059 449063
<b>description</b>	tension spring ø 10.5mm total length 200mm wire gauge ø 1.3mm for door mechanism		
<b>For models:</b>	915160, 915161, 915162, 915166, 915167, 915168, 915172, 915173, 915175, 915176, 915177, 915285, 915319, 915338, 915341, 915348, 915418, 915419, 915420, 915421, 915422, 915479, 915496, 915497, 915547, 915558, 915635, 915663, 915747, 916054, 916068, 916069, 916080, 916205, 916206, 916207, 916208, 916209, 916365, 916366, 916367, 916368, 916414, 916415, 916416, 916417, 916422, 916423, 916424, 916684...(Other models you can see in the webshop)		

			
1			
<b>GEV No.</b>	518260	<b>Ref. No.</b>	449049
<b>description</b>	tension spring ø 10mm total length 145mm wire gauge ø 1mm		
<b>For models:</b>	2312-007, 2312-009-CRP, 67R, 913992, 913993, 914100, 914101, 914214, 914316, 914317, 914318, 914319, 914338, 914339, 914342, 914343, 914431, 914583, 914592, 914612, 914613, 914624, 914625, 914626, 914627, 914628, 914850, 914851, 914854, 914874, 914944, 915143, 915150, 915151, 915152, 915154, 915155, 915157, 915158, 915492, 915493, 915494, 915495, 916067, 916079, 916201, 916202, 916203, 916204, 916411...(Other models you can see in the webshop)		

			
1			
<b>GEV No.</b>	701227	<b>Ref. No.</b>	449057 H.227855 H.231937
<b>description</b>	tension spring ø 10mm total length 155mm wire gauge ø 1.1mm L1 60mm L2 11mm for door mechanism		
<b>For models:</b>	2312-007, 2312-009-CRP, 914100, 914101, 914339, 914342, 914343, 914624, 914625, 914626, 914627, 914628, 914850, 914851, 914854, 914944, RIVER-48, RIVER-50, RIVER-50-CRP, RIVER-50-CRP-SP, River-54, RIVER-54CRP, River-54-CRP-s.p., RIVER-54-CRP-SP, RIVER-61		

			
1			
<b>GEV No.</b>	513206	<b>Ref. No.</b>	926007
<b>description</b>	tension spring ø 29.8mm total length 513mm wire gauge ø 5.8mm		
<b>For models:</b>	10, 12, 14, 80, 81, 82, CE78HZ23, CGL74CABT, CLEAN-100, CLEAN-110, CLEAN-120, CNT800CH, E1, E10, E100, E110, E12, E120, E14, E140, E78, E78HP, Fast180, Fast180-230V-3Ph-60Hz, Fast181, FAST-181, Fast181-230V-3Ph-60Hz, Fast181-400V-3NPh-60Hz, FAST-60, FAST-73, HM1, Niagara-283A, PLUVIA-280, Pluvia280-230V-3PH-60HZ, PS-60, PV280, PV280FAST, PV280FAST2, PV280FAST2BIO, PV280FAST2HZ23, PV-280FASTCH, PV280FASTHB, PV280HZ23, RIVER-78, RIVER-80, River-81, River-81CRP, RIVER-81-CRP, RIVER-82, River-82CRP...(Other models you can see in the webshop)		

			
1			
<b>GEV No.</b>	517448	<b>Ref. No.</b>	926108
<b>description</b>	tension spring ø 30mm total length 505mm wire gauge ø 5.5mm for hood mechanics Qty 1 pcs		
<b>For models:</b>	80, 81, 82, CGL74CABT, NG281, NG281CDD, NG281HP, NG281HPDD, NG281HZ23, NG281HZ23DD, NG381, NG38123, NG38123TERMO, NG381C, NG381CDD, NG381CFUR, NG381DDHZ23, NG381DDPS, NG381DDPSHZ23, NG381HPDD, NG381L, NG381LC, NG381LCFUR, NG381LDDPS, NG381TERMO, NG381TXCDD, NIAGARA-281, Niagara-281-2, Niagara-281HP, NIAGARA-283, Niagara-283L-2, Niagara-381, Niagara-381-230V-3Ph-50Hz, Niagara-381-230V-3Ph-60Hz, Niagara-381DP, Niagara-381HPD, Niagara-381L, Niagara-381LC, OC380, OC-380FUR, OC380HZ23, Ocean380, RIVER-282, River-282-2, River-282L-2, River-282LS-2TDE, River-282S-2TDE, River-285, River-382, River-382-230V-3Ph-50Hz...(Other models you can see in the webshop)		

			
1			
<b>GEV No.</b>	517451	<b>Ref. No.</b>	35020
<b>description</b>	tension spring ø 8mm total length 150mm wire gauge ø 1mm Qty 1 pcs		
<b>For models:</b>	LP60, NG271, NG291, NIAGARA-271, NIAGARA-291, RIVER-294, RIVER-71, RV294, RV71, U60E		





## dosing pumps

### peristaltic dosing pumps

#### BORES

##### built-in version

##### with flow control



<b>GEV No.</b>	361027	<b>Ref. No.</b>	209009
<b>description</b>	dosing pump BORES flow control 0.72l/h 230VAC detergent hose ø 4x6mm hose type 361130 hose Santoprene type Perios CODE P1D		
<b>For models:</b>	45, 450, 46, 460		
<b>spare parts for</b>	361027		
	<b>GEV No.</b>	<b>Ref. No.</b>	—
	361128		
	pump hose Perios detergent hose ø 4x7mm hose type Santoprene L 120mm		
	<b>GEV No.</b>	<b>Ref. No.</b>	143181
	361130		
	pump hose Perios detergent hose ø 4x7mm hose type Santoprene		
	<b>GEV No.</b>	<b>Ref. No.</b>	—
	361464		
	roller assembly rinse aid/detergent hose type Santoprene/silicone pump type Perios		
<b>accessories for</b>	361027		
	<b>GEV No.</b>	<b>Ref. No.</b>	—
	361142		
	mounting set detergent hose type 4x6mm hose length 2m PVC 2x hose/container filter/tank intake transparent		
	<b>GEV No.</b>	<b>Ref. No.</b>	143194
	520090		
	PVC hose ID ø 4mm ED ø 6mm L 2m thickness 1mm t.max. 60°C transparent		
	<b>GEV No.</b>	<b>Ref. No.</b>	—
	520091		
	nylon hose ID ø 4mm ED ø 6mm L 2m thickness 1mm operating p. 10bar burst p. 50bar t.max. 100°C transparent		

##### with time control



<b>GEV No.</b>	361216	<b>Ref. No.</b>	DWD11
<b>description</b>	dosing pump time control rinse aid type PD2.0 230V voltage AC hose ø 4x6mm hose silicone		

#### GERMAC

##### built-in version

##### without control



<b>GEV No.</b>	361022	<b>Ref. No.</b>	209014
<b>description</b>	dosing pump GERMAC without control 2l/h 230VAC detergent hose ø 4x6mm hose thermoplastic type G200 built-in version dimensions 55x70x88mm		
<b>spare parts for</b>	361022		
	<b>GEV No.</b>	<b>Ref. No.</b>	—
	361263		
	roller assembly GERMAC suitable for G80/82/150/152/200/202/250 /252/600		
	<b>GEV No.</b>	<b>Ref. No.</b>	—
	361554		
	pump hose GERMAC detergent hose type thermoplastic hose ø 5x8mm for model G200/G250/G252		
<b>accessories for</b>	361022		
	<b>GEV No.</b>	<b>Ref. No.</b>	143194
	520090		
	PVC hose ID ø 4mm ED ø 6mm L 2m thickness 1mm t.max. 60°C transparent		
	<b>GEV No.</b>	<b>Ref. No.</b>	—
	520091		
	nylon hose ID ø 4mm ED ø 6mm L 2m thickness 1mm operating p. 10bar burst p. 50bar t.max. 100°C transparent		

#### SEKO







##### built-in version



##### with frequency control







<b>GEV No.</b>	361767 <sup>1</sup>	<b>Ref. No.</b>	209021
<b>description</b>	dosing pump SEKO 3l/h 230VAC detergent hose ø 4x6mm hose type K hose Santoprene suction level 1.5m type NBR 3 8W built-in version peristaltic pump		
<b>For models:</b>	913291, 913292, 913297, 913298, 913299, 913300, 913357, 913360, 913361, 913363, 913364, 913374, 913375, 913376, 913377, 913391, 913392, 913416, 913418, 913435, 913545, 913546, 913547, 913578, 913611, 913666, 913668, 913684, 913685, 913773, 913774, 913911, 913912, 913913, 913914, 913932, 913933, 913948, 913950, 913977, 913984, 913990, 913992, 913993, 914100, 914101, 914165, 914166, 914167, 914168...(Other models you can see in the webshop)		
<b>spare parts for</b>	361767		
	<b>GEV No.</b>	<b>Ref. No.</b>	—
	361815		
	pump hose detergent hose ø 6x10mm hose ø 4x6mm hose type K hose Santoprene type SEKO		

<sup>1</sup>incl. inlet and conveyor hose



							
1							
<b>GEV No.</b>	361215	<b>Ref. No.</b>	209016				
<b>description</b>	dosing pump SEKO frequency control 0.3-3.0l/h 230VAC detergent hose ø 4x6mm hose type K hose Santoprene suction level 1.5m type PBR protection IP55 dimensions 100x67x68mm power input 3.5W						
<b>For models:</b>	2312-001, 2312-002, 2312-007, 2312-009-CRP, 31F, 31FD, 31R, 31RD, 67F, 67R, 80, 81, 82, 913289, 913290, 913356, 913372, 913373, 913544, 913665, 913667, 913771, 913772, 913832, 913837, 914214, 914316, 914317, 914339, 914342, 914343, 914386, 914387, 914388, 914390, 914391, 914626, 914692, 914693, 914694, 914703, 914870, 914874, CGL74CABT, E.35, E.35-Elettrobar, E.35H, E.35H-Elettrobar, E.40, E.40H...(Other models you can see in the webshop)						
<b>spare parts for</b>	361215						
		<table border="1"> <tr> <td>GEV No.</td> <td>361136</td> <td>Ref. No.</td> <td>—</td> </tr> </table>	GEV No.	361136	Ref. No.	—	roller assembly for dosing pump hole ø 4.8x4mm
GEV No.	361136	Ref. No.	—				
		<table border="1"> <tr> <td>GEV No.</td> <td>361226</td> <td>Ref. No.</td> <td>—</td> </tr> </table>	GEV No.	361226	Ref. No.	—	PCB L 59mm W 26mm electronic control
GEV No.	361226	Ref. No.	—				
		<table border="1"> <tr> <td>GEV No.</td> <td>361815</td> <td>Ref. No.</td> <td>—</td> </tr> </table>	GEV No.	361815	Ref. No.	—	pump hose detergent hose ø 6x10mm hose ø 4x6mm hose type K hose Santoprene type SEKO
GEV No.	361815	Ref. No.	—				
<b>accessories for</b>	361215						
		<table border="1"> <tr> <td>GEV No.</td> <td>361142</td> <td>Ref. No.</td> <td>—</td> </tr> </table>	GEV No.	361142	Ref. No.	—	mounting set detergent hose type 4x6mm hose length 2m PVC 2x hose/container filter/tank intake transparent
GEV No.	361142	Ref. No.	—				
		<table border="1"> <tr> <td>GEV No.</td> <td>520090</td> <td>Ref. No.</td> <td>143194</td> </tr> </table>	GEV No.	520090	Ref. No.	143194	PVC hose ID ø 4mm ED ø 6mm L 2m thickness 1mm t.max. 60°C transparent
GEV No.	520090	Ref. No.	143194				
		<table border="1"> <tr> <td>GEV No.</td> <td>520091</td> <td>Ref. No.</td> <td>—</td> </tr> </table>	GEV No.	520091	Ref. No.	—	nylon hose ID ø 4mm ED ø 6mm L 2m thickness 1mm operating p. 10bar burst p. 50bar t.max. 100°C transparent
GEV No.	520091	Ref. No.	—				

							
1							
<b>GEV No.</b>	361949	<b>Ref. No.</b>	209034 209037				
<b>description</b>	dosing pump SEKO frequency control 0.4l/h 230VAC rinse aid hose ø 4x6mm hose type E hose Sekobril suction level 1.5m type NBR 0.4						
<b>For models:</b>	913363, 913364, 915160, 915161, 915162, 915175, 915319, 915611, 915612, 915613, 915663, 915670, 915695, 915696, 916237, 916238, 916239, 916240, 916241, 916242, 916243, 916244, 916245, 916246, 916247, 916248, 916249, 916250, 916251, 916252, 916365, 916366, 916382, 916383, 916401, 916402, 916403, 916404, 916405, 916406, 916407, 916408, 916451, 916452, 916504, 916583, 916584, 916670, 916687, 916688...(Other models you can see in the webshop)						
<b>accessories for</b>	361949						
		<table border="1"> <tr> <td>GEV No.</td> <td>361925</td> <td>Ref. No.</td> <td>143266</td> </tr> </table>	GEV No.	361925	Ref. No.	143266	pump hose SEKO rinse aid hose ø 3x8mm with backflow preventer hose ø 6mm hose type E hose Sekobril
GEV No.	361925	Ref. No.	143266				

							
1							
<b>GEV No.</b>	361948	<b>Ref. No.</b>	209029 209038				
<b>description</b>	dosing pump SEKO frequency control 3l/h 230VAC detergent hose ø 4x6mm hose type L hose Santoprene suction level 1.5m type NBR 3						
<b>For models:</b>	913363, 913364, 915160, 915161, 915162, 915175, 915319, 915479, 915611, 915612, 915613, 915614, 915615, 915616, 915635, 915663, 915670, 915671, 915686, 915687, 915688, 915689, 915690, 915691, 915692, 915693, 915694, 915695, 915696, 915697, 915698, 915699, 915700, 915701, 915702, 915747, 915756, 915799, 915800, 915819, 915830, 915959, 916162, 916237, 916238, 916239, 916240, 916241, 916242, 916243...(Other models you can see in the webshop)						
<b>spare parts for</b>	361948						
		<table border="1"> <tr> <td>GEV No.</td> <td>362004</td> <td>Ref. No.</td> <td>143267</td> </tr> </table>	GEV No.	362004	Ref. No.	143267	dosing hose SEKO detergent hose ø 6x9mm hose length 138mm hose ø 4x6mm hose type L hose Santoprene
GEV No.	362004	Ref. No.	143267				

without control							
							
1							
<b>GEV No.</b>	361902	<b>Ref. No.</b>	209028 209039 999296				
<b>description</b>	dosing pump SEKO 3l/h 230VAC detergent hose ø 4x6mm hose type L hose Santoprene suction level 1.5m type NPG 3						
<b>For models:</b>	915154, 915155, 915157, 915158, 915172, 915173, 915285, 915422, 915492, 915493, 915494, 915495, 915496, 915497, 915617, 915618, 915672, 915773, 915774, 916020, 916021, 916024, 916025, 916026, 916027, 916030, 916031, 916045, 916054, 916066, 916067, 916068, 916069, 916077, 916078, 916079, 916080, 916181, 916183, 916184, 916185, 916196, 916197, 916198, 916199, 916200, 916201, 916202, 916203, 916204...(Other models you can see in the webshop)						
<b>spare parts for</b>	361902						
		<table border="1"> <tr> <td>GEV No.</td> <td>362004</td> <td>Ref. No.</td> <td>143267</td> </tr> </table>	GEV No.	362004	Ref. No.	143267	dosing hose SEKO detergent hose ø 6x9mm hose length 138mm hose ø 4x6mm hose type L hose Santoprene
GEV No.	362004	Ref. No.	143267				



			
1			
<b>GEV No.</b>	361929 <sup>1</sup>	<b>Ref. No.</b>	209024 209033 209036 999309
<b>description</b>	dosing pump SEKO without control 0.4l/h 230VAC rinse aid hose ø 4x6mm hose type E hose Sekobril suction level 1.5m type NPG 0.4 8W cable length 45mm built-in version with backflow preventer		
<b>For models:</b>	915154, 915155, 915157, 915158, 915172, 915173, 915422, 915492, 915493, 915494, 915495, 915496, 915497, 915617, 915618, 915672, 915773, 915774, 916020, 916021, 916024, 916025, 916026, 916027, 916030, 916031, 916045, 916054, 916066, 916067, 916068, 916069, 916077, 916078, 916079, 916080, 916181, 916183, 916184, 916185, 916196, 916197, 916198, 916199, 916200, 916201, 916202, 916203, 916204, 916205...(Other models you can see in the webshop)		
<b>spare parts for</b>	361929		
	<b>GEV No.</b>	<b>Ref. No.</b>	143266
	 pump hose SEKO rinse aid hose ø 3x8mm with backflow preventer hose ø 6mm hose type E hose Sekobril		

<sup>1</sup>with accessories



spare parts			
			
1			
<b>GEV No.</b>	698712	<b>Ref. No.</b>	143219 143258
<b>description</b>	dosing hose SEKO detergent hose ø 4x8.6mm hose ø 4x6mm hose type H hose Santoprene		
<b>For models:</b>	2312-001, 2312-002, 2312-007, 2312-009-CRP, 913289, 913290, 913291, 913292, 913297, 913298, 913299, 913300, 913356, 913357, 913360, 913361, 913372, 913373, 913374, 913375, 913391, 913392, 913416, 913418, 913435, 913544, 913545, 913546, 913547, 913578, 913611, 913665, 913666, 913667, 913668, 913684, 913685, 913771, 913772, 913773, 913774, 913832, 913837, 913911, 913912, 913913, 913914, 913932, 913933, 913948...(Other models you can see in the webshop)		

			
1			
<b>GEV No.</b>	362004	<b>Ref. No.</b>	143267
<b>description</b>	dosing hose SEKO detergent hose ø 6x9mm hose length 138mm hose ø 4x6mm hose type L hose Santoprene		
<b>For models:</b>	915160, 915161, 915162, 915175, 915319, 915611, 915612, 915613, 915617, 915618, 915663, 915670, 916020, 916021, 916024, 916025, 916026, 916027, 916030, 916031, 916045, 916066, 916067, 916068, 916069, 916077, 916078, 916079, 916080, 916181, 916183, 916184, 916185, 916196, 916197, 916198, 916199, 916200, 916201, 916202, 916203, 916204, 916205, 916206, 916207, 916237, 916238, 916239...(Other models you can see in the webshop)		

			
1			
<b>GEV No.</b>	698710 <sup>1</sup>	<b>Ref. No.</b>	143261
<b>description</b>	dosing hose SEKO rinse aid hose ø 5x10mm hose length 116mm with backflow preventer hose ø 4x6mm hose type F hose Sekobril		
<b>For models:</b>	913363, 913364, 915154, 915155, 915157, 915158, 915172, 915173, 915422, 915492, 915493, 915494, 915495, 915496, 915497, 915617, 915618, 915672, 915773, 915774, 916054, 916788, E41, Fast140, NG381LCFUR, Niagara-283L-2, River-242, RIVER-252, River-253, RIVER-262, River-282L-2, RV382LFUR		

<sup>1</sup>with backflow preventer

			
1			
<b>GEV No.</b>	698711	<b>Ref. No.</b>	143259
<b>description</b>	dosing hose SEKO rinse aid hose ø 6x10mm hose length 113mm hose ø 4x6mm hose type G hose Sekobril		
<b>For models:</b>	915285, RIVER-262		

			
1			
<b>GEV No.</b>	361135	<b>Ref. No.</b>	143251
<b>description</b>	pump hose SEKO rinse aid hose ø 3x8mm hose ø 4x6mm hose type D hose Sekobril		
<b>For models:</b>	A3EBDAKRKYK, A3EBDRKYK, A4EBDAKEKYK, A4EBDPKWKYK, A4EBSAKKYK, A5EBDAKYK, A5EBSAKRKYK, A5EBSAKWKYK		
<b>spare parts for</b>	361135		
	<b>GEV No.</b>	<b>Ref. No.</b>	—
	 union nut for hose connector ø 17mm		



			
1			
<b>GEV No.</b>	361925 <sup>1</sup>	<b>Ref. No.</b>	143266
<b>description</b>	pump hose SEKO rinse aid hose ø 3x8mm with backflow preventer hose ø 6mm hose type E hose Sekobril		
<b>For models:</b>	913363, 915160, 915161, 915162, 915175, 915319, 915611, 915612, 915613, 915617, 915618, 915663, 915670, 915695, 915696, 916020, 916021, 916024, 916025, 916026, 916027, 916030, 916031, 916045, 916066, 916067, 916068, 916069, 916077, 916078, 916079, 916080, 916181, 916183, 916184, 916185, 916196, 916197, 916198, 916199, 916200, 916201, 916202, 916203, 916204, 916205, 916206, 916207, 916208, 916209...(Other models you can see in the webshop)		

<sup>1</sup>with backflow preventer

piston pumps

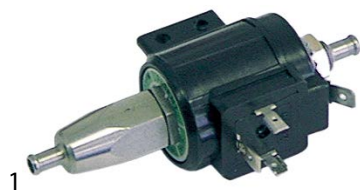
with solenoid coil



<b>GEV No.</b>	361026	<b>Ref. No.</b>	987017
<b>description</b>	dosing pump inlet 5mm outlet 5mm 230V detergent duty cycle 30% type EV1		
<b>For models:</b>	10, 11F, 11FD, 11F-DVGW, 11R, 11RD, 12, 14, 22F, 22R, 40F, 440F, 44F, 45, 450, 46, 460, 66, CLEAN-100, CLEAN-110, CLEAN-120, CLEAN-3, E.45, E.46, TF-503, TF-513, TF-515		
<b>spare parts for</b>	361026		
	<b>GEV No.</b>	361365	<b>Ref. No.</b> 201020
	solenoid coil 230VAC for type EV1		
	<b>GEV No.</b>	510298	<b>Ref. No.</b> 144012 144026
	lip valve dosing pump suitable for DB2/DS5		

spare parts



<b>GEV No.</b>	361113	<b>Ref. No.</b>	201002
<b>description</b>	solenoid coil 230VAC for type DB2		
<b>For models:</b>	10, 11F, 11FD, 11F-DVGW, 11R, 11RD, 12, 21F, 21FD, 21R, 21RD, 22F, 22R, 25F, 25FD, 25R, 25RD, 30F, 30FD, 30R, 30RD, 31F, 31FD, 31R, 31RD, 350F, 350FD, 350R, 350RD, 35-ELECTRONIC, 35F, 35FD, 35R, 35RD, 400F, 400FD, 400R, 400RD, 40-ELECTRONIC, 40F, 40FD, 40R, 40RD, 440F, 44F, 45, 450, 46, 460, 500F...(Other models you can see in the webshop)		



<b>GEV No.</b>	361365	<b>Ref. No.</b>	201020
<b>description</b>	solenoid coil 230VAC for type EV1		
<b>For models:</b>	10, 11F, 11FD, 11F-DVGW, 11R, 11RD, 12, 14, 21F, 21FD, 21R, 21RD, 22F, 22R, 25F, 25FD, 25R, 25RD, 30F, 30FD, 30R, 30RD, 31F, 31FD, 31R, 31RD, 40F, 440F, 44F, 46, 460, 66, CLEAN-100, CLEAN-110, CLEAN-120, CLEAN-3, E.45, E.46, TF-503, TF-513, TF-515		



<b>GEV No.</b>	510298	<b>Ref. No.</b>	144012 144026
<b>description</b>	lip valve dosing pump suitable for DB2/DS5		
<b>For models:</b>	050F, 050FP, 2312-007, 913992, 913993, E.35, E.35H, E.40, E.40H, E.50, E.51, E.55, F85, F85P, LF50, LF55, MC201CL, MC501E, MC501EP, MC501S, MC501SP, MINIBAR, MISTRAL-51, NIAGARA-40, NIAGARA-51, RIVER-40, RIVER-50, RIVER-61, S280		











<b>GEV No.</b>	361366	<b>Ref. No.</b>	215001
<b>description</b>	PCB dishwasher 11F suitable for DB2 type DB2/EV1/EKP-M		
<b>For models:</b>	10, 11F, 11FD, 11F-DVGW, 11R, 11RD, 12, 14, 21F, 21FD, 21R, 21RD, 22F, 22R, 25F, 25FD, 25R, 25RD, 30F, 30FD, 30R, 30RD, 31F, 31FD, 31R, 31RD, 40F, 440F, 46, 460, 66, CLEAN-100, CLEAN-110, CLEAN-120, CLEAN-3, E.45, E.46		

membrane dosing pumps

self-priming



SEKO





<b>GEV No.</b>	361364 <sup>1</sup>	<b>Ref. No.</b>	209025 926278 DWD3
<b>description</b>	dosing pump type DIB5E self-sucking rinse aid pump rate 0-5cm <sup>3</sup> per stroke pressure connection ø 4x6mm suction connection ø 4x6mm SEKO supporting pressure closed		
<b>For models:</b>	80, 81, 82, 913291, 913292, 913297, 913298, 913299, 913300, 913357, 913360, 913361, 913374, 913375, 913391, 913392, 913416, 913418, 913435, 913545, 913546, 913547, 913578, 913611, 913666, 913668, 913684, 913685, 913773, 913774, 913911, 913912, 913913, 913914, 913932, 913933, 913948, 913950, 913977, 913984, 913990, 913992, 913993, 914100, 914101, 914167, 914168, 914214, 914284, 914316... (Other models you can see in the webshop)		
<b>spare parts for</b>	361364		
	<b>GEV No.</b>	361301	<b>Ref. No.</b> —
	hose connector for type DIB3E/DIB5E		
	<b>GEV No.</b>	361302	<b>Ref. No.</b> —
	valve bush for type DIB3E/DIB5E		
	<b>GEV No.</b>	361304	<b>Ref. No.</b> 456042
	O-ring EPDM ID ø 11.11mm thickness 1.78mm Qty 1 pcs for type DIB3E/DIB5E		
	<b>GEV No.</b>	361305	<b>Ref. No.</b> —
	valve disc for type DIB3E/DIB5E DIB3P/DIB5P		
	<b>GEV No.</b>	361306	<b>Ref. No.</b> —
	membrane for type DIB3E/DIB5E ø 49mm hole ø 5mm		
	<b>GEV No.</b>	361307	<b>Ref. No.</b> —
	membrane dosing pump ø 68mm hole ø 6mm for type DIB3P/DIB5P		
	<b>GEV No.</b>	361459	<b>Ref. No.</b> —
	hose connector ø 6mm for dosing pump		
	<b>GEV No.</b>	361481	<b>Ref. No.</b> —
	lip valve for type DIB3P/DIB5P DIB3E/DIB5E		



<sup>1</sup>auxiliary pressure connection closed  
Table continues overleaf





<b>accessories for</b> 361364	
	GEV No. 361240 Ref. No. —
hose connector 1-way hose ø 6mm plastic connection M10x1	
	GEV No. 361241 Ref. No. —
hose connector 1-way hose ø 9mm plastic connection M10x1	

spare parts	
	
1	
<b>GEV No.</b>	361304 <b>Ref. No.</b> 456042
<b>description</b>	O-ring EPDM ID ø 11.1mm thickness 1.78mm Qty 1 pcs for type DIB3E/DIB5E
<b>For models:</b>	350R, 350RD, 35-ELECTRONIC, 35R, 35RD, 67R, E.42, MINIBAR, S280

various	
spare parts	
	
1	
<b>GEV No.</b>	510298 <b>Ref. No.</b> 144012 144026
<b>description</b>	lip valve dosing pump suitable for DB2/DS5
<b>For models:</b>	050F, 050FP, 2312-007, 913992, 913993, E.35, E.35H, E.40, E.40H, E.50, E.51, E.55, F85, F85P, LF50, LF55, MC201CL, MC501E, MC501EP, MC501S, MC501SP, MINIBAR, MISTRAL-51, NIAGARA-40, NIAGARA-51, River-40, RIVER-50, RIVER-61, S280

self-priming with supporting pressure	
ELETTROBAR	
	
1	
<b>GEV No.</b>	361362 <b>Ref. No.</b> 209985 987023
<b>description</b>	dosing pump rinse aid pressure connection ø 6mm pressure connection 6
<b>For models:</b>	050F, 050FP, 2312-001, 2312-002, 2312-007, 2312-009-CRP, 913289, 913290, 913356, 913372, 913373, 913544, 913665, 913667, 913771, 913772, 913832, 913837, 913992, 913993, 914165, 914166, 914206, 914339, 914342, 914343, 914355, 914386, 914387, 914388, 914389, 914390, 914391, 914626, 914692, 914693, 914694, 914703, 914870, 915686, 915687, 915688, 915689, 915690, 915691, E.35, E.35-Elettrobar, E.35H, E.35H-Elettrobar, E.40...(Other models you can see in the webshop)
<b>spare parts for</b>	361362
	GEV No. 361363 Ref. No. 199012
membrane	
	GEV No. 510298 Ref. No. 144012 144026
lip valve dosing pump suitable for DB2/DS5	

	
1	
<b>GEV No.</b>	510298 <b>Ref. No.</b> 144012 144026
<b>description</b>	lip valve dosing pump suitable for DB2/DS5
<b>For models:</b>	050F, 050FP, 2312-007, 913992, 913993, E.35, E.35H, E.40, E.40H, E.50, E.51, E.55, F85, F85P, LF50, LF55, MC201CL, MC501E, MC501EP, MC501S, MC501SP, MINIBAR, MISTRAL-51, NIAGARA-40, NIAGARA-51, River-40, RIVER-50, RIVER-61, S280

	
1	
<b>GEV No.</b>	361363 <b>Ref. No.</b> 199012
<b>description</b>	membrane
<b>For models:</b>	050F, 050FP, 2312-007, 913289, 913290, 913356, 913372, 913373, 913544, 913665, 913667, 913771, 913772, 913832, 913837, 913992, 913993, 914165, 914166, 914206, 914339, 914342, 914343, 914355, 914386, 914387, 914388, 914389, 914390, 914391, 914626, 914692, 914693, 914694, 914703, 914870, 915686, 915687, 915688, 915689, 915690, 915691, E.35, E.35-Elettrobar, E.35H, E.35H-Elettrobar, E.40, E.40H, E.50, E.51...(Other models you can see in the webshop)

GERMAC	
spare parts	
	
1	
<b>GEV No.</b>	510298 <b>Ref. No.</b> 144012 144026
<b>description</b>	lip valve dosing pump suitable for DB2/DS5
<b>For models:</b>	050F, 050FP, 2312-007, 913992, 913993, E.35, E.35H, E.40, E.40H, E.50, E.51, E.55, F85, F85P, LF50, LF55, MC201CL, MC501E, MC501EP, MC501S, MC501SP, MINIBAR, MISTRAL-51, NIAGARA-40, NIAGARA-51, River-40, RIVER-50, RIVER-61, S280

SEKO









1

<b>GEV No.</b>	362013	<b>Ref. No.</b>	929198
<b>description</b>	dosing pump type DIB P with auxiliary pressure connection for dishwashers pump rate 0-3cm <sup>3</sup> per stroke pressure connection ø 4x6mm suction connection ø 4x6mm auxiliary pressure connection 10mm SEKO		
<b>For models:</b>	914583, 914628, 914944, 915143, 915611, 915612, 915613, 915614, 915615, 915616, 915670, 915671, 915959, KLP105EB, KLP201DDDTEB, KLP201EB, LP105DDDTEB, LP105DDDTEBN, LP105EB, LP201DDDTEB, LP201EB, LP60, NIAGARA-241, PLUVIA-240, River-44-CRP-ST, RIVER-44CRP-ST, RIVER-54CRP, River-54-CRP-s.p., River-81CRP, RIVER-81-CRP, River-82CRP, RIVER-82-CRP, RV81CCR, RV81CRP, RV82CCR, RV82CRP, U132, U60E, U61, U61E, U61H, U61HE, U70, U70e		



2

<b>GEV No.</b>	361039	<b>Ref. No.</b>	DWD4
<b>description</b>	dosing pump type DIB5P with auxiliary pressure connection rinse aid 0-5cm <sup>3</sup> per stroke/h pressure connection ø 4x6mm suction connection ø 4x6mm auxiliary pressure connection 10mm SEKO		
<b>spare parts for</b>	361039		
	<b>GEV No.</b>	361301	<b>Ref. No.</b> —
	hose connector for type DIB3E/DIB5E		
	<b>GEV No.</b>	361302	<b>Ref. No.</b> —
	valve bush for type DIB3E/DIB5E		
	<b>GEV No.</b>	361304	<b>Ref. No.</b> 456042
	O-ring EPDM ID ø 11.11mm thickness 1.78mm Qty 1 pcs for type DIB3E/DIB5E		
	<b>GEV No.</b>	361305	<b>Ref. No.</b> —
	valve disc for type DIB3E/DIB5E DIB3P/DIB5P		
	<b>GEV No.</b>	361307	<b>Ref. No.</b> —
	membrane dosing pump ø 68mm hole ø 6mm for type DIB3P/DIB5P		
	<b>GEV No.</b>	361481	<b>Ref. No.</b> —
	lip valve for type DIB3P/DIB5P DIB3E/DIB5E		



1

<b>GEV No.</b>	361304	<b>Ref. No.</b>	456042
<b>description</b>	O-ring EPDM ID ø 11.11mm thickness 1.78mm Qty 1 pcs for type DIB3E/DIB5E		
<b>For models:</b>	350R, 350RD, 35-ELECTRONIC, 35R, 35RD, 67R, E.42, MINIBAR, S280		

accessories

container filters



1

<b>GEV No.</b>	513043	<b>Ref. No.</b>	121017
<b>description</b>	container filter hose ø 4mm		
<b>For models:</b>	050F, 050FP, 10, 12, 14, 22F, 22R, 2312-001, 2312-002, 2312-007, 2312-009-CRP, 31F, 31FD, 31R, 31RD, 350F, 350FD, 350R, 350RD, 35-ELECTRONIC, 35F, 35FD, 35R, 35RD, 400F, 400FD, 400R, 400RD, 40-ELECTRONIC, 40F, 40FD, 40R, 40RD, 440F, 44F, 45, 450, 46, 460, 500F, 500FD, 50-ELECTRONIC, 50F, 50FD, 510F, 510FD, 55, 66, 67F, 67R...(Other models you can see in the webshop)		



1

<b>GEV No.</b>	361141	<b>Ref. No.</b>	121075
<b>description</b>	container filter with weight ceramic hose ø 4mm		
<b>For models:</b>	2312-001, 2312-002, 2312-007, 2312-009-CRP, 31F, 31FD, 31R, 31RD, 913289, 913290, 913291, 913292, 913297, 913298, 913299, 913300, 913356, 913357, 913360, 913361, 913363, 913364, 913372, 913373, 913374, 913375, 913376, 913377, 913391, 913392, 913416, 913418, 913435, 913544, 913545, 913546, 913547, 913578, 913611, 913665, 913666, 913667, 913668, 913684, 913685, 913771, 913772, 913773, 913774, 913832...(Other models you can see in the webshop)		



1

<b>GEV No.</b>	361462	<b>Ref. No.</b>	121993
<b>description</b>	container filter with weight SS hose ø 4x6mm		
<b>For models:</b>	913363, 913364, 915150, 915151, 915152, 915154, 915155, 915157, 915158, 915160, 915161, 915162, 915166, 915167, 915168, 915172, 915173, 915175, 915319, 915348, 915418, 915419, 915420, 915421, 915422, 915479, 915492, 915493, 915494, 915495, 915496, 915497, 915547, 915558, 915611, 915612, 915613, 915614, 915615, 915616, 915617, 915618, 915635, 915663, 915664, 915670, 915671, 915672, 915686, 915687...(Other models you can see in the webshop)		



### intake lances



<b>GEV No.</b>	698713	<b>Ref. No.</b>	999257
<b>description</b>	intake lance plastic L 380mm with plug tube ø 9mm hose ø 5mm cable length 1500mm		



<b>GEV No.</b>	518544	<b>Ref. No.</b>	986006
<b>description</b>	intake lance		
<b>For models:</b>	CLEAN-3, TF-503, TF-513, TF-515		

### hoses

#### silicone hoses





<b>GEV No.</b>	520242	<b>Ref. No.</b>	143235
<b>description</b>	silicone hose for peristaltic pump ID ø 4mm ED ø 7mm L 5m thickness 1.5mm t.max. 200°C Shore A 55° transparent dosing Qty 5m		
<b>For models:</b>	2312-009-CRP, 914583, 914628, 914944, 915143, 915150, 915151, 915152, 915154, 915155, 915157, 915158, 915160, 915161, 915162, 915166, 915167, 915168, 915172, 915173, 915175, 915176, 915177, 915285, 915319, 915338, 915341, 915348, 915418, 915419, 915420, 915421, 915422, 915479, 915492, 915493, 915494, 915495, 915496, 915497, 915547, 915558, 915611, 915612, 915613, 915614, 915615, 915616, 915617, 915618...(Other models you can see in the webshop)		

#### PVC hoses



<b>GEV No.</b>	520090	<b>Ref. No.</b>	143194	
<b>description</b>	PVC hose ID ø 4mm ED ø 6mm L 2m thickness 1mm t.max. 60°C transparent			
<b>For models:</b>	2312-001, 2312-002, 2312-007, 2312-009-CRP, 31F, 31FD, 31R, 31RD, 67F, 67R, 913289, 913290, 913291, 913292, 913297, 913298, 913299, 913300, 913356, 913357, 913360, 913361, 913363, 913364, 913372, 913373, 913374, 913375, 913376, 913377, 913391, 913392, 913416, 913418, 913435, 913544, 913545, 913546, 913547, 913578, 913611, 913665, 913666, 913667, 913668, 913684, 913685, 913771, 913772, 913773...(Other models you can see in the webshop)			
<b>accessories for</b>	520090			
	<b>GEV No.</b>	361058	<b>Ref. No.</b>	—
	<b>GEV No.</b>	361066	<b>Ref. No.</b>	—
	<b>GEV No.</b>	361106	<b>Ref. No.</b>	—
	<b>GEV No.</b>	361141	<b>Ref. No.</b>	121075

<b>accessories for</b>	520090			
	<b>GEV No.</b>	361230	<b>Ref. No.</b>	—
	<b>GEV No.</b>	361462	<b>Ref. No.</b>	121993
	<b>GEV No.</b>	361728	<b>Ref. No.</b>	—

### tank inlets



<b>GEV No.</b>	518489	<b>Ref. No.</b>	468024
<b>description</b>	tank inlet		
<b>For models:</b>	21F, 21FD, 21R, 21RD, 25F, 25FD, 25R, 25RD, 30F, 30FD, 30R, 30RD, 31F, 31FD, 31R, 31RD, R495, R497, R499, R501, R503, R505, R507, R509, R511, R704, R706, R708, S621, S623, S624, S626, S631, S633, S634, S636, S641, S643, S651, S651P, S653, S654, S655, S810, S815, S830, S835, S850, S870, S950...(Other models you can see in the webshop)		



<b>GEV No.</b>	361270	<b>Ref. No.</b>	468151 999104
<b>description</b>	tank inlet SS M12 hose ø 4mm		
<b>For models:</b>	10, 11F, 11FD, 11R, 11RD, 12, 14, 22F, 2312-001, 2312-002, 2312-007, 2312-009-CRP, 31F, 31FD, 31R, 31RD, 440F, 44F, 45, 450, 46, 460, 80, 81, 82, 913289, 913290, 913291, 913292, 913297, 913298, 913299, 913300, 913356, 913357, 913360, 913361, 913363, 913364, 913372, 913373, 913374, 913375, 913376, 913377, 913391, 913392, 913416, 913418, 913435...(Other models you can see in the webshop)		

### miscellaneous



<b>GEV No.</b>	521735	<b>Ref. No.</b>	466005
<b>description</b>	spacer piece for rinse aid pump		
<b>For models:</b>	2312-007, 2312-009-CRP, 913289, 913290, 913356, 913372, 913373, 913544, 913665, 913667, 913771, 913772, 913832, 913837, 913992, 913993, 914165, 914166, 914206, 914339, 914342, 914343, 914355, 914386, 914387, 914388, 914389, 914390, 914391, 914626, 914692, 914693, 914694, 914703, 914870, 915686, 915687, 915688, 915689, 915690, 915691, E.35, E.35-Elettrobar, E.35H, E.35H-Elettrobar, E.40, E.40H, FAST-135, FAST-135CT, FAST-135D...(Other models you can see in the webshop)		

## hoses

### supply hoses

#### stainless steel flexi hoses

#### universal hoses

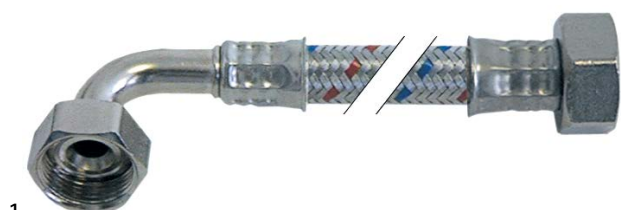

1





<b>GEV No.</b>	520008	<b>Ref. No.</b>	143016 143112
<b>description</b>	flex hose SS braid straight-curved DN12 connection 1: 3/4" connection 2: 3/4" L 1500mm approval DVGW operating p. 10bar test pressure 32bar burst p. 95bar		
<b>For models:</b>	10, 12, 14, 22F, 22R, 40F, 440F, 44F, 66, 913363, 913364, 913992, 913993, 914592, 914612, 914613, 916045, CLEAN-100, CLEAN-110, CLEAN-120, E.52, E1, E10, E100, E110, E12, E120, E14, E140, E41, Ocean360-UK, River-40, River-44, S651, S654, S810, S815, S830, S835, S850, S870, S950, TF-503, TF-513, TF-515		
<b>accessories for</b>	520008		
	<b>GEV No.</b>	520054	<b>Ref. No.</b> —
	flat gasket rubber ED ø 23.5mm ID ø 14mm thickness 2.3mm Qty 10 pcs		

### PVC supply hoses



1

<b>GEV No.</b>	520010	<b>Ref. No.</b>	143170
<b>description</b>	supply hose PVC straight-curved DN13 connections 3/4" L 1500mm operating p. 10bar burst p. 32bar t.max. 90°C blue approval VDE flat seal		
<b>For models:</b>	050F, 050FP, 2312-001, 2312-002, 2312-007, 2312-009-CRP, 350F, 350FD, 350R, 350RD, 35-ELECTRONIC, 35F, 35FD, 35R, 35RD, 400F, 400FD, 400R, 400RD, 40-ELECTRONIC, 40F, 40FD, 40R, 40RD, 45, 450, 46, 460, 500F, 500FD, 50-ELECTRONIC, 50F, 50FD, 510F, 510FD, 67F, 67R, 913289, 913290, 913356, 913363, 913364, 913372, 913373, 913544, 913665, 913667, 913771, 913772, 913832...(Other models you can see in the webshop)		
<b>accessories for</b>	520010		
	<b>GEV No.</b>	520053	<b>Ref. No.</b> —
	screen connection 3/4" D1 ø 26mm D2 ø 15mm Qty 10 pcs rubber thickness 8mm		
	<b>GEV No.</b>	520054	<b>Ref. No.</b> —
	flat gasket rubber ED ø 23.5mm ID ø 14mm thickness 2.3mm Qty 10 pcs		

	<b>GEV No.</b>	520011	<b>Ref. No.</b>	143270 929169
<b>description</b>	supply hose PVC straight-curved DN13 connections 3/4" L 2000mm operating p. 10bar burst p. 32bar t.max. 90°C approval VDE flat seal			
<b>For models:</b>	913291, 913292, 913297, 913298, 913299, 913300, 913357, 913360, 913361, 913374, 913375, 913391, 913392, 913416, 913418, 913435, 913545, 913546, 913547, 913578, 913611, 913666, 913668, 913684, 913685, 913773, 913774, 913911, 913912, 913913, 913914, 913932, 913933, 913948, 913950, 913977, 913984, 913990, 914167, 914168, 914214, 914284, 914316, 914317, 914318, 914319, 914326, 914331, 914338, 914356...(Other models you can see in the webshop)			

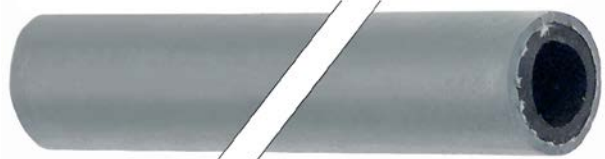
	<b>GEV No.</b>	520015	<b>Ref. No.</b>	143004
<b>description</b>	supply hose ID ø 10mm ED ø 17mm L 5m operating p. 20bar burst p. 60bar t.max. 95°C grey Qty 5m			
<b>For models:</b>	050F, 050FP, 10, 11F, 11FD, 11F-DVGW, 11R, 11RD, 12, 14, 21F, 21FD, 21R, 21RD, 22F, 22R, 2312-001, 2312-002, 2312-007, 2312-009-CRP, 25F, 25FD, 25R, 25RD, 30F, 30FD, 30R, 30RD, 31F, 31FD, 31R, 31RD, 350F, 350FD, 350R, 350RD, 35-ELECTRONIC, 35F, 35FD, 35R, 35RD, 400F, 400FD, 400R, 400RD, 40-ELECTRONIC, 40F, 40FD, 40R, 40RD...(Other models you can see in the webshop)			
<b>accessories for</b>	520015			
	<b>GEV No.</b>	504377	<b>Ref. No.</b>	—
	hose connector grommet ø 23mm grommet length 25mm total length 55mm for water filling			

### drain hoses

	<b>GEV No.</b>	513718	<b>Ref. No.</b>	143120
<b>description</b>	drain hose DN19 L 1500mm straight ø inside 24mm straight ext. ø 28mm outer hose ø 23mm			
<b>For models:</b>	11F, 11FD, 11F-DVGW, 11R, 11RD, 21F, 21FD, 21R, 21RD, 25F, 25FD, 25R, 25RD, 30F, 30FD, 30R, 30RD, 31F, 31FD, 31R, 31RD, 350F, 350FD, 350R, 350RD, 35-ELECTRONIC, 35F, 35FD, 35R, 35RD, 400F, 400FD, 400R, 400RD, 40-ELECTRONIC, 40F, 40FD, 40R, 40RD, 67F, 67R, 913289, 913290, 913291, 913292, 913356, 913357, 913363, 913364, 913372...(Other models you can see in the webshop)			



1

<b>GEV No.</b>	518068	<b>Ref. No.</b>	143136 929200
<b>description</b>	drain hose DN34 L 2000mm elbow ø inside 50mm elbow ext. ø 59mm inner hose ø 35mm outer hose ø 42mm PVC		
<b>For models:</b>	10, 12, 14, 22F, 22R, 40F, 44F, 80, 81, 82, 914326, 914406, 915729, CE78HZ23, CGL74CABT, CLEAN-100, CLEAN-110, CLEAN-120, E.55, E.60, E.65, E1, E10, E100, E110, E12, E120, E14, E140, E78, E78HP, Fast181, FAST-181, Fast181-230V-3Ph-60Hz, Fast181-400V-3NPh-60Hz, FAST-63, HM1, KLP105EB, LP105DDDTEB, LP105DDDTEBN, LP105EB, LP60, NG271, NG291, NG292, NG292HZ, NG293, NIAGARA-271, NIAGARA-283, Niagara-283A...(Other models you can see in the webshop)		

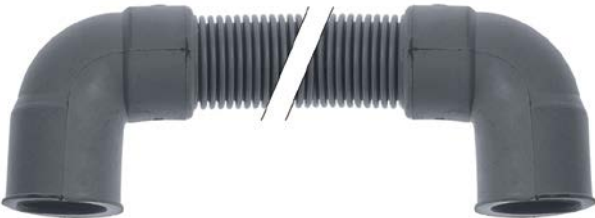

1

<b>GEV No.</b>	530373	<b>Ref. No.</b>	127077
<b>description</b>	drain hose L 680mm elbow ø inside 20mm outer hose ø 24mm		
<b>For models:</b>	914628, 914944, RIVER-50-CRP-SP, RIVER-54CRP, River-54-CRP-s.p., RIVER-54-CRP-SP		



1

<b>GEV No.</b>	518518	<b>Ref. No.</b>	143178
<b>description</b>	drain hose DN19 L 1500mm A int. ø 21mm A ext. ø 27mm B int. ø 29mm B ext. ø 35mm outer hose ø 25mm		

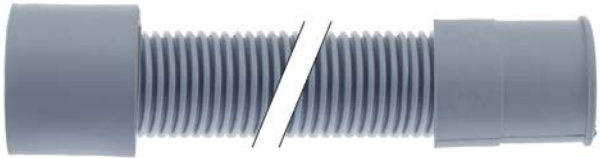

1

<b>GEV No.</b>	511205	<b>Ref. No.</b>	143019
<b>description</b>	drain hose DN19 L 1500mm A int. ø 23mm A ext. ø 29mm B int. ø 29mm outer hose ø 29mm B ext. ø 35mm		
<b>For models:</b>	11F, 11FD, 11R, 11RD, R495, R497, R499, R501, R503, R505, R507, R509, R511, S621, S623, S624, S626, S631, S633, S634, S636, S641, S643		



1

<b>GEV No.</b>	513258	<b>Ref. No.</b>	127044
<b>description</b>	drain hose DN19 L 270mm A int. ø 22mm A ext. ø 28mm B int. ø 24mm B ext. ø 28mm outer hose ø 22mm		
<b>For models:</b>	2312-001, 2312-002, 913297, 913298, 913299, 913300, 913360, 913361, 913391, 913392, 913546, 913547, 913578, 913611, 913684, 913913, 913914, 913932, 913933, 914284, 914318, 914319, 914331, 914338, 914356, 914400, 914401, 914402, 914403, 914404, 914405, 914431, 914449, 914517, 914545, 914568, 914642, 914688, 914909, 914979, 915136, 915137, 915140, 915248, 915483, 915484, 915528, 915537, 915538, 915539...(Other models you can see in the webshop)		

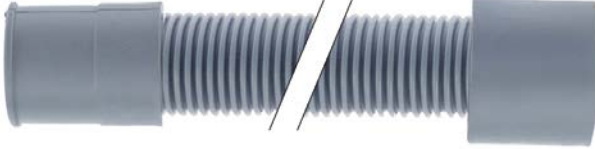

1

<b>GEV No.</b>	518219	<b>Ref. No.</b>	127037
<b>description</b>	drain hose DN19 L 630mm A int. ø 20mm A ext. ø 27mm B int. ø 21mm B ext. ø 28mm outer hose ø 24mm		
<b>For models:</b>	2312-001, 2312-002, 2312-007, 2312-009-CRP, 913297, 913298, 913299, 913300, 913360, 913361, 913391, 913392, 913546, 913547, 913578, 913611, 913684, 913913, 913914, 913932, 913933, 913992, 913993, 914100, 914101, 914284, 914318, 914319, 914326, 914331, 914338, 914339, 914342, 914343, 914356, 914400, 914401, 914402, 914403, 914404, 914405, 914406, 914431, 914449, 914517, 914545, 914568, 914624, 914625, 914626...(Other models you can see in the webshop)		



1

<b>GEV No.</b>	530608	<b>Ref. No.</b>	70110
<b>description</b>	drain hose DN24 L 1500mm A int. ø 24mm A ext. ø 28mm B int. ø 28mm B ext. ø 35mm outer hose ø 29mm temp.-resist. 90°C		
<b>For models:</b>	NG381DDPS, NG381DDPSHZ23, NG381LDDPS, Niagara-381-230V-3Ph-60Hz, Niagara-381DP, Niagara-381L, Niagara-381LC, River-295P, River-296P, RV295PS, RV296PS		

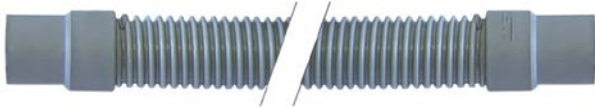

1

<b>GEV No.</b>	530616	<b>Ref. No.</b>	DZS151
<b>description</b>	drain hose L 1500mm A int. ø 25mm B int. ø 25mm outer hose ø 32mm		
<b>For models:</b>	CNT800CH, Fast180, Fast180-230V-3Ph-60Hz, NG271, NG281CDD, NG281HPDD, NG281HZ23, NG281HZ23DD, NG291, NIAGARA-271, Niagara-281, Niagara-281-2, Niagara-281HP, NIAGARA-291, OC380, OC380FUR, OC380HZ23, Ocean380, Pluvia280-230V-3PH-60HZ, PV280FAST2, PV280FAST2BIO, PV280FAST2HZ23, PV280HZ23, RIVER-294, RV294, SevenE		



1

<b>GEV No.</b>	530374	<b>Ref. No.</b>	127086
<b>description</b>	drain hose L 160mm DN19 A int. ø 28mm A ext. ø 34mm B int. ø 28mm B ext. ø 34mm outer hose ø 24mm		
<b>For models:</b>	2312-007, 914100, 914101, 914339, 914342, 914343, 914624, 914625, 914626, 914627, 914628, 914850, 914851, 914854, 914944, RIVER-48, RIVER-54, RIVER-54CRP, River-54-CRP-s.p.		



1

<b>GEV No.</b>	530372	<b>Ref. No.</b>	80702
<b>description</b>	drain hose DN19 L 1000mm straight ø inside 21mm straight ext. ø 27mm elbow ø inside 21mm elbow ext. ø 28mm outer hose ø 24mm		
<b>For models:</b>	RIVER-282, River-282-2, River-282L-2, River-282LS-2TDE, River-282S-2TDE, River-285, River-382, River-382-230V-3Ph-50Hz, River-382H, River-382L, River-382L-230V-3Ph-50Hz, River-382LNRG, River-382LTDE, River-382NRG, River-382NRG-230-3Ph-50Hz, River-382TDE, River-482, RV282, RV282DD, RV282R, RV382, RV38223TERMO, RV382AHP, RV382FUR, RV382L, RV382L23TERMO, RV382LFUR, RV382LR, RV382LS, RV382LSFUR, RV382LTX, RV382LTXR, RV382R, RV382R23TERMO, RV382RFUR, RV382S, RV382SFUR, RV382TERMO, RV382TX, RV382TXR, RV482		



1

<b>GEV No.</b>	530819	<b>Ref. No.</b>	143137
<b>description</b>	drain hose DN20 L 2500mm straight ø inside 19mm straight ext. ø 24mm elbow ø inside 22mm elbow ext. ø 27mm outer hose ø 24mm		
<b>For models:</b>	050F, 050FP, 21F, 21FD, 21R, 21RD, 22F, 22R, 25F, 25FD, 25R, 25RD, 30F, 30FD, 30R, 30RD, 31F, 31FD, 31R, 31RD, 40F, 40F, 44F, 45, 450, 46, 460, 500F, 500FD, 50-ELECTRONIC, 50F, 50FD, 510F, 510FD, 913289, 913290, 913291, 913292, 913356, 913357, 913363, 913364, 913372, 913373, 913374, 913375, 913376, 913377, 913416, 913418...(Other models you can see in the webshop)		



1

<b>GEV No.</b>	518638	<b>Ref. No.</b>	143252
<b>description</b>	drain hose DN24 L 1700mm straight ø inside 28mm straight ext. ø 34mm elbow ø inside 28mm elbow ext. ø 34mm outer hose ø 30mm		
<b>For models:</b>	915150, 915151, 915152, 915154, 915155, 915160, 915161, 915162, 915166, 915167, 915168, 915175, 915176, 915177, 915319, 915338, 915341, 915348, 915418, 915419, 915420, 915421, 915479, 915492, 915493, 915547, 915558, 915635, 915663, 915747, 916020, 916021, 916024, 916025, 916026, 916027, 916030, 916031, 916045, 916201, 916202, 916203, 916204, 916205, 916206, 916207, 916208, 916209, 916247, 916248...(Other models you can see in the webshop)		



1

<b>GEV No.</b>	518652	<b>Ref. No.</b>	70097
<b>description</b>	drain hose DN24 L 600mm straight ø inside 30mm straight ext. ø 34mm elbow ø inside 29mm elbow ext. ø 33mm outer hose ø 29mm		
<b>For models:</b>	NG281HZ23, NG381DDPS, NG381DDPSHZ23, NG381LDDPS, Niagara-381-230V-3Ph-60Hz, Niagara-381DP, Niagara-381L, Niagara-381LC, River-282-2, River-282L-2, River-282LS-2TDE, River-282S-2TDE, River-285, River-382, River-382-230V-3Ph-50Hz, River-382H, River-382L, River-382L-230V-3Ph-50Hz, River-382LNRG, River-382LTDE, River-382NRG, River-382NRG-230-3Ph-50Hz, River-382TDE, River-482, RV382, RV38223TERMO, RV382AHP, RV382FUR, RV382L, RV382L-23TERMO, RV382LFUR, RV382LR, RV382LS, RV382LSFUR, RV382LTX, RV382LTXR, RV382R, RV382R23TERMO, RV382RFUR, RV382S, RV382SFUR, RV382TERMO, RV382TX, RV382TXR, RV482		



1

<b>GEV No.</b>	506208	<b>Ref. No.</b>	143183
<b>description</b>	drain hose DN25 L 1500mm straight ø inside 25mm straight ext. ø 30mm elbow ø inside 40mm elbow ext. ø 46mm outer hose ø 32mm		
<b>For models:</b>	22F, 440F, 44F, E.52		



1

<b>GEV No.</b>	518515	<b>Ref. No.</b>	127033
<b>description</b>	drain hose DN28 L 260mm straight ø inside 33mm straight ext. ø 40mm elbow ø inside 52mm elbow ext. ø 58mm outer hose ø 35mm		
<b>For models:</b>	22F, 22R, 40F, 440F, 44F, E.52, E.60, E.65		



1

<b>GEV No.</b>	518078	<b>Ref. No.</b>	127032
<b>description</b>	drain hose DN34 L 500mm straight ø inside 40mm straight ext. ø 48mm elbow ø inside 50mm elbow ext. ø 58mm outer hose ø 42mm		
<b>For models:</b>	22F, 440F, 44F, E.52, E1, E10, E100, E110, E12, E120, E14, E140		





1

<b>GEV No.</b>	518654	<b>Ref. No.</b>	127056
<b>description</b>	drain hose DN34 L 600mm straight $\phi$ inside 30mm straight ext. $\phi$ 40mm elbow $\phi$ inside 51mm elbow ext. $\phi$ 61mm outer hose $\phi$ 34mm		
<b>For models:</b>	NG271, NG291, NIAGARA-271, NIAGARA-291, RIVER-282, River-285, RIVER-294, River-295P, River-296P, RIVER-HL-81, RIVER-HL-82, RV282, RV282DD, RV282R, RV294, RV295PS, RV296PS		



1

<b>GEV No.</b>	518653	<b>Ref. No.</b>	70116
<b>description</b>	drain hose DN24 L 500mm elbow $\phi$ inside 29mm elbow ext. $\phi$ 34mm outer hose $\phi$ 29mm		
<b>For models:</b>	NG381, NG38123, NG38123TERMO, NG381C, NG381CDD, NG381C-FUR, NG381DDHZ23, NG381HPDD, NG381L, NG381LC, NG381LC-FUR, NG381TERMO, NG381TXCDD, Niagara-283L-2, Niagara-381, Niagara-381-230V-3Ph-50Hz, Niagara-381-230V-3Ph-60Hz, Niagara-381HPD, Niagara-381L, Niagara-381LC		



1

<b>GEV No.</b>	530562	<b>Ref. No.</b>	143010
<b>description</b>	pressure hose ID $\phi$ 13mm ED $\phi$ 21mm L 5m operating p. 10bar burst p. 30bar t.max. 110°C		
<b>For models:</b>	161, 221, 271, 272, 362, 80, 81, 82, 914380, 914436, 915747, A3EB, A3EBD, A3EBDAKRKYK, A3EBDAKWK, A3EBDBKWK, A3EBDRKYK, A3EBDWK, A3EBDYK, A3ESAK, A3ESAKRK, A3ESAKWK, A3ESB-KWKYK, A3EBSEKWK, A3ESBWK, A4EB, A4EBD, A4EBDAKEYK, A4EBDAKRK, A4EBDAKWK, A4EBDAKZK, A4EBDBKRK, A4EBDPKWKYK, A4EBDRK, A4ESB, A4ESAK, A4ESAKCK, A4ESAKEKYK, A4ESAKRK, A4ESAKRKP, A4ESAKYK, A4ESBCK, A4EBT, A4EBTSAK, A5EB, A5EBD, A5EBDAKPWK, A5EBDAKWK, A5EBDAKYK, A5EBDRK...(Other models you can see in the webshop)		

pressure control hoses



1

<b>GEV No.</b>	530560	<b>Ref. No.</b>	143005 143131
<b>description</b>	pressure control hose ID $\phi$ 5mm ED $\phi$ 9mm L 5m operating p. 30bar burst p. 90bar temp.-resist. 60°C		
<b>For models:</b>	050F, 050FP, 10, 11F, 11FD, 11F-DVGW, 11R, 11RD, 12, 14, 161, 21F, 21FD, 21R, 21RD, 221, 22F, 22R, 2312-001, 2312-002, 2312-007, 2312-009-CRP, 25F, 25FD, 25R, 25RD, 271, 272, 30F, 30FD, 30R, 30RD, 31F, 31FD, 31R, 31RD, 350F, 350FD, 350R, 350RD, 35-ELECTRONIC, 35F, 35FD, 35R, 35RD, 362, 400F, 400FD, 400R, 400RD...(Other models you can see in the webshop)		

industrial hoses

Niplaflex hoses



1

<b>GEV No.</b>	570561	<b>Ref. No.</b>	143182
<b>description</b>	pressure hose ID $\phi$ 10mm ED $\phi$ 17mm L 40m thickness 3.5mm operating p. 10bar burst p. 30bar t.max. 110°C		
<b>For models:</b>	11F, 11FD, 11R, 11RD, 2312-001, 2312-002, 2312-007, 31F, 31FD, 31R, 31RD, 350F, 350FD, 350R, 350RD, 35F, 35FD, 35R, 35RD, 400F, 400FD, 400R, 400RD, 40F, 40FD, 40R, 40RD, 440F, 44F, 45, 450, 46, 460, 500F, 500FD, 50F, 50FD, 510F, 510FD, 914100, 914101, 914339, 914342, 914343, 914624, 914625, 914626, 914627, 914850, 914851...(Other models you can see in the webshop)		

PVC hoses





PVC hoses without fabric



1

<b>GEV No.</b>	520383	<b>Ref. No.</b>	H.775601
<b>description</b>	PVC hose ID $\phi$ 4mm ED $\phi$ 6mm L 2m thickness 1mm t.max. 60°C blue		
<b>For models:</b>	913291, 913292, 913297, 913298, 913299, 913300, 913357, 913360, 913361, 913363, 913364, 913374, 913375, 913391, 913392, 913416, 913418, 913435, 913545, 913546, 913547, 913578, 913611, 913666, 913668, 913684, 913685, 913773, 913774, 913911, 913912, 913913, 913914, 913932, 913933, 913948, 913950, 913977, 913984, 913990, 914214, 914284, 914316, 914317, 914318, 914319, 914326, 914331, 914338, 914356...(Other models you can see in the webshop)		
<b>accessories for</b>	520383		
	<b>GEV No.</b>	361058	<b>Ref. No.</b> —
	container filter with non-return valve SS hose $\phi$ 4x6mm $\phi$ 20mm L 56mm		
	<b>GEV No.</b>	361066	<b>Ref. No.</b> —
	container filter straight SS hose $\phi$ 4x6mm L 37mm non return valve ball valve		
	<b>GEV No.</b>	361106	<b>Ref. No.</b> —
	container filter with weight and non-return valve SS hose $\phi$ 4x6mm $\phi$ 21mm L 51mm non return valve lip valve		

Table continues overleaf

accessories for		520383	
GEV No.	361141	Ref. No.	121075
	container filter with weight ceramic hose ø 4mm		
GEV No.	361230	Ref. No.	—
	container filter with weight stainless steel hose ø 4x6mm		
GEV No.	361462	Ref. No.	121993
	container filter with weight SS hose ø 4x6mm		
GEV No.	361728	Ref. No.	—
	container filter with 4m 4x6 hose SS hose ø 4x6mm hose length 4000mm		

accessories for		520090	
GEV No.	361058	Ref. No.	—
	container filter with non-return valve SS hose ø 4x6mm ø 20mm L 56mm		
GEV No.	361066	Ref. No.	—
	container filter straight SS hose ø 4x6mm L 37mm non return valve ball valve		
GEV No.	361106	Ref. No.	—
	container filter with weight and non-return valve SS hose ø 4x6mm ø 21mm L 51mm non return valve lip valve		
GEV No.	361141	Ref. No.	121075
	container filter with weight ceramic hose ø 4mm		
GEV No.	361230	Ref. No.	—
	container filter with weight stainless steel hose ø 4x6mm		
GEV No.	361462	Ref. No.	121993
	container filter with weight SS hose ø 4x6mm		
GEV No.	361728	Ref. No.	—
	container filter with 4m 4x6 hose SS hose ø 4x6mm hose length 4000mm		

accessories for		520027	
GEV No.	143013	Ref. No.	143028
	PVC hose ID ø 4mm ED ø 7mm L 10m thickness 1.5mm t.max. 60°C transparent		
For models:	050F, 050FF, 10, 11F, 11FD, 11F-DVGW, 11R, 11RD, 12, 14, 21F, 21FD, 21R, 21RD, 22F, 22R, 2312-001, 2312-002, 2312-007, 2312-009-CRP, 25F, 25FD, 25R, 25RD, 30F, 30FD, 30R, 30RD, 31F, 31FD, 31R, 31RD, 350F, 350FD, 350R, 350RD, 35-ELECTRONIC, 35F, 35FD, 35R, 35RD, 400F, 400FD, 400R, 400RD, 40-ELECTRONIC, 40F, 40FD, 40R, 40RD... (Other models you can see in the webshop)		

accessories for		520935	
GEV No.	520935	Ref. No.	H.165168
	PVC hose ID ø 6mm ED ø 9mm L 1m transparent warewashing		
For models:	2312-007, 914100, 914101, 914339, 914342, 914343, 914624, 914625, 914626, 914627, 914628, 914850, 914851, 914854, 914944, 915154, 915155, 915157, 915158, 915172, 915173, 915285, 915422, 915492, 915493, 915494, 915495, 915496, 915497, 915611, 915612, 915613, 915614, 915615, 915616, 915617, 915618, 915670, 915671, 915672, 915773, 915774, 915959, 916020, 916021, 916024, 916025, 916026, 916027, 916030...(Other models you can see in the webshop)		

accessories for		520242	
GEV No.	520242	Ref. No.	143235
	silicone hose for peristaltic pump ID ø 4mm ED ø 7mm L 5m thickness 1.5mm t.max. 200°C Shore A 55° transparent dosing Qty 5m		
For models:	2312-009-CRP, 914583, 914628, 914944, 915143, 915150, 915151, 915152, 915154, 915155, 915157, 915158, 915160, 915161, 915162, 915166, 915167, 915168, 915172, 915173, 915175, 915176, 915177, 915285, 915319, 915338, 915341, 915348, 915418, 915419, 915420, 915421, 915422, 915479, 915492, 915493, 915494, 915495, 915496, 915497, 915547, 915558, 915611, 915612, 915613, 915614, 915615, 915616, 915617, 915618...(Other models you can see in the webshop)		

accessories for		520842	
GEV No.	520842	Ref. No.	143253
	silicone hose ID ø 3mm ED ø 6mm L 1m thickness 1.5mm t.max. 200°C brown		
For models:	915172, 915173, 915285, 915422, 915496, 915497, 915617, 915618, 915672, 915773, 915774, 916054, NG292, NG292HZ, NG293, NIAGARA-292, Niagara-292-400V-3Ph-60Hz, NIAGARA-293, RIVER-242, RIVER-262, RIVER-282, RIVER-295, River-295P, RIVER-296, River-296P, RIVER-297, RIVER-298, RV282, RV282DD, RV295, RV295PS, RV296, RV296PS, RV297, RV298, RV298HZ		

accessories for		520242	
GEV No.	520242	Ref. No.	143235
	silicone hose for peristaltic pump ID ø 4mm ED ø 7mm L 5m thickness 1.5mm t.max. 200°C Shore A 55° transparent dosing Qty 5m		
For models:	2312-009-CRP, 914583, 914628, 914944, 915143, 915150, 915151, 915152, 915154, 915155, 915157, 915158, 915160, 915161, 915162, 915166, 915167, 915168, 915172, 915173, 915175, 915176, 915177, 915285, 915319, 915338, 915341, 915348, 915418, 915419, 915420, 915421, 915422, 915479, 915492, 915493, 915494, 915495, 915496, 915497, 915547, 915558, 915611, 915612, 915613, 915614, 915615, 915616, 915617, 915618...(Other models you can see in the webshop)		



formed hoses

straight



1

<b>GEV No.</b>	518303	<b>Ref. No.</b>	127065
<b>description</b>	formed hose		
<b>For models:</b>	2312-007, 2312-009-CRP, 914100, 914101, 914339, 914342, 914343, 914624, 914625, 914626, 914627, 914628, 914850, 914851, 914854, 914944, RIVER-48, RIVER-50, RIVER-50-CRP, RIVER-50-CRP-SP, River-54, RIVER-54CRP, River-54-CRP-s.p., RIVER-54-CRP-SP, RIVER-61		





Image not available

1

<b>GEV No.</b>	518514	<b>Ref. No.</b>	143133
<b>description</b>	formed hose		
<b>For models:</b>	22F, 22R		



1

<b>GEV No.</b>	518519	<b>Ref. No.</b>	127054
<b>description</b>	formed hose dishwasher straight equiv. no. 127054		
<b>For models:</b>	913289, 913290, 913291, 913292, 913356, 913357, 913372, 913373, 913374, 913375, 913416, 913435, 913544, 913545, 913665, 913666, 913667, 913668, 913685, 913771, 913772, 913773, 913774, 913832, 913837, 913911, 913912, 913948, 913950, 913977, 913984, 913990, 914165, 914166, 914206, 914214, 914316, 914317, 914355, 914386, 914387, 914388, 914389, 914390, 914391, 914392, 914393, 914394, 914395, 914396...(Other models you can see in the webshop)		



1

<b>GEV No.</b>	518213	<b>Ref. No.</b>	143009
<b>description</b>	formed hose dishwasher straight equiv. no. 143009		
<b>For models:</b>	35OR, 35ORD, 35-ELECTRONIC, 35R, 35RD, 400F, 400FD, 400R, 400RD, 40-ELECTRONIC, 40F, 40FD, 40R, 40RD, 45, 450, 67F, 67R, 913418, 914167, 914168, 914398, 914399, 914443, 914943, 915695, 915696, 915819, E.45, Fast145, FAST-145, Fast145D, FAST-145D, NIAGARA-45, S641, S643		



1

<b>GEV No.</b>	518223	<b>Ref. No.</b>	127022
<b>description</b>	formed hose dishwasher straight mounting pos. lower equiv. no. 127022		
<b>For models:</b>	11F, 11FD, 11F-DVGW, 11R, 11RD, 45, 450, 913363, 913364, 913376, 913377, 913418, 914167, 914168, 914398, 914399, 914443, 914943, 915695, 915696, 915819, E.41, E.42, E.45, E41, Fast145, FAST-145, Fast145D, FAST-145D, NIAGARA-45		



1

<b>GEV No.</b>	518070	<b>Ref. No.</b>	127026
<b>description</b>	formed hose dishwasher straight mounting pos. upper equiv. no. 127026		
<b>For models:</b>	050F, 050FP, 22F, 22R, 2312-001, 2312-002, 40F, 440F, 44F, 46, 460, 500F, 500FD, 50F, 50FD, 510F, 510FD, 913297, 913298, 913299, 913300, 913360, 913361, 913391, 913392, 913546, 913547, 913578, 913611, 913684, 913913, 913914, 913932, 913933, 914284, 914318, 914319, 914326, 914331, 914338, 914356, 914400, 914401, 914402, 914403, 914404, 914405, 914406, 914431, 914449...(Other models you can see in the webshop)		



1

<b>GEV No.</b>	518381	<b>Ref. No.</b>	127035
<b>description</b>	formed hose dishwasher straight mounting pos. upper equiv. no. 127035		
<b>For models:</b>	46, 460, 500F, 500FD, 50-ELECTRONIC, 50F, 50FD, 510F, 510FD, E.46, E.50, E.51, E.60, E.65, TF-503, TF-513, TF-515		



1

<b>GEV No.</b>	518513	<b>Ref. No.</b>	143158
<b>description</b>	formed hose ext. ø 43.5 ID ø 35mm L 925mm dishwasher straight mounting pos. upper equiv. no. 143158		
<b>For models:</b>	22F, 22R, 40F, 440F, 44F, E.52		



1

<b>GEV No.</b>	518380	<b>Ref. No.</b>	127036 80189
<b>description</b>	formed hose ext. ø 53 ID ø 43mm L 65mm dishwasher straight mounting pos. upper equiv. no. 127036		
<b>For models:</b>	22F, 2312-001, 2312-002, 440F, 44F, 46, 460, 500F, 500FD, 50-ELECTRONIC, 50F, 50FD, 510F, 510FD, 80, 81, 82, 913297, 913298, 913299, 913300, 913360, 913361, 913391, 913392, 913546, 913547, 913578, 913611, 913684, 913913, 913914, 913932, 913933, 914284, 914318, 914319, 914331, 914338, 914356, 914400, 914401, 914402, 914403, 914404, 914405, 914431, 914449, 914517, 914545...(Other models you can see in the webshop)		



<b>GEV No.</b>	513294	<b>Ref. No.</b>	41525 43149
<b>description</b>	formed hose hose ext. ø 20mm ID ø 13mm hose int. ø 25mm L 1350mm		
<b>For models:</b>	915747, A3EB, A3EBD, A3EBDAKRKYK, A3EBDAKWK, A3EBDBKWK, A3EBDRKYK, A3EBDWK, A3EBDYK, A3EBSAK, A3EBSAKRK, A3EBSAKWK, A3EBSBKWKYK, A3EBSKWK, A3EBSWK, A4EB, A4EBD, A4EBDAKEYK, A4EBDAKRK, A4EBDAKWK, A4EBDAKZK, A4EBDBKRK, A4EBDPKWYK, A4EBDRK, A4EBS, A4EBSAK, A4EBSAKCK, A4EBSAKKEYK, A4EBSAKRK, A4EBSAKRKP, A4EBSAKYK, A4EBSCK, A4EBT, A4EBTSAK, A5EB, A5EBD, A5EBDAKPKWK, A5EBDAKWK, A5EBDAKYK, A5EBDRK, A5EBS, A5EBSAKPKWK, A5EBSAKRK, A5EBSAKRKYK, A5EBSAKWK, A5EBSAKWKYK, A5EBSBKRKPK, A5EBSBKWK, A5EBSRK, A5EBSYK...(Other models you can see in the webshop)		



<b>GEV No.</b>	513301	<b>Ref. No.</b>	70543
<b>description</b>	formed hose end piece A ext. ø 18mm end piece A int. ø 10mm AD2 ø 18mm ø end piece B 10mm L 174mm		
<b>For models:</b>	River-285, River-382LNRG, River-382NRG, River-382NRG-230-3Ph-50Hz, RV282R, RV382LR, RV382LTXR, RV382R, RV382R23TERMO, RV382RFUR, RV382TXR		



<b>GEV No.</b>	504795	<b>Ref. No.</b>	127096
<b>description</b>	formed hose L 47mm warewashing		
<b>For models:</b>	915154, 915155, 915157, 915158, 915172, 915173, 915285, 915422, 915492, 915493, 915494, 915495, 915496, 915497, 916054, 916067, 916068, 916069, 916079, 916080, 916368, 916420, 916421, 916422, 916423, 916424, 916686, 916760, RIVER-252, River-252-2, River-252-2T, River-253, RIVER-262, River-262-2, River-262-2T, River-272, RIVER-282, River-352C, River-352T, River-362C, River-362C-230V-3Ph-50Hz, River-362T, River-362T-230V-3Ph-50Hz, River-372, RV282, RV282DD		



<b>GEV No.</b>	513299	<b>Ref. No.</b>	127090
<b>description</b>	formed hose end piece A ext. ø 18mm end piece A int. ø 10mm AD2 ø 18mm ø end piece B 10mm L 435mm		
<b>For models:</b>	915150, 915151, 915152, 915160, 915161, 915162, 915166, 915167, 915168, 915175, 915176, 915177, 915319, 915338, 915341, 915348, 915418, 915419, 915420, 915421, 915479, 915547, 915558, 915635, 915663, 915747, 916201, 916202, 916203, 916204, 916205, 916206, 916207, 916208, 916209, 916365, 916366, 916367, 916411, 916412, 916413, 916414, 916415, 916416, 916417, 916684, 916685, 916761, 916762, 916802...(Other models you can see in the webshop)		

form L



<b>GEV No.</b>	518302	<b>Ref. No.</b>	127064
<b>description</b>	formed hose		
<b>For models:</b>	2312-007, 2312-009-CRP, 914100, 914101, 914339, 914342, 914343, 914624, 914625, 914626, 914627, 914628, 914850, 914851, 914854, 914944, PS-60, RIVER-48, RIVER-50, RIVER-50-CRP, RIVER-50-CRP-SP, RIVER-54, RIVER-54CRP, River-54-CRP-s.p., RIVER-54-CRP-SP, RIVER-61		



<b>GEV No.</b>	513302	<b>Ref. No.</b>	127107
<b>description</b>	formed hose end piece A ext. ø 18mm end piece A int. ø 10mm AD2 ø 18mm ø end piece B 10mm L 450mm		
<b>For models:</b>	915611, 915612, 915613, 915614, 915615, 915616, 915670, 915671, 915959, 916196, 916197, 916198, 916199, 916200, 916409, 916410, 916591, 916592, 916593, 916877, Niagara-241, Niagara-241-2, Niagara-341, Pluvia-240		



<b>GEV No.</b>	513311	<b>Ref. No.</b>	127128
<b>description</b>	formed hose end piece A ext. ø 17mm end piece A int. ø 10mm AD2 ø 17mm ø end piece B 10mm L 112mm		
<b>For models:</b>	915611, 915612, 915613, 915614, 915615, 915616, 915670, 915671, 915959, 916196, 916197, 916198, 916199, 916200, 916409, 916410, 916591, 916592, 916593, 916877, Niagara-241, Niagara-241-2, Niagara-341, Pluvia-240		



<b>GEV No.</b>	518639	<b>Ref. No.</b>	143237
<b>description</b>	formed hose end piece A ext. ø 18mm end piece A int. ø 11mm AD2 ø 18mm ø end piece B 11mm L 460mm		
<b>For models:</b>	913289, 913290, 913291, 913292, 913356, 913357, 913372, 913373, 913374, 913375, 913416, 913435, 913544, 913545, 913665, 913666, 913667, 913668, 913685, 913771, 913772, 913773, 913774, 913832, 913837, 913911, 913912, 913948, 913950, 913977, 913984, 913990, 914165, 914166, 914206, 914214, 914316, 914317, 914355, 914386, 914387, 914388, 914389, 914390, 914391, 914392, 914393, 914394, 914395, 914396...(Other models you can see in the webshop)		



<b>GEV No.</b>	513296	<b>Ref. No.</b>	69388
<b>description</b>	formed hose end piece A ext. ø 32mm end piece A int. ø 28mm AD2 ø 28mm ø end piece B 20mm L 590mm		
<b>For models:</b>	River-282LS-2TDE, River-282S-2TDE, River-382LTDE, River-382TDE, RV382LS, RV382LSFUR, RV382S, RV382SFUR		



			
1			
<b>GEV No.</b>	513305	<b>Ref. No.</b>	35603
<b>description</b>	formed hose end piece A ext. ø 51mm end piece A int. ø 44mm AD2 ø 42mm ø end piece B 33mm L 300mm		
<b>For models:</b>	LP60, NG271, NG291, NIAGARA-271, NIAGARA-291, RIVER-294, RIVER-71, RV294, RV71, U60E		

			
1			
<b>GEV No.</b>	513313	<b>Ref. No.</b>	70020
<b>description</b>	formed hose end piece A ext. ø 54mm end piece A int. ø 44mm AD2 ø 48mm ø end piece B 38mm L 900mm		
<b>For models:</b>	NG381L, NG381LC, NG381LCFUR, NG381LDDPS, Niagara-283L-2, Niagara-381L, Niagara-381LC, River-282L-2, River-282LS-2TDE, River-382L, River-382L-230V-3Ph-50Hz, River-382LNRG, River-382LTDE, River-482, RV382L, RV382L23TERMO, RV382LFUR, RV382LR, RV382LS, RV382LSFUR, RV382LTX, RV382LTXR, RV482		

			
1			
<b>GEV No.</b>	513251	<b>Ref. No.</b>	80187
<b>description</b>	formed hose end piece A ext. ø 59mm end piece A int. ø 47mm AD2 ø 58mm ø end piece B 46mm warewashing L-shape equiv. no. 80187 mounting pos. upper		
<b>For models:</b>	80, 81, 82, 915747, CGL74CABT, Fast200, FAST-200, Fast93, GL280EB, GL280EB23, GL280EB23DAR, GL280EB23HZ, GL280EB23HZDY, GL280EBD, GL280EBDA, GL280EBDAE, GL280EBDAR, GL280EBDARY, GL280EBDAW, GL280EBDAWY, GL280EBDAY, GL280EBDB, GL280EBDBR, GL280EBDBW, GL280EBDWY, GL280EBDY, GL280EBS, GL280EBSA, GL280EBSAE, GL280EBSAEW, GL280EBSAEWY, GL280EBSAR, GL280EBSARY, GL280EBSAW, GL280EBSAWY, GL280EBSAY, GL280EBSB, GL280EBSR, GL280EBSWY, GL280EBSY, GL282EB, GL282EB93, GL282EB93DA, GL282EB93HZ23, GL282EBCH, GL282EBCHD, GL282EBD, GL282EBDA, GL282EBDAE, GL282EBDAR...(Other models you can see in the webshop)		

			
1			
<b>GEV No.</b>	518124	<b>Ref. No.</b>	927016 DZG52
<b>description</b>	formed hose end piece A ext. ø 61mm end piece A int. ø 49mm AD2 ø 65mm ø end piece B 53mm L 290mm rubber Qty 1 for dishwasher L-shape outflow		
<b>For models:</b>	161, 221, 271, 272, 362, CLEAN-160, CLEAN-161, CLEAN-220, CLEAN-221, CLEAN-270, CLEAN-271, CLEAN-272, CLEAN-361, CLEAN-361P, CLEAN-362, CLEAN-471, CLEAN-471P		

			
1			
<b>GEV No.</b>	503178	<b>Ref. No.</b>	127106
<b>description</b>	formed hose for drain pump warewashing		
<b>For models:</b>	915611, 915612, 915613, 915614, 915615, 915616, 915617, 915618, 915670, 915671, 915672, 915773, 915774, 915959, 916066, 916077, 916078, 916196, 916197, 916198, 916199, 916200, 916409, 916410, 916418, 916419, 916591, 916592, 916593, 916594, 916595, 916877, 916921, 916922, 916992, 916993, Fast145-2, Fast150, Niagara-241, Niagara-241-2, Niagara-341, Pluvia-240, River-242, River-242-2, River-242-2T, River-342C, River-342T		

			
1			
<b>GEV No.</b>	503179	<b>Ref. No.</b>	127120
<b>description</b>	formed hose for drain pump warewashing		
<b>For models:</b>	915611, 915612, 915613, 915614, 915615, 915616, 915617, 915618, 915670, 915671, 915672, 915773, 915774, 915959, 916066, 916077, 916078, 916196, 916197, 916198, 916199, 916200, 916409, 916410, 916418, 916419, 916591, 916592, 916593, 916594, 916595, 916877, Niagara-241, Niagara-241-2, Niagara-341, Pluvia-240, River-242, River-242-2, River-242-2T, River-342C, River-342T		

			
1			
<b>GEV No.</b>	503180	<b>Ref. No.</b>	41560
<b>description</b>	formed hose for drain pump warewashing		
<b>For models:</b>	NG292, NG292HZ, NG293, NIAGARA-292, Niagara-292-400V-3Ph-60Hz, NIAGARA-293, RIVER-295, River-295P, RIVER-296, River-296P, RV295, RV295PS, RV296, RV296PS		

			
1			
<b>GEV No.</b>	503181	<b>Ref. No.</b>	127084
<b>description</b>	formed hose for drain pump warewashing		
<b>For models:</b>	915150, 915151, 915152, 915154, 915155, 915157, 915158, 915160, 915161, 915162, 915166, 915167, 915168, 915172, 915173, 915175, 915176, 915177, 915285, 915319, 915338, 915341, 915348, 915418, 915419, 915420, 915421, 915422, 915479, 915492, 915493, 915494, 915495, 915496, 915497, 915547, 915558, 915635, 915663, 915747, 916054, 916067, 916068, 916069, 916079, 916080, 916201, 916202, 916203, 916204...(Other models you can see in the webshop)		

			
<b>1</b>			
<b>GEV No.</b>	503182	<b>Ref. No.</b>	73024
<b>description</b>	formed hose for drain pump warewashing		
<b>For models:</b>	NG381, NG38123, NG38123TERMO, NG381C, NG381CDD, NG381CFUR, NG381DDHZ23, NG381DDPS, NG381DDPSHZ23, NG381HPDD, NG381TERMO, NG381TXCDD, Niagara-381, Niagara-381-230V-3Ph-50Hz, Niagara-381-230V-3Ph-60Hz, Niagara-381DP, Niagara-381HPD, River-282-2, River-282S-2TDE, River-285, River-382, River-382-230V-3Ph-50Hz, River-382H, River-382NRG, River-382NRG-230-3Ph-50Hz, River-382TDE, RV382, RV38223TERMO, RV382AHP, RV382FUR, RV382R, RV382R23TERMO, RV382RFUR, RV382S, RV382SFUR, RV382TERMO, RV382TX, RV382TXR		

			
<b>1</b>			
<b>GEV No.</b>	513254	<b>Ref. No.</b>	80186
<b>description</b>	formed hose L 340mm warewashing L-shape equiv. no. 80186 ID ø 60mm		
<b>For models:</b>	80, 81, 82, 915747, A4EB, A4EBD, A4EBDAKEKYK, A4EBDAKRK, A4EBDAKWK, A4EBDAKZK, A4EBDBKRK, A4EBDPKWYK, A4EBDRK, A4EBS, A4EBSAK, A4EBSAKCK, A4EBSAKEKYK, A4EBSAKRK, A4EBSAKRKP, A4EBSAKYK, A4EBSCK, A4EBT, A4EBTSAK, A5EB, A5EBD, A5EBDAKP-KWK, A5EBDAKWK, A5EBDAKYK, A5EBDRK, A5EBS, A5EBSAKPKWK, A5EBSAKRK, A5EBSAKRKYK, A5EBSAKWK, A5EBSAKWKYK, A5EBSB-KRKP, A5EBSBKWK, A5EBSRK, A5EBSYK, CE78HZ23, CGL74CABT, E78, E78HP, Fast181, FAST-181, Fast181-230V-3Ph-60Hz, Fast181-400V-3NPh-60Hz, GL284EB, GL284EBD, GL284EBDA...(Other models you can see in the webshop)		

			
<b>2</b>			
<b>GEV No.</b>	503175	<b>Ref. No.</b>	127134
<b>description</b>	formed hose for intake body warewashing		
<b>For models:</b>	916020, 916021, 916024, 916025, 916026, 916027, 916030, 916031, 916045, 916247, 916248, 916249, 916250, 916251, 916252, 916382, 916383, 916452, 916504, 916584, 916654, 916670, 916688, 916763, 917044, 917049, Clean161, Fast160-2, Fast160C, Fast161-2, Ocean360, Ocean360M, Ocean360-UK		

			
<b>1</b>			
<b>GEV No.</b>	503174	<b>Ref. No.</b>	127102
<b>description</b>	formed hose warewashing		
<b>For models:</b>	915154, 915155, 915157, 915158, 915172, 915173, 915285, 915422, 915492, 915493, 915494, 915495, 915496, 915497, 915695, 915696, 915819, 916054, 916067, 916068, 916069, 916079, 916080, 916368, 916420, 916421, 916422, 916423, 916424, 916686, 916760, 916921, 916922, 916992, 916993, Fast145, FAST-145, Fast145-2, Fast145D, FAST-145D, Fast150, RIVER-252, River-252-2, River-252-2T, RIVER-253, RIVER-262, River-262-2, River-262-2T, River-272, River-282LS-2TDE...(Other models you can see in the webshop)		

			
<b>1</b>			
<b>GEV No.</b>	513250	<b>Ref. No.</b>	80188
<b>description</b>	formed hose ID ø 48mm ED ø 60mm thickness 6mm L1 235mm L2 140mm L-shape		
<b>For models:</b>	80, 81, 82, 914380, 914436, A3EB, A3EBD, A3EBDAKRKYK, A3EBDAKWK, A3EBDBKWK, A3EBDRKYK, A3EBDWK, A3EBDYK, A3EBSAK, A3EBSAKRK, A3EBSAKWK, A3EBSBKWKYK, A3EBSEKWK, A3EBSWK, A4EB, A4EBD, A4EBDAKEKYK, A4EBDAKRK, A4EBDAKWK, A4EBDAKZK, A4EBDBKRK, A4EBDPKWYK, A4EBDRK, A4EBS, A4EBSAK, A4EBSAKCK, A4EBSAKEKYK, A4EBSAKRK, A4EBSAKRKP, A4EBSAKYK, A4EBSCK, A4EBT, A4EBTSAK, A5EB, A5EBD, A5EBDAKP-KWK, A5EBDAKWK, A5EBDAKYK, A5EBDRK, A5EBS, A5EBSAKPKWK, A5EBSAKRK, A5EBSAKRKYK, A5EBSAKWK, A5EBSAKWKYK...(Other models you can see in the webshop)		

			
<b>1</b>			
<b>GEV No.</b>	503176	<b>Ref. No.</b>	127098
<b>description</b>	formed hose warewashing		
<b>For models:</b>	915150, 915151, 915152, 915154, 915155, 915157, 915158, 915160, 915161, 915162, 915166, 915167, 915168, 915172, 915173, 915175, 915176, 915177, 915285, 915319, 915338, 915341, 915348, 915418, 915419, 915420, 915421, 915422, 915479, 915492, 915493, 915494, 915495, 915496, 915497, 915547, 915558, 915635, 915663, 915695, 915696, 915747, 915819, 916054, 916067, 916068, 916069, 916079, 916080, 916201...(Other models you can see in the webshop)		

			
<b>1</b>			
<b>GEV No.</b>	503177	<b>Ref. No.</b>	127111
<b>description</b>	formed hose warewashing		
<b>For models:</b>	915617, 915618, 915672, 915773, 915774, 916066, 916077, 916078, 916418, 916419, 916594, 916595, River-242, River-242-2, River-242-2T, River-342C, River-342T		



1

<b>GEV No.</b>	518216	<b>Ref. No.</b>	127001
<b>description</b>	formed hose warewashing L-shape equiv. no. 127001 mounting pos. upper		
<b>For models:</b>	21F, 21FD, 21R, 21RD, 22F, 22R, 25F, 25FD, 25R, 25RD, 30F, 30FD, 30R, 30RD, 31F, 31FD, 31R, 31RD, 40F, 440F, 44F, 45, 450, 67F, 67R, 913418, 914167, 914168, 914398, 914399, 914443, 914943, 915695, 915696, 915819, E.45, E.52, Fast145, FAST-145, Fast145D, FAST-145D, Niagra-45, S621, S623, S624, S626, S631, S633, S634, S636		



1

<b>GEV No.</b>	518520	<b>Ref. No.</b>	127005
<b>description</b>	formed hose warewashing L-shape equiv. no. 127005		
<b>For models:</b>	11F, 11FD, 11R, 11RD, 21F, 21FD, 21R, 21RD, 25F, 25FD, 25R, 25RD, 30F, 30FD, 30R, 30RD, 31F, 31FD, 31R, 31RD, 913363, 913364, 913376, 913377, E.41, E.42, E41, S621, S623, S624, S626, S631, S633, S634, S636		



1

<b>GEV No.</b>	518225	<b>Ref. No.</b>	127041
<b>description</b>	formed hose warewashing L-shape equiv. no. 127041		
<b>For models:</b>	050F, 050FP, 2312-001, 2312-002, 46, 460, 500F, 500FD, 50F, 50FD, 510F, 510FD, 913297, 913298, 913299, 913300, 913360, 913361, 913391, 913392, 913546, 913547, 913578, 913611, 913684, 913913, 913914, 913932, 913933, 914284, 914318, 914319, 914331, 914338, 914356, 914400, 914401, 914402, 914403, 914404, 914405, 914431, 914449, 914517, 914545, 914568, 914642, 914688, 914909, 914979... (Other models you can see in the webshop)		



1

<b>GEV No.</b>	518224	<b>Ref. No.</b>	127042
<b>description</b>	formed hose warewashing L-shape equiv. no. 127042		
<b>For models:</b>	45, 450, 913418, 914167, 914168, 914398, 914399, 914443, 914943, 915695, 915696, 915819, E.45, Fast145, FAST-145, Fast145D, FAST-145D, Niagra-45		



1

<b>GEV No.</b>	513245	<b>Ref. No.</b>	926032
<b>description</b>	formed hose warewashing L-shape equiv. no. 926032, DZG441		
<b>For models:</b>	10, 12, 14, CLEAN-100, CLEAN-110, CLEAN-120, E1, E10, E100, E110, E12, E120, E14, E140		



1

<b>GEV No.</b>	513134	<b>Ref. No.</b>	926034
<b>description</b>	formed hose warewashing L-shape equiv. no. 926034, DZG47		
<b>For models:</b>	10, 12, 14, 82, CLEAN-100, CLEAN-110, CLEAN-120, E.60, E.65, E1, E10, E100, E110		



1

<b>GEV No.</b>	513135	<b>Ref. No.</b>	926056
<b>description</b>	formed hose warewashing L-shape equiv. no. 926056, DZG461		
<b>For models:</b>	12, 14, 161, 221, 271, 272, 362, 914380, 914436, 915747, A3EB, A3EBD, A3EBDAKRKYK, A3EBDAKWK, A3EBDBKWK, A3EBDRKYK, A3EBDWWK, A3EBDYK, A3EBSAK, A3EBSAKRK, A3EBSAKWK, A3EBSBKWKYK, A3EBSEKWK, A3EBSWK, A4EB, A4EBD, A4EBDAKEYK, A4EBDAKRK, A4EBDAKWK, A4EBDAKZK, A4EBDBKRK, A4EBDPKWYK, A4EBDRK, A4EBS, A4EBSAK, A4EBSAKCK, A4EBSAKEKYK, A4EBSAKRK, A4EBSAKRKP, A4EBSAKYK, A4EBSCK, A4EBT, A4EBTSAK, A5EB, A5EBD, A5EBDAKPKWK, A5EBDAKWK, A5EBDAKYK, A5EBDRK, A5EBS...(Other models you can see in the webshop)		



1

<b>GEV No.</b>	513246	<b>Ref. No.</b>	926157
<b>description</b>	formed hose warewashing L-shape equiv. no. 926157, DZG6162		
<b>For models:</b>	CLEAN-100, CLEAN-110, E1, E10, E100, E110		



1

<b>GEV No.</b>	518578	<b>Ref. No.</b>	127010
<b>description</b>	formed hose warewashing L-shape equiv. no. DZG30, 127010		
<b>For models:</b>	R509, R511, R704		



1

<b>GEV No.</b>	513075	<b>Ref. No.</b>	929164
<b>description</b>	formed hose warewashing L-shape equiv. no. DZG60, 929164		
<b>For models:</b>	914380, 914436, 915747, A3EB, A3EBD, A3EBDAKRKYK, A3EBDAKWK, A3EBDBKWK, A3EBDRKYK, A3EBDVK, A3EBDYK, A3EBSAK, A3EBSAKRK, A3EBSAKWK, A3EBSBKWKYK, A3EBSEKWK, A3EBSWK, A4EB, A4EBD, A4EBDAKEKYK, A4EBDAKRK, A4EBDAKWK, A4EBDAKZK, A4EBDBKRK, A4EBDPKWKYK, A4EBDRK, A4EBS, A4EBSAK, A4EBSAKCK, A4EBSAKEKYK, A4EBSAKRK, A4EBSAKRKP, A4EBSAKYK, A4EBSCK, A4EBT, A4EBTSAK, A5EB, A5EBD, A5EBDAKPKWK, A5EBDAKWK, A5EBDAKYK, A5EBDRK, A5EBS, A5EBSAKPKWK, A5EBSAKRK, A5EBSAKRKYK, A5EBSAKWK, A5EBSAKWKYK, A5EBSBKRKPK, A5EBSBKWK... (Other models you can see in the webshop)		

with branch



1

<b>GEV No.</b>	511929	<b>Ref. No.</b>	143239
<b>description</b>	formed hose ext. ø 17 L 430mm plastic black Qty 1		
<b>For models:</b>	913289, 913290, 913291, 913292, 913356, 913357, 913363, 913364, 913372, 913373, 913374, 913375, 913376, 913377, 913416, 913435, 913544, 913545, 913665, 913666, 913667, 913668, 913685, 913771, 913772, 913773, 913774, 913832, 913837, 913911, 913912, 913948, 913950, 913977, 913984, 913990, 914165, 914166, 914206, 914214, 914316, 914317, 914355, 914386, 914387, 914388, 914389, 914390, 914391, 914392... (Other models you can see in the webshop)		



1

<b>GEV No.</b>	513247	<b>Ref. No.</b>	926158
<b>description</b>	formed hose warewashing equiv. no. 926158, DZG6364 mounting pos. upper with piggyback		
<b>For models:</b>	E12, E120, E14, E140		

form S



1

<b>GEV No.</b>	512448	<b>Ref. No.</b>	127103
<b>description</b>	formed hose ED ø 17mm hose int. ø 10mm warewashing		
<b>For models:</b>	915154, 915155, 915157, 915158, 915172, 915173, 915285, 915422, 915492, 915493, 915494, 915495, 915496, 915497, 916054, 916067, 916068, 916069, 916079, 916080, 916368, 916420, 916421, 916422, 916423, 916424, 916686, 916760, RIVER-252, River-252-2, River-252-2T, River-253, RIVER-262, River-262-2, River-262-2T, River-272, River-282LS-2TDE, River-282S-2TDE, River-352C, River-352T, River-362C, River-362C-230V-3Ph-50Hz, River-362T, River-362T-230V-3Ph-50Hz, River-372, River-382LTDE, River-382TDE, RV382LS, RV382LSFUR, RV382S... (Other models you can see in the webshop)		



1

<b>GEV No.</b>	512450	<b>Ref. No.</b>	127116
<b>description</b>	formed hose ED ø 29mm hose int. ø 21mm warewashing		
<b>For models:</b>	915617, 915618, 915672, 915773, 915774, 916066, 916077, 916078, 916418, 916419, 916594, 916595, River-242, River-242-2, River-242-2T, River-342C, River-342T		

1

<b>GEV No.</b>	512454	<b>Ref. No.</b>	127105
<b>description</b>	formed hose for drain pump warewashing		
<b>For models:</b>	915611, 915612, 915613, 915614, 915615, 915616, 915617, 915618, 915670, 915671, 915672, 915773, 915774, 915959, 916066, 916077, 916078, 916196, 916197, 916198, 916199, 916200, 916409, 916410, 916418, 916419, 916591, 916592, 916593, 916594, 916595, 916877, 916921, 916922, 916992, 916993, Fast145-2, Fast150, Niagara-241, Niagara-241-2, Niagara-341, Pluvia-240, River-242, River-242-2, River-242-2T, River-342C, River-342T		



1

<b>GEV No.</b>	513237	<b>Ref. No.</b>	127121
<b>description</b>	formed hose for drain pump warewashing		
<b>For models:</b>	915611, 915612, 915613, 915614, 915615, 915616, 915617, 915618, 915670, 915671, 915672, 915773, 915774, 915959, 916066, 916077, 916078, 916196, 916197, 916198, 916199, 916200, 916409, 916410, 916418, 916419, 916591, 916592, 916593, 916594, 916595, 916877, NIAGARA-241, NIAGARA-241-2, NIAGARA-341, PLUVIA-240, RIVER-242, RIVER-242-2, RIVER-242-2T, RIVER-342C, RIVER-342T		



1

<b>GEV No.</b>	513312	<b>Ref. No.</b>	127114
<b>description</b>	formed hose ID ø 10mm hose ext. ø 17mm ED ø 17mm hose int. ø 10mm L 115mm		
<b>For models:</b>	915617, 915618, 915672, 915773, 915774, 916066, 916077, 916078, 916418, 916419, 916594, 916595, River-242, River-242-2, River-242-2T, River-342C, River-342T		



1

<b>GEV No.</b>	513300	<b>Ref. No.</b>	127093
<b>description</b>	formed hose ID ø 30mm hose ext. ø 35mm ED ø 27mm hose int. ø 21mm L 460mm		
<b>For models:</b>	915150, 915151, 915152, 915154, 915155, 915157, 915158, 915160, 915161, 915162, 915166, 915167, 915168, 915172, 915173, 915175, 915176, 915177, 915285, 915319, 915338, 915341, 915348, 915418, 915419, 915420, 915421, 915422, 915479, 915492, 915493, 915494, 915495, 915496, 915497, 915547, 915558, 915635, 915663, 915747, 916054, 916067, 916068, 916069, 916079, 916080, 916201, 916202, 916203, 916204...(Other models you can see in the webshop)		



1

<b>GEV No.</b>	513244	<b>Ref. No.</b>	926033
<b>description</b>	formed hose S-shape warewashing equiv. no. 926033, DZG63		
<b>For models:</b>	10, CLEAN-100, CLEAN-110, E1, E10, E100, E110		



1

<b>GEV No.</b>	512449	<b>Ref. No.</b>	127092
<b>description</b>	formed hose warewashing		
<b>For models:</b>	915150, 915151, 915152, 915154, 915155, 915157, 915158, 915160, 915161, 915162, 915166, 915167, 915168, 915172, 915173, 915175, 915176, 915177, 915285, 915319, 915338, 915341, 915348, 915418, 915419, 915420, 915421, 915422, 915479, 915492, 915493, 915494, 915495, 915496, 915497, 915547, 915558, 915635, 915663, 915747, 916054, 916067, 916068, 916069, 916079, 916080, 916201, 916202, 916203, 916204...(Other models you can see in the webshop)		



1

<b>GEV No.</b>	512451	<b>Ref. No.</b>	127101
<b>description</b>	formed hose warewashing		
<b>For models:</b>	915154, 915155, 915157, 915158, 915172, 915173, 915285, 915422, 915492, 915493, 915494, 915495, 915496, 915497, 916054, 916067, 916068, 916069, 916079, 916080, 916368, 916420, 916421, 916422, 916423, 916424, 916686, 916760, RIVER-252, RIVER-252-2, RIVER-252-2T, RIVER-253, RIVER-262, RIVER-262-2, RIVER-262-2T, RIVER-272, RIVER-282LS-2TDE, RIVER-282S-2TDE, RIVER-352C, RIVER-352T, RIVER-362C, RIVER-362C-230V-3Ph-50Hz, RIVER-362T, RIVER-362T-230V-3Ph-50Hz, RIVER-372, RIVER-382LTDE, RIVER-382TDE, RV382LS, RV382LSFUR, RV382S...(Other models you can see in the webshop)		



1

<b>GEV No.</b>	512452	<b>Ref. No.</b>	127122
<b>description</b>	formed hose warewashing		
<b>For models:</b>	915611, 915612, 915613, 915614, 915615, 915616, 915617, 915618, 915670, 915671, 915672, 915773, 915774, 915959, 916066, 916077, 916078, 916196, 916197, 916198, 916199, 916200, 916409, 916410, 916418, 916419, 916591, 916592, 916593, 916594, 916595, 916877, NIAGARA-241, NIAGARA-241-2, NIAGARA-341, PLUVIA-240, RIVER-242, RIVER-242-2, RIVER-242-2T, RIVER-342C, RIVER-342T		



1

<b>GEV No.</b>	512453	<b>Ref. No.</b>	127112
<b>description</b>	formed hose warewashing		
<b>For models:</b>	915617, 915618, 915672, 915773, 915774, 916066, 916077, 916078, 916418, 916419, 916594, 916595, River-242, River-242-2, River-242-2T, River-342C, River-342T		

form U



1

<b>GEV No.</b>	518516	<b>Ref. No.</b>	127045
<b>description</b>	formed hose		
<b>For models:</b>	46, 460		



1

<b>GEV No.</b>	513233	<b>Ref. No.</b>	127087
<b>description</b>	formed hose D1 ø 30mm D2 ø 30mm for drain pump rubber warewashing		
<b>For models:</b>	915150, 915151, 915152, 915154, 915155, 915157, 915158, 915160, 915161, 915162, 915166, 915167, 915168, 915172, 915173, 915175, 915176, 915177, 915285, 915319, 915338, 915341, 915348, 915418, 915419, 915420, 915421, 915422, 915479, 915492, 915493, 915494, 915495, 915496, 915497, 915547, 915558, 915635, 915663, 915747, 916054, 916067, 916068, 916069, 916079, 916080, 916201, 916202, 916203, 916204...(Other models you can see in the webshop)		



1

<b>GEV No.</b>	513297	<b>Ref. No.</b>	127109
<b>description</b>	formed hose ext. ø 30 D1 ø 25mm D2 ø 11mm L 860mm		
<b>For models:</b>	915617, 915618, 915672, 915773, 915774, 916066, 916077, 916078, 916418, 916419, 916594, 916595, River-242, River-242-2, River-242-2T, River-342C, River-342T		



1

<b>GEV No.</b>	698840	<b>Ref. No.</b>	44354
<b>description</b>	formed hose ext. ø 40.5 D1 ø 32.5mm D2 ø 42.5mm 1210 warewashing Qty 1		
<b>For models:</b>	NG293, NIAGARA-293, RIVER-296, River-296P, RV296, RV296PS		



1

<b>GEV No.</b>	698842	<b>Ref. No.</b>	127133
<b>description</b>	formed hose ext. ø 44 D1 ø 34mm D2 ø 34mm L 630mm warewashing Qty 1		
<b>For models:</b>	916020, 916021, 916024, 916025, 916026, 916027, 916030, 916031, 916045, 916247, 916248, 916249, 916250, 916251, 916252, 916382, 916383, 916452, 916504, 916584, 916654, 916670, 916688, 916763, 917044, 917049, Clean161, Fast160-2, Fast160C, Fast161-2, Ocean360, Ocean360M, Ocean360-UK		



1

<b>GEV No.</b>	513315	<b>Ref. No.</b>	43555
<b>description</b>	formed hose ext. ø 52 D1 ø 44mm L 1200mm		
<b>For models:</b>	RIVER-297, RIVER-298, RV297, RV298, RV298HZ		



1

<b>GEV No.</b>	513314	<b>Ref. No.</b>	41554
<b>description</b>	formed hose ext. ø 52 D1 ø 46mm D2 ø 42mm L 1000mm		
<b>For models:</b>	NG292, NG292HZ, NIAGARA-292, Niagara-292-400V-3Ph-60Hz, RIVER-295, River-295P, RV295, RV295PS		



			
1			
<b>GEV No.</b>	518517	<b>Ref. No.</b>	127050
<b>description</b>	formed hose for drain pump D1 ø 28mm D2 ø 21mm warewashing U-shape		
<b>For models:</b>	050F, 050FP, 2312-001, 2312-002, 500F, 500FD, 50F, 50FD, 510F, 510FD, 913297, 913298, 913299, 913300, 913360, 913361, 913391, 913392, 913546, 913547, 913578, 913611, 913684, 913913, 913914, 913932, 913933, 914284, 914318, 914319, 914331, 914338, 914356, 914400, 914401, 914402, 914403, 914404, 914405, 914431, 914449, 914517, 914545, 914568, 914642, 914688, 914909, 914979, 915136, 915137... (Other models you can see in the webshop)		

			
1			
<b>GEV No.</b>	513260	<b>Ref. No.</b>	143242
<b>description</b>	formed hose warewashing		
<b>For models:</b>	913289, 913290, 913291, 913292, 913356, 913357, 913372, 913373, 913374, 913375, 913416, 913435, 913544, 913545, 913665, 913666, 913667, 913668, 913685, 913771, 913772, 913773, 913774, 913832, 913837, 913911, 913912, 913948, 913950, 913977, 913984, 913990, 914165, 914166, 914206, 914214, 914316, 914317, 914355, 914386, 914387, 914388, 914389, 914390, 914391, 914392, 914393, 914394, 914395, 914396... (Other models you can see in the webshop)		

			
2			
<b>GEV No.</b>	513199	<b>Ref. No.</b>	69068
<b>description</b>	formed hose for drain pump warewashing		
<b>For models:</b>	915154, 915155, 915157, 915158, 915172, 915173, 915285, 915422, 915492, 915493, 915494, 915495, 915496, 915497, 916045, 916054, 916067, 916068, 916069, 916079, 916080, 916368, 916420, 916421, 916422, 916423, 916424, 916654, 916686, 916760, Fast160C, Ocean360-UK, River-252, River-252-2, River-252-2T, River-253, RIVER-262, River-262-2, River-262-2T, River-272, RIVER-282, River-282-2, River-282L-2, River-282LS-2TDE, River-282S-2TDE, River-285, RIVER-294, RIVER-295, River-295P, RIVER-296... (Other models you can see in the webshop)		

			
1			
<b>GEV No.</b>	513278	<b>Ref. No.</b>	127136
<b>description</b>	formed hose warewashing		
<b>For models:</b>	916020, 916021, 916024, 916025, 916026, 916027, 916030, 916031, 916045, 916247, 916248, 916249, 916250, 916251, 916252, 916382, 916383, 916452, 916504, 916584, 916654, 916670, 916688, 916763, 916921, 916922, 916992, 916993, 917044, 917049, Clean161, Fast145-2, Fast150, Fast160-2, Fast160C, Fast161-2, Ocean360, Ocean360M, Ocean360-UK		

			
1			
<b>GEV No.</b>	513232	<b>Ref. No.</b>	127115
<b>description</b>	formed hose for drain pump warewashing		
<b>For models:</b>	915611, 915612, 915613, 915614, 915615, 915616, 915617, 915618, 915670, 915671, 915672, 915773, 915774, 915959, 916066, 916077, 916078, 916196, 916197, 916198, 916199, 916200, 916409, 916410, 916418, 916419, 916591, 916592, 916593, 916594, 916595, 916877, Niagara-241, Niagara-241-2, Niagara-341, Pluvia-240, River-242, River-242-2, River-242-2T, River-342C, River-342T		

<p>miscellaneous</p> 			
1			
<b>GEV No.</b>	518036	<b>Ref. No.</b>	127012
<b>description</b>	formed hose angled warewashing		
<b>For models:</b>	21F, 21FD, 25F, 25FD, 30F, 30FD, 31F, 31FD, 31R, 31RD, S621, S623, S624, S626, S631, S633, S634, S636		

			
1			
<b>GEV No.</b>	513234	<b>Ref. No.</b>	127123
<b>description</b>	formed hose for drain pump warewashing		
<b>For models:</b>	915617, 915618, 915672, 915773, 915774, 916066, 916077, 916078, 916418, 916419, 916594, 916595, RIVER-242, River-242-2, River-242-2T, River-342C, River-342T		

			
1			
<b>GEV No.</b>	513303	<b>Ref. No.</b>	127135
<b>description</b>	formed hose end piece A ext. ø 28mm end piece A int. ø 20mm AD2 ø 28mm end piece B 20mm L 410mm		
<b>For models:</b>	916020, 916021, 916024, 916025, 916026, 916027, 916030, 916031, 916045, 916247, 916248, 916249, 916250, 916251, 916252, 916382, 916383, 916452, 916504, 916584, 916654, 916670, 916688, 916763, 917044, 917049, Clean161, Fast160-2, Fast160C, Fast161-2, Ocean360, Ocean360M, Ocean360-UK		

1

<b>GEV No.</b>	513293	<b>Ref. No.</b>	143236
<b>description</b>	formed hose ext. ø 18 ID ø 11mm L 535mm dishwasher		
<b>For models:</b>	913289, 913290, 913291, 913292, 913356, 913357, 913372, 913373, 913374, 913375, 913416, 913435, 913544, 913545, 913665, 913666, 913667, 913668, 913685, 913771, 913772, 913773, 913774, 913832, 913837, 913911, 913912, 913948, 913950, 913977, 913984, 913990, 913992, 913993, 914165, 914166, 914206, 914214, 914316, 914317, 914355, 914386, 914387, 914388, 914389, 914390, 914391, 914392, 914393, 914394...(Other models you can see in the webshop)		



1

<b>GEV No.</b>	513298	<b>Ref. No.</b>	127144
<b>description</b>	formed hose ext. ø 19 ID ø 11mm L 360mm		
<b>For models:</b>	916045, 916654, Fast160C, Ocean360-UK		



1

<b>GEV No.</b>	513295	<b>Ref. No.</b>	127143
<b>description</b>	formed hose ext. ø 31 ID ø 24mm D1 ø 19mm D2 ø 11mm		
<b>For models:</b>	916045, 916654, Fast160C, Ocean360-UK		



1

<b>GEV No.</b>	513306	<b>Ref. No.</b>	127085
<b>description</b>	formed hose ext. ø 43 ID ø 34mm ED ø 23mm D1 ø 32mm L 140mm		
<b>For models:</b>	915150, 915151, 915152, 915154, 915155, 915157, 915158, 915160, 915161, 915162, 915166, 915167, 915168, 915172, 915173, 915175, 915176, 915177, 915285, 915319, 915338, 915341, 915348, 915418, 915419, 915420, 915421, 915422, 915479, 915492, 915493, 915494, 915495, 915496, 915497, 915547, 915558, 915635, 915663, 915747, 916020, 916021, 916024, 916025, 916026, 916027, 916030, 916031, 916045, 916054...(Other models you can see in the webshop)		



1

<b>GEV No.</b>	698841	<b>Ref. No.</b>	69020
<b>description</b>	formed hose ext. ø 44.5 ID ø 34.5mm ED ø 53mm D1 ø 43mm		
<b>For models:</b>	CNT800CH, Fast180, Fast180-230V-3Ph-60Hz, FAST-60, FAST-73, NG281, NG281CDD, NG281HP, NG281HPDD, NG281HZ23, NG281H-Z23DD, NG381, NG38123, NG38123TERMO, NG381C, NG381CDD, NG381CFUR, NG381DDHZ23, NG381DDPS, NG381DDPSHZ23, NG381HPDD, NG381TERMO, NG381TXCDD, NIAGARA-281, Niagara-281-2, Niagara-281HP, Niagara-381, Niagara-381-230V-3Ph-50Hz, Niagara-381-230V-3Ph-60Hz, Niagara-381DP, Niagara-381HPD, OC380, OC380FUR, OC380HZ23, Ocean380, PLUVIA-280, Pluvia280-230V-3Ph-60Hz, PV280, PV280FAST, PV280FAST2, PV280FAST2BIO, PV280FAST2HZ23, PV280FASTCH, PV280FASTHB, PV280HZ23, River-282-2, River-2825-2TDE, River-285, River-382, River-382-230V-3Ph-50Hz...(Other models you can see in the webshop)		



1

<b>GEV No.</b>	513307	<b>Ref. No.</b>	127082
<b>description</b>	formed hose ext. ø 47 ID ø 39mm ED ø 47mm D1 ø 39mm L 82mm		
<b>For models:</b>	915150, 915151, 915152, 915154, 915155, 915157, 915158, 915160, 915161, 915162, 915166, 915167, 915168, 915172, 915173, 915175, 915176, 915177, 915285, 915319, 915338, 915341, 915348, 915418, 915419, 915420, 915421, 915422, 915479, 915492, 915493, 915494, 915495, 915496, 915497, 915547, 915558, 915635, 915663, 915747, 916020, 916021, 916024, 916025, 916026, 916027, 916030, 916031, 916045, 916054...(Other models you can see in the webshop)		



1

<b>GEV No.</b>	513308	<b>Ref. No.</b>	73008
<b>description</b>	formed hose ext. ø 65 ID ø 58mm ED ø 49.5mm D1 ø 58mm L 90mm		
<b>For models:</b>	NG381, NG38123, NG38123TERMO, NG381C, NG381CDD, NG381CFUR, NG381DDHZ23, NG381DDPS, NG381DDPSHZ23, NG381HPDD, NG381TERMO, NG381TXCDD, Niagara-381, Niagara-381-230V-3Ph-50Hz, Niagara-381-230V-3Ph-60Hz, Niagara-381DP, Niagara-381HPD, River-282-2, River-2825-2TDE, River-285, River-382, River-382-230V-3Ph-50Hz, River-382H, River-382NRG, River-382NRG-230-3Ph-50Hz, River-382TDE, RV382, RV38223TERMO, RV382AHP, RV382FUR, RV382R, RV382R23TERMO, RV382RFUR, RV382S, RV382SFUR, RV382TERMO, RV382TX, RV382TXR		



			
<b>GEV No.</b>	513235	<b>Ref. No.</b>	127108
<b>description</b>	formed hose for boiler warewashing		
<b>For models:</b>	915611, 915612, 915613, 915614, 915615, 915616, 915670, 915671, 915959, 916196, 916197, 916198, 916199, 916200, 916409, 916410, 916591, 916592, 916593, 916877, 916921, 916922, 916992, 916993, Fast145-2, Fast150, Niagara-241, Niagara-241-2, Niagara-341, Pluvia-240		

			
<b>GEV No.</b>	517800	<b>Ref. No.</b>	127097
<b>description</b>	formed hose ID ø 11/25mm ED ø 18/29mm warewashing		
<b>For models:</b>	915154, 915155, 915157, 915158, 915172, 915173, 915285, 915422, 915492, 915493, 915494, 915495, 915496, 915497, 916054, 916067, 916068, 916069, 916079, 916080, 916368, 916420, 916421, 916422, 916423, 916424, 916686, 916760, RIVER-252, River-252-2, River-252-2T, River-253, RIVER-262, River-262-2, River-262-2T, River-272, River-352C, River-352T, River-362C, River-362C-230V-3PH-50Hz, River-362T, River-362T-230V-3PH-50Hz, River-372		

			
<b>GEV No.</b>	513169	<b>Ref. No.</b>	127091
<b>description</b>	formed hose warewashing		
<b>For models:</b>	915150, 915151, 915152, 915160, 915161, 915162, 915166, 915167, 915168, 915175, 915176, 915177, 915319, 915338, 915341, 915348, 915418, 915419, 915420, 915421, 915479, 915547, 915558, 915635, 915663, 915747, 916201, 916202, 916203, 916204, 916205, 916206, 916207, 916208, 916209, 916365, 916366, 916367, 916411, 916412, 916413, 916414, 916415, 916416, 916417, 916684, 916685, 916761, 916762, 916802...(Other models you can see in the webshop)		

			
<b>GEV No.</b>	513236	<b>Ref. No.</b>	127118
<b>description</b>	formed hose warewashing		
<b>For models:</b>	915617, 915618, 915672, 915773, 915774, 916066, 916077, 916078, 916418, 916419, 916594, 916595, River-242, River-242-2, River-242-2T, River-342C, River-342T		

			
<b>GEV No.</b>	513239	<b>Ref. No.</b>	127099
<b>description</b>	formed hose warewashing		
<b>For models:</b>	915150, 915151, 915152, 915154, 915155, 915157, 915158, 915160, 915161, 915162, 915166, 915167, 915168, 915172, 915173, 915175, 915176, 915177, 915285, 915319, 915338, 915341, 915348, 915418, 915419, 915420, 915421, 915422, 915479, 915492, 915493, 915494, 915495, 915496, 915497, 915547, 915558, 915635, 915663, 915747, 916054, 916067, 916068, 916069, 916079, 916080, 916201, 916202, 916203, 916204...(Other models you can see in the webshop)		

			
<b>GEV No.</b>	513252	<b>Ref. No.</b>	127129
<b>description</b>	formed hose warewashing		
<b>For models:</b>	915611, 915612, 915613, 915614, 915615, 915616, 915670, 915671, 915959, 916196, 916197, 916198, 916199, 916200, 916409, 916410, 916591, 916592, 916593, 916877, Niagara-241, Niagara-241-2, Niagara-341, Pluvia-240		

			
<b>GEV No.</b>	513263	<b>Ref. No.</b>	127124
<b>description</b>	formed hose warewashing		
<b>For models:</b>	915611, 915612, 915613, 915614, 915615, 915616, 915617, 915618, 915670, 915671, 915672, 915773, 915774, 915959, 916066, 916077, 916078, 916196, 916197, 916198, 916199, 916200, 916409, 916410, 916418, 916419, 916591, 916592, 916593, 916594, 916595, 916877, 916921, 916922, 916992, 916993, Fast145-2, Fast150, Niagara-241, Niagara-241-2, Niagara-341, Pluvia-240, River-242, River-242-2, River-242-2T, River-342C, River-342T		

			
<b>GEV No.</b>	513279	<b>Ref. No.</b>	127126
<b>description</b>	formed hose warewashing		
<b>For models:</b>	915611, 915612, 915613, 915614, 915615, 915616, 915670, 915671, 915959, 916196, 916197, 916198, 916199, 916200, 916409, 916410, 916591, 916592, 916593, 916877, Niagara-241, Niagara-241-2, Niagara-341, Pluvia-240		





1

<b>GEV No.</b>	513280	<b>Ref. No.</b>	127113
<b>description</b>	formed hose warewashing		
<b>For models:</b>	915617, 915618, 915672, 915773, 915774, 916066, 916077, 916078, 916418, 916419, 916594, 916595, River-242, River-242-2, River-242-2T, River-342C, River-342T		



1

<b>GEV No.</b>	513281	<b>Ref. No.</b>	127100
<b>description</b>	formed hose warewashing		
<b>For models:</b>	915154, 915155, 915157, 915158, 915172, 915173, 915285, 915422, 915492, 915493, 915494, 915495, 915496, 915497, 915695, 915696, 915819, 916054, 916067, 916068, 916069, 916079, 916080, 916368, 916420, 916421, 916422, 916423, 916424, 916686, 916760, Fast145, FAST-145, Fast145D, FAST-145D, RIVER-252, River-252-2, River-252-2T, RIVER-253, RIVER-262, River-262-2, River-262-2T, River-272, River-282LS-2TDE, River-282S-2TDE, River-352C, River-352T, River-362C, River-362C-230V-3Ph-50Hz, River-362T...(Other models you can see in the webshop)		



1

<b>GEV No.</b>	513276	<b>Ref. No.</b>	127145
<b>description</b>	formed hose warewashing for boiler		
<b>For models:</b>	916045, 916654, Fast160C, Ocean360-UK		



1

<b>GEV No.</b>	513282	<b>Ref. No.</b>	70021
<b>description</b>	formed hose warewashing for drain pump		
<b>For models:</b>	NG381L, NG381LC, NG381LCFUR, NG381LDDPS, Niagara-283L-2, Niagara-381L, Niagara-381LC, River-282L-2, River-282LS-2TDE, River-382L, River-382L-230V-3Ph-50Hz, River-382LNRG, River-382LTDE, River-482, RV382L, RV382L23TERMO, RV382LFUR, RV382LR, RV382LS, RV382LSFUR, RV382LTX, RV382LTXR, RV482		



1

<b>GEV No.</b>	513716	<b>Ref. No.</b>	127053
<b>description</b>	pressure hose warewashing		
<b>For models:</b>	913291, 913292, 913357, 913363, 913364, 913374, 913375, 913376, 913377, 913416, 913435, 913545, 913666, 913668, 913685, 913773, 913774, 913911, 913912, 913948, 913950, 913977, 913984, 913990, 914214, 914316, 914317, 914392, 914393, 914394, 914395, 914396, 914397, 914441, 914442, 914515, 914516, 914537, 914543, 914547, 914683, 914684, 914689, 914863, 914874, 915138, 915139, 915527, 915692, 915693...(Other models you can see in the webshop)		

## for dishwashers

### pressure hoses



1

<b>GEV No.</b>	698807	<b>Ref. No.</b>	143263
<b>description</b>	rinse hose ext. ø 18 ID ø 11mm		
<b>For models:</b>	916020, 916021, 916024, 916025, 916026, 916027, 916030, 916031, 916247, 916248, 916249, 916250, 916251, 916252, 916382, 916383, 916452, 916504, 916584, 916670, 916688, 916763, 917044, 917049, Clean161, Fast160-2, Fast161-2, Ocean360, Ocean360M		

### ventilation hoses





1

<b>GEV No.</b>	698717	<b>Ref. No.</b>	H.775611-001
<b>description</b>	PVC hose ext. ø 14 L 1044mm PVC D1 ø 10mm		
<b>For models:</b>	915150, 915151, 915152, 915154, 915155, 915157, 915158, 915160, 915161, 915162, 915166, 915167, 915168, 915172, 915173, 915175, 915319, 915348, 915418, 915419, 915420, 915421, 915422, 915479, 915492, 915493, 915494, 915495, 915496, 915497, 915547, 915558, 915635, 915663, 915747, 916054, 916067, 916068, 916069, 916079, 916080, 916201, 916202, 916203, 916204, 916205, 916206, 916207, 916208, 916209...(Other models you can see in the webshop)		





			
<b>GEV No.</b>	513265	<b>Ref. No.</b>	143189
<b>description</b>	ventilation hose ext. ø 17 ID ø 14mm L 75mm warewashing back-flow restrictor		
<b>For models:</b>	050F, 050FP, 2312-001, 2312-002, 350F, 350FD, 350R, 350RD, 35F, 35FD, 35R, 35RD, 400F, 400FD, 400R, 400RD, 40F, 40FD, 40R, 40RD, 45, 450, 46, 460, 500F, 500FD, 50F, 50FD, 510F, 510FD, 913297, 913298, 913299, 913300, 913360, 913361, 913391, 913392, 913546, 913547, 913578, 913611, 913684, 913913, 913914, 913932, 913933, 913992, 913993, 914284...(Other models you can see in the webshop)		

<p>miscellaneous</p> 			
<b>GEV No.</b>	511633	<b>Ref. No.</b>	999231
<b>description</b>	conversion kit		
<b>For models:</b>	914326, 914406, E.55		

			
<b>GEV No.</b>	530770	<b>Ref. No.</b>	929171
<b>description</b>	hose ED ø 30mm ID ø 20mm L 1050mm rubber black Qty 1		
<b>For models:</b>	KLP105EB, KLP201DDDTEB, KLP201EB, KLP301, KLP301DDDTEB, LP105DDDTEB, LP105DDDTEBN, LP105EB, LP201DDDTEB, LP201EB, LP301, LP301EB, LP60, River-282-2, River-282L-2, River-282LS-2TDE, River-282S-2TDE, River-285, RIVER-294, RIVER-295, River-295P, RIVER-296, RIVER-296P, RIVER-297, RIVER-298, River-382, River-382-230V-3Ph-50Hz, River-382H, River-382L, River-382L-230V-3Ph-50Hz, River-382LNRG, River-382LTDE, River-382NRG, River-382NRG-230-3Ph-50Hz, River-382TDE, River-482, River-81CRP, RIVER-81-CRP, River-82CRP, RIVER-82-CRP, RV282R, RV294, RV295, RV295PS, RV296, RV296PS, RV297, RV298, RV298HZ, RV382...(Other models you can see in the webshop)		

			
<b>GEV No.</b>	698706	<b>Ref. No.</b>	127095
<b>description</b>	hose ED ø 31mm ID ø 25mm L 34mm plastic for rinsing		
<b>For models:</b>	915154, 915155, 915157, 915158, 915172, 915173, 915285, 915422, 915492, 915493, 915494, 915495, 915496, 915497, 915617, 915618, 915672, 915773, 915774, 916045, 916054, 916066, 916067, 916068, 916069, 916077, 916078, 916079, 916080, 916368, 916418, 916419, 916420, 916421, 916422, 916423, 916424, 916594, 916595, 916654, 916686, 916760, Fast160C, Ocean360-UK, River-242, River-242-2, River-242-2T, River-252, River-252-2, River-252-2T...(Other models you can see in the webshop)		

			
<b>GEV No.</b>	518220	<b>Ref. No.</b>	143193
<b>description</b>	hose for pressure switch		
<b>For models:</b>	CLEAN-3, RIVER-43		

## fittings, hose and pipe connectors

### hose connectors

#### without screw connection

			
<b>GEV No.</b>	501524	<b>Ref. No.</b>	70996
<b>description</b>	Y-piece plastic hose ø 4mm 3-way		
<b>For models:</b>	915747, A4EBT, A4EBTSAK, NG381DDPS, NG381DDPSHZ23, NG381LDDPS, Niagara-381-230V-3Ph-60Hz, Niagara-381DP, Niagara-381L, Niagara-381LC, River-multi-2256		

			
<b>GEV No.</b>	541109	<b>Ref. No.</b>	035031
<b>description</b>	Y-piece plastic hose ø 8-6-8mm for pressure switch		
<b>For models:</b>	050F, 050FP, 22F, 22R, 2312-002, 2312-007, 2312-009-CRP, 40F, 440F, 45, 450, 460, 500F, 500FD, 510F, 510FD, 913297, 913298, 913299, 913300, 913360, 913361, 913391, 913392, 913546, 913547, 913578, 913611, 913684, 913913, 913914, 913932, 913933, 913992, 913993, 914100, 914101, 914284, 914318, 914319, 914326, 914331, 914338, 914339, 914342, 914343, 914356, 914400, 914401, 914402...(Other models you can see in the webshop)		

			
<b>GEV No.</b>	518347	<b>Ref. No.</b>	468149
<b>description</b>	T-piece plastic hose ø 10-10-10mm 3-way		
<b>For models:</b>	22F, 440F, 44F, 45, 450, 46, 460, CLEAN-3, E.45, E.46, E.50, E.51, E.52, RIVER-43		

fittings

screw pipe fittings

angle pieces



<b>GEV No.</b>	698714	<b>Ref. No.</b>	929077
<b>description</b>	angle piece thread 1/2" tube ø 12mm brass		
<b>For models:</b>	55		

hose connectors

brass



<b>GEV No.</b>	513253	<b>Ref. No.</b>	108006
<b>description</b>	hose connector brass angled thread 1/4" hose ø 12mm Qty 1 pcs		
<b>For models:</b>	10, 11F, 11FD, 11R, 11RD, 12, 14, 161, 21F, 21FD, 21R, 21RD, 221, 22F, 22R, 25F, 25FD, 25R, 25RD, 271, 272, 30F, 30FD, 30R, 30RD, 31F, 31FD, 31R, 31RD, 362, 40F, 440F, 44F, 500F, 500FD, 50F, 50FD, 510F, 510FD, 66, 913297, 913298, 913299, 913300, 913360, 913361, 913391, 913392, 913546, 913547...(Other models you can see in the webshop)		

nickel-plated brass



<b>GEV No.</b>	520202	<b>Ref. No.</b>	927015
<b>description</b>	hose connector nickel-plated brass straight thread 3/8" hose ø 12mm Qty 1 pcs		
<b>For models:</b>	161, 221, 271, 272, 362, 914380, 914436, A3EB, A3EBD, A3EBDAKRYK, A3EBDAKWK, A3EBDBKWK, A3EBDRKYK, A3EBDVK, A3EBDYK, A3EBSAK, A3EBSAKRK, A3EBSAKWK, A3EBSBKWKYK, A3EBSEKWK, A3EBSWK, A4EB, A4EBD, A4EBDAKEKYK, A4EBDAKRK, A4EBDAKW, A4EBDAKZK, A4EBDBKWK, A4EBDPKWKYK, A4EBDRK, A4EBS, A4EBSAK, A4EBSAKCK, A4EBSAKEKYK, A4EBSAKRK, A4EBSAKRKP, A4EBSAKYK, A4EBSCK, A5EB, A5EBD, A5EBDAKPKWK, A5EBDAKWK, A5EBDAKYK, A5EBDRK, A5EBS, A5EBSAKPKWK, A5EBSAKRK, A5EBSAKRKYK, A5EBSAKWK, A5EBSAKWKYK...(Other models you can see in the webshop)		

producer-specific



<b>GEV No.</b>	504388	<b>Ref. No.</b>	468205
<b>description</b>	hose connector grommet ø 10.5mm grommet length 15mm total length 26mm plastic for drain hose		
<b>For models:</b>	915150, 915151, 915152, 915154, 915155, 915157, 915158, 915160, 915161, 915162, 915166, 915167, 915168, 915172, 915173, 915175, 915319, 915348, 915418, 915419, 915420, 915421, 915422, 915479, 915492, 915493, 915494, 915495, 915496, 915497, 915547, 915558, 915617, 915618, 915635, 915663, 915672, 915747, 915773, 915774, 916054, 916066, 916067, 916068, 916069, 916077, 916078, 916079, 916080, 916201...(Other models you can see in the webshop)		

push-in fittings

JOHN GUEST



<b>GEV No.</b>	521179	<b>Ref. No.</b>	9300339
<b>description</b>	push-in fitting John Guest straight thread 3/8" BSP stub ø 8mm		

valves and tank inlets

ball valves

universal

ball valves with butterfly handle



<b>GEV No.</b>	540646	<b>Ref. No.</b>	720010
<b>description</b>	ball valve connection 3/4" IT - 3/4" IT DN20 total length 56mm		
<b>For models:</b>	FRI15, FRI15M, ME15, ME20, ME30, ME40, MG15, MG20, MG30, MG40		

water softeners

manual softener



<b>GEV No.</b>	530128	<b>Ref. No.</b>	922011
<b>description</b>	base suitable for type LT/BP		
<b>For models:</b>	LT12, LT16, LT8		



## water cycle components

### pressure reduction valves

#### pressure reduction valves

##### universal



<b>1</b>			
<b>GEV No.</b>	520868	<b>Ref. No.</b>	927150
<b>description</b>	pressure reduction valve OR series PN40 connection 1/2" setting range 1-7bar p max 40bar t.max. 80°C brass		
<b>For models:</b>	161, 221, 271, 272, 362, 914380, 914436, A3EB, A3EBD, A3EBDAKRYK, A3EBDAKWK, A3EBDBKWK, A3EBDRKYK, A3EBDWK, A3EBDYK, A3EBSAK, A3EBSAKRK, A3EBSAKWK, A3EBSBKWKYK, A3EBSEKWK, A3EBSWK, A4EB, A4EBD, A4EBDAKEYK, A4EBDAKWK, A4EBDAKWK, A4EBDAKZK, A4EBDBKWK, A4EBDPKWKYK, A4EBDRK, A4EBS, A4EBSAK, A4EBSAKCK, A4EBSAKEKYK, A4EBSAKRK, A4EBSAKRKP, A4EBSAKYK, A4EBSCK, A5EB, A5EBD, A5EBDAKPKWK, A5EBDAKWK, A5EBDAKYK, A5EBDRK, A5EBS, A5EBSAKPKWK, A5EBSAKRK, A5EBSAKRKYK, A5EBSAKWK, A5EBSAKWKYK...(Other models you can see in the webshop)		

### supply filters



<b>1</b>			
<b>GEV No.</b>	520261	<b>Ref. No.</b>	927078
<b>description</b>	supply filter thread 1/2" IT - 1/2" IT total length 58mm red brass mesh opening 0.4mm		
<b>For models:</b>	161, 221, 271, 272, 362, CLEAN-160, CLEAN-161, CLEAN-220, CLEAN-221, CLEAN-270, CLEAN-271, CLEAN-272, CLEAN-361, CLEAN-361P, CLEAN-362, CLEAN-471, CLEAN-471P		

## ancillary products

### clamps

#### hose clamps

##### DIN 3017 - W2



<b>1</b>			
<b>GEV No.</b>	520117	<b>Ref. No.</b>	CFS1A
<b>description</b>	hose clamp stainless steel ø 40-60mm width 9mm Qty 5 pcs DIN 3017		
<b>For models:</b>	CGL74CABT, CNT800CH, Fast180, Fast180-230V-3Ph-60Hz, FAST-60, FAST-73, NG271, NG281, NG281CDD, NG281HP, NG281HPDD, NG281HZ23, NG281HZ23DD, NG291, NG381, NG38123, NG38123TERMO, NG381C, NG381CDD, NG381CFUR, NG381DDHZ23, NG381DDPS, NG381DDPSHZ23, NG381HPDD, NG381L, NG381LC, NG381LCFUR, NG381LDDPS, NG381TERMO, NG381TXCDD, NIAGARA-271, NIAGARA-281, Niagara-281-2, Niagara-281HP, NIAGARA-283, Niagara-283A, Niagara-283L-2, NIAGARA-291, Niagara-381, Niagara-381-230V-3Ph-50Hz, Niagara-381-230V-3Ph-60Hz, Niagara-381DP, Niagara-381HPD, Niagara-381L, Niagara-381LC, OC380, OC380FUR, OC380HZ23, Ocean380, PLUVIA-280...(Other models you can see in the webshop)		

##### DIN 3017 - W4



<b>1</b>			
<b>GEV No.</b>	520120	<b>Ref. No.</b>	927322
<b>description</b>	hose clamp SS W4 ø 12-20mm width 9mm Qty 1 pcs DIN 3017		
<b>For models:</b>	CLEAN-161, CLEAN-221, CLEAN-271, CLEAN-272, CLEAN-362, CNT800CH, Fast180, Fast180-230V-3Ph-60Hz, FAST-60, FAST-73, NG271, NG281, NG281CDD, NG281HP, NG281HPDD, NG281HZ23, NG281HZ23DD, NG291, NG292, NG292HZ, NG293, NG381, NG38123, NG38123TERMO, NG381C, NG381CDD, NG381CFUR, NG381DDHZ23, NG381DDPS, NG381DDPSHZ23, NG381HPDD, NG381L, NG381LC, NG381LCFUR, NG381LDDPS, NG381TERMO, NG381TXCDD, NIAGARA-271, NIAGARA-281, Niagara-281-2, Niagara-281HP, Niagara-283L-2, NIAGARA-291, NIAGARA-292, Niagara-292-400V-3Ph-60Hz, NIAGARA-293, Niagara-381, Niagara-381-230V-3Ph-50Hz, Niagara-381-230V-3Ph-60Hz, Niagara-381DP...(Other models you can see in the webshop)		

### double wire clamps



<b>1</b>			
<b>GEV No.</b>	513268	<b>Ref. No.</b>	423011
<b>description</b>	hose clamp ø 8-10mm wire gauge ø 1mm Qty 1 pcs		
<b>For models:</b>	050F, 050FP, 2312-001, 2312-002, 2312-007, 2312-009-CRP, 31F, 31FD, 31R, 31RD, 500F, 500FD, 50F, 50FD, 510F, 510FD, 67F, 67R, 913297, 913298, 913299, 913300, 913360, 913361, 913391, 913392, 913546, 913547, 913578, 913611, 913684, 913913, 913914, 913932, 913933, 914100, 914101, 914284, 914318, 914319, 914326, 914331, 914338, 914356, 914400, 914401, 914402, 914403, 914404, 914405...(Other models you can see in the webshop)		



			
1			
<b>GEV No.</b>	560503	<b>Ref. No.</b>	CFF10073
<b>description</b>	hose clamp ø 8-10mm wire gauge ø 1mm Qty 1 pcs		
<b>For models:</b>	NG292, NG292HZ, NG293, NIAGARA-292, Niagara-292-400V-3Ph-60Hz, NIAGARA-293, RIVER-282, RIVER-295, River-295P, RIVER-296, River-296P, RIVER-297, RIVER-298, RV282, RV282DD, RV295, RV295PS, RV296, RV296PS, RV297, RV298, RV298HZ		

<b>knurled screws</b>			
			
1			
<b>GEV No.</b>	510112	<b>Ref. No.</b>	454002
<b>description</b>	Thumb screw thread M10 thread L 10mm ø 22mm H 4.5mm SS		
<b>For models:</b>	050F, 050FP, 11F, 11FD, 11F-DVGW, 21F, 21FD, 2312-001, 2312-002, 25F, 25FD, 30F, 30FD, 31F, 31FD, 400F, 400FD, 40-ELECTRONIC, 40F, 40FD, 45, 450, 46, 460, 500F, 500FD, 50F, 50FD, 510F, 510FD, 67R, 913363, 913364, 913376, 913377, 914568, 915830, E.41, E.42, E.45, E.46, E.50, E.50D.PA, E.51, E.41, F85, F85P, FAST-160DP, GSP50, GSP50P... (Other models you can see in the webshop)		

measuring equipment

thermometers

built-in thermometers

			
1			
<b>GEV No.</b>	541095	<b>Ref. No.</b>	926100
<b>description</b>	thermometer mounting measurements 58x25.5mm 0 up to +120°C capillary pipe 3000mm probe ø 6.5mm probe L 20mm		
<b>For models:</b>	CLEAN-160, CLEAN-220, CLEAN-270, CLEAN-271		

miscellaneous



			
1			
<b>GEV No.</b>	513098	<b>Ref. No.</b>	DWP296
<b>description</b>	screw for door handle		

ø60mm

			
			
1			
<b>GEV No.</b>	542106	<b>Ref. No.</b>	DET1L
<b>description</b>	thermometer mounting ø 60mm t.max. 120°C 0-120°C probe ø 8.5mm probe L 35mm capillary pipe 5000mm connection M10x1		

nuts

knurled nuts

			
1			
<b>GEV No.</b>	517444	<b>Ref. No.</b>	80697
<b>description</b>	knurled nut thread M10x1 ø 25mm H 4mm SS		
<b>For models:</b>	915830, Fast160DP		

fastening material

screws

hexagonal screws

			
1			
<b>GEV No.</b>	506447	<b>Ref. No.</b>	486041
<b>description</b>	hexagonal screw thread M8 thread L 16mm SS WS 13 Qty 1 pcs DIN 933 / ISO 4017		

			
1			
<b>GEV No.</b>	518028	<b>Ref. No.</b>	454004
<b>description</b>	knurled nut thread M5 ø 25mm H 4mm SS		
<b>For models:</b>	050F, 050FP, 10, 12, 14, 22F, 2312-001, 2312-002, 350F, 350FD, 350R, 350RD, 35-ELECTRONIC, 35F, 35FD, 35R, 35RD, 40F, 440F, 44F, 500F, 500FD, 50-ELECTRONIC, 50F, 50FD, 510F, 510FD, 55, 66, 914684, CLEAN-100, CLEAN-110, CLEAN-120, E.35, E.35H, E.40, E.40H, E.50, E.51, E.52, E.60, E.65, E1, E10, E100, E110, E12, E120, E14, E140... (Other models you can see in the webshop)		





hexagonal nuts			
DIN 934 / ISO 4032/8673			
			
1			
<b>GEV No.</b>	560340	<b>Ref. No.</b>	CDI204
<b>description</b>	hexagonal nut thread M4 H 3.2mm WS 7 SS DIN/ISO DIN 934 / ISO 4032/8673 Qty 1 pcs		

DIN 985			
			
1			
<b>GEV No.</b>	560518	<b>Ref. No.</b>	926087
<b>description</b>	hexagonal nut thread M8 H 9.2mm SS WS 13 self-locking Qty 1 pcs		
<b>For models:</b>	12, 14, CLEAN-110, CLEAN-120, E1, E110		

hexagonal nuts metric (without norm)			
			
1			
<b>GEV No.</b>	521134	<b>Ref. No.</b>	417017
<b>description</b>	hexagonal nut thread M14x1 SS		
<b>For models:</b>	10, 11F, 11FD, 11F-DVGW, 11R, 11RD, 12, 14, 21F, 21FD, 21R, 21RD, 22F, 22R, 2312-001, 2312-002, 25F, 25FD, 25R, 25RD, 30F, 30FD, 30R, 30RD, 31F, 31FD, 31R, 31RD, 40F, 440F, 44F, 45, 450, 46, 460, 500F, 500FD, 50F, 50FD, 510F, 510FD, 67F, 67R, 913297, 913298, 913299, 913300, 913360, 913361, 913391...(Other models you can see in the webshop)		

			
1			
<b>GEV No.</b>	560014	<b>Ref. No.</b>	417002
<b>description</b>	hexagonal nut thread M8x1 H 4.7mm WS 12 chrome-plated brass Qty 1 pcs DIN/ISO DIN 934 / ISO 4032/8673		
<b>For models:</b>	21F, 21FD, 21R, 21RD, 25F, 25FD, 25R, 25RD, 30F, 30FD, 30R, 30RD, 31F, 31FD, 31R, 31RD, 440F, 44F		

			
1			
<b>GEV No.</b>	513266	<b>Ref. No.</b>	417104
<b>description</b>	nut		
<b>For models:</b>	913289, 913290, 913291, 913292, 913356, 913357, 913372, 913373, 913374, 913375, 913416, 913435, 913544, 913545, 913665, 913666, 913667, 913668, 913685, 913771, 913772, 913773, 913774, 913832, 913837, 913911, 913912, 913948, 913950, 913977, 913984, 913990, 914165, 914166, 914206, 914214, 914316, 914317, 914355, 914386, 914387, 914388, 914389, 914390, 914391, 914392, 914393, 914394, 914395, 914396...(Other models you can see in the webshop)		

hexagonal nuts inch thread			
			
1			
<b>GEV No.</b>	513025	<b>Ref. No.</b>	929047
<b>description</b>	nut thread 1/2" nickel-plated brass H 7.5mm WS 27 Qty 1 pcs		
<b>For models:</b>	161, 221, 271, 272, 362, 55, CLEAN-160, CLEAN-161, CLEAN-220, CLEAN-221, CLEAN-270, CLEAN-271, CLEAN-272, CLEAN-361, CLEAN-361P, CLEAN-362, CLEAN-471, CLEAN-471P		

			
1			
<b>GEV No.</b>	518508	<b>Ref. No.</b>	926222
<b>description</b>	nut thread 1 1/4" H 7mm WS 50 brass Qty 1 pcs		
<b>For models:</b>	E12, E120, E14, E140		

			
1			
<b>GEV No.</b>	503042	<b>Ref. No.</b>	CDO138C
<b>description</b>	nut thread 3/8" H 6mm brass WS 22 Qty 1 pcs		

miscellaneous			
			
Image not available			
1			
<b>GEV No.</b>	513197	<b>Ref. No.</b>	CDI206AU
<b>description</b>	nut		
<b>For models:</b>	RIVER-150		

## washers

### washers

#### miscellaneous

			
1			
<b>GEV No.</b>	513223	<b>Ref. No.</b>	926249
<b>description</b>	disc		

fasteners

clamps

hose clamps

DIN 3017 - W2



<b>GEV No.</b>	520117	<b>Ref. No.</b>	CFS1A
<b>description</b>	hose clamp stainless steel ø 40-60mm width 9mm Qty 5 pcs DIN 3017		
<b>For models:</b>	CGL74CABT, CNT800CH, Fast180, Fast180-230V-3Ph-60Hz, FAST-60, FAST-73, NG271, NG281, NG281CDD, NG281HP, NG281HPDD, NG281HZ23, NG281HZ23DD, NG291, NG381, NG38123, NG-38123TERMO, NG381C, NG381CDD, NG381CFUR, NG381DDHZ23, NG381DDPS, NG381DDPSHZ23, NG381HPDD, NG381L, NG381LC, NG381LCFUR, NG381LDDPS, NG381TERMO, NG381TXCDD, NIAGARA-271, NIAGARA-281, Niagara-281-2, Niagara-281HP, NIAGARA-283, Niagara-283A, Niagara-283L-2, NIAGARA-291, Niagara-381, Niagara-381-230V-3Ph-50Hz, Niagara-381-230V-3Ph-60Hz, Niagara-381DP, Niagara-381HPD, Niagara-381L, Niagara-381LC, OC380, OC380FUR, OC380HZ23, Ocean380, PLUVIA-280...(Other models you can see in the webshop)		

DIN 3017 - W4



<b>GEV No.</b>	520120	<b>Ref. No.</b>	927322
<b>description</b>	hose clamp SS W4 ø 12-20mm width 9mm Qty 1 pcs DIN 3017		
<b>For models:</b>	CLEAN-161, CLEAN-221, CLEAN-271, CLEAN-272, CLEAN-362, CNT800CH, Fast180, Fast180-230V-3Ph-60Hz, FAST-60, FAST-73, NG271, NG281, NG281CDD, NG281HP, NG281HPDD, NG281HZ23, NG281HZ23DD, NG291, NG292, NG292HZ, NG293, NG381, NG38123, NG38123TERMO, NG381C, NG381CDD, NG381CFUR, NG381DDHZ23, NG381DDPS, NG381DDPSHZ23, NG381HPDD, NG381L, NG381LC, NG381LCFUR, NG381LDDPS, NG381TERMO, NG381TXCDD, NIAGARA-271, NIAGARA-281, Niagara-281-2, Niagara-281HP, Niagara-283L-2, NIAGARA-291, NIAGARA-292, Niagara-292-400V-3Ph-60Hz, NIAGARA-293, Niagara-381, Niagara-381-230V-3Ph-50Hz, Niagara-381-230V-3Ph-60Hz, Niagara-381DP...(Other models you can see in the webshop)		

double wire clamps



<b>GEV No.</b>	513268	<b>Ref. No.</b>	423011
<b>description</b>	hose clamp ø 8-10mm wire gauge ø 1mm Qty 1 pcs		
<b>For models:</b>	050F, 050FP, 2312-001, 2312-002, 2312-007, 2312-009-CRP, 31F, 31FD, 31R, 31RD, 500F, 500FD, 50F, 50FD, 510F, 510FD, 67F, 67R, 913297, 913298, 913299, 913300, 913360, 913361, 913391, 913392, 913546, 913547, 913578, 913611, 913684, 913913, 913914, 913932, 913933, 914100, 914101, 914284, 914318, 914319, 914326, 914331, 914338, 914356, 914400, 914401, 914402, 914403, 914404, 914405...(Other models you can see in the webshop)		



<b>GEV No.</b>	560503	<b>Ref. No.</b>	CFF10073
<b>description</b>	hose clamp ø 8-10mm wire gauge ø 1mm Qty 1 pcs		
<b>For models:</b>	NG292, NG292HZ, NG293, NIAGARA-292, Niagara-292-400V-3Ph-60Hz, NIAGARA-293, RIVER-282, RIVER-295, River-295P, RIVER-296, River-296P, RIVER-297, RIVER-298, RV282, RV282DD, RV295, RV295PS, RV296, RV296PS, RV297, RV298, RV298HZ		

retaining rings

DIN 471



<b>GEV No.</b>	110087	<b>Ref. No.</b>	499066
<b>description</b>	retaining ring shaft ø 8mm DIN 471		
<b>For models:</b>	10, 12, 22F, 22R, 40F, 66, CLEAN-100, CLEAN-110, CLEAN-120		

DIN 6799



<b>GEV No.</b>	518557	<b>Ref. No.</b>	929017
<b>description</b>	retaining ring E D1 ø 5mm D2 ø 11mm SS DIN 6799 thickness 0.7mm		
<b>For models:</b>	55, E.65, RIVER-HL-81, RIVER-HL-82		



<b>GEV No.</b>	507015	<b>Ref. No.</b>	929014 CWA5D7
<b>description</b>	retaining ring E D1 ø 7mm D2 ø 14mm SS DIN 6799 thickness 0.9mm for shaft ø 8-11mm		
<b>For models:</b>	55, E.65		

DIN 7993



<b>GEV No.</b>	518308	<b>Ref. No.</b>	303019
<b>description</b>	retaining ring DIN 7993 for drain assembly thickness 3mm ED ø 57mm		
<b>For models:</b>	050F, 050FP, 2312-001, 2312-002, 45, 450, 46, 460, 500F, 500FD, 50F, 50FD, 510F, 510FD, 913297, 913298, 913299, 913300, 913360, 913361, 913391, 913392, 913418, 913546, 913547, 913578, 913611, 913684, 913913, 913914, 913932, 913933, 914167, 914168, 914284, 914318, 914319, 914331, 914338, 914356, 914398, 914399, 914400, 914401, 914402, 914403, 914404, 914405, 914431, 914443...(Other models you can see in the webshop)		





consumables

fuses

fine fuses

			
1			
<b>GEV No.</b>	358530	<b>Ref. No.</b>	926284
<b>description</b>	fine fuse size $\phi$ 5x20mm 0.8A fast-acting rated 250V Qty 10 pcs		
<b>For models:</b>	80, 81, 914380, 914436, CE78HZ23, CGL74CABT, E78, E78HP, FAST-181, HM1, KLP105EB, KLP201DDDTEB, KLP201EB, KLP301, KLP301DDDTEB, LP105DDDTEB, LP105DDDTEBN, LP105EB, LP201DDDTEB, LP201EB, LP301, LP301EB, LP60, PS-60, RIVER-150, River-152, RIVER-154, RIVER-71, RIVER-80, River-81, River-81CRP, RIVER-81-CRP, RIVER-82, River-82CRP, RIVER-82-CRP, RIVER-E78, RIVER-HL-81, RV150, RV15023, RV15023DA, RV150D, RV150DA, RV150DAR, RV150DARY, RV150DAW, RV150DAWY, RV150DAY, RV150DE, RV150DRW, RV150DW...(Other models you can see in the webshop)		

			
1			
<b>GEV No.</b>	358677	<b>Ref. No.</b>	228004 228010
<b>description</b>	fine fuse size $\phi$ 5x20mm 4A fast-acting rated 250V Qty 10 pcs		
<b>For models:</b>	2312-007, 2312-009-CRP, 80, 81, 82, 913363, 913364, 913911, 913912, 913913, 913914, 913950, 913977, 913984, 913990, 913992, 913993, 914100, 914101, 914165, 914166, 914167, 914168, 914206, 914214, 914284, 914316, 914317, 914318, 914319, 914338, 914339, 914342, 914343, 914355, 914356, 914380, 914431, 914436, 914516, 914543, 914583, 914592, 914612, 914613, 914624, 914625, 914626, 914627, 914628...(Other models you can see in the webshop)		

			
1			
<b>GEV No.</b>	358693	<b>Ref. No.</b>	80874
<b>description</b>	fine fuse size $\phi$ 5x20mm 2A medium lag rated 250V Qty 10 pcs		
<b>For models:</b>	RIVER-298, RV298, RV298HZ		

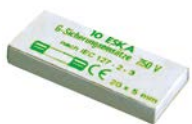
			
1			
<b>GEV No.</b>	358594	<b>Ref. No.</b>	228012
<b>description</b>	fine fuse size $\phi$ 5x20mm 0.16A slow-acting rated 250V Qty 10 pcs		
<b>For models:</b>	915154, 915155, 915157, 915158, 915172, 915173, 915285, 915422, 915492, 915493, 915494, 915495, 915496, 915497, 915747, 916045, 916054, 916067, 916068, 916069, 916079, 916080, 916368, 916420, 916421, 916422, 916423, 916424, 916654, 916686, 916760, Fast160C, Fast200, FAST-200, Fast93, GL280EB, GL280EB23, GL280EB23DAR, GL280EB23HZ, GL280EB23HZDY, GL280EBD, GL280EBDA, GL280EBDAE, GL280EBDAR, GL280EBDARY, GL280EBDAW, GL280EBDAWY, GL280EBDAY, GL280EBDB, GL280EBDBR...(Other models you can see in the webshop)		

			
1			
<b>GEV No.</b>	358603	<b>Ref. No.</b>	228011
<b>description</b>	fine fuse size $\phi$ 5x20mm 2A slow-acting rated 250V Qty 10 pcs		
<b>For models:</b>	915154, 915155, 915157, 915158, 915172, 915173, 915285, 915422, 915492, 915493, 915494, 915495, 915496, 915497, 915747, 916045, 916054, 916067, 916068, 916069, 916079, 916080, 916368, 916420, 916421, 916422, 916423, 916424, 916654, 916686, 916760, Fast160C, Fast200, FAST-200, Fast93, GL280EB, GL280EB23, GL280EB23DAR, GL280EB23HZ, GL280EB23HZDY, GL280EBD, GL280EBDA, GL280EBDAE, GL280EBDAR, GL280EBDARY, GL280EBDAW, GL280EBDAWY, GL280EBDAY, GL280EBDB, GL280EBDBR...(Other models you can see in the webshop)		

			
1			
<b>GEV No.</b>	358606	<b>Ref. No.</b>	228014
<b>description</b>	fine fuse size $\phi$ 5x20mm 4A slow-acting rated 250V Qty 10 pcs		
<b>For models:</b>	916237, 916238, 916239, 916240, 916241, 916242, 916243, 916244, 916245, 916246, 916401, 916402, 916403, 916404, 916405, 916406, 916407, 916408, 916451, 916583, 916687, 916787, 916991, 917042, 917043, Clean140, Clean140S, Fast130, Fast135-2, Fast135-2S, Fast135H-2, Fast135H-2S, Fast139-2, Fast139-2S, Fast139H-2, Fast139H-2S, Fast140		

<p><math>\phi</math>6.3x32mm 250V</p> 			
1			
<b>GEV No.</b>	358760	<b>Ref. No.</b>	926283
<b>description</b>	fine fuse size $\phi$ 6.3x32mm 0.315A medium lag rated 250V Qty 10 pcs		
<b>For models:</b>	80, 81, 914380, 914436, CE78HZ23, CGL74CABT, E78, E78HP, FAST-181, HM1, KLP105EB, KLP201DDDTEB, KLP201EB, KLP301, KLP301DDDTEB, LP105DDDTEB, LP105DDDTEBN, LP105EB, LP201DDDTEB, LP201EB, LP301, LP301EB, LP60, PS-60, RIVER-150, River-152, RIVER-154, RIVER-71, RIVER-80, River-81, River-81CRP, RIVER-81-CRP, RIVER-82, River-82CRP, RIVER-82-CRP, RIVER-E78, RIVER-HL-81, RV150, RV15023, RV15023DA, RV150D, RV150DA, RV150DAR, RV150DARY, RV150DAW, RV150DAWY, RV150DAY, RV150DE, RV150DRW, RV150DW...(Other models you can see in the webshop)		

<p>fine fuse holders</p> 			
1			
<b>GEV No.</b>	550519	<b>Ref. No.</b>	H.228048
<b>description</b>	cover plate suitable fuseA ratedV connection for fuse holder		
<b>For models:</b>	2312-007, 2312-009-CRP, 80, 81, 82, 913911, 913912, 913950, 913977, 913984, 913990, 914165, 914166, 914206, 914214, 914316, 914317, 914339, 914342, 914343, 914355, 914380, 914436, 914516, 914543, 914626, 914684, 914874, 915138, CE78HZ23, CGL74CABT, CNT800CH, E78, E78HP, Fast180, Fast180-230V-3Ph-60Hz, Fast181, FAST-181, Fast181-230V-3Ph-60Hz, Fast181-400V-3NPh-60Hz, Fast200, FAST-200, FAST-60, FAST-73, Fast93, GL280EB, GL280EB23, GL280EB23DAR, GL280EB23HZ, GL280EB23HZDY...(Other models you can see in the webshop)		

tools, fastening materials, consumables





<b>B</b>			
ball valves	218		
bi-metal thermostats	15, 16		
booster pumps I	83		
booster pumps II	88		
<b>C</b>			
cables	92		
cam switches	27		
clamps	219, 222		
coil heating elements	4		
condensators & interference suppression filters	89		
consumables	223		
contact heaters	3		
contactors	36		
container filters	198		
control equipment	30		
control thermostats	16, 18		
<b>D</b>			
door seals for dishwashers	187		
dosing pumps	193		
double wire clamps	219, 222		
drain hoses	200		
drain pumps	84		
<b>E</b>			
electric accessories	92		
electronic controllers	41		
<b>F</b>			
fasteners	222		
fastening material	220		
filters	90		
fine fuses	223		
fittings	218		
flow meters	57		
foil heating elements	13		
formed hoses	205		
fuses	91, 223		
<b>G</b>			
gas nozzles	96		
gas thermostats	94		
gaskets for wash arm support	189		
<b>H</b>			
heating elements	3		
heating elements for contact grills	3		
heating elements for fryers	3		
hexagonal nuts	221		
hexagonal screws	220		
hose clamps	219, 222		
hose connectors	217, 218		
hoses	200		
<b>I</b>			
ignition cables	95		
immersion heating elements	4		
indicator lights	30		
indicator lights (complete)	31		
industrial hoses	203		
intake lances	199		
<b>K</b>			
knurled nuts	220		
knurled screws	220		
<b>L</b>			
lamps	30		
LED	32		
<b>M</b>			
magnetic switches	28		
manual softener	218		
measuring equipment	220		
mechanical timers	35		
microswitches	22		
motors	57		
<b>N</b>			
neon light bulbs	30, 32		
Niplaflex hoses	203		
nuts	220		
<b>O</b>			
operating capacitors	89		
O-rings	176		
<b>P</b>			
piezoelectric igniters	96		
pilot burners	95		
plug connectors	93		
plunger sockets	20		
position switches	22		
pressure control hoses	203		
pressure hoses	216		
pressure reduction valves	219, 219		
pressure switches	53		
probes	41		
programme timers	32		
pump hoses	199		
pumps	58		
push/momentary push switches	21		
push-in fittings	218		

PVC hoses	203	water softeners	218
PVC supply hoses	200		
<b>Q</b>			
quartz heating elements	3		
<b>R</b>			
refrigeration gaskets	176		
relays	38		
retaining rings	222		
ribbon cables	92		
rocker/momentary rocker switches	20		
rotary switches	27		
<b>S</b>			
safety bi-metal thermostats	15		
safety thermostats	17, 19		
screw pipe fittings	218		
screw-in gaskets	176		
screws	220		
sealing washers	182		
shaft gaskets	186		
silicone hoses	199, 204		
solenoid valves	49		
stainless steel flexi hoses	200		
supply filters	219, 219		
supply hoses	200		
switches and momentary switches	20		
system switches	26		
system switches (ROLD)	23		
<b>T</b>			
tank inlets	199		
temperature probes	41		
terminals	93		
thermocouples	96		
thermostats	15		
time relays	40		
timers	32		
transformers	40		
<b>U</b>			
universal hoses	200		
universal probes	41		
<b>V</b>			
valves and tank inlets	218		
ventilation hoses	216		
<b>W</b>			
wash and rinse pumps	58		
washers	221		
water cycle components	219		