



**GAS COMPONENTS**



**ELECTRIC COMPONENTS**



**WATER TECHNOLOGY**



**MECHANICAL COMPONENTS**



**TOOLS**

Spare parts suitable for

**ELOMA**

Find the complete and up-to-date range of products in our GEV Webshop



# Manufacturer catalogue

The most important spare parts and accessories arranged clearly for every manufacturer

- ✓ Complete product range and all appliance data always up to date in the GEV Webshop
- ✓ Alphabetical Index at the end of the catalogue

## GEV Webshop

[www.gev-online.co.uk](http://www.gev-online.co.uk)

[www.gev-online.com](http://www.gev-online.com)





- 🔍 Add to Favourites
- 🔍 Sign In with email address and usual password
- 🔍 Easy-order – place several items in your basket at the same time
- 🔍 Quick Item search – no login needed



## heating elements





### heating elements for chicken rotisseries



			
<b>GEV No.</b>	415532	<b>Ref. No.</b>	103691 E318012 EL0103691 ELE318012 R0210
<b>description</b>	heating element 1000W 230V L 700mm W 64mm Hmm heating circuits 1 connection male faston 6.3mm dry heating element tube ø 6.3mm connection distance 59mm		

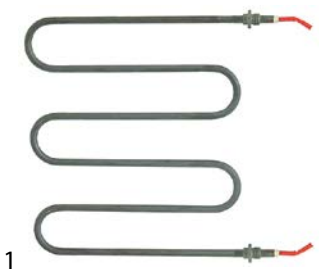





			
<b>GEV No.</b>	415531	<b>Ref. No.</b>	530905 E318013 EL0530905 ELE318013 R0215
<b>description</b>	heating element 1000W 230V L 725mm W 50mm Hmm heating circuits 1 connection male faston 6.3mm dry heating element tube ø 6.3mm connection distance 46mm		

			
<b>GEV No.</b>	415533	<b>Ref. No.</b>	532177 E318014 EL0532177 ELE318014 R0220
<b>description</b>	heating element 1100W 230V L 727mm W 50mm Hmm heating circuits 1 connection M4 dry heating element tube ø 8.6mm connection length 19mm		

### heating elements for hot counters

			
<b>GEV No.</b>	416510	<b>Ref. No.</b>	E318020 ELE318020 R0230
<b>description</b>	heating element 1200W 230V heating circuits 1 L 260mm W 284mm connection length 46mm tube ø 8.5mm cable length 480mm dry heating element hot bar 2 hole fixing thread M14x1.5 mounting distance 275mm		
<b>spare parts for</b>	416510		
	GEV No.	550262	Ref. No. —
flat gasket copper ED ø 20mm ID ø 14mm thickness 2mm			
<b>accessories for</b>	416510		
	GEV No.	510417	Ref. No. —
flat gasket fibre ED ø 20mm ID ø 14mm thickness 2mm Qty 1 pcs			
	GEV No.	520228	Ref. No. —
tooth lock washer ID ø 15.3mm ED ø 24mm steel Qty 1 pcs for thread M14			

<b>accessories for</b>	416510		
	GEV No.	520230	Ref. No. —
nut thread M14x1.5 H 5mm WS 19 zinc-coated steel Qty 1 pcs			
	GEV No.	521101	Ref. No. —
nut thread M14x1.5 H 5mm WS 19 SS Qty 1 pcs			

			
<b>GEV No.</b>	416431	<b>Ref. No.</b>	E318042 ELE318042 R0299
<b>description</b>	heating element 1600W 230V heating circuits 1 L 212mm W 450mm connection length 38mm tube ø 8.5mm connection male faston 6.3mm dry heating element hot bar 2 hole fixing thread M14x1.5 mounting distance 442mm		
<b>accessories for</b>	416431		
	GEV No.	510417	Ref. No. —
flat gasket fibre ED ø 20mm ID ø 14mm thickness 2mm Qty 1 pcs			
	GEV No.	520228	Ref. No. —
tooth lock washer ID ø 15.3mm ED ø 24mm steel Qty 1 pcs for thread M14			
	GEV No.	520230	Ref. No. —
nut thread M14x1.5 H 5mm WS 19 zinc-coated steel Qty 1 pcs			
	GEV No.	521101	Ref. No. —
nut thread M14x1.5 H 5mm WS 19 SS Qty 1 pcs			
	GEV No.	550262	Ref. No. —
flat gasket copper ED ø 20mm ID ø 14mm thickness 2mm			

			
<b>GEV No.</b>	416429	<b>Ref. No.</b>	E318044 ELE318044 R0303
<b>description</b>	heating element 1600W 230V heating circuits 1 L 300mm W 205mm W1 5mm W2 195mm tube ø 8.5mm connection male faston 6.3mm dry heating element hot bar L1 50mm L2 20mm L3 230mm 2 hole fixing thread M14x1.5 mounting distance 202mm		

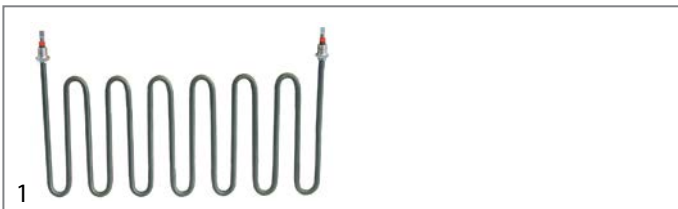



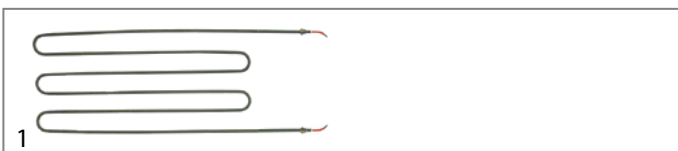

<b>GEV No.</b>	416430	<b>Ref. No.</b>	E318043 ELE318043 R0301
<b>description</b>	heating element 2000W 230V L 215mm W 415mm tube ø 8.5mm connection male faston 6.3mm dry heating element hot bar 2 hole fixing thread M14x1.5 mounting distance 409mm		



<b>GEV No.</b>	416512	<b>Ref. No.</b>	E318022 ELE318022 R0240
<b>description</b>	heating element 2700W 230V heating circuits 1 L 822mm W 300mm connection length 55mm tube ø 8.6mm cable length 440mm dry heating element hot bar 2 hole fixing thread M14x1.5 mounting distance 291mm		

**accessories for** 416512

	<b>GEV No.</b>	510417	<b>Ref. No.</b>	—
	flat gasket fibre ED ø 20mm ID ø 14mm thickness 2mm Qty 1 pcs			
	<b>GEV No.</b>	520228	<b>Ref. No.</b>	—
	tooth lock washer ID ø 15.3mm ED ø 24mm steel Qty 1 pcs for thread M14			
	<b>GEV No.</b>	520230	<b>Ref. No.</b>	—
	nut thread M14x1.5 H 5mm WS 19 zinc-coated steel Qty 1 pcs			
	<b>GEV No.</b>	521101	<b>Ref. No.</b>	—
	nut thread M14x1.5 H 5mm WS 19 SS Qty 1 pcs			
	<b>GEV No.</b>	550262	<b>Ref. No.</b>	—
	flat gasket copper ED ø 20mm ID ø 14mm thickness 2mm			

heating elements for coffee machine



<b>GEV No.</b>	415436	<b>Ref. No.</b>	E318036 ELE318036 R0285	
<b>description</b>	heating element 1600W 220V L 240mm W 33mm H 30mm L1 65mm L2 175mm mounting distance 25mm thread M12x1 stainless steel connection M4 tube ø 8.5mm 2 hole fixing immersion heater			
<b>accessories for</b>	415436			
	<b>GEV No.</b>	510413	<b>Ref. No.</b>	—
	flat gasket L 43mm W 19mm hole ø 12mm hole distance 24mm copper thickness 2.3mm for heating element			
	<b>GEV No.</b>	510901	<b>Ref. No.</b>	—
	O-ring EPDM thickness 2mm ID ø 13mm Qty 1 pcs			
	<b>GEV No.</b>	520229	<b>Ref. No.</b>	—
	nut thread M12x1 H 4mm WS 16 zinc-coated steel Qty 1 pcs			

**accessories for** 415436

	<b>GEV No.</b>	521103	<b>Ref. No.</b>	—
	nut thread M4 H 3mm WS 7 brass Qty 20 pcs			
	<b>GEV No.</b>	521104	<b>Ref. No.</b>	—
	washer ID ø 4.3mm ED ø 8mm thickness 0.5mm brass Qty 20 pcs for thread M4			
	<b>GEV No.</b>	521110	<b>Ref. No.</b>	—
	flat gasket fibre ED ø 20mm ID ø 13mm thickness 2mm Qty 1 pcs			
	<b>GEV No.</b>	521131	<b>Ref. No.</b>	—
	nut thread M12x1 H 3.5mm WS 17 SS Qty 1 pcs			
	<b>GEV No.</b>	560111	<b>Ref. No.</b>	—
	plain washer ID ø 4.3mm ED ø 9mm thickness 0.8mm SS Qty 20 pcs DIN 125A for thread M4			
	<b>GEV No.</b>	560131	<b>Ref. No.</b>	—
	hexagonal nut thread M4 H 3.2mm WS 7 SS DIN/ISO DIN 934 / ISO 4032/8673 Qty 20 pcs			



<b>GEV No.</b>	415439	<b>Ref. No.</b>	E318039 ELE318039 R0296
<b>description</b>	heating element 2000W 230V heating circuits 1 L 342mm W 33mm H 26mm mounting distance 25mm thread M12x1 connection M4 tube ø 8.5mm 2 hole fixing immersion heater		

**spare parts for** 415439

	<b>GEV No.</b>	532009	<b>Ref. No.</b>	—
	O-ring EPDM thickness 1.78mm ID ø 14mm Qty 10 pcs			

**accessories for** 415439

	<b>GEV No.</b>	520228	<b>Ref. No.</b>	—
	tooth lock washer ID ø 15.3mm ED ø 24mm steel Qty 1 pcs for thread M14			
	<b>GEV No.</b>	520229	<b>Ref. No.</b>	—
	nut thread M12x1 H 4mm WS 16 zinc-coated steel Qty 1 pcs			
	<b>GEV No.</b>	521103	<b>Ref. No.</b>	—
	nut thread M4 H 3mm WS 7 brass Qty 20 pcs			
	<b>GEV No.</b>	521104	<b>Ref. No.</b>	—
	washer ID ø 4.3mm ED ø 8mm thickness 0.5mm brass Qty 20 pcs for thread M4			
	<b>GEV No.</b>	560111	<b>Ref. No.</b>	—
	plain washer ID ø 4.3mm ED ø 9mm thickness 0.8mm SS Qty 20 pcs DIN 125A for thread M4			
	<b>GEV No.</b>	560131	<b>Ref. No.</b>	—
	hexagonal nut thread M4 H 3.2mm WS 7 SS DIN/ISO DIN 934 / ISO 4032/8673 Qty 20 pcs			



			
<b>GEV No.</b>	415438	<b>Ref. No.</b>	E318038 ELE318038 R0295
<b>description</b>	heating element 4000W 220V L 430mm W 30mm H 37mm mounting distance 22mm thread M12x1 connection M4 tube ø 8.5mm 2 hole fixing immersion heater		
<b>accessories for</b>	415438		
	<b>GEV No.</b>	510413	<b>Ref. No.</b> —
	flat gasket L 43mm W 19mm hole ø 12mm hole distance 24mm copper thickness 2.3mm for heating element		
	<b>GEV No.</b>	520229	<b>Ref. No.</b> —
	nut thread M12x1 H 4mm WS 16 zinc-coated steel Qty 1 pcs		
	<b>GEV No.</b>	521103	<b>Ref. No.</b> —
	nut thread M4 H 3mm WS 7 brass Qty 20 pcs		
	<b>GEV No.</b>	521104	<b>Ref. No.</b> —
	washer ID ø 4.3mm ED ø 8mm thickness 0.5mm brass Qty 20 pcs for thread M4		
	<b>GEV No.</b>	521110	<b>Ref. No.</b> —
	flat gasket fibre ED ø 20mm ID ø 13mm thickness 2mm Qty 1 pcs		
	<b>GEV No.</b>	521131	<b>Ref. No.</b> —
	nut thread M12x1 H 3.5mm WS 17 SS Qty 1 pcs		
	<b>GEV No.</b>	528110	<b>Ref. No.</b> —
	O-ring EPDM thickness 2.62mm ID ø 12.37mm Qty 1 pcs		
	<b>GEV No.</b>	560111	<b>Ref. No.</b> —
	plain washer ID ø 4.3mm ED ø 9mm thickness 0.8mm SS Qty 20 pcs DIN 125A for thread M4		
	<b>GEV No.</b>	560131	<b>Ref. No.</b> —
	hexagonal nut thread M4 H 3.2mm WS 7 SS DIN/ISO DIN 934 / ISO 4032/8673 Qty 20 pcs		





heating elements for pizza ovens

			
<b>GEV No.</b>	415524	<b>Ref. No.</b>	E318052 ELE318052 P0154
<b>description</b>	heating element 1100W 230V L 720mm W 200mm thread M14x1.5 mounting distance 210mm connection length 40mm tube ø 8.5mm cable length 1000mm heating circuits 1 dry heating element 2 hole fixing		
<b>accessories for</b>	415524		
	<b>GEV No.</b>	361182	<b>Ref. No.</b> —
	nut thread 1/4" H 5mm nickel-plated brass WS 17 Qty 1 pcs		
	<b>GEV No.</b>	510417	<b>Ref. No.</b> —
	flat gasket fibre ED ø 20mm ID ø 14mm thickness 2mm Qty 1 pcs		
	<b>GEV No.</b>	520228	<b>Ref. No.</b> —
	tooth lock washer ID ø 15.3mm ED ø 24mm steel Qty 1 pcs for thread M14		
	<b>GEV No.</b>	550262	<b>Ref. No.</b> —
	flat gasket copper ED ø 20mm ID ø 14mm thickness 2mm		

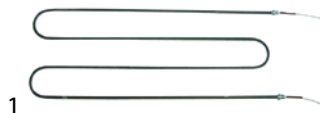



			
<b>GEV No.</b>	415525	<b>Ref. No.</b>	E318053 ELE318053 P0155
<b>description</b>	heating element 1100W 380V L 716mm W 205mm thread M15x1 mounting distance 197mm connection length 40mm tube ø 8mm cable length 980mm heating circuits 1 dry heating element 2 hole fixing		

			
<b>GEV No.</b>	415527	<b>Ref. No.</b>	E318055 ELE318055 P0161
<b>description</b>	heating element 1500W 220V L 720mm W 260mm thread M14x1.5 mounting distance 252mm tube ø 8.5mm cable length 1000mm heating circuits 1 dry heating element 2 hole fixing		

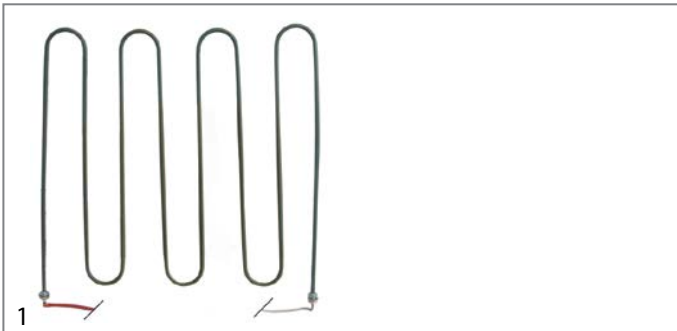
			
<b>GEV No.</b>	415526	<b>Ref. No.</b>	E318054 ELE318054 P0160
<b>description</b>	heating element 1500W 380V L 720mm W 260mm thread M14x1.5 mounting distance 290mm connection cable tube ø 8.5mm cable length 1000mm heating circuits 1 dry heating element 2 hole fixing		

			
<b>GEV No.</b>	415528	<b>Ref. No.</b>	E318050 ELE318050 P0150
<b>description</b>	heating element 2000W 230V L 465mm W 450mm thread M14x1.5 mounting distance 441mm connection length 36mm tube ø 8.5mm cable length 430mm heating circuits 1 dry heating element 2 hole fixing		
<b>spare parts for</b>	415528		
	<b>GEV No.</b>	510417	<b>Ref. No.</b> —
	flat gasket fibre ED ø 20mm ID ø 14mm thickness 2mm Qty 1 pcs		
<b>accessories for</b>	415528		
	<b>GEV No.</b>	361182	<b>Ref. No.</b> —
	nut thread 1/4" H 5mm nickel-plated brass WS 17 Qty 1 pcs		
	<b>GEV No.</b>	520228	<b>Ref. No.</b> —
	tooth lock washer ID ø 15.3mm ED ø 24mm steel Qty 1 pcs for thread M14		
	<b>GEV No.</b>	550262	<b>Ref. No.</b> —
	flat gasket copper ED ø 20mm ID ø 14mm thickness 2mm		



<b>GEV No.</b>	416432	<b>Ref. No.</b>	E318051 ELE318051 P0151
<b>description</b>	heating element 2500W 230V L 575mm W 570mm thread M14x1.5 mounting distance 561mm connection length 37mm tube ø 8.7mm cable length 570mm heating circuits 1 dry heating element 2 hole fixing		
<b>accessories for</b>	416432		
	<b>GEV No.</b>	510417	<b>Ref. No.</b> —
	flat gasket fibre ED ø 20mm ID ø 14mm thickness 2mm Qty 1 pcs		
	<b>GEV No.</b>	520228	<b>Ref. No.</b> —
	tooth lock washer ID ø 15.3mm ED ø 24mm steel Qty 1 pcs for thread M14		
	<b>GEV No.</b>	520230	<b>Ref. No.</b> —
	nut thread M14x1.5 H 5mm WS 19 zinc-coated steel Qty 1 pcs		
	<b>GEV No.</b>	521101	<b>Ref. No.</b> —
	nut thread M14x1.5 H 5mm WS 19 SS Qty 1 pcs		
	<b>GEV No.</b>	550262	<b>Ref. No.</b> —
	flat gasket copper ED ø 20mm ID ø 14mm thickness 2mm		

heating elements for salamanders/toast-

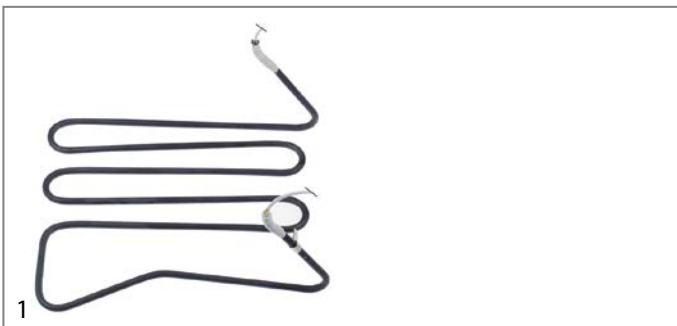

<b>GEV No.</b>	415541	<b>Ref. No.</b>	318048 T0119
<b>description</b>	heating element 2000W 230V heating circuits 1 mounting pos. left L 250mm W 210mm H 120mm W2 170mm connection distance 164mm tube ø 6.3mm cable length 500mm dry heating element salamander grill		



<b>GEV No.</b>	415540	<b>Ref. No.</b>	318049 T0120
<b>description</b>	heating element 2000W 230V heating circuits 1 mounting pos. right L 250mm W 210mm H 120mm W2 170mm connection distance 164mm tube ø 6.5mm cable length 500mm dry heating element salamander grill		

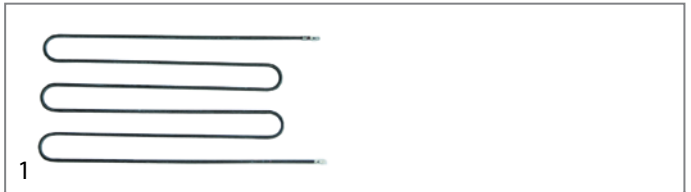

<b>GEV No.</b>	415539	<b>Ref. No.</b>	127132 E318011 EL0127132 ELE318011 R0205
<b>description</b>	heating element 2100W 220V heating circuits 1 L 470mm W 207mm connection male faston 6.3mm connection distance 201mm tube ø 6.3mm dry heating element H 6.3mm		



<b>GEV No.</b>	415538	<b>Ref. No.</b>	102644 E318010 EL0102644 ELE318010 R0200
<b>description</b>	heating element 2200W 230V heating circuits 1 L 365mm W 178mm connection male faston 6.3mm connection distance 172mm tube ø 6.3mm dry heating element H 6.3mm		

immersion heating elements







<b>GEV No.</b>	415438	<b>Ref. No.</b>	E318038 ELE318038 R0295
<b>description</b>	heating element 4000W 220V L 430mm W 30mm H 37mm mounting distance 22mm thread M12x1 connection M4 tube ø 8.5mm 2 hole fixing immersion heater		
<b>accessories for</b>	415438		
	<b>GEV No.</b>	510413	<b>Ref. No.</b> —
	flat gasket L 43mm W 19mm hole ø 12mm hole distance 24mm copper thickness 2.3mm for heating element		
	<b>GEV No.</b>	520229	<b>Ref. No.</b> —
	nut thread M12x1 H 4mm WS 16 zinc-coated steel Qty 1 pcs		

Table continues overleaf



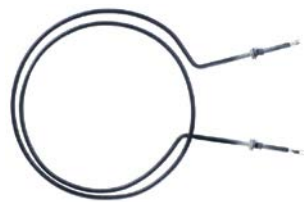

<b>accessories for</b> 415438	
	GEV No. 521103 Ref. No. — nut thread M4 H 3mm WS 7 brass Qty 20 pcs
	GEV No. 521104 Ref. No. — washer ID ø 4.3mm ED ø 8mm thickness 0.5mm brass Qty 20 pcs for thread M4
	GEV No. 521110 Ref. No. — flat gasket fibre ED ø 20mm ID ø 13mm thickness 2mm Qty 1 pcs
	GEV No. 521131 Ref. No. — nut thread M12x1 H 3.5mm WS 17 SS Qty 1 pcs
	GEV No. 528110 Ref. No. — O-ring EPDM thickness 2.62mm ID ø 12.37mm Qty 1 pcs
	GEV No. 560111 Ref. No. — plain washer ID ø 4.3mm ED ø 9mm thickness 0.8mm SS Qty 20 pcs DIN 125A for thread M4
	GEV No. 560131 Ref. No. — hexagonal nut thread M4 H 3.2mm WS 7 SS DIN/ISO DIN 934 / ISO 4032/8673 Qty 20 pcs



	
1	
<b>GEV No.</b> 418897	<b>Ref. No.</b> 318004 576344 E318004 E318090 EL0576344 EL0581984 ELE318004 ELE318090 R0188
<b>description</b>	heating element 1600W 230V heating circuits 1 ID ø 220mm ED ø 240mm L 330mm L1 90mm thread M10x1 connection male faston 6.3mm tube ø 6.5mm convection heating element for combi-steamer
<b>For models:</b>	ELH53, ELH5-3-McDonalds, MD523

	
1	
<b>GEV No.</b> 419254	<b>Ref. No.</b> EL0501247
<b>description</b>	heating element 600W 230V heating circuits 1 L 340mm W 45mm H 55mm L1 40mm L2 30mm L3 270mm thread M10x1 mounting distance 40mm tube ø 6.5mm connection length 20mm 2 hole fixing connection male faston 6.3mm

	
1	
<b>GEV No.</b> 419252	<b>Ref. No.</b> EL0584126 ELE318091
<b>description</b>	heating element 2000W 230V heating circuits 1 ID ø 180mm ED ø 193mm L 258mm H 25mm L1 60mm W1 30mm H1 7mm H2 18mm flange length 70mm flange width 22mm hole distance 56mm connection male faston 6.3mm connection length 55mm tube ø 6.5mm convection heating element hole ø M4mm rectangular flange

heating elements for convection





	
1	
<b>GEV No.</b> 418739	<b>Ref. No.</b> 318105 742414 EL0742414 ELE318105
<b>description</b>	heating element 10500W 230V heating circuits 3 ID ø 411mm ED ø 428mm L 480mm H 110mm L1 52mm W1 99mm H1 18mm H2 92mm flange length 130mm flange width 54mm hole distance 55mm connection M5 connection length 96mm tube ø 8.5mm convection heating element mounting thread M6 rectangular flange with thread bolt
<b>For models:</b>	1011, 2011, 611, AUTOCLEAN, GENIUS, GENIUS6-11, MAKT, MB, MULTIMAXA, MULTIMAXB
<b>accessories for</b> 418739	
	GEV No. 551240 Ref. No. 749451 E427064 EL0749451 ELE427064
<b>description</b>	gasket L 129mm W 87mm D1 ø 12mm D2 ø 7mm 12 holes graphite thickness 1mm

	
1	
<b>GEV No.</b> 418959	<b>Ref. No.</b> 742422 E318106 EL0742422 ELE318106
<b>description</b>	heating element 21600W 230V heating circuits 6 ID ø 414mm ED ø 466mm L 522mm H 121.5mm L1 88mm W1 97mm H1 30.5mm H2 91mm flange length 130mm flange width 88mm connection M5 connection length 70mm tube ø 6.5mm mounting thread M6 flange with bolt M6
<b>For models:</b>	1011, 2011, 611, AUTOCLEAN, GENIUS, MAKT, MB, MULTIMAXA, MULTIMAXB
<b>accessories for</b> 418959	
	GEV No. 519647 Ref. No. E412169 EL0757993 ELE412169
<b>description</b>	counterflange ø 8mm perforation ø 13mm L 130mm W 88mm suitable for convection heating element 12 holes
	GEV No. 551240 Ref. No. 749451 E427064 EL0749451 ELE427064
<b>description</b>	gasket L 129mm W 87mm D1 ø 12mm D2 ø 7mm 12 holes graphite thickness 1mm

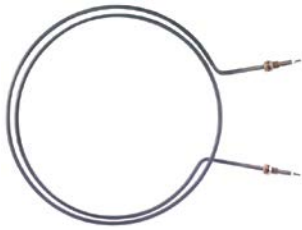

1	
<b>GEV No.</b>	420300
<b>Ref. No.</b>	318071 318087 590118 E318087 EL0318087 EL0590118 ELE318087
<b>description</b>	heating element 3400W 230V heating circuits 1 ID ø 200mm ED ø 212mm L 268mm H 33mm L1 50mm W1 30mm H1 5mm H2 30mm flange length 70mm flange width 22mm hole distance 56mm connection male faston 6.3mm tube ø 6.5mm convection heating element hole ø 3.5mm flange
<b>For models:</b>	EB30, EB30XLDIGITAL, EBM3e-McDonalds





1	
<b>GEV No.</b>	418766
<b>Ref. No.</b>	E318002 ELE318002 R0184
<b>description</b>	heating element 4500W 230V heating circuits 1 ID ø 380mm ED ø 405mm L 530mm H 17mm thread M14x1.5 connection M4 tube ø 8.5mm
<b>For models:</b>	MD1011, MD2011, MMD1011, MMD2011
<b>spare parts for</b>	418766
	GEV No. 510417 Ref. No. — flat gasket fibre ED ø 20mm ID ø 14mm thickness 2mm Qty 1 pcs
<b>accessories for</b>	418766
	GEV No. 520228 Ref. No. — tooth lock washer ID ø 15.3mm ED ø 24mm steel Qty 1 pcs for thread M14
	GEV No. 520230 Ref. No. — nut thread M14x1.5 H 5mm WS 19 zinc-coated steel Qty 1 pcs
	GEV No. 521101 Ref. No. — nut thread M14x1.5 H 5mm WS 19 SS Qty 1 pcs
	GEV No. 550262 Ref. No. — flat gasket copper ED ø 20mm ID ø 14mm thickness 2mm









1	
<b>GEV No.</b>	415805
<b>Ref. No.</b>	693383 E318078 EL0693383 ELE318078
<b>description</b>	heating element 5700W 230V heating circuits 3 ID ø 206mm ED ø 245mm L 290mm H 42mm L1 45mm W1 97mm H1 2mm H2 40mm flange length 110mm flange width 20mm hole distance 35mm connection male faston 6.3mm connection length 58mm tube ø 6.3mm convection heating element hole ø 6.5mm rectangular flange
<b>For models:</b>	EB30, JOKERB, JOKERC



1	
<b>GEV No.</b>	415133
<b>Ref. No.</b>	318017 ELE318017
<b>description</b>	heating element 1430W 230V heating circuits 1 L 85mm W 395mm connection male faston 6.3mm tube ø 6.3mm thread M10x1 2 hole fixing dry heating element mounting distance 389mm
<b>For models:</b>	EBM5, ELH61, MD2011, MD611, MMC2011, MMC611, MMD2011, MMD611
<b>accessories for</b>	415133
	GEV No. 520231 Ref. No. — nut thread M10x1 H 6mm WS 14 zinc-coated steel Qty 1 pcs
	GEV No. 521129 Ref. No. — nut thread M10 H 6mm SS WS 17 Qty 1 pcs DIN/ISO DIN 439
	GEV No. 528433 Ref. No. — flat gasket copper ED ø 14mm ID ø 10mm thickness 1mm
	097071 217840 E427020 E427039 EL0097071 EL0217840 EL0571849 ELE427020 ELE427039 R0300











			
<b>GEV No.</b>	415221	<b>Ref. No.</b>	332429 E318045 EL0332429 ELE318045 R0305
<b>description</b>	heating element 1430W 230V heating circuits 1 L 90mm W 390mm connection male faston 6.3mm tube ø 6.3mm thread M10x1 2 hole fixing dry heating element mounting distance 376mm		
<b>For models:</b>	MD611, MMD611		
<b>spare parts for</b>	415221		
	GEV No.	510416	Ref. No. —
flat gasket fibre ED ø 19mm ID ø 10.5mm thickness 1.5mm for thread M10 Qty 1 pcs			
<b>accessories for</b>	415221		
	GEV No.	510893	Ref. No. —
O-ring EPDM thickness 2.62mm ID ø 9.92mm Qty 1 pcs			
	GEV No.	520231	Ref. No. —
nut thread M10x1 H 6mm WS 14 zinc-coated steel Qty 1 pcs			
	GEV No.	521129	Ref. No. —
nut thread M10 H 6mm SS WS 17 Qty 1 pcs DIN/ISO DIN 439			
	GEV No.	528433	Ref. No. 097071 217840 E427020 E427039 EL0097071 EL0217840 EL0571849 ELE427020 ELE427039 R0300
flat gasket copper ED ø 14mm ID ø 10mm thickness 1mm			

			
<b>GEV No.</b>	418970	<b>Ref. No.</b>	585726 EL0585726 ELO585726
<b>description</b>	heating element 1450W 230V heating circuits 1 L 90mm W 315mm		

			
<b>GEV No.</b>	415222	<b>Ref. No.</b>	318018 576581 E318082 EL0576581 ELE318082
<b>description</b>	heating element 2300W 230V heating circuits 1 L 90mm W 395mm connection M4 tube ø 8.5mm thread M14x1.5 2 hole fixing dry heating element		
<b>For models:</b>	ELH101, MD1011, MD2011, MMC1011, MMC2011, MMD1011, MMD2011		
<b>accessories for</b>	415222		
	GEV No.	521103	Ref. No. —
nut thread M4 H 3mm WS 7 brass Qty 20 pcs			
	GEV No.	521104	Ref. No. —
washer ID ø 4.3mm ED ø 8mm thickness 0.5mm brass Qty 20 pcs for thread M4			
	GEV No.	560111	Ref. No. —
plain washer ID ø 4.3mm ED ø 9mm thickness 0.8mm SS Qty 20 pcs DIN 125A for thread M4			
	GEV No.	560131	Ref. No. —
hexagonal nut thread M4 H 3.2mm WS 7 SS DIN/ISO DIN 934 / ISO 4032/8673 Qty 20 pcs			

			
<b>GEV No.</b>	415542	<b>Ref. No.</b>	318047 E318084 ELE318047 ELE318084 R0321
<b>description</b>	heating element 2500W 230V heating circuits 1 L 131mm W 485mm connection length 20mm connection M4 tube ø 8.5mm thread M14x1.5 2 hole fixing convection heating element mounting distance 480mm		
<b>For models:</b>	MMC2021, MMD2021		
<b>accessories for</b>	415542		
	GEV No.	510417	Ref. No. —
flat gasket fibre ED ø 20mm ID ø 14mm thickness 2mm Qty 1 pcs			
	GEV No.	520228	Ref. No. —
tooth lock washer ID ø 15.3mm ED ø 24mm steel Qty 1 pcs for thread M14			
	GEV No.	520230	Ref. No. —
nut thread M14x1.5 H 5mm WS 19 zinc-coated steel Qty 1 pcs			
	GEV No.	521101	Ref. No. —
nut thread M14x1.5 H 5mm WS 19 SS Qty 1 pcs			
	GEV No.	550262	Ref. No. —
flat gasket copper ED ø 20mm ID ø 14mm thickness 2mm			





<b>GEV No.</b>	415543	<b>Ref. No.</b>	E318083 ELE318083 R0320
<b>description</b>	heating element 4000W 230V heating circuits 1 L 131mm W 485mm connection M4 tube ø 8.5mm thread M14x1.5 2 hole fixing dry heating element		
<b>For models:</b>	MMD2021		

## energy regulators

### EGO

#### 1-circuit



<b>GEV No.</b>	380015	<b>Ref. No.</b>	314544 E0180 E344009 EL0314544 ELE344009
<b>description</b>	energy regulator 230V 13A single-circuit turn direction right shaft ø 6x4.6mm shaft L 23mm mounting thread M4 power release 6-100% no. 50.57021.010		

### accessories

#### knobs



<b>GEV No.</b>	110235	<b>Ref. No.</b>	E0322
<b>description</b>	knob energy regulator 1-3 t.max.°C ø 50mm shaft ø 6x4.6mm shaft flat upper black		

## thermostats

### control and safety thermostats

#### EGO

#### control thermostats

#### 55.10/19\_series



<b>GEV No.</b>	375070	<b>Ref. No.</b>	091634 E0268 E334007 EL0091634 ELE334007
<b>description</b>	thermostat t.max. 250°C temperature range 55-250°C 1-pole 1CO 16A probe ø 3.1mm probe L 226mm capillary pipe 1170mm capillary pipe isolated 1100mm gland nut M9x1 shaft L 23mm shaft position upper rotation 270°		
<b>For models:</b>	1011, 611, AUTOCLEAN, JOKERB, JOKERC, MD1011, MD2011, MD523, MD611, MMD1011, MMD2011, MMD2021, MMD611, MULTIMAXA, WU14		



<b>GEV No.</b>	375462	<b>Ref. No.</b>	E0250 E334002 ELE334002
<b>description</b>	thermostat t.max. 250°C temperature range 55-250°C 1-pole 1NO 16A probe ø 3.1mm probe L 226mm capillary pipe 2420mm capillary pipe isolated 1100mm gland nut shaft ø 6x4.6mm shaft L 23mm shaft position upper rotation 270°		

55.13\_series



<b>GEV No.</b>	375179	<b>Ref. No.</b>	E0260 E334006 ELE334006
<b>description</b>	thermostat t.max. 131°C temperature range 80-131°C 1-pole 1NO 16A probe ø 6mm probe L 98mm capillary pipe 1730mm capillary pipe isolatedmm gland nut shaft ø 6x4.6mm shaft L 23mm shaft position upper rotation 270°		

55.31\_series



<b>GEV No.</b>	375072	<b>Ref. No.</b>	E0160 E336001 ELE336001
<b>description</b>	safety thermostat switch-off temp. 170°C 3-pole 20A probe ø 3.1mm probe L 524mm capillary pipe 350mm capillary pipe isolated 350mm gland nut probe SS		

55.34\_series



<b>GEV No.</b>	375101	<b>Ref. No.</b>	E334008 ELE334008 P0180
<b>description</b>	thermostat t.max. 360°C temperature range 140-360°C 3-pole 3NO 16A probe ø 4mm probe L 292mm capillary pipe 990mm capillary pipe isolated 500mm gland nut shaft L 23mm shaft position upper rotation 318°		

55.32\_series



<b>GEV No.</b>	390921	<b>Ref. No.</b>	336003 572705 EL0572705
<b>description</b>	safety thermostat switch-off temp. 305°C 3-pole 3NC 20A probe ø 4mm probe L 128mm capillary pipe 890mm capillary pipe isolated 800mm gland nut probe		
<b>For models:</b>	ELH101, ELH51, ELH53, ELH5-3-McDonalds, ELH61, MD1011, MD523, MD611		

safety thermostats

55.11\_series



<b>GEV No.</b>	375093	<b>Ref. No.</b>	E0232 E336004 ELE336004
<b>description</b>	safety thermostat switch-off temp. 318°C 1-pole 12A probe ø 4mm probe L 111mm capillary pipe 530mm capillary pipe isolated 450mm gland nut M9x1 probe SS		
<b>For models:</b>	MD1011, MD2011, MD523, MD611, MMD1011, MMD2011, MMD2021, MMD611		



<b>GEV No.</b>	375065	<b>Ref. No.</b>	E0234 E336005 ELE336005
<b>description</b>	safety thermostat switch-off temp. 500°C 3-pole 3NC 20A probe ø 4mm probe L 308mm capillary pipe 890mm capillary pipe isolatedmm gland nut probe SS		



## 55.33\_ series



<b>GEV No.</b>	375075	<b>Ref. No.</b>	384429 E0240 E336017 EL0384429 ELE336017
<b>description</b>	safety thermostat switch-off temp. 305°C 3-pole probe		

## accessories



<b>GEV No.</b>	518669	<b>Ref. No.</b>	0373079 EL0373079	
<b>description</b>	gasket PTFE ED ø 21mm ID ø 15mm thickness 3.5mm			
<b>accessories for</b>	518669			
	<b>GEV No.</b>	375889	<b>Ref. No.</b>	504602 E336029 EL0504602 ELE336029
<b>description</b>	safety thermostat switch-off temp. 360°C 1-pole 16A probe ø 15mm probe L 6.5mm capillary pipe 1140mm capillary pipe isolated 1100mm gland nut probe			

## control thermostats with actual value



<b>GEV No.</b>	375118	<b>Ref. No.</b>	580457 E336027 EL0580457 ELE336027
<b>description</b>	safety thermostat switch-off temp. 360°C 3-pole 20A probe ø 15mm probe L 8mm capillary pipe 1150mm capillary pipe isolated 1100mm gland nut probe with knob		



<b>GEV No.</b>	379034	<b>Ref. No.</b>	E336015 ELE336015 P0183
<b>description</b>	thermostat t.max. 450°C temperature range 50-450°C 1-pole 1CO 5A probe ø 6mm probe L 30mm capillary pipe 1150mm capillary pipe isolatedmm gland nut mounting ø 80mm mounting measurements 96x96mm		

## 56\_ series

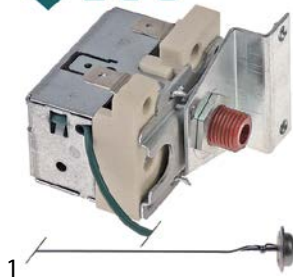

<b>GEV No.</b>	375889	<b>Ref. No.</b>	504602 E336029 EL0504602 ELE336029	
<b>description</b>	safety thermostat switch-off temp. 360°C 1-pole 16A probe ø 15mm probe L 6.5mm capillary pipe 1140mm capillary pipe isolated 1100mm gland nut probe			
<b>For models:</b>	1011, 1221, 2011, 2021, 611, AUTOCLEAN, EB30, EB30XLDIGITAL, GENIUS, GENIUS6-11, GENIUS6-11GAS, GENIUSGAS, JOKERB, JOKERC, MAKT, MB, MULTIMAXA, MULTIMAXB, MULTIMAXB6-11AUTOCLEAN			
<b>accessories for</b>	375889			
	<b>GEV No.</b>	518669	<b>Ref. No.</b>	0373079 EL0373079
<b>description</b>	gasket PTFE ED ø 21mm ID ø 15mm thickness 3.5mm			

## switches and momentary switches



## rocker/momentary rocker switches

## 30x22mm



<b>GEV No.</b>	301003	<b>Ref. No.</b>	E320032 ELE320032 P0187	
<b>description</b>	rocker switch mounting measurements 30x22mm green 2NO 250V 16A illuminated 0-1 connection male faston 6.3mm ambient temperature max. 125/55°C protection IP65			
<b>accessories for</b>	301003			
	<b>GEV No.</b>	301036	<b>Ref. No.</b>	—
<b>description</b>	protective cover internal size 30x22mm for rocker switch mounting measurementsmm			



 <p>1</p>			
<b>GEV No.</b>	301001	<b>Ref. No.</b>	E320030 ELE320030 P0185
<b>description</b>	rocker switch mounting measurements 30x22mm red 2NO 250V 16A illuminated 0-I connection male faston 6.3mm ambient temperature max. 125/55°C protection IP65		
<b>accessories for</b>	301001		
		<b>GEV No.</b>	301036
		<b>Ref. No.</b>	—
	protective cover internal size 30x22mm for rocker switch mounting measurementsmm		

microswitches

universal



<p>1</p>			
<b>GEV No.</b>	345042	<b>Ref. No.</b>	570540 E320055 EL0570540 ELE320055
<b>description</b>	microswitch with plunger 250V 16A 1CO connection male faston 6.3mm L 28mm ambient temperature max. 125°C mounting distance 22mm type EF83161.3 actuating force: 75g blue/black		
<b>For models:</b>	EB30, EB30XLDIGITAL, JOKERB, JOKERC		
<b>accessories for</b>	345042		
		<b>GEV No.</b>	345043
		<b>Ref. No.</b>	—
	lever set 5-piece		

pin-plunger actuated



<p>1</p>			
<b>GEV No.</b>	345042	<b>Ref. No.</b>	570540 E320055 EL0570540 ELE320055
<b>description</b>	microswitch with plunger 250V 16A 1CO connection male faston 6.3mm L 28mm ambient temperature max. 125°C mounting distance 22mm type EF83161.3 actuating force: 75g blue/black		
<b>For models:</b>	EB30, EB30XLDIGITAL, JOKERB, JOKERC		
<b>accessories for</b>	345042		
		<b>GEV No.</b>	345043
		<b>Ref. No.</b>	—
	lever set 5-piece		

M16

 <p>1</p>			
<b>GEV No.</b>	345046	<b>Ref. No.</b>	092444 E0290 E320036 EL0092444 ELE320036 V0600
<b>description</b>	microswitch with plunger thread M16x1 thread L 25mm 250V 5A 1NC/1NO connection male faston 6.3mm stroke 6mm ambient temperature max. 85°C actuating force: 400g		
<b>For models:</b>	MD1011, MD2011, MD523, MD611, MMD1011, MMD2011, MMD2021, MMD611		

accessories

 <p>1</p>			
<b>GEV No.</b>	347013	<b>Ref. No.</b>	E320058 EL0587141
<b>description</b>	lever for microswitch		
<b>For models:</b>	JOKERB, JOKERC		

cam switches

4-position

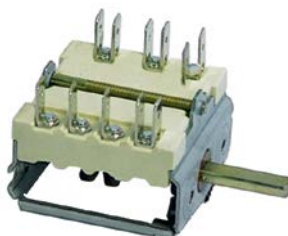
 <p>1</p>			
<b>GEV No.</b>	300016	<b>Ref. No.</b>	E0185
<b>description</b>	cam switch 4 operating positions 1NO/2CO sequence 0-1-2-3 16A shaft ø 6x4.6mm shaft L 23mm connection male faston 6.3mm ceramic		

 <p>1</p>			
<b>GEV No.</b>	300104	<b>Ref. No.</b>	532215 E0187 E320003 EL0532215 ELE320003
<b>description</b>	cam switch 4 operating positions 3NO/1CO sequence 0-1-2-3 32A shaft ø 6x4.6mm shaft L 23mm connection screw ceramic		



4 operating positions

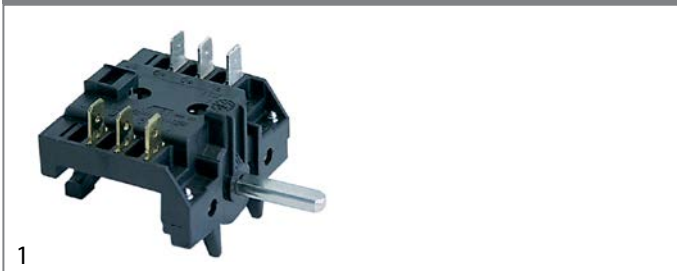

1			
<b>GEV No.</b>	300033	<b>Ref. No.</b>	E0190 E320005 ELE320005
<b>description</b>	cam switch 4 operating positions 4NO sequence 0-1-2-3 16A shaft ø 6x4.6mm shaft L 23mm connection male faston 6.3mm plastic		

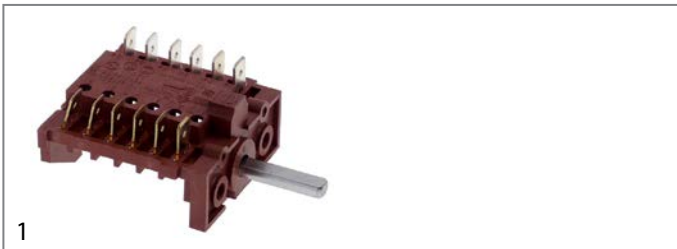

1			
<b>GEV No.</b>	300057	<b>Ref. No.</b>	292664 E0194 E320008 EL0292664 ELE320008
<b>description</b>	cam switch 4 operating positions 6NO sequence 0-1-2-3 16A shaft ø 6x4.6mm shaft L 23mm connection male faston 6.3mm 6CH/141 plastic		
<b>For models:</b>	MD1011, MD523, MD611		



1			
<b>GEV No.</b>	348195	<b>Ref. No.</b>	320009 EL0553611
<b>description</b>	cam switch 4 operating positions 9NO sequence 0-1-2-3 16A shaft ø 6x4.6mm shaft L 23mm connection F6.3 outer switch		
<b>For models:</b>	ELH101, ELH53, ELH5-3-McDonalds, ELH61		

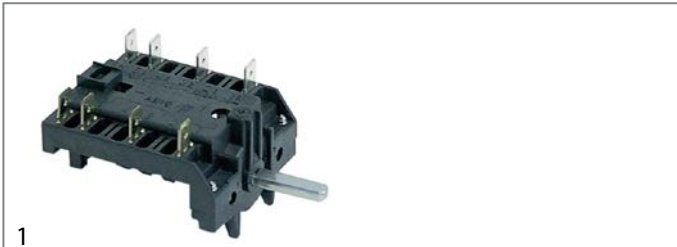

1			
<b>GEV No.</b>	300034	<b>Ref. No.</b>	E0193
<b>description</b>	cam switch 4 operating positions selector switch sequence 0-1-2-3 16A shaft ø 6x4.6mm connection male faston 6.3mm 4-pole		

5 operating positions

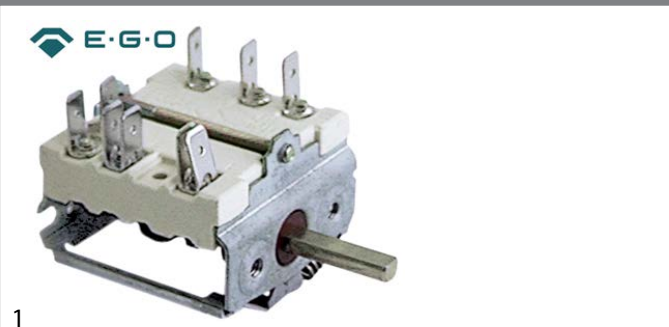

1			
<b>GEV No.</b>	345199	<b>Ref. No.</b>	E320034 ELE320034 T0133
<b>description</b>	cam switch 5 operating positions 2NO/1CO sequence 0-1-2-3-4 16A shaft ø 6x4.6mm shaft L 23mm connection male faston 6.3mm		

operation switches



1			
<b>GEV No.</b>	345321	<b>Ref. No.</b>	E0189 E320004 ELE320004
<b>description</b>	operation switch 4 operating positions 5NO 16A sequence 0-1-2-3 shaft ø 6x4.6mm shaft L 23mm connection male faston 6.3mm plastic 3-pole ambient temperature max. 300°C		

magnetic switches

ø 5.22mm



1			
<b>GEV No.</b>	347011	<b>Ref. No.</b>	581038 E320072 EL0581038 ELE320072
<b>description</b>	magnetic switch 250V 0.04A P max. 10W probe L 26mm 1NO cable length 1000mm		
<b>For models:</b>	1011, 1221, 2011, 2021, 611, AUTOCLEAN, GENIUS, GENIUS6-11, GENIUS6-11GAS, GENIUSGAS, MAKT, MB, MULTIMAXA, MULTIMAXB		





1

<b>GEV No.</b>	359184	<b>Ref. No.</b>	323535 E0786 E320024 EL0323535 ELE320024
<b>description</b>	contact block momentary 1NC/1NO connection male faston 2.8mm socket type AT		
<b>For models:</b>	MD1011, MD523, MD611		

### accessories



1

<b>GEV No.</b>	359768	<b>Ref. No.</b>	580376 E320068 EL0580376 ELE320068
<b>description</b>	cap for momentary switch transparent/colourless octagonal L 19.4mm W 19.4mm		

## encoders and potentiometers



1

<b>GEV No.</b>	300263	<b>Ref. No.</b>	E340083 EL0340083 ELE340083
<b>description</b>	encoder rotation 360° shaft ø 6mm shaft L 13mm 0.1W		



1

<b>GEV No.</b>	300062	<b>Ref. No.</b>	E606002 ELE606002
<b>description</b>	potentiometer 2x2KOhm		

## lamps

### indicator lights

#### indicator lights 3-piece (housing, lens and bulb)

ø16.2mm



1

<b>GEV No.</b>	359070	<b>Ref. No.</b>	E0275 E314003 ELE314003
<b>description</b>	indicator light lens yellow		









### lamps

#### neon light bulbs



1

<b>GEV No.</b>	359600	<b>Ref. No.</b>	E0560 E312001 ELE312001
<b>description</b>	neon light bulb socket E10 220V 0.35W clear ø 10mm L 28mm		

<b>accessories for</b>	359600			
	<b>GEV No.</b>	359060	<b>Ref. No.</b>	—
	<b>GEV No.</b>	359063	<b>Ref. No.</b>	—
	<b>GEV No.</b>	359064	<b>Ref. No.</b>	—
	<b>GEV No.</b>	359685	<b>Ref. No.</b>	—
	<b>GEV No.</b>	359832	<b>Ref. No.</b>	—
	<b>GEV No.</b>	359853	<b>Ref. No.</b>	—
	<b>GEV No.</b>	359988	<b>Ref. No.</b>	—
	<b>GEV No.</b>	359988	<b>Ref. No.</b>	—







indicator lights (complete)			
ø 6mm			
 <p>1</p>			
<b>GEV No.</b>	359004	<b>Ref. No.</b>	332771 E0960 E0960E E314010 EL0332771 ELE314010
<b>description</b>	indicator light ø 6mm 230V green cable length 400mm temp.-resist. 106°C		
<b>For models:</b>	MD1011, MD2011, MD523, MD611		

 <p>1</p>			
<b>GEV No.</b>	359005	<b>Ref. No.</b>	314011 332798 E0961 E314011 EL0332798 ELE314011
<b>description</b>	indicator light ø 6mm 230V yellow cable length 400mm		
<b>For models:</b>	EBM5, ELH101, ELH53, ELH5-3-McDonalds, ELH61, MD1011, MD2011, MD523, MD611		

ø10mm			
with plug-in socket			
 <p>1</p>			
<b>GEV No.</b>	359140	<b>Ref. No.</b>	E0278 E314002 E314018 EL0091642 ELE314018
<b>description</b>	indicator light ø 10mm yellow 230V connection male faston 6.3mm Qty 1 pcs		

30x22mm			
 <p>1</p>			
<b>GEV No.</b>	359157	<b>Ref. No.</b>	E314021 ELE314021 P0191
<b>description</b>	indicator light mounting measurements 30x22mm 230V green connection male faston 6.3mm temp.-resist. 125/55°C type RL2		
<b>accessories for</b>	359157		
	<b>GEV No.</b>	301036	<b>Ref. No.</b> —
protective cover internal size 30x22mm for rocker switch mounting measurementsmm			

 <p>1</p>			
<b>GEV No.</b>	359156	<b>Ref. No.</b>	E314020 ELE314020 P0190
<b>description</b>	indicator light mounting measurements 30x22mm 230V yellow connection male faston 6.3mm temp.-resist. 125/55°C type RL2		

**screw-on/push-on fit**

neon light bulbs			
 <p>1</p>			
<b>GEV No.</b>	359600	<b>Ref. No.</b>	E0560 E312001 ELE312001
<b>description</b>	neon light bulb socket E10 220V 0.35W clear ø 10mm L 28mm		
<b>accessories for</b>	359600		
	<b>GEV No.</b>	359060	<b>Ref. No.</b> —
lamp socket mounting measurements ø16.2mm socket E10 connection screw			
	<b>GEV No.</b>	359063	<b>Ref. No.</b> —
lamp socket mounting measurements ø19.2mm socket E14 connection screw			
	<b>GEV No.</b>	359064	<b>Ref. No.</b> —
lamp socket mounting measurements ø22.3mm socket E14 connection screw 250/380V ambient temperature at 1W 100°C ambient temperature at 2W 85°C			
	<b>GEV No.</b>	359685	<b>Ref. No.</b> —
lamp socket mounting measurements ø16.2mm socket E10			
	<b>GEV No.</b>	359832	<b>Ref. No.</b> —
lamp socket mounting measurements ø16.2mm socket Ba9s connection male faston 6.3mm			
	<b>GEV No.</b>	359853	<b>Ref. No.</b> —
lamp socket mounting measurements ø18.2mm socket Ba9s connection male faston 6.3mm			
	<b>GEV No.</b>	359988	<b>Ref. No.</b> —
lamp socket mounting measurements ø30.5mm 250V connection F6.3 temp.-resist. 55°C E14			

**light bulbs**

for ovens			
 <p>1</p>			
<b>GEV No.</b>	359610	<b>Ref. No.</b>	E0565 E312004 ELE312004
<b>description</b>	light bulb t.max. 300°C socket E14 15W 230V ø 22mm L 47mm lens L 20mm for oven lamp type Philips		



1

<b>GEV No.</b>	359612	<b>Ref. No.</b>	354252 E0566 E312003 EL0354252 ELE312003
<b>description</b>	light bulb t.max. 300°C socket E14 25W 230V ø 25mm L 56mm lens L 30mm for oven lamp type Philips		
<b>For models:</b>	MD1011, MD2011, MD523, MD611, MMD1011, MMD2011, MMD2021, MMD611		

miscellaneous



1

<b>GEV No.</b>	362023	<b>Ref. No.</b>	581488 E0826 E312012 EL0581488 ELE312012
<b>description</b>	light bulb socket T5.5K 48V 1.2W 0.025A		
<b>For models:</b>	1011, 2011, 611, EB30, EB30XLDIGITAL, JOKERB, MULTIMAXA		

halogen lamp

for socket G4 / G6.35 / G9



1

<b>GEV No.</b>	359596	<b>Ref. No.</b>	571954 E312023 EL0571954 ELE312023
<b>description</b>	halogen lamp socket G4 12V 10W temp.-resist. 500°C		
<b>For models:</b>	EB30		



1

<b>GEV No.</b>	359599	<b>Ref. No.</b>	570478 E312021 EL0570478 ELE312021
<b>description</b>	halogen lamp socket G4 12V 20W temp.-resist. 500°C		
<b>For models:</b>	1011, 1221, 2011, 2021, 611, AUTOCLEAN, EB30XLDIGITAL, GENIUS, GENIUS6-11, GENIUS6-11GAS, GENIUSGAS, JOKERB, JOKERC, MAKT, MB, MULTIMAXA, MULTIMAXB		

linear lamps

infrared lamps

with base type R7s



1

<b>GEV No.</b>	359628	<b>Ref. No.</b>	E0574 E312006 ELE312006
<b>description</b>	infrared lamp socket R7s L 117.6mm 240V 300W IMPORT unjacketed		



1

<b>GEV No.</b>	359622	<b>Ref. No.</b>	EL0531332
<b>description</b>	infrared lamp socket Li_R base 230V 1000W L 428mm cable length 100mm		

with base type X lug



1

<b>GEV No.</b>	359617	<b>Ref. No.</b>	531332 E0575 E0577 E312007 E312008 ELE312007 ELE312008
<b>description</b>	infrared lamp 1000W 220V L 365mm lens L 340mm total length 480mm with mounting strap		

sockets for linear lamps

X lug



1

<b>GEV No.</b>	359710	<b>Ref. No.</b>	E0576 E314007 ELE314007
<b>description</b>	lamp socket L 70mm W 70mm H 49mm mounting distance 50mm bracket mounting		

fluorescent lamps

fluorescent lamps

2G11



1

<b>GEV No.</b>	359640	<b>Ref. No.</b>	E1013 E312015 ELE312015
<b>description</b>	fluorescent lamp socket 2G11 L 217mm 18W 230V		

			
<b>GEV No.</b>	359634	<b>Ref. No.</b>	E1010 E312014 ELE312014
<b>description</b>	fluorescent lamp socket 2G11 L 411mm 36W 230V		

accessories





sockets

			
<b>GEV No.</b>	381156	<b>Ref. No.</b>	E1011 E314015 ELE314015
<b>description</b>	lamp socket socket 2G11 hole distance 24mm t.max. 140°C for fluorescent lamps		

oven lamps





universal oven lamps

mounting diameter 35.5mm

			
<b>GEV No.</b>	359701	<b>Ref. No.</b>	E0530 E314004 EL0527777 ELE314004
<b>description</b>	lamp socket socket E14 220-230V mounting ø 35.5mm connection male faston 6.3mm 15W		
<b>For models:</b>	MD1011, MD2011, MD523, MD611, MMD1011, MMD2011, MMD2021, MMD611		
<b>accessories for</b>	359701		
	<b>GEV No.</b>	359705	<b>Ref. No.</b> 092339 E0555 E460003 EL0092339 ELE460003
oven lamp glass thr.ø 33.5mm ø 52mm hard glas temp.-resist. 350°C			
	<b>GEV No.</b>	359709	<b>Ref. No.</b> E0532 E460002 ELE460002
oven lamp glass thr.ø 33.5mm ø 42mm hard glas temp.-resist. 350°C			
	<b>GEV No.</b>	359721	<b>Ref. No.</b> 425132 693421 976024 E0556 E425005 E425132 EL0976024 ELE425005 ELE425132
gasket silicone ED ø 48mm ID ø 39.5mm thickness 5mm Qty 1 pcs			
	<b>GEV No.</b>	359942	<b>Ref. No.</b> —
oven lamp glass thr.ø 33.5mm ø 41mm hard glas temp.-resist. 350°C			

			
<b>GEV No.</b>	359709	<b>Ref. No.</b>	E0532 E460002 ELE460002
<b>description</b>	oven lamp glass thr.ø 33.5mm ø 42mm hard glas temp.-resist. 350°C		
<b>For models:</b>	MD2011, MMD2011, MMD2021		

			
<b>GEV No.</b>	359705	<b>Ref. No.</b>	092339 E0555 E460003 EL0092339 ELE460003
<b>description</b>	oven lamp glass thr.ø 33.5mm ø 52mm hard glas temp.-resist. 350°C		
<b>accessories for</b>	359705		

	<b>GEV No.</b>	359610	<b>Ref. No.</b> E0565 E312004 ELE312004
light bulb t.max. 300°C socket E14 15W 230V ø 22mm L 47mm lens L 20mm for oven lamp type Philips			
	<b>GEV No.</b>	359700	<b>Ref. No.</b> —
gasket for pizza oven fibre glass ID ø 32.5mm ED ø 55mm thickness 5mm			
	<b>GEV No.</b>	359721	<b>Ref. No.</b> 425132 693421 976024 E0556 E425005 E425132 EL0976024 ELE425005 ELE425132
gasket silicone ED ø 48mm ID ø 39.5mm thickness 5mm Qty 1 pcs			
	<b>GEV No.</b>	359837	<b>Ref. No.</b> —
gasket ID ø 33mm ED ø 46mm thickness 1mm graphite			
	<b>GEV No.</b>	359838	<b>Ref. No.</b> —
gasket ID ø 33mm ED ø 45mm			

			
<b>GEV No.</b>	359721	<b>Ref. No.</b>	425132 693421 976024 E0556 E425005 E425132 EL0976024 ELE425005 ELE425132
<b>description</b>	gasket silicone ED ø 48mm ID ø 39.5mm thickness 5mm Qty 1 pcs		
<b>For models:</b>	EBM3e-McDonalds, JOKERB, JOKERC		

producer-specific oven lamps

ELOMA



<b>GEV No.</b>	357129	<b>Ref. No.</b>	EL0510288
<b>description</b>	lamp socket socket E14 hole distance 52x89mm mounting measurements 70x80mm		



<b>GEV No.</b>	359639	<b>Ref. No.</b>	367664 B0382 E314001 EL0367664 ELE314001
<b>description</b>	lamp socket socket E14 with grip fixing		



<b>GEV No.</b>	359068	<b>Ref. No.</b>	E314019 ELE314019 P0166
<b>description</b>	lamp socket with 2 hole fixing socket E14 ø 25mm		

lamps

light bulbs



<b>GEV No.</b>	359610	<b>Ref. No.</b>	E0565 E312004 ELE312004
<b>description</b>	light bulb t.max. 300°C socket E14 15W 230V ø 22mm L 47mm lens L 20mm for oven lamp type Philips		



<b>GEV No.</b>	359612	<b>Ref. No.</b>	354252 E0566 E312003 EL0354252 ELE312003
<b>description</b>	light bulb t.max. 300°C socket E14 25W 230V ø 25mm L 56mm lens L 30mm for oven lamp type Philips		
<b>For models:</b>	MD1011, MD2011, MD523, MD611, MMD1011, MMD2011, MMD2021, MMD611		

halogen lamps

for socket G4 / G6.35 / G9



<b>GEV No.</b>	359596	<b>Ref. No.</b>	571954 E312023 EL0571954 ELE312023
<b>description</b>	halogen lamp socket G4 12V 10W temp.-resist. 500°C		
<b>For models:</b>	EB30		



<b>GEV No.</b>	359599	<b>Ref. No.</b>	570478 E312021 EL0570478 ELE312021
<b>description</b>	halogen lamp socket G4 12V 20W temp.-resist. 500°C		
<b>For models:</b>	1011, 1221, 2011, 2021, 611, AUTOCLEAN, EB30XLDIGITAL, GENIUS, GENIUS6-11, GENIUS6-11GAS, GENIUSGAS, JOKERB, JOKERC, MAKT, MB, MULTIMAXA, MULTIMAXB		

sockets

G4 / G5,3 / G6,35



<b>GEV No.</b>	359646	<b>Ref. No.</b>	577294 E314031 EL0577294 ELE314031
<b>description</b>	lamp socket socket G4/G5.3/G6.35 24V ø 17mm H 15mm connection cable 130mm mounting distance 26mm for halogen lamp holder length 31mm cable length 130mm		
<b>For models:</b>	1011, 1221, 2011, 2021, 611, GENIUS, JOKERB, JOKERC, MAKT, MB		



timers

electric timers

<b>GEV No.</b>	350191	<b>Ref. No.</b>	0157988
<b>description</b>	timer 1CO/1NO permanent position yes impulse electric shaft ø 6x4.6mm shaft L 23mm mounting distance 28mm connection lateral 2-pole operation time 120min		



			
1			
<b>GEV No.</b>	350001	<b>Ref. No.</b>	E0205 E330006 ELE330006
<b>description</b>	timer 2CO at 250V 16A permanent position yes impulse electric shaft ø 6x4.6mm shaft L 22mm mounting distance 28mm connection rear 2-pole operation time 120min		
<b>For models:</b>	MD1011, MD523, MD611		

			
1			
<b>GEV No.</b>	350059	<b>Ref. No.</b>	871400 E598179 EL0871400 ELE598179
<b>description</b>	timer MS65 operation time 120min time spreadmin 2CO/1NO at 250V 16A permanent position yes impulse electric shaft ø 6x4.6mm shaft L 20mm mounting distance 28mm mounting thread M4 connection lateral 3-pole		
<b>accessories for</b>	350059		
	<b>GEV No.</b>	110366	<b>Ref. No.</b> —
	<b>GEV No.</b>	110381	<b>Ref. No.</b> —

mechanical timers

			
1			
<b>GEV No.</b>	350203	<b>Ref. No.</b>	592323 EL0505428 EL0592323
<b>description</b>	timer C20 2-pole operation time 15min impulse mechanical 2CO at 250V 16A permanent position no shaft ø 6x4.6mm shaft 6x4.6mm shaft L 23mm mounting distance 28mm connection male faston 6.3mm ambient temperature max. 125°C		

audible timers

			
1			
<b>GEV No.</b>	350014	<b>Ref. No.</b>	E330016 ELE330016 T0142
<b>description</b>	audible timer operation time 15min ø 56mm shaft ø 6x4.6mm shaft L 24mm mounting distance 28mm		

alarm devices

buzzers

			
1			
<b>GEV No.</b>	350051	<b>Ref. No.</b>	091472 E0225 E348002 EL0091472 ELE348002
<b>description</b>	buzzer 230VAC connection male faston 6.3mm screw thread M4 buzzer 62dB		
<b>For models:</b>	MD1011, MD2011, MD523, MD611, MMD2011, MMD2021		

loudspeakers

 <p>Image not available</p>			
1			
<b>GEV No.</b>	350226	<b>Ref. No.</b>	749877 E348018 EL0749877 ELE348018
<b>description</b>	loudspeaker ø 64mm built-in depth 20mm 500hm 0.3W connection male faston 2.8mm		



## contactors

ABB

## power contactors



1

<b>GEV No.</b>	380112	<b>Ref. No.</b>	EL0523895
<b>description</b>	power contactor resistive load 45A 230VAC (AC3/400V) 26A/11kW main contacts 3NO auxiliary contacts 1NO connection screw connection type A26-30-10		
<b>accessories for</b>	380112		
	<b>GEV No.</b>	381031	<b>Ref. No.</b> —
	auxiliary contact contacts 1NO/1NC AC1 16A AC15 3A connection screw connection for contactors B6/B7/VB7		



1

<b>GEV No.</b>	380306	<b>Ref. No.</b>	580481 E324023 EL0580481 ELE324023
<b>description</b>	power contactor AC3 4A		
<b>For models:</b>	1011, 1221, 2011, 2021, 611, AUTOCLEAN, GENIUS, GENIUS6-11, GENIUS6-11GAS, GENIUSGAS, MAKT, MB, MULTIMAXA, MULTIMAXB, MULTIMAXB6-11AUTOCLEAN		



1

<b>GEV No.</b>	380214	<b>Ref. No.</b>	332682 E0470 E324004 EL0332682 ELE324004
<b>description</b>	power contactor resistive load 20A 230VAC (AC3/400V) 8.5A/5.5kW main contacts 3NO auxiliary contacts 1NO connection screw connection type Fanal DSL7 00 type ISKRA K07M 00		
<b>For models:</b>	MD1011, MD2011, MD523, MD611, MMD2011, MMD2021		



Image not available

1

<b>GEV No.</b>	381547	<b>Ref. No.</b>	5239090 E324044 EL0510675 EL0523909 ELE324044
<b>description</b>	power contactor resistive load 25A 100-250VAC (AC3/400V) 9A/4kW main contacts 3NO auxiliary contacts 1NO connection screw connection type AF09-30-10-13		



1

<b>GEV No.</b>	380213	<b>Ref. No.</b>	324001 EL0324001 ELE324001
<b>description</b>	power contactor resistive load 20A 230VAC (AC3/400V) 8.5A/5.5kW main contacts 3NO auxiliary contacts 1NO connection screw connection type Fanal DSL7 10 type ISKRA K07M 10		
<b>For models:</b>	EBM3e-McDonalds, EBM5, EDC6-11, ELH101, ELH51, ELH53, ELH5-3-McDonalds, ELH61, HUD511, MD523, MD611, MMC1011, MMC611, MMD1011, MMD611		

## ISKRA (FANAL)

## power contactors



1

<b>GEV No.</b>	380211	<b>Ref. No.</b>	E0465 E324001 ELE324001
<b>description</b>	power contactor 230VAC		
<b>For models:</b>	1011, 2011, 611, AUTOCLEAN, GENIUS, GENIUS6-11, GENIUS6-11GAS, GENIUSGAS, JOKERB, JOKERC, MD523, MD611, MMD611		



1

<b>GEV No.</b>	380216	<b>Ref. No.</b>	E0467 E324002 ELE324002
<b>description</b>	power contactor 230VAC		
<b>For models:</b>	1011, 2011, 611, AUTOCLEAN, GENIUS, GENIUS6-11, MD1011, MD2011, MMD1011, MMD2011, MMD2021, MULTIMAXA, MULTIMAXB, MULTIMAXB6-11AUTOCLEAN		



1

<b>GEV No.</b>	380217	<b>Ref. No.</b>	584150 E0487 E324009 ELE324009
<b>description</b>	power contactor resistive load 75A 230VAC (AC3/400V) 32A/22kW main contacts 3NO auxiliary contacts 1NO/1NC connection screw connection type Fanal DSL43 11 type ISKRA KNL43		
<b>For models:</b>	MD2011, MMD2011, MMD2021		



auxiliary contacts

			
1			
<b>GEV No.</b>	380225	<b>Ref. No.</b>	332690 E0471 E324005 EL0873683 ELE324005
<b>description</b>	auxiliary contact contacts 3NO/1NC AC15 6A for contactors K03C/K07C connection screw connection type Fanal SC4 31 type ISKRA ND4C 31		
<b>For models:</b>	MD1011, MD2011, MD523, MD611, MMD2011, MMD2021		

CRYDOM

			
1			
<b>GEV No.</b>	402052	<b>Ref. No.</b>	EL0752665 ELE324032
<b>description</b>	solid state relay CRYDOM 1 phase 90A 600V 4-32VDC L 58.6mm W 45mm screw type H12WD4890PG		

TELEMECANIQUE (Schneider Electric)

auxiliary contacts

			
1			
<b>GEV No.</b>	380987	<b>Ref. No.</b>	751790 E324038 EL0751790 ELE324038
<b>description</b>	auxiliary contact contacts 3NO/1NC AC15 10A for contactors LC1K connection screw type LA1KN31		
<b>For models:</b>	1011, 1221, 2011, 2021, 611, AUTOCLEAN, GENIUS, GENIUS6-11, MAKT, MB, MULTIMAXB, MULTIMAXB6-11AUTOCLEAN		



relays

time relays

			
1			
<b>GEV No.</b>	381009	<b>Ref. No.</b>	780421 E332013 EL0780421 ELE332013
<b>description</b>	time relay ABB CT-AHE time range 0.3-30s 220-240VAC 4A		
<b>For models:</b>	1011, 2011, 611, EB30, EB30XLDIGITAL, GENIUS, MAKT, MB		

solid state relays

CELDUC

			
1			
<b>GEV No.</b>	402049	<b>Ref. No.</b>	752401 E324033 EL0752401 ELE324033
<b>description</b>	solid state relay CELDUC 1 phase 60A 24-600V 3-32VDC L 58mm W 45mm screw type SO965460		
<b>For models:</b>	1011, 2011, 611, AUTOCLEAN, GENIUS, GENIUS6-11, GENIUS6-11GAS, GENIUSGAS, MAKT, MB, MULTIMAXA, MULTIMAXB		
<b>accessories for</b>	402049		
	<b>GEV No.</b>	401564	<b>Ref. No.</b> —
	 heat-conducting foil L 62mm W 45mm for solid state relay		

			
1			
<b>GEV No.</b>	380288	<b>Ref. No.</b>	332615 E0237 E332002 EL0332615 ELE332002
<b>description</b>	time relay ELEKTRON VZE 806 time range 60s 24-250 AC/DC 5A connection cable mounting measurements DIN railmm		
<b>For models:</b>	MD1011, MD2011, MD523, MD611, MMD2011, MMD2021		



			
1			
<b>GEV No.</b>	350151	<b>Ref. No.</b>	767344 E320080 EL0767344 ELE320080
<b>description</b>	time relay FIBER 5A clock generator 230V voltage AC time range T1 4min T2 10s		

			
1			
<b>GEV No.</b>	402051	<b>Ref. No.</b>	742775 E310031 EL0742775 ELE310031
<b>description</b>	transformer primary 230VAC secondary 16.5VAC 2x15VA connection male faston 50/60Hz		
<b>For models:</b>	1011, 1221, 2011, 2021, 611, AUTOCLEAN, GENIUS, GENIUS6-11, GENIUS6-11GAS, GENIUSGAS, MAKT, MB, MULTIMAXA, MULTIMAXB, MULTIMAXB6-11AUTOCLEAN		

## transformers

### encapsulated transformers

#### multiple connections

			
1			
<b>GEV No.</b>	400252	<b>Ref. No.</b>	570443 E310024 EL0570443 ELE310024
<b>description</b>	transformer		
<b>For models:</b>	2011, 2021, AUTOCLEAN, GENIUS, GENIUSGAS, MULTIMAXA, MULTIMAXB		

<b>PMA</b>			
			
1			
<b>GEV No.</b>	379054	<b>Ref. No.</b>	P0264
<b>description</b>	transformer primary 230VAC secondary 12VAC 3VA secondary 0.25A H 40mm L 45mm W 50mm connection screw 50/60Hz type 153/M		

			
1			
<b>GEV No.</b>	400251	<b>Ref. No.</b>	572217 E310021 EL0572217 ELE310021
<b>description</b>	transformer 44VA		
<b>For models:</b>	1011, 1221, 2021, 611, AUTOCLEAN, EB30, EB30XLDIGITAL, GENIUS, GENIUS6-11, GENIUS6-11GAS, GENIUSGAS, JOKERB, JOKERC, MAKT, MB, MULTIMAXA, MULTIMAXB		

## electronic controllers

### SHANGFANG

#### accessories

			
1			
<b>GEV No.</b>	379054	<b>Ref. No.</b>	P0264
<b>description</b>	transformer primary 230VAC secondary 12VAC 3VA secondary 0.25A H 40mm L 45mm W 50mm connection screw 50/60Hz type 153/M		





TECNOLOGIC

universal controllers

built-in version



1

<b>GEV No.</b>	379246	<b>Ref. No.</b>	329657 E0615 E336011 EL0329657 ELE336011
<b>description</b>	electronic controller TECNOLOGIC type TLK96HCRR-S mounting measurements 90x90mm 100-240V voltage AC Pt100/TC (J,K) relay outputs 2 CO-8A(3) CO-8A(3) Pt100/TC (J,K) front measurements 96x96mm built-in depth 60mm protection IP65 built-in version yes defr. funct. no -100 up to +1600°C display 4 digits		
<b>For models:</b>	MD2011		
<b>accessories for</b>	379246		
	<b>GEV No.</b>	379052	<b>Ref. No.</b> —
	temperature probe PTC 1kOhm cable silicone probe -50 up to +150°C cable -50 up to +180°C probe ø6x40mm cable length 1.5m without screw connection 2-wire		
	<b>GEV No.</b>	379053	<b>Ref. No.</b> —
	temperature probe PTC 1kOhm cable PVC probe -50 up to +150°C cable -10 up to 100°C probe ø6x30mm cable length 3m without screw connection 2-wire		

electronic thermometers

built-in version



1

<b>GEV No.</b>	379203	<b>Ref. No.</b>	E348010 ELE348010 P0260
<b>description</b>	thermometer TECNOLOGIC K38VFC-----E---- mounting measurements 70x28mm built-in depth 64mm 12V voltage AC/DC Pt100/TC (J,K) -200 up to +1760°C display 3½ digits 1 RoomTempIN Pt100/TC (J,K) defr. funct. no front measurements 35x78.5mm		
<b>accessories for</b>	379203		
	<b>GEV No.</b>	379050	<b>Ref. No.</b> —
	temperature probe Pt100 cable Vetrotex probe -200 up to +600°C cable -50 up to +350°C probe ø6x100mm cable length 2.7m without screw connection 3-wire		
	<b>GEV No.</b>	379054	<b>Ref. No.</b> P0264
	transformer primary 230VAC secondary 12VAC 3VA secondary 0.25A H 40mm L 45mm W 50mm connection screw 50/60Hz type 153/M		

miscellaneous

universal controllers



1

<b>GEV No.</b>	400206	<b>Ref. No.</b>	332143 E0432 E336010 EL0332143 ELE336010
<b>description</b>	electronic controller 230V TempIn1 thermocouple K (NiCr-Ni) temperature controller		
<b>For models:</b>	MD1011, MD2011, MD523, MD611, MMD2011, MMD2021		

probes

universal probes

temperature probes



1

<b>GEV No.</b>	379062	<b>Ref. No.</b>	E316009 ELE316009 P0268
<b>description</b>	temperature probe thermocouple J (Fe-CuNi) cable Vetrotex probe -50 up to +750°C cable -50 up to +350°C probe ø6x50mm cable length 3m without screw connection 2-wire		

producer-specific probes

probes



1

<b>GEV No.</b>	379117	<b>Ref. No.</b>	316016 873241 E316016 EL0873241
<b>description</b>	core temperature probe Pt100 cable PVC probe -100 up to 450°C cable -10 up to 100°C connection male faston 6.3mm thread 1/4" probe ø4x82mm cable length 1.4m		



1

<b>GEV No.</b>	379088	<b>Ref. No.</b>	E0431
<b>description</b>	temperature probe Pt100 cable silicone probe -100 up to 450°C cable -50 up to +180°C connection 2-wire thread probe ø3.2x28mm cable length 1.1m		
<b>For models:</b>	MD2011, MMD2011, MMD2021		



			
<b>GEV No.</b>	379087	<b>Ref. No.</b>	E0436 E316004 EL0570621 ELE316004 ELO570621
<b>description</b>	temperature probe thermocouple K (NiCr-Ni) cable silicone probe -50 up to 1150°C cable -50 up to +180°C connection male faston 2.8mm thread probe ø1x30mm cable length 1.6m		
<b>For models:</b>	1011, 1221, 2011, 2021, 611, AUTOCLEAN, GENIUS, GENIUS6-11, GENIUS6-11GAS, GENIUSGAS, JOKERB, JOKERC, MD2011, MMD2021, MULTIMAXA, MULTIMAXB, WU14		

			
<b>GEV No.</b>	379086	<b>Ref. No.</b>	E0433 E316003 ELE316003
<b>description</b>	temperature probe thermocouple K (NiCr-Ni) cable silicone probe -50 up to 1150°C cable -50 up to +180°C connection male faston thread probe ø1x30mm cable length 1.2m		
<b>For models:</b>	MD1011, MD2011, MD523, MD611, MMD1011, MMD2011, MMD611		

core probes





<b>GEV No.</b>	378358	<b>Ref. No.</b>	747017 EL0747017
<b>description</b>	core temperature probe		

			
<b>GEV No.</b>	379592 <sup>1</sup>	<b>Ref. No.</b>	752363 E316024 EL0752363 ELE316024
<b>description</b>	core temperature probe 3 point probe cable PTFE probe -40 up to +250°C cable -40 up to +250°C connection 5-wire probe ø4x100mm thread cable length 4.5m handle ø 12mm handle length 85mm		
<b>For models:</b>	1011, 1221, 2011, 2021, 611, AUTOCLEAN, GENIUS, GENIUS6-11, GENIUS6-11GAS, GENIUSGAS, MAKT, MB, MULTIMAXA, MULTIMAXB		

<sup>1</sup>multipoint probe

			
<b>GEV No.</b>	379692	<b>Ref. No.</b>	783668 E316026 EL0783668 ELE316026
<b>description</b>	core temperature probe Pt100 cable PTFE probe -40 up to +250°C cable -40 up to +250°C connection 2-wire probe ø4x82mm thread 1/4" cable length 1.8m handle ø 12mm handle length 90mm		

			
<b>GEV No.</b>	379116	<b>Ref. No.</b>	316015 E316027 ELE316027
<b>description</b>	core temperature probe Pt100 cable PTFE probe -40 up to +250°C cable -40 up to +250°C connection 2-wire probe ø4x82mm thread 1/4" cable length 3m handle ø 12mm handle length 90mm		
<b>For models:</b>	EDC6-11		

			
<b>GEV No.</b>	379089	<b>Ref. No.</b>	E316010 ELE316010 V0602
<b>description</b>	core temperature probe Pt100 cable SS corrugated hose probe -40 up to +250°C cable -40 up to +250°C connection 3-wire probe ø4x100mm thread cable length 1.9m handle ø 15mm handle length 85mm		
<b>For models:</b>	MD2011, MMD1011, MMD2011, MMD2021, MMD611		

electronics

frequency converters



<b>GEV No.</b>	403178	<b>Ref. No.</b>	EL0508588 EL0779393 EL2002608
<b>description</b>	frequency converter kit motor control 230V 50/60 L 135mm W 110mm H 135mm		

rectifiers





<b>GEV No.</b>	400253	<b>Ref. No.</b>	570532 E308056 EL0570532 ELE308056
<b>description</b>	rectifier		
<b>For models:</b>	1011, 1221, 2011, 2021, 611, AUTOCLEAN, EB30, EB30XLDIGITAL, GENIUS, GENIUS6-11, GENIUS6-11GAS, GENIUSGAS, JOKERB, JOKERC, MAKT, MB, MULTIMAXB, MULTIMAXB6-11AUTOCLEAN		





PCBs

			
1			
<b>GEV No.</b>	403181	<b>Ref. No.</b>	742457 EL0502031 EL0742457
<b>description</b>	conversion kit combi-steamer Genius T 6-11 10-11 L 155mm W 115mm cable length 60mm display with PCB		
<b>For models:</b>	1011, 1221, 2011, 2021, 611, AUTOCLEAN, GENIUS, GENIUS6-11, GENIUS6-11GAS, GENIUSGAS, MULTIMAXB		

			
1			
<b>GEV No.</b>	402619	<b>Ref. No.</b>	742465 E340053 EL0742465 ELE340053
<b>description</b>	keypad PCB combi-steamer 1121/2021 L 350mm W 121mm with display		
<b>For models:</b>	1011, 1221, 2011, 2021, 611, AUTOCLEAN, GENIUS, MB, MULTIMAXB, MULTIMAXB6-11AUTOCLEAN		

			
1			
<b>GEV No.</b>	401000	<b>Ref. No.</b>	580740 E340040 EL0580740 ELE340040
<b>description</b>	keypad PCB suitable for ELOMA with display		
<b>For models:</b>	EDC6-11		

			
1			
<b>GEV No.</b>	401937	<b>Ref. No.</b>	344010 EL0344010
<b>description</b>	main PCB		
<b>For models:</b>	MMC1011, MMC611, MMD1011, MMD611		

			
1			
<b>GEV No.</b>	400013	<b>Ref. No.</b>	E0510 E344002 ELE344002
<b>description</b>	PCB combi-steamer 6x1/1 5x2/3 level control		

			
1			
<b>GEV No.</b>	403179	<b>Ref. No.</b>	EL0791458
<b>description</b>	PCB combi-steamer Genius T 6-11 10-11 L 400mm W 155mm		

			
1			
<b>GEV No.</b>	400015	<b>Ref. No.</b>	332704 E0506 E332009 EL0332704 ELE332009
<b>description</b>	PCB combi-steamer MD 1011 without mounting angle pulse timer for steaming		
<b>For models:</b>	MD1011, MD2011, MD523, MD611, MMD2011, MMD2021		

			
1			
<b>GEV No.</b>	400016	<b>Ref. No.</b>	593648 E0505 E332008 EL0593648 ELE332008
<b>description</b>	PCB pulse timer for steaming with mounting angle		



# solenoid valves

## solenoid valves (water)

### INTERELEKTRIK

medium temperature: 90°C 90°C 60°C  
ambient temperature: 60°C 25°C 60°C  
duty cycle: 40% 100% 100%



<b>GEV No.</b>	370688	<b>Ref. No.</b>	754463 EL0754463
<b>description</b>	solenoid valve 220-240VAC inlet 3/4" outlet 13.5mm DN8 t.max. 90°C plastic		
<b>For models:</b>	1011, 1221, 2011, 2021, 611, GENIUS, MAKT, MB		

### MÜLLER

medium temperature: 90°C  
duty cycle: 100%

#### spare parts and accessories

##### filters



<b>GEV No.</b>	371122	<b>Ref. No.</b>	0249688 418017 EL0249688 H0421
<b>description</b>	solenoid valve filter ø 19mm H 10mm suitable for MÜLLER		
<b>For models:</b>	1011, 1221, 2011, 2021, 611, EB30, EB30XLDIGITAL, EBMS, EDC6-11, ELH101, ELH51, ELH53, ELH61, GENIUS, MAKT, MB, MD1011, MD2011, MD523, MD611, MMC1011, MMC1011G, MMC2011, MMC2021, MMC611, MMD1011, MMD1011G, MMD2011, MMD2021, MMD611		

### RPE

### JOHN GUEST



<b>GEV No.</b>	374113	<b>Ref. No.</b>	EL0508945 EL0508982
<b>description</b>	solenoid valve triple straight inlet 3/4" outlet 10mm output 0.07-0.14l/min t.max. 60°C RPE		

### solenoid valves with reducers

#### 2-fold



<b>GEV No.</b>	374102 <sup>1</sup>	<b>Ref. No.</b>	EL0508944 EL0508981
<b>description</b>	solenoid valve double straight 220-240VAC inlet 3/4" outlet 10mm input 10l/min DN10 RPE output B 0.32-0.42l/min		

<sup>1</sup>cylindrical outlet

#### 3-fold



<b>GEV No.</b>	374113	<b>Ref. No.</b>	EL0508945 EL0508982
<b>description</b>	solenoid valve triple straight inlet 3/4" outlet 10mm output 0.07-0.14l/min t.max. 60°C RPE		

### metal

### M&M

### 2-way

#### D-265/266 series



<b>GEV No.</b>	370041	<b>Ref. No.</b>	436003 E0150 ELE436003
----------------	--------	-----------------	------------------------------

**description** solenoid valve 2-ways 230VAC connection 3/8" L 54mm DN 10.5mm slide-on receptacle DIN -10 up to 130°C M&M type series D-265/266 coil type 7700 membranes FKM (water) p max 16bar

<b>spare parts for</b>	370041			
	<b>GEV No.</b>	371026	<b>Ref. No.</b>	—
solenoid coil M&M 230VAC 18VA 50Hz coil type 7700 seat ø 15mm				

<b>accessories for</b>	370041			
	<b>GEV No.</b>	371090	<b>Ref. No.</b>	—
power socket plug type DIN 43650A screw				



MÜLLER			
2-way			
			
1			
<b>GEV No.</b>	370069 <sup>1</sup>	<b>Ref. No.</b>	024775 374806 436004 436007 436033 436039 436040 754471 E0153 E0157 E436004 E436007 E436033 E436039 EL0024775 EL0374806 EL0436040 EL0754471 ELE436004 ELE436007 ELE436033 ELE436039
<b>description</b>	solenoid valve 2-ways 230VAC inlet 1/8" IT outlet 1/8" IT L 30mm water MÜLLER DN10		
<b>For models:</b>	1011, 1221, 2011, 2021, 611, AUTOCLEAN, EB30, EB30XLDIGITAL, EBM3e-McDonalds, EBM5, EDC6-11, ELH101, ELH51, ELH53, ELH61, GENIUS, GENIUSGAS, MAKT, MB, MD1011, MD2011, MD523, MD611, MMC1011, MMC1011G, MMC2011, MMC2021, MMC611, MMD1011, MMD1011G, MMD2011, MMD2021, MMD611, MULTIMAXB		

<sup>1</sup>with adjusting screw

			
1			
<b>GEV No.</b>	370037 <sup>1</sup>	<b>Ref. No.</b>	E0155
<b>description</b>	solenoid valve 2-ways 230VAC inlet 1/8" IT outlet M16x1 outer steam MÜLLER		

<sup>1</sup>with adjusting screw

Solenoid valve - accessories

filters

			
1			
<b>GEV No.</b>	371122	<b>Ref. No.</b>	0249688 418017 EL0249688 H0421
<b>description</b>	solenoid valve filter ø 19mm H 10mm suitable for MÜLLER		
<b>For models:</b>	1011, 1221, 2011, 2021, 611, EB30, EB30XLDIGITAL, EBM5, EDC6-11, ELH101, ELH51, ELH53, ELH61, GENIUS, MAKT, MB, MD1011, MD2011, MD523, MD611, MMC1011, MMC1011G, MMC2011, MMC2021, MMC611, MMD1011, MMD1011G, MMD2011, MMD2021, MMD611		

			
Image not available			
1			
<b>GEV No.</b>	370863	<b>Ref. No.</b>	502733 889555 EL0502733 EL0508595
<b>description</b>	bracket thread 3/4" for solenoid valve L 100mm brass		

pressure switches for coffee machines

ø 45mm

			
1			
<b>GEV No.</b>	541015	<b>Ref. No.</b>	E0159 E434001 ELE434001
<b>description</b>	pressure control ø 45mm pressure range 400/360mbar pressure range 0.4/0.36bar p max 1.02bar pressure connection vertical coffee machine parts connection 1/4" 1CO suitable for Palux, Bremer pressure connection 1/4"		





for steam control

			
1			
<b>GEV No.</b>	541015	<b>Ref. No.</b>	E0159 E434001 ELE434001
<b>description</b>	pressure control ø 45mm pressure range 400/360mbar pressure range 0.4/0.36bar p max 1.02bar pressure connection vertical coffee machine parts connection 1/4" 1CO suitable for Palux, Bremer pressure connection 1/4"		

for combi-steamers

			
1			
<b>GEV No.</b>	541526	<b>Ref. No.</b>	772305 784028 E320083 EL0784028 ELE320083
<b>description</b>	pressure control p max 0.5bar pressure connection 1/8"		
<b>For models:</b>	1011, 1221, 2011, 2021, 611, AUTOCLEAN, GENIUS, GENIUS6-11, GENIUS6-11GAS, GENIUSGAS, MAKT, MB, MULTIMAXB		

import

			
1			
<b>GEV No.</b>	601080 <sup>1</sup>	<b>Ref. No.</b>	693456 E390024 EL0693456 ELE390024
<b>description</b>	axial fan L 119mm W 119mm H 38mm 230VAC 50/60Hz 23/20W bearing ball bearing connection male faston 2.8mm metal ADDA fan wheel ø 110mm temp.-resist. 70°C		
<b>For models:</b>	1011, 2011, 611, EB30, EB30XLDIGITAL, GENIUS, JOKERB, JOKERC, MAKT, MB		
<b>accessories for</b>	601080		
	<b>GEV No.</b>	550898	<b>Ref. No.</b> —
	connecting cable cable length 2000mm connection F 2.8 connection distance 7.9mm for axial flow fan		
	<b>GEV No.</b>	692519	<b>Ref. No.</b> —
	guard L 120mm W 120mm plastic		

<sup>1</sup>with ball bearings

cross flow fans

COPREL

with standard coil

			
1			
<b>GEV No.</b>	601032	<b>Ref. No.</b>	573469 E390023 EL0573469 ELE390023
<b>description</b>	cross flow fan COPREL TFL(FN) roller ø 60mm roller length 180mm laminated core thickness 15mm motor position left 230V/50Hz 19W bearing rubber connection male faston 6.3mm coil type airflow 107m <sup>3</sup> /h -10 up to +60°C refrigeration		
<b>For models:</b>	1221, 2011, AUTOCLEAN, GENIUS, GENIUSGAS, MULTIMAXA, MULTIMAXB		

fans

axial fans

ebm-papst

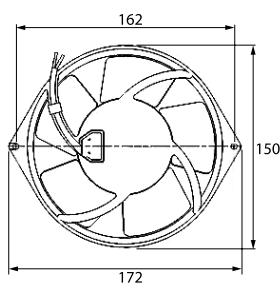
			
1			
			
<b>GEV No.</b>	601806 <sup>1</sup>	<b>Ref. No.</b>	0503226 EL0503226
<b>description</b>	axial fan L 172mm W 150mm H 55mm 230VAC 50/60Hz 45/39W bearing ball bearing connection cable 300mm manuf. no. W2S130-AB03-15 ebm-papst		

<sup>1</sup>with ball bearings



1

<b>GEV No.</b>	601452	<b>Ref. No.</b>	573469
<b>description</b>	cross flow fan TFL 180 roller ø 60mm roller length 180mm laminated core thickness 20mm motor position left 230V/50Hz 19W universal bearing silicone connection male faston 6.3mm airflow 100m <sup>3</sup> /h -30 up to +100°C 230V 50Hz		
<b>For models:</b>	1011, 1221, 2011, 2021, 611, GENIUS, MAKT, MB		

hot air motors



1

<b>GEV No.</b>	510675	<b>Ref. No.</b>	373621 E412037 EL0373621 ELE412037
<b>description</b>	counterflange for fan motor ED ø 60mm int. ø 230mm thickness 5mm stainless steel		
<b>For models:</b>	1011, 1221, 2011, 2021, 611, AUTOCLEAN, GENIUS, GENIUS6-11, GENIUS6-11GAS, GENIUSGAS, MAKT, MB, MULTIMAXA, MULTIMAXB		

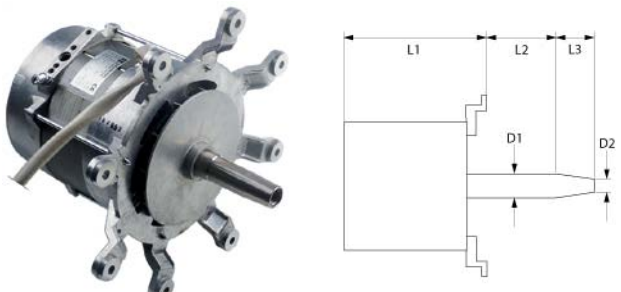

1

<b>GEV No.</b>	500171	<b>Ref. No.</b>	E390012 ELE390012 M0129
<b>description</b>	fan motor		
<b>For models:</b>	MD1011, MD2011, MMD1011, MMD2011, MMD2021		

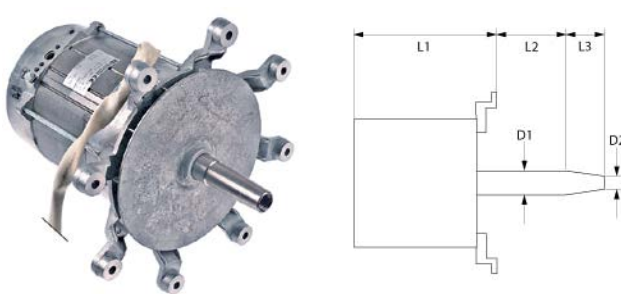

1

<b>GEV No.</b>	500172	<b>Ref. No.</b>	E390053 ELE390053
<b>description</b>	fan motor 220-240/380-415V 3 phase 50Hz 1kW 1400rpm speeds 1 L1 220mm L2 34mm L3 31mm M12R IT 4.5/2.6A power input 1350W at 50Hz 1400rpm type L9FGw4D-363 no. N7 D1 ø 23mm D2 ø 20mm		

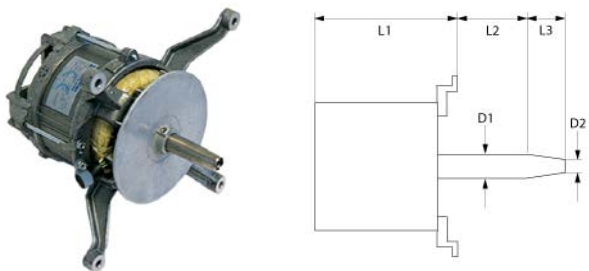

1

<b>GEV No.</b>	500102	<b>Ref. No.</b>	332410 E390019 EL0332410 ELE390019 M0155
<b>description</b>	fan motor 230-240V 1 phase 50Hz 0.09kW 1390rpm speeds 1 L1 150mm L2 32mm L3 27mm ø 125mm M10R IT 1.1A suitable capacitor 4µF/400V power input 200W at 50Hz 1390rpm type L7yzw4B-207 no. X5 D1 ø 17mm D2 ø 14mm		
<b>For models:</b>	MD1011, MD611, MMD1011, MMD611		

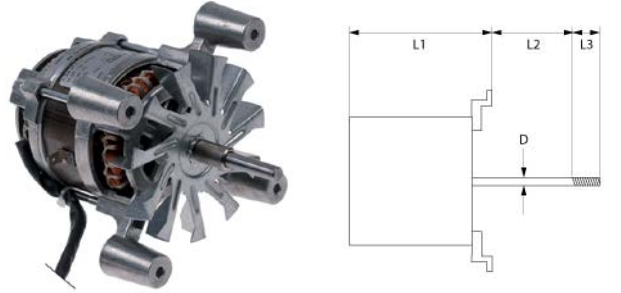

1

<b>GEV No.</b>	601474	<b>Ref. No.</b>	693286 E390033 EL0693286 ELE390033	
<b>description</b>	fan motor 230V 1 phase 50/60Hz 0.03kW 3600rpm speeds 1 L1 115mm L2 20mm L3 32mm ø 12mm shaft flat length 23mm 7.5/8 0.35/0.56A suitable capacitor 3µF400V power input 75/125W at 50Hz 3600rpm type L5ow2B-317 no. W9			
<b>For models:</b>	EB30, EB30XLDIGITAL, JOKERB, JOKERC			
<b>accessories for</b>	601474			
	<b>GEV No.</b>	602166	<b>Ref. No.</b>	0693375 E392020 EL0693375 ELE392020
	fan wheel blades 9 D1 ø 175mm D2 ø 8mm D3 ø 8mm H1 30mm H2 28mm ED 6-23			

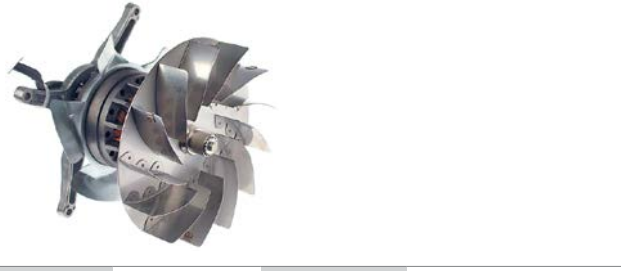

1

<b>GEV No.</b>	601871	<b>Ref. No.</b>	302821 EL0302821 EL302821
<b>description</b>	fan motor 230V 1 phase 50Hz 85kW 2400rpm speeds 1 L1 85mm L2 40mm L3 33mm L4 133.5mm fan wheel ø 180mm at 50Hz 230V at 60Hz 230V at 50Hz 2600rpm at 60Hz 2850rpm type R2E180-AU01-09		
<b>For models:</b>	ELH-3		

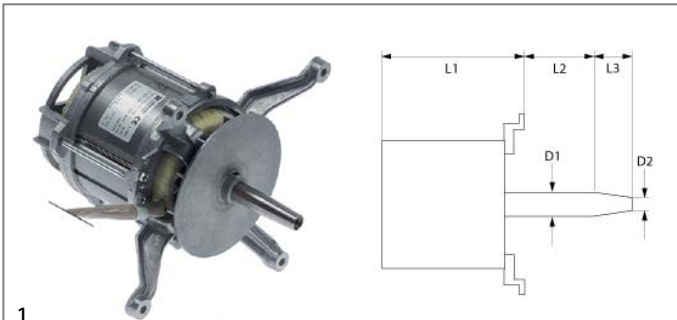

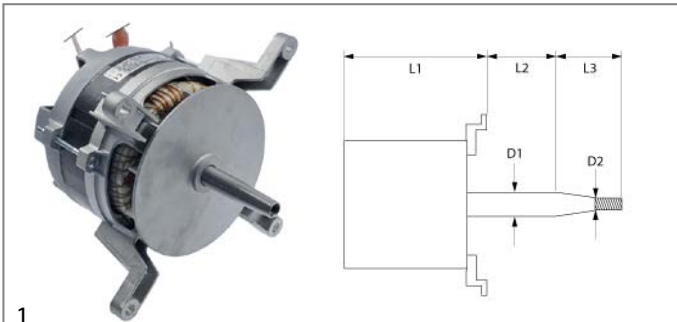

<b>GEV No.</b>	500170	<b>Ref. No.</b>	580287 E390052 EL0580287 ELE390052
<b>description</b>	fan motor 3 phase		



<b>GEV No.</b>	601864	<b>Ref. No.</b>	509846 742740 EL0509846
<b>description</b>	fan motor 380-415V 3 phase 50Hz 0.21kW 700/1400rpm speeds 2 L1 160mm L2 25mm L3 40mm D1 ø 17mm D2 ø 13mm M10R IT at 50Hz 700/1400rpm type 3081DH4052		
<b>For models:</b>	1011, 2011, 611, AUTOCLEAN, GENIUS, GENIUS6-11, MAKT, MB, MULTIMAXB		



<b>GEV No.</b>	602166	<b>Ref. No.</b>	0693375 E392020 EL0693375 ELE392020	
<b>description</b>	fan wheel blades 9 D1 ø 175mm D2 ø 8mm D3 ø 8mm H1 30mm H2 28mm ED 6-23			
<b>For models:</b>	JOKERB, JOKERC			
<b>accessories for</b>	602166			
	<b>GEV No.</b>	601474	<b>Ref. No.</b>	693286 E390033 EL0693286 ELE390033
<b>description</b>	fan motor 230V 1 phase 50/60Hz 0.03kW 3600rpm speeds 1 L1 115mm L2 20mm L3 32mm ø 12mm shaft flat length 23mm 7.5/8 0.35/0.56A suitable capacitor 3µF400V power input 75/125W at 50Hz 3600rpm type L5ow2B-317 no. W9			



<b>GEV No.</b>	602168	<b>Ref. No.</b>	E390077 EL0899992 ELE390077
<b>description</b>	fan wheel for motor cooling ED ø 180mm H 20mm ID ø 25mm		
<b>For models:</b>	1011, 1221, 2011, 2021, 611, AUTOCLEAN, GENIUS, GENIUS6-11, GENIUS6-11GAS, GENIUSGAS, MULTIMAXA, MULTIMAXB		





<b>GEV No.</b>	510673	<b>Ref. No.</b>	580600 E412089 EL0580600 ELE412089
<b>description</b>	flange for fan motor ED ø 60mm int. ø 143mm int. ø 229mm thickness 6mm stainless steel		
<b>For models:</b>	1011, 1221, 2011, 2021, 611, AUTOCLEAN, GENIUS, GENIUS6-11, GENIUS6-11GAS, GENIUSGAS, MAKT, MB, MULTIMAXA, MULTIMAXB		



<b>GEV No.</b>	503149	<b>Ref. No.</b>	E427010 ELE427010 H0312
<b>description</b>	gasket fibre for fan motor ID ø 32mm ED ø 60mm thickness 1mm with 4 screw holes		
<b>For models:</b>	MD1011, MD2011, MD523, MD611, MMD1011, MMD2011, MMD2021, MMD611		



<b>GEV No.</b>	500106	<b>Ref. No.</b>	E390006 ELE390006 M0120	
<b>description</b>	hot air fan 230V 1 phase 50Hz 0.12kW 2600rpm speeds 1 L1 100mm L2 34mm L3 33mm L4 178mm power input 115W 0.51A fan wheel ø 180mm at 50Hz 230V at 60Hz 230V at 50Hz 2600rpm at 60Hz 2850rpm suitable capacitor 3µF400V type R2E180-AH05-06			
<b>For models:</b>	MD523			
<b>accessories for</b>	500106			
	<b>GEV No.</b>	100021	<b>Ref. No.</b>	—
<b>description</b>	female faston size 2.8x0.8mm 0.5-1.0mm <sup>2</sup> CuZn t.max. 125°C Qty 20 pcs			
	<b>GEV No.</b>	365028	<b>Ref. No.</b>	—
<b>description</b>	operating capacitor capacity 3µF 450V tolerance 5% 50/60Hz ambient temperature max. -25 to +85°C ø 35.5mm L 75mm M8 plastic connection male faston 6.3mm protection			





1 			
<b>GEV No.</b>	694997	<b>Ref. No.</b>	782939 E316025 EL0782939 ELE316025
<b>description</b>	speed sensor for hot air motors cable length 450mm		
<b>For models:</b>	1011, 1221, 2011, 2021, 611, AUTOCLEAN, GENIUS, GENIUS6-11, GENIUS6-11GAS, GENIUSGAS, MAKT, MB, MULTIMAXA, MULTIMAXB		

hot air fans

ebm-papst

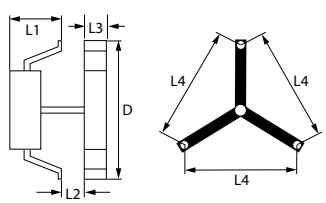
1 			
			
<b>GEV No.</b>	601059	<b>Ref. No.</b>	E390021 ELE390021 W0320
<b>description</b>	hot air fan 220-230V 36W 0.26A L1 60mm L2 10mm L3 20mm L4 87mm fan wheel ø 150mm type R2K150-AN27-17 ebm-papst		

motors

gear motors

for drink dispensers

1 			
<b>GEV No.</b>	499156	<b>Ref. No.</b>	781894
<b>description</b>	gear motor FIBER type G025J0BCD86 230V 50/60Hz 4rpm shaft ø 5x6mm L 15mm motor type M51BJ0R6400		
<b>For models:</b>	EB30, EB30XLDIGITAL		

for combi-steamers

1 			
<b>GEV No.</b>	502293	<b>Ref. No.</b>	2002236 EL2002236
<b>description</b>	gear motor SYNCHRONOUS MOTOR type 60SM60-63-S 14W 230V voltage AC 50/60Hz 20/40rpm shaft ø 6x5mm L 82mm W 60mm H 60mm kit		

pumps

vibration pumps

1 			
<b>GEV No.</b>	499010	<b>Ref. No.</b>	501313 772550 E434022 EL0501313 EL0772550 ELE434022
<b>description</b>	vibration pump type E512/B46 230V 60W 50/60Hz inlet ø 7 outlet ø 1/8" IT CEME L 125mm		
<b>For models:</b>	1011, 1221, 2011, 2021, 611, AUTOCLEAN, GENIUS, GENIUS6-11, GENIUS6-11GAS, GENIUSGAS, MB, MULTIMAXA, MULTIMAXB		

condensators & interference suppression filters

operating capacitors

metal

1 			
<b>GEV No.</b>	365191	<b>Ref. No.</b>	EL0693480 ELE308035
<b>description</b>	operating capacitor capacity 3µF 400V tolerance 5% 60Hz ambient temperature max. -40 up to +85°C ø 30mm L 85mm M8 aluminium connection cable 400mm MLR25L40303063		





			
1			
<b>GEV No.</b>	365002	<b>Ref. No.</b>	292753 E0454 E308007 EL0292753 ELE308007
<b>description</b>	operating capacitor capacity 4µF 400V tolerance 5% 50/60Hz ambient temperature max. -25 to +85°C ø 30mm L 75mm with cable M8 aluminium connection cable 300mm MKP protection IP65		
<b>For models:</b>	MD611, MMD611		

## fuses

## fine fuses

			
1			
<b>GEV No.</b>	358532	<b>Ref. No.</b>	190756 E0173 E375007 EL0190756 ELE375007
<b>description</b>	fine fuse size ø5x20mm 2A fast-acting rated 250V Qty 10 pcs		
<b>For models:</b>	1011, 1221, 2011, 2021, 611, AUTOCLEAN, GENIUS, GENIUS6-11, GENIUS6-11GAS, GENIUSGAS, JOKERC, MAKT, MB, MD1011, MD2011, MD611, MMD1011, MMD2011, MMD2021, MMD611, MULTIMAXA, MULTIMAXB		

			
1			
<b>GEV No.</b>	358699	<b>Ref. No.</b>	572047 E0168 E375004 EL0572047 ELE375004
<b>description</b>	fine fuse size ø5x20mm 10A medium lag rated 250V Qty 10 pcs		
<b>For models:</b>	JOKERC, MD2011, MMD1011, MMD2011, MMD2021, MMD611, WU14		

			
1			
<b>GEV No.</b>	358697	<b>Ref. No.</b>	E0167 E375003 ELE375003
<b>description</b>	fine fuse size ø5x20mm 6.3A medium lag rated 250V Qty 10 pcs		

			
1			
<b>GEV No.</b>	358608	<b>Ref. No.</b>	578975 EL0578975
<b>description</b>	fine fuse size ø5x20mm 10A slow-acting rated 250V Qty 10 pcs		
<b>For models:</b>	1011, 1221, 2011, 2021, 611, GENIUS, MAKT, MB		

## fine fuse holders

			
1			
<b>GEV No.</b>	358049	<b>Ref. No.</b>	751847 E0965 E373028 EL0751847 ELE373028
<b>description</b>	fuse holder		
<b>For models:</b>	1221, 2011, 2021, AUTOCLEAN, GENIUS, MAKT, MB, MD2011, MMD2011, MMD2021, MULTIMAXA, MULTIMAXB		

			
1			
<b>GEV No.</b>	550105	<b>Ref. No.</b>	326941 E0345 E373009 EL0326941 ELE373009
<b>description</b>	rail-mounted terminal WIELAND type WK10/SIU 5X20 /V0 suitable fuse ø5x20mm 1.0-16mm <sup>2</sup> 10A rated 250V		
<b>For models:</b>	1011, 1221, 2011, 2021, 611, AUTOCLEAN, GENIUS, GENIUS6-11, GENIUS6-11GAS, GENIUSGAS, JOKERB, JOKERC, MAKT, MB, MD1011, MD2011, MD611, MMD2011, MMD2021, MULTIMAXA, MULTIMAXB, MULTIMAXB6-11AUTOCLEAN, WU14		

## screw locks

## D0-system (NEOZED)

			
1			
<b>GEV No.</b>	358043	<b>Ref. No.</b>	658294 E0974 E375015 EL0658294 ELE375015
<b>description</b>	fuse size D01 16A rated 250/400V E14 ø 11mm L 36mm Qty 10 pcs		
<b>For models:</b>	1221, 2021, AUTOCLEAN, GENIUS, MB, MD2011, MMD2011, MMD2021, MULTIMAXB		



 <p>1</p>			
<b>GEV No.</b>	358045	<b>Ref. No.</b>	751863 E0970 E375013 EL0751863 ELE375013
<b>description</b>	fuse size D02 35A rated 250/400V E18 ø 15mm L 36mm Qty 10 pcs		
<b>For models:</b>	2011, AUTOCLEAN, GENIUS, MAKT, MB, MD2011, MMD2011, MMD2021, MULTIMAXA, MULTIMAXB		

 <p>1</p>			
<b>GEV No.</b>	358046	<b>Ref. No.</b>	658286 E0969 E375012 EL0658286 ELE375012
<b>description</b>	fuse size D02 50A rated 250/400V E18 ø 15mm L 36mm Qty 10 pcs		
<b>For models:</b>	1221, 2021, AUTOCLEAN, GENIUS, MB, MD2011, MMD2011, MMD2021, MULTIMAXB		

gauge pieces (NEOZED)			
 <p>1</p>			
<b>GEV No.</b>	358064	<b>Ref. No.</b>	658308 E0976 E373023 EL0658308
<b>description</b>	gauge piece size D02 suitable for 16A		
<b>For models:</b>	1221, 2021, AUTOCLEAN, GENIUS, MB, MD2011, MMD2011, MMD2021, MULTIMAXB		

 <p>1</p>			
<b>GEV No.</b>	358067	<b>Ref. No.</b>	751855 E0972 E373021 EL0751855 ELE373021
<b>description</b>	gauge piece size D02 suitable for 35A		
<b>For models:</b>	2011, AUTOCLEAN, GENIUS, MAKT, MB, MD2011, MMD2011, MMD2021, MULTIMAXA, MULTIMAXB		

 <p>1</p>			
<b>GEV No.</b>	358068	<b>Ref. No.</b>	658278 E0971 E373020 ELE373020
<b>description</b>	gauge piece size D02 suitable for 50A		
<b>For models:</b>	1221, 2021, AUTOCLEAN, GENIUS, MB, MD2011, MMD2011, MMD2021, MULTIMAXB		

## electric accessories

### terminals

#### rail-mounted terminals

#### WIELAND

#### fuse terminal blocks

 <p>1</p>			
<b>GEV No.</b>	550105	<b>Ref. No.</b>	326941 E0345 E373009 EL0326941 ELE373009
<b>description</b>	rail-mounted terminal WIELAND type WK10/SIU 5X20 /V0 suitable fuse ø5x20mm 1.0-16mm <sup>2</sup> 10A rated 250V		
<b>For models:</b>	1011, 1221, 2011, 2021, 611, AUTOCLEAN, GENIUS, GENIUS6-11, GENIUS6-11GAS, GENIUSGAS, JOKERB, JOKERC, MAKT, MB, MD1011, MD2011, MD611, MMD2011, MMD2021, MULTIMAXA, MULTIMAXB, MULTIMAXB6-11AUTOCLEAN, WU14		

#### accessories

 <p>1</p>			
<b>GEV No.</b>	550337	<b>Ref. No.</b>	327514 E0346 E371009 EL0327514 ELE371009
<b>description</b>	end barrier for fuse terminal clampsmm <sup>2</sup>		
<b>For models:</b>	1011, 1221, 2011, 2021, 611, AUTOCLEAN, EB30, EB30XLDIGITAL, GENIUS, GENIUS6-11, GENIUS6-11GAS, GENIUSGAS, JOKERB, JOKERC, MAKT, MB, MD1011, MD2011, MD611, MMD2011, MMD2021, MULTIMAXA, MULTIMAXB, MULTIMAXB6-11AUTOCLEAN, WU14		



## gas valves and ignition boxes

### gas control valves

#### HONEYWELL



1			
<b>GEV No.</b>	106206	<b>Ref. No.</b>	744050 E434020 EL0744050 ELE434020
<b>description</b>	gas valve type VK4115V 220-240V 50/60Hz gas inlet flange 32x32mm gas outlet flange 32x32mm thermocouple connection pilot connection pressure range 15-60mbar max 60mbar operator type HONEYWELL flange 32x32mm		
<b>For models:</b>	1011, 1221, 2011, 2021, 611, AUTOCLEAN, GENIUS, GENIUS6-11 GAS, GENIUSGAS		
<b>accessories for</b>	106206		
	GEV No.	102845	Ref. No. —
	GEV No.	102846	Ref. No. —

#### SIT

#### NOVASIT



1			
<b>GEV No.</b>	101540	<b>Ref. No.</b>	371424 E434008 EL0371424 ELE434008 G0900
<b>description</b>	gas valve SIT series Novasit 822 230V 50Hz gas inlet 1/2" gas outlet 1/2" thermocouple connection pilot connection closed ignition pressure 3-5mbar pressure range 3-30mbar pressure regulator connection blind equiv. no. 0.822.113		
<b>spare parts for</b>	101540		
	GEV No.	101313	Ref. No. —
	GEV No.	101542	Ref. No. —

<b>accessories for</b>	101540		
	GEV No.	101305	Ref. No. —
	GEV No.	101306	Ref. No. —
	GEV No.	101307	Ref. No. —
	GEV No.	101308	Ref. No. —
	GEV No.	101317	Ref. No. —
	GEV No.	101503	Ref. No. —
	GEV No.	101924	Ref. No. —

### ignition boxes

#### HONEYWELL



1			
<b>GEV No.</b>	101166	<b>Ref. No.</b>	371416 E340001 EL0371416 ELE340001 G0901
<b>description</b>	ignition box HONEYWELL type S4560B 1006 electrodes 1 waiting time 0s safety time 10s 220-240V 10VA 50Hz		

#### miscellaneous





1			
<b>GEV No.</b>	107936	<b>Ref. No.</b>	EL0506522
<b>description</b>	ignition box PACTROL suitable for ELOMA electrodes 1 waiting time 1s safety time 5s 230V 50/60Hz		





## ignition parts

### electrodes

			
1			
<b>GEV No.</b>	108151	<b>Ref. No.</b>	EL0507496
<b>description</b>	gasket igniter L 22.5mm W 15.5mm thickness 2mm graphite		

			
1			
<b>GEV No.</b>	699472	<b>Ref. No.</b>	0507495 0507997 0874833 EL0507495 EL0507997 EL0874833
<b>description</b>	gasket ignition electrode ID ø 13mm hole ø 6mm L 60mm W 22mm suitable for ELOMA graphite		

			
1			
<b>GEV No.</b>	107890	<b>Ref. No.</b>	507184 EL0507184
<b>description</b>	ignition electrode flange length 24mm flange width 20mm D1 ø 7mm L1 45mm L2 70mm BL1 35mm BL2 22mm connection F6.3 cable length 450mm mounting distance 9mm		

							
1							
<b>GEV No.</b>	106996	<b>Ref. No.</b>	874787 EL0874787				
<b>description</b>	ignition electrode flange length 60mm flange width 22mm D1 ø 9mm L1 17mm L2 45mm L3 6mm L4 34/10mm BL1 37mm BL2 32mm cable length 350mm connection ø 4mm						
<b>For models:</b>	1011, 2011, 611, GENIUS						
<b>accessories for</b>	106996						
		<table border="1"> <tr> <td><b>GEV No.</b></td> <td>699472</td> <td><b>Ref. No.</b></td> <td>0507495 0507997 0874833 EL0507495 EL0507997 EL0874833</td> </tr> </table>	<b>GEV No.</b>	699472	<b>Ref. No.</b>	0507495 0507997 0874833 EL0507495 EL0507997 EL0874833	
<b>GEV No.</b>	699472	<b>Ref. No.</b>	0507495 0507997 0874833 EL0507495 EL0507997 EL0874833				
	gasket ignition electrode ID ø 13mm hole ø 6mm L 60mm W 22mm suitable for ELOMA graphite						

			
1			
<b>GEV No.</b>	107889	<b>Ref. No.</b>	5071833 EL0507183
<b>description</b>	ignition electrode flange length 60mm flange width 22mm D1 ø 9mm L1 33mm L2 45mm L3 6mm L4 45/7mm BL1 29mm BL2 28mm connection ø4mm cable length 350mm mounting distance 50mm		

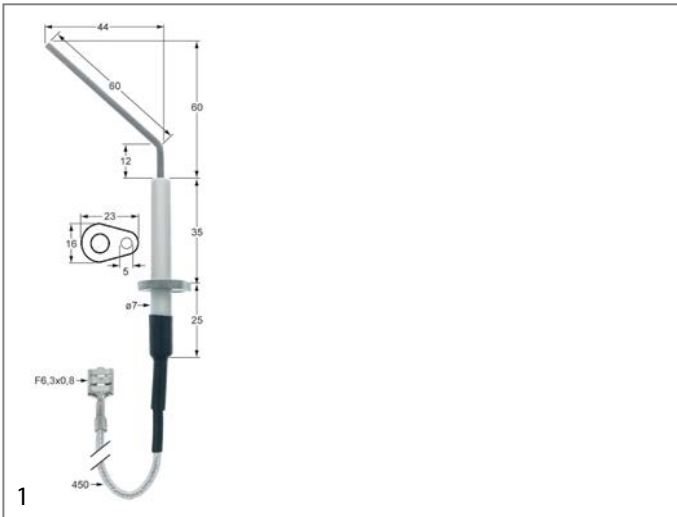

<b>GEV No.</b>	106997	<b>Ref. No.</b>	874906 EL0874906
<b>description</b>	monitoring electrode connection $\varnothing$ F6.3mm flange length 23mm flange width 16mm D1 $\varnothing$ 7mm L1 60mm L2 44mm L4 12mm L3 60mm BL1 35mm BL2 25mm connection F6.3x0.8 cable length 450mm fixing dimensions $\varnothing$ 5mm		
<b>For models:</b>	1011, 2011, 611, GENIUS		

### ignition units



<b>GEV No.</b>	107533	<b>Ref. No.</b>	EL0874892
<b>description</b>	ignition unit outputs 2 230VAC dimensions 85x63x38mm mounting distance 60mm inlet F2.8x0.8 outlet $\varnothing$ 4mm type EB14 60VA 50/60Hz secondary 15KV		

### thermocouples

#### plug-in thermocouples

#### plug-in thermocouples standard

#### with barrel socket $\varnothing$ 5mm - type Junkers with aluminised tip

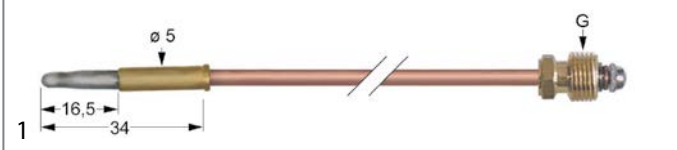

<b>GEV No.</b>	102216	<b>Ref. No.</b>	E316012 ELE316012 G0686
<b>description</b>	thermocouple M10x1 L 1500mm plug connection $\varnothing$ 5.0mm		

### gas nozzles

#### pilot burner nozzles

#### pilot burner nozzles JUNKERS

#### CB 50203\_/503\_ series



<b>GEV No.</b>	100222	<b>Ref. No.</b>	E438019 ELE438019 X0342
<b>description</b>	pilot burner nozzle LPG gas pressure 50mbar code 5 Qty 1 pcs suitable for JUNKERS CB50203_		

### auxiliary gas parts

#### consumables

#### thread sealants



<b>GEV No.</b>	890058	<b>Ref. No.</b>	593567
<b>description</b>	thread sealing LOCTITE 511 liquid bottle 50ml		
<b>description</b>	LOCTITE® 511™ - bottle 50ml It is designed for the locking and sealing of metal threaded pipes and fittings. The product cures rapidly when confined in the absence of air between close fitting metal surfaces.		
<b>For models:</b>	1011, 1221, 2011, 2021, 611, EB30, EB30XLDIGITAL, GENIUS, MAKT, MB		

### equipment-specific units

#### for dough mixers

#### chains

#### connectors



<b>GEV No.</b>	697069	<b>Ref. No.</b>	395021 E395021 ELE395021
<b>description</b>	connector single DIN/ISO 06 B-1 splitting 3/8" links 1 L 17.8mm internal width 8.8mm roller $\varnothing$ 3mm metal		



for convection ovens/combi-steamers

1  Image not available

<b>GEV No.</b>	692909	<b>Ref. No.</b>	782432 EL0782432
<b>description</b>	bushing for door hinge H 7mm plastic D1 ø 18mm D2 ø 12mm ID ø 10mm		

1  Image not available

<b>GEV No.</b>	692910	<b>Ref. No.</b>	E401038 EL0563420 EL0568945
<b>description</b>	bushing for door hinge L 8mm ø 8mm ID ø 6mm		

injection pipes

1 

<b>GEV No.</b>	692838	<b>Ref. No.</b>	753793 EL0753793 ELE442262
<b>description</b>	injection pipe for combi-steamer straight ED ø 12mm ID ø 8mm L 180mm -		
<b>For models:</b>	1011, 2011, 611, GENIUS, MB		

1 

<b>GEV No.</b>	692839	<b>Ref. No.</b>	442263 743267
<b>description</b>	injection pipe for combi-steamer U-shape ED ø 12mm ID ø 10mm L 265mm		
<b>For models:</b>	1011, 2011, 611, AUTOCLEAN, GENIUS, GENIUS6-11, GENIUS6-11GAS, GENIUSGAS, MAKT, MB, MULTIMAXB		

cleaning system

coupling bushings

1 

<b>GEV No.</b>	501591	<b>Ref. No.</b>	0753890 E440154 EL0753890 ELE440154
<b>description</b>	hose connector stainless steel hose ø 10/13mm M9 for cleaning system combi-steamer		

cleaning arms

1 

<b>GEV No.</b>	542416	<b>Ref. No.</b>	0775177 E600647 EL0775177 ELE600647
<b>description</b>	mounting flange ø 55mm hub with gasket for wash arm suitable for ELOMA combi-steamer		

drip water trays

1 

<b>GEV No.</b>	699837	<b>Ref. No.</b>	783331 EL0783331 ELE474094
<b>description</b>	drip tray with grip fixing L 530mm W 52mm H 25mm		
<b>For models:</b>	1011, 611, GENIUS, MAKT, MB		

1 

<b>GEV No.</b>	699269	<b>Ref. No.</b>	0781177 EL0781177
<b>description</b>	plug H 10mm ø 20mm		

1 

<b>GEV No.</b>	699270	<b>Ref. No.</b>	0781185 EL0781185
<b>description</b>	spring L 65mm W 32.5mm H 28mm		

door mechanics

miscellaneous



1			
<b>GEV No.</b>	692909	<b>Ref. No.</b>	782432 EL0782432
<b>description</b>	bushing for door hinge H 7mm plastic D1 ø 18mm D2 ø 12mm ID ø 10mm		



1			
<b>GEV No.</b>	692910	<b>Ref. No.</b>	E401038 EL0563420 EL0568945
<b>description</b>	bushing for door hinge L 8mm ø 8mm ID ø 6mm		

door bumpers



1			
<b>GEV No.</b>	694922	<b>Ref. No.</b>	0886726 407079 EL0886726 ELE407079
<b>description</b>	rubber pad ø 11.5mm H 19mm rubber		

locking mechanism



1			
<b>GEV No.</b>	692714	<b>Ref. No.</b>	0791652 EL0791652
<b>description</b>	disc for catch ø 44mm hole ø 6x8mm		



1			
<b>GEV No.</b>	692716	<b>Ref. No.</b>	588504 980080 E380093 EL0588504 EL0980080 ELE380093
<b>description</b>	door catch with switch L 140mm W 25mm H 63mm hole distance 120mm ID ø 12mm		
<b>For models:</b>	JOKERB, JOKERC		



1			
<b>GEV No.</b>	692715	<b>Ref. No.</b>	775061 888575 EL0775061 EL0888575
<b>description</b>	sleeve ø 50mm L 72mm W 59mm H 31mm hole distance 60mm ID ø 37mm		
<b>For models:</b>	1011, 2011, 611, AUTOCLEAN, GENIUS, GENIUS6-11, GENIUS6-11GAS, GENIUSGAS, MAKT, MB, MULTIMAXA, MULTIMAXB		

accessories



1			
<b>GEV No.</b>	699836	<b>Ref. No.</b>	0569593 E407059 EL0569593
<b>description</b>	plug for door W 32mm plastic L 50mm		

vibration pumps



1			
<b>GEV No.</b>	499010	<b>Ref. No.</b>	501313 772550 E434022 EL0501313 EL0772550 ELE434022
<b>description</b>	vibration pump type E512/B46 230V 60W 50/60Hz inlet ø 7 outlet ø 1/8" IT CEME L 125mm		
<b>For models:</b>	1011, 1221, 2011, 2021, 611, AUTOCLEAN, GENIUS, GENIUS6-11, GENIUS6-11GAS, GENIUSGAS, MB, MULTIMAXA, MULTIMAXB		

miscellaneous



1			
<b>GEV No.</b>	696857	<b>Ref. No.</b>	427060 566594 EL0566594 ELE427060
<b>description</b>	boot L 42mm D1 ø 12mm D2 ø 36mm		
<b>For models:</b>	1011, 1221, 2011, 2021, 611, GENIUS, MAKT, MB		







Image not available

<b>GEV No.</b>	692915	<b>Ref. No.</b>	E442044 EL0213500 ELE442044 H0448
<b>description</b>	injection pipe double L 192mm D1 ø 8mm D2 ø 6mm WS 19 hole ø 10mm		



<b>GEV No.</b>	692306	<b>Ref. No.</b>	213519 442042 EL0213519 ELE442042 H0446
<b>description</b>	pipe long D1 ø 10mm D2 ø 6mm L 134mm WS 19 thread 3/8"		
<b>For models:</b>	EBM5, EDC6-11, ELH101, ELH51, ELH53, ELH61, MD2011, MMC2011, MMC2021, MMD2011, MMD2021		

for pizza ovens

firebricks



<b>GEV No.</b>	850022	<b>Ref. No.</b>	E450029 ELE450029 P0210
<b>description</b>	bottom plate L 495mm W 495mm H 16mm pizza oven for ELP500		

knobs

universal knobs



<b>GEV No.</b>	110235	<b>Ref. No.</b>	E0322
<b>description</b>	knob energy regulator 1-3 t.max.°C ø 50mm shaft ø 6x4.6mm shaft flat upper black		



<b>GEV No.</b>	110253	<b>Ref. No.</b>	301086 E0337 E365018 EL0301086 ELE365018
<b>description</b>	knob switch zero mark t.max.°C ø 50mm shaft ø 6x4.6mm shaft flat upper black		



<b>GEV No.</b>	110241	<b>Ref. No.</b>	E0340 E365020 ELE365020
<b>description</b>	knob thermostat t.max. 110°C ø 50mm shaft ø 6x4.6mm shaft flat upper black temperature range 30-110°C		

producer-specific knobs

ELOMA





<b>GEV No.</b>	110235	<b>Ref. No.</b>	E0322
<b>description</b>	knob energy regulator 1-3 t.max.°C ø 50mm shaft ø 6x4.6mm shaft flat upper black		





<b>GEV No.</b>	110253	<b>Ref. No.</b>	301086 E0337 E365018 EL0301086 ELE365018
<b>description</b>	knob switch zero mark t.max.°C ø 50mm shaft ø 6x4.6mm shaft flat upper black		

			
1			
<b>GEV No.</b>	111499	<b>Ref. No.</b>	332658 E0314 E365003 EL0332658 ELE365003
<b>description</b>	knob switch zero mark t.max.°C ø 52mm shaft ø 6x4mm shaft flat upper black/red		
<b>For models:</b>	MD1011, MD2011, MD523, MD611		



			
1			
<b>GEV No.</b>	111498	<b>Ref. No.</b>	743690 E365086 EL0743690 ELE365086
<b>description</b>	knob t.max.°C ø 48mm shaft ø 6.5mm shaft flat blue		
<b>For models:</b>	1011, 1221, 2011, 2021, 611, AUTOCLEAN, GENIUS, MAKT, MB, MULTIMAXA, MULTIMAXB, MULTIMAXB6-11AUTOCLEAN		
<b>accessories for</b>	111498		
		<b>GEV No.</b>	111510
		<b>Ref. No.</b>	748781 E365087 EL0748781 ELE365087
	lid t.max.°C ø 37mm shaft ømm shaft flat silver for knob ELOMA		

			
1			
<b>GEV No.</b>	110241	<b>Ref. No.</b>	E0340 E365020 ELE365020
<b>description</b>	knob thermostat t.max. 110°C ø 50mm shaft ø 6x4.6mm shaft flat upper black temperature range 30-110°C		

			
1			
<b>GEV No.</b>	112877	<b>Ref. No.</b>	EL0504699 EL0748668
<b>description</b>	knob kit ø 40mm shaft ø 6.3mm		

			
1			
<b>GEV No.</b>	111510	<b>Ref. No.</b>	748781 E365087 EL0748781 ELE365087
<b>description</b>	lid t.max.°C ø 37mm shaft ømm shaft flat silver for knob ELOMA		
<b>For models:</b>	1011, 1221, 2011, 2021, 611, AUTOCLEAN, GENIUS, GENIUS6-11, GENIUS6-11GAS, GENIUSGAS, MAKT, MB, MULTIMAXA, MULTIMAXB, MULTIMAXB6-11AUTOCLEAN		
<b>accessories for</b>	111510		
		<b>GEV No.</b>	111498
		<b>Ref. No.</b>	743690 E365086 EL0743690 ELE365086
	knob t.max.°C ø 48mm shaft ø 6.5mm shaft flat blue		

accessories

			
1			
<b>GEV No.</b>	111510	<b>Ref. No.</b>	748781 E365087 EL0748781 ELE365087
<b>description</b>	lid t.max.°C ø 37mm shaft ømm shaft flat silver for knob ELOMA		
<b>For models:</b>	1011, 1221, 2011, 2021, 611, AUTOCLEAN, GENIUS, GENIUS6-11, GENIUS6-11GAS, GENIUSGAS, MAKT, MB, MULTIMAXA, MULTIMAXB, MULTIMAXB6-11AUTOCLEAN		
<b>accessories for</b>	111510		
		<b>GEV No.</b>	111498
		<b>Ref. No.</b>	743690 E365086 EL0743690 ELE365086
	knob t.max.°C ø 48mm shaft ø 6.5mm shaft flat blue		

locks

turning lever locks

			
1			
<b>GEV No.</b>	699268	<b>Ref. No.</b>	588458 E410046 EL0588458
<b>description</b>	bolt L 19mm H 10mm SS		
<b>For models:</b>	JOKERB, JOKERC		



electromagnetic closer

 <p>1</p>			
<b>GEV No.</b>	701439	<b>Ref. No.</b>	EL0503973
<b>description</b>	door catch 24V voltage DC L 134mm W 28mm H 40mm SS with connecting cable		
<b>spare parts for</b>	701439		
	<b>GEV No.</b>	692216	<b>Ref. No.</b>
	electromagnetic closer 24V voltage DC L 104mm W 24mm H 34mm series 8440		

 <p>1</p>			
<b>GEV No.</b>	692596	<b>Ref. No.</b>	EL0503607
<b>description</b>	electromagnetic closer 24V voltage DC L 104mm W 24mm H 34mm		

handle latches

producer-specific



ELOMA

 <p>1</p>			
<b>GEV No.</b>	692714	<b>Ref. No.</b>	0791652 EL0791652
<b>description</b>	disc for catch ø 44mm hole ø 6x8mm		

 <p>1</p>			
<b>GEV No.</b>	694067	<b>Ref. No.</b>	747998 E380120 EL0747998 ELE380120
<b>description</b>	door catch with spigot 1-stage L 26mm total length 51mm thread M8		
<b>For models:</b>	1011, 2011, 611, GENIUS, GENIUS6-11, GENIUS6-11GAS, GENIUSGAS, MAKT, MB, MULTIMAXA, MULTIMAXB		



 <p>1</p>			
<b>GEV No.</b>	694254	<b>Ref. No.</b>	758272 E380122 EL0758272 ELE380122
<b>description</b>	door catch with spigot 2-stage L 36mm total length 60mm thread M8 thread L 25mm mounting pos. hinged at left		
<b>For models:</b>	1011, 2011, 611, AUTOCLEAN, GENIUS, GENIUS6-11, GENIUS6-11GAS, GENIUSGAS, MAKT, MB, MULTIMAXB		

 <p>1</p>			
<b>GEV No.</b>	694253	<b>Ref. No.</b>	758264 E380121 EL0758264 ELE380121
<b>description</b>	door catch with spigot 2-stage L 36mm total length 60mm thread M8 thread L 25mm mounting pos. hinged at right		
<b>For models:</b>	1011, 2011, 611, AUTOCLEAN, GENIUS, GENIUS6-11, GENIUS6-11GAS, GENIUSGAS, MAKT, MB, MULTIMAXB		

 <p>1</p>			
<b>GEV No.</b>	692847	<b>Ref. No.</b>	0782505 365152 EL0782505 ELE365152
<b>description</b>	door handle combi-steamer hinged at left L 100mm W 55mm H 35mm handle ø 35mm blue suitable for ELOMA		
<b>accessories for</b>	692847		
	<b>GEV No.</b>	692848	<b>Ref. No.</b>
	 <p>spring for door handle hinged at left combi-steamer suitable for ELOMA ED ø 15mm L 44/11mm spring thickness 1.6mm</p>		

 <p>1</p>			
<b>GEV No.</b>	692744	<b>Ref. No.</b>	758388 E365106 EL0758388 ELE365106
<b>description</b>	door handle hinged at left blue		
<b>For models:</b>	1011, 611, AUTOCLEAN, GENIUS, GENIUS6-11, GENIUS6-11GAS, GENIUSGAS, MAKT, MB, MULTIMAXA, MULTIMAXB		

			
1			
<b>GEV No.</b>	691990	<b>Ref. No.</b>	748765 E365091 EL0748765 ELE365091
<b>description</b>	door handle hinged at right L 155mm W 60mm H 58mm spring length 53mm blue mounting distance 40mm mounting thread M4		
<b>For models:</b>	1011, 611, AUTOCLEAN, GENIUS, GENIUS6-11, GENIUS6-11GAS, GENIUSGAS, MAKT, MB, MULTIMAXA, MULTIMAXB		
<b>accessories for</b>	691990		
			
<b>GEV No.</b>	111510	<b>Ref. No.</b>	748781 E365087 EL0748781 ELE365087
lid t.max. °C 37mm shaft ømm shaft flat silver for knob ELOMA			

			
1			
<b>GEV No.</b>	691988	<b>Ref. No.</b>	749532 EL0749532
<b>description</b>	door handle L 155mm W 60mm H 58mm spring length 53mm blue mounting distance 40mm spring thickness 3mm		
<b>For models:</b>	2011, AUTOCLEAN, GENIUS, GENIUSGAS, MULTIMAXA, MULTIMAXB		
<b>accessories for</b>	691988		
			
<b>GEV No.</b>	111510	<b>Ref. No.</b>	748781 E365087 EL0748781 ELE365087
lid t.max. °C 37mm shaft ømm shaft flat silver for knob ELOMA			

			
1			
<b>GEV No.</b>	692848	<b>Ref. No.</b>	0783382 EL0783382
<b>description</b>	spring for door handle hinged at left combi-steamer suitable for ELOMA ED ø 15mm L 44/11mm spring thickness 1.6mm		



			
1			
<b>GEV No.</b>	692849	<b>Ref. No.</b>	0783390 416078 EL0783390 ELE416078
<b>description</b>	spring for door handle hinged at right combi-steamer suitable for ELOMA ED ø 15mm L 44/11mm spring thickness 1.6mm		

			
1			
<b>GEV No.</b>	514450	<b>Ref. No.</b>	791504 EL0791504
<b>description</b>	spring for door handle ø 6mm L 61mm W 27.5mm		

edgmount latches

handle latches

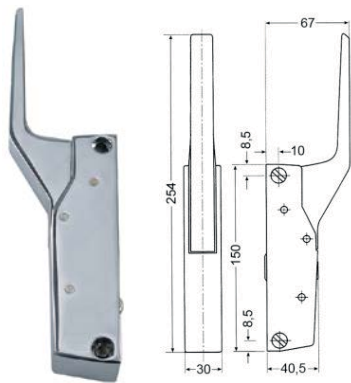
CAFF/FERMOD

			
1			
<b>GEV No.</b>	700060	<b>Ref. No.</b>	377732 E380010 EL0377732 ELE380010 H0195
<b>description</b>	handle latch L 150mm mounting distance 133mm non lockable heated units G 791		
<b>For models:</b>	MD1011, MD523, MD611, MMD1011, MMD611		
<b>accessories for</b>	700060		
			
<b>GEV No.</b>	700061	<b>Ref. No.</b>	382825 382833 E380011 E380012 E598001 EL0382825 ELE380012 ELE598001 H0196 H0197 V0603
door catch L 58mm W 20mm H 35mm mounting distance 42mm chrome-plated brass for headed units			
			
<b>GEV No.</b>	700062	<b>Ref. No.</b>	292532 E407029 EL0292532 ELE407029 K0443
handle protection heated units			

RAHRBACH

6188 ERGO series

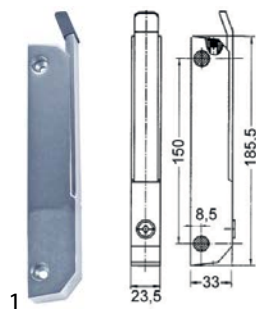

<b>GEV No.</b>	690808	<b>Ref. No.</b>	565458 B0280 E380002 EL0565458
<b>description</b>	handle latch L 185mm mounting distance 150mm chrome-plated non lockable for headed units 6188 type ERGO		
<b>For models:</b>	WU14		
<b>accessories for</b>	690808		
	<b>GEV No.</b>	690110	<b>Ref. No.</b> —
	base plate H 1mm L 38mm W 11mm mounting distance 26mm plastic		
	<b>GEV No.</b>	690111	<b>Ref. No.</b> —
	base plate H 2mm L 38mm W 11mm mounting distance 26mm plastic		
	<b>GEV No.</b>	690114	<b>Ref. No.</b> —
	base plate H 3.5mm L 185mm W 30mm mounting distance 150mm with inclination thread M5		
	<b>GEV No.</b>	700082	<b>Ref. No.</b> —
	door catch L 38mm W 18mm mounting distance 26mm		

magnetic locks

miscellaneous



<b>GEV No.</b>	701660	<b>Ref. No.</b>	EL0037265 EL0510585
<b>description</b>	magnetic lock L 56mm mounting distance 46mm white RALY-6		

door catches



<b>GEV No.</b>	700061	<b>Ref. No.</b>	382825 382833 E380011 E380012 E598001 EL0382825 ELE380012 ELE598001 H0196 H0197 V0603
<b>description</b>	door catch L 58mm W 20mm H 35mm mounting distance 42mm chrome-plated brass for headed units		
<b>For models:</b>	MD1011, MD523, MD611, MMD1011, MMD611		
<b>accessories for</b>	700061		
	<b>GEV No.</b>	690414	<b>Ref. No.</b> —
	handle latch L 150mm mounting distance 133mm non lockable refrigeration units G 791		

walk-in fridge catches

STUV

3.31.015x.x series



<b>GEV No.</b>	700072	<b>Ref. No.</b>	000043 E380015 EL0000043 ELE380015 H0201
<b>description</b>	door catch H 17mm L 84mm W 53mm mounting distance 68mm zinc die cast with wedge heated units		
<b>For models:</b>	MD2011, MMD2011, MMD2021		



<b>GEV No.</b>	700071	<b>Ref. No.</b>	030732 E380014 EL0030732 ELE380014 H0200
<b>description</b>	snap lock H 58mm L 87mm W 64mm mounting distance 68mm		
<b>For models:</b>	MD2011, MMD2011, MMD2021		

snap locks

producer-specific

ELOMA

 <p>1</p>		<p>380075 587125 593516 E380046 E380072 EL0587125 EL0593516 ELE380046 ELE380072</p>	
<b>GEV No.</b>	701303	<b>Ref. No.</b>	
<b>description</b>	door catch for convection oven L 140mm W 26mm H 65mm		
<b>For models:</b>	EB30, EB30XLDIGITAL, EDB 6-23		

miscellaneous

 <p>Image not available</p> <p>1</p>		<p>EL0037265 EL0510585</p>	
<b>GEV No.</b>	701660	<b>Ref. No.</b>	
<b>description</b>	magnetic lock L 56mm mounting distance 46mm white RALY-6		

door bearing

 <p>1</p>		<p>E382017 EL0569178</p>	
<b>GEV No.</b>	692688	<b>Ref. No.</b>	
<b>description</b>	hinge L 78mm W 40mm H 5mm mounting distance 21mm mounting pos. lower bolt 12mm bolt ø 6mm		
<b>For models:</b>	JOKERB, JOKERC		

 <p>1</p>		<p>E382016 EL0565601</p>	
<b>GEV No.</b>	692687	<b>Ref. No.</b>	
<b>description</b>	hinge L 78mm W 40mm H 5mm mounting distance 21mm mounting pos. upper bolt 12mm bolt ø 6mm		
<b>For models:</b>	JOKERB, JOKERC		

 <p>1</p>		<p>EL0502734</p>	
<b>GEV No.</b>	692689	<b>Ref. No.</b>	
<b>description</b>	hinge repair set		

accessories

bushes



 <p>Image not available</p> <p>1</p>		<p>782432 EL0782432</p>	
<b>GEV No.</b>	692909	<b>Ref. No.</b>	
<b>description</b>	bushing for door hinge H 7mm plastic D1 ø 18mm D2 ø 12mm ID ø 10mm		

 <p>Image not available</p> <p>1</p>		<p>E401038 EL0563420 EL0568945</p>	
<b>GEV No.</b>	692910	<b>Ref. No.</b>	
<b>description</b>	bushing for door hinge L 8mm ø 8mm ID ø 6mm		

hinges

edgemount hinges

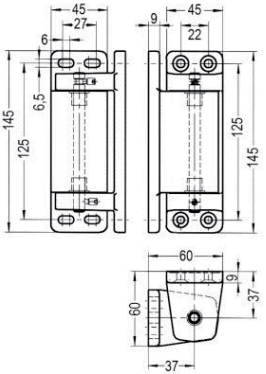
STUV

 <p>1</p>			<p>000051 E382006 EL0000051 ELE382006 H0198</p>
<b>GEV No.</b>	700073	<b>Ref. No.</b>	
<b>description</b>	edgemount hinge L 145mm W 45mm mounting distance 125mm hinging left/right without lift centre of rotation 37mm zinc die cast, chrome-plated refrigeration units		
<b>For models:</b>	MD2011, MMD2011, MMD2021		
<b>accessories for</b>	700073		
	<b>GEV No.</b>	<b>Ref. No.</b>	—
	690310		
 <p>base plate for 4000/4001 series thickness 5mm</p>			



miscellaneous



<b>GEV No.</b>	694994	<b>Ref. No.</b>	0875023 EL0875023
<b>description</b>	locking disc for hinge ID ø 12mm ED ø 30mm plastic		

**pullouts**

rollers

rollers

accessories



<b>GEV No.</b>	560133	<b>Ref. No.</b>	EL0251887
<b>description</b>	hexagonal nut thread M6 H 5mm WS 10 SS DIN/ISO DIN 934 / ISO 4032/8673 Qty 20 pcs		

**equipment feet and end caps**

end caps and plugs

for square pipes



<b>GEV No.</b>	696728	<b>Ref. No.</b>	E407057 EL0568929
<b>description</b>	plug rectangular mounting measurements 31x28mm plastic		
<b>For models:</b>	JOKERB, JOKERC		

**DERBY RUOTE**

spare parts and accessories

miscellaneous



<b>GEV No.</b>	560193	<b>Ref. No.</b>	0349771 EL0349771
<b>description</b>	tooth lock washer ID ø 10.4mm ED ø 18mm zinc-coated steel DIN/ISO DIN 6798A Qty 1 pcs for thread M10		

**gaskets**

**gaskets for heated units**

window seals

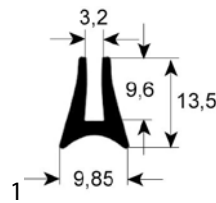

<b>GEV No.</b>	900110	<b>Ref. No.</b>	215961 425041 E425041 EL0215961 ELE425041 H0515
<b>description</b>	window gasket profile 1590 Qty supplied by meter		
<b>For models:</b>	EBM5, ELH101, ELH51, ELH61, MD1011, MD2011, MD611, MMC1011, MMC1011G, MMC611, MMD1011, MMD1011G, MMD2011, MMD2021, MMD611		

door seals

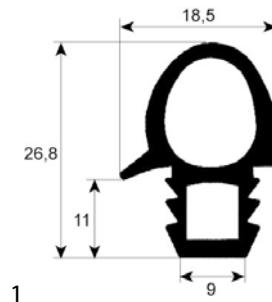

<b>GEV No.</b>	900100	<b>Ref. No.</b>	384410 425030 E425030 EL0384410 ELE425030 H0497
<b>description</b>	door seal profile 2070 W 460mm L 645mm external size Qty 1 6 x 1/1		
<b>For models:</b>	EDC6-11, MD611, MMC611, MMD611		

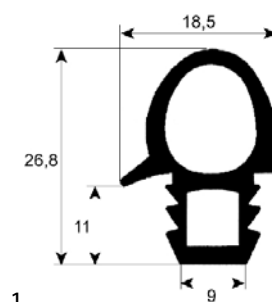

<b>GEV No.</b>	900101	<b>Ref. No.</b>	382310 E425033 EL0382310 ELE425033 H0502
<b>description</b>	door seal profile 2070 W 645mm L 700mm external size Qty 1 10 x 1/1		

<b>GEV No.</b>	900204	<b>Ref. No.</b>	E425056 ELE425056
<b>description</b>	door seal profile 2448 W 710mm L 1470mm external size Qty 1		

<b>GEV No.</b>	900203	<b>Ref. No.</b>	E425090 ELE425090
<b>description</b>	door seal profile 2448 W 730mm L 980mm external size Qty 1		

<b>GEV No.</b>	900865	<b>Ref. No.</b>	742368 E425198 EL0742368 ELE425198
<b>description</b>	door seal profile 2449 W 490mm L 520mm Qty 1		
<b>For models:</b>	611, GENIUS, GENIUS6-11, GENIUS6-11GAS, MAKT, MB, MULTIMAXB6-11AUTOCLEAN		

<b>GEV No.</b>	901483	<b>Ref. No.</b>	200021 742384 E425200 EL0742384 ELE425200
<b>description</b>	door seal profile 2449 W 520mm L 1505mm Qty 1		
<b>For models:</b>	2011, GENIUS, MAKT, MB		

<b>GEV No.</b>	900497	<b>Ref. No.</b>	742376 E425199 EL0742376 ELE425199
<b>description</b>	door seal profile 2449 W 520mm L 775mm Qty 1		
<b>For models:</b>	1011, GENIUS, MAKT, MB		

<b>GEV No.</b>	901490	<b>Ref. No.</b>	742406 E425202 EL0742406 ELE425202
<b>description</b>	door seal profile 2449 W 690mm L 1550mm Qty 1		
<b>For models:</b>	1221, 2021, AUTOCLEAN, GENIUS, MB, MULTIMAXB		

<b>GEV No.</b>	900498	<b>Ref. No.</b>	425121 425166 693219 E425166 EL0693219 ELE425166
<b>description</b>	door seal profile 2515 perimeter 1670mm Qty 1		
<b>For models:</b>	EBM3e-McDonalds, EDB 6-23, JOKERB, JOKERC		





<b>GEV No.</b>	901277	<b>Ref. No.</b>	E425207 ELE425207
<b>description</b>	door seal profile 2690 L 2275mm		

<b>GEV No.</b>	901821	<b>Ref. No.</b>	425127 E425208 ELE425208
<b>description</b>	door seal profile 2690 L 2920mm		

<b>GEV No.</b>	902491	<b>Ref. No.</b>	0501645 EL0501645
<b>description</b>	door seal profile 2710 L 1555mm suitable for ELOMA closed		

<b>GEV No.</b>	900050	<b>Ref. No.</b>	131385 425060 E425031 EL0131385 ELE425031 ELE425060 H0500
<b>description</b>	door seal profile 2710 Qty supplied by meter		
<b>For models:</b>	EB30, EB30XLDIGITAL, ELH61, MD1011, MD523, MD611, MMD1011, MMD611, WU14		

<b>GEV No.</b>	902505	<b>Ref. No.</b>	2000214 EL2000214
<b>description</b>	door seal profile 2736 W 510mm L 1487mm outer plug size Qty 1 suitable for ELOMA 20-11		

<b>GEV No.</b>	902507	<b>Ref. No.</b>	2000212 EL2000212
<b>description</b>	door seal profile 2736 W 510mm L 484mm outer plug size Qty 1 suitable for ELOMA 6-11		

<b>GEV No.</b>	902504	<b>Ref. No.</b>	2000213 EL2000213
<b>description</b>	door seal profile 2736 W 510mm L 763mm outer plug size Qty 1 suitable for ELOMA 10-11		

<b>GEV No.</b>	902506	<b>Ref. No.</b>	2000216 EL2000216
<b>description</b>	door seal profile 2736 W 685mm L 1535mm outer plug size Qty 1 suitable for ELOMA 20-21		

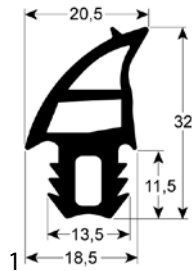

<b>GEV No.</b>	902492	<b>Ref. No.</b>	2000215 742392 E425201 EL0742392 EL2000215 ELE425201
<b>description</b>	door seal profile 2736 W 695mm L 1000mm outer plug size Qty 1 suitable for ELOMA 12-21 silicone		
<b>For models:</b>	1221, 2021, AUTOCLEAN, GENIUS, MB, MULTIMAXB		

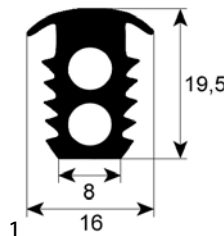

<b>GEV No.</b>	901298	<b>Ref. No.</b>	693200 E425113 EL0693200 ELE425113
<b>description</b>	door seal profile 2775 Qty supplied by meter		
<b>For models:</b>	JOKERB, JOKERC		

**gaskets for tray rack trolleys**



<b>GEV No.</b>	900199	<b>Ref. No.</b>	549207 E425062 EL0549207 ELE425062
<b>description</b>	tray rack trolley gasket profile 4070 L 1000mm Qty 1		
<b>For models:</b>	1011, 1221, 2021, 611, GENIUS, MAKT, MB		

**gaskets for control panels**



<b>GEV No.</b>	902493	<b>Ref. No.</b>	0742309 E425194 EL0742309 ELE425194
<b>description</b>	gasket for control panel W 220mm L 890mm suitable for ELOMA for combi-steamer with 8 mounting clips		



<b>GEV No.</b>	902556	<b>Ref. No.</b>	EL0742295 ELE425193
<b>description</b>	gasket for control panel W 225mm L 635mm suitable for ELOMA for combi-steamer with 6 mounting clips		

**O-rings**

**EPDM**

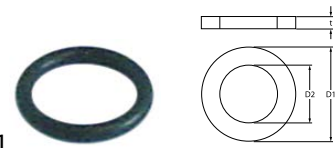

<b>GEV No.</b>	504574	<b>Ref. No.</b>	013471 E425026 EL0013471 ELE425026 H0403
<b>description</b>	O-ring EPDM thickness 1.78mm ID ø 9.25mm Qty 1 pcs		
<b>For models:</b>	1011, 1221, 2011, 2021, 611, AUTOCLEAN, GENIUS, GENIUS6-11, GENIUS6-11GAS, GENIUSGAS, MD1011, MD2011, MD523, MD611, MMD1011, MMD2011, MMD611, MULTIMAXA, MULTIMAXB		

**silicone**



<b>GEV No.</b>	532726	<b>Ref. No.</b>	577642 E425153 EL0577642 ELE425153
<b>description</b>	O-ring silicone thickness 1.5mm ID ø 17mm Qty 10 pcs		
<b>For models:</b>	JOKERB, JOKERC		

**Viton**



<b>GEV No.</b>	510579	<b>Ref. No.</b>	581410 E425066 EL0581410 ELE425066
<b>description</b>	O-ring Viton thickness 2.62mm ID ø 34.6mm Qty 1 pcs		
<b>For models:</b>	1011, 1221, 2011, 2021, 611, AUTOCLEAN, GENIUS, GENIUS6-11, GENIUS6-11GAS, GENIUSGAS, MAKT, MB, MULTIMAXA, MULTIMAXB		



			
<b>GEV No.</b>	529357	<b>Ref. No.</b>	753742 E425183 EL0753742 ELE425183
<b>description</b>	O-ring Viton thickness 3.53mm ID ø 23.4mm Qty 1 pcs		
<b>For models:</b>	1011, 1221, 2011, 2021, 611, AUTOCLEAN, GENIUS, GENIUS6-11, GENIUS6-11GAS, GENIUSGAS, MB, MULTIMAXB		

<p>NBR</p> 			
<b>GEV No.</b>	532735	<b>Ref. No.</b>	0503932 425185 E425185 EL0503932 ELE425185
<b>description</b>	O-ring NBR 70 thickness 1mm ID ø 6mm		
<b>For models:</b>	JOKERB		



sealing washers

copper gaskets

DIN-7603-A

			
<b>GEV No.</b>	528433	<b>Ref. No.</b>	097071 217840 E427020 E427039 EL0097071 EL0217840 EL0571849 ELE427020 ELE427039 R0300
<b>description</b>	flat gasket copper ED ø 14mm ID ø 10mm thickness 1mm		
<b>For models:</b>	1011, 1221, 2011, 2021, 611, AUTOCLEAN, GENIUS, GENIUS6-11, GENIUS6-11GAS, GENIUSGAS, MAKT, MB, MD1011, MD523, MD611, MMD611, MULTIMAXA, MULTIMAXB, WU14		

PTFE gaskets

			
<b>GEV No.</b>	518669	<b>Ref. No.</b>	0373079 EL0373079
<b>description</b>	gasket PTFE ED ø 21mm ID ø 15mm thickness 3.5mm		
<b>accessories for</b>	518669		
	<b>GEV No.</b>	375889	<b>Ref. No.</b>
			504602 E336029 EL0504602 ELE336029
<b>description</b>	safety thermostat switch-off temp. 360°C 1-pole 16A probe ø 15mm probe L 6.5mm capillary pipe 1140mm capillary pipe isolated 1100mm gland nut probe		

silicone gaskets

			
<b>GEV No.</b>	359721	<b>Ref. No.</b>	425132 693421 976024 E0556 E425005 E425132 EL0976024 ELE425005 ELE425132
<b>description</b>	gasket silicone ED ø 48mm ID ø 39.5mm thickness 5mm Qty 1 pcs		
<b>For models:</b>	EBM3e-McDonalds, JOKERB, JOKERC		

special gaskets

for combi-steamers

			
<b>GEV No.</b>	699835	<b>Ref. No.</b>	E425011 EL0307025
<b>description</b>	gasket external height 18mm ED ø 65mm ID ø 56mm		



			
<b>GEV No.</b>	699472	<b>Ref. No.</b>	0507495 0507997 0874833 EL0507495 EL0507997 EL0874833
<b>description</b>	gasket ignition electrode ID ø 13mm hole ø 6mm L 60mm W 22mm suitable for ELOMA graphite		

			
1			
<b>GEV No.</b>	699471	<b>Ref. No.</b>	0507494 0874876 EL0507494 EL0874876
<b>description</b>	gasket suitable for ELOMA for model Genius T 6-11 10-11 for burner chamber L 108mm W 100mm graphite combi-steamer		

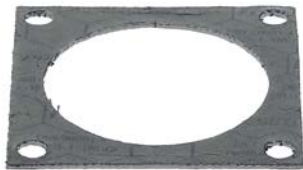
			
1			
<b>GEV No.</b>	699470	<b>Ref. No.</b>	0505956 874841 EL0505956 EL0874841
<b>description</b>	gasket suitable for ELOMA for model Genius T 6-11 10-11 for radial fan L 65mm W 82mm for combi-steamer ID ø 25mm graphite thickness 1.7mm		
<b>For models:</b>	1011, 1221, 2011, 2021, 611, GENIUS		

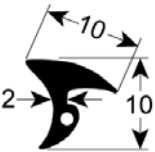
			
1			
<b>GEV No.</b>	699469	<b>Ref. No.</b>	0505953 874868 EL0505953 EL0874868
<b>description</b>	gasket suitable for ELOMA for model Genius T 6-11 10-11 L 64mm W 64mm for combi-steamer ID ø 50mm graphite thickness 1.7mm		
<b>For models:</b>	1011, 1221, 2011, 2021, 611, GENIUS		

			
1			
<b>GEV No.</b>	560648	<b>Ref. No.</b>	0584096 E425133 EL0584096 ELE425133
<b>description</b>	gasket suitable for ELOMA L 1000mm Qty 1m for combi-steamer		
<b>For models:</b>	JOKERB, JOKERC		

			
1			
<b>GEV No.</b>	518669	<b>Ref. No.</b>	0373079 EL0373079
<b>description</b>	gasket PTFE ED ø 21mm ID ø 15mm thickness 3.5mm		
<b>accessories for</b>	518669		
			
<b>GEV No.</b>	375889	<b>Ref. No.</b>	504602 E336029 EL0504602 ELE336029
<b>description</b>	safety thermostat switch-off temp. 360°C 1-pole 16A probe ø 15mm probe L 6.5mm capillary pipe 1140mm capillary pipe isolated 1100mm gland nut probe		

## transmission technology and ball bearings

### chains

#### connectors

			
1			
<b>GEV No.</b>	697069	<b>Ref. No.</b>	395021 E395021 ELE395021
<b>description</b>	connector single DIN/ISO 06 B-1 splitting 3/8" links 1 L 17.8mm internal width 8.8mm roller ø 3mm metal		

## springs

### torsion springs

			
Image not available			
1			
<b>GEV No.</b>	692908	<b>Ref. No.</b>	E416030 ELE416030
<b>description</b>	torsion spring hinged at right ø 35mm L2 13mm wire gauge ø 2.5mm mounting pos. for door handle L1 13mm L3 13mm Qty 1 pcs		
<b>For models:</b>	EDC 20/11		





			
1			
<b>GEV No.</b>	692523	<b>Ref. No.</b>	897531 E416055 E416073 EL0897531 ELE416055 ELE416073
<b>description</b>	torsion spring ø 27.8mm ID ø 21.7mm L2 44mm wire gauge ø 3mm L1 13mm L3 44mm Qty 1 pcs		
<b>For models:</b>	1221, 2021, AUTOCLEAN, GENIUS, MB, MULTIMAXB		

 <p>Image not available</p>			
1			
<b>GEV No.</b>	692911	<b>Ref. No.</b>	EL0791520
<b>description</b>	torsion spring ø 27mm wire gauge ø 2.3mm mounting pos. door handle L1 11mm Qty 1 pcs		

miscellaneous

			
1			
<b>GEV No.</b>	514450	<b>Ref. No.</b>	791504 EL0791504
<b>description</b>	spring for door handle ø 6mm L 61mm W 27.5mm		

tension springs

			
1			
<b>GEV No.</b>	700030	<b>Ref. No.</b>	416002 527343 EL0527343 ELE416002 G0195
<b>description</b>	tension spring ø 12.9mm total length 187mm wire gauge ø 2.1mm		
			
1			
<b>GEV No.</b>	700031	<b>Ref. No.</b>	514586 EL0514586 G0197
<b>description</b>	tension spring ø 15mm total length 290mm wire gauge ø 2.3mm		

			
1			
<b>GEV No.</b>	700032	<b>Ref. No.</b>	G0199
<b>description</b>	tension spring ø 24.8mm total length 220mm wire gauge ø 3.2mm		

			
1			
<b>GEV No.</b>	700033	<b>Ref. No.</b>	G0201
<b>description</b>	tension spring ø 30mm total length 300mm wire gauge ø 4.1mm		

manometers

			
1			
<b>GEV No.</b>	541979	<b>Ref. No.</b>	224758 E348009 EL0224758 ELE348009 H0376
<b>description</b>	manometer ø 40mm pressure range 0-4bar connection at the rear in the centre thread 1/8"		
<b>For models:</b>	1011, 1221, 2011, 2021, 611, AUTOCLEAN, GENIUS, GENIUS6-11, GENIUS6-11GAS, GENIUSGAS, MAKT, MB, MULTIMAXA, MULTIMAXB		

			
1			
<b>GEV No.</b>	542449	<b>Ref. No.</b>	224758
<b>description</b>	manometer ø 40mm pressure range 0-6bar connection at the rear in the centre thread 1/8"		

hose reels and spray guns

spray guns

			
1			
<b>GEV No.</b>	548636	<b>Ref. No.</b>	EL0393002
<b>description</b>	spray gun 1/2" ET L 250mm		
<b>spare parts for</b>	548636		
		<b>GEV No.</b>	540457
		<b>Ref. No.</b>	—
		pressure pin ø 10mm D1 ø 18mm L 48.7mm with spring for spray gun edition ab 03/2016	
		<b>GEV No.</b>	549970
		<b>Ref. No.</b>	—
		pressure pin ø 10mm D1 ø 18mm L 50.2mm with spring for spray gun	



1

<b>GEV No.</b>	540301	<b>Ref. No.</b>	587583 E250059 EL0587583 EL0783404 ELE250059
<b>description</b>	spray gun for appliances 1/2" ET L 128mm		
<b>For models:</b>	1011, 1221, 2011, 2021, 611, AUTOCLEAN, GENIUS, GENIUS6-11, GENIUS6-11GAS, GENIUSGAS, JOKERB, JOKERC, MAKT, MB, MULTIMAXA, MULTIMAXB, MULTIMAXB6-11AUTOCLEAN		
<b>accessories for</b>	540301		
 <b>GEV</b> Image not available	<b>GEV No.</b>	530922	<b>Ref. No.</b> EL0504696 ELE444057
shower hose connections 1/2" L 800mm SS for combi-steamer			



1

<b>GEV No.</b>	540158	<b>Ref. No.</b>	393002 A0460 E250004 EL0393002 ELE250004
<b>description</b>	spray gun for appliances 1/2" ET type ECHTERMANN		



1

<b>GEV No.</b>	530922	<b>Ref. No.</b>	EL0504696 ELE444057
<b>description</b>	shower hose connections 1/2" L 800mm SS for combi-steamer		
<b>accessories for</b>	530922		
	<b>GEV No.</b>	540301	<b>Ref. No.</b> 587583 E250059 EL0587583 EL0783404 ELE250059
spray gun for appliances 1/2" ET L 128mm			

hose reels

appliance hose reels



1

<b>GEV No.</b>	545067	<b>Ref. No.</b>	753181 E250103 EL0753181 ELE250103
<b>description</b>	hose reel without spray gun hose length 1.55m		
<b>For models:</b>	1011, 611, AUTOCLEAN, GENIUS, GENIUS6-11, GENIUS6-11GAS, GENIUSGAS, MAKT, MB, MULTIMAXA, MULTIMAXB, MULTIMAXB6-11AUTOCLEAN		

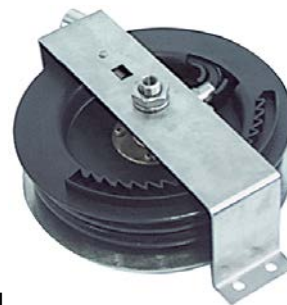

1

<b>GEV No.</b>	540480	<b>Ref. No.</b>	580953 E250069 EL0580953 ELE250069
<b>description</b>	hose reel without spray gun hose length 1.7m		



1

<b>GEV No.</b>	540481	<b>Ref. No.</b>	E250070 ELE250070
<b>description</b>	hose reel without spray gun hose length 2.1m		
<b>accessories for</b>	540481		
	<b>GEV No.</b>	540301	<b>Ref. No.</b> 587583 E250059 EL0587583 EL0783404 ELE250059
spray gun for appliances 1/2" ET L 128mm			



## hoses

### pre-rinse hoses

#### stainless steel spiral tubes



Image not available

<b>GEV No.</b>	530922	<b>Ref. No.</b>	EL0504696 ELE444057
<b>description</b>	shower hose connections 1/2" L 800mm SS for combi-steamer		
<b>accessories for</b>	530922		
	<b>GEV No.</b>	540301	<b>Ref. No.</b>
			587583 E250059 EL0587583 EL0783404 ELE250059
spray gun for appliances 1/2" ET L 128mm			

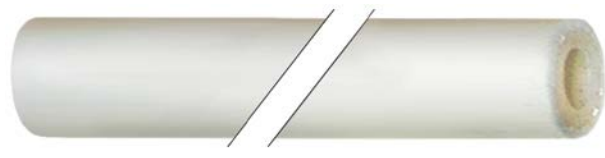
			
<b>GEV No.</b>	520024	<b>Ref. No.</b>	253847 593303 E444013 E444050 EL0253847 EL0593303 ELE444013 ELE444050 K0432
<b>description</b>	silicone hose with glass fibre sleeving ID ø 9.5mm ED ø 17mm L 5m thickness 3.75mm operating p. 4bar burst pressure at 95°C 26bar burst pressure 130°C 14bar t.max. 200°C white		
<b>For models:</b>	1011, 1221, 2011, 2021, 611, AUTOCLEAN, GENIUS, GENIUS6-11, GENIUS6-11GAS, GENIUSGAS, MAKT, MB, MD1011, MD2011, MD523, MD611, MMD1011, MMD2011, MMD2021, MMD611, MULTIMAXA, MULTIMAXB, WU14		

### industrial hoses

#### nylon hoses



<b>GEV No.</b>	520252	<b>Ref. No.</b>	785857 EL0785857
<b>description</b>	nylon hose ID ø 6mm ED ø 8mm L 5m thickness 1mm operating p. 10bar burst p. 50bar t.max. 100°C white		
<b>For models:</b>	1011, 1221, 2011, 2021, 611, GENIUS, MAKT, MB		

## fittings, hose and pipe connectors

### hose connectors

#### miscellaneous



<b>GEV No.</b>	501591	<b>Ref. No.</b>	0753890 E440154 EL0753890 ELE440154
<b>description</b>	hose connector stainless steel hose ø 10/13mm M9 for cleaning system combi-steamer		

### silicone hoses

#### with fabric

#### with glass fibre sleeving

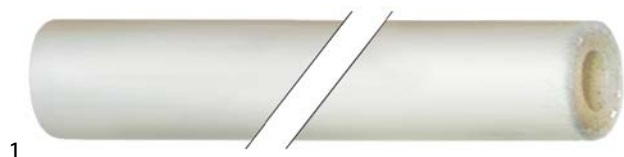

<b>GEV No.</b>	520023	<b>Ref. No.</b>	375500 E444014 EL0375500 ELE444014 K0435
<b>description</b>	silicone hose with glass fibre sleeving ID ø 6mm ED ø 12mm L 5m thickness 3mm operating p. 4bar burst pressure at 95°C 26bar burst pressure 130°C 14bar t.max. 200°C white temp.-resist. max. 200°C		
<b>For models:</b>	MD1011, MD2011, MD523, MD611, MMD1011, MMD2011, MMD2021, MMD611		

### fittings

#### double nipples



<b>GEV No.</b>	520160	<b>Ref. No.</b>	440092 754447 E440156 EL0440092 EL0754447 ELE440156
<b>description</b>	double nipple nickel-plated brass thread 1/8" - 1/8" Qty 1 pcs		
<b>For models:</b>	1011, 1221, 2011, 2021, 611, AUTOCLEAN, EB30, EB30XLDIGITAL, EBMS, EDC6-11, ELH101, ELH61, GENIUS, GENIUS6-11, GENIUS6-11GAS, GENIUSGAS, MAKT, MB, MD1011, MD2011, MD523, MD611, MMC1011, MMC2011, MMC2021, MMC611, MMD1011, MMD2011, MMD2021, MMD611, MULTIMAXA, MULTIMAXB		



			
1			
<b>GEV No.</b>	521187	<b>Ref. No.</b>	570451 E440047 EL0570451 ELE440047 H0654
<b>description</b>	double nipple nickel-plated brass thread 1/8" - 3/8" Qty 1 pcs int. ø 1.5mm int. ø 2.93mm		
<b>For models:</b>	EB30, EB30XLDIGITAL, MD1011, MD2011, MD523, MD611, MMD1011, MMD2011, MMD2021, MMD611		

<b>reducers</b>			
			
1			
<b>GEV No.</b>	520963	<b>Ref. No.</b>	E440039 EL0249696 ELE440039
<b>description</b>	reducer thread 3/4" ET - 3/8" IT nickel-plated brass total length 26.5mm WS 27 Qty 1 pcs		
<b>For models:</b>	1011, 1221, 2011, 2021, 611, AUTOCLEAN, GENIUS, GENIUS6-11, GENIUS6-11GAS, GENIUSGAS, JOKERB, JOKERC, MULTIMAXA, MULTIMAXB		

<b>angle pieces</b>			
			
1			
<b>GEV No.</b>	520824	<b>Ref. No.</b>	773719 E440172
<b>description</b>	angle piece thread 1/8" ET - 1/8" IT nickel-plated brass		
<b>For models:</b>	1011, 1221, 2011, 2021, 611, AUTOCLEAN, EB30, EB30XLDIGITAL, GENIUS, GENIUS6-11, GENIUS6-11GAS, GENIUSGAS, MB, MULTIMAXA, MULTIMAXB		

## water cycle components

### pressure reduction valves

#### pressure reduction valves

#### producer-specific

			
1			
<b>GEV No.</b>	520502	<b>Ref. No.</b>	577316 871419 E0731 E436009 E598198 EL0871419 ELE436009 ELE598198
<b>description</b>	pressure reduction valve Norgren series R91 connection 1/8" default settingbar setting range 0.1-3bar p max 10bar t.max. 50°C brass		
<b>For models:</b>	1011, 1221, 2011, 2021, 611, AUTOCLEAN, GENIUS, GENIUS6-11, GENIUS6-11GAS, GENIUSGAS, JOKERB, JOKERC, MAKT, MB, MULTIMAXA, MULTIMAXB		
<b>accessories for</b>	520502		
	<b>GEV No.</b>	541979	<b>Ref. No.</b>
			224758 E348009 EL0224758 ELE348009 H0376
<b>description</b>	manometer ø 40mm pressure range 0-4bar connection at the rear in the centre thread 1/8"		
	<b>GEV No.</b>	542449	<b>Ref. No.</b>
			224758
<b>description</b>	manometer ø 40mm pressure range 0-6bar connection at the rear in the centre thread 1/8"		

## ancillary products

### thread sealants

			
1			
<b>GEV No.</b>	890058	<b>Ref. No.</b>	593567
<b>description</b>	thread sealing LOCTITE 511 liquid bottle 50ml		
<b>description</b>	LOCTITE® 511™ - bottle 50ml It is designed for the locking and sealing of metal threaded pipes and fittings. The product cures rapidly when confined in the absence of air between close fitting metal surfaces.		
<b>For models:</b>	1011, 1221, 2011, 2021, 611, EB30, EB30XLDIGITAL, GENIUS, MAKT, MB		





silicone

food-grade silicones



<b>GEV No.</b>	890106	<b>Ref. No.</b>	E522026 EL0063096 ELE522026
<b>description</b>	silicone TB40 transparent tube 90g -40 up to +160°C		
<b>description</b>	Tomabond - TB40 - tube 90g - transparent For flexible sealing in drinking water, food, water and industrial kitchen areas. Securely joins glass, metal, wood-based materials, ceramic and plastics with high adhesion (1.1 N/mm <sup>2</sup> ). Fungicide-, algicide- and solvent-free, ageing-resistant. Temperature-resistant from -40 °C to +160 °C Tested and approved by KTW / KSW.		

<b>GEV No.</b>	520070	<b>Ref. No.</b>	276642 E422019 EL0276642 ELE422019 H0285
<b>description</b>	hose clamp SS/brass ø 16-21mm width 11mm Qty 5 pcs		
<b>For models:</b>	1011, 611, GENIUS, MAKT, MB		

<b>GEV No.</b>	520071	<b>Ref. No.</b>	572160 E422020 EL0572160 ELE422020 H0286
<b>description</b>	hose clamp SS/brass ø 17-22mm width 11mm Qty 5 pcs		
<b>For models:</b>	1011, 1221, 2011, 2021, 611, AUTOCLEAN, GENIUS, GENIUS6-11, GENIUS6-11GAS, GENIUSGAS, MB, MULTIMAXA, MULTIMAXB, WU14		

clamps

hose clamps

DIN 3017 - W2



<b>GEV No.</b>	520116	<b>Ref. No.</b>	422007 EL0422007
<b>description</b>	hose clamp ø 32-50mm width 9mm Qty 5 pcs DIN 3017		
<b>For models:</b>	MMC1011, MMC611, MMD1011, MMD611		

<b>GEV No.</b>	520067	<b>Ref. No.</b>	277665 E422017 EL0277665 ELE422017 H0282
<b>description</b>	hose clamp SS/brass ø 9-14mm width 10mm Qty 5 pcs		
<b>For models:</b>	1011, 1221, 2011, 2021, 611, AUTOCLEAN, EB30, EB30XLDIGITAL, GENIUS, GENIUS6-11, GENIUS6-11GAS, GENIUSGAS, MD1011, MD2011, MD523, MD611, MMD1011, MMD2011, MMD2021, MMD611, MULTIMAXA, MULTIMAXB, WU14		

security hose clamps

SS/brass



<b>GEV No.</b>	520069	<b>Ref. No.</b>	276634 E422018 EL0276634 ELE422018 H0284
<b>description</b>	hose clamp SS/brass ø 14-19mm width 11mm Qty 5 pcs		
<b>For models:</b>	1011, 1221, 2011, 2021, 611, AUTOCLEAN, EB30, EB30XLDIGITAL, GENIUS, GENIUS6-11, GENIUS6-11GAS, GENIUSGAS, MAKT, MB, MD1011, MD2011, MD523, MD611, MMD1011, MMD2011, MMD2021, MMD611, MULTIMAXA, MULTIMAXB		

fastening material

screws

sheet metal screws



<b>GEV No.</b>	560104	<b>Ref. No.</b>	EL0011800
<b>description</b>	sheet metal screws ø 3.9mm L 19mm SS Qty 20 pcs DIN 7981/ISO 7049 head ø 7.5mm oval head		

## countersunk screws



1

<b>GEV No.</b>	560450	<b>Ref. No.</b>	ELE500172
<b>description</b>	countersunk screw thread M4 L 8mm SS DIN 965/ISO 7046 Qty 1 pcs intake Phillips head ø 7.3mm		

## flat-headed bolts



1

<b>GEV No.</b>	560491	<b>Ref. No.</b>	162469 E500096 EL0162469 ELE500096 N0206
<b>description</b>	flat-headed bolt thread M3 thread L 16mm stainless steel DIN 7985 Qty 20 pcs intake Phillips head ø 6mm head thickness 2.5mm		



1

<b>GEV No.</b>	560063	<b>Ref. No.</b>	EL0037311
<b>description</b>	flat-headed bolt thread M4 thread L 16mm SS DIN 7985/ISO 7045 Qty 20 pcs intake Phillips head ø 8mm head thickness 2mm		



1

<b>GEV No.</b>	102600	<b>Ref. No.</b>	ELE500102
<b>description</b>	screw thread M4 thread L 25mm Minisit		

## hexagonal screws



1

<b>GEV No.</b>	560084	<b>Ref. No.</b>	231657 E500021 EL0231657 ELE500021 N0052
<b>description</b>	hexagonal screw thread M5 thread L 16mm SS WS 8 Qty 20 pcs DIN 933 / ISO 4017		
<b>For models:</b>	1011, 1221, 2011, 611, GENIUS, MAKT, MB, MD1011, MD523, MD611, MMD1011, MMD611		



1

<b>GEV No.</b>	560086	<b>Ref. No.</b>	251836
<b>description</b>	hexagonal screw thread M6 thread L 10mm SS WS 10 Qty 20 pcs DIN 933 / ISO 4017		
<b>For models:</b>	EB30, EB30XLDIGITAL		

## cylinder head bolts

## DIN 912/ISO 4762



1

<b>GEV No.</b>	560025	<b>Ref. No.</b>	500070 E500070 ELE500070
<b>description</b>	cylinder head bolt thread M4 thread L 10mm WS 3 SS Qty 20 pcs DIN 912/ISO 4762		

## grub screws

## DIN 913/ISO 4026



1

<b>GEV No.</b>	560497	<b>Ref. No.</b>	753785 E500268 EL0753785 ELE500268
<b>description</b>	grub screw thread M8 L 8mm A2-A2L DIN 913/ISO 4026 WS 4 Qty 20 pcs		
<b>For models:</b>	1011, 1221, 2011, 2021, 611, AUTOCLEAN, GENIUS, GENIUS6-11, GENIUS6-11GAS, GENIUSGAS, MB, MULTIMAXB		

## DIN 916/ISO 4029



1

<b>GEV No.</b>	560173	<b>Ref. No.</b>	588512 895415 E500203 E500261 EL0588512 EL0895415 ELE500203 N0044
<b>description</b>	grub screw thread M4 L 10mm SS DIN 916/ISO 4029 intake internal hexagon WS 2 Qty 20 pcs		
<b>For models:</b>	1011, 1221, 2011, 2021, 611, AUTOCLEAN, GENIUS, GENIUS6-11, GENIUS6-11GAS, GENIUSGAS, JOKERB, JOKERC, MAKT, MB, MD2011, MMD2011, MMD2021, MULTIMAXA, MULTIMAXB		





miscellaneous			
			
1			
<b>GEV No.</b>	560621	<b>Ref. No.</b>	399280 E440101 EL0399280 ELE440101
<b>description</b>	grub screw thread 1/8" L 5mm brass WS hexagonal 5mm Qty 1 pcs		
<b>For models:</b>	1011, 1221, 2011, 2021, 611, AUTOCLEAN, GENIUS, GENIUS6-11, GENIUS6-11GAS, GENIUSGAS, JOKERB, JOKERC, MAKT, MB, MULTIMAXA, MULTIMAXB		

## nuts

plate nuts			
			
1			
<b>GEV No.</b>	560004	<b>Ref. No.</b>	E505046 ELE505046 H0630
<b>description</b>	plate nut hole ø 2.9mm L 17mm W 12mm		
<b>For models:</b>	MD1011, MD2011, MD523, MD611, MMD1011, MMD2011, MMD2021, MMD611		

## hexagonal nuts

DIN 934 / ISO 4032/8673			
			
1			
<b>GEV No.</b>	560340	<b>Ref. No.</b>	003905
<b>description</b>	hexagonal nut thread M4 H 3.2mm WS 7 SS DIN/ISO DIN 934 / ISO 4032/8673 Qty 1 pcs		
<b>For models:</b>	1011, 1221, 2011, 2021, 611, EB30, EB30XLDIGITAL, GENIUS, MAKT, MB		

			
1			
<b>GEV No.</b>	560132	<b>Ref. No.</b>	EL0252867
<b>description</b>	hexagonal nut thread M5 H 4mm WS 8 SS DIN/ISO DIN 934 / ISO 4032/8673 Qty 20 pcs		

			
1			
<b>GEV No.</b>	560133	<b>Ref. No.</b>	EL0251887
<b>description</b>	hexagonal nut thread M6 H 5mm WS 10 SS DIN/ISO DIN 934 / ISO 4032/8673 Qty 20 pcs		

			
1			
<b>GEV No.</b>	506166	<b>Ref. No.</b>	E505027 EL0012343
<b>description</b>	nut thread M12 H 10mm WS 19 SS DIN/ISO DIN 934 / ISO 4032/8673 Qty 1 pcs		

## DIN 985

			
1			
<b>GEV No.</b>	560143	<b>Ref. No.</b>	0587095 EL587095
<b>description</b>	hexagonal nut thread M8 H 8.5mm SS WS 13 Qty 20 pcs DIN/ISO DIN 985 self-locking		

## hexagonal nuts metric (without norm)

 Image not available			
1			
<b>GEV No.</b>	519646	<b>Ref. No.</b>	E505106 EL0765651 ELE505106
<b>description</b>	nut thread M9x0.75 H 2.5mm WS 14 SS Qty 1 pcs		

## washers

### washers

DIN 125A			
			
1			
<b>GEV No.</b>	560332	<b>Ref. No.</b>	EL001007
<b>description</b>	plain washer ID ø 4.3mm ED ø 9mm thickness 0.8mm SS Qty 1 pcs		

			
1			
<b>GEV No.</b>	560112	<b>Ref. No.</b>	EL0003980
<b>description</b>	plain washer ID ø 5,3mm ED ø 10mm thickness 1mm SS Qty 20 pcs DIN 125A for thread M5		

<b>DIN 9021</b>			
			
1			
<b>GEV No.</b>	560117	<b>Ref. No.</b>	000582 E508033 EL0000582
<b>description</b>	plain washer ID ø 6,4mm ED ø 18mm thickness 1.5mm SS Qty 20 pcs DIN 9021 for thread M6		
<b>For models:</b>	1011, 1221, 2011, 2021, 611, AUTOCLEAN, EB30, EB30XLDIGITAL, GENIUS, GENIUS6-11, GENIUS6-11GAS, GENIUSGAS, JOKERB, JOKERC, MAKT, MB, MULTIMAXA, MULTIMAXB, MULTIMAXB6-11AUTOCLEAN		

<b>tooth lock washers</b>			
<b>DIN 6798A</b>			
			
1			
<b>GEV No.</b>	560193	<b>Ref. No.</b>	0349771 EL0349771
<b>description</b>	tooth lock washer ID ø 10,4mm ED ø 18mm zinc-coated steel DIN/ISO DIN 6798A Qty 1 pcs for thread M10		

			
1			
<b>GEV No.</b>	560127	<b>Ref. No.</b>	892912
<b>description</b>	tooth lock washer ID ø 6,2mm ED ø 11mm SS DIN/ISO DIN 6798A Qty 20 pcs for thread M6		
<b>For models:</b>	1011, 1221, 2011, 2021, 611, EB30, EB30XLDIGITAL, GENIUS, MAKT, MB		

<b>fasteners</b>			
<b>slot nuts</b>			
			
1			
<b>GEV No.</b>	694995	<b>Ref. No.</b>	0760978 EL0760978 ELE512082
<b>description</b>	slot nut W 4mm H 5mm L 12mm half-round for door latch DIN 6888		
<b>For models:</b>	1221, 2021, GENIUS, MB		

<b>clamps</b>			
<b>hose clamps</b>			
<b>DIN 3017 - W2</b>			
			
1			
<b>GEV No.</b>	520116	<b>Ref. No.</b>	422007 EL0422007
<b>description</b>	hose clamp ø 32-50mm width 9mm Qty 5 pcs DIN 3017		
<b>For models:</b>	MMC1011, MMC611, MMD1011, MMD611		

<b>security hose clamps</b>			
<b>SS/brass</b>			
			
1			
<b>GEV No.</b>	520069	<b>Ref. No.</b>	276634 E422018 EL0276634 ELE422018 H0284
<b>description</b>	hose clamp SS/brass ø 14-19mm width 11mm Qty 5 pcs		
<b>For models:</b>	1011, 1221, 2011, 2021, 611, AUTOCLEAN, EB30, EB30XLDIGITAL, GENIUS, GENIUS6-11, GENIUS6-11GAS, GENIUSGAS, MAKT, MB, MD1011, MD2011, MD523, MD611, MMD1011, MMD2011, MMD2021, MMD611, MULTIMAXA, MULTIMAXB		

			
1			
<b>GEV No.</b>	520070	<b>Ref. No.</b>	276642 E422019 EL0276642 ELE422019 H0285
<b>description</b>	hose clamp SS/brass ø 16-21mm width 11mm Qty 5 pcs		
<b>For models:</b>	1011, 611, GENIUS, MAKT, MB		

			
1			
<b>GEV No.</b>	520071	<b>Ref. No.</b>	572160 E422020 EL0572160 ELE422020 H0286
<b>description</b>	hose clamp SS/brass ø 17-22mm width 11mm Qty 5 pcs		
<b>For models:</b>	1011, 1221, 2011, 2021, 611, AUTOCLEAN, GENIUS, GENIUS6-11, GENIUS6-11GAS, GENIUSGAS, MB, MULTIMAXA, MULTIMAXB, WU14		



			
1			
<b>GEV No.</b>	520067	<b>Ref. No.</b>	277665 E422017 EL0277665 ELE422017 H0282
<b>description</b>	hose clamp SS/brass ø 9-14mm width 10mm Qty 5 pcs		
<b>For models:</b>	1011, 1221, 2011, 2021, 611, AUTOCLEAN, EB30, EB30XLDIGITAL, GENIUS, GENIUS6-11, GENIUS6-11GAS, GENIUSGAS, MD1011, MD2011, MD523, MD611, MMD1011, MMD2011, MMD2021, MMD611, MULTIMAXA, MULTIMAXB, WU14		

roll pins			
			
1			
<b>GEV No.</b>	692474	<b>Ref. No.</b>	ELE512046
<b>description</b>	roll pin ø 2.5mm L 20mm		

			
1			
<b>GEV No.</b>	691637	<b>Ref. No.</b>	512046 E512046
<b>description</b>	roll pin ø 3mm L 20mm		

## consumables

### sealants and adhesives

#### high temperature silicone

			
1			
<b>GEV No.</b>	890107	<b>Ref. No.</b>	500402 E522021 EL0500402 ELE522021 H0635
<b>description</b>	high temperature silicone TOMABOND TB76 -40 up to +250°C red/ brown tube 90ml		
<b>description</b>	Tomabond TB76 - tube 90ml - red brown Special elastic silicone for general bonding & sealing applications with high thermal loads. TB 76 is primarily used in building services, HVAC and mechanical engineering. Temperature-resistant to 300 °C over the short term		
<b>For models:</b>	1221, 2021, GENIUS, MB, MD2011, MMD2011, MMD2021		

#### food-grade silicones

			
1			
<b>GEV No.</b>	890106	<b>Ref. No.</b>	E522026 EL0063096 ELE522026
<b>description</b>	silicone TB40 transparent tube 90g -40 up to +160°C		
<b>description</b>	Tomabond - TB40 - tube 90g - transparent For flexible sealing in drinking water, food, water and industrial kitchen areas. Securely joins glass, metal, wood-based materials, ceramic and plastics with high adhesion (1.1 N/mm <sup>2</sup> ). Fungicide-, algicide- and solvent-free, ageing-resistant. Temperature-resistant from -40 °C to +160 °C Tested and approved by KTW / KSW.		

thread sealants



<b>GEV No.</b>	890058	<b>Ref. No.</b>	593567
<b>description</b>	thread sealing LOCTITE 511 liquid bottle 50ml		
<b>description</b>	LOCTITE® 511™ - bottle 50ml It is designed for the locking and sealing of metal threaded pipes and fittings. The product cures rapidly when confined in the absence of air between close fitting metal surfaces.		
<b>For models:</b>	1011, 1221, 2011, 2021, 611, EB30, EB30XLDIGITAL, GENIUS, MAKT, MB		

fuses

fine fuses



<b>GEV No.</b>	358532	<b>Ref. No.</b>	190756 E0173 E375007 EL0190756 ELE375007
<b>description</b>	fine fuse size ø5x20mm 2A fast-acting rated 250V Qty 10 pcs		
<b>For models:</b>	1011, 1221, 2011, 2021, 611, AUTOCLEAN, GENIUS, GENIUS6-11, GENIUS6-11GAS, GENIUSGAS, JOKERC, MAKT, MB, MD1011, MD2011, MD611, MMD1011, MMD2011, MMD2021, MMD611, MULTIMAXA, MULTIMAXB		



<b>GEV No.</b>	358699	<b>Ref. No.</b>	572047 E0168 E375004 EL0572047 ELE375004
<b>description</b>	fine fuse size ø5x20mm 10A medium lag rated 250V Qty 10 pcs		
<b>For models:</b>	JOKERC, MD2011, MMD1011, MMD2011, MMD2021, MMD611, WU14		



<b>GEV No.</b>	358697	<b>Ref. No.</b>	E0167 E375003 ELE375003
<b>description</b>	fine fuse size ø5x20mm 6.3A medium lag rated 250V Qty 10 pcs		



<b>GEV No.</b>	358608	<b>Ref. No.</b>	578975 EL0578975
<b>description</b>	fine fuse size ø5x20mm 10A slow-acting rated 250V Qty 10 pcs		
<b>For models:</b>	1011, 1221, 2011, 2021, 611, GENIUS, MAKT, MB		

fine fuse holders



<b>GEV No.</b>	358049	<b>Ref. No.</b>	751847 E0965 E373028 EL0751847 ELE373028
<b>description</b>	fuse holder		
<b>For models:</b>	1221, 2011, 2021, AUTOCLEAN, GENIUS, MAKT, MB, MD2011, MMD2011, MMD2021, MULTIMAXA, MULTIMAXB		

screw locks

D0-system (NEOZED)





<b>GEV No.</b>	358043	<b>Ref. No.</b>	658294 E0974 E375015 EL0658294 ELE375015
<b>description</b>	fuse size D01 16A rated 250/400V E14 ø 11mm L 36mm Qty 10 pcs		
<b>For models:</b>	1221, 2021, AUTOCLEAN, GENIUS, MB, MD2011, MMD2011, MMD2021, MULTIMAXB		





<b>GEV No.</b>	358045	<b>Ref. No.</b>	751863 E0970 E375013 EL0751863 ELE375013
<b>description</b>	fuse size D02 35A rated 250/400V E18 ø 15mm L 36mm Qty 10 pcs		
<b>For models:</b>	2011, AUTOCLEAN, GENIUS, MAKT, MB, MD2011, MMD2011, MMD2021, MULTIMAXA, MULTIMAXB		



 <p>1</p>			
<b>GEV No.</b>	358046	<b>Ref. No.</b>	658286 E0969 E375012 EL0658286 ELE375012
<b>description</b>	fuse size D02 50A rated 250/400V E18 ø 15mm L 36mm Qty 10 pcs		
<b>For models:</b>	1221, 2021, AUTOCLEAN, GENIUS, MB, MD2011, MMD2011, MMD2021, MULTIMAXB		

 <p>1</p>			
<b>GEV No.</b>	358067	<b>Ref. No.</b>	751855 E0972 E373021 EL0751855 ELE373021
<b>description</b>	gauge piece size D02 suitable for 35A		
<b>For models:</b>	2011, AUTOCLEAN, GENIUS, MAKT, MB, MD2011, MMD2011, MMD2021, MULTIMAXA, MULTIMAXB		

gauge pieces (NEOZED)			
 <p>1</p>			
<b>GEV No.</b>	358064	<b>Ref. No.</b>	658308 E0976 E373023 EL0658308
<b>description</b>	gauge piece size D02 suitable for 16A		
<b>For models:</b>	1221, 2021, AUTOCLEAN, GENIUS, MB, MD2011, MMD2011, MMD2021, MULTIMAXB		

 <p>1</p>			
<b>GEV No.</b>	358068	<b>Ref. No.</b>	658278 E0971 E373020 ELE373020
<b>description</b>	gauge piece size D02 suitable for 50A		
<b>For models:</b>	1221, 2021, AUTOCLEAN, GENIUS, MB, MD2011, MMD2011, MMD2021, MULTIMAXB		





<b>A</b>		<b>H</b>	
alarm devices	21	halogen lamp	18
appliance hose reels	54	handle latches	44
audible timers	21	heating elements	3
axial fans	30	heating elements for coffee machine	4
<b>C</b>		heating elements for convection	7
cam switches	13	heating elements for pizza ovens	5
castors and bumper angles	47	heating elements for salamanders/toasters	6
clamps	57, 60	hexagonal nuts	59
condensators & interference suppression filters	33	hexagonal screws	58
consumables	61	high temperature silicone	61
contactors	22	hose clamps	57, 60
control equipment	15	hose connectors	55
control thermostats	10	hose reels	54
countersunk screws	58	hoses	55
cross flow fans	30	hot air fans	33
cylinder head bolts	58	hot air motors	31
<b>D</b>		<b>I</b>	
door catches	45	ignition boxes	36
door seals	47	ignition units	38
double nipples	55	immersion heating elements	6
<b>E</b>		indicator lights	16
edgemount hinges	46	indicator lights (complete)	17
edgemount latches	44	industrial hoses	55
electric accessories	35	infrared lamps	18
electric timers	20	<b>L</b>	
electromagnetic closer	43	lamps	16
electronic controllers	24	light bulbs	17
end caps and plugs	47	linear lamps	18
energy regulators	10	<b>M</b>	
<b>F</b>		magnetic locks	45
fans	30	magnetic switches	14
fasteners	60	mechanical timers	21
fastening material	57	microswitches	13
fine fuses	62	motors	33
fittings	55	<b>N</b>	
flat-headed bolts	58	neon light bulbs	16, 17
fluorescent lamps	18, 18	nuts	59
food-grade silicones	57, 61	nylon hoses	55
fuses	34, 62	<b>O</b>	
<b>G</b>		operating capacitors	33
gas control valves	36	O-rings	50
gas nozzles	38	oven lamps	19
gaskets for control panels	50	<b>P</b>	
gaskets for heated units	47	plate nuts	59
gaskets for tray rack trolleys	50	pre-rinse hoses	55
grub screws	58		

pressure reduction valves	56, 56	window seals	47
pressure switches	29		
probes	25		
pumps	33		
<b>R</b>			
reducers	56		
relays	23		
rocker/momentary rocker switches	12		
roll pins	61		
<b>S</b>			
safety thermostats	11		
screw locks	62		
screws	57		
sealants and adhesives	61		
sealing washers	51		
security hose clamps	57, 60		
sheet metal screws	57		
silicone	57, 61		
silicone hoses	55		
slot nuts	60		
snap locks	46		
solenoid valves	28		
solid state relays	23		
spray guns	53		
spray guns with external thread	53		
stainless steel spiral tubes	55		
switches and momentary switches	12		
<b>T</b>			
temperature probes	25		
terminals	35		
thermocouples	38		
thermostat gaskets	52		
thermostats	10		
thread sealants	38, 56, 62		
time relays	23		
timers	20		
tooth lock washers	60		
transformers	24		
turning lever locks	42		
<b>U</b>			
universal probes	25		
<b>V</b>			
vibration pumps	33		
<b>W</b>			
walk-in fridge catches	45		
washers	59		
water cycle components	56		