



GAS COMPONENTS



ELECTRIC COMPONENTS



WATER TECHNOLOGY



MECHANICAL COMPONENTS



TOOLS

Spare parts suitable for

ELVIOMEX-ALFA

Find the complete and up-to-date range of products in our GEV Webshop



Manufacturer catalogue

The most important spare parts and accessories arranged clearly for every manufacturer

- ✓ Complete product range and all appliance data always up to date in the GEV Webshop
- ✓ Alphabetical Index at the end of the catalogue

GEV Webshop

www.gev-online.co.uk

www.gev-online.com



- 🔍 Add to Favourites
- 🔍 Sign In with email address and usual password
- 🔍 Easy-order – place several items in your basket at the same time
- 🔍 Quick Item search – no login needed



heating elements

immersion heating elements







with compression flange (miscellaneous)





GEV No.	416251	Ref. No.	003.40.00011 HLE.EU.00011
description	heating element 2500W 230V heating circuits 1 flange ø 60mm L 290mm W 285mm H 45mm connection male faston 6.3mm tube ø 8.5mm immersion heater connection length 34mm thread M6		
For models:	Euroline-40F		





with round flange ø47.5mm



GEV No.	416254	Ref. No.	003.35.00009 HLE.BL.00009
description	heating element 2400W 230V heating circuits 1 mounting ø 47.5mm L 295mm W 40mm H 46mm round flange connection male faston 6.3mm immersion heater tube ø 9.1mm		
For models:	Barline-35F		
spare parts for	416254		
	GEV No.	510408	Ref. No. —
O-ring EPDM thickness 5.34mm ID ø 47mm Qty 1 pcs			
accessories for	416254		
	GEV No.	510408	Ref. No. —
O-ring EPDM thickness 5.34mm ID ø 47mm Qty 1 pcs			
	GEV No.	510562	Ref. No. —
O-ring silicone thickness 5.34mm ID ø 47mm Qty 1 pcs			
	GEV No.	520235	Ref. No. —
3 hole flange hole distance 70.5mm perforation ø 6.5mm ID ø 53.5mm			
	GEV No.	520236	Ref. No. —
flange for heating element ID ø 50mm ED ø 90mm hole ø 6.5mm 3 holes			
	GEV No.	550002	Ref. No. —
tension strap H 10mm L 21mm W 10mm hole ø 6.5mm for heating element			
	GEV No.	550362	Ref. No. —
blind flange ø 64mm mounting ø 47.5mm			



GEV No.	416255	Ref. No.	003.40.00006 HLE.EU.00006
description	heating element 2500W 230V heating circuits 1 L 230mm W 34mm H 27mm tube ø 8.5mm connection length 58mm		
For models:	Euroline-40F		
spare parts for	416255		
	GEV No.	510408	Ref. No. —
O-ring EPDM thickness 5.34mm ID ø 47mm Qty 1 pcs			

accessories for	416255		
	GEV No.	510562	Ref. No. —
O-ring silicone thickness 5.34mm ID ø 47mm Qty 1 pcs			
	GEV No.	520235	Ref. No. —
3 hole flange hole distance 70.5mm perforation ø 6.5mm ID ø 53.5mm			
	GEV No.	520236	Ref. No. —
flange for heating element ID ø 50mm ED ø 90mm hole ø 6.5mm 3 holes			
	GEV No.	550002	Ref. No. —
tension strap H 10mm L 21mm W 10mm hole ø 6.5mm for heating element			
	GEV No.	550362	Ref. No. —
blind flange ø 64mm mounting ø 47.5mm			



GEV No.	418216	Ref. No.	003.50.00005 HLE.VK.00005
description	heating element 3000W 230V heating circuits 1 mounting ø 47.5mm L 370mm W 40mm H 38mm round flange connection M4 immersion heater tube ø 8.7mm connection length 31mm		
For models:	Vergina-50SF		
accessories for	418216		
	GEV No.	510408	Ref. No. —
O-ring EPDM thickness 5.34mm ID ø 47mm Qty 1 pcs			
	GEV No.	510562	Ref. No. —
O-ring silicone thickness 5.34mm ID ø 47mm Qty 1 pcs			
	GEV No.	520235	Ref. No. —
3 hole flange hole distance 70.5mm perforation ø 6.5mm ID ø 53.5mm			
	GEV No.	520236	Ref. No. —
flange for heating element ID ø 50mm ED ø 90mm hole ø 6.5mm 3 holes			
	GEV No.	550002	Ref. No. —
tension strap H 10mm L 21mm W 10mm hole ø 6.5mm for heating element			
	GEV No.	550362	Ref. No. —
blind flange ø 64mm mounting ø 47.5mm			











GEV No.	416258	Ref. No.	003.00.00351 HLE.OO.00351
description	heating element 4000W 230V heating circuits 3 mounting ø 47.5mm L 363mm W 33mm H 33mm round flange connection M4 immersion heater tube ø 8.5mm		
For models:	Turbo-1500		
spare parts for	416258		
	GEV No.	510408	Ref. No. —
O-ring EPDM thickness 5.34mm ID ø 47mm Qty 1 pcs			
accessories for	416258		
	GEV No.	510562	Ref. No. —
O-ring silicone thickness 5.34mm ID ø 47mm Qty 1 pcs			





Table continues overleaf







accessories for 416258			
	GEV No.	520235	Ref. No. —
3 hole flange hole distance 70.5mm perforation ϕ 6.5mm ID ϕ 53.5mm			
	GEV No.	520236	Ref. No. —
flange for heating element ID ϕ 50mm ED ϕ 90mm hole ϕ 6.5mm 3 holes			
	GEV No.	550002	Ref. No. —
tension strap H 10mm L 21mm W 10mm hole ϕ 6.5mm for heating element			
	GEV No.	550362	Ref. No. —
blind flange ϕ 64mm mounting ϕ 47.5mm			



			
GEV No.	416257	Ref. No.	003.00.00411 HLE.00.00411 HLE.VK.00411
description	heating element 6000W 230/400V heating circuits 3 mounting ϕ 47.5mm L 360mm W 37mm H 33mm connection male faston 6.3mm immersion heater tube ϕ 8.5mm		
spare parts for	416257		
	GEV No.	510408	Ref. No. —
O-ring EPDM thickness 5.34mm ID ϕ 47mm Qty 1 pcs			
accessories for	416257		
	GEV No.	510562	Ref. No. —
O-ring silicone thickness 5.34mm ID ϕ 47mm Qty 1 pcs			
	GEV No.	520235	Ref. No. —
3 hole flange hole distance 70.5mm perforation ϕ 6.5mm ID ϕ 53.5mm			
	GEV No.	520236	Ref. No. —
flange for heating element ID ϕ 50mm ED ϕ 90mm hole ϕ 6.5mm 3 holes			
	GEV No.	550002	Ref. No. —
tension strap H 10mm L 21mm W 10mm hole ϕ 6.5mm for heating element			
	GEV No.	550362	Ref. No. —
blind flange ϕ 64mm mounting ϕ 47.5mm			

with round flange ϕ60.0mm			
			
GEV No.	417573	Ref. No.	003.10.00000 HLE.10.00000 HLE.10.00024
description	heating element 3990W 230V heating circuits 3 mounting ϕ 60mm L 320mm W 120mm H 40mm connection male faston 6.3mm tube ϕ 8.5mm		

1 1/4"			
			
GEV No.	416253	Ref. No.	003.15.00095 HLE.15.00095
description	heating element 6000W 230V heating circuits 3 thread 1 1/4" L 360mm W 115mm H 50mm L1 180mm L2 10mm W1 41mm W2 32mm H1 24mm H2 30mm tube ϕ 8.5mm connection M4 flange with thread immersion heater		
For models:	Turbo-1500		
spare parts for	416253		
	GEV No.	510405	Ref. No. —
flat gasket fibre ED ϕ 56mm ID ϕ 42mm thickness 2mm for thread 1 1/4" Qty 1 pcs			
	GEV No.	520232	Ref. No. —
nut thread 1 1/4" H 5mm nickel-plated brass WS 47 Qty 1 pcs			
accessories for	416253		
	GEV No.	528021	Ref. No. —
flat gasket PTFE ED ϕ 53mm ID ϕ 42.5mm thickness 3mm Qty 1 pcs equiv. no. 12001/02286 suitable for Astoria/Aurora/Brasilia/Wega			

1"			
			
GEV No.	416250	Ref. No.	003.30.00000 HLE.B3.00000
description	heating element 2000W 230V heating circuits 1 thread 1" L 250mm W 25mm H 26mm tube ϕ 8.5mm connection M4 immersion heater flange with thread		
For models:	Barline-35F		
spare parts for	416250		
	GEV No.	510404	Ref. No. —
flat gasket fibre ED ϕ 44mm ID ϕ 34mm thickness 2mm Qty 1 pcs			
	GEV No.	520233	Ref. No. —
nut thread 1" H 6mm brass WS 47 Qty 1 pcs			
accessories for	416250		
	GEV No.	510422	Ref. No. —
gasket copper ED ϕ 37.7mm ID ϕ 32.5mm thickness 2.7mm for thread 1"			



 <p>1</p>			
GEV No.	416252	Ref. No.	003.50.00008 003.70.00003 HLE.70.00003 HLE.VK.00008
description	heating element 2800W 230V heating circuits 1 L 370mm W 240mm H 30mm thread M14x1.5 mounting distance 50mm tube ø 8.5mm connection M4 flange with thread immersion heater W1 115mm W2 53mm		
For models:	Vergina-50SF		
spare parts for	416252		
	GEV No.	521101	Ref. No. —
	nut thread M14x1.5 H 5mm WS 19 SS Qty 1 pcs		
accessories for	416252		
	GEV No.	532103	Ref. No. —
	O-ring EPDM thickness 3.53mm ID ø 13.87mm Qty 10 pcs		

accessories

protection caps

 <p>1</p>			
GEV No.	520560	Ref. No.	003.00.00004 HLE.00.00004
description	protection cap for heating element ø 48mm plastic L 48mm		
For models:	Barline-35F, Euroline-40F, Turbo-1500, Vergina-50SF		

thermostats

bi-metal thermostats

safety bi-metal thermostats

 <p>1</p>			
GEV No.	390758	Ref. No.	003.00.00180 HLE.00.00180
description	bi-metal safety thermostat hole distance 23.5mm switch-off temp. 105°C 1NC 1-pole 16A connection F6.3		
For models:	Barline-35F, Euroline-40F, Turbo-1500, Vergina-50SF		

 <p>1</p>			
GEV No.	390759	Ref. No.	003.00.00168 HLE.00.00168
description	bi-metal safety thermostat hole distance 23.5mm switch-off temp. 90°C 1NC 1-pole 16A connection F6.3		
For models:	Barline-35F, Euroline-40F, Turbo-1500, Vergina-50SF		

control and safety thermostats

CAMPINI

control thermostats

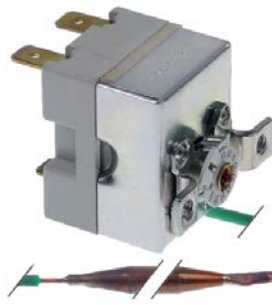
 <p>1</p>			
GEV No.	390465	Ref. No.	003.00.00213 HLE.00.00213
description	thermostat t.max. 90°C temperature range 0-90°C 1-pole 1CO 16A probe ø 6.5mm probe L 87mm capillary pipe 1470mm capillary pipe isolated 1450mm gland nut shaft ømm shaft Lmm shaft position rotation 270° probe material copper 95 CAMPINI		
For models:	Barline-35F, Euroline-40F, Turbo-1500, Vergina-50SF		

switches and momentary switches

push/momentary push switches

28.5x28.5mm

 <p>1</p>			
GEV No.	301178	Ref. No.	003.00.00399 HLE.00.00399
description	momentary push switch mounting measurements 28.5x28.5mm green 1NO 250V 16A connection male faston 6.3mm ambient temperature max. 150°C protection IP40		
For models:	Barline-35F, Euroline-40F, Vergina-50SF		

 <p>1</p>			
GEV No.	301177	Ref. No.	003.00.00247 HLE.00.00247
description	push switch mounting measurements 28.5x28.5mm green 1CO 250V 16A connection male faston 6.3mm ambient temperature max. 150°C protection IP40		
For models:	Vergina-50SF		

			
1			
GEV No.	301179	Ref. No.	003.00.00137 HLE.00.00137
description	push switch mounting measurements 28.5x28.5mm grey/red 2CO 250V 16A connection male faston 6.3mm ambient temperature max. 150°C protection IP40 with indicator		
For models:	Euroline-40F, Vergina-50SF		



			
1			
GEV No.	301176	Ref. No.	003.00.00009 HLE.00.00009
description	push switch mounting measurements 28.5x28.5mm blue/green 2CO 250V 16A connection male faston 6.3mm ambient temperature max. 150°C protection IP40 with indicator		
For models:	Barline-35F, Euroline-40F, Vergina-50SF		

ø22.3mm			
			
1			
GEV No.	347580	Ref. No.	003.15.00019 HLE.15.00019
description	push switch mounting ø 22.3mm green 1CO 250V 10A connection screw ambient temperature max. 85°C protection IP40		

microswitches

lever actuated

			
1			
GEV No.	345813	Ref. No.	003.00.00069 HLE.00.00069
description	microswitch with lever 250V 10A 1CO connection male faston 6.3mm ambient temperature max. 85°C		

				
1				
GEV No.	347583	Ref. No.	003.00.00426 HLE.00.00426	
description	microswitch with lever 250V 15A 1CO connection male faston 6.3mm ambient temperature max. 85°C door switch lever length 28mm			
For models:	Barline-35F, Euroline-40F, Vergina-50SF			
spare parts for	347583			
	GEV No.	345813	Ref. No.	003.00.00069 HLE.00.00069
	microswitch with lever 250V 10A 1CO connection male faston 6.3mm ambient temperature max. 85°C			

non-standard			
			
1			
GEV No.	345814	Ref. No.	003.00.00231 HLE.00.00231
description	microswitch		
For models:	Barline-35F, Euroline-40F, Vergina-50SF		

position switches

LOVATO			
			
1			
GEV No.	347579	Ref. No.	003.15.00003 HLE.15.00003
description	position switch plastic 1NO/1NC 400V 3A L 110mm W 30mm H 44mm protection IP66/67 actuating force: 380g screw connection M16 mounting distance 22mm type ZCP21		

TELEMECANIQUE (EFA)			
			
1			
GEV No.	347579	Ref. No.	003.15.00003 HLE.15.00003
description	position switch plastic 1NO/1NC 400V 3A L 110mm W 30mm H 44mm protection IP66/67 actuating force: 380g screw connection M16 mounting distance 22mm type ZCP21		

control equipment

RENY

switches (complete)			
			
1			
GEV No.	347581	Ref. No.	003.00.00008 HLE.00.00008
description	rotary selector mounting measurements ø22mm green sequence 0-1 latching		
For models:	Turbo-1500		



 <p>1</p>			
GEV No.	347582	Ref. No.	003.00.00509 HLE.00.00509
description	rotary selector mounting measurements ø22mm green sequence 1-0-2 latching		

lamps

indicator lights

indicator lights (complete)

ø10mm

with plug-in socket

 <p>1</p>			
GEV No.	359361	Ref. No.	003.00.00176 HLE.00.00176
description	indicator light ø 10mm 230V green		
For models:	Barline-35F, Euroline-40F, Turbo-1500, Vergina-50SF		

 <p>1</p>			
GEV No.	359360	Ref. No.	003.00.00028 HLE.00.00028
description	indicator light ø 10mm 230V yellow with cable		
For models:	Barline-35F, Euroline-40F, Turbo-1500, Vergina-50SF		

timers

programme timers

 <p>1</p>			
GEV No.	360518	Ref. No.	003.00.00448 HLE.00.00448
description	timer CDC 7803F1 engines 1 chambers 3 operation time 120s 230V shaft ømm shaft Lmm voltage AC		
For models:	Barline-35F, Euroline-40F		



 <p>1</p>			
GEV No.	360274 ¹	Ref. No.	003.00.00215 HLE.00.00215
description	timer FIBER P26 engines 1 chambers 3 operation time 120s 230V shaft ø 6x4.6mm shaft L 18mm manif. no. P265J03H358 motor type M61B40L6400		
For models:	Turbo-1500		

¹incl. knob

contactors

LS Industrial Systems

overload switches

 <p>1</p>				
GEV No.	381118	Ref. No.	003.15.00010 HLE.15.00010	
description	overload switch setting range 2.5-4A type GTK-12M LS Industrial Systems			
For models:	Turbo-1500			
accessories for	381118			
	GEV No.	380238	Ref. No.	003.00.00056 HLE.00.00056
	power contactor resistive load 20A 230VAC (AC3/400V) 8.4A/4kW main contacts 3NO auxiliary contacts 1NO connection screw connection type LS0510A type AEG LS0510A type GE MC1A 310A			

GENERAL ELECTRIC (AEG)

power contactors

 <p>1</p>			
GEV No.	380238	Ref. No.	003.00.00056 HLE.00.00056
description	power contactor resistive load 20A 230VAC (AC3/400V) 8.4A/4kW main contacts 3NO auxiliary contacts 1NO connection screw connection type LS0510A type AEG LS0510A type GE MC1A 310A		
For models:	Turbo-1500, Vergina-50SF		



relays

power relays

with bracket mounting



1

GEV No.	380815	Ref. No.	003.00.00306
description	power relays 230VAC 16A 2NO connection male faston 6.3mm flange dimensions 36x38x68mm		
For models:	Euroline-40F		



1

GEV No.	380808	Ref. No.	003.00.00082
description	power relays FINDER 230VAC 16A 3CO connection male faston 6.3mm bracket mounting manuf. no. 62.83.8.230.0000		

with male contacts

bullet connectors, 11 contacts





1

GEV No.	380132	Ref. No.	003.15.00098 HLE.15.00098	
description	power relays Italiana Relè 230VAC 10A 3CO connection plug-in connection round 11-pole manuf. no. C43-230AC ZVE11 250V 11-pole			
For models:	Turbo-1500			
accessories for	380132			
	GEV No.	380136	Ref. No.	003.15.00099 HLE.15.00099
	relay socket 11-pole connection plug-in connection round 11-pole dimensions 65x28x40mm 250V voltage AC 10A Italiana Relè manuf. no. ZVE11			

bullet connectors, 8 contacts



1

GEV No.	380134	Ref. No.	003.00.00055 HLE.00.00055	
description	power relays Italiana Relè 230VAC 10A 2CO connection plug-in connection round 8-pole manuf. no. C42-230VAC 90.26/ZVE8 250V			
accessories for	380134			
	GEV No.	380137	Ref. No.	003.00.00034 HLE.00.00034
	relay socket 8-pole connection plug-in connection round 8-pole dimensions 65x28x40mm 380V voltage AC 10A Italiana Relè manuf. no. ZVE8			
	GEV No.	380638	Ref. No.	—
	relay socket 8-pole dimensions 51x41x23mm 250V 10A FINDER manuf. no. 90.26			

relay sockets



1

GEV No.	380136	Ref. No.	003.15.00099 HLE.15.00099	
description	relay socket 11-pole connection plug-in connection round 11-pole dimensions 65x28x40mm 250V voltage AC 10A Italiana Relè manuf. no. ZVE11			
For models:	Turbo-1500			
accessories for	380136			
	GEV No.	380805	Ref. No.	—
	support bracket			



1

GEV No.	380137	Ref. No.	003.00.00034 HLE.00.00034	
description	relay socket 8-pole connection plug-in connection round 8-pole dimensions 65x28x40mm 380V voltage AC 10A Italiana Relè manuf. no. ZVE8			
accessories for	380137			
	GEV No.	380805	Ref. No.	—
	support bracket			



keypads

front foils

1 			
GEV No.	401134	Ref. No.	003.35.00000 HLE.BL.00000
description	front foil		

solenoid valves

solenoid valves (water)

ELBI			
1 			
GEV No.	370251	Ref. No.	003.00.00031 HLE.00.00031
description	solenoid valve single straight 230VAC inlet 3/4" outlet 11.5mm input 10l/min t.max. 90°C ELBI plastic flow regulating valve inlet red		
For models:	Barline-35F, Euroline-40F, Turbo-1500, Vergina-50SF		

pressure switches

for warewashing

ø 58mm with male faston 6.3mm

with connection horizontal







1 			
GEV No.	541019	Ref. No.	003.00.00033 HLE.00.00033
description	pressure control pressure range 70/30mbar connection 6mm ø 58mm pressure connection horizontal warewashing pressure connection ø 6mm		
For models:	Barline-35F, Euroline-40F, Turbo-1500, Vergina-50SF		

pumps





wash and rinse pumps

FIR

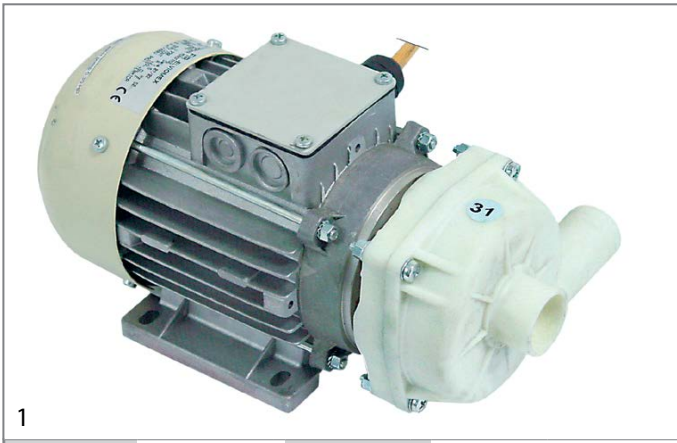
pumps

1 			
GEV No.	500387	Ref. No.	003.00.00060 HLE.00.00060
description	pump inlet ø 28mm outlet ø 26mm type 2211.1408 220V 50Hz 1 phase 0.074kW 0.1HP L 190mm rotation direction left capacitor 5µF FIR 2600rpm		
For models:	Barline-35F		
spare parts for	500387		
	GEV No.	365017	Ref. No. —
	operating capacitor capacity 5µF 450V tolerance 5% 50/60Hz ambient temperature max. -25 to +85°C ø 28mm L 54mm M8 plastic connection male faston 6.3mm 16.10.08 protection		
	GEV No.	510384	Ref. No. 003.00.00477 HLE.00.00477
	pump cover inlet ø 28mm outlet ø 26mm ø 100mm ID ø 76mm		
	GEV No.	510695	Ref. No. —
	mechanical shaft seal height counter ring 5.5mm ID ø 11mm		
	GEV No.	521203	Ref. No. 003.35.00010 HLE.BL.00010
	impellor ø 72mm H 18mm thread M7 shaft ø 11mm shaft length 32mm blades 3		
	GEV No.	521703	Ref. No. —
	pump cover gasket EPDM thickness 2.5mm ID ø 75mm Qty 1 pcs		



GEV No.	500388	Ref. No.	003.40.00005 HLE.EU.00005
description	pump inlet \varnothing 33mm outlet \varnothing 30mm type B265.1500 230V 50Hz 1 phase 0.22kW 0.3HP L 265mm rotation direction left capacitor 6.3 μ F FIR		
For models:	Euroline-40F		
spare parts for	500388		
	GEV No.	365012	Ref. No. —
	operating capacitor capacity 6.3 μ F 450V tolerance 5% 50Hz ambient temperature max. -25 to +85°C \varnothing 30mm L 61mm M8 plastic connection male faston 6.3mm protection		
	GEV No.	501309	Ref. No. 003.40.00007
	impellor \varnothing 80mm H 19mm M7R pump type type D1		
	GEV No.	510702	Ref. No. —
	mechanical shaft seal height counter ring 5.5mm ID \varnothing 12mm		
	GEV No.	521500	Ref. No. 003.00.00134 HLE.00.00134
	pump cover		
	GEV No.	521700	Ref. No. —
	pump cover gasket		



GEV No.	500710	Ref. No.	003.00.00350 old version HLE.00.00350 old version
description	pump inlet \varnothing 45mm outlet \varnothing 40mm type 1217/A 230V 50Hz 1 phase 0.56kW 0.75HP L 295mm rotation direction right capacitor 12.5 μ F FIR		



GEV No.	500389	Ref. No.	003.00.00083 HLE.00.00083
description	pump inlet \varnothing 45mm outlet \varnothing 40mm type 3911 230V 50Hz 1 phase 0.55kW 0.75HP rotation direction right FIR		



GEV No.	500111	Ref. No.	003.00.00063 HLE.00.00063 HLE.VK.00063
description	pump inlet \varnothing 63mm outlet \varnothing 53mm type 1241.2500 230/400V 50Hz 3 phase 1.1kW 1.5HP L 330mm rotation direction left FIR		
For models:	Turbo-1500		
spare parts for	500111		
	GEV No.	510531	Ref. No. 003.00.00480 HLE.00.00480
	pump cover FIR inlet \varnothing 63mm outlet \varnothing 53mm auxiliary pressure connection M16x1.5mm supporting pressure open turn direction left \varnothing 185mm ID \varnothing 150mm inner height 37mm		
	GEV No.	510612	Ref. No. 003.15.00029 HLE.15.00029
	impellor \varnothing 110mm H 34mm M8R		
	GEV No.	510693	Ref. No. —
	mechanical shaft seal for shaft \varnothing 12mm slide ring ext. \varnothing 24mm slide ring H 15.5mm slide ring int. \varnothing 11mm counter ring mounting \varnothing 24mm height counter ring 8mm counter ring int. \varnothing 13.5mm		
	GEV No.	524416	Ref. No. —
	pump cover gasket thickness 4x4mm Qty 1 pcs		





OLYMPIA

pumps





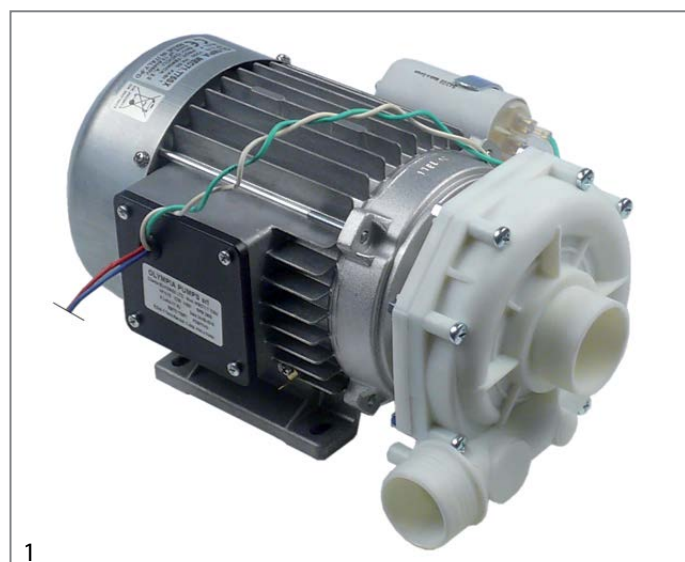

1

GEV No.	499322	Ref. No.	003.40.00005
description	pump inlet \varnothing 33mm outlet \varnothing 30/28mm type L63.T33DX 230V 50Hz 1 phase 0.26kW 0.33HP L 260mm rotation direction left capacitor 5 μ F OLYMPIA		
spare parts for	499322		
	GEV No.	365017	Ref. No. —
	operating capacitor capacity 5 μ F 450V tolerance 5% 50/60Hz ambient temperature max. -25 to +85°C \varnothing 28mm L 54mm M8 plastic connection male faston 6.3mm 16.10.08 protection		
	GEV No.	510693	Ref. No. —
	mechanical shaft seal for shaft \varnothing 12mm slide ringext. \varnothing 24mm slide ring H 15.5mm slide ring int. \varnothing 11mm counter ring mounting \varnothing 24mm height counter ring 8mm counter ring int. \varnothing 13.5mm		
	GEV No.	521258	Ref. No. —
	impellor \varnothing 80mm H 13mm thread M10R shaft \varnothing 12mm shaft length 7.5mm blades 6		
	GEV No.	521551	Ref. No. 003.00.00478 HLE.00.00478
	pump cover OLYMPIA inlet \varnothing 33mm outlet \varnothing 30mm outlet 2 \varnothing 28 turn direction left \varnothing 103mm ID \varnothing 93mm inner high 30mm		
	GEV No.	521723	Ref. No. —
	pump cover gasket EPDM thickness 2mm ID \varnothing 90mm Qty 1 pcs		



1

GEV No.	499050	Ref. No.	003.00.00350 HLE.00.00350
description	pump inlet \varnothing 45mm outlet \varnothing 40mm type MEC71.T75SX 230V 50Hz 1 phase 0.55kW 0.75HP L 283mm rotation direction right capacitor 12.5 μ F OLYMPIA		
For models:	Vergina-50SF		
spare parts for	499050		
	GEV No.	365014	Ref. No. —
	operating capacitor capacity 12.5 μ F 450V tolerance 5%Hz ambient temperature max. -25 to +85°C \varnothing 35mm L 70mm M8 plastic connection male faston 6.3mm 45S.C3DS.12.5 protection		
	GEV No.	510554	Ref. No. —
	O-ring EPDM thickness 2mm ID \varnothing 120mm Qty 1 pcs		
	GEV No.	510693	Ref. No. —
	mechanical shaft seal for shaft \varnothing 12mm slide ringext. \varnothing 24mm slide ring H 15.5mm slide ring int. \varnothing 11mm counter ring mounting \varnothing 24mm height counter ring 8mm counter ring int. \varnothing 13.5mm		
	GEV No.	517368	Ref. No. —
	impellor \varnothing 102mm H 21mm rotation direction right thread M10L suitable for Dibr blades 8		
	GEV No.	521158	Ref. No. —
	pump cover OLYMPIA inlet 45 inlet \varnothing 40mm pump type MEC71.T75SX		



drain pumps

HANNING



1

GEV No.	499339	Ref. No.	003.00.00184 HLE.00.00184
description	drain pump 65W 230V inlet ø 24mm outlet ø 24mm 50Hz type BE20B2-017 HANNING		
For models:	Euroline-40F, Vergina-50SF		



1

GEV No.	499133	Ref. No.	003.00.00635
description	drain pump 65W 230V inlet ø 24mm outlet ø 24mm 50Hz type BE20B2-017 HANNING kit		
spare parts for	499133		
	GEV No.	499339	Ref. No.
			003.00.00184 HLE.00.00184
	drain pump 65W 230V inlet ø 24mm outlet ø 24mm 50Hz type BE20B2-017 HANNING		

accessories

pump cover gaskets



1

GEV No.	501312	Ref. No.	002.00.00262
description	O-ring EPDM thickness 1.78mm ID ø 88.62mm Qty 1 pcs		



1

GEV No.	521715	Ref. No.	002.00.00232 YDR.00.00232
description	pump cover gasket		

fuses

thermal fuses



1

GEV No.	390734	Ref. No.	003.00.00168 old version HLE.00.00168 old version
description	thermal fuse switch-off temp. 90°C 1NC 1-pole 15A 250V connection male faston 6.3mm hole distance 24mm		

electric accessories

terminals

connection terminals with screw/faston connections



1

GEV No.	550278	Ref. No.	003.00.00392 HLE.00.00392
description	power terminal block 3-pole max. 40A max 400V connection ø6mm ² / F6.3 temp.-resist. 150°C cross section 6mm ²		
For models:	Barline-35F, Euroline-40F		



1

GEV No.	550411	Ref. No.	003.00.00030 HLE.00.00030
description	power terminal block 6-pole max. 40A max 450V connection ø6mm ² / F6.3 temp.-resist. 150°C cross section 6mm ²		



rail-mounted terminals

WEIDMÜLLER

feed-through terminals



GEV No. 551094 **Ref. No.** 003.00.00023
HLE.00.00023

description rail-mounted terminal 10mm² for DIN rail 35mm grey 1-pole

For models: Turbo-1500

accessories for 551094



GEV No. 551095 **Ref. No.** 003.00.00024
HLE.00.00024

description isolation barrier clamps 2.5-10mm² grey for DIN rail 35mm

accessories



GEV No. 551095 **Ref. No.** 003.00.00024
HLE.00.00024

description isolation barrier clamps 2.5-10mm² grey for DIN rail 35mm

For models: Turbo-1500

equipment-specific units

for dishwashers

drain and intake components

ELVIOMEX-ALFA

drain /intake bodies



GEV No. 503323 **Ref. No.** 002.00.00084
YDR.00.00084

description drain fitting

For models: Barline-35F, Euroline-40F, Vergina-50SF



GEV No. 524613 **Ref. No.** 002.00.00257

description drain fitting complete thread M36x1.5 ED ø 60mm H 42mm ID ø 30mm hose ø 30mm



GEV No. 503325 **Ref. No.** 002.15.00017
YDR.15.00017

description drain fitting thread 1½" ED ø 60mm H 49mm ID ø 40mm

For models: Turbo-1500

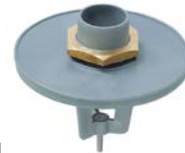

GEV No. 503329 **Ref. No.** 002.00.00081
YDR.00.00081

description intake body

For models: Vergina-50SF

filters



GEV No. 524593 **Ref. No.** 002.15.00012
YDR.15.00012

description filter support for drain filter ø 117mm thread M6

For models: Turbo-1500



GEV No. 517392 **Ref. No.** 001.40.00045

description round filters for drain pump ø 106mm H 95mm



GEV No. 517391 **Ref. No.** 001.50.00040
ANO.VK.00040

description round filters for drain pump ø 145mm H 90mm

			
1			
GEV No.	503326	Ref. No.	001.30.00030 ANO.30.00030 ANO.B3.00000
description	round filters suction ø 110mm		
For models:	Barline-35F, Euroline-40F		

			
1			
GEV No.	503328	Ref. No.	001.70.00000 ANO.7V.00000
description	round filters suction ø 140mm		
For models:	Vergina-50SF		

			
1			
GEV No.	503327	Ref. No.	001.15.00078 ANO.00.00042 ANO.15.00078
description	round filters suction ø 180mm H 85mm		
For models:	Turbo-1500		

			
1			
GEV No.	518134	Ref. No.	001.00.00017 ANO.00.00017
description	Thumb screw for filter fixing ø 20mm thread M6/M10		

			
1			
GEV No.	503320	Ref. No.	002.30.00007 YDR.BA.00007
description	overflow pipe L 100mm ø 29mm		
For models:	Barline-35F, Euroline-40F		

			
1			
GEV No.	503321	Ref. No.	002.30.00009 YDR.30.00009
description	overflow pipe L 120mm ø 29mm		

			
1			
GEV No.	503322	Ref. No.	002.70.00013 YDR.70.00013
description	overflow pipe L 145mm ø 29mm		
For models:	Vergina-50SF		

			
1			
GEV No.	503324	Ref. No.	002.15.00031 YDR.15.00031
description	overflow pipe L 165mm ø 39mm		
For models:	Turbo-1500		



boilers

boilers for dishwashers



1

GEV No.	524603	Ref. No.	001.40.00026 ANO.EU.00026
description	boiler ø 143mm L 270mm flange 3 hole flange inlet ø 10mm		
For models:	Euroline-40F		



1

GEV No.	524600	Ref. No.	001.50.00017 ANO.VE.00017
description	boiler ø 143mm L 400mm flange 3 hole flange inlet ø 10mm		
For models:	Vergina-50SF		



1

GEV No.	524599	Ref. No.	001.15.00027 ANO.15.00027
description	boiler ø 200mm L 453mm flange 3 hole flange inlet ø 10mm		
For models:	Turbo-1500		



1

GEV No.	524592	Ref. No.	001.35.00055 ANO.BL.00055
description	boiler ø 96mm L 325mm flange 3 hole flange inlet ø 10mm		
For models:	Barline-35F		

accessories



1

GEV No.	524614	Ref. No.	002.50.00001 YDR.VE.00001
description	connecting fitting for boiler thread 1/4"-1/2" ø 30mm L 50mm W 56mm WS 30 hose ø 10mm		
For models:	Vergina-50SF		

hood mechanics for dishwashers

miscellaneous



1

GEV No.	511967	Ref. No.	002.15.00044
description	guide for hood linkage ID ø 31mm L 66mm plastic mounting pos. left/right H 24mm black W 51mm		
For models:	Turbo-1500		

air traps

air traps



1

GEV No.	503337	Ref. No.	003.00.00014 HLE.00.00014
description	air trap		
For models:	Barline-35F, Euroline-40F, Turbo-1500, Vergina-50SF		



1

GEV No.	524607	Ref. No.	003.00.00552
description	air trap ø 49mm H 74mm thread M10x1.5 hose ø 6mm plastic		

backflow preventers

backflow preventers



1

GEV No.	516101	Ref. No.	003.00.00269 HLE.00.00269
description	backflow preventer dishwasher hose ø 12mm		
For models:	Vergina-50SF		
spare parts for	516101		
	GEV No.	506367	Ref. No. —
flat gasket rubber ED ø 40mm ID ø 28mm thickness 1.8mm Qty 1 pcs			

miscellaneous



1

GEV No.	524620	Ref. No.	002.00.00230 YDR.00.00230
description	bush PTFE H 6mm D1 ø 18mm D2 ø 13mm ID ø 10mm for ELVIOMEX ALFA		



1

GEV No.	524598	Ref. No.	002.00.00229 YDR.00.00229
description	bush PTFE H 9.4mm D1 ø 22mm D2 ø 8.5mm ID ø 15mm for ELVIOMEX ALFA		



1

GEV No.	524623	Ref. No.	002.35.00026
description	bush PTFE H 9mm D1 ø 18mm D2 ø 14mm ID ø 10mm for ELVIOMEX ALFA		
For models:	Turbo-1500		

door mechanics

springs

tension springs



1

GEV No.	519518	Ref. No.	001.15.00037 ANO.15.00037
description	tension spring ø 39mm wire gauge ø 5mm total length 510mm for door		
For models:	Turbo-1500		

locks



1

GEV No.	518133	Ref. No.	001.00.00051 ANO.00.00051
description	snap lock mounting pos. upper for door		
For models:	Barline-35F, Euroline-40F, Vergina-50SF		

screw connections



1

GEV No.	524617	Ref. No.	002.00.00224 YDR.00.00224
description	cap thread 1/2" H 21mm metal Qty 1 pcs		
For models:	Turbo-1500		

washing and rinsing systems





1

GEV No.	524620	Ref. No.	002.00.00230 YDR.00.00230
description	bush PTFE H 6mm D1 ø 18mm D2 ø 13mm ID ø 10mm for ELVIOMEX ALFA		





 <p>1</p>			
GEV No.	524623	Ref. No.	002.35.00026
description	bush PTFE H 9mm D1 ø 18mm D2 ø 14mm ID ø 10mm for ELVIOMEX ALFA		
For models:	Turbo-1500		

 <p>1</p>			
GEV No.	524597	Ref. No.	002.00.00223 YDR.00.00223
description	gasket for wash arm support rubber ø 109mm ID ø 54mm thickness 3mm		
For models:	Turbo-1500		

 <p>1</p>			
GEV No.	524622	Ref. No.	002.00.00105
description	gasket rubber ø 103mm ID ø 58mm thickness 3mm		

 <p>1</p>			
GEV No.	517393	Ref. No.	002.00.00083 YDR.00.00083
description	rinse arm support H 60mm thread 1/2" WS 30 hose ø 10mm		

 <p>1</p>			
GEV No.	503345	Ref. No.	002.15.00011 YDR.15.00011
description	rinse pipe		

 <p>1</p>			
GEV No.	518131	Ref. No.	002.50.00016 YDR.VK.00016
description	throttle disc ED ø 45mm ID ø 13mm thickness 1mm		

 <p>1</p>			
GEV No.	518132	Ref. No.	002.15.00103 YDR.15.00103
description	throttle disc L 32mm W 32mm ID ø 14mm thickness 1mm		

 <p>1</p>			
GEV No.	524624	Ref. No.	002.50.00004 YDR.VK.00004
description	Thumb screw thread M6x1 thread L 8mm ø 19mm H 3.5mm SS Qty 1 pcs		
For models:	Barline-35F, Euroline-40F, Vergina-50SF		

 <p>1</p>			
GEV No.	524608	Ref. No.	002.50.00017 YDR.VK.00017
description	wash pipe L 143mm plastic		
For models:	Vergina-50SF		

washing and rinsing systems (sorted by producer)

ELVIOMEX-ALFA

 <p>1</p>			
GEV No.	524601	Ref. No.	001.15.00012 ANO.15.00012
description	flat filter H 21mm SS L 275mm W 231mm		
For models:	Turbo-1500		

 <p>1</p>			
GEV No.	503304	Ref. No.	002.40.00013 YDR.EU.00013
description	wash and rinse arm mounting pos. upper/lower 2 wash arms/ 2 rinse arms		
For models:	Euroline-40F		





			
1			
GEV No.	503300	Ref. No.	002.35.00035 YDR.BL.00035
description	wash and rinse arm wash arm L 350mm rinse arm L 350mm w. jets 10 r. jets 5 mounting ø 10/32mm mounting pos. lower 2 wash arms/ 2 rinse arms		
For models:	Barline-35F		

			
1			
GEV No.	503317	Ref. No.	002.11.00008 YDR.11.00008
description	rinse jet H 13mm thread M6x1 WS 10 conical seal		
For models:	Barline-35F, Euroline-40F, Turbo-1500, Vergina-50SF		

			
1			
GEV No.	524612	Ref. No.	002.35.00018 002.40.00011 YDR.BL.00018 YDR.EU.00011
description	wash arm boss L 80mm W 64mm H 40mm		
For models:	Barline-35F, Euroline-40F		

 <p>Image not available</p>			
1			
GEV No.	503312	Ref. No.	002.15.00015 YDR.15.00015
description	rinse arm mounting pos. lower		

 <p>Image not available</p>			
1			
GEV No.	503311	Ref. No.	002.15.00016 YDR.15.00016
description	wash and rinse arm mounting pos. lower		

			
1			
GEV No.	503339	Ref. No.	002.15.00091 YDR.15.00091
description	wash and rinse arm wash arm L 550mm rinse arm L 545mm w. jets 10 r. jets 6 mounting ø 10/55mm mounting pos. upper/lower		
For models:	Turbo-1500		
spare parts for	503339		
			
GEV No.	503317	Ref. No.	002.11.00008 YDR.11.00008
description	rinse jet H 13mm thread M6x1 WS 10 conical seal		
			
GEV No.	524596	Ref. No.	002.15.00085 YDR.15.00085
description	wash arm boss ø 61mm L 120mm W 90mm H 51mm		
			
GEV No.	524623	Ref. No.	002.35.00026
description	bush PTFE H 9mm D1 ø 18mm D2 ø 14mm ID ø 10mm for ELVIOMEX ALFA		
			
GEV No.	524927	Ref. No.	002.15.00089 YDR.15.00089
description	wash arm mounting pos. upper/lower L 248mm nozzles 5 mounting ø 28mm ø 30mm		
accessories for	503339		
			
GEV No.	524610	Ref. No.	002.15.00082 YDR.15.00082
description	rinse arm shaft mounting pos. lower ø 20mm H 76mm thread 1/4"/ M8		

 <p>Image not available</p>			
1			
GEV No.	503313	Ref. No.	002.15.00091 YDR.15.00004 YDR.15.00091
description	wash arm mounting pos. lower		

			
1			
GEV No.	503317	Ref. No.	002.11.00008 YDR.11.00008
description	rinse jet H 13mm thread M6x1 WS 10 conical seal		
For models:	Barline-35F, Euroline-40F, Turbo-1500, Vergina-50SF		

			
1			
GEV No.	524927	Ref. No.	002.15.00089 YDR.15.00089
description	wash arm mounting pos. upper/lower L 248mm nozzles 5 mounting ø 28mm ø 30mm		
For models:	Turbo-1500		





 <p>1</p>			
GEV No.	524596	Ref. No.	002.15.00085 YDR.15.00085
description	wash arm boss ø 61mm L 120mm W 90mm H 51mm		

 <p>1</p>			
GEV No.	503301	Ref. No.	002.35.00023 YDR.BL.00023
description	rinse arm L 370mm nozzles 5 mounting ø 10mm mounting pos. upper		
For models:	Barline-35F		

 <p>1</p>			
GEV No.	503308	Ref. No.	002.50.00005 002.50.00026 YDR.VE.00026 YDR.VK.00006
description	rinse arm L 465mm nozzles 6 mounting ø 10mm mounting pos. upper/lower		
For models:	Vergina-50SF		

 <p>1</p>			
GEV No.	503317	Ref. No.	002.11.00008 YDR.11.00008
description	rinse jet H 13mm thread M6x1 WS 10 conical seal		
For models:	Barline-35F, Euroline-40F, Turbo-1500, Vergina-50SF		

 <p>1</p>			
GEV No.	503307	Ref. No.	002.50.00006 YDR.VE.00006
description	wash arm L 510mm nozzles 6 mounting ø 15/62mm mounting pos. lower		
For models:	Vergina-50SF		

 <p>1</p>			
GEV No.	503343	Ref. No.	002.15.00018_3 YDR.15.00018_3
description	wash arm H 105mm L 198mm nozzles 3 mounting pos. upper right		

 <p>1</p>			
GEV No.	503341	Ref. No.	002.15.00018_1 YDR.15.00018_1
description	wash arm H 200mm L 105mm nozzles 3 mounting pos. upper left		

 <p>1</p>			
GEV No.	503342	Ref. No.	002.15.00018_2 YDR.15.00018_2
description	wash arm H 200mm L 160mm nozzles 3 mounting pos. upper left		

 <p>1</p>			
GEV No.	503344	Ref. No.	002.15.00018_4 YDR.15.00018_4
description	wash arm H 200mm L 160mm nozzles 3 mounting pos. upper right		

 <p>1</p>			
GEV No.	503316	Ref. No.	002.15.00021 YDR.15.00021
description	wash jet		

			
1			
GEV No.	503340	Ref. No.	002.15.00035 YDR.15.00035
description	rinse arm H 225mm L 520mm nozzles 10 mounting pos. upper		

			
1			
GEV No.	503318	Ref. No.	002.15.00026 YDR.15.00008 YDR.15.00026
description	rinse jet		

			
1			
GEV No.	503306	Ref. No.	002.50.00007 YDR.VE.00007
description	wash arm H 555mm L 485mm nozzles 8 mounting pos. upper		

			
1			
GEV No.	503314	Ref. No.	002.50.00003 YDR.VE.00003
description	wash jet		

			
1			
GEV No.	503315	Ref. No.	002.50.00030 YDR.VK.00014
description	wash jet		
For models:	Vergina-50SF		

miscellaneous





			
1			
GEV No.	524621	Ref. No.	002.00.00145 YDR.00.00145
description	end cap for rinse arm thread M11x1 ø 12mm H 6mm suitable for ELVIOMEX ALFA		

			
1			
GEV No.	524594	Ref. No.	002.35.00047
description	end cap for rinse arm thread M9x1 ø 10mm H 6mm		

			
1			
GEV No.	503156	Ref. No.	002.1500093 A YDR.15.00093 A
description	rinse arm mounting pos. A L 247mm nozzles 3		

			
1			
GEV No.	503157	Ref. No.	002.1500093 B YDR.15.00093 B
description	rinse arm mounting pos. B L 274mm nozzles 3 tube ø 12mm		

			
1			
GEV No.	503319	Ref. No.	002.15.00022 YDR.15.00022
description	rinse jet		

				
Image not available				
1				
GEV No.	503346	Ref. No.	002.15.00018 YDR.15.00018	
description	wash arm 6-piece			
spare parts for	503346			
	GEV No.	503341	Ref. No.	002.15.00018_1 YDR.15.00018_1
	wash arm H 200mm L 105mm nozzles 3 mounting pos. upper left			
	GEV No.	503342	Ref. No.	002.15.00018_2 YDR.15.00018_2
	wash arm H 200mm L 160mm nozzles 3 mounting pos. upper left			
	GEV No.	503343	Ref. No.	002.15.00018_3 YDR.15.00018_3
	wash arm H 105mm L 198mm nozzles 3 mounting pos. upper right			
	GEV No.	503344	Ref. No.	002.15.00018_4 YDR.15.00018_4
	wash arm H 200mm L 160mm nozzles 3 mounting pos. upper right			

1

GEV No.	503303	Ref. No.	002.35.00029 YDR.BL.00029
description	rinse arm support mounting pos. upper		
For models:	Barline-35F, Vergina-50SF		



1

GEV No.	503309	Ref. No.	002.50.00027 YDR.VE.00010 YDR.VE.00027
description	rinse arm support mounting pos. upper until year of construction 2002		



1

GEV No.	503302	Ref. No.	002.35.00041 YDR.BL.00041
description	wash arm support mounting pos. lower		
For models:	Barline-35F		



1

GEV No.	503310	Ref. No.	002.00.00080 002.50.00036 YDR.00.00080 YDR.VE.00080
description	wash arm support mounting pos. lower		
For models:	Vergina-50SF		



1

GEV No.	524595	Ref. No.	002.35.00019 YDR.BL.00019
description	wash arm support mounting pos. lower H 53mm		
For models:	Barline-35F, Euroline-40F		



1

GEV No.	524604	Ref. No.	002.15.00084 YDR.15.00084
description	wash arm support mounting pos. lower ø 52mm H 252mm ID ø 44mm		
For models:	Turbo-1500		



1

GEV No.	524605	Ref. No.	002.40.00012 YDR.EU.00012
description	wash arm support mounting pos. lower thread M6 ø 30mm H 280mm ID ø 28mm		
For models:	Euroline-40F		



1

GEV No.	503305	Ref. No.	002.40.00014 YDR.EU.00014
description	wash arm support mounting pos. upper		
For models:	Euroline-40F		



1

GEV No.	524606	Ref. No.	002.15.00086 YDR.15.00086
description	wash arm support mounting pos. upper H 60mm		
For models:	Turbo-1500		

rinse arm shafts



1

GEV No.	524625	Ref. No.	002.35.00016 YDR.BL.00016
description	rinse arm shaft mounting pos. lower ø 16mm H 55mm thread M6		
For models:	Barline-35F, Euroline-40F		





1

GEV No.	524611	Ref. No.	002.11.00002 YDR.11.00002
description	rinse arm shaft mounting pos. lower ø 20mm H 75mm thread 1/4\"/>		
For models:	Vergina-50SF		



1

GEV No.	524610	Ref. No.	002.15.00082 YDR.15.00082
description	rinse arm shaft mounting pos. lower ø 20mm H 76mm thread 1/4\"/>		
For models:	Turbo-1500		
accessories for	524610		
	GEV No.	524619	Ref. No.
			002.15.00083 YDR.15.00083
	knurled nut thread M8 ø 25mm H 7mm SS		



1

GEV No.	524618	Ref. No.	002.50.00012 YDR.VK.00012
description	rinse arm shaft mounting pos. upper ø 10mm H 31mm thread M10		
For models:	Vergina-50SF		



1

GEV No.	524609	Ref. No.	002.40.00001 YDR.EU.00001
description	rinse arm shaft mounting pos. upper ø 16mm H 54mm thread M6\"/>		
For models:	Euroline-40F		



1

GEV No.	524615	Ref. No.	002.35.00015 YDR.BL.00015
description	rinse arm shaft ø 12mm H 101mm thread M10		
For models:	Barline-35F		



			
1			
GEV No.	524616	Ref. No.	002.40.00004
description	rinse arm shaft ø 12mm H 122mm thread M10		
For models:	Euroline-40F		

handles and hand wheels

bracket handles

			
1			
GEV No.	503338	Ref. No.	001.00.00119 ANO.00.00119
description	pull handle		
For models:	Barline-35F, Euroline-40F		

			
1			
GEV No.	503160	Ref. No.	001.00.00118 ANO.00.00118
description	pull handle L 418mm H 35mm mounting distance 378mm thread M8x1.25 W 25mm complete grey		
For models:	Vergina-50SF		

equipment feet and end caps

screw-in feet

			
1			
GEV No.	701048	Ref. No.	001.00.00016 ANO.00.00016
description	equipment foot thread M10 thread L 26mm ø 40mm H 46mm Qty 1 pcs		
For models:	Barline-35F, Euroline-40F, Vergina-50SF		

baskets

warewashing baskets

accessories

plate inserts

			
1			
GEV No.	972036	Ref. No.	003.00.00517 HLE.00.00517
description	plate insert L 290mm W 90mm H 75mm plates 12		

			
1			
GEV No.	971147	Ref. No.	003.40.00015 HLE.EU.00015
description	plate insert L 370mm W 380mm H 75mm plates 8 plastic-coated steel		

gaskets

O-rings

EPDM

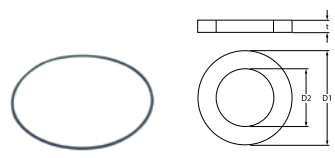
			
1			
GEV No.	501312	Ref. No.	002.00.00262
description	O-ring EPDM thickness 1.78mm ID ø 88.62mm Qty 1 pcs		

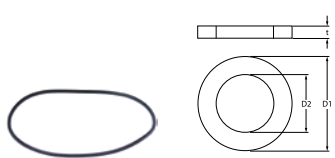
			
1			
GEV No.	510551	Ref. No.	002.00.00261
description	pump cover gasket ID ø 158.3mm pump type 1214/1293/1225/2243/1226/1204/3473/1241 thickness 3.53mm EPDM Qty 1 pcs		

special gaskets

gaskets for wash arm support



1

GEV No.	524622	Ref. No.	002.00.00105
description	gasket rubber ø 103mm ID ø 58mm thickness 3mm		

industrial hoses

Niplaflex hoses



1

GEV No.	530561	Ref. No.	002.15.00099 YDR.15.00099
description	pressure hose ID ø 10mm ED ø 17mm L 5m thickness 3.5mm operating p. 10bar burst p. 30bar t.max. 110°C		
For models:	Turbo-1500		

dosing pumps

membrane dosing pumps

self-priming

various



2x

1

GEV No.	361370	Ref. No.	003.00.00268 HLE.00.00268	
description	dosing pump type model 2 rinse aid inlet 4x6mm outlet 4x6mm pressure connection ø 4x6mm suction connection ø 4x6mm			
For models:	Barline-35F, Euroline-40F, Turbo-1500, Vergina-50SF			
spare parts for	361370			
	GEV No.	361307	Ref. No.	—
	membrane dosing pump ø 68mm hole ø 6mm for type DIB3P/DIB5P			
	GEV No.	361459	Ref. No.	—
	hose connector ø 6mm for dosing pump			

formed hoses

straight



1

GEV No.	503332	Ref. No.	002.00.00178 YDR.00.00178
description	formed hose dishwasher straight equiv. no. YDR.00.00178		
For models:	Euroline-40F		



1

GEV No.	503336	Ref. No.	002.15.00029 YDR.15.00029
description	formed hose dishwasher straight equiv. no. YDR.15.00029		

hoses

drain hoses



1

GEV No.	530572	Ref. No.	002.00.00234 YDR.00.00234
description	drain hose DN24 L 2000mm straight ø inside 24mm straight ext. ø 29mm elbow ø inside 29mm elbow ext. ø 35mm outer hose ø 29mm		
For models:	Vergina-50SF		



1

GEV No.	503331	Ref. No.	002.35.00025 YDR.BL.00025
description	formed hose dishwasher straight equiv. no. YDR.BL.00025		
For models:	Barline-35F		



form L



1

GEV No.	524629	Ref. No.	002.50.00014 YDR.VE.00014
description	formed hose end piece A ext. ø 41mm end piece A int. ø 26mm AD2 ø 41mm ø end piece B 26mm L 62mm plastic Qty 1 warewashing L-shape for drain pump mounting pos. supply		
For models:	Vergina-50SF		



1

GEV No.	524628	Ref. No.	002.35.00048
description	formed hose end piece A ext. ø 41mm end piece A int. ø 27mm AD2 ø 41mm ø end piece B 30/27mm L 100mm plastic Qty 1 warewashing L-shape supply		
For models:	Barline-35F		



1

GEV No.	524627	Ref. No.	002.40.00024
description	formed hose end piece A ext. ø 41mm end piece A int. ø 27mm AD2 ø 41mm ø end piece B 30/27mm L 96mm plastic Qty 1 warewashing L-shape supply		
For models:	Euroline-40F		



1

GEV No.	524626	Ref. No.	002.40.00025
description	formed hose end piece A ext. ø 41mm end piece A int. ø 30mm AD2 ø 41mm ø end piece B 26mm L 90mm plastic Qty 1 warewashing L-shape supply		
For models:	Euroline-40F		



1

GEV No.	517390	Ref. No.	002.15.00027 YDR.15.00027
description	formed hose end piece A ext. ø 51mm end piece A int. ø 41mm AD2 ø 46mm ø end piece B 36mm L 490mm Qty 1 warewashing L-shape		
For models:	Turbo-1500		



1

GEV No.	503333	Ref. No.	002.00.00127 YDR.00.00127
description	formed hose end piece A int. ø 44mm ø end piece B 41mm L 130mm L1 130mm warewashing L-shape equiv. no. YDR.00.00027		
For models:	Vergina-50SF		



1

GEV No.	503330	Ref. No.	002.00.00126 YDR.00.00126
description	formed hose warewashing L-shape equiv. no. YDR.00.00126		



1

GEV No.	503335	Ref. No.	002.15.00058 YDR.15.00058
description	formed hose warewashing L-shape equiv. no. YDR.15.00058		
For models:	Turbo-1500		



1

GEV No.	503334	Ref. No.	002.50.00032 YDR.VK.00013
description	formed hose warewashing L-shape equiv. no. YDR.VK.00013		
For models:	Vergina-50SF		



form U



1

GEV No.	517389	Ref. No.	002.40.00023
description	formed hose D1 ø 38mm D2 ø 28mm L 590mm warewashing black Qty 1		
For models:	Euroline-40F		

fittings, hose and pipe connectors

fittings

double nipples



1

GEV No.	520168	Ref. No.	002.00.00030
description	double nipple nickel-plated brass thread 1/2" - 1/2" Qty 1 pcs		

angle pieces



1

GEV No.	541493	Ref. No.	002.00.00225 002.00.00226 YDR.00.00225 YDR.00.00226
description	angle piece thread 1/2" IT - 1/2" ET chrome-plated brass		
For models:	Turbo-1500		

measuring equipment

thermometers

built-in thermometers



1

GEV No.	541306	Ref. No.	003.00.00019 003.00.00505 HLE.00.00019 HLE.00.00505
description	thermometer mounting measurements 62x11mm 0 up to +120°C capillary pipe 3000mm probe ø 6mm probe L 27mm		
For models:	Turbo-1500, Vergina-50SF		

fastening material

screws

knurled screws



1

GEV No.	524624	Ref. No.	002.50.00004 YDR.VK.00004
description	Thumb screw thread M6x1 thread L 8mm ø 19mm H 3.5mm SS Qty 1 pcs		
For models:	Barline-35F, Euroline-40F, Vergina-50SF		

nuts

knurled nuts



1

GEV No.	524619	Ref. No.	002.15.00083 YDR.15.00083
description	knurled nut thread M8 ø 25mm H 7mm SS		
For models:	Turbo-1500		

union nuts



1

GEV No.	520559	Ref. No.	002.00.00144 YDR.00.00144
description	union nut chrome-plated thread 1/2" H 13mm WS 26 Qty 1 pcs for pipe ø 12mm		
For models:	Vergina-50SF		



consumables

fuses

thermal fuses



GEV No.	390734	Ref. No.	003.00.00168 old version HLE.00.00168 old version
description	thermal fuse switch-off temp. 90°C 1NC 1-pole 15A 250V connection male faston 6.3mm hole distance 24mm		

B		
bi-metal thermostats	5	
C		
consumables	27	
contactors	7	
control equipment	6	
D		
dosing pumps	24	
double nipples	26	
drain hoses	24	
drain pumps	12	
E		
electric accessories	12	
F		
fastening material	26	
fittings	26	
formed hoses	24	
fuses	12, 27	
G		
gaskets for wash arm support	24	
H		
heating elements	3	
hoses	24	
I		
immersion heating elements	3	
indicator lights	7	
indicator lights (complete)	7	
industrial hoses	24	
K		
knurled nuts	26	
knurled screws	26	
L		
lamps	7	
M		
measuring equipment	26	
microswitches	6	
N		
Niplaflex hoses	24	
nuts	26	
O		
O-rings	23	
P		
position switches	6	
pressure switches	9	
programme timers	7	
pumps	9	
push/momentary push switches	5	
R		
relays	8	
S		
safety bi-metal thermostats	5	
screws	26	
solenoid valves	9	
switches and momentary switches	5	
T		
terminals	12	
thermal fuses	27	
thermostats	5	
timers	7	
U		
union nuts	26	
W		
wash and rinse pumps	9	