



GAS COMPONENTS



ELECTRIC COMPONENTS



WATER TECHNOLOGY



MECHANICAL COMPONENTS



TOOLS

Spare parts suitable for

EMAINOX

Find the complete and up-to-date range of products in our GEV Webshop



Manufacturer catalogue

The most important spare parts and accessories arranged clearly for every manufacturer

- ✓ Complete product range and all appliance data always up to date in the GEV Webshop
- ✓ Alphabetical Index at the end of the catalogue

GEV Webshop

www.gev-online.co.uk

www.gev-online.com



- 🔍 Add to Favourites
- 🔍 Sign In with email address and usual password
- 🔍 Easy-order – place several items in your basket at the same time
- 🔍 Quick Item search – no login needed



heating elements

heating elements for bain maries

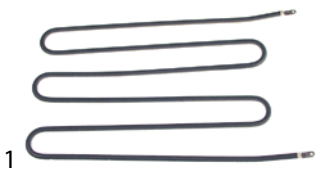
			
GEV No.	418344	Ref. No.	3710003
description	heating element 1200W 220V heating circuits 1 L 395mm W 220mm H 24mm connection M4 tube ø 8mm dry heating element L1 50mm L2 345mm connection distance 212mm		

heating elements for heated cabinets

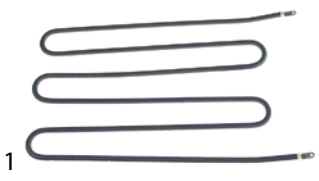

			
GEV No.	418344	Ref. No.	3710003
description	heating element 1200W 220V heating circuits 1 L 395mm W 220mm H 24mm connection M4 tube ø 8mm dry heating element L1 50mm L2 345mm connection distance 212mm		

heating cartridges

			
GEV No.	418346	Ref. No.	3710022
description	heating element 400W 230V ø 10mm L 380mm thread M14x1.25 cable length 110mm flange with thread		

			
GEV No.	418841	Ref. No.	3710024
description	heating element 500W 230V ø 10mm L 490mm thread M14x1.25 cable length 110mm		

heating elements for convection

			
GEV No.	418345	Ref. No.	3710004
description	heating element 1600W 230V heating circuits 1 ID ø 178mm ED ø 191mm L 250mm H 40mm L1 50mm W1 32mm H1 16mm H2 24mm flange length 70mm flange width 22mm hole distance 56mm connection male faston 6.3mm tube ø 6.3mm convection heating element hole ø 5mm rectangular flange		
accessories for	418345		
			
GEV No.	510368	Ref. No.	—
description	gasket L 70mm W 23.5mm hole ø 5mm hole distance 56mm FIBER thickness 2mm for heating element		

foil heating elements

			
GEV No.	418842	Ref. No.	3710036
description	foil heating element L 480mm W 280mm 400W 230V probe ø 6mm with temperature limiter 150°C silicone		

energy regulators

EGO

1-circuit

			
GEV No.	380015	Ref. No.	3700010
description	energy regulator 230V 13A single-circuit turn direction right shaft ø 6x4.6mm shaft L 23mm mounting thread M4 power release 6-100% no. 50.57021.010		

thermostats

control and safety thermostats

EGO

control thermostats

55.10/19_series

			
GEV No.	375381	Ref. No.	3700002
description	thermostat t.max. 90°C temperature range 30-90°C 1-pole 1NO 16A probe ø 6mm probe L 130mm capillary pipe 2000mm capillary pipe isolated 2000mm gland nut shaft ø 6x4.6mm shaft L 23mm shaft position upper rotation 270°		



safety thermostats

55.11_ series

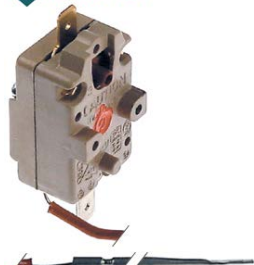

GEV No.	375767	Ref. No.	3700014
description	safety thermostat switch-off temp. 170°C 1-pole 16A probe ø 3.1mm probe L 160mm capillary pipe 650mm capillary pipe isolated 600mm gland nut probe		

refrigeration thermostats

universal without housing



GEV No.	390534	Ref. No.	3700018
description	thermostat temperature range -35 up to +35°C probe ø6x110mm capillary pipe 1800mm PRODIGY		
accessories for	390534		
	GEV No.	110305	Ref. No. —
	knob thermostat t.max. 35°C temperature range -35 up to +35°C ø 45mm shaft ø 6x4.6mm shaft flat inclined rotation 270° white		

accessories

connecting bows



GEV No.	550060	Ref. No.	3700007
description	connecting bow long for thermostat Qty 1 pcs		

switches and momentary switches

rocker/momentary rocker switches

30x22mm



GEV No.	301018	Ref. No.	3700102
description	momentary rocker switch mounting measurements 30x22mm orange 2NO 250V 16A illuminated 0-I connection male faston 6.3mm ambient temperature max. 125/55°C protection IP65		
accessories for	301018		
	GEV No.	301036	Ref. No. —
	protective cover internal size 30x22mm for rocker switch mounting measurementsmm		

labelled



GEV No.	300125	Ref. No.	3700100
description	rocker switch mounting measurements 30x22mm green 2NO 230V 16A 0-I connection male faston 6.3mm ambient temperature max. 125/55°C protection IP65 with cover cap		
accessories for	300125		
	GEV No.	301036	Ref. No. —
	protective cover internal size 30x22mm for rocker switch mounting measurementsmm		



GEV No.	301006	Ref. No.	3700101
description	rocker switch mounting measurements 30x22mm orange 2NO 250V 16A illuminated connection male faston 6.3mm ambient temperature max. 125/55°C protection IP65 with cover cap		
accessories for	301006		
	GEV No.	301036	Ref. No. —
	protective cover internal size 30x22mm for rocker switch mounting measurementsmm		



cam switches

operation switches



1	GEV No.	300091	Ref. No.	3700003
description operation switch EGO 2 operating positions 2NO 16A sequence 0-1 shaft ø6x4.6mm shaft L 23mm connection screw ceramic				

lamps

indicator lights

indicator lights (complete)

ø10mm

with screw socket



1	GEV No.	359791	Ref. No.	3760004
description indicator light ø 10mm 230V green cable length 250mm				



1	GEV No.	359387	Ref. No.	3760002
description indicator light ø 10mm 230V red cable length 250mm				

fluorescent lamps

fluorescent lamps

G13



1	GEV No.	359386	Ref. No.	3760019 3760026
description fluorescent lamp socket G13 L 1198mm 36W 230V Qty 1 pcs				



1	GEV No.	359390	Ref. No.	3760015
description fluorescent lamp socket G13 L 1500mm 58W 230V Qty 1 pcs				



1	GEV No.	359383	Ref. No.	3760025
description fluorescent lamp socket G13 L 438mm 15W 230V Qty 1 pcs light colour 640				



GEV No.	359372	Ref. No.	3760027
description fluorescent lamp socket G13 L 895mm 30W 230V Qty 1 pcs			

complete with holder

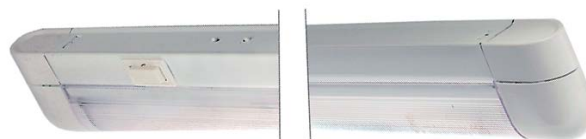

1	GEV No.	359391	Ref. No.	3760018
description fluorescent lamp L 1245mm W 37mm 36W				

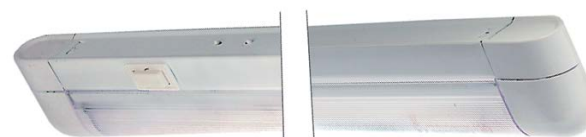

1	GEV No.	359392	Ref. No.	3760009
description fluorescent lamp L 1545mm W 37mm 58W				

accessories

sockets



1	GEV No.	358175	Ref. No.	AAG3251/C-TR
description lamp socket socket G13 for fluorescent lamps				



1	GEV No.	358176	Ref. No.	3760023 AAG251/S
description lamp socket socket G13 for fluorescent lamps				



1	GEV No.	359388	Ref. No.	3760024
description lamp socket socket G13 for fluorescent lamps				



contactors

ISKRA (FANAL)

power contactors

			
1			
GEV No.	380211	Ref. No.	3700037
description	power contactor 230VAC		



			
1			
GEV No.	380213	Ref. No.	3700080
description	power contactor resistive load 20A 230VAC (AC3/400V) 8.5A/5.5kW main contacts 3NO auxiliary contacts 1NO connection screw connection type Fanal DSL7 10 type ISKRA K07M 10		

relays

power relays

with male contacts

female contact 2.0mm

				
1				
GEV No.	380494	Ref. No.	3700053	
description	power relays FINDER 230VAC 7A 4CO connection F2 plug-in connection manuf. no. 55.34.8.230.0054 94.74/ZMD4 250V connection 2mm			
accessories for	380494			
	GEV No.	380341	Ref. No.	—
	relay socket 4-pole contacts 12 300V voltage AC 6A Italiana Relè manuf. no. ZMD4			
	GEV No.	380399	Ref. No.	—
	relay socket 4-pole dimensions 76.2x27x86.1mm 250V voltage AC 1A FINDER manuf. no. 94.94.3			

			
1			
GEV No.	359389	Ref. No.	3760023
description	lamp socket socket G13 for fluorescent lamps		

starter			
			
1			
GEV No.	380464	Ref. No.	3760028
description	starter 4-65W		

ballasts			
			
1			
GEV No.	401440	Ref. No.	3760020
description	electrical ballast 15W 230V for fluorescent lamps		

			
1			
GEV No.	401141	Ref. No.	3760021
description	electrical ballast 30W 230V for fluorescent lamps Qty 1 pcs		

			
1			
GEV No.	401142	Ref. No.	3760022
description	electrical ballast 30W for fluorescent lamps		

			
1			
GEV No.	401441	Ref. No.	3760022
description	electrical ballast 36-40W for fluorescent lamps		



relay sockets



1

GEV No.	380393	Ref. No.	3700054
description	relay socket 4-pole		

electronic controllers

EVCO - EVERY CONTROL

refrigeration controllers

built-in version



1

GEV No.	379998	Ref. No.	3700041
description	electronic controller EVERY CONTROL type FK200XN7 mounting measurements 71x29mm 230V voltage AC NTC		

electronics

PCBs



1

GEV No.	401450	Ref. No.	3700120
description	keypad PCB for water filling		

solenoid valves

solenoid valves (water)

RPE



1

GEV No.	374017	Ref. No.	3740017
description	solenoid valve single straight 230VAC inlet 3/4" outlet 10mm input 6l/min DN10 RPE polyamide flow regulating valve inlet white membranes NBR pressure range 0.2-10bar		



1

GEV No.	370009	Ref. No.	3740017
description	solenoid valve single straight 230VAC inlet 3/4" outlet 3/4" DN10 RPE total length 88.5mm		

solenoid valves (refrigeration)

PARKER

valves



1

GEV No.	370366	Ref. No.	3740021	
description	solenoid valve NC type YB09 with cable 230V pressure range 0-10bar connection 4mm soldering connection PARKER refrigeration straight			
spare parts for	370366			
	GEV No.	371033	Ref. No.	—
	solenoid coil PARKER 230VAC 9VA coil type YB09 with cable seat ø 14mm			



compressors

EMBRACO / ASPERA

R404a/R507

LBP monophase

Lower evaporation temperature below -20°C



1

GEV No.	605005	Ref. No.	3650048
description	compressor coolant R404a/R507 type T2155GK 230V 50Hz LBP fully hermetic 16.3kg power input 458W cylinder capacity 14.5cm ³ CSR H 221mm 368W 524W 717W 948W 1215W test method ASHRAE		

HMBP monophase

High/Medium evaporation temperature above -20/-15 °C



1

GEV No.	605004	Ref. No.	3650047
description	compressor coolant R404a/R507 type EMT6152GK 220-240V 50Hz HMBP fully hermetic 7.8kg 1/5HP cylinder capacity 4.5cm ³ CSIR H 166mm WWW 267W 332W 351W 437W 535W 646W 769W test method ASHRAE		



fans

refrigeration fans

cooling motors (complete)



1

GEV No.	601280	Ref. No.	3650032
description	fan 230V 5W 50/60Hz fan wheel ø 172mm		
spare parts for	601280		
	GEV No.	601020	Ref. No. —
	fan motor 5W 230V 50-60Hz L1 44mm L2 48mm L3 79mm W 84mm cable length 500mm 1300rpm YZF5-13-18/26 5 mounting options bearing slide bearing		
	GEV No.	601069	Ref. No. —
	fan wheel sucking ø 172mm turn direction left fan wheel mounting 25.4mm blade angle 25° W 32mm aluminium		

hot air fans

miscellaneous



1

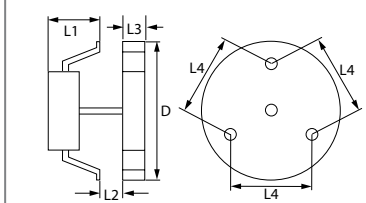

GEV No.	601531	Ref. No.	3740035
description	hot air fan 220V 30W 50Hz L1 70mm L2 12mm L3 30mm L4 87mm fan wheel ø 155mm FIME type C30R0407		



equipment-specific units

for display coolers

doors



1

GEV No.	695247	Ref. No.	2300550
description	trapdoor W 638mm H 215mm		

door mechanics

miscellaneous



1

GEV No.	700907	Ref. No.	3990001
description	bracket complete for glass plate plastic L 80mm W 26mm H 49mm		

for bain marie

drain systems



1

GEV No.	515060	Ref. No.	3600034 3600077
description	drain fitting thread 3/4" H 18mm ID ø 20mm ED ø 38mm		

for dishwashers

drain and intake components

miscellaneous

overflow pipes



1

GEV No.	515061	Ref. No.	2300567
description	overflow pipe		

knobs

universal knobs



1

GEV No.	111934	Ref. No.	3700057
description	knob thermostat t.max. 90°C ø 50mm shaft ø 6x4.6mm shaft flat upper black temperature range 30-90°C rotation 270°		
accessories for	111934		
	GEV No.	Ref. No.	—
	110135		
	rosette knob up to ø 52mm		

producer-specific knobs

EMAINOX



1

GEV No.	111933	Ref. No.	3700021
description	knob switch zero mark t.max.°C ø 44mm shaft ø 6x4.6mm shaft flat upper silver		



1

GEV No.	111934	Ref. No.	3700057
description	knob thermostat t.max. 90°C ø 50mm shaft ø 6x4.6mm shaft flat upper black temperature range 30-90°C rotation 270°		
accessories for	111934		
	GEV No.	Ref. No.	—
	110135		
	rosette knob up to ø 52mm		

pullouts

rollers

roller with holder



1			
GEV No.	690955	Ref. No.	2330706
description	roller rollerø 28mm B1 6mm with holder SS/Nylon mounting pos. upper bearing slide bearing Qty 1 pcs H 5mm L 62mm mounting distance 25/45mm		

shelves and shelf rails

shelf rails and supports

producer-specific



1			
GEV No.	690760	Ref. No.	2330094
description	guide U-shape L 503mm W 24mm H 13mm mounting pos. left/right		



1			
GEV No.	693481	Ref. No.	3380001
description	shelf support L 23mm W 20mm H 26mm		

gaskets

refrigeration gaskets

screw-in gaskets

profile 9030

We offer custom-made gaskets for this profile

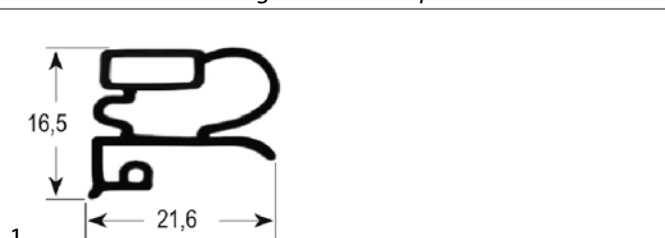

GEV No.	900541	Ref. No.	2320081
description	refrigeration gasket profile 9030 W 175mm L 403mm external size		

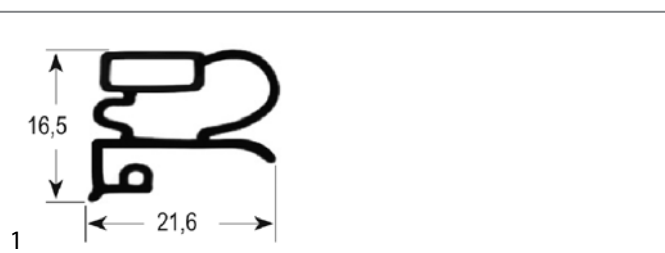

GEV No.	900543	Ref. No.	2320082 3965048
description	refrigeration gasket profile 9030 W 188mm L 403mm external size		



GEV No.	900540	Ref. No.	2320043 3960127
description	refrigeration gasket profile 9030 W 372mm L 403mm external size		

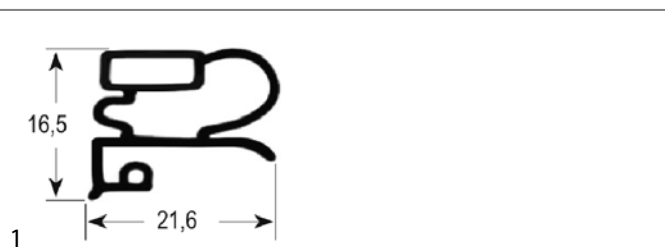

GEV No.	900542	Ref. No.	3965045
description	refrigeration gasket profile 9030 W 410mm L 430mm external size		



O-rings

EPDM

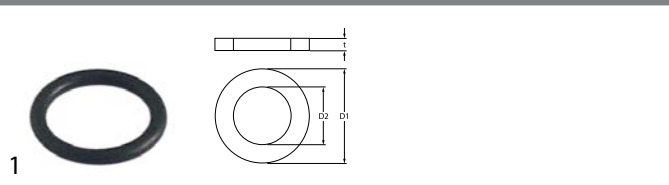

GEV No.	504618	Ref. No.	3600035
description	O-ring EPDM thickness 2.62mm ID ø 15.54mm Qty 1 pcs		

refrigeration cycle components

valves

expansion valves

DANFOSS

valves

type TS2/TE2



GEV No.	750015	Ref. No.	3650065
description	expansion valve DANFOSS type TES2 coolant R404a/R507 angled 90° thermostatically controlled inlet 3/8" SAE outlet 1/2" SAE 1/4" p max 34bar -40 up to +10°C capillary pipe 1500mm		

accessories for	750015			
	GEV No.	750020	Ref. No.	—
	nozzle insert size 0X type 068-2002 T/TE 2 DANFOSS			
	GEV No.	750021	Ref. No.	—
	nozzle insert size 00 type 068-2003 T/TE 2 DANFOSS			
	GEV No.	750022	Ref. No.	—
	nozzle insert size 01 type 068-2010 T/TE 2 DANFOSS			
	GEV No.	750023	Ref. No.	—
	nozzle insert size 02 type 068-2015 T/TE 2 DANFOSS			
	GEV No.	750024	Ref. No.	—
	nozzle insert size 03 type 068-2006 T/TE 2 DANFOSS			
	GEV No.	750483	Ref. No.	—
	nozzle insert size 04 type 068-2007 T2/TE2 DANFOSS			
	GEV No.	750484	Ref. No.	—
	nozzle insert size 05 type 068-2008 T2/TE2 DANFOSS			
	GEV No.	750485	Ref. No.	—
	nozzle insert size 06 type 068-2009 T2/TE2 DANFOSS			

indicators

CASTEL



GEV No.	750070	Ref. No.	3650018
description	sight glass CASTEL type 3950/22 with indicator connection 7/16" UNF (1/4" SAE) internal/external thread L 68mm -30 jusqu'à +110°C p max 45bar		

evaporators

for fridges

producer-specific

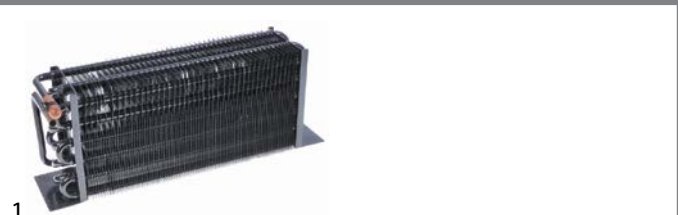

GEV No.	750155	Ref. No.	3650025 3650105
description	evaporator L 320mm W 90mm H 150mm		

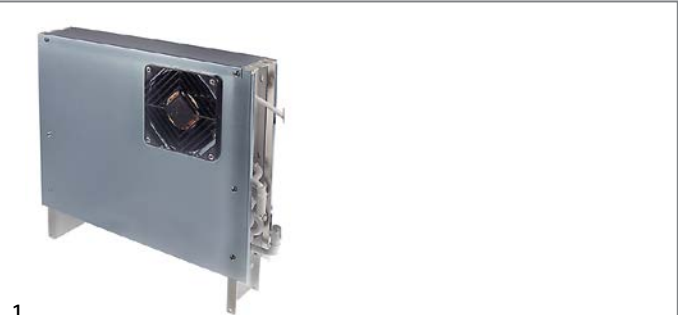

GEV No.	750153	Ref. No.	3650007
description	evaporator L 390mm W 75mm H 300mm complete with fan		

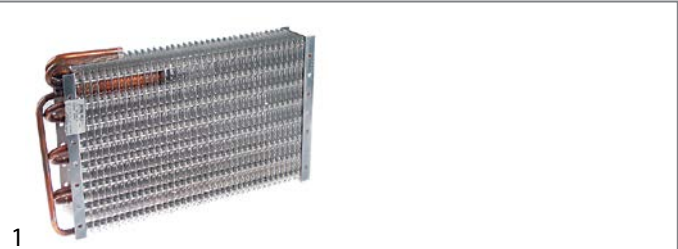

GEV No.	750154	Ref. No.	3650010
description	evaporator L 445mm W 75mm H 280mm total length 510mm		

kitchen accessories

gastronorm

gastronorm plates



1

GEV No.	695246	Ref. No.	3400202
description	gastronorm plate size GN 1/1 W 325mm L 530mm		

bridges



1

GEV No.	693484	Ref. No.	2300306
description	bridge for Gastronorm container L1 530mm L2 510mm SS W 22mm H 19.5mm Qty 1 pcs thickness 0.75mm		

valves and tank inlets

ball valves

universal

ball valves with lever handle



1

GEV No.	514360	Ref. No.	3600259
description	ball valve connection 1/2" IT - 1/2" IT DN15 total length 49mm		

tank inlets



1

GEV No.	693483	Ref. No.	3600032
description	tank inlet connection 1/2" WS 27 L1 12mm L2 20mm		



drain systems and wash basins

standpipes

3/4"



1

GEV No.	515048	Ref. No.	2300567
description	standpipe size 3/4" usable height 48mm overall height 74mm ED ø 20mm chrome-plated brass with O-ring		
spare parts for	515048		
	GEV No.	Ref. No.	—
	528813		
	O-ring EPDM thickness 2mm ID ø 17mm Qty 1 pcs		
accessories for	515048		
	GEV No.	Ref. No.	—
	515041		
	drain fitting size 3/4" usable heightmm overall height 30mm ED ø 38mm chrome-plated brass		

producer-specific

EMAINOX



1

GEV No.	515060	Ref. No.	3600034 3600077
description	drain fitting thread 3/4" H 18mm ID ø 20mm ED ø 38mm		



1

GEV No.	504618	Ref. No.	3600035
description	O-ring EPDM thickness 2.62mm ID ø 15.54mm Qty 1 pcs		



1



GEV No.	515048	Ref. No.	2300567
description	standpipe size 3/4" usable height 48mm overall height 74mm ED ø 20mm chrome-plated brass with O-ring		
spare parts for	515048		
	GEV No.	Ref. No.	—
	528813		
	O-ring EPDM thickness 2mm ID ø 17mm Qty 1 pcs		

Table continues overleaf



accessories for	515048		
	GEV No.	515041	Ref. No. —
	drain fitting size 3/4" usable heightmm overall height 30mm ED ø 38mm chrome-plated brass		

measuring equipment

thermometers

built-in thermometers

			
1			
GEV No.	541080	Ref. No.	3700042
description	thermometer mounting measurements 58x25.5mm -40 up to +40°C capillary pipe 2500mm probe ø 6mm probe L 30mm		

ø52mm			
			
1			
GEV No.	541413	Ref. No.	3700039
description	thermometer mounting ø 52mm t.max. 120°C 0 up to +120°C probe ø 6mm probe L 36mm capillary pipe 1500mm		

B				
ball valves	12		refrigeration gaskets	10
ballasts	6		refrigeration thermostats	4
C			relays	6
cam switches	5		rocker/momentary rocker switches	4
compressors	8		S	
contactors	6		safety thermostats	4
control thermostats	3		screw-in gaskets	10
D			shelves and shelf rails	10
drain systems and wash basins	12		solenoid valves	7
E			standpipes	12
electronic controllers	7		starter	6
energy regulators	3		switches and momentary switches	4
evaporators	11		T	
expansion valves	11		tank inlets	12
F			thermostats	3
fans	8		V	
fluorescent lamps	5, 5		valves and tank inlets	12
foil heating elements	3			
G				
gastronorm	12			
H				
heating cartridges	3			
heating elements	3			
heating elements for bain maries	3			
heating elements for convection	3			
heating elements for heated cabinets	3			
hot air fans	8			
I				
indicator lights	5			
indicator lights (complete)	5			
indicators	11			
L				
lamps	5			
M				
measuring equipment	13			
O				
O-rings	11			
R				
refrigeration cycle components	11			
refrigeration fans	8			