



**GAS COMPONENTS**



**ELECTRIC COMPONENTS**



**WATER TECHNOLOGY**



**MECHANICAL COMPONENTS**



**TOOLS**

Spare parts suitable for

**EURFRIGOR**

Find the complete and up-to-date range of products in our GEV Webshop



# Manufacturer catalogue

The most important spare parts and accessories arranged clearly for every manufacturer

- ✓ Complete product range and all appliance data always up to date in the GEV Webshop
- ✓ Alphabetical Index at the end of the catalogue

## GEV Webshop

[www.gev-online.co.uk](http://www.gev-online.co.uk)

[www.gev-online.com](http://www.gev-online.com)



- 🔍 Add to Favourites
- 🔍 Sign In with email address and usual password
- 🔍 Easy-order – place several items in your basket at the same time
- 🔍 Quick Item search – no login needed



## thermostats

### refrigeration thermostats

#### RANCO

##### K22 series

RANCO



1

<b>GEV No.</b>	390524	<b>Ref. No.</b>	RFS0B893
<b>description</b>	thermostat RANCO type K22L1082 probe ømm probe Lmm capillary pipe 2000mm temperature range -22 up to -3°C		

RANCO



1

<b>GEV No.</b>	390296	<b>Ref. No.</b>	RF000618
<b>description</b>	thermostat RANCO type K22-L2069 probe ø 2mm probe L 10mm capillary pipe 1500mm		

##### K50 series

RANCO



1

<b>GEV No.</b>	390270	<b>Ref. No.</b>	RF000610
<b>description</b>	thermostat RANCO type K50L3019 probe ømm probe Lmm capillary pipe 1250mm temperature range +1 up to +7.5°C		

RANCO



1

<b>GEV No.</b>	390286	<b>Ref. No.</b>	RFS0B892
<b>description</b>	thermostat RANCO type K50L3383 probe ømm probe Lmm capillary pipe 1500mm temperature range +1 up to +3°C		

## switches and momentary switches

### rocker/momentary rocker switches

#### 30x22mm

##### labelled



1

<b>GEV No.</b>	346870	<b>Ref. No.</b>	RI000751
<b>description</b>	rocker switch mounting measurements 30x22mm blue 2NO 250V 16A illuminated 0-1 connection male faston 6.3mm ambient temperature max. 85°C protection IP65 with cover cap		

<b>accessories for</b>	346870			
	<b>GEV No.</b>	301036	<b>Ref. No.</b>	—
	protective cover internal size 30x22mm for rocker switch mounting measurementsmm			

### push/momentary push switches

#### 19x13mm



1

<b>GEV No.</b>	346871 <sup>1</sup>	<b>Ref. No.</b>	RI00B281
<b>description</b>	push switch mounting measurements 19x13mm green 2NO 250V 16A illuminated connection male faston 4.8mm ambient temperature max. 105/55°C protection IP40		

<b>accessories for</b>	346871			
	<b>GEV No.</b>	346541	<b>Ref. No.</b>	—
	protective cover for rocker switch external size 23.4x17.4mm internal size 19x13mm H 9.5mm mounting measurementsmm			

<sup>1</sup>illuminated

#### ø25mm



1

<b>GEV No.</b>	345011	<b>Ref. No.</b>	RI00C883
<b>description</b>	push switch mounting ø 25mm green 2NO 250V 16A illuminated connection male faston 6.3mm ambient temperature max. 85°C protection IP65		

<b>accessories for</b>	345011			
	<b>GEV No.</b>	345039	<b>Ref. No.</b>	—
	protective cover round ED ø 33mm external size 23mm internal size 21mm H 12mm clear mounting ø 25mm			



## microswitches

## lever actuated



1

<b>GEV No.</b>	346872	<b>Ref. No.</b>	RI000800
<b>description</b>	microswitch with lever 250V 0.1A 1CO connection male faston 6.3mm L 50mm ambient temperature max. 85°C mounting distance 22mm type D41X actuating force: 6g lever length 36mm		

## roller-lever actuated

## with mounting components



1

<b>GEV No.</b>	347568	<b>Ref. No.</b>	RI00A240
<b>description</b>	microswitch with handle with a switch 250V 10A 1CO connection male faston 6.3mm L 25mm ambient temperature max. 85°C mounting distance 24mm type VR actuating force: 50g lever length 31mm		



1

<b>GEV No.</b>	345370	<b>Ref. No.</b>	RH003800
<b>description</b>	microswitch with handle with a switch 250V 16A 1CO connection male faston 6.3mm L 27mm ambient temperature max. 125°C mounting distance 24mm actuating force: 45g lever length 26.5mm		

## float switches

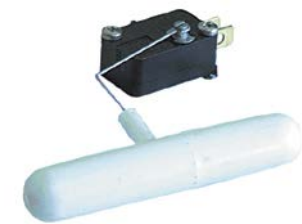

1

<b>GEV No.</b>	345372	<b>Ref. No.</b>	RH000830 RI00A241
<b>description</b>	float switch 1CO ø 15mm L 104mm 250V 6A male faston 6.3mm cable lengthmm		



1

<b>GEV No.</b>	345371	<b>Ref. No.</b>	RH00A310
<b>description</b>	float switch with plunger 250V 16A 1CO male faston 6.3mm L 60mm ambient temperature max. 125°C mounting distance 22mm type EF83161.5 actuating force: 20g blue/black		

## floats



1

<b>GEV No.</b>	695044	<b>Ref. No.</b>	RH000679
<b>description</b>	float		

## timers

## programme timers



1

<b>GEV No.</b>	360524	<b>Ref. No.</b>	RFS0B869	
<b>description</b>	timer CDC 11904 engines 1 chambers 4 operation time 12min 230V shaft ømm shaft Lmm manif. no. 11904F1 / BDR000.0000 motor type M48R ATS			
<b>spare parts for</b>	360524			
	<b>GEV No.</b>	360118	<b>Ref. No.</b>	—
	motor CDC pinion ø 4.9mm teeth 10 230V voltage AC 50/60Hz turn direction right motor ø 47mm H 19.3mm motor type M48R ATS for timer cable length 260mm 1.9/2.5W			



1

<b>GEV No.</b>	360609	<b>Ref. No.</b>	RFS0C111
<b>description</b>	timer CDC 11904 engines 1 chambers 4 operation time 15min 230V 60Hz shaft ømm shaft Lmm manif. no. 11904F1BEY000.0010		



1

<b>GEV No.</b>	360051	<b>Ref. No.</b>	RES0A822	
<b>description</b>	timer FIBER P36 engines 1 chambers 2 operation time 15min 230V shaft ømm shaft Lmm manif. no. P365JR2J717 motor type M51B-J0R6400			
<b>spare parts for</b>	360051			
	<b>GEV No.</b>	360673	<b>Ref. No.</b>	—
	motor kit pinion ø 6.8mm teeth 15 230V voltage AC 50/60Hz turn direction clockwise motor ø 48mm H 18.5mm motor type UDS-40NE1RNZ165 cable length 150mm with holder			



## relays

### power relays

#### with bracket mounting



1			
<b>GEV No.</b>	380312	<b>Ref. No.</b>	RI000761
<b>description</b>	power relays FINDER 230VAC 10A 3CO connection male faston 4.8mm bracket mounting dimensions 52x32.2x36.5mm manuf. no. 60.63.8.230.0000		

1			
<b>GEV No.</b>	380329	<b>Ref. No.</b>	RF000555
<b>description</b>	time relay FIBER 85.02.8.240 time range 0.05s - 100h 230-240VAC 10A mounting measurements 20.6x27.7mm 2CO connection 2.0		
<b>accessories for</b>	380329		
	<b>GEV No.</b>	380378	<b>Ref. No.</b> RF000556
	relay socket 2-pole 55/85 dimensions 70.5x30x27mm 250V voltage AC 10A FINDER manuf. no. 94.72		
	<b>GEV No.</b>	380803	<b>Ref. No.</b> —
	relay socket 2-pole dimensions 76.2x27x86.1mm 250V voltage AC 10A FINDER manuf. no. 94.92.3		

### relay sockets

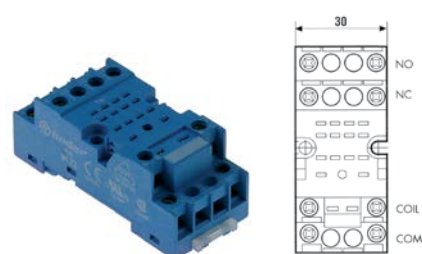

1			
<b>GEV No.</b>	380378	<b>Ref. No.</b>	RF000556
<b>description</b>	relay socket 2-pole 55/85 dimensions 70.5x30x27mm 250V voltage AC 10A FINDER manuf. no. 94.72		
<b>accessories for</b>	380378		
	<b>GEV No.</b>	380804	<b>Ref. No.</b> —
	support bracket		

## electronics

### PCBs



1			
<b>GEV No.</b>	401606	<b>Ref. No.</b>	RI00A031
<b>description</b>	display		

## solenoïd valves

### solenoïd valves (water)

TP			
1			
<b>GEV No.</b>	370019	<b>Ref. No.</b>	RF000625
<b>description</b>	solenoïd valve double angled 230VAC inlet 3/4" outlet 11.5mm DN10 TP plastic		
<b>spare parts for</b>	370019		
	<b>GEV No.</b>	371013	<b>Ref. No.</b> —
	solenoïd coil TP 230VAC 50/60Hz		
<b>accessories for</b>	370019		
	<b>GEV No.</b>	371220	<b>Ref. No.</b> —
	reducer TP flow rate 3l/min red tolerance ±15%		
	<b>GEV No.</b>	371221	<b>Ref. No.</b> —
	reducer TP flow rate 5.5l/min yellow tolerance ±15%		
	<b>GEV No.</b>	371222	<b>Ref. No.</b> —
	reducer TP flow rate 6l/min grey tolerance ±15%		

### time relays

#### time relays



1			
<b>GEV No.</b>	380770	<b>Ref. No.</b>	RF000555
<b>description</b>	time relay connection plug-in connection round 8-pole		

Table continues overleaf

solenoid valves (refrigeration)

CASTEL

valves



1

<b>GEV No.</b>	370567	<b>Ref. No.</b>	RF000532
<b>description</b>	solenoid valve angled type 1018/M617A6 230V p max 35bar connection 6mm soldering connection -35 up to 110°C CASTEL 50/60Hz cable length 600mm		





valve bodies















STANDARD series

suitable for refrigerants R22, R134a, R404A, R407C, R410A, R507



1

<b>GEV No.</b>	370151	<b>Ref. No.</b>	RF000557	
<b>description</b>	solenoid valve body NC type 1028/2 S p max 45bar connection 1/4" soldering connection DN 2.2mm -35 up to +105°C L 125mm refrigeration straight CASTEL			
<b>accessories for</b>	370151			
	<b>GEV No.</b>	371084	<b>Ref. No.</b>	—
	solenoid coil CASTEL 230VAC 8VA 50/60Hz connection cable 1000mm type CM2			
	<b>GEV No.</b>	371090	<b>Ref. No.</b>	—
	power socket plug type DIN 43650A screw			
	<b>GEV No.</b>	371301	<b>Ref. No.</b>	—
	solenoid coil CASTEL 110VAC 8VA 50/60Hz seat ø 11.5mm connection DIN 43650A type HF2			
	<b>GEV No.</b>	371314	<b>Ref. No.</b>	—
	solenoid coil CASTEL 240VAC 8VA 50/60Hz seat ø 11.5mm			
	<b>GEV No.</b>	371321	<b>Ref. No.</b>	—
	solenoid coil CASTEL 12/24VAC 50/60Hz seat ø 11.5mm connection DIN 43650A type HF2			

<b>accessories for</b>	370019			
	<b>GEV No.</b>	371223	<b>Ref. No.</b>	—
	reducer TP flow rate 10l/min white tolerance ±15%			
	<b>GEV No.</b>	371224	<b>Ref. No.</b>	—
	reducer TP flow rate 12l/min bronze tolerance ±15%			
	<b>GEV No.</b>	371225	<b>Ref. No.</b>	—
	reducer TP flow rate 16l/min light brown tolerance ±15%			
	<b>GEV No.</b>	371226	<b>Ref. No.</b>	—
	reducer TP flow rate 20l/min red tolerance ±15%			
	<b>GEV No.</b>	371230	<b>Ref. No.</b>	—
	reducer TP flow rate 0.25l/min red tolerance ±25%			
	<b>GEV No.</b>	371231	<b>Ref. No.</b>	—
	reducer TP flow rate 0.35l/min violet tolerance ±25%			
	<b>GEV No.</b>	371232	<b>Ref. No.</b>	—
	reducer TP flow rate 0.5l/min orange tolerance ±25%			
	<b>GEV No.</b>	371233	<b>Ref. No.</b>	—
	reducer TP flow rate 0.8l/min white tolerance ±25%			
	<b>GEV No.</b>	371234	<b>Ref. No.</b>	—
	reducer TP flow rate 1l/min light blue tolerance ±25%			
	<b>GEV No.</b>	371235	<b>Ref. No.</b>	—
	reducer TP flow rate 1.2l/min brown tolerance ±25%			
	<b>GEV No.</b>	371236	<b>Ref. No.</b>	—
	reducer TP flow rate 1.5l/min light brown tolerance ±25%			
	<b>GEV No.</b>	371237	<b>Ref. No.</b>	—
	reducer TP flow rate 2.5l/min yellow tolerance ±25%			
	<b>GEV No.</b>	371238	<b>Ref. No.</b>	—
	reducer TP flow rate 3.4l/min dark green tolerance ±25%			
	<b>GEV No.</b>	371239	<b>Ref. No.</b>	—
	reducer TP flow rate 5l/min black tolerance ±25%			
	<b>GEV No.</b>	371240	<b>Ref. No.</b>	—
	reducer TP flow rate 8l/min blue tolerance ±20%			

solenoid valves with reducers



1

<b>GEV No.</b>	370401	<b>Ref. No.</b>	RF000624
<b>description</b>	solenoid valve single angled 230VAC inlet 3/4" outlet 11.5mm output 2.5l/min t.max. 90°C TP plastic flow regulating valve outlet yellow		



CEME

valves

with pipe clamp



1

<b>GEV No.</b>	370408	<b>Ref. No.</b>	RF00B770
<b>description</b>	solenoid valve straight CEME type 6807 230V pressure range 0.1-25bar DN2.5 connection 6mm soldering connection -45 up to +125°C refrigeration		

various

valves



1

<b>GEV No.</b>	370406	<b>Ref. No.</b>	RF000531 RF000532
<b>description</b>	solenoid valve angled type 5925 p max 25bar DN1.5 connection 6mm soldering connection -45 up to +125°C CEME refrigeration 230V		



1

<b>GEV No.</b>	370407	<b>Ref. No.</b>	RF000532
<b>description</b>	solenoid valve angled type 5925 pressure range 0.1-25bar DN2.0 connection 6mm soldering connection -45 up to +125°C CEME refrigeration 230V		

pressure switches

for refrigeration

SAGI NO MIYA



1

<b>GEV No.</b>	541120	<b>Ref. No.</b>	RF000621
<b>description</b>	pressure control HD reset automatic refrigeration type HTB-X3028 connection male faston 6.3mm switch-on pressure 17bar		

compressors

ACC/ZEL

R404a/R507

HMBP monophase

High/Medium evaporation temperature above -20/-15 °C



1

<b>GEV No.</b>	605020	<b>Ref. No.</b>	RB00A795
<b>description</b>	compressor coolant R404a/R507 type ML40TB 220-240V 50Hz HMBP fully hermetic 10kg 1/6HP cylinder capacity 4.04cm <sup>3</sup> CSIR H 175.5mmW 168W 218W 276W 342W 416W 499W 589W 688W test method ASHRAE		



1

<b>GEV No.</b>	605068	<b>Ref. No.</b>	RB00B133/1
<b>description</b>	compressor coolant R404a/R507 type ML45TB 220-240V 50Hz HMBP fully hermetic 10kg 1/5HP cylinder capacity 4.5cm <sup>3</sup> CSIR H 175.5mmW 192W 246W 309W 382W 465W 557W 659W 771W test method ASHRAE		



1

<b>GEV No.</b>	605074	<b>Ref. No.</b>	RB00B369
<b>description</b>	compressor coolant R404a/R507 type ML60TG 220-240V 50Hz HMBP fully hermetic 10kg 1/4HP cylinder capacity 5.7cm <sup>3</sup> CSIR H 191.1mmW 218W 286W 365W 457W 562W 678W 807W 947W test method ASHRAE		



1

<b>GEV No.</b>	605014	<b>Ref. No.</b>	RB00A797
<b>description</b>	compressor coolant R404a/R507 type ML80TB 220-240V 50Hz HMBP fully hermetic 11.4kg 3/8HP cylinder capacity 7.57cm <sup>3</sup> CSIR H 175.5mmW 261W 346W 446W 561W 691W 835W 993W 1167W test method ASHRAE ambient temperature max. 43°C		



1

<b>GEV No.</b>	605029	<b>Ref. No.</b>	RB00B149
<b>description</b>	compressor coolant R404a/R507 type MP12RB 220-240V 50Hz HMBP fully hermetic 13.5kg 1/2HP cylinder capacity 12cm <sup>3</sup> CSR H 203.6mmW 561W 734W 933W 1157W 1407W 1681W 1982WW test method ASHRAE ambient temperature max. 43°C		



1

<b>GEV No.</b>	605028	<b>Ref. No.</b>	RB00A798
<b>description</b>	compressor coolant R404a/R507 type ML90TB 220-240V 50Hz HMBP fully hermetic 11.6kg 3/8HP cylinder capacity 8.85cm <sup>3</sup> CSIR H 175.5mmW 323W 418W 532W 666W 819W 990W 1181W 1391W test method ASHRAE ambient temperature max. 43°C		

**EMBRACO / ASPERA**  
**R404a/R507**  
**HMBP monophase**  
*High/Medium evaporation temperature above -20/-15 °C*



1

<b>GEV No.</b>	605030	<b>Ref. No.</b>	RB00B162
<b>description</b>	compressor coolant R404a/R507 type NJ9226GK 220-240V 50Hz HMBP fully hermetic 20.8kg 1HP cylinder capacity 21.7cm <sup>3</sup> CSR H 265mmW 1363W 1764W 2249W 2819W 3472W 4210W 5032W test method ASHRAE		

**CUBIGEL**  
**R404a/R507**  
**HMBP monophase**  
*High/Medium evaporation temperature above -20/-15 °C*



1

<b>GEV No.</b>	605013	<b>Ref. No.</b>	RB00A796 RB00B369
<b>description</b>	compressor coolant R404a/R507 type ML60TB 220-240V 50Hz HMBP fully hermetic 10.1kg 1/4HP power input 647W cylinder capacity 5.68cm <sup>3</sup> CSIR H 175.5mmW 244W 319W 407W 511W 628W 760W 906W 1067W test method ASHRAE		





L'UNITE HERMETIQUE / TECUMSEH

R404A  
HMBP monophase

High/Medium evaporation temperature above -20/-15 °C



1

<b>GEV No.</b>	605025	<b>Ref. No.</b>	RB00B620
<b>description</b>	compressor coolant R404A type AE4430Z-FZ 220-240V 50Hz HMBP fully hermetic 10.2kg 1/4HP power input 427W cylinder capacity 5.7cm <sup>3</sup> CSIR H 186mmWW 258W 346W 441W 550W 682W 794W test method EN 12900 908W		
<b>spare parts for</b>	605025		
	<b>GEV No.</b>	380061	<b>Ref. No.</b> —
	start relay MTRP0027-31 120/240V voltage AC 8A 1NO		



1

<b>GEV No.</b>	605023	<b>Ref. No.</b>	RB00A798
<b>description</b>	compressor coolant R404A type AE4450Z 220-240V 50Hz HMBP fully hermetic 12.5kg 3/8HP cylinder capacity 8.85cm <sup>3</sup> CSIR H 207mmWW 434W 567W 734W 927W 1270W 1367W test method EN 12900 1729W		



1

<b>GEV No.</b>	605021	<b>Ref. No.</b>	RB00B133
<b>description</b>	compressor coolant R404A type AEZ4425Z 220-240V 50Hz HMBP fully hermetic 9.8kg 1/5HP cylinder capacity 4.5cm <sup>3</sup> CSIR H 186mmWW 198W 263W 341W 432W 537W 629W test method EN 12900 723W		



1

<b>GEV No.</b>	605022	<b>Ref. No.</b>	RB000440
<b>description</b>	compressor coolant R404A type AEZ4440Z 230V 50Hz HMBP fully hermetic 21kg cylinder capacity 7.55cm <sup>3</sup> CSIR H 292mm 415W 517W 637W 772W 919W 1074W test method EN 12900 1234W		

fans

refrigeration fans

- refrigeration motors universal
- ebm-papst
- miscellaneous







1

<b>GEV No.</b>	601405	<b>Ref. No.</b>	RC000451 RD00B934
<b>description</b>	fan motor M4Q045-CA01-19 7W 230V 50Hz W 83mm		
<b>spare parts for</b>	601405		
	<b>GEV No.</b>	601413	<b>Ref. No.</b> —
	fixing plate suitable for fanwheel ED ø 32mm shaft ø 7 mounting distance 26mm		

ELCO

N series - multi fit



<b>GEV No.</b>	601427	<b>Ref. No.</b>	RC000452
<b>description</b>	fan motor ELCO 10W 230V 50/60Hz bearing slide bearing L1 49mm L2 59mm L3 86.5mm W 83mm connection cable 500mm 1300/1550rpm 5 mounting options VNT10-20/028		
<b>spare parts for</b>	601427		
	<b>GEV No.</b>	560140	<b>Ref. No.</b> —
	hexagonal nut thread M4 H 4.8mm SS WS 7 Qty 20 pcs DIN/ISO DIN 985 self-locking		
	<b>GEV No.</b>	560332	<b>Ref. No.</b> —
	plain washer ID ø 4.3mm ED ø 9mm thickness 0.8mm SS Qty 1 pcs		
	<b>GEV No.</b>	560340	<b>Ref. No.</b> —
	hexagonal nut thread M4 H 3.2mm WS 7 SS DIN/ISO DIN 934 / ISO 4032/8673 Qty 1 pcs		
	<b>GEV No.</b>	601413	<b>Ref. No.</b> —
	fixing plate suitable for fanwheel ED ø 32mm shaft ø 7 mounting distance 26mm		

N series - standard



<b>GEV No.</b>	601527	<b>Ref. No.</b>	RC00A807
<b>description</b>	fan motor 16W 230V 50/60Hz W 84mm 1300rpm VN16-38		

IMPORT

multi fit fan motors



<b>GEV No.</b>	601022	<b>Ref. No.</b>	RD000512
<b>description</b>	fan motor 10W 230V 50-60Hz L1 44mm L2 54mm L3 85mm W 84mm cable length 500mm 1300rpm YZF10-20-18/26 5 mounting options bearing slide bearing		



<b>GEV No.</b>	601023	<b>Ref. No.</b>	RD000513
<b>description</b>	fan motor 16W 230V 50-60Hz L1 45mm L2 61mm L3 92mm W 84mm cable length 500mm 1300rpm YZF16-25-18/26 5 mounting options bearing slide bearing		



<b>GEV No.</b>	601020	<b>Ref. No.</b>	RD000511
<b>description</b>	fan motor 5W 230V 50-60Hz L1 44mm L2 48mm L3 79mm W 84mm cable length 500mm 1300rpm YZF5-13-18/26 5 mounting options bearing slide bearing		



accessories

fan wheels

aluminium

1

<b>GEV No.</b>	601069	<b>Ref. No.</b>	RD000518
<b>description</b>	fan wheel sucking ø 172mm turn direction left fan wheel mounting 25.4mm blade angle 25° W 32mm aluminium		

<b>GEV No.</b>	601069	<b>Ref. No.</b>	RD000518
<b>description</b>	fan wheel sucking ø 172mm turn direction left fan wheel mounting 25.4mm blade angle 25° W 32mm aluminium		

1

<b>GEV No.</b>	601070	<b>Ref. No.</b>	RD000519
<b>description</b>	fan wheel sucking ø 200mm fan wheel mounting 25.4mm blade angle 28° W 38mm aluminium		

<b>GEV No.</b>	601070	<b>Ref. No.</b>	RD000519
<b>description</b>	fan wheel sucking ø 200mm fan wheel mounting 25.4mm blade angle 28° W 38mm aluminium		

1

<b>GEV No.</b>	601071	<b>Ref. No.</b>	RD000520
<b>description</b>	fan wheel sucking ø 230mm fan wheel mounting 25.4mm blade angle 25° W 37mm aluminium		

<b>GEV No.</b>	601071	<b>Ref. No.</b>	RD000520
<b>description</b>	fan wheel sucking ø 230mm fan wheel mounting 25.4mm blade angle 25° W 37mm aluminium		

1

<b>GEV No.</b>	601409	<b>Ref. No.</b>	RD000521 RD00A629
<b>description</b>	fan wheel sucking ø 254mm fan wheel mounting 25.4mm blade angle 25° W 38mm aluminium		

<b>GEV No.</b>	601409	<b>Ref. No.</b>	RD000521 RD00A629
<b>description</b>	fan wheel sucking ø 254mm fan wheel mounting 25.4mm blade angle 25° W 38mm aluminium		

1

<b>GEV No.</b>	601410	<b>Ref. No.</b>	RD000499
<b>description</b>	fan wheel sucking ø 300mm fan wheel mounting 25.4mm blade angle 28° W 45mm aluminium		

<b>GEV No.</b>	601410	<b>Ref. No.</b>	RD000499
<b>description</b>	fan wheel sucking ø 300mm fan wheel mounting 25.4mm blade angle 28° W 45mm aluminium		

cold air circulating fans (complete)

COPREL

AX series

1

<b>GEV No.</b>	601078	<b>Ref. No.</b>	RD000508 RD000510	
<b>description</b>	fan blowing 230V 18W 50Hz fan wheel ø 130mm shaft L 21mm feet depth 29mm connection left			
<b>spare parts for</b>	601078			
	<b>GEV No.</b>	510923	<b>Ref. No.</b>	—
	clamping ring for shaft ø 10mm ID ø 9.4mm H 6mm			

<b>GEV No.</b>	601078	<b>Ref. No.</b>	RD000508 RD000510
<b>description</b>	fan blowing 230V 18W 50Hz fan wheel ø 130mm shaft L 21mm feet depth 29mm connection left		

**spare parts for** 601078

	<b>GEV No.</b>	510923	<b>Ref. No.</b>	—
	clamping ring for shaft ø 10mm ID ø 9.4mm H 6mm			

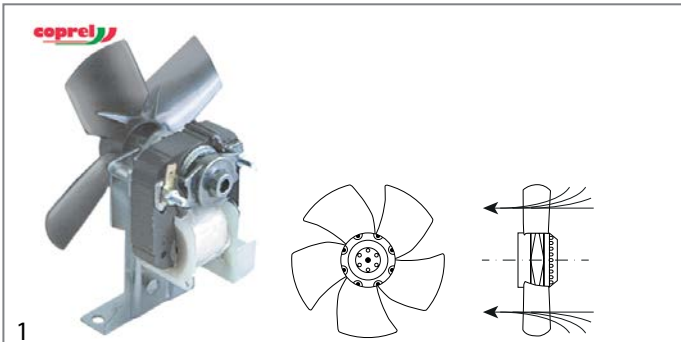

1

<b>GEV No.</b>	601079	<b>Ref. No.</b>	RD000509
<b>description</b>	fan sucking 230V 18W 50Hz fan wheel ø 130mm shaft L 20mm feet depth 31mm connection right		

miscellaneous

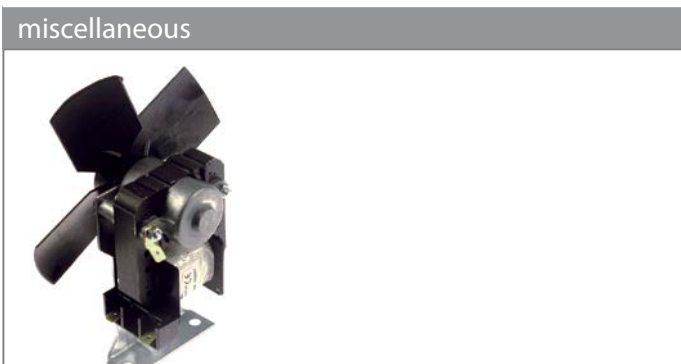

1

<b>GEV No.</b>	601411	<b>Ref. No.</b>	RD000508
<b>description</b>	fan 230V		

**motors**

gear motors

for ice-cube maker

for paddles



1

<b>GEV No.</b>	500407	<b>Ref. No.</b>	926061 RG000636 RG636
<b>description</b>	gear motor LIP type 123MR 8W 220/240V voltage AC 50/60Hz 50rpm turn direction counterclockwise shaft ø 4mm shaft intake ø 6.2mm groove width 2.3mm shaft L 8mm shaft ø 4mm W 74mm		

for sumps



1

<b>GEV No.</b>	500412	<b>Ref. No.</b>	RG000640
<b>description</b>	gear motor LIP type 021B 11W 230V 50Hz 1rpm shaft ø 7mm shaft length 20mm W 74mm D 67mm H 110mm for sump		



1

<b>GEV No.</b>	500688	<b>Ref. No.</b>	RG000640 RG00A684
<b>description</b>	gear motor LIP type 068 11W 230V voltage AC 50Hz 1rpm shaft ø 7mm shaft length 20mm W 75mm D 80mm H 110mm for sump shaft with transverse hole		

miscellaneous



1

<b>GEV No.</b>	500788	<b>Ref. No.</b>	RG000650
<b>description</b>	gear motor 230V		

**motors**

for ice-cube maker

complete



1

<b>GEV No.</b>	500787	<b>Ref. No.</b>	RG000647
<b>description</b>	motor 180W 230V 50/60HzHz 1 phase shaft ø 12.8mm 1300rpm RPM 0.18kW		



## electric accessories

### terminals

connection terminals with screw/faston connections



1

<b>GEV No.</b>	550411	<b>Ref. No.</b>	RI000709
<b>description</b>	power terminal block 6-pole max. 40A max 450V connection $\phi 6\text{mm}^2$ / F6.3 temp.-resist. 150°C cross section 6mm <sup>2</sup>		

## equipment-specific units

### for ice-cube maker

ice chutes

slide grates



1

<b>GEV No.</b>	692097	<b>Ref. No.</b>	RN00A017 RNA017
<b>description</b>	slide grate for ice-cube maker L 160mm W 170mm H 60mm		

gearboxes



1

<b>GEV No.</b>	695383	<b>Ref. No.</b>	RG000649
<b>description</b>	gearbox		



1

<b>GEV No.</b>	695382	<b>Ref. No.</b>	RG000646
<b>description</b>	gearbox H 140mm L 160mm W 150mm shaft L 23mm drive shaft $\phi$ 11.5mm		

doors

doors



1

<b>GEV No.</b>	698942	<b>Ref. No.</b>	RP00A667
<b>description</b>	door W 378mm H 245mm plastic		

pan mechanics

sumps



1

<b>GEV No.</b>	695358	<b>Ref. No.</b>	RH00A004
<b>description</b>	sump for ice maker L 180mm W 140mm H 60mm EUROFRIGOR white		



1

<b>GEV No.</b>	695359	<b>Ref. No.</b>	RH00A005 RHA005
<b>description</b>	sump for ice maker L 180mm W 180mm H 60mm EUROFRIGOR		



			
1			
<b>GEV No.</b>	695360	<b>Ref. No.</b>	RH00A006 RHA006
<b>description</b>	sump for ice maker L 180mm W 245mm H 60mm EUROFRIGOR white		

			
1			
<b>GEV No.</b>	695361	<b>Ref. No.</b>	RM00A050
<b>description</b>	sump for ice maker L 330mm W 195mm H 60mm		

			
1			
<b>GEV No.</b>	695362	<b>Ref. No.</b>	RM00A079
<b>description</b>	sump for ice maker L 465mm W 200mm H 70mm		

			
1			
<b>GEV No.</b>	695363	<b>Ref. No.</b>	RM00A047
<b>description</b>	sump for ice maker L 690mm W 200mm H 70mm		

spare parts and accessories

			
1			
<b>GEV No.</b>	695376	<b>Ref. No.</b>	RQ001152
<b>description</b>	adjusting ring for spindle H 7mm ID ø 6mm ED ø 12mm thread M4 stainless steel		

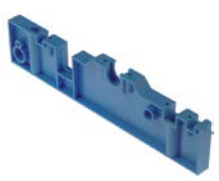
			
1			
<b>GEV No.</b>	695364	<b>Ref. No.</b>	RH003616
<b>description</b>	bracket for sump		

			
1			
<b>GEV No.</b>	695365	<b>Ref. No.</b>	RQ003619
<b>description</b>	bush for impulse		

			
1			
<b>GEV No.</b>	695367	<b>Ref. No.</b>	RH003618
<b>description</b>	lever for pan tilting		

			
1			
<b>GEV No.</b>	695030	<b>Ref. No.</b>	RH00A008
<b>description</b>	lever for pan tilting new edition EUROFRIGOR		

			
1			
<b>GEV No.</b>	695031	<b>Ref. No.</b>	RH00669 RM1063
<b>description</b>	lever for pan tilting old edition EUROFRIGOR		

			
1			
<b>GEV No.</b>	695032	<b>Ref. No.</b>	RH000675 RH675
<b>description</b>	paddle short ø 135mm shaft intake ø 6mm shaft lengthmm 1		

			
1			
<b>GEV No.</b>	695368	<b>Ref. No.</b>	RQ003626
<b>description</b>	pin for pan tilting		

			
1			
<b>GEV No.</b>	695369	<b>Ref. No.</b>	RQ003625
<b>description</b>	spindle for ice maker ø 6mm L 160mm		

			
1			
<b>GEV No.</b>	695370	<b>Ref. No.</b>	RQ00A028
<b>description</b>	spindle for ice maker ø 6mm L 195mm		

			
1			
<b>GEV No.</b>	695371	<b>Ref. No.</b>	RQ00A029
<b>description</b>	spindle for ice maker ø 6mm L 235mm		





			
1			
<b>GEV No.</b>	695378	<b>Ref. No.</b>	RQ000976
<b>description</b>	spindle for ice maker ø 6mm L 235mm		

			
1			
<b>GEV No.</b>	695372	<b>Ref. No.</b>	RQ00A030
<b>description</b>	spindle for ice maker ø 6mm L 300mm		

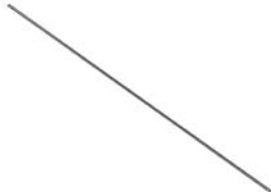
			
1			
<b>GEV No.</b>	695373	<b>Ref. No.</b>	RQ00A062
<b>description</b>	spindle for ice maker ø 6mm L 380mm		

			
1			
<b>GEV No.</b>	695374	<b>Ref. No.</b>	RQ00A075
<b>description</b>	spindle for ice maker ø 6mm L 517mm		

			
1			
<b>GEV No.</b>	695375	<b>Ref. No.</b>	RQ00A063
<b>description</b>	spindle for ice maker ø 6mm L 742mm		

			
1			
<b>GEV No.</b>	695028	<b>Ref. No.</b>	RQ00A064
<b>description</b>	spindle for pan tilting		

			
1			
<b>GEV No.</b>	695029	<b>Ref. No.</b>	RQ00A065
<b>description</b>	spindle for pan tilting ø 6mm length external size 31mm L 26mm EUROFRIGOR		

			
1			
<b>GEV No.</b>	695366	<b>Ref. No.</b>	RH003620
<b>description</b>	wheel for pan tilting ø 100mm		

drive technology

			
1			
<b>GEV No.</b>	695384	<b>Ref. No.</b>	RV003202
<b>description</b>	toothed belt disc disc ø 38mm shaft intake ø 13mm groove depth 5mm disc width 13mm groove width 10x10mm overall width 22mm splitting 5 shaft ø 23.5mm		

 <p>Image not available</p>			
1			
<b>GEV No.</b>	695386	<b>Ref. No.</b>	RV003201
<b>description</b>	toothed belt disc large type ES40-100		

mechanics for evaporators

gear motors

motors

			
1			
<b>GEV No.</b>	500787	<b>Ref. No.</b>	RG000647
<b>description</b>	motor 180W 230V 50/60Hz 1 phase shaft ø 12.8mm 1300rpm RPM 0.18kW		

## hoses

## formed hoses

## straight

## silicone hoses



<b>GEV No.</b>	530879	<b>Ref. No.</b>	913037210
<b>description</b>	drain hose straight ID ø 19mm ED ø 24mm L 210mm		

## hose connectors

## without thread



<b>GEV No.</b>	695055	<b>Ref. No.</b>	RH003285+A716+B267
<b>description</b>	hose connector		



<b>GEV No.</b>	695054	<b>Ref. No.</b>	RH000665
<b>description</b>	hose connector for ice-cube maker		



<b>GEV No.</b>	695056	<b>Ref. No.</b>	RH003286+A716+B267
<b>description</b>	hose connector for ice-cube maker		



<b>GEV No.</b>	695057	<b>Ref. No.</b>	RH001080
<b>description</b>	hose connector hose ø 12mm L 100mm L-shape plastic		

## floats

## float containers



<b>GEV No.</b>	695070	<b>Ref. No.</b>	RH000828
<b>description</b>	float container		



<b>GEV No.</b>	695073	<b>Ref. No.</b>	RH00B632
----------------	--------	-----------------	----------

**description** float container

**spare parts for** 695073



<b>GEV No.</b>	346872	<b>Ref. No.</b>	RI000800
<b>description</b>	microswitch with lever 250V 0.1A 1CO connection male faston 6.3mm L 50mm ambient temperature max. 85°C mounting distance 22mm type D41X actuating force: 6g lever length 36mm		

## for ice crusher

## V-belts



<b>GEV No.</b>	695387	<b>Ref. No.</b>	RV00A296
<b>description</b>	V-belt pulley single disc ø 128mm shaft intake ø 14mm groove depth 14mm disc width 19mm groove width 4mm overall width 35mm aluminium		

## refrigeration cycle components

## filter driers

## miscellaneous



<b>GEV No.</b>	750226	<b>Ref. No.</b>	RF000546
<b>description</b>	dryer size 20g ø 24mm L 117mm connection 6.2/6.3mm		





## transmission technology and ball bearings

### ball bearings

#### deep-groove ball bearings 2RS



1

<b>GEV No.</b>	523513	<b>Ref. No.</b>	RV003322
<b>description</b>	deep-groove ball bearing type 6205-2RS shaft $\varnothing$ 25mm ED $\varnothing$ 52mm W 15mm with sealing discs deep-groove ball bearing DIN 625-1		



1

<b>GEV No.</b>	523504	<b>Ref. No.</b>	RV003647 RV3647
<b>description</b>	deep-groove ball bearing type 626-2RS shaft $\varnothing$ 6mm ED $\varnothing$ 19mm W 6mm with sealing discs deep-groove ball bearing DIN 625-1		

### drive belts

#### toothed belts



1

<b>GEV No.</b>	695388	<b>Ref. No.</b>	RV003233 RV00B075
<b>description</b>	toothed belt profile XL L 196mm H 2mm teeth 98 splitting rubber with textile insertion CODE 196XL W 10mm type BI 4 164		

### springs

#### compression springs



1

<b>GEV No.</b>	695034	<b>Ref. No.</b>	RR003629
<b>description</b>	compression spring $\varnothing$ 10mm L 35mm wire gauge $\varnothing$ 1.7mm		

## hoses

### drain hoses



1

<b>GEV No.</b>	530726	<b>Ref. No.</b>	RH001181
<b>description</b>	drain hose DN19 L 1530mm A int. $\varnothing$ 19mm A ext. $\varnothing$ 23mm B int. $\varnothing$ 22mm B ext. $\varnothing$ 28mm outer hose $\varnothing$ 24mm		



1

<b>GEV No.</b>	530724	<b>Ref. No.</b>	RH001180
<b>description</b>	drain hose DN19 L 180mm A int. $\varnothing$ 19mm A ext. $\varnothing$ 27mm B int. $\varnothing$ 19mm B ext. $\varnothing$ 27mm outer hose $\varnothing$ 24mm		



1

<b>GEV No.</b>	530727	<b>Ref. No.</b>	RH001177
<b>description</b>	drain hose DN19 L 280mm A int. $\varnothing$ 19mm A ext. $\varnothing$ 27mm B int. $\varnothing$ 19mm B ext. $\varnothing$ 27mm outer hose $\varnothing$ 24mm		



1

<b>GEV No.</b>	530725	<b>Ref. No.</b>	RH001176
<b>description</b>	drain hose L 210mm A int. $\varnothing$ 19mm B int. $\varnothing$ 19mm outer hose $\varnothing$ 24mm		



1

<b>GEV No.</b>	530728	<b>Ref. No.</b>	RH001182
<b>description</b>	drain hose L 270mm A int. $\varnothing$ 19mm A ext. $\varnothing$ 27mm B int. $\varnothing$ 19mm B ext. $\varnothing$ 27mm outer hose $\varnothing$ 24mm		



1

<b>GEV No.</b>	530722	<b>Ref. No.</b>	RH001175
<b>description</b>	drain hose DN19 L 180mm straight $\varnothing$ inside 19mm straight ext. $\varnothing$ 25mm elbow $\varnothing$ inside 21mm elbow ext. $\varnothing$ 27mm outer hose $\varnothing$ 24mm		

## fastening material

## screws

## grub screws

## miscellaneous



1

<b>GEV No.</b>	560458	<b>Ref. No.</b>	RR003646 RR3646
<b>description</b>	grub screw thread M4 L 5mm intake slotted Qty 1 pcs		

## fasteners

## retaining rings

## DIN 6799



1

<b>GEV No.</b>	528709	<b>Ref. No.</b>	RR3644
<b>description</b>	retaining ring E D1 ø 4mm D2 ø 9mm steel DIN 6799 thickness 0.7mm for shaft ø 5-7mm		

## roll pins



1

<b>GEV No.</b>	692013	<b>Ref. No.</b>	RR003645
<b>description</b>	roll pin ø 3mm L 16mm		

**C**

cold air circulating fans (complete)	11
compressors	7

**D**

drain hoses	17
-------------	----

**E**

electric accessories	13
----------------------	----

**F**

fans	9
fasteners	18
fastening material	18
filter driers	16
float switches	4

**G**

grub screws	18
-------------	----

**H**

hoses	17
-------	----

**M**

microswitches	4
motors	12

**P**

pressure switches	7
programme timers	4
push/momentary push switches	3

**R**

refrigeration cycle components	16
refrigeration fans	9
refrigeration motors universal	9
refrigeration thermostats	3
relays	5
retaining rings	18
rocker/momentary rocker switches	3
roll pins	18

**S**

screws	18
solenoid valves	5
switches and momentary switches	3

**T**

terminals	13
thermostats	3
time relays	5
timers	4