



GAS COMPONENTS



ELECTRIC COMPONENTS



WATER TECHNOLOGY



MECHANICAL COMPONENTS



TOOLS

Spare parts suitable for

FABAR

Find the complete and up-to-date range of products in our GEV Webshop



Manufacturer catalogue

The most important spare parts and accessories arranged clearly for every manufacturer

- ✓ Complete product range and all appliance data always up to date in the GEV Webshop
- ✓ Alphabetical Index at the end of the catalogue

GEV Webshop

www.gev-online.co.uk

www.gev-online.com







- 🔍 Add to Favourites
- 🔍 Sign In with email address and usual password
- 🔍 Easy-order – place several items in your basket at the same time
- 🔍 Quick Item search – no login needed

heating elements



immersion heating elements

miscellaneous

			
1			
GEV No.	415161	Ref. No.	10162
description	heating element 2700W 230/400V heating circuits 3 mounting ϕ 57.5mm L 235mm W 47mm H 44mm number of thermostat sleeves 1 thermostat sleeves ϕ 10mm length thermostat sleeves 235mm thermostat sleeve centre not clinging tube ϕ 8.5mm hole distance 56mm hole ϕ 9mm connection M5 4 hole flange immersion heater flange ϕ 98mm		
accessories for	415161		
	GEV No.	503105	Ref. No. 10160
	gasket fibre D1 ϕ 54mm D2 ϕ 96mm thickness 3mm hole ϕ 7.4mm hole distance 55mm with 4 screw holes for heating element equiv. no. 10160		





			
1			
GEV No.	415162	Ref. No.	10162B
description	heating element 4800W 220/380V heating circuits 3 mounting ϕ 57.5mm L 340mm W 47mm H 41mm number of thermostat sleeves 1 thermostat sleeves ϕ 10mm length thermostat sleeves 225mm thermostat sleeve centre not clinging tube ϕ 8.5mm hole distance 56mm hole ϕ 9mm connection M5 4 hole flange immersion heater flange ϕ 98mm		
accessories for	415162		
	GEV No.	503105	Ref. No. 10160
	gasket fibre D1 ϕ 54mm D2 ϕ 96mm thickness 3mm hole ϕ 7.4mm hole distance 55mm with 4 screw holes for heating element equiv. no. 10160		

			
1			
GEV No.	420322	Ref. No.	10162C
description	heating element 8000W 230/400V heating circuits 3 L 400mm W 47mm H 42mm number of thermostat sleeves 1 length thermostat sleeves 215mm thermostat sleeve centre not clinging tube ϕ 8.5mm connection M6 flange connection immersion heater flange ϕ 98mm		

<h3>3/4"</h3>			
			
1			
GEV No.	415160	Ref. No.	10163
description	heating element 1000W 230V heating circuits 1 thread 3/4" L 205mm W 21mm H 20mm tube ϕ 8mm connection male faston 6.3mm immersion heater flange with thread		
spare parts for	415160		
	GEV No.	510403	Ref. No. —
	flat gasket fibre ED ϕ 36.5mm ID ϕ 27mm thickness 2mm Qty 1 pcs		
accessories for	415160		
	GEV No.	510421	Ref. No. —
	gasket copper ED ϕ 31.8mm ID ϕ 26.4mm thickness 2.2mm for thread 3/4"		

accessories for	415160		
	GEV No.	520234	Ref. No. —
	nut thread 3/4" H 5mm brass WS 30 Qty 1 pcs		

			
1			
GEV No.	415163	Ref. No.	18253
description	heating element 1400W 220V heating circuits 1 L 310mm W 135mm H 20mm L1 70mm L2 50mm thread 3/8" mounting distance 178mm tube ϕ 7.8mm connection male faston 6.3mm immersion heater 2 hole fixing		

			
1			
GEV No.	416260	Ref. No.	18253D
description	heating element 2500W 230V heating circuits 1 L 357mm W 34mm H 39mm H1 4mm H2 35mm thread M10x1 mounting distance 28mm tube ϕ 6.3mm connection male faston 6.3mm 2 hole fixing immersion heater connection length 25mm		
accessories for	416260		
	GEV No.	510416	Ref. No. —
	flat gasket fibre ED ϕ 19mm ID ϕ 10.5mm thickness 1.5mm for thread M10 Qty 1 pcs		
	GEV No.	510893	Ref. No. —
	O-ring EPDM thickness 2.62mm ID ϕ 9.92mm Qty 1 pcs		
	GEV No.	520231	Ref. No. —
	nut thread M10x1 H 6mm WS 14 zinc-coated steel Qty 1 pcs		
	GEV No.	521129	Ref. No. —
	nut thread M10 H 6mm SS WS 17 Qty 1 pcs DIN/ISO DIN 439		

accessories

sealing washers

fibre gaskets

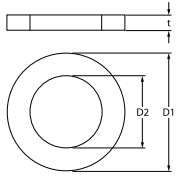
 			
1			
GEV No.	503106	Ref. No.	10161
description	flat gasket fibre ED ϕ 32mm ID ϕ 26mm thickness 3mm Qty 1 pcs		

O-rings

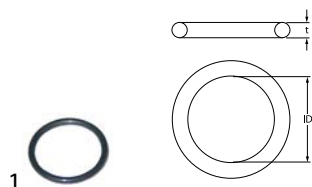

GEV No.	510072	Ref. No.	03030
description	O-ring EPDM thickness 3.53mm ID ø 32.93mm Qty 1 pcs		

flange gaskets



GEV No.	503105	Ref. No.	10160
description	gasket fibre D1 ø 54mm D2 ø 96mm thickness 3mm hole ø 7.4mm hole distance 55mm with 4 screw holes for heating element equiv. no. 10160		

thermostats

control and safety thermostats

IMIT / TEMPOMATIC / ARATHERMO

control thermostats



GEV No.	390421	Ref. No.	14197
description	thermostat t.max. 85°C temperature range 0-90°C 1-pole 1CO 16A probe ø 6.5mm probe L 95mm capillary pipe 1500mm capillary pipe isolated 1450mm gland nut shaft ømm shaft Lmm shaft position rotation 270° probe material copper		

safety thermostats

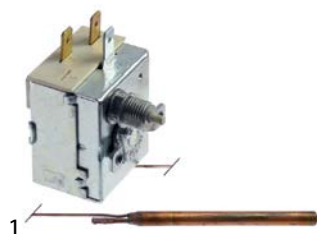

GEV No.	390023	Ref. No.	14197A
description	safety thermostat switch-off temp. 90-110°C 1-pole 16A probe ø 6.5mm probe L 90mm capillary pipe 1000mm capillary pipe isolated-mm gland nut probe		

switches and momentary switches

push/momentary push switches

28.5x28.5mm



GEV No.	345557	Ref. No.	13401
description	momentary push switch mounting measurements 28.5x28.5mm black 1NO 250V 16A START connection male faston 6.3mm ambient temperature max. 150°C protection IP40		

28.5x77.5mm



GEV No.	345558	Ref. No.	13403
description	switch combination latching mounting measurements 28.5x77.5mm black/orange/green 2NO/indicator light/indicator light 250V 16A with indicator green/red ON-OFF/temperature/rinse connection male faston 6.3mm ambient temperature max. 85°C protection IP40		

microswitches

lever actuated



GEV No.	345363	Ref. No.	01035
description	microswitch with lever 250V 16A 1CO connection male faston 6.3mm L 56mm ambient temperature max. 125°C		



GEV No.	503001	Ref. No.	01035K
description	microswitch with lever 250V 1NO connection male faston 6.3mm ambient temperature max. 85°C		

accessories



GEV No.	503000	Ref. No.	01034D
description	bar for microswitch		



			
1			
GEV No.	503043	Ref. No.	04047B old version
description	nut thread 1/2"		

 <p>Image not available</p>			
1			
GEV No.	503005	Ref. No.	01039
description	spring for microswitch		

rotary switches

GIOVENZANA

rotary switches

			
1			
GEV No.	345559	Ref. No.	13186
description	rotary switch 2 0-1 sets of contacts 2 690V 20A shaft ø 5x5mm shaft L 17mm shaft square connection male faston 6.3mm		

lamps

indicator lights

indicator lights (complete)

ø12mm

with screw socket

			
1			
GEV No.	359048	Ref. No.	13183
description	indicator light ø 12mm 230V yellow connection male faston 6.3mm		

			
1			
GEV No.	359027	Ref. No.	13183B
description	indicator light ø 12mm 250V green connection male faston 6.3mm		

timers

programme timers

			
1			
GEV No.	360378	Ref. No.	13190F
description	timer BIGATTI 11803 engines 1 chambers 3 operation time 120s 230V manuf. no. FAR011 / 13190F motor type UDS40NE1RK		

			
1			
GEV No.	360211	Ref. No.	13190 (old version)
description	timer BIGATTI engines 1 chambers 2 operation time 120s 230V shaft ø 5x5mm shaft L 20mm manuf. no. FAR005 motor type UDS40NE1RK		

			
1			
GEV No.	360210	Ref. No.	13191 old version
description	timer BIGATTI engines 1 chambers 2 operation time 240s 230V shaft ø 5x5mm shaft L 19mm manuf. no. FAR012 motor type 82354011L		

			
1			
GEV No.	360213	Ref. No.	13190M
description	timer BIGATTI engines 1 chambers 3 operation time 180s 230V manuf. no. 13190M motor type UDS40NE1RK		



solenoid valves

solenoid valves (water)

metal

SIRAI

2-way

L140-B series



GEV No. 370239 **Ref. No.** 09132

description solenoid valve 2-ways 230VAC connection 1/2" L 41mm DN 10mm slide-on receptacle compact -10 up to +90°C SIRAI type series L140-B coil type Z610A membranes NBR (water) p max 12bar p min 0.35bar

spare parts for 370239

GEV No. 371085 **Ref. No.** —
description solenoid coil 230VAC 4VA SIRAI coil type ZB10A seat ø 10mm 50/60Hz

GEV No. 371163 **Ref. No.** —
description membrane connection 1/2" series L140-B membrane type NBR (water)

accessories for 370239

GEV No. 371091 **Ref. No.** —
description power socket plug type DIN 43650B cable lengthmm small

spare parts and accessories

solenoid coils



GEV No. 371071 **Ref. No.** 09139

description solenoid coil 230VAC 10VA SIRAI coil type Z610A seat ø 10mm H 33mm L 33mm W 25mm 50/60Hz

accessories for 371071

GEV No. 371091 **Ref. No.** —
description power socket plug type DIN 43650B cable lengthmm small

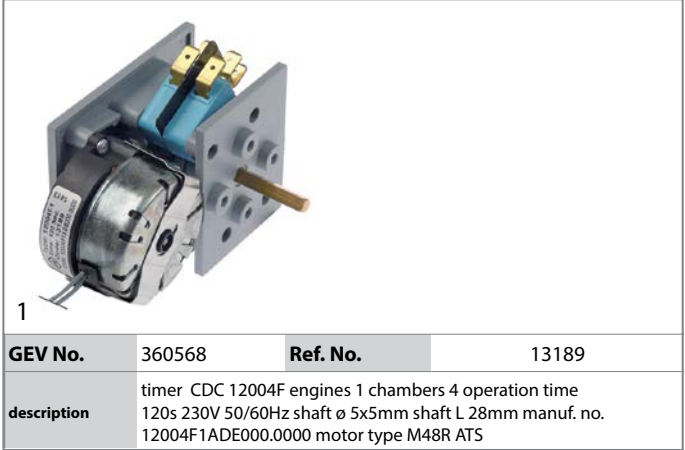

GEV No. 360568 **Ref. No.** 13189

description timer CDC 12004F engines 1 chambers 4 operation time 120s 230V 50/60Hz shaft ø 5x5mm shaft L 28mm manuf. no. 12004F1ADE000.0000 motor type M48R ATS

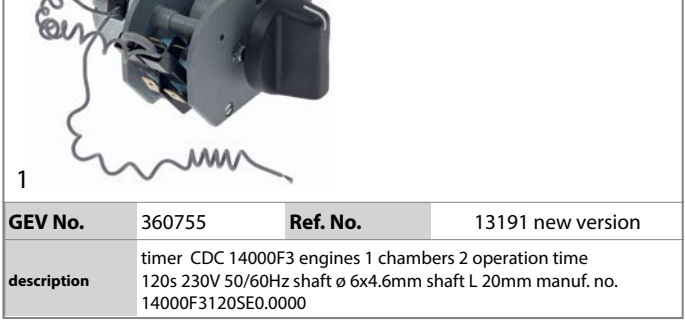

GEV No. 360755 **Ref. No.** 13191 new version

description timer CDC 14000F3 engines 1 chambers 2 operation time 120s 230V 50/60Hz shaft ø 6x4.6mm shaft L 20mm manuf. no. 14000F3120SE0.0000



GEV No. 360722 **Ref. No.** 13190

description timer CROUZET engines 1 chambers 2 operation time 120s 230V 50Hz shaft ø 6x4.6mm shaft L 19mm

relays

power relays

with bracket mounting



GEV No. 380139 **Ref. No.** 13192C

description power relays FINDER 230VAC 16A 2CO connection F6.3 bracket mounting dimensions 68x38.2x35.8mm manuf. no. 62.82.8.230.0000

Solenoid valve - accessories

filters



1			
GEV No.	503139	Ref. No.	09134
description	solenoid valve filter ø 19.5mm H 16mm		

pressure switches

for warewashing

ø 58mm with male faston 6.3mm

with connection horizontal



1			
GEV No.	541162	Ref. No.	21001A
description	pressure control pressure range 80/50mbar connection male faston 6.3mm ø 58mm pressure connection horizontal warewashing pressure connection ø 6mm		

pumps

wash and rinse pumps

LGB



1			
GEV No.	500335	Ref. No.	121230
description	pump inlet ø 1½" ET outlet ø 1 1/4" ET type 075HPSX 230V 50Hz 1 phase 0.6kW 0.82HP L 300mm rotation direction left capacitor 16µF LGB		



1			
GEV No.	500336	Ref. No.	121220
description	pump inlet ø 1½" ET outlet ø 1½" ET type 075HSPX 230V 50Hz 1 phase 0.6kW 0.8HP L 315mm rotation direction right capacitor 16µF LGB		
spare parts for	500336		
		GEV No.	503125
		Ref. No.	11167
		pump cover gasket EPDM thickness 3mm ID ø 129mm Qty 1 pcs	
		GEV No.	503132
		Ref. No.	12177
		pump cover	
		GEV No.	503136
		Ref. No.	12182
		pump casing	
		GEV No.	510693
		Ref. No.	—
		mechanical shaft seal for shaft ø 12mm slide ring ext. ø 24mm slide ring H 15.5mm slide ring int. ø 11mm counter ring mounting ø 24mm height counter ring 8mm counter ring int. ø 13.5mm	
accessories for	500336		
		GEV No.	365021
		Ref. No.	—
		operating capacitor capacity 16µF 425V tolerance 5% 50/60Hz ambient temperature max. -25 to +85°C ø 35mm L 73mm single M8 plastic connection male faston 6.3mm 416.10.99 protection	





1

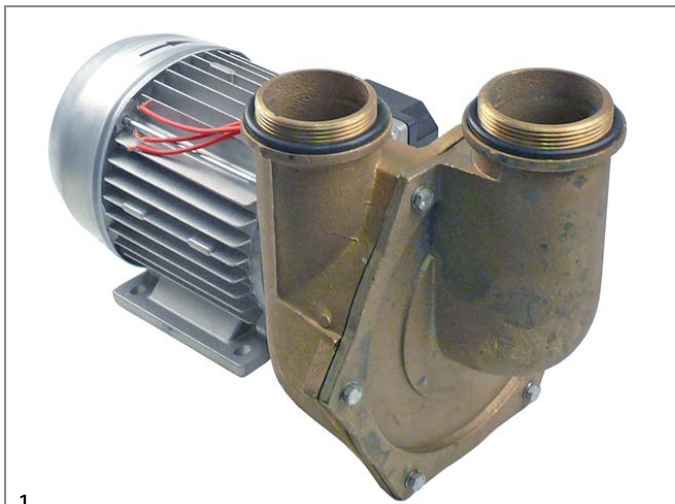

GEV No.	500334	Ref. No.	111130
description	pump inlet \varnothing 1 1/2" IT outlet \varnothing 1" ET type ZF130SX 230V 50Hz 1 phase 0.37kW 0.54HP L 220mm rotation direction right capacitor 10 μ F LGB inlet \varnothing 1 1/4" ITmm outlet \varnothing 1" ETmm		
spare parts for	500334		
	GEV No.	365012	Ref. No. —
	operating capacitor capacity 6.3 μ F 450V tolerance 5% 50Hz ambient temperature max. -25 to +85°C \varnothing 30mm L 61mm M8 plastic connection male faston 6.3mm protection		
	GEV No.	510122	Ref. No. —
	pump cover LGB inlet \varnothing 28mm outlet \varnothing 26mm auxiliary pressure connection 13mm supporting pressure open \varnothing 98mm ID \varnothing 77mm inner high 31mm		
	GEV No.	510703	Ref. No. —
	mechanical shaft seal for shaft \varnothing 13mm slide ring H 13mm height counter ring 5.5mm ED \varnothing 26mm		
	GEV No.	521085	Ref. No. —
	impellor \varnothing 72mm H 17mm thread M7L shaft \varnothing 13mm shaft length 12mm blades 3		
	GEV No.	528800	Ref. No. —
	O-ring EPDM thickness 2.62mm ID \varnothing 75.87mm Qty 1 pcs		
accessories for	500334		
	GEV No.	503030	Ref. No. 03035
	round filters outflow		
	GEV No.	503108	Ref. No. 11164
	round filters outflow		
	GEV No.	506015	Ref. No. 08123 11165
	O-ring EPDM thickness 3.53mm ID \varnothing 39.69mm Qty 1 pcs		
	GEV No.	510072	Ref. No. 03030
	O-ring EPDM thickness 3.53mm ID \varnothing 32.93mm Qty 1 pcs		



1

GEV No.	499234	Ref. No.	121260
description	pump inlet \varnothing 2 1/4" outlet \varnothing 2" type CF1402 230/400V 50Hz 3 phase 0.9kW L 360mm rotation direction right LGB		
spare parts for	499234		
	GEV No.	510703	Ref. No. —
	mechanical shaft seal for shaft \varnothing 13mm slide ring H 13mm height counter ring 5.5mm ED \varnothing 26mm		
	GEV No.	510896	Ref. No. —
	O-ring EPDM thickness 3.53mm ID \varnothing 183.75mm Qty 1 pcs		
	GEV No.	521097	Ref. No. —
	impellor \varnothing 100mm H 31mm thread M8L shaft \varnothing 20mm shaft length 14mm		

booster pumps I

			
1	GEV No.	500451	Ref. No. 121270
	description	pump inlet \varnothing 1 1/2" ET outlet \varnothing 1 1/4" ET type 0338/SM024 230V 50Hz 0.89kW 1.2HP	
	accessories for	500451	
	GEV No.	532020	Ref. No. —
	O-ring EPDM thickness 1.78mm ID \varnothing 31.47mm Qty 10 pcs		
	GEV No.	532023	Ref. No. —
	O-ring EPDM thickness 1.78mm ID \varnothing 37.82mm Qty 10 pcs		



condensators & interference suppression filters

filters

interference suppression filters



1

GEV No.	365060	Ref. No.	13300
description	interference suppression filter capacity 0.1µF(X2)+2x0.0047µF(Y2) 2x2.2MOhm		

electric accessories

terminals

connection terminals with screw connection



1

GEV No.	550034	Ref. No.	01212
description	connection terminal 5-pole max. 41A max 450V connection ø6mm ² temp.-resist. 150°C cross section 6mm ² mounting distance 50mm bridged		

connection boxes



1

GEV No.	550488	Ref. No.	01213
description	power terminal block 3-pole		

equipment-specific units

for dishwashers

drain and intake components

FABAR

drain /intake bodies



1

GEV No.	503023	Ref. No.	030310
description	drain fitting complete thread 1"		



1

GEV No.	503018	Ref. No.	03029 03029P
description	drain fitting thread 1" ID ø 24mm		



1

GEV No.	503026	Ref. No.	030320
description	drain fitting thread 1¼"		



1

GEV No.	503019	Ref. No.	03029BP
description	drain fitting thread 1¼" ID ø 35mm		



1

GEV No.	516068	Ref. No.	03030C 03032
description	flat gasket rubber ED ø 43mm ID ø 32mm thickness 2mm Qty 1 pcs		



1

GEV No.	503021	Ref. No.	03030B 03032B
description	flat gasket rubber Qty 1 pcs size 1¼"		



1

GEV No.	516069	Ref. No.	03031
description	nut thread 1" ø 46mm H 8mm WS 36 brass Qty 1 pcs		



1

GEV No.	503024	Ref. No.	03031B
description	nut thread 1¼"		

filters



1

GEV No.	503030	Ref. No.	03035
description	round filters outflow		



1

GEV No.	503031	Ref. No.	03035A
description	round filters outflow		



1

GEV No.	503032	Ref. No.	03035B
description	round filters outflow		



1

GEV No.	503108	Ref. No.	11164
description	round filters outflow		



1

GEV No.	503110	Ref. No.	12175
description	round filters outflow ø 60mm H 13mm		

overflow pipes



1

GEV No.	503016	Ref. No.	03028B
description	overflow pipe L 118mm ø 35/41mm		



1

GEV No.	503017	Ref. No.	03028 03028A 03028F
description	overflow pipe L 80mm ø 25/31mm		

miscellaneous

filters



1

GEV No.	503029	Ref. No.	03034D
description	drain pipe thread 1¼" with gasket		

boilers



boilers for dishwashers







1





GEV No.	503101	Ref. No.	10157B
description	boiler		

accessories for 503101

	GEV No.	503042	Ref. No.	04047
	description	nut thread 3/8" H 6mm brass WS 22 Qty 1 pcs		
	GEV No.	503098	Ref. No.	10156
	description	heat exchanger		
	GEV No.	508008	Ref. No.	04046
	description	O-ring EPDM thickness 2.62mm ID ø 15.88mm Qty 1 pcs		



 <p>1</p>			
GEV No.	503102	Ref. No.	10157G
description	boiler		
accessories for	503102		
	GEV No.	503099	Ref. No. 10156E
	heat exchanger		
	GEV No.	505073	Ref. No. 02018
	O-ring EPDM thickness 2.62mm ID ø 20.63mm Qty 1 pcs		
	GEV No.	511470	Ref. No. 04047B new version
	nut thread 1/2" ø 40mm H 8mm WS 25 brass Qty 1 pcs		

 <p>1</p>			
GEV No.	503103	Ref. No.	10157I
description	boiler		
accessories for	503103		
	GEV No.	503099	Ref. No. 10156E
	heat exchanger		
	GEV No.	505073	Ref. No. 02018
	O-ring EPDM thickness 2.62mm ID ø 20.63mm Qty 1 pcs		
	GEV No.	511470	Ref. No. 04047B new version
	nut thread 1/2" ø 40mm H 8mm WS 25 brass Qty 1 pcs		

 <p>1</p>			
GEV No.	503142	Ref. No.	10157IE
description	boiler		

 <p>1</p>			
GEV No.	503146	Ref. No.	10157D
description	boiler 4800W ø 140mm L 370mm		

accessories			
 <p>1</p>			
GEV No.	503098	Ref. No.	10156
description	heat exchanger		

 <p>1</p>			
GEV No.	503099	Ref. No.	10156E
description	heat exchanger		

 <p>1</p>			
GEV No.	503107	Ref. No.	10165B
description	screw connection angled		

rotation plates			
rotation plates			
 <p>1</p>			
GEV No.	503033	Ref. No.	04039
description	rotation plate		

rotation plate bearings			
 <p>1</p> <p>Image not available</p>			
GEV No.	503035	Ref. No.	04040I
description	bolt for rotation plate bearings		







			
1			
GEV No.	503034	Ref. No.	04040
description	hinge bearing complete		

accessories

			
1			
GEV No.	503040	Ref. No.	04045
description	bracket for rotation plate bearings		

air traps

air traps

			
1			
GEV No.	503113	Ref. No.	21002
description	air trap		
accessories for	503113		
	GEV No.	503114	Ref. No. 21002A
	silicone hose ED ø 7mm ID ø 4mm for pressure switch warewashing		
	GEV No.	503115	Ref. No. 21003A
	nut		
	GEV No.	503116	Ref. No. 21003B
	screw connection		
	GEV No.	503117	Ref. No. 21003C
	hose connector		
	GEV No.	503118	Ref. No. 21004
	gasket ø 16x24mm H 2mm rubber		
	GEV No.	503119	Ref. No. 21005
	gasket ø 24x36mm H 2mm rubber		

air trap accessories

			
1			
GEV No.	503118	Ref. No.	21004
description	gasket ø 16x24mm H 2mm rubber		

			
1			
GEV No.	503119	Ref. No.	21005
description	gasket ø 24x36mm H 2mm rubber		

			
1			
GEV No.	503117	Ref. No.	21003C
description	hose connector		

			
1			
GEV No.	503115	Ref. No.	21003A
description	nut		

			
1			
GEV No.	503116	Ref. No.	21003B
description	screw connection		

			
1			
GEV No.	503141	Ref. No.	21003D
description	screw connection with hose connection for air trap		

miscellaneous

			
Image not available			
1			
GEV No.	503097	Ref. No.	10154
description	tap body		



door mechanics

miscellaneous

			
1			
GEV No.	503013	Ref. No.	02020
description	fastening angle fastening angle		

			
1			
GEV No.	503002	Ref. No.	01036
description	guide for door contact switch		

screw connections

 <p>Image not available</p>			
1			
GEV No.	503004	Ref. No.	01038
description	screw connection		

washing and rinsing systems

			
1			
GEV No.	503120	Ref. No.	CUF3812
description	angle piece thread 3/8" for rinse arm		

			
1			
GEV No.	503051	Ref. No.	06084
description	bush		

			
1			
GEV No.	503062	Ref. No.	06104
description	bush		

			
1			
GEV No.	503067	Ref. No.	07096C
description	flange		

 <p>Image not available</p>			
1			
GEV No.	503138	Ref. No.	07107
description	gasket conical		

			
1			
GEV No.	503086	Ref. No.	09130
description	gasket suitable for 1/4" ø 12mm thickness 4mm		

			
1			
GEV No.	503054	Ref. No.	06086 06086I
description	screw		

			
1			
GEV No.	503063	Ref. No.	07095B
description	wash pipe		

			
1			
GEV No.	503064	Ref. No.	07095C
description	wash pipe		



GEV No.	503065	Ref. No.	07095D
description	wash pipe		









washing and rinsing systems (sorted by producer)

FABAR



GEV No.	503050	Ref. No.	06083 06083P
description	rinse arm L 337mm nozzles 2 mounting ø 15mm mounting pos. upper		

accessories for 503050

	GEV No.	503042	Ref. No.	04047
	description	nut thread 3/8" H 6mm brass WS 22 Qty 1 pcs		
	GEV No.	503051	Ref. No.	06084
	description	bush		
	GEV No.	503052	Ref. No.	06085
	description	rinse arm shaft		
	GEV No.	503053	Ref. No.	06085R
	description	reducer thread 3/8" ET - M10 IT		
	GEV No.	503057	Ref. No.	06088B
	description	rinse jet H 10mm thread M10x0.75 WS 12		
	GEV No.	503120	Ref. No.	CUF3812
	description	angle piece thread 3/8" for rinse arm		
	GEV No.	508008	Ref. No.	04046
	description	O-ring EPDM thickness 2.62mm ID ø 15.88mm Qty 1 pcs		
	GEV No.	510303	Ref. No.	15215
	description	O-ring EPDM thickness 1.78mm ID ø 6.75mm Qty 1 pcs		



GEV No.	503071	Ref. No.	07101
description	rinse arm mounting pos. lower		



GEV No.	503143	Ref. No.	suehe Bemerkung
description	wash and rinse arm 2 wash arms/ 2 rinse arms		



GEV No.	503069	Ref. No.	07098B
description	wash and rinse arm mounting pos. upper 2 wash arms/ 2 rinse arms		



GEV No.	503127	Ref. No.	07098BI
description	wash and rinse arm mounting pos. upper 2 wash arms/ 2 rinse arms		



GEV No.	503056	Ref. No.	06087CI
description	wash and rinse arm wash arm L 335mm rinse arm L 326mm w. jets 3 r. jets 3 mounting ø 18/50mm mounting pos. lower 2 wash arms/ 2 rinse arms		



GEV No.	503055	Ref. No.	06087I
description	wash and rinse arm wash arm L 370mm rinse arm L 365mm w. jets 4 r. jets 4 mounting ø 15/50mm mounting pos. lower 2 wash arms/ 2 rinse arms		



			
1			
GEV No.	503068	Ref. No.	07098I
description	wash and rinse arm wash arm L 477mm rinse arm L 473mm w. jets 5 r. jets 5 mounting ø 15/50mm mounting pos. upper 2 wash arms/ 2 rinse arms		

			
1			
GEV No.	503011	Ref. No.	07103I
description	wash arm L 475mm nozzles 5 mounting ø 15/50mm mounting pos. lower		

			
1			
GEV No.	503074	Ref. No.	07103
description	wash arm mounting pos. lower		

			
1			
GEV No.	503075	Ref. No.	07103B 07103BI
description	wash arm mounting pos. lower		

			
1			
GEV No.	503152	Ref. No.	07098DI
description	wash arm without nozzles L 520mm		

			
1			
GEV No.	510303	Ref. No.	15215
description	O-ring EPDM thickness 1.78mm ID ø 6.75mm Qty 1 pcs		

			
1			
GEV No.	503057	Ref. No.	06088B
description	rinse jet H 10mm thread M10x0.75 WS 12		

			
1			
GEV No.	503073	Ref. No.	07102
description	wash jet		

			
1			
GEV No.	503047	Ref. No.	05063
description	wash arm		

			
1			
GEV No.	503048	Ref. No.	05063B
description	wash arm		

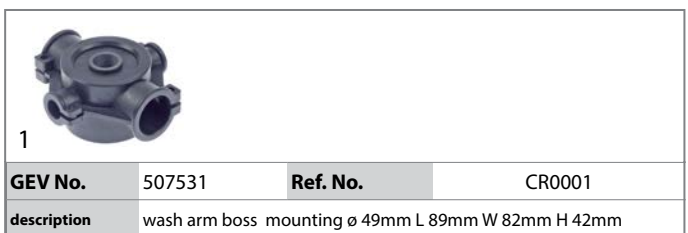
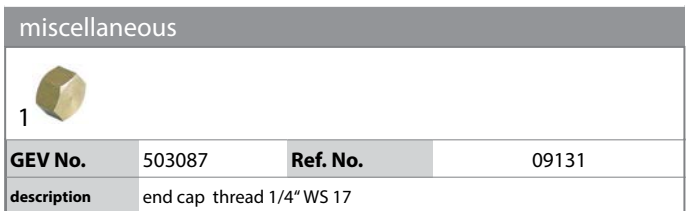
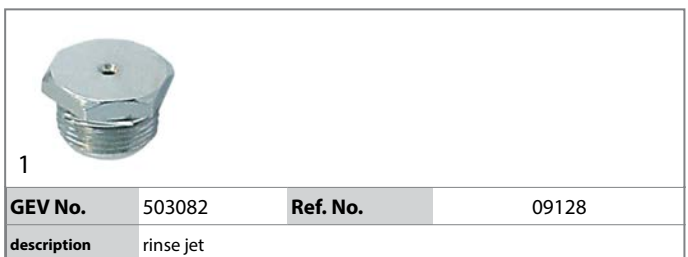
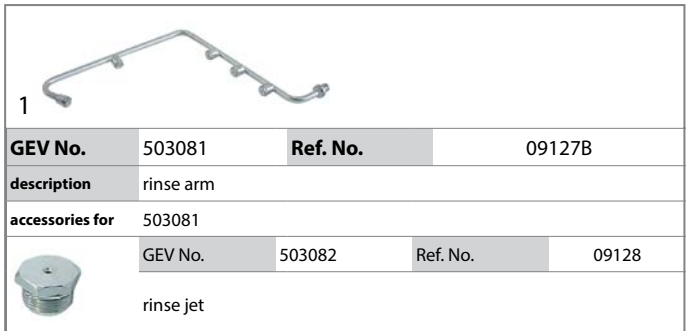
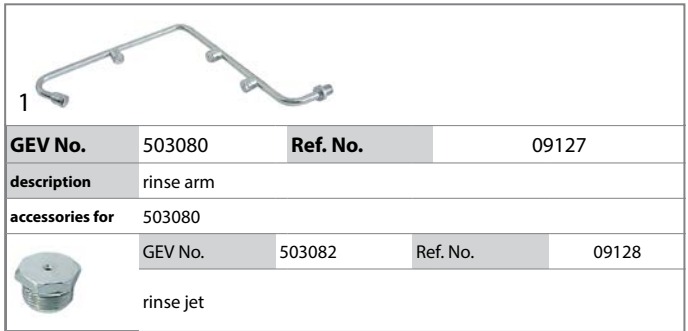
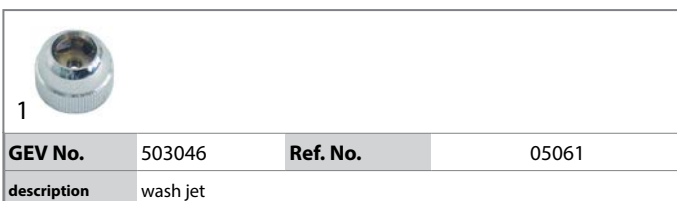
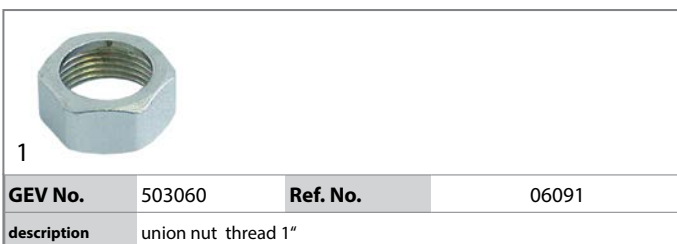
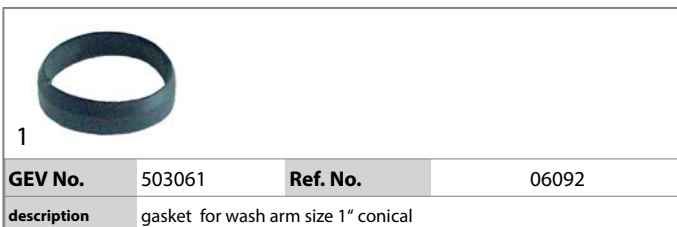
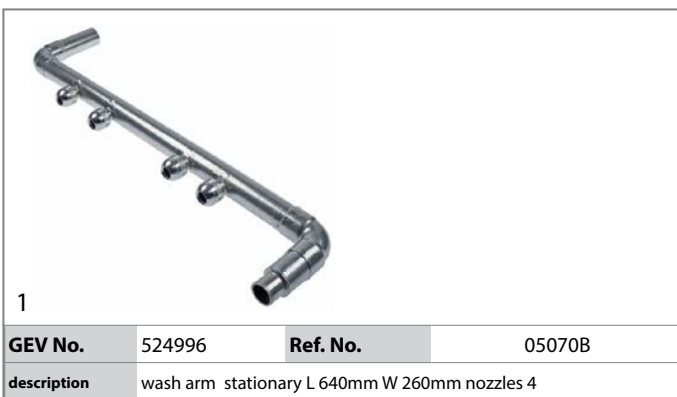



1

GEV No.	503059	Ref. No.	06090E 06090EI
description	wash arm support		
accessories for	503059		
	GEV No.	503058	Ref. No. 06089
	rinse arm shaft		
	GEV No.	503060	Ref. No. 06091
	union nut thread 1"		
	GEV No.	503061	Ref. No. 06092
	gasket for wash arm size 1" conical		
	GEV No.	508008	Ref. No. 04046
	O-ring EPDM thickness 2.62mm ID ø 15.88mm Qty 1 pcs		



1

GEV No.	503076	Ref. No.	07105A
description	wash arm support mounting pos. lower		

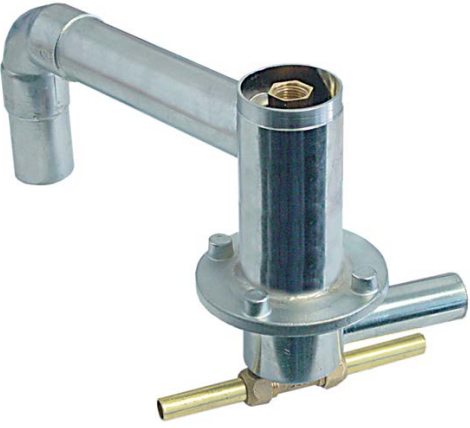

1

GEV No.	503077	Ref. No.	07105B
description	wash arm support mounting pos. lower		



1

GEV No.	503066	Ref. No.	07096B
description	wash arm support mounting pos. upper		
accessories for	503066		
	GEV No.	503054	Ref. No. 06086 06086I
	screw		
	GEV No.	503058	Ref. No. 06089
	rinse arm shaft		
	GEV No.	503062	Ref. No. 06104
	bush		
	GEV No.	503067	Ref. No. 07096C
	flange		
	GEV No.	503112	Ref. No. 16241
	gasket D1 ø 62mm D2 ø 96mm thickness 1mm rubber with 4 screw holes equiv. no. 16241 suitable for FABAR		

rinse arm shafts



1

GEV No.	503052	Ref. No.	06085
description	rinse arm shaft		



1

GEV No.	503058	Ref. No.	06089
description	rinse arm shaft		



1

GEV No.	503070	Ref. No.	07099
description	rinse arm shaft		

knobs

producer-specific knobs

FABAR



1

GEV No.	503094	Ref. No.	10151
description	knob		



1

GEV No.	110340	Ref. No.	13188
description	knob switch zero mark \varnothing 40mm shaft \varnothing 5x5mm black		

handles and hand wheels

miscellaneous



1

GEV No.	503009	Ref. No.	02017B
description	handle		

baskets

warewashing baskets

steel wire baskets round

mix baskets



1

GEV No.	970496	Ref. No.	CEB006
description	mix basket ED \varnothing 340mm H 135mm usable height 120mm		



1

GEV No.	970497	Ref. No.	CEB011
description	mix basket ED \varnothing 395mm H 190mm seat \varnothing 340mm usable height 120mm		



1

GEV No.	970498	Ref. No.	CEB021
description	mix basket ED \varnothing 446mm H 190mm seat \varnothing 400mm usable height 120mm		



1

GEV No.	970818	Ref. No.	CEB050
description	mix basket ED \varnothing 495mm H 150mm seat \varnothing 395mm usable height 125mm		



1

GEV No.	970499	Ref. No.	CEB049
description	mix basket ED \varnothing 540mm H 175mm usable height 120mm		



plate baskets

1 

GEV No.	970500	Ref. No.	CER021
description	plate basket ED ø 405mm H 160mm seat ø 400mm plates 13		

1 

GEV No.	970502	Ref. No.	CEP021
description	plate basket ED ø 445mm H 165mm seat ø 400mm plates 16 for pizza plates		

1 

GEV No.	970817	Ref. No.	CESG50
description	plate basket ED ø 490mm H 110mm seat ø 395mm		

1 

GEV No.	970501	Ref. No.	CER049
description	plate basket ED ø 530mm H 140mm plates 20		

1 

GEV No.	970503	Ref. No.	CEP049
description	plate basket ED ø 535mm H 175mm plates 20 for pizza plates		

gaskets

O-rings

EPDM

1 

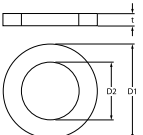

GEV No.	510303	Ref. No.	15215
description	O-ring EPDM thickness 1.78mm ID ø 6.75mm Qty 1 pcs		

1 

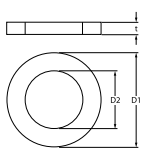

GEV No.	508008	Ref. No.	04046
description	O-ring EPDM thickness 2.62mm ID ø 15.88mm Qty 1 pcs		

1 

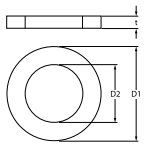

GEV No.	505073	Ref. No.	02018
description	O-ring EPDM thickness 2.62mm ID ø 20.63mm Qty 1 pcs		

1 

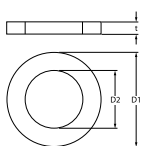

GEV No.	507314	Ref. No.	08113B
description	O-ring EPDM thickness 2.62mm ID ø 32.99mm		
accessories for	507314		
	GEV No.	Ref. No.	08113B
	507314		
	O-ring EPDM thickness 2.62mm ID ø 32.99mm		

1 

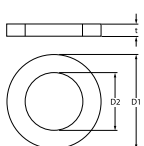

GEV No.	510072	Ref. No.	03030
description	O-ring EPDM thickness 3.53mm ID ø 32.93mm Qty 1 pcs		

1 

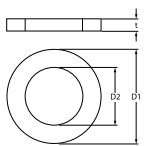

GEV No.	506015	Ref. No.	08123 11165
description	O-ring EPDM thickness 3.53mm ID ø 39.69mm Qty 1 pcs		

sealing washers

fibre gaskets

1 

GEV No.	503003	Ref. No.	01037
description	flat gasket FIBER ED ø 27mm ID ø 21mm thickness 2mm Qty 1 pcs		



1

GEV No.	503089	Ref. No.	09133B
description	flat gasket fibre ED ø 24mm ID ø 10.8mm thickness 3mm Qty 1 pcs equiv. no. 09133B size 3/4"		



1

GEV No.	503106	Ref. No.	10161
description	flat gasket fibre ED ø 32mm ID ø 26mm thickness 3mm Qty 1 pcs		

rubber gaskets



1

GEV No.	516068	Ref. No.	03030C 03032
description	flat gasket rubber ED ø 43mm ID ø 32mm thickness 2mm Qty 1 pcs		



1

GEV No.	503021	Ref. No.	03030B 03032B
description	flat gasket rubber Qty 1 pcs size 1 1/4"		

special gaskets

group gaskets



1

GEV No.	510567	Ref. No.	N/A
description	group gasket D1 ø 56mm D2 ø 95mm thickness 2mm suitable for CIMSA		

gaskets for wash arm support



1

GEV No.	503112	Ref. No.	16241
description	gasket D1 ø 62mm D2 ø 96mm thickness 1mm rubber with 4 screw holes equiv. no. 16241 suitable for FABAR		

miscellaneous



1
Image not available

GEV No.	503095	Ref. No.	10152
description	gasket size 1/4"		

transmission technology and ball bearings

ball bearings

miscellaneous



1
Image not available

GEV No.	503036	Ref. No.	04041
description	ball bearing		



1
Image not available

GEV No.	503037	Ref. No.	04042
description	ball bearing		

hoses

drain hoses



1

GEV No.	530571	Ref. No.	TS024G
description	drain hose DN24 L 1500mm straight ø inside 24mm straight ext. ø 29mm elbow ø inside 29mm elbow ext. ø 35mm outer hose ø 28mm		



for dishwashers

miscellaneous



GEV No.	503114	Ref. No.	21002A
description	silicone hose ED ø 7mm ID ø 4mm for pressure switch warewashing		

fittings, hose and pipe connectors

fittings

double nipples



GEV No.	520208	Ref. No.	09133
description	double nipple nickel-plated brass thread 1/2" - 3/4" Qty 1 pcs		

reducers



GEV No.	503053	Ref. No.	06085R
description	reducer thread 3/8" ET - M10 IT		

hose connectors

producer-specific



GEV No.	503137	Ref. No.	09149E
description	connection angle		



GEV No.	503090	Ref. No.	09149
description	connection angle copper		

GEV No.	503091	Ref. No.	09149I
description	connection angle copper		
accessories for	503091		
GEV No.	503085	Ref. No.	09129Q
description	manifold		
GEV No.	503086	Ref. No.	09130
description	gasket suitable for 1/4" ø 12mm thickness 4mm		
GEV No.	520702	Ref. No.	—
description	end cap thread 1/4" brass WS 16		

GEV No.	503092	Ref. No.	09149L
description	connection angle copper		

GEV No.	503085	Ref. No.	09129Q
description	manifold		

GEV No.	503083	Ref. No.	09129
description	T-piece		

GEV No.	503084	Ref. No.	09129B
description	T-piece		
accessories for	503084		
GEV No.	503042	Ref. No.	04047
description	nut thread 3/8" H 6mm brass WS 22 Qty 1 pcs		
GEV No.	503086	Ref. No.	09130
description	gasket suitable for 1/4" ø 12mm thickness 4mm		
GEV No.	508008	Ref. No.	04046
description	O-ring EPDM thickness 2.62mm ID ø 15.88mm Qty 1 pcs		

Table continues overleaf



accessories for	503084			
	GEV No.	520702	Ref. No.	—
	end cap thread 1/4" brass WS 16			

	1		
GEV No.	503060	Ref. No.	06091
description	union nut thread 1"		

	1		
GEV No.	503078	Ref. No.	07106
description	union nut thread 1"		

valves and tank inlets

shut-off valves

universal

	1		
GEV No.	503093	Ref. No.	101010
description	shut-off valve		

fastening material

screws

hexagonal screws

	1		
GEV No.	503122	Ref. No.	V810E
description	hexagonal screw thread M8 thread L 10mm SS WS 13 Qty 1 pcs DIN 933 / ISO 4017		

thumbscrews



GEV No.	693607	Ref. No.	04044
description	thumbscrew thread M6 thread L 20mm		

knurled screws



GEV No.	503054	Ref. No.	06086 06086I
description	screw		

nuts

hexagonal nuts

hexagonal nuts inch thread



GEV No.	503043	Ref. No.	04047B old version
description	nut thread 1/2"		



GEV No.	503045	Ref. No.	04049
description	nut thread 1/4" H 4.5mm brass WS 17 Qty 1 pcs		





GEV No.	503042	Ref. No.	04047
description	nut thread 3/8" H 6mm brass WS 22 Qty 1 pcs		



GEV No.	503012	Ref. No.	02019
description	hexagonal nut thread 1/2" ø 40mm H 8mm WS 26 chrome-plated brass Qty 1 pcs		



			
1			
GEV No.	516069	Ref. No.	03031
description	nut thread 1" ø 46mm H 8mm WS 36 brass Qty 1 pcs		

			
1			
GEV No.	511470	Ref. No.	04047B new version
description	nut thread 1/2" ø 40mm H 8mm WS 25 brass Qty 1 pcs		

			
1			
GEV No.	503024	Ref. No.	03031B
description	nut thread 1 1/4"		

washers

tooth lock washers

DIN 6798A

			
1			
GEV No.	503121	Ref. No.	R0008A
description	tooth lock washer ID ø 8.4mm ED ø 15mm SS Qty 1 pcs		

