



GAS COMPONENTS



ELECTRIC COMPONENTS



WATER TECHNOLOGY



MECHANICAL COMPONENTS



TOOLS

Spare parts suitable for

FAGOR

Find the complete and up-to-date range of products in our GEV Webshop



Manufacturer catalogue

The most important spare parts and accessories arranged clearly for every manufacturer

- ✓ Complete product range and all appliance data always up to date in the GEV Webshop
- ✓ Alphabetical Index at the end of the catalogue

GEV Webshop

www.gev-online.co.uk

www.gev-online.com



- 🔍 Add to Favourites
- 🔍 Sign In with email address and usual password
- 🔍 Easy-order – place several items in your basket at the same time
- 🔍 Quick Item search – no login needed



heating elements

heating elements for ovens

GEV No.	416018	Ref. No.	12024610 U803004
description	heating element 1000W 230V L 515mm W 125mm L1 55mm L2 460mm W1 65mm W2 60mm flange length 80mm flange width 20mm tube ø 6.5mm connection length 50mm connection male faston 6.3mm heating circuits 1 rectangular flange dry heating element		
For models:	CE7-41, CE7-41Q, CE9-41, CE9-41AD, CE9-41PLUS, CG-210G, CG-310G, CGE7-224, CGE7-41, CGE7-41H, CGE9-11, CGE9-41, CGE9-41AD, CGE9-41PLUS, HE9-10, HE9-20		

GEV No.	416608	Ref. No.	12018965 U183030
description	heating element 1000W 230V L 515mm W 170mm L1 70mm L2 445mm W1 110mm W2 60mm flange length 80mm flange width 20mm tube ø 6.3mm connection length 50mm connection male faston 6.3mm heating circuits 1 rectangular flange dry heating element		
For models:	CE-410, CE9-41		

GEV No.	416624	Ref. No.	X363023
description	heating element 1500W 230V heating circuits 1 L 300mm W 50mm H 180mm L1 20mm L2 280mm H1 150mm H2 30mm windings 3 flange length 56mm flange width 16mm hole distance 18mm hole ø 5mm mounting thread M4 tube ø 8mm		

GEV No.	416628	Ref. No.	X373005
description	heating element 2000W 230V heating circuits 1 L 298mm W 49mm H 179mm L1 19mm L2 279mm H1 150mm H2 31mm windings 3 flange length 56mm flange width 16mm hole distance 18mm hole ø 5mm connection M4 connection length 23mm tube ø 8mm rectangular flange immersion heater		

heating elements for fryers

center connection

GEV No.	416824	Ref. No.	FAG6000001
description	heating element 7000W 230/400V heating circuits 3 L 325mm W 110mm H 33mm flange length 19.5mm flange length 1 9.5mm flange length 2 9.8mm flange ø1 62mm flange ø2 57mm thermostat sleeves ø 8mm sensor screw connection 2x M10x1 thermostat sleeve upper/lower L1 18mm L2 307mm W1 40mm W2 35mm thread M54x1.5 tube ø 8.5mm cable length 520mm rotation flange immersion heater fryer connection length 50mm 2		
spare parts for	416824		
	GEV No.	Ref. No.	—
	510243		
	O-ring Viton thickness 3.53mm ID ø 55.56mm Qty 1 pcs		
	GEV No.	Ref. No.	—
	550496		
	O-ring Viton thickness 3.53mm ID ø 50.39mm Qty 1 pcs		
accessories for	416824		
	GEV No.	Ref. No.	—
	550447		
	ring nut thread M54x1.5		

GEV No.	416625	Ref. No.	12024654 X373022
description	heating element 2000W 230V heating circuits 1 L 310mm W 50mm H 180mm L1 30mm L2 280mm H1 150mm H2 30mm windings 3 flange length 56mm flange width 16mm hole distance 18mm hole ø 5mm connection M4 tube ø 8mm rectangular flange immersion heater		
For models:	FE-8		

GEV No.	416622	Ref. No.	12024670 12039909 X353005 X353024
description	heating element 3000W 230V heating circuits 1 L 303mm W 45mm H 190mm L1 20mm L2 283mm H1 148mm H2 42mm windings 4 flange length 56mm flange width 16mm hole distance 18mm hole ø 5mm connection M4 connection length 35mm tube ø 8mm rectangular flange fryer		
For models:	FE-4		

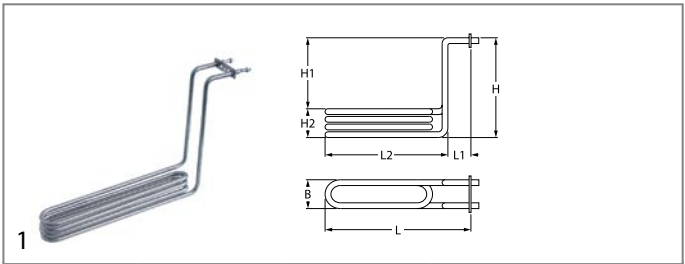

GEV No.	416630	Ref. No.	12024695 X383020
description	heating element 3000W 230V heating circuits 1 L 342mm W 48mm H 220mm L1 47mm L2 295mm H1 174mm H2 46mm windings 4 flange length 56mm flange width 16mm hole distance 18mm hole ø 5mm connection M4 connection length 32mm tube ø 8.5mm rectangular flange immersion heater AISI 304		
For models:	FE-18		

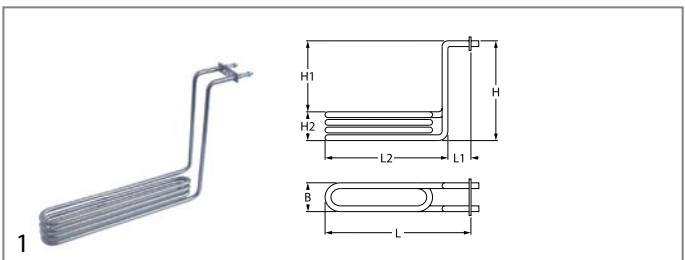

GEV No.	416631	Ref. No.	X393010
description	heating element 4250W windings 4		

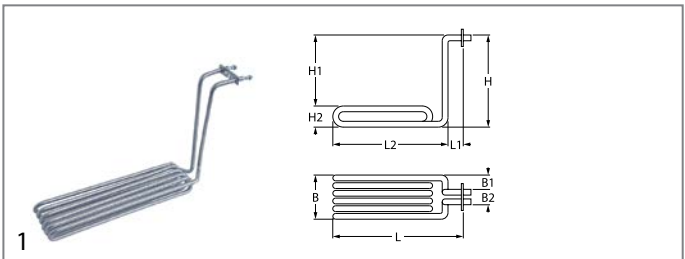







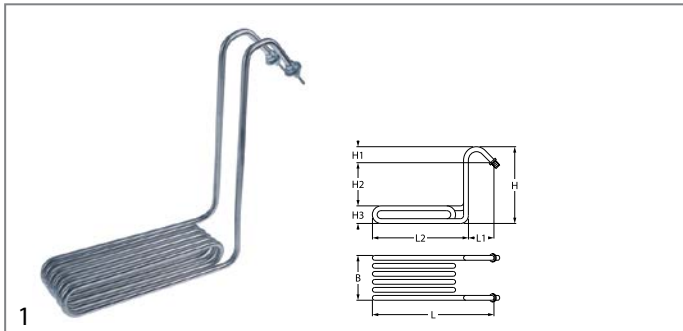

GEV No.	416632	Ref. No.	12024745 X393021
description	heating element 4250W 230V heating circuits 1 L 380mm W 104mm H 230mm L1 46mm L2 335mm W1 28mm W2 48mm H1 194mm H2 40mm windings 6 flange length 57mm flange width 17mm hole distance 18mm hole ø 5mm connection M4 connection length 35mm tube ø 8.5mm rectangular flange immersion heater		
For models:	FE-25		

2 hole fixing group 4



GEV No.	420157	Ref. No.	12024661 J153007
description	heating element 2750W 230V heating circuits 1 L 298mm W 150mm L1 46mm L2 252mm W1 98mm W2 52mm thread 1/4" mounting distance 44mm tube ø 8mm connection length 22mm 2 hole fixing fryer heaters		
For models:	FE6-05, FE6-10		



GEV No.	417160	Ref. No.	12000058 12024757 X183021 X183068
description	heating element 6000W 230V heating circuits 1 L 380mm W 90mm H 355mm L1 85mm L2 295mm H1 35mm H2 268mm H3 52mm thread M15x1 tube ø 10mm 2 hole fixing connection M4 immersion heater windings 6		
For models:	FE9-05, FE9-05-1C, FE9-05-2C, FE9-05AD, FE9-05PLUS, FE9-05PLUS-S, FE9-05S, FE9-05S-1C, FE9-05S-2C, FE9-05S-AD, FE9-05USMC, FE9-10, FE9-10-2C, FE9-10-4C, FE9-10AD, FE9-10PLUS		
spare parts for	417160		
	GEV No.	508017	Ref. No. —
	flat gasket FIBER ED ø 24mm ID ø 17mm thickness 2mm Qty 1 pcs		
	GEV No.	528401	Ref. No. —
	flat gasket fibre ED ø 22mm ID ø 16mm thickness 2mm Qty 1 pcs		
accessories for	417160		
	GEV No.	401703	Ref. No. 12024416 X183070
	copper wire 4mm ² insulation glass fibre connection cable lug ø4mm L 1400mm		
	GEV No.	521103	Ref. No. —
	nut thread M4 H 3mm WS 7 brass Qty 20 pcs		
	GEV No.	521104	Ref. No. —
	washer ID ø 4.3mm ED ø 8mm thickness 0.5mm brass Qty 20 pcs for thread M4		
	GEV No.	560111	Ref. No. 12009987 Q232020
	plain washer ID ø 4.3mm ED ø 9mm thickness 0.8mm SS Qty 20 pcs DIN 125A for thread M4		
	GEV No.	560131	Ref. No. 12009839 Q162020
	hexagonal nut thread M4 H 3.2mm WS 7 SS DIN/ISO DIN 934 / ISO 4032/8673 Qty 20 pcs		



GEV No.	416603	Ref. No.	X323001
description	heating element 4000W 230V heating circuits 1 mounting pos. right + centre L 300mm W 85mm H 300mm L1 40mm L2 260mm W1 41mm W2 44mm H1 40mm H2 210mm H3 50mm mounting distance 35mm thread M14x1.25 tube ø 8.5mm 2 hole fixing connection M4 fryer connection length 27mm		
accessories for	416603		
	GEV No.	521103	Ref. No. —
	nut thread M4 H 3mm WS 7 brass Qty 20 pcs		
	GEV No.	521104	Ref. No. —
	washer ID ø 4.3mm ED ø 8mm thickness 0.5mm brass Qty 20 pcs for thread M4		
	GEV No.	528401	Ref. No. —
	flat gasket fibre ED ø 22mm ID ø 16mm thickness 2mm Qty 1 pcs		
	GEV No.	560111	Ref. No. 12009987 Q232020
	plain washer ID ø 4.3mm ED ø 9mm thickness 0.8mm SS Qty 20 pcs DIN 125A for thread M4		
	GEV No.	560131	Ref. No. 12009839 Q162020
	hexagonal nut thread M4 H 3.2mm WS 7 SS DIN/ISO DIN 934 / ISO 4032/8673 Qty 20 pcs		



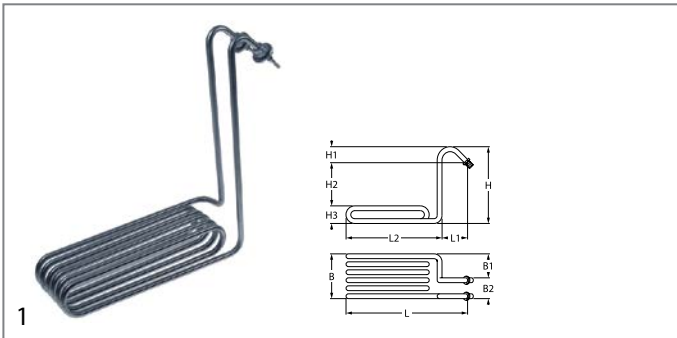

GEV No.	416548	Ref. No.	12024704
description	heating element 4000W 230V heating circuits 1 mounting pos. right + centre L 300mm W 85mm H 300mm L1 40mm L2 260mm W1 41mm W2 44mm H1 40mm H2 210mm H3 50mm mounting distance 36mm thread M14x1.25 tube ø 8mm 2 hole fixing connection M4 immersion heater connection length 27mm windings 6 fryer		
For models:	FE7-05-1C, FE7-05-2C, FE7-10-2C, FE7-10-4C		
accessories for	416548		
	GEV No.	401088	Ref. No. 12020238 12024400 X323008 X323011
	copper wire 2.5mm ² insulation glass fibre connection cable lug ø4mm L 1400mm		
	GEV No.	521103	Ref. No. —
	nut thread M4 H 3mm WS 7 brass Qty 20 pcs		
	GEV No.	521104	Ref. No. —
	washer ID ø 4.3mm ED ø 8mm thickness 0.5mm brass Qty 20 pcs for thread M4		

accessories for	416548		
	GEV No.	560111	Ref. No. 12009987 Q232020
	plain washer ID ø 4.3mm ED ø 9mm thickness 0.8mm SS Qty 20 pcs DIN 125A for thread M4		
	GEV No.	560131	Ref. No. 12009839 Q162020
	hexagonal nut thread M4 H 3.2mm WS 7 SS DIN/ISO DIN 934 / ISO 4032/8673 Qty 20 pcs		

GEV No.	416604	Ref. No.	X323002 X323010
description	heating element 4000W 230V heating circuits 1 mounting pos. left L 285mm W 85mm H 290mm L1 35mm L2 260mm W1 45mm W2 40mm H1 242mm H2 48mm H3 50mm mounting distance 26mm thread M14x1.25 tube ø 8mm 2 hole fixing cable length 1350mm connection M4 immersion heater connection length 26mm		
accessories for	416604		
	GEV No.	521103	Ref. No. —
	nut thread M4 H 3mm WS 7 brass Qty 20 pcs		
	GEV No.	521104	Ref. No. —
	washer ID ø 4.3mm ED ø 8mm thickness 0.5mm brass Qty 20 pcs for thread M4		
	GEV No.	528401	Ref. No. —
	flat gasket fibre ED ø 22mm ID ø 16mm thickness 2mm Qty 1 pcs		
	GEV No.	560111	Ref. No. 12009987 Q232020
	plain washer ID ø 4.3mm ED ø 9mm thickness 0.8mm SS Qty 20 pcs DIN 125A for thread M4		
	GEV No.	560131	Ref. No. 12009839 Q162020
	hexagonal nut thread M4 H 3.2mm WS 7 SS DIN/ISO DIN 934 / ISO 4032/8673 Qty 20 pcs		



GEV No.	417166	Ref. No.	12024707
description	heating element 4000W 230V heating circuits 1 mounting pos. left L 295mm W 90mm H 290mm L1 35mm L2 260mm W1 45mm W2 45mm H1 35mm H2 207mm H3 48mm mounting distance 36mm thread M14x1.25 tube ø 8.5mm 2 hole fixing connection M4 immersion on heater connection length 38mm windings 6		

accessories for	417166			
	GEV No.	401088	Ref. No.	12020238 12024400 X323008 X323011
	copper wire 2.5mm ² insulation glass fibre connection cable lug ø4mm L 1400mm			
	GEV No.	521103	Ref. No.	—
	nut thread M4 H 3mm WS 7 brass Qty 20 pcs			
	GEV No.	521104	Ref. No.	—
	washer ID ø 4.3mm ED ø 8mm thickness 0.5mm brass Qty 20 pcs for thread M4			
	GEV No.	560111	Ref. No.	12009987 Q232020
	plain washer ID ø 4.3mm ED ø 9mm thickness 0.8mm SS Qty 20 pcs DIN 125A for thread M4			
	GEV No.	560131	Ref. No.	12009839 Q162020
	hexagonal nut thread M4 H 3.2mm WS 7 SS DIN/ISO DIN 934 / ISO 4032/8673 Qty 20 pcs			

group 10

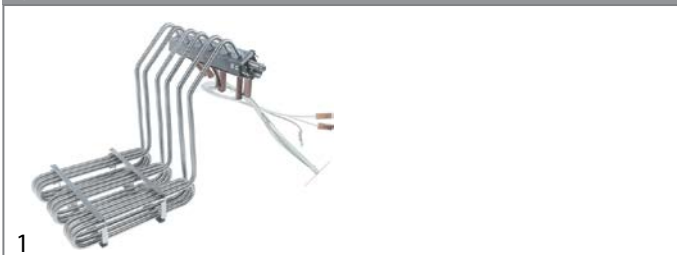

GEV No.	419112	Ref. No.	12004358
description	heating element 6000W 230V heating circuits 3 L 385mm W 200mm H 285mm cable length 1700mm tube ø 8.5mm		
For models:	FE6-05TE, FE6-10TE		

heating elements for griddles

	GEV No.	416602	Ref. No.	12024616 R893000
description	heating element 1500W 230V heating circuits 1 L 517mm W 87mm H 71mm tube ø 9mm connection M4 connection length 26mm connection distance 78mm dry heating element			
For models:	FTE7-05, FTE7-05L, FTE7-05R, FTE7-10, FTE7-10L, FTE7-10L+R, FTE7-10R, FTEC7-05L, FTEC7-10L			

	GEV No.	416633	Ref. No.	12024626 R573010
description	heating element 2000W 230V heating circuits 1 L 585mm W 100mm H 100mm tube ø 8mm connection M4 connection length 25mm connection distance 92mm dry heating element			
For models:	FTE9-05L, FTE9-05L-AD, FTE9-05PLUS-CL, FTE9-05PLUS-CR, FTE9-05PLUS-L, FTE9-05PLUS-R, FTE9-05R, FTE9-05R-AD, FTE9-10L, FTE9-10L+R, FTE9-10L+R-AD, FTE9-10L-AD, FTE9-10PLUS-CL, FTE9-10PLUS-CLR, FTE9-10PLUS-CR, FTE9-10PLUS-L, FTE9-10PLUS-LR, FTE9-10PLUS-R, FTE9-10R, FTE9-10R-AD, FTEC9-05L, FTEC9-05L-AD, FTEC9-05R, FTEC9-05R-AD, FTEC9-05USMC, FTEC9-10L, FTEC9-10L+R, FTEC9-10L+R-AD, FTEC9-10L-AD, FTEC9-10R, FTEC9-10R-AD, FTEC9-10USMC			

heating elements for refrigeration

heating elements for defrosting

	GEV No.	417221	Ref. No.	12034275 12034637 6001508021 6021250019
description	heating element 350W 230V L 360mm W 114mm H 12mm cable length 1000mm tube ø 8.5mm defrosting connection with cable			
For models:	AF-1402-MIX, AF-1403-C, AF-1404-C, AF-1602-MIX, AF-1603-C, AF-1604-C, AF-2104-C, AF-2105-C, AF-2106-C, AF-702-C, AF-802-C, AFN-701, AFN-702, AFN-801, AFN-802, AFP-1402-MIX, AP-701, CAF-1402MIXT, CAF-1602MIX, CAF-802-P, CAFN-701, CAFN-702, CAFN-801, CAFN-802, CAP-701, CMFN-135, CMFN-180, CMPN-117-R, CMPN-150, CMPN-169-R, CMPN-202, CMSN-117-R, CMSN-150, CMSN-169-R, CMSN-200, MCN-102-GN-R, MCN-135-GN, MCN-147-GN-R, MCN-180-GN, MCN-192-GN-R, MCN-225-GN, MCN-237-GN-R, MCN-270-GN, MFN-102-GN-R, MFN-135-GN, MFN-147-GN-R, MFN-180-GN, MFN-192-GN-R, MFN-225-GN, MFN-237-GN-R...(Other models you can see in the webshop)			

	GEV No.	417527	Ref. No.	12033938 6021250021
description	heating element 350W 230V L 380mm W 115mm H 12mm cable length 1000mm tube ø 8.5mm defrosting connection with cable			
For models:	CAF-1603-C, CAF-1604-C, CAF-702C, MCN-270-GN, MFN-135, MFN-180, MFN-225-GN, MFN-270-GN, MFP-225-GN, MFP-270-GN, MPN-255, MPN-255-C, MPN-274-R, MSN-150, MSN-200, MSN-250, MSN-300			

	GEV No.	417223	Ref. No.	12034050 12037967 6001508024 6021250022
description	heating element 650W 220V L 660mm W 180mm W1 65mm W2 115mm cable length 1000mm tube ø 8.5mm connection with cable			
For models:	AFN-1402, AFN-1403, AFN-1404, AFN-1602, AFN-1603, AFN-1604, CAFN-1402, CAFN-1403, CAFN-1404			



heating elements for tilting bratt pan

			
GEV No.	416607	Ref. No.	12024620 X273000
description	heating element 1500W 230V L 417mm W 95mm H 46mm connection M4 dry heating element heating circuits 1 tube ø 9mm connection distance 77mm		
For models:	FTE6-05L, FTE6-05R, SBE7-10		

			
GEV No.	416615	Ref. No.	12018865 X143000
description	heating element 2000W 230V L 523mm W 95mm H 81mm connection M4 dry heating element heating circuits 1 tube ø 8mm connection length 26mm connection distance 87mm		
For models:	SBE9-10, SBE9-10I, SBE9-10IM		

			
GEV No.	416616	Ref. No.	12024617 X143010
description	heating element 2000W 230V L 525mm W 82mm H 46mm connection M4 dry heating element heating circuits 1 tube ø 8.5mm connection distance 69mm		
For models:	SBE9-10, SBE9-10I, SBE9-10I-AD, SBE9-10I-AD-S, SBE9-10IM, SBE9-10IM-AD, SBE9-10IM-AD-S, SBE9-10IMS, SBE9-10IS, SBE9-10M, SBE9-10MS, SBE9-10PLUS-I, SBE9-10PLUS-IM, SBE9-10PLUS-SI, SBE9-10PLUS-SIM, SBE9-10S, SBE9-10USMC, SBE9-15IM, SBE9-15IM-AD, SBE9-15IM-AD-S, SBE9-15IMS, SBE9-15M, SBE9-15MS, SBE9-15PLUS-IM, SBE9-15PLUS-SIM		

heating elements for pasta cookers

			
GEV No.	418799	Ref. No.	12024715 H063002
description	heating element 4000W 230V heating circuits 3 L 348mm W 65mm H 27mm expansion flange connection male faston 6.3mm tube ø 6.2mm pasta cooker flange 70x18mm		
For models:	CPE7-05, CPE7-05NC, CPE9-05, CPE9-05AD, CPE9-05AD-S, CPE9-05NC, CPE9-05PLUS, CPE9-05PLUS-S, CPE9-05S, CPE9-05SNC, EPC-350		

heating elements for heated trolleys

			
GEV No.	418802	Ref. No.	12034205 6021250024
description	heating element dinner cart 1000W 230V L 385mm W 80mm H 35mm connection M4 thread M12x1.25 tube ø 8mm mounting distance 71mm		

			
GEV No.	418801	Ref. No.	12032595 6021250023
description	heating element dinner cart 1500W 230V L 390mm W 80mm H 35mm connection M5 thread M12x1 tube ø 8.5mm mounting distance 72mm		

dry heating elements for dishwashers

			
GEV No.	420561	Ref. No.	12048965
description	heating element 2800W 230V heating circuits 1 L 325mm W 55mm H 40mm tube ø 6.5mm connection F6.3x0.8 dry heating element dishwasher		
For models:	CO-500, CO-500B, CO-500BDD, CO-500DD, CO-501, CO-501B, CO-501BDD, CO-501DD, CO-501-SOFT, CO-502B, CO-502BDD, CO-502DD, CO-502W, COP-503, COP-503B, COP-503BDD, COP-503DD, COP-503-SOFT, COP-504, COP-504B, COP-504BDD, COP-504DD, COP-504W		

heating cables

connection on both sides

with male fastons

			
GEV No.	418807	Ref. No.	12035911 12036102 6001508011 6021250011
description	heating cable 18W 230V L 4750mm silicone connection male faston 6.3mm		
For models:	AF-1403-C, AF-1404-C, AF-1603-C, AF-1604-C, AF-2104-C, AF-2105-C, AF-2106-C, AF-702-C, AFN-1402, AFN-1403, AFN-1404, AFN-1602, AFN-1603, AFN-1604, AFN-701, AFN-702, AFN-801, AFN-802, AFP-1402-MIX, AFP-702, AP-701, CAF-1403C, CAF-1404C, CAF-1603-C, CAF-1604-C, CAF-2104P, CAF-2105P, CAF-2106P, CAF-702C, CAF-802-P, CMPN-117-R, CMPN-150, CMPN-169-R, CMPN-202, CMPN-222-R, CMPN-255, MCN-102-GN-R, MCN-135-GN, MCN-147-GN-R, MCN-180-GN, MCN-192-GN-R, MCN-225-GN, MCN-237-GN-R, MCN-270-GN, MFN-102-GN-R, MFN-135, MFN-135-GN, MFN-147-GN-R, MFN-180, MFN-180-GN...(Other models you can see in the webshop)		

			
GEV No.	418808	Ref. No.	12033714 12036313 6001508005 6021250005
description	heating cable 20W 220V L 3450mm L1 (unheated) 2150mm L2 (heated) 1300mm silicone connection male faston 6.3mm		
For models:	ADAFN-1602, ADAFN-801, ADMCN-135, ADMCN-180, ADMCN-225, ADMFN-135, ADMFN-180, ADMFN-225, AEP-1602, AEP-802, AF-1402-MIX, AF-1403-C, AF-1404-C, AF-1602-MIX, AF-1603-C, AF-1603-P, AF-1604-C, AF-1604-P, AF-2104-C, AF-2105-C, AF-2106-C, AF-702-P, AF-802-C, AFN-1402, AFN-1403, AFN-1404, AFN-1602, AFN-1603, AFN-1604, AFN-701, AFN-702, AFN-801, AFN-802, AFP-1402-MIX, AFP-1602, AFP-1603, AFP-1604, AFP-701, AFP-702, AFP-702-C, AFP-702-P, ANF-1602AD, ANF-1603AD, ANF-1604AD, ANF-801AD, ANF-802AD, AP-701, CAF-1402MIX, CAF-1602MIX, CAFN-1402...(Other models you can see in the webshop)		





			
GEV No.	418806	Ref. No.	12031355 12035540 6001508007 6021250007
description	heating cable 26W 230V L 6400mm silicone connection male faston 6.3mm		
For models:	AEP-1402, AEP-1403, AEP-1404, AEP-1602, AEP-1603, AEP-1604, AF-1402-MIX, AF-1403-C, AF-1404-C, AF-1602-MIX, AF-1603-C, AF-1604-C, AFN-1402, AFN-1403, AFN-1404, AFN-1602, AFN-1603, AFN-1604, AFN-701, AFP-1402, AFP-1402-MIX, AFP-1403, AFP-1403-C, AFP-1403-FORZ, AFP-1403-P, AFP-1404, AFP-1404-C, AFP-1404-FORZ, AFP-1404-P, AFP-1602, AFP-1602-2, AFP-1603, AFP-1604, CAF-1403C, CAF-1404C, CAF-1603-C, CAF-1604-C, CAFN-1402, CAFN-1403, CAFN-1404, CAFN-1602, CAFN-1603, CAFN-1604		

			
GEV No.	418803	Ref. No.	12035174 12035494 6001508015 6021250015
description	heating cable 60W 230V 50Hz L 7400mm silicone defrosting connection male faston 6.3mm		
For models:	AFP-2103, AFP-2104, AFP-2104-C, AFP-2104-P, AFP-2105, AFP-2105-C, AFP-2105-P, AFP-2106, AFP-2106-C, AFP-2106-P		

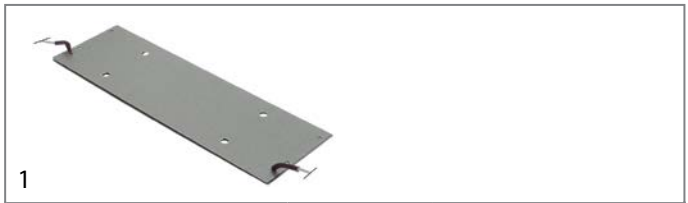
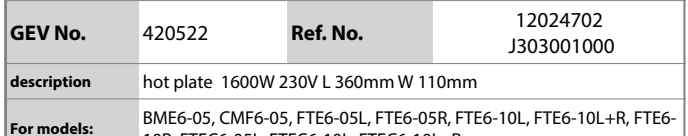
			
GEV No.	418804	Ref. No.	12032620 12036191 6001508010 6021250010
description	heating cable 31W 230V L 3200mm L1 (unheated) 2000mm L2 (heated) 1200mm silicone connection male faston 6.3mm mounting pos. vertical		
For models:	AEP-1402, AEP-1403, AEP-1404, AEP-1602, AEP-1603, AEP-1604, AF-1402-MIX, AF-1403-C, AF-1404-C, AF-1602-MIX, AF-1603-C, AF-1604-C, AFN-1402, AFN-1403, AFN-1404, AFN-1602, AFN-1603, AFN-1604, AFN-701, AFP-1402, AFP-1402-MIX, AFP-1403, AFP-1403-C, AFP-1403-P, AFP-1404, AFP-1404-C, AFP-1404-P, AFP-1602, AFP-1602-2, AFP-1603, AFP-1604, AFP-2103, AFP-2104, AFP-2104-C, AFP-2104-P, AFP-2105, AFP-2105-C, AFP-2105-P, AFP-2106, AFP-2106-C, AFP-2106-P, ATM-101, CAF-1403C, CAF-1404C, CAF-1603-C, CAF-1604-C, CAFN-1402, CAFN-1403, CAFN-1404, CAFN-1602...(Other models you can see in the webshop)		

			
heating plates			
			
GEV No.	420522	Ref. No.	12024702 J303001000
description	hot plate 1600W 230V L 360mm W 110mm		
For models:	BME6-05, CMF6-05, FTE6-05L, FTE6-05R, FTE6-10L, FTE6-10L+R, FTE6-10R, FTE6-05L, FTE6-10L, FTE6-10L+R		

			
GEV No.	418809	Ref. No.	12034144 12034613 6001508006 6021250006
description	heating cable 41W 220V L 6250mm L1 (unheated) 3550mm L2 (heated) 2700mm silicone connection male faston 6.3mm		
For models:	AEP-1602, AEP-1603, AEP-1604, AEP-801, AEP-802, AF-1602-MIX, AF-1603-C, AF-1603-P, AF-1604-C, AF-1604-P, AF-802-C, AF-802-P, AFN-1402, AFN-1403, AFN-1404, AFN-1602, AFN-1603, AFN-1604, AFN-701, AFN-801, AFN-802, AFP-1402, AFP-1403, AFP-1403-C, AFP-1403-FORZ, AFP-1403-P, AFP-1404, AFP-1404-C, AFP-1404-FORZ, AFP-1404-P, AFP-1602, AFP-1602-2, AFP-1603, AFP-1603-2, AFP-1604, AFP-801, AFP-802, AFP-802-2, AP-701, APP-701, VM-100-I, VM-100-M, VM-135-I, VM-135-M		

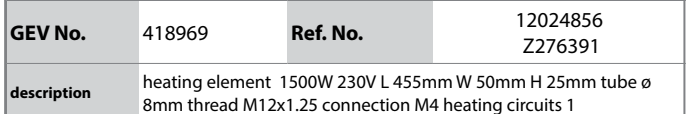
			
coil heating elements			
			
GEV No.	418969	Ref. No.	12024856 Z276391
description	heating element 1500W 230V L 455mm W 50mm H 25mm tube ø 8mm thread M12x1.25 connection M4 heating circuits 1		
For models:	ECO-160, ECO-160D, ECO-160I, ECO-200, ECO-200D, ECO-200H, ECO-200HD, ECO-200HI, ECO-200I, ECO-2700D, ECO-2700I, ECO-280D, ECO-280I, ECO-370D, ECO-370I, ECO-4000D, ECO-4000I, ECO-460D, ECO-460I, ECO-550D, ECO-550I, ECO-6000D, ECO-6000I, FI-160, FI-160AR, FI-160D, FI-160I, FI-200, FI-200AR, FI-200D, FI-200H, FI-200HD, FI-200HI, FI-200I, FI-200W, FI-200WL, FI-200WR, FI-2700D, FI-2700I, FI-280D, FI-280I, FI-370D, FI-370I, FI-4000D, FI-4000I, FI-460D, FI-460I, FI-550D, FI-550I, FI-6000D...(Other models you can see in the webshop)		

			
GEV No.	418805	Ref. No.	12032324 12036014 6001508009 6021250009
description	heating cable 43W 230V L 5000mm silicone connection male faston 6.3mm		
For models:	ADAEP-801, ADAFN-1602, ADAFN-801, ADAFP-801, AEP-701, AEP-702, AEP-801, AEP-802, AF-1402-MIX, AF-1403-C, AF-1404-C, AF-1602-MIX, AF-702-C, AF-702-P, AF-802-C, AFN-1402, AFN-701, AFN-702, AFN-801, AFN-802, AFP-1402-FORZ, AFP-1402-MIX, AFP-1403-FORZ, AFP-2103, AFP-2104, AFP-2104-C, AFP-2104-P, AFP-2105, AFP-2105-C, AFP-2105-P, AFP-2106, AFP-2106-C, AFP-2106-P, AFP-701, AFP-702, AFP-702-C, AFP-702-FORZ, AFP-702-P, AFP-801, AFP-802, AFP-802-2, ANF-1602AD, ANF-1603AD, ANF-1604AD, ANF-801AD, ANF-802AD, CAF-1402MIXT, CAF-1602MIX, CAF-702C, CAF-802-P...(Other models you can see in the webshop)		



immersion heating elements

3 hole flange ø57.5mm

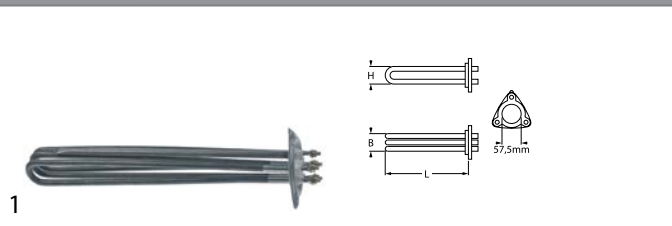

GEV No.	415021	Ref. No.	12024713 Z313601
----------------	--------	-----------------	---------------------

description heating element 6000W 230V mounting ø 57.5mm heating circuits 3 L 343mm W 37mm H 50mm number of thermostat sleeves 1 thermostat sleeves ø 7mm length thermostat sleeves 294mm thermostat sleeve not clinging tube ø 8.5mm hole distance 72mm hole ø 8mm connection M5 3 hole flange

For models: ECO-2700D, ECO-2700I, ECO-280D, ECO-280I, ECO-370D, ECO-370I, ECO-4000D, ECO-4000I, ECO-460D, ECO-460I, ECO-550D, ECO-550I, ECO-6000D, ECO-6000I, FI-2700D, FI-2700I, FI-280D, FI-280I, FI-370D, FI-370I, FI-4000D, FI-4000I, FI-460D, FI-460I, FI-550D, FI-550I, FI-6000D, FI-6000I

spare parts for 415021

	GEV No.	510409	Ref. No.	12010040 Q307044
O-ring EPDM thickness 5.34mm ID ø 56.52mm Qty 1 pcs				

accessories for 415021

	GEV No.	550002	Ref. No.	—
tension strap H 10mm L 21mm W 10mm hole ø 6.5mm for heating element				

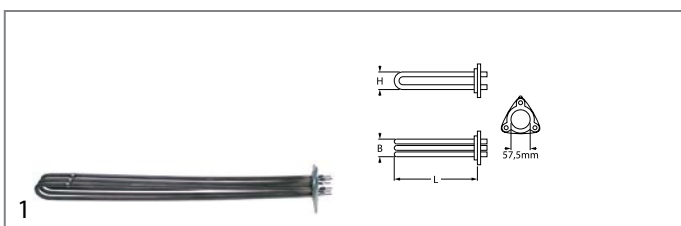

GEV No.	418798	Ref. No.	12024214 12040415 Z121740 Z121741
----------------	--------	-----------------	--

description heating element 9600W 230V mounting ø 57.5mm heating circuits 3 L 545mm W 36mm H 53mm number of thermostat sleeves 1 thermostat sleeves ø 7mm length thermostat sleeves 190mm tube ø 8mm hole distance 73mm hole ø 8mm connection M4

For models: ECO-160, ECO-1600, ECO-160D, ECO-160I, ECO-200, ECO-200D, ECO-200H, ECO-200HD, ECO-200HI, ECO-200I, ECO-2300, ECO-2700D, ECO-2700I, ECO-3000, ECO-4000D, ECO-4000I, ECO-6000D, ECO-6000I, FI-160, FI-1600, FI-160AR, FI-160D, FI-160I, FI-200, FI-200AR, FI-200D, FI-200H, FI-200HD, FI-200HI, FI-200I, FI-200WL, FI-200WR, FI-2300, FI-2700D, FI-2700I, FI-280D, FI-280I, FI-3000, FI-370D, FI-370I, FI-4000D, FI-4000I, FI-460D, FI-460I, FI-550D, FI-550I, FI-6000D, FI-6000I

accessories for 418798

	GEV No.	510409	Ref. No.	12010040 Q307044
O-ring EPDM thickness 5.34mm ID ø 56.52mm Qty 1 pcs				

3 hole flange ø60.0mm

connection straight

group 1



GEV No.	420325	Ref. No.	12024721 Z129502
----------------	--------	-----------------	---------------------

description heating element 12000W 230V mounting ø 60mm heating circuits 3 L 545mm W 36mm H 41mm number of thermostat sleeves 1 thermostat sleeves ø 7mm length thermostat sleeves 175mm thermostat sleeve eccentric, non clinging tube ø 8.5mm hole distance 73mm hole ø 10mm connection M4 3 hole flange immersion heater

For models: ECO-6000D, ECO-6000I, FI-160D, FI-160I, FI-200AR, FI-200D, FI-200HD, FI-200HI, FI-200I, FI-200W, FI-2700D, FI-2700I, FI-4000D, FI-4000I, FI-460D, FI-460I, FI-550D, FI-550I, FI-6000D, FI-6000I



GEV No.	420324	Ref. No.	12024740 Z101720 Z101740
----------------	--------	-----------------	--------------------------------

description heating element 6000W 230V mounting ø 60mm heating circuits 3 L 545mm W 36mm H 41mm number of thermostat sleeves 1 thermostat sleeves ø 7mm length thermostat sleeves 175mm thermostat sleeve eccentric, non clinging tube ø 8.5mm hole distance 73mm hole ø 10mm connection M4 3 hole flange immersion heater

For models: ECO-1600, ECO-2300, ECO-280D, ECO-280I, ECO-3000, ECO-370D, ECO-370I, ECO-460D, ECO-460I, ECO-550D, ECO-550I, FI-1600, FI-2300, FI-280D, FI-280I, FI-3000, FI-370D, FI-370I, FI-460D, FI-460I, FI-550D, FI-550I

with expansion flange 70 x 18mm



GEV No.	416380	Ref. No.	12024986 Z733601
----------------	--------	-----------------	---------------------

description heating element 1000W 230V heating circuits 1 flange 70x18mm L 273mm W 63mm H 27mm connection M4 immersion heater expansion flange tube ø 6.5mm

For models: ECO-120, LVC-12, LVC-15, LVC-21, LVR-10

accessories for 416380

	GEV No.	510429	Ref. No.	—
gasket L 76mm W 23mm hole distance 25mm 3 holes for heating element type DB 70 without thermostat sensor hole				



GEV No.	416381	Ref. No.	12024951 R223005
description	heating element 2000W 230V heating circuits 1 flange 70x18mm L 280mm W 78mm H 22mm connection M4 immersion heater expansion flange tube ø 8.5mm		
For models:	AD-15, AD-15D, AD-20C-UK, AD-21, AD-21B, AD-21BDD, AD-21C, AD-21D, AD-21DD, AD-21W, AD-45BBT, BME7-05, BME7-10, BME9-10, BME9-10AD, BME9-10PLUS, BME9-10V-T, FI-30, FI-30AR, FI-30AR+DD, FI-30B-BT-UK, FI-30-UK, LVC-12, LVC-15, LVC-15D, LVC-21, LVC-21B, LVC-21C, LVC-21D, LVC-21W, LVR-14, LVR-14D, LVR-20, LVR-20B, LVR-20D, MF-21		
accessories for	416381		
	GEV No.	510429	Ref. No. —
	gasket L 76mm W 23mm hole distance 25mm 3 holes for heating element type DB 70 without thermostat sensor hole		



GEV No.	416382	Ref. No.	12024645 Z203601
description	heating element 2800W 230V heating circuits 1 flange 70x18mm L 370mm W 102mm H 27mm immersion heater tube ø 8.5mm		
For models:	AD-48, AD-48B, AD-48BDD, AD-48C, AD-48D, AD-48DD, AD-48HY, AD-48W, AD-64, AD-64B, AD-64BBT, AD-64BDD, AD-64BTDD, AD-64C, AD-64CW, AD-64D, AD-64DD, AD-64HY, AD-72, AD-72W, BME9-05, BME9-05AD, BME9-05PLUS, BME9-05V-T, EASY-500, EASY-500B, EASY-500DD, EASY-500HP, EASY-500HPWBDD, ECO-120, ECO-120B, FI-100, FI-120, FI-120W, FI-30, FI-30AR, FI-30AR+DD, FI-30B, FI-30-UK, FI-48, FI-48AR, FI-48B, FI-48B-BT-UK, FI-48C, FI-48D, FI-48HY-CLINIC, FI-48W, FI-50, FI-60DD, FI-64...(Other models you can see in the webshop)		



GEV No.	418800	Ref. No.	12024577 12041359 P533001
description	heating element 2x3000W 230V heating circuits 2 flange 70x18mm L 510mm W 60mm connection M4 tube ø 8mm expansion flange		
For models:	LA-25M, LA-AC-25M, LA-AC-25MA, LA-AC-25MP, LAC-25, LAC-25MP, LAC-25MPP, LAC-55, LAC-55MP, LAC-55MPP, LA-E-25M, LA-E-25MA, LA-E-25MP, LC-25, LC-E-25, LF-25MPP, LF-E-25, LF-E-25MP, LF-E-25MPP, LF-E-55, LF-E-55MP, LF-E-55MPP, LR-AC-25M, LR-AC-25MA, LR-AC-25MP, LR-E-25M, LR-E-25MA, LR-E-25MP		



GEV No.	418832	Ref. No.	12018752 P143002
description	heating element 3000W 230V heating circuits 1 flange 70x18mm L 350mm W 63mm connection M4 tube ø 8mm immersion heater		
For models:	LAC-10, LAC-10MP, LAC-10MPP, LC-10, LC-E-10, LC-E-10A, LF-E-10, LF-E-10A, LF-E-10MP, LF-E-10MPP		



GEV No.	418885	Ref. No.	12023242 P633002
description	heating element 4000W 230V heating circuits 1 flange 70x18mm L 350mm W 63mm H 18mm L1 23mm L2 19mm L3 308mm tube ø 8mm connection M4 immersion heater connection length 37mm expansion flange EPDM		
For models:	LA-18MP, LA-AC-18M, LA-AC-18MA, LA-AC-18MP, LA-E-18M, LA-E-18MA, LA-E-18MP, LF-18MPP, LR-AC-18M, LR-AC-18MA, LR-E-18M, LR-E-18MA, LR-E-18MP		



GEV No.	417236	Ref. No.	12017885 R673003
description	heating element 4200W 230V heating circuits 2 flange 70x18mm L 395mm W 70mm connection male faston 6.3mm tube ø 8mm expansion flange		
For models:	HME-10-11, HME-10-21, HME-2-10-11, HME-6-11, HMM-10-11, HMM-10-21, HMM-2-10-11, HMM-6-11, HMP-10-11, HMP-10-21, HMP-2-10-11, HMP-6-11		





GEV No.	418529	Ref. No.	12023778 Z743601
description	heating element 4500W 230V heating circuits 3 flange 70x18mm L 365mm W 65mm H 27mm connection male faston 6.3mm immersion heater expansion flange tube ø 6.7mm		
For models:	AD-120, AD-120B, AD-120BBTDD-UK, AD-120C, AD-120CW, AD-120HY, AD-90, AD-90BA, AD-90BBT, AD-90BDD, AD-90DD, ADE-120, ADE-120B, ECO-120, ECO-120B, FI-100, FI-100AR, FI-100B, FI-100BBT-UK, FI-120, FI-120AR+DD, FI-120B, FI-120C, FI-120HY-CLINIC, FI-120W, FI-80, FI-80AR, FI-80BBT-UK, FI-80W, FI-E-100, MF-120		



with round flange (miscellaneous)







GEV No.	419284	Ref. No.	12024718 Z201708000
description	heating element 2200W 230V mounting ø 62mm L 422mm W 39mm H 39mm heating circuits 1 flange ø 98mm mounting thread M4 flange tube ø 8.5mm thermostat sleeves ø 7.5mm number of thermostat sleeves 1 length thermostat sleeves 193mm thermostat sleeve centre not clinging		



			
GEV No.	420326	Ref. No.	12017495 Z691751
description	heating element 9000W 220V mounting ø 63mm heating circuits 3 L 454mm W 48mm H 38mm thermostat sleeves ø 7mm length thermostat sleeves 180mm number of thermostat sleeves 1 thermostat sleeve centre not clinging tube ø 8mm hole distance 41mm hole ø 7mm connection M4 immersion heater 6 hole flange		
For models:	FI-1200, ME9-10BM, ME9-15BM		



			
GEV No.	417694	Ref. No.	12029395 RT4400194
description	heating element 9000W 230V heating circuits 3 L 192mm W 39mm H 68mm hole distance 90mm hole ø 8mm thermostat sleeves ø 2.5/6.5mm length thermostat sleeves 155mm number of thermostat sleeves 2 thermostat sleeve eccentric, clinging flange length 82mm flange width 82mm tube ø 6.5mm cable length 200mm immersion heater 5 hole flange		

				
GEV No.	417695	Ref. No.	12027948 12029916 RT32011004 RT32011009	
description	heating element 9000W 230V heating circuits 3 L 205mm W 38mm H 70mm number of thermostat sleeves 1 thermostat sleeves ø 2.5mm length thermostat sleeves 120mm thermostat sleeve eccentric, clinging tube ø 6.3mm hole distance 64mm hole ø 8mm connection male faston 6.3mm 4 hole flange immersion heater flange width 82mm flange length 82mm			
accessories for	417695			
	GEV No.	512482	Ref. No.	12036210 RT51101003
	gasket rubber L 82mm W 82mm thickness 4mm hole ø 9mm hole distance 64mm for heating element suitable for RATIONAL 4 holes			



				
GEV No.	420362	Ref. No.	12024747	
description	heating element 9000W 230V heating circuits 3 L 280mm W 77mm H 29mm flange hole distance 47.5mm hole ø 6mm connection male faston 6.3mm tube ø 8.5mm flange length 105mm flange width 60mm immersion heater			
For models:	ACE-102, AE-101, AE-101W, AE-102, AE-102W, AE-201, AE-202, APE-101, APE-101W, APE-102, APE-102W, APE-201, APE-202, HEP-10-21, HEP-20-21, ME9-10BM, ME9-10BMS, ME9-15BM, ME9-15BM316, ME9-15BMS, MPE9-10BM, MPE9-10BMS, MPE9-15BM, MPE9-15BMS, VE-102, VE-201, VE-202, VPE-102, VPE-201, VPE-202			
accessories for	420362			
	GEV No.	550994	Ref. No.	12023680 T323007
	gasket L 105mm W 60mm thickness 3mm for heating element			

				
GEV No.	417197	Ref. No.	12024752 T323006	
description	heating element 9000W 230V heating circuits 3 L 280mm W 78mm H 35mm hole distance 48mm hole ø 6mm tube ø 8.5mm flange length 105mm flange width 60mm immersion heater thermostat sleeves ø 3mm number of thermostat sleeves 1 length thermostat sleeves 115mm			
For models:	ACE-061, ACE-102, AE-061, AE-061W, AE-101, AE-101W, AE-102, AE-102W, AE-201, AE-202, APE-061, APE-061W, APE-101, APE-101W, APE-102, APE-102W, APE-201, APE-202, HEM-10-21, HEM-20-21, HEP-10-21, HEP-20-21, VE-102, VE-201, VE-202, VPE-102, VPE-201, VPE-202			
accessories for	417197			
	GEV No.	550994	Ref. No.	12023680 T323007
	gasket L 105mm W 60mm thickness 3mm for heating element			







				
GEV No.	416606	Ref. No.	12023494 R143000	
description	heating element 9000W 230V heating circuits 3 L 380mm W 75mm H 28mm rectangular flange hole distance 100mm hole ø 5mm connection male faston 6.3mm tube ø 8.1mm flange length 105mm flange width 60mm immersion heater since year of construction 2011			
For models:	HEM-10-11, HEM-20-11, HEM-6-11, HEP-10-11, HEP-20-11, HEP-6-11, HME-10-11, HME-10-21, HME-20-11, HME-20-21, HME-2-10-11, HME-2-20-11, HME-6-11, HMM-10-11, HMM-10-11UL, HMM-10-21, HMM-10-21UL, HMM-20-11, HMM-20-11UL, HMM-20-21, HMM-20-21UL, HMM-2-10-11, HMM-2-20-11, HMM-40-11-USMC, HMM-6-11, HMM-6-11UL, HMP-10-11, HMP-10-21, HMP-20-11, HMP-20-21, HMP-2-10-11, HMP-2-20-11, HMP-6-11, ME7-10BM, ME9-10BM, ME9-10BMS, ME9-15BM, ME9-15BM316, ME9-15BMS, MPE9-10BM, MPE9-10BMS, MPE9-15BM, MPE9-15BMS, VE-101, VE-201, VPE-101, VPE-201			
accessories for	416606			
	GEV No.	691014	Ref. No.	12007832 R145012
	gasket L 105mm W 55mm thickness 5mm for heating element suitable for FAGOR equiv. no. R145012			

				
GEV No.	417711	Ref. No.	12029915 RT32011006	
description	heating element 9000W 255V heating circuits 3 L 204mm W 38mm H 75mm number of thermostat sleeves 1 thermostat sleeves ø 3mm length thermostat sleeves 102mm thermostat sleeve eccentric, clinging tube ø 6.5mm hole distance 65mm hole ø 8mm connection length 38mm connection male faston 6.3mm rectangular flange immersion heater flange width 82mm flange length 82mm			
spare parts for	417711			
	GEV No.	512485	Ref. No.	12036965 RT4400280
	gasket L 81mm W 81mm hole distance 65mm thickness 4mm for heating element suitable for RATIONAL equiv. no. 4400280			





			
1			
GEV No.	416614	Ref. No.	12023926 Z721701
description	heating element 9600W 230V mounting ϕ 63mm heating circuits 3 L 425mm W 50mm H 45mm thermostat sleeves ϕ 6.5mm length thermostat sleeves 200mm number of thermostat sleeves 1 thermostat sleeve eccentric, non clinging tube ϕ 6.5mm hole distance 82mm hole ϕ 7mm connection M4 immersion heater 6 hole flange		
For models:	CO-142W, CO-142WDD, FI-100, FI-100AR, FI-100B, FI-100BBT-UK, FI-120, FI-80, FI-80W, FI-E-100, LABP-1000, ME9-10BM, ME9-10BMS, ME9-15BM, ME9-15BM316, ME9-15BMS, MPE9-10BM, MPE9-10BMS, MPE9-15BM, MPE9-15BMS		
spare parts for	416614		
	GEV No.	532163	Ref. No. —
	O-ring EPDM thickness 5.34mm ID ϕ 62.87mm Qty 10 pcs		
	GEV No.	691033	Ref. No. 12010051 Q307035
	O-ring EPDM thickness 5.34mm ID ϕ 62.87mm Qty 1 pcs		

			
1			
GEV No.	417222	Ref. No.	12017628 Z603601
description	heating element 2000W 230V heating circuits 1 L 280mm W 140mm H 23mm thread 1/4" mounting distance 132mm tube ϕ 8mm connection male faston 6.3mm immersion heater 2 hole fixing stainless steel		

			
1			
GEV No.	416235	Ref. No.	12030300 EU80677
description	heating element 3000W 230V heating circuits 1 L 320mm W 50mm H 40mm thread M10x1 mounting distance 44mm tube ϕ 6.3mm connection male faston 6.3mm 2 hole fixing L1 32mm L2 288mm		
spare parts for	416235		
	GEV No.	510893	Ref. No. —
	O-ring EPDM thickness 2.62mm ID ϕ 9.92mm Qty 1 pcs		
accessories for	416235		
	GEV No.	510416	Ref. No. —
	flat gasket fibre ED ϕ 19mm ID ϕ 10.5mm thickness 1.5mm for thread M10 Qty 1 pcs		
	GEV No.	510893	Ref. No. —
	O-ring EPDM thickness 2.62mm ID ϕ 9.92mm Qty 1 pcs		
	GEV No.	521129	Ref. No. —
	nut thread M10 H 6mm SS WS 17 Qty 1 pcs DIN/ISO DIN 439		
	GEV No.	560192	Ref. No. —
	tooth lock washer ID ϕ 10.4mm ED ϕ 18mm SS DIN/ISO DIN 6798A Qty 1 pcs for thread M10		

heating elements for convection

			
1			
GEV No.	419270	Ref. No.	12024349 T323034 T323034000
description	heating element 15000W 230V heating circuits 3 ID ϕ 540mm ED ϕ 560mm L 580mm H 148mm W1 160mm H1 16mm H2 132mm flange length 210mm flange width 30mm hole distance 180mm connection M4 tube ϕ 10mm mounting thread M6		
For models:	ACE-102, ACE-202, AE-102, AE-102W, AE-202, APE-102, APE-102W, APE-202		

			
1			
GEV No.	419271	Ref. No.	12024359 T323035 T323035000
description	heating element 15000W 230V heating circuits 3 ID ϕ 620mm ED ϕ 640mm L 660mm H 152mm W1 160mm H1 20mm H2 132mm flange length 210mm flange width 30mm hole distance 180mm connection M4 tube ϕ 10mm mounting thread M6		
For models:	ACE-102, ACE-202, AE-102, AE-102W, AE-202, APE-102, APE-102W, APE-202		

			
1			
GEV No.	417670	Ref. No.	12026971 RT32001002
description	heating element 15000W 230V heating circuits 6 ID ϕ 505mm ED ϕ 517mm L 620mm H 195mm W1 155mm H1 27mm H2 168mm flange length 210mm flange width 25mm		



1

GEV No.	417198	Ref. No.	12018441 T323002
description	heating element 15000W 230V heating circuits 6 ID ø 508mm ED ø 515mm L 605mm H 205mm L1 30mm H1 35mm H2 170mm flange length 210mm flange width 30mm tube ø 8.5mm mounting pos. inner		
For models:	HEI-10-21, HEM-10-21		





1

GEV No.	417676	Ref. No.	12038126 RT4000265
description	heating element 18000W 230V heating circuits 3 ID ø 410mm ED ø 477mm L 477mm H 110mm W1 110mm H1 20mm H2 90mm flange length 140mm flange width 62mm hole distance 64mm connection cable connection length 70mm tube ø 6.3mm convection heating element		



1

GEV No.	417675	Ref. No.	12026859 12026880 RT32001003 RT32001017	
description	heating element 15000W 230V heating circuits 6 ID ø 635mm ED ø 650mm L 696mm H 200mm L1 23mm W1 156mm H1 35mm H2 165mm flange length 210mm flange width 24mm hole distance 31mm connection male faston 6.3mm connection length 80mm tube ø 6.3mm convection heating element hole ø 7mm mounting pos. outer rectangular flange			
spare parts for	417675			
	GEV No.	512484	Ref. No.	12035774 RT51101009
	gasket L 210mm W 24mm thickness 2mm for heating element			





1

GEV No.	417677	Ref. No.	12025968 RT4000597
description	heating element 18000W 230V heating circuits 6 ID ø 407mm ED ø 485mm L 485mm H 106mm W1 111mm H1 11mm H2 85mm flange length 140mm flange width 72mm hole distance 128mm connection cable connection length 98mm tube ø 6.6mm cable length 600mm convection heating element hole ø 5mm rectangular flange L1 485mm		



1

GEV No.	417683	Ref. No.	12025672 RT4000267	
description	heating element 30000W 230V heating circuits 6 ID ø 573mm ED ø 630mm L 655mm H 120mm W1 135mm H1 15mm H2 110mm flange length 160mm flange width 75mm hole distance 74mm connection cable connection length 95mm tube ø 8.5mm cable length 600mm convection heating element hole ø 6mm rectangular flange L1 8mm			
accessories for	417683			
	GEV No.	560611	Ref. No.	—
	gasket L 160mm W 75mm for heating element thickness 2mm hole distance 74mm SCC Linie 102/202			



1

GEV No.	417199	Ref. No.	12018381 T323000
description	heating element 15000W 230V heating circuits 6 ID ø 650mm ED ø 668mm L 670mm H 213mm W1 158mm H1 35mm H2 165mm flange length 210mm flange width 30mm tube ø 8mm convection heating element mounting pos. outer		
For models:	HEI-10-21, HEM-10-21		





1

GEV No.	417690	Ref. No.	12027912 RT4000261
description	heating element 9000W 230V heating circuits 3 ID ø 407mm ED ø 420mm L 443mm H 105mm W1 107mm H1 21mm H2 88mm flange length 140mm flange width 62mm hole distance 65mm connection cable connection length 90mm tube ø 6.5mm cable length 270mm convection heating element hole ø 5mm rectangular flange L1 6mm		





1

GEV No.	419268	Ref. No.	12039496 T803050 T803050000
description	heating element 9000W 230V heating circuits 3 ID ø 410mm ED ø 417mm L 450mm H 100mm W1 105mm H1 80mm H2 20mm flange length 142mm flange width 25mm mounting distance 125mm connection M4 tube ø 8.5mm mounting thread M6		
For models:	ACE-061, ACE-101, ACE-201, AE-061, AE-061W, AE-101, AE-101W, AE-201, APE-061, APE-061W, APE-101, APE-101W, APE-201		
accessories for	419268		
	GEV No.	521284	Ref. No. 12041165 T803052000
	gasket for heating element L 142mm W 25mm thickness 2mm graphite		



1

GEV No.	417692	Ref. No.	12028209
description	heating element 9000W 230V heating circuits 3 ID ø 445mm ED ø 458mm L 474mm H 130mm W1 156mm H1 33mm H2 97mm flange length 210mm flange width 25mm hole distance 31mm connection male faston 6.3mm connection length 80mm tube ø 6.5mm dry heating element hole ø 7.5mm mounting pos. inner rectangular flange		
accessories for	417692		
	GEV No.	512484	Ref. No. 12035774 RT51101009
	gasket L 210mm W 24mm thickness 2mm for heating element		



1

GEV No.	419269	Ref. No.	T803051 T803051000 12039497
description	heating element 9000W 230V heating circuits 3 ID ø 490mm ED ø 507mm L 53mm H 100mm L1 14mm W1 100mm H1 83mm H2 17mm flange length 142mm flange width 25mm mounting distance 125mm connection M4 tube ø 8.5mm mounting thread M6		
For models:	ACE-101, ACE-201, AE-101, AE-101W, AE-201, APE-101, APE-101W, APE-201		





1

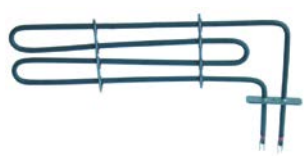

GEV No.	417693	Ref. No.	12026871 RT32001001
description	heating element 9000W 230V heating circuits 3 ID ø 504mm ED ø 516mm L 535mm H 130mm W1 156mm H1 35mm H2 95mm flange length 210mm flange width 25mm hole distance 31mm connection male faston 6.3mm connection length 80mm tube ø 6.5mm dry heating element hole ø 7.5mm mounting pos. outer rectangular flange L1 19mm		





1

GEV No.	416634	Ref. No.	12024692 R663016
description	heating element 1500W 230V heating circuits 1 L 350mm W 102mm L1 30mm L2 320mm W2 82mm flange length 70mm flange width 22mm hole distance 56mm connection length 71mm connection male faston 6.3mm tube ø 6.3mm hole ø 6mm W1 20mm rectangular flange convection heating element windings 2		
For models:	COE-061, HEI-6-11, HEM-6-11, HEP-6-11, HME-6-11, HMI-6-11, HMI-6-11UL, HMM-6-11, HMM-6-11UL, HMP-6-11, VE-061, VPE-061		
spare parts for	416634		
	GEV No.	510368	Ref. No. —
	gasket L 70mm W 23.5mm hole ø 5mm hole distance 56mm FIBER thickness 2mm for heating element		
accessories for	416634		
	GEV No.	550761	Ref. No. 12023637 R693017
	gasket L 69mm W 22mm D1 ø 12mm D2 ø 6mm graphite thickness 2mm for heating element		

			
1			
GEV No.	417658	Ref. No.	12031112 12043757 D01AC02257 D01AC02254 D01AC02257
description	heating element 2000W 230V L 500mm W 86mm connection male faston 6.3mm		
For models:	SF-13, SF-8		

			
1			
GEV No.	416620	Ref. No.	12024727 R673002
description	heating element 3000W 230V heating circuits 2 L 570mm W 100mm L1 70mm L2 500mm W2 70mm flange length 100mm flange width 22mm hole distance 44mm connection length 90mm connection male faston 6.3mm tube ø 8.5mm hole ø M5mm W1 30mm rectangular flange convection heating element		
For models:	COE-101, HEI-10-11, HEM-10-11, HEP-10-11, HME-10-11, HMI-10-11, HMI-10-11UL, HMM-10-11, HMM-10-11UL, HMP-10-11, VE-101, VPE-101		
accessories for	416620		
		GEV No.	550760
		Ref. No.	12023655 R673063
	gasket L 100mm W 22mm D1 ø 12mm D2 ø 7mm graphite thickness 2mm for heating element		

			
1			
GEV No.	416621	Ref. No.	12017124 R093002
description	heating element 4000W 230V heating circuits 2 L 1155mm W 100mm L1 70mm L2 1085mm W2 75mm flange length 100mm flange width 22mm hole distance 88mm connection length 90mm connection male faston 6.3mm tube ø 8mm hole ø M6mm W1 25mm rectangular flange convection heating element		
For models:	COE-201, HEI-20-11, HEM-20-11, HEP-20-11, HME-20-11, HMM-20-11, HMM-20-11UL, HMP-20-11, MFHMM-20-11, VE-201, VPE-201		

			
1			
GEV No.	416019	Ref. No.	12017453 R683000
description	heating element 4000W 230V heating circuits 2 L 570mm W 100mm L1 70mm L2 500mm W2 70mm flange length 100mm flange width 22mm hole distance 44mm connection length 90mm connection male faston 6.3mm tube ø 8mm W1 30mm rectangular flange convection heating element mounting thread M6		
For models:	HEP-10-11, HME-10-21, HME-20-11, HME-20-21, HME-2-10-11, HME-2-20-11, HMI-10-21, HMI-10-21UL, HMI-2-10-11, HMM-10-21, HMM-10-21UL, HMM-20-21, HMM-20-21UL, HMM-2-10-11, HMM-2-20-11, HMM-40-11-USMC, HMP-10-21, HMP-20-11, HMP-20-21, HMP-2-10-11, HMP-2-20-11		

hot plates

square & rectangular

with radiused edge

			
1			
GEV No.	490056 ¹	Ref. No.	12024805 U673011
description	hot plate dimensions 300x300mm 3000W 230V with spill ring connection 4 screw clamps protector yes square		
For models:	CE7-20Q, CE7-40Q, CE7-41Q, CE9-20, CE9-20AD, CE9-20PLUS, CE9-40, CE9-40AD, CE9-40PLUS, CE9-41, CE9-41AD, CE9-41PLUS		

¹incl. protector

			
1			
GEV No.	490073	Ref. No.	12024803 U673012
description	hot plate dimensions 300x300mm 3000W 400V with spill ring connection 4 screw clamps protector no square		
For models:	CE7-20Q, CE7-40Q, CE7-41Q, CE9-20, CE9-40, CE9-41		

			
1			
GEV No.	490071 ¹	Ref. No.	12024806 U673010
description	hot plate dimensions 300x300mm 4000W 230V with spill ring connection 4 screw clamps protector yes square		
For models:	CE9-20, CE9-20AD, CE9-20PLUS, CE9-40, CE9-40AD, CE9-40PLUS, CE9-41, CE9-41AD, CE9-41PLUS		

¹incl. protector



			
1			
GEV No.	490074 ¹	Ref. No.	12024802 U673013
description	hot plate dimensions 300x300mm 4000W 400V with spill ring connection 4 screw clamps protector yes square		
For models:	CE9-20, CE9-40, CE9-41		

¹incl. protector

round
with radiused edge
for domestic and commercial kitchens

			
1			
GEV No.	490012	Ref. No.	12024602 U803002
description	hot plate ø 145mm 1500W 230V connection 4 screw clamps with 8mm spill ring		
For models:	CE6-40, CE6-41, CE7-20, CE7-40, CE7-41		

			
1			
GEV No.	490020	Ref. No.	12024076 U803000
description	hot plate ø 220mm 2600W 230V connection 4 screw clamps with 8mm spill ring		
For models:	CE7-20, CE7-40, CE7-41		
accessories for	490020		
	GEV No.	550796	Ref. No.
			—
	fixing plate for hot plate ø220mm		

energy regulators

EGO

1-circuit



			
1			
GEV No.	380015	Ref. No.	12024522 12029890 K002B42045 S333001
description	energy regulator 230V 13A single-circuit turn direction right shaft ø 6x4.6mm shaft L 23mm mounting thread M4 power release 6-100% no. 50.57021.010		
For models:	CPE6-05, CPE7-05, CPE7-05NC, CPE9-05, CPE9-05AD, CPE9-05AD-S, CPE9-05NC, CPE9-05PLUS, CPE9-05PLUS-S, CPE9-05S, CPE9-05SNC, CV6-20, CV6-40, EPC-350, HGV-10-11, HGV-20-11, HVG-10-11, HVG-10-11UL, HVG-10-21, HVG-10-21UL, HVG-20-11, HVG-20-21, HVG-2-10-11, HVG-2-20-21, ME7-10BM, ME9-10BM, ME9-10BMS, ME9-10PLUS-BM, ME9-10PLUS-BMS, ME9-15BM, ME9-15BM316, ME9-15BM-AD, ME9-15BMS, ME9-15PLUS-BM, ME9-15PLUS-BMS, MFHVG-10-11, MFHVG-10-21, MG9-10AD, MG9-10BMAD, MG9-10BMSAD, MG9-10PLUS, MG9-10PLUS-BM, MG9-10PLUS-BMS, MG9-10PLUS-S, MG9-10S-AD, MG9-15AD, MG9-15BMAD, MG9-15BMSAD, MG9-15PLUS, MG9-15PLUS-BM...(Other models you can see in the webshop)		

thermostats

bi-metal thermostats

safety bi-metal thermostats

			
1			
GEV No.	390590	Ref. No.	12033906 BR00C23114
description	bi-metal safety thermostat hole distance 24mm switch-off temp.°C 1NC 1-poleAV connection plug 2 hole fixing		

			
1			
GEV No.	390451	Ref. No.	12025141 R213004
description	bi-metal safety thermostat hole distance mm switch-off temp. 115°C 1NC 1-pole 16A connection F6.3		
For models:	AD-120, AD-120B, AD-120BBTDD-UK, AD-120C, AD-120CW, AD-120HY, AD-90, AD-90BA, AD-90BBT, AD-90BDD, AD-90DD, ADE-120, ADE-120B, BME7-05, BME7-10, BME9-05, BME9-10, ECO-120, ECO-120B, FI-100, FI-100AR, FI-100B, FI-100BBT-UK, FI-120, FI-120AR+DD, FI-120B, FI-120C, FI-120HY-CLINIC, FI-120W, FI-80, FI-80AR, FI-80BBT-UK, FI-80W, FI-E-100, LABP-1000, LABP-1200, MF-120		
accessories for	390451		
	GEV No.	505093	Ref. No.
			12024049 N503017
	 gasket for thermostat ED ø 35mm ID ø 24mm thickness 7mm equiv. no. N503017		

bi-metal thermostats



GEV No.	391045	Ref. No.	12095019
description	bi-metal thermostat hole distance 23.5mm switch-off temp. 51°C 1NC 1-pole 10A connection F6.3 threaded probe ø 16mm		
For models:	ACE-061, ACE-101, ACE-102, ACE-201, ACE-202, ACG-061, ACG-101, ACG-102, ACG-201, ACG-202, AE-061, AE-101, AE-102, AE-201, AE-202, AG-061, AG-101, AG-102, AG-201, AG-202, CO-350, CO-350-B, CO-350-B-DD, CO-350-COLD, CO-350-COLD-B, CO-350-COLD-B-DD, CO-350-COLD-DD, CO-350-DD, CO-400, CO-400-B, CO-400-B-DD, CO-400-COLD, CO-400-COLD-B, CO-400-COLD-B-DD, CO-400-COLD-DD, CO-400-DD, CO-400-SOFT		



GEV No.	375160	Ref. No.	12035324 RT30140325
description	bi-metal thermostat hole distancemm switch-off temp. 110°C 1NC 1-pole 16A connection F6.3 M4		



GEV No.	390450	Ref. No.	12023708 Z653013 Z718405
description	bi-metal thermostat hole distancemm switch-off temp. 66/57°C NC/NO 2-pole 16A connection F6.3		
For models:	EASY-500, EASY-500B, EASY-500DD, EASY-500HP, EASY-500HPWBDD, ECO-120, ECO-1200, ECO-120B, FI-100, FI-100AR, FI-100B, FI-100BBT-UK, FI-120, FI-1200, FI-120AR+DD, FI-120B, FI-120C, FI-120HY-CLINIC, FI-120W, FI-30, FI-300B, FI-300R, FI-30AR, FI-30AR+DD, FI-30B, FI-30B-BT-UK, FI-30-UK, FI-48, FI-48B, FI-48B-BT-UK, FI-48D, FI-48W, FI-60DD, FI-64, FI-64AR, FI-64B, FI-64C, FI-64D, FI-64W, FI-650R, FI-72, FI-72AR, FI-80, FI-80AR, FI-80BBT-UK, FI-80W, FI-900, LABP-1000, LABP-1200, LABP-800...(Other models you can see in the webshop)		
accessories for	390450		
	GEV No.	505093	Ref. No. 12024049 N503017
	gasket for thermostat ED ø 35mm ID ø 24mm thickness 7mm equiv. no. N503017		



GEV No.	390428	Ref. No.	12023814 P503025
description	bi-metal thermostat hole distancemm switch-off temp.°C 1NO/1NC 2-pole 15A 250V connection F6.3		
For models:	LA-13M, LA-18MP, LA-25M, LA-AC-10M, LA-AC-10MA, LA-AC-10MP, LA-AC-13M, LA-AC-13MA, LA-AC-13MP, LA-AC-18M, LA-AC-18MA, LA-AC-18MP, LA-AC-25M, LA-AC-25MA, LA-AC-25MP, LAC-10MP, LAC-10MPP, LAC-14MP, LAC-14MPP, LAC-25MP, LAC-25MPP, LAC-55MP, LAC-55MPP, LAC-7MP, LAC-7MPP, LA-E-10M, LA-E-10MA, LA-E-10MP, LA-E-13M, LA-E-13MA, LA-E-13MP, LA-E-18M, LA-E-18MA, LA-E-18MP, LA-E-25M, LA-E-25MA, LA-E-25MP, LA-V-10M, LA-V-10MP, LA-V-13M, LA-V-13MP, LA-V-18M, LA-V-18MP, LA-V-25M, LA-V-25MP, LB-AC-10M, LB-E-10M, LB-V-10M, LF-13MPP, LF-18MPP...(Other models you can see in the webshop)		
accessories for	390428		
	GEV No.	505093	Ref. No. 12024049 N503017
	gasket for thermostat ED ø 35mm ID ø 24mm thickness 7mm equiv. no. N503017		

control and safety thermostats

EGO

control thermostats

55.13_ series

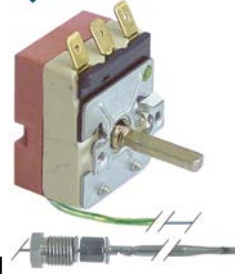

GEV No.	375415	Ref. No.	12018245 R343018
description	thermostat t.max. 105°C temperature range 52-105°C 1-pole 1CO 16A probe ø 3.03mm probe L 201mm capillary pipe 2380mm capillary pipe isolated 2200mm gland nut M9x1 shaft ø 6x4.6mm shaft L 23mm shaft position upper rotation 270°		
For models:	HCV-10-11, HCV-10-21, HCV-2-10-21, HCV-5-11, HCV-6-11, HEI-10-11, HEI-20-11, HEI-6-11, HGV-10-11, HGV-20-11, HMI-10-11, HMI-10-11UL, HMI-10-21, HMI-10-21UL, HMI-2-10-11, HMI-6-11, HMI-6-11UL, HMM-10-11, HMM-10-11UL, HMM-10-21, HMM-10-21UL, HMM-20-11, HMM-20-11UL, HMM-20-21, HMM-20-21UL, HMM-2-10-11, HMM-40-11-USMC, HMM-6-11, HMM-6-11UL, HVG-10-11, HVG-10-11UL, HVG-10-21, HVG-10-21UL, HVG-20-11, HVG-20-21, HVG-2-10-11, HVG-2-20-21, MFHMM-20-11, MFHVG-10-11, MFHVG-10-21		



GEV No.	375123	Ref. No.	12024662 K008B41006 X033000
description	thermostat t.max. 215°C temperature range 60-215°C 1-pole 1NO 16A probe ø 6mm probe L 77mm capillary pipe 2250mm capillary pipe isolated 2100mm gland nut shaft L 23mm shaft position upper rotation 270°		
For models:	FE-18, FE-25, FE-4, FE-6, FE6-05TE, FE6-10TE, FE-71-15, FE-8, FE-91-20		



GEV No.	390086	Ref. No.	12018764 R013002 R013002000
description	thermostat t.max. 300°C temperature range -10 to +300°C 1-pole 1CO probe ø 3mm probe L 201mm capillary pipe 1170mm capillary pipe isolated 1100mm shaft ø 6x4.6mm shaft L 26mm rotation 250° probe material SS		



GEV No.	375204	Ref. No.	12024623 X163010
description	thermostat t.max. 215°C temperature range 61-215°C 1-pole 1NO 16A probe ø 3.1mm probe L 201mm capillary pipe 870mm capillary pipe isolated 600mm gland nut M9x1 shaft L 23mm shaft position upper rotation 270°		
For models:	FE6-05, FE6-10, FE7-05-1C, FE7-05-2C, FE-710, FE7-10-2C, FE7-10-4C, FE-720, FE9-05, FE9-05-1C, FE9-05-2C, FE9-05AD, FE9-05PLUS, FE9-05PLUS-S, FE9-05S, FE9-05S-1C, FE9-05S-2C, FE9-05S-AD, FE9-05US-MC, FE9-10, FE9-10-2C, FE9-10-4C, FE9-10AD, FE9-10PLUS, FE-920, FG7-05-1C, FG7-05-2C, FG-710, FG7-10-2C, FG7-104C, FG7-10-4C, FG-720, FG9-05, FG9-05-1C, FG9-05-2C, FG9-05AD, FG9-05PLUS, FG9-05PLUS-S, FG9-05S, FG9-05S-1C, FG9-05S-2C, FG9-05S-AD, FG9-10, FG9-10-2C, FG9-10-4C, FG9-10AD, FG9-10PLUS, FG-920, FGCL9-05, FGCL9-05-1C...(Other models you can see in the webshop)		



GEV No.	375459	Ref. No.	12024939 Z953001
description	thermostat t.max. 82°C temperature range fixed 82°C 1-pole 1COA probe ø 15/9mm probe L 21mm capillary pipe 1000mm capillary pipe isolated 950mm gland nut shaft ømm shaft Lmm shaft position rotation° probe material SS		
For models:	GA-20, GA-20D, GA-40, GA-40D		



GEV No.	375460	Ref. No.	12018390 R343073
description	thermostat t.max. 255°C temperature range 55-255°C 1-pole 1NO 16A probe ø 3.1mm probe L 201mm capillary pipe 1170mm capillary pipe isolated 1100mm gland nut shaft ø 6x4.6mm shaft L 23mm shaft position upper		
For models:	HCV-10-11, HCV-5-11		

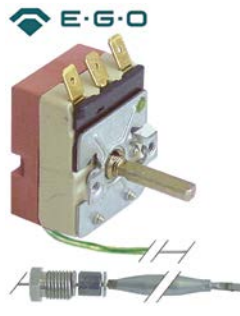

GEV No.	375414	Ref. No.	12024648 R343100
description	thermostat t.max. 85°C temperature range 30-85°C 1-pole 1CO 16A probe ø 6mm probe L 73mm capillary pipe 1540mm capillary pipe isolated 1400mm gland nut M9x1 shaft ø 6x4.6mm shaft L 23mm shaft position upper rotation 270°		
For models:	FI-120W, FI-80W, HCV-10-11, HCV-10-21, HCV-2-10-21, HCV-6-11, HEI-10-21, HEM-10-11, HEM-20-11, HEM-6-11, HEP-10-11, HEP-20-11, HEP-6-11, HGV-10-11, HGV-20-11, HME-10-11, HME-10-21, HME-20-11, HME-20-21, HME-2-10-11, HME-2-20-11, HME-6-11, HMM-10-11, HMM-10-11UL, HMM-10-21, HMM-10-21UL, HMM-20-11, HMM-20-11UL, HMM-20-21, HMM-20-21UL, HMM-2-10-11, HMM-40-11-USMC, HMM-6-11, HMM-6-11UL, HMP-10-11, HMP-10-21, HMP-20-11, HMP-20-21, HMP-2-10-11, HMP-6-11, HVG-10-11, HVG-10-11UL, HVG-10-21, HVG-10-21UL, HVG-20-11, HVG-20-21, HVG-2-10-11, HVG-2-20-21, MFHMM-20-11, MFHVG-10-11...(Other models you can see in the webshop)		

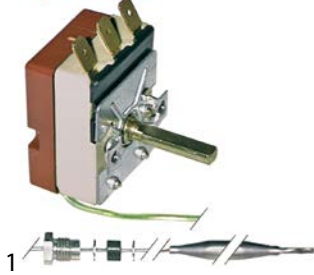

GEV No.	375400	Ref. No.	12024096 Z393005
description	thermostat t.max. 90°C temperature range 30-90°C 1-pole 1CO 16A probe ø 6mm probe L 98mm capillary pipe 2380mm capillary pipe isolated 1700mm gland nut M9x1 shaft ø 6x4.6mm shaft L 18mm shaft position upper rotation 270°		
For models:	AD-15, AD-15D, AD-20C-UK, AD-21, AD-21B, AD-21BDD, AD-21C, AD-21D, AD-21DD, AD-21W, AD-90, AD-90DD, FI-30, FI-30AR, FI-30AR+DD, FI-30B, FI-30B-BT-UK, FI-30-UK, FI-80, FI-80AR, FI-80W, LABP-800, LVC-12, LVC-15, LVC-15D, LVC-21, LVC-21B, LVC-21C, LVC-21D, LVC-21W, LVR-10, LVR-14, LVR-14D, LVR-20, LVR-20B, LVR-20D, MF-21		



GEV No.	375130	Ref. No.	12024573 12030953 AL00000121 Z203014
description	thermostat t.max. 90°C temperature range 32-90°C 1-pole 1CO 16A probe ø 6mm probe L 129mm capillary pipe 710mm capillary pipe isolated 500mm gland nut shaft ø 6x4.6mm shaft L 23mm shaft position upper rotation 270°		
For models:	AD-120, AD-120B, AD-120BBTDD-UK, AD-120C, AD-120CW, AD-120HY, AD-45BBT, AD-48, AD-48B, AD-48BDD, AD-48C, AD-48D, AD-48DD, AD-48HY, AD-48W, AD-64, AD-64B, AD-64BBT, AD-64BDD, AD-64C, AD-64CW, AD-64D, AD-64DD, AD-64HY, AD-72, AD-72W, AD-90, AD-90BA, AD-90BBT, AD-90BDD, AD-90DD, ADE-120, ADE-120B, BME6-05, BME7-05, BME7-10, BME9-05, BME9-05AD, BME9-05PLUS, BME9-05V-T, BME9-10, BME9-10AD, BME9-10PLUS, BME9-10V-T, ECO-120, ECO-120B, ECO-160, ECO-160D, ECO-160I...(Other models you can see in the webshop)		

55.18_ series



GEV No.	376094	Ref. No.	39FA0010
description	thermostat t.max. 324°C temperature range 54-324°C 1-pole 1NO 16A probe ø 3.03mm probe L 160mm capillary pipe 1130mm capillary pipe isolated 870mm gland nut shaft ø 6x4.6mm shaft L 23mm shaft position upper rotation 270°		

safety thermostats

55.11_ series



GEV No.	375120	Ref. No.	12024600 X033001
description	safety thermostat switch-off temp. 245°C 1-pole 16A probe ø 6mm probe L 77mm capillary pipe 2290mm capillary pipe isolated 2260mm gland nut probe SS		
For models:	FE-18, FE-25, FE-4, FE-6, FE6-05TE, FE6-10TE, FE-71-15, FE-8, FE-91-20, MG7-10BM, MG9-10BM, MG9-10BMAD, MG9-10BMS, MG9-10BMSAD, MG9-10PLUS-BM, MG9-10PLUS-BMS, MG9-15BM, MG9-15BM316, MG9-15BMAD, MG9-15BMS, MG9-15BMSAD, MG9-15PLUS-BM, MG9-15PLUS-BMS, MPG9-10BM, MPG9-10BMS, MPG9-15BM, MPG9-15BMS		



GEV No.	375461	Ref. No.	12023818 Z953002
description	safety thermostat switch-off temp. 92°C 1-pole 1NC 16A probe ø 9/15mm probe L 20mm capillary pipe 50mm capillary pipe isolated-gland nut shaft ømm probe probe material SS		
For models:	GA-20, GA-20D, GA-40, GA-40D		



55.12_series



GEV No.	375084	Ref. No.	12030006 RT30140328
description	safety thermostat switch-off temp. 135°C 1-pole 10A probe ø 6mm probe L 83mm capillary pipe 1440mm capillary pipe isolated 1360mm gland nut probe SS		



GEV No.	375775	Ref. No.	12028861 RT4001329
description	safety thermostat switch-off temp. 160°C 1-pole 10A probe ø 6mm probe L 87mm capillary pipe 1440mm capillary pipe isolated 1400mm gland nut probe		

55.13_series



GEV No.	375205	Ref. No.	12017873 X012130
description	safety thermostat switch-off temp. 225°C 1-pole 16A probe ø 11mm probe L 16.5mm capillary pipe 830mm capillary pipe isolatedmm gland nut probe screw-in probe probe thread M14x1		
For models:	FE-710, FE-720, FE-920, FG-710, FG-720, FG-91-20, FG-920, FG-92-40		



GEV No.	390806	Ref. No.	12024607 X163001
description	safety thermostat switch-off temp. 245°C 1-pole 16A probe ø 3.1mm probe L 201mm capillary pipe 870mm capillary pipe isolated 600mm gland nut M9x1 probe		
For models:	FE6-05, FE6-10, FE7-05-1C, FE7-05-2C, FE7-10-2C, FE7-10-4C, FE9-05, FE9-05-1C, FE9-05-2C, FE9-05AD, FE9-05PLUS, FE9-05PLUS-S, FE9-05S, FE9-05S-1C, FE9-05S-2C, FE9-05S-AD, FE9-10, FE9-10-2C, FE9-10-4C, FE9-10AD, FE9-10PLUS, FG6-05, FG6-10, FG7-05-1C, FG7-05-2C, FG7-10-2C, FG7-104C, FG7-10-4C, FG9-05, FG9-05-1C, FG9-05-2C, FG9-05AD, FG9-05PLUS, FG9-05PLUS-S, FG9-05S, FG9-05S-1C, FG9-05S-2C, FG9-05S-AD, FG9-10, FG9-10-2C, FG9-10-4C, FG9-10AD, FG9-10PLUS, FGCL9-05, FGCL9-05-1C, FGCL9-05-2C, FGCL9-05S-1C, FGCL9-05S-2C		



GEV No.	375131	Ref. No.	12018982 X163040
description	safety thermostat switch-off temp. 245°C 1-pole 16A probe ø 3.1mm probe L 201mm capillary pipe 870mm capillary pipe isolated 600mm gland nut probe		

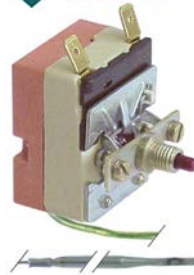

GEV No.	375416	Ref. No.	12019062 R243016
description	safety thermostat switch-off temp. 329°C 1-pole 16A probe ø 3.03mm probe L 160mm capillary pipe 1230mm capillary pipe isolated 1060mm gland nut probe		
For models:	HCG-10-11, HCG-10-21, HCG-20-11, HCG-20-21, HCG-2-10-11, HCG-2-20-11, HCG-6-11, HCV-10-11, HCV-10-21, HCV-2-10-21, HCV-5-11, HCV-6-11, HE-10-11, HE-10-21, HE-2-10-11, HE-5-11, HE-6-11, HEI-10-11, HEI-20-11, HEI-6-11, HEM-10-11, HEM-20-11, HEM-6-11, HEP-10-11, HEP-20-11, HEP-6-11, HG-10-11, HG-10-21, HG-2-10-11, HGC-10-11, HGC-20-11, HGC-6-11, HGV-10-11, HGV-20-11, HME-10-11, HME-10-21, HME-20-11, HME-2-10-11, HME-2-20-11, HME-6-11, HMG-10-11, HMG-10-11UL, HMG-10-21, HMG-10-21UL, HMG-20-11, HMG-2-10-11, HMG-6-11, HMI-10-11, HMI-10-11UL... (Other models you can see in the webshop)		



GEV No.	375441	Ref. No.	12024591 T303009
description	safety thermostat switch-off temp. 360°C 1-pole 1NC 16A probe ø 3mm probe L 110mm capillary pipe 870mm capillary pipe isolated 700mm gland nut probe screw connection M8x1		



GEV No.	375121	Ref. No.	12024691 R612103
description	safety thermostat switch-off temp. 420°C 1-pole 1NO 16A probe ø 3.9mm probe L 228mm capillary pipe 1130mm capillary pipe isolated 700mm gland nut starting temperature 394°C probe		
For models:	CMF6-05, FTE6-05L, FTE6-05R, FTE6-10L, FTE6-10L+R, FTE6-10R, FTE7-05, FTE7-05L, FTE7-05R, FTE7-10, FTE7-10L, FTE7-10L+R, FTE7-10R, FTE9-05L, FTE9-05L-AD, FTE9-05PLUS-CL, FTE9-05PLUS-CR, FTE9-05PLUS-L, FTE9-05PLUS-R, FTE9-05R, FTE9-05R-AD, FTE9-10L, FTE9-10L+R, FTE9-10L+R-AD, FTE9-10L-AD, FTE9-10PLUS-CL, FTE9-10PLUS-CLR, FTE9-10PLUS-CR, FTE9-10PLUS-L, FTE9-10PLUS-LR, FTE9-10PLUS-R, FTE9-10R, FTE9-10R-AD, FTEC6-05L, FTEC6-10L, FTEC6-10L+R, FTEC7-05L, FTEC7-10L, FTEC9-05, FTEC9-05L, FTEC9-05L-AD, FTEC9-05R, FTEC9-05R-AD, FTEC9-05USMC, FTEC9-10, FTEC9-10L, FTEC9-10L+R, FTEC9-10L+R-AD, FTEC9-10L-AD, FTEC9-10R...(Other models you can see in the webshop)		

55.33_series



GEV No.	375764	Ref. No.	12124621
description	safety thermostat switch-off temp. 282°C 3-pole 20A probe ø 4mm probe L 157mm capillary pipe 1770mm capillary pipe isolated 1490mm gland nut probe SS		

56._series



GEV No.	375447	Ref. No.	12024884 Z953035
description	safety thermostat switch-off temp. 150°C 1-pole 1CO 16A probe ø 6mm probe L 77mm capillary pipe 1460mm capillary pipe isolated 1100mm gland nut M9x1 starting temperature 139°C probe		
For models:	AE-061, AE-061W, AE-101, AE-101W, AE-102, AE-102W, AE-201, AE-202, AG-061, AG-061W, AG-101, AG-101W, AG-102, AG-102W, AG-201, AG-202, APE-061, APE-061W, APE-101, APE-101W, APE-102, APE-102W, APE-201, APE-202, APG-061, APG-061W, APG-101, APG-101W, APG-102, APG-102W, APG-201, APG-202, GA-20, GA-20D, GA-40, GA-40D, HEM-10-21, HEM-20-21, HEP-10-21, HEP-20-21, HGP-10-21, HGP-20-21, HGV-10-11, HGV-20-11, HVG-10-11, HVG-20-11, HVG-10-11UL, HVG-20-11UL, HVG-20-11...(Other models you can see in the webshop)		



GEV No.	390854	Ref. No.	12048400
description	safety thermostat switch-off temp. 245°C 1-pole 1NC 16A probe ø 3.1mm probe L 155mm capillary pipe 1130mm capillary pipe isolatedmm gland nut M9x1 probe		





GEV No.	375774	Ref. No.	12028972 12029862 RT4000605 RT4001482
description	safety thermostat switch-off temp. 365°C 1-pole 16A probe ø 4mm probe L 96mm capillary pipe 1160mm capillary pipe isolated 1100mm gland nut probe SS with special screwing screw connection M10x1		

			
GEV No.	375159	Ref. No.	12029569 RT30140326
description	safety thermostat switch-off temp. 365°C 1-pole 16A probe ø 4mm probe L 96mm capillary pipe 1160mm capillary pipe isolated 1100mm gland nut probe with special screwing screw connection M14x1		

TECASA

control thermostats

			
GEV No.	376058	Ref. No.	12024549 X153110
description	thermostat t.max. 310°C temperature range 50-310°C 1-pole 16A probe ø 3mm probe L 160mm capillary pipe 850mm capillary pipe isolated 700mm shaft ø 6x4.6mm		
For models:	BME6-05, CE6-41, CE7-41, CE7-41Q, CE9-41, CE9-41AD, CE9-41PLUS, CGE6-41, CGE7-227, CGE7-41, CGE7-41H, CGE9-11, CGE9-41, CGE9-41AD, CGE9-41PLUS, CMF6-05, FTE6-05L, FTE6-05R, FTE6-10L, FTE6-10L+R, FTE6-10R, FTE7-05, FTE7-05L, FTE7-05R, FTE7-10, FTE7-10L, FTE7-10L+R, FTE7-10R, FTE9-05L, FTE9-05L-AD, FTE9-05PLUS-CL, FTE9-05PLUS-CR, FTE9-05PLUS-L, FTE9-05PLUS-R, FTE9-05R, FTE9-05R-AD, FTE9-10L, FTE9-10L+R, FTE9-10L+R-AD, FTE9-10L-AD, FTE9-10PLUS-CL, FTE9-10PLUS-CLR, FTE9-10PLUS-CR, FTE9-10PLUS-L, FTE9-10PLUS-LR, FTE9-10PLUS-R, FTE9-10R, FTE9-10R-AD, FTEC6-05L, FTEC6-10L...(Other models you can see in the webshop)		

			
GEV No.	375448	Ref. No.	12034068 6021350005
description	thermostat t.max. 85°C temperature range 30-90°C 1-pole 1NO 16A probe ø 6mm probe L 90mm capillary pipe 2000mm capillary pipe isolated 1950mm gland nut shaft ø 6x4.6mm shaft L 23mm shaft position upper rotation 270° probe material SS		
For models:	AC-120, AC-180, CCF-10, CCF-10Cl, CCF-20, CCF-20Cl, CCF-40, CCF-40Cl		

safety thermostats

			
GEV No.	390452	Ref. No.	12023830 R34312400 Z213014
description	safety thermostat switch-off temp. 125°C 1-pole 16A probe ø 6mm probe L 73mm capillary pipe 870mm capillary pipe isolated 690mm gland nut M9x1 probe SS		
For models:	AD-120, AD-120B, AD-120BBTDD-UK, AD-120C, AD-120CW, AD-120HY, AD-125, AD-125HRS, AD-125-SOFT, AD-21W, AD-45BBT, AD-48, AD-48B, AD-48BDD, AD-48C, AD-48D, AD-48DD, AD-48HY, AD-48W, AD-505, AD-505-SOFT, AD-64, AD-64B, AD-64BBT, AD-64BDD, AD-64BTDD, AD-64C, AD-64CW, AD-64D, AD-64DD, AD-64HY, AD-72, AD-72W, AD-90, AD-90BA, AD-90BBT, AD-90BDD, AD-90DD, BME6-05, BME7-05, BME7-10, BME9-05, BME9-05AD, BME9-05PLUS, BME9-05V-T, BME9-10, BME9-10AD, BME9-10PLUS, BME9-10V-T, CO-110...(Other models you can see in the webshop)		

			
GEV No.	376078	Ref. No.	12038157 12135898 DO1DG11154
description	thermostat switch-off temp. 180°C 2-pole 16A probe ø 6mm probe L 59mm capillary pipe 2000mm capillary pipe isolatedmm shaft ømm 240V		
For models:	SF-13, SF-8, SR-10MP-PSM, SR-13MP-PSM, SR-32MP-PSM		

			
GEV No.	376074	Ref. No.	12044749
description	thermostat switch-off temp. 290°C 1-pole 1NO 20A probe ø 6mm probe L 52mm capillary pipe 1500mm capillary pipe isolated 1300mm gland nut starting temperature 245°C probe SS		
For models:	FE-18, FE-25, FE-4, FE-6, FE6-05TE, FE6-10TE, FE-8, MG7-10BM, MG9-10BM, MG9-10BMS, MG9-10PLUS-BM, MG9-10PLUS-BMS, MG9-15BM, MG9-15BM316, MG9-15BMS, MG9-15PLUS-BM, MG9-15PLUS-BMS, MPG9-10BM, MPG9-10BMS, MPG9-15BM, MPG9-15BMS		

various			
safety thermostats			
			
1			
GEV No.	390798	Ref. No.	12032244 GR51000028
description	safety thermostat switch-off temp. 235°C 1-pole 1CO probe ø 6mm probe L 63mm capillary pipe 1600mm capillary pipe isolated 80mm		
For models:	PE-18-100, PE-18-120		

refrigeration thermostats			
DANFOSS			
control thermostats			
			
1			
GEV No.	390677	Ref. No.	6021350023
description	thermostat type 077B0028 capillary pipe 1200mm temperature range -4,5 up to +10,5°C probe ømm probe Lmm		
For models:	BFP-100A, BFP-100I, BFP-150A, BFP-150I, BFP-200A, BFP-200I, BFP-250A, BFP-250I, BFP-300I		

RANCO			
K22 series			
			
1			
GEV No.	390524	Ref. No.	12033335 12033350 BR00023004 BR00023591
description	thermostat RANCO type K22L1082 probe ømm probe Lmm capillary pipe 2000mm temperature range -22 up to -3°C		

K50 series			
			
1			
GEV No.	390427 ¹	Ref. No.	12035536 6021350009
description	thermostat RANCO type K50L3389 capillary pipe 1200mm		
For models:	BFP-150, BFP-200, BFP-250, BFP-300		

¹incl. knob

accessories			
probe clips			
miscellaneous			
			
1			
GEV No.	550770	Ref. No.	12011614 R662630
description	probe clip for combi-steamer		
For models:	HCG-10-11, HCG-10-21, HCG-20-11, HCG-20-21, HCG-2-10-11, HCG-2-20-11, HCG-6-11, HME-10-11, HME-10-21, HME-20-11, HME-20-21, HME-2-10-11, HME-2-20-11, HME-6-11, HMG-10-11, HMG-10-11UL, HMG-10-21, HMG-10-21UL, HMG-20-11, HMG-2-10-11, HMG-6-11, HMI-10-11, HMI-10-11UL, HMI-10-21, HMI-10-21UL, HMI-2-10-11, HMI-6-11, HMI-6-11UL, HMM-10-11, HMM-10-11UL, HMM-10-21, HMM-10-21UL, HMM-20-11, HMM-20-11UL, HMM-20-21, HMM-20-21UL, HMM-2-10-11, HMM-40-11-USMC, HMM-6-11, HMM-6-11UL, HMP-10-11, HMP-10-21, HMP-20-11, HMP-20-21, HMP-2-10-11, HMP-6-11, HVG-10-11, HVG-10-11UL, HVG-10-21, HVG-10-21UL...(Other models you can see in the webshop)		

gland nut accessories			
ducts			
			
1			
GEV No.	691731	Ref. No.	12020538 X166113
description	duct ET M14x1 IT M9x1		
For models:	FE-710, FE-720, FE-920, FG-710, FG-720, FG-920		



plunger sockets

 <p>1</p>			
GEV No.	505207	Ref. No.	12022418 Z263002
description	thermowell thread M12x1.75 IT ET M12x1.75 ID ø 8mm L 95mm SS/brass single ø 10mm		
For models:	ECO-120, ECO-1200, ECO-120B, ECO-160, ECO-160D, ECO-160I, ECO-200, ECO-200D, ECO-200H, ECO-200HD, ECO-200HI, ECO-200I, ECO-2700D, ECO-2700I, ECO-280D, ECO-280I, ECO-370D, ECO-370I, ECO-4000D, ECO-4000I, ECO-460D, ECO-460I, ECO-550D, ECO-550I, ECO-6000D, ECO-6000I, FI-100, FI-100AR, FI-100B, FI-100BBT-UK, FI-120, FI-1200, FI-120AR+DD, FI-120B, FI-120C, FI-120HY-CLINIC, FI-120W, FI-160, FI-160AR, FI-160D, FI-160I, FI-200, FI-200AR, FI-200D, FI-200H, FI-200HD, FI-200HI, FI-200I, FI-200W, FI-200WL...(Other models you can see in the webshop)		

connecting bows



 <p>1</p>			
GEV No.	691005	Ref. No.	12001816 X313001
description	support bracket for thermostat and switch		
For models:	BME7-05, BME7-10, BME9-05, BME9-05V-T, BME9-10, BME9-10V-T, FE7-05-1C, FE7-05-2C, FE-710, FE7-10-2C, FE7-10-4C, FE-720, FE9-05, FE9-05-1C, FE9-05-2C, FE9-05S, FE9-05S-1C, FE9-05S-2C, FE9-05USMC, FE9-10, FE9-10-2C, FE9-10-4C, FG7-05-1C, FG7-05-2C, FG-710, FG7-10-2C, FG7-104C, FG7-10-4C, FG-720, FG9-05, FG9-05-1C, FG9-05-2C, FG9-05S, FG9-05S-1C, FG9-05S-2C, FG9-10, FG9-10-2C, FG9-10-4C, FGCL9-05, FI-120, FI-180, FI-250, FTE7-05, FTE7-05L, FTE7-05R, FTE7-10, FTE7-10L, FTE7-10L+R, FTE7-10R, FTE9-05L...(Other models you can see in the webshop)		

miscellaneous

 <p>1</p>			
GEV No.	510214	Ref. No.	12016656 X163015
description	union screw thread M9x1 hole ø 3.7mm L 12mm		
For models:	FE9-05, FE9-05S, FE9-05USMC, FE9-10, FG9-05, FG9-05S, FG9-10		

switches and momentary switches

rocker/momentary rocker switches

<p>19x13mm</p>  <p>1</p>			
GEV No.	301066	Ref. No.	12016888 R743008
description	rocker switch mounting measurements 19x13mm black 2NO 250V 6A 0-I connection male faston 4.8mm ambient temperature max. 85°C protection IP40		
For models:	HGV-10-11, HGV-20-11, HME-20-11, HMG-10-11, HMG-10-11UL, HMG-10-21, HMG-10-21UL, HMG-20-11, HMG-2-10-11, HMG-6-11, HMM-10-11, HMM-10-11UL, HMM-10-21, HMM-10-21UL, HMM-20-11, HMM-20-11UL, HMM-20-21, HMM-20-21UL, HMM-2-10-11, HMM-40-11-USMC, HMM-6-11, HMM-6-11UL, HMP-20-11, HVG-10-11, HVG-10-11UL, HVG-10-21, HVG-10-21UL, HVG-20-11, HVG-20-21, HVG-2-10-11, HVG-2-20-21, MFHMM-20-11, MFHVG-10-11, MFHVG-10-21		
accessories for	301066		
		GEV No.	301064
		Ref. No.	—
	protective cover for pressure switch external size 23.4x17.4mm internal size 19x13mm H 7.5mm clear mounting measurementsmm		



<p>28x13.5mm</p>  <p>1</p>			
GEV No.	347873	Ref. No.	12024372 Z20307
description	momentary rocker switch mounting measurements 27.4x12.4mm black 1NO 250V 16A connection male faston 6.3mm ambient temperature max. 85°C protection IP40		
For models:	FI-48D, FI-64D, LVC-15, LVC-15D, LVC-21, LVC-21D		



<p>30x11mm</p>  <p>1</p>			
GEV No.	345489	Ref. No.	12023616 Z403033
description	momentary rocker switch mounting measurements 30x11mm orange 1NO 250V 16A connection male faston 6.3mm ambient temperature max. 90°C protection IP40		
For models:	FI-48, FI-48AR, FI-48B, FI-48B-BT-UK, FI-48C, FI-48D, FI-48HY-CLINIC, FI-48W, FI-64, FI-64AR, FI-64B, FI-64B-BT-UK, FI-64C, FI-64D, FI-64HY-CLINIC, FI-64W, LVC-12, LVC-15, LVC-15D, LVC-21, LVC-21B, LVC-21C, LVC-21D, LVC-21W, LVR-14, LVR-14D, LVR-20, LVR-20D		

			
1			
GEV No.	301011	Ref. No.	12037353 6021130002
description	rocker switch mounting measurements 30x11mm orange 1NO/indicator light 250V 16A 0-I connection male faston 6.3mm ambient temperature max. 85/125°C protection IP40		
For models:	AEP-1402, AEP-1602, AEP-2103, AEP-701, AEP-801, AEP-802, AF-1402-MIX, AF-1403-C, AF-1403-P, AF-1404-C, AF-1404-P, AF-1602-MIX, AF-1603-C, AF-1603-P, AF-1604-C, AF-1604-P, AF-2104-C, AF-2104-P, AF-2105-C, AF-2105-P, AF-2106-C, AF-2106-P, AF-702-C, AF-702-P, AF-802-C, AF-802-P, AFN-1402, AFN-1403, AFN-1404, AFN-1602, AFN-1603, AFN-1604, AFN-701, AFN-702, AFN-801, AFN-802, AFP-1402, AFP-1403, AFP-1404, AFP-1404-USMC, AFP-1602, AFP-1602-2, AFP-1603, AFP-1603-2, AFP-1604, AFP-2103, AFP-2104, AFP-2105, AFP-2106, AFP-701...(Other models you can see in the webshop)		

			
1			
GEV No.	346787	Ref. No.	12037702 6003010074
description	dummy element external size 30x11mm black		
For models:	AF-1402-MIX, AF-1403-C, AF-1403-P, AF-1404-C, AF-1404-P, AF-1602-MIX, AF-1603-C, AF-1603-P, AF-1604-C, AF-1604-P, AF-2104-C, AF-2104-P, AF-2105-C, AF-2105-P, AF-2106-C, AF-2106-P, AF-702-C, AF-702-P, AF-802-C, AF-802-P, AFN-1402, AFN-1403, AFN-1404, AFN-1602, AFN-1603, AFN-1604, AFN-702, AFN-801, AFN-802, MFP-135-B, MFP-180-B, MFP-225-B, MFP-270-B		



30x22mm

			
1			
GEV No.	301002	Ref. No.	12024356 12035989 12036781 12037293 6001507003 6021130001 Z203003 Z203033 ZAINTE0009
description	rocker switch mounting measurements 30x22mm orange 2NO 250V 16A illuminated 0-I connection male faston 6.3mm ambient temperature max. 85/125°C protection IP65		
For models:	AC-120, AC-180, AEP-1402, AEP-1403, AEP-1404, AEP-1602, AEP-1603, AEP-1604, AEP-2103, AEP-701, AEP-702, AEP-801, AEP-802, AF-1402-MIX, AF-1403-C, AF-1403-P, AF-1404-C, AF-1404-P, AF-1602-MIX, AF-1603-C, AF-1603-P, AF-1604-C, AF-1604-P, AF-2104-C, AF-2104-P, AF-2105-C, AF-2105-P, AF-2106-C, AF-2106-P, AF-702-C, AF-702-P, AF-802-C, AF-802-P, AFN-1402, AFN-1403, AFN-1404, AFN-1602, AFN-1603, AFN-1604, AFN-701, AFN-702, AFN-801, AFN-802, AFP-1402, AFP-1402-FORZ, AFP-1402-MIX, AFP-1403, AFP-1403-C, AFP-1403-FORZ, AFP-1403-P...(Other models you can see in the webshop)		
accessories for	301002		
	GEV No.	301036	Ref. No. —
	protective cover internal size 30x22mm for rocker switch mounting measurementsmm		

			
1			
GEV No.	345491	Ref. No.	12039115 Z213001 Z213033
description	momentary rocker switch mounting measurements 30x22mm orange 1NO/indicator light 250V 16A connection male faston 6.3mm ambient temperature max. 100/55°C protection IP40		
For models:	EASY-500, EASY-500B, EASY-500DD, EASY-500HP, EASY-500HPWBDD, FI-48, FI-48AR, FI-48B, FI-48B-BT-UK, FI-48C, FI-48D, FI-48HY-CLINIC, FI-48W, FI-64, FI-64AR, FI-64B, FI-64B-BT-UK, FI-64C, FI-64D, FI-64HY-CLINIC, FI-64W, FI-72, GA-20, GA-20D, GA-40, GA-40D, HCG-10-11, HCG-10-21, HCG-20-11, HCG-20-21, HCG-2-10-11, HCG-2-20-11, HCG-6-11, HCG-10-11, HCG-20-11, HCG-6-11, HGV-10-11, HGV-20-11, HVG-10-11, HVG-10-11UL, HVG-10-21, HVG-10-21UL, HVG-20-11, HVG-20-21, HVG-2-10-11, HVG-2-20-21, LAC-10MP, LAC-10MPP, LAC-14MP, LAC-14MPP...(Other models you can see in the webshop)		
accessories for	345491		
	GEV No.	301036	Ref. No. —
	protective cover internal size 30x22mm for rocker switch mounting measurementsmm		

			
1			
GEV No.	346689	Ref. No.	12024213 Z203080
description	momentary rocker switch mounting measurements 30x22mm orange 1NO/indicator light 230V 16A illuminated connection male faston 6.3mm ambient temperature max. 125°C protection IP40		
For models:	FI-48, FI-48AR, FI-48B, FI-48B-BT-UK, FI-48C, FI-48D, FI-48HY-CLINIC, FI-48W, FI-64, FI-64AR, FI-64B, FI-64B-BT-UK, FI-64C, FI-64D, FI-64HY-CLINIC, FI-64W, FI-72, FI-72AR, FI-72W, GA-20, GA-40, LVC-15, LVC-15D, LVC-21, LVC-21B, LVC-21C, LVC-21D, LVC-21W		

			
1			
GEV No.	301061	Ref. No.	12025209 Z203071
description	rocker switch mounting measurements 30x22mm orange 2NO 250V 16A illuminated connection male faston 6.3mm ambient temperature max. 125/55°C protection IP40		
For models:	FI-30, FI-30AR, FI-30AR+DD, FI-30-UK, FI-60DD, LVC-12, LVC-15, LVC-21		

			
1			
GEV No.	346377	Ref. No.	12037317 12049461
description	rocker switch mounting measurements 30x22mm black 2CO 230V 16A 0-I connection male faston 6.3mm ambient temperature max. 125/55°C protection IP40		
accessories for	346377		
	GEV No.	301036	Ref. No. —
	protective cover internal size 30x22mm for rocker switch mounting measurementsmm		



			
1			
GEV No.	345423	Ref. No.	12020632 X343002
description	momentary rocker switch mounting measurements 30x22mm black 2CO 230V 16A with neutral position arrow up/down connection male faston 6.3mm ambient temperature max. 125/55°C protection IP40		
For models:	SBE9-10IM, SBE9-10IMS, SBE9-10M, SBE9-10MS, SBE9-15IM, SBE9-15IMS, SBG9-10IM, SBG9-10IMS, SBG9-10M, SBG9-10MS, SBG9-15IM, SBG9-15IMS		

			
1			
GEV No.	345689 ¹	Ref. No.	12020974 R723027
description	momentary rocker switch mounting measurements 30x22mm orange 1NO 250V 16A illuminated, lamp 12 V connection male faston 6.3mm ambient temperature max. 85/125°C protection IP40		
For models:	HCG-10-11, HCG-10-21, HCG-20-11, HCG-2-10-11, HCG-6-11, HMG-10-11, HMG-10-11UL, HMG-10-21, HMG-10-21UL, HMG-20-11, HMG-2-10-11, HMG-6-11		

¹illuminated

			
1			
GEV No.	347092	Ref. No.	12035896 OSC0000107
description	rocker switch mounting measurements 30x22mm red/black 1CO/indicator light 250V 16A connection male faston 6.3mm ambient temperature max. 85°C protection IP65 with cover cap		

push/momentary push switches

<p>19x13mm</p> 			
1			
GEV No.	345690	Ref. No.	12016811 R663032
description	momentary push switch mounting measurements 19x13mm black 1NO 250V 16A connection male faston 4.8mm ambient temperature max. 105°C protection IP40		
For models:	FF-35, HCG-10-11, HCG-10-21, HCG-20-11, HCG-20-21, HCG-2-10-11, HCG-2-20-11, HCG-6-11, HEI-10-11, HEI-20-11, HEI-6-11, HEM-10-11, HEM-20-11, HEM-6-11, HEP-10-11, HEP-20-11, HEP-6-11, HGC-10-11, HGC-20-11, HGC-6-11, HME-10-11, HME-10-21, HME-20-11, HME-20-21, HME-2-10-11, HME-2-20-11, HME-6-11, HMG-10-11, HMG-10-11UL, HMG-10-21, HMG-10-21UL, HMG-20-11, HMG-2-10-11, HMG-6-11, HMI-10-11, HMI-10-11UL, HMI-10-21, HMI-10-21UL, HMI-2-10-11, HMI-6-11, HMI-6-11UL, HMP-10-11, HMP-10-21, HMP-20-11, HMP-20-21, HMP-2-10-11, HMP-6-11		

<p>30x22mm</p> 			
1			
GEV No.	301047 ¹	Ref. No.	12024373 Z853001
description	push switch mounting measurements 30x22mm green 2NO 250V 16A illuminated connection male faston 6.3mm ambient temperature max. 85°C protection IP40 latching		
For models:	FE-18, FE-25, FE-4, FE-6, FE-71-15, FE-8, FE-91-20, FI-300R, FI-650R, HCV-10-11, HCV-10-21, HCV-2-10-21		



¹illuminated

<p>ø22mm</p> 			
1			
GEV No.	348233	Ref. No.	12023927 T723009000
description	momentary push switch mounting ø 22mm black 1NO/1NC 250V 3A connection F2,8x0,5		
For models:	ACE-061, ACE-101, AE-061, AE-101, APE-061, APE-101, APE-102, APE-201, APE-202, APG-061, APG-101, APG-102, APG-201, APG-202, CG9-31PLUS-D, CG9-31PLUS-I		

			
1			
GEV No.	348220	Ref. No.	12115383
description	momentary push switch mounting ø 22mm silver 1NO/1NC/indicator light 220V 5A connection male faston 2.8mm round		
For models:	CO-350, CO-350-B, CO-350-B-DD, CO-350-COLD, CO-350-COLD-B, CO-350-COLD-B-DD, CO-350-COLD-DD, CO-350-DD, CO-400, CO-400-B, CO-400-B-DD, CO-400-COLD, CO-400-COLD-B, CO-400-COLD-B-DD, CO-400-COLD-DD, CO-400-DD, CO-400-SOFT, CO-500, CO-500B, CO-500BDD, CO-500DD, CO-501, CO-501B, CO-501BDD, CO-501DD, CO-501-SOFT		

			
1			
GEV No.	346662	Ref. No.	12000066 X022108
description	protective cover internal size 30x55mm		
For models:	SBE9-10I, SBE9-10IM, SBE9-10IMS, SBE9-10IS, SBE9-10M, SBE9-10MS, SBE9-15IM, SBE9-15IMS, SBE9-15M, SBE9-15MS, SBG9-10IM, SBG9-10IMS, SBG9-10M, SBG9-10MS, SBG9-15IM, SBG9-15IMS		





ø25mm			
			
1			
GEV No.	345039	Ref. No.	12036803 FX40100036
description	protective cover round ED ø 33mm external size 23mm internal size 21mm H 12mm clear mounting ø 25mm		
accessories for	345039		
		GEV No.	345001 Ref. No. —
	momentary push switch mounting ø 25mm yellow 1NO/indicator light 250V 16A cover connection male faston 6.3mm ambient temperature max. 85°C protection IP65		

accessories

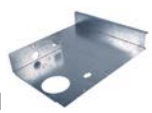
fitting parts

			
1			
GEV No.	691716	Ref. No.	12013476 T093000
description	mounting plate electric suitable for convection oven		
For models:	HCG-20-11, HMG-20-11		

			
1			
GEV No.	691717	Ref. No.	12012593 T083003
description	mounting plate electric suitable for convection oven		
For models:	HCG-10-11, HCG-10-21, HCG-20-11, HCG-20-21, HCG-2-10-11, HCG-2-20-11, HCG-6-11, HGC-10-11, HGC-20-11, HGC-6-11		

			
1			
GEV No.	401784	Ref. No.	12003412 X342608
description	mounting plate for switch		
For models:	SBE9-10, SBE9-10I, SBE9-10IM, SBE9-10IMS, SBE9-10IS, SBE9-10M, SBE9-10MS, SBE9-10S, SBE9-15IM, SBE9-15IMS, SBE9-15M, SBE9-15MS, SBG9-10IM, SBG9-10IMS, SBG9-10M, SBG9-10MS, SBG9-15IM, SBG9-15IMS		

			
1			
GEV No.	401785	Ref. No.	12012103 S322613
description	mounting plate for switch		
For models:	MG7-10BM		

			
1			
GEV No.	691005	Ref. No.	12001816 X313001
description	support bracket for thermostat and switch		
For models:	BME7-05, BME7-10, BME9-05, BME9-05V-T, BME9-10, BME9-10V-T, FE7-05-1C, FE7-05-2C, FE-710, FE7-10-2C, FE7-10-4C, FE-720, FE9-05, FE9-05-1C, FE9-05-2C, FE9-05S, FE9-05S-1C, FE9-05S-2C, FE9-05USMC, FE9-10, FE9-10-2C, FE9-10-4C, FG7-05-1C, FG7-05-2C, FG-710, FG7-10-2C, FG7-104C, FG7-10-4C, FG-720, FG9-05, FG9-05-1C, FG9-05-2C, FG9-05S, FG9-05S-1C, FG9-05S-2C, FG9-10, FG9-10-2C, FG9-10-4C, FGCL9-05, FI-120, FI-180, FI-250, FTE7-05, FTE7-05L, FTE7-05R, FTE7-10, FTE7-10L, FTE7-10L+R, FTE7-10R, FTE9-05L...(Other models you can see in the webshop)		

microswitches

lever actuated

			
1			
GEV No.	345254	Ref. No.	12033747 GMP831613
description	microswitch with lever 250V 16A 1CO connection male faston 6.3mm ambient temperature max. 120°C mounting distance 22mm actuating force: 60g lever length 58mm		

roller-lever actuated

microswitches

			
1			
GEV No.	345216	Ref. No.	12035139 RT30160101
description	microswitch 250V 16A 1CO connection male faston 6.3mm ambient temperature max. 125°C mounting distance 22mm with handle with a switch blue/black		

			
1			
GEV No.	347949	Ref. No.	12035191 RT30160102
description	microswitch with handle with a switch 250V 0.1A 1NC connection male faston 6.3mm L 21mm L1 12mm mounting distance 24mm white		





			
1			
GEV No.	345250	Ref. No.	12025193 R010534
description	microswitch with handle with a switch 250V 16A 1CO connection male faston 6.3mm L 27mm L1 36mm ambient temperature max. 125°C mounting distance 22mm type RL6-1-FGE-P12-5-L actuating force: 90g		
For models:	ACE-061, ACE-101, ACE-102, ACE-201, ACE-202, ACG-061, ACG-101, ACG-102, ACG-201, ACG-202, AE-061, AE-061W, AE-101, AE-101W, AE-102, AE-102W, AE-201, AE-202, AG-061, AG-061W, AG-101, AG-101W, AG-102, AG-102W, AG-201, AG-202, APE-061, APE-061W, APE-101, APE-101W, APE-102, APE-102W, APE-201, APE-202, APG-061, APG-061W, APG-101, APG-101W, APG-102, APG-102W, APG-201, APG-202, COE-061, COE-101, COE-102, COE-201, COE-202, FE-710, FE-720, FE-905...(Other models you can see in the webshop)		

pin-plunger actuated			
			
1			
GEV No.	345105	Ref. No.	12037903 BR00023055
description	microswitch with plunger 250V 16A 1CO connection male faston 6.3mm L 28mm ambient temperature max. 125°C mounting distance 22mm type SM-51 actuating force: 280g black		

M10			
			
1			
GEV No.	345032	Ref. No.	12040850 GMP831318
description	microswitch with plunger thread M10x1 thread L 12mm 250V 16A 1CO connection male faston 6.3mm stroke 7mm mounting distance 22mm L 28mm ambient temperature max. 125°C type SP9603 actuating force: 180g		
For models:	FE-18, FE-25, FE-4, FE-6, FE-8, SBE7-10, SBE9-10, SBE9-10I, SBE9-10IM, SBE9-10IMS, SBE9-10IS, SBE9-10M, SBE9-10MS, SBE9-10PLUS-I, SBE9-10PLUS-IM, SBE9-10PLUS-SI, SBE9-10PLUS-SIM, SBE9-10S, SBE9-15IM, SBE9-15IMS, SBE9-15M, SBE9-15MS, SBE9-15PLUS-IM, SBE9-15PLUS-SIM, SBG7-10, SBG9-10, SBG9-10I, SBG9-10IM, SBG9-10IMS, SBG9-10IS, SBG9-10M, SBG9-10MS, SBG9-10PLUS-I, SBG9-10PLUS-IM, SBG9-10PLUS-SI, SBG9-10PLUS-SIM, SBG9-10S, SBG9-15IM, SBG9-15IMS, SBG9-15PLUS-IM, SBG9-15PLUS-SIM		

with push button			
switches with snap-fit			
			
1			
GEV No.	346724	Ref. No.	12037396 6021130008
description	microswitch with push button 250V 0.25A 1NO connection male faston 4.8mm L 25x12.5mm ambient temperature max. 85°C actuating force: 900g		
For models:	AEP-1402, AEP-1602, AEP-2103, AEP-701, AEP-801, AEP-802, AF-1402-MIX, AF-1403-C, AF-1403-P, AF-1404-C, AF-1404-P, AF-1602-MIX, AF-1603-C, AF-1603-P, AF-1604-C, AF-1604-P, AF-2104-C, AF-2104-P, AF-2105-C, AF-2105-P, AF-2106-C, AF-2106-P, AF-702-C, AF-702-P, AF-802-C, AF-802-P, AFN-1402, AFN-1403, AFN-1404, AFN-1602, AFN-1603, AFN-1604, AFN-702, AFN-801, AFN-802, AFP-1402, AFP-1403, AFP-1404, AFP-1404-USMC, AFP-1602, AFP-1602-2, AFP-1603, AFP-1603-2, AFP-1604, AFP-2103, AFP-2104, AFP-2105, AFP-2106, AFP-701, AFP-702...(Other models you can see in the webshop)		

			
1			
GEV No.	348207	Ref. No.	12036888 12037050 6021130032 6021130041
description	switch 250V 5A 1CO connection F4.8 L 27.5mm type 5E4 25T85 actuating force: 150g		
For models:	ADAEP-1602, ADAEP-1602, ADAFN-1602, ADAFN-801, ADAFP-1602, ADAFP-801, AEF-801AD, AEF-802AD, AEP-1402, AEP-1602, AEP-1602AD, AEP-1603AD, AEP-1604AD, AEP-2103, AEP-701, AEP-801, AEP-802, AF-1402-MIX, AF-1403-C, AF-1403-P, AF-1404-C, AF-1404-P, AF-1602-MIX, AF-1603-C, AF-1603-P, AF-1604-C, AF-1604-P, AF-2104-C, AF-2104-P, AF-2105-C, AF-2105-P, AF-2106-C, AF-2106-P, AF-702-C, AF-702-P, AF-802-C, AF-802-P, AFN-1402, AFN-1403, AFN-1404, AFN-1602, AFN-1603, AFN-1604, AFN-701, AFN-702, AFN-801, AFN-802, AFP-1402, AFP-1403, AFP-1404...(Other models you can see in the webshop)		

accessories			
			
1			
GEV No.	505166	Ref. No.	Z653010
description	actuator for microswitch		

			
1			
GEV No.	691863	Ref. No.	12020591 X153007
description	bar L 200mm ø 8mm		
For models:	SBE7-10, SBE9-10, SBE9-10I, SBE9-10IM, SBE9-10IMS, SBE9-10IS, SBE9-10M, SBE9-10MS, SBE9-10S, SBE9-15IM, SBE9-15IMS, SBE9-15M, SBE9-15MS, SBE9-15PLUS-IM, SBE9-15PLUS-SIM, SBE9-15S, SBE9-15MS, SBE9-15PLUS-IM, SBE9-15PLUS-SIM		

			
GEV No.	691077	Ref. No.	12009985 R010535
description	insulation L 45mm for microswitch W 30mm thickness 1mm		
For models:	ACE-061, ACE-101, ACE-102, ACE-201, ACE-202, ACG-061, ACG-101, ACG-102, ACG-201, ACG-202, AE-061, AE-061W, AE-101, AE-101W, AE-102, AE-102W, AE-201, AE-202, AG-061, AG-061W, AG-101, AG-101W, AG-102, AG-102W, AG-201, AG-202, APE-061, APE-061W, APE-101, APE-101W, APE-102, APE-102W, APE-201, APE-202, APG-061, APG-061W, APG-101, APG-101W, APG-102, APG-102W, APG-201, APG-202, COE-061, COE-101, COE-102, COE-201, COE-202, FE-710, FE-720, FE9-05...(Other models you can see in the webshop)		

			
GEV No.	691079	Ref. No.	12020976 R010533
description	pressure pin for microswitch		
For models:	FE-710, FE-720, FE9-05, FE9-05S, FE9-05USMC, FE9-10, FE-920, HCG-10-11, HCG-10-21, HCG-20-11, HCG-2-10-11, HCG-6-11, HCV-10-11, HCV-10-21, HCV-2-10-21, HE-10-11, HE-10-21, HE-2-10-11, HE-6-11, HG-10-21, HG-2-10-11, HME-10-11, HME-10-21, HME-20-11, HME-20-21, HME-2-10-11, HME-6-11, HMG-10-11, HMG-10-11UL, HMG-10-21, HMG-10-21UL, HMG-20-11, HMG-2-10-11, HMG-6-11, HMI-10-11, HMI-10-11UL, HMI-10-21, HMI-10-21UL, HMI-2-10-11, HMI-6-11, HMI-6-11UL, HMM-10-11, HMM-10-11UL, HMM-10-21, HMM-10-21UL, HMM-20-11, HMM-20-11UL, HMM-20-21, HMM-2-10-11, HMM-6-11...(Other models you can see in the webshop)		

system switches (ROLD)

			
GEV No.	346499	Ref. No.	12009331 X022107
description	element holder mounting measurements 28.5x52.6mm black two-fold element holder		
For models:	SBE9-10, SBE9-10I, SBE9-10IM, SBE9-10IM-AD, SBE9-10IM-AD-S, SBE9-10IMS, SBE9-10IS, SBE9-10M, SBE9-10MS, SBE9-10PLUS-IM, SBE9-10PLUS-SIM, SBE9-10S, SBE9-15IM, SBE9-15IM-AD, SBE9-15IM-AD-S, SBE9-15IMS, SBE9-15M, SBE9-15MS, SBE9-15PLUS-IM, SBE9-15PLUS-SIM, SBG9-10IM, SBG9-10IM-AD, SBG9-10IM-AD-S, SBG9-10IMS, SBG9-10M, SBG9-10MS, SBG9-10PLUS-IM, SBG9-10PLUS-SIM, SBG9-15IM, SBG9-15IM-AD, SBG9-15IM-AD-S, SBG9-15IMS, SBG9-15PLUS-IM, SBG9-15PLUS-SIM		

			
GEV No.	345650	Ref. No.	12024804 X022109
description	momentary switch unit 2CO 250V 16A connection male faston 6.3mm		
For models:	SBE9-10, SBE9-10I, SBE9-10IM, SBE9-10IM-AD, SBE9-10IM-AD-S, SBE9-10IMS, SBE9-10IS, SBE9-10M, SBE9-10MS, SBE9-10PLUS-IM, SBE9-10PLUS-SIM, SBE9-10S, SBE9-15IM, SBE9-15IM-AD, SBE9-15IM-AD-S, SBE9-15IMS, SBE9-15M, SBE9-15MS, SBE9-15PLUS-IM, SBE9-15PLUS-SIM, SBG9-10IM, SBG9-10IM-AD, SBG9-10IM-AD-S, SBG9-10IMS, SBG9-10M, SBG9-10MS, SBG9-10PLUS-IM, SBG9-10PLUS-SIM, SBG9-15IM, SBG9-15IM-AD, SBG9-15IM-AD-S, SBG9-15IMS, SBG9-15PLUS-IM, SBG9-15PLUS-SIM		

			
GEV No.	346626	Ref. No.	12009956 X022106
description	push button ø 23mm black arrow		
For models:	SBE9-10, SBE9-10I, SBE9-10IM, SBE9-10IM-AD, SBE9-10IM-AD-S, SBE9-10IMS, SBE9-10IS, SBE9-10M, SBE9-10MS, SBE9-10PLUS-IM, SBE9-10PLUS-SIM, SBE9-10S, SBE9-15IM, SBE9-15IM-AD, SBE9-15IM-AD-S, SBE9-15IMS, SBE9-15M, SBE9-15MS, SBE9-15PLUS-IM, SBE9-15PLUS-SIM, SBG9-10IM, SBG9-10IM-AD, SBG9-10IM-AD-S, SBG9-10IMS, SBG9-10M, SBG9-10MS, SBG9-10PLUS-IM, SBG9-10PLUS-SIM, SBG9-15IM, SBG9-15IM-AD, SBG9-15IM-AD-S, SBG9-15IMS, SBG9-15PLUS-IM, SBG9-15PLUS-SIM		

cam switches

on/off

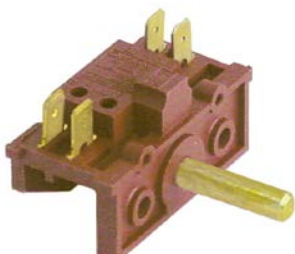
			
GEV No.	345686	Ref. No.	12020265 R753000
description	cam switch 2 operating positions 2NO sequence 0-1 10A shaft ø 6x4.6mm shaft L 23mm connection male faston 6.3mm ON-OFF plastic		
For models:	HEI-10-11, HEI-20-11, HME-20-11, HMI-10-11, HMI-10-11UL, HMI-10-21, HMI-10-21UL, HMI-2-10-11, HMM-10-11, HMM-10-11UL, HMM-10-21, HMM-10-21UL, HMM-20-11, HMM-20-11UL, HMM-20-21, HMM-20-21UL, HMM-2-10-11, HMM-6-11, HMP-20-11, MFHMM-20-11		

7-position

			
GEV No.	300031	Ref. No.	12024405 U673007
description	cam switch 7 operating positions 1NO/2CO sequence 0-1-2-3-4-5-6 16A shaft ø 6x4.6mm shaft L 23mm connection male faston 6.3mm 7-position plastic		
For models:	CE6-20, CE6-40, CE6-41, CE7-20, CE7-20Q, CE7-40, CE7-40Q, CE7-41, CE7-41Q, CE9-20, CE9-20AD, CE9-20PLUS, CE9-40, CE9-40AD, CE9-40PLUS, CE9-41, CE9-41AD, CE9-41PLUS		



2 operating positions



GEV No.	301316	Ref. No.	12024465 T343008
description	cam switch 2 operating positions 2NO sequence 0-1 16A shaft ø 6x4.6mm shaft L 23mm connection male faston 6.3mm 660201		
For models:	BME7-05, BME7-10, BMG7-10, CPE9-05, CPE9-05NC, CPE9-05S, CPE9-05SNC, CPG9-05, CPG9-05NC, CPG9-05S, CPG9-05SNC, HGC-10-21, HGC-20-21, MV7-10BM, MV9-10BM, MV9-15BM, SBE7-10, SBE9-10, SBE9-10I, SBE9-10IM, SBE9-10IMS, SBE9-10IS, SBE9-10M, SBE9-10MS, SBE9-10S, SBE9-15IM, SBE9-15IMS, SBE9-15M, SBE9-15MS, SBG7-10, SBG9-10, SBG9-10I, SBG9-10IM, SBG9-10IMS, SBG9-10IS, SBG9-10M, SBG9-10MS, SBG9-10S, SBG9-15IM, SBG9-15IMS		

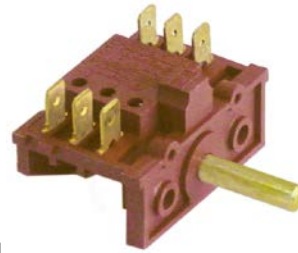

GEV No.	345687	Ref. No.	12019852 T013001
description	cam switch 3 operating positions sequence 1-0-2 16A shaft ø 6x4.6mm shaft L 23mm connection male faston 6.3mm plastic		
For models:	HCG-10-11, HCG-10-21, HCG-20-11, HCG-20-21, HCG-2-10-11, HCG-2-20-11, HCG-6-11, HGC-10-11, HGC-20-11, HGC-6-11		
accessories for	345687		
	GEV No.	691074	Ref. No.
			12024516 R663046
	gasket switch shaft		

3 operating positions



GEV No.	345684	Ref. No.	12019182 R663026
description	cam switch 3 operating positions 10NO sequence 1-2-3 16A shaft ø 6x4.6mm shaft L 34mm connection male faston 6.3mm plastic		
For models:	HEI-10-21, HEI-20-21, HEM-10-11, HEM-10-21, HEM-20-11, HEM-20-21, HEM-6-11, HEP-10-11, HEP-20-11, HEP-6-11, HGC-10-21, HGC-20-21, HGV-10-21, HGV-20-21, HME-10-11, HME-10-21, HME-20-11, HME-20-21, HME-2-10-11, HME-2-20-11, HME-6-11, HMP-10-11, HMP-10-21, HMP-20-11, HMP-20-21, HMP-2-10-11, HMP-6-11		

4 operating positions



GEV No.	347386	Ref. No.	12024733 Z273005
description	cam switch 4 operating positions 6NO sequence 0-1-2-3 16A shaft ø 6x4.6mm shaft L 23mm connection male faston 6.3mm 7LA 840601		
For models:	ECO-160, ECO-160D, ECO-160I, ECO-200, ECO-200D, ECO-200H, ECO-200HD, ECO-200HI, ECO-200I, ECO-2700D, ECO-2700I, ECO-280D, ECO-280I, ECO-370D, ECO-370I, ECO-4000D, ECO-4000I, ECO-460D, ECO-460I, ECO-550D, ECO-550I, ECO-6000D, ECO-6000I, FI-160, FI-160AR, FI-160D, FI-160I, FI-200, FI-200AR, FI-200D, FI-200H, FI-200HD, FI-200HI, FI-200I, FI-200W, FI-200WL, FI-200WR, FI-2700D, FI-2700I, FI-280D, FI-280I, FI-370D, FI-370I, FI-4000D, FI-4000I, FI-460D, FI-460I, FI-550D, FI-550I, FI-6000D... (Other models you can see in the webshop)		

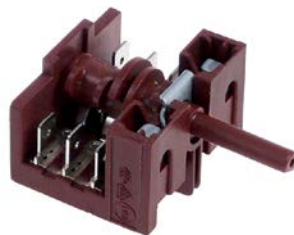

GEV No.	345492	Ref. No.	12025105 Z213003
description	cam switch 3 operating positions 3NO sequence 1-0-2 16A shaft ø 6x4.6mm shaft L 23mm connection male faston 6.3mm		



GEV No.	347638	Ref. No.	12023800 R693004
description	cam switch 4 operating positions 6NO sequence 0-1-2-3 16A shaft ø 6x4.6mm shaft L 23mm connection male faston 6.3mm plastic		
For models:	CPE9-05, CPE9-05AD, CPE9-05AD-S, CPE9-05NC, CPE9-05PLUS, CPE9-05PLUS-S, CPE9-05S, CPE9-05SNC, CPG9-05, CPG9-05AD, CPG9-05AD-S, CPG9-05NC, CPG9-05PLUS, CPG9-05PLUS-S, CPG9-05S, CPG9-05SNC, HEI-10-11, HEI-20-11, HEI-6-11, HMI-10-11, HMI-10-11UL, HMI-10-21, HMI-10-21UL, HMI-2-10-11, HMI-6-11, HMI-6-11UL, ME7-10BM, ME9-10BM, ME9-10BMS, ME9-10PLUS-BM, ME9-10PLUS-BMS, ME9-15BM, ME9-15BM316, ME9-15BM-AD, ME9-15BMS, ME9-15PLUS-BM, ME9-15PLUS-BMS, MG7-10, MG7-10BM, MG9-10, MG9-10AD, MG9-10BM, MG9-10BMAD, MG9-10BMS, MG9-10BMSAD, MG9-10PLUS, MG9-10PLUS-BM, MG9-10PLUS-BMS, MG9-10PLUS-S, MG9-10S... (Other models you can see in the webshop)		

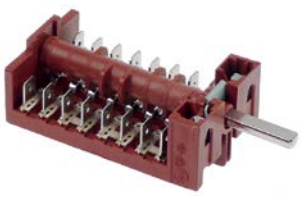

1

GEV No.	345409	Ref. No.	12023918 U673006
description	cam switch 4 operating positions 8NO sequence 0-1-2-3 16A shaft ø 6x4.6mm shaft L 23mm connection male faston 6.3mm plastic		
For models:	CE6-41, CE7-41, CE7-41Q, CE9-41, CE9-41AD, CE9-41PLUS, CGE6-41, CGE7-229, CGE7-41, CGE7-41H, CGE9-11, CGE9-41, CGE9-41AD, CGE9-41PLUS, HE9-10, HE9-20		



1

GEV No.	347817	Ref. No.	12024445
description	cam switch 4 operating positions 8NO sequence 1-0-2-3 16A shaft ø 6x4.6mm shaft L 23mm connection male faston 6.3mm plastic		
For models:	CO-500, CO-500B, CO-500BDD, CO-500DD, CO-501, CO-501B, CO-501BDD, CO-501DD, CO-501-SOFT, EASY-500, EASY-500B, EASY-500DD, EASY-500HP, EASY-500HPWBDD		

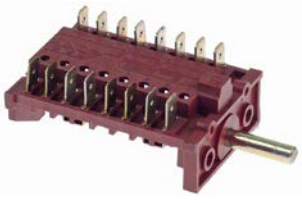

1

GEV No.	345494	Ref. No.	12024972 old version Z433001
description	cam switch 4 operating positions sequence 1-0-2-3 momentary 16A(4)A shaft ø 6x4.6mm shaft L 23mm connection male faston 6.3mm plastic		
For models:	LVC-15D, LVC-21B, LVC-21C, LVC-21D, LVC-21W, LVR-14D, LVR-20, LVR-20B, LVR-20D, MF-21		

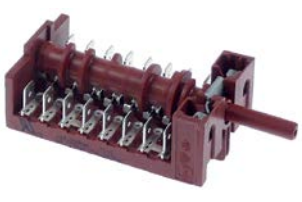

1

GEV No.	348225	Ref. No.	12024972 new version
description	cam switch 4 operating positions sequence 1-0-2-3 momentary 16A(4)A shaft ø 6x4.6mm shaft L 23mm connection male faston 6.3mm plastic		

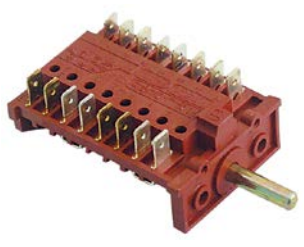

1

GEV No.	345493	Ref. No.	Z223001
description	cam switch 4 operating positions sequence 1-0-2-3 shaft ø 6x4.6mm connection male faston 8-pole		
For models:	FI-30, FI-30AR, FI-30AR+DD, FI-30B, FI-30B-BT-UK, FI-30-UK, FI-48, FI-48AR, FI-48B, FI-48B-BT-UK, FI-48C, FI-48D, FI-48HY-CLINIC, FI-48W, FI-64, FI-64AR, FI-64B, FI-64B-BT-UK, FI-64C, FI-64D, FI-64HY-CLINIC, FI-64W, MF-48, MF-64		

6 operating positions

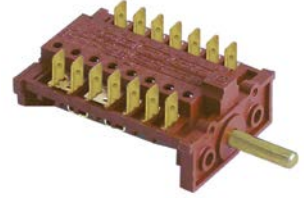

1

GEV No.	345683	Ref. No.	12019003 R663025
description	cam switch 6 operating positions 7NO sequence 0-1-2-3-4-5 16A shaft ø 6x4.6mm shaft L 23mm connection male faston 6.3mm plastic		
For models:	HEM-10-11, HEM-20-11, HEM-6-11, HEP-10-11, HEP-20-11, HEP-6-11, HME-10-11, HME-10-21, HME-20-11, HME-20-21, HME-2-10-11, HME-2-20-11, HME-6-11, HMP-10-11, HMP-10-21, HMP-20-11, HMP-20-21, HMP-2-10-11, HMP-6-11		



1

GEV No.	347578	Ref. No.	12024290 Z683085
description	cam switch 6 operating positions 7NO sequence 0-1-2-3-4-5 16A shaft ø 6x4.6mm shaft L 23mm connection male faston 6.3mm plastic		
For models:	ECO-120, ECO-120B, FI-100, FI-100AR, FI-100B, FI-120, FI-1200, FI-120AR+DD, FI-120B, FI-120W, FI-900, LABP-1000, LABP-1200, MF-120		



1

GEV No.	345688	Ref. No.	12019026 R723011
description	cam switch 6 operating positions sequence 0-1-2-3-4-5 16A shaft ø 6x4.6mm shaft L 23mm connection male faston 6.3mm plastic		
For models:	HMG-10-11, HMG-10-11UL, HMG-10-21, HMG-10-21UL, HMG-20-11, HMG-2-10-11, HMG-6-11		

1

GEV No.	347091	Ref. No.	12018564 T113030
description	cam switch 6 operating positions sequence 0-1-2-3-4-5 16A shaft \varnothing 6x4.6mm shaft L 23mm connection male faston 6.3mm plastic		
For models:	HGV-10-11, HGV-20-11, HVG-10-11, HVG-10-11UL, HVG-10-21, HVG-10-21UL, HVG-20-11, HVG-20-21, HVG-2-10-11, HVG-2-20-21, MFHVG-10-11, MFHVG-10-21		

7 operating positions

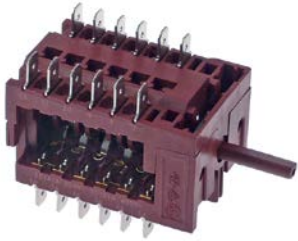

1

GEV No.	301298	Ref. No.	12024932 Z713097
description	cam switch 7 operating positions 12NO sequence 0-1-2-3-4-5-6 16A shaft \varnothing 6x4.6mm shaft L 23mm connection male faston 6.3mm plastic 12-pole		
For models:	CO-110, CO-110B, CO-110BDD, CO-110DD, CO-170, CO-170B, CO-170BDD, CO-170DD, CO-170HRS, CO-170HRSDD, CO-170HRS-SOFT, CO-170-SOFT, ECO-120B, FI-100B, FI-100BBT-UK, FI-120B, FI-120C, FI-120HY-CLINIC		

operation switches

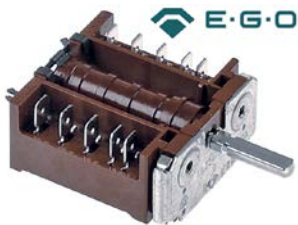

1

GEV No.	301109	Ref. No.	12024459 X163007
description	cam switch 2 operating positions 4NO 16A sequence 0-1 shaft \varnothing 6x4.6mm shaft L 23mm connection male faston 6.3mm plastic 4-pole		
For models:	BME6-05, BME7-05, BME7-10, BME9-05, BME9-05AD, BME9-05PLUS, BME9-05V-T, BME9-10, BME9-10AD, BME9-10PLUS, BME9-10V-T, CMF6-05, CPE6-05, FE6-05, FE6-05TE, FE6-10, FE6-10TE, FE7-05-1C, FE7-05-2C, FE-710, FE7-10-2C, FE7-10-4C, FE-720, FE9-05, FE9-05-1C, FE9-05-2C, FE9-05AD, FE9-05PLUS, FE9-05PLUS-S, FE9-05S, FE9-05S-1C, FE9-05S-2C, FE9-05S-AD, FE9-05USMC, FE9-10, FE9-10-2C, FE9-10-4C, FE9-10AD, FE9-10PLUS, FE-920, FG7-05-1C, FG7-05-2C, FG-710, FG7-10-2C, FG7-104C, FG7-10-4C, FG-720, FG9-05, FG9-05-1C, FG9-05-2C...(Other models you can see in the webshop)		

rotary switches

GOTTAK



1

GEV No.	347874	Ref. No.	12023965 Z743019
description	rotary switch 5 0-1-2-3-4 sets of contacts 10 type 46RCTH 400V 16A shaft \varnothing 6x4.6mm shaft L 23mm shaft 6x4.6 connection male faston 6.3mm		
For models:	FI-80BBT-UK		

magnetic switches

32x15mm



1

GEV No.	346510	Ref. No.	12032901 RT4000335
description	magnetic switch		

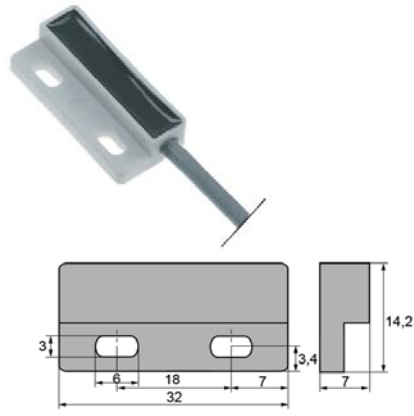

1

GEV No.	345109	Ref. No.	12034091 RT30161415
description	magnetic switch L 32mm W 15mm 1NO 250V 1A P max. 40W connection cable length 2000mm		

65x20mm

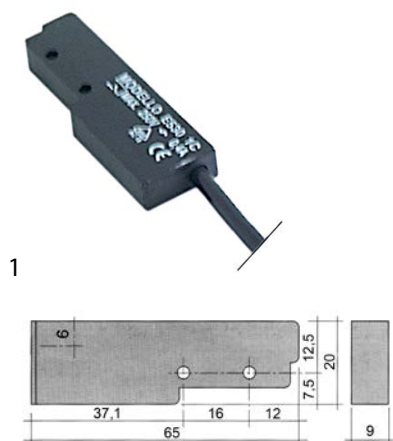

GEV No.	345116	Ref. No.	12024560 Z100522
description	magnetic switch L 65mm W 20mm 1NO 250V 0.4A P max. 100W connection cable cable length 3000mm		
For models:	ACE-061, ACE-101, ACE-102, ACE-201, ACE-202, ACG-061, ACG-101, ACG-102, ACG-201, ACG-202, AE-061, AE-061W, AE-101, AE-101W, AE-102, AE-102W, AE-201, AE-202, AG-061, AG-061W, AG-101, AG-101W, AG-102, AG-102W, AG-201, AG-202, APE-061, APE-061W, APE-101, APE-101W, APE-102, APE-102W, APE-201, APE-202, APG-061, APG-061W, APG-101, APG-101W, APG-102, APG-102W, APG-201, APG-202, COE-061, COE-101, COE-102, COE-201, COE-202, COG-061, COG-101, COG-102...(Other models you can see in the webshop)		
accessories for	345116		
		GEV No.	345399
		Ref. No.	—
	magnet ø 3.3mm L 40mm H 8mm W 13mm hole distance 30mm M3		

84x30mm



GEV No.	347089	Ref. No.	12039784 Z100511
description	magnetic switch L 84mm W 30mm		

ø 6mm



GEV No.	345202	Ref. No.	12024477 Z203009
description	magnetic switch 250V 0.04A P max. 10W probe L 29mm 1NO connection plug cable length 1400mm		
For models:	AD-120, AD-120B, AD-120BBTDD-UK, AD-120C, AD-120CW, AD-120HY, AD-125, AD-125HRS, AD-125-SOFT, AD-15, AD-15D, AD-20C-UK, AD-21, AD-21B, AD-21BDD, AD-21C, AD-21D, AD-21DD, AD-21W, AD-45BBT, AD-48, AD-48B, AD-48BDD, AD-48C, AD-48D, AD-48DD, AD-48HY, AD-48W, AD-505, AD-505-SOFT, AD-64, AD-64B, AD-64BBT, AD-64BDD, AD-64BTDD, AD-64C, AD-64CW, AD-64D, AD-64DD, AD-64HY, AD-72, AD-72W, AD-90, AD-90BA, AD-90BBT, AD-90BDD, AD-90DD, ADE-120, ADE-120B, ATA-061...(Other models you can see in the webshop)		

ø 8mm



GEV No.	346511	Ref. No.	12031820 RT30161417
description	magnetic switch 230V 0.2A P max. 50W probe L 60mm 1NO connection cable cable length 2500mm		

accessories

magnets



GEV No.	346514	Ref. No.	12033601 RT30161409
description	magnet ø 10mm L 40mm Hmm Wmm		



			
1			
GEV No.	347093	Ref. No.	12024499 Z271207
description	magnet ø 31mm Lmm H 15mm Wmm M5		
For models:	ECO-160, ECO-160D, ECO-160I, ECO-200, ECO-200D, ECO-200H, ECO-200HD, ECO-200HI, ECO-200I, ECO-280D, ECO-280I, ECO-370D, ECO-370I, ECO-460D, ECO-460I, ECO-550D, ECO-550I, FI-160, FI-160AR, FI-160D, FI-160I, FI-200, FI-200AR, FI-200D, FI-200H, FI-200HD, FI-200HI, FI-200I, FI-200W, FI-200WL, FI-200WR, FI-280D, FI-280I, FI-370D, FI-370I, FI-460D, FI-460I, FI-550D, FI-550I		

			
1			
GEV No.	505004	Ref. No.	12024303 Z200506
description	magnet ømm L 17mm H 12mm W 14mm		
For models:	ACE-061, ACE-101, ACE-102, ACG-061, ACG-101, ACG-102, AD-120, AD-120B, AD-120BBTDD-UK, AD-120C, AD-120CW, AD-120HY, AD-15, AD-15D, AD-20C-UK, AD-21, AD-21B, AD-21BDD, AD-21C, AD-21D, AD-21DD, AD-21W, AD-45BBT, AD-48, AD-48B, AD-48BDD, AD-48C, AD-48D, AD-48DD, AD-48HY, AD-48W, AD-64, AD-64B, AD-64BBT, AD-64BDD, AD-64BTDD, AD-64C, AD-64CW, AD-64D, AD-64DD, AD-64HY, AD-72, AD-72W, AD-90, AD-90BA, AD-90BBT, AD-90BDD, AD-90DD, ADE-120, ADE-120B...(Other models you can see in the webshop)		

magnetic holders			
			
1			
GEV No.	700816	Ref. No.	12024094 Z200507
description	protection cap for magnet internal size 14x17mm H 17mm for dishwasher		
For models:	AD-120, AD-120B, AD-120BBTDD-UK, AD-120C, AD-120CW, AD-120HY, AD-15, AD-15D, AD-20C-UK, AD-21, AD-21B, AD-21BDD, AD-21C, AD-21D, AD-21DD, AD-21W, AD-45BBT, AD-48, AD-48B, AD-48BDD, AD-48C, AD-48D, AD-48DD, AD-48HY, AD-48W, AD-64, AD-64B, AD-64BBT, AD-64BDD, AD-64BTDD, AD-64C, AD-64CW, AD-64D, AD-64DD, AD-64HY, AD-72, AD-72W, AD-90, AD-90BA, AD-90BBT, AD-90BDD, AD-90DD, ADE-120, ADE-120B, COE-061, COE-101, COE-102, COG-061, COG-101, COG-102...(Other models you can see in the webshop)		

control equipment

TELEMECANIQUE (EFA)

XB2 series

rotary switches

			
1			
GEV No.	345222	Ref. No.	12024490 Z103044
description	rotary selector mounting measurements ø22mm black latching sequence 0-1		
For models:	ECO-1600, ECO-2300, ECO-3000, FI-1600, FI-2300, FI-3000		

lamps

			
1			
GEV No.	359807	Ref. No.	12039863 Z103056
description	light bulb socket Ba9s 24V 2W ø 10mm L 28mm clear		
For models:	ECO-1600, ECO-2300, ECO-3000, FI-1600, FI-2300, FI-3000		

encoders and potentiometers

			
1			
GEV No.	300198	Ref. No.	12030862 RT4000404
description	encoder		

			
1			
GEV No.	300253	Ref. No.	12024753 T513009
description	encoder shaft L 16mm for combi-steamer cable length 125mm shaft 6x4.6mm		
For models:	VE-061, VE-101, VE-102, VE-201, VE-202, VG-101, VG-102, VG-201, VG-202		

			
GEV No.	300254	Ref. No.	12018546 T303022
description	encoder shaft L 16mm for combi-steamer cable length 160mm shaft 6x4.6mm		
For models:	HEI-10-21, HEI-20-21, HEM-10-21, HEM-20-21, HEP-10-21, HEP-20-21, HGC-10-21, HGC-20-21, HGP-10-21, HGP-20-21, HGV-10-21, HGV-20-21		

			
GEV No.	401717	Ref. No.	12020078 T303020
description	potentiometer		
For models:	HEI-10-21, HEI-20-21, HEM-10-21, HEM-20-21, HGV-10-21, HGV-20-21		

			
GEV No.	300197	Ref. No.	12032034 RT4000464
description	potentiometer 4.7KOhm rotation 360° shaft ø 5.9mm with switch shaft L 22mm		

			
GEV No.	403747	Ref. No.	12043405
description	potentiometer rotation 360° shaft ø 6x4.6mm shaft L 13mm		
For models:	ACE-061, ACE-101, AE-061, AE-061W, AE-101, AE-101W, AE-102, AE-102W, AE-201, AE-202, AG-061, AG-061W, AG-101, AG-101W, AG-102, AG-102W, AG-201, AG-202, APE-061, APE-101		

			
GEV No.	400106	Ref. No.	12027410 RT88171303
description	pulsar KOhm rotation 360° shaft ø 6mm type CPC		

lamps

indicator lights

indicator lights 3-piece (housing, lens and bulb)

lamps

light bulbs

			
GEV No.	359807	Ref. No.	12039863 Z103056
description	light bulb socket Ba9s 24V 2W ø 10mm L 28mm clear		
For models:	ECO-1600, ECO-2300, ECO-3000, FI-1600, FI-2300, FI-3000		

indicator lights (complete)

32x14mm

			
GEV No.	348218	Ref. No.	12037303 6021130010
description	indicator light mounting measurements 32x14mm 230V connection male faston 6.3mm temp.-resist. 105°C		
For models:	AEP-1402, AEP-1602, AEP-2103, AEP-701, AEP-801, AEP-802, AF-1402-MIX, AF-1403-C, AF-1403-P, AF-1404-C, AF-1404-P, AF-1602-MIX, AF-1603-C, AF-1603-P, AF-1604-C, AF-1604-P, AF-2104-C, AF-2104-P, AF-2105-C, AF-2105-P, AF-2106-C, AF-2106-P, AF-702-C, AF-702-P, AF-802-C, AF-802-P, AFN-1402, AFN-1403, AFN-1404, AFN-1602, AFN-1603, AFN-1604, AFN-702, AFN-801, AFN-802, AFP-1402, AFP-1403, AFP-1404, AFP-1404-USMC, AFP-1602, AFP-1602-2, AFP-1603, AFP-1603-2, AFP-1604, AFP-2103, AFP-2104, AFP-2105, AFP-2106, AFP-701, AFP-702...(Other models you can see in the webshop)		

ø 9mm

			
GEV No.	359137	Ref. No.	12024344
description	indicator light ø 9mm 230V yellow connection male faston 6.3mm temp.-resist. 120°C with lens		
For models:	ECO-120, ECO-120B, FI-100, FI-100AR, FI-100B, FI-100BBT-UK, FI-120, FI-120AR+DD, FI-120B, FI-120C, FI-120HY-CLINIC, FI-120W, FI-80, FI-80AR, FI-80BBT-UK, FI-80W, GA-20, GA-20D, GA-40, GA-40D		

ø12mm

with screw socket

			
GEV No.	359048	Ref. No.	12035239 ICR13205
description	indicator light ø 12mm 230V yellow connection male faston 6.3mm		





			
1			
GEV No.	359027	Ref. No.	12025211 12036324 DO1DL14313 R693055
description	indicator light ø 12mm 250V green connection male faston 6.3mm		
For models:	BME6-05, BME7-05, BME7-10, BME9-05, BME9-05AD, BME9-05PLUS, BME9-05V-T, BME9-10, BME9-10AD, BME9-10PLUS, BME9-10V-T, CE6-41, CE7-41, CE7-41Q, CE9-41, CGE6-41, CGE7-41, CGE7-41H, CGE9-11, CGE9-41, CGE9-41AD, CGE9-41PLUS, CMF6-05, CPE6-05, CPE7-05, CPE7-05NC, CPE9-05, CPE9-05AD, CPE9-05AD-S, CPE9-05NC, CPE9-05PLUS, CPE9-05PLUS-S, CPE9-05S, CPE9-05SNC, EASY-500, EASY-500B, EASY-500DD, EASY-500HP, EASY-500HPWBDD, EPC-350, FE-18, FE-25, FE-4, FE-6, FE6-05, FE6-05TE, FE6-10, FE6-10TE, FE7-05-1C, FE7-05-2C...(Other models you can see in the webshop)		

with plug-in socket			
			
1			
GEV No.	359898	Ref. No.	12021166 Z203004
description	indicator light ø 12mm 230V green connection male faston 6.3mm		
For models:	BME7-05, BME7-10, BME9-05, BME9-10, CE7-41, CE9-41, CGE7-203, CGE7-41, CGE9-41, FE-18, FE-25, FE-4, FE-6, FE-710, FE-8, FE9-05, FE9-05S, FE9-10, FE-920, FG-710, FG-720, FG9-05, FG9-05S, FG9-10, FG-920, FG-940, FI-30, FI-48, FI-48B, FI-48W, FI-64, FI-64B, FI-64W, FTE7-05, FTE7-10, FTE9-05L, FTE9-05R, FTE9-10L, FTE9-10L+R, FTE9-10R, FTEC9-05, FTEC9-05L, FTEC9-05R, FTEC9-10, FTEC9-10L, FTEC9-10L+R, FTEC9-10R, GA-20, GA-40, HCG-10-11...(Other models you can see in the webshop)		

			
1			
GEV No.	505099	Ref. No.	12016901 12024254 12036445 K008B41002 R214902 R693056 X353021 Z203005
description	indicator light ø 12mm 230V yellow		
For models:	BME6-05, BME7-05, BME7-10, BME9-05, BME9-05AD, BME9-05PLUS, BME9-05V-T, BME9-10, BME9-10AD, BME9-10PLUS, BME9-10V-T, CE6-20, CE6-40, CE6-41, CE7-20, CE7-20Q, CE7-40, CE7-40Q, CE7-41, CE7-41Q, CE9-20, CE9-20AD, CE9-20PLUS, CE9-40, CE9-40AD, CE9-40PLUS, CE9-41, CE9-41AD, CE9-41PLUS, CGE6-41, CGE7-41, CGE7-41H, CGE9-11, CGE9-41, CGE9-41AD, CGE9-41PLUS, CMF6-05, CPE6-05, CPE7-05, CPE7-05NC, CPE9-05, CPE9-05AD, CPE9-05AD-S, CPE9-05NC, CPE9-05PLUS, CPE9-05PLUS-S, CPE9-05S, CPE9-05SNC, CV6-20, CV6-40...(Other models you can see in the webshop)		

			
1			
GEV No.	359493	Ref. No.	12023599 X143017
description	indicator light ø 12mm 250V green connection male faston 6.3mm temp.-resist. 120°C		
For models:	CE9-41AD, CE9-41PLUS, ME7-10BM, SBE7-10, SBE9-10, SBE9-10I, SBE9-10I-AD, SBE9-10I-AD-S, SBE9-10IM, SBE9-10IM-AD, SBE9-10IM-AD-S, SBE9-10IMS, SBE9-10IS, SBE9-10M, SBE9-10MS, SBE9-10PLUS-I, SBE9-10PLUS-IM, SBE9-10S, SBE9-10USMC, SBE9-15IM, SBE9-15IM-AD, SBE9-15IM-AD-S, SBE9-15IMS, SBE9-15M, SBE9-15MS, SBE9-15PLUS-IM, SBG7-10, SBG9-10, SBG9-10I, SBG9-10I-AD, SBG9-10I-AD-S, SBG9-10IM, SBG9-10IM-AD, SBG9-10IM-AD-S, SBG9-10IMS, SBG9-10IS, SBG9-10M, SBG9-10MS, SBG9-10PLUS-I, SBG9-10PLUS-IM, SBG9-10PLUS-SI, SBG9-10PLUS-SIM, SBG9-10S, SBG9-15IM, SBG9-15IM-AD, SBG9-15IM-AD-S, SBG9-15IMS, SBG9-15PLUS-IM, SBG9-15PLUS-SIM		

ø13mm			
with plug-in socket			
			
1			
GEV No.	359142	Ref. No.	Z203004
description	indicator light ø 13mm green 230V connection male faston 6.3mm temp.-resist. 120°C Qty 1 pcs		

ø14mm			
with plug-in socket			
			
1			
GEV No.	359148	Ref. No.	12021153 12039891 R343123 U183044
description	indicator light ø 14mm green 230V connection male faston 6.3mm temp.-resist. 120°C voltage AC		
For models:	CE-410, FE-18, FE-25, FE-4, FE-6, FE-8, FE-91-20, HCV-10-11, HCV-10-21, HCV-2-10-21, HE-10-11, HE-10-21, HE-2-10-11, HE-6-11, HG-10-21, HG-2-10-11		

			
1			
GEV No.	359149	Ref. No.	12039886 R343125
description	indicator light ø 14mm yellow 230V connection male faston 6.3mm temp.-resist. 105°C		
For models:	CE-410, FE-18, FE-25, FE-4, FE-6, FE-8, FE-91-20, HCV-10-11, HCV-10-21, HCV-2-10-21, HE-10-11, HE-10-21, HE-2-10-11, HE-6-11, HG-10-21, HG-2-10-11		



ø18mm



1

GEV No.	358197	Ref. No.	12024669 Z313080000
description	indicator light ø 18mm yellow 250V connection F6.3 temp.-resist. 120°C plastic/metal complete		
For models:	BME6-05, BME7-05, BME7-10, BME9-05, BME9-05PLUS, BME9-05V-T, BME9-10, BME9-10PLUS, BME9-10V-T, CE6-20, CE6-40, CE6-41, CE7-20, CE7-20Q, CE7-40, CE7-40Q, CE7-41, CE7-41Q, CE9-20, CE9-20PLUS, CE9-40, CE9-40PLUS, CE9-41, CE9-41PLUS, CGE6-41, CGE7-41, CGE7-41H, CGE9-11, CGE9-41, CGE9-41PLUS, CMF6-05, CPE6-05, CPE7-05, CPE7-05NC, CPE9-05, CPE9-05NC, CPE9-05PLUS, CPE9-05PLUS-S, CPE9-05S, CPE9-05SNC, CV6-20, CV6-40, CV9-20PLUS, CV9-40PLUS, FE-18, FE-25, FE-4, FE-6, FE6-05TE, FE6-10TE...(Other models you can see in the webshop)		

screw-on/push-on fit

light bulbs

for indicator lights



1

GEV No.	359807	Ref. No.	12039863 Z103056
description	light bulb socket Ba9s 24V 2W ø 10mm L 28mm clear		
For models:	ECO-1600, ECO-2300, ECO-3000, FI-1600, FI-2300, FI-3000		

halogen lamp

for socket G4 / G6.35 / G9



1

GEV No.	359596	Ref. No.	12025123 12036215 R663013 RT30240201
description	halogen lamp socket G4 12V 10W temp.-resist. 500°C		
For models:	ACE-061, ACE-101, ACE-102, ACE-201, ACE-202, ACG-061, ACG-101, ACG-102, ACG-201, ACG-202, AE-061, AE-061W, AE-101, AE-101W, AE-102, AE-102W, AE-201, AE-202, AG-061, AG-061W, AG-101, AG-101W, AG-102, AG-102W, AG-201, AG-202, APE-061, APE-061W, APE-101, APE-101W, APE-102, APE-102W, APE-201, APE-202, APG-061, APG-061W, APG-101, APG-101W, APG-102, APG-102W, APG-201, APG-202, HCG-10-11, HCG-10-21, HCG-20-11, HCG-20-21, HCG-2-10-11, HCG-2-20-11, HCG-6-11, HEI-10-21...(Other models you can see in the webshop)		

linear lamps

sockets for linear lamps

R7s

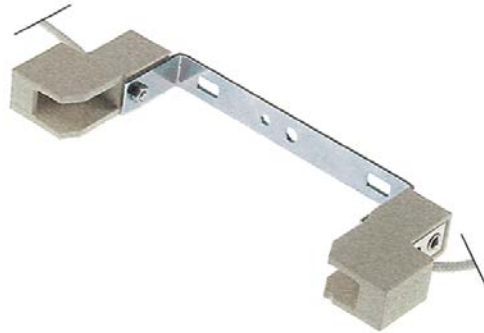

1

GEV No.	359663	Ref. No.	12035430 6021290015
description	lamp socket socket R7s 250V ømm for length of lamp 117.6mm H 47mm connection cable 150mm mounting distance 65mm holder length 140.5mm Qty 1 pcs		

fluorescent lamps

fluorescent lamps

G13



1

GEV No.	359383	Ref. No.	12036923 12037057 6001509001 6021290001
description	fluorescent lamp socket G13 L 438mm 15W 230V Qty 1 pcs light colour 640		
For models:	AEP-1402, AEP-1403, AEP-1404, AEP-1602, AEP-1603, AEP-1604, AEP-2103, AEP-701, AEP-702, AEP-801, AEP-802, AF-1402-MIX, AF-1403-C, AF-1403-P, AF-1404-C, AF-1404-P, AF-1602-MIX, AF-1603-C, AF-1603-P, AF-1604-C, AF-1604-P, AF-2104-C, AF-2104-P, AF-2105-C, AF-2105-P, AF-2106-C, AF-2106-P, AF-702-C, AF-702-P, AF-802-C, AF-802-P, AFP-1402, AFP-1402-FORZ, AFP-1402-MIX, AFP-1403, AFP-1403-C, AFP-1403-FORZ, AFP-1403-P, AFP-1404, AFP-1404-C, AFP-1404-FORZ, AFP-1404-P, AFP-1404-USMC, AFP-1602, AFP-1602-2, AFP-1603, AFP-1603-2, AFP-1604, AFP-2103, AFP-2104...(Other models you can see in the webshop)		



1

GEV No.	359371	Ref. No.	12036885 12036938 6001509002 6021290002
description	fluorescent lamp socket G13 L 590mm 18W 230V Qty 1 pcs		
For models:	VM-100-I, VM-100-M, VM-135-I, VM-135-M		



complete with holder

			
1			
GEV No.	360610	Ref. No.	12033320 12058986 6021290052
description	fluorescent lamp L 343mm W 23mm 8W 220-240V plug type Euro-8 (C7) type T5/T4 for FAGOR		
For models:	AEP-1402, AEP-1602, AEP-2103, AEP-701, AEP-801, AEP-802, AF-1402-MIX, AF-1403-C, AF-1403-P, AF-1404-C, AF-1404-P, AF-1602-MIX, AF-1603-C, AF-1603-P, AF-1604-C, AF-1604-P, AF-2104-C, AF-2104-P, AF-2105-C, AF-2105-P, AF-2106-C, AF-2106-P, AF-702-C, AF-702-P, AF-802-C, AF-802-P, AFP-1402, AFP-1403, AFP-1404, AFP-1602, AFP-1602-2, AFP-1603, AFP-1603-2, AFP-1604, AFP-2103, AFP-2104, AFP-2105, AFP-2106, AFP-701, AFP-702, AFP-801, AFP-802, AFP-802-2, AFP-802-2C, AFP-802-3C, ERM-150		

covers

			
1			
GEV No.	550772	Ref. No.	12033470 12036835 6000202505 6007170105
description	cover for fluorescent lamps L 540mm		
For models:	AEP-1402, AEP-1403, AEP-1404, AEP-1602, AEP-1603, AEP-1604, AEP-2103, AEP-701, AEP-702, AEP-801, AEP-802, AF-1402-MIX, AF-1403-C, AF-1403-P, AF-1404-C, AF-1404-P, AF-1602-MIX, AF-1603-C, AF-1603-P, AF-1604-C, AF-1604-P, AF-2104-C, AF-2104-P, AF-2105-C, AF-2105-P, AF-2106-C, AF-2106-P, AF-702-C, AF-702-P, AF-802-C, AF-802-P, AFP-1402, AFP-1402-FORZ, AFP-1402-MIX, AFP-1403, AFP-1403-C, AFP-1403-FORZ, AFP-1403-P, AFP-1404, AFP-1404-C, AFP-1404-FORZ, AFP-1404-P, AFP-1404-USMC, AFP-1602, AFP-1602-2, AFP-1603, AFP-1603-2, AFP-1604, AFP-2103, AFP-2104...(Other models you can see in the webshop)		

accessories

ballasts

			
1			
GEV No.	401504	Ref. No.	12035299 6001507022
description	electrical ballast 18W 230V Qty 1 pcs		
For models:	AEP-701, AEP-702, AEP-801, AEP-802, AFP-1402-MIX, AFP-2103, AFP-2104, AFP-2104-C, AFP-2104-P, AFP-2105, AFP-2105-C, AFP-2105-P, AFP-2106, AFP-2106-C, AFP-2106-P, AFP-701, AFP-702, AFP-702-C, AFP-702-P, AFP-801, AFP-802, AFP-802-2, VC-14-I, VC-14-M, VM-100-I, VM-100-M, VTP-139-C, VTP-139-P		

			
1			
GEV No.	401505	Ref. No.	12035296 12036849 6001507023 6021290014
description	electrical ballast 36W 230V Qty 1 pcs		
For models:	AEP-1402, AEP-1403, AEP-1404, AEP-1602, AEP-1603, AEP-1604, AEP-2103, AEP-701, AEP-801, AEP-802, AF-1602-MIX, AF-1603-C, AF-1603-P, AF-1604-C, AF-1604-P, AF-2104-C, AF-2104-P, AF-2105-C, AF-2105-P, AF-2106-C, AF-2106-P, AF-702-C, AF-702-P, AF-802-C, AF-802-P, AFP-1402, AFP-1403, AFP-1403-C, AFP-1403-P, AFP-1404, AFP-1404-C, AFP-1404-P, AFP-1602, AFP-1602-2, AFP-1603, AFP-1603-2, AFP-1604, AFP-2103, AFP-2104, AFP-2105, AFP-2106, AFP-701, AFP-702, AFP-801, AFP-802, AFP-802-2, AP-701, APP-701, VC-14-I, VC-14-M...(Other models you can see in the webshop)		

oven lamps





producer-specific oven lamps

FAGOR

			
1			
GEV No.	359433	Ref. No.	12017827 R660535
description	gasket		
For models:	HCG-10-11, HCG-10-21, HCG-20-11, HCG-2-10-11, HCG-6-11, HME-10-11, HME-10-21, HME-20-11, HME-2-10-11, HME-6-11, HMG-10-11, HMG-10-11UL, HMG-10-21, HMG-10-21UL, HMG-20-11, HMG-2-10-11, HMG-6-11, HMI-10-11, HMI-10-11UL, HMI-10-21, HMI-10-21UL, HMI-2-10-11, HMI-6-11, HMI-6-11UL, HMM-10-11, HMM-10-11UL, HMM-10-21, HMM-10-21UL, HMM-20-11, HMM-20-11UL, HMM-20-21, HMM-2-10-11, HMM-6-11, HMM-6-11UL, HMP-10-11, HMP-10-21, HMP-20-11, HMP-20-21, HMP-2-10-11, HMP-6-11		

			
1			
GEV No.	359432	Ref. No.	12019933 R663058
description	lamp socket 25V socket G4 cable length 350mm connection male faston 4.8mm ømm H 18mm with 2 hole fixing mounting distance 16mm holder length 23mm Qty 1 pcs		
For models:	HCG-10-11, HCG-10-21, HCG-20-11, HCG-20-21, HCG-2-10-11, HCG-2-20-11, HCG-6-11, HEI-20-11, HEM-20-11, HEP-20-11, HME-10-11, HME-10-21, HME-20-11, HME-20-21, HME-2-10-11, HME-2-20-11, HME-6-11, HMG-10-11, HMG-10-11UL, HMG-10-21, HMG-10-21UL, HMG-20-11, HMG-2-10-11, HMG-6-11, HMI-10-11, HMI-10-11UL, HMI-10-21, HMI-10-21UL, HMI-2-10-11, HMI-6-11, HMI-6-11UL, HMM-10-11, HMM-10-11UL, HMM-10-21, HMM-10-21UL, HMM-20-11, HMM-20-11UL, HMM-20-21, HMM-20-21UL, HMM-2-10-11, HMM-2-20-11, HMM-40-11-USMC, HMM-6-11, HMM-6-11UL, HMP-10-11, HMP-10-21, HMP-20-11, HMP-20-21, HMP-2-10-11, HMP-2-20-11...(Other models you can see in the webshop)		





			
1			
GEV No.	359424	Ref. No.	12012381 R670608
description	frame L 75mm W 75mm mounting distance 61mm		
For models:	HCG-10-11, HCG-10-21, HCG-20-11, HCG-20-21, HCG-2-10-11, HCG-2-20-11, HCG-6-11, HEI-20-11, HEM-20-11, HEP-20-11, HME-10-11, HME-10-21, HME-20-11, HME-20-21, HME-2-10-11, HME-2-20-11, HME-6-11, HMI-10-11, HMI-10-11UL, HMI-10-21, HMI-10-21UL, HMI-2-10-11, HMI-6-11, HMI-6-11UL, HMM-10-11, HMM-10-11UL, HMM-10-21, HMM-10-21UL, HMM-20-11, HMM-20-11UL, HMM-20-21, HMM-20-21UL, HMM-2-10-11, HMM-2-20-11, HMM-40-11-USMC, HMM-6-11, HMM-6-11UL, HMP-10-11, HMP-10-21, HMP-20-11, HMP-20-21, HMP-2-10-11, HMP-2-20-11, HMP-6-11, HVG-10-11, HVG-10-11UL, HVG-10-21, HVG-10-21UL, HVG-20-11, HVG-20-21...(Other models you can see in the webshop)		
accessories for	359424		
	GEV No.	359425	Ref. No. 12020892 R670609
gasket L 71mm W 71mm rubber thickness 1.5mm for oven lamp			
	GEV No.	359426	Ref. No. 12016678 R670618
lamp glass L 38mm W 38mm thickness 3mm			
	GEV No.	359432	Ref. No. 12019933 R663058
lamp socket 25V socket G4 cable length 350mm connection male faston 4.8mm ømm H 18mm with 2 hole fixing mounting distance 16mm holder length 23mm Qty 1 pcs			

			
1			
GEV No.	359425	Ref. No.	12020892 R670609
description	gasket L 71mm W 71mm rubber thickness 1.5mm for oven lamp		
For models:	HCG-10-11, HCG-10-21, HCG-20-11, HCG-20-21, HCG-2-10-11, HCG-2-20-11, HCG-6-11, HEI-20-11, HEM-20-11, HEP-20-11, HME-10-11, HME-10-21, HME-20-11, HME-20-21, HME-2-10-11, HME-2-20-11, HME-6-11, HMI-10-11, HMI-10-11UL, HMI-10-21, HMI-10-21UL, HMI-2-10-11, HMI-6-11, HMI-6-11UL, HMM-10-11, HMM-10-11UL, HMM-10-21, HMM-10-21UL, HMM-20-11, HMM-20-11UL, HMM-20-21, HMM-20-21UL, HMM-2-10-11, HMM-2-20-11, HMM-40-11-USMC, HMM-6-11, HMM-6-11UL, HMP-10-11, HMP-10-21, HMP-20-11, HMP-20-21, HMP-2-10-11, HMP-2-20-11, HMP-6-11, HVG-10-11, HVG-10-11UL, HVG-10-21, HVG-10-21UL, HVG-20-11, HVG-20-21...(Other models you can see in the webshop)		

			
1			
GEV No.	359426	Ref. No.	12016678 R670618
description	lamp glass L 38mm W 38mm thickness 3mm		
For models:	HCG-10-11, HCG-10-21, HCG-20-11, HCG-20-21, HCG-2-10-11, HCG-2-20-11, HCG-6-11, HEI-20-11, HEM-20-11, HEP-20-11, HME-10-11, HME-10-21, HME-20-11, HME-20-21, HME-2-10-11, HME-2-20-11, HME-6-11, HMI-10-11, HMI-10-11UL, HMI-10-21, HMI-10-21UL, HMI-2-10-11, HMI-6-11, HMI-6-11UL, HMM-10-11, HMM-10-11UL, HMM-10-21, HMM-10-21UL, HMM-20-11, HMM-20-11UL, HMM-20-21, HMM-20-21UL, HMM-2-10-11, HMM-2-20-11, HMM-40-11-USMC, HMM-6-11, HMM-6-11UL, HMP-10-11, HMP-10-21, HMP-20-11, HMP-20-21, HMP-2-10-11, HMP-2-20-11, HMP-6-11, HVG-10-11, HVG-10-11UL, HVG-10-21, HVG-10-21UL, HVG-20-11, HVG-20-21...(Other models you can see in the webshop)		

			
1			
GEV No.	359432	Ref. No.	12019933 R663058
description	lamp socket 25V socket G4 cable length 350mm connection male faston 4.8mm ømm H 18mm with 2 hole fixing mounting distance 16mm holder length 23mm Qty 1 pcs		
For models:	HCG-10-11, HCG-10-21, HCG-20-11, HCG-20-21, HCG-2-10-11, HCG-2-20-11, HCG-6-11, HEI-20-11, HEM-20-11, HEP-20-11, HME-10-11, HME-10-21, HME-20-11, HME-20-21, HME-2-10-11, HME-2-20-11, HME-6-11, HMI-10-11, HMI-10-11UL, HMI-10-21, HMI-10-21UL, HMI-2-10-11, HMI-6-11, HMI-6-11UL, HMM-10-11, HMM-10-11UL, HMM-10-21, HMM-10-21UL, HMM-20-11, HMM-20-11UL, HMM-20-21, HMM-20-21UL, HMM-2-10-11, HMM-2-20-11, HMM-40-11-USMC, HMM-6-11, HMM-6-11UL, HMP-10-11, HMP-10-21, HMP-20-11, HMP-20-21, HMP-2-10-11, HMP-2-20-11, HMP-6-11, HVG-10-11, HVG-10-11UL, HVG-10-21, HVG-10-21UL, HVG-20-11, HVG-20-21...(Other models you can see in the webshop)		

			
1			
GEV No.	359428	Ref. No.	12012053 R670610
description	reflector		
For models:	HCG-10-11, HCG-10-21, HCG-20-11, HCG-20-21, HCG-2-10-11, HCG-2-20-11, HCG-6-11, HEI-20-11, HEM-20-11, HEP-20-11, HME-10-11, HME-10-21, HME-20-11, HME-20-21, HME-2-10-11, HME-2-20-11, HME-6-11, HMI-10-11, HMI-10-11UL, HMI-10-21, HMI-10-21UL, HMI-2-10-11, HMI-6-11, HMI-6-11UL, HMM-10-11, HMM-10-11UL, HMM-10-21, HMM-10-21UL, HMM-20-11, HMM-20-11UL, HMM-20-21, HMM-20-21UL, HMM-2-10-11, HMM-2-20-11, HMM-40-11-USMC, HMM-6-11, HMM-6-11UL, HMP-10-11, HMP-10-21, HMP-20-11, HMP-20-21, HMP-2-10-11, HMP-2-20-11, HMP-6-11, HVG-10-11, HVG-10-11UL, HVG-10-21, HVG-10-21UL, HVG-20-11, HVG-20-21...(Other models you can see in the webshop)		



			
1			
GEV No.	359423	Ref. No.	12024464 T303047
description	frame L 95mm W 80mm for oven lamp thickness 6mm		
For models:	ACE-061, ACE-101, ACE-102, ACE-201, ACE-202, ACG-061, ACG-101, ACG-102, ACG-201, ACG-202, AE-061, AE-061W, AE-101, AE-101W, AE-102, AE-102W, AE-201, AE-202, AG-061, AG-061W, AG-101, AG-101W, AG-102, AG-102W, AG-201, AG-202, APE-061, APE-061W, APE-101, APE-101W, APE-102, APE-102W, APE-201, APE-202, APG-061, APG-061W, APG-101, APG-101W, APG-102, APG-102W, APG-201, APG-202, COE-061, COE-101, COE-102, COE-201, COE-202, COG-061, COG-101, COG-102...(Other models you can see in the webshop)		





			
1			
GEV No.	359415	Ref. No.	12023532 T303027
description	gasket for oven lamp L 78mm W 62mm thickness 1mm graphite		
For models:	ACE-061, ACE-101, ACE-102, ACE-201, ACE-202, ACG-061, ACG-101, ACG-102, ACG-201, ACG-202, AE-061, AE-061W, AE-101, AE-101W, AE-102, AE-102W, AE-201, AE-202, AG-061, AG-061W, AG-101, AG-101W, AG-102, AG-102W, AG-201, AG-202, APE-061, APE-061W, APE-101, APE-101W, APE-102, APE-102W, APE-201, APE-202, APG-061, APG-061W, APG-101, APG-101W, APG-102, APG-102W, APG-201, APG-202, COE-061, COE-101, COE-102, COE-201, COE-202, COG-061, COG-101, COG-102...(Other models you can see in the webshop)		

			
2			
GEV No.	359405	Ref. No.	12023578 T303026
description	gasket L 95mm W 80mm thickness 2mm graphite hole ø 5mm		
For models:	ACE-061, ACE-101, ACE-102, ACE-201, ACE-202, ACG-061, ACG-101, ACG-102, ACG-201, ACG-202, AE-061, AE-061W, AE-101, AE-101W, AE-102, AE-102W, AE-201, AE-202, AG-061, AG-061W, AG-101, AG-101W, AG-102, AG-102W, AG-201, AG-202, APE-061, APE-061W, APE-101, APE-101W, APE-102, APE-102W, APE-201, APE-202, APG-061, APG-061W, APG-101, APG-101W, APG-102, APG-102W, APG-201, APG-202, COE-061, COE-101, COE-102, COE-201, COE-202, COG-061, COG-101, COG-102...(Other models you can see in the webshop)		

			
1			
GEV No.	359408	Ref. No.	12023668
description	glass panel L 74mm W 59mm thickness 3mm		
For models:	ACE-061, ACE-101, ACE-102, ACE-201, ACE-202, ACG-061, ACG-101, ACG-102, ACG-201, ACG-202, AE-061, AE-061W, AE-101, AE-101W, AE-102, AE-102W, AE-201, AE-202, AG-061, AG-061W, AG-101, AG-101W, AG-102, AG-102W, AG-201, AG-202, APE-061, APE-061W, APE-101, APE-101W, APE-102, APE-102W, APE-201, APE-202, APG-061, APG-061W, APG-101, APG-101W, APG-102, APG-102W, APG-201, APG-202, COE-061, COE-101, COE-102, COE-201, COE-202, COG-061, COG-101, COG-102...(Other models you can see in the webshop)		



			
1			
GEV No.	359295	Ref. No.	12024545 T303023
description	lamp socket for halogen lamp 12V 20W socket G4 mounting measurements 55 x 70mm cable length 135mm		
For models:	ACE-061, ACE-101, ACE-102, ACE-201, ACE-202, ACG-061, ACG-101, ACG-102, ACG-201, ACG-202, AE-061, AE-061W, AE-101, AE-101W, AE-102, AE-102W, AE-201, AE-202, AG-061, AG-061W, AG-101, AG-101W, AG-102, AG-102W, AG-201, AG-202, APE-061, APE-061W, APE-101, APE-101W, APE-102, APE-102W, APE-201, APE-202, APG-061, APG-061W, APG-101, APG-101W, APG-102, APG-102W, APG-201, APG-202, COE-061, COE-101, COE-102, COE-201, COE-202, COG-061, COG-101, COG-102...(Other models you can see in the webshop)		
spare parts for	359295		
		GEV No.	359599
		Ref. No.	—
	halogen lamp socket G4 12V 20W temp.-resist. 500°C		

accessories for	359295		
		GEV No.	359296
		Ref. No.	—
	lamp glass L 74mm W 58mm thickness 3mm		
		GEV No.	551336
		Ref. No.	—
	gasket for lamp L 92mm W 92mm thickness 2.3mm		

lamps

halogen lamps

for socket G4 / G6.35 / G9

			
1			
			
GEV No.	359596	Ref. No.	12025123 12036215 R663013 RT30240201
description	halogen lamp socket G4 12V 10W temp.-resist. 500°C		
For models:	ACE-061, ACE-101, ACE-102, ACE-201, ACE-202, ACG-061, ACG-101, ACG-102, ACG-201, ACG-202, AE-061, AE-061W, AE-101, AE-101W, AE-102, AE-102W, AE-201, AE-202, AG-061, AG-061W, AG-101, AG-101W, AG-102, AG-102W, AG-201, AG-202, APE-061, APE-061W, APE-101, APE-101W, APE-102, APE-102W, APE-201, APE-202, APG-061, APG-061W, APG-101, APG-101W, APG-102, APG-102W, APG-201, APG-202, HCG-10-11, HCG-10-21, HCG-20-11, HCG-20-21, HCG-2-10-11, HCG-2-20-11, HCG-6-11, HEI-10-21...(Other models you can see in the webshop)		

lamp accessories

lenses

glass panels

			
1			
GEV No.	699473	Ref. No.	12037049
description	lamp glass L 135mm W 30mm half-round		

timers

programme timers

			
1			
GEV No.	361353	Ref. No.	Z683099
description	timer		

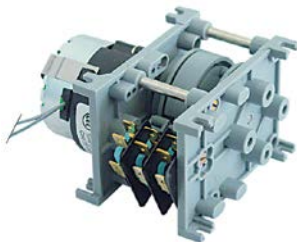



1

GEV No.	361350	Ref. No.	12024867 Z613003
description	timer CDC 4803F1 engines 1 chambers 3 operation time 20min 230V shaft ømm shaft Lmm		
For models:	CO-170-SOFT, CO-400-SOFT, CO-501-SOFT, FI-48, FI-48AR, FI-48B, FI-48B-BT-UK, FI-48C, FI-48D, FI-48HY-CLINIC, FI-48W, FI-64, FI-64AR, FI-64B, FI-64B-BT-UK, FI-64C, FI-64D, FI-64HY-CLINIC, FI-64W, LVC-15D, LVC-21D, LVR-14D, LVR-20D		



1

GEV No.	360525	Ref. No.	12030573 BR00023247
description	timer CDC 11904 engines 1 chambers 4 operation time 10min 230V shaft ømm shaft Lmm manuf. no. 11904F1 / BCR000.0000 motor type M48R ATS		
spare parts for	360525		
	GEV No.	360118	Ref. No. —
	motor CDC pinion ø 4.9mm teeth 10 230V voltage AC 50/60Hz turn direction right motor ø 47mm H 19.3mm motor type M48R ATS for timer cable length 260mm 1.9/2.5W		



1

GEV No.	360566	Ref. No.	12030499 BR00023259
description	timer CDC 11904 engines 1 chambers 4 operation time 15min 115V 60Hz shaft ømm shaft Lmm manuf. no. 11904F1BEI000.0010 motor type M48R ATS voltage AC		



1

GEV No.	361358	Ref. No.	12017510 Z728302
description	timer CDC 4905DV engines 2 chambers 5 operation time 6s / 2min 230V 60Hz shaft ømm shaft Lmm motor type M48R ATS / M48L ATS		
For models:	ECO-120, ECO-120B, FI-100, FI-100AR, FI-100B, FI-120, FI-120B, FI-120W, MF-120		



1

GEV No.	360683	Ref. No.	12024571 Z713055
description	timer CDC 4905DV engines 2 chambers 5 operation time 6s / 2min 230V shaft ømm shaft Lmm		
For models:	FI-100, FI-100AR, FI-100B, FI-120, FI-120AR+DD, FI-120B, FI-120C, LABP-1000, LABP-1200		



1

GEV No.	360696	Ref. No.	12023458
description	timer CDC 4906DV engines 2 chambers 6 operation time 6s / 2min 230V 50Hz shaft ømm shaft Lmm manuf. no. 4906DV0AOE000.1010		



1

GEV No.	360441	Ref. No.	12023466 Z728412
description	timer CDC 4906DV engines 2 chambers 6 operation time 6s / 2min 230V 60Hz shaft ømm shaft Lmm manuf. no. 4906DV0ADY000.0000		
For models:	FI-120W, MF-120		



1

GEV No.	361357	Ref. No.	12024873 Z433002
description	timer CDC 7803 engines 1 chambers 3 operation time 120s 230V shaft ømm shaft Lmm motor type M37LN		
For models:	CO-350, CO-350-B, CO-350-B-DD, CO-350-COLD, CO-350-COLD-B, CO-350-COLD-B-DD, CO-350-COLD-DD, CO-350-DD, CO-400, CO-400-B, CO-400-B-DD, CO-400-COLD, CO-400-COLD-B, CO-400-COLD-B-DD, CO-400-COLD-DD, CO-400-DD, CO-400-SOFT, EASY-500, EASY-500B, EASY-500DD, LVC-21B, LVC-21C, LVR-20, LVR-20B		



1

GEV No.	360586	Ref. No.	12017931 R763006
description	timer CDC 7803 engines 1 chambers 3 operation time 240s 230V shaft ømm shaft Lmm motor type M37LN type 7903F3 voltage AC		
For models:	HEI-10-11, HEI-20-11, HEI-6-11, HEM-10-11, HEM-20-11, HEM-6-11, HEP-10-11, HEP-20-11, HEP-6-11, HGC-10-11, HGC-20-11, HGC-6-11, HGV-10-11, HGV-20-11		



1

GEV No.	360438	Ref. No.	12024202 Z258412
description	timer CDC 7805DV engines 2 chambers 5 operation time 6s / 3min 230V 60Hz shaft ømm shaft Lmm		
For models:	FI-48W, FI-64B, FI-64W, FI-72, FI-72W, FI-80BBT-UK, FI-80W, MF-48, MF-64		



1

GEV No.	361354	Ref. No.	12024178 Z213008
description	timer CDC 7804DV engines 2 chambers 4 operation time 6s / 3min 230V shaft ømm shaft Lmm motor type M37RN/M37LN		
For models:	FI-48, FI-48B, FI-48D, FI-48W		



1

GEV No.	360439	Ref. No.	12024204 Z243001
description	timer CDC 7805DV engines 2 chambers 5 operation time 6s/180s 230V 50Hz shaft ømm shaft Lmm		
For models:	EASY-500HPWBDD, FI-48, FI-48B, FI-48W, FI-64, FI-64B, FI-64B-BT-UK, FI-64HY-CLINIC, FI-64W, MF-48, MF-64		



1

GEV No.	361355	Ref. No.	12024177 Z243004
description	timer CDC 7804DV engines 2 chambers 4 operation time 6s / 3min 230V shaft ømm shaft Lmm motor type M37RN/M37LN		
For models:	EASY-500HP, FI-64, FI-64AR, FI-64B, FI-64C, FI-64D, FI-72, FI-72AR, FI-80, FI-80AR, LABP-800		



1

GEV No.	361352	Ref. No.	12024089 Z403002
description	timer CDC 7903F engines 1 chambers 3 operation time 120s 230V shaft ø 6x4.6mm shaft L 13mm dishwasher		
For models:	LVC-12, LVC-15, LVC-15D, LVC-21, LVC-21D, LVC-21W, LVR-10, LVR-14, LVR-14D, LVR-20, LVR-20D		



1

GEV No.	360440	Ref. No.	12024203 Z213002
description	timer CDC 7805DV engines 2 chambers 5 operation time 6s / 3min 230V 50Hz shaft ømm shaft Lmm		
For models:	FI-48, FI-48AR, FI-48B, FI-48B-BT-UK, FI-48C, FI-48D, FI-48HY-CLINIC, FI-48W, FI-64, FI-64B, FI-64W, MF-48, MF-64		





1

GEV No.	361351	Ref. No.	12017667 12024087 Z203030 Z268302
description	timer CDC 7903F engines 1 chambers 3 operation time 4min 230V shaft ø 6x4.6mm shaft L 13mm		
For models:	FI-30, FI-30AR, FI-30AR+DD, FI-30B, FI-30B-BT-UK, FI-30-UK, FI-60DD, FI-64, FI-64B, FI-64W, FI-72, FI-80, FI-80W		





1

GEV No.	360557	Ref. No.	12095827 IT4864
description	timer FIBER P19 engines 1 chambers 2 operation time 15min 230V shaft ømm shaft Lmm manu. no. P195JE2J730 motor type M51B-J0L6400 cable length 250mm voltage AC		
For models:	FIM-110A, FIM-110W, FIM-150A, FIM-150W, FIM-20A, FIM-20W, FIM-30A, FIM-30W, FIM-40A, FIM-40W, FIM-55A, FIM-55W, FIM-80A, FIM-80W		
spare parts for	360557		
	GEV No.	Ref. No.	—
	motor kit pinion ø 6.8mm teeth 15 230V voltage AC 50/60Hz turn direction counterclockwise motor ø 48mm H 18.5mm motor type UDS40NE1RNZ165 cable length 150mm with holder		



1

GEV No.	360154	Ref. No.	12029594 12030574 BR00023222 BR00023248
description	timer FIBER P20 engines 1 chambers 4 operation time 15min 230V shaft ømm shaft Lmm manu. no. P205J04J714 motor type M51B-J0R6400		
spare parts for	360154		
	GEV No.	Ref. No.	—
	motor kit pinion ø 6.8mm teeth 15 230V voltage AC 50/60Hz turn direction clockwise motor ø 48mm H 18.5mm motor type UDS-40NE1RNZ165 cable length 150mm with holder		



1

GEV No.	360532	Ref. No.	12023458 (old version) Z718937
description	timer FIBER P25 engines 2 chambers 6 operation time 6s / 2min 230V 50Hz shaft ømm shaft Lmm manu. no. P255J06JDU2 motor type M51BJ0L0000/M51BJ0R0000 voltage AC		



1

GEV No.	361356	Ref. No.	12017561 Z703004
description	timer M48L ATS engines 2 chambers 5 operation time 6s / 2min 230V shaft ømm shaft Lmm		
For models:	ECO-120, ECO-1200, ECO-120B		

mechanical timers



1

GEV No.	350066	Ref. No.	12018407 R723000
description	timer C20 2-pole operation time 120min impulse mechanical 1NO/1NC at 250V 16A permanent position yes shaft ø 6x4.6mm shaft 6x4.6mm shaft L 23mm mounting distance 28mm connection lateral		
For models:	HCG-10-11, HCG-10-21, HCG-20-11, HCG-20-21, HCG-2-10-11, HCG-2-20-11, HCG-6-11, HEI-10-11, HEI-20-11, HEI-6-11, HGC-10-11, HGC-20-11, HGC-6-11, HGV-10-11, HGV-20-11, HME-20-11, HMG-10-11, HMG-10-11UL, HMG-10-21, HMG-10-21UL, HMG-20-11, HMG-2-10-11, HMG-6-11, HMI-10-11, HMI-10-11UL, HMI-10-21, HMI-10-21UL, HMI-2-10-11, HMI-6-11, HMI-6-11UL, HMM-10-11, HMM-10-11UL, HMM-10-21, HMM-10-21UL, HMM-20-11, HMM-20-11UL, HMM-20-21, HMM-20-21UL, HMM-2-10-11, HMM-40-11-USMC, HMM-6-11, HMM-6-11UL, HMP-20-11, HVG-10-11, HVG-10-11UL, HVG-10-21, HVG-10-21UL, HVG-20-11, HVG-20-21, HVG-2-10-11...(Other models you can see in the webshop)		



1

GEV No.	360732	Ref. No.	12030066 12049916 DO1DI13315 DO1DL13350
description	timer MT59 2-pole operation time 60min impulse mechanical 2NO at 250V 16A permanent position no shaft ø 6x4.6mm shaft L 21mm mounting distance 28mm connection lateral shaft flat lower		
For models:	SF-10, SF-13, SF-15, SF-22, SF-31, SF-8, SR-10MP-PSM, SR-13MP-PSM, SR-32MP-PSM		



			
1			
GEV No.	360447	Ref. No.	12029415 K017C21101
description	timer T203 1-pole operation time 5min impulse mechanical 1NO at 250V 16(3)A permanent position no shaft ø 6x4.6mm shaft 6x4.6mm shaft L 16mm mounting distance 30mm connection rear ambient temperature max. 55°C		

alarm devices

buzzer boards

			
1			
GEV No.	400879	Ref. No.	12018224 R723033
description	buzzer board connection connector		
For models:	HCG-10-11, HCG-10-21, HCG-20-11, HCG-2-10-11, HCG-6-11, HMG-10-11, HMG-10-11UL, HMG-10-21, HMG-10-21UL, HMG-20-11, HMG-2-10-11, HMG-6-11		

buzzers

			
1			
GEV No.	350053	Ref. No.	12032927 12033283 RT30060107
description	buzzer 12VAC connection male faston 3.2mm screw mounting buzzer		

			
1			
GEV No.	350067	Ref. No.	12018850 R693067
description	buzzer buzzer		
For models:	HCG-10-11, HCG-10-21, HCG-20-11, HCG-20-21, HCG-2-10-11, HCG-2-20-11, HCG-6-11, HEI-10-11, HEI-20-11, HEI-6-11, HGC-10-11, HGC-20-11, HGC-6-11, HGV-10-11, HGV-20-11, HMG-20-11, HMI-10-11, HMI-10-11UL, HMI-10-21, HMI-10-21UL, HMI-2-10-11, HMI-6-11, HMI-6-11UL, HMM-10-11, HMM-10-11UL, HMM-10-21, HMM-10-21UL, HMM-20-11, HMM-20-11UL, HMM-20-21, HMM-20-21UL, HMM-2-10-11, HMM-40-11-USMC, HMM-6-11, HMM-6-11UL, HVG-10-11, HVG-10-21, HVG-20-11, HVG-20-21, HVG-2-10-11, HVG-2-20-21, MFHMM-20-11		

contactors

ABB

power contactors

			
1			
GEV No.	380117	Ref. No.	SAM2600123
description	power contactor resistive load 25A 230VAC (AC3/400V) 9A/4kW main contacts 4NO auxiliary contacts connection screw connection type A9-40-00		

			
1			
GEV No.	381175	Ref. No.	12024040 (old version) Z203050 (old version)
description	power contactor resistive load 22A 230VAC (AC3/400V) 5.5kW main contacts 3NO auxiliary contacts 1NO connection plug-in connection type AS12-30-10S-26 50/60Hz		

GEV No.	381175	Ref. No.	12024040 (old version) Z203050 (old version)
description	power contactor resistive load 22A 230VAC (AC3/400V) 5.5kW main contacts 3NO auxiliary contacts 1NO connection plug-in connection type AS12-30-10S-26 50/60Hz		

BENEDIKT & JÄGER

power contactors

			
1			
GEV No.	381501	Ref. No.	12030536 RT30280557
description	power contactor resistive load 32A 230VAC (AC3/400V) 17A/7.5kW main contacts 3NO auxiliary contacts 1NC connection screw connection		



1





GEV No.	382001	Ref. No.	12030415 RT30280569
description	power contactor resistive load 32A 230VAC (AC3/400V) 17A/7.5kW main contacts 4NO auxiliary contacts connection screw connection		

GENERAL ELECTRIC (AEG)

power contactors



1

GEV No.	380267	Ref. No.	12027712 RT4001558
description	power contactor resistive load 110A 230VAC (AC3/400V) 65A/30kW main contacts 3NO auxiliary contacts connection screw connection type AEG LS30K 00A type GE CL07A 300		
accessories for	380267		
	GEV No.	Ref. No.	12034954 RT30280560
	auxiliary contact contacts 1NO for contactors CL+LS_K connection screw AC-12 10A type AEG HS07K 10 type GE BCLF 10		
	GEV No.	Ref. No.	12035138 RT30280561
	auxiliary contact contacts 1NC AC15 6A for contactors CL+LS_K connection screw AC-12 10A type AEG HS07K 01 type GE BCLF 01		
	GEV No.	Ref. No.	—
	auxiliary contact contacts 1NO/1NC for contactors CL+LS_K connection screw AC-12 10A type AEG HS08K 11 type GE BCLL 11		
	GEV No.	Ref. No.	—
	auxiliary contact contacts 2NO for contactors CL+LS_K connection screw AC-12 10A type AEG HS08K 20 type GE BCLL 20		



1

GEV No.	380237	Ref. No.	12024011 Z213007
description	power contactor resistive load 16A 230VAC (AC3/400V) 6A/3kW main contacts 3NO auxiliary contacts 1NC connection male faston 6.3mm type AEG LS0701F		
For models:	ACE-061, ACE-101, ACE-102, ACE-201, ACE-202, ACG-061, ACG-101, ACG-102, ACG-201, ACG-202, AD-125, AD-125HRS, AD-125-SOFT, AD-15, AD-15D, AD-21, AD-21B, AD-21BDD, AD-21D, AD-21W, AD-505, AD-505-SOFT, AD-64BTDD, AE-061, AE-061W, AE-101, AE-101W, AE-102, AE-102W, AE-201, AE-202, AG-061, AG-061W, AG-101, AG-101W, AG-102, AG-102W, AG-201, AG-202, APE-061, APE-061W, APE-101, APE-101W, APE-102, APE-102W, APE-201, APE-202, APG-061, APG-061W, APG-101...(Other models you can see in the webshop)		



1

GEV No.	380498	Ref. No.	12030013 RT4000451
description	power contactor resistive load 20A 230VAC (AC3/400V) 9A/4kW main contacts 4NO auxiliary contacts connection male faston 6.3mm type MC1A 400A type AEG LS05 01 FA type GE MC1A 400A		



1

GEV No.	380245	Ref. No.	12031082 RT30280550
description	power contactor resistive load 25A 230VAC (AC3/400V) 9A/4kW main contacts 3NO auxiliary contacts 1NC connection screw connection type AEG LS4K 01A type GE CL00A 301 H 85mm		



1

GEV No.	380244	Ref. No.	12018159 12027320 12029911 12031081 R663031 RT30280551 RT4001554 RT4001556
description	power contactor resistive load 25A 230VAC (AC3/400V) 9A/4kW main contacts 3NO auxiliary contacts 1NO connection screw connection type AEG LS4K 10A type GE CL00A 310		
For models:	ECO-1600, ECO-160D, ECO-160I, ECO-200D, ECO-200HD, ECO-200HI, ECO-200I, ECO-2300, ECO-280D, ECO-280I, ECO-3000, ECO-370D, ECO-370I, ECO-460D, ECO-460I, ECO-550D, ECO-550I, FE-18, FE-25, FE-710, FI-120, FI-120B, FI-1600, FI-160D, FI-160I, FI-200D, FI-200HD, FI-200HI, FI-200I, FI-2300, FI-280D, FI-280I, FI-3000, FI-370D, FI-370I, FI-460D, FI-460I, FI-550D, FI-550I, HME-10-11, HME-10-21, HME-20-11, HME-20-21, HME-2-10-11, HME-6-11, HMI-10-11, HMI-10-11UL, HMI-10-21, HMI-10-21UL, HMI-2-10-11...(Other models you can see in the webshop)		



2

GEV No.	380261	Ref. No.	12028282 12029618 12030540 ICR13042 RT30280552 RT4001555
description	power contactor resistive load 32A 230VAC (AC3/400V) 17A/7.5kW main contacts 3NO auxiliary contacts 1NO connection screw connection type AEG LS7K 10A type GE CL02A 310		



1

GEV No.	380265	Ref. No.	12028308 RT30280554
description	power contactor resistive load 60A 230VAC (AC3/400V) 32A/16kW main contacts 3NO auxiliary contacts 1NO connection screw connection type AEG LS15K 00A type GE CL04A 310 H 98mm L 87mm W 55mm		

auxiliary contacts



1

GEV No.	380269	Ref. No.	12035138 RT30280561
description	auxiliary contact contacts 1NC AC15 6A for contactors CL+LS_K connection screw AC-12 10A type AEG HS07K 01 type GE BCLF 01		



1

GEV No.	380268	Ref. No.	12034954 RT30280560
description	auxiliary contact contacts 1NO for contactors CL+LS_K connection screw AC-12 10A type AEG HS07K 10 type GE BCLF 10		

ISKRA (FANAL)

power contactors



1

GEV No.	380212	Ref. No.	12000219 P453023
description	power contactor resistive load 20A 230VAC (AC3/400V) 8.5A/5.5kW main contacts 3NO auxiliary contacts 1NC connection screw connection type Fanal K07M 01 type ISKRA DSL7 01		
For models:	FE-6, FE-8, FI-300B, FI-300R, FI-650R		



SIEMENS

power contactors



1

GEV No.	380614	Ref. No.	12024040 12111795 Z203050
description	power contactor resistive load 22A 230VAC (AC3/400V) 9A/4kW main contacts 3NO auxiliary contacts 1NO connection elastic terminals type 3RT2016-2AP01		
For models:	ACE-061, ACE-101, AD-120, AD-120B, AD-120BBTDD-UK, AD-120C, AD-120CW, AD-120HY, AD-125, AD-125HRS, AD-125-SOFT, AD-90, AD-90BA, AD-90BBT, AD-90BDD, AD-90DD, ADE-120, ADE-120B, AE-061, AE-061W, AE-101, AE-101W, APE-061, APE-061W, APE-101, APE-101W, CO-110, CO-110B, CO-110BDD, CO-110DD, CO-112, CO-112B, CO-112BDD, CO-112DD, CO-142W, CO-142WDD, CO-170, CO-170B, CO-170BDD, CO-170DD, CO-170HRS, CO-170HRSDD, CO-170HRS-SOFT, CO-170-SOFT, CO-172, CO-172B, CO-172BDD, CO-172DD, COE-061, COE-101...(Other models you can see in the webshop)		



2

GEV No.	380389	Ref. No.	12018160 12024039 P433030 Z743009
description	power contactor resistive load 22A 230VAC (AC3/400V) 9A/4kW main contacts 3NO auxiliary contacts 1NO connection screw connection type 3RT10-16-1AP01		
For models:	ECO-160, ECO-200, ECO-200D, ECO-200H, ECO-200HD, ECO-200HI, ECO-200I, ECO-2700D, ECO-2700I, ECO-280D, ECO-280I, ECO-370D, ECO-370I, ECO-4000D, ECO-4000I, ECO-460D, ECO-460I, ECO-550D, ECO-550I, ECO-6000D, ECO-6000I, FI-120W, FI-160, FI-160AR, FI-160D, FI-160I, FI-200, FI-200AR, FI-200D, FI-200H, FI-200HD, FI-200HI, FI-200I, FI-200W, FI-2700D, FI-2700I, FI-280D, FI-280I, FI-370D, FI-370I, FI-4000D, FI-4000I, FI-460D, FI-460I, FI-48, FI-48AR, FI-48B, FI-48B-BT-UK, FI-48C, FI-48D...(Other models you can see in the webshop)		



1

GEV No.	380390	Ref. No.	12024075 12039754 12040142 R143002 R673007 X183011
description	power contactor resistive load 40A 230VAC (AC3/400V) 12A/5.5kW main contacts 3NO auxiliary contacts connection screw connection type 3RT10-24-1AL20 50/60Hz		
For models:	COE-102, COE-201, ECO-160, ECO-1600, ECO-160D, ECO-160I, ECO-200, ECO-200D, ECO-200H, ECO-200HD, ECO-200HI, ECO-200I, ECO-2300, ECO-2700D, ECO-2700I, ECO-280D, ECO-280I, ECO-3000, ECO-370D, ECO-370I, ECO-4000D, ECO-4000I, ECO-460D, ECO-460I, ECO-550D, ECO-550I, ECO-6000D, ECO-6000I, FE9-05, FE9-05-1C, FE9-05-2C, FE9-05AD, FE9-05PLUS, FE9-05PLUS-S, FE9-05S, FE9-05S-1C, FE9-05S-2C, FE9-05S-AD, FE9-05USMC, FE9-10, FE9-10-2C, FE9-10-4C, FE9-10AD, FE9-10PLUS, FE-920, FI-160, FI-1600, FI-160AR, FI-160D, FI-160I...(Other models you can see in the webshop)		



1

GEV No.	381543	Ref. No.	12041014
description	power contactor resistive load 40A 230VAC (AC3/400V) 5.5kW main contacts 3NO auxiliary contacts 1NO/1NC connection plug-in connection type 3RT2024-2AL20		
For models:	ACE-102, ACE-201, AE-102, AE-102W, AE-201, APE-102, APE-102W, APE-201, LA-E-25M, LA-E-25MA, LA-E-25MP, LR-E-25M, LR-E-25MA, LR-E-25MP		



auxiliary contacts



GEV No.	380539	Ref. No.	12023704 Z103070
description	auxiliary contact contacts 1NO AC15 3A for contactors 3RT102 3 RT103 connection screw connection type 3RH1921-1CA10 resistive load 10A AC-12 10A		
For models:	ECO-160, ECO-1600, ECO-160D, ECO-160I, ECO-200, ECO-200D, ECO-200H, ECO-200HD, ECO-200HI, ECO-200I, ECO-2300, ECO-2700D, ECO-2700I, ECO-280D, ECO-280I, ECO-3000, ECO-370D, ECO-370I, ECO-4000D, ECO-4000I, ECO-460D, ECO-460I, ECO-550D, ECO-550I, ECO-6000D, ECO-6000I, FI-160, FI-1600, FI-160AR, FI-160D, FI-160I, FI-200, FI-200AR, FI-200D, FI-200H, FI-200HD, FI-200HI, FI-200I, FI-200W, FI-2300, FI-2700D, FI-2700I, FI-280D, FI-280I, FI-3000, FI-370D, FI-370I, FI-4000D, FI-4000I, FI-460D...(Other models you can see in the webshop)		

small relay switches



GEV No.	380696	Ref. No.	12024012 Z683087
description	small relay switch 230V (AC3/400V) 9A/4kW main contacts 3NO auxiliary contacts 1NC connection male faston 6.3mm resistive load 16A		
For models:	AD-15, AD-15D, AD-20C-UK, AD-21, AD-21B, AD-21BDD, AD-21C, AD-21D, AD-21DD, AD-48, AD-48BDD, AD-48C, AD-48D, AD-48DD, AD-64, AD-64B, AD-64BDD, AD-64C, AD-64D, AD-64DD, AD-72, CO-110, CO-110B, CO-110BDD, CO-110DD, CO-112, CO-112B, CO-112BDD, CO-112DD, CO-170, CO-170B, CO-170BDD, CO-170DD, CO-170HRS, CO-170HRSDD, CO-170HRS-SOFT, CO-170-SOFT, CO-172, CO-172B, CO-172BDD, CO-172DD, COP-173, COP-173B, COP-173BDD, COP-173DD, COP-173HRS, COP-173HRSDD, COP-173-SOFT, COP-174, COP-174B...(Other models you can see in the webshop)		

solid state relays

CELDUC



GEV No.	400105	Ref. No.	12028184 12029297 12029298 RT30280533 RT4000453 RT4000453P
description	solid state relay CELDUC 2 phase 65A 400V 24VDC L 58mm W 45mm plug-in connection screw type 40.00.453		
accessories for	400105		
	GEV No.	401794	Ref. No. —
	connecting cable L 1440mm 4-pole suitable for RATIONAL		

relays

power relays

with DIN rail mounting

upper



GEV No.	380610	Ref. No.	1200002018 12019647 12038273 Z203018
description	power relays connection male faston DIN rail		
For models:	ECO-1600, ECO-2300, ECO-3000, FI-1200, FI-1600, FI-2300, FI-30, FI-3000, FI-48, FI-48B, FI-48W, FI-64, FI-64B, FI-64W, FI-72, FI-900, LVC-12, LVC-15, LVC-15D, LVC-21, LVC-21B, LVC-21D, LVC-21W, LVR-10, LVR-14, LVR-14D, LVR-20, LVR-20B, LVR-20D		



GEV No.	380809	Ref. No.	12023706 12033296 12034668 6021130007 6021130033 Z203062
description	power relays FINDER 230VAC 16A 2NO connection male faston 6.3mm bracket mounting manuf. no. 62.82.8.230.0307		
For models:	AD-120, AD-120B, AD-120BTTDD-UK, AD-120C, AD-120CW, AD-120HY, AD-15, AD-15D, AD-20C-UK, AD-21, AD-21B, AD-21BDD, AD-21C, AD-21D, AD-21DD, AD-21W, AD-90, AD-90BA, AD-90BBT, AD-90BDD, AD-90DD, ADE-120, ADE-120B, ATM-051, ATM-051ECO, ATM-051VCH, ATM-051VCH-60Hz, ATM-081VCH, ATM-081VCH-60Hz, ATM-101, ATM-101VCH, ATM-101VCH-60Hz, CM-201, CM-202, CMP-201, CO-352-COLD, CO-352-COLD-B, CO-352-COLD-B-DD, CO-352-COLD-DD, CO-400-SOFT, CO-402-COLD, CO-402-COLD-B, CO-402-COLD-B-DD, CO-402-COLD-DD, CO-402W, CO-500, CO-500B, CO-500BDD, CO-500DD, CO-501...(Other models you can see in the webshop)		

with bracket mounting



GEV No.	380139	Ref. No.	12031875 EU929115
description	power relays FINDER 230VAC 16A 2CO connection F6.3 bracket mounting dimensions 68x38.2x35.8mm manuf. no. 62.82.8.230.0000		

with male contacts

female contact 2.0mm



GEV No.	380502	Ref. No.	12030936 RT30350485
description	power relays connection 2.0 plug-in connection		

plug-in/print relays



GEV No.	380501	Ref. No.	12032188 RT30350486
description	print relay 12VDC		

relay sockets



GEV No.	380136	Ref. No.	12024185 R743009
description	relay socket 11-pole connection plug-in connection round 11-pole dimensions 65x28x40mm 250V voltage AC 10A Italiana Relè manuf. no. ZVE11		
For models:	GA-20, GA-20D, GA-40, GA-40D, HGV-10-11, HGV-20-11, HMM-10-11, HMM-10-11UL, HMM-10-21, HMM-10-21UL, HMM-20-11, HMM-20-11UL, HMM-20-21, HMM-20-21UL, HMM-2-10-11, HMM-40-11-USMC, HMM-6-11, HMM-6-11UL, HVG-10-11, HVG-10-11UL, HVG-10-21, HVG-10-21UL, HVG-20-11, HVG-20-21, HVG-2-10-11, HVG-2-20-21, ME9-10PLUS-BM, ME9-10PLUS-BMS, ME9-15BM-AD, ME9-15PLUS-BM, ME9-15PLUS-BMS, MFHMM-20-11, MFHVG-10-11, MFHVG-10-21, MG9-10BMAD, MG9-10BMSAD, MG9-10PLUS-BM, MG9-10PLUS-BMS, MG9-15BMAD, MG9-15BMSAD, MG9-15PLUS-BM, MG9-15PLUS-BMS		
accessories for	380136		
	GEV No.	380805	Ref. No. —
	support bracket		

accessories



GEV No.	691697	Ref. No.	12011818 U805615
description	fastening angle for contactor suitable for		
For models:	CE7-41, CGE7-217, CGE7-41		

level relays

miscellaneous



GEV No.	400880	Ref. No.	12017268 12024209 R343072
description	level relay 50/60Hz 230/400V contacts 1CO type VyF		
For models:	GA-20, GA-20D, GA-40, GA-40D, HCV-10-11, HCV-10-21, HCV-2-10-21, HCV-5-11, HCV-6-11, HGV-10-11, HGV-20-11, HMM-10-11, HMM-10-21, HMM-20-11, HMM-20-21, HMM-2-10-11, HMM-2-20-11, HMM-6-11, HVG-10-11, HVG-10-21, HVG-20-11, HVG-20-21, HVG-2-10-11, HVG-2-20-21, ME9-10PLUS-BM, ME9-10PLUS-BMS, ME9-15BM-AD, ME9-15PLUS-BM, ME9-15PLUS-BMS, MG9-10BMAD, MG9-10BMSAD, MG9-10PLUS-BM, MG9-10PLUS-BMS, MG9-15BMAD, MG9-15BMSAD, MG9-15PLUS-BM, MG9-15PLUS-BMS		



time relays

time relays



1

GEV No.	360318	Ref. No.	12017722 12039922 R013030 R723061
description	time relay FIBER E58F47 time range 0-12min 230VAC 5A mounting measurements 45x45mm connection plug-in connection round 8-pole		
For models:	HCG-10-11, HCG-10-21, HCG-20-11, HCG-2-10-11, HCG-6-11, HMG-10-11, HMG-10-21, HMG-20-11, HMG-2-10-11, HMG-6-11		
accessories for	360318		
	GEV No.	380638	Ref. No. —
	relay socket 8-pole dimensions 51x41x23mm 250V 10A FINDER manuf. no. 90.26		



1

GEV No.	360554	Ref. No.	12024079 Z123022 Z123022000
description	time relay TELEMECANIQUE RE17RMMU time range 0.1s-100h 24-240VAC/24VDC 8A mounting measurements DIN railmm 1 CO connection screw connection		
For models:	ECO-160, ECO-1600, ECO-160D, ECO-160I, ECO-200, ECO-200D, ECO-200H, ECO-200HD, ECO-200HI, ECO-200I, ECO-2300, ECO-2700D, ECO-2700I, ECO-280D, ECO-280I, ECO-3000, ECO-370D, ECO-370I, ECO-4000D, ECO-4000I, ECO-460D, ECO-460I, ECO-550D, ECO-550I, ECO-6000D, ECO-6000I, FI-160, FI-1600, FI-160AR, FI-160D, FI-160I, FI-200, FI-200AR, FI-200D, FI-200H, FI-200HD, FI-200HI, FI-200I, FI-200W, FI-2300, FI-2700D, FI-2700I, FI-280D, FI-280I, FI-3000, FI-370D, FI-370I, FI-4000D, FI-4000I, FI-460D...(Other models you can see in the webshop)		

transformers

open transformers

with clamp terminal



1

GEV No.	400888	Ref. No.	12017582 R723044
description	transformer primary 220VAC secondary 230VAC 150VA secondary 0.65A connection spring terminal 50/60Hz		
For models:	HCG-20-11, HMG-20-11		



1

GEV No.	400887	Ref. No.	12024153 12024173 12033065 12040013 50GL951275 R503005 R663039
description	transformer primary 230VAC secondary 12/24VAC 65VA connection screw 50-60Hz		
For models:	ACE-061, ACE-101, ACE-102, ACE-201, ACE-202, ACG-061, ACG-101, ACG-102, ACG-201, ACG-202, AE-061, AE-101, AE-102, AE-201, AE-202, AG-061, AG-101, AG-102, AG-201, AG-202, APE-061, APE-101, APE-102, APE-201, APE-202, APG-061, APG-101, APG-102, APG-201, APG-202, COE-061, COE-101, COE-102, COE-201, COE-202, COG-061, COG-101, COG-102, COG-201, COG-202, HCG-10-11, HCG-10-21, HCG-20-11, HCG-20-21, HCG-2-10-11, HCG-2-20-11, HCG-6-11, HEI-10-11, HEI-10-21, HEI-20-11...(Other models you can see in the webshop)		



1

GEV No.	400104	Ref. No.	12028922 RT30370242
description	transformer primary 230VAC secondary 24VAC 40VA secondary 1.7A connection screw 50/60Hz with fuse		



with plug connection



GEV No.	400101	Ref. No.	12029247 RT30370240
description	transformer primary 200-260VAC secondary 4.2/14.4/11.5VAC 68.4VA		

toroidal core transformers



GEV No.	401791	Ref. No.	12016605 R693060 R723063
description	transformer primary 230VAC secondary 12VAC 15/50VA secondary 2.1A 50/60Hz		
For models:	HMG-10-11UL, HMG-10-21UL, HMI-10-11UL, HMI-10-21UL, HMI-6-11UL, HMM-10-11UL, HMM-10-21UL, HMM-20-11, HMM-20-11UL, HMM-20-21UL, HMM-40-11-USMC, HMM-6-11UL, HVG-10-11, HVG-10-11UL, HVG-10-21, HVG-10-21UL, HVG-2-10-11, MFHMM-20-11, MFHVG-10-11, MFHVG-10-21		

encapsulated transformers

with plug connection



GEV No.	401472	Ref. No.	12028416 RT4000277
description	transformer 1/20/50VA secondary A H 70mm L 76mm W 104mm connection plug 50/60Hz type 110170 with fuse secondary 2.1/11.5/12VAC primary 230VAC		
spare parts for	401472		
	GEV No.	358602	Ref. No. —
	fine fuse size ø5x20mm 1.6A slow-acting rated 250V Qty 10 pcs		



GEV No.	401473	Ref. No.	12028264 RT4000592
description	transformer 21.6VA H 70mm L 94mm W 71mm connection plug 50-60Hz type 40.00.592 moulded secondary 12VDC primary 200-250VAC		

electronic controllers

CAREL

refrigeration controllers

built-in version



GEV No.	378527	Ref. No.	6021350106
description	electronic controller CAREL PYCO1L051G mounting measurements 71x29mm built-in depth 74mm 230V voltage AC NTC relay outputs 1 CO-12A(2) NTC NTC DI yes protection IP54 -50 up to +90°C display 3½ digits		



GEV No.	379779	Ref. No.	12038178 12049777 6021350010
description	electronic controller CAREL PYCO1LOXXX mounting measurements 71x29mm built-in depth 74mm 230V voltage AC NTC relay outputs 3 CO-8A(4) NO-8A(4) NO-8A(4) NTC NTC DI yes 2x NTC 10K protection IP54 -50 up to +90°C display 3½ digits		
For models:	AEP-802, AF-1402-MIX, AF-1403-C, AF-1403-P, AF-1404-C, AF-1404-P, AF-1602-MIX, AF-1603-C, AF-1603-P, AF-1604-C, AF-1604-P, AF-2104-C, AF-2104-P, AF-2105-C, AF-2105-P, AF-2106-C, AF-2106-P, AF-702-C, AF-702-P, AF-802-C, AF-802-P, AFN-1402, AFN-1403, AFN-1404, AFN-1602, AFN-1603, AFN-1604, AFN-701, AFN-702, AFN-801, AFN-802, AFP-702, AP-701, APP-701, MCN-135-GN, MCN-180-GN, MCN-270-GN, MFN-135, MFN-135-GN, MFN-180, MFN-180-GN, MFN-225-GN, MFN-270-GN, MPN-117-R, MPN-150, MPN-169-R, MPN-202, MPN-255, MPN-255-C, MPN-274-R...(Other models you can see in the webshop)		



			
1			
GEV No.	378673	Ref. No.	12047691 6021350115
description	electronic controller CAREL PYCO1SN50P mounting measurements 71x29mm built-in depth 59mm 230V voltage AC NTC		

accessories

			
1			
GEV No.	378669	Ref. No.	12110849 6003010410
description	frame L 162mm W 35mm H 1mm CAREL plastic black		

DIXELL

refrigeration controllers

built-in version

			
1			
GEV No.	378526	Ref. No.	6021350114
description	electronic controller DIXELL mounting measurements 30x150mm built-in depth 42mm 230V voltage AC NTC relay outputs 3 NO-16A(8) NO-5A NO-8(3) NTC DI DI incl. probe -40 up to 110°C display 2.5		

ELIWELL

universal controllers

built-in version

			
1			
GEV No.	379622	Ref. No.	12016193 12017189
description	electronic controller ELIWELL type IC912 mounting measurements 71x29mm 12V Pt100/TC (J,K) temperature controller protection IP65 defr. funct. no 8A		
For models:	HGV-10-11, HGV-20-11		

refrigeration controllers

built-in version

			
1			
GEV No.	378214	Ref. No.	12016682 R743003 T133004
description	electronic controller ELIWELL type EWPC902T mounting measurements 71x29mm 12V voltage AC/DC TC/J compressor relay 8A		

			
1			
GEV No.	379018	Ref. No.	R743005
description	electronic controller ELIWELL type EWPC902T thermocouple J		

			
1			

GEV No.	379645	Ref. No.	12029316 12029317 12031127 12031161 6001507039 6001567002 6021350006 6021350015
----------------	--------	-----------------	--

description electronic controller ELIWELL type ID961 mounting measurements 71x29mm 230V voltage AC NTC/PTC relay outputs 1 relay -55 up to +150°C display 3½ digits compressor relay 15A

For models: AEP-1402, AEP-1403, AEP-1404, AEP-1602, AEP-1603, AEP-1604, AEP-2103, AEP-701, AEP-702, AEP-801, AEP-802, AF-1402-MIX, AF-1403-C, AF-1403-P, AF-1404-C, AF-1404-P, AF-1602-MIX, AF-1603-C, AF-1603-P, AF-1604-C, AF-1604-P, AF-2104-C, AF-2104-P, AF-2105-C, AF-2105-P, AF-2106-C, AF-2106-P, AF-702-C, AF-702-P, AF-802-C, AF-802-P, AFP-1402, AFP-1403, AFP-1403-C, AFP-1403-P, AFP-1404, AFP-1404-C, AFP-1404-P, AFP-1404-USMC, AFP-1602, AFP-1602-2, AFP-1603, AFP-1603-2, AFP-1604, AFP-2103, AFP-2104, AFP-2104-C, AFP-2104-P, AFP-2105, AFP-2105-C...(Other models you can see in the webshop)

accessories for	379645		
	GEV No.	379053	Ref. No. —
	temperature probe PTC 1kOhm cable PVC probe -50 up to +150°C cable -10 up to 100°C probe ø6x30mm cable length 3m without screw connection 2-wire		
	GEV No.	379064	Ref. No. —
	temperature probe PTC 1kOhm cable silicone probe -50 up to +150°C cable -50 up to +180°C probe ø6x40mm cable length 3m without screw connection 2-wire		

Table continues overleaf

accessories for 379645			
GEV No.	379161	Ref. No.	—
temperature probe NTC 10kOhm cable thermoplastic probe -40 up to +110°C cable -40 up to +110°C probe ø6x14mm cable length 3m without screw connection 2-wire			
GEV No.	379782	Ref. No.	—
temperature probe PTC 1kOhm cable thermoplastic probe -50 up to +150°C cable -40 up to +110°C probe ø6x14mm cable length 3m 2-wire resistor 1kOhm			



GEV No.	379571	Ref. No.	12028942 6001507002
description	electronic controller ELIWELL type ID961 mounting measurements 71x29mm 230V voltage AC NTC/PTC relay outputs 1 relay -55 up to +150°C display 3½ digits RoomTempIN yes compressor relay 8A		
For models:	AEP-1402, AEP-1403, AEP-1404, AEP-1602, AEP-1603, AEP-1604, AEP-701, AEP-702, AEP-801, AEP-802, AFP-1402, AFP-1402-FORZ, AFP-1403, AFP-1403-C, AFP-1403-FORZ, AFP-1403-P, AFP-1404, AFP-1404-C, AFP-1404-FORZ, AFP-1404-P, AFP-1602, AFP-1602-2, AFP-1603, AFP-1604, AFP-2103, AFP-2104, AFP-2104-C, AFP-2104-P, AFP-2105, AFP-2105-C, AFP-2105-P, AFP-2106, AFP-2106-C, AFP-2106-P, AFP-701, AFP-701-FORZ, AFP-702, AFP-702-C, AFP-702-FORZ, AFP-702-P, AFP-801, AFP-802, AFP-802-2, APP-701, FMP-117-R, FMP-150, FMP-169-R, FMP-200, FMP-222-R, FMP-250...(Other models you can see in the webshop)		
accessories for 379571			
GEV No.	379053	Ref. No.	—
temperature probe PTC 1kOhm cable PVC probe -50 up to +150°C cable -10 up to 100°C probe ø6x30mm cable length 3m without screw connection 2-wire			
GEV No.	379064	Ref. No.	—
temperature probe PTC 1kOhm cable silicone probe -50 up to +150°C cable -50 up to +180°C probe ø6x40mm cable length 3m without screw connection 2-wire			
GEV No.	379161	Ref. No.	—
temperature probe NTC 10kOhm cable thermoplastic probe -40 up to +110°C cable -40 up to +110°C probe ø6x14mm cable length 3m without screw connection 2-wire			
GEV No.	379782	Ref. No.	—
temperature probe PTC 1kOhm cable thermoplastic probe -50 up to +150°C cable -40 up to +110°C probe ø6x14mm cable length 3m 2-wire resistor 1kOhm			



GEV No.	379577	Ref. No.	12028377 12028398 12029857 12029858 12030168 6001507012 6001507042 6021350002 6021350007 6021350019
description	electronic controller ELIWELL type ID974 mounting measurements 71x29mm 230V voltage AC NTC/PTC relay outputs 3 relays -50 up to +150°C display 3½ digits RoomTempIN yes DEF Probe yes DEF Relay 8A fan relay 5A compressor relay 8A		
For models:	AF-1402-MIX, AF-1403-C, AF-1403-P, AF-1404-C, AF-1404-P, AF-1602-MIX, AF-1603-C, AF-1603-P, AF-1604-C, AF-1604-P, AF-2104-C, AF-2104-P, AF-2105-C, AF-2105-P, AF-2106-C, AF-2106-P, AF-702-C, AF-702-P, AF-802-C, AF-802-P, AFN-1402, AFN-1403, AFN-1404, AFN-1602, AFN-1603, AFN-1604, AFN-701, AFN-702, AFN-801, AFN-802, AFP-1402-MIX, AP-701, APP-701, MCN-102-GN-R, MCN-102-R, MCN-135, MCN-135-GN, MCN-147-GN-R, MCN-147-R, MCN-180, MCN-180-GN, MCN-192-GN-R, MCN-192-R, MCN-225, MCN-225-GN, MCN-237-GN-R, MCN-237-R, MCN-270, MCN-270-GN, MFN-102-GN-R...(Other models you can see in the webshop)		
accessories for 379577			
GEV No.	379053	Ref. No.	—
temperature probe PTC 1kOhm cable PVC probe -50 up to +150°C cable -10 up to 100°C probe ø6x30mm cable length 3m without screw connection 2-wire			
GEV No.	379064	Ref. No.	—
temperature probe PTC 1kOhm cable silicone probe -50 up to +150°C cable -50 up to +180°C probe ø6x40mm cable length 3m without screw connection 2-wire			
GEV No.	379161	Ref. No.	—
temperature probe NTC 10kOhm cable thermoplastic probe -40 up to +110°C cable -40 up to +110°C probe ø6x14mm cable length 3m without screw connection 2-wire			
GEV No.	379782	Ref. No.	—
temperature probe PTC 1kOhm cable thermoplastic probe -50 up to +150°C cable -40 up to +110°C probe ø6x14mm cable length 3m 2-wire resistor 1kOhm			







EVCO - EVERY CONTROL

universal controllers

built-in version





1	GEV No.	378131	Ref. No.	12017197
description	electronic controller EVERY CONTROL EVK411M mounting measurements 71x29mm 12V voltage AC/DC NTC/PTC/Pt100/Pt1000 relay outputs 1 CO-16A(8) NTC/PTC/Pt100/Pt1000/TC(J,K)/mV/mA yes protection IP65 depend on probe°C display 3½ digits			
accessories for	378131			
	GEV No.	379050	Ref. No.	—
description	temperature probe Pt100 cable Vetrotex probe -200 up to +600°C cable -50 up to +350°C probe ø6x100mm cable length 2.7m without screw connection 3-wire			
	GEV No.	379160	Ref. No.	—
description	temperature probe NTC 10kOhm cable thermoplastic probe -40 up to +110°C cable -40 up to +110°C probe ø6x14mm cable length 1.5m without screw connection 2-wire			
	GEV No.	379781	Ref. No.	—
description	temperature probe PTC 1kOhm cable thermoplastic probe -50 up to +150°C cable -40 up to +110°C probe ø6x14mm cable length 1.5m without screw connection 2-wire			
	GEV No.	379944	Ref. No.	—
description	temperature probe Pt1000 cable Vetrotex probe -70 up to +500°C cable -50 up to +350°C connection 2-wire thread probe ø6x180mm cable length 1.7m			

probes

universal probes

temperature probes

1			
GEV No.	379343	Ref. No.	12040436 6021350013
description	temperature probe NTC 10kOhm cable silicone probe -40 up to +110°C cable -50 up to +180°C probe ø6x40mm cable length 3m 2-wire		
For models:	AEP-1402, AEP-1602, AEP-2103, AEP-701, AEP-801, AEP-802, AF-1402-MIX, AF-1403-C, AF-1403-P, AF-1404-C, AF-1404-P, AF-1602-MIX, AF-1603-C, AF-1603-P, AF-1604-C, AF-1604-P, AF-2104-C, AF-2104-P, AF-2105-C, AF-2105-P, AF-2106-C, AF-2106-P, AF-702-C, AF-702-P, AF-802-C, AF-802-P, AFN-1402, AFN-1403, AFN-1404, AFN-1602, AFN-1603, AFN-1604, AFN-702, AFN-801, AFN-802, AFP-1402, AFP-1403, AFP-1404, AFP-1404-USMC, AFP-1602, AFP-1602-2, AFP-1603, AFP-1603-2, AFP-1604, AFP-2103, AFP-2104, AFP-2105, AFP-2106, AFP-701, AFP-702...(Other models you can see in the webshop)		
1			
GEV No.	379630	Ref. No.	6021350083
description	temperature probe NTC 10kOhm cable thermoplastic probe -40 up to +110°C cable -40 up to +110°C probe ø6x14mm cable length 2.5m without screw connection 2-wire resistor 10kOhm		

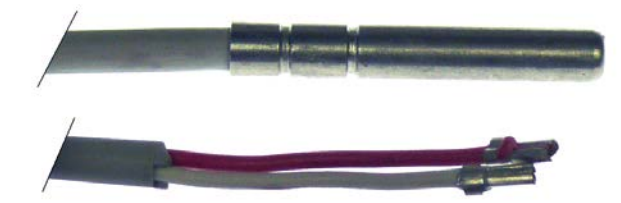

1			
GEV No.	379478	Ref. No.	12038239 6002000057
description	temperature probe NTC 10kOhm cable thermoplastic probe -40 up to +110°C cable -40 up to +110°C probe ø6x40mm cable length 3m cable colours white/red 2-wire		

1			
GEV No.	379142	Ref. No.	12033839 6021350026
description	temperature probe PTC 1kOhm cable PVC probe -50 up to +150°C cable -10 up to 100°C probe ø6x30mm cable length 1.5m without screw connection 2-wire		
For models:	ATM-101, VTP-139-C, VTP-139-CD, VTP-139-P, VTP-139-PD, VTP-139-RC, VTP-139-RCD, VTP-139-RP, VTP-139-RPD, VTP-175-C, VTP-175-CD, VTP-175-P, VTP-175-PD, VTP-175-RC, VTP-175-RCD, VTP-175-RP, VTP-175-RPD		

1			
GEV No.	379487	Ref. No.	12032993 FR995562
description	temperature probe PTC cable silicone probe -50 up to +150°C cable -50 up to +180°C probe ø6x30mm cable length 2.5m without screw connection 2-wire		

1			
GEV No.	379553	Ref. No.	12017340 T113088
description	core temperature probe thermocouple K (NiCr-Ni) cable PTFE probe -40 up to +250°C cable -40 up to +250°C probe ø4x120mm cable length 2m thread handle ø 10mm handle length 60mm 2-wire		
For models:	HGV-10-11, HGV-20-11		

core probes

1				
GEV No.	379529	Ref. No.	12017395 R673059 R673076	
description	temperature probe thermocouple J (Fe-CuNi) cable PTFE probe -50 up to +750°C cable -40 up to +250°C probe ø4x120mm cable length 1.9m 2-wire			
For models:	HEM-10-11, HEM-20-11, HEM-6-11, HEP-10-11, HEP-20-11, HEP-6-11, HME-10-11, HME-10-21, HME-2-10-11, HMM-10-11, HMM-10-11UL, HMM-10-21, HMM-10-21UL, HMM-2-10-11, HMP-10-11, HMP-10-21, HMP-2-10-11			
accessories for	379529			
	GEV No.	691097	Ref. No.	12024241 T133037
description	holding plate for probe mounting pos. upper L 35mm W 12mm H 4mm SS			
	GEV No.	691098	Ref. No.	12024243 T133036
description	holding plate for probe mounting pos. lower L 35mm W 12mm H 4mm SS			



producer-specific probes

probes



GEV No.	379489	Ref. No.	12024649 T303007
description	core temperature probe thermocouple J (Fe-CuNi) cable PTFE probe -50 up to +750°C cable -40 up to +250°C connection male faston thread probe ø4x120mm cable length 1.85m		
For models:	HEM-10-21, HEM-20-21, HGV-10-21, HGV-20-21, VE-102, VE-202, VG-102, VG-202		



GEV No.	379430	Ref. No.	12040499 RT4001095
description	core temperature probe thermocouple K (NiCr-Ni) cable silicone probe -50 up to +1150°C cable -50 up to +180°C connection coded plug thread probe ø1.5x140mm cable length 1.65m		

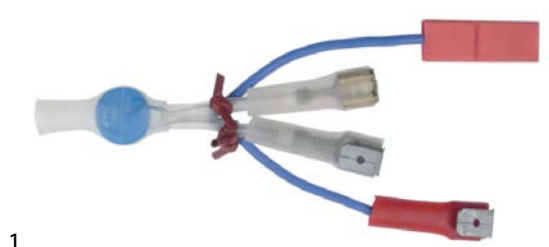

GEV No.	379554	Ref. No.	12020413 R073008
description	probe PTC cable silicone probe -50 up to +150°C cable -50 up to +180°C connection plug-in connection thread probe ø4x13mm cable length 0.05m		
For models:	HCG-10-11, HCG-10-21, HCG-20-11, HCG-20-21, HCG-2-10-11, HCG-2-20-11, HCG-6-11, HG-10-21, HG-2-10-11, HMG-10-11, HMG-10-11UL, HMG-10-21, HMG-10-21UL, HMG-20-11, HMG-2-10-11, HMG-6-11, HVG-10-11, HVG-10-11UL, HVG-10-21, HVG-10-21UL, HVG-20-11, HVG-20-21, HVG-2-10-11, HVG-2-20-11, MFHVG-10-11, MFHVG-10-21		



GEV No.	381544	Ref. No.	12039678 T953051000
description	temperature probe connection plug probe 4x540mm cable length 2m		
For models:	ACE-202, ACG-202, AE-202, AG-202, APE-102, APE-202, APG-102, APG-202		



GEV No.	403925	Ref. No.	12041634
description	temperature probe connection plug probe ø4x362 cable length 2m		
For models:	ACE-061, ACE-101, ACE-102, ACE-201, ACG-061, ACG-101, ACG-102, ACG-201, AE-061, AE-101, AE-102, AE-201, AG-061, AG-101, AG-102, AG-201		



GEV No.	403924	Ref. No.	12044609
description	temperature probe connection plug probe ø4x425mm cable length 2m		
For models:	APE-061, APE-101, APE-201, APG-061, APG-101, APG-201		



GEV No.	403929	Ref. No.	12047675
description	temperature probe connection plug probe ø4x627 cable length 2m		
For models:	ACE-202, ACG-202, AE-202, AG-202		



GEV No.	379550	Ref. No.	12019258 Z233007
description	temperature probe NTC 10kOhm cable silicone probe -40 up to +110°C cable -50 up to +180°C connection male faston thread probe ø6x30mm cable length 0.35m		
For models:	FI-50		



GEV No.	378339	Ref. No.	12025036 Z713028
description	temperature probe NTC 64kOhm cable silicone probe -40 up to +110°C cable -50 up to +180°C connection plug thread probe ø6x14mm cable length 2.5m		
For models:	AD-120, AD-120B, AD-120BBTDD-UK, AD-120C, AD-120CW, AD-120HY, AD-125, AD-125HRS, AD-125-SOFT, AD-15, AD-15D, AD-20C-UK, AD-21, AD-21B, AD-21BDD, AD-21C, AD-21D, AD-21DD, AD-21W, AD-45BBT, AD-48, AD-48B, AD-48BDD, AD-48C, AD-48D, AD-48DD, AD-48HY, AD-48W, AD-505, AD-505-SOFT, AD-64, AD-64B, AD-64BBT, AD-64BDD, AD-64BTDD, AD-64C, AD-64CW, AD-64D, AD-64DD, AD-64HY, AD-72, AD-72W, AD-90, AD-90BA, AD-90BBT, AD-90BDD, AD-90DD, ADE-120, ADE-120B, CO-112...(Other models you can see in the webshop)		



GEV No.	402005	Ref. No.	62040410
description	temperature probe PTC 2kOhm cable TPE probe -50 up to +150°C cable -40 up to +110°C connection plug thread probe ø6x50mm cable length 1.6m		



GEV No.	400874	Ref. No.	12018718 R663090
description	temperature probe thermocouple J (Fe-CuNi) cable PTFE probe -50 up to +750°C cable -40 up to +250°C connection male faston thread probe ø3x70mm cable length 1.5m		
For models:	HCG-10-11, HCG-10-21, HCG-20-11, HCG-20-21, HCG-2-10-11, HCG-2-20-11, HCG-6-11, HEI-10-11, HEI-20-11, HEI-6-11, HEM-10-11, HEM-20-11, HEM-6-11, HEP-10-11, HEP-20-11, HEP-6-11, HGC-10-11, HGC-20-11, HGC-6-11, HME-10-11, HME-10-21, HME-20-11, HME-20-21, HME-2-10-11, HME-2-20-11, HME-6-11, HMG-20-11, HMI-10-11, HMI-10-11UL, HMI-10-21, HMI-10-21UL, HMI-2-10-11, HMI-6-11, HMI-6-11UL, HMM-10-11, HMM-10-11UL, HMM-10-21, HMM-10-21UL, HMM-20-11, HMM-20-11UL, HMM-20-21, HMM-20-21UL, HMM-2-10-11, HMM-40-11-USMC, HMM-6-11, HMM-6-11UL, HMP-10-11, HMP-10-21, HMP-20-11, HMP-20-21...(Other models you can see in the webshop)		



GEV No.	400873	Ref. No.	12018312 R663089
description	temperature probe thermocouple J (Fe-CuNi) cable PTFE probe -50 up to 1150°C cable -40 up to +250°C connection 2-wire thread probe ø3x70mm cable length 2.5m		
For models:	HEM-10-11, HEM-20-11, HEM-6-11, HEP-10-11, HEP-20-11, HEP-6-11, HGV-10-11, HGV-20-11, HME-10-11, HME-10-21, HME-20-11, HME-20-21, HME-2-10-11, HME-2-20-11, HME-6-11, HMP-10-11, HMP-10-21, HMP-20-11, HMP-20-21, HMP-2-10-11, HMP-6-11		



GEV No.	381430	Ref. No.	12031446
description	temperature probe thermocouple K (NiCr-Ni) cable silicone probe -50 up to 1150°C cable -50 up to +180°C connection 2-wire thread probe ø2x100mm cable length 0.25m		



GEV No.	379525	Ref. No.	12024642 T323011
description	temperature probe thermocouple K (NiCr-Ni) cable PTFE probe -50 up to 1150°C cable -40 up to +250°C connection male faston 6.3mm thread probe ø3x70mm cable length 1m		
For models:	ACE-061, ACE-101, ACE-102, ACE-201, ACE-202, ACG-061, ACG-101, ACG-102, ACG-201, ACG-202, AE-061, AE-101, AE-102, AE-201, AE-202, AG-061, AG-101, AG-102, AG-201, AG-202, APE-061, APE-101, APE-102, APE-201, APE-202, APG-061, APG-101, APG-102, APG-201, APG-202, COE-061, COE-101, COE-102, COE-201, COE-202, COG-061, COG-101, COG-102, COG-201, COG-202, HEI-10-21, HEI-20-21, HEM-10-21, HEM-20-21, HEP-10-21, HEP-20-21, HGC-10-21, HGC-20-21, HGP-10-21, HGP-20-21, HGV-10-21...(Other models you can see in the webshop)		



GEV No.	381433	Ref. No.	12038044 RT30141004
description	temperature probe thermocouple K (NiCr-Ni) cable silicone probe -50 up to 1150°C cable -50 up to +180°C connection 2-wire thread probe ø2x100mm cable length 2.2m		



GEV No.	379528	Ref. No.	12023901 T323024
description	temperature probe thermocouple K (NiCr-Ni) cable PTFE probe -50 up to 1150°C cable -40 up to +250°C connection male faston thread probe ø3x70mm cable length 1.6m		
For models:	ACE-061, ACE-102, AE-061, AE-101, AE-102, AE-201, AE-202, AG-061, AG-101, AG-102, AG-201, AG-202, APE-061, APE-101, APE-102, APE-201, APE-202, APG-061, APG-101, APG-102, APG-201, APG-202, COE-061, COE-101, COE-102, COE-201, COE-202, HEI-10-21, HEI-20-21, HEM-10-21, HEM-20-21, HEP-10-21, HEP-20-21, HGP-10-21, HGP-20-21, HGV-10-21, HGV-20-21, VE-061, VE-101, VE-102, VE-201, VE-202, VG-101, VG-102, VG-201, VG-202, VPE-061, VPE-101, VPE-102, VPE-201...(Other models you can see in the webshop)		





GEV No.	381424	Ref. No.	12029772 RT87201003
description	temperature probe thermocouple K (NiCr-Ni) cable silicone probe -50 up to 1150°C cable -50 up to +180°C connection 2-wire thread probe ø2x100mm cable length 2m		



GEV No.	381431	Ref. No.	12031553 RT30140165
description	temperature probe thermocouple K (NiCr-Ni) cable silicone probe -50 up to 1150°C cable -50 up to +180°C connection 2-wire thread probe ø1.5x100mm cable length 1.8m		



GEV No.	379077	Ref. No.	12029895 RT87201002	
description	temperature probe thermocouple K (NiCr-Ni) cable silicone probe -50 up to 1150°C cable -50 up to +180°C connection 2-wire thread probe ø2x40mm cable length 2.6m			
accessories for	379077			
	GEV No.	550365	Ref. No.	12037350 RT30140162
	gasket for thermocouple			
	GEV No.	550366	Ref. No.	12037422 RT30140163
	screw for thermocouple			



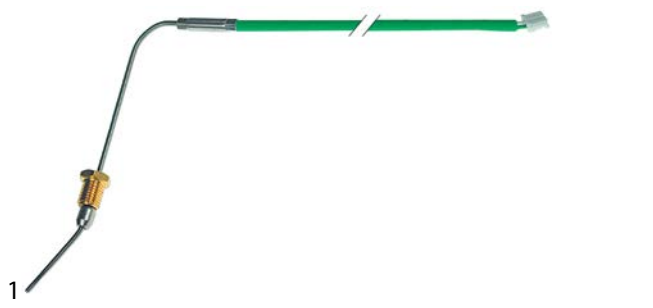

GEV No.	379429	Ref. No.	12030579 RT30141020
description	temperature probe thermocouple K (NiCr-Ni) cable silicone probe -50 up to 1150°C cable -50 up to +180°C connection 2-wire thread probe ø10.5mm cable length 1.7m		





GEV No.	379864	Ref. No.	12029713 RT4000594
description	temperature probe thermocouple K (NiCr-Ni) cable silicone probe -50 up to 1150°C cable -50 up to +180°C connection coded plug thread M8 probe ø2x50mm cable length 1.2m		





			
GEV No.	379873	Ref. No.	12031261 RT4000292
description	temperature probe thermocouple K (NiCr-Ni) cable silicone probe -50 up to 1150°C cable -50 up to +180°C connection coded plug thread probe ø1.5x180mm cable length 1.6m		

			
GEV No.	379441	Ref. No.	12031482 RT4000291
description	temperature probe thermocouple K (NiCr-Ni) cable silicone probe -50 up to 1150°C cable -50 up to +180°C connection coded plug thread probe ø2x125mm cable length 1.5m		

			
GEV No.	379869	Ref. No.	12029187 12029188 12036625 RT4000287 RT4000398 RT8700058
description	temperature probe thermocouple K (NiCr-Ni) cable silicone probe -50 up to 1150°C cable -50 up to +180°C connection coded plug thread probe ø2x70mm cable length 2.5m		

			
GEV No.	379442	Ref. No.	12040500 RT4001094
description	temperature probe thermocouple K (NiCr-Ni) cable silicone probe -50 up to 1150°C cable -50 up to +180°C connection coded plug thread probe ø2x90mm cable length 1.5m		

			
GEV No.	379870	Ref. No.	12033003 RT4000399
description	temperature probe thermocouple K (NiCr-Ni) cable silicone probe -50 up to 1150°C cable -50 up to +180°C connection coded plug thread probe ø4.2mm cable length 1.7m		

core probes			
			
GEV No.	379867	Ref. No.	12026815 RT4000298P
description	conversion kit thermocouple K (NiCr-Ni) cable PTFE probe -40 up to +250°C cable -40 up to +250°C connection plug probe ø3x100mm thread M16 cable length 2.2m handle ø 10mm handle length 40mm		

			
GEV No.	379167	Ref. No.	12028770 6021350027
description	core temperature probe PTC cable silicone probe -50 up to +150°C cable -50 up to +180°C connection 2-wire probe ø6x180mm thread cable length 3.1m handle ø 12mm handle length 120/40mm L1 130mm L2 50mm		
For models:	ATM-051, ATM-101, ATM-102		

			
GEV No.	400875	Ref. No.	12039138 12040015 R663015
description	core temperature probe thermocouple J (Fe-CuNi) cable SS corrugated hose probe -40 up to +250°C cable -40 up to +250°C connection 2-wire probe ø3x90mm thread cable length 1.5m handle ø 8mm handle length 60mm		
For models:	HME-6-11, HMG-6-11, HMM-10-11, HMM-10-21, HMM-2-10-11, HMM-6-11, HMM-6-11UL, HMP-6-11		

			
GEV No.	400876	Ref. No.	R673001
description	core temperature probe thermocouple J (Fe-CuNi) cable SS corrugated hose probe -40 up to +250°C cable -40 up to +250°C connection 2-wire probe ø3x90mm thread cable length 1.65m handle ø 8mm handle length 60mm		

			
GEV No.	400877	Ref. No.	12000187 R093000 R093019
description	core temperature probe thermocouple J (Fe-CuNi) cable SS corrugated hose probe -40 up to +250°C cable -40 up to +250°C connection 2-wire probe ø3x90mm thread cable length 2.2m handle ø 8mm handle length 60mm		
For models:	HME-20-11, HME-20-21, HME-2-20-11, HMG-20-11, HMM-20-11, HMM-20-11UL, HMM-20-21, HMM-20-21UL, HMP-20-11, HMP-20-21, MFHMM-20-11		





GEV No.	381426	Ref. No.	12027356 RT30350709
description	core temperature probe thermocouple K (NiCr-Ni) cable PTFE probe -40 up to +250°C cable -40 up to +250°C connection 2-wire probe ø3.2x100mm thread M12 cable length 1.9m handle ø 10mm handle length 100mm		



GEV No.	378670	Ref. No.	12039548 T843062000
description	core temperature probe thermocouple K (NiCr-Ni) cable PTFE probe -40 up to +250°C cable -40 up to +250°C connection 5-wire probe ø4x100mm thread 1/4" cable length 2m handle ømm handle length 55mm multipoint probe		
For models:	ACE-061, ACE-101, ACE-102, ACE-201, ACE-202, ACG-061, ACG-101, ACG-102, ACG-201, ACG-202, AE-061, AE-061W, AE-101, AE-101W, AE-102, AE-102W, AE-201, AE-202, AG-061, AG-061W, AG-101, AG-101W, AG-102, AG-102W, AG-201, AG-202, APE-061, APE-061W, APE-101, APE-101W, APE-102, APE-102W, APE-201, APE-202, APG-061, APG-061W, APG-101, APG-101W, APG-102, APG-102W, APG-201, APG-202		



GEV No.	379792 ¹	Ref. No.	12026252 RT30350717	
description	core temperature probe thermocouple K (NiCr-Ni) cable PTFE probe -40 up to +250°C cable -40 up to +250°C connection grip connection probe ø3.2x100mm thread M16x2 cable length 1.9m handle ø 10mm handle length 40mm			
accessories for	379792			
	GEV No.	510179	Ref. No.	12010145 Q306012
	flat gasket fibre ED ø 18mm ID ø 13mm thickness 1.5mm Qty 1 pcs			
	GEV No.	560519	Ref. No.	—
	nut thread M12x1 H 5mm WS 17 SS Qty 1 pcs			



GEV No.	379868 ¹	Ref. No.	12026495 12103868 RT4000295 RT8700096
description	core temperature probe thermocouple K (NiCr-Ni) cable PTFE probe -40 up to +250°C cable -40 up to +250°C connection plug probe ø3x100mm thread M16 cable length 2.2m handle ø 10mm handle length 40mm		

¹ multipoint probe



GEV No.	379866 ¹	Ref. No.	12026609 12027340 RT4000606 RT4000606P
description	core temperature probe thermocouple K (NiCr-Ni) cable PTFE probe -40 up to +250°C cable -40 up to +250°C connection plug probe ø3x100mm thread M16 cable length 2.3m handle ømm handle length 50mm		

¹ multipoint probe



GEV No.	379552	Ref. No.	12039150 T113007
description	core temperature probe thermocouple K (NiCr-Ni) cable Vetrotex probe -40 up to +250°C cable -50 up to +350°C connection 2-wire probe ø3x90mm thread cable length 1.65m handle ø 8mm handle length 50mm		
For models:	HVG-10-11, HVG-10-11UL, HVG-10-21, HVG-10-21UL, HVG-2-10-11, MFHVG-10-11, MFHVG-10-21		

¹ multipoint probe



GEV No.	691084	Ref. No.	12023773 R662659
description	duct for probe		
For models:	COE-061, COE-101, COG-061, COG-101, HCG-10-11, HCG-10-21, HCG-20-11, HCG-20-21, HCG-2-10-11, HCG-2-20-11, HCG-6-11, HEI-10-11, HEI-20-11, HEI-6-11, HEM-10-11, HEM-20-11, HEM-6-11, HEP-10-11, HEP-20-11, HEP-6-11, HGC-10-11, HGC-20-11, HGC-6-11, HGV-10-11, HGV-20-11, HME-10-11, HME-10-21, HME-20-11, HME-20-21, HME-2-10-11, HME-2-20-11, HME-6-11, HMG-10-11, HMG-10-11UL, HMG-10-21, HMG-10-21UL, HMG-20-11, HMG-2-10-11, HMG-6-11, HMI-10-11, HMI-10-11UL, HMI-10-21, HMI-10-21UL, HMI-2-10-11, HMI-6-11, HMI-6-11UL, HMM-10-11, HMM-10-11UL, HMM-10-21, HMM-10-21UL... (Other models you can see in the webshop)		

accessories

fasteners

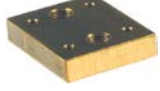



GEV No.	691098	Ref. No.	12024243 T133036
description	holding plate for probe mounting pos. lower L 35mm W 12mm H 4mm SS		
For models:	HEM-10-11, HEM-20-11, HEM-6-11, HEP-10-11, HEP-20-11, HEP-6-11, HGV-10-11, HGV-20-11, VE-061, VE-101, VE-201, VPE-061, VPE-101, VPE-201		





GEV No.	691097	Ref. No.	12024241 T133037
description	holding plate for probe mounting pos. upper L 35mm W 12mm H 4mm SS		



			
GEV No.	691097	Ref. No.	12024241 T133037
description	holding plate for probe mounting pos. upper L 35mm W 12mm H 4mm SS		
For models:	COE-061, COE-101, HEM-10-11, HEM-20-11, HEM-6-11, HEP-10-11, HEP-20-11, HEP-6-11, HGV-10-11, HGV-20-11, VE-061, VE-101, VE-201, VPE-061, VPE-101, VPE-201		
accessories for	691097		
			
GEV No.	691098	Ref. No.	12024243 T133036
description	holding plate for probe mounting pos. lower L 35mm W 12mm H 4mm SS		

			
GEV No.	551462	Ref. No.	12021987 Z718446000
description	holding plate for temperature probe L 35mm W 35mm H 2mm hole ø 4mm		
For models:	LVC-21W		

screw connections

			
GEV No.	550366	Ref. No.	12037422 RT30140163
description	screw for thermocouple		
accessories for	550366		
			
GEV No.	550365	Ref. No.	12037350 RT30140162
description	gasket for thermocouple		

			
GEV No.	691086	Ref. No.	12023581 R662629
description	union screw		
For models:	ACE-061, ACE-101, ACE-102, ACE-201, ACE-202, ACG-061, ACG-101, ACG-102, ACG-201, ACG-202, AE-061, AE-061W, AE-101, AE-101W, AE-102, AE-102W, AE-201, AE-202, AG-061, AG-061W, AG-101, AG-101W, AG-102, AG-102W, AG-201, AG-202, APE-061, APE-061W, APE-101, APE-101W, APE-102, APE-102W, APE-201, APE-202, APG-061, APG-061W, APG-101, APG-101W, APG-102, APG-102W, APG-201, APG-202, COE-061, COE-101, COE-102, COE-201, COE-202, COG-061, COG-101, COG-102...(Other models you can see in the webshop)		

miscellaneous

			
GEV No.	550365	Ref. No.	12037350 RT30140162
description	gasket for thermocouple		

			
GEV No.	691085	Ref. No.	12024247 R662652
description	sealing ring for probe		
For models:	ACE-061, ACE-101, ACE-102, ACE-201, ACE-202, ACG-061, ACG-101, ACG-102, ACG-201, ACG-202, AE-061, AE-061W, AE-101, AE-101W, AE-102, AE-102W, AE-201, AE-202, AG-061, AG-061W, AG-101, AG-101W, AG-102, AG-102W, AG-201, AG-202, APE-061, APE-061W, APE-101, APE-101W, APE-102, APE-102W, APE-201, APE-202, APG-061, APG-061W, APG-101, APG-101W, APG-102, APG-102W, APG-201, APG-202, COE-061, COE-101, COE-102, COE-201, COE-202, COG-061, COG-101, COG-102...(Other models you can see in the webshop)		

electronics

electronics accessories

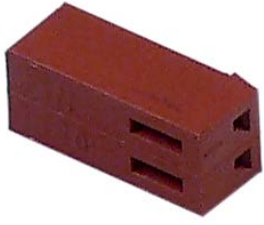
			
GEV No.	401792	Ref. No.	12018408 R663092
description	female connector 2-pole		
For models:	HCG-10-11, HCG-10-21, HCG-20-11, HCG-20-21, HCG-2-10-11, HCG-2-20-11, HCG-6-11, HEI-10-11, HEI-20-11, HEI-6-11, HGC-10-11, HGC-20-11, HGC-6-11, HGV-10-11, HGV-20-11, HMG-20-11, HMI-10-11, HMI-10-11UL, HMI-10-21, HMI-10-21UL, HMI-2-10-11, HMI-6-11, HMI-6-11UL, HMM-10-11, HMM-10-11UL, HMM-10-21, HMM-10-21UL, HMM-20-11, HMM-20-11UL, HMM-20-21, HMM-20-21UL, HMM-2-10-11, HMM-40-11-USMC, HMM-6-11, HMM-6-11UL, HVG-10-11, HVG-10-11UL, HVG-10-21, HVG-10-21UL, HVG-20-11, HVG-20-21, HVG-2-10-11, HVG-2-20-21, MFHMM-20-11, MFHVG-10-11, MFHVG-10-21		



EPROMS

			
1			
GEV No.	403018	Ref. No.	12040195 RT30400311
description	EPROM type CPC CODE XS5.06S		

frequency converters

			
1			
GEV No.	403922	Ref. No.	12048794
description	frequency converter with heat sink for combi-steamer 200-240V 47-63 Hz L 150mm W 115mm H 90mm output frequency 0-550Hz 6.2A output current 2.3A SIEMENS SINAMICS G110 CPM110 AIN 6SL3211-0AB13-7UA1		
For models:	ACE-061, AE-061, AE-061W, APE-061, APE-061W		

			
1			
GEV No.	403935	Ref. No.	12048798
description	frequency converter with heat sink for combi-steamer 200-240V L 150mm W 115mm H 90mm output frequency 0-550Hz 6.2A output current 2.3A		
For models:	ACE-101, ACE-102, ACE-201, ACE-202, ACG-061, ACG-101, ACG-102, ACG-201, ACG-202, AE-101, AE-101W, AE-102, AE-102W, AE-201, AE-202, AG-061, AG-101, AG-102, AG-201, AG-202, APE-101, APE-101W, APE-102, APE-102W, APE-201, APE-202, APG-061, APG-101, APG-102, APG-201, APG-202		

PCBs



			
1			
GEV No.	400098	Ref. No.	12025859 RT30403001
description	control PCB combi-steamer CD 101/CM 101 without EPROM		

			
1			
GEV No.	400103	Ref. No.	12026014 RT30403020
description	control PCB combi-steamer CM 61-202 L 460mm W 154mm 61-202		

			
1			
GEV No.	400099	Ref. No.	12026123 RT30403010
description	control PCB combi-steamer CM101		

			
1			
GEV No.	403319	Ref. No.	12026065 RT30403210
description	control PCB combi-steamer CPC-Linie CM 61-202/G model since 10/1997		

			
1			
GEV No.	400862	Ref. No.	12018475 12040110 R663044 R663051 R663085
description	control PCB combi-steamer HME 611/1011		
For models:	HEM-10-11, HEM-20-11, HEM-6-11, HEP-10-11, HEP-20-11, HEP-6-11, HME-10-11, HME-10-21, HME-20-11, HME-20-21, HME-2-10-11, HME-2-20-11, HME-6-11, HMP-10-11, HMP-10-21, HMP-20-11, HMP-20-21, HMP-2-10-11, HMP-6-11		

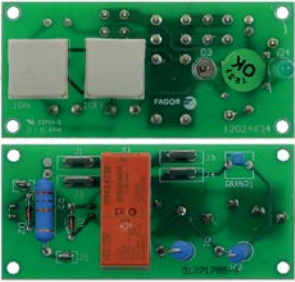

			
1			
GEV No.	401475	Ref. No.	12016327 12025432 RT4200002 RT4200002P
description	control PCB combi-steamer SCC Line		
accessories for	401475		
	 GEV No. 358791 fine fuse size ø6.3x32mm 6.3A slow-acting rated 250V Qty 10 pcs	Ref. No. 12037374 RT40010224	

			
1			
GEV No.	400810	Ref. No.	12016516 Z233005
description	control PCB dishwasher FI-50 with display		
For models:	FI-50		

			
1			
GEV No.	403743	Ref. No.	12024634 Z218030 Z218030000
description	control PCB for dishwasher L 75mm W 35mm suitable for FAGOR		
For models:	LA-AC-10M, LA-AC-10MP, LA-AC-13M, LA-AC-13MP, LA-AC-18M, LA-AC-18MP, LA-AC-25M, LA-AC-25MP, LA-E-10M, LA-E-10MP, LA-E-13M, LA-E-13MP, LA-E-18M, LA-E-18MP, LA-E-25M, LA-E-25MP, LA-V-10M, LA-V-10MP, LA-V-13M, LA-V-13MP, LA-V-18M, LA-V-18MP, LA-V-25M, LA-V-25MP, LB-AC-10M, LB-E-10M, LB-V-10M, LR-AC-10M, LR-AC-10MP, LR-AC-13M, LR-AC-13MP, LR-AC-18M, LR-AC-18MP, LR-AC-25M, LR-AC-25MP, LR-E-10M, LR-E-10MP, LR-E-13M, LR-E-13MP, LR-E-18M, LR-E-18MP, LR-E-25M, LR-E-25MP, LR-V-10M, LR-V-10MP, LR-V-13M, LR-V-13MP, LR-V-18M, LR-V-18MP, LR-V-25M...(Other models you can see in the webshop)		

			
1			
GEV No.	402226	Ref. No.	12009372 12023361 12046658 T913003
description	display combi-steamer		

			
1			
GEV No.	403632	Ref. No.	12010836 T623004
description	display for combi-steamer VPE202 L 195mm W 145mm		
For models:	VPE-102, VPE-202		

			
1			
GEV No.	402147	Ref. No.	12029542 6021250061
description	display PCB blast freezer ATM101		
For models:	ATM-051, ATM-101		
accessories for	402147		
	 GEV No. 403056 keypad foil blast freezer ATM101 L 200mm W 60mm buttons 8	Ref. No. 12031295 6003010194	

			
1			
GEV No.	401789	Ref. No.	12017191 T083002 T303048
description	PCB combi-steamer HCG1011		
For models:	HCG-10-11, HCG-10-21, HCG-20-11, HCG-20-21, HCG-2-10-11, HCG-2-20-11, HCG-6-11, HGC-10-11, HGC-10-21, HGC-20-11, HGC-20-21, HGC-6-11, HGP-10-21, HGP-20-21, HGV-10-11, HGV-10-21, HGV-20-11, HGV-20-21, HVG-10-11, HVG-10-11UL, HVG-10-21, HVG-10-21UL, HVG-20-11, HVG-20-21, HVG-2-10-11, HVG-2-20-21, MFHVG-10-11, MFHVG-10-21		

			
1			
GEV No.	400860	Ref. No.	12018459 R743013
description	PCB combi-steamer t.max. 270°C		
For models:	HCG-10-11, HCG-10-21, HCG-20-11, HCG-20-21, HCG-2-10-11, HCG-2-20-11, HCG-6-11, HEI-10-11, HEI-20-11, HEI-6-11, HGC-10-11, HGC-20-11, HGC-6-11, HGV-10-11, HGV-20-11, HMG-10-11, HMG-10-21, HMG-20-11, HMG-2-10-11, HMG-6-11, HMI-10-11, HMI-10-21, HMI-2-10-11, HMI-6-11, HMM-10-11, HMM-10-21, HMM-20-11, HMM-20-21, HMM-2-10-11, HMM-2-20-11, HMM-6-11, HVG-10-11, HVG-10-11UL, HVG-10-21, HVG-10-21UL, HVG-20-11, HVG-20-21, HVG-2-10-11, HVG-2-20-21, MFHVG-10-11, MFHVG-10-21		

			
1			
GEV No.	401721	Ref. No.	12018453 T353003
description	PCB combi-steamer HEI 1021/HGV 1021		
For models:	HEI-10-21, HEI-20-21, HGC-10-21, HGC-20-21		

			
1			
GEV No.	402225	Ref. No.	12024266 12046670 T553002
description	PCB combi-steamer VE101/202		
For models:	ACE-061, ACE-101, AE-061, AE-061W, AE-101, AE-101W, AE-102, AE-102W, AE-201, AE-202, AG-061, AG-061W, AG-101, AG-101W, AG-102, AG-102W, AG-201, AG-202, APE-061, APE-061W, APE-101, APE-101W, APE-102, APE-102W, APE-201, APE-202, APG-061, APG-061W, APG-101, APG-101W, APG-102, APG-102W, APG-201, APG-202, VE-061, VE-101, VE-102, VE-201, VE-202, VG-101, VG-102, VG-201, VG-202, VPE-061, VPE-101, VPE-102, VPE-201, VPE-202, VPG-101, VPG-102...(Other models you can see in the webshop)		

			
1			
GEV No.	400863	Ref. No.	12017162 R663004
description	PCB combi-steamer HMP 611/1011/2011		
For models:	HEP-10-11, HEP-20-11, HEP-6-11, HMP-10-11, HMP-10-21, HMP-20-11, HMP-20-21, HMP-2-10-11, HMP-6-11		

			
1			
GEV No.	403308	Ref. No.	12008750 Z213073
description	PCB dishwasher AD-72/48/64 L 128mm W 118mm suitable for FAGOR with housing H 55mm for dishwasher Qty 1 pcs		
For models:	AD-120, AD-120B, AD-120BBTDD-UK, AD-120C, AD-120CW, AD-120HY, AD-15, AD-15D, AD-20C-UK, AD-21, AD-21B, AD-21BDD, AD-21C, AD-21D, AD-21DD, AD-21W, AD-45BBT, AD-48, AD-48B, AD-48BDD, AD-48C, AD-48D, AD-48DD, AD-48HY, AD-48W, AD-64, AD-64B, AD-64BBT, AD-64BDD, AD-64BTDD, AD-64C, AD-64CW, AD-64D, AD-64DD, AD-64HY, AD-72, AD-72W, AD-90, AD-90BA, AD-90BBT, AD-90BDD, AD-90DD, ADE-120, ADE-120B, CO-112, CO-112B, CO-112BDD, CO-112DD, CO-142W, CO-142WDD...(Other models you can see in the webshop)		

			
1			
GEV No.	400110	Ref. No.	12026627 RT30403100
description	PCB combi-steamer level control		



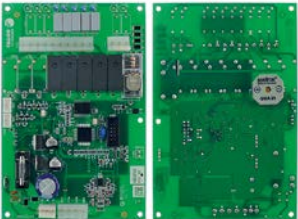

			
1			
GEV No.	403633	Ref. No.	12016866
description	PCB for boiler VPE202		
For models:	VPE-102, VPE-201, VPE-202		

			
1			
GEV No.	402230	Ref. No.	12007938 12024255 12097540 T553003
description	PCB for combi-steamer		
For models:	COE-061, COE-101, COE-102, COE-201, COE-202, COG-061, COG-101, COG-102, COG-201, COG-202, VE-061, VE-101, VE-102, VE-201, VE-202, VG-101, VG-102, VG-201, VG-202, VPE-061, VPE-101, VPE-102, VPE-201, VPE-202, VPG-101, VPG-102, VPG-201, VPG-202		

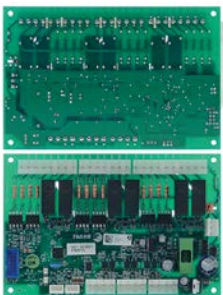
			
1			
GEV No.	403923	Ref. No.	12046673
description	PCB for combi-steamer 61/101 L 150mm W 100mm suitable for FAGOR		
For models:	ACG-061, ACG-101, ACG-102, ACG-201, ACG-202, AG-061, AG-061W, AG-101, AG-101W, AG-102, AG-102W, AG-201, AG-202, APG-061, APG-061W, APG-101, APG-101W, APG-102, APG-102W, APG-201, APG-202		

			
1			
GEV No.	403932	Ref. No.	12130677
description	PCB for combi-steamer L 150mm W 100mm suitable for FAGOR		
For models:	ACG-061, ACG-101, ACG-102, ACG-201, ACG-202, AG-061, AG-101, AG-102, AG-201, AG-202, APG-061, APG-101, APG-102, APG-201, APG-202		

			
1			
GEV No.	403934	Ref. No.	12046659
description	PCB for combi-steamer L 155mm W 100mm		
For models:	ACE-061, ACE-101, ACE-102, ACE-201, ACE-202, ACG-061, ACG-101, ACG-102, ACG-201, ACG-202, AE-061, AE-061W, AE-101, AE-101W, AE-102, AE-102W, AE-201, AE-202, AG-061, AG-061W, AG-101, AG-101W, AG-102, AG-102W, AG-201, AG-202, APE-061, APE-061W, APE-101, APE-101W, APE-102, APE-102W, APE-201, APE-202, APG-061, APG-061W, APG-101, APG-101W, APG-102, APG-102W, APG-201, APG-202, COE-061, COE-101, COG-061, COG-101, VE-061, VE-101, VG-101, VPE-061...(Other models you can see in the webshop)		

			
1			
GEV No.	403931	Ref. No.	12130672
description	PCB for combi-steamer L 155mm W 100mm suitable for FAGOR		
For models:	ACE-061, ACE-101, ACE-102, ACE-201, ACE-202, ACG-061, ACG-101, ACG-102, ACG-201, ACG-202, AE-061, AE-101, AE-102, AE-201, AE-202, AG-061, AG-101, AG-102, AG-201, AG-202, APE-061, APE-101, APE-102, APE-201, APE-202, APG-061, APG-101, APG-102, APG-201, APG-202		

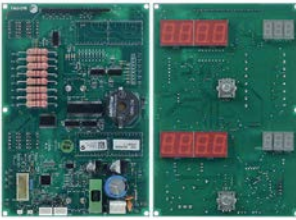
			
1			
GEV No.	403933	Ref. No.	12130674
description	PCB for combi-steamer L 160mm W 110mm		
For models:	ACE-061, ACE-101, ACE-102, ACE-201, ACE-202, ACG-061, ACG-101, ACG-102, ACG-201, ACG-202, AE-061, AE-101, APE-061, APE-101		



1

GEV No.	403930	Ref. No.	12046672
description	PCB for combi-steamer L 176mm W 96mm		
For models:	ACE-061, ACE-101, AE-061, AE-061W, AE-101, AE-101W, AE-102, AE-102W, AE-201, AE-202, AG-061, AG-061W, AG-101, AG-101W, AG-102, AG-102W, AG-201, AG-202, APE-061, APE-101, VE-061, VE-101, VG-101		



1

GEV No.	403918	Ref. No.	12130675
description	PCB for combi-steamer L 177mm W 96mm suitable for FAGOR		
For models:	ACE-061, ACE-101, AE-061, AE-101, AE-102, AE-201, AE-202, AG-061, AG-101, AG-102, AG-201, AG-202, APE-061, APE-101		



1

GEV No.	401629	Ref. No.	12026129 12026671 RT4000049 RT4000049P
description	relay shroud I/O-Board SCC Line		
accessories for	401629		
	GEV No.	Ref. No.	—
	fine fuse size ø6.3x32mm 2A slow-acting rated 250V Qty 10 pcs		



1

GEV No.	401787	Ref. No.	12016841 R693007
description	temperatur p.c.b combi-steamer HEI 6/11 HMI 6/11 °C		



1

GEV No.	401786	Ref. No.	12016954 R693058
description	temperatur p.c.b combi-steamer HMI1011		
For models:	HMG-10-11UL, HMG-10-21UL, HMI-10-11UL, HMI-10-21UL, HMI-6-11UL, HMM-10-11UL, HMM-10-21UL, HMM-20-11, HMM-20-11UL, HMM-20-21UL, HMM-40-11-USMC, HMM-6-11UL, HVG-10-11, HVG-10-11UL, HVG-10-21, HVG-10-21UL, HVG-2-10-11, MFHMM-20-11, MFHVG-10-11, MFHVG-10-21		

central units



1

GEV No.	401790	Ref. No.	12023465 Z953004
description	control box burner regulation		
For models:	COG-061, COG-101, COG-201, GA-20, GA-40, HCG-10-11, HCG-10-21, HCG-20-11, HCG-20-21, HCG-2-10-11, HCG-2-20-11, HCG-6-11, HGC-10-11, HGC-20-11, HGC-6-11, HGV-10-11, HGV-20-11, HVG-10-11, HVG-10-21, HVG-20-11, HVG-20-21, HVG-2-10-11, HVG-2-20-21, VG-101, VG-201, VPG-101, VPG-201		



1

GEV No.	402991	Ref. No.	12024809 Z213069
description	control box for dishwasher 230V		
For models:	AD-120, AD-120B, AD-120C, AD-120HY, AD-15, AD-15D, AD-20C-UK, AD-21, AD-21B, AD-21BDD, AD-21C, AD-21D, AD-21DD, AD-45BBT, AD-48, AD-48B, AD-48BDD, AD-48C, AD-48D, AD-48DD, AD-48HY, AD-64, AD-64B, AD-64BBT, AD-64BDD, AD-64C, AD-64D, AD-64DD, AD-64HY, AD-72, AD-90, AD-90DD, ADE-120, ADE-120B		



keypads

front foils



GEV No.	403816	Ref. No.	12024760 T813005000
description	front foil combi-steamer FAGOR L 480mm W 125mm		
For models:	VE-061, VE-101, VE-201		

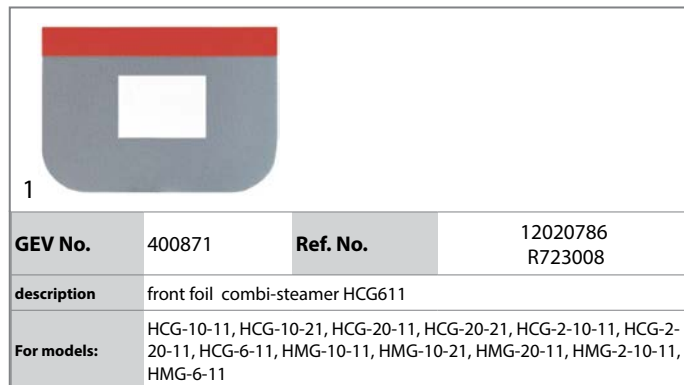

GEV No.	400871	Ref. No.	12020786 R723008
description	front foil combi-steamer HCG611		
For models:	HCG-10-11, HCG-10-21, HCG-20-11, HCG-20-21, HCG-2-10-11, HCG-2-20-11, HCG-6-11, HMG-10-11, HMG-10-21, HMG-20-11, HMG-2-10-11, HMG-6-11		

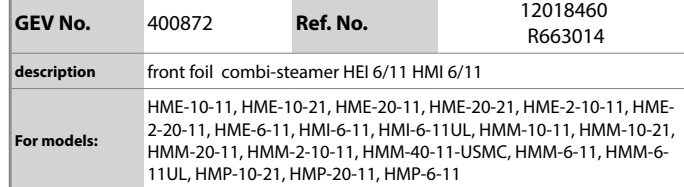

GEV No.	400872	Ref. No.	12018460 R663014
description	front foil combi-steamer HEI 6/11 HMI 6/11		
For models:	HME-10-11, HME-10-21, HME-20-11, HME-20-21, HME-2-10-11, HME-2-20-11, HME-6-11, HMI-6-11, HMI-6-11UL, HMM-10-11, HMM-10-21, HMM-20-11, HMM-2-10-11, HMM-40-11-USMC, HMM-6-11, HMM-6-11UL, HMP-10-21, HMP-20-11, HMP-6-11		

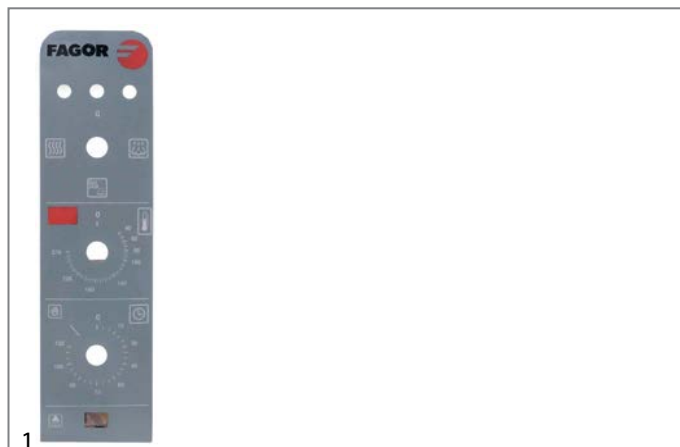

GEV No.	401723	Ref. No.	12019869 R693014
description	front foil combi-steamer HEI611/1011/1021 L 365mm W 98mm		
For models:	HMI-10-11, HMI-10-21, HMI-2-10-11, HMI-6-11		



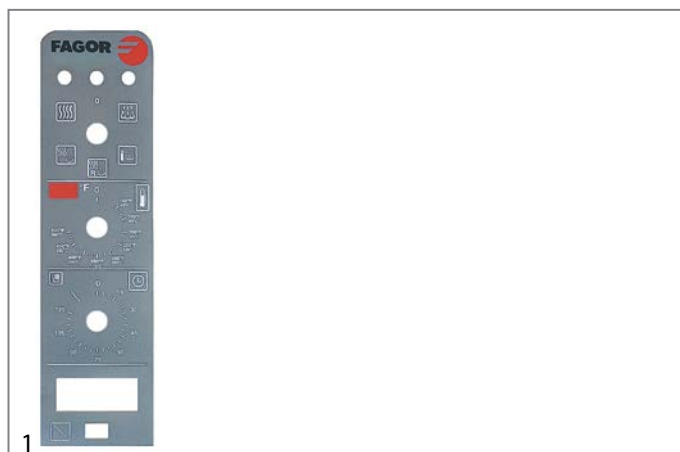

GEV No.	401783	Ref. No.	12018494 R673067
description	front foil combi-steamer HEM 10/11-20/11 L 480mm W 100mm		
For models:	HEM-10-11, HEM-20-11		



GEV No.	400866	Ref. No.	12019113 R693030
description	front foil combi-steamer HMI1011		
For models:	HMI-10-11UL, HMI-10-21UL, HMI-6-11UL		

1 electric components

			
1			
GEV No.	505205	Ref. No.	12020129 Z732901
description	front foil dishwasher ECO120		
For models:	ECO-120, ECO-120B		

			
1			
GEV No.	401843	Ref. No.	12017916 Z322902
description	front foil dishwasher ECO200 L 645mm W 173mm		
For models:	ECO-200, ECO-200D, ECO-200H, ECO-200HD, ECO-200HI, ECO-200I		

			
1			
GEV No.	505125	Ref. No.	12020028 Z710516
description	front foil dishwasher FI-100		
For models:	ECO-120, ECO-120B, ECO-160D, ECO-160I, ECO-200D, ECO-200I, ECO-280D, ECO-280I, ECO-370D, ECO-370I, ECO-460D, ECO-460I, ECO-550D, ECO-550I, FI-100, FI-100AR, FI-100B, FI-100I, FI-120, FI-120B, FI-120W, FI-160D, FI-160I, FI-200D, FI-200I, FI-280D, FI-280I, FI-370D, FI-370I, FI-460D, FI-460I, FI-550D, FI-550I, FI-80, FI-80W		

			
1			
GEV No.	505117	Ref. No.	12020315 Z202909
description	front foil dishwasher FI30		
For models:	FI-30		

			
1			
GEV No.	403240	Ref. No.	12025130
description	front foil dishwasher FI30 grey model FI30 suitable for FAGOR L 585mm W 62.5mm		
For models:	FI-30, FI-30AR, FI-30AR+DD, FI-30-UK		

			
1			
GEV No.	403238	Ref. No.	12023961 Z222903
description	front foil dishwasher FI48 grey model FI-48B suitable for FAGOR L 585mm W 62.5mm		
For models:	FI-48, FI-48B		

			
1			
GEV No.	505119	Ref. No.	12020146 Z212910
description	front foil dishwasher FI-48 run-time 120/180s		
For models:	FI-48, FI-48W		

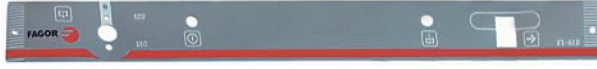
			
1			
GEV No.	505120	Ref. No.	12020147 Z222902
description	front foil dishwasher FI-48B model FI-48B drain pump		
For models:	FI-48B		

			
1			
GEV No.	505118	Ref. No.	12019162 Z232901
description	front foil dishwasher FI-50 model FI-50		
For models:	FI-50		

			
1			
GEV No.	505121	Ref. No.	12018990 Z242901
description	front foil dishwasher FI-64 run-time 90/180s		
For models:	FI-64, FI-64W		

			
1			
GEV No.	505124	Ref. No.	12018622 Z262906
description	front foil dishwasher FI-72		
For models:	FI-72		

			
1			
GEV No.	505123	Ref. No.	12018989 Z252901
description	front foil warewashing FI-64B/FI64W		
For models:	FI-64B		

			
1			
GEV No.	505122	Ref. No.	12019191 Z258501
description	front foil warewashing FI-64B/FI64W model FI-64B/FI64W drain pump		
For models:	FI-64B, MF-64		

1

GEV No.	505128	Ref. No.	Z718502
description	keypad foil		

2

GEV No.	403056	Ref. No.	12031295 6003010194
description	keypad foil blast freezer ATM101 L 200mm W 60mm buttons 8		
For models:	ATM-051, ATM-101		

1

GEV No.	400867	Ref. No.	12019107 12019204 T013006
description	keypad foil combi-steamer HCG611/1011		
For models:	HCG-10-11, HCG-10-21, HCG-20-11, HCG-20-21, HCG-2-10-11, HCG-2-20-11, HCG-6-11, HGC-10-11, HGC-20-11, HGC-6-11		

1

GEV No.	400868	Ref. No.	12019010 R723022
description	keypad foil combi-steamer HCG611/1011		
For models:	HCG-10-11, HCG-10-21, HCG-2-10-11, HCG-6-11, HMG-10-11, HMG-10-21, HMG-20-11, HMG-2-10-11, HMG-6-11		

1

GEV No.	401718	Ref. No.	12018060 T353004
description	keypad foil combi-steamer HEI 1021/HGV 1021 L 670mm W 160mm		
For models:	HEI-10-21, HEI-20-21		

1

GEV No.	400865	Ref. No.	12019205 R673000
description	keypad foil combi-steamer HEM1011/2011 HME1011/1021/2011		
For models:	HME-10-11, HME-10-21, HME-20-11, HME-20-21, HME-2-10-11, HME-2-20-11, HMP-10-11, HMP-10-21, HMP-20-11, HMP-20-21, HMP-2-10-11, HMP-2-20-11		

1

GEV No.	400869	Ref. No.	12020664 R693000
description	keypad foil combi-steamer HMI1011		
For models:	HMI-10-11, HMI-10-11UL, HMI-10-21, HMI-10-21UL, HMI-2-10-11, HMM-10-11, HMM-10-11UL, HMM-10-21, HMM-10-21UL, HMM-20-11, HMM-20-11UL, HMM-20-21, HMM-20-21UL, HMM-2-10-11, HMM-2-20-11, HMM-6-11		

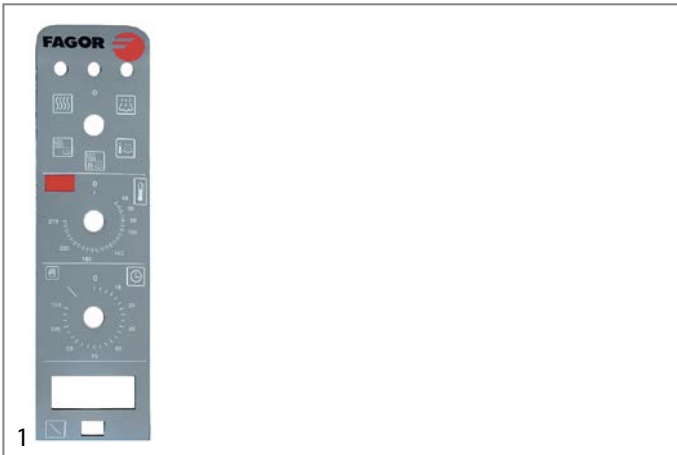

GEV No.	400864	Ref. No.	12020040 12020107 R743012
description	keypad foil combi-steamer HMM2011/2021/22011		
For models:	HMM-10-11, HMM-10-21, HMM-20-11, HMM-20-21, HMM-2-10-11, HMM-2-20-11, HMM-6-11		

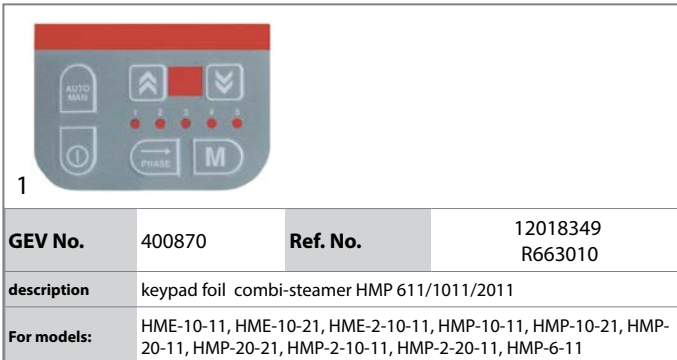

GEV No.	400870	Ref. No.	12018349 R663010
description	keypad foil combi-steamer HMP 611/1011/2011		
For models:	HME-10-11, HME-10-21, HME-2-10-11, HMP-10-11, HMP-10-21, HMP-20-11, HMP-20-21, HMP-2-10-11, HMP-2-20-11, HMP-6-11		

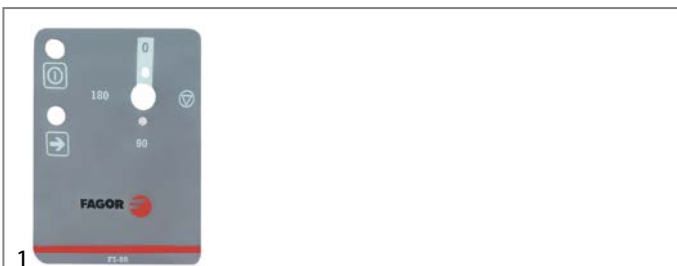

GEV No.	505126	Ref. No.	12019909 Z742906
description	keypad foil dishwasher FI80		
For models:	FI-80		

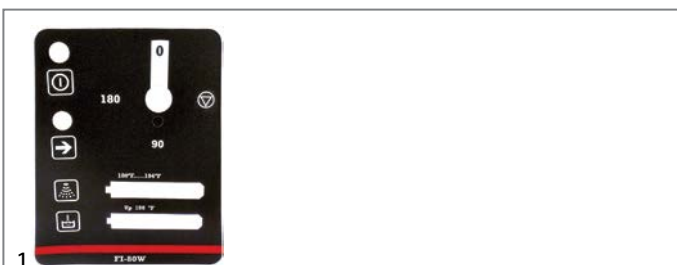

GEV No.	505127	Ref. No.	12019473 Z748404
description	keypad foil dishwasher FI80		
For models:	FI-80W		



GEV No.	505204	Ref. No.	12019475 Z722901
description	keypad foil dishwasher FI120		
For models:	FI-120, FI-120B		



GEV No.	505108	Ref. No.	12020486 Z462901
description	keypad foil dishwasher LVC12		
For models:	LVC-12, LVC-15, LVC-21, LVR-10, LVR-14, LVR-20		



GEV No.	505109	Ref. No.	12018909 Z412901
description	keypad foil dishwasher LVC15		
For models:	LVC-12, LVC-15, LVC-21, LVR-10, LVR-14, LVR-20		



GEV No.	505115	Ref. No.	12019307 Z482901
description	keypad foil dishwasher LVC15D		
For models:	LVC-15D		



GEV No.	505113	Ref. No.	12018973 Z472902
description	keypad foil dishwasher LVC15D/21D/14D/20D		
For models:	LVR-14D		

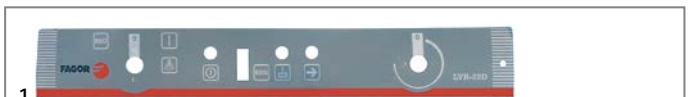

GEV No.	505114	Ref. No.	Z492902
description	keypad foil dishwasher LVC15D/21D/14D/20D		

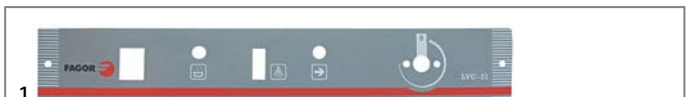

GEV No.	505110	Ref. No.	12020451 Z442901
description	keypad foil dishwasher LVC21		
For models:	LVC-12, LVC-15, LVC-21, LVC-21W, LVR-10, LVR-14, LVR-20		

1

GEV No.	505112	Ref. No.	12019096 Z452901
description	keypad foil dishwasher LVC21B		
For models:	LVC-21B, LVR-20B		

1

GEV No.	505116	Ref. No.	12018125 Z502901
description	keypad foil dishwasher LVC21D		
For models:	LVC-21D		

1

GEV No.	505105	Ref. No.	12019135 Z392901
description	keypad foil dishwasher LVR10		
For models:	LVC-12, LVC-15, LVC-21, LVR-10, LVR-14, LVR-20		

1

GEV No.	505106	Ref. No.	Z402909
description	keypad foil dishwasher LVR14		

1

GEV No.	403927	Ref. No.	12044109
description	keypad foil for combi-steamer black L 540mm W 173mm		
For models:	ACE-061, ACE-101, ACE-102, ACE-201, ACE-202, AE-061, AE-101, APE-061, APE-101		

1

GEV No.	403928	Ref. No.	12044176
description	keypad foil for combi-steamer black L 540mm W 173mm		
For models:	ACG-061, ACG-101, ACG-102, ACG-201, ACG-202		

1

GEV No.	403920	Ref. No.	12129465
description	keypad foil for combi-steamer black suitable for FAGOR L 540mm W 173mm		

1

GEV No.	505202	Ref. No.	12020127 Z712908
description	keypad foil warewashing FI100		
For models:	FI-100, FI-100AR, FI-100B		



GEV No.	505203	Ref. No.	12020324 Z728501
description	keypad foil warewashing FI120		
For models:	FI-120W, MF-120		



GEV No.	505201	Ref. No.	Z742901
description	keypad foil warewashing FI80		

membrane keypads



GEV No.	403466	Ref. No.	12024723
description	membrane keypad dishwasher AD48/AD64 buttons 4 suitable for FAGOR Qty 1 pcs L 585mm W 50mm		
For models:	AD-45BBT, AD-48B, AD-48BDD, AD-48C, AD-64B, AD-64BBT, AD-64BDD, AD-64C		



GEV No.	403467	Ref. No.	12023437
description	membrane keypad dishwasher AD90 buttons 4 suitable for FAGOR Qty 1 pcs L 200mm W 120mm		
For models:	AD-90, AD-90DD		



GEV No.	402579	Ref. No.	12023215
description	membrane keypad warewashing LA13 buttons 6 L 640mm W 160mm		
For models:	LA-13M, LB-AC-10M, LB-E-10M, LB-V-10M		

control panel



GEV No.	403637	Ref. No.	12044139
description	keypad foil combi-steamer APE-061/101 L 540mm W 172mm thickness 1mm		
For models:	ACE-061, ACE-101, AE-061, AE-061W, AE-101, AE-101W, AE-102, AE-102W, AE-201, AE-202, AG-061, AG-061W, AG-101, AG-101W, AG-102, AG-102W, AG-201, AG-202, APE-061, APE-101		

solenoid valves

solenoid valves (water)

ELBI

straight



GEV No.	373021	Ref. No.	12032024 RT30020330
----------------	--------	-----------------	------------------------

description solenoid valve double straight 230VAC inlet 3/4" outlet 11.5mm output 1x 4.7l/min DN10 ELBI

spare parts for 373021

GEV No.	370467	Ref. No.	—
----------------	--------	-----------------	---

description solenoid valve filter suitable for ELBI

Table continues overleaf

spare parts for 373021			
	GEV No.	371263	Ref. No. —
reducer ELBI type EATON (INVENSYS) flow rate 4.7l/min pressure range 0 up to 10bar tolerance ±15/25% grey			

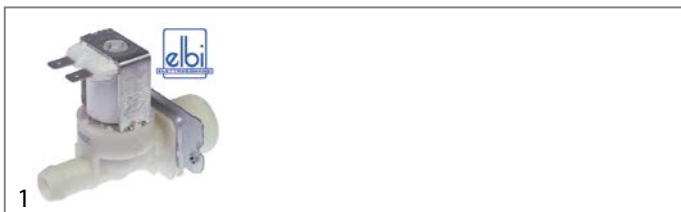

GEV No.	373018	Ref. No.	RT30020331
description	solenoid valve single straight 230VAC inlet 3/4" outlet 14mm DN10 ELBI		

spare parts for 373018			
	GEV No.	370467	Ref. No. —
solenoid valve filter suitable for ELBI			

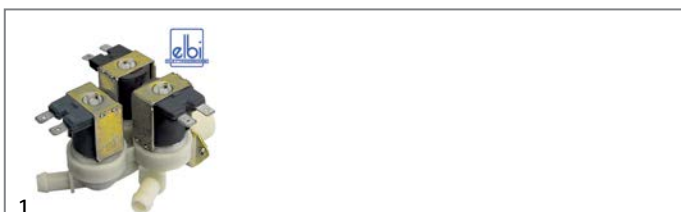

GEV No.	373025	Ref. No.	12023921 Z611123
description	solenoid valve triple straight 230VAC inlet 3/4" outlet 11.5mm DN10 ELBI		

For models: AE-061, AE-061W, AE-101, AE-101W, AE-102, AE-102W, AE-201, AE-202, AG-061, AG-061W, AG-101, AG-101W, AG-102, AG-102W, AG-201, AG-202, APE-061, APE-061W, APE-101, APE-101W, APE-102, APE-102W, APE-201, APE-202, APG-061, APG-061W, APG-101, APG-101W, APG-102, APG-102W, APG-201, APG-202, HEM-10-11, HEM-20-11, HEM-6-11, HEP-10-11, HEP-20-11, HEP-6-11, LA-13M, LA-18MP, LA-25M, LA-AC-10M, LA-AC-10MA, LA-AC-10MP, LA-AC-13M, LA-AC-13MA, LA-AC-13MP, LA-AC-18M, LA-AC-18MA, LA-AC-18MP...(Other models you can see in the webshop)

spare parts for 373025			
	GEV No.	370467	Ref. No. —
solenoid valve filter suitable for ELBI			



GEV No.	370852	Ref. No.	12032546 RT5000139
description	solenoid valve single straight 230VAC inlet 3/4" outlet 11.5mm DN10		



GEV No.	370851	Ref. No.	12031080 RT5000138
description	solenoid valve double straight 230VAC inlet 3/4" outlet 11.5mm DN10		



GEV No.	370849	Ref. No.	12115418
description	solenoid valve triple straight 220-240V/50-60Hz inlet 3/4" outlet 10.5 t.max. 90°C duty cycle 100% ELBI 369 plastic flow regulating valve inlet black		
For models:	AE-061, AE-061W, AE-101, AE-101W, AE-102, AE-102W, AE-201, AE-202, AG-061, AG-061W, AG-101, AG-101W, AG-102, AG-102W, AG-201, AG-202, APE-061, APE-061W, APE-101, APE-101W, APE-102, APE-102W, APE-201, APE-202, APG-061, APG-061W, APG-101, APG-101W, APG-102, APG-102W, APG-201, APG-202		

ROBERTSHAW/INVENSYS

medium temperature: 90°C 90°C 60°C
ambient temperature: 60°C 25°C 60°C
duty cycle: 40% 100% 100%



GEV No.	372025	Ref. No.	12003285 Z611124
description	solenoid valve triple straight 230VAC inlet 3/4" outlet 11.5mm DN10 EATON (INVENSYS)		
For models:	AD-15D, AD-21D, LVC-15D, LVC-21D, LVR-14D, LVR-20D		









with coded terminal



GEV No.	370270	Ref. No.	12029780 RT30020343
description	solenoid valve single straight 230VAC inlet 3/8" outlet 3/8" DN10 Invensys		



RPE			
solenoid valves with reducers			
single			
			
1			
GEV No.	370440	Ref. No.	BR00010368
description	solenoid valve 1-fold, without membrane (constantly open) angled inlet 3/4" outlet 11.5mm input 10-12l/min RPE plastic flow regulating valve inlet white		

TP			
			
1			
GEV No.	370021	Ref. No.	12023794 12032085 EU929172 P255001
description	solenoid valve double straight 230VAC inlet 3/4" outlet 11.5mm DN10 TP flow regulating valve inlet white		
For models:	ACE-061, ACE-101, ACE-102, ACE-201, ACE-202, ACG-061, ACG-101, ACG-102, ACG-201, ACG-202, AD-15, AD-20C-UK, AD-21, AD-21B, AD-21BDD, AD-21C, AD-21DD, AD-21W, AD-48D, AD-64D, AE-061, AE-101, AE-102, AE-201, AE-202, AG-061, AG-101, AG-102, AG-201, AG-202, COE-061, COE-101, COE-102, COE-201, COE-202, CPE9-05, CPE9-05AD, CPE9-05AD-S, CPE9-05NC, CPE9-05PLUS, CPE9-05PLUS-S, CPE9-05S, CPE9-05SNC, CPG9-05, CPG9-05AD, CPG9-05AD-S, CPG9-05NC, CPG9-05PLUS, CPG9-05PLUS-S, CPG9-05S...(Other models you can see in the webshop)		
spare parts for	370021		
	GEV No.	371013	Ref. No. —
solenoid coil TP 230VAC 50/60Hz			
accessories for	370021		
	GEV No.	371220	Ref. No. —
reducer TP flow rate 3l/min red tolerance ±15%			
	GEV No.	371221	Ref. No. —
reducer TP flow rate 5.5l/min yellow tolerance ±15%			
	GEV No.	371222	Ref. No. —
reducer TP flow rate 6l/min grey tolerance ±15%			
	GEV No.	371223	Ref. No. —
reducer TP flow rate 10l/min white tolerance ±15%			
	GEV No.	371224	Ref. No. —
reducer TP flow rate 12l/min bronze tolerance ±15%			
	GEV No.	371225	Ref. No. —
reducer TP flow rate 16l/min light brown tolerance ±15%			
	GEV No.	371226	Ref. No. —
reducer TP flow rate 20l/min red tolerance ±15%			

accessories for	370021		
	GEV No.	371230	Ref. No. —
reducer TP flow rate 0.25l/min red tolerance ±25%			
	GEV No.	371231	Ref. No. —
reducer TP flow rate 0.35l/min violet tolerance ±25%			
	GEV No.	371232	Ref. No. —
reducer TP flow rate 0.5l/min orange tolerance ±25%			
	GEV No.	371233	Ref. No. —
reducer TP flow rate 0.8l/min white tolerance ±25%			
	GEV No.	371234	Ref. No. 12025263 P305013
reducer TP flow rate 1l/min light blue tolerance ±25%			
	GEV No.	371235	Ref. No. —
reducer TP flow rate 1.2l/min brown tolerance ±25%			
	GEV No.	371236	Ref. No. —
reducer TP flow rate 1.5l/min light brown tolerance ±25%			
	GEV No.	371237	Ref. No. —
reducer TP flow rate 2.5l/min yellow tolerance ±25%			
	GEV No.	371238	Ref. No. —
reducer TP flow rate 3.4l/min dark green tolerance ±25%			
	GEV No.	371239	Ref. No. —
reducer TP flow rate 5l/min black tolerance ±25%			
	GEV No.	371240	Ref. No. —
reducer TP flow rate 8l/min blue tolerance ±20%			



			
1			
GEV No.	370017	Ref. No.	12025161 Z701135
description	solenoid valve single straight 230VAC inlet 3/4" outlet 11.5mm DN10 TP p max 10bar		
For models:	ACE-061, ACE-101, ACE-102, ACE-201, ACE-202, ACG-061, ACG-101, ACG-102, ACG-201, ACG-202, AD-120, AD-120B, AD-120BTTDD-UK, AD-120C, AD-120HY, AD-45BBT, AD-48, AD-48B, AD-48BDD, AD-48C, AD-48DD, AD-48HY, AD-48W, AD-64, AD-64B, AD-64BBT, AD-64BDD, AD-64BTTDD, AD-64C, AD-64CW, AD-64D, AD-64DD, AD-64HY, AD-72, AD-72W, AD-90, AD-90BA, AD-90BBT, AD-90BDD, AD-90DD, AE-061, AE-061W, AE-101, AE-101W, AE-102, AE-102W, AE-201, AE-202, AG-061, AG-061W...(Other models you can see in the webshop)		
spare parts for	370017		
	GEV No.	371013	Ref. No. —
solenoid coil TP 230VAC 50/60Hz			
accessories for	370017		
	GEV No.	371220	Ref. No. —
reducer TP flow rate 3l/min red tolerance ±15%			

Table continues overleaf



accessories for		370017		
	GEV No.	371221	Ref. No.	—
reducer TP flow rate 5.5l/min yellow tolerance ±15%				
	GEV No.	371222	Ref. No.	—
reducer TP flow rate 6l/min grey tolerance ±15%				
	GEV No.	371223	Ref. No.	—
reducer TP flow rate 10l/min white tolerance ±15%				
	GEV No.	371224	Ref. No.	—
reducer TP flow rate 12l/min bronze tolerance ±15%				
	GEV No.	371225	Ref. No.	—
reducer TP flow rate 16l/min light brown tolerance ±15%				
	GEV No.	371226	Ref. No.	—
reducer TP flow rate 20l/min red tolerance ±15%				
	GEV No.	371230	Ref. No.	—
reducer TP flow rate 0.25l/min red tolerance ±25%				
	GEV No.	371231	Ref. No.	—
reducer TP flow rate 0.35l/min violet tolerance ±25%				
	GEV No.	371232	Ref. No.	—
reducer TP flow rate 0.5l/min orange tolerance ±25%				
	GEV No.	371233	Ref. No.	—
reducer TP flow rate 0.8l/min white tolerance ±25%				
	GEV No.	371234	Ref. No.	12025263 P305013
reducer TP flow rate 1l/min light blue tolerance ±25%				
	GEV No.	371235	Ref. No.	—
reducer TP flow rate 1.2l/min brown tolerance ±25%				
	GEV No.	371236	Ref. No.	—
reducer TP flow rate 1.5l/min light brown tolerance ±25%				
	GEV No.	371237	Ref. No.	—
reducer TP flow rate 2.5l/min yellow tolerance ±25%				
	GEV No.	371238	Ref. No.	—
reducer TP flow rate 3.4l/min dark green tolerance ±25%				
	GEV No.	371239	Ref. No.	—
reducer TP flow rate 5l/min black tolerance ±25%				
	GEV No.	371240	Ref. No.	—
reducer TP flow rate 8l/min blue tolerance ±20%				





			
			
1			
GEV No.	370018	Ref. No.	12034078
description	solenoid valve single straight 230VAC inlet 3/4" outlet 14mm DN10 TP		
spare parts for	370018		
	GEV No.	371013	Ref. No.
solenoid coil TP 230VAC 50/60Hz			
accessories for	370018		
	GEV No.	371220	Ref. No.
reducer TP flow rate 3l/min red tolerance ±15%			
	GEV No.	371221	Ref. No.
reducer TP flow rate 5.5l/min yellow tolerance ±15%			
	GEV No.	371222	Ref. No.
reducer TP flow rate 6l/min grey tolerance ±15%			
	GEV No.	371223	Ref. No.
reducer TP flow rate 10l/min white tolerance ±15%			
	GEV No.	371224	Ref. No.
reducer TP flow rate 12l/min bronze tolerance ±15%			
	GEV No.	371225	Ref. No.
reducer TP flow rate 16l/min light brown tolerance ±15%			
	GEV No.	371226	Ref. No.
reducer TP flow rate 20l/min red tolerance ±15%			
	GEV No.	371230	Ref. No.
reducer TP flow rate 0.25l/min red tolerance ±25%			
	GEV No.	371231	Ref. No.
reducer TP flow rate 0.35l/min violet tolerance ±25%			
	GEV No.	371232	Ref. No.
reducer TP flow rate 0.5l/min orange tolerance ±25%			
	GEV No.	371233	Ref. No.
reducer TP flow rate 0.8l/min white tolerance ±25%			
	GEV No.	371234	Ref. No.
reducer TP flow rate 1l/min light blue tolerance ±25%			
	GEV No.	371235	Ref. No.
reducer TP flow rate 1.2l/min brown tolerance ±25%			
	GEV No.	371236	Ref. No.
reducer TP flow rate 1.5l/min light brown tolerance ±25%			
	GEV No.	371237	Ref. No.
reducer TP flow rate 2.5l/min yellow tolerance ±25%			

Table continues overleaf





drain valves

 <p>1</p>			
GEV No.	401889	Ref. No.	12026018 RT5400357
description	drain valve 12V single inlet 40mm outlet 40mm for combi-steamer		
accessories for	401889		
	GEV No.	532727	Ref. No. 12037152 RT1000512
	O-ring silicone thickness 3.5mm ID ø 26mm Qty 5 pcs for model SCC, CM		
	GEV No.	532728	Ref. No. 12037113 RT1000511
	O-ring silicone thickness 3.5mm ID ø 46mm Qty 5 pcs for model SCC, CM		

 <p>1</p>			
GEV No.	370789	Ref. No.	12024781 P302120
description	drain valve 220-240V 50/60Hz NO inlet 50mm outlet 50/35mm MDB-O-2-SO		
For models:	LA-13M, LA-18MP, LA-AC-10M, LA-AC-10MA, LA-AC-10MP, LA-AC-13M, LA-AC-13MA, LA-AC-13MP, LA-AC-18M, LA-AC-18MA, LA-AC-18MP, LAC-10, LAC-10MP, LAC-10MPP, LAC-14, LAC-14MP, LAC-14MPP, LAC-7, LAC-7MP, LAC-7MPP, LA-E-10M, LA-E-10MA, LA-E-10MP, LA-E-13M, LA-E-13MA, LA-E-13MP, LA-E-18M, LA-E-18MA, LA-E-18MP, LA-V-10M, LA-V-10MP, LA-V-13M, LA-V-13MP, LA-V-18M, LA-V-18MP, LB-AC-10M, LB-E-10M, LB-V-10M, LC-10, LC-14, LC-7, LC-AC-10, LC-AC-10A, LC-AC-14, LC-AC-14A, LC-AC-7, LC-AC-7A, LC-E-10, LC-E-10A, LC-E-14... (Other models you can see in the webshop)		

Solenoid valve - accessories

 <p>1</p>			
GEV No.	500738	Ref. No.	12039924 R725047
description	fastening angle for solenoid coil		
For models:	HMG-10-11, HMG-10-11UL, HMG-10-21, HMG-10-21UL, HMG-2-10-11, HMG-6-11		

 <p>1</p>			
GEV No.	699812	Ref. No.	12036665 RT5000086
description	locking plate for solenoid valve L 37mm W 29mm H 4mm		

pressure switches

for warewashing

ø 58mm with male faston 6.3mm

with connection horizontal

 <p>1</p>			
GEV No.	541137	Ref. No.	12025063 Z513001
description	pressure control pressure range 155/40mbar connection 6mm ø 58mm pressure connection horizontal warewashing		
For models:	ECO-2700D, ECO-2700I, ECO-4000D, ECO-4000I, ECO-6000D, ECO-6000I, FI-120HY-CLINIC, FI-2700D, FI-2700I, FI-4000D, FI-4000I, FI-6000D, FI-6000I		

 <p>1</p>			
GEV No.	541776	Ref. No.	12023804 Z713002
description	pressure control pressure range 170/95mbar connection 6mm ø 58mm pressure connection horizontal warewashing		
For models:	AD-120, AD-120B, AD-120BTTDD-UK, AD-120C, AD-120CW, AD-120HY, AD-45BBT, AD-48HY, AD-64BBT, AD-64HY, AD-90, AD-90BA, AD-90BBT, AD-90BDD, AD-90DD, ADE-120, ADE-120B, ECO-120, ECO-120B, FI-100, FI-100AR, FI-100B, FI-100BBT-UK, FI-120, FI-120AR+DD, FI-120B, FI-120C, FI-120HY-CLINIC, FI-120W, FI-80, FI-80AR, FI-80BBT-UK, FI-80W, FI-E-100, LABP-1000, LABP-1200, LABP-800, MF-120		

 <p>1</p>			
GEV No.	541885	Ref. No.	12023855 Z273006
description	pressure control pressure range 205/40mbar connection 6mm ø 58mm pressure connection horizontal pressure connection ø 5.5mm		
For models:	ECO-160, ECO-160D, ECO-160I, ECO-200, ECO-200D, ECO-200H, ECO-200HD, ECO-200HI, ECO-200I, ECO-280D, ECO-280I, ECO-370D, ECO-370I, ECO-460D, ECO-460I, ECO-550D, ECO-550I, FI-160, FI-160AR, FI-160D, FI-160I, FI-200, FI-200AR, FI-200D, FI-200H, FI-200HD, FI-200HI, FI-200I, FI-200W, FI-200WL, FI-200WR, FI-280D, FI-280I, FI-370D, FI-370I, FI-460D, FI-460I, FI-550D, FI-550I		



GEV No.	541683	Ref. No.	Z273006 old
description	pressure control pressure range 205/40mbar connection male faston 6.3mm ø 58mm pressure connection horizontal pressure connection ø 6mm		



GEV No.	541832	Ref. No.	12023856 Z713098
description	pressure control pressure range 24.7/22.2mbar connection 6mm ø 58mm pressure connection horizontal warewashing pressure connection ø 6mm		
For models:	AD-120B, AD-120BTTDD-UK, AD-120C, AD-120HY, AD-90BA, AD-90BBT, AD-90BDD, ADE-120B, ECO-120B, FI-100, FI-100AR, FI-100B, FI-100BBT-UK, FI-120B, FI-120C, FI-120HY-CLINIC, FI-80BBT-UK		



GEV No.	541864	Ref. No.	12023803 Z403021
description	pressure control pressure range 28/13mbar connection 6mm ø 58mm pressure connection horizontal warewashing suitable for FAGOR		
For models:	AD-15, AD-15D, AD-21, AD-21B, AD-21C, AD-21D, AD-21DD, CO-350, CO-350-B, CO-350-B-DD, CO-350-COLD, CO-350-COLD-B, CO-350-COLD-B-DD, CO-350-COLD-DD, CO-352-COLD, CO-352-COLD-B, CO-352-COLD-B-DD, CO-352-COLD-DD, CO-400, CO-400-B, CO-400-B-DD, CO-400-COLD, CO-400-COLD-B, CO-400-COLD-B-DD, CO-400-COLD-DD, CO-400-DD, CO-400-SOFT, CO-402-COLD, CO-402-COLD-B, CO-402-COLD-B-DD, CO-402-COLD-DD, ECO-280D, ECO-280I, ECO-370D, ECO-370I, ECO-460D, ECO-460I, ECO-550D, ECO-550I, FI-160AR, FI-160D, FI-160I, FI-200AR, FI-200D, FI-200HD, FI-200HI, FI-200I, FI-200WL, FI-200WR...(Other models you can see in the webshop)		



GEV No.	541302	Ref. No.	12023802 Z203023
description	pressure control pressure range 40/15mbar connection 6mm ø 58mm pressure connection horizontal warewashing		
For models:	AD-45BBT, AD-48, AD-48B, AD-48BDD, AD-48C, AD-48D, AD-48DD, AD-48HY, AD-48W, AD-64, AD-64B, AD-64BBT, AD-64BDD, AD-64BTDD, AD-64C, AD-64CW, AD-64D, AD-64DD, AD-64HY, AD-72, AD-72W, EASY-500, EASY-500B, EASY-500DD, EASY-500HP, EASY-500HPWBDD, FI-120HY-CLINIC, FI-30, FI-30AR, FI-30AR+DD, FI-30B, FI-30B-BT-UK, FI-30-UK, FI-48, FI-48AR, FI-48B, FI-48B-BT-UK, FI-48C, FI-48D, FI-48HY-CLINIC, FI-48W, FI-50, FI-60DD, FI-64, FI-64AR, FI-64B, FI-64B-BT-UK, FI-64C, FI-64D, FI-64HY-CLINIC...(Other models you can see in the webshop)		



GEV No.	541593	Ref. No.	12023854 Z313006
description	pressure control pressure range 50/35mbar connection 6mm ø 58mm pressure connection horizontal		
For models:	ECO-2700D, ECO-2700I, ECO-280D, ECO-280I, ECO-370D, ECO-370I, ECO-4000D, ECO-4000I, ECO-460D, ECO-460I, ECO-550D, ECO-550I, ECO-6000D, ECO-6000I, FI-2700D, FI-2700I, FI-280D, FI-280I, FI-370D, FI-370I, FI-4000D, FI-4000I, FI-460D, FI-460I, FI-550D, FI-550I, FI-6000D, FI-6000I		



GEV No.	541594	Ref. No.	12020076 Z683071
description	pressure control pressure range 85/50mbar connection 6mm ø 58mm pressure connection horizontal pressure connection ø 6mm		
For models:	ECO-1200, FI-1200, FI-900		



GEV No.	541299	Ref. No.	12023805 Z223005
description	pressure control pressure range 95/75mbar connection 6mm ø 58mm pressure connection horizontal warewashing pressure connection ø 6mm		
For models:	AD-48B, AD-48BDD, AD-48C, AD-48HY, AD-48W, AD-64B, AD-64BBT, AD-64BDD, AD-64C, AD-64CW, AD-64HY, AD-72W, EASY-500B, EASY-500HPWBDD, FI-30, FI-30AR, FI-30AR+DD, FI-30B, FI-30B-BT-UK, FI-30-UK, FI-48, FI-48AR, FI-48B, FI-48B-BT-UK, FI-48C, FI-48D, FI-48HY-CLINIC, FI-48W, FI-64, FI-64AR, FI-64B, FI-64B-BT-UK, FI-64C, FI-64D, FI-64HY-CLINIC, FI-64W, MF-48, MF-64		



ø 84mm with coded plug



GEV No.	541296	Ref. No.	12024981 Z433011
description	pressure control 2 pressure ranges pressure range 28/13 65/50mbar connection 6mm ø 84mm pressure connection horizontal warewashing pressure connection ø 5.5mm		
For models:	AD-20C-UK, AD-21B, AD-21BDD, AD-21C, AD-21W, CO-350, CO-350-B, CO-350-B-DD, CO-350-COLD, CO-350-COLD-B, CO-350-COLD-B-DD, CO-350-COLD-DD, CO-350-DD, CO-352-COLD, CO-352-COLD-B, CO-352-COLD-B-DD, CO-352-COLD-DD, CO-400, CO-400-B, CO-400-B-DD, CO-400-COLD, CO-400-COLD-B, CO-400-COLD-B-DD, CO-400-COLD-DD, CO-400-DD, CO-400-SOFT, CO-402-COLD, CO-402-COLD-B, CO-402-COLD-B-DD, CO-402-COLD-DD, CO-402W, LVC-21B, LVC-21C, LVC-21W, MF-21		



GEV No.	541592	Ref. No.	12024269 Z213059
description	pressure control 3 pressure ranges pressure range 40/15 120/60 150/95mbar connection 6mm ø 84mm pressure connection ø 6mm		
For models:	AD-120BTTDD-UK, AD-120HY, AD-45BBT, AD-48HY, AD-64BBT, AD-64BTDD, AD-64HY, AD-90BA, AD-90BBT, AD-90BDD, EASY-500HPWBDD, FI-100BBT-UK, FI-120HY-CLINIC, FI-30B-BT-UK, FI-48B-BT-UK, FI-48HY-CLINIC, FI-64B-BT-UK, FI-64HY-CLINIC, FI-80BBT-UK		



GEV No.	541297	Ref. No.	12020019 Z103074
description	pressure control pressure range 28/13mbar connection 6mm ø 84mm pressure connection horizontal warewashing suitable for FAGOR pressure connection ø 6mm		
For models:	ECO-160, ECO-1600, ECO-200, ECO-200H, ECO-2300, ECO-2700D, ECO-2700I, ECO-280D, ECO-280I, ECO-3000, ECO-370D, ECO-370I, ECO-4000D, ECO-4000I, ECO-460D, ECO-460I, ECO-550D, ECO-550I, ECO-6000D, ECO-6000I, FI-160, FI-1600, FI-160D, FI-160I, FI-200, FI-200D, FI-200H, FI-200HD, FI-200HI, FI-200I, FI-200W, FI-2300, FI-2700D, FI-2700I, FI-280D, FI-280I, FI-3000, FI-370D, FI-370I, FI-4000D, FI-4000I, FI-460D, FI-460I, FI-550D, FI-550I, FI-6000D, FI-6000I, LVC-12, LVC-15, LVC-15D...(Other models you can see in the webshop)		

miscellaneous

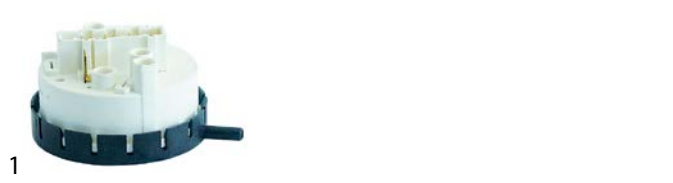

GEV No.	541603	Ref. No.	12040359 Z433003
description	pressure control pressure range 28/13 65/50mbar connection coded plug ø 75mm pressure connection horizontal warewashing pressure connection ø 5.5mm		
For models:	LVC-21B, LVR-20, LVR-20B		

accessories



GEV No.	541598	Ref. No.	12023163 Z602923
description	bracket stainless steel H 37mm L 60mm W 12mm for pressure switch		
For models:	AD-120, AD-120B, AD-120BTTDD-UK, AD-120C, AD-120CW, AD-120HY, AD-45BBT, AD-48HY, AD-48W, AD-64BBT, AD-64BTDD, AD-64CW, AD-64HY, AD-72W, AD-90, AD-90BA, AD-90BBT, AD-90BDD, AD-90DD, ADE-120, ADE-120B, CO-350, CO-350-B, CO-350-B-DD, CO-350-COLD, CO-350-COLD-B, CO-350-COLD-B-DD, CO-350-COLD-DD, CO-350-DD, CO-352-COLD, CO-352-COLD-B, CO-352-COLD-B-DD, CO-352-COLD-DD, CO-400, CO-400-B, CO-400-B-DD, CO-400-COLD, CO-400-COLD-B, CO-400-COLD-B-DD, CO-400-COLD-DD, CO-400-DD, CO-400-SOFT, CO-402-COLD, CO-402-COLD-B, CO-402-COLD-B-DD, CO-402-COLD-DD, CO-402W, EASY-500, EASY-500B, EASY-500DD...(Other models you can see in the webshop)		



GEV No.	541109	Ref. No.	12023510 Z103077
description	Y-piece plastic hose ø 8-6-8mm for pressure switch		
For models:	AD-120B, AD-120BTTDD-UK, AD-120C, AD-120HY, AD-45BBT, AD-48B, AD-48BDD, AD-48C, AD-48HY, AD-48W, AD-64B, AD-64BBT, AD-64BDD, AD-64BTDD, AD-64C, AD-64CW, AD-64HY, AD-72W, AD-90BA, AD-90BBT, AD-90BDD, ADE-120B, CO-500, CO-500B, CO-500BDD, CO-500DD, CO-501, CO-501B, CO-501BDD, CO-501DD, CO-501-SOFT, CO-502B, CO-502BDD, CO-502DD, CO-502W, COP-503, COP-503B, COP-503BDD, COP-503DD, COP-503-SOFT, COP-504, COP-504B, COP-504BDD, COP-504DD, COP-504W, EASY-500B, EASY-500HPWBDD, ECO-120B, ECO-160, ECO-1600...(Other models you can see in the webshop)		



for gas equipment



1

GEV No.	541108	Ref. No.	12029376 RT30171004
description	pressure control		



1

GEV No.	541304	Ref. No.	12018227 R723004
description	pressure control pressure range 2.7/2.15mbar pressure connection horizontal gas technology connection 6mm		
For models:	HCG-10-11, HCG-10-21, HCG-20-11, HCG-2-10-11, HCG-6-11, HMG-10-11, HMG-10-21, HMG-20-11, HMG-2-10-11, HMG-6-11		



1

GEV No.	541111	Ref. No.	12030211 RT30171010
description	pressure control pressure range adjustable 0.2- 3mbar pressure connection horizontal gas technology connection 6mm suitable for RATIONAL		

for steam control



1

GEV No.	541769	Ref. No.	12024188 S093000
description	pressure control ø 45mm kettle pressure range up to 1.0bar connection 1/4" 250V 8A p max 1bar pressure connection 1/4"		
For models:	ME7-10BM, ME9-10BM, ME9-10BMS, ME9-10PLUS-BM, ME9-10PLUS-BMS, ME9-15BM, ME9-15BM316, ME9-15BM-AD, ME9-15BMS, ME9-15PLUS-BM, ME9-15PLUS-BMS, MG9-10BMAD, MG9-10BMSAD, MG9-10PLUS-BM, MG9-10PLUS-BMS, MG9-15BMAD, MG9-15BMSAD, MG9-15PLUS-BM, MG9-15PLUS-BMS, MPE9-10BM, MPE9-10BMS, MPE9-15BM, MPE9-15BMS		

for combi-steamers



1

GEV No.	345709	Ref. No.	12027847 RT30171011
description	pressure control ø 84mm pressure range 0-3mbar for humidity measuring connection 6mm p max 0.025bar pressure connection 6mm		



1

GEV No.	345218	Ref. No.	12026621 RT30171002
description	pressure control pressure range 0-3mbar connection 6mm pressure connection 6mm		

for refrigeration

SAGI NO MIYA



1

GEV No.	541479	Ref. No.	12030110 12031100 BR00023117 BR00023175
description	pressure control HD reset automatic refrigeration type HTB-X114 connection 2.4mm		

miscellaneous





1

GEV No.	542434	Ref. No.	507476
description	pressure control switch-off pressure 16bar switch-on pressure 18bar reset automatic type NSDHF10A00101 refrigeration -30 up to +85°C pressure connection soldering connection 6.35mmmm connection male faston 6.3mm		





electrodes

 <p>1</p>			
GEV No.	694804	Ref. No.	12024460 R345069
description	duct for level electrode screw mounting total length 49mm plastic ø 8mm		
For models:	ACE-061, ACE-102, AE-061, AE-061W, AE-101, AE-101W, AE-102, AE-102W, AE-201, AE-202, AG-061, AG-061W, AG-101, AG-101W, AG-102, AG-102W, AG-201, AG-202, APE-061, APE-061W, APE-101, APE-101W, APE-102, APE-102W, APE-201, APE-202, APG-061, APG-061W, APG-101, APG-101W, APG-102, APG-102W, APG-201, APG-202, GA-20, GA-20D, GA-40, GA-40D, ME9-10PLUS-BM, ME9-10PLUS-BMS, ME9-15BM-AD, ME9-15PLUS-BM, ME9-15PLUS-BMS, MG9-10BMAD, MG9-10BMSAD, MG9-10PLUS-BM, MG9-10PLUS-BMS, MG9-15BMAD, MG9-15BMSAD, MG9-15PLUS-BM...(Other models you can see in the webshop)		

 <p>2</p>			
GEV No.	400163	Ref. No.	12038015 RT30020409
description	level electrode PG9 total length 100mm probe L 72/43/22mm insulated probe length 70/62/52mm with 3 probes connection grip connection		

 <p>1</p>			
GEV No.	403138	Ref. No.	12130422 RT8701220
description	level electrode PG9 total length 100mm probe L 85mm insulated probe length 70mm with connection cable connection coded plug		

 <p>1</p>			
GEV No.	400021	Ref. No.	12032499 RT30020401
description	level electrode PG9 total length 110mm probe L 70/47/24mm insulated probe length 62/38/16mm with 3 probes connection grip connection		

 <p>1</p>			
GEV No.	400022	Ref. No.	12031231 RT30020402
description	level electrode PG9 total length 135mm probe L 89/59/28mm insulated probe length 80mm with 3 probes connection grip connection		
accessories for	400022		
	GEV No.	Ref. No.	—
	 connection cable L 1230mm 4-pole for level electrode plug type coded		

accessories for	400022		
	GEV No.	Ref. No.	—
	 nut thread PG9 H 3mm WS 28 nickel-plated brass Qty 1 pcs mounting ømm cable ømm		

 <p>1</p>			
GEV No.	400884	Ref. No.	12023573 R345060
description	level electrode push-in total length 105mm probe L 95mm insulated probe lengthmm connection M4		
For models:	ACE-061, ACE-102, AE-061, AE-061W, AE-101, AE-101W, AE-102, AE-102W, AE-201, AE-202, AG-061, AG-061W, AG-101, AG-101W, AG-102, AG-102W, AG-201, AG-202, APE-061, APE-061W, APE-101, APE-101W, APE-102, APE-102W, APE-201, APE-202, APG-061, APG-061W, APG-101, APG-101W, APG-102, APG-102W, APG-201, APG-202, GA-20, GA-20D, GA-40, GA-40D, HCV-10-11, HCV-10-21, HCV-2-10-21, HCV-5-11, HCV-6-11, HEM-10-11, HEM-10-21, HEM-20-11, HEM-20-21, HEM-6-11, HEP-10-11, HEP-10-21...(Other models you can see in the webshop)		

 <p>1</p>			
GEV No.	400885	Ref. No.	12023574 R345063
description	level electrode push-in total length 120mm probe L 110mm insulated probe lengthmm connection M4		
For models:	ACE-061, ACE-102, AE-061, AE-061W, AE-101, AE-101W, AE-102, AE-102W, AE-201, AE-202, AG-061, AG-061W, AG-101, AG-101W, AG-102, AG-102W, AG-201, AG-202, APE-061, APE-061W, APE-101, APE-101W, APE-102, APE-102W, APE-201, APE-202, APG-061, APG-061W, APG-101, APG-101W, APG-102, APG-102W, APG-201, APG-202, GA-20, GA-20D, GA-40, GA-40D, HCV-10-11, HCV-10-21, HCV-2-10-21, HCV-5-11, HCV-6-11, HEM-10-11, HEM-10-21, HEM-20-11, HEM-20-21, HEM-6-11, HEP-10-11, HEP-10-21...(Other models you can see in the webshop)		

 <p>1</p>			
GEV No.	400886	Ref. No.	12023575 R345064
description	level electrode push-in total length 130mm probe L 120mm insulated probe lengthmm connection M4		
For models:	ACE-061, ACE-102, AE-061, AE-061W, AE-101, AE-101W, AE-102, AE-102W, AE-201, AE-202, AG-061, AG-061W, AG-101, AG-101W, AG-102, AG-102W, AG-201, AG-202, APE-061, APE-061W, APE-101, APE-101W, APE-102, APE-102W, APE-201, APE-202, APG-061, APG-061W, APG-101, APG-101W, APG-102, APG-102W, APG-201, APG-202, GA-20, GA-20D, GA-40, GA-40D, HCV-10-11, HCV-10-21, HCV-2-10-21, HCV-5-11, HCV-6-11, HEM-10-11, HEM-10-21, HEM-20-11, HEM-20-21, HEM-6-11, HEP-10-11, HEP-10-21...(Other models you can see in the webshop)		

 <p>1</p>			
GEV No.	403804	Ref. No.	12031074 RT4400287
description	level electrode with cable M15x1.5 probe L 12mm total length 325mm insulated probe length 114mm straight connection plug-in connection ø 1.5mm EPDM		

electric components

flow meters and flow sensors

flow sensors

			
1			
GEV No.	402256	Ref. No.	12028357 12028358 RT30171050 RT4400211
description	flow sensor inlet ø 10mm outlet ø 10mm L 110mm flow rate 1-25l/min		

cooling aggregates

GEV No.	379304***	Ref. No.	123456
description			
For models:			
GEV No.	379304***	Ref. No.	123456
description			
For models:			

compressors

EMBRACO / ASPERA

R404a/R507

LBP monophase

Lower evaporation temperature below -20°C

			
1			
GEV No.	605174	Ref. No.	602101006
description	compressor coolant R404a/R507 type NJ2192GK 220-240V 50Hz LBP 20.4kg 1 1/4HP cylinder capacity 26.2cm ³ CSR H 265mm 685W 989W 1342W 1745W 2196W 2196WWWWWW		

SECOF DANFOSS

R134A

HMBP monophase

High/Medium evaporation temperature above -20/-15 °C

			
1			
GEV No.	605088	Ref. No.	12027501 12029101 12048631 2040900039 6001700003 6021010004
description	compressor coolant R134a type FR7.5G 220-240V 50Hz HMBP fully hermetic 10.6kg 1/5HP power input 175W cylinder capacity 6.93cm ³ RSIR/CSIR H 196mm 62W 99W 142W 193W 254W 325W 408W 505W 618W test method ASHRAEW		
For models:	AF-702-P, BFP-150, BFP-150A, BFP-150I, CFMP-150, CFMP-150F, CFMP-150PC, CFMP-150TV, CMFP-135, CMFP-135-B, CMFP-135-B2, CMFP-135-BP, CMFP-135F, CMFP-135-GR, CMFP-135HD, CMFP-135HH, CMFP-135PC, CMMZ-150, CMMZ-180-7, CMMZ-202, CMPP-150, CMPP-150-C, ERM-250, FMP-150, FMP-150-TV, FMP-202, FMP-255, FMP-307, MCP-135, MCP-135-AD, MCP-135-GN, MCP-180-AD, MEP-100, MEP-100G, MFP-135, MFP-135-2C, MFP-135-2C-GN, MFP-135-4C, MFP-135-4C-GN, MFP-135-AD, MFP-135-AD-2C, MFP-135-AD-4C, MFP-135-AD-PC, MFP-135-B, MFP-135-B2-GN, MFP-135-B-GN, MFP-135-BP-GN, MFP-135-F, MFP-135-F-GN, MFP-135-GN...(Other models you can see in the webshop)		
spare parts for	605088		
	GEV No.	381529	Ref. No. —
start relay DANFOSS 117U6001			



1

GEV No.	605091	Ref. No.	12027431 12028976 6001700004 6021010007
description	compressor coolant R134a type FR8.5G 220-240V 50Hz HMBP 10.6kg 1/4HP power input 261W cylinder capacity 7.95cm ³ RSIR/CSIR H 196mm 85W 123W 171W 228W 298W 381W 478W 592W 722WW		
For models:	AEP-701, AEP-702, AEP-801, AEP-802, AF-1402-MIX, AF-1602-MIX, AF-1603-C, AF-1603-P, AF-1604-C, AF-1604-P, AF-702-C, AF-702-P, AFP-1402-MIX, AFP-1602, AFP-1602-2, AFP-1603, AFP-1603-2, AFP-701, AFP-701-FORZ, AFP-702, AFP-702-C, AFP-702-FORZ, AFP-702-P, AFP-801, AFP-802, AFP-802-2C, AFP-802-3C, BFP-200, BFP-200A, BFP-200I, CAEP-701, CAEP-801, CAEP-802, CAF-1402MIXT, CAF-1602MIX, CAFP-1602-2, CAFP-1603-2, CAFP-701, CAFP-702, CAFP-801, CAFP-802, CAFP-802-2C, CAFP-802-3C, CFMP-202, CFMP-202F, CFMP-202PC, CFMP-202TV, CMFP-180, CMFP-180-B, CMFP-180-B2...(Other models you can see in the webshop)		
spare parts for	605076		
	GEV No.	380058	Ref. No. —
start relay DANFOSS 117U6019/F278 HST			



1

GEV No.	605076	Ref. No.	12027766 6001700009 6021010009
description	compressor coolant R134a type SC18G 220-240V 50Hz HMBP fully hermetic 13.7kg 1/2HP power input 495W cylinder capacity 17.7cm ³ CSIR H 219mmW 348W 485W 649W 844W 1074W 1343W 1655W 2014W test method ASHRAE		
For models:	AEP-2103, AF-2104-C, AF-2104-P, AF-2105-C, AF-2105-P, AF-2106-C, AF-2106-P, AFP-2103, AFP-2104, AFP-2104-C, AFP-2104-P, AFP-2105, AFP-2105-C, AFP-2105-P, AFP-2106, AFP-2106-C, AFP-2106-P		
spare parts for	605076		
	GEV No.	380058	Ref. No. —
start relay DANFOSS 117U6019/F278 HST			



1

GEV No.	605087	Ref. No.	12026937 12028366 6001700007 6021010008
description	compressor coolant R134a type SC12G 220-240V 50Hz HMBP fully hermetic 12.6kg 1/3HP power input 470W cylinder capacity 12.9cm ³ RSIR/CSIR H 203mm 140W 216W 312W 430W 574W 746W 951W 1191W 1469W test method ASHRAE 79.6W 1790W		
For models:	AEP-1402, AEP-1403, AEP-1404, AEP-1602, AEP-1603, AEP-1604, AF-1403-C, AF-1403-P, AF-1404-C, AF-1404-P, AFP-1402, AFP-1402-FORZ, AFP-1403, AFP-1403-C, AFP-1403-FORZ, AFP-1403-P, AFP-1404, AFP-1404-C, AFP-1404-FORZ, AFP-1404-P, AFP-1404-USMC, AFP-1602, AFP-1602-2, AFP-1603, AFP-1603-2, AFP-1604, AP-701, APP-701, BFP-250, BFP-300, FMP-250, FMP-300, MCP-270-GN, MEP-180, MFP-225-B, MFP-270-B, MFP-270-GN, MPP-255, MPP-255-C, MPP-307, MPP-307-C, MPZ1-200, MSP-200-F, MSP-250, MSP-250-F, MSP-300, VC-14-I, VC-14-M, VC-20-I, VC-20-M...(Other models you can see in the webshop)		
spare parts for	605087		
	GEV No.	380483	Ref. No. 12019417 12034971 12035095 12058828 6004000003 6009990224 6021010019
start relay DANFOSS 117U6003 HST			

R404a/R507

LBP monophase

Lower evaporation temperature below -20°C





1

GEV No.	605058	Ref. No.	12027322 6021010002
description	compressor coolant R404a/R507 type SC15CL 220-240V 50Hz LBP fully hermetic 13.8kg 1/2HP cylinder capacity 15.28cm ³ CSIR H 219mm 486W 637W 813W 1017W 1251W 1699WWWW test method ASHRAE 175W 358W		
For models:	ADMEN-180, ADMFN-180, AF-1402-MIX, AF-1602-MIX, AFN-701, AFN-702, AFN-801, AFN-802, ANF-801AD, ANF-802AD, CAF-1402MIXT, CAF-1602MIX, CAFN-701, CAFN-702, CAFN-801, CAFN-802, CMFN-180, CMFN-225, CMFN-270, CMPN-202, CMPN-255, CMSN-200, CMSN-250, CMSN-300, CPAFN-801, MCN-180, MFN-180, MPN-202, MPN-202-C, MSN-200, MSN-250, MSN-300		

accessories

			
1			
GEV No.	380483	Ref. No.	12019417 12034971 12035095 12058828 6004000003 6009990224 6021010019
description	start relay DANFOSS 117U6003 HST		
For models:	AEP-1402, AEP-1403, AEP-1404, AEP-1602, AEP-1603, AEP-1604, AF-1403-C, AF-1404-C, AF-702-C, AFP-1402, AFP-1403, AFP-1403-C, AFP-1403-P, AFP-1404, AFP-1404-C, AFP-1404-P, AFP-1404-USMC, AFP-1602, AFP-1602-2, AFP-1603, AFP-1603-2, AFP-1604, AP-701, APP-701, BFP-250, BFP-300, FMP-250, FMP-300, MCP-270-GN, MEP-180, MFP-270-GN, MPP-255, MPP-255-C, MPP-307, MPP-307-C, MPZ1-200, MSP-200-F, MSP-250, MSP-250-F, MSP-300, VC-14-I, VC-14-M, VC-20-I, VC-20-M, VM-100-I, VM-100-M, VM-135-I, VM-135-M		

			
1			
GEV No.	380534	Ref. No.	12040409 6004000006
description	start relay DANFOSS 117U6015/F082 HST		
For models:	AFP-2103, AFP-2104, AFP-2104-C, AFP-2104-P, AFP-2105, AFP-2105-C, AFP-2105-P, AFP-2106, AFP-2106-C, AFP-2106-P		

			
1			
GEV No.	380572	Ref. No.	12034743 6002000031
description	start relay DANFOSS 117U6015/F331 HST		
For models:	AEP-701, AEP-702, AEP-801, AEP-802, AFP-1402-MIX, AFP-1602-2, AFP-701, AFP-701-FORZ, AFP-702, AFP-702-C, AFP-702-FORZ, AFP-702-P, AFP-801, AFP-802, BFP-200, FMP-200, MCP-180-GN, MCP-225-GN, MEP-135, MFP-147-GN-R, MFP-180-GN, MFP-192-GN-R, MFP-225-GN, MPP-202, MPP-202-C, MSP-200, MSP-200-F, VM-100-I, VM-100-M		

			
1			
GEV No.	380484	Ref. No.	12034947 12058829 6021010025
description	start relay DANFOSS 117U6015/F394 HST		
For models:	AEP-701, AEP-801, AEP-802, AF-1402-MIX, AF-1602-MIX, AF-1603-C, AF-1603-P, AF-1604-C, AF-1604-P, AF-702-C, AF-702-P, AFN-701, AFP-1602, AFP-1602-2, AFP-1603, AFP-1603-2, AFP-701, AFP-702, AFP-801, AFP-802, AFP-802-2C, AFP-802-3C, BFP-150, BFP-200, BFP-200A, BFP-200I, CAEP-701, CAEP-801, CAEP-802, CAF-1402MIXT, CAF-1602MIX, CAF-1602-2, CAF-1603-2, CAF-701, CAF-702, CAF-801, CAF-802, CAF-802-2C, CAF-802-3C, CFMP-202, CFMP-202F, CFMP-202PC, CFMP-202TV, CMFP-135-GR, CMFP-180, CMFP-180-B, CMFP-180-B2, CMFP-180-BP, CMFP-180F, CMFP-180-GR...(Other models you can see in the webshop)		

			
1			
GEV No.	380573	Ref. No.	6004000004
description	start relay DANFOSS 117U6019/F152 HST		
For models:	AFN-701, AFN-702, AFN-801, AFN-802, AFP-1402-MIX, MCN-135-GN, MCN-180-GN, MFN-135-GN, MFN-180-GN, MPN-150, MPN-150-C, MSN-150, MSN-200		

miscellaneous

accessories

			
1			
GEV No.	381135	Ref. No.	12031673 6021010050
description	start relay GENERAL ELECTRIC 3ARR3B3AV3 220V connection screw clamp		
For models:	AFN-1402, AFN-1403, AFN-1404, AFN-1602, AFN-1603, AFN-1604, ATM-051, ATM-101, MCN-270, MFN-270, MPN-255, MPN-255-C, MPN-307, MPN-307-C		



fans

axial fans

ebm-papst



1

GEV No.	601309 ¹	Ref. No.	12027993 RT4000474
description	axial fan L 127mm W 127mm H 38mm 12VDC 21W bearing ball bearing manuf. no. DV5212N metal connection cable ebm-papst suitable for RATIONAL fan wheel ø 120mm temp.-resist. 65°C		

¹with ball bearings

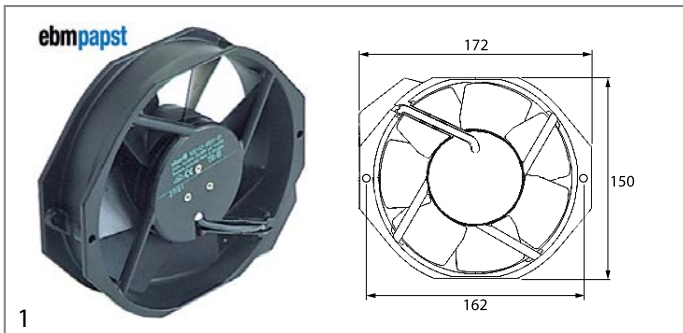

1

GEV No.	601113 ¹	Ref. No.	12026852 RT31011013
description	axial fan L 172mm W 150mm H 38mm 230VAC 50/60Hz 27/28W bearing ball bearing connection male faston 2.8mm manuf. no. 7056ES metal ebm-papst fan wheel ø 145mm temp.-resist. 55°C		

¹with ball bearings

import



1

GEV No.	601510 ¹	Ref. No.	12032884 12033472 6001506003 6021050008
description	axial fan L 119mm W 119mm H 38mm 230VAC 50/60Hz 22/21W bearing ball bearing connection male faston 6.3mm SUNON temp.-resist. 70°C		
For models:	AEP-1402, AEP-701, AFP-1402, AFP-1402-FORZ, AFP-1403, AFP-1403-C, AFP-1403-FORZ, AFP-1403-P, AFP-1404, AFP-1404-C, AFP-1404-P, AFP-2103, AFP-2104, AFP-2104-C, AFP-2104-P, AFP-2105, AFP-2105-C, AFP-2105-P, AFP-2106, AFP-2106-C, AFP-2106-P, AFP-701, AFP-701-FORZ, AFP-702, AFP-702-C, AFP-702-FORZ, AFP-702-P, APP-701, CMPZ1-135, CMPZ1-180, ECE-80, ERM-150, ERM-250, ERM-350, ERMS-250, MEP-100, MEP-100G, MEP-135, MEP-135-GN, MEP-180, MEP-180-GN, MI-202, MPZ1-135, MPZ1-150, MPZ1-180, MPZ1-200, MPZ1-225, MPZ1-250, MPZ1-250, VTP-139-C...(Other models you can see in the webshop)		

¹with ball bearings



1

GEV No.	601080 ¹	Ref. No.	12023862 12031028 12031777 12032776 6021050006 RT31011008 ST25000040 Z103066
description	axial fan L 119mm W 119mm H 38mm 230VAC 50/60Hz 23/20W bearing ball bearing connection male faston 2.8mm metal ADDA fan wheel ø 110mm temp.-resist. 70°C		
For models:	ACE-061, ACE-101, ACE-102, ACG-061, ACG-101, ACG-102, AD-120, AD-120B, AD-120BTTDD-UK, AD-120C, AD-120CW, AD-120HY, AD-90, AD-90BA, AD-90BBT, AD-90BDD, AD-90DD, AE-061, AE-101, AE-102, AG-061, AG-101, AG-102, APE-061, APE-101, APE-102, APG-061, APG-101, APG-102, CI9-20, CI9-40, COE-061, COE-101, COE-102, COE-201, COG-061, COG-101, COG-102, COG-201, ECO-120, ECO-120B, ECO-160, ECO-1600, ECO-160D, ECO-160I, ECO-200, ECO-200D, ECO-200H, ECO-200HD, ECO-200HI...(Other models you can see in the webshop)		
accessories for	601080		
	GEV No.	550898	Ref. No. —
	connecting cable cable length 2000mm connection F 2.8 connection distance 7.9mm for axial flow fan		
	GEV No.	692519	Ref. No. 12025177 Z713015
	guard L 120mm W 120mm plastic		

¹with ball bearings

1 electric components



GEV No.	601670 ¹	Ref. No.	12031029 RT31011018
description	axial fan L 80mm W 80mm H 25mm 12VDC 1.8W bearing ball bearing connection cable 300mm fan wheel ø 75mm		

¹with ball bearings

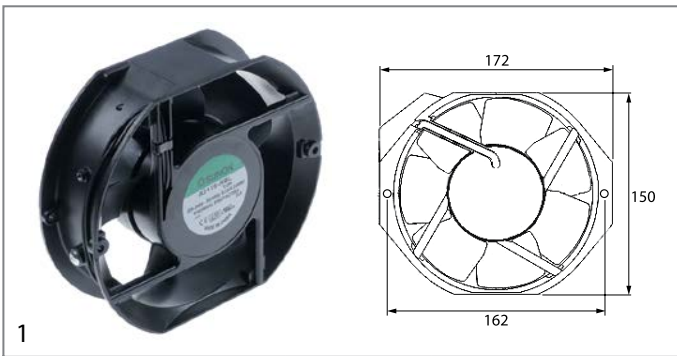

GEV No.	601654 ¹	Ref. No.	12024106 T453005
description	axial fan L 172mm W 150mm H 51mm 230VAC 50/60Hz 28/24W bearing ball bearing manuf. no. A2175-HBL T.GN connection cable cable length 280mm metal SUNON fan wheel ø 142mm temp.-resist. -10 up to +80°C mounting distance 162mm		
For models:	ACE-201, ACE-202, ACG-201, ACG-202, AE-201, AE-202, AG-201, AG-202, APE-201, APE-202, APG-201, APG-202, COE-201, COE-202, COG-201, COG-202, HEI-20-21, HEM-20-21, HEP-20-21, HGC-20-21, HGP-20-21, HGV-20-21, VE-201, VE-202, VG-102, VG-201, VG-202, VPE-201, VPE-202, VPG-102, VPG-201, VPG-202		

¹with ball bearings

accessories

fan guards



GEV No.	692519	Ref. No.	12025177 Z713015
description	guard L 120mm W 120mm plastic		
For models:	AD-120, AD-120B, AD-120BBTDD-UK, AD-120C, AD-120CW, AD-120HY, AD-90, AD-90BA, AD-90BBT, AD-90BDD, AD-90DD, ADE-120, ADE-120B, ECO-120, ECO-120B, FI-100, FI-100AR, FI-100B, FI-100BBT-UK, FI-120, FI-120AR+DD, FI-120B, FI-120C, FI-120HY-CLINIC, FI-120W, FI-80, FI-80AR, FI-80BBT-UK, FI-80W, FI-E-100, LABP-1000, LABP-1200		
accessories for	692519		

	GEV No.	601080	Ref. No.	12023862 12031028 12031777 12032776 6021050006 RT31011008 ST25000040 Z103066
axial fan L 119mm W 119mm H 38mm 230VAC 50/60Hz 23/20W bearing ball bearing connection male faston 2.8mm metal ADDA fan wheel ø 110mm temp.-resist. 70°C				



GEV No.	602141	Ref. No.	12030835 RT84551393
description	guard with filter for axial flow fan L 126mm W 126mm H 13.5mm mounting distance 115mm suitable for ebm-papst		



refrigeration fans

refrigeration motors universal

ELCO

N series - standard



GEV No.	601359	Ref. No.	12031842 6021050055
description	fan motor 18W 230V 50/60Hz bearing slide bearing W 83mm connection 3-wire cable length 1000mm 1300/1550rpm 3 mounting options VNT18-30/150		
spare parts for	601359		
	GEV No.	601413	Ref. No. —
	fixing plate suitable for fanwheel ED ø 32mm shaft ø 7 mounting distance 26mm		

accessories

fan wheels

plastic

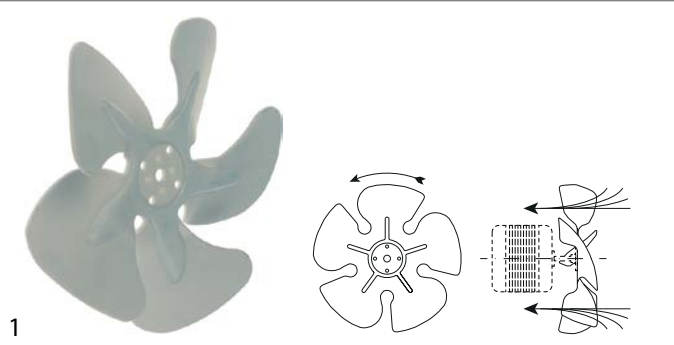

GEV No.	601412	Ref. No.	12037081 BR00010213
description	fan wheel sucking ø 154mm fan wheel mounting 25.4mm blade angle 28° W 34mm plastic		

cooling motors (complete)



GEV No.	601394	Ref. No.	6021050004
description	fan 230V 5W 50/60Hz fan wheel ø 200mm shaft L 12mm feet depth 71mm L 60mm W 83mm H 83mm blade angle 28° connection cable 500mm		
For models:	AF-1403-P, AF-1404-P, AF-1603-P, AF-1604-P, AF-2104-P, AF-2105-P, AF-2106-P, AF-702-C, AF-702-P, AF-802-C, AFP-802, AFP-802-2, EC-150, ECC-150, ERM-250, ERM-350, ERMS-250, VM-100-I, VM-100-M, VM-135-I, VM-135-M, VTP-139-RC, VTP-139-RCD, VTP-139-RP, VTP-139-RPD, VTP-175-RC, VTP-175-RCD, VTP-175-RP, VTP-175-RPD		



GEV No.	601693	Ref. No.	12033477 6001506002 6021050002
description	fan motor 230V 10W 50/60Hz fan wheel ø 254mm feet depth 85mm W 84mm 1300rpm		
For models:	AEP-1402, AEP-1403, AEP-1404, AEP-1602, AEP-1603, AEP-1604, AEP-2103, AEP-701, AEP-702, AEP-801, AEP-802, AF-1402-MIX, AF-1403-C, AF-1403-P, AF-1404-C, AF-1404-P, AF-1602-MIX, AF-1603-C, AF-1603-P, AF-1604-C, AF-1604-P, AF-2104-C, AF-2104-P, AF-2105-C, AF-2105-P, AF-2106-C, AF-2106-P, AF-702-C, AF-702-P, AF-802-C, AF-802-P, AFN-1402, AFN-1403, AFN-1404, AFN-1602, AFN-1603, AFN-1604, AFN-701, AFN-702, AFN-801, AFN-802, AFP-1402, AFP-1402-FORZ, AFP-1402-MIX, AFP-1403, AFP-1403-C, AFP-1403-FORZ, AFP-1403-P, AFP-1404, AFP-1404-C...(Other models you can see in the webshop)		

			
1			
GEV No.	601511	Ref. No.	12018609 12038161 6004000012 6021050010
description	fan 230V 10W 50Hz fan wheel ø 195mm blade angle 22° connection cable 500mm		
For models:	ADAFN-1602, ADMCN-180, ADMCN-225, ADMCP-225, ADMFN-180, ADMFN-225, ADMFP-225, ADMFP-225-GR, ADMFP-225HDDD, ADMFP-225HHDD, ADMFP-225HHHD, ADMFP-225HHHH, ADMFP-225PC, AEP-2103, AF-2104-C, AF-2104-P, AF-2105-C, AF-2105-P, AF-2106-C, AF-2106-P, AFN-1402, AFN-1403, AFN-1404, AFN-1602, AFN-1603, AFN-1604, AFN-801, AFN-802, AFP-2103, AFP-2104, AFP-2105, AFP-2106, ATA-061, ATA-061-60Hz, ATM-051VCH, ATM-051VCH-60Hz, ATM-081VCH, ATM-081VCH-60Hz, ATM-101VCH, ATM-101VCH-60Hz, CPAFN-1602, MCN-192-GN-R, MCN-225-GN, MCN-237-GN-R, MCN-270-GN, MFN-192-GN-R, MFN-225-GN, MFN-237-GN-R, MFN-270-GN, MSN-222-R...(Other models you can see in the webshop)		

			
1			
GEV No.	601512	Ref. No.	6004000011
description	fan 230V 5W 50Hz fan wheel ø 200mm blade angle 28° connection cable 1500mm		
For models:	AFN-1402, AFN-1403, AFN-1404, AFN-701, AFN-702, AFP-1402-MIX, AP-701, APP-701, MCN-102-GN-R, MCN-135-GN, MCN-147-GN-R, MCN-180-GN, MFN-102-GN-R, MFN-135-GN, MFN-147-GN-R, MFN-180-GN, MSN-117-R, MSN-150, MSN-169-R, MSN-200		

cold air circulating fans (complete)

			
1			
GEV No.	601811	Ref. No.	12026785 6021050019
description	fan type R09R-3030HP-4M-2543 fan wheel ø 300mm 230V 50/60Hz 65/90W suitable capacitor 2.5µF HIDRIA suitable for blast chiller suitable for FRIULINOX 1400/1500rpm blowing H 138mm cable lengthmm mounting distance 265mm		
For models:	ATA-061, ATA-061-60Hz, ATA-101, ATA-101-60Hz, ATM-051, ATM-081VCH, ATM-081VCH-60Hz, ATM-101, ATM-101VCH, ATM-101VCH-60Hz, ATM-121VCH, ATM-121VCH-60Hz, ATM-121VCHP, ATM-161VCH, CM-201, CS-201		

			
2			
GEV No.	601552	Ref. No.	12032883 12033165 6001506001 6021050001
description	fan 230V 5W 50/60Hz fan wheel ø 165mm shaft L 15mm blade angle 34° connection cable		
For models:	AEP-1402, AEP-1403, AEP-1404, AEP-1602, AEP-1603, AEP-1604, AEP-701, AEP-702, AEP-801, AEP-802, AF-1402-MIX, AF-1403-C, AF-1403-P, AF-1404-C, AF-1404-P, AF-1602-MIX, AF-1603-C, AF-1603-P, AF-1604-C, AF-1604-P, AF-702-C, AF-702-P, AF-802-C, AF-802-P, AFP-1402, AFP-1403, AFP-1404, AFP-1404-USMC, AFP-1602, AFP-1602-2, AFP-1603, AFP-1603-2, AFP-1604, AFP-701, AFP-702, AFP-801, AFP-802, AFP-802-2, FMP-117-R, FMP-150, FMP-169-R, FMP-200, FMP-202, FMP-222-R, FMP-250, FMP-255, FMP-274-R, FMP-300, FMP-307, MCN-102-R...(Other models you can see in the webshop)		

cross flow fans



			
1			
GEV No.	602084	Ref. No.	12031541 6021050046
description	cross flow fan ebm-papst RL76/8600Z roller ø 58mm roller length 84mm laminated core thickness 1mm motor position right connection F6.3 W 190mm H 135mm D 135		

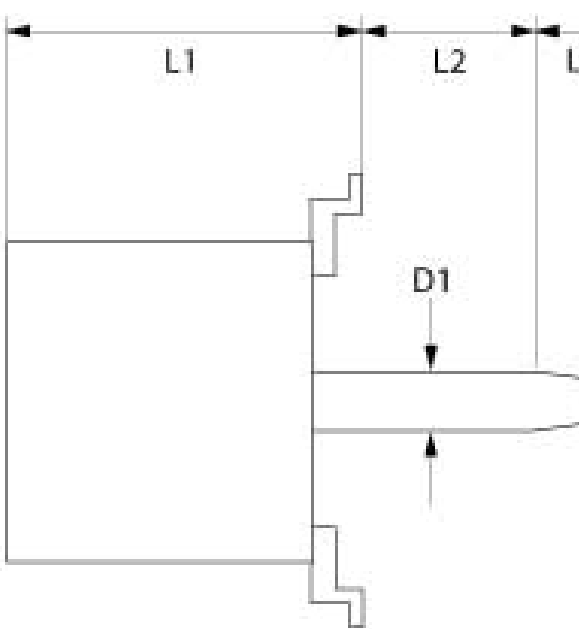

hot air motors

			
1			
GEV No.	697780	Ref. No.	12032334 RT2200083
description	engine shaft gasket plastic for fan ID ø 15mm ED ø 29.5mm thickness 4.5mm		

 <p>Image not available</p>			
			
1			
GEV No.	601321	Ref. No.	12025899 RT31001064
description	fan motor		

			
1			
GEV No.	601301	Ref. No.	12025570 RT4000274P
description	fan motor 100-240V 1 phase 50/60Hz 0.45kW 2000rpm speeds 1 L1 160mm L2mm L3mm L4mm M8R IT fan wheel ø 130mm type M3G084-FA22-16		
accessories for	601301		
	GEV No.	511685	Ref. No. —
	shaft seal kit ID ø 15mm ED ø 27mm shaft seal flange mounting gauge with mountign material		

accessories for	601301		
	GEV No.	601327	Ref. No. 12027162 22.00.192S RT2200192
	fan wheel D1 ø 340mm H1 135mm blades 9 D2 ø 13mm D3 ø 16mm H2 38mm		

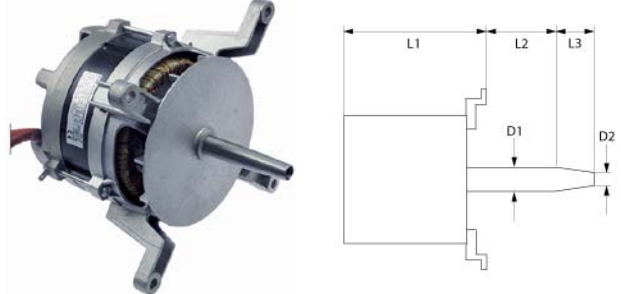
			
1			
GEV No.	601629	Ref. No.	12018605 T493004
description	fan motor 208/240V 3 phase 50/60Hz 0.66/0.18kW 1400/700rpm speeds 2 L1 150mm L2 40mm L3 35mm D1 ø 17mm D2 ø 13.5mm 2.2/0.85A at 50Hz 208/240V at 60Hz 208/240V at 50Hz 1400/700rpm at 60Hz 1700/850rpm type 3036E2470		
For models:	HEI-20-21, HEM-10-11, HEM-20-11, HEM-20-21, HEM-6-11, HEP-10-11, HEP-20-11, HEP-6-11, HGC-20-21, HGV-20-21		

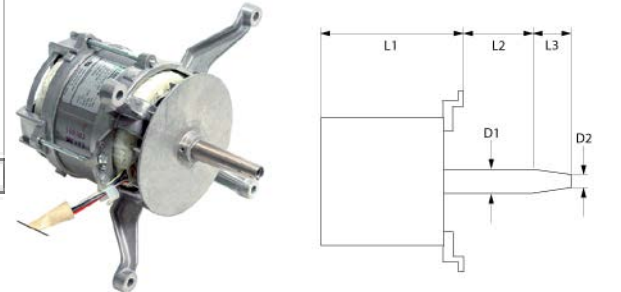
			
1			
GEV No.	500506	Ref. No.	12016554 R663034
description	fan motor 220-230V 3 phase 50Hz 0.02/0.16kW 710/1390rpm speeds 2 L1 152mm L2 31mm L3 35mm M10R IT 0.35/0.9A power input 60/250W at 50Hz 220-230V at 60Hz 220-230V at 50Hz 710/1390rpm at 60Hz 840/1660rpm Y/YY type L7mw84D-380 no. T7 D1 ø 17mm D2 ø 13mm		
For models:	HME-10-11, HME-10-21, HME-20-11, HME-20-21, HME-2-10-11, HME-2-20-11, HME-6-11, HMP-10-11, HMP-10-21, HMP-20-11, HMP-20-21, HMP-2-10-11, HMP-2-20-11, HMP-6-11		

→ electric components

1

GEV No.	500505	Ref. No.	12016565 R253049
description	fan motor 220-240/380-415V 3 phase 50/60Hz 0.16-0.26kW 1440/1700rpm speeds 2 L1 140mm L2 27mm L3 35mm M10R IT 1.2/0.7A Cos(fi) 0.63 type L7zAw4D-014 D1 ø 17mm D2 ø 13mm		
For models:	HCG-10-11, HCG-10-21, HCG-20-11, HCG-20-21, HCG-2-10-11, HCG-2-20-11, HCG-6-11, HCV-10-11, HCV-10-21, HCV-2-10-21, HCV-5-11, HCV-6-11, HE-10-11, HE-10-21, HE-2-10-11, HE-5-11, HE-6-11, HG-10-11, HG-10-21, HG-2-10-11, HME-20-11, HMG-10-11, HMG-10-11UL, HMG-10-21, HMG-10-21UL, HMG-20-11, HMG-2-10-11, HMG-6-11, HMI-10-11, HMI-10-11UL, HMI-10-21, HMI-10-21UL, HMI-2-10-11, HMI-6-11, HMI-6-11UL, HMM-10-11, HMM-10-11UL, HMM-10-21, HMM-10-21UL, HMM-20-11, HMM-20-11UL, HMM-20-21, HMM-20-21UL, HMM-2-10-11, HMM-2-20-11, HMM-40-11-USMC, HMM-6-11, HMM-6-11UL, HMP-20-11, HVG-10-11...(Other models you can see in the webshop)		
accessories for	500505		
	GEV No.	601503	Ref. No. 12016581 R253042
	fan wheel D1 ø 350mm H1 125mm blades 12 D2 ø 13mm D3 ø 16mm		

1

GEV No.	601551	Ref. No.	12018468 R703049
description	fan motor 230-415V 3 phase 50/60Hz 0.65kW 1400/1650rpm speeds 1 L1 147mm L2 41mm L3 36mm M10R IT at 50Hz 1400rpm at 60Hz 1650rpm D1 ø 17mm D2 ø 13.5mm		
For models:	HEI-10-11, HEI-20-11, HEI-6-11, HGC-10-11, HGC-20-11, HGC-6-11, HGV-10-11, HGV-20-11		

1

GEV No.	601300	Ref. No.	RT31001080
description	fan motor 240V 3 phase 60Hz 0.68kW 1730rpm speeds 1 L1 145mm L2 24mm L3 34mm M10R IT 2.9A number of pole pairs 2 power input 870W at 60Hz 1730rpm Y type L9DFw4D-518 no. X6 D1 ø 17mm D2 ø 13mm		

1

GEV No.	601318	Ref. No.	12025810 RT31001044
description	fan motor 230-240V 1 phase 50Hz 0.450/0.615kW 1440rpm speeds 1 L1 150mm L2 34mm L3 35mm M10x1.5 3.1A type L9Fw4D-397 no. CO D1 ø 17mm D2 ø 13mm		

1

GEV No.	601308	Ref. No.	12025795 12025796 RT31001081 RT31001084
description	fan motor 240V 3 phase 60Hz 0.68kW 1730rpm speeds 1 L1 155mm L2 47mm L3 35mm M10R IT 2.9A power input 870W at 60Hz 1730rpm type L9DFw4D-519 no. W8 D1 ø 17mm D2 ø 13mm		
accessories for	601308		
	GEV No.	510573	Ref. No. 12033667 RT50010207
	shaft seal ID ø 17mm ED ø 29mm thickness 4.5mm		

1

GEV No.	601815	Ref. No.	12026105 RT31001061
description	fan motor 230-240V 1 phase 50Hz 0.450/0.615kW 1440rpm speeds 1 L1 150mm L2 34mm L3 35mm ø 125mm M10x1.5 3.1A type L9Fw4D-397 no. CO D1 ø 17mm D2 ø 13mm kit		

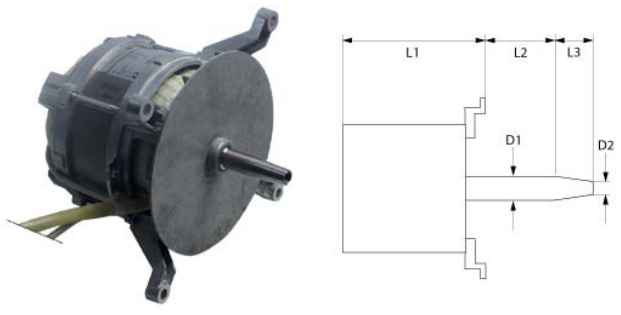

1

GEV No.	601704	Ref. No.	12025608 12026125 RT31001041 RT31001062
description	fan motor 240V 3 phase 60Hz 0.7kW 1720rpm speeds 1 L1 152mm L2 31mm L3 35mm M10L 3A D1 ø 17mm D2 ø 13.5mm		



1

GEV No.	602129	Ref. No.	12026111 RT31001049
description	fan motor 380-415V 3 phase 50Hz 0.08/0.45kW 700/1400rpm speeds 2 L1 147mm L2 35mm L3 35mm ø 125mm M10R IT 0.4/1.15A at 50Hz 700/1400rpm Y/YY type L9xw84D-393 no. V2 D1 ø 17mm D2 ø 13mm		
spare parts for	602129		
	GEV No.	551350	Ref. No. —
	gasket set for motor CPC, CM, CD		



1

GEV No.	602143	Ref. No.	12024325 T323040000
description	fan motor 3 phase 50Hz 0.75kW 1400rpm L1 150mm L2 45mm L3 37mm D1 ø 17mm D2 ø 14mm 3.2A type 3036AB2350		
For models:	ACE-061, ACE-101, ACE-102, ACE-201, ACE-202, ACG-061, ACG-101, ACG-102, ACG-201, ACG-202, AE-061, AE-061W, AE-101, AE-101W, AE-102, AE-102W, AE-201, AE-202, AG-061, AG-061W, AG-101, AG-101W, AG-102, AG-102W, AG-201, AG-202, APE-061, APE-061W, APE-101, APE-101W, APE-102, APE-102W, APE-201, APE-202, APG-061, APG-061W, APG-101, APG-101W, APG-102, APG-102W, APG-201, APG-202, COE-101, COE-201, COG-101, COG-201, VE-101, VE-201, VG-101, VG-201...(Other models you can see in the webshop)		

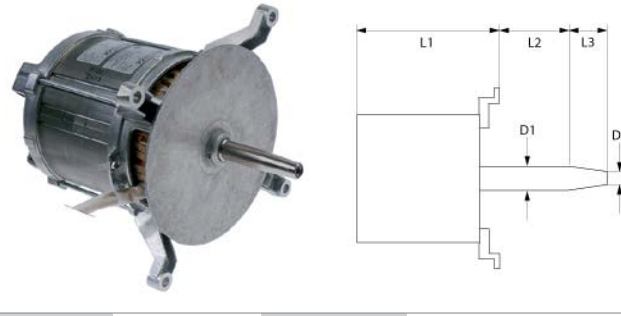

1

GEV No.	601504	Ref. No.	12018488 T323022
description	fan motor 380-415V 3 phase 50Hz 0.12/0.9kW 700/1380rpm speeds 2 L1 202mm L2 48mm L3 35mm M10R IT 0.9/2.1A power input 240/1200W at 50Hz 380-415V at 60Hz 380-480V at 50Hz 700/1380rpm at 60Hz 820/1690rpm Y/YY type L9zw84D-565 no. W4 D1 ø 17mm D2 ø 13.5mm		
For models:	HEI-10-21, HEM-10-21, HEP-10-21, HGC-10-21, HGP-10-21, HGV-10-21		

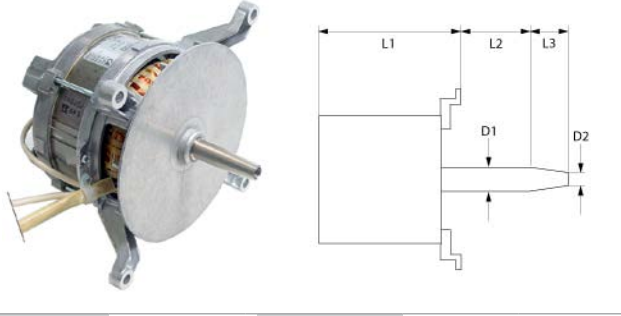

1

GEV No.	500162	Ref. No.	12025820 RT31001020
description	fan motor 380-415V 3 phase 50Hz 0.08/0.45kW 700/1400rpm speeds 2 L1 147mm L2 35mm L3 35mm ø 125mm M10R IT 0.4/1.15A at 50Hz 700/1400rpm Y/YY type L9xw84D-393 no. V2 D1 ø 17mm D2 ø 13mm		
spare parts for	500162		
	GEV No.	601730	Ref. No. —
	fan wheel for motor cooling ED ø 180mm H 20mm ID ø 20mm		

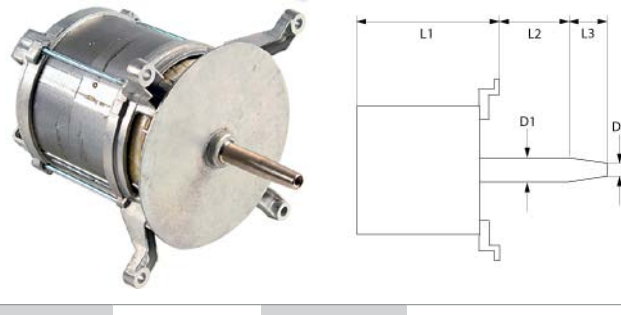

1

GEV No.	601299	Ref. No.	12025895 RT31001068
description	fan motor 380-415V 3 phase 50Hz 0.12/0.9kW 700/1380rpm speeds 2 L1 205mm L2 40mm L3 35mm M10R IT 0.9/2.1A power input 240/1200W at 50Hz 700/1380rpm type L9zw84D-394 no. X4 D1 ø 17mm D2 ø 13mm		

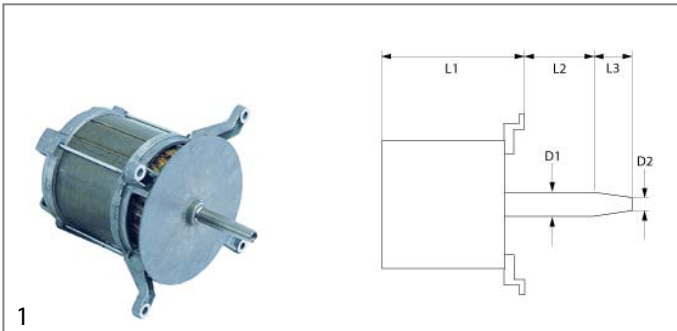

1

GEV No.	500168	Ref. No.	12025825 RT31001022
description	fan motor 380-415V 3 phase 50Hz 0.12/0.9kW 700/1380rpm speeds 2 L1 205mm L2 47mm L3 35mm 0.9/2.1A power input 240/1200W at 50Hz 700/1380rpm type L9zw84D-394 no. X6 D1 ø 13mm D2 ø 13mm L4 17mm		

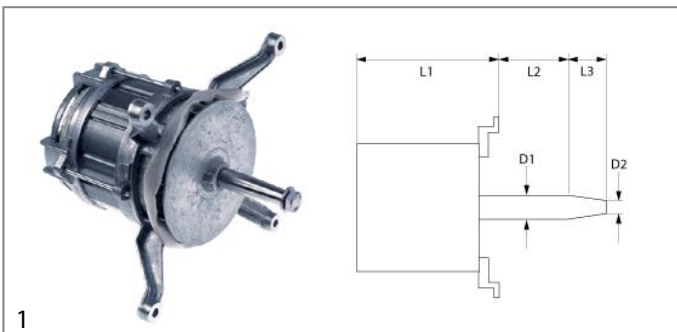

1

GEV No.	500507	Ref. No.	12016547 R663033
description	fan motor 400V 3 phase 50Hz 0.02/0.16kW 710/1390rpm speeds 2 L1 140mm L2 30mm L3 35mm M10R IT 0.2/0.5A power input 50/250W at 50Hz 380-400V at 60Hz 380-400V at 50Hz 710/1390rpm at 60Hz 840/1660rpm Y/YY type L7mw84D-379 no. X2 D1 ø 17mm D2 ø 13mm		
For models:	HME-10-11, HME-10-21, HME-20-11, HME-20-21, HME-2-10-11, HME-2-20-11, HME-6-11, HMP-10-11, HMP-10-21, HMP-20-11, HMP-20-21, HMP-2-10-11, HMP-2-20-11, HMP-6-11		



1

GEV No.	601326	Ref. No.	12025751 RT20120514
description	fan wheel		



1

GEV No.	602182	Ref. No.	12024786 T083005000
description	fan wheel blades 12 D1 ø 280mm D2 ø 13mm D3 ø 16.5mm H1 128mm H2 20.5mm H3 80mm		
For models:	ACG-061, AG-061, AG-061W, APG-061, APG-061W		



1

GEV No.	601327	Ref. No.	12027162 22.00.192S RT2200192
description	fan wheel D1 ø 340mm H1 135mm blades 9 D2 ø 13mm D3 ø 16mm H2 38mm		



1

GEV No.	601306	Ref. No.	12027559 RT2200188
description	fan wheel D1 ø 340mm H1 95mm blades 9 D2 ø 13mm D3 ø 16mm H2 37mm		



1

GEV No.	601503	Ref. No.	12016581 R253042
description	fan wheel D1 ø 350mm H1 125mm blades 12 D2 ø 13mm D3 ø 16mm		
For models:	HCG-10-11, HCG-10-21, HCG-20-11, HCG-20-21, HCG-2-10-11, HCG-2-20-11, HCV-10-11, HCV-10-21, HCV-2-10-21, HE-10-11, HE-10-21, HE-2-10-11, HG-10-11, HME-10-11, HME-10-21, HME-20-11, HME-20-21, HME-2-10-11, HME-2-20-11, HME-6-11, HMG-10-11, HMG-10-11UL, HMG-10-21, HMG-10-21UL, HMG-20-11, HMG-2-10-11, HMI-10-11, HMI-10-11UL, HMI-10-21, HMI-10-21UL, HMI-2-10-11, HMI-6-11, HMI-6-11UL, HMM-10-11, HMM-10-11UL, HMM-10-21, HMM-10-21UL, HMM-20-11, HMM-20-11UL, HMM-20-21, HMM-20-21UL, HMM-2-10-11, HMM-2-20-11, HMM-40-11-USMC, HMM-6-11, HMM-6-11UL, HMP-10-11, HMP-10-21, HMP-20-11, HMP-20-21...(Other models you can see in the webshop)		
accessories for	601503		
	GEV No.	500505	Ref. No. 12016565 R253049
	fan motor 220-240/380-415V 3 phase 50/60Hz 0.16-0.26kW 1440/1700rpm speeds 2 L1 140mm L2 27mm L3 35mm M10R IT 1.2/0.7A Cos(f) 0.63 type L7zAw4D-014 D1 ø 17mm D2 ø 13mm		



1

GEV No.	601322	Ref. No.	12026355 RT20120507
description	fan wheel D1 ø 350mm H1 125mm blades 12 D2 ø 13mm D3 ø 16mm H2 37mm		



1

GEV No.	601323	Ref. No.	12026699 RT20120512
description	fan wheel D1 ø 350mm H1 135mm blades 12 D2 ø 13mm D3 ø 16mm H2 45mm		



1

GEV No.	601795	Ref. No.	12024306 12024789 T493017
description	fan wheel D1 ø 350mm H1 125mm blades 12 D2 ø 13mm D3 ø 16mm H2 15mm		
For models:	ACE-061, ACE-101, ACE-102, ACE-201, ACE-202, ACG-101, ACG-102, ACG-201, ACG-202, AE-061, AE-061W, AE-101, AE-101W, AE-102, AE-102W, AE-201, AE-202, AG-101, AG-101W, AG-102, AG-102W, AG-201, AG-202, APE-061, APE-061W, APE-101, APE-101W, APE-102, APE-102W, APE-201, APE-202, APG-101, APG-101W, APG-102, APG-102W, APG-201, APG-202, COE-101, COE-102, COE-201, COE-202, COG-102, COG-202, HEI-20-21, HEM-10-11, HEM-20-11, HEM-20-21, HEM-6-11, HEP-10-11, HEP-20-11...(Other models you can see in the webshop)		



1

GEV No.	601324	Ref. No.	12025824 RT20120508
description	fan wheel D1 ø 450mm H1 155mm blades 12 D2 ø 13.5mm D3 ø 17mm H2 45mm		





1

GEV No.	601502	Ref. No.	12018490 T303015
description	fan wheel D1 ø 450mm H1 160mm blades 12 D2 ø 13mm D3 ø 17mm		
For models:	HEI-10-21, HEM-10-21, HEP-10-21, HGC-10-21, HGP-10-21, HGV-10-21		

			
1			
GEV No.	601325	Ref. No.	12026227 RT20120513
description	fan wheel D1 ø 450mm H1 165mm blades 12 D2 ø 14mm D3 ø 17mm H2 45mm		

			
1			
GEV No.	510587	Ref. No.	12033987 RT20160876
description	flange for fan motor ED ø 60mm int. ø 1 24mm int. ø 2 18.5mm thickness 3mm steel		

			
1			
GEV No.	691680	Ref. No.	12017909 R662623
description	flange for fan motor ED ø 60mm int. ø 1 28mm int. ø 2 19mm thickness 20mm SS		
For models:	HCG-10-11, HCG-10-21, HCG-20-11, HCG-20-21, HCG-2-10-11, HCG-2-20-11, HCG-6-11, HME-10-11, HME-10-21, HME-20-11, HME-20-21, HME-2-10-11, HME-2-20-11, HME-6-11, HMG-10-11, HMG-10-11UL, HMG-10-21, HMG-10-21UL, HMG-20-11, HMG-2-10-11, HMG-6-11, HMI-10-11, HMI-10-11UL, HMI-10-21, HMI-10-21UL, HMI-2-10-11, HMI-6-11, HMI-6-11UL, HMM-10-11, HMM-10-11UL, HMM-10-21, HMM-10-21UL, HMM-20-11, HMM-20-11UL, HMM-20-21, HMM-20-21UL, HMM-2-10-11, HMM-2-20-11, HMM-40-11-USMC, HMM-6-11, HMM-6-11UL, HMP-10-11, HMP-10-21, HMP-20-11, HMP-20-21, HMP-2-10-11, HMP-2-20-11, HMP-6-11, HVG-10-11, HVG-10-11UL...(Other models you can see in the webshop)		
accessories for	691680		
	GEV No.	691049	Ref. No.
			12024510 R012635000 R662627
description	shaft seal ID ø 17mm ED ø 28mm thickness 7mm		

			
1			
GEV No.	691049	Ref. No.	12024510 R012635000 R662627
description	shaft seal ID ø 17mm ED ø 28mm thickness 7mm		
For models:	ACE-061, ACE-101, ACE-102, ACE-201, ACE-202, ACG-061, ACG-101, ACG-102, ACG-201, ACG-202, AE-061, AE-061W, AE-101, AE-101W, AE-102, AE-102W, AE-201, AE-202, AG-061, AG-061W, AG-101, AG-101W, AG-102, AG-102W, AG-201, AG-202, APE-061, APE-061W, APE-101, APE-101W, APE-102, APE-102W, APE-201, APE-202, APG-061, APG-061W, APG-101, APG-101W, APG-102, APG-102W, APG-201, APG-202, COE-061, COE-101, COE-102, COE-201, COE-202, COG-061, COG-101, COG-102...(Other models you can see in the webshop)		

			
1			
GEV No.	510573	Ref. No.	12033667 RT50010207
description	shaft seal ID ø 17mm ED ø 29mm thickness 4.5mm		

			
1			
GEV No.	511682	Ref. No.	12034102 RT85141343
description	shaft seal kit ID ø 17mm ED ø 29mm shaft seal flange mounting gauge with mountign material		

			
1			
GEV No.	691891	Ref. No.	12024172 R663057
description	spacer bush for fan motor ED ø 9mm H 11mm ID ø 6.5mm		
For models:	COE-061, COE-101, COE-102, COE-201, COE-202, COG-061, COG-101, COG-201, HEM-10-11, HEM-20-11, HEM-6-11, HEP-10-11, HEP-20-11, HEP-6-11, HME-10-11, HME-10-21, HME-20-11, HME-20-21, HME-2-10-11, HME-2-20-11, HME-6-11, HMM-20-11, HMM-20-11UL, HMM-20-21, HMP-10-11, HMP-10-21, HMP-20-11, HMP-20-21, HMP-2-10-11, HMP-2-20-11, HMP-6-11, VE-061, VE-101, VE-102, VE-201, VE-202, VG-101, VG-201, VPE-061, VPE-101, VPE-102, VPE-201, VPE-202, VPG-101, VPG-201		



hot air fans

ebm-papst

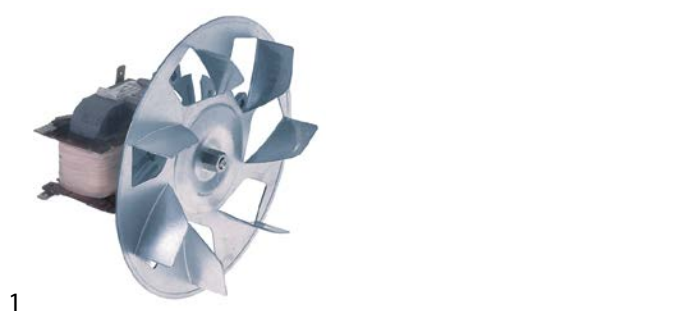

1

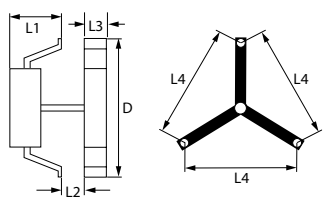



GEV No.	601513	Ref. No.	12032214 6021050005
description	hot air fan 220-240V 41W L1 60mm L2 12mm L3 25mm L4 87mm fan wheel ø 154mm type RRL140/0024 A36-3020LH-459 ebm-papst WS 10		
For models:	AC-120, AC-180, CCF-10, CCF-10CI, CCF-20, CCF-20CI, CCF-40, CCF-40CI		

miscellaneous

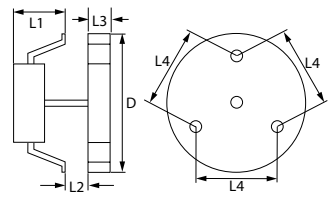

1



GEV No.	601448	Ref. No.	12031294 AS30480001
description	hot air fan 220-240V 32W 50/60Hz L1 60mm L2 11mm L3 25mm L4 87mm fan wheel ø 155mm FIME type C20X0E01/11		
spare parts for	601448		
		GEV No.	601261
		Ref. No.	—
	fan wheel ø 154mm W 25mm shaft intake ø 6x5mm chrome-plated blades 7		
accessories for	601448		
		GEV No.	550879
		Ref. No.	—
	insulation ø 130mm thickness 3mm hole ø 20mm for hot air fan		

radial fans



1

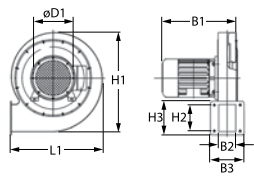

GEV No.	602181	Ref. No.	12039373 T543052000
description	radial fan 230V voltage AC 50/60Hz 135W H1 193mm L1 182mm D1 ø 90mm W1 145mm W2 28mm H2 50mm W3 83mm H3 80mm combi-steamer		
For models:	AG-202, APG-202		

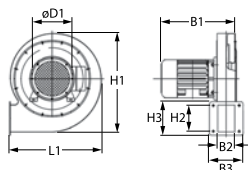
1

GEV No.	601709	Ref. No.	12025823 RT31011017
description	radial fan 230V voltage AC 50/60Hz H1 180mm L1 175mm D1 ø 43mm W1 82mm W2 33mm H2 60mm W3 83mm H3 83mm for combi-steamer		

1

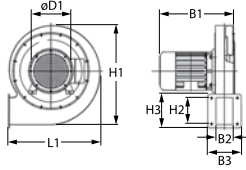
GEV No.	601295	Ref. No.	12024797 12026033 RT7000028 T083000
description	radial fan 230V voltage AC 50Hz 50W H1 180mm L1 180mm D1 ø 43mm W1 105mm W2 33mm H2 59mm W3 66mm H3 83mm		
For models:	COG-061, COG-101, COG-201, HCG-10-11, HCG-10-21, HCG-20-11, HCG-2-10-11, HCG-6-11, HGC-10-11, HGC-20-11, HGC-6-11, HGV-10-11, HGV-20-11, HVG-10-11, HVG-10-11UL, HVG-10-21, HVG-10-21UL, HVG-20-11, HVG-2-10-11, MFHVG-10-11, MFHVG-10-21, VG-101, VG-201, VPG-101, VPG-201		

1

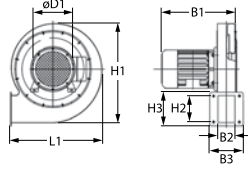
GEV No.	601296	Ref. No.	12025691 RT7000067
description	radial fan 230V voltage AC 50Hz 140W H1 190mm L1 190mm D1 ø 50mm W1 133mm W2 28mm H2 55mm W3 83mm H3 83mm		

1

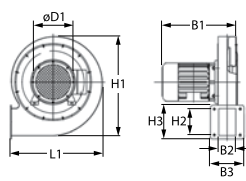
GEV No.	602183	Ref. No.	12044607
description	radial fan 230V voltage AC 50Hz 55W H1 156mm L1 160mm D1 ø 126mm W1 90mm H2 50mm W3 83mm combi-steamer		
For models:	ACG-061, ACG-101, ACG-102, ACG-201, ACG-202, AG-061, AG-101, AG-102, AG-201, AG-202, APG-061, APG-101, APG-102, APG-201, APG-202		

1

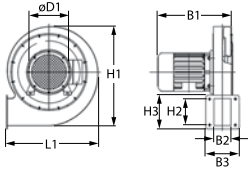
GEV No.	500798	Ref. No.	12026360 RT31011016
description	radial fan 230V voltage AC 50Hz 25W H1 143mm L1 127mm D1 ø 27mm W1 85mm W2 23mm H2 43mm W3 76mm H3 83mm		

1

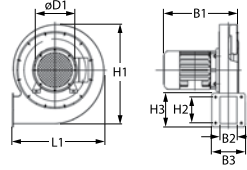
GEV No.	601114	Ref. No.	12026776 RT87201418
description	radial fan 24V voltage AC 50Hz 20W H1 141mm L1 130mm D1 ø 27mm W1 86mm W2 23mm H2 42.5mm W3 75.5mm H3 83mm gas burner		



GEV No.	601115	Ref. No.	12026189 RT31011014
description	radial fan 24V voltage AC 50Hz H1 180mm L1 175mm D1 ø 43mm W1 84mm W2 33mm H2 59mm W3 82mm H3 83mm		

GEV No.	691058	Ref. No.	12016374 T093001
description	radial fan 230V voltage AC 50Hz 370W		
For models:	HCG-20-11, HMG-20-11		

Image not available

GEV No.	691868	Ref. No.	12016428 R723025
description	radial fan 230V voltage AC 60Hz 200W		
For models:	HCG-10-11, HCG-10-21, HCG-2-10-11, HCG-6-11, HMG-10-11, HMG-10-11UL, HMG-10-21, HMG-10-21UL, HMG-2-10-11, HMG-6-11		

Image not available

GEV No.	691867	Ref. No.	12016367 T093002
description	radial fan 230V voltage AC 60Hz 370W		
For models:	HCG-20-11, HMG-20-11		

motors

gear motors

for tilting bratt pans

GEV No.	500348	Ref. No.	12016368 X343000
description	gear motor ERREKA type 65-T2100CF01 220W 230V 50Hz 1 phase 0.27rpm shaft ø 59.5mm L 460mm W 88mm H 88mm for tilting bratt pan		
For models:	SBE9-10IM, SBE9-10IMS, SBE9-10M, SBE9-10MS, SBE9-15IM, SBE9-15IMS, SBG9-10IM, SBG9-10IMS, SBG9-10M, SBG9-10MS, SBG9-15IM, SBG9-15IMS		

for ovens

for flues

GEV No.	361999	Ref. No.	12031548 RT31011010 RT31011010S
description	gear motor CROUZET type 82841042 12V voltage DC shaft ø 4mm L 65mm W 50mm H 51mm for oven		

GEV No.	530008	Ref. No.	12024638 T323010
description	gear motor MECHTEX type SOE-40 3.5W 230V voltage AC 50/60Hz 10rpm shaft ø 6x5mm L 65mm W 51mm H 40mm chimney motor		
For models:	ACE-061, ACE-101, ACE-102, ACE-201, ACE-202, ACG-061, ACG-101, ACG-102, ACG-201, ACG-202, AE-061, AE-061W, AE-101, AE-101W, AE-102, AE-102W, AE-201, AE-202, AG-061, AG-061W, AG-101, AG-101W, AG-102, AG-102W, AG-201, AG-202, APE-061, APE-061W, APE-101, APE-101W, APE-102, APE-102W, APE-201, APE-202, APG-061, APG-061W, APG-101, APG-101W, APG-102, APG-102W, APG-201, APG-202, COE-061, COE-101, COE-102, COE-201, COE-202, HEI-10-21, HEI-20-21, HEM-10-21...(Other models you can see in the webshop)		
spare parts for	530008		
	GEV No.	360673	Ref. No. —
	motor kit pinion ø 6.8mm teeth 15 230V voltage AC 50/60Hz turn direction clockwise motor ø 48mm H 18.5mm motor type UDS- 40NE1RNZ165 cable length 150mm with holder		

pumps

wash and rinse pumps

FIR

pumps



GEV No.	499353	Ref. No.	12024782 T360715 T360715000
description	pump inlet ø 30mm outlet ø 26mm type 5213E2451 230V 50Hz 1 phase 0.22kW 0.1HP L 190mm rotation direction left capacitor 5µF FIR		
For models:	APE-201, APE-202, APG-201, APG-202, HEP-10-21, HEP-20-21, HGP-10-21, HGP-20-21, VPE-102, VPE-201, VPE-202, VPG-102, VPG-201, VPG-202		



GEV No.	499334	Ref. No.	EU929174
description	pump inlet ø 62mm outlet ø 62mm type 2250.2731 230/400V 50Hz 1 phase 3kW FIR		
spare parts for	499334		
	GEV No.	510687	Ref. No. —
	mechanical shaft seal for shaft ø 18mm height counter ring 8mm ID ø 17mm ED ø 39mm H 15mm mounting ø 42mm int. ø 1 21mm		
	GEV No.	512455	Ref. No. —
	fan wheel ø 155mm H 18mm shaft intake ø 18mm plastic blades 12		
	GEV No.	521026	Ref. No. —
	pump cover gasket ID ø 182.5mm thickness 5x4.5mm		

Table continues overleaf

GEV No.	500873	Ref. No.	12027771 RT2200318
description	ventilation valve CROUZET type G70C10AFTEG 12V voltage DC shaft ø 6mm L 95mm W 63mm H 136mm for combi-steamer ø 50mm		

for dishwashers



GEV No.	601662	Ref. No.	12023304 Z315001 Z315006
description	gear motor C.M.E type 71 B 6/4 0.18/0.25W 230V 50Hz 1 phase 1380rpm MI 50 transmission 60/1 for dishwasher		
For models:	ECO-280D, ECO-280I, ECO-370D, ECO-370I, ECO-460D, ECO-460I, ECO-550D, ECO-550I, FI-280D, FI-280I, FI-370D, FI-370I, FI-460D, FI-460I, FI-550D, FI-550I		





GEV No.	500783	Ref. No.	12024739 Z275073 Z275074
description	gear motor type 71E00147 250W 230/400V 50/60Hz 3 phase L 365mm W 200mm H 170mm MI 50 transmission 100/1 for dishwasher		
For models:	ECO-160, ECO-160D, ECO-160I, FI-160, FI-160AR, FI-160D, FI-160I		

miscellaneous



GEV No.	501518	Ref. No.	12024754
description	gear motor 230V 50/60Hz		
For models:	AE-102W, APE-061, APE-061W, APE-101, APE-101W, APE-102, APE-102W, APE-201, APE-202, APG-061, APG-061W, APG-101, APG-101W, APG-102, APG-102W, APG-201, APG-202, HEP-10-21, HEP-20-21, HGP-10-21, HGP-20-21, VG-101, VPE-061, VPE-101, VPE-102, VPE-201, VPE-202, VPG-101, VPG-102, VPG-201, VPG-202		



spare parts for 499334				
	GEV No.	521028	Ref. No.	—
pump cover FIR inlet ø 62mm outlet ø 62mm turn direction right ø 215mm ID ø 175mm inner height 40mm				
	GEV No.	521277	Ref. No.	12038035 EU929181
impellor ø 135mm H 39mm pump type Fir 2275 - 3.6HP thread M14L				



1

GEV No.	500705	Ref. No.	12024812 Z101001	
description	pump inlet ø 63mm outlet ø 53mm type 1243 230/400V 50Hz 3 phase 2.39kW 3.2HP L 363mm rotation direction left FIR			
For models:	ECO-1600, ECO-2300, ECO-280D, ECO-280I, ECO-3000, ECO-370D, ECO-370I, ECO-460D, ECO-460I, ECO-550D, ECO-550I, FI-1600, FI-2300, FI-280D, FI-280I, FI-3000, FI-370D, FI-370I, FI-460D, FI-460I, FI-550D, FI-550I			
spare parts for	500705			
	GEV No.	510357	Ref. No.	—
impellor ø 124mm H 34/16mm thread M8R blades 6				

HANNING

pumps

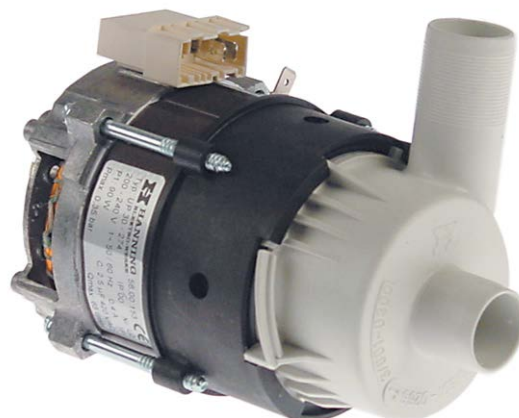

1



GEV No.	500578	Ref. No.	12026928 RT5600153P	
description	pump inlet ø 24mm outlet ø 24mm type UP30-274 230V 50/60Hz 1 phase 0.09kW 0.12HP L 145mm rotation direction left capacitor 2.5µF HANNING			
spare parts for	500578			
	GEV No.	501345	Ref. No.	—
O-ring EPDM thickness 3mm ID ø 58mm Qty 1 pcs				

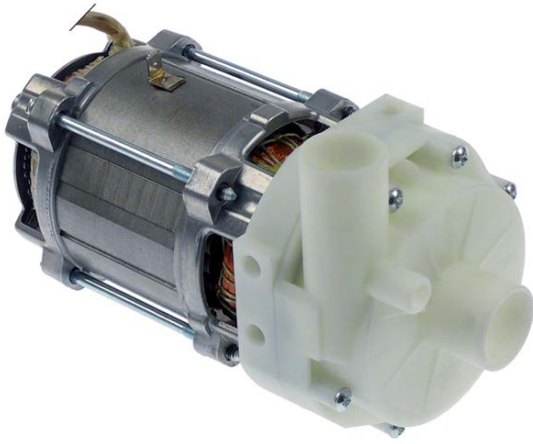

1

GEV No.	500579	Ref. No.	12026728 RT5600178P	
description	pump inlet ø 24mm outlet ø 24mm type UP30-275 230V 50/60Hz 1 phase 0.09kW 0.12HP L 145mm rotation direction left capacitor 2.5µF HANNING			
spare parts for	500579			
	GEV No.	501345	Ref. No.	—
O-ring EPDM thickness 3mm ID ø 58mm Qty 1 pcs				





1			
GEV No.	499166	Ref. No.	12024233
description	pump inlet \varnothing 28mm outlet \varnothing 26mm type UP60-414 220-240V 50/60Hz 1 phase 0.25kW L 190mm rotation direction right capacitor 5 μ F HANNING p max 1bar Qmax. 150l/min		
For models:	AD-125, AD-125HRS, AD-125-SOFT, AD-45BBT, AD-48HY, AD-505, AD-64BBT, AD-64BTDD, AD-64HY, COP-173, COP-173B, COP-173BDD, COP-173DD, COP-173HRS, COP-173HRSDD, COP-173-SOFT, COP-174, COP-174B, COP-174BDD, COP-174DD, COP-174HRS, COP-174HRSDD, COP-174W, COP-174WHRS, COP-503, COP-503B, COP-503BDD, COP-503DD, COP-503-SOFT, COP-504, COP-504B, COP-504BDD, COP-504DD, COP-504W, EASY-500HPWBDD, FI-30B-BT-UK, FI-48B-BT-UK, FI-48HY-CLINIC, FI-64B-BT-UK, FI-64HY-CLINIC		
spare parts for	499166		
	GEV No.	365017	Ref. No. —
	operating capacitor capacity 5 μ F 450V tolerance 5% 50/60Hz ambient temperature max. -25 to +85°C \varnothing 28mm L 54mm M8 plastic connection male faston 6.3mm 16.10.08 protection		
	GEV No.	507558	Ref. No. —
	mechanical shaft seal for shaft \varnothing 7mm height counter ring 5mm ID \varnothing 6.75mm ED \varnothing 20mm mounting \varnothing counter ring 18.5/slide ring 20mm		
	GEV No.	532644	Ref. No. —
	O-ring EPDM thickness 3mm ID \varnothing 78mm Qty 1 pcs		

INSERT STAR

pumps



1			
GEV No.	500321	Ref. No.	12023429 Z401001
description	pump inlet \varnothing 38mm outlet \varnothing 38mm type 2/102FA10 230V 50/60Hz 1 phase 0.26kW 0.35HP L 195mm rotation direction right capacitor 6 μ F INSERTSTAR		
For models:	AD-120BBTDD-UK, AD-120HY, AD-15, AD-15D, AD-20C-UK, AD-21, AD-21B, AD-21BDD, AD-21C, AD-21D, AD-21DD, AD-21W, AD-90BBT, ADE-120, ADE-120B, CO-350, CO-350-B, CO-350-B-DD, CO-350-COLD, CO-350-COLD-B, CO-350-COLD-B-DD, CO-350-COLD-DD, CO-350-DD, CO-352-COLD, CO-352-COLD-B, CO-352-COLD-B-DD, CO-352-COLD-DD, CO-400, CO-400-B, CO-400-B-DD, CO-400-COLD, CO-400-COLD-B, CO-400-COLD-B-DD, CO-400-COLD-DD, CO-400-DD, CO-400-SOFT, CO-402-COLD, CO-402-COLD-B, CO-402-COLD-B-DD, CO-402-COLD-DD, CO-402W, ECO-120, ECO-1200, ECO-120B, ECO-160, ECO-160D, ECO-160I, ECO-200, ECO-200D, ECO-200H...(Other models you can see in the webshop)		
spare parts for	500321		
	GEV No.	504578	Ref. No. —
	O-ring EPDM thickness 3.53mm ID \varnothing 94.84mm Qty 1 pcs		
	GEV No.	510693	Ref. No. 12018735 Z201081
	mechanical shaft seal for shaft \varnothing 12mm slide ring ext. \varnothing 24mm slide ring H 15.5mm slide ring int. \varnothing 11mm counter ring mounting \varnothing 24mm height counter ring 8mm counter ring int. \varnothing 13.5mm		
accessories for	500321		
	GEV No.	365093	Ref. No. 12024346 V817100
	operating capacitor capacity 6 μ F 400V tolerance 5% 50/60Hz ambient temperature max. -25 to +85°C \varnothing 31.5mm L 55mm M8 plastic connection male faston 6.3mm protection		



1			
GEV No.	501562	Ref. No.	12043287
description	pump inlet ø 38mm outlet ø 38mm type 2/123 FA-22 230V 50Hz 1 phase 0.59kW 0.8HP rotation direction right capacitor 10µF INSERT-STAR		
For models:	AD-120C, AD-120HY, AD-125, AD-125HRS, AD-125-SOFT, AD-505, AD-505-SOFT, AD-64BTDD, CO-110, CO-110B, CO-110BDD, CO-110DD, CO-112, CO-112B, CO-112BDD, CO-112DD, CO-170, CO-170B, CO-170BDD, CO-170DD, CO-170HRS, CO-170HRSDD, CO-170HRS-SOFT, CO-170-SOFT, CO-172, CO-172B, CO-172BDD, CO-172DD, CO-500, CO-500B, CO-500BDD, CO-500DD, CO-501, CO-501B, CO-501BDD, CO-501DD, CO-501-SOFT, CO-502B, CO-502BDD, CO-502DD, COP-173, COP-173B, COP-173BDD, COP-173DD, COP-173HRS, COP-173HRSDD, COP-173-SOFT, COP-174, COP-174B, COP-174BDD...(Other models you can see in the webshop)		



2			
GEV No.	499075	Ref. No.	12024270 Z203501 Z203511
description	pump inlet ø 38mm outlet ø 38mm type 2/123 FA31 230V 60Hz 1 phase 0.59kW L 240mm rotation direction right capacitor 10µF INSERTSTAR		
For models:	AD-120, AD-120B, AD-120CW, AD-48, AD-48W, AD-64, AD-64CW, AD-72, AD-72W, AD-90, AD-90BA, AD-90BDD, AD-90DD, ADE-120, ADE-120B, EASY-500, EASY-500B, EASY-500DD, EASY-500HP, EASY-500HPWBDD, ECO-120, ECO-1200, ECO-120B, ECO-160D, ECO-160I, ECO-200D, ECO-200HD, ECO-200HI, ECO-200I, ECO-370D, ECO-370I, ECO-550D, ECO-550I, FI-100, FI-100AR, FI-100B, FI-100BBT-UK, FI-120, FI-1200, FI-120AR+DD, FI-120B, FI-120C, FI-120HY-CLINIC, FI-120W, FI-160AR, FI-160D, FI-160I, FI-200AR, FI-200D...(Other models you can see in the webshop)		
spare parts for	499075		
	GEV No.	510693	Ref. No. 12018735 Z201081
	mechanical shaft seal for shaft ø 12mm slide ring ext. ø 24mm slide ring H 15.5mm slide ring int. ø 11mm counter ring mounting ø 24mm height counter ring 8mm counter ring int. ø 13.5mm		
	GEV No.	521000	Ref. No. 12019782 Z201085
	pump cover FAGOR inlet ø 38mm outlet ø 38mm		
	GEV No.	532491	Ref. No. —
	O-ring EPDM thickness 3.53mm ID ø 120.2mm Qty 1 pcs		
	GEV No.	650238	Ref. No. —
	impellor ø 77mm H 32mm pump type 2/123 FA31 shaft intake ø 8mm rotation direction right thread M8L suitable for INSERTSTAR shaft ø 12mm shaft length 26mm blades 6		

accessories for	499075		
	GEV No.	365015	Ref. No. 12024376 V321300
	operating capacitor capacity 10µF 400V tolerance 5%Hz ambient temperature max. -25 to +85°C ø 35.5mm L 59mm M8 plastic connection male faston 6.3mm protection		

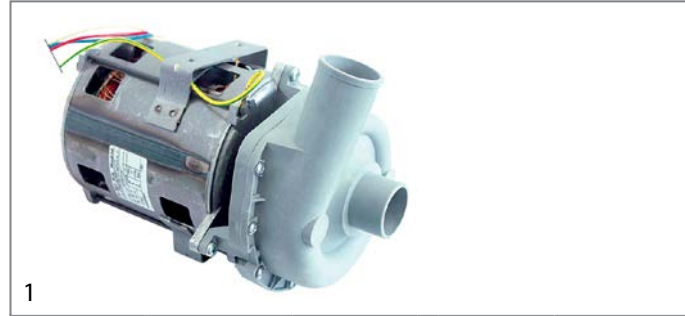

1			
GEV No.	500320	Ref. No.	12024265 Z201001 Z201011
description	pump inlet ø 38mm outlet ø 38mm type 2/123/FA30 230V 50Hz 1 phase 0.59kW 0.8HP L 235mm rotation direction right capacitor 10µF INSERTSTAR		
For models:	AD-120, AD-120B, AD-120BBTDD-UK, AD-120C, AD-120HY, AD-45BBT, AD-48, AD-48B, AD-48BDD, AD-48C, AD-48D, AD-48DD, AD-48HY, AD-64, AD-64B, AD-64BBT, AD-64BDD, AD-64BTDD, AD-64C, AD-64D, AD-64DD, AD-64HY, AD-72, AD-90, AD-90BA, AD-90BBT, AD-90BDD, AD-90DD, ADE-120, ADE-120B, EASY-500, EASY-500B, EASY-500DD, EASY-500HP, EASY-500HPWBDD, ECO-120, ECO-1200, ECO-120B, ECO-160, ECO-1600, ECO-160D, ECO-160I, ECO-200, ECO-200D, ECO-200H, ECO-200HD, ECO-200HI, ECO-200I, ECO-2300, ECO-3000...(Other models you can see in the webshop)		

spare parts for	500320		
	GEV No.	510693	Ref. No. 12018735 Z201081
	mechanical shaft seal for shaft ø 12mm slide ring ext. ø 24mm slide ring H 15.5mm slide ring int. ø 11mm counter ring mounting ø 24mm height counter ring 8mm counter ring int. ø 13.5mm		
	GEV No.	521000	Ref. No. 12019782 Z201085
	pump cover FAGOR inlet ø 38mm outlet ø 38mm		
	GEV No.	521255	Ref. No. 12018550 Z201082
	impellor ø 88mm H 33mm M8L pump type 2/123/FA30 shaft ø 12mm		
	GEV No.	532491	Ref. No. —
	O-ring EPDM thickness 3.53mm ID ø 120.2mm Qty 1 pcs		

accessories for	500320		
	GEV No.	365015	Ref. No. 12024376 V321300
	operating capacitor capacity 10µF 400V tolerance 5%Hz ambient temperature max. -25 to +85°C ø 35.5mm L 59mm M8 plastic connection male faston 6.3mm protection		
	GEV No.	551227	Ref. No. —
	female faston size 6.3x0.8mm 1.0-2.5mm ² straight CuZn gal Sn t.max. 110°C Qty 10 pcs		



booster pumps I



1

GEV No.	499155	Ref. No.	12023344 Z209508
description	pump inlet ø 1" IT outlet ø 1" IT type PRISMA15 230V 50Hz 0.6kW L 400mm capacitor 12µF		
For models:	ECO-120, ECO-1200, FI-100, FI-120, FI-1200, FI-120W, FI-30, FI-30AR, FI-30AR+DD, FI-30-UK, FI-48, FI-48AR, FI-48B, FI-48B-BT-UK, FI-48C, FI-48D, FI-48HY-CLINIC, FI-48W, FI-50, FI-64, FI-64AR, FI-64B, FI-64B-BT-UK, FI-64C, FI-64D, FI-64HY-CLINIC, FI-64W, FI-72, FI-72AR, FI-72W, FI-900, MF-48, MF-64		



1

GEV No.	499073	Ref. No.	12017575 12017826 12024708
description	pump inlet ø 31 outlet ø 27 type 887084885 230V 50Hz 0.75kW L 146mm capacitor 2.5µF NIDEC		
For models:	APE-061, APE-101, APE-102, APG-061, APG-101, APG-102, FI-30B-BT-UK, FI-48B-BT-UK, FI-48HY-CLINIC, FI-64B-BT-UK, FI-64HY-CLINIC, VPE-061, VPE-101		

drain pumps

COPRECI



1

GEV No.	500322	Ref. No.	12024273 Z220901
description	drain pump inlet ø 25mm outlet ø 22mm 230V 30W 50Hz COPRECI		
For models:	AD-20C-UK, AD-21B, AD-21BDD, AD-21C, AD-45BBT, AD-48B, AD-48BDD, AD-48C, AD-48HY, AD-64B, AD-64BBT, AD-64BDD, AD-64C, AD-64HY, FI-30, FI-30AR, FI-30AR+DD, FI-30B, FI-30B-BT-UK, FI-30-UK, FI-48, FI-48AR, FI-48B, FI-48B-BT-UK, FI-48C, FI-48D, FI-48HY-CLINIC, FI-48W, FI-64, FI-64AR, FI-64B, FI-64B-BT-UK, FI-64C, FI-64D, FI-64HY-CLINIC, FI-64W, GA-20, GA-20D, GA-40, GA-40D, HEM-10-21, HEM-20-21, HEP-10-21, HEP-20-21, HGP-10-21, HGP-20-21, HGV-10-21, HGV-20-21, LVC-21B, LVC-21C...(Other models you can see in the webshop)		

HANNING



1

GEV No.	500573	Ref. No.	12029471 RT4400207P
description	drain pump 30W 4-piece 230V inlet ø 24/30mm outlet ø 24mm 50Hz HANNING type DPS25-032 1x pump, 3x pump cover		



1

GEV No.	501561	Ref. No.	12094265
description	drain pump 38W 200-240V inlet ø 30mm outlet ø 24mm 50/60Hz HANNING type DP25R-396		
For models:	AD-505, AD-505-SOFT, CO-350-B, CO-350-B-DD, CO-350-COLD-B, CO-350-COLD-B-DD, CO-352-COLD-B, CO-352-COLD-B-DD, CO-400-B, CO-400-B-DD, CO-400-COLD-B, CO-400-COLD-B-DD, CO-402-COLD-B, CO-402-COLD-B-DD, CO-402W, CO-500B, CO-500BDD, CO-501B, CO-501BDD, CO-502B, CO-502BDD, CO-502W, COP-503B, COP-503BDD, COP-504B, COP-504BDD, COP-504W, EASY-500B, EASY-500DD		



1

GEV No.	501595	Ref. No.	12039546 T843060000
description	drain pump 38W 200-240V inlet ø 30mm outlet ø 24mm 50-60Hz HANNING type DPS25R-391 max. 15min input current 0.4A		
For models:	ACE-061, ACE-102, AE-061, AE-061W, AE-101, AE-101W, AE-102, AE-102W, AE-201, AE-202, AG-061, AG-061W, AG-101, AG-101W, AG-102, AG-102W, AG-201, AG-202, APE-061, APE-061W, APE-101, APE-101W, APE-102, APE-102W, APE-201, APE-202, APG-061, APG-061W, APG-101, APG-101W, APG-102, APG-102W, APG-201, APG-202		

1

GEV No.	500737	Ref. No.	12023456 Z711007
description	drain pump inlet ø 24mm outlet ø 24mm 230V 95W 50Hz HANNING type BE38B5-017		
For models:	AD-120B, AD-120BBTDD-UK, AD-120C, AD-120HY, AD-125, AD-125HRS, AD-125-SOFT, AD-90BA, AD-90BBT, AD-90BDD, ADE-120B, CO-110B, CO-110BDD, CO-112B, CO-112BDD, CO-170B, CO-170BDD, CO-172B, CO-172BDD, COP-173B, COP-173BDD, COP-174B, COP-174BDD, ECO-120B, FI-100, FI-100AR, FI-100B, FI-100BBT-UK, FI-120B, FI-120C, FI-120HY-CLINIC, FI-80BBT-UK		



1

GEV No.	500044	Ref. No.	12029264 12029492 RT30021000P
description	drain pump inlet ø 30mm outlet ø 24mm 230V 100W 50Hz HANNING type BE28B4-017		
spare parts for	500044		
	GEV No.	510168	Ref. No. —
	fan wheel shaft intake ø 5mm ø 62mm H 14mm		



1

GEV No.	501542	Ref. No.	12029791 RT30021005
description	drain pump inlet ø 30mm outlet ø 24mm 230V 32W		

service kits



1

GEV No.	500573	Ref. No.	12029471 RT4400207P
description	drain pump 30W 4-piece 230V inlet ø 24/30mm outlet ø 24mm 50Hz HANNING type DPS25-032 1x pump, 3x pump cover		

booster pumps II

accessories



1

GEV No.	365015	Ref. No.	12024376 V321300
description	operating capacitor capacity 10µF 400V tolerance 5%Hz ambient temperature max. -25 to +85°C ø 35.5mm L 59mm M8 plastic connection male faston 6.3mm protection		
For models:	AD-120, AD-120B, AD-120BBTDD-UK, AD-120C, AD-120CW, AD-120HY, AD-125, AD-125HRS, AD-125-SOFT, AD-45BBT, AD-48, AD-48B, AD-48BDD, AD-48C, AD-48D, AD-48DD, AD-48HY, AD-48W, AD-505, AD-505-SOFT, AD-64, AD-64B, AD-64BBT, AD-64BDD, AD-64BTDD, AD-64C, AD-64CW, AD-64D, AD-64DD, AD-64HY, AD-72, AD-72W, AD-90, AD-90BA, AD-90BBT, AD-90BDD, AD-90DD, ADE-120, ADE-120B, CO-110, CO-110B, CO-110BDD, CO-110DD, CO-112, CO-112B, CO-112BDD, CO-112DD, CO-142W, CO-142WDD, CO-170...(Other models you can see in the webshop)		



1

GEV No.	365012	Ref. No.	SAM4420032
description	operating capacitor capacity 6.3µF 450V tolerance 5% 50Hz ambient temperature max. -25 to +85°C ø 30mm L 61mm M8 plastic connection male faston 6.3mm protection		



vibration pumps



1

GEV No.	500580	Ref. No.	12028569 RT87201526
description	vibration pump 230V 60W 50/60Hz inlet ø 7 outlet ø 1/8" IT CEME type E512 with accessories duty cycle 1/2 ambient temperature max. 60°C medium temp max. 35°C overheating protection 110°C CleanJet		

spare parts for	500165			
	GEV No.	601413	Ref. No.	—
	fixing plate suitable for fanwheel ED ø 32mm shaft ø 7 mounting distance 26mm			

pumps for ice machines







1

GEV No.	500590	Ref. No.	12028429 BR00023377	
description	pump FIR type 4240.2300 120W 230V 50/60Hz inlet ø 22mm outlet ø 22mm L 240mm rotation direction right for ice-cube maker capacitor 5µF			
spare parts for	500590			
	GEV No.	601412	Ref. No.	12037081 BR00010213
	fan wheel sucking ø 154mm fan wheel mounting 25.4mm blade angle 28° W 34mm plastic			
	GEV No.	601413	Ref. No.	—
	fixing plate suitable for fanwheel ED ø 32mm shaft ø 7 mounting distance 26mm			





1

GEV No.	500166	Ref. No.	12028448 BR00023068	
description	pump REBO type 63/45 150W 230V 50/60Hz inlet ø 28mm outlet ø 26mm L 200mm rotation direction right capacitor 5µF			
spare parts for	500166			
	GEV No.	365017	Ref. No.	—
	operating capacitor capacity 5µF 450V tolerance 5% 50/60Hz ambient temperature max. -25 to +85°C ø 28mm L 54mm M8 plastic connection male faston 6.3mm 16.10.08 protection			
	GEV No.	601412	Ref. No.	12037081 BR00010213
	fan wheel sucking ø 154mm fan wheel mounting 25.4mm blade angle 28° W 34mm plastic			
	GEV No.	601413	Ref. No.	—
	fixing plate suitable for fanwheel ED ø 32mm shaft ø 7 mounting distance 26mm			



1

GEV No.	500165	Ref. No.	12028445 BR00023002	
description	pump REBO type 63/35 120W 230V 50/60Hz inlet ø 28mm outlet ø 26mm L 180mm rotation direction right for ice-cube maker capacitor 5µF			
spare parts for	500165			
	GEV No.	365017	Ref. No.	—
	operating capacitor capacity 5µF 450V tolerance 5% 50/60Hz ambient temperature max. -25 to +85°C ø 28mm L 54mm M8 plastic connection male faston 6.3mm 16.10.08 protection			
	GEV No.	601412	Ref. No.	12037081 BR00010213
	fan wheel sucking ø 154mm fan wheel mounting 25.4mm blade angle 28° W 34mm plastic			



1

GEV No.	500161	Ref. No.	12026128 BR00C23076	
description	pump REBO type NR40 55W 230V 50Hz outlet ø 17mm L 110mm rotation direction left for ice-cube maker			
spare parts for	500161			
	GEV No.	500970	Ref. No.	—
	pump motor 55W 230V 50Hz REBO L 205mm type outlet ømm suitable for for ice maker			



condensators & interference suppression filters

starting capacitors

starting capacitors



1

GEV No.	365061	Ref. No.	12033454 6004000008 6021010037
description	starting capacitor 220/300V 50Hz DANFOSS duty cycle 1.7/0.10% capacity 80µF for FR/NL		
For models:	AEP-701, AEP-702, AEP-801, AEP-802, AF-1402-MIX, AF-1602-MIX, AF-1603-C, AF-1603-P, AF-1604-C, AF-1604-P, AF-702-C, AF-702-P, AFN-701, AFP-1402-MIX, AFP-1602, AFP-1602-2, AFP-1603, AFP-1603-2, AFP-701, AFP-702, AFP-702-C, AFP-702-P, AFP-801, AFP-802, AFP-802-2, AFP-802-2C, AFP-802-3C, BFP-150, BFP-150A, BFP-150I, BFP-200, BFP-200A, BFP-200I, CAEP-701, CAEP-801, CAEP-802, CAF-1402MIXT, CAF-1602MIX, CAFP-1602-2, CAFP-1603-2, CAFP-701, CAFP-702, CAFP-801, CAFP-802, CAFP-802-2C, CAFP-802-3C, CFMP-150, CFMP-150F, CFMP-150PC, CFMP-150TV...(Other models you can see in the webshop)		



1

GEV No.	365062	Ref. No.	12018649 6004000009 6021010035
description	starting capacitor 80µF 220/300V 50/60Hz duty cycle 3min/1min ø 38mm L 98mm plastic connection cable 100mm		
For models:	AEP-1402, AEP-1403, AEP-1404, AEP-1602, AEP-1603, AEP-1604, AEP-2103, AF-1402-MIX, AF-1403-C, AF-1403-P, AF-1404-C, AF-1404-P, AF-1602-MIX, AF-1603-C, AF-1604-C, AF-2104-C, AF-2104-P, AF-2105-C, AF-2105-P, AF-2106-C, AF-2106-P, AF-702-C, AF-702-P, AF-802-C, AFN-701, AFN-702, AFN-801, AFN-802, AFP-1402, AFP-1402-MIX, AFP-1403, AFP-1403-C, AFP-1403-P, AFP-1404, AFP-1404-C, AFP-1404-P, AFP-1602, AFP-1602-2, AFP-1603, AFP-1603-2, AFP-1604, AFP-2103, AFP-2104, AFP-2104-C, AFP-2104-P, AFP-2105, AFP-2105-C, AFP-2105-P, AFP-2106, AFP-2106-C...(Other models you can see in the webshop)		

operating capacitors

plastic



1

GEV No.	365015	Ref. No.	12024376 V321300
description	operating capacitor capacity 10µF 400V tolerance 5%Hz ambient temperature max. -25 to +85°C ø 35.5mm L 59mm M8 plastic connection male faston 6.3mm protection		
For models:	AD-120, AD-120B, AD-120BBTDD-UK, AD-120C, AD-120CW, AD-120HY, AD-125, AD-125SHRS, AD-125-SOFT, AD-45BBT, AD-48, AD-48B, AD-48BDD, AD-48C, AD-48D, AD-48DD, AD-48HY, AD-48W, AD-505, AD-505-SOFT, AD-64, AD-64B, AD-64BBT, AD-64BDD, AD-64BTDD, AD-64C, AD-64CW, AD-64D, AD-64DD, AD-64HY, AD-72, AD-72W, AD-90, AD-90BA, AD-90BBT, AD-90BDD, AD-90DD, ADE-120, ADE-120B, CO-110, CO-110B, CO-110BDD, CO-110DD, CO-112, CO-112B, CO-112BDD, CO-112DD, CO-142W, CO-142WDD, CO-170...(Other models you can see in the webshop)		



1

GEV No.	365020	Ref. No.	12020898 R293000
description	operating capacitor capacity 14µF 400V tolerance 5%Hz ambient temperature max. -25 to +85°C ø 35mm L 70mm M8 plastic connection male faston 6.3mm protection		
For models:	HCG-10-11, HCG-10-21, HCG-2-10-11, HCG-6-11, HCV-10-11, HCV-10-21, HCV-2-10-21, HCV-5-11, HCV-6-11, HE-5-11, HG-10-11, HG-10-21, HG-2-10-11, HMG-10-11, HMG-10-11UL, HMG-10-21, HMG-10-21UL, HMG-2-10-11, HMG-6-11, HVG-10-11, HVG-10-11UL, HVG-10-21, HVG-10-21UL, HVG-2-10-11, MFHVG-10-11, MFHVG-10-21		



1

GEV No.	365226	Ref. No.	12025135 Z258927000
description	operating capacitor capacity 3µF 450V with plastic sheathing tolerance 5% 50/60Hz ø 34mm L 64mm		
For models:	ACE-102, AE-061W, AE-101W, AE-102, AG-061W, APE-061, APE-061W, APE-101, APE-101W, APE-102, APE-102W, APG-061, APG-061W, APG-101, APG-101W, APG-102, APG-102W		



1

GEV No.	365035	Ref. No.	12020052 T093005
description	operating capacitor capacity 30µF 400V tolerance 5% 50/60Hz ambient temperature max. -25 to +85°C ø 45mm L 95mm M8 plastic connection male faston 6.3mm protection		
For models:	HCG-20-11, HCG-20-21, HCG-2-20-11, HMG-20-11, HVG-20-11, HVG-20-21, HVG-2-20-21		



			
1			
GEV No.	365029	Ref. No.	12039812 X343001
description	operating capacitor capacity 5µF with plastic sheathing		
For models:	SBE9-10IM, SBE9-10IMS, SBE9-10M, SBE9-10MS, SBE9-15IM, SBE9-15IMS, SBG9-10IM, SBG9-10IMS, SBG9-10M, SBG9-10MS, SBG9-15IM, SBG9-15IMS		

			
1			
GEV No.	365012	Ref. No.	SAM4420032
description	operating capacitor capacity 6.3µF 450V tolerance 5% 50Hz ambient temperature max. -25 to +85°C ø 30mm L 61mm M8 plastic connection male faston 6.3mm protection		

			
1			
GEV No.	365093	Ref. No.	12024346 V817100
description	operating capacitor capacity 6µF 400V tolerance 5% 50/60Hz ambient temperature max. -25 to +85°C ø 31.5mm L 55mm M8 plastic connection male faston 6.3mm protection		
For models:	AD-120BBTDD-UK, AD-120HY, AD-15, AD-15D, AD-20C-UK, AD-21, AD-21B, AD-21BDD, AD-21C, AD-21D, AD-21DD, AD-21W, AD-90BBT, ADE-120, ADE-120B, CO-350, CO-350-B, CO-350-B-DD, CO-350-COLD, CO-350-COLD-B, CO-350-COLD-B-DD, CO-350-COLD-DD, CO-350-DD, CO-352-COLD, CO-352-COLD-B, CO-352-COLD-B-DD, CO-352-COLD-DD, CO-400, CO-400-B, CO-400-B-DD, CO-400-COLD, CO-400-COLD-B, CO-400-COLD-B-DD, CO-400-COLD-DD, CO-400-SOFT, CO-402-COLD, CO-402-COLD-B, CO-402-COLD-B-DD, CO-402-COLD-DD, CO-402W, ECO-120, ECO-120B, ECO-160, ECO-160D, ECO-160I, ECO-200, ECO-200D, ECO-200H, ECO-200HD...(Other models you can see in the webshop)		

metal			
			
1			
GEV No.	365139	Ref. No.	12032744 EU206002
description	operating capacitor capacity 10µF 450V tolerance 5% 60Hz ambient temperature max. -25 up to +70°C ø 40mm L 83mm M8 aluminium connection male faston 6.3mm C.87.8BF2 MKP protection		

filters

interference suppression filters			
			
1			
GEV No.	365217	Ref. No.	12035029
description	interference suppression filter capacity 1.5µF 250V for combi-steamer CPC-Linie 61-202		

			
1			
GEV No.	365108	Ref. No.	12029809 RT30010455
description	interference suppression filter type 3001.0455 250/440V 50/60Hz conductor 3 with E connection male faston 6.3mm L 52mm ø 60mm Hmm Wmm M8 aluminium Qty 1 pcs		

line filters

with housing			
			
1			
GEV No.	365103	Ref. No.	12017894 T113023
description	line filter type FF-6Z 110/250V 50/60Hz conductor 2 with E connection male faston 6.3mm L 90mm H 29.5mm W 51mm flange metal Qty 1 pcs		
For models:	HCG-10-11, HCG-10-21, HCG-20-11, HCG-20-21, HCG-2-10-11, HCG-2-20-11, HCG-6-11, HEI-10-21, HEM-10-21, HGC-10-11, HGC-10-21, HGC-20-11, HGC-6-11, HGV-10-11, HGV-10-21, HGV-20-11, HVG-10-11, HVG-10-11UL, HVG-10-21, HVG-10-21UL, HVG-20-11, HVG-20-21, HVG-2-10-11, HVG-2-20-21, MFHVG-10-11, MFHVG-10-21		

RC circuits

			
1			
GEV No.	380272	Ref. No.	12034748 RT30280562
description	RC circuit for contactors type 910-304-585-50 130-250V 50-60Hz conductor 2 connection cable plastic Qty 1 pcs for contactors LS4_LS15K type AEG LR2K A250 type GE BS2R2R		



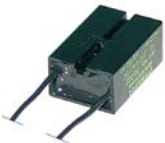

 <p>1</p>			
GEV No.	380177	Ref. No.	12034804 RT30350508
description	RC circuit type 20002 110/220V 50/60/DChz conductor 2 connection cable 230mm L 29mm ømm H 15mm W 20mm adhesive tape plastic Qty 1 pcs		

fuses

fine fuses

 <p>1</p>			
GEV No.	358671	Ref. No.	12039844 R663101
description	fine fuse size ø5x20mm 1A fast-acting rated 250V Qty 10 pcs		
For models:	HME-10-11, HME-10-21, HME-20-11, HME-20-21, HME-2-10-11, HME-2-20-11, HME-6-11, HMP-10-11, HMP-10-21, HMP-20-11, HMP-20-21, HMP-2-10-11, HMP-6-11		

 <p>1</p>			
GEV No.	358677	Ref. No.	12024333 12035393 P184011 RT30190112
description	fine fuse size ø5x20mm 4A fast-acting rated 250V Qty 10 pcs		
For models:	CE-15, CE-9, ECO-160, ECO-1600, ECO-160D, ECO-160I, ECO-200, ECO-200D, ECO-200H, ECO-200HD, ECO-200HI, ECO-200I, ECO-2300, ECO-280D, ECO-280I, ECO-3000, ECO-370D, ECO-370I, ECO-460D, ECO-460I, ECO-550D, ECO-550I, FF-35, FI-160, FI-1600, FI-160AR, FI-160D, FI-160I, FI-200, FI-200AR, FI-200D, FI-200H, FI-200HD, FI-200HI, FI-200I, FI-200W, FI-2300, FI-280D, FI-280I, FI-3000, FI-370D, FI-370I, FI-460D, FI-460I, FI-550D, FI-550I, GA-20, GA-40, HCV-10-11, HCV-10-21... (Other models you can see in the webshop)		

 <p>1</p>			
GEV No.	358603	Ref. No.	12034888 RT30190120
description	fine fuse size ø5x20mm 2A slow-acting rated 250V Qty 10 pcs		

 <p>1</p>			
GEV No.	358792	Ref. No.	12035115 RT40010225
description	fine fuse size ø6.3x32mm 10A slow-acting rated 250V Qty 10 pcs		

 <p>1</p>			
GEV No.	358791	Ref. No.	12037374 RT40010224
description	fine fuse size ø6.3x32mm 6.3A slow-acting rated 250V Qty 10 pcs		

fine fuse holders

 <p>1</p>			
GEV No.	358382	Ref. No.	12035986 RT40011295
description	fuse holder suitable fuse ø5x30mm 10A rated 250V connection screw connection		

 <p>1</p>			
GEV No.	550536	Ref. No.	12025158 R073005
description	fuse holder suitable fuse ø10x38mm 30A rated 600V		
For models:	ACE-061, ACE-101, ACE-102, ACE-201, ACE-202, ACG-061, ACG-101, ACG-102, ACG-201, ACG-202, AD-120, AD-120B, AD-120BBTDD-UK, AD-120C, AD-120CW, AD-120HY, AD-125, AD-125HRS, AD-125-SOFT, AD-90, AD-90BA, AD-90BBT, AD-90BDD, AD-90DD, ADE-120, ADE-120B, AE-061, AE-061W, AE-101, AE-101W, AE-102, AE-102W, AE-201, AE-202, AG-061, AG-061W, AG-101, AG-101W, AG-102, AG-102W, APE-061, APE-061W, APE-101, APE-101W, APE-102, APE-102W, APE-201, APE-202, APG-061, APG-061W...(Other models you can see in the webshop)		

 <p>1</p>			
GEV No.	550348	Ref. No.	12033785 RT40011283
description	fuse holder WIELAND type WK4/THSI 6.3 U/V0 suitable fuse ø6.3x32mm 6.3A rated 600V		



screw locks

D0-system (NEOZED)



GEV No.	358043	Ref. No.	12033846 RT30190401
description	fuse size D01 16A rated 250/400V E14 ø 11mm L 36mm Qty 10 pcs		



GEV No.	358047	Ref. No.	12032709 RT30190405
description	fuse size D02 63A rated 250/400V E18 ø 15mm L 36mm Qty 10 pcs		

gauge pieces (NEOZED)



GEV No.	358064	Ref. No.	12037278 RT40011238
description	gauge piece size D02 suitable for 16A		

fuse holders



GEV No.	358060	Ref. No.	12032263 RT40011234
description	fuse holder suitable fuse D02 3-pole-pole 63A rated 400V		



GEV No.	358061	Ref. No.	12036497 RT40011235
description	fuse holder suitable fuse D02 ø 25mm mounting ø 18mm rated 400V L 30mm		

overload switches



GEV No.	358524	Ref. No.	12033449 RT30140402
description	overload switch drop-away current 0.05A		

electric accessories

cables

accessories

protection hoses

JOHN GUEST



GEV No.	550788	Ref. No.	12008694 X033027
description	screw connection ID ø 14mm for protection hose plastic Qty 1 pcs thread PG11		
For models:	FE7-05-1C, FE7-05-2C, FE-710, FE7-10-2C, FE7-10-4C, FE-71-15, FE-720, FE9-05, FE9-05-1C, FE9-05-2C, FE9-05AD, FE9-05PLUS, FE9-05PLUS-S, FE9-05S, FE9-05S-1C, FE9-05S-2C, FE9-05S-AD, FE9-05USMC, FE9-10, FE9-10-2C, FE9-10-4C, FE9-10AD, FE9-10PLUS, FE-91-20, FE-920, FG-710, FG-720, FI-200W		

miscellaneous



GEV No.	550787	Ref. No.	11000146 3712300
description	protection pipe ID ø 23mm ED ø 28mm Qty 1m plastic for cable		
For models:	ECO-120, ECO-120B, ECO-160, ECO-160D, ECO-160I, ECO-200, ECO-200D, ECO-200H, ECO-200HD, ECO-200HI, ECO-200I, ECO-2700D, ECO-2700I, ECO-280D, ECO-280I, ECO-370D, ECO-370I, ECO-4000D, ECO-4000I, ECO-460D, ECO-460I, ECO-550D, ECO-550I, ECO-6000D, ECO-6000I, FE7-05-1C, FE7-05-2C, FE-710, FE7-10-2C, FE7-10-4C, FE-720, FE9-05, FE9-05-1C, FE9-05-2C, FE9-05AD, FE9-05PLUS, FE9-05PLUS-S, FE9-05S, FE9-05S-1C, FE9-05S-2C, FE9-05S-AD, FE9-05USMC, FE9-10, FE9-10-2C, FE9-10-4C, FE9-10AD, FE9-10PLUS, FI-160, FI-160AR, FI-160D...(Other models you can see in the webshop)		

cable glands

cable glands



GEV No.	551102	Ref. No.	6003010082
description	cable gland ID ø 10mm mounting ø 12mm Neoprene -30 up to +120°C Qty 1 pcs		
For models:	ATM-031, ATM-031-60Hz, ATM-051VCH, ATM-051VCH-60Hz, ATM-081VCH, ATM-081VCH-60Hz, ATM-101VCH, ATM-101VCH-60Hz, ATM-121VCH, ATM-121VCH-60Hz, ATM-121VCHP, ATM-161VCH		

			
1			
GEV No.	550998	Ref. No.	12037670 RT20220111
description	cable gland ID ø 2.5mm mounting ø 7mm rubber Qty 5 pcs		

			
1			
GEV No.	550311	Ref. No.	12018128 N023064
description	cable gland ID ø 6mm mounting ø 9mm ED ø 14mm Neoprene -30 up to +90°C Qty 10 pcs		
For models:	ECO-120, ECO-120B, FI-100, FI-100AR, FI-100B, FI-120, FI-120B, FI-120W, FI-30, FI-48, FI-48B, FI-48W, FI-50, FI-64, FI-64B, FI-64W, FI-72, MF-120, MF-48, MF-64		

threaded cable glands

screw connections

			
1			
GEV No.	550971	Ref. No.	12009963 R013022
description	cable gland thread PG16 cable ø 14mm mounting ø 22.5mm Qty 1 pcs plastic WS 27		
For models:	ACE-061, AE-061, AE-061W, APE-061, APE-061W, BME7-05, BME7-10, BME9-05, BME9-10, CGE6-41, FTE7-05, FTE7-05L, FTE7-05R, FTE9-05L, FTE9-05L-AD, FTE9-05PLUS-CL, FTE9-05PLUS-CR, FTE9-05PLUS-L, FTE9-05PLUS-R, FTE9-05R, FTE9-05R-AD, FTEC7-05L, FTEC9-05, FTEC9-05L, FTEC9-05L-AD, FTEC9-05R, FTEC9-05R-AD, FTEC9-05USMC, HCG-10-11, HCG-10-21, HCG-2-10-11, HCV-6-11, HE-6-11, HMG-10-11, HMG-10-21, HMG-2-10-11, HMM-6-11		

fastening nuts

			
1			
GEV No.	550578	Ref. No.	12009764 Q223016
description	nut thread PG21 H 4.6mm WS 32 nickel-plated brass Qty 1 pcs mounting ømm cable ømm		
For models:	ECO-120, ECO-120B, FI-100, FI-100AR, FI-100B, FI-120, FI-120B, FI-120W, FI-30, FI-48, FI-48B, FI-48W, FI-50, FI-64, FI-64B, FI-64W, FI-72, FI-80, FI-80W, LA-13M, LA-18MP, LA-AC-10M, LA-AC-10MA, LA-AC-10MP, LA-AC-13M, LA-AC-13MA, LA-AC-13MP, LA-AC-18M, LA-AC-18MA, LA-AC-18MP, LA-AC-25M, LA-AC-25MA, LA-AC-25MP, LA-E-10M, LA-E-10MA, LA-E-10MP, LA-E-13M, LA-E-13MA, LA-E-13MP, LA-E-18M, LA-E-18MA, LA-E-18MP, LA-E-25M, LA-E-25MA, LA-E-25MP, LA-V-10M, LA-V-10MP, LA-V-13M, LA-V-13MP, LA-V-18M...(Other models you can see in the webshop)		

			
1			
GEV No.	550974	Ref. No.	12010063 R023025
description	nut thread PG21 WS 34 plastic Qty 1 pcs thickness 7.5mm mounting ømm cable ømm		
For models:	ACE-061, ACE-101, AE-061, AE-101, AE-101W, APE-061, APE-101, APE-101W, CE9-20, CE9-20AD, CE9-20PLUS, CE9-40, CE9-40AD, CE9-40PLUS, CE9-41, CGE9-41, COE-061, CPE7-05, CPE7-05NC, CPE9-05, CPE9-05AD, CPE9-05AD-S, CPE9-05NC, CPE9-05PLUS, CPE9-05PLUS-S, CPE9-05S, CPE9-05SNC, CPG9-05, CPG9-05NC, CPG9-05S, CPG9-05SNC, ECO-160, ECO-160D, ECO-160I, ECO-200, ECO-200D, ECO-200H, ECO-200HD, ECO-200HI, ECO-200I, ECO-2700D, ECO-2700I, ECO-280D, ECO-280I, ECO-370D, ECO-370I, ECO-4000D, ECO-4000I, ECO-460D, ECO-460I...(Other models you can see in the webshop)		

ribbon cables

group 1

			
1			
GEV No.	402970	Ref. No.	12034267 EU41523
description	ribbon cable 10-pole L 1200mm plug type 2 row coded Qty 1m		

			
1			
GEV No.	400878	Ref. No.	12020200 R663102
description	ribbon cable 26-pole L 100mm plug type FC-26P raster size 2.54mm		
For models:	HME-10-11, HME-10-21, HME-20-11, HME-20-21, HME-2-10-11, HME-2-20-11, HME-6-11, HMP-10-11, HMP-10-21, HMP-20-11, HMP-20-21, HMP-2-10-11, HMP-6-11		

cable harnesses

			
1			
GEV No.	550774	Ref. No.	12018040 12018658 T113037 T113075
description	cable harness		
For models:	HVG-10-11, HVG-10-11UL, HVG-10-21, HVG-10-21UL, HVG-2-10-11, MFHVG-10-11, MFHVG-10-21		

			
1			
GEV No.	691855	Ref. No.	Z743001
description	cable harness for dishwasher		



miscellaneous

1

GEV No.	550773	Ref. No.	12018558 T113036
description	connecting cable L 1.9m		
For models:	HCG-10-11, HCG-10-21, HCG-2-10-11, HCG-6-11, HGC-10-11, HGC-6-11, HGV-10-11, HVG-10-11, HVG-10-21, HVG-2-10-11		

connection cables



GEV No.	403815	Ref. No.	12033832 RT88171040
description	connection cable 9-pole RS232/USB L 790mm		



GEV No.	403812	Ref. No.	12032677 RT4000235
description	connection cable L 1500mm 8-pole for combi-steamer suitable for SCC Linie 202 connection plug-in connection		



GEV No.	403811	Ref. No.	12033169 RT87201302
description	connection cable L 525mm 7-pole for combi-steamer CPC-Linie CPC/CM 61-202 connection plug-in connection plug type coded for PCB		



GEV No.	579001	Ref. No.	12035183 RT4000472
description	data cable L 1300mm 8-pole suitable for RATIONAL plug type RJ45		



GEV No.	579005	Ref. No.	12034255 RT87201300
description	data cable L 550mm 4-pole for combi-steamer suitable for CPC-Linie CPC/CM 61-202 plug type USB		



GEV No.	579002	Ref. No.	12035364 RT4000471
description	data cable L 800mm 8-pole for combi-steamer suitable for SCC Line plug type RJ45		

terminals and connectors

not insulated

female fastons

iron nickel-plated



GEV No.	550001	Ref. No.	12034541 RT40020100
description	female faston size 6.3x0.8mm 1.0-2.5mm ² straight Fe gal Ni t.max. 340°C Qty 100 pcs		

terminals

terminal blocks



GEV No.	550239	Ref. No.	12025086 Z743006
description	lustre terminal 12-pole cross section 16mm ² max. 75A max 500V temp.-resist. 150°C		
For models:	AD-90, AD-90DD, ADE-120, ADE-120B, ECO-120, ECO-120B, FI-80, FI-80AR, FI-80BBT-UK, FI-80W		

connection terminals with screw/faston connections





GEV No.	505212	Ref. No.	12024110 Z603025
description	power terminal block 2-pole max. 20A max 600V connection ø2.5mm ² / F6.3 temp.-resist. 150°C cross section 4mm ²		
For models:	AD-15, AD-15D, AD-20C-UK, AD-21, AD-21B, AD-21BDD, AD-21C, AD-21D, AD-21DD, AD-21W, AD-505, AD-505-SOFT, CG-210G, CG-310G, CO-500, CO-500B, CO-500BDD, CO-500DD, CO-501, CO-501B, CO-501BDD, CO-501DD, CO-501-SOFT, CO-502B, CO-502BDD, CO-502DD, CO-502W, COP-503, COP-503B, COP-503BDD, COP-503DD, COP-503-SOFT, COP-504, COP-504B, COP-504BDD, COP-504DD, COP-504W, LVC-12, LVC-15, LVC-15D, LVC-21, LVC-21B, LVC-21C, LVC-21D, LVC-21W, LVR-10, LVR-14, LVR-14D, LVR-20, LVR-20B...(Other models you can see in the webshop)		





 <p>1</p>			
GEV No.	550278	Ref. No.	12024382 U183046
description	power terminal block 3-pole max. 40A max 400V connection \varnothing 6mm ² / F6.3 temp.-resist. 150°C cross section 6mm ²		
For models:	BME6-05, BME7-05, BME9-05, BME9-05AD, BME9-05PLUS, BME9-05V-T, CE-410, CO-350, CO-350-B, CO-350-B-DD, CO-350-COLD, CO-350-COLD-B, CO-350-COLD-B-DD, CO-350-COLD-DD, CO-350-DD, CO-352-COLD, CO-352-COLD-B, CO-352-COLD-B-DD, CO-352-COLD-DD, CO-400, CO-400-B, CO-400-B-DD, CO-400-COLD, CO-400-COLD-B, CO-400-COLD-B-DD, CO-400-COLD-DD, CO-400-DD, CO-400-SOFT, CO-402-COLD, CO-402-COLD-B, CO-402-COLD-B-DD, CO-402-COLD-DD, CO-402W, CPG9-05, CPG9-05NC, CPG9-05S, CPG9-05SNC, CV6-20, CV6-40, FE-4, FG7-05-1C, FG7-05-2C, FG-710, FG7-10-2C, FG7-104C, FG7-10-4C, FG-720, FG9-05, FG9-05-1C, FG9-05-2C...(Other models you can see in the webshop)		

 <p>2</p>			
GEV No.	550411	Ref. No.	12025183 12034943 EU220011 R253044
description	power terminal block 6-pole max. 40A max 450V connection \varnothing 6mm ² / F6.3 temp.-resist. 150°C cross section 6mm ²		
For models:	AD-45BBT, AD-48, AD-48B, AD-48BDD, AD-48C, AD-48D, AD-48DD, AD-48HY, AD-48W, AD-505, AD-505-SOFT, AD-64, AD-64B, AD-64BBT, AD-64BDD, AD-64BTDD, AD-64C, AD-64CW, AD-64D, AD-64DD, AD-64HY, AD-72, AD-72W, BME7-10, BME9-10, BME9-10AD, BME9-10PLUS, BME9-10V-T, CE6-20, CE6-40, CE6-41, CE7-20, CE7-20Q, CE7-40, CE7-40Q, CE7-41, CE7-41Q, CGE6-41, CGE7-231, CI9-20AD, CI9-20PLUS, CI9-40AD, CI9-40PLUS, CMF6-05, CO-500, CO-500B, CO-500BDD, CO-500DD, CO-501, CO-501B...(Other models you can see in the webshop)		

<p>PCB terminal blocks</p>			
 <p>1</p>			
GEV No.	550779	Ref. No.	12019476 R663043
description	PCB terminal block 2-pole raster size 5mm PCB		
For models:	HCG-10-11, HCG-10-21, HCG-2-10-11, HCG-6-11, HME-20-11, HMG-10-11, HMG-10-11UL, HMG-10-21, HMG-10-21UL, HMG-2-10-11, HMG-6-11, HMI-10-11, HMI-10-11UL, HMI-10-21, HMI-10-21UL, HMI-2-10-11, HMI-6-11, HMI-6-11UL, HMM-10-11, HMM-10-11UL, HMM-10-21, HMM-10-21UL, HMM-20-11, HMM-20-11UL, HMM-20-21, HMM-2-10-11, HMM-6-11, HMM-6-11UL, HMP-20-11		

<p>rail-mounted terminals</p>			
<p>WEIDMÜLLER</p>			
<p>feed-through terminals</p>			
 <p>1</p>			
GEV No.	550792	Ref. No.	12024229 Z103029
description	rail-mounted terminal 2.5mm ² for DIN rail 35mm grey 1-pole		
For models:	ECO-160, ECO-1600, ECO-160D, ECO-160I, ECO-200, ECO-200D, ECO-200HI, ECO-200HD, ECO-200H, ECO-200I, ECO-2300, ECO-2700D, ECO-2700I, ECO-280D, ECO-280I, ECO-280I, ECO-3000, ECO-370D, ECO-370I, ECO-4000D, ECO-4000I, ECO-460D, ECO-460I, ECO-550D, ECO-550I, ECO-6000D, ECO-6000I, FI-160, FI-1600, FI-160AR, FI-160D, FI-160I, FI-200, FI-200AR, FI-200D, FI-200H, FI-200HD, FI-200HI, FI-200I, FI-200W, FI-200WL, FI-200WR, FI-2300, FI-2700D, FI-2700I, FI-280D, FI-280I, FI-3000, FI-370D, FI-370I, FI-4000D...(Other models you can see in the webshop)		

 <p>1</p>			
GEV No.	551230	Ref. No.	12024942 R143011
description	rail-mounted terminal 70mm ² for DIN rail 35mm grey 1-pole		
For models:	ACE-202, AE-202, APE-202, COE-202, ECO-280D, ECO-280I, ECO-370D, ECO-370I, ECO-460D, ECO-460I, ECO-550D, ECO-550I, FI-160, FI-160AR, FI-160D, FI-160I, FI-200, FI-200AR, FI-200D, FI-200H, FI-200HD, FI-200HI, FI-200I, FI-200W, FI-200WL, FI-200WR, FI-2700D, FI-2700I, FI-280D, FI-280I, FI-370D, FI-370I, FI-4000D, FI-4000I, FI-460D, FI-460I, FI-550D, FI-550I, FI-6000D, FI-6000I, HEI-20-21, HEM-20-21, HEP-20-21, HME-20-21, HME-2-20-11, HMM-20-21, HMM-20-21UL, HMM-40-11-USMC, HMP-20-21, VE-202...(Other models you can see in the webshop)		

<p>accessories</p>			
 <p>1</p>			
GEV No.	550789	Ref. No.	12024199 Z263303
description	rail-mounted terminal grey for DIN rail 35mm		
For models:	ACG-061, ACG-101, ACG-102, ACG-201, ACG-202, AD-125, AD-125HRS, AD-125-SOFT, AG-061, AG-061W, AG-101, AG-101W, AG-102, AG-102W, AG-201, AG-202, APG-061, APG-061W, APG-101, APG-101W, APG-102, APG-102W, APG-201, APG-202, CE6-20, CE6-40, CE6-41, CE7-20, CE7-20Q, CE7-40, CE7-40Q, CE7-41, CE9-20, CE9-20AD, CE9-20PLUS, CGE6-41, CGE7-211, CGE7-41, CGE7-41H, CGE9-11, CGE9-41, CGE9-41AD, CGE9-41PLUS, CO-110, CO-110B, CO-110BDD, CO-110DD, CO-112, CO-112B, CO-112BDD...(Other models you can see in the webshop)		



WIELAND

rail-mounted terminals type 9700A



1

GEV No.	550374	Ref. No.	12025191 12035926 RT40011250 Z683097
description	rail-mounted terminal WIELAND type 9700A/10 S35 1.5-16mm ² top-hat rail 35mm blue W 10mm L 49mm		
For models:	AD-120, AD-120B, AD-120BBTDD-UK, AD-120C, AD-120HY, AD-90, AD-90BA, AD-90BBT, AD-90BDD, AD-90DD, ADE-120, ADE-120B, CE6-20, CE6-40, CE6-41, CE7-41, CE9-40, FE9-05, FE9-05-1C, FE9-05-2C, FE9-05AD, FE9-05PLUS, FE9-05PLUS-S, FE9-05S, FE9-05S-1C, FE9-05S-2C, FE9-05S-AD, FE9-05USMC, FE9-10, FE9-10-2C, FE9-10-4C, FE9-10AD, FE9-10PLUS, FE-920, FI-100, FI-100AR, FI-100B, FI-100BBT-UK, FI-120, FI-1200, FI-120AR+DD, FI-120B, FI-120C, FI-120HY-CLINIC, FI-120W, FI-80BBT-UK, FI-80W, FI-900, FI-E-100, FTE9-10L...(Other models you can see in the webshop)		



1

GEV No.	550373	Ref. No.	12025214 12035988 RT40011202 Z683069
description	rail-mounted terminal WIELAND type 9700A/10 S35 1.5-16mm ² top-hat rail 35mm grey W 10mm L 49mm		
For models:	AD-120, AD-120B, AD-120BBTDD-UK, AD-120C, AD-120HY, AD-90, AD-90BA, AD-90BBT, AD-90BDD, AD-90DD, ADE-120, ADE-120B, CE-410, CE9-40, CE9-41, CE9-41AD, CE9-41PLUS, FE9-05, FE9-05-1C, FE9-05-2C, FE9-05AD, FE9-05PLUS, FE9-05PLUS-S, FE9-05S, FE9-05S-1C, FE9-05S-2C, FE9-05S-AD, FE9-05USMC, FE9-10, FE9-10-2C, FE9-10-4C, FE9-10AD, FE9-10PLUS, FE-920, FI-100, FI-100AR, FI-100B, FI-100BBT-UK, FI-120, FI-1200, FI-120AR+DD, FI-120B, FI-120C, FI-120HY-CLINIC, FI-120W, FI-650R, FI-80BBT-UK, FI-80W, FI-900, FI-E-100...(Other models you can see in the webshop)		



1

GEV No.	550375	Ref. No.	12023727 Z683070
description	rail-mounted terminal WIELAND type 9700A/10 SL2 S35 1.5-16mm ² top-hat rail 35mm yellow/green W 10mm L 53mm		
For models:	AD-120, AD-120B, AD-120BBTDD-UK, AD-120C, AD-120CW, AD-120HY, AD-90, AD-90BA, AD-90BBT, AD-90BDD, AD-90DD, ADE-120, ADE-120B, CE-410, CE9-40, FE9-05, FE9-05-1C, FE9-05-2C, FE9-05AD, FE9-05PLUS, FE9-05PLUS-S, FE9-05S, FE9-05S-1C, FE9-05S-2C, FE9-05S-AD, FE9-05USMC, FE9-10, FE9-10-2C, FE9-10-4C, FE9-10AD, FE9-10PLUS, FE-920, FI-100, FI-100AR, FI-100B, FI-100BBT-UK, FI-120, FI-1200, FI-120AR+DD, FI-120B, FI-120C, FI-120HY-CLINIC, FI-120W, FI-650R, FI-80BBT-UK, FI-80W, FI-900, FI-E-100, FTE9-10L, FTE9-10L+R...(Other models you can see in the webshop)		



1

GEV No.	550377	Ref. No.	12034956 RT40011252
description	rail-mounted terminal WIELAND type 9700A/16 S35 2.5-35mm ² top-hat rail 35mm blue W 16mm L 59mm		



1

GEV No.	550376	Ref. No.	12034955 RT40011206
description	rail-mounted terminal WIELAND type 9700A/16 S35 2.5-35mm ² top-hat rail 35mm grey W 16mm L 59mm		



1

GEV No.	550378	Ref. No.	12033543 RT40011233
description	rail-mounted terminal WIELAND type 9700A/16 SL2 S35 2.5-35mm ² top-hat rail 35mm yellow/green W 16mm L 53mm		



1

GEV No.	550371	Ref. No.	12036964 RT40011216
description	rail-mounted terminal WIELAND type 9700A/6 S35 0.5-4mm ² top-hat rail 35mm grey W 6mm L 46.6mm		





1

GEV No.	550372	Ref. No.	12035662 RT40011222
description	rail-mounted terminal WIELAND type 9700A/6 SL2 S35 0.5-4mm ² top-hat rail 35mm yellow/green W 6mm L 48.5mm		





			
GEV No.	550381	Ref. No.	12023373 P453025
description	rail-mounted terminal WIELAND type 9700A/8 S35 1.0-10mm ² top-hat rail 35mm grey W 8mm L 46.6mm		
For models:	ACE-061, AD-125, AD-125HRS, AD-125-SOFT, AE-061, AE-061W, APE-061, APE-061W, CE6-20, CE6-40, CE6-41, CE7-20, CE7-20Q, CE7-40, CE7-40Q, CE7-41, CE9-20, CE9-20AD, CE9-20PLUS, CGE6-41, CGE7-208, CGE7-41, CGE7-41H, CGE9-11, CGE9-41, CGE9-41AD, CGE9-41PLUS, CO-110, CO-110B, CO-110BDD, CO-110DD, CO-112, CO-112B, CO-112BDD, CO-112DD, CO-142W, CO-142WDD, CO-170, CO-170B, CO-170BDD, CO-170DD, CO-170HRS, CO-170HRSDD, CO-170HRS-SOFT, CO-170-SOFT, CO-172, CO-172B, CO-172BDD, CO-172DD, COE-061...(Other models you can see in the webshop)		

fuse terminal blocks			
			
GEV No.	550348	Ref. No.	12033785 RT40011283
description	fuse holder WIELAND type WK4/THSI 6.3 U/V0 suitable fuse ø6.3x-32mm 6.3A rated 600V		

accessories			
			
GEV No.	550370	Ref. No.	12036737 RT40011203
description	terminal block end bracket clampsmm ²		

accessories			
marking labels			
			
GEV No.	505000	Ref. No.	12017607 12023957 Z213005 Z743005
description	signboard R/S/T/N		
For models:	AD-45BBT, AD-48, AD-48B, AD-48BDD, AD-48C, AD-48D, AD-48DD, AD-48HY, AD-48W, AD-64, AD-64B, AD-64BBT, AD-64BDD, AD-64BTDD, AD-64C, AD-64CW, AD-64D, AD-64DD, AD-64HY, AD-72, AD-72W, ECO-120, ECO-120B, FI-48, FI-48AR, FI-48B, FI-48B-BT-UK, FI-48C, FI-48D, FI-48HY-CLINIC, FI-48W, FI-50, FI-60DD, FI-64, FI-64AR, FI-64B, FI-64B-BT-UK, FI-64C, FI-64D, FI-64HY-CLINIC, FI-64W, FI-72, FI-72AR, FI-72W, FI-80, FI-80W, MF-48, MF-64		

DIN rails			
			
GEV No.	551017	Ref. No.	12022603 Z103084
description	DIN rail W 35mm L 138mm hole distance 118mm		
For models:	COE-102, ECO-1600, ECO-2300, ECO-3000, FI-1600, FI-2300, FI-3000, FI-48, FI-48B, FI-48W, FI-50, FI-64, FI-64B, FI-64W, FI-72, HEI-10-21, HEM-10-11, HEM-10-21, HEM-20-11, HEM-6-11, HEP-10-11, HEP-10-21, HEP-20-11, HEP-6-11, HGC-10-21, HGP-10-21, HGV-10-21, HME-10-11, HME-10-21, HME-20-11, HME-2-10-11, HME-6-11, HMM-10-11, HMM-10-11UL, HMM-10-21, HMM-10-21UL, HMM-20-11, HMM-20-11UL, HMM-2-10-11, HMM-6-11, HMM-6-11UL, HMP-10-11, HMP-10-21, HMP-20-11, HMP-2-10-11, HMP-6-11, LC-AC-10, LC-AC-10A, LC-AC-14, LC-AC-14A...(Other models you can see in the webshop)		

			
GEV No.	551016	Ref. No.	12022790 Z123018
description	DIN rail W 35mm L 55mm hole distance 35mm		
For models:	CE6-41, CE7-41, CGE6-41, CGE7-220, CGE7-41, CGE7-41H, CMF6-05, COE-102, COE-202, CPE6-05, ECO-1600, ECO-2300, ECO-3000, FE6-05, FE6-05TE, FE6-10, FE6-10TE, FI-1600, FI-2300, FI-30, FI-3000, FI-30AR+DD, FI-30B-BT-UK, FI-30-UK, FI-48, FI-48B, FI-48B-BT-UK, FI-48D, FI-48HY-CLINIC, FI-48W, FI-50, FI-64W, FTE6-05L, FTE6-05R, FTE6-10L, FTE6-10L+R, FTE6-10R, FTE7-05, FTE7-05L, FTE7-05R, FTE7-10, FTE7-10L, FTE7-10L+R, FTE7-10R, FTE9-05L, FTE9-05L-AD, FTE9-05PLUS-CL, FTE9-05PLUS-CR, FTE9-05PLUS-L, FTE9-05PLUS-R...(Other models you can see in the webshop)		

			
GEV No.	551018	Ref. No.	12022528 Z103083
description	DIN rail W 35mm L 72mm hole distance 52mm		
For models:	ACE-061, ACE-101, ACE-102, ACE-201, ACE-202, AD-120, AD-120B, AD-120BBTDD-UK, AD-120C, AD-120CW, AD-120HY, AD-90, AD-90BA, AD-90BBT, AD-90BDD, AD-90DD, ADE-120, ADE-120B, AE-061, AE-101, AE-102, AE-201, AE-202, APE-061, APE-101, APE-102, APE-201, APE-202, CE6-20, CE6-40, CE6-41, CE7-20, CE7-20Q, CE7-40, CE7-40Q, CE7-41, CE7-41Q, CE9-20, CE9-40, CGE6-41, CGE7-207, CGE7-41, CGE7-41H, ECO-120, ECO-120B, ECO-1600, ECO-2300, ECO-3000, FF-35, FI-100...(Other models you can see in the webshop)		



electronic magnets

1



GEV No.	691059	Ref. No.	12017119 R663030
description	lifting magnet 230V voltage AC 50/60Hz duty cycle 100% 0.1A		
For models:	HEI-10-11, HEI-20-11, HEI-6-11, HEM-10-11, HEM-20-11, HEM-6-11, HEP-10-11, HEP-20-11, HEP-6-11, HME-10-11, HME-10-21, HME-20-11, HME-20-21, HME-2-10-11, HME-2-20-11, HME-6-11, HMI-10-11, HMI-10-11UL, HMI-10-21, HMI-10-21UL, HMI-2-10-11, HMI-6-11, HMI-6-11UL, HMM-10-11, HMM-10-11UL, HMM-10-21, HMM-10-21UL, HMM-20-11, HMM-20-11UL, HMM-20-21, HMM-20-21UL, HMM-2-10-11, HMM-2-20-11, HMM-40-11-USMC, HMM-6-11, HMM-6-11UL, HMP-10-11, HMP-10-21, HMP-20-11, HMP-20-21, HMP-2-10-11, HMP-2-20-11, HMP-6-11, MFHMM-20-11		

2



GEV No.	691052	Ref. No.	12017052 R723012
description	lifting magnet 230V voltage AC 50/60Hz duty cycle 100% 0.2A		
For models:	HMG-10-11, HMG-10-11UL, HMG-10-21, HMG-10-21UL, HMG-2-10-11, HMG-6-11		

1



GEV No.	691057	Ref. No.	12016965 R723060
description	lifting magnet 230V voltage AC 50/60Hz duty cycle 100% 0.3A		
For models:	HMG-20-11		

gas taps

PEL

22S/O series



1



GEV No.	109513	Ref. No.	12017435 T032101
description	gas tap PEL type 22S/O gas inlet M20x1.5 (tube ø 12mm) bypass nozzle ø 1.1mm gas outlet M20x1.5 (tube ø 12/10mm) thermocouple connection M8x1 pilot connection M10x1 shaft ø 10x8mm shaft L 25/17mm shaft flat right		
For models:	BG7-05, BG7-10		
spare parts for	109513		
	GEV No.	100436	Ref. No. —
	bypass nozzle type PEL22 bore ø 1.1mm thread M6x0.5		
	GEV No.	101058	Ref. No. —
	magnet unit L 39mm D1 ø 15.4mm D2 ø 13.5mm suitable for PEL22/EGA24197 standard		
	GEV No.	101202	Ref. No. —
	gas tap front part shaft ø 8x10mm shaft L 25/17mm shaft flat right/left suitable for PEL22		
	GEV No.	101230	Ref. No. —
	thermocouple nut T1: M8x1 T2: M18x1 aluminium		
	GEV No.	101240	Ref. No. —
	gas connection thread M20x1.5 tube ø 12/10mm for PEL gas taps with gasket and screws horizontal		
	GEV No.	101460	Ref. No. —
	O-ring ø 12.37mm D1 ø 2.62mm suitable for PEL22		
	GEV No.	101461	Ref. No. —
	screw kit suitable for PEL22 Qty 4 pcs		
accessories for	109513		
	GEV No.	100908	Ref. No. 12017481 T052101
	union screw thread M10x1 for pipe ø 4mm Qty 1 pcs		
	GEV No.	100909	Ref. No. 12008740 12016658 S312107 U265703
	union screw thread M10x1 for pipe ø 6mm Qty 1 pcs		
	GEV No.	101241	Ref. No. —
	gas connection thread M20x1.5 tube ø 12/10mm for PEL gas taps vertical		
	GEV No.	101246	Ref. No. 12018994 U265026
	olive for pipe ø 4mm Qty 1 pcs		
	GEV No.	101248	Ref. No. —
	olive for pipe ø 12mm Qty 1 pcs suitable for PEL		
	GEV No.	101249	Ref. No. —
	olive for pipe ø 10mm Qty 1 pcs		
	GEV No.	101250	Ref. No. —
	union nut thread M20x1.5 for pipe ø 10mm		



Table continues overleaf

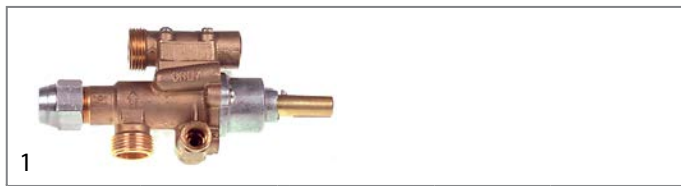

accessories for 109513				
	GEV No.	101251	Ref. No.	—
union nut thread M20x1.5 for pipe ø 12mm				
	GEV No.	101286	Ref. No.	12008476 S312108000 X205028
olive ID ø 6mm Qty 1 pcs				



1	GEV No.	109510	Ref. No.	12017451 T052100
description gas tap PEL type 22S/O gas inlet M20x1.5 (tube ø 12mm) bypass nozzle ø 1.3mm gas outlet M20x1.5 (tube ø 12/10mm) thermocouple connection M8x1 pilot connection M10x1 shaft ø 10x8mm shaft L 25/17mm shaft flat right				
For models: BG9-05, BG9-05I, BG9-10, BG9-10I				
spare parts for 109510				
	GEV No.	100438	Ref. No.	—
bypass nozzle type PEL22 bore ø 1.2mm thread M6x0.5				
	GEV No.	101058	Ref. No.	—
magnet unit L 39mm D1 ø 15.4mm D2 ø 13.5mm suitable for PEL22/ EGA24197 standard				
	GEV No.	101202	Ref. No.	—
gas tap front part shaft ø 8x10mm shaft L 25/17mm shaft flat right/ left suitable for PEL22				
	GEV No.	101230	Ref. No.	—
thermocouple nut T1: M8x1 T2: M18x1 aluminium				
	GEV No.	101240	Ref. No.	—
gas connection thread M20x1.5 tube ø 12/10mm for PEL gas taps with gasket and screws horizontal				
	GEV No.	101460	Ref. No.	—
O-ring ø 12.37mm D1 ø 2.62mm suitable for PEL22				
	GEV No.	101461	Ref. No.	—
screw kit suitable for PEL22 Qty 4 pcs				
accessories for 109510				
	GEV No.	100908	Ref. No.	12017481 T052101
union screw thread M10x1 for pipe ø 4mm Qty 1 pcs				
	GEV No.	100909	Ref. No.	12008740 12016658 S312107 U265703
union screw thread M10x1 for pipe ø 6mm Qty 1 pcs				
	GEV No.	101241	Ref. No.	—
gas connection thread M20x1.5 tube ø 12/10mm for PEL gas taps vertical				
	GEV No.	101246	Ref. No.	12018994 U265026
olive for pipe ø 4mm Qty 1 pcs				
	GEV No.	101248	Ref. No.	—
olive for pipe ø 12mm Qty 1 pcs suitable for PEL				
	GEV No.	101249	Ref. No.	—
olive for pipe ø 10mm Qty 1 pcs				

accessories for 109510				
	GEV No.	101250	Ref. No.	—
union nut thread M20x1.5 for pipe ø 10mm				
	GEV No.	101251	Ref. No.	—
union nut thread M20x1.5 for pipe ø 12mm				
	GEV No.	101286	Ref. No.	12008476 S312108000 X205028
olive ID ø 6mm Qty 1 pcs				

22S/V series



1	GEV No.	106421	Ref. No.	12026757 K002B42010
description gas tap PEL type 22S/V gas inlet M20x1.5 (tube ø 12mm) bypass nozzle ø 0mm gas outlet M20x1.5 (tube ø 12/10mm) thermocouple connection M9x1 pilot connection M10x1 shaft ø 10x8mm shaft L 25/17mm shaft flat lower				
spare parts for 106421				
	GEV No.	101058	Ref. No.	—
magnet unit L 39mm D1 ø 15.4mm D2 ø 13.5mm suitable for PEL22/ EGA24197 standard				
	GEV No.	101201	Ref. No.	—
gas tap front part shaft ø 10x8mm shaft L 25/17mm shaft flat upper/ lower suitable for PEL22				
	GEV No.	101231	Ref. No.	—
thermocouple nut T1: M9x1 T2: M18x1				
	GEV No.	101241	Ref. No.	—
gas connection thread M20x1.5 tube ø 12/10mm for PEL gas taps vertical				
	GEV No.	101460	Ref. No.	—
O-ring ø 12.37mm D1 ø 2.62mm suitable for PEL22				
	GEV No.	101461	Ref. No.	—
screw kit suitable for PEL22 Qty 4 pcs				
	GEV No.	106191	Ref. No.	—
bypass nozzle type PEL22 bore ø 0mm thread M6x0.5				
accessories for 106421				
	GEV No.	100908	Ref. No.	12017481 T052101
union screw thread M10x1 for pipe ø 4mm Qty 1 pcs				
	GEV No.	100909	Ref. No.	12008740 12016658 S312107 U265703
union screw thread M10x1 for pipe ø 6mm Qty 1 pcs				
	GEV No.	101240	Ref. No.	—
gas connection thread M20x1.5 tube ø 12/10mm for PEL gas taps with gasket and screws horizontal				

Table continues overleaf





















accessories for		106421		
	GEV No.	101246	Ref. No.	12018994 U265026
olive for pipe ø 4mm Qty 1 pcs				
	GEV No.	101248	Ref. No.	—
olive for pipe ø 12mm Qty 1 pcs suitable for PEL				
	GEV No.	101249	Ref. No.	—
olive for pipe ø 10mm Qty 1 pcs				
	GEV No.	101250	Ref. No.	—
union nut thread M20x1.5 for pipe ø 10mm				
	GEV No.	101251	Ref. No.	—
union nut thread M20x1.5 for pipe ø 12mm				
	GEV No.	101286	Ref. No.	12008476 S312108000 X205028
olive ID ø 6mm Qty 1 pcs				
	GEV No.	101331	Ref. No.	—
adapter suitable for PEL22 for flanged cable 10/12mm				

23S/O series



1

GEV No.	101091	Ref. No.	12027178 ICR10038	
description	gas tap PEL type 23S/O gas inlet M28x1.5 (tube ø 20mm) bypass nozzle ø 0.35mm gas outlet M24x1.5 (tube ø 16mm) thermocouple connection M9x1 pilot connection M10x1 shaft ø 10x8mm shaft L 35/19mm shaft flat upper			
spare parts for	101091			
	GEV No.	100455	Ref. No.	—
bypass nozzle type PEL23/24 bore ø 0.35mm thread M8x0.5				
	GEV No.	101045	Ref. No.	—
magnet unit T1: M9x1 T2: M22x1 L 46mm ø 18mm suitable for PEL23S M9x1				
	GEV No.	101244	Ref. No.	—
gas connection thread M24x1.5 tube ø 12/16mm horizontal for PEL gas taps				
	GEV No.	101336	Ref. No.	—
gas tap front part shaft ø 10x8mm shaft L 35/17mm shaft flat upper/lower suitable for PEL23S				
	GEV No.	101463	Ref. No.	—
screw suitable for PEL23S Qty 4 pcs				
	GEV No.	528455	Ref. No.	—
O-ring Viton thickness 2.62mm ID ø 18.72mm Qty 1 pcs				
accessories for	101091			
	GEV No.	100908	Ref. No.	12017481 T052101
union screw thread M10x1 for pipe ø 4mm Qty 1 pcs				

accessories for		101091		
	GEV No.	100909	Ref. No.	12008740 12016658 S312107 U2650703
union screw thread M10x1 for pipe ø 6mm Qty 1 pcs				
	GEV No.	101246	Ref. No.	12018994 U265026
olive for pipe ø 4mm Qty 1 pcs				
	GEV No.	101252	Ref. No.	—
union nut thread M24x1.5 for pipe ø 12mm				
	GEV No.	101253	Ref. No.	12008865 S312105
union nut thread M24x1.5 PEL for pipe ø 16mm				
	GEV No.	101254	Ref. No.	12008921 S312103
union nut thread M28x1.5 tube ø 20mm				
	GEV No.	101255	Ref. No.	—
olive for pipe ø 12mm Qty 1 pcs				
	GEV No.	101256	Ref. No.	12008773
olive for pipe ø 16mm Qty 1 pcs				
	GEV No.	101257	Ref. No.	12008828 S312104
olive for pipe ø 20mm Qty 1 pcs				
	GEV No.	101286	Ref. No.	12008476 S312108000 X205028
olive ID ø 6mm Qty 1 pcs				
	GEV No.	110080	Ref. No.	12032882 ICR15738
knob ø 70mm shaft ø 10x8mm shaft flat universal				
	GEV No.	112206	Ref. No.	—
knob dial plate silver gas tap PEL21/22/23 t.max.°C ED ø 63mm ID ø 45.5mm				

23S/V series



1

GEV No.	109511	Ref. No.	12009525 S312101	
description	gas tap PEL type 23S/V gas inlet M28x1.5 (tube ø 20mm) bypass nozzle ø 1.4mm gas outlet M24x1.5 (tube ø 16/12mm) thermocouple connection M9x1 pilot connection M10x1 shaft ø 10x8mm shaft L 25/17mm shaft flat lower			
For models:	MG7-10, MG7-10BM, MG9-10, MG9-10BM, MG9-10BMS, MG9-10S, MG9-15, MG9-15BM, MG9-15BM316, MG9-15BMS, MG9-15S, MG9-20, MG9-20S, MPG9-10, MPG9-10BM, MPG9-10BMS, MPG9-10S, MPG9-15, MPG9-15BM, MPG9-15BMS, MPG9-15S, MPG9-20, MPG9-20S			
spare parts for	109511			
	GEV No.	100455	Ref. No.	—
bypass nozzle type PEL23/24 bore ø 0.35mm thread M8x0.5				

Table continues overleaf



spare parts for		109511		
	GEV No.	101059	Ref. No.	—
magnet unit T1: M10x1 T2: M22x1 L 46mm ø 18mm suitable for PEL23S M10x1				
	GEV No.	101204	Ref. No.	—
gas tap front part shaft ø 10x8mm shaft L 25/17mm shaft flat upper/lower suitable for PEL23S				
	GEV No.	101245	Ref. No.	—
gas connection thread M24x1.5 tube ø 12/16mm vertical for PEL gas taps				
	GEV No.	101463	Ref. No.	—
screw suitable for PEL23S Qty 4 pcs				
	GEV No.	528455	Ref. No.	—
O-ring Viton thickness 2.62mm ID ø 18.72mm Qty 1 pcs				
accessories for		109511		
	GEV No.	100908	Ref. No.	12017481 T052101
union screw thread M10x1 for pipe ø 4mm Qty 1 pcs				
	GEV No.	100909	Ref. No.	12008740 12016658 S312107 U265703
union screw thread M10x1 for pipe ø 6mm Qty 1 pcs				
	GEV No.	101246	Ref. No.	12018994 U265026
olive for pipe ø 4mm Qty 1 pcs				
	GEV No.	101252	Ref. No.	—
union nut thread M24x1.5 for pipe ø 12mm				
	GEV No.	101253	Ref. No.	12008865 S312105
union nut thread M24x1.5 PEL for pipe ø 16mm				
	GEV No.	101254	Ref. No.	12008921 S312103
union nut thread M28x1.5 tube ø 20mm				
	GEV No.	101255	Ref. No.	—
olive for pipe ø 12mm Qty 1 pcs				
	GEV No.	101256	Ref. No.	12008773
olive for pipe ø 16mm Qty 1 pcs				
	GEV No.	101257	Ref. No.	12008828 S312104
olive for pipe ø 20mm Qty 1 pcs				
	GEV No.	101286	Ref. No.	12008476 S312108000 X205028
olive ID ø 6mm Qty 1 pcs				
	GEV No.	110080	Ref. No.	12032882 ICR15738
knob ø 70mm shaft ø 10x8mm shaft flat universal				
	GEV No.	112206	Ref. No.	—
knob dial plate silver gas tap PEL21/22/23 t.max.°C ED ø 63mm ID ø 45.5mm				

COPRECI
CAL-3200





spare parts for		109503		
	GEV No.	106173	Ref. No.	—
magnet unit L 43mm D1 ø 19mm D2 ø 15.5mm suitable for COPRECI				
accessories for		109503		
	GEV No.	100944	Ref. No.	12007951 Q221336
union nut thread M18x1.5 for pipe ø 12mm				
	GEV No.	101273	Ref. No.	12008501 U055043
olive for pipe ø 12mm L 9.5mm brass Qty 1 pcs suitable for universal				

spare parts for		109500		
	GEV No.	106173	Ref. No.	—
magnet unit L 43mm D1 ø 19mm D2 ø 15.5mm suitable for COPRECI				
accessories for		109500		
	GEV No.	100944	Ref. No.	12007951 Q221336
union nut thread M18x1.5 for pipe ø 12mm				
	GEV No.	101273	Ref. No.	12008501 U055043
olive for pipe ø 12mm L 9.5mm brass Qty 1 pcs suitable for universal				

description		12017387 12040023 R642100 R642100000 U262106		
gas tap COPRECI type CAL-3200 gas inlet M18x1.5 (tube ø 12mm) bypass nozzle ø 0.55mm gas outlet M18x1.5 (tube ø 12mm) thermo-couple connection M8x1 pilot connection 1/8" shaft ø 10x8mm shaft flat right shaft L 46/12mm with pipe outlet				
For models:		CG7-20, CG-7200, CG7-40, CG-7400, CG7-41, CG-7415, CG7-61, CG-7615, CGB7-61, CGE7-140, CGE7-41, FTG-7050L, FTG-7050R, FTG-7100L, FTG-7100L+R, FTG-7100R		







1

GEV No.	109509	Ref. No.	12017385 R612100
description	gas tap COPRECI type CAL-3200 gas inlet M18x1.5 (tube ø 12mm) bypass nozzle ø 0.8mm gas outlet M18x1.5 (tube ø 12mm) thermo-couple connection M8x1 pilot connection 1/8" shaft ø 10x8mm shaft flat right shaft L 29/12mm with pipe outlet		
For models:	CG-110, CG-2000-2P, CPG7-05, FTG-9050L, FTG-9050R, FTG9-05L, FTG9-05R, FTG9-05VL, FTG9-05VR, FTG-9100L, FTG-9100L+R, FTG-9100R, FTG9-10L, FTG9-10L+R, FTG9-10R, FTG9-10VL, FTG9-10VL+R, FTG9-10VR, FTG9-11L, FTG9-11L+R, FTG9-11R, FTGC9-05L, FTGC9-05R, FTGC9-10L, FTGC9-10L+R, FTGC9-10R, FTGC9-11L, FTGC9-11L+R, FTGC9-11R		
spare parts for	109509		
	GEV No.	106173	Ref. No. —
magnet unit L 43mm D1 ø 19mm D2 ø 15.5mm suitable for COPRECI			
accessories for	109509		
	GEV No.	100944	Ref. No. 12007951 Q221336
union nut thread M18x1.5 for pipe ø 12mm			
	GEV No.	101273	Ref. No. 12008501 U055043
olive for pipe ø 12mm L 9.5mm brass Qty 1 pcs suitable for universal			







1

GEV No.	109501	Ref. No.	12017386 U262107
description	gas tap COPRECI type CAL-3200 gas inlet M18x1.5 (tube ø 12mm) bypass nozzle ø 0.9mm gas outlet M18x1.5 (tube ø 12mm) thermo-couple connection M8x1 pilot connection 1/8" shaft ø 10x8mm shaft flat right shaft L 46/12mm with pipe outlet		
For models:	CG-7115, CG-7200, CG7-40, CG-7400, CG7-41, CG-7415, CG7-61, CG-7615, CGB7-61, CGE7-137, CGE7-41		
spare parts for	109501		
	GEV No.	106173	Ref. No. —
magnet unit L 43mm D1 ø 19mm D2 ø 15.5mm suitable for COPRECI			
	GEV No.	109413	Ref. No. 12016664 U022111
bypass nozzle type COPRECI CAL-3200 bore ø 0.9mm thread M8x0.75 WS 11			
accessories for	109501		
	GEV No.	100944	Ref. No. 12007951 Q221336
union nut thread M18x1.5 for pipe ø 12mm			
	GEV No.	101273	Ref. No. 12008501 U055043
olive for pipe ø 12mm L 9.5mm brass Qty 1 pcs suitable for universal			



1

GEV No.	109504	Ref. No.	12009464 U249402 U262113
description	gas tap COPRECI type CAL-3200 gas inlet M18x1.5 (tube ø 12mm) bypass nozzle ø 0.9mm gas outlet M18x1.5 (tube ø 12mm) thermo-couple connection M8x1 pilot connection 1/8" shaft ø 10x8mm shaft flat right shaft L 30/12mm with pipe outlet		
For models:	CG-1002, CG-1502, CG-2000, CG-2000-2P, CG-2002, CG-2002P, CG-2005, CG-210, CG-210G, CG-300S, CG-310, CG-310G, CG9-20, CG9-40, CG9-41, CG9-51L, CG9-51LC, CG9-51R, CG9-51RC, CG9-60, CG9-61, CG9-82, CGE9-41, CPG9-05, CPG9-05NC, CPG9-05S, CPG9-05SNC, FTG7-05VL, FTG7-05VR, FTG7-10VL, FTG7-10VL+R, FTG7-10VR		
spare parts for	109504		
	GEV No.	106173	Ref. No. —
magnet unit L 43mm D1 ø 19mm D2 ø 15.5mm suitable for COPRECI			
	GEV No.	109413	Ref. No. 12016664 U022111
bypass nozzle type COPRECI CAL-3200 bore ø 0.9mm thread M8x0.75 WS 11			
accessories for	109504		
	GEV No.	100944	Ref. No. 12007951 Q221336
union nut thread M18x1.5 for pipe ø 12mm			
	GEV No.	101273	Ref. No. 12008501 U055043
olive for pipe ø 12mm L 9.5mm brass Qty 1 pcs suitable for universal			











1





GEV No.	109506	Ref. No.	12018189 U262111
description	gas tap COPRECI type CAL-3200 gas inlet M18x1.5 (tube ø 12mm) bypass nozzle ø 0.9mm gas outlet M18x1.5 (tube ø 12mm) thermo-couple connection pilot connection 1/8" shaft ø 10x8mm shaft flat right shaft L 29/12mm with pipe outlet		
For models:	CG-2000, CG-2000-2P, CG9-41, CG9-61, CG9-82		
spare parts for	109506		
	GEV No.	106173	Ref. No. —
magnet unit L 43mm D1 ø 19mm D2 ø 15.5mm suitable for COPRECI			
	GEV No.	109413	Ref. No. 12016664 U022111
bypass nozzle type COPRECI CAL-3200 bore ø 0.9mm thread M8x0.75 WS 11			
accessories for	109506		
	GEV No.	100944	Ref. No. 12007951 Q221336
union nut thread M18x1.5 for pipe ø 12mm			
	GEV No.	101273	Ref. No. 12008501 U055043
olive for pipe ø 12mm L 9.5mm brass Qty 1 pcs suitable for universal			



 <p>1</p>			
GEV No.	109049	Ref. No.	12018190 U262101
description	gas tap COPRECI type CAL-3200 gas inlet M18x1.5 (tube ø 12mm) bypass nozzle ø 0.9mm gas outlet M18x1.5 (tube ø 12mm) thermo-couple connection pilot connection 1/8" shaft ø 10x8mm shaft flat right shaft L 46/12mm		
For models:	CG-7200, CG-7400, CG-7415, CG-7615		
spare parts for	109049		
	GEV No.	106173	Ref. No. —
	magnet unit L 43mm D1 ø 19mm D2 ø 15.5mm suitable for COPRECI		
	GEV No.	109413	Ref. No. 12016664 U022111
	bypass nozzle type COPRECI CAL-3200 bore ø 0.9mm thread M8x0.75 WS 11		
accessories for	109049		
	GEV No.	100944	Ref. No. 12007951 Q221336
	union nut thread M18x1.5 for pipe ø 12mm		
	GEV No.	101273	Ref. No. 12008501 U055043
	olive for pipe ø 12mm L 9.5mm brass Qty 1 pcs suitable for universal		



 <p>1</p>			
GEV No.	109060	Ref. No.	12018400 T032103
description	gas tap COPRECI type CAL-3200 gas inlet M18x1.5 (tube ø 12mm) bypass nozzle ø 1.1mm gas outlet M18x1.5 (tube ø 12mm) thermo-couple connection M8x1 pilot connection 1/8" shaft ø 10x8mm shaft flat right shaft L 29/12mm		
For models:	BG7-05, BG7-05I, BG7-10, BG7-10I		
spare parts for	109060		
	GEV No.	106173	Ref. No. —
	magnet unit L 43mm D1 ø 19mm D2 ø 15.5mm suitable for COPRECI		
accessories for	109060		
	GEV No.	100944	Ref. No. 12007951 Q221336
	union nut thread M18x1.5 for pipe ø 12mm		
	GEV No.	101273	Ref. No. 12008501 U055043
	olive for pipe ø 12mm L 9.5mm brass Qty 1 pcs suitable for universal		

 <p>1</p>			
GEV No.	109508	Ref. No.	12012263 U222101
description	gas tap COPRECI type CAL-3200 gas inlet M18x1.5 (tube ø 12mm) bypass nozzle ø 1.2mm gas outlet M18x1.5 (tube ø 12mm) thermo-couple connection M8x1 pilot connection 1/8" shaft ø 10x8mm shaft flat right shaft L 30/12mm with pipe outlet		
For models:	CG9-10, CG9-11, CG-9110, HP-G-15		
spare parts for	109508		
	GEV No.	106173	Ref. No. —
	magnet unit L 43mm D1 ø 19mm D2 ø 15.5mm suitable for COPRECI		
accessories for	109508		
	GEV No.	100944	Ref. No. 12007951 Q221336
	union nut thread M18x1.5 for pipe ø 12mm		
	GEV No.	101273	Ref. No. 12008501 U055043
	olive for pipe ø 12mm L 9.5mm brass Qty 1 pcs suitable for universal		

 <p>1</p>			
GEV No.	109502	Ref. No.	12011453 U772100
description	gas tap COPRECI type CAL-3200 gas inlet M18x1.5 (tube ø 12mm) bypass nozzle ø 1.2mm gas outlet M18x1.5 (tube ø 12mm) thermo-couple connection M8x1 pilot connection 1/8" shaft ø 10x8mm shaft flat right shaft L 46/12mm with pipe outlet		
For models:	CG7-10, CG7-11		
spare parts for	109502		
	GEV No.	106173	Ref. No. —
	magnet unit L 43mm D1 ø 19mm D2 ø 15.5mm suitable for COPRECI		
accessories for	109502		
	GEV No.	100944	Ref. No. 12007951 Q221336
	union nut thread M18x1.5 for pipe ø 12mm		
	GEV No.	101273	Ref. No. 12008501 U055043
	olive for pipe ø 12mm L 9.5mm brass Qty 1 pcs suitable for universal		



1

GEV No.	109505	Ref. No.	12009462 U702101
description	gas tap COPRECI type CAL-3200 gas inlet M18x1.5 (tube ø 12mm) bypass nozzle ø 1.3mm gas outlet M18x1.5 (tube ø 12mm) thermocouple connection M8x1 pilot connection 1/8" shaft ø 10x8mm shaft flat right shaft L 29/12mm with pipe outlet		
For models:	BG9-05, BG9-05I, BG9-10, BG9-10I, CG-1002, CG-1502, CG-2002, CG-2002P, CG9-40, CG9-41, CG9-51L, CG9-51LC, CG9-51RC, CG9-60, CG9-61, CG9-82, CGE9-41, HP-G-15, HPG-15		
spare parts for	109505		
	GEV No.	106173	Ref. No. —
	magnet unit L 43mm D1 ø 19mm D2 ø 15.5mm suitable for COPRECI		
accessories for	109505		
	GEV No.	100944	Ref. No. 12007951 Q221336
	union nut thread M18x1.5 for pipe ø 12mm		
	GEV No.	101273	Ref. No. 12008501 U055043
	olive for pipe ø 12mm L 9.5mm brass Qty 1 pcs suitable for universal		



1



GEV No.	109185	Ref. No.	12009457 U912102
description	gas tap COPRECI type CAL-3200 gas inlet pipe flange ø21mm bypass nozzle ø 1mm gas outlet 3/8" (tube ø 10mm) thermocouple connection M8x1 pilot connection 1/8" shaft ø 8x6.5mm shaft flat upper shaft L 29/12mm		
For models:	CPG9-05, CPG9-05AD, CPG9-05AD-S, CPG9-05NC, CPG9-05PLUS, CPG9-05PLUS-S, CPG9-05S, CPG9-05SNC		



1



GEV No.	109000	Ref. No.	12017322 U022101
description	gas tap COPRECI type CAL-3200 gas inlet pipe flange ø27mm bypass nozzle ø 0.55mm gas outlet 3/8" (tube ø 10mm) thermocouple connection M8x1 pilot connection 1/8" shaft ø 10x8mm shaft flat right shaft L 30/12mm		
For models:	CG9-10, CG9-11, CG9-20, CG9-40, CG9-41, CG9-51L, CG9-51LC, CG9-51R, CG9-51RC, CG9-60, CG9-61, CG9-82, CGE9-41, CGF9-120D, CGF9-120I, CGF9-121D, CGF9-121I, CPG9-05, CPG9-05S		
spare parts for	109000		
	GEV No.	106173	Ref. No. —
	magnet unit L 43mm D1 ø 19mm D2 ø 15.5mm suitable for COPRECI		

accessories for 109000

	GEV No.	100944	Ref. No.	12007951 Q221336
	union nut thread M18x1.5 for pipe ø 12mm			
	GEV No.	101273	Ref. No.	12008501 U055043
	olive for pipe ø 12mm L 9.5mm brass Qty 1 pcs suitable for universal			
	GEV No.	109195	Ref. No.	12016681 U022113
	bypass nozzle type COPRECI bore ø 1.3mm thread M8x0.75 WS 11			





1

GEV No.	109095	Ref. No.	12011431 U022108
description	gas tap COPRECI type CAL-3200 gas inlet pipe flange ø27mm bypass nozzle ø 1.3mm gas outlet M18x1.5 (tube ø 12mm) thermocouple connection M8x1 pilot connection 1/8" shaft ø 10x8mm shaft flat right shaft L 29/12mm		
For models:	BG9-05, BG9-05I, BG9-10, BG9-10I		
spare parts for	109095		
	GEV No.	106173	Ref. No. —
	magnet unit L 43mm D1 ø 19mm D2 ø 15.5mm suitable for COPRECI		
accessories for	109095		
	GEV No.	100944	Ref. No. 12007951 Q221336
	union nut thread M18x1.5 for pipe ø 12mm		
	GEV No.	101273	Ref. No. 12008501 U055043
	olive for pipe ø 12mm L 9.5mm brass Qty 1 pcs suitable for universal		

CAL-5200





1

GEV No.	107693	Ref. No.	12018254 U872107
description	gas tap COPRECI type CAL-5200 gas inlet pipe flange ø21mm bypass nozzle ø 0.7mm gas outlet 3/8" thermocouple connection M8x1 pilot connection shaft ø 8x6.5mm shaft L 32/12mm shaft flat right		
For models:	CGP9-10, CGP9-11		
accessories for	107693		
	GEV No.	101537	Ref. No. 12010025 12017549 Q307034
	gasket ID ø 8mm ED ø 11.5mm H 3mm Qty 1 pcs		
	GEV No.	101538	Ref. No. 12025294 Z982018
	clamp		



CPMM18700			
			
1			
GEV No.	106665	Ref. No.	12009411 12038526 H122103 U912101
description	gas tap COPRECI type CPMM18700 gas inlet pipe flange ø21mm bypass nozzle ø 0.5 / 0.75 / 0.9 / 1.15 / 1.45mm gas outlet 3/8" (tube ø 10mm) thermocouple connection M8x1 pilot connection M10x1 shaft ø 8x6.5mm shaft flat upper shaft L 41/12mm front fixing M15x1		
For models:	CG7-20, CG7-30D, CG7-30I, CG7-31D, CG7-31I, CG7-40, CG7-41, CG7-50, CG7-51, CG7-60, CG7-61, CGB7-61, CGB7-61R, CGE7-41		
spare parts for	106665		
	GEV No.	107563	Ref. No. 12002030
flange for gas tap L 48mm			

			
1			
GEV No.	107314	Ref. No.	12003724 12038522 R902102
description	gas tap with ignition flame COPRECI type CPMM18700 gas inlet pipe flange ø21mm bypass nozzle ø 0.9mm gas outlet 3/8" (tube ø 10mm) thermocouple connection M8x1 pilot connection M10x1 shaft ø 8x6.5mm shaft L 41/12mm shaft flat right front fixing M15x1		
For models:	FTG7-05VL, FTG7-05VR, FTG7-10VL, FTG7-10VL+R, FTG7-10VR, FTG9-05LV-AD, FTG9-05PLUS-LV, FTG9-05PLUS-RV, FTG9-05RV-AD, FTG9-05VL, FTG9-05VR, FTG9-10L+RV-AD, FTG9-10LV-AD, FTG9-10PLUS-LRV, FTG9-10PLUS-LV, FTG9-10PLUS-RV, FTG9-10RV-AD, FTG9-10VL, FTG9-10VL+R, FTG9-10VR		

			
1			
GEV No.	106958	Ref. No.	11U9121090 12038507
description	gas tap with ignition flame COPRECI type CPMM18700 gas inlet pipe flange ø21mm bypass nozzle ø 1.15mm gas outlet 3/8" (tube ø 10mm) thermocouple connection M8x1 pilot connection M10x1 shaft ø 8x6.5mm shaft flat right shaft L 41/12mm with pipe outlet front fixing M15x1		
spare parts for	106958		
	GEV No.	101060	Ref. No. 608205 608205000
magnet unit standard L 39mm D1 ø 15.4mm D2 ø 11mm suitable for PEL20-21/JUNKERS/EGA			

			
1			
GEV No.	106948	Ref. No.	12003728 12038505 U912117
description	gas tap with ignition flame COPRECI type CPMM18700 gas inlet pipe flange ø21mm bypass nozzle ø 1.45mm gas outlet 3/8" (tube ø 10mm) thermocouple connection M8x1 pilot connection M10x1 shaft ø 8x6.5mm shaft flat left shaft L 41/12mm with pipe outlet front fixing M15x1		
For models:	CG9-20AD-H, CG9-20H, CG9-20PLUS, CG9-20PLUS-H, CG9-40, CG9-40AD, CG9-40AD-H, CG9-40H, CG9-40PLUS, CG9-40PLUS-H, CG9-41, CG9-41AD, CG9-41AD-H, CG9-41H, CG9-41PLUS, CG9-41PLUS-H, CG9-51L, CG9-51LC, CG9-51R, CG9-51RC, CG9-60, CG9-60AD, CG9-60AD-H, CG9-60H, CG9-60PLUS, CG9-60PLUS-H, CG9-61, CG9-61AD, CG9-61AD-H, CG9-61H, CG9-61OP, CG9-61PLUS, CG9-61PLUS-H, CG9-82, CG9-82AD, CG9-82PLUS, CGE9-41, CGE9-41AD, CGE9-41PLUS		

			
1			
GEV No.	106947	Ref. No.	11U9121150 12003727 12038506
description	gas tap with ignition flame type CPMM18700 gas inlet pipe flange ø21mm bypass nozzle ø 0.75mm gas outlet 3/8" (tube ø 10mm) thermocouple connection M8x1 pilot connection M10x1 shaft ø 8x6.5mm shaft flat upper shaft L 41/12mm with pipe outlet front fixing M15x1		
For models:	CG9-05AD, CG9-05PLUS, CG9-20, CG9-20AD, CG9-20H, CG9-20PLUS, CG9-31PLUS-D, CG9-31PLUS-I, CG9-40, CG9-40AD, CG9-40H, CG9-40PLUS, CG9-41, CG9-41AD, CG9-41H, CG9-41PLUS, CG9-51L, CG9-51LC, CG9-51R, CG9-51RC, CG9-60, CG9-60AD, CG9-60H, CG9-60PLUS, CG9-61, CG9-61AD, CG9-61H, CG9-61OP, CG9-61PLUS, CG9-82, CG9-82AD, CG9-82PLUS, CGE9-41, CGE9-41AD, CGE9-41PLUS, CGF9-120D, CGF9-120D-AD, CGF9-120I, CGF9-120I-AD, CGF9-120PLUS-D, CGF9-120PLUS-I, CGF9-121D, CGF9-121D-AD, CGF9-121I, CGF9-121I-AD, CGF9-121PLUS-D, CGF9-121PLUS-I		

gas thermostats











SIT

630 Eurosit series



GEV No.	106164	Ref. No.	12023415 R152102
description	gas thermostat type 630 Eurosit series t.max. 340°C 100-340°C gas inlet 3/8" gas outlet 3/8" thermocouple connection M9x1 pilot connection M10x1 probe ø 4mm probe L 72mm capillary pipe 1050mm pressure regulator 13-18mbar ambient temperature max. 0-120°C		
For models:	CG7-11, CG7-31D, CG7-31I, CG7-41, CG7-41H, CG7-51, CG7-61, CG7-61H, CG9-51L, CG9-51LC, CG9-51R, CG9-51RC, CGB7-61, CGB7-61H, CGB7-61R, CGB7-61RH, CGP9-11, FTG9-05L, FTG9-05L-AD, FTG9-05PLUS-CL, FTG9-05PLUS-CR, FTG9-05PLUS-L, FTG9-05PLUS-R, FTG9-05R, FTG9-05R-AD, FTG9-05VL, FTG9-05VR, FTG9-10L, FTG9-10L+R, FTG9-10L+R-AD, FTG9-10L-AD, FTG9-10PLUS-CL, FTG9-10PLUS-CLR, FTG9-10PLUS-CR, FTG9-10PLUS-L, FTG9-10PLUS-LR, FTG9-10PLUS-R, FTG9-10R, FTG9-10R-AD, FTG9-10VL, FTG9-10VL+R, FTG9-10VR, FTG9-11L, FTG9-11L+R, FTG9-11R, FTGC9-05L, FTGC9-05L-AD, FTGC9-05R, FTGC9-05R-AD, FTGC9-10L...(Other models you can see in the webshop)		
accessories for	106164		
	GEV No.	100904	Ref. No. 12008755
	locking screw M10x1 for pipe ø 4mm Qty 1 pcs		
	GEV No.	100905	Ref. No. 12008715 U134323
	locking screw M10x1 for pipe ø 6mm Qty 1 pcs		
	GEV No.	101273	Ref. No. 12008501 U055043
	olive for pipe ø 12mm L 9.5mm brass Qty 1 pcs suitable for universal		
	GEV No.	101276	Ref. No. 12008081 U264310
	union screw thread 3/8" tube ø 12mm Qty 1 pcs		
	GEV No.	101333	Ref. No. 12008964
	plug thread 3/8" with O-ring		



GEV No.	101125	Ref. No.	12009504 T982100
description	gas thermostat type 630 Eurosit series t.max. 340°C 100-340°C gas inlet 3/8" gas outlet 3/8" thermocouple connection M9x1 pilot connection M10x1 probe ø 4mm probe L 72mm capillary pipe 1050mm SIT		
For models:	CG-210, CG-210G, CG-310, CG-310G, CG7-11, CG7-31D, CG7-31I, CG7-41, CG7-41H, CG7-51, CG7-61, CG7-61H, CG9-51L, CG9-51LC, CG9-51R, CG9-51RC, CGB7-61, CGB7-61H, CGB7-61R, CGB7-61RH, CGP9-11, FTG7-05L, FTG7-05R, FTG7-10L, FTG7-10L+R, FTG7-10R, FTG9-05L, FTG9-05R, FTG9-10L, FTG9-10L+R, FTG9-10R, FTG9-11L, FTG9-11L+R, FTG9-11R, FTGC7-05L, FTGC7-10L, FTGC9-05L, FTGC9-05R, FTGC9-10L, FTGC9-10L+R, FTGC9-10R, FTGC9-11L, FTGC9-11L+R, FTGC9-11R, HG9-10, HG9-20		
accessories for	101125		
	GEV No.	100825	Ref. No. —
	gas tap spindle shaft ø 8x6.5mm shaft L 22/14mm suitable for EUROISIT		
	GEV No.	100904	Ref. No. 12008755
	locking screw M10x1 for pipe ø 4mm Qty 1 pcs		
	GEV No.	100905	Ref. No. 12008715 U134323
	locking screw M10x1 for pipe ø 6mm Qty 1 pcs		
	GEV No.	100949	Ref. No. —
	gasket suitable for 630 Eurosit series		
	GEV No.	101273	Ref. No. 12008501 U055043
	olive for pipe ø 12mm L 9.5mm brass Qty 1 pcs suitable for universal		
	GEV No.	101276	Ref. No. 12008081 U264310
	union screw thread 3/8" tube ø 12mm Qty 1 pcs		
	GEV No.	101333	Ref. No. 12008964
	plug thread 3/8" with O-ring		
	GEV No.	101390	Ref. No. —
	gas tap spindle shaft ø 6x4.6mm shaft L 32/15mm gas tap with ignition flame suitable for ZANUSSI, MARENO for gas thermostat EUROISIT		
	GEV No.	101392	Ref. No. —
	adapter suitable for 630 Eurosit series		
	GEV No.	110357	Ref. No. —
	gas tap spindle shaft ø 8x6.5mm shaft L 36/12mm suitable for 630 Eurosit series		
	GEV No.	110358	Ref. No. —
	adapter shaft ø 10x8mm shaft L 29/18mm suitable for 630 Eurosit series		

1 gas components



710 Minisit series



GEV No.	101435	Ref. No.	12009530 U134316 U134324
description	gas thermostat SIT type MINISIT 710 t.max. 340°C 100-340°C gas inlet 1/2" gas outlet 3/8" thermocouple connection M9x1 pilot connection M10x1 probe ø 4mm probe L 72mm capillary pipe 1050mm probe type type C1 pressure controller no pressure regulator mbar gland nut		
For models:	CG-1002, CG-1502, CG-2000, CG-2000-2P, CG-2002, CG-2002P, CG9-11, CG-9110, CG9-11AD, CG9-11PLUS, CG9-31PLUS-D, CG9-31PLUS-I, CG9-41, CG9-41AD, CG9-41AD-H, CG9-41H, CG9-41PLUS, CG9-41PLUS-H, CG9-51L, CG9-51LC, CG9-51R, CG9-51RC, CG9-61, CG9-61AD, CG9-61AD-H, CG9-61H, CG9-61OP, CG9-61PLUS, CG9-61PLUS-H, CG9-82, CG9-82AD, CG9-82PLUS, CGF9-121D, CGF9-121D-AD, CGF9-121I, CGF9-121PLUS-D, CGF9-121PLUS-I, CG-HP-20, FI-5420, FI-7630, FTG9-11L, FTG9-11L+R, FTG9-11R, FTGC9-11L, FTGC9-11L+R, FTGC9-11R, HG9-10, HG9-15, HG9-20		
spare parts for	101435		
	GEV No.	101053	Ref. No. 12019677 U264399
	magnet unit T1: M9x1 T2: M24x1 L 45mm ø 17mm suitable for Minisit		
	GEV No.	102107	Ref. No. —
	probe 100-340°C probe ø 4mm probe L 72mm capillary pipe 1050mm t.max. 340°C oven/grill probe type type C1 suitable for MINISIT 710		
accessories for	101435		
	GEV No.	100809	Ref. No. —
	O-ring EPDM thickness 2mm ID ø 21mm Qty 1 pcs		
	GEV No.	100904	Ref. No. 12008755
	locking screw M10x1 for pipe ø 4mm Qty 1 pcs		
	GEV No.	100905	Ref. No. 12008715 U134323
	locking screw M10x1 for pipe ø 6mm Qty 1 pcs		
	GEV No.	101054	Ref. No. —
	magnet unit T1: M10x1 T2: M24x1 L 45mm ø 17mm suitable for Minisit		
	GEV No.	101136	Ref. No. —
	piezoelectric igniter suitable for Minisit with cover cap ømm connection F6.3x0.8		
	GEV No.	101137	Ref. No. 12008932 U134318
	cover cap without piezoelectric igniter		
	GEV No.	101267	Ref. No. —
	reducer IT 3/8" ET 1/2" L 21mm		
	GEV No.	101268	Ref. No. 12008944 U264300
	gas connection thread 3/8" angled with O-ring MINISIT 710		
	GEV No.	101269	Ref. No. —
	gas connection thread 1/2" angled with O-ring MINISIT 710		

accessories for	101435		
	GEV No.	101270	Ref. No. —
	screw connection IT 3/8" ET 3/8" L 28mm		
	GEV No.	101272	Ref. No. —
	screw connection IT 1/2" ET 3/8" L 57mm		
	GEV No.	101273	Ref. No. 12008501 U055043
	olive for pipe ø 12mm L 9.5mm brass Qty 1 pcs suitable for universal		
	GEV No.	101274	Ref. No. X012105
	olive for pipe ø 16mm Qty 1 pcs		
	GEV No.	101275	Ref. No. 12008951 X012104
	union screw thread 1/2" for pipe ø 16mm Qty 1 pcs		
	GEV No.	101276	Ref. No. 12008081 U264310
	union screw thread 3/8" tube ø 12mm Qty 1 pcs		
	GEV No.	110068	Ref. No. 12008789 U134317
	knob suitable for Minisit ø 37mm		



GEV No.	106332	Ref. No.	11U2643150 12003345 12007319
description	gas thermostat SIT type MINISIT 710 t.max. 340°C 100-340°C gas inlet 3/8" pipe input ø 12mm gas outlet 3/8" pipe output ø 12mm thermocouple connection M9x1 probe ø 4mm probe L 72mm pressure controller no		
For models:	CG-1002, CG-1502, CG-2000, CG-2000-2P, CG-2002, CG9-11, CG9-41, CG9-51L, CG9-51LC, CG9-51R, CG9-51RC, CG9-61, CG9-82, FTG9-11L, FTG9-11L+R, FTG9-11R, FTGC9-11L, FTGC9-11L+R, FTGC9-11R		
spare parts for	106332		
	GEV No.	100809	Ref. No. —
	O-ring EPDM thickness 2mm ID ø 21mm Qty 1 pcs		
	GEV No.	101053	Ref. No. 12019677 U264399
	magnet unit T1: M9x1 T2: M24x1 L 45mm ø 17mm suitable for Minisit		
	GEV No.	101137	Ref. No. 12008932 U134318
	cover cap without piezoelectric igniter		
	GEV No.	101268	Ref. No. 12008944 U264300
	gas connection thread 3/8" angled with O-ring MINISIT 710		
	GEV No.	102107	Ref. No. —
	probe 100-340°C probe ø 4mm probe L 72mm capillary pipe 1050mm t.max. 340°C oven/grill probe type type C1 suitable for MINISIT 710		
	GEV No.	110068	Ref. No. 12008789 U134317
	knob suitable for Minisit ø 37mm		

Table continues overleaf

accessories for		106332	
	GEV No.	100904	Ref. No. 12008755
locking screw M10x1 for pipe ø 4mm Qty 1 pcs			
	GEV No.	100905	Ref. No. 12008715 U134323
locking screw M10x1 for pipe ø 6mm Qty 1 pcs			
	GEV No.	101054	Ref. No. —
magnet unit T1: M10x1 T2: M24x1 L 45mm ø 17mm suitable for Minisit			
	GEV No.	101136	Ref. No. —
piezoelectric igniter suitable for Minisit with cover cap ømm connection F6.3x0.8			
	GEV No.	101267	Ref. No. —
reducer IT 3/8" ET 1/2" L 21mm			
	GEV No.	101269	Ref. No. —
gas connection thread 1/2" angled with O-ring MINISIT 710			
	GEV No.	101270	Ref. No. —
screw connection IT 3/8" ET 3/8" L 28mm			
	GEV No.	101272	Ref. No. —
screw connection IT 1/2" ET 3/8" L 57mm			
	GEV No.	101273	Ref. No. 12008501 U055043
olive for pipe ø 12mm L 9.5mm brass Qty 1 pcs suitable for universal			
	GEV No.	101274	Ref. No. X012105
olive for pipe ø 16mm Qty 1 pcs			
	GEV No.	101275	Ref. No. 12008951 X012104
union screw thread 1/2" for pipe ø 16mm Qty 1 pcs			
	GEV No.	101276	Ref. No. 12008081 U264310
union screw thread 3/8" tube ø 12mm Qty 1 pcs			

accessories

probes

	1		
GEV No.	102102	Ref. No.	12018712 U264398
description probe 100-340°C probe ø 5mm probe L 68mm capillary pipe 1750mm t.max. 340°C oven/grill probe type type B1 suitable for MINISIT 710			
For models: CG-1002, CG-1502, CG-2000, CG-2000-2P, CG-2002, CG9-11, CG9-41, CG9-51L, CG9-51LC, CG9-51R, CG9-51RC, CG9-61, CG9-82, FTG9-11L, FTG9-11L+R, FTG9-11R, FTGC9-11L, FTGC9-11L+R, FTGC9-11R			



	1		
GEV No.	102104 ¹	Ref. No.	12017711 X012198
description probe 110-190°C probe ø 11mm probe thread 1/4" probe L 26mm capillary pipe 1050mm t.max. 190°C fryer probe type type F3 suitable for MINISIT 710			
accessories for		102104	
	GEV No.	361182	Ref. No. —
nut thread 1/4" H 5mm nickel-plated brass WS 17 Qty 1 pcs			
	GEV No.	510420	Ref. No. —
gasket copper ED ø 19.9mm ID ø 14.3mm thickness 2mm Qty 1 pcs			
	GEV No.	529251	Ref. No. —
O-ring EPDM thickness 2.62mm ID ø 15.08mm Qty 1 pcs			



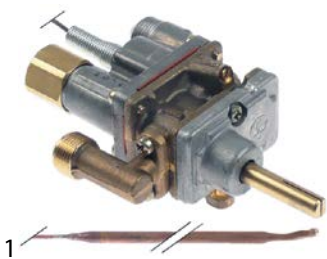

¹probe thread 1/4"

COPRECI



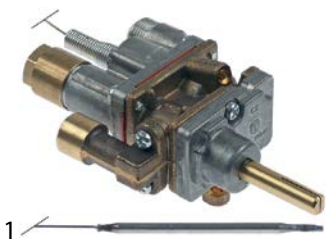

	1		
GEV No.	101533	Ref. No.	12017423 R202104 R432102 U262102
description gas thermostat COPRECI t.max. 110°C gas inlet pipe flange ø21mm bypass nozzle ø 0.35mm gas outlet 3/8" pilot connection 1/8" thermocouple connection M8x1 capillary pipe 1000mm probe ø 6mm probe L 135mm shaft ø 8x6.5mm shaft L 33/12mm shaft flat right			
For models: BMG7-10, BMG9-05, BMG9-10, FTG7-05, FTG7-10			
spare parts for		101533	
	GEV No.	101060	Ref. No. 608205 608205000
magnet unit standard L 39mm D1 ø 15.4mm D2 ø 11mm suitable for PEL20-21/JUNKERS/EGA			
	GEV No.	101537	Ref. No. 12010025 12017549 Q307034
gasket ID ø 8mm ED ø 11.5mm H 3mm Qty 1 pcs			
accessories for		101533	
	GEV No.	101538	Ref. No. 12025294 Z982018
clamp			

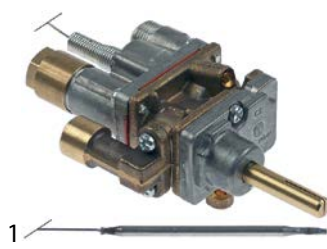

			
GEV No.	109050	Ref. No.	12017437 U018700
description	gas thermostat COPRECI t.max. 300°C gas inlet pipe flange ø21mm bypass nozzle ø 0.64mm gas outlet 3/8" pilot connection 1/8" thermocouple connection 2x M8x1 capillary pipe 1000mm probe ø 5mm probe L 110mm shaft ø 8x6.5mm shaft L 33/12mm shaft flat right		
For models:	CG-210G, CG-310G		
spare parts for	109050		
	GEV No.	101060	Ref. No. 608205 608205000
	magnet unit standard L 39mm D1 ø 15.4mm D2 ø 11mm suitable for PEL20-21/JUNKERS/EGA		
	GEV No.	101537	Ref. No. 12010025 12017549 Q307034
	gasket ID ø 8mm ED ø 11.5mm H 3mm Qty 1 pcs		
accessories for	109050		
	GEV No.	101538	Ref. No. 12025294 Z982018
	clamp		

			
GEV No.	109051	Ref. No.	11R5321030 12012011 12012114 12017288 12040477 R532101 R612101
description	gas thermostat COPRECI t.max. 300°C gas inlet pipe flange ø21mm bypass nozzle ø 0.6mm gas outlet 3/8" pilot connection 1/8" thermocouple connection M8x1 capillary pipe 1100mm probe ø 4mm probe L 84mm shaft ø 8x6.5mm shaft L 33/12mm shaft flat right		
For models:	FTG9-05L, FTG9-05R, FTG9-05VL, FTG9-05VR, FTG9-10L, FTG9-10L+R, FTG9-10R, FTG9-10VL, FTG9-10VL+R, FTG9-10VR, FTG9-11L, FTG9-11L+R, FTG9-11R, FTGC9-05, FTGC-9050, FTGC9-05L, FTGC9-05R, FTGC9-10, FTGC-9100, FTGC9-10L, FTGC9-10L+R, FTGC9-10R, FTGC9-11L, FTGC9-11L+R, FTGC9-11R, PL-105C, PL-110C		
spare parts for	109051		
	GEV No.	101060	Ref. No. 608205 608205000
	magnet unit standard L 39mm D1 ø 15.4mm D2 ø 11mm suitable for PEL20-21/JUNKERS/EGA		
	GEV No.	101537	Ref. No. 12010025 12017549 Q307034
	gasket ID ø 8mm ED ø 11.5mm H 3mm Qty 1 pcs		
accessories for	109051		
	GEV No.	101376	Ref. No. —
	gasket ID ø 8mm ED ø 12mm H 3/5mm		

accessories for	109051		
	GEV No.	101538	Ref. No. 12025294 Z982018
	clamp		

			
GEV No.	109534	Ref. No.	12009479 12015257 329200 R782130 U329200 U742130
description	gas thermostat COPRECI type CAL-5200 t.max. 300°C gas inlet pipe flange ø21mm bypass nozzle ø 0.5mm gas outlet 3/8" pilot connection closed thermocouple connection M8x1 capillary pipe 1100mm probe ø 4mm probe L 82mm shaft ø 8x6.5mm shaft L 33/12mm shaft flat right		
For models:	CG-210, CG-210G, CG-310, CG-310G, CG6-41, CG7-11, CG-7115, CG7-41, CG-7415, CG7-61, CG-7615, CGB7-61, FTG7-05, FTG7-10, FTGC6-05L, FTGC6-10L, FTGC6-10L+R		
spare parts for	109534		
	GEV No.	101060	Ref. No. 608205 608205000
	magnet unit standard L 39mm D1 ø 15.4mm D2 ø 11mm suitable for PEL20-21/JUNKERS/EGA		
accessories for	109534		
	GEV No.	101537	Ref. No. 12010025 12017549 Q307034
	gasket ID ø 8mm ED ø 11.5mm H 3mm Qty 1 pcs		
	GEV No.	101538	Ref. No. 12025294 Z982018
	clamp		

			
GEV No.	109112	Ref. No.	12007980 H352101
description	gas thermostat COPRECI type MTZ22300 gas inlet pipe flange ø21mm bypass nozzle ø 0.5mm gas outlet M14x1.5 pilot connection 1/8" thermocouple connection M8x1 capillary pipe 850mm probe ø 6mm probe L 130mm shaft ø 8x6.5mm shaft L 42/12mm shaft flat right		
For models:	BMG7-10, BMG9-05, BMG9-05V-T, BMG9-10, BMG9-10V-T		



gas valves and ignition boxes

gas control valves

DUNGS



GEV No.	106050	Ref. No.	12026701 RT7000220
description	gas valve 230V 50/60Hz gas inlet 1/2" gas outlet 1/2" DUNGS type GB 055 243 443		



GEV No.	106051	Ref. No.	12026482 RT7000031
description	gas valve 230V 50/60Hz gas inlet 1/2" gas outlet 1/2" DUNGS type GB-WND 055 243 442		



GEV No.	107554	Ref. No.	12026440 RT7000029
description	gas valve 230V 50/60Hz gas inlet 1/2" gas outlet 1/2" total length 105mm DUNGS type GB-WND 055 D01 S02 243442		



GEV No.	107555	Ref. No.	12040554 RT7000033
description	gas valve 230V 50/60Hz gas inlet 1/2" IT gas outlet 1/2" IT total length 105mm DUNGS type GB-ND 055 D01 S02 243443		

HONEYWELL



GEV No.	101186	Ref. No.	12027429 RT30390241	
description	gas valve type VK4105C 220-240V 50/60Hz gas inlet flange 32x32mm gas outlet flange 32x32mm thermocouple connection pilot connection pressure range 15-60mbar max 60mbar operator type pressure controller type V5360E 1226 1 HONEYWELL flange 32x32mm			
accessories for	101186			
	GEV No.	102845	Ref. No.	—
	gas connection angled 1/2" flange 32x32mm hole distance 24x24mm Tandem			
	GEV No.	102846	Ref. No.	—
	gas connection straight 1/2" flange 32x32mm hole distance 24x24mm suitable for Tandem			













GEV No.	106420	Ref. No.	12024609 T303017	
description	gas valve type VK4115V 220/240V 50/60Hz gas inlet 1/2" NPT gas outlet flange 32x32mm thermocouple connection pilot connection pressure range 15-60mbar max 60mbar operator type HONEYWELL flange 32x32mm			
For models:	COG-102, HGC-10-21, HGC-20-21, HGP-10-21, HGP-20-21, HGV-10-21, HGV-20-21, VG-102, VPG-102			
accessories for	106420			
	GEV No.	102845	Ref. No.	—
	gas connection angled 1/2" flange 32x32mm hole distance 24x24mm Tandem			
	GEV No.	102846	Ref. No.	—
	gas connection straight 1/2" flange 32x32mm hole distance 24x24mm suitable for Tandem			



			
1			
GEV No.	106054	Ref. No.	12027246 RT30390245
description	gas valve type VK4115V 220-240V 50/60Hz gas inlet flange 32x32mm gas outlet flange 32x32mm thermocouple connection pilot connection pressure range 15-60mbar operator type HONEYWELL flange 32x32mm		
accessories for	106054		
	GEV No.	102845	Ref. No. —
	gas connection angled 1/2" flange 32x32mm hole distance 24x24mm Tandem		
	GEV No.	102846	Ref. No. —
	gas connection straight 1/2" flange 32x32mm hole distance 24x24mm suitable for Tandem		

			
1			
GEV No.	106417	Ref. No.	11T1350370 12003943 12038515
description	gas valve type VR4605V LPG 230V 50Hz gas inlet 1/2" gas outlet 1/2" thermocouple connection pilot connection operator type 230V (V4346A 1006)		
For models:	COG-201, HCG-20-11, HGC-20-11, HGV-20-11, HVG-20-11, VG-201, VPG-201		

			
1			
GEV No.	106419	Ref. No.	12003940 12038517 T115098
description	gas valve type VR4605V natural gas 230V 50Hz gas inlet 1/2" gas outlet 1/2" thermocouple connection pilot connection operator type 230V (V4346A 1006)		
For models:	COG-101, HCG-10-11, HGC-10-21, HCG-2-10-11, HGC-10-11, HGV-10-11, HVG-10-11, HVG-10-21, HVG-2-10-11, VG-101, VPG-101		

SIT			
ELETTROSIT			
			
1			
GEV No.	101127	Ref. No.	R275003000
description	gas valve SIT type ELETTROSIT 230V gas inlet 3/4" gas outlet 3/4" thermocouple connection M9x1 pilot connection M10x1 lateral equiv. no. 0.810.175		
spare parts for	101127		
	GEV No.	101312	Ref. No. 12024469 R275027
	microswitch		
	GEV No.	101352	Ref. No. —
	solenoid coil 230V 50Hz suitable for ELETTROSIT		
accessories for	101127		
	GEV No.	100006	Ref. No. T982001000
	piezoelectric igniter suitable for ELETTROSIT body plastic blowing connection ø2.4mm ø 14mm		
	GEV No.	100904	Ref. No. 12008755
	locking screw M10x1 for pipe ø 4mm Qty 1 pcs		
	GEV No.	100905	Ref. No. 12008715 U134323
	locking screw M10x1 for pipe ø 6mm Qty 1 pcs		
	GEV No.	101301	Ref. No. —
	gas connection thread 1/2" straight ELETTROSIT screw with O-ring		
	GEV No.	101303	Ref. No. —
	gas connection straight thread 3/4" ELETTROSIT		
	GEV No.	101309	Ref. No. —
	extension		



NOVASIT



1			
GEV No.	101908	Ref. No.	12024768 12097292 X163000
description	gas valve SIT series Novasit 820 230V 50Hz gas inlet 1/2" gas outlet 1/2" thermocouple connection M9x1 pilot connection M10x1 ignition pressurebar pressure regulator connection blind equiv. no. 0.820.018 output pilot burner M10x1 input pressure max. 60bar setting range 3-30bar		
For models:	FG7-05-1C, FG7-05-2C, FG-710, FG7-10-2C, FG7-104C, FG7-10-4C, FG-720, FG9-05, FG9-05-1C, FG9-05-2C, FG9-05AD, FG9-05PLUS, FG9-05PLUS-S, FG9-05S, FG9-05S-1C, FG9-05S-2C, FG9-05S-AD, FG9-10, FG9-10-2C, FG9-10-4C, FG9-10AD, FG9-10PLUS, FG-920, FG-940, FGCL9-05, FGCL9-05-1C, FGCL9-05-2C, FGCL9-05S-1C, FGCL9-05S-2C, MG9-10AD, MG9-10BMAD, MG9-10BMSAD, MG9-10PLUS, MG9-10PLUS-BM, MG9-10PLUS-BMS, MG9-10PLUS-S, MG9-10S-AD, MG9-15AD, MG9-15BMAD, MG9-15BMSAD, MG9-15PLUS, MG9-15PLUS-BM, MG9-15PLUS-BMS, MG9-15PLUS-S, MG9-15S-AD, MG9-20AD, MG9-20PLUS, MG9-20PLUS-S, MG9-20S-AD, SBG7-10...(Other models you can see in the webshop)		
spare parts for	101908		
	GEV No.	101065	Ref. No. 12033710 X163098
magnet unit with cable L 44mm D1 ø 30mm D2 ø 20mm suitable for NOVASIT			
	GEV No.	101313	Ref. No. 12018959 X163099
solenoid coil 230V 50Hz			
accessories for	101908		
	GEV No.	100006	Ref. No. T982001000
piezoelectric igniter suitable for ELETTROSIT body plastic blowing connection ø2.4mm ø 14mm			
	GEV No.	101305	Ref. No. 12020648 X153005
gas connection straight 1/2" flange 45x45mm ELETTROSIT/V4400/4600/4605 suitable for SIT/HONEYWELL hole distance 36x36mm			
	GEV No.	101306	Ref. No. 12009216 X153004
gas connection angled flange 45x45mm hole distance 36x36mm 1/2" ELETTROSIT/V4400/4600/4605 screw with O-ring suitable for SIT/HONEYWELL			
	GEV No.	101307	Ref. No. —
gas connection straight flange 45x45mm hole distance 36x36mm 3/4" ELETTROSIT/V4400/4600/4605 screw with O-ring suitable for SIT/HONEYWELL			
	GEV No.	101308	Ref. No. —
gas connection angled flange 45x45mm hole distance 36x36mm 3/4" ELETTROSIT/V4400/4600/4605 screw with O-ring suitable for SIT/HONEYWELL			
	GEV No.	101312	Ref. No. 12024469 R275027
microswitch			
	GEV No.	101314	Ref. No. —
solenoid coil 24V 50Hz			

accessories for	101908		
	GEV No.	101317	Ref. No. 12024504 X163008
plug with cable L 1000mm suitable for NOVASIT			
	GEV No.	101318	Ref. No. —
cover cap for solenoid coil suitable for NOVASIT			

SIGMA



1			
GEV No.	107926	Ref. No.	12046364
description	gas valve type 0848160 230V 50Hz gas inlet 3/4" gas outlet 3/4" pressure range 0.5-12mbar SIT equiv. no. 0848160		
For models:	ACG-061, ACG-101, ACG-102, ACG-201, ACG-202, AG-061, AG-101, AG-102, AG-201, AG-202, APG-061, APG-101, APG-102, APG-201, APG-202		

TANDEM



1			
GEV No.	101684	Ref. No.	12023419 Z952201
description	gas valve 230V 50Hz gas inlet 1/2" gas outlet 1/2" pilot connection level slow ignition standard ignition time 3-7s pressure range 3-50mbar power supply for modulator type SIT equiv. no. 0.830.034		
For models:	GA-20, GA-40, HCG-10-11, HCG-10-21, HCG-20-11, HCG-2-10-11, HCG-6-11, HGV-10-11, HGV-20-11, HMG-10-11, HMG-10-21, HMG-20-11, HMG-2-10-11, HMG-6-11, HVG-10-11, HVG-10-21, HVG-20-11, HVG-2-10-11, HVG-2-10-11, HVG-2-20-21, VG-101, VG-201, VPG-101, VPG-201		
spare parts for	101684		
	GEV No.	101379	Ref. No. —
solenoid coil 230V 50Hz suitable for Tandem			
accessories for	101684		
	GEV No.	101274	Ref. No. X012105
olive for pipe ø 16mm Qty 1 pcs			
	GEV No.	101275	Ref. No. 12008951 X012104
union screw thread 1/2" for pipe ø 16mm Qty 1 pcs			
	GEV No.	102845	Ref. No. —
gas connection angled 1/2" flange 32x32mm hole distance 24x24mm Tandem			

Table continues overleaf



accessories for	101684		
	GEV No.	102846	Ref. No. —
	GEV No.	102847	Ref. No. —

ignition boxes

HONEYWELL

Honeywell



1

GEV No.	102381	Ref. No.	12026363 RT30390107
description	ignition box HONEYWELL type S4565BD 1064 electrodes 3 waiting times safety time 5s 220-240V 4VA 50/60Hz		

Honeywell



1

GEV No.	103330	Ref. No.	12023720 T303013 T303013000
description	ignition box HONEYWELL type S4565BD 2005U electrodes 3 waiting times safety time 5s 220-240V 4VA 50/60Hz		
For models:	COG-102, GA-20, GA-20D, GA-40, GA-40D, HGC-10-21, HGC-20-21, HGP-10-21, HGP-20-21, HGV-10-21, HGV-20-21, VG-102, VG-202, VPG-102, VPG-202		

Honeywell



1

GEV No.	101184	Ref. No.	12027187 RT30390105
description	ignition box HONEYWELL type S4565C 1033 equiv. no. S4565C 1033 electrodes 2 waiting times safety time 5s 220-240V 4VA 50/60Hz		

Honeywell



1

GEV No.	104598	Ref. No.	12027445 DO1AB01416
description	ignition box HONEYWELL type S4565XXXXX electrodes 3 waiting times safety time 10s 220-240V 4VA 50/60Hz		
For models:	SF-10, SF-10MP, SF-10MPP, SF-13, SF-15, SF-15MP, SF-15MPP, SF-22, SF-22MP, SF-22MPP, SF-31, SF-31MP, SF-31MPP, SF-8, SR-10MP-PSM, SR-13MP-PSM, SR-32MP-PSM		

SIT



1

GEV No.	107497	Ref. No.	12039440 T643002000
description	ignition box SIT type 579DBC electrodes 1 waiting time 1s safety time 5s 220/240V 12VA 50/60Hz		

miscellaneous



1

GEV No.	102380	Ref. No.	12026073 RT7400221
description	ignition box type 3a9PHC070-R1		

White
Rodgers



1

GEV No.	101377	Ref. No.	12016821 R723010
description	ignition box WHITE RODGERS type 50A72-213 waiting time 0s safety time 2s		
For models:	HCG-10-11, HCG-10-21, HCG-2-10-11, HMG-10-11, HMG-10-21, HMG-2-10-11		



1			
GEV No.	101569	Ref. No.	12016800 R723032
description	ignition box WHITE RODGERS type 50A72-250-04 waiting time 0s safety time 5s 220/240V 50/60Hz		
For models:	HCG-10-11, HCG-10-21, HCG-20-11, HCG-2-10-11, HCG-6-11, HMG-10-11, HMG-10-11UL, HMG-10-21, HMG-10-21UL, HMG-20-11, HMG-2-10-11, HMG-6-11		

ignition parts

pilot burners

SIT

100 series



1			
GEV No.	102445	Ref. No.	11U4421340 12003282 12004905
description	pilot burner SIT type 100 series 2 flames nozzle \varnothing 0.25mm gas connection 4mm		
For models:	CG-1002, CG-1502, CG-2000, CG-2000-2P, CG-2002, CG-2002P, CG-2005, CG-210, CG-210G, CG-3005, CG-310, CG-310G, CG7-20, CG-7200, CG7-40, CG-7400, CG7-41, CG-7415, CG7-61, CG-7615, CG9-20, CG9-40, CG9-41, CG9-51L, CG9-51LC, CG9-51R, CG9-51RC, CG9-60, CG9-61, CG9-82, CGB7-61, CGE7-100, CGE7-41, CGE9-41, CGF9-120D, CGF9-120I, CGF9-121D, CGF9-121I		







1			
GEV No.	106906	Ref. No.	12009166 12034540 FX30100005 U322118
description	pilot burner SIT type 100 series 3 flames nozzle \varnothing 0.2mm gas connection 6mm		
For models:	BG7-05, BG7-05I, BG7-10, BG7-10I, BG9-05, BG9-05AD, BG9-05I, BG9-05PF, BG9-05PI, BG9-05PLUS-I, BG9-10, BG9-10AD, BG9-10I, BG9-10PF, BG9-10PI, BG9-10PLUS-I, BMG7-10, BMG-9045, CG-1002, CG-1502, CG-2000, CG-2000-2P, CG-2002, CG-2002P, CG6-41, CG7-11, CG-7115, CG7-31D, CG7-31I, CG7-41, CG-7415, CG7-41H, CG7-51, CG7-61, CG-7615, CG7-61H, CG9-11, CG-9110, CG9-11AD, CG9-11PLUS, CG9-31PLUS-D, CG9-31PLUS-I, CG9-41, CG9-41AD, CG9-41AD-H, CG9-41H, CG9-41PLUS, CG9-41PLUS-H, CG9-51L, CG9-51LC...(Other models you can see in the webshop)		
spare parts for	106906		
	GEV No.	100245	Ref. No.
			12021187 U442138
			pilot burner nozzle LPG code 20 bore \varnothing 0.2mm Qty 1 pcs thread M8x0.75



spare parts for	106906		
	GEV No.	100855	Ref. No.
			—
			pilot burner bracket triple
	GEV No.	100885	Ref. No.
			12008510 X012122
			air mixing sleeve for pilot burner Qty 1 pcs
	GEV No.	100916	Ref. No.
			—
			compression spring for pilot burner Qty 1 pcs
	GEV No.	100917	Ref. No.
			—
			gasket for pilot burner Qty 1 pcs aluminium
	GEV No.	100918	Ref. No.
			—
			screw for pilot burner
	GEV No.	107162	Ref. No.
			—
			pilot burner cap SIT 3 flames Hmm Lmm Qty 1 pcs
	GEV No.	107701	Ref. No.
			12009076 X012126
			pilot burner bottom part SIT 100 series nozzle \varnothing 0.2mm
accessories for	106906		
	GEV No.	100245	Ref. No.
			12021187 U442138
			pilot burner nozzle LPG code 20 bore \varnothing 0.2mm Qty 1 pcs thread M8x0.75
	GEV No.	100246	Ref. No.
			—
			pilot burner nozzle natural gas bore \varnothing 0.35mm Qty 1 pcs thread M8x0.75
	GEV No.	100904	Ref. No.
			12008755
			locking screw M10x1 for pipe \varnothing 4mm Qty 1 pcs
	GEV No.	100905	Ref. No.
			12008715 U134323
			locking screw M10x1 for pipe \varnothing 6mm Qty 1 pcs
	GEV No.	102110	Ref. No.
			12019428
			pilot tube copper pipe \varnothing 4mm thickness 1mm L 3000mm
	GEV No.	102111	Ref. No.
			—
			pilot tube copper pipe \varnothing 6mm thickness 1mm L 3000mm
	GEV No.	107171	Ref. No.
			—
			pilot burner nozzle SIT natural/liquid gas bore \varnothing 0.25mm Qty 1 pcs
	GEV No.	107700	Ref. No.
			—
			pilot burner bottom part SIT 100 series nozzle \varnothing 0.25mm
	GEV No.	107702	Ref. No.
			—
			pilot burner bottom part SIT 100 series nozzle \varnothing 0.35mm





accessories			
pilot burner caps			
 <p>1</p>			
GEV No.	100837	Ref. No.	12009152 X012117
description	pilot burner cap 3 flames H 24mm L 48mm Qty 1 pcs		
For models:	FG7-05-1C, FG7-05-2C, FG-710, FG7-10-2C, FG7-104C, FG7-10-4C, FG-71-15, FG-720, FG-72-30, FG9-05, FG9-05-1C, FG9-05-2C, FG9-05AD, FG9-05PLUS, FG9-05PLUS-S, FG9-05S, FG9-05S-1C, FG9-05S-2C, FG9-05S-AD, FG9-10, FG9-10-2C, FG9-10-4C, FG9-10AD, FG9-10PLUS, FG-91-20, FG-920, FG-92-40, FG-940		

 <p>1</p>			
GEV No.	102665	Ref. No.	12009214 X502103
description	pilot burner cap 3 flames suitable for 100 series H 28mm L 87mm Qty 1 pcs		
For models:	FGCL9-05, FGCL9-05-1C, FGCL9-05-2C, FGCL9-05S-1C, FGCL9-05S-2C		

pilot burner bottom parts			
 <p>1</p>			
GEV No.	107701	Ref. No.	12009076 X012126
description	pilot burner bottom part SIT 100 series nozzle \varnothing 0.2mm		
For models:	CG-1002, CG-1502, CG-2002, CG-2002P, CG7-20, CG7-20H, CG7-30D, CG7-30I, CG7-31D, CG7-31I, CG7-40, CG7-40H, CG7-41, CG7-41H, CG7-50, CG7-51, CG7-60, CG7-60H, CG7-61, CG7-61H, CG9-20, CG9-20H, CG9-40, CG9-40H, CG9-41, CG9-41H, CG9-51L, CG9-51LC, CG9-51R, CG9-51RC, CG9-60, CG9-60H, CG9-61, CG9-61H, CG9-61OP, CG9-82, CGB7-61, CGB7-61H, CGB7-61R, CGB7-61RH, CGE7-41, CGE7-41H, CGE9-41, CGE9-41H, CGF9-120D, CGF9-120I, CGF9-121D, CGF9-121I, FG7-05-1C, FG7-05-2C, FG-710...(Other models you can see in the webshop)		
spare parts for	107701		
	GEV No.	100245	Ref. No.
			12021187 U442138
description	pilot burner nozzle LPG code 20 bore \varnothing 0.2mm Qty 1 pcs thread M8x0.75		
	GEV No.	100916	Ref. No.
			—
description	compression spring for pilot burner Qty 1 pcs		
	GEV No.	100917	Ref. No.
			—
description	gasket for pilot burner Qty 1 pcs aluminium		
	GEV No.	100918	Ref. No.
			—
description	screw for pilot burner		

accessories for 107701			
	GEV No.	100246	Ref. No.
			—
description	pilot burner nozzle natural gas bore \varnothing 0.35mm Qty 1 pcs thread M8x0.75		
	GEV No.	100904	Ref. No.
			12008755
description	locking screw M10x1 for pipe \varnothing 4mm Qty 1 pcs		
	GEV No.	100905	Ref. No.
			12008715 U134323
description	locking screw M10x1 for pipe \varnothing 6mm Qty 1 pcs		
	GEV No.	102110	Ref. No.
			12019428
description	pilot tube copper pipe \varnothing 4mm thickness 1mm L 3000mm		
	GEV No.	102111	Ref. No.
			—
description	pilot tube copper pipe \varnothing 6mm thickness 1mm L 3000mm		
	GEV No.	102742	Ref. No.
			—
description	pilot burner nozzle LPG code 25 bore \varnothing 0.25mm Qty 1 pcs		

 <p>1</p>			
GEV No.	100880	Ref. No.	12009075 U442136
description	pilot burner bottom part SIT 100 series nozzle \varnothing 0.4mm		
For models:	CG7-20, CG7-20H, CG7-30D, CG7-30I, CG7-31D, CG7-31I, CG7-40, CG7-40H, CG7-41, CG7-41H, CG7-50, CG7-51, CG7-60, CG7-60H, CG7-61, CG7-61H, CG9-20, CG9-20H, CG9-40, CG9-40H, CG9-41, CG9-41H, CG9-60, CG9-60H, CG9-61, CG9-61H, CG9-61OP, CG9-82, CGB7-61, CGB7-61H, CGB7-61R, CGB7-61RH, CGE7-41, CGE7-41H, CGE9-41, FG7-05-1C, FG7-05-2C, FG7-10-2C, FG7-104C, FG7-10-4C, FG9-05-1C, FG9-05-2C, FG9-05S-1C, FG9-05S-2C, FG9-10-2C, FG9-10-4C		

pilot burner brackets			
universal			
 <p>1</p>			
GEV No.	100887	Ref. No.	12008620 X012114
description	opposite support for pilot burner suitable for 100 series		
For models:	FG7-05-1C, FG7-05-2C, FG-710, FG7-10-2C, FG7-104C, FG7-10-4C, FG-71-15, FG-720, FG-72-30, FG9-05, FG9-05-1C, FG9-05-2C, FG9-05AD, FG9-05PLUS, FG9-05PLUS-S, FG9-05S, FG9-05S-1C, FG9-05S-2C, FG9-05S-AD, FG9-10, FG9-10-2C, FG9-10-4C, FG9-10AD, FG9-10PLUS, FG-91-20, FG-920, FG-92-40, FG-940		



			
1			
GEV No.	100886	Ref. No.	12008676 X012113
description	pilot burner bracket suitable for 100 series 3-piece		
For models:	FG7-05-1C, FG7-05-2C, FG-710, FG7-10-2C, FG7-104C, FG7-10-4C, FG-71-15, FG-720, FG-72-30, FG9-05, FG9-05-1C, FG9-05-2C, FG9-05AD, FG9-05PLUS, FG9-05PLUS-S, FG9-05S, FG9-05S-1C, FG9-05S-2C, FG9-05S-AD, FG9-10, FG9-10-2C, FG9-10-4C, FG9-10AD, FG9-10PLUS, FG-91-20, FG-920, FG-92-40, FG-940		

			
2			
GEV No.	100888	Ref. No.	12008458 X012116
description	screw bolt for pilot burner		
For models:	CG-1002, CG-1502, CG-2002, CG-2002P, CG7-20, CG7-20H, CG7-30D, CG7-30I, CG7-31D, CG7-31I, CG7-40, CG7-40H, CG7-41, CG7-41H, CG7-50, CG7-51, CG7-60, CG7-60H, CG7-61, CG7-61H, CG9-20, CG9-20H, CG9-40, CG9-40H, CG9-41, CG9-41H, CG9-51L, CG9-51LC, CG9-51R, CG9-51RC, CG9-60, CG9-60H, CG9-61, CG9-61H, CG9-61OP, CG9-82, CGB7-61, CGB7-61H, CGB7-61R, CGB7-61RH, CGE7-41, CGE7-41H, CGE9-41, CGF9-120D, CGF9-120I, CGF9-121D, CGF9-121I, FG7-05-1C, FG7-05-2C, FG-710...(Other models you can see in the webshop)		

producer-specific

			
1			
GEV No.	101022	Ref. No.	12011611 U745418
description	pilot burner bracket		
For models:	CG7-20, CG7-40, CG7-41, CG7-61, CGB7-61, CGE7-41		

			
1			
GEV No.	104742	Ref. No.	12002362 R302130
description	pilot burner bracket suitable for 100 series		
For models:	HP-G-15, HPG-15		

pilot burner nozzles

			
1			
GEV No.	100245	Ref. No.	12021187 U442138
description	pilot burner nozzle LPG code 20 bore ø 0.2mm Qty 1 pcs thread M8x0.75		
For models:	BG7-05, BG7-05I, BG7-10, BG7-10I, BG9-05, BG9-05I, BG9-10, BG9-10I, BMG7-10, BMG9-05, BMG9-10, CG-1002, CG-1502, CG-2002, CG-200S, CG-210, CG-210G, CG-300S, CG-310, CG-310G, CG7-10, CG7-11, CG7-20, CG7-40, CG7-41, CG7-61, CG9-10, CG9-11, CG9-20, CG9-40, CG9-41, CG9-51L, CG9-51LC, CG9-51R, CG9-51RC, CG9-60, CG9-61, CG9-82, CGB7-61, CGE7-41, CGE9-41, CGF9-120D, CGF9-120I, CGF9-121D, CGF9-121I, CGP9-11, CPG7-05, CPG9-05, CPG9-05NC, CPG9-05S...(Other models you can see in the webshop)		





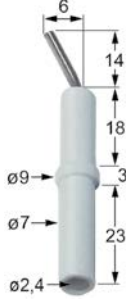





			
1			
GEV No.	102972	Ref. No.	12008938 U442137
description	pilot burner nozzle natural gas code 40 bore ø 0.4mm Qty 1 pcs		
For models:	BG6-05I, BG7-05, BG7-05I, BG7-10, BG7-10I, BG9-05, BG9-05AD, BG9-05I, BG9-05PF, BG9-05PI, BG9-05PLUS-I, BG9-10, BG9-10AD, BG9-10I, BG9-10PF, BG9-10PI, BG9-10PLUS-I, BMG7-10, BMG9-05, BMG9-05V-T, BMG9-10, BMG9-10V-T, CG-1002, CG-1502, CG-2002, CG-2002P, CG-200S, CG-210, CG-210G, CG-300S, CG-310, CG-310G, CG7-10, CG7-11, CG7-20, CG7-20H, CG7-30D, CG7-30I, CG7-31D, CG7-31I, CG7-40, CG7-40H, CG7-41, CG7-41H, CG7-50, CG7-51, CG7-60, CG7-60H, CG7-61, CG7-61H...(Other models you can see in the webshop)		

ignition electrodes

			
1			
GEV No.	100707	Ref. No.	12008994 X012101
description	ignition electrode D1 ø 7mm D2 ø 9mm connection ø2.4mm L1 14mm L2 6mm BL1 18mm BL2 3mm BL3 23mm to clip Qty 1 pcs		
For models:	BG7-05, BG7-05I, BG7-10, BG7-10I, BG9-05, BG9-05I, BG9-10, BG9-10I, BMG-9045, BMG9-05, BMG9-10, CG-1002, CG-110, CG-1502, CG-2000, CG-2000-2P, CG-2002, CG-7115, CG-7415, CG-7615, CG9-05AD, CG9-05PLUS, CG9-10, CG9-11, CG-9110, CG9-20AD, CG9-20AD-H, CG9-20PLUS, CG9-20PLUS-H, CG9-31PLUS-D, CG9-31PLUS-I, CG9-40AD, CG9-40AD-H, CG9-40PLUS, CG9-40PLUS-H, CG9-41, CG9-41AD, CG9-41AD-H, CG9-41PLUS, CG9-41PLUS-H, CG9-51L, CG9-51LC, CG9-51R, CG9-51RC, CG9-60AD, CG9-60AD-H, CG9-60PLUS, CG9-60PLUS-H, CG9-61, CG9-61AD...(Other models you can see in the webshop)		



miscellaneous			
			
GEV No.	100885	Ref. No.	12008510 X012122
description	air mixing sleeve for pilot burner Qty 1 pcs		
For models:	CG-1002, CG-1502, CG-2002, CG-2002P, CG7-20, CG7-20H, CG7-30D, CG7-30I, CG7-31D, CG7-31I, CG7-40, CG7-40H, CG7-41, CG7-41H, CG7-50, CG7-51, CG7-60, CG7-60H, CG7-61, CG7-61H, CG9-20, CG9-20H, CG9-40, CG9-40H, CG9-41, CG9-41H, CG9-51L, CG9-51LC, CG9-51R, CG9-51RC, CG9-60, CG9-60H, CG9-61, CG9-61H, CG9-61OP, CG9-82, CGB7-61, CGB7-61H, CGB7-61R, CGB7-61RH, CGE7-41, CGE7-41H, CGE9-41, CGF9-120D, CGF9-120I, CGF9-121D, CGF9-121I, FG7-05-1C, FG7-05-2C, FG-710...(Other models you can see in the webshop)		

POLIDORO			
pilot burners			
			
GEV No.	102800	Ref. No.	12037976 ICR08122
description	pilot burner POLIDORO 3 flames code gas connection 6mm		
spare parts for	102800		
	GEV No.	100906	Ref. No. —
	screw connection thread M10x1 for ignition electrode brass Qty 1 pcs WS 10		
	GEV No.	100907	Ref. No. —
	screw connection thread M10x1 Qty 1 pcs type SEF 1 0mm for thermocouple		
	GEV No.	100909	Ref. No. 12008740 12016658 S312107 U265703
	union screw thread M10x1 for pipe ø 6mm Qty 1 pcs		
	GEV No.	101287	Ref. No. —
	olive for pipe ø 6mm Qty 1 pcs		
accessories for	102800		
	GEV No.	100208	Ref. No. —
	pilot burner nozzle POLIDORO LPG code 20 bore ø 0.2mm Qty 1 pcs		
	GEV No.	100209	Ref. No. —
	pilot burner nozzle POLIDORO natural gas code 40 bore ø 0.4mm Qty 1 pcs		
	GEV No.	100701	Ref. No. —
	ignition electrode connection M4 Qty 1 pcs		
	GEV No.	100908	Ref. No. 12017481 T052101
	union screw thread M10x1 for pipe ø 4mm Qty 1 pcs		
	GEV No.	101280	Ref. No. —
	olive for pipe ø 4mm Qty 1 pcs		

			
GEV No.	102876	Ref. No.	12040640 ICR10042
description	pilot burner POLIDORO 3 flames code gas connection 6mm		











PRO-GAS			
100 series			
pilot burners			
			
GEV No.	100124	Ref. No.	12001371 R202100
description	pilot burner PRO-GAS type 100 series 3 flames nozzle ø 0.25mm		
For models:	BMG7-10, BMG9-05, BMG9-05V-T, BMG9-10, BMG9-10V-T, CG7-10, CG7-11, FTGC6-05L, FTGC6-10L, FTGC6-10L+R, MG7-10, MG7-10BM, MG9-10, MG9-10BM, MG9-10BMS, MG9-10S, MG9-15, MG9-15BM, MG9-15BM316, MG9-15BMS, MG9-15S, MG9-20, MG9-20S, MPG9-10, MPG9-10BM, MPG9-10BMS, MPG9-10S, MPG9-15, MPG9-15BM, MPG9-15BMS, MPG9-15S, MPG9-20, MPG9-20S		
spare parts for	100124		
	GEV No.	100764	Ref. No. —
	pilot burner bracket with angle		
	GEV No.	100843	Ref. No. —
	pilot burner cap 3 flames Qty 1 pcs		
	GEV No.	100885	Ref. No. 12008510 X012122
	air mixing sleeve for pilot burner Qty 1 pcs		
	GEV No.	100916	Ref. No. —
	compression spring for pilot burner Qty 1 pcs		
	GEV No.	100917	Ref. No. —
	gasket for pilot burner Qty 1 pcs aluminium		
	GEV No.	100918	Ref. No. —
	screw for pilot burner		
	GEV No.	102742	Ref. No. —
	pilot burner nozzle LPG code 25 bore ø 0.25mm Qty 1 pcs		
accessories for	100124		
	GEV No.	100245	Ref. No. 12021187 U442138
	pilot burner nozzle LPG code 20 bore ø 0.2mm Qty 1 pcs thread M8x0.75		
	GEV No.	100246	Ref. No. —
	pilot burner nozzle natural gas bore ø 0.35mm Qty 1 pcs thread M8x0.75		

Table continues overleaf



accessories for		100124		
	GEV No.	100882	Ref. No.	—
pilot burner bottom part PRO-GAS 100 series nozzle ø 0.25mm				
	GEV No.	100883	Ref. No.	—
pilot burner bottom part PRO-GAS 100 series nozzle ø 0.35mm				
	GEV No.	100904	Ref. No.	12008755
locking screw M10x1 for pipe ø 4mm Qty 1 pcs				
	GEV No.	100905	Ref. No.	12008715 U134323
locking screw M10x1 for pipe ø 6mm Qty 1 pcs				
	GEV No.	102110	Ref. No.	12019428
pilot tube copper pipe ø 4mm thickness 1mm L 3000mm				
	GEV No.	102111	Ref. No.	—
pilot tube copper pipe ø 6mm thickness 1mm L 3000mm				



1

GEV No.	100139	Ref. No.	12005122 U192104	
description	pilot burner type 100 series 3 flames nozzle ø 0.25mm nozzle A			
For models:	CG-7115, CG9-10, CG9-10AD, CG9-10PLUS, CG9-11, CG-9110, CG9-11AD, CG9-11PLUS, CGE9-11, CGF9-120D, CGF9-120D-AD, CGF9-120I, CGF9-120I-AD, CGF9-120PLUS-D, CGF9-120PLUS-I, CGF9-121D, CGF9-121D-AD, CGF9-121I, CGF9-121I-AD, CGF9-121PLUS-D, CGF9-121PLUS-I, MG-9100, MG-9150, MG-9150BM, MG-9200, MPG-9150, MPG-9200			
spare parts for	100139			
	GEV No.	100843	Ref. No.	—
pilot burner cap 3 flames Qty 1 pcs				
	GEV No.	100882	Ref. No.	—
pilot burner bottom part PRO-GAS 100 series nozzle ø 0.25mm				
	GEV No.	100885	Ref. No.	12008510 X012122
air mixing sleeve for pilot burner Qty 1 pcs				
	GEV No.	100916	Ref. No.	—
compression spring for pilot burner Qty 1 pcs				
	GEV No.	100917	Ref. No.	—
gasket for pilot burner Qty 1 pcs aluminium				
	GEV No.	100918	Ref. No.	—
screw for pilot burner				
	GEV No.	102742	Ref. No.	—
pilot burner nozzle LPG code 25 bore ø 0.25mm Qty 1 pcs				
accessories for	100139			
	GEV No.	100245	Ref. No.	12021187 U442138
pilot burner nozzle LPG code 20 bore ø 0.2mm Qty 1 pcs thread M8x0.75				

accessories for		100139		
	GEV No.	100246	Ref. No.	—
pilot burner nozzle natural gas bore ø 0.35mm Qty 1 pcs thread M8x0.75				
	GEV No.	100881	Ref. No.	—
pilot burner bottom part PRO-GAS 100 series nozzle ø 0.2mm				
	GEV No.	100883	Ref. No.	—
pilot burner bottom part PRO-GAS 100 series nozzle ø 0.35mm				
	GEV No.	100904	Ref. No.	12008755
locking screw M10x1 for pipe ø 4mm Qty 1 pcs				
	GEV No.	100905	Ref. No.	12008715 U134323
locking screw M10x1 for pipe ø 6mm Qty 1 pcs				
	GEV No.	102110	Ref. No.	12019428
pilot tube copper pipe ø 4mm thickness 1mm L 3000mm				
	GEV No.	102111	Ref. No.	—
pilot tube copper pipe ø 6mm thickness 1mm L 3000mm				

producer-specific pilot burners

FAGOR



1

GEV No.	102445	Ref. No.	11U4421340 12003282 12004905
description	pilot burner SIT type 100 series 2 flames nozzle ø 0.25mm gas connection 4mm		
For models:	CG-1002, CG-1502, CG-2000, CG-2000-2P, CG-2002, CG-2002P, CG-2005, CG-210, CG-210G, CG-300S, CG-310, CG-310G, CG7-20, CG-7200, CG7-40, CG-7400, CG7-41, CG-7415, CG7-61, CG-7615, CG9-20, CG9-40, CG9-41, CG9-51L, CG9-51LC, CG9-51R, CG9-51RC, CG9-60, CG9-61, CG9-82, CGB7-61, CGE7-100, CGE7-41, CGE9-41, CGF9-120D, CGF9-120I, CGF9-121D, CGF9-121I		



accessories universal

pilot burner brackets

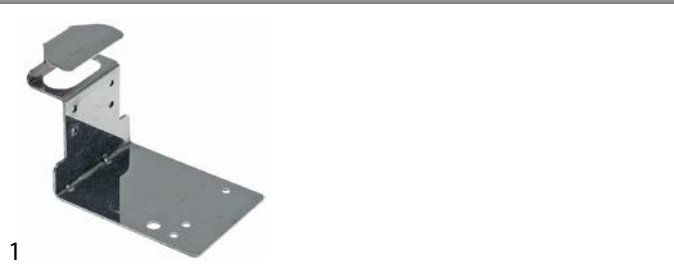

GEV No.	107847	Ref. No.	12002953 U445441000
description	pilot burner bracket chrome-plated steel suitable for FAGOR H 85mm		
For models:	CG-200S, CG-210, CG-210G, CG-300S, CG-310, CG-310G		

electrodes



GEV No.	106829	Ref. No.	12037099 RT7400290
description	gasket for ignition electrode ID \varnothing 10mm hole \varnothing 4.5mm L 27mm W 17mm		

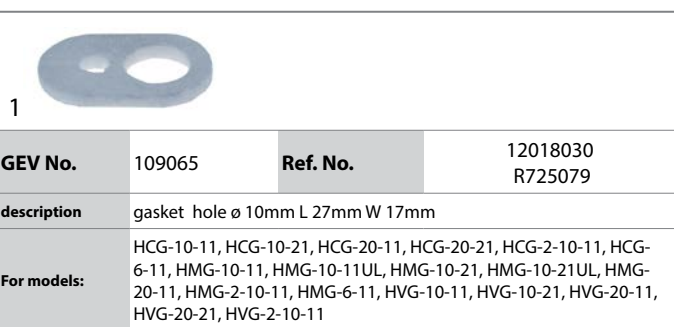

GEV No.	109065	Ref. No.	12018030 R725079
description	gasket hole \varnothing 10mm L 27mm W 17mm		
For models:	HCG-10-11, HCG-10-21, HCG-20-11, HCG-20-21, HCG-2-10-11, HCG-6-11, HMG-10-11, HMG-10-11UL, HMG-10-21, HMG-10-21UL, HMG-20-11, HMG-2-10-11, HMG-6-11, HVG-10-11, HVG-10-21, HVG-20-11, HVG-20-21, HVG-2-10-11		

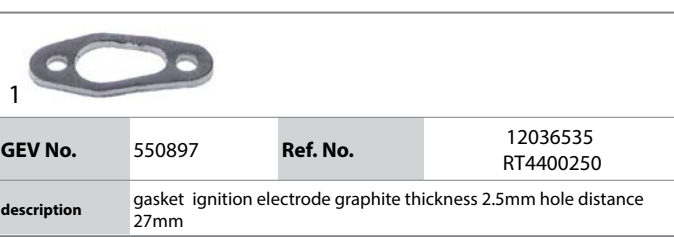

GEV No.	550897	Ref. No.	12036535 RT4400250
description	gasket ignition electrode graphite thickness 2.5mm hole distance 27mm		

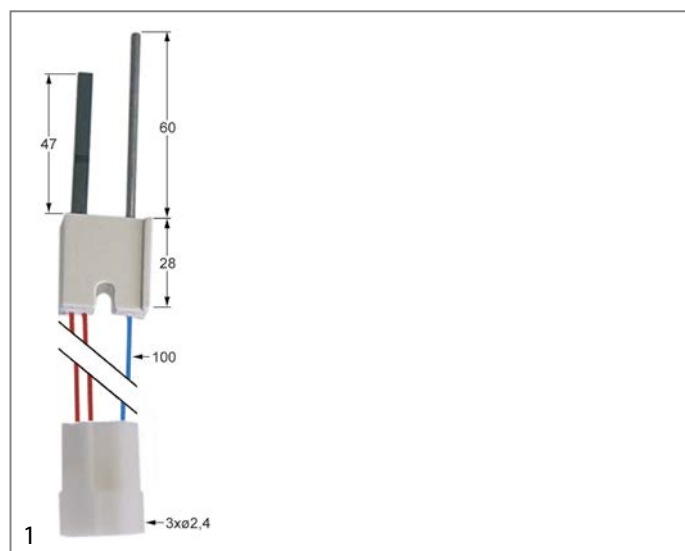

GEV No.	100730	Ref. No.	12027683
description	glow plug cable length 100mm connection \varnothing 2.4mm L1 47mm L2 60mm		

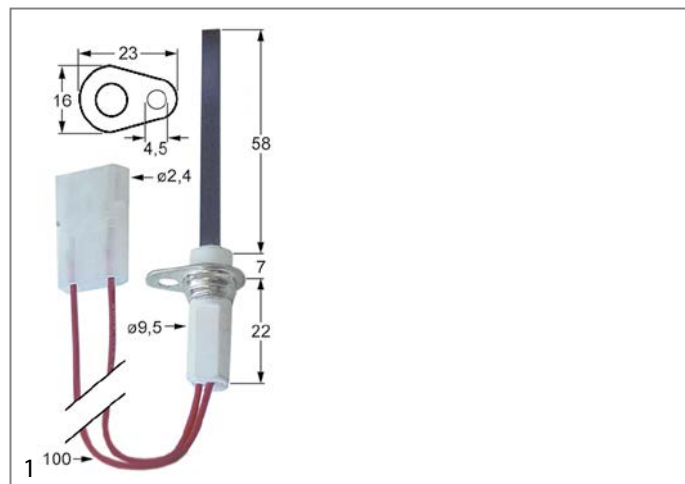



GEV No.	100757	Ref. No.	12017356 R723005
description	glow plug flange length 23mm flange width 16mm \varnothing 9.5mm cable length 100mm connection \varnothing 2.4mm total length 220mm L1 58mm fixing dimensions 4.5mm		
For models:	HCG-10-11, HCG-10-21, HCG-20-11, HCG-2-10-11, HCG-6-11, HMG-10-11, HMG-10-11UL, HMG-10-21, HMG-10-21UL, HMG-20-11, HMG-2-10-11, HMG-6-11		

			
GEV No.	107848	Ref. No.	12009060 X022131000
description	ignition electrode D1 ø 7mm D2 ø 8mm L1 2mm L2 8mm BL1 23mm BL2 3mm BL3 18mm		
For models:	BG6-05I, BG7-05, BG7-05I, BG7-10, BG7-10I, BG9-05AD, BG9-05PF, BG9-05PI, BG9-05PLUS-I, BG9-10AD, BG9-10PF, BG9-10PI, BG9-10PLUS-I, BMG9-05, BMG9-05V-T, BMG9-10, BMG9-10V-T, CG-1002, CG-1502, CG-2002, CG-2002P, CG6-41, CG9-10, CG9-10AD, CG9-10PLUS, CG9-11, CG9-11AD, CG9-11PLUS, CG9-31PLUS-D, CG9-31PLUS-I, CG9-41, CG9-41AD, CG9-41AD-H, CG9-41H, CG9-41PLUS, CG9-41PLUS-H, CG9-51L, CG9-51LC, CG9-51R, CG9-51RC, CG9-61, CG9-61AD, CG9-61AD-H, CG9-61H, CG9-61OP, CG9-61PLUS, CG9-61PLUS-H, CG9-82, CG9-82AD, CG9-82PLUS...(Other models you can see in the webshop)		

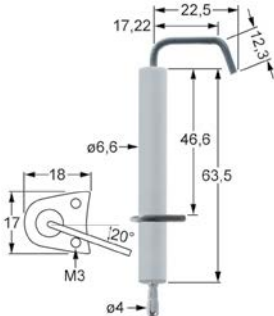
			
GEV No.	100707	Ref. No.	12008994 X012101
description	ignition electrode D1 ø 7mm D2 ø 9mm connection ø2.4mm L1 14mm L2 6mm BL1 18mm BL2 3mm BL3 23mm to clip Qty 1 pcs		
For models:	BG7-05, BG7-05I, BG7-10, BG7-10I, BG9-05, BG9-05I, BG9-10, BG9-10I, BMG-9045, BMG9-05, BMG9-10, CG-1002, CG-110, CG-1502, CG-2000, CG-2000-2P, CG-2002, CG-7115, CG-7415, CG-7615, CG9-05AD, CG9-05PLUS, CG9-10, CG9-11, CG-9110, CG9-20AD, CG9-20AD-H, CG9-20PLUS, CG9-20PLUS-H, CG9-31PLUS-D, CG9-31PLUS-I, CG9-40AD, CG9-40AD-H, CG9-40PLUS, CG9-40PLUS-H, CG9-41, CG9-41AD, CG9-41AD-H, CG9-41PLUS, CG9-41PLUS-H, CG9-51L, CG9-51LC, CG9-51R, CG9-51RC, CG9-60AD, CG9-60AD-H, CG9-60PLUS, CG9-60PLUS-H, CG9-61, CG9-61AD...(Other models you can see in the webshop)		

			
GEV No.	107858	Ref. No.	12033209 RT20680300
description	ignition electrode flange length 18mm flange width 17mm D1 ø 7mm D2 ø 7.5mm L1 5.5mm L2 23mm L3 14mm BL1 46.5mm BL2 13.5mm mounting distance 10mm connection ø 4mm		

			
GEV No.	104806	Ref. No.	12039586 T855753000
description	ignition electrode flange length 23mm flange width 1 16mm D1 ø 9.4mm D2 ø 9.4mm L1 25mm BL1 17mm BL2 36mm		
For models:	AG-061, AG-061W, AG-101, AG-101W, APG-061, APG-061W, APG-101, APG-101W		

			
GEV No.	104803	Ref. No.	12039448 T645746000
description	ignition electrode flange length 23mm flange width 1 16mm D1 ø 9.5mm D2 ø 9.5mm L1 10mm L2 79mm BL1 72.5mm BL2 24mm flange		
For models:	ACG-102, ACG-202, AG-102, AG-102W, AG-202, APG-102, APG-102W, APG-202		

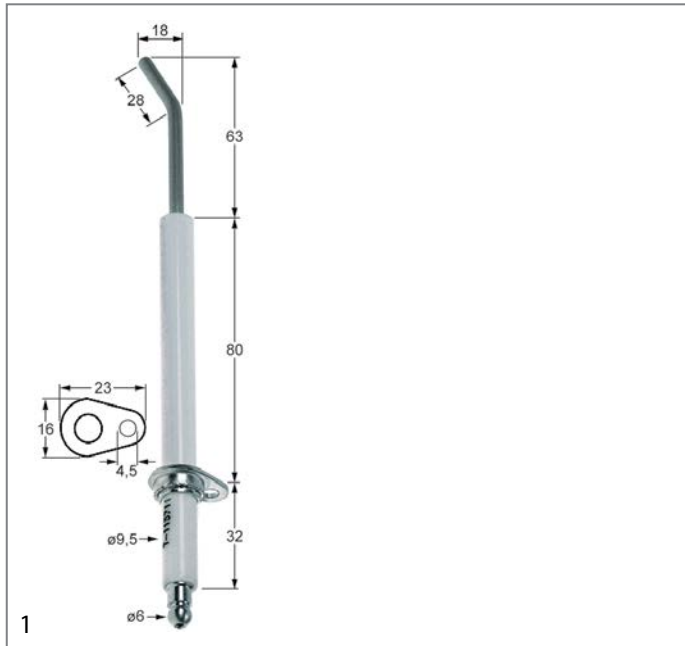

GEV No.	102448	Ref. No.	12018798 T115711
description	ignition electrode flange length 23mm flange width 16mm D1 ø 9.5mm L1 63mm L2 18mm L3 28mm BL1 80mm BL2 32mm fixing dimensions 4.5mm flange connection ø 6mm		
For models:	HCG-10-11, HCG-10-21, HCG-2-10-11, HVG-10-11, HVG-10-21, HVG-2-10-11		

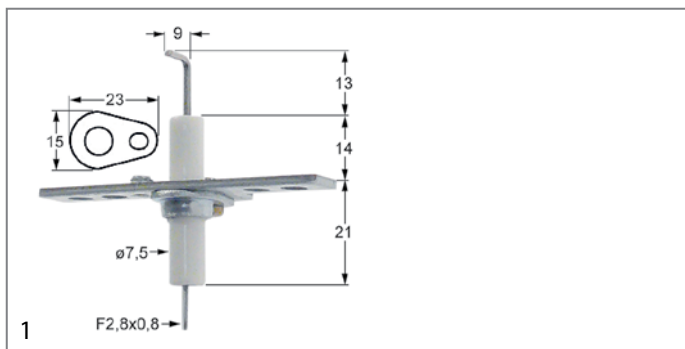

GEV No.	102446	Ref. No.	12025163 Z955803
description	ignition electrode flange length 23mm flange width 15mm D1 ø 7.5mm L1 13mm L2 9mm BL1 14mm BL2 21mm connection F2.8x0.8		
For models:	GA-20, GA-20D, GA-40, GA-40D, HGP-10-21, HGP-20-21, HGV-10-11, HGV-10-21, HGV-20-11, HGV-20-21, HVG-10-11, HVG-10-11UL, HVG-10-21, HVG-10-21UL, HVG-20-11, HVG-20-21, HVG-2-10-11, HVG-2-20-21, MFHVG-10-11, MFHVG-10-21, VG-101, VG-102, VG-201, VG-202, VPG-101, VPG-102, VPG-201, VPG-202		



GEV No.	104804	Ref. No.	12039685 T955755000
description	ignition electrode flange length 23mm flange width 16mm D1 ø 9mm D2 ø 9mm L1 17mm L2 79mm BL1 80mm BL2 17mm connection M4 flange		
For models:	ACG-061, ACG-101, ACG-201, AG-061, AG-061W, AG-101, AG-101W, AG-201, APG-061, APG-061W, APG-101, APG-101W, APG-201		

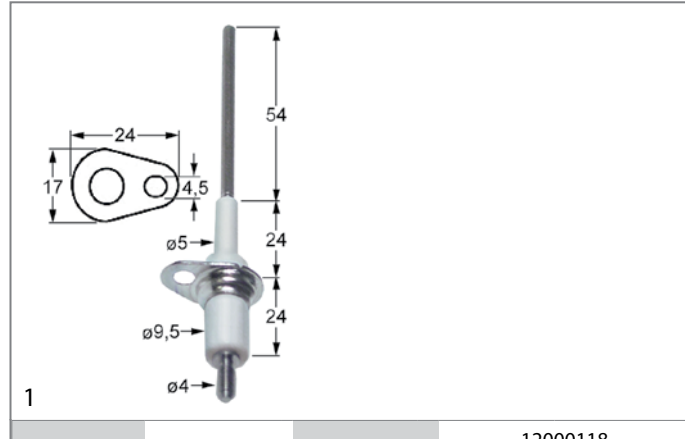

GEV No.	100759	Ref. No.	12000118 12023896 12040020 R725014 T115059 T135705
description	ignition electrode flange length 24mm flange width 17mm D1 ø 5mm D2 ø 9.5mm L1 54mm BL1 24mm BL2 24mm fixing dimensions ø4.5mm with flange connection ø 4mm A1/B13/C2		
For models:	COG-201, COG-202, HCG-10-11, HCG-10-21, HCG-20-11, HCG-20-21, HCG-2-10-11, HCG-2-20-11, HCG-6-11, HGC-20-11, HGC-20-21, HGP-20-21, HGV-20-11, HGV-20-21, HMG-10-11, HMG-10-11UL, HMG-10-21, HMG-10-21UL, HMG-20-11, HMG-2-10-11, HMG-6-11, HVG-20-11, HVG-20-21, HVG-2-20-21, VG-201, VG-202, VPG-201, VPG-202		
accessories for	100759		

	GEV No.	109065	Ref. No.	12018030 R725079
gasket hole ø 10mm L 27mm W 17mm				



GEV No.	103302	Ref. No.	12038022 RT7400230
description	ignition electrode flange length 26mm flange width 16mm D1 ø 9mm L1 9mm L2 73mm BL1 82mm BL2 14mm connection F 4.8x0.8mm cable length 400mm mounting distance 19mm with flange		

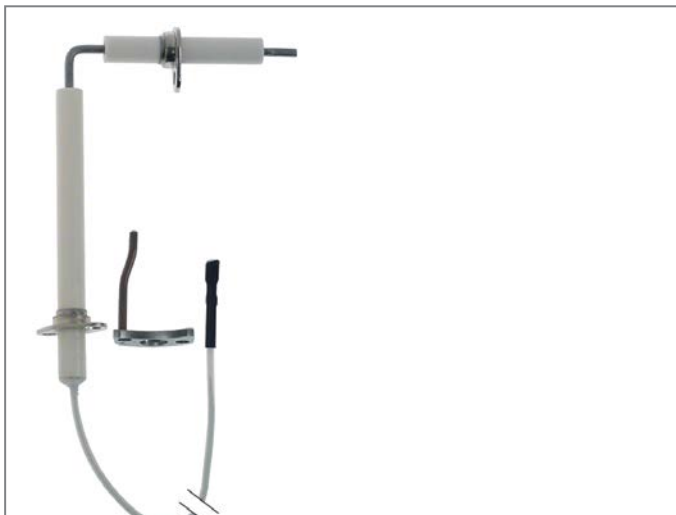

GEV No.	104805	Ref. No.	12039684 T955754000
description	ignition electrode flange length 28mm flange width 16mm D1 ø 9mm D2 ø 9mm L1 16.5mm L2 80mm BL1 81mm BL2 16.5mm connection F2.8 cable length 250mm mounting distance 20mm flange		
For models:	ACG-061, ACG-101, ACG-201, AG-061, AG-061W, AG-101, AG-101W, AG-201, APG-061, APG-061W, APG-101, APG-101W, APG-201		



GEV No.	104802	Ref. No.	12039447
description	ignition electrode flange length 28mm flange width 16mm D1 ø 9.4mm D2 ø 9.4mm L1 9mm L2 73mm BL1 72.5mm BL2 26mm connection F2.8 cable length 260mm mounting distance 20mm flange		
For models:	ACG-102, ACG-202, AG-102, AG-102W, AG-202, APG-102, APG-102W, APG-202		

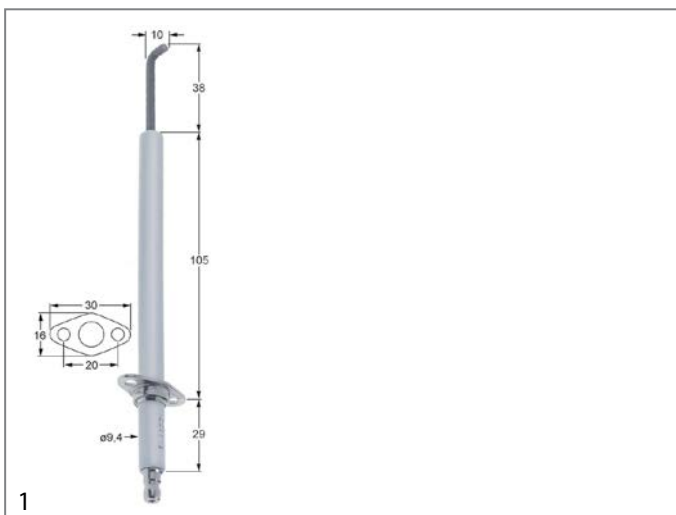

GEV No.	109111	Ref. No.	12024726
description	ignition electrode flange length 30mm flange width 16mm D1 ø 9.4mm L1 38mm L2 10mm BL1 105mm BL2 29mm mounting distance 20mm flange connection		
For models:	COG-201, COG-202, HGC-20-11, HGC-20-21, HGP-20-21, HGV-20-11, HGV-20-21, VG-201, VG-202, VPG-201, VPG-202		

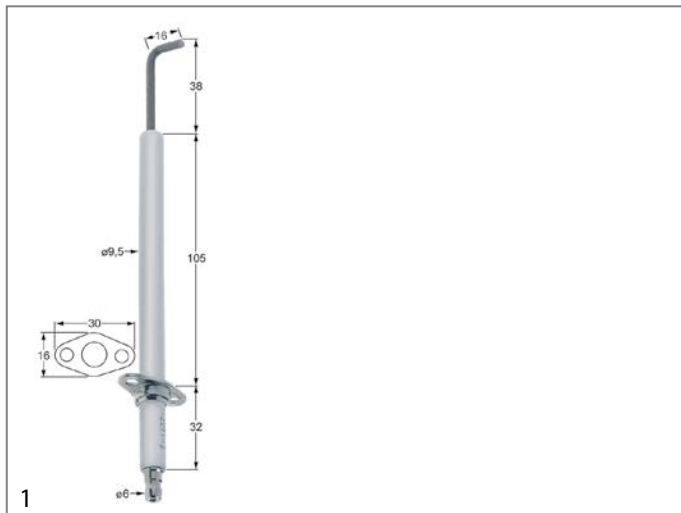

GEV No.	102765	Ref. No.	12024719 T115781
description	ignition electrode flange length 30mm flange width 16mm D1 \varnothing 9.5mm L1 38mm L2 16mm BL1 105mm BL2 32mm connection \varnothing 6mm		
For models:	COG-101, COG-102, HCG-10-11, HCG-10-21, HCG-2-10-11, HGC-10-11, HGC-10-21, HGP-10-21, HGV-10-11, HGV-10-21, HVG-10-11, HVG-10-11UL, HVG-10-21, HVG-10-21UL, HVG-2-10-11, MFHVG-10-11, MFHVG-10-21, VG-101, VG-102, VPG-101, VPG-102		

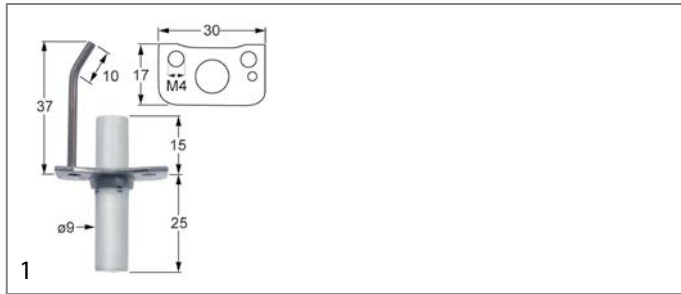

GEV No.	103333	Ref. No.	12037972 RT7400235
description	ignition electrode flange length 30mm flange width 17mm D1 \varnothing 9mm L1 37mm L2 10mm BL1 15mm BL2 25mm fixing dimensions M4mm with flange with earthing contact		



GEV No.	104807	Ref. No.	12039585 T855752000
description	ignition electrode flange length 38mm flange width 16mm D1 \varnothing 9.4mm D2 \varnothing 9.4mm L1 25mm BL1 17mm BL2 36mm connection F2.8 cable length 250mm fixing dimensions 4mm mounting distance 28mm flange		
For models:	AG-061, AG-061W, AG-101, AG-101W, APG-061, APG-061W, APG-101, APG-101W		

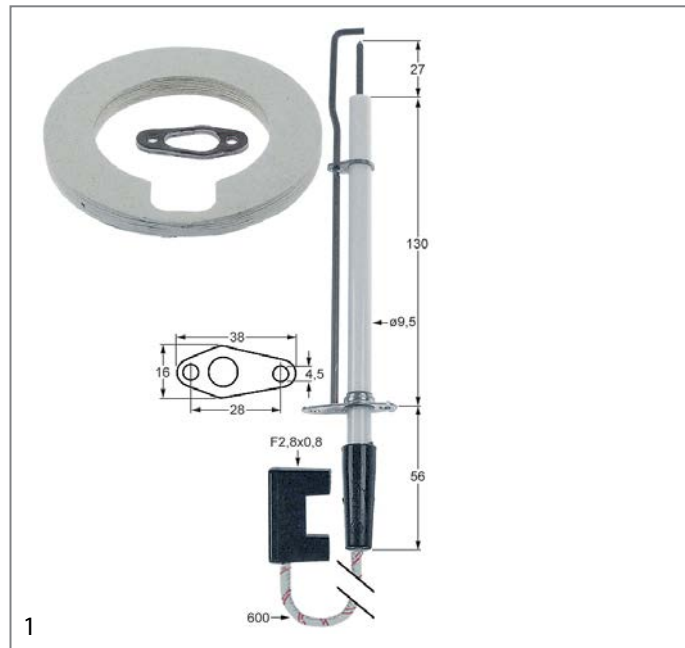

GEV No.	102884	Ref. No.	12028814 87.00.662 RT4400249
description	ignition electrode flange length 38mm flange width 16mm D1 \varnothing 9.5mm L1 27mm BL1 130mm BL2 56mm connection F 2.8x0.8mm cable length 600mm fixing dimensions \varnothing 4.5mm mounting distance 28mm with flange with earthing contact		



GEV No.	107849	Ref. No.	12025155 Z955802000
description	ignition electrode flange length 66mm flange width 24mm D1 \varnothing 7mm D2 \varnothing 2mm L1 11mm L2 10mm BL1 15mm BL2 6mm BL3 15mm connection 2.8		
For models:	GA-20, GA-20D, GA-40, GA-40D, HGP-10-21, HGP-20-21, HGV-10-11, HGV-20-11, HGV-20-21, VG-101, VG-102, VG-201, VG-202, VPG-101, VPG-102, VPG-201, VPG-202		



mounting diameter 22mm



GEV No.	100005	Ref. No.	12024807 S113034
description	piezoelectric igniter body plastic blowing mounting ø 22mm connection ø2.4mm cable lengthmm SIT		
For models:	BG6-05I, BG7-05, BG7-05I, BG7-10, BG7-10I, BG9-05, BG9-05I, BG9-05PF, BG9-05PI, BG9-10, BG9-10I, BG9-10PF, BG9-10PI, BMG9-05, BMG9-05V-T, BMG9-10, BMG9-10V-T, CG-1002, CG-1502, CG-2000, CG-2000-2P, CG-2002, CG-2002P, CG6-20, CG6-40, CG6-41, CG9-10, CG9-11, CG9-40H, CG9-41, CG9-41H, CG9-51L, CG9-51LC, CG9-51R, CG9-51RC, CG9-61, CG9-61H, CG9-61OP, CG9-82, CGB7-61, CGB7-61H, CGB7-61R, CGB7-61RH, CGE6-41, CGE9-11, CGF9-120D, CGF9-120I, CGF9-121D, CGF9-121I, CGP9-11...(Other models you can see in the webshop)		

miscellaneous



GEV No.	100006	Ref. No.	T982001000
description	piezoelectric igniter suitable for ELETROSIT body plastic blowing connection ø2.4mm ø 14mm		

ignition units



GEV No.	101012	Ref. No.	12020231 12024347 R073007 X163014
description	ignition unit outputs 2 230VAC dimensions 48x32x32mm mounting distance 56mm inlet F2.8x0.8 outlet F2.8x0.8 type ZIG2 50-60Hz		
For models:	BG9-05AD, BG9-05PLUS-I, BG9-10AD, BG9-10PLUS-I, CG-7200, CG-7415, CG9-05AD, CG9-05PLUS, CG9-10AD, CG9-10PLUS, CG9-11AD, CG9-11PLUS, CG9-20AD, CG9-20AD-H, CG9-20PLUS, CG9-20PLUS-H, CG9-31PLUS-D, CG9-31PLUS-I, CG9-41AD, CG9-41AD-H, CG9-41PLUS, CG9-41PLUS-H, CG9-61AD, CG9-61AD-H, CG9-61PLUS, CG9-61PLUS-H, CG9-82AD, CG9-82PLUS, CGF9-121D-AD, CGF9-121PLUS-D, CGF9-121PLUS-I, CPG9-05AD, CPG9-05AD-S, CPG9-05PLUS, CPG9-05PLUS-S, FG7-05-1C, FG7-05-2C, FG-710, FG7-10-2C, FG7-104C, FG7-10-4C, FG-720, FG9-05, FG9-05-1C, FG9-05-2C, FG9-05AD, FG9-05PLUS, FG9-05PLUS-S, FG9-05S, FG9-05S-1C...(Other models you can see in the webshop)		

thermocouples

plug-in thermocouples

plug-in thermocouples standard

with barrel socket ø6(6.5)mm

thermocouples SIT

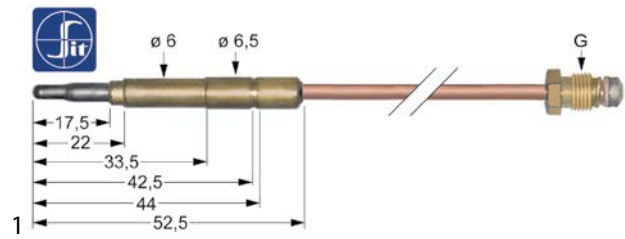

GEV No.	107621	Ref. No.	12037971 ICR10070
description	thermocouple SIT M10x1 L 1500mm plug connection ø6.0(6.5)mm		

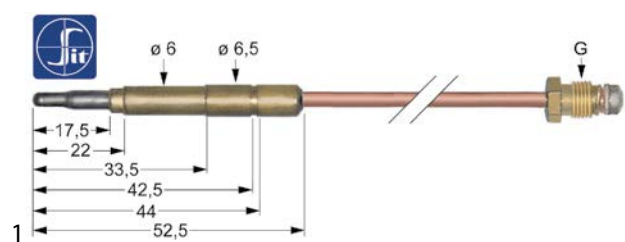

GEV No.	107605	Ref. No.	12020122 12020138 U322101 U322130
description	thermocouple SIT M8x1 L 1500mm plug connection ø6.0(6.5)mm		
For models:	CG7-11, CG7-41, CG-7415, CG7-61, CG-7615, CGB7-61, CGP9-11		

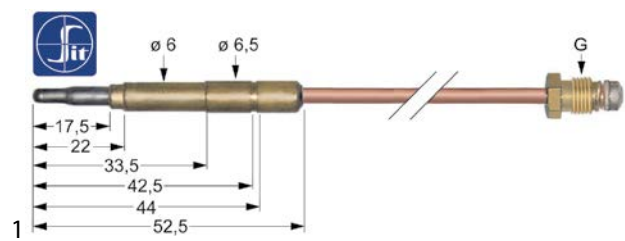

GEV No.	107601	Ref. No.	12020688 U222100
description	thermocouple SIT M8x1 L 600mm plug connection ø6.0(6.5)mm		
For models:	BG7-05, BG7-10, BG9-05, BG9-10, BMG7-10, BMG-9045, BMG9-05, BMG9-10, CG-2000, CG-2000-2P, CG-2005, CG-210, CG-210G, CG-300S, CG-310, CG-310G, CG7-10, CG7-11, CG7-20, CG-7200, CG7-40, CG-7400, CG7-41, CG-7415, CG7-61, CG-7615, CG9-20, CG9-40, CG9-41, CG9-51L, CG9-51LC, CG9-51R, CG9-51RC, CG9-60, CG9-61, CG9-82, CGE7-134, FG-91-20, FG-92-40, FTG7-05, FTG-7050L, FTG-7050R, FTG7-10, FTG-7100L, FTG-7100L+R, FTG-7100R, FTG-9050L, FTG-9050R, FTG9-05L, FTG9-05R...(Other models you can see in the webshop)		

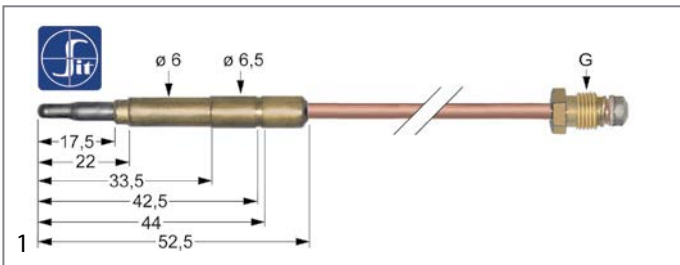

GEV No.	107612	Ref. No.	U562120
description	thermocouple SIT M9x1 L 1000mm plug connection ø6.0(6.5)mm		

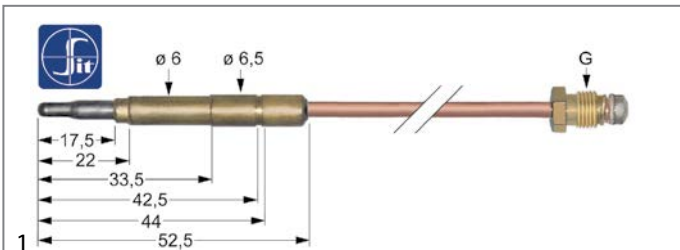

GEV No.	107614	Ref. No.	12009208
description	thermocouple SIT M9x1 L 1500mm plug connection ø6.0(6.5)mm		
For models:	CG7-11, CG7-31D, CG7-31I, CG7-41, CG7-41H, CG7-51, CG7-61, CG7-61H, CGB7-61, CGB7-61H, CGB7-61R, CGB7-61RH, CGP9-11		

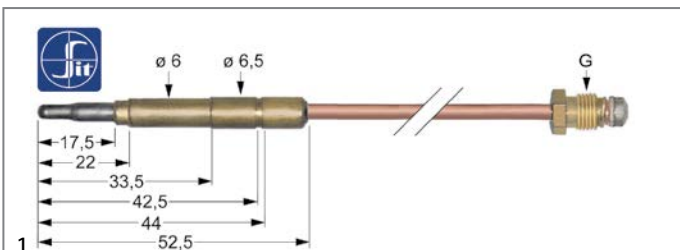

GEV No.	107611	Ref. No.	12009182 U562130
description	thermocouple SIT M9x1 L 850mm plug connection ø6.0(6.5)mm		
For models:	CG-1002, CG-1502, CG-2002, CG-2002P, CG-210, CG-210G, CG-310, CG-310G, CG9-11, CG9-11AD, CG9-11PLUS, CG9-31PLUS-D, CG9-31PLUS-I, CG9-41, CG9-41AD, CG9-41AD-H, CG9-41H, CG9-41PLUS, CG9-41PLUS-H, CG9-51L, CG9-51LC, CG9-51R, CG9-51RC, CG9-61, CG9-61AD, CG9-61AD-H, CG9-61H, CG9-61OP, CG9-61PLUS, CG9-61PLUS-H, CG9-82, CG9-82AD, CG9-82PLUS, CGF9-121D, CGF9-121D-AD, CGF9-121I, CGF9-121PLUS-D, CGF9-121PLUS-I, CPG7-05, CPG9-05, CPG9-05NC, CPG9-05S, CPG9-05SNC, FG7-05-1C, FG7-05-2C, FG-710, FG7-10-2C, FG7-104C, FG7-10-4C, FG-720...(Other models you can see in the webshop)		

thermocouples with aluminised tip

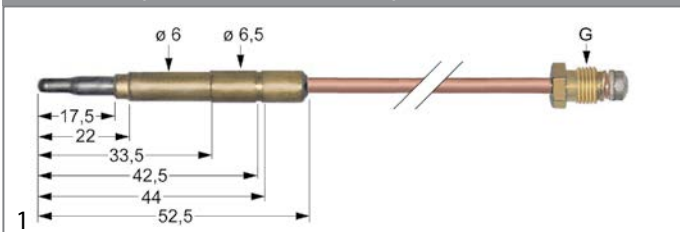

GEV No.	102042	Ref. No.	12021360 U262120 X152120
description	thermocouple M9x1 L 850mm plug connection ø6.0(6.5)mm		

threaded thermocouples (miscellaneous)

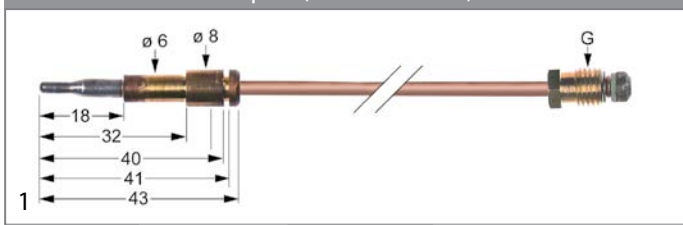

GEV No.	102462	Ref. No.	12008344 U262130
description	thermocouple M8x1 L 1000mm barrel socket		
For models:	CG-210, CG-210G, CG-310, CG-310G, CG6-41, CG9-20, CG9-20H, CG9-40, CG9-40H, CG9-41, CG9-41H, CG9-51L, CG9-51LC, CG9-51R, CG9-51RC, CG9-60, CG9-60H, CG9-61, CG9-61H, CG9-61OP, CG9-82, CGE9-41, CGF9-120D, CGF9-120I, CGF9-121D, CGF9-121I, CPG7-05, CPG7-05NC, CPG9-05, CPG9-05AD, CPG9-05AD-S, CPG9-05NC, CPG9-05PLUS, CPG9-05PLUS-S, CPG9-05S, CPG9-05SNC, GPC-350		

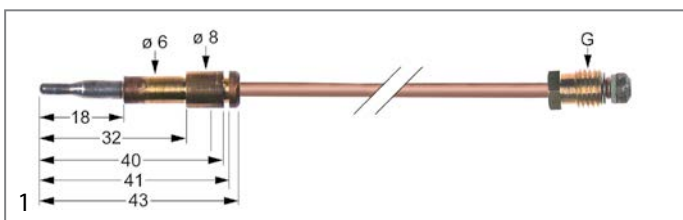





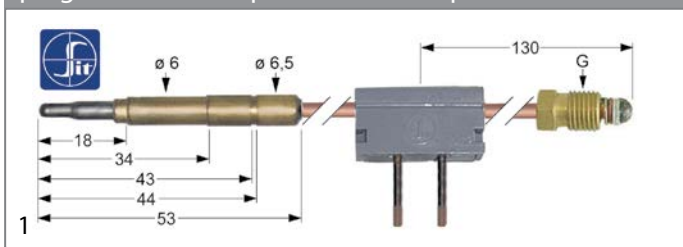

GEV No.	102451	Ref. No.	12009768 U222130
description	thermocouple M8x1 L 600mm barrel socket		
For models:	BG6-05I, BG7-05, BG7-05I, BG7-10, BG7-10I, BG9-05, BG9-05AD, BG9-05I, BG9-05PF, BG9-05PI, BG9-05PLUS-I, BG9-10, BG9-10AD, BG9-10I, BG9-10PF, BG9-10PI, BG9-10PLUS-I, BMG7-10, BMG9-05, BMG9-05V-T, BMG9-10, BMG9-10V-T, CG-1002, CG-1502, CG-2002, CG-2002P, CG-2005, CG-210, CG-210G, CG-300S, CG-310, CG-310G, CG7-10, CG7-11, CG7-20, CG7-20H, CG7-30D, CG7-30I, CG7-31D, CG7-31I, CG7-40, CG7-40H, CG7-41, CG7-41H, CG7-50, CG7-51, CG7-60, CG7-60H, CG7-61, CG7-61H...(Other models you can see in the webshop)		



plug-in thermocouples with interruption



GEV No.	107164	Ref. No.	12008273 S042106
description	thermocouple SIT with interrupter M9x1 L 1000mm plug connection ø6.0(6.5)mm soldering connection		
For models:	FG6-05, FG6-10, MG7-10BM, MG9-10BM, MG9-10BMS, MG9-10S, MG9-15BM, MG9-15BM316, MG9-15BMS, MG9-15S, MG9-20S, MPG9-10BM, MPG9-10BMS, MPG9-15BM, MPG9-15BMS		





			
1			
GEV No.	109024	Ref. No.	12019997 U235704
description	air mixing sleeve ø 46mm L 55mm		
accessories for	109024		
	GEV No.	109026	Ref. No. 12013457 U235700
burner head ø 120mm for burner cap ø 130mm 12kW			





			
1			
GEV No.	109005	Ref. No.	12008124 12039162 U445731 U4457315 U445731500
description	burner cap ø 100mm 4kW with central hole		
For models:	CG-1002, CG-1502, CG-2000, CG-2002, CG-2002P, CG-2005, CG-210, CG-210G, CG-300S, CG-310, CG-310G, CG-7115, CG-7200, CG7-20H, CG7-30D, CG7-30I, CG7-31D, CG7-31I, CG7-40, CG-7400, CG7-41, CG-7415, CG7-41H, CG7-50, CG7-51, CG7-60, CG7-60H, CG7-61, CG-7615, CG9-05AD, CG9-05PLUS, CG9-20, CG9-20AD, CG9-20H, CG9-20PLUS, CG9-31PLUS-D, CG9-31PLUS-I, CG9-40, CG9-40AD, CG9-40H, CG9-40PLUS, CG9-41, CG9-41AD, CG9-41H, CG9-41PLUS, CG9-51L, CG9-51LC, CG9-51R, CG9-51RC, CG9-60, CG9-60AD, CG9-60H, CG9-60PLUS...(Other models you can see in the webshop)		
accessories for	109005		
	GEV No.	109004	Ref. No. 12009292 U445730
burner head ø 100mm 4.6kW			
	GEV No.	109704	Ref. No. 12014055 U745417
drain tray L 340mm W 310mm H 41mm ø 130mm for burner cap ø 120mm			
	GEV No.	109710	Ref. No. 12005899 12038914 12120850 U505408
drain tray L 420mm W 344mm H 39mm ø 115mm for burner cap ø 100mm			



			
1			
GEV No.	109002	Ref. No.	12009109 12017945 U135702 U1357025 U135702500 U445732
description	burner cap ø 120mm 9.3kW with central hole		
For models:	CG-1002, CG-1502, CG-2000, CG-2000-2P, CG-2002, CG-2002P, CG-2005, CG-210, CG-210G, CG-300S, CG-310, CG-310G, CG-7115, CG-7200, CG7-20H, CG7-30D, CG7-30I, CG7-31D, CG7-31I, CG7-40, CG-7400, CG7-40H, CG7-41, CG-7415, CG7-41H, CG7-50, CG7-51, CG7-60, CG7-60H, CG7-61, CG-7615, CG7-61H, CG9-20, CG9-20AD, CG9-20AD-H, CG9-20H, CG9-20PLUS, CG9-20PLUS-H, CG9-31PLUS-D, CG9-31PLUS-I, CG9-40, CG9-40AD, CG9-40AD-H, CG9-40H, CG9-40PLUS, CG9-40PLUS-H, CG9-41, CG9-41AD, CG9-41AD-H, CG9-41H...(Other models you can see in the webshop)		
accessories for	109002		
	GEV No.	109007	Ref. No. 12007684 12040161 U565701
burner head ø 120mm 7kW			





			
1			
GEV No.	109027	Ref. No.	12007682 12009367 12047137 U235701 U235701500
description	burner cap ø 130mm 11.6kW with central hole		
For models:	CG-1002, CG-1502, CG-2002, CG-2002P, CG9-20AD-H, CG9-20H, CG9-20PLUS-H, CG9-40, CG9-40AD, CG9-40AD-H, CG9-40H, CG9-40PLUS, CG9-40PLUS-H, CG9-41, CG9-41AD, CG9-41AD-H, CG9-41H, CG9-41PLUS, CG9-41PLUS-H, CG9-51L, CG9-51LC, CG9-51R, CG9-51RC, CG9-60, CG9-60AD, CG9-60AD-H, CG9-60H, CG9-60PLUS, CG9-60PLUS-H, CG9-61, CG9-61AD, CG9-61AD-H, CG9-61H, CG9-61OP, CG9-61PLUS, CG9-61PLUS-H, CG9-82, CG9-82AD, CG9-82PLUS, CG9-41, CGE9-41AD, CGE9-41PLUS, HP-G-15, HPG-15		
accessories for	109027		
	GEV No.	109026	Ref. No. 12013457 U235700
burner head ø 120mm for burner cap ø 130mm 12kW			







 <p>1</p>			
GEV No.	109004	Ref. No.	12009292 U445730
description	burner head ø 100mm 4.6kW		
For models:	CG-1002, CG-1502, CG-2000, CG-2002, CG-2005, CG-210, CG-210G, CG-300S, CG-310, CG-310G, CG7-20, CG-7200, CG7-40, CG-7400, CG7-41, CG-7415, CG7-61, CG-7615, CG9-20, CG9-40, CG9-41, CG9-51L, CG9-51LC, CG9-51R, CG9-51RC, CG9-60, CG9-61, CG9-82, CGB7-61, CGE7-118, CGE7-41, CGE9-41		
accessories for	109004		
	GEV No.	109001	Ref. No.
			12009400 U125720
	venturi ø 11.5mm L 90mm		
	GEV No.	109003	Ref. No.
			12008071 U265702
	air mixing sleeve ø 40mm L 55mm		
	GEV No.	109005	Ref. No.
			12008124 12039162 U445731 U4457315 U445731500
	burner cap ø 100mm 4kW with central hole		



 <p>1</p>			
GEV No.	109007	Ref. No.	12007684 12040161 U565701
description	burner head ø 120mm 7kW		
For models:	CG-1002, CG-1502, CG-2000, CG-2000-2P, CG-2002, CG-2005, CG-210, CG-210G, CG-300S, CG-310, CG-310G, CG7-40, CG7-41, CG7-61, CG9-20, CG9-40, CG9-41, CG9-51L, CG9-51LC, CG9-51R, CG9-51RC, CG9-60, CG9-61, CG9-82, CGB7-61, CGE7-108, CGE7-41, CGE9-41		
accessories for	109007		
	GEV No.	109002	Ref. No.
			12009109 12017945 U135702 U1357025 U135702500 U445732
	burner cap ø 120mm 9.3kW with central hole		
	GEV No.	109003	Ref. No.
			12008071 U265702
	air mixing sleeve ø 40mm L 55mm		
	GEV No.	109006	Ref. No.
			12008429 U565700
	venturi ø 27.7mm L 90mm		

 <p>1</p>			
GEV No.	109205	Ref. No.	12008471 U915702000
description	burner head ø 120mm 7kW suitable for FAGOR		
For models:	CG7-20H, CG7-30D, CG7-30I, CG7-31D, CG7-31I, CG7-40, CG7-40H, CG7-41, CG7-41H, CG7-50, CG7-51, CG7-60, CG7-60H, CG7-61, CG7-61H, CGB7-61, CGB7-61H, CGB7-61R, CGB7-61RH, CGE7-41, CGE7-41H		
accessories for	109205		
	GEV No.	109002	Ref. No.
			12009109 12017945 U135702 U1357025 U135702500 U445732
	burner cap ø 120mm 9.3kW with central hole		

 <p>1</p>			
GEV No.	109026	Ref. No.	12013457 U235700
description	burner head ø 120mm for burner cap ø 130mm 12kW		
For models:	CG-1002, CG-1502, CG-2002, CG9-40, CG9-41, CG9-51L, CG9-51LC, CG9-51R, CG9-51RC, CG9-60, CG9-61, CG9-82, CGE9-41		
accessories for	109026		
	GEV No.	109024	Ref. No.
			12019997 U235704
	air mixing sleeve ø 46mm L 55mm		
	GEV No.	109025	Ref. No.
			12008019 12008611 U235702
	venturi ø 40mm L 160mm		
	GEV No.	109027	Ref. No.
			12007682 12009367 12047137 U235701 U235701500
	burner cap ø 130mm 11.6kW with central hole		



			
GEV No.	109001	Ref. No.	12009400 U125720
description	venturi ø 11.5mm L 90mm		
For models:	CG-1002, CG-1502, CG-2000, CG-2002, CG-2002P, CG-2005, CG-210, CG-210G, CG-300S, CG-310, CG-310G, CG7-20, CG-7200, CG7-30D, CG7-30I, CG7-31D, CG7-31I, CG7-40, CG-7400, CG7-41, CG-7415, CG7-50, CG7-51, CG7-60, CG7-61, CG-7615, CG9-05AD, CG9-05PLUS, CG9-20, CG9-20AD, CG9-20H, CG9-20PLUS, CG9-31PLUS-D, CG9-31PLUS-I, CG9-40, CG9-40AD, CG9-40H, CG9-40PLUS, CG9-41, CG9-41AD, CG9-41H, CG9-41PLUS, CG9-51L, CG9-51LC, CG9-51R, CG9-51RC, CG9-60, CG9-60AD, CG9-60H, CG9-60PLUS...(Other models you can see in the webshop)		
accessories for	109001		
	GEV No.	109004	Ref. No. 12009292 U445730
burner head ø 100mm 4.6kW			





			
GEV No.	109006	Ref. No.	12008429 U565700
description	venturi ø 27.7mm L 90mm		
For models:	CG-1002, CG-1502, CG-2000, CG-2000-2P, CG-2002, CG-2002P, CG-2005, CG-210, CG-210G, CG-300S, CG-310, CG-310G, CG7-20H, CG7-30D, CG7-30I, CG7-31D, CG7-31I, CG7-40, CG7-40H, CG7-41, CG7-41H, CG7-50, CG7-51, CG7-60, CG7-60H, CG7-61, CG7-61H, CG9-20, CG9-20AD, CG9-20AD-H, CG9-20H, CG9-20PLUS, CG9-20PLUS-H, CG9-31PLUS-D, CG9-31PLUS-I, CG9-40, CG9-40AD, CG9-40AD-H, CG9-40H, CG9-40PLUS, CG9-40PLUS-H, CG9-41, CG9-41AD, CG9-41AD-H, CG9-41H, CG9-41PLUS, CG9-41PLUS-H, CG9-51L, CG9-51LC, CG9-51R...		
accessories for	109006		
	GEV No.	109007	Ref. No. 12007684 12040161 U565701
burner head ø 120mm 7kW			

			
GEV No.	109025	Ref. No.	12008019 12008611 U235702
description	venturi ø 40mm L 160mm		
For models:	CG-1002, CG-1502, CG-2002, CG-2002P, CG9-40, CG9-41, CG9-51L, CG9-51LC, CG9-51R, CG9-51RC, CG9-60, CG9-61, CG9-82, CG9-41		
accessories for	109025		
	GEV No.	109026	Ref. No. 12013457 U235700
burner head ø 120mm for burner cap ø 130mm 12kW			



900 (since 2006) series

			
GEV No.	109062	Ref. No.	12008073 U025706
description	air mixing sleeve L 56mm D1 ø 49mm D2 ø 51mm		
For models:	CG-1002, CG-1502, CG-2002, CG-2002P, CG9-20AD-H, CG9-20H, CG9-20PLUS-H, CG9-40, CG9-40AD, CG9-40AD-H, CG9-40H, CG9-40PLUS, CG9-40PLUS-H, CG9-41, CG9-41AD, CG9-41AD-H, CG9-41H, CG9-41PLUS, CG9-41PLUS-H, CG9-51L, CG9-51LC, CG9-51R, CG9-51RC, CG9-60, CG9-60AD, CG9-60AD-H, CG9-60H, CG9-60PLUS, CG9-60PLUS-H, CG9-61, CG9-61AD, CG9-61AD-H, CG9-61H, CG9-61OP, CG9-61PLUS, CG9-61PLUS-H, CG9-82, CG9-82AD, CG9-82PLUS, CG9-41, CG9-41AD, CG9-41PLUS		

			
GEV No.	109003	Ref. No.	12008071 U265702
description	air mixing sleeve ø 40mm L 55mm		
For models:	CG-1002, CG-1502, CG-2000, CG-2000-2P, CG-2002, CG-2002P, CG-2005, CG-210, CG-210G, CG-300S, CG-310, CG-310G, CG7-20, CG-7200, CG7-30D, CG7-30I, CG7-31D, CG7-31I, CG7-40, CG-7400, CG7-40H, CG7-41, CG-7415, CG7-41H, CG7-50, CG7-51, CG7-60, CG7-60H, CG7-61, CG-7615, CG7-61H, CG9-05AD, CG9-05PLUS, CG9-20, CG9-20AD, CG9-20AD-H, CG9-20H, CG9-20PLUS, CG9-20PLUS-H, CG9-31PLUS-D, CG9-31PLUS-I, CG9-40, CG9-40AD, CG9-40AD-H, CG9-40H, CG9-40PLUS, CG9-40PLUS-H, CG9-41, CG9-41AD...(Other models you can see in the webshop)		
accessories for	109003		
	GEV No.	109004	Ref. No. 12009292 U445730
burner head ø 100mm 4.6kW			
	GEV No.	109007	Ref. No. 12007684 12040161 U565701
burner head ø 120mm 7kW			

			
GEV No.	109005	Ref. No.	12008124 12039162 U445731 U4457315 U445731500
description	burner cap ø 100mm 4kW with central hole		
For models:	CG-1002, CG-1502, CG-2000, CG-2002, CG-2002P, CG-2005, CG-210, CG-210G, CG-300S, CG-310, CG-310G, CG7-20, CG-7200, CG7-30D, CG7-30I, CG7-31D, CG7-31I, CG7-40, CG-7400, CG7-41, CG-7415, CG7-50, CG7-51, CG7-60, CG7-61, CG-7615, CG9-05AD, CG9-05PLUS, CG9-20, CG9-20AD, CG9-20H, CG9-20PLUS, CG9-31PLUS-D, CG9-31PLUS-I, CG9-40, CG9-40AD, CG9-40AD-H, CG9-40H, CG9-40PLUS, CG9-40PLUS-H, CG9-41, CG9-41AD, CG9-41AD-H, CG9-41H, CG9-41PLUS, CG9-51L, CG9-51LC, CG9-51R, CG9-51RC, CG9-60, CG9-60AD, CG9-60H, CG9-60PLUS...(Other models you can see in the webshop)		
accessories for	109005		
	GEV No.	109004	Ref. No. 12009292 U445730
burner head ø 100mm 4.6kW			
	GEV No.	109704	Ref. No. 12014055 U745417
drain tray L 340mm W 310mm H 41mm ø 130mm for burner cap ø 120mm			
	GEV No.	109710	Ref. No. 12005899 12038914 12120850 U505408
drain tray L 420mm W 344mm H 39mm ø 115mm for burner cap ø 100mm			





			
1			
GEV No.	109002	Ref. No.	12009109 12017945 U135702 U1357025 U135702500 U445732
description	burner cap ø 120mm 9.3kW with central hole		
For models:	CG-1002, CG-1502, CG-2000, CG-2000-2P, CG-2002, CG-2002P, CG-2005, CG-210, CG-210G, CG-300S, CG-310, CG-310G, CG-7115, CG-7200, CG7-20H, CG7-30D, CG7-30I, CG7-31D, CG7-31I, CG7-40, CG-7400, CG7-40H, CG7-41, CG-7415, CG7-41H, CG7-50, CG7-51, CG7-60, CG7-60H, CG7-61, CG-7615, CG7-61H, CG9-20, CG9-20AD, CG9-20AD-H, CG9-20H, CG9-20PLUS, CG9-20PLUS-H, CG9-31PLUS-D, CG9-31PLUS-I, CG9-40, CG9-40AD, CG9-40AD-H, CG9-40H, CG9-40PLUS, CG9-40PLUS-H, CG9-41, CG9-41AD, CG9-41AD-H, CG9-41H... (Other models you can see in the webshop)		
accessories for	109002		
			
GEV No.	109007	Ref. No.	12007684 12040161 U565701
burner head ø 120mm 7kW			



			
1			
GEV No.	109027	Ref. No.	12007682 12009367 12047137 U235701 U235701500
description	burner cap ø 130mm 11.6kW with central hole		
For models:	CG-1002, CG-1502, CG-2002, CG-2002P, CG9-20AD-H, CG9-20H, CG9-20PLUS-H, CG9-40, CG9-40AD, CG9-40AD-H, CG9-40H, CG9-40PLUS, CG9-40PLUS-H, CG9-41, CG9-41AD, CG9-41AD-H, CG9-41H, CG9-41PLUS, CG9-41PLUS-H, CG9-51L, CG9-51LC, CG9-51R, CG9-51RC, CG9-60, CG9-60AD, CG9-60AD-H, CG9-60H, CG9-60PLUS, CG9-60PLUS-H, CG9-61, CG9-61AD, CG9-61AD-H, CG9-61H, CG9-61OP, CG9-61PLUS, CG9-61PLUS-H, CG9-82, CG9-82AD, CG9-82PLUS, CGE9-41, CGE9-41AD, CGE9-41PLUS, HP-G-15, HPG-15		
accessories for	109027		
			
GEV No.	109026	Ref. No.	12013457 U235700
burner head ø 120mm for burner cap ø 130mm 12kW			



			
1			
GEV No.	109063	Ref. No.	12009498 U025701
description	burner head ø 100mm 4.7kW 4kcal for burner cap ø 100mm L 280mm H 113mm		
For models:	CG-1002, CG-1502, CG-2002, CG-2002P, CG9-20, CG9-40, CG9-41, CG9-51L, CG9-51LC, CG9-51R, CG9-51RC, CG9-60, CG9-61, CG9-82, CGE9-41, CGF9-120D, CGF9-120I, CGF9-121D, CGF9-121I		

			
1			
GEV No.	109106	Ref. No.	12009326 U025702
description	burner head ø 118mm 9.3kW 8000kcal for burner cap ø 120mm L 280mm H 90mm		
For models:	CG-1002, CG-1502, CG-2002, CG-2002P, CG9-20, CG9-40, CG9-41, CG9-51L, CG9-51LC, CG9-51R, CG9-51RC, CG9-60, CG9-61, CG9-82, CGE9-41, CGF9-120D, CGF9-120I, CGF9-121D, CGF9-121I		

			
1			
GEV No.	109102	Ref. No.	12008525 U025703
description	burner head ø 120mm 11.6kW for burner cap ø 130mm L 280mm H 94mm		
For models:	CG-1002, CG-1502, CG-2002, CG-2002P, CG9-40, CG9-41, CG9-51L, CG9-51LC, CG9-51R, CG9-51RC, CG9-60, CG9-61, CG9-82, CGE9-41		
accessories for	109102		
			
GEV No.	109003	Ref. No.	12008071 U265702
air mixing sleeve ø 40mm L 55mm			





			
1			
GEV No.	109001	Ref. No.	12009400 U125720
description	venturi ø 11.5mm L 90mm		
For models:	CG-1002, CG-1502, CG-2000, CG-2002, CG-2002P, CG-2005, CG-210, CG-210G, CG-300S, CG-310, CG-310G, CG7-20, CG-7200, CG7-30D, CG7-30I, CG7-31D, CG7-31I, CG7-40, CG-7400, CG7-41, CG-7415, CG7-50, CG7-51, CG7-60, CG7-61, CG-7615, CG9-05AD, CG9-05PLUS, CG9-20, CG9-20AD, CG9-20H, CG9-20PLUS, CG9-31PLUS-D, CG9-31PLUS-I, CG9-40, CG9-40AD, CG9-40H, CG9-40PLUS, CG9-41, CG9-41AD, CG9-41H, CG9-41PLUS, CG9-51L, CG9-51LC, CG9-51R, CG9-51RC, CG9-60, CG9-60AD, CG9-60H, CG9-60PLUS... (Other models you can see in the webshop)		
accessories for	109001		
			
GEV No.	109004	Ref. No.	12009292 U445730
burner head ø 100mm 4.6kW			





			
GEV No.	109006	Ref. No.	12008429 U565700
description	venturi ø 27.7mm L 90mm		
For models:	CG-1002, CG-1502, CG-2000, CG-2000-2P, CG-2002, CG-2002P, CG-2005, CG-210, CG-210G, CG-300S, CG-310, CG-310G, CG7-20H, CG7-30D, CG7-30I, CG7-31D, CG7-31I, CG7-40, CG7-40H, CG7-41, CG7-41H, CG7-50, CG7-51, CG7-60, CG7-60H, CG7-61, CG7-61H, CG9-20, CG9-20AD, CG9-20AD-H, CG9-20H, CG9-20PLUS, CG9-20PLUS-H, CG9-31PLUS-D, CG9-31PLUS-I, CG9-40, CG9-40AD, CG9-40AD-H, CG9-40H, CG9-40PLUS, CG9-40PLUS-H, CG9-41, CG9-41AD, CG9-41AD-H, CG9-41H, CG9-41PLUS, CG9-41PLUS-H, CG9-51L, CG9-51LC, CG9-51R... (Other models you can see in the webshop)		
accessories for	109006		
			
GEV No.	109007	Ref. No.	12007684 12040161 U565701
description	burner head ø 120mm 7kW		





			
GEV No.	109025	Ref. No.	12008019 12008611 U235702
description	venturi ø 40mm L 160mm		
For models:	CG-1002, CG-1502, CG-2002, CG-2002P, CG9-40, CG9-41, CG9-51L, CG9-51LC, CG9-51R, CG9-51RC, CG9-60, CG9-61, CG9-82, CGE9-41		
accessories for	109025		
			
GEV No.	109026	Ref. No.	12013457 U235700
description	burner head ø 120mm for burner cap ø 130mm 12kW		

solid tops / stockpot stoves





			
GEV No.	109031	Ref. No.	U195704
description	air mixing tube		

			
GEV No.	109014	Ref. No.	12009172 12040022 U195701 U1957015 U195701500
description	burner cap ø 120mm with central hole		
For models:	CG-110, CG7-10, CG7-11, CG9-10, CG9-10AD, CG9-10PLUS, CG9-11, CG9-11PLUS, CGE9-11, CGF9-120D, CGF9-120D-AD, CGF9-120I, CGF9-120I-AD, CGF9-120PLUS-D, CGF9-120PLUS-I, CGF9-121D, CGF9-121D-AD, CGF9-121I, CGF9-121I-AD, CGF9-121PLUS-D, CGF9-121PLUS-I		
accessories for	109014		
			
GEV No.	109015	Ref. No.	12007687 U195702
description	burner head for burner cap ø 120mm		
			
GEV No.	109016	Ref. No.	12009160 U775701
description	venturi		
			
GEV No.	109017	Ref. No.	12009164 12014412 U615700 U615700500
description	burner holder		

			
GEV No.	109015	Ref. No.	12007687 U195702
description	burner head for burner cap ø 120mm		
For models:	CG-110, CG7-10, CG7-11, CG-7115, CG9-10, CG9-10AD, CG9-10PLUS, CG9-11, CG-9110, CG9-11AD, CG9-11PLUS, CGE9-11, CGF9-120D, CGF9-120D-AD, CGF9-120I, CGF9-120I-AD, CGF9-120PLUS-D, CGF9-120PLUS-I, CGF9-121D, CGF9-121D-AD, CGF9-121I, CGF9-121I-AD, CGF9-121PLUS-D, CGF9-121PLUS-I, HP-G-15, HPG-15		
accessories for	109015		
			
GEV No.	109014	Ref. No.	12009172 12040022 U195701 U1957015 U195701500
description	burner cap ø 120mm with central hole		
			
GEV No.	109016	Ref. No.	12009160 U775701
description	venturi		
			
GEV No.	109017	Ref. No.	12009164 12014412 U615700 U615700500
description	burner holder		

			
GEV No.	109017	Ref. No.	12009164 12014412 U615700 U615700500
description	burner holder		
For models:	CG7-10, CG7-11, CG9-10, CG9-10AD, CG9-10PLUS, CG9-11, CG9-11AD, CG9-11PLUS, CGE9-11, CGF9-120D, CGF9-120D-AD, CGF9-120I, CGF9-120I-AD, CGF9-120PLUS-D, CGF9-120PLUS-I, CGF9-121D, CGF9-121D-AD, CGF9-121I, CGF9-121I-AD, CGF9-121PLUS-D, CGF9-121PLUS-I, HP-G-15, HPG-15		
accessories for	109017		
			
GEV No.	109014	Ref. No.	12009172 12040022 U195701 U1957015 U195701500
description	burner cap ø 120mm with central hole		
			
GEV No.	109015	Ref. No.	12007687 U195702
description	burner head for burner cap ø 120mm		
			
GEV No.	109016	Ref. No.	12009160 U775701
description	venturi		





1 			
GEV No.	109016	Ref. No.	12009160 U775701
description	venturi		
For models:	CG7-10, CG7-11, CG9-10, CG9-10AD, CG9-10PLUS, CG9-11, CG9-11AD, CG9-11PLUS, CGE9-11, CGF9-120D, CGF9-120D-AD, CGF9-120I, CGF9-120I-AD, CGF9-120PLUS-D, CGF9-120PLUS-I, CGF9-121D, CGF9-121D-AD, CGF9-121I, CGF9-121I-AD, CGF9-121PLUS-D, CGF9-121PLUS-I, HP-G-15, HPG-15		
accessories for	109016		
	GEV No.	109014	Ref. No. 12009172 12040022 U195701 U1957015 U195701500
burner cap ø 120mm with central hole			
	GEV No.	109015	Ref. No. 12007687 U195702
burner head for burner cap ø 120mm			
	GEV No.	109017	Ref. No. 12009164 12014412 U615700 U615700500
burner holder			

1 			
GEV No.	109702	Ref. No.	12016262 U745413
description	pan support W 310mm L 350mm suitable for FAGOR for burner cap ø 100mm		
For models:	CG7-20, CG7-40, CG7-41, CG7-61, CGE7-88		

1 			
GEV No.	109701	Ref. No.	12016263 U745412
description	pan support W 310mm L 350mm suitable for FAGOR for burner cap ø 120mm		
For models:	CG7-20, CG7-40, CG7-41, CG7-61, CGE7-89		

pan supports			
1 			
GEV No.	109705	Ref. No.	12016228 U745415
description	pan support W 310mm L 345mm H 50mm suitable for FAGOR black, varnished		
For models:	CG7-20, CG7-40, CG7-41, CG7-61, CGB7-61, CGE7-41		

1 			
GEV No.	109716	Ref. No.	12007691 U565403
description	pan support W 345mm L 425mm		
For models:	CG-1002, CG-1502, CG-2000, CG-2000-2P, CG-2002, CG-2005, CG-210, CG-210G, CG-3005, CG-310, CG-310G, CG9-20, CG9-40, CG9-41, CG9-51L, CG9-51LC, CG9-51R, CG9-51RC, CG9-60, CG9-61, CG9-82, CGE9-41		

1 			
GEV No.	109069	Ref. No.	12009419 U915413
description	pan support W 310mm L 348mm H 54mm suitable for FAGOR cast iron		
For models:	CG7-20, CG7-20H, CG7-30D, CG7-30I, CG7-31D, CG7-31I, CG7-40, CG7-40H, CG7-41, CG7-41H, CG7-50, CG7-51, CG7-60, CG7-60H, CG7-61, CG7-61H, CGB7-61, CGB7-61H, CGB7-61R, CGB7-61RH, CGE7-41, CGE7-41H		

spillage trays			
1 			
GEV No.	109703	Ref. No.	12014294 U745416
description	drain tray L 340mm W 310mm H 38mm ø 115mm for burner cap ø 100mm		
For models:	CG7-20, CG7-40, CG7-41, CG7-61, CGB7-61, CGE7-41		

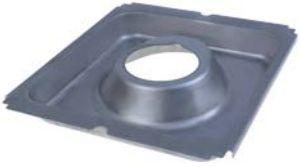

			
1			
GEV No.	109706	Ref. No.	12002032 U025404
description	drain tray L 405mm W 348mm H 50mm for burner cap ø 100mm		
For models:	CG-1002, CG-1502, CG9-20, CG9-40, CG9-41, CG9-51L, CG9-51LC, CG9-51R, CG9-51RC, CG9-60, CG9-61, CG9-82, CGE9-41, CGF9-120D, CGF9-120I, CGF9-121D, CGF9-121I		

			
1			
GEV No.	109721	Ref. No.	12002033 U025405
description	drain tray L 405mm W 348mm H 50mm for burner cap ø 120mm		
For models:	CG-1002, CG-1502, CG-2002, CG-2002P, CG9-20, CG9-40, CG9-41, CG9-51L, CG9-51LC, CG9-51R, CG9-51RC, CG9-60, CG9-61, CG9-82, CGE9-41, CGF9-120D, CGF9-120I, CGF9-121D, CGF9-121I		

			
1			
GEV No.	109710	Ref. No.	12005899 12038914 12120850 U505408
description	drain tray L 420mm W 344mm H 39mm ø 115mm for burner cap ø 100mm		
For models:	CG-1002, CG-1502, CG-2005, CG-210, CG-210G, CG-300S, CG-310, CG-310G, CG9-20, CG9-40, CG9-41, CG9-51L, CG9-51LC, CG9-51R, CG9-51RC, CG9-60, CG9-61, CG9-82, CGE9-41		

			
1			
GEV No.	109711	Ref. No.	12005898 12038913 U505409
description	drain tray L 420mm W 344mm H 45mm ø 140mm for burner cap ø 120mm		
For models:	CG-1002, CG-1502, CG-2000, CG-2000-2P, CG-2002, CG-2005, CG-210, CG-210G, CG-300S, CG-310, CG-310G, CG9-20, CG9-40, CG9-41, CG9-51L, CG9-51LC, CG9-51R, CG9-51RC, CG9-60, CG9-61, CG9-82, CGE9-41		

solid tops			
			
1			
GEV No.	109087	Ref. No.	12007681 U195421
description	cast plate ø 260mm		
For models:	CG-110, CG7-10, CG7-11, CG9-05AD, CG9-05PLUS, CG9-10, CG9-10AD, CG9-10PLUS, CG9-11, CG-9110, CG9-11AD, CG9-11PLUS, CG9-31PLUS-D, CG9-31PLUS-I, CGE9-11, CGF9-120D, CGF9-120I, CGF9-121D, CGF9-121I		

simmering plates			
			
1			
GEV No.	109088	Ref. No.	12009018 U915414
description	simmer plate L 343mm W 310mm H 32mm for gas range		

			
1			
GEV No.	109700	Ref. No.	12011961 U745411
description	simmer plate L 345mm W 310mm H 40mm		
For models:	CG7-20, CG7-40, CG7-41, CG7-61, CGB7-61, CGE7-41, CGE7-90		

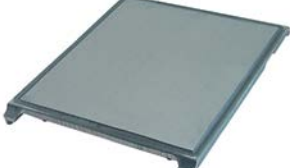
			
1			
GEV No.	109709	Ref. No.	12007699 U565406
description	simmer plate L 420mm W 345mm H 25mm		
For models:	CG-1002, CG-1502, CG-2000, CG-2002, CG-2005, CG-210, CG-210G, CG-300S, CG-310, CG-310G, CG9-20, CG9-40, CG9-41, CG9-60, CG9-61, CG9-82, CGE9-41		



accessories

pan supports

			
1			
GEV No.	109705	Ref. No.	12016228 U745415
description	pan support W 310mm L 345mm H 50mm suitable for FAGOR black, varnished		
For models:	CG7-20, CG7-40, CG7-41, CG7-61, CGB7-61, CGE7-41		

			
1			
GEV No.	109069	Ref. No.	12009419 U915413
description	pan support W 310mm L 348mm H 54mm suitable for FAGOR cast iron		
For models:	CG7-20, CG7-20H, CG7-30D, CG7-30I, CG7-31D, CG7-31I, CG7-40, CG7-40H, CG7-41, CG7-41H, CG7-50, CG7-51, CG7-60, CG7-60H, CG7-61, CG7-61H, CGB7-61, CGB7-61H, CGB7-61R, CGB7-61RH, CGE7-41, CGE7-41H		

			
1			
GEV No.	109702	Ref. No.	12016262 U745413
description	pan support W 310mm L 350mm suitable for FAGOR for burner cap ø 100mm		
For models:	CG7-20, CG7-40, CG7-41, CG7-61, CGE7-88		

			
1			
GEV No.	109701	Ref. No.	12016263 U745412
description	pan support W 310mm L 350mm suitable for FAGOR for burner cap ø 120mm		
For models:	CG7-20, CG7-40, CG7-41, CG7-61, CGE7-89		

			
1			
GEV No.	109716	Ref. No.	12007691 U565403
description	pan support W 345mm L 425mm		
For models:	CG-1002, CG-1502, CG-2000, CG-2000-2P, CG-2002, CG-2005, CG-210, CG-210G, CG-300S, CG-310, CG-310G, CG9-20, CG9-40, CG9-41, CG9-51L, CG9-51LC, CG9-51R, CG9-51RC, CG9-60, CG9-61, CG9-82, CGE9-41		

			
1			
GEV No.	109703	Ref. No.	12014294 U745416
description	drain tray L 340mm W 310mm H 38mm ø 115mm for burner cap ø 100mm		
For models:	CG7-20, CG7-40, CG7-41, CG7-61, CGB7-61, CGE7-41		

			
1			
GEV No.	109706	Ref. No.	12002032 U025404
description	drain tray L 405mm W 348mm H 50mm for burner cap ø 100mm		
For models:	CG-1002, CG-1502, CG9-20, CG9-40, CG9-41, CG9-51L, CG9-51LC, CG9-51R, CG9-51RC, CG9-60, CG9-61, CG9-82, CGE9-41, CGF9-120D, CGF9-120I, CGF9-121D, CGF9-121I		

			
1			
GEV No.	109721	Ref. No.	12002033 U025405
description	drain tray L 405mm W 348mm H 50mm for burner cap ø 120mm		
For models:	CG-1002, CG-1502, CG-2002, CG-2002P, CG9-20, CG9-40, CG9-41, CG9-51L, CG9-51LC, CG9-51R, CG9-51RC, CG9-60, CG9-61, CG9-82, CGE9-41, CGF9-120D, CGF9-120I, CGF9-121D, CGF9-121I		



			
1			
GEV No.	109710	Ref. No.	12005899 12038914 12120850 U505408
description	drain tray L 420mm W 344mm H 39mm ø 115mm for burner cap ø 100mm		
For models:	CG-1002, CG-1502, CG-2005, CG-210, CG-210G, CG-3005, CG-310, CG-310G, CG9-20, CG9-40, CG9-41, CG9-51L, CG9-51LC, CG9-51R, CG9-51RC, CG9-60, CG9-61, CG9-82, CGE9-41		

			
1			
GEV No.	109711	Ref. No.	12005898 12038913 U505409
description	drain tray L 420mm W 344mm H 45mm ø 140mm for burner cap ø 120mm		
For models:	CG-1002, CG-1502, CG-2000, CG-2000-2P, CG-2002, CG-2005, CG-210, CG-210G, CG-3005, CG-310, CG-310G, CG9-20, CG9-40, CG9-41, CG9-51L, CG9-51LC, CG9-51R, CG9-51RC, CG9-60, CG9-61, CG9-82, CGE9-41		

simmering plates

			
1			
GEV No.	109088	Ref. No.	12009018 U915414
description	simmer plate L 343mm W 310mm H 32mm for gas range		

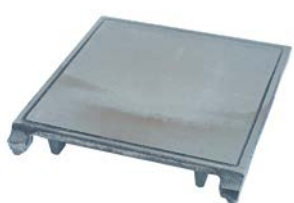
			
1			
GEV No.	109700	Ref. No.	12011961 U745411
description	simmer plate L 345mm W 310mm H 40mm		
For models:	CG7-20, CG7-40, CG7-41, CG7-61, CGB7-61, CGE7-41, CGE7-90		

			
1			
GEV No.	109709	Ref. No.	12007699 U565406
description	simmer plate L 420mm W 345mm H 25mm		
For models:	CG-1002, CG-1502, CG-2000, CG-2002, CG-2005, CG-210, CG-210G, CG-3005, CG-310, CG-310G, CG9-20, CG9-40, CG9-41, CG9-60, CG9-61, CG9-82, CGE9-41		

air mixers

			
1			
GEV No.	109032	Ref. No.	12039944 X015705
description	air mixing tube L 36mm ø 20mm		
For models:	FG-71-15, FG-72-30, FG-91-20, FG-920, FG-92-40, FG-940		

			
1			
GEV No.	109013	Ref. No.	12008047 U325707
description	air mixing tube L 43mm ø 20mm		
For models:	BG6-05I, BG7-05, BG7-05I, BG7-10, BG7-10I, BG9-05, BG9-05AD, BG9-05I, BG9-05PF, BG9-05PI, BG9-05PLUS-I, BG9-10, BG9-10AD, BG9-10I, BG9-10PF, BG9-10PI, BG9-10PLUS-I, BMG7-10, BMG-9045, BMG9-05, BMG9-05V-T, BMG9-10, BMG9-10V-T, CG-1002, CG-1502, CG-2000, CG-2000-2P, CG-2002, CG-2002P, CG-210, CG-210G, CG-310, CG-310G, CG6-41, CG7-11, CG-7115, CG7-41, CG-7415, CG7-61, CG-7615, CG9-11, CG9-41, CG9-51L, CG9-51LC, CG9-51R, CG9-51RC, CG9-61, CG9-82, CGB7-61, CGB7-61H...(Other models you can see in the webshop)		

			
1			
GEV No.	109036	Ref. No.	R425704
description	air mixing tube L 43mm ø 20mm		

bar burners

bar burners

			
1			
GEV No.	103029	Ref. No.	12007339 X285710
description	bar burner 10-row L 600mm W 1150mm ømm H 65mm tilting bratt pan		
For models:	SBG9-10, SBG9-10S, SBG9-15IM, SBG9-15IMS		



			
1			
GEV No.	109021	Ref. No.	12006607 R405700
description	bar burner 2 row L 490mm W 400mm ømm H 55mm bain marie		
For models:	BMG7-10, BMG-9045, BMG9-10, BMG9-10V-T		

			
1			
GEV No.	109020	Ref. No.	12017305 T035700
description	bar burner 2 row L 530mm W 200mm ømm H 45mm chargrill		
For models:	BG7-05, BG7-05I, BG7-10, BG7-10I		

			
1			
GEV No.	109099	Ref. No.	12009491 12009491+2x12011165 T035702
description	bar burner 2 row L 530mm W 200mm ømm H 57mm chargrill		
For models:	BG6-05I, BG7-05, BG7-05I, BG7-10, BG7-10I		
spare parts for	109099		
			
	GEV No.	691853	Ref. No.
			12011165 T035473
	bracket L 480mm H 45mm W 20mm		

			
1			
GEV No.	109053	Ref. No.	12017260 T035701
description	bar burner 2 row L 530mm W 200mm ømm H 75mm chargrill		

			
1			
GEV No.	105431	Ref. No.	12009503 T055703
description	bar burner 2 row L 540mm W 220mm ømm H 60mm chargrill		
For models:	BG9-05, BG9-05AD, BG9-05I, BG9-05PF, BG9-05PI, BG9-05PLUS-I, BG9-10, BG9-10AD, BG9-10I, BG9-10PF, BG9-10PI, BG9-10PLUS-I		

			
1			
GEV No.	109030	Ref. No.	12007058 R635700
description	bar burner 2 row L 680mm W 238mm ømm H 110mm griddle		
For models:	CG9-51L, CG9-51LC, CG9-51R, CG9-51RC, FTG-9050L, FTG-9050R, FTG9-05L, FTG9-05L-AD, FTG9-05LV-AD, FTG9-05PLUS-CL, FTG9-05PLUS-CR, FTG9-05PLUS-L, FTG9-05PLUS-LV, FTG9-05PLUS-R, FTG9-05PLUS-RV, FTG9-05R, FTG9-05R-AD, FTG9-05RV-AD, FTG9-05VL, FTG9-05VR, FTG-9100L, FTG-9100L+R, FTG-9100R, FTG9-10L, FTG9-10L+R, FTG9-10L+R-AD, FTG9-10L+RV-AD, FTG9-10L-AD, FTG9-10LV-AD, FTG9-10PLUS-CL, FTG9-10PLUS-CLR, FTG9-10PLUS-CR, FTG9-10PLUS-L, FTG9-10PLUS-LR, FTG9-10PLUS-LRV, FTG9-10PLUS-LV, FTG9-10PLUS-R, FTG9-10PLUS-RV, FTG9-10R, FTG9-10R-AD, FTG9-10RV-AD, FTG9-10VL, FTG9-10VL+R, FTG9-10VR, FTG9-11L, FTG9-11L+R, FTG9-11R, FTGC9-05, FTGC9-05L, FTGC9-05L-AD...(Other models you can see in the webshop)		

			
1			
GEV No.	109033	Ref. No.	T055700
description	bar burner 2 row ømm chargrill		

			
1			
GEV No.	109034	Ref. No.	12017234 T055701
description	bar burner 2 row ømm chargrill		
For models:	BG9-05, BG9-05I, BG9-10, BG9-10I		





			
1			
GEV No.	109037	Ref. No.	S035700
description	bar burner 4 row L 450mm W 420mm ømm kettle		

			
1			
GEV No.	109039	Ref. No.	S275700
description	bar burner 4 row L 590mm W 248mm ømm H 80mm kettle		

			
1			
GEV No.	109038	Ref. No.	12012385 S275705
description	bar burner 4 row L 595mm W 420mm ømm H 80mm 17.8kW kettle		
For models:	MG9-10, MG9-10BM, MG9-10BMS, MG9-10S, MG9-15, MG9-15BM, MG9-15BM316, MG9-15BMS, MG9-15S, MG9-20, MG9-20S, MPG9-10, MPG9-10BM, MPG9-10BMS, MPG9-10S, MPG9-15, MPG9-15BM, MPG9-15BMS, MPG9-15S, MPG9-20, MPG9-20S		

			
1			
GEV No.	109012	Ref. No.	12006166 U855702
description	bar burner angled L 325mm W 355mm ømm Hmm gas range		
For models:	CG-1502		

			
1			
GEV No.	109008	Ref. No.	12013187 U745700
description	bar burner angled L 570mm W 260mm ømm Hmm gas range		
For models:	CG7-11, CG7-41, CG7-61, CG9-11, CG9-41, CG9-51L, CG9-51LC, CG9-51R, CG9-51RC, CG9-61, CG9-82, CGF9-121D, CGF9-121I, FTG9-11L, FTG9-11L+R, FTG9-11R, FTGC9-11L, FTGC9-11L+R, FTGC9-11R, HG9-10, HG9-20		

			
1			
GEV No.	109009	Ref. No.	12039902 U329201
description	bar burner angled L 660mm W 260mm ømm Hmm gas range		

			
1			
GEV No.	109011	Ref. No.	12006629 U855700
description	bar burner angled L 700mm W 320mm ømm Hmm gas range		

			
1			
GEV No.	109010	Ref. No.	12006657 U705700
description	bar burner angled L 745mm W 260mm ømm Hmm gas range		
For models:	CG-2000, CG-2000-2P, CG-2002, CG-2002P		

			
1			
GEV No.	109187	Ref. No.	12024674 Z955801
description	bar burner multiple L 180mm W 270mm ømm H 45mm flange support combi-steamer zinc-plated FAGOR		
For models:	GA-20, GA-20D, GA-40, GA-40D, HGP-10-21, HGP-20-21, HGV-10-11, HGV-10-21, HGV-20-11, HGV-20-21, HVG-10-11, HVG-10-11UL, HVG-10-21, HVG-10-21UL, HVG-20-11, HVG-20-21, HVG-2-10-11, HVG-2-20-21, MFHVG-10-11, MFHVG-10-21, VG-101, VG-102, VG-201, VG-202, VPG-101, VPG-102, VPG-201, VPG-202		

			
1			
GEV No.	105920	Ref. No.	12030250 ICR10053
description	bar burner ø 50mm Wmm Hmm L 450mm flange with bolt M4 flange width 65mm flange length 71mm kettle		

			
1			
GEV No.	105697	Ref. No.	12030251 ICR09485
description	bar burner ø 50mm Wmm Hmm L 450mm with bolt M5x12 flange width 65mm flange length 71mm kettle		





 <p>1</p>			
GEV No.	109035	Ref. No.	R495700
description	bar burner ømm W 38mm H 33mm L 405mm bain marie		

 <p>1</p>			
GEV No.	109018	Ref. No.	12013487 R795700
description	bar burner U-shape L 500mm W 145mm ø 30mm Hmm griddle		
For models:	FTG7-05, FTG7-05L, FTG7-05R, FTG7-05VL, FTG7-05VR, FTG7-10, FTG7-10L, FTG7-10L+R, FTG7-10R, FTG7-10VL, FTG7-10VL+R, FTG7-10VR, FTGC7-05L, FTGC7-10L		

 <p>1</p>			
GEV No.	109188	Ref. No.	12017291 12024272 R735700 T115710
description	burner fabric ø 38mm Wmm Hmm L 170mm connection thread combi-steamer SS		
For models:	COG-101, COG-102, HCG-10-11, HCG-10-21, HCG-2-10-11, HGC-10-11, HGC-10-21, HGP-10-21, HGV-10-11, HGV-10-21, HMG-10-21, HMG-10-21UL, HMG-2-10-11, HVG-10-11, HVG-10-11UL, HVG-10-21, HVG-10-21UL, HVG-2-10-11, MFHVG-10-11, MFHVG-10-21, VG-101, VG-102, VPG-101, VPG-102		

 <p>1</p>			
GEV No.	211047	Ref. No.	12009424 T035464
description	chargrill grid L 508mm W 339mm H 22mm		
For models:	BG7-05, BG7-10		

 <p>1</p>			
GEV No.	211007	Ref. No.	12016512 T035455 T035481
description	chargrill grid L 570mm W 345mm H 75mm stainless steel chargrill		
For models:	BG7-05I, BG7-10I		

 <p>1</p>			
GEV No.	211046	Ref. No.	12009442 12016227 T055413
description	chargrill grid L 580mm W 410mm H 25mm chargrill		
For models:	BG9-05, BG9-05I, BG9-05PF, BG9-10, BG9-10I, BG9-10PF		

 <p>1</p>			
GEV No.	109708	Ref. No.	12008843 T035425
description	chargrill grid L 585mm W 323mm H 40mm chargrill meat		
For models:	BG7-05, BG7-10		

 <p>1</p>			
GEV No.	211045	Ref. No.	12016527 12040319 T055452 T055462
description	chargrill grid L 655mm W 411mm H 70mm stainless steel chargrill		
For models:	BG9-05, BG9-05I, BG9-10, BG9-10I		

 <p>1</p>			
GEV No.	109715	Ref. No.	12008240 T055439
description	grid handle L 180mm ø 16mm thread M10x1.5		
For models:	BG9-05, BG9-05I, BG9-10, BG9-10I		

 <p>1</p>			
GEV No.	109707	Ref. No.	12011720 T035406
description	lava rock grid L 480mm W 290mm H 20mm		





			
1			
GEV No.	109067	Ref. No.	12002411 H122605
description	lava rock grid L 485mm W 275mm H 40mm		
For models:	BG7-05, BG7-05I, BG7-10, BG7-10I		

			
1			
GEV No.	109090	Ref. No.	12002481
description	lava rock grid L 545mm W 330mm H 30mm SS		
For models:	BG9-05AD, BG9-05PF, BG9-05PI, BG9-05PLUS-I, BG9-10AD, BG9-10PF, BG9-10PI, BG9-10PLUS-I		

			
1			
GEV No.	109714	Ref. No.	12012897 T055405
description	lava rock grid L 555mm W 350mm H 20mm		
For models:	BG9-05, BG9-05I, BG9-10, BG9-10I		

chargrill grids

			
1			
GEV No.	211047	Ref. No.	12009424 T035464
description	chargrill grid L 508mm W 339mm H 22mm		
For models:	BG7-05, BG7-10		

			
1			
GEV No.	211007	Ref. No.	12016512 T035455 T035481
description	chargrill grid L 570mm W 345mm H 75mm stainless steel chargrill		
For models:	BG7-05I, BG7-10I		

			
1			
GEV No.	211046	Ref. No.	12009442 12016227 T055413
description	chargrill grid L 580mm W 410mm H 25mm chargrill		
For models:	BG9-05, BG9-05I, BG9-05PF, BG9-10, BG9-10I, BG9-10PF		

			
1			
GEV No.	109708	Ref. No.	12008843 T035425
description	chargrill grid L 585mm W 323mm H 40mm chargrill meat		
For models:	BG7-05, BG7-10		

			
1			
GEV No.	211045	Ref. No.	12016527 12040319 T055452 T055462
description	chargrill grid L 655mm W 411mm H 70mm stainless steel chargrill		
For models:	BG9-05, BG9-05I, BG9-10, BG9-10I		

lava rock grids

			
1			
GEV No.	109707	Ref. No.	12011720 T035406
description	lava rock grid L 480mm W 290mm H 20mm		

			
1			
GEV No.	109067	Ref. No.	12002411 H122605
description	lava rock grid L 485mm W 275mm H 40mm		
For models:	BG7-05, BG7-05I, BG7-10, BG7-10I		

			
1			
GEV No.	109090	Ref. No.	12002481
description	lava rock grid L 545mm W 330mm H 30mm SS		
For models:	BG9-05AD, BG9-05PF, BG9-05PI, BG9-05PLUS-I, BG9-10AD, BG9-10PF, BG9-10PI, BG9-10PLUS-I		

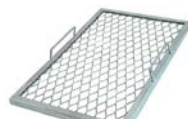
			
1			
GEV No.	109714	Ref. No.	12012897 T055405
description	lava rock grid L 555mm W 350mm H 20mm		
For models:	BG9-05, BG9-05I, BG9-10, BG9-10I		



			
1			
GEV No.	109184	Ref. No.	12034224 RT7200048
description	insulation for burner ø 97.5mm ID ø 62.5mm thickness 9.5mm		

			
1			
GEV No.	109022	Ref. No.	12016252 S135733
description	venturi L 150mm		
For models:	HPG-35, MG7-10, MG7-10BM, MG9-10, MG-9100, MG9-10BM, MG9-10BMS, MG9-10S, MG9-15, MG-9150, MG-9150BM, MG9-15BM, MG9-15BM316, MG9-15BMS, MG9-15S, MG9-20, MG-9200, MG9-20S, MPG9-10, MPG9-10BM, MPG9-10BMS, MPG9-10S, MPG9-15, MPG-9150, MPG9-15BM, MPG9-15BMS, MPG9-15S, MPG9-20, MPG-9200, MPG9-20S		

tube burners

			
1			
GEV No.	109019	Ref. No.	12009433 X015700
description	tubular burner L 340mm W 61mm H 58mm oval		
For models:	FG7-05-1C, FG7-05-2C, FG-710, FG7-10-2C, FG7-104C, FG7-10-4C, FG-71-15, FG-720, FG-72-30, FG9-05, FG9-05-1C, FG9-05-2C, FG9-05AD, FG9-05PLUS, FG9-05PLUS-S, FG9-05S, FG9-05S-1C, FG9-05S-2C, FG9-05S-AD, FG9-10, FG9-10-2C, FG9-10-4C, FG9-10AD, FG9-10PLUS, FG-91-20, FG-920, FG-92-40, FG-940		

round burners

			
1			
GEV No.	106963	Ref. No.	12009065 U875707
description	round burner ø 410mm L 590mm H 100mm D1 ø 220mm		
For models:	CGP9-10, CGP9-11		

forced air burners

			
1			
GEV No.	109070	Ref. No.	12017311 T075709
description	burner L 118mm ø 30.6mm		
For models:	HCG-6-11, HMG-6-11		

			
1			
GEV No.	107930	Ref. No.	12039680 T955750000
description	burner L 250mm ø 38mm combi-steamer FAGOR		
For models:	ACG-061, AG-061, AG-061W, APG-061, APG-061W		

			
1			
GEV No.	107929	Ref. No.	12039583 T855750000
description	burner L 260mm ø 37.5mm for combi-steamer FAGOR		
For models:	AG-061, AG-061W, AG-101, AG-101W, APG-061, APG-061W, APG-101, APG-101W		

			
1			
GEV No.	107927	Ref. No.	12039556 T845750000
description	burner L 270mm ø 38mm for combi-steamer		
For models:	ACG-101, ACG-201, AG-101, AG-101W, AG-201, APG-101, APG-101W, APG-201		

			
GEV No.	107925	Ref. No.	12039442 T645739000
description	burner L 300mm ø 44mm for combi-steamer FAGOR		
For models:	ACG-102, ACG-202, AG-102, AG-102W, AG-202, APG-102, APG-102W, APG-202		

			
GEV No.	107899	Ref. No.	12044424
description	burner L 435mm ø 52mm for combi-steamer FAGOR		
For models:	AG-201, APG-201		

			
GEV No.	101190	Ref. No.	12022913 T015700
description	burner chamber L 190mm ø 150mm		
For models:	COG-101, HCG-10-11, HCG-10-21, HCG-2-10-11, HGC-10-11		

accessories

covers

			
GEV No.	104211	Ref. No.	12013981 U745705
description	cover L 550mm W 155mm H 24mm SS for burner		
For models:	CG7-11, CG7-41, CG7-61, CG9-11, CG9-41, CG9-51L, CG9-51LC, CG9-51R, CG9-51RC, CG9-61, CG9-82, CGF9-121D, CGF9-121I, FTG9-11L, FTG9-11L+R, FTG9-11R, FTGC9-11L, FTGC9-11L+R, FTGC9-11R, HG9-10, HG9-20		

			
GEV No.	104796	Ref. No.	12004960 U915703000
description	cover ø 180mm thickness 2mm hole ø 118mm stainless steel for gas range suitable for FAGOR		
For models:	CG7-20H, CG7-30D, CG7-30I, CG7-31D, CG7-31I, CG7-40, CG7-40H, CG7-41, CG7-41H, CG7-50, CG7-51, CG7-60, CG7-60H, CG7-61, CG7-61H, CG9-20, CG9-20AD, CG9-20AD-H, CG9-20H, CG9-20PLUS, CG9-20PLUS-H, CG9-31PLUS-D, CG9-31PLUS-I, CG9-40, CG9-40AD, CG9-40AD-H, CG9-40H, CG9-40PLUS, CG9-40PLUS-H, CG9-41, CG9-41AD, CG9-41AD-H, CG9-41H, CG9-41PLUS, CG9-41PLUS-H, CG9-51L, CG9-51LC, CG9-51R, CG9-51RC, CG9-60, CG9-60AD, CG9-60AD-H, CG9-60H, CG9-60PLUS, CG9-60PLUS-H, CG9-61, CG9-61AD, CG9-61AD-H, CG9-61H, CG9-61OP...(Other models you can see in the webshop)		

gaskets

			
GEV No.	109044	Ref. No.	12023733 T075013
description	gasket D1 ø 102mm D2 ø 71mm thickness 3.3mm graphite		
For models:	COG-061, HCG-6-11, HGC-6-11, HMG-6-11		

			
GEV No.	109045	Ref. No.	12023765 R725055
description	gasket D1 ø 130mm D2 ø 95mm thickness 3.3mm graphite		
For models:	COG-101, COG-102, COG-201, COG-202, HCG-10-11, HCG-10-21, HCG-20-11, HCG-20-21, HCG-2-10-11, HCG-2-20-11, HGC-10-11, HGC-10-21, HGC-20-11, HGC-20-21, HGP-10-21, HGP-20-21, HGV-10-11, HGV-10-21, HGV-20-11, HGV-20-21, HMG-10-11, HMG-10-11UL, HMG-10-21, HMG-10-21UL, HMG-20-11, HMG-2-10-11, HVG-10-11, HVG-10-11UL, HVG-10-21, HVG-10-21UL, HVG-20-11, HVG-20-21, HVG-2-10-11, HVG-2-20-21, MFHVG-10-11, MFHVG-10-21, VG-101, VG-102, VG-201, VG-202, VPG-101, VPG-102, VPG-201, VPG-202		

			
GEV No.	109046	Ref. No.	12023994 T075014
description	gasket D1 ø 168mm D2 ø 132mm thickness 3.3mm graphite		
For models:	COG-061, HCG-6-11, HGC-6-11, HMG-6-11		





 <p>1</p>			
GEV No.	109047	Ref. No.	12023991 R725051
description	gasket D1 ø 200mm D2 ø 153mm thickness 3.3mm graphite		
For models:	COG-101, COG-102, HCG-10-11, HCG-10-21, HCG-20-11, HCG-2-10-11, HGC-10-11, HGC-10-21, HGP-10-21, HGV-10-11, HGV-10-21, HMG-10-11, HMG-10-11UL, HMG-10-21, HMG-10-21UL, HMG-20-11, HMG-2-10-11, HVG-10-11, HVG-10-11UL, HVG-10-21, HVG-10-21UL, HVG-2-10-11, MFHVG-10-11, MFHVG-10-21, VG-101, VG-102, VPG-101, VPG-102		

 <p>2</p>			
GEV No.	104283	Ref. No.	12035017 RT51101318
description	gasket L 100mm W 100mm hole ø 64mm		

 <p>1</p>			
GEV No.	109048	Ref. No.	12024476 R725052
description	gasket L 110mm W 110mm H 3.3mm hole ø 81mm graphite		
For models:	HGV-10-11, HMG-10-11, HMG-10-11UL, HMG-10-21, HMG-10-21UL, HMG-20-11, HMG-2-10-11, HVG-10-11, HVG-10-11UL, HVG-10-21, HVG-10-21UL, HVG-2-10-11, MFHVG-10-11, MFHVG-10-21, VG-101, VPG-101		

 <p>1</p>			
GEV No.	510125	Ref. No.	12021217 R725009
description	gasket L 62mm W 42mm H 3mm hole ø 24mm hole distance 49mm graphite oval for gas burner		
For models:	HCG-10-11, HCG-10-21, HCG-2-10-11, HCG-6-11, HMG-10-11, HMG-10-11UL, HMG-10-21, HMG-10-21UL, HMG-2-10-11, HMG-6-11		

 <p>1</p>			
GEV No.	105583	Ref. No.	12020725 T075015
description	gasket L 70mm W 70mm thickness 3.5mm hole ø 51mm graphite		
For models:	HMG-6-11		

 <p>1</p>			
GEV No.	510128	Ref. No.	12017015 R725011
description	gasket L 71mm W 46mm H 2mm hole ø 28mm hole distance 55mm rubber oval for gas burner		
For models:	HCG-10-11, HCG-10-21, HCG-20-11, HCG-2-10-11, HCG-6-11, HMG-10-11, HMG-10-11UL, HMG-10-21, HMG-10-21UL, HMG-20-11, HMG-2-10-11, HMG-6-11		

nozzle holders

 <p>1</p>			
GEV No.	109058	Ref. No.	12013850 12018677 R155012
description	nozzle holder nozzle M10x1 3/8" screw pipe fitting 3/8" with pipe tube ø 10mm		
For models:	FTG9-05L, FTG9-05R, FTGC9-05L, FTGC9-05R		

miscellaneous

 <p>1</p>			
GEV No.	109043	Ref. No.	12015347 T035472
description	bracket for burner L 480mm W 62mm H 20mm		
For models:	BG9-05, BG9-05I, BG9-10, BG9-10I		

 <p>1</p>			
GEV No.	104147	Ref. No.	12022614 T075708
description	flange ø 167mm thickness 1.6mm hole ø 9.6mm		
For models:	HCG-6-11, HMG-6-11		

gas nozzles

main nozzles

gas nozzles M6x0.75



GEV No.	106482	Ref. No.	12023498 Z956104
description	gas injector thread M6x0.75 WS 7 bore ø 1.1mm		
For models:	GA-20, GA-20D, GA-40, GA-40D, HGP-10-21, HGP-20-21, HGV-10-11, HGV-10-21, HGV-20-21, HVG-10-11, HVG-10-21, HVG-20-11, HVG-20-21, HVG-2-10-11, HVG-2-20-21, VG-101, VG-102, VG-201, VG-202, VPG-101, VPG-102, VPG-201, VPG-202		



GEV No.	109414	Ref. No.	12024100 Z956108
description	gas injector thread M6x0.75 WS 7 bore ø 2.25mm		
For models:	GA-20, GA-20D, GA-40, GA-40D		

gas nozzles M10x1



GEV No.	109410	Ref. No.	12008787 U322401
description	gas injector thread M10x1 WS 13 bore ø 0.8mm		
For models:	BMG9-05, BMG9-05V-T		



GEV No.	109415	Ref. No.	12008802 U122407
description	gas injector thread M10x1 WS 13 bore ø 1.05mm		
For models:	CG-1002, CG-1502, CG-2000, CG-2002, CG-2002P, CG-2005, CG-210, CG-210G, CG-300S, CG-310, CG-310G, CG7-20, CG-7200, CG7-30D, CG7-30I, CG7-31D, CG7-31I, CG7-40, CG-7400, CG7-41, CG-7415, CG7-50, CG7-51, CG7-60, CG7-61, CG-7615, CG9-05AD, CG9-05PLUS, CG9-20, CG9-20AD, CG9-20H, CG9-20PLUS, CG9-31PLUS-D, CG9-31PLUS-I, CG9-40, CG9-40AD, CG9-40H, CG9-40PLUS, CG9-41, CG9-41AD, CG9-41H, CG9-41PLUS, CG9-51L, CG9-51LC, CG9-51R, CG9-51RC, CG9-60, CG9-60AD, CG9-60H, CG9-60PLUS...(Other models you can see in the webshop)		



GEV No.	109416	Ref. No.	12008800 X312400
description	gas injector thread M10x1 WS 13 bore ø 1.1mm		
For models:	CG-1502, CG6-41, CG7-20, CG7-30D, CG7-30I, CG7-31D, CG7-31I, CG7-40, CG7-41, CG7-50, CG7-51, CG7-60, CG7-61, CG9-20, CG9-20H, CG9-40, CG9-40H, CG9-41, CG9-41H, CG9-51L, CG9-51LC, CG9-51R, CG9-51RC, CG9-60, CG9-60H, CG9-61, CG9-61H, CG9-61OP, CG9-82, CGB7-61, CGB7-61R, CGE7-41, CGE9-41, CGF9-120D, CGF9-120I, CGF9-121D, CGF9-121I, CGP9-10, CGP9-11, CPG7-05, CPG7-05NC, FG7-05-1C, FG7-05-2C, FG-710, FG7-10-2C, FG7-104C, FG7-10-4C, FG-720, GPC-350		



GEV No.	109419	Ref. No.	12008939 12039112 R422400 X162403
description	gas injector thread M10x1 WS 13 bore ø 1.25mm		
For models:	BMG7-10, BMG9-10, BMG9-10V-T, CG-200S, CG-210, CG-210G, CG-300S, CG-310, CG-310G, CG7-11, CG7-20H, CG7-30D, CG7-30I, CG7-31D, CG7-31I, CG7-40, CG7-40H, CG7-41, CG7-41H, CG7-50, CG7-51, CG7-60, CG7-60H, CG7-61, CG7-61H, CGB7-61, CGB7-61H, CGB7-61R, CGB7-61RH, CGE7-104, CGE7-41, CGE7-41H, FG9-05, FG9-05-1C, FG9-05-2C, FG9-05AD, FG9-05PLUS, FG9-05PLUS-S, FG9-05S, FG9-05S-1C, FG9-05S-2C, FG9-05S-AD, FG9-10, FG9-10-2C, FG9-10-4C, FG9-10AD, FG9-10PLUS, FTG7-05, FTG7-05L, FTG7-05R...(Other models you can see in the webshop)		





GEV No.	109418	Ref. No.	12008806 9271300
description	gas injector thread M10x1 WS 13 bore ø 1.2mm		
For models:	BMG9-05, BMG9-05V-T, CG-7415, CG-7615, FG-710, FG-720, FTE7-05, FTE7-10, FTG7-05, FTG7-10, FTGC7-05L, FTGC7-10L		





GEV No.	109421	Ref. No.	12008809 12019845 12020928 R612400 X162400
description	gas injector thread M10x1 WS 13 bore ø 1.35mm		
For models:	BG7-05, BG7-05I, BG7-10, BG7-10I, CG7-31D, CG7-31I, CG7-41, CG7-41H, CG7-51, CG7-61, CG7-61H, CGB7-61, CGB7-61H, CGB7-61R, CGB7-61RH, CGP9-11, FG6-05, FG6-10, FG-920, FG-940, FTG6-10VL, FTG6-10VL+R, FTG6-10VR, FTGC6-10L, FTGC6-10L+R, SBG9-10I-AD, SBG9-10I-AD-S, SBG9-10IIM-AD, SBG9-10IIM-AD-S, SBG9-15IM-AD, SBG9-15IM-AD-S		





			
1			
GEV No.	109420	Ref. No.	12008770 U052402
description	gas injector thread M10x1 WS 13 bore ø 1.3mm		
For models:	BG6-05I, BMG-9045, CG-200S, CG-210, CG-210G, CG-300S, CG-310, CG-310G, CG-7200, CG-7400, CG-7415, CG-7615, FTG-7050L, FTG-7050R, FTG7-05L, FTG7-05R, FTG7-05VL, FTG7-05VR, FTG-7100L, FTG-7100L+R, FTG-7100R, FTG7-10L, FTG7-10L+R, FTG7-10R, FTG7-10VL, FTG7-10VL+R, FTG7-10VR, FTGC7-05L, FTGC7-10L, SBG7-10		

			
1			
GEV No.	109424	Ref. No.	12009579 9105100
description	gas injector thread M10x1 WS 13 bore ø 1.5mm		
For models:	CG-1002, CG-1502, CG-2000, CG-2002, CG-2002P, CG-200S, CG-210, CG-210G, CG-300S, CG-310, CG-310G, CG7-20, CG7-40, CG7-41, CG7-61, CG9-11, CG9-20, CG9-40, CG9-41, CG9-51L, CG9-51C, CG9-51R, CG9-51RC, CG9-60, CG9-61, CG9-82, CGB7-61, CGE7-111, CGE7-41, CGE9-41, CGF9-120D, CGF9-120I, CGF9-121D, CGF9-121I, CG-HP-20, CGP9-10, CGP9-11, FI-5420, FI-7630, FTG9-05L, FTG9-05L-AD, FTG9-05LV-AD, FTG9-05PLUS-CL, FTG9-05PLUS-CR, FTG9-05PLUS-L, FTG9-05PLUS-LV, FTG9-05PLUS-R, FTG9-05PLUS-RV, FTG9-05R, FTG9-05R-AD...(Other models you can see in the webshop)		

			
1			
GEV No.	109423	Ref. No.	12008796 U052401
description	gas injector thread M10x1 WS 13 bore ø 1.45mm		
For models:	CG7-10, CG7-11, CG-7115, CG9-11, CG9-11AD, CG9-11PLUS, CG9-20H, CG9-31PLUS-D, CG9-31PLUS-I, CG9-40H, CG9-41, CG9-41AD, CG9-41AD-H, CG9-41H, CG9-41PLUS, CG9-41PLUS-H, CG9-51L, CG9-51LC, CG9-51R, CG9-51RC, CG9-60H, CG9-61, CG9-61AD, CG9-61AD-H, CG9-61H, CG9-61PLUS, CG9-61PLUS-H, CG9-82, CG9-82AD, CG9-82PLUS, CGF9-121D, CGF9-121D-AD, CGF9-121I, CGF9-121I-AD, CGF9-121PLUS-D, CGF9-121PLUS-I, CPG9-05, CPG9-05AD, CPG9-05AD-S, CPG9-05NC, CPG9-05PLUS, CPG9-05PLUS-S, CPG9-05S, CPG9-05SNC, FTG6-05VL, FTG6-05VR, FTG9-05L, FTG9-05PLUS-CL, FTG9-05PLUS-CR, FTG9-05PLUS-L...(Other models you can see in the webshop)		

			
1			
GEV No.	109427	Ref. No.	12008793 R302400
description	gas injector thread M10x1 WS 13 bore ø 1.65mm		
For models:	BG9-05, BG9-05AD, BG9-05I, BG9-05PF, BG9-05PI, BG9-05PLUS-I, BG9-10, BG9-10AD, BG9-10I, BG9-10PF, BG9-10PI, BG9-10PLUS-I, CG7-20, CG7-30D, CG7-30I, CG7-31D, CG7-31I, CG7-40, CG7-41, CG7-50, CG7-51, CG7-60, CG7-61, CG9-05AD, CG9-05PLUS, CG9-10, CG9-10AD, CG9-10PLUS, CG9-11, CG9-11AD, CG9-11PLUS, CG9-20, CG9-20AD, CG9-20H, CG9-20PLUS, CG9-31PLUS-D, CG9-31PLUS-I, CG9-40, CG9-40AD, CG9-40H, CG9-40PLUS, CG9-41, CG9-41AD, CG9-41H, CG9-41PLUS, CG9-51L, CG9-51LC, CG9-51R, CG9-51RC, CG9-60...(Other models you can see in the webshop)		

			
1			
GEV No.	109422	Ref. No.	12008805 631000 631000000 9631000 O631000
description	gas injector thread M10x1 WS 13 bore ø 1.4mm		
For models:	BG7-05, BG7-05I, BG7-10, BG7-10I, CG-1002, CG-1502, CG-2002, CG-2002P, CG9-20, CG9-20H, CG9-31PLUS-D, CG9-31PLUS-I, CG9-40, CG9-40H, CG9-41, CG9-41H, CG9-51L, CG9-51LC, CG9-51R, CG9-51RC, CG9-60, CG9-60H, CG9-61, CG9-61H, CG9-61OP, CG9-82, CGE9-41, CGF9-120D, CGF9-120I, CGF9-121D, CGF9-121I, HG9-15		

			
1			
GEV No.	109426	Ref. No.	12017204 X102401
description	gas injector thread M10x1 WS 13 bore ø 1.6mm		
For models:	CG-2000-2P, FGCL9-05, FTG-9050L, FTG-9050R, FTG9-05L, FTG9-05R, FTG-9100L, FTG-9100L+R, FTG-9100R, FTG9-10L, FTG9-10L+R, FTG9-10R, FTGC9-05, FTGC-9050, FTGC9-10, FTGC-9100		

			
1			
GEV No.	109425	Ref. No.	12008797 U112401
description	gas injector thread M10x1 WS 13 bore ø 1.55mm		
For models:	BG9-05, BG9-05I, BG9-10, BG9-10I, CG-1002, CG-1502, CG-2002, CG-2002P, CG-200S, CG-210, CG-210G, CG-300S, CG-310, CG-310G, CG-7200, CG-7400, CG-7415, CG-7615, CG9-20AD-H, CG9-20H, CG9-20PLUS-H, CG9-40, CG9-40AD, CG9-40AD-H, CG9-40H, CG9-40PLUS, CG9-40PLUS-H, CG9-41, CG9-41AD, CG9-41AD-H, CG9-41H, CG9-41PLUS, CG9-41PLUS-H, CG9-51L, CG9-51LC, CG9-51R, CG9-51RC, CG9-60, CG9-60AD, CG9-60AD-H, CG9-60H, CG9-60PLUS, CG9-60PLUS-H, CG9-61, CG9-61AD, CG9-61AD-H, CG9-61H, CG9-61OP, CG9-61PLUS, CG9-61PLUS-H...(Other models you can see in the webshop)		

			
1			
GEV No.	109428	Ref. No.	12024249 N502401
description	gas injector thread M10x1 WS 13 bore ø 1.7mm		
For models:	CG-1002, CG-1502, CG-2000, CG-2000-2P, CG-2002, CG-2002P, CG-210, CG-210G, CG-310, CG-310G, CG6-41, CG9-10, CG9-11, CG9-51L, CG9-51C, CG9-51R, CG9-51RC, CGP9-10, CGP9-11, CPG7-05, CPG7-05NC, FG7-05-1C, FG7-05-2C, FG-710, FG7-10-2C, FG7-104C, FG7-10-4C, FG-720, FI-5420, FI-7630, FTG9-05L, FTG9-05R, FTG9-05VL, FTG9-05VR, FTG9-10L, FTG9-10L+R, FTG9-10R, FTG9-10VL, FTG9-10VL+R, FTG9-10VR, FTGC9-05L, FTGC9-05R, FTGC9-10L, FTGC9-10L+R, FTGC9-10R, GPC-350, MG9-15, MG9-15AD, MG9-15BM, MG9-15BM316...(Other models you can see in the webshop)		



			
1			
GEV No.	109409	Ref. No.	12008799 U054401
description	gas injector thread M10x1 WS 13 bore ø 2.8mm		
For models:	FI-5420, FI-7630, HP-G-15, HPG-15		

			
1			
GEV No.	109417	Ref. No.	12017458 U122408
description	gas injector thread M10x1 WS 13 bore ø 2.95mm		
For models:	CG-200S, CG-210, CG-210G, CG-300S, CG-310, CG-310G, CG-7200, CG-7400, CG-7415, CG-7615, CG9-51L, CG9-51LC, CG9-51R, CG9-51RC, CG-HP-20, FI-5420, FI-7630, FTG9-05L, FTG9-05R, FTG9-05VL, FTG9-05VR, FTG9-10L, FTG9-10L+R, FTG9-10R, FTG9-10VL, FTG9-10VL+R, FTG9-10VR, FTGC9-05L, FTGC9-05R, FTGC9-10L, FTGC9-10L+R, FTGC9-10R		

			
1			
GEV No.	109404	Ref. No.	12008801 R302401
description	gas injector thread M10x1 WS 13 bore ø 2.9mm		
For models:	CG-1002, CG-1502, CG-2000, CG-2002, CG-2002P, CG-200S, CG-210, CG-210G, CG-300S, CG-310, CG-310G, CG7-20, CG7-40, CG7-41, CG7-61, CG9-20, CG9-40, CG9-41, CG9-51L, CG9-51LC, CG9-51R, CG9-51RC, CG9-60, CG9-61, CG9-82, CGB7-61, CGE7-112, CGE7-41, CGE9-41, CGF9-120D, CGF9-120I, CGF9-121D, CGF9-121I, FGCL9-05-1C, FGCL9-05-2C, FGCL9-05S-1C, FGCL9-05S-2C		

			
1			
GEV No.	109434	Ref. No.	12008812 R614500
description	gas injector thread M10x1 WS 13 bore ø 2mm		
For models:	BMG-9045, CG-1002, CG-1502, CG-2000, CG-2000-2P, CG-2002, CG-2002P, CG-200S, CG-210, CG-210G, CG-300S, CG-310, CG-310G, CG-7200, CG-7400, CG-7415, CG-7615, CG9-20, CG9-40, CG9-41, CG9-51L, CG9-51LC, CG9-51R, CG9-51RC, CG9-60, CG9-61, CG9-82, CGB7-61, CGE9-41, CGF9-120D, CGF9-120I, CGF9-121D, CGF9-121I, FG-91-20, FG-92-40, SBG9-10I-AD, SBG9-15IM-AD, SBG9-15IM-AD-S		

			
1			
GEV No.	109405	Ref. No.	12008717 U742400
description	gas injector thread M10x1 WS 13 bore ø 3.6mm		
For models:	CG-200S, CG-210, CG-210G, CG-300S, CG-310, CG-310G, CG7-40, CG7-41, CG7-61, CGB7-61, CGE7-106, CGE7-41		

			
1			
GEV No.	109403	Ref. No.	12008719 R642400
description	gas injector thread M10x1 WS 13 bore ø 3.7mm		
For models:	FG9-05, FG9-05-1C, FG9-05-2C, FG9-05S, FG9-05S-1C, FG9-05S-2C, FG9-10, FG9-10-2C, FG9-10-4C, FG-920, FG-940, FTG-7050L, FTG-7050R, FTG-7100L, FTG-7100L+R, FTG-7100R		

			
1			
GEV No.	109400	Ref. No.	12040563 9483100
description	gas injector thread M10x1 WS 13 bore ø 3mm		
For models:	FG-710, FG-720, HPG-35		

			
1			
GEV No.	109401	Ref. No.	12008774 U262401
description	gas injector thread M10x1 WS 13 bore ø 4.1mm		
For models:	CG-1002, CG-1502, CG-2000, CG-2000-2P, CG-2002, CG-2002P, CG7-10, CG7-11, CG9-20, CG9-40, CG9-41, CG9-51L, CG9-51LC, CG9-51R, CG9-51RC, CG9-60, CG9-61, CG9-82, CGE9-41, CGF9-120D, CGF9-120I, CGF9-121D, CGF9-121I		

			
1			
GEV No.	109402	Ref. No.	12008764 942460
description	gas injector thread M10x1 WS 13 bore ø 4.25mm		
For models:	FE-91-20, FG-91-20, FG-92-40, FGCL9-05-1C, FGCL9-05-2C, FGCL9-05S-1C, FGCL9-05S-2C		

			
1			
GEV No.	109412	Ref. No.	12008718 X102403
description	gas injector thread M10x1 WS 13 bore ø 4.55mm		
For models:	CG9-10, CG9-11, CGF9-120D, CGF9-120I, CGF9-121D, CGF9-121I, CPG9-05, CPG9-05NC, CPG9-05S, CPG9-05SNC, FTG9-05L, FTG9-05R, FTG9-05VL, FTG9-05VR, FTG9-10L, FTG9-10L+R, FTG9-10R, FTG9-10VL, FTG9-10VL+R, FTG9-10VR, FTG9-11L, FTG9-11L+R, FTG9-11R, FTGC9-05L, FTGC9-05R, FTGC9-10L, FTGC9-10L+R, FTGC9-10R, FTGC9-11L, FTGC9-11L+R, FTGC9-11R, SBG7-10, SBG9-10, SBG9-10I, SBG9-10IM, SBG9-10IMS, SBG9-10IS, SBG9-10M, SBG9-10MS, SBG9-10S, SBG9-15IM, SBG9-15IMS		



1

GEV No.	109407	Ref. No.	12008763 U192402
description	gas injector thread M10x1 WS 13 bore ø 4.9mm		
For models:	BMG7-10, BMG9-10, BMG9-10V-T, CG-1002, CG-110, CG-1502, CG-2002, CG-2002P, CG-9110, CG9-40, CG9-41, CG9-51L, CG9-51LC, CG9-51R, CG9-51RC, CG9-60, CG9-61, CG9-82, CGE9-41		



1

GEV No.	109408	Ref. No.	12017462 R792400
description	gas injector thread M10x1 WS 13 bore ø 4mm		
For models:	BG7-05, BG7-05I, BG7-10, BG7-10I, FTG7-05, FTG7-05L, FTG7-05R, FTG7-10, FTG7-10L, FTG7-10L+R, FTG7-10R, FTGC7-05L, FTGC7-10L		



1

GEV No.	109406	Ref. No.	12008818 942450
description	gas injector thread M10x1 WS 13 bore ø 5.35mm		
For models:	BG9-05PF, BG9-05PI, BG9-10PF, BG9-10PI, CG-1002, CG-1502, CG-2002, CG-2002P		

gas nozzles M14x1



1

GEV No.	109450	Ref. No.	12021078 S312400
description	gas injector thread M14x1 WS 17 bore ø 2.05mm		
For models:	MG7-10, MG7-10BM		



1

GEV No.	109452	Ref. No.	12021165 S012400
description	gas injector thread M14x1 WS 17 bore ø 2.2mm		
For models:	MG9-10, MG9-10BM, MG9-10BMS, MG9-10S, MPG9-10, MPG9-10BM, MPG9-10BMS, MPG9-10S		



1

GEV No.	109455	Ref. No.	12021170 S032400
description	gas injector thread M14x1 WS 17 bore ø 2.45mm		
For models:	MG9-15, MG9-15BM, MG9-15BM316, MG9-15BMS, MG9-15S, MPG9-15, MPG9-15BM, MPG9-15BMS, MPG9-15S		



1

GEV No.	109457	Ref. No.	12021195 S172400
description	gas injector thread M14x1 WS 17 bore ø 2.55mm		
For models:	MG9-20, MG-9200, MG9-20S, MPG9-20, MPG-9200, MPG9-20S		



1

GEV No.	109462	Ref. No.	12021077 S312401
description	gas injector thread M14x1 WS 17 bore ø 3.05mm		
For models:	MG7-10, MG7-10BM		



1

GEV No.	109463	Ref. No.	12021206 S012401
description	gas injector thread M14x1 WS 17 bore ø 3.1mm		
For models:	MG9-10, MG9-10BM, MG9-10BMS, MG9-10S, MPG9-10, MPG9-10BM, MPG9-10BMS, MPG9-10S		



1

GEV No.	109465	Ref. No.	12021203 S114401
description	gas injector thread M14x1 WS 17 bore ø 3.65mm		
For models:	MG-9100, MG9-15, MG9-15BM, MG9-15BM316, MG9-15BMS, MG9-15S, MPG9-15, MPG9-15BM, MPG9-15BMS, MPG9-15S		





 <p>1</p>			
GEV No.	109468	Ref. No.	12021216 S114400
description	gas injector thread M14x1 WS 17 bore ø 3.8mm		
For models:	MG-9150, MG-9150BM, MG9-20, MG9-20S, MPG-9150, MPG9-20, MPG9-20S		

 <p>1</p>			
GEV No.	109470	Ref. No.	12040503 S172401
description	gas injector thread M14x1 WS 17 bore ø 3.9mm		
For models:	MG9-20, MG-9200, MG9-20S, MPG9-20, MPG-9200, MPG9-20S		

gas nozzles (other)

 <p>1</p>			
GEV No.	109475	Ref. No.	12039797 T075020
description	gas injector bore ø 1.65mm		
For models:	HCG-6-11, HMG-6-11		

 <p>1</p>			
GEV No.	109477	Ref. No.	12021221 R725066
description	gas injector bore ø 2.2mm		
For models:	HCG-10-11, HCG-6-11, HMG-10-11		

 <p>1</p>			
GEV No.	109497	Ref. No.	12021006 R725084
description	gas injector bore ø 2.2mm		
For models:	HMG-10-11UL		

 <p>1</p>			
GEV No.	109480	Ref. No.	12019416 R735010
description	gas injector bore ø 2.5mm		
For models:	HCG-10-21, HCG-2-10-11, HCG-6-11, HMG-10-21, HMG-2-10-11, HMG-6-11		

 <p>1</p>			
GEV No.	109485	Ref. No.	12019726 T095012
description	gas injector bore ø 2.85mm		
For models:	HCG-20-11, HMG-20-11		

 <p>1</p>			
GEV No.	109492	Ref. No.	12021231 R735009
description	gas injector bore ø 3.5mm		
For models:	HCG-10-21, HCG-2-10-11, HMG-10-21, HMG-2-10-11		

 <p>1</p>			
GEV No.	109488	Ref. No.	12021232 R725067
description	gas injector bore ø 3mm		
For models:	HCG-10-11, HMG-10-11, HMG-6-11		

 <p>1</p>			
GEV No.	109496	Ref. No.	12021233 T095013
description	gas injector bore ø 4.5mm		
For models:	HCG-20-11, HMG-20-11		



pilot burner nozzles

pilot burner nozzles SIT

100 series



GEV No.	100245	Ref. No.	12021187 U442138
description	pilot burner nozzle LPG code 20 bore \varnothing 0.2mm Qty 1 pcs thread M8x0.75		
For models:	BG7-05, BG7-05I, BG7-10I, BG9-05, BG9-05I, BG9-10, BG9-10I, BMG7-10, BMG9-05, BMG9-10, CG-1002, CG-1502, CG-2002, CG-200S, CG-210, CG-210G, CG-300S, CG-310, CG-310G, CG7-10, CG7-11, CG7-20, CG7-40, CG7-41, CG7-61, CG9-10, CG9-11, CG9-20, CG9-40, CG9-41, CG9-51L, CG9-51LC, CG9-51R, CG9-51RC, CG9-60, CG9-61, CG9-82, CGB7-61, CGE7-41, CGE9-41, CGF9-120D, CGF9-120I, CGF9-121D, CGF9-121I, CPG9-11, CPG7-05, CPG9-05, CPG9-05NC, CPG9-05S... (Other models you can see in the webshop)		



GEV No.	102972	Ref. No.	12008938 U442137
description	pilot burner nozzle natural gas code 40 bore \varnothing 0.4mm Qty 1 pcs		
For models:	BG6-05I, BG7-05, BG7-05I, BG7-10, BG7-10I, BG9-05, BG9-05AD, BG9-05I, BG9-05PF, BG9-05PI, BG9-05PLUS-I, BG9-10, BG9-10AD, BG9-10I, BG9-10PF, BG9-10PI, BG9-10PLUS-I, BMG7-10, BMG9-05, BMG9-05V-T, BMG9-10, BMG9-10V-T, CG-1002, CG-1502, CG-2002, CG-2002P, CG-200S, CG-210, CG-210G, CG-300S, CG-310, CG-310G, CG7-10, CG7-11, CG7-20, CG7-20H, CG7-30D, CG7-30I, CG7-31D, CG7-31I, CG7-40, CG7-40H, CG7-41, CG7-41H, CG7-50, CG7-51, CG7-60, CG7-60H, CG7-61, CG7-61H... (Other models you can see in the webshop)		

pilot burner nozzles (other)

FAGOR



GEV No.	109471	Ref. No.	12021092 U122401
description	pilot burner nozzle bore \varnothing 0.2mm thread M10x1 WS 12		
For models:	CG-HP-20, FI-5420, FI-7630		

bypass nozzles

bypass nozzles COPRECI



GEV No.	109195	Ref. No.	12016681 U022113
description	bypass nozzle type COPRECI bore \varnothing 1.3mm thread M8x0.75 WS 11		
For models:	CG9-40, CG9-41, CG9-51L, CG9-51LC, CG9-51R, CG9-51RC, CG9-60, CG9-61, CG9-82, CGE9-41		

GAS NOZZLES/AUXILIARY GAS PARTS FAGOR



GEV No.	109413	Ref. No.	12016664 U022111
description	bypass nozzle type COPRECI CAL-3200 bore \varnothing 0.9mm thread M8x0.75 WS 11		
For models:	CG9-20, CG9-40, CG9-41, CG9-51L, CG9-51LC, CG9-51R, CG9-51RC, CG9-60, CG9-61, CG9-82, CGE9-41, CGF9-120D, CGF9-120I, CGF9-121D, CGF9-121I		

auxiliary gas parts

screw connections



end caps



GEV No.	106342	Ref. No.	12008078 U635008
description	blind screw connection L 18mm thread M26x1.5 WS 30 brass		
For models:	BG7-05, BG7-05I, BG7-10, BG7-10I, BG9-05, BG9-05AD, BG9-05I, BG9-05PF, BG9-05PI, BG9-05PLUS-I, BG9-10, BG9-10AD, BG9-10I, BG9-10PF, BG9-10PI, BG9-10PLUS-I, BMG7-10, BMG9-05, BMG9-05V-T, BMG9-10, BMG9-10V-T, CG-210, CG-210G, CG7-10, CG7-20, CG7-20H, CG7-30D, CG7-30I, CG7-40, CG7-40H, CG7-50, CG7-60, CG7-60H, CG9-05AD, CG9-05PLUS, CG9-10, CG9-10AD, CG9-10PLUS, CG9-20, CG9-40, CG9-60, CGB7-61, CGE7-41, CGE7-41H, CGF9-120D, CGF9-120D-AD, CGF9-120I, CGF9-120I-AD, CGF9-120PLUS-D, CGF9-120PLUS-I... (Other models you can see in the webshop)		



olives







GEV No.	101273	Ref. No.	12008501 U055043	
description	olive for pipe \varnothing 12mm L 9.5mm brass Qty 1 pcs suitable for universal			
For models:	BG7-05, BG7-05I, BG7-10, BG7-10I, BG9-05, BG9-05I, BG9-10, BG9-10I, CG-1002, CG-1502, CG-2000, CG-2000-2P, CG-2002, CG-2002P, CG-200S, CG-210, CG-210G, CG-300S, CG-310, CG-310G, CG7-10, CG7-11, CG-7115, CG7-20, CG-7200, CG7-40, CG-7400, CG7-41, CG-7415, CG7-61, CG-7615, CG9-10, CG9-11, CG9-20, CG9-40, CG9-41, CG9-51L, CG9-51LC, CG9-51R, CG9-51RC, CG9-60, CG9-61, CG9-82, CGB7-61, CGE7-138, CGE7-41, CGE9-41, CPG7-05, CPG9-05, CPG9-05NC... (Other models you can see in the webshop)			
accessories for	101273			
	GEV No.	100944	Ref. No.	12007951 Q221336
	union nut thread M18x1.5 for pipe \varnothing 12mm			
	GEV No.	101276	Ref. No.	12008081 U264310
	union screw thread 3/8" tube \varnothing 12mm Qty 1 pcs			





			
1			
GEV No.	101000	Ref. No.	12008775 S312106
description	olive for pipe ø 16mm L 10.5mm brass Qty 1 pcs		
For models:	ACG-102, ACG-201, ACG-202, AG-061, AG-061W, AG-101, AG-101W, AG-102, AG-102W, AG-201, AG-202, APG-061, APG-061W, APG-101, APG-101W, APG-102, APG-102W, APG-201, APG-202, MG7-10, MG7-10BM, MG9-10, MG9-10BM, MG9-10BMS, MG9-10S, MG9-15, MG9-15BM, MG9-15BM316, MG9-15BMS, MG9-15S, MG9-20, MG9-20S, MPG9-10, MPG9-10BM, MPG9-10BMS, MPG9-10S, MPG9-15, MPG9-15BM, MPG9-15BMS, MPG9-15S, MPG9-20, MPG9-20S		

			
1			
GEV No.	101256	Ref. No.	12008773
description	olive for pipe ø 16mm Qty 1 pcs		
For models:	MG9-10AD, MG9-10BMAD, MG9-10BMSAD, MG9-10PLUS, MG9-10PLUS-BM, MG9-10PLUS-BMS, MG9-10PLUS-S, MG9-10S-AD, MG9-15AD, MG9-15BMAD, MG9-15BMSAD, MG9-15PLUS, MG9-15PLUS-BM, MG9-15PLUS-BMS, MG9-15PLUS-S, MG9-15S-AD, MG9-20AD, MG9-20PLUS, MG9-20PLUS-S, MG9-20S-AD, SBG7-10, SBG9-10, SBG9-10I, SBG9-10I-AD, SBG9-10I-AD-S, SBG9-10IM, SBG9-10IM-AD, SBG9-10IM-AD-S, SBG9-10IMS, SBG9-10IS, SBG9-10M, SBG9-10MS, SBG9-10PLUS-I, SBG9-10PLUS-IM, SBG9-10PLUS-SI, SBG9-10PLUS-SIM, SBG9-10S, SBG9-15IM, SBG9-15IM-AD, SBG9-15IM-AD-S, SBG9-15IMS, SBG9-15PLUS-IM, SBG9-15PLUS-SIM		
accessories for	101256		
	GEV No.	101253	Ref. No. 12008865 S312105
union nut thread M24x1.5 PEL for pipe ø 16mm			

			
1			
GEV No.	101274	Ref. No.	X012105
description	olive for pipe ø 16mm Qty 1 pcs		
For models:	FG-710, FG-71-15, FG-720, FG-72-30, FG9-05, FG9-05S, FG9-10, FG-91-20, FG-920, FG-92-40, FG-940, SBG7-10, SBG9-10, SBG9-10I, SBG9-10IM, SBG9-10IMS, SBG9-10IS, SBG9-10M, SBG9-10MS, SBG9-10S, SBG9-15IM, SBG9-15IMS		
accessories for	101274		
	GEV No.	101275	Ref. No. 12008951 X012104
union screw thread 1/2" for pipe ø 16mm Qty 1 pcs			

			
1			
GEV No.	101257	Ref. No.	12008828 S312104
description	olive for pipe ø 20mm Qty 1 pcs		
For models:	MG7-10, MG7-10BM, MG9-10, MG9-10BM, MG9-10BMS, MG9-10S, MG9-15, MG9-15BM, MG9-15BM316, MG9-15BMS, MG9-15S, MG9-20, MG9-20S, MPG9-10, MPG9-10BM, MPG9-10BMS, MPG9-10S, MPG9-15, MPG9-15BM, MPG9-15BMS, MPG9-15S, MPG9-20, MPG9-20S		
accessories for	101257		
	GEV No.	101254	Ref. No. 12008921 S312103
union nut thread M28x1.5 tube ø 20mm			

			
1			
GEV No.	101246	Ref. No.	12018994 U265026
description	olive for pipe ø 4mm Qty 1 pcs		
For models:	BG7-05, BG7-05I, BG7-10, BG7-10I, BG9-05, BG9-05I, BG9-10, BG9-10I, CG-1002, CG-1502, CG-2000, CG-2000-2P, CG-2002, CG-200S, CG-210, CG-210G, CG-300S, CG-310, CG-310G, CG7-20, CG-7200, CG7-40, CG-7400, CG7-41, CG-7415, CG7-61, CG-7615, CG9-20, CG9-40, CG9-41, CG9-51L, CG9-51LC, CG9-51R, CG9-51RC, CG9-60, CG9-61, CG9-82, CGB7-61, CGE7-136, CGE7-41, CGE9-41, CGF9-120D, CGF9-120I, CGF9-121D, CGF9-121I, HMG-10-11UL, HMG-10-21UL		
accessories for	101246		
	GEV No.	100908	Ref. No. 12017481 T052101
union screw thread M10x1 for pipe ø 4mm Qty 1 pcs			

			
1			
GEV No.	101879	Ref. No.	12019962 U135023
description	olive for pipe ø 5mm Qty 1 pcs		
For models:	CG-210, CG-210G, CG-310, CG-310G, CG-HP-20, FI-5420, FI-7630, HPG-15, HPG-35		

			
1			
GEV No.	101286	Ref. No.	12008476 S312108000 X205028
description	olive ID ø 6mm Qty 1 pcs		
For models:	BMG7-10, BMG-9045, BMG9-05, BMG9-05V-T, BMG9-10, BMG9-10V-T, CG-1002, CG-1502, CG-2000, CG-2000-2P, CG-2002, CG-2002P, CG-200S, CG-210, CG-210G, CG-300S, CG-310, CG-310G, CG6-41, CG7-10, CG7-11, CG-7115, CG7-41, CG-7415, CG7-61, CG-7615, CG9-05AD, CG9-05PLUS, CG9-10, CG9-10AD, CG9-10PLUS, CG9-11, CG-9110, CG9-11AD, CG9-11PLUS, CG9-20AD, CG9-20AD-H, CG9-20PLUS, CG9-20PLUS-H, CG9-31PLUS-D, CG9-31PLUS-I, CG9-40AD, CG9-40AD-H, CG9-40PLUS, CG9-40PLUS-H, CG9-41, CG9-41AD, CG9-41AD-H, CG9-41PLUS, CG9-41PLUS-H...(Other models you can see in the webshop)		
accessories for	101286		
	GEV No.	100909	Ref. No. 12008740 12016658 S312107 U265703
union screw thread M10x1 for pipe ø 6mm Qty 1 pcs			
	GEV No.	101464	Ref. No. —
union nut thread M12x1 for pipe ø 6mm			



miscellaneous



1

GEV No.	104628	Ref. No.	12008165
description	bush thread 3/4" tube ø 17mm for ignition gas pipe WS 30 L 30mm metal Qty 1 pcs		
For models:	MG9-10, MG9-10BM, MG9-10BMS, MG9-10S, MG9-15, MG9-15BM, MG9-15BM316, MG9-15BMS, MG9-15S, MG9-20, MG9-20S, MPG9-10, MPG9-10BM, MPG9-10BMS, MPG9-10S, MPG9-15, MPG9-15BM, MPG9-15BMS, MPG9-15S, MPG9-20, MPG9-20S, PL-105C, PL-105L, PL-110C, PL-110L, PL-110L+R, PL-110R, SBE9-10, SBE9-10I, SBE9-10IM, SBE9-10IMS, SBE9-10IS, SBE9-10M, SBE9-10MS, SBE9-10S, SBE9-15IM, SBE9-15IMS, SBE9-15M, SBE9-15MS, SBG9-10, SBG9-10I, SBG9-10IM, SBG9-10IMS, SBG9-10IS, SBG9-10M, SBG9-10MS, SBG9-10S, SBG9-15IM, SBG9-15IMS		

union nuts



1

GEV No.	103035	Ref. No.	12007903 Q221334
description	union nut thread 1/2" WS 24 for pipe ø 12mm		
For models:	CG-1002, CG-1502, CG-2002, CG-2002P, CG9-11, CG9-41, CG9-51L, CG9-51LC, CG9-51R, CG9-51RC, CG9-61, CG9-82, FI-5420, FI-7630, FTG9-11L, FTG9-11L+R, FTG9-11R, FTGC9-11L, FTGC9-11L+R, FTGC9-11R, HG9-10, HG9-20, HGP-10-21, HGV-10-11, HGV-10-21, HGV-20-11, HVG-10-11, HVG-10-11UL, HVG-10-21, HVG-10-21UL, HVG-20-11, HVG-20-21, HVG-2-10-11, HVG-2-20-21, MFHVG-10-11, MFHVG-10-21, VG-101, VG-102, VG-201, VG-202, VPG-101, VPG-102, VPG-201, VPG-202		



1

GEV No.	100944	Ref. No.	12007951 Q221336	
description	union nut thread M18x1.5 for pipe ø 12mm			
For models:	BG7-05, BG7-05I, BG7-10, BG7-10I, BG9-05, BG9-05I, BG9-10, BG9-10I, CG-1002, CG-1502, CG-2000, CG-2000-2P, CG-2002, CG-2002P, CG-2005, CG-210, CG-210G, CG-300S, CG-310, CG-310G, CG7-10, CG7-11, CG-7115, CG7-20, CG-7200, CG7-40, CG-7400, CG7-41, CG-7415, CG7-61, CG-7615, CG9-10, CG9-11, CG9-20, CG9-40, CG9-41, CG9-51L, CG9-51LC, CG9-51R, CG9-51RC, CG9-60, CG9-61, CG9-82, CGB7-61, CGE7-139, CGE7-41, CGE9-41, CPG7-05, CPG9-05, CPG9-05NC...(Other models you can see in the webshop)			
accessories for	100944			
	GEV No.	101273	Ref. No.	12008501 U055043
olive for pipe ø 12mm L 9.5mm brass Qty 1 pcs suitable for universal				

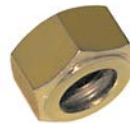

1

GEV No.	101253	Ref. No.	12008865 S312105	
description	union nut thread M24x1.5 PEL for pipe ø 16mm			
For models:	MG7-10, MG7-10BM, MG9-10, MG9-10BM, MG9-10BMS, MG9-10S, MG9-15, MG9-15BM, MG9-15BM316, MG9-15BMS, MG9-15S, MG9-20, MG9-20S, MPG9-10, MPG9-10BM, MPG9-10BMS, MPG9-10S, MPG9-15, MPG9-15BM, MPG9-15BMS, MPG9-15S, MPG9-20, MPG9-20S			
accessories for	101253			
	GEV No.	101256	Ref. No.	12008773
olive for pipe ø 16mm Qty 1 pcs				

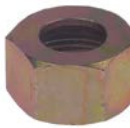

1

GEV No.	106331	Ref. No.	12008085 U725006
description	union nut thread M26x1.5 WS 30 L 17.5mm brass for pipe ø 17mm		
For models:	ACG-102, ACG-201, ACG-202, AG-061, AG-101, AG-102, AG-201, AG-202, APG-061, APG-101, APG-102, APG-201, APG-202, BG7-05, BG7-10, BG9-05, BG9-10, BMG7-10, BMG9-05, BMG9-10, CG-1002, CG-1502, CG-2002, CG7-10, CG7-11, CG7-20, CG7-40, CG7-41, CG7-61, CG9-10, CG9-11, CG9-20, CG9-40, CG9-41, CG9-51L, CG9-51LC, CG9-51R, CG9-51RC, CG9-60, CG9-61, CG9-82, CGB7-61, CGE7-123, CGE7-41, CGE9-41, CPG9-11, CPG7-05, CPG9-05, CPG9-05NC, FG-710...(Other models you can see in the webshop)		

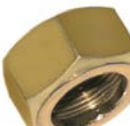



1

GEV No.	101254	Ref. No.	12008921 S312103	
description	union nut thread M28x1.5 tube ø 20mm			
For models:	MG7-10, MG7-10BM, MG9-10, MG9-10BM, MG9-10BMS, MG9-10S, MG9-15, MG9-15BM, MG9-15BM316, MG9-15BMS, MG9-15S, MG9-20, MG9-20S, MPG9-10, MPG9-10BM, MPG9-10BMS, MPG9-10S, MPG9-15, MPG9-15BM, MPG9-15BMS, MPG9-15S, MPG9-20, MPG9-20S			
accessories for	101254			
	GEV No.	101257	Ref. No.	12008828 S312104
olive for pipe ø 20mm Qty 1 pcs				





union screws





 <p>1</p>			
GEV No.	100904	Ref. No.	12008755
description	locking screw M10x1 for pipe ø 4mm Qty 1 pcs		
For models:	BG9-05, BG9-05I, BG9-10, BG9-10I, CG7-20, CG7-20H, CG7-30D, CG7-30I, CG7-31D, CG7-31I, CG7-40, CG7-40H, CG7-41, CG7-41H, CG7-50, CG7-51, CG7-60, CG7-60H, CG7-61, CG7-61H, CGB7-61, CGB7-61H, CGB7-61R, CGB7-61RH, CGE7-41, CGE7-41H		





 <p>2</p>			
GEV No.	100905	Ref. No.	12008715 U134323
description	locking screw M10x1 for pipe ø 6mm Qty 1 pcs		
For models:	BG6-05I, BG7-05, BG7-05I, BG7-10, BG7-10I, BMG7-10, BMG9-05, BMG9-05V-T, BMG9-10, BMG9-10V-T, CG-1002, CG-1502, CG-2000, CG-2000-2P, CG-2002, CG-2002P, CG-210, CG-210G, CG-310, CG-310G, CG6-41, CG7-10, CG7-11, CG7-20, CG7-20H, CG7-30D, CG7-30I, CG7-31D, CG7-31I, CG7-40, CG7-40H, CG7-41, CG7-41H, CG7-50, CG7-51, CG7-60, CG7-60H, CG7-61, CG7-61H, CG9-10, CG9-11, CG-9110, CG9-11AD, CG9-11PLUS, CG9-20, CG9-20H, CG9-31PLUS-D, CG9-31PLUS-I, CG9-40, CG9-40H...(Other models you can see in the webshop)		

 <p>1</p>			
GEV No.	101275	Ref. No.	12008951 X012104
description	union screw thread 1/2" for pipe ø 16mm Qty 1 pcs		
For models:	FG-710, FG-71-15, FG-720, FG-72-30, FG9-05, FG9-05S, FG9-10, FG-91-20, FG-920, FG-92-40, FG-940, MG9-10AD, MG9-10BMAD, MG9-10BMSAD, MG9-10PLUS, MG9-10PLUS-BM, MG9-10PLUS-BMS, MG9-10PLUS-S, MG9-10S-AD, MG9-15AD, MG9-15BMAD, MG9-15BMSAD, MG9-15PLUS, MG9-15PLUS-BM, MG9-15PLUS-BMS, MG9-15PLUS-S, MG9-15S-AD, MG9-20AD, MG9-20PLUS, MG9-20PLUS-S, MG9-20S-AD, SBG7-10, SBG9-10, SBG9-10I, SBG9-10I-AD, SBG9-10I-AD-S, SBG9-10IM, SBG9-10IM-AD, SBG9-10IM-AD-S, SBG9-10IMS, SBG9-10IS, SBG9-10M, SBG9-10MS, SBG9-10PLUS-I, SBG9-10PLUS-IM, SBG9-10PLUS-SI, SBG9-10PLUS-SIM, SBG9-10S, SBG9-15IM, SBG9-15IM-AD...(Other models you can see in the webshop)		
accessories for	101275		
	GEV No.	101274	Ref. No. X012105
olive for pipe ø 16mm Qty 1 pcs			

 <p>1</p>			
GEV No.	102453	Ref. No.	12008018 U195009
description	union screw thread 1/8" for pipe ø 1/4" CCT L 12mm brass Qty 1 pcs WS 10		
For models:	BMG7-10, BMG-9045, BMG9-05, BMG9-05V-T, BMG9-10, BMG9-10V-T, CG-1002, CG-1502, CG-2002, CG-2002P, CG-2005, CG-210, CG-210G, CG-300S, CG-310, CG-310G, CG6-41, CG7-10, CG7-11, CG-7115, CG7-41, CG-7415, CG7-61, CG-7615, CG9-10, CG9-11, CG-9110, CGB7-61, CGE9-11, CGF9-120D, CGF9-120I, CGF9-121D, CGF9-121I, CPG7-05, CPG9-05, CPG9-05NC, CPG9-05S, CPG9-05SNC, FTG7-05, FTG-7050L, FTG-7050R, FTG7-05L, FTG7-05R, FTG7-05VL, FTG7-05VR, FTG7-10, FTG-7100L, FTG-7100L+R, FTG-7100R, FTG7-10L...(Other models you can see in the webshop)		

 <p>1</p>			
GEV No.	102454	Ref. No.	12017406 U322109
description	union screw thread 1/8" for pipe ø 4mm L 11mm brass Qty 1 pcs WS 10		
For models:	BG7-05, BG7-05I, BG7-10, BG7-10I, BG9-05, BG9-05I, BG9-10, BG9-10I, CG-1002, CG-1502, CG-2000, CG-2000-2P, CG-2002, CG-2005, CG-210, CG-210G, CG-300S, CG-310, CG-310G, CG7-20, CG7-40, CG7-41, CG7-61, CG9-20, CG9-40, CG9-41, CG9-51L, CG9-51LC, CG9-51R, CG9-51RC, CG9-60, CG9-61, CG9-82, CGB7-61, CGE7-135, CGE7-41, CGE9-41, CGF9-120D, CGF9-120I, CGF9-121D, CGF9-121I, HMG-10-11UL, HMG-10-21UL		

 <p>1</p>			
GEV No.	100908	Ref. No.	12017481 T052101
description	union screw thread M10x1 for pipe ø 4mm Qty 1 pcs		
For models:	BG7-05, BG7-10, BG9-05, BG9-05I, BG9-10, BG9-10I, CG-200S, CG-210, CG-210G, CG-300S, CG-310, CG-310G		
accessories for	100908		
	GEV No.	100897	Ref. No. —
olive for pipe ø 4mm Qty 1 pcs for pilot burner			
	GEV No.	101246	Ref. No. 12018994 U265026
olive for pipe ø 4mm Qty 1 pcs			
	GEV No.	101280	Ref. No. —
olive for pipe ø 4mm Qty 1 pcs			
	GEV No.	101282	Ref. No. —
olive for pipe ø 4mm L 7.4mm Qty 1 pcs			

			
1			
GEV No.	100909	Ref. No.	12008740 12016658 S312107 U265703
description	union screw thread M10x1 for pipe ø 6mm Qty 1 pcs		
For models:	CG-2005, CG-210, CG-210G, CG-300S, CG-310, CG-310G, CG-7200, CG-7400, CG-7415, CG-7615, CG9-05AD, CG9-05PLUS, CG9-10AD, CG9-10PLUS, CG9-11AD, CG9-11PLUS, CG9-20AD, CG9-20AD-H, CG9-20PLUS, CG9-20PLUS-H, CG9-31PLUS-D, CG9-31PLUS-I, CG9-40AD, CG9-40AD-H, CG9-40PLUS, CG9-40PLUS-H, CG9-41AD, CG9-41AD-H, CG9-41PLUS, CG9-41PLUS-H, CG9-60AD, CG9-60AD-H, CG9-60PLUS, CG9-60PLUS-H, CG9-61AD, CG9-61AD-H, CG9-61PLUS, CG9-61PLUS-H, CG9-82AD, CG9-82PLUS, CGE9-41AD, CGE9-41PLUS, CGF9-120D-AD, CGF9-120I-AD, CGF9-120PLUS-D, CGF9-120PLUS-I, CGF9-121D-AD, CGF9-121I-AD, CGF9-121PLUS-D, CGF9-121PLUS-I...(Other models you can see in the webshop)		
accessories for	100909		
	GEV No.	100898	Ref. No. —
	olive for pipe ø 6mm Qty 1 pcs for pilot burner		
	GEV No.	101286	Ref. No. 12008476 S312108000 X205028
	olive ID ø 6mm Qty 1 pcs		
	GEV No.	101287	Ref. No. —
	olive for pipe ø 6mm Qty 1 pcs		
	GEV No.	101288	Ref. No. —
	olive for pipe ø 6mm L 6mm aluminium Qty 1 pcs ED ø 8.5mm		

angle pieces			
			
1			
GEV No.	106415	Ref. No.	12009102 S115013
description	angle piece		
For models:	BME7-05, BME9-05, BMG9-05, CPE7-05, CPE7-05NC, CPE9-05, CPE9-05S, CPG7-05, CPG7-05NC, CPG9-05, CPG9-05S, EPC-350, GPC-350, LA-13M, LA-18MP, LA-V-10M, LA-V-10MP, LA-V-13M, LA-V-13MP, LA-V-18M, LA-V-18MP, LB-AC-10M, LB-E-10M, LB-V-10M, LF-13MPP, LF-18MPP, LF-8MPP, LR-V-10M, LR-V-10MP, LR-V-13M, LR-V-13MP, LR-V-18M, LR-V-18MP, LR-V-25M, LR-V-25MP, ME7-10BM, ME9-10BM, ME9-10BMS, ME9-15BM, ME9-15BM316, ME9-15BMS, MG7-10, MG7-10BM, MG9-10, MG-9100, MG9-10BM, MG9-10BMS, MG9-10S, MG9-15, MG-9150...(Other models you can see in the webshop)		

accessories			
			
1			
GEV No.	694676	Ref. No.	12009347 U195420
description	cast plate cast iron ø 260mm COCINA CG9-10 suitable for FAGOR		
For models:	CG-110, CG7-10, CG7-11, CG-7115, CG9-05AD, CG9-05PLUS, CG9-10, CG9-10AD, CG9-10PLUS, CG9-11, CG-9110, CG9-11AD, CG9-11PLUS, CGE9-11, CGF9-120D, CGF9-120D-AD, CGF9-120I, CGF9-120I-AD, CGF9-120PLUS-D, CGF9-120PLUS-I, CGF9-121D, CGF9-121D-AD, CGF9-121I, CGF9-121I-AD, CGF9-121PLUS-D, CGF9-121PLUS-I		

			
1			
GEV No.	109100	Ref. No.	12010033 Q153002
description	screw for nozzle holder		
For models:	BG7-05, BG7-05I, BG7-10, BG7-10I, BG9-05, BG9-05AD, BG9-05I, BG9-05PF, BG9-05PI, BG9-05PLUS-I, BG9-10, BG9-10AD, BG9-10I, BG9-10PF, BG9-10PI, BG9-10PLUS-I, BMG7-10, BMG-9045, BMG9-05, BMG9-10, CG-1002, CG-1502, CG-2000, CG-2000-2P, CG-2002, CG-2002P, CG-2005, CG-210, CG-210G, CG-300S, CG-310, CG-310G, CG7-10, CG7-11, CG-7115, CG7-20, CG-7200, CG7-20H, CG7-30D, CG7-30I, CG7-31D, CG7-31I, CG7-40, CG-7400, CG7-40H, CG7-41, CG-7415, CG7-41H, CG7-50, CG7-51...(Other models you can see in the webshop)		

gas lines			
main gas lines			
producer-specific			
			
1			
GEV No.	109061	Ref. No.	12008153 U565007
description	connection angle tube ø 15mm L 70mm		
For models:	CG-1002, CG-1502, CG-2002, CG7-11, CG7-41, CG7-61, CG9-11, CG9-41, CG9-51L, CG9-51LC, CG9-51R, CG9-51RC, CG9-61, CG9-82, CGB7-61, CGE7-41, CGE9-41, CGP9-11, CPG7-05, CPG9-05, CPG9-05NC, FG-710, FG-720, FG9-05, FG9-10, FTG9-11L, FTG9-11L+R, FTG9-11R, FTGC9-11L, FTGC9-11L+R, FTGC9-11R, HG9-10, HG9-20, MG7-10, MG7-10BM, MG9-10, MG9-10BM, MG9-10BMS, MG9-10S, MG9-15, MG9-15BM, MG9-15BM316, MG9-15BMS, MG9-15S, MG9-20, MG9-20S, MPG9-10, MPG9-10BM, MPG9-15, MPG9-15BM...(Other models you can see in the webshop)		

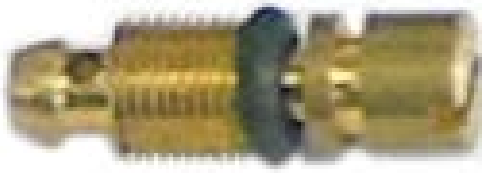
			
1			
GEV No.	106263	Ref. No.	12015649 U725008
description	gas line		
For models:	CG7-20		





1

GEV No.	106416	Ref. No.	S045012
description	gas line L 260mm ø 20mm		



1

GEV No.	107928	Ref. No.	12019022 H015018000
description	gas line tube ø 12mm copper with nozzle holder		



1

GEV No.	106340	Ref. No.	12013654 U745023
description	gas line tube ø 12mm SS with nozzle holder		
For models:	CG7-20, CG7-40, CG7-41, CG7-61, CGB7-61, CGE7-128, CGE7-41		



1

GEV No.	106339	Ref. No.	12008392 12019896 U025014 U565023
description	gas line tube ø 12mm SS without screw connection		
For models:	CG-1002, CG-1502, CG9-11, CG9-41, CG9-51L, CG9-51LC, CG9-51R, CG9-51RC, CG9-61, CG9-82, CGF9-121D, CGF9-121I, FTG9-11L, FTG9-11L+R, FTG9-11R, FTGC9-11L, FTGC9-11L+R, FTGC9-11R, HG9-10, HG9-15, HG9-20		



1

GEV No.	109071	Ref. No.	12019057 T125026
description	gas line tube ø 14mm L 420mm WS 24		
For models:	HVG-10-21		



1

GEV No.	106343	Ref. No.	12017786 S035025
description	gas line tube ø 16mm L 150mm IT M14x1 ET 1/2"		
For models:	MG9-15, MG9-15S, MPG9-15, MPG9-15S		



1

GEV No.	106412	Ref. No.	S045020
description	gas line tube ø 16mm L 310mm		



1

GEV No.	106413	Ref. No.	12014116 12017567 S035030
description	gas line tube ø 21mm		
For models:	MG9-10, MG9-10BM, MG9-15, MG9-15BM, MG9-15S, MG9-20, MG9-20S, MPG9-10, MPG9-10BM, MPG9-15, MPG9-15BM, MPG9-15S, MPG9-20, MPG9-20S		



pilot tubes

producer-specific



GEV No.	109301	Ref. No.	12019938 U745006
description	pilot tube		
For models:	CG7-41, CG7-61		



1

GEV No.	106336	Ref. No.	12019504 U745011
description	pilot tube tube ø 4mm SS without screw connection		
For models:	CG7-40, CG7-41, CG7-61, CGB7-61, CGE7-133, CGE7-41		

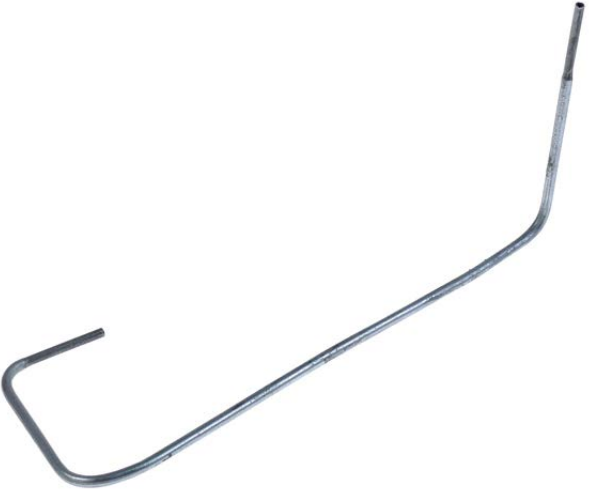

1

GEV No.	106414	Ref. No.	12020132 T035001
description	pilot tube tube ø 4.75mm L 260mm		
For models:	BG7-05, BG7-10		



1

GEV No.	106338	Ref. No.	12019498 U565034
description	pilot tube tube ø 4mm SS without screw connection		
For models:	CG9-20, CG9-40, CG9-41, CG9-51L, CG9-51LC, CG9-51R, CG9-51RC, CG9-60, CG9-61, CG9-82, CGE9-41		

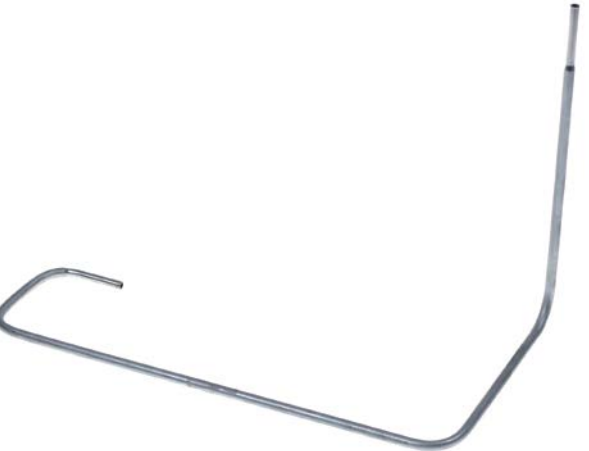

1

GEV No.	106264	Ref. No.	12020093 H015014
description	pilot tube tube ø 4/5mm steel		
For models:	BG9-05, BG9-05I, BG9-10, BG9-10I		

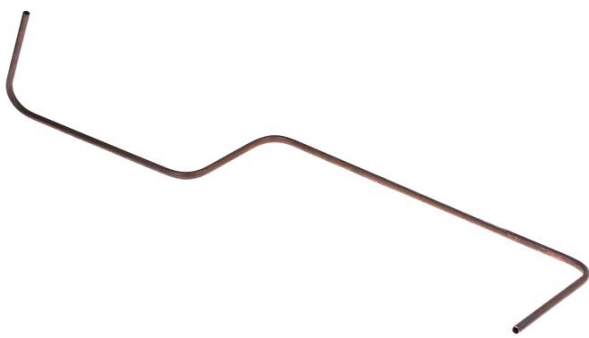

1

GEV No.	106333	Ref. No.	12020165 S015012
description	pilot tube tube ø 6mm copper without screw connection		
For models:	MG9-10, MG9-10BM, MG9-10BMS, MG9-10S, MPG9-10, MPG9-10BM, MPG9-10BMS, MPG9-10S		



1

GEV No.	106334	Ref. No.	12020169 S045031
description	pilot tube tube ø 6mm copper without screw connection		
For models:	MG9-15BM, MG9-15BM316, MG9-15BMS, MG9-20, MG9-20S, MPG9-15BM, MPG9-15BMS, MPG9-20, MPG9-20S		

1

GEV No.	109110	Ref. No.	12014422
description	pilot tube tube ø 6mm L 640mm copper		
For models:	CG9-20, CG9-40, CG9-41, CG9-51L, CG9-51LC, CG9-51R, CG9-51RC, CG9-60, CG9-61, CG9-82, CGE9-41, CGF9-120D, CGF9-120I, CGF9-121D, CGF9-121I		





1

GEV No.	106337	Ref. No.	12020337 R165019
description	pilot tube tube ø 6mm SS without screw connection		
For models:	FTG9-05L, FTG9-05R, FTG9-05VL, FTG9-05VR, FTG9-10L, FTG9-10L+R, FTG9-10R, FTG9-10VL, FTG9-10VL+R, FTG9-10VR, FTG9-11L, FTG9-11L+R, FTG9-11R, FTGC9-05, FTGC9-05L, FTGC9-05R, FTGC9-10, FTGC9-10L, FTGC9-10L+R, FTGC9-10R, FTGC9-11L, FTGC9-11L+R, FTGC9-11R		

universal



1

GEV No.	102110	Ref. No.	12019428	
description	pilot tube copper pipe ø 4mm thickness 1mm L 3000mm			
For models:	BG9-05, BG9-05I, BG9-10, BG9-10I			
accessories for	102110			
	GEV No.	100908	Ref. No.	12017481 T052101
	union screw thread M10x1 for pipe ø 4mm Qty 1 pcs			
	GEV No.	101246	Ref. No.	12018994 U265026
	olive for pipe ø 4mm Qty 1 pcs			

accessories



1

GEV No.	691761	Ref. No.	12017847 R725060
description	clamping ring ø 33.5mm wire gauge ø 2mm		
For models:	HCG-10-11, HCG-10-21, HCG-20-11, HCG-2-10-11, HCG-6-11, HMG-10-11, HMG-10-11UL, HMG-10-21, HMG-10-21UL, HMG-20-11, HMG-2-10-11, HMG-6-11		

gas hoses

miscellaneous



1

GEV No.	109074	Ref. No.	12017902 R725019
description	gas hose L 400mm nominal-ø 23mm		
For models:	HCG-10-11, HCG-10-21, HCG-2-10-11, HMG-10-11, HMG-10-11UL, HMG-10-21, HMG-10-21UL, HMG-2-10-11		

pressure switches



1

GEV No.	541108	Ref. No.	12029376 RT30171004
description	pressure control		



1

GEV No.	541304	Ref. No.	12018227 R723004
description	pressure control pressure range 2.7/2.15mbar pressure connection horizontal gas technology connection 6mm		
For models:	HCG-10-11, HCG-10-21, HCG-20-11, HCG-2-10-11, HCG-6-11, HMG-10-11, HMG-10-21, HMG-20-11, HMG-2-10-11, HMG-6-11		



			
1			
GEV No.	541111	Ref. No.	12030211 RT30171010
description	pressure control pressure range adjustable 0.2- 3mbar pressure connection horizontal gas technology connection 6mm suitable for RATIONAL		

for dough mixers

drive shafts			
			
1			
GEV No.	691875	Ref. No.	12039839 R010502
description	spindle L 50mm W 16mm		
For models:	HCV-10-11, HCV-10-21, HCV-2-10-21, HCV-6-11, HE-10-11, HE-10-21, HE-2-10-11, HE-6-11, HG-10-11, HG-10-21, HG-2-10-11		

equipment-specific units

for vegetable slicers

miscellaneous

			
1			
GEV No.	110703	Ref. No.	12020819 T055434 T055440
description	cylindrical handle thread M10 ø 28mm L 87mm		
For models:	BG7-05, BG7-10, BG9-05, BG9-05I, BG9-10, BG9-10I		

chains

connectors			
			
1			
GEV No.	693276	Ref. No.	12023767 Z105012
description	connector single DIN/ISO 08 B-1 splitting 1/2" links 1 L 23mm internal width 11.8mm rollerø 4.3mm metal		
For models:	ECO-160, ECO-1600, ECO-160D, ECO-160I, ECO-200, ECO-200D, ECO-200H, ECO-200HD, ECO-200HI, ECO-200I, ECO-2300, ECO-2700D, ECO-2700I, ECO-280D, ECO-280I, ECO-3000, ECO-370D, ECO-370I, ECO-4000D, ECO-4000I, ECO-460D, ECO-460I, ECO-550D, ECO-550I, ECO-6000D, ECO-6000I, FI-160, FI-1600, FI-160AR, FI-160D, FI-160I, FI-200, FI-200AR, FI-200D, FI-200H, FI-200HD, FI-200HI, FI-200I, FI-200W, FI-200WL, FI-200WR, FI-2300, FI-2700D, FI-2700I, FI-280D, FI-280I, FI-3000, FI-370D, FI-370I, FI-4000D...(Other models you can see in the webshop)		

			
1			
GEV No.	692145	Ref. No.	12043760
description	pulley disc ø 157mm disc width 31mm shaft intake ø 15mm overall width 30mm plastic for potato peeler device		

for hand blenders

couplings			
			
1			
GEV No.	699275	Ref. No.	12032134 SAM4039060
description	coupling set for hand blender shaft diameter 8mm D1 ø 17.5mm D2 ø 24mm int. ø 1 8mm int. ø 2 17mm L1 11.5mm L2 30mm		

for cheese graters

miscellaneous

			
1			
GEV No.	110703	Ref. No.	12020819 T055434 T055440
description	cylindrical handle thread M10 ø 28mm L 87mm		
For models:	BG7-05, BG7-10, BG9-05, BG9-05I, BG9-10, BG9-10I		

for fridges

spare parts and accessories



GEV No.	700814	Ref. No.	12037835 6000202201 6003010020
description	bracket for grate for fridge for refrigerated counters plastic		
For models:	AEP-1402, AEP-1403, AEP-1404, AEP-1602, AEP-2103, AEP-701, AEP-702, AEP-801, AEP-802, AF-1402-MIX, AF-1403-C, AF-1403-P, AF-1404-C, AF-1404-P, AF-2104-C, AF-2104-P, AF-2105-C, AF-2105-P, AF-2106-C, AF-2106-P, AF-702-C, AF-702-P, AFN-1402, AFN-1403, AFN-1404, AFN-701, AFN-702, AFP-1402, AFP-1402-FORZ, AFP-1402-MIX, AFP-1403, AFP-1403-C, AFP-1403-FORZ, AFP-1403-P, AFP-1404, AFP-1404-C, AFP-1404-FORZ, AFP-1404-P, AFP-1404-USMC, AFP-2103, AFP-2104, AFP-2104-C, AFP-2104-P, AFP-2105, AFP-2105-C, AFP-2105-P, AFP-2106, AFP-2106-C, AFP-2106-P, AFP-701...(Other models you can see in the webshop)		



GEV No.	698845	Ref. No.	6003010484
description	protection cap L 15mm W 15mm H 4mm		

housing and bezels



GEV No.	691710	Ref. No.	12037397 6003010105
description	front panel W 350mm H 80mm for fridge		
For models:	AEP-1402, AEP-1602, AEP-2103, AEP-701, AEP-801, AEP-802, AF-1402-MIX, AF-1403-C, AF-1403-P, AF-1404-C, AF-1404-P, AF-1602-MIX, AF-1603-C, AF-1603-P, AF-1604-C, AF-1604-P, AF-2104-C, AF-2104-P, AF-2105-C, AF-2105-P, AF-2106-C, AF-2106-P, AFN-1402, AFN-1403, AFN-1404, AFN-1602, AFN-1603, AFN-1604, AFN-702, AFN-801, AFN-802, AFP-1402, AFP-1403, AFP-1404, AFP-1602, AFP-1602-2, AFP-1603, AFP-1603-2, AFP-1604, AFP-2103, AFP-2104, AFP-2105, AFP-2106, AFP-701, AFP-702, AFP-801, AFP-802, AP-701, APP-701, FMP-150...(Other models you can see in the webshop)		

drawers

drawers



GEV No.	691842	Ref. No.	12030222 M177010070
description	control panel L 635mm W 125mm		
For models:	MCP-147-GN-R, MFP-102-GN-R, MFP-147-GN-R, MFP-192-GN-R, MFP-237-GN-R, MSP-117-2RC, MSP-117-4RC, MSP-117-R, MSP-169-R, MSP-169-R2C, MSP-169-R4C, MSP-169-R6C, MSP-222-R, MSP-222-R4C, MSP-222-R6C, MSP-222-R8C, MSP-274-R, MSP-274-R10C		



GEV No.	691886	Ref. No.	12027259 M169120015
description	drawer conversion kit		



1

GEV No.	691889	Ref. No.	12027330 M169120016
description	drawer conversion kit		



1

GEV No.	691850	Ref. No.	141911406
description	drawer for deep freezer L 540mm W 530mm H 100mm		



1

GEV No.	691885	Ref. No.	12032484 M109050066
description	drawer L 475mm W 400mm H 195mm		
For models:	CMSP-150HD, CMSP-150HH, CMSP-200HDD, CMSP-200HHD, CMSP-200HHH, CMSP-250HDDD, CMSP-250HHDD, CMSP-250HHHD, CMSP-250HHHH, MSP-117-2C, MSP-117-4C, MSP-117-R2C, MSP-117-R4C, MSP-150-2C, MSP-150-4C, MSP-169-2C, MSP-169-4C, MSP-169-6C, MSP-169-R2C, MSP-169-R4C, MSP-169-R6C, MSP-200-2C, MSP-200-4C, MSP-200-6C, MSP-222-2C, MSP-222-4C, MSP-222-6C, MSP-222-8C, MSP-222-R2C, MSP-222-R4C, MSP-222-R6C, MSP-222-R8C, MSP-250-2C, MSP-250-4C, MSP-250-6C, MSP-250-8C, MSP-274-10C, MSP-274-2C, MSP-274-4C, MSP-274-6C, MSP-274-8C, MSP-274-R10C, MSP-274-R6C, MSP-300-10C, MSP-300-2C, MSP-300-4C, MSP-300-6C, MSP-300-8C		

accessories

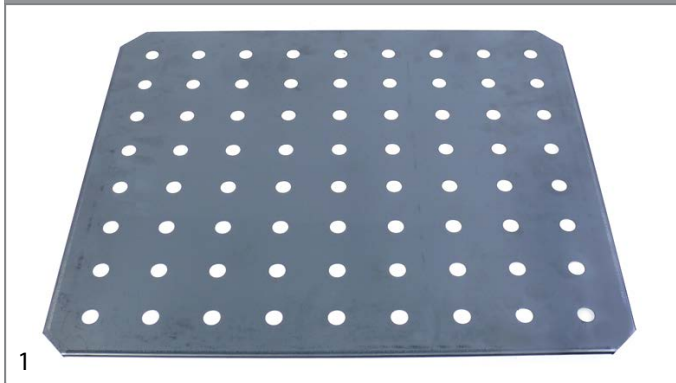

1

GEV No.	691914	Ref. No.	12034642 6009990102 A109050103
description	bottom plate for fish drawer L 445mm W 380mm H 12mm		
For models:	AF-1403-P, AF-1404-P, AF-2104-P, AF-2105-P, AF-2106-P, AF-702-P, CAF-1403P, CAF-1404P, CAF-2104C, CAF-2105C, CAF-2106C, CAF-702P		
accessories for	691914		
	GEV No.	691903	Ref. No. 141911404
	plastic insert drawer L 530mm W 460mm H 100mm fish		

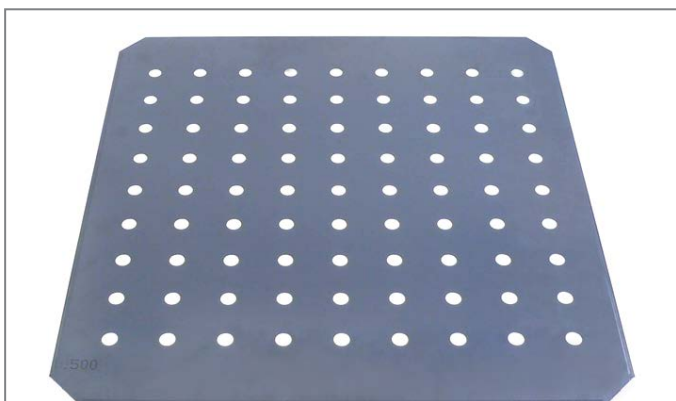

1

GEV No.	691915	Ref. No.	12034466 12034707 6009990101 A109050143
description	bottom plate for fish drawer L 460mm W 480mm H 10mm		
For models:	AF-1603-P, AF-1604-P, AF-802-P, CAF-1603-P, CAF-1604-P, CAF-802-C		
accessories for	691915		
	GEV No.	691850	Ref. No. 141911406
	drawer for deep freezer L 540mm W 530mm H 100mm		



1

GEV No.	691903	Ref. No.	141911404
description	plastic insert drawer L 530mm W 460mm H 100mm fish		
accessories for	691903		
	GEV No.	691914	Ref. No.
			12034642 6009990102 A109050103
	bottom plate for fish drawer L 445mm W 380mm H 12mm		

for upright freezers



1

GEV No.	699342	Ref. No.	12037375 6003010184
description	drip tray L 190mm W 50mm H 50mm		
For models:	AEP-1402, AEP-1602, AEP-2103, AEP-701, AEP-801, AEP-802, AF-1402-MIX, AF-1403-C, AF-1403-P, AF-1404-C, AF-1404-P, AF-1602-MIX, AF-1603-C, AF-1603-P, AF-1604-C, AF-1604-P, AF-2104-C, AF-2104-P, AF-2105-C, AF-2105-P, AF-2106-C, AF-2106-P, AF-702-C, AF-702-P, AF-802-C, AF-802-P, AFN-1402, AFN-1403, AFN-1404, AFN-1602, AFN-1603, AFN-1604, AFN-702, AFN-801, AFN-802, AFP-1402, AFP-1403, AFP-1404, AFP-1602, AFP-1602-2, AFP-1603, AFP-1603-2, AFP-1604, AFP-2103, AFP-2104, AFP-2105, AFP-2106, AFP-701, AFP-702, AFP-801...(Other models you can see in the webshop)		

for blast chiller



1

GEV No.	698847	Ref. No.	6003010326
description	drain pipe ø 40mm H 95mm 3/4"		
For models:	ATM-051, ATM-051VCH, ATM-051VCH-60Hz, ATM-081VCH, ATM-081VCH-60Hz, ATM-101, ATM-101VCH, ATM-101VCH-60Hz, ATM-102, ATM-121VCH, ATM-121VCH-60Hz, ATM-121VCHP, ATM-161VCH, BFP-100A, BFP-100I, BFP-150A, BFP-150I, BFP-200A, BFP-200I, BFP-250A, BFP-250I, BFP-300I, FMP-117-R, FMP-150, FMP-150-TV, FMP-169-R, FMP-200, FMP-202, FMP-202-TV, FMP-222-R, FMP-250, FMP-255, FMP-255-TV, FMP-274-R, FMP-300, FMP-307, FMP-307-TV, MCN-135-GN, MCN-180-GN, MCN-270-GN, MCP-135-AD, MCP-135-GN, MCP-147-GN-R, MCP-180-AD, MCP-180-GN, MCP-192-GN-R, MCP-225-AD, MCP-225-GN, MCP-237-GN-R, MCP-270-GN...(Other models you can see in the webshop)		

for refrigerated counters

lid hinges



1

GEV No.	695176	Ref. No.	12034284 12035092 6009990251 6033110003
description	hinge stainless steel left/right set saladette		
For models:	MEP-100, MEP-135, MEP-180		

spare parts and accessories



1

GEV No.	700814	Ref. No.	12037835 6000202201 6003010020
description	bracket for grate for fridge for refrigerated counters plastic		
For models:	AEP-1402, AEP-1403, AEP-1404, AEP-1602, AEP-2103, AEP-701, AEP-702, AEP-801, AEP-802, AF-1402-MIX, AF-1403-C, AF-1403-P, AF-1404-C, AF-1404-P, AF-2104-C, AF-2104-P, AF-2105-C, AF-2105-P, AF-2106-C, AF-2106-P, AF-702-C, AF-702-P, AFN-1402, AFN-1403, AFN-1404, AFN-701, AFN-702, AFP-1402, AFP-1402-FORZ, AFP-1402-MIX, AFP-1403, AFP-1403-C, AFP-1403-FORZ, AFP-1403-P, AFP-1404, AFP-1404-C, AFP-1404-FORZ, AFP-1404-P, AFP-1404-USMC, AFP-2103, AFP-2104, AFP-2104-C, AFP-2104-P, AFP-2105, AFP-2105-C, AFP-2105-P, AFP-2106, AFP-2106-C, AFP-2106-P, AFP-701...(Other models you can see in the webshop)		



1

GEV No.	699229	Ref. No.	12037381 12037616 12061084 2061700015 6000202215 6003010034
description	drain pipe H 29.5mm ø 29.5mm L 29.5mm		
For models:	CMPP-117-R, CMPP-150, CMPP-150-C, CMPP-169-R, CMPP-202, CMPP-202-C, CMPP-222-R, CMPP-255, CMPP-255-C, CMPP-307, CMPZ1-135, CMPZ1-180, FMP-117-R, FMP-150, FMP-169-R, FMP-202, FMP-222-R, FMP-255, FMP-274-R, FMP-307, MCN-102-R, MCN-135, MCN-147-R, MCN-180, MCN-192-R, MCN-225, MCN-237-R, MCN-270, MCP-135, MCP-180, MCP-225, MCP-225-GN, MEP-135, MEP-135-GN, MEP-180, MEP-180-GN, MFN-102-R, MFN-135, MFN-147-R, MFN-180, MFN-192-R, MFN-225, MFN-237-R, MFN-270, MFP-102-2C, MFP-102-4C, MFP-135, MFP-135-2C, MFP-135-4C, MFP-135-F...(Other models you can see in the webshop)		

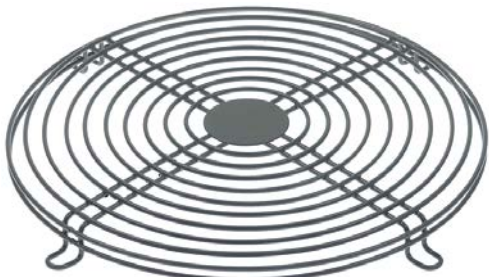

1

GEV No.	692812	Ref. No.	12034663 6027130004
description	guard for evaporator fan round ø 225mm mounting distance 235mm		
For models:	AEP-1402, AEP-1602, AEP-2103, AEP-701, AEP-801, AEP-802, AF-1402-MIX, AF-1403-C, AF-1403-P, AF-1404-C, AF-1404-P, AF-1602-MIX, AF-1603-C, AF-1603-P, AF-1604-C, AF-1604-P, AF-2104-C, AF-2104-P, AF-2105-C, AF-2105-P, AF-2106-C, AF-2106-P, AF-702-C, AF-702-P, AF-802-C, AF-802-P, AFN-1402, AFN-1403, AFN-1404, AFN-1602, AFN-1603, AFN-1604, AFN-701, AFN-702, AFN-801, AFN-802, AFP-1402, AFP-1403, AFP-1404, AFP-1602, AFP-1602-2, AFP-1603, AFP-1603-2, AFP-1604, AFP-2103, AFP-2104, AFP-2105, AFP-2106, AFP-701, AFP-702...(Other models you can see in the webshop)		



1

GEV No.	699629	Ref. No.	12085225 M169090013
description	mounting set for refrigerated counters FAGOR MPZ-1		
For models:	MPZ1-150, MPZ1-200, MPZ1-250		

housing and bezels



1

GEV No.	210059	Ref. No.	12040457 M109250148
description	cover for evaporator fan stainless steel W 400mm H 80mm L 415mm thickness 1mm		
For models:	CFMP-117-R, CFMP-117-RPC, CFMP-150, CFMP-150F, CFMP-150PC, CFMP-150TV, CFMP-169-R, CFMP-169-RPC, CFMP-202, CFMP-202F, CFMP-202PC, CFMP-202TV, CFMP-222-R, CFMP-222-RPC, CFMP-255, CFMP-255F, CFMP-255PC, CFMP-255TV, CFMP-307, CFMP-307F, CFMP-307TV, CMFN-102-R, CMFN-135, CMFN-147-R, CMFN-180, CMFP-102-R, CMFP-135, CMFP-135-B, CMFP-135-B2, CMFP-135-BP, CMFP-135F, CMFP-135-GR, CMFP-135HD, CMFP-135HH, CMFP-135PC, CMFP-147-R, CMFP-180, CMFP-180-B, CMFP-180-B2, CMFP-180-BP, CMFP-180F, CMFP-180-GR, CMFP-180HDD, CMFP-180HHD, CMFP-180HHH, CMFP-180PC, CMFP-192-R, CMFP-225, CMFP-225-B, CMFP-225-B2...(Other models you can see in the webshop)		



1

GEV No.	691710	Ref. No.	12037397 6003010105
description	front panel W 350mm H 80mm for fridge		
For models:	AEP-1402, AEP-1602, AEP-2103, AEP-701, AEP-801, AEP-802, AF-1402-MIX, AF-1403-C, AF-1403-P, AF-1404-C, AF-1404-P, AF-1602-MIX, AF-1603-C, AF-1603-P, AF-1604-C, AF-1604-P, AF-2104-C, AF-2104-P, AF-2105-C, AF-2105-P, AF-2106-C, AF-2106-P, AFN-1402, AFN-1403, AFN-1404, AFN-1602, AFN-1603, AFN-1604, AFN-701, AFN-702, AFN-801, AFN-802, AFP-1402, AFP-1403, AFP-1404, AFP-1602, AFP-1602-2, AFP-1603, AFP-1603-2, AFP-1604, AFP-2103, AFP-2104, AFP-2105, AFP-2106, AFP-701, AFP-702, AFP-801, AFP-802, AP-701, APP-701, FMP-150...(Other models you can see in the webshop)		



1 

GEV No.	691844	Ref. No.	12032239 6039010009
description	side panel H 224mm L 334mm mounting pos. right thickness 8mm		
For models:	MI-135, MI-150, MI-180, MI-202, MI-225, MI-255, MPZ-150, MPZ-202		

1 

GEV No.	691845	Ref. No.	12031913 6039010010
description	side panel H 224mm L 334mm thickness 8mm		
For models:	MI-135, MI-150, MI-180, MI-202, MI-225, MI-255, MPZ-150, MPZ-202		

1 

GEV No.	505326	Ref. No.	12037176 6023010064
description	sticker FAGOR L 108mm W 33mm ø 2mm		
For models:	MFP-135-B, MFP-180-B, MFP-225-B, MFP-270-B, MMC-100, MMC-150, MMC-200, MMC-250		

drawers

1 

GEV No.	691922	Ref. No.	12031995 M169120021
description	drawer front W 520mm H 430mm thickness 40mm with gasket		



1 

GEV No.	694198	Ref. No.	12033303 M169120024
description	drawer front with gasket W 440mm H 428mm thickness 40mm		

doors



1

GEV No.	694309	Ref. No.	12030565 M169010084
description	door W 630mm H 435mm thickness 40mm		
accessories for	694309		
	GEV No.	690763	Ref. No.
			12038130 6033010100
	spring assisted hinge right/left L 111mm W 75mm refrigerator mounting distance 25mm		
	GEV No.	690764	Ref. No.
			12037723 6003010136
	bush W 23.5mm H 53.5mm mounting pos. upper/lower ø 16mm ID ø 10mm grey for hinge		
	GEV No.	901164	Ref. No.
			12038156 6045010119
	refrigeration gasket profile 9797 W 365mm L 560mm plug size		

worktops



1

GEV No.	691905	Ref. No.	12033431 6031010028
description	side panel granite L 1460mm W 120mm thickness 20mm Qty 1 pcs		
For models:	MMZ-150, MPZ-150		



1

GEV No.	691894	Ref. No.	12034667 6031010026
description	side panel Qty 2 pcs granite L 800mm W 120mm thickness 20mm		
For models:	MMZ-150, MMZ-202, MPZ-150, MPZ-202		

for freezer cabinets

doors



1

GEV No.	650104	Ref. No.	12031769 12035085 12045302 6009990015 6031030001
description	lid for beverage refrigerator		
For models:	BFP-100, BFP-150, BFP-200, BFP-250, BFP-300		

for display coolers

housing and bezels

side parts



1

GEV No.	691846	Ref. No.	12035234 6003010171
description	side panel L 408mm thickness 20mm H 245mm		
For models:	VTP-139-C, VTP-139-RC, VTP-175-C, VTP-175-RC		



1

GEV No.	694071	Ref. No.	12034937 6003010170
description	side panel mounting pos. left W 410mm H 245mm for tapas display		
For models:	VTP-139-C, VTP-175-C		



			
1			
GEV No.	694072	Ref. No.	12035148 6003010172
description	side panel mounting pos. right W 410mm H 245mm for tapas display		
For models:	VTP-139-P, VTP-139-RP, VTP-175-P, VTP-175-RP		

glass panels

glass panels

			
1			
GEV No.	700839	Ref. No.	12031917 12035036 6002101007 6035050012
description	glass panel L 725mm W 165mm thickness 3mm		
For models:	VTP-175-C, VTP-175-CD, VTP-175-P, VTP-175-PD		

doors

			
1			
GEV No.	694196	Ref. No.	12035230 6035050006
description	door W 550mm H 166mm glas thickness 3mm		
For models:	VTP-139-C, VTP-139-CD, VTP-139-P, VTP-139-PD		

door mechanics



miscellaneous

			
1			
GEV No.	700811	Ref. No.	12035982 E107090005
description	balance weight for sliding door L 400mm W 25mm H 15mm		

for ice-cube maker

drain systems

overflow pipes

			
1			
GEV No.	695622	Ref. No.	12037650 B00010305
description	lid for overflow pipe tube ø 34mm		
accessories for	695622		
	GEV No.	695086	Ref. No.
			—
			
	overflow pipe tube ø 20.5mm pipe length 88.6mm		

doors

doors

			
1			
GEV No.	695514	Ref. No.	12038019
description	door for ice-cube maker W 447mm H 217mm thickness 22mm		

curtains

with holder

			
1			
GEV No.	695507	Ref. No.	12033184 BR00C22035
description	curtain for ice maker W 433mm H 165mm with holder shaft length 438mm shaft ø 7.5mm		

floats

float containers

			
1			
GEV No.	695072	Ref. No.	12030020 BR00C10201
description	float container for ice maker with microswitch plastic		

for espresso machines

brewing units

filter holder gaskets

O-rings



1

GEV No.	510409	Ref. No.	12010040 Q307044
description	O-ring EPDM thickness 5.34mm ID ø 56.52mm Qty 1 pcs		
For models:	ECO-160, ECO-1600, ECO-160D, ECO-160I, ECO-200, ECO-200D, ECO-200H, ECO-200HD, ECO-200HI, ECO-200I, ECO-2300, ECO-2700D, ECO-2700I, ECO-280D, ECO-280I, ECO-3000, ECO-370D, ECO-370I, ECO-4000D, ECO-4000I, ECO-460D, ECO-460I, ECO-550D, ECO-550I, ECO-6000D, ECO-6000I, FI-160, FI-1600, FI-160AR, FI-160D, FI-160I, FI-200, FI-200AR, FI-200D, FI-200H, FI-200HD, FI-200HI, FI-200I, FI-200W, FI-200WL, FI-200WR, FI-2300, FI-2700D, FI-2700I, FI-280D, FI-280I, FI-3000, FI-370D, FI-370I, FI-4000D...(Other models you can see in the webshop)		

intake valves

accessories

miscellaneous



1

GEV No.	528422	Ref. No.	12039801 Z605922
description	ball ø 8mm SS		

for bain marie

spare parts and accessories



1

GEV No.	691650	Ref. No.	12019228
description	connecting fitting brass L 52mm W 30mm H 30mm		



1

GEV No.	691651	Ref. No.	12020990
description	threaded part brass L 27mm ID ø 12.4mm thread 1/2"		

housing and bezels



1

GEV No.	691722	Ref. No.	12004214 R062811
description	back panel chargin grill		
For models:	BG9-05AD, BG9-05PF, BG9-05PI, BG9-05PLUS-I, BG9-10AD, BG9-10PF, BG9-10PI, BG9-10PLUS-I, BME9-05, BME9-05AD, BME9-05PLUS, BME9-05V-T, BME9-10, BME9-10AD, BME9-10PLUS, BME9-10V-T, BMG9-05, BMG9-05V-T, BMG9-10, BMG9-10V-T, CE9-20, CE9-20AD, CE9-20PLUS, CE9-40, CE9-40AD, CE9-40PLUS, CG9-05AD, CG9-05PLUS, CG9-10, CG9-10AD, CG9-10PLUS, CG9-20, CG9-20AD, CG9-20AD-H, CG9-20H, CG9-20PLUS, CG9-20PLUS-H, CG9-40, CG9-40AD, CG9-40AD-H, CG9-40H, CG9-40PLUS, CG9-40PLUS-H, CG9-60, CG9-60AD, CG9-60AD-H, CG9-60H, CG9-60PLUS, CG9-60PLUS-H, CGF9-120D...(Other models you can see in the webshop)		



1

GEV No.	691708	Ref. No.	12014063 R982802
description	back panel for bain marie		
For models:	BME7-10, BMG7-10		





1

GEV No.	691712	Ref. No.	12013779 R966105
description	cover for bain marie		
For models:	BME7-05		





1

GEV No.	210022	Ref. No.	12020193 U452805
description	cover L 177mm W 52mm H 16mm for control panel mounting pos. left suitable for 700 series		
For models:	BG7-05, BG7-05I, BG7-10, BG7-10I, BME7-05, BME7-10, BMG7-10, CE7-20, CE7-40, CE7-41, CG7-10, CG7-11, CG7-20, CG-7200, CG7-40, CG-7400, CG7-41, CG-7415, CG7-61, CG-7615, CGB7-61, CGE7-41, CGE7-69, CPG7-05, EN7-05, EN7-10, FE-710, FE-720, FG-710, FG-720, FTE7-05, FTE7-05L, FTE7-05R, FTE7-10, FTE7-10L, FTE7-10L+R, FTE7-10R, FTEC7-05L, FTEC7-10L, FTG7-05, FTG7-05L, FTG7-05R, FTG7-05VL, FTG7-05VR, FTG7-10, FTG7-10L, FTG7-10L+R, FTG7-10R, FTG7-10VL, FTG7-10VL+R...(Other models you can see in the webshop)		
accessories for	210022		
	GEV No.	210021	Ref. No.
			12020194 U452804
	cover L 177mm W 52mm H 16mm for control panel mounting pos. right suitable for 700 series		



1

GEV No.	210021	Ref. No.	12020194 U452804
description	cover L 177mm W 52mm H 16mm for control panel mounting pos. right suitable for 700 series		
For models:	BG7-05, BG7-05I, BG7-10, BG7-10I, BME7-05, BME7-10, BMG7-10, CE7-20, CE7-40, CE7-41, CG7-10, CG7-11, CG7-20, CG-7200, CG7-40, CG-7400, CG7-41, CG-7415, CG7-61, CG-7615, CGB7-61, CGE7-41, CGE7-62, CPG7-05, EN7-05, EN7-10, FE-710, FE-720, FG-710, FG-720, FTE7-05, FTE7-05L, FTE7-05R, FTE7-10, FTE7-10L, FTE7-10L+R, FTE7-10R, FTEC7-05L, FTEC7-10L, FTG7-05, FTG7-05L, FTG7-05R, FTG7-05VL, FTG7-05VR, FTG7-10, FTG7-10L, FTG7-10L+R, FTG7-10R, FTG7-10VL, FTG7-10VL+R...(Other models you can see in the webshop)		
accessories for	210021		
	GEV No.	210022	Ref. No.
			12020193 U452805
	cover L 177mm W 52mm H 16mm for control panel mounting pos. left suitable for 700 series		



1

GEV No.	700809	Ref. No.	12007564 R205409
description	fastening angle L 120mm W 67mm H 28mm		
For models:	BG9-05, BG9-10, BME9-05, BME9-10, BMG9-05, BMG9-10, CE9-20, CE9-40, CE9-41, CG9-10, CG9-11, CG9-20, CG9-40, CG9-41, CG9-60, CG9-61, CG9-82, EN9-05, EN9-10, FE-920, FG-920, FG-940, FTE9-05L, FTE9-05R, FTE9-10L, FTE9-10L+R, FTE9-10R, FTEC9-05, FTEC9-05L, FTEC9-05R, FTEC9-10, FTEC9-10L, FTEC9-10L+R, FTEC9-10R, FTG9-05L, FTG9-05R, FTG9-05VL, FTG9-05VR, FTG9-10L, FTG9-10L+R, FTG9-10R, FTG9-10VL, FTG9-10VL+R, FTG9-10VR, FTGC9-05, FTGC9-05L, FTGC9-05R, FTGC9-10, FTGC9-10L, FTGC9-10L+R...(Other models you can see in the webshop)		

Reglado a BUTANO-PROPANO
Reglage BUTANE-PROPANE
Regulated for L.P.G. using

1

GEV No.	691735	Ref. No.	12008203 U136501
description	sticker Regulated for L.P.G. using		
For models:	BG7-05, BG7-05I, BG7-10, BG7-10I, BG9-05, BG9-05I, BG9-05PF, BG9-05PI, BG9-10, BG9-10I, BG9-10PF, BG9-10PI, BME9-05, BME9-05V-T, BME9-10, BME9-10V-T, BMG7-10, BMG9-05, BMG9-05V-T, BMG9-10, BMG9-10V-T, CG-1002, CG-1502, CG-2000, CG-2005, CG-210, CG-210G, CG-300S, CG-310, CG-310G, CG7-10, CG7-11, CG-7115, CG7-20, CG-7200, CG7-20H, CG7-30D, CG7-30I, CG7-31D, CG7-31I, CG7-40, CG-7400, CG7-40H, CG7-41, CG-7415, CG7-41H, CG7-50, CG7-51, CG7-61, CG-7615...(Other models you can see in the webshop)		

Reglado a GAS NATURAL
Reglage GAZ NATUREL
Regulated for NATURAL GAS using

1

GEV No.	691736	Ref. No.	12008202 U134402
description	sticker regulated for NATURAL GAS using		
For models:	BG7-05, BG7-05I, BG7-10, BG7-10I, BG9-05, BG9-05I, BG9-05PF, BG9-05PI, BG9-10, BG9-10I, BG9-10PF, BG9-10PI, BME9-05, BME9-05V-T, BME9-10, BME9-10V-T, BMG7-10, BMG-9045, BMG9-05, BMG9-05V-T, BMG9-10, BMG9-10V-T, CG-1002, CG-1502, CG-2000, CG-2005, CG-210, CG-210G, CG-300S, CG-310, CG-310G, CG7-10, CG7-11, CG-7115, CG7-20, CG-7200, CG7-20H, CG7-30D, CG7-30I, CG7-31D, CG7-31I, CG7-40, CG-7400, CG7-40H, CG7-41, CG-7415, CG7-41H, CG7-50, CG7-51, CG7-61...(Other models you can see in the webshop)		

			
1			
GEV No.	691691	Ref. No.	12009010 12009015 U022836 U262806
description	type plate FAGOR metal		
For models:	BG6-05I, BG7-05, BG7-05I, BG7-10, BG7-10I, BG9-05, BG9-05AD, BG9-05I, BG9-05PF, BG9-05PI, BG9-05PLUS-I, BG9-10, BG9-10AD, BG9-10I, BG9-10PF, BG9-10PI, BG9-10PLUS-I, BME6-05, BME7-05, BME7-10, BME9-05, BME9-05AD, BME9-05PLUS, BME9-05V-T, BME9-10, BME9-10AD, BME9-10PLUS, BME9-10V-T, BMG7-10, BMG9-05, BMG9-05V-T, BMG9-10, BMG9-10V-T, CE6-20, CE6-40, CE6-41, CE7-20, CE7-40, CE7-41, CE9-20, CE9-20AD, CE9-20PLUS, CE9-40, CE9-40AD, CE9-40PLUS, CE9-41, CE9-41AD, CE9-41PLUS, CG-1002, CG-1502...(Other models you can see in the webshop)		

for deep fryers

lids

			
1			
GEV No.	691685	Ref. No.	12004790 X352825
description	cover suitable for fryer L 297mm W 175mm FE4		
For models:	FE-4		

housing and bezels

			
1			
GEV No.	691722	Ref. No.	12004214 R062811
description	back panel chargrill		
For models:	BG9-05AD, BG9-05PF, BG9-05PI, BG9-05PLUS-I, BG9-10AD, BG9-10PF, BG9-10PI, BG9-10PLUS-I, BME9-05, BME9-05AD, BME9-05PLUS, BME9-05V-T, BME9-10, BME9-10AD, BME9-10PLUS, BME9-10V-T, BMG9-05, BMG9-05V-T, BMG9-10, BMG9-10V-T, CE9-20, CE9-20AD, CE9-20PLUS, CE9-40, CE9-40AD, CE9-40PLUS, CG9-05AD, CG9-05PLUS, CG9-10, CG9-10AD, CG9-10PLUS, CG9-20, CG9-20AD, CG9-20AD-H, CG9-20H, CG9-20PLUS, CG9-20PLUS-H, CG9-40, CG9-40AD, CG9-40AD-H, CG9-40H, CG9-40PLUS, CG9-40PLUS-H, CG9-60, CG9-60AD, CG9-60AD-H, CG9-60H, CG9-60PLUS, CG9-60PLUS-H, CGF9-120D...(Other models you can see in the webshop)		

			
1			
GEV No.	700808	Ref. No.	X330504
description	fastening angle for door hinge		

			
1			
GEV No.	700809	Ref. No.	12007564 R205409
description	fastening angle L 120mm W 67mm H 28mm		
For models:	BG9-05, BG9-10, BME9-05, BME9-10, BMG9-05, BMG9-10, CE9-20, CE9-40, CE9-41, CG9-10, CG9-11, CG9-20, CG9-40, CG9-41, CG9-60, CG9-61, CG9-82, EN9-05, EN9-10, FE-920, FG-920, FG-940, FTE9-05L, FTE9-05R, FTE9-10L, FTE9-10L+R, FTE9-10R, FTEC9-05, FTEC9-05L, FTEC9-05R, FTEC9-10, FTEC9-10L, FTEC9-10L+R, FTEC9-10R, FTG9-05L, FTG9-05R, FTG9-05VL, FTG9-05VR, FTG9-10L, FTG9-10L+R, FTG9-10R, FTG9-10VL, FTG9-10VL+R, FTG9-10VR, FTGC9-05, FTGC9-05L, FTGC9-05R, FTGC9-10, FTGC9-10L, FTGC9-10L+R...(Other models you can see in the webshop)		

1

GEV No.	691718	Ref. No.	12014050 X332800
description	front panel for fryer W 700mm H 175mm		
For models:	FE-720, FG-720		

Reglado a BUTANO-PROPANO
Reglage BUTANE-PROPANE
Regulated for L.P.G. using

1

GEV No.	691735	Ref. No.	12008203 U136501
description	sticker Regulated for L.P.G. using		
For models:	BG7-05, BG7-05I, BG7-10, BG7-10I, BG9-05, BG9-05I, BG9-05PF, BG9-05PI, BG9-10, BG9-10I, BG9-10PF, BG9-10PI, BME9-05, BME9-05V-T, BME9-10, BME9-10V-T, BMG7-10, BMG9-05, BMG9-05V-T, BMG9-10, BMG9-10V-T, CG-1002, CG-1502, CG-2000, CG-2005, CG-210, CG-210G, CG-3005, CG-310, CG-310G, CG7-10, CG7-11, CG-7115, CG7-20, CG-7200, CG7-20H, CG7-30D, CG7-30I, CG7-31D, CG7-31I, CG7-40, CG-7400, CG7-40H, CG7-41, CG-7415, CG7-41H, CG7-50, CG7-51, CG7-61, CG-7615...(Other models you can see in the webshop)		

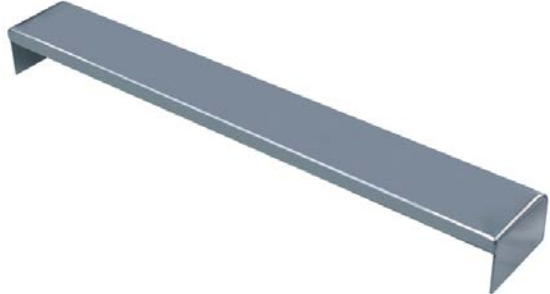

1

GEV No.	506169	Ref. No.	FAG6000005
description	front panel W 400mm H 60mm fryer		

Reglado a GAS NATURAL
Reglage GAZ NATUREL
Regulated for NATURAL GAS using

1

GEV No.	691736	Ref. No.	12008202 U134402
description	sticker regulated for NATURAL GAS using		
For models:	BG7-05, BG7-05I, BG7-10, BG7-10I, BG9-05, BG9-05I, BG9-05PF, BG9-05PI, BG9-10, BG9-10I, BG9-10PF, BG9-10PI, BME9-05, BME9-05V-T, BME9-10, BME9-10V-T, BMG7-10, BMG-9045, BMG9-05, BMG9-05V-T, BMG9-10, BMG9-10V-T, CG-1002, CG-1502, CG-2000, CG-2005, CG-210, CG-210G, CG-3005, CG-310, CG-310G, CG7-10, CG7-11, CG-7115, CG7-20, CG-7200, CG7-20H, CG7-30D, CG7-30I, CG7-31D, CG7-31I, CG7-40, CG-7400, CG7-40H, CG7-41, CG-7415, CG7-41H, CG7-50, CG7-51, CG7-61...(Other models you can see in the webshop)		



1

GEV No.	104123	Ref. No.	12013999 U742640
description	mounting plate for gas range L 690mm W 110mm H 25mm		
For models:	CE7-41, CG7-11, CG7-41, CGE7-41, FE-720, FG-720, MB7-10, MG7-10, MG7-10BM		



1

GEV No.	550771	Ref. No.	12004055 X163022
description	terminal box L 170mm W 150mm H 70mm for thermostat		
For models:	FG9-05, FG9-05-1C, FG9-05-2C, FG9-10, FG9-10-2C, FG9-10-4C, FGCL9-05, FGCL9-05-1C, FGCL9-05-2C		

			
1			
GEV No.	691691	Ref. No.	12009010 12009015 U022836 U262806
description	type plate FAGOR metal		
For models:	BG6-05I, BG7-05, BG7-05I, BG7-10, BG7-10I, BG9-05, BG9-05AD, BG9-05I, BG9-05PF, BG9-05PI, BG9-05PLUS-I, BG9-10, BG9-10AD, BG9-10I, BG9-10PF, BG9-10PI, BG9-10PLUS-I, BME6-05, BME7-05, BME7-10, BME9-05, BME9-05AD, BME9-05PLUS, BME9-05V-T, BME9-10, BME9-10AD, BME9-10PLUS, BME9-10V-T, BMG7-10, BMG9-05, BMG9-05V-T, BMG9-10, BMG9-10V-T, CE6-20, CE6-40, CE6-41, CE7-20, CE7-40, CE7-41, CE9-20, CE9-20AD, CE9-20PLUS, CE9-40, CE9-40AD, CE9-40PLUS, CE9-41, CE9-41AD, CE9-41PLUS, CG-1002, CG-1502...(Other models you can see in the webshop)		

glass panels

			
1			
GEV No.	692158	Ref. No.	12008981 9294600
description	glass panel ø 29.5mm thickness 5mm		
For models:	FE-18, FE-25, FGCL9-05, MG7-10, MG7-10BM, MG9-10, MG9-10AD, MG9-10BM, MG9-10BMAD, MG9-10BMS, MG9-10BMSAD, MG9-10PLUS, MG9-10PLUS-BM, MG9-10PLUS-BMS, MG9-10PLUS-S, MG9-10S, MG9-10S-AD, MG9-15, MG-9150BM, MG9-15AD, MG9-15BM, MG9-15BM316, MG9-15BMAD, MG9-15BMS, MG9-15BMSAD, MG9-15PLUS, MG9-15PLUS-BM, MG9-15PLUS-BMS, MG9-15PLUS-S, MG9-15S, MG9-15S-AD, MG9-20, MG9-20AD, MG9-20PLUS, MG9-20PLUS-S, MG9-20S, MG9-20S-AD, MPG9-10, MPG9-10BM, MPG9-10BMS, MPG9-10S, MPG9-15, MPG9-15BM, MPG9-15BMS, MPG9-15S, MPG9-20, MPG9-20S		

door magnets

			
1			
GEV No.	691000	Ref. No.	12009033 X960501
description	door magnet ø 32mm H 7mm M4		
For models:	CG-310, CG-310G, CG7-51, CG7-61, CG7-61H, CG9-41H, CG9-51L, CG9-51LC, CG9-51R, CG9-51RC, CG9-61, CG9-61H, CGF9-121D, CGF9-121D-AD, CGF9-121I, CGF9-121I-AD, CGF9-121PLUS-D, CGF9-121PLUS-I, CPE7-05, CPE7-05NC, CPE9-05, CPE9-05AD, CPE9-05AD-S, CPE9-05NC, CPE9-05PLUS, CPE9-05PLUS-S, CPE9-05S, CPE9-05SNC, CPG7-05, CPG7-05NC, CPG9-05, CPG9-05AD, CPG9-05AD-S, CPG9-05NC, CPG9-05PLUS, CPG9-05PLUS-S, CPG9-05S, CPG9-05SNC, EPC-350, FE-18, FE-25, FE7-05-1C, FE7-05-2C, FE-710, FE7-10-2C, FE7-10-4C, FE-720, FE9-05, FE9-05-1C, FE9-05-2C...(Other models you can see in the webshop)		

sumps

			
Image not available			
1			
GEV No.	691892	Ref. No.	1100002846 1100002848 12038270 12038338 X316100
description	sump for fryer suitable for FAGOR FG7-00		
For models:	FG-710, FG-720		

			
1			
GEV No.	691893	Ref. No.	1100002845 12038344 X166124
description	sump for fryer suitable for FAGOR FG9-00		

for grills

spare parts and accessories

			
1			
GEV No.	691853	Ref. No.	12011165 T035473
description	bracket L 480mm H 45mm W 20mm		



GEV No.	691871	Ref. No.	12012807 T052603
description	cover L 73mm H 33mm W 30mm		
For models:	BG7-05, BG7-05I, BG7-10, BG7-10I, BG9-05, BG9-05I, BG9-10, BG9-10I		

for griddles

spare parts and accessories



GEV No.	691703	Ref. No.	12019787 U125409
description	distance washer for handrail		
For models:	CG-HP-20, FI-5420, FI-7630		



GEV No.	691683	Ref. No.	12007464 R152607
description	holding plate for drain L 110mm W 60mm ID ø 48mm		
For models:	CG9-51L, CG9-51LC, CG9-51R, CG9-51RC, FTE7-05, FTE7-05L, FTE7-05R, FTE7-10, FTE7-10L, FTE7-10L+R, FTE7-10R, FTE9-05L, FTE9-05R, FTE9-10L, FTE9-10L+R, FTE9-10R, FTEC7-05L, FTEC7-10L, FTEC9-05L, FTEC9-05R, FTEC9-05USMC, FTEC9-10L, FTEC9-10L+R, FTEC9-10R, FTEC9-10USMC, FTG7-05, FTG7-05L, FTG7-05R, FTG7-05VL, FTG7-05VR, FTG7-10, FTG7-10L, FTG7-10L+R, FTG7-10R, FTG7-10VL, FTG7-10VL+R, FTG7-10VR, FTG9-05L, FTG9-05R, FTG9-05VL, FTG9-05VR, FTG9-10L, FTG9-10L+R, FTG9-10R, FTG9-10VL, FTG9-10VL+R, FTG9-10VR, FTG9-11L, FTG9-11L+R, FTG9-11R...(Other models you can see in the webshop)		

housing and bezels

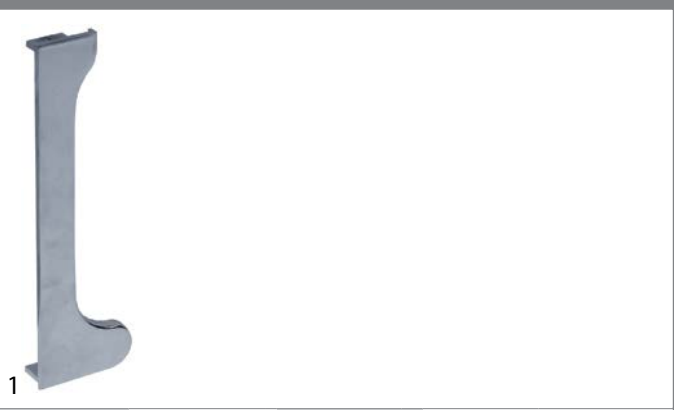

GEV No.	210022	Ref. No.	12020193 U452805
description	cover L 177mm W 52mm H 16mm for control panel mounting pos. left suitable for 700 series		
For models:	BG7-05, BG7-05I, BG7-10, BG7-10I, BME7-05, BME7-10, BMG7-10, CE7-20, CE7-40, CE7-41, CG7-10, CG7-11, CG7-20, CG-7200, CG7-40, CG-7400, CG7-41, CG-7415, CG7-61, CG-7615, CGB7-61, CGE7-41, CGE7-69, CPG7-05, EN7-05, EN7-10, FE-710, FE-720, FG-710, FG-720, FTE7-05, FTE7-05L, FTE7-05R, FTE7-10, FTE7-10L, FTE7-10L+R, FTE7-10R, FTEC7-05L, FTEC7-10L, FTG7-05, FTG7-05L, FTG7-05R, FTG7-05VL, FTG7-05VR, FTG7-10, FTG7-10L, FTG7-10L+R, FTG7-10R, FTG7-10VL, FTG7-10VL+R...(Other models you can see in the webshop)		

accessories for	210022			
	GEV No.	210021	Ref. No.	12020194 U452804
description	cover L 177mm W 52mm H 16mm for control panel mounting pos. right suitable for 700 series			

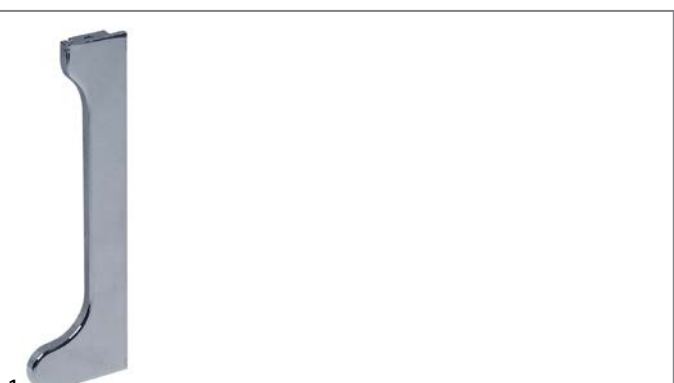

GEV No.	210021	Ref. No.	12020194 U452804
description	cover L 177mm W 52mm H 16mm for control panel mounting pos. right suitable for 700 series		
For models:	BG7-05, BG7-05I, BG7-10, BG7-10I, BME7-05, BME7-10, BMG7-10, CE7-20, CE7-40, CE7-41, CG7-10, CG7-11, CG7-20, CG-7200, CG7-40, CG-7400, CG7-41, CG-7415, CG7-61, CG-7615, CGB7-61, CGE7-41, CGE7-62, CPG7-05, EN7-05, EN7-10, FE-710, FE-720, FG-710, FG-720, FTE7-05, FTE7-05L, FTE7-05R, FTE7-10, FTE7-10L, FTE7-10L+R, FTE7-10R, FTEC7-05L, FTEC7-10L, FTG7-05, FTG7-05L, FTG7-05R, FTG7-05VL, FTG7-05VR, FTG7-10, FTG7-10L, FTG7-10L+R, FTG7-10R, FTG7-10VL, FTG7-10VL+R...(Other models you can see in the webshop)		

accessories for	210021			
	GEV No.	210022	Ref. No.	12020193 U452805
description	cover L 177mm W 52mm H 16mm for control panel mounting pos. left suitable for 700 series			

			
1			
GEV No.	700809	Ref. No.	12007564 R205409
description	fastening angle L 120mm W 67mm H 28mm		
For models:	BG9-05, BG9-10, BME9-05, BME9-10, BMG9-05, BMG9-10, CE9-20, CE9-40, CE9-41, CG9-10, CG9-11, CG9-20, CG9-40, CG9-41, CG9-60, CG9-61, CG9-82, EN9-05, EN9-10, FE-920, FG-920, FG-940, FTE9-05L, FTE9-05R, FTE9-10L, FTE9-10L+R, FTE9-10R, FTEC9-05, FTEC9-05L, FTEC9-05R, FTEC9-10, FTEC9-10L, FTEC9-10L+R, FTEC9-10R, FTG9-05L, FTG9-05R, FTG9-05VL, FTG9-05VR, FTG9-10L, FTG9-10L+R, FTG9-10R, FTG9-10VL, FTG9-10VL+R, FTG9-10VR, FTGC9-05, FTGC9-05L, FTGC9-05R, FTGC9-10, FTGC9-10L, FTGC9-10L+R...(Other models you can see in the webshop)		

			
1			
GEV No.	691721	Ref. No.	12012797 R162808
description	front panel for griddle W 850mm H 150mm		
For models:	FTG9-10L, FTG9-10L+R, FTG9-10R, FTG9-10VL, FTG9-10VL+R, FTG9-10VR, FTGC9-10L, FTGC9-10L+R, FTGC9-10R		

<div style="border: 1px solid black; padding: 5px; width: fit-content; margin: 0 auto;"> <p style="color: red; font-size: small;">Reglado a BUTANO-PROPANO Reglage BUTANE-PROPANE Regulated for L.P.G. using</p> </div>			
1			
GEV No.	691735	Ref. No.	12008203 U136501
description	sticker Regulated for L.P.G. using		
For models:	BG7-05, BG7-05I, BG7-10, BG7-10I, BG9-05, BG9-05I, BG9-05PF, BG9-05PI, BG9-10, BG9-10I, BG9-10PF, BG9-10PI, BME9-05, BME9-05V-T, BME9-10, BME9-10V-T, BMG7-10, BMG9-05, BMG9-05V-T, BMG9-10, BMG9-10V-T, CG-1002, CG-1502, CG-2000, CG-200S, CG-210, CG-210G, CG-300S, CG-310, CG-310G, CG7-10, CG7-11, CG-7115, CG7-20, CG-7200, CG7-20H, CG7-30D, CG7-30I, CG7-31D, CG7-31I, CG7-40, CG-7400, CG7-40H, CG7-41, CG-7415, CG7-41H, CG7-50, CG7-51, CG7-61, CG-7615...(Other models you can see in the webshop)		

<div style="border: 1px solid black; padding: 5px; width: fit-content; margin: 0 auto;"> <p style="color: red; font-size: small;">Reglado a GAS NATURAL Reglage GAZ NATUREL Regulated for NATURAL GAS using</p> </div>			
1			
GEV No.	691736	Ref. No.	12008202 U134402
description	sticker regulated for NATURAL GAS using		
For models:	BG7-05, BG7-05I, BG7-10, BG7-10I, BG9-05, BG9-05I, BG9-05PF, BG9-05PI, BG9-10, BG9-10I, BG9-10PF, BG9-10PI, BME9-05, BME9-05V-T, BME9-10, BME9-10V-T, BMG7-10, BMG-9045, BMG9-05, BMG9-05V-T, BMG9-10, BMG9-10V-T, CG-1002, CG-1502, CG-2000, CG-200S, CG-210, CG-210G, CG-300S, CG-310, CG-310G, CG7-10, CG7-11, CG-7115, CG7-20, CG-7200, CG7-20H, CG7-30D, CG7-30I, CG7-31D, CG7-31I, CG7-40, CG-7400, CG7-40H, CG7-41, CG-7415, CG7-41H, CG7-50, CG7-51, CG7-61...(Other models you can see in the webshop)		

griddles

			
1			
GEV No.	691854	Ref. No.	12015268 R795416
description	griddle L 620mm W 695mm H 80mm		
For models:	FTG7-10, FTG7-10L, FTG7-10VL		



			
1			
GEV No.	691902	Ref. No.	12000919 R065407
description	griddle L 875mm W 720mm H 80mm stainless steel		
For models:	FTG9-10PLUS-CLR, FTGC9-10L+R, FTGC9-10L+R-AD, FTGC9-11L+R		

sumps

			
1			
GEV No.	691684	Ref. No.	12014843 R792606
description	grease collecting tray L 265mm W 125mm H 50mm		
For models:	FTE7-05, FTE7-05L, FTE7-05R, FTE7-10, FTE7-10L, FTE7-10L+R, FTE7-10R, FTEC7-05L, FTEC7-10L, FTG7-05, FTG7-05L, FTG7-05R, FTG7-05VL, FTG7-05VR, FTG7-10, FTG7-10L, FTG7-10L+R, FTG7-10R, FTG7-10VL, FTG7-10VL+R, FTG7-10VR, FTGC7-05L, FTGC7-10L		

drain stoppers



GEV No.	691686	Ref. No.	12019460 R619912
description	plug bottom part D1 ø 40mm D2 ø 33.5mm H 30mm		
For models:	CG9-51LC, CG9-51RC, FTE7-05, FTE7-05L, FTE7-05R, FTE7-10, FTE7-10L, FTE7-10L+R, FTE7-10R, FTE9-05L, FTE9-05R, FTE9-10L, FTE9-10L+R, FTE9-10R, FTEC7-05L, FTEC7-10L, FTEC9-05, FTEC9-05L, FTEC9-05R, FTEC9-05USMC, FTEC9-10, FTEC9-10L, FTEC9-10L+R, FTEC9-10R, FTEC9-10USMC, FTG7-05, FTG7-05L, FTG7-05R, FTG7-10, FTG7-10L, FTG7-10L+R, FTG7-10R, FTG9-05L, FTG9-05R, FTG9-05VL, FTG9-05VR, FTG9-10L, FTG9-10L+R, FTG9-10R, FTG9-10VL, FTG9-10VL+R, FTG9-10VR, FTGC7-05L, FTGC7-10L, FTGC9-05, FTGC9-05L, FTGC9-05R, FTGC9-10, FTGC9-10L, FTGC9-10L+R...(Other models you can see in the webshop)		
accessories for	691686		
	GEV No.	111129	Ref. No. 12008060 S116122
	cone handle thread M10 ø 34mm L 55mm plastic black		
	GEV No.	527396	Ref. No. 12020466 R619913
	thread bolt for griddle L 50mm thread M10 stainless steel		

for chicken rotisserie

miscellaneous



GEV No.	691877	Ref. No.	12039840 Z200513
description	bolt ø 8mm L 31.5mm head ø 12mm head thickness 2.5mm SS		

for convection ovens/combi-steamers

drain units

drip rails



GEV No.	696855	Ref. No.	12039485 T800563000
description	drip rail L 540mm plastic W 44.5mm		
For models:	ACE-061, ACE-101, ACG-061, ACG-101, AE-061, AE-061W, AE-101, AE-101W, AG-061, AG-061W, AG-101, AG-101W, APE-061, APE-061W, APE-101, APE-101W, APG-061, APG-061W, APG-101, APG-101W		



GEV No.	692329	Ref. No.	12023771
description	drip rail L 700mm ABS plastic W 22mm hole ø 5mm for combi-steamer		
For models:	COE-061, COE-101, COG-061, COG-101, VE-061, VE-101, VG-101, VPE-061, VPE-101, VPG-101		

drain valves



GEV No.	696854	Ref. No.	12126816
description	drain fitting for combi-steamer		
For models:	APE-201, APE-202, APG-201, APG-202		



GEV No.	696858	Ref. No.	12043409
description	bush ID ø 4mm ED ø 8mm L 5.5mm		
For models:	ACE-061, ACE-101, ACE-102, ACE-201, ACE-202, ACG-061, ACG-101, ACG-201, ACG-202, AE-061, AE-061W, AE-101, AE-101W, AE-102, AE-102W, AE-201, AE-202, AG-061, AG-061W, AG-101, AG-101W, AG-201, AG-202, APE-061, APE-061W, APE-101, APE-101W, APE-102, APE-102W, APE-201, APE-202, APG-061, APG-061W, APG-101, APG-101W, APG-201, APG-202		



GEV No.	696856	Ref. No.	12023506 Z608410 Z608410000
description	bush ID ø 7mm ED ø 11mm L 8mm		
For models:	ACE-201, ACE-202, ACG-201, ACG-202, AE-201, AE-202, AG-201, AG-202, APE-201, APE-202, APG-201, APG-202		

steam generators

steam generators



1

GEV No.	692897	Ref. No.	12046049
description	steam generator L 290mm W 120mm H 300mm		
For models:	AE-101, AE-101W, APE-101, APE-101W		



1

GEV No.	692906	Ref. No.	12046048
description	steam generator L 300mm W 120mm H 420mm		
For models:	ACE-061, AE-061, AE-061W, APE-061, APE-061W		



1

GEV No.	696836	Ref. No.	12046053
description	steam generator L 310mm W 120mm H 530mm		
For models:	ACE-102, AE-102, AE-102W, AE-201, APE-102, APE-102W, APE-201		



1

GEV No.	691849	Ref. No.	1100002823 12000181 12010918 R145001
description	steam generator L 425mm W 110mm H 530mm		
For models:	HME-20-21, HME-2-20-11, HMM-20-21, HMM-20-21UL, HMM-2-20-11, HMM-40-11-USMC, HMP-20-21, HMP-2-20-11		



1

GEV No.	697779	Ref. No.	12025526 RT83507100
description	steam generator suitable for RATIONAL		

steam pipes



1

GEV No.	530875	Ref. No.	12031550 RT4400362
description	steam hose ext. \varnothing 78 ID \varnothing 70mm L 54mm silicone red/black		



1

GEV No.	521283	Ref. No.	12047930
description	steam pipe L 200mm W 85mm ø 53mm for combi-steamer steam generator		
For models:	ACE-061, ACE-102, AE-061, AE-061W, AE-101, AE-101W, AE-102, AE-102W, AE-201, AE-202, APE-061, APE-061W, APE-101, APE-101W, APE-102, APE-102W, APE-201, APE-202		



1

GEV No.	692042	Ref. No.	12012959 R722702
description	injection pipe steam		



1

GEV No.	691729	Ref. No.	12015182 R675019
description	steam pipe T-piece SS L 190mm ID ø 50mm ED ø 53mm		
For models:	HEM-10-11, HEM-6-11, HEP-10-11, HEP-6-11, HME-10-11, HME-10-21, HME-20-21, HME-2-10-11, HME-2-20-11, HME-6-11, HMM-10-11, HMM-10-21, HMM-20-21, HMM-20-21UL, HMM-2-10-11, HMM-2-20-11, HMM-40-11-USMC, HMM-6-11, HMP-10-11, HMP-10-21, HMP-20-21, HMP-2-10-11, HMP-2-20-11, HMP-6-11		

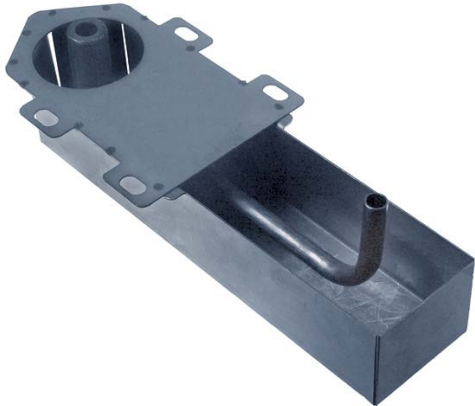

1

GEV No.	692043	Ref. No.	12013564 T072605
description	injection pipe steam		
For models:	HMG-6-11		

injection pipes



1

GEV No.	694069	Ref. No.	12013716 T07500
description	injection pipe L1 180mm L2 65mm tube ø 10mm		



1

GEV No.	691901	Ref. No.	12014384 R665020
description	injector pipe L1 175mm L2 65mm tube ø 10mm mounting distance 36mm		
For models:	HME-6-11, HMI-6-11, HMI-6-11UL, HMP-6-11		



1

GEV No.	694070	Ref. No.	12014333 R675017
description	injection pipe L1 225mm L2 65mm tube ø 10mm mounting distance 36mm		
For models:	HME-10-11, HME-10-21, HME-20-11, HME-20-21, HME-2-10-11, HME-2-20-11, HMI-10-11, HMI-10-11UL, HMI-10-21, HMI-10-21UL, HMI-2-10-11, HMP-10-11, HMP-10-21, HMP-20-11, HMP-20-21, HMP-2-10-11, HMP-2-20-11		

spare parts and accessories



1

GEV No.	551460	Ref. No.	12023647 T723007000
description	cover cap for USB-conection with internal thread ø 38mm		
For models:	ACE-061, ACE-101, AE-061, AE-101, APE-061, APE-061W, APE-101, APE-101W, APE-102, APE-102W, APE-201, APE-202, APG-061, APG-061W, APG-101, APG-101W, APG-102, APG-102W, APG-201, APG-202		

			
1			
GEV No.	403747	Ref. No.	12043405
description	potentiometer rotation 360° shaft ø 6x4.6mm shaft L 13mm		
For models:	ACE-061, ACE-101, AE-061, AE-061W, AE-101, AE-101W, AE-102, AE-102W, AE-201, AE-202, AG-061, AG-061W, AG-101, AG-101W, AG-102, AG-102W, AG-201, AG-202, APE-061, APE-101		

filters

			
1			
GEV No.	701580	Ref. No.	12032599 RT20050307
description	drain filter ø 71mm H 18mm IT M6 for combi-steamer model CPC-Linie CPC 61/101/201		

housing and bezels

			
Image not available			
1			
GEV No.	691882	Ref. No.	12011627 R675005
description	fastening angle L 35mm W 35mm H 42mm		
For models:	HEI-10-11, HEI-20-11, HEI-6-11, HEM-10-11, HEM-20-11, HEM-6-11, HEP-10-11, HEP-20-11, HEP-6-11, HME-10-11, HME-10-21, HME-20-11, HME-20-21, HME-2-10-11, HME-2-20-11, HME-6-11, HMI-10-11, HMI-10-11UL, HMI-10-21, HMI-10-21UL, HMI-2-10-11, HMI-6-11, HMI-6-11UL, HMM-10-11, HMM-10-11UL, HMM-10-21, HMM-10-21UL, HMM-20-11, HMM-20-11UL, HMM-20-21, HMM-20-21UL, HMM-2-10-11, HMM-2-20-11, HMM-40-11-USMC, HMM-6-11, HMM-6-11UL, HMP-10-11, HMP-10-21, HMP-20-11, HMP-20-21, HMP-2-10-11, HMP-2-20-11, HMP-6-11		

			
1			
GEV No.	691691	Ref. No.	12009010 12009015 U022836 U262806
description	type plate FAGOR metal		
For models:	BG6-05I, BG7-05, BG7-05I, BG7-10, BG7-10I, BG9-05, BG9-05AD, BG9-05I, BG9-05PF, BG9-05PI, BG9-05PLUS-I, BG9-10, BG9-10AD, BG9-10I, BG9-10PF, BG9-10PI, BG9-10PLUS-I, BME6-05, BME7-05, BME7-10, BME9-05, BME9-05AD, BME9-05PLUS, BME9-05V-T, BME9-10, BME9-10AD, BME9-10PLUS, BME9-10V-T, BMG7-10, BMG9-05, BMG9-05V-T, BMG9-10, BMG9-10V-T, CE6-20, CE6-40, CE6-41, CE7-20, CE7-40, CE7-41, CE9-20, CE9-20AD, CE9-20PLUS, CE9-40, CE9-40AD, CE9-40PLUS, CE9-41, CE9-41AD, CE9-41PLUS, CG-1002, CG-1502...(Other models you can see in the webshop)		

glass panels

			
1			
GEV No.	692856	Ref. No.	12025892 RT2400212
description	door glass for combi-steamer SCC/CM202 L 1340mm mounting pos. inner W 680mm thickness 6mm		

			
1			
GEV No.	694938	Ref. No.	RT2400200
description	glass panel for door inside combi-steamer SCC/CM102 L 763mm W 680mm thickness 7mm		

			
1			
GEV No.	694492	Ref. No.	12027606 RT2400163
description	glass panel L 485mm W 508mm thickness 6mm mounting pos. inner for combi-steamer		

			
1			
GEV No.	700832	Ref. No.	12017461 R680508
description	glass panel L 820mm W 765mm thickness 5mm rectangular mounting pos. inner		
For models:	HCG-10-21, HCG-2-10-11, HME-10-21, HME-2-10-11, HMG-10-21, HMG-10-21UL, HMG-2-10-11, HMI-10-21, HMI-10-21UL, HMI-2-10-11, HMM-10-21, HMM-10-21UL, HMM-2-10-11, HMP-10-21, HMP-2-10-11		

air filters

			
1			
GEV No.	692694	Ref. No.	12033202 RT1600673
description	filter L 220mm W 50mm ømm H 150mm SCC Line		



			
1			
GEV No.	692695	Ref. No.	12034505 RT84551377
description	filter insert L 213mm W 60mm ømm H 90mm		

cleaning system

nozzles

			
1			
GEV No.	505230	Ref. No.	12017281 Z651931
description	rinse jet H 12mm thread M10x1 WS 14 hole ø 1.6mm		
For models:	FI-300B, FI-300R, FI-650R, HCV-10-11, HCV-10-21, HCV-2-10-21, HCV-6-11, HEM-10-11, HEM-20-11, HEM-6-11, HEP-10-11, HEP-20-11, HEP-6-11, HME-10-11, HME-10-21, HME-20-11, HME-20-21, HME-2-10-11, HME-2-20-11, HME-6-11, HMM-10-11, HMM-10-11UL, HMM-10-21, HMM-10-21UL, HMM-20-11, HMM-20-11UL, HMM-20-21, HMM-20-21UL, HMM-2-10-11, HMM-2-20-11, HMM-40-11-USMC, HMM-6-11, HMM-6-11UL, HMP-10-11, HMP-10-21, HMP-20-11, HMP-20-21, HMP-2-10-11, HMP-2-20-11, HMP-6-11		

			
1			
GEV No.	505232	Ref. No.	12021186 Z651932
description	swirl H 10.7mm ø 6mm 1.5mm H1 5mm		
For models:	FI-300B, FI-300R, FI-650R, HCV-10-11, HCV-10-21, HCV-2-10-21, HCV-6-11, HEM-10-11, HEM-20-11, HEM-6-11, HEP-10-11, HEP-20-11, HEP-6-11, HME-10-11, HME-10-21, HME-20-11, HME-20-21, HME-2-10-11, HME-2-20-11, HME-6-11, HMM-10-11, HMM-10-11UL, HMM-10-21, HMM-10-21UL, HMM-20-11, HMM-20-11UL, HMM-20-21, HMM-20-21UL, HMM-2-10-11, HMM-2-20-11, HMM-40-11-USMC, HMM-6-11, HMM-6-11UL, HMP-10-11, HMP-10-21, HMP-20-11, HMP-20-21, HMP-2-10-11, HMP-2-20-11, HMP-6-11		

coupling bushings

			
1			
GEV No.	694486	Ref. No.	12031521 RT20620348
description	coupling bush for cleaning system		

			
1			
GEV No.	694487	Ref. No.	12031179 RT20620347
description	coupling bush for cleaning system		

			
1			
GEV No.	694488	Ref. No.	12030870 RT20620350
description	coupling bush for cleaning system		

			
1			
GEV No.	694489	Ref. No.	12029908 RT20620349
description	coupling bush for cleaning system		

pumps

			
1			
GEV No.	500578	Ref. No.	12026928 RT5600153P
description	pump inlet ø 24mm outlet ø 24mm type UP30-274 230V 50/60Hz 1 phase 0.09kW 0.12HP L 145mm rotation direction left capacitor 2.5µF HANNING		
spare parts for	500578		
	GEV No.	Ref. No.	—
	O-ring EPDM thickness 3mm ID ø 58mm Qty 1 pcs		

			
1			
GEV No.	500579	Ref. No.	12026728 RT5600178P
description	pump inlet ø 24mm outlet ø 24mm type UP30-275 230V 50/60Hz 1 phase 0.09kW 0.12HP L 145mm rotation direction left capacitor 2.5µF HANNING		
spare parts for	500579		
	GEV No.	Ref. No.	—
	O-ring EPDM thickness 3mm ID ø 58mm Qty 1 pcs		

cleaning arms



1

GEV No.	541433	Ref. No.	12026700 RT86552101
description	cleaning arm CleanJet suitable for RATIONAL _101-_202		

non-return valves



1

GEV No.	531321	Ref. No.	12035266 RT20690107
description	non-return valve		



1

GEV No.	531297	Ref. No.	12033754 RT5000078
description	non-return valve \varnothing 16.4mm L 18mm		

hoses



1

GEV No.	530794	Ref. No.	12031663 RT21121304
description	formed hose ED \varnothing 29mm ID \varnothing 23mm L 485mm for combi-steamer CPC-Linie 102/201E		



1

GEV No.	530791	Ref. No.	12031730 RT4400242
description	formed hose ED \varnothing 29mm ID \varnothing 23mm L 730mm for combi-steamer SCC Linie 202		



1

GEV No.	530792	Ref. No.	12031089 RT21121305
description	formed hose ID \varnothing 22mm ED \varnothing 29mm L 640mm for combi-steamer CPC 202		



1

GEV No.	694490	Ref. No.	12036856 RT21121310
description	formed hose ID \varnothing 22mm ED \varnothing 30mm L 80mm steam generator		



1

GEV No.	696852	Ref. No.	12024425 T330731000
description	hose ID \varnothing 30/23mm ED \varnothing 36/30mm L 177mm for combi-steamer		
For models:	APE-102, APE-102W, APE-202, APG-102, APG-202		



1

GEV No.	530918	Ref. No.	12039649 T945056000
description	hose ID \varnothing 30mm ED \varnothing 40mm L 110mm for steam generator		
For models:	ACE-102, AE-102, AE-102W, AE-201, AE-202, AG-061, AG-061W, AG-101, AG-101W, AG-102, AG-102W, AG-201, AG-202, APE-102, APE-102W, APE-201, APE-202, APG-061, APG-061W, APG-101, APG-101W, APG-102, APG-102W, APG-201, APG-202		

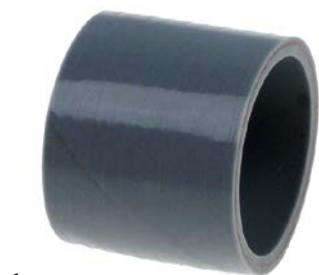

1

GEV No.	692102	Ref. No.	12031714 RT21121006
description	hose ID \varnothing 50mm ED \varnothing 60mm L 50mm		





1

GEV No.	694321	Ref. No.	12037987 RT21121307
description	hose ID ϕ 70mm ext. ϕ 80 L 80mm for combi-steamer		



1

GEV No.	530919	Ref. No.	12044832
description	hose ID ϕ 73mm ED ϕ 85mm L 150mm for steam generator		
For models:	AG-202, APG-202		



1

GEV No.	530795	Ref. No.	12035289 RT21101029
description	silicone hose ID ϕ 6mm ED ϕ 10mm L 1085mm for combi-steamer CPC-Linie CM 61-202/G white		



1

GEV No.	530798	Ref. No.	12034250 RT21101030
description	silicone hose ID ϕ 6mm ED ϕ 10mm L 1120mm for combi-steamer CPC-Linie CM 61-202/G		



1

GEV No.	530875	Ref. No.	12031550 RT4400362
description	steam hose ext. ϕ 78 ID ϕ 70mm L 54mm silicone red/black		

service kits



1

GEV No.	530874	Ref. No.	12026779 RT87201521	
description	conversion kit - for combi-steamer CPC-Linie 61-102E RATIONAL			
spare parts for	530874			
	GEV No.	692215	Ref. No.	—
	conversion kit for tank inlet fitting			

drip water trays



1

GEV No.	699800	Ref. No.	12033203 RT5000300
description	drip tray plastic L 745mm W 47mm H 20mm		

door mechanics

holders



1

GEV No.	691904	Ref. No.	12002903 U065658
description	bracket for gasket angled L 405mm W 20mm H 20mm mounting distance 98mm stainless steel		

miscellaneous



1

GEV No.	694934	Ref. No.	12031180 RT29401306
description	cover for door latch suitable for combi-steamer CPC-Linie 201/202 aluminium L 96.5mm W 65.5mm		

accessories



1

GEV No.	696851	Ref. No.	12022138 R660538 R660538000
description	base plate W 40mm zinc-plated sheet steel L 44mm		
For models:	ACE-201, ACE-202, ACG-201, ACG-202, AE-201, AE-202, AG-201, AG-202, APE-201, APE-202, APG-201, APG-202		



1

GEV No.	694656	Ref. No.	12037230 RT20390402
description	door bumper silicone ø 13mm L 19mm		

vibration pumps



1

GEV No.	500580	Ref. No.	12028569 RT87201526
description	vibration pump 230V 60W 50/60Hz inlet ø 7 outlet ø 1/8" IT CEME type E512 with accessories duty cycle 1/2 ambient temperature max. 60°C medium temp max. 35°C overheating protection 110°C CleanJet		

heat exchangers



1

GEV No.	109075	Ref. No.	12022680 R725709
description	flange ED ø 85mm thickness 2mm		
For models:	HCG-10-11, HCG-10-21, HCG-20-11, HCG-2-10-11, HMG-10-11, HMG-10-11UL, HMG-10-21, HMG-10-21UL, HMG-20-11, HMG-2-10-11		



1

GEV No.	109072	Ref. No.	12011760 T075700
description	heat exchanger ED ø 405mm H 500mm W 140mm		
For models:	HMG-6-11		



1

GEV No.	109076	Ref. No.	12011269 T135700
description	heat exchanger H 1200mm W 570mm		



1

GEV No.	520404	Ref. No.	12023740 T115084
description	reducing washer gas burner brass ID ø 16mm ED ø 58mm thickness 3mm type 16		



1

GEV No.	520403	Ref. No.	12018367 T115082
description	reducing washer gas burner brass ID ø 18mm ED ø 58mm thickness 3mm type 18		
For models:	HCG-10-11, HCG-10-21, HCG-2-10-11, HGC-10-11, HGV-10-11, HVG-10-11, HVG-10-11UL, HVG-10-21, HVG-10-21UL, HVG-2-10-11, MFHVG-10-11, MFHVG-10-21		



1

GEV No.	109073	Ref. No.	12018368 T115083
description	reducing washer ID ø 20mm ED ø 58mm W 3mm code 20		
For models:	HCG-10-11, HCG-10-21, HCG-2-10-11, HGC-10-11, HGV-10-11, HVG-10-11, HVG-10-11UL, HVG-10-21, HVG-10-21UL, HVG-2-10-11, MFHVG-10-11, MFHVG-10-21		

miscellaneous



1

GEV No.	694433	Ref. No.	12036082 RT20690108	
description	air valve for combi-steamer bore ø 2mm L 18mm plastic ø 20mm			
accessories for	694433			
	GEV No.	694402	Ref. No.	12033922 RT83541304
valve body for air valve hose ø 10mm				



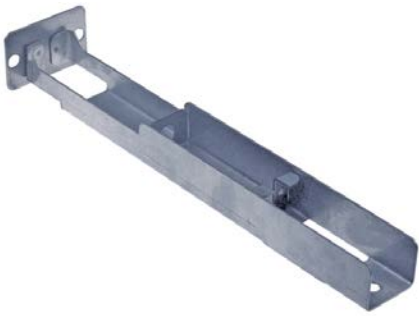

 <p>1</p>			
GEV No.	692330	Ref. No.	12022242
description	atomizer for combi-steamer L 97mm ø 43mm hole ø 10mm		
For models:	ACE-201, ACE-202, COE-061, COE-101, COE-102, COE-201, COE-202, HEI-20-11		

 <p>1</p>			
GEV No.	693533	Ref. No.	12035275 RT29201300
description	bracket for level electrode		

 <p>1</p>			
GEV No.	691689	Ref. No.	12014956 R660539
description	bracket for lighting		
For models:	HCG-10-11, HCG-10-21, HCG-20-11, HCG-2-10-11, HCG-6-11, HME-10-11, HME-10-21, HME-20-11, HME-20-21, HME-2-10-11, HME-6-11, HMG-10-11, HMG-10-11UL, HMG-10-21, HMG-10-21UL, HMG-20-11, HMG-2-10-11, HMG-6-11, HMI-10-11, HMI-10-11UL, HMI-10-21, HMI-10-21UL, HMI-2-10-11, HMI-6-11, HMI-6-11UL, HMM-10-11, HMM-10-11UL, HMM-10-21, HMM-10-21UL, HMM-20-11, HMM-20-11UL, HMM-2-10-11, HMM-6-11, HMM-6-11UL, HMP-10-11, HMP-10-21, HMP-20-11, HMP-20-21, HMP-2-10-11, HMP-6-11		

 <p>1</p>			
GEV No.	692101	Ref. No.	12037114 RT20390331
description	cap D1 ø 19mm D2 ø 10mm		

 <p>1</p>			
GEV No.	699809	Ref. No.	12037366 RT5000156
description	clamp for spray gun L 24mm		

 <p>1</p>			
GEV No.	696553	Ref. No.	12017801 Z883001
description	compression spring ø 7.5mm L 23mm wire gauge ø 0.7mm		
For models:	ECO-280D, ECO-280I, ECO-370D, ECO-370I, ECO-460D, ECO-460I, ECO-550D, ECO-550I, FI-280D, FI-280I, FI-370D, FI-370I, FI-460D, FI-460I, FI-550D, FI-550I, HEI-10-11, HEI-20-11, HEI-6-11, HEM-10-11, HEM-20-11, HEM-6-11, HEP-10-11, HEP-20-11, HEP-6-11, HME-10-11, HME-10-21, HME-20-11, HME-20-21, HME-2-10-11, HME-2-20-11, HME-6-11, HMI-10-11, HMI-10-11UL, HMI-10-21, HMI-10-21UL, HMI-2-10-11, HMI-6-11, HMI-6-11UL, HMM-10-11, HMM-10-11UL, HMM-10-21, HMM-10-21UL, HMM-20-11, HMM-20-11UL, HMM-20-21, HMM-20-21UL, HMM-2-10-11, HMM-2-20-11, HMM-40-11-USMC... (Other models you can see in the webshop)		

 <p>1</p>			
GEV No.	510559	Ref. No.	12034914
description	connection for pump		

 <p>1</p>			
GEV No.	691878	Ref. No.	12011814 R722629
description	cover L 150mm		
For models:	HMG-10-11, HMG-10-11UL, HMG-10-21, HMG-10-21UL, HMG-2-10-11, HVG-10-11, HVG-10-11UL, HVG-10-21, HVG-2-10-11, MFHVG-10-11		

 <p>1</p>			
GEV No.	702000	Ref. No.	12037186 RT1000357
description	cover cap for tray rack trolley D1 ø 20mm H 13.5mm D2 ø 26mm plastic Qty 5 pcs SCC-Linie 201/202		

			
1			
GEV No.	691690	Ref. No.	12020763 R725033
description	disc D1 ø 65mm D2 ø 6.5mm brass thickness 2mm		
For models:	HMG-10-11, HMG-10-11UL, HMG-10-21, HMG-10-21UL, HMG-2-10-11, HMG-6-11		

			
1			
GEV No.	694652	Ref. No.	12035010 RT20700050
description	drain pipe angled D1 ø 54mm D2 ø 40mm L 95mm plastic H 95mm		

			
1			
GEV No.	694391	Ref. No.	12034434 RT5000299
description	drain pipe with sleeve for drip pan L 560mm PE		

			
1			
GEV No.	524459	Ref. No.	12033475 RT5000286
description	drip rail L 540mm plastic W 63mm		
accessories for	524459		
	GEV No.	697931	Ref. No. —
mounting clip plastic W 20mm Qty 5 pcs			

			
1			
GEV No.	691695	Ref. No.	12024231 R662813
description	duct for flues D1 ø 80mm D2 ø 55mm rubber		
For models:	ACE-061, ACE-101, ACE-102, ACE-201, ACG-061, ACG-101, ACG-102, ACG-201, AE-061, AE-061W, AE-101, AE-101W, AE-102, AE-102W, AE-201, AG-061, AG-061W, AG-101, AG-101W, AG-102, AG-102W, AG-201, APE-061, APE-061W, APE-101, APE-101W, APE-102, APE-102W, APE-201, APG-061, APG-061W, APG-101, APG-101W, APG-102, APG-102W, APG-201, COE-061, COE-101, COE-102, COE-201, COE-202, HEI-10-11, HEI-10-21, HEI-20-11, HEI-6-11, HEM-10-11, HEM-10-21, HEM-20-11, HEM-6-11, HEP-10-11...(Other models you can see in the webshop)		

			
1			
GEV No.	694651	Ref. No.	12031441 12032850 RT20050301 RT20050308
description	filter for combi-steamer ø 97mm hole ø 6mm H 17.5mm		

			
1			
GEV No.	691732	Ref. No.	12012292 12022207 R345120 T115105
description	fixing plate bore ø 13mm L 54mm W 29mm		
For models:	HEI-10-11, HEI-20-11, HEI-6-11, HEM-10-11, HEM-20-11, HEM-6-11, HEP-10-11, HEP-20-11, HEP-6-11, HME-10-11, HME-10-21, HME-20-11, HME-20-21, HME-2-10-11, HME-2-20-11, HME-6-11, HMI-10-11, HMI-10-11UL, HMI-10-21, HMI-10-21UL, HMI-2-10-11, HMI-6-11, HMI-6-11UL, HMM-10-11, HMM-10-11UL, HMM-10-21, HMM-10-21UL, HMM-20-11, HMM-20-11UL, HMM-20-21, HMM-20-21UL, HMM-2-10-11, HMM-2-20-11, HMM-40-11-USMC, HMM-6-11, HMM-6-11UL, HMP-10-11, HMP-10-21, HMP-20-11, HMP-20-21, HMP-2-10-11, HMP-2-20-11, HMP-6-11, MFHMM-20-11		

			
1			
GEV No.	520917	Ref. No.	12034964
description	gasket for heat exchanger D1 ø 104mm D2 ø 132mm		

			
1			
GEV No.	694320	Ref. No.	12034776 RT50120566
description	gasket for lid ø 145mm		



1

GEV No.	692520	Ref. No.	12023750 T842809
description	gutter for inner door plastic W 675mm FAGOR		
For models:	COE-061, COE-101, COG-061, COG-101, VE-061, VE-101, VG-101, VPE-061, VPE-101, VPG-101		



1

GEV No.	691706	Ref. No.	12016458 T075003
description	heat exchanger complete SS		
For models:	HMG-6-11		



1

GEV No.	512184	Ref. No.	12032196 RT86641301
description	hose connector plastic thread 3/4" Qty 1 pcs connection distance 60mm T-shape		



1

GEV No.	694936	Ref. No.	12028877 RT50030300
description	insulating mat for combi-steamer CPC-Linie L 1078mm W 635mm H 11mm foam Qty 2 pcs		



1

GEV No.	691857	Ref. No.	12013749 12018338 12039157 R335030 R665046 T325040 T325077
description	level tank L 178mm ø 75mm		
For models:	HCV-5-11, HCV-6-11, HEM-10-11, HEM-10-21, HEM-20-11, HEM-20-21, HEM-6-11, HEP-10-11, HEP-10-21, HEP-20-11, HEP-20-21, HEP-6-11, HGP-10-21, HGP-20-21, HGV-10-11, HGV-10-21, HGV-20-11, HGV-20-21, HME-10-11, HME-10-21, HME-2-10-11, HME-6-11, HMM-6-11, HMM-6-11UL, HMP-10-11, HMP-10-21, HMP-2-10-11, HMP-6-11, HVG-10-11, HVG-10-11UL, HVG-10-21, HVG-10-21UL, HVG-20-11, HVG-20-21, HVG-2-10-11, HVG-2-20-21, MFHVG-10-11, MFHVG-10-21, VE-061, VE-101, VE-102, VE-201, VE-202, VPE-061, VPE-101, VPE-102, VPE-201, VPE-202		





1

GEV No.	691677	Ref. No.	12012047 R025011
description	level tank L 235mm SS ø 75mm		
For models:	HCV-10-11, HCV-10-21, HCV-2-10-21, HME-10-11, HME-10-21, HME-20-11, HME-20-21, HME-2-10-11, HME-2-20-11, HME-6-11, HMM-10-11, HMM-10-11UL, HMM-10-21, HMM-10-21UL, HMM-20-11, HMM-20-11UL, HMM-20-21, HMM-20-21UL, HMM-2-10-11, HMM-2-20-11, HMM-40-11-USMC, HMP-10-11, HMP-10-21, HMP-20-11, HMP-20-21, HMP-2-10-11, HMP-2-20-11, HMP-6-11, MFHMM-20-11		

			
1			
GEV No.	698491	Ref. No.	12024419 12113061 T325079
description	level tank level control bore ϕ 17mm L 205mm thread M12 W 28mm ϕ 20.5mm H 80mm		
For models:	ACE-061, ACE-102, AE-061, AE-061W, AE-101, AE-101W, AE-102, AE-102W, AE-201, AE-202, AG-061, AG-061W, AG-101, AG-101W, AG-102, AG-102W, AG-201, AG-202, APE-061, APE-061W, APE-101, APE-101W, APE-102, APE-102W, APE-201, APE-202, APG-061, APG-061W, APG-101, APG-101W, APG-102, APG-102W, APG-201, APG-202, GA-20, GA-20D, GA-40, GA-40D, VE-061, VE-101, VE-102, VE-201, VE-202, VG-101, VG-102, VG-201, VG-202, VPE-061, VPE-101, VPE-102...(Other models you can see in the webshop)		

			
2			
GEV No.	512497	Ref. No.	12037410 RT20390350
description	protection cap for pulser suitable for combi-steamer CPC-Linie CPC/CM 61-202 D1 ϕ 13.5mm H 8.5mm D2 ϕ 6mm silicone		

			
1			
GEV No.	691869	Ref. No.	12011086 R142614
description	protective plate for fan motor L 160mm		
For models:	HCG-10-11, HCG-10-21, HCG-20-11, HCG-20-21, HCG-2-10-11, HCG-2-20-11, HCG-6-11, HGC-10-11, HGC-20-11, HGC-6-11, HGV-10-11, HGV-20-11, HME-20-21, HMM-20-21, HMM-40-11-USMC, HMP-20-21, HVG-10-11, HVG-10-11UL, HVG-10-21, HVG-10-21UL, HVG-20-11, HVG-20-21, HVG-2-10-11, HVG-2-20-21, MFHVG-10-11, MFHVG-10-21		

			
1			
GEV No.	696427	Ref. No.	12009970 Q222011
description	rivet nut thread M5 DN 4mm L 12mm SS Qty 1 pcs ϕ 7mm WS 6		
For models:	ACE-061, ACE-101, ACE-102, ACE-201, ACE-202, ACG-061, ACG-101, ACG-102, ACG-201, ACG-202, AD-45BBT, AD-48HY, AD-64BBT, AD-64BTDD, AD-64HY, AE-061, AE-061W, AE-101, AE-101W, AE-102, AE-102W, AE-201, AE-202, AG-061, AG-061W, AG-101, AG-101W, AG-102, AG-102W, AG-201, AG-202, APE-061, APE-061W, APE-101, APE-101W, APE-102, APE-102W, APE-201, APE-202, APG-061, APG-061W, APG-101, APG-101W, APG-102, APG-102W, APG-201, APG-202, CE9-40, CE9-41, CG-2000...(Other models you can see in the webshop)		

			
1			
GEV No.	696393	Ref. No.	12027056 RT85141346
description	rotary nozzle for combi-steamer L 125mm stainless steel		

			
1			
GEV No.	694322	Ref. No.	12110550 RT5000303
description	sleeve for drip pan D1 ϕ 15mm D2 ϕ 20mm L 62mm		

			
1			
GEV No.	691734	Ref. No.	12020472 R675008
description	thread bolt for cavity degassing D1 ϕ 12mm L 58mm stainless steel thread M6		
For models:	HEI-10-11, HEI-20-11, HEI-6-11, HEM-10-11, HEM-20-11, HEM-6-11, HEP-10-11, HEP-20-11, HEP-6-11, HME-10-11, HME-10-21, HME-20-11, HME-20-21, HME-2-10-11, HME-2-20-11, HME-6-11, HMI-10-11, HMI-10-11UL, HMI-10-21, HMI-10-21UL, HMI-2-10-11, HMI-6-11, HMI-6-11UL, HMM-10-11, HMM-10-11UL, HMM-10-21, HMM-10-21UL, HMM-20-11, HMM-20-11UL, HMM-20-21, HMM-20-21UL, HMM-2-10-11, HMM-2-20-11, HMM-40-11-USMC, HMM-6-11, HMM-6-11UL, HMP-10-11, HMP-10-21, HMP-20-11, HMP-20-21, HMP-2-10-11, HMP-2-20-11, HMP-6-11		



GEV No.	694402	Ref. No.	12033922 RT83541304
description	valve body for air valve hose ø 10mm		
accessories for	694402		
	GEV No.	694433	Ref. No. 12036082 RT20690108
	air valve for combi-steamer bore ø 2mm L 18mm plastic ø 20mm		



GEV No.	542288	Ref. No.	12024796
description	valve body for combi-steamer hose ø 24mm		
For models:	APE-061, APE-061W, APE-101, APE-101W, APE-102, APE-102W, APE-201, APE-202, APG-061, APG-061W, APG-101, APG-101W, APG-102, APG-102W, APG-201, APG-202, HEP-10-21, HEP-20-21, HGP-10-21, HGP-20-21, VG-101, VPE-061, VPE-101, VPE-102, VPE-201, VPE-202, VPG-101, VPG-102, VPG-201, VPG-202		



GEV No.	530799	Ref. No.	12034624 RT5000073
description	water distributor for combi-steamer SCC, CM L 83mm bore ø 13mm thread 3/4"		



GEV No.	691883	Ref. No.	12016138 R675002
description	water pipe L 650mm		
For models:	HCG-10-11, HCG-20-11, HCG-6-11, HEM-10-11, HEM-20-11, HEM-6-11, HEP-10-11, HEP-20-11, HEP-6-11, HGV-10-11, HME-10-11, HME-20-11, HME-6-11, HMG-10-11, HMG-10-11UL, HMG-20-11, HMG-6-11, HMI-10-11, HMI-10-11UL, HMI-6-11, HMI-6-11UL, HMM-10-11, HMM-10-11UL, HMM-20-11, HMM-20-11UL, HMM-6-11, HMM-6-11UL, HMP-10-11, HMP-20-11, HMP-6-11, HVG-10-11, HVG-10-11UL, HVG-2-10-11, MFHMM-20-11, MFHVG-10-11		



GEV No.	691884	Ref. No.	12015187 R685003
description	water pipe L 860mm		
For models:	HCG-10-21, HCG-20-21, HCG-2-10-11, HCG-2-20-11, HME-10-21, HME-20-21, HME-2-10-11, HMG-10-21, HMG-10-21UL, HMG-2-10-11, HMI-10-21, HMI-10-21UL, HMI-2-10-11, HMM-10-21, HMM-10-21UL, HMM-2-10-11, HMP-10-21, HMP-20-21, HMP-2-10-11, HVG-10-21, HVG-10-21UL, MFHVG-10-21		

for tilting bratt pans

housing and bezels





GEV No.	210022	Ref. No.	12020193 U452805
description	cover L 177mm W 52mm H 16mm for control panel mounting pos. left suitable for 700 series		
For models:	BG7-05, BG7-05I, BG7-10, BG7-10I, BME7-05, BME7-10, BMG7-10, CE7-20, CE7-40, CE7-41, CG7-10, CG7-11, CG7-20, CG-7200, CG7-40, CG-7400, CG7-41, CG-7415, CG7-61, CG-7615, CGB7-61, CGE7-41, CGE7-69, CPG7-05, EN7-05, EN7-10, FE-710, FE-720, FG-710, FG-720, FTE7-05, FTE7-05L, FTE7-05R, FTE7-10, FTE7-10L, FTE7-10L+R, FTE7-10R, FTEC7-05L, FTEC7-10L, FTG7-05, FTG7-05L, FTG7-05R, FTG7-05VL, FTG7-05VR, FTG7-10, FTG7-10L, FTG7-10L+R, FTG7-10R, FTG7-10VL, FTG7-10VL+R...(Other models you can see in the webshop)		
accessories for	210022		
	GEV No.	210021	Ref. No. 12020194 U452804
	cover L 177mm W 52mm H 16mm for control panel mounting pos. right suitable for 700 series		

			
GEV No.	210021	Ref. No.	12020194 U452804
description	cover L 177mm W 52mm H 16mm for control panel mounting pos. right suitable for 700 series		
For models:	BG7-05, BG7-05I, BG7-10, BG7-10I, BME7-05, BME7-10, BMG7-10, CE7-20, CE7-40, CE7-41, CG7-10, CG7-11, CG7-20, CG-7200, CG7-40, CG-7400, CG7-41, CG-7415, CG7-61, CG-7615, CGB7-61, CGE7-41, CGE7-62, CPG7-05, EN7-05, EN7-10, FE-710, FE-720, FG-710, FG-720, FTE7-05, FTE7-05L, FTE7-05R, FTE7-10, FTE7-10L, FTE7-10L+R, FTE7-10R, FTEC7-05L, FTEC7-10L, FTG7-05, FTG7-05L, FTG7-05R, FTG7-05VL, FTG7-05VR, FTG7-10, FTG7-10L, FTG7-10L+R, FTG7-10R, FTG7-10VL, FTG7-10VL+R...(Other models you can see in the webshop)		
accessories for	210021		
	GEV No.	Ref. No.	12020193 U452805
	cover L 177mm W 52mm H 16mm for control panel mounting pos. left suitable for 700 series		

<p>Reglado a BUTANO-PROPANO Reglage BUTANE-PROPANE Regulated for L.P.G. using</p>			
GEV No.	691735	Ref. No.	12008203 U136501
description	sticker Regulated for L.P.G. using		
For models:	BG7-05, BG7-05I, BG7-10, BG7-10I, BG9-05, BG9-05I, BG9-05PF, BG9-05PI, BG9-10, BG9-10I, BG9-10PF, BG9-10PI, BME9-05, BME9-05V-T, BME9-10, BME9-10V-T, BMG7-10, BMG9-05, BMG9-05V-T, BMG9-10, BMG9-10V-T, CG-1002, CG-1502, CG-2000, CG-2005, CG-210, CG-210G, CG-3005, CG-310, CG-310G, CG7-10, CG7-11, CG-7115, CG7-20, CG-7200, CG7-20H, CG7-30D, CG7-30I, CG7-31D, CG7-31I, CG7-40, CG-7400, CG7-40H, CG7-41, CG-7415, CG7-41H, CG7-50, CG7-51, CG7-61, CG-7615...(Other models you can see in the webshop)		

<p>Reglado a GAS NATURAL Reglage GAZ NATUREL Regulated for NATURAL GAS using</p>			
GEV No.	691736	Ref. No.	12008202 U134402
description	sticker regulated for NATURAL GAS using		
For models:	BG7-05, BG7-05I, BG7-10, BG7-10I, BG9-05, BG9-05I, BG9-05PF, BG9-05PI, BG9-10, BG9-10I, BG9-10PF, BG9-10PI, BME9-05, BME9-05V-T, BME9-10, BME9-10V-T, BMG7-10, BMG9-05, BMG9-05V-T, BMG9-10, BMG9-10V-T, CG-1002, CG-1502, CG-2000, CG-2005, CG-210, CG-210G, CG-3005, CG-310, CG-310G, CG7-10, CG7-11, CG-7115, CG7-20, CG-7200, CG7-20H, CG7-30D, CG7-30I, CG7-31D, CG7-31I, CG7-40, CG-7400, CG7-40H, CG7-41, CG-7415, CG7-41H, CG7-50, CG7-51, CG7-61...(Other models you can see in the webshop)		

			
GEV No.	691691	Ref. No.	12009010 12009015 U022836 U262806
description	type plate FAGOR metal		
For models:	BG6-05I, BG7-05, BG7-05I, BG7-10, BG7-10I, BG9-05, BG9-05AD, BG9-05I, BG9-05PF, BG9-05PI, BG9-05PLUS-I, BG9-10, BG9-10AD, BG9-10I, BG9-10PF, BG9-10PI, BG9-10PLUS-I, BME6-05, BME7-05, BME7-10, BME9-05, BME9-05AD, BME9-05PLUS, BME9-05V-T, BME9-10, BME9-10AD, BME9-10PLUS, BME9-10V-T, BMG7-10, BMG9-05, BMG9-05V-T, BMG9-10, BMG9-10V-T, CE6-20, CE6-40, CE6-41, CE7-20, CE7-40, CE7-41, CE9-20, CE9-20AD, CE9-20PLUS, CE9-40, CE9-40AD, CE9-40PLUS, CE9-41, CE9-41AD, CE9-41PLUS, CG-1002, CG-1502...(Other models you can see in the webshop)		

spindles			
			
GEV No.	514183	Ref. No.	12008720 X156113
description	bearing block for spindle		
For models:	SBE7-10, SBE9-10, SBE9-10I, SBE9-10I-AD, SBE9-10I-AD-S, SBE9-10IM, SBE9-10IMS, SBE9-10IS, SBE9-10PLUS-I, SBE9-10PLUS-SI, SBE9-10S, SBE9-10USMC, SBG7-10, SBG9-10, SBG9-10I, SBG9-10I-AD, SBG9-10I-AD-S, SBG9-10IS, SBG9-10PLUS-I, SBG9-10PLUS-SI, SBG9-10S		

			
GEV No.	691699	Ref. No.	12009226 X156114
description	bearing block for spindle		
For models:	SBE7-10, SBE9-10, SBE9-10I, SBE9-10I-AD, SBE9-10I-AD-S, SBE9-10IM, SBE9-10IMS, SBE9-10IS, SBE9-10PLUS-I, SBE9-10PLUS-SI, SBE9-10S, SBE9-10USMC, SBG7-10, SBG9-10, SBG9-10I, SBG9-10I-AD, SBG9-10I-AD-S, SBG9-10IS, SBG9-10PLUS-I, SBG9-10PLUS-SI, SBG9-10S		







			
GEV No.	514199	Ref. No.	12008106 X156115
description	bush for spindle ID \varnothing 18mm ED \varnothing 30mm L 45mm		
For models:	SBE7-10, SBE9-10, SBE9-10I, SBE9-10I-AD, SBE9-10I-AD-S, SBE9-10IM, SBE9-10IMS, SBE9-10IS, SBE9-10PLUS-I, SBE9-10PLUS-SI, SBE9-10S, SBE9-10USMC, SBG7-10, SBG9-10, SBG9-10I, SBG9-10I-AD, SBG9-10I-AD-S, SBG9-10IS, SBG9-10PLUS-I, SBG9-10PLUS-SI, SBG9-10S		
accessories for	514199		
	GEV No.	Ref. No.	12019420 X156116
	spindle for spindle L 165mm		
	GEV No.	Ref. No.	12008262 X156125
	thrust ball bearing shaft \varnothing 20mm ED \varnothing 40mm W 14mm type 51204 DIN 711		

Table continues overleaf





accessories for	514199		
	GEV No.	560028	Ref. No. —
	cylinder head bolt thread M5 thread L 14mm WS 4 SS Qty 20 pcs DIN 912/ISO 4762		

	GEV No.	514182	Ref. No.	12019420 X156116
1	description spindle for spindle L 165mm			
For models:	SBE7-10, SBE9-10, SBE9-10I, SBE9-10IS, SBE9-10S, SBG7-10, SBG9-10, SBG9-10I, SBG9-10IS, SBG9-10S			
accessories for	514182			
	GEV No.	514199	Ref. No.	12008106 X156115
	bush for spindle ID ø 18mm ED ø 30mm L 45mm			
	GEV No.	523536	Ref. No.	12008262 X156125
	thrust ball bearing shaft ø 20mm ED ø 40mm W 14mm type 51204 DIN 711			
	GEV No.	560028	Ref. No.	—
	cylinder head bolt thread M5 thread L 14mm WS 4 SS Qty 20 pcs DIN 912/ISO 4762			

	GEV No.	691694	Ref. No.	12017865 12040547 X266111 X266119
1	description spindle L 470mm ø 26mm for 700 series			
For models:	SBE7-10, SBG7-10			
accessories for	691694			
	GEV No.	691696	Ref. No.	12017767 X156154
	spindle nut thread TR26x8 right-hand thread W 60.6mm D 35mm H 35mm suitable for 700/900 series			

	GEV No.	514198	Ref. No.	12017861 X266101
1	description spindle thread TR26x8 L 525mm ø 26mm total length 565mm for tilting bratt pan			
For models:	SBE7-10, SBG7-10			

	GEV No.	691696	Ref. No.	12017767 X156154
1	description spindle nut thread TR26x8 right-hand thread W 60.6mm D 35mm H 35mm suitable for 700/900 series			
For models:	SBE7-10, SBE9-10, SBE9-10I, SBE9-10IM, SBE9-10IMS, SBE9-10IS, SBE9-10M, SBE9-10MS, SBE9-10S, SBE9-10USMC, SBE9-15IM, SBE9-15IMS, SBG7-10, SBG9-10, SBG9-10I, SBG9-10IM, SBG9-10IMS, SBG9-10IS, SBG9-10M, SBG9-10MS, SBG9-10S, SBG9-15IM, SBG9-15IMS			

	GEV No.	691692	Ref. No.	12040024 12040025 X026107 X156152
1	description threaded rod L 610mm ø 26mm for 900 series			
For models:	SBE9-10, SBE9-10I, SBE9-10IM, SBE9-10IMS, SBE9-10IS, SBE9-10M, SBE9-10MS, SBE9-10S, SBE9-10USMC, SBE9-15IM, SBE9-15IMS, SBG9-10, SBG9-10I, SBG9-10IM, SBG9-10IMS, SBG9-10IS, SBG9-10M, SBG9-10MS, SBG9-10S, SBG9-15IM, SBG9-15IMS			
accessories for	691692			
	GEV No.	691696	Ref. No.	12017767 X156154
	spindle nut thread TR26x8 right-hand thread W 60.6mm D 35mm H 35mm suitable for 700/900 series			

	GEV No.	692535	Ref. No.	12009467 12046631 X146138
1	description threaded rod L 620mm ø 26mm TR26x5 complete			

sumps

	GEV No.	691900	Ref. No.	12009590 X286111
1	description sump for tilting bratt pan L 1260mm W 700mm H 200mm stainless steel			
For models:	SBE9-10IM, SBE9-10IMS, SBE9-10M, SBE9-10MS, SBE9-15IM, SBE9-15IMS, SBG9-15IM, SBG9-15IMS			

	GEV No.	691898	Ref. No.	12007698 X146125
1	description sump for tilting bratt pan L 840mm W 700mm cast iron since July 2002			
For models:	SBE9-10, SBE9-10I, SBE9-10IM, SBE9-10IMS, SBE9-10IS, SBE9-10M, SBE9-10MS, SBE9-10S, SBE9-15IM, SBE9-15IMS, SBG9-10, SBG9-10IM, SBG9-10IMS, SBG9-10M, SBG9-10MS, SBG9-10S			

			
1			
GEV No.	691899	Ref. No.	12010883 X146116
description	sump for tilting bratt pan L 840mm W 700mm cast iron until June 2002		
For models:	SBE9-10, SBE9-10M, SBE9-10MS, SBE9-10S, SBG9-10M, SBG9-10MS		

			
1			
GEV No.	691897	Ref. No.	12009588 12016309 12016311 X146133 X156150 X156168
description	sump for tilting bratt pan L 840mm W 700mm stainless steel		
For models:	SBE9-10I, SBE9-10IM, SBE9-10IMS, SBE9-10IS, SBE9-10M, SBE9-10MS, SBE9-15IM, SBE9-15IMS, SBG9-10, SBG9-10I, SBG9-10IM, SBG9-10IMS, SBG9-10IS, SBG9-10M, SBG9-10MS, SBG9-10S, SBG9-15IM, SBG9-15IMS		

miscellaneous

			
1			
GEV No.	505335	Ref. No.	12009773 X109550
description	bushing L 30mm ø 22/28mm for tilting bratt pan brass		
For models:	SBE7-10, SBE9-10, SBE9-10I, SBE9-10I-AD, SBE9-10I-AD-S, SBE9-10IM, SBE9-10IM-AD, SBE9-10IM-AD-S, SBE9-10IMS, SBE9-10IS, SBE9-10M, SBE9-10MS, SBE9-10PLUS-I, SBE9-10PLUS-IM, SBE9-10PLUS-SI, SBE9-10PLUS-SIM, SBE9-10S, SBE9-10USMC, SBE9-15IM, SBE9-15IM-AD, SBE9-15IM-AD-S, SBE9-15IMS, SBE9-15PLUS-IM, SBE9-15PLUS-SIM, SBG7-10, SBG-9040, SBG9-10, SBG9-10I, SBG9-10I-AD, SBG9-10I-AD-S, SBG9-10IM, SBG9-10IM-AD, SBG9-10IM-AD-S, SBG9-10IMS, SBG9-10IS, SBG9-10M, SBG9-10MS, SBG9-10PLUS-I, SBG9-10PLUS-IM, SBG9-10PLUS-SI, SBG9-10PLUS-SIM, SBG9-10S, SBG9-15IM, SBG9-15IM-AD, SBG9-15IM-AD-S, SBG9-15IMS, SBG9-15PLUS-IM, SBG9-15PLUS-SIM		

			
1			
GEV No.	514427	Ref. No.	12002206 X152679
description	fastening angle L 46mm for tilting bratt pan W 24mm H 25mm thickness 2mm		
For models:	SBG7-10, SBG9-10, SBG9-10I, SBG9-10IM, SBG9-10IMS, SBG9-10IS, SBG9-10M, SBG9-10MS, SBG9-10S, SBG9-15IM, SBG9-15IMS		

for boiling pans

spare parts and accessories

			
1			
GEV No.	691650	Ref. No.	12019228
description	connecting fitting brass L 52mm W 30mm H 30mm		

			
1			
GEV No.	691651	Ref. No.	12020990
description	threaded part brass L 27mm ID ø 12.4mm thread 1/2"		

filters

			
1			
GEV No.	514159	Ref. No.	12014430 S316120
description	drain filter for kettle		
For models:	ME7-10BM, MG7-10, MG7-10BM		

			
1			
GEV No.	514503	Ref. No.	12031575 FX30700122
description	drain filter for kettle size 76x145mm		



1

GEV No.	514338	Ref. No.	12031318 ICRE32300340
description	drain filter size 12,5x24mm for kettle		

housing and bezels



1

GEV No.	210022	Ref. No.	12020193 U452805
description	cover L 177mm W 52mm H 16mm for control panel mounting pos. left suitable for 700 series		
For models:	BG7-05, BG7-05I, BG7-10, BG7-10I, BME7-05, BME7-10, BMG7-10, CE7-20, CE7-40, CE7-41, CG7-10, CG7-11, CG7-20, CG-7200, CG7-40, CG-7400, CG7-41, CG-7415, CG7-61, CG-7615, CGB7-61, CGE7-41, CGE7-69, CPG7-05, EN7-05, EN7-10, FE-710, FE-720, FG-710, FG-720, FTE7-05, FTE7-05L, FTE7-05R, FTE7-10, FTE7-10L, FTE7-10L+R, FTE7-10R, FTEC7-05L, FTEC7-10L, FTG7-05, FTG7-05L, FTG7-05R, FTG7-05VL, FTG7-05VR, FTG7-10, FTG7-10L, FTG7-10L+R, FTG7-10R, FTG7-10VL, FTG7-10VL+R...(Other models you can see in the webshop)		
accessories for	210022		
	GEV No.	Ref. No.	12020194 U452804
	cover L 177mm W 52mm H 16mm for control panel mounting pos. right suitable for 700 series		

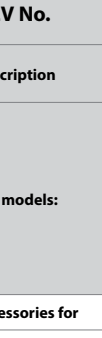

1

GEV No.	210021	Ref. No.	12020194 U452805
description	cover L 177mm W 52mm H 16mm for control panel mounting pos. left suitable for 700 series		
For models:	BG7-05, BG7-05I, BG7-10, BG7-10I, BME7-05, BME7-10, BMG7-10, CE7-20, CE7-40, CE7-41, CG7-10, CG7-11, CG7-20, CG-7200, CG7-40, CG-7400, CG7-41, CG-7415, CG7-61, CG-7615, CGB7-61, CGE7-41, CGE7-69, CPG7-05, EN7-05, EN7-10, FE-710, FE-720, FG-710, FG-720, FTE7-05, FTE7-05L, FTE7-05R, FTE7-10, FTE7-10L, FTE7-10L+R, FTE7-10R, FTEC7-05L, FTEC7-10L, FTG7-05, FTG7-05L, FTG7-05R, FTG7-05VL, FTG7-05VR, FTG7-10, FTG7-10L, FTG7-10L+R, FTG7-10R, FTG7-10VL, FTG7-10VL+R...(Other models you can see in the webshop)		
accessories for	210022		
	GEV No.	Ref. No.	12020193 U452805
	cover L 177mm W 52mm H 16mm for control panel mounting pos. right suitable for 700 series		



1

GEV No.	210021	Ref. No.	12020194 U452804
description	cover L 177mm W 52mm H 16mm for control panel mounting pos. right suitable for 700 series		
For models:	BG7-05, BG7-05I, BG7-10, BG7-10I, BME7-05, BME7-10, BMG7-10, CE7-20, CE7-40, CE7-41, CG7-10, CG7-11, CG7-20, CG-7200, CG7-40, CG-7400, CG7-41, CG-7415, CG7-61, CG-7615, CGB7-61, CGE7-41, CGE7-62, CPG7-05, EN7-05, EN7-10, FE-710, FE-720, FG-710, FG-720, FTE7-05, FTE7-05L, FTE7-05R, FTE7-10, FTE7-10L, FTE7-10L+R, FTE7-10R, FTEC7-05L, FTEC7-10L, FTG7-05, FTG7-05L, FTG7-05R, FTG7-05VR, FTG7-10, FTG7-10L, FTG7-10L+R, FTG7-10R, FTG7-10VL, FTG7-10VL+R...(Other models you can see in the webshop)		
accessories for	210021		
	GEV No.	Ref. No.	12020193 U452805
	cover L 177mm W 52mm H 16mm for control panel mounting pos. left suitable for 700 series		

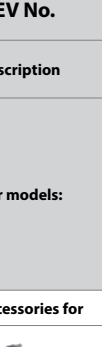

1

GEV No.	210021	Ref. No.	12020194 U452804
description	cover L 177mm W 52mm H 16mm for control panel mounting pos. right suitable for 700 series		
For models:	BG7-05, BG7-05I, BG7-10, BG7-10I, BME7-05, BME7-10, BMG7-10, CE7-20, CE7-40, CE7-41, CG7-10, CG7-11, CG7-20, CG-7200, CG7-40, CG-7400, CG7-41, CG-7415, CG7-61, CG-7615, CGB7-61, CGE7-41, CGE7-62, CPG7-05, EN7-05, EN7-10, FE-710, FE-720, FG-710, FG-720, FTE7-05, FTE7-05L, FTE7-05R, FTE7-10, FTE7-10L, FTE7-10L+R, FTE7-10R, FTEC7-05L, FTEC7-10L, FTG7-05, FTG7-05L, FTG7-05R, FTG7-05VR, FTG7-10, FTG7-10L, FTG7-10L+R, FTG7-10R, FTG7-10VL, FTG7-10VL+R...(Other models you can see in the webshop)		
accessories for	210021		
	GEV No.	Ref. No.	12020193 U452805
	cover L 177mm W 52mm H 16mm for control panel mounting pos. left suitable for 700 series		



1

GEV No.	700809	Ref. No.	12007564 R205409
description	fastening angle L 120mm W 67mm H 28mm		
For models:	BG9-05, BG9-10, BME9-05, BME9-10, BMG9-05, BMG9-10, CE9-20, CE9-40, CE9-41, CG9-10, CG9-11, CG9-20, CG9-40, CG9-41, CG9-60, CG9-61, CG9-82, EN9-05, EN9-10, FE-920, FG-920, FG-940, FTE9-05L, FTE9-05R, FTE9-10L, FTE9-10L+R, FTE9-10R, FTEC9-05, FTEC9-05L, FTEC9-05R, FTEC9-10, FTEC9-10L, FTEC9-10L+R, FTEC9-10R, FTG9-05L, FTG9-05R, FTG9-05VL, FTG9-05VR, FTG9-10L, FTG9-10L+R, FTG9-10R, FTG9-10VL, FTG9-10VL+R, FTG9-10VR, FTGC9-05, FTGC9-05L, FTGC9-05R, FTGC9-10, FTGC9-10L, FTGC9-10L+R...(Other models you can see in the webshop)		



1

GEV No.	691702	Ref. No.	12011406 S312613
description	front panel W 110mm H 70mm thickness 1mm		
For models:	MG7-10, MG7-10BM		

			
1			
GEV No.	691711	Ref. No.	12012336 S312614
description	front panel W 457mm H 80mm for kettle		
For models:	MG7-10, MG7-10BM		

			
1			
GEV No.	104123	Ref. No.	12013999 U742640
description	mounting plate for gas range L 690mm W 110mm H 25mm		
For models:	CE7-41, CG7-11, CG7-41, CGE7-41, FE-720, FG-720, MB7-10, MG7-10, MG7-10BM		

<div style="border: 1px solid black; padding: 5px; text-align: center;"> Reglado a BUTANO-PROPANO Reglage BUTANE-PROPANE Regulated for L.P.G. using </div>			
1			
GEV No.	691735	Ref. No.	12008203 U136501
description	sticker Regulated for L.P.G. using		
For models:	BG7-05, BG7-05I, BG7-10, BG7-10I, BG9-05, BG9-05I, BG9-05PF, BG9-05PI, BG9-10, BG9-10I, BG9-10PF, BG9-10PI, BME9-05, BME9-05V-T, BME9-10, BME9-10V-T, BMG7-10, BMG9-05, BMG9-05V-T, BMG9-10, BMG9-10V-T, CG-1002, CG-1502, CG-2000, CG-200S, CG-210, CG-210G, CG-300S, CG-310, CG-310G, CG7-10, CG7-11, CG-7115, CG7-20, CG-7200, CG7-20H, CG7-30D, CG7-30I, CG7-31D, CG7-31I, CG7-40, CG-7400, CG7-40H, CG7-41, CG-7415, CG7-41H, CG7-50, CG7-51, CG7-61, CG-7615...(Other models you can see in the webshop)		

<div style="border: 1px solid black; padding: 5px; text-align: center;"> Reglado a GAS NATURAL Reglage GAZ NATUREL Regulated for NATURAL GAS using </div>			
1			
GEV No.	691736	Ref. No.	12008202 U134402
description	sticker regulated for NATURAL GAS using		
For models:	BG7-05, BG7-05I, BG7-10, BG7-10I, BG9-05, BG9-05I, BG9-05PF, BG9-05PI, BG9-10, BG9-10I, BG9-10PF, BG9-10PI, BME9-05, BME9-05V-T, BME9-10, BME9-10V-T, BMG7-10, BMG-9045, BMG9-05, BMG9-05V-T, BMG9-10, BMG9-10V-T, CG-1002, CG-1502, CG-2000, CG-200S, CG-210, CG-210G, CG-300S, CG-310, CG-310G, CG7-10, CG7-11, CG-7115, CG7-20, CG-7200, CG7-20H, CG7-30D, CG7-30I, CG7-31D, CG7-31I, CG7-40, CG-7400, CG7-40H, CG7-41, CG-7415, CG7-41H, CG7-50, CG7-51, CG7-61...(Other models you can see in the webshop)		

glass panels			
			
1			
GEV No.	692158	Ref. No.	12008981 9294600
description	glass panel ø 29.5mm thickness 5mm		
For models:	FE-18, FE-25, FGCL9-05, MG7-10, MG7-10BM, MG9-10, MG9-10AD, MG9-10BM, MG9-10BMAD, MG9-10BMS, MG9-10BMSAD, MG9-10PLUS, MG9-10PLUS-BM, MG9-10PLUS-BMS, MG9-10PLUS-S, MG9-10S, MG9-10S-AD, MG9-15, MG-9150BM, MG9-15AD, MG9-15BM, MG9-15BM316, MG9-15BMAD, MG9-15BMS, MG9-15BMSAD, MG9-15PLUS, MG9-15PLUS-BM, MG9-15PLUS-BMS, MG9-15PLUS-S, MG9-15S, MG9-15S-AD, MG9-20, MG9-20AD, MG9-20PLUS, MG9-20PLUS-S, MG9-20S, MG9-20S-AD, MPG9-10, MPG9-10BM, MPG9-10BMS, MPG9-10S, MPG9-15, MPG9-15BM, MPG9-15BMS, MPG9-15S, MPG9-20, MPG9-20S		

level glasses			
components			
gaskets			
			
1			
GEV No.	691010	Ref. No.	12010108 Q307069
description	O-ring thickness 2.62mm ID ø 12.37mm Qty 1 pcs for water level tube		
For models:	ME9-10BM, ME9-10BMS, ME9-15BM, ME9-15BM316, ME9-15BMS, MG9-10BM, MG9-10BMS, MG9-15BM, MG9-15BM316, MG9-15BMS, MPE9-10BM, MPE9-10BMS, MPE9-15BM, MPE9-15BMS, MPG9-10BM, MPG9-10BMS, MPG9-15BM, MPG9-15BMS		

level glass pipes			
			
1			
GEV No.	691071	Ref. No.	12008327 S042102
description	water level tube D1 ø 13mm D2 ø 8.6mm L 138.5mm marking red/blue		
For models:	ME9-10BM, ME9-10BMS, ME9-15BM, ME9-15BM316, ME9-15BMS, MG9-10BM, MG9-10BMS, MG9-15BM, MG9-15BM316, MG9-15BMS, MPE9-10BM, MPE9-10BMS, MPE9-15BM, MPE9-15BMS, MPG9-10BM, MPG9-10BMS, MPG9-15BM, MPG9-15BMS		

screw connections



1

GEV No.	691072	Ref. No.	12008966 S042101
description	connection angle for water level tube thread 3/8" brass hole ø 13.5mm		
For models:	ME9-10BM, ME9-10BMS, ME9-15BM, ME9-15BM316, ME9-15BMS, MG9-10BM, MG9-10BMS, MG9-15BM, MG9-15BM316, MG9-15BMS, MPE9-10BM, MPE9-10BMS, MPE9-15BM, MPE9-15BMS, MPG9-10BM, MPG9-10BMS, MPG9-15BM, MPG9-15BMS		

complete



1

GEV No.	691031	Ref. No.	12000135 S082100
description	water level tube complete		
For models:	ME9-10BM, ME9-10BMS, ME9-15BM, ME9-15BMS, MG9-10BM, MG9-10BMS, MG9-15BM, MG9-15BMS, MPE9-10BM, MPE9-10BMS, MPE9-15BM, MPE9-15BMS, MPG9-10BM, MPG9-10BMS, MPG9-15BM, MPG9-15BMS		

accessories



1

GEV No.	691070	Ref. No.	12004490 S042647
description	protector for level glass		
For models:	ME9-10BM, ME9-10BMS, ME9-15BM, ME9-15BM316, ME9-15BMS, MG9-10BM, MG9-10BMS, MG9-15BM, MG9-15BM316, MG9-15BMS, MPE9-10BM, MPE9-10BMS, MPE9-15BM, MPE9-15BMS, MPG9-10BM, MPG9-10BMS, MPG9-15BM, MPG9-15BMS		

sumps



1

GEV No.	691896	Ref. No.	12016271 S226102
description	sump for kettle ID ø 680mm H 550mm L 850mm W 750mm stainless steel		
For models:	MG9-15BM, MG9-15BMS		

for pasta cookers

spare parts and accessories

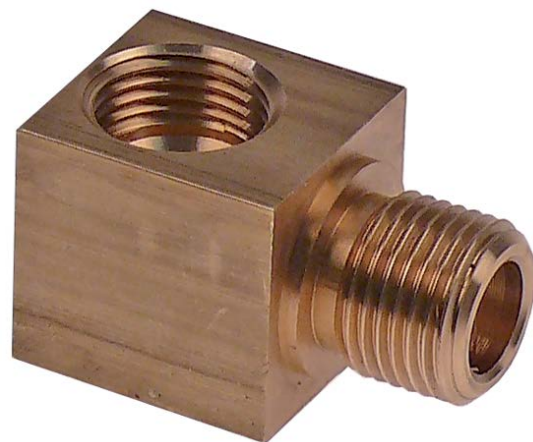

1

GEV No.	691650	Ref. No.	12019228
description	connecting fitting brass L 52mm W 30mm H 30mm		



1

GEV No.	691651	Ref. No.	12020990
description	threaded part brass L 27mm ID ø 12.4mm thread 1/2"		

for ovens

spare parts and accessories



1

GEV No.	691703	Ref. No.	12019787 U125409
description	distance washer for handrail		
For models:	CG-HP-20, FI-5420, FI-7630		



1

GEV No.	691707	Ref. No.	FAG6000009
description	distance washer SS H 10mm ID ø 18mm ext. ø 16		



1

GEV No.	691676	Ref. No.	FAG600008
description	hanging bracket SS L 350mm ø 8mm		



1

GEV No.	691675	Ref. No.	FAG600007
description	hanging bracket SS L 383mm ø 8mm		



1

GEV No.	691683	Ref. No.	12007464 R152607
description	holding plate for drain L 110mm W 60mm ID ø 48mm		
For models:	CG9-51L, CG9-51LC, CG9-51R, CG9-51RC, FTE7-05, FTE7-05L, FTE7-05R, FTE7-10, FTE7-10L, FTE7-10L+R, FTE7-10R, FTE9-05L, FTE9-05R, FTE9-10L, FTE9-10L+R, FTE9-10R, FTEC7-05L, FTEC7-10L, FTEC9-05L, FTEC9-05R, FTEC9-05USMC, FTEC9-10L, FTEC9-10L+R, FTEC9-10R, FTEC9-10USMC, FTG7-05, FTG7-05L, FTG7-05R, FTG7-05VL, FTG7-05VR, FTG7-10, FTG7-10L, FTG7-10L+R, FTG7-10R, FTG7-10VL, FTG7-10VL+R, FTG7-10VR, FTG9-05L, FTG9-05R, FTG9-05VL, FTG9-05VR, FTG9-10L, FTG9-10L+R, FTG9-10R, FTG9-10VL, FTG9-10VL+R, FTG9-10VR, FTG9-11L, FTG9-11L+R, FTG9-11R...(Other models you can see in the webshop)		

housing and bezels





1

GEV No.	691722	Ref. No.	12004214 R062811
description	back panel chargin grill		
For models:	BG9-05AD, BG9-05PF, BG9-05PI, BG9-05PLUS-I, BG9-10AD, BG9-10PF, BG9-10PI, BG9-10PLUS-I, BME9-05, BME9-05AD, BME9-05PLUS, BME9-05V-T, BME9-10, BME9-10AD, BME9-10PLUS, BME9-10V-T, BMG9-05, BMG9-05V-T, BMG9-10, BMG9-10V-T, CE9-20, CE9-20AD, CE9-20PLUS, CE9-40, CE9-40AD, CE9-40PLUS, CG9-05AD, CG9-05PLUS, CG9-10, CG9-10AD, CG9-10PLUS, CG9-20, CG9-20AD, CG9-20AD-H, CG9-20H, CG9-20PLUS, CG9-20PLUS-H, CG9-40, CG9-40AD, CG9-40AD-H, CG9-40H, CG9-40PLUS, CG9-40PLUS-H, CG9-60, CG9-60AD, CG9-60AD-H, CG9-60H, CG9-60PLUS, CG9-60PLUS-H, CGF9-120D...(Other models you can see in the webshop)		



1

GEV No.	210022	Ref. No.	12020193 U452805
description	cover L 177mm W 52mm H 16mm for control panel mounting pos. left suitable for 700 series		
For models:	BG7-05, BG7-05I, BG7-10, BG7-10I, BME7-05, BME7-10, BMG7-10, CE7-20, CE7-40, CE7-41, CG7-10, CG7-11, CG7-20, CG-7200, CG7-40, CG-7400, CG7-41, CG-7415, CG7-61, CG-7615, CGB7-61, CGE7-41, CGE7-69, CPG7-05, EN7-05, EN7-10, FE-710, FE-720, FG-710, FG-720, FTE7-05, FTE7-05L, FTE7-05R, FTE7-10, FTE7-10L, FTE7-10L+R, FTE7-10R, FTEC7-05L, FTEC7-10L, FTG7-05, FTG7-05L, FTG7-05R, FTG7-05VL, FTG7-05VR, FTG7-10, FTG7-10L, FTG7-10L+R, FTG7-10R, FTG7-10VL, FTG7-10VL+R...(Other models you can see in the webshop)		
accessories for	210022		
	GEV No.	210021	Ref. No.
			12020194 U452804
	cover L 177mm W 52mm H 16mm for control panel mounting pos. right suitable for 700 series		



1

GEV No.	210021	Ref. No.	12020194 U452804
description	cover L 177mm W 52mm H 16mm for control panel mounting pos. right suitable for 700 series		
For models:	BG7-05, BG7-05I, BG7-10, BG7-10I, BME7-05, BME7-10, BMG7-10, CE7-20, CE7-40, CE7-41, CG7-10, CG7-11, CG7-20, CG-7200, CG7-40, CG-7400, CG7-41, CG-7415, CG7-61, CG-7615, CGB7-61, CGE7-41, CGE7-62, CPG7-05, EN7-05, EN7-10, FE-710, FE-720, FG-710, FG-720, FTE7-05, FTE7-05L, FTE7-05R, FTE7-10, FTE7-10L, FTE7-10L+R, FTE7-10R, FTEC7-05L, FTEC7-10L, FTG7-05, FTG7-05L, FTG7-05R, FTG7-05VL, FTG7-05VR, FTG7-10, FTG7-10L, FTG7-10L+R, FTG7-10R, FTG7-10VL, FTG7-10VL+R...(Other models you can see in the webshop)		
accessories for	210021		
	GEV No.	210022	Ref. No.
			12020193 U452805
	cover L 177mm W 52mm H 16mm for control panel mounting pos. left suitable for 700 series		

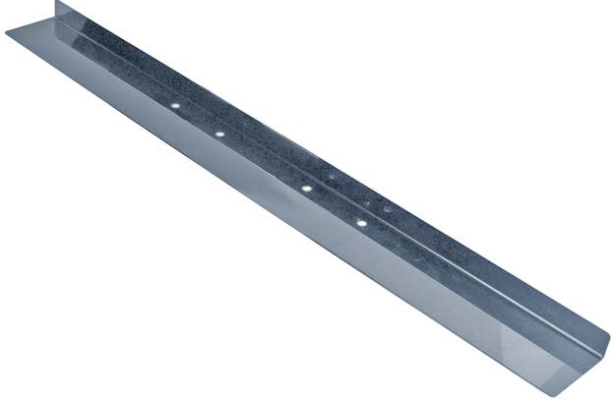

1

GEV No.	550769	Ref. No.	12015009 U805616
description	cover plate for switch		
For models:	CE7-41, CGE7-215, CGE7-41		

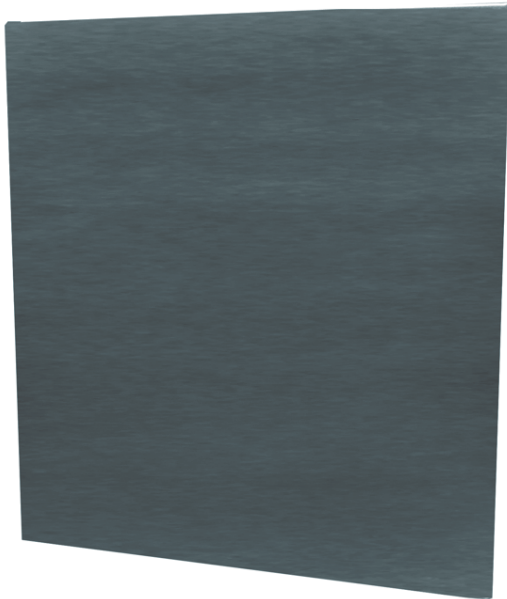

1

GEV No.	691851	Ref. No.	12011376
description	cover plate L 697mm W 623mm plate thickness max. 20mm		





1

GEV No.	700809	Ref. No.	12007564 R205409
description	fastening angle L 120mm W 67mm H 28mm		
For models:	BG9-05, BG9-10, BME9-05, BME9-10, BMG9-05, BMG9-10, CE9-20, CE9-40, CE9-41, CG9-10, CG9-11, CG9-20, CG9-40, CG9-41, CG9-60, CG9-61, CG9-82, EN9-05, EN9-10, FE-920, FG-920, FG-940, FTE9-05L, FTE9-05R, FTE9-10L, FTE9-10L+R, FTE9-10R, FTEC9-05, FTEC9-05L, FTEC9-05R, FTEC9-10, FTEC9-10L, FTEC9-10L+R, FTEC9-10R, FTG9-05L, FTG9-05R, FTG9-05VL, FTG9-05VR, FTG9-10L, FTG9-10L+R, FTG9-10R, FTG9-10VL, FTG9-10VL+R, FTG9-10VR, FTGC9-05, FTGC9-05L, FTGC9-05R, FTGC9-10, FTGC9-10L, FTGC9-10L+R...(Other models you can see in the webshop)		

			
1			
GEV No.	691724	Ref. No.	12014588 R942800
description	front panel		
For models:	EN7-05		

			
1			
GEV No.	691714	Ref. No.	12004071 H012821
description	front panel for drawers 1/2 W 420mm H 80mm		
For models:	BG9-05, BG9-05AD, BG9-05I, BG9-05PF, BG9-05PI, BG9-05PLUS-I, BG9-10, BG9-10AD, BG9-10I, BG9-10PF, BG9-10PI, BG9-10PLUS-I, CG9-10, CG9-20, CG9-40, CG9-60, CGF9-120D, CGF9-120I, FTE9-05L, FTE9-05L-AD, FTE9-05PLUS-CL, FTE9-05PLUS-CR, FTE9-05PLUS-L, FTE9-05PLUS-R, FTE9-05R, FTE9-05R-AD, FTE9-10L, FTE9-10L+R, FTE9-10L+R-AD, FTE9-10L-AD, FTE9-10PLUS-CL, FTE9-10PLUS-LR, FTE9-10PLUS-R, FTE9-10R, FTE9-10R-AD, FTEC9-05L, FTEC9-05L-AD, FTEC9-05R, FTEC9-05R-AD, FTEC9-10L, FTEC9-10L+R, FTEC9-10L+R-AD, FTEC9-10L-AD, FTEC9-10R, FTEC9-10R-AD, FTG9-05L, FTG9-05L-AD...(Other models you can see in the webshop)		

			
1			
GEV No.	691719	Ref. No.	12014273 U732805
description	front panel for gas range W 700mm H 170mm		

 Image not available			
1			
GEV No.	691723	Ref. No.	12008013 U745610
description	insulation		
For models:	CG7-11, CG7-41, CG7-61, CG9-11, CG9-41, CG9-51L, CG9-51LC, CG9-51R, CG9-51RC, CG9-61, CG9-82, CGF9-121D, CGF9-121I, FTG9-11L, FTG9-11L+R, FTG9-11R, FTGC9-11L, FTGC9-11L+R, FTGC9-11R, HG9-10, HG9-20		

			
1			
GEV No.	104123	Ref. No.	12013999 U742640
description	mounting plate for gas range L 690mm W 110mm H 25mm		
For models:	CE7-41, CG7-11, CG7-41, CGE7-41, FE-720, FG-720, MB7-10, MG7-10, MG7-10BM		

			
1			
GEV No.	691735	Ref. No.	12008203 U136501
description	sticker Regulated for L.P.G. using		
For models:	BG7-05, BG7-05I, BG7-10, BG7-10I, BG9-05, BG9-05I, BG9-05PF, BG9-05PI, BG9-10, BG9-10I, BG9-10PF, BG9-10PI, BME9-05, BME9-05V-T, BME9-10, BME9-10V-T, BMG7-10, BMG9-05, BMG9-05V-T, BMG9-10, BMG9-10V-T, CG-1002, CG-1502, CG-2000, CG-2005, CG-210, CG-210G, CG-300S, CG-310, CG-310G, CG7-10, CG7-11, CG-7115, CG7-20, CG-7200, CG7-20H, CG7-30D, CG7-30I, CG7-31D, CG7-31I, CG7-40, CG-7400, CG7-40H, CG7-41, CG-7415, CG7-41H, CG7-50, CG7-51, CG7-61, CG-7615...(Other models you can see in the webshop)		

			
1			
GEV No.	691736	Ref. No.	12008202 U134402
description	sticker regulated for NATURAL GAS using		
For models:	BG7-05, BG7-05I, BG7-10, BG7-10I, BG9-05, BG9-05I, BG9-05PF, BG9-05PI, BG9-10, BG9-10I, BG9-10PF, BG9-10PI, BME9-05, BME9-05V-T, BME9-10, BME9-10V-T, BMG7-10, BMG-9045, BMG9-05, BMG9-05V-T, BMG9-10, BMG9-10V-T, CG-1002, CG-1502, CG-2000, CG-2005, CG-210, CG-210G, CG-300S, CG-310, CG-310G, CG7-10, CG7-11, CG-7115, CG7-20, CG-7200, CG7-20H, CG7-30D, CG7-30I, CG7-31D, CG7-31I, CG7-40, CG-7400, CG7-40H, CG7-41, CG-7415, CG7-41H, CG7-50, CG7-51, CG7-61...(Other models you can see in the webshop)		



1 

GEV No.	691691	Ref. No.	12009010 12009015 U022836 U262806
description	type plate FAGOR metal		
For models:	BG6-05I, BG7-05, BG7-05I, BG7-10, BG7-10I, BG9-05, BG9-05AD, BG9-05I, BG9-05PF, BG9-05PI, BG9-05PLUS-I, BG9-10, BG9-10AD, BG9-10I, BG9-10PF, BG9-10PI, BG9-10PLUS-I, BME6-05, BME7-05, BME7-10, BME9-05, BME9-05AD, BME9-05PLUS, BME9-05V-T, BME9-10, BME9-10AD, BME9-10PLUS, BME9-10V-T, BMG7-10, BMG9-05, BMG9-05V-T, BMG9-10, BMG9-10V-T, CE6-20, CE6-40, CE6-41, CE7-20, CE7-40, CE7-41, CE9-20, CE9-20AD, CE9-20PLUS, CE9-40, CE9-40AD, CE9-40PLUS, CE9-41, CE9-41AD, CE9-41PLUS, CG-1002, CG-1502...(Other models you can see in the webshop)		

doors

1 

GEV No.	691848	Ref. No.	1100002599 12015851
description	door W 690mm H 480mm thickness 40mm		

for pizza ovens

glass panels

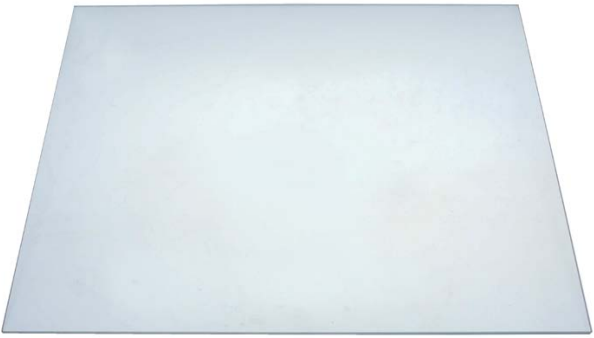
1 

GEV No.	700831	Ref. No.	12018687 R670509
description	glass panel L 460mm H 539mm thickness 5mm rectangular mounting pos. outer		
For models:	HCG-10-11, HCG-10-21, HCG-20-11, HCG-2-10-11, HME-10-11, HME-10-21, HME-20-11, HME-2-10-11, HMG-10-11, HMG-10-11UL, HMG-10-21, HMG-10-21UL, HMG-20-11, HMG-2-10-11, HMI-10-11, HMI-10-11UL, HMI-10-21, HMI-10-21UL, HMI-2-10-11, HMM-10-11, HMM-10-11UL, HMM-10-21, HMM-10-21UL, HMM-20-11, HMM-20-11UL, HMM-2-10-11, HMM-2-10-11UL, HMP-10-11, HMP-10-21, HMP-20-11, HMP-2-10-11		

for dishwashers

drain and intake components

FAGOR

drain /intake bodies

1 

GEV No.	505162	Ref. No.	12025238 Z602101
description	drain connection ED ø 45/27mm ID ø 21/18mm		
For models:	ECO-1200, ECO-1600, ECO-2300, ECO-2700D, ECO-2700I, ECO-280D, ECO-280I, ECO-3000, ECO-370D, ECO-370I, ECO-4000D, ECO-4000I, ECO-460D, ECO-460I, ECO-550D, ECO-550I, ECO-6000D, ECO-6000I, FI-1200, FI-1600, FI-2300, FI-2700D, FI-2700I, FI-280D, FI-280I, FI-3000, FI-300R, FI-370D, FI-370I, FI-4000D, FI-4000I, FI-460D, FI-460I, FI-550D, FI-550I, FI-6000D, FI-6000I, FI-650R, FI-900		

			
1			
GEV No.	515000	Ref. No.	12037642 6003010062
description	drain connection for refrigerated counters thread 1/2" ID ø 146mm L 93.5mm		
For models:	ADM-CN-135, ADM-CN-180, ADM-CN-225, ADMCP-135, ADMCP-180, ADMCP-225, ADMFN-135, ADMFN-180, ADMFN-225, ADMFP-135, ADMFP-135-GR, ADMFP-135HD, ADMFP-135HH, ADMFP-135PC, ADMFP-180, ADMFP-180-GR, ADMFP-180HDD, ADMFP-180HHD, ADMFP-180HHH, ADMFP-180PC, ADMFP-225, ADMFP-225-GR, ADMFP-225HDD, ADMFP-225HDD, ADMFP-225HHDD, ADMFP-225HHHD, ADMFP-225HHHH, ADMFP-225PC, ATA-061, ATA-061-60Hz, ATA-101, ATA-101-60Hz, ATM-051ECO, ATM-051VCH, ATM-051VCH-60Hz, ATM-081VCH, ATM-081VCH-60Hz, ATM-101VCH, ATM-101VCH-60Hz, ATM-121VCH, ATM-121VCH-60Hz, ATM-121VCHP, ATM-161VCH, MCP-135-AD, MCP-180-AD, MCP-225-AD, MEP-100, MEP-100G, MFP-135-AD, MFP-135-AD-2C, MFP-135-AD-4C...(Other models you can see in the webshop)		

			
2			
GEV No.	505259	Ref. No.	12024339 Z102104
description	drain fitting thread 1½" H 42mm		
For models:	ECO-1600, ECO-2300, ECO-2700D, ECO-2700I, ECO-280D, ECO-280I, ECO-3000, ECO-370D, ECO-370I, ECO-4000D, ECO-4000I, ECO-460D, ECO-460I, ECO-550D, ECO-550I, ECO-6000D, ECO-6000I, FI-1600, FI-2300, FI-2700D, FI-2700I, FI-280D, FI-280I, FI-3000, FI-370D, FI-370I, FI-4000D, FI-4000I, FI-460D, FI-460I, FI-550D, FI-550I, FI-6000D, FI-6000I		

			
1			
GEV No.	505193	Ref. No.	12024234 Z710902
description	drain fitting thread 1¾" ID ø 44mm		
For models:	AD-120, AD-120B, AD-120BBTDD-UK, AD-120C, AD-120CW, AD-120HY, AD-90, AD-90BA, AD-90BBT, AD-90BDD, AD-90DD, ADE-120, ADE-120B, ECO-120, ECO-120B, ECO-160, ECO-160D, ECO-160I, ECO-200, ECO-200D, ECO-200H, ECO-200HD, ECO-200HI, ECO-200I, ECO-2700D, ECO-2700I, ECO-280D, ECO-280I, ECO-370D, ECO-370I, ECO-4000D, ECO-4000I, ECO-460D, ECO-460I, ECO-550D, ECO-550I, ECO-6000D, ECO-6000I, FI-100, FI-100AR, FI-100B, FI-100BBT-UK, FI-120, FI-120AR+DD, FI-120B, FI-120C, FI-120HY-CLINIC, FI-120W, FI-160, FI-160AR...(Other models you can see in the webshop)		

			
1			
GEV No.	505104	Ref. No.	12024603 Z220902
description	drain unit ED ø 32/56mm		
For models:	AD-45BBT, AD-48B, AD-48BDD, AD-48C, AD-48HY, AD-48W, AD-64B, AD-64BBT, AD-64BDD, AD-64C, AD-64CW, AD-64HY, FI-30, FI-30AR, FI-30AR+DD, FI-30B, FI-30B-BT-UK, FI-30-UK, FI-48, FI-48AR, FI-48B, FI-48B-BT-UK, FI-48C, FI-48D, FI-48HY-CLINIC, FI-48W, FI-64, FI-64AR, FI-64B, FI-64B-BT-UK, FI-64C, FI-64D, FI-64HY-CLINIC, FI-64W, MF-48, MF-64		

			
1			
GEV No.	505085 ¹	Ref. No.	12024914 Z430901
description	drain unit hose ø 32/38mm		
For models:	AD-20C-UK, AD-21B, AD-21BDD, AD-21C, AD-21W, LVC-21B, LVC-21C, LVC-21W, LVR-20B, MF-21		

¹for drain pump

			
1			
GEV No.	515018	Ref. No.	12009947 Q307032
description	flat gasket rubber ED ø 32mm ID ø 21mm thickness 3mm Qty 1 pcs		
For models:	AD-120, AD-120B, AD-120BBTDD-UK, AD-120C, AD-120CW, AD-120HY, AD-90, AD-90BA, AD-90BBT, AD-90BDD, AD-90DD, ADE-120, ADE-120B, BME7-05, BME7-10, BME9-05, BME9-05AD, BME9-05PLUS, BME9-05V-T, BME9-10, BME9-10AD, BME9-10PLUS, BME9-10V-T, BMG7-10, BMG9-05, BMG9-05V-T, BMG9-10, BMG9-10V-T, CO-142W, CO-142WDD, COP-174W, COP-174WHR, ECO-120, ECO-1200, ECO-120B, ECO-160, ECO-1600, ECO-160D, ECO-160I, ECO-200, ECO-200D, ECO-200H, ECO-200HD, ECO-200HI, ECO-200I, ECO-2300, ECO-2700D, ECO-2700I, ECO-280D, ECO-280I...(Other models you can see in the webshop)		

			
1			
GEV No.	505161	Ref. No.	12010028 Q307027
description	flat gasket rubber ED ø 45mm ID ø 35mm thickness 2mm Qty 1 pcs		
For models:	BMG-9045, ECO-1200, ECO-1600, ECO-2300, ECO-2700D, ECO-2700I, ECO-280D, ECO-280I, ECO-3000, ECO-370D, ECO-370I, ECO-4000D, ECO-4000I, ECO-460D, ECO-460I, ECO-550D, ECO-550I, ECO-6000D, ECO-6000I, FI-1200, FI-1600, FI-2300, FI-2700D, FI-2700I, FI-280D, FI-280I, FI-3000, FI-300B, FI-300R, FI-370D, FI-370I, FI-4000D, FI-4000I, FI-460D, FI-460I, FI-550D, FI-550I, FI-6000D, FI-6000I, FI-650R, FI-900		

			
1			
GEV No.	505224	Ref. No.	12009960 Q307058
description	flat gasket rubber ED ø 60mm ID ø 44mm thickness 2mm Qty 1 pcs		
For models:	AD-120, AD-120B, AD-120BBTDD-UK, AD-120C, AD-120CW, AD-120HY, AD-90, AD-90BA, AD-90BBT, AD-90BDD, AD-90DD, ADE-120, ADE-120B, ECO-120, ECO-120B, ECO-160, ECO-160D, ECO-160I, ECO-200, ECO-200D, ECO-200H, ECO-200HD, ECO-200HI, ECO-200I, ECO-370D, ECO-370I, ECO-550D, ECO-550I, FI-100, FI-100AR, FI-100B, FI-100BBT-UK, FI-120, FI-120AR+DD, FI-120B, FI-120C, FI-120HY-CLINIC, FI-120W, FI-160, FI-160AR, FI-160D, FI-160I, FI-200, FI-200AR, FI-200D, FI-200H, FI-200HD, FI-200HI, FI-200I, FI-200W...(Other models you can see in the webshop)		



			
GEV No.	505223	Ref. No.	12009939 Q307009
description	flat gasket rubber ED ø 70mm ID ø 48mm thickness 1.5mm Qty 1 pcs		
For models:	BMG-9045, ECO-1200, ECO-1600, ECO-2300, ECO-2700D, ECO-2700I, ECO-280D, ECO-280I, ECO-3000, ECO-370D, ECO-370I, ECO-4000D, ECO-4000I, ECO-460D, ECO-460I, ECO-550D, ECO-550I, ECO-6000D, ECO-6000I, FI-1200, FI-1600, FI-2300, FI-2700D, FI-2700I, FI-280D, FI-280I, FI-3000, FI-300B, FI-300R, FI-370D, FI-370I, FI-4000D, FI-4000I, FI-460D, FI-460I, FI-550D, FI-550I, FI-6000D, FI-6000I, FI-650R, FI-900		

			
GEV No.	505249	Ref. No.	12009936 Q307011
description	gasket ED ø 56mm ID ø 39mm thickness 1mm Qty 1 pcs		
For models:	ECO-1600, ECO-2300, ECO-280D, ECO-280I, ECO-3000, ECO-370D, ECO-370I, ECO-460D, ECO-460I, ECO-550D, ECO-550I, FI-1600, FI-2300, FI-280D, FI-280I, FI-3000, FI-370D, FI-370I, FI-460D, FI-460I, FI-550D, FI-550I		

			
GEV No.	505194	Ref. No.	12009937 Q307059
description	flat gasket rubber ED ø 72mm ID ø 57mm thickness 2mm Qty 1 pcs		
For models:	AD-120, AD-120B, AD-120BBTDD-UK, AD-120C, AD-120CW, AD-120HY, AD-90, AD-90BA, AD-90BBT, AD-90BDD, AD-90DD, ADE-120, ADE-120B, ECO-120, ECO-120B, ECO-160, ECO-160D, ECO-160I, ECO-200, ECO-200D, ECO-200H, ECO-200HD, ECO-200HI, ECO-200I, ECO-2700D, ECO-2700I, ECO-280D, ECO-280I, ECO-370D, ECO-370I, ECO-4000D, ECO-4000I, ECO-460D, ECO-460I, ECO-550D, ECO-550I, ECO-6000D, ECO-6000I, FI-100, FI-100AR, FI-100B, FI-100BBT-UK, FI-120, FI-120AR+DD, FI-120B, FI-120C, FI-120HY-CLINIC, FI-120W, FI-160, FI-160AR...(Other models you can see in the webshop)		

			
GEV No.	518609	Ref. No.	12023618 Z310901
description	inlet valve thread 2 1/4" ED ø 90mm H 131mm		
For models:	ECO-2700D, ECO-2700I, ECO-280D, ECO-280I, ECO-370D, ECO-370I, ECO-4000D, ECO-4000I, ECO-460D, ECO-460I, ECO-550D, ECO-550I, ECO-6000D, ECO-6000I, FI-2700D, FI-2700I, FI-280D, FI-280I, FI-370D, FI-370I, FI-4000D, FI-4000I, FI-460D, FI-460I, FI-550D, FI-550I, FI-6000D, FI-6000I		

			
GEV No.	510832	Ref. No.	12023571 Z310902
description	flat gasket rubber ED ø 92mm ID ø 66mm thickness 2mm Qty 1 pcs equiv. no. 200906/33456		
For models:	ECO-2700D, ECO-2700I, ECO-280D, ECO-280I, ECO-370D, ECO-370I, ECO-4000D, ECO-4000I, ECO-460D, ECO-460I, ECO-550D, ECO-550I, ECO-6000D, ECO-6000I, FI-2700D, FI-2700I, FI-280D, FI-280I, FI-370D, FI-370I, FI-4000D, FI-4000I, FI-460D, FI-460I, FI-550D, FI-550I, FI-6000D, FI-6000I		

			
GEV No.	519617	Ref. No.	12023627 Z330787000
description	intake body ED ø 48mm H 49mm ID ø 30mm		
For models:	ECO-160D, ECO-160I, ECO-200D, ECO-200HD, ECO-200HI, ECO-200I, ECO-280D, ECO-280I, ECO-370D, ECO-370I, ECO-460D, ECO-460I, ECO-550D, ECO-550I, FI-160AR, FI-160D, FI-160I, FI-200AR, FI-200D, FI-200HD, FI-200HI, FI-200I, FI-200WL, FI-200WR, FI-280D, FI-280I, FI-370D, FI-370I, FI-460D, FI-460I, FI-550D, FI-550I		



			
GEV No.	505222	Ref. No.	12009817 Q307026
description	gasket conical ED ø 72mm ID ø 45mm		
For models:	BMG-9045, ECO-1200, ECO-1600, ECO-2300, ECO-2700D, ECO-2700I, ECO-280D, ECO-280I, ECO-3000, ECO-370D, ECO-370I, ECO-4000D, ECO-4000I, ECO-460D, ECO-460I, ECO-550D, ECO-550I, ECO-6000D, ECO-6000I, FI-1200, FI-1600, FI-2300, FI-2700D, FI-2700I, FI-280D, FI-280I, FI-3000, FI-300B, FI-300R, FI-370D, FI-370I, FI-4000D, FI-4000I, FI-460D, FI-460I, FI-550D, FI-550I, FI-6000D, FI-6000I, FI-650R, FI-900		

			
GEV No.	524780	Ref. No.	12025261 Z710903
description	intake body thread 1 1/2" ED ø 60mm H 42mm hose ø 38mm		
For models:	AD-120, AD-120B, AD-120BBTDD-UK, AD-120C, AD-120CW, AD-120HY, AD-90, AD-90BA, AD-90BBT, AD-90BDD, AD-90DD, ADE-120, ADE-120B, ECO-120, ECO-120B, ECO-160, ECO-160D, ECO-160I, ECO-200, ECO-200D, ECO-200H, ECO-200HD, ECO-200HI, ECO-200I, ECO-370D, ECO-370I, ECO-550D, ECO-550I, FI-100, FI-100AR, FI-100B, FI-100BBT-UK, FI-120, FI-120AR+DD, FI-120B, FI-120C, FI-120HY-CLINIC, FI-120W, FI-160, FI-160AR, FI-160D, FI-160I, FI-200, FI-200AR, FI-200D, FI-200H, FI-200HD, FI-200HI, FI-200I, FI-200W...(Other models you can see in the webshop)		

			
1			
GEV No.	505160	Ref. No.	12025225 Z600905
description	intake body thread 1½" ED ø 71mm ID ø 36mm		
For models:	ECO-1200, ECO-2700D, ECO-2700I, ECO-280D, ECO-280I, ECO-370D, ECO-370I, ECO-4000D, ECO-4000I, ECO-460D, ECO-460I, ECO-550D, ECO-550I, ECO-6000D, ECO-6000I, FI-1200, FI-2700D, FI-2700I, FI-280D, FI-280I, FI-370D, FI-370I, FI-4000D, FI-4000I, FI-460D, FI-460I, FI-550D, FI-550I, FI-6000D, FI-6000I, FI-900		

			
1			
GEV No.	505156	Ref. No.	12024315 Z702101
description	nut thread 1½"		
For models:	BMG-9045, ECO-1200, ECO-1600, ECO-2300, ECO-2700D, ECO-2700I, ECO-280D, ECO-280I, ECO-3000, ECO-370D, ECO-370I, ECO-4000D, ECO-4000I, ECO-460D, ECO-460I, ECO-550D, ECO-550I, ECO-6000D, ECO-6000I, FI-1200, FI-1600, FI-2300, FI-2700D, FI-2700I, FI-280D, FI-280I, FI-3000, FI-300B, FI-300R, FI-370D, FI-370I, FI-4000D, FI-4000I, FI-460D, FI-460I, FI-550D, FI-550I, FI-6000D, FI-6000I, FI-650R, FI-900		

			
1			
GEV No.	505163	Ref. No.	12025276 Z602102
description	nut thread 1½"		
For models:	ECO-1200, ECO-1600, ECO-2300, ECO-2700D, ECO-2700I, ECO-280D, ECO-280I, ECO-3000, ECO-370D, ECO-370I, ECO-4000D, ECO-4000I, ECO-460D, ECO-460I, ECO-550D, ECO-550I, ECO-6000D, ECO-6000I, FI-1200, FI-1600, FI-2300, FI-2700D, FI-2700I, FI-280D, FI-280I, FI-3000, FI-300B, FI-300R, FI-370D, FI-370I, FI-4000D, FI-4000I, FI-460D, FI-460I, FI-550D, FI-550I, FI-6000D, FI-6000I, FI-650R, FI-900		

			
1			
GEV No.	518080	Ref. No.	12023537 Z710708
description	nut thread 1½" WS 50 duct thickness 15mm		
For models:	AD-120, AD-120B, AD-120BBTDD-UK, AD-120C, AD-120CW, AD-120HY, AD-90, AD-90BA, AD-90BBT, AD-90BDD, AD-90DD, ADE-120, ADE-120B, ECO-120, ECO-120B, ECO-160, ECO-160D, ECO-160I, ECO-200, ECO-200D, ECO-200H, ECO-200HD, ECO-200HI, ECO-200I, ECO-370D, ECO-370I, ECO-550D, ECO-550I, FI-100, FI-100AR, FI-100B, FI-100BBT-UK, FI-120, FI-120AR+DD, FI-120B, FI-120C, FI-120HY-CLINIC, FI-120W, FI-160, FI-160AR, FI-160D, FI-160I, FI-200, FI-200AR, FI-200D, FI-200H, FI-200HD, FI-200HI, FI-200I, FI-200W...(Other models you can see in the webshop)		
spare parts for	518080		
	GEV No.	507425	Ref. No.
			12018740 Z710707
duct D1 ø 38mm D2 ø 45mm L 72mm int. ø 1 31mm int. ø 2 39mm			

			
1			
GEV No.	505155	Ref. No.	12009844 Q220001
description	nut thread 1¾"		
For models:	AD-120, AD-120B, AD-120BBTDD-UK, AD-120C, AD-120CW, AD-120HY, AD-90, AD-90BA, AD-90BBT, AD-90BDD, AD-90DD, ADE-120, ADE-120B, ECO-120, ECO-120B, ECO-160, ECO-160D, ECO-160I, ECO-200, ECO-200D, ECO-200H, ECO-200HD, ECO-200HI, ECO-200I, ECO-2700D, ECO-2700I, ECO-280D, ECO-280I, ECO-370D, ECO-370I, ECO-4000D, ECO-4000I, ECO-460D, ECO-460I, ECO-550D, ECO-550I, ECO-6000D, ECO-6000I, FI-100, FI-100AR, FI-100B, FI-100BBT-UK, FI-120, FI-120AR+DD, FI-120B, FI-120C, FI-120HY-CLINIC, FI-120W, FI-160, FI-160AR...(Other models you can see in the webshop)		

			
1			
GEV No.	517432	Ref. No.	12025231 Z310903
description	nut thread 2¼"		
For models:	ECO-2700D, ECO-2700I, ECO-280D, ECO-280I, ECO-370D, ECO-370I, ECO-4000D, ECO-4000I, ECO-460D, ECO-460I, ECO-550D, ECO-550I, ECO-6000D, ECO-6000I, FI-2700D, FI-2700I, FI-280D, FI-280I, FI-370D, FI-370I, FI-4000D, FI-4000I, FI-460D, FI-460I, FI-550D, FI-550I, FI-6000D, FI-6000I		

			
1			
GEV No.	505244	Ref. No.	12009949 Q228006
description	nut thread M39x3		
For models:	ECO-1600, ECO-2300, ECO-280D, ECO-280I, ECO-3000, ECO-370D, ECO-370I, ECO-460D, ECO-460I, ECO-550D, ECO-550I, FI-1600, FI-2300, FI-280D, FI-280I, FI-3000, FI-370D, FI-370I, FI-460D, FI-460I, FI-550D, FI-550I		

			
1			
GEV No.	505159	Ref. No.	12009815 Q228005
description	nut thread M48x1.5		
For models:	ECO-1200, ECO-2700D, ECO-2700I, ECO-280D, ECO-280I, ECO-370D, ECO-370I, ECO-4000D, ECO-4000I, ECO-460D, ECO-460I, ECO-550D, ECO-550I, ECO-6000D, ECO-6000I, FI-1200, FI-2700D, FI-2700I, FI-280D, FI-280I, FI-370D, FI-370I, FI-4000D, FI-4000I, FI-460D, FI-460I, FI-550D, FI-550I, FI-6000D, FI-6000I, FI-900		



filters			
			
1			
GEV No.	505141	Ref. No.	12003451 Z270803
description	flat filter H 15mm L 315mm W 223mm		
For models:	ECO-160, ECO-160D, ECO-160I, ECO-200, ECO-200D, ECO-200H, ECO-200HD, ECO-200HI, ECO-200I, FI-160, FI-160AR, FI-160D, FI-160I, FI-200, FI-200AR, FI-200D, FI-200H, FI-200HD, FI-200HI, FI-200I, FI-200W, FI-200WL, FI-200WR		

			
1			
GEV No.	505137	Ref. No.	12003450 12038499 Z270801
description	flat filter H 15mm L 315mm W 225mm		
For models:	ECO-160, ECO-160D, ECO-160I, ECO-200, ECO-200D, ECO-200H, ECO-200HD, ECO-200HI, ECO-200I, FI-160, FI-160AR, FI-160D, FI-160I, FI-200, FI-200AR, FI-200D, FI-200H, FI-200HD, FI-200HI, FI-200I, FI-200W, FI-200WL, FI-200WR		

			
1			
GEV No.	505187	Ref. No.	12003519 12038373 12Z7108010
description	flat filter H 16mm L 630mm W 220mm		
For models:	AD-120, AD-120B, AD-120BBTDD-UK, AD-120C, AD-120CW, AD-120HY, AD-90, AD-90BA, AD-90BBT, AD-90BDD, AD-90DD, ADE-120, ADE-120B, ECO-120, ECO-120B, FI-100, FI-100AR, FI-100B, FI-100BBT-UK, FI-120, FI-120AR+DD, FI-120B, FI-120C, FI-120HY-CLINIC, FI-120W, FI-80, FI-80AR, FI-80BBT-UK, FI-80W, FI-E-100, LABP-1000, LABP-1200, LABP-800, MF-120		

			
1			
GEV No.	505142	Ref. No.	12004370 12011137 12022559 12Z2108010
description	flat filter H 8mm L 263mm W 200mm		
For models:	AD-45BBT, AD-48, AD-48B, AD-48BDD, AD-48C, AD-48D, AD-48DD, AD-48HY, AD-48W, AD-64, AD-64B, AD-64BBT, AD-64BDD, AD-64BTDD, AD-64C, AD-64CW, AD-64D, AD-64DD, AD-64HY, AD-72, AD-72W, EASY-500HP, EASY-500HPWBDD, FI-48, FI-48AR, FI-48B, FI-48B-BT-UK, FI-48C, FI-48D, FI-48HY-CLINIC, FI-48W, FI-50, FI-64, FI-64AR, FI-64B, FI-64B-BT-UK, FI-64C, FI-64D, FI-64HY-CLINIC, FI-64W, FI-72, FI-72AR, FI-72W, MF-48, MF-64		



			
1			
GEV No.	505078	Ref. No.	12024556 Z200907
description	gasket external height 23.5mm for sump ED ø 225mm ID ø 200mm		
For models:	AD-45BBT, AD-48, AD-48B, AD-48BDD, AD-48C, AD-48D, AD-48DD, AD-48HY, AD-48W, AD-64, AD-64B, AD-64BBT, AD-64BDD, AD-64BTDD, AD-64C, AD-64CW, AD-64D, AD-64DD, AD-64HY, AD-72, AD-72W, EASY-500, EASY-500B, EASY-500DD, EASY-500HP, FI-30, FI-30AR, FI-30AR+DD, FI-30B, FI-30B-BT-UK, FI-30-UK, FI-48, FI-48AR, FI-48B, FI-48B-BT-UK, FI-48C, FI-48D, FI-48HY-CLINIC, FI-48W, FI-50, FI-60DD, FI-64, FI-64AR, FI-64B, FI-64B-BT-UK, FI-64C, FI-64D, FI-64HY-CLINIC, FI-64W, FI-72...(Other models you can see in the webshop)		

			
1			
GEV No.	505077	Ref. No.	12024113 Z400902
description	gasket external height 23mm for sump		
For models:	AD-15, AD-15D, AD-20C-UK, AD-21, AD-21B, AD-21BDD, AD-21C, AD-21D, AD-21DD, AD-21W, CO-350, CO-350-B, CO-350-B-DD, CO-350-COLD, CO-350-COLD-B, CO-350-COLD-B-DD, CO-350-COLD-DD, CO-350-DD, CO-352-COLD, CO-352-COLD-B, CO-352-COLD-B-DD, CO-352-COLD-DD, CO-400, CO-400-B, CO-400-B-DD, CO-400-COLD, CO-400-COLD-B, CO-400-COLD-B-DD, CO-400-COLD-DD, CO-400-DD, CO-400-SOFT, CO-402-COLD, CO-402-COLD-B, CO-402-COLD-B-DD, CO-402-COLD-DD, CO-402W, LVC-12, LVC-15, LVC-15D, LVC-21, LVC-21B, LVC-21C, LVC-21D, LVC-21W, LVR-10, LVR-14, LVR-14D, LVR-20, LVR-20B, LVR-20D...(Other models you can see in the webshop)		

			
1			
GEV No.	505274	Ref. No.	12025229 Z310906
description	intake filter ø 88mm H 82mm		
For models:	ECO-2700D, ECO-2700I, ECO-280D, ECO-280I, ECO-370D, ECO-370I, ECO-4000D, ECO-4000I, ECO-460D, ECO-460I, ECO-550D, ECO-550I, ECO-6000D, ECO-6000I, FI-2700D, FI-2700I, FI-280D, FI-280I, FI-370D, FI-370I, FI-4000D, FI-4000I, FI-460D, FI-460I, FI-550D, FI-550I, FI-6000D, FI-6000I		



			
1			
GEV No.	505186	Ref. No.	12003428 12038374 Z710804
description	rectangular filter H 73mm L 150mm W 100mm		
For models:	AD-120, AD-120B, AD-120BBTDD-UK, AD-120C, AD-120CW, AD-120HY, AD-90, AD-90BA, AD-90BBT, AD-90BDD, AD-90DD, ADE-120, ADE-120B, ECO-120, ECO-120B, FI-100, FI-100AR, FI-100B, FI-100BBT-UK, FI-120, FI-120AR+DD, FI-120B, FI-120C, FI-120HY-CLINIC, FI-120W, FI-80, FI-80AR, FI-80BBT-UK, FI-80W, FI-E-100, LABP-1000, LABP-1200, LABP-800, MF-120		

			
1			
GEV No.	505234	Ref. No.	12016636 12025219 Z400920
description	round filters ø 143mm H 125mm		
For models:	AD-15, AD-15D, AD-20C-UK, AD-21, AD-21B, AD-21BDD, AD-21C, AD-21D, AD-21DD, AD-21W, LVC-12, LVC-15, LVC-15D, LVC-21, LVC-21B, LVC-21C, LVC-21D, LVC-21W		

			
1			
GEV No.	505098	Ref. No.	12024410 Z200922
description	round filters ø 204mm H 140mm		
For models:	AD-45BBT, AD-48, AD-48B, AD-48BDD, AD-48C, AD-48D, AD-48DD, AD-48HY, AD-48W, AD-64, AD-64B, AD-64BBT, AD-64BDD, AD-64BTDD, AD-64C, AD-64CW, AD-64D, AD-64DD, AD-64HY, AD-72, AD-72W, EASY-500, EASY-500B, EASY-500DD, EASY-500HP, FI-30, FI-30AR, FI-30AR+DD, FI-30B, FI-30B-BT-UK, FI-30-UK, FI-48, FI-48AR, FI-48B, FI-48B-BT-UK, FI-48C, FI-48D, FI-48HY-CLINIC, FI-48W, FI-60DD, FI-64, FI-64AR, FI-64B, FI-64B-BT-UK, FI-64C, FI-64D, FI-64HY-CLINIC, FI-64W, FI-72, FI-72AR...(Other models you can see in the webshop)		
accessories for	505098		
	GEV No.	505071	Ref. No. 12024323 12153291 Z200909
overflow pipe L 180mm ø 40mm			

			
1			
GEV No.	505164	Ref. No.	12024284 Z600906
description	round filters ø 80mm H 63mm		
For models:	ECO-1200, ECO-2700D, ECO-2700I, ECO-280D, ECO-280I, ECO-370D, ECO-370I, ECO-4000D, ECO-4000I, ECO-460D, ECO-460I, ECO-550D, ECO-550I, ECO-6000D, ECO-6000I, FI-1200, FI-2700D, FI-2700I, FI-280D, FI-280I, FI-370D, FI-370I, FI-4000D, FI-4000I, FI-460D, FI-460I, FI-550D, FI-550I, FI-6000D, FI-6000I, FI-900		

			
1			
GEV No.	505075	Ref. No.	Z400904
description	round filters outflow		
For models:	LVC-12, LVC-15, LVC-15D, LVC-21, LVC-21B, LVC-21D, LVC-21W, LVR-10, LVR-14, LVR-14D, LVR-20, LVR-20B, LVR-20D, MF-21		

			
1			
GEV No.	505076	Ref. No.	Z200901
description	round filters outflow		
For models:	FI-30, FI-48, FI-48B, FI-48W, FI-50, FI-64, FI-64B, FI-64W, FI-72, MF-48, MF-64		
accessories for	505076		
	GEV No.	505071	Ref. No. 12024323 12153291 Z200909
overflow pipe L 180mm ø 40mm			

			
1			
GEV No.	505012	Ref. No.	12023617 Z400901
description	sump for filter ø 158mm H 67mm		
For models:	AD-15, AD-15D, AD-20C-UK, AD-21, AD-21B, AD-21BDD, AD-21C, AD-21D, AD-21DD, AD-21W, LVC-12, LVC-15, LVC-15D, LVC-21, LVC-21B, LVC-21C, LVC-21D, LVC-21W, LVR-10, LVR-14, LVR-14D, LVR-20, LVR-20B, LVR-20D, MF-21		

			
1			
GEV No.	505013	Ref. No.	12024367 Z200906
description	sump for filter ø 220mm H 67mm		
For models:	AD-45BBT, AD-48, AD-48B, AD-48BDD, AD-48C, AD-48D, AD-48DD, AD-48HY, AD-48W, AD-64, AD-64B, AD-64BBT, AD-64BDD, AD-64BTDD, AD-64C, AD-64CW, AD-64D, AD-64DD, AD-64HY, AD-72, AD-72W, EASY-500, EASY-500B, EASY-500DD, EASY-500HP, EASY-500HPWBDD, FI-30, FI-30AR, FI-30AR+DD, FI-30B, FI-30B-BT-UK, FI-30-UK, FI-48, FI-48AR, FI-48B, FI-48B-BT-UK, FI-48C, FI-48D, FI-48HY-CLINIC, FI-48W, FI-50, FI-60DD, FI-64, FI-64AR, FI-64B, FI-64B-BT-UK, FI-64C, FI-64D, FI-64HY-CLINIC, FI-64W...(Other models you can see in the webshop)		

overflow pipes			
			
1			
GEV No.	505073	Ref. No.	12010282 Q307041
description	O-ring EPDM thickness 2.62mm ID ø 20.63mm Qty 1 pcs		
For models:	AD-15, AD-15D, AD-20C-UK, AD-21, AD-21B, AD-21BDD, AD-21C, AD-21D, AD-21W, CG-1002, CG-1502, CG-2000, CG-2000-2P, CG-2002, CG-2002P, CG9-11, CG9-11AD, CG9-11PLUS, CG9-31PLUS-D, CG9-31PLUS-I, CG9-41, CG9-41AD, CG9-41AD-H, CG9-41H, CG9-41PLUS, CG9-41PLUS-H, CG9-51L, CG9-51LC, CG9-51R, CG9-51RC, CG9-61, CG9-61AD, CG9-61AD-H, CG9-61H, CG9-61OP, CG9-61PLUS, CG9-61PLUS-H, CG9-82, CG9-82AD, CG9-82PLUS, CGF9-121D, CGF9-121D-AD, CGF9-121I, CGF9-121PLUS-D, CGF9-121PLUS-I, FF-35, FI-5420, FI-7630, FTG9-11L, FTG9-11L+R...(Other models you can see in the webshop)		





 <p>1</p>			
GEV No.	532494	Ref. No.	12010165 Q307051 Q307061
description	O-ring EPDM thickness 2.62mm ID ø 36.14mm Qty 1 pcs		
For models:	AD-120, AD-120B, AD-120BBTDD-UK, AD-120C, AD-120CW, AD-120HY, AD-45BBT, AD-48, AD-48B, AD-48BDD, AD-48C, AD-48D, AD-48DD, AD-48HY, AD-48W, AD-64, AD-64B, AD-64BBT, AD-64BDD, AD-64BTDD, AD-64C, AD-64CW, AD-64D, AD-64DD, AD-64HY, AD-72, AD-72W, AD-90, AD-90BA, AD-90BBT, AD-90BDD, AD-90DD, ADE-120, ADE-120B, EASY-500, EASY-500B, EASY-500DD, EASY-500HP, ECO-120, ECO-120B, ECO-160, ECO-160D, ECO-160I, ECO-200, ECO-200D, ECO-200H, ECO-200HD, ECO-200HI, ECO-200I, ECO-2700D...(Other models you can see in the webshop)		

 <p>1</p>			
GEV No.	505158	Ref. No.	12040035 Z62104
description	overflow pipe		

 <p>1</p>			
GEV No.	518608	Ref. No.	12023593 Z652101
description	overflow pipe L 150mm ø 42mm		
For models:	ECO-280D, ECO-280I, ECO-370D, ECO-370I, ECO-460D, ECO-460I, ECO-550D, ECO-550I, FI-280D, FI-280I, FI-300R, FI-370D, FI-370I, FI-460D, FI-460I, FI-550D, FI-550I, FI-650R		



 <p>1</p>			
GEV No.	691024	Ref. No.	12019791 R205018
description	overflow pipe L 165mm ø 20mm		
For models:	BME7-05, BME7-10, BME9-05, BME9-10, BMG7-10, BMG9-05, BMG9-10		

 <p>1</p>			
GEV No.	505070	Ref. No.	12025249 Z400907
description	overflow pipe L 165mm ø 25mm		
For models:	AD-15, AD-15D, AD-20C-UK, AD-21, AD-21B, AD-21BDD, AD-21C, AD-21D, AD-21DD, AD-21W, LVC-12, LVC-15, LVC-15D, LVC-21, LVC-21B, LVC-21C, LVC-21D, LVC-21W, LVR-10, LVR-14, LVR-14D, LVR-20, LVR-20B, LVR-20D, MF-21		
accessories for	505070		
	GEV No.	505073	Ref. No. 12010282 Q307041
O-ring EPDM thickness 2.62mm ID ø 20.63mm Qty 1 pcs			

 <p>1</p>			
GEV No.	501337	Ref. No.	12008044 H216111
description	overflow pipe L 172mm ø 16mm		
For models:	BME7-05, BME7-10, BMG7-10		

 <p>1</p>			
GEV No.	505071	Ref. No.	12024323 12153291 Z200909
description	overflow pipe L 180mm ø 40mm		
For models:	AD-45BBT, AD-48, AD-48B, AD-48BDD, AD-48C, AD-48D, AD-48DD, AD-48HY, AD-48W, AD-64, AD-64B, AD-64BBT, AD-64BDD, AD-64C, AD-64CW, AD-64D, AD-64DD, AD-64HY, AD-72, AD-72W, EASY-500, EASY-500DD, EASY-500HP, FI-30, FI-30AR, FI-30AR+DD, FI-30B, FI-30B-BT-UK, FI-30-UK, FI-48, FI-48AR, FI-48B, FI-48B-BT-UK, FI-48C, FI-48D, FI-48HY-CLINIC, FI-48W, FI-50, FI-60DD, FI-64, FI-64AR, FI-64B, FI-64B-BT-UK, FI-64C, FI-64D, FI-64HY-CLINIC, FI-64W, FI-72, FI-72AR, FI-72W...(Other models you can see in the webshop)		
accessories for	505071		
	GEV No.	505098	Ref. No. 12024410 Z200922
round filters ø 204mm H 140mm			
	GEV No.	517004	Ref. No. —
O-ring EPDM thickness 2.62mm ID ø 34.6mm Qty 1 pcs			

 <p>1</p>			
GEV No.	512022	Ref. No.	12016680 Z682101
description	overflow pipe L 195mm ø 42mm plastic dishwasher		
For models:	ECO-1200, FI-1200, FI-900		

			
1			
GEV No.	505072	Ref. No.	12023658 Z710901
description	overflow pipe L 395mm ø 42mm		
For models:	AD-120, AD-120B, AD-120BBTDD-UK, AD-120C, AD-120CW, AD-120HY, AD-90, AD-90BA, AD-90BBT, AD-90BDD, AD-90DD, ADE-120, ADE-120B, ECO-120, ECO-120B, FI-100, FI-100AR, FI-100B, FI-100BBT-UK, FI-120, FI-120AR+DD, FI-120B, FI-120C, FI-120HY-CLINIC, FI-120W, FI-80, FI-80AR, FI-80BBT-UK, FI-80W, FI-E-100, LABP-1000, LABP-1200, LABP-800, MF-120		
accessories for	505072		
	GEV No.	532494	Ref. No.
			12010165 Q307051 Q307061
	O-ring EPDM thickness 2.62mm ID ø 36.14mm Qty 1 pcs		

containers

container lids

			
1			
GEV No.	510001	Ref. No.	12018055 Z211108
description	lid ø 66mm suitable for rinse aid container		

dosing containers

			
1			
GEV No.	505263	Ref. No.	12021190
description	dosing container L 90mm W 80mm H 105mm		

drive shafts

			
1			
GEV No.	692327	Ref. No.	12024595 Z275011
description	spindle D1 ø 16.5mm warewashing ø 20mm L 165mm D2 ø 20mm FAGOR		
For models:	ECO-160, ECO-160D, ECO-160I, ECO-200, ECO-200D, ECO-200H, ECO-200HD, ECO-200HI, ECO-200I, FI-160, FI-160AR, FI-160D, FI-160I, FI-200, FI-200AR, FI-200D, FI-200H, FI-200HD, FI-200HI, FI-200I, FI-200W, FI-200WL, FI-200WR		

salt tanks

			
1			
GEV No.	505229	Ref. No.	12023847 Z471105
description	filter L 71mm ø 10mm salt tank conical		
For models:	AD-15D, AD-21D, AD-48D, AD-64D, FI-48, FI-48AR, FI-48B, FI-48B-BT-UK, FI-48C, FI-48D, FI-48HY-CLINIC, FI-48W, FI-64, FI-64AR, FI-64B, FI-64B-BT-UK, FI-64C, FI-64D, FI-64HY-CLINIC, FI-64W, LVC-15D, LVC-21D		

1



GEV No.	505220	Ref. No.	12025267 12047154 Z471107
description	flat gasket for salt tank rubber thickness 3.9mm ID ø 68mm ED ø 86mm		
For models:	AD-15D, AD-21D, AD-48D, AD-64D, CO-400-SOFT, FI-48, FI-48AR, FI-48B, FI-48B-BT-UK, FI-48C, FI-48D, FI-48HY-CLINIC, FI-48W, FI-64, FI-64AR, FI-64B, FI-64B-BT-UK, FI-64C, FI-64D, FI-64HY-CLINIC, FI-64W, LVC-15D, LVC-21D		

2



GEV No.	524177	Ref. No.	12025273 Z471108
description	lid ø 69mm H 20mm for salt tank ID ø 50mm		
For models:	AD-15D, AD-21D, AD-48D, AD-64D, CO-400-SOFT, FI-48, FI-48AR, FI-48B, FI-48B-BT-UK, FI-48C, FI-48D, FI-48HY-CLINIC, FI-48W, FI-64, FI-64AR, FI-64B, FI-64B-BT-UK, FI-64C, FI-64D, FI-64HY-CLINIC, FI-64W, LVC-15D, LVC-21D		
accessories for	524177		
		GEV No.	524148
		Ref. No.	—
	O-ring EPDM thickness 3.53mm ID ø 40.86mm Qty 1 pcs		



1



GEV No.	517401	Ref. No.	12025272 Z471106
description	nut ø 92mm H 10.5mm for salt tank ID ø 64.5mm		
For models:	AD-15D, AD-21D, AD-48D, AD-64D, CO-400-SOFT, FI-48, FI-48AR, FI-48B, FI-48B-BT-UK, FI-48C, FI-48D, FI-48HY-CLINIC, FI-48W, FI-64, FI-64AR, FI-64B, FI-64B-BT-UK, FI-64C, FI-64D, FI-64HY-CLINIC, FI-64W, LVC-15D, LVC-21D		

1



GEV No.	505101	Ref. No.	12025142 Z471102
description	salt tank ø 90mm H 86mm		
For models:	AD-15D, AD-21D, AD-48D, AD-64D, FI-48, FI-48AR, FI-48B, FI-48B-BT-UK, FI-48C, FI-48D, FI-48HY-CLINIC, FI-48W, FI-64, FI-64AR, FI-64B, FI-64B-BT-UK, FI-64C, FI-64D, FI-64HY-CLINIC, FI-64W, LVC-15D, LVC-21D, LVR-14D, LVR-20D		
accessories for	505101		
		GEV No.	505220
		Ref. No.	12025267 12047154 Z471107
	flat gasket for salt tank rubber thickness 3.9mm ID ø 68mm ED ø 86mm		
		GEV No.	506015
		Ref. No.	12024031 Z471109
	O-ring EPDM thickness 3.53mm ID ø 39.69mm Qty 1 pcs		
		GEV No.	517401
		Ref. No.	12025272 Z471106
	nut ø 92mm H 10.5mm for salt tank ID ø 64.5mm		
		GEV No.	524177
		Ref. No.	12025273 Z471108
	lid ø 69mm H 20mm for salt tank ID ø 50mm		

boilers

boilers for dishwashers

1



GEV No.	505209	Ref. No.	1200002017 12022893 12038284 Z401701 Z401730
description	boiler ø 130mm L 310mm		
For models:	AD-15, AD-15D, AD-20C-UK, AD-21, AD-21B, AD-21BDD, AD-21C, AD-21D, AD-21DD, AD-21W, LVC-12, LVC-15, LVC-15D, LVC-21, LVC-21B, LVC-21C, LVC-21D, LVC-21W, LVR-10, LVR-14, LVR-14D, LVR-20, LVR-20B, LVR-20D, MF-21		

			
GEV No.	505210	Ref. No.	1200005017 12022943 12038293 Z201701 Z201710
description	boiler ø 150mm L 460mm inlet ø 10		
For models:	AD-120, AD-120B, AD-120C, AD-120CW, AD-48, AD-48B, AD-48BDD, AD-48C, AD-48D, AD-48DD, AD-48W, AD-64, AD-64B, AD-64BDD, AD-64C, AD-64CW, AD-64D, AD-64DD, AD-72, AD-72W, AD-90, AD-90BA, AD-90BDD, AD-90DD, EASY-500, EASY-500B, EASY-500DD, EASY-500HP, FI-100, FI-100AR, FI-100B, FI-120, FI-120AR+DD, FI-120B, FI-120C, FI-120W, FI-30, FI-30AR, FI-30AR+DD, FI-30B, FI-30-UK, FI-48, FI-48AR, FI-48B, FI-48C, FI-48D, FI-48W, FI-50, FI-60DD, FI-64...(Other models you can see in the webshop)		

			
GEV No.	505296	Ref. No.	12038196 WX0116204
description	boiler ø 180mm L 410mm		

 <p>Image not available</p>			
GEV No.	501342	Ref. No.	1200003017 12038306 Z101701 Z316426
description	boiler ø 220mm L 580mm flange flange with thread		
For models:	ECO-1600, ECO-2300, ECO-3000, FI-1600, FI-2300, FI-2700D, FI-2700I, FI-3000, FI-4000D, FI-4000I, FI-6000D, FI-6000I		

accessories			
			
GEV No.	518671	Ref. No.	12097453
description	hose connector for boiler L 54mm hose ø 10mm		
For models:	AD-125, AD-125HRS, AD-125-SOFT, AD-505, COP-173, COP-173B, COP-173BDD, COP-173DD, COP-173HRS, COP-173HRSDD, COP-173-SOFT, COP-174, COP-174B, COP-174BDD, COP-174DD, COP-174HRS, COP-174HRSDD, COP-174W, COP-174WHRS, COP-503, COP-503B, COP-503BDD, COP-503DD, COP-503-SOFT, COP-504, COP-504B, COP-504BDD, COP-504DD, COP-504W		

gaskets			
			
GEV No.	699343	Ref. No.	12048366
description	gasket L 118mm W 73mm H 9mm thickness 9mm		
For models:	AD-125, AD-125HRS, AD-125-SOFT, CO-110, CO-110B, CO-110BDD, CO-110DD, CO-112, CO-112B, CO-112BDD, CO-112DD, CO-170, CO-170B, CO-170BDD, CO-170DD, CO-170HRS, CO-170HRSDD, CO-170HRS-SOFT, CO-170-SOFT, CO-172, CO-172B, CO-172BDD, CO-172DD, COP-173, COP-173B, COP-173BDD, COP-173DD, COP-173HRS, COP-173HRSDD, COP-173-SOFT, COP-174, COP-174B, COP-174BDD, COP-174DD, COP-174HRS, COP-174HRSDD		

rotation plates			
			
GEV No.	505144	Ref. No.	12019337 12020267 Z645901 Z645920
description	rotation plate		

			
GEV No.	505170	Ref. No.	12019954 Z405901
description	rotation plate ø 290mm plastic seat ø 22mm overall height 54mm		
For models:	LVR-10, LVR-14, LVR-14D, LVR-20, LVR-20B, LVR-20D		



rotation plate bearings

			
1			
GEV No.	505015	Ref. No.	12024910 old Z405903 old
description	bearing for rotation plate complete		

			
1			
GEV No.	505165	Ref. No.	12019578 12039828 Z605911
description	bearing rotation olate		

			
1			
GEV No.	505154	Ref. No.	12019027 Z645909
description	bearing rotation olate complete		

softener cartridges

softening columns

			
1			
GEV No.	505102	Ref. No.	12024874 Z471101
description	softener 4-fold L 380mm W 180mm		
For models:	AD-15D, AD-21D, AD-48D, AD-64D, CO-400-SOFT, FI-48, FI-48AR, FI-48B, FI-48B-BT-UK, FI-48C, FI-48D, FI-48HY-CLINIC, FI-48W, FI-64, FI-64AR, FI-64B, FI-64B-BT-UK, FI-64C, FI-64D, FI-64HY-CLINIC, FI-64W, LVC-15D, LVC-21D, LVR-14D, LVR-20D		

			
1			
GEV No.	530000	Ref. No.	270064
description	softener 4-fold L 380mm W 180mm		

spare parts and accessories

			
1			
GEV No.	691865	Ref. No.	12018145 Z643013
description	actuator for door for switch L 102mm ext. ø 11.4		
For models:	FI-300B, FI-300R, FI-650R		

			
1			
GEV No.	691767	Ref. No.	12012834 R722631
description	bracket SS L 40mm W 30mm H 50mm		
For models:	FI-30, FI-30AR, FI-30AR+DD, FI-30B, FI-30B-BT-UK, FI-30-UK, FI-48, FI-48AR, FI-48B, FI-48C, FI-48D, FI-48W, FI-50, FI-64, FI-64AR, FI-64B, FI-64C, FI-64D, FI-64W, FI-72, FI-72AR, FI-72W, MF-48, MF-64		

			
1			
GEV No.	530905	Ref. No.	12024487 Z105055000
description	spacer bush for impulse L 24.5mm ID ø 17.5mm ED ø 20mm suitable for FAGOR		
For models:	ECO-160D, ECO-160I, ECO-200D, ECO-200HD, ECO-200HI, ECO-200I, FI-160AR, FI-160D, FI-160I, FI-200AR, FI-200D, FI-200HD, FI-200HI, FI-200I, FI-200WL, FI-200WR		

housing and bezels

fastening angles



1

GEV No.	650103	Ref. No.	12015774 Z400106
description	cross rail L 380mm W 50mm H 10mm mounting distance 355mm		
For models:	LVC-12, LVC-15, LVC-15D, LVR-10, LVR-14, LVR-14D		



1

GEV No.	505239	Ref. No.	12021876 Z276354
description	fastening angle L 80mm W 80mm H 38mm		
For models:	ECO-120, ECO-120B, ECO-160, ECO-160D, ECO-160I, ECO-200, ECO-200D, ECO-200H, ECO-200HD, ECO-200HI, ECO-200I, ECO-280D, ECO-280I, ECO-370D, ECO-370I, ECO-460D, ECO-460I, ECO-550D, ECO-550I, FI-100, FI-100AR, FI-100B, FI-120, FI-120B, FI-120W, FI-160, FI-160AR, FI-160D, FI-160I, FI-200, FI-200AR, FI-200D, FI-200H, FI-200HD, FI-200HI, FI-200I, FI-200W, FI-200WL, FI-200WR, FI-280D, FI-280I, FI-370D, FI-370I, FI-460D, FI-460I, FI-550D, FI-550I, FI-80, FI-80W, MF-120		



1

GEV No.	505325	Ref. No.	12023093 Z850111
description	mounting flange for thermostat stainless steel L 48mm W 35mm thickness 1.2mm H 17mm		
For models:	ECO-160, ECO-1600, ECO-160D, ECO-160I, ECO-200, ECO-200D, ECO-200H, ECO-200HD, ECO-200HI, ECO-200I, ECO-2300, ECO-2700D, ECO-2700I, ECO-280D, ECO-280I, ECO-3000, ECO-370D, ECO-370I, ECO-4000D, ECO-4000I, ECO-460D, ECO-460I, ECO-550D, ECO-550I, ECO-6000D, ECO-6000I, FI-160, FI-1600, FI-160AR, FI-160D, FI-160I, FI-200, FI-200AR, FI-200D, FI-200H, FI-200HD, FI-200HI, FI-200I, FI-200W, FI-200WL, FI-200WR, FI-2300, FI-2700D, FI-2700I, FI-280D, FI-280I, FI-3000, FI-370D, FI-370I, FI-4000D...(Other models you can see in the webshop)		

fascias



1

GEV No.	505337	Ref. No.	12025012 Z208918
description	front foil for dishwasher FI-48C L 583mm W 62mm		
For models:	FI-48AR, FI-48C		

trapdoors



1

GEV No.	505241	Ref. No.	12014320 Z212902
description	door for rinse aid container W 120mm H 110mm thickness 8mm		
For models:	FI-30, FI-48, FI-48B, FI-50, FI-64, FI-64B, FI-72		





1

GEV No.	505235	Ref. No.	1200002020 12038297
description	trapdoor for dishwasher W 460mm H 340mm thickness 25mm		
For models:	AD-21W, LVC-21, LVC-21B, LVC-21C, LVC-21D, LVC-21W		

hood mechanics for dishwashers			
bolts			
 <p>1</p>			
GEV No.	505219	Ref. No.	12023966 Z710542
description	shaft for roller		
For models:	AD-120, AD-120B, AD-120BBTDD-UK, AD-120C, AD-120CW, AD-120HY, AD-90, AD-90BA, AD-90BBT, AD-90BDD, AD-90DD, ADE-120, ADE-120B, ECO-120, ECO-120B, FI-100, FI-100AR, FI-100B, FI-100BBT-UK, FI-120, FI-120AR+DD, FI-120B, FI-120C, FI-120HY-CLINIC, FI-120W, FI-80, FI-80AR, FI-80BBT-UK, FI-80W, FI-E-100, LABP-1000, LABP-1200, LABP-800, MF-120		

bushes			
 <p>1</p>			
GEV No.	505272	Ref. No.	12025255 Z710515
description	bush ED ø 22mm ID ø 10mm L 7mm plastic		
For models:	AD-120, AD-120B, AD-120BBTDD-UK, AD-120C, AD-120CW, AD-120HY, AD-125, AD-125HRS, AD-125-SOFT, AD-90, AD-90BA, AD-90BBT, AD-90BDD, AD-90DD, ADE-120, ADE-120B, CO-110, CO-110B, CO-110BDD, CO-110DD, CO-112, CO-112B, CO-112BDD, CO-112DD, CO-142W, CO-142WDD, CO-170, CO-170B, CO-170BDD, CO-170DD, CO-170HRS, CO-170HRSDD, CO-170HRS-SOFT, CO-170-SOFT, CO-172, CO-172B, CO-172BDD, CO-172DD, COP-173, COP-173B, COP-173BDD, COP-173DD, COP-173HRS, COP-173HRSDD, COP-173-SOFT, COP-174, COP-174B, COP-174BDD, COP-174DD, COP-174HRS...(Other models you can see in the webshop)		

spring holders			
 <p>1</p>			
GEV No.	505261	Ref. No.	12023671 Z270512
description	spring holder hood mechanics D1 ø 46mm D2 ø 36mm W 27mm		
For models:	ECO-160, ECO-160D, ECO-160I, ECO-200, ECO-200D, ECO-200H, ECO-200HD, ECO-200HI, ECO-200I, ECO-2700D, ECO-2700I, ECO-280D, ECO-280I, ECO-370D, ECO-370I, ECO-4000D, ECO-4000I, ECO-460D, ECO-460I, ECO-550D, ECO-550I, ECO-6000D, ECO-6000I, FI-160, FI-160AR, FI-160D, FI-160I, FI-200, FI-200AR, FI-200D, FI-200H, FI-200HD, FI-200HI, FI-200I, FI-200W, FI-200WL, FI-200WR, FI-2700D, FI-2700I, FI-280D, FI-280I, FI-370D, FI-370I, FI-4000D, FI-4000I, FI-460D, FI-460I, FI-550D, FI-550I, FI-6000D...(Other models you can see in the webshop)		

linkage			
 <p>1</p>			
GEV No.	501482	Ref. No.	12019124 Z680522
description	tie bar L 500mm for hood mechanics for dishwasher		
For models:	ECO-1200, FI-1200, FI-900		

friction rings			
 <p>1</p>			
GEV No.	505226	Ref. No.	12018644 Q308009
description	slide ring PTFE ED ø 19mm ID ø 7.5mm thickness 2mm Qty 1 pcs		
For models:	FI-300B, FI-300R, FI-650R		

 <p>1</p>			
GEV No.	505225	Ref. No.	12009922 Q308012
description	slide ring PTFE ED ø 30mm ID ø 10mm thickness 3mm for hood joint Qty 1 pcs		
For models:	AD-120, AD-120B, AD-120BBTDD-UK, AD-120C, AD-120CW, AD-120HY, AD-90, AD-90BA, AD-90BBT, AD-90BDD, AD-90DD, ADE-120, ADE-120B, ECO-120, ECO-120B, FI-100, FI-100AR, FI-100B, FI-100BBT-UK, FI-120, FI-120AR+DD, FI-120B, FI-120C, FI-120HY-CLINIC, FI-120W, FI-80, FI-80AR, FI-80BBT-UK, FI-80W, FI-E-100, LABP-1000, LABP-1200, LABP-800, MF-120		

rollers			
 <p>1</p>			
GEV No.	505218	Ref. No.	12025210 Z710546
description	roller ø 37mm H 12mm plastic hole ø 12.1mm		
For models:	AD-120, AD-120B, AD-120BBTDD-UK, AD-120C, AD-120CW, AD-120HY, AD-90, AD-90BA, AD-90BBT, AD-90BDD, AD-90DD, ADE-120, ADE-120B, ECO-120, ECO-120B, FI-100, FI-100AR, FI-100B, FI-100BBT-UK, FI-120, FI-120AR+DD, FI-120B, FI-120C, FI-120HY-CLINIC, FI-120W, FI-80, FI-80AR, FI-80BBT-UK, FI-80W, FI-E-100, LABP-1000, LABP-1200, LABP-800, MF-120		

miscellaneous			
 <p>1</p>			
GEV No.	517431	Ref. No.	12011392 Z270515
description	bracket for roller spring ømm L 105mm W 44mm H 20mm		
For models:	ECO-160, ECO-160D, ECO-160I, ECO-200, ECO-200D, ECO-200H, ECO-200HD, ECO-200HI, ECO-200I, FI-160, FI-160AR, FI-160D, FI-160I, FI-200, FI-200AR, FI-200D, FI-200H, FI-200HD, FI-200HI, FI-200I, FI-200W, FI-200WL, FI-200WR		

			
1			
GEV No.	529240	Ref. No.	12010068 Q308000
description	flat washer ED ø 16.5mm ID ø 8.2mm plastic thickness 4mm		
For models:	AD-120, AD-120B, AD-120BBTDD-UK, AD-120C, AD-120CW, AD-120HY, AD-90, AD-90BA, AD-90BBT, AD-90BDD, AD-90DD, ADE-120, ADE-120B, ECO-120, ECO-1200, ECO-120B, ECO-160, ECO-1600, ECO-160D, ECO-160I, ECO-200, ECO-200D, ECO-200H, ECO-200HD, ECO-200HI, ECO-200I, ECO-2300, ECO-280D, ECO-280I, ECO-3000, ECO-370D, ECO-370I, ECO-460D, ECO-460I, ECO-550D, ECO-550I, FI-100, FI-100AR, FI-100B, FI-100BBT-UK, FI-120, FI-1200, FI-120AR+DD, FI-120B, FI-120C, FI-120HY-CLINIC, FI-120W, FI-160, FI-1600, FI-160D... (Other models you can see in the webshop)		

			
1			
GEV No.	529241	Ref. No.	12010132 Q308002
description	plain washer for dishwashers ED ø 13mm ID ø 6mm plastic thickness 3.5mm		
For models:	AD-120, AD-120B, AD-120BBTDD-UK, AD-120C, AD-120CW, AD-120HY, AD-90, AD-90BA, AD-90BBT, AD-90BDD, AD-90DD, ADE-120, ADE-120B, CE-15, CE-9, EASY-500, EASY-500B, EASY-500DD, EASY-500HP, EASY-500HPWBDD, ECO-120, ECO-120B, ECO-160, ECO-1600, ECO-160D, ECO-160I, ECO-200, ECO-200D, ECO-200H, ECO-200HD, ECO-200HI, ECO-200I, ECO-2300, ECO-2700D, ECO-2700I, ECO-280D, ECO-280I, ECO-3000, ECO-370D, ECO-370I, ECO-4000D, ECO-4000I, ECO-460D, ECO-460I, ECO-550D, ECO-550I, ECO-6000D, ECO-6000I, FI-100, FI-100AR... (Other models you can see in the webshop)		

			
1			
GEV No.	691890	Ref. No.	12023973 Z270516
description	rubber pad D1 ø 13mm D2 ø 7mm H 10mm		
For models:	ECO-160, ECO-160D, ECO-160I, ECO-200, ECO-200D, ECO-200H, ECO-200HD, ECO-200HI, ECO-200I, ECO-280D, ECO-280I, ECO-370D, ECO-370I, ECO-460D, ECO-460I, ECO-550D, ECO-550I, FI-160, FI-160AR, FI-160D, FI-160I, FI-200, FI-200AR, FI-200D, FI-200H, FI-200HD, FI-200HI, FI-200I, FI-200W, FI-200WL, FI-200WR, FI-280D, FI-280I, FI-370D, FI-370I, FI-460D, FI-460I, FI-550D, FI-550I		

basket guides

guide bars

			
1			
GEV No.	505329	Ref. No.	12038483 12Z3150290
description	basket guide L 593mm H 75mm		
For models:	ECO-280D, ECO-280I, ECO-370D, ECO-370I, ECO-460D, ECO-460I, ECO-550D, ECO-550I, FI-280D, FI-280I, FI-370D, FI-370I, FI-460D, FI-460I, FI-550D, FI-550I		

			
1			
GEV No.	505327	Ref. No.	12041428 12Z3350250
description	basket guide mounting pos. left bottom L 590mm H 70mm		
For models:	ECO-370I, ECO-550I, FI-370I, FI-550I		





			
1			
GEV No.	505328	Ref. No.	12038478 12Z3350050
description	basket guide mounting pos. right bottom L 590mm H 70mm		
For models:	ECO-370D, ECO-550D, FI-370D, FI-550D		









 <p>1</p>			
GEV No.	971056	Ref. No.	12014772 12021776 Z710317 Z710326
description	basket guide mounting pos. upper L 490mm H 36mm hole ø 6mm hole distance 400mm		
For models:	AD-120, AD-120B, AD-120BBTDD-UK, AD-120C, AD-120CW, AD-120HY, AD-90, AD-90BA, AD-90BBT, AD-90BDD, AD-90DD, ADE-120, ADE-120B, ECO-120, ECO-120B, FI-100, FI-100AR, FI-100B, FI-100BBT-UK, FI-120, FI-120AR+DD, FI-120B, FI-120C, FI-120HY-CLINIC, FI-120W, FI-80, FI-80AR, FI-80BBT-UK, FI-80W, FI-E-100, LABP-1000, LABP-1200, LABP-800, MF-120		

 <p>1</p>			
GEV No.	524591	Ref. No.	12024307 Z275041 Z275075
description	sliding block for guide bar L 50mm W 27mm H 16mm		
For models:	ECO-160, ECO-160D, ECO-160I, ECO-200, ECO-200D, ECO-200H, ECO-200HD, ECO-200HI, ECO-200I, ECO-280D, ECO-280I, ECO-370D, ECO-370I, ECO-460D, ECO-460I, ECO-550D, ECO-550I, FI-160, FI-160AR, FI-160D, FI-160I, FI-200, FI-200AR, FI-200D, FI-200H, FI-200HD, FI-200HI, FI-200I, FI-200W, FI-200WL, FI-200WR, FI-280D, FI-280I, FI-370D, FI-370I, FI-460D, FI-460I, FI-550D, FI-550I		

<p>basket holders</p>  <p>1</p>			
GEV No.	504248	Ref. No.	12023365 Z312509
description	basket support L 435m W 420mm H 90mm 90°		

<p>air traps</p>  <p>1</p>				
GEV No.	505094	Ref. No.	12024350 Z203011	
description	air trap			
For models:	AD-120, AD-120B, AD-120BBTDD-UK, AD-120C, AD-120CW, AD-120HY, AD-15, AD-15D, AD-20C-UK, AD-21, AD-21B, AD-21BDD, AD-21C, AD-21D, AD-21DD, AD-21W, AD-45BBT, AD-48, AD-48B, AD-48BDD, AD-48C, AD-48D, AD-48DD, AD-48HY, AD-48W, AD-64, AD-64B, AD-64BBT, AD-64BDD, AD-64BTDD, AD-64C, AD-64CW, AD-64D, AD-64DD, AD-64HY, AD-72, AD-72W, AD-90, AD-90BA, AD-90BBT, AD-90BDD, AD-90DD, ADE-120, ADE-120B, EASY-500, EASY-500B, EASY-500DD, EASY-500HP, EASY-500HPWBDD, ECO-120...(Other models you can see in the webshop)			
accessories for	505094			
	GEV No.	505096	Ref. No.	12024157 Z201312 Z203012
elbow				
	GEV No.	505184	Ref. No.	12024222 Z203013
eye bolt				
	GEV No.	529412	Ref. No.	12009873 Q307003
O-ring EPDM thickness 2.62mm ID ø 10.78mm Qty 1 pcs				

<p>miscellaneous</p>  <p>1</p>			
GEV No.	970861	Ref. No.	12024644 Z105027
description	bush for basket transport system mounting pos. rotation plate ext. ø 40 ID ø 33.5mm H 31.5mm brass		
For models:	ECO-160, ECO-160D, ECO-160I, ECO-200, ECO-200D, ECO-200H, ECO-200HD, ECO-200HI, ECO-200I, ECO-2300, ECO-280D, ECO-280I, ECO-3000, ECO-370D, ECO-370I, ECO-460D, ECO-460I, ECO-550D, ECO-550I, FI-160, FI-160AR, FI-160D, FI-160I, FI-200, FI-200AR, FI-200D, FI-200H, FI-200HD, FI-200HI, FI-200I, FI-200W, FI-200WL, FI-200WR, FI-2300, FI-280D, FI-280I, FI-3000, FI-370D, FI-370I, FI-460D, FI-460I, FI-550D, FI-550I		

			
1			
GEV No.	510103	Ref. No.	12090549 12134442
description	air trap L 85mm W 20mm H 80mm hose ø 6mm plastic		
For models:	CO-350, CO-350-B, CO-350-B-DD, CO-350-COLD, CO-350-COLD-B, CO-350-COLD-B-DD, CO-350-COLD-DD, CO-350-DD, CO-352-COLD, CO-352-COLD-B, CO-352-COLD-B-DD, CO-352-COLD-DD, CO-400, CO-400-B, CO-400-B-DD, CO-400-COLD, CO-400-COLD-B, CO-400-COLD-B-DD, CO-400-COLD-DD, CO-400-DD, CO-400-SOFT, CO-402-COLD, CO-402-COLD-B, CO-402-COLD-B-DD, CO-402-COLD-DD, CO-402W		
spare parts for	510103		
			
GEV No.	505045	Ref. No.	12009912 Q307036
description	O-ring EPDM thickness 1.78mm ID ø 5.28mm Qty 1 pcs		
			
GEV No.	505094	Ref. No.	12024350 Z203011
description	air trap		
			
GEV No.	510016	Ref. No.	—
description	eye bolt for rinse aid container connection		
			
GEV No.	510105	Ref. No.	—
description	hose connector for air trap		

mechanics for flight type dishwashers

			
1			
GEV No.	505240	Ref. No.	12018670 Z331202
description	actuator		
For models:	ECO-370D, ECO-550D, FI-370D, FI-550D		

			
1			
GEV No.	505338	Ref. No.	12002678 12Z2712130
description	bracket L 70mm W 70mm H 30mm thread M5		
For models:	ECO-160, ECO-160D, ECO-160I, ECO-200, ECO-200D, ECO-200H, ECO-200HD, ECO-200HI, ECO-200I, ECO-280D, ECO-280I, ECO-370D, ECO-370I, ECO-460D, ECO-460I, ECO-550D, ECO-550I, FI-160, FI-160AR, FI-160D, FI-160I, FI-200, FI-200AR, FI-200D, FI-200H, FI-200HD, FI-200HI, FI-200I, FI-200WL, FI-200WR, FI-280D, FI-280I, FI-370D, FI-370I, FI-460D, FI-460I, FI-550D, FI-550I		

			
1			
GEV No.	517826	Ref. No.	12024682 Z270336 Z270336000
description	door guides L 620mm W 37mm H 13mm mounting pos. right		
For models:	ECO-160, ECO-160D, ECO-160I, ECO-200, ECO-200D, ECO-200H, ECO-200HD, ECO-200HI, ECO-200I, ECO-280D, ECO-280I, ECO-370D, ECO-370I, ECO-460D, ECO-460I, ECO-550D, ECO-550I, FI-160, FI-160AR, FI-160D, FI-160I, FI-200, FI-200AR, FI-200D, FI-200H, FI-200HD, FI-200HI, FI-200I, FI-200WL, FI-200WR, FI-280D, FI-280I, FI-370D, FI-370I, FI-460D, FI-460I, FI-550D, FI-550I		

			
1			
GEV No.	519525	Ref. No.	12023176 Z275021
description	flange for drive shaft ø 44mm ID ø 35mm ED ø 119mm suitable for FAGOR		
For models:	ECO-160, ECO-160D, ECO-160I, ECO-200, ECO-200D, ECO-200H, ECO-200HD, ECO-200HI, ECO-200I, FI-160, FI-160AR, FI-160D, FI-160I, FI-200, FI-200AR, FI-200D, FI-200H, FI-200HD, FI-200HI, FI-200I, FI-200WL, FI-200WR		

			
1			
GEV No.	697775	Ref. No.	12024102 Z275007
description	gear wheel DIN/ISO 08 B-1x26T splitting 1/2" teeth 26 shaft intake ø 20mm H 28mm hub ø 43mm		
For models:	ECO-160, ECO-160D, ECO-160I, ECO-200HD, ECO-200HI, ECO-280D, ECO-280I, FI-160, FI-160AR, FI-160D, FI-160I, FI-200HD, FI-200HI, FI-200WL, FI-200WR, FI-280D, FI-280I		

			
1			
GEV No.	505333	Ref. No.	1200000140 12038281 Z335011
description	holder frame for rack conveyor dishwashing machine L 595mm W 480mm H 40mm		
For models:	ECO-370D, ECO-370I, ECO-550D, ECO-550I, FI-370D, FI-370I, FI-550D, FI-550I		





			
1			
GEV No.	505321	Ref. No.	12022145 Z271206
description	magnet holder for transport system ø 35mm hole ø 6mm hole distance 21mm thickness 2mm		
For models:	ECO-160, ECO-160D, ECO-160I, ECO-200, ECO-200D, ECO-200H, ECO-200HD, ECO-200HI, ECO-200I, ECO-280D, ECO-280I, ECO-370D, ECO-370I, ECO-460D, ECO-460I, ECO-550D, ECO-550I, FI-160, FI-160AR, FI-160D, FI-160I, FI-200, FI-200AR, FI-200D, FI-200H, FI-200HD, FI-200HI, FI-200I, FI-200W, FI-200WL, FI-200WR, FI-280D, FI-280I, FI-370D, FI-370I, FI-460D, FI-460I, FI-550D, FI-550I		

			
2			
GEV No.	504451	Ref. No.	12009828 12021015 Q362000 Z105026
description	roll pin ø 6.3mm L 50mm SS		
For models:	ECO-160, ECO-160D, ECO-160I, ECO-200, ECO-200D, ECO-200H, ECO-200HD, ECO-200HI, ECO-200I, ECO-2300, ECO-280D, ECO-280I, ECO-3000, ECO-370D, ECO-370I, ECO-460D, ECO-460I, ECO-550D, ECO-550I, FI-160, FI-160D, FI-160I, FI-200, FI-200AR, FI-200D, FI-200H, FI-200HD, FI-200HI, FI-200I, FI-200W, FI-200WL, FI-200WR, FI-2300, FI-280D, FI-280I, FI-3000, FI-370D, FI-370I, FI-460D, FI-460I, FI-550D, FI-550I		



			
1			
GEV No.	505330	Ref. No.	12031651 12048195 INXC401001
description	roller for rack conveyor dishwashing machine L 500mm ø 40mm plastic shaft ø 10mm shaft L 15mm		

			
1			
GEV No.	505331	Ref. No.	12032894 6020000446
description	roller for rack conveyor dishwashing machine L 505mm ø 40mm thread M8		

			
1			
GEV No.	505332	Ref. No.	12033009 6020000447
description	roller for rack conveyor dishwashing machine short L 100mm ø 40mm		

			
1			
GEV No.	530905	Ref. No.	12024487 Z105055000
description	spacer bush for impulse L 24.5mm ID ø 17.5mm ED ø 20mm suitable for FAGOR		
For models:	ECO-160D, ECO-160I, ECO-200D, ECO-200HD, ECO-200HI, ECO-200I, FI-160AR, FI-160D, FI-160I, FI-200AR, FI-200D, FI-200HD, FI-200HI, FI-200I, FI-200WL, FI-200WR		

			
1			
GEV No.	504387	Ref. No.	12024391 Z271204
description	spring right for transport system shaft diametermm ø 10.5mm L 36mm Wmm Hmm wire gauge ø 1.4mm		
For models:	ECO-160, ECO-160D, ECO-160I, ECO-200, ECO-200D, ECO-200H, ECO-200HD, ECO-200HI, ECO-200I, ECO-280D, ECO-280I, ECO-370D, ECO-370I, ECO-460D, ECO-460I, ECO-550D, ECO-550I, FI-160, FI-160AR, FI-160D, FI-160I, FI-200, FI-200AR, FI-200D, FI-200H, FI-200HD, FI-200HI, FI-200I, FI-200W, FI-200WL, FI-200WR, FI-280D, FI-280I, FI-370D, FI-370I, FI-460D, FI-460I, FI-550D, FI-550I		

							
1							
GEV No.	504450	Ref. No.	12024681 Z275022 Z275025				
description	tension bolt for transport system L 98mm ID ø 45mm ED ø 50/34mm						
For models:	ECO-160, ECO-160D, ECO-160I, ECO-200, ECO-200D, ECO-200H, ECO-200HD, ECO-200HI, ECO-200I, ECO-280D, ECO-280I, ECO-370D, ECO-370I, ECO-460D, ECO-460I, ECO-550D, ECO-550I, FI-160, FI-160AR, FI-160D, FI-160I, FI-200, FI-200AR, FI-200D, FI-200H, FI-200HD, FI-200HI, FI-200I, FI-200W, FI-200WL, FI-200WR, FI-280D, FI-280I, FI-370D, FI-370I, FI-460D, FI-460I, FI-550D, FI-550I						
accessories for	504450						
		<table border="1"> <tr> <td>GEV No.</td> <td>504451</td> <td>Ref. No.</td> <td>12009828 12021015 Q362000 Z105026</td> </tr> </table>	GEV No.	504451	Ref. No.	12009828 12021015 Q362000 Z105026	
GEV No.	504451	Ref. No.	12009828 12021015 Q362000 Z105026				
	roll pin ø 6.3mm L 50mm SS						

backflow preventers

backflow preventers

			
1			
GEV No.	505091	Ref. No.	12018668 Z231105
description	backflow preventer dishwasher		
For models:	ECO-120, ECO-120B, FI-100, FI-100AR, FI-100B, FI-120, FI-120B, FI-120W, FI-30, FI-48, FI-48B, FI-48W, FI-50, FI-64, FI-64B, FI-64W, FI-72, FI-80, FI-80W, LVC-21W, MF-120, MF-21, MF-48, MF-64		

			
1			
GEV No.	505183	Ref. No.	12023857 1210305189 Z718418
description	backflow preventer dishwasher		
For models:	AD-120CW, CO-142W, CO-142WDD, FI-120W, FI-200W, FI-200WL, FI-200WR, FI-48, FI-48B, FI-48W, FI-64, FI-64B, FI-64W, FI-80W, MF-120, MF-48, MF-64		

			
1			
GEV No.	516101	Ref. No.	12024568 Z231106
description	backflow preventer dishwasher hose ø 12mm		
For models:	AD-120, AD-120B, AD-120C, AD-20C-UK, AD-21, AD-21B, AD-21BDD, AD-21C, AD-21DD, AD-21W, AD-48, AD-48B, AD-48BDD, AD-48C, AD-48DD, AD-48W, AD-64, AD-64B, AD-64BDD, AD-64C, AD-64CW, AD-64D, AD-64DD, AD-72, AD-72W, AD-90, AD-90BA, AD-90BDD, AD-90DD, CO-110, CO-110B, CO-110BDD, CO-110DD, CO-112, CO-112B, CO-112BDD, CO-112DD, CO-170, CO-170B, CO-170BDD, CO-170DD, CO-170HRS, CO-170HRSDD, CO-170HRS-SOFT, CO-170-SOFT, CO-172, CO-172B, CO-172BDD, CO-172DD, CO-350...(Other models you can see in the webshop)		
spare parts for	516101		
	GEV No.	506367	Ref. No. —
	flat gasket rubber ED ø 40mm ID ø 28mm thickness 1.8mm Qty 1 pcs		

miscellaneous

			
1			
GEV No.	505151	Ref. No.	Z850603
description	pin plastic		

			
1			
GEV No.	506160	Ref. No.	Q231450000
description	plain washer ID ø 8.6mm ED ø 16mm thickness 1.5mm SS Qty 1 pcs		

door mechanics

springs

roller springs

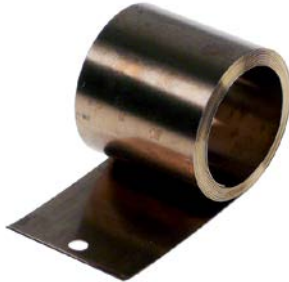
			
1			
GEV No.	519451	Ref. No.	12024689 Z270513
description	roller spring W 40mm ID ø 35mm lug length 50mm		
For models:	ECO-160, ECO-160D, ECO-160I, ECO-200, ECO-200D, ECO-200H, ECO-200HD, ECO-200HI, ECO-200I, ECO-2700D, ECO-2700I, ECO-280D, ECO-280I, ECO-370D, ECO-370I, ECO-4000D, ECO-4000I, ECO-460D, ECO-460I, ECO-550D, ECO-550I, ECO-6000D, ECO-6000I, FI-160, FI-160AR, FI-160D, FI-160I, FI-200, FI-200AR, FI-200D, FI-200H, FI-200HD, FI-200HI, FI-200I, FI-200W, FI-200WL, FI-200WR, FI-2700D, FI-2700I, FI-280D, FI-280I, FI-370D, FI-370I, FI-4000D, FI-4000I, FI-460D, FI-460I, FI-550D, FI-550I, FI-6000D...(Other models you can see in the webshop)		

linkage

			
1			
GEV No.	519410	Ref. No.	12019100 Z200521
description	linkage		
For models:	FI-30, FI-30AR, FI-30AR+DD, FI-30B, FI-30B-BT-UK, FI-30-UK, FI-48, FI-48AR, FI-48B, FI-48B-BT-UK, FI-48C, FI-48D, FI-48HY-CLINIC, FI-48W, FI-50, FI-64, FI-64AR, FI-64B, FI-64B-BT-UK, FI-64C, FI-64D, FI-64HY-CLINIC, FI-64W, MF-48, MF-64		

sliding plates

			
1			
GEV No.	505195	Ref. No.	12024180 Z200310
description	sliding plate sliding plate		
For models:	AD-20C-UK, AD-21, AD-21B, AD-21BDD, AD-21C, AD-21D, AD-21DD, AD-21W, AD-45BBT, AD-48, AD-48B, AD-48BDD, AD-48C, AD-48D, AD-48DD, AD-48HY, AD-48W, AD-64, AD-64B, AD-64BBT, AD-64BDD, AD-64BTDD, AD-64C, AD-64CW, AD-64D, AD-64DD, AD-64HY, AD-72, AD-72W, EASY-500, EASY-500B, EASY-500DD, EASY-500HP, EASY-500HPWBDD, FI-30, FI-30AR, FI-30AR+DD, FI-30B, FI-30B-BT-UK, FI-30-UK, FI-48, FI-48AR, FI-48B, FI-48B-BT-UK, FI-48C, FI-48D, FI-48HY-CLINIC, FI-48W, FI-50, FI-60DD...(Other models you can see in the webshop)		



hinges



1

GEV No.	505005	Ref. No.	12022324 Z400514
description	door hinge hinge left mounting pos. left		
For models:	AD-15, AD-15D, AD-20C-UK, AD-21, AD-21B, AD-21BDD, AD-21C, AD-21D, AD-21DD, AD-21W, AD-45BBT, AD-48, AD-48B, AD-48BDD, AD-48C, AD-48D, AD-48DD, AD-48HY, AD-48W, AD-64, AD-64B, AD-64BBT, AD-64BDD, AD-64BTDD, AD-64C, AD-64CW, AD-64D, AD-64DD, AD-64HY, AD-72, AD-72W, EASY-500, EASY-500B, EASY-500DD, EASY-500HP, EASY-500HPWBDD, FI-30, FI-30AR, FI-30AR+DD, FI-30B, FI-30B-BT-UK, FI-30-UK, FI-48, FI-48AR, FI-48B, FI-48B-BT-UK, FI-48C, FI-48D, FI-48HY-CLINIC, FI-48W...(Other models you can see in the webshop)		
spare parts for	505005		
	GEV No.	700818	Ref. No.
			12024071 Z400516
	hinge bolt L 32mm stainless steel D1 ø 7.8mm D2 ø 12mm		



1

GEV No.	505006	Ref. No.	12022325 Z400515
description	door hinge hinge right mounting pos. right		
For models:	AD-15, AD-15D, AD-20C-UK, AD-21, AD-21B, AD-21BDD, AD-21C, AD-21D, AD-21DD, AD-21W, AD-45BBT, AD-48, AD-48B, AD-48BDD, AD-48C, AD-48D, AD-48DD, AD-48HY, AD-48W, AD-64, AD-64B, AD-64BBT, AD-64BDD, AD-64BTDD, AD-64C, AD-64CW, AD-64D, AD-64DD, AD-64HY, AD-72, AD-72W, EASY-500, EASY-500B, EASY-500DD, EASY-500HP, EASY-500HPWBDD, FI-30, FI-30AR, FI-30AR+DD, FI-30B, FI-30B-BT-UK, FI-30-UK, FI-48, FI-48AR, FI-48B, FI-48B-BT-UK, FI-48C, FI-48D, FI-48HY-CLINIC, FI-48W...(Other models you can see in the webshop)		

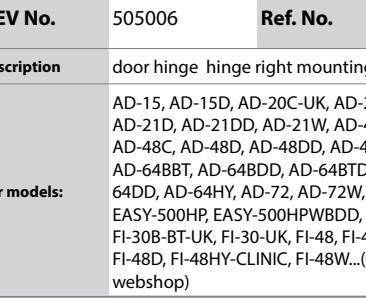

1

GEV No.	501479	Ref. No.	12036714 12037269 6009990017 A169090003
description	door hinge L 130mm for fridge FAGOR		
For models:	AEP-1402, AEP-1403, AEP-1404, AEP-1602, AEP-1603, AEP-1604, AEP-702, AEP-802, AF-1403-C, AF-1403-P, AF-1404-C, AF-1404-P, AF-1603-C, AF-1603-P, AF-1604-C, AF-1604-P, AF-2104-C, AF-2104-P, AF-2105-C, AF-2105-P, AF-2106-C, AF-2106-P, AFN-1402, AFN-1403, AFN-1404, AFN-1603, AFN-1604, AFN-702, AFN-802, AFP-1402, AFP-1403, AFP-1403-C, AFP-1403-FORZ, AFP-1403-P, AFP-1404, AFP-1404-C, AFP-1404-FORZ, AFP-1404-P, AFP-1603, AFP-1603-2, AFP-1604, AFP-2104, AFP-2104-C, AFP-2104-P, AFP-2105, AFP-2105-C, AFP-2105-P, AFP-2106, AFP-2106-C, AFP-2106-P...(Other models you can see in the webshop)		

doors



1
Image not available

GEV No.	507439	Ref. No.	1200002010 12038286
description	door W 423mm H 300mm thickness 40mm		
For models:	LVC-12, LVC-15, LVC-15D		



1

GEV No.	507443	Ref. No.	12015782 Z420531
description	door W 455mm H 370mm thickness 35mm FAGOR suitable for LVC / LVR		
For models:	LVC-21, LVC-21B, LVC-21D, LVC-21W, LVR-20, LVR-20B, LVR-20D, MF-21		



1

GEV No.	507442	Ref. No.	1200005030 12006603 12013502 12038302 12Z2005410
description	door W 585mm H 430mm thickness 50mm complete FAGOR		
For models:	FI-30, FI-30AR, FI-30AR+DD, FI-30B, FI-30B-BT-UK, FI-30-UK, FI-48, FI-48AR, FI-48B, FI-48B-BT-UK, FI-48C, FI-48D, FI-48HY-CLINIC, FI-48W, FI-64, FI-64AR, FI-64B, FI-64B-BT-UK, FI-64C, FI-64D, FI-64HY-CLINIC, FI-64W		

			
1			
GEV No.	691912	Ref. No.	12015781 Z420511
description	inner door W 405mm H 340mm thickness 18mm FAGOR suitable for LVC / LVR		
For models:	LVC-21, LVC-21B, LVC-21D, LVC-21W, LVR-20, LVR-20B, LVR-20D, MF-21		

door guides

			
1			
GEV No.	517826	Ref. No.	12024682 Z270336 Z270336000
description	door guides L 620mm W 37mm H 13mm mounting pos. right		
For models:	ECO-160, ECO-160D, ECO-160I, ECO-200, ECO-200D, ECO-200H, ECO-200HD, ECO-200HI, ECO-200I, ECO-280D, ECO-280I, ECO-370D, ECO-370I, ECO-460D, ECO-460I, ECO-550D, ECO-550I, FI-160, FI-160AR, FI-160D, FI-160I, FI-200, FI-200AR, FI-200D, FI-200H, FI-200HD, FI-200HI, FI-200I, FI-200W, FI-200WL, FI-200WR, FI-280D, FI-280I, FI-370D, FI-370I, FI-460D, FI-460I, FI-550D, FI-550I		

door frames

			
1			
GEV No.	504239	Ref. No.	12024295 Z200524
description	door frame L 360mm W 15mm H 14mm plastic L-shape mounting distance 150mm		
For models:	AD-45BBT, AD-48, AD-48B, AD-48BDD, AD-48C, AD-48D, AD-48DD, AD-48HY, AD-48W, AD-64, AD-64B, AD-64BBT, AD-64BDD, AD-64BTDD, AD-64C, AD-64CW, AD-64D, AD-64DD, AD-64HY, EASY-500, EASY-500B, EASY-500DD, EASY-500HP, EASY-500HPBDD, FI-30, FI-30AR, FI-30AR+DD, FI-30B, FI-30B-BT-UK, FI-30-UK, FI-48, FI-48AR, FI-48B, FI-48B-BT-UK, FI-48C, FI-48D, FI-48HY-CLINIC, FI-48W, FI-50, FI-60DD, FI-64, FI-64AR, FI-64B, FI-64B-BT-UK, FI-64C, FI-64D, FI-64HY-CLINIC, FI-64W, MF-48, MF-64		

rod support

			
1			
GEV No.	505238	Ref. No.	12008904 623600000
description	hook L 245mm		
For models:	CG-1002, CG-1502, CG-2002, CG-2002P, CG-210, CG-210G, CG-310, CG-310G		

door bumpers

			
1			
GEV No.	505149	Ref. No.	12024299 Z200522
description	door bumper door bumper		
For models:	AD-20C-UK, AD-21, AD-21B, AD-21BDD, AD-21C, AD-21D, AD-21DD, AD-21W, AD-45BBT, AD-48, AD-48B, AD-48BDD, AD-48C, AD-48D, AD-48DD, AD-48HY, AD-48W, AD-64, AD-64B, AD-64BBT, AD-64BDD, AD-64BTDD, AD-64C, AD-64CW, AD-64D, AD-64DD, AD-64HY, AD-72, AD-72W, EASY-500, EASY-500B, EASY-500DD, EASY-500HP, EASY-500HPBDD, FI-30, FI-30AR, FI-30AR+DD, FI-30B, FI-30B-BT-UK, FI-30-UK, FI-48, FI-48AR, FI-48B, FI-48B-BT-UK, FI-48C, FI-48D, FI-48HY-CLINIC, FI-48W, FI-50, FI-60DD...(Other models you can see in the webshop)		

			
1			
GEV No.	506266	Ref. No.	12016638 Z105042
description	door bumper H 28mm L 66mm W 7.5mm mounting pos. door plastic		
For models:	ECO-1600, ECO-2300, ECO-3000, FI-1600, FI-2300, FI-3000		

locks

			
1			
GEV No.	505196	Ref. No.	12024235 Z200601
description	door catch		
For models:	AD-15, AD-15D, AD-20C-UK, AD-21, AD-21B, AD-21BDD, AD-21C, AD-21D, AD-21DD, AD-21W, AD-45BBT, AD-48, AD-48B, AD-48BDD, AD-48C, AD-48D, AD-48DD, AD-48HY, AD-48W, AD-64, AD-64B, AD-64BBT, AD-64BDD, AD-64BTDD, AD-64C, AD-64CW, AD-64D, AD-64DD, AD-64HY, AD-72, AD-72W, EASY-500, EASY-500B, EASY-500DD, EASY-500HP, EASY-500HPBDD, ECO-2700D, ECO-2700I, ECO-4000D, ECO-4000I, ECO-6000D, ECO-6000I, FI-2700D, FI-2700I, FI-30, FI-30AR, FI-30AR+DD, FI-30B, FI-30B-BT-UK, FI-30-UK...(Other models you can see in the webshop)		





 <p>1</p>			
GEV No.	505007	Ref. No.	12003212 12003363 12Z2006070
description	door catch door locking catch		
For models:	AD-15, AD-15D, AD-20C-UK, AD-21, AD-21B, AD-21BDD, AD-21C, AD-21D, AD-21DD, AD-21W, AD-45BBT, AD-48, AD-48B, AD-48BDD, AD-48C, AD-48D, AD-48DD, AD-48HY, AD-48W, AD-64, AD-64B, AD-64BBT, AD-64BDD, AD-64BTDD, AD-64C, AD-64CW, AD-64D, AD-64DD, AD-64HY, AD-72, AD-72W, EASY-500, EASY-500B, EASY-500DD, EASY-500HP, EASY-500HPWBDD, ECO-2700D, ECO-2700I, ECO-4000D, ECO-4000I, ECO-6000D, ECO-6000I, FI-2700D, FI-2700I, FI-30, FI-30AR, FI-30AR+DD, FI-30B, FI-30B-BT-UK, FI-30-UK...(Other models you can see in the webshop)		

 <p>1</p>			
GEV No.	508396	Ref. No.	12021923 Z710543
description	spring rod straight stainless steel L 140mm W 24mm		
For models:	AD-120, AD-120B, AD-120BBTDD-UK, AD-90, AD-90BA, AD-90BBT, AD-90BDD, AD-90DD, ADE-120, ADE-120B, ECO-120, ECO-120B, FI-100, FI-100AR, FI-100B, FI-100BBT-UK, FI-120, FI-120AR+DD, FI-120B, FI-120C, FI-120HY-CLINIC, FI-120W, FI-80, FI-80AR, FI-80BBT-UK, FI-80W, FI-E-100, LABP-1000, LABP-1200, LABP-800, MF-120		

<p>miscellaneous</p>			
 <p>1</p>			
GEV No.	505010	Ref. No.	12023624 Z710544
description	screw screw		
For models:	AD-120, AD-120B, AD-120BBTDD-UK, AD-90, AD-90BA, AD-90BBT, AD-90BDD, AD-90DD, ADE-120, ADE-120B, ECO-120, ECO-120B, FI-100, FI-100AR, FI-100B, FI-100BBT-UK, FI-120, FI-120AR+DD, FI-120B, FI-120C, FI-120HY-CLINIC, FI-120W, FI-80, FI-80AR, FI-80BBT-UK, FI-80W, FI-E-100, LABP-1000, LABP-1200, LABP-800, MF-120		

<p>screw connections</p>			
 <p>1</p>			
GEV No.	505163	Ref. No.	12025276 Z602102
description	nut thread 1½"		
For models:	ECO-1200, ECO-1600, ECO-2300, ECO-2700D, ECO-2700I, ECO-280D, ECO-280I, ECO-3000, ECO-370D, ECO-370I, ECO-4000D, ECO-4000I, ECO-460D, ECO-460I, ECO-550D, ECO-550I, ECO-6000D, ECO-6000I, FI-1200, FI-1600, FI-2300, FI-2700D, FI-2700I, FI-280D, FI-280I, FI-3000, FI-300B, FI-300R, FI-370D, FI-370I, FI-4000D, FI-4000I, FI-460D, FI-460I, FI-550D, FI-550I, FI-6000D, FI-6000I, FI-650R, FI-900		

 <p>1</p>			
GEV No.	505008	Ref. No.	12025166 Z710529
description	spring compressor spring compressor		
For models:	AD-120, AD-120B, AD-120BBTDD-UK, AD-90, AD-90BA, AD-90BBT, AD-90BDD, AD-90DD, ADE-120, ADE-120B, ECO-120, ECO-120B, FI-100, FI-100AR, FI-100B, FI-100BBT-UK, FI-120, FI-120AR+DD, FI-120B, FI-120C, FI-120HY-CLINIC, FI-120W, FI-80, FI-80AR, FI-80BBT-UK, FI-80W, FI-E-100, LABP-1000, LABP-1200, LABP-800, MF-120		

 <p>1</p>			
GEV No.	504369	Ref. No.	12007871 Q223023
description	nut thread 5/8" pipe (22.7mm) H 7.3mm WS 32 brass Qty 1 pcs		
For models:	AD-120, AD-120B, AD-120BBTDD-UK, AD-120C, AD-120CW, AD-120HY, AD-90, AD-90BA, AD-90BBT, AD-90BDD, AD-90DD, ADE-120, ADE-120B, CO-142W, CO-142WDD, COP-174W, COP-174WHR, ECO-120, ECO-1200, ECO-120B, ECO-160, ECO-1600, ECO-160D, ECO-160I, ECO-200, ECO-200D, ECO-200H, ECO-200HD, ECO-200HI, ECO-200I, ECO-2300, ECO-2700D, ECO-2700I, ECO-280D, ECO-280I, ECO-3000, ECO-370D, ECO-370I, ECO-4000D, ECO-4000I, ECO-460D, ECO-460I, ECO-550D, ECO-550I, ECO-6000D, ECO-6000I, FI-100, FI-100AR, FI-100B, FI-100BBT-UK...(Other models you can see in the webshop)		

curtains

curtains



GEV No.	533002	Ref. No.	12039834 Z106405
description	curtain W 615mm H 400mm rubber thickness 2.7mm		
For models:	ECO-1600, ECO-2300, ECO-3000, FI-1600, FI-2300, FI-3000		



GEV No.	533015	Ref. No.	12003701 12006760 12012962 12Z2764290 Z276410
description	curtain W 620mm H 410mm thickness 1.6mm warewashing		
For models:	ECO-160, ECO-160D, ECO-160I, ECO-200, ECO-200D, ECO-200H, ECO-200HD, ECO-200HI, ECO-200I, ECO-2700D, ECO-2700I, ECO-280D, ECO-280I, ECO-370D, ECO-370I, ECO-4000D, ECO-4000I, ECO-460D, ECO-460I, ECO-550D, ECO-550I, ECO-6000D, ECO-6000I, FI-160, FI-160AR, FI-160D, FI-160I, FI-200, FI-200AR, FI-200D, FI-200H, FI-200HD, FI-200HI, FI-200I, FI-200W, FI-200WL, FI-200WR, FI-2700D, FI-2700I, FI-280D, FI-280I, FI-370D, FI-370I, FI-4000D, FI-4000I, FI-460D, FI-460I, FI-550D, FI-550I, FI-6000D... (Other models you can see in the webshop)		



GEV No.	533014	Ref. No.	12006850 12012916 12Z2764190 Z276401
description	curtain W 620mm H 500mm thickness 1.4mm warewashing		
For models:	ECO-160, ECO-160D, ECO-160I, ECO-200, ECO-200D, ECO-200H, ECO-200HD, ECO-200HI, ECO-200I, ECO-2700D, ECO-2700I, ECO-280D, ECO-280I, ECO-370D, ECO-370I, ECO-4000D, ECO-4000I, ECO-460D, ECO-460I, ECO-550D, ECO-550I, ECO-6000D, ECO-6000I, FI-160, FI-160AR, FI-160D, FI-160I, FI-200, FI-200D, FI-200H, FI-200HD, FI-200HI, FI-200I, FI-200W, FI-2700D, FI-2700I, FI-280D, FI-280I, FI-370D, FI-370I, FI-4000D, FI-4000I, FI-460D, FI-460I, FI-550D, FI-550I, FI-6000D, FI-6000I		

washing and rinsing systems



GEV No.	505040	Ref. No.	12023726 12110631 Z650704
description	bush for wash arm		
For models:	AD-45BBT, AD-48, AD-48B, AD-48BDD, AD-48C, AD-48D, AD-48DD, AD-48HY, AD-48W, AD-505, AD-505-SOFT, AD-64, AD-64B, AD-64BBT, AD-64BDD, AD-64BTDD, AD-64C, AD-64CW, AD-64D, AD-64DD, AD-64HY, AD-72, AD-72W, AD-90, AD-90BA, AD-90BBT, AD-90BDD, AD-90DD, CO-110, CO-110B, CO-110BDD, CO-110DD, CO-112, CO-112B, CO-112BDD, CO-112DD, CO-500, CO-500B, CO-500BDD, CO-500DD, CO-501, CO-501B, CO-501BDD, CO-501DD, CO-501-SOFT, CO-502B, CO-502BDD, CO-502DD, CO-502W, COP-503... (Other models you can see in the webshop)		



GEV No.	505041	Ref. No.	12025116 Z710712
description	bush for wash arm		
For models:	AD-120, AD-120B, AD-120BBTDD-UK, AD-120C, AD-120CW, AD-120HY, AD-125, AD-125HRS, AD-125-SOFT, ADE-120, ADE-120B, CO-142W, CO-142WDD, CO-170, CO-170B, CO-170BDD, CO-170DD, CO-170HRS, CO-170HRSDD, CO-170HRS-SOFT, CO-170-SOFT, CO-172, CO-172B, CO-172BDD, CO-172DD, COP-173, COP-173B, COP-173BDD, COP-173DD, COP-173HRS, COP-173HRSDD, COP-173-SOFT, COP-174, COP-174B, COP-174BDD, COP-174DD, COP-174HRS, COP-174HRSDD, COP-174W, COP-174WHRS, ECO-120, ECO-120B, FI-100, FI-100AR, FI-100B, FI-100BBT-UK, FI-120, FI-120AR+DD, FI-120B, FI-120C... (Other models you can see in the webshop)		



GEV No.	507425	Ref. No.	12018740 Z710707
description	duct D1 ø 38mm D2 ø 45mm L 72mm int. ø 1 31mm int. ø 2 39mm		
For models:	ECO-120, ECO-120B, ECO-160D, ECO-160I, ECO-200D, ECO-200I, FI-100, FI-100AR, FI-100B, FI-120, FI-120AR+DD, FI-120B, FI-120C, FI-120HY-CLINIC, FI-120W, FI-160D, FI-160I, FI-200D, FI-200I, FI-E-100, MF-120		

spare parts for	507425	GEV No.	518080	Ref. No.	12023537 Z710708
					nut thread 1½" WS 50 duct thickness 15mm



1

GEV No.	505260	Ref. No.	12024287 Z310721	
description	end cap for wash arm ø 32mm L 33mm suitable for FAGOR			
For models:	ECO-2700D, ECO-2700I, ECO-280D, ECO-280I, ECO-370D, ECO-370I, ECO-4000D, ECO-4000I, ECO-460D, ECO-460I, ECO-550D, ECO-550I, ECO-6000D, ECO-6000I, FI-2700D, FI-2700I, FI-280D, FI-280I, FI-370D, FI-370I, FI-4000D, FI-4000I, FI-460D, FI-460I, FI-550D, FI-550I, FI-6000D, FI-6000I			
accessories for	505260			
	GEV No.	502036	Ref. No.	—
	O-ring EPDM thickness 2.62mm ID ø 28.25mm Qty 1 pcs			



1

GEV No.	505171	Ref. No.	12017466 12020831 12024375 Z200705
description	knurled nut thread M14x1 ø 35mm H 5mm SS		
For models:	AD-45BBT, AD-48, AD-48B, AD-48BDD, AD-48C, AD-48D, AD-48DD, AD-48HY, AD-48W, AD-64, AD-64B, AD-64BDD, AD-64BDD, AD-64BTDD, AD-64C, AD-64CW, AD-64D, AD-64DD, AD-64HY, AD-72, AD-72W, AD-90, AD-90BA, AD-90BBT, AD-90BDD, AD-90DD, EASY-500, EASY-500B, EASY-500DD, EASY-500HP, EASY-500HPWBDD, FI-30, FI-30AR, FI-30AR+DD, FI-30B, FI-30B-BT-UK, FI-30-UK, FI-48, FI-48AR, FI-48B, FI-48B-BT-UK, FI-48C, FI-48D, FI-48HY-CLINIC, FI-48W, FI-50, FI-60DD, FI-64, FI-64AR, FI-64B...(Other models you can see in the webshop)		



1

GEV No.	505184	Ref. No.	12024222 Z203013
description	eye bolt		
For models:	AD-120, AD-120B, AD-120BBTDD-UK, AD-120C, AD-120CW, AD-120HY, AD-15, AD-15D, AD-20C-UK, AD-21, AD-21B, AD-21BDD, AD-21C, AD-21D, AD-21DD, AD-21W, AD-45BBT, AD-48, AD-48B, AD-48BDD, AD-48C, AD-48D, AD-48DD, AD-48HY, AD-48W, AD-64, AD-64B, AD-64BBT, AD-64BDD, AD-64BTDD, AD-64C, AD-64CW, AD-64D, AD-64DD, AD-64HY, AD-72, AD-72W, AD-90, AD-90BA, AD-90BBT, AD-90BDD, AD-90DD, ADE-120, ADE-120B, EASY-500, EASY-500B, EASY-500DD, EASY-500HP, EASY-500HPWBDD, ECO-120...(Other models you can see in the webshop)		



1

GEV No.	505168	Ref. No.	12017869 Z400708
description	nut		
For models:	LVR-10, LVR-14, LVR-14D, LVR-20, LVR-20B, LVR-20D		





1

GEV No.	505227	Ref. No.	12019816 Z270731
description	gasket for wash arm ø 55mm ID ø 39mm thickness 10mm		
For models:	ECO-160, ECO-160D, ECO-160I, ECO-200, ECO-200D, ECO-200H, ECO-200HD, ECO-200HI, ECO-200I, FI-160, FI-160D, FI-160I, FI-200, FI-200D, FI-200H, FI-200HD, FI-200HI, FI-200I, FI-200W		



1

GEV No.	518080	Ref. No.	12023537 Z710708	
description	nut thread 1½" WS 50 duct thickness 15mm			
For models:	AD-120, AD-120B, AD-120BBTDD-UK, AD-120C, AD-120CW, AD-120HY, AD-90, AD-90BA, AD-90BBT, AD-90BDD, AD-90DD, ADE-120, ADE-120B, ECO-120, ECO-120B, ECO-160, ECO-160D, ECO-160I, ECO-200, ECO-200D, ECO-200H, ECO-200HD, ECO-200HI, ECO-200I, ECO-370D, ECO-370I, ECO-550D, ECO-550I, FI-100, FI-100AR, FI-100B, FI-100BBT-UK, FI-120, FI-120AR+DD, FI-120B, FI-120C, FI-120HY-CLINIC, FI-120W, FI-160, FI-160AR, FI-160D, FI-160I, FI-200, FI-200AR, FI-200D, FI-200H, FI-200HD, FI-200HI, FI-200I, FI-200W...(Other models you can see in the webshop)			
spare parts for	518080			
	GEV No.	507425	Ref. No.	12018740 Z710707
	duct D1 ø 38mm D2 ø 45mm L 72mm int. ø 1 31mm int. ø 2 39mm			



1

GEV No.	505173	Ref. No.	12023653 Z680738
description	knurled nut		
For models:	AD-120, AD-120B, AD-120BBTDD-UK, AD-120C, AD-120CW, AD-120HY, ADE-120, ADE-120B, ECO-120, ECO-120D, ECO-120B, FI-100, FI-100AR, FI-100B, FI-100BBT-UK, FI-120, FI-120D, FI-120AR+DD, FI-120B, FI-120C, FI-120HY-CLINIC, FI-120W, FI-80BBT-UK, FI-900, FI-E-100, LABP-1000, LABP-1200, MF-120		





1

GEV No.	505089	Ref. No.	12017331 Z401913
description	rinse arm support mounting pos. upper		
For models:	LVR-10, LVR-14, LVR-20, LVR-20B		

			
1			
GEV No.	505134	Ref. No.	12023115 12038952 Z821910
description	rinse arm support thread M23x1.75 L 61mm WS 32 hose ø 10mm		
For models:	ECO-1200, ECO-1600, ECO-2300, ECO-2700D, ECO-2700I, ECO-280D, ECO-280I, ECO-3000, ECO-370D, ECO-370I, ECO-4000D, ECO-4000I, ECO-460D, ECO-460I, ECO-550D, ECO-550I, ECO-6000D, ECO-6000I, FI-1200, FI-1600, FI-2300, FI-2700D, FI-2700I, FI-280D, FI-280I, FI-3000, FI-370D, FI-370I, FI-4000D, FI-4000I, FI-460D, FI-460I, FI-550D, FI-550I, FI-6000D, FI-6000I, FI-900		

			
1			
GEV No.	505034	Ref. No.	12009829 Q152016
description	Thumb screw thread M5 thread L 7mm ø 20mm H 3mm SS		
For models:	AD-120, AD-120B, AD-120BBTDD-UK, AD-120C, AD-120CW, AD-120HY, AD-15, AD-15D, AD-20C-UK, AD-21, AD-21B, AD-21BDD, AD-21C, AD-21D, AD-21DD, AD-21W, AD-45BBT, AD-48, AD-48B, AD-48BDD, AD-48C, AD-48D, AD-48DD, AD-48HY, AD-48W, AD-64, AD-64B, AD-64BBT, AD-64BDD, AD-64BTDD, AD-64C, AD-64CW, AD-64D, AD-64DD, AD-64HY, AD-72, AD-72W, AD-90, AD-90BA, AD-90BBT, AD-90BDD, AD-90DD, ADE-120, ADE-120B, CO-110, CO-110B, CO-110BDD, CO-110DD, CO-112, CO-112B...(Other models you can see in the webshop)		

			
1			
GEV No.	505243	Ref. No.	12009769 Q223108
description	union nut ø 14mm thread M24x2.5		
For models:	ECO-160, ECO-160D, ECO-160I, ECO-200, ECO-200D, ECO-200H, ECO-200HD, ECO-200HI, ECO-200I, ECO-2700D, ECO-2700I, ECO-280D, ECO-280I, ECO-370D, ECO-370I, ECO-4000D, ECO-4000I, ECO-460D, ECO-460I, ECO-550D, ECO-550I, ECO-6000D, ECO-6000I, FI-160, FI-160AR, FI-160D, FI-160I, FI-200, FI-200AR, FI-200D, FI-200H, FI-200HD, FI-200HI, FI-200I, FI-200W, FI-200WL, FI-200WR, FI-2700D, FI-2700I, FI-280D, FI-280I, FI-370D, FI-370I, FI-4000D, FI-4000I, FI-460D, FI-460I, FI-550D, FI-550I, FI-6000D...(Other models you can see in the webshop)		

			
1			
GEV No.	501546	Ref. No.	12048173
description	wash arm support mounting pos. upper ø 42mm H 78mm L1 340mm		
For models:	AD-125, AD-125HRS, AD-125-SOFT, CO-110, CO-110B, CO-110BDD, CO-110DD, CO-112, CO-112B, CO-112BDD, CO-112DD, CO-170, CO-170B, CO-170BDD, CO-170DD, CO-170HRS, CO-170HRSDD, CO-170HRS-SOFT, CO-170-SOFT, CO-172, CO-172B, CO-172BDD, CO-172DD, COP-173, COP-173B, COP-173BDD, COP-173DD, COP-173HRS, COP-173HRSDD, COP-173-SOFT, COP-174, COP-174B, COP-174BDD, COP-174DD, COP-174HRS, COP-174HRSDD		
accessories for	501546		
	GEV No.	532103	Ref. No. 12049214
	O-ring EPDM thickness 3.53mm ID ø 13.87mm Qty 10 pcs		
	GEV No.	699343	Ref. No. 12048366
	gasket L 118mm W 73mm H 9mm thickness 9mm		

			
1			
GEV No.	501483	Ref. No.	12024859 Z310753
description	wash distributor 4-fold for dishwasher H 29mm ø 45mm ID ø 30mm hole ø 18mm thread L 20mm		
For models:	ECO-2700D, ECO-2700I, ECO-280D, ECO-280I, ECO-370D, ECO-370I, ECO-4000D, ECO-4000I, ECO-460D, ECO-460I, ECO-550D, ECO-550I, ECO-6000D, ECO-6000I, FI-2700D, FI-2700I, FI-280D, FI-280I, FI-370D, FI-370I, FI-4000D, FI-4000I, FI-460D, FI-460I, FI-550D, FI-550I, FI-6000D, FI-6000I		

			
1			
GEV No.	505181	Ref. No.	12024059 Z410711
description	wash pipe L 530mm		
For models:	AD-15, AD-15D, CO-350, CO-350-B, CO-350-B-DD, CO-350-COLD, CO-350-COLD-B, CO-350-COLD-B-DD, CO-350-COLD-DD, CO-350-DD, CO-352-COLD, CO-352-COLD-B, CO-352-COLD-B-DD, CO-352-COLD-DD, LVC-12, LVC-15, LVC-15D		

			
1			
GEV No.	505182	Ref. No.	12025154 Z440711
description	wash pipe L 605mm		
For models:	AD-20C-UK, AD-21, AD-21B, AD-21BDD, AD-21C, AD-21D, AD-21DD, AD-21W, CO-400, CO-400-B, CO-400-B-DD, CO-400-COLD, CO-400-COLD-B, CO-400-COLD-B-DD, CO-400-COLD-DD, CO-400-DD, CO-400-SOFT, CO-402-COLD, CO-402-COLD-B, CO-402-COLD-B-DD, CO-402-COLD-DD, CO-402W, LVC-21, LVC-21B, LVC-21C, LVC-21D, LVC-21W, MF-21		



			
GEV No.	505169	Ref. No.	12023699 Z200706
description	wash pipe L 681mm		
For models:	AD-45BBT, AD-48, AD-48B, AD-48BDD, AD-48C, AD-48D, AD-48DD, AD-48HY, AD-48W, AD-64, AD-64B, AD-64BBT, AD-64BDD, AD-64BTDD, AD-64C, AD-64CW, AD-64D, AD-64DD, AD-64HY, EASY-500, EASY-500B, EASY-500DD, EASY-500HP, EASY-500HPWBDD, FI-30, FI-30AR, FI-30AR+DD, FI-30B, FI-30B-BT-UK, FI-30-UK, FI-48, FI-48AR, FI-48B, FI-48B-BT-UK, FI-48C, FI-48D, FI-48HY-CLINIC, FI-48W, FI-50, FI-60DD, FI-64, FI-64AR, FI-64B, FI-64B-BT-UK, FI-64C, FI-64D, FI-64HY-CLINIC, FI-64W, MF-48, MF-64		

			
GEV No.	505188	Ref. No.	12024606 Z260701
description	wash pipe L 790mm		
For models:	AD-72, AD-72W, FI-72, FI-72AR, FI-72W		

			
GEV No.	505320	Ref. No.	12040593 12Z3107010
description	wash pipe mounting pos. lower ø 53mm L 40mm suitable for FAGOR		
For models:	ECO-280D, ECO-280I, ECO-370D, ECO-370I, ECO-460D, ECO-460I, ECO-550D, ECO-550I, FI-280D, FI-280I, FI-370D, FI-370I, FI-460D, FI-460I, FI-550D, FI-550I		

			
GEV No.	511991	Ref. No.	12006587 12Z7107090
description	wash pipe ø 38mm L 730mm SS		
For models:	AD-120, AD-120B, AD-120BBTDD-UK, AD-120C, AD-120CW, AD-120HY, AD-90, AD-90BA, AD-90BBT, AD-90BDD, AD-90DD, ADE-120, ADE-120B, ECO-120, ECO-120B, FI-100, FI-100AR, FI-100B, FI-100BBT-UK, FI-120, FI-120AR+DD, FI-120B, FI-120C, FI-120HY-CLINIC, FI-120W, FI-80, FI-80AR, FI-80BBT-UK, FI-80W, FI-E-100, LABP-1000, LABP-1200, LABP-800, MF-120		

washing and rinsing systems (sorted by producer)

<p>FAGOR</p> 			
GEV No.	505038	Ref. No.	12011257 12025122 Z650716
description	wash arm L 490mm nozzles 9 mounting ø 32mm mounting pos. upper/lower		
For models:	AD-45BBT, AD-48, AD-48B, AD-48BDD, AD-48C, AD-48D, AD-48DD, AD-48HY, AD-48W, AD-505, AD-505-SOFT, AD-64, AD-64B, AD-64BBT, AD-64BDD, AD-64BTDD, AD-64C, AD-64CW, AD-64D, AD-64DD, AD-64HY, AD-72, AD-72W, AD-90, AD-90BA, AD-90BBT, AD-90BDD, AD-90DD, CO-110, CO-110B, CO-110BDD, CO-110DD, CO-112, CO-112B, CO-112BDD, CO-112DD, CO-500, CO-500B, CO-500BDD, CO-500DD, CO-501, CO-501B, CO-501BDD, CO-501DD, CO-501-SOFT, CO-502B, CO-502BDD, CO-502DD, CO-502W, COP-503...(Other models you can see in the webshop)		

			
GEV No.	505039	Ref. No.	12003421 12038375 12Z7107010
description	wash arm L 525mm nozzles 14 mounting ø 50mm mounting pos. upper/lower		
For models:	AD-120, AD-120B, AD-120BBTDD-UK, AD-120C, AD-120CW, AD-120HY, AD-125, AD-125HRS, AD-125-SOFT, ADE-120, ADE-120B, CO-142W, CO-142WDD, CO-170, CO-170B, CO-170BDD, CO-170DD, CO-170HRS, CO-170HRSDD, CO-170HRS-SOFT, CO-170-SOFT, CO-172, CO-172B, CO-172BDD, CO-172DD, COP-173, COP-173B, COP-173BDD, COP-173DD, COP-173HRS, COP-173HRSDD, COP-173-SOFT, COP-174, COP-174B, COP-174BDD, COP-174DD, COP-174HRS, COP-174HRSDD, COP-174W, COP-174WHRS, ECO-120, ECO-120B, FI-100, FI-100AR, FI-100B, FI-100BBT-UK, FI-120, FI-120AR+DD, FI-120B, FI-120C...(Other models you can see in the webshop)		

			
GEV No.	505031	Ref. No.	12023710 Z400711
description	opposite support		
For models:	AD-15, AD-15D, AD-20C-UK, AD-21, AD-21B, AD-21BDD, AD-21C, AD-21D, AD-21DD, AD-21W, CO-350, CO-350-B, CO-350-B-DD, CO-350-COLD, CO-350-COLD-B, CO-350-COLD-B-DD, CO-350-COLD-DD, CO-350-DD, CO-352-COLD, CO-352-COLD-B, CO-352-COLD-B-DD, CO-352-COLD-DD, CO-400, CO-400-B, CO-400-B-DD, CO-400-COLD, CO-400-COLD-B, CO-400-COLD-B-DD, CO-400-COLD-DD, CO-400-DD, CO-400-SOFT, CO-402-COLD, CO-402-COLD-B, CO-402-COLD-B-DD, CO-402-COLD-DD, CO-402W, ECO-2700D, ECO-2700I, ECO-280D, ECO-280I, ECO-370D, ECO-370I, ECO-4000D, ECO-4000I, ECO-460D, ECO-460I, ECO-550D, ECO-550I, ECO-6000D, ECO-6000I...(Other models you can see in the webshop)		

			
GEV No.	505046	Ref. No.	12024006 Z201906
description	opposite support rinse jet		
For models:	AD-15, AD-15D, AD-90, AD-90BA, AD-90BDD, AD-90DD, FI-30, FI-30AR, FI-30AR+DD, FI-30B, FI-30B-BT-UK, FI-30-UK, FI-48, FI-48AR, FI-48B, FI-48B-BT-UK, FI-48C, FI-48D, FI-48HY-CLINIC, FI-48W, FI-60DD, FI-80, FI-80AR, FI-80W, FI-E-100, LABP-800, LVC-12, LVC-15, LVC-15D, LVC-21, LVC-21B, LVC-21C, LVC-21D, LVC-21W, LVR-10, LVR-14, LVR-20, LVR-20B, MF-21		

			
GEV No.	505045	Ref. No.	12009912 Q307036
description	O-ring EPDM thickness 1.78mm ID ø 5.28mm Qty 1 pcs		
For models:	AD-15, AD-15D, AD-90, AD-90BA, AD-90BDD, AD-90DD, COG-202, EASY-500, EASY-500B, EASY-500DD, EASY-500HP, EASY-500HPWBDD, FI-30, FI-30AR, FI-30AR+DD, FI-30B, FI-30B-BT-UK, FI-30-UK, FI-48, FI-48AR, FI-48B, FI-48B-BT-UK, FI-48C, FI-48D, FI-48HY-CLINIC, FI-48W, FI-60DD, FI-80, FI-80AR, FI-80W, FI-E-100, HGC-20-21, HGP-10-21, HGP-20-21, HGV-20-21, LABP-800, LF-13MPP, LF-18MPP, LF-25MPP, LF-8MPP, LVC-12, LVC-15, LVC-15D, LVC-21, LVC-21B, LVC-21D, LVC-21W, LVR-10, LVR-14, LVR-20...(Other models you can see in the webshop)		

			
GEV No.	505065	Ref. No.	12020476 Z411902
description	rinse arm		
For models:	CO-350, CO-350-B, CO-350-B-DD, CO-350-COLD, CO-350-COLD-B, CO-350-COLD-B-DD, CO-350-COLD-DD, CO-350-DD, CO-352-COLD, CO-352-COLD-B, CO-352-COLD-B-DD, CO-352-COLD-DD, LVC-12, LVC-15, LVC-15D		

			
GEV No.	505042	Ref. No.	12025253 Z461902
description	rinse arm L 144mm nozzles 2 mounting ø 11.7mm mounting pos. „A“		
For models:	AD-15, AD-15D, LVC-12, LVC-15, LVC-15D		

			
GEV No.	505063	Ref. No.	12024137 Z461901
description	rinse arm L 144mm nozzles 2 mounting ø 7mm mounting pos. „B“		
For models:	AD-15, AD-15D, LVC-12, LVC-15, LVC-15D		



			
GEV No.	505066	Ref. No.	12020475 Z411901
description	rinse arm L 145mm		
For models:	CO-350, CO-350-B, CO-350-B-DD, CO-350-COLD, CO-350-COLD-B, CO-350-COLD-B-DD, CO-350-COLD-DD, CO-350-DD, CO-352-COLD, CO-352-COLD-B, CO-352-COLD-B-DD, CO-352-COLD-DD, LVC-12, LVC-15, LVC-15D		

			
GEV No.	505043	Ref. No.	12022613 Z441901
description	rinse arm L 166mm nozzles 2 mounting ø 11.5mm mounting pos. „A“		
For models:	AD-20C-UK, AD-21, AD-21B, AD-21BDD, AD-21C, AD-21D, AD-21DD, AD-21W, CO-400, CO-400-B, CO-400-B-DD, CO-400-COLD, CO-400-COLD-B, CO-400-COLD-B-DD, CO-400-COLD-DD, CO-400-DD, CO-400-SOFT, CO-402-COLD, CO-402-COLD-B, CO-402-COLD-B-DD, CO-402-COLD-DD, CO-402W, LVC-15D, LVC-21, LVC-21B, LVC-21C, LVC-21D, LVC-21W, MF-21		

			
GEV No.	505064	Ref. No.	12022710 Z441902
description	rinse arm L 166mm nozzles 3 mounting ø 11.5mm mounting pos. „B“		
For models:	AD-20C-UK, AD-21, AD-21B, AD-21BDD, AD-21C, AD-21D, AD-21DD, AD-21W, CO-400, CO-400-B, CO-400-B-DD, CO-400-COLD, CO-400-COLD-B, CO-400-COLD-B-DD, CO-400-COLD-DD, CO-400-DD, CO-400-SOFT, CO-402-COLD, CO-402-COLD-B, CO-402-COLD-B-DD, CO-402-COLD-DD, CO-402W, LVC-15D, LVC-21, LVC-21B, LVC-21C, LVC-21D, LVC-21W, MF-21		

			
GEV No.	505407	Ref. No.	12023525 Z448712 Z448712000
description	rinse arm L 166mm ø 12mm plastic nozzles 3		





 1			
GEV No.	505044	Ref. No.	12024077 Z201905
description	rinse jet		
For models:	AD-15, AD-15D, AD-90, AD-90BA, AD-90BBT, AD-90BDD, AD-90DD, EASY-500, EASY-500B, EASY-500DD, EASY-500HP, EASY-500HPWBDD, FI-30, FI-30AR, FI-30AR+DD, FI-30B, FI-30B-BT-UK, FI-30-UK, FI-48, FI-48AR, FI-48B, FI-48B-BT-UK, FI-48C, FI-48D, FI-48HY-CLINIC, FI-48W, FI-60DD, FI-80, FI-80AR, FI-80BBT-UK, FI-80W, FI-E-100, LABP-800, LVC-12, LVC-15, LVC-15D, LVC-21, LVC-21B, LVC-21C, LVC-21D, LVC-21W, LVR-10, LVR-14, LVR-20, LVR-20B, MF-21		
accessories for	505044		
	GEV No.	505045	Ref. No. 12009912 Q307036
	O-ring EPDM thickness 1.78mm ID ø 5.28mm Qty 1 pcs		
	GEV No.	505046	Ref. No. 12024006 Z201906
	opposite support rinse jet		

 1			
GEV No.	505103	Ref. No.	12024252 Z211903
description	rinse jet		
For models:	AD-120, AD-120B, AD-120BBTDD-UK, AD-120C, AD-120CW, AD-120HY, AD-20C-UK, AD-21, AD-21B, AD-21BDD, AD-21C, AD-21D, AD-21DD, AD-21W, AD-45BBT, AD-48, AD-48B, AD-48BDD, AD-48C, AD-48D, AD-48DD, AD-48HY, AD-48W, AD-64, AD-64B, AD-64BBT, AD-64BDD, AD-64BTDD, AD-64C, AD-64CW, AD-64D, AD-64DD, AD-64HY, AD-72, AD-72W, AD-90, AD-90BA, AD-90BDD, AD-90DD, ADE-120, ADE-120B, CO-110, CO-110B, CO-110BDD, CO-110DD, CO-112, CO-112B, CO-112BDD, CO-112DD, CO-142W...(Other models you can see in the webshop)		



 1			
GEV No.	505147	Ref. No.	12019827 Z410706
description	wash arm		
For models:	CO-350, CO-350-B, CO-350-B-DD, CO-350-COLD, CO-350-COLD-B, CO-350-COLD-B-DD, CO-350-COLD-DD, CO-350-DD, CO-352-COLD, CO-352-COLD-B, CO-352-COLD-B-DD, CO-352-COLD-DD, LVC-12, LVC-15, LVC-15D		



 1			
GEV No.	505054	Ref. No.	12025251 Z460701
description	wash arm L 140mm nozzles 2 mounting ø 21.5mm mounting pos. „B“		
For models:	AD-15, AD-15D, LVC-12, LVC-15, LVC-15D		

 1			
GEV No.	505036	Ref. No.	12024138 Z460702
description	wash arm L 140mm nozzles 3 mounting ø 21.5mm mounting pos. „A“		
For models:	AD-15, AD-15D, LVC-12, LVC-15, LVC-15D		

 1			
GEV No.	505037	Ref. No.	12022381 Z440706
description	wash arm L 163mm nozzles 3 mounting ø 18mm mounting pos. „A“		
For models:	AD-20C-UK, AD-21, AD-21B, AD-21BDD, AD-21C, AD-21D, AD-21DD, AD-21W, CO-400, CO-400-B, CO-400-B-DD, CO-400-COLD, CO-400-COLD-B, CO-400-COLD-B-DD, CO-400-COLD-DD, CO-400-DD, CO-400-SOFT, CO-402-COLD, CO-402-COLD-B, CO-402-COLD-B-DD, CO-402-COLD-DD, CO-402W, LVC-21, LVC-21B, LVC-21C, LVC-21D, LVC-21W, MF-21		

 1			
GEV No.	505055	Ref. No.	12022382 Z440707
description	wash arm L 163mm nozzles 3 mounting ø 18mm mounting pos. „B“		
For models:	AD-20C-UK, AD-21, AD-21B, AD-21BDD, AD-21C, AD-21D, AD-21DD, AD-21W, CO-400, CO-400-B, CO-400-B-DD, CO-400-COLD, CO-400-COLD-B, CO-400-COLD-B-DD, CO-400-COLD-DD, CO-400-DD, CO-400-SOFT, CO-402-COLD, CO-402-COLD-B, CO-402-COLD-B-DD, CO-402-COLD-DD, CO-402W, LVC-21, LVC-21B, LVC-21C, LVC-21D, LVC-21W, MF-21		

 1			
GEV No.	505068	Ref. No.	12025216 Z410704
description	wash arm boss		
For models:	AD-15, AD-15D, AD-20C-UK, AD-21, AD-21B, AD-21BDD, AD-21C, AD-21D, AD-21DD, AD-21W, CO-350, CO-350-B, CO-350-B-DD, CO-350-COLD, CO-350-COLD-B, CO-350-COLD-B-DD, CO-350-COLD-DD, CO-350-DD, CO-352-COLD, CO-352-COLD-B, CO-352-COLD-B-DD, CO-352-COLD-DD, CO-400, CO-400-B, CO-400-B-DD, CO-400-COLD, CO-400-COLD-B, CO-400-COLD-B-DD, CO-400-COLD-DD, CO-400-DD, CO-400-SOFT, CO-402-COLD, CO-402-COLD-B, CO-402-COLD-B-DD, CO-402-COLD-DD, CO-402W, LVC-12, LVC-15, LVC-15D, LVC-21, LVC-21B, LVC-21C, LVC-21D, LVC-21W, MF-21		
accessories for	505068		
	GEV No.	505035	Ref. No. 12024086 Z410705
	bushing		



			
GEV No.	505033	Ref. No.	12023732 Z400709
description	wash jet		
For models:	AD-15, AD-15D, AD-20C-UK, AD-21, AD-21B, AD-21BDD, AD-21C, AD-21D, AD-21DD, AD-21W, CO-350, CO-350-B, CO-350-B-DD, CO-350-COLD, CO-350-COLD-B, CO-350-COLD-B-DD, CO-350-COLD-DD, CO-350-DD, CO-352-COLD, CO-352-COLD-B, CO-352-COLD-B-DD, CO-352-COLD-DD, CO-400, CO-400-B, CO-400-B-DD, CO-400-COLD, CO-400-COLD-B, CO-400-COLD-B-DD, CO-400-COLD-DD, CO-400-DD, CO-400-SOFT, CO-402-COLD, CO-402-COLD-B, CO-402-COLD-B-DD, CO-402-COLD-DD, CO-402W, LVC-12, LVC-15, LVC-15D, LVC-21, LVC-21B, LVC-21C, LVC-21D, LVC-21W, LVR-10, LVR-14, LVR-14D, LVR-20, LVR-20B, LVR-20D...(Other models you can see in the webshop)		
accessories for	505033		
			
GEV No.	505031	Ref. No.	12023710 Z400711
	opposite support		



			
GEV No.	505046	Ref. No.	12024006 Z201906
description	opposite support rinse jet		
For models:	AD-15, AD-15D, AD-90, AD-90BA, AD-90BDD, AD-90DD, FI-30, FI-30AR, FI-30AR+DD, FI-30B, FI-30B-BT-UK, FI-30-UK, FI-48, FI-48AR, FI-48B, FI-48B-BT-UK, FI-48C, FI-48D, FI-48HY-CLINIC, FI-48W, FI-60DD, FI-80, FI-80AR, FI-80W, FI-E-100, LABP-800, LVC-12, LVC-15, LVC-15D, LVC-21, LVC-21B, LVC-21C, LVC-21D, LVC-21W, LVR-10, LVR-14, LVR-20, LVR-20B, MF-21		

			
GEV No.	505045	Ref. No.	12009912 Q307036
description	O-ring EPDM thickness 1.78mm ID ø 5.28mm Qty 1 pcs		
For models:	AD-15, AD-15D, AD-90, AD-90BA, AD-90BDD, AD-90DD, COG-202, EASY-500, EASY-500B, EASY-500DD, EASY-500HP, EASY-500HPWBDD, FI-30, FI-30AR, FI-30AR+DD, FI-30B, FI-30B-BT-UK, FI-30-UK, FI-48, FI-48AR, FI-48B, FI-48B-BT-UK, FI-48C, FI-48D, FI-48HY-CLINIC, FI-48W, FI-60DD, FI-80, FI-80AR, FI-80W, FI-E-100, HGC-20-21, HGP-10-21, HGP-20-21, HGV-20-21, LABP-800, LF-13MPP, LF-18MPP, LF-25MPP, LF-8MPP, LVC-12, LVC-15, LVC-15D, LVC-21, LVC-21B, LVC-21D, LVC-21W, LVR-10, LVR-14, LVR-20...(Other models you can see in the webshop)		

			
GEV No.	505061	Ref. No.	12022442 12113596 Z201902
description	rinse arm L 220mm nozzles 3 mounting ø 11.7mm mounting pos. left		
For models:	AD-120, AD-120B, AD-120BBTDD-UK, AD-120C, AD-120CW, AD-120HY, AD-45BBT, AD-48, AD-48B, AD-48BDD, AD-48C, AD-48D, AD-48DD, AD-48HY, AD-48W, AD-64, AD-64B, AD-64BBT, AD-64BDD, AD-64BTDD, AD-64C, AD-64CW, AD-64D, AD-64DD, AD-64HY, AD-72, AD-72W, AD-90, AD-90BA, AD-90BBT, AD-90BDD, AD-90DD, ADE-120, ADE-120B, CO-110, CO-110B, CO-110BDD, CO-110DD, CO-112, CO-112B, CO-112BDD, CO-112DD, CO-142W, CO-142WDD, CO-170, CO-170B, CO-170BDD, CO-170DD, CO-170HRS, CO-170HRSDD...(Other models you can see in the webshop)		

			
GEV No.	505062	Ref. No.	12022441 12113595 Z201901
description	rinse arm L 220mm nozzles 3 mounting ø 12mm mounting pos. right		
For models:	AD-120, AD-120B, AD-120BBTDD-UK, AD-120C, AD-120CW, AD-120HY, AD-45BBT, AD-48, AD-48B, AD-48BDD, AD-48C, AD-48D, AD-48DD, AD-48HY, AD-48W, AD-64, AD-64B, AD-64BBT, AD-64BDD, AD-64BTDD, AD-64C, AD-64CW, AD-64D, AD-64DD, AD-64HY, AD-72, AD-72W, AD-90, AD-90BA, AD-90BBT, AD-90BDD, AD-90DD, ADE-120, ADE-120B, CO-110, CO-110B, CO-110BDD, CO-110DD, CO-112, CO-112B, CO-112BDD, CO-112DD, CO-142W, CO-142WDD, CO-170, CO-170B, CO-170BDD, CO-170DD, CO-170HRS, CO-170HRSDD...(Other models you can see in the webshop)		

			
GEV No.	505069	Ref. No.	12024470 Z201903
description	rinse arm boss mounting pos. upper/lower ø 12mm H 22mm L 59mm		
For models:	AD-120, AD-120B, AD-120BBTDD-UK, AD-120C, AD-120CW, AD-120HY, AD-45BBT, AD-48, AD-48B, AD-48BDD, AD-48C, AD-48D, AD-48DD, AD-48HY, AD-48W, AD-64, AD-64B, AD-64BBT, AD-64BDD, AD-64BTDD, AD-64C, AD-64CW, AD-64D, AD-64DD, AD-64HY, AD-72, AD-72W, AD-90, AD-90BA, AD-90BBT, AD-90BDD, AD-90DD, ADE-120, ADE-120B, CO-110, CO-110B, CO-110BDD, CO-110DD, CO-112, CO-112B, CO-112BDD, CO-112DD, CO-142W, CO-142WDD, CO-170, CO-170B, CO-170BDD, CO-170DD, CO-170HRS, CO-170HRSDD...(Other models you can see in the webshop)		
accessories for	505069		
			
GEV No.	560076	Ref. No.	12009852 12010293 Q152024
	countersunk screw thread M4 L 10mm SS DIN 963/ISO 2009 Qty 20 pcs intake slotted head ø 7.5mm		

			
GEV No.	505044	Ref. No.	12024077 Z201905
description	rinse jet		
For models:	AD-15, AD-15D, AD-90, AD-90BA, AD-90BBT, AD-90BDD, AD-90DD, EASY-500, EASY-500B, EASY-500DD, EASY-500HP, EASY-500HPWBDD, FI-30, FI-30AR, FI-30AR+DD, FI-30B, FI-30B-BT-UK, FI-30-UK, FI-48, FI-48AR, FI-48B, FI-48B-BT-UK, FI-48C, FI-48D, FI-48HY-CLINIC, FI-48W, FI-60DD, FI-80, FI-80AR, FI-80BBT-UK, FI-80W, FI-E-100, LABP-800, LVC-12, LVC-15, LVC-15D, LVC-21, LVC-21B, LVC-21C, LVC-21D, LVC-21W, LVR-10, LVR-14, LVR-20, LVR-20B, MF-21		
accessories for	505044		
			
GEV No.	505045	Ref. No.	12009912 Q307036
	O-ring EPDM thickness 1.78mm ID ø 5.28mm Qty 1 pcs		
			
GEV No.	505046	Ref. No.	12024006 Z201906
	opposite support rinse jet		





			
1			
GEV No.	505136	Ref. No.	12018104 Z680742
description	wash arm L 225mm nozzles 4 ø 25mm		
For models:	ECO-1200, FI-1200, FI-900		

			
1			
GEV No.	505067	Ref. No.	12017301 Z401915
description	rinse arm mounting pos. upper/lower L 157mm mounting ø 11.5mm nozzles 4		
For models:	LVR-10, LVR-14		



			
1			
GEV No.	505217	Ref. No.	12018636 Z680741
description	wash arm L 225mm nozzles 4 ø 25mm		
For models:	ECO-1200, FI-1200, FI-900		

			
1			
GEV No.	505090	Ref. No.	12040402 Z421904
description	rinse arm mounting pos. upper/lower L 175mm mounting ø 10mm nozzles 5		
For models:	LVR-20, LVR-20B		

			
1			
GEV No.	505216	Ref. No.	12039835 Z680745
description	wash arm boss L 90mm W 90mm H 38mm		
For models:	ECO-1200, FI-1200, FI-900		

			
1			
GEV No.	505044	Ref. No.	12024077 Z201905
description	rinse jet		
For models:	AD-15, AD-15D, AD-90, AD-90BA, AD-90BBT, AD-90BDD, AD-90DD, EASY-500, EASY-500B, EASY-500DD, EASY-500HP, EASY-500HPWBDD, FI-30, FI-30AR, FI-30AR+DD, FI-30B, FI-30B-BT-UK, FI-30-UK, FI-48, FI-48AR, FI-48B, FI-48B-BT-UK, FI-48C, FI-48D, FI-48HY-CLINIC, FI-48W, FI-60DD, FI-80, FI-80AR, FI-80BBT-UK, FI-80W, FI-E-100, LABP-800, LVC-12, LVC-15, LVC-15D, LVC-21, LVC-21B, LVC-21C, LVC-21D, LVC-21W, LVR-10, LVR-14, LVR-20, LVR-20B, MF-21		

			
1			
GEV No.	505267	Ref. No.	12017814 Z600705
description	wash jet for pipe ø 25mm		
For models:	ECO-1200, FI-1200, FI-900		

accessories for 505044				
	GEV No.	505045	Ref. No.	12009912 Q307036
O-ring EPDM thickness 1.78mm ID ø 5.28mm Qty 1 pcs				
	GEV No.	505046	Ref. No.	12024006 Z201906
opposite support rinse jet				

			
1			
GEV No.	505046	Ref. No.	12024006 Z201906
description	opposite support rinse jet		
For models:	AD-15, AD-15D, AD-90, AD-90BA, AD-90BDD, AD-90DD, FI-30, FI-30AR, FI-30AR+DD, FI-30B, FI-30B-BT-UK, FI-30-UK, FI-48, FI-48AR, FI-48B, FI-48B-BT-UK, FI-48C, FI-48D, FI-48HY-CLINIC, FI-48W, FI-60DD, FI-80, FI-80AR, FI-80W, FI-E-100, LABP-800, LVC-12, LVC-15, LVC-15D, LVC-21, LVC-21B, LVC-21C, LVC-21D, LVC-21W, LVR-10, LVR-14, LVR-20, LVR-20B, MF-21		



			
1			
GEV No.	505046	Ref. No.	12024006 Z201906
description	opposite support rinse jet		
For models:	AD-15, AD-15D, AD-90, AD-90BA, AD-90BDD, AD-90DD, FI-30, FI-30AR, FI-30AR+DD, FI-30B, FI-30B-BT-UK, FI-30-UK, FI-48, FI-48AR, FI-48B, FI-48B-BT-UK, FI-48C, FI-48D, FI-48HY-CLINIC, FI-48W, FI-60DD, FI-80, FI-80AR, FI-80W, FI-E-100, LABP-800, LVC-12, LVC-15, LVC-15D, LVC-21, LVC-21B, LVC-21C, LVC-21D, LVC-21W, LVR-10, LVR-14, LVR-20, LVR-20B, MF-21		



			
1			
GEV No.	505045	Ref. No.	12009912 Q307036
description	O-ring EPDM thickness 1.78mm ID ø 5.28mm Qty 1 pcs		
For models:	AD-15, AD-15D, AD-90, AD-90BA, AD-90BDD, AD-90DD, COG-202, EASY-500, EASY-500B, EASY-500DD, EASY-500HP, EASY-500HPWBDD, FI-30, FI-30AR, FI-30AR+DD, FI-30B, FI-30B-BT-UK, FI-30-UK, FI-48, FI-48AR, FI-48B, FI-48B-BT-UK, FI-48C, FI-48D, FI-48HY-CLINIC, FI-48W, FI-60DD, FI-80, FI-80AR, FI-80W, FI-E-100, HGC-20-21, HGP-10-21, HGP-20-21, HGV-20-21, LABP-800, LF-13MPP, LF-18MPP, LF-25MPP, LF-8MPP, LVC-12, LVC-15, LVC-15D, LVC-21, LVC-21B, LVC-21D, LVC-21W, LVR-10, LVR-14, LVR-20...(Other models you can see in the webshop)		

			
GEV No.	505045	Ref. No.	12009912 Q307036
description	O-ring EPDM thickness 1.78mm ID ø 5.28mm Qty 1 pcs		
For models:	AD-15, AD-15D, AD-90, AD-90BA, AD-90BDD, AD-90DD, COG-202, EASY-500, EASY-500B, EASY-500DD, EASY-500HP, EASY-500HPWBDD, FI-30, FI-30AR, FI-30AR+DD, FI-30B, FI-30B-BT-UK, FI-30-UK, FI-48, FI-48AR, FI-48B, FI-48B-BT-UK, FI-48C, FI-48D, FI-48HY-CLINIC, FI-48W, FI-60DD, FI-80, FI-80AR, FI-80W, FI-E-100, HGC-20-21, HGP-10-21, HGP-20-21, HGV-20-21, LABP-800, LF-13MPP, LF-18MPP, LF-25MPP, LF-8MPP, LVC-12, LVC-15, LVC-15D, LVC-21, LVC-21B, LVC-21D, LVC-21W, LVR-10, LVR-14, LVR-20...(Other models you can see in the webshop)		

			
GEV No.	505265	Ref. No.	12023524 Z208712
description	rinse arm L 230mm nozzles 3		
For models:	AD-90, AD-90BA, AD-90BBT, AD-90BDD, AD-90DD, EASY-500, EASY-500B, EASY-500DD, EASY-500HP, EASY-500HPWBDD, FI-30, FI-30AR, FI-30AR+DD, FI-30B, FI-30B-BT-UK, FI-30-UK, FI-48, FI-48AR, FI-48B, FI-48B-BT-UK, FI-48C, FI-48D, FI-48HY-CLINIC, FI-48W, FI-60DD, FI-80, FI-80AR, FI-80W, FI-E-100, LABP-800		

			
GEV No.	505266	Ref. No.	12023527 Z208713
description	rinse arm L 230mm nozzles 3 right		
For models:	AD-90, AD-90BA, AD-90BBT, AD-90BDD, AD-90DD, EASY-500, EASY-500B, EASY-500DD, EASY-500HP, EASY-500HPWBDD, FI-30, FI-30AR, FI-30AR+DD, FI-30B, FI-30B-BT-UK, FI-30-UK, FI-48, FI-48AR, FI-48B, FI-48B-BT-UK, FI-48C, FI-48D, FI-48HY-CLINIC, FI-48W, FI-60DD, FI-80, FI-80AR, FI-80W, FI-E-100, LABP-800		

			
GEV No.	505069	Ref. No.	12024470 Z201903
description	rinse arm boss mounting pos. upper/lower ø 12mm H 22mm L 59mm		
For models:	AD-120, AD-120B, AD-120BBTDD-UK, AD-120C, AD-120CW, AD-120HY, AD-45BBT, AD-48, AD-48B, AD-48BDD, AD-48C, AD-48D, AD-48DD, AD-48HY, AD-48W, AD-64, AD-64B, AD-64BBT, AD-64BDD, AD-64BTDD, AD-64C, AD-64CW, AD-64D, AD-64DD, AD-64HY, AD-72, AD-72W, AD-90, AD-90BA, AD-90BBT, AD-90BDD, AD-90DD, ADE-120, ADE-120B, CO-110, CO-110B, CO-110BDD, CO-110DD, CO-112, CO-112B, CO-112BDD, CO-112DD, CO-142W, CO-142WDD, CO-170, CO-170B, CO-170BDD, CO-170DD, CO-170HRS, CO-170HRSDD...(Other models you can see in the webshop)		
accessories for	505069		
	GEV No.	560076	Ref. No.
			12009852 12010293 Q152024
countersunk screw thread M4 L 10mm SS DIN 963/ISO 2009 Qty 20 pcs intake slotted head ø 7.5mm			

			
GEV No.	505044	Ref. No.	12024077 Z201905
description	rinse jet		
For models:	AD-15, AD-15D, AD-90, AD-90BA, AD-90BBT, AD-90BDD, AD-90DD, EASY-500, EASY-500B, EASY-500DD, EASY-500HP, EASY-500HPWBDD, FI-30, FI-30AR, FI-30AR+DD, FI-30B, FI-30B-BT-UK, FI-30-UK, FI-48, FI-48AR, FI-48B, FI-48B-BT-UK, FI-48C, FI-48D, FI-48HY-CLINIC, FI-48W, FI-60DD, FI-80, FI-80AR, FI-80BBT-UK, FI-80W, FI-E-100, LABP-800, LVC-12, LVC-15, LVC-15D, LVC-21, LVC-21B, LVC-21C, LVC-21D, LVC-21W, LVR-10, LVR-14, LVR-20, LVR-20B, MF-21		
accessories for	505044		
	GEV No.	505045	Ref. No.
			12009912 Q307036
O-ring EPDM thickness 1.78mm ID ø 5.28mm Qty 1 pcs			
	GEV No.	505046	Ref. No.
			12024006 Z201906
opposite support rinse jet			

			
GEV No.	507537	Ref. No.	12007166 12Z3119100
description	rinse arm W 630mm H 645mm nozzles 12		
For models:	ECO-280D, ECO-280I, ECO-370D, ECO-370I, ECO-460D, ECO-460I, ECO-550D, ECO-550I, FI-280D, FI-280I, FI-370D, FI-370I, FI-460D, FI-460I, FI-550D, FI-550I		

			
GEV No.	505031	Ref. No.	12023710 Z400711
description	opposite support		
For models:	AD-15, AD-15D, AD-20C-UK, AD-21, AD-21B, AD-21BDD, AD-21C, AD-21D, AD-21DD, AD-21W, CO-350, CO-350-B, CO-350-B-DD, CO-350-COLD, CO-350-COLD-B, CO-350-COLD-B-DD, CO-350-COLD-DD, CO-350-DD, CO-352-COLD, CO-352-COLD-B, CO-352-COLD-B-DD, CO-352-COLD-DD, CO-400, CO-400-B, CO-400-B-DD, CO-400-COLD, CO-400-COLD-B, CO-400-COLD-B-DD, CO-400-COLD-DD, CO-400-DD, CO-400-SOFT, CO-402-COLD, CO-402-COLD-B, CO-402-COLD-B-DD, CO-402-COLD-DD, CO-402W, ECO-2700D, ECO-2700I, ECO-280D, ECO-280I, ECO-370D, ECO-370I, ECO-4000D, ECO-4000I, ECO-460D, ECO-460I, ECO-550D, ECO-550I, ECO-6000D, ECO-6000I...(Other models you can see in the webshop)		



			
GEV No.	505231	Ref. No.	12021106 Z791931
description	rinse jet ø 14mm H 22mm thread M10x0.9		
For models:	ECO-1600, ECO-2300, ECO-3000, FI-1600, FI-2300, FI-3000		





 <p>1</p>			
GEV No.	505258	Ref. No.	12023568 Z311831
description	wash jet		
For models:	ECO-2700D, ECO-2700I, ECO-280D, ECO-280I, ECO-370D, ECO-370I, ECO-4000D, ECO-4000I, ECO-460D, ECO-460I, ECO-550D, ECO-550I, ECO-6000D, ECO-6000I, FI-2700D, FI-2700I, FI-280D, FI-280I, FI-370D, FI-370I, FI-4000D, FI-4000I, FI-460D, FI-460I, FI-550D, FI-550I, FI-6000D, FI-6000I		

 <p>1</p>			
GEV No.	505324	Ref. No.	12017004 Z100707
description	end cap for wash arm screw mounting H 13mm WS 42		
For models:	ECO-1600, ECO-2300, ECO-3000, FI-1600, FI-2300, FI-3000		

 <p>1</p>			
GEV No.	505233	Ref. No.	12020338 Z100706
description	wash arm with flange L 180mm		
For models:	ECO-1600, ECO-2300, ECO-3000, FI-1600, FI-2300, FI-3000		

 <p>1</p>			
GEV No.	505319	Ref. No.	12020529 Z100705
description	wash arm with flange L 255mm nozzles 3		
For models:	ECO-1600, ECO-2300, ECO-3000, FI-1600, FI-2300, FI-3000		
accessories for	505319		
	GEV No.	Ref. No.	12017004 Z100707
	505324		
	end cap for wash arm screw mounting H 13mm WS 42		
	GEV No.	Ref. No.	12017168 Z100709
	510116		
	wash jet mounting pos. upper H 37mm type B hose ø 37mm		

 <p>1</p>			
GEV No.	510116	Ref. No.	12017168 Z100709
description	wash jet mounting pos. upper H 37mm type B hose ø 37mm		
For models:	ECO-1600, ECO-2300, ECO-3000, FI-1600, FI-2300, FI-3000		

miscellaneous			
 <p>1</p>			
GEV No.	505334	Ref. No.	12024302 Z270721
description	end cap for wash arm ø 27mm L 33mm suitable for FAGOR		
For models:	ECO-160, ECO-160D, ECO-160I, ECO-200, ECO-200D, ECO-200H, ECO-200HD, ECO-200HI, ECO-200I, FI-160, FI-160AR, FI-160D, FI-160I, FI-200, FI-200AR, FI-200D, FI-200H, FI-200HD, FI-200HI, FI-200I, FI-200W, FI-200WL, FI-200WR		
accessories for	505334		
	GEV No.	Ref. No.	12010230 Q307062
	532499		
	O-ring EPDM thickness 2.62mm ID ø 23.47mm Qty 1 pcs		

 <p>1</p>			
GEV No.	505215	Ref. No.	12017837 Z600704
description	wash jet		

wash arm supports			
 <p>1</p>			
GEV No.	505020	Ref. No.	12016686 Z400702
description	opposite support mounting pos. lower		
For models:	LVR-10, LVR-14, LVR-14D, LVR-20, LVR-20B, LVR-20D		

 <p>1</p>			
GEV No.	505021	Ref. No.	12024312 Z710706
description	opposite support mounting pos. lower		
For models:	AD-120, AD-120B, AD-120BBTDD-UK, AD-120C, AD-120CW, AD-120HY, AD-90, AD-90BA, AD-90BBT, AD-90BDD, AD-90DD, ADE-120, ADE-120B, ECO-120, ECO-120B, FI-100, FI-100AR, FI-100B, FI-100BBT-UK, FI-120, FI-120AR+DD, FI-120B, FI-120C, FI-120HY-CLINIC, FI-120W, FI-80, FI-80AR, FI-80BBT-UK, FI-80W, FI-E-100, LABP-1000, LABP-1200, LABP-800, MF-120		

			
1			
GEV No.	505053	Ref. No.	12024703 Z410702
description	opposite support mounting pos. lower		
For models:	AD-15, AD-15D, AD-20C-UK, AD-21, AD-21B, AD-21BDD, AD-21C, AD-21D, AD-21DD, AD-21W, CO-350, CO-350-B, CO-350-B-DD, CO-350-COLD, CO-350-COLD-B, CO-350-COLD-B-DD, CO-350-COLD-DD, CO-350-DD, CO-352-COLD, CO-352-COLD-B, CO-352-COLD-B-DD, CO-352-COLD-DD, CO-400, CO-400-B, CO-400-B-DD, CO-400-COLD, CO-400-COLD-B, CO-400-COLD-B-DD, CO-400-COLD-DD, CO-400-DD, CO-400-SOFT, CO-402-COLD, CO-402-COLD-B, CO-402-COLD-B-DD, CO-402-COLD-DD, CO-402W, LVC-12, LVC-15, LVC-15D, LVC-21, LVC-21B, LVC-21C, LVC-21D, LVC-21W, MF-21		

			
1			
GEV No.	505051	Ref. No.	12023613 Z200703
description	opposite support mounting pos. lower for wash arm support		
For models:	AD-45BBT, AD-48, AD-48B, AD-48BDD, AD-48C, AD-48D, AD-48DD, AD-48HY, AD-48W, AD-64, AD-64B, AD-64BBT, AD-64BDD, AD-64BTDD, AD-64C, AD-64CW, AD-64D, AD-64DD, AD-64HY, AD-72, AD-72W, EASY-500, EASY-500B, EASY-500DD, EASY-500HP, EASY-500HPWBDD, FI-30, FI-30AR, FI-30AR+DD, FI-30B, FI-30B-BT-UK, FI-30-UK, FI-48, FI-48AR, FI-48B, FI-48B-BT-UK, FI-48C, FI-48D, FI-48HY-CLINIC, FI-48W, FI-50, FI-60DD, FI-64, FI-64AR, FI-64B, FI-64B-BT-UK, FI-64C, FI-64D, FI-64HY-CLINIC, FI-64W...(Other models you can see in the webshop)		

			
1			
GEV No.	505017	Ref. No.	12020347 Z400701
description	wash arm support mounting pos. lower		
For models:	LVR-10, LVR-14, LVR-14D, LVR-20, LVR-20B, LVR-20D		

			
1			
GEV No.	505018	Ref. No.	12024480 Z200701 Z210701
description	wash arm support mounting pos. lower		
For models:	AD-45BBT, AD-48, AD-48B, AD-48BDD, AD-48C, AD-48D, AD-48DD, AD-48HY, AD-48W, AD-64, AD-64B, AD-64BBT, AD-64BDD, AD-64BTDD, AD-64C, AD-64CW, AD-64D, AD-64DD, AD-64HY, AD-72, AD-72W, EASY-500, EASY-500B, EASY-500DD, EASY-500HP, EASY-500HPWBDD, FI-30, FI-30AR, FI-30AR+DD, FI-30B, FI-30B-BT-UK, FI-30-UK, FI-48, FI-48AR, FI-48B, FI-48B-BT-UK, FI-48C, FI-48D, FI-48HY-CLINIC, FI-48W, FI-50, FI-60DD, FI-64, FI-64AR, FI-64B, FI-64B-BT-UK, FI-64C, FI-64D, FI-64HY-CLINIC, FI-64W...(Other models you can see in the webshop)		

			
1			
GEV No.	505019	Ref. No.	12020989 12025170 Z740702 Z740705
description	wash arm support mounting pos. lower		
For models:	AD-90, AD-90BA, AD-90BBT, AD-90BDD, AD-90DD, FI-80, FI-80AR, FI-80BBT-UK, FI-80W, FI-E-100, LABP-800		

			
1			
GEV No.	505022	Ref. No.	12023652 Z710704
description	wash arm support mounting pos. lower		
For models:	AD-120, AD-120B, AD-120BBTDD-UK, AD-120C, AD-120CW, AD-120HY, ADE-120, ADE-120B, ECO-120, ECO-120B, FI-100, FI-100AR, FI-100B, FI-120, FI-120AR+DD, FI-120B, FI-120C, FI-120HY-CLINIC, FI-120W, FI-E-100, LABP-1200, MF-120		

			
1			
GEV No.	505275	Ref. No.	12024478 Z710719
description	wash arm support mounting pos. lower D1 ø 47mm H 91mm L1 86mm		
For models:	FI-100, FI-100AR, FI-100B, FI-100BBT-UK, LABP-1000		

			
1			
GEV No.	505050	Ref. No.	12025133 Z410701
description	wash arm support mounting pos. lower H 102mm D1 ø 40mm D2 ø 48mm D3 ø 68mm		
For models:	AD-15, AD-15D, AD-20C-UK, AD-21, AD-21B, AD-21BDD, AD-21C, AD-21D, AD-21DD, AD-21W, LVC-12, LVC-15, LVC-15D, LVC-21, LVC-21B, LVC-21C, LVC-21D, LVC-21W, MF-21		

			
1			
GEV No.	505056	Ref. No.	12023590 Z410703
description	wash arm support mounting pos. upper		
For models:	AD-15, AD-15D, AD-20C-UK, AD-21, AD-21B, AD-21BDD, AD-21C, AD-21D, AD-21DD, AD-21W, LVC-12, LVC-15, LVC-15D, LVC-21, LVC-21B, LVC-21C, LVC-21D, LVC-21W, MF-21		





			
1			
GEV No.	505057	Ref. No.	12024471 Z200707
description	wash arm support mounting pos. upper		
For models:	AD-45BBT, AD-48, AD-48B, AD-48BDD, AD-48C, AD-48D, AD-48DD, AD-48HY, AD-48W, AD-64, AD-64B, AD-64BBT, AD-64BDD, AD-64BTDD, AD-64C, AD-64CW, AD-64D, AD-64DD, AD-64HY, AD-72, AD-72W, EASY-500, EASY-500B, EASY-500DD, EASY-500HP, EASY-500HPWBDD, FI-30, FI-30AR, FI-30AR+DD, FI-30B, FI-30B-BT-UK, FI-30-UK, FI-48, FI-48AR, FI-48B, FI-48B-BT-UK, FI-48C, FI-48D, FI-48HY-CLINIC, FI-48W, FI-50, FI-60DD, FI-64, FI-64AR, FI-64B, FI-64B-BT-UK, FI-64C, FI-64D, FI-64HY-CLINIC, FI-64W...(Other models you can see in the webshop)		

			
1			
GEV No.	505058	Ref. No.	Z200702
description	wash arm support mounting pos. upper		

			
1			
GEV No.	505059	Ref. No.	12024927 Z740703
description	wash arm support mounting pos. upper		
For models:	AD-120BBTDD-UK, AD-90, AD-90BA, AD-90BBT, AD-90BDD, AD-90DD, FI-80, FI-80AR, FI-80BBT-UK, FI-80W, FI-E-100, LABP-800		

			
1			
GEV No.	505060	Ref. No.	12024934 Z710705
description	wash arm support mounting pos. upper		
For models:	AD-120, AD-120B, AD-120BBTDD-UK, AD-120C, AD-120CW, AD-120HY, AD-90, AD-90BA, AD-90BDD, AD-90DD, ADE-120, ADE-120B, CO-142W, CO-142WDD, COP-174W, COP-174WHRS, ECO-120, ECO-120B, FI-100, FI-100AR, FI-100B, FI-100BBT-UK, FI-120, FI-120AR+DD, FI-120B, FI-120C, FI-120HY-CLINIC, FI-120W, FI-E-100, LABP-1000, LABP-1200, LABP-800, MF-120		

			
1			
GEV No.	501546	Ref. No.	12048173
description	wash arm support mounting pos. upper ø 42mm H 78mm L1 340mm		
For models:	AD-125, AD-125HRS, AD-125-SOFT, CO-110, CO-110B, CO-110BDD, CO-110DD, CO-112, CO-112B, CO-112BDD, CO-112DD, CO-170, CO-170B, CO-170BDD, CO-170DD, CO-170HRS, CO-170HRSDD, CO-170HRS-SOFT, CO-170-SOFT, CO-172, CO-172B, CO-172BDD, CO-172DD, COP-173, COP-173B, COP-173BDD, COP-173DD, COP-173HRS, COP-173HRSDD, COP-173-SOFT, COP-174, COP-174B, COP-174BDD, COP-174DD, COP-174HRS, COP-174HRSDD		
accessories for	501546		
	GEV No.	532103	Ref. No.
			12049214
			
	O-ring EPDM thickness 3.53mm ID ø 13.87mm Qty 10 pcs		

accessories for	501546		
	GEV No.	699343	Ref. No.
			12048366
			
	gasket L 118mm W 73mm H 9mm thickness 9mm		

rinse arm shafts			
			
1			
GEV No.	505047	Ref. No.	12025114 Z410708
description	rinse arm shaft		
For models:	AD-15, AD-15D, AD-20C-UK, AD-21, AD-21B, AD-21BDD, AD-21C, AD-21D, AD-21DD, AD-21W, CO-350, CO-350-B, CO-350-B-DD, CO-350-COLD, CO-350-COLD-B, CO-350-COLD-B-DD, CO-350-COLD-DD, CO-350-DD, CO-352-COLD, CO-352-COLD-B, CO-352-COLD-B-DD, CO-352-COLD-DD, CO-400, CO-400-B, CO-400-B-DD, CO-400-COLD, CO-400-COLD-B, CO-400-COLD-B-DD, CO-400-COLD-DD, CO-400-SOFT, CO-402-COLD, CO-402-COLD-B, CO-402-COLD-B-DD, CO-402-COLD-DD, CO-402W, LVC-12, LVC-15, LVC-15D, LVC-21, LVC-21B, LVC-21C, LVC-21D, LVC-21W, MF-21		

			
1			
GEV No.	505048	Ref. No.	12023844 Z200704
description	rinse arm shaft		
For models:	AD-45BBT, AD-48, AD-48B, AD-48BDD, AD-48C, AD-48D, AD-48DD, AD-48HY, AD-48W, AD-64, AD-64B, AD-64BBT, AD-64BDD, AD-64BTDD, AD-64C, AD-64CW, AD-64D, AD-64DD, AD-64HY, AD-72, AD-72W, AD-90, AD-90BA, AD-90BBT, AD-90BDD, AD-90DD, EASY-500, EASY-500B, EASY-500DD, EASY-500HP, EASY-500HPWBDD, FI-30, FI-30AR, FI-30AR+DD, FI-30B, FI-30B-BT-UK, FI-30-UK, FI-48, FI-48AR, FI-48B, FI-48B-BT-UK, FI-48C, FI-48D, FI-48HY-CLINIC, FI-48W, FI-50, FI-60DD, FI-64, FI-64AR, FI-64B...(Other models you can see in the webshop)		

			
1			
GEV No.	505049	Ref. No.	12023601 Z710711
description	rinse arm shaft		
For models:	AD-120, AD-120B, AD-120BBTDD-UK, AD-120C, AD-120CW, AD-120HY, ADE-120, ADE-120B, ECO-120, ECO-120B, FI-100, FI-100AR, FI-100B, FI-100BBT-UK, FI-120, FI-120AR+DD, FI-120B, FI-120C, FI-120HY-CLINIC, FI-120W, FI-E-100, LABP-1000, LABP-1200, MF-120		

			
1			
GEV No.	513122	Ref. No.	12029990 EU926130
description	rinse arm shaft		



			
1			
GEV No.	505251	Ref. No.	12018232 Z680748
description	rinse arm shaft H 85mm		
For models:	ECO-1200, FI-1200, FI-900		

			
1			
GEV No.	505052	Ref. No.	12023801 Z410712
description	rinse arm shaft L1 102mm L2 84mm L3 26mm		
For models:	AD-15, AD-15D, AD-20C-UK, AD-21, AD-21B, AD-21BDD, AD-21C, AD-21D, AD-21DD, AD-21W, CO-350, CO-350-B, CO-350-B-DD, CO-350-COLD, CO-350-COLD-B, CO-350-COLD-B-DD, CO-350-COLD-DD, CO-350-DD, CO-352-COLD, CO-352-COLD-B, CO-352-COLD-B-DD, CO-352-COLD-DD, CO-400, CO-400-B, CO-400-B-DD, CO-400-COLD, CO-400-COLD-B, CO-400-COLD-B-DD, CO-400-COLD-DD, CO-400-DD, CO-400-SOFT, CO-402-COLD, CO-402-COLD-B, CO-402-COLD-B-DD, CO-402-COLD-DD, CO-402W, LVC-12, LVC-15, LVC-15D, LVC-21, LVC-21B, LVC-21C, LVC-21D, LVC-21W, MF-21		

for washing machine

			
1			
GEV No.	698504	Ref. No.	12026769 D000V21001
description	rack FAGOR center piece for washing machine		

knobs

producer-specific knobs

FAGOR

			
1			
GEV No.	113009	Ref. No.	12021151 12040067 S333005 S333006
description	knob energy regulator 1-9 ø 71mm shaft ø 6x4.6mm shaft flat upper black		
For models:	CPE7-05, ME7-10BM, ME9-10BM, ME9-10BMS, ME9-15BM, ME9-15BMS, MPE9-10BM, MPE9-10BMS, MPE9-15BM, MPE9-15BMS		

			
1			
GEV No.	113020	Ref. No.	12040255 U532130
description	knob gas tap with ignition flame ø 71mm shaft ø 10x8mm shaft flat right		
For models:	CG-200S, CG-210, CG-210G, CG-300S, CG-310, CG-310G		

			
1			
GEV No.	113010	Ref. No.	12008927 U542100 U542101
description	knob gas tap with ignition flame ø 71mm shaft ø 10x8mm shaft flat right black		
For models:	BG7-05, BG7-05I, BG7-10, BG7-10I, BG9-05, BG9-05I, BG9-10, BG9-10I, CG-1002, CG-1502, CG-2000, CG-2000-2P, CG-2002, CG-2002P, CG-2005, CG-210, CG-210G, CG-300S, CG-310, CG-310G, CG7-10, CG7-11, CG7-20, CG7-40, CG7-41, CG7-61, CG9-10, CG9-11, CG9-20, CG9-40, CG9-41, CG9-51L, CG9-51LC, CG9-51R, CG9-51RC, CG9-60, CG9-61, CG9-82, CGB7-61, CGE7-141, CGE7-41, CGE9-41, CPG7-05, CPG9-05, CPG9-05NC, CPG9-05S, CPG9-05SNC, FTG7-05VL, FTG7-05VR, FTG7-10VL... (Other models you can see in the webshop)		

			
1			
GEV No.	113008	Ref. No.	12021150 12040256 S312102 S31211000
description	knob gas tap with ignition flame ø 71mm shaft ø 10x8mm shaft flat right grey		
For models:	BG7-05, BG7-10, BG9-05, BG9-10, CG-200S, CG-210, CG-210G, CG-300S, CG-310, CG-310G, MG7-10, MG7-10BM, MG9-10, MG9-10BM, MG9-10BMS, MG9-10S, MG9-15, MG9-15BM, MG9-15BMS, MG9-15S, MG9-20, MG9-20S, MPG9-10, MPG9-10S, MPG9-15, MPG9-15BM, MPG9-15BMS, MPG9-15S, MPG9-20, MPG9-20S, PL-105L, PL-110L+R		



1

GEV No.	113038	Ref. No.	12007906 H122101
description	knob gas tap with ignition flame ø 72mm shaft ø 8x6mm shaft flat right black		
For models:	BG6-05I, BG7-05, BG7-05I, BG7-10, BG7-10I, CG7-10, CG7-11, CG7-20, CG7-20H, CG7-30D, CG7-30I, CG7-31D, CG7-31I, CG7-40, CG7-40H, CG7-41, CG7-41H, CG7-50, CG7-51, CG7-60, CG7-60H, CG7-61, CG7-61H, CGB7-61, CGB7-61H, CGB7-61R, CGB7-61RH, CGE7-41, CGE7-41H, CPG7-05, CPG7-05NC, FTG7-05VL, FTG7-05VR, FTG7-10VL, FTG7-10VL+R, FTG7-10VR		



1

GEV No.	113015	Ref. No.	12021132 12040259 X152110 X152111
description	knob gas thermostat 1-8 ø 71mm shaft ø 6x4.6mm shaft flat upper black		
For models:	SBG7-10, SBG9-10, SBG9-10I, SBG9-10IM, SBG9-10IMS, SBG9-10IS, SBG9-10M, SBG9-10MS, SBG9-10S, SBG9-15IM, SBG9-15IMS		



2

GEV No.	113040	Ref. No.	12008918 U912105
description	knob gas thermostat 1-7 ø 71mm shaft ø 8x6.5mm shaft flat right black		
For models:	CG7-11, CG7-31D, CG7-31I, CG7-41, CG7-41H, CG7-51, CG7-61, CG7-61H, CGB7-61, CGB7-61H, CGB7-61R, CGB7-61RH		



1

GEV No.	113016	Ref. No.	12040261 X162100
description	knob gas thermostat 1-8 ø 71mm shaft ø 6x4.6mm shaft flat upper black		
For models:	FG-920		



1

GEV No.	113019	Ref. No.	12008928 12040258 U842101 U842102
description	knob gas thermostat 1-7 ø 71mm shaft ø 8x6.5mm shaft flat right grey		
For models:	CG-210, CG-210G, CG-310, CG-310G, CG9-51L, CG9-51LC, CG9-51R, CG9-51RC, CGP9-11, FTG7-05L, FTG7-05R, FTG7-10L, FTG7-10L+R, FTG7-10R, FTG9-05L, FTG9-05R, FTG9-10L, FTG9-10L+R, FTG9-10R, FTGC7-05L, FTGC7-10L, FTGC9-05L, FTGC9-05R, FTGC9-10L, FTGC9-10L+R, FTGC9-10R		



1

GEV No.	113001	Ref. No.	12021178 R202103 R202106
description	knob gas thermostat 1-8 ø 71mm shaft ø 8x6.5mm shaft flat right grey		
For models:	BMG7-10, BMG9-05, BMG9-10, CG-210, CG-210G, CG-310, CG-310G, CG7-11, CG7-41, CG7-61, CGB7-61, FTG7-05, FTG7-10, FTG9-05L, FTG9-05R, FTG9-05VL, FTG9-05VR, FTG9-10L, FTG9-10L+R, FTG9-10R, FTG9-10VL, FTG9-10VL+R, FTG9-10VR, FTG9-11L, FTG9-11L+R, FTG9-11R, FTGC9-05, FTGC9-05L, FTGC9-05R, FTGC9-10, FTGC9-10L, FTGC9-10L+R, FTGC9-10R, FTGC9-11L, FTGC9-11L+R, FTGC9-11R, PL-105C, PL-110C		



1

GEV No.	113018	Ref. No.	X313002
description	knob gas thermostat 1-8 ø 71mm shaft ø 6x4.6mm shaft flat lower		



1

GEV No.	113013	Ref. No.	12021155 U673004 U673016
description	knob oven TH/TH+BH/BH ø 71mm shaft ø 6x4.6mm shaft flat upper black		
For models:	CE7-41, CE9-20, CE9-40, CE9-41, CGE7-204, CGE9-41, HE9-10, HE9-20		



1

GEV No.	113012	Ref. No.	12021136 12040069 U673003 U673015
description	knob switch 7-position ø 71mm shaft ø 6x4.6mm shaft flat upper grey		
For models:	CE7-20, CE7-40, CE7-41, CE9-20, CE9-40, CE9-41		



1

GEV No.	112606	Ref. No.	12008048 U952101
description	knob switch 7-position ø 72mm shaft ø 6x4.6mm shaft flat upper black long pole		
For models:	CE6-20, CE6-40, CE6-41, CE7-20, CE7-20Q, CE7-40, CE7-40Q, CE7-41, CE7-41Q		



1

GEV No.	113017	Ref. No.	12021138 12040262 X183020 X183025
description	knob thermostat 1-8 ø 71mm shaft ø 6x4.6mm shaft flat lower black		
For models:	FE-710, FE-720, FE9-05, FE9-05S, FE9-10, FE-920		



1

GEV No.	113014	Ref. No.	12021137 U673005 U673017
description	knob thermostat 1-8 ø 71mm shaft ø 6x4.6mm shaft flat upper		
For models:	CE7-41, CE9-41, CGE7-205, CGE9-41, FTE7-05, FTE7-05L, FTE7-05R, FTE7-10, FTE7-10L, FTE7-10L+R, FTE7-10R, FTE9-05L, FTE9-05R, FTE9-10L, FTE9-10L+R, FTE9-10R, FTEC7-05L, FTEC7-10L, FTEC9-05, FTEC9-05L, FTEC9-05R, FTEC9-10, FTEC9-10L, FTEC9-10L+R, FTEC9-10R, HE9-10, HE9-20, SBE7-10, SBE9-10, SBE9-10L, SBE9-10IM, SBE9-10IMS, SBE9-10IS, SBE9-10M, SBE9-10MS, SBE9-10S, SBE9-15IM, SBE9-15IMS		



1

GEV No.	113002	Ref. No.	12021133 12040260 R212100
description	knob thermostat 1-8 ø 71mm shaft ø 6x4.6mm shaft flat upper black		
For models:	BME7-05, BME7-10, BME9-05, BME9-10, FI-120, FI-180, FI-250, ME9-10BM, ME9-15BM		



1

GEV No.	113023	Ref. No.	12021135 X313003
description	knob thermostat 1-8 with ignition flame ø 71mm shaft ø 6x4.6mm shaft flat lower black		
For models:	FG-710, FG-720, FG9-05, FG9-05S, FG9-10		



1

GEV No.	113048	Ref. No.	12046201
description	knob ø 48mm shaft ø 6x4mm black		
For models:	ACE-061, ACE-101, ACE-102, ACE-201, ACE-202, ACG-061, ACG-101, ACG-102, ACG-201, ACG-202, AE-061, AE-101, APE-061, APE-101		



1

GEV No.	505097	Ref. No.	12040066 Z203008
description	knob switch zero mark ø 34mm shaft ø 6x4.6mm shaft flat lower grey		
For models:	ECO-120, ECO-1200, FI-100, FI-1200, FI-80, FI-900, HCG-10-11, HCG-10-21, HCG-2-10-11, HCG-6-11, HME-10-11, HME-10-21, HME-20-11, HME-2-10-11, HME-6-11, HMG-10-11, HMG-10-21, HMG-2-10-11, HMG-6-11, HMM-10-11, HMM-10-21, HMM-20-11, HMM-2-10-11, HMM-6-11, HMP-10-11, HMP-10-21, HMP-20-11, HMP-2-10-11, HMP-6-11, LVC-12, LVC-15, LVC-15D, LVC-21, LVC-21B, LVC-21D, LVC-21W, LVR-10, LVR-14, LVR-14D, LVR-20, LVR-20B, LVR-20D		

			
1			
GEV No.	112293	Ref. No.	12024300 Z203069
description	knob switch zero mark ø 39mm shaft ø 6x4.6mm shaft flat lower black		
For models:	ECO-160D, ECO-160I, ECO-200D, ECO-200HD, ECO-200HI, ECO-200I, ECO-280D, ECO-280I, ECO-370D, ECO-370I, ECO-460D, ECO-460I, ECO-550D, ECO-550I, FI-160AR, FI-160D, FI-160I, FI-200AR, FI-200D, FI-200HD, FI-200HI, FI-200I, FI-200WL, FI-200WR, FI-280D, FI-280I, FI-30, FI-30AR, FI-30AR+DD, FI-30B, FI-30B-BT-UK, FI-30-UK, FI-370D, FI-370I, FI-460D, FI-460I, FI-48, FI-48AR, FI-48B, FI-48B-BT-UK, FI-48C, FI-48D, FI-48HY-CLINIC, FI-48W, FI-550D, FI-550I, FI-60DD, FI-64, FI-64AR, FI-64B...(Other models you can see in the webshop)		

			
1			
GEV No.	113021	Ref. No.	12018462 R663027000 R663063
description	knob switch zero mark ø 39mm shaft ø 6x4.6mm shaft flat lower white		
For models:	CGE7-41, HCG-10-11, HCG-10-21, HCG-20-11, HCG-20-21, HCG-2-10-11, HCG-2-20-11, HCG-6-11, HEI-10-11, HEI-20-11, HEI-6-11, HEM-10-11, HEM-20-11, HEM-6-11, HEP-10-11, HEP-20-11, HEP-6-11, HGC-10-11, HGC-20-11, HGC-6-11, HGV-10-11, HGV-20-11, HME-10-11, HME-10-21, HME-20-11, HME-20-21, HME-2-10-11, HME-2-20-11, HME-6-11, HMG-10-11, HMG-10-21, HMG-20-11, HMG-2-10-11, HMG-6-11, HMI-10-11, HMI-10-11UL, HMI-10-21, HMI-10-21UL, HMI-2-10-11, HMI-6-11, HMI-6-11UL, HMM-10-11, HMM-10-11UL, HMM-10-21, HMM-10-21UL, HMM-20-11, HMM-20-11UL, HMM-20-21, HMM-2-10-11, HMM-2-10-11UL...(Other models you can see in the webshop)		

			
1			
GEV No.	112296	Ref. No.	12024309 Z214902
description	knob switch zero mark ø 39mm shaft ø 6x4.6mm shaft flat lower black shaft L 19mm		
For models:	ECO-120, ECO-120B, FI-100, FI-100AR, FI-100B, FI-120, FI-120B, FI-120W, FI-30, FI-30AR, FI-30AR+DD, FI-30B, FI-30B-BT-UK, FI-30-UK, FI-48, FI-48AR, FI-48B, FI-48B-BT-UK, FI-48C, FI-48D, FI-48HY-CLINIC, FI-48W, FI-64, FI-64AR, FI-64B, FI-64B-BT-UK, FI-64C, FI-64D, FI-64HY-CLINIC, FI-64W, FI-80, FI-80AR, FI-80BBT-UK, LABP-1000, LABP-1200, LABP-800, LVC-12, LVC-15, LVC-15D, LVC-21, LVC-21B, LVC-21C, LVC-21D, LVC-21W, MF-120, MF-48, MF-64		

			
1			
GEV No.	113043	Ref. No.	12044074
description	knob t.max.°C ø 60mm shaft ø 6mm shaft flat black		
For models:	ACE-061, ACE-101, AE-061, AE-061W, AE-101, AE-101W, AE-102, AE-102W, AE-201, AE-202, AG-061, AG-061W, AG-101, AG-101W, AG-102, AG-102W, AG-201, AG-202, APE-061, APE-101		

			
1			
GEV No.	113005	Ref. No.	12024317 R663062
description	knob switch zero mark ø 39mm shaft ø 6x4.6mm shaft flat lower white		
For models:	ECO-120, ECO-120B, ECO-160, ECO-160D, ECO-160I, ECO-200, ECO-200D, ECO-200H, ECO-200HD, ECO-200HI, ECO-200I, ECO-2700D, ECO-2700I, ECO-280D, ECO-280I, ECO-370D, ECO-370I, ECO-4000D, ECO-4000I, ECO-460D, ECO-460I, ECO-550D, ECO-550I, ECO-6000D, ECO-6000I, FE-18, FE-25, FE-4, FE-6, FE-8, FI-100, FI-100AR, FI-100B, FI-120, FI-120B, FI-120HY-CLINIC, FI-120W, FI-160, FI-160D, FI-160I, FI-200, FI-200D, FI-200H, FI-200HD, FI-200HI, FI-200I, FI-200W, FI-2700D, FI-2700I, FI-280D...(Other models you can see in the webshop)		

			
1			
GEV No.	113003	Ref. No.	12040072 R343043
description	knob zero mark ø 39mm shaft ø 6x4.6mm shaft flat lower		
For models:	FE-18, FE-25, FE-4, FE-6, FE-8, FI-300B, HCV-10-11, HCV-10-21, HCV-2-10-21, HCV-5-11, HE-10-11, HE-10-21, HE-2-10-11, HE-5-11, HE-6-11, HG-10-11, HG-10-21, HG-2-10-11		



GEV No.	113042	Ref. No.	12009885 Z513024000
description	knob zero mark t.max.°C ø 50mm shaft ø 6x4.6mm shaft flat lower black		
For models:	ECO-160D, ECO-160I, ECO-200D, ECO-200HD, ECO-200HI, ECO-200I, ECO-2700D, ECO-2700I, ECO-280D, ECO-280I, ECO-370D, ECO-370I, ECO-4000D, ECO-4000I, ECO-460D, ECO-460I, ECO-550D, ECO-550I, ECO-6000D, ECO-6000I, FI-160AR, FI-160D, FI-160I, FI-200AR, FI-200D, FI-200HD, FI-200HI, FI-200I, FI-200WL, FI-200WR, FI-2700D, FI-2700I, FI-280D, FI-280I, FI-370D, FI-370I, FI-4000D, FI-4000I, FI-460D, FI-460I, FI-550D, FI-550I, FI-6000D, FI-6000I		



GEV No.	113046	Ref. No.	12007854 R042102000
description	knob gas tap ø 75mm shaft ø 8x6mm black/silver		
For models:	CG9-51L, CG9-51LC, CG9-51R, CG9-51RC, CGP9-11, FTG9-05L, FTG9-05L-AD, FTG9-05PLUS-CL, FTG9-05PLUS-CR, FTG9-05PLUS-L, FTG9-05PLUS-R, FTG9-05R, FTG9-05R-AD, FTG9-05VL, FTG9-05VR, FTG9-10L, FTG9-10L+R, FTG9-10L+R-AD, FTG9-10L-AD, FTG9-10PLUS-CL, FTG9-10PLUS-CLR, FTG9-10PLUS-CR, FTG9-10PLUS-L, FTG9-10PLUS-LR, FTG9-10PLUS-R, FTG9-10R, FTG9-10R-AD, FTG9-10VL, FTG9-10VL+R, FTG9-10VR, FTG9-11L, FTG9-11L+R, FTG9-11R, FTGC9-05L, FTGC9-05L-AD, FTGC9-05R, FTGC9-05R-AD, FTGC9-10L, FTGC9-10L+R, FTGC9-10L+R-AD, FTGC9-10L-AD, FTGC9-10R, FTGC9-10R-AD, FTGC9-11L, FTGC9-11L+R, FTGC9-11R		



GEV No.	550438	Ref. No.	12039850 Z603052
description	indicator for knob		
For models:	FE-18, FE-25, FE-4, FE-6, FE-8, FI-300B, FI-300R, FI-650R, HCV-10-11, HCV-10-21, HCV-2-10-21, HCV-5-11, HE-10-11, HE-10-21, HE-2-10-11, HE-5-11, HE-6-11, HG-10-11, HG-10-21, HG-2-10-11, LC-10, LC-14, LC-7, LC-7A		



GEV No.	113039	Ref. No.	12020425 U022105
description	knob gas tap with ignition flame ø 74mm shaft ø 10x8mm shaft flat right black		
For models:	BG9-05, BG9-05I, BG9-10, BG9-10I, CG9-10, CG9-11, CG9-20, CG9-40, CG9-41, CG9-51L, CG9-51LC, CG9-51R, CG9-51RC, CG9-60, CG9-61, CG9-82, CGE9-41, CGF9-120D, CGF9-120I, CGF9-121D, CGF9-121I, CPG9-05, CPG9-05S, FTG9-05VL, FTG9-05VR, FTG9-10VL, FTG9-10VL+R, FTG9-10VR		



GEV No.	113000	Ref. No.	12018461 T303010
description	knob switch zero mark ø 50mm shaft ø 5.5x4mm shaft flat lower grey		
For models:	HEI-10-21, HEI-20-21, HEM-10-21, HEM-20-21, HGC-10-21, HGC-20-21, HGV-10-21, HGV-20-21		





GEV No.	113044	Ref. No.	12009005 U022117 U022117000
description	knob gas tap with ignition flame t.max.°C ø 75mm shaft ø 8x6mm black/silver		
For models:	BG9-05AD, BG9-05PF, BG9-05PI, BG9-05PLUS-I, BG9-10AD, BG9-10PF, BG9-10PI, BG9-10PLUS-I, CG9-05AD, CG9-05PLUS, CG9-10, CG9-10AD, CG9-10PLUS, CG9-11, CG9-11AD, CG9-11PLUS, CG9-20, CG9-20AD, CG9-20AD-H, CG9-20H, CG9-20PLUS, CG9-20PLUS-H, CG9-31PLUS-D, CG9-31PLUS-I, CG9-40, CG9-40AD, CG9-40AD-H, CG9-40H, CG9-40PLUS, CG9-40PLUS-H, CG9-41, CG9-41AD, CG9-41AD-H, CG9-41H, CG9-41PLUS, CG9-41PLUS-H, CG9-51L, CG9-51LC, CG9-51R, CG9-51RC, CG9-60, CG9-60AD, CG9-60AD-H, CG9-60H, CG9-60PLUS, CG9-60PLUS-H, CG9-61, CG9-61AD, CG9-61AD-H, CG9-61H... (Other models you can see in the webshop)		



GEV No.	113006	Ref. No.	12018553 T303011
description	knob t.max.°C ø 50mm shaft ø 6x5mm shaft flat vertical grey		
For models:	HEI-10-21, HEI-20-21, HEM-10-21, HEM-20-21, HEP-10-21, HEP-20-21, HGC-10-21, HGC-20-21, HGP-10-21, HGP-20-21, HGV-10-21, HGV-20-21		



			
1			
GEV No.	112813	Ref. No.	12009011 X022133000
description	knob zero mark ø 75mm shaft ø 6x4.6mm shaft flat upper silver/black		
For models:	CPE9-05, CPE9-05NC, CPE9-05S, CPE9-05SNC, CPG9-05, CPG9-05NC, CPG9-05S, CPG9-05SNC, MV9-10BM, MV9-15BM, SBE9-10, SBE9-10I, SBE9-10IM, SBE9-10IMS, SBE9-10IS, SBE9-10M, SBE9-10MS, SBE9-10S, SBE9-15IM, SBE9-15IMS, SBE9-15M, SBE9-15MS, SBG9-10, SBG9-10I, SBG9-10IM, SBG9-10IMS, SBG9-10IS, SBG9-10M, SBG9-10MS, SBG9-10S, SBG9-15IM, SBG9-15IMS		

			
1			
GEV No.	691074	Ref. No.	12024516 R663046
description	gasket switch shaft		
For models:	CO-350, CO-350-B, CO-350-B-DD, CO-350-COLD, CO-350-COLD-B, CO-350-COLD-B-DD, CO-350-COLD-DD, CO-350-DD, CO-400, CO-400-B, CO-400-B-DD, CO-400-COLD, CO-400-COLD-B, CO-400-COLD-B-DD, CO-400-COLD-DD, CO-400-DD, CO-400-SOFT, CO-500, CO-500B, CO-500BDD, CO-500DD, CO-501, CO-501B, CO-501BDD, CO-501DD, CO-501-SOFT, COP-503, COP-503B, COP-503BDD, COP-503DD, COP-503-SOFT, COP-504, COP-504B, COP-504BDD, COP-504DD, ECO-2700D, ECO-2700I, ECO-4000D, ECO-4000I, ECO-6000D, ECO-6000I, FI-200W, FI-2700D, FI-2700I, FI-4000D, FI-4000I, FI-6000D, FI-6000I, HCG-10-11, HCG-10-21...(Other models you can see in the webshop)		

steam/water taps

			
1			
GEV No.	505322	Ref. No.	12009121 S102110
description	knob ø 55mm L 49mm shaft 7.5x7.5mm		
For models:	ME9-10BM, ME9-10BMS, ME9-15BM, ME9-15BM316, ME9-15BMS, MG9-10, MG9-10BM, MG9-10BMS, MG9-10S, MG9-15, MG9-15BM, MG9-15BM316, MG9-15BMS, MG9-15S, MG9-20, MG9-20S, MPE9-10BM, MPE9-10BMS, MPE9-15BM, MPE9-15BMS, MPG9-10, MPG9-10BM, MPG9-10BMS, MPG9-10S, MPG9-15, MPG9-15BM, MPG9-15BMS, MPG9-15S, MPG9-20, MPG9-20S		

miscellaneous

			
1			
GEV No.	691075	Ref. No.	12018344 R662810
description	disc for knob ID ø 10mm ED ø 25mm H 1mm		
For models:	HCG-10-11, HCG-10-21, HCG-20-11, HCG-20-21, HCG-2-10-11, HCG-2-20-11, HCG-6-11, HEI-10-11, HEI-20-11, HEI-6-11, HEM-10-11, HEM-20-11, HEM-6-11, HEP-10-11, HEP-20-11, HEP-6-11, HGC-10-11, HGC-20-11, HGC-6-11, HGV-10-11, HGV-20-11, HME-10-11, HME-10-21, HME-20-11, HME-20-21, HME-2-10-11, HME-2-20-11, HME-6-11, HMG-10-11, HMG-10-11UL, HMG-10-21, HMG-10-21UL, HMG-20-11, HMG-2-10-11, HMG-6-11, HMI-10-11, HMI-10-11UL, HMI-10-21, HMI-10-21UL, HMI-2-10-11, HMI-6-11, HMI-6-11UL, HMM-10-11, HMM-10-11UL, HMM-10-21, HMM-10-21UL, HMM-20-11, HMM-20-11UL, HMM-20-21, HMM-20-21UL...(Other models you can see in the webshop)		

accessories

			
1			
GEV No.	691076	Ref. No.	12020848 R663045
description	gasket		
For models:	HCG-10-11, HCG-10-21, HCG-20-11, HCG-20-21, HCG-2-10-11, HCG-2-20-11, HCG-6-11, HEI-10-11, HEI-20-11, HEI-6-11, HEM-10-11, HEM-20-11, HEM-6-11, HEP-10-11, HEP-20-11, HEP-6-11, HGC-10-11, HGC-20-11, HGC-6-11, HGV-10-11, HGV-20-11, HME-10-11, HME-10-21, HME-20-11, HME-20-21, HME-2-10-11, HME-2-20-11, HME-6-11, HMG-10-11, HMG-10-11UL, HMG-10-21, HMG-10-21UL, HMG-20-11, HMG-2-10-11, HMG-6-11, HMI-10-11, HMI-10-11UL, HMI-10-21, HMI-10-21UL, HMI-2-10-11, HMI-6-11, HMI-6-11UL, HMM-10-11, HMM-10-11UL, HMM-10-21, HMM-10-21UL, HMM-20-11, HMM-20-11UL, HMM-20-21, HMM-20-21UL...(Other models you can see in the webshop)		

			
1			
GEV No.	113004	Ref. No.	12018348 R662809
description	spacer ring		
For models:	HCG-10-11, HCG-10-21, HCG-20-11, HCG-20-21, HCG-2-10-11, HCG-2-20-11, HCG-6-11, HEI-10-11, HEI-20-11, HEI-6-11, HEM-10-11, HEM-20-11, HEM-6-11, HEP-10-11, HEP-20-11, HEP-6-11, HGC-10-11, HGC-20-11, HGC-6-11, HGV-10-11, HGV-20-11, HME-10-11, HME-10-21, HME-20-11, HME-20-21, HME-2-10-11, HME-2-20-11, HME-6-11, HMG-10-11, HMG-10-11UL, HMG-10-21, HMG-10-21UL, HMG-20-11, HMG-2-10-11, HMG-6-11, HMI-10-11, HMI-10-11UL, HMI-10-21, HMI-10-21UL, HMI-2-10-11, HMI-6-11, HMI-6-11UL, HMM-10-11, HMM-10-11UL, HMM-10-21, HMM-10-21UL, HMM-20-11, HMM-20-11UL, HMM-20-21, HMM-20-21UL...(Other models you can see in the webshop)		



handles and hand wheels

hand wheels

hand wheels



1

GEV No.	690086	Ref. No.	12009585 X156117 X156139
description	hand wheel \varnothing 200mm D1 \varnothing 48mm bore \varnothing 20mm thread M8 hole distance 9mm groove widthmm L1 30mm L2 60mm handle length 82mm with folding handle		
For models:	SBE7-10, SBE9-10, SBE9-10I, SBE9-10I-AD, SBE9-10I-AD-S, SBE9-10IM, SBE9-10IMS, SBE9-10IS, SBE9-10PLUS-I, SBE9-10PLUS-SI, SBE9-10S, SBE9-10USMC, SBG7-10, SBG9-10, SBG9-10I, SBG9-10I-AD, SBG9-10I-AD-S, SBG9-10IS, SBG9-10PLUS-I, SBG9-10PLUS-SI, SBG9-10S		
spare parts for	690086		
	GEV No.	514255	Ref. No. —
	folding handle \varnothing 26mm total length 85mm seat \varnothing 20mm shaft \varnothing mm thread M6 with pin L 85mm		
accessories for	690086		
	GEV No.	560175	Ref. No. 12010091 Q131504 Q131552
	grub screw thread M8 L 16mm DIN 914/ISO 4027 intake internal hexagon WS 4 Qty 1 pcs		

spare parts and accessories



1

GEV No.	691037	Ref. No.	12009478 X156135
description	folding handle \varnothing 26mm total length 100mm seat \varnothing 20mm thread M6 with pin		
For models:	SBE7-10, SBE9-10, SBE9-10I, SBE9-10IS, SBE9-10S, SBE9-10USMC, SBG7-10, SBG9-10, SBG9-10I, SBG9-10IS, SBG9-10S		



1

GEV No.	514523	Ref. No.	12008845 X156161 X156161000
description	spindle for hand wheel L 280mm for tilting bratt pan		
For models:	SBE7-10, SBE9-10, SBE9-10I, SBE9-10I-AD, SBE9-10I-AD-S, SBE9-10IM, SBE9-10IMS, SBE9-10IS, SBE9-10PLUS-I, SBE9-10PLUS-SI, SBE9-10S, SBG7-10, SBG9-10, SBG9-10I, SBG9-10I-AD, SBG9-10I-AD-S, SBG9-10IS, SBG9-10PLUS-I, SBG9-10PLUS-SI, SBG9-10S		

cylindrical handles

fixed



1

GEV No.	110703	Ref. No.	12020819 T055434 T055440
description	cylindrical handle thread M10 \varnothing 28mm L 87mm		
For models:	BG7-05, BG7-10, BG9-05, BG9-05I, BG9-10, BG9-10I		

cone handles



1

GEV No.	111464	Ref. No.	12021169 Z102105
description	cone handle thread M10 \varnothing 26mm L 42mm plastic black		
For models:	ECO-1600, ECO-2300, ECO-3000, FI-1600, FI-2300, FI-3000		



1

GEV No.	111129	Ref. No.	12008060 S116122
description	cone handle thread M10 \varnothing 34mm L 55mm plastic black		
For models:	CG9-51LC, CG9-51RC, FTE7-05, FTE7-05L, FTE7-05R, FTE7-10, FTE7-10L, FTE7-10L+R, FTE7-10R, FTE9-05L, FTE9-05R, FTE9-10L, FTE9-10L+R, FTE9-10R, FTEC7-05L, FTEC7-10L, FTEC9-05, FTEC9-05L, FTEC9-05R, FTEC9-05USMC, FTEC9-10, FTEC9-10L, FTEC9-10L+R, FTEC9-10R, FTEC9-10USMC, FTG7-05, FTG7-05L, FTG7-05R, FTG7-10, FTG7-10L, FTG7-10L+R, FTG7-10R, FTG9-05L, FTG9-05R, FTG9-05VL, FTG9-05VR, FTG9-10L, FTG9-10L+R, FTG9-10R, FTG9-10VL, FTG9-10VL+R, FTG9-10VR, FTGC7-05L, FTGC7-10L, FTGC9-05, FTGC9-05L, FTGC9-05R, FTGC9-10, FTGC9-10L, FTGC9-10L+R...(Other models you can see in the webshop)		

handle bars

consoles



1

GEV No.	694208	Ref. No.	12037118 6003010094
description	console for handle rod tube \varnothing 25mm H 47mm plastic		



handle rails

FAGOR



1

GEV No.	507538	Ref. No.	12009630 12019260 Z450502
description	handle rail L 505mm W 29mm H 35mm hole distance 277mm Qty 1 pcs		
For models:	AD-20C-UK, AD-21C		

bracket handles



Image not available

1

GEV No.	505003	Ref. No.	12014635 Z650531
description	pull handle		



1

GEV No.	505001	Ref. No.	12016135 U580521
description	pull handle L 182mm H 42mm mounting distance 170mm thread M6 W 36mm		
For models:	CG-310, CG-310G, CG7-61, CG9-51L, CG9-51LC, CG9-51R, CG9-51RC, CG9-61, CGB7-61, CPG7-05, ECO-280D, ECO-280I, ECO-370D, ECO-370I, ECO-460D, ECO-460I, ECO-550D, ECO-550I, EN9-05C, EN9-10C, FE-710, FE-720, FE9-05, FE9-05S, FE9-10, FE-920, FG-710, FG-720, FG9-05, FG9-05S, FG9-10, FG-920, FG-940, FI-280D, FI-280I, FI-370D, FI-370I, FI-460D, FI-460I, FI-550D, FI-550I, LVC-12, LVC-15, LVC-15D, LVC-21, LVC-21B, LVC-21D, LVC-21W, LVR-10, LVR-14...(Other models you can see in the webshop)		



1

GEV No.	691681	Ref. No.	12024991 Z400540
description	pull handle L 205mm mounting distance 170mm ø 30mm handle M5		
For models:	CG9-51L, CG9-51LC, CG9-51R, CG9-51RC, CG9-61, CPG9-11, CPG9-05, CPG9-05NC, CPG9-05S, CPG9-05SNC, ECO-2700D, ECO-2700I, ECO-280D, ECO-280I, ECO-370D, ECO-370I, ECO-4000D, ECO-4000I, ECO-460D, ECO-460I, ECO-550D, ECO-550I, ECO-6000D, ECO-6000I, EN9-05C, EN9-10C, FE9-05, FE9-05S, FE9-05USMC, FE9-10, FG9-05, FG9-05S, FG9-10, FI-2700D, FI-2700I, FI-280D, FI-280I, FI-370D, FI-370I, FI-4000D, FI-4000I, FI-460D, FI-460I, FI-550D, FI-550I, FI-6000D, FI-6000I, MB9-05-PUERTA-DCHA, MB9-05-PUERTA-IZDA, MB9-10-PUERTA-DOBLE...(Other models you can see in the webshop)		



1

GEV No.	691687	Ref. No.	12009199 S036123
description	pull handle L 220mm H 60mm mounting distance 200mm W 140mm handle M10		
For models:	ME9-10BM, ME9-10BMS, ME9-15BM, ME9-15BM316, ME9-15BMS, MG9-10, MG9-10BM, MG9-10BMS, MG9-10S, MG9-15, MG9-15BM, MG9-15BMS, MG9-15S, MG9-20, MG9-20S, MPE9-10BM, MPE9-10BMS, MPE9-15BM, MPE9-15BMS, MPG9-10, MPG9-10BM, MPG9-10BMS, MPG9-10S, MPG9-15, MPG9-15BM, MPG9-15BMS, MPG9-15S, MPG9-20, MPG9-20S, MV9-10BM, MV9-15BM, SBE7-10, SBE9-10, SBE9-10I, SBE9-10IM, SBE9-10IMS, SBE9-10IS, SBE9-10M, SBE9-10MS, SBE9-10S, SBE9-10USMC, SBE9-15IM, SBE9-15IMS, SBE9-15M, SBE9-15MS, SBG7-10, SBG9-10, SBG9-10I, SBG9-10IM, SBG9-10IMS...(Other models you can see in the webshop)		



1

GEV No.	505002	Ref. No.	12010961 Z200512
description	pull handle L 272mm H 42mm mounting distance 260mm thread M6 W 36mm		
For models:	ECO-120, ECO-120B, ECO-160D, ECO-160I, ECO-200D, ECO-200I, ECO-280D, ECO-280I, ECO-3000, ECO-370D, ECO-370I, ECO-460D, ECO-460I, ECO-550D, ECO-550I, FI-100, FI-100AR, FI-100B, FI-100BBT-UK, FI-120, FI-120AR+DD, FI-120B, FI-120C, FI-120HY-CLINIC, FI-120W, FI-160D, FI-160I, FI-200D, FI-200I, FI-280D, FI-280I, FI-30, FI-3000, FI-370D, FI-370I, FI-460D, FI-460I, FI-48, FI-48B, FI-48W, FI-50, FI-550D, FI-550I, FI-64, FI-64B, FI-64W, FI-72, FI-80, FI-80AR, FI-80BBT-UK...(Other models you can see in the webshop)		



1

GEV No.	505316	Ref. No.	12024005 Z200550
description	pull handle L 293mm H 65mm mounting distance 260mm thread M6 W 36mm		
For models:	ECO-160, ECO-160D, ECO-160I, ECO-200, ECO-200D, ECO-200H, ECO-200HD, ECO-200HI, ECO-200I, ECO-2700D, ECO-2700I, ECO-280D, ECO-280I, ECO-370D, ECO-370I, ECO-4000D, ECO-4000I, ECO-460D, ECO-460I, ECO-550D, ECO-550I, ECO-6000D, ECO-6000I, FI-100, FI-100AR, FI-100B, FI-100BBT-UK, FI-160, FI-160AR, FI-160D, FI-160I, FI-200, FI-200AR, FI-200D, FI-200H, FI-200HD, FI-200HI, FI-200I, FI-200W, FI-200WL, FI-200WR, FI-2700D, FI-2700I, FI-280D, FI-280I, FI-370D, FI-370I, FI-4000D, FI-4000I, FI-460D...(Other models you can see in the webshop)		



1

GEV No.	691679	Ref. No.	12024557 Z400542
description	pull handle L 310mm H 32mm mounting distance 260mm dishwasher since 2007 handle M6		
For models:	ATM-031ECO, CE6-41, CG-310, CG-310G, CG6-41, CGE6-41, FI-100, FI-100AR, FI-100B, FI-100BBT-UK, FI-80, FI-80AR, FI-80BBT-UK, FI-80W, FI-E-100, LVC-12, LVC-15, LVC-15D, LVC-21, LVC-21B, LVC-21C, LVC-21D, LVC-21W		



1

GEV No.	691678	Ref. No.	12018087 U560501
description	pull handle L 615mm H 55mm mounting distance 580mm ø 30mm handle M5		
For models:	CE9-41, CG-1002, CG-1502, CG-2002, CG9-11, CG9-41, CG9-51L, CG9-51LC, CG9-51R, CG9-51RC, CG9-61, CG9-82, CGE9-41, FTG9-11L, FTG9-11L+R, FTG9-11R, FTGC9-11L, FTGC9-11L+R, FTGC9-11R		

accessories

extensions



1

GEV No.	527396	Ref. No.	12020466 R619913
description	thread bolt for griddle L 50mm thread M10 stainless steel		
For models:	CG9-51LC, CG9-51RC, FTE7-05, FTE7-05L, FTE7-05R, FTE7-10, FTE7-10L, FTE7-10L+R, FTE7-10R, FTE9-05L, FTE9-05R, FTE9-10L, FTE9-10L+R, FTE9-10R, FTEC7-05L, FTEC7-10L, FTEC9-05, FTEC9-05L, FTEC9-05R, FTEC9-05USMC, FTEC9-10, FTEC9-10L, FTEC9-10L+R, FTEC9-10R, FTEC9-10USMC, FTG7-05, FTG7-05L, FTG7-05R, FTG7-10, FTG7-10L, FTG7-10L+R, FTG7-10R, FTG9-05L, FTG9-05R, FTG9-05VL, FTG9-05VR, FTG9-10L, FTG9-10L+R, FTG9-10R, FTG9-10VL, FTG9-10VL+R, FTG9-10VR, FTGC7-05L, FTGC7-10L, FTGC9-05, FTGC9-05L, FTGC9-05R, FTGC9-10, FTGC9-10L, FTGC9-10L+R...(Other models you can see in the webshop)		

locks

locking devices

producer-specific

FAGOR



GEV No.	691856	Ref. No.	12030475 A169150001
description	key cylinder ø 22mm		

electromagnetic closer



GEV No.	692613	Ref. No.	12003922 12038364 12038446 12127838 12154822 13P6205160
description	electromagnetic closer L 220mm W 100mm H 50mm		
For models:	LA-25M, LA-AC-10M, LA-AC-10MA, LA-AC-10MP, LA-AC-13M, LA-AC-13MA, LA-AC-13MP, LA-AC-18M, LA-AC-18MA, LA-AC-18MP, LA-AC-25M, LA-AC-25MA, LA-AC-25MP, LA-E-10M, LA-E-10MA, LA-E-10MP, LA-E-13M, LA-E-13MA, LA-E-13MP, LA-E-18M, LA-E-18MA, LA-E-18MP, LA-E-25M, LA-E-25MA, LA-E-25MP, LA-V-10M, LA-V-10MP, LA-V-13M, LA-V-13MP, LA-V-18M, LA-V-18MP, LA-V-25M, LA-V-25MP, LB-AC-10M, LB-E-10M, LB-V-10M, LF-13MPP, LF-18MPP, LF-8MPP, LR-AC-10M, LR-AC-10MA, LR-AC-10MP, LR-AC-13M, LR-AC-13MA, LR-AC-13MP, LR-AC-18M, LR-AC-18MA, LR-AC-18MP, LR-AC-25M, LR-AC-25MA...(Other models you can see in the webshop)		

handle latches

producer-specific

FAGOR



GEV No.	693576	Ref. No.	12029692 RT2400176 RT2402762	
description	catch L 83mm ø 41mm clamp length 43mm BL 45mm			
spare parts for	693576			
	GEV No.	693577	Ref. No.	12031725 12038017 RT2400506 RT2401100 RT2402761
D-lock W 29mm H 17mm spring length 50mm spring thickness 3mm				





1

GEV No.	696850	Ref. No.	12044773 12160858
description	door handle for combi-steamer L 200mm W 108mm H 52mm black		



1

GEV No.	696853	Ref. No.	12044776
description	door handle for combi-steamer L 200mm W 65mm H 50mm black shaft 8x8mm		
For models:	ACE-201, ACE-202, ACG-201, ACG-202, AE-201, AE-202, AG-201, AG-202, APE-201, APE-202, APG-201, APG-202		



1

GEV No.	692902	Ref. No.	12161224
description	door handle L 180mm W 50mm handle ø 50mm spring length 55mm threaded black mounting distance 30mm mounting thread M3		



1

GEV No.	694666	Ref. No.	12024750
description	door handle L 180mm W 56mm H 56mm handle ø 32mm spring length 46mm black plastic mounting distance 40mm mounting thread M5		
For models:	COE-061, COE-101, COE-102, COG-061, COG-101, COG-102, VE-061, VE-101, VE-102, VG-101, VG-102, VPE-061, VPE-101, VPE-102, VPG-101, VPG-102		
spare parts for	694666		
	GEV No.	514390	Ref. No. —
	spring for door handle ø 6mm L 54mm W 27.5mm		



1

GEV No.	693575	Ref. No.	12031594 RT2400152
description	door handle L 200mm W 50mm H 66mm blue plastic		
accessories for	693575		
	GEV No.	693576	Ref. No. 12029692 RT2400176 RT2402762
	catch L 83mm ø 41mm clamp length 43mm BL 45mm		



1

GEV No.	692752	Ref. No.	12044774 12047580
description	door handle L 200mm W 50mm handle ø 50mm spring length 55mm threaded black mounting distance 30mm mounting thread M3		
For models:	ACE-061, ACE-101, ACE-102, ACG-061, ACG-101, ACG-102, AE-061, AE-061W, AE-101, AE-101W, AE-102, AE-102W, AG-061, AG-061W, AG-101, AG-101W, AG-102, AG-102W, APE-061, APE-061W, APE-101, APE-101W, APE-102, APE-102W, APG-061, APG-061W, APG-101, APG-101W, APG-102, APG-102W		

edgmount latches

handle latches

CAFF/FERMOD

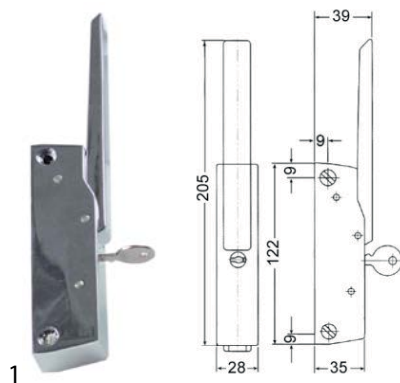

GEV No.	700556	Ref. No.	12032862 6033010007
description	catch L 122mm mounting distance 104mm lockable refrigeration units G 885 W 28mm handle length 135mm overall height 205mm		
For models:	CCF-10, CCF-10CI, CCF-20, CCF-20CI, CCF-40, CCF-40CI		
accessories for	700556		
	GEV No.	690418	Ref. No. —
	door catch L 36mm W 19mm H 29mm mounting distance 12mm zinc-coated steel for refrigeration units		
	GEV No.	690419	Ref. No. —
	door catch L 52mm W 20mm H 30mm mounting distance 26-37mm zamak for refrigeration units		
	GEV No.	700061	Ref. No. —
	door catch L 58mm W 20mm H 35mm mounting distance 42mm chrome-plated brass for headed units		
	GEV No.	700435	Ref. No. —
	door catch L 58mm W 20mm H 35mm mounting distance 42mm zamak for refrigeration units		

espagnolette locks

universal



GEV No.	690041	Ref. No.	12018701 R260544
description	cam L 148mm mounting distance 32mm		
For models:	HCG-10-11, HCG-10-21, HCG-20-11, HCG-20-21, HCG-2-10-11, HCG-6-11, HCV-10-11, HCV-10-21, HCV-2-10-21, HCV-6-11, HE-10-11, HE-10-21, HE-2-10-11, HE-6-11, HG-10-11, HG-10-21, HG-2-10-11, HME-10-11, HME-10-21, HME-20-11, HME-20-21, HME-2-10-11, HME-6-11, HMG-10-11, HMG-10-11UL, HMG-10-21, HMG-10-21UL, HMG-20-11, HMG-2-10-11, HMG-6-11, HMI-10-11, HMI-10-11UL, HMI-10-21, HMI-10-21UL, HMI-2-10-11, HMI-6-11, HMI-6-11UL, HMM-10-11, HMM-10-11UL, HMM-10-21, HMM-10-21UL, HMM-20-11, HMM-20-11UL, HMM-2-10-11, HMM-40-11-USMC, HMM-6-11, HMM-6-11UL, HMP-10-11, HMP-10-21...(Other models you can see in the webshop)		



GEV No.	700771	Ref. No.	12024673 T130509
description	latch gear opening to the left shaft intake ø 8x8mm L 170mm W 40mm H 40mm		
For models:	ACE-201, ACE-202, ACG-201, ACG-202, AE-201, AE-202, AG-201, AG-202, APE-201, APE-202, APG-201, APG-202, COE-201, COE-202, COG-201, COG-202, HCG-10-11, HCG-10-21, HCG-20-11, HCG-20-21, HCG-2-10-11, HCG-2-20-11, HCG-6-11, HEI-10-11, HEI-10-21, HEI-20-11, HEI-20-21, HEI-6-11, HEM-10-11, HEM-10-21, HEM-20-11, HEM-20-21, HEM-6-11, HEP-10-11, HEP-10-21, HEP-20-11, HEP-20-21, HEP-6-11, HGC-10-11, HGC-10-21, HGC-20-11, HGC-20-21, HGC-6-11, HGP-10-21, HGP-20-21, HGV-10-11, HGV-10-21, HGV-20-11, HGV-20-21, HME-10-11...(Other models you can see in the webshop)		

producer-specific

FAGOR

group 1



GEV No.	694266	Ref. No.	12001539 R090514
description	bar door catch ø 10mm L 415mm		
For models:	COE-201, COG-201, HCG-20-11, HCG-20-21, HCG-2-20-11, HEI-20-11, HEM-20-11, HEP-20-11, HGC-20-11, HGV-20-11, HME-20-11, HME-20-21, HME-2-20-11, HMG-20-11, HMM-20-11, HMM-20-11UL, HMM-20-21, HMM-20-21UL, HMM-2-20-11, HMM-40-11-USMC, HMP-20-11, HMP-20-21, HMP-2-20-11, HVG-20-11, HVG-20-21, HVG-2-20-21, MFHMM-20-11, VE-201, VG-201, VPE-201, VPG-201		





GEV No.	694258	Ref. No.	12014385 T300507
description	bar for door latch ø 10mm L 235mm		
For models:	HEI-10-21, HEM-10-21, HEP-10-21, HGC-10-21, HGP-10-21, HGV-10-21		





GEV No.	691050	Ref. No.	12014653 R020502
description	bar ø 10mm for door latch L 113.5mm		
For models:	HCG-10-11, HCG-10-21, HCG-2-10-11, HCG-6-11, HCV-10-11, HCV-10-21, HCV-2-10-21, HCV-6-11, HE-10-11, HE-10-21, HE-2-10-11, HEI-10-11, HEM-10-11, HEP-10-11, HG-10-11, HG-10-21, HG-2-10-11, HGC-10-11, HGV-10-11, HME-10-11, HME-10-21, HME-2-10-11, HME-6-11, HMG-10-11, HMG-10-11UL, HMG-10-21, HMG-10-21UL, HMG-2-10-11, HMI-10-11, HMI-10-11UL, HMI-10-21, HMI-10-21UL, HMI-2-10-11, HMM-10-11, HMM-10-11UL, HMM-10-21, HMM-10-21UL, HMM-20-11, HMM-2-10-11, HMM-6-11, HMP-10-11, HMP-10-21, HMP-2-10-11, HMP-6-11, HVG-10-11, HVG-10-11UL, HVG-10-21, HVG-10-21UL, HVG-2-10-11, MFHVG-10-11, MFHVG-10-21		





			
1			
GEV No.	690041	Ref. No.	12018701 R260544
description	cam L 148mm mounting distance 32mm		
For models:	HCG-10-11, HCG-10-21, HCG-20-11, HCG-20-21, HCG-2-10-11, HCG-6-11, HCV-10-11, HCV-10-21, HCV-2-10-21, HCV-6-11, HE-10-11, HE-10-21, HE-2-10-11, HE-6-11, HG-10-11, HG-10-21, HG-2-10-11, HME-10-11, HME-10-21, HME-20-11, HME-20-21, HME-2-10-11, HME-6-11, HMG-10-11, HMG-10-11UL, HMG-10-21, HMG-10-21UL, HMG-20-11, HMG-2-10-11, HMG-6-11, HMI-10-11, HMI-10-11UL, HMI-10-21, HMI-10-21UL, HMI-2-10-11, HMI-6-11, HMI-6-11UL, HMM-10-11, HMM-10-11UL, HMM-10-21, HMM-10-21UL, HMM-20-11, HMM-20-11UL, HMM-20-21, HMM-2-10-11, HMM-40-11-USMC, HMM-6-11, HMM-6-11UL, HMP-10-11, HMP-10-21...(Other models you can see in the webshop)		

			
1			
GEV No.	700771	Ref. No.	12024673 T130509
description	latch gear opening to the left shaft intake ø 8x8mm L 170mm W 40mm H 40mm		
For models:	ACE-201, ACE-202, ACG-201, ACG-202, AE-201, AE-202, AG-201, AG-202, APE-201, APE-202, APG-201, APG-202, COE-201, COE-202, COG-201, COG-202, HCG-10-11, HCG-10-21, HCG-20-11, HCG-20-21, HCG-2-10-11, HCG-2-20-11, HCG-6-11, HEI-10-11, HEI-10-21, HEI-20-11, HEI-20-21, HEI-6-11, HEM-10-11, HEM-10-21, HEM-20-11, HEM-20-21, HEM-6-11, HEP-10-11, HEP-10-21, HEP-20-11, HEP-20-21, HEP-6-11, HGC-10-11, HGC-10-21, HGC-20-11, HGC-20-21, HGC-6-11, HGP-10-21, HGP-20-21, HGV-10-11, HGV-10-21, HGV-20-11, HGV-20-21, HME-10-11...(Other models you can see in the webshop)		

			
1			
GEV No.	700766	Ref. No.	12018956 12024495 R260545 T110506
description	door catch heated units L 44mm W 40mm H 42mm SS mounting distance 26mm		
For models:	ACE-201, ACE-202, ACG-201, ACG-202, AE-201, AE-202, AG-201, AG-202, APE-201, APE-202, APG-201, APG-202, COE-201, COE-202, COG-201, COG-202, HCG-10-11, HCG-10-21, HCG-20-11, HCG-20-21, HCG-2-10-11, HCG-2-20-11, HCG-6-11, HCV-10-11, HCV-10-21, HCV-2-10-21, HCV-6-11, HE-10-11, HE-10-21, HE-2-10-11, HE-6-11, HEI-10-11, HEI-10-21, HEI-20-11, HEI-20-21, HEI-6-11, HEM-10-11, HEM-10-21, HEM-20-11, HEM-20-21, HEM-6-11, HEP-10-11, HEP-10-21, HEP-20-11, HEP-20-21, HEP-6-11, HG-10-11, HG-10-21, HG-2-10-11, HGC-10-11...(Other models you can see in the webshop)		

			
1			
GEV No.	690042	Ref. No.	12018273 R260543
description	latch gear opening to the right shaft intake ø 8x8mm L 170mm W 40mm H 40mm		
For models:	HCG-10-11, HCG-10-21, HCG-20-11, HCG-2-10-11, HCG-6-11, HCV-10-11, HCV-10-21, HCV-2-10-21, HCV-6-11, HE-10-11, HE-10-21, HE-2-10-11, HE-6-11, HG-10-11, HG-10-21, HG-2-10-11, HME-10-11, HME-10-21, HME-20-11, HME-20-21, HME-2-10-11, HME-6-11, HMG-10-11, HMG-10-11UL, HMG-10-21, HMG-10-21UL, HMG-20-11, HMG-2-10-11, HMG-6-11, HMI-10-11, HMI-10-11UL, HMI-10-21, HMI-10-21UL, HMI-2-10-11, HMI-6-11, HMI-6-11UL, HMM-10-11, HMM-10-11UL, HMM-10-21, HMM-10-21UL, HMM-20-11, HMM-20-11UL, HMM-20-21, HMM-2-10-11, HMM-6-11, HMM-6-11UL, HMP-10-11, HMP-10-21, HMP-20-11, HMP-20-21...(Other models you can see in the webshop)		

											
1											
GEV No.	691044	Ref. No.	12017896 R660532								
description	door handle handle ø 23mm metal mounting distance 43mm flange 28x68mm shaft 7x7mm										
For models:	HCG-10-11, HCG-10-21, HCG-20-11, HCG-2-10-11, HCG-6-11, HME-10-11, HME-10-21, HME-20-11, HME-20-21, HME-2-10-11, HME-6-11, HMG-10-11, HMG-10-11UL, HMG-10-21, HMG-10-21UL, HMG-20-11, HMG-2-10-11, HMG-6-11, HMI-10-11, HMI-10-11UL, HMI-10-21, HMI-10-21UL, HMI-2-10-11, HMI-6-11, HMI-6-11UL, HMM-10-11, HMM-10-11UL, HMM-10-21, HMM-10-21UL, HMM-20-11, HMM-20-11UL, HMM-20-21, HMM-2-10-11, HMM-6-11, HMM-6-11UL, HMP-10-11, HMP-10-21, HMP-20-11, HMP-20-21, HMP-2-10-11, HMP-6-11										
accessories for	691044										
		<table border="1"> <tr> <td>GEV No.</td> <td>690042</td> <td>Ref. No.</td> <td>12018273 R260543</td> </tr> </table>	GEV No.	690042	Ref. No.	12018273 R260543	<table border="1"> <tr> <td>description</td> <td colspan="3">latch gear opening to the right shaft intake ø 8x8mm L 170mm W 40mm H 40mm</td> </tr> </table>	description	latch gear opening to the right shaft intake ø 8x8mm L 170mm W 40mm H 40mm		
GEV No.	690042	Ref. No.	12018273 R260543								
description	latch gear opening to the right shaft intake ø 8x8mm L 170mm W 40mm H 40mm										

accessories for	690042										
		<table border="1"> <tr> <td>GEV No.</td> <td>690040</td> <td>Ref. No.</td> <td>—</td> </tr> </table>	GEV No.	690040	Ref. No.	—	<table border="1"> <tr> <td>description</td> <td colspan="3">door catch with roller H 42mm L 40mm W 40mm zinc die cast mounting distance 26mm type 0751 series</td> </tr> </table>	description	door catch with roller H 42mm L 40mm W 40mm zinc die cast mounting distance 26mm type 0751 series		
GEV No.	690040	Ref. No.	—								
description	door catch with roller H 42mm L 40mm W 40mm zinc die cast mounting distance 26mm type 0751 series										
		<table border="1"> <tr> <td>GEV No.</td> <td>690041</td> <td>Ref. No.</td> <td>12018701 R260544</td> </tr> </table>	GEV No.	690041	Ref. No.	12018701 R260544	<table border="1"> <tr> <td>description</td> <td colspan="3">cam L 148mm mounting distance 32mm</td> </tr> </table>	description	cam L 148mm mounting distance 32mm		
GEV No.	690041	Ref. No.	12018701 R260544								
description	cam L 148mm mounting distance 32mm										
		<table border="1"> <tr> <td>GEV No.</td> <td>691050</td> <td>Ref. No.</td> <td>12014653 R020502</td> </tr> </table>	GEV No.	691050	Ref. No.	12014653 R020502	<table border="1"> <tr> <td>description</td> <td colspan="3">bar ø 10mm for door latch L 113.5mm</td> </tr> </table>	description	bar ø 10mm for door latch L 113.5mm		
GEV No.	691050	Ref. No.	12014653 R020502								
description	bar ø 10mm for door latch L 113.5mm										

group 2			
			
1			
GEV No.	700836	Ref. No.	12017388 T130504
description	bearing ø 42.6mm H 12.5mm ID ø 21mm brass		
For models:	HCG-10-11, HCG-10-21, HCG-20-11, HCG-20-21, HCG-2-10-11, HCG-6-11, HMM-40-11-USMC, HVG-10-11, HVG-10-21, HVG-20-11, HVG-20-21, HVG-2-10-11		

			
1			
GEV No.	700762	Ref. No.	12024389 T130515
description	bearing ø 44mm for door latch H 23mm ID ø 11mm thread M5 brass		
For models:	ACE-201, ACE-202, ACG-201, ACG-202, AE-201, AE-202, AG-201, AG-202, APE-201, APE-202, APG-201, APG-202, COE-201, COE-202, COG-201, COG-202, HCG-10-11, HCG-10-21, HCG-20-11, HCG-20-21, HCG-2-10-11, HCG-2-20-11, HCG-6-11, HEI-10-11, HEI-10-21, HEI-20-11, HEI-20-21, HEI-6-11, HEM-10-11, HEM-10-21, HEM-20-11, HEM-20-21, HEM-6-11, HEP-10-11, HEP-10-21, HEP-20-11, HEP-20-21, HEP-6-11, HGC-10-11, HGC-10-21, HGC-20-11, HGC-20-21, HGC-6-11, HGP-10-21, HGP-20-21, HGV-10-11, HGV-10-21, HGV-20-11, HGV-20-21, HME-10-11...(Other models you can see in the webshop)		

			
1			
GEV No.	700767	Ref. No.	12018457 T130507
description	bolt ø 5.4/8mm for door latch L 22mm		
For models:	HCG-10-11, HCG-10-21, HCG-20-11, HCG-20-21, HCG-2-10-11, HCG-2-20-11, HCG-6-11, HEI-10-11, HEI-10-21, HEI-6-11, HEM-10-11, HEM-10-21, HEM-6-11, HEP-10-11, HEP-10-21, HEP-6-11, HGC-10-11, HGC-10-21, HGC-6-11, HGP-10-21, HGV-10-11, HGV-10-21, HME-10-11, HME-10-21, HME-20-11, HME-20-21, HME-2-10-11, HME-2-20-11, HMI-6-11, HMI-10-11, HMI-10-11UL, HMI-10-21, HMI-10-21UL, HMI-2-10-11, HMI-6-11, HMI-6-11UL, HMM-10-11, HMM-10-11UL, HMM-10-21, HMM-10-21UL, HMM-20-11, HMM-20-11UL, HMM-20-21, HMM-20-21UL, HMM-2-10-11, HMM-2-20-11, HMM-40-11-USMC, HMM-6-11, HMM-6-11UL, HMP-10-11...(Other models you can see in the webshop)		



			
1			
GEV No.	691646	Ref. No.	12022265 T130511
description	bracket L 133mm W 45mm thread M6 SS		
For models:	COE-201, COE-202, COG-201, COG-202, HCG-10-11, HCG-10-21, HCG-20-11, HCG-20-21, HCG-2-10-11, HCG-2-20-11, HCG-6-11, HEI-10-11, HEI-10-21, HEI-20-11, HEI-20-21, HEI-6-11, HEM-10-11, HEM-10-21, HEM-20-11, HEM-20-21, HEM-6-11, HEP-10-11, HEP-10-21, HEP-20-11, HEP-20-21, HEP-6-11, HGC-10-11, HGC-10-21, HGC-20-11, HGC-20-21, HGC-6-11, HGP-10-21, HGP-20-21, HGV-10-11, HGV-10-21, HGV-20-11, HGV-20-21, HME-10-11, HME-10-21, HME-20-11, HME-20-21, HME-2-10-11, HME-2-20-11, HMI-10-11, HMI-10-11UL, HMI-10-21, HMI-10-21UL, HMI-2-10-11, HMI-6-11...(Other models you can see in the webshop)		

			
1			
GEV No.	505273	Ref. No.	12024245 T130505
description	bush for door mechanism		
For models:	ACE-201, ACE-202, ACG-201, ACG-202, AE-201, AE-202, AG-201, AG-202, APE-201, APE-202, APG-201, APG-202, COE-201, COG-201, HCG-10-11, HCG-10-21, HCG-20-11, HCG-20-21, HCG-2-10-11, HCG-2-20-11, HCG-6-11, HEI-10-11, HEI-10-21, HEI-20-11, HEI-20-21, HEI-6-11, HEM-10-11, HEM-10-21, HEM-20-11, HEM-20-21, HEM-6-11, HEP-10-11, HEP-10-21, HEP-20-11, HEP-20-21, HEP-6-11, HGC-10-11, HGC-10-21, HGC-20-11, HGC-20-21, HGC-6-11, HGP-10-21, HGP-20-21, HGV-10-11, HGV-10-21, HGV-20-11, HGV-20-21, HME-10-11, HME-10-21, HME-20-11, HME-20-21, HME-2-10-11, HME-2-20-11, HMI-10-11, HMI-10-11UL, HMI-10-21, HMI-10-21UL, HMI-2-10-11, HMI-6-11...(Other models you can see in the webshop)		

			
1			
GEV No.	700765	Ref. No.	12024164 T130506
description	compression spring ø 8.1mm L 20.4mm wire gauge ø 1.2mm		
For models:	ACE-201, ACE-202, ACG-201, ACG-202, AE-201, AE-202, AG-201, AG-202, APE-201, APE-202, APG-201, APG-202, COE-201, COE-202, COG-201, COG-202, HCG-10-11, HCG-10-21, HCG-20-11, HCG-20-21, HCG-2-10-11, HCG-2-20-11, HCG-6-11, HEI-10-11, HEI-10-21, HEI-20-11, HEI-20-21, HEI-6-11, HEM-10-11, HEM-10-21, HEM-20-11, HEM-20-21, HEM-6-11, HEP-10-11, HEP-10-21, HEP-20-11, HEP-20-21, HEP-6-11, HGC-10-11, HGC-10-21, HGC-20-11, HGC-20-21, HGC-6-11, HGP-10-21, HGP-20-21, HGV-10-11, HGV-10-21, HGV-20-11, HGV-20-21, HME-10-11...(Other models you can see in the webshop)		

			
1			
GEV No.	700770	Ref. No.	12024657 T080504
description	door catch L 149mm W 29mm H 29mm chrome-plated brass		
For models:	ACE-201, ACE-202, ACG-201, ACG-202, AE-201, AE-202, AG-201, AG-202, APE-201, APE-202, APG-201, APG-202, COE-201, COE-202, COG-201, COG-202, HCG-10-11, HCG-10-21, HCG-20-11, HCG-20-21, HCG-2-10-11, HCG-2-20-11, HCG-6-11, HEI-10-11, HEI-10-21, HEI-20-11, HEI-20-21, HEI-6-11, HEM-10-11, HEM-10-21, HEM-20-11, HEM-20-21, HEM-6-11, HEP-10-11, HEP-10-21, HEP-20-11, HEP-20-21, HEP-6-11, HGC-10-11, HGC-10-21, HGC-20-11, HGC-20-21, HGC-6-11, HGP-10-21, HGP-20-21, HGV-10-11, HGV-10-21, HGV-20-11, HGV-20-21, HME-10-11...(Other models you can see in the webshop)		

			
1			
GEV No.	700768	Ref. No.	12024095 T130502
description	door handle ø 50mm shaft intake ø 8x8mm L 180mm		
For models:	COE-201, COE-202, COG-201, COG-202, HCG-10-11, HCG-10-21, HCG-20-11, HCG-20-21, HCG-2-10-11, HCG-2-20-11, HCG-6-11, HEI-10-11, HEI-10-21, HEI-20-11, HEI-20-21, HEI-6-11, HEM-10-11, HEM-10-21, HEM-20-11, HEM-20-21, HEM-6-11, HEP-10-11, HEP-10-21, HEP-20-11, HEP-20-21, HEP-6-11, HGC-10-11, HGC-10-21, HGC-20-11, HGC-20-21, HGC-6-11, HGP-10-21, HGP-20-21, HGV-10-11, HGV-10-21, HGV-20-11, HGV-20-21, HME-10-11, HME-10-21, HME-20-11, HME-20-21, HME-2-10-11, HME-2-20-11, HMI-10-11, HMI-10-11UL, HMI-10-21, HMI-10-21UL, HMI-2-10-11, HMI-6-11...(Other models you can see in the webshop)		

accessories for	700768			
	GEV No.	700762	Ref. No.	12024389 T130515
	bearing ø 44mm for door latch H 23mm ID ø 11mm thread M5 brass			
	GEV No.	700763	Ref. No.	12024505 T130514
	spring holder ø 43mm for door latch H 12.5mm ID ø 20mm brass			
	GEV No.	700771	Ref. No.	12024673 T130509
	latch gear opening to the left shaft intake ø 8x8mm L 170mm W 40mm H 40mm			





			
GEV No.	560068	Ref. No.	12010213 Q032032
description	flat-headed bolt thread M5 thread L 16mm SS DIN 7985/ISO 7045 Qty 20 pcs intake Phillips head ø 10mm head thickness 2mm		
For models:	ACE-201, ACE-202, ACG-201, ACG-202, AD-120B, AD-120BBTDD-UK, AD-120C, AD-120HY, AD-15, AD-15D, AD-20C-UK, AD-21, AD-21B, AD-21BDD, AD-21C, AD-21D, AD-21DD, AD-21W, AD-90BA, AD-90BBT, AD-90BDD, ADE-120B, AE-201, AE-202, AG-201, AG-202, APE-201, APE-202, APG-201, APG-202, COE-201, COE-202, COG-201, COG-202, ECO-120B, FI-100B, FI-100BBT-UK, FI-120B, FI-120C, FI-120HY-CLINIC, FI-80BBT-UK, GA-20, GA-20D, GA-40, GA-40D, HCG-10-11, HCG-10-21, HCG-20-11, HCG-20-21, HCG-2-10-11...(Other models you can see in the webshop)		

			
GEV No.	560549	Ref. No.	12010236
description	grub screw thread M6 L 15mm SS DIN 916/ISO 4029 intake internal hexagon WS 3 Qty 1 pcs		
For models:	ACE-201, ACE-202, ACG-201, ACG-202, AE-201, AE-202, AG-201, AG-202, APE-201, APE-202, APG-201, APG-202, CG9-20, CG9-20AD, CG9-20H, CG9-20PLUS, CG9-40, CG9-40AD, CG9-40H, CG9-40PLUS, CG9-41, CG9-41H, CG9-51L, CG9-51LC, CG9-51R, CG9-51RC, CG9-60, CG9-60AD, CG9-60H, CG9-60PLUS, CG9-61, CG9-61H, CG9-61OP, CG9-82, CGE9-41, CGE9-41AD, CGE9-41PLUS, CGF9-120D, CGF9-120I, CGF9-121D, CGF9-121I, COE-201, COE-202, COG-201, COG-202, HEI-10-11, HEI-20-11, HEI-20-21, HEI-6-11, HEM-10-11...(Other models you can see in the webshop)		

			
GEV No.	560132	Ref. No.	12010194 12010284 Q162030 Q163030
description	hexagonal nut thread M5 H 4mm WS 8 SS DIN/ISO DIN 934 / ISO 4032/8673 Qty 20 pcs		
For models:	ACE-061, ACE-101, ACE-102, ACE-201, ACE-202, ACG-061, ACG-101, ACG-102, ACG-201, ACG-202, AD-120, AD-120B, AD-120BBTDD-UK, AD-120C, AD-120CW, AD-120HY, AD-15, AD-15D, AD-20C-UK, AD-21, AD-21B, AD-21BDD, AD-21C, AD-21D, AD-21DD, AD-21W, AD-45BBT, AD-48, AD-48B, AD-48BDD, AD-48C, AD-48D, AD-48DD, AD-48HY, AD-48W, AD-64, AD-64B, AD-64BBT, AD-64BDD, AD-64BTDD, AD-64C, AD-64CW, AD-64D, AD-64DD, AD-64HY, AD-72, AD-72W, AD-90, AD-90BA, AD-90BBT...(Other models you can see in the webshop)		

			
GEV No.	511212	Ref. No.	12010255 Q162040 Q163140000
description	hexagonal nut thread M6 H 5mm WS 10 SS DIN/ISO DIN 934 / ISO 4032/8673 Qty 1 pcs		
For models:	ACE-061, ACE-101, ACE-102, ACE-201, ACE-202, ACG-061, ACG-101, ACG-102, ACG-201, ACG-202, AD-120, AD-120B, AD-120BBTDD-UK, AD-120C, AD-120CW, AD-120HY, AD-15, AD-15D, AD-20C-UK, AD-21, AD-21B, AD-21BDD, AD-21C, AD-21D, AD-21DD, AD-21W, AD-45BBT, AD-48, AD-48B, AD-48BDD, AD-48C, AD-48D, AD-48DD, AD-48HY, AD-48W, AD-64, AD-64B, AD-64BBT, AD-64BDD, AD-64BTDD, AD-64C, AD-64CW, AD-64D, AD-64DD, AD-64HY, AD-72, AD-72W, AD-90, AD-90BA, AD-90BBT...(Other models you can see in the webshop)		

			
GEV No.	700771	Ref. No.	12024673 T130509
description	latch gear opening to the left shaft intake ø 8x8mm L 170mm W 40mm H 40mm		
For models:	ACE-201, ACE-202, ACG-201, ACG-202, AE-201, AE-202, AG-201, AG-202, APE-201, APE-202, APG-201, APG-202, COE-201, COE-202, COG-201, COG-202, HCG-10-11, HCG-10-21, HCG-20-11, HCG-20-21, HCG-2-10-11, HCG-2-20-11, HCG-6-11, HEI-10-11, HEI-20-11, HEI-20-21, HEI-6-11, HEM-10-11, HEM-20-11, HEM-20-21, HEM-6-11, HEP-10-11, HEP-10-21, HEP-20-11, HEP-20-21, HEP-6-11, HGC-10-11, HGC-10-21, HGC-20-11, HGC-20-21, HGC-6-11, HGP-10-21, HGP-20-21, HGV-10-11, HGV-10-21, HGV-20-11, HGV-20-21, HME-10-11...(Other models you can see in the webshop)		

			
GEV No.	560123	Ref. No.	12009872 Q262040
description	lock washer ID ø 6.3mm ED ø 11mm SS DIN127 Qty 20 pcs for thread M6		
For models:	ACE-061, ACE-101, ACE-102, ACE-201, ACE-202, AD-120, AD-120B, AD-120BBTDD-UK, AD-120C, AD-120CW, AD-120HY, AD-15, AD-15D, AD-20C-UK, AD-21, AD-21B, AD-21BDD, AD-21C, AD-21D, AD-21DD, AD-21W, AD-45BBT, AD-48, AD-48B, AD-48BDD, AD-48C, AD-48D, AD-48DD, AD-48HY, AD-48W, AD-64, AD-64B, AD-64BBT, AD-64BDD, AD-64BTDD, AD-64C, AD-64CW, AD-64D, AD-64DD, AD-64HY, AD-72, AD-72W, AD-90, AD-90BA, AD-90BBT, AD-90BDD, AD-90DD, ADE-120, ADE-120B, AE-061...(Other models you can see in the webshop)		

			
GEV No.	516198	Ref. No.	12010285 Q271033 Q301033
description	retaining ring E D1 ø 6mm D2 ø 12mm SS DIN 6799 thickness 0.7mm for shaft ø 7-9mm		
For models:	COE-201, COE-202, COG-201, COG-202, FE-710, FE-720, FE9-05, FE9-05S, FE9-05USMC, FE9-10, FE-920, HCG-10-11, HCG-10-21, HCG-20-11, HCG-20-21, HCG-2-10-11, HCG-2-20-11, HCG-6-11, HCV-10-11, HCV-10-21, HCV-2-10-21, HCV-6-11, HE-10-11, HE-10-21, HE-2-10-11, HE-6-11, HEI-10-21, HEI-20-21, HEM-10-21, HEM-20-21, HEP-10-21, HEP-20-21, HG-10-21, HG-2-10-11, HGC-10-21, HGC-20-21, HGP-10-21, HGP-20-21, HGV-10-11, HGV-10-21, HGV-20-11, HGV-20-21, HME-10-11, HME-10-21, HME-20-11, HME-20-21, HME-2-10-11, HME-2-20-11, HME-6-11, HMG-10-11...(Other models you can see in the webshop)		

			
GEV No.	700769	Ref. No.	12021034 T130508
description	shaft ø 8x8mm for door latch L 80mm		
For models:	HCG-10-11, HCG-10-21, HCG-20-11, HCG-20-21, HCG-2-10-11, HCG-2-20-11, HCG-6-11, HEI-10-11, HEI-10-21, HEI-6-11, HEM-10-11, HEM-10-21, HEM-6-11, HEP-10-11, HEP-10-21, HEP-6-11, HGC-10-11, HGC-10-21, HGC-6-11, HGP-10-21, HGV-10-11, HGV-10-21, HME-10-11, HME-10-21, HME-20-11, HME-20-21, HME-2-10-11, HME-2-20-11, HME-6-11, HMI-10-11, HMI-10-11UL, HMI-10-21, HMI-10-21UL, HMI-2-10-11, HMI-6-11, HMI-6-11UL, HMM-10-11, HMM-10-11UL, HMM-10-21, HMM-10-21UL, HMM-20-11, HMM-20-11UL, HMM-20-21, HMM-20-21UL, HMM-2-10-11, HMM-2-20-11, HMM-40-11-USMC, HMM-6-11, HMM-6-11UL, HMP-10-11...(Other models you can see in the webshop)		

			
1			
GEV No.	700763	Ref. No.	12024505 T130514
description	spring holder ø 43mm for door latch H 12.5mm ID ø 20mm brass		
For models:	ACE-201, ACE-202, ACG-201, ACG-202, AE-201, AE-202, AG-201, AG-202, APE-201, APE-202, APG-201, APG-202, COE-201, COE-202, COG-201, COG-202, HCG-10-11, HCG-10-21, HCG-20-11, HCG-20-21, HCG-2-10-11, HCG-2-20-11, HCG-6-11, HEI-10-11, HEI-10-21, HEI-20-11, HEI-20-21, HEM-10-11, HEM-10-21, HEM-20-11, HEM-20-21, HEM-6-11, HEP-10-11, HEP-10-21, HEP-20-11, HEP-20-21, HEP-6-11, HGC-10-11, HGC-10-21, HGC-20-11, HGC-20-21, HGC-6-11, HGP-10-21, HGP-20-21, HGV-10-11, HGV-10-21, HGV-20-11, HGV-20-21, HME-10-11...(Other models you can see in the webshop)		

			
1			
GEV No.	560126	Ref. No.	12009890 Q242030
description	tooth lock washer ID ø 5.2mm ED ø 10mm SS DIN/ISO DIN 6798A Qty 20 pcs for thread M5		
For models:	ACE-061, ACE-101, ACE-102, ACE-201, ACE-202, ACG-061, ACG-101, ACG-102, ACG-201, ACG-202, AD-120, AD-120B, AD-120BTTDD-UK, AD-120C, AD-120CW, AD-120HY, AD-15, AD-15D, AD-20C-UK, AD-21, AD-21B, AD-21BDD, AD-21C, AD-21D, AD-21DD, AD-21W, AD-45BBT, AD-48, AD-48B, AD-48BDD, AD-48C, AD-48D, AD-48DD, AD-48HY, AD-48W, AD-64, AD-64B, AD-64BBT, AD-64BDD, AD-64C, AD-64CW, AD-64D, AD-64DD, AD-64HY, AD-72, AD-72W, AD-90, AD-90BA, AD-90BBT, AD-90BDD...(Other models you can see in the webshop)		

miscellaneous

			
1			
GEV No.	691873	Ref. No.	12019998 U060526
description	bolt		

			
Image not available			
1			
GEV No.	691064	Ref. No.	R260546
description	catch hook		

			
1			
GEV No.	691872	Ref. No.	12020157 U060518
description	sleeve		



hinges

spring assisted hinges

producer-specific

CORECO

			
1			
GEV No.	690763	Ref. No.	12038130 6033010100
description	spring assisted hinge right/left L 111mm W 75mm refrigerator mounting distance 25mm		
For models:	ADAEP-1602, ADAEP-801, ADAFN-1602, ADAFN-801, ADAFP-1602, ADAFP-801, ADMCN-135, ADMCN-180, ADMCN-225, ADMCP-135, ADMCP-180, ADMCP-225, ADMFN-135, ADMFN-180, ADMFN-225, ADMFP-135, ADMFP-135-GR, ADMFP-135HD, ADMFP-135PC, ADMFP-180, ADMFP-180-GR, ADMFP-180HDD, ADMFP-180HDD, ADMFP-180PC, ADMFP-225, ADMFP-225-GR, ADMFP-225HDD, ADMFP-225HHDD, ADMFP-225HHDD, ADMFP-225PC, AEF-801AD, AEF-802AD, AEP-1402, AEP-1602, AEP-1602AD, AEP-1603AD, AEP-1604AD, AEP-2103, AEP-701, AEP-801, AEP-802, AF-1402-MIX, AF-1403-C, AF-1403-P, AF-1404-C, AF-1404-P, AF-1602-MIX, AF-1603-C, AF-1603-P, AF-1604-C...(Other models you can see in the webshop)		
accessories for	690763		
	GEV No.	691738	Ref. No.
			12038085 6033010098
	hinge L 100mm W 48mm mounting pos. left thickness 5mm for door for refrigerated counters		
	GEV No.	701161	Ref. No.
			12037017 6033010130
	hinge camp mounting pos. bottom right L 100mm W 48mm H 17mm shaft diameter 8x8mm		



							
1							
GEV No.	700830	Ref. No.	12031972 12034927 12058528 6000300007 6009991521 6033010003 6033010030				
description	spring assisted hinge right/left L 75mm W 26mm H 102mm refrigeration units mounting distance 25mm						
For models:	AEP-1402, AEP-1403, AEP-1404, AEP-1602, AEP-1603, AEP-1604, AEP-2103, AEP-701, AEP-702, AEP-801, AEP-802, AF-1402-MIX, AF-1403-C, AF-1403-P, AF-1404-C, AF-1404-P, AF-1602-MIX, AF-1603-C, AF-1603-P, AF-1604-C, AF-1604-P, AF-2104-C, AF-2104-P, AF-2105-C, AF-2105-P, AF-2106-C, AF-2106-P, AF-702-C, AF-702-P, AF-802-C, AF-802-P, AFN-1402, AFN-1403, AFN-1404, AFN-1602, AFN-1603, AFN-1604, AFN-701, AFN-702, AFN-801, AFN-802, AFP-1402, AFP-1402-FORZ, AFP-1402-MIX, AFP-1403, AFP-1403-C, AFP-1403-FORZ, AFP-1403-P, AFP-1404, AFP-1404-C...(Other models you can see in the webshop)						
accessories for	700830						
		<table border="1"> <tr> <td>GEV No.</td> <td>700854</td> <td>Ref. No.</td> <td>12036924 6033010084</td> </tr> </table>	GEV No.	700854	Ref. No.	12036924 6033010084	hinge camp type TRB/L1 36mm mounting pos. bottom right L 100mm W 48mm H 17mm zinc die cast, chrome-plated hole distance 6.5x51x28mm shaft diameter torx 12x12mmmm
GEV No.	700854	Ref. No.	12036924 6033010084				

			
1			
GEV No.	701569	Ref. No.	12058502 2030800022
description	spring assisted hinge left/right L 102mm W 75mm mounting distance 25mm		

							
1							
GEV No.	690763	Ref. No.	12038130 6033010100				
description	spring assisted hinge right/left L 111mm W 75mm refrigerator mounting distance 25mm						
For models:	ADAEP-1602, ADAEP-801, ADAFN-1602, ADAFN-801, ADAFP-1602, ADAFP-801, ADMCN-135, ADMCN-180, ADMCN-225, ADMCP-135, ADMCP-180, ADMCP-225, ADMFN-135, ADMFN-180, ADMFN-225, ADMFP-135, ADMFP-135-GR, ADMFP-135HD, ADMFP-135PC, ADMFP-180, ADMFP-180-GR, ADMFP-180HDD, ADMFP-180HHD, ADMFP-180PC, ADMFP-225, ADMFP-225-GR, ADMFP-225HDD, ADMFP-225HHDD, ADMFP-225HHHD, ADMFP-225PC, AEF-801AD, AEF-802AD, AEP-1402, AEP-1602, AEP-1602AD, AEP-1603AD, AEP-1604AD, AEP-2103, AEP-701, AEP-801, AEP-802, AF-1402-MIX, AF-1403-C, AF-1403-P, AF-1404-C, AF-1404-P, AF-1602-MIX, AF-1603-C, AF-1603-P, AF-1604-C...(Other models you can see in the webshop)						
accessories for	690763						
		<table border="1"> <tr> <td>GEV No.</td> <td>691738</td> <td>Ref. No.</td> <td>12038085 6033010098</td> </tr> </table>	GEV No.	691738	Ref. No.	12038085 6033010098	hinge L 100mm W 48mm mounting pos. left thickness 5mm for door for refrigerated counters
GEV No.	691738	Ref. No.	12038085 6033010098				
		<table border="1"> <tr> <td>GEV No.</td> <td>701161</td> <td>Ref. No.</td> <td>12037017 6033010130</td> </tr> </table>	GEV No.	701161	Ref. No.	12037017 6033010130	hinge camp mounting pos. bottom right L 100mm W 48mm H 17mm shaft diameter 8x8mm
GEV No.	701161	Ref. No.	12037017 6033010130				

<p>FAGOR</p> 			
1			
GEV No.	701570	Ref. No.	12036986 6033010129
description	hinge camp L 98mm W 46mm mounting distance 80mm mounting pos. bottom left		
For models:	ADAEP-1602, ADAEP-801, ADAFN-1602, ADAFN-801, ADAFP-1602, ADAFP-801, ADMCN-135, ADMCN-180, ADMCN-225, ADMCP-135, ADMCP-180, ADMCP-225, ADMFN-135, ADMFN-180, ADMFN-225, ADMFP-135, ADMFP-135-GR, ADMFP-135HD, ADMFP-135PC, ADMFP-180, ADMFP-180-GR, ADMFP-180HDD, ADMFP-180HHD, ADMFP-180PC, ADMFP-225, ADMFP-225-GR, ADMFP-225HDD, ADMFP-225HHDD, ADMFP-225HHHD, ADMFP-225PC, AEF-801AD, AEF-802AD, AEP-1402, AEP-1602, AEP-1602AD, AEP-1603AD, AEP-1604AD, AEP-2103, AEP-701, AEP-801, AEP-802, AF-1402-MIX, AF-1403-C, AF-1403-P, AF-1404-C, AF-1404-P, AF-1602-MIX, AF-1603-C, AF-1603-P, AF-1604-C...(Other models you can see in the webshop)		



			
1			
GEV No.	701158	Ref. No.	12035423 M169090003
description	hinge camp mounting pos. bottom left L 100mm W 48mm H 17mm zinc die cast, chrome-plated		
For models:	FMP-117-R, FMP-150, FMP-169-R, FMP-200, FMP-222-R, FMP-250, FMP-274-R, FMP-300, MEP-100, MEP-100G, MEP-135, MEP-180, MFN-135, MFN-180, MFP-102-GN-R, MFP-135-F-GN, MFP-135-GN, MFP-147-GN-R, MFP-180-F-GN, MFP-180-GN, MFP-192-GN-R, MFP-225-F-GN, MFP-225-GN, MFP-237-GN-R, MFP-270-F-GN, MFP-270-GN, MPP-150, MPP-202, MPP-255, MPP-307, MPZ1-150, MPZ1-200, MPZ1-250, MSN-150, MSN-200, MSP-117-2RC, MSP-117-R, MSP-150, MSP-150-2C, MSP-150-F, MSP-169-R, MSP-169-R2C, MSP-169-R4C, MSP-200, MSP-200-2C, MSP-200-4C, MSP-200-F, MSP-222-R, MSP-222-R4C, MSP-222-R6C...(Other models you can see in the webshop)		

			
1			
GEV No.	700830	Ref. No.	12031972 12034927 12058528 6000300007 6009991521 6033010003 6033010030
description	spring assisted hinge right/left L 75mm W 26mm H 102mm refrigeration units mounting distance 25mm		
For models:	AEP-1402, AEP-1403, AEP-1404, AEP-1602, AEP-1603, AEP-1604, AEP-2103, AEP-701, AEP-702, AEP-801, AEP-802, AF-1402-MIX, AF-1403-C, AF-1403-P, AF-1404-C, AF-1404-P, AF-1602-MIX, AF-1603-C, AF-1603-P, AF-1604-C, AF-1604-P, AF-2104-C, AF-2104-P, AF-2105-C, AF-2105-P, AF-2106-C, AF-2106-P, AF-702-C, AF-702-P, AF-802-C, AF-802-P, AFN-1402, AFN-1403, AFN-1404, AFN-1602, AFN-1603, AFN-1604, AFN-701, AFN-702, AFN-801, AFN-802, AFP-1402, AFP-1402-FORZ, AFP-1402-MIX, AFP-1403, AFP-1403-C, AFP-1403-FORZ, AFP-1403-P, AFP-1404, AFP-1404-C...(Other models you can see in the webshop)		
accessories for	700830		
	GEV No.	700854	Ref. No. 12036924 6033010084
	hinge camp type TRB/L1 36mm mounting pos. bottom right L 100mm W 48mm H 17mm zinc die cast, chrome-plated hole distance 6.5x51x28mm shaft diameter torx 12x12mmmm		

oven hinges

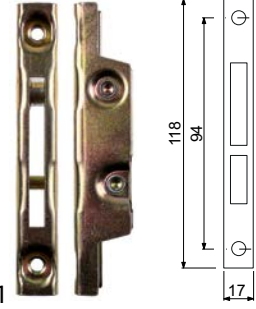
			
1			
GEV No.	691003	Ref. No.	12002123 U010510
description	guide L 128mm W 26mm thickness 1mm cut-out 7x41 7x22.5mm for hinge		
For models:	CE7-41, CE9-41, CG-1002, CG-1502, CG-2000, CG-2000-2P, CG-2002, CG-2002P, CG-210, CG-210G, CG-310, CG-310G, CG7-11, CG-7115, CG7-41, CG-7415, CG7-61, CG-7615, CG9-11, CG9-41, CG9-51L, CG9-51LC, CG9-51R, CG9-51RC, CG9-61, CG9-82, CGE7-195, CGE7-41, CGE9-41, CGF9-121D, CGF9-121I, FTG9-11L, FTG9-11L+R, FTG9-11R, FTGC9-11L, FTGC9-11L+R, FTGC9-11R, HE9-10, HE9-20, HG9-10, HG9-20		

			
1			
GEV No.	700001	Ref. No.	12008998 U010512
description	opposite support L 118mm W 17mm mounting distance 94mm		
For models:	CE6-41, CE7-41, CE7-41Q, CE9-41, CE9-41AD, CE9-41PLUS, CG-1002, CG-1502, CG-2000, CG-2000-2P, CG-2002, CG-2002P, CG-210, CG-210G, CG-310, CG-310G, CG6-41, CG7-11, CG-7115, CG7-31D, CG7-31I, CG7-41, CG-7415, CG7-41H, CG7-51, CG7-61, CG-7615, CG7-61H, CG9-11, CG9-11AD, CG9-11PLUS, CG9-41, CG9-41AD, CG9-41AD-H, CG9-41H, CG9-41PLUS, CG9-41PLUS-H, CG9-51L, CG9-51LC, CG9-51R, CG9-51RC, CG9-61, CG9-61AD, CG9-61AD-H, CG9-61H, CG9-61OP, CG9-61PLUS, CG9-61PLUS-H, CG9-82, CG9-82AD...(Other models you can see in the webshop)		

			
1			
GEV No.	700006	Ref. No.	12019715 U010504
description	oven hinge mounting distance 173mm mounting distance 2 105mm lug mounting 14mm lever length 120mm groove distance 11mm spring thickness 3.5mm mounting ear position left spring length 112mm W 25mm		
For models:	CE7-41, CE9-41, CG-1002, CG-1502, CG-2000, CG-2000-2P, CG-2002, CG-210, CG-210G, CG-310, CG-310G, CG7-11, CG-7115, CG7-41, CG-7415, CG7-61, CG-7615, CG9-11, CG9-41, CG9-51L, CG9-51LC, CG9-51R, CG9-51RC, CG9-61, CG9-82, CGE7-194, CGE7-41, CGE9-41, CGF9-121D, CGF9-121I, FTG9-11L, FTG9-11L+R, FTG9-11R, FTGC9-11L+R, FTGC9-11R, HE9-10, HE9-20, HG9-10, HG9-20		
accessories for	700006		
	GEV No.	700001	Ref. No. 12008998 U010512
	opposite support L 118mm W 17mm mounting distance 94mm		
	GEV No.	700007	Ref. No. 12019714 U010511
	oven hinge mounting distance 173mm mounting distance 2 105mm lug mounting 14mm lever length 120mm groove distance 11mm spring thickness 3.5mm mounting ear position right spring length 112mm W 25mm		

1

GEV No.	700007	Ref. No.	12019714 U010511
description	oven hinge mounting distance 173mm mounting distance 2 105mm lug mounting 14mm lever length 120mm groove distance 11mm spring thickness 3.5mm mounting ear position right spring length 112mm W 25mm		
For models:	CE7-41, CE9-41, CG-1002, CG-1502, CG-2000, CG-2000-2P, CG-2002, CG-210, CG-210G, CG-310, CG-310G, CG7-11, CG-7115, CG7-41, CG-7415, CG7-61, CG-7615, CG9-11, CG9-41, CG9-51L, CG9-51LC, CG9-51R, CG9-51RC, CG9-61, CG9-82, CGE7-193, CGE7-41, CGE9-41, CGF9-121D, CGF9-121I, FTG9-11L, FTG9-11L+R, FTG9-11R, FTGC9-11L, FTGC9-11L+R, FTGC9-11R, HE9-10, HE9-20, HG9-10, HG9-20		
accessories for	700007		
	GEV No.	700001	Ref. No. 12008998 U010512
	opposite support L 118mm W 17mm mounting distance 94mm		

1

GEV No.	700820	Ref. No.	12009225 U020528
description	oven hinge mounting distance 173mm mounting distance 2mm lug mounting 14mm lever length 119mm groove distance 11mm spring thickness 3.5mm mounting ear position left/right spring length 112mm L 207mm W 25mm		
For models:	CE6-41, CE7-41, CE7-41Q, CE9-41, CE9-41AD, CE9-41PLUS, CG-1002, CG-1502, CG-2002, CG-2002P, CG-210, CG-210G, CG-310, CG-310G, CG6-41, CG7-11, CG7-31D, CG7-31I, CG7-41, CG7-41H, CG7-51, CG7-61, CG7-61H, CG9-11, CG9-11AD, CG9-11PLUS, CG9-31PLUS-D, CG9-31PLUS-I, CG9-41, CG9-41AD, CG9-41AD-H, CG9-41H, CG9-41PLUS, CG9-41PLUS-H, CG9-51L, CG9-51LC, CG9-51R, CG9-51RC, CG9-61, CG9-61AD, CG9-61AD-H, CG9-61H, CG9-61OP, CG9-61PLUS, CG9-61PLUS-H, CG9-82, CG9-82AD, CG9-82PLUS, CGE6-41, CGE7-41... (Other models you can see in the webshop)		
accessories for	700820		
	GEV No.	700001	Ref. No. 12008998 U010512
	opposite support L 118mm W 17mm mounting distance 94mm		

door bearing

1

GEV No.	693569	Ref. No.	12034578 RT21201254
description	bolt mounting pos. upper		

1

GEV No.	693568	Ref. No.	12032516 RT29401300
description	bush mounting pos. upper		

1

GEV No.	690764	Ref. No.	12037723 6003010136
description	bush W 23.5mm H 53.5mm mounting pos. upper/lower ø 16mm ID ø 10mm grey for hinge		

GEV No.	690764	Ref. No.	12037723 6003010136
description	bush W 23.5mm H 53.5mm mounting pos. upper/lower ø 16mm ID ø 10mm grey for hinge		
For models:	ADM CN-135, ADM CN-180, ADM CN-225, ADM CP-135, ADM CP-180, ADM CP-225, ADM FN-135, ADM FN-180, ADM FN-225, ADM FP-135, ADM FP-135-GR, ADM FP-135HD, ADM FP-135PC, ADM FP-180, ADM FP-180-GR, ADM FP-180HDD, ADM FP-180HHD, ADM FP-180PC, ADM FP-225, ADM FP-225-GR, ADM FP-225HDD, ADM FP-225HHD, ADM FP-225HHDD, ADM FP-225PC, AEP-1402, AEP-1602, AEP-2103, AEP-701, AEP-801, AEP-802, AF-1402-MIX, AF-1403-C, AF-1403-P, AF-1404-C, AF-1404-P, AF-1602-MIX, AF-1603-C, AF-1603-P, AF-1604-C, AF-1604-P, AF-2104-C, AF-2104-P, AF-2105-C, AF-2105-P, AF-2106-C, AF-2106-P, AF-702-C, AF-702-P, AF-802-C, AF-802-P...(Other models you can see in the webshop)		

1

GEV No.	700817	Ref. No.	12038076 6033090064
description	hinge bolt upper ø 10mm L 30mm IT M6 for refrigerated counters mounting pos. upper		

1

GEV No.	691647	Ref. No.	12024596 T130500
description	door hinge L 156mm W 50mm mounting pos. upper right thickness 6mm		
For models:	COE-061, COE-101, COG-061, COG-101, HCG-10-11, HCG-10-21, HCG-20-11, HCG-20-21, HCG-2-10-11, HCG-2-20-11, HCG-6-11, HEI-10-11, HEI-6-11, HEM-10-11, HEM-6-11, HEP-10-11, HEP-6-11, HGC-10-11, HGC-6-11, HGV-10-11, HME-10-11, HME-10-21, HME-20-11, HME-20-21, HME-2-10-11, HME-2-20-11, HME-6-11, HMI-10-11, HMI-10-11UL, HMI-10-21, HMI-10-21UL, HMI-2-10-11, HMI-6-11, HMI-6-11UL, HMM-10-11, HMM-10-11UL, HMM-10-21, HMM-10-21UL, HMM-20-11, HMM-20-11UL, HMM-20-21, HMM-20-21UL, HMM-2-10-11, HMM-2-20-11, HMM-40-11-USMC, HMM-6-11, HMM-6-11UL, HMP-10-11, HMP-10-21, HMP-20-11...(Other models you can see in the webshop)		



GEV No.	700835	Ref. No.	12011159 U060515
description	door hinge L 96mm W 33mm H 44mm mounting pos. left upper		
For models:	CGB7-61		



GEV No.	700834	Ref. No.	12015573 U060514
description	door hinge L 96mm W 33mm H 44mm mounting pos. right upper		
For models:	CGB7-61		



GEV No.	692297	Ref. No.	12036829 6033010111
description	hinge L 100mm W 17mm H 48mm mounting pos. bottom left thickness 5mm		
For models:	AEP-1402, AEP-1602, AEP-2103, AF-1402-MIX, AF-1403-C, AF-1403-P, AF-1404-C, AF-1404-P, AF-1602-MIX, AF-1603-C, AF-1603-P, AF-1604-C, AF-1604-P, AF-2104-C, AF-2104-P, AF-2105-C, AF-2105-P, AF-2106-C, AF-2106-P, AFN-1402, AFN-1403, AFN-1404, AFN-1602, AFN-1603, AFN-1604, AFP-1402, AFP-1403, AFP-1404, AFP-1602, AFP-1602-2, AFP-1603, AFP-1603-2, AFP-1604, AFP-2103, AFP-2104, AFP-2105, AFP-2106, ERM-150, ERM-250, ERM-350		



GEV No.	691738	Ref. No.	12038085 6033010098
description	hinge L 100mm W 48mm mounting pos. left thickness 5mm for door for refrigerated counters		
For models:	AEP-2103, AF-2104-C, AF-2104-P, AF-2105-C, AF-2105-P, AF-2106-C, AF-2106-P, AFP-2103, AFP-2104, AFP-2105, AFP-2106, FMP-117-R, FMP-150, FMP-169-R, FMP-200, FMP-222-R, FMP-250, FMP-274-R, FMP-300, MCP-135-GN, MCP-147-GN-R, MCP-180-GN, MCP-225-GN, MCP-270-GN, MEP-100, MEP-100G, MEP-135, MEP-180, MFN-135, MFN-180, MFP-102-GN-R, MFP-135-F-GN, MFP-135-GN, MFP-147-GN-R, MFP-180-F-GN, MFP-180-GN, MFP-192-GN-R, MFP-225-F-GN, MFP-225-GN, MFP-237-GN-R, MFP-270-F-GN, MFP-270-GN, MPP-150, MPP-202, MPP-255, MPP-307, MPZ1-150, MPZ1-200, MPZ1-250, MSN-150...(Other models you can see in the webshop)		





GEV No.	691737	Ref. No.	12037938 6033010099 M19090004
description	hinge L 100mm W 48mm mounting pos. right thickness 5mm for door for refrigerated counters		
For models:	AEP-2103, AF-2104-C, AF-2104-P, AF-2105-C, AF-2105-P, AF-2106-C, AF-2106-P, AFP-2103, AFP-2104, AFP-2105, AFP-2106, MCP-135-GN, MCP-147-GN-R, MCP-180-GN, MCP-225-GN, MCP-270-GN, MEP-100, MEP-100G, MSP-150-GI, MSP-200-GI, MSP-250-GI, MSP-300-GI		



GEV No.	690765	Ref. No.	12037372 6033090090
description	hinge L 47mm H 20mm mounting pos. bottom right ø 10mm		
For models:	ADMCN-135, ADMCN-180, ADMCN-225, ADMCP-135, ADMCP-180, ADMCP-225, ADMFN-135, ADMFN-180, ADMFN-225, ADMFP-135, ADMFP-135-GR, ADMFP-135HD, ADMFP-135HH, ADMFP-135PC, ADMFP-180, ADMFP-180-GR, ADMFP-180HDD, ADMFP-180HHD, ADMFP-180HHH, ADMFP-180PC, ADMFP-225, ADMFP-225-GR, ADMFP-225HDD, ADMFP-225HDD, ADMFP-225HHHD, ADMFP-225HHHH, ADMFP-225PC, CFMP-150, CFMP-150F, CFMP-150PC, CFMP-150TV, CFMP-202, CFMP-202F, CFMP-202PC, CFMP-202TV, CFMP-255, CFMP-255F, CFMP-255PC, CFMP-255TV, CFMP-307, CFMP-307F, CFMP-307TV, CMFN-135, CMFN-180, CMFN-225, CMFN-270, CMFP-135, CMFP-135-B, CMFP-135-B2, CMFP-135-BP...(Other models you can see in the webshop)		





GEV No.	701159	Ref. No.	12036086 12038111 6009992205 6009992206
description	hinge L 50mm W 35mm H 39mm mounting pos. bottom right		
For models:	FMP-117-R, FMP-150, FMP-169-R, FMP-200, FMP-222-R, FMP-250, FMP-274-R, FMP-300, MCN-102-GN-R, MCN-135-GN, MCN-147-GN-R, MCN-180-GN, MCN-192-GN-R, MCN-225-GN, MCN-237-GN-R, MCN-270-GN, MCP-102-GN-R, MCP-135-GN, MCP-147-GN-R, MCP-180-GN, MCP-192-GN-R, MCP-225-GN, MCP-237-GN-R, MCP-270-GN, MEP-100, MEP-135, MEP-180, MFN-102-GN-R, MFN-135-GN, MFN-147-GN-R, MFN-180-GN, MFN-192-GN-R, MFN-225-GN, MFN-237-GN-R, MFP-270-GN, MFP-102-GN-R, MFP-135-GN, MFP-147-GN-R, MFP-180-GN, MFP-192-GN-R, MFP-225-GN, MFP-237-GN-R, MFP-270-GN, MPN-117-R, MPN-117-R-C, MPN-150, MPN-150-C, MPN-169-R, MPN-169-R-C, MPN-202...(Other models you can see in the webshop)		

							
GEV No.	701157	Ref. No.	12035983 12036088 6009992203 V169090002				
description	hinge L 50mm W 36mm H 30mm mounting pos. left/upper and bottom kit						
For models:	FMP-117-R, FMP-150, FMP-169-R, FMP-200, FMP-222-R, FMP-250, FMP-274-R, FMP-300, MCN-102-GN-R, MCN-102-R, MCN-135, MCN-135-GN, MCN-147-GN-R, MCN-147-R, MCN-180, MCN-180-GN, MCN-192-GN-R, MCN-192-R, MCN-225, MCN-225-GN, MCN-237-GN-R, MCN-237-R, MCN-270, MCN-270-GN, MCP-102-GN-R, MCP-135, MCP-135-GN, MCP-147-GN-R, MCP-180, MCP-180-GN, MCP-192-GN-R, MCP-225, MCP-225-GN, MCP-237-GN-R, MCP-270-GN, MEP-100, MEP-100G, MEP-135, MEP-180, MFN-102-GN-R, MFN-135-GN, MFN-147-GN-R, MFN-180-GN, MFN-192-GN-R, MFN-225-GN, MFN-237-GN-R, MFN-270-GN, MFP-102-GN-R, MFP-135-GN, MFP-147-GN-R...(Other models you can see in the webshop)						
accessories for	701157						
		<table border="1"> <tr> <td>GEV No.</td> <td>690764</td> <td>Ref. No.</td> <td>12037723 6003010136</td> </tr> </table>	GEV No.	690764	Ref. No.	12037723 6003010136	bush W 23.5mm H 53.5mm mounting pos. upper/lower ø 16mm ID ø 10mm grey for hinge
GEV No.	690764	Ref. No.	12037723 6003010136				

			
GEV No.	692903	Ref. No.	12047967
description	hinge L 54mm W 32mm H 12.5mm mounting pos. lower thread M6 ID ø 15.5mm		
For models:	ACE-061, ACE-101, ACE-102, ACE-201, ACE-202, ACG-061, ACG-101, ACG-102, ACG-201, ACG-202, AE-061, AE-061W, AE-101, AE-101W, AE-102, AE-102W, AE-201, AE-202, AG-061, AG-061W, AG-101, AG-101W, AG-102, AG-102W, AG-201, AG-202, APE-061, APE-061W, APE-101, APE-101W, APE-102, APE-102W, APE-201, APE-202, APG-061, APG-061W, APG-101, APG-101W, APG-102, APG-102W, APG-201, APG-202		

			
GEV No.	691728	Ref. No.	12014955 E022608
description	hinge L 85mm W 66mm thickness 2.5mm L-shape for fryer		
For models:	CG7-61, CG9-51L, CG9-51LC, CG9-51R, CG9-51RC, CG9-61, CPG7-05, CPG9-05, CPG9-05NC, FE-710, FE-720, FE9-05, FE9-05USMC, FE9-10, FG-710, FG-720, FG9-05, FG9-10, MB7-05, MB7-10, MB9-05-PUERTA-DCHA, MB9-10-PUERTA-DOBLE, MB9-15-PUERTA-DCHA, MB9-15-PUERTA-IZDA		

			
GEV No.	701160	Ref. No.	12036087 6009992204
description	hinge L 51mm W 36mm H 40mm mounting pos. bottom left		
For models:	FMP-117-R, FMP-150, FMP-169-R, FMP-200, FMP-222-R, FMP-250, FMP-274-R, FMP-300, MCN-102-GN-R, MCN-135-GN, MCN-147-GN-R, MCN-180-GN, MCN-192-GN-R, MCN-225-GN, MCN-237-GN-R, MCN-270-GN, MCP-102-GN-R, MCP-135-GN, MCP-147-GN-R, MCP-180-GN, MCP-192-GN-R, MCP-225-GN, MCP-237-GN-R, MCP-270-GN, MEP-100, MEP-135, MEP-180, MFN-102-GN-R, MFN-135-GN, MFN-147-GN-R, MFN-180-GN, MFN-192-GN-R, MFN-225-GN, MFN-237-GN-R, MFN-270-GN, MFP-102-GN-R, MFP-135-GN, MFP-147-GN-R, MFP-180-GN, MFP-192-GN-R, MFP-225-GN, MFP-237-GN-R, MFP-270-GN, MMZ-202, MPN-117-R, MPN-117-R-C, MPN-150, MPN-150-C, MPN-169-R, MPN-169-R-C...(Other models you can see in the webshop)		

			
GEV No.	700812	Ref. No.	12037672 6003010048
description	hinge mounting distance 12mm mounting pos. upper and bottom for technical chamber door for refrigerated counters shaft ø 9mm		
For models:	FMP-150, FMP-202, FMP-255, FMP-307, MCN-135, MCN-180, MCN-225, MCN-270, MCP-135, MCP-135-GN, MCP-180, MCP-180-GN, MCP-225, MCP-225-GN, MCP-270-GN, MEP-135, MEP-180, MFN-135, MFN-180, MFN-225, MFN-270, MFP-135, MFP-135-2C, MFP-135-4C, MFP-135-F, MFP-180, MFP-180-2C, MFP-180-4C, MFP-180-6C, MFP-180-F, MFP-225, MFP-225-2C, MFP-225-4C, MFP-225-6C, MFP-225-8C, MFP-225-F, MFP-270-10C, MFP-270-2C, MFP-270-4C, MFP-270-6C, MFP-270-8C, MFP-270-F, MMZ-150, MMZ-202, MPN-150, MPN-150-C, MPN-202, MPN-202-C, MPN-255, MPN-255-C...(Other models you can see in the webshop)		

			
GEV No.	692904	Ref. No.	12039311 T540565000
description	hinge L 54mm W 32mm H 10mm mounting pos. lower thread M6 ID ø 15.5mm		
For models:	ACE-061, ACE-101, ACE-102, ACE-201, ACE-202, ACG-061, ACG-101, ACG-102, ACG-201, ACG-202, AE-061, AE-101, AE-102, AE-201, AE-202, AG-061, AG-101, AG-102, AG-201, AG-202, APE-061, APE-101, APE-102, APE-201, APE-202, APG-061, APG-101, APG-102, APG-201, APG-202		

			
GEV No.	700890	Ref. No.	12038100 6009992202 V169090001
description	hinge mounting pos. left/upper and bottom		
For models:	EC-150, ECC-150, FMP-117-R, FMP-150, FMP-169-R, FMP-202, FMP-222-R, FMP-255, FMP-274-R, FMP-307, MCN-102-R, MCN-135, MCN-147-R, MCN-180, MCN-192-R, MCN-225, MCN-237-R, MCN-270, MCP-135, MCP-180, MCP-225, MEP-100, MEP-100G, MEP-135, MEP-180, MFN-102-R, MFN-135, MFN-147-R, MFN-180, MFN-192-R, MFN-225, MFN-237-R, MFN-270, MFP-102-2C, MFP-135, MFP-135-2C, MFP-135-F, MFP-147-2C, MFP-147-4C, MFP-180, MFP-180-2C, MFP-180-4C, MFP-180-F, MFP-192-2C, MFP-192-4C, MFP-192-6C, MFP-225, MFP-225-2C, MFP-225-4C, MFP-225-6C...(Other models you can see in the webshop)		

			
1			
GEV No.	693567	Ref. No.	12031970 RT29301307
description	hinge mounting pos. upper		

			
1			
GEV No.	521285	Ref. No.	12039312 T540566000
description	hinge bearing L 152mm W 29mm H 8.5mm mounting pos. upper without bolt		
For models:	ACE-061, ACE-101, ACE-102, ACE-201, ACE-202, ACG-061, ACG-101, ACG-102, ACG-201, ACG-202, AE-061, AE-061W, AE-101, AE-101W, AE-102, AE-102W, AE-201, AE-202, AG-061, AG-061W, AG-101, AG-101W, AG-102, AG-102W, AG-201, AG-202, APE-061, APE-061W, APE-101, APE-101W, APE-102, APE-102W, APE-201, APE-202, APG-061, APG-061W, APG-101, APG-101W, APG-102, APG-102W, APG-201, APG-202		

			
1			
GEV No.	691091	Ref. No.	12024517 R660507 R660551
description	hinge bearing mounting pos. lower without bolt		
For models:	COE-061, COE-101, COG-061, COG-101, HCG-10-11, HCG-10-21, HCG-20-11, HCG-20-21, HCG-2-10-11, HCG-2-20-11, HCG-6-11, HME-10-11, HME-10-21, HME-20-11, HME-20-21, HME-2-10-11, HME-2-20-11, HME-6-11, HMG-10-11, HMG-10-11UL, HMG-10-21, HMG-10-21UL, HMG-20-11, HMG-2-10-11, HMG-6-11, HMI-10-11, HMI-10-11UL, HMI-10-21, HMI-10-21UL, HMI-2-10-11, HMI-6-11, HMI-6-11UL, HMM-10-11, HMM-10-11UL, HMM-10-21, HMM-10-21UL, HMM-20-11, HMM-20-11UL, HMM-20-21, HMM-20-21UL, HMM-2-10-11, HMM-2-20-11, HMM-40-11-USMC, HMM-6-11, HMM-6-11UL, HMP-10-11, HMP-10-21, HMP-20-11, HMP-20-21, HMP-2-10-11...(Other models you can see in the webshop)		

			
1			
GEV No.	691088	Ref. No.	12020438 R660517 R660550
description	hinge bearing mounting pos. upper right without bolt		
For models:	HCG-10-11, HCG-10-21, HCG-20-11, HCG-2-10-11, HCG-6-11, HME-10-11, HME-10-21, HME-20-11, HME-20-21, HME-2-10-11, HME-6-11, HMG-10-11, HMG-10-11UL, HMG-10-21, HMG-10-21UL, HMG-20-11, HMG-2-10-11, HMG-6-11, HMI-10-11, HMI-10-11UL, HMI-10-21, HMI-10-21UL, HMI-2-10-11, HMI-6-11, HMI-6-11UL, HMM-10-11, HMM-10-11UL, HMM-10-21, HMM-10-21UL, HMM-20-11, HMM-20-11UL, HMM-20-21, HMM-2-10-11, HMM-6-11, HMM-6-11UL, HMP-10-11, HMP-10-21, HMP-20-11, HMP-20-21, HMP-2-10-11, HMP-6-11		

			
1			
GEV No.	701161	Ref. No.	12037017 6033010130
description	hinge camp mounting pos. bottom right L 100mm W 48mm H 17mm shaft diameter 8x8mm		
For models:	ADAEP-1602, ADAFN-1602, ADAFP-1602, ADMCN-135, ADMCN-180, ADMCN-225, ADMCP-135, ADMCP-180, ADMCP-225, AEP-1402, AEP-1602, AEP-1602AD, AEP-1603AD, AEP-1604AD, AEP-2103, AF-1402-MIX, AF-1403-C, AF-1403-P, AF-1404-C, AF-1404-P, AF-1602-MIX, AF-1603-C, AF-1603-P, AF-1604-C, AF-1604-P, AF-2104-C, AF-2104-P, AF-2105-C, AF-2105-P, AF-2106-C, AF-2106-P, AFN-1402, AFN-1403, AFN-1404, AFN-1602, AFN-1603, AFN-1604, AFP-1402, AFP-1403, AFP-1404, AFP-1602, AFP-1602-2, AFP-1603, AFP-1603-2, AFP-1604, AFP-2103, AFP-2104, AFP-2105, AFP-2106, ANF-1602AD...(Other models you can see in the webshop)		

			
1			
GEV No.	701162	Ref. No.	12041472 6033010140
description	hinge camp mounting pos. upper right L 100mm W 48mm H 17mm shaft diameter M6mm		
For models:	ADAEP-1602, ADAFN-1602, ADAFP-1602, AEP-1402, AEP-1602, AEP-1602AD, AEP-1603AD, AEP-1604AD, AEP-2103, AF-1402-MIX, AF-1403-C, AF-1403-P, AF-1404-C, AF-1404-P, AF-1602-MIX, AF-1603-C, AF-1603-P, AF-1604-C, AF-1604-P, AF-2104-C, AF-2104-P, AF-2105-C, AF-2105-P, AF-2106-C, AF-2106-P, AFN-1402, AFN-1403, AFN-1404, AFN-1602, AFN-1603, AFN-1604, AFP-1402, AFP-1403, AFP-1404, AFP-1602, AFP-1602-2, AFP-1603, AFP-1603-2, AFP-1604, AFP-2103, AFP-2104, AFP-2105, AFP-2106, ANF-1602AD, ANF-1603AD, ANF-1604AD, APF-1602AD, APF-1603AD, APF-1604AD, CAEP-1402...(Other models you can see in the webshop)		

			
1			
GEV No.	700854	Ref. No.	12036924 6033010084
description	hinge camp type TRB/L1 36mm mounting pos. bottom right L 100mm W 48mm H 17mm zinc die cast, chrome-plated hole distance 6.5x51x28mm shaft diameter torx 12x12mmmm		
For models:	ATM-051, ATM-101, ATM-102		

			
1			
GEV No.	700855	Ref. No.	12036932 6033010083
description	hinge camp type TRB/R1 36mm mounting pos. bottom left L 100mm W 48mm H 17mm zinc die cast, chrome-plated hole distance 6.5x51x28mm shaft diameter torx 12x12mmmm		
For models:	AEP-1402, AEP-701, AF-1403-C, AF-1404-C, AF-702-C, AF-702-P, AFN-702, AFP-1402, AFP-1403, AFP-1404, AFP-701, AFP-702, AP-701, APP-701		

			
1			
GEV No.	691089	Ref. No.	12023636 R660534
description	hinge pin		
For models:	ACE-061, ACE-101, ACE-102, ACE-201, ACE-202, ACG-061, ACG-101, ACG-102, ACG-201, ACG-202, AE-061, AE-061W, AE-101, AE-101W, AE-102, AE-102W, AE-201, AE-202, AG-061, AG-061W, AG-101, AG-101W, AG-102, AG-102W, AG-201, AG-202, APE-061, APE-061W, APE-101, APE-101W, APE-102, APE-102W, APE-201, APE-202, APG-061, APG-061W, APG-101, APG-101W, APG-102, APG-102W, APG-201, APG-202, COE-061, COE-101, COE-102, COE-201, COE-202, COG-061, COG-101, COG-102...(Other models you can see in the webshop)		



			
2			
GEV No.	691093	Ref. No.	12018292 R660504
description	hinge pin		
For models:	HCG-10-11, HCG-10-21, HCG-20-11, HCG-2-10-11, HCG-6-11, HME-10-11, HME-10-21, HME-20-11, HME-20-21, HME-2-10-11, HME-6-11, HMG-10-11, HMG-10-11UL, HMG-10-21, HMG-10-21UL, HMG-20-11, HMG-2-10-11, HMG-6-11, HMI-10-11, HMI-10-11UL, HMI-10-21, HMI-10-21UL, HMI-2-10-11, HMI-6-11, HMI-6-11UL, HMM-10-11, HMM-10-11UL, HMM-10-21, HMM-10-21UL, HMM-20-11, HMM-20-11UL, HMM-20-21, HMM-2-10-11, HMM-6-11, HMM-6-11UL, HMP-10-11, HMP-10-21, HMP-20-11, HMP-20-21, HMP-2-10-11, HMP-6-11		

miscellaneous

			
1			
GEV No.	691870	Ref. No.	12036878 A169090001
description	hinge L 130mm W 60mm		
For models:	AEP-1602, AF-1403-C, AF-1403-P, AF-1404-C, AF-1404-P, AF-1604-C, AF-1604-P, AF-2104-C, AF-2104-P, AF-2105-C, AF-2105-P, AF-2106-C, AF-2106-P, AF-702-C, AF-702-P, AF-802-C, AF-802-P, AFN-1404, AFN-702, AFN-802, AFP-1404, AFP-1604, AFP-2104, AFP-2105, AFP-2106, AFP-702, AFP-802, AFP-802-2		

accessories

shafts

			
1			
GEV No.	700818	Ref. No.	12024071 Z400516
description	hinge bolt L 32mm stainless steel D1 ø 7.8mm D2 ø 12mm		
For models:	AD-15, AD-15D, AD-20C-UK, AD-21, AD-21B, AD-21BDD, AD-21C, AD-21D, AD-21DD, AD-21W, AD-45BBT, AD-48, AD-48B, AD-48BDD, AD-48C, AD-48D, AD-48DD, AD-48HY, AD-48W, AD-64, AD-64B, AD-64BBT, AD-64BDD, AD-64BTDD, AD-64C, AD-64CW, AD-64D, AD-64DD, AD-64HY, AD-72, AD-72W, EASY-500, EASY-500B, EASY-500DD, EASY-500HP, EASY-500HPWDD, FI-30, FI-30AR, FI-30AR+DD, FI-30B, FI-30B-BT-UK, FI-30-UK, FI-48, FI-48AR, FI-48B, FI-48B-BT-UK, FI-48C, FI-48D, FI-48HY-CLINIC, FI-48W...(Other models you can see in the webshop)		
spare parts for	700818		
			
GEV No.	505005	Ref. No.	12022324 Z400514
door hinge hinge left mounting pos. left			

			
1			
GEV No.	700817	Ref. No.	12038076 6033090064
description	hinge bolt upper ø 10mm L 30mm IT M6 for refrigerated counters mounting pos. upper		
For models:	AEP-1402, AEP-1602, AEP-2103, AEP-701, AEP-801, AEP-802, AF-1402-MIX, AF-1403-C, AF-1403-P, AF-1404-C, AF-1404-P, AF-1602-MIX, AF-1603-C, AF-1603-P, AF-1604-C, AF-1604-P, AF-2104-C, AF-2104-P, AF-2105-C, AF-2105-P, AF-2106-C, AF-2106-P, AF-702-C, AF-702-P, AF-802-C, AF-802-P, AFN-1402, AFN-1403, AFN-1404, AFN-1602, AFN-1603, AFN-1604, AFN-701, AFN-702, AFN-801, AFN-802, AFP-1402, AFP-1403, AFP-1404, AFP-1602, AFP-1602-2, AFP-1603, AFP-1603-2, AFP-1604, AFP-2103, AFP-2104, AFP-2105, AFP-2106, AFP-701, AFP-702...(Other models you can see in the webshop)		

mounting aids

			
1			
GEV No.	691701	Ref. No.	12002537 U746501
description	mounting aid for hinge		
For models:	CE7-41, CE9-41, CG-1002, CG-1502, CG-2002, CG-2002P, CG-210, CG-210G, CG-310, CG-310G, CG7-11, CG7-41, CG7-61, CG9-11, CG9-41, CG9-51L, CG9-51LC, CG9-51R, CG9-51RC, CG9-61, CG9-82, CGE7-41, CGE9-41, CGF9-121D, CGF9-121I, FTG9-11L, FTG9-11L+R, FTG9-11R, FTGC9-11L, FTGC9-11L+R, FTGC9-11R, HE9-10, HE9-20, HG9-10, HG9-20		

miscellaneous



1			
GEV No.	691092	Ref. No.	12024304 870005941 R660531 R660549
description	guide for hinge		
For models:	COE-061, COE-101, COE-102, COE-201, COE-202, COG-061, COG-101, COG-102, COG-201, COG-202, HCG-10-11, HCG-10-21, HCG-20-11, HCG-20-21, HCG-2-10-11, HCG-2-20-11, HCG-6-11, HEI-10-11, HEI-10-21, HEI-20-11, HEI-20-21, HEI-6-11, HEM-10-11, HEM-10-21, HEM-20-11, HEM-20-21, HEM-6-11, HEP-10-11, HEP-10-21, HEP-20-11, HEP-20-21, HEP-6-11, HGC-10-11, HGC-10-21, HGC-20-11, HGC-20-21, HGC-6-11, HGP-10-21, HGP-20-21, HGV-10-11, HGV-10-21, HGV-20-11, HGV-20-21, HME-10-11, HME-10-21, HME-20-11, HME-20-21, HME-2-10-11, HME-2-20-11, HME-6-11...(Other models you can see in the webshop)		



1			
GEV No.	693570	Ref. No.	12033778 RT29401302
description	sleeve latching		



1			
GEV No.	693571	Ref. No.	12033852 RT29401303
description	spigot latching		

pullouts

drawer slides



1			
GEV No.	696478	Ref. No.	12031241 6033050006
description	drawer slide L 550mm W 17mm H 60mm pair		
For models:	AFP-802, AFP-802-2, AFP-802-2C, AFP-802-3C, MFP-102-2C, MFP-102-4C, MFP-102-R2C-GN, MFP-102-R4C-GN, MFP-135-2C, MFP-135-2C-GN, MFP-135-4C, MFP-135-4C-GN, MFP-135-B, MFP-135-B2-GN, MFP-135-B-GN, MFP-147-2C, MFP-147-4C, MFP-147-6C, MFP-147-R2C-GN, MFP-147-R4C-GN, MFP-147-R6C-GN, MFP-180-2C, MFP-180-2C-GN, MFP-180-4C, MFP-180-4C-GN, MFP-180-6C, MFP-180-6C-GN, MFP-180-B, MFP-180-B2-GN, MFP-180-B-GN, MFP-192-2C, MFP-192-4C, MFP-192-6C, MFP-192-8C, MFP-192-R2C-GN, MFP-192-R4C-GN, MFP-192-R6C-GN, MFP-192-R8C-GN, MFP-225-2C, MFP-225-2C-GN, MFP-225-4C, MFP-225-4C-GN, MFP-225-6C, MFP-225-6C-GN, MFP-225-8C, MFP-225-8C-GN, MFP-225-B, MFP-225-B2-GN, MFP-225-B-GN, MFP-237-10C...(Other models you can see in the webshop)		

rollers

rollers



1			
GEV No.	501343	Ref. No.	12034280 12038133 GQ500214 SPQ510708P
description	roller rollerø 75mm B1 12mm overall width 25mm A 75mm B 12mm C 25mm plastic tread rubber		
For models:	SE-7		

accessories



1			
GEV No.	505252	Ref. No.	12037139 12038096 SPQ56461 SPQ56461P
description	shaft for roller		



fittings for catering equipment

outlet taps

producer-specific

FAGOR



1

GEV No.	514325	Ref. No.	12009231 X036107
description	ball valve connection 1" IT - 1" IT DN25 total length 83mm with lever handle		



1

GEV No.	541595	Ref. No.	12019141 X166134
description	drain pipe L 140mm thread 1" ET		
For models:	FE9-05, FE9-05S, FE9-05USMC, FE9-10, FG9-05, FG9-05S, FG9-10		

aerators and air bleeders



1

GEV No.	540827	Ref. No.	12009434 S022103
description	aerator and air bleeder thread 3/4" ET chrome-plated L 45mm ø 36mm		
For models:	ME7-10BM, ME9-10BM, ME9-10BMS, ME9-10PLUS-BM, ME9-10PLUS-BMS, ME9-15BM, ME9-15BM316, ME9-15BM-AD, ME9-15BMS, ME9-15PLUS-BM, ME9-15PLUS-BMS, MG9-10BM, MG9-10BMAD, MG9-10BMS, MG9-10BMSAD, MG9-10PLUS-BM, MG9-10PLUS-BMS, MG9-15BM, MG9-15BM316, MG9-15BMAD, MG9-15BMS, MG9-15BMSAD, MG9-15PLUS-BM, MG9-15PLUS-BMS, MPE9-10BM, MPE9-10BMS, MPE9-15BM, MPE9-15BMS, MPG9-10BM, MPG9-10BMS, MPG9-15BM, MPG9-15BMS, MV9-10BM, MV9-15BM		



1

GEV No.	540825	Ref. No.	12038036 ICR14945
description	aerator and air bleeder thread 3/8" ET WS 24 chrome-plated L 37mm		

lid hinges

type RUBINETTERIE DEL FRIULI

for circular lids

spare parts



1

GEV No.	540855	Ref. No.	12032821 ICR08052
description	torsion spring ø 50.8mm wire gauge ø 5.1mm L1 34mm L2 104mm L3 29mm mounting pos. left		



1

GEV No.	540854	Ref. No.	12032818 ICR08051
description	torsion spring ø 50.8mm wire gauge ø 5.1mm L1 34mm L2 104mm L3 29mm mounting pos. right		

FIREX

spare parts



1

GEV No.	540855	Ref. No.	12032821 ICR08052
description	torsion spring ø 50.8mm wire gauge ø 5.1mm L1 34mm L2 104mm L3 29mm mounting pos. left		

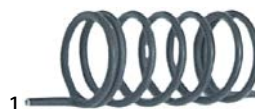

1

GEV No.	540854	Ref. No.	12032818 ICR08051
description	torsion spring ø 50.8mm wire gauge ø 5.1mm L1 34mm L2 104mm L3 29mm mounting pos. right		

ICOS



1

GEV No.	514129	Ref. No.	12029452 ICR16158
description	adjusting bush L 100mm ø 70/60mm		

			
GEV No.	540855	Ref. No.	12032821 ICR08052
description	torsion spring ø 50.8mm wire gauge ø 5.1mm L1 34mm L2 104mm L3 29mm mounting pos. left		

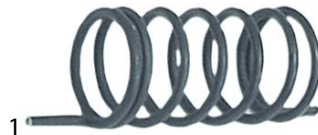
			
GEV No.	540854	Ref. No.	12032818 ICR08051
description	torsion spring ø 50.8mm wire gauge ø 5.1mm L1 34mm L2 104mm L3 29mm mounting pos. right		

			
GEV No.	514346	Ref. No.	12032819 ICR08008
description	torsion spring ø 51.5mm wire gauge ø 4.1mm L1 21mm L2 110mm L3 21mm mounting pos. left		

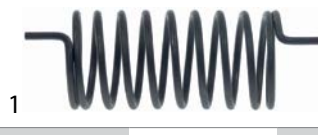
			
GEV No.	514339	Ref. No.	ICR08007
description	torsion spring ø 51.8mm wire gauge ø 4.1mm L1 20mm L2 106mm L3 20mm mounting pos. right		

			
GEV No.	514352	Ref. No.	12032815 12033015 ICR08093 ICRI08093
description	torsion spring ø 51mm wire gauge ø 6.5mm L1 28mm L2 101mm L3 28mm mounting pos. left		

			
GEV No.	514351	Ref. No.	12032816 12033014 ICR08083 ICRI08083
description	torsion spring ø 51mm wire gauge ø 6.5mm L1 28mm L2 101mm L3 28mm mounting pos. right		

			
GEV No.	514350	Ref. No.	12032817 ICR08055
description	torsion spring ø 51mm wire gauge ø 6mm L1 28mm L2 95mm L3 28mm mounting pos. left		

			
GEV No.	514349	Ref. No.	12032814 ICR08054
description	torsion spring ø 51mm wire gauge ø 6mm L1 28mm L2 95mm L3 28mm mounting pos. right		

miscellaneous

spare parts

			
GEV No.	514165	Ref. No.	12009142 S116120
description	adjusting bush for lid hinge		
For models:	ME9-10BM, ME9-10BMS, ME9-15BM, ME9-15BM316, ME9-15BMS, MG9-10, MG-9100, MG9-10BM, MG9-10BMS, MG9-10S, MG9-15, MG-9150, MG-9150BM, MG9-15BM, MG9-15BMS, MG9-15S, MG9-20, MG-9200, MG9-20S, MPE9-10BM, MPE9-10BMS, MPE9-15BM, MPE9-15BMS, MPG9-10, MPG9-10BM, MPG9-10BMS, MPG9-10S, MPG9-15, MPG-9150, MPG9-15BM, MPG9-15BMS, MPG9-15S, MPG9-20, MPG-9200, MPG9-20S, MV9-10BM, MV9-15BM, SBE7-10, SBE9-10, SBE9-10I, SBE9-10IM, SBE9-10IMS, SBE9-10IS, SBE9-10M, SBE9-10MS, SBE9-10S, SBE9-10USMC, SBE9-15IM, SBE9-15IMS, SBE9-15M...(Other models you can see in the webshop)		



1

GEV No.	691727	Ref. No.	12009136 S116118
description	bearing brass H 15mm ID ø 22mm ø 49mm		
For models:	ME9-10BM, ME9-10BMS, ME9-15BM, ME9-15BM316, ME9-15BMS, MG9-10, MG-9100, MG9-10BM, MG9-10BMS, MG9-10S, MG9-15, MG-9150, MG-9150BM, MG9-15BM, MG9-15BM316, MG9-15BMS, MG9-15S, MG9-20, MG-9200, MG9-20S, MPE9-10BM, MPE9-10BMS, MPE9-15BM, MPE9-15BMS, MPG9-10, MPG9-10BM, MPG9-10BMS, MPG9-10S, MPG9-15, MPG-9150, MPG9-15BM, MPG9-15BMS, MPG9-15S, MPG9-20, MPG-9200, MPG9-20S, MV9-10BM, MV9-15BM, SBE7-10, SBE9-10, SBE9-10I, SBE9-10IM, SBE9-10IMS, SBE9-10IS, SBE9-10M, SBE9-10MS, SBE9-10S, SBE9-10USMC, SBE9-15IM, SBE9-15IMS...(Other models you can see in the webshop)		



1

GEV No.	514167	Ref. No.	12008056 S116126
description	bush for lid hinge ID ø 15mm ED ø 20mm H 10mm		
For models:	ME9-10BM, ME9-10BMS, ME9-15BM, ME9-15BM316, ME9-15BMS, MG9-10, MG-9100, MG9-10BM, MG9-10BMS, MG9-10S, MG9-15, MG-9150, MG-9150BM, MG9-15BM, MG9-15BM316, MG9-15BMS, MG9-15S, MG9-20, MG-9200, MG9-20S, MPE9-10BM, MPE9-10BMS, MPE9-15BM, MPE9-15BMS, MPG9-10, MPG9-10BM, MPG9-10BMS, MPG9-10S, MPG9-15, MPG-9150, MPG9-15BM, MPG9-15BMS, MPG9-15S, MPG9-20, MPG-9200, MPG9-20S, MV9-10BM, MV9-15BM, SBE7-10, SBE9-10, SBE9-10I, SBE9-10I-AD, SBE9-10I-AD-S, SBE9-10IM, SBE9-10IMS, SBE9-10IS, SBE9-10M, SBE9-10MS, SBE9-10PLUS-I, SBE9-10PLUS-SI...(Other models you can see in the webshop)		



2

GEV No.	514166	Ref. No.	12008144 S116119
description	bearing for lid hinge		
For models:	ME9-10BM, ME9-10BMS, ME9-15BM, ME9-15BM316, ME9-15BMS, MG9-10, MG-9100, MG9-10BM, MG9-10BMS, MG9-10S, MG9-15, MG-9150, MG-9150BM, MG9-15BM, MG9-15BMS, MG9-15S, MG9-20, MG-9200, MG9-20S, MPE9-10BM, MPE9-10BMS, MPE9-15BM, MPE9-15BMS, MPG9-10, MPG9-10BM, MPG9-10BMS, MPG9-10S, MPG9-15, MPG-9150, MPG9-15BM, MPG9-15BMS, MPG9-15S, MPG9-20, MPG-9200, MPG9-20S, MV9-10BM, MV9-15BM, SBE7-10, SBE9-10, SBE9-10I, SBE9-10IM, SBE9-10IMS, SBE9-10IS, SBE9-10M, SBE9-10MS, SBE9-10S, SBE9-10USMC, SBE9-15IM, SBE9-15IMS, SBE9-15M...(Other models you can see in the webshop)		



1

GEV No.	514162	Ref. No.	12009452 12040017 S036130 S036143
description	lid hinge body		
For models:	ME9-10BM, ME9-10BMS, ME9-15BM, ME9-15BM316, ME9-15BMS, MG9-10, MG9-10BM, MG9-10BMS, MG9-10S, MG9-15, MG9-15BM, MG9-15BMS, MG9-15S, MG9-20, MG9-20S, MPE9-10BM, MPE9-10BMS, MPE9-15BM, MPE9-15BMS, MPG9-10, MPG9-10BM, MPG9-10BMS, MPG9-10S, MPG9-15, MPG9-15BM, MPG9-15BMS, MPG9-15S, MPG9-20, MPG9-20S, MV9-10BM, MV9-15BM		



1

GEV No.	514169	Ref. No.	12038909 12039166 X286102
description	bracket for lid hinge		
For models:	SBE7-10, SBE9-10, SBE9-10I, SBE9-10IM, SBE9-10IMS, SBE9-10IS, SBE9-10M, SBE9-10MS, SBE9-10S, SBE9-10USMC, SBE9-15IM, SBE9-15IMS, SBE9-15M, SBE9-15MS, SBG7-10, SBG9-10, SBG9-10I, SBG9-10IM, SBG9-10IMS, SBG9-10IS, SBG9-10M, SBG9-10MS, SBG9-10S, SBG9-15IM, SBG9-15IMS		



1

GEV No.	514164	Ref. No.	12009439 X156101
description	lid hinge body		
For models:	SBE7-10, SBE9-10, SBE9-10I, SBE9-10IM, SBE9-10IMS, SBE9-10IS, SBE9-10M, SBE9-10MS, SBE9-10S, SBE9-10USMC, SBE9-15IM, SBE9-15IMS, SBE9-15M, SBE9-15MS, SBG7-10, SBG9-10, SBG9-10I, SBG9-10IM, SBG9-10IMS, SBG9-10IS, SBG9-10M, SBG9-10MS, SBG9-10S, SBG9-15IM, SBG9-15IMS		

			
1			
GEV No.	691016	Ref. No.	12009030 S116121
description	torsion spring ø 44mm L 124mm wire gauge ø 5.6mm		
For models:	ME9-10BM, ME9-10BMS, ME9-15BM, ME9-15BM316, ME9-15BMS, MG9-10, MG-9100, MG9-10BM, MG9-10BMS, MG9-10S, MG9-15, MG-9150, MG-9150BM, MG9-15BM, MG9-15BMS, MG9-15S, MG9-20, MG-9200, MG9-20S, MPE9-10BM, MPE9-10BMS, MPE9-15BM, MPE9-15BMS, MPG9-10, MPG9-10BM, MPG9-10BMS, MPG9-10S, MPG9-15, MPG-9150, MPG9-15BM, MPG9-15BMS, MPG9-15S, MPG9-20, MPG-9200, MPG9-20S, MV9-10BM, MV9-15BM, SBE7-10, SBE9-10, SBE9-10I, SBE9-10IM, SBE9-10IMS, SBE9-10IS, SBE9-10M, SBE9-10MS, SBE9-10S, SBE9-10USMC, SBE9-15IM, SBE9-15IMS, SBE9-15M...(Other models you can see in the webshop)		

lid catches

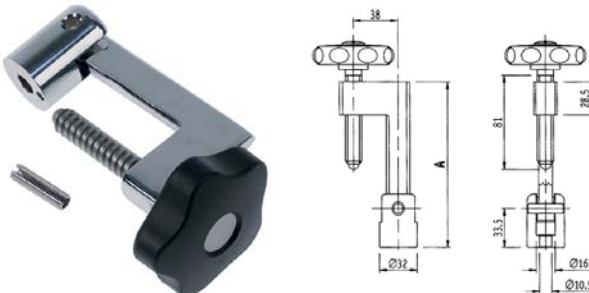
			
1			
GEV No.	514127	Ref. No.	12038051 ICR10030
description	lid lock handle ø 70mm L 143mm		

drain taps



brass





drain taps

			
1			
GEV No.	540132	Ref. No.	12016791 S312100
description	drain tap 1 1/2" IT conical seal kettle A 90mm B 137mm B1 70mm chrome-plated brass		
For models:	ME7-10BM, MG7-10, MG7-10BM		
spare parts for	540132		
	GEV No.	540213	Ref. No. —
	handle ID ø 5mm L 117mm		
	GEV No.	540461	Ref. No. —
	shim for drain tap		
	GEV No.	540464	Ref. No. —
	nut for drain tap thread 1 1/2"		

accessories for	540132		
	GEV No.	510404	Ref. No. —
	flat gasket fibre ED ø 44mm ID ø 34mm thickness 2mm Qty 1 pcs		

			
1			
GEV No.	541673	Ref. No.	12008890 12016692 S312112 S532106
description	drain tap 1 1/2" IT with union nut conical seal		
For models:	ME7-10BM, MG7-10, MG7-10BM, MV7-10BM		
spare parts for	541673		



	GEV No.	540213	Ref. No. —
	handle ID ø 5mm L 117mm		
	GEV No.	540956	Ref. No. —
	gasket for drain tap hose ext. ø 46mm ID ø 38mm H 2mm		

accessories for	541673		
	GEV No.	510404	Ref. No. —
	flat gasket fibre ED ø 44mm ID ø 34mm thickness 2mm Qty 1 pcs		
	GEV No.	890116	Ref. No. —
	fitting grease FERMIT GLISSA tube 60g -20 up to +140°C approval complies with KTW recommendation		
	GEV No.	890118	Ref. No. —
	fitting grease FERMIT GLISSA can 1000g -20 up to +140°C approval complies with KTW recommendation		
	GEV No.	890119	Ref. No. —
	fitting grease FERMIT GLISSA tube 30g -20 up to +140°C approval complies with KTW recommendation		

			
1			
GEV No.	540275	Ref. No.	12026376 ICR10027
description	drain tap 2" IT with union nut A 90mm B 151mm B1 80mm chrome-plated brass		
spare parts for	540275		
	GEV No.	540214	Ref. No. —
	handle ID ø 6mm L 145mm		

Table continues overleaf



accessories for 540275			
	GEV No.	529484	Ref. No. —
flat gasket fibre ED ø 58mm ID ø 50mm thickness 2mm Qty 1 pcs			
	GEV No.	542448	Ref. No. —
gasket silicone 60x49x2 for drain tap 2"			

			
1			
GEV No.	540267	Ref. No.	12016604 12016772 S042107 S112150
description	drain tap connection with union nut thread 2"		
For models:	ME9-10BM, ME9-10BMS, ME9-15BM, ME9-15BM316, ME9-15BMS, MG9-10, MG9-10BM, MG9-10BMS, MG9-10S, MG9-15, MG9-15BM, MG9-15BM316, MG9-15BMS, MG9-15S, MG9-20, MG9-20S, MPE9-10BM, MPE9-10BMS, MPE9-15BM, MPE9-15BMS, MPG9-10, MPG9-10BM, MPG9-10BMS, MPG9-10S, MPG9-15, MPG9-15BM, MPG9-15BMS, MPG9-15S, MPG9-20, MPG9-20S		
spare parts for	540267		
	GEV No.	505517	Ref. No. —
O-ring EPDM thickness 5.34mm ID ø 53.34mm Qty 1 pcs			
	GEV No.	540214	Ref. No. —
handle ID ø 6mm L 145mm			





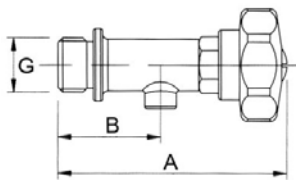

test taps

test taps



			
1			
			
GEV No.	540818	Ref. No.	12009417 12030706 12038031 FX30200050 ICR10044 S102124
description	test tap thread 1/2" ET W 88mm W1 38mm		
For models:	ME7-10BM, ME9-10BM, ME9-10BMS, ME9-15BM, ME9-15BM316, ME9-15BMS, MG7-10BM, MG9-10BM, MG9-10BMS, MG9-15BM, MG9-15BM316, MG9-15BMS, MPE9-10BM, MPE9-10BMS, MPE9-15BM, MPE9-15BMS, MPG9-10BM, MPG9-10BMS, MPG9-15BM, MPG9-15BMS		

safety fittings



safety fittings

			
1			
GEV No.	514276	Ref. No.	12038064 ICR11032
description	safety fitting thread 3/4" 0.45bar H 165mm ø 65mm		
spare parts for	514276		
	GEV No.	514094	Ref. No. —
angle piece thread 3/8"			
	GEV No.	514276	Ref. No. 12038064 ICR11032
safety fitting thread 3/4" 0.45bar H 165mm ø 65mm			
	GEV No.	540825	Ref. No. 12038036 ICR14945
aerator and air bleeder thread 3/8" ET WS 24 chrome-plated L 37mm			
	GEV No.	540828	Ref. No. 12009418 12030738 ICR10023 S022102
manometer siphon thread 3/8"			
	GEV No.	541579	Ref. No. 12038013 ICR10022
manometer ø 52mm pressure range 0 up to 1bar connection marking 0.5 thread 1/4"			

accessories

			
1			
GEV No.	540817	Ref. No.	12028301 ICR10014
description	fitting support thread 1/2" ET suitable for manometer		
			
1			
GEV No.	540832	Ref. No.	12009386 S332100
description	fitting support thread 1/2" ET suitable for manometer		
For models:	ME7-10BM		
accessories for	540832		
	GEV No.	510166	Ref. No. 12019584 Q306049
flat gasket fibre ED ø 31.3mm ID ø 26.3mm thickness 1.2mm Qty 1 pcs			

			
1			
GEV No.	540822	Ref. No.	12009448 S022100
description	fitting support thread 3/4"		
For models:	ME9-10BM, ME9-10BMS, ME9-10PLUS-BM, ME9-10PLUS-BMS, ME9-15BM, ME9-15BM316, ME9-15BM-AD, ME9-15BMS, ME9-15PLUS-BM, ME9-15PLUS-BMS, MG9-10BM, MG9-10BMAD, MG9-10BMS, MG9-10BMSAD, MG9-10PLUS-BM, MG9-10PLUS-BMS, MG9-15BM, MG9-15BM316, MG9-15BMAD, MG9-15BMS, MG9-15BMSAD, MG9-15PLUS-BM, MG9-15PLUS-BMS, MPE9-10BM, MPE9-10BMS, MPE9-15BM, MPE9-15BMS, MPG9-10BM, MPG9-10BMS, MPG9-15BM, MPG9-15BMS, MV9-10BM, MV9-15BM		

			
1			
GEV No.	540835	Ref. No.	ICR10013
description	screw cap thread 3/4"		
spare parts for	540835		
	GEV No.	513016	Ref. No. —
	O-ring EPDM thickness 3.53mm ID ø 26.58mm Qty 1 pcs		
accessories for	540835		
	GEV No.	513016	Ref. No. —
	O-ring EPDM thickness 3.53mm ID ø 26.58mm Qty 1 pcs		

			
1			
GEV No.	540828	Ref. No.	12009418 12030738 ICR10023 S022102
description	manometer siphon thread 3/8"		
For models:	ME9-10BM, ME9-10BMS, ME9-10PLUS-BM, ME9-10PLUS-BMS, ME9-15BM, ME9-15BM316, ME9-15BM-AD, ME9-15BMS, ME9-15PLUS-BM, ME9-15PLUS-BMS, MG9-10BM, MG9-10BMAD, MG9-10BMS, MG9-10BMSAD, MG9-10PLUS-BM, MG9-10PLUS-BMS, MG9-15BM, MG9-15BM316, MG9-15BMAD, MG9-15BMS, MG9-15BMSAD, MG9-15PLUS-BM, MG9-15PLUS-BMS, MPE9-10BM, MPE9-10BMS, MPE9-15BM, MPE9-15BMS, MPG9-10BM, MPG9-10BMS, MPG9-15BM, MPG9-15BMS, MV9-10BM, MV9-15BM		

safety valves			
			
1			
GEV No.	540722	Ref. No.	12040552 ICR10004
description	safety valve with outlet for lid		

equipment feet and end caps

equipment feet			
with screw mounting			
universal			
			
1			
GEV No.	700810	Ref. No.	12036002 6007050015
description	equipment foot tube ø 50mm thread M10 thread L 14mm H 110-140mm SS size 2" Qty 1 pcs		
For models:	BFP-150, BFP-200, BFP-250, BFP-300, FMP-117-R, FMP-150, FMP-169-R, FMP-202, FMP-222-R, FMP-255, FMP-274-R, FMP-307, MCN-102-R, MCN-135, MCN-147-R, MCN-180, MCN-192-R, MCN-225, MCN-237-R, MCN-270, MCP-135, MCP-180, MCP-225, MEP-100, MEP-100G, MEP-135, MEP-180, MFN-102-R, MFN-135, MFN-147-R, MFN-180, MFN-192-R, MFN-225, MFN-237-R, MFN-270, MFP-102-2C, MFP-102-4C, MFP-135, MFP-135-2C, MFP-135-4C, MFP-135-F, MFP-147-2C, MFP-147-4C, MFP-147-6C, MFP-180, MFP-180-2C, MFP-180-4C, MFP-180-6C, MFP-180-F, MFP-192-2C...(Other models you can see in the webshop)		





with fixing plate			
			
GEV No.	701100	Ref. No.	12009104 12033566 6007050017 X260151
description	equipment foot tube ø 64mm plate size 82x82mm hole distance 65x65mm H 135-200mm SS size 2 1/2" Qty 1 pcs		
For models:	AC-120, AC-180, ACE-061, ACE-101, ACE-102, ACG-061, ACG-101, ACG-102, AD-120, AD-120B, AD-120BBTDD-UK, AD-120C, AD-120CW, AD-120HY, AD-125, AD-125HRS, AD-125-SOFT, AD-72, AD-72W, AD-90, AD-90BA, AD-90BBT, AD-90BDD, AD-90DD, ADAEP-1602, ADAEP-801, ADAFN-1602, ADAFN-801, ADAFP-1602, ADAFP-801, ADE-120, ADE-120B, ADMCN-135, ADMCN-180, ADMCN-225, ADMCP-135, ADMCP-180, ADMCP-225, ADMFN-135, ADMFN-180, ADMFN-225, ADMFP-135, ADMFP-135-GR, ADMFP-135HD, ADMFP-135HH, ADMFP-135PC, ADMFP-180, ADMFP-180-GR, ADMFP-180HDD, ADMFP-180HHD...(Other models you can see in the webshop)		

screw-in feet			
			
GEV No.	510115	Ref. No.	12024163 6003010275 Z200107
description	equipment foot thread M10 thread L 40mm ø 30mm H 10mm Qty 1 pcs		
For models:	AD-15, AD-15D, AD-20C-UK, AD-21, AD-21B, AD-21BDD, AD-21C, AD-21D, AD-21DD, AD-21W, AD-45BBT, AD-48, AD-48B, AD-48BDD, AD-48C, AD-48D, AD-48DD, AD-48HY, AD-48W, AD-505, AD-505-SOFT, AD-64, AD-64B, AD-64BBT, AD-64BDD, AD-64BTDD, AD-64C, AD-64CW, AD-64D, AD-64DD, AD-64HY, BG6-05I, BG7-05, BG7-05I, BG7-10, BG7-10I, BG9-05, BG9-05AD, BG9-05I, BG9-05PF, BG9-05PI, BG9-05PLUS-I, BG9-10, BG9-10AD, BG9-10I, BG9-10PF, BG9-10PI, BG9-10PLUS-I, BME6-05, BME7-05...(Other models you can see in the webshop)		

bullet feet			
plastic/SS			
			
GEV No.	700110	Ref. No.	12024301 R675610
description	equipment foot pipe type 40x40 thickness 1-1.2mm H 23-60mm plastic/SS Qty 1 pcs		
For models:	ECO-120, ECO-120B, ECO-160, ECO-1600, ECO-160D, ECO-160I, ECO-200, ECO-200D, ECO-200H, ECO-200HD, ECO-200HI, ECO-200I, ECO-2300, ECO-280D, ECO-280I, ECO-3000, ECO-370D, ECO-370I, ECO-460D, ECO-460I, ECO-550D, ECO-550I, FI-100, FI-100AR, FI-100B, FI-120, FI-120B, FI-120W, FI-160, FI-160D, FI-160I, FI-200, FI-200D, FI-200H, FI-200HD, FI-200HI, FI-200I, FI-200W, FI-2300, FI-280D, FI-280I, FI-3000, FI-370D, FI-370I, FI-460D, FI-460I, FI-550D, FI-550I, FI-80...(Other models you can see in the webshop)		

end caps and plugs			
for circular pipes			
			
GEV No.	698846	Ref. No.	12037989 6003010262
description	plug ø 20.5mm H 23.5mm Qty 1 pcs		
For models:	ADMFCN-135, ADMFCN-180, ADMFCN-225, ADMCP-135, ADMCP-180, ADMCP-225, ADMFN-135, ADMFN-180, ADMFN-225, ADMFP-135, ADMFP-135-GR, ADMFP-135HD, ADMFP-135HH, ADMFP-135PC, ADMFP-180, ADMFP-180-GR, ADMFP-180HDD, ADMFP-180HHD, ADMFP-180HHH, ADMFP-180PC, ADMFP-225, ADMFP-225-GR, ADMFP-225HDD, ADMFP-225HDD, ADMFP-225HHD, ADMFP-225HH-HH, ADMFP-225PC, ATM-051, ATM-051VCH, ATM-051VCH-60Hz, ATM-081VCH, ATM-081VCH-60Hz, ATM-101, ATM-102, BFP-100, BFP-100A, BFP-100I, BFP-150, BFP-150A, BFP-150I, BFP-200, BFP-200A, BFP-200I, BFP-250, BFP-250A, BFP-250I, BFP-300, BFP-300I, CFMP-117-R, CFMP-117-RPC...(Other models you can see in the webshop)		

zamak/SS			
			
GEV No.	700112	Ref. No.	12029781 RT20390111
description	equipment foot pipe type 40x40 thickness 1mm H 33-60mm Zamak/SS Qty 1 pcs		

DERBY RUOTE			
with bolt hole			
stainless steel			
			
GEV No.	700222	Ref. No.	12031557 RT20050500
description	swivel castor ø 125mm bolt hole bolt hole ø 12mm housing SS capacity 100kg bearing ball bearing wheel body polypropylene tread TPE tyres H 159mm wheel width 30mm Qty 1 pcs		

			
1			
GEV No.	700223 ¹	Ref. No.	12030113 RT20050602
description	swivel castor with swivel brake ø 125mm bolt hole bolt hole ø 12mm housing SS capacity 100kg bearing ball bearing wheel body polypropylene tread TPE tyres H 159mm wheel width 30mm Qty 1 pcs		

¹with swivel brake**BLICKLE**

plastic

ø125mm

			
1			
GEV No.	701029	Ref. No.	12028289 RT6060100
description	swivel castor with brake ø 125mm threaded shaft M10 housing plastic H 128mm		

			
1			
GEV No.	700988	Ref. No.	12028422 RT6060101
description	swivel castor without brake ø 125mm threaded shaft M10 housing plastic H 127mm		

bumper angles

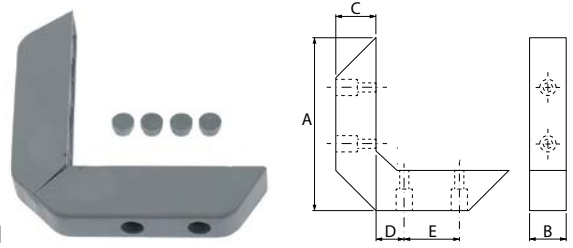
			
1			
GEV No.	691926	Ref. No.	12044928 6003010002
description	bumper angle outer length 152mm inner length 118mm W 35mm H 28mm mounting distance 40mm hole distance 40mm hole ø 7mm plastic grey		

baskets**fryer baskets****FAGOR**

			
1			
GEV No.	691023	Ref. No.	12017424 X316503
description	fryer basket L1 250mm W1 280mm H1 120mm		
For models:	FE-710, FE-720, FG-710, FG-720		

			
1			
GEV No.	970111	Ref. No.	12008702 X316531
description	fryer basket L1 250mm W1 280mm H1 120mm stainless steel		
For models:	FE7-05-1C, FE7-10-2C, FG7-05-1C, FG7-10-2C		

			
1			
GEV No.	970631	Ref. No.	12009361 12017681 X316530 X316532
description	fryer basket L1 255mm W1 135mm H1 120mm L2 230mm H2 185mm H3 225mm chrome-plated steel		
For models:	FE7-05-2C, FE-710, FE7-10-4C, FE-720, FG7-05-2C, FG-710, FG7-104C, FG7-10-4C, FG-720		

			
1			
GEV No.	970251	Ref. No.	12009390 X376503
description	fryer basket L1 255mm W1 285mm H1 100mm		
For models:	FE-8		

1

GEV No.	970359	Ref. No.	FAG6000002
description	fryer basket L1 310mm W1 130mm H1 120mm chrome-plated steel		
accessories for	970359		
	GEV No.	970632	Ref. No. FAG6000013
	crumb screen L 338mm W 134mm H 100mm		



1

GEV No.	970652	Ref. No.	12017089 X066595
description	fryer basket L1 315mm W1 335mm H1 135mm		
For models:	FE9-05, FE9-05S, FE9-10, FE-920, FG9-05, FG9-05S, FG9-10, FG-920, FG-940		



1

GEV No.	970486	Ref. No.	12009368 X166525
description	fryer basket L1 310mm W1 160mm H1 130mm L2 550mm H2 180mm stainless steel		
For models:	FE9-05, FE9-05-2C, FE9-05AD, FE9-05PLUS, FE9-05PLUS-S, FE9-05S, FE9-05S-2C, FE9-05S-AD, FE9-05USMC, FE9-10, FE9-10-4C, FE9-10AD, FE9-10PLUS, FG9-05, FG9-05-2C, FG9-05AD, FG9-05PLUS, FG9-05PLUS-S, FG9-05S, FG9-05S-2C, FG9-05S-AD, FG9-10, FG9-10-4C, FG9-10AD, FG9-10PLUS, FGCL9-05, FGCL9-05-2C, FGCL9-05S-2C		



1

GEV No.	691009	Ref. No.	X066596
description	fryer basket L1 330mm W1 315mm H1 135mm chrome-plated iron		



1

GEV No.	970487	Ref. No.	12009408 X166526
description	fryer basket L1 310mm W1 330mm H1 130mm stainless steel		
For models:	FE9-05, FE9-05-1C, FE9-05-2C, FE9-05S, FE9-05S-1C, FE9-10, FE9-10-2C, FE9-10-4C, FG9-05, FG9-05-1C, FG9-05S, FG9-05S-1C, FG9-10, FG9-10-2C, FGCL9-05-1C, FGCL9-05S-1C		



1

GEV No.	505130	Ref. No.	12017414 X356502
description	fryer basket W1 130mm L1 250mm H1 105mm stainless steel		
For models:	FE-4, FE-8		



1

GEV No.	691020	Ref. No.	X066590
description	fryer basket L1 315mm W1 160mm H1 130mm		



1





GEV No.	505297	Ref. No.	12009365 X356506
description	fryer basket W1 130mm L1 255mm H1 105mm L2 460mm H2 180mm H3 190mm		
For models:	FE-4, FE-8		

			
1			
GEV No.	505131	Ref. No.	12009483 12017105 X399901 X399902
description	fryer basket W1 150mm L1 325mm H1 120mm		
For models:	FE-25		

			
1			
GEV No.	691065	Ref. No.	12009392 12017245 X366502
description	fryer basket W1 220mm L1 250mm H1 100mm stainless steel		
For models:	FE-6		

			
1			
GEV No.	505129	Ref. No.	12017031 X386501
description	fryer basket W1 233mm L1 265mm H1 120mm		
For models:	FE-18		

			
1			
GEV No.	505270	Ref. No.	12009460
description	fryer basket W1 235mm L1 265mm H1 130mm H3 255mm		
For models:	FE-18		

				
1				
GEV No.	691066	Ref. No.	12017178 X376502	
description	fryer basket W1 280mm L1 250mm H1 100mm			
For models:	FE-8			
accessories for	691066			
	GEV No.	560141	Ref. No.	—
	hexagonal nut thread M5 H 5.4mm SS WS 8 Qty 20 pcs DIN/ISO DIN 985 self-locking			
	GEV No.	560271	Ref. No.	—
	raised countersunk head screw thread M5 thread L 14mm SS DIN 966/ISO 7047 Qty 20 pcs intake Phillips sunk head			
	GEV No.	691001	Ref. No.	12021230 9616402
	handle for fryer basket upper			
	GEV No.	691002	Ref. No.	12021134 9616401
	handle for fryer basket lower			

			
1			
GEV No.	691006	Ref. No.	12009617 12017023 X396501 X396503
description	fryer basket W1 330mm L1 320mm H1 125mm stainless steel		
For models:	FE-25		

			
1			
GEV No.	970649	Ref. No.	12009174 X166527
description	basket support for fryer basket		
For models:	FE9-05, FE9-05-1C, FE9-05-2C, FE9-05AD, FE9-05PLUS, FE9-05PLUS-S, FE9-05S, FE9-05S-1C, FE9-05S-2C, FE9-05S-AD, FE9-10, FE9-10-2C, FE9-10-4C, FE9-10AD, FE9-10PLUS, FG9-05, FG9-05-1C, FG9-05-2C, FG9-05AD, FG9-05PLUS, FG9-05PLUS-S, FG9-05S, FG9-05S-1C, FG9-05S-2C, FG9-05S-AD, FG9-10, FG9-10-2C, FG9-10-4C, FG9-10AD, FG9-10PLUS		

			
1			
GEV No.	970634	Ref. No.	12009173 X316501
description	basket support for fryer basket L 300mm H 90mm		
For models:	FE-710, FE-720, FG-710, FG-720		



1 			
GEV No.	691002	Ref. No.	12021134 9616401
description	handle for fryer basket lower		
For models:	FE-18, FE-25, FE-4, FE-6, FE-710, FE-720, FE-8, FE9-05, FE9-05S, FE9-10, FE-920, FG-1-40, FG-2-80, FG-710, FG-720, FG9-05, FG9-05S, FG9-10, FG-920, FG-940		

1 			
GEV No.	691001	Ref. No.	12021230 9616402
description	handle for fryer basket upper		
For models:	FE-18, FE-25, FE-4, FE-6, FE-710, FE-720, FE-8, FE9-05, FE9-05S, FE9-10, FE-920, FG-1-40, FG-2-80, FG-710, FG-720, FG9-05, FG9-05S, FG9-10, FG-920, FG-940		

pasta baskets

FAGOR

1 			
GEV No.	970645	Ref. No.	12008637 H506500
description	pasta basket L1 160mm W1 290mm H1 210mm stainless steel		
For models:	CPE9-05, CPE9-05AD, CPE9-05AD-S, CPE9-05NC, CPE9-05PLUS, CPE9-05PLUS-S, CPE9-05S, CPG9-05, CPG9-05AD, CPG9-05AD-S, CPG9-05NC, CPG9-05PLUS, CPG9-05PLUS-S, CPG9-05S, CPG9-05SNC		

1 			
GEV No.	970646	Ref. No.	12009268 H526501
description	pasta basket L1 170mm W1 115mm H1 265mm stainless steel left		

1 			
GEV No.	970647	Ref. No.	12007730 H526503
description	pasta basket L1 170mm W1 115mm H1 265mm stainless steel right		

1 			
GEV No.	970644	Ref. No.	12009502 H526500
description	pasta basket L1 180mm W1 230mm H1 265mm stainless steel		
For models:	CPE7-05, CPE7-05NC, CPG7-05, CPG7-05NC, EPC-350, GPC-350		

crumb screens

1 			
GEV No.	691007	Ref. No.	12009154 X316502
description	crumb screen L 332mm W 277mm suitable for fryer		
For models:	FG7-05-1C, FG7-05-2C, FG-710, FG7-10-2C, FG7-104C, FG7-10-4C, FG-720		

1 			
GEV No.	505143	Ref. No.	12009165 X186522
description	crumb screen L 365mm W 350mm suitable for fryer		
For models:	FE9-05, FE9-05-1C, FE9-05-2C, FE9-05S, FE9-05S-1C, FE9-05S-2C, FE9-05USMC, FE9-10, FE9-10-2C, FE9-10-4C		



1

GEV No.	691022	Ref. No.	12009175 X166522
description	crumb screen L 392mm W 342mm suitable for fryer		
For models:	FE9-05AD, FE9-05PLUS, FE9-05PLUS-S, FE9-05S-AD, FE9-10AD, FE9-10PLUS, FG9-05, FG9-05-1C, FG9-05-2C, FG9-05AD, FG9-05PLUS, FG9-05PLUS-S, FG9-05S, FG9-05S-1C, FG9-05S-2C, FG9-05S-AD, FG9-10, FG9-10-2C, FG9-10-4C, FG9-10AD, FG9-10PLUS, FGCL9-05, FGCL9-05-1C, FGCL9-05-2C, FGCL9-05S-1C, FGCL9-05S-2C		



1

GEV No.	691021	Ref. No.	12019119 X166503
description	crumb screen L 395mm W 335mm suitable for fryer		
For models:	FE-920, FG-920, FG-940		

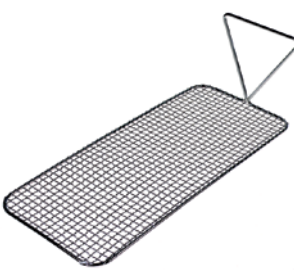

1

GEV No.	970632	Ref. No.	FAG6000013
description	crumb screen L 338mm W 134mm H 100mm		

warewashing baskets

plastic baskets round



1

GEV No.	970648	Ref. No.	12020206 Z605304
description	mix basket ED ø 350mm H 120mm seat ø 280mm		
For models:	LVR-10, LVR-14, LVR-14D		

plastic baskets square

mix baskets



1

GEV No.	971136	Ref. No.	12024550 Z415320
description	mix basket L 352mm W 352mm H 105mm		
For models:	AD-15, AD-15D, CO-350, CO-350-B, CO-350-B-DD, CO-350-COLD, CO-350-COLD-B, CO-350-COLD-B-DD, CO-350-COLD-DD, CO-350-DD, CO-352-COLD, CO-352-COLD-B, CO-352-COLD-B-DD, CO-352-COLD-DD, LVC-12, LVC-15, LVC-15D		



1

GEV No.	976000	Ref. No.	12025069 Z44532
description	mix basket L 395mm W 395mm H 145mm		
For models:	AD-20C-UK, AD-21, AD-21B, AD-21BDD, AD-21C, AD-21D, AD-21DD, AD-21W, CO-400, CO-400-B, CO-400-B-DD, CO-400-COLD, CO-400-COLD-B, CO-400-COLD-B-DD, CO-400-COLD-DD, CO-400-DD, CO-400-SOFT, CO-402-COLD, CO-402-COLD-B, CO-402-COLD-B-DD, CO-402-COLD-DD, CO-402W, LVC-21, LVC-21B, LVC-21C, LVC-21D, LVC-21W		

accessories

cutlery inserts



1

GEV No.	976010	Ref. No.	12025242
description	cutlery insert Lmm Wmm ø 95mm H 105mm plastic		
For models:	AD-15, AD-15D, AD-20C-UK, AD-21, AD-21B, AD-21BDD, AD-21C, AD-21D, AD-21DD, AD-21W, CO-350, CO-350-B, CO-350-B-DD, CO-350-COLD, CO-350-COLD-B, CO-350-COLD-B-DD, CO-350-COLD-DD, CO-350-DD, CO-352-COLD, CO-352-COLD-B, CO-352-COLD-B-DD, CO-352-COLD-DD, CO-400, CO-400-B, CO-400-B-DD, CO-400-COLD, CO-400-COLD-B, CO-400-COLD-B-DD, CO-400-COLD-DD, CO-400-DD, CO-400-SOFT, CO-402-COLD, CO-402-COLD-B, CO-402-COLD-B-DD, CO-402-COLD-DD, CO-402W, LVC-12, LVC-15, LVC-15D, LVC-21, LVC-21B, LVC-21C, LVC-21D, LVC-21W		

sliding corners



1

GEV No.	970001	Ref. No.	12039794 Z855303
description	sliding corner wire gauge ø 5mm L 120mm W 120mm H 12mm L-shape		
For models:	FI-300B, LVC-12, LVC-15		



basket holders



GEV No.	691910	Ref. No.	12000014 12000235 12012770 12038455 12Z7103250 12Z7103770 Z710311
description	basket support L 540mm W 630mm suitable for FI 80 - 120 stainless steel		
For models:	ECO-120, ECO-120B, FI-100, FI-100AR, FI-100B, FI-100BBT-UK, FI-120, FI-120AR+DD, FI-120B, FI-120C, FI-120HY-CLINIC, FI-120W, FI-80, FI-80AR, FI-80BBT-UK, FI-80W, FI-E-100, MF-120		

plate inserts



GEV No.	976005	Ref. No.	12024286 Z605302
description	plate insert L 335mm W 195mm H 105mm plates 10 plastic-coated		
For models:	AD-15, AD-15D, CO-350, CO-350-B, CO-350-B-DD, CO-350-COLD, CO-350-COLD-B, CO-350-COLD-B-DD, CO-350-COLD-DD, CO-350-COLD-DD, CO-352-COLD, CO-352-COLD-B, CO-352-COLD-B-DD, CO-352-COLD-DD, LVC-12, LVC-15, LVC-15D, LVR-14, LVR-14D		

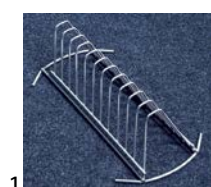

GEV No.	976014	Ref. No.	12025030 Z625302
description	plate insert L 370mm W 195mm H 105mm plates 11 plastic-coated		
For models:	AD-20C-UK, AD-21, AD-21B, AD-21BDD, AD-21C, AD-21D, AD-21DD, AD-21W, CO-400, CO-400-B, CO-400-B-DD, CO-400-COLD, CO-400-COLD-B, CO-400-COLD-B-DD, CO-400-COLD-DD, CO-400-DD, CO-400-SOFT, CO-402-COLD, CO-402-COLD-B, CO-402-COLD-B-DD, CO-402-COLD-DD, CO-402W, LVC-21, LVC-21B, LVC-21C, LVC-21D, LVC-21W, LVR-20, LVR-20B, LVR-20D, MF-21		

shelves and shelf rails

chargrill grids



GEV No.	211047	Ref. No.	12009424 T035464
description	chargrill grid L 580mm W 339mm H 22mm		
For models:	BG7-05, BG7-10		



GEV No.	211046	Ref. No.	12009442 12016227 T055413
description	chargrill grid L 580mm W 410mm H 25mm chargrill		
For models:	BG9-05, BG9-05I, BG9-05PF, BG9-10, BG9-10I, BG9-10PF		

grates

universal

without upstand



GEV No.	698836	Ref. No.	12035781 6027010003
description	grate W 325mm D 530mm GN 1/1 H 10mm plastic-coated steel wire gauge frame 8mm lengthwise wires gauge 3mm crossing wires 2 grey		
For models:	ADMFCN-135, ADMFCN-180, ADMFCN-225, ADMFCP-135, ADMFCP-180, ADMFCP-225, ADMFCN-135, ADMFCN-180, ADMFCN-225, ADMFCP-135, ADMFCP-180, ADMFCP-135-GR, ADMFCP-135HD, ADMFCP-135PC, ADMFCP-180, ADMFCP-180-GR, ADMFCP-180HDD, ADMFCP-180HHD, ADMFCP-180PC, ADMFCP-225, ADMFCP-225-GR, ADMFCP-225HDD, ADMFCP-225HHDD, ADMFCP-225HHHD, ADMFCP-225PC, CMFCN-102-R, CMFCN-135, CMFCN-147-R, CMFCN-180, CMFCN-192-R, CMFCN-225, CMFCN-237-R, CMFCN-270, CMFCP-102-R, CMFCP-135, CMFCP-135-BP, CMFCP-135F, CMFCP-135-GR, CMFCP-135HD, CMFCP-135PC, CMFCP-147-R, CMFCP-180, CMFCP-180-BP, CMFCP-180F, CMFCP-180-GR, CMFCP-180HDD, CMFCP-180HHD, CMFCP-180PC, CMFCP-192-R, CMFCP-225, CMFCP-225-BP...(Other models you can see in the webshop)		



GEV No.	970883	Ref. No.	12034975 6027010079
description	grate W 460mm D 405mm H 10mm plastic-coated steel enamelled wire gauge frame 8mm lengthwise wires gauge 3mm crossing wires 2 grey		
For models:	CFMP-117-R, CFMP-117-RPC, CFMP-150, CFMP-150F, CFMP-150PC, CFMP-150TV, CFMP-169-R, CFMP-169-RPC, CFMP-202, CFMP-202F, CFMP-202PC, CFMP-202TV, CFMP-222-R, CFMP-222-RPC, CFMP-255, CFMP-255F, CFMP-255PC, CFMP-255TV, CFMP-307, CFMP-307F, CFMP-307TV, CMSN-117-R, CMSN-150, CMSN-169-R, CMSN-200, CMSN-222-R, CMSN-250, CMSN-300, CMSP-117-R, CMSP-150, CMSP-150F, CMSP-150HD, CMSP-150PC, CMSP-169-R, CMSP-200, CMSP-200F, CMSP-200HDD, CMSP-200HDD, CMSP-200PC, CMSP-222-R, CMSP-250, CMSP-250F, CMSP-250HDD, CMSP-250HDD, CMSP-250HDD, CMSP-250PC, CMSP-274-R, CMSP-300, CMSP-300F, FMP-117-R...(Other models you can see in the webshop)		



GEV No.	698838	Ref. No.	6027010009
description	grate W 650mm D 530mm GN 2/1 H 10mm wire gauge frame 8mm lengthwise wires gauge 3mm crossing wires 2 grey		
For models:	AEF-801AD, AEF-802AD, AEP-1602, AEP-1602AD, AEP-1603AD, AEP-1604AD, AEP-801, AEP-802, AF-1602-MIX, AF-1603-C, AF-1603-P, AF-1604-C, AF-1604-P, AF-802-C, AF-802-P, AFN-1602, AFN-1603, AFN-1604, AFN-801, AFN-802, AFP-1602, AFP-1602-2, AFP-1603, AFP-1603-2, AFP-1604, AFP-801, AFP-802, AFP-802-2, AFP-802-2C, AFP-802-3C, ANF-1602AD, ANF-1603AD, ANF-1604AD, ANF-801AD, ANF-802AD, APF-1602AD, APF-1603AD, APF-1604AD, APF-801AD, APF-802AD		

producer-specific



GEV No.	698837	Ref. No.	12034317 6027010087
description	grate W 560mm D 540mm H 10mm wire gauge frame 8mm lengthwise wires gauge 3.5mm crossing wires 3 grey		
For models:	AEP-1402, AEP-2103, AEP-701, AF-1402-MIX, AF-1403-C, AF-1403-P, AF-1404-C, AF-1404-P, AF-2104-C, AF-2104-P, AF-2105-C, AF-2105-P, AF-2106-C, AF-2106-P, AF-702-C, AF-702-P, AFN-1402, AFN-1403, AFN-1404, AFN-701, AFN-702, AFP-1402, AFP-1403, AFP-1404, AFP-2103, AFP-2104, AFP-2105, AFP-2106, AFP-701, AFP-702, CAEP-1402, CAEP-2103, CAEP-701, CAF-1402MIX, CAF-1403C, CAF-1403P, CAF-1404C, CAF-1404P, CAF-2104C, CAF-2104P, CAF-2105C, CAF-2105P, CAF-2106C, CAF-2106P, CAF-702C, CAF-702P, CAFN-1402, CAFN-1403, CAFN-1404, CAFN-701...(Other models you can see in the webshop)		



GEV No.	970654	Ref. No.	12009267 U015630 U015631
description	grate GN 1/1 W 325mm D 530mm H 8mm chrome-plated steel oven wire gauge frame 6mm lengthwise wires gauge 3mm crossing wires 1		
For models:	CG-1502, CG-210, CG-210G, CG-310, CG-310G, HCV-10-11, HCV-10-21, HCV-2-10-21, HCV-6-11, HE-10-11, HE-10-21, HE-2-10-11, HE-6-11, HG-10-11, HG-10-21, HG-2-10-11		





GEV No.	970650	Ref. No.	12009338 12040318 U135635 U135642
description	grate W 650mm D 530mm GN 2/1 chrome-plated steel wire gauge frame 8mm lengthwise wires gauge 3mm crossing wires 2		
For models:	CE-410, CE7-41, CE7-41Q, CE9-41, CG-110, CG-2000, CG-2000-2P, CG7-11, CG-7115, CG7-31D, CG7-31I, CG7-41, CG-7415, CG7-41H, CG7-51, CG7-61, CG-7615, CG7-61H, CG9-11, CG-9110, CG9-41, CG9-51L, CG9-51LC, CG9-51R, CG9-51RC, CG9-61, CG9-82, CGE7-154, CGE7-41, CGE7-41H, CGE9-41, CGF9-121D, CGF9-121I, FI-5420, FI-7630, FTG9-11L, FTG9-11L+R, FTG9-11R, FTGC9-11L, FTGC9-11L+R, FTGC9-11R, HCV-10-21, HCV-2-10-21, HE9-10, HE9-20, HG9-10, HG9-20		





GEV No.	970928	Ref. No.	12035775 6027010002
description	grate W 424mm D 450mm H 14mm wire gauge frame 7mm lengthwise wires gauge 3.5mm crossing wires 1 grey		
For models:	FMP-117-R, FMP-150, FMP-169-R, FMP-202, FMP-222-R, FMP-255, FMP-274-R, FMP-307, MSN-117-R, MSN-150, MSN-169-R, MSN-200, MSN-222-R, MSN-250, MSN-274-R, MSN-300, MSP-117-R, MSP-150, MSP-150-2C, MSP-150-F, MSP-169-R, MSP-200, MSP-200-4C, MSP-200-F, MSP-222-R, MSP-250, MSP-250-F, MSP-274-R, MSP-300, MSP-300-F		



			
1			
GEV No.	691858	Ref. No.	12035899 6027010017
description	grate W 430mm D 160mm H 15mm plastic-coated steel refrigeration wire gauge frame 7.4mm lengthwise wires gauge 2.8mm crossing wires 1 grey with holder		
For models:	AEP-1402, AEP-2103, AF-1403-C, AF-1403-P, AF-1404-C, AF-1404-P, AF-2104-C, AF-2104-P, AF-2105-C, AF-2105-P, AF-2106-C, AF-2106-P, AFN-1402, AFN-1403, AFN-1404, AFP-1402, AFP-1403, AFP-1404, AFP-1404-USMC, AFP-2103, AFP-2104, AFP-2105, AFP-2106		

			
1			
GEV No.	970761	Ref. No.	12037978 6027010016
description	grate W 525mm D 565mm plastic-coated steel		
For models:	AEP-1402, AEP-2103, AEP-701, AF-1402-MIX, AF-1403-C, AF-1403-P, AF-1404-C, AF-1404-P, AF-2104-C, AF-2104-P, AF-2105-C, AF-2105-P, AF-2106-C, AF-2106-P, AF-702-C, AF-702-P, AFN-1402, AFN-1403, AFN-1404, AFN-702, AFP-1402, AFP-1403, AFP-1404, AFP-1404-USMC, AFP-2103, AFP-2104, AFP-2105, AFP-2106, AFP-701, AFP-702		

 <p>Image not available</p>			
1			
GEV No.	691859	Ref. No.	12032755 6027010052
description	grate W 826mm D 334mm H 25mm plastic-coated steel refrigeration wire gauge frame 6.5mm lengthwise wires gauge 3.4mm crossing wires 1 grey with hinge camp		
For models:	ERM-250, ERMS-250		

			
1			
GEV No.	970651	Ref. No.	12009381 U065624
description	grate W 855mm D 535mm chrome-plated steel with hinge camp wire gauge frame 8mm lengthwise wires gauge 4mm crossing wires 2		
For models:	CGB7-61, CGB7-61H, CGB7-61R, CGB7-61RH		

grates

			
1			
GEV No.	691713	Ref. No.	12004675 H125404
description	chimney grate L 350mm W 75mm H 100mm SS		
For models:	BG7-05, BG7-05I, CE7-20, CG7-20, CG7-20H, CPE7-05, CPE7-05NC, CPG7-05, CPG7-05NC, EN7-05, FG7-05-1C, FG7-05-2C, FG7-10-2C, FG7-104C, FG7-10-4C, FTE7-05L, FTE7-05R, FTEC7-05L, FTG7-05L, FTG7-05R, FTG7-05VL, FTG7-05VR, FTGC7-05L		

			
1			
GEV No.	691843	Ref. No.	12007683 R205425
description	chimney grate L 425mm W 101mm H 22mm		
For models:	BG9-05, BG9-05AD, BG9-05I, BG9-05PF, BG9-05PI, BG9-05PLUS-I, BG9-10, BG9-10AD, BG9-10I, BG9-10PF, BG9-10PI, BG9-10PLUS-I, BME9-05, BME9-05AD, BME9-05PLUS, BME9-05V-T, BME9-10, BME9-10AD, BME9-10PLUS, BME9-10V-T, BMG9-05, BMG9-05V-T, BMG9-10, BMG9-10V-T, CE9-20, CE9-20AD, CE9-20PLUS, CE9-40, CE9-40AD, CE9-40PLUS, CE9-41, CE9-41AD, CE9-41PLUS, CG9-05AD, CG9-05PLUS, CG9-10, CG9-10AD, CG9-10PLUS, CG9-11, CG9-11AD, CG9-11PLUS, CG9-20, CG9-20AD, CG9-20AD-H, CG9-20H, CG9-20PLUS, CG9-20PLUS-H, CG9-31PLUS-D, CG9-31PLUS-I, CG9-40...(Other models you can see in the webshop)		

			
1			
GEV No.	691720	Ref. No.	12005077 S565401
description	chimney grate L 700mm W 75mm H 90mm SS		
For models:	BG7-10, BG7-10I, CE7-40, CE7-41, CG7-10, CG7-11, CG7-30D, CG7-30I, CG7-31D, CG7-31I, CG7-40, CG7-40H, CG7-41, CG7-41H, CGE7-41, CGE7-41H, EN7-10, FTE7-10L, FTE7-10L+R, FTE7-10R, FTEC7-10L, FTG7-10L, FTG7-10L+R, FTG7-10R, FTG7-10VL, FTG7-10VL+R, FTG7-10VR, FTGC7-10L, ME7-10BM, MG7-10, MG7-10BM, MV7-10BM, SBE7-10, SBG7-10		

grid attachments



1

GEV No.	691906	Ref. No.	12011674 R662670
description	rack support mounting pos. left L 380mm H 400mm stainless steel suitable for 6/11		
For models:	HCG-6-11, HME-6-11, HMI-6-11, HMI-6-11UL, HMM-6-11, HMM-6-11UL, HMP-6-11		



1

GEV No.	691918	Ref. No.	12012088 T122616
description	rack support mounting pos. left L 585mm H 635mm W 40mm stainless steel suitable for 10/21		
For models:	HCG-10-21, HME-10-21, HMI-10-21, HMM-10-21, HMP-10-21, HVG-10-21		



1

GEV No.	691909	Ref. No.	12012692 12022802 R662645
description	rack support mounting pos. left L 380mm H 400mm stainless steel suitable for HEI 6/11 HMI 6/11		
For models:	COE-061, COG-061, HCG-6-11, HEI-6-11, HEM-6-11, HEP-6-11, HGC-6-11, HME-6-11, HMG-6-11, HMI-6-11, HMI-6-11UL, HMM-10-11, HMM-10-11UL, HMM-6-11, HMM-6-11UL, HMP-6-11, VE-061, VPE-061		



1

GEV No.	691907	Ref. No.	12013088 R662668
description	rack support mounting pos. right L 380mm H 400mm stainless steel suitable for 6/11		
For models:	HCG-6-11, HME-6-11, HMI-6-11, HMI-6-11UL, HMM-6-11, HMM-6-11UL, HMP-6-11		



1

GEV No.	691921	Ref. No.	12012184 R672646 T112617
description	rack support mounting pos. left L 380mm H 635mm W 40mm stainless steel suitable for 10/11		
For models:	HCG-10-11, HME-10-11, HMG-10-11, HMI-10-11, HMI-10-11UL, HMM-10-11, HMM-10-11UL, HMP-10-11, HVG-10-11, HVG-10-11UL, HVG-2-10-11, MFHVG-10-11		





1

GEV No.	691908	Ref. No.	12014126 12022801 R662646
description	rack support mounting pos. right L 380mm H 400mm stainless steel suitable for HEI 6/11 HMI 6/11		
For models:	COE-061, COG-061, HCG-6-11, HEI-6-11, HEM-6-11, HEP-6-11, HGC-6-11, HME-6-11, HMG-6-11, HMI-6-11, HMI-6-11UL, HMM-10-11, HMM-10-11UL, HMM-6-11, HMM-6-11UL, HMP-6-11, VE-061, VPE-061		



			
1			
GEV No.	691920	Ref. No.	12012759 R672645 T112615
description	rack support mounting pos. right L 380mm H 635mm W 40mm stainless steel suitable for 10/11		
For models:	HCG-10-11, HME-10-11, HMG-10-11, HMI-10-11, HMI-10-11UL, HMM-10-11, HMM-10-11UL, HMP-10-11, HVG-10-11, HVG-10-11UL, HVG-2-10-11, MFHVG-10-11		

			
1			
GEV No.	691919	Ref. No.	12011984 T122614
description	rack support mounting pos. right L 585mm H 635mm W 40mm stainless steel suitable for 10/21		
For models:	HCG-10-21, HME-10-21, HMI-10-21, HMM-10-21, HMP-10-21, HVG-10-21		

			
1			
GEV No.	700837	Ref. No.	12022577 R672668
description	guide L-shape L 390mm W 24mm H 114mm mounting pos. left		

			
1			
GEV No.	700838	Ref. No.	12022578 R672669
description	guide L-shape L 390mm W 24mm H 114mm mounting pos. right		

			
1			
GEV No.	692123	Ref. No.	12036419 12037055 6003001006 6033050014
description	guide L-shape L 648mm W 15mm H 23mm mounting pos. left/right		
For models:	CMMZ-150, CMMZ-202, CMPN-117-R, CMPN-150, CMPN-169-R, CMPN-202, CMPN-222-R, CMPN-255, CMPP-117-R, CMPP-150, CMPP-150-C, CMPP-169-R, CMPP-202, CMPP-202-C, CMPP-222-R, CMPP-255, CMPP-255-C, CMPP-307, MMZ-150, MMZ-202, MPN-117-R, MPN-150, MPN-169-R, MPN-202, MPN-222-R, MPN-255, MPN-274-R, MPN-307, MPP-117-R, MPP-117-R-G, MPP-150, MPP-150-G, MPP-169-R, MPP-169-R-G, MPP-202, MPP-202-G, MPP-222-R, MPP-222-R-G, MPP-255, MPP-255-G, MPP-274-R, MPP-274-R-G, MPP-307, MPP-307-G, MPP-307-R, MPZ-150, MPZ-202		

shelf rails and supports

producer-specific

			
1			
GEV No.	701568	Ref. No.	12037936 6033050015
description	guide L 562mm W 16mm H 25.5mm mounting pos. left/right		
For models:	ADAEP-1602, ADAFN-1602, ADAFP-1602, AEP-1602AD, AEP-1603AD, AEP-1604AD, AF-1403-C, AF-1404-C, AF-1603-C, AF-1604-C, AF-2104-C, AF-2105-C, AF-2106-C, AF-702-C, AFP-702, ANF-1602AD, ANF-1603AD, ANF-1604AD, APF-1602AD, APF-1603AD, APF-1604AD, CAF-1403C, CAF-1404C, CAF-2104P, CAF-2105P, CAF-2106P, CAF-702C, CMFN-102-R, CMFN-135, CMFN-147-R, CMFN-180, CMFN-192-R, CMFN-225, CMFN-237-R, CMFN-270, CMFP-102-R, CMFP-135, CMFP-135-BP, CMFP-135F, CMFP-135-GR, CMFP-135HD, CMFP-135PC, CMFP-147-R, CMFP-180, CMFP-180-BP, CMFP-180F, CMFP-180-GR, CMFP-180HDD, CMFP-180HHD, CMFP-180PC...(Other models you can see in the webshop)		

			
1			
GEV No.	692110	Ref. No.	12036758 12036819 12037054 6009990002 6009990037 6033050011
description	guide U-shape L 549mm W 15mm H 22mm mounting pos. left/right		
For models:	MCN-102-GN-R, MCN-135-GN, MCN-147-GN-R, MCN-180-GN, MCN-192-GN-R, MCN-225-GN, MCN-237-GN-R, MCN-270-GN, MCP-102-GN-R, MCP-135-GN, MCP-147-GN-R, MCP-180-GN, MCP-192-GN-R, MCP-225-GN, MCP-237-GN-R, MCP-270-GN, MEP-100, MEP-100G, MEP-135, MEP-180, MFN-102-GN-R, MFN-102-R, MFN-135, MFN-135-GN, MFN-147-GN-R, MFN-147-R, MFN-180, MFN-180-GN, MFN-192-GN-R, MFN-192-R, MFN-225, MFN-225-GN, MFN-237-GN-R, MFN-237-R, MFN-270, MFN-270-GN, MFP-102-2C, MFP-102-GN-R, MFP-135, MFP-135-2C, MFP-135-F, MFP-135-GN, MFP-147-2C, MFP-147-4C, MFP-147-GN-R, MFP-180, MFP-180-2C, MFP-180-4C, MFP-180-F, MFP-180-GN...(Other models you can see in the webshop)		

			
1			
GEV No.	700884	Ref. No.	12036565 12036836 12037948 6009990004 6009990064 6033050016
description	guide U-shape L 662mm W 15mm mounting pos. left/right inner height 22mm		
For models:	AEP-1602, AEP-1603, AEP-1604, AEP-801, AEP-802, AF-1602-MIX, AF-1603-C, AF-1603-P, AF-1604-C, AF-1604-P, AF-802-C, AF-802-P, AFN-1602, AFN-1603, AFN-1604, AFN-801, AFN-802, AFP-1602, AFP-1602-2, AFP-1603, AFP-1603-2, AFP-1604, AFP-801, AFP-802, AFP-802-2, AFP-802-2C, AFP-802-3C, CAEP-1602, CAEP-801, CAEP-802, CAF-1602MIX, CAF-1603-C, CAF-1603-P, CAF-1604-C, CAF-1604-P, CAF-802-C, CAF-802-P, CAFN-1602, CAFN-1603, CAFN-1604, CAFN-801, CAFN-802, CAFP-1602, CAFP-1602-2, CAFP-1603, CAFP-1603-2, CAFP-1604, CAFP-801, CAFP-802, CAFP-802-2...(Other models you can see in the webshop)		

			
1			
GEV No.	692663	Ref. No.	6033050025
description	pair of setting bar L 662mm W 15mm H 24mm mounting pos. left/right		

			
1			
GEV No.	692662	Ref. No.	6033050028
description	pair of setting bar L 549mm W 15mm H 24mm mounting pos. left/right		

			
1			
GEV No.	700815	Ref. No.	12037855 12090875 2021500320 6003010124
description	shelf support for grate L 26mm W 20mm H 23mm plastic for fridge		
For models:	BFP-100, BFP-100A, BFP-100I, BFP-150, BFP-150A, BFP-150I, BFP-200, BFP-200A, BFP-200I, BFP-250, BFP-250A, BFP-250I, BFP-300, BFP-300I		

			
1			
GEV No.	692660	Ref. No.	6033050027
description	pair of setting bar L 562mm W 15mm mounting pos. left/right mounting distance 525mm hook width 12mm inner height 24mm		

			
1			
GEV No.	691887	Ref. No.	12021988 Z712509
description	shelf support L 28mm W 20mm H 15mm SS		
For models:	ECO-120, ECO-120B, FI-100, FI-100AR, FI-100B, FI-120, FI-120B, FI-120W, FI-80, FI-80W, MF-120		

			
1			
GEV No.	692661	Ref. No.	6033050029
description	pair of setting bar L 613mm W 15mm H 24mm mounting pos. left/right		

			
1			
GEV No.	698843	Ref. No.	6033210019
description	shelf support L 42mm W 22mm H 27mm		



gaskets

refrigeration gaskets

plug-in gaskets

profile 9013

We offer custom-made gaskets for this profile

GEV No.	901764	Ref. No.	12034906
description	refrigeration gasket profile 9013 W 1503mm L 685mm plug size		

GEV No.	900902	Ref. No.	12035763 6045010020
description	refrigeration gasket profile 9013 W 155mm L 375mm plug size		

GEV No.	900910	Ref. No.	12035439 12035723 6001401119 6045010024
description	refrigeration gasket profile 9013 W 155mm L 450mm plug size		
For models:	MSN-117-R, MSN-150, MSN-169-R, MSN-200, MSN-222-R, MSN-250, MSN-274-R, MSN-300, MSP-117-R, MSP-150, MSP-150-F, MSP-169-R, MSP-200, MSP-200-F, MSP-222-R, MSP-250, MSP-250-F, MSP-274-R, MSP-300		

GEV No.	901529	Ref. No.	12036161 6045010122
description	refrigeration gasket profile 9013 W 245mm L 370mm plug size		
For models:	CMFP-135HD, CMFP-135HH, CMFP-180HDD, CMFP-180HHD, CMFP-180HHH, CMFP-225HDDD, CMFP-225HHDD, CMFP-225HHHD, CMFP-225HHHH, MFP-102-R2C-GN, MFP-102-R4C-GN, MFP-135-2C-GN, MFP-135-4C-GN, MFP-147-R2C-GN, MFP-147-R4C-GN, MFP-147-R6C-GN, MFP-180-2C-GN, MFP-180-4C-GN, MFP-180-6C-GN, MFP-192-R2C-GN, MFP-192-R4C-GN, MFP-192-R6C-GN, MFP-192-R8C-GN, MFP-225-2C-GN, MFP-225-4C-GN, MFP-225-6C-GN, MFP-225-8C-GN, MFP-237-R2C-GN, MFP-237-R6C-GN, MFP-237-R8C-GN, MFP-270-10C-GN, MFP-270-2C-GN, MFP-270-4C-GN, MFP-270-6C-GN, MFP-270-8C-GN		

GEV No.	900880	Ref. No.	12034834 12036435 6001401107 6045010012
description	refrigeration gasket profile 9013 W 255mm L 375mm plug size		
For models:	MCN-102-GN-R, MCN-135-GN, MCN-147-GN-R, MCN-180-GN, MCN-192-GN-R, MCN-225-GN, MCN-237-GN-R, MCN-270-GN, MCP-102-GN-R, MCP-135-GN, MCP-147-GN-R, MCP-180-GN, MCP-192-GN-R, MCP-225-GN, MCP-237-GN-R, MCP-270-GN, MFN-102-GN-R, MFN-135-GN, MFN-147-GN-R, MFN-180-GN, MFN-192-GN-R, MFN-225-GN, MFN-237-GN-R, MFN-270-GN, MFP-102-GN-R, MFP-135-2C, MFP-135-4C, MFP-135-GN, MFP-147-GN-R, MFP-180-2C, MFP-180-4C, MFP-180-6C, MFP-180-GN, MFP-192-2C, MFP-192-4C, MFP-192-6C, MFP-192-8C, MFP-192-GN-R, MFP-225-2C, MFP-225-4C, MFP-225-6C, MFP-225-8C, MFP-225-GN, MFP-237-10C, MFP-237-4C, MFP-237-6C, MFP-237-8C, MFP-237-GN-R, MFP-270-10C, MFP-270-2C...(Other models you can see in the webshop)		

GEV No.	900911	Ref. No.	12035440 12035441 6001401102 6045010007
description	refrigeration gasket profile 9013 W 380mm L 400mm plug size		
For models:	MEP-100, MEP-100G		

GEV No.	901180	Ref. No.	12035974 6001401101 6045010006
description	refrigeration gasket profile 9013 W 380mm L 585mm plug size		
For models:	MCN-102-GN-R, MCN-102-R, MCN-135, MCN-135-GN, MCN-147-GN-R, MCN-147-R, MCN-180, MCN-180-GN, MCN-192-GN-R, MCN-192-R, MCN-225, MCN-225-GN, MCN-237-GN-R, MCN-237-R, MCN-270, MCN-270-GN, MCP-102-GN-R, MCP-135, MCP-135-GN, MCP-147-GN-R, MCP-180, MCP-180-GN, MCP-192-GN-R, MCP-225, MCP-225-GN, MCP-237-GN-R, MCP-270-GN, MEP-135, MEP-180, MFN-102-GN-R, MFN-102-R, MFN-135, MFN-135-GN, MFN-147-GN-R, MFN-147-R, MFN-180, MFN-180-GN, MFN-192-GN-R, MFN-192-R, MFN-225, MFN-225-GN, MFN-237-GN-R, MFN-237-R, MFN-270, MFN-270-GN, MFP-102-2C, MFP-102-GN-R, MFP-135, MFP-135-2C, MFP-135-F...(Other models you can see in the webshop)		

GEV No.	901765	Ref. No.	12036345
description	refrigeration gasket profile 9013 W 450mm L 260mm plug size		

GEV No.	900893	Ref. No.	12034290 12035834 6001401104 6045010009
description	refrigeration gasket profile 9013 W 450mm L 580mm plug size		

For models: MMZ-150, MMZ-202, MPN-117-C, MPN-117-R, MPN-117-R-C, MPN-150, MPN-150-C, MPN-169-C, MPN-169-R, MPN-169-R-C, MPN-202, MPN-202-C, MPN-222-C, MPN-222-R, MPN-222-R-C, MPN-255, MPN-255-C, MPN-274-C, MPN-274-R, MPN-274-R-C, MPN-307, MPN-307-C, MPP-117-C, MPP-117-C-G, MPP-117-R, MPP-117-R-C, MPP-117-R-G, MPP-150, MPP-150-C, MPP-150-C-G, MPP-150-G, MPP-169-C, MPP-169-C-G, MPP-169-R, MPP-169-R-C, MPP-169-R-G, MPP-202, MPP-202-C, MPP-202-C-G, MPP-202-G, MPP-222-C, MPP-222-C-G, MPP-222-R, MPP-222-R-C, MPP-222-R-G, MPP-255, MPP-255-C, MPP-255-C-G, MPP-255-G, MPP-274-C...(Other models you can see in the webshop)

GEV No.	900907	Ref. No.	12034473 12035547 6001401113 6045010018
description	refrigeration gasket profile 9013 W 455mm L 770mm plug size		
For models:	FMP-117-R, FMP-150, FMP-169-R, FMP-200, FMP-202, FMP-222-R, FMP-250, FMP-255, FMP-274-R, FMP-300, FMP-307		

GEV No.	900903	Ref. No.	12033951 12035400 6001401108 6045010013
description	refrigeration gasket profile 9013 W 615mm L 710mm plug size		

For models: AEP-1602, AEP-802, AF-1403-C, AF-1403-P, AF-1404-C, AF-1404-P, AF-1603-C, AF-1603-P, AF-1604-C, AF-1604-P, AF-2104-C, AF-2104-P, AF-2105-C, AF-2105-P, AF-2106-C, AF-2106-P, AF-702-C, AF-702-P, AF-802-P, AFN-1402, AFN-1403, AFN-1404, AFN-1603, AFN-1604, AFN-702, AFN-802, AFP-1403, AFP-1403-C, AFP-1403-FORZ, AFP-1403-P, AFP-1404, AFP-1404-C, AFP-1404-FORZ, AFP-1404-P, AFP-1404-USMC, AFP-1603, AFP-1603-2, AFP-1604, AFP-2104, AFP-2104-C, AFP-2104-P, AFP-2105, AFP-2105-C, AFP-2105-P, AFP-2106, AFP-2106-C, AFP-2106-P, AFP-702, AFP-702-C, AFP-702-FORZ...(Other models you can see in the webshop)

GEV No.	900028	Ref. No.	12034015 12034625 6010220002 6045010002
description	refrigeration gasket profile 9013 W 618mm L 1500mm plug size door		

description refrigeration gasket profile 9013 W 618mm L 1500mm plug size door

GEV No.	901580	Ref. No.	12035207
description	refrigeration gasket profile 9013 W 618mm L 722mm plug size with magnet		

description refrigeration gasket profile 9013 W 618mm L 722mm plug size with magnet

GEV No.	900906	Ref. No.	12034170 12034292 6001401111 6045010016
description	refrigeration gasket profile 9013 W 683mm L 1501mm plug size		

For models: AP-701, APP-701



GEV No.	902028	Ref. No.	N/A
description	refrigeration gasket profile 9013 Wmm L 2500mm		

profile 9797

We offer custom-made gaskets for this profile

GEV No.	901763	Ref. No.	12038148 6045010131
description	refrigeration gasket profile 9797 W 1435mm L 615mm plug size		

For models:	AEP-1402, AEP-1602, AEP-2103, AEP-701, AEP-801, AF-1402-MIX, AF-1403-C, AF-1403-P, AF-1602-MIX, AF-1603-C, AF-1603-P, AF-1604-C, AF-1604-P, AF-2104-C, AF-2104-P, AF-2105-C, AF-2105-P, AFN-1402, AFN-1403, AFN-1602, AFN-1603, AFN-1604, AFN-701, AFN-801, AFP-1402, AFP-1403, AFP-1602, AFP-1602-2, AFP-1603, AFP-1603-2, AFP-1604, AFP-2103, AFP-2104, AFP-2105, AFP-701, AFP-801, CAEP-1402, CAEP-1602, CAEP-2103, CAEP-701, CAEP-801, CAF-1402MIXT, CAF-1403C, CAF-1403P, CAF-1602MIX, CAF-1603-C, CAF-1603-P, CAF-2104C, CAF-2104P, CAF-2105C...(Other models you can see in the webshop)		
--------------------	---	--	--

GEV No.	901759	Ref. No.	12034580 12057676 6045010050
description	refrigeration gasket profile 9797 W 1680mm L 580mm plug size		

For models:	CMFN-102-R, CMFN-135, CMFN-147-R, CMFN-180, CMFN-192-R, CMFN-225, CMFN-237-R, CMFN-270, CMFP-102-R, CMFP-135, CMFP-135F, CMFP-135-GR, CMFP-135HD, CMFP-135PC, CMFP-147-R, CMFP-180, CMFP-180F, CMFP-180-GR, CMFP-180HDD, CMFP-180HHD, CMFP-180PC, CMFP-192-R, CMFP-225, CMFP-225F, CMFP-225-GR, CMFP-225HDDD, CMFP-225HHDD, CMFP-225HHHD, CMFP-225PC, CMFP-237-R, CMFP-270, CMMZ-180-7, CMMZ-225-7, CMPZ1-135, CMPZ1-180, MCN-135-GN, MCN-180-GN, MCN-270-GN, MCP-135-GN, MCP-147-GN-R, MCP-180-GN, MCP-192-GN-R, MCP-225-GN, MCP-237-GN-R, MCP-270-GN, MEP-135, MEP-135-GN, MEP-180, MEP-180-GN, MFN-135...(Other models you can see in the webshop)		
--------------------	---	--	--

GEV No.	901181	Ref. No.	12036036 12036158 6045010120 6045010152
description	refrigeration gasket profile 9797 W 350mm L 370mm plug size		

For models:	CMFP-135-B, CMFP-135-B2, CMFP-135-BP, CMFP-180-B, CMFP-180-B2, CMFP-180-BP, CMFP-225-B, CMFP-225-B2, CMFP-225-BP, CMFP-270-B, CMFP-270-B2, CMFP-270-BP, MEP-100, MEP-100G, MFP-102-R2C-GN, MFP-102-R4C-GN, MFP-135-2C-GN, MFP-135-4C-GN, MFP-135-B, MFP-135-B2-GN, MFP-135-B-GN, MFP-135-BP-GN, MFP-147-R2C-GN, MFP-147-R4C-GN, MFP-147-R6C-GN, MFP-180-2C-GN, MFP-180-4C-GN, MFP-180-6C-GN, MFP-180-B, MFP-180-B2-GN, MFP-180-B-GN, MFP-180-BP-GN, MFP-192-R2C-GN, MFP-192-R4C-GN, MFP-192-R6C-GN, MFP-192-R8C-GN, MFP-225-2C-GN, MFP-225-4C-GN, MFP-225-6C-GN, MFP-225-8C-GN, MFP-225-B, MFP-225-B2-GN, MFP-225-B-GN, MFP-225-BP-GN, MFP-237-R2C-GN, MFP-237-R6C-GN, MFP-237-R8C-GN, MFP-270-10C-GN, MFP-270-2C-GN, MFP-270-4C-GN...(Other models you can see in the webshop)		
--------------------	---	--	--

GEV No.	901164	Ref. No.	12038156 6045010119
description	refrigeration gasket profile 9797 W 365mm L 560mm plug size		

For models:	CMFN-102-R, CMFN-135, CMFN-147-R, CMFN-180, CMFN-192-R, CMFN-225, CMFN-237-R, CMFN-270, CMFP-102-R, CMFP-135, CMFP-135F, CMFP-135-GR, CMFP-135HD, CMFP-135PC, CMFP-147-R, CMFP-180, CMFP-180F, CMFP-180-GR, CMFP-180HDD, CMFP-180HHD, CMFP-180PC, CMFP-192-R, CMFP-225, CMFP-225F, CMFP-225-GR, CMFP-225HDDD, CMFP-225HHDD, CMFP-225HHHD, CMFP-225PC, CMFP-237-R, CMFP-270, CMMZ-180-7, CMMZ-225-7, CMPZ1-135, CMPZ1-180, MCN-135-GN, MCN-180-GN, MCN-270-GN, MCP-135-GN, MCP-147-GN-R, MCP-180-GN, MCP-192-GN-R, MCP-225-GN, MCP-237-GN-R, MCP-270-GN, MEP-135, MEP-135-GN, MEP-180, MEP-180-GN, MFN-135...(Other models you can see in the webshop)		
--------------------	---	--	--

GEV No.	902188	Ref. No.	12068575 6045010158
description	refrigeration gasket profile 9797 W 370mm L 548mm plug size Qty 1		
For models:	ADM-CN-135, ADM-CN-180, ADM-CN-225, ADMCP-135, ADMCP-180, ADMCP-225, ADMFN-135, ADMFN-180, ADMFN-225, ADMFP-135, ADMFP-135-GR, ADMFP-135HD, ADMFP-135PC, ADMFP-180, ADMFP-180-GR, ADMFP-180HDD, ADMFP-180HHD, ADMFP-180PC, ADMFP-225, ADMFP-225-GR, ADMFP-225HDD, ADMFP-225HHD, ADMFP-225HHHD, ADMFP-225PC, MCP-135-AD, MCP-180-AD, MCP-225-AD, MFP-135-AD, MFP-135-AD-2C, MFP-135-AD-PC, MFP-180-AD, MFP-180-AD-2C, MFP-180-AD-4C, MFP-180-AD-PC, MFP-225-AD, MFP-225-AD-2C, MFP-225-AD-4C, MFP-225-AD-6C, MFP-225-AD-PC, MFPG-135-AD, MFPG-180-AD, MFPG-225-AD		

GEV No.	901754	Ref. No.	12035142 6045010124
description	refrigeration gasket profile 9797 W 440mm L 755mm plug size		
For models:	CFMP-117-R, CFMP-117-RPC, CFMP-150, CFMP-150F, CFMP-150PC, CFMP-150TV, CFMP-169-R, CFMP-169-RPC, CFMP-202, CFMP-202F, CFMP-202PC, CFMP-202TV, CFMP-222-R, CFMP-222-RPC, CFMP-255, CFMP-255F, CFMP-255PC, CFMP-255TV, CFMP-307, CFMP-307F, CFMP-307TV, FMP-117-R, FMP-150, FMP-150-TV, FMP-169-R, FMP-200, FMP-202, FMP-202-TV, FMP-222-R, FMP-250, FMP-255, FMP-255-TV, FMP-274-R, FMP-300, FMP-307, FMP-307-TV		

GEV No.	900904	Ref. No.	12034291
description	refrigeration gasket profile 9797 W 380mm L 585mm plug size		

GEV No.	901751	Ref. No.	12035824 6045010118
description	refrigeration gasket profile 9797 W 445mm L 246mm plug size		
For models:	CMSP-150HD, CMSP-150HH, CMSP-200HDD, CMSP-200HHD, CMSP-200HHH, CMSP-250HDD, CMSP-250HHD, CMSP-250HHH, CMSP-250HHH, MSP-117-2RC, MSP-117-4RC, MSP-117-R2C, MSP-117-R4C, MSP-150-2C, MSP-150-4C, MSP-169-R2C, MSP-169-R4C, MSP-169-R6C, MSP-200-2C, MSP-200-4C, MSP-200-6C, MSP-222-R2C, MSP-222-R4C, MSP-222-R6C, MSP-222-R8C, MSP-250-2C, MSP-250-4C, MSP-250-6C, MSP-250-8C, MSP-274-R10C, MSP-274-R6C, MSP-300-10C, MSP-300-2C, MSP-300-4C, MSP-300-8C		

GEV No.	901530	Ref. No.	12035412 6045010115
description	refrigeration gasket profile 9797 W 440mm L 560mm plug size		
For models:	CMMZ-150, CMMZ-202, CMPN-117-R, CMPN-150, CMPN-169-R, CMPN-202, CMPN-222-R, CMPN-255, CMPP-117-R, CMPP-150, CMPP-150-C, CMPP-169-R, CMPP-202, CMPP-202-C, CMPP-222-R, CMPP-255, CMPP-255-C, CMPP-307, CMSN-117-R, CMSN-150, CMSN-169-R, CMSN-200, CMSN-222-R, CMSN-250, CMSN-300, CMSP-117-R, CMSP-150, CMSP-150F, CMSP-150HD, CMSP-150PC, CMSP-169-R, CMSP-200, CMSP-200F, CMSP-200HDD, CMSP-200HHD, CMSP-200PC, CMSP-222-R, CMSP-250, CMSP-250F, CMSP-250HDD, CMSP-250HHD, CMSP-250HHH, CMSP-250PC, CMSP-274-R, CMSP-300, CMSP-300F, MMZ-150, MMZ-202, MPN-117-R, MPN-150...(Other models you can see in the webshop)		

GEV No.	901753	Ref. No.	12047040 6045010154
description	refrigeration gasket profile 9797 W 565mm L 440mm plug size		
For models:	ATM-051ECO, ATM-051VCH, ATM-051VCH-60Hz		

GEV No.	900905	Ref. No.	12032337 12033379 12034384 12034419 6001401109 6045010014 6045010026 6045010030
description	refrigeration gasket profile 9797 W 610mm L 1500mm plug size L1 1520mm W1 630mm external size		
For models:	AEP-1402, AEP-1602, AEP-2103, AEP-701, AEP-801, AF-1402-MIX, AF-1403-C, AF-1403-P, AF-1404-C, AF-1404-P, AF-1602-MIX, AF-1603-C, AF-1603-P, AF-1604-C, AF-1604-P, AF-2104-C, AF-2104-P, AF-2105-C, AF-2105-P, AF-2106-C, AF-2106-P, AFN-1402, AFN-1403, AFN-1602, AFN-1603, AFN-701, AFN-801, AFP-1402, AFP-1402-FORZ, AFP-1402-MIX, AFP-1403, AFP-1403-C, AFP-1403-FORZ, AFP-1403-P, AFP-1602, AFP-1602-2, AFP-1603, AFP-1603-2, AFP-2103, AFP-2104, AFP-2104-C, AFP-2104-P, AFP-2105, AFP-2105-C, AFP-2105-P, AFP-701, AFP-801, AP-701, APP-701		

GEV No.	901601	Ref. No.	12038144 12092626 2021700092 6045010132
description	refrigeration gasket profile 9797 W 615mm L 670mm plug size		
For models:	AEP-1602, AEP-802, AF-1403-C, AF-1403-P, AF-1404-C, AF-1404-P, AF-1603-C, AF-1603-P, AF-1604-C, AF-1604-P, AF-2104-C, AF-2104-P, AF-2105-C, AF-2105-P, AF-2106-C, AF-2106-P, AF-702-C, AF-702-P, AF-802-C, AF-802-P, AFN-1403, AFN-1404, AFN-1602, AFN-1603, AFN-1604, AFN-702, AFN-802, AFP-1403, AFP-1404, AFP-1602, AFP-1603, AFP-1603-2, AFP-1604, AFP-2104, AFP-2105, AFP-2106, AFP-702, AFP-802, AFP-802-2, AFP-802-2C, AFP-802-3C, CAEP-802, CAF-1403C, CAF-1403P, CAF-1404C, CAF-1404P, CAF-1603-C, CAF-1603-P, CAF-1604-C, CAF-1604-P...(Other models you can see in the webshop)		

GEV No.	901802	Ref. No.	12033677 12034720 6001401001 6045010001
description	refrigeration gasket profile 9797 W 720mm L 620mm plug size		
For models:	AEP-1403, AEP-1404, AEP-1603, AEP-1604, AEP-702, AEP-802		

GEV No.	901760	Ref. No.	12034676 6045010054
description	refrigeration gasket profile 9797 W 805mm L 460mm plug size		

profile 9333

We offer custom-made gaskets for this profile

GEV No.	902167	Ref. No.	N/A
description	refrigeration gasket profile 9333 Wmm L 2500mm		

profile 9373

We offer custom-made gaskets for this profile

GEV No.	902163	Ref. No.	N/A
description	refrigeration gasket profile 9373 Wmm L 2500mm plug size		

screw-in gaskets

profile 9106

We offer custom-made gaskets for this profile

GEV No.	902262	Ref. No.	N/A
description	refrigeration gasket profile 9106 Wmm L 2500mm		

profile 9170

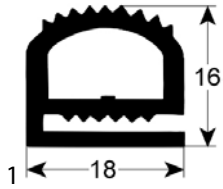

GEV No.	901293	Ref. No.	12030627 6045050004
description	refrigeration gasket profile 9170 W 605mm L 1295mm external size		

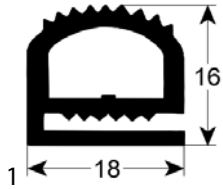

GEV No.	902139	Ref. No.	12029402 6045050008
description	refrigeration gasket profile 9170 W 630mm L 1233mm external size		
For models:	CCF-20, CCF-20CI, CCF-40, CCF-40CI		

gaskets for heated units

window seals



GEV No.	691056	Ref. No.	12039758 3712700
description	window gasket		

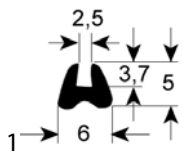

GEV No.	691068	Ref. No.	11000170 3713800
description	window gasket profile 1505 L 1300mm suitable for FAGOR Qty 1		
For models:	HCG-20-11, HMG-20-11		

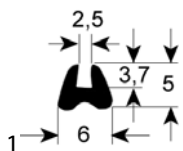

GEV No.	691041	Ref. No.	R660501
description	window gasket profile 1505 L 1700mm suitable for FAGOR Qty 1		



GEV No.	691042	Ref. No.	R670528
description	window gasket profile 1505 L 2800mm suitable for FAGOR Qty 1		

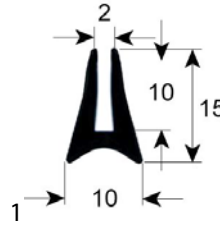

GEV No.	900835	Ref. No.	11000086 3715200
description	window gasket profile 1605 Qty supplied by meter		

For models: COE-061, COE-101, COE-102, COE-201, COE-202, COG-061, COG-101, COG-102, COG-201, COG-202, HCG-10-11, HCG-10-21, HCG-20-11, HCG-20-21, HCG-2-10-11, HCG-2-20-11, HCG-6-11, HEI-10-11, HEI-10-21, HEI-20-11, HEI-20-21, HEI-6-11, HEM-10-11, HEM-10-21, HEM-20-11, HEM-20-21, HEM-6-11, HEP-10-11, HEP-10-21, HEP-20-11, HEP-20-21, HEP-6-11, HGC-10-11, HGC-10-21, HGC-20-11, HGC-20-21, HGC-6-11, HGP-10-21, HGP-20-21, HGV-10-11, HGV-10-21, HGV-20-11, HGV-20-21, HME-10-11, HME-10-21, HME-20-11, HME-20-21, HME-2-10-11, HME-2-20-11, HME-6-11...(Other models you can see in the webshop)

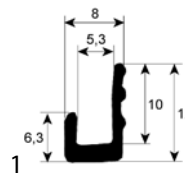

GEV No.	691038	Ref. No.	11000173 R660500
description	window gasket profile 1905 L 2500mm Qty 1		

For models: HCG-6-11, HME-6-11, HMG-6-11, HMI-6-11, HMI-6-11UL, HMM-6-11, HMM-6-11UL, HMP-6-11





GEV No.	691096	Ref. No.	R670529
description	window gasket profile 1905 L 3000mm suitable for FAGOR Qty 1 mounting pos. inner		



GEV No.	691040	Ref. No.	R680515
description	window gasket profile 1905 L 4000mm Qty 1		



1 			
GEV No.	691061	Ref. No.	R090515
description	window gasket profile 1905 L 4100mm suitable for FAGOR Qty 1 mounting pos. inner		

 Image not available 1			
GEV No.	691063	Ref. No.	R140508
description	window gasket profile 1905 L 4600mm suitable for FAGOR Qty 1 mounting pos. inner		

door seals

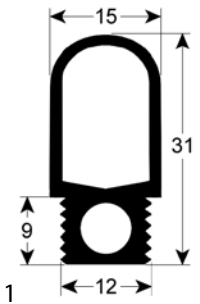
 1			
GEV No.	901706	Ref. No.	12024276 T490500
description	door seal profile 2048 W 675mm L 1450mm external size		
For models:	COE-202, COG-202, HEI-20-21, HEM-20-21, HEP-20-21, HGC-20-21, HGP-20-21, HGV-20-21, VE-202, VG-202, VPE-202, VPG-202		

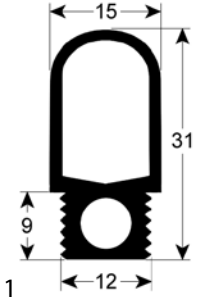
 1			
GEV No.	901707	Ref. No.	12023944 T300500
description	door seal profile 2048 W 675mm L 775mm external size		
For models:	COE-102, COG-102, HEI-10-21, HEM-10-21, HEP-10-21, HGC-10-21, HGP-10-21, HGV-10-21, VE-102, VG-102, VPE-102, VPG-102		

 1			
GEV No.	691035	Ref. No.	12024187 R660503
description	door seal profile 2270 W 465mm L 650mm external size Qty 1		
For models:	COE-061, COG-061, HCG-6-11, HEI-6-11, HEM-6-11, HEP-6-11, HGC-6-11, HME-6-11, HMG-6-11, HMI-6-11, HMI-6-11UL, HMM-6-11, HMM-6-11UL, HMP-6-11, VE-061, VPE-061		

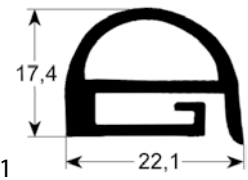
 1			
GEV No.	691055	Ref. No.	12007972 R090510
description	door seal profile 2270 W 650mm L 1300mm external size Qty 1		
For models:	COE-201, COG-201, HCG-20-11, HEI-20-11, HEM-20-11, HEP-20-11, HGC-20-11, HGV-20-11, HME-20-11, HMG-20-11, HMM-20-11, HMM-20-11UL, HMP-20-11, HVG-20-11, MFHMM-20-11, VE-201, VG-201, VPE-201, VPG-201		

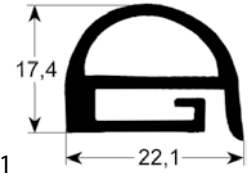
 1			
GEV No.	691036	Ref. No.	12024186 R670500
description	door seal profile 2270 W 650mm L 705mm external size Qty 1		
For models:	COE-101, COG-101, HCG-10-11, HEI-10-11, HEM-10-11, HEP-10-11, HGC-10-11, HGV-10-11, HME-10-11, HMG-10-11, HMG-10-11UL, HMI-10-11, HMI-10-11UL, HMM-10-11, HMM-10-11UL, HMP-10-11, HVG-10-11, HVG-10-11UL, HVG-2-10-11, MFHVG-10-11, VE-101, VG-101, VPE-101, VPG-101		

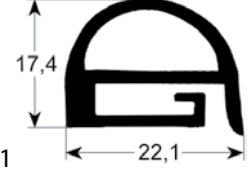
 1			
GEV No.	691062	Ref. No.	12017241 R140506
description	door seal profile 2270 W 775mm L 1300mm external size Qty 1		
For models:	HCG-20-21, HCG-2-20-11, HME-20-21, HME-2-20-11, HMM-20-21, HMM-20-21UL, HMM-2-20-11, HMM-40-11-USMC, HMP-20-21, HMP-2-20-11, HVG-20-21, HVG-2-20-21		

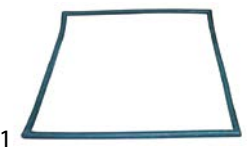
 1			
GEV No.	691069	Ref. No.	12017439 R680500
description	door seal profile 2270 W 775mm L 705mm external size Qty 1		
For models:	HCG-10-11, HCG-10-21, HCG-2-10-11, HME-10-21, HME-2-10-11, HMG-10-11, HMG-10-21, HMG-10-21UL, HMG-2-10-11, HMI-10-21, HMI-10-21UL, HMI-2-10-11, HMM-10-21, HMM-10-21UL, HMM-2-10-11, HMP-10-21, HMP-2-10-11, HVG-10-21, HVG-10-21UL, MFH-VG-10-21		

GEV No.	902219	Ref. No.	12028909 RT51051020
description	door seal profile 2730 W 465mm L 520mm external size Qty 1		

GEV No.	902248	Ref. No.	12038090 RT2000399P
description	door seal profile 2730 W 675mm L 1475mm suitable for RATIONAL for model SCC/CM202 outer plug size		

GEV No.	902246	Ref. No.	12028517 RT2000398P
description	door seal profile 2730 W 470mm L 1475mm suitable for RATIONAL for model SCC/CM201 outer plug size Qty 1		

GEV No.	902197	Ref. No.	12041578
description	door seal profile 2730 W 675mm L 775mm		
For models:	ACE-102, ACG-102, AE-102, AE-102W, AG-102, AG-102W, APE-102, APE-102W, APG-102, APG-102W		

GEV No.	902221	Ref. No.	12029172 12029261 RT2000394 RT2000394P
description	door seal profile 2730 W 470mm L 500mm suitable for RATIONAL for model SCC/CM 61 outer plug size Qty 1		

GEV No.	900292	Ref. No.	RT51051022
description	door seal profile 2730 W 685mm L 780mm outer plug size		

GEV No.	902247	Ref. No.	12028537 RT51051021
description	door seal profile 2730 W 470mm L 785mm suitable for RATIONAL for model CPC 101 outer plug size Qty 1		

GEV No.	902220	Ref. No.	12028287 RT51051022P
description	door seal profile 2730 W 685mm L 780mm suitable for RATIONAL for model SCC/CM102 edition since 11/2011 outer plug size		

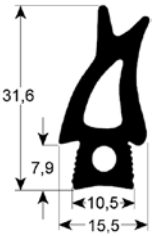

 <p>Image not available</p>			
GEV No.	902222	Ref. No.	12028152 12028843 RT2000396 RT2000396P
description	door seal profile 2731 W 470mm L 760mm suitable for RATIONAL for model SCC/CM 101 edition since 05/2011 outer plug size		

			
GEV No.	902480	Ref. No.	12039475 T800550000
description	door seal profile 2732 W 460mm L 770mm outer plug size for combi-steamer suitable for FAGOR		
For models:	ACE-101, ACG-101, AE-101, AE-101W, AG-101, AG-101W, APE-101, APE-101W, APG-101, APG-101W		

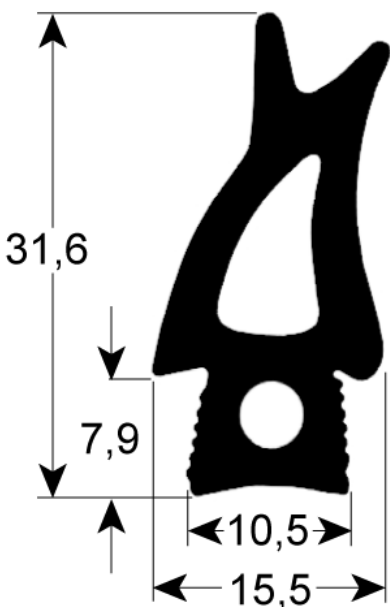
			
GEV No.	902555	Ref. No.	12041134 T740563000
description	door seal profile 2732 W 470mm L 1150mm outer plug size Qty 1 suitable for FAGOR		
For models:	ACE-201, ACG-201, AE-201, AG-201, APE-201, APG-201		

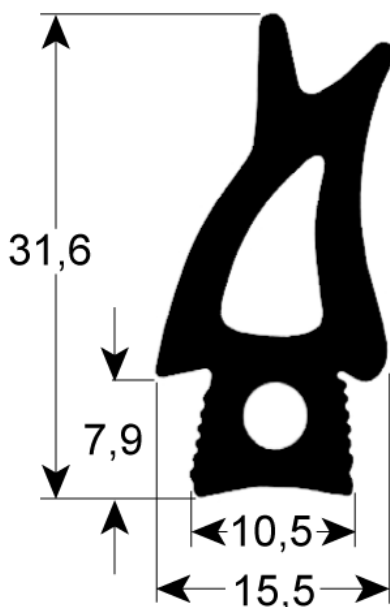
			
GEV No.	902554	Ref. No.	12039599 T910550000
description	door seal profile 2732 W 470mm L 500mm Qty 1 for model outer plug size suitable for FAGOR		
For models:	ACE-061, ACG-061, AE-061, AE-061W, AG-061, AG-061W, APE-061, APE-061W, APG-061, APG-061W		

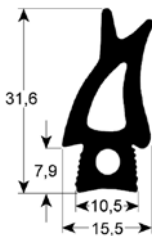
			
GEV No.	902223	Ref. No.	12027994 RT51051023
description	door seal profile 2732 W 485mm L 1495mm external size Qty 1		

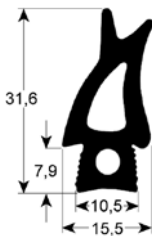
			
GEV No.	902250	Ref. No.	12027846 RT51051024
description	door seal profile 2732 W 680mm L 1495mm suitable for RATIONAL for model CPC 202 outer plug size		

GEV No.	902249	Ref. No.	12029014 RT2000397P
description	door seal profile 2733 W 675mm L 760mm suitable for RATIONAL for model SCC/CM102 edition since 05/2011 outer plug size		

GEV No.	902060	Ref. No.	12009413
description	door seal W 10mm L 1650mm Qty 1		
For models:	CGB7-61, CGB7-61H, CGB7-61R, CGB7-61RH		

door seals with fixing hook

GEV No.	691027	Ref. No.	12020663 U745626
description	door seal W 500mm long side open with 4 mounting clips H 290mm		
For models:	CE7-41, CE9-41, CG-1002, CG-1502, CG-2002, CG-210, CG-210G, CG-310, CG-310G, CG7-11, CG7-41, CG7-61, CG9-11, CG9-41, CG9-51L, CG9-51LC, CG9-51R, CG9-51RC, CG9-61, CG9-82, CGE7-160, CGE7-41, CGE9-41, FTG9-11L, FTG9-11L+R, FTG9-11R, FTGC9-11L, FTGC9-11L+R, FTGC9-11R, HE9-10, HE9-20, HG9-10, HG9-20		

GEV No.	901705	Ref. No.	12008213
description	door seal W 520mm with 4 mounting clips H 300mm		
For models:	CE7-41, CE9-41, CG-1002, CG-1502, CG-2002, CG-2002P, CG-210, CG-210G, CG-310, CG-310G, CG7-11, CG7-31D, CG7-31I, CG7-41, CG7-41H, CG7-51, CG7-61, CG7-61H, CG9-11, CG9-41, CG9-41H, CG9-51L, CG9-51LC, CG9-51R, CG9-51RC, CG9-61, CG9-61H, CG9-82, CGE7-41, CGE7-41H, CGE9-11, CGE9-41, CGF9-121D, CGF9-121I, FTG9-11L, FTG9-11L+R, FTG9-11R, FTGC9-11L, FTGC9-11L+R, FTGC9-11R, HE9-10, HE9-20, HG9-10, HG9-20		

GEV No.	901429	Ref. No.	12009146 U105605
description	door seal W 900mm with 6 mounting clips H 340mm long side open		
For models:	CG9-61OP, HG9-15		

gaskets for tray rack trolleys

GEV No.	902440	Ref. No.	12007990
description	tray rack trolley gasket L 705mm suitable for FAGOR Qty 1		

GEV No.	902229	Ref. No.	12031433 RT51051025
description	tray rack trolley gasket profile 4090 L 615mm Qty 1		

GEV No.	902230	Ref. No.	12030369 RT51051026
description	tray rack trolley gasket profile 4090 L 820mm Qty 1		

GEV No.	902231	Ref. No.	12031375 RT2400187
description	tray rack trolley gasket profile 4095 L 575mm Qty 1		



GEV No.	902232	Ref. No.	12028867 RT2400194
description	tray rack trolley gasket profile 4095 L 780mm Qty 1		

GEV No.	902553	Ref. No.	12041088 T740562000
description	tray rack trolley gasket profile 4160 L 510mm suitable for FAGOR Qty 1		
For models:	ACE-201, ACG-201, AE-201, AG-201, APE-201, APG-201		

gaskets for control panels

GEV No.	900575	Ref. No.	12032981 RT1600387
description	gasket for control panel		

GEV No.	901454	Ref. No.	12034523 RT51001011
description	gasket for control panel L 2000mm foam rubber self-adhesive		

boiling pan gaskets

GEV No.	900514	Ref. No.	12026686 ICRE30100030
description	boiling pan gasket profile 3020 L 3200mm		

GEV No.	900908	Ref. No.	12009435
description	lid gasket ED ø 65mm		
For models:	MPE9-10BM, MPE9-10BMS, MPE9-15BM, MPE9-15BMS, MPG9-10, MPG9-10BM, MPG9-10BMS, MPG9-10S, MPG9-15, MPG9-15BM, MPG9-15BMS, MPG9-15S, MPG9-20, MPG9-20S		

O-rings

EPDM

GEV No.	529545	Ref. No.	12009911 Q307056
description	O-ring EPDM thickness 1.78mm ID ø 10.82mm Qty 1 pcs		
For models:	AD-15, AD-15D, AD-20C-UK, AD-21, AD-21B, AD-21BDD, AD-21C, AD-21D, AD-21DD, AD-21W, CO-350, CO-350-B, CO-350-B-DD, CO-350-COLD, CO-350-COLD-B, CO-350-COLD-B-DD, CO-350-COLD-DD, CO-350-DD, CO-352-COLD, CO-352-COLD-B, CO-352-COLD-B-DD, CO-352-COLD-DD, CO-400, CO-400-B, CO-400-B-DD, CO-400-COLD, CO-400-COLD-B, CO-400-COLD-B-DD, CO-400-COLD-DD, CO-400-DD, CO-400-SOFT, CO-402-COLD, CO-402-COLD-B, CO-402-COLD-B-DD, CO-402-COLD-DD, CO-402W, LVC-12, LVC-15, LVC-15D, LVC-21, LVC-21B, LVC-21C, LVC-21D, LVC-21W, MF-21		

GEV No.	505045	Ref. No.	12009912 Q307036
description	O-ring EPDM thickness 1.78mm ID ø 5.28mm Qty 1 pcs		
For models:	AD-15, AD-15D, AD-90, AD-90BA, AD-90BDD, AD-90DD, COG-202, EASY-500, EASY-500B, EASY-500DD, EASY-500HP, EASY-500HPWBDD, FI-30, FI-30AR, FI-30AR+DD, FI-30B, FI-30B-BT-UK, FI-30-UK, FI-48, FI-48AR, FI-48B, FI-48B-BT-UK, FI-48C, FI-48D, FI-48HY-CLINIC, FI-48W, FI-60DD, FI-80, FI-80AR, FI-80W, FI-E-100, HGC-20-21, HGP-10-21, HGP-20-21, HGV-20-21, LABP-800, LF-13MPP, LF-18MPP, LF-25MPP, LF-8MPP, LVC-12, LVC-15, LVC-15D, LVC-21, LVC-21B, LVC-21D, LVC-21W, LVR-10, LVR-14, LVR-20...(Other models you can see in the webshop)		

GEV No.	532731	Ref. No.	12037437 RT50120565
description	O-ring EPDM thickness 2.5mm ID ø 115mm Qty 5 pcs suitable for combi-steamer CPC-Linie		



GEV No.	529412	Ref. No.	12009873 Q307003
description	O-ring EPDM thickness 2.62mm ID \varnothing 107.8mm Qty 1 pcs		
For models:	AD-120, AD-120B, AD-120BBTDD-UK, AD-120C, AD-120CW, AD-120HY, AD-15, AD-15D, AD-20C-UK, AD-21, AD-21B, AD-21BDD, AD-21C, AD-21D, AD-21DD, AD-21W, AD-45BBT, AD-48, AD-48B, AD-48BDD, AD-48C, AD-48D, AD-48DD, AD-48HY, AD-48W, AD-64, AD-64B, AD-64BBT, AD-64BDD, AD-64BTDD, AD-64C, AD-64CW, AD-64D, AD-64DD, AD-64HY, AD-72, AD-72W, AD-90, AD-90BA, AD-90BBT, AD-90BDD, AD-90DD, ADE-120, ADE-120B, CO-350, CO-350-B, CO-350-B-DD, CO-350-COLD, CO-350-COLD-B, CO-350-COLD-B-DD... (Other models you can see in the webshop)		

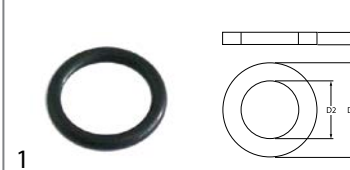

GEV No.	507313	Ref. No.	12009837 Q307050
description	O-ring EPDM thickness 2.62mm ID \varnothing 139.5mm Qty 1 pcs		
For models:	AD-120, AD-120B, AD-120BBTDD-UK, AD-120C, AD-120CW, AD-120HY, AD-45BBT, AD-48, AD-48B, AD-48BDD, AD-48C, AD-48D, AD-48DD, AD-48HY, AD-48W, AD-64, AD-64B, AD-64BBT, AD-64BDD, AD-64BTDD, AD-64C, AD-64CW, AD-64D, AD-64DD, AD-64HY, AD-72, AD-72W, AD-90, AD-90BA, AD-90BBT, AD-90BDD, AD-90DD, ADE-120, ADE-120B, BME7-05, BME7-10, BME9-05, BME9-10, BMG7-10, BMG9-05, BMG9-10, EASY-500, EASY-500B, EASY-500DD, EASY-500HP, EASY-500HPWDD, ECO-120, ECO-120B, FI-100, FI-100AR... (Other models you can see in the webshop)		

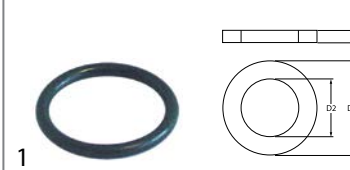

GEV No.	505073	Ref. No.	12010282 Q307041
description	O-ring EPDM thickness 2.62mm ID \varnothing 206.3mm Qty 1 pcs		
For models:	AD-15, AD-15D, AD-20C-UK, AD-21, AD-21B, AD-21BDD, AD-21C, AD-21D, AD-21W, CG-1002, CG-1502, CG-2000, CG-2000-2P, CG-2002, CG-2002P, CG9-11, CG9-11AD, CG9-11PLUS, CG9-31PLUS-D, CG9-31PLUS-I, CG9-41, CG9-41AD, CG9-41AD-H, CG9-41H, CG9-41PLUS, CG9-41PLUS-H, CG9-51L, CG9-51LC, CG9-51R, CG9-51RC, CG9-61, CG9-61AD, CG9-61AD-H, CG9-61H, CG9-61OP, CG9-61PLUS, CG9-61PLUS-H, CG9-82, CG9-82AD, CG9-82PLUS, CGF9-121D, CGF9-121D-AD, CGF9-121I, CGF9-121PLUS-D, CGF9-121PLUS-I, FF-35, FI-5420, FI-7630, FTG9-11L, FTG9-11L+R... (Other models you can see in the webshop)		

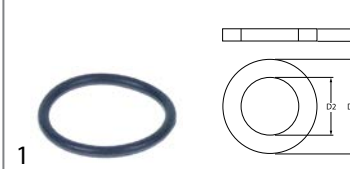

GEV No.	532499	Ref. No.	12010230 Q307062
description	O-ring EPDM thickness 2.62mm ID \varnothing 234.7mm Qty 1 pcs		
For models:	ECO-160, ECO-160D, ECO-160I, ECO-200, ECO-200D, ECO-200H, ECO-200HD, ECO-200HI, ECO-200I, FI-160, FI-160AR, FI-160D, FI-160I, FI-200, FI-200AR, FI-200D, FI-200H, FI-200HD, FI-200HI, FI-200I, FI-200W, FI-200WL, FI-200WR		

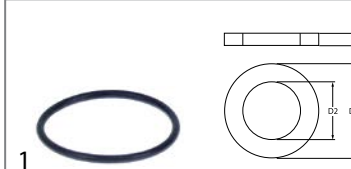

GEV No.	532494	Ref. No.	12010165 Q307051 Q307061
description	O-ring EPDM thickness 2.62mm ID \varnothing 36.14mm Qty 1 pcs		
For models:	AD-120, AD-120B, AD-120BBTDD-UK, AD-120C, AD-120CW, AD-120HY, AD-45BBT, AD-48, AD-48B, AD-48BDD, AD-48C, AD-48D, AD-48DD, AD-48HY, AD-48W, AD-64, AD-64B, AD-64BBT, AD-64BDD, AD-64BTDD, AD-64C, AD-64CW, AD-64D, AD-64DD, AD-64HY, AD-72, AD-72W, AD-90, AD-90BA, AD-90BBT, AD-90BDD, AD-90DD, ADE-120, ADE-120B, EASY-500, EASY-500B, EASY-500DD, EASY-500HP, ECO-120, ECO-120B, ECO-160, ECO-160D, ECO-160I, ECO-200, ECO-200D, ECO-200H, ECO-200HD, ECO-200HI, ECO-200I, ECO-2700D... (Other models you can see in the webshop)		



GEV No.	532546	Ref. No.	12010184 Q307064
description	O-ring EPDM thickness 2.62mm ID \varnothing 52.07mm Qty 1 pcs		
For models:	ECO-280D, ECO-280I, ECO-370D, ECO-370I, ECO-460D, ECO-460I, ECO-550D, ECO-550I, FI-280D, FI-280I, FI-370D, FI-370I, FI-460D, FI-460I, FI-550D, FI-550I		

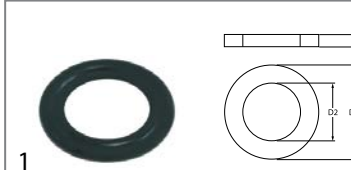

GEV No.	532102	Ref. No.	12010234 Q307063
description	O-ring EPDM thickness 3.53mm ID \varnothing 12.29mm Qty 10 pcs		
For models:	ECO-160, ECO-160D, ECO-160I, ECO-200, ECO-200D, ECO-200H, ECO-200HD, ECO-200HI, ECO-200I, ECO-2700D, ECO-2700I, ECO-280D, ECO-280I, ECO-370D, ECO-370I, ECO-4000D, ECO-4000I, ECO-460D, ECO-460I, ECO-550D, ECO-550I, ECO-6000D, ECO-6000I, FI-160, FI-160AR, FI-160D, FI-160I, FI-200, FI-200AR, FI-200D, FI-200H, FI-200HD, FI-200HI, FI-200I, FI-200W, FI-200WL, FI-200WR, FI-2700D, FI-2700I, FI-280D, FI-280I, FI-370D, FI-370I, FI-4000D, FI-4000I, FI-460D, FI-460I, FI-550D, FI-550I, FI-6000D... (Other models you can see in the webshop)		

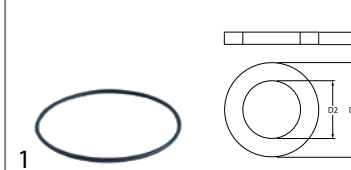

GEV No.	532151	Ref. No.	12021011 Z201084
description	O-ring EPDM thickness 3.53mm ID \varnothing 120.2mm Qty 10 pcs		
For models:	ECO-120, ECO-120B, FI-100, FI-100AR, FI-100B, FI-120, FI-120B, FI-120W, MF-120		



GEV No.	532103	Ref. No.	12049214
description	O-ring EPDM thickness 3.53mm ID ϕ 13.87mm Qty 10 pcs		
For models:	AD-125, AD-125HRS, AD-125-SOFT, CO-110, CO-110B, CO-110BDD, CO-110DD, CO-112, CO-112B, CO-112BDD, CO-112DD, CO-170, CO-170B, CO-170BDD, CO-170DD, CO-170HRS, CO-170HRSDD, CO-170HRS-SOFT, CO-170-SOFT, CO-172, CO-172B, CO-172BDD, CO-172DD, COP-173, COP-173B, COP-173BDD, COP-173DD, COP-173HRS, COP-173HRSDD, COP-173-SOFT, COP-174, COP-174B, COP-174BDD, COP-174DD, COP-174HRS, COP-174HRSDD		

GEV No.	505180	Ref. No.	12010118 Q307057
description	O-ring EPDM thickness 3.53mm ID ϕ 47.22mm Qty 1 pcs		
For models:	AD-120, AD-120B, AD-120BBTDD-UK, AD-120C, AD-120CW, AD-120HY, AD-90, AD-90BA, AD-90BBT, AD-90BDD, AD-90DD, ADE-120, ADE-120B, ECO-120, ECO-120B, ECO-160, ECO-160D, ECO-160I, ECO-200, ECO-200D, ECO-200H, ECO-200HD, ECO-200HI, ECO-200I, ECO-280D, ECO-280I, ECO-370D, ECO-370I, ECO-460D, ECO-460I, ECO-550D, ECO-550I, FI-100, FI-100AR, FI-100B, FI-100BBT-UK, FI-120, FI-120AR+DD, FI-120B, FI-120C, FI-120HY-CLINIC, FI-120W, FI-160, FI-160D, FI-160I, FI-200, FI-200D, FI-200H, FI-200HD, FI-200HI... (Other models you can see in the webshop)		

GEV No.	505152	Ref. No.	12009666 Q307000
description	O-ring EPDM thickness 3.53mm ID ϕ 29mm Qty 1 pcs		
For models:	ECO-1200, ECO-1600, ECO-2300, ECO-3000, FE-18, FE-25, FI-1200, FI-1600, FI-2300, FI-3000, FI-300B, FI-300R, FI-650R, FI-900		

GEV No.	532498	Ref. No.	12010256 Q307048
description	O-ring EPDM thickness 3.53mm ID ϕ 9.12mm Qty 1 pcs		
For models:	AD-120, AD-120B, AD-120BBTDD-UK, AD-120C, AD-120CW, AD-120HY, AD-45BBT, AD-48, AD-48B, AD-48BDD, AD-48C, AD-48D, AD-48DD, AD-48HY, AD-48W, AD-64, AD-64B, AD-64BBT, AD-64BDD, AD-64BTDD, AD-64C, AD-64CW, AD-64D, AD-64DD, AD-64HY, AD-72, AD-72W, AD-90, AD-90BA, AD-90BBT, AD-90BDD, AD-90DD, ADE-120, ADE-120B, EASY-500, EASY-500B, EASY-500DD, EASY-500HP, EASY-500HPWBDD, ECO-120, ECO-1200, ECO-120B, ECO-160, ECO-1600, ECO-160D, ECO-160I, ECO-200, ECO-200D, ECO-200H, ECO-200HD... (Other models you can see in the webshop)		

GEV No.	512511	Ref. No.	12115850
description	O-ring EPDM thickness 3.53mm ID ϕ 32mm Qty 10 pcs		
For models:	CO-500, CO-500B, CO-500BDD, CO-500DD, CO-501, CO-501B, CO-501BDD, CO-501DD, CO-501-SOFT, CO-502B, CO-502BDD, CO-502DD, CO-502W, COP-503, COP-503B, COP-503BDD, COP-503DD, COP-503-SOFT, COP-504, COP-504B, COP-504BDD, COP-504DD, COP-504W		

GEV No.	532548	Ref. No.	12010176 Q307068
description	O-ring EPDM thickness 3mm ID ϕ 27mm Qty 1 pcs		
For models:	ECO-2700D, ECO-2700I, ECO-280D, ECO-280I, ECO-370D, ECO-370I, ECO-4000D, ECO-4000I, ECO-460D, ECO-460I, ECO-550D, ECO-550I, ECO-6000D, ECO-6000I, FI-2700D, FI-2700I, FI-280D, FI-280I, FI-370D, FI-370I, FI-4000D, FI-4000I, FI-460D, FI-460I, FI-550D, FI-550I, FI-6000D, FI-6000I		

GEV No.	506015	Ref. No.	12024031 Z471109
description	O-ring EPDM thickness 3.53mm ID ϕ 39.69mm Qty 1 pcs		
For models:	AD-15D, AD-21D, AD-48D, AD-64D, CO-400-SOFT, FI-48, FI-48AR, FI-48B, FI-48B-BT-UK, FI-48C, FI-48D, FI-48HY-CLINIC, FI-48W, FI-64, FI-64AR, FI-64B, FI-64B-BT-UK, FI-64C, FI-64D, FI-64HY-CLINIC, FI-64W, LVC-15D, LVC-21D		

GEV No.	505092	Ref. No.	12010062 12016701 Q307053 S312113
description	O-ring EPDM thickness 5.34mm ID ϕ 43.82mm Qty 1 pcs		
For models:	AD-15, AD-15D, AD-20C-UK, AD-21, AD-21B, AD-21BDD, AD-21C, AD-21D, AD-21DD, AD-21W, LVC-12, LVC-15, LVC-15D, LVC-21, LVC-21B, LVC-21C, LVC-21D, LVC-21W, LVR-10, LVR-14, LVR-14D, LVR-20, LVR-20B, LVR-20D, MF-21		

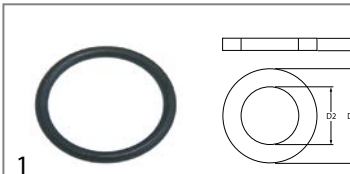

GEV No.	510408	Ref. No.	12039760 eu456002 Q307020
description	O-ring EPDM thickness 5.34mm ID ø 47mm Qty 1 pcs		
For models:	ECO-1200, FI-1200, FI-300B, FI-300R, FI-650R, FI-900		

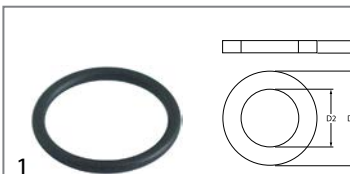

GEV No.	505175	Ref. No.	12010079 Q307052
description	O-ring EPDM thickness 5.34mm ID ø 50.16mm Qty 1 pcs		
For models:	AD-15, AD-15D, AD-20C-UK, AD-21, AD-21B, AD-21BDD, AD-21C, AD-21D, AD-21DD, AD-21W, AD-45BBT, AD-48, AD-48B, AD-48BDD, AD-48C, AD-48D, AD-48DD, AD-48HY, AD-48W, AD-64, AD-64B, AD-64BBT, AD-64BDD, AD-64BTDD, AD-64C, AD-64CW, AD-64D, AD-64DD, AD-64HY, AD-72, AD-72W, CO-350, CO-350-B, CO-350-B-DD, CO-350-COLD, CO-350-COLD-B, CO-350-COLD-B-DD, CO-350-COLD-DD, CO-350-DD, CO-352-COLD, CO-352-COLD-B, CO-352-COLD-B-DD, CO-352-COLD-DD, CO-400, CO-400-B, CO-400-B-DD, CO-400-COLD, CO-400-COLD-B, CO-400-COLD-B-DD, CO-400-COLD-DD...(Other models you can see in the webshop)		

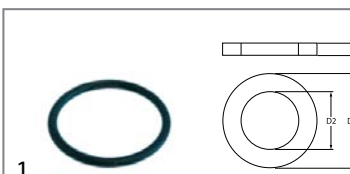

GEV No.	510409	Ref. No.	12010040 Q307044
description	O-ring EPDM thickness 5.34mm ID ø 56.52mm Qty 1 pcs		
For models:	ECO-160, ECO-1600, ECO-160D, ECO-160I, ECO-200, ECO-200D, ECO-200H, ECO-200HD, ECO-200HI, ECO-200I, ECO-2300, ECO-2700D, ECO-2700I, ECO-280D, ECO-280I, ECO-3000, ECO-370D, ECO-370I, ECO-4000D, ECO-4000I, ECO-460D, ECO-460I, ECO-550D, ECO-550I, ECO-6000D, ECO-6000I, FI-160, FI-1600, FI-160AR, FI-160D, FI-160I, FI-200, FI-200AR, FI-200D, FI-200H, FI-200HD, FI-200HI, FI-200I, FI-200W, FI-200WL, FI-200WR, FI-2300, FI-2700D, FI-2700I, FI-280D, FI-280I, FI-3000, FI-370D, FI-370I, FI-4000D...(Other models you can see in the webshop)		

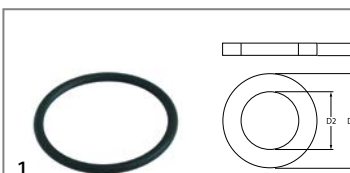

GEV No.	691033	Ref. No.	12010051 Q307035
description	O-ring EPDM thickness 5.34mm ID ø 62.87mm Qty 1 pcs		
For models:	AD-120, AD-120B, AD-120BBTDD-UK, AD-120C, AD-120HY, AD-45BBT, AD-48, AD-48B, AD-48BDD, AD-48C, AD-48D, AD-48DD, AD-48HY, AD-48W, AD-64, AD-64B, AD-64BBT, AD-64BDD, AD-64BTDD, AD-64C, AD-64CW, AD-64D, AD-64DD, AD-64HY, AD-72, AD-72W, AD-90, AD-90BA, AD-90BBT, AD-90BDD, AD-90DD, CO-110, CO-110B, CO-110BDD, CO-110DD, CO-112, CO-112B, CO-112BDD, CO-112DD, CO-142W, CO-142WDD, CO-170, CO-170B, CO-170BDD, CO-170DD, CO-170HRS, CO-170HRSDD, CO-170HRS-SOFT, CO-170-SOFT, CO-172...(Other models you can see in the webshop)		

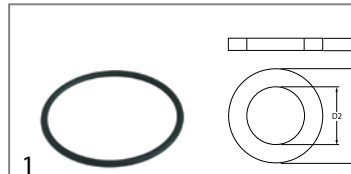

GEV No.	505178	Ref. No.	12009976 Q307049
description	O-ring EPDM thickness 5.34mm ID ø 85.09mm Qty 1 pcs		
For models:	AD-45BBT, AD-48, AD-48B, AD-48BDD, AD-48C, AD-48D, AD-48DD, AD-48HY, AD-48W, AD-64, AD-64B, AD-64BBT, AD-64BDD, AD-64BTDD, AD-64C, AD-64CW, AD-64D, AD-64DD, AD-64HY, AD-72, AD-72W, EASY-500, EASY-500B, EASY-500DD, EASY-500HP, EASY-500HPWBDD, FI-30, FI-30AR, FI-30AR+DD, FI-30B, FI-30B-BT-UK, FI-30-UK, FI-48, FI-48AR, FI-48B, FI-48B-BT-UK, FI-48C, FI-48D, FI-48HY-CLINIC, FI-48W, FI-50, FI-60DD, FI-64, FI-64AR, FI-64B, FI-64B-BT-UK, FI-64C, FI-64D, FI-64HY-CLINIC, FI-64W...(Other models you can see in the webshop)		



GEV No.	532639	Ref. No.	12009995 Q307045
description	O-ring EPDM thickness 5.34mm ID ø 94.62mm Qty 1 pcs		
For models:	ECO-160, ECO-1600, ECO-160D, ECO-160I, ECO-200, ECO-200D, ECO-200H, ECO-200HD, ECO-200HI, ECO-200I, ECO-2300, ECO-280D, ECO-280I, ECO-3000, ECO-370D, ECO-370I, ECO-460D, ECO-460I, ECO-550D, ECO-550I, FI-160, FI-1600, FI-160AR, FI-160D, FI-160I, FI-200, FI-200AR, FI-200D, FI-200H, FI-200HD, FI-200HI, FI-200I, FI-200W, FI-200WL, FI-200WR, FI-2300, FI-280D, FI-280I, FI-3000, FI-370D, FI-370I, FI-460D, FI-460I, FI-550D, FI-550I		

silicone

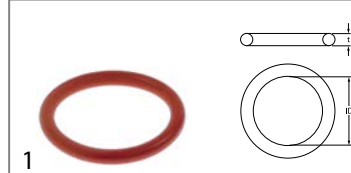

GEV No.	532727	Ref. No.	12037152 RT1000512
description	O-ring silicone thickness 3.5mm ID ø 26mm Qty 5 pcs for model SCC, CM		

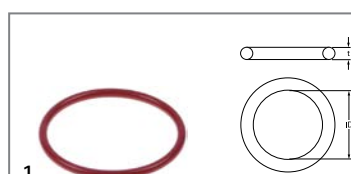

GEV No.	532728	Ref. No.	12037113 RT1000511
description	O-ring silicone thickness 3.5mm ID ø 46mm Qty 5 pcs for model SCC, CM		



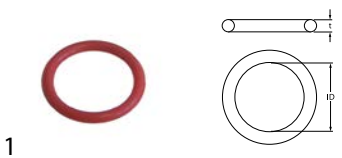

GEV No.	512414	Ref. No.	12036812 RT50120560
description	O-ring silicone thickness 3mm ID ø 47.5mm Qty 5 pcs		

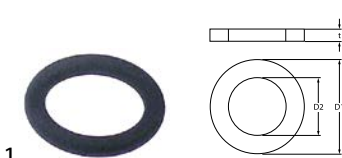

GEV No.	532519	Ref. No.	12021028 S042108
description	O-ring silicone thickness 5.34mm ID ø 53.34mm Qty 1 pcs		

Viton



GEV No.	530027	Ref. No.	12017304 X012127
description	O-ring Viton thickness 3mm ID ø 14mm Qty 1 pcs		
For models:	FE-710, FE-720, FE-920, FG-710, FG-71-15, FG-720, FG-72-30, FG-91-20, FG-920, FG-92-40		

miscellaneous

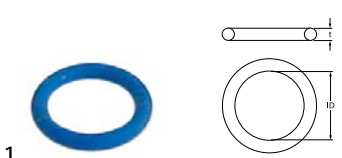

GEV No.	691010	Ref. No.	12010108 Q307069
description	O-ring thickness 2.62mm ID ø 12.37mm Qty 1 pcs for water level tube		
For models:	ME9-10BM, ME9-10BMS, ME9-15BM, ME9-15BM316, ME9-15BMS, MG9-10BM, MG9-10BMS, MG9-15BM, MG9-15BM316, MG9-15BMS, MPE9-10BM, MPE9-10BMS, MPE9-15BM, MPE9-15BMS, MPG9-10BM, MPG9-10BMS, MPG9-15BM, MPG9-15BMS		

sealing washers

fibre gaskets



GEV No.	505246	Ref. No.	12016868 Z953097
description	flat gasket FIBER ED ø 17mm ID ø 13.5mm thickness 1.5mm Qty 1 pcs		
For models:	GA-20, GA-20D, GA-40, GA-40D		



GEV No.	510033	Ref. No.	12009977 Q306013
description	flat gasket FIBER ED ø 30mm ID ø 21mm thickness 3mm Qty 1 pcs		
For models:	BME9-05, BME9-05AD, BME9-05PLUS, BME9-05V-T, BME9-10, BME9-10AD, BME9-10PLUS, BME9-10V-T, BMG9-05, BMG9-05V-T, BMG9-10, BMG9-10V-T, CPE7-05, CPE7-05NC, CPE9-05, CPE9-05S, CPG7-05, CPG7-05NC, CPG9-05, CPG9-05NC, CPG9-05S, CPG9-05SNC, EPC-350, FG7-05-1C, FG7-05-2C, FG7-10-2C, FG7-104C, FG7-10-4C, FG9-05, FG9-05-1C, FG9-05-2C, FG9-05AD, FG9-05PLUS, FG9-05PLUS-S, FG9-05S, FG9-05S-1C, FG9-05S-2C, FG9-05S-AD, FG9-10, FG9-10-2C, FG9-10-4C, FG9-10AD, FG9-10PLUS, FGCL9-05, FGCL9-05-1C, FGCL9-05-2C, FGCL9-05S-1C, FGCL9-05S-2C, GA-20, GA-40...(Other models you can see in the webshop)		



GEV No.	510123	Ref. No.	12016709 S112152
description	flat gasket FIBER ED ø 60mm ID ø 46mm thickness 2mm Qty 1 pcs		
For models:	ME9-10BM, ME9-10BMS, ME9-15BM, ME9-15BMS, MG9-10, MG9-10BM, MG9-10BMS, MG9-10S, MG9-15, MG9-15BM, MG9-15BMS, MG9-15S, MG9-20, MG9-20S, MPE9-10BM, MPE9-10BMS, MPE9-15BM, MPE9-15BMS, MPG9-10, MPG9-10BM, MPG9-10BMS, MPG9-10S, MPG9-15, MPG9-15BM, MPG9-15BMS, MPG9-15S, MPG9-20, MPG9-20S		



GEV No.	510153	Ref. No.	12010206 Q306050
description	flat gasket fibre ED ø 12mm ID ø 6.2mm thickness 1.5mm Qty 1 pcs		
For models:	AD-120, AD-120B, AD-120C, AD-120CW, AD-45BBT, AD-48, AD-48B, AD-48C, AD-48D, AD-48DD, AD-48HY, AD-48W, AD-64, AD-64B, AD-64BT, AD-64BBT, AD-64BTDD, AD-64C, AD-64CW, AD-64D, AD-64DD, AD-64HY, AD-72, AD-72W, AD-90, AD-90BA, AD-90BBT, AD-90BDD, AD-90DD, ADE-120, ADE-120B, ECO-120, ECO-120B, ECO-160, ECO-160D, ECO-160I, ECO-200, ECO-200D, ECO-200H, ECO-200HD, ECO-200HI, ECO-200I, FI-100, FI-100AR, FI-100B, FI-100BBT-UK, FI-120, FI-120AR+DD, FI-120B, FI-120C, FI-120HY-CLINIC...(Other models you can see in the webshop)		



GEV No.	507332	Ref. No.	12010260 Q306024
description	flat gasket fibre ED ø 18mm ID ø 12mm thickness 2mm Qty 1 pcs		
For models:	AD-120, AD-120B, AD-120BBTDD-UK, AD-120C, AD-120CW, AD-120HY, AD-45BBT, AD-48, AD-48B, AD-48BDD, AD-48C, AD-48D, AD-48DD, AD-48HY, AD-48W, AD-64, AD-64B, AD-64BBT, AD-64BDD, AD-64BTDD, AD-64C, AD-64CW, AD-64D, AD-64DD, AD-64HY, AD-72, AD-72W, AD-90, AD-90BA, AD-90BBT, AD-90BDD, AD-90DD, ADE-120, ADE-120B, BME7-05, BME7-10, BME9-05, BME9-05AD, BME9-05PLUS, BME9-05V-T, BME9-10, BME9-10AD, BME9-10PLUS, BME9-10V-T, BMG7-10, BMG9-04S, BMG9-05, BMG9-05V-T, BMG9-10, BMG9-10V-T...(Other models you can see in the webshop)		



GEV No.	510179	Ref. No.	12010145 Q306012
description	flat gasket fibre ED ø 18mm ID ø 13mm thickness 1.5mm Qty 1 pcs		
For models:	BG9-05, BG9-10, CG-200S, CG-210, CG-210G, CG-300S, CG-310, CG-310G, CG9-51L, CG9-51LC, CG9-51R, CG9-51RC, CG-HP-20, FI-5420, FI-7630, HCG-10-11, HCG-10-21, HCG-20-11, HCG-20-21, HCG-2-10-11, HCG-2-20-11, HCG-6-11, HG-10-11, HG-10-21, HG-2-10-11, HGC-10-11, HGC-10-21, HGC-20-21, HGC-6-11, HGP-10-21, HGP-20-21, HGV-10-11, HGV-10-21, HGV-20-11, HMG-20-11, HVG-10-11, HVG-10-11UL, HVG-10-21, HVG-10-21UL, HVG-20-11, HVG-20-21, HVG-2-10-11, HVG-2-20-21, MFHVG-10-11, MFHVG-10-21, MG9-10, MG9-10BM, MG9-15, MG9-15BM...(Other models you can see in the webshop)		



GEV No.	510152	Ref. No.	12010203 Q306038
description	flat gasket fibre ED ø 31mm ID ø 21mm thickness 1.5mm Qty 1 pcs		
For models:	ADE-120, ADE-120B, BME7-05, BME7-10, BME9-05, BME9-10, BMG7-10, BMG-9045, BMG9-05, BMG9-10, CPE9-05, CPE9-05S, CPG7-05, CPG9-05, CPG9-05NC, CPG9-05S, CPG9-05SNC, ECO-120, ECO-1200, ECO-120B, ECO-160, ECO-1600, ECO-160D, ECO-160I, ECO-200, ECO-200D, ECO-200H, ECO-200HD, ECO-200HI, ECO-200I, ECO-2300, ECO-2700D, ECO-2700I, ECO-280D, ECO-280I, ECO-3000, ECO-370D, ECO-370I, ECO-4000D, ECO-4000I, ECO-460D, ECO-460I, ECO-550D, ECO-550I, ECO-6000D, ECO-6000I, GA-20, GA-20D, GA-40, GA-40D...(Other models you can see in the webshop)		



GEV No.	510164	Ref. No.	12010055 Q306052
description	flat gasket fibre ED ø 24mm ID ø 16mm thickness 3mm Qty 1 pcs		
For models:	BME7-05, BME7-10, BMG7-10, CG-1002, CG-1502, CG-2002, CG7-11, CG7-41, CG7-61, CG9-11, CG9-41, CG9-51L, CG9-51LC, CG9-51R, CG9-51RC, CG9-61, CG9-82, CGB7-61, CGE7-41, CGE9-41, CGP9-11, CPG7-05, CPG9-05, CPG9-05NC, FG7-05-1C, FG7-05-2C, FG-710, FG7-10-2C, FG7-104C, FG7-10-4C, FG-720, FG9-05, FG9-05-1C, FG9-05-2C, FG9-05AD, FG9-05PLUS, FG9-05PLUS-S, FG9-05S-1C, FG9-05S-2C, FG9-05S-AD, FG9-10, FG9-10-2C, FG9-10-4C, FG9-10AD, FG9-10PLUS, FGCL9-05-1C, FGCL9-05-2C, FGCL9-05S-1C, FGCL9-05S-2C, FTG9-11L...(Other models you can see in the webshop)		



GEV No.	510406	Ref. No.	12035981 ICR09387
description	flat gasket fibre ED ø 60mm ID ø 48mm thickness 3mm for thread 1½" Qty 1 pcs		

rubber gaskets



GEV No.	510129	Ref. No.	12010207 Q306039
description	flat gasket fibre ED ø 25mm ID ø 16.5mm thickness 1.5mm Qty 1 pcs		
For models:	BME7-05, BME7-10, BME9-05, BME9-05AD, BME9-05PLUS, BME9-05V-T, BME9-10, BME9-10AD, BME9-10PLUS, BME9-10V-T, BMG7-10, BMG-9045, FF-35, HE-10-11, HE-10-21, HE-2-10-11, HE-5-11, HEI-10-21, HEM-10-11, HEM-10-21, HEM-20-11, HEM-6-11, HEP-10-11, HEP-10-21, HEP-20-11, HEP-6-11, HG-10-11, HG-10-21, HG-2-10-11, HGC-10-21, HGP-10-21, HGV-10-11, HGV-10-21, HGV-20-11, ME7-10BM, ME9-10BM, ME9-10BMS, ME9-15BM, ME9-15BMS, MG9-10BM, MG9-10BMS, MG9-15BM, MG9-15BMS, MPE9-10BM, MPE9-10BMS, MPE9-15BM, MPE9-15BMS, MPG9-10BM, MPG9-10BMS, MPG9-15BM...(Other models you can see in the webshop)		



GEV No.	505245	Ref. No.	12039712 Q307038
description	flat gasket ED ø 77mm ID ø 48mm thickness 1.5mm Qty 1 pcs		
For models:	ECO-1200, FI-1200, FI-900		



GEV No.	510166	Ref. No.	12019584 Q306049
description	flat gasket fibre ED ø 31.3mm ID ø 26.3mm thickness 1.2mm Qty 1 pcs		
For models:	ME7-10BM, ME9-10BM, ME9-10BMS, ME9-15BM, ME9-15BMS, MG7-10BM, MG9-10BM, MG9-10BMS, MG9-15BM, MG9-15BMS, MPE9-10BM, MPE9-10BMS, MPE9-15BM, MPE9-15BMS, MPG9-10BM, MPG9-10BMS, MPG9-15BM, MPG9-15BMS		





GEV No.	510169	Ref. No.	12039857 R725032
description	flat gasket rubber ED ø 16mm ID ø 10mm thickness 2mm Qty 1 pcs		
For models:	HMG-10-11, HMG-10-11UL, HMG-10-21, HMG-10-21UL, HMG-2-10-11, HMG-6-11		





GEV No.	505199	Ref. No.	12010191 Q307031
description	flat gasket rubber ED ø 24mm ID ø 14mm thickness 3mm Qty 1 pcs		
For models:	AD-45BBT, AD-48B, AD-48BDD, AD-48C, AD-48HY, AD-48W, AD-64B, AD-64BBT, AD-64BDD, AD-64C, AD-64CW, AD-64HY, BME7-05, BME7-10, BMG7-10, ECO-120, ECO-1200, FI-100, FI-100AR, FI-100B, FI-100BBT-UK, FI-120, FI-1200, FI-120B, FI-120W, FI-200W, FI-30, FI-300B, FI-300R, FI-30B, FI-30B-BT-UK, FI-48, FI-48AR, FI-48B, FI-48B-BT-UK, FI-48C, FI-48HY-CLINIC, FI-48W, FI-50, FI-64, FI-64AR, FI-64B, FI-64B-BT-UK, FI-64C, FI-64HY-CLINIC, FI-64W, FI-650R, FI-72, FI-80, FI-80BBT-UK...(Other models you can see in the webshop)		





			
1			
GEV No.	900909	Ref. No.	12018710 Z401905
description	flat gasket rubber ED ø 31mm ID ø 18mm thickness 2mm Qty 1 pcs		
For models:	LVR-10, LVR-14, LVR-20, LVR-20B		

			
1			
GEV No.	515018	Ref. No.	12009947 Q307032
description	flat gasket rubber ED ø 32mm ID ø 21mm thickness 3mm Qty 1 pcs		
For models:	AD-120, AD-120B, AD-120BBTDD-UK, AD-120C, AD-120CW, AD-120HY, AD-90, AD-90BA, AD-90BBT, AD-90BDD, AD-90DD, ADE-120, ADE-120B, BME7-05, BME7-10, BME9-05, BME9-05AD, BME9-05PLUS, BME9-05V-T, BME9-10, BME9-10AD, BME9-10PLUS, BME9-10V-T, BMG7-10, BMG9-05, BMG9-05V-T, BMG9-10, BMG9-10V-T, CO-142W, CO-142WDD, COP-174W, COP-174WHR, ECO-120, ECO-1200, ECO-120B, ECO-160, ECO-1600, ECO-160D, ECO-160I, ECO-200, ECO-200D, ECO-200H, ECO-200HD, ECO-200HI, ECO-200I, ECO-2300, ECO-2700D, ECO-2700I, ECO-280D, ECO-280I...(Other models you can see in the webshop)		

			
1			
GEV No.	510154	Ref. No.	12010053 Q307029
description	flat gasket rubber ED ø 33mm ID ø 26mm thickness 2mm Qty 1 pcs		
For models:	ECO-120, FE-18, FE-25, FG-1-40, FG-2-80, FI-100, FI-120, FI-120W, FI-30, FI-48, FI-48B, FI-48W, FI-50, FI-64, FI-64B, FI-64W, FI-72, LVC-21W, MF-21, MF-48, MF-64, MG-9150BM		

			
1			
GEV No.	505161	Ref. No.	12010028 Q307027
description	flat gasket rubber ED ø 45mm ID ø 35mm thickness 2mm Qty 1 pcs		
For models:	BMG-9045, ECO-1200, ECO-1600, ECO-2300, ECO-2700D, ECO-2700I, ECO-280D, ECO-280I, ECO-3000, ECO-370D, ECO-370I, ECO-4000D, ECO-4000I, ECO-460D, ECO-460I, ECO-550D, ECO-550I, ECO-6000D, ECO-6000I, FI-1200, FI-1600, FI-2300, FI-2700D, FI-2700I, FI-280D, FI-280I, FI-3000, FI-300B, FI-300R, FI-370D, FI-370I, FI-4000D, FI-4000I, FI-460D, FI-460I, FI-550D, FI-550I, FI-6000D, FI-6000I, FI-650R, FI-900		

			
1			
GEV No.	501302	Ref. No.	12023554 R675007
description	flat gasket rubber ED ø 57mm ID ø 30mm thickness 2mm Qty 1 pcs		
For models:	AD-45BBT, AD-48HY, AD-64BBT, AD-64BTDD, AD-64HY, EA-SY-500HPWBDD, FI-30B-BT-UK, FI-48B-BT-UK, FI-48HY-CLINIC, FI-64B-BT-UK, FI-64HY-CLINIC, HEI-10-11, HEI-20-11, HEI-6-11, HEM-10-11, HEM-20-11, HEM-6-11, HEP-10-11, HEP-20-11, HEP-6-11, HME-10-11, HME-10-21, HME-20-11, HME-20-21, HME-2-10-11, HME-2-20-11, HME-6-11, HMI-10-11, HMI-10-11UL, HMI-10-21, HMI-10-21UL, HMI-2-10-11, HMI-6-11, HMI-6-11UL, HMM-10-11, HMM-10-11UL, HMM-10-21, HMM-10-21UL, HMM-20-11, HMM-20-11UL, HMM-20-21, HMM-20-21UL, HMM-2-10-11, HMM-2-20-11, HMM-40-11-USMC, HMM-6-11, HMM-6-11UL, HMP-10-11, HMP-10-21, HMP-20-11...(Other models you can see in the webshop)		

			
1			
GEV No.	505224	Ref. No.	12009960 Q307058
description	flat gasket rubber ED ø 60mm ID ø 44mm thickness 2mm Qty 1 pcs		
For models:	AD-120, AD-120B, AD-120BBTDD-UK, AD-120C, AD-120CW, AD-120HY, AD-90, AD-90BA, AD-90BBT, AD-90BDD, AD-90DD, ADE-120, ADE-120B, ECO-120, ECO-120B, ECO-160, ECO-160D, ECO-160I, ECO-200, ECO-200D, ECO-200H, ECO-200HD, ECO-200HI, ECO-200I, ECO-370D, ECO-370I, ECO-550D, ECO-550I, FI-100, FI-100AR, FI-100B, FI-100BBT-UK, FI-120, FI-120AR+DD, FI-120B, FI-120C, FI-120HY-CLINIC, FI-120W, FI-160, FI-160AR, FI-160D, FI-160I, FI-200, FI-200AR, FI-200D, FI-200H, FI-200HD, FI-200HI, FI-200I, FI-200W...(Other models you can see in the webshop)		

			
1			
GEV No.	505223	Ref. No.	12009939 Q307009
description	flat gasket rubber ED ø 70mm ID ø 48mm thickness 1.5mm Qty 1 pcs		
For models:	BMG-9045, ECO-1200, ECO-1600, ECO-2300, ECO-2700D, ECO-2700I, ECO-280D, ECO-280I, ECO-3000, ECO-370D, ECO-370I, ECO-4000D, ECO-4000I, ECO-460D, ECO-460I, ECO-550D, ECO-550I, ECO-6000D, ECO-6000I, FI-1200, FI-1600, FI-2300, FI-2700D, FI-2700I, FI-280D, FI-280I, FI-3000, FI-300B, FI-300R, FI-370D, FI-370I, FI-4000D, FI-4000I, FI-460D, FI-460I, FI-550D, FI-550I, FI-6000D, FI-6000I, FI-650R, FI-900		

			
1			
GEV No.	505247	Ref. No.	12039795 Q307024
description	flat gasket rubber ED ø 72mm ID ø 54mm thickness 2mm Qty 1 pcs		
For models:	ECO-280D, ECO-280I, ECO-370D, ECO-370I, ECO-460D, ECO-460I, ECO-550D, ECO-550I, FI-280D, FI-280I, FI-300B, FI-300R, FI-370D, FI-370I, FI-460D, FI-460I, FI-550D, FI-550I, FI-650R		

			
1			
GEV No.	505194	Ref. No.	12009937 Q307059
description	flat gasket rubber ED ø 72mm ID ø 57mm thickness 2mm Qty 1 pcs		
For models:	AD-120, AD-120B, AD-120BBTDD-UK, AD-120C, AD-120CW, AD-120HY, AD-90, AD-90BA, AD-90BBT, AD-90BDD, AD-90DD, ADE-120, ADE-120B, ECO-120, ECO-120B, ECO-160, ECO-160D, ECO-160I, ECO-200, ECO-200D, ECO-200H, ECO-200HD, ECO-200HI, ECO-200I, ECO-2700D, ECO-2700I, ECO-280D, ECO-280I, ECO-370D, ECO-370I, ECO-4000D, ECO-4000I, ECO-460D, ECO-460I, ECO-550D, ECO-550I, ECO-6000D, ECO-6000I, FI-100, FI-100AR, FI-100B, FI-100BBT-UK, FI-120, FI-120AR+DD, FI-120B, FI-120C, FI-120HY-CLINIC, FI-120W, FI-160, FI-160AR...(Other models you can see in the webshop)		



1

GEV No.	510832	Ref. No.	12023571 Z310902
description	flat gasket rubber ED ø 92mm ID ø 66mm thickness 2mm Qty 1 pcs equiv. no. 200906/33456		
For models:	ECO-2700D, ECO-2700I, ECO-280D, ECO-280I, ECO-370D, ECO-370I, ECO-4000D, ECO-4000I, ECO-460D, ECO-460I, ECO-550D, ECO-550I, ECO-6000D, ECO-6000I, FI-2700D, FI-2700I, FI-280D, FI-280I, FI-370D, FI-370I, FI-4000D, FI-4000I, FI-460D, FI-460I, FI-550D, FI-550I, FI-6000D, FI-6000I		



1

GEV No.	691693	Ref. No.	12019066 R725031
description	flat gasket rubber ED ø 94mm ID ø 54mm thickness 4mm Qty 1 pcs		
For models:	HMG-10-11, HMG-10-11UL, HMG-10-21, HMG-10-21UL, HMG-2-10-11, HMG-6-11		



1

GEV No.	560616	Ref. No.	12037537 RT51101024
description	gasket ED ø 24mm ID ø 15mm thickness 3mm Qty 5 pcs for model C-Line, CPC, SCC 61-202		



1

GEV No.	505249	Ref. No.	12009936 Q307011
description	gasket ED ø 56mm ID ø 39mm thickness 1mm Qty 1 pcs		
For models:	ECO-1600, ECO-2300, ECO-280D, ECO-280I, ECO-3000, ECO-370D, ECO-370I, ECO-460D, ECO-460I, ECO-550D, ECO-550I, FI-1600, FI-2300, FI-280D, FI-280I, FI-3000, FI-370D, FI-370I, FI-460D, FI-460I, FI-550D, FI-550I		



1

GEV No.	560617	Ref. No.	12037232 RT50120539
description	gasket rubber ED ø 19.5mm ID ø 12mm thickness 2.3mm Qty 5 pcs		



1

GEV No.	510213	Ref. No.	12020523 X163016
description	gasket rubber ED ø 7mm ID ø 3mm thickness 6mm Qty 1 pcs		
For models:	FE9-05, FE9-05S, FE9-05USMC, FE9-10, FG9-05, FG9-05S, FG9-10		

plastic gaskets



1

GEV No.	510212	Ref. No.	12019069 Q308008
description	flat gasket plastic ED ø 12mm ID ø 7.3mm thickness 2mm Qty 1 pcs		
For models:	FI-300B, FI-300R, FI-650R		

copper gaskets

DIN-7603-A



1

GEV No.	528197	Ref. No.	12037845
description	flat gasket copper ED ø 10mm ID ø 6mm thickness 1mm Qty 1 pcs		



1

GEV No.	530883	Ref. No.	RT13150101
description	flat gasket copper ED ø 10mm ID ø 6mm thickness 1mm Qty 10 pcs		



1

GEV No.	560200	Ref. No.	12036402 RT13150105
description	flat gasket copper ED ø 16mm ID ø 10mm thickness 1.5mm Qty 1 pcs		



1

GEV No.	560615	Ref. No.	12037551 RT13150109
description	gasket copper ED ø 16mm ID ø 8.5mm thickness 1.2mm for combi-steamer suitable for CPC Qty 5 pcs		





1

GEV No.	560614	Ref. No.	12036587 RT13150104
description	gasket copper ED ø 20mm ID ø 16mm thickness 1.5mm suitable for CPC Qty 10 pcs		



PTFE gaskets

 <p>1</p>			
GEV No.	505226	Ref. No.	12018644 Q308009
description	slide ring PTFE ED ϕ 19mm ID ϕ 7.5mm thickness 2mm Qty 1 pcs		
For models:	FI-300B, FI-300R, FI-650R		

 <p>1</p>			
GEV No.	505225	Ref. No.	12009922 Q308012
description	slide ring PTFE ED ϕ 30mm ID ϕ 10mm thickness 3mm for hood joint Qty 1 pcs		
For models:	AD-120, AD-120B, AD-120BBTDD-UK, AD-120C, AD-120CW, AD-120HY, AD-90, AD-90BA, AD-90BBT, AD-90BDD, AD-90DD, ADE-120, ADE-120B, ECO-120, ECO-120B, FI-100, FI-100AR, FI-100B, FI-100BBT-UK, FI-120, FI-120AR+DD, FI-120B, FI-120C, FI-120HY-CLINIC, FI-120W, FI-80, FI-80AR, FI-80BBT-UK, FI-80W, FI-E-100, LABP-1000, LABP-1200, LABP-800, MF-120		

foam rubber gaskets

 <p>1</p>			
GEV No.	505408	Ref. No.	12041815
description	foam rubber gasket W 15mm thickness 2mm self-adhesive Qty 1 suitable for FAGOR control panel combi-steamer L 540mm		
For models:	ACE-061, ACE-101, ACE-102, ACE-201, ACE-202, ACG-061, ACG-101, ACG-102, ACG-201, ACG-202, AE-061, AE-061W, AE-101, AE-101W, AE-102, AE-102W, AE-201, AE-202, AG-061, AG-061W, AG-101, AG-101W, AG-102, AG-102W, AG-201, AG-202, APE-061, APE-061W, APE-101, APE-101W, APE-102, APE-102W, APE-201, APE-202, APG-061, APG-061W, APG-101, APG-101W, APG-102, APG-102W, APG-201, APG-202		

 <p>1</p>			
GEV No.	505250	Ref. No.	12021459 Z680532
description	foam rubber gasket W 20mm thickness 5mm Qty 720mm		
For models:	ECO-1200, FI-1200, FI-900		

 <p>1</p>			
GEV No.	505248	Ref. No.	12023929 Z950318
description	foam rubber gasket W 21mm thickness 1.5mm self-adhesive Qty 350mm		
For models:	GA-20, GA-20D, GA-40, GA-40D		

 <p>1</p>			
GEV No.	505237	Ref. No.	12025277 Z400309
description	foam rubber gasket W 8mm thickness 2mm self-adhesive Qty 450mm		
For models:	AD-15, AD-15D, LVC-12, LVC-15, LVC-15D, LVR-10, LVR-14, LVR-14D		

 <p>1</p>			
GEV No.	505264	Ref. No.	12024174 Z200313
description	foam rubber gasket W 9mm thickness 2.5mm self-adhesive Qty 625mm		
For models:	AD-45BBT, AD-48, AD-48B, AD-48BDD, AD-48C, AD-48D, AD-48DD, AD-48HY, AD-48W, AD-64, AD-64B, AD-64BBT, AD-64BDD, AD-64BTDD, AD-64C, AD-64CW, AD-64D, AD-64DD, AD-64HY, AD-72, AD-72W, EASY-500, EASY-500B, EASY-500DD, EASY-500HP, EASY-500HPWBDD, FI-30, FI-30AR, FI-30AR+DD, FI-30B, FI-30B-BT-UK, FI-30-UK, FI-48, FI-48AR, FI-48B, FI-48B-BT-UK, FI-48C, FI-48D, FI-48HY-CLINIC, FI-48W, FI-50, FI-60DD, FI-64, FI-64AR, FI-64B, FI-64B-BT-UK, FI-64C, FI-64D, FI-64HY-CLINIC, FI-64W...(Other models you can see in the webshop)		

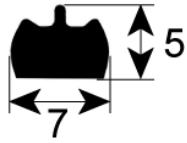
 <p>1</p>			
GEV No.	901454	Ref. No.	12034523 RT51001011
description	gasket for control panel L 2000mm foam rubber self-adhesive		

shaft gaskets

shaft gaskets

 <p>1</p>			
GEV No.	691049	Ref. No.	12024510 R012635000 R662627
description	shaft seal ID ϕ 17mm ED ϕ 28mm thickness 7mm		
For models:	ACE-061, ACE-101, ACE-102, ACE-201, ACE-202, ACG-061, ACG-101, ACG-102, ACG-201, ACG-202, AE-061, AE-061W, AE-101, AE-101W, AE-102, AE-102W, AE-201, AE-202, AG-061, AG-061W, AG-101, AG-101W, AG-102, AG-102W, AG-201, AG-202, APE-061, APE-061W, APE-101, APE-101W, APE-102, APE-102W, APE-201, APE-202, APG-061, APG-061W, APG-101, APG-101W, APG-102, APG-102W, APG-201, APG-202, COE-061, COE-101, COE-102, COE-201, COE-202, COG-061, COG-101, COG-102...(Other models you can see in the webshop)		



1

GEV No.	698001	Ref. No.	12025169 Z105016
description	shaft seal ID ø 20mm ED ø 35mm thickness 7mm		
For models:	ECO-160, ECO-1600, ECO-160D, ECO-160I, ECO-200, ECO-200D, ECO-200H, ECO-200HD, ECO-200HI, ECO-200I, ECO-2300, ECO-280D, ECO-280I, ECO-3000, ECO-370D, ECO-370I, ECO-460D, ECO-460I, ECO-550D, ECO-550I, FI-160, FI-1600, FI-160AR, FI-160D, FI-160I, FI-200, FI-200AR, FI-200D, FI-200H, FI-200HD, FI-200HI, FI-200I, FI-200W, FI-200WL, FI-200WR, FI-2300, FI-280D, FI-280I, FI-3000, FI-370D, FI-370I, FI-460D, FI-460I, FI-550D, FI-550I		



1

GEV No.	510574	Ref. No.	RT50010211
description	shaft sealing type 20 for fan motor		

miscellaneous



1

GEV No.	510573	Ref. No.	12033667 RT50010207
description	shaft seal ID ø 17mm ED ø 29mm thickness 4.5mm		



1

GEV No.	511682	Ref. No.	12034102 RT85141343
description	shaft seal kit ID ø 17mm ED ø 29mm shaft seal flange mounting gauge with mountign material		

special gaskets
for combi-steamers



1

GEV No.	560612	Ref. No.	12036211 RT51101310
description	flange gasket ED ø 79mm ID ø 51mm thickness 2mm hole distance 34mm CPC-Linie 101-201/G		



1

GEV No.	560599	Ref. No.	12034765 RT51101311
description	gasket ED ø 132mm ID ø 105mm thickness 2mm CPC-Linie CM 61-202/G		



1

GEV No.	560622	Ref. No.	12036615 RT7000242
description	gasket ED ø 82mm ID ø 50mm thickness 2.5mm hole distance 50mm SCC Line since 04/04		



1

GEV No.	699803	Ref. No.	12040239 RT7200020
description	gasket L 139mm W 130mm silicone thickness 4mm		



1

GEV No.	560613	Ref. No.	12037070 RT7400301
description	gasket L 43mm W 67mm thickness 4mm SCC, CM61-202 since 06/2007 for combi-steamer		



1

GEV No.	560619	Ref. No.	12036104 RT51101327
description	gasket L 76mm W 77mm CPC-Linie CM 61-202/G thickness 1mm		

door seals for dishwashers



1

GEV No.	518215	Ref. No.	12024374
description	door seal L 590mm W 26mm H 6mm silicone FAGOR suitable for dishwasher		
For models:	AD-45BBT, AD-48, AD-48B, AD-48BDD, AD-48C, AD-48D, AD-48DD, AD-48HY, AD-48W, AD-64, AD-64B, AD-64BBT, AD-64BDD, AD-64BTDD, AD-64C, AD-64CW, AD-64D, AD-64DD, AD-64HY, AD-72, AD-72W, EASY-500, EASY-500B, EASY-500DD, EASY-500HP, EASY-500HPWBDD, FI-30, FI-30AR, FI-30AR+DD, FI-30B, FI-30B-BT-UK, FI-30-UK, FI-48, FI-48AR, FI-48B, FI-48B-BT-UK, FI-48C, FI-48D, FI-48HY-CLINIC, FI-48W, FI-60DD, FI-64, FI-64AR, FI-64B, FI-64B-BT-UK, FI-64C, FI-64D, FI-64HY-CLINIC, FI-64W, FI-72...(Other models you can see in the webshop)		



1

GEV No.	505237	Ref. No.	12025277 Z400309
description	foam rubber gasket W 8mm thickness 2mm self-adhesive Qty 450mm		
For models:	AD-15, AD-15D, LVC-12, LVC-15, LVC-15D, LVR-10, LVR-14, LVR-14D		



1

GEV No.	505250	Ref. No.	12021459 Z680532
description	foam rubber gasket W 20mm thickness 5mm Qty 720mm		
For models:	ECO-1200, FI-1200, FI-900		



1

GEV No.	505264	Ref. No.	12024174 Z200313
description	foam rubber gasket W 9mm thickness 2.5mm self-adhesive Qty 625mm		
For models:	AD-45BBT, AD-48, AD-48B, AD-48BDD, AD-48C, AD-48D, AD-48DD, AD-48HY, AD-48W, AD-64, AD-64B, AD-64BBT, AD-64BDD, AD-64BTDD, AD-64C, AD-64CW, AD-64D, AD-64DD, AD-64HY, AD-72, AD-72W, EASY-500, EASY-500B, EASY-500DD, EASY-500HP, EASY-500HPWBDD, FI-30, FI-30AR, FI-30AR+DD, FI-30B, FI-30B-BT-UK, FI-30-UK, FI-48, FI-48AR, FI-48B, FI-48B-BT-UK, FI-48C, FI-48D, FI-48HY-CLINIC, FI-48W, FI-50, FI-60DD, FI-64, FI-64AR, FI-64B, FI-64B-BT-UK, FI-64C, FI-64D, FI-64HY-CLINIC, FI-64W...(Other models you can see in the webshop)		



1

GEV No.	505248	Ref. No.	12023929 Z950318
description	foam rubber gasket W 21mm thickness 1.5mm self-adhesive Qty 350mm		
For models:	GA-20, GA-20D, GA-40, GA-40D		

sealing discs



1

GEV No.	109066	Ref. No.	12009984 Q306051
description	flat gasket ø 23mm thickness 3mm fibre Qty 1 pcs		
For models:	BG7-05, BG7-05I, BG7-10, BG7-10I, BG9-05, BG9-05AD, BG9-05I, BG9-05PF, BG9-05PI, BG9-05PLUS-I, BG9-10, BG9-10AD, BG9-10I, BG9-10PF, BG9-10PI, BG9-10PLUS-I, BMG7-10, BMG9-05, BMG9-05V-T, BMG9-10, BMG9-10V-T, CG-210, CG-210G, CG7-10, CG7-20, CG7-20H, CG7-30D, CG7-30I, CG7-40, CG7-40H, CG7-50, CG7-60, CG7-60H, CG9-05AD, CG9-05PLUS, CG9-10, CG9-10AD, CG9-10PLUS, CG9-20, CG9-40, CG9-60, CGB7-61, CGE7-41, CGE7-41H, CGF9-120D, CGF9-120D-AD, CGF9-120I, CGF9-120I-AD, CGF9-120PLUS-D, CGF9-120PLUS-I...(Other models you can see in the webshop)		

miscellaneous



1

GEV No.	900870	Ref. No.	12037063 V107170001
description	door seal for glass door L 770mm plug-in gasket		
For models:	VM-100-I, VM-100-M, VM-135-I, VM-135-M		

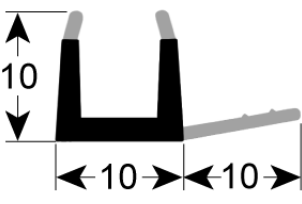

1

GEV No.	900874	Ref. No.	12037220 S107170001
description	door seal L 575mm external weith 5mm		



1

GEV No.	505078	Ref. No.	12024556 Z200907
description	gasket external hight 23.5mm for sump ED ø 225mm ID ø 200mm		
For models:	AD-45BBT, AD-48, AD-48B, AD-48BDD, AD-48C, AD-48D, AD-48DD, AD-48HY, AD-48W, AD-64, AD-64B, AD-64BBT, AD-64BDD, AD-64BTDD, AD-64C, AD-64CW, AD-64D, AD-64DD, AD-64HY, AD-72, AD-72W, EASY-500, EASY-500B, EASY-500DD, EASY-500HP, FI-30, FI-30AR, FI-30AR+DD, FI-30B, FI-30B-BT-UK, FI-30-UK, FI-48, FI-48AR, FI-48B, FI-48B-BT-UK, FI-48C, FI-48D, FI-48HY-CLINIC, FI-48W, FI-50, FI-60DD, FI-64, FI-64AR, FI-64B, FI-64B-BT-UK, FI-64C, FI-64D, FI-64HY-CLINIC, FI-64W, FI-72...(Other models you can see in the webshop)		



1

GEV No.	505077	Ref. No.	12024113 Z400902
description	gasket external hight 23mm for sump		
For models:	AD-15, AD-15D, AD-20C-UK, AD-21, AD-21B, AD-21BDD, AD-21C, AD-21D, AD-21DD, AD-21W, CO-350, CO-350-B, CO-350-B-DD, CO-350-COLD, CO-350-COLD-B, CO-350-COLD-B-DD, CO-350-COLD-DD, CO-350-DD, CO-352-COLD, CO-352-COLD-B, CO-352-COLD-B-DD, CO-352-COLD-DD, CO-400, CO-400-B, CO-400-B-DD, CO-400-COLD, CO-400-COLD-B, CO-400-COLD-B-DD, CO-400-COLD-DD, CO-400-DD, CO-400-SOFT, CO-402-COLD, CO-402-COLD-B, CO-402-COLD-B-DD, CO-402-COLD-DD, CO-402W, LVC-12, LVC-15, LVC-15D, LVC-21, LVC-21B, LVC-21C, LVC-21D, LVC-21W, LVR-10, LVR-14, LVR-14D, LVR-20, LVR-20B, LVR-20D...(Other models you can see in the webshop)		



1

GEV No.	691087	Ref. No.	12039997 R012623
description	gasket suitable for FAGOR equiv. no. R012623 L 20mm silicone		
For models:	HCG-10-11, HCG-10-21, HCG-2-10-11, HCG-6-11, HME-10-11, HME-10-21, HME-20-11, HME-20-21, HME-2-10-11, HME-6-11, HMG-10-11, HMG-10-11UL, HMG-10-21, HMG-10-21UL, HMG-2-10-11, HMG-6-11, HMI-10-11, HMI-10-11UL, HMI-10-21, HMI-10-21UL, HMI-2-10-11, HMI-6-11, HMI-6-11UL, HMM-10-11, HMM-10-11UL, HMM-10-21, HMM-10-21UL, HMM-20-11, HMM-20-11UL, HMM-20-21, HMM-2-10-11, HMM-40-11-USMC, HMM-6-11, HMM-6-11UL, HMP-10-11, HMP-10-21, HMP-20-11, HMP-20-21, HMP-2-10-11, HMP-6-11		



1

GEV No.	511992	Ref. No.	12023517 Z710547
description	gasket suitable for FAGOR for hood mechanics L 100mm W 86mm thickness 2mm hole distance 30/45mm		
For models:	AD-120, AD-120B, AD-120BBTDD-UK, AD-120C, AD-120CW, AD-120HY, AD-90, AD-90BA, AD-90BBT, AD-90BDD, AD-90DD, ADE-120, ADE-120B, ECO-120, ECO-120B, FI-100, FI-100AR, FI-100B, FI-100BBT-UK, FI-120, FI-120AR+DD, FI-120B, FI-120C, FI-120HY-CLINIC, FI-120W, FI-80, FI-80AR, FI-80BBT-UK, FI-80W, FI-E-100, LABP-1000, LABP-1200, LABP-800, MF-120		



1

GEV No.	550895	Ref. No.	12035290 RT51101308
description	gasket suitable for RATIONAL equiv. no. 51101308 L 179mm W 90mm electrode thickness 3mm		



1

GEV No.	505179	Ref. No.	12024227 Z710714
description	gasket D1 ø 82.5mm D2 ø 44mm thickness 2.5mm with 4 screw holes wash arm support equiv. no. Z710714 suitable for FAGOR		
For models:	AD-120, AD-120B, AD-120BBTDD-UK, AD-120C, AD-120CW, AD-120HY, AD-90, AD-90BA, AD-90BBT, AD-90BDD, AD-90DD, ADE-120, ADE-120B, ECO-120, ECO-120B, ECO-160, ECO-160D, ECO-160I, ECO-200, ECO-200D, ECO-200H, ECO-200HD, ECO-200HI, ECO-200I, FI-100, FI-100AR, FI-100B, FI-100BBT-UK, FI-120, FI-120AR+DD, FI-120B, FI-120C, FI-120HY-CLINIC, FI-120W, FI-160, FI-160D, FI-160I, FI-200, FI-200D, FI-200H, FI-200HD, FI-200HI, FI-200I, FI-200W, FI-80, FI-80AR, FI-80BBT-UK, FI-80W, FI-E-100, LABP-1000...(Other models you can see in the webshop)		

thermostat gaskets



1

GEV No.	505093	Ref. No.	12024049 N503017
description	gasket for thermostat ED ø 35mm ID ø 24mm thickness 7mm equiv. no. N503017		
For models:	AD-120, AD-120B, AD-120BBTDD-UK, AD-120C, AD-120CW, AD-120HY, AD-15, AD-15D, AD-20C-UK, AD-21, AD-21B, AD-21BDD, AD-21C, AD-21D, AD-21DD, AD-21W, AD-45BBT, AD-48, AD-48B, AD-48BDD, AD-48C, AD-48D, AD-48DD, AD-48HY, AD-48W, AD-64, AD-64B, AD-64BBT, AD-64BDD, AD-64BTDD, AD-64C, AD-64CW, AD-64D, AD-64DD, AD-64HY, AD-72, AD-72W, AD-90, AD-90BA, AD-90BBT, AD-90BDD, AD-90DD, ADE-120, ADE-120B, BME7-05, BME7-10, BME9-05, BME9-10, EASY-500, EASY-500B...(Other models you can see in the webshop)		

gaskets for wash arm support



1

GEV No.	505167	Ref. No.	12023533 Z400703
description	gasket D1 ø 68mm D2 ø 35mm thickness 3.5mm with 4 screw holes equiv. no. Z400703 suitable for FAGOR		
For models:	AD-15, AD-15D, AD-20C-UK, AD-21, AD-21B, AD-21BDD, AD-21C, AD-21D, AD-21DD, AD-21W, CO-350, CO-350-B, CO-350-B-DD, CO-350-COLD, CO-350-COLD-B, CO-350-COLD-B-DD, CO-350-COLD-DD, CO-350-DD, CO-352-COLD, CO-352-COLD-B, CO-352-COLD-B-DD, CO-352-COLD-DD, CO-400, CO-400-B, CO-400-B-DD, CO-400-COLD, CO-400-COLD-B, CO-400-COLD-B-DD, CO-400-COLD-DD, CO-400-DD, CO-400-SOFT, CO-402-COLD, CO-402-COLD-B, CO-402-COLD-B-DD, CO-402-COLD-DD, CO-402W, LVC-12, LVC-15, LVC-15D, LVC-21, LVC-21B, LVC-21C, LVC-21D, LVC-21W, LVR-10, LVR-14, LVR-14D, LVR-20, LVR-20B, LVR-20D...(Other models you can see in the webshop)		

refrigeration cycle components

valves

Schrader valves

valve bodies



1

GEV No.	750097	Ref. No.	12037574 BR00014007
description	valve body for Schrader valve thread 1/4" SAE connection 6mm soldering connection		

filter driers

miscellaneous



1

GEV No.	750119	Ref. No.	12036253 12036970 12048655 6000601003 6047010003
description	dryer size 40g ø 24mm L 167mm connection 6,3/6,3mm		
For models:	AEP-1402, AEP-1403, AEP-1404, AEP-1602, AEP-1603, AEP-1604, AEP-701, AEP-702, AEP-801, AEP-802, AFN-1402, AFN-1403, AFN-1404, AFN-1602, AFN-1603, AFN-1604, AFN-701, AFN-702, AFN-801, AFN-802, AFP-1402, AFP-1402-FORZ, AFP-1402-MIX, AFP-1403, AFP-1403-C, AFP-1403-FORZ, AFP-1403-P, AFP-1404, AFP-1404-C, AFP-1404-FORZ, AFP-1404-P, AFP-1602, AFP-1602-2, AFP-1603, AFP-1604, AFP-2103, AFP-2104, AFP-2104-C, AFP-2104-P, AFP-2105, AFP-2105-C, AFP-2105-P, AFP-2106, AFP-2106-C, AFP-2106-P, AFP-701, AFP-701-FORZ, AFP-702, AFP-702-C, AFP-702-FORZ...(Other models you can see in the webshop)		



refrigeration pipes

capillary pipes



1

GEV No.	694200	Ref. No.	12037191 M107020002
description	capillary pipe ED ø 2.4mm ID ø 1.25mm L 1300mm copper		
For models:	MEP-180, MPZ1-200		

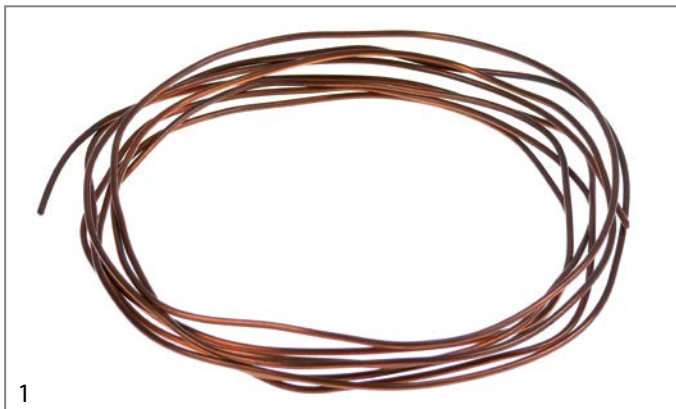

1

GEV No.	694203	Ref. No.	12037496 M107020001
description	capillary pipe ED ø 2mm ID ø 1mm L 3300mm copper		
For models:	BFP-200, FMP-150, FMP-202, FMP-255, FMP-307, MCP-135, MCP-135-AD, MCP-180, MCP-180-AD, MCP-225, MEP-100, MEP-100G, MEP-135, MEP-180, MFP-135, MFP-135-2C, MFP-135-4C, MFP-135-AD, MFP-135-AD-2C, MFP-135-AD-4C, MFP-135-AD-PC, MFP-135-B, MFP-135-F, MFP-180, MFP-180-2C, MFP-180-4C, MFP-180-6C, MFP-180-AD, MFP-180-AD-2C, MFP-180-AD-4C, MFP-180-AD-6C, MFP-180-AD-PC, MFP-180-B, MFP-180-F, MFP-225, MFP-225-2C, MFP-225-4C, MFP-225-6C, MFP-225-8C, MFP-225-B, MFP-225-F, MFP-270-B, MFPG-135-AD, MFPG-180-AD, MMZ-150, MMZ-202, MPN-150-C, MPN-202-C, MPP-150, MPP-150-C...(Other models you can see in the webshop)		



1

GEV No.	694201	Ref. No.	12035797 M107020004
description	capillary pipe ED ø 2.4mm ID ø 1.25mm L 3500mm copper		
For models:	MPN-150		

heating tubes

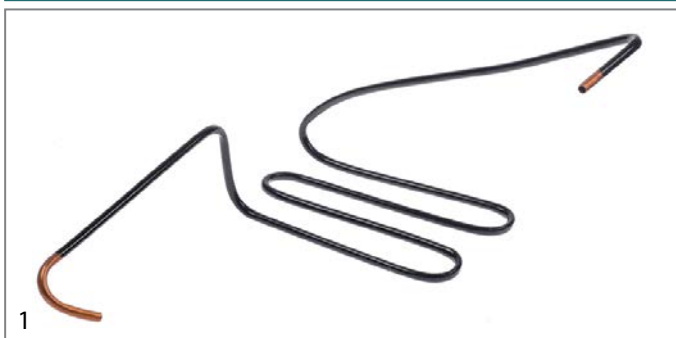

1

GEV No.	701656	Ref. No.	12050455
description	heater ED ø 8mm ID ø 6mm copper Qty 1 for refrigerated counters FAGOR MSN-MFN		



evaporators

for fridges

producer-specific

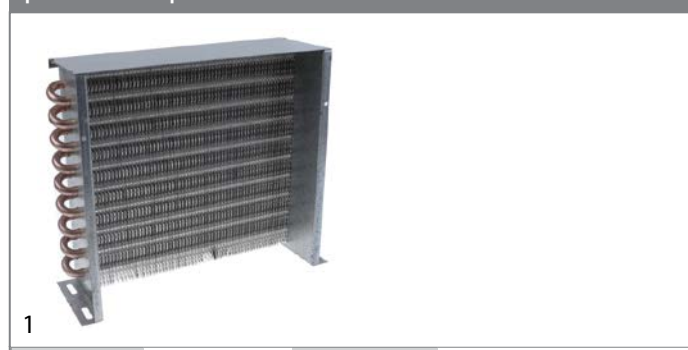

GEV No.	750205	Ref. No.	12032903 6029020002
description	condenser L 330mm W 103mm H 265mm		
For models:	AEP-701, AEP-801, AEP-802, AF-1402-MIX, AF-1602-MIX, AF-1603-C, AF-1603-P, AF-1604-C, AF-1604-P, AF-802-C, AF-802-P, AFP-1602, AFP-1602-2, AFP-1603, AFP-1603-2, AFP-701, AFP-702, AFP-801, AFP-802, AFP-802-2C, AFP-802-3C, BFP-150, BFP-150A, BFP-150I, BFP-200, BFP-200A, BFP-200I, CAEP-701, CAEP-801, CAEP-802, CAF-1402MIXT, CAF-1602MIX, CAF-802-C, CAF-802-P, CAFP-1602-2, CAFP-1603-2, CAFP-701, CAFP-702, CAFP-801, CAFP-802, CAFP-802-2C, CAFP-802-3C, CFMP-150, CFMP-150F, CFMP-150PC, CFMP-150TV, CFMP-202, CFMP-202F, CFMP-202PC, CFMP-202TV...(Other models you can see in the webshop)		



GEV No.	750719	Ref. No.	12030681 6001902002 6029010005 M129010004
description	evaporator L 330mm D 90mm H 205mm total length 450mm overall width 90mm overall height 205mm suitable for FAGOR		
For models:	AEP-801, AEP-802, AFP-1602-2, AFP-701-FORZ, AFP-702-FORZ, AFP-801, AFP-802, FMP-117-R, FMP-150, FMP-169-R, FMP-200, FMP-202, FMP-222-R, FMP-250, FMP-255, FMP-274-R, FMP-300, FMP-307, MCN-237-R, MCP-237-GN-R, MCP-270-GN, MFN-237-R, MFP-225-4C, MFP-225-6C, MFP-225-8C, MFP-237-10C, MFP-237-2C, MFP-237-4C, MFP-237-6C, MFP-237-8C, MFP-237-GN-R, MFP-270-10C, MFP-270-2C, MFP-270-4C, MFP-270-6C, MFP-270-8C, MFP-270-F, MFP-270-GN, MPP-222-R, MPP-222-R-C, MPP-255, MPP-255-C, MPP-274-R, MPP-274-R-C, MPP-307, MPP-307-C, MSP-117-R, MSP-200-F, MSP-250, MSP-250-2C...(Other models you can see in the webshop)		



GEV No.	750399	Ref. No.	12031900 6029010140
description	evaporator L 330mm W 125mm H 90mm total length 535mm overall width 130mm overall height 93mm connection 12mm suitable for FAGOR		
For models:	CMPZ1-180, MEP-180, MEP-180-GN, MPZ1-180, MPZ1-200, MPZ1-225, MPZ1-250		



GEV No.	750688	Ref. No.	12031794 6029010146
description	evaporator L 380mm W 95mm H 380mm H2 650mm		
For models:	AEP-701, AEP-801, AEP-802, AF-1402-MIX, AF-1602-MIX, AFP-1602, AFP-1602-2, AFP-1603, AFP-1603-2, AFP-701, AFP-702, AFP-801, AFP-802, AFP-802-2C, AFP-802-3C, APP-701, CAEP-801, CAEP-802, CAF-1602MIX, CAFP-1602-2, CAFP-1603-2, CAFP-801, CAFP-802, CAFP-802-2C, CAFP-802-3C, CAPP-701		



GEV No.	750299	Ref. No.	12030888 12031493 12031626 6029010034 6029010042 A129010010
description	evaporator L 432mm W 90mm H 133mm suitable for FAGOR		
For models:	AEP-701, AF-1402-MIX, AF-702-C, AF-702-P, AF-802-C, AF-802-P, AFP-701, AFP-702, AFP-802, AFP-802-2		

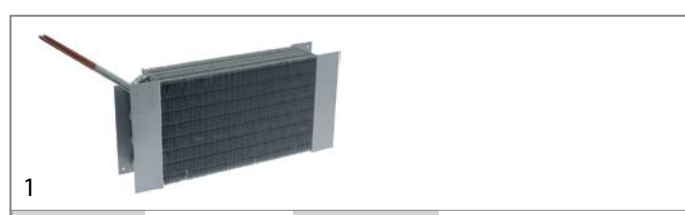

GEV No.	750206	Ref. No.	12030388 12030606 6029010011 6029010040 A129010008
description	evaporator L 440mm W 210mm H 90mm		
For models:	AEP-801, AEP-802, AF-1602-MIX, AF-802-C, AFP-1602, AFP-1602-2, AFP-1603, AFP-1603-2, AFP-801, AFP-802, AFP-802-2		

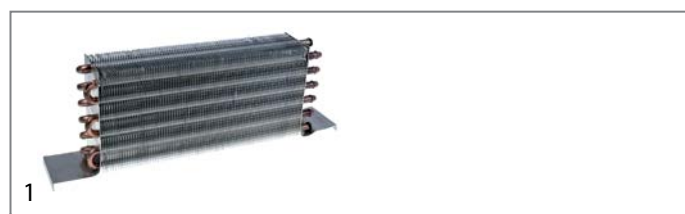

GEV No.	750260	Ref. No.	12031290 12031386 12031866 6001902006 6029010013 M129010007
description	evaporator L 460mm W 65mm H 150mm		
For models:	MEP-100, MEP-100G		

mechanical components, equipment accessories



1

GEV No.	750208	Ref. No.	12029094 12030075 12030785 6001901005 6029010010 A129010003
description	evaporator L 500mm W 300mm H 170mm		
For models:	AEP-701, AFP-1402-MIX, AFP-701, AFP-701-FORZ, AFP-702, AFP-702-C, AFP-702-FORZ, AFP-702-P		



1

GEV No.	750642	Ref. No.	12030276 12030449 6029010039 A129010007
description	evaporator L 515mm W 108mm H 497mm mounting distance 1 437mm suitable for FAGOR		
For models:	AEP-1402, AEP-1602, AF-1403-C, AF-1403-P, AF-1404-C, AF-1404-P, AF-1603-C, AF-1603-P, AF-1604-C, AF-1604-P, AFP-1402, AFP-1403, AFP-1404, AFP-1404-USMC, AFP-1602, AFP-1602-2, AFP-1603, AFP-1603-2, AFP-1604		



1

GEV No.	750207	Ref. No.	12031339 6029010088
description	evaporator L 520mm W 65mm H 170mm		
For models:	FMP-117-R, FMP-150, FMP-169-R, FMP-200, MCP-135-GN, MCP-147-GN-R, MCP-180-GN, MFP-102-GN-R, MFP-135-B-GN, MFP-135-F-GN, MFP-135-GN, MFP-147-GN-R, MFP-180-B-GN, MFP-180-F-GN, MFP-180-GN, MFP-192-GN-R, MSP-117-2RC, MSP-117-4RC, MSP-117-R, MSP-150, MSP-150-2C, MSP-150-4C, MSP-150-F, MSP-150-GI, MSP-169-R, MSP-169-R2C, MSP-169-R4C, MSP-169-R6C, MSP-200, MSP-200-2C, MSP-200-4C, MSP-200-6C, MSP-200-F, MSP-200-GI		



1

GEV No.	750444	Ref. No.	12042017 12044960 6029010036 6029010148
description	evaporator L 565mm W 125mm H 405mm mounting distance 1 650mm suitable for FAGOR		
For models:	AEP-1402, AEP-1602, AF-1402-MIX, AF-1403-C, AF-1403-P, AF-1404-C, AF-1404-P, AF-1603-C, AF-1603-P, AF-1604-C, AF-1604-P, AF-2104-C, AF-2105-C, AF-2106-C, AF-702-C, AF-802-C, AFN-702, AFP-1402, AFP-1403, AFP-1404, AFP-1602, AFP-1602-2, AFP-1603, AFP-1604, AP-701, APP-701		



1

GEV No.	750258	Ref. No.	12028920 12028921 12029453 6029010032 6029010035 A129010004
description	evaporator L 660mm W 120mm H 385mm H2 165mm		
For models:	AEP-2103, AF-2104-C, AF-2104-P, AF-2105-C, AF-2105-P, AF-2106-C, AF-2106-P, AFN-1402, AFN-1403, AFN-1404, AFN-1602, AFN-1603, AFN-1604, AFP-2103, AFP-2104, AFP-2105, AFP-2106		



1

GEV No.	750259	Ref. No.	12028458 6001903002
description	evaporator L 660mm W 120mm H 385mm H2 165mm		
For models:	AFN-1402, AFN-1403, AFN-1404		



			
1			
GEV No.	750727	Ref. No.	12083695 A171010137
description	evaporator total length 370mm overall width 250mm overall height 230mm complete		
For models:	AEP-1602AD, AEP-1603AD, AEP-1604AD, APF-1602AD, APF-1603AD, APF-1604AD, CPAEP-1602, CPAFP-1602		
spare parts for	750727		
	GEV No.	601020	Ref. No. —
	fan motor 5W 230V 50-60Hz L1 44mm L2 48mm L3 79mm W 84mm cable length 500mm 1300rpm YZF5-13-18/26 5 mounting options bearing slide bearing		
	GEV No.	601070	Ref. No. —
	fan wheel sucking ø 200mm fan wheel mounting 25.4mm blade angle 28° W 38mm aluminium		

for saladettes

			
1			
GEV No.	750614	Ref. No.	12031326 12031771 6029010015 M129010009
description	evaporator L 385mm W 130mm D 90mm H 90mm total length 540mm overall width 130mm overall height 90mm mounting distance 1 530mm mounting distance 2 420mm		
For models:	MEP-135, MEP-180, MPZ1-150, MPZ1-200		

for ice-cube maker

for ice cube maker

			
1			
GEV No.	750201	Ref. No.	12028613 BR00D10046
description	evaporator for ice-cube maker 36 cubes L 440mm W 190mm H 40mm		

accessories

housings

			
1			
GEV No.	691847	Ref. No.	12033760 12034208 12034209 12034210 6000201012 6003050001 6003060001 6009992010
description	sump for evaporator L 455mm W 515mm H 98mm		
For models:	MCN-102-R, MCN-135, MCN-147-R, MCN-180, MCN-192-R, MCN-225, MCN-237-R, MCN-270, MCP-102-GN-R, MCP-135, MCP-135-GN, MCP-147-GN-R, MCP-180, MCP-180-GN, MCP-192-GN-R, MCP-225, MCP-225-GN, MCP-237-GN-R, MCP-270-GN, MFN-102-R, MFN-135, MFN-147-R, MFN-180, MFN-192-R, MFN-225, MFN-237-R, MFN-270, MFP-102-2C, MFP-102-4C, MFP-102-GN-R, MFP-135, MFP-135-2C, MFP-135-4C, MFP-135-F, MFP-135-GN, MFP-147-2C, MFP-147-4C, MFP-147-6C, MFP-147-GN-R, MFP-180, MFP-180-2C, MFP-180-4C, MFP-180-6C, MFP-180-F, MFP-180-GN, MFP-192-2C, MFP-192-4C, MFP-192-6C, MFP-192-8C, MFP-192-GN-R...(Other models you can see in the webshop)		

			
1			
GEV No.	692160	Ref. No.	12033558 6003050037
description	sump for evaporator L 525mm W 450mm H 98mm		
For models:	MFP-102-GN-R, MFP-135-B, MFP-135-B-GN, MFP-135-F-GN, MFP-135-GN, MFP-147-GN-R, MFP-180-B, MFP-180-B-GN, MFP-180-F-GN, MFP-180-GN, MFP-192-GN-R, MFP-225-B, MFP-225-F-GN, MFP-225-GN, MFP-237-GN-R, MFP-270-B, MFP-270-F-GN, MFP-270-GN		

condensors

condensors

			
1			
GEV No.	750661	Ref. No.	12029667 BR00020019
description	condenser W 215mm D 270mm H 117mm Qty 1 pcs		



evaporation and condensing trays

unheated condensing trays

			
1			
GEV No.	750067	Ref. No.	12018237 12036623 6000202204 6003010023
description	condensing tray L 255mm W 127mm H 70mm		
For models:	ADMFCN-135, ADMFCN-180, ADMFCN-225, ADMCP-135, ADMCP-180, ADMCP-225, ADMFN-135, ADMFN-180, ADMFN-225, ADMFP-135, ADMFP-135-GR, ADMFP-135HD, ADMFP-135HH, ADMFP-135PC, ADMFP-180, ADMFP-180-GR, ADMFP-180HDD, ADMFP-180HHD, ADMFP-180HHH, ADMFP-180PC, ADMFP-225, ADMFP-225-GR, ADMFP-225HDD, ADMFP-225HHD, ADMFP-225HHH, ADMFP-225HH, ADMFP-225PC, AEP-1402, AEP-1403, AEP-1404, AEP-2103, AEP-701, AEP-702, AF-1402-MIX, AF-1403-C, AF-1403-P, AF-1404-C, AF-1404-P, AF-2104-C, AF-2104-P, AF-2105-C, AF-2105-P, AF-2106-C, AF-2106-P, AF-702-C, AF-702-P, AFN-1402, AFN-1403, AFN-1404, AFN-701...(Other models you can see in the webshop)		

miscellaneous

			
1			
GEV No.	750281	Ref. No.	12033557 12033759 12101127 6003050002 6009992002
description	evaporation tray L 476mm W 427mm H 100mm		
For models:	FMP-117-R, FMP-150, FMP-169-R, FMP-200, FMP-202, FMP-222-R, FMP-255, FMP-274-R, FMP-307, MSN-117-R, MSN-150, MSN-169-R, MSN-200, MSN-222-R, MSN-250, MSN-274-R, MSN-300, MSP-117-2C, MSP-117-4C, MSP-117-R, MSP-150, MSP-150-2C, MSP-150-4C, MSP-150-F, MSP-169-2C, MSP-169-4C, MSP-169-6C, MSP-169-R, MSP-200, MSP-200-2C, MSP-200-4C, MSP-200-6C, MSP-200-F, MSP-222-2C, MSP-222-4C, MSP-222-6C, MSP-222-8C, MSP-222-R, MSP-250, MSP-250-2C, MSP-250-4C, MSP-250-6C, MSP-250-8C, MSP-250-F, MSP-274-10C, MSP-274-2C, MSP-274-4C, MSP-274-6C, MSP-274-8C, MSP-274-R...(Other models you can see in the webshop)		

transmission technology and ball bearings

chains

roller chains 08B-1 single

			
1			
GEV No.	505339	Ref. No.	12025097 Z275008
description	roller chain DIN/ISO 08 B-1 splitting 1/2" / 12.7mm links 28 internal width 7.75mm rollerø 8.51mm		
For models:	ECO-160, ECO-160D, ECO-160I, ECO-200, ECO-200D, ECO-200H, ECO-200HD, ECO-200HI, ECO-200I, ECO-2700D, ECO-2700H, ECO-280D, ECO-280I, ECO-370D, ECO-370I, ECO-4000D, ECO-4000I, ECO-460D, ECO-460I, ECO-550D, ECO-550I, ECO-6000D, ECO-6000I, FI-160, FI-160AR, FI-160D, FI-160I, FI-200, FI-200AR, FI-200D, FI-200H, FI-200HD, FI-200HI, FI-200I, FI-200W, FI-200WL, FI-200WR, FI-2700D, FI-2700I, FI-280D, FI-280I, FI-370D, FI-370I, FI-4000D, FI-4000I, FI-460D, FI-460I, FI-550D, FI-550I, FI-6000D...(Other models you can see in the webshop)		

connectors

			
1			
GEV No.	693276	Ref. No.	12023767 Z105012
description	connector single DIN/ISO 08 B-1 splitting 1/2" links 1 L 23mm internal width 11.8mm rollerø 4.3mm metal		
For models:	ECO-160, ECO-160D, ECO-160I, ECO-200, ECO-200D, ECO-200H, ECO-200HD, ECO-200HI, ECO-200I, ECO-2300, ECO-2700D, ECO-2700I, ECO-280D, ECO-280I, ECO-3000, ECO-370D, ECO-370I, ECO-4000D, ECO-4000I, ECO-460D, ECO-460I, ECO-550D, ECO-550I, ECO-6000D, ECO-6000I, FI-160, FI-160D, FI-160AR, FI-160D, FI-160I, FI-200, FI-200AR, FI-200D, FI-200H, FI-200HD, FI-200HI, FI-200I, FI-200W, FI-200WL, FI-200WR, FI-2300, FI-2700D, FI-2700I, FI-280D, FI-280I, FI-3000, FI-370D, FI-370I, FI-4000D...(Other models you can see in the webshop)		

springs

torsion springs

			
1			
GEV No.	692159	Ref. No.	12024390 Z271203
description	torsion spring ø 10.3mm L2 20mm wire gauge ø 1.4mm L1 2mm L3 33mm Qty 1 pcs		
For models:	ECO-160, ECO-160D, ECO-160I, ECO-200, ECO-200D, ECO-200H, ECO-200HD, ECO-200HI, ECO-200I, ECO-280D, ECO-280I, ECO-370D, ECO-370I, ECO-460D, ECO-460I, ECO-550D, ECO-550I, FI-160, FI-160AR, FI-160D, FI-160I, FI-200, FI-200AR, FI-200D, FI-200H, FI-200HD, FI-200HI, FI-200I, FI-200W, FI-200WL, FI-200WR, FI-280D, FI-280I, FI-370D, FI-370I, FI-460D, FI-460I, FI-550D, FI-550I		

			
1			
GEV No.	691067	Ref. No.	12009262 S316110
description	torsion spring ø 28.2mm L2 107mm wire gauge ø 4mm L1 42mm		
For models:	ME7-10BM, MG7-10, MG7-10BM, MV7-10BM, SBE7-10, SBG7-10		

			
1			
GEV No.	692811	Ref. No.	12093685
description	torsion spring ø 34mm L2 6mm wire gauge ø 2mm L1 10mm L3 6mm Qty 1 pcs		
For models:	ACE-201, ACE-202, ACG-201, ACG-202, AE-201, AE-202, AG-201, AG-202, APE-201, APE-202, APG-201, APG-202		



GEV No.	540855	Ref. No.	12032821 ICR08052
description	torsion spring ø 50.8mm wire gauge ø 5.1mm L1 34mm L2 104mm L3 29mm mounting pos. left		

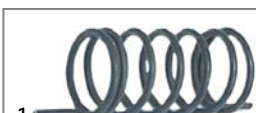

GEV No.	540854	Ref. No.	12032818 ICR08051
description	torsion spring ø 50.8mm wire gauge ø 5.1mm L1 34mm L2 104mm L3 29mm mounting pos. right		

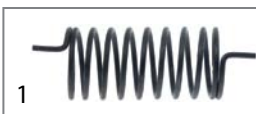

GEV No.	514346	Ref. No.	12032819 ICR08008
description	torsion spring ø 51.5mm wire gauge ø 4.1mm L1 21mm L2 110mm L3 21mm mounting pos. left		



GEV No.	514339	Ref. No.	ICR08007
description	torsion spring ø 51.8mm wire gauge ø 4.1mm L1 20mm L2 106mm L3 20mm mounting pos. right		



GEV No.	514352	Ref. No.	12032815 12033015 ICR08093 ICRI08093
description	torsion spring ø 51mm wire gauge ø 6.5mm L1 28mm L2 101mm L3 28mm mounting pos. left		



GEV No.	514351	Ref. No.	12032816 12033014 ICR08083 ICRI08083
description	torsion spring ø 51mm wire gauge ø 6.5mm L1 28mm L2 101mm L3 28mm mounting pos. right		



GEV No.	514350	Ref. No.	12032817 ICR08055
description	torsion spring ø 51mm wire gauge ø 6mm L1 28mm L2 95mm L3 28mm mounting pos. left		



GEV No.	514349	Ref. No.	12032814 ICR08054
description	torsion spring ø 51mm wire gauge ø 6mm L1 28mm L2 95mm L3 28mm mounting pos. right		

compression springs



GEV No.	505138	Ref. No.	12040429 Z600605
description	compression spring		
For models:	FI-300B, FI-300R, FI-650R, FTG7-05, FTG7-10, FTG9-05L, FTG9-05R, FTG9-10L, FTG9-10L+R, FTG9-10R, FTGC9-05, FTGC9-10, LC-10, LC-14, LC-7, LC-7A		



GEV No.	691008	Ref. No.	12025252 Z700603
description	compression spring ø 10mm L 28mm wire gauge ø 0.9mm		
For models:	BG9-05PLUS-I, BG9-10PLUS-I, CE-15, CE-9, FE-710, FE-720, FE9-05, FE9-05S, FE9-05USMC, FE9-10, FI-300B, FI-300R, FI-650R, FTG9-05PLUS-CL, FTG9-05PLUS-CR, FTG9-05PLUS-L, FTG9-05PLUS-LV, FTG9-05PLUS-R, FTG9-05PLUS-RV, FTG9-10PLUS-CL, FTG9-10PLUS-CLR, FTG9-10PLUS-CR, FTG9-10PLUS-L, FTG9-10PLUS-LR, FTG9-10PLUS-LRV, FTG9-10PLUS-LV, FTG9-10PLUS-R, FTG9-10PLUS-RV, HCG-10-11, HCG-10-21, HCG-20-11, HCG-2-10-11, HCG-6-11, HME-10-11, HME-10-21, HME-20-11, HME-20-21, HME-2-10-11, HME-6-11, HMG-10-11, HMG-10-11UL, HMG-10-21, HMG-10-21UL, HMG-20-11, HMG-2-10-11, HMG-6-11, HMI-10-11, HMI-10-11UL, HMI-10-21, HMI-10-21UL...(Other models you can see in the webshop)		

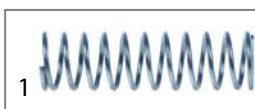



GEV No.	691880	Ref. No.	12016846 R725007
description	compression spring ø 13.3mm L 47.5mm wire gauge ø 1.2mm		
For models:	FF-35, HMG-10-11, HMG-10-11UL, HMG-10-21, HMG-10-21UL, HMG-20-11, HMG-2-10-11, HMG-6-11		





			
GEV No.	691876	Ref. No.	12024277 R725008
description	compression spring \varnothing 14.5mm L 20mm wire gauge \varnothing 1.8mm		
For models:	HGP-10-21, HGP-20-21, HGV-10-11, HGV-10-21, HGV-20-11, HGV-20-21, HMG-10-11, HMG-10-21, HMG-2-10-11, HMG-6-11, HVG-10-11, HVG-10-11UL, HVG-10-21, HVG-10-21UL, HVG-20-11, HVG-20-21, HVG-2-10-11, HVG-2-20-21, MFHVG-10-11, MFHVG-10-21, VG-101, VG-102, VG-201, VG-202, VPG-101, VPG-102, VPG-201, VPG-202		

			
GEV No.	693591	Ref. No.	12037536 RT20010109
description	compression spring \varnothing 14mm L 27mm wire gauge \varnothing 1.5mm		

			
GEV No.	691043	Ref. No.	12017094 R010511
description	compression spring \varnothing 16.1mm L 70mm wire gauge \varnothing 1.8mm		
For models:	FE-920, FF-35, HCG-10-11, HCG-10-21, HCG-20-11, HCG-2-10-11, HCG-6-11, HCV-10-11, HCV-10-21, HCV-2-10-21, HCV-6-11, HE-10-11, HE-10-21, HE-2-10-11, HE-6-11, HG-10-11, HG-10-21, HG-2-10-11, HME-10-11, HME-10-21, HME-20-11, HME-20-21, HME-2-10-11, HME-6-11, HMG-10-11, HMG-10-11UL, HMG-10-21, HMG-10-21UL, HMG-20-11, HMG-2-10-11, HMG-6-11, HMI-10-11, HMI-10-11UL, HMI-10-21, HMI-10-21UL, HMI-2-10-11, HMI-6-11, HMI-6-11UL, HMM-10-11, HMM-10-11UL, HMM-10-21, HMM-10-21UL, HMM-20-11, HMM-20-11UL, HMM-20-21, HMM-2-10-11, HMM-6-11, HMM-6-11UL, HMP-10-11, HMP-10-21...(Other models you can see in the webshop)		

			
GEV No.	691032	Ref. No.	12009265 S136080 S136108
description	compression spring \varnothing 42.6mm L 129mm wire gauge \varnothing 7mm		
For models:	MPE9-10BM, MPE9-10BMS, MPE9-15BM, MPE9-15BMS, MPG9-10, MPG9-10BM, MPG9-10BMS, MPG9-10S, MPG9-15, MPG9-15BM, MPG9-15BMS, MPG9-15S, MPG9-20, MPG9-20S		

			
GEV No.	691881	Ref. No.	12019099 Z850608
description	compression spring \varnothing 6mm L 24mm wire gauge \varnothing 0.8mm		

			
GEV No.	691090	Ref. No.	12023716 Z850519
description	compression spring \varnothing 7.1mm L 25.5mm wire gauge \varnothing 0.7mm		
For models:	ACE-061, ACE-101, ACE-102, ACE-201, ACE-202, ACG-061, ACG-101, ACG-102, ACG-201, ACG-202, AE-061, AE-061W, AE-101, AE-101W, AE-102, AE-102W, AE-201, AE-202, AG-061, AG-061W, AG-101, AG-101W, AG-102, AG-102W, AG-201, AG-202, APE-061, APE-061W, APE-101, APE-101W, APE-102, APE-102W, APE-201, APE-202, APG-061, APG-061W, APG-101, APG-101W, APG-102, APG-102W, APG-201, APG-202, COE-061, COE-101, COE-102, COE-201, COE-202, COG-061, COG-101, COG-102...(Other models you can see in the webshop)		

			
GEV No.	696553	Ref. No.	12017801 Z883001
description	compression spring \varnothing 7.5mm L 23mm wire gauge \varnothing 0.7mm		
For models:	ECO-280D, ECO-280I, ECO-370D, ECO-370I, ECO-460D, ECO-460I, ECO-550D, ECO-550I, FI-280D, FI-280I, FI-370D, FI-370I, FI-460D, FI-460I, FI-550D, FI-550I, HEI-10-11, HEI-20-11, HEI-6-11, HEM-10-11, HEM-20-11, HEM-6-11, HEP-10-11, HEP-20-11, HEP-6-11, HME-10-11, HME-20-11, HME-6-11, HMI-10-11, HMI-10-11UL, HMI-10-21, HMI-10-21UL, HMI-2-10-11, HMI-6-11, HMI-6-11UL, HMM-10-11, HMM-10-11UL, HMM-10-21, HMM-10-21UL, HMM-20-11, HMM-20-11UL, HMM-20-21, HMM-2-10-11, HMM-2-20-11, HMM-40-11-USMC...(Other models you can see in the webshop)		

			
GEV No.	691011	Ref. No.	12008888 S112105
description	compression spring \varnothing 70mm L 95mm wire gauge \varnothing 3mm for drain tap		
For models:	FTE7-05, FTE7-10, FTE9-05L, FTE9-05R, FTE9-10L, FTE9-10L+R, FTE9-10R, FTEC9-05, FTEC9-05L, FTEC9-05R, FTEC9-10, FTEC9-10L, FTEC9-10L+R, FTEC9-10R, FTG7-05, FTG7-10, FTG-9050L, FTG-9050R, FTG9-05L, FTG9-05R, FTG9-05VL, FTG9-05VR, FTG-9100L, FTG-9100L+R, FTG-9100R, FTG9-10L, FTG9-10L+R, FTG9-10R, FTG9-10VL, FTG9-10VL+R, FTG9-10VR, FTG9-05, FTG9-05L, FTG9-05R, FTG9-05R, FTG9-10, FTG9-10L, FTG9-10L+R, FTG9-10R, ME7-10BM, ME9-10BM, ME9-10BMS, ME9-15BM, ME9-15BMS, MG7-10, MG7-10BM, MG9-10, MG-9100, MG9-10AD...(Other models you can see in the webshop)		

			
GEV No.	700765	Ref. No.	12024164 T130506
description	compression spring \varnothing 8.1mm L 20.4mm wire gauge \varnothing 1.2mm		
For models:	ACE-201, ACE-202, ACG-201, ACG-202, AE-201, AE-202, AG-201, AG-202, APE-201, APE-202, APG-201, APG-202, COE-201, COE-202, COG-201, COG-202, HCG-10-11, HCG-10-21, HCG-20-11, HCG-20-21, HCG-2-10-11, HCG-2-20-11, HCG-6-11, HEI-10-11, HEI-10-21, HEI-20-11, HEI-20-21, HEI-6-11, HEM-10-11, HEM-10-21, HEM-20-11, HEM-20-21, HEM-6-11, HEP-10-11, HEP-10-21, HEP-20-11, HEP-20-21, HEP-6-11, HGC-10-11, HGC-10-21, HGC-20-11, HGC-20-21, HGC-6-11, HGP-10-21, HGP-20-21, HGV-10-11, HGV-10-21, HGV-20-11, HGV-20-21, HME-10-11...(Other models you can see in the webshop)		



GEV No.	691016	Ref. No.	12009030 S116121
description	torsion spring \varnothing 44mm L 124mm wire gauge \varnothing 5.6mm		
For models:	ME9-10BM, ME9-10BMS, ME9-15BM, ME9-15BM316, ME9-15BMS, MG9-10, MG-9100, MG9-10BM, MG9-10BMS, MG9-10S, MG9-15, MG-9150, MG-9150BM, MG9-15BM, MG9-15BMS, MG9-15S, MG9-20, MG-9200, MG9-20S, MPE9-10BM, MPE9-10BMS, MPE9-15BM, MPE9-15BMS, MPG9-10, MPG9-10BM, MPG9-10BMS, MPG9-10S, MPG9-15, MPG-9150, MPG9-15BM, MPG9-15BMS, MPG9-15S, MPG9-20, MPG-9200, MPG9-20S, MV9-10BM, MV9-15BM, SBE7-10, SBE9-10, SBE9-10I, SBE9-10IM, SBE9-10IMS, SBE9-10IS, SBE9-10M, SBE9-10MS, SBE9-10S, SBE9-10USMC, SBE9-15IM, SBE9-15IMS, SBE9-15M...(Other models you can see in the webshop)		

roller springs



GEV No.	501430	Ref. No.	12024877 Z310511
description	roller spring W 40mm ID \varnothing 33mm lug length 49mm mounting distance 10mm		
For models:	ECO-280D, ECO-280I, ECO-370D, ECO-370I, ECO-460D, ECO-460I, ECO-550D, ECO-550I, FI-280D, FI-280I, FI-370D, FI-370I, FI-460D, FI-460I, FI-550D, FI-550I		



GEV No.	519451	Ref. No.	12024689 Z270513
description	roller spring W 40mm ID \varnothing 35mm lug length 50mm		
For models:	ECO-160, ECO-160D, ECO-160I, ECO-200, ECO-200D, ECO-200H, ECO-200HD, ECO-200HI, ECO-200I, ECO-2700D, ECO-2700I, ECO-280D, ECO-280I, ECO-370D, ECO-370I, ECO-4000D, ECO-4000I, ECO-460D, ECO-460I, ECO-550D, ECO-550I, ECO-6000D, ECO-6000I, FI-160, FI-160AR, FI-160D, FI-160I, FI-200, FI-200AR, FI-200D, FI-200H, FI-200HD, FI-200HI, FI-200I, FI-200W, FI-200WL, FI-200WR, FI-2700D, FI-2700I, FI-280D, FI-280I, FI-370D, FI-370I, FI-4000D, FI-4000I, FI-460D, FI-460I, FI-550D, FI-550I, FI-6000D...(Other models you can see in the webshop)		

accessories

holders



GEV No.	517431	Ref. No.	12011392 Z270515
description	bracket for roller spring \varnothing mm L 105mm W 44mm H 20mm		
For models:	ECO-160, ECO-160D, ECO-160I, ECO-200, ECO-200D, ECO-200H, ECO-200HD, ECO-200HI, ECO-200I, FI-160, FI-160AR, FI-160D, FI-160I, FI-200, FI-200AR, FI-200D, FI-200H, FI-200HD, FI-200HI, FI-200I, FI-200W, FI-200WL, FI-200WR		

miscellaneous



GEV No.	513328	Ref. No.	12024244 T840509000
description	spring for combi-steamer L 34mm W 27mm wire gauge \varnothing 0.6mm		



GEV No.	504387	Ref. No.	12024391 Z271204
description	spring right for transport system shaft diametermm \varnothing 10.5mm L 36mm Wmm Hmm wire gauge \varnothing 1.4mm		
For models:	ECO-160, ECO-160D, ECO-160I, ECO-200, ECO-200D, ECO-200H, ECO-200HD, ECO-200HI, ECO-200I, ECO-280D, ECO-280I, ECO-370D, ECO-370I, ECO-460D, ECO-460I, ECO-550D, ECO-550I, FI-160, FI-160AR, FI-160D, FI-160I, FI-200, FI-200AR, FI-200D, FI-200H, FI-200HD, FI-200HI, FI-200I, FI-200W, FI-200WL, FI-200WR, FI-280D, FI-280I, FI-370D, FI-370I, FI-460D, FI-460I, FI-550D, FI-550I		

tension springs



GEV No.	505009	Ref. No.	12024948 Z710528
description	tension spring \varnothing 35mm total length 420mm wire gauge \varnothing 5mm		
For models:	AD-120, AD-120B, AD-120BBTDD-UK, AD-90, AD-90BA, AD-90BBT, AD-90BDD, AD-90DD, ADE-120, ADE-120B, ECO-120, ECO-120B, FI-100, FI-100AR, FI-100B, FI-100BBT-UK, FI-120, FI-120AR+DD, FI-120B, FI-120C, FI-120HY-CLINIC, FI-120W, FI-80, FI-80AR, FI-80BBT-UK, FI-80W, FI-E-100, LABP-1000, LABP-1200, LABP-800, MF-120		



coffee accessories

coffee grounds drawers

1			
GEV No.	698839	Ref. No.	6009990065
description	coffee drawer bar ø 35mm L 375mm		

kitchen accessories

gastronorm

bridges



1			
GEV No.	700807	Ref. No.	12002780 R966104
description	bridge for Gastronorm container L1 327mm L2 307mm SS W 25mm H 15mm Qty 1 pcs		
For models:	BME6-05, BME7-05		

manometers

1			
GEV No.	541596	Ref. No.	12025146 Z102316
description	manometer ø 52mm pressure range 0 up to 10bar connection dishwasher thread 1/4"		
For models:	ECO-160, ECO-1600, ECO-200, ECO-200H, ECO-2300, ECO-3000, FI-160, FI-1600, FI-160AR, FI-160D, FI-160I, FI-200, FI-200AR, FI-200D, FI-200H, FI-200HD, FI-200HI, FI-200I, FI-2300, FI-2700D, FI-2700I, FI-2800, FI-280I, FI-3000, FI-370D, FI-370I, FI-4000D, FI-4000I, FI-460D, FI-460I, FI-550D, FI-550I, FI-6000D, FI-6000I		

1			
GEV No.	541579	Ref. No.	12038013 ICR10022
description	manometer ø 52mm pressure range 0 up to 1bar connection marking 0.5 thread 1/4"		

1			
GEV No.	541793	Ref. No.	12019289 12024625 Z271125 Z718417
description	manometer ø 52mm pressure range 0-4bar thread 1/4"		
For models:	AD-120CW, CO-142W, CO-142WDD, FI-120W, FI-200W, FI-200WL, FI-200WR, FI-80W, MF-120		

1					
GEV No.	541062	Ref. No.	12009399 9220815		
description	manometer ø 63mm pressure range 0 up to 1bar connection marking adjustable kettle thread 1/4"				
For models:	ME9-10BM, ME9-10BMS, ME9-10PLUS-BM, ME9-10PLUS-BMS, ME9-15BM, ME9-15BM316, ME9-15BM-AD, ME9-15BMS, ME9-15PLUS-BM, ME9-15PLUS-BMS, MG9-10BM, MG9-10BMAD, MG9-10BMS, MG9-10BMSAD, MG9-10PLUS-BM, MG9-10PLUS-BMS, MG-9150BM, MG9-15BM, MG9-15BM316, MG9-15BMAD, MG9-15BMS, MG9-15BMSAD, MG9-15PLUS-BM, MG9-15PLUS-BMS, MPE9-10BM, MPE9-10BMS, MPE9-15BM, MPE9-15BMS, MPG9-10BM, MPG9-10BMS, MPG9-15BM, MPG9-15BMS, MV9-10BM, MV9-15BM				
spare parts for	541062				
		GEV No.	541130	Ref. No.	—
	glass panel ø 58mm thickness 2mm				

hose reels and spray guns

spray guns



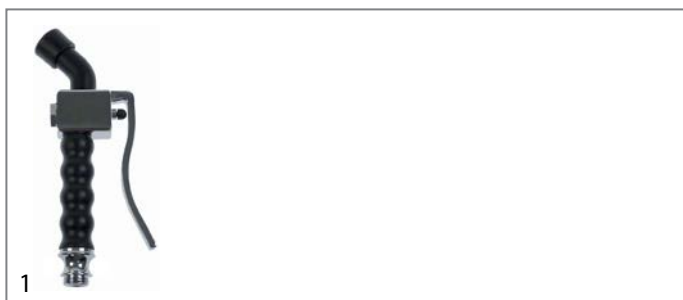

1					
GEV No.	540302	Ref. No.	12030181 RT20601006		
description	spray gun for appliances 1/2" ET L 135mm type RATIONAL				
spare parts for	540302				
		GEV No.	517056	Ref. No.	—
	O-ring EPDM thickness 2mm ID ø 6.5mm Qty 1 pcs				
		GEV No.	532535	Ref. No.	—
	O-ring EPDM thickness 5mm ID ø 10mm Qty 1 pcs				
		GEV No.	548016	Ref. No.	—
	compression spring ø 10mm L 17mm wire gauge ø 0.9mm for hand spray				

Table continues overleaf

spare parts for 540302			
	GEV No.	548017	Ref. No. —
pressure bolt for hand spray			



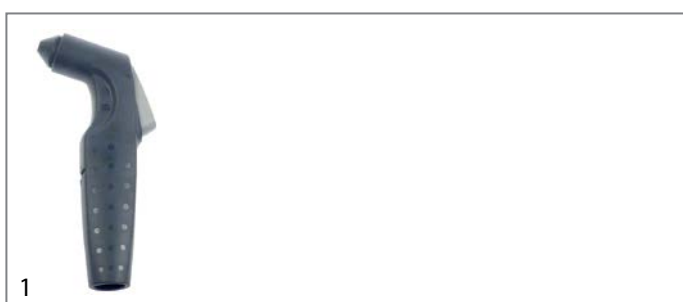

GEV No.	691048	Ref. No.	12004216 R095005
description	spray gun for appliances 1/2" ET L 225mm type STAR		
For models:	HCG-10-11, HCG-10-21, HCG-20-11, HCG-20-21, HCG-2-10-11, HCG-2-20-11, HCG-6-11, HME-10-11, HME-10-21, HME-20-11, HME-20-21, HME-2-10-11, HME-2-20-11, HME-6-11, HMG-10-11, HMG-10-11UL, HMG-10-21, HMG-10-21UL, HMG-20-11, HMG-2-10-11, HMG-6-11, HMI-10-11, HMI-10-11UL, HMI-10-21, HMI-10-21UL, HMI-2-10-11, HMI-6-11, HMI-6-11UL, HMM-10-11, HMM-10-11UL, HMM-10-21, HMM-10-21UL, HMM-20-11, HMM-20-11UL, HMM-20-21, HMM-20-21UL, HMM-2-10-11, HMM-2-20-11, HMM-40-11-USMC, HMM-6-11, HMM-6-11UL, HMP-10-11, HMP-10-21, HMP-20-11, HMP-20-21, HMP-2-10-11, HMP-2-20-11, HMP-6-11, HVG-10-11, HVG-10-11UL...(Other models you can see in the webshop)		

spare parts for 691048			
	GEV No.	507309	Ref. No. —
O-ring EPDM thickness 2.62mm ID ø 17.13mm Qty 1 pcs			
	GEV No.	510322	Ref. No. —
O-ring EPDM thickness 1.78mm ID ø 17.17mm Qty 1 pcs			
	GEV No.	524055	Ref. No. —
flat gasket rubber ED ø 18mm ID ø 12mm thickness 2mm Qty 1 pcs			
	GEV No.	528485	Ref. No. —
O-ring EPDM thickness 1.78mm ID ø 6.07mm Qty 1 pcs			
	GEV No.	528494	Ref. No. —
gasket rubber ED ø 13mm ID ø 4mm thickness 4mm Qty 1 pcs			

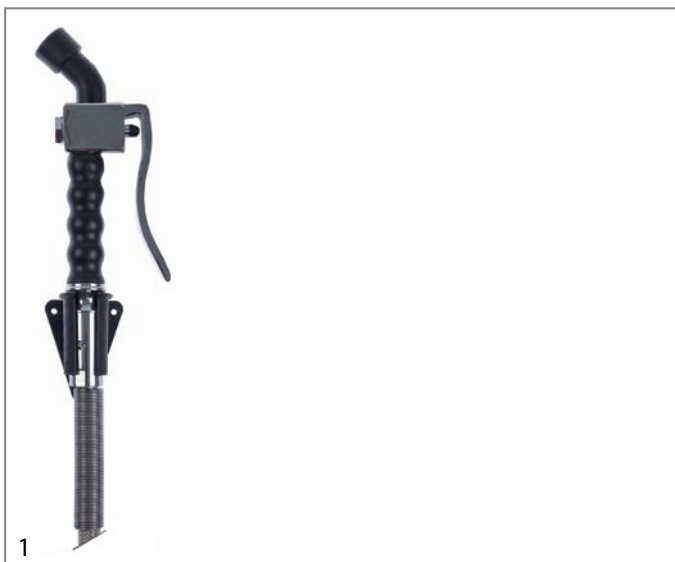

GEV No.	540664	Ref. No.	12030307 RT5000130
description	spray gun for appliances 1/2" (12.83mm) L 165mm		
spare parts for 540664			
	GEV No.	699809	Ref. No. 12037366 RT5000156
clamp for spray gun L 24mm			



GEV No.	691618	Ref. No.	12007934 R095009
description	spray gun for appliances 1/2" ET L 225mm with hose (2m) and wall holder type STAR		
For models:	HEM-10-11, HEM-20-11, HEM-6-11, HEP-10-11, HEP-20-11, HEP-6-11, HGV-10-11, HGV-20-11		
spare parts for 691618			
	GEV No.	542966	Ref. No. —
wall holder for hand spray			



GEV No.	691094	Ref. No.	12020555 R095007
description	wall holder for hand spray		
For models:	HCG-10-11, HCG-10-21, HCG-20-11, HCG-20-21, HCG-2-10-11, HCG-2-20-11, HCG-6-11, HME-10-11, HME-10-21, HME-20-11, HME-20-21, HME-2-10-11, HME-2-20-11, HME-6-11, HMG-10-11, HMG-10-11UL, HMG-10-21, HMG-10-21UL, HMG-20-11, HMG-2-10-11, HMG-6-11, HMI-10-11, HMI-10-11UL, HMI-10-21, HMI-10-21UL, HMI-2-10-11, HMI-6-11, HMI-6-11UL, HMM-10-11, HMM-10-11UL, HMM-10-21, HMM-10-21UL, HMM-20-11, HMM-20-11UL, HMM-20-21, HMM-20-21UL, HMM-2-10-11, HMM-2-20-11, HMM-40-11-USMC, HMM-6-11, HMM-6-11UL, HMP-10-11, HMP-10-21, HMP-20-11, HMP-20-21, HMP-2-10-11, HMP-2-20-11, HMP-6-11, HVG-10-11, HVG-10-11UL...(Other models you can see in the webshop)		



hose reels

appliance hose reels



1

GEV No.	542093	Ref. No.	12024800 12040977
description	hose reel complete with spray gun hose length 1.8m		
For models:	AE-061, AE-061W, AE-101, AE-101W, AE-102, AE-102W, AE-201, AE-202, AG-061, AG-061W, AG-101, AG-101W, AG-102, AG-102W, AG-201, AG-202, APE-061, APE-061W, APE-101, APE-101W, APE-102, APE-102W, APE-201, APE-202, APG-061, APG-061W, APG-101, APG-101W, APG-102, APG-102W, APG-201, APG-202, COG-202, HEM-20-21, HEP-10-21, HEP-20-21, HGP-10-21, HGP-20-21, HGV-20-21, VE-061, VE-101, VE-102, VE-201, VE-202, VG-101, VG-102, VG-201, VG-202, VPE-061, VPE-101...(Other models you can see in the webshop)		



1

GEV No.	541444	Ref. No.	12026185 RT5000176P
description	hose reel without spray gun hose length 1.5m		



1

GEV No.	540661	Ref. No.	12026732 12026734 RT5000140 RT5000140P	
description	hose reel without spray gun hose length 1m			
accessories for	540661			
	GEV No.	540664	Ref. No.	12030307 RT5000130
	spray gun for appliances 1/2" (12.83mm) L 165mm			
	GEV No.	560630	Ref. No.	12037727 RT11070100
	clamping washer nominal-ø 4mm ED ø 11.5mm SS thickness 0.2mm			
	GEV No.	694491	Ref. No.	—
	supply tube for hose reel			
	GEV No.	699802	Ref. No.	—
	cover for spray gun D1 ø 90/145mm L 145mm H 68mm			



1

GEV No.	540483	Ref. No.	12026642 RT86552020
description	hose reel without spray gun hose length 2.1m		

dosing pumps

peristaltic dosing pumps

GERMAC

built-in version

with frequency control









1

GEV No.	361795 ¹	Ref. No.	1200000132 19022347	
description	dosing pump GERMAC frequency control 3l/h 230VAC detergent hose ø 4x6mm hose thermoplastic type G300 3.5W 230V code 82334968 installation kit inclusive			
For models:	CO-110DD, CO-112DD, CO-142WDD, CO-170DD, CO-172DD, CO-350-COLD-DD, CO-350-DD, CO-400-COLD-DD, CO-400-DD, CO-402-COLD, CO-402-COLD-B, CO-402-COLD-B-DD, CO-402-COLD-DD, CO-402W, CO-500DD, CO-501DD, CO-502DD, CO-502W, COP-173DD, COP-174DD, COP-174W, COP-174WHR, COP-503DD, COP-504DD, COP-504W, FI-30, FI-30AR, FI-30AR+DD, FI-30-UK, FI-48, FI-48AR, FI-48B, FI-48B-BT-UK, FI-48C, FI-48D, FI-48HY-CLINIC, FI-48W, FI-64, FI-64AR, FI-64B, FI-64B-BT-UK, FI-64C, FI-64D, FI-64HY-CLINIC, FI-64W, FI-72, FI-72AR, FI-72W			
spare parts for	361795			
	GEV No.	361142	Ref. No.	—
	mounting set detergent hose type 4x6mm hose length 2m PVC 2x hose/container filter/tank intake transparent			
	GEV No.	361268	Ref. No.	12017199 12024224 Z209521 Z209530
	dosing pump GERMAC frequency control 3l/h 230VAC detergent hose ø 4x6mm hose thermoplastic type G300 built-in version dimensions 67x72x101mm			
	GEV No.	361467	Ref. No.	—
	pump hose GERMAC detergent hose type thermoplastic hose ø 6x10mm for model G43/G45/G53/G54/G55/G300/G305			

¹with accessories













			
1			
GEV No.	361268	Ref. No.	12017199 12024224 Z209521 Z209530
description	dosing pump GERMAC frequency control 3l/h 230VAC detergent hose ø 4x6mm hose thermoplastic type G300 built-in version dimensions 67x72x101mm		
For models:	FI-30, FI-48, FI-48B, FI-48W, FI-50, FI-64, FI-64B, FI-64W, FI-72, MF-48, MF-64		
spare parts for	361268		
	GEV No.	361467	Ref. No. —
	pump hose GERMAC detergent hose type thermoplastic hose ø 6x10mm for model G43/G45/G53/G54/G55/G300/G305		
	GEV No.	361557	Ref. No. —
	control PCB type G300/G302/G305 GERMAC		
	GEV No.	361589	Ref. No. —
	roller assembly GERMAC suitable for G42/43/45/53/54/55/300/302/305/705		
accessories for	361268		
	GEV No.	361106	Ref. No. —
	container filter with weight and non-return valve SS hose ø 4x6mm ø 21mm L 51mm non return valve lip valve		
	GEV No.	520090	Ref. No. —
	PVC hose ID ø 4mm ED ø 6mm L 2m thickness 1mm t.max. 60°C transparent		
	GEV No.	520091	Ref. No. —
	nylon hose ID ø 4mm ED ø 6mm L 2m thickness 1mm operating p. 10bar burst p. 50bar t.max. 100°C transparent		



membrane dosing pumps



self-priming

LANG

			
1			
GEV No.	361221	Ref. No.	12024105 12039170 Z211109 Z651123
description	dosing pump type N6 rinse aid pressure connection ø 4x6mm suction connection ø 6x8mm LANG		
For models:	AD-120, AD-120B, AD-120C, AD-120CW, AD-15, AD-15D, AD-20C-UK, AD-21, AD-21B, AD-21BDD, AD-21C, AD-21D, AD-21DD, AD-21W, AD-48, AD-48B, AD-48BDD, AD-48C, AD-48D, AD-48DD, AD-48W, AD-64, AD-64B, AD-64BDD, AD-64C, AD-64CW, AD-64D, AD-64DD, AD-72, AD-72W, AD-90, AD-90BA, AD-90BDD, AD-90DD, ADE-120, ADE-120B, ECO-120, ECO-1200, ECO-120B, FI-100, FI-100AR, FI-100B, FI-100BBT-UK, FI-120, FI-1200, FI-120AR+DD, FI-120B, FI-120C, FI-120HY-CLINIC, FI-120W...(Other models you can see in the webshop)		
spare parts for	361221		
	GEV No.	361079	Ref. No. —
	spring for type N5/N6 for ball		
	GEV No.	361080	Ref. No. —
	O-ring EPDM thickness 2mm ID ø 16mm Qty 1 pcs		
	GEV No.	361085	Ref. No. —
	O-ring EPDM thickness 2mm ID ø 8mm Qty 1 pcs		
	GEV No.	361309	Ref. No. —
	ball for type N5/N6		
	GEV No.	361310	Ref. No. —
	bracket for type N6 ball guide		
	GEV No.	361311	Ref. No. —
	O-ring EPDM thickness 2mm ID ø 6mm Qty 1 pcs for type N6		
	GEV No.	361314	Ref. No. —
	valve ring for type N6 holder for O-ring		
	GEV No.	361317	Ref. No. —
	sealing disc for type N6		
	GEV No.	361886	Ref. No. —
	non-return valve inletmm outletmm outlet ø 12.4mm L 12.7mm		



accessories			
			
GEV No.	101286	Ref. No.	12008476 S312108000 X205028
description	olive ID ø 6mm Qty 1 pcs		
For models:	BMG7-10, BMG-9045, BMG9-05, BMG9-05V-T, BMG9-10, BMG9-10V-T, CG-1002, CG-1502, CG-2000, CG-2000-2P, CG-2002, CG-2002P, CG-200S, CG-210, CG-210G, CG-300S, CG-310, CG-310G, CG6-41, CG7-10, CG7-11, CG-7115, CG7-41, CG-7415, CG7-61, CG-7615, CG9-05AD, CG9-05PLUS, CG9-10, CG9-10AD, CG9-10PLUS, CG9-11, CG-9110, CG9-11AD, CG9-11PLUS, CG9-20AD, CG9-20AD-H, CG9-20PLUS, CG9-20PLUS-H, CG9-31PLUS-D, CG9-31PLUS-I, CG9-40AD, CG9-40AD-H, CG9-40PLUS, CG9-40PLUS-H, CG9-41, CG9-41AD, CG9-41AD-H, CG9-41PLUS, CG9-41PLUS-H...(Other models you can see in the webshop)		
accessories for	101286		
			
GEV No.	100909	Ref. No.	12008740 12016658 S312107 U265703
description	union screw thread M10x1 for pipe ø 6mm Qty 1 pcs		
			
GEV No.	101464	Ref. No.	—
description	union nut thread M12x1 for pipe ø 6mm		

various			
			
GEV No.	361015	Ref. No.	12045206
description	dosing pump membrane dosing pump rinse aid inlet 6x8mm outlet 4x6mm pressure connection ø 4x6mm suction connection ø 6x8mm		
For models:	AD-120, AD-120B, AD-120C, AD-15, AD-15D, AD-20C-UK, AD-21, AD-21B, AD-21BDD, AD-21C, AD-21D, AD-21W, AD-48, AD-48B, AD-48BDD, AD-48C, AD-48D, AD-48DD, AD-48W, AD-64, AD-64B, AD-64BDD, AD-64C, AD-64CW, AD-64DD, AD-72, AD-72W, AD-90, AD-90A, AD-90BDD, AD-90DD, ADE-120, ADE-120B, CO-110, CO-110B, CO-110BDD, CO-110DD, CO-112, CO-112B, CO-112BDD, CO-112DD, CO-142W, CO-142WDD, CO-170, CO-170B, CO-170BDD, CO-170DD, CO-170HRS, CO-170HRSDD, CO-170HRS-SOFT...(Other models you can see in the webshop)		
spare parts for	361015		
			
GEV No.	361132	Ref. No.	—
description	membrane dosing pump		
			
GEV No.	510298	Ref. No.	—
description	lip valve dosing pump suitable for DB2/DS5		

accessories			
			
GEV No.	361062	Ref. No.	12011355 Z601153
description	container filter hose ø 4mm		
For models:	AD-125, AD-125HRS, AD-125-SOFT, AD-505, CO-110DD, CO-112DD, CO-142WDD, CO-170DD, CO-172DD, COP-173, COP-173B, COP-173BDD, COP-173DD, COP-173HRS, COP-173HRSDD, COP-173-SOFT, COP-174, COP-174B, COP-174BDD, COP-174DD, COP-174HRS, COP-174HRSDD, COP-174W, COP-174WHRS, COP-503, COP-503B, COP-503BDD, COP-503DD, COP-503-SOFT, COP-504, COP-504B, COP-504BDD, COP-504DD, COP-504W, ECO-120, ECO-1200, ECO-120B, FI-100, FI-100AR, FI-100B, FI-120, FI-1200, FI-120B, FI-120W, FI-30, FI-300B, FI-300R, FI-48, FI-48B, FI-48W...(Other models you can see in the webshop)		

filter weights			
			
GEV No.	505409	Ref. No.	12024353
description	filter weight ID ø 7.6mm ext. ø 20 L 6mm 12g SS		
For models:	AD-125, AD-125HRS, AD-125-SOFT, AD-505, AD-505-SOFT, AD-64BTDD, CO-110DD, CO-112DD, CO-142WDD, CO-170DD, CO-172DD, CO-350-COLD-DD, CO-350-DD, CO-400-COLD-DD, CO-400-DD, CO-402-COLD, CO-402-COLD-B, CO-402-COLD-B-DD, CO-402-COLD-DD, CO-402W, CO-500DD, CO-501DD, CO-502DD, CO-502W, COP-173, COP-173B, COP-173BDD, COP-173DD, COP-173HRS, COP-173HRSDD, COP-173-SOFT, COP-174, COP-174B, COP-174BDD, COP-174DD, COP-174HRS, COP-174HRSDD, COP-174W, COP-174WHRS, COP-503, COP-503B, COP-503BDD, COP-503DD, COP-503-SOFT, COP-504, COP-504B, COP-504BDD, COP-504DD, COP-504W, EASY-500...(Other models you can see in the webshop)		

			
GEV No.	505197	Ref. No.	12024353 old version Z701152
description	filter weight ID ø 8x9mm ext. ø 14 L 20mm 17g brass		
For models:	AD-120, AD-120B, AD-120C, AD-120CW, AD-120HY, AD-15, AD-15D, AD-20C-UK, AD-21, AD-21B, AD-21BDD, AD-21C, AD-21D, AD-21DD, AD-21W, AD-45BBT, AD-48, AD-48B, AD-48BDD, AD-48C, AD-48D, AD-48DD, AD-48HY, AD-48W, AD-64, AD-64B, AD-64BBT, AD-64BDD, AD-64C, AD-64CW, AD-64D, AD-64DD, AD-64HY, AD-72, AD-72W, AD-90, AD-90A, AD-90BBT, AD-90BDD, AD-90DD, ADE-120, ADE-120B, ECO-120, ECO-1200, FI-100, FI-100AR, FI-100B, FI-100BBT-UK, FI-120, FI-1200, FI-120AR+DD...(Other models you can see in the webshop)		



hose couplings

plastic



GEV No.	361102	Ref. No.	12036243 RT20620339
description	hose connector plastic angled thread M10x1 hose ø 6mm Qty 1 pcs connection M10x1 hose ø 6mm		



GEV No.	361100	Ref. No.	12036489 RT20620351
description	hose connector plastic straight thread M10x1 hose ø 6mm Qty 1 pcs connection M10x1 hose ø 6mm		

T-pieces

without non-return valve



GEV No.	505086	Ref. No.	12025288 Z601157
description	T-piece connection 1: 10mm connection 2: 4mm		

For models: AD-120, AD-120B, AD-120C, AD-120CW, AD-125, AD-125HRS, AD-15, AD-15D, AD-20C-UK, AD-21, AD-21B, AD-21BDD, AD-21C, AD-21D, AD-21DD, AD-21W, AD-48, AD-48B, AD-48BDD, AD-48C, AD-48D, AD-48DD, AD-48W, AD-64, AD-64B, AD-64BDD, AD-64C, AD-64CW, AD-64D, AD-64DD, AD-72, AD-72W, AD-90, AD-90BA, AD-90BDD, AD-90DD, ADE-120, ADE-120B, CO-110, CO-110B, CO-110BDD, CO-110DD, CO-112, CO-112B, CO-112BDD, CO-112DD, CO-142W, CO-142WDD, CO-170, CO-170B...(Other models you can see in the webshop)

tank inlets



GEV No.	361105	Ref. No.	FAG1200026
description	tank inlet plastic M10 hose ø 4x6mm		



GEV No.	508427	Ref. No.	12024531 Z208927000
description	tank inlet stainless steel M10 hose ø 4mm		



GEV No.	361656	Ref. No.	6000012
description	tank inlet stainless steel M10x1.5 hose ø 4mm		

mounting sets

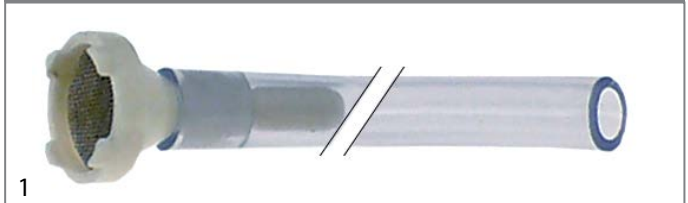

GEV No.	520398	Ref. No.	12003213 12Z60115 12Z6011500
description	hose detergent hose type 4x6mm hose length 1.3m PVC with filter transparent		

hoses

supply hoses

PVC supply hoses

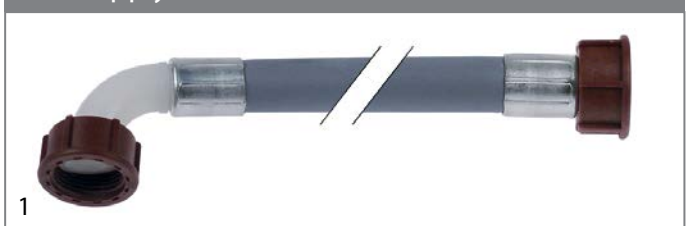

GEV No.	520010	Ref. No.	12024115 Z602121
description	supply hose PVC straight-curved DN13 connections 3/4" L 1500mm operating p. 10bar burst p. 32bar t.max. 90°C blue approval VDE flat seal		

For models: AD-120, AD-120B, AD-120BTTDD-UK, AD-120C, AD-120CW, AD-120HY, AD-125, AD-125HRS, AD-125-SOFT, AD-15D, AD-21D, AD-45BBT, AD-48, AD-48B, AD-48BDD, AD-48C, AD-48D, AD-48DD, AD-48HY, AD-48W, AD-505, AD-64, AD-64B, AD-64BBT, AD-64BDD, AD-64BTDD, AD-64C, AD-64CW, AD-64D, AD-64DD, AD-64HY, AD-72, AD-72W, AD-90, AD-90BA, AD-90BBT, AD-90BDD, AD-90DD, ADE-120, ADE-120B, CO-110, CO-110B, CO-110BDD, CO-110DD, CO-112, CO-112B, CO-112BDD, CO-112DD, CO-142W, CO-142WDD...(Other models you can see in the webshop)

accessories for 520010

GEV No.	520053	Ref. No.	12025278 Z701132
description	screen connection 3/4" D1 ø 26mm D2 ø 15mm Qty 10 pcs rubber thickness 8mm		

GEV No.	520054	Ref. No.	—
description	flat gasket rubber ED ø 23.5mm ID ø 14mm thickness 2.3mm Qty 10 pcs		

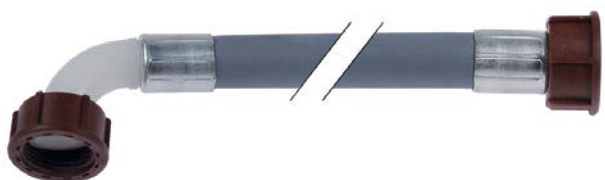
GEV No.	520012	Ref. No.	12025198 Z601114
description	supply hose PVC straight-curved DN13 connections 3/4" L 2500mm operating p. 10bar burst p. 32bar t.max. 90°C approval VDE flat seal		
For models:	ACE-061, ACE-101, ACE-102, ACE-201, ACE-202, ACG-061, ACG-101, ACG-102, ACG-201, ACG-202, AD-15, AD-20C-UK, AD-21, AD-21B, AD-21BDD, AD-21C, AD-21DD, AE-061, AE-061W, AE-101, AE-101W, AE-102, AE-102W, AE-201, AE-202, AG-061, AG-061W, AG-101, AG-101W, AG-102, AG-102W, AG-201, AG-202, APE-061, APE-061W, APE-101, APE-101W, APE-102, APE-102W, APE-201, APE-202, APG-061, APG-061W, APG-101, APG-101W, APG-102, APG-102W, APG-201, APG-202, COG-061...(Other models you can see in the webshop)		

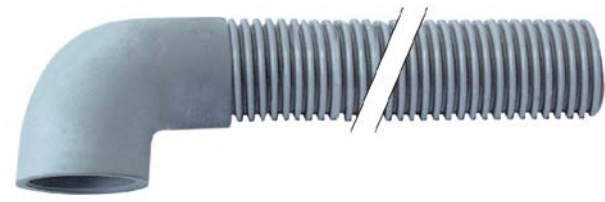

GEV No.	505081	Ref. No.	12024114 Z400908
description	drain hose DN25 L 1600mm elbow ø inside 31mm elbow ext. ø 40mm outer hose ø 30mm		
For models:	AD-15, AD-15D, AD-21, AD-21D, AD-21DD, ATM-051ECO, CO-350, CO-350-COLD, CO-350-COLD-DD, CO-350-DD, CO-352-COLD, CO-352-COLD-DD, CO-400, CO-400-COLD, CO-400-COLD-DD, CO-400-DD, CO-400-SOFT, CO-402-COLD, CO-402-COLD-DD, ECO-2700D, ECO-2700I, ECO-4000D, ECO-4000I, ECO-6000D, ECO-6000I, FI-2700D, FI-2700I, FI-4000D, FI-4000I, FI-6000D, FI-6000I, GA-20, GA-20D, GA-40, GA-40D, LVC-12, LVC-15, LVC-15D, LVC-21, LVC-21B, LVC-21C, LVC-21D, LVC-21W, LVR-10, LVR-14, LVR-14D, LVR-20, LVR-20D		

pre-rinse hoses

stainless steel flexi hoses



GEV No.	691095	Ref. No.	12039111 R095006
description	shower hose SS with flexible fabric		
For models:	HCG-10-11, HCG-10-21, HCG-20-11, HCG-20-21, HCG-2-10-11, HCG-2-20-11, HCG-6-11, HME-10-11, HME-10-21, HME-20-11, HME-20-21, HME-2-10-11, HME-2-20-11, HME-6-11, HMG-10-11, HMG-10-11UL, HMG-10-21, HMG-10-21UL, HMG-20-11, HMG-2-10-11, HMG-6-11, HMI-10-11, HMI-10-11UL, HMI-10-21, HMI-10-21UL, HMI-2-10-11, HMI-6-11, HMI-6-11UL, HMM-10-11, HMM-10-11UL, HMM-10-21, HMM-10-21UL, HMM-20-11, HMM-20-11UL, HMM-20-21, HMM-20-21UL, HMM-2-10-11, HMM-2-20-11, HMM-40-11-USMC, HMM-6-11, HMM-6-11UL, HMP-10-11, HMP-10-21, HMP-20-11, HMP-20-21, HMP-2-10-11, HMP-2-20-11, HMP-6-11, HVG-10-11, HVG-10-11UL...(Other models you can see in the webshop)		

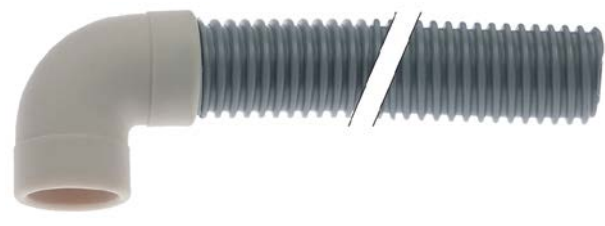

GEV No.	505402	Ref. No.	12115471
description	drain hose DN25 L 2000mm elbow ø inside 27mm elbow ext. ø 35mm inner hose ø 25mm outer hose ø 30mm plastic		
For models:	CO-500, CO-500DD, CO-501, CO-501DD, CO-501-SOFT, CO-502DD, COP-503, COP-503DD, COP-503-SOFT, COP-504, COP-504DD		

drain hoses



GEV No.	505082	Ref. No.	12024473 Z200910
description	drain hose DN25 L 1500mm elbow ø inside 48mm elbow ext. ø 58mm outer hose ø 31mm		
For models:	AD-120, AD-120CW, AD-48, AD-48D, AD-48DD, AD-64, AD-64BTDD, AD-64D, AD-64DD, AD-72, AD-72W, AD-90, AD-90DD, ADE-120, APE-061, APE-101, APE-102, APE-201, APE-202, APG-061, APG-101, APG-102, APG-201, APG-202, CO-110, CO-110B, CO-110BDD, CO-110DD, CO-112DD, CO-142W, CO-142WDD, CO-170, CO-170B, CO-170BDD, CO-170DD, CO-170HRS, CO-170HRSDD, CO-170HRS-SOFT, CO-170-SOFT, CO-172DD, COP-173, COP-173B, COP-173BDD, COP-173DD, COP-173HRS, COP-173HRSDD, COP-173-SOFT, COP-174DD, COP-174W, COP-174WHR... (Other models you can see in the webshop)		



GEV No.	505084	Ref. No.	12023666 Z220903
description	drain hose DN19 L 2000mm straight ø inside 21mm straight ext. ø 26mm elbow ø inside 21mm elbow ext. ø 27mm outer hose ø 27mm		
For models:	AD-120B, AD-120BBTDD-UK, AD-120C, AD-120HY, AD-125, AD-125HRS, AD-125-SOFT, AD-20C-UK, AD-21B, AD-21BDD, AD-21C, AD-21W, AD-45BBT, AD-48B, AD-48BDD, AD-48C, AD-48HY, AD-48W, AD-64B, AD-64BBT, AD-64BDD, AD-64C, AD-64CW, AD-64HY, AD-90BA, AD-90BBT, AD-90BDD, ADE-120B, BME7-05, BME7-10, BMG7-10, CO-350-B, CO-350-B-DD, CO-350-COLD-B, CO-350-COLD-B-DD, CO-352-COLD-B, CO-352-COLD-B-DD, CO-400-B, CO-400-B-DD, CO-400-COLD-B, CO-400-COLD-B-DD, CO-402-COLD-B, CO-402-COLD-B-DD, CO-402W, CO-500B, CO-500BDD, CO-501B, CO-501BDD, CO-502B, CO-502BDD...(Other models you can see in the webshop)		

industrial hoses
Niplaflex hoses

GEV No.	530561	Ref. No.	11000083 S102121000
description	pressure hose ID \varnothing 10mm ED \varnothing 17mm L 5m thickness 3.5mm operating p. 10bar burst p. 30bar t.max. 110°C		
For models:	ACE-061, ACE-101, ACE-102, ACE-201, ACE-202, ACG-061, ACG-101, ACG-102, ACG-201, ACG-202, AD-120, AD-120B, AD-120BBTDD-UK, AD-120C, AD-120CW, AD-120HY, AD-125, AD-125HRS, AD-125-SOFT, AD-15, AD-15D, AD-20C-UK, AD-21, AD-21B, AD-21BDD, AD-21C, AD-21D, AD-21DD, AD-21W, AD-45BBT, AD-48, AD-48B, AD-48BDD, AD-48C, AD-48D, AD-48DD, AD-48HY, AD-48W, AD-505, AD-505-SOFT, AD-64, AD-64B, AD-64BBT, AD-64BDD, AD-64BTDD, AD-64C, AD-64CW, AD-64D, AD-64DD, AD-64HY...(Other models you can see in the webshop)		

pressure control hoses

GEV No.	530560	Ref. No.	11000066 3702400
description	pressure control hose ID \varnothing 5mm ED \varnothing 9mm L 5m operating p. 30bar burst p. 90bar temp.-resist. 60°C		
For models:	AD-120, AD-120B, AD-120BBTDD-UK, AD-120C, AD-120CW, AD-120HY, AD-125, AD-125HRS, AD-125-SOFT, AD-15, AD-15D, AD-20C-UK, AD-21, AD-21B, AD-21BDD, AD-21C, AD-21D, AD-21DD, AD-21W, AD-45BBT, AD-48, AD-48B, AD-48BDD, AD-48C, AD-48D, AD-48DD, AD-48HY, AD-48W, AD-505, AD-505-SOFT, AD-64, AD-64B, AD-64BBT, AD-64BDD, AD-64BTDD, AD-64C, AD-64CW, AD-64D, AD-64DD, AD-64HY, AD-72, AD-72W, AD-90, AD-90BA, AD-90BBT, AD-90BDD, AD-90DD, ADE-120, ADE-120B, CO-110...(Other models you can see in the webshop)		

silicone hoses
without fabric

GEV No.	520399	Ref. No.	11000157 11000158 3715600
description	silicone hose ID \varnothing 18mm ED \varnothing 26mm thickness 4mm t.max. 200°C red		
For models:	ACE-061, ACE-102, AE-061, AE-061W, AE-101, AE-101W, AE-102, AE-102W, AE-201, AE-202, AG-061, AG-061W, AG-101, AG-101W, AG-102, AG-102W, AG-201, AG-202, APE-061, APE-061W, APE-101, APE-101W, APE-102, APE-102W, APE-201, APE-202, APG-061, APG-061W, APG-101, APG-101W, APG-102, APG-102W, APG-201, APG-202, HCG-10-11, HCG-10-21, HCG-20-11, HCG-2-10-11, HCG-6-11, HEI-10-11, HEI-10-21, HEI-6-11, HEM-10-11, HEM-10-21, HEM-20-11, HEM-20-21, HEM-6-11, HEP-10-11, HEP-10-21, HEP-20-11...(Other models you can see in the webshop)		

GEV No.	530052	Ref. No.	11000154 11000171 3710900 3715800 R345021 R345024
description	silicone hose ID \varnothing 43mm ED \varnothing 51mm L 0.8m thickness 4mm t.max. 200°C red		
For models:	COE-102, COG-061, COG-101, COG-102, COG-201, COG-202, HCV-10-11, HCV-10-21, HCV-2-10-21, HCV-5-11, HCV-6-11, HEI-10-11, HEI-10-21, HEI-20-11, HEI-20-21, HEI-6-11, HEM-10-11, HEM-10-21, HEM-20-11, HEM-20-21, HEM-6-11, HEP-10-11, HEP-10-21, HEP-20-11, HEP-20-21, HEP-6-11, HGP-10-21, HGV-20-21, HME-10-11, HME-10-21, HME-20-11, HME-20-21, HME-2-10-11, HME-2-20-11, HME-6-11, HMI-10-11, HMI-10-11UL, HMI-10-21, HMI-10-21UL, HMI-2-10-11, HMI-6-11, HMI-6-11UL, HMM-10-11, HMM-10-11UL, HMM-10-21, HMM-10-21UL, HMM-20-11, HMM-20-11UL, HMM-20-21, HMM-20-21UL...(Other models you can see in the webshop)		

GEV No.	530067	Ref. No.	12034862 RT21121301
description	silicone hose ID \varnothing 50mm ED \varnothing 56mm L 0.13m thickness 3mm t.max. 200°C		

GEV No.	530798	Ref. No.	12034250 RT21101030
description	silicone hose ID \varnothing 6mm ED \varnothing 10mm L 1120mm for combi-steamer CPC-Linie CM 61-202/G		

GEV No.	530550	Ref. No.	12034590 RT21101008
description	silicone hose ID \varnothing 6mm ED \varnothing 10mm L 5m thickness 2mm operating pressure without pressure burst pressure non defined t.max. 200°C transparent Shore 55°		



with fabric

with monofilament braid



1

GEV No.	530693	Ref. No.	12033361 RT20670050
description	silicone hose with monofilament braid ID ø 10mm ED ø 17mm L 1m thickness 3.5mm operating p. 4bar t.max. 200°C Qty 1m		

pressure hoses (other)



1

GEV No.	530567	Ref. No.	36769 36769000
description	universal hose ID ø 10mm ED ø 17mm Qty supplied by meter		

formed hoses

straight



1

GEV No.	505026	Ref. No.	12023607 Z400906
description	formed hose dishwasher straight		
For models:	AD-15, AD-15D, AD-20C-UK, AD-21, AD-21B, AD-21BDD, AD-21C, AD-21D, AD-21DD, AD-21W, CO-350, CO-350-B, CO-350-B-DD, CO-350-COLD, CO-350-COLD-B, CO-350-COLD-B-DD, CO-350-COLD-DD, CO-350-DD, CO-352-COLD, CO-352-COLD-B, CO-352-COLD-B-DD, CO-352-COLD-DD, CO-400, CO-400-B, CO-400-B-DD, CO-400-COLD, CO-400-COLD-B, CO-400-COLD-B-DD, CO-400-COLD-DD, CO-400-DD, CO-400-SOFT, CO-402-COLD, CO-402-COLD-B, CO-402-COLD-B-DD, CO-402-COLD-DD, CO-402W, LVC-12, LVC-15, LVC-15D, LVC-21, LVC-21B, LVC-21C, LVC-21D, LVC-21W, LVR-10, LVR-14, LVR-14D, LVR-20, LVR-20B, LVR-20D...(Other models you can see in the webshop)		



1

GEV No.	503150	Ref. No.	12000050 12023567 Z162301 Z740902
description	formed hose hose ext. ø 54mm hose int. ø 38mm L 55mm		
For models:	AD-120BTTDD-UK, AD-120HY, AD-90, AD-90BA, AD-90BBT, AD-90BDD, AD-90DD, ADE-120, ADE-120B, ECO-120, ECO-120B, ECO-160, ECO-1600, ECO-160D, ECO-160I, ECO-200, ECO-200D, ECO-200H, ECO-200HD, ECO-200HI, ECO-200I, ECO-2300, ECO-2700D, ECO-2700I, ECO-280D, ECO-280I, ECO-3000, ECO-370D, ECO-370I, ECO-4000D, ECO-4000I, ECO-460D, ECO-460I, ECO-550D, ECO-550I, ECO-6000D, ECO-6000I, FI-100, FI-100AR, FI-100B, FI-100BBT-UK, FI-120HY-CLINIC, FI-2700D, FI-2700I, FI-280D, FI-280I, FI-370D, FI-370I, FI-4000D, FI-4000I...(Other models you can see in the webshop)		



1

GEV No.	530880	Ref. No.	12024437
description	formed hose hose int. ø 30.5mm D1 ø 39mm D2 ø 44.5mm L 45mm Qty 1		
For models:	AD-64BTDD, EASY-500HPWBDD		



1

GEV No.	530025	Ref. No.	12019517 R345020
description	formed hose ID ø 51mm ED ø 62mm L 101mm straight steam		
For models:	HCV-10-11, HCV-10-21, HCV-2-10-21, HCV-5-11, HCV-6-11, HEI-10-11, HEI-10-21, HEI-20-11, HEI-6-11, HEM-10-11, HEM-10-21, HEM-20-11, HEM-6-11, HEP-10-11, HEP-10-21, HEP-20-11, HEP-6-11, HGP-20-21, HGV-20-21, HME-10-11, HME-10-21, HME-20-11, HME-20-21, HME-2-10-11, HME-2-20-11, HME-6-11, HMM-10-11, HMM-10-11UL, HMM-10-21, HMM-10-21UL, HMM-20-11, HMM-20-11UL, HMM-20-21, HMM-20-21UL, HMM-2-10-11, HMM-2-20-11, HMM-40-11-USMC, HMM-6-11, HMM-6-11UL, HMP-10-11, HMP-10-21, HMP-20-11, HMP-20-21, HMP-2-10-11, HMP-2-20-11, HMP-6-11, HVG-20-21, HVG-2-20-21		

			
1			
GEV No.	694706	Ref. No.	12024122 T722608
description	hose ID ø 52mm ext. ø 57 L 363mm silicone discharge air steam generator red Qty 1		
For models:	ACE-061, ACE-101, ACE-102, ACE-201, ACE-202, ACG-061, ACG-101, ACG-102, ACG-201, ACG-202, AE-061, AE-061W, AE-101, AE-101W, AE-102, AE-102W, AE-201, AE-202, AG-061, AG-061W, AG-101, AG-101W, AG-102, AG-102W, AG-201, AG-202, APE-061, APE-061W, APE-101, APE-101W, APE-102, APE-102W, APE-201, APE-202, APG-061, APG-061W, APG-101, APG-101W, APG-102, APG-102W, APG-201, APG-202, COE-061, COE-101, COE-102, COE-201, COE-202, VE-061, VE-101, VE-102...(Other models you can see in the webshop)		

			
2			
GEV No.	694321	Ref. No.	12037987 RT21121307
description	hose ID ø 70mm ext. ø 80 L 80mm for combi-steamer		

			
1			
GEV No.	530067	Ref. No.	12034862 RT21121301
description	silicone hose ID ø 50mm ED ø 56mm L 0.13m thickness 3mm t.max. 200°C		

			
1			
GEV No.	530875	Ref. No.	12031550 RT4400362
description	steam hose ext. ø 78 ID ø 70mm L 54mm silicone red/black		

<p>form L</p> 			
1			

GEV No.	505336	Ref. No.	12024143 Z310904
description	extraction hose ED ø 76mm L 220mm L-shape ID ø 60mm for FAGOR		
For models:	ECO-2700D, ECO-2700I, ECO-280D, ECO-280I, ECO-370D, ECO-370I, ECO-4000D, ECO-4000I, ECO-460D, ECO-460I, ECO-550D, ECO-550I, ECO-6000D, ECO-6000I, FI-2700D, FI-2700I, FI-280D, FI-280I, FI-370D, FI-370I, FI-4000D, FI-4000I, FI-460D, FI-460I, FI-550D, FI-550I, FI-6000D, FI-6000I		

			
1			

GEV No.	524028	Ref. No.	12023698 12Z7409010
description	formed hose 90° L2 120mm L1 190mm ID ø 38mm ED ø 54mm		
For models:	AD-120C, AD-120HY, AD-90, AD-90BA, AD-90BDD, AD-90DD, ECO-160D, ECO-160I, ECO-200D, ECO-200HD, ECO-200HI, ECO-200I, FI-160AR, FI-160D, FI-160I, FI-200AR, FI-200D, FI-200HD, FI-200HI, FI-200I, FI-200WL, FI-200WR, FI-80, FI-80AR, FI-80W, FI-E-100, LABP-800		

			
1			

GEV No.	530794	Ref. No.	12031663 RT21121304
description	formed hose ED ø 29mm ID ø 23mm L 485mm for combi-steamer CPC-Linie 102/201E		

			
1			

GEV No.	530791	Ref. No.	12031730 RT4400242
description	formed hose ED ø 29mm ID ø 23mm L 730mm for combi-steamer SCC Linie 202		





			
GEV No.	505028	Ref. No.	12023689 Z200905
description	formed hose end piece A int. ø 50mm ø end piece B 38mm L 2500mm warewashing L-shape equiv. no. Z200905		
For models:	AD-45BBT, AD-48, AD-48B, AD-48BDD, AD-48C, AD-48D, AD-48DD, AD-48HY, AD-48W, AD-64, AD-64B, AD-64BBT, AD-64BDD, AD-64BTDD, AD-64C, AD-64CW, AD-64D, AD-64DD, AD-64HY, AD-72, AD-72W, EASY-500, EASY-500B, EASY-500DD, EASY-500HP, EASY-500HPWBDD, FI-30, FI-30AR, FI-30AR+DD, FI-30B, FI-30B-BT-UK, FI-30-UK, FI-48, FI-48AR, FI-48B, FI-48B-BT-UK, FI-48C, FI-48D, FI-48HY-CLINIC, FI-48W, FI-50, FI-60DD, FI-64, FI-64AR, FI-64B, FI-64B-BT-UK, FI-64C, FI-64D, FI-64HY-CLINIC, FI-64W...(Other models you can see in the webshop)		

			
GEV No.	505029	Ref. No.	12023741 Z710905
description	formed hose warewashing L-shape equiv. no. Z710905 mounting pos. lower		
For models:	AD-120, AD-120B, AD-120BBTDD-UK, AD-120C, AD-120CW, AD-120HY, AD-90BBT, ADE-120, ADE-120B, ECO-120, ECO-120B, ECO-160, ECO-160D, ECO-160I, ECO-200, ECO-200D, ECO-200H, ECO-200HD, ECO-200HI, ECO-200I, ECO-2700D, ECO-2700I, ECO-370D, ECO-370I, ECO-4000D, ECO-4000I, ECO-550D, ECO-550I, ECO-6000D, ECO-6000I, FI-100, FI-100AR, FI-100B, FI-100BBT-UK, FI-120, FI-120AR+DD, FI-120B, FI-120C, FI-120HY-CLINIC, FI-120W, FI-160, FI-160AR, FI-160D, FI-160I, FI-200, FI-200AR, FI-200D, FI-200H, FI-200HD, FI-200HI...(Other models you can see in the webshop)		

			
GEV No.	530792	Ref. No.	12031089 RT21121305
description	formed hose ID ø 22mm ED ø 29mm L 640mm for combi-steamer CPC 202		

			
GEV No.	505030	Ref. No.	12023519 Z710906
description	formed hose warewashing L-shape equiv. no. Z710906 mounting pos. upper		
For models:	AD-120, AD-120B, AD-120BBTDD-UK, AD-120C, AD-120CW, AD-120HY, AD-90BBT, ADE-120, ADE-120B, ECO-120, ECO-120B, ECO-160, ECO-160D, ECO-160I, ECO-200, ECO-200D, ECO-200H, ECO-200HD, ECO-200HI, ECO-200I, ECO-370D, ECO-370I, ECO-550D, ECO-550I, FI-100, FI-100AR, FI-100B, FI-100BBT-UK, FI-120, FI-120AR+DD, FI-120B, FI-120C, FI-120HY-CLINIC, FI-120W, FI-160, FI-160AR, FI-160D, FI-160I, FI-200, FI-200AR, FI-200D, FI-200H, FI-200HD, FI-200HI, FI-200I, FI-200W, FI-200WL, FI-200WR, FI-370D, FI-370I...(Other models you can see in the webshop)		

			
GEV No.	505024	Ref. No.	12023683 Z200904
description	formed hose warewashing L-shape equiv. no. Z200904		
For models:	AD-45BBT, AD-48, AD-48B, AD-48BDD, AD-48C, AD-48D, AD-48DD, AD-48HY, AD-48W, AD-64, AD-64B, AD-64BBT, AD-64BDD, AD-64BTDD, AD-64C, AD-64CW, AD-64D, AD-64DD, AD-64HY, AD-72, AD-72W, EASY-500, EASY-500B, EASY-500DD, EASY-500HP, EASY-500HPWBDD, FI-30, FI-30AR, FI-30AR+DD, FI-30B, FI-30B-BT-UK, FI-30-UK, FI-48, FI-48AR, FI-48B, FI-48B-BT-UK, FI-48C, FI-48D, FI-48HY-CLINIC, FI-48W, FI-50, FI-60DD, FI-64, FI-64AR, FI-64B, FI-64B-BT-UK, FI-64C, FI-64D, FI-64HY-CLINIC, FI-64W...(Other models you can see in the webshop)		

			
GEV No.	505027	Ref. No.	12023625 Z710904
description	formed hose warewashing L-shape equiv. no. Z740901		
For models:	AD-120, AD-120B, AD-120BBTDD-UK, AD-120C, AD-120CW, AD-120HY, AD-90, AD-90BA, AD-90BBT, AD-90BDD, AD-90DD, ADE-120, ADE-120B, ECO-120, ECO-120B, ECO-160, ECO-160D, ECO-160I, ECO-200, ECO-200D, ECO-200H, ECO-200HD, ECO-200HI, ECO-200I, ECO-370D, ECO-370I, ECO-550D, ECO-550I, FI-100, FI-100AR, FI-100B, FI-100BBT-UK, FI-120, FI-120AR+DD, FI-120B, FI-120C, FI-120HY-CLINIC, FI-120W, FI-160, FI-160AR, FI-160D, FI-160I, FI-200, FI-200AR, FI-200D, FI-200H, FI-200HD, FI-200HI, FI-200I, FI-200W...(Other models you can see in the webshop)		

			
GEV No.	505023	Ref. No.	12023670 Z400905
description	formed hose warewashing L-shape equiv. no. Z400905		
For models:	AD-15, AD-15D, AD-20C-UK, AD-21, AD-21B, AD-21BDD, AD-21C, AD-21D, AD-21DD, AD-21W, CO-350, CO-350-B, CO-350-B-DD, CO-350-COLD, CO-350-COLD-B, CO-350-COLD-B-DD, CO-350-COLD-DD, CO-350-DD, CO-352-COLD, CO-352-COLD-B, CO-352-COLD-B-DD, CO-352-COLD-DD, CO-400, CO-400-B, CO-400-B-DD, CO-400-COLD, CO-400-COLD-B, CO-400-COLD-B-DD, CO-400-COLD-DD, CO-400-DD, CO-400-SOFT, CO-402-COLD, CO-402-COLD-B, CO-402-COLD-B-DD, CO-402-COLD-DD, CO-402W, LVC-12, LVC-15, LVC-15D, LVC-21, LVC-21B, LVC-21C, LVC-21D, LVC-21W, LVR-10, LVR-14, LVR-14D, LVR-20, LVR-20B, LVR-20D...(Other models you can see in the webshop)		

			
1			
GEV No.	505032	Ref. No.	12023779 Z740903
description	formed hose warewashing L-shape equiv. no. Z740903 mounting pos. lower		
For models:	AD-90, AD-90BA, AD-90BDD, AD-90DD, FI-80, FI-80AR, FI-80W, FI-E-100, LABP-800		

			
1			
GEV No.	530918	Ref. No.	12039649 T945056000
description	hose ID ø 30mm ED ø 40mm L 110mm for steam generator		
For models:	ACE-102, AE-102, AE-102W, AE-201, AE-202, AG-061, AG-061W, AG-101, AG-101W, AG-102, AG-102W, AG-201, AG-202, APE-102, APE-102W, APE-201, APE-202, APG-061, APG-061W, APG-101, APG-101W, APG-102, APG-102W, APG-201, APG-202		

			
1			
GEV No.	530919	Ref. No.	12044832
description	hose ID ø 73mm ED ø 85mm L 150mm for steam generator		
For models:	AG-202, APG-202		

for dishwashers

pressure hoses

			
1			
GEV No.	513136	Ref. No.	11000070
description	pressure hose ext. ø 10 ID ø 4.5mm L 1000mm dosage black Qty 1 rinse aid		
For models:	AD-120, AD-120B, AD-120BBTDD-UK, AD-120C, AD-120CW, AD-120HY, AD-15, AD-15D, AD-20C-UK, AD-21, AD-21B, AD-21BDD, AD-21C, AD-21D, AD-21DD, AD-21W, AD-48, AD-48B, AD-48BDD, AD-48C, AD-48D, AD-48DD, AD-48W, AD-64, AD-64B, AD-64BDD, AD-64C, AD-64CW, AD-64D, AD-64DD, AD-72, AD-72W, AD-90, AD-90BA, AD-90BBT, AD-90BDD, AD-90DD, ADE-120, ADE-120B, CO-110, CO-110B, CO-110BDD, CO-110DD, CO-112, CO-112B, CO-112BDD, CO-112DD, CO-142W, CO-142WDD, CO-170...(Other models you can see in the webshop)		

miscellaneous

			
1			
GEV No.	511557	Ref. No.	11000142 3715300
description	dosing hose ED ø 26mm ID ø 15mm L 1200mm burst p. 20bar		
For models:	ECO-160, ECO-160D, ECO-160I, ECO-200, ECO-200D, ECO-200H, ECO-200HD, ECO-200HI, ECO-200I, ECO-2700D, ECO-2700I, ECO-280D, ECO-280I, ECO-370D, ECO-370I, ECO-4000D, ECO-4000I, ECO-460D, ECO-460I, ECO-550D, ECO-550I, ECO-6000D, ECO-6000I, FI-2700D, FI-2700I, FI-280D, FI-280I, FI-30B-BT-UK, FI-370D, FI-370I, FI-4000D, FI-4000I, FI-460D, FI-460I, FI-48B-BT-UK, FI-48HY-CLINIC, FI-550D, FI-550I, FI-6000D, FI-6000I, FI-64B-BT-UK, FI-64HY-CLINIC		

			
1			
GEV No.	105503	Ref. No.	12023858 Z951101
description	extraction hose ED ø 35mm IT 1" L 970mm SS		
For models:	ADE-120, ADE-120B, ECO-120, ECO-120B, ECO-160, ECO-1600, ECO-160D, ECO-160I, ECO-200, ECO-200D, ECO-200H, ECO-200HD, ECO-200HI, ECO-200I, ECO-2300, ECO-2700D, ECO-2700I, ECO-280D, ECO-280I, ECO-3000, ECO-370D, ECO-370I, ECO-4000D, ECO-4000I, ECO-460D, ECO-460I, ECO-550D, ECO-550I, ECO-6000D, ECO-6000I, GA-20, GA-20D, GA-40, GA-40D		

			
1			
GEV No.	505336	Ref. No.	12024143 Z310904
description	extraction hose ED ø 76mm L 220mm L-shape ID ø 60mm for FAGOR		
For models:	ECO-2700D, ECO-2700I, ECO-280D, ECO-280I, ECO-370D, ECO-370I, ECO-4000D, ECO-4000I, ECO-460D, ECO-460I, ECO-550D, ECO-550I, ECO-6000D, ECO-6000I, FI-2700D, FI-2700I, FI-280D, FI-280I, FI-370D, FI-370I, FI-4000D, FI-4000I, FI-460D, FI-460I, FI-550D, FI-550I, FI-6000D, FI-6000I		

accessories

			
1			
GEV No.	520053	Ref. No.	12025278 Z701132
description	screen connection 3/4" D1 ø 26mm D2 ø 15mm Qty 10 pcs rubber thickness 8mm		
For models:	FI-100, FI-100AR, FI-100B, FI-120, FI-1200, FI-120B, FI-120W, FI-30, FI-300B, FI-300R, FI-48, FI-48B, FI-48W, FI-50, FI-64, FI-64B, FI-64W, FI-650R, FI-72, FI-80, FI-80W, FI-900, GA-20, GA-20D, GA-40, GA-40D, HCG-10-11, HCG-10-21, HCG-20-11, HCG-20-21, HCG-2-10-11, HCG-2-20-11, HCG-6-11, HCV-10-11, HCV-10-21, HCV-2-10-21, HCV-5-11, HCV-6-11, HEI-10-11, HEI-10-21, HEI-2-10-11, HEI-5-11, HEI-6-11, HEI-10-11, HEI-10-21, HEI-20-11, HEI-20-21, HEI-6-11, HEM-10-11, HEM-10-21...(Other models you can see in the webshop)		



fittings, hose and pipe connectors

hose connectors

without screw connection



GEV No.	505088	Ref. No.	12023511 Z201106
description	Y-piece plastic hose ø 12-12-12mm L 75mm		
For models:	AD-120, AD-120B, AD-120C, AD-120CW, AD-125, AD-125HRS, AD-125-SOFT, AD-45BBT, AD-48, AD-48B, AD-48BDD, AD-48C, AD-48D, AD-48DD, AD-48HY, AD-48W, AD-64, AD-64B, AD-64BBT, AD-64BDD, AD-64BTDD, AD-64C, AD-64CW, AD-64D, AD-64DD, AD-64HY, AD-72, AD-72W, AD-90, AD-90BA, AD-90BDD, AD-90DD, ADE-120, ADE-120B, CO-110, CO-110B, CO-110BDD, CO-110DD, CO-112, CO-112B, CO-112BDD, CO-112DD, CO-142W, CO-142WDD, CO-170, CO-170B, CO-170BDD, CO-170DD, CO-170HRS, CO-170HRSDD...(Other models you can see in the webshop)		



GEV No.	541109	Ref. No.	12023510 Z103077
description	Y-piece plastic hose ø 8-6-8mm for pressure switch		
For models:	AD-120B, AD-120BBTDD-UK, AD-120C, AD-120HY, AD-45BBT, AD-48B, AD-48BDD, AD-48C, AD-48HY, AD-48W, AD-64B, AD-64BBT, AD-64BDD, AD-64BTDD, AD-64C, AD-64CW, AD-64HY, AD-72W, AD-90BA, AD-90BBT, AD-90BDD, ADE-120B, CO-500, CO-500B, CO-500BDD, CO-500DD, CO-501, CO-501B, CO-501BDD, CO-501DD, CO-501-SOFT, CO-502B, CO-502BDD, CO-502DD, CO-502W, COP-503, COP-503B, COP-503BDD, COP-503DD, COP-503-SOFT, COP-504, COP-504B, COP-504BDD, COP-504DD, COP-504W, EASY-500B, EASY-500HPWBDD, ECO-120B, ECO-160, ECO-1600...(Other models you can see in the webshop)		



GEV No.	505086	Ref. No.	12025288 Z601157
description	T-piece connection 1: 10mm connection 2: 4mm		
For models:	AD-120, AD-120B, AD-120C, AD-120CW, AD-125, AD-125HRS, AD-15, AD-15D, AD-20C-UK, AD-21, AD-21B, AD-21BDD, AD-21C, AD-21D, AD-21DD, AD-21W, AD-48, AD-48B, AD-48BDD, AD-48C, AD-48D, AD-48DD, AD-48W, AD-64, AD-64B, AD-64BDD, AD-64C, AD-64CW, AD-64D, AD-64DD, AD-72, AD-72W, AD-90, AD-90BA, AD-90BDD, AD-90DD, ADE-120, ADE-120B, CO-110, CO-110B, CO-110BDD, CO-110DD, CO-112, CO-112B, CO-112BDD, CO-112DD, CO-142W, CO-142WDD, CO-170, CO-170B...(Other models you can see in the webshop)		



GEV No.	505087	Ref. No.	12024192 Z401108
description	cross fitting		
For models:	AD-15, AD-15D, AD-20C-UK, AD-21, AD-21B, AD-21BDD, AD-21C, AD-21D, AD-21DD, AD-21W, CO-350-COLD, CO-350-COLD-B, CO-350-COLD-B-DD, CO-350-COLD-DD, CO-352-COLD, CO-352-COLD-B, CO-352-COLD-B-DD, CO-352-COLD-DD, CO-400-COLD, CO-400-COLD-B, CO-400-COLD-B-DD, CO-400-COLD-DD, CO-402-COLD, CO-402-COLD-B, CO-402-COLD-B-DD, CO-402-COLD-DD, LVC-15, LVC-15D, LVC-21, LVC-21B, LVC-21C, LVC-21D, LVC-21W, LVR-14, LVR-14D, LVR-20, LVR-20B, LVR-20D, MF-21		

fittings

double nipples



GEV No.	520169	Ref. No.	12023958 12024396 Z102301 Z209509
description	double nipple brass thread 3/4" - 3/4" Qty 1 pcs		
For models:	AD-120CW, BME7-05, BME7-10, BMG7-10, CO-142W, CO-142WDD, ECO-120, ECO-1200, ECO-120B, ECO-160, ECO-1600, ECO-200, ECO-200H, ECO-2300, ECO-3000, FI-100, FI-100AR, FI-100B, FI-120, FI-1200, FI-120B, FI-120W, FI-160, FI-1600, FI-160AR, FI-160D, FI-160I, FI-200, FI-200AR, FI-200D, FI-200H, FI-200HD, FI-200HI, FI-200I, FI-200W, FI-200WL, FI-200WR, FI-2300, FI-2700D, FI-2700I, FI-280D, FI-280I, FI-30, FI-3000, FI-30AR, FI-30AR+DD, FI-30-UK, FI-370D, FI-370I, FI-4000D...(Other models you can see in the webshop)		

T-pieces

miscellaneous



1

GEV No.	520456	Ref. No.	12009162 S205022
description	T-piece		
For models:	ME7-10BM, ME9-10BM, ME9-10BMS, ME9-15BM, ME9-15BM316, ME9-15BMS, MG7-10, MG7-10BM, MG9-10, MG-9100, MG9-10BM, MG9-10BMS, MG9-10S, MG9-15, MG-9150, MG-9150BM, MG9-15BM, MG9-15BM316, MG9-15BMS, MG9-15S, MG9-20, MG-9200, MG9-20S, MPE9-10BM, MPE9-10BMS, MPE9-15BM, MPE9-15BMS, MPG9-10, MPG9-10BM, MPG9-10BMS, MPG9-10S, MPG9-15, MPG-9150, MPG9-15BM, MPG9-15BMS, MPG9-15S, MPG9-20, MPG-9200, MPG9-20S		

hose connectors

plastic



1

GEV No.	361100	Ref. No.	12036489 RT20620351
description	hose connector plastic straight thread M10x1 hose ø 6mm Qty 1 pcs connection M10x1 hose ø 6mm		



1

GEV No.	361102	Ref. No.	12036243 RT20620339
description	hose connector plastic angled thread M10x1 hose ø 6mm Qty 1 pcs connection M10x1 hose ø 6mm		

brass



1

GEV No.	505323	Ref. No.	12023772 Z102309
description	hose connector brass straight thread 3/4" hose ø 10mm Qty 1 pcs		
For models:	ECO-1600, ECO-2300, ECO-280D, ECO-280I, ECO-3000, ECO-370D, ECO-370I, ECO-460D, ECO-460I, ECO-550D, ECO-550I, FI-1600, FI-200W, FI-200WL, FI-200WR, FI-2300, FI-280D, FI-280I, FI-3000, FI-370D, FI-370I, FI-460D, FI-460I, FI-550D, FI-550I		

producer-specific



1

GEV No.	505262	Ref. No.	12018650 12019642 12024428 Z208914 Z230902 Z230905
description	duct thread M12x1.75 for hose ID 4mm SS		
For models:	AD-120C, AD-120HY, AD-20C-UK, AD-21B, AD-21BDD, AD-21C, AD-21DD, AD-21W, AD-45BBT, AD-48B, AD-48BDD, AD-48C, AD-48DD, AD-48HY, AD-48W, AD-64B, AD-64BBT, AD-64BDD, AD-64C, AD-64CW, AD-64DD, AD-64HY, AD-90BBT, AD-90BDD, AD-90DD, ECO-120, ECO-1200, FI-100, FI-100AR, FI-100BBT-UK, FI-120, FI-1200, FI-120AR+DD, FI-120C, FI-120HY-CLINIC, FI-120W, FI-30, FI-30AR, FI-30AR+DD, FI-30B, FI-30B-BT-UK, FI-30-UK, FI-48, FI-48AR, FI-48B, FI-48B-BT-UK, FI-48C, FI-48D, FI-48HY-CLINIC, FI-48W...(Other models you can see in the webshop)		



1

GEV No.	505133	Ref. No.	12023967 Z701104
description	hose connector for hose ID 38-11mm brass		
For models:	AD-120BBTDD-UK, AD-120HY, AD-90BBT, ADE-120, ADE-120B, ECO-120, ECO-1200, ECO-120B, ECO-1600, ECO-2300, ECO-3000, FI-100, FI-100AR, FI-100B, FI-100BBT-UK, FI-120HY-CLINIC, FI-80BBT-UK		



1

GEV No.	505236	Ref. No.	12023983 Z2819010
description	hose connector grommet ø 13mm ID ø 11mm grommet length 18mm WS 32 total length 51mm thread L 17mm		
For models:	ECO-160D, ECO-160I, ECO-200D, ECO-200HD, ECO-200HI, ECO-200I, ECO-2700D, ECO-2700I, ECO-280D, ECO-280I, ECO-370D, ECO-370I, ECO-4000D, ECO-4000I, ECO-460D, ECO-460I, ECO-550D, ECO-550I, ECO-6000D, ECO-6000I, FI-2700D, FI-2700I, FI-280D, FI-280I, FI-370D, FI-370I, FI-4000D, FI-4000I, FI-460D, FI-460I, FI-550D, FI-550I, FI-6000D, FI-6000I		



			
1			
GEV No.	361840	Ref. No.	12024395 Z711904
description	hose connector thread M20x2.5 5/8" pipe (22.7mm) grommet ø 11.5mm ID ø chrome-plated brassmm grommet length 20mm total length 52mm thread L 31mm T2: 5/8" pipe (22.7mm)		
For models:	AD-120, AD-120B, AD-120BBTDD-UK, AD-120C, AD-120CW, AD-120HY, AD-90, AD-90BA, AD-90BBT, AD-90BDD, AD-90DD, ADE-120, ADE-120B, ECO-120, ECO-120B, FI-100, FI-100AR, FI-100B, FI-100BBT-UK, FI-120, FI-120AR+DD, FI-120B, FI-120C, FI-120HY-CLINIC, FI-120W, FI-160AR, FI-200AR, FI-280D, FI-280I, FI-370D, FI-370I, FI-460D, FI-460I, FI-550D, FI-550I, FI-80, FI-80AR, FI-80BBT-UK, FI-80W, FI-E-100, LABP-1000, LABP-1200, LABP-800, MF-120		
accessories for	361840		
			
GEV No.	507534	Ref. No.	12009819 Q223107
description	nut thread M20x2.5 WS 24 SS Qty 1 pcs H 13mm for pipe ø 12mm		

			
1			
GEV No.	512517	Ref. No.	12018487 T325063000
description	manifold thread 3/4" IT - 3/4" ET - 3/4" ET 3-way plastic suitable for combi-steamer FAGOR		

			
1			
GEV No.	507534	Ref. No.	12009819 Q223107
description	nut thread M20x2.5 WS 24 SS Qty 1 pcs H 13mm for pipe ø 12mm		
For models:	AD-120, AD-120B, AD-120BBTDD-UK, AD-120C, AD-120CW, AD-120HY, AD-90, AD-90BA, AD-90BBT, AD-90BDD, AD-90DD, ADE-120, ADE-120B, ECO-120, ECO-120B, FI-100, FI-100AR, FI-100B, FI-100BBT-UK, FI-120, FI-120AR+DD, FI-120B, FI-120C, FI-120HY-CLINIC, FI-120W, FI-160AR, FI-200AR, FI-280D, FI-280I, FI-370D, FI-370I, FI-460D, FI-460I, FI-550D, FI-550I, FI-80, FI-80AR, FI-80BBT-UK, FI-80W, FI-E-100, LABP-1000, LABP-1200, LABP-800, MF-120		

			
1			
GEV No.	698612	Ref. No.	12034095 RT86641300
description	T-piece thread 3/4" ET - 1/2" ET - 3/4" IT plastic		

valves and tank inlets

ball valves

universal

ball valves with lever handle

			
1			
GEV No.	514325	Ref. No.	12009231 X036107
description	ball valve connection 1" IT - 1" IT DN25 total length 83mm with lever handle		

producer-specific

TMM

			
1			
GEV No.	514532	Ref. No.	12009691 R015034 R015034000
description	ball valve inlet 3/8" IT outlet 3/8" IT L 54.5mm H 82mm		

shut-off valves

universal

			
1			
GEV No.	514085	Ref. No.	12009132 S012102
description	rosette connection 26x19G chrome-plated total lengthmm mounting pos.		
For models:	BME9-05, BME9-05AD, BME9-05PLUS, BME9-05V-T, BME9-10, BME9-10AD, BME9-10PLUS, BME9-10V-T, BMG9-05, BMG9-05V-T, BMG9-10, BMG9-10V-T, CPE7-05, CPE7-05NC, CPE9-05, CPE9-05S, CPG7-05, CPG7-05NC, CPG9-05, CPG9-05S, EPC-350, GPC-350, ME9-10BM, ME9-10BMS, ME9-15BM, ME9-15BM316, ME9-15BMS, MG9-10, MG9-10BM, MG9-10BMS, MG9-10S, MG9-15, MG9-15BM, MG9-15BM316, MG9-15BMS, MG9-15S, MG9-20, MG9-20S, MPE9-10BM, MPE9-10BMS, MPE9-15BM, MPE9-15BMS, MPG9-10, MPG9-10BM, MPG9-10BMS, MPG9-10S, MPG9-15, MPG9-15BM, MPG9-15BMS, MPG9-15S...(Other models you can see in the webshop)		

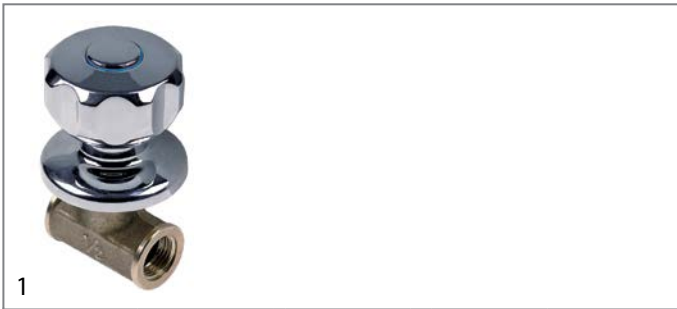

GEV No.	693107	Ref. No.	12039149 S112151
----------------	--------	-----------------	---------------------

description shut-off valve connection 1/2" 1/2" cold total length 54mm L1 27mm L2 30mm marking blue rosette thread G2 26x19G connection ø M4x0.7 ITmm

For models: BME7-05, BME7-10, BME9-05, BME9-10, BMG7-10, BMG9-05, BMG9-10, CPG7-05, CPG9-05, CPG9-05NC, CPG9-05S, CPG9-05SNC, ME7-10BM, ME9-10BM, ME9-10BMS, ME9-15BM, ME9-15BMS, MG7-10, MG7-10BM, MG9-10, MG9-10BM, MG9-10BMS, MG9-10S, MG9-15, MG9-15BM, MG9-15BMS, MG9-15S, MG9-20, MG9-20S, MPE9-10BM, MPE9-10BMS, MPE9-15BM, MPE9-15BMS, MPG9-10, MPG9-10BM, MPG9-10BMS, MPG9-10S, MPG9-15, MPG9-15BM, MPG9-15BMS, MPG9-15S, MPG9-20, MPG9-20S, SBE7-10, SBE9-10, SBE9-10I, SBE9-10IM, SBE9-10IMS, SBE9-10IS, SBE9-10M...(Other models you can see in the webshop)

spare parts for 693107

	GEV No.	514085	Ref. No.	12009132 S012102
---	----------------	--------	-----------------	---------------------

rosette connection 26x19G chrome-plated total lengthmm mounting pos.

	GEV No.	514086	Ref. No.	—
--	----------------	--------	-----------------	---

hexagonal nut connection 26x19G brass total lengthmm mounting pos. H 6mm WS 34 Qty 1 pcs

	GEV No.	540672	Ref. No.	—
---	----------------	--------	-----------------	---

gasket suitable for tap head

	GEV No.	547711	Ref. No.	—
---	----------------	--------	-----------------	---

hood handle shaft intake ø 8mm marking blue metal H2 21mm D1 ø 33mm type D suitable for MONOLITH shaft length H1 8mm

	GEV No.	548168	Ref. No.	—
---	----------------	--------	-----------------	---

star handle connection hot total lengthmm mounting pos. ø 57mm marking red

	GEV No.	548169	Ref. No.	12019545 S012104
---	----------------	--------	-----------------	---------------------

star handle connection cold total lengthmm mounting pos. chrome-plated ø 57mm

accessories for 693107

	GEV No.	514086	Ref. No.	—
---	----------------	--------	-----------------	---

hexagonal nut connection 26x19G brass total lengthmm mounting pos. H 6mm WS 34 Qty 1 pcs



GEV No.	548169	Ref. No.	12019545 S012104
----------------	--------	-----------------	---------------------

description star handle connection cold total lengthmm mounting pos. chrome-plated ø 57mm



GEV No.	514085	Ref. No.	12009132 S012102
----------------	--------	-----------------	---------------------

description rosette connection 26x19G chrome-plated total lengthmm mounting pos.

For models: BME9-05, BME9-05AD, BME9-05PLUS, BME9-05V-T, BME9-10, BME9-10AD, BME9-10PLUS, BME9-10V-T, BMG9-05, BMG9-05V-T, BMG9-10, BMG9-10V-T, CPE7-05, CPE7-05NC, CPE9-05, CPE9-05S, CPG7-05, CPG7-05NC, CPG9-05, CPG9-05S, EPC-350, GPC-350, ME9-10BM, ME9-10BMS, ME9-15BM, ME9-15BM316, ME9-15BMS, MG9-10, MG9-10BM, MG9-10BMS, MG9-10S, MG9-15, MG9-15BM, MG9-15BM316, MG9-15BMS, MG9-15S, MG9-20, MG9-20S, MPE9-10BM, MPE9-10BMS, MPE9-15BM, MPE9-15BMS, MPG9-10, MPG9-10BM, MPG9-10BMS, MPG9-10S, MPG9-15, MPG9-15BM, MPG9-15BMS, MPG9-15S...(Other models you can see in the webshop)



GEV No.	540415	Ref. No.	12009120 S102109
----------------	--------	-----------------	---------------------

description star handle connection cold total lengthmm mounting pos. shaft diameter 7x7mm ø 55mm 35 built-in depth 22mm

For models: BME9-05, BME9-05AD, BME9-05PLUS, BME9-05V-T, BME9-10, BME9-10AD, BME9-10PLUS, BME9-10V-T, BMG9-05, BMG9-05V-T, BMG9-10, BMG9-10V-T, CPE7-05, CPE7-05NC, CPE9-05, CPE9-05S, CPG7-05, CPG7-05NC, CPG9-05, CPG9-05S, EPC-350, GPC-350, ME9-10BM, ME9-10BMS, ME9-15BM, ME9-15BM316, ME9-15BMS, MG9-10, MG9-10BM, MG9-10BMS, MG9-10S, MG9-15, MG9-15BM, MG9-15BM316, MG9-15BMS, MG9-15S, MG9-20, MG9-20S, MPE9-10BM, MPE9-10BMS, MPE9-15BM, MPE9-15BMS, MPG9-10, MPG9-10BM, MPG9-10BMS, MPG9-10S, MPG9-15, MPG9-15BM, MPG9-15BMS, MPG9-15S...(Other models you can see in the webshop)









GEV No.	514085	Ref. No.	12009132 S012102
----------------	--------	-----------------	---------------------

description rosette connection 26x19G chrome-plated total lengthmm mounting pos.

For models: BME9-05, BME9-05AD, BME9-05PLUS, BME9-05V-T, BME9-10, BME9-10AD, BME9-10PLUS, BME9-10V-T, BMG9-05, BMG9-05V-T, BMG9-10, BMG9-10V-T, CPE7-05, CPE7-05NC, CPE9-05, CPE9-05S, CPG7-05, CPG7-05NC, CPG9-05, CPG9-05S, EPC-350, GPC-350, ME9-10BM, ME9-10BMS, ME9-15BM, ME9-15BM316, ME9-15BMS, MG9-10, MG9-10BM, MG9-10BMS, MG9-10S, MG9-15, MG9-15BM, MG9-15BM316, MG9-15BMS, MG9-15S, MG9-20, MG9-20S, MPE9-10BM, MPE9-10BMS, MPE9-15BM, MPE9-15BMS, MPG9-10, MPG9-10BM, MPG9-10BMS, MPG9-10S, MPG9-15, MPG9-15BM, MPG9-15BMS, MPG9-15S...(Other models you can see in the webshop)

			
1			
GEV No.	514085	Ref. No.	12009132 S012102
description	rosette connection 26x19G chrome-plated total lengthmm mounting pos.		
For models:	BME9-05, BME9-05AD, BME9-05PLUS, BME9-05V-T, BME9-10, BME9-10AD, BME9-10PLUS, BME9-10V-T, BMG9-05, BMG9-05V-T, BMG9-10, BMG9-10V-T, CPE7-05, CPE7-05NC, CPE9-05, CPE9-05S, CPG7-05, CPG7-05NC, CPG9-05, CPG9-05S, EPC-350, GPC-350, ME9-10BM, ME9-10BMS, ME9-15BM, ME9-15BM316, ME9-15BMS, MG9-10, MG9-10BM, MG9-10BMS, MG9-10S, MG9-15, MG9-15BM, MG9-15BM316, MG9-15BMS, MG9-15S, MG9-20, MG9-20S, MPE9-10BM, MPE9-10BMS, MPE9-15BM, MPE9-15BMS, MPG9-10, MPG9-10BM, MPG9-10BMS, MPG9-10S, MPG9-15, MPG9-15BM, MPG9-15BMS, MPG9-15S...(Other models you can see in the webshop)		

			
1			
GEV No.	514160	Ref. No.	12019085 S012101
description	shut-off valve connection 1/2" 1/2" straight total length 54mm mounting pos. star-shaped mounting thread 26x19G		
accessories for	514160		
	GEV No.	514085	Ref. No.
			12009132 S012102
	GEV No.	514086	Ref. No.
			—
	GEV No.	548168	Ref. No.
			—
	GEV No.	548169	Ref. No.
			12019545 S012104
description	star handle connection cold total lengthmm mounting pos. chrome-plated ø 57mm		

			
1			
GEV No.	548169	Ref. No.	12019545 S012104
description	star handle connection cold total lengthmm mounting pos. chrome-plated ø 57mm		

inlet taps

			
1			
GEV No.	691015	Ref. No.	12009374 S052100
description	inlet spout connection 1/2" ET		
For models:	CPE7-05, CPE7-05NC, CPG7-05, CPG7-05NC, EPC-350, GPC-350, ME7-10BM, ME9-10BM, ME9-10BMS, ME9-10PLUS-BM, ME9-10PLUS-BMS, ME9-15BM, ME9-15BM316, ME9-15BM-AD, ME9-15BMS, ME9-15PLUS-BM, ME9-15PLUS-BMS, MG7-10, MG7-10BM, MG9-10, MG9-10AD, MG9-10BM, MG9-10BMAD, MG9-10BMS, MG9-10BMSAD, MG9-10PLUS, MG9-10PLUS-BM, MG9-10PLUS-BMS, MG9-10PLUS-S, MG9-10S, MG9-10S-AD, MG9-15, MG9-15AD, MG9-15BM, MG9-15BM316, MG9-15BMAD, MG9-15BMS, MG9-15BMSAD, MG9-15PLUS, MG9-15PLUS-BM, MG9-15PLUS-BMS, MG9-15PLUS-S, MG9-15S, MG9-15S-AD, MG9-20, MG9-20AD, MG9-20PLUS, MG9-20PLUS-S, MG9-20S, MG9-20S-AD...(Other models you can see in the webshop)		

			
1			
GEV No.	691019	Ref. No.	12014163 12040128 X156104 X156140
description	inlet spout connection 1/2" ET tube ø 14mm projection 110mm overall height 80mm spout height 60mm rotation°		
For models:	SBE7-10, SBE9-10, SBE9-10I, SBE9-10IM, SBE9-10IMS, SBE9-10IS, SBE9-10M, SBE9-10MS, SBE9-10S, SBE9-15IM, SBE9-15IMS, SBG7-10, SBG9-10, SBG9-10I, SBG9-10IM, SBG9-10IMS, SBG9-10IS, SBG9-10M, SBG9-10MS, SBG9-10S, SBG9-15IM, SBG9-15IMS		

accessories

diaphragms

			
1			
GEV No.	542000	Ref. No.	S206121
description	plain washer ID ø 22mm ED ø 50mm thickness 8mm		



drain systems and wash basins

drain fittings

universal



GEV No.	515041	Ref. No.	12000168 R205019
description	drain fitting size 3/4" usable heightmm overall height 30mm ED ø 38mm chrome-plated brass		
For models:	BME7-05, BME7-10, BME9-05, BME9-10, BMG7-10, BMG9-05, BMG9-10		
accessories for	515041		
	GEV No.	515047	Ref. No. —
	standpipe size 3/4" usable height 28mm overall height 54mm ED ø 20mm chrome-plated brass with O-ring		
	GEV No.	515048	Ref. No. —
	standpipe size 3/4" usable height 48mm overall height 74mm ED ø 20mm chrome-plated brass with O-ring		
	GEV No.	515049	Ref. No. —
	standpipe size 3/4" usable height 68mm overall height 94mm ED ø 20mm chrome-plated brass with O-ring		
	GEV No.	515050	Ref. No. —
	standpipe size 3/4" usable height 98mm overall height 124mm ED ø 20mm chrome-plated brass with O-ring		

standpipes

3/4"



GEV No.	515041	Ref. No.	12000168 R205019
description	drain fitting size 3/4" usable heightmm overall height 30mm ED ø 38mm chrome-plated brass		
For models:	BME7-05, BME7-10, BME9-05, BME9-10, BMG7-10, BMG9-05, BMG9-10		
accessories for	515041		
	GEV No.	515047	Ref. No. —
	standpipe size 3/4" usable height 28mm overall height 54mm ED ø 20mm chrome-plated brass with O-ring		
	GEV No.	515048	Ref. No. —
	standpipe size 3/4" usable height 48mm overall height 74mm ED ø 20mm chrome-plated brass with O-ring		
	GEV No.	515049	Ref. No. —
	standpipe size 3/4" usable height 68mm overall height 94mm ED ø 20mm chrome-plated brass with O-ring		
	GEV No.	515050	Ref. No. —
	standpipe size 3/4" usable height 98mm overall height 124mm ED ø 20mm chrome-plated brass with O-ring		

producer-specific

FAGOR



GEV No.	515041	Ref. No.	12000168 R205019
description	drain fitting size 3/4" usable heightmm overall height 30mm ED ø 38mm chrome-plated brass		
For models:	BME7-05, BME7-10, BME9-05, BME9-10, BMG7-10, BMG9-05, BMG9-10		
accessories for	515041		
	GEV No.	515047	Ref. No. —
	standpipe size 3/4" usable height 28mm overall height 54mm ED ø 20mm chrome-plated brass with O-ring		
	GEV No.	515048	Ref. No. —
	standpipe size 3/4" usable height 48mm overall height 74mm ED ø 20mm chrome-plated brass with O-ring		
	GEV No.	515049	Ref. No. —
	standpipe size 3/4" usable height 68mm overall height 94mm ED ø 20mm chrome-plated brass with O-ring		
	GEV No.	515050	Ref. No. —
	standpipe size 3/4" usable height 98mm overall height 124mm ED ø 20mm chrome-plated brass with O-ring		



GEV No.	691024	Ref. No.	12019791 R205018
description	overflow pipe L 165mm ø 20mm		
For models:	BME7-05, BME7-10, BME9-05, BME9-10, BMG7-10, BMG9-05, BMG9-10		

accessories



GEV No.	691004	Ref. No.	12000169 R202617
description	protective plate for drain		
For models:	BMG9-05, BMG9-10		



water cycle components

pressure reduction valves

pressure reduction valves

producer-specific



1			
GEV No.	520558	Ref. No.	12024846 Z102307
description	pressure reduction valve RBM series RINOXDUE connection 3/4" default setting 3bar setting range 0.5-4bar p max 25bar t.max. 80°C nickel-plated brass ACS		
For models:	AD-120CW, CO-142W, CO-142WDD, ECO-160, ECO-1600, ECO-200, ECO-200H, ECO-2300, ECO-3000, FI-120W, FI-160, FI-1600, FI-160AR, FI-160D, FI-160I, FI-200, FI-200AR, FI-200D, FI-200H, FI-200HD, FI-200HI, FI-200I, FI-200W, FI-200WL, FI-200WR, FI-2300, FI-2700D, FI-2700I, FI-280D, FI-280I, FI-3000, FI-370D, FI-370I, FI-4000D, FI-4000I, FI-460D, FI-460I, FI-550D, FI-550I, FI-6000D, FI-6000I, FI-80W		

ancillary products

silicone

food-grade silicones



1			
GEV No.	890106	Ref. No.	12032727 RT50060200
description	silicone TB40 transparent tube 90g -40 up to +160°C		
description	<p>Tomabond - TB40 - tube 90g - transparent</p> <p>For flexible sealing in drinking water, food, water and industrial kitchen areas. Securely joins glass, metal, wood-based materials, ceramic and plastics with high adhesion (1.1 N/mm²).</p> <p>Fungicide-, algicide- and solvent-free, ageing-resistant.</p> <p>Temperature-resistant from -40 °C to +160 °C</p> <p>Tested and approved by KTW / KSW.</p>		

clamps

hose clamps

DIN 3017 - W2



1			
GEV No.	520111	Ref. No.	12035874 RT20660205
description	hose clamp ø 10-16mm width 9mm Qty 10 pcs DIN 3017		





1			
GEV No.	520114	Ref. No.	12010023 12035505 Q881304 RT20660506
description	hose clamp ø 20-32mm width 9mm Qty 10 pcs DIN 3017		
For models:	AD-120B, AD-120BBTDD-UK, AD-120C, AD-120HY, AD-125, AD-125HRS, AD-125-SOFT, AD-505, AD-505-SOFT, AD-90BA, AD-90BBT, AD-90BDD, ADE-120B, APE-061, APE-061W, APE-101, APE-101W, APE-102, APE-102W, APE-201, APE-202, APG-061, APG-061W, APG-101, APG-101W, APG-102, APG-102W, APG-201, APG-202, BME9-05, BME9-10, BMG9-10, CO-110B, CO-110BDD, CO-112B, CO-112BDD, CO-170B, CO-170BDD, CO-172B, CO-172BDD, CO-500B, CO-500BDD, CO-501B, CO-501BDD, CO-502B, CO-502BDD, CO-502W, COP-173, COP-173B, COP-173BDD...(Other models you can see in the webshop)		



1			
GEV No.	520115	Ref. No.	12009997 Q881305
description	hose clamp ø 25-40mm width 9mm Qty 10 pcs DIN 3017		
For models:	AD-45BBT, AD-48, AD-48B, AD-48BDD, AD-48C, AD-48D, AD-48DD, AD-48HY, AD-48W, AD-505, AD-64, AD-64B, AD-64BBT, AD-64BDD, AD-64BTDD, AD-64C, AD-64CW, AD-64D, AD-64DD, AD-64HY, AD-72, AD-72W, AE-201, AE-202, AG-061, AG-061W, AG-101, AG-101W, AG-102, AG-102W, AG-201, AG-202, APE-061, APE-061W, APE-101, APE-101W, APE-102, APE-102W, APE-201, APE-202, APG-061, APG-061W, APG-101, APG-101W, APG-102, APG-102W, APG-201, APG-202, BME7-05, BME7-10...(Other models you can see in the webshop)		





			
1			
GEV No.	520118	Ref. No.	12009933 12036496 Q881324 RT20660300
description	hose clamp ø 50-70mm width 9mm Qty 5 pcs DIN 3017		
For models:	AD-45BBT, AD-48, AD-48B, AD-48BDD, AD-48C, AD-48D, AD-48DD, AD-48HY, AD-48W, AD-505, AD-505-SOFT, AD-64, AD-64B, AD-64BBT, AD-64BDD, AD-64BTDD, AD-64C, AD-64CW, AD-64D, AD-64DD, AD-64HY, AD-72, AD-72W, CO-500, CO-500B, CO-500BDD, CO-500DD, CO-501, CO-501B, CO-501BDD, CO-501DD, CO-501-SOFT, CO-502B, CO-502BDD, CO-502DD, CO-502W, COP-503, COP-503B, COP-503BDD, COP-503DD, COP-503-SOFT, COP-504, COP-504B, COP-504BDD, COP-504DD, COP-504W, EASY-500, EASY-500B, EASY-500DD, EASY-500HP... (Other models you can see in the webshop)		

			
1			
GEV No.	520117	Ref. No.	12009962 12035446 Q881306000 Q881307 RT20660504
description	hose clamp stainless steel ø 40-60mm width 9mm Qty 5 pcs DIN 3017		
For models:	ACE-061, ACE-101, ACE-102, ACE-201, ACE-202, ACG-061, ACG-101, ACG-102, ACG-201, ACG-202, AD-120, AD-120B, AD-120BBTDD-UK, AD-120C, AD-120CW, AD-120HY, AD-125, AD-125HRS, AD-125-SOFT, AD-15, AD-15D, AD-20C-UK, AD-21, AD-21B, AD-21BDD, AD-21C, AD-21D, AD-21DD, AD-21W, AD-45BBT, AD-48, AD-48B, AD-48BDD, AD-48C, AD-48D, AD-48DD, AD-48HY, AD-48W, AD-505, AD-505-SOFT, AD-64, AD-64B, AD-64BBT, AD-64BDD, AD-64BTDD, AD-64C, AD-64CW, AD-64D, AD-64DD, AD-64HY... (Other models you can see in the webshop)		

			
2			
GEV No.	520119	Ref. No.	12036081 RT20660516
description	hose clamp ø 60-80mm width 9mm Qty 5 pcs DIN 3017		

DIN 3017 - W4			
			
1			
GEV No.	520120	Ref. No.	12010036 Q881302
description	hose clamp SS W4 ø 12-20mm width 9mm Qty 1 pcs DIN 3017		
For models:	ACE-061, ACE-101, ACE-102, ACE-201, ACE-202, ACG-061, ACG-101, ACG-102, ACG-201, ACG-202, AD-120, AD-120B, AD-120BBTDD-UK, AD-120C, AD-120CW, AD-120HY, AD-125, AD-125HRS, AD-125-SOFT, AD-15, AD-15D, AD-20C-UK, AD-21, AD-21B, AD-21BDD, AD-21C, AD-21D, AD-21DD, AD-21W, AD-45BBT, AD-48, AD-48B, AD-48BDD, AD-48C, AD-48D, AD-48DD, AD-48HY, AD-48W, AD-505, AD-505-SOFT, AD-64, AD-64B, AD-64BBT, AD-64BDD, AD-64BTDD, AD-64C, AD-64CW, AD-64D, AD-64DD, AD-64HY... (Other models you can see in the webshop)		

			
1			
GEV No.	520454	Ref. No.	12009914 12036146 Q881326 RT20660505
description	hose clamp ø 70-90mm width 9mm Qty 5 pcs DIN 3017		
For models:	ACE-202, ACG-202, AE-202, AG-202, APE-202, APG-202, COE-202, ECO-2700D, ECO-2700I, ECO-280D, ECO-280I, ECO-370D, ECO-370I, ECO-4000D, ECO-4000I, ECO-460D, ECO-460I, ECO-550D, ECO-550I, ECO-6000D, ECO-6000I, FI-2700D, FI-2700I, FI-280D, FI-280I, FI-370D, FI-370I, FI-4000D, FI-4000I, FI-460D, FI-460I, FI-550D, FI-550I, FI-6000D, FI-6000I, HMG-10-21-STACKING, LA-13M, LA-18MP, LA-25M, LAC-25, LAC-25MP, LAC-25MPP, LAC-55, LAC-55MP, LAC-55MPP, LB-AC-10M, LB-E-10M, LB-V-10M, LC-10, LC-14... (Other models you can see in the webshop)		

double wire clamps			
			
1			
GEV No.	511658	Ref. No.	12035823 RT20660533
description	hose clamp ø 10mm wire gauge ø 1.3mm steel Qty 5 pcs		

			
1			
GEV No.	520110	Ref. No.	12010047 12037543 GH51X003 Q881308
description	hose clamp ø 8-12mm width 9mm Qty 10 pcs DIN 3017		
For models:	AD-120, AD-120B, AD-120BBTDD-UK, AD-120C, AD-120CW, AD-120HY, AD-15, AD-15D, AD-20C-UK, AD-21, AD-21B, AD-21BDD, AD-21C, AD-21D, AD-21DD, AD-21W, AD-48, AD-48B, AD-48BDD, AD-48C, AD-48D, AD-48DD, AD-48W, AD-64, AD-64B, AD-64BDD, AD-64C, AD-64CW, AD-64D, AD-64DD, AD-72, AD-72W, AD-90, AD-90BA, AD-90BBT, AD-90BDD, AD-90DD, ADE-120, ADE-120B, CO-110, CO-110B, CO-110BDD, CO-110DD, CO-112, CO-112B, CO-112BDD, CO-112DD, CO-142W, CO-142WDD, CO-170... (Other models you can see in the webshop)		

			
1			
GEV No.	520916	Ref. No.	12036614 RT20660518
description	hose clamp ø 30mm wire gauge ø 2.7mm chrome-plated steel Qty 1 pcs		

			
1			
GEV No.	560570	Ref. No.	12036450 RT20660519
description	hose clamp ø 35.6mm wire gauge ø 3mm Qty 1 pcs		

			
1			
GEV No.	505190	Ref. No.	12009972 Q901307
description	hose clamp ø 36-42mm wire gauge ø 3mm zinc-coated steel Qty 1 pcs		
For models:	AD-15, AD-15D, AD-20C-UK, AD-21, AD-21B, AD-21BDD, AD-21C, AD-21D, AD-21DD, AD-21W, ECO-1200, FI-1200, FI-900, HEI-10-21, HEM-10-21, HGC-10-21, HGC-20-21, HGV-10-21, LVC-12, LVC-15, LVC-15D, LVC-21, LVC-21B, LVC-21C, LVC-21D, LVC-21W, LVR-10, LVR-14, LVR-14D, LVR-20, LVR-20B, LVR-20D, MF-21		

			
1			
GEV No.	505191	Ref. No.	12007966 Q901308
description	hose clamp ø 52-59mm wire gauge ø 3.5mm Qty 1 pcs		
For models:	AD-45BBT, AD-48, AD-48B, AD-48BDD, AD-48C, AD-48D, AD-48DD, AD-48HY, AD-48W, AD-64, AD-64B, AD-64BBT, AD-64BDD, AD-64BTDD, AD-64C, AD-64CW, AD-64D, AD-64DD, AD-64HY, AD-72, AD-72W, EASY-500, EASY-500B, EASY-500DD, EASY-500HP, FI-30, FI-30AR, FI-30AR+DD, FI-30B, FI-30B-BT-UK, FI-30-UK, FI-48, FI-48AR, FI-48B, FI-48B-BT-UK, FI-48C, FI-48D, FI-48HY-CLINIC, FI-48W, FI-50, FI-60DD, FI-64, FI-64AR, FI-64B, FI-64B-BT-UK, FI-64C, FI-64D, FI-64HY-CLINIC, FI-64W, FI-72...(Other models you can see in the webshop)		

			
1			
GEV No.	505351	Ref. No.	12036929 RT20660527
description	wire clamp ø 11.6-12.2mm wire gauge ø 1.5mm zinc-coated steel Qty 100 pcs		

			
1			
GEV No.	505358	Ref. No.	12036811 RT20660530
description	wire clamp ø 14.4-15.1mm wire gauge ø 1.8mm zinc-coated steel Qty 50 pcs		

double wire clamps with screw			
			
1			
GEV No.	505079	Ref. No.	12025195 Z400903
description	hose clamp ø 186-172mm Qty 1 pcs		
For models:	AD-15, AD-15D, AD-20C-UK, AD-21, AD-21B, AD-21BDD, AD-21C, AD-21D, AD-21DD, AD-21W, CO-350, CO-350-B, CO-350-B-DD, CO-350-COLD, CO-350-COLD-B, CO-350-COLD-B-DD, CO-350-COLD-DD, CO-350-DD, CO-352-COLD, CO-352-COLD-B, CO-352-COLD-B-DD, CO-352-COLD-DD, CO-400, CO-400-B, CO-400-B-DD, CO-400-COLD, CO-400-COLD-B, CO-400-COLD-B-DD, CO-400-COLD-DD, CO-400-DD, CO-400-SOFT, CO-402-COLD, CO-402-COLD-B, CO-402-COLD-B-DD, CO-402-COLD-DD, CO-402W, LVC-12, LVC-15, LVC-15D, LVC-21, LVC-21B, LVC-21C, LVC-21D, LVC-21W, LVR-10, LVR-14, LVR-14D, LVR-20, LVR-20B, LVR-20D...(Other models you can see in the webshop)		

			
1			
GEV No.	505080	Ref. No.	12023841 Z200908
description	hose clamp ø 235-215mm Qty 1 pcs		
For models:	AD-45BBT, AD-48, AD-48B, AD-48BDD, AD-48C, AD-48D, AD-48DD, AD-48HY, AD-48W, AD-64, AD-64B, AD-64BBT, AD-64BDD, AD-64BTDD, AD-64C, AD-64CW, AD-64D, AD-64DD, AD-64HY, AD-72, AD-72W, EASY-500, EASY-500B, EASY-500DD, EASY-500HP, FI-30, FI-30AR, FI-30AR+DD, FI-30B, FI-30B-BT-UK, FI-30-UK, FI-48, FI-48AR, FI-48B, FI-48B-BT-UK, FI-48C, FI-48D, FI-48HY-CLINIC, FI-48W, FI-50, FI-60DD, FI-64, FI-64AR, FI-64B, FI-64B-BT-UK, FI-64C, FI-64D, FI-64HY-CLINIC, FI-64W, FI-72...(Other models you can see in the webshop)		

pipes

miscellaneous

			
1			
GEV No.	691674	Ref. No.	12018389 R725005
description	drain pipe ø 30mm L 440mm SS		



			
1			
GEV No.	691673	Ref. No.	12007494 R155010
description	drain pipe ø 38mm L 195mm		
For models:	CG9-51L, CG9-51LC, CG9-51R, CG9-51RC, FTE9-05L, FTE9-05L-AD, FTE9-05PLUS-CL, FTE9-05PLUS-CR, FTE9-05PLUS-L, FTE9-05PLUS-R, FTE9-05R, FTE9-05R-AD, FTE9-10L, FTE9-10L+R, FTE9-10L+R-AD, FTE9-10L-AD, FTE9-10PLUS-CL, FTE9-10PLUS-CLR, FTE9-10PLUS-CR, FTE9-10PLUS-L, FTE9-10PLUS-LR, FTE9-10PLUS-R, FTE9-10R, FTE9-10R-AD, FTEC9-05L, FTEC9-05L-AD, FTEC9-05R, FTEC9-05R-AD, FTEC9-05USMC, FTEC9-10L, FTEC9-10L+R, FTEC9-10L+R-AD, FTEC9-10L-AD, FTEC9-10R, FTEC9-10R-AD, FTEC9-10USMC, FTG9-05L, FTG9-05L-AD, FTG9-05LV-AD, FTG9-05PLUS-CL, FTG9-05PLUS-CR, FTG9-05PLUS-L, FTG9-05PLUS-LV, FTG9-05PLUS-R, FTG9-05PLUS-RV, FTG9-05R, FTG9-05R-AD, FTG9-05RV-AD, FTG9-05VL, FTG9-05VR...(Other models you can see in the webshop)		

			
1			
GEV No.	539003	Ref. No.	12049669
description	thermometer mounting measurements 62x11mm 0 up to +120°C capillary pipe 1700mm probe ø 6mm probe L 25mm		
For models:	COP-503, COP-503B, COP-503BDD, COP-503DD, COP-503-SOFT		

tools

cleaning tools

descaling pumps

descaling pumps

			
1			
GEV No.	890294	Ref. No.	12027850 RT60040203
description	descaling pump manual 12l/min connection stuff		

			
1			
GEV No.	542447	Ref. No.	12024717
description	thermometer mounting ø 52mm t.max. 105°C 20-105°C probe ø 8mm probe L 63mm capillary pipe 3400mm		

measuring equipment

thermometers

built-in thermometers

			
1			
GEV No.	501492	Ref. No.	12023939 Z513023
description	thermometer mounting measurements 58x25.5mm +20 up to +120°C capillary pipe 3470mm probe ø 6mm probe L 35mm		
For models:	ECO-160D, ECO-160I, ECO-200D, ECO-200HD, ECO-200HI, ECO-200I, ECO-2700D, ECO-2700I, ECO-280D, ECO-280I, ECO-370D, ECO-370I, ECO-4000D, ECO-4000I, ECO-460D, ECO-460I, ECO-550D, ECO-550I, ECO-6000D, ECO-6000I, FI-160AR, FI-160D, FI-160I, FI-200AR, FI-200D, FI-200HD, FI-200HI, FI-200I, FI-2700D, FI-2700I, FI-280D, FI-280I, FI-370D, FI-370I, FI-4000D, FI-4000I, FI-460D, FI-460I, FI-550D, FI-550I, FI-6000D, FI-6000I		

			
1			
GEV No.	541794	Ref. No.	12033869 6021350003
description	thermometer mounting ø 52mm t.max. 120°C 0 up to +120°C probe ø 6.5mm probe L 23mm capillary pipe 2000mm		
For models:	AC-120, AC-180		

fastening material

rivets/rivet nuts

blind rivets DIN 7337 - aluminium

			
1			
GEV No.	560048	Ref. No.	12010266 Q419005
description	blind rivet aluminium ø 4mm L 8mm Qty 1 pcs		
For models:	AD-120, AD-120B, AD-120BBTDD-UK, AD-120C, AD-120CW, AD-120HY, AD-15, AD-15D, AD-20C-UK, AD-21, AD-21B, AD-21BDD, AD-21C, AD-21D, AD-21DD, AD-21W, AD-64BTDD, AD-90, AD-90BA, AD-90BBT, AD-90BDD, AD-90DD, ADE-120, ADE-120B, BG6-05I, BG7-05, BG7-05I, BG7-10, BG7-10I, BG9-05, BG9-05AD, BG9-05I, BG9-05PF, BG9-05PI, BG9-05PLUS-I, BG9-10, BG9-10AD, BG9-10I, BG9-10PF, BG9-10PI, BG9-10PLUS-I, BME6-05, BME7-05, BME7-10, BME9-05, BME9-05AD, BME9-05PLUS, BME9-05V-T, BME9-10, BME9-10AD...(Other models you can see in the webshop)		

blind rivets DIN 7337 - stainless steel



1

GEV No.	560157	Ref. No.	12010065
description	blind rivet SS ϕ 3.2mm L 6mm Qty 50 pcs DIN 1700		
For models:	ACE-201, ACE-202, ACG-201, ACG-202, AE-201, AE-202, AG-201, AG-202, APE-201, APE-202, APG-201, APG-202, COE-202, COG-102, COG-202, EN9-05C, EN9-05C-AD, EN9-05PLUS-C, EN9-10C, EN9-10C-AD, EN9-10PLUS-C, HEI-20-21, HEM-20-21, HEP-10-21, HEP-20-21, HGC-20-21, HGP-10-21, HGP-20-21, HGV-20-21, VE-202, VG-102, VG-202, VPE-202, VPG-102, VPG-202		



1

GEV No.	560049	Ref. No.	12010090 Q412002
description	blind rivet SS ϕ 4mm L 7.5mm Qty 50 pcs		
For models:	ACE-061, ACE-101, ACE-102, ACE-201, ACE-202, ACG-061, ACG-101, ACG-102, ACG-201, ACG-202, AE-061, AE-061W, AE-101, AE-101W, AE-102, AE-102W, AE-201, AE-202, AG-061, AG-061W, AG-101, AG-101W, AG-102, AG-102W, AG-201, AG-202, APE-061, APE-061W, APE-101, APE-101W, APE-102, APE-102W, APE-201, APE-202, APG-061, APG-061W, APG-101, APG-101W, APG-102, APG-102W, APG-201, APG-202, BG6-05I, BG7-05, BG7-05I, BG7-10, BG7-10I, CE9-41, CGE9-41, COE-061...(Other models you can see in the webshop)		

blind rivets DIN 7337 - zinc-coated steel



1

GEV No.	560047	Ref. No.	12010117 Q411304
description	blind rivet steel ϕ 4.8mm L 11.3mm Qty 1 pcs		
For models:	AD-120, AD-120B, AD-120BTTDD-UK, AD-120C, AD-120CW, AD-120HY, AD-48BDD, AD-48C, AD-48DD, AD-48W, AD-64BDD, AD-64C, AD-64CW, AD-64DD, AD-72, AD-72W, AD-90, AD-90BA, AD-90BBT, AD-90BDD, AD-90DD, ADE-120, ADE-120B, BG9-05, BG9-10, BME7-05, BME7-10, BME9-05, BME9-05AD, BME9-05PLUS, BME9-05V-T, BME9-10, BME9-10AD, BME9-10PLUS, BME9-10V-T, BMG7-10, BMG9-05, BMG9-05V-T, BMG9-10, BMG9-10V-T, CE6-41, CE7-41, CE7-41Q, CE9-41, CE9-41AD, CE9-41PLUS, CG-1002, CG-1502, CG-2002, CG-2002P...(Other models you can see in the webshop)		

sealed blind rivets



1

GEV No.	560180	Ref. No.	12037604 RT16030165
description	sealed blank rivets SS ϕ 3.2mm L 10mm Qty 50 pcs		

blind rivet nuts hexagonal



1

GEV No.	550777	Ref. No.	12010024 Q221345
description	rivet nut thread M10 DN 13mm L 22mm Qty 1 pcs		
For models:	BG6-05I, BG7-05, BG7-05I, BG7-10, BG7-10I, BG9-05, BG9-05AD, BG9-05I, BG9-05PF, BG9-05PI, BG9-05PLUS-I, BG9-10, BG9-10AD, BG9-10I, BG9-10PF, BG9-10PI, BG9-10PLUS-I, BME7-05, BME7-10, BME9-05, BME9-05AD, BME9-05PLUS, BME9-05V-T, BME9-10, BME9-10AD, BME9-10PLUS, BME9-10V-T, BMG7-10, BMG9-05, BMG9-05V-T, BMG9-10, BMG9-10V-T, CE7-20, CE7-20Q, CE7-40, CE7-40Q, CE9-20, CE9-20AD, CE9-20PLUS, CE9-40, CE9-40AD, CE9-40PLUS, CG-2005, CG-210, CG-210G, CG-3005, CG-310, CG-310G, CG7-10, CG7-20...(Other models you can see in the webshop)		



1

GEV No.	696427	Ref. No.	12009970 Q222011
description	rivet nut thread M5 DN 4mm L 12mm SS Qty 1 pcs ϕ 7mm WS 6		
For models:	ACE-061, ACE-101, ACE-102, ACE-201, ACE-202, ACG-061, ACG-101, ACG-102, ACG-201, ACG-202, AD-45BBT, AD-48HY, AD-64BBT, AD-64BTDD, AD-64HY, AE-061, AE-061W, AE-101, AE-101W, AE-102, AE-102W, AE-201, AE-202, AG-061, AG-061W, AG-101, AG-101W, AG-102, AG-102W, AG-201, AG-202, APE-061, APE-061W, APE-101, APE-101W, APE-102, APE-102W, APE-201, APE-202, APG-061, APG-061W, APG-101, APG-101W, APG-102, APG-102W, APG-201, APG-202, CE9-40, CE9-41, CG-2000...(Other models you can see in the webshop)		



1

GEV No.	551034	Ref. No.	12010163 Q221342
description	rivet nut thread M5 DN 7mm L 12mm Qty 10 pcs		
For models:	ACE-061, ACE-101, ACE-102, ACE-201, ACE-202, ACG-061, ACG-101, ACG-102, ACG-201, ACG-202, AD-120, AD-120B, AD-120BTTDD-UK, AD-120C, AD-120CW, AD-120HY, AD-45BBT, AD-48HY, AD-64, AD-64B, AD-64BBT, AD-64BTDD, AD-64C, AD-64D, AD-64DD, AD-64HY, AD-72, AD-90, AD-90BA, AD-90BBT, AD-90BDD, AD-90DD, ADE-120, ADE-120B, AE-061, AE-061W, AE-101, AE-101W, AE-102, AE-102W, AE-201, AE-202, AG-061, AG-061W, AG-101, AG-101W, AG-102, AG-102W, AG-201, AG-202...(Other models you can see in the webshop)		



1

GEV No.	550776	Ref. No.	12010126 Q221343
description	rivet nut thread M6 DN 10mm L 15mm SS Qty 1 pcs		
For models:	ACE-061, ACE-101, ACE-102, ACE-201, ACE-202, ACG-061, ACG-101, ACG-102, ACG-201, ACG-202, ADE-120, ADE-120B, AE-061, AE-061W, AE-101, AE-101W, AE-102, AE-102W, AE-201, AE-202, AG-061, AG-061W, AG-101, AG-101W, AG-102, AG-102W, AG-201, AG-202, APE-061, APE-061W, APE-101, APE-101W, APE-102, APE-102W, APE-201, APE-202, APG-061, APG-061W, APG-101, APG-101W, APG-102, APG-102W, APG-201, APG-202, BG6-05I, BG7-05, BG7-05I, BG7-10, BG7-10I, BG9-05...(Other models you can see in the webshop)		

countersunk screws



1

GEV No.	560041	Ref. No.	12010199
description	countersunk screw thread M5 L 16mm WS 3 SS DIN 7991/ISO 10642 Qty 20 pcs intake hexagonal		
For models:	ACE-061, ACE-101, ACE-102, ACG-061, ACG-101, ACG-102, AE-061, AE-061W, AE-101, AE-101W, AE-102, AE-102W, AG-061, AG-061W, AG-101, AG-101W, AG-102, AG-102W, APE-061, APE-061W, APE-101, APE-101W, APE-102, APE-102W, APG-061, APG-061W, APG-101, APG-101W, APG-102, APG-102W		

SCREWS

sheet metal screws



1

GEV No.	560098	Ref. No.	12010290 Q082032
description	sheet metal screws ø 3.5mm L 9.5mm SS Qty 20 pcs DIN 7981/ISO 7049 head ø 6.9mm oval head		
For models:	AD-120, AD-120B, AD-120BBTDD-UK, AD-120C, AD-120CW, AD-120HY, AD-15, AD-15D, AD-20C-UK, AD-21, AD-21B, AD-21BDD, AD-21C, AD-21D, AD-21DD, AD-21W, AD-45BBT, AD-48, AD-48B, AD-48BDD, AD-48C, AD-48D, AD-48DD, AD-48HY, AD-48W, AD-64, AD-64B, AD-64BBT, AD-64BDD, AD-64BTDD, AD-64C, AD-64CW, AD-64D, AD-64DD, AD-64HY, AD-72, AD-72W, AD-90, AD-90BA, AD-90BBT, AD-90BDD, AD-90DD, ADE-120, ADE-120B, EASY-500, EASY-500B, EASY-500DD, EASY-500HP, EASY-500HPWBDD, ECO-120...(Other models you can see in the webshop)		



1

GEV No.	560076	Ref. No.	12009852 12010293 Q152024
description	countersunk screw thread M4 L 10mm SS DIN 963/ISO 2009 Qty 20 pcs intake slotted head ø 7.5mm		
For models:	AD-120, AD-120B, AD-120BBTDD-UK, AD-120C, AD-120CW, AD-120HY, AD-15, AD-15D, AD-20C-UK, AD-21, AD-21B, AD-21BDD, AD-21C, AD-21D, AD-21DD, AD-21W, AD-45BBT, AD-48, AD-48B, AD-48BDD, AD-48C, AD-48D, AD-48DD, AD-48HY, AD-48W, AD-64, AD-64B, AD-64BBT, AD-64BDD, AD-64BTDD, AD-64C, AD-64CW, AD-64D, AD-64DD, AD-64HY, AD-72, AD-72W, AD-90, AD-90BA, AD-90BBT, AD-90BDD, AD-90DD, ADE-120, ADE-120B, CGP9-11, EASY-500, EASY-500B, EASY-500DD, EASY-500HP, EASY-500HPWBDD...(Other models you can see in the webshop)		



1

GEV No.	560108	Ref. No.	12010257 Q082005
description	sheet metal screws ø 4.2mm L 13mm SS Qty 20 pcs DIN 7981/ISO 7049 head ø 8.2mm oval head		
For models:	CPG9-05AD, CPG9-05AD-S, CPG9-05PLUS, CPG9-05PLUS-S, CV9-20AD, CV9-20PLUS, CV9-40AD, CV9-40PLUS, ECO-160D, ECO-160I, ECO-200D, ECO-200HD, ECO-200HI, ECO-200I, ECO-280D, ECO-280I, ECO-370D, ECO-370I, ECO-460D, ECO-460I, ECO-550D, ECO-550I, FG7-05-1C, FG7-05-2C, FG7-10-2C, FG7-104C, FG7-10-4C, FG9-05-1C, FG9-05-2C, FG9-05AD, FG9-05PLUS, FG9-05PLUS-S, FG9-05S-1C, FG9-05S-2C, FG9-05S-AD, FG9-10-2C, FG9-10-4C, FG9-10AD, FG9-10PLUS, FGCL9-05-1C, FGCL9-05-2C, FGCL9-05S-1C, FGCL9-05S-2C, FI-160AR, FI-160D, FI-160I, FI-200AR, FI-200D, FI-200HD, FI-200HI...(Other models you can see in the webshop)		



1

GEV No.	560211	Ref. No.	12010262 Q042022
description	countersunk screw thread M4 L 14mm SS DIN 963/ISO 2009 Qty 20 pcs intake slotted head ø 7.5mm		
For models:	ACE-061, ACE-101, ACE-102, ACE-201, ACE-202, ACG-061, ACG-101, ACG-102, ACG-201, ACG-202, AD-120, AD-120B, AD-120BBTDD-UK, AD-120C, AD-120CW, AD-120HY, AD-15, AD-15D, AD-20C-UK, AD-21, AD-21B, AD-21BDD, AD-21C, AD-21D, AD-21DD, AD-21W, AD-45BBT, AD-48, AD-48B, AD-48BDD, AD-48C, AD-48D, AD-48DD, AD-48HY, AD-64, AD-64B, AD-64BDD, AD-64BTDD, AD-64C, AD-64D, AD-64DD, AD-64HY, AD-72, AD-90, AD-90BA, AD-90BBT, AD-90BDD, AD-90DD, ADE-120, ADE-120B...(Other models you can see in the webshop)		



1

GEV No.	560263	Ref. No.	12010287 Q041324
description	countersunk screw thread M4 L 25mm SS DIN 963/ISO 2009 Qty 20 pcs intake slotted head ø 7.5mm		
For models:	AD-45BBT, AD-48, AD-48B, AD-48BDD, AD-48C, AD-48D, AD-48DD, AD-48HY, AD-48W, AD-64, AD-64B, AD-64BBT, AD-64BDD, AD-64BTDD, AD-64C, AD-64CW, AD-64D, AD-64DD, AD-64HY, AD-72, AD-72W, EASY-500, EASY-500B, EASY-500DD, EASY-500HP, EASY-500HPWBDD, ECO-120, ECO-120B, ECO-160, ECO-160D, ECO-160I, ECO-200, ECO-200D, ECO-200H, ECO-200HD, ECO-200HI, ECO-200I, ECO-2700D, ECO-2700I, ECO-280D, ECO-280I, ECO-370D, ECO-370I, ECO-4000D, ECO-4000I, ECO-460D, ECO-460I, ECO-550D, ECO-550I, ECO-6000D...(Other models you can see in the webshop)		



GEV No.	560077	Ref. No.	12010265 Q042031
description	countersunk screw thread M5 L 10mm SS DIN 963/ISO 2009 Qty 20 pcs intake slotted head ø 9.2mm		
For models:	ECO-1200, FE-18, FE-25, FE-4, FE-6, FE-8, FE9-05, FE9-05S, FE9-10, FF-35, FG9-05, FG9-05S, FG9-10, FI-1200, FI-900, HCG-10-11, HCG-10-21, HCG-20-11, HCG-2-10-11, HCG-2-20-11, HCG-6-11, HEI-20-11, HEM-20-11, HEP-20-11, HGP-10-21, HGP-20-21, HGV-10-11, HGV-10-21, HGV-20-11, HME-10-11, HME-10-21, HME-20-11, HME-2-10-11, HME-2-20-11, HME-6-11, HMG-10-11, HMG-10-11UL, HMG-10-21, HMG-10-21UL, HMG-2-10-11, HMG-2-10-11UL, HMI-10-11, HMI-10-11UL, HMI-10-21, HMI-10-21UL, HMI-2-10-11...(Other models you can see in the webshop)		



GEV No.	560019	Ref. No.	12009838 Q152015 Q153112
description	flat-headed bolt thread M3 thread L 6mm SS DIN 7985/ISO 7045 Qty 20 pcs head ø 6mm head thickness 2mm Phillips		
For models:	AD-45BBT, AD-48, AD-48B, AD-48BDD, AD-48C, AD-48D, AD-48DD, AD-48HY, AD-48W, AD-64, AD-64B, AD-64BBT, AD-64BDD, AD-64BTDD, AD-64C, AD-64CW, AD-64D, AD-64DD, AD-64HY, AD-72, AD-72W, EASY-500, EASY-500B, EASY-500DD, EASY-500HP, EASY-500HPWDD, FI-30, FI-300B, FI-300R, FI-30AR, FI-30AR+DD, FI-30B, FI-30B-BT-UK, FI-30-UK, FI-48, FI-48AR, FI-48B, FI-48B-BT-UK, FI-48C, FI-48D, FI-48HY-CLINIC, FI-48W, FI-50, FI-60DD, FI-64, FI-64AR, FI-64B, FI-64B-BT-UK, FI-64C, FI-64D...(Other models you can see in the webshop)		



GEV No.	560220	Ref. No.	12010192 Q042043
description	countersunk screw thread M6 L 20mm SS DIN 963/ISO 2009 Qty 20 pcs intake slotted head ø 11mm		
For models:	CE7-41, CE9-41, CG-1002, CG-1502, CG-2002, CG-210, CG-210G, CG-310, CG-310G, CG7-11, CG7-41, CG7-61, CG9-11, CG9-41, CG9-51L, CG9-51LC, CG9-51R, CG9-51RC, CG9-61, CG9-61OP, CG9-82, CGE7-41, CGE9-41, CGF9-121D, CGF9-121I, FTG9-11L, FTG9-11L+R, FTG9-11R, FTGC9-11L, FTGC9-11L+R, FTGC9-11R, HCG-10-11, HCG-10-21, HCG-20-11, HCG-2-10-11, HCG-2-20-11, HCG-6-11, HE9-10, HE9-20, HG9-10, HG9-20, HME-10-11, HME-10-21, HME-20-11, HME-2-10-11, HME-2-10-11UL, HME-2-20-11, HME-6-11, HMI-10-11...(Other models you can see in the webshop)		



GEV No.	560062	Ref. No.	12010278 Q032021
description	flat-headed bolt thread M4 thread L 10mm SS DIN 7985/ISO 7045 Qty 20 pcs intake Phillips head ø 8mm head thickness 2mm		
For models:	ACE-061, ACE-101, ACE-102, ACE-201, ACE-202, ACG-061, ACG-101, ACG-102, ACG-201, ACG-202, AD-15, AD-15D, AD-20C-UK, AD-21, AD-21B, AD-21BDD, AD-21C, AD-21D, AD-21DD, AD-21W, AE-061, AE-061W, AE-101, AE-101W, AE-102, AE-102W, AE-201, AE-202, AG-061, AG-101, AG-102, AG-201, AG-202, APE-061, APE-061W, APE-101, APE-101W, APE-102, APE-102W, APE-201, APE-202, APG-061, APG-101, APG-102, APG-201, APG-202, BMG7-10, CG-1002, CG-1502, CG-2002...(Other models you can see in the webshop)		

flat-headed bolts



GEV No.	560021	Ref. No.	12010286 Q032011
description	flat-headed bolt thread M3 thread L 10mm SS DIN 7985/ISO 7045 Qty 20 pcs head ø 6mm head thickness 2mm Phillips		
For models:	AD-120, AD-120B, AD-120BBTDD-UK, AD-120C, AD-120CW, AD-120HY, AD-90, AD-90BA, AD-90BBT, AD-90BDD, AD-90DD, ADE-120, ADE-120B, ECO-120, ECO-120B, FI-100, FI-100AR, FI-100B, FI-100BBT-UK, FI-120, FI-120AR+DD, FI-120B, FI-120C, FI-120HY-CLINIC, FI-120W, FI-64, FI-64AR, FI-64B, FI-64B-BT-UK, FI-64C, FI-64D, FI-64HY-CLINIC, FI-64W, FI-E-100, HGC-10-21, HGV-10-21, LABP-1000, LABP-1200, LAC-10, LAC-10MP, LAC-10MPP, LAC-14, LAC-14MP, LAC-14MPP, LAC-7, LAC-7MP, LAC-7MPP, LC-AC-10, LC-AC-10A, LC-AC-14...(Other models you can see in the webshop)		





GEV No.	560063	Ref. No.	12009862
description	flat-headed bolt thread M4 thread L 16mm SS DIN 7985/ISO 7045 Qty 20 pcs intake Phillips head ø 8mm head thickness 2mm		





GEV No.	560061	Ref. No.	12009876 Q151320
description	flat-headed bolt thread M4 thread L 6mm SS DIN 7985/ISO 7045 Qty 20 pcs intake Phillips head ø 8mm head thickness 2mm		
For models:	ACE-061, ACE-101, ACE-102, ACE-201, ACE-202, ACG-061, ACG-101, ACG-102, ACG-201, ACG-202, AE-061, AE-061W, AE-101, AE-101W, AE-102, AE-102W, AE-201, AE-202, AG-061, AG-061W, AG-101, AG-101W, AG-102, AG-102W, AG-201, AG-202, APE-061, APE-061W, APE-101, APE-101W, APE-102, APE-102W, APE-201, APE-202, APG-061, APG-061W, APG-101, APG-101W, APG-102, APG-102W, APG-201, APG-202, BME6-05, BME7-05, BME7-10, BME9-05, BME9-05AD, BME9-05PLUS, BME9-05V-T, BME9-10...(Other models you can see in the webshop)		





			
1			
GEV No.	560068	Ref. No.	12010213 Q032032
description	flat-headed bolt thread M5 thread L 16mm SS DIN 7985/ISO 7045 Qty 20 pcs intake Phillips head ø 10mm head thickness 2mm		
For models:	ACE-201, ACE-202, ACG-201, ACG-202, AD-120B, AD-120BBTDD-UK, AD-120C, AD-120HY, AD-15, AD-15D, AD-20C-UK, AD-21, AD-21B, AD-21BD, AD-21C, AD-21D, AD-21DD, AD-21W, AD-90BA, AD-90BBT, AD-90BDD, ADE-120B, AE-201, AE-202, AG-201, AG-202, APE-201, APE-202, APG-201, APG-202, COE-201, COE-202, COG-201, COG-202, ECO-120B, FI-100B, FI-100BBT-UK, FI-120B, FI-120C, FI-120HY-CLINIC, FI-80BBT-UK, GA-20, GA-20D, GA-40, GA-40D, HCG-10-11, HCG-10-21, HCG-20-11, HCG-20-21, HCG-2-10-11...(Other models you can see in the webshop)		

			
1			
GEV No.	560071	Ref. No.	12010166 Q032035
description	flat-headed bolt thread M5 thread L 30mm SS DIN 7985/ISO 7045 Qty 20 pcs intake Phillips head ø 10mm head thickness 2mm		
For models:	AD-45BBT, AD-48HY, AD-64BBT, AD-64HY, CG-1002, CG-1502, FE-18, FE-25, FE-4, FE-6, FE-8, FI-30B-BT-UK, FI-48B-BT-UK, FI-48HY-CLINIC, FI-64B-BT-UK, FI-64HY-CLINIC, HCV-10-11, HCV-10-21, HCV-2-10-21, HCV-5-11, HCV-6-11, HE-10-11, HE-10-21, HE-2-10-11, HE-5-11, HE-6-11, HG-10-11, HG-10-21, HG-2-10-11, LAC-10, LAC-10MP, LAC-10MPP, LAC-14, LAC-14MP, LAC-14MPP, LAC-25, LAC-25MP, LAC-25MPP, LAC-55, LAC-55MP, LAC-55MPP, LAC-7, LAC-7MP, LAC-7MPP, LC-10, LC-14, LC-25, LC-7, LC-7A		

			
1			
GEV No.	560018	Ref. No.	12010157 Q032041
description	flat-headed bolt thread M6 thread L 10mm SS DIN 7985/ISO 7045 Qty 20 pcs head ø 12mm head thickness 5mm Phillips		
For models:	AD-120, AD-120B, AD-120BBTDD-UK, AD-120HY, AD-90, AD-90BA, AD-90BBT, AD-90BDD, AD-90DD, ADE-120, ADE-120B, EASY-500, EASY-500B, EASY-500DD, EASY-500HP, EASY-500HPWBDD, ECO-120, ECO-120B, FI-100, FI-100AR, FI-100B, FI-100BBT-UK, FI-120, FI-120AR+DD, FI-120B, FI-120C, FI-120HY-CLINIC, FI-120W, FI-30, FI-30AR, FI-30AR+DD, FI-30B, FI-30B-BT-UK, FI-30-UK, FI-48, FI-48AR, FI-48B, FI-48B-BT-UK, FI-48C, FI-48D, FI-48HY-CLINIC, FI-48W, FI-50, FI-60DD, FI-64, FI-64AR, FI-64B, FI-64B-BT-UK, FI-64C, FI-64D...(Other models you can see in the webshop)		

			
1			
GEV No.	560355	Ref. No.	Q062031
description	flat-headed bolt thread M5 thread L 10mm SS DIN 84/ISO 1207 Qty 1 pcs intake slotted head ø 8.3mm head thickness 3.2mm		
For models:	FI-1200, FI-300B, FI-300R, FI-650R, FI-900, HCV-10-11, HCV-10-21, HCV-2-10-21, HCV-5-11, HCV-6-11, HE-10-11, HE-10-21, HE-2-10-11, HE-5-11, HE-6-11, HME-10-11, HME-10-21, HME-20-11, HME-2-10-11, HME-6-11, HMI-10-11, HMI-10-11UL, HMI-10-21, HMI-10-21UL, HMI-2-10-11, HMI-6-11, HMI-6-11UL, HMM-10-11, HMM-10-11UL, HMM-10-21, HMM-10-21UL, HMM-20-11, HMM-20-11UL, HMM-2-10-11, HMM-6-11, HMM-6-11UL, HMP-10-11, HMP-10-21, HMP-20-11, HMP-2-10-11, HMP-6-11, LC-10, LC-14, LC-7, LC-7A, LF-AC-25, LF-AC-25MP, LF-AC-25MPP, LF-AC-55, LF-AC-55MP...(Other models you can see in the webshop)		

oval head screws			
			
1			
GEV No.	560057	Ref. No.	12010242 Q152004
description	oval head screw thread M5 L 13mm stainless steel intake Phillips Qty 10 pcs		
For models:	ACE-061, ACE-101, ACE-102, ACE-201, ACE-202, ACG-061, ACG-101, ACG-102, ACG-201, ACG-202, AD-120, AD-120B, AD-120BBTDD-UK, AD-120C, AD-120CW, AD-120HY, AD-125, AD-125HRS, AD-125-SOFT, AD-15, AD-15D, AD-20C-UK, AD-21, AD-21B, AD-21BD, AD-21C, AD-21D, AD-21DD, AD-21W, AD-45BBT, AD-48, AD-48B, AD-48BDD, AD-48C, AD-48D, AD-48DD, AD-48HY, AD-48W, AD-64, AD-64B, AD-64BBT, AD-64BDD, AD-64BTDD, AD-64C, AD-64CW, AD-64D, AD-64DD, AD-64HY, AD-72, AD-72W...(Other models you can see in the webshop)		

hexagonal screws			
			
1			
GEV No.	560311	Ref. No.	12010030 Q012063
description	hexagonal screw thread M10 thread L 20mm SS WS 17 Qty 1 pcs DIN 933 / ISO 4017		
For models:	ACE-061, ACE-101, ACE-102, ACE-201, ACE-202, ACG-061, ACG-101, ACG-102, ACG-201, ACG-202, AD-120, AD-120B, AD-120C, AD-120CW, AD-48, AD-48B, AD-48BDD, AD-48C, AD-48D, AD-48DD, AD-48W, AD-64, AD-64B, AD-64BDD, AD-64BTDD, AD-64C, AD-64CW, AD-64D, AD-64DD, AD-72, AD-72W, AD-90, AD-90BA, AD-90BDD, AD-90DD, AE-061, AE-061W, AE-101, AE-101W, AE-102, AE-102W, AE-201, AE-202, AG-061, AG-061W, AG-101, AG-101W, AG-102, AG-102W, AG-201...(Other models you can see in the webshop)		

			
1			
GEV No.	560081	Ref. No.	12010249 Q012021
description	hexagonal screw thread M4 thread L 10mm SS WS 7 Qty 20 pcs DIN 933 / ISO 4017		
For models:	ACE-061, ACE-101, ACE-102, ACE-201, ACE-202, ACG-061, ACG-101, ACG-102, ACG-201, ACG-202, AE-061, AE-061W, AE-101, AE-101W, AE-102, AE-102W, AE-201, AE-202, AG-061, AG-061W, AG-101, AG-101W, AG-102, AG-102W, AG-201, AG-202, APE-061, APE-061W, APE-101, APE-101W, APE-102, APE-102W, APE-201, APE-202, APG-061, APG-061W, APG-101, APG-101W, APG-102, APG-102W, APG-201, APG-202, CG-2000, CG-2000-2P, CG-2005, CG-210, CG-210G, CG-3005, CG-310, CG-310G...(Other models you can see in the webshop)		

			
1			
GEV No.	560083	Ref. No.	12010238 Q012031
description	hexagonal screw thread M5 thread L 10mm SS WS 8 Qty 20 pcs DIN 933 / ISO 4017		
For models:	ACE-061, ACE-101, ACE-102, ACE-201, ACE-202, ACG-061, ACG-101, ACG-102, ACG-201, ACG-202, AD-120, AD-120B, AD-120BBTDD-UK, AD-120C, AD-120CW, AD-120HY, AD-20C-UK, AD-21B, AD-21BDD, AD-21C, AD-21DD, AD-21W, AD-45BBT, AD-48, AD-48B, AD-48BDD, AD-48C, AD-48D, AD-48DD, AD-48HY, AD-48W, AD-64, AD-64B, AD-64BBT, AD-64BDD, AD-64BTDD, AD-64C, AD-64CW, AD-64D, AD-64DD, AD-64HY, AD-72, AD-72W, AD-90, AD-90BA, AD-90BBT, AD-90BDD, AD-90DD, ADE-120, ADE-120B...(Other models you can see in the webshop)		

			
1			
GEV No.	560086	Ref. No.	12010202 Q012041
description	hexagonal screw thread M6 thread L 10mm SS WS 10 Qty 20 pcs DIN 933 / ISO 4017		
For models:	AD-120, AD-120B, AD-120BBTDD-UK, AD-120C, AD-120CW, AD-120HY, AD-45BBT, AD-48, AD-48B, AD-48BDD, AD-48C, AD-48D, AD-48DD, AD-48HY, AD-48W, AD-64, AD-64B, AD-64BBT, AD-64BDD, AD-64BTDD, AD-64C, AD-64CW, AD-64D, AD-64DD, AD-64HY, AD-72, AD-72W, AD-90, AD-90BA, AD-90BBT, AD-90BDD, AD-90DD, ADE-120, ADE-120B, BME9-05, BME9-10, BMG7-10, BMG9-05, BMG9-10, CE6-41, CE7-41, CE7-41Q, CE9-41, CE9-41AD, CE9-41PLUS, CG-1002, CG-1502, CG-2000, CG-2000-2P, CG-2002...(Other models you can see in the webshop)		

			
2			
GEV No.	560254	Ref. No.	12018360 R725057
description	hexagonal screw thread M5 thread L 30mm SS WS 8 Qty 20 pcs DIN 933 / ISO 4017		
For models:	HCG-10-11, HCG-10-21, HCG-2-10-11, HCG-6-11, HMG-10-11, HMG-10-11UL, HMG-10-21, HMG-10-21UL, HMG-2-10-11, HMG-6-11		

			
1			
GEV No.	560079	Ref. No.	12037772 RT10060761
description	hexagonal screw thread M6 thread L 12mm SS WS 10 Qty 20 pcs DIN 933 / ISO 4017		

			
1			
GEV No.	560253	Ref. No.	12010083 Q011338
description	hexagonal screw thread M5 thread L 60mm SS WS 8 Qty 1 pcs DIN 933 / ISO 4017		
For models:	FG6-05, FG6-10, FTG7-05L, FTG7-05R, FTG7-10L, FTG7-10L+R, FTG7-10R, FTG9-05L, FTG9-05L-AD, FTG9-05PLUS-CL, FTG9-05PLUS-CR, FTG9-05PLUS-L, FTG9-05PLUS-R, FTG9-05R, FTG9-05R-AD, FTG9-05VL, FTG9-05VR, FTG9-10L, FTG9-10L+R, FTG9-10L+R-AD, FTG9-10L-AD, FTG9-10PLUS-CL, FTG9-10PLUS-CLR, FTG9-10PLUS-CR, FTG9-10PLUS-L, FTG9-10PLUS-LR, FTG9-10PLUS-R, FTG9-10R, FTG9-10R-AD, FTG9-10VL, FTG9-10VL+R, FTG9-10VR, FTG9-11L, FTG9-11L+R, FTG9-11R, FTGC7-05L, FTGC7-10L, FTGC9-05L, FTGC9-05L-AD, FTGC9-05R, FTGC9-05R-AD, FTGC9-10L, FTGC9-10L+R, FTGC9-10L+R-AD, FTGC9-10L-AD, FTGC9-10R, FTGC9-10R-AD, FTGC9-11L, FTGC9-11L+R, FTGC9-11R		

			
1			
GEV No.	524118	Ref. No.	12010186 Q012042
description	hexagonal screw thread M6 thread L 16mm SS WS 10 Qty 1 pcs DIN 933 / ISO 4017		
For models:	ACE-061, ACE-101, ACE-102, ACE-201, ACE-202, ACG-061, ACG-101, ACG-102, ACG-201, ACG-202, AD-120, AD-120B, AD-120BBTDD-UK, AD-120C, AD-120CW, AD-120HY, AD-15, AD-15D, AD-20C-UK, AD-21, AD-21B, AD-21BDD, AD-21C, AD-21D, AD-21DD, AD-21W, AD-45BBT, AD-48, AD-48B, AD-48BDD, AD-48C, AD-48D, AD-48DD, AD-48HY, AD-48W, AD-64, AD-64B, AD-64BBT, AD-64BDD, AD-64BTDD, AD-64C, AD-64CW, AD-64D, AD-64DD, AD-64HY, AD-72, AD-72W, AD-90, AD-90BA, AD-90BBT...(Other models you can see in the webshop)		

			
1			
GEV No.	560448	Ref. No.	12036376 RT10080753
description	hexagonal screw thread M5 thread L 8mm SS WS 8 Qty 1 pcs head thickness 4mm DIN 933 / ISO 4017		

			
1			
GEV No.	560088	Ref. No.	12010180 Q012043
description	hexagonal screw thread M6 thread L 20mm SS WS 10 Qty 20 pcs DIN 933 / ISO 4017		
For models:	ACE-061, ACE-101, ACE-102, ACG-061, ACG-101, ACG-102, AE-061, AE-061W, AE-101, AE-101W, AE-102, AE-102W, AG-061, AG-061W, AG-101, AG-101W, AG-102, AG-102W, APE-061, APE-061W, APE-101, APE-101W, APE-102, APE-102W, APG-061, APG-061W, APG-101, APG-101W, APG-102, APG-102W, BME9-05, BME9-10, BMG9-05, BMG9-10, CE7-41, CE7-41Q, CE9-41, CG-1002, CG-1502, CG7-11, CG7-31D, CG7-31I, CG7-41, CG7-41H, CG7-51, CG7-61, CG7-61H, CG9-10, CG9-11, CG9-11AD...(Other models you can see in the webshop)		





 <p>1</p>			
GEV No.	560089	Ref. No.	12010153 Q012044
description	hexagonal screw thread M6 thread L 25mm SS WS 10 Qty 20 pcs DIN 933 / ISO 4017		
For models:	AD-120, AD-120B, AD-120BBTDD-UK, AD-120C, AD-120CW, AD-120HY, AD-90, AD-90BA, AD-90BBT, AD-90BDD, AD-90DD, ADE-120, ADE-120B, CE9-41, CG-1002, CG-1502, CG-2000, CG-2000-2P, CG-2002, CG-2005, CG-210, CG-210G, CG-3005, CG-310, CG-310G, CG7-20, CG-7200, CG7-40, CG-7400, CG7-41, CG-7415, CG7-61, CG-7615, CG9-20, CG9-40, CG9-41, CG9-51L, CG9-51LC, CG9-51R, CG9-51RC, CG9-60, CG9-61, CG9-82, CGB7-61, CGE7-41, CGE9-41, COG-061, COG-101, ECO-120, ECO-120B...(Other models you can see in the webshop)		

 <p>1</p>			
GEV No.	560252	Ref. No.	12010115 Q012046
description	hexagonal screw thread M6 thread L 40mm SS WS 10 Qty 20 pcs DIN 933 / ISO 4017		
For models:	AD-45BBT, AD-48, AD-48B, AD-48C, AD-48D, AD-48DD, AD-48HY, AD-48W, AD-64, AD-64B, AD-64BBT, AD-64BTDD, AD-64C, AD-64CW, AD-64D, AD-64DD, AD-64HY, AD-72, AD-72W, EASY-500, EASY-500B, EASY-500DD, EASY-500HP, EASY-500HPWBDD, ECO-160, ECO-1600, ECO-160D, ECO-160I, ECO-200, ECO-200D, ECO-200H, ECO-200HD, ECO-200HI, ECO-200I, ECO-2300, ECO-280D, ECO-280I, ECO-3000, ECO-370D, ECO-370I, ECO-460D, ECO-460I, ECO-550D, ECO-550I, FI-160, FI-1600, FI-160D, FI-160I, FI-200, FI-200D...(Other models you can see in the webshop)		

 <p>1</p>			
GEV No.	503122	Ref. No.	12010112 Q012051 Q012051000
description	hexagonal screw thread M8 thread L 10mm SS WS 13 Qty 1 pcs DIN 933 / ISO 4017		

 <p>1</p>			
GEV No.	506175	Ref. No.	12008844 X152809
description	hexagonal screw thread M8 thread L 14mm SS WS 13 Qty 20 pcs head thickness 3mm DIN 933 / ISO 4017		
For models:	SBE7-10, SBE9-10, SBE9-10I, SBE9-10IM, SBE9-10IMS, SBE9-10IS, SBE9-10M, SBE9-10MS, SBE9-10S, SBE9-10USMC, SBE9-15IM, SBE9-15IMS, SBE9-15M, SBE9-15MS, SBG7-10, SBG9-10, SBG9-10I, SBG9-10IM, SBG9-10IMS, SBG9-10IS, SBG9-10M, SBG9-10MS, SBG9-10S, SBG9-15IM, SBG9-15IMS		

 <p>1</p>			
GEV No.	550682	Ref. No.	12010076 Q012053
description	hexagonal screw thread M8 thread L 20mm SS WS 13 Qty 1 pcs DIN 933 / ISO 4017		
For models:	AD-120, AD-120B, AD-120BBTDD-UK, AD-120C, AD-120CW, AD-120HY, AD-90, AD-90BA, AD-90BBT, AD-90BDD, AD-90DD, ADE-120, ADE-120B, CE-410, CG-110, CG-9110, CGB7-61H, CGB7-61R, CGB7-61RH, ECO-120, ECO-120B, ECO-160, ECO-1600, ECO-160D, ECO-160I, ECO-200, ECO-200D, ECO-200H, ECO-200HD, ECO-200HI, ECO-200I, ECO-2300, ECO-2700D, ECO-2700I, ECO-280D, ECO-280I, ECO-3000, ECO-370D, ECO-370I, ECO-4000D, ECO-4000I, ECO-460D, ECO-460I, ECO-550D, ECO-550I, ECO-6000D, ECO-6000I, FI-100, FI-100AR, FI-100B...(Other models you can see in the webshop)		

 <p>1</p>			
GEV No.	560205	Ref. No.	12036562 RT10080766
description	hexagonal screw thread M8 thread L 30mm SS WS 13 Qty 1 pcs DIN 933 / ISO 4017		

 <p>1</p>			
GEV No.	506446	Ref. No.	12010056 Q012056
description	hexagonal screw thread M8 thread L 40mm SS WS 13 Qty 1 pcs DIN 933 / ISO 4017		
For models:	ACE-061, ACE-101, ACE-102, ACE-201, ACE-202, ACG-061, ACG-101, ACG-102, ACG-201, ACG-202, AE-061, AE-061W, AE-101, AE-101W, AE-102, AE-102W, AE-201, AE-202, AG-061, AG-061W, AG-101, AG-101W, AG-102, AG-102W, AG-201, AG-202, APE-061, APE-061W, APE-101, APE-101W, APE-102, APE-102W, APE-201, APE-202, APG-061, APG-061W, APG-101, APG-101W, APG-102, APG-102W, APG-201, APG-202, COE-102, COE-202, COG-102, COG-201, COG-202, ECO-1600, ECO-2300, ECO-3000...(Other models you can see in the webshop)		

 <p>1</p>			
GEV No.	550528	Ref. No.	12040516 RT10052000
description	safety screw thread M5 WS 8 Qty 10 pcs L 8mm head ø 11mm		

cylinder head bolts

DIN 912/ISO 4762

 <p>1</p>			
GEV No.	530454	Ref. No.	12038252 RT10040665
description	cylinder head bolt thread M4 thread L 6mm L 9.5mm WS 3 SS Qty 1 pcs intake internal hexagon DIN 912/ISO 4762		



GEV No.	520455	Ref. No.	12038360 Q052053
description	screw thread M8 thread L 20mm WS 6 SS Qty 1 pcs DIN 912/ISO 4762		
For models:	CE-15, CE-9, SBE7-10, SBE9-10, SBE9-10I, SBE9-10IM, SBE9-10IMS, SBE9-10IS, SBE9-10M, SBE9-10MS, SBE9-10S, SBE9-15IM, SBE9-15IMS, SBG7-10, SBG9-10, SBG9-10I, SBG9-10IM, SBG9-10IMS, SBG9-10IS, SBG9-10M, SBG9-10MS, SBG9-10S, SBG9-15IM, SBG9-15IMS		



GEV No.	560380	Ref. No.	12010084 12018750 Q052046 Q152033
description	cylinder head bolt thread M6 L 40mm thread L 25mm WS 5 SS Qty 1 pcs DIN 912/ISO 4762		
For models:	ACG-061, ACG-101, ACG-102, ACG-201, ACG-202, AG-061, AG-061W, AG-101, AG-101W, AG-102, AG-102W, AG-201, AG-202, APG-061, APG-061W, APG-101, APG-101W, APG-102, APG-102W, APG-201, APG-202, ECO-1200, FI-1200, FI-120W, FI-200W, FI-200WL, FI-200WR, FI-80W, FI-900, LAC-25, LAC-25MP, LAC-25MPP, LAC-55, LAC-55MP, LAC-55MPP, LC-25, LC-AC-25, LC-E-25, LC-V-25, LF-25MPP, LF-AC-25, LF-AC-25MP, LF-AC-25MPP, LF-AC-55, LF-AC-55MP, LF-AC-55MPP, LF-E-25, LF-E-25MP, LF-E-25MPP, LF-E-55...(Other models you can see in the webshop)		

side bolts



GEV No.	560038	Ref. No.	12010148 Q152017
description	side bolts thread M6 L 13mm Qty 20 pcs intake Phillips head ø 15mm		
For models:	BME9-05, BME9-10, BMG9-05, BMG9-10, CE7-41, CE9-41, CG-1002, CG-1502, CG-2000, CG-2000-2P, CG-2002, CG-2002P, CG-2005, CG-210, CG-210G, CG-300S, CG-310, CG-310G, CG7-11, CG7-41, CG7-61, CG9-11, CG9-20, CG9-40, CG9-41, CG9-51L, CG9-51LC, CG9-51R, CG9-51RC, CG9-60, CG9-61, CG9-82, CGE7-198, CGE7-202, CGE7-41, CGE9-41, CGF9-121D, CGF9-121I, CGP9-11, ECO-120, ECO-120B, ECO-160, ECO-160D, ECO-160I, ECO-200, ECO-200D, ECO-200H, ECO-200HD, ECO-200HI, ECO-200I...(Other models you can see in the webshop)		



GEV No.	560037	Ref. No.	12010129 Q152022
description	side bolts thread M6 L 10mm SS Qty 20 pcs intake Phillips head ø 15mm		
For models:	CE6-41, CE7-41, CE7-41Q, CE9-41, CE9-41AD, CE9-41PLUS, CG-1002, CG-1502, CG-2002, CG-2002P, CG-210, CG-210G, CG-310, CG-310G, CG6-41, CG7-11, CG7-31D, CG7-31I, CG7-41, CG7-41H, CG7-51, CG7-61, CG7-61H, CG9-11, CG9-11AD, CG9-11PLUS, CG9-31PLUS-D, CG9-31PLUS-I, CG9-41, CG9-41AD, CG9-41AD-H, CG9-41H, CG9-41PLUS, CG9-41PLUS-H, CG9-51L, CG9-51LC, CG9-51R, CG9-51RC, CG9-61, CG9-61AD, CG9-61AD-H, CG9-61H, CG9-61OP, CG9-61PLUS, CG9-61PLUS-H, CG9-82, CG9-82AD, CG9-82PLUS, CGE6-41, CGE7-41...(Other models you can see in the webshop)		

grub screws

DIN 913/ISO 4026



GEV No.	560022	Ref. No.	12010279 Q132054
description	grub screw thread M6 L 12mm DIN 913/ISO 4026 WS 3 Qty 20 pcs		
For models:	CG-2002, CG-2002P, CG7-20H, CG7-30D, CG7-30I, CG7-31D, CG7-31I, CG7-40, CG7-40H, CG7-41, CG7-41H, CG7-50, CG7-51, CG7-60, CG7-60H, CG7-61, CG7-61H, CG9-20, CG9-20AD, CG9-20AD-H, CG9-20H, CG9-20PLUS, CG9-20PLUS-H, CG9-31PLUS-D, CG9-31PLUS-I, CG9-40, CG9-40AD, CG9-40AD-H, CG9-40H, CG9-40PLUS, CG9-40PLUS-H, CG9-41, CG9-41AD, CG9-41AD-H, CG9-41H, CG9-41PLUS, CG9-41PLUS-H, CG9-51L, CG9-51LC, CG9-51R, CG9-51RC, CG9-60, CG9-60AD, CG9-60AD-H, CG9-60H, CG9-60PLUS, CG9-60PLUS-H, CG9-61, CG9-61AD, CG9-61AD-H...(Other models you can see in the webshop)		



GEV No.	560024	Ref. No.	12010197 Q131542
description	grub screw thread M6 L 16mm SS DIN 913/ISO 4026 intake internal hexagon WS 3 Qty 20 pcs		
For models:	CG-1002, CG-1502, CG-2002, CG-2005, CG-210, CG-210G, CG-300S, CG-310, CG-310G, CG7-20, CG7-30D, CG7-30I, CG7-31D, CG7-31I, CG7-40, CG7-41, CG7-50, CG7-51, CG7-60, CG7-61, CG9-05AD, CG9-05PLUS, CG9-20, CG9-20AD, CG9-20H, CG9-20PLUS, CG9-40, CG9-40AD, CG9-40H, CG9-40PLUS, CG9-41, CG9-41AD, CG9-41PLUS, CG9-51L, CG9-51LC, CG9-51R, CG9-51RC, CG9-60, CG9-60AD, CG9-60H, CG9-60PLUS, CG9-61, CG9-61AD, CG9-61OP, CG9-61PLUS, CG9-82, CG9-82AD, CG9-82PLUS, CGB7-61, CGB7-61R...(Other models you can see in the webshop)		

DIN 914/ISO 4027





GEV No.	560175	Ref. No.	12010091 Q131504 Q131552
description	grub screw thread M8 L 16mm DIN 914/ISO 4027 intake internal hexagon WS 4 Qty 1 pcs		
For models:	SBE7-10, SBE9-10, SBE9-10I, SBE9-10I-AD, SBE9-10I-AD-S, SBE9-10IM, SBE9-10IMS, SBE9-10IS, SBE9-10PLUS-I, SBE9-10PLUS-SI, SBE9-10S, SBE9-10USMC, SBG7-10, SBG-9040, SBG9-10, SBG9-10I, SBG9-10I-AD, SBG9-10I-AD-S, SBG9-10IS, SBG9-10PLUS-I, SBG9-10PLUS-SI, SBG9-10S		





GEV No.	696737	Ref. No.	12024023 Z105051 Z105051000
description	grub screw thread M8 L 16mm DIN 914/ISO 4027 Qty 1 pcs		
For models:	ECO-160, ECO-1600, ECO-160D, ECO-160I, ECO-200, ECO-200D, ECO-200H, ECO-200HD, ECO-200HI, ECO-200I, ECO-2300, ECO-280D, ECO-280I, ECO-3000, ECO-370D, ECO-370I, ECO-460D, ECO-460I, ECO-550D, ECO-550I, FI-160, FI-1600, FI-160AR, FI-160D, FI-160I, FI-200, FI-200AR, FI-200D, FI-200H, FI-200HD, FI-200HI, FI-200I, FI-200W, FI-200WL, FI-200WR, FI-2300, FI-280D, FI-280I, FI-3000, FI-370D, FI-370I, FI-460D, FI-460I, FI-550D, FI-550I		





DIN 916/ISO 4029			
			
1			
GEV No.	560549	Ref. No.	12010236
description	grub screw thread M6 L 15mm SS DIN 916/ISO 4029 intake internal hexagon WS 3 Qty 1 pcs		
For models:	ACE-201, ACE-202, ACG-201, ACG-202, AE-201, AE-202, AG-201, AG-202, APE-201, APE-202, APG-201, APG-202, CG9-20, CG9-20AD, CG9-20H, CG9-20PLUS, CG9-40, CG9-40AD, CG9-40H, CG9-40PLUS, CG9-41, CG9-41H, CG9-51L, CG9-51LC, CG9-51R, CG9-51RC, CG9-60, CG9-60AD, CG9-60H, CG9-60PLUS, CG9-61, CG9-61H, CG9-61OP, CG9-82, CGE9-41, CGE9-41AD, CGE9-41PLUS, CGF9-120D, CGF9-120I, CGF9-121D, CGF9-121I, COE-201, COE-202, COG-201, COG-202, HEI-10-11, HEI-20-11, HEI-20-21, HEI-6-11, HEM-10-11...(Other models you can see in the webshop)		

knurled screws			
			
1			
GEV No.	505034	Ref. No.	12009829 Q152016
description	Thumb screw thread M5 thread L 7mm ø 20mm H 3mm SS		
For models:	AD-120, AD-120B, AD-120BBTDD-UK, AD-120C, AD-120CW, AD-120HY, AD-15, AD-15D, AD-20C-UK, AD-21, AD-21B, AD-21BDD, AD-21C, AD-21D, AD-21DD, AD-21W, AD-45BBT, AD-48, AD-48B, AD-48BDD, AD-48C, AD-48D, AD-48DD, AD-48HY, AD-48W, AD-64, AD-64B, AD-64BBT, AD-64BDD, AD-64BTDD, AD-64C, AD-64CW, AD-64D, AD-64DD, AD-64HY, AD-72, AD-72W, AD-90, AD-90BA, AD-90BBT, AD-90BDD, AD-90DD, ADE-120, ADE-120B, CO-110, CO-110B, CO-110BDD, CO-110DD, CO-112, CO-112B...(Other models you can see in the webshop)		

miscellaneous			
			
1			
GEV No.	505140	Ref. No.	12016848 Z643015
description	screw SS		
For models:	FI-300B, FI-300R, FI-650R		

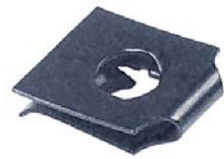
			
1			
GEV No.	527391	Ref. No.	12010011 Q151336
description	thread bolt thread M6 L 25mm thread L 10mm ø 7mm		
For models:	BG6-05I, BG7-05, BG7-05I, BG7-10, BG7-10I, BG9-05, BG9-05I, BG9-05PF, BG9-05PI, BG9-10, BG9-10I, BG9-10PF, BG9-10PI, BME7-05, BME7-10, BME9-05, BME9-05AD, BME9-05PLUS, BME9-05V-T, BME9-10, BME9-10AD, BME9-10PLUS, BME9-10V-T, BMG7-10, BMG9-05, BMG9-05V-T, BMG9-10, BMG9-10V-T, CE7-20, CE7-20Q, CE7-40, CE7-40Q, CE7-41, CE7-41Q, CE9-20, CE9-20AD, CE9-20PLUS, CE9-40, CE9-40AD, CE9-40PLUS, CE9-41, CE9-41AD, CE9-41PLUS, CG-2000, CG-2000-2P, CG-2002, CG-2005, CG-210, CG-210G, CG-3005...(Other models you can see in the webshop)		

nuts			
plate nuts			
			
1			
GEV No.	560046	Ref. No.	12010134 Q221012
description	plate nut hole ø M5mm L 16mm W 10mm		
For models:	AD-15, AD-15D, AD-21, AD-21B, AD-21BDD, AD-21D, AD-21DD, AD-21W, AD-45BBT, AD-48, AD-48B, AD-48BDD, AD-48C, AD-48D, AD-48DD, AD-48HY, AD-48W, AD-64, AD-64B, AD-64BBT, AD-64BDD, AD-64C, AD-64CW, AD-64D, AD-64DD, AD-64HY, AD-72, AD-72W, EASY-500, EASY-500B, EASY-500DD, EASY-500HP, EASY-500HPWBDD, ECO-1200, FI-1200, FI-30, FI-300B, FI-300R, FI-30AR, FI-30AR+DD, FI-30B, FI-30B-BT-UK, FI-30-UK, FI-48, FI-48AR, FI-48B, FI-48B-BT-UK, FI-48C, FI-48D, FI-48HY-CLINIC...(Other models you can see in the webshop)		

cap nuts			
			
1			
GEV No.	560136	Ref. No.	12010167 Q212031
description	cap nuts thread M5 WS 8 SS Qty 20 pcs DIN/ISO DIN 1587		
For models:	ECO-160, ECO-160D, ECO-160I, ECO-200, ECO-200D, ECO-200H, ECO-200HD, ECO-200HI, ECO-200I, ECO-2700D, ECO-2700I, ECO-280D, ECO-280I, ECO-370D, ECO-370I, ECO-4000D, ECO-4000I, ECO-460D, ECO-460I, ECO-550D, ECO-550I, ECO-6000D, ECO-6000I, FE9-05, FE9-05S, FE9-05USMC, FE9-10, FG9-05, FG9-05S, FG9-10, FI-160, FI-160AR, FI-160D, FI-160I, FI-200, FI-200AR, FI-200D, FI-200H, FI-200HD, FI-200HI, FI-200I, FI-200W, FI-200WL, FI-200WR, FI-2700D, FI-2700I, FI-280D, FI-280I, FI-370D, FI-370I...(Other models you can see in the webshop)		

			
1			
GEV No.	560137	Ref. No.	12010143 12034573 Q212040 RT11060360
description	cap nuts thread M6 WS 10 SS Qty 20 pcs DIN/ISO DIN 1587		
For models:	ECO-160, ECO-160D, ECO-160I, ECO-200, ECO-200D, ECO-200H, ECO-200HD, ECO-200HI, ECO-200I, ECO-2700D, ECO-2700I, ECO-280D, ECO-280I, ECO-370D, ECO-370I, ECO-4000D, ECO-4000I, ECO-460D, ECO-460I, ECO-550D, ECO-550I, ECO-6000D, ECO-6000I, FE-710, FE-720, FE-920, FF-35, FG-710, FG-720, FG-920, FI-160, FI-160AR, FI-160D, FI-160I, FI-200, FI-200AR, FI-200D, FI-200H, FI-200HD, FI-200HI, FI-200I, FI-200W, FI-200WL, FI-200WR, FI-2700D, FI-2700I, FI-280D, FI-280I, FI-370D, FI-370I...(Other models you can see in the webshop)		

			
1			
GEV No.	560138	Ref. No.	12010094 Q212051
description	cap nuts thread M8 WS 13 SS Qty 20 pcs DIN/ISO DIN 1587		
For models:	FF-35, HCG-10-11, HCG-10-21, HCG-20-11, HCG-20-21, HCG-2-10-11, HCG-2-20-11, HCG-6-11, HEI-10-11, HEI-20-11, HEI-6-11, HEM-10-11, HEM-20-11, HEM-6-11, HEP-10-11, HEP-20-11, HEP-6-11, HGC-10-11, HGC-20-11, HGC-6-11, HGV-10-11, HGV-20-11, HME-10-11, HME-20-11, HME-2-10-11, HME-2-20-11, HME-6-11, HMI-10-11, HMI-10-11UL, HMI-10-21, HMI-10-21UL, HMI-2-10-11, HMI-6-11, HMI-6-11UL, HMM-10-11, HMM-10-11UL, HMM-10-21, HMM-10-21UL, HMM-20-11, HMM-20-11UL, HMM-20-21, HMM-20-21UL, HMM-2-10-11, HMM-2-20-11, HMM-40-11-USMC, HMM-6-11, HMM-6-11UL, HMP-10-11...(Other models you can see in the webshop)		

knurled nuts			
			
1			
GEV No.	505173	Ref. No.	12023653 Z680738
description	knurled nut		
For models:	AD-120, AD-120B, AD-120BTTDD-UK, AD-120C, AD-120CW, AD-120HY, ADE-120, ADE-120B, ECO-120, ECO-1200, ECO-120B, FI-100, FI-100AR, FI-100B, FI-100BBT-UK, FI-120, FI-1200, FI-120AR+DD, FI-120B, FI-120C, FI-120HY-CLINIC, FI-120W, FI-80BBT-UK, FI-900, FI-E-100, LABP-1000, LABP-1200, MF-120		

			
1			
GEV No.	505171	Ref. No.	12017466 12020831 12024375 Z200705
description	knurled nut thread M14x1 ø 35mm H 5mm SS		
For models:	AD-45BBT, AD-48, AD-48B, AD-48BDD, AD-48C, AD-48D, AD-48DD, AD-48HY, AD-48W, AD-64, AD-64B, AD-64BBT, AD-64BDD, AD-64BTDD, AD-64C, AD-64CW, AD-64D, AD-64DD, AD-64HY, AD-72, AD-72W, AD-90, AD-90BA, AD-90BBT, AD-90BDD, AD-90DD, EASY-500, EASY-500B, EASY-500DD, EASY-500HP, EASY-500HPWBDD, FI-30, FI-30AR, FI-30AR+DD, FI-30B, FI-30B-BT-UK, FI-30-UK, FI-48, FI-48AR, FI-48B, FI-48B-BT-UK, FI-48C, FI-48D, FI-48HY-CLINIC, FI-48W, FI-50, FI-60DD, FI-64, FI-64AR, FI-64B...(Other models you can see in the webshop)		

hexagonal nuts			
DIN 934 / ISO 4032/8673			
			
1			
GEV No.	560199	Ref. No.	12036825 RT11120110
description	hexagonal nut thread M10 H 8mm WS 17 SS DIN/ISO DIN 934 / ISO 4032/8673 Qty 10 pcs		

			
1			
GEV No.	560131	Ref. No.	12009839 Q162020
description	hexagonal nut thread M4 H 3.2mm WS 7 SS DIN/ISO DIN 934 / ISO 4032/8673 Qty 20 pcs		
For models:	ACE-201, ACE-202, AD-120, AD-120B, AD-120BTTDD-UK, AD-120C, AD-120CW, AD-120HY, AD-15, AD-15D, AD-20C-UK, AD-21, AD-21B, AD-21BDD, AD-21C, AD-21D, AD-21DD, AD-21W, AD-45BBT, AD-48, AD-48B, AD-48BDD, AD-48C, AD-48D, AD-48DD, AD-48HY, AD-48W, AD-64, AD-64B, AD-64BBT, AD-64BDD, AD-64C, AD-64CW, AD-64D, AD-64DD, AD-64HY, AD-72, AD-72W, AD-90, AD-90BA, AD-90BBT, AD-90BDD, AD-90DD, ADE-120, ADE-120B, AE-061, AE-061W, AE-101, AE-101W, AE-102...(Other models you can see in the webshop)		

			
1			
GEV No.	560132	Ref. No.	12010194 12010284 Q162030 Q163030
description	hexagonal nut thread M5 H 4mm WS 8 SS DIN/ISO DIN 934 / ISO 4032/8673 Qty 20 pcs		
For models:	ACE-061, ACE-101, ACE-102, ACE-201, ACE-202, ACG-061, ACG-101, ACG-102, ACG-201, ACG-202, AD-120, AD-120B, AD-120BTTDD-UK, AD-120C, AD-120CW, AD-120HY, AD-15, AD-15D, AD-20C-UK, AD-21, AD-21B, AD-21BDD, AD-21C, AD-21D, AD-21DD, AD-21W, AD-45BBT, AD-48, AD-48B, AD-48BDD, AD-48C, AD-48D, AD-48DD, AD-48HY, AD-48W, AD-64, AD-64B, AD-64BBT, AD-64BDD, AD-64BTDD, AD-64C, AD-64CW, AD-64D, AD-64DD, AD-64HY, AD-72, AD-72W, AD-90, AD-90BA, AD-90BBT...(Other models you can see in the webshop)		





 1			
GEV No.	511212	Ref. No.	12010255 Q162040 Q163140000
description	hexagonal nut thread M6 H 5mm WS 10 SS DIN/ISO DIN 934 / ISO 4032/8673 Qty 1 pcs		
For models:	ACE-061, ACE-101, ACE-102, ACE-201, ACE-202, ACG-061, ACG-101, ACG-102, ACG-201, ACG-202, AD-120, AD-120B, AD-120BBTDD-UK, AD-120C, AD-120CW, AD-120HY, AD-15, AD-15D, AD-20C-UK, AD-21, AD-21B, AD-21BDD, AD-21C, AD-21D, AD-21DD, AD-21W, AD-45BBT, AD-48, AD-48B, AD-48BDD, AD-48C, AD-48D, AD-48DD, AD-48HY, AD-48W, AD-64, AD-64B, AD-64BBT, AD-64BDD, AD-64BTDD, AD-64C, AD-64CW, AD-64D, AD-64DD, AD-64HY, AD-72, AD-72W, AD-90, AD-90BA, AD-90BBT...(Other models you can see in the webshop)		

 2			
GEV No.	560134	Ref. No.	12010210 12037260 Q162050 RT11080260
description	hexagonal nut thread M8 H 6.5mm WS 13 SS DIN/ISO DIN 934 / ISO 4032/8673 Qty 20 pcs		
For models:	ACE-061, ACE-101, ACE-102, ACE-201, ACE-202, ACG-061, ACG-101, ACG-102, ACG-201, ACG-202, AD-120, AD-120B, AD-120BBTDD-UK, AD-120C, AD-120CW, AD-120HY, AD-45BBT, AD-48, AD-48B, AD-48BDD, AD-48C, AD-48D, AD-48DD, AD-48HY, AD-48W, AD-64, AD-64B, AD-64BBT, AD-64BDD, AD-64BTDD, AD-64C, AD-64CW, AD-64D, AD-64DD, AD-64HY, AD-72, AD-72W, AD-90, AD-90BA, AD-90BBT, AD-90BDD, AD-90DD, ADE-120, ADE-120B, AE-061, AE-061W, AE-101, AE-101W, AE-102, AE-102W...(Other models you can see in the webshop)		

 1			
GEV No.	505200	Ref. No.	12010027 Q162070
description	nut thread M12x1.75 H 10mm WS 19 SS DIN/ISO DIN 934 / ISO 4032/8673 Qty 1 pcs		
For models:	AD-120, AD-120B, AD-120BBTDD-UK, AD-120C, AD-120CW, AD-120HY, AD-45BBT, AD-48, AD-48B, AD-48BDD, AD-48C, AD-48D, AD-48DD, AD-48HY, AD-48W, AD-64, AD-64B, AD-64BBT, AD-64BDD, AD-64BTDD, AD-64C, AD-64CW, AD-64D, AD-64DD, AD-64HY, AD-72, AD-72W, AD-90, AD-90BA, AD-90BBT, AD-90BDD, AD-90DD, ADE-120, ADE-120B, EASY-500, EASY-500B, EASY-500DD, EASY-500HP, EASY-500HPWBDD, ECO-120, ECO-1200, ECO-120B, ECO-160, ECO-160D, ECO-160I, ECO-200, ECO-200D, ECO-200H, ECO-200HD, ECO-200HI...(Other models you can see in the webshop)		

 1			
GEV No.	560140	Ref. No.	12009897
description	hexagonal nut thread M4 H 4.8mm SS WS 7 Qty 20 pcs DIN/ISO DIN 985 self-locking		
For models:	AD-64BTDD		

 1			
GEV No.	560142	Ref. No.	12010251 Q222012
description	hexagonal nut thread M6 H 6mm SS WS 10 Qty 20 pcs DIN/ISO DIN 985 self-locking		
For models:	AD-120, AD-120B, AD-120BBTDD-UK, AD-15, AD-15D, AD-20C-UK, AD-21, AD-21B, AD-21BDD, AD-21C, AD-21D, AD-21DD, AD-21W, AD-45BBT, AD-48, AD-48B, AD-48BDD, AD-48C, AD-48D, AD-48DD, AD-48HY, AD-48W, AD-64, AD-64B, AD-64BBT, AD-64BDD, AD-64BTDD, AD-64C, AD-64CW, AD-64D, AD-64DD, AD-64HY, AD-72, AD-72W, AD-90, AD-90BA, AD-90BBT, AD-90BDD, AD-90DD, ADE-120, ADE-120B, EASY-500, EASY-500B, EASY-500DD, EASY-500HP, EASY-500HPWBDD, ECO-120, ECO-120B, ECO-160, ECO-160D...(Other models you can see in the webshop)		

 1			
GEV No.	542383	Ref. No.	12103867 RT11050121
description	hexagonal nut thread M5 H 6mm zinc-coated steel WS 8 Qty 10 pcs for combi-steamer SCC WE		

 1			
GEV No.	507533	Ref. No.	12009948 Q222016
description	nut thread M20 H 9.5mm SS WS 29.5 Qty 1 pcs DIN/ISO DIN 439		
For models:	AD-120, AD-120B, AD-120BBTDD-UK, AD-90, AD-90BA, AD-90BBT, AD-90BDD, AD-90DD, ADE-120, ADE-120B, ECO-120, ECO-120B, FI-100, FI-100AR, FI-100B, FI-100BBT-UK, FI-120, FI-120AR+DD, FI-120B, FI-120C, FI-120HY-CLINIC, FI-120W, FI-80, FI-80AR, FI-80BBT-UK, FI-80W, FI-E-100, LABP-1000, LABP-1200, LABP-800, MF-120		

 1			
GEV No.	530881	Ref. No.	12037870 RT11060220
description	hexagonal nut thread M6 H 3mm WS 10 SS Qty 25 pcs for combi-steamer CPC-Linie		



1

GEV No.	691860	Ref. No.	12037639 Z9530980
description	nut thread M12x0.75 H 3.4mm WS 17 SS Qty 1 pcs		
For models:	GA-20, GA-20D, GA-40, GA-40D		



1

GEV No.	550261	Ref. No.	12016635 X163012 Z600603
description	nut thread M14x1 H 4mm WS 19 SS Qty 1 pcs		
For models:	BG9-05, BG9-05I, BG9-10, BG9-10I, FE-710, FE-720, FE-920, FG-710, FG-720, FG-920, FI-300B, FI-300R, FI-650R, LVC-15, LVC-21, LVR-14, LVR-20, LVR-20B		



1

GEV No.	101345	Ref. No.	12009877 Q223021
description	nut thread M15x1 H 3mm WS 19 brass Qty 1 pcs		
For models:	BME7-05, BME7-10, BME9-05, BME9-05AD, BME9-05PLUS, BME9-05V-T, BME9-10, BME9-10AD, BME9-10PLUS, BME9-10V-T, FG-1-40, FG-2-80, FG7-05-1C, FG7-05-2C, FG-710, FG7-10-2C, FG7-104C, FG7-10-4C, FG-71-15, FG-720, FG-72-30, FG9-05, FG9-05-1C, FG9-05-2C, FG9-05AD, FG9-05PLUS, FG9-05PLUS-S, FG9-05S, FG9-05S-1C, FG9-05S-2C, FG9-05S-AD, FG9-10, FG9-10-2C, FG9-10-4C, FG9-10AD, FG9-10PLUS, FG-91-20, FG-920, FG-92-40, FG-940, FI-300B, FI-300R, FI-650R		



1

GEV No.	691862	Ref. No.	12016713 Q223011
description	nut thread M18x1.5 H 5mm WS 22 SS Qty 1 pcs		
For models:	FI-300B, FI-300R, FI-650R, LVR-10, LVR-14, LVR-20, LVR-20B		



1

GEV No.	691861	Ref. No.	12016617 U060519
description	nut thread M20x1 H 4mm WS 23 brass Qty 1 pcs		



1

GEV No.	507536	Ref. No.	12018993 Q223022
description	nut thread M8x1 H 3mm WS 11 brass Qty 1 pcs		
For models:	CG-210G, CG-310G, CG-7200, CG-7400, CG-7415, CG-7615, CG-HP-20, ECO-1600, ECO-2300, ECO-3000, FE-710, FE-720, FG-1-40, FG-2-80, FG7-05-1C, FG7-05-2C, FG-710, FG7-10-2C, FG7-104C, FG7-10-4C, FG-71-15, FG-720, FG-72-30, FG-91-20, FG-92-40, FI-100, FI-120, FI-120W, FI-1600, FI-160D, FI-160I, FI-200D, FI-200I, FI-2300, FI-280D, FI-280I, FI-3000, FI-370D, FI-370I, FI-460D, FI-460I, FI-48, FI-48B, FI-48W, FI-50, FI-5420, FI-550D, FI-550I, FI-64, FI-64B...(Other models you can see in the webshop)		

hexagonal nuts inch thread



1

GEV No.	507532	Ref. No.	12009831 Q223014
description	nut thread 1" H 10mm WS 40 brass Qty 1 pcs		
For models:	AD-45BBT, AD-48HY, AD-64BBT, AD-64BTDD, AD-64HY, EA-SY-500HPWBDD, FE-18, FE-25, FE-710, FE-720, FE-91-20, FG-1-40, FG-2-80, FG-710, FG-720, FG-91-20, FG-920, FG-92-40, FG-940, FGCL9-05, FI-30B-BT-UK, FI-48B-BT-UK, FI-48HY-CLINIC, FI-64B-BT-UK, FI-64HY-CLINIC, HCG-10-11, HCG-10-21, HCG-20-11, HCG-20-21, HCG-2-10-11, HCG-2-20-11, HCG-6-11, HEI-10-11, HEI-20-11, HEI-6-11, HEM-10-11, HEM-20-11, HEM-6-11, HEP-10-11, HEP-20-11, HEP-6-11, HGC-10-11, HGC-20-11, HGC-6-11, HGV-10-11, HGV-20-11, HME-10-11, HME-10-21, HME-20-11, HME-20-21...(Other models you can see in the webshop)		



1

GEV No.	521102	Ref. No.	12009843 12040388 Q221302 Q221401
description	nut thread 1/2" H 8mm SS WS 32 Qty 1 pcs		
For models:	BME7-05, BME7-10, BME9-05, BME9-05AD, BME9-05PLUS, BME9-05V-T, BME9-10, BME9-10AD, BME9-10PLUS, BME9-10V-T, BMG7-10, BMG9-05, BMG9-05V-T, BMG9-10, BMG9-10V-T, CE7-41, CE9-41, CGE7-173, CGE7-41, CGE9-41, CPE9-05, CPE9-05S, CPG7-05, CPG9-05, CPG9-05NC, CPG9-05S, CPG9-05SNC, ECO-1200, ECO-1600, ECO-2300, ECO-3000, FI-1200, FI-1600, FI-2300, FI-3000, FI-300B, FI-300R, FI-5420, FI-650R, FI-7630, FI-900, HE9-10, HE9-20, HPG-15, ME7-10BM, ME9-10BM, ME9-10BMS, ME9-15BM, ME9-15BM316, ME9-15BMS...(Other models you can see in the webshop)		





1

GEV No.	521003	Ref. No.	12039941 X012121
description	nut thread 1/4" H 6.3mm chrome-plated brass WS 20 Qty 1 pcs		
For models:	FG-71-15, FG-72-30, FG-91-20, FG-92-40		





			
1			
GEV No.	507535	Ref. No.	12009899 Q221324
description	nut thread 3/4" H 7mm WS 30 SS Qty 1 pcs		
For models:	BG7-05, BG7-05I, BG7-10, BG7-10I, BG9-05, BG9-05I, BG9-05PF, BG9-05PI, BG9-10, BG9-10I, BG9-10PF, BG9-10PI, BMG7-10, BMG-9045, BMG9-05, BMG9-05V-T, BMG9-10, BMG9-10V-T, CE-410, CE9-41, CG-2000-2P, CG9-51L, CG9-51LC, CG9-51R, CG9-51RC, ECO-160, ECO-200, ECO-200H, ECO-2700D, ECO-2700I, ECO-280D, ECO-280I, ECO-370D, ECO-370I, ECO-4000D, ECO-4000I, ECO-460D, ECO-460I, ECO-550D, ECO-550I, ECO-6000D, ECO-6000I, FG-71-15, FG-72-30, FI-160, FI-160AR, FI-160D, FI-160I, FI-200, FI-200AR...(Other models you can see in the webshop)		

			
1			
GEV No.	503042	Ref. No.	12007923 Q223019
description	nut thread 3/8" H 6mm brass WS 22 Qty 1 pcs		
For models:	BG6-05I, BG7-05, BG7-05I, BG7-10, BG7-10I, BG9-05, BG9-05AD, BG9-05I, BG9-05PF, BG9-05PI, BG9-05PLUS-I, BG9-10, BG9-10AD, BG9-10I, BG9-10PF, BG9-10PI, BG9-10PLUS-I, BMG7-10, BMG-9045, BMG9-05, BMG9-05V-T, BMG9-10, BMG9-10V-T, CG-1002, CG-1502, CG-2000, CG-2000-2P, CG-2002, CG-210, CG-210G, CG-310, CG-310G, CG6-41, CG7-10, CG7-11, CG-7115, CG-7200, CG7-31D, CG7-31I, CG-7400, CG7-41, CG-7415, CG7-41H, CG7-51, CG7-61, CG-7615, CG7-61H, CG9-10, CG9-10AD, CG9-10PLUS...(Other models you can see in the webshop)		

			
1			
GEV No.	514196	Ref. No.	12039127 Q222015
description	nut thread 3/8" H 8.5mm WS 22 SS Qty 1 pcs		
For models:	SBE7-10, SBE9-10, SBE9-10I, SBE9-10IM, SBE9-10IMS, SBE9-10IS, SBE9-10M, SBE9-10MS, SBE9-10S, SBE9-10USMC, SBE9-15IM, SBE9-15IMS, SBG7-10, SBG9-10, SBG9-10I, SBG9-10IM, SBG9-10IMS, SBG9-10IS, SBG9-10M, SBG9-10MS, SBG9-10S, SBG9-15IM, SBG9-15IMS		

hexagonal nuts with PG thread			
			
1			
GEV No.	550578	Ref. No.	12009764 Q223016
description	nut thread PG21 H 4.6mm WS 32 nickel-plated brass Qty 1 pcs mounting ømm cable ømm		
For models:	ECO-120, ECO-120B, FI-100, FI-100AR, FI-100B, FI-120, FI-120B, FI-120W, FI-30, FI-48, FI-48B, FI-48W, FI-50, FI-64, FI-64B, FI-64W, FI-72, FI-80, FI-80W, LA-13M, LA-18MP, LA-AC-10M, LA-AC-10MA, LA-AC-10MP, LA-AC-13M, LA-AC-13MA, LA-AC-13MP, LA-AC-18M, LA-AC-18MA, LA-AC-18MP, LA-AC-25M, LA-AC-25MA, LA-AC-25MP, LA-E-10M, LA-E-10MA, LA-E-10MP, LA-E-13M, LA-E-13MA, LA-E-13MP, LA-E-18M, LA-E-18MA, LA-E-18MP, LA-E-25M, LA-E-25MA, LA-E-25MP, LA-V-10M, LA-V-10MP, LA-V-13M, LA-V-13MP, LA-V-18M...(Other models you can see in the webshop)		

washers			
spring rings			
			
1			
GEV No.	560122	Ref. No.	12009924 Q262030
description	lock washer ID ø 5.2mm ED ø 9mm SS DIN127 Qty 20 pcs for thread M5		
For models:	AD-15, AD-15D, AD-20C-UK, AD-21, AD-21B, AD-21BDD, AD-21C, AD-21D, AD-21DD, AD-21W, AD-45BBT, AD-48, AD-48B, AD-48BDD, AD-48C, AD-48D, AD-48DD, AD-48HY, AD-48W, AD-64, AD-64B, AD-64BBT, AD-64BDD, AD-64BTDD, AD-64C, AD-64CW, AD-64D, AD-64DD, AD-64HY, AD-72, AD-72W, AD-90, AD-90DD, ADE-120, ADE-120B, BG9-05AD, BG9-05PLUS-I, BG9-10AD, BG9-10PLUS-I, BME9-05, BME9-05AD, BME9-05PLUS, BME9-05V-T, BME9-10, BME9-10AD, BME9-10PLUS, BME9-10V-T, BMG7-10, BMG9-05, BMG9-05V-T...(Other models you can see in the webshop)		

			
1			
GEV No.	560123	Ref. No.	12009872 Q262040
description	lock washer ID ø 6.3mm ED ø 11mm SS DIN127 Qty 20 pcs for thread M6		
For models:	ACE-061, ACE-101, ACE-102, ACE-201, ACE-202, AD-120, AD-120B, AD-120BBTDD-UK, AD-120C, AD-120CW, AD-120HY, AD-15, AD-15D, AD-20C-UK, AD-21, AD-21B, AD-21BDD, AD-21C, AD-21D, AD-21DD, AD-21W, AD-45BBT, AD-48, AD-48B, AD-48BDD, AD-48C, AD-48D, AD-48DD, AD-48HY, AD-48W, AD-64, AD-64B, AD-64BBT, AD-64BDD, AD-64BTDD, AD-64C, AD-64CW, AD-64D, AD-64DD, AD-64HY, AD-72, AD-72W, AD-90, AD-90BA, AD-90BBT, AD-90BDD, AD-90DD, ADE-120, ADE-120B, AE-061...(Other models you can see in the webshop)		

			
1			
GEV No.	560124	Ref. No.	12010272 12037421 Q262050 RT12080260
description	lock washer ID ø 8.3mm ED ø 15mm SS DIN127 Qty 20 pcs for thread M8		
For models:	AD-120, AD-120B, AD-120BBTDD-UK, AD-120C, AD-120CW, AD-120HY, AD-90, AD-90BA, AD-90BBT, AD-90BDD, AD-90DD, ADE-120, ADE-120B, CE7-20Q, CE7-40Q, CE7-41Q, CE9-20, CE9-20AD, CE9-20PLUS, CE9-40, CE9-40AD, CE9-40PLUS, CE9-41, CE9-41AD, CE9-41PLUS, CGB7-61H, CGB7-61R, CGB7-61RH, ECO-120, ECO-120B, ECO-160, ECO-1600, ECO-160D, ECO-160I, ECO-200, ECO-200D, ECO-200H, ECO-200HD, ECO-200HI, ECO-200I, ECO-2300, ECO-2700D, ECO-2700I, ECO-280D, ECO-280I, ECO-3000, ECO-370D, ECO-370I, ECO-4000D, ECO-4000I...(Other models you can see in the webshop)		

spring washers



GEV No.	560056	Ref. No.	12010233 Q301035
description	clamping washer nominal- ϕ 4mm ED ϕ 10mm spring steel		
For models:	HEI-10-11, HEI-6-11, HEM-10-11, HEM-6-11, HEP-10-11, HEP-6-11, HME-10-11, HME-10-21, HME-20-11, HME-20-21, HME-2-10-11, HME-2-20-11, HME-6-11, HMG-10-11, HMG-10-11UL, HMG-10-21, HMG-10-21UL, HMG-20-11, HMG-2-10-11, HMG-6-11, HMI-10-11, HMI-10-11UL, HMI-10-21, HMI-10-21UL, HMI-2-10-11, HMI-6-11, HMI-6-11UL, HMM-10-11, HMM-10-11UL, HMM-10-21, HMM-10-21UL, HMM-20-11, HMM-20-11UL, HMM-20-21, HMM-2-10-11, HMM-2-20-11, HMM-40-11-USMC, HMM-6-11, HMM-6-11UL, HMP-10-11, HMP-10-21, HMP-20-11, HMP-20-21, HMP-2-10-11, HMP-2-20-11, HMP-6-11, MFHMM-20-11		



GEV No.	560630	Ref. No.	12037727 RT11070100
description	clamping washer nominal- ϕ 4mm ED ϕ 11.5mm SS thickness 0.2mm		

washers

DIN 125A



GEV No.	560312	Ref. No.	12010235 Q232060
description	plain washer ID ϕ 10.5mm ED ϕ 20mm thickness 2mm SS Qty 1 pcs DIN 125A for thread M10		
For models:	CG-1002, CG-1502, CG-2000, CG-2000-2P, CG-2002, CG-2002P, ECO-280D, ECO-280I, ECO-370D, ECO-370I, ECO-460D, ECO-460I, ECO-550D, ECO-550I, FI-280D, FI-280I, FI-300B, FI-300R, FI-370D, FI-370I, FI-460D, FI-460I, FI-550D, FI-550I, FI-650R, FTEC9-05USMC, FTEC9-10USMC, HCG-10-11, HCG-10-21, HCG-20-11, HCG-20-21, HCG-2-10-11, HCG-6-11, HCV-10-11, HCV-10-21, HCV-2-10-21, HCV-5-11, HCV-6-11, HE-10-11, HE-10-21, HE-2-10-11, HE-5-11, HE-6-11, HG-10-11, HG-10-21, HG-2-10-11, HME-10-11, HME-10-21, HME-20-11, HME-20-21...(Other models you can see in the webshop)		



GEV No.	560111	Ref. No.	12009987 Q232020
description	plain washer ID ϕ 4.3mm ED ϕ 9mm thickness 0.8mm SS Qty 20 pcs DIN 125A for thread M4		
For models:	ACE-061, ACE-101, ACE-102, ACE-201, ACE-202, ACG-061, ACG-101, ACG-102, ACG-201, ACG-202, AD-120, AD-120B, AD-120BTTDD-UK, AD-120C, AD-120CW, AD-120HY, AD-15, AD-15D, AD-21, AD-21B, AD-21BDD, AD-21C, AD-21D, AD-21DD, AD-21W, AD-48, AD-48B, AD-48C, AD-48D, AD-48DD, AD-64, AD-64B, AD-64BTTDD, AD-64C, AD-64D, AD-64DD, AD-72, AD-90, AD-90BA, AD-90BBT, AD-90BDD, AD-90DD, ADE-120, ADE-120B, AE-061, AE-061W, AE-101, AE-101W, AE-102, AE-102W...(Other models you can see in the webshop)		



GEV No.	560112	Ref. No.	12009944 Q232030
description	plain washer ID ϕ 5.3mm ED ϕ 10mm thickness 1mm SS Qty 20 pcs DIN 125A for thread M5		
For models:	ACE-061, ACE-101, ACE-102, ACE-201, ACE-202, ACG-061, ACG-101, ACG-102, ACG-201, ACG-202, AD-120, AD-120B, AD-120BTTDD-UK, AD-120C, AD-120CW, AD-120HY, AD-15, AD-15D, AD-20C-UK, AD-21, AD-21B, AD-21BDD, AD-21C, AD-21D, AD-21DD, AD-21W, AD-45BBT, AD-48, AD-48B, AD-48BDD, AD-48C, AD-48D, AD-48DD, AD-48HY, AD-48W, AD-64, AD-64B, AD-64BBT, AD-64BDD, AD-64BTTDD, AD-64C, AD-64CW, AD-64D, AD-64DD, AD-64HY, AD-72, AD-72W, AD-90, AD-90BA, AD-90BBT...(Other models you can see in the webshop)		





GEV No.	560113	Ref. No.	12009868 12038251 Q232040 RT13060120
description	plain washer ID ϕ 6.4mm ED ϕ 12mm thickness 1.6mm SS Qty 20 pcs DIN 125A for thread M6		
For models:	ACE-061, ACE-101, ACE-102, ACE-201, ACE-202, ACG-061, ACG-101, ACG-102, ACG-201, ACG-202, AD-120, AD-120B, AD-120BTTDD-UK, AD-120C, AD-120CW, AD-120HY, AD-15, AD-15D, AD-20C-UK, AD-21, AD-21B, AD-21BDD, AD-21C, AD-21D, AD-21DD, AD-21W, AD-45BBT, AD-48, AD-48B, AD-48BDD, AD-48C, AD-48D, AD-48DD, AD-48HY, AD-48W, AD-64, AD-64B, AD-64BBT, AD-64BDD, AD-64BTTDD, AD-64C, AD-64CW, AD-64D, AD-64DD, AD-64HY, AD-72, AD-72W, AD-90, AD-90BA, AD-90BBT...(Other models you can see in the webshop)		





GEV No.	560114	Ref. No.	12010268 12037409 Q232050 RT13080160
description	plain washer ID ϕ 8.4mm ED ϕ 16mm thickness 1.6mm SS Qty 20 pcs DIN 125A for thread M8		
For models:	AD-120, AD-120B, AD-120BTTDD-UK, AD-120C, AD-120CW, AD-120HY, AD-90, AD-90BA, AD-90BBT, AD-90BDD, AD-90DD, ADE-120, ADE-120B, CE7-20Q, CE7-40Q, CE7-41Q, CE9-20, CE9-20AD, CE9-20PLUS, CE9-40, CE9-40AD, CE9-40PLUS, CE9-41, CE9-41AD, CE9-41PLUS, CG7-51, CG7-61, CG7-61H, CGB7-61, CGP9-11, CPE7-05, CPE7-05NC, CPE9-05, CPE9-05AD, CPE9-05AD-S, CPE9-05NC, CPE9-05PLUS, CPE9-05PLUS-S, CPE9-05S, CPE9-05SNC, CPG7-05, CPG7-05NC, CPG9-05, CPG9-05AD, CPG9-05AD-S, CPG9-05NC, CPG9-05PLUS, CPG9-05PLUS-S, CPG9-05S, CPG9-05SNC...(Other models you can see in the webshop)		



DIN 9021			
			
1			
GEV No.	560117	Ref. No.	12010267 Q302022
description	plain washer ID ø 6.4mm ED ø 18mm thickness 1.5mm SS Qty 20 pcs DIN 9021 for thread M6		
For models:	ACE-061, ACE-101, ACE-102, ACE-201, ACE-202, ACG-061, ACG-101, ACG-102, ACG-201, ACG-202, AD-120, AD-120B, AD-120BTTDD-UK, AD-120C, AD-120CW, AD-120HY, AD-15, AD-15D, AD-20C-UK, AD-21, AD-21B, AD-21BDD, AD-21C, AD-21D, AD-21DD, AD-21W, AD-45BBT, AD-48, AD-48B, AD-48BDD, AD-48C, AD-48D, AD-48DD, AD-48HY, AD-48W, AD-64, AD-64B, AD-64BBT, AD-64BDD, AD-64BTDD, AD-64C, AD-64CW, AD-64D, AD-64DD, AD-64HY, AD-72, AD-72W, AD-90, AD-90BA, AD-90BBT...(Other models you can see in the webshop)		

			
1			
GEV No.	560580	Ref. No.	12036873 RT13060222
description	plain washer ID ø 6.4mm ED ø 15mm thickness 1.5mm Qty 10 pcs		

			
1			
GEV No.	506160	Ref. No.	Q231450000
description	plain washer ID ø 8.6mm ED ø 16mm thickness 1.5mm SS Qty 1 pcs		

miscellaneous			
			
1			
GEV No.	529239	Ref. No.	12016722 T075021
description	flat washer ID ø 11mm ED ø 32mm thickness 0.8mm brass Qty 1 pcs		
For models:	HCG-6-11, HMG-6-11		

			
1			
GEV No.	560313	Ref. No.	12035156 RT13280102
description	serrated locking washer ID ø 10mm ED ø 22mm thickness 1.5mm SS Qty 1 pcs for thread M10		

tooth lock washers

DIN 6798A			
			
1			
GEV No.	560036	Ref. No.	12009953 Q242010
description	tooth lock washer ID ø 3.1mm ED ø 5.7mm SS Qty 10 pcs		
For models:	AD-120, AD-120B, AD-120BTTDD-UK, AD-120C, AD-120CW, AD-120HY, AD-15, AD-15D, AD-20C-UK, AD-21, AD-21B, AD-21BDD, AD-21C, AD-21D, AD-21DD, AD-21W, AD-45BBT, AD-48, AD-48B, AD-48BDD, AD-48C, AD-48D, AD-48DD, AD-48HY, AD-48W, AD-64, AD-64B, AD-64BBT, AD-64BDD, AD-64BTDD, AD-64C, AD-64CW, AD-64D, AD-64DD, AD-64HY, AD-72, AD-72W, AD-90, AD-90BA, AD-90BBT, AD-90BDD, AD-90DD, ADE-120, ADE-120B, CE-15, CE-9, EASY-500, EASY-500B, EASY-500DD, EASY-500HP...(Other models you can see in the webshop)		

			
1			
GEV No.	529238	Ref. No.	12016739 R725065
description	flat washer ID ø 18mm ED ø 32mm thickness 1.2mm brass Qty 1 pcs		
For models:	HCG-10-11, HMG-10-11		

			
1			
GEV No.	560125	Ref. No.	12009928 Q242020
description	tooth lock washer ID ø 4.2mm ED ø 8mm SS DIN/ISO DIN 6798A Qty 20 pcs for thread M4		
For models:	ACE-061, ACE-101, ACE-102, ACE-201, ACE-202, ACG-061, ACG-101, ACG-102, ACG-201, ACG-202, AD-120, AD-120B, AD-120BTTDD-UK, AD-120C, AD-120CW, AD-120HY, AD-15, AD-15D, AD-20C-UK, AD-21, AD-21B, AD-21BDD, AD-21C, AD-21D, AD-21DD, AD-21W, AD-45BBT, AD-48, AD-48B, AD-48BDD, AD-48C, AD-48D, AD-48DD, AD-48HY, AD-48W, AD-64, AD-64B, AD-64BBT, AD-64BDD, AD-64BTDD, AD-64C, AD-64CW, AD-64D, AD-64DD, AD-64HY, AD-72, AD-72W, AD-90, AD-90BA, AD-90BBT, AD-90BDD...(Other models you can see in the webshop)		

			
1			
GEV No.	529242	Ref. No.	12039798 R725034
description	plain washer ID ø 10mm ED ø 16mm thickness 2mm brass Qty 1 pcs		
For models:	HMG-10-11, HMG-10-11UL, HMG-10-21, HMG-10-21UL, HMG-2-10-11, HMG-6-11		

			
1			
GEV No.	529237	Ref. No.	12016723 R735011
description	plain washer ID ø 21mm ED ø 32mm thickness 1.2mm brass Qty 1 pcs		
For models:	HCG-10-21, HCG-2-10-11, HMG-10-21, HMG-2-10-11		

			
1			
GEV No.	560126	Ref. No.	12009890 Q242030
description	tooth lock washer ID ø 5.2mm ED ø 10mm SS DIN/ISO DIN 6798A Qty 20 pcs for thread M5		
For models:	ACE-061, ACE-101, ACE-102, ACE-201, ACE-202, ACG-061, ACG-101, ACG-102, ACG-201, ACG-202, AD-120, AD-120B, AD-120BTTDD-UK, AD-120C, AD-120CW, AD-120HY, AD-15, AD-15D, AD-20C-UK, AD-21, AD-21B, AD-21BDD, AD-21C, AD-21D, AD-21DD, AD-21W, AD-45BBT, AD-48, AD-48B, AD-48BDD, AD-48C, AD-48D, AD-48DD, AD-48HY, AD-48W, AD-64, AD-64B, AD-64BBT, AD-64BDD, AD-64C, AD-64CW, AD-64D, AD-64DD, AD-64HY, AD-72, AD-72W, AD-90, AD-90BA, AD-90BBT, AD-90BDD...(Other models you can see in the webshop)		

			
1			
GEV No.	560342	Ref. No.	12009882 Q242040
description	tooth lock washer ID ø 6.5mm ED ø 11mm SS Qty 1 pcs for thread M6		
For models:	ACE-061, ACE-101, ACE-102, ACE-201, ACE-202, ACG-061, ACG-101, ACG-102, ACG-201, ACG-202, AD-120, AD-120B, AD-120BTTDD-UK, AD-120C, AD-120CW, AD-120HY, AD-64BTTDD, AD-90, AD-90BA, AD-90BBT, AD-90BDD, AD-90DD, ADE-120, ADE-120B, AE-061, AE-061W, AE-101, AE-101W, AE-102, AE-102W, AE-201, AE-202, AG-061, AG-061W, AG-101, AG-101W, AG-102, AG-102W, AG-201, AG-202, APE-061, APE-061W, APE-101, APE-101W, APE-102, APE-102W, APE-201, APE-202, APG-061, APG-061W...(Other models you can see in the webshop)		

			
1			
GEV No.	524031	Ref. No.	12008693 X012612
description	spigot nominal-ø 7mm thread M5 L 38mm		
For models:	BME6-05, BMG7-10, CE6-20, CE6-40, CE6-41, CG-310, CG-310G, CG6-20, CG6-40, CG6-41, CG-7615, CGE6-41, CMF6-05, CPE6-05, CV6-20, CV6-40, EN6-05, EN6-10, FE6-05, FE6-10, FE-71-15, FE-91-20, FG6-05, FG6-10, FG-71-15, FG-72-30, FG-91-20, FG-92-40, HE9-10, HE9-20, HG9-10, HG9-15, HG9-20, LA-13M, LA-18MP, LA-25M, LA-AC-10M, LA-AC-10MA, LA-AC-10MP, LA-AC-13M, LA-AC-13MA, LA-AC-13MP, LA-AC-18M, LA-AC-18MA, LA-AC-18MP, LA-AC-25M, LA-AC-25MA, LA-AC-25MP, LA-E-10M, LA-E-10MA...(Other models you can see in the webshop)		

			
1			
GEV No.	560286	Ref. No.	12023513 Z105014
description	slot nut W 6mm H 6mm L 25mm		
For models:	ECO-160, ECO-1600, ECO-160D, ECO-160I, ECO-200, ECO-200D, ECO-200H, ECO-200HD, ECO-200HI, ECO-200I, ECO-2300, ECO-2700D, ECO-2700I, ECO-280D, ECO-280I, ECO-3000, ECO-370D, ECO-370I, ECO-4000D, ECO-4000I, ECO-460D, ECO-460I, ECO-550D, ECO-550I, ECO-6000D, ECO-6000I, FI-160, FI-1600, FI-160AR, FI-160D, FI-160I, FI-200, FI-200AR, FI-200D, FI-200H, FI-200HD, FI-200HI, FI-200I, FI-200W, FI-200WL, FI-200WR, FI-2300, FI-2700D, FI-2700I, FI-2700I, FI-280D, FI-280I, FI-3000, FI-370D, FI-370I, FI-4000D...(Other models you can see in the webshop)		

			
1			
GEV No.	520111	Ref. No.	12035874 RT20660205
description	hose clamp ø 10-16mm width 9mm Qty 10 pcs DIN 3017		

			
1			
GEV No.	520114	Ref. No.	12010023 12035505 Q881304 RT20660506
description	hose clamp ø 20-32mm width 9mm Qty 10 pcs DIN 3017		
For models:	AD-120B, AD-120BTTDD-UK, AD-120C, AD-120HY, AD-125, AD-125HRS, AD-125-SOFT, AD-505, AD-505-SOFT, AD-90BA, AD-90BBT, AD-90BDD, ADE-120B, APE-061, APE-061W, APE-101, APE-101W, APE-102, APE-102W, APE-201, APE-202, APG-061, APG-061W, APG-101, APG-101W, APG-102, APG-102W, APG-201, APG-202, BME9-05, BME9-10, BMG9-10, CO-110B, CO-110BDD, CO-112B, CO-112BDD, CO-170B, CO-170BDD, CO-172B, CO-172BDD, CO-500B, CO-500BDD, CO-501B, CO-501BDD, CO-502B, CO-502BDD, CO-502W, COP-173, COP-173B, COP-173BDD...(Other models you can see in the webshop)		

fasteners

mounting spigots

clamps

hose clamps

DIN 3017 - W2





 <p>1</p>			
GEV No.	520115	Ref. No.	12009997 Q881305
description	hose clamp ø 25-40mm width 9mm Qty 10 pcs DIN 3017		
For models:	AD-45BBT, AD-48, AD-48B, AD-48BDD, AD-48C, AD-48D, AD-48DD, AD-48HY, AD-48W, AD-505, AD-505, AD-64, AD-64B, AD-64BBT, AD-64BDD, AD-64BTDD, AD-64C, AD-64CW, AD-64D, AD-64DD, AD-64HY, AD-72, AD-72W, AE-201, AE-202, AG-061, AG-061W, AG-101, AG-101W, AG-102, AG-102W, AG-201, AG-202, APE-061, APE-061W, APE-101, APE-101W, APE-102, APE-102W, APE-201, APE-202, APG-061, APG-061W, APG-101, APG-101W, APG-102, APG-102W, APG-201, APG-202, BME7-05, BME7-10...(Other models you can see in the webshop)		

 <p>2</p>			
GEV No.	520118	Ref. No.	12009933 12036496 Q881324 RT20660300
description	hose clamp ø 50-70mm width 9mm Qty 5 pcs DIN 3017		
For models:	AD-45BBT, AD-48, AD-48B, AD-48BDD, AD-48C, AD-48D, AD-48DD, AD-48HY, AD-48W, AD-505, AD-505-SOFT, AD-64, AD-64B, AD-64BBT, AD-64BDD, AD-64BTDD, AD-64C, AD-64CW, AD-64D, AD-64DD, AD-64HY, AD-72, AD-72W, CO-500, CO-500B, CO-500BDD, CO-500DD, CO-501, CO-501B, CO-501BDD, CO-501DD, CO-501-SOFT, CO-502B, CO-502BDD, CO-502DD, CO-502W, COP-503, COP-503B, COP-503BDD, COP-503DD, COP-503-SOFT, COP-504, COP-504B, COP-504BDD, COP-504DD, COP-504W, EASY-500, EASY-500B, EASY-500DD, EASY-500HP...(Other models you can see in the webshop)		

 <p>1</p>			
GEV No.	520119	Ref. No.	12036081 RT20660516
description	hose clamp ø 60-80mm width 9mm Qty 5 pcs DIN 3017		

 <p>1</p>			
GEV No.	520454	Ref. No.	12009914 12036146 Q881326 RT20660505
description	hose clamp ø 70-90mm width 9mm Qty 5 pcs DIN 3017		
For models:	ACE-202, ACG-202, AE-202, AG-202, APE-202, APG-202, COE-202, ECO-2700D, ECO-2700I, ECO-280D, ECO-280I, ECO-370D, ECO-370I, ECO-4000D, ECO-4000I, ECO-460D, ECO-460I, ECO-550D, ECO-550I, ECO-6000D, ECO-6000I, FI-2700D, FI-2700I, FI-280D, FI-280I, FI-370D, FI-370I, FI-4000D, FI-4000I, FI-460D, FI-460I, FI-550D, FI-550I, FI-6000D, FI-6000I, HMG-10-21-STACKING, LA-13M, LA-18MP, LA-25M, LAC-25, LAC-25MP, LAC-25MPP, LAC-55, LAC-55MP, LAC-55MPP, LB-AC-10M, LB-E-10M, LB-V-10M, LC-10, LC-14...(Other models you can see in the webshop)		

 <p>1</p>			
GEV No.	520110	Ref. No.	12010047 12037543 GH51X003 Q881308
description	hose clamp ø 8-12mm width 9mm Qty 10 pcs DIN 3017		
For models:	AD-120, AD-120B, AD-120BBTDD-UK, AD-120C, AD-120CW, AD-120HY, AD-15, AD-15D, AD-20C-UK, AD-21, AD-21B, AD-21BDD, AD-21C, AD-21D, AD-21DD, AD-21W, AD-48, AD-48B, AD-48BDD, AD-48C, AD-48D, AD-48DD, AD-48W, AD-64, AD-64B, AD-64BDD, AD-64C, AD-64CW, AD-64D, AD-64DD, AD-72, AD-72W, AD-90, AD-90BA, AD-90BBT, AD-90BDD, AD-90DD, ADE-120, ADE-120B, CO-110, CO-110B, CO-110BDD, CO-110DD, CO-112, CO-112B, CO-112BDD, CO-112DD, CO-142W, CO-142WDD, CO-170...(Other models you can see in the webshop)		

 <p>1</p>			
GEV No.	520117	Ref. No.	12009962 12035446 Q881306000 Q881307 RT20660504
description	hose clamp stainless steel ø 40-60mm width 9mm Qty 5 pcs DIN 3017		
For models:	ACE-061, ACE-101, ACE-102, ACE-201, ACE-202, ACG-061, ACG-101, ACG-102, ACG-201, ACG-202, AD-120, AD-120B, AD-120BBTDD-UK, AD-120C, AD-120CW, AD-120HY, AD-125, AD-125HRS, AD-125-SOFT, AD-15, AD-15D, AD-20C-UK, AD-21, AD-21B, AD-21BDD, AD-21C, AD-21D, AD-21DD, AD-21W, AD-45BBT, AD-48, AD-48B, AD-48BDD, AD-48C, AD-48D, AD-48DD, AD-48HY, AD-48W, AD-505, AD-505-SOFT, AD-64, AD-64B, AD-64BBT, AD-64BDD, AD-64BTDD, AD-64C, AD-64CW, AD-64D, AD-64DD, AD-64HY...(Other models you can see in the webshop)		

DIN 3017 - W4

 <p>1</p>			
GEV No.	520120	Ref. No.	12010036 Q881302
description	hose clamp SS W4 ø 12-20mm width 9mm Qty 1 pcs DIN 3017		
For models:	ACE-061, ACE-101, ACE-102, ACE-201, ACE-202, ACG-061, ACG-101, ACG-102, ACG-201, ACG-202, AD-120, AD-120B, AD-120BBTDD-UK, AD-120C, AD-120CW, AD-120HY, AD-125, AD-125HRS, AD-125-SOFT, AD-15, AD-15D, AD-20C-UK, AD-21, AD-21B, AD-21BDD, AD-21C, AD-21D, AD-21DD, AD-21W, AD-45BBT, AD-48, AD-48B, AD-48BDD, AD-48C, AD-48D, AD-48DD, AD-48HY, AD-48W, AD-505, AD-505-SOFT, AD-64, AD-64B, AD-64BBT, AD-64BDD, AD-64BTDD, AD-64C, AD-64CW, AD-64D, AD-64DD, AD-64HY...(Other models you can see in the webshop)		

double wire clamps

			
1			
GEV No.	511658	Ref. No.	12035823 RT20660533
description	hose clamp ø 10mm wire gauge ø 1.3mm steel Qty 5 pcs		

			
1			
GEV No.	520916	Ref. No.	12036614 RT20660518
description	hose clamp ø 30mm wire gauge ø 2.7mm chrome-plated steel Qty 1 pcs		

			
1			
GEV No.	560570	Ref. No.	12036450 RT20660519
description	hose clamp ø 35.6mm wire gauge ø 3mm Qty 1 pcs		

			
1			
GEV No.	505190	Ref. No.	12009972 Q901307
description	hose clamp ø 36-42mm wire gauge ø 3mm zinc-coated steel Qty 1 pcs		
For models:	AD-15, AD-15D, AD-20C-UK, AD-21, AD-21B, AD-21BDD, AD-21C, AD-21D, AD-21DD, AD-21W, ECO-1200, FI-1200, FI-900, HEI-10-21, HEM-10-21, HGC-10-21, HGC-20-21, HGV-10-21, LVC-12, LVC-15, LVC-15D, LVC-21, LVC-21B, LVC-21C, LVC-21D, LVC-21W, LVR-10, LVR-14, LVR-14D, LVR-20, LVR-20B, LVR-20D, MF-21		

			
1			
GEV No.	505191	Ref. No.	12007966 Q901308
description	hose clamp ø 52-59mm wire gauge ø 3.5mm Qty 1 pcs		
For models:	AD-45BBT, AD-48, AD-48B, AD-48BDD, AD-48C, AD-48D, AD-48DD, AD-48HY, AD-48W, AD-64, AD-64B, AD-64BBT, AD-64BDD, AD-64BTDD, AD-64C, AD-64CW, AD-64D, AD-64DD, AD-64HY, AD-72, AD-72W, EASY-500, EASY-500B, EASY-500DD, EASY-500HP, FI-30, FI-30AR, FI-30AR+DD, FI-30B, FI-30B-BT-UK, FI-30-UK, FI-48, FI-48AR, FI-48B, FI-48B-BT-UK, FI-48C, FI-48D, FI-48HY-CLINIC, FI-48W, FI-50, FI-60DD, FI-64, FI-64AR, FI-64B, FI-64B-BT-UK, FI-64C, FI-64D, FI-64HY-CLINIC, FI-64W, FI-72...(Other models you can see in the webshop)		

			
1			
GEV No.	505351	Ref. No.	12036929 RT20660527
description	wire clamp ø 11.6-12.2mm wire gauge ø 1.5mm zinc-coated steel Qty 100 pcs		

			
1			
GEV No.	505358	Ref. No.	12036811 RT20660530
description	wire clamp ø 14.4-15.1mm wire gauge ø 1.8mm zinc-coated steel Qty 50 pcs		

double wire clamps with screw

			
1			
GEV No.	505079	Ref. No.	12025195 Z400903
description	hose clamp ø 186-172mm Qty 1 pcs		
For models:	AD-15, AD-15D, AD-20C-UK, AD-21, AD-21B, AD-21BDD, AD-21C, AD-21D, AD-21DD, AD-21W, CO-350, CO-350-B, CO-350-B-DD, CO-350-COLD, CO-350-COLD-B, CO-350-COLD-B-DD, CO-350-COLD-DD, CO-350-DD, CO-352-COLD, CO-352-COLD-B, CO-352-COLD-B-DD, CO-352-COLD-DD, CO-400, CO-400-B, CO-400-B-DD, CO-400-COLD, CO-400-COLD-B, CO-400-COLD-B-DD, CO-400-COLD-DD, CO-400-DD, CO-400-SOFT, CO-402-COLD, CO-402-COLD-B, CO-402-COLD-B-DD, CO-402-COLD-DD, CO-402W, LVC-12, LVC-15, LVC-15D, LVC-21, LVC-21B, LVC-21C, LVC-21D, LVC-21W, LVR-10, LVR-14, LVR-14D, LVR-20, LVR-20B, LVR-20D...(Other models you can see in the webshop)		

			
1			
GEV No.	505080	Ref. No.	12023841 Z200908
description	hose clamp ø 235-215mm Qty 1 pcs		
For models:	AD-45BBT, AD-48, AD-48B, AD-48BDD, AD-48C, AD-48D, AD-48DD, AD-48HY, AD-48W, AD-64, AD-64B, AD-64BBT, AD-64BDD, AD-64BTDD, AD-64C, AD-64CW, AD-64D, AD-64DD, AD-64HY, AD-72, AD-72W, EASY-500, EASY-500B, EASY-500DD, EASY-500HP, FI-30, FI-30AR, FI-30AR+DD, FI-30B, FI-30B-BT-UK, FI-30-UK, FI-48, FI-48AR, FI-48B, FI-48B-BT-UK, FI-48C, FI-48D, FI-48HY-CLINIC, FI-48W, FI-50, FI-60DD, FI-64, FI-64AR, FI-64B, FI-64B-BT-UK, FI-64C, FI-64D, FI-64HY-CLINIC, FI-64W, FI-72...(Other models you can see in the webshop)		

			
1			
GEV No.	691398	Ref. No.	12010283 Q371028
description	roll pin ø 3mm L 16mm		
For models:	CG-1002, CG-1502, CG-2002, CG-2002P, CG9-20AD-H, CG9-20H, CG9-20PLUS-H, CG9-40, CG9-40AD, CG9-40AD-H, CG9-40H, CG9-40PLUS, CG9-40PLUS-H, CG9-41, CG9-41AD, CG9-41AD-H, CG9-41H, CG9-41PLUS, CG9-41PLUS-H, CG9-51L, CG9-51LC, CG9-51R, CG9-51RC, CG9-60, CG9-60AD, CG9-60AD-H, CG9-60H, CG9-60PLUS, CG9-60PLUS-H, CG9-61, CG9-61AD, CG9-61AD-H, CG9-61H, CG9-61OP, CG9-61PLUS, CG9-61PLUS-H, CG9-82, CG9-82AD, CG9-82PLUS, CGE9-41, CGE9-41AD, CGE9-41PLUS, LF-AC-55, LF-AC-55MP, LF-AC-55MPP, LF-E-55, LF-E-55MP, LF-E-55MPP, LF-V-55, LF-V-55MP...(Other models you can see in the webshop)		

			
1			
GEV No.	551305	Ref. No.	12010292 Q352001
description	cotter pin ø 2mm L 23mm SS Qty 20 pcs		
For models:	ACE-201, ACE-202, ACG-201, ACG-202, AE-201, AE-202, AG-201, AG-202, APE-201, APE-202, APG-201, APG-202, COE-201, COE-202, COG-201, COG-202, ECO-120, ECO-120B, ECO-160, ECO-160D, ECO-160I, ECO-200, ECO-200D, ECO-200H, ECO-200HD, ECO-200HI, ECO-200I, ECO-2700D, ECO-2700I, ECO-280D, ECO-280I, ECO-370D, ECO-370I, ECO-4000D, ECO-4000I, ECO-460D, ECO-460I, ECO-550D, ECO-550I, ECO-6000D, ECO-6000I, FI-100, FI-100AR, FI-100B, FI-120, FI-120B, FI-120W, FI-160, FI-160AR, FI-160D...(Other models you can see in the webshop)		

			
2			
GEV No.	691725	Ref. No.	12010273 Q371026
description	roll pin ø 4.5mm L 15mm		
For models:	AE-102W, APE-061, APE-061W, APE-101, APE-101W, APE-102, APE-102W, APE-201, APE-202, APG-061, APG-061W, APG-101, APG-101W, APG-102, APG-102W, APG-201, APG-202, CG-1002, CG-1502, CG-2000, CG-2000-2P, CG-2002, CG-2002P, CG-2005, CG-210, CG-210G, CG-3005, CG-310, CG-310G, CG7-20, CG-7200, CG7-20H, CG7-30D, CG7-30I, CG7-31D, CG7-31I, CG7-40, CG-7400, CG7-40H, CG7-41, CG-7415, CG7-41H, CG7-50, CG7-51, CG7-60, CG7-60H, CG7-61, CG-7615, CG7-61H, CG9-05AD...(Other models you can see in the webshop)		

			
1			
GEV No.	551461	Ref. No.	12010169 Q352024 Q352024000
description	cotter pin ø 4mm L 25mm stainless steel Qty 10 pcs DIN 94		

			
1			
GEV No.	504451	Ref. No.	12009828 12021015 Q362000 Z105026
description	roll pin ø 6.3mm L 50mm SS		
For models:	ECO-160, ECO-1600, ECO-160D, ECO-160I, ECO-200, ECO-200D, ECO-200H, ECO-200HD, ECO-200HI, ECO-200I, ECO-2300, ECO-280D, ECO-280I, ECO-3000, ECO-370D, ECO-370I, ECO-460D, ECO-460I, ECO-550D, ECO-550I, FI-160, FI-1600, FI-160AR, FI-160D, FI-160I, FI-200, FI-200AR, FI-200D, FI-200H, FI-200HD, FI-200HI, FI-200I, FI-200W, FI-200WL, FI-200WR, FI-2300, FI-280D, FI-280I, FI-3000, FI-370D, FI-370I, FI-460D, FI-460I, FI-550D, FI-550I		

consumables

sealants and adhesives

food-grade silicones

			
1			
GEV No.	890106	Ref. No.	12032727 RT50060200
description	silicone TB40 transparent tube 90g -40 up to +160°C		
description	Tomabond - TB40 - tube 90g - transparent For flexible sealing in drinking water, food, water and industrial kitchen areas. Securely joins glass, metal, wood-based materials, ceramic and plastics with high adhesion (1.1 N/mm ²). Fungicide-, algicide- and solvent-free, ageing-resistant. Temperature-resistant from -40 °C to +160 °C Tested and approved by KTW / KSW.		



screw fixings



GEV No.	890137	Ref. No.	12030041 RT20010042
description	screw fixing LOCTITE 243 medium-strength bottle 5ml		
description	LOCTITE® 243™ - bottle 5ml Is a general purpose threadlocker of medium bond strength. This threadlocker secures and seal bolts, nuts and studs to prevent loosening due to vibration. The product works on all metals, including passive substrates such as stainless steel, aluminium and plated surfaces. It is proven to be tolerant of minor contamination due to industrial oils, e.g. engine oils, corrosion prevention oils and cutting fluids.		

cleaning agents

combi-steamer detergents/descalers

Notice: Articles labelled 'DANGEROUS GOODS' are delivered by road through a forwarder for reasons of safety and are charged separately!



GEV No.	802186	Ref. No.	12029940 RT90060136
description	detergent for combi-steamer 10 litres		

descalers



GEV No.	890045	Ref. No.	12030129 RT60060110
description	descaler RATIONAL descaler 10 litres		

fuses

fine fuses



GEV No.	358671	Ref. No.	12039844 R663101
description	fine fuse size ø5x20mm 1A fast-acting rated 250V Qty 10 pcs		
For models:	HME-10-11, HME-10-21, HME-20-11, HME-20-21, HME-2-10-11, HME-2-20-11, HME-6-11, HMP-10-11, HMP-10-21, HMP-20-11, HMP-20-21, HMP-2-10-11, HMP-6-11		



GEV No.	358677	Ref. No.	12024333 12035393 P184011 RT30190112
description	fine fuse size ø5x20mm 4A fast-acting rated 250V Qty 10 pcs		
For models:	CE-15, CE-9, ECO-160, ECO-1600, ECO-160D, ECO-160I, ECO-200, ECO-200D, ECO-200H, ECO-200HD, ECO-200HI, ECO-200I, ECO-2300, ECO-280D, ECO-280I, ECO-3000, ECO-370D, ECO-370I, ECO-460D, ECO-460I, ECO-550D, ECO-550I, FF-35, FI-160, FI-1600, FI-160AR, FI-160D, FI-160I, FI-200, FI-200AR, FI-200D, FI-200H, FI-200HD, FI-200HI, FI-200I, FI-200W, FI-2300, FI-280D, FI-280I, FI-3000, FI-370D, FI-370I, FI-460D, FI-460I, FI-550D, FI-550I, GA-20, GA-40, HCV-10-11, HCV-10-21... (Other models you can see in the webshop)		



GEV No.	358603	Ref. No.	12034888 RT30190120
description	fine fuse size ø5x20mm 2A slow-acting rated 250V Qty 10 pcs		

ø6.3x32mm 250V



GEV No.	358792	Ref. No.	12035115 RT40010225
description	fine fuse size ø6.3x32mm 10A slow-acting rated 250V Qty 10 pcs		



GEV No.	358791	Ref. No.	12037374 RT40010224
description	fine fuse size ø6.3x32mm 6.3A slow-acting rated 250V Qty 10 pcs		

screw locks

D0-system (NEOZED)



1

GEV No.	358043	Ref. No.	12033846 RT30190401
description	fuse size D01 16A rated 250/400V E14 ø 11mm L 36mm Qty 10 pcs		



1

GEV No.	358047	Ref. No.	12032709 RT30190405
description	fuse size D02 63A rated 250/400V E18 ø 15mm L 36mm Qty 10 pcs		

gauge pieces (NEOZED)



1

GEV No.	358064	Ref. No.	12037278 RT40011238
description	gauge piece size D02 suitable for 16A		

A			
alarm devices	45		
appliance hose reels	319		
axial fans	85		
B			
ball valves	331		
ballasts	39		
bar burners	152		
bi-metal thermostats	17, 18		
boiling pan gaskets	295		
booster pumps I	102		
booster pumps II	103		
C			
cable glands	108, 108		
cables	108		
cam switches	30		
cap nuts	347		
capillary pipes	308		
castors and bumper angles	273		
clamps	336, 354		
cleaning agents	359		
cleaning tools	339		
coffee grounds drawers	317		
coil heating elements	8		
cold air circulating fans (complete)	88		
combi-steamer detergents/descalers	359		
compressors	82		
condensators & interference suppression filters	105		
connection cables	110		
consumables	358		
contactors	45		
container filters	321		
control equipment	35		
control thermostats	18		
cooling aggregates	82		
core probes	55		
cotter pins	358		
countersunk screws	341		
cross flow fans	88		
cylinder head bolts	345		
D			
descalers	359		
DIN rails	113		
door seals	291		
door seals for dishwashers	305		
door seals with fixing hook	294		
dosing pumps	319		
double nipples	329		
double wire clamps	337, 356		
		double wire clamps with screw	338, 356
		drain fittings	335
		drain hoses	323
		drain pumps	102
		drain systems and wash basins	335
E			
		edgemount latches	254
		electric accessories	108
		electrodes	81
		electromagnetic closer	252
		electronic controllers	52
		electronic magnets	114
		end caps and plugs	273
		energy regulators	17
		espagnolette locks	254
		evaporators	309
F			
		fans	85
		fasteners	354
		fastening material	339
		female fastons	110
		filter driers	307
		filter weights	321
		filters	106
		fine fuses	359
		fittings	329
		flat-headed bolts	342
		flow sensors	82
		fluorescent lamps	38, 38
		foam rubber gaskets	303
		food-grade silicones	336, 358
		forced air burners	157
		formed hoses	325
		fuses	107, 359
G			
		gas burners	143
		gas control valves	126
		gas hoses	173
		gas lines	170
		gas nozzles	160
		gas taps	114
		gas thermostats	122
		gaskets for control panels	295
		gaskets for heated units	290
		gaskets for tray rack trolleys	294
		gaskets for wash arm support	307
		gastronorm	317
		grates	279
		group 1	308
		grub screws	346

H

halogen lamp	38
handle latches	254
heating cables	7
heating elements	3, 7
heating elements for convection	13
heating elements for defrosting	6
heating elements for fryers	3
heating elements for griddles	6
heating elements for heated trolleys	7
heating elements for ovens	3
heating elements for pasta cookers	7
heating elements for refrigeration	6
heating elements for tilting bratt pan	7
heating plates	8
hexagonal nuts	348
hexagonal screws	343
hob burners	143
hose clamps	336, 354
hose connectors	329, 330
hose couplings	322
hose reels	319
hoses	322
hot air fans	95
hot air motors	89
hot plates	16

I

ignition boxes	129
ignition bridges	143
ignition cables	140
ignition units	141
immersion heating elements	9
indicator lights	36
indicator lights (complete)	36
industrial hoses	324
inlet spouts	334
inlet taps	334

K

knurled nuts	348
knurled screws	347

L

lamp accessories	41
lamps	36
light bulbs	38
linear lamps	38

M

magnetic switches	33
measuring equipment	339

mechanical timers	44
microswitches	28
miscellaneous	108
motors	97
mounting spigots	354

N

Niplaflex hoses	324
nuts	347

O

operating capacitors	105
O-rings	295
oval head screws	343
oven hinges	260
oven lamps	39

P

piezoelectric igniters	140
pilot burners	130
plate nuts	347
plug-in gaskets	285
plunger sockets	25
pre-rinse hoses	323
pressure control hoses	324
pressure hoses	328
pressure reduction valves	336, 336
pressure switches	77, 173
probe clips	24
probes	55
programme timers	41
protection hoses	108
pumps	98
pumps for ice machines	104
push/momentary push switches	27
PVC supply hoses	322

R

radial fans	95
refrigeration cycle components	307
refrigeration fans	87
refrigeration gaskets	285
refrigeration motors universal	87
refrigeration pipes	308
refrigeration thermostats	24
relays	49
retaining rings	357
ribbon cables	109
rivets/rivet nuts	339
rocker/momentary rocker switches	25
roll pins	357
rotary switches	33
round burners	157

S

safety bi-metal thermostats	17
safety thermostats	20
Schrader valves	307
screw fixings	359
screw locks	360
screw-in gaskets	289
screws	341
sealants and adhesives	358
sealing discs	305
sealing washers	299
shaft gaskets	303
sheet metal screws	341
shelves and shelf rails	279
shut-off valves	331
side bolts	346
silicone	336, 358
silicone hoses	324
slot nuts	354
solenoid valves	72
solid state relays	49
spray guns	317
spray guns with external thread	317
spring assisted hinges	258
spring rings	351
spring washers	352
stainless steel flexi hoses	323
standpipes	335
starting capacitors	105
supply hoses	322
switches and momentary switches	25
system switches (ROLD)	30

T

tank inlets	322
temperature probes	55
terminals	110
terminals and connectors	110
thermocouples	141
thermostat gaskets	307
thermostats	17
threaded cable glands	109
time relays	51
timers	41
tools	339
tooth lock washers	353
transformers	51
tube burners	157

U

universal probes	55
------------------	----

V

valves and tank inlets	331
vibration pumps	104

W

wash and rinse pumps	98
washers	352
water cycle components	336
window seals	290