



GAS COMPONENTS



ELECTRIC COMPONENTS



WATER TECHNOLOGY



MECHANICAL COMPONENTS



TOOLS

Spare parts suitable for

FIAMMA

Find the complete and up-to-date range of products in our GEV Webshop



Manufacturer catalogue

The most important spare parts and accessories arranged clearly for every manufacturer

- ✓ Complete product range and all appliance data always up to date in the GEV Webshop
- ✓ Alphabetical Index at the end of the catalogue

GEV Webshop

www.gev-online.co.uk

www.gev-online.com



- 🔍 Add to Favourites
- 🔍 Sign In with email address and usual password
- 🔍 Easy-order – place several items in your basket at the same time
- 🔍 Quick Item search – no login needed



heating elements

heating elements for fryers

2 hole fixing

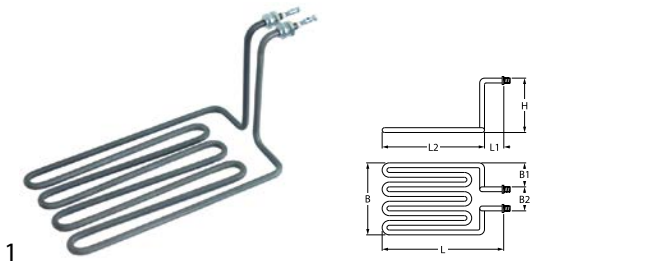

GEV No.	416587	Ref. No.	4.0.085.0005
description	heating element 2500W 230V heating circuits 1 L 300mm W 154mm H 158mm 2 hole fixing connection M4 fryer L1 22mm L2 278mm W1 63mm W2 28mm thread M13x1 windings 4		
For models:	FCF6, FCF6+6, FF6, FF6+6		
accessories for	416587		
	GEV No.	521103	Ref. No. —
	nut thread M4 H 3mm WS 7 brass Qty 20 pcs		
	GEV No.	521104	Ref. No. —
	washer ID ø 4.3mm ED ø 8mm thickness 0.5mm brass Qty 20 pcs for thread M4		
	GEV No.	560111	Ref. No. —
	plain washer ID ø 4.3mm ED ø 9mm thickness 0.8mm SS Qty 20 pcs DIN 125A for thread M4		
	GEV No.	560131	Ref. No. —
	hexagonal nut thread M4 H 3.2mm WS 7 SS DIN/ISO DIN 934 / ISO 4032/8673 Qty 20 pcs		

GEV No.	417095	Ref. No.	5.0.000.0802
description	heating element 3500W 230V heating circuits 2 mounting ø 39mm hole distance 57mm L 330mm W 34mm H 53mm L1 30mm L2 70mm L3 225mm H1 24mm H2 29mm windings 2 hole ø 11mm tube ø 8.3mm connection M6 immersion heater 3 hole flange		
For models:	ATLANTIC-II-CV-NV, ATLANTIC-II-CV-PCI-NV, ATLANTIC-II-CV-TALL-CUPS, ATLANTIC-II-CV-TI-NV, ATLANTIC-II-CV-TI-TALL-CUPS, ATLANTIC-II-NV, ATLANTIC-II-PCI-NV, ATLANTIC-II-TALL-CUPS, ATLANTIC-II-TI-NV, PACIFIC-2CV, Prestige-II, PRESTIGE-II-CV-ECC, PRESTIGE-II-CV-REVOL, PRESTIGE-II-ECC, PRESTIGE-III-CV-REVOL, PRESTIGE-III-REVOL, PRESTIGE-II-REVOL		
accessories for	417095		
	GEV No.	528013	Ref. No. —
	gasket ID ø 40mm fibre thickness 4mm hole ø 11mm hole distance 57mm for heating element coffee machine parts		
	GEV No.	528740	Ref. No. —
	gasket ID ø 44mm PTFE thickness 3.5mm hole ø 9.5mm hole distance 58mm suitable for ITALCREM, VISACREM for heating element coffee machine parts		

GEV No.	417468	Ref. No.	4.0.000.0217
description	heating element 5000W 230V heating circuits 2 mounting ø 38mm hole distance 56mm L 438mm W 35mm H 52mm L1 40mm L2 68mm L3 330mm H1 23mm H2 29mm hole ø 11mm tube ø 8.3mm connection M6 immersion heater 3 hole flange		
For models:	ATLANTIC-III, ATLANTIC-III-CV, ATLANTIC-III-CV-TI, ATLANTIC-III-TI, PACIFIC-3CV, PACIFIC-3CV-W, PRESTIGE-III-CV-REVOL, PRESTIGE-III-REVOL		

heating elements for coffee machine

GEV No.	417466	Ref. No.	4.0.000.0218
description	heating element 1800W 230V heating circuits 1 thread 1" L 155mm W 21mm H 22mm tube ø 8.3mm connection male faston 6.3mm immersion heater flange with thread WS 30 coffee machine		
For models:	MARINA, MARINA-CV, MARINA-CV-DI		

GEV No.	417467	Ref. No.	4.0.000.0214
description	heating element 1800W 230V heating circuits 2 mounting ø 38mm hole distance 57mm L 178mm W 28mm H 46mm H1 24mm H2 22mm hole ø 11mm tube ø 8.3mm connection M6 immersion heater 3 hole flange		
For models:	ATLANTIC-I-CV-NV, ATLANTIC-I-CV-PCI-NV, ATLANTIC-I-CV-TI-NV, ATLANTIC-II-COMPACT, ATLANTIC-II-CV-COMPACT, ATLANTIC-II-CV-TI-COMPACT, ATLANTIC-I-PCI-NV, ATLANTIC-I-TI-NV		

heating elements for contact grills

GEV No.	416586	Ref. No.	4.0.066.0083
description	heating element 1150W 240V L 210mm W 230mm H 28mm W1 120mm W2 5mm tube ø 6.5mm connection length 23mm mounting pos. lower connection M4 dry heating element windings 3		
For models:	GR-4.1-L, GR-4.1-LTL, GR-4.2, GR-8, GR-8.1-L, GR-8.2, GR-8.2-L, GR-8.2-LTL, GR-8-L, GR-M, GR-M.1, GR-M.2, GR-M.2-TLC		



GEV No.	418838	Ref. No.	4.0.069.0050
description	heating element 1350W 240V L 200mm W 300mm H 26mm W1 118mm W2 64mm tube ø 6.5mm for contact grill windings 4		
For models:	GR-6.1, GR-6.1-L, GR-6.1-LTL		



GEV No.	418839	Ref. No.	4.0.069.0045
description	heating element 1900W 240V L 200mm W 320mm H 30mm W1 28mm W2 140mm tube ø 6.5mm for contact grill windings 5		
For models:	GR-6.1, GR-6.1-L, GR-6.1-LTL		



GEV No.	416585	Ref. No.	4.0.066.0084
description	heating element 850W 240V L 200mm W 215mm H 26mm W1 70mm W2 75mm tube ø 6.3mm connection M4 connection length 22mm mounting pos. upper dry heating element windings 3		
For models:	GR-4.1-L, GR-4.1-LTL, GR-4.2, GR-8.1-L, GR-8.2, GR-8.2-L, GR-8.2-LTL, GR-M.1, GR-M.2, GR-M.2-TLC		

heating elements for salamanders/toast-



GEV No.	417668	Ref. No.	4.0.130.0007
description	heating element 1300W 230V L 425mm W 230mm tube ø 6.5mm cable lengthmm heating circuits 1 mounting pos. lower suitable for SEF 450 I		
For models:	SEF-450I		

quartz heating elements



GEV No.	416583	Ref. No.	4.0.075.1137
description	quartz heating element 250W 75V L 395mm ø 12mm connection male faston 6.3mm 210hm		
For models:	TOSTI-D3, TOSTI-S3, TRD-30.2, TRS-20.2		



GEV No.	416582	Ref. No.	4.0.075.1135
description	quartz heating element 330W 75V L 395mm ø 12mm connection male faston 6.3mm 170hm		
For models:	TOSTI-D3, TOSTI-S3, TRD-30.2, TRS-20.2		



GEV No.	416584	Ref. No.	4.0.074.1003
description	quartz heating element 450W 115V L 395mm ø 12mm connection male faston 6.3mm 290hm		
For models:	TOSTI-D3, TOSTI-S3, TRD-30.2, TRS-20.2		

immersion heating elements





3 hole flange ø60.0mm
 connection straight
 group 1



GEV No.	415166	Ref. No.	1324	
description	heating element 2000W 230V mounting ø 60mm heating circuits 1 L 180mm W 42mm H 65mm number of thermostat sleeves 1 thermostat sleeves ø 7mm length thermostat sleeves 170mm tube ø 6.3mm hole distance 83mm hole ø 10mm connection male faston 6.3mm 3 hole flange immersion heater			
For models:	F-1221-N, F-1221-REVOL, F-400			
accessories for	415166			
	GEV No.	521121	Ref. No.	57
	O-ring EPDM thickness 8mm ID ø 62mm Qty 1 pcs			



GEV No.	418711	Ref. No.	1294	
description	heating element 3000W 230V mounting ø 60mm heating circuits 1 L 285mm W 42mm H 36mm number of thermostat sleeves 1 thermostat sleeves ø 7mm length thermostat sleeves 185mm tube ø 6.5mm hole distance 84mm hole ø 10mm connection male faston 6.3mm 3 hole flange immersion heater			
For models:	F-1221-N, F-430			
accessories for	418711			
	GEV No.	521121	Ref. No.	57
	O-ring EPDM thickness 8mm ID ø 62mm Qty 1 pcs			

			
1			
GEV No.	415145	Ref. No.	1350
description	heating element 1500W 230V heating circuits 1 L 254mm W 36mm H 28mm thread M10x1 mounting distance 26mm tube ø 6.6mm connection male faston 6.3mm 2 hole fixing connection length 22mm immersion heater		
For models:	F-1040, F-532		
accessories for	415145		
	GEV No.	510416	Ref. No. —
	flat gasket fibre ED ø 19mm ID ø 10.5mm thickness 1.5mm for thread M10 Qty 1 pcs		
	GEV No.	510893	Ref. No. 697
	O-ring EPDM thickness 2.62mm ID ø 9.92mm Qty 1 pcs		
	GEV No.	520231	Ref. No. 267
	nut thread M10x1 H 6mm WS 14 zinc-coated steel Qty 1 pcs		
	GEV No.	521129	Ref. No. —
	nut thread M10 H 6mm SS WS 17 Qty 1 pcs DIN/ISO DIN 439		

			
1			
GEV No.	416247	Ref. No.	2114
description	heating element 2000W 230V heating circuits 1 L 264mm W 38mm H 19mm thread M10x1 mounting distance 32mm tube ø 6.3mm connection male faston 6.3mm 2 hole fixing immersion heater		
For models:	F-1221-N, F-1221-REVOL, F-400, F-430		
spare parts for	416247		
	GEV No.	510416	Ref. No. —
	flat gasket fibre ED ø 19mm ID ø 10.5mm thickness 1.5mm for thread M10 Qty 1 pcs		
	GEV No.	510893	Ref. No. 697
	O-ring EPDM thickness 2.62mm ID ø 9.92mm Qty 1 pcs		
	GEV No.	520231	Ref. No. 267
	nut thread M10x1 H 6mm WS 14 zinc-coated steel Qty 1 pcs		
	GEV No.	521129	Ref. No. —
	nut thread M10 H 6mm SS WS 17 Qty 1 pcs DIN/ISO DIN 439		

accessories

hexagonal nuts

			
1			
GEV No.	520231	Ref. No.	267
description	nut thread M10x1 H 6mm WS 14 zinc-coated steel Qty 1 pcs		
For models:	F-1040, F-1221-N, F-1221-REVOL, F-400, F-430, F-532		

sealing washers

PTFE gaskets

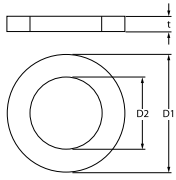
 			
1			
GEV No.	528018	Ref. No.	5.0.000.0305
description	flat gasket PTFE ED ø 41mm ID ø 33mm thickness 3mm size 1" Qty 1 pcs		
For models:	MARINA, MARINA-CV, MARINA-CV-DI, Superbar		

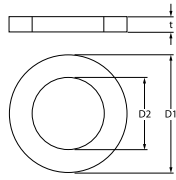
 			
1			
GEV No.	528021	Ref. No.	5.0.000.0307
description	flat gasket PTFE ED ø 53mm ID ø 42.5mm thickness 3mm Qty 1 pcs equiv. no. 12001/02286 suitable for Astoria/Aurora/Brasilia/Wega		
For models:	ATLANTIC-I-CV-NV, ATLANTIC-I-CV-PCI-NV, ATLANTIC-I-CV-TI-NV, ATLANTIC-II-COMPACT, ATLANTIC-II-CV-COMPACT, ATLANTIC-II-CV-NV, ATLANTIC-II-CV-PCI-NV, ATLANTIC-II-CV-TALL-CUPS, ATLANTIC-II-CV-TI-COMPACT, ATLANTIC-II-CV-TI-NV, ATLANTIC-II-CV-TI-TALL-CUPS, ATLANTIC-III, ATLANTIC-III-CV, ATLANTIC-III-CV-TI, ATLANTIC-III-TI, ATLANTIC-II-NV, ATLANTIC-II-PCI-NV, ATLANTIC-II-TALL-CUPS, ATLANTIC-II-TI-NV, ATLANTIC-I-PCI-NV, ATLANTIC-I-TI-NV, PACIFIC-2CV, PACIFIC-3CV, PACIFIC-3CV-W, PRESTIGE-II-CV-ECC, PRESTIGE-II-CV-REVOL, PRESTIGE-II-ECC, PRESTIGE-III-CV-REVOL, PRESTIGE-III-REVOL, PRESTIGE-II-REVOL		

O-rings

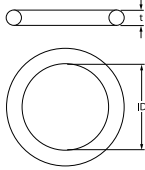
 			
1			
GEV No.	510893	Ref. No.	697
description	O-ring EPDM thickness 2.62mm ID ø 9.92mm Qty 1 pcs		
For models:	F-1040, F-1221-N, F-1221-REVOL, F-400, F-430, F-532		

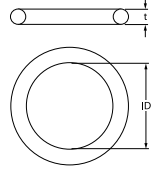
 			
1			
GEV No.	521121	Ref. No.	57
description	O-ring EPDM thickness 8mm ID ø 62mm Qty 1 pcs		
For models:	F-1040, F-1221-N, F-1221-REVOL, F-400, F-430, F-532		

flange gaskets

counterflanges



GEV No.	508080	Ref. No.	1871
description	flange		
For models:	F-1040, F-1221-N, F-430, F-532		

capillary tube clips



GEV No.	550491	Ref. No.	4.0.085.0017
description	capillary tube clip for pipe ø 8.5mm for circular tube heating elements		
For models:	FCF10, FCF10+10, FCF10+10-TR, FCF10-TR, FCF15+15, FCF15-TR, FCF6, FCF6+6, FF10, FF-10, FF10+10, FF-10+10, FF10+10TR, FF-10+10-TR, FF10+10TR-NV, FF10-NV, FF10TR, FF-10-TR, FF10TR-NV, FF15+15TR, FF15TR, FF6, FF6+6, FF6+6-NV		

spring clips



GEV No.	550498	Ref. No.	4.0.085.0014
description	probe clip for pipe ø 8.5mm for probe ø 4mm Qty 1 pcs		
For models:	FCF10, FCF10+10, FCF10+10-TR, FCF10-TR, FCF15+15, FCF15-TR, FCF6, FCF6+6, FF-10, FF-10+10, FF10+10TR, FF-10+10-TR, FF10TR, FF-10-TR, FF6, FF6+6		



GEV No.	550258	Ref. No.	4.0.085.0016
description	probe clip for pipe ø 8mm for probe ø 6mm		
For models:	FF6, FF6+6		



GEV No.	551025	Ref. No.	4.0.085.0114
description	probe clip for pipe ø 2x8.5mm for probe ø 6mm L 36mm Qty 1 pcs		
For models:	FF10, FF10+10, FF10+10TR, FF10+10TR-NV, FF10-NV, FF10TR, FF-10TR-NV, FF15+15TR, FF15TR, FF6, FF6+6, FF6+6-NV		

thermostats

bi-metal thermostats

safety bi-metal thermostats



GEV No.	390367	Ref. No.	4.0.000.0250 4.0.066.0108
description	bi-metal safety thermostat hole distance 39-44mm switch-off temp. 130°C 2NC 2-pole 16A connection F6.3 2 hole fixing		
For models:	ATLANTIC-I-CV-NV, ATLANTIC-I-CV-PCI-NV, ATLANTIC-I-CV-TI-NV, ATLANTIC-II-COMPACT, ATLANTIC-II-CV-COMPACT, ATLANTIC-II-CV-NV, ATLANTIC-II-CV-PCI-NV, ATLANTIC-II-CV-TALL-CUPS, ATLANTIC-II-CV-TI-COMPACT, ATLANTIC-II-CV-TI-NV, ATLANTIC-II-CV-TI-TALL-CUPS, ATLANTIC-III, ATLANTIC-III-CV, ATLANTIC-III-CV-TI, ATLANTIC-III-TI, ATLANTIC-II-NV, ATLANTIC-II-PCI-NV, ATLANTIC-II-TALL-CUPS, ATLANTIC-II-TI-NV, ATLANTIC-I-PCI-NV, ATLANTIC-I-TI-NV, CG2x4GGGG, CG2x4GGS, CG2x4SGGG, CG2x4SGS, CG2x4SSGG, CG2x4SSSS, CG2x4SSSS, CG4GG, CG4SG, CG4SS, CG6GG, CG6GG-VITRO, CG6G-VITRO, CG6SG, CG6SG-VITRO, CG6SS, CG6SS-VITRO, CG6S-VITRO, CG8GG-VITRO, CG8SG-VITRO, CG8SS-VITRO, ECT-2, ECT-2X2, EGP10.6-DIGIT, EGP10.6-MEC, EGP10.8-DIGIT, EGP10.8-MEC, EGP15.10C-MEC...(Other models you can see in the webshop)		

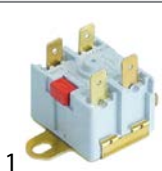

GEV No.	390187	Ref. No.	4.0.066.0108
description	bi-metal safety thermostat hole distance 40mm switch-off temp. 180°C 2NC 2-pole 16A connection F6.3 2 hole fixing		



GEV No.	390462	Ref. No.	4913
description	bi-metal safety thermostat hole distance mm switch-off temp. 105°C 1NC 1-pole 10A connection F6.3 1 hole fixing		
For models:	F-1040, F-1221-N, F-1221-REVOL, F-400, F-430, F-532		
accessories for	390462		
	GEV No.	550388	Ref. No. —
	bracket for contact thermostat mounting distance 24.5mm mounting ø 3.8		

control and safety thermostats

EGO

control thermostats

55.13_ series



GEV No.	375356	Ref. No.	4.0.085.0009 old
description	thermostat t.max. 180°C temperature range 100-180°C 1-pole 1NO 16A probe ø 6mm probe L 98mm capillary pipe 870mm capillary pipe isolatedmm gland nut shaft ø 6x4.6mm shaft L 23mm shaft position upper rotation 270°		

55.17_ series

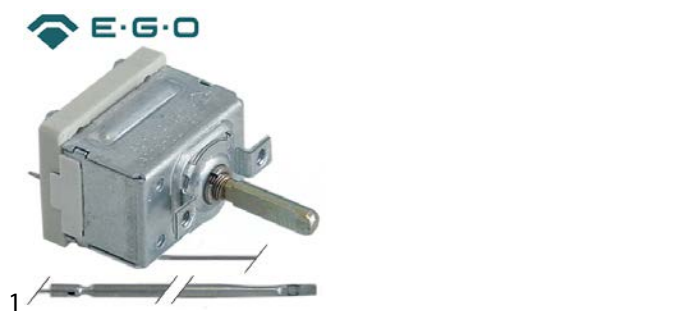

GEV No.	375349	Ref. No.	4.0.066.0114
description	thermostat t.max. 250°C temperature range 50-250°C 1-pole 1NO 16A probe ø 3.03mm probe L 178mm capillary pipe 840mm capillary pipe isolatedmm gland nut shaft ø 6x4.6mm shaft L 23mm shaft position upper rotation 270°		
For models:	CG6GG-VITRO, CG6SG-VITRO, CG6SS-VITRO, CG8GG-VITRO, CG8SG-VITRO, CG8SS-VITRO, EGP10.6-MEC, EGP10.8-MEC, EGP15.10C-MEC, EGP15.10MC-MEC, EGP15.10-MEC, EGP15.10M-MEC, EGP15.6C-MEC, EGP15.6MC-MEC, EGP15.6-MEC, EGP15.6M-MEC, EGP15.8C-MEC, EGP15.8MC-MEC, EGP15.8-MEC, EGP15.8M-MEC, GR-4.1-L, GR-4.1-LTL, GR-4.2, GR-6.1, GR-6.1-L, GR-6.1-LTL, GR-8, GR-8.1-L, GR-8.2, GR-8.2-L, GR-8.2-LTL, GR-8-L, GR-M, GR-M.1, GR-M.2, GR-M.2-TLC, PPEF-600, PPEF-600-CRD, PPEF-800, PPEF-800-CRD, PPEF-800-MN, PPEF-M-600, PPEF-M-600-CRD, PPEF-M-800, PPEF-M-800-CRD, VCR-6C-TC-NV, VCR-6L-TC-NV, VCR-6L-TL-NV, VCR-8C-TC, VCR-8L-TC...(Other models you can see in the webshop)		

safety thermostats

56_ series



GEV No.	375351	Ref. No.	4.0.085.0011 old
description	safety thermostat switch-off temp. 220°C 1-pole 1NC 16A probe ø 5mm probe L 71mm capillary pipe 960mm capillary pipe isolatedmm gland nut		

IMIT / TEMPOMATIC / ARTERMO

control thermostats



GEV No.	390006	Ref. No.	359
description	thermostat t.max. 86°C temperature range 0-86°C 1-pole 1CO 16A probe ø 6.5mm probe L 95mm capillary pipe 1500mm capillary pipe isolatedmm gland nut shaft ø 6x4.6mm shaft L 19mm rotation 270°		
For models:	F-1040, F-1221-N, F-1221-REVOL, F-400, F-430, F-532		
accessories for	390006		
	GEV No.	110100	Ref. No. —
	knob thermostat t.max. 90°C 0-90°C ø 42mm shaft ø 6x4.6mm shaft flat -135° black		
	GEV No.	110105	Ref. No. —
	rosette knob ø 42mm ø 56mm zero mark		

TECASA

control thermostats



GEV No.	390975	Ref. No.	4.0.085.0008 4.0.085.0009
description	thermostat t.max. 175°C temperature range 50-175°C 1-pole 1NO 16A probe ø 5mm probe L 90mm capillary pipe 620mm capillary pipe isolated 290mm gland nut shaft ø 6x4.6mm shaft L 16mm shaft position upper rotation 270°		
For models:	FCF10, FCF10+10, FCF10+10-TR, FCF10-TR, FCF15+15, FCF15-TR, FCF6, FCF6+6, FF10, FF-10, FF10+10, FF-10+10, FF10+10TR, FF-10+10-TR, FF10+10TR-NV, FF10-NV, FF10TR, FF-10-TR, FF10TR-NV, FF15+15TR, FF-15+15-TR, FF15TR, FF-15-TR, FF6, FF6+6, FF6+6-NV		

safety thermostats



GEV No.	390856	Ref. No.	4.0.085.0011
description	safety thermostat set switch-off temp. 235°C 1-pole 1NC 16A probe ø 5mm probe L 73mm capillary pipe 1030mm capillary pipe isolated 600mm gland nut probe SS		
For models:	FCF10, FCF10+10, FCF10+10-TR, FCF10-TR, FCF15+15, FCF15-TR, FCF6, FCF6+6, FF10, FF-10, FF10+10, FF-10+10, FF10+10TR, FF-10+10-TR, FF10+10TR-NV, FF10-NV, FF10TR, FF-10-TR, FF10TR-NV, FF15+15TR, FF-15+15-TR, FF15TR, FF-15-TR, FF6, FF6+6, FF6+6-NV		

CAMPINI

safety thermostats



GEV No.	375510	Ref. No.	4.0.085.0011
description	safety thermostat t.max. 220°C 1-pole 16A probe ø 5mm probe L 67mm capillary pipe 970mm		

accessories

probe clips

spring clips

for thermostat



GEV No.	550498	Ref. No.	4.0.085.0014
description	probe clip for pipe ø 8.5mm for probe ø 4mm Qty 1 pcs		
For models:	FCF10, FCF10+10, FCF10+10-TR, FCF10-TR, FCF15+15, FCF15-TR, FCF6, FCF6+6, FF-10, FF-10+10, FF10+10TR, FF-10+10-TR, FF10TR, FF-10-TR, FF6, FF6+6		



GEV No.	550258	Ref. No.	4.0.085.0016
description	probe clip for pipe ø 8mm for probe ø 6mm		
For models:	FF6, FF6+6		

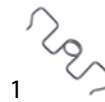

GEV No.	551025	Ref. No.	4.0.085.0114
description	probe clip for pipe ø 2x8.5mm for probe ø 6mm L 36mm Qty 1 pcs		
For models:	FF10, FF10+10, FF10+10TR, FF10+10TR-NV, FF10-NV, FF10TR, FF-10TR-NV, FF15+15TR, FF15TR, FF6, FF6+6, FF6+6-NV		

capillary tube clips



GEV No.	550491	Ref. No.	4.0.085.0017
description	capillary tube clip for pipe ø 8.5mm for circular tube heating elements		
For models:	FCF10, FCF10+10, FCF10+10-TR, FCF10-TR, FCF15+15, FCF15-TR, FCF6, FCF6+6, FF10, FF-10, FF10+10, FF-10+10, FF10+10TR, FF-10+10-TR, FF10+10TR-NV, FF10-NV, FF10TR, FF-10-TR, FF10TR-NV, FF15+15TR, FF15TR, FF6, FF6+6, FF6+6-NV		



switches and momentary switches

rocker/momentary rocker switches

30x22mm



GEV No.	301001	Ref. No.	4.2.000.9236
description	rocker switch mounting measurements 30x22mm red 2NO 250V 16A illuminated 0-I connection male faston 6.3mm ambient temperature max. 125/55°C protection IP65		
For models:	MCF-4, MCF-4A, MCF-6S, MCF-7, MCF-7A, MCF-MC, TOSTI-D3, TOSTI-S3, TRD-30.2, TRS-20.2		

accessories for



GEV No.	301036	Ref. No.	—
description	protective cover internal size 30x22mm for rocker switch mounting measurementsmm		

blank



GEV No.	301165	Ref. No.	1
description	rocker switch mounting measurements 30x22mm black 2CO 250V 16A connection male faston 6.3mm ambient temperature max. 125/55°C protection IP65 with cover cap		
For models:	F-1040		

accessories for



GEV No.	301036	Ref. No.	—
description	protective cover internal size 30x22mm for rocker switch mounting measurementsmm		

labelled



GEV No.	301162	Ref. No.	1146
description	momentary rocker switch mounting measurements 30x22mm orange 2NO 250V 16A illuminated connection male faston 6.3mm ambient temperature max. 100/55°C protection IP65 with cover cap		
For models:	F-1040, F-430, F-532		

accessories for



GEV No.	301036	Ref. No.	—
description	protective cover internal size 30x22mm for rocker switch mounting measurementsmm		



GEV No.	301164	Ref. No.	364
description	rocker switch mounting measurements 30x22mm green 2NO 250V 16A illuminated connection male faston 6.3mm ambient temperature max. 85°C protection IP65 with cover cap		
For models:	F-1040, F-430, F-532		

accessories for



GEV No.	301036	Ref. No.	—
description	protective cover internal size 30x22mm for rocker switch mounting measurementsmm		

push/momentary push switches

28.5x52.6mm



GEV No.	345691	Ref. No.	4.0.000.0520
description	switch combination mounting measurements 28.5x52.6mm black 1NO/NO 250V 16A connection male faston 6.3mm ambient temperature max. 85°C protection IP40		
For models:	TOSTI-D3, TOSTI-S3, TRD-30.2, TRS-20.2		

28.5x77.5mm



GEV No.	345692	Ref. No.	4.0.000.0523 4.0.000.0530
description	switch combination latching mounting measurements 28.5x77.5mm black 1NO/1NO/1NO 250V 16A with indicator connection male faston 6.3mm ambient temperature max. 85°C protection IP40		
For models:	TOSTI-D3, TOSTI-S3, TRD-30.2, TRS-20.2		

30x22mm



GEV No.	301086	Ref. No.	4.0.085.0018
description	push switch mounting measurements 30x22mm black 2NO 250V 12A 0-1 connection male faston 6.3mm ambient temperature max. 85/55°C protection IP54 with protective collar		
For models:	ALF-3, FCF10, FCF10+10, FCF10+10-TR, FCF10-TR, FCF15+15, FCF15-TR, FCF6, FCF6+6, FF10, FF-10, FF10+10, FF-10+10, FF10+10TR, FF-10+10-TR, FF10+10TR-NV, FF10TR, FF-10-TR, FF10TR-NV, FF15+15TR, FF-15+15-TR, FF15TR, FF-15-TR, FF6, FF6+6, VCR-6C-NV, VCR-6L-NV, VCR-8C-TC, VCR-8L-TC, VCR-8L-TL		

ø16mm



GEV No.	301172	Ref. No.	4043
description	momentary push switch mounting ø 16mm black 1NO 250V 16A connection male faston 6.3mm protection IP40 ambient temperature max. 150°C		
For models:	F-1221-N, F-1221-REVOL, F-400		



1

GEV No.	301174	Ref. No.	4042
description	push switch mounting \varnothing 16mm black 2NO 250V 16A connection male faston 6.3mm protection IP40 ambient temperature max. 150°C		
For models:	F-1221-N, F-1221-REVOL, F-400		

microswitches

lever actuated



1

GEV No.	345254	Ref. No.	2384
description	microswitch with lever 250V 16A 1CO connection male faston 6.3mm ambient temperature max. 120°C mounting distance 22mm actuating force: 60g lever length 58mm		
For models:	F-1040		

pin-plunger actuated

M10



1

GEV No.	345224	Ref. No.	4.0.085.0021
description	microswitch with plunger thread M10x0.75 250V 16A 1CO connection male faston 6.3mm stroke 6mm		
For models:	AEF-15.30, AEF-30.60, EF-15.30, FCF10, FCF10+10, FCF10+10-TR, FCF10-TR, FCF15+15, FCF15-TR, FCF6, FCF6+6, FF10, FF-10, FF10+10, FF-10+10, FF10+10TR, FF-10+10-TR, FF10+10TR-NV, FF10-NV, FF10TR, FF-10-TR, FF10TR-NV, FF15+15TR, FF-15+15-TR, FF15TR, FF-15-TR, FF6, FF6+6, FF6+6-NV		



1

GEV No.	347864	Ref. No.	3528
description	microswitch with plunger thread M10x0.75 thread L 18mm 230V 10A 1CO connection male faston 6.3mm stroke 4mm mounting distance mm ambient temperature max. 125°C actuating force: 240g		
For models:	F-1221-REVOL, F-400		

M12



1

GEV No.	345810	Ref. No.	2651
description	microswitch with plunger thread M12 thread L 14mm 230V 12A 1CO connection male faston 6.3mm stroke 2mm ambient temperature max. 125°C type U83161.3 actuating force: 2000g		
For models:	F-1221-N		

miscellaneous



1

GEV No.	345811	Ref. No.	4159
description	microswitch with plunger thread M12 thread L 14mm 250V 12A 2CO connection male faston 6.3mm stroke 3mm ambient temperature max. 125°C type U83161.1 actuating force: 1800g		
For models:	F-430, F-532		

accessories



1

GEV No.	508189	Ref. No.	2832
description	lever for microswitch		
For models:	F-1040		

system switches (ROLD)



1

GEV No.	345536	Ref. No.	4046
description	element holder mounting \varnothing 16mm flat black		
For models:	F-1221-N		



1

GEV No.	359246	Ref. No.	4048
description	indicator light lens \varnothing 12.2mm yellow		
For models:	F-1221-N		



1

GEV No.	345130	Ref. No.	4322
description	momentary switch unit 1NO 250V 16A connection male faston 6.3mm		
For models:	F-1221-N		



			
1			
GEV No.	345538	Ref. No.	4044
description	push button ø 11.9mm black		
For models:	F-1221-N		

			
1			
GEV No.	345722	Ref. No.	4.0.000.0510
description	switch 1NO 250V 16A connection male faston 6.3mm		
For models:	ATLANTIC-II-CV-NV, ATLANTIC-II-CV-PCI-NV, ATLANTIC-II-CV-TALL-CUPS, ATLANTIC-II-CV-TI-NV, ATLANTIC-II-CV-TI-TALL-CUPS, ATLANTIC-III, ATLANTIC-III-CV, ATLANTIC-III-CV-TI, ATLANTIC-III-TI, ATLANTIC-II-NV, ATLANTIC-II-PCI-NV, ATLANTIC-II-TALL-CUPS, ATLANTIC-II-TI-NV, CG2x4GGGG, CG2x4GGS, CG2x4SGGG, CG2x4SGS, CG2x4SGSG, CG2x4SSGG, CG2x4SSSG, CG2x4SSSS, CG4GG, CG4SG, CG4SS, CG6GG, CG6GG-VITRO, CG6SG, CG6SG-VITRO, CG6SS, CG6SS-VITRO, CG8GG-VITRO, CG8SG-VITRO, CG8SS-VITRO, PRESTIGE-II-CV-ECC, PRESTIGE-II-CV-REVOL, PRESTIGE-II-ECC, PRESTIGE-III-CV-REVOL, PRESTIGE-III-REVOL, PRESTIGE-II-REVOL, TRD-30.2, TRS-20.2		

			
1			
GEV No.	345720	Ref. No.	4.0.000.0513 4323
description	switch 2NO 250V 16A connection male faston 6.3mm		
For models:	ATLANTIC-II-COMPACT, ATLANTIC-II-CV-PCI-NV, ATLANTIC-II-CV-TI-COMPACT, ATLANTIC-II-CV-TI-NV, ATLANTIC-III, ATLANTIC-III-TI, ATLANTIC-II-NV, ATLANTIC-II-PCI-NV, ATLANTIC-II-TALL-CUPS, ATLANTIC-II-TI-NV, ATLANTIC-I-PCI-NV, ATLANTIC-I-TI-NV, F-1040, F-1221-N, F-1221-REVOL, F-430-MN, F-532-TR, MARINA, MARINA-CV, MARINA-CV-DI, MINIBAR-NV, PACIFIC-2CV, PACIFIC-3CV, PACIFIC-3CV-W, Prestige-II, PRESTIGE-II-CV-REVOL, PRESTIGE-II-ECC, Prestige-III, PRESTIGE-III-CV-REVOL, PRESTIGE-III-REVOL, PRESTIGE-II-REVOL, TLF-6		

element holders			
			
1			
GEV No.	347403	Ref. No.	4.0.000.0503
description	frame for pressure switch black		
For models:	ATLANTIC-II-COMPACT, ATLANTIC-II-CV-NV, ATLANTIC-II-CV-PCI-NV, ATLANTIC-II-CV-TALL-CUPS, ATLANTIC-II-CV-TI-COMPACT, ATLANTIC-II-CV-TI-NV, ATLANTIC-II-CV-TI-TALL-CUPS, ATLANTIC-III, ATLANTIC-III-CV, ATLANTIC-III-CV-TI, ATLANTIC-III-TI, ATLANTIC-II-NV, ATLANTIC-II-PCI-NV, ATLANTIC-II-TALL-CUPS, ATLANTIC-II-TI-NV, ATLANTIC-I-PCI-NV, ATLANTIC-I-TI-NV, CG2x4GGGG, CG2x4GGS, CG2x4SGGG, CG2x4SGS, CG2x4SGSG, CG2x4SSGG, CG2x4SSSG, CG2x4SSSS, CG4GG, CG4SG, CG4SS, CG6GG, CG6GG-VITRO, CG6SG, CG6SG-VITRO, CG6SS, CG6SS-VITRO, CG8GG-VITRO, CG8SG-VITRO, CG8SS-VITRO, CG8SS-VITRO, MARINA, MARINA-CV, MARINA-CV-DI, MINIBAR-NV, PACIFIC-2CV, PACIFIC-3CV, PACIFIC-3CV-W, Prestige-II, PRESTIGE-II-CV-ECC, PRESTIGE-II-CV-REVOL, PRESTIGE-II-ECC, Prestige-III, PRESTIGE-III-CV-REVOL...(Other models you can see in the webshop)		

switches			
			
1			
GEV No.	345722	Ref. No.	4.0.000.0510
description	switch 1NO 250V 16A connection male faston 6.3mm		
For models:	ATLANTIC-II-CV-NV, ATLANTIC-II-CV-PCI-NV, ATLANTIC-II-CV-TALL-CUPS, ATLANTIC-II-CV-TI-NV, ATLANTIC-II-CV-TI-TALL-CUPS, ATLANTIC-III, ATLANTIC-III-CV, ATLANTIC-III-CV-TI, ATLANTIC-III-TI, ATLANTIC-II-NV, ATLANTIC-II-PCI-NV, ATLANTIC-II-TALL-CUPS, ATLANTIC-II-TI-NV, CG2x4GGGG, CG2x4GGS, CG2x4SGGG, CG2x4SGS, CG2x4SGSG, CG2x4SSGG, CG2x4SSSG, CG2x4SSSS, CG4GG, CG4SG, CG4SS, CG6GG, CG6GG-VITRO, CG6SG, CG6SG-VITRO, CG6SS, CG6SS-VITRO, CG8GG-VITRO, CG8SG-VITRO, CG8SS-VITRO, PRESTIGE-II-CV-ECC, PRESTIGE-II-CV-REVOL, PRESTIGE-II-ECC, PRESTIGE-III-CV-REVOL, PRESTIGE-III-REVOL, PRESTIGE-II-REVOL, TRD-30.2, TRS-20.2		

system switches

RST-FIAMMA

push buttons

			
1			
GEV No.	347402	Ref. No.	4.0.000.0507
description	push button external size 11x21mm black/orange		
For models:	ATLANTIC-II-COMPACT, ATLANTIC-II-CV-NV, ATLANTIC-II-CV-PCI-NV, ATLANTIC-II-CV-TALL-CUPS, ATLANTIC-II-CV-TI-COMPACT, ATLANTIC-II-CV-TI-NV, ATLANTIC-II-CV-TI-TALL-CUPS, ATLANTIC-III, ATLANTIC-III-CV, ATLANTIC-III-CV-TI, ATLANTIC-III-TI, ATLANTIC-II-NV, ATLANTIC-II-PCI-NV, ATLANTIC-II-TALL-CUPS, ATLANTIC-II-TI-NV, ATLANTIC-I-PCI-NV, ATLANTIC-I-TI-NV, CG2x4GGGG, CG2x4GGS, CG2x4SGGG, CG2x4SGS, CG2x4SGSG, CG2x4SSGG, CG2x4SSSG, CG2x4SSSS, CG4GG, CG4SG, CG4SS, CG6GG, CG6GG-VITRO, CG6SG, CG6SG-VITRO, CG6SS, CG6SS-VITRO, CG8GG-VITRO, CG8SG-VITRO, CG8SS-VITRO, MARINA, MARINA-CV, MARINA-CV-DI, MINIBAR-NV, PACIFIC-2CV, PACIFIC-3CV, PACIFIC-3CV-W, Prestige-II, PRESTIGE-II-CV-ECC, PRESTIGE-II-CV-REVOL, PRESTIGE-II-ECC, Prestige-III, PRESTIGE-III-CV-REVOL...(Other models you can see in the webshop)		

rotary switches

BREMAS

A1700 series

			
1			
GEV No.	346397	Ref. No.	5.0.000.0061
description	rotary switch 3 0-1-2 sets of contacts 6 type CA020V200 400V 20A shaft ø 5x5mm shaft L 23mm shaft square connection screw		
For models:	ATLANTIC-I-CV-NV, ATLANTIC-I-CV-PCI-NV, ATLANTIC-I-CV-TI-NV, ATLANTIC-II-COMPACT, ATLANTIC-II-CV-COMPACT, ATLANTIC-II-CV-NV, ATLANTIC-II-CV-PCI-NV, ATLANTIC-II-CV-TALL-CUPS, ATLANTIC-II-CV-TI-COMPACT, ATLANTIC-II-CV-TI-NV, ATLANTIC-II-CV-TI-TALL-CUPS, ATLANTIC-III, ATLANTIC-III-CV, ATLANTIC-III-CV-TI, ATLANTIC-III-TI, ATLANTIC-II-NV, ATLANTIC-II-PCI-NV, ATLANTIC-II-TALL-CUPS, ATLANTIC-II-TI-NV, ATLANTIC-I-PCI-NV, ATLANTIC-I-TI-NV, PRESTIGE-II-CV-ECC, PRESTIGE-II-CV-REVOL, PRESTIGE-II-ECC, PRESTIGE-III-CV-REVOL, PRESTIGE-III-REVOL, PRESTIGE-II-REVOL		
accessories for	346397		
	GEV No.	110619	Ref. No. —
	knob switch zero mark t.max.°C ø 48mm shaft ø 5x5mm shaft flat black		



lamps

indicator lights

indicator lights (complete)

ø 9mm



1

GEV No.	359134	Ref. No.	6204
description	indicator light ø 9mm 230V clear connection male faston 6.3mm temp.-resist. 120°C		
For models:	F-1221-N		



1

GEV No.	359136	Ref. No.	6207
description	indicator light ø 9mm 230V green connection male faston 6.3mm temp.-resist. 120°C		
For models:	F-1221-N		



1

GEV No.	359137	Ref. No.	4.0.085.0025 6206
description	indicator light ø 9mm 230V yellow connection male faston 6.3mm temp.-resist. 120°C with lens		
For models:	F-1221-N		

ø10mm

with plug-in socket



1

GEV No.	359139	Ref. No.	4.0.025.0130
description	indicator light ø 10mm green 230V connection male faston 6.3mm Qty 1 pcs		
For models:	ATLANTIC-I-CV-NV, ATLANTIC-I-CV-PCI-NV, ATLANTIC-I-CV-TI-NV, ATLANTIC-II-COMPACT, ATLANTIC-II-CV-COMPACT, ATLANTIC-II-CV-NV, ATLANTIC-II-CV-PCI-NV, ATLANTIC-II-CV-TALL-CUPS, ATLANTIC-II-CV-TI-COMPACT, ATLANTIC-II-CV-TI-NV, ATLANTIC-II-CV-TI-TALL-CUPS, ATLANTIC-III, ATLANTIC-III-CV, ATLANTIC-III-CV-TI, ATLANTIC-III-TI, ATLANTIC-II-NV, ATLANTIC-II-PCI-NV, ATLANTIC-II-TALL-CUPS, ATLANTIC-II-TI-NV, ATLANTIC-I-PCI-NV, ATLANTIC-I-TI-NV, MARINA, MARINA-CV, MARINA-CV-DI, PACIFIC-2CV, PACIFIC-3CV, PACIFIC-3CV-W, PRESTIGE-II-CV-ECC, PRESTIGE-II-CV-REVOL, PRESTIGE-II-ECC, PRESTIGE-III-CV-REVOL, PRESTIGE-III-REVOL, PRESTIGE-II-REVOL		



1

GEV No.	359140	Ref. No.	4.0.025.0135
description	indicator light ø 16mm yellow 230V connection male faston 6.3mm Qty 1 pcs		
For models:	ATLANTIC-I-CV-NV, ATLANTIC-I-CV-PCI-NV, ATLANTIC-I-CV-TI-NV, ATLANTIC-II-COMPACT, ATLANTIC-II-CV-COMPACT, ATLANTIC-II-CV-NV, ATLANTIC-II-CV-PCI-NV, ATLANTIC-II-CV-TALL-CUPS, ATLANTIC-II-CV-TI-COMPACT, ATLANTIC-II-CV-TI-NV, ATLANTIC-II-CV-TI-TALL-CUPS, ATLANTIC-III, ATLANTIC-III-CV, ATLANTIC-III-CV-TI, ATLANTIC-III-TI, ATLANTIC-II-NV, ATLANTIC-II-PCI-NV, ATLANTIC-II-TALL-CUPS, ATLANTIC-II-TI-NV, ATLANTIC-I-PCI-NV, ATLANTIC-I-TI-NV, FCF10, FCF10+10, FCF10+10-TR, FCF10-TR, FCF15+15, FCF15-TR, FCF6, FCF6+6, IRCT1.8W, IRCT2x1.8W, MARINA, MARINA-CV, MARINA-CV-DI, PACIFIC-2CV, PACIFIC-3CV, PACIFIC-3CV-W, PPEF-M-800, PPEF-M-800-CRD, PRESTIGE-II-CV-ECC, PRESTIGE-II-CV-REVOL, PRESTIGE-II-ECC, PRESTIGE-III-CV-REVOL, PRESTIGE-III-REVOL, PRESTIGE-II-REVOL		

ø16mm

with plug-in socket



1

GEV No.	359790	Ref. No.	4092
description	indicator light ø 16mm 230V clear connection male faston 6.3mm		
For models:	F-1221-REVOL, F-400		



1

GEV No.	359788	Ref. No.	4091
description	indicator light ø 16mm 230V green connection male faston 6.3mm		
For models:	F-1221-REVOL, F-400		



1

GEV No.	359789	Ref. No.	4090
description	indicator light ø 16mm 230V yellow connection male faston 6.3mm		
For models:	F-1221-REVOL, F-400		

30x22mm



1

GEV No.	301166	Ref. No.	71
description	indicator light mounting measurements 30x22mm 230V blue		
For models:	F-1040, F-430, F-532		
accessories for	301166		
	GEV No.	301036	Ref. No. —
	protective cover internal size 30x22mm for rocker switch mounting measurementsmm		



timers

programme timers

			
1			
GEV No.	360077	Ref. No.	1623
description	timer CROUZET engines 1 chambers 2 operation time 120s 230V shaft ømm shaft Lmm manuf. no. 627/5261 motor type 82340		
For models:	F-1040, F-1221-N, F-1221-REVOL, F-400, F-430, F-532		

mechanical timers

			
1			
GEV No.	350032	Ref. No.	4.0.075.0002
description	timer M2 2-pole operation time 15min impulse mechanical 2NO at 250V 16A permanent position no shaft ø 6x4.6mm shaft 6x4.6mm shaft L 18mm mounting distance 28mm connection rear		
For models:	TOSTI-D3, TOSTI-S3, TRD-30.2, TRS-20.2		
accessories for	350032		
	GEV No.	110366	Ref. No. —
	knob switch zero mark t.max.°C ø 44mm shaft ø 6x4.6mm shaft flat upper black		
	GEV No.	110371	Ref. No. —
	dial plate graduation 15min permanent position no rotation 30-330° ø 60mm timers knob ø 45mm		

contactors

GENERAL ELECTRIC (AEG)

power contactors

			
1			
GEV No.	380238	Ref. No.	355
description	power contactor resistive load 20A 230VAC (AC3/400V) 8.4A/4kW main contacts 3NO auxiliary contacts 1NO connection screw connection type LS0510A type AEG LS0510A type GE MC1A 310A		
For models:	F-430		

ISKRA (FANAL)

power contactors

			
1			
GEV No.	380213	Ref. No.	4.0.089.0003 5140
description	power contactor resistive load 20A 230VAC (AC3/400V) 8.5A/5.5kW main contacts 3NO auxiliary contacts 1NO connection screw connection type Fanal DSL7 10 type ISKRA K07M 10		
For models:	F-532, FCF10, FCF10+10, FCF10+10-TR, FCF10-TR, FCF15+15, FCF15-TR, FCF6, FCF6+6, FF10, FF-10, FF10+10, FF-10+10, FF10+10TR, FF-10+10-TR, FF10+10TR-NV, FF10TR, FF-10-TR, FF10TR-NV, FF6, FF6+6, PPEF-800, PPEF-800-CRD, PPEF-M-800, PPEF-M-800-CRD		

			
1			
GEV No.	380204	Ref. No.	4375
description	power contactor resistive load 25A 230VAC (AC3/400V) 9A/4kW main contacts 3NO auxiliary contacts 1NO connection screw connection type Fanal DSL9 10 type ISKRA KNL9 10		
For models:	F-1040		

relays

level relays

miscellaneous

			
1			
GEV No.	402724	Ref. No.	5.0.000.1035 RST1
description	level controller 230V voltage AC 8-pole type RST1		
For models:	ATLANTIC-II-COMPACT, ATLANTIC-II-CV-TI-COMPACT, ATLANTIC-III, ATLANTIC-III-TI, ATLANTIC-II-NV, ATLANTIC-II-PCI-NV, ATLANTIC-II-TALL-CUPS, ATLANTIC-II-TI-NV, ATLANTIC-I-PCI-NV, ATLANTIC-I-TI-NV, MARINA, Prestige-II, PRESTIGE-II-ECC, Prestige-III, PRESTIGE-III-REVOL, PRESTIGE-II-REVOL, Superbar		



electric components

transformers

miscellaneous



GEV No.	402152	Ref. No.	4.0.080.0006
description	ignition transformer primary 230V secondary 2x2500V 50Hz		
For models:	30.5-INOX, 30.6-INOX, EI30.5, EI30.5-Inox, EI30.6, EI30.6-Inox		

electronics

central units



GEV No.	403703	Ref. No.	4.0.000.0953
description	central unit 240V 50/60Hz L 130mm W 120mm suitable for GICAR		
For models:	ATLANTIC-I-CV-NV, ATLANTIC-I-CV-PCI-NV, ATLANTIC-I-CV-TI-NV, ATLANTIC-II-CV-COMPACT, ATLANTIC-II-CV-NV, ATLANTIC-II-CV-PCI-NV, ATLANTIC-II-CV-TALL-CUPS, ATLANTIC-II-CV-TI-COMPACT, ATLANTIC-II-CV-TI-NV, ATLANTIC-II-CV-TI-TALL-CUPS, ATLANTIC-III-CV, ATLANTIC-III-CV-TI, MARINA-CV, PRESTIGE-II-CV-ECC, PRESTIGE-II-CV-REVOL, PRESTIGE-III-CV-REVOL		

keypads

keypad units



GEV No.	402667	Ref. No.	4.0.000.0955
description	keypad unit buttons 5 silver/black L 120mm W 50mm		
For models:	ATLANTIC-I-CV-NV, ATLANTIC-I-CV-PCI-NV, ATLANTIC-I-CV-TI-NV, ATLANTIC-II-CV-COMPACT, ATLANTIC-II-CV-NV, ATLANTIC-II-CV-PCI-NV, ATLANTIC-II-CV-TALL-CUPS, ATLANTIC-II-CV-TI-COMPACT, ATLANTIC-II-CV-TI-NV, ATLANTIC-II-CV-TI-TALL-CUPS, ATLANTIC-III-CV, ATLANTIC-III-CV-TI, MARINA-CV, PRESTIGE-II-CV-ECC, PRESTIGE-II-CV-REVOL, PRESTIGE-III-CV-REVOL		



GEV No.	402722	Ref. No.	4.0.000.0980
description	keypad unit coffee machine BUTTERFLY/MARINA buttons 5 black/white/silver type 1d5e GRCZ NKP S10 „Tank Probe“ 230V		
For models:	MARINA-CV, MARINA-CV-DI		

solenoïd valves

solenoïd valves (water)





TP



GEV No.	370015	Ref. No.	394	
description	solenoïd valve single angled 230VAC inlet 3/4" outlet 11.5mm DN10 TP			
For models:	F-1040, F-1221-N, F-1221-REVOL, F-400, F-430, F-532			
accessories for	370015			
	GEV No.	371220	Ref. No.	—
	reducer TP flow rate 3l/min red tolerance ±15%			
	GEV No.	371221	Ref. No.	—
	reducer TP flow rate 5.5l/min yellow tolerance ±15%			
	GEV No.	371222	Ref. No.	—
	reducer TP flow rate 6l/min grey tolerance ±15%			
	GEV No.	371223	Ref. No.	—
	reducer TP flow rate 10l/min white tolerance ±15%			
	GEV No.	371224	Ref. No.	—
	reducer TP flow rate 12l/min bronze tolerance ±15%			
	GEV No.	371225	Ref. No.	—
	reducer TP flow rate 16l/min light brown tolerance ±15%			
	GEV No.	371226	Ref. No.	—
	reducer TP flow rate 20l/min red tolerance ±15%			
	GEV No.	371230	Ref. No.	—
	reducer TP flow rate 0.25l/min red tolerance ±25%			
	GEV No.	371231	Ref. No.	—
	reducer TP flow rate 0.35l/min violet tolerance ±25%			
	GEV No.	371232	Ref. No.	—
	reducer TP flow rate 0.5l/min orange tolerance ±25%			
	GEV No.	371233	Ref. No.	—
	reducer TP flow rate 0.8l/min white tolerance ±25%			
	GEV No.	371234	Ref. No.	—
	reducer TP flow rate 1l/min light blue tolerance ±25%			
	GEV No.	371235	Ref. No.	—
	reducer TP flow rate 1.2l/min brown tolerance ±25%			
	GEV No.	371236	Ref. No.	—
	reducer TP flow rate 1.5l/min light brown tolerance ±25%			

Table continues overleaf



accessories for		370015		
GEV No.	371237	Ref. No.	—	
	reducer TP flow rate 2.5l/min yellow tolerance ±25%			
GEV No.	371238	Ref. No.	—	
	reducer TP flow rate 3.4l/min dark green tolerance ±25%			
GEV No.	371239	Ref. No.	—	
	reducer TP flow rate 5l/min black tolerance ±25%			
GEV No.	371240	Ref. No.	—	
	reducer TP flow rate 8l/min blue tolerance ±20%			

metal
LUCIFER

3-way
131F series

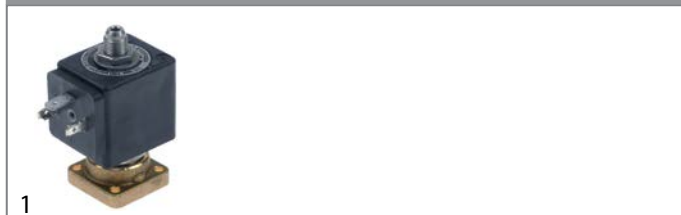



1

GEV No.	370053	Ref. No.	5.0.000.0123	
description	solenoid valve 3-ways 230VAC DN 2.5mm slide-on receptacle DIN -10 up to 140°C type series 131F coil type DZ06S6 membranes FKM (water/steam) p max 10bar flange 32x32mm			

For models: ATLANTIC-I-CV-NV, ATLANTIC-I-CV-PCI-NV, ATLANTIC-I-CV-TI-NV, ATLANTIC-II-COMPACT, ATLANTIC-II-CV-COMPACT, ATLANTIC-II-CV-NV, ATLANTIC-II-CV-PCI-NV, ATLANTIC-II-CV-TALL-CUPS, ATLANTIC-II-CV-TI-COMPACT, ATLANTIC-II-CV-TI-NV, ATLANTIC-II-CV-TI-TALL-CUPS, ATLANTIC-III, ATLANTIC-III-CV, ATLANTIC-III-CV-TI, ATLANTIC-III-TI, ATLANTIC-II-NV, ATLANTIC-II-PCI-NV, ATLANTIC-II-TALL-CUPS, ATLANTIC-II-TI-NV, ATLANTIC-I-PCI-NV, ATLANTIC-I-TI-NV, MARINA, MARINA-CV, MARINA-CV-DI, MINIBAR-NV, PACIFIC-2CV, PACIFIC-3CV, PACIFIC-3CV-W, Prestige-II, PRESTIGE-II-CV-ECC, PRESTIGE-II-CV-REVOL, PRESTIGE-II-ECC, Prestige-III, PRESTIGE-III-CV-REVOL, PRESTIGE-III-REVOL, PRESTIGE-II-REVOL

spare parts for 370053

GEV No.	370061	Ref. No.	—	
	solenoid valve body LUCIFER-PARKER 3-ways outer cone			

GEV No.	371031	Ref. No.	—	
	solenoid coil LUCIFER-PARKER 230VAC 9VA coil type DZ06S6 seat ø 15mm			

accessories for 370053

GEV No.	371090	Ref. No.	—	
	power socket plug type DIN 43650A screw			

GEV No.	371095	Ref. No.	—	
	O-ring Viton thickness 1.78mm ID ø 6.07mm Qty 1 pcs			

GEV No.	371100	Ref. No.	—	
	O-ring silicone thickness 1.78mm ID ø 6.07mm Qty 1 pcs			

PARKER

2-way
VE-161 series

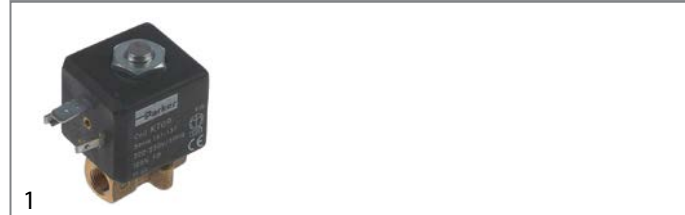

1

GEV No.	370553	Ref. No.	4.0.002.0041	
description	solenoid valve 2-ways 230VAC connection 1/8" L 32mm DN 2.2mm t.max. 80°C -10 up to 140°C type series VE-161.4 coil type KT09 membranes Viton p max 10bar p min 0bar 50Hz brass			
For models:	MARINA, MARINA-CV, MARINA-CV-DI, PACIFIC-3CV-W			

pressure switches
for warewashing

ø 58mm with male faston 6.3mm
with connection horizontal

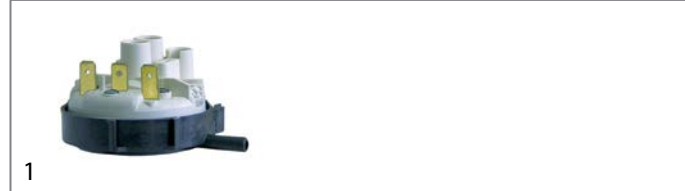

1

GEV No.	541142	Ref. No.	351	
description	pressure control pressure range 123/75mbar connection 6mm ø 58mm pressure connection horizontal warewashing			
For models:	F-1040			



1

GEV No.	541140	Ref. No.	35110	
description	pressure control pressure range 55/30mbar connection 6mm ø 58mm pressure connection horizontal warewashing			
For models:	F-1221-N, F-1221-REVOL, F-400, F-430, F-532			



pumps





wash and rinse pumps

ALBA (C&A)

pumps









1

GEV No.	500372	Ref. No.	10511
description	pump inlet ø 45mm outlet ø 40mm type C10511 230V 50Hz 1 phase 0.37kW 0.5HP L 200mm rotation direction right capacitor 12.5µF ALBA PUMPS (C&A)		
For models:	F-430		
spare parts for	500372		
	GEV No.	365014	Ref. No. 234
	operating capacitor capacity 12.5µF 450V tolerance 5%Hz ambient temperature max. -25 to +85°C ø 35mm L 70mm M8 plastic connection male faston 6.3mm 45S.C3DS.12.5 protection		
	GEV No.	509021	Ref. No. —
	impeller ø 102mm H 32mm shaft intake ø 9/8mm rotation direction right		
	GEV No.	510692	Ref. No. —
	mechanical shaft seal for shaft ø 11mm slide ring ext. ø 24mm slide ring H 13mm counter ring mounting ø 26mm height counter ring 8mm counter ring int. ø 14mm		
	GEV No.	521531	Ref. No. —
	pump cover ALBA PUMPS (C&A) inlet ø 45mm outlet ø 40mm turn direction right ø 153mm ID ø 127mm inner height 24mm		
	GEV No.	521709	Ref. No. —
	O-ring EPDM thickness 3mm ID ø 126mm Qty 1 pcs		







1

GEV No.	500368	Ref. No.	2868
description	pump inlet ø 45mm outlet ø 40mm type C2868 230V 50Hz 1 phase 0.74kW 1HP L 230mm rotation direction right capacitor 12.5µF ALBA PUMPS (C&A)		
For models:	F-532		
spare parts for	500368		
	GEV No.	365014	Ref. No. 234
	operating capacitor capacity 12.5µF 450V tolerance 5%Hz ambient temperature max. -25 to +85°C ø 35mm L 70mm M8 plastic connection male faston 6.3mm 45S.C3DS.12.5 protection		
	GEV No.	509021	Ref. No. —
	impeller ø 102mm H 32mm shaft intake ø 9/8mm rotation direction right		
	GEV No.	510692	Ref. No. —
	mechanical shaft seal for shaft ø 11mm slide ring ext. ø 24mm slide ring H 13mm counter ring mounting ø 26mm height counter ring 8mm counter ring int. ø 14mm		
	GEV No.	521044	Ref. No. —
	fanwheel cover suitable for ALBA PUMPS (C&A) ID ø 132mm ED ø 138mm H 70mm for wash pump plastic		
	GEV No.	521531	Ref. No. —
	pump cover ALBA PUMPS (C&A) inlet ø 45mm outlet ø 40mm turn direction right ø 153mm ID ø 127mm inner height 24mm		
	GEV No.	521709	Ref. No. —
	O-ring EPDM thickness 3mm ID ø 126mm Qty 1 pcs		



1



GEV No.	500037	Ref. No.	397
description	pump inlet ø 28mm outlet ø 26mm type 2211.1410 230V 50Hz 1 phase 0.074kW 0.1HP L 190mm rotation direction left capacitor 5µF FIR		
For models:	F-1221-N, F-1221-REVOL, F-400		
spare parts for	500037		
	GEV No.	365017	Ref. No. —
	operating capacitor capacity 5µF 450V tolerance 5% 50/60Hz ambient temperature max. -25 to +85°C ø 28mm L 54mm M8 plastic connection male faston 6.3mm 16.10.08 protection		
	GEV No.	510384	Ref. No. —
	pump cover inlet ø 28mm outlet ø 26mm ø 100mm ID ø 76mm		
	GEV No.	510695	Ref. No. —
	mechanical shaft seal height counter ring 5.5mm ID ø 11mm		
	GEV No.	521203	Ref. No. —
	impellor ø 72mm H 18mm thread M7 shaft ø 11mm shaft length 32mm blades 3		
	GEV No.	521703	Ref. No. —
	pump cover gasket EPDM thickness 2.5mm ID ø 75mm Qty 1 pcs		

LGB



1



GEV No.	499135	Ref. No.	4054
description	pump inlet ø 45mm outlet ø 40mm type ZF350SX 230/400V 50Hz 3 phase 0.61kW L 220mm rotation direction right LGB		
For models:	F-1040		
spare parts for	499135		
	GEV No.	510702	Ref. No. —
	mechanical shaft seal height counter ring 5.5mm ID ø 12mm		

spare parts for	499135		
	GEV No.	521278	Ref. No. —
	impellor ø 93mm H 32mm pump type ZF350SX thread M8L		
	GEV No.	521542	Ref. No. —
	pump cover LGB inlet ø 45mm outlet ø 40mm auxiliary pressure connection 13mm supporting pressure open ø 150mm ID ø 120mm inner height 25mm		
	GEV No.	521714	Ref. No. —
	pump cover gasket thickness 4x4mm Qty 1 pcs		

OLYMPIA



1

GEV No.	499208	Ref. No.	4053
description	pump inlet ø 45mm outlet ø 40mm type L80.T100 230V 50Hz 1 phase 0.75kW 1HP L 210mm rotation direction right capacitor 12.5µF OLYMPIA		
For models:	F-1040		
spare parts for	499208		
	GEV No.	365014	Ref. No. 234
	operating capacitor capacity 12.5µF 450V tolerance 5%Hz ambient temperature max. -25 to +85°C ø 35mm L 70mm M8 plastic connection male faston 6.3mm 45S.C3DS.12.5 protection		
	GEV No.	510693	Ref. No. —
	mechanical shaft seal for shaft ø 12mm slide ring ext. ø 24mm slide ring H 15.5mm slide ring int. ø 11mm counter ring mounting ø 24mm height counter ring 8mm counter ring int. ø 13.5mm		



booster pumps II

accessories



1

GEV No.	365012	Ref. No.	402
description	operating capacitor capacity 6.3µF 450V tolerance 5% 50Hz ambient temperature max. -25 to +85°C ø 30mm L 61mm M8 plastic connection male faston 6.3mm protection		
For models:	F-1221-N, F-1221-REVOL, F-400		

condensators & interference suppression filters

operating capacitors

plastic



1

GEV No.	365014	Ref. No.	234
description	operating capacitor capacity 12.5µF 450V tolerance 5%Hz ambient temperature max. -25 to +85°C ø 35mm L 70mm M8 plastic connection male faston 6.3mm 45S.C3DS.12.5 protection		
For models:	F-430		



1

GEV No.	365021	Ref. No.	2036
description	operating capacitor capacity 16µF 425V tolerance 5% 50/60Hz ambient temperature max. -25 to +85°C ø 35mm L 73mm single M8 plastic connection male faston 6.3mm 416.10.99 protection		
For models:	F-532		



1

GEV No.	365012	Ref. No.	402
description	operating capacitor capacity 6.3µF 450V tolerance 5% 50Hz ambient temperature max. -25 to +85°C ø 30mm L 61mm M8 plastic connection male faston 6.3mm protection		
For models:	F-1221-N, F-1221-REVOL, F-400		

filters

interference suppression filters



1

GEV No.	365044	Ref. No.	2779
description	interference suppression filter type FC701Y2F 250V 50-60Hz conductor 2 with E connection cable 200mm L 42mm ø 23mm Hmm Wmm plastic Qty 1 pcs		
For models:	F-430, F-532		

electric accessories

terminals

terminal blocks



1

GEV No.	550838	Ref. No.	4251 891
description	lustre terminal 12-pole cross section 6mm ² max. 41A max 750V temp.-resist. 150°C		
For models:	F-1040, F-1221-N, F-1221-REVOL, F-400, F-430, F-532		

accessories

miscellaneous





1

GEV No.	508218	Ref. No.	3125
description	signboard		
For models:	F-1221-N, F-430, F-532		



gas taps

SABAF

							
1							
GEV No.	106581	Ref. No.	4.0.100.0030				
description	gas tap SABAF type 10 gas inlet pipe flange ø14mm bypass nozzle ø 0mm gas outlet 1/4" (tube ø 8mm) front fixing M13x1 thermocouple connection M8x1 shaft ø 8x6.5mm shaft L 31.5/12.5mm shaft flat right						
For models:	GCT2x6, GCT6, GGP10.6, GGP10.8, GGP15.10, GGP15.10M, GGP15.6, GGP15.6M, GGP15.8, GGP15.8M, GGP6.4F, GGP6.6F, GGP6.8F, PGF-1200, PGF-300, PGF-300-F, PGF-600, PGF-600-F, PGF-800, PGF-800-F, PPGF-600, PPGF-600-CRD, PPGF-800, PPGF-800-CRD, PPGF-M-600, PPGF-M-600-CRD, PPGF-M-800, PPGF-M-800-CRD						
spare parts for	106581						
		<table border="1"> <tr> <td>GEV No.</td> <td>106724</td> <td>Ref. No.</td> <td>—</td> </tr> </table>	GEV No.	106724	Ref. No.	—	
GEV No.	106724	Ref. No.	—				
	magnet unit L 30mm D1 ø 12.5mm D2 ø 8.5mm suitable for SABAF						
accessories for	106581						
		<table border="1"> <tr> <td>GEV No.</td> <td>101277</td> <td>Ref. No.</td> <td>—</td> </tr> </table>	GEV No.	101277	Ref. No.	—	
GEV No.	101277	Ref. No.	—				
	olive ID ø 8mm Qty 1 pcs						
		<table border="1"> <tr> <td>GEV No.</td> <td>101376</td> <td>Ref. No.</td> <td>—</td> </tr> </table>	GEV No.	101376	Ref. No.	—	
GEV No.	101376	Ref. No.	—				
	gasket ID ø 8mm ED ø 12mm H 3/5mm						
		<table border="1"> <tr> <td>GEV No.</td> <td>101751</td> <td>Ref. No.</td> <td>—</td> </tr> </table>	GEV No.	101751	Ref. No.	—	
GEV No.	101751	Ref. No.	—				
	bracket						
		<table border="1"> <tr> <td>GEV No.</td> <td>520656</td> <td>Ref. No.</td> <td>—</td> </tr> </table>	GEV No.	520656	Ref. No.	—	
GEV No.	520656	Ref. No.	—				
	union nut thread 1/4" tube ø 6/8mm						

ignition parts

electrodes

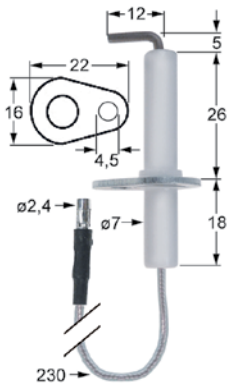
			
1			
GEV No.	106583	Ref. No.	4.0.100.0075
description	ignition electrode flange length 22mm flange width 16mm D1 ø 7mm L1 5mm L2 12mm BL1 26mm BL2 18mm connection ø2.4mm cable length 230mm fixing dimensions ø4.5mm		
For models:	BMF-1-1-G, BMF-1-1-G-SP, BMF-6CG, GGP10.6, GGP10.8, GGP15.10, GGP15.10C, GGP15.10M, GGP15.10MC, GGP15.6, GGP15.6C, GGP15.6M, GGP15.6MC, GGP15.8, GGP15.8C, GGP15.8M, GGP15.8MC, PGF-1200, PGF-300, PGF-300-F, PGF-600, PGF-600-F, PGF-800, PGF-800-F, PPGF-600, PPGF-600-CRD, PPGF-600-CRD-T, PPGF-800, PPGF-800-CRD, PPGF-800-CRD-T, PPGF-M-600, PPGF-M-600-CRD, PPGF-M-600-CRD-T, PPGF-M-800, PPGF-M-800-CRD, PPGF-M-800-CRD-T		

piezoelectric igniters

mounting diameter 18mm

							
1							
GEV No.	100009	Ref. No.	4.0.100.0070 4.0.100.0075				
description	piezoelectric igniter body plastic blowing mounting ø 18mm connection ø2.4mm front measurements 26mm M18x1.5						
For models:	BMF-1-1-G, BMF-1-1-G-SP, BMF-6CG, GGP10.6, GGP10.8, GGP15.10, GGP15.10C, GGP15.10M, GGP15.10MC, GGP15.6, GGP15.6C, GGP15.6M, GGP15.6MC, GGP15.8, GGP15.8C, GGP15.8M, GGP15.8MC, PGF-1200, PGF-300, PGF-300-F, PGF-600, PGF-600-F, PGF-800, PGF-800-F, PPGF-600, PPGF-600-CRD, PPGF-600-CRD-T, PPGF-800, PPGF-800-CRD, PPGF-800-CRD-T, PPGF-M-600, PPGF-M-600-CRD, PPGF-M-800, PPGF-M-800-CRD, PPGF-M-800-CRD-T						
accessories for	100009						
		<table border="1"> <tr> <td>GEV No.</td> <td>101339</td> <td>Ref. No.</td> <td>—</td> </tr> </table>	GEV No.	101339	Ref. No.	—	
GEV No.	101339	Ref. No.	—				
	cover cap for piezoelectric igniter						
		<table border="1"> <tr> <td>GEV No.</td> <td>106869</td> <td>Ref. No.</td> <td>—</td> </tr> </table>	GEV No.	106869	Ref. No.	—	
GEV No.	106869	Ref. No.	—				
	cover cap for piezoelectric igniter ID ø 22mm ED ø 35mm H 25mm						
		<table border="1"> <tr> <td>GEV No.</td> <td>107931</td> <td>Ref. No.</td> <td>—</td> </tr> </table>	GEV No.	107931	Ref. No.	—	
GEV No.	107931	Ref. No.	—				
	cover cap for piezoelectric igniter ID ø 21mm ED ø 36mm						

thermocouples

threaded thermocouples

threaded thermocouples standard

with socket with thread M8x1

SIT

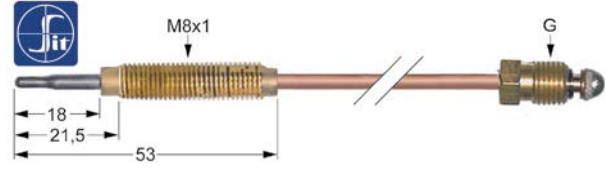
			
1			
GEV No.	107627	Ref. No.	4.0.100.0055
description	thermocouple SIT M8x1 L 220mm M8x1		
For models:	BMF-1-1-G, BMF-1-1-G-SP, GGP10.6, GGP10.8, GGP15.10, GGP15.10M, GGP15.6, GGP15.6M, GGP15.8, GGP15.8M, PGF-1200, PGF-300, PGF-300-F, PGF-600, PGF-600-F, PGF-800, PGF-800-F, PPGF-600, PPGF-600-CRD, PPGF-600-CRD-T, PPGF-800, PPGF-800-CRD, PPGF-800-CRD-T, PPGF-M-600, PPGF-M-600-CRD, PPGF-M-800, PPGF-M-800-CRD, PPGF-M-800-CRD-T		

gas burners

bar burners

bar burners



GEV No.	104770	Ref. No.	7.0.120.0038
description	bar burner ø 40mm Wmm Hmm L 290mm 5kW chargrill		
For models:	GGP10.6, GGP10.8, GGP15.10, GGP15.10C, GGP15.10M, GGP15.10MC, GGP15.6, GGP15.6C, GGP15.6M, GGP15.6MC, GGP15.8, GGP15.8C, GGP15.8M, GGP15.8MC, PPGF-600, PPGF-600-CRD, PPGF-600-CRD-T, PPGF-800, PPGF-800-CRD, PPGF-800-CRD-T, PPGF-M-600, PPGF-M-600-CRD, PPGF-M-800, PPGF-M-800-CRD, PPGF-M-800-CRD-T		

filter holders short



GEV No.	525845	Ref. No.	5.0.000.0657
description	filter holder mounting ø 83mm outlet 3/8" ID ø 62mm handle M12x1.75 wedge height 9mm wedge position horizontal number of wedges 2 lever inclined		
For models:	ATLANTIC-I-CV-NV, ATLANTIC-I-CV-PCI-NV, ATLANTIC-I-CV-TI-NV, ATLANTIC-II-COMPACT, ATLANTIC-II-CV-COMPACT, ATLANTIC-II-CV-NV, ATLANTIC-II-CV-PCI-NV, ATLANTIC-II-CV-TALL-CUPS, ATLANTIC-II-CV-TI-COMPACT, ATLANTIC-II-CV-TI-NV, ATLANTIC-II-CV-TI-TALL-CUPS, ATLANTIC-III, ATLANTIC-III-CV, ATLANTIC-III-CV-TI, ATLANTIC-III-TI, ATLANTIC-II-NV, ATLANTIC-II-PCI-NV, ATLANTIC-II-TALL-CUPS, ATLANTIC-II-TI-NV, ATLANTIC-I-PCI-NV, ATLANTIC-I-TI-NV, MARINA, MARINA-CV, MARINA-CV-DI, MINIBAR-NV, PACIFIC-2CV, PACIFIC-3CV, PACIFIC-3CV-W, PRESTIGE-II-CV-ECC, PRESTIGE-II-CV-REVOL, PRESTIGE-II-ECC, PRESTIGE-III-CV-REVOL, PRESTIGE-III-REVOL, PRESTIGE-II-REVOL		

gas nozzles

main nozzles

gas nozzles (other)



GEV No.	106582	Ref. No.	4.0.100.0062
description	gas injector T1: 1/4" T2: 1/8" WS 17 bore ø 0.9mm		
For models:	GGP10.6, GGP10.8, GGP15.6, GGP15.6C, GGP15.6M, GGP15.6MC, GGP15.8, GGP15.8C, GGP15.8M, GGP15.8MC, PPGF-600, PPGF-600-CRD, PPGF-600-CRD-T, PPGF-800, PPGF-800-CRD, PPGF-800-CRD-T, PPGF-M-600, PPGF-M-600-CRD, PPGF-M-800, PPGF-M-800-CRD, PPGF-M-800-CRD-T		

filters

for 1 cup



GEV No.	526261	Ref. No.	5.0.000.0170
description	coffee filter ø 70mm mounting ø 60.5mm H 20.5mm cups 1 amount of coffee 6.5g		
For models:	ATLANTIC-I-CV-NV, ATLANTIC-I-CV-PCI-NV, ATLANTIC-I-CV-TI-NV, ATLANTIC-II-COMPACT, ATLANTIC-II-CV-COMPACT, ATLANTIC-II-CV-NV, ATLANTIC-II-CV-PCI-NV, ATLANTIC-II-CV-TALL-CUPS, ATLANTIC-II-CV-TI-COMPACT, ATLANTIC-II-CV-TI-NV, ATLANTIC-II-CV-TI-TALL-CUPS, ATLANTIC-III, ATLANTIC-III-CV, ATLANTIC-III-CV-TI, ATLANTIC-III-TI, ATLANTIC-II-NV, ATLANTIC-II-PCI-NV, ATLANTIC-II-TALL-CUPS, ATLANTIC-II-TI-NV, ATLANTIC-I-PCI-NV, ATLANTIC-I-TI-NV, MARINA, MARINA-CV, MARINA-CV-DI, Minibar, MINIBAR-NV, PACIFIC-2CV, PACIFIC-3CV, PACIFIC-3CV-W, Prestige-II, PRESTIGE-II-CV-ECC, PRESTIGE-II-CV-REVOL, PRESTIGE-II-ECC, Prestige-III, PRESTIGE-III-CV-REVOL, PRESTIGE-III-REVOL, PRESTIGE-II-REVOL, Superbar		

equipment-specific units

for espresso machines

filter holders

filter holders standard

filter holder without spout



GEV No.	525999	Ref. No.	N/A
description	filter holder suitable for RST-FIAMMA without outlet mounting ø 83mm outlet 3/8" ID ø 62mm wedge height 9mm wedge position horizontal number of wedges 2 lever inclined		

for 2 cups



GEV No.	529014	Ref. No.	5.0.000.0173
description	coffee filter ø 70mm mounting ø 60mm H 21mm cups 2 amount of coffee 12g perforation ø 0.3mm round		
For models:	ATLANTIC-I-CV-NV, ATLANTIC-I-CV-PCI-NV, ATLANTIC-I-CV-TI-NV, ATLANTIC-II-COMPACT, ATLANTIC-II-CV-COMPACT, ATLANTIC-II-CV-NV, ATLANTIC-II-CV-PCI-NV, ATLANTIC-II-CV-TALL-CUPS, ATLANTIC-II-CV-TI-COMPACT, ATLANTIC-II-CV-TI-NV, ATLANTIC-II-CV-TI-TALL-CUPS, ATLANTIC-III, ATLANTIC-III-CV, ATLANTIC-III-CV-TI, ATLANTIC-III-TI, ATLANTIC-II-NV, ATLANTIC-II-PCI-NV, ATLANTIC-II-TALL-CUPS, ATLANTIC-II-TI-NV, ATLANTIC-I-PCI-NV, ATLANTIC-I-TI-NV, MARINA, MARINA-CV, MARINA-CV-DI, Minibar, MINIBAR-NV, PACIFIC-2CV, PACIFIC-3CV, PACIFIC-3CV-W, Prestige-II, PRESTIGE-II-CV-ECC, PRESTIGE-II-CV-REVOL, PRESTIGE-II-ECC, Prestige-III, PRESTIGE-III-CV-REVOL, PRESTIGE-III-REVOL, PRESTIGE-II-REVOL, Superbar		

brewing units

shower screens

with upstand



1

GEV No.	525844	Ref. No.	5.0.025.0010
description	shower screen ø 55.3mm H 18.2mm		
For models:	ATLANTIC-I-CV-NV, ATLANTIC-I-CV-PCI-NV, ATLANTIC-I-CV-TI-NV, ATLANTIC-II-COMPACT, ATLANTIC-II-CV-COMPACT, ATLANTIC-II-CV-NV, ATLANTIC-II-CV-PCI-NV, ATLANTIC-II-CV-TALL-CUPS, ATLANTIC-II-CV-TI-COMPACT, ATLANTIC-II-CV-TI-NV, ATLANTIC-II-CV-TI-TALL-CUPS, ATLANTIC-III, ATLANTIC-III-CV, ATLANTIC-III-CV-TI, ATLANTIC-III-TI, ATLANTIC-II-NV, ATLANTIC-II-PCI-NV, ATLANTIC-II-TALL-CUPS, ATLANTIC-II-TI-NV, ATLANTIC-I-PCI-NV, ATLANTIC-I-TI-NV, MARINA, MARINA-CV, MARINA-CV-DI, PACIFIC-2CV, PACIFIC-3CV, PACIFIC-3CV-W, PRESTIGE-II-CV-ECC, PRESTIGE-II-CV-REVOL, PRESTIGE-II-ECC, PRESTIGE-III-CV-REVOL, PRESTIGE-III-REVOL, PRESTIGE-II-REVOL		

filter holder gaskets

flat

standard



1

GEV No.	526064	Ref. No.	5.0.025.0012
description	filter holder gasket D1 ø 73.3mm D2 ø 57.3mm H 8.5mm Qty 1 pcs		
For models:	ATLANTIC-I-CV-NV, ATLANTIC-I-CV-PCI-NV, ATLANTIC-I-CV-TI-NV, ATLANTIC-II-COMPACT, ATLANTIC-II-CV-COMPACT, ATLANTIC-II-CV-NV, ATLANTIC-II-CV-PCI-NV, ATLANTIC-II-CV-TALL-CUPS, ATLANTIC-II-CV-TI-COMPACT, ATLANTIC-II-CV-TI-NV, ATLANTIC-II-CV-TI-TALL-CUPS, ATLANTIC-III, ATLANTIC-III-CV, ATLANTIC-III-CV-TI, ATLANTIC-III-TI, ATLANTIC-II-NV, ATLANTIC-II-PCI-NV, ATLANTIC-II-TALL-CUPS, ATLANTIC-II-TI-NV, ATLANTIC-I-PCI-NV, ATLANTIC-I-TI-NV, MARINA, MARINA-CV, MARINA-CV-DI, MINIBAR-NV, PACIFIC-2CV, PACIFIC-3CV, PACIFIC-3CV-W, PRESTIGE-II-CV-ECC, PRESTIGE-II-CV-REVOL, PRESTIGE-II-ECC, PRESTIGE-III-CV-REVOL, PRESTIGE-III-REVOL, PRESTIGE-II-REVOL		

brewing units with solenoid valve

components



1

GEV No.	525840	Ref. No.	5.0.016.0105
description	infusor 1/2" L 42mm WS 23		
For models:	ATLANTIC-I-CV-NV, ATLANTIC-I-CV-PCI-NV, ATLANTIC-I-CV-TI-NV, ATLANTIC-II-COMPACT, ATLANTIC-II-CV-COMPACT, ATLANTIC-II-CV-NV, ATLANTIC-II-CV-PCI-NV, ATLANTIC-II-CV-TALL-CUPS, ATLANTIC-II-CV-TI-COMPACT, ATLANTIC-II-CV-TI-NV, ATLANTIC-II-CV-TI-TALL-CUPS, ATLANTIC-III, ATLANTIC-III-CV, ATLANTIC-III-CV-TI, ATLANTIC-III-TI, ATLANTIC-II-NV, ATLANTIC-II-PCI-NV, ATLANTIC-II-TALL-CUPS, ATLANTIC-II-TI-NV, ATLANTIC-I-PCI-NV, ATLANTIC-I-TI-NV, MARINA, MARINA-CV, MARINA-CV-DI, PRESTIGE-II-CV-ECC, PRESTIGE-II-ECC		

components

nozzles

with thread



1

GEV No.	528486	Ref. No.	5.0.016.0110
description	nozzle bore ø 0.7mm thread M6x0.75 L 9mm WS 7		
For models:	ATLANTIC-I-CV-NV, ATLANTIC-I-CV-PCI-NV, ATLANTIC-I-CV-TI-NV, ATLANTIC-II-COMPACT, ATLANTIC-II-CV-COMPACT, ATLANTIC-II-CV-NV, ATLANTIC-II-CV-PCI-NV, ATLANTIC-II-CV-TALL-CUPS, ATLANTIC-II-CV-TI-COMPACT, ATLANTIC-II-CV-TI-NV, ATLANTIC-II-CV-TI-TALL-CUPS, ATLANTIC-III, ATLANTIC-III-CV, ATLANTIC-III-CV-TI, ATLANTIC-III-TI, ATLANTIC-II-NV, ATLANTIC-II-PCI-NV, ATLANTIC-II-TALL-CUPS, ATLANTIC-II-TI-NV, ATLANTIC-I-PCI-NV, ATLANTIC-I-TI-NV, MARINA, MARINA-CV, MARINA-CV-DI, PRESTIGE-II-CV-ECC, PRESTIGE-II-ECC		



1

GEV No.	525250	Ref. No.	5.0.025.0024
description	nozzle bore ø 0.8mm thread M6x0.75 L 9mm		
For models:	PACIFIC-2CV, PACIFIC-3CV, PACIFIC-3CV-W, PRESTIGE-II-CV-REVOL, PRESTIGE-III-CV-REVOL, PRESTIGE-III-REVOL, PRESTIGE-II-REVOL		

water dispersions

water dispersions

group 2



1

GEV No.	525756	Ref. No.	5.0.025.0009
description	water distributor ø 30mm hole ø 1.5mm H 15mm ET M10x1 grooves 6 2.6mm brass 2 holes perforation ø 1mm		
For models:	ATLANTIC-I-CV-NV, ATLANTIC-I-CV-PCI-NV, ATLANTIC-I-CV-TI-NV, ATLANTIC-II-COMPACT, ATLANTIC-II-CV-COMPACT, ATLANTIC-II-CV-NV, ATLANTIC-II-CV-PCI-NV, ATLANTIC-II-CV-TALL-CUPS, ATLANTIC-II-CV-TI-COMPACT, ATLANTIC-II-CV-TI-NV, ATLANTIC-II-CV-TI-TALL-CUPS, ATLANTIC-III, ATLANTIC-III-CV, ATLANTIC-III-CV-TI, ATLANTIC-III-TI, ATLANTIC-II-NV, ATLANTIC-II-PCI-NV, ATLANTIC-II-TALL-CUPS, ATLANTIC-II-TI-NV, ATLANTIC-I-PCI-NV, ATLANTIC-I-TI-NV, MARINA, MARINA-CV, MARINA-CV-DI, PACIFIC-2CV, PACIFIC-3CV, PACIFIC-3CV-W, PRESTIGE-II-CV-ECC, PRESTIGE-II-CV-REVOL, PRESTIGE-II-ECC, PRESTIGE-III-CV-REVOL, PRESTIGE-III-REVOL, PRESTIGE-II-REVOL		

safety valves

safety valves

3/8"



1

GEV No.	529879	Ref. No.	4.0.000.0051
description	safety valve connection 3/8" triggering pressure 1.6bar approval CE 0036 sealed		
For models:	ATLANTIC-I-CV-NV, ATLANTIC-I-CV-PCI-NV, ATLANTIC-I-CV-TI-NV, ATLANTIC-II-COMPACT, ATLANTIC-II-CV-COMPACT, ATLANTIC-II-CV-NV, ATLANTIC-II-CV-PCI-NV, ATLANTIC-II-CV-TALL-CUPS, ATLANTIC-II-CV-TI-COMPACT, ATLANTIC-II-CV-TI-NV, ATLANTIC-II-CV-TI-TALL-CUPS, ATLANTIC-III, ATLANTIC-III-CV, ATLANTIC-III-CV-TI, ATLANTIC-III-TI, ATLANTIC-II-NV, ATLANTIC-II-PCI-NV, ATLANTIC-II-TALL-CUPS, ATLANTIC-II-TI-NV, ATLANTIC-I-PCI-NV, ATLANTIC-I-TI-NV, MARINA, MARINA-CV, MARINA-CV-DI, PACIFIC-2CV, PACIFIC-3CV, PACIFIC-3CV-W, Prestige-II, PRESTIGE-II-CV-ECC, PRESTIGE-II-CV-REVOL, PRESTIGE-II-ECC, Prestige-III, PRESTIGE-III-CV-REVOL, PRESTIGE-III-REVOL, PRESTIGE-II-REVOL, Superbar		

expansion valves

with hose connection



1

GEV No.	526587	Ref. No.	5.0.016.0220
description	expansion valve T1: 1/4" ET hose ø 9.5mm L 42mm		
For models:	ATLANTIC-I-CV-NV, ATLANTIC-I-CV-PCI-NV, ATLANTIC-I-CV-TI-NV, ATLANTIC-II-COMPACT, ATLANTIC-II-CV-COMPACT, ATLANTIC-II-CV-NV, ATLANTIC-II-CV-PCI-NV, ATLANTIC-II-CV-TALL-CUPS, ATLANTIC-II-CV-TI-COMPACT, ATLANTIC-II-CV-TI-NV, ATLANTIC-II-CV-TI-TALL-CUPS, ATLANTIC-III, ATLANTIC-III-CV, ATLANTIC-III-CV-TI, ATLANTIC-III-TI, ATLANTIC-II-NV, ATLANTIC-II-PCI-NV, ATLANTIC-II-TALL-CUPS, ATLANTIC-II-TI-NV, ATLANTIC-I-PCI-NV, ATLANTIC-I-TI-NV, MARINA, MARINA-CV, MARINA-CV-DI, PACIFIC-2CV, PACIFIC-3CV, PACIFIC-3CV-W, PRESTIGE-II-CV-ECC, PRESTIGE-II-CV-REVOL, PRESTIGE-II-ECC, PRESTIGE-III-CV-REVOL, PRESTIGE-III-REVOL, PRESTIGE-II-REVOL		

gaskets



1

GEV No.	525822	Ref. No.	5.0.016.0223
description	gasket ED ø 15mm seat ø 6mm H 5.2mm overall height 10mm		
For models:	ATLANTIC-I-CV-NV, ATLANTIC-I-CV-PCI-NV, ATLANTIC-I-CV-TI-NV, ATLANTIC-II-COMPACT, ATLANTIC-II-CV-COMPACT, ATLANTIC-II-CV-NV, ATLANTIC-II-CV-PCI-NV, ATLANTIC-II-CV-TALL-CUPS, ATLANTIC-II-CV-TI-COMPACT, ATLANTIC-II-CV-TI-NV, ATLANTIC-II-CV-TI-TALL-CUPS, ATLANTIC-III, ATLANTIC-III-CV, ATLANTIC-III-CV-TI, ATLANTIC-III-TI, ATLANTIC-II-NV, ATLANTIC-II-PCI-NV, ATLANTIC-II-TALL-CUPS, ATLANTIC-II-TI-NV, ATLANTIC-I-PCI-NV, ATLANTIC-I-TI-NV, MARINA, MARINA-CV, MARINA-CV-DI, PACIFIC-2CV, PACIFIC-3CV, PACIFIC-3CV-W, PRESTIGE-II-CV-ECC, PRESTIGE-II-CV-REVOL, PRESTIGE-II-ECC, PRESTIGE-III-CV-REVOL, PRESTIGE-III-REVOL, PRESTIGE-II-REVOL		

drain pans

drain pans



1

GEV No.	525841	Ref. No.	4.0.000.0840
description	drain pan L 110mm W 85mm H 50mm hose ø 15mm		
For models:	ATLANTIC-I-CV-NV, ATLANTIC-I-CV-PCI-NV, ATLANTIC-I-CV-TI-NV, ATLANTIC-II-COMPACT, ATLANTIC-II-CV-COMPACT, ATLANTIC-II-CV-NV, ATLANTIC-II-CV-PCI-NV, ATLANTIC-II-CV-TALL-CUPS, ATLANTIC-II-CV-TI-COMPACT, ATLANTIC-II-CV-TI-NV, ATLANTIC-II-CV-TI-TALL-CUPS, ATLANTIC-III, ATLANTIC-III-CV, ATLANTIC-III-CV-TI, ATLANTIC-III-TI, ATLANTIC-II-NV, ATLANTIC-II-PCI-NV, ATLANTIC-II-TALL-CUPS, ATLANTIC-II-TI-NV, ATLANTIC-I-PCI-NV, ATLANTIC-I-TI-NV, MARINA, MARINA-CV, MARINA-CV-DI, PACIFIC-2CV, PACIFIC-3CV, PACIFIC-3CV-W, PRESTIGE-II-CV-ECC, PRESTIGE-II-CV-REVOL, PRESTIGE-II-ECC, PRESTIGE-III-CV-REVOL, PRESTIGE-III-REVOL, PRESTIGE-II-REVOL		

aerators and air bleeders



1

GEV No.	529304	Ref. No.	5.0.000.1002
description	aerator and air bleeder screw connection 1/4"		
For models:	ATLANTIC-I-CV-NV, ATLANTIC-I-CV-PCI-NV, ATLANTIC-I-CV-TI-NV, ATLANTIC-II-COMPACT, ATLANTIC-II-CV-COMPACT, ATLANTIC-II-CV-NV, ATLANTIC-II-CV-PCI-NV, ATLANTIC-II-CV-TALL-CUPS, ATLANTIC-II-CV-TI-COMPACT, ATLANTIC-II-CV-TI-NV, ATLANTIC-II-CV-TI-TALL-CUPS, ATLANTIC-III, ATLANTIC-III-CV, ATLANTIC-III-CV-TI, ATLANTIC-III-TI, ATLANTIC-II-NV, ATLANTIC-II-PCI-NV, ATLANTIC-II-TALL-CUPS, ATLANTIC-II-TI-NV, ATLANTIC-I-PCI-NV, ATLANTIC-I-TI-NV, MARINA, MARINA-CV, MARINA-CV-DI, PACIFIC-2CV, PACIFIC-3CV, PACIFIC-3CV-W, Prestige-II, PRESTIGE-II-CV-ECC, PRESTIGE-II-CV-REVOL, PRESTIGE-II-ECC, Prestige-III, PRESTIGE-III-CV-REVOL, PRESTIGE-III-REVOL, PRESTIGE-II-REVOL, Superbar		

steam/water taps

steam/water taps

steam/water taps





1

GEV No.	525833	Ref. No.	5.0.002.0100
description	steam/water tap inlet 1/4" outlet 1/4" series MARINA		
For models:	MARINA, MARINA-CV, MARINA-CV-DI		





			
1			
GEV No.	531053	Ref. No.	5.0.016.0350
description	steam/water tap inlet 1/4" outlet 3/8" shaft 6mm shaft L 14mm		
For models:	ATLANTIC-I-CV-NV, ATLANTIC-I-CV-PCI-NV, ATLANTIC-I-CV-TI-NV, ATLANTIC-II-COMPACT, ATLANTIC-II-CV-COMPACT, ATLANTIC-II-CV-NV, ATLANTIC-II-CV-PCI-NV, ATLANTIC-II-CV-TALL-CUPS, ATLANTIC-II-CV-TI-COMPACT, ATLANTIC-II-CV-TI-NV, ATLANTIC-II-CV-TI-TALL-CUPS, ATLANTIC-III, ATLANTIC-III-CV, ATLANTIC-III-CV-TI, ATLANTIC-III-TI, ATLANTIC-II-NV, ATLANTIC-II-PCI-NV, ATLANTIC-II-TALL-CUPS, ATLANTIC-II-TI-NV, ATLANTIC-I-PCI-NV, ATLANTIC-I-TI-NV, PACIFIC-2CV, PACIFIC-3CV, PACIFIC-3CV-W, PRESTIGE-II-CV-ECC, PRESTIGE-II-CV-REVOL, PRESTIGE-III-CV-REVOL, PRESTIGE-III-REVOL, PRESTIGE-II-REVOL		

<p>steam taps</p> <p>steam taps (complete)</p> 			
1			
GEV No.	525835	Ref. No.	4.0.016.0020
description	steam tap inlet 1/4" thread Tr18x2		
For models:	ATLANTIC-I-CV-NV, ATLANTIC-I-CV-PCI-NV, ATLANTIC-I-CV-TI-NV, ATLANTIC-II-COMPACT, ATLANTIC-II-CV-COMPACT, ATLANTIC-II-CV-NV, ATLANTIC-II-CV-PCI-NV, ATLANTIC-II-CV-TALL-CUPS, ATLANTIC-II-CV-TI-COMPACT, ATLANTIC-II-CV-TI-NV, ATLANTIC-II-CV-TI-TALL-CUPS, ATLANTIC-III, ATLANTIC-III-CV, ATLANTIC-III-CV-TI, ATLANTIC-III-TI, ATLANTIC-II-NV, ATLANTIC-II-PCI-NV, ATLANTIC-II-TALL-CUPS, ATLANTIC-II-TI-NV, ATLANTIC-I-PCI-NV, ATLANTIC-I-TI-NV, PRESTIGE-II-CV-ECC, PRESTIGE-II-CV-REVOL, PRESTIGE-II-ECC, PRESTIGE-III-CV-REVOL, PRESTIGE-III-REVOL, PRESTIGE-II-REVOL		

<p>components</p> <p>bushes</p> 			
1			
GEV No.	525827	Ref. No.	5.0.016.0305
description	bush for steam-/water-tap D1 ø 9mm D2 ø 10.4mm ID ø 6.2mm H 4.5mm brass		
For models:	ATLANTIC-I-CV-NV, ATLANTIC-I-CV-PCI-NV, ATLANTIC-I-CV-TI-NV, ATLANTIC-II-COMPACT, ATLANTIC-II-CV-COMPACT, ATLANTIC-II-CV-NV, ATLANTIC-II-CV-PCI-NV, ATLANTIC-II-CV-TALL-CUPS, ATLANTIC-II-CV-TI-COMPACT, ATLANTIC-II-CV-TI-NV, ATLANTIC-II-CV-TI-TALL-CUPS, ATLANTIC-III, ATLANTIC-III-CV, ATLANTIC-III-CV-TI, ATLANTIC-III-TI, ATLANTIC-II-NV, ATLANTIC-II-PCI-NV, ATLANTIC-II-TALL-CUPS, ATLANTIC-II-TI-NV, ATLANTIC-I-PCI-NV, ATLANTIC-I-TI-NV, PACIFIC-2CV, PACIFIC-3CV, PACIFIC-3CV-W, PRESTIGE-II-CV-ECC, PRESTIGE-II-CV-REVOL, PRESTIGE-II-ECC, PRESTIGE-III-CV-REVOL, PRESTIGE-III-REVOL, PRESTIGE-II-REVOL		

<p>gaskets</p> 			
1			
GEV No.	526258	Ref. No.	5.0.016.0301
description	gasket D1 ø 12.5mm thickness 5.5mm silicone		
For models:	ATLANTIC-I-CV-NV, ATLANTIC-I-CV-PCI-NV, ATLANTIC-I-CV-TI-NV, ATLANTIC-II-COMPACT, ATLANTIC-II-CV-COMPACT, ATLANTIC-II-CV-NV, ATLANTIC-II-CV-PCI-NV, ATLANTIC-II-CV-TALL-CUPS, ATLANTIC-II-CV-TI-COMPACT, ATLANTIC-II-CV-TI-NV, ATLANTIC-II-CV-TI-TALL-CUPS, ATLANTIC-III, ATLANTIC-III-CV, ATLANTIC-III-CV-TI, ATLANTIC-III-TI, ATLANTIC-II-NV, ATLANTIC-II-PCI-NV, ATLANTIC-II-TI-NV, ATLANTIC-I-PCI-NV, ATLANTIC-I-TI-NV, PACIFIC-2CV, PACIFIC-3CV, PACIFIC-3CV-W, PRESTIGE-II-CV-ECC, PRESTIGE-II-CV-REVOL, PRESTIGE-II-ECC, PRESTIGE-III-CV-REVOL, PRESTIGE-III-REVOL, PRESTIGE-II-REVOL		

			
1			
GEV No.	525832	Ref. No.	5.0.002.0113
description	sealing disc D1 ø 7mm thickness 2mm PTFE for steam-/water-tap		
For models:	MARINA, MARINA-CV, MARINA-CV-DI		

<p>water taps</p> <p>water taps</p> 			
1			
GEV No.	525834	Ref. No.	4.0.016.0021
description	water tap inlet 1/4" thread Tr18x2		
For models:	ATLANTIC-I-CV-NV, ATLANTIC-I-CV-PCI-NV, ATLANTIC-I-CV-TI-NV, ATLANTIC-II-COMPACT, ATLANTIC-II-CV-COMPACT, ATLANTIC-II-CV-NV, ATLANTIC-II-CV-PCI-NV, ATLANTIC-II-CV-TALL-CUPS, ATLANTIC-II-CV-TI-COMPACT, ATLANTIC-II-CV-TI-NV, ATLANTIC-II-CV-TI-TALL-CUPS, ATLANTIC-III, ATLANTIC-III-CV, ATLANTIC-III-CV-TI, ATLANTIC-III-TI, ATLANTIC-II-NV, ATLANTIC-II-PCI-NV, ATLANTIC-II-TALL-CUPS, ATLANTIC-II-TI-NV, ATLANTIC-I-PCI-NV, ATLANTIC-I-TI-NV, PACIFIC-2CV, PACIFIC-3CV, PRESTIGE-II-CV-ECC, PRESTIGE-II-CV-REVOL, PRESTIGE-II-ECC, PRESTIGE-III-CV-REVOL, PRESTIGE-III-REVOL, PRESTIGE-II-REVOL		

<p>steam/water pipes</p> <p>steam pipes</p> 			
1			
GEV No.	525839	Ref. No.	5.0.002.0120
description	steam pipe thread 1/4" H 160mm tube ø 8mm suitable for FIAMMA		
For models:	MARINA, MARINA-CV, MARINA-CV-DI		

			
1			
GEV No.	525838	Ref. No.	5.0.016.0320
description	steam pipe thread 3/8" H 180mm L 210mm ϕ 14.5mm tube ϕ 10mm stainless steel		
For models:	ATLANTIC-I-CV-NV, ATLANTIC-I-CV-PCI-NV, ATLANTIC-I-CV-TI-NV, ATLANTIC-II-COMPACT, ATLANTIC-II-CV-COMPACT, ATLANTIC-II-CV-NV, ATLANTIC-II-CV-PCI-NV, ATLANTIC-II-CV-TALL-CUPS, ATLANTIC-II-CV-TI-COMPACT, ATLANTIC-II-CV-TI-NV, ATLANTIC-II-CV-TI-TALL-CUPS, ATLANTIC-III, ATLANTIC-III-CV, ATLANTIC-III-CV-TI, ATLANTIC-III-TI, ATLANTIC-II-NV, ATLANTIC-II-PCI-NV, ATLANTIC-II-TALL-CUPS, ATLANTIC-II-TI-NV, ATLANTIC-I-PCI-NV, ATLANTIC-I-TI-NV, PRESTIGE-II-CV-ECC, PRESTIGE-II-CV-REVOL, PRESTIGE-II-ECC, PRESTIGE-III-CV-REVOL, PRESTIGE-III-REVOL, PRESTIGE-II-REVOL		

water pipes

			
1			
GEV No.	531054	Ref. No.	5.0.016.0330
description	water pipe ϕ 23.5mm L 96mm tube ϕ 8mm head ϕ 14.5mm		
For models:	ATLANTIC-I-CV-NV, ATLANTIC-I-CV-PCI-NV, ATLANTIC-I-CV-TI-NV, ATLANTIC-II-COMPACT, ATLANTIC-II-CV-COMPACT, ATLANTIC-II-CV-NV, ATLANTIC-II-CV-PCI-NV, ATLANTIC-II-CV-TALL-CUPS, ATLANTIC-II-CV-TI-COMPACT, ATLANTIC-II-CV-TI-NV, ATLANTIC-II-CV-TI-TALL-CUPS, ATLANTIC-III, ATLANTIC-III-CV, ATLANTIC-III-CV-TI, ATLANTIC-III-TI, ATLANTIC-II-NV, ATLANTIC-II-PCI-NV, ATLANTIC-II-TALL-CUPS, ATLANTIC-II-TI-NV, ATLANTIC-I-PCI-NV, ATLANTIC-I-TI-NV, PACIFIC-2CV, PACIFIC-3CV, PACIFIC-3CV-W, PRESTIGE-II-CV-ECC, PRESTIGE-II-CV-REVOL, PRESTIGE-II-ECC, PRESTIGE-III-CV-REVOL, PRESTIGE-III-REVOL, PRESTIGE-II-REVOL		

			
1			
GEV No.	531055	Ref. No.	5.0.002.0130
description	water pipe thread 1/4" ϕ 23.5mm L 95.5mm tube ϕ 8mm		
For models:	MARINA, MARINA-CV, MARINA-CV-DI		

accessories

bushes

			
1			
GEV No.	525826	Ref. No.	5.0.025.6508
description	bush D1 ϕ 9mm D2 ϕ 12mm int. ϕ 17mm H 5mm brass		
For models:	ATLANTIC-I-CV-NV, ATLANTIC-I-CV-PCI-NV, ATLANTIC-I-CV-TI-NV, ATLANTIC-II-COMPACT, ATLANTIC-II-CV-COMPACT, ATLANTIC-II-CV-NV, ATLANTIC-II-CV-PCI-NV, ATLANTIC-II-CV-TALL-CUPS, ATLANTIC-II-CV-TI-COMPACT, ATLANTIC-II-CV-TI-NV, ATLANTIC-II-CV-TI-TALL-CUPS, ATLANTIC-III, ATLANTIC-III-CV, ATLANTIC-III-CV-TI, ATLANTIC-III-TI, ATLANTIC-II-NV, ATLANTIC-II-PCI-NV, ATLANTIC-II-TALL-CUPS, ATLANTIC-II-TI-NV, ATLANTIC-I-PCI-NV, ATLANTIC-I-TI-NV, PACIFIC-2CV, PACIFIC-3CV, PACIFIC-3CV-W, PRESTIGE-II-CV-ECC, PRESTIGE-II-CV-REVOL, PRESTIGE-II-ECC, PRESTIGE-III-CV-REVOL, PRESTIGE-III-REVOL, PRESTIGE-II-REVOL		

gaskets

			
1			
GEV No.	510893	Ref. No.	697
description	O-ring EPDM thickness 2.62mm ID ϕ 9.92mm Qty 1 pcs		
For models:	F-1040, F-1221-N, F-1221-REVOL, F-400, F-430, F-532		

fine filters

fine filters

			
1			
GEV No.	528357	Ref. No.	5.0.025.0023
description	fine filter ϕ 8.5mm H 22mm		
For models:	ATLANTIC-I-CV-NV, ATLANTIC-I-CV-PCI-NV, ATLANTIC-I-CV-TI-NV, ATLANTIC-II-COMPACT, ATLANTIC-II-CV-COMPACT, ATLANTIC-II-CV-NV, ATLANTIC-II-CV-PCI-NV, ATLANTIC-II-CV-TALL-CUPS, ATLANTIC-II-CV-TI-COMPACT, ATLANTIC-II-CV-TI-NV, ATLANTIC-II-CV-TI-TALL-CUPS, ATLANTIC-III, ATLANTIC-III-CV, ATLANTIC-III-CV-TI, ATLANTIC-III-TI, ATLANTIC-II-NV, ATLANTIC-II-PCI-NV, ATLANTIC-II-TALL-CUPS, ATLANTIC-II-TI-NV, ATLANTIC-I-PCI-NV, ATLANTIC-I-TI-NV, PRESTIGE-II-CV-ECC, PRESTIGE-II-CV-REVOL, PRESTIGE-II-ECC, PRESTIGE-III-CV-REVOL, PRESTIGE-III-REVOL, PRESTIGE-II-REVOL		

intake valves

intake valves

			
1			
GEV No.	523048	Ref. No.	4.0.002.0010
description	intake valve complete with solenoid valve		
For models:	MARINA, MARINA-CV, MARINA-CV-DI		

			
1			
GEV No.	525836	Ref. No.	5.0.000.0032
description	intake valve for FIAMMA		
For models:	PRESTIGE-II-CV-REVOL, PRESTIGE-III-CV-REVOL, PRESTIGE-III-REVOL, PRESTIGE-II-REVOL		



1

GEV No.	525837	Ref. No.	4.0.016.0010
description	intake valve for FIAMMA		
For models:	ATLANTIC-I-CV-NV, ATLANTIC-I-CV-PCI-NV, ATLANTIC-I-CV-TI-NV, ATLANTIC-II-COMPACT, ATLANTIC-II-CV-COMPACT, ATLANTIC-II-CV-NV, ATLANTIC-II-CV-PCI-NV, ATLANTIC-II-CV-TALL-CUPS, ATLANTIC-II-CV-TI-COMPACT, ATLANTIC-II-CV-TI-NV, ATLANTIC-II-CV-TI-TALL-CUPS, ATLANTIC-III, ATLANTIC-III-CV, ATLANTIC-III-CV-TI, ATLANTIC-III-TI, ATLANTIC-II-NV, ATLANTIC-II-PCI-NV, ATLANTIC-II-TALL-CUPS, ATLANTIC-II-TI-NV, ATLANTIC-I-PCI-NV, ATLANTIC-I-TI-NV, PACIFIC-2CV, PACIFIC-3CV, PACIFIC-3CV-W, PRESTIGE-II-CV-ECC, PRESTIGE-II-ECC		

accessories

valves



1

GEV No.	525831	Ref. No.	5.0.016.0212
description	valve for filling valve L 25.2mm square ED ø 16mm		
For models:	PRESTIGE-II-CV-REVOL, PRESTIGE-III-CV-REVOL, PRESTIGE-III-REVOL, PRESTIGE-II-REVOL		

level glasses

level glasses

pressure rings



1

GEV No.	525828	Ref. No.	5.0.000.0000
description	press ring D1 ø 14.6mm ID ø 11.6mm H 3.6mm brass		
For models:	Prestige-II, PRESTIGE-II-CV-REVOL, Prestige-III, PRESTIGE-III-CV-REVOL, PRESTIGE-III-REVOL, PRESTIGE-II-REVOL		

level glasses (complete)



1

GEV No.	525843	Ref. No.	5.0.000.1020
description	level glass pipe suitable for FIAMMA		
For models:	PRESTIGE-II-CV-REVOL, PRESTIGE-III-CV-REVOL, PRESTIGE-III-REVOL, PRESTIGE-II-REVOL		

level glass pipes



1

GEV No.	525842	Ref. No.	5.0.000.1017
description	level glass pipe ø 11mm H 134mm ID ø 7.7mm marking Min/Max black		
For models:	Prestige-II, PRESTIGE-II-CV-REVOL, Prestige-III, PRESTIGE-III-CV-REVOL, PRESTIGE-III-REVOL, PRESTIGE-II-REVOL		

non-return valves

pistons



1

GEV No.	525830	Ref. No.	5.0.016.0231
description	piston for non-return valve triangular ø 12mm L 20.3mm		
For models:	ATLANTIC-I-CV-NV, ATLANTIC-I-CV-PCI-NV, ATLANTIC-I-CV-TI-NV, ATLANTIC-II-COMPACT, ATLANTIC-II-CV-COMPACT, ATLANTIC-II-CV-NV, ATLANTIC-II-CV-PCI-NV, ATLANTIC-II-CV-TALL-CUPS, ATLANTIC-II-CV-TI-COMPACT, ATLANTIC-II-CV-TI-NV, ATLANTIC-II-CV-TI-TALL-CUPS, ATLANTIC-III, ATLANTIC-III-CV, ATLANTIC-III-CV-TI, ATLANTIC-III-TI, ATLANTIC-II-NV, ATLANTIC-II-PCI-NV, ATLANTIC-II-TALL-CUPS, ATLANTIC-II-TI-NV, ATLANTIC-I-PCI-NV, ATLANTIC-I-TI-NV, MARINA, MARINA-CV, MARINA-CV-DI, PACIFIC-2CV, PACIFIC-3CV, PACIFIC-3CV-W, PRESTIGE-II-CV-ECC, PRESTIGE-II-CV-REVOL, PRESTIGE-II-ECC, PRESTIGE-III-CV-REVOL, PRESTIGE-III-REVOL, PRESTIGE-II-REVOL		

for contact grills

miscellaneous



1

GEV No.	700845	Ref. No.	4.0.075.0064
description	foot L 218mm H 40mm mounting distance 160mm for toaster W 75mm		
For models:	GR-4.1-L, GR-4.1-LTL, GR-4.2, GR-6.1, GR-6.1-L, GR-6.1-LTL, GR-8, GR-8.1-L, GR-8.2, GR-8.2-L, GR-8.2-LTL, GR-8-L, GR-M, GR-M.1, GR-M.2, GR-M.2-TLC, SEF-450, SEF-450I, SEF-650, SEF-650I, TOSTI-D3, TOSTI-S3, TRD-30.2, TRS-20.2		

for dishwashers

boilers

boilers for dishwashers



1

GEV No.	508209	Ref. No.	2995
description	boiler		
For models:	F-430, F-532		



1

GEV No.	508283	Ref. No.	4889
description	boiler		
For models:	F-1040		



1

GEV No.	508221	Ref. No.	3161
description	boiler ø 120mm L 210mm		
For models:	F-1221-N, F-1221-REVOL, F-400		

housing and bezels

miscellaneous



1

GEV No.	508170	Ref. No.	2748
description	side panel mounting pos. lower		
For models:	F-1040		

hood mechanics for dishwashers

bushes



1

GEV No.	508134	Ref. No.	2579
description	cylinder liner hood guide		
For models:	F-1040		



1

GEV No.	508139	Ref. No.	2585
description	cylinder liner hood mechanics		
For models:	F-1040		



1

GEV No.	508130	Ref. No.	2574
description	spacer bush for spindle hood mechanics		
For models:	F-1040		

spring holders



1

GEV No.	508131	Ref. No.	2576
description	bush for spring holder hood mechanics		
For models:	F-1040		

guide bars



1

GEV No.	508190	Ref. No.	2862
description	guide bar hood mechanics		
For models:	F-1040		

linkage



1

GEV No.	508154	Ref. No.	2706
description	spindle for hood handle		
For models:	F-1040		



hood handles



1			
GEV No.	508153	Ref. No.	2705
description	hood handle		
For models:	F-1040		

rollers

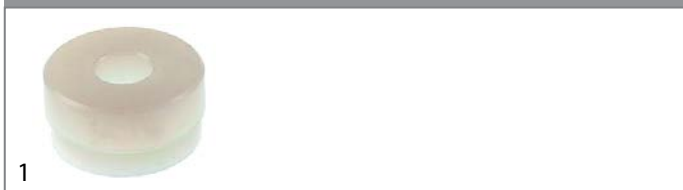

1			
GEV No.	508133	Ref. No.	2578
description	roller hood mechanics		
For models:	F-1040		

miscellaneous

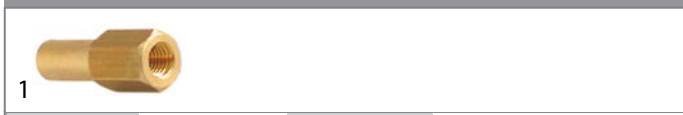

1			
GEV No.	508137	Ref. No.	2582
description	actuator for microswitch hood mechanics		
For models:	F-1040		



1			
GEV No.	508132	Ref. No.	2577
description	bearing bolt hood mechanics		
For models:	F-1040		



1			
GEV No.	508140	Ref. No.	2586
description	bush for spindle with thread hood mechanics		
For models:	F-1040		



1			
GEV No.	508160	Ref. No.	2712
description	con rod for door shaft		
For models:	F-1040		

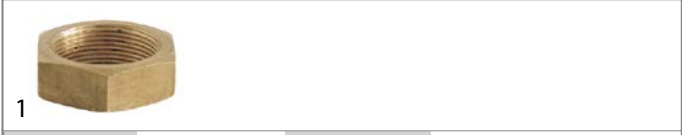

1			
GEV No.	508136	Ref. No.	2581
description	nut hood mechanics thread M32x1.5		
For models:	F-1040		



1			
GEV No.	508041	Ref. No.	626
description	rubber pad hood mechanics		
For models:	F-1040		

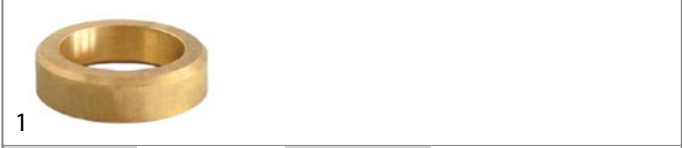

1			
GEV No.	508135	Ref. No.	2580
description	spacer piece hood mechanics		
For models:	F-1040		



1			
GEV No.	508168	Ref. No.	2738
description	spring holder		
For models:	F-1040		



			
1			
GEV No.	508159	Ref. No.	2711
description	spring holder hood mechanics		
For models:	F-1040		

			
1			
GEV No.	508138	Ref. No.	2583
description	stop bolt hood mechanics		
For models:	F-1040		

air traps

air traps

			
1			
GEV No.	508202	Ref. No.	2932
description	air trap		
For models:	F-1040, F-1221-N, F-430, F-532		
spare parts for	508202		
	GEV No.	508377	Ref. No. 3536
	hose connector		
accessories for	508202		
	GEV No.	508201	Ref. No. 2927
	formed hose warewashing L-shape equiv. no. 2927		
	GEV No.	508203	Ref. No. 2933
	pipe		
	GEV No.	511322	Ref. No. —
	O-ring EPDM thickness 3.53mm ID ø 20.22mm Qty 1 pcs		

			
1			
GEV No.	508376	Ref. No.	3535
description	air trap		
For models:	F-1221-REVOL		
accessories for	508376		
	GEV No.	508377	Ref. No. 3536
	hose connector		

accessories for	508376		
	GEV No.	511322	Ref. No. —
	O-ring EPDM thickness 3.53mm ID ø 20.22mm Qty 1 pcs		

air trap accessories

			
1			
GEV No.	508377	Ref. No.	3536
description	hose connector		
For models:	F-1221-REVOL		

pipes

			
1			
GEV No.	508203	Ref. No.	2933
description	pipe		
For models:	F-1040, F-1221-N, F-1221-REVOL, F-430, F-532		

backflow preventers



backflow preventers

			
1			
GEV No.	504140	Ref. No.	2802
description	backflow preventer		
For models:	F-1040		

			
1	Image not available		
GEV No.	508267	Ref. No.	4728
description	backflow preventer		
For models:	F-1221-N		



 <p>Image not available</p>			
1			
GEV No.	508271	Ref. No.	4732
description	backflow preventer		
For models:	F-532		

			
2			
GEV No.	516101	Ref. No.	4731
description	backflow preventer dishwasher hose ø 12mm		
For models:	F-430		
spare parts for	516101		
	GEV No.	506367	Ref. No.
			—
	 flat gasket rubber ED ø 40mm ID ø 28mm thickness 1.8mm Qty 1 pcs		

miscellaneous			
 <p>Image not available</p>			
1			
GEV No.	508025	Ref. No.	186
description	bracket for plate		
For models:	F-1221-N		

door mechanics			
linkage			
			
1			
GEV No.	508275	Ref. No.	4744
description	door pin door pin		
For models:	F-1221-N, F-1221-REVOL, F-400, F-430, F-532		

sliding plates			
			
1			
GEV No.	508198	Ref. No.	2919
description	sliding plate sliding plate		
For models:	F-1221-N, F-1221-REVOL, F-400, F-430, F-532		

hinge pins			
			
1			
GEV No.	508225	Ref. No.	3167
description	hinge pin hinge pin		
For models:	F-1221-N, F-430, F-532		

door bumpers			
			
1			
GEV No.	508256	Ref. No.	4609
description	door bumper guide washer SS		
For models:	F-1221-N, F-430, F-532		

locks			
			
1			
GEV No.	508102	Ref. No.	2194
description	door catch complete catch		
For models:	F-1221-N, F-1221-REVOL, F-400, F-430, F-532		

miscellaneous			
			
1			
GEV No.	508223	Ref. No.	3165
description	bush bush		
For models:	F-1221-N, F-1221-REVOL, F-400, F-430, F-532		

			
1			
GEV No.	508362	Ref. No.	4438
description	deflector drop collecting tank		
For models:	F-1221-N, F-430, F-532		

			
1			
GEV No.	508360	Ref. No.	897
description	nut microswitch nut		
For models:	F-1221-N, F-1221-REVOL, F-400, F-430, F-532		



1	
GEV No.	508222
Ref. No.	3164
description	nut nut
For models:	F-1221-N, F-1221-REVOL, F-400, F-430, F-532

screw connections

1	
GEV No.	508116
Ref. No.	2450
description	union nut thread M10x1 H 16mm WS 16 plastic Qty 1 pcs
For models:	F-1040, F-1221-N, F-1221-REVOL, F-400, F-430, F-532

washing and rinsing systems

1	
GEV No.	508241
Ref. No.	4120 4807 4808 4810 4943
description	manifold 3-way hose ø 12-12-12mm plastic
For models:	F-1040, F-1221-N, F-1221-REVOL, F-400, F-430, F-532

1	
GEV No.	508195
Ref. No.	2904
description	throttle disc
For models:	F-1040, F-430, F-532



knobs

producer-specific knobs

RST-FIAMMA

1	
GEV No.	110432
Ref. No.	4.0.075.0040
description	knob switch zero mark t.max.°C temperature range°C ø 42mm shaft ø 6x4.6mm shaft flat upper black
For models:	AEF-15.30, AEF-30.60, EF-15.30, FCF10, FCF10+10, FCF10+10-TR, FCF10-TR, FCF15+15, FCF15-TR, FCF6, FCF6+6, FF10, FF-10, FF10+10, FF-10+10, FF10+10TR, FF-10+10-TR, FF10+10TR-NV, FF10-NV, FF10TR, FF-10-TR, FF10TR-NV, FF15+15TR, FF-15+15-TR, FF15TR, FF-15-TR, FF6, FF6+6, FF6+6-NV, TOSTI-D3, TOSTI-S3, TRD-30.2, TRS-20.2

1	
GEV No.	110439
Ref. No.	4.0.066.0112
description	knob thermostat t.max. 250°C temperature range 50-250°C ø 50mm shaft ø 6x4.6mm shaft flat upper black
For models:	GR-4.1-L, GR-4.1-LTL, GR-4.2, GR-6.1, GR-6.1-L, GR-6.1-LTL, GR-8, GR-8.1-L, GR-8.2, GR-8.2-L, GR-8.2-LTL, GR-8-L, GR-M, GR-M.1, GR-M.2, GR-M.2-TLC, PPEF-600, PPEF-600-CRD, PPEF-800, PPEF-800-CRD, PPEF-M-600, PPEF-M-600-CRD, PPEF-M-800, PPEF-M-800-CRD

1	
GEV No.	111487
Ref. No.	4.0.066.0100
description	knob thermostat t.max. 250°C temperature range 50-250°C ø 53mm shaft ø 6x4.6mm shaft flat upper rotation 270° black
For models:	PPEF-800-CRD, PPEF-800-MN
accessories for	111487
	GEV No. 111490 Ref. No. —
	gasket for knob ED ø 51mm Qty 1 pcs plastic

steam/water taps

steam/water taps

1	
GEV No.	111389
Ref. No.	4.0.002.0029
description	knob ø 40mm L 42mm black
For models:	MARINA, MARINA-CV, MARINA-CV-DI, MINIBAR-NV





1	
GEV No.	111272
Ref. No.	4.0.016.0023
description	turning handle ø 42.5mm L 53mm thread Tr18x2 black
For models:	ATLANTIC-I-CV-NV, ATLANTIC-I-CV-PCI-NV, ATLANTIC-I-CV-TI-NV, ATLANTIC-II-COMPACT, ATLANTIC-II-CV-COMPACT, ATLANTIC-II-CV-NV, ATLANTIC-II-CV-PCI-NV, ATLANTIC-II-CV-TALL-CUPS, ATLANTIC-II-CV-TI-COMPACT, ATLANTIC-II-CV-TI-NV, ATLANTIC-II-CV-TI-TALL-CUPS, ATLANTIC-III, ATLANTIC-III-CV, ATLANTIC-III-CV-TI, ATLANTIC-III-TI, ATLANTIC-II-NV, ATLANTIC-II-PCI-NV, ATLANTIC-II-TALL-CUPS, ATLANTIC-II-TI-NV, ATLANTIC-I-PCI-NV, ATLANTIC-I-TI-NV, PACIFIC-2CV, PACIFIC-3CV, PACIFIC-3CV-W, PRESTIGE-II-CV-ECC, PRESTIGE-II-CV-REVOL, PRESTIGE-II-ECC, PRESTIGE-III-CV-REVOL, PRESTIGE-III-REVOL, PRESTIGE-II-REVOL
accessories for	111272
	GEV No. 111269 Ref. No. 4.0.016.0028
	symbol water ø 28mm L 27mm black
	GEV No. 111270 Ref. No. 4.0.016.0027
	symbol steam ø 28mm L 27mm black

Table continues overleaf



accessories for 111272			
	GEV No.	111273	Ref. No. 4.0.016.0025
cotter pin ø 1.3mm L 25mm			

knob dial plates

	1		
GEV No.	525829	Ref. No.	4.0.016.0024
description	plain washer with turning handle ø 21.5mm ID ø 6.5mm thickness 2mm brass		
For models:	ATLANTIC-I-CV-NV, ATLANTIC-I-CV-PCI-NV, ATLANTIC-I-CV-TI-NV, ATLANTIC-II-COMPACT, ATLANTIC-II-CV-COMPACT, ATLANTIC-II-CV-NV, ATLANTIC-II-CV-PCI-NV, ATLANTIC-II-CV-TALL-CUPS, ATLANTIC-II-CV-TI-COMPACT, ATLANTIC-II-CV-TI-NV, ATLANTIC-II-CV-TI-TALL-CUPS, ATLANTIC-III, ATLANTIC-III-CV, ATLANTIC-III-CV-TI, ATLANTIC-III-TI, ATLANTIC-II-NV, ATLANTIC-II-PCI-NV, ATLANTIC-II-TALL-CUPS, ATLANTIC-II-TI-NV, ATLANTIC-I-PCI-NV, ATLANTIC-I-TI-NV, PACIFIC-2CV, PACIFIC-3CV, PACIFIC-3CV-W, PRESTIGE-II-CV-ECC, PRESTIGE-II-CV-REVOL, PRESTIGE-II-ECC, PRESTIGE-III-CV-REVOL, PRESTIGE-III-REVOL, PRESTIGE-II-REVOL		

	1		
GEV No.	111270	Ref. No.	4.0.016.0027
description	symbol steam ø 28mm L 27mm black		
For models:	ATLANTIC-I-CV-NV, ATLANTIC-I-CV-PCI-NV, ATLANTIC-I-CV-TI-NV, ATLANTIC-II-COMPACT, ATLANTIC-II-CV-COMPACT, ATLANTIC-II-CV-NV, ATLANTIC-II-CV-PCI-NV, ATLANTIC-II-CV-TALL-CUPS, ATLANTIC-II-CV-TI-COMPACT, ATLANTIC-II-CV-TI-NV, ATLANTIC-II-CV-TI-TALL-CUPS, ATLANTIC-III, ATLANTIC-III-CV, ATLANTIC-III-CV-TI, ATLANTIC-III-TI, ATLANTIC-II-NV, ATLANTIC-II-PCI-NV, ATLANTIC-II-TALL-CUPS, ATLANTIC-II-TI-NV, ATLANTIC-I-PCI-NV, ATLANTIC-I-TI-NV, PACIFIC-2CV, PACIFIC-3CV, PACIFIC-3CV-W, PRESTIGE-II-CV-ECC, PRESTIGE-II-CV-REVOL, PRESTIGE-II-ECC, PRESTIGE-III-CV-REVOL, PRESTIGE-III-REVOL, PRESTIGE-II-REVOL		

	1		
GEV No.	111269	Ref. No.	4.0.016.0028
description	symbol water ø 28mm L 27mm black		
For models:	ATLANTIC-I-CV-NV, ATLANTIC-I-CV-PCI-NV, ATLANTIC-I-CV-TI-NV, ATLANTIC-II-COMPACT, ATLANTIC-II-CV-COMPACT, ATLANTIC-II-CV-NV, ATLANTIC-II-CV-PCI-NV, ATLANTIC-II-CV-TALL-CUPS, ATLANTIC-II-CV-TI-COMPACT, ATLANTIC-II-CV-TI-NV, ATLANTIC-II-CV-TI-TALL-CUPS, ATLANTIC-III, ATLANTIC-III-CV, ATLANTIC-III-CV-TI, ATLANTIC-III-TI, ATLANTIC-II-NV, ATLANTIC-II-PCI-NV, ATLANTIC-II-TALL-CUPS, ATLANTIC-II-TI-NV, ATLANTIC-I-PCI-NV, ATLANTIC-I-TI-NV, PACIFIC-2CV, PACIFIC-3CV, PRESTIGE-II-CV-ECC, PRESTIGE-II-CV-REVOL, PRESTIGE-II-ECC, PRESTIGE-III-CV-REVOL, PRESTIGE-III-REVOL, PRESTIGE-II-REVOL		

accessories

	1		
GEV No.	111273	Ref. No.	4.0.016.0025
description	cotter pin ø 1.3mm L 25mm		
For models:	ATLANTIC-I-CV-NV, ATLANTIC-I-CV-PCI-NV, ATLANTIC-I-CV-TI-NV, ATLANTIC-II-COMPACT, ATLANTIC-II-CV-COMPACT, ATLANTIC-II-CV-NV, ATLANTIC-II-CV-PCI-NV, ATLANTIC-II-CV-TALL-CUPS, ATLANTIC-II-CV-TI-COMPACT, ATLANTIC-II-CV-TI-NV, ATLANTIC-II-CV-TI-TALL-CUPS, ATLANTIC-III, ATLANTIC-III-CV, ATLANTIC-III-CV-TI, ATLANTIC-III-TI, ATLANTIC-II-NV, ATLANTIC-II-PCI-NV, ATLANTIC-II-TALL-CUPS, ATLANTIC-II-TI-NV, ATLANTIC-I-PCI-NV, ATLANTIC-I-TI-NV, PACIFIC-2CV, PACIFIC-3CV, PACIFIC-3CV-W, PRESTIGE-II-CV-ECC, PRESTIGE-II-CV-REVOL, PRESTIGE-II-ECC, PRESTIGE-III-CV-REVOL, PRESTIGE-III-REVOL, PRESTIGE-II-REVOL		

miscellaneous

	1		
GEV No.	111390	Ref. No.	4.0.025.0015
description	knob ø 25.5mm L 38mm black		
For models:	ATLANTIC-I-CV-NV, ATLANTIC-I-CV-PCI-NV, ATLANTIC-I-CV-TI-NV, ATLANTIC-II-COMPACT, ATLANTIC-II-CV-COMPACT, ATLANTIC-II-CV-NV, ATLANTIC-II-CV-PCI-NV, ATLANTIC-II-CV-TALL-CUPS, ATLANTIC-II-CV-TI-COMPACT, ATLANTIC-II-CV-TI-NV, ATLANTIC-II-CV-TI-TALL-CUPS, ATLANTIC-III, ATLANTIC-III-CV, ATLANTIC-III-CV-TI, ATLANTIC-III-TI, ATLANTIC-II-NV, ATLANTIC-II-PCI-NV, ATLANTIC-II-TALL-CUPS, ATLANTIC-II-TI-NV, ATLANTIC-I-PCI-NV, ATLANTIC-I-TI-NV, Prestige-II, PRESTIGE-II-CV-ECC, PRESTIGE-II-CV-REVOL, PRESTIGE-II-ECC, Prestige-III, PRESTIGE-III-CV-REVOL, PRESTIGE-III-REVOL, PRESTIGE-II-REVOL		

handles and hand wheels

cone handles

	1		
GEV No.	110461	Ref. No.	4.0.066.0046
description	cone handle plastic black		
For models:	GR-4.1-L, GR-4.2, GR-6.1, GR-6.1-L, GR-6.1-LTL, GR-8.2, GR-8.2-L, GR-M.2		

handle rails

end caps

	1		
GEV No.	508338	Ref. No.	126010
description	end cap mounting pos. left		
For models:	F-430, F-532		

	1		
GEV No.	508339	Ref. No.	126011
description	end cap mounting pos. right		
For models:	F-430, F-532		

folding grill handles



1

GEV No.	514174	Ref. No.	7.0.066.0023
description	lever ø 10mm left		
For models:	GR-4.1-L, GR-4.1-LTL, GR-4.2, GR-8.1-L, GR-8.2, GR-8.2-L, GR-8.2-LTL, GR-M.1, GR-M.2, GR-M.2-TLC		



1



GEV No.	514173	Ref. No.	7.0.066.0025
description	lever ø 10mm right		
For models:	GR-4.1-L, GR-4.1-LTL, GR-4.2, GR-8.1-L, GR-8.2, GR-8.2-L, GR-8.2-LTL, GR-M.1, GR-M.2, GR-M.2-TLC		

hinges

door bearing





1

GEV No.	701297	Ref. No.	10247
description	hinge L 103mm W 33mm H 15mm mounting pos. left with base plate for dishwasher Qty 1 pcs		
For models:	F-1221-REVOL, F-400		
spare parts for	701297		
	GEV No.	701298	Ref. No. 10294
	base plate plastic L 113mm W 33mm thickness 1.5mm for hinge mounting pos. left/right Qty 1 pcs		
accessories for	701297		
	GEV No.	701298	Ref. No. 10294
	base plate plastic L 113mm W 33mm thickness 1.5mm for hinge mounting pos. left/right Qty 1 pcs		



1

GEV No.	701296	Ref. No.	10246
description	hinge L 103mm W 33mm H 15mm mounting pos. right with base plate for dishwasher		
For models:	F-1221-REVOL, F-400		
spare parts for	701296		
	GEV No.	701298	Ref. No. 10294
	base plate plastic L 113mm W 33mm thickness 1.5mm for hinge mounting pos. left/right Qty 1 pcs		
accessories for	701296		
	GEV No.	701298	Ref. No. 10294
	base plate plastic L 113mm W 33mm thickness 1.5mm for hinge mounting pos. left/right Qty 1 pcs		

accessories

base plate



1

GEV No.	519414	Ref. No.	3159
description	base plate L 37mm W 15mm for hinge		
For models:	F-1221-N, F-430, F-532		



1

GEV No.	701298	Ref. No.	10294
description	base plate plastic L 113mm W 33mm thickness 1.5mm for hinge mounting pos. left/right Qty 1 pcs		
For models:	F-1221-REVOL, F-400		

baskets

fryer baskets

RST-FIAMMA



1

GEV No.	970336	Ref. No.	4.0.085.0031
description	fryer basket L1 255mm W1 190mm H1 95mm		
For models:	FF6, FF6+6		





1

GEV No.	970991	Ref. No.	4.0.085.1031
description	fryer basket W1 225mm L1 255mm H1 100mm		
For models:	FF10+10TR-NV, FF10-NV, FF10TR-NV, FF6+6-NV		

accessories

cutlery inserts



1

GEV No.	976011	Ref. No.	189
description	cutlery insert Lmm Wmm ø 110mm H 130mm		
For models:	F-1040, F-430, F-532		

warewashing baskets

plastic baskets square

mix baskets



1

GEV No.	971058	Ref. No.	2461 2461S
description	mix basket L 350mm W 350mm H 150mm		
For models:	F-1221-N, F-1221-REVOL		

plate inserts



1

GEV No.	508026	Ref. No.	187
description	plate insert		
For models:	F-1040, F-1221-N, F-1221-REVOL, F-400, F-430, F-532		



1

GEV No.	971078	Ref. No.	21455
description	mix basket L 400mm W 400mm H 150mm		
For models:	F-400		

gaskets

O-rings

EPDM

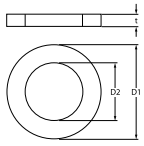
1

GEV No.	510303	Ref. No.	2531
description	O-ring EPDM thickness 1.78mm ID ø 6.75mm Qty 1 pcs		
For models:	F-1040, F-1221-N, F-1221-REVOL, F-400, F-430, F-532		



1

GEV No.	970696	Ref. No.	2491
description	mix basket L 450mm W 450mm H 165mm		
For models:	F-430		

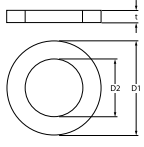
1

GEV No.	525821	Ref. No.	5.0.016.0251
description	O-ring EPDM thickness 1.9mm ID ø 4.9mm Qty 1 pcs		
For models:	PRESTIGE-II-CV-REVOL, PRESTIGE-III-CV-REVOL, PRESTIGE-III-REVOL, PRESTIGE-II-REVOL		

plate baskets



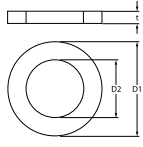

1

GEV No.	970694	Ref. No.	2492
description	plate basket L 450mm W 450mm H 106mm plates 14		
For models:	F-430		

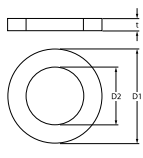
 			
GEV No.	525255	Ref. No.	5.0.000.0565
description	O-ring EPDM thickness 1.9mm ID ø 7.2mm Qty 1 pcs		
For models:	ATLANTIC-I-CV-NV, ATLANTIC-I-CV-PCI-NV, ATLANTIC-I-CV-TI-NV, ATLANTIC-II-COMPACT, ATLANTIC-II-CV-COMPACT, ATLANTIC-II-CV-NV, ATLANTIC-II-CV-PCI-NV, ATLANTIC-II-CV-TALL-CUPS, ATLANTIC-II-CV-TI-COMPACT, ATLANTIC-II-CV-TI-NV, ATLANTIC-II-CV-TI-TALL-CUPS, ATLANTIC-III, ATLANTIC-III-CV, ATLANTIC-III-CV-TI, ATLANTIC-III-TI, ATLANTIC-II-NV, ATLANTIC-II-PCI-NV, ATLANTIC-II-TALL-CUPS, ATLANTIC-II-TI-NV, ATLANTIC-I-PCI-NV, ATLANTIC-I-TI-NV, MARINA, MARINA-CV, MARINA-CV-DI, PACIFIC-2CV, PACIFIC-3CV, PACIFIC-3CV-W, Prestige-II, PRESTIGE-II-CV-ECC, PRESTIGE-II-CV-REVOL, PRESTIGE-II-ECC, Prestige-III, PRESTIGE-III-CV-REVOL, PRESTIGE-III-REVOL, PRESTIGE-II-REVOL, Superbar		

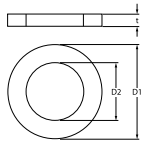
 			
GEV No.	529412	Ref. No.	5.0.000.0560
description	O-ring EPDM thickness 2.62mm ID ø 10.78mm Qty 1 pcs		
For models:	Prestige-II, PRESTIGE-II-CV-REVOL, Prestige-III, PRESTIGE-III-CV-REVOL, PRESTIGE-III-REVOL, PRESTIGE-II-REVOL		

 			
GEV No.	528223	Ref. No.	123 5.0.025.0205
description	O-ring EPDM thickness 2.62mm ID ø 11.91mm Qty 1 pcs		
For models:	ATLANTIC-I-CV-NV, ATLANTIC-I-CV-PCI-NV, ATLANTIC-I-CV-TI-NV, ATLANTIC-II-COMPACT, ATLANTIC-II-CV-COMPACT, ATLANTIC-II-CV-NV, ATLANTIC-II-CV-PCI-NV, ATLANTIC-II-CV-TALL-CUPS, ATLANTIC-II-CV-TI-COMPACT, ATLANTIC-II-CV-TI-NV, ATLANTIC-II-CV-TI-TALL-CUPS, ATLANTIC-III, ATLANTIC-III-CV, ATLANTIC-III-CV-TI, ATLANTIC-III-TI, ATLANTIC-II-NV, ATLANTIC-II-PCI-NV, ATLANTIC-II-TALL-CUPS, ATLANTIC-II-TI-NV, ATLANTIC-I-PCI-NV, ATLANTIC-I-TI-NV, F-1040, F-1221-N, F-430, F-532, PACIFIC-2CV, PACIFIC-3CV, PACIFIC-3CV-W, PRESTIGE-II-CV-ECC, PRESTIGE-II-CV-REVOL, PRESTIGE-II-ECC, PRESTIGE-III-CV-REVOL, PRESTIGE-III-REVOL, PRESTIGE-II-REVOL		

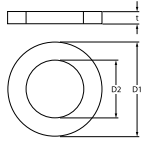
 			
GEV No.	508008	Ref. No.	93
description	O-ring EPDM thickness 2.62mm ID ø 15.88mm Qty 1 pcs		
For models:	F-1040, F-1221-N, F-1221-REVOL, F-400, F-430, F-532		

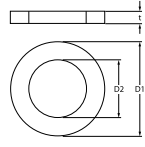
 			
GEV No.	505073	Ref. No.	25 5.0.025.0026
description	O-ring EPDM thickness 2.62mm ID ø 20.63mm Qty 1 pcs		
For models:	F-1040, F-430, F-532, PACIFIC-2CV, PACIFIC-3CV, PACIFIC-3CV-W, PRESTIGE-II-CV-REVOL, PRESTIGE-III-CV-REVOL, PRESTIGE-III-REVOL, PRESTIGE-II-REVOL		

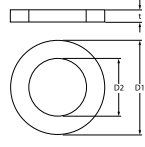
 			
GEV No.	510893	Ref. No.	697
description	O-ring EPDM thickness 2.62mm ID ø 9.92mm Qty 1 pcs		
For models:	F-1040, F-1221-N, F-1221-REVOL, F-400, F-430, F-532		

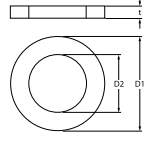
 			
GEV No.	528813	Ref. No.	5.0.016.0225
description	O-ring EPDM thickness 2mm ID ø 17mm Qty 1 pcs		
For models:	ATLANTIC-I-CV-NV, ATLANTIC-I-CV-PCI-NV, ATLANTIC-I-CV-TI-NV, ATLANTIC-II-COMPACT, ATLANTIC-II-CV-COMPACT, ATLANTIC-II-CV-NV, ATLANTIC-II-CV-PCI-NV, ATLANTIC-II-CV-TALL-CUPS, ATLANTIC-II-CV-TI-COMPACT, ATLANTIC-II-CV-TI-NV, ATLANTIC-II-CV-TI-TALL-CUPS, ATLANTIC-III, ATLANTIC-III-CV, ATLANTIC-III-CV-TI, ATLANTIC-III-TI, ATLANTIC-II-NV, ATLANTIC-II-PCI-NV, ATLANTIC-II-TALL-CUPS, ATLANTIC-II-TI-NV, ATLANTIC-I-PCI-NV, ATLANTIC-I-TI-NV, MARINA, MARINA-CV, MARINA-CV-DI, PACIFIC-2CV, PACIFIC-3CV, PACIFIC-3CV-W, PRESTIGE-II-CV-ECC, PRESTIGE-II-CV-REVOL, PRESTIGE-II-ECC, PRESTIGE-III-CV-REVOL, PRESTIGE-III-REVOL, PRESTIGE-II-REVOL		

 			
GEV No.	361311	Ref. No.	5.0.016.0306
description	O-ring EPDM thickness 2mm ID ø 6mm Qty 1 pcs for type N6		
For models:	ATLANTIC-I-CV-NV, ATLANTIC-I-CV-PCI-NV, ATLANTIC-I-CV-TI-NV, ATLANTIC-II-COMPACT, ATLANTIC-II-CV-COMPACT, ATLANTIC-II-CV-NV, ATLANTIC-II-CV-PCI-NV, ATLANTIC-II-CV-TALL-CUPS, ATLANTIC-II-CV-TI-COMPACT, ATLANTIC-II-CV-TI-NV, ATLANTIC-II-CV-TI-TALL-CUPS, ATLANTIC-III, ATLANTIC-III-CV, ATLANTIC-III-CV-TI, ATLANTIC-III-TI, ATLANTIC-II-NV, ATLANTIC-II-PCI-NV, ATLANTIC-II-TALL-CUPS, ATLANTIC-II-TI-NV, ATLANTIC-I-PCI-NV, ATLANTIC-I-TI-NV, PACIFIC-2CV, PACIFIC-3CV, PACIFIC-3CV-W, PRESTIGE-II-CV-ECC, PRESTIGE-II-CV-REVOL, PRESTIGE-II-ECC, PRESTIGE-III-CV-REVOL, PRESTIGE-III-REVOL, PRESTIGE-II-REVOL		

GEV No.	508061	Ref. No.	1633
description	O-ring EPDM thickness 3.53mm ID \varnothing 42.86mm Qty 1 pcs		
For models:	F-1040, F-1221-N, F-1221-REVOL, F-400, F-430, F-532		

GEV No.	532534	Ref. No.	5206
description	O-ring EPDM thickness 3.53mm ID \varnothing 82.14mm Qty 1 pcs		
For models:	F-1221-N		

GEV No.	508109	Ref. No.	2374
description	O-ring EPDM thickness 5.34mm ID \varnothing 69.22mm Qty 1 pcs		
For models:	F-1040, F-430, F-532		

GEV No.	521121	Ref. No.	57
description	O-ring EPDM thickness 8mm ID \varnothing 62mm Qty 1 pcs		
For models:	F-1040, F-1221-N, F-1221-REVOL, F-400, F-430, F-532		

Viton

GEV No.	532560	Ref. No.	5.0.025.0005
description	O-ring Viton thickness 2.62mm ID \varnothing 20.63mm Qty 1 pcs		
For models:	PACIFIC-2CV, PACIFIC-3CV, PACIFIC-3CV-W, PRESTIGE-II-CV-REVOL, PRESTIGE-III-CV-REVOL, PRESTIGE-III-REVOL, PRESTIGE-II-REVOL		

sealing washers

rubber gaskets

GEV No.	508011	Ref. No.	109
description	flat gasket rubber D1 \varnothing 45mm D2 \varnothing 26mm thickness 2mm equiv. no. for model Aliseo/Master/Minibar/Gemini/Program		
For models:	F-1221-N, F-1221-REVOL, F-400		

GEV No.	508029	Ref. No.	204
description	flat gasket rubber D1 \varnothing 59mm D2 \varnothing 45mm thickness 2.5mm Qty 1 pcs for model AE/AL/AP/AS/GL/F		
For models:	F-1040, F-430, F-532		

GEV No.	508215	Ref. No.	3086
description	flat gasket rubber ED \varnothing 40mm ID \varnothing 27mm thickness 1.4mm Qty 1 pcs		
For models:	F-1040, F-1221-N, F-430, F-532		

copper gaskets

DIN-7603-A

GEV No.	526461	Ref. No.	5.0.016.0303
description	flat gasket copper ED \varnothing 22mm ID \varnothing 17mm thickness 2mm Qty 1 pcs		
For models:	ATLANTIC-I-CV-NV, ATLANTIC-I-CV-PCI-NV, ATLANTIC-I-CV-TI-NV, ATLANTIC-II-COMPACT, ATLANTIC-II-CV-COMPACT, ATLANTIC-II-CV-NV, ATLANTIC-II-CV-PCI-NV, ATLANTIC-II-CV-TALL-CUPS, ATLANTIC-II-CV-TI-COMPACT, ATLANTIC-II-CV-TI-NV, ATLANTIC-II-CV-TI-TALL-CUPS, ATLANTIC-III, ATLANTIC-III-CV, ATLANTIC-III-CV-TI, ATLANTIC-III-TI, ATLANTIC-II-NV, ATLANTIC-II-PCI-NV, ATLANTIC-II-TALL-CUPS, ATLANTIC-II-TI-NV, ATLANTIC-I-PCI-NV, ATLANTIC-I-TI-NV, PACIFIC-2CV, PACIFIC-3CV, PACIFIC-3CV-W, PRESTIGE-II-CV-ECC, PRESTIGE-II-CV-REVOL, PRESTIGE-II-ECC, PRESTIGE-III-CV-REVOL, PRESTIGE-III-REVOL, PRESTIGE-II-REVOL		

DIN-7603-C

GEV No.	525819	Ref. No.	4.0.000.0013
description	gasket copper ED \varnothing 17mm ID \varnothing 13mm thickness 2mm for thread 1/4" Qty 1 pcs		
For models:	ATLANTIC-I-CV-NV, ATLANTIC-I-CV-PCI-NV, ATLANTIC-I-CV-TI-NV, ATLANTIC-II-COMPACT, ATLANTIC-II-CV-COMPACT, ATLANTIC-II-CV-NV, ATLANTIC-II-CV-PCI-NV, ATLANTIC-II-CV-TALL-CUPS, ATLANTIC-II-CV-TI-COMPACT, ATLANTIC-II-CV-TI-NV, ATLANTIC-II-CV-TI-TALL-CUPS, ATLANTIC-III, ATLANTIC-III-CV, ATLANTIC-III-CV-TI, ATLANTIC-III-TI, ATLANTIC-II-NV, ATLANTIC-II-PCI-NV, ATLANTIC-II-TALL-CUPS, ATLANTIC-II-TI-NV, ATLANTIC-I-PCI-NV, ATLANTIC-I-TI-NV, MARINA, MARINA-CV, MARINA-CV-DI, PACIFIC-2CV, PACIFIC-3CV, PACIFIC-3CV-W, PRESTIGE-II-CV-ECC, PRESTIGE-II-CV-REVOL, PRESTIGE-II-ECC, PRESTIGE-III-CV-REVOL, PRESTIGE-III-REVOL, PRESTIGE-II-REVOL		

PTFE gaskets



GEV No.	508049	Ref. No.	1173
description	flat gasket PTFE ED ø 16mm ID ø 10mm thickness 2mm Qty 1 pcs		
For models:	F-1040, F-1221-N, F-1221-REVOL, F-400, F-430, F-532		



GEV No.	525609	Ref. No.	5.0.000.0315
description	flat gasket PTFE ED ø 18mm ID ø 13.5mm thickness 2mm Qty 1 pcs		
For models:	ATLANTIC-I-CV-NV, ATLANTIC-I-CV-PCI-NV, ATLANTIC-I-CV-TI-NV, ATLANTIC-II-COMPACT, ATLANTIC-II-CV-COMPACT, ATLANTIC-II-CV-NV, ATLANTIC-II-CV-PCI-NV, ATLANTIC-II-CV-TALL-CUPS, ATLANTIC-II-CV-TI-COMPACT, ATLANTIC-II-CV-TI-NV, ATLANTIC-II-CV-TI-TALL-CUPS, ATLANTIC-III, ATLANTIC-III-CV, ATLANTIC-III-CV-TI, ATLANTIC-III-TI, ATLANTIC-II-NV, ATLANTIC-II-PCI-NV, ATLANTIC-II-TALL-CUPS, ATLANTIC-II-TI-NV, ATLANTIC-I-PCI-NV, ATLANTIC-I-TI-NV, MARINA, MARINA-CV, MARINA-CV-DI, PACIFIC-2CV, PACIFIC-3CV, PACIFIC-3CV-W, Prestige-II, PRESTIGE-II-CV-ECC, PRESTIGE-II-CV-REVOL, PRESTIGE-II-ECC, Prestige-III, PRESTIGE-III-CV-REVOL, PRESTIGE-III-REVOL, PRESTIGE-II-REVOL, Superbar		



GEV No.	359332	Ref. No.	5.0.025.1386
description	flat gasket PTFE ED ø 21mm ID ø 16.8mm thickness 1.7mm Qty 1 pcs		
For models:	ATLANTIC-I-CV-NV, ATLANTIC-I-CV-PCI-NV, ATLANTIC-I-CV-TI-NV, ATLANTIC-II-COMPACT, ATLANTIC-II-CV-COMPACT, ATLANTIC-II-CV-NV, ATLANTIC-II-CV-PCI-NV, ATLANTIC-II-CV-TALL-CUPS, ATLANTIC-II-CV-TI-COMPACT, ATLANTIC-II-CV-TI-NV, ATLANTIC-II-CV-TI-TALL-CUPS, ATLANTIC-III, ATLANTIC-III-CV, ATLANTIC-III-CV-TI, ATLANTIC-III-TI, ATLANTIC-II-NV, ATLANTIC-II-PCI-NV, ATLANTIC-II-TALL-CUPS, ATLANTIC-II-TI-NV, ATLANTIC-I-PCI-NV, ATLANTIC-I-TI-NV, MARINA, MARINA-CV, MARINA-CV-DI, PACIFIC-2CV, PACIFIC-3CV, PACIFIC-3CV-W, PRESTIGE-II-CV-ECC, PRESTIGE-II-CV-REVOL, PRESTIGE-II-ECC, PRESTIGE-III-CV-REVOL, PRESTIGE-III-REVOL, PRESTIGE-II-REVOL		



GEV No.	525611	Ref. No.	5.0.025.0022
description	flat gasket PTFE ED ø 22mm ID ø 17mm thickness 2mm Qty 1 pcs		
For models:	ATLANTIC-I-CV-NV, ATLANTIC-I-CV-PCI-NV, ATLANTIC-I-CV-TI-NV, ATLANTIC-II-COMPACT, ATLANTIC-II-CV-COMPACT, ATLANTIC-II-CV-NV, ATLANTIC-II-CV-PCI-NV, ATLANTIC-II-CV-TALL-CUPS, ATLANTIC-II-CV-TI-COMPACT, ATLANTIC-II-CV-TI-NV, ATLANTIC-II-CV-TI-TALL-CUPS, ATLANTIC-III, ATLANTIC-III-CV, ATLANTIC-III-CV-TI, ATLANTIC-III-TI, ATLANTIC-II-NV, ATLANTIC-II-PCI-NV, ATLANTIC-II-TALL-CUPS, ATLANTIC-II-TI-NV, ATLANTIC-I-PCI-NV, ATLANTIC-I-TI-NV, MARINA, MARINA-CV, MARINA-CV-DI, PACIFIC-2CV, PACIFIC-3CV, PACIFIC-3CV-W, PRESTIGE-II-CV-ECC, PRESTIGE-II-CV-REVOL, PRESTIGE-II-ECC, PRESTIGE-III-CV-REVOL, PRESTIGE-III-REVOL, PRESTIGE-II-REVOL		



GEV No.	526265	Ref. No.	5.0.016.0211
description	flat gasket PTFE ED ø 24mm ID ø 19mm thickness 2mm Qty 1 pcs		
For models:	ATLANTIC-I-CV-NV, ATLANTIC-I-CV-PCI-NV, ATLANTIC-I-CV-TI-NV, ATLANTIC-II-COMPACT, ATLANTIC-II-CV-COMPACT, ATLANTIC-II-CV-NV, ATLANTIC-II-CV-PCI-NV, ATLANTIC-II-CV-TALL-CUPS, ATLANTIC-II-CV-TI-COMPACT, ATLANTIC-II-CV-TI-NV, ATLANTIC-II-CV-TI-TALL-CUPS, ATLANTIC-III, ATLANTIC-III-CV, ATLANTIC-III-CV-TI, ATLANTIC-III-TI, ATLANTIC-II-NV, ATLANTIC-II-PCI-NV, ATLANTIC-II-TALL-CUPS, ATLANTIC-II-TI-NV, ATLANTIC-I-PCI-NV, ATLANTIC-I-TI-NV, PACIFIC-2CV, PACIFIC-3CV, PACIFIC-3CV-W, PRESTIGE-II-CV-ECC, PRESTIGE-II-CV-REVOL, PRESTIGE-II-ECC, PRESTIGE-III-CV-REVOL, PRESTIGE-III-REVOL, PRESTIGE-II-REVOL		



GEV No.	528683	Ref. No.	5.0.016.0106
description	flat gasket PTFE ED ø 26mm ID ø 21mm thickness 2mm Qty 1 pcs suitable for GAGGIA, SPAZIALE		
For models:	ATLANTIC-I-CV-NV, ATLANTIC-I-CV-PCI-NV, ATLANTIC-I-CV-TI-NV, ATLANTIC-II-COMPACT, ATLANTIC-II-CV-COMPACT, ATLANTIC-II-CV-NV, ATLANTIC-II-CV-PCI-NV, ATLANTIC-II-CV-TALL-CUPS, ATLANTIC-II-CV-TI-COMPACT, ATLANTIC-II-CV-TI-NV, ATLANTIC-II-CV-TI-TALL-CUPS, ATLANTIC-III, ATLANTIC-III-CV, ATLANTIC-III-CV-TI, ATLANTIC-III-TI, ATLANTIC-II-NV, ATLANTIC-II-PCI-NV, ATLANTIC-II-TALL-CUPS, ATLANTIC-II-TI-NV, ATLANTIC-I-PCI-NV, ATLANTIC-I-TI-NV, MARINA, MARINA-CV, MARINA-CV-DI, PRESTIGE-II-CV-ECC, PRESTIGE-II-ECC		





GEV No.	526014	Ref. No.	5.0.025.0002
description	flat gasket PTFE ED ø 35mm ID ø 30mm thickness 2mm Qty 1 pcs		
For models:	ATLANTIC-I-CV-NV, ATLANTIC-I-CV-PCI-NV, ATLANTIC-I-CV-TI-NV, ATLANTIC-II-COMPACT, ATLANTIC-II-CV-COMPACT, ATLANTIC-II-CV-NV, ATLANTIC-II-CV-PCI-NV, ATLANTIC-II-CV-TALL-CUPS, ATLANTIC-II-CV-TI-COMPACT, ATLANTIC-II-CV-TI-NV, ATLANTIC-II-CV-TI-TALL-CUPS, ATLANTIC-III, ATLANTIC-III-CV, ATLANTIC-III-CV-TI, ATLANTIC-III-TI, ATLANTIC-II-NV, ATLANTIC-II-PCI-NV, ATLANTIC-II-TALL-CUPS, ATLANTIC-II-TI-NV, ATLANTIC-I-PCI-NV, ATLANTIC-I-TI-NV, MARINA, MARINA-CV, MARINA-CV-DI, PACIFIC-2CV, PACIFIC-3CV, PACIFIC-3CV-W, PRESTIGE-II-CV-ECC, PRESTIGE-II-CV-REVOL, PRESTIGE-II-ECC, PRESTIGE-III-CV-REVOL, PRESTIGE-III-REVOL, PRESTIGE-II-REVOL		



GEV No.	528018	Ref. No.	5.0.000.0305
description	flat gasket PTFE ED ø 41mm ID ø 33mm thickness 3mm size 1" Qty 1 pcs		
For models:	MARINA, MARINA-CV, MARINA-CV-DI, Superbar		





			
GEV No.	528021	Ref. No.	5.0.000.0307
description	flat gasket PTFE ED ø 53mm ID ø 42.5mm thickness 3mm Qty 1 pcs equiv. no. 12001/02286 suitable for Astoria/Aurora/Brasilia/Wega		
For models:	ATLANTIC-I-CV-NV, ATLANTIC-I-CV-PCI-NV, ATLANTIC-I-CV-TI-NV, ATLANTIC-II-COMPACT, ATLANTIC-II-CV-COMPACT, ATLANTIC-II-CV-NV, ATLANTIC-II-CV-PCI-NV, ATLANTIC-II-CV-TALL-CUPS, ATLANTIC-II-CV-TI-COMPACT, ATLANTIC-II-CV-TI-NV, ATLANTIC-II-CV-TI-TALL-CUPS, ATLANTIC-III, ATLANTIC-III-CV, ATLANTIC-III-CV-TI, ATLANTIC-III-TI, ATLANTIC-II-TI-NV, ATLANTIC-II-PCI-NV, ATLANTIC-II-TALL-CUPS, ATLANTIC-II-TI-NV, ATLANTIC-I-PCI-NV, ATLANTIC-I-TI-NV, PACIFIC-2CV, PACIFIC-3CV, PACIFIC-3CV-W, PRESTIGE-II-CV-ECC, PRESTIGE-II-CV-REVOL, PRESTIGE-II-ECC, PRESTIGE-III-CV-REVOL, PRESTIGE-III-REVOL, PRESTIGE-II-REVOL		

<h3>compression springs</h3>			
			
GEV No.	526260	Ref. No.	5.0.016.0302
description	compression spring ø 10.3mm L 31.5mm wire gauge ø 1.2mm		
For models:	ATLANTIC-I-CV-NV, ATLANTIC-I-CV-PCI-NV, ATLANTIC-I-CV-TI-NV, ATLANTIC-II-COMPACT, ATLANTIC-II-CV-COMPACT, ATLANTIC-II-CV-NV, ATLANTIC-II-CV-PCI-NV, ATLANTIC-II-CV-TALL-CUPS, ATLANTIC-II-CV-TI-COMPACT, ATLANTIC-II-CV-TI-NV, ATLANTIC-II-CV-TI-TALL-CUPS, ATLANTIC-III, ATLANTIC-III-CV, ATLANTIC-III-CV-TI, ATLANTIC-III-TI, ATLANTIC-II-TI-NV, ATLANTIC-II-PCI-NV, ATLANTIC-II-TALL-CUPS, ATLANTIC-II-TI-NV, ATLANTIC-I-PCI-NV, ATLANTIC-I-TI-NV, PACIFIC-2CV, PACIFIC-3CV, PACIFIC-3CV-W, PRESTIGE-II-CV-ECC, PRESTIGE-II-CV-REVOL, PRESTIGE-II-ECC, PRESTIGE-III-CV-REVOL, PRESTIGE-III-REVOL, PRESTIGE-II-REVOL		

<h3>foam rubber gaskets</h3>			
			
GEV No.	508406	Ref. No.	6233
description	foam rubber gasket W 9mm thickness 3mm self-adhesive Qty supplied by meter		
For models:	F-1221-REVOL, F-400		

			
GEV No.	525825	Ref. No.	5.0.025.7060
description	spring ø 12mm L 14.5mm wire gauge ø 1.5mm windings 2		
For models:	ATLANTIC-I-CV-NV, ATLANTIC-I-CV-PCI-NV, ATLANTIC-I-CV-TI-NV, ATLANTIC-II-COMPACT, ATLANTIC-II-CV-COMPACT, ATLANTIC-II-CV-NV, ATLANTIC-II-CV-PCI-NV, ATLANTIC-II-CV-TALL-CUPS, ATLANTIC-II-CV-TI-COMPACT, ATLANTIC-II-CV-TI-NV, ATLANTIC-II-CV-TI-TALL-CUPS, ATLANTIC-III, ATLANTIC-III-CV, ATLANTIC-III-CV-TI, ATLANTIC-III-TI, ATLANTIC-II-NV, ATLANTIC-II-PCI-NV, ATLANTIC-II-TALL-CUPS, ATLANTIC-II-TI-NV, ATLANTIC-I-PCI-NV, ATLANTIC-I-TI-NV, PACIFIC-2CV, PACIFIC-3CV, PACIFIC-3CV-W, PRESTIGE-II-CV-ECC, PRESTIGE-II-CV-REVOL, PRESTIGE-II-ECC, PRESTIGE-III-CV-REVOL, PRESTIGE-III-REVOL, PRESTIGE-II-REVOL		

<h3>springs</h3> <h4>torsion springs</h4>			
			
GEV No.	697004	Ref. No.	4.0.066.0020
description	torsion spring		

			
GEV No.	525823	Ref. No.	5.0.016.0214
description	spring ø 14.5mm L 27.5mm wire gauge ø 2mm windings 4		
For models:	ATLANTIC-I-CV-NV, ATLANTIC-I-CV-PCI-NV, ATLANTIC-I-CV-TI-NV, ATLANTIC-II-COMPACT, ATLANTIC-II-CV-COMPACT, ATLANTIC-II-CV-NV, ATLANTIC-II-CV-PCI-NV, ATLANTIC-II-CV-TALL-CUPS, ATLANTIC-II-CV-TI-COMPACT, ATLANTIC-II-CV-TI-NV, ATLANTIC-II-CV-TI-TALL-CUPS, ATLANTIC-III, ATLANTIC-III-CV, ATLANTIC-III-CV-TI, ATLANTIC-III-TI, ATLANTIC-II-NV, ATLANTIC-II-PCI-NV, ATLANTIC-II-TALL-CUPS, ATLANTIC-II-TI-NV, ATLANTIC-I-PCI-NV, ATLANTIC-I-TI-NV, MARINA, MARINA-CV, MARINA-CV-DI, PACIFIC-2CV, PACIFIC-3CV, PACIFIC-3CV-W, PRESTIGE-II-CV-ECC, PRESTIGE-II-CV-REVOL, PRESTIGE-II-ECC, PRESTIGE-III-CV-REVOL, PRESTIGE-III-REVOL, PRESTIGE-II-REVOL		

			
GEV No.	700167	Ref. No.	4.0.066.0020
description	torsion spring ø 26.9mm L2 87mm wire gauge ø 5.1mm L1 23mm L3 11mm		
For models:	CG2x4GGGG, CG2x4GGS, CG2x4SGGG, CG2x4SGS, CG2x4SGSG, CG2x4SSGG, CG2x4SSSS, CG4GG, CG4SG, CG4SS, CG6GG, CG6GG-VITRO, CG6SG, CG6SG-VITRO, CG6SS, CG6SS-VITRO, CG8GG-VITRO, CG8SG-VITRO, CG8SS-VITRO, GA 8.2, GR-4.1-L, GR-4.1-LTL, GR-4.2, GR-6.1, GR-6.1-L, GR-6.1-LTL, GR-8.1-L, GR-8.2, GR-8.2-L, GR-8.2-LTL, GR-M.1, GR-M.2, GR-M.2-TLC, VCR-6C-TC-NV, VCR-6L-TC-NV, VCR-6L-TL-NV, VCR-8C-TC, VCR-8L-TC, VCR-8L-TL		

			
GEV No.	525824	Ref. No.	5.0.016.0234
description	spring ø 8mm L 33mm wire gauge ø 0.4mm windings 11.5		
For models:	ATLANTIC-I-CV-NV, ATLANTIC-I-CV-PCI-NV, ATLANTIC-I-CV-TI-NV, ATLANTIC-II-COMPACT, ATLANTIC-II-CV-COMPACT, ATLANTIC-II-CV-NV, ATLANTIC-II-CV-PCI-NV, ATLANTIC-II-CV-TALL-CUPS, ATLANTIC-II-CV-TI-COMPACT, ATLANTIC-II-CV-TI-NV, ATLANTIC-II-CV-TI-TALL-CUPS, ATLANTIC-III, ATLANTIC-III-CV, ATLANTIC-III-CV-TI, ATLANTIC-III-TI, ATLANTIC-II-NV, ATLANTIC-II-PCI-NV, ATLANTIC-II-TALL-CUPS, ATLANTIC-II-TI-NV, ATLANTIC-I-PCI-NV, ATLANTIC-I-TI-NV, MARINA, MARINA-CV, MARINA-CV-DI, PACIFIC-2CV, PACIFIC-3CV, PACIFIC-3CV-W, PRESTIGE-II-CV-ECC, PRESTIGE-II-CV-REVOL, PRESTIGE-II-ECC, PRESTIGE-III-CV-REVOL, PRESTIGE-III-REVOL, PRESTIGE-II-REVOL		

tension springs

			
1			
GEV No.	508127	Ref. No.	2543
description	tension spring		
For models:	F-1040		

manometers

			
1			
GEV No.	541767	Ref. No.	5.0.000.0391
description	manometer ø 39mm pressure range 0-16bar thread 1/8" marking 7-9 connection on the backside FIAMMA		
For models:	ATLANTIC-I-CV-NV, ATLANTIC-I-CV-PCI-NV, ATLANTIC-I-CV-TI-NV, ATLANTIC-II-CV-NV, ATLANTIC-II-CV-PCI-NV, ATLANTIC-II-CV-TALL-CUPS, ATLANTIC-II-CV-TI-NV, ATLANTIC-II-CV-TI-TALL-CUPS, ATLANTIC-III, ATLANTIC-III-CV, ATLANTIC-III-CV-TI, ATLANTIC-III-TI, ATLANTIC-II-NV, ATLANTIC-II-PCI-NV, ATLANTIC-II-TALL-CUPS, ATLANTIC-II-TI-NV, ATLANTIC-I-PCI-NV, ATLANTIC-I-TI-NV, PACIFIC-2CV, PACIFIC-3CV, PACIFIC-3CV-W, PRESTIGE-II-CV-ECC, PRESTIGE-II-CV-REVOL, PRESTIGE-II-ECC, PRESTIGE-III-CV-REVOL, PRESTIGE-III-REVOL, PRESTIGE-II-REVOL		

			
1			
GEV No.	541768	Ref. No.	5.0.000.0392
description	manometer ø 39mm pressure range 0-3bar FIAMMA thread 1/8" marking 1.5 connection on the backside		
For models:	ATLANTIC-I-CV-NV, ATLANTIC-I-CV-PCI-NV, ATLANTIC-I-CV-TI-NV, ATLANTIC-II-COMPACT, ATLANTIC-II-CV-COMPACT, ATLANTIC-II-CV-NV, ATLANTIC-II-CV-PCI-NV, ATLANTIC-II-CV-TALL-CUPS, ATLANTIC-II-CV-TI-COMPACT, ATLANTIC-II-CV-TI-NV, ATLANTIC-II-CV-TI-TALL-CUPS, ATLANTIC-III, ATLANTIC-III-CV, ATLANTIC-III-CV-TI, ATLANTIC-III-TI, ATLANTIC-II-NV, ATLANTIC-II-PCI-NV, ATLANTIC-II-TALL-CUPS, ATLANTIC-II-TI-NV, ATLANTIC-I-PCI-NV, ATLANTIC-I-TI-NV, MARINA, MARINA-CV, MARINA-CV-DI, PRESTIGE-II-CV-ECC, PRESTIGE-II-CV-REVOL, PRESTIGE-II-ECC, PRESTIGE-III-CV-REVOL, PRESTIGE-III-REVOL, PRESTIGE-II-REVOL		

dosing pumps

membrane dosing pumps



self-priming

LANG

spare parts

			
1			
GEV No.	361311	Ref. No.	5.0.016.0306
description	O-ring EPDM thickness 2mm ID ø 6mm Qty 1 pcs for type N6		
For models:	ATLANTIC-I-CV-NV, ATLANTIC-I-CV-PCI-NV, ATLANTIC-I-CV-TI-NV, ATLANTIC-II-COMPACT, ATLANTIC-II-CV-COMPACT, ATLANTIC-II-CV-NV, ATLANTIC-II-CV-PCI-NV, ATLANTIC-II-CV-TALL-CUPS, ATLANTIC-II-CV-TI-COMPACT, ATLANTIC-II-CV-TI-NV, ATLANTIC-II-CV-TI-TALL-CUPS, ATLANTIC-III, ATLANTIC-III-CV, ATLANTIC-III-CV-TI, ATLANTIC-III-TI, ATLANTIC-II-NV, ATLANTIC-II-PCI-NV, ATLANTIC-II-TALL-CUPS, ATLANTIC-II-TI-NV, ATLANTIC-I-PCI-NV, ATLANTIC-I-TI-NV, PACIFIC-2CV, PACIFIC-3CV, PACIFIC-3CV-W, PRESTIGE-II-CV-ECC, PRESTIGE-II-CV-REVOL, PRESTIGE-II-ECC, PRESTIGE-III-CV-REVOL, PRESTIGE-III-REVOL, PRESTIGE-II-REVOL		

various

			
1			
GEV No.	361370	Ref. No.	60
description	dosing pump type model 2 rinse aid inlet 4x6mm outlet 4x6mm pressure connection ø 4x6mm suction connection ø 4x6mm		
For models:	F-1040, F-1221-N, F-1221-REVOL, F-400, F-430, F-532		
spare parts for	361370		
		GEV No.	361307
		Ref. No.	—
		description	membrane dosing pump ø 68mm hole ø 6mm for type DIB3P/DIB5P
		GEV No.	361459
		Ref. No.	—
		description	hose connector ø 6mm for dosing pump



accessories

T-pieces

without non-return valve



GEV No.	508123	Ref. No.	2503
description	T-piece 3-way hose ø 13-5-13mm plastic		
For models:	F-1040, F-1221-N, F-1221-REVOL, F-400, F-430, F-532		
accessories for	508123		
	GEV No.	508116	Ref. No.
			2450
	union nut thread M10x1 H 16mm WS 16 plastic Qty 1 pcs		

tank inlets



GEV No.	508301	Ref. No.	5073
description	tank inlet plastic M9x1.5 hose ø 4mm		
For models:	F-1040, F-430, F-532		

hoses

supply hoses

PVC supply hoses

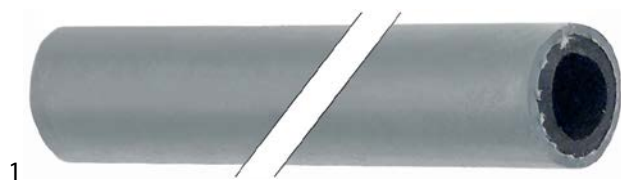

GEV No.	520016	Ref. No.	2800 3051
description	supply hose ID ø 13mm ED ø 20mm L 40m operating p. 20bar burst p. 60bar t.max. 95°C grey Qty 40m		
For models:	F-1221-N, F-1221-REVOL, F-400, F-430, F-532		

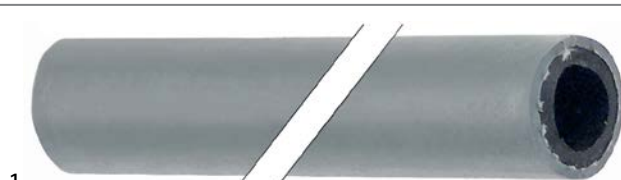

GEV No.	520017	Ref. No.	247
description	supply hose ID ø 13mm ED ø 20mm L 5m operating p. 20bar burst p. 60bar t.max. 95°C grey Qty 5m		
For models:	F-1040		

drain hoses



GEV No.	508043	Ref. No.	638
description	drain hose DN19 L 2000mm straight ø inside 19/30mm straight ext. ø 26/34mm outer hose ø 25mm		
For models:	F-1221-N, F-1221-REVOL, F-400		

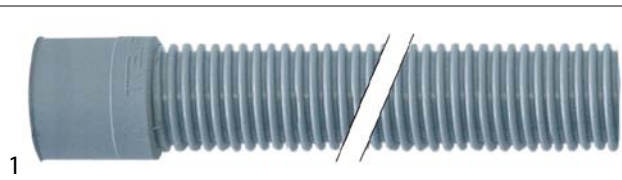

GEV No.	530587	Ref. No.	2188
description	drain hose DN28 L 2000mm straight ø inside 32mm straight ext. ø 40mm outer hose ø 35mm		
For models:	F-1040, F-430, F-532		

industrial hoses

nylon hoses



GEV No.	520091	Ref. No.	135
description	nylon hose ID ø 4mm ED ø 6mm L 2m thickness 1mm operating p. 10bar burst p. 50bar t.max. 100°C transparent		
For models:	F-1040, F-1221-N, F-1221-REVOL, F-400, F-430, F-532		

pressure control hoses



GEV No.	530560	Ref. No.	2329
description	pressure control hose ID ø 5mm ED ø 9mm L 5m operating p. 30bar burst p. 90bar temp.-resist. 60°C		
For models:	F-1040, F-1221-N, F-1221-REVOL, F-400, F-430, F-532		



formed hoses

straight



1	
GEV No. 508092	Ref. No. 2139
description	formed hose dishwasher straight
For models:	F-1221-N



1	
GEV No. 508118	Ref. No. 2480
description	formed hose dishwasher straight
For models:	F-1221-REVOL, F-400, F-430



1	
GEV No. 508290	Ref. No. 4935
description	formed hose dishwasher straight equiv. no. 4935
For models:	F-1040



1	
GEV No. 508213	Ref. No. 3072
description	formed hose dishwasher straight mounting pos. upper equiv. no. 3072
For models:	F-1040, F-532

form L



1	
GEV No. 508147	Ref. No. 2655
description	formed hose warewashing L-shape equiv. no. 2655
For models:	F-1040, F-430, F-532



1	
GEV No. 508201	Ref. No. 2927
description	formed hose warewashing L-shape equiv. no. 2927
For models:	F-1040, F-1221-N, F-1221-REVOL, F-430, F-532



1	
GEV No. 508205	Ref. No. 2962
description	formed hose warewashing L-shape equiv. no. 2962
For models:	F-430, F-532



1	
GEV No. 508214	Ref. No. 3080
description	formed hose warewashing L-shape equiv. no. 3080
For models:	F-1221-N, F-1221-REVOL, F-400

fittings, hose and pipe connectors

hose connectors

producer-specific



1	
GEV No. 508123	Ref. No. 2503
description	T-piece 3-way hose ø 13-5-13mm plastic
For models:	F-1040, F-1221-N, F-1221-REVOL, F-400, F-430, F-532
accessories for	508123



GEV No. 508116	Ref. No. 2450
union nut thread M10x1 H 16mm WS 16 plastic Qty 1 pcs	



fastening material

screws

knurled screws



1

GEV No.	508047	Ref. No.	1133 4374
description	Thumb screw ø 22mm thread M6 thread L 6mm		
For models:	F-1040, F-1221-N, F-1221-REVOL, F-400, F-430, F-532		

nuts

hexagonal nuts

hexagonal nuts metric (without norm)



1

GEV No.	519546	Ref. No.	10273
description	nut thread M10x0.75 H 3.45mm WS 14 brass Qty 1 pcs		
For models:	F-1221-REVOL, F-400		



1

GEV No.	520231	Ref. No.	267
description	nut thread M10x1 H 6mm WS 14 zinc-coated steel Qty 1 pcs		
For models:	F-1040, F-1221-N, F-1221-REVOL, F-400, F-430, F-532		

fasteners

retaining rings

DIN 471



1

GEV No.	508014	Ref. No.	113
description	retaining ring shaft ø 9mm DIN 471		
For models:	F-1040, F-430, F-532		

cotter pins



1

GEV No.	111273	Ref. No.	4.0.016.0025
description	cotter pin ø 1.3mm L 25mm		
For models:	ATLANTIC-I-CV-NV, ATLANTIC-I-CV-PCI-NV, ATLANTIC-I-CV-TI-NV, ATLANTIC-II-COMPACT, ATLANTIC-II-CV-COMPACT, ATLANTIC-II-CV-NV, ATLANTIC-II-CV-PCI-NV, ATLANTIC-II-CV-TALL-CUPS, ATLANTIC-II-CV-TI-COMPACT, ATLANTIC-II-CV-TI-NV, ATLANTIC-II-CV-TI-TALL-CUPS, ATLANTIC-III, ATLANTIC-III-CV, ATLANTIC-III-CV-TI, ATLANTIC-III-TI, ATLANTIC-II-NV, ATLANTIC-II-PCI-NV, ATLANTIC-II-TALL-CUPS, ATLANTIC-II-TI-NV, ATLANTIC-I-PCI-NV, ATLANTIC-I-TI-NV, PACIFIC-2CV, PACIFIC-3CV, PACIFIC-3CV-W, PRESTIGE-II-CV-ECC, PRESTIGE-II-CV-REVOL, PRESTIGE-II-ECC, PRESTIGE-III-CV-REVOL, PRESTIGE-III-REVOL, PRESTIGE-II-REVOL		

B		M	
bar burners	20	mechanical timers	13
bi-metal thermostats	6	microswitches	10
booster pumps II	18	N	
C		nuts	41
capillary tube clips	8	nylon hoses	39
condensators & interference suppression filters	18	O	
contactors	13	operating capacitors	18
control thermostats	7, 7	O-rings	33
cotter pins	41	P	
D		piezoelectric igniters	19
dosing pumps	38	pressure control hoses	39
drain hoses	39	pressure switches	15
E		probe clips	8
electric accessories	18	programme timers	13
F		pumps	16
fasteners	41	push/momentary push switches	9
fastening material	41	PVC supply hoses	39
filters	18	Q	
foam rubber gaskets	37	quartz heating elements	4
formed hoses	40	R	
G		relays	13
gas burners	20	retaining rings	41
gas nozzles	20	rocker/momentary rocker switches	9
gas taps	19	rotary switches	11
H		S	
heating elements	3	safety bi-metal thermostats	6
heating elements for coffee machine	3	safety thermostats	7
heating elements for contact grills	3	screws	41
heating elements for fryers	3	sealing washers	35
heating elements for salamanders/toasters	4	solenoid valves	14
hexagonal nuts	41	spring clips	8
hose connectors	40	supply hoses	39
hoses	39	switches and momentary switches	9
I		system switches	11
immersion heating elements	4	system switches (ROLD)	10
indicator lights	12	T	
indicator lights (complete)	12	tank inlets	39
industrial hoses	39	terminals	18
K		thermocouples	19
knurled screws	41	thermostats	6
L		timers	13
lamps	12	transformers	14

W

wash and rinse pumps

16