



**GAS COMPONENTS**



**ELECTRIC COMPONENTS**



**WATER TECHNOLOGY**



**MECHANICAL COMPONENTS**



**TOOLS**

Spare parts suitable for

**FIREX**

Find the complete and up-to-date range of products in our GEV Webshop



# Manufacturer catalogue

The most important spare parts and accessories arranged clearly for every manufacturer

- ✓ Complete product range and all appliance data always up to date in the GEV Webshop
- ✓ Alphabetical Index at the end of the catalogue

## GEV Webshop

[www.gev-online.co.uk](http://www.gev-online.co.uk)

[www.gev-online.com](http://www.gev-online.com)



- 🔍 Add to Favourites
- 🔍 Sign In with email address and usual password
- 🔍 Easy-order – place several items in your basket at the same time
- 🔍 Quick Item search – no login needed



## heating elements

### heating elements for tilting bratt pan





<b>GEV No.</b>	416692	<b>Ref. No.</b>	40400082
<b>description</b>	heating element tilting bratt pan 2900W 230V L 312mm W 200mm H 82mm connection M5 dry heating element heating circuits 1 tube ø 8.5mm W1 66mm W2 68mm connection distance 61mm		

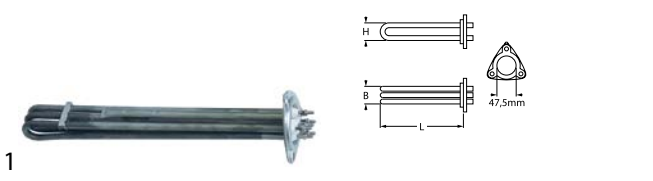

### immersion heating elements

#### 3 hole flange ø47.5mm

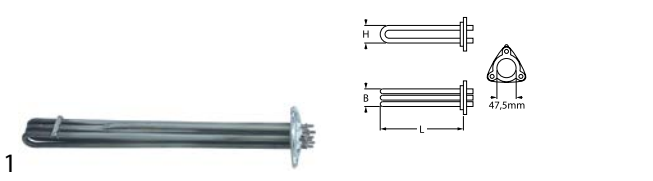

<b>GEV No.</b>	416834	<b>Ref. No.</b>	40400040	
<b>description</b>	heating element 8000W 230V mounting ø 47.5mm heating circuits 3 L 323mm W 35mm H 45mm number of thermostat sleeves 1 thermostat sleeves ø 7mm length thermostat sleeves 263mm thermostat sleeve eccentric, clinging tube ø 8.5mm hole distance 64mm hole ø 8mm connection M4 3 hole flange immersion heater			
<b>accessories for</b>	416834			
	<b>GEV No.</b>	510408	<b>Ref. No.</b>	—
	O-ring EPDM thickness 5.34mm ID ø 47mm Qty 1 pcs			
	<b>GEV No.</b>	510562	<b>Ref. No.</b>	—
	O-ring silicone thickness 5.34mm ID ø 47mm Qty 1 pcs			



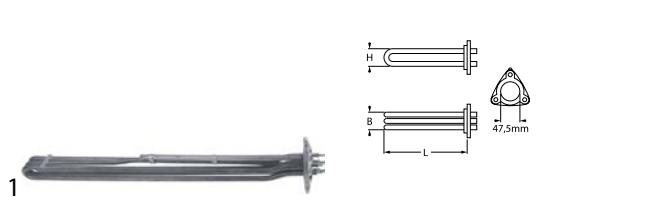

<b>GEV No.</b>	416835	<b>Ref. No.</b>	40400042	
<b>description</b>	heating element 9000W 230V mounting ø 47.5mm heating circuits 3 L 415mm W 30mm H 46mm number of thermostat sleeves 1 thermostat sleeves ø 7.5mm length thermostat sleeves 255mm thermostat sleeve eccentric, clinging hole distance 62mm hole ø 8mm connection M4 3 hole flange immersion heater			
<b>For models:</b>	KPI15ETA-GIGA, KPI15ET-GIGA, KPI30ETA-GIGA, KPI30ET-GIGA, KPI50ETA-GIGA, KPI50ET-GIGA			
<b>accessories for</b>	416835			
	<b>GEV No.</b>	510408	<b>Ref. No.</b>	—
	O-ring EPDM thickness 5.34mm ID ø 47mm Qty 1 pcs			
	<b>GEV No.</b>	510562	<b>Ref. No.</b>	—
	O-ring silicone thickness 5.34mm ID ø 47mm Qty 1 pcs			



<b>GEV No.</b>	419113	<b>Ref. No.</b>	40400038	
<b>description</b>	heating element 9000W 230V mounting ø 47.5mm heating circuits 3 L 550mm W 38mm H 45mm number of thermostat sleeves 1 thermostat sleeves ø 7.3mm length thermostat sleeves 260mm tube ø 8.5mm connection M4 3 hole flange immersion heater L1 55mm H1 33mm H2 34mm			
<b>accessories for</b>	419113			
	<b>GEV No.</b>	510408	<b>Ref. No.</b>	—
	O-ring EPDM thickness 5.34mm ID ø 47mm Qty 1 pcs			

#### group 7



<b>GEV No.</b>	418505	<b>Ref. No.</b>	40400048	
<b>description</b>	heating element 8000W 230V heating circuits 3 flange ø 47.5mm L 497mm W 35mm H 56mm tube ø 8.5mm thermostat sleeves ø 7.5mm length thermostat sleeves 266mm number of thermostat sleeves 1 thermostat sleeve not clinging connection M4 immersion heater 3 hole flange hole distance 58mm mounting ø 47.5mm hole ø 8mm			
<b>For models:</b>	KPI10ETA-GIGA, KPI10ET-GIGA, KPI20ETA-GIGA			
<b>accessories for</b>	418505			
	<b>GEV No.</b>	510408	<b>Ref. No.</b>	—
	O-ring EPDM thickness 5.34mm ID ø 47mm Qty 1 pcs			
	<b>GEV No.</b>	510562	<b>Ref. No.</b>	—
	O-ring silicone thickness 5.34mm ID ø 47mm Qty 1 pcs			



## thermostats

## control and safety thermostats

EGO

control thermostats

55.10/19\_series

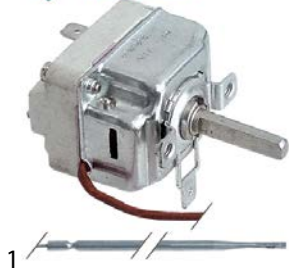

<b>GEV No.</b>	375363	<b>Ref. No.</b>	40100050
<b>description</b>	thermostat t.max. 161°C temperature range 73-161°C 1-pole 1NO 16A probe ø 3mm probe L 144mm capillary pipe 1600mm capillary pipe isolated 1600mm gland nut shaft ø 6x4.6mm shaft L 23mm shaft position upper rotation 270°		
<b>For models:</b>	KPI10ETA-GIGA, KPI10ET-GIGA, KPI15ETA-GIGA, KPI15ET-GIGA, KPI20EA-GIGA, KPI20E-GIGA, KPI20ETA-GIGA, KPI20ET-GIGA, KPI30EA-GIGA, KPI30E-GIGA, KPI30ETA-GIGA, KPI30ET-GIGA, KPI50EA-GIGA, KPI50E-GIGA, KPI50ETA-GIGA, KPI50ET-GIGA		

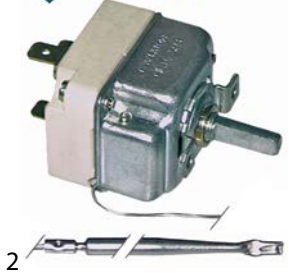

<b>GEV No.</b>	375270	<b>Ref. No.</b>	40100042
<b>description</b>	thermostat t.max. 295°C temperature range 45-295°C 1-pole 1NO 16A probe ø 4mm probe L 100mm capillary pipe 900mm capillary pipe isolated 350mm gland nut shaft L 23mm shaft position upper rotation 270°		

safety thermostats

55.32\_series

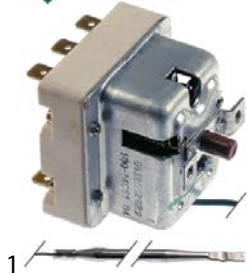

<b>GEV No.</b>	375364	<b>Ref. No.</b>	40100041
<b>description</b>	safety thermostat switch-off temp. 190°C 3-pole 20A probe ø 4mm probe L 120mm capillary pipe 3000mm capillary pipe isolated 3000mm gland nut probe		
<b>For models:</b>	KPI10ETA-GIGA, KPI10ET-GIGA, KPI15ETA-GIGA, KPI15ET-GIGA, KPI20ETA-GIGA, KPI20ET-GIGA, KPI30ETA-GIGA, KPI30ET-GIGA, KPI50ETA-GIGA, KPI50ET-GIGA, PM9.G170GN-FAGOR, PM9.G270GN-FAGOR, PM9.G370GN-FAGOR		

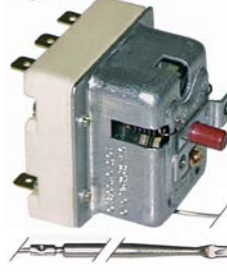

<b>GEV No.</b>	375350	<b>Ref. No.</b>	40100062
<b>description</b>	safety thermostat switch-off temp. 360°C 3-pole 20A probe ø 4mm probe L 120mm capillary pipe 1800mm capillary pipe isolated 1800mm gland nut probe SS		



<b>GEV No.</b>	390227	<b>Ref. No.</b>	40100062
<b>description</b>	safety thermostat switch-off temp. 360°C 3-pole 20A probe ø 4mm probe L 120mm capillary pipe 1800mm capillary pipe isolated 1800mm gland nut probe SS		
<b>For models:</b>	KPI20EA-GIGA, KPI20E-GIGA, KPI30EA-GIGA, KPI30E-GIGA, KPI50EA-GIGA, KPI50E-GIGA		

## accessories

## gland nut accessories

ducts



<b>GEV No.</b>	550148	<b>Ref. No.</b>	10400188
<b>description</b>	gland duct ET M12x0.75 IT M9x1 probe ø max. 6.5mm WS 17 silicone		

## switches and momentary switches



## push/momentary push switches

ø25mm



<b>GEV No.</b>	345038	<b>Ref. No.</b>	40100034
<b>description</b>	momentary push switch mounting ø 25mm black 2NO 250V 16A connection male faston 6.3mm ambient temperature max. 85°C protection IP40		
<b>For models:</b>	PM9.G170GN-FAGOR, PM9.G270GN-FAGOR, PM9.G370GN-FAGOR		



 <p>1</p>			
<b>GEV No.</b>	345039	<b>Ref. No.</b>	40100036
<b>description</b>	protective cover round ED ø 33mm external size 23mm internal size 21mm H 12mm clear mounting ø 25mm		
<b>For models:</b>	PM9.G170GN-FAGOR, PM9.G270GN-FAGOR, PM9.G370GN-FAGOR		
<b>accessories for</b>	345039		
		<b>GEV No.</b>	345001
		<b>Ref. No.</b>	—
	momentary push switch mounting ø 25mm yellow 1NO/indicator light 250V 16A cover connection male faston 6.3mm ambient temperature max. 85°C protection IP65		

**microswitches**

**lever actuated**

 <p>1</p>			
<b>GEV No.</b>	345044	<b>Ref. No.</b>	40100007
<b>description</b>	microswitch with lever 250V 16A 1CO connection male faston 6.3mm ambient temperature max. 85°C mounting distance 25mm type C99ZP3 actuating force: 25g lever length 71mm		

**roller-lever actuated**

**microswitches**

 <p>1</p>			
<b>GEV No.</b>	347272	<b>Ref. No.</b>	40100122
<b>description</b>	microswitch with handle with a switch 250V 16A 1CO connection male faston ambient temperature max. 85°C mounting distance 22.2mm white lever length 20mm		

**cam switches**

**3 operating positions**

 <p>1</p>			
<b>GEV No.</b>	300167	<b>Ref. No.</b>	40100004 40100004+SMP0936-00+SMP0938-00
<b>description</b>	cam switch 3 operating positions 2NO/1CO sequence 0-1-2 16A shaft ø 6x4.6mm shaft L 23mm connection screw		
<b>For models:</b>	KPI10ETA-GIGA, KPI10ET-GIGA, KPI15ETA-GIGA, KPI15ET-GIGA, KPI20EA-GIGA, KPI20E-GIGA, KPI20ETA-GIGA, KPI20ET-GIGA, KPI30EA-GIGA, KPI30E-GIGA, KPI30ETA-GIGA, KPI30ET-GIGA, KPI50EA-GIGA, KPI50E-GIGA, KPI50ETA-GIGA, KPI50ET-GIGA		

**lamps**

**indicator lights**

**indicator lights 2-piece (lens and indicator lamp)**

**indicator lamps for socket type SRZ / SDK / SDY / SFK**

 <p>1</p>			
<b>GEV No.</b>	359133	<b>Ref. No.</b>	40200154
<b>description</b>	indicator lamp 400V green connection male faston 6.3mm		
<b>For models:</b>	KPI10ETA-GIGA, KPI10ET-GIGA, KPI15ETA-GIGA, KPI15ET-GIGA, KPI20EA-GIGA, KPI20E-GIGA, KPI20ETA-GIGA, KPI20ET-GIGA, KPI30EA-GIGA, KPI30E-GIGA, KPI30ETA-GIGA, KPI30ET-GIGA, KPI50EA-GIGA, KPI50E-GIGA, KPI50ETA-GIGA, KPI50ET-GIGA		

**indicator lights (complete)**

**ø12mm**

**with screw socket**

 <p>1</p>			
<b>GEV No.</b>	359291	<b>Ref. No.</b>	40200152
<b>description</b>	indicator light ø 12mm 400V green connection male faston 6.3mm		
<b>For models:</b>	KPI10ETA-GIGA, KPI10ET-GIGA, KPI15ETA-GIGA, KPI15ET-GIGA, KPI20EA-GIGA, KPI20E-GIGA, KPI20ETA-GIGA, KPI20ET-GIGA, KPI30EA-GIGA, KPI30E-GIGA, KPI30ETA-GIGA, KPI30ET-GIGA, KPI50EA-GIGA, KPI50E-GIGA, KPI50ETA-GIGA, KPI50ET-GIGA		

 <p>1</p>			
<b>GEV No.</b>	359292	<b>Ref. No.</b>	40200148
<b>description</b>	indicator light ø 12mm 400V red connection male faston 6.3mm		
<b>For models:</b>	KPI10ETA-GIGA, KPI10ET-GIGA, KPI15ETA-GIGA, KPI15ET-GIGA, KPI20ETA-GIGA, KPI20ET-GIGA, KPI30ETA-GIGA, KPI30ET-GIGA, KPI50ETA-GIGA, KPI50ET-GIGA		

 <p>1</p>			
<b>GEV No.</b>	359290	<b>Ref. No.</b>	40200150
<b>description</b>	indicator light ø 12mm 400V yellow connection male faston 6.3mm		
<b>For models:</b>	KPI10ETA-GIGA, KPI10ET-GIGA, KPI15ETA-GIGA, KPI15ET-GIGA, KPI20EA-GIGA, KPI20E-GIGA, KPI20ETA-GIGA, KPI20ET-GIGA, KPI30EA-GIGA, KPI30E-GIGA, KPI30ETA-GIGA, KPI30ET-GIGA, KPI50EA-GIGA, KPI50E-GIGA, KPI50ETA-GIGA, KPI50ET-GIGA		







## timers

## mechanical timers



1

<b>GEV No.</b>	350176	<b>Ref. No.</b>	40100158
<b>description</b>	timer C20 2-pole operation time 5min 2NO at 250V 16A permanent position no shaft ø 6x4.6mm shaft 6x4.6mm shaft L 20mm mounting distance 28mm		
<b>accessories for</b>	350176		
	<b>GEV No.</b>	110366	<b>Ref. No.</b> —
	knob switch zero mark t.max.°C ø 44mm shaft ø 6x4.6mm shaft flat upper black		
	<b>GEV No.</b>	112138	<b>Ref. No.</b> —
	dial plate graduation 5min permanent position no rotation 0-290° ø 60mm		

## relays

## level relays

## GICAR



1

<b>GEV No.</b>	403748	<b>Ref. No.</b>	40800054
<b>description</b>	level controller 230V voltage AC 50/60Hz connection male faston 6.3mm type RL30/2E-2C/F		

## solenoid valves

## solenoid valves (water)

## metal

## SIRAI

## solenoid valves steam (water)

## 2-way

## L153-D series



1

<b>GEV No.</b>	370326	<b>Ref. No.</b>	30100066
<b>description</b>	solenoid valve 2-ways 230VAC connection 1" L 105mm DN 22mm slide-on receptacle DIN -10 up to 140°C SIRAI type series L153-D coil type Z914A membranes EPDM (steam/water) p max 8bar p min 0.1bar		
<b>spare parts for</b>	370326		
	<b>GEV No.</b>	371161	<b>Ref. No.</b> —
	solenoid coil 230VAC 27VA SIRAI coil type Z923A seat ø 16mm 50Hz		

## fuses

## fine fuses



1

<b>GEV No.</b>	358605	<b>Ref. No.</b>	40200084
<b>description</b>	fine fuse size ø5x20mm 3.15A slow-acting rated 250V Qty 10 pcs		
<b>For models:</b>	KPI10ETA-GIGA, KPI10ET-GIGA, KPI15ETA-GIGA, KPI15ET-GIGA		

## gas taps

## PEL

## 22S/O series



1



<b>GEV No.</b>	101892	<b>Ref. No.</b>	30100009
<b>description</b>	gas tap PEL type 22S/O gas inlet M20x1.5 (tube ø 12mm) bypass nozzle ø 0.35mm gas outlet M20x1.5 (tube ø 12/10mm) thermocouple connection M9x1 pilot connection M10x1 shaft ø 10x8mm shaft L 25/17mm shaft flat lower		
<b>spare parts for</b>	101892		
	<b>GEV No.</b>	101058	<b>Ref. No.</b> —
	magnet unit L 39mm D1 ø 15.4mm D2 ø 13.5mm suitable for PEL22/EGA24197 standard		
	<b>GEV No.</b>	101201	<b>Ref. No.</b> —
	gas tap front part shaft ø 10x8mm shaft L 25/17mm shaft flat upper/lower suitable for PEL22		

Table continues overleaf



spare parts for		101892	
	GEV No.	101231	Ref. No. —
thermocouple nut T1: M9x1 T2: M18x1			
	GEV No.	101240	Ref. No. —
gas connection thread M20x1.5 tube ø 12/10mm for PEL gas taps with gasket and screws horizontal			
	GEV No.	101460	Ref. No. —
O-ring ø 12.37mm D1 ø 2.62mm suitable for PEL22			
	GEV No.	101461	Ref. No. —
screw kit suitable for PEL22 Qty 4 pcs			
accessories for		101892	
	GEV No.	100908	Ref. No. —
union screw thread M10x1 for pipe ø 4mm Qty 1 pcs			
	GEV No.	100909	Ref. No. —
union screw thread M10x1 for pipe ø 6mm Qty 1 pcs			
	GEV No.	101246	Ref. No. —
olive for pipe ø 4mm Qty 1 pcs			
	GEV No.	101248	Ref. No. —
olive for pipe ø 12mm Qty 1 pcs suitable for PEL			
	GEV No.	101249	Ref. No. —
olive for pipe ø 10mm Qty 1 pcs			
	GEV No.	101250	Ref. No. —
union nut thread M20x1.5 for pipe ø 10mm			
	GEV No.	101251	Ref. No. —
union nut thread M20x1.5 for pipe ø 12mm			
	GEV No.	101286	Ref. No. —
olive ID ø 6mm Qty 1 pcs			
	GEV No.	110080	Ref. No. —
knob ø 70mm shaft ø 10x8mm shaft flat universal			
	GEV No.	112206	Ref. No. —
knob dial plate silver gas tap PEL21/22/23 t.max.°C ED ø 63mm ID ø 45.5mm			

















23S/O series			
			
1			
GEV No.	101893	Ref. No.	30100003
description	gas tap PEL type 23S/O gas inlet M28x1.5 (tube ø 20mm) bypass nozzle ø 0.35mm gas outlet M24x1.5 (tube ø 16mm) thermocouple connection M9x1 pilot connection M10x1 shaft ø 10x8mm shaft L 25/17mm shaft flat lower		
For models:	KP20GA-GIGA, KP20G-GIGA, KP20GTA-GIGA, KP20GT-GIGA, KP30GA-GIGA, KP30G-GIGA, KP30GTA-GIGA, KP30GT-GIGA, KP50GA-GIGA, KP50G-GIGA, KP50GTA-GIGA, KP50GT-GIGA, KPGN18G-GIGA, KPGN27G-GIGA, KPGN37G-GIGA, KPI20GA-GIGA, KPI20G-GIGA, KPI20GTA-GIGA, KPI20GT-GIGA, KPI30GA-GIGA, KPI30G-GIGA, KPI30GTA-GIGA, KPI30GT-GIGA, KPI50GA-GIGA, KPI50G-GIGA, KPI50GTA-GIGA, KPI50GT-GIGA, KPIGN18G-GIGA, KPIGN27G-GIGA, KPIGN37G-GIGA, PM9.G170GN-FAGOR, PM9.G270GN-FAGOR, PM9.G370GN-FAGOR		
spare parts for		101893	
	GEV No.	101045	Ref. No. —
magnet unit T1: M9x1 T2: M22x1 L 46mm ø 18mm suitable for PEL23S M9x1			
	GEV No.	101204	Ref. No. —
gas tap front part shaft ø 10x8mm shaft L 25/17mm shaft flat upper/lower suitable for PEL23S			
	GEV No.	101244	Ref. No. —
gas connection thread M24x1.5 tube ø 12/16mm horizontal for PEL gas taps			
	GEV No.	101463	Ref. No. —
screw suitable for PEL23S Qty 4 pcs			
accessories for		101893	
	GEV No.	100908	Ref. No. —
union screw thread M10x1 for pipe ø 4mm Qty 1 pcs			
	GEV No.	100909	Ref. No. —
union screw thread M10x1 for pipe ø 6mm Qty 1 pcs			
	GEV No.	101246	Ref. No. —
olive for pipe ø 4mm Qty 1 pcs			
	GEV No.	101252	Ref. No. —
union nut thread M24x1.5 for pipe ø 12mm			
	GEV No.	101253	Ref. No. —
union nut thread M24x1.5 PEL for pipe ø 16mm			
	GEV No.	101254	Ref. No. —
union nut thread M28x1.5 tube ø 20mm			
	GEV No.	101255	Ref. No. —
olive for pipe ø 12mm Qty 1 pcs			
	GEV No.	101256	Ref. No. —
olive for pipe ø 16mm Qty 1 pcs			
	GEV No.	101257	Ref. No. —
olive for pipe ø 20mm Qty 1 pcs			

Table continues overleaf

<b>accessories for</b>	101893			
	GEV No.	101286	Ref. No.	—
	olive ID ø 6mm Qty 1 pcs			
	GEV No.	110080	Ref. No.	—
	knob ø 70mm shaft ø 10x8mm shaft flat universal			
	GEV No.	112206	Ref. No.	—
	knob dial plate silver gas tap PEL21/22/23 t.max.°C ED ø 63mm ID ø 45.5mm			

## gas thermostats

### SIT

#### 630 Eurosit series



<b>GEV No.</b>	101125	<b>Ref. No.</b>	30100080
<b>description</b>	gas thermostat type 630 Eurosit series t.max. 340°C 100-340°C gas inlet 3/8" gas outlet 3/8" thermocouple connection M9x1 pilot connection M10x1 probe ø 4mm probe L 72mm capillary pipe 1050mm SIT		
<b>accessories for</b>	101125		
	GEV No.	100825	Ref. No. —
	gas tap spindle shaft ø 8x6.5mm shaft L 22/14mm suitable for EUROSIT		
	GEV No.	100904	Ref. No. —
	locking screw M10x1 for pipe ø 4mm Qty 1 pcs		
	GEV No.	100905	Ref. No. —
	locking screw M10x1 for pipe ø 6mm Qty 1 pcs		
	GEV No.	100949	Ref. No. —
	gasket suitable for 630 Eurosit series		
	GEV No.	101273	Ref. No. —
	olive for pipe ø 12mm L 9.5mm brass Qty 1 pcs suitable for universal		
	GEV No.	101276	Ref. No. —
	union screw thread 3/8" tube ø 12mm Qty 1 pcs		
	GEV No.	101333	Ref. No. —
	plug thread 3/8" with O-ring		
	GEV No.	101390	Ref. No. —
	gas tap spindle shaft ø 6x4.6mm shaft L 32/15mm gas tap with ignition flame suitable for ZANUSSI, MARENO for gas thermostat EUROSIT		
	GEV No.	101392	Ref. No. —
	adapter suitable for 630 Eurosit series		
	GEV No.	110357	Ref. No. —
	gas tap spindle shaft ø 8x6.5mm shaft L 36/12mm suitable for 630 Eurosit series		

<b>accessories for</b>	101125			
	GEV No.	110358	Ref. No.	—
	adapter shaft ø 10x8mm shaft L 29/18mm suitable for 630 Eurosit series			







## gas valves and ignition boxes

### gas control valves

#### SIT

#### NOVASIT



<b>GEV No.</b>	101187	<b>Ref. No.</b>	30100014
<b>description</b>	gas valve SIT series Novasit 820 0.17VHz gas inlet 1/2" gas outlet 1/2" thermocouple connection M9x1 pilot connection M10x1 ignition pressurebar pressure range 5-50mbar pressure regulator connection blind equiv. no. 0.820.301 supply Operator millivolt		
<b>spare parts for</b>	101187		
	GEV No.	101065	Ref. No. —
	magnet unit with cable L 44mm D1 ø 30mm D2 ø 20mm suitable for NOVASIT		
<b>accessories for</b>	101187		
	GEV No.	100110	Ref. No. 30100000
	pilot burner SIT type 190 series 3 flames nozzle ømm gas connectionmm		
	GEV No.	101305	Ref. No. —
	gas connection straight 1/2" flange 45x45mm ELETTROSIT/V4400/4600/4605 suitable for SIT/HONEYWELL hole distance 36x36mm		
	GEV No.	101306	Ref. No. —
	gas connection angled flange 45x45mm hole distance 36x36mm 1/2" ELETTROSIT/V4400/4600/4605 screw with O-ring suitable for SIT/HONEYWELL		
	GEV No.	101307	Ref. No. —
	gas connection straight flange 45x45mm hole distance 36x36mm 3/4" ELETTROSIT/V4400/4600/4605 screw with O-ring suitable for SIT/HONEYWELL		
	GEV No.	101308	Ref. No. —
	gas connection angled flange 45x45mm hole distance 36x36mm 3/4" ELETTROSIT/V4400/4600/4605 screw with O-ring suitable for SIT/HONEYWELL		
	GEV No.	102116	Ref. No. 40400130
	thermopile ROBERTSHAW L 900mm probe ø 9mm probe L 57mm 250-750mV screw connection 7/16"		







spare parts for		106906	
	GEV No.	100917	Ref. No. —
gasket for pilot burner Qty 1 pcs aluminium			
	GEV No.	100918	Ref. No. —
screw for pilot burner			
	GEV No.	107162	Ref. No. —
pilot burner cap SIT 3 flames Hmm Lmm Qty 1 pcs			
	GEV No.	107701	Ref. No. —
pilot burner bottom part SIT 100 series nozzle ø 0.2mm			
accessories for		106906	
	GEV No.	100245	Ref. No. 30500005
pilot burner nozzle LPG code 20 bore ø 0.2mm Qty 1 pcs thread M8x0.75			
	GEV No.	100246	Ref. No. —
pilot burner nozzle natural gas bore ø 0.35mm Qty 1 pcs thread M8x0.75			
	GEV No.	100904	Ref. No. —
locking screw M10x1 for pipe ø 4mm Qty 1 pcs			
	GEV No.	100905	Ref. No. —
locking screw M10x1 for pipe ø 6mm Qty 1 pcs			
	GEV No.	102110	Ref. No. —
pilot tube copper pipe ø 4mm thickness 1mm L 3000mm			
	GEV No.	102111	Ref. No. —
pilot tube copper pipe ø 6mm thickness 1mm L 3000mm			
	GEV No.	107171	Ref. No. —
pilot burner nozzle SIT natural/liquid gas bore ø 0.25mm Qty 1 pcs			
	GEV No.	107700	Ref. No. —
pilot burner bottom part SIT 100 series nozzle ø 0.25mm			
	GEV No.	107702	Ref. No. —
pilot burner bottom part SIT 100 series nozzle ø 0.35mm			

accessories

pilot burner nozzles

	1		
GEV No.	100245	Ref. No.	30500005
description pilot burner nozzle LPG code 20 bore ø 0.2mm Qty 1 pcs thread M8x0.75			

	1		
GEV No.	102972	Ref. No.	30500003
description pilot burner nozzle natural gas code 40 bore ø 0.4mm Qty 1 pcs			
For models: KP20GA-GIGA, KP20G-GIGA, KP20GTA-GIGA, KP20GT-GIGA, KP-30GA-GIGA, KP30G-GIGA, KP30GTA-GIGA, KP30GT-GIGA, KP50GA-GIGA, KP50G-GIGA, KP50GTA-GIGA, KP50GT-GIGA, KPGN18G-GIGA, KPGN27G-GIGA, KPGN37G-GIGA, KPI20GA-GIGA, KPI20G-GIGA, KPI20GTA-GIGA, KPI20GT-GIGA, KPI30GA-GIGA, KPI30G-GIGA, KPI30GTA-GIGA, KPI30GT-GIGA, KPI50GA-GIGA, KPI50G-GIGA, KPI50GTA-GIGA, KPI50GT-GIGA, KPIGN18G-GIGA, KPIGN27G-GIGA, KPIGN37G-GIGA, PM9.G170GN-FAGOR, PM9.G270GN-FAGOR, PM9.G370GN-FAGOR			

ignition electrodes

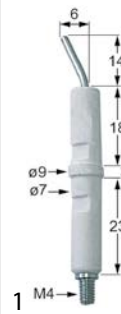

GEV No.	100706	Ref. No.	30100054
description ignition electrode connection M4 Qty 1 pcs			
For models: KP20GA-GIGA, KP20G-GIGA, KP20GTA-GIGA, KP20GT-GIGA, KP-30GA-GIGA, KP30G-GIGA, KP30GTA-GIGA, KP30GT-GIGA, KP50GA-GIGA, KP50G-GIGA, KP50GTA-GIGA, KP50GT-GIGA, KPGN18G-GIGA, KPGN27G-GIGA, KPGN37G-GIGA, KPI20GA-GIGA, KPI20G-GIGA, KPI20GTA-GIGA, KPI20GT-GIGA, KPI30GA-GIGA, KPI30G-GIGA, KPI30GTA-GIGA, KPI30GT-GIGA, KPI50GA-GIGA, KPI50G-GIGA, KPI50GTA-GIGA, KPI50GT-GIGA, KPIGN18G-GIGA, KPIGN27G-GIGA, KPIGN37G-GIGA			

190 series









GEV No.	100110	Ref. No.	30100000
description pilot burner SIT type 190 series 3 flames nozzle ømm gas connectionmm			
accessories for 100110			
	GEV No.	100202	Ref. No. —
pilot burner nozzle natural gas code 41 Qty 1 pcs nozzle ø 0.41mm			
	GEV No.	100203	Ref. No. —
pilot burner nozzle LPG code 25 Qty 1 pcs nozzle ø 0.25mm			
	GEV No.	100701	Ref. No. —
ignition electrode connection M4 Qty 1 pcs			
	GEV No.	100906	Ref. No. —
screw connection thread M10x1 for ignition electrode brass Qty 1 pcs WS 10			
	GEV No.	100907	Ref. No. —
screw connection thread M10x1 Qty 1 pcs type SEF 1 ømm for thermocouple			
	GEV No.	100908	Ref. No. —
union screw thread M10x1 for pipe ø 4mm Qty 1 pcs			
	GEV No.	100909	Ref. No. —
union screw thread M10x1 for pipe ø 6mm Qty 1 pcs			
	GEV No.	101282	Ref. No. —
olive for pipe ø 4mm L 7.4mm Qty 1 pcs			
	GEV No.	101287	Ref. No. —
olive for pipe ø 6mm Qty 1 pcs			

Table continues overleaf



<b>accessories for</b>	100110		
	<b>GEV No.</b>	102110	<b>Ref. No.</b> —
	pilot tube copper pipe ø 4mm thickness 1mm L 3000mm		
	<b>GEV No.</b>	102111	<b>Ref. No.</b> —
	pilot tube copper pipe ø 6mm thickness 1mm L 3000mm		
	<b>GEV No.</b>	107650	<b>Ref. No.</b> 30500006
	pilot burner nozzle SIT LPG code 30 Qty 1 pcs		

**electrodes**

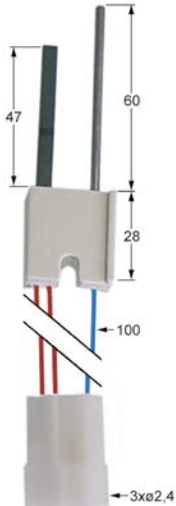

<b>GEV No.</b>	100730	<b>Ref. No.</b>	30100032/1
<b>description</b>	glow plug cable length 100mm connection ø2.4mm L1 47mm L2 60mm		

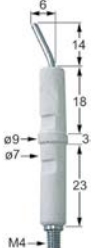

<b>GEV No.</b>	100706	<b>Ref. No.</b>	30100054
<b>description</b>	ignition electrode connection M4 Qty 1 pcs		
<b>For models:</b>	KP20GA-GIGA, KP20G-GIGA, KP20GTA-GIGA, KP20GT-GIGA, KP-30GA-GIGA, KP30G-GIGA, KP30GTA-GIGA, KP30GT-GIGA, KP50GA-GIGA, KP50G-GIGA, KP50GTA-GIGA, KP50GT-GIGA, KPGN18G-GIGA, KPGN27G-GIGA, KPGN37G-GIGA, KPI20GA-GIGA, KPI20G-GIGA, KPI20GTA-GIGA, KPI20GT-GIGA, KPI30GA-GIGA, KPI30G-GIGA, KPI30GTA-GIGA, KPI30GT-GIGA, KPI50GA-GIGA, KPI50G-GIGA, KPI50GTA-GIGA, KPI50GT-GIGA, KPIGN18G-GIGA, KPIGN27G-GIGA, KPIGN37G-GIGA		



<b>GEV No.</b>	100709	<b>Ref. No.</b>	30100050
<b>description</b>	ignition electrode D1 ø 7mm D2 ø 9mm connection M4 L1 13mm L2 13mm L3 23mm BL1 18mm BL2 3mm BL3 23mm to clip		
<b>For models:</b>	PM9.G170GN-FAGOR, PM9.G270GN-FAGOR, PM9.G370GN-FAGOR		

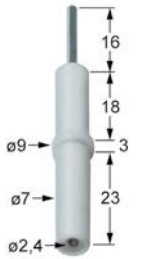

<b>GEV No.</b>	102330	<b>Ref. No.</b>	30100052
<b>description</b>	ignition electrode D1 ø 7mm D2 ø 9mm L1 16mm BL1 18mm BL2 3mm BL3 23mm to clip connection ø 2.4mm		

**piezoelectric igniters**

mounting diameter 22mm



<b>GEV No.</b>	100013	<b>Ref. No.</b>	40100130
<b>description</b>	piezoelectric igniter body plastic blowing mounting ø 22mm connection ø2.4mm cable lengthmm		
<b>For models:</b>	KP20GA-GIGA, KP20G-GIGA, KP20GTA-GIGA, KP20GT-GIGA, KP-30GA-GIGA, KP30G-GIGA, KP30GTA-GIGA, KP30GT-GIGA, KP50GA-GIGA, KP50G-GIGA, KP50GTA-GIGA, KP50GT-GIGA, KPGN18G-GIGA, KPGN27G-GIGA, KPGN37G-GIGA, KPI20GA-GIGA, KPI20G-GIGA, KPI20GTA-GIGA, KPI20GT-GIGA, KPI30GA-GIGA, KPI30G-GIGA, KPI30GTA-GIGA, KPI30GT-GIGA, KPI50GA-GIGA, KPI50G-GIGA, KPI50GTA-GIGA, KPI50GT-GIGA, KPIGN18G-GIGA, KPIGN27G-GIGA, KPIGN37G-GIGA		
<b>accessories for</b>	100013		
	<b>GEV No.</b>	100023	<b>Ref. No.</b> —
	female bullet size 2.3mm 0.5-1.5mm <sup>2</sup> CuZn t.max. 125°C Qty 20 pcs		





## gas nozzles

### pilot burner nozzles

#### pilot burner nozzles SIT

##### 100 series



1

<b>GEV No.</b>	100245	<b>Ref. No.</b>	30500005
<b>description</b>	pilot burner nozzle LPG code 20 bore $\varnothing$ 0.2mm Qty 1 pcs thread M8x0.75		



1

<b>GEV No.</b>	102972	<b>Ref. No.</b>	30500003
<b>description</b>	pilot burner nozzle natural gas code 40 bore $\varnothing$ 0.4mm Qty 1 pcs		
<b>For models:</b>	KP20GA-GIGA, KP20G-GIGA, KP20GTA-GIGA, KP20GT-GIGA, KP30GA-GIGA, KP30G-GIGA, KP30GTA-GIGA, KP30GT-GIGA, KP50GA-GIGA, KP50G-GIGA, KP50GTA-GIGA, KP50GT-GIGA, KPGN18G-GIGA, KPGN27G-GIGA, KPGN37G-GIGA, KPI20GA-GIGA, KPI20G-GIGA, KPI20GTA-GIGA, KPI20GT-GIGA, KPI30GA-GIGA, KPI30G-GIGA, KPI30GTA-GIGA, KPI30GT-GIGA, KPI50GA-GIGA, KPI50G-GIGA, KPI50GTA-GIGA, KPI50GT-GIGA, KPIGN18G-GIGA, KPIGN27G-GIGA, KPIGN37G-GIGA, PM9.G170GN-FAGOR, PM9.G270GN-FAGOR, PM9.G370GN-FAGOR		

##### 160 series



1

<b>GEV No.</b>	107650	<b>Ref. No.</b>	30500006
<b>description</b>	pilot burner nozzle SIT LPG code 30 Qty 1 pcs		



1

<b>GEV No.</b>	107175	<b>Ref. No.</b>	30500007
<b>description</b>	pilot burner nozzle SIT natural gas code 51 Qty 1 pcs suitable for 160 series		

## equipment-specific units

### for dough mixers

#### flange bearings



1

<b>GEV No.</b>	693112	<b>Ref. No.</b>	20400012
<b>description</b>	flange bearing type UCF204 shaft $\varnothing$ 20mm 4 hole flange hole distance 64mm H 33mm flange length 86mm flange width 86mm hole $\varnothing$ 12mm flange F204 ball bearing UC204G2 FH 25.5mm		

### for tilting bratt pans

#### spindles



1

<b>GEV No.</b>	693110	<b>Ref. No.</b>	SMB012800 SMB129-00
<b>description</b>	threaded rod L 363mm $\varnothing$ 20mm		

#### miscellaneous



1

<b>GEV No.</b>	693111	<b>Ref. No.</b>	SMB013000
<b>description</b>	spindle		



1

<b>GEV No.</b>	693114	<b>Ref. No.</b>	SMB063000
<b>description</b>	spindle		



1

<b>GEV No.</b>	693109	<b>Ref. No.</b>	SC02200 SC02200+10300042
<b>description</b>	threaded bush for tilting bratt pan brass thread TR20x4		



## for boiling pans

## filters



1

<b>GEV No.</b>	514503	<b>Ref. No.</b>	30700122 FX30700122
<b>description</b>	drain filter for kettle size 76x145mm		
<b>For models:</b>	KPI10ETA-GIGA, KPI10ET-GIGA, KPI10VTA-GIGA, KPI10VT-GIGA, KPI15ETA-GIGA, KPI15ET-GIGA, KPI15VTA-GIGA, KPI15VT-GIGA, PM9.G170GN-FAGOR, PM9.G270GN-FAGOR, PM9.G370GN-FAGOR		

## miscellaneous



1

<b>GEV No.</b>	540639	<b>Ref. No.</b>	10400058
<b>description</b>	extension		
<b>For models:</b>	KPI10VTA-GIGA, KPI10VT-GIGA, KPI15VTA-GIGA, KPI15VT-GIGA, KPI20VTA-GIGA, KPI20VT-GIGA, KPI30VTA-GIGA, KPI30VT-GIGA, KPI50VTA-GIGA, KPI50VT-GIGA		

## knobs

## producer-specific knobs

## FIREX



1

<b>GEV No.</b>	112571	<b>Ref. No.</b>	20200001
<b>description</b>	knob gas tap with ignition flame $\varnothing$ 65mm shaft $\varnothing$ 10x8mm shaft flat lower		
<b>For models:</b>	KP20GA-GIGA, KP20G-GIGA, KP20GTA-GIGA, KP20GT-GIGA, KP30GA-GIGA, KP30G-GIGA, KP30GTA-GIGA, KP30GT-GIGA, KP50GA-GIGA, KP50G-GIGA, KP50GTA-GIGA, KP50GT-GIGA, KPGN18G-GIGA, KPGN27G-GIGA, KPGN37G-GIGA, KPI20GA-GIGA, KPI20G-GIGA, KPI20GTA-GIGA, KPI20GT-GIGA, KPI30GA-GIGA, KPI30G-GIGA, KPI30GTA-GIGA, KPI30GT-GIGA, KPI50GA-GIGA, KPI50G-GIGA, KPI50GTA-GIGA, KPI50GT-GIGA, KPIGN18G-GIGA, KPIGN27G-GIGA, KPIGN37G-GIGA, PM9.G170GN-FAGOR, PM9.G270GN-FAGOR, PM9.G370GN-FAGOR		

## handles and hand wheels

## hand wheels

## hand wheels



1

<b>GEV No.</b>	692443	<b>Ref. No.</b>	SMB013600
<b>description</b>	hand wheel $\varnothing$ 150mm D1 $\varnothing$ 38mm bore $\varnothing$ 14mm thread groove width 6mm groove depth 13mm mounting distance 18mm L1 40mm L2 43mm handle length 65mm with folding handle		



1

<b>GEV No.</b>	692430	<b>Ref. No.</b>	SMB063600
<b>description</b>	hand wheel $\varnothing$ 200mm D1 $\varnothing$ 50mm bore $\varnothing$ 20mm thread groove width 6mm groove depth 13mm mounting distance 30mm L1 47mm L2 50mm handle length 90mm with folding handle		

## ball handles



1

<b>GEV No.</b>	540323	<b>Ref. No.</b>	20200013
<b>description</b>	ball handle thread M10 $\varnothing$ 40mm with metal bush black		
<b>For models:</b>	KPI10ETA-GIGA, KPI10ET-GIGA, KPI15ETA-GIGA, KPI15ET-GIGA, KPI20ETA-GIGA, KPI20ET-GIGA, KPI20VTA-GIGA, KPI20VT-GIGA, KPI30ETA-GIGA, KPI30ET-GIGA, KPI30VTA-GIGA, KPI30VT-GIGA, KPI50ETA-GIGA, KPI50ET-GIGA, KPI50VTA-GIGA, KPI50VT-GIGA		



## fittings for catering equipment

### lid hinges

type RUBINETTERIE DEL FRIULI

for circular lids

spare parts



<b>GEV No.</b>	540855	<b>Ref. No.</b>	20500046
<b>description</b>	torsion spring $\varnothing$ 50.8mm wire gauge $\varnothing$ 5.1mm L1 34mm L2 104mm L3 29mm mounting pos. left		



<b>GEV No.</b>	540854	<b>Ref. No.</b>	20500044
<b>description</b>	torsion spring $\varnothing$ 50.8mm wire gauge $\varnothing$ 5.1mm L1 34mm L2 104mm L3 29mm mounting pos. right		

## FIREX

lid hinges



<b>GEV No.</b>	514412	<b>Ref. No.</b>	20300096	
<b>description</b>	lid hinge L 230mm mounting distance 1 150mm flange radius 320mm spring thickness 4mm for circular lids			
<b>For models:</b>	KPI10ETA-GIGA, KPI10ET-GIGA, KPI10VTA-GIGA, KPI10VT-GIGA, KPI15ETA-GIGA, KPI15ET-GIGA, KPI15VTA-GIGA, KPI15VT-GIGA			
<b>spare parts for</b>	514412			
	<b>GEV No.</b>	540846	<b>Ref. No.</b>	—
	torsion spring $\varnothing$ 42.5mm wire gauge $\varnothing$ 4.1mm L1 93mm L2 26mm L3 26mm mounting pos. left			
	<b>GEV No.</b>	540847	<b>Ref. No.</b>	—
	torsion spring $\varnothing$ 42.5mm wire gauge $\varnothing$ 4.1mm L1 93mm L2 26mm L3 26mm mounting pos. right			



<b>GEV No.</b>	514413	<b>Ref. No.</b>	20300086	
<b>description</b>	lid hinge L 270mm mounting distance 1 139mm flange radius 395mm spring thickness 5mm bore $\varnothing$ M15mm for circular lids			
<b>For models:</b>	KP20GA-GIGA, KP20G-GIGA, KP20GTA-GIGA, KP20GT-GIGA, KP30GA-GIGA, KP30G-GIGA, KP30GTA-GIGA, KP30GT-GIGA, KP50GA-GIGA, KP50G-GIGA, KP50GTA-GIGA, KP50GT-GIGA, KPI20EA-GIGA, KPI20E-GIGA, KPI20ET-GIGA, KPI20GA-GIGA, KPI20G-GIGA, KPI20GTA-GIGA, KPI20GT-GIGA, KPI20VTA-GIGA, KPI20VT-GIGA, KPI30EA-GIGA, KPI30E-GIGA, KPI30GA-GIGA, KPI30G-GIGA, KPI30GT-GIGA, KPI30GT-GIGA, KPI50EA-GIGA, KPI50E-GIGA, KPI50GA-GIGA, KPI50G-GIGA, KPI50GTA-GIGA, KPI50GT-GIGA			
<b>spare parts for</b>	514413			
	<b>GEV No.</b>	540854	<b>Ref. No.</b>	20500044
	torsion spring $\varnothing$ 50.8mm wire gauge $\varnothing$ 5.1mm L1 34mm L2 104mm L3 29mm mounting pos. right			
	<b>GEV No.</b>	540855	<b>Ref. No.</b>	20500046
	torsion spring $\varnothing$ 50.8mm wire gauge $\varnothing$ 5.1mm L1 34mm L2 104mm L3 29mm mounting pos. left			



<b>GEV No.</b>	514414	<b>Ref. No.</b>	20300108	
<b>description</b>	lid hinge L 270mm mounting distance 1 139mm flange radius 470mm spring thickness 6mm bore $\varnothing$ M15mm for circular lids			
<b>For models:</b>	KPI30ET-GIGA, KPI30VTA-GIGA, KPI30VT-GIGA, KPI50ET-GIGA, KPI50VTA-GIGA, KPI50VT-GIGA			
<b>spare parts for</b>	514414			
	<b>GEV No.</b>	540856	<b>Ref. No.</b>	—
	torsion spring $\varnothing$ 52mm wire gauge $\varnothing$ 6.2mm L1 30mm L2 95mm L3 30mm mounting pos. right			
	<b>GEV No.</b>	540857	<b>Ref. No.</b>	—
	torsion spring $\varnothing$ 52mm wire gauge $\varnothing$ 6.2mm L1 30mm L2 95mm L3 30mm mounting pos. left			

spare parts



<b>GEV No.</b>	540855	<b>Ref. No.</b>	20500046
<b>description</b>	torsion spring $\varnothing$ 50.8mm wire gauge $\varnothing$ 5.1mm L1 34mm L2 104mm L3 29mm mounting pos. left		



<b>GEV No.</b>	540854	<b>Ref. No.</b>	20500044
<b>description</b>	torsion spring $\varnothing$ 50.8mm wire gauge $\varnothing$ 5.1mm L1 34mm L2 104mm L3 29mm mounting pos. right		

**ICOS**



<b>GEV No.</b>	540855	<b>Ref. No.</b>	20500046
<b>description</b>	torsion spring $\varnothing$ 50.8mm wire gauge $\varnothing$ 5.1mm L1 34mm L2 104mm L3 29mm mounting pos. left		



<b>GEV No.</b>	540854	<b>Ref. No.</b>	20500044
<b>description</b>	torsion spring $\varnothing$ 50.8mm wire gauge $\varnothing$ 5.1mm L1 34mm L2 104mm L3 29mm mounting pos. right		

**lid catches**

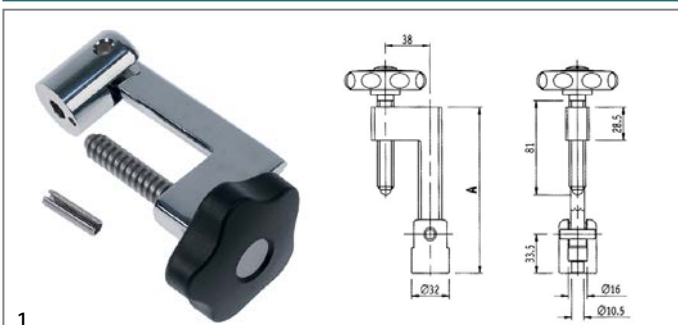

<b>GEV No.</b>	514127	<b>Ref. No.</b>	20300093
<b>description</b>	lid lock handle $\varnothing$ 70mm L 143mm		
<b>For models:</b>	KP20GA-GIGA, KP20GTA-GIGA, KP30GA-GIGA, KP30GTA-GIGA, KP50GA-GIGA, KP50GTA-GIGA, KPI10ETA-GIGA, KPI10VTA-GIGA, KPI15ETA-GIGA, KPI15VTA-GIGA, KPI20EA-GIGA, KPI20ETA-GIGA, KPI20GA-GIGA, KPI20GTA-GIGA, KPI20VTA-GIGA, KPI20VT-GIGA, KPI30EA-GIGA, KPI30ETA-GIGA, KPI30GA-GIGA, KPI30GTA-GIGA, KPI30VTA-GIGA, KPI30VT-GIGA, KPI50EA-GIGA, KPI50ETA-GIGA, KPI50GA-GIGA, KPI50GTA-GIGA, KPI50VTA-GIGA, KPI50VT-GIGA		

**inlet taps**



<b>GEV No.</b>	693108	<b>Ref. No.</b>	30200005
<b>description</b>	shut-off valve		

**drain taps**

**brass drain taps**



<b>GEV No.</b>	540275	<b>Ref. No.</b>	30200198	
<b>description</b>	drain tap 2" IT with union nut A 90mm B 151mm B1 80mm chrome-plated brass			
<b>For models:</b>	KP20GA-GIGA, KP20G-GIGA, KP20GTA-GIGA, KP20GT-GIGA, KP30GA-GIGA, KP30G-GIGA, KP30GTA-GIGA, KP30GT-GIGA, KP50GA-GIGA, KP50G-GIGA, KP50GTA-GIGA, KP50GT-GIGA, KPGN18G-GIGA, KPGN27G-GIGA, KPGN37G-GIGA, KPI10ETA-GIGA, KPI10ET-GIGA, KPI10VTA-GIGA, KPI10VT-GIGA, KPI15ETA-GIGA, KPI15ET-GIGA, KPI15VTA-GIGA, KPI15VT-GIGA, KPI20EA-GIGA, KPI20E-GIGA, KPI20ETA-GIGA, KPI20ET-GIGA, KPI20GA-GIGA, KPI20G-GIGA, KPI20GTA-GIGA, KPI20GT-GIGA, KPI20VTA-GIGA, KPI20VT-GIGA, KPI30EA-GIGA, KPI30E-GIGA, KPI30ETA-GIGA, KPI30ET-GIGA, KPI30GA-GIGA, KPI30G-GIGA, KPI30GTA-GIGA, KPI30GT-GIGA, KPI30VTA-GIGA, KPI30VT-GIGA, KPI50EA-GIGA, KPI50E-GIGA, KPI50ETA-GIGA, KPI50ET-GIGA, KPI50GA-GIGA, KPI50G-GIGA, KPI50GTA-GIGA...(Other models you can see in the webshop)			
<b>spare parts for</b>	540275			
	<b>GEV No.</b>	540214	<b>Ref. No.</b>	—
		handle ID $\varnothing$ 6mm L 145mm		
<b>accessories for</b>	540275			
	<b>GEV No.</b>	529484	<b>Ref. No.</b>	—
		flat gasket fibre ED $\varnothing$ 58mm ID $\varnothing$ 50mm thickness 2mm Qty 1 pcs		
	<b>GEV No.</b>	542448	<b>Ref. No.</b>	—
		gasket silicone 60x49x2 for drain tap 2"		



**accessories**



1

<b>GEV No.</b>	540956	<b>Ref. No.</b>	10500062
<b>description</b>	gasket for drain tap hose ext. ø 46mm ID ø 38mm H 2mm		



1

<b>GEV No.</b>	540959	<b>Ref. No.</b>	10500060
<b>description</b>	gasket for drain tap hose ext. ø 60mm ID ø 50mm H 2mm		
<b>For models:</b>	KP20GA-GIGA, KP20G-GIGA, KP20GTA-GIGA, KP20GT-GIGA, KP30GA-GIGA, KP30G-GIGA, KP30GTA-GIGA, KP30GT-GIGA, KP50GA-GIGA, KP50G-GIGA, KP50GTA-GIGA, KP50GT-GIGA, KPGN18G-GIGA, KPGN27G-GIGA, KPGN37G-GIGA, KPI10ETA-GIGA, KPI10ET-GIGA, KPI10VTA-GIGA, KPI10VT-GIGA, KPI15ETA-GIGA, KPI15ET-GIGA, KPI15VTA-GIGA, KPI15VT-GIGA, KPI20EA-GIGA, KPI20E-GIGA, KPI20ETA-GIGA, KPI20ET-GIGA, KPI20GA-GIGA, KPI20G-GIGA, KPI20GTA-GIGA, KPI20GT-GIGA, KPI20VTA-GIGA, KPI20VT-GIGA, KPI30EA-GIGA, KPI30E-GIGA, KPI30ETA-GIGA, KPI30ET-GIGA, KPI30GA-GIGA, KPI30G-GIGA, KPI30GTA-GIGA, KPI30GT-GIGA, KPI30VTA-GIGA, KPI30VT-GIGA, KPI50EA-GIGA, KPI50E-GIGA, KPI50ETA-GIGA, KPI50ET-GIGA, KPI50GA-GIGA, KPI50G-GIGA, KPI50GTA-GIGA...(Other models you can see in the webshop)		



1

<b>GEV No.</b>	540958	<b>Ref. No.</b>	10200002
<b>description</b>	rosette for drain tap hose ext. ø 120mm ID ø 60mm H 13mm		
<b>For models:</b>	KP20GA-GIGA, KP20G-GIGA, KP20GTA-GIGA, KP20GT-GIGA, KP30GA-GIGA, KP30G-GIGA, KP30GTA-GIGA, KP30GT-GIGA, KP50GA-GIGA, KP50G-GIGA, KP50GTA-GIGA, KP50GT-GIGA, KPGN18G-GIGA, KPGN27G-GIGA, KPGN37G-GIGA, KPI10ETA-GIGA, KPI10ET-GIGA, KPI10VTA-GIGA, KPI10VT-GIGA, KPI15ETA-GIGA, KPI15ET-GIGA, KPI15VTA-GIGA, KPI15VT-GIGA, KPI20EA-GIGA, KPI20E-GIGA, KPI20ETA-GIGA, KPI20ET-GIGA, KPI20GA-GIGA, KPI20G-GIGA, KPI20GTA-GIGA, KPI20GT-GIGA, KPI20VTA-GIGA, KPI20VT-GIGA, KPI30EA-GIGA, KPI30E-GIGA, KPI30ETA-GIGA, KPI30ET-GIGA, KPI30GA-GIGA, KPI30G-GIGA, KPI30GTA-GIGA, KPI30GT-GIGA, KPI30VTA-GIGA, KPI30VT-GIGA, KPI50EA-GIGA, KPI50E-GIGA, KPI50ETA-GIGA, KPI50ET-GIGA, KPI50GA-GIGA, KPI50G-GIGA, KPI50GTA-GIGA...(Other models you can see in the webshop)		



1

<b>GEV No.</b>	540955	<b>Ref. No.</b>	10200004
<b>description</b>	rosette for drain tap thread 1 1/2"		



1

<b>GEV No.</b>	540954	<b>Ref. No.</b>	10400009
<b>description</b>	screw-in socket for drain tap thread 1 1/2"		



1

<b>GEV No.</b>	540957	<b>Ref. No.</b>	10400006
<b>description</b>	screw-in socket for drain tap thread 2" L 120mm		
<b>For models:</b>	KPI10VTA-GIGA, KPI10VT-GIGA, KPI15VTA-GIGA, KPI15VT-GIGA		

**safety fittings**

**accessories**



1

<b>GEV No.</b>	540835	<b>Ref. No.</b>	10400061
<b>description</b>	screw cap thread 3/4"		
<b>For models:</b>	KP20GTA-GIGA, KP20GT-GIGA, KP30GTA-GIGA, KP30GT-GIGA, KP50GTA-GIGA, KP50GT-GIGA, KPI10ETA-GIGA, KPI10ET-GIGA, KPI15ETA-GIGA, KPI15ET-GIGA, KPI20EA-GIGA, KPI20E-GIGA, KPI20ETA-GIGA, KPI20ET-GIGA, KPI20GA-GIGA, KPI20G-GIGA, KPI20GTA-GIGA, KPI20GT-GIGA, KPI30EA-GIGA, KPI30E-GIGA, KPI30ETA-GIGA, KPI30ET-GIGA, KPI30GA-GIGA, KPI30G-GIGA, KPI30GTA-GIGA, KPI30GT-GIGA, KPI50EA-GIGA, KPI50E-GIGA, KPI50ETA-GIGA, KPI50ET-GIGA, KPI50GA-GIGA, KPI50G-GIGA, KPI50GTA-GIGA, KPI50GT-GIGA, KPIGN37G-GIGA, PM9.G170GN-FAGOR, PM9.G270GN-FAGOR, PM9.G370GN-FAGOR		
<b>spare parts for</b>	540835		
	<b>GEV No.</b>	513016	<b>Ref. No.</b>
	 O-ring EPDM thickness 3.53mm ID ø 26.58mm Qty 1 pcs		
<b>accessories for</b>	540835		
	<b>GEV No.</b>	513016	<b>Ref. No.</b>
	 O-ring EPDM thickness 3.53mm ID ø 26.58mm Qty 1 pcs		

safety valves



<b>GEV No.</b>	514415	<b>Ref. No.</b>	30300018 30300024 30300026
<b>description</b>	safety valve for kettle thread M33		
<b>For models:</b>	KP20GA-GIGA, KP20GTA-GIGA, KP30GA-GIGA, KP30GTA-GIGA, KP50GA-GIGA, KP50GTA-GIGA, KPI10VTA-GIGA, KPI15VTA-GIGA, KPI20EA-GIGA, KPI20GA-GIGA, KPI20GTA-GIGA, KPI20VTA-GIGA, KPI20VT-GIGA, KPI30EA-GIGA, KPI30GA-GIGA, KPI30GTA-GIGA, KPI30VTA-GIGA, KPI30VT-GIGA, KPI50EA-GIGA, KPI50GA-GIGA, KPI50GTA-GIGA, KPI50VTA-GIGA, KPI50VT-GIGA		



<b>GEV No.</b>	540722	<b>Ref. No.</b>	30300026
<b>description</b>	safety valve with outlet for lid		
<b>For models:</b>	KPI10ETA-GIGA, KPI15ETA-GIGA, KPI20ETA-GIGA, KPI30ETA-GIGA, KPI50ETA-GIGA		

gaskets

gaskets for heated units

boiling pan gaskets

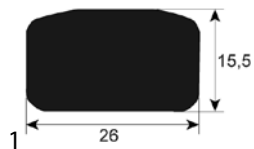

<b>GEV No.</b>	900819	<b>Ref. No.</b>	10600300
<b>description</b>	boiling pan gasket profile 3010 L 1000mm		
<b>For models:</b>	KP20GA-GIGA, KP20GTA-GIGA, KP30GA-GIGA, KP30GTA-GIGA, KP50GA-GIGA, KP50GTA-GIGA, KPI10ETA-GIGA, KPI10VTA-GIGA, KPI15ETA-GIGA, KPI15VTA-GIGA, KPI20EA-GIGA, KPI20GA-GIGA, KPI20GTA-GIGA, KPI20VTA-GIGA, KPI20VT-GIGA, KPI30EA-GIGA, KPI30GA-GIGA, KPI30GTA-GIGA, KPI30VTA-GIGA, KPI30VT-GIGA, KPI50EA-GIGA, KPI50GA-GIGA, KPI50GTA-GIGA		

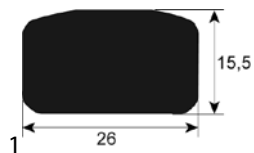

<b>GEV No.</b>	900821	<b>Ref. No.</b>	10600300/1
<b>description</b>	boiling pan gasket profile 3010 L 2000mm		
<b>For models:</b>	KPI10ETA-GIGA, KPI10VTA-GIGA, KPI15ETA-GIGA, KPI15VTA-GIGA		

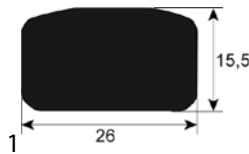

<b>GEV No.</b>	900822	<b>Ref. No.</b>	10600300/2
<b>description</b>	boiling pan gasket profile 3010 L 2400mm		
<b>For models:</b>	KPI20ETA-GIGA, KPI20VTA-GIGA		

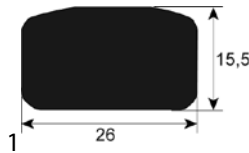

<b>GEV No.</b>	900823	<b>Ref. No.</b>	10600300/3
<b>description</b>	boiling pan gasket profile 3010 L 3000mm		
<b>For models:</b>	KPI30ETA-GIGA, KPI30VTA-GIGA, KPI50ETA-GIGA, KPI50VTA-GIGA		

O-rings

EPDM

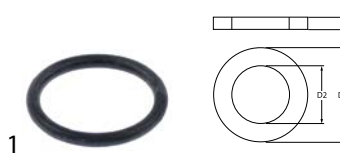

<b>GEV No.</b>	511937	<b>Ref. No.</b>	10500110
<b>description</b>	O-ring EPDM thickness 3.53mm ID ø 28.17mm Qty 1 pcs		
<b>For models:</b>	KP20GTA-GIGA, KP20GT-GIGA, KP30GTA-GIGA, KP30GT-GIGA, KP50GTA-GIGA, KP50GT-GIGA, KPI10ETA-GIGA, KPI10ET-GIGA, KPI15ETA-GIGA, KPI15ET-GIGA, KPI20EA-GIGA, KPI20E-GIGA, KPI20ETA-GIGA, KPI20E-TA-GIGA, KPI20ET-GIGA, KPI20GA-GIGA, KPI20G-GIGA, KPI20GTA-GIGA, KPI20GT-GIGA, KPI30EA-GIGA, KPI30E-GIGA, KPI30ETA-GIGA, KPI30ET-GIGA, KPI30GA-GIGA, KPI30G-GIGA, KPI30GTA-GIGA, KPI30GT-GIGA, KPI50EA-GIGA, KPI50E-GIGA, KPI50ETA-GIGA, KPI50ET-GIGA, KPI50GA-GIGA, KPI50G-GIGA, KPI50GTA-GIGA, KPI50GT-GIGA, KPIGN37G-GIGA, PM9.G170GN-FAGOR, PM9.G270GN-FAGOR, PM9.G370GN-FAGOR		

transmission technology and ball bearings

ball bearings

flange bearings



<b>GEV No.</b>	693112	<b>Ref. No.</b>	20400012
<b>description</b>	flange bearing type UCF204 shaft ø 20mm 4 hole flange hole distance 64mm H 33mm flange length 86mm flange width 86mm hole ø 12mm flange F204 ball bearing UC204G2 FH 25.5mm		





## springs

### torsion springs

			
<b>GEV No.</b>	540855	<b>Ref. No.</b>	20500046
<b>description</b>	torsion spring ø 50.8mm wire gauge ø 5.1mm L1 34mm L2 104mm L3 29mm mounting pos. left		

			
<b>GEV No.</b>	540854	<b>Ref. No.</b>	20500044
<b>description</b>	torsion spring ø 50.8mm wire gauge ø 5.1mm L1 34mm L2 104mm L3 29mm mounting pos. right		

### gas tension springs

#### gas tension springs

			
<b>GEV No.</b>	698322	<b>Ref. No.</b>	20300270
<b>description</b>	gas tension spring 882.5N hub 100mm D1 ø 22mm D2 ø 10mm hole distance 300mm hole ø 8/10mm L 315mm		









## manometers

				
<b>GEV No.</b>	541062	<b>Ref. No.</b>	30300022	
<b>description</b>	manometer ø 63mm pressure range 0 up to 1bar connection marking adjustable kettle thread 1/4"			
<b>For models:</b>	KP20GTA-GIGA, KP20GT-GIGA, KP30GTA-GIGA, KP30GT-GIGA, KP50GTA-GIGA, KP50GT-GIGA, KPI10ETA-GIGA, KPI10ET-GIGA, KPI10VTA-GIGA, KPI10VT-GIGA, KPI15ETA-GIGA, KPI15ET-GIGA, KPI15VTA-GIGA, KPI15VT-GIGA, KPI20EA-GIGA, KPI20E-GIGA, KPI20ETA-GIGA, KPI20ET-GIGA, KPI20GA-GIGA, KPI20G-GIGA, KPI20GTA-GIGA, KPI20GT-GIGA, KPI20VTA-GIGA, KPI20VT-GIGA, KPI30EA-GIGA, KPI30E-GIGA, KPI30ETA-GIGA, KPI30ET-GIGA, KPI30GA-GIGA, KPI30G-GIGA, KPI30GTA-GIGA, KPI30GT-GIGA, KPI30VTA-GIGA, KPI30VT-GIGA, KPI50EA-GIGA, KPI50E-GIGA, KPI50ETA-GIGA, KPI50ET-GIGA, KPI50GA-GIGA, KPI50G-GIGA, KPI50GTA-GIGA, KPI50GT-GIGA, KPI50VTA-GIGA, KPI50VT-GIGA, KPIGN37G-GIGA, PM9.G170GN-FAGOR, PM9.G270GN-FAGOR, PM9.G370GN-FAGOR			
<b>spare parts for</b>	541062			
	<b>GEV No.</b>	541130	<b>Ref. No.</b>	—
	 glass panel ø 58mm thickness 2mm			

## valves and tank inlets

### shut-off valves

#### universal

				
<b>GEV No.</b>	693107	<b>Ref. No.</b>	30200008	
<b>description</b>	shut-off valve connection 1/2" 1/2" cold total length 54mm L1 27mm L2 30mm marking blue rosette thread G2 26x19G connection ø M4x0.7 ITmm			
<b>spare parts for</b>	693107			
	<b>GEV No.</b>	514085	<b>Ref. No.</b>	—
	 rosette connection 26x19G chrome-plated total lengthmm mounting pos.			
	<b>GEV No.</b>	514086	<b>Ref. No.</b>	—
	 hexagonal nut connection 26x19G brass total lengthmm mounting pos. H 6mm WS 34 Qty 1 pcs			
	<b>GEV No.</b>	540672	<b>Ref. No.</b>	—
	 gasket suitable for tap head			
	<b>GEV No.</b>	547711	<b>Ref. No.</b>	—
	 hood handle shaft intake ø 8mm marking blue metal H2 21mm D1 ø 33mm type D suitable for MONOLITH shaft length H1 8mm			
	<b>GEV No.</b>	548168	<b>Ref. No.</b>	—
	 star handle connection hot total lengthmm mounting pos. ø 57mm marking red			
	<b>GEV No.</b>	548169	<b>Ref. No.</b>	—
	 star handle connection cold total lengthmm mounting pos. chrome-plated ø 57mm			
<b>accessories for</b>	693107			
	<b>GEV No.</b>	514086	<b>Ref. No.</b>	—
	 hexagonal nut connection 26x19G brass total lengthmm mounting pos. H 6mm WS 34 Qty 1 pcs			

## consumables

### fuses

#### fine fuses

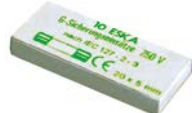
			
<b>GEV No.</b>	358605	<b>Ref. No.</b>	40200084
<b>description</b>	fine fuse size ø5x20mm 3.15A slow-acting rated 250V Qty 10 pcs		
<b>For models:</b>	KPI10ETA-GIGA, KPI10ET-GIGA, KPI15ETA-GIGA, KPI15ET-GIGA		



