



**GAS COMPONENTS**



**ELECTRIC COMPONENTS**



**WATER TECHNOLOGY**



**MECHANICAL COMPONENTS**



**TOOLS**

Spare parts suitable for

**FORCAR**

Find the complete and up-to-date range of products in our GEV Webshop



# Manufacturer catalogue

The most important spare parts and accessories arranged clearly for every manufacturer

- ✓ Complete product range and all appliance data always up to date in the GEV Webshop
- ✓ Alphabetical Index at the end of the catalogue

## GEV Webshop

[www.gev-online.co.uk](http://www.gev-online.co.uk)

[www.gev-online.com](http://www.gev-online.com)



- 🔍 Add to Favourites
- 🔍 Sign In with email address and usual password
- 🔍 Easy-order – place several items in your basket at the same time
- 🔍 Quick Item search – no login needed



## heating elements

### heating elements for bain maries

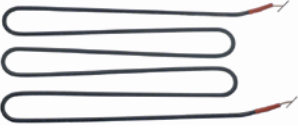
			
<b>GEV No.</b>	417748	<b>Ref. No.</b>	SL0006
<b>description</b>	heating element 1200W 230V heating circuits 1 L 365mm W 190mm connection cable 500mm tube ø 6.3mm		
<b>For models:</b>	BM11, BM21, BM31, BMV11, BMV21, BMV31, CT1758TD, CT1760TD, CT1765, CT1765A700, CT1766, CT1766A700, CT1770, CT1770A700, CT1771, CT1771A700		

### heating elements for refrigeration

#### heating elements for defrosting

			
<b>GEV No.</b>	420150	<b>Ref. No.</b>	GN650BT.01 RC0136
<b>description</b>	heating element 400W 230V L 290mm W 75mm H 90mm L1 60mm L2 230mm W1 16mm W2 43mm connection spate terminal M4 cable length 1200mm tube ø 10mm refrigeration for evaporator		
<b>For models:</b>	GN650BT, GN650BTG, GN650BTM, GN650TN, GN650TNG, GN650TNM		

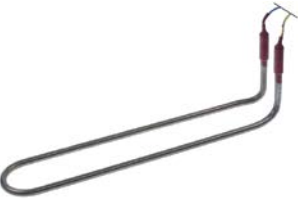
			
<b>GEV No.</b>	420523	<b>Ref. No.</b>	RC0234
<b>description</b>	heating element 450W 220V L 400mm W 75mm H 135mm cable length 1480mm tube ø 9.6mm		

			
<b>GEV No.</b>	420153	<b>Ref. No.</b>	GN140BT.02 GN1410BT.01 PA800BT.01 RC0062
<b>description</b>	heating element 700W L 590mm W 75mm H 115mm L1 60mm L2 530mm W1 13.5mm W2 48mm connection spate terminal M4 cable length 1700mm tube ø 10mm immersion heater refrigeration		
<b>For models:</b>	GE800BT, GN1410BT, GN1410BTM, GN1410TN, GN1410TNG, GN1410TNM, PA800BT, PA800TN		

### immersion heating elements

#### with expansion flange 70 x 18mm

			
<b>GEV No.</b>	420058	<b>Ref. No.</b>	SL0560
<b>description</b>	heating element 1950W 230V heating circuits 1 flange 70x18mm L 238mm W 64mm connection male faston 6.3mm tube ø 8.5mm		

			
<b>GEV No.</b>	417618	<b>Ref. No.</b>	SL0004
<b>description</b>	heating element 2000W		
<b>For models:</b>	BM1780, BM1782, BM1784, BM1786, CL2772, CL2774, CL2774W, CL2777, CL2777W, CL2778, CL2778W, CS1751, CS1753, CS1755, CT1756, CT1758, CT1760, CT1762, DC1703, DC1704, ELC2828, ELC2828W, ELC2832, ELC2832W, ELC2834, ELC2834W, ELS2830		

## switches and momentary switches

### rocker/momentary rocker switches

#### 30x22mm

			
<b>GEV No.</b>	347791	<b>Ref. No.</b>	S900.01 SL0621
<b>description</b>	rocker switch mounting measurements 30x22mm green 2NO 230V 20A illuminated 0-I connection male faston 6.3mm ambient temperature max. 125/55°C protection IP65 with rubber collar		
<b>For models:</b>	BC2PS, BC3PS, BI4719, BM11, BM1780, BM1782, BM1784, BM1786, BM21, BM31, BMS1781, BMS1783, BMS1785, BMV11, BMV21, BMV31, CA1439R, CA1439RG, CA1440AC, CA1440ACG, CAR2779, CAR2780, CAR2780BT, CL2772, CL2774, CL2774W, CL2775, CL2775W, CL2776, CL2776W, CL2777, CL2777W, CL2778, CL2778W, CL2781, CL2781W, CLR2782, CLR2782W, CLR2784, CLR2786, CLR2786W, CLR2787, CLR2787BT, CLR2787BTW, CLR2787W, CLR2788, CLR2788BT, CLR2788BTW, CLR2788W, CS1751...(Other models you can see in the webshop)		

microswitches

with push button

switches with snap-fit



<b>GEV No.</b>	346772	<b>Ref. No.</b>	GN650TN.48 RC0228
<b>description</b>	microswitch with push button 250V 5A 1CO connection male faston 4.8mm L 24x27mm ambient temperature max. 85°C actuating force: 160g		
<b>For models:</b>	GE800BT, GN1200BT, GN1200DT, GN1200DTV, GN1200TN, GN1410BT, GN1410BTM, GN1410TN, GN1410TNG, GN1410TNM, GN600BT, GN600DTV, GN600TN, GN650BT, GN650BTG, GN650BTM, GN650TN, GN650TNG, GN650TNM, GNB1200BT, GNB1200TN, GNB600BT, GNV1200DT, GNV600DT, PA800BT, PA800TN, SNACK400BT, SNACK400SBT, SNACK400STN, SNACK400TN		

<b>accessories for</b>	378256			
	<b>GEV No.</b>	378194	<b>Ref. No.</b>	—
	temperature probe NTC 10kOhm cable PVC probe -20 up to +80°C cable -10 up to 100°C probe ø7x24.5mm cable length 1.5m without screw connection 2-wire			
	<b>GEV No.</b>	379057	<b>Ref. No.</b>	—
	temperature probe NTC 10kOhm cable PVC probe -20 up to +80°C cable -10 up to 100°C probe ø6x25mm cable length 3m 2-wire			
	<b>GEV No.</b>	379160	<b>Ref. No.</b>	—
	temperature probe NTC 10kOhm cable thermoplastic probe -40 up to +110°C cable -40 up to +110°C probe ø6x14mm cable length 1.5m without screw connection 2-wire			
	<b>GEV No.</b>	379161	<b>Ref. No.</b>	RC0321 S900.32
	temperature probe NTC 10kOhm cable thermoplastic probe -40 up to +110°C cable -40 up to +110°C probe ø6x14mm cable length 3m without screw connection 2-wire			
	<b>GEV No.</b>	379343	<b>Ref. No.</b>	—
	temperature probe NTC 10kOhm cable silicone probe -40 up to +110°C cable -50 up to +180°C probe ø6x40mm cable length 3m 2-wire			
	<b>GEV No.</b>	379458	<b>Ref. No.</b>	—
	temperature probe NTC 10kOhm cable silicone probe -40 up to +110°C cable -50 up to +180°C probe ø6x40mm cable length 1.5m without screw connection 2-wire			

lamps

indicator lights

indicator lights (complete)

30x22mm



<b>GEV No.</b>	346965	<b>Ref. No.</b>	GN650BT.08 RC0109
<b>description</b>	indicator light mounting measurements 30x22mm 230V yellow		



<b>GEV No.</b>	378273	<b>Ref. No.</b>	GN650BT.16 GN650TN.47 SL0050
<b>description</b>	electronic controller DIXELL XR06CX-5N0C1 mounting measurements 71x29mm 230V voltage AC NTC -40 up to +110°C display 2½ digit DEF Relay 8A fan relay 8A compressor relay 20A		
<b>For models:</b>	GE800BT, GN1200DTV, GN1410BT, GN1410BTM, GN1410TN, GN1410TNG, GN1410TNM, GN2100BT, GN2100TN, GN2100TNG, GN3100BT, GN3100TN, GN3100TNG, GN3200BT, GN4100BT, GN4100TN, GN4100TNG, GN4200TN, GN600DTV, GN650BT, GN650BTM, GN650TN, GN650TNG, GN650TNM, GNV1200DT, GNV600DT, PA2100TN, PA3100TN, PA800BT, PA800TN, PZ2600TN, PZ2610TN, PZ3600TN, SNACK2100TN, SNACK3100TN, SNACK4100TN, U-GN2100TN, U-GN3100TN, U-GN4100TN		

electronic controllers

DIXELL

refrigeration controllers

built-in version



<b>GEV No.</b>	378256	<b>Ref. No.</b>	S900.02	
<b>description</b>	electronic controller DIXELL XR02CX-5N0C0 mounting measurements 71x29mm built-in depth 56mm 230V voltage AC NTC relay outputs 1 CO-8A(4) NTC protection IP54 defrosting function/time control -40 up to +110°C display 2½ digit			
<b>For models:</b>	BC2PS, GN1200BT, GN1200DT, GN1200TN, GN2200TN, GN600BT, GN600TN, GNB600BT, PS200, PS300, PS900, S900, S901TOP, S902STD, S903, S903PZ, S903TOP, SNACK340, SNACK400SBT, SNACK400STN, SNACK400TN, SNACK638, SS45BT, VRX1200-330, VRX1200-380, VRX1400-330, VRX1500-330, VRX1500-380, VRX1800-330, VRX1800-380, VRX2000-330, VRX2000-380			
<b>spare parts for</b>	378256			
	<b>GEV No.</b>	379161	<b>Ref. No.</b>	RC0321 S900.32
	temperature probe NTC 10kOhm cable thermoplastic probe -40 up to +110°C cable -40 up to +110°C probe ø6x14mm cable length 3m without screw connection 2-wire			





EKTRON

refrigeration controllers

built-in version



1

<b>GEV No.</b>	378034	<b>Ref. No.</b>	CO0862 SL0531
<b>description</b>	electronic controller EKTRON type REK31ED-0021 mounting measurements 71x29mm 230V voltage AC NTC/PTC relay outputs 1 CO-8A(4) NTC/PTC NTC/PTC built-in depth 71mm defr. funct. yes -50 up to +95°C display 3 digits		
<b>For models:</b>	CA1439RG, CAR2779, CAR2780, CAR2780BT, CLR2782, CLR2782W, CLR2786, CLR2786W, CLR2787, CLR2787BT, CLR2787BTW, CLR2787W, CLR2788, CLR2788BT, CLR2788BTW, CLR2788W, ELR2825, ELR2825W, ELR2826, ELR2826W, ELR2827, ELR2827W, ELS2830, GN1200BT, GN1200TN, GN600BT, GN600TN, GNB1200BT, GNB1200TN, PS200, PS300, PS900, RI330, RI380, S900, S901, S902, S903, S903PZ, S903TOP, SNACK340, SNACK400BT, SNACK400TN, SNACK638, SS45		
<b>accessories for</b>	378034		
	<b>GEV No.</b>	379053	<b>Ref. No.</b> —
	temperature probe PTC 1kOhm cable PVC probe -50 up to +150°C cable -10 up to 100°C probe ø6x30mm cable length 3m without screw connection 2-wire		
	<b>GEV No.</b>	379782	<b>Ref. No.</b> —
	temperature probe PTC 1kOhm cable thermoplastic probe -50 up to +150°C cable -40 up to +110°C probe ø6x14mm cable length 3m 2-wire resistor 1kOhm		



1

<b>GEV No.</b>	378118	<b>Ref. No.</b>	CO0019
<b>description</b>	electronic controller EKTRON type REK33-1021 mounting measurements 71x29mm 230V voltage AC PTC relay outputs 3 NO-16A NO-8A(4) NO-8A(4) PTC PTC built-in depth 71 mm -50 up to +95°C display 3½ digits		
<b>accessories for</b>	378118		
	<b>GEV No.</b>	379052	<b>Ref. No.</b> —
	temperature probe PTC 1kOhm cable silicone probe -50 up to +150°C cable -50 up to +180°C probe ø6x40mm cable length 1.5m without screw connection 2-wire		

probes

universal probes

temperature probes

1 			
<b>GEV No.</b>	379161	<b>Ref. No.</b>	RC0321 S900.32
<b>description</b>	temperature probe NTC 10kOhm cable thermoplastic probe -40 up to +110°C cable -40 up to +110°C probe ø6x14mm cable length 3m without screw connection 2-wire		
<b>For models:</b>	BC2PS, BC3PS, EF400, EF600, ER400, ER400G, ER600, ER600G, GN1200BT, GN1200TN, GN600BT, GN600TN, GNB1200BT, GNB1200TN, PS200, PS300, PS900, RI330, RI380, S900, S901, S901TOP, S902, S902STD, S903, S903PZ, S903TOP, SNACK400BT, SNACK400TN, SS45, SS45BT		

electronics

PCBs

1 			
<b>GEV No.</b>	402813	<b>Ref. No.</b>	HR600.07 RC0419
<b>description</b>	display PCB for fridge L 150mm W 37mm suitable for ER400/600 with potentiometer with thermostat type LTC-20HT		
<b>For models:</b>	ER400, ER400G, ER600, ER600G		

1 			
<b>GEV No.</b>	402812	<b>Ref. No.</b>	HF600.07 RC0429
<b>description</b>	display PCB refrigerator EF400/600 L 150mm W 38mm with potentiometer with thermostat type LTC-24HT		
<b>For models:</b>	EF600		





electric components

## compressors

### ACC/ZEL

R134A

LBP monophase

Lower evaporation temperature below -20°C



<b>GEV No.</b>	605126	<b>Ref. No.</b>	RC0047 S900.41
<b>description</b>	compressor coolant R134a type OF1350A 220-240V 50Hz LBPkg 1/4HP power input 158W cylinder capacity 7.5cm <sup>3</sup> RSIR H 183mmWWWWWWWWWW ZEL		
<b>For models:</b>	BC3PS, ER600, ER600G, GN1200DT, GN1200DTV, GN2100TN, GN2100TNG, GN2200TN, GN3100TN, GN3100TNG, GN600DTV, GN600TN, GNV1200DT, GNV600DT, PA2100TN, PS200, PS300, PS900, PZ2600TN, PZ2610TN, S900, S901, S901TOP, S902, S902STD, SNACK176, SNACK2100TN, SNACK251, SNACK290, SNACK3100TN, SNACK340, SNACK400STN, SNACK400TN, U-GN2100TN, U-GN3100TN, VRX2000-330, VRX2000-380		

### EMBRACO / ASPERA

R134A

HMBP monophase

High/Medium evaporation temperature above -20/-15 °C



<b>GEV No.</b>	605244	<b>Ref. No.</b>	GN1410TN.11 NE1130Z RC0564
<b>description</b>	compressor coolant R134a type FFI12HBK 220-240V 50Hz HMBP 10.8kg 1/3HP cylinder capacity 11.15cm <sup>3</sup> CSIR H 180mm 223W 304W 405W 527W 671W 836W 1024W 1236W 1471W test method EN 12900		
<b>For models:</b>	EF600, GN1200TN, GN1410TN, GN1410TNG, GN1410TNM, SNACK638, SS45BT		

## fans

### axial fans



import



<b>GEV No.</b>	601604 <sup>1</sup>	<b>Ref. No.</b>	RC0011 RC0654 S900.34
<b>description</b>	axial fan L 119mm W 119mm H 38mm 230VAC 50/60Hz 17/15W bearing slide bearing manuf. no. AA1282HS-AT connection cable 300mm fan wheel ø 110mm temp.-resist. 70°C input current 0.1A airflow 130m <sup>3</sup> /h 2600rpm		
<b>For models:</b>	BC2PS, BC3PS, EF400, EF600, ER400, ER400G, ER600, ER600G, GN1200BT, GN1200DT, GN1200TN, GN600BT, GN600TN, GNB1200BT, GNB1200TN, GNB600BT, PS200, PS300, PS900, RI330, RI380, S900, S901, S902, S902STD, S903, S903PZ, S903TOP, SNACK176, SNACK251, SNACK290, SNACK340, SNACK400BT, SNACK400SBT, SNACK400STN, SNACK400TN, SNACK638, SS45, SS45BT, VRX1200-330, VRX1200-380, VRX1400-330, VRX1500-330, VRX1500-380, VRX1800-330, VRX1800-380, VRX2000-330, VRX2000-380		

<sup>1</sup>with slide bearings



<b>GEV No.</b>	601055 <sup>1</sup>	<b>Ref. No.</b>	GN2100TN.35
<b>description</b>	axial fan L 92mm W 92mm H 25mm 230VAC 50/60Hz 14.5/14W bearing ball bearing connection male faston 2.8mm metal ADDA fan wheel ø 85mm temp.-resist. 70°C		
<b>For models:</b>	GN2100BT, GN2100TN, GN2100TNG, GN2200TN, GN3100BT, GN3100TN, GN3100TNG, GN4100BT, GN4100TN, GN4100TNG, GN4200TN, PA2100TN, PA3100TN, PZ2600TN, PZ2610TN, PZ3600TN, SNACK2100TN, SNACK3100TN, SNACK340, SNACK4100TN, SNACK638		
<b>accessories for</b>	601055		
	<b>GEV No.</b>	550898	<b>Ref. No.</b> —
	connecting cable cable length 2000mm connection F 2.8 connection distance 7.9mm for axial flow fan		
	<b>GEV No.</b>	691103	<b>Ref. No.</b> —
	guard ø 90mm mounting distance 83mm for axial fan 92mm		

<sup>1</sup>with ball bearings



refrigeration fans

refrigeration motors universal

ebm-papst

miscellaneous



<b>GEV No.</b>	601783	<b>Ref. No.</b>	GN650TN.34 S900.37
<b>description</b>	fan motor 10W 230V 50/60Hz L3 87mm W 67mm cable length 400mm 1300rpm ebm-papst M4Q045-CA03-51/C18 3 mounting options bearing slide bearing for refrigerated counters		
<b>For models:</b>	GN1200BT, GN1200DT, GN1200DTV, GN1200TN, GN1410BT, GN1410BTM, GN1410TN, GN1410TNG, GN1410TNM, GN2100BT, GN2100TN, GN2100TNG, GN2200TN, GN3100BT, GN3100TN, GN3100TNG, GN3200BT, GN4100BT, GN4100TN, GN4100TNG, GN4200TN, GN600DTV, GN600TN, GN650BT, GN650BTG, GN650BTM, GN650TN, GN650TNG, GN650TNM, GNV1200DT, GNV600DT, PA2100TN, PA3100TN, PA800TN, PS200, PS300, PS900, PZ2600TN, PZ2610TN, PZ3600TN, S900, S901TOP, S902STD, S903, S903PZ, S903TOP, SNACK2100TN, SNACK3100TN, SNACK340, SNACK400SBT... (Other models you can see in the webshop)		
<b>spare parts for</b>	601783		
	<b>GEV No.</b>	601413	<b>Ref. No.</b> —
<b>accessories for</b>	601783		
	<b>GEV No.</b>	601385	<b>Ref. No.</b> —

accessories

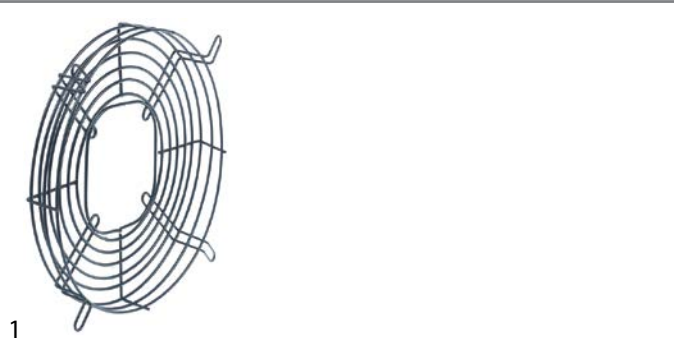

fan guards



<b>GEV No.</b>	601738	<b>Ref. No.</b>	RC0219 S900.38
<b>description</b>	guard for fan wheel ø 170mm ø 216mm H 30mm mounting distance 1 224 up to 254mm mounting distance 2 94.5mm		
<b>For models:</b>	PS200, PS900, S901TOP, S902STD, SNACK3100TN, SNACK638, SS45BT, U-GN2100TN, U-GN3100TN, U-GN4100TN		

cooling motors (complete)



<b>GEV No.</b>	601739	<b>Ref. No.</b>	GN650BT.11 RC0229
<b>description</b>	fan 230V 10W 50Hz fan wheel ø 230mm shaft L 20mm L 86mm W 67mm blade angle 34° connection spate terminal M4 cable length 1100mm		
<b>For models:</b>	GE800BT, GN1200BT, GN1200DT, GN1200DTV, GN1200TN, GN1410BT, GN1410BTM, GN1410TN, GN1410TNG, GN1410TNM, GN600BT, GN600DTV, GN600TN, GN650BT, GN650BTG, GN650BTM, GN650TN, GN650TNG, GN650TNM, GNB1200BT, GNB1200TN, GNB600BT, GNV1200DT, GNV600DT, PA800BT, PA800TN, PS200, PS300, PS900, S900, S901, S902, S903, S903PZ, S903TOP, SNACK340, SNACK400BT, SNACK400TN, SNACK638, SS45		
<b>spare parts for</b>	601739		
	<b>GEV No.</b>	601172	<b>Ref. No.</b> —
<b>description</b>	fan wheel sucking ø 230mm fan wheel mounting 25.4mm blade angle 34° W 50mm aluminium		
	<b>GEV No.</b>	601757	<b>Ref. No.</b> —
<b>description</b>	fan motor 10W 230V 50/60Hz L1 43.5mm L3 82mm W 67mm cable length 1500mm 1300/1550rpm ebm-papst M4Q045-CA03-75 5 mounting options bearing slide bearing		
	<b>GEV No.</b>	601783	<b>Ref. No.</b> GN650TN.34 S900.37
<b>description</b>	fan motor 10W 230V 50/60Hz L3 87mm W 67mm cable length 400mm 1300rpm ebm-papst M4Q045-CA03-51/C18 3 mounting options bearing slide bearing for refrigerated counters		



<b>GEV No.</b>	602042	<b>Ref. No.</b>	RC1184
<b>description</b>	fan 240V 7.5W 50/60Hz fan wheel ø 100mm mounting distance 95mm ø 150mm		



## electric accessories

## cables

## power supply cables



1

<b>GEV No.</b>	551085	<b>Ref. No.</b>	SL0130
<b>description</b>	cable CEE7/7 type E+F 3-pole contacts P+N+E 1.5mm <sup>2</sup> max. 16A max 230V 2m with plug H05VV-F 3G1.5		
<b>For models:</b>	BI4719, BM11, BM1780, BM1782, BM1784, BM1786, BM21, BM31, BMS1781, BMS1783, BMS1785, BMV11, BMV21, BMV31, CA1439R, CA1439RG, CA1440AC, CA1440ACG, CAR2779, CAR2780, CAR2780BT, CL2772, CL2774, CL2774W, CL2775, CL2775W, CL2776, CL2776W, CL2777, CL2777W, CL2778, CL2778W, CL2781, CL2781W, CLR2782, CLR2782W, CLR2784, CLR2786, CLR2786W, CLR2787, CLR2787BT, CLR2787BTW, CLR2787W, CLR2788, CLR2788BT, CLR2788BTW, CLR2788W, CS1751, CS1753, CS1755...(Other models you can see in the webshop)		

## terminal boxes



1

<b>GEV No.</b>	551214	<b>Ref. No.</b>	S900.48
<b>description</b>	terminal box 4-pole L 90mm W 52mm H 28mm with strain relief Qty 1 pcs		
<b>For models:</b>	PS200, PS300, PS900, S900, S901TOP, S902STD, S903, S903PZ, S903TOP, SNACK176, SNACK251, SNACK290, SS45BT, VRX1200-330, VRX1400-330, VRX1500-330, VRX1500-380, VRX1800-330, VRX1800-380, VRX2000-330, VRX2000-380		



1

<b>GEV No.</b>	551090	<b>Ref. No.</b>	GN650TN.16 RC0235
<b>description</b>	terminal box 5-pole L 95mm W 63mm H 27mm		
<b>For models:</b>	EF400, EF600, ER400, ER400G, ER600, ER600G, GE800BT, GN1200BT, GN1200DT, GN1200DTV, GN1200TN, GN1410BT, GN1410BTM, GN1410TN, GN1410TNG, GN1410TNM, GN2100BT, GN2100TN, GN2100TNG, GN2200TN, GN3100BT, GN3100TN, GN3100TNG, GN3200BT, GN4100BT, GN4100TN, GN4100TNG, GN4200TN, GN600BT, GN600DTV, GN600TN, GN650BT, GN650BTG, GN650BTM, GN650TN, GN650TNG, GN650TNM, GNB1200BT, GNB1200TN, GNB600BT, GNV1200DT, GNV600DT, PA2100TN, PA3100TN, PA800BT, PA800TN, PZ2600TN, PZ2610TN, RI330, RI380...(Other models you can see in the webshop)		

## equipment-specific units

## for fridges

## housing and bezels

## caps



1

<b>GEV No.</b>	692372	<b>Ref. No.</b>	PS900.03 RC0736
<b>description</b>	cap grey ø 16.5mm mounting ø 12.5mm H 7mm Qty 1 pcs		
<b>For models:</b>	PS200, PS300, PS900, RI330, RI380, S900, S901, S901TOP, S902, S902STD, S903, S903PZ, S903TOP, SNACK340, SNACK400SBT, SNACK400STN, SNACK638, SS45, SS45BT, VRX1200-330, VRX1200-380, VRX1400-330, VRX1500-330, VRX1500-380, VRX1800-330, VRX1800-380, VRX2000-330, VRX2000-380		

## miscellaneous



1

<b>GEV No.</b>	696413	<b>Ref. No.</b>	GN650TN.01 RC0316
<b>description</b>	screw thread M6 L 18mm		
<b>For models:</b>	GN1200BT, GN1200TN, GN1410BT, GN1410BTM, GN1410TN, GN1410TNG, GN1410TNM, GN600BT, GN600TN, GN650BT, GN650BTG, GN650BTM, GN650TN, GN650TNG, GN650TNM, GNB600BT, SNACK400SBT, SNACK400STN, SNACK400TN		

## for refrigerated counters

## spare parts and accessories





1

<b>GEV No.</b>	697917	<b>Ref. No.</b>	CO0140 S900.29	
<b>description</b>	fixing plate with opposite support thread M5			
<b>For models:</b>	PS200, PS300, S900, S902STD, S903			
<b>accessories for</b>	697917			
	<b>GEV No.</b>	697916	<b>Ref. No.</b>	CO0139 S900.28
	screw bolt with nut L 8mm thread M5 ø 6mm			









 <p>1</p>			
<b>GEV No.</b>	697916	<b>Ref. No.</b>	CO0139 S900.28
<b>description</b>	screw bolt with nut L 8mm thread M5 ø 6mm		
<b>For models:</b>	PS200, PS300, PZ2610TN, S900, S902STD, S903		
<b>accessories for</b>	697916		
			
<b>GEV No.</b>	697917	<b>Ref. No.</b>	CO0140 S900.29
<b>description</b>	fixing plate with opposite support thread M5		

for saladettes

spare parts and accessories

 <p>1</p>			
<b>GEV No.</b>	697917	<b>Ref. No.</b>	CO0140 S900.29
<b>description</b>	fixing plate with opposite support thread M5		
<b>For models:</b>	PS200, PS300, S900, S902STD, S903		
<b>accessories for</b>	697917		
			
<b>GEV No.</b>	697916	<b>Ref. No.</b>	CO0139 S900.28
<b>description</b>	screw bolt with nut L 8mm thread M5 ø 6mm		

 <p>1</p>			
<b>GEV No.</b>	697916	<b>Ref. No.</b>	CO0139 S900.28
<b>description</b>	screw bolt with nut L 8mm thread M5 ø 6mm		
<b>For models:</b>	PS200, PS300, PZ2610TN, S900, S902STD, S903		
<b>accessories for</b>	697916		
			
<b>GEV No.</b>	697917	<b>Ref. No.</b>	CO0140 S900.29
<b>description</b>	fixing plate with opposite support thread M5		

for dishwashers

hood mechanics for dishwashers

rollers

 <p>1</p>			
<b>GEV No.</b>	694774	<b>Ref. No.</b>	RC1207
<b>description</b>	roller for vitrine L 42mm		



locks

locking devices

producer-specific

FORCAR

 <p>1</p>			
<b>GEV No.</b>	692338	<b>Ref. No.</b>	RC0725
<b>description</b>	hook H 25mm L 44mm W 30mm hole ø 3.5mm for catch		

 <p>1</p>			
<b>GEV No.</b>	692188	<b>Ref. No.</b>	RC0128
<b>description</b>	key cylinder with lever ø 17.3mm rotation 90° cam length 49mm cam width 13mm		
<b>For models:</b>	GN1200BT, GN1200TN, GN600BT, GN600TN, GNB1200BT, GNB1200TN, SNACK340, SNACK400BT, SNACK400TN, SNACK638		
<b>accessories for</b>	692188		
			
<b>GEV No.</b>	692338	<b>Ref. No.</b>	RC0725
<b>description</b>	hook H 25mm L 44mm W 30mm hole ø 3.5mm for catch		

 <p>1</p>			
<b>GEV No.</b>	692148	<b>Ref. No.</b>	GN2100TN.02 GN650TN.86 RC0243 RC0425
<b>description</b>	key cylinder with lever ø 17.5mm		
<b>For models:</b>	EF400, EF600, ER400, ER400G, ER600, ER600G, GE800BT, GN1200BT, GN1200DT, GN1200DTV, GN1200TN, GN1410BT, GN1410BTM, GN1410TN, GN1410TNG, GN1410TNM, GN2100BT, GN2100TN, GN2100TNG, GN2200TN, GN3100BT, GN3100TN, GN3100TNG, GN3200BT, GN4100BT, GN4100TN, GN4100TNG, GN4200TN, GN600BT, GN600DTV, GN600TN, GN650BT, GN650BTG, GN650BTM, GN650TN, GN650TNG, GN650TNM, GNB600BT, GNV1200DT, GNV600DT, PA2100TN, PA3100TN, PA800BT, PA800TN, PZ2600TN, PZ2610TN, PZ3600TN, SNACK176, SNACK2100TN, SNACK251...(Other models you can see in the webshop)		

# hinges

## spring assisted hinges

universal

INTERKLIMAT

hinges

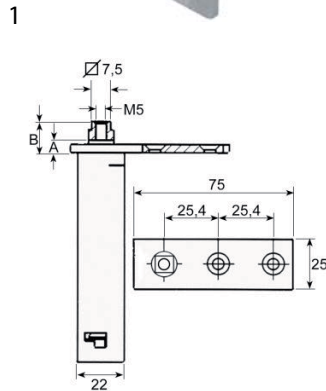

<b>GEV No.</b>	690622	<b>Ref. No.</b>	GN650TN.14 RC0089
<b>description</b>	spring assisted hinge series 28L mounting pos. left/right L 75mm W 25mm H 103mm A 13mm B 18mm mounting measurements 22x22mm intake 7.5x7.5 refrigeration units		
<b>For models:</b>	GE800BT, GN1200BT, GN1200DT, GN1200DTV, GN1200TN, GN1410BT, GN1410BTM, GN1410TN, GN1410TNG, GN1410TNM, GN2100BT, GN2100TN, GN2100TNG, GN2200TN, GN3100BT, GN3100TN, GN3100TNG, GN3200BT, GN4100BT, GN4100TN, GN4100TNG, GN4200TN, GN600BT, GN600DTV, GN600TN, GN650BT, GN650BTG, GN650BTM, GN650TN, GN650TNG, GN650TNM, GNB1200BT, GNB1200TN, GNB600BT, GNV1200DT, GNV600DT, PA2100TN, PA3100TN, PA800BT, PA800TN, PZ2600TN, PZ2610TN, SNACK2100TN, SNACK3100TN, SNACK340, SNACK400BT, SNACK400SBT, SNACK400STN, SNACK400TN, SNACK4100TN...(Other models you can see in the webshop)		

## door bearing



<b>GEV No.</b>	700975	<b>Ref. No.</b>	HF600.19 RC0536
<b>description</b>	bolt L 20mm mounting pos. upper/lower thread M5 ø 7mm for hinge		
<b>For models:</b>	EF400, EF600, ER400, ER400G, ER600, ER600G		

<b>GEV No.</b>	701257	<b>Ref. No.</b>	S900.06
<b>description</b>	bolt L 25mm mounting pos. upper thread M5 ø 7mm complete for door hinge Qty 1 pcs		
<b>For models:</b>	GE800BT, GN1200BT, GN1200DT, GN1200DTV, GN1200TN, GN1410BT, GN1410BTM, GN1410TN, GN1410TNG, GN1410TNM, GN600BT, GN600DTV, GN600TN, GN650BT, GN650BTM, GN650TN, GN650TNG, GN650TNM, GNB600BT, GNV1200DT, PA800BT, PA800TN, PS200, PS300, PS900, S900, S901TOP, S902STD, S903, S903PZ, S903TOP, SNACK400TN, SS45BT		

<b>GEV No.</b>	701032	<b>Ref. No.</b>	GN2100TN.03 GN2100TN.05 GN2100TN.06 RC0175 RC0652
<b>description</b>	bolt L 32.4mm mounting pos. upper thread M8x1.25 ø 5/7mm with nut for door		
<b>For models:</b>	GN2100BT, GN2100TN, GN2100TNG, GN2200TN, GN3100BT, GN3100TN, GN3100TNG, GN4100BT, GN4100TN, GN4100TNG, GN4200TN, PA2100TN, PA3100TN, PS200, PS300, PS900, PZ2600TN, PZ2610TN, PZ3600TN, S900, S901, S902, S903, S903PZ, S903TOP, SNACK2100TN, SNACK3100TN, SNACK4100TN, SS45, U-GN2100TN, U-GN3100TN, U-GN4100TN		

<b>GEV No.</b>	700976	<b>Ref. No.</b>	GN2100TN.07O RC0176
<b>description</b>	bush L 20mm ø 9mm ID ø 7.1mm for hinge		
<b>For models:</b>	PS200, PS300, PS900, S900, S901, S902, S903, S903PZ, S903TOP, SNACK340, SNACK638, SS45		

<b>GEV No.</b>	692258	<b>Ref. No.</b>	S900.55
<b>description</b>	hinge L 30mm W 30mm H 45mm mounting pos. bottom left thickness 3mm		





 <p>1</p>			
<b>GEV No.</b>	692374	<b>Ref. No.</b>	S900.05
<b>description</b>	hinge L 30mm W 30mm H 45mm mounting pos. bottom right thickness 3mm Qty 1 pcs		
<b>For models:</b>	PS200, PS300, PS900, S900, S901TOP, S902STD, S903, S903PZ, S903TOP, SS45BT		

 <p>2</p>			
<b>GEV No.</b>	700974	<b>Ref. No.</b>	HF600.08 RC0535
<b>description</b>	hinge L 49mm W 40mm H 43mm mounting pos. lower thickness 4mm		
<b>For models:</b>	EF400, EF600, ER400, ER400G, ER600, ER600G		

 <p>1</p>			
<b>GEV No.</b>	700973	<b>Ref. No.</b>	HF600.01 RC0534
<b>description</b>	hinge L 51mm W 40mm mounting pos. upper thickness 3mm		
<b>For models:</b>	EF400, EF600, ER400, ER400G, ER600, ER600G		

 <p>1</p>			
<b>GEV No.</b>	701034	<b>Ref. No.</b>	RC0064
<b>description</b>	hinge camp mounting pos. bottom right L 86mm W 46mm H 17mm hole distance 25mm shaft diameter 8x8mm		

 <p>1</p>			
<b>GEV No.</b>	701033	<b>Ref. No.</b>	GN2100TN.28 RC0063
<b>description</b>	hinge camp mounting pos. left bottom L 86mm W 44mm H 19mm hole distance 25mm shaft diameter 8x8mm		

 <p>1</p>			
<b>GEV No.</b>	701035	<b>Ref. No.</b>	GN650TN.51 RC0088
<b>description</b>	hinge camp mounting pos. upper left L 100mm W 63mm H 30mm hole distance 60mm shaft diameter 8x8mm		

 <p>1</p>			
<b>GEV No.</b>	701038	<b>Ref. No.</b>	GN650TN.15 RC0087
<b>description</b>	hinge camp mounting pos. upper right L 99mm W 64mm H 30mm hole distance 60mm shaft diameter 8x8mm		
<b>For models:</b>	GE800BT, GN1200BT, GN1200DT, GN1200DTV, GN1200TN, GN1410BT, GN1410BTM, GN1410TN, GN1410TNG, GN1410TNM, GN600BT, GN600DTV, GN600TN, GN650BT, GN650BTM, GN650TN, GN650TNM, GNB1200BT, GNB1200TN, GNB600BT, GNV1200DT, PA800BT, PA800TN, SNACK400BT, SNACK400SBT, SNACK400STN, SNACK400TN		

## equipment feet and end caps

### screw-in feet

 <p>1</p>			
<b>GEV No.</b>	700972	<b>Ref. No.</b>	S900.13 SL0494
<b>description</b>	equipment foot thread M10 thread L 16mm ø 29mm H 11.5mm Qty 1 pcs for fridge		
<b>For models:</b>	BM11, BM21, BM31, CA1439B, CA1439BG, CA1440B, CA1440BG, EF400, EF600, ER400, ER400G, ER600, ER600G, GE800BT, GN2100BT, GN2100TN, GN2100TNG, GN2200TN, GN3100BT, GN3200BT, GN4100BT, GN4100TN, GN4100TNG, GN4200TN, GN650BT, GN650BTG, GN650BTM, GN650TN, GN650TNG, GN650TNM, PA2100TN, PA3100TN, PA800BT, PA800TN, PS200, PS300, PS900, PZ2600TN, S900, S901, S901TOP, S902, S902STD, S903, S903PZ, S903TOP, SNACK2100TN, SNACK340, SNACK4100TN, SNACK638... (Other models you can see in the webshop)		

## baskets

### warewashing baskets

#### accessories

#### cutlery inserts

 <p>1</p>			
<b>GEV No.</b>	972032	<b>Ref. No.</b>	CP8
<b>description</b>	cutlery insert L 430mm W 205mm ømm H 150mm		

## shelves and shelf rails

### grates

#### universal

#### without upstand

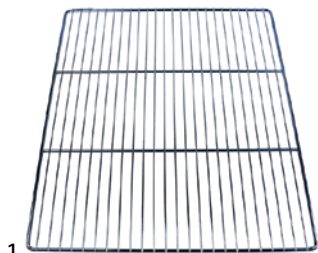

<b>GEV No.</b>	970123	<b>Ref. No.</b>	GN650TN.08 GRI21
<b>description</b>	grate W 650mm D 530mm GN 2/1 stainless steel wire gauge frame 7.8mm lengthwise wires gauge 3.8mm crossing wires 2 suitable for refrigerator		
<b>For models:</b>	GN1200DTV, GN1410BT, GN1410BTM, GN1410TN, GN1410TNG, GN1410TNM, GN600DTV, GN650BT, GN650BTG, GN650BTM, GN650TN, GN650TNG, GN650TNM, GNV1200DT, GNV600DT		
<b>accessories for</b>	970123		
	<b>GEV No.</b>	<b>Ref. No.</b>	—
	690330		
<b>description</b>	rack L 1000mm W 22mm H 4mm aperture 3x8mm hole distance 12.5mm stainless steel		
	<b>GEV No.</b>	<b>Ref. No.</b>	—
	694700		
<b>description</b>	shelf support L 31/28mm W 22mm H 18mm SS Qty 12 pcs		
	<b>GEV No.</b>	<b>Ref. No.</b>	—
	694701		
<b>description</b>	shelf support L 31/28mm W 22mm H 17mm SS with hook Qty 12 pcs		

#### with upstand



<b>GEV No.</b>	970772	<b>Ref. No.</b>	GRP600
<b>description</b>	grate W 650mm D 530mm GN 2/1 H 40mm plastic-coated steel with hinge camp crossing wires 4		

### shelf rails and supports

#### producer-specific



<b>GEV No.</b>	696443	<b>Ref. No.</b>	S900.10.1
<b>description</b>	pair of setting bar U-shape L 548mm W 20mm inner height 13mm mounting pos. left/right		



<b>GEV No.</b>	696388	<b>Ref. No.</b>	CG11 GN2100TN.31 S900.10
<b>description</b>	pair of setting bar U-shape L 550mm W 20mm H 17mm mounting pos. left/right		
<b>For models:</b>	GN2100BT, GN2100TN, GN2100TNG, GN2200TN, GN3100BT, GN3100TN, GN3100TNG, GN3200BT, GN4100BT, GN4100TN, GN4100TNG, GN4200TN, PS200, PS300, PS900, S900, S901, S901TOP, S902, S902STD, S903, S903PZ, S903TOP, SS45, SS45BT, U-GN2100TN, U-GN3100TN, U-GN4100TN		



<b>GEV No.</b>	694507	<b>Ref. No.</b>	AG G350.08 RC0361
<b>description</b>	shelf support L 38/26mm W 22mm H 24mm SS Qty 4 pcs		
<b>For models:</b>	BC2PS, BC3PS, SNACK176, SNACK251, SNACK290, SNACK340, SNACK638		

## gaskets

### refrigeration gaskets

#### plug-in gaskets

#### profile 9153

We offer custom-made gaskets for this profile

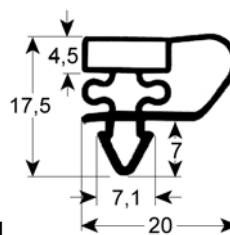

<b>GEV No.</b>	902266	<b>Ref. No.</b>	N/A
<b>description</b>	refrigeration gasket profile 9153 Wmm L 2500mm		

**profile 9150**

<b>GEV No.</b>	901279	<b>Ref. No.</b>	RC0072 S900.08
<b>description</b>	refrigeration gasket profile 9150 W 395mm L 490mm plug size		
<b>For models:</b>	PS200, PS300, PS900, S900, S901, S901TOP, S902, S902STD, S903, S903PZ, S903TOP, SS45		

<b>GEV No.</b>	901282	<b>Ref. No.</b>	HF600.06 RC0426
<b>description</b>	refrigeration gasket profile 9157 W 750mm L 1700mm plug size		
<b>For models:</b>	EF600, ER600, ER600G		

**profile 9157**

<b>GEV No.</b>	901281	<b>Ref. No.</b>	HF400.03 RC0421
<b>description</b>	refrigeration gasket profile 9157 W 570mm L 1650mm plug size Qty 1		
<b>For models:</b>	EF400, ER400, ER400G		

**profile 9041**

<b>GEV No.</b>	901957	<b>Ref. No.</b>	GN2100TN.33 RC0041
<b>description</b>	refrigeration gasket profile 9041 W 385mm L 595mm plug size		
<b>For models:</b>	GN2100BT, GN2100TN, GN2200TN, GN3100BT, GN3100TN, GN4100BT, GN4100TN, GN4200TN, SNACK2100TN, SNACK3100TN, SNACK4100TN		

<b>GEV No.</b>	901975	<b>Ref. No.</b>	RC0199 SNACK400TN.06
<b>description</b>	refrigeration gasket profile 9157 W 615mm L 1445mm plug size		
<b>For models:</b>	GN1200BT, GN1200DT, GN1200DTV, GN1200TN, GN600BT, GN600DTV, GN600TN, GNB600BT, GNV1200DT, SNACK400SBT, SNACK400STN, SNACK400TN		

<b>GEV No.</b>	901958	<b>Ref. No.</b>	PA2100TN.9 RC0162
<b>description</b>	refrigeration gasket profile 9041 W 460mm L 592mm plug size		
<b>For models:</b>	PA2100TN, PA3100TN, PZ2600TN, PZ2610TN, PZ3600TN		

<b>GEV No.</b>	901333	<b>Ref. No.</b>	GN650TN.13 RC0153
<b>description</b>	refrigeration gasket profile 9157 W 695mm L 1477mm plug size L1 1467mm W1 685mm external size		
<b>For models:</b>	GE800BT, GN1410BT, GN1410TN, GN4100TN, GN4100TNG, GN4200TN, GN650BT, GN650BTG, GN650TN, PA800BT, PA800TN, PZ3600TN, SNACK4100TN		

**profile 9326**

<b>GEV No.</b>	901959	<b>Ref. No.</b>	RC0770
<b>description</b>	refrigeration gasket profile 9326 W 535mm L 1155mm plug size		





## refrigeration cycle components

### valves

#### Schrader valves

##### Schrader valves (complete)



<b>GEV No.</b>	750101	<b>Ref. No.</b>	S900.42
<b>description</b>	Schrader valve complete connection 1/4" SAE L 130mm		

### filter driers

#### miscellaneous



<b>GEV No.</b>	750618	<b>Ref. No.</b>	GN1410TN.14
<b>description</b>	dryer size 15g ø 19mm L 114mm connection 2,7/6,5mm type XHY Qty 1 pcs		
<b>For models:</b>	GE800BT, GN1200BT, GN1200DTV, GN1200TN, GN1410BT, GN1410BTM, GN1410TN, GN1410TNG, GN1410TNM, GN2100BT, GN2100TNG, GN3100BT, GN3200BT, GN4100BT, GN4100TNG, GN600BT, GN600TN, GN650BT, GN650BTG, GN650BTM, GN650TN, GN650TNG, GN650TNM, GNB600BT, GNV600DT, PA2100TN, PA3100TN, PA800BT, PA800TN, PZ2600TN, PZ3600TN, SNACK400SBT, SNACK400STN, SNACK400TN		



<b>GEV No.</b>	750324	<b>Ref. No.</b>	RC0066 S900.44
<b>description</b>	dryer size 20g ø 23mm L 117mm connection 4,8/8,3mm		
<b>For models:</b>	GN1200BT, GN1200TN, GN2100TN, GN2200TN, GN3100TN, GN3100TNG, GN4100TN, GN4200TN, GN600BT, GN600TN, GNB1200BT, GNB1200TN, PS200, PS300, PS900, PZ2610TN, RI330, RI380, S900, S901, S901TOP, S902, S902STD, S903, S903PZ, S903TOP, SNACK2100TN, SNACK3100TN, SNACK340, SNACK400BT, SNACK400TN, SNACK4100TN, SNACK638, SS45, SS45BT, U-GN2100TN, U-GN3100TN, U-GN4100TN, VRX1200-330, VRX1200-380, VRX1400-330, VRX1500-330, VRX1500-380, VRX1800-330, VRX1800-380, VRX2000-330, VRX2000-380		



<b>GEV No.</b>	750619	<b>Ref. No.</b>	RC0768
<b>description</b>	dryer size 30g ø 24mm L 140mm connection 2,6/6,5mm Qty 1 pcs		

### refrigeration pipes

#### capillary pipes



<b>GEV No.</b>	694442	<b>Ref. No.</b>	RC0523 S900.43
<b>description</b>	capillary pipe ID ø 1.15mm copper Qty 1m L 300mm refrigeration ED ø 2.1mm		
<b>For models:</b>	BC2PS, BC3PS, GN1200BT, GN1200TN, GN2100BT, GN2100TN, GN2100TNG, GN2200TN, GN3100BT, GN3100TN, GN3100TNG, GN3200BT, GN4100BT, GN4100TN, GN4100TNG, GN4200TN, GN600BT, GN600TN, GNB600BT, PA2100TN, PA3100TN, PS200, PS300, PS900, PZ2600TN, PZ2610TN, PZ3600TN, S900, S901TOP, S902STD, S903, S903PZ, S903TOP, SNACK2100TN, SNACK3100TN, SNACK340, SNACK400STN, SNACK400TN, SNACK4100TN, SNACK638, SS45BT, U-GN2100TN, U-GN3100TN, U-GN4100TN		



<b>GEV No.</b>	694443	<b>Ref. No.</b>	GN1410BT.05
<b>description</b>	capillary pipe ID ø 1.4mm copper Qty 1m L 2500mm refrigeration ED ø 2.8mm		
<b>For models:</b>	GN1410BT, GN1410BTM		



1

<b>GEV No.</b>	694444	<b>Ref. No.</b>	GN1410TN.13
<b>description</b>	capillary pipe ID ø 1.4mm copper Qty 1m L 3000mm refrigeration ED ø 2.8mm		
<b>For models:</b>	GN1410TN, GN1410TNG, GN1410TNM		

copper pipes uninsulated



1

<b>GEV No.</b>	694452	<b>Ref. No.</b>	GN2100TN.09
<b>description</b>	refrigeration pipe copper ED ø 6mm L 0.5m Qty 1m for evaporator		
<b>For models:</b>	GN2100BT, GN2100TN, GN2100TNG, GN2200TN, GN3100BT, GN3100TN, GN3100TNG, GN3200BT, GN4100BT, GN4100TN, GN4100TNG, GN4200TN, PA2100TN, PA3100TN, PZ2600TN, PZ2610TN, PZ3600TN, U-GN2100TN, U-GN3100TN, U-GN4100TN		



Image not available

1

<b>GEV No.</b>	694441	<b>Ref. No.</b>	GN650TN.40
<b>description</b>	refrigeration pipe insulated copper ID ø 7mm ED ø 8mm L 1.8m suction line		
<b>For models:</b>	GE800BT, GN1410TN, GN1410TNG, GN1410TNM, GN650TN, GN650TNG, GN650TNM, PA800BT, PA800TN, SNACK400TN		

evaporators

for fridges

producer-specific



1

<b>GEV No.</b>	750300	<b>Ref. No.</b>	RC0589
<b>description</b>	condenser L 170mm W 85mm H 180mm suitable for ER600		



1

<b>GEV No.</b>	750294	<b>Ref. No.</b>	HR400.07 RC0605
<b>description</b>	evaporator for fridge ER400 L 1000mm W 440mm		
<b>For models:</b>	ER400, ER400G		



1

<b>GEV No.</b>	750295	<b>Ref. No.</b>	HR600.04 RC0606
<b>description</b>	evaporator for fridge ER600 L 1000mm W 580mm		
<b>For models:</b>	ER600, ER600G		



1

<b>GEV No.</b>	750410	<b>Ref. No.</b>	GN650TN.21 RC0319
<b>description</b>	evaporator L 216mm W 130mm H 200mm total length 298mm overall width 130mm overall height 220mm		
<b>For models:</b>	GN650TN, GN650TNG, GN650TNM		



1

<b>GEV No.</b>	750317	<b>Ref. No.</b>	GN650BT.02 RC0283
<b>description</b>	evaporator L 298mm W 152mm H 220mm total length 518mm for fridge		
<b>For models:</b>	GN650BT, GN650BTG, GN650BTM		

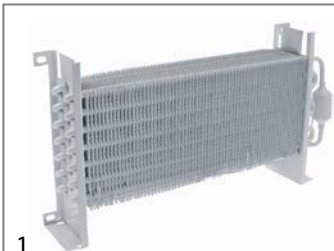

1

<b>GEV No.</b>	750322	<b>Ref. No.</b>	GN2100TN.18 GN2100TN21 RC0285
<b>description</b>	evaporator L 505mm W 95mm H 265mm suitable for ER400/ER400G/ER400SS		
<b>For models:</b>	GN2100BT, GN2100TN, GN2100TNG, GN2200TN, GN3100BT, GN3100TN, GN3100TNG, GN4100BT, GN4100TN, GN4100TNG, GN4200TN, PA2100TN, PA3100TN, PZ2600TN, PZ2610TN, PZ3600TN, SNACK2100TN, SNACK3100TN, SNACK4100TN		



1

<b>GEV No.</b>	750318	<b>Ref. No.</b>	GN1410TN.01 RC0320
<b>description</b>	evaporator L 595mm W 130mm H 220mm for fridge		
<b>For models:</b>	GN1410TN, GN1410TNG, GN1410TNM		

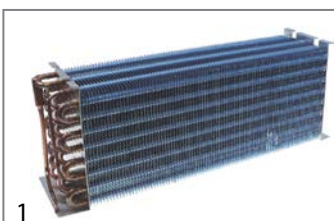

1

<b>GEV No.</b>	750321	<b>Ref. No.</b>	GN1410BT.08 RC0221
<b>description</b>	evaporator L 595mm W 130mm H 220mm for fridge		
<b>For models:</b>	GN1410BT, GN1410BTM		

## condensers

### filters



1

<b>GEV No.</b>	694587	<b>Ref. No.</b>	S900.04
<b>description</b>	air filter for condenser L 218mm W 194mm thickness 6mm Qty 1 pcs		
<b>For models:</b>	PS200, PS900, S900, S901TOP, S902STD, SS45BT		



1

<b>GEV No.</b>	694446	<b>Ref. No.</b>	RC0122 S903.08
<b>description</b>	air filter for condenser L 218mm W 205mm thickness 6mm		
<b>For models:</b>	GN1200BT, GN1200DT, GN1200DTV, GN1200TN, GN600BT, GN600DTV, GN600TN, GN650TN, GN650TNG, GN650TNM, GN-B1200BT, GN-B1200TN, GNV1200DT, GNV600DT, PA800TN, PS200, PS300, PS900, S900, S901, S902, S903, S903PZ, S903TOP, SNACK400BT, SNACK400SBT, SNACK400STN, SNACK400TN, SS45		



1

<b>GEV No.</b>	694445	<b>Ref. No.</b>	GN1410BT.07 RC0556
<b>description</b>	air filter for condenser L 245mm W 215mm thickness 6mm		
<b>For models:</b>	GN1410BT, GN1410BTM		



1

<b>GEV No.</b>	694447	<b>Ref. No.</b>	GN2100TN.34
<b>description</b>	air filter for condenser W 175mm H 228mm thickness 6mm		
<b>For models:</b>	GN2100TN, GN2200TN, GN3100TN, GN4100TN, GN4200TN, SNACK2100TN, SNACK3100TN, SNACK4100TN		





1

<b>GEV No.</b>	694860	<b>Ref. No.</b>	RC1340
<b>description</b>	air filter L 218mm W 175mm thickness 4.5mm		

condensors

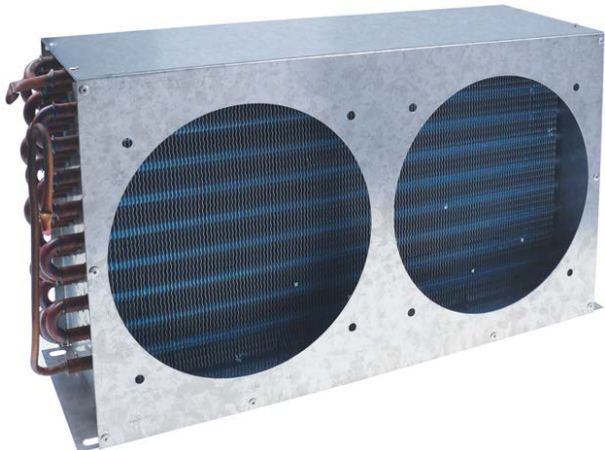

1

<b>GEV No.</b>	750323	<b>Ref. No.</b>	GN1410BT.06 RC0292
<b>description</b>	condenser for fridge W 140mm H 271mm L 500mm		
<b>For models:</b>	GN1410BT, GN1410BTM		



1

<b>GEV No.</b>	750319	<b>Ref. No.</b>	RC0201 VRX.11
<b>description</b>	condenser for pizza table W 228mm D 77mm H 179mm		
<b>For models:</b>	VRX1200-330, VRX1200-380, VRX1400-330, VRX1500-330, VRX1500-380, VRX1800-330, VRX1800-380, VRX2000-330, VRX2000-380		



1

<b>GEV No.</b>	750320	<b>Ref. No.</b>	GN2100TN.08 RC0286
<b>description</b>	condenser for pizza table W 280mm D 190mm H 230mm		
<b>For models:</b>	GN2100BT, GN2100TN, GN2100TNG, GN2200TN, GN3100BT, GN3100TN, GN3100TNG, GN4100BT, GN4100TN, GN4100TNG, GN4200TN, PA2100TN, PA3100TN, PZ2600TN, PZ2610TN, PZ3600TN, SNACK2100TN, SNACK3100TN, SNACK340, SNACK4100TN, SNACK638		

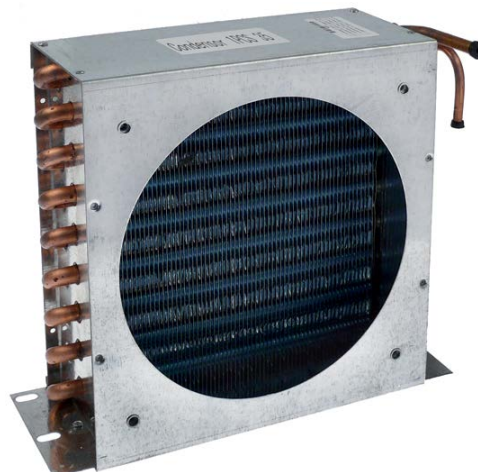

1

<b>GEV No.</b>	750347	<b>Ref. No.</b>	S900.35
<b>description</b>	condenser W 220mm D 100mm H 230mm L 270mm		
<b>For models:</b>	PS200, PS900, S900, S901TOP, S902STD, SS45BT		

## fastening material

## screws

## hexagonal screws



1

<b>GEV No.</b>	696413	<b>Ref. No.</b>	GN650TN.01 RC0316
<b>description</b>	screw thread M6 L 18mm		
<b>For models:</b>	GN1200BT, GN1200TN, GN1410BT, GN1410BTM, GN1410TN, GN1410TNG, GN1410TNM, GN600BT, GN600TN, GN650BT, GN650BTG, GN650BTM, GN650TN, GN650TNG, GN650TNM, GNB600BT, SNACK400SBT, SNACK400STN, SNACK400TN		



<b>A</b>			
axial fans	6		
<b>C</b>			
cables	8		
capillary pipes	14		
compressors	6		
copper pipes uninsulated	15		
<b>E</b>			
electric accessories	8		
electronic controllers	4		
evaporators	15		
<b>F</b>			
fans	6		
fastening material	18		
filter driers	14		
<b>G</b>			
grates	12		
group 1	14		
<b>H</b>			
heating elements	3		
heating elements for bain maries	3		
heating elements for defrosting	3		
heating elements for refrigeration	3		
hexagonal screws	18		
<b>I</b>			
immersion heating elements	3		
indicator lights	4		
indicator lights (complete)	4		
<b>L</b>			
lamps	4		
<b>M</b>			
microswitches	4		
<b>P</b>			
plug-in gaskets	12		
power supply cables	8		
probes	5		
<b>R</b>			
refrigeration cycle components	14		
refrigeration fans	7		
refrigeration gaskets	12		
refrigeration motors universal	7		
refrigeration pipes	14		
rocker/momentary rocker switches		3	
<b>S</b>			
Schrader valves		14	
screws		18	
shelves and shelf rails		12	
spring assisted hinges		10	
switches and momentary switches		3	
<b>T</b>			
temperature probes		5	
terminal boxes		8	
<b>U</b>			
universal probes		5	