



**GAS COMPONENTS**



**ELECTRIC COMPONENTS**



**WATER TECHNOLOGY**



**MECHANICAL COMPONENTS**



**TOOLS**

Spare parts suitable for

**FRACINO**

Find the complete and up-to-date range of products in our GEV Webshop



# Manufacturer catalogue

The most important spare parts and accessories arranged clearly for every manufacturer

- ✓ Complete product range and all appliance data always up to date in the GEV Webshop
- ✓ Alphabetical Index at the end of the catalogue

## GEV Webshop

[www.gev-online.co.uk](http://www.gev-online.co.uk)

[www.gev-online.com](http://www.gev-online.com)



- 🔍 Add to Favourites
- 🔍 Sign In with email address and usual password
- 🔍 Easy-order – place several items in your basket at the same time
- 🔍 Quick Item search – no login needed



## heating elements

### heating elements for coffee machine

1 

<b>GEV No.</b>	417247	<b>Ref. No.</b>	FC161
<b>description</b>	heating element 2700W 230V heating circuits 2 mounting $\varnothing$ 42mm hole distance 75mm L 175mm W 32mm H 66mm L1 25mm L2 30mm L3 120mm H1 32mm H2 34mm hole $\varnothing$ 10mm tube $\varnothing$ 8.5mm thermostat sleeves $\varnothing$ 7mm length thermostat sleeves 200mm thermostat sleeve eccentric, non clinging number of thermostat sleeves 1 connection male faston 6.3mm immersion heater 2 hole flange		

1 

<b>GEV No.</b>	417246	<b>Ref. No.</b>	HEA161
<b>description</b>	heating element 2850W 230V heating circuits 1 thread 1 1/4" L 117mm $\varnothing$ 37mm tube $\varnothing$ 6.3mm connection male faston 6.3mm immersion heater connection length 11mm flange with thread WS 37		

1 

<b>GEV No.</b>	417248	<b>Ref. No.</b>	FC162
<b>description</b>	heating element 4000W 230V heating circuits 2 mounting $\varnothing$ 42mm hole distance 75mm L 395mm W 28mm H 53mm L1 36mm L2 32mm L3 327mm H1 32mm H2 21mm hole $\varnothing$ 10mm tube $\varnothing$ 8.5mm thermostat sleeves $\varnothing$ 7mm length thermostat sleeves 193mm thermostat sleeve eccentric, non clinging number of thermostat sleeves 1 connection male faston 6.3mm immersion heater 2 hole flange		

1 

<b>GEV No.</b>	417249	<b>Ref. No.</b>	FC163
<b>description</b>	heating element 7500W 230V heating circuits 3 mounting $\varnothing$ 42mm hole distance 75mm L 555mm W 34mm H 60mm L1 30mm L2 50mm L3 475mm H1 31mm H2 29mm hole $\varnothing$ 10mm tube $\varnothing$ 8.5mm thermostat sleeves $\varnothing$ 7mm length thermostat sleeves 342mm thermostat sleeve centre not clinging number of thermostat sleeves 1 connection male faston 6.3mm immersion heater 2 hole flange		

### accessories

#### sealing washers

#### fibre gaskets

1 

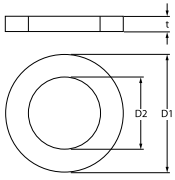

<b>GEV No.</b>	526060	<b>Ref. No.</b>	FC165F
<b>description</b>	flat gasket fibre D1 $\varnothing$ 60mm D2 $\varnothing$ 43mm thickness 3mm coffee machine Qty 1 pcs		

1 

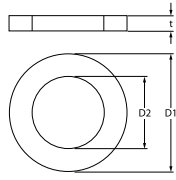

<b>GEV No.</b>	528017	<b>Ref. No.</b>	HEA165
<b>description</b>	flat gasket fibre ED $\varnothing$ 53mm ID $\varnothing$ 42mm thickness 2mm for thread 1 1/4" Qty 1 pcs		

#### PTFE gaskets

1 

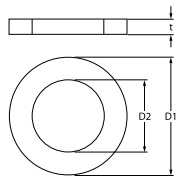

<b>GEV No.</b>	528925	<b>Ref. No.</b>	FC165T
<b>description</b>	flat gasket PTFE ED $\varnothing$ 59.5mm ID $\varnothing$ 42mm thickness 3mm Qty 1 pcs suitable for VFA Express		

#### Viton gaskets

1 

<b>GEV No.</b>	526061	<b>Ref. No.</b>	FC165 FC165V
<b>description</b>	flat gasket Viton D1 $\varnothing$ 60mm D2 $\varnothing$ 43mm thickness 3mm		

## thermostats

### bi-metal thermostats

#### safety bi-metal thermostats

1 

<b>GEV No.</b>	390689	<b>Ref. No.</b>	HEA166
<b>description</b>	bi-metal safety thermostat switch-off temp. 200°C 1-pole 16A connection F6.3 thread M4 with extension		



## switches and momentary switches

### rocker/momentary rocker switches

30x22mm



1

<b>GEV No.</b>	301247	<b>Ref. No.</b>	FC189
<b>description</b>	rocker switch mounting measurements 30x22mm red 2NO 250V 16A illuminated connection male faston 6.3mm ambient temperature max. 125/55°C protection IP40		
<b>spare parts for</b>	301247		
	<b>GEV No.</b>	301060	<b>Ref. No.</b> —
	rocker switch mounting measurements 30x22mm red 2NO 250V 16A illuminated connection male faston 6.3mm ambient temperature max. 125/55°C protection IP40		

ø20mm



1



<b>GEV No.</b>	301246	<b>Ref. No.</b>	HEA189
<b>description</b>	rocker switch mounting ø 20mm black 2NO 250V 10A connection male faston 4.8mm ambient temperature max. 85°C protection IP40		

### push/momentary push switches

ø16mm



1

<b>GEV No.</b>	301248	<b>Ref. No.</b>	FC189/C
<b>description</b>	push switch mounting measurements ø16mm silver 2CO 6A with connecting cable 250V connection male faston 6.3mm cup protection IP40 ambient temperature max. 125/55°C		
<b>spare parts for</b>	301248		
	<b>GEV No.</b>	347448	<b>Ref. No.</b> FC189/CA
	push button mounting measurements ø16mm silver illuminated cup		
	<b>GEV No.</b>	347449	<b>Ref. No.</b> FC189/CS
	contact block momentary 2CO 3-pole		

### accessories

frame



1

<b>GEV No.</b>	347212	<b>Ref. No.</b>	FC189S/P
<b>description</b>	frame for rocker switch oval external size 40x46mm internal size 30x22mm 0-1 black plastic		

## control equipment

### miscellaneous



1

<b>GEV No.</b>	347449	<b>Ref. No.</b>	FC189/CS
<b>description</b>	contact block momentary 2CO 3-pole		





1

<b>GEV No.</b>	347448	<b>Ref. No.</b>	FC189/CA
<b>description</b>	push button mounting measurements ø16mm silver illuminated cup		



1

<b>GEV No.</b>	301248	<b>Ref. No.</b>	FC189/C
<b>description</b>	push switch mounting measurements ø16mm silver 2CO 6A with connecting cable 250V connection male faston 6.3mm cup protection IP40 ambient temperature max. 125/55°C		

<b>spare parts for</b>	301248		
	<b>GEV No.</b>	347448	<b>Ref. No.</b> FC189/CA
	push button mounting measurements ø16mm silver illuminated cup		
	<b>GEV No.</b>	347449	<b>Ref. No.</b> FC189/CS
	contact block momentary 2CO 3-pole		



1

<b>GEV No.</b>	347535	<b>Ref. No.</b>	FCC189
<b>description</b>	push switch mounting measurements ø16mm silver illuminated cup		

## lamps

### indicator lights

#### indicator lights (complete)

ø10mm

with plug-in socket



1

<b>GEV No.</b>	359139	<b>Ref. No.</b>	FC190/G
<b>description</b>	indicator light ø 10mm green 230V connection male faston 6.3mm Qty 1 pcs		

			
1			
<b>GEV No.</b>	359138	<b>Ref. No.</b>	FC190/R
<b>description</b>	indicator light ø 10mm red 230V connection male faston 6.3mm Qty 1 pcs		

			
1			
<b>GEV No.</b>	359140	<b>Ref. No.</b>	FC190
<b>description</b>	indicator light ø 10mm yellow 230V connection male faston 6.3mm Qty 1 pcs		

**relays**

level relays

<p>GICAR</p> 			
1			
<b>GEV No.</b>	402103	<b>Ref. No.</b>	FC172/A
<b>description</b>	level controller 230/240V voltage AC 50/60Hz connection F6.3 type NRL30/1E-2C/F		

			
1			
<b>GEV No.</b>	528636	<b>Ref. No.</b>	HEA172
<b>description</b>	level controller 230V voltage AC 50/60Hz 16/5A connection F6.3 type RL30 MICRO ST		

			
1			
<b>GEV No.</b>	400240	<b>Ref. No.</b>	FC172
<b>description</b>	level relay 230V voltage AC 50/60Hz 8-pole 5A connection plug-in connection round 8-pole type RL30/1E-2C/8		

**electronics**

central units

			
1			
<b>GEV No.</b>	402254	<b>Ref. No.</b>	FC91/2/NT
<b>description</b>	central unit 2 groups 230V 50/60Hz type ET30 F 2GRCZ voltage AC		

			
1			
<b>GEV No.</b>	402253	<b>Ref. No.</b>	FC91/3/ET40
<b>description</b>	central unit 3 groups		

dosing electronics

<p>GICAR</p> 			
1			
<b>GEV No.</b>	402255	<b>Ref. No.</b>	FC90/NT
<b>description</b>	dosing electronics 1 group 230V voltage AC 50/60Hz type RL30 MICRO Z		

**keypads**

membrane keypads

			
1			
<b>GEV No.</b>	402252	<b>Ref. No.</b>	FC94CD
<b>description</b>	membrane keypad FRACINO L 133mm W 40.5mm		





1

<b>GEV No.</b>	402567	<b>Ref. No.</b>	FC94C
<b>description</b>	membrane keypad L 134mm W 39mm		

control panel



1

<b>GEV No.</b>	527973	<b>Ref. No.</b>	FC94
<b>description</b>	control panel L 153.5mm W 44mm black plastic		

accessories



1

<b>GEV No.</b>	347213	<b>Ref. No.</b>	N/A
<b>description</b>	push button brass external size 25mm mounting ø 22mm ET M22x1 IT M12x1		

solenoid valves

solenoid valves (water)

metal

PARKER

2-way

VE-161 series



1

<b>GEV No.</b>	370552	<b>Ref. No.</b>	FC171COM/07
<b>description</b>	solenoid valve 2-ways 230VAC connection 1/4" ET L 44mm with fittings DN 2.2mm t.max. 80°C -10 up to 180°C type series 161.4 coil type KT09 membranes Viton p max 10bar p min 0bar 50Hz 230V voltage AC		



1

<b>GEV No.</b>	370553	<b>Ref. No.</b>	FC171
<b>description</b>	solenoid valve 2-ways 230VAC connection 1/8" L 32mm DN 2.2mm t.max. 80°C -10 up to 140°C type series VE-161.4 coil type KT09 membranes Viton p max 10bar p min 0bar 50Hz brass		

3-way

VE-128 series



1

<b>GEV No.</b>	370060	<b>Ref. No.</b>	FC125/1	
<b>description</b>	solenoid valve 3-ways 230VAC body outer cone DN 1.2mm slide-on receptacle DIN -20° up to 140°C PARKER type series VE-128 coil type YB09 with cable membranes Viton p max 10bar brass flange 32x32mm			
<b>spare parts for</b>	370060			
	<b>GEV No.</b>	370062	<b>Ref. No.</b>	—
	solenoid valve body PARKER 3-ways outer cone			
	<b>GEV No.</b>	371033	<b>Ref. No.</b>	—
	solenoid coil PARKER 230VAC 9VA coil type YB09 with cable seat ø 14mm			
	<b>GEV No.</b>	371095	<b>Ref. No.</b>	—
	O-ring Viton thickness 1.78mm ID ø 6.07mm Qty 1 pcs			
<b>accessories for</b>	370060			
	<b>GEV No.</b>	101527	<b>Ref. No.</b>	FC120
	O-ring Viton thickness 1.78mm ID ø 6.75mm Qty 1 pcs			
	<b>GEV No.</b>	532193	<b>Ref. No.</b>	—
	O-ring silicone thickness 1.78mm ID ø 6.75mm Qty 10 pcs			

electrodes



1

<b>GEV No.</b>	401258	<b>Ref. No.</b>	FC191
<b>description</b>	level electrode 1/4" total length 120mm probe L 94mm insulated probe length 90mm PTFE insulated connection angled, male faston 6.3mm stainless steel ø 2.5mm		



## equipment-specific units

### for espresso machines

#### filter holders

##### filter holders standard

##### filter holder without spout



1

<b>GEV No.</b>	525988	<b>Ref. No.</b>	N/A
<b>description</b>	filter holder suitable for FRACINO without outlet mounting ø 80.2mm outlet 3/8" ID ø 62mm wedge height 11mm wedge position horizontal number of wedges 2 lever straight		

##### filter holders short



1

<b>GEV No.</b>	526066	<b>Ref. No.</b>	FC105/P
<b>description</b>	filter holder mounting ø 80.2mm outlet 3/8" ID ø 62mm handle M12x1.75 wedge height 11mm wedge position horizontal number of wedges 2 lever straight chrome-plated brass		



1

<b>GEV No.</b>	531160	<b>Ref. No.</b>	FC105/B
<b>description</b>	filter holder mounting ø 82mm outlet 3/8" ID ø 62mm handle M14x1.5 wedge height 10mm wedge position horizontal number of wedges 2 lever straight chrome-plated brass		

##### accessories for

531160



<b>GEV No.</b>	531159	<b>Ref. No.</b>	FC106/9/16
<b>description</b>	handle ø 34mm thread M14x1.5 thread L 15mm L 130mm black		

#### handles

##### with external thread



1

<b>GEV No.</b>	531159	<b>Ref. No.</b>	FC106/9/16
<b>description</b>	handle ø 34mm thread M14x1.5 thread L 15mm L 130mm black		

#### filters

##### for 1 cup



1

<b>GEV No.</b>	526069	<b>Ref. No.</b>	FC107
<b>description</b>	coffee filter ø 70mm mounting ø 60mm H 20.5mm cups 1 amount of coffee 7g perforation ø 0.4mm		



1

<b>GEV No.</b>	526132	<b>Ref. No.</b>	FC107/D
<b>description</b>	coffee filter ø 70mm mounting ø 60mm H 23.5mm cups 1 amount of coffee 10g perforation ø 0.4mm		

##### for 2 cups



1

<b>GEV No.</b>	526067	<b>Ref. No.</b>	FC108
<b>description</b>	coffee filter ø 70mm mounting ø 60mm H 20.5mm cups 2 amount of coffee 12g		



1

<b>GEV No.</b>	526068	<b>Ref. No.</b>	FC108/D
<b>description</b>	coffee filter ø 70mm mounting ø 60mm H 24.5mm cups 2 amount of coffee 14g		

##### for coffee pods



1

<b>GEV No.</b>	526070	<b>Ref. No.</b>	FC107/POD
<b>description</b>	coffee filter ø 70mm mounting ø 60mm H 17mm cups 1 für coffee pods		

for 2 cups



1

<b>GEV No.</b>	526899	<b>Ref. No.</b>	FC108/POD
<b>description</b>	coffee filter ø 70mm mounting ø 60.5mm H 19.3mm cups 2 für coffee pods perforation ø 0.4mm		

brewing units

shower screens

flat



1

<b>GEV No.</b>	529193	<b>Ref. No.</b>	FC103M
<b>description</b>	shower screen ø 52.1mm hole ø 6.3mm		
<b>accessories for</b>	529193		
	<b>GEV No.</b>	560300	<b>Ref. No.</b>
			FC103S
<b>description</b>	countersunk screw thread M5 L 16mm SS DIN 963/ISO 2009 Qty 1 pcs intake slotted head ø 9mm		

screws



1

<b>GEV No.</b>	560300	<b>Ref. No.</b>	FC103S
<b>description</b>	countersunk screw thread M5 L 16mm SS DIN 963/ISO 2009 Qty 1 pcs intake slotted head ø 9mm		

filter holder gaskets

flat

standard



1

<b>GEV No.</b>	526064	<b>Ref. No.</b>	FC104/8.5
<b>description</b>	filter holder gasket D1 ø 73.3mm D2 ø 57.3mm H 8.5mm Qty 1 pcs		



1

<b>GEV No.</b>	526063	<b>Ref. No.</b>	FC104
<b>description</b>	filter holder gasket D1 ø 73.3mm D2 ø 57.3mm H 8mm		



1

<b>GEV No.</b>	526065	<b>Ref. No.</b>	FC104/9
<b>description</b>	filter holder gasket D1 ø 73.3mm D2 ø 57.3mm H 9mm Qty 1 pcs		

shim gaskets



1

<b>GEV No.</b>	528599	<b>Ref. No.</b>	FC104/P
<b>description</b>	shim gasket D1 ø 72mm D2 ø 58mm thickness 0.4mm paper Qty 1 pcs		

safety valves

safety valves

3/8"



1

<b>GEV No.</b>	526047	<b>Ref. No.</b>	FC134
<b>description</b>	safety valve connection 3/8" triggering pressure 1.8bar approval CE 0036 sealed		

expansion valves

with hose connection



1

<b>GEV No.</b>	526049	<b>Ref. No.</b>	HEA178
<b>description</b>	expansion valve T1: 1/8" IT hose ø 6mm L 48mm		



## compression springs



1

<b>GEV No.</b>	526053	<b>Ref. No.</b>	FC178/B
<b>description</b>	compression spring $\phi$ 13.8mm L 19.6mm wire gauge $\phi$ 2mm		

## with non-return valve



1

<b>GEV No.</b>	526048	<b>Ref. No.</b>	HEA138C
<b>description</b>	expansion valve with non-return valve connection 1/8"		

## drain pans

### drain pans



1

<b>GEV No.</b>	526021	<b>Ref. No.</b>	FC140/A
<b>description</b>	drain pan L 81mm W 65mm H 48mm hole $\phi$ 8mm hose $\phi$ 20mm suitable for FRACINO		

## aerators and air bleeders



1

<b>GEV No.</b>	529303	<b>Ref. No.</b>	FC135
<b>description</b>	aerator and air bleeder connection 1/4" only steam		

### spare parts for 529303



<b>GEV No.</b>	528687	<b>Ref. No.</b>	HEA180A
<b>description</b>	O-ring Viton thickness 1.78mm ID $\phi$ 3.69mm Qty 1 pcs		

## steam/water taps

### steam/water taps

### steam taps

### steam taps (complete)



1

<b>GEV No.</b>	526036	<b>Ref. No.</b>	HEA222AA
<b>description</b>	steam tap steam tap inlet 1/4"		



1

<b>GEV No.</b>	526031	<b>Ref. No.</b>	CHE222AA
<b>description</b>	steam tap with steam pipe and knob inlet 1/4"/1/2"		

### spare parts for 526031



<b>GEV No.</b>	526032	<b>Ref. No.</b>	FC194/B
<b>description</b>	steam nozzle thread M10x1 4 holes chrome-plated brass		



<b>GEV No.</b>	526035	<b>Ref. No.</b>	HEA221
<b>description</b>	steam pipe thread 3/8" H 155mm L 190mm $\phi$ 11.4mm tube $\phi$ 9.5mm stainless steel suitable for FRACINO		

### accessories for 526031



<b>GEV No.</b>	526039	<b>Ref. No.</b>	FC56
<b>description</b>	tube handle L 34mm plastic		

			
1			
<b>GEV No.</b>	526030	<b>Ref. No.</b>	BAM222AA
<b>description</b>	steam tap with steam pipe and knob steam inlet 1/4"		

			
1			
<b>GEV No.</b>	526034	<b>Ref. No.</b>	BAM222AA FC222AA
<b>description</b>	steam tap with steam pipe and knob steam inlet 1/4"		

			
1			
<b>GEV No.</b>	526033	<b>Ref. No.</b>	FC222AA/04
<b>description</b>	steam tap with steam pipe inlet 1/4"		

components

bushes

			
1			
<b>GEV No.</b>	526040	<b>Ref. No.</b>	FC222T
<b>description</b>	bush D1 ø 10.35mm D2 ø 8.85mm ID ø 6.1mm H 6.35mm brass		

			
1			
<b>GEV No.</b>	527961	<b>Ref. No.</b>	FC77
<b>description</b>	flat gasket copper ED ø 21mm ID ø 17.2mm thickness 1.5mm		

			
1			
<b>GEV No.</b>	531194	<b>Ref. No.</b>	FC198A (D1b)
<b>description</b>	gasket D1 ø 12mm thickness 5.1mm green Viton steam/water tap		

			
1			
<b>GEV No.</b>	527958	<b>Ref. No.</b>	FC222U
<b>description</b>	compression spring ø 10.5mm L 32mm wire gauge ø 1.3mm for steam-/water-tap		

			
1			
<b>GEV No.</b>	526055	<b>Ref. No.</b>	FC222U
<b>description</b>	compression spring ø 10.7mm L 32mm wire gauge ø 1.3mm		

			
water taps			
water taps			
1			
<b>GEV No.</b>	526026	<b>Ref. No.</b>	HEA222B
<b>description</b>	water tap with handle inlet 1/4"		



1

<b>GEV No.</b>	526027	<b>Ref. No.</b>	FC222AB/CON
<b>description</b>	water tap with water pipe and knob inlet 1/4"		



1

<b>GEV No.</b>	526029	<b>Ref. No.</b>	CHE222B
<b>description</b>	water tap with water pipe and knob inlet 1/4"/1/2"		



1

<b>GEV No.</b>	526028	<b>Ref. No.</b>	BAM222AB
<b>description</b>	water tap with water pipe and knob water inlet 1/4"		



1



<b>GEV No.</b>	526038	<b>Ref. No.</b>	FC222AB/04
<b>description</b>	water tap with water pipe inlet 1/4"		

steam/water pipes

steam pipes



1

<b>GEV No.</b>	526035	<b>Ref. No.</b>	HEA221	
<b>description</b>	steam pipe thread 3/8" H 155mm L 190mm ø 11.4mm tube ø 9.5mm stainless steel suitable for FRACINO			
<b>spare parts for</b>	526035			
	<b>GEV No.</b>	526032	<b>Ref. No.</b>	FC194/B
<b>accessories for</b>	526035			
	<b>GEV No.</b>	526039	<b>Ref. No.</b>	FC56
	tube handle L 34mm plastic			



1

<b>GEV No.</b>	526037	<b>Ref. No.</b>	BAM222X/SS FC222X
<b>description</b>	steam pipe thread 3/8" H 210mm ø 14.3mm tube ø 9.5mm BAMBI-NO, CLASSIC		

nozzles for steam pipes



1

<b>GEV No.</b>	526032	<b>Ref. No.</b>	FC194/B
<b>description</b>	steam nozzle thread M10x1 4 holes chrome-plated brass		

## nozzles for water pipes

## tap aerators



1

<b>GEV No.</b>	527974	<b>Ref. No.</b>	FC194E
----------------	--------	-----------------	--------

<b>description</b>	tap aerator H 17mm
--------------------	--------------------

## accessories

## bushes



1

<b>GEV No.</b>	526052	<b>Ref. No.</b>	FC222F/M
----------------	--------	-----------------	----------

<b>description</b>	bush D1 ø 15mm H 5mm brass inner cone steam/water tap ID ø 7.1mm
--------------------	--



1

<b>GEV No.</b>	531150	<b>Ref. No.</b>	UNI222FP
----------------	--------	-----------------	----------

<b>description</b>	bush D1 ø 15mm int. ø 11mm H 5.5mm PTFE inner cone
--------------------	--

## gaskets



1

<b>GEV No.</b>	531149	<b>Ref. No.</b>	UNI222EM
----------------	--------	-----------------	----------

<b>description</b>	gasket PTFE ID ø 12.5mm H 3mm thickness 1.5mm inner cone D1 ø 15mm D2 ø 12mm
--------------------	--



1

<b>GEV No.</b>	528402	<b>Ref. No.</b>	FC182
----------------	--------	-----------------	-------

<b>description</b>	O-ring Viton thickness 2.62mm ID ø 10.78mm Qty 1 pcs
--------------------	--

## springs



1

<b>GEV No.</b>	526054	<b>Ref. No.</b>	FC222C
----------------	--------	-----------------	--------

<b>description</b>	compression spring ø 10.8mm L 23.8mm wire gauge ø 1.6mm steam pipe
--------------------	--

## tube handles



1

<b>GEV No.</b>	526039	<b>Ref. No.</b>	FC56
----------------	--------	-----------------	------

<b>description</b>	tube handle L 34mm plastic
--------------------	----------------------------

## washers



1

<b>GEV No.</b>	560485	<b>Ref. No.</b>	UNI222F
----------------	--------	-----------------	---------

<b>description</b>	plain washer ID ø 6.4mm ED ø 14mm thickness 1.4mm stainless steel Qty 1 pcs
--------------------	---

## fine filters

## fine filters



1

<b>GEV No.</b>	526045	<b>Ref. No.</b>	FC130
----------------	--------	-----------------	-------

<b>description</b>	fine filter ø 9mm H 22mm
--------------------	--------------------------

## intake valves

## intake valves



1

<b>GEV No.</b>	526430	<b>Ref. No.</b>	FC138COM
----------------	--------	-----------------	----------

<b>description</b>	intake valve complete
--------------------	-----------------------

## accessories

## gaskets



1

<b>GEV No.</b>	526062	<b>Ref. No.</b>	FC198
----------------	--------	-----------------	-------

<b>description</b>	gasket D1 ø 12.1mm thickness 4mm white for non-return valve
--------------------	---

## level glasses

## level glasses

## pressure rings



1

<b>GEV No.</b>	526051	<b>Ref. No.</b>	FC183
----------------	--------	-----------------	-------

<b>description</b>	press ring D1 ø 14.8mm D2 ø 11.5mm thickness 3.1mm brass water level glass
--------------------	--



## level glasses (complete)



<b>GEV No.</b>	526043	<b>Ref. No.</b>	FC181A	
<b>description</b>	water level tube set			
<b>spare parts for</b>	526043			
	<b>GEV No.</b>	526042	<b>Ref. No.</b>	FC181
	water level tube ø 11mm H 140mm ID ø 8mm red			

## level glass pipes

	<b>GEV No.</b>	526042	<b>Ref. No.</b>	FC181
<b>description</b>	water level tube ø 11mm H 140mm ID ø 8mm red			

## pipes

	<b>GEV No.</b>	526044	<b>Ref. No.</b>	BAM2221ES FC2221ES
<b>description</b>	pipe ø 9.5mm L 64.5mm T1: M10x1 ET T2: M8x1 IT extension			

## non-return valves

### compression springs

	<b>GEV No.</b>	526056	<b>Ref. No.</b>	HEA180C
<b>description</b>	compression spring ø 7mm L 15mm wire gauge ø 0.3mm for non-return valve			

	<b>GEV No.</b>	526057	<b>Ref. No.</b>	FC180DNT
<b>description</b>	compression spring ø 9.7mm L 14mm wire gauge ø 0.4mm for non-return valve			

## complete

	<b>GEV No.</b>	526050	<b>Ref. No.</b>	HEA180
<b>description</b>	non-return valve inlet 1/8" IT outlet 1/8" ET			

## miscellaneous

	<b>GEV No.</b>	526041	<b>Ref. No.</b>	HEA138COM
<b>description</b>	pip kit T1: 1/8" T2: 1/8" T3: 1/4" with solenoid valve L 140mm for FRACINO			

## for coffee grinders

### miscellaneous

	<b>GEV No.</b>	111286	<b>Ref. No.</b>	HEA307C
<b>description</b>	knob spring L 20.3mm W 9.5mm H 12.5mm			

## knobs

### steam/water taps

#### steam/water taps

	<b>GEV No.</b>	111280	<b>Ref. No.</b>	FC222H/R FR222H ROM222H
<b>description</b>	knob ø 51mm thread Tr18x4 black			
<b>accessories for</b>	111280			
	<b>GEV No.</b>	111287	<b>Ref. No.</b>	FC222Q
<b>description</b>	spacer ring for knob thread 1/2" ID ø 29mm ED ø 25mm H 22.5mm			
	<b>GEV No.</b>	111288	<b>Ref. No.</b>	FC222N
<b>description</b>	compression spring ø 33mm L 33mm wire gauge ø 1.6mm knob			
	<b>GEV No.</b>	111289	<b>Ref. No.</b>	FC222P
<b>description</b>	ring for spring ID ø 29.3mm ED ø 27mm H 3.3mm			





			
1			
<b>GEV No.</b>	111285	<b>Ref. No.</b>	HEA307A
<b>description</b>	turning handle ø 44.3mm shaft ø 9.5mm black		

knob dial plates

			
1			
<b>GEV No.</b>	111283	<b>Ref. No.</b>	FC222L/RS
<b>description</b>	symbol steam ø 44mm black		

			
1			
<b>GEV No.</b>	111282	<b>Ref. No.</b>	FC222L/R ROM222L
<b>description</b>	symbol steam ø 44mm chrome		

			
1			
<b>GEV No.</b>	111284	<b>Ref. No.</b>	FC222L/RW
<b>description</b>	symbol water ø 44mm black		

			
1			
<b>GEV No.</b>	111281	<b>Ref. No.</b>	FC222L/HR ROM222M
<b>description</b>	symbol water ø 44mm chrome		

accessories

			
1			
<b>GEV No.</b>	111288	<b>Ref. No.</b>	FC222N
<b>description</b>	compression spring ø 33mm L 33mm wire gauge ø 1.6mm knob		

			
1			
<b>GEV No.</b>	111280	<b>Ref. No.</b>	FC222H/R FR222H ROM222H
<b>description</b>	knob ø 51mm thread Tr18x4 black		
<b>accessories for</b>	111280		

	<b>GEV No.</b>	111287	<b>Ref. No.</b>	FC222Q
spacer ring for knob thread 1/2" ID ø 29mm ED ø 25mm H 22.5mm				

	<b>GEV No.</b>	111288	<b>Ref. No.</b>	FC222N
compression spring ø 33mm L 33mm wire gauge ø 1.6mm knob				

<b>accessories for</b>	111280			
	<b>GEV No.</b>	111289	<b>Ref. No.</b>	FC222P
ring for spring ID ø 29.3mm ED ø 27mm H 3.3mm				

			
1			
<b>GEV No.</b>	526046	<b>Ref. No.</b>	FC222K/D.91
<b>description</b>	retainer clip L 20mm wire gauge ø 1.5mm SS Qty 1 pcs		

			
1			
<b>GEV No.</b>	111289	<b>Ref. No.</b>	FC222P
<b>description</b>	ring for spring ID ø 29.3mm ED ø 27mm H 3.3mm		

accessories

button springs

			
1			
<b>GEV No.</b>	111286	<b>Ref. No.</b>	HEA307C
<b>description</b>	knob spring L 20.3mm W 9.5mm H 12.5mm		

miscellaneous

			
1			
<b>GEV No.</b>	111289	<b>Ref. No.</b>	FC222P
<b>description</b>	ring for spring ID ø 29.3mm ED ø 27mm H 3.3mm		

			
1			
<b>GEV No.</b>	111287	<b>Ref. No.</b>	FC222Q
<b>description</b>	spacer ring for knob thread 1/2" ID ø 29mm ED ø 25mm H 22.5mm		

gaskets

O-rings

silicone

			
1			
<b>GEV No.</b>	530311	<b>Ref. No.</b>	FC178/C
<b>description</b>	O-ring silicone thickness 1.78mm ID ø 17.17mm Qty 1 pcs		



**Viton**

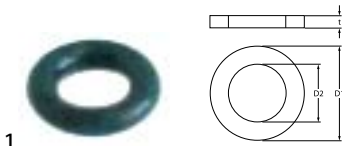

1

<b>GEV No.</b>	528687	<b>Ref. No.</b>	HEA180A
<b>description</b>	O-ring Viton thickness 1.78mm ID ø 3.69mm Qty 1 pcs		

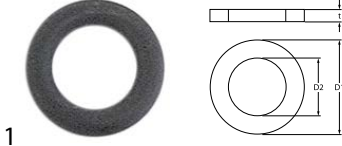

1

<b>GEV No.</b>	101527	<b>Ref. No.</b>	FC120
<b>description</b>	O-ring Viton thickness 1.78mm ID ø 6.75mm Qty 1 pcs		

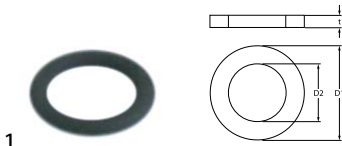

1

<b>GEV No.</b>	528402	<b>Ref. No.</b>	FC182
<b>description</b>	O-ring Viton thickness 2.62mm ID ø 10.78mm Qty 1 pcs		

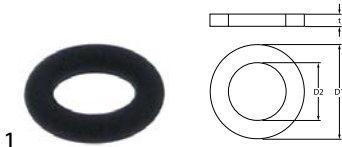

1

<b>GEV No.</b>	526071	<b>Ref. No.</b>	FC222SG
<b>description</b>	O-ring Viton thickness 2mm ID ø 5.6mm Qty 1 pcs		

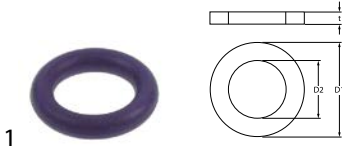

1

<b>GEV No.</b>	526072	<b>Ref. No.</b>	FC222E/M
<b>description</b>	O-ring Viton thickness 3mm ID ø 9.8mm Qty 1 pcs		

**sealing washers**

**aluminium gaskets**



1

<b>GEV No.</b>	526059	<b>Ref. No.</b>	FC77A
<b>description</b>	gasket aluminium ED ø 22.4mm ID ø 16.6mm thickness 0.9mm for thread 3/8" Qty 1 pcs		

**fibre gaskets**



1

<b>GEV No.</b>	528017	<b>Ref. No.</b>	HEA165
<b>description</b>	flat gasket fibre ED ø 53mm ID ø 42mm thickness 2mm for thread 1 1/4" Qty 1 pcs		

**copper gaskets**

DIN-7603-A



1

<b>GEV No.</b>	527961	<b>Ref. No.</b>	FC77
<b>description</b>	flat gasket copper ED ø 21mm ID ø 17.2mm thickness 1.5mm		



1

<b>GEV No.</b>	528660	<b>Ref. No.</b>	FC222G
<b>description</b>	flat gasket copper ED ø 21mm ID ø 17mm thickness 1.5mm suitable for 3/8"		

**PTFE gaskets**



1

<b>GEV No.</b>	528925	<b>Ref. No.</b>	FC165T
<b>description</b>	flat gasket PTFE ED ø 59.5mm ID ø 42mm thickness 3mm Qty 1 pcs suitable for VFA Expres		

**springs**

**compression springs**



1

<b>GEV No.</b>	527958	<b>Ref. No.</b>	FC222U
<b>description</b>	compression spring ø 10.5mm L 32mm wire gauge ø 1.3mm for steam-/water-tap		



1

<b>GEV No.</b>	111288	<b>Ref. No.</b>	FC222N
<b>description</b>	compression spring ø 33mm L 33mm wire gauge ø 1.6mm knob		

## manometers

 <p>1</p>			
<b>GEV No.</b>	541708	<b>Ref. No.</b>	FC179 FC179M
<b>description</b>	manometer double scale ø 60mm pressure range 0-2.5 / 0-16bar connection on the backside thread 1/8"		

 <p>1</p>			
<b>GEV No.</b>	541692	<b>Ref. No.</b>	HEA179
<b>description</b>	manometer ø 41mm pressure range 0-3bar FRACINO thread 1/8" connection on the backside		

## water softeners

### automatic softeners

#### spare parts

 <p>1</p>			
<b>GEV No.</b>	530311	<b>Ref. No.</b>	FC178/C
<b>description</b>	O-ring silicone thickness 1.78mm ID ø 17.17mm Qty 1 pcs		

## fastening material

### screws

#### countersunk screws

 <p>1</p>			
<b>GEV No.</b>	560300	<b>Ref. No.</b>	FC103S
<b>description</b>	countersunk screw thread M5 L 16mm SS DIN 963/ISO 2009 Qty 1 pcs intake slotted head ø 9mm		

### washers

#### washers

#### miscellaneous

 <p>1</p>			
<b>GEV No.</b>	526058	<b>Ref. No.</b>	FC222J
<b>description</b>	washer ID ø 6.65mm ED ø 25mm thickness 1.5mm		

### fasteners

#### retainer clips

 <p>1</p>			
<b>GEV No.</b>	526046	<b>Ref. No.</b>	FC222K/D.91
<b>description</b>	retainer clip L 20mm wire gauge ø 1.5mm SS Qty 1 pcs		

**A**

automatic softeners 16

**B**

bi-metal thermostats 3

**C**

control equipment 4

countersunk screws 16

**E**

electrodes 6

**F**

fasteners 16

fastening material 16

**H**

heating elements 3

heating elements for coffee machine 3

**I**

indicator lights 4

indicator lights (complete) 4

**L**

lamps 4

**O**

O-rings 14

**P**

push/momentary push switches 4

**R**

relays 5

retainer clips 16

rocker/momentary rocker switches 4

**S**

safety bi-metal thermostats 3

screws 16

sealing washers 15

solenoid valves 6

switches and momentary switches 4

**T**

thermostats 3

**W**

washers 16

water softeners 16