



GAS COMPONENTS



ELECTRIC COMPONENTS



WATER TECHNOLOGY



MECHANICAL COMPONENTS



TOOLS

Spare parts suitable for

FRANKE

Find the complete and up-to-date range of products in our GEV Webshop



Manufacturer catalogue

The most important spare parts and accessories arranged clearly for every manufacturer

- ✓ Complete product range and all appliance data always up to date in the GEV Webshop
- ✓ Alphabetical Index at the end of the catalogue

GEV Webshop

www.gev-online.co.uk

www.gev-online.com



- 🔍 Add to Favourites
- 🔍 Sign In with email address and usual password
- 🔍 Easy-order – place several items in your basket at the same time
- 🔍 Quick Item search – no login needed



heating elements

heating elements for chip scuttles

			
GEV No.	418465	Ref. No.	178980 1G592028
description	heating element 800W 230V heating circuits 1 L 370mm W 95mm connection male faston 6.3mm tube ø 6.3mm dry heating element connection distance 89mm		

heating elements for fryers

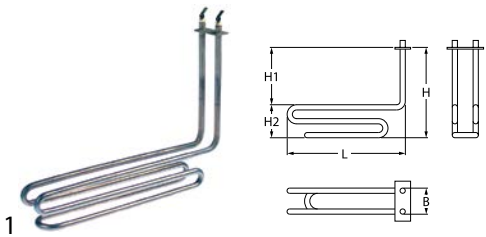
			
GEV No.	418460	Ref. No.	178613 1G592018
description	heating element 2000W 230V heating circuits 1 L 280mm W 42mm H 200mm rectangular flange connection male faston 6.3mm H1 146mm H2 54mm hole ø 5mm flange length 48mm flange width 18mm fryer		

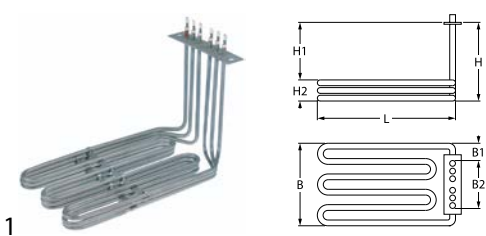
			
GEV No.	418474	Ref. No.	1G564035
description	heating element 6000W 230/400V heating circuits 3 L 285mm W 155mm H 173mm rectangular flange connection male faston 6.3mm immersion heater W1 32.5mm W2 90mm H1 151mm H2 22mm hole distance 124mm hole ø 8mm flange length 136mm flange width 30mm tube ø 6.5mm connection length 33mm		

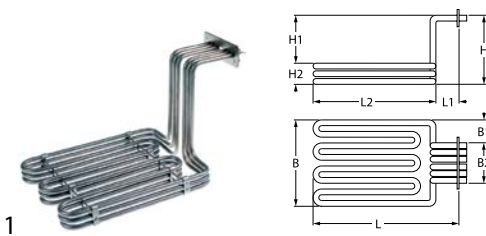
			
GEV No.	418461	Ref. No.	178871
description	heating element 6000W 230/400V heating circuits 3 L 357mm W 208mm H 210mm L1 77mm L2 283mm W1 67mm W2 74mm H1 178mm H2 32mm windings 9 flange length 100mm flange width 40mm hole distance 83mm connection male faston 6.3mm mounting thread M5 tube ø 8.5mm rectangular flange immersion heater		

heating elements for griddles

			
GEV No.	418575	Ref. No.	1V421471
description	heating element 100W 230V heating circuits 1 L 94mm W 68mm tube ø 6.5mm cable length 70mm connection length 20mm dry heating element		

			
GEV No.	418463	Ref. No.	1G563025
description	heating element 3300W 400V heating circuits 1 L 420mm W 255mm H 45mm tube ø 6.5mm cable length 450mm connection length 23mm connection distance 249mm dry heating element		

			
GEV No.	418435	Ref. No.	178859 1G870069
description	heating element 3500W 230V heating circuits 1 L 460mm W 233mm H 73mm tube ø 6.3mm cable length 1050mm connection length 25mm griddle dry heating element		

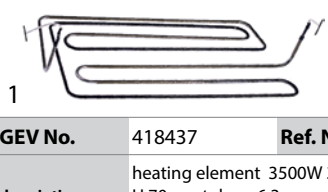
			
GEV No.	418437	Ref. No.	178996
description	heating element 3500W 380V heating circuits 1 L 478mm W 250mm H 70mm tube ø 6.3mm cable length 115mm mounting pos. right griddle dry heating element		

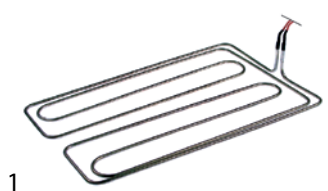
			
GEV No.	418434	Ref. No.	178993 1G870133
description	heating element 3500W 380V heating circuits 1 L 480mm W 310mm H 70mm tube ø 6.5mm cable length 550mm connection length 35mm griddle dry heating element		



			
1			
GEV No.	418406	Ref. No.	178857
description	heating element 3500W 400V heating circuits 1 L 455mm W 287mm H 77mm tube ø 6.5mm cable length 1100mm dry heating element		

			
1			
GEV No.	418436	Ref. No.	BK178995
description	heating element 3500W 400V heating circuits 1 L 480mm W 250mm H 70mm tube ø 6.5mm cable length 115mm mounting pos. left griddle dry heating element		

heating elements for large hobs

			
1			
GEV No.	418485	Ref. No.	1G532081
description	heating element 1100W 400V L 258mm W 258mm H 82mm heating circuits 1 tube ø 6.5mm mounting pos. centre/inside connection length 20mm connection M4 dry heating element		

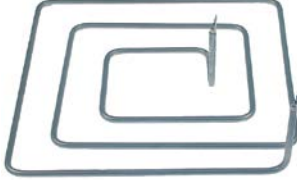
			
1			
GEV No.	418484	Ref. No.	1G532080
description	heating element 1300W 400V L 284mm W 284mm H 81mm heating circuits 1 tube ø 6.5mm mounting pos. centre/outside connection length 20mm connection M4 dry heating element		

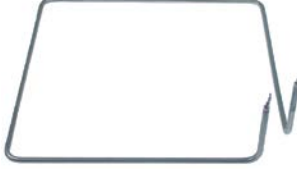
			
1			
GEV No.	418483	Ref. No.	1G532079
description	heating element 650W 400V L 315mm W 315mm H 80mm heating circuits 1 tube ø 6.5mm mounting pos. outer connection length 20mm connection M4 dry heating element		

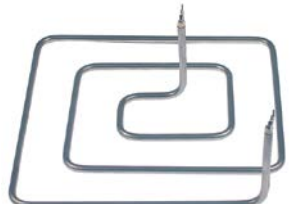
			
1			
GEV No.	418486	Ref. No.	1G532082
description	heating element 900W 400V L 230mm W 230mm H 81mm heating circuits 1 tube ø 6.5mm mounting pos. inner connection length 20mm connection M4 dry heating element		

heating elements for salamanders/toast-

			
1			
GEV No.	419184	Ref. No.	409100
description	heating element 2000W 230V heating circuits 1 L 205mm W 262mm W2 305mm flange length 26mm flange width 11mm tube ø 4mm connection length 36mm dry heating element connection F6.3 salamander grill H 4mm		

			
1			
GEV No.	415541	Ref. No.	279801
description	heating element 2000W 230V heating circuits 1 mounting pos. left L 250mm W 210mm H 120mm W2 170mm connection distance 164mm tube ø 6.3mm cable length 500mm dry heating element salamander grill		

			
1			
GEV No.	415540	Ref. No.	279802
description	heating element 2000W 230V heating circuits 1 mounting pos. right L 250mm W 210mm H 120mm W2 170mm connection distance 164mm tube ø 6.5mm cable length 500mm dry heating element salamander grill		



bottom heaters





1

GEV No.	390410	Ref. No.	1G963100
description	bi-metal safety thermostat hole distance 24mm switch-off temp. 200°C 1NC 1-pole 16A connection F6.3 2 hole fixing		



1

GEV No.	418429	Ref. No.	1G564207	
description	bottom heater 1800W 230V heating circuits 1 ø 196mm safety thermostat 250°C M5 mounting distance 180mm			
spare parts for	418429			
	GEV No.	375137	Ref. No.	—
	safety thermostat switch-off temp. 250°C 1-pole 16A probe ø 3.03mm probe L 160mm capillary pipe 880mm capillary pipe isolated 800mm gland nut probe SS with curved probe			





1

GEV No.	418473	Ref. No.	1G963111
description	bottom heater 1800W 230V heating circuits 1 ø 196mm safety thermostat°C M5 mounting distance 180mm		





1

GEV No.	418466	Ref. No.	1G963110	
description	bottom heater 1800W 230V heating circuits 1 ø 196mm thermostat 128°C M5 mounting distance 180mm			
spare parts for	418466			
	GEV No.	375782	Ref. No.	—
	thermostat t.max. 128°C temperature range 30-128°C 1-pole 1NO 16A probe ø 3.03mm probe L 178mm capillary pipe 870mm capillary pipe isolated 800mm gland nut shaft ømm shaft L 23mm shaft position upper rotation 270° outer switch 2NO with curved probe			
	GEV No.	520323	Ref. No.	—
	gasket ID ø 160mm ED ø 200mm hole distance 90/180mm hole ø 7mm silicone for bottom heaters			

accessories for	418466			
	GEV No.	520323	Ref. No.	—
	gasket ID ø 160mm ED ø 200mm hole distance 90/180mm hole ø 7mm silicone for bottom heaters			





1

GEV No.	418467	Ref. No.	1G564199	
description	bottom heater 1800W 230V heating circuits 2 ø 196mm safety thermostat 250°C thermostat 105°C M5 mounting distance 180mm			
spare parts for	418467			
	GEV No.	375137	Ref. No.	—
	safety thermostat switch-off temp. 250°C 1-pole 16A probe ø 3.03mm probe L 160mm capillary pipe 880mm capillary pipe isolated 800mm gland nut probe SS with curved probe			
	GEV No.	375794	Ref. No.	—
	thermostat t.max. 105°C temperature range 30-105°C 1-pole 1NO 16A probe ø 3.03mm probe L 178mm capillary pipe 870mm capillary pipe isolated 800mm gland nut shaft ø6x4.6mm shaft L 23mm shaft position upper rotation 270° outer switch 2NO with curved probe			
accessories for	418467			
	GEV No.	520323	Ref. No.	—
	gasket ID ø 160mm ED ø 200mm hole distance 90/180mm hole ø 7mm silicone for bottom heaters			



1



GEV No.	418482	Ref. No.	1G564209	
description	bottom heater 2000W 400V heating circuits 1 ø 196mm safety thermostat 250°C thermostat 128°C M5 H 5mm mounting distance 180mm connection male faston 6.3mm			
spare parts for	418482			
	GEV No.	375137	Ref. No.	—
	safety thermostat switch-off temp. 250°C 1-pole 16A probe ø 3.03mm probe L 160mm capillary pipe 880mm capillary pipe isolated 800mm gland nut probe SS with curved probe			
	GEV No.	375782	Ref. No.	—
	thermostat t.max. 128°C temperature range 30-128°C 1-pole 1NO 16A probe ø 3.03mm probe L 178mm capillary pipe 870mm capillary pipe isolated 800mm gland nut shaft ømm shaft L 23mm shaft position upper rotation 270° outer switch 2NO with curved probe			



E-G-O



1

GEV No.	419008	Ref. No.	1G564319 834963
description	bottom heater 3000W 400V heating circuits 2 ø 196mm safety thermostat 250°C thermostat 128°C M5 H 180mm		
spare parts for	419008		
	GEV No.	375137	Ref. No. —
	safety thermostat switch-off temp. 250°C 1-pole 16A probe ø 3.03mm probe L 160mm capillary pipe 880mm capillary pipe isolated 800mm gland nut probe SS with curved probe		
	GEV No.	375782	Ref. No. —
	thermostat t.max. 128°C temperature range 30-128°C 1-pole 1NO 16A probe ø 3.03mm probe L 178mm capillary pipe 870mm capillary pipe isolated 800mm gland nut shaft ømm shaft L 23mm shaft position upper rotation 270° outer switch 2NO with curved probe		

heating plates







1

GEV No.	418438	Ref. No.	BK178987
description	hot plate 700W 230V heating circuits 1 cable length 750mm L 480mm W 80mm		

heating elements for convection



1

GEV No.	418690	Ref. No.	10295641
description	heating element 2000W 230V L 90mm W 390mm connection F 6.3 tube ø 8.5mm M14x1.5 mounting distance 390mm		
accessories for	418690		
	GEV No.	510417	Ref. No. —
	flat gasket fibre ED ø 20mm ID ø 14mm thickness 2mm Qty 1 pcs		
	GEV No.	520228	Ref. No. —
	tooth lock washer ID ø 15.3mm ED ø 24mm steel Qty 1 pcs for thread M14		
	GEV No.	520230	Ref. No. —
	nut thread M14x1.5 H 5mm WS 19 zinc-coated steel Qty 1 pcs		
	GEV No.	521101	Ref. No. —
	nut thread M14x1.5 H 5mm WS 19 SS Qty 1 pcs		
	GEV No.	550262	Ref. No. —
	flat gasket copper ED ø 20mm ID ø 14mm thickness 2mm		

radiation heaters



1

GEV No.	490148	Ref. No.	1G962926
description	radiation heater rectangular 2500W 400V without pan detection L 300mm W 570mm heating circuits 2 EGO		



1

GEV No.	490147	Ref. No.	1G962922
description	radiation heater rectangular 3500W 230V with pan detection L 300mm W 570mm heating circuits 2 EGO		



1

GEV No.	490198	Ref. No.	409.101
description	radiation heater rectangular flange 2300W 230V L 320mm W 230mm H 35mm heating circuits 1 EGO		

1-circuit



1

GEV No.	490131	Ref. No.	1G962948
description	radiation heater ø 250mm 2500W 400V heating circuits 1 energy regulation with temperature signalization with ribbon heater connections 2+2 connection type male faston 6.3mm EGO		

foil heating elements



1

GEV No.	418472	Ref. No.	1G962947
description	foil heating element L 400mm W 230mm 175W 230V aluminium cable length 490mm thickness 3mm		



energy regulators

EGO

1-circuit



GEV No.	380015	Ref. No.	962529
description	energy regulator 230V 13A single-circuit turn direction right shaft ø 6x4.6mm shaft L 23mm mounting thread M4 power release 6-100% no. 50.57021.010		

thermostats

bi-metal thermostats

safety bi-metal thermostats



GEV No.	390410	Ref. No.	1G963100
description	bi-metal safety thermostat hole distance 24mm switch-off temp. 200°C 1NC 1-pole 16A connection F6.3 2 hole fixing		

bi-metal thermostats



GEV No.	390592	Ref. No.	1V421472
description	bi-metal thermostat hole distance 24mm switch-off temp. 100°C 1NC 1-pole 2 hole fixing		



control and safety thermostats

EGO

control thermostats

55.13_ series



GEV No.	375007	Ref. No.	178983	
description	thermostat t.max. 110°C temperature range 30-110°C 1-pole 1NO 16A probe ø 6mm probe L 113mm capillary pipe 870mm capillary pipe isolatedmm gland nut M9x1 shaft L 25mm shaft position upper rotation 270°			
accessories for	375007			
	GEV No.	110119	Ref. No.	—
	knob thermostat t.max. 110°C ø 50mm shaft ø 6x4.6mm shaft flat upper black temperature range 30-110°C rotation 270°			
	GEV No.	110241	Ref. No.	—
	knob thermostat t.max. 110°C ø 50mm shaft ø 6x4.6mm shaft flat upper black temperature range 30-110°C			

safety thermostats

55.11_ series



GEV No.	375790	Ref. No.	178882 BK178610
description	safety thermostat switch-off temp. 273°C 1-pole 16A probe ø 6mm probe L 77mm capillary pipe 400mm capillary pipe isolatedmm gland nut probe SS		

55.13_series

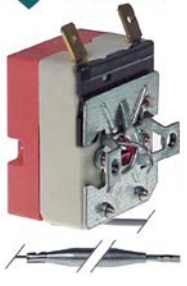

GEV No.	375784	Ref. No.	178982
description	safety thermostat switch-off temp. 140°C 1-pole 16A probe ø 6mm probe L 77mm capillary pipe 870mm capillary pipe isolated 790mm gland nut probe SS		

55.32_series



GEV No.	375787	Ref. No.	1G962526
description	safety thermostat switch-off temp. 380°C 2-pole 20A probe ø 4mm probe L 163mm capillary pipe 1190mm capillary pipe isolated 800mm gland nut probe SS		

55.33_series



GEV No.	375781	Ref. No.	1G962532
description	safety thermostat switch-off temp. 275°C 3-pole 20A probe ø 4mm probe L 157mm capillary pipe 870mm capillary pipe isolated 350mm gland nut probe SS		

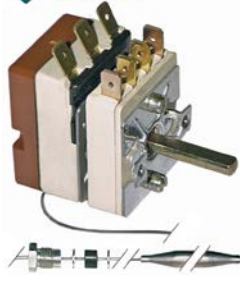

control thermostats with operation switch

55.13_series



GEV No.	375406	Ref. No.	1G873027
description	thermostat t.max. 110°C temperature range 30-110°C 1-pole 1CO 16A probe ø 6mm probe L 113mm capillary pipe 2380mm capillary pipe isolated 1700mm gland nut M9x1 shaft ø 6x4.6mm shaft L 18mm shaft position upper rotation 270° outer switch 2NO		

accessories for 375406

	GEV No.	110545	Ref. No.	—
	knob dial plate silver thermostat t.max. 110°C 30-110°C rotation 310° ED ø 59mm ID ø 45.5mm			
	GEV No.	112173	Ref. No.	—
	knob universal ø 62mm black without adaptor/dial plate			
	GEV No.	112311	Ref. No.	—
	knob adapter shaft ø 6x4.6mm L 0mm with spring			

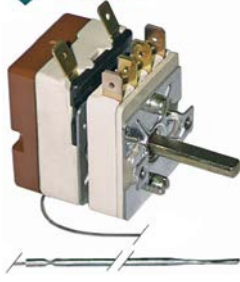

GEV No.	375408	Ref. No.	178855 1G873056
description	thermostat t.max. 320°C temperature range 50-320°C 1-pole 1NO 16A probe ø 3.03mm probe L 160mm capillary pipe 1150mm capillary pipe isolatedmm gland nut shaft ø 6x4.6mm shaft L 23mm shaft position upper rotation 270° outer switch 2NO		

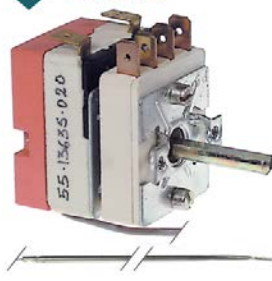

GEV No.	375780	Ref. No.	1G962531
description	thermostat temperature range 120-190°C 1-pole 1NO 16A probe ø 3mm probe L 248mm capillary pipe 1730mm capillary pipe isolated 1660mm gland nut shaft ø 6x4.6mm shaft L 23mm shaft position upper rotation 270° outer switch 2NO		



55.34_series



GEV No.	375570	Ref. No.	179312
description	thermostat t.max. 470°C temperature range 100-470°C 1-pole 1NO 16A probe ø 3.9mm probe L 228mm capillary pipe 1110mm capillary pipe isolated 600mm gland nut shaft ø 6x4.6mm shaft L 24mm shaft position upper rotation 270° outer switch 2NO		



GEV No.	375140	Ref. No.	179302
description	thermostat t.max. 650°C temperature range 50°C/50-600°C/70-650°C 3-pole 3NO 16A probe ø 4mm probe L 228mm capillary pipe 1200mm capillary pipe isolated 1200mm gland nut shaft ø 6x4.6mm shaft L 23mm shaft position left rotation 318° outer switch 2NO		

INVENSYS / ROBERTSHAW

control thermostats



GEV No.	390636	Ref. No.	719.390.554
description	thermostat t.max. 204°C temperature range 93-204°C 1-pole 1NO 0.67A probe ø 9.5mm probe L 123mm capillary pipe 915mm capillary pipe isolatedmm gland nut 1/4" NPT shaft ø 6x4.6mm shaft L 21mm shaft position lower rotation 315° probe material nickel-plated probe thread 1/4" US		

safety thermostats



GEV No.	390965	Ref. No.	S19.000.067
description	safety thermostat switch-off temp. 232°C 1-poleA probe ø 7.93mm probe L 77mm capillary pipe 760mm capillary pipe isolatedmm gland nut shaft ømm probe SS		

PRODIGY / FIRT

control thermostats



GEV No.	390595	Ref. No.	995574
description	thermostat type PRODIGY temperature range 30-90°C probe ø 6.5mm probe L 63mm capillary pipe 1500mm		

switches and momentary switches

rocker/momentary rocker switches

30x22mm



GEV No.	346899	Ref. No.	1V420303
description	rocker switch mounting measurements 30x22mm yellow 2NO 230V 16A illuminated 0-I connection male faston 6.3mm ambient temperature max. 125/55°C protection IP65 with rubber collar		

push/momentary push switches

ø12mm



GEV No.	346594	Ref. No.	1G564257
description	momentary push switch mounting ø 12mm black 1NO 250V 4A connection male faston 6.3mm ambient temperature max. 85°C protection IP40		

1

GEV No.	346583	Ref. No.	178883
description	push switch mounting ø 12mm black 1NO 250V 6A connection male faston 4.8mm ambient temperature max. 100/55°C protection IP40		

microswitches

pin-plunger actuated

M10



1

GEV No.	348013	Ref. No.	279-075
description	microswitch with plunger thread M10x0.75 thread L 20mm 250V 6A 1NO connection cable stroke 5.8mm mounting distance 22mm ambient temperature max. 125°C for door actuating force: 360g		

mercury tilt switches



1

GEV No.	346582	Ref. No.	178612 1G594020
description	mercury tilt switch		

cam switches

on/off

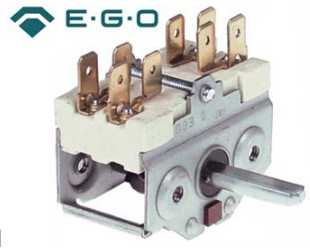



1

GEV No.	300074	Ref. No.	178843 1G960702
description	cam switch 4 operating positions 2NO sequence 0-1-0-1 16A shaft ø 6x4.6mm shaft L 23mm connection male faston 6.3mm ceramic		

7-position



1

GEV No.	300025	Ref. No.	178851	
description	cam switch 7 operating positions 1NO/2CO sequence 0-1-2-3-4-5-6 16A shaft ø 6x4.6mm shaft L 23mm connection screw 7-position ceramic			
accessories for	300025			
	GEV No.	112172	Ref. No.	—
	knob universal ø 70mm black without adaptor/dial plate			
	GEV No.	112213	Ref. No.	—
	knob dial plate silver switch 7-position t.max.°C ED ø 63mm ID ø 45.5mm			
	GEV No.	112311	Ref. No.	—
	knob adapter shaft ø 6x4.6mm L 0mm with spring			

5 operating positions



1

GEV No.	345199	Ref. No.	279800
description	cam switch 5 operating positions 2NO/1CO sequence 0-1-2-3-4 16A shaft ø 6x4.6mm shaft L 23mm connection male faston 6.3mm		



1

GEV No.	347708	Ref. No.	1E409312	
description	cam switch shaft ø 6x4.6mm shaft L 23.5mm connection male faston 6.3mm 3-pole conversion kit			
spare parts for	347708			
	GEV No.	301319	Ref. No.	—
	cam switch 16A shaft ø 6x4.6mm shaft L 23mm connection male faston 6.3mm plastic			



10 operating positions



GEV No.	348183	Ref. No.	1G960000
description	cam switch 10 operating positions sequence 0-1-2-3-4-5-6-7-8-9 16A shaft ø 6x4.6mm shaft L 23mm connection male faston 6.3mm		

control equipment

SCHLEGEL

ø30.5mm



GEV No.	348048	Ref. No.	385.230
description	push switch mounting measurements ø30.5 anthracite/transparent IP67 2NO sequence 0-1 with membrane		

lamps



GEV No.	359896	Ref. No.	887026
description	neon light bulb socket Ba9s 230V green ø 10mm L 28mm		

lamps

indicator lights

indicator lights 3-piece (housing, lens and bulb)

ø18.2mm



GEV No.	359855	Ref. No.	178839
description	indicator light housings mounting measurements ø18.2mm socket Ba9s green		

lamps

neon light bulbs



GEV No.	359896	Ref. No.	887026
description	neon light bulb socket Ba9s 230V green ø 10mm L 28mm		

indicator lights (complete)

ø10mm

with plug-in socket



GEV No.	359139	Ref. No.	177.681
description	indicator light ø 10mm green 230V connection male faston 6.3mm Qty 1 pcs		



GEV No.	359138	Ref. No.	177680
description	indicator light ø 10mm red 230V connection male faston 6.3mm Qty 1 pcs		

ø16mm

with plug-in socket



GEV No.	359909	Ref. No.	BK178985
description	indicator light ø 16mm 230V green cable length 200mm cable material silicone wire		



GEV No.	359908	Ref. No.	178999
description	indicator light ø 16mm 230V yellow cable length 200mm cable material silicone wire		



GEV No.	359094	Ref. No.	1G962017
description	indicator light ø 16mm 400V yellow cable length 200mm cable material silicone wire		

screw-on/push-on fit

neon light bulbs



GEV No.	359896	Ref. No.	887026
description	neon light bulb socket Ba9s 230V green ø 10mm L 28mm		



timers

audible timers



1

GEV No.	350014	Ref. No.	279803
description	audible timer operation time 15min ø 56mm shaft ø 6x4.6mm shaft L 24mm mounting distance 28mm		

contactors

ABB

power contactors



1

GEV No.	380104	Ref. No.	279788
description	power contactor resistive load 25A 230VAC (AC3/400V) 9A/4kW main contacts 3NO auxiliary contacts 1NO connection screw connection type A9-30-10		

HARTLAND

power contactors



1

GEV No.	381277	Ref. No.	719.384.213
description	power contactor resistive load 50A 24VAC 40A/10HP (AC3/240V) 40A/7.46kW main contacts 3NO auxiliary contacts connection screw clamp/male faston 6.3mm type HCCY3XQ04CG		

solid state relays

CRYDOM



1

GEV No.	401563	Ref. No.	1G533279
description	solid state relay CRYDOM 1 phase 50A 600V 4-32VDC L 59mm W 46mm screw type HD4850-10		
accessories for	401563		
	GEV No.	401564	Ref. No. 1G946000
	heat-conducting foil L 62mm W 45mm for solid state relay		

heat-conducting foils



1

GEV No.	401564	Ref. No.	1G946000
description	heat-conducting foil L 62mm W 45mm for solid state relay		

relays

power relays

with bracket mounting



1

GEV No.	380403	Ref. No.	1G962019
description	power relays FINDER 230VAC 16A 3CO connection F6.3 bracket mounting manuf. no. 62.83.8.230.0500		

1

GEV No.	380185	Ref. No.	1V420302
description	power relays Italiana Relè 230VAC 30A 1NO connection F6.3 bracket mounting dimensions 36.5x32.2x51.8mm manuf. no. A10-230AC-FA		

electronic controllers

LAE

refrigeration controllers

built-in version



1

GEV No.	379852	Ref. No.	1K267923
description	electronic controller LAE type AT1-5AS4D-G mounting measurements 71x29mm 12V voltage AC/DC NTC/PTC relay outputs 2 NO-16A(5) NO-4A(1) NTC/PTC front measurements 77x35mm built-in depth 70mm protection IP55 accuracy 1% defr. funct. -50 to +120°C display 3 digits		



1

GEV No.	378043	Ref. No.	1K267923 old
description	electronic controller LAE type SDU12T0RD mounting measurements 71x29mm 12V voltage AC/DC PTC relay outputs 1 relay protection IP54 -19 up to +99°C compressor relay 5A		

probes

universal probes

temperature probes



1

GEV No.	379860	Ref. No.	1V421494
description	temperature probe NTC 10kOhm cable PVC probe -20 up to +80°C cable -10 up to 100°C probe ø6x40mm cable length 1.5m without screw connection 2-wire		

producer-specific probes

probes



1

GEV No.	379880	Ref. No.	178881
description	temperature probe NTC 900kOhm cable silicone probe -40 up to +150°C cable -50 up to +180°C connection male faston thread probe ø6x80/170mm cable length 0.4m		



1

GEV No.	379879	Ref. No.	BK178611
description	temperature probe NTC 900kOhm cable silicone probe -40 up to +150°C cable -50 up to +180°C connection male faston thread probe ø6x80/170mm cable length 0.65m		



1

GEV No.	379882	Ref. No.	1G943000
description	temperature probe thermocouple K (NiCr-Ni) cable glass fibre probe -50 up to 1150°C cable -50 up to +350°C connection 2-wire probe ø4x20mm		
accessories for	379882		
	GEV No.	Ref. No.	1G534536
	bayonet adapter L 66mm thread M6x1 ID ø 7/4mm ED ø 12mm		

accessories

adapters



1

GEV No.	379881	Ref. No.	1G534536
description	bayonet adapter L 66mm thread M6x1 ID ø 7/4mm ED ø 12mm		



electronics

PCBs



1

GEV No.	401516	Ref. No.	BK178616
description	keypad PCB L 250mm W 75mm		



1

GEV No.	401562	Ref. No.	1G534537
description	PCB		

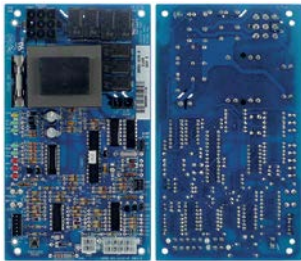

1

GEV No.	403123	Ref. No.	719.391.063
description	PCB ice cube maker L 175mm W 99mm		



1

GEV No.	403125	Ref. No.	719.391.097
description	PCB L 175mm W 99mm for ice-cube maker		



1

GEV No.	400411	Ref. No.	179303
description	PCB pyroceram range CH 40/45/80 230V		

solenoid valves

solenoid valves (water)

metal

ASCO

spare parts and accessories

solenoid coils



1

GEV No.	371113	Ref. No.	278270
description	solenoid coil Asco 230VAC 50Hz coil type 400526-117 seat ø 16mm		

fans

cross flow fans

ebm-papst



1

GEV No.	601437	Ref. No.	1V422429
description	cross flow fan ebm-papst QLZ06/1800-2518 roller ø 60mm roller length 180mm laminated core thickness 18mm motor position right 230V/50Hz 28W refrigeration bearing rubber connection male faston 6.3mm airflow 130m³/h 0 up to +60°C		



hot air fans

miscellaneous



1

GEV No.	500128	Ref. No.	295.101
description	hot air fan 230V 120W 0.53A 2000rpm L2 135mm L3 35mm L4 40mm fan wheel ø 180mm ebm-papst type R2E180-AI01-12		
spare parts for	500128		
	GEV No.	365170	Ref. No.
			—



capacitor capacity 2µF 425V tolerance 5% 50/60Hz ambient temperature max. -25 to +85°C ø 25mm L 49mm M8 plastic connection cable 250mm 416.17.74 protection

motors

gear motors

miscellaneous



1

GEV No.	602068	Ref. No.	6013212 AN7.000.240
description	gear motor MERKLE type B3715UP-095 3.45W 230V 50Hz 10rpm shaft ø 8mm L 125mm W 70mm H 75mm		

fuses

thermal fuses



1

GEV No.	358298	Ref. No.	1V421473
description	thermal fuse switch-off temp. 128°C nominal 10A		

electric accessories

plugs - couplings - power sockets

protective contact power sockets

universal



1

GEV No.	551128	Ref. No.	385.259
description	power socket CEE7/4 type F flush-mounted 3-pole contacts P+N+E max. 16A max 230V with lid countries D/I		

terminals

connection terminals with faston connections



1

GEV No.	550953	Ref. No.	1V420304
description	connection terminal 6-pole max. 20A max 450V connection F6.3/F6.3 temp.-resist. 90°C		



1

GEV No.	550954	Ref. No.	1V421490
description	connection terminal 9-pole max. 20A max 450V connection F6.3/F6.3 temp.-resist. 90°C		

electronic components

varistors



1

GEV No.	401565	Ref. No.	1G946001
description	varistor		

resistors



1

GEV No.	359502	Ref. No.	16-888002 BK178853
description	resistor 120KOhm 3W		



1			
GEV No.	359503	Ref. No.	178854 1G888001
description	resistor 680KOhm		

gas taps

PEL

22S/O series

1			
GEV No.	106056	Ref. No.	BK178901
description	gas tap PEL type 22S/O gas inlet M20x1.5 (tube ø 12mm) bypass nozzle ø 0.35mm gas outlet M20x1.5 (tube ø 12/10mm) thermocouple connection M10x1 pilot connection M10x1 shaft ø 6x4.6mm shaft L 45/20mm shaft flat left		
spare parts for	106056		
	GEV No.	101058	Ref. No. —
	magnet unit L 39mm D1 ø 15.4mm D2 ø 13.5mm suitable for PEL22/EGA24197 standard		
	GEV No.	101213	Ref. No. —
	gas tap front part shaft ø 6x4.6mm shaft L 45/20mm shaft flat right/left suitable for PEL22		
	GEV No.	101240	Ref. No. —
	gas connection thread M20x1.5 tube ø 12/10mm for PEL gas taps with gasket and screws horizontal		
	GEV No.	101290	Ref. No. —
	thermocouple nut T1: M10x1 T2: M18x1 suitable for PEL20/21		
	GEV No.	101460	Ref. No. —
	O-ring ø 12.37mm D1 ø 2.62mm suitable for PEL22		
	GEV No.	101461	Ref. No. —
	screw kit suitable for PEL22 Qty 4 pcs		
accessories for	106056		
	GEV No.	100908	Ref. No. —
	union screw thread M10x1 for pipe ø 4mm Qty 1 pcs		
	GEV No.	100909	Ref. No. —
	union screw thread M10x1 for pipe ø 6mm Qty 1 pcs		
	GEV No.	101241	Ref. No. —
	gas connection thread M20x1.5 tube ø 12/10mm for PEL gas taps vertical		
	GEV No.	101246	Ref. No. —
	olive for pipe ø 4mm Qty 1 pcs		
	GEV No.	101248	Ref. No. —
	olive for pipe ø 12mm Qty 1 pcs suitable for PEL		
	GEV No.	101249	Ref. No. —
	olive for pipe ø 10mm Qty 1 pcs		
	GEV No.	101250	Ref. No. —
	union nut thread M20x1.5 for pipe ø 10mm		

accessories for	106056		
	GEV No.	101251	Ref. No. —
	union nut thread M20x1.5 for pipe ø 12mm		
	GEV No.	101286	Ref. No. —
	olive ID ø 6mm Qty 1 pcs		
	GEV No.	110080	Ref. No. —
	knob ø 70mm shaft ø 10x8mm shaft flat universal		
	GEV No.	112206	Ref. No. —
	knob dial plate silver gas tap PEL21/22/23 t.max.°C ED ø 63mm ID ø 45.5mm		

ignition parts

pilot burners

AEM

pilot burners

1			
GEV No.	102906	Ref. No.	1G564253
description	pilot burner 1 flame gas connection 6mm mounting thread M5		
accessories for	102906		
	GEV No.	106427	Ref. No. —
	pilot burner nozzle natural/liquid gas bore ø 0.3mm code 30 thread 7/32" (28G) WS 6		
	GEV No.	106428	Ref. No. —
	pilot burner nozzle LPG bore ø 0.25mm code 25 thread 7/32" (28G) WS 6		
	GEV No.	106429	Ref. No. —
	pilot burner nozzle natural gas bore ø 0.35mm thread M5x0.75 WS 6		

electrodes

1			
GEV No.	102907	Ref. No.	1G564251
description	ignition electrode D1 ø 7mm connection F 2.8x0.8mm L1 6mm L2 6mm L3 16mm BL1 50mm to clip		



ignition units

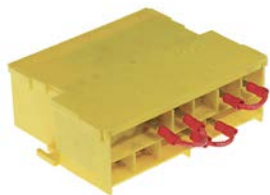

1	GEV No.	102908	Ref. No.	1G564254
description ignition unit outputs 8 1.5 V/DC inlet F6.3x0.8 outlet F2.8x0.8 mounting ø 103mm				

ignition switches



1	GEV No.	102909	Ref. No.	1G564255
description battery holder for battery type AA 1.5V mounting ø 19mm connection male faston 2.8mm				

thermocouples

plug-in thermocouples

plug-in thermocouples standard

with barrel socket ø6mm

type Junkers with aluminised tip

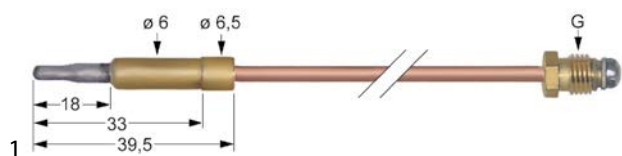

1	GEV No.	102229	Ref. No.	178899
description thermocouple M10x1 L 1000mm plug connection ø6.0mm				

with barrel socket ø6(6.5)mm

thermocouples SIT

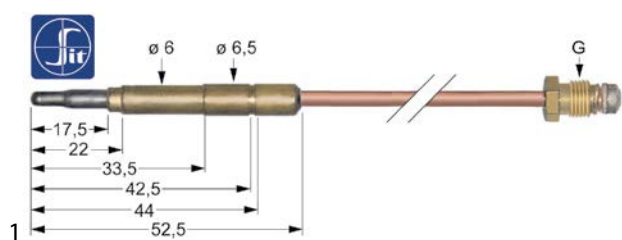

1	GEV No.	107604	Ref. No.	1G564261
description thermocouple SIT M8x1 L 1200mm plug connection ø6.0(6.5)mm				

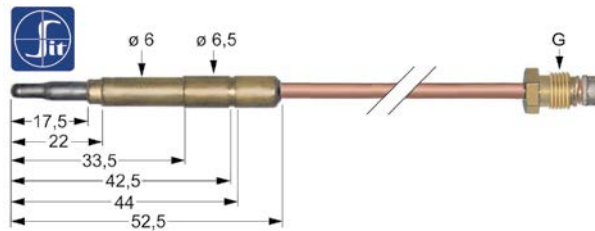

1	GEV No.	107601	Ref. No.	1G564250
description thermocouple SIT M8x1 L 600mm plug connection ø6.0(6.5)mm				

gas nozzles

pilot burner nozzles

pilot burner nozzles JUNKERS

CB 50203_/503_ series



1	GEV No.	100222	Ref. No.	178895 1G820090
description pilot burner nozzle LPG gas pressure 50mbar code 5 Qty 1 pcs suitable for JUNKERS CB50203_				

equipment-specific units

for convection ovens/combi-steamers

glass panels



1	GEV No.	691256	Ref. No.	295582
description glass panel L 755mm W 690mm thickness 4mm				

pullouts

frame



1	 Image not available		
GEV No.	695464	Ref. No.	1V421650
description	frame for pullout size 1/1 L 660mm		



1	 Image not available		
GEV No.	695468	Ref. No.	1V421651
description	frame fortelescopic rail size 1/1 L 660mm capacity 120kg		



1	 Image not available		
GEV No.	695474	Ref. No.	1V421653
description	frame fortelescopic rail size 2/1 L 760mm capacity 120kg		



1	 Image not available		
GEV No.	695471	Ref. No.	1V421652
description	frame fortelescopic rail size 2/1 L 760mm capacity 70kg		



rails



1	 Image not available		
GEV No.	695470	Ref. No.	1V421658
description	rail L 660mm size 1/1 fortelescopic rail capacity 120kg		



1	 Image not available		
GEV No.	695466	Ref. No.	1V421682
description	rail L 660mm size 1/1 fortelescopic rail capacity 70kg		



1	 Image not available		
GEV No.	695476	Ref. No.	1V421659
description	rail L 760mm size 2/1 fortelescopic rail capacity 120kg		

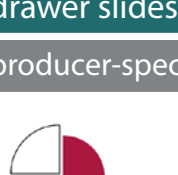

1	 Image not available		
GEV No.	695473	Ref. No.	1V421683
description	rail L 760mm size 2/1 fortelescopic rail capacity 70kg		

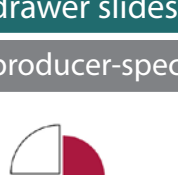

drawer slides

producer-specific





1	 Image not available		
GEV No.	695469	Ref. No.	1V421655
description	pullout size 1/1 L 660mm capacity 120kg		



1	 Image not available		
GEV No.	695465	Ref. No.	1V421654
description	pullout size 1/1 L 660mm capacity 70kg		



 <p>Image not available</p>			
1			
GEV No.	695475	Ref. No.	1V421657
description	pullout size 2/1 L 760mm capacity 120kg		

 <p>Image not available</p>			
1			
GEV No.	695472	Ref. No.	1V421656
description	pullout size 2/1 L 760mm capacity 70kg		

TENTE

with bolt hole

chrome-plated steel

			
1			
GEV No.	700253	Ref. No.	719.383.405
description	swivel castor ø 125mm bolt hole bolt hole ø 11mm housing chrome-plated sheet steel capacity 100kg bearing slide bearing wheel body polypropylene tread TPE tyres H 160mm wheel width 32mm -20 up to +60°C Qty 1 pcs		

			
1			
GEV No.	700254 ¹	Ref. No.	719.383.404
description	swivel castor with swivel brake ø 125mm bolt hole bolt hole ø 11mm housing chrome-plated sheet steel capacity 100kg bearing slide bearing wheel body polypropylene tread TPE tyres H 160mm wheel width 32mm -20 up to +60°C Qty 1 pcs		

¹with swivel brake

baskets

fryer baskets

miscellaneous

			
1			
GEV No.	993176	Ref. No.	718.384.803
description	basket W1 100mm L1 300mm H1 75mm chrome-plated steel baked potato/Sandwich		

			
1			
GEV No.	993264	Ref. No.	718.384.806
description	basket W1 100mm L1 300mm H1 75mm steel PTFE coated black		

warewashing baskets

system baskets CAMBRO 500x500mm

universal baskets

			
1			
GEV No.	972102	Ref. No.	718.384.733
description	plate basket CAMBRO L 500mm W 500mm H 101mm usable height 83mm		

shelves and shelf rails

grates

universal

without upstand



1

GEV No.	970122	Ref. No.	BI177994
description	grate W 325mm D 530mm GN 1/1 H 8mm stainless steel wire gauge frame 7mm lengthwise wires gauge 4mm crossing wires 1		
accessories for	970122		
	GEV No.	690330	Ref. No.
	rack L 1000mm W 22mm H 4mm aperture 3x8mm hole distance 12.5mm stainless steel		
	GEV No.	694700	Ref. No.
	shelf support L 31/28mm W 22mm H 18mm SS Qty 12 pcs		
	GEV No.	694701	Ref. No.
	shelf support L 31/28mm W 22mm H 17mm SS with hook Qty 12 pcs		

shelf rails and supports

producer-specific



1

GEV No.	690615	Ref. No.	990166
description	pair of setting bar U-shape L 567mm W 13mm H 19mm mounting pos. left/right		

gaskets

refrigeration gaskets

plug-in gaskets

profile 9048

We offer custom-made gaskets for this profile

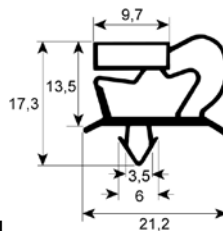

1

GEV No.	900285	Ref. No.	925314
description	blast freezer gasket profile 9048 W 460mm L 580mm plug size for blast chiller		

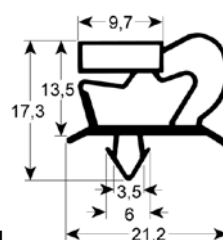

1

GEV No.	901295	Ref. No.	719.390.556
description	refrigeration gasket profile 9048 W 418mm L 495mm plug size plug-in gasket		

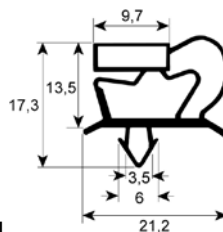

1

GEV No.	900310	Ref. No.	935306
description	refrigeration gasket profile 9048 W 677mm L 1512mm plug size door		

profile 9794

We offer custom-made gaskets for this profile

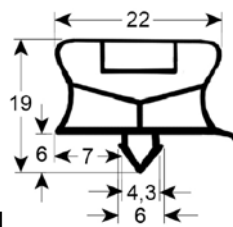

1

GEV No.	900691	Ref. No.	925282
description	refrigeration gasket profile 9794 W 265mm L 390mm plug size		

GEV No.	901558	Ref. No.	384.205
description	refrigeration gasket profile 9794 W 385mm L 635mm plug size		

GEV No.	901597	Ref. No.	935307
description	refrigeration gasket profile 9794 W 678mm L 730mm plug size with magnet		

profile 9252

We offer custom-made gaskets for this profile

GEV No.	901553	Ref. No.	384.212
description	refrigeration gasket profile 9252 W 410mm L 550mm plug size		

GEV No.	901548	Ref. No.	384.217
description	refrigeration gasket profile 9252 W 455mm L 645mm plug size		

GEV No.	901549	Ref. No.	719.388.206
description	refrigeration gasket profile 9252 W 455mm L 690mm plug size		

GEV No.	901551	Ref. No.	384.215
description	refrigeration gasket profile 9252 W 530mm L 655mm plug size		

GEV No.	901552	Ref. No.	384.213
description	refrigeration gasket profile 9252 W 610mm L 640mm plug size		

GEV No.	901550	Ref. No.	384.214
description	refrigeration gasket profile 9252 W 640mm L 710mm plug size		

profile 9184

GEV No.	902021	Ref. No.	719.388.221
description	refrigeration gasket profile 9184 W 570mm L 725mm plug size		

profile 9185

We offer custom-made gaskets for this profile

GEV No.	901543	Ref. No.	384.152
description	refrigeration gasket profile 9185 W 365mm L 415mm plug size		

GEV No.	901542	Ref. No.	251297-4M 384.558
description	refrigeration gasket profile 9185 W 380mm L 540mm plug size		

GEV No.	901544	Ref. No.	384.557 4007069
description	refrigeration gasket profile 9185 W 385mm L 450mm plug size		

GEV No.	901545	Ref. No.	384.233
description	refrigeration gasket profile 9185 W 395mm L 580mm plug size		

GEV No.	901546	Ref. No.	384.153 700053
description	refrigeration gasket profile 9185 W 410mm L 575mm plug size		

GEV No.	901547	Ref. No.	384.592
description	refrigeration gasket profile 9185 W 625mm L 715mm plug size		

GEV No.	902271	Ref. No.	N/A
description	refrigeration gasket profile 9185 Wmm L 2500mm		

profile 9162

universal

GEV No.	900071	Ref. No.	N/A
description	refrigeration gasket profile 9162 W 380mm L 225mm external size drawer for refrigerated counter refrigeration size 1/3		

GEV No.	900070	Ref. No.	N/A
description	refrigeration gasket profile 9162 W 380mm L 652mm external size door for refrigerated counter refrigeration size 1/1		

GEV No.	900073	Ref. No.	N/A
description	refrigeration gasket profile 9162 W 386mm L 200mm external size drawer for refrigerated counter refrigeration size 1/3		

GEV No.	900072	Ref. No.	N/A
description	refrigeration gasket profile 9162 W 580mm L 335mm external size size 1/1		

GEV No.	902269	Ref. No.	N/A
description	refrigeration gasket profile 9162 Wmm L 2500mm		

GEV No.	900644	Ref. No.	1V420004
description	refrigeration gasket profile 9162 W 385mm L 321mm external size		

Salvis series 1999

GEV No.	900640	Ref. No.	1V420000
description	refrigeration gasket profile 9162 W 385mm L 184mm external size		

GEV No.	900645	Ref. No.	1V420005
description	refrigeration gasket profile 9162 W 385mm L 359mm external size		

GEV No.	900641	Ref. No.	1V420001
description	refrigeration gasket profile 9162 W 385mm L 206mm external size		

GEV No.	900647	Ref. No.	1V420007
description	refrigeration gasket profile 9162 W 385mm L 451mm external size		

GEV No.	900642	Ref. No.	1V420002
description	refrigeration gasket profile 9162 W 385mm L 229mm external size		

GEV No.	900648	Ref. No.	1V420008
description	refrigeration gasket profile 9162 W 385mm L 651mm external size		

GEV No.	900643	Ref. No.	1V420003
description	refrigeration gasket profile 9162 W 385mm L 314mm external size		

GEV No.	900649	Ref. No.	1V420009
description	refrigeration gasket profile 9162 W 385mm L 781mm external size		

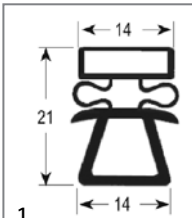

GEV No.	900650	Ref. No.	1V420010
description	refrigeration gasket profile 9162 W 585mm L 184mm external size		

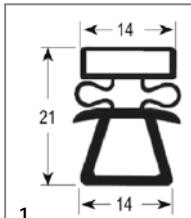

GEV No.	900655	Ref. No.	1V420015
description	refrigeration gasket profile 9162 W 585mm L 359mm external size		

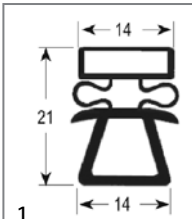

GEV No.	900651	Ref. No.	1V420011
description	refrigeration gasket profile 9162 W 585mm L 206mm external size		

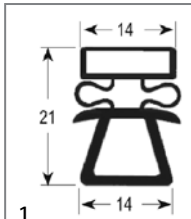

GEV No.	900656	Ref. No.	1V420016
description	refrigeration gasket profile 9162 W 585mm L 406mm external size		

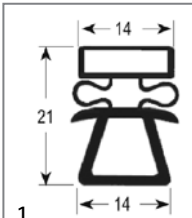

GEV No.	900652	Ref. No.	1V420012
description	refrigeration gasket profile 9162 W 585mm L 229mm external size		

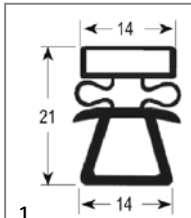

GEV No.	900657	Ref. No.	1V420017
description	refrigeration gasket profile 9162 W 585mm L 451mm external size		

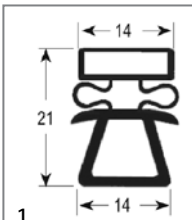

GEV No.	900653	Ref. No.	1V420013
description	refrigeration gasket profile 9162 W 585mm L 314mm external size		

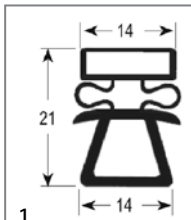

GEV No.	900658	Ref. No.	1V420018
description	refrigeration gasket profile 9162 W 585mm L 651mm external size		

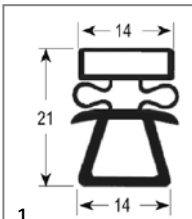

GEV No.	900654	Ref. No.	1V420014
description	refrigeration gasket profile 9162 W 585mm L 321mm external size		

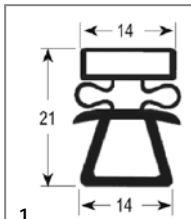

GEV No.	900659	Ref. No.	1V420019
description	refrigeration gasket profile 9162 W 585mm L 781mm external size		

Salvis series 2000

GEV No.	900660	Ref. No.	1V421560
description	refrigeration gasket profile 9162 W 385mm L 185mm external size		

GEV No.	900665	Ref. No.	1V421565
description	refrigeration gasket profile 9162 W 385mm L 320mm external size		

GEV No.	900661	Ref. No.	1V421561
description	refrigeration gasket profile 9162 W 385mm L 206mm external size		

GEV No.	900666	Ref. No.	1V421566
description	refrigeration gasket profile 9162 W 385mm L 354mm external size		

GEV No.	900662	Ref. No.	1V421562
description	refrigeration gasket profile 9162 W 385mm L 224mm external size		

GEV No.	900667	Ref. No.	1V421567
description	refrigeration gasket profile 9162 W 385mm L 405mm external size		

GEV No.	900663	Ref. No.	1V421563
description	refrigeration gasket profile 9162 W 385mm L 309mm external size		

GEV No.	900668	Ref. No.	1V421568
description	refrigeration gasket profile 9162 W 385mm L 445mm external size		

GEV No.	900664	Ref. No.	1V421564
description	refrigeration gasket profile 9162 W 385mm L 318mm external size		

GEV No.	900669	Ref. No.	1V421569
description	refrigeration gasket profile 9162 W 385mm L 642mm external size		

GEV No.	900670	Ref. No.	1V421570
description	refrigeration gasket profile 9162 W 385mm L 772mm external size		

GEV No.	900675	Ref. No.	1V421584
description	refrigeration gasket profile 9162 W 585mm L 318mm external size		

GEV No.	900671	Ref. No.	1V421580
description	refrigeration gasket profile 9162 W 585mm L 188mm external size		

GEV No.	900676	Ref. No.	1V421585
description	refrigeration gasket profile 9162 W 585mm L 321mm external size		

GEV No.	900672	Ref. No.	1V421581
description	refrigeration gasket profile 9162 W 585mm L 206mm external size		

GEV No.	900677	Ref. No.	1V421586
description	refrigeration gasket profile 9162 W 585mm L 354mm external size		

GEV No.	900673	Ref. No.	1V421582
description	refrigeration gasket profile 9162 W 585mm L 224mm external size		

GEV No.	900678	Ref. No.	1V421587
description	refrigeration gasket profile 9162 W 585mm L 406mm external size		

GEV No.	900674	Ref. No.	1V421583
description	refrigeration gasket profile 9162 W 585mm L 309mm external size		

GEV No.	900679	Ref. No.	1V421588
description	refrigeration gasket profile 9162 W 585mm L 442mm external size		

GEV No.	900680	Ref. No.	1V421589
description	refrigeration gasket profile 9162 W 585mm L 642mm external size		

GEV No.	900681	Ref. No.	1V421590
description	refrigeration gasket profile 9162 W 585mm L 772mm external size		

screw-in gaskets

profile 9207

We offer custom-made gaskets for this profile

GEV No.	901554	Ref. No.	719.388.204
description	refrigeration gasket profile 9207 W 404mm L 595mm external size magnet 3-sided		

GEV No.	901555	Ref. No.	719.388.203
description	refrigeration gasket profile 9207 W 595mm L 699mm external size magnet 3-sided		

profile 9191

We offer custom-made gaskets for this profile

GEV No.	901556	Ref. No.	719.388.202
description	refrigeration gasket profile 9191 W 330mm L 590mm external size		

miscellaneous

GEV No.	902026	Ref. No.	384.331 700396
description	gasket		

gaskets for heated units

door seals

GEV No.	900100	Ref. No.	1L295594
description	door seal profile 2070 W 460mm L 645mm external size Qty 1 6 x 1/1		

GEV No.	900101	Ref. No.	295593
description	door seal profile 2070 W 645mm L 700mm external size Qty 1 10 x 1/1		

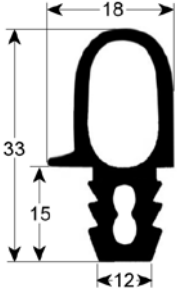

GEV No.	900497	Ref. No.	742376
description	door seal profile 2449 W 520mm L 775mm Qty 1		

miscellaneous

profile 2218



GEV No.	901557	Ref. No.	181275 384.216
description	gasket profile 2218 W 180mm L 920mm external size Qty 1 suitable for FRANKE perforated		

kitchen accessories

accessories



GEV No.	993248	Ref. No.	719.385.163
description	container for Accu-Salt		

preparation





GEV No.	993270	Ref. No.	719.387.936
description	measuring cup 1000ml stainless steel		





GEV No.	993268	Ref. No.	718.385.085
description	plier L 165mm chrome-plated steel		



GEV No.	993276	Ref. No.	270.067.05	
description	scraper with scraper L 310mm W 127mm H 65mm for 10:1			
spare parts for	993276			
	GEV No.	993273	Ref. No.	—
	scraper W 45mm L 110mm for 10:1			



GEV No.	993277	Ref. No.	400.896.0	
description	scraper with scraper L 310mm W 130mm H 60mm for 4:1			
spare parts for	993277			
	GEV No.	993275	Ref. No.	—
	scraper W 45mm L 130mm for 4:1			



GEV No.	993300	Ref. No.	719.395.492
description	screw		

gastronorm

trays and inserts



GEV No.	993232	Ref. No.	718.383.401
description	crumb tray W 216mm L 648mm H 54mm for UHC yellow		



GEV No.	993225	Ref. No.	718.385.348
description	tray „Opti-Loc“ W 143mm L 654mm H 56mm for UHC grey		



GN containers

SS 18/10 - standard



1

GEV No.	993035	Ref. No.	384.465
description	GN container SS 18/10 size GN 1/1 D 150mm		
accessories for	993035		
	GEV No.	993074	Ref. No. 718.384.003
	lid SS 18/10 size GN 1/1 for GN container		



1

GEV No.	993036	Ref. No.	718.382.333 CNS
description	GN container SS 18/10 size GN 1/1 D 200mm		
accessories for	993036		
	GEV No.	993074	Ref. No. 718.384.003
	lid SS 18/10 size GN 1/1 for GN container		



1

GEV No.	993030	Ref. No.	718.383.365
description	GN container SS 18/10 size GN 1/1 D 20mm		
accessories for	993030		
	GEV No.	993074	Ref. No. 718.384.003
	lid SS 18/10 size GN 1/1 for GN container		



1

GEV No.	993019	Ref. No.	384.960
description	GN container SS 18/10 size GN 1/1 D 55mm		
accessories for	993019		
	GEV No.	993074	Ref. No. 718.384.003
	lid SS 18/10 size GN 1/1 for GN container		



1

GEV No.	993033	Ref. No.	718.382.318
description	GN container SS 18/10 size GN 1/1 D 65mm		
accessories for	993033		
	GEV No.	993074	Ref. No. 718.384.003
	lid SS 18/10 size GN 1/1 for GN container		



1

GEV No.	993045	Ref. No.	718.382.367
description	GN container SS 18/10 size GN 1/2 D 100mm		
accessories for	993045		
	GEV No.	993076	Ref. No. 384..090
	lid SS 18/10 size GN 1/2 for GN container		



1

GEV No.	993046	Ref. No.	718.383.117
description	GN container SS 18/10 size GN 1/2 D 150mm		
accessories for	993046		
	GEV No.	993076	Ref. No. 384..090
	lid SS 18/10 size GN 1/2 for GN container		



1

GEV No.	993047	Ref. No.	718.382.366
description	GN container SS 18/10 size GN 1/2 D 200mm		



1

GEV No.	993044	Ref. No.	S18.000.404 CNS
description	GN container SS 18/10 size GN 1/2 D 65mm		
accessories for	993044		
	GEV No.	993076	Ref. No. 384..090
	lid SS 18/10 size GN 1/2 for GN container		



1

GEV No.	993049	Ref. No.	718.384.163 CNS
description	GN container SS 18/10 size GN 1/3 D 100mm		



1

GEV No.	993050	Ref. No.	718.382.385
description	GN container SS 18/10 size GN 1/3 D 150mm		



1

GEV No.	993051	Ref. No.	718.384.367
description	GN container SS 18/10 size GN 1/3 D 200mm		



1

GEV No.	993048	Ref. No.	384.028
description	GN container SS 18/10 size GN 1/3 D 65mm		
accessories for	993048		
	GEV No.	993077	Ref. No. 719.388.050
	lid SS 18/10 size GN 1/3 for GN container		



1

GEV No.	993053	Ref. No.	718.383.419
description	GN container SS 18/10 size GN 1/4 D 100mm		
accessories for	993053		
	GEV No.	993078	Ref. No. —
	lid SS 18/10 size GN 1/4 for GN container		



1

GEV No.	993056	Ref. No.	718.382.331
description	GN container SS 18/10 size GN 1/6 D 65mm		
accessories for	993056		
	GEV No.	993076	Ref. No. 384..090
	lid SS 18/10 size GN 1/2 for GN container		



1

GEV No.	993057	Ref. No.	718.382.315
description	GN container SS 18/10 size GN 1/6 D 100mm		
accessories for	993057		
	GEV No.	993079	Ref. No. 718.382.322
	lid SS 18/10 size GN 1/6 for GN container		



1

GEV No.	993061	Ref. No.	718.382.972
description	GN container SS 18/10 size GN 1/9 D 100mm		
accessories for	993061		
	GEV No.	993080	Ref. No. P18.000.038
	lid SS 18/10 size GN 1/9 for GN container		



1

GEV No.	993058	Ref. No.	718.382.386
description	GN container SS 18/10 size GN 1/6 D 150mm		
accessories for	993058		
	GEV No.	993079	Ref. No. 718.382.322
	lid SS 18/10 size GN 1/6 for GN container		



1

GEV No.	993041	Ref. No.	717.918.316
description	GN container SS 18/10 size GN 2/3 D 150mm		
accessories for	993041		
	GEV No.	993075	Ref. No. 717.918.315
	lid SS 18/10 size GN 2/3 for GN container		



1

GEV No.	993106	Ref. No.	718.382.358
description	GN container SS 18/10 size GN 2/3 D 200mm		
accessories for	993106		
	GEV No.	993075	Ref. No. 717.918.315
	lid SS 18/10 size GN 2/3 for GN container		



1

GEV No.	993110	Ref. No.	384.679
description	GN container SS 18/10 size GN 2/4 D 150mm		

SS 18/10 - perforated



1

GEV No.	993073	Ref. No.	718.385.230
description	GN container SS 18/10 size GN 1/2 perforated D 100mm		
accessories for	993073		
	GEV No.	993076	Ref. No. 384..090
	lid SS 18/10 size GN 1/2 for GN container		

polycarbonate



1

GEV No.	993023	Ref. No.	S18.000.384
description	GN container polycarbonate size GN 1/1 D 150mm		
accessories for	993023		
	GEV No.	993094	Ref. No. S18.000.389
	lid polycarbonate size GN 1/1		





1

GEV No.	993024	Ref. No.	718.382.333
description	GN container polycarbonate size GN 1/1 D 200mm		
accessories for	993024		
	GEV No.	993094	Ref. No. S18.000.389
	lid polycarbonate size GN 1/1		





1

GEV No.	993027	Ref. No.	S18.000.385
description	GN container polycarbonate size GN 1/2 D 150mm		
accessories for	993027		
	GEV No.	993095	Ref. No. S18.000.390
	lid polycarbonate size GN 1/2		





1

GEV No.	993028	Ref. No.	718.384.164
description	GN container polycarbonate size GN 1/2 D 200mm		
accessories for	993028		
	GEV No.	993095	Ref. No. S18.000.390
	lid polycarbonate size GN 1/2		





1

GEV No.	993032	Ref. No.	718.384.163
description	GN container polycarbonate size GN 1/3 D 200mm		
accessories for	993032		
	GEV No.	993096	Ref. No. 718.382.393
	lid polycarbonate size GN 1/3		





1

GEV No.	993031	Ref. No.	S18.000.404
description	GN container polycarbonate size GN 1/3 D 100mm		
accessories for	993031		
	GEV No.	993096	Ref. No. 718.382.393
	lid polycarbonate size GN 1/3		





1

GEV No.	993029	Ref. No.	S18.000.380
description	GN container polycarbonate size GN 1/3 D 65mm		
accessories for	993029		
	GEV No.	993096	Ref. No. 718.382.393
	lid polycarbonate size GN 1/3		



1

GEV No.	993015	Ref. No.	S18.000.386
description	GN container polycarbonate size GN 1/3 D 150mm		
accessories for	993015		
	GEV No.	993096	Ref. No. 718.382.393
	lid polycarbonate size GN 1/3		



1

GEV No.	993090	Ref. No.	S18.000.407
description	GN container polycarbonate size GN 1/6 D 100mm		
accessories for	993090		
	GEV No.	993098	Ref. No. 718.382.558
	lid polycarbonate size GN 1/6		



1

GEV No.	993091	Ref. No.	S18.000.388
description	GN container polycarbonate size GN 1/6 D 150mm		
accessories for	993091		
	GEV No.	993098	Ref. No. 718.382.558
	lid polycarbonate size GN 1/6		



1

GEV No.	993089	Ref. No.	718.385.377
description	GN container polycarbonate size GN 1/6 D 65mm		
accessories for	993089		
	GEV No.	993098	Ref. No. 718.382.558
	lid polycarbonate size GN 1/6		



1

GEV No.	993093	Ref. No.	S18.000.408
description	GN container polycarbonate size GN 1/9 D 100mm		

lids

1

GEV No.	993094	Ref. No.	S18.000.389
description	lid polycarbonate size GN 1/1		

1

GEV No.	993095	Ref. No.	S18.000.390
description	lid polycarbonate size GN 1/2		

1

GEV No.	993096	Ref. No.	718.382.393
description	lid polycarbonate size GN 1/3		

1

GEV No.	993098	Ref. No.	718.382.558
description	lid polycarbonate size GN 1/6		

1

GEV No.	993074	Ref. No.	718.384.003
description	lid SS 18/10 size GN 1/1 for GN container		

1

GEV No.	993076	Ref. No.	384.090
description	lid SS 18/10 size GN 1/2 for GN container		

1

GEV No.	993077	Ref. No.	719.388.050
description	lid SS 18/10 size GN 1/3 for GN container		



1

GEV No.	993079	Ref. No.	718.382.322
description	lid SS 18/10 size GN 1/6 for GN container		



1

GEV No.	993080	Ref. No.	P18.000.038
description	lid SS 18/10 size GN 1/9 for GN container		



1

GEV No.	993075	Ref. No.	717.918.315
description	lid SS 18/10 size GN 2/3 for GN container		

hoses

pre-rinse hoses

stainless steel flexi hoses



1

GEV No.	699838	Ref. No.	K19.000.183
description	hose L 800mm		

water filters

EVERPURE

filters

for cold drinks



1

GEV No.	530101	Ref. No.	719389139	
description	water filter EVERPURE type 4C capacity 11000l flow rate 114l/h operation p max 10bar water temperature max. 38°C filter power 0.5µm for filter head QL2/QL3 ø 80mm H 370mm activated carbon filtration for beverage vending machine			
accessories for	530101			
	GEV No.	520218	Ref. No.	—
	double nipple brass thread 3/8" - 3/4" Qty 1 pcs L1 12mm L2 12mm			
	GEV No.	530106	Ref. No.	—
	filter head EVERPURE type QL3 connection 3/8" vertical with shut-off valve ø 96mm H 90mm			
	GEV No.	530115	Ref. No.	—
	filter head EVERPURE type QL2 connection 3/8" horizontal without shut-off valve ø 96mm H 80mm			

consumables

fuses

thermal fuses



1

GEV No.	358298	Ref. No.	1V421473
description	thermal fuse switch-off temp. 128°C nominal 10A		

A			
audible timers	12		
B			
bi-metal thermostats	7, 7		
bottom heaters	5		
C			
cam switches	10		
castors and bumper angles	19		
consumables	35		
contactors	12		
control equipment	11		
control thermostats	7		
cross flow fans	14		
D			
door seals	27		
E			
electric accessories	15		
electronic controllers	13		
energy regulators	7		
F			
fans	14		
foil heating elements	6		
fuses	15, 35		
G			
gas nozzles	17		
gas taps	16		
gaskets for heated units	27		
gastronorm	28		
grates	20		
H			
heating elements	3		
heating elements for chip scuttles	3		
heating elements for convection	6		
heating elements for fryers	3		
heating elements for griddles	3		
heating elements for large hobs	4		
heating elements for salamanders/toasters	4		
heating plates	6		
hoses	35		
hot air fans	15		
I			
ignition switches	17		
ignition units	17		
indicator lights	11		
		indicator lights (complete)	11
L			
		lamps	11
M			
		mercury tilt switches	10
		microswitches	10
		motors	15
N			
		neon light bulbs	11, 11
P			
		pilot burners	16
		plug-in gaskets	20
		plugs - couplings - power sockets	15
		pre-rinse hoses	35
		probes	13
		protective contact power sockets	15
		push/momentary push switches	9
R			
		radiation heaters	6
		refrigeration gaskets	20
		relays	12
		rocker/momentary rocker switches	9
S			
		safety bi-metal thermostats	7
		safety thermostats	7
		screw-in gaskets	27
		shelves and shelf rails	20
		solenoid valves	14
		solid state relays	12
		stainless steel flexi hoses	35
		switches and momentary switches	9
T			
		temperature probes	13
		terminals	15
		thermal fuses	35
		thermocouples	17
		thermostats	7
		timers	12
U			
		universal probes	13
W			
		water filters	35