



GAS COMPONENTS



ELECTRIC COMPONENTS



WATER TECHNOLOGY



MECHANICAL COMPONENTS



TOOLS

Spare parts suitable for

FRENOX

Find the complete and up-to-date range of products in our GEV Webshop



Manufacturer catalogue

The most important spare parts and accessories arranged clearly for every manufacturer

- ✓ Complete product range and all appliance data always up to date in the GEV Webshop
- ✓ Alphabetical Index at the end of the catalogue

GEV Webshop

www.gev-online.co.uk

www.gev-online.com



- 🔍 Add to Favourites
- 🔍 Sign In with email address and usual password
- 🔍 Easy-order – place several items in your basket at the same time
- 🔍 Quick Item search – no login needed



heating elements

heating elements for refrigeration

heating elements for defrosting



GEV No.	419200	Ref. No.	B00REZ114
description	heating element 1080W 220V L 1065mm W 170mm L1 10mm L2 1060mm W1 70mm W2 60mm cable length 800mm tube ø 8.5mm		
For models:	GL13-G, GN13-G, WL13-G		



GEV No.	419195	Ref. No.	B00REZ116
description	heating element 2x100W 2x115V L 380mm Wmm cable length 1500mm tube ø 8.5mm defrosting		
For models:	BGH2-TG, BGH3-TG, BGH4-TG, BGN2, BGN2-2G, BGN2-3G, BGN2-3SGC, BGN2-OG, BGN2-SG, BGN2-SGC, BGN2-TG, BGN2-V, BGN2-VT, BGN3, BGN3-2G, BGN3-4G, BGN3-4SGC, BGN3-OG, BGN3-SG, BGN3-SGC, BGN3-TG, BGN3-V, BGN3-VT, BGN4, BGN4-2G, BGN4-5SGC, BGN4-OG, BGN4-SG, BGN4-SGC, BGN4-TG, BGN4-V, BGN4-VT, BMN-155, BMN-210, BN14-3M, BN14-M, BN14-M-H, BN7-M, BN7-M-H, BN9-V, BN9-VG, BN9-VT, BN9-VTG, BSN2, BSN2-V, BSN2-VT, BSN3, BSN3-V, BSN3-VT, BSN4...(Other models you can see in the webshop)		



GEV No.	419197	Ref. No.	B00REZ111
description	heating element 2x200W 2x110V L 400mm Wmm cable length 1500mm tube ø 8.5mm defrosting		
For models:	BGL2, BGL2-V, BGL2-VT, BGL3, BGL3-V, BGL3-VT, BGL4, BGL4-V, BGL4-VT, BGN4, BGN4-2G, BGN4-V, BL10-V, BL10-VT, BL14-M, BL14-MG, BL14-M-H, BL18-V, BL18-VG, BL18-VT, BL18-VTG, BL20-V, BL20-VT, BL7-M, BL7-MG, BL7-M-H, BL9-V, BL9-VG, BL9-VT, BL9-VTG, BN10-V, BN10-VT, BN14-MG, BN14-M-H, BN18-V, BN18-VG, BN18-VT, BN18-VTG, BN20-V, BN20-VT, BN7-M, BN7-MG, BN7-M-H, BN9-V, BN9-VG, BN9-VT, BN9-VTG, BSL2, BSL2-V, BSL2-VT...(Other models you can see in the webshop)		



GEV No.	419196	Ref. No.	B00REZ100
description	heating element 55W 220V L 410mm W 50mm H 80mm cable length 1600mm tube ø 8.5mm defrosting		
For models:	BL10-V, BL10-VT, BL14-M, BL14-MG, BL14-M-H, BL18-V, BL18-VG, BL18-VT, BL18-VTG, BL20-V, BL20-VT, BL7-M, BL7-MG, BL7-M-H, BL9-V, BL9-VG, BL9-VT, BL9-VTG, BN10-V, BN10-VT, BN20-V, BN20-VT, CGL2A-V, CGL3A-V, CGN2A-V, CGN2-MTG, CGN2-TG, CGN3A-V, CGN3-MTG, CGN3-TG, CGN4A-V, CGN4-MTG, CGN4-TG, CSN2-MTG, CSN3-MTG, CSN4-MTG, MGN4-9G-V, MPN2-V, MPN3-V, PPN2-G-V, PPN3-G-V, PZT155, PZT160-3D, PZT210, VL10-V, VL10-VT, VL10-VTG, VL14-M, VL14-MG, VL14-M-H...(Other models you can see in the webshop)		

heating cables

drain heating cables



GEV No.	381244	Ref. No.	B00REZ104
description	drain heating cable 40W 220V 50Hz L 2000mm L1 (unheated) 1000mm L2 (heated) 1000mm cable ø 5mm connection 2-wire		
For models:	BGL2, BGL2-V, BGL2-VT, BGL3, BGL3-V, BGL3-VT, BGL4, BGL4-V, BGL4-VT, BSL2, BSL2-V, BSL2-VT, BSL3, BSL3-V, BSL3-VT, BSL4, BSL4-V, BSL4-VT, CGL2, CGL2-V, CGL2-VT, CGL3, CGL3-V, CGL3-VT, CGL4, CGL4-V, CGL4-VT, CLL2, CLL3, CSL2, CSL2-V, CSL2-VT, CSL3, CSL3-V, CSL3-VT, CSL4, CSL4-V, CSL4-VT, GL13-G, GL6-G, GN13-G, PPL2, PPL2-G, PPL3, PPL3-G, WL13-G, WL6-G		



GEV No.	381250	Ref. No.	B00REZ103
description	drain heating cable 80W 220V ø 5.5mm L 3000mm L1 (unheated) 950mm L2 (heated) 2050mm thread probe ø 8x7mm rubber probe L 42mm cable silicone resistor at +20°C 0.6kOhm cable colours grey cable length 3m 2-wire		
For models:	BL14, BL14-G, BL7, BL7-G, GN13-G, SL13-G, SL6-G, VL14, VL14-G, VL14-P, VL7, VL7-G, VL7-P, VLL7, VNL14, VNL14-3T, VNL7, VNL7-ST, VNL7-V-T, VNLF14-3T, VNN7, VNNF14-3T, WN13-G		

connection on both sides

with wire end ferrules



GEV No.	381402	Ref. No.	B00REZ112
description	heating cable 37W 220V 50Hz L 7000mm L1 (unheated) 300mm L2 (heated) 6700mm cable ø 3mm		
For models:	BGL3, BGL3-V, BGL3-VT, BSL3, BSL3-V, BSL3-VT, CGL3, CGL3-R, CGL3-R-A, CGL3-V, CGL3-VT, CSL3, CSL3-V, CSL3-VT, USL3		



GEV No.	419220	Ref. No.	B00REZ113
description	heating cable 37W 220V L 9000mm L1 (unheated) 740mm L2 (heated) 8260mm silicone impregnated glass fibre braiding ø 3mm connection terminal		
For models:	BGL4, BGL4-V, BGL4-VT, BSL4, BSL4-V, BSL4-VT, CGL4, CGL4-R, CGL4-R-A, CGL4-V, CGL4-VT, CSL4, CSL4-V, CSL4-VT, USL4		

1 electric components



heating cartridges



GEV No.	419212	Ref. No.	B00REZ106 BOOREZ106
description	heating cartridge 190W 230V ø 12mm L 180mm thread 3/8" cable length 1000mm		
For models:	BL14, BL14-G, BL7, BL7-G, BN14, BN14-G, BN7, BN7-G, GRN-BN9-EV-V, VL14, VL14-G, VL14-P, VL7, VL7-G, VL7-P, VLL7, VN14, VN14-G, VN14-P, VN7, VN7-G, VN7-P, VNL14, VNL14-3T, VNL7, VNL7-5T, VNL7-V-T, VNL14-3T, VNN14, VNN7, VNNF14-3T		

switches and momentary switches

rocker/momentary rocker switches

30x22mm



GEV No.	301003	Ref. No.	B00DU102
description	rocker switch mounting measurements 30x22mm green 2NO 250V 16A illuminated 0-1 connection male faston 6.3mm ambient temperature max. 125/55°C protection IP65		
For models:	BB150, BB150-SS, BB250, BB250-SL, BB250-SS, BB350, BB350-SL, BB350-SS, BF4, BGH2-TG, BGH3-TG, BGH4-TG, BGL2, BGL2-V, BGL2-VT, BGL3, BGL3-V, BGL3-VT, BGL4, BGL4-V, BGL4-VT, BGN2, BGN2-2G, BGN2-3G, BGN2-3SGC, BGN2-OG, BGN2-SG, BGN2-SGC, BGN2-TG, BGN2-V, BGN2-VT, BGN3, BGN3-2G, BGN3-4G, BGN3-4SGC, BGN3-OG, BGN3-SG, BGN3-SGC, BGN3-TG, BGN3-V, BGN3-VT, BGN4, BGN4-2G, BGN4-5SGC, BGN4-OG, BGN4-SG, BGN4-SGC, BGN4-TG, BGN4-V, BGN4-VT...(Other models you can see in the webshop)		
accessories for	301003		
	GEV No.	301036	Ref. No. —
	protective cover internal size 30x22mm for rocker switch mounting measurementsmm		



GEV No.	301002	Ref. No.	B00DU104 Yellow
description	rocker switch mounting measurements 30x22mm orange 2NO 250V 16A illuminated 0-1 connection male faston 6.3mm ambient temperature max. 85/125°C protection IP65		
accessories for	301002		
	GEV No.	301036	Ref. No. —
	protective cover internal size 30x22mm for rocker switch mounting measurementsmm		



GEV No.	301001	Ref. No.	B00DU104
description	rocker switch mounting measurements 30x22mm red 2NO 250V 16A illuminated 0-1 connection male faston 6.3mm ambient temperature max. 125/55°C protection IP65		
accessories for	301001		
	GEV No.	301036	Ref. No. —
	protective cover internal size 30x22mm for rocker switch mounting measurementsmm		

microswitches

with push button

switches with snap-fit



GEV No.	348008	Ref. No.	B00DU103
description	microswitch with push button 250V 2.5A 1NO/1NC connection male faston 2.8mm/6.3mm L 27mm L1 22mm ambient temperature max. 104°C actuating force: 180g		
For models:	BF4, BL10-V, BL10-VT, BL14, BL14-G, BL14-M, BL14-MG, BL14-M-H, BL18-V, BL18-VG, BL18-VT, BL18-VTG, BL20-V, BL20-VT, BL4, BL4-G, BL5, BL7, BL7-G, BL7-M, BL7-MG, BL7-M-H, BL9-V, BL9-VG, BL9-VT, BL9-VTG, BN10-V, BN10-VT, BN14, BN14-3M, BN14-G, BN14-M, BN14-MG, BN14-M-H, BN18-V, BN18-VG, BN18-VT, BN18-VTG, BN20-V, BN20-VT, BN4, BN4-G, BN5, BN7, BN7-G, BN7-M, BN7-MG, BN7-M-H, BN9-V, BN9-VG...(Other models you can see in the webshop)		

position switches

EMAS



GEV No.	348162	Ref. No.	B00DU106
description	position switch plastic 1NC/1NO 240V 3A L 93mm W 30mm H 30mm protection IP67 actuating force: 750g screw connection PG13.5 mounting distance 22mm		

lamps

indicator lights

indicator lights (complete)

30x22mm



GEV No.	301303	Ref. No.	B00DU101
description	indicator lamp mounting measurements 30x22mm red indicator light 250V 16A connection male faston 6.3mm ambient temperature max. 125°C protection IP40		
For models:	BF4, BGH2-TG, BGH3-TG, BGH4-TG, BGL2, BGL2-V, BGL2-VT, BGL3, BGL3-V, BGL3-VT, BGL4, BGL4-V, BGL4-VT, BGN2, BGN2-2G, BGN2-3G, BGN2-3SGC, BGN2-OG, BGN2-SG, BGN2-SGC, BGN2-TG, BGN2-V, BGN2-VT, BGN3, BGN3-2G, BGN3-4G, BGN3-4SGC, BGN3-OG, BGN3-SG, BGN3-SGC, BGN3-TG, BGN3-V, BGN3-VT, BGN4, BGN4-2G, BGN4-5SGC, BGN4-OG, BGN4-SG, BGN4-SGC, BGN4-TG, BGN4-V, BGN4-VT, BL10-V, BL14, BL14-G, BL14-M, BL14-MG, BL18-V, BL18-VG, BL20-V...(Other models you can see in the webshop)		



LED

LED bars



1

GEV No.	357216	Ref. No.	B00LA350 B00LA370
description	LED bar L 1200mm W 20mm H 20mm aluminium cable length 1000mm		
For models:	BB350, BB350-SL, BB350-SS, BGH2-TG, BGN2-OG, BGN2-SGC, BGN2-TG, BGN3-2G, BGN3-4SGC, CGN2-OG, CGN2-SGC, CGN2-TG, CGN3-2G, CGN3-4SGC, CGN3-G, CSN3-G, HGH2-TG, SS350, ST350		

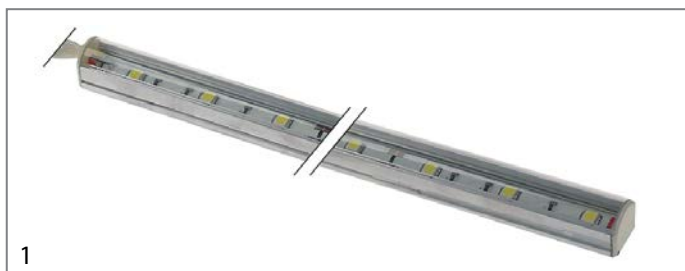

1

GEV No.	357211	Ref. No.	B00LA110
description	LED bar L 1320mm W 20mm H 20mm aluminium cable length 1mm		
For models:	GL13-G, GL6-G, GN13-G, GN13-SL, GN6-G, SL13-G, SL6-G, WL13-G, WL6-G, WN13-G, WN6-G		



1

GEV No.	357213	Ref. No.	B00LA140
description	LED bar L 1435mm W 15mm H 7mm aluminium cable length 1800mm		
For models:	SB300, SS300, WA4, WN4		

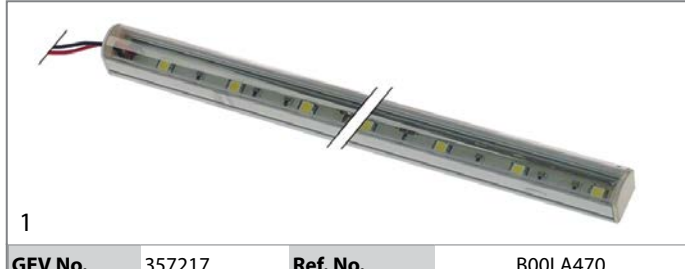

1

GEV No.	357217	Ref. No.	B00LA470
description	LED bar L 1600mm W 20mm H 20mm aluminium cable length 750mm		
For models:	BGH3-TG, BGH4-TG, BGN3-OG, BGN3-SGC, BGN3-TG, BGN4-2G, BGN4-5SGC, BGN4-OG, BGN4-SGC, BGN4-TG, CGN3-OG, CGN3-SGC, CGN3-TG, CGN4-2G, CGN4-5SGC, CGN4-G, CGN4-OG, CGN4-SGC, CGN4-TG, CSN4-G, HGH3-TG, HGH4-TG		

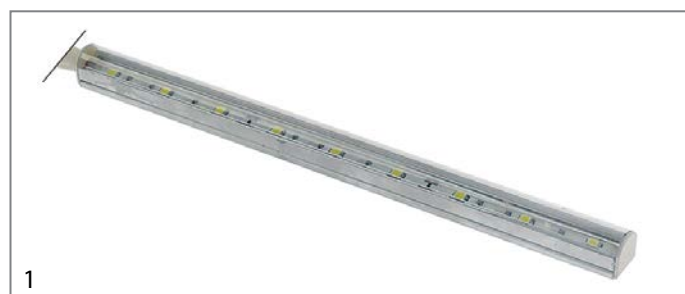

1

GEV No.	357212	Ref. No.	B00LA150
description	LED bar L 300mm W 20mm H 20mm aluminium cable length 1500mm		
For models:	BB150, BB150-SS, SS150, ST150		



1

GEV No.	357215	Ref. No.	B00LA700
description	LED bar L 500mm W 19mm H 7mm aluminium cable length 900mm		
For models:	BL14-G, BL14-MG, BL18-VG, BL18-VTG, BL7-G, BL7-MG, BL9-VG, BL9-VTG, BN14-G, BN14-MG, BN18-VG, BN18-VTG, BN7-G, BN7-MG, BN9-VG, BN9-VTG, VL10-VTG, VL14-G, VL14-MG, VL14-MPG, VL15-G, VL18-VG, VL18-VTG, VL20-VTG, VL7-G, VL7-MG, VL8-G, VL9-VG, VL9-VTG, VN14-G, VN14-MG, VN15-G, VN18-VG, VN18-VTG, VN7-G, VN7-MG, VN8-G, VN9-VG, VN9-VTG		

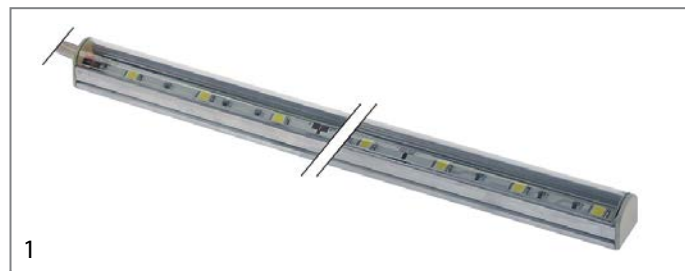

1

GEV No.	357214	Ref. No.	B00LA270
description	LED bar L 690mm W 20mm H 20mm aluminium cable length 850mm		
For models:	BGN2-2G, BGN2-3SGC, CGN2-2G, CGN2-3SGC, CGN2-G, CSN2-G		

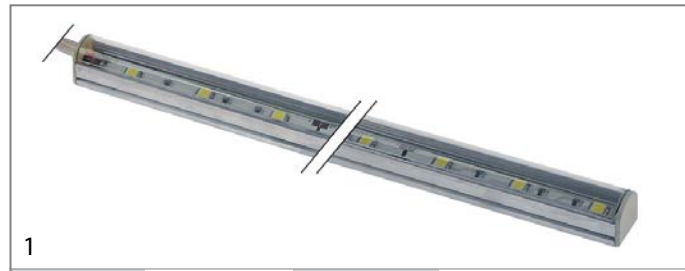

1

GEV No.	357218	Ref. No.	B00LA250
description	LED bar L 700mm W 20mm H 20mm aluminium cable length 1000mm		
For models:	BB250, BB250-SL, BB250-SS, SS250, ST250		



fridge lamps

producer-specific fridge lamps

FRENOX



1

GEV No.	357242	Ref. No.	B00LA142
description	lamp with protective grid 42W 230V ømm L 225mm W 105mm H 110mm cable lengthmm		



1

GEV No.	378661	Ref. No.	B00LA106
description	power supply primary 100-240VAC secondary 12VDC H 31mm L 100mm W 83mm connection screw 50/60Hz type LRS-50-12 switched-mode power supply		
For models:	BGH2-TG, BGH3-TG, BGH4-TG, BGN2-3G, BGN2-3SGC, BGN2-OG, BGN2-SGC, BGN2-TG, BGN3-4G, BGN3-4SGC, BGN3-OG, BGN3-SGC, BGN3-TG, BGN4-5SGC, BGN4-OG, BGN4-SGC, BGN4-TG, BN7-G, BN7-MG, BN9-VG, BN9-VTG, CGN2-3SGC, CGN2-G, CGN2-OG, CGN2-SGC, CGN3-4SGC, CGN3-G, CGN3-OG, CGN3-SGC, CGN4-5SGC, CGN4-G, CGN4-OG, CGN4-SGC, CSN2-G, CSN3-G, CSN4-G, HGH2-TG, HGH3-TG, HGH4-TG, VN7-G, VN7-MG, VN8-G, VN9-VG, VN9-VTG, WA1, WAA, WN1, WN4		

transformers

power supplies



1

GEV No.	378410	Ref. No.	B00LA106 old version B00LA222
description	power supply primary 100-240VAC secondary 12VDC 15.6VA secondary 1.3A H 28.5mm L 91mm W 52mm connection screw 50/60Hz type NES-15-12 switched-mode power supply		
For models:	BB150-SS, BGH2-TG, BGH3-TG, BGH4-TG, BGN2-TG, BGN3-TG, BGN4-TG, HGH2-TG, HGH3-TG, HGH4-TG		



1

GEV No.	378362	Ref. No.	B00LA111 B00LA114
description	power supply primary 100-240VAC secondary 12VDC 50VA secondary 4.2A H 40mm L 130mm W 100mm connection screw 50-60Hz type NES-50-12		
For models:	BGN2-2G, BGN3-2G, BGN4-2G, BL14-G, BL14-MG, BL18-VG, BL18-VTG, BN14-G, BN14-MG, BN18-VG, BN18-VTG, CGN2-2G, CGN3-2G, CGN4-2G, GL13-G, GL6-G, GN13-G, GN13-SL, GN6-G, SB300, SL13-G, SL6-G, SS300, VL14-G, VL14-MG, VL14-MPG, VL15-G, VL18-VTG, VL20-VTG, VN14-G, VN14-MG, VN15-G, VN18-VG, VN18-VTG, WL13-G, WL6-G, WN13-G, WN6-G		

electronic controllers

DIXELL

universal controllers



1

GEV No.	403393	Ref. No.	A00DJ124
description	electronic controller DIXELL type XT110C-5H1AU mounting measurements 71x29mm 230V voltage AC mV/mA relay outputs 1 CO-8A(3) mV/mA DI DI yes defr. funct. no dependent on probe°C display 3½ digits		

refrigeration controllers



built-in version





1



GEV No.	378267	Ref. No.	A00DJ101-DI	
description	electronic controller DIXELL XR02CX-5N0C1 mounting measurements 71x29mm built-in depth 56mm 230V voltage AC NTC relay outputs 1 NO-20A(8) NTC DI protection IP54 defrosting function/time control -40 up to +110°C display 2½ digit			
accessories for	378267			
	GEV No.	379161	Ref. No.	—
		temperature probe NTC 10kOhm cable thermoplastic probe -40 up to +110°C cable -40 up to +110°C probe ø6x14mm cable length 3m without screw connection 2-wire		
	GEV No.	381249	Ref. No.	A00DJ109
		temperature probe NTC 10kOhm cable PVC probe -40 up to +110°C cable -10 up to 100°C connection 2-wire thread probe ø6x14mm cable length 3m		



			
1			
GEV No.	378363	Ref. No.	A00DJ100-DI
description	electronic controller DIXELL XR06CX-5R0C1 mounting measurements 71x29mm 230V voltage AC NTC relay outputs 3 NO-20A(8) CO-8A(3) NO-5A(2) NTC NTC DI protection IP54 -40 up to +110°C display 3½ digits		
accessories for	378363		
	GEV No.	381249	Ref. No. A00DJ109
	temperature probe NTC 10kOhm cable PVC probe -40 up to +110°C cable -10 up to 100°C connection 2-wire thread probe ø6x14mm cable length 3m		

<p style="background-color: #cccccc; padding: 2px;">built-in version 2-piece</p>			
			
1			
GEV No.	381448	Ref. No.	A00DJ139
description	refrigeration controller DIXELL XW60K-5L1CO mounting measurements 140x110mm built-in depth 60mm 230V voltage AC NTC relay outputs 4 NO-20A(8) NO-16A(5) NO-8A(3) NO-16A(5) NTC NTC DI DI kit yes protection -40 up to 110°C display DX60		
For models:	GRN-BGL2-M, GRN-BN9-EV-V		
spare parts for	381448		
	GEV No.	381247	Ref. No. A00DJ108
	data cable DIXELL		

<p style="background-color: #cccccc; padding: 2px;">accessories</p>			
			
1			
GEV No.	381377	Ref. No.	A00DJ128
description	cable harness FRENOX A00DJ128 L 1200mm conductor 9 in corrugated hose		

			
1			
GEV No.	381247	Ref. No.	A00DJ108
description	data cable DIXELL		
For models:	BF4, BGL2-V, BGL2-VT, BGL3-V, BGL3-VT, BGL4-V, BGL4-VT, BGN2-V, BGN2-VT, BGN3-V, BGN3-VT, BGN4-V, BGN4-VT, BL10-VT, BL14-M, BL14-M-H, BL18-VT, BL18-VTG, BL20-VT, BL4, BL4-G, BL5, BL7-M, BL7-M-H, BL9-VT, BL9-VTG, BN10-VT, BN14-M, BN14-M-H, BN18-VT, BN18-VTG, BN20-VT, BN4, BN4-G, BN5, BN7-M, BN7-M-H, BN9-VT, BN9-VTG, BSL2-V, BSL2-VT, BSL3-V, BSL3-VT, BSL4-V, BSL4-VT, BSN2-V, BSN2-VT, BSN3-V, BSN3-VT, BSN4-V...(Other models you can see in the webshop)		
accessories for	381247		
	GEV No.	381245	Ref. No. A00DJ104-DI
	display DIXELL DX60 mounting measurements 157x28mm built-in depth 20mmV voltage relay outputs protection IP00°C display 3½ digits		
	GEV No.	381246	Ref. No. A00DJ103-DI
	refrigeration controller DIXELL XW60K-5L1CO mounting measurements 140x110mm built-in depth 60mm 230V voltage AC NTC relay outputs 4 NO-20A(8) NO-16A(5) NO-8A(3) NO-16A(5) NTC NTC DI DI yes protection -40 up to 110°C display DX60		

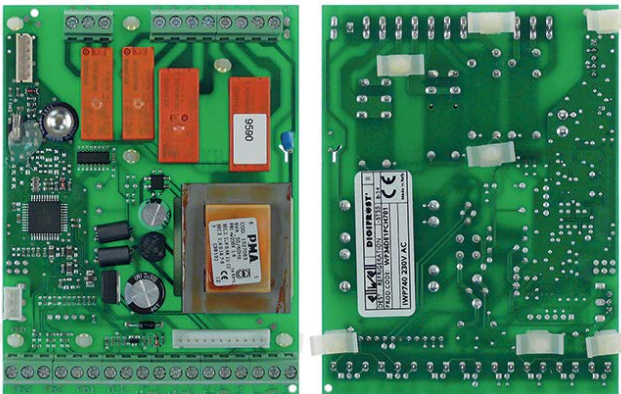
<p style="background-color: #f4a460; padding: 5px;">ELIWELL</p>			
<p style="background-color: #cccccc; padding: 2px;">refrigeration controllers</p>			
<p style="background-color: #cccccc; padding: 2px;">built-in version 2-piece</p>			
			
1			
GEV No.	381420	Ref. No.	A00DJ103-EL
description	refrigeration controller ELIWELL type IWP740LX model WP34DE-1PCH701 mounting measurements 92x120mm 230V voltage AC NTC/PTC relay outputs 4 NO-16A(12) NO-8A(3) CO-8A(3) NTC/PTC NTC/PTC NTC/PTC DI		

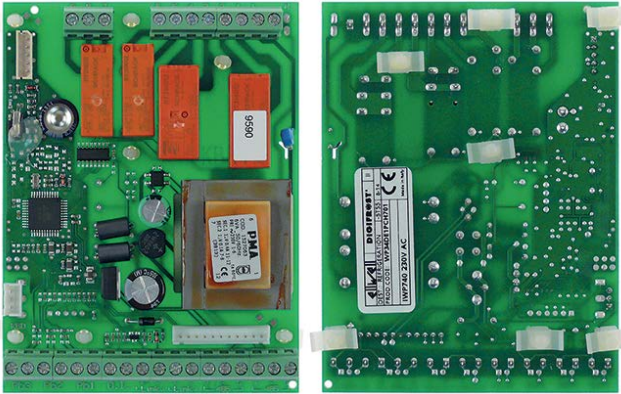
			
1			
GEV No.	381420	Ref. No.	A00DJ103-EL
description	refrigeration controller ELIWELL type IWP740LX model WP34DE-1PCH701 mounting measurements 92x120mm 230V voltage AC NTC/PTC relay outputs 4 NO-16A(12) NO-8A(3) CO-8A(3) NTC/PTC NTC/PTC NTC/PTC DI		

<p style="background-color: #f4a460; padding: 5px;">EVCO - EVERY CONTROL</p>			
<p style="background-color: #cccccc; padding: 2px;">refrigeration controllers</p>			
<p style="background-color: #cccccc; padding: 2px;">built-in version</p>			
			
1			
GEV No.	378445	Ref. No.	A00DJ100-EV
description	electronic controller EVERY CONTROL type EV3B33N7 mounting measurements 71x29mm 230V voltage AC NTC/PTC relay outputs 3 NO-30A(12) CO-8A(4) NO-5A(2) NTC NTC DI front measurementsmm built-in depth 59mm protection IP65 -40 up to +105°C display 3½ digits		



1

GEV No.	378443	Ref. No.	A00DJ101-EV
description	electronic controller EVERY CONTROL type EV3X21N7 Touch mounting measurements 71x29mm 230V voltage AC NTC/PTC relay outputs 1 NO-16A(5) NTC DI front measurements 34x76mm built-in depth 39.5mm protection IP65 -50 up to +150°C display 3½ digits		

built-in version 2-piece



1

GEV No.	403412	Ref. No.	A00DJ120
description	keypad PCB refrigerated counter BGL2-VT incl. control panel mounting pos. horizontal buttons 6		
For models:	BGL2-V, BGL2-VT, BGL3-V, BGL3-VT, BGL4-V, BGL4-VT, BGN2-V, BGN2-VT, BGN3-V, BGN3-VT, BGN4-V, BGN4-VT, BL10-VT, BL18-VT, BL18-VTG, BL20-VT, BL9-VT, BL9-VTG, BN10-VT, BN18-VT, BN18-VTG, BN20-VT, BN9-VT, BN9-VTG, BSL2-V, BSL2-VT, BSL3-V, BSL3-VT, BSL4-V, BSL4-VT, BSN2-V, BSN2-VT, BSN3-V, BSN3-VT, BSN4-V, BSN4-VT, CGL2A-V, CGL2-V, CGL2-VT, CGL3A-V, CGL3-V, CGL3-VT, CGL4-V, CGL4-VT, CGN2A-V, CGN2-V, CGN2-VT, CGN3A-V, CGN3-V, CGN3-VT...(Other models you can see in the webshop)		
accessories for	403412		
	GEV No.	381249	Ref. No. A00DJ109
	temperature probe NTC 10kOhm cable PVC probe -40 up to +110°C cable -10 up to 100°C connection 2-wire thread probe ø6x14mm cable length 3m		

for blast chiller

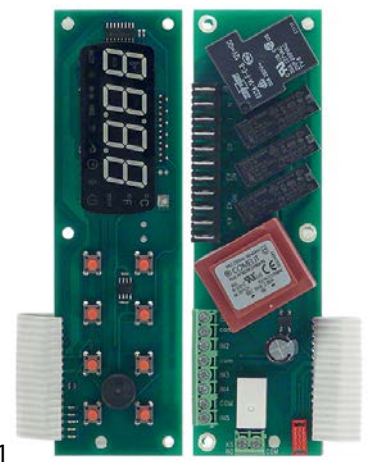

1

GEV No.	381535	Ref. No.	A00DJ132
description	electronic controller EVCO type EVX805 mounting measurements 156x45mm 230V voltage AC relay outputs 5 NO-30A NO-8A NO-8A NO-8A NO-8A NTC/PTC NTC/PTC NTC/PTC NTC/PTC blast freezer built-in depth 50mm yes yes display -50 up to +99		
For models:	VBL-10, VBL-15, VBL-5, VBL-7		

probes

universal probes

temperature probes



1

GEV No.	379160	Ref. No.	A00DJ102
description	temperature probe NTC 10kOhm cable thermoplastic probe -40 up to +110°C cable -40 up to +110°C probe ø6x14mm cable length 1.5m without screw connection 2-wire		
For models:	BF4, BGH2-TG, BGH3-TG, BGH4-TG, BGL2, BGL2-V, BGL2-VT, BGL3, BGL3-V, BGL3-VT, BGL4, BGL4-V, BGL4-VT, BGN2, BGN2-2G, BGN2-3G, BGN2-3SGC, BGN2-OG, BGN2-SG, BGN2-SGC, BGN2-TG, BGN2-V, BGN2-VT, BGN3, BGN3-2G, BGN3-4G, BGN3-4SGC, BGN3-OG, BGN3-SG, BGN3-SGC, BGN3-TG, BGN3-V, BGN3-VT, BGN4, BGN4-2G, BGN4-5SGC, BGN4-OG, BGN4-SG, BGN4-SGC, BGN4-TG, BGN4-V, BGN4-VT, BL10-V, BL10-VT, BL14, BL14-G, BL14-M, BL14-MG, BL14-M-H, BL18-V...		
	(Other models you can see in the webshop)		

humidity probes



1

GEV No.	403390	Ref. No.	A00DJ114
description	humidity probe humidity range 0-99% supply 9-28VDC outlet 4-20mA probe ø17.5x120mm cable lengthm 0 up to +70°C XH20P		



producer-specific probes

probes

			
1			
GEV No.	381249	Ref. No.	A00DJ109
description	temperature probe NTC 10kOhm cable PVC probe -40 up to +110°C cable -10 up to 100°C connection 2-wire thread probe ø6x14mm cable length 3m		
For models:	BB150, BB150-SS, BB250, BB250-SL, BB250-SS, BB350, BB350-SL, BB350-SS, BF4, BGH2-TG, BGH3-TG, BGH4-TG, BGL2, BGL2-V, BGL2-VT, BGL3, BGL3-V, BGL3-VT, BGL4, BGL4-V, BGL4-VT, BGN2, BGN2-2G, BGN2-3G, BGN2-3SGC, BGN2-OG, BGN2-SG, BGN2-SGC, BGN2-TG, BGN2-V, BGN2-VT, BGN3, BGN3-2G, BGN3-4G, BGN3-4SGC, BGN3-OG, BGN3-SG, BGN3-SGC, BGN3-TG, BGN3-V, BGN3-VT, BGN4, BGN4-2G, BGN4-5SGC, BGN4-OG, BGN4-SG, BGN4-SGC, BGN4-TG, BGN4-V, BGN4-VT...(Other models you can see in the webshop)		

core probes

			
1			
GEV No.	378408	Ref. No.	A00DJ130
description	core temperature probe PTC cable silicone probe -40 up to +120°C cable -50 up to +180°C connection 2-wire probe ø4-6x105mm cable length 3.5m handle ø 13mm handle length 120mm		

electronics

PCBs

			
1			
GEV No.	403709	Ref. No.	A00DJ104-EL
description	display PCB for fridge L 158mm W 27mm suitable for FRENOX IWK		

keypads

front foils

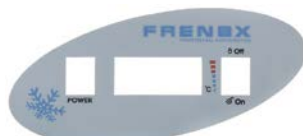
			
1			
GEV No.	403710	Ref. No.	A00DJ105
description	keypad foil for fridge suitable for FRENOX		
For models:	BF4, BGH2-TG, BGH3-TG, BGH4-TG, BGL2, BGL2-V, BGL2-VT, BGL3, BGL3-V, BGL3-VT, BGL4, BGL4-V, BGL4-VT, BGN2, BGN2-2G, BGN2-3G, BGN2-3SGC, BGN2-OG, BGN2-SG, BGN2-SGC, BGN2-TG, BGN2-V, BGN2-VT, BGN3, BGN3-2G, BGN3-4G, BGN3-4SGC, BGN3-OG, BGN3-SG, BGN3-SGC, BGN3-TG, BGN3-V, BGN3-VT, BGN4, BGN4-2G, BGN4-5SGC, BGN4-OG, BGN4-SG, BGN4-SGC, BGN4-TG, BGN4-V, BGN4-VT, BL10-V, BL10-VT, BL14, BL14-G, BL14-M, BL14-MG, BL18-V, BL18-VG...(Other models you can see in the webshop)		

			
1			
GEV No.	403711	Ref. No.	A00DJ106-EL
description	keypad unit for fridge suitable for FRENOX		

			
1			
GEV No.	403712	Ref. No.	A00DJ106-DI
description	keypad unit for fridge suitable for FRENOX		

			
1			
GEV No.	403858	Ref. No.	A00DJ140
description	keypad unit for fridge suitable for FRENOX		

solenoid valves

solenoid valves (refrigeration)

CASTEL

valves



GEV No.	370402	Ref. No.	A00SL100
description	solenoid valve CASTEL type 1028/2 230V p max 45bar 1/4" connection 1/4" -35 up to 110°C refrigeration copper/brass DN 6.35mm		
For models:	BL14-M, BL7-M, BN14, BN14-G, BN14-M, BN4, BN4-G, BN5, BN7, BN7-G, BN7-M, CGN2A-V, CGN3A-V, CGN4A-V, GN13-G, GRN-BN9-EV-V, MGN4-9G-V, MPN2-V, MPN3-V, VL14-M, VL15-M-V, VL7-M, VL7-PG, VL8-M-V, VL8-P-V, VN14, VN14-G, VN14-M, VN14-MG-V, VN14-MP-V, VN14-M-V, VN14-P, VN14-ST, VN7, VN7-G, VN7-M, VN7-MG-V, VN7-MPG-V, VN7-MP-V, VN7-M-V, VN7-P, VN7-PG, VN7-ST, VNL14, VNL14-3T, VNL14-3T, VNN14, VNN7, VNNF14-3T, WN13-G		

SANHUA

valves



GEV No.	370837	Ref. No.	A00SL101
description	solenoid valve SANHUA type MDF-A03-3H003 230V p max 45bar L 112mm -35 up to 110°C refrigeration copper/brass		
For models:	BF4, BL14, BL14-G, BL4, BL4-G, BL5, BL7, BL7-G, BN4, CGL2A-V, CGL3A-V, VBL-10, VBL-15, VBL-5, VBL-7, VL14, VL14-G, VL14-P, VL7, VL7-G, VL7-P, VLL7, VN7-ST-V, VNL14, VNL14-3T, VNL14-M-V, VNL7, VNL7-ST, VNL7-V, VNL7-V-T, VNL14-3T		

pressure switches

for refrigeration

SAGI NO MIYA



GEV No.	542444	Ref. No.	A00MV101
description	pressure control p max 45bar type ACB-2U C69W connection 1/4" switch-off pressure 21bar switch-on pressure 16bar		

GEV No.	541613	Ref. No.	A00MU101
description	pressure control p max 45bar type ACB-2UC85W switch-off pressure 25bar switch-on pressure 20bar		

cooling aggregates

GEV No.	379304***	Ref. No.	123456
description			
For models:			

GEV No.	379304***	Ref. No.	123456
description			
For models:			

GEV No.	379304***	Ref. No.	123456
description			
For models:			

GEV No.	379304***	Ref. No.	123456
description			
For models:			

compressors

EMBRACO / ASPERA

R134A

HBP monophase

High evaporation temperature above -15°C

GEV No.	605189	Ref. No.	A00KO110
description	compressor coolant R134a type EMT6160Z 220-240V 50Hz HBP 7.8kg 1/4HP cylinder capacity 6.76cm ³ CSIR H 166mmWWW 325W 412W 513W 630W 762W 910W ambient temperature max. 45°C		
For models:	BGN2, BGN2-2G, BGN2-V, BGN2-VT, BMN-155, BSN2, BSN2-V, BSN2-VT, BZT140-R, BZT155, BZT155-D, BZT160-3D, CGN2, CGN2-2G, CGN2-E, CGN2-G, CGN2-MTG, CGN2-R, CGN2-SH, CGN2-V, CGN2-VT, CGN2-YM, CSN2, CSN2-E, CSN2-G, CSN2-MTG, CSN2-R, CSN2-V, CSN2-VT, MGN2, MPN2, PMN-155, PPN2, PPN2-G, PZT155, PZT155-D, PZT160-3D, UGN2, UGN2-SH, USN2, USN3		



1

GEV No.	605135	Ref. No.	A00KO101
description	compressor coolant R134a type EMT6170Z 220-240V 50Hz HBP fully hermetic 8.1kg 1/6HP cylinder capacity 7.69cm ³ CSIR H 166mmWWW 281W 358W 448W 550W 663W 982W		
For models:	BB350, BB350-SL, BB350-SS, BF4, BGH2-TG, BGH3-TG, BGN2-3G, BGN2-3SGC, BGN2-OG, BGN2-SG, BGN2-SGC, BGN2-TG, BGN3, BGN3-2G, BGN3-4G, BGN3-4SGC, BGN3-OG, BGN3-SG, BGN3-SGC, BGN3-TG, BGN3-V, BGN3-VT, BGN4, BGN4-2G, BGN4-V, BGN4-VT, BMN-210, BN14, BN14-G, BN5, BN7, BN7-G, BN7-M, BN7-MG, BN7-M-H, BN9-V, BN9-VG, BN9-VT, BN9-VTG, BSN3, BSN3-V, BSN3-VT, BSN4, BSN4-V, BSN4-VT, BZT186-R, BZT210, BZT210-D, BZT215-3D, CGN2-3SGC... (Other models you can see in the webshop)		

HMBP monophase

High/Medium evaporation temperature above -20/-15 °C



1

GEV No.	605016	Ref. No.	A00KO100
description	compressor coolant R134a type EM65HHR 220-240V 50Hz HBP fully hermetic 7.62kg 1/6HP cylinder capacity 5.54cm ³ CSIRWWW 287W 389W 499W 617W 742W test method ASHRAE 842W		
For models:	BB150, BB150-SS, BB250, BB250-SL, BB250-SS, BGN2, BGN2-2G, BGN2-V, BGN2-VT, BMN-155, BMN-210, BN4, BN4-G, BSN2, BSN2-V, BSN2-VT, BZT140-R, BZT155, BZT160-3D, CGN2, CGN2-2G, CGN2A-V, CGN2-E, CGN2-G, CGN2-MTG, CGN2-R, CGN2-SH, CGN2-TG, CGN2-V, CGN2-VT, CGN2-YM, CSN2, CSN2-E, CSN2-G, CSN2-MTG, CSN2-R, CSN2-V, CSN2-VT, CSN3-R, CSN4-R, DSP-100, DSP-140, DSP-155, DSP-160, DSP-186, DSP-210, DSP-215, MGN2, MPN2, MPN2-V...(Other models you can see in the webshop)		



1

GEV No.	605208	Ref. No.	A00KO109
description	compressor coolant R134a type NEK6210Z-A 220-240V 50Hz HBP 11kg 1/3HP cylinder capacity 12.1cm ³ CSIR H 200mmWWW 364W 485W 636W 818W 1030W 1273W test method EN 12900 ambient temperature max. 55°C		
For models:	BGH4-TG, BGN4-5SGC, BGN4-OG, BGN4-SG, BGN4-SGC, BGN4-TG, BN14-3M, BN14-M, BN14-MG, BN14-M-H, BN18-V, BN18-VG, BN18-VT, BN18-VTG, CGN4-5SGC, CGN4-OG, CGN4-S, CGN4-SG, CGN4-SGC, CGN4-SH, CGN4-YM, GN13-G, GN13-SL, MGN4, MPN4, VN14-M, VN14-MG, VN14-M-H, VN18-V, VN18-VG, VN18-VT, VN18-VTG		

R404a/R507

LBP monophase

Lower evaporation temperature below -20°C



1

GEV No.	605256	Ref. No.	A00KO105
description	compressor coolant R404A type NEU2140GK 220-240V 50Hz LBP 10.6kg 1/2HP cylinder capacity 8.77cm ³ CSIR H 206mm 326W 421W 531W 658W 801W test method EN 12900		
For models:	BL4, BL4-G, VLL7, VNL14-3T, VNL7, VNL7-ST, VNL7-V, VNL7-V-T, VNL7-14-3T		



1

GEV No.	605152	Ref. No.	A00KO104
description	compressor coolant R404a/R507 type NEK2134GK 220-240V 50Hz LBP 11kg 1/2HP cylinder capacity 8.77cm ³ CSIR H 180mm 227W 302W 394W 501W 621W 753W test method ASHRAE		



1

GEV No.	605144	Ref. No.	A00KO102 NEU2168GK
description	compressor coolant R404a/R507 type NEK2168GK 220-240V 50Hz LBP 22.9kg 3/4HP cylinder capacity 14.28cm ³ CSR H 200mm 345W 454W 587W 742W 921W 1123W test method ASHRAE		
For models:	BL20-V, BL20-VT, BL5, BL7, BL7-G, BL7-M, BL7-MG, BL7-M-H, BL9-V, BL9-VG, BL9-VT, BL9-VTG, BN10-V, BN10-VT, GL6-G, SL6-G, VL15, VL15-G, VL15-M-V, VL20-V, VL20-VT, VL20-VTG, VL7, VL7-G, VL7-M, VL7-MG, VL7-M-H, VL7-P, VL7-PG, VL7-RO, VL7-RO-2, VL9-V, VL9-VG, VL9-VT, VL9-VTG, VN10-V, VN10-VT, VN14, VN7-MG-V, VN7-MPG-V, VN7-MP-V, VN7-M-V, VN8, VN8-G, VNL14, VNL14-M-V, WL6-G		



1

GEV No.	605174	Ref. No.	A00KO103
description	compressor coolant R404a/R507 type NJ2192GK 220-240V 50Hz LBP 20.4kg 1 1/4HP cylinder capacity 26.2cm ³ CSR H 265mm 685W 989W 1342W 1745W 2196W 2196W test method ASHRAE		
For models:	BGL2, BGL2-V, BGL2-VT, BGL3, BGL3-V, BGL3-VT, BGL4, BGL4-V, BGL4-VT, BL10-V, BL10-VT, BL14, BL14-G, BL14-M, BL14-MG, BL14-M-H, BL18-V, BL18-VG, BL18-VT, BL18-VTG, BN20-V, BN20-VT, BSL2, BSL2-V, BSL2-VT, BSL3, BSL3-V, BSL3-VT, BSL4, BSL4-V, BSL4-VT, CGL2, CGL2A-V, CGL2-R, CGL2-R-A, CGL2-V, CGL2-VT, CGL3, CGL3A-V, CGL3-R, CGL3-R-A, CGL3-V, CGL3-VT, CGL4, CGL4-R, CGL4-R-A, CGL4-V, CGL4-VT, CLL2, CLL3...(Other models you can see in the webshop)		



1

GEV No.	605164	Ref. No.	A00KO305
description	compressor coolant R404a/R507 type NT2178GK 220-240V 50Hz LBP 17kg 1HP cylinder capacity 17.4cm ³ CSR H 220mm 442W 610W 808W 1032W 1285W 1565W test method ASHRAE		
For models:	VBL-5, VBL-7		



1

GEV No.	605235	Ref. No.	A00KO114
description	compressor coolant R404a/R507 type NT2212GK 220-240V 50Hz LBP 18.3kg 1 1/4HP cylinder capacity 27.8cm ³ CSR H 250mm 876W 1125W 1421W 1770W 2174W test method EN 12900		
For models:	VBL-10		

HMBP monophase

High/Medium evaporation temperature above -20/-15 °C



1

GEV No.	605227	Ref. No.	A00KO111
description	compressor coolant R404A type NT6220GK 220-240V 50Hz HMBP 17kg 3/4HP cylinder capacity 14.5cm ³ CSIRWW 1005W 1245W 1540W 1890W 2300W 2770W 3300W test method EN 12900		



1

GEV No.	605178	Ref. No.	A00KO113
description	compressor coolant R404a/R507 type NEK6217GK 220-240V 50Hz HMBP 11.6kg 5/8HP cylinder capacity 14.3cm ³ CSR H 206mmW 777W 954W 955W 1171W 1386W 1651W 1916W		



1

GEV No.	605132	Ref. No.	A00KO115	
description	compressor coolant R404a/R507 type NT6222GK 200-240V 50Hz HMBP fully hermetic 17kg 1HP cylinder capacity 17.39cm ³ CSR H 252mmW 810W 1032W 1040W 1174W 1307W 1583W 2247W test method ASHRAE			
accessories for	605132			
	GEV No.	365142	Ref. No.	—
	operating capacitor capacity 15µF 450V with metal case tolerance 5% 50/60Hz ø 40mm L 110mm M8x1.25			
	GEV No.	365153	Ref. No.	—
	starting capacitor 52µF 330V 50/60Hz duty cycle 3s 41280A133 2252347 ø 36mm L 83mm M8 plastic connection cable 350mm			
	GEV No.	390981	Ref. No.	—
	klixon suitable for NT6222GK			

SECOP DANFOSS

R404a/R507

LBP 3-phase

Lower evaporation temperature below -20°C



1

GEV No.	605255	Ref. No.	A00KO112
description	compressor coolant R404a/R507 type NTZ048A4LR1A 380-415/380-460V 50/60Hz LBP 21kg 2HP cylinder capacity 48cm ³ H 333mm 1239W 1700W 2236W 2856W 3567W test method EN 12900		

miscellaneous

various



1

GEV No.	605280	Ref. No.	A00KO118
description	compressor DORIN coolant R134a type H300CS 220/380-240/420V 50Hz 54kg		
For models:	VBL-15		



fans

axial fans

import



GEV No.	601934	Ref. No.	A00FA100
description	axial fan L 120mm W 120mm H 40mm 220V 50-60Hz 21W bearing slide bearing manuf. no. DMX-G12038HA ² BL connection cable cable length 200mm DEMEX input current 0.14A		
For models:	BB150, BB150-SS, BB250, BB250-SL, BB250-SS, BB350, BB350-SL, BB350-SS, CGN2-SH, CGN3-SH, CGN4-SH, GRN-BGL2-M, SS150, SS250, SS350, ST150, ST250, ST350, UGN2-SH, UGN3-SH, UGN4-SH		

accessories for	601934		
	GEV No.	601935	Ref. No. A00FA101 old
	fanwheel cover ø 120mm mounting distance 103mm for axial fan 119mm		

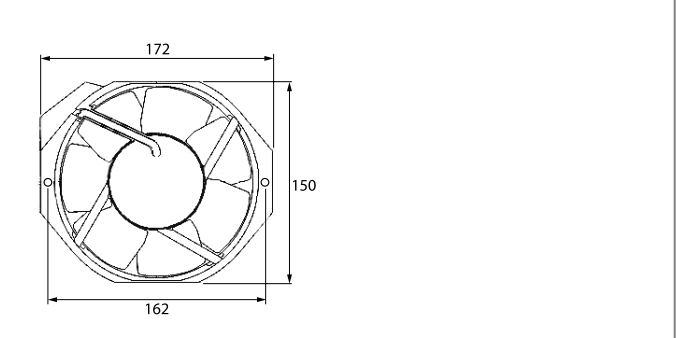

GEV No.	601932	Ref. No.	A00FA107
description	axial fan L 172mm W 150mm H 51mm 230 50/60Hz 23W bearing ball bearing manuf. no. AC17251CU7C1Y connection cable 1000mm MA-VIB airflow 336/390m ³ /h		
For models:	BL10-V, BL10-VT, BL14-M, BL14-MG, BL14-M-H, BL18-V, BL18-VG, BL18-VT, BL18-VTG, BL20-V, BL20-VT, BL7-M, BL7-MG, BL7-M-H, BL9-V, BL9-VG, BL9-VT, BL9-VTG, BN10-V, BN10-VT, BN14-3M, BN14-M, BN14-MG, BN14-M-H, BN18-V, BN18-VG, BN18-VT, BN18-VTG, BN20-V, BN20-VT, BN7-M, BN7-MG, BN7-M-H, BN9-V, BN9-VG, BN9-VT, BN9-VTG, VL10-V, VL10-VT, VL10-VTG, VL14-M, VL14-MG, VL14-M-H, VL14-MP, VL14-MPG, VL15, VL15-G, VL15-M-V, VL18-V, VL18-VG...(Other models you can see in the webshop)		

accessories

fan guards



GEV No.	601935	Ref. No.	A00FA101 old
description	fanwheel cover ø 120mm mounting distance 103mm for axial fan 119mm		



GEV No.	691104	Ref. No.	A00FA101
description	guard ø 115mm mounting distance 105mm for axial fan 119mm		
For models:	BB150, BB150-SS, BB250, BB250-SL, BB250-SS, BB350, BB350-SL, BB350-SS, DSP-160, SS150, SS250, SS350, ST150, ST250, ST350		

refrigeration fans

refrigeration motors universal

ELCO

N series - standard



1

GEV No.	601930	Ref. No.	A00EV112-A A00EV113-A A00FA109 A00KN100-A A00KN101-A A00KN700-A A00SHS012-A A00SHS018-A
description	fan motor ELCO 10W 230V 50/60Hz bearing slide bearing L1 55.5mm L2 91.5mm L3 119mm W 83mm cable length 2000mm 1300/1550rpm 5 mounting options VN10-20/929		
For models:	BF4, BGH2-TG, BGH3-TG, BGH4-TG, BGN2, BGN2-2G, BGN2-3G, BGN2-3SGC, BGN2-OG, BGN2-SG, BGN2-SGC, BGN2-TG, BGN2-V, BGN2-VT, BGN3, BGN3-2G, BGN3-4G, BGN3-4SGC, BGN3-OG, BGN3-SG, BGN3-SGC, BGN3-TG, BGN3-V, BGN3-VT, BGN4, BGN4-2G, BGN4-5SGC, BGN4-OG, BGN4-SG, BGN4-SGC, BGN4-TG, BGN4-V, BGN4-VT, BL20-V, BL20-VT, BL4, BL4-G, BL5, BL7, BL7-G, BL7-M, BL7-MG, BL7-M-H, BL9-V, BL9-VG, BL9-VT, BL9-VTG, BMN-155, BMN-210, BN10-V...(Other models you can see in the webshop)		
spare parts for	601930		
	GEV No.	601284	Ref. No. —
fan wheel sucking ø 254mm fan wheel mounting 25.4mm blade angle 28° W 42mm aluminium			

	1		
GEV No.	601928	Ref. No.	A00FA104 A00KN102-A A00KN103-A A00KN140-A A00KN153-A A00KN701-A
description	fan motor ELCO 16W 230V 50Hz bearing slide bearing L1 55.5mm L2 91.5mm L3 119mm W 83mm cable length 2000mm 1300/1550rpm 5 mounting options VNT16-25/1774		
For models:	BGL2, BGL2-V, BGL2-VT, BGL3, BGL3-V, BGL3-VT, BGL4, BGL4-V, BGL4-VT, BL10-V, BL10-VT, BL14, BL14-G, BL14-M, BL14-MG, BL14-M-H, BL18-V, BL18-VG, BL18-VT, BL18-VTG, BL20-V, BL20-VT, BL4, BL4-G, BL5, BL7, BL7-G, BL7-M, BL7-MG, BL7-M-H, BL9-V, BL9-VG, BL9-VT, BL9-VTG, BN10-V, BN10-VT, BN14-3M, BN14-M, BN14-MG, BN14-M-H, BN18-V, BN18-VG, BN18-VT, BN18-VTG, BN20-V, BN20-VT, BN7-M, BN7-MG, BN7-M-H, BN9-V...(Other models you can see in the webshop)		
spare parts for	601928		
	GEV No.	601284	Ref. No. —
fan wheel sucking ø 254mm fan wheel mounting 25.4mm blade angle 28° W 42mm aluminium			
	GEV No.	601413	Ref. No. —
fixing plate suitable for fanwheel ED ø 32mm shaft ø 7 mounting distance 26mm			

R series

	1		
GEV No.	601931	Ref. No.	A00EV114-A A00FA110
description	fan motor 18W 230/240V 50/60Hz L1 55.5mm L2 91.5mm L3 119mm W 83mm cable length 1500mm 2600rpm ELCO R18-25/001 4 mounting options bearing slide bearing capacitor 2µF		
spare parts for	601931		
	GEV No.	601284	Ref. No. —
fan wheel sucking ø 254mm fan wheel mounting 25.4mm blade angle 28° W 42mm aluminium			
	GEV No.	601413	Ref. No. —
fixing plate suitable for fanwheel ED ø 32mm shaft ø 7 mounting distance 26mm			

accessories

fan wheels

aluminium

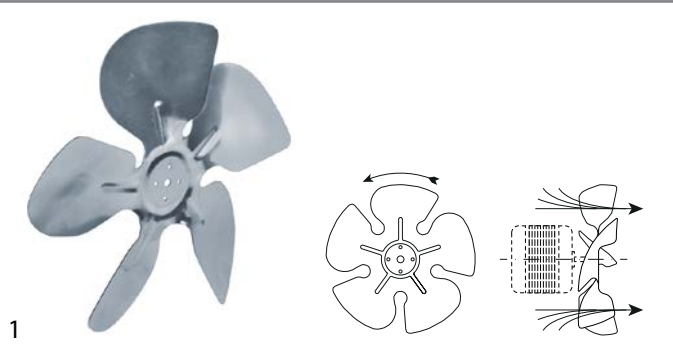

GEV No.	601573	Ref. No.	A00FA105
description	fan wheel blowing \varnothing 254mm fan wheel mounting 25.4mm blade angle 28° W 44mm aluminium		

cold air circulating fans (complete)

ebm-papst

A2E series

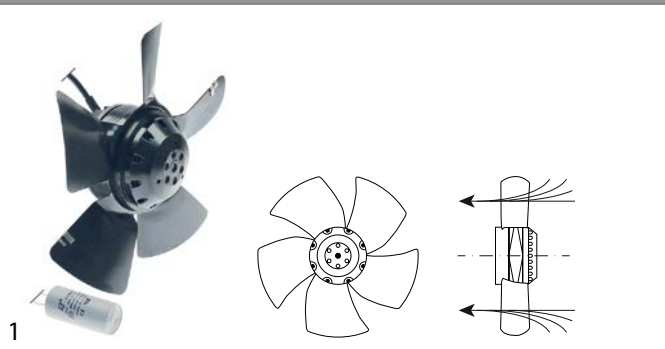

GEV No.	602114	Ref. No.	A00FA119
description	fan A2E250-AE65-01 fan wheel \varnothing 250mm blades 5 230V 50/60Hz 115/165W 2550/2750rpm cable length 1800mm ebm-papst sucking		

cooling motors (complete)



GEV No.	602152	Ref. No.	A00FA114
description	fan A4E300-AS72-19 fan wheel \varnothing 300mm blades 5 230V 50/60Hz 72/90W 1320/1500rpm ebm-papst suitable capacitor 2 μ F nominal 0.32/0.40A		

For models:	VBL-5
accessories for	602152

GEV No.	365170	Ref. No.	—
description	capacitor capacity 2 μ F 425V tolerance 5% 50/60Hz ambient temperature max. -25 to +85°C \varnothing 25mm L 49mm M8 plastic connection cable 250mm 416.17.74 protection		

S4E series

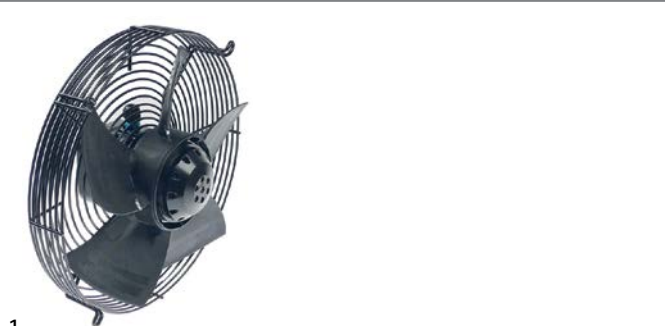

GEV No.	602115	Ref. No.	A00FA112
description	fan A4E300-AS72-80 fan wheel \varnothing 300mm blades 5 230V 50/60Hz 72/90W 1320/1500rpm blowing		

HIDRIA

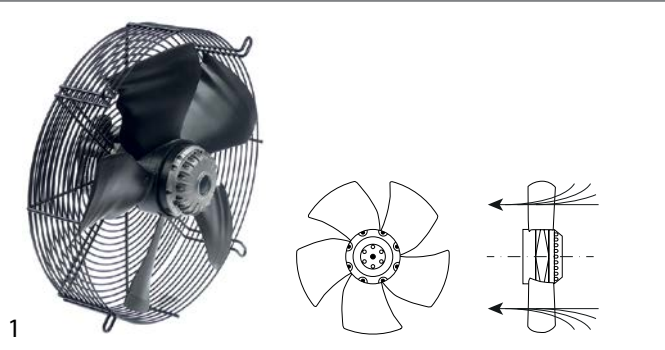

GEV No.	602172	Ref. No.	A00FA111
description	fan type R11R-40LPS-4M-5150 fan wheel \varnothing 400mm 230V 50/60Hz 190/260W HIDRIA 1310/1450rpm sucking H 155mm cable lengthmm mounting distance 330mm		
For models:	VBL-15		



cold air circulating fans

cold air circulating fans



GEV No.	601919	Ref. No.	A00FA102 A00FA108 A00SHP006-A A00SHP009-A
description	fan motor 220-230V 50-60Hz 5W shaft ø 6mm shaft L 14mm L 73mm W 62mm H 62mm cable length 2900mm input current 2A		
For models:	BGH2-TG, BGH3-TG, BGH4-TG, BGL2, BGL2-V, BGL2-VT, BGL3, BGL3-V, BGL3-VT, BGL4, BGL4-V, BGL4-VT, BGN2, BGN2-2G, BGN2-3G, BGN2-3SGC, BGN2-OG, BGN2-SG, BGN2-SGC, BGN2-TG, BGN2-V, BGN2-VT, BGN3, BGN3-2G, BGN3-4G, BGN3-4SGC, BGN3-OG, BGN3-SG, BGN3-SGC, BGN3-TG, BGN3-V, BGN3-VT, BGN4, BGN4-2G, BGN4-5SGC, BGN4-OG, BGN4-SG, BGN4-SGC, BGN4-TG, BGN4-V, BGN4-VT, BL4, BL4-G, BMN-155, BMN-210, BN4, BN4-G, BN5, BN7, BN7-G...(Other models you can see in the webshop)		
spare parts for	601919		
	GEV No.	601568	Ref. No. —
	fan wheel blowing ø 154mm fan wheel mounting 25.4mm blade angle 28° W 34mm aluminium		

cross flow fans

ebmpapst



GEV No.	601936	Ref. No.	A00FA103
description	cross flow fan QLZ06/1800A265-2524 roller ø 60mm roller length 180mm laminated core thickness 28mm motor position right 230V/50Hz 31W refrigeration bearing rubber connection male faston 6.3mm airflow 160m³/h 0 up to +60°C 230V 150m³/h 50Hz		
For models:	BF4, BL4, BN4, BN5, SB1, SB300, VN14-ST, VN7-ST, VN7-ST-V, VNL14-3T, VNL7-ST, VNL7-V, VNL14-3T, VNNF14-3T		

accessories universal



GEV No.	521073	Ref. No.	A00EP101 A00EP111-A
description	fanwheel cover ø 290mm for evaporator fan hole distance 210mm plastic black H 50mm		
For models:	BF4, BGH2-TG, BGH3-TG, BGH4-TG, BGL2, BGL2-V, BGL2-VT, BGL3, BGL3-V, BGL3-VT, BGL4, BGL4-V, BGL4-VT, BGN2, BGN2-2G, BGN2-3G, BGN2-3SGC, BGN2-OG, BGN2-SG, BGN2-SGC, BGN2-TG, BGN2-V, BGN2-VT, BGN3, BGN3-2G, BGN3-4G, BGN3-4SGC, BGN3-OG, BGN3-SG, BGN3-SGC, BGN3-TG, BGN3-V, BGN3-VT, BGN4, BGN4-2G, BGN4-5SGC, BGN4-OG, BGN4-SG, BGN4-SGC, BGN4-TG, BGN4-V, BGN4-VT, BL10-V, BL10-VT, BL14, BL14-G, BL14-M, BL14-MG, BL14-M-H, BL18-V...(Other models you can see in the webshop)		



GEV No.	601933	Ref. No.	A00EP100
description	fanwheel cover W 180mm for fan wheel H 50mm mounting distance 160mm		
For models:	BGH2-TG, BGH3-TG, BGH4-TG, BGL2, BGL2-V, BGL2-VT, BGL3, BGL3-V, BGL3-VT, BGL4, BGL4-V, BGL4-VT, BGN2, BGN2-2G, BGN2-3G, BGN2-3SGC, BGN2-OG, BGN2-SG, BGN2-SGC, BGN2-TG, BGN2-V, BGN2-VT, BGN3, BGN3-2G, BGN3-4G, BGN3-4SGC, BGN3-OG, BGN3-SG, BGN3-SGC, BGN3-TG, BGN3-V, BGN3-VT, BGN4, BGN4-2G, BGN4-5SGC, BGN4-OG, BGN4-SG, BGN4-SGC, BGN4-TG, BGN4-V, BGN4-VT, BMN-155, BMN-210, BSL2, BSL2-V, BSL2-VT, BSL3, BSL3-V, BSL3-VT, BSL4...(Other models you can see in the webshop)		

electric accessories

cables

power supply cables



GEV No.	551265	Ref. No.	B00FK100
description	supply cord CEE7/7 type E+F 3-pole contacts P+N+E 1.5mm² max. 16A max 230V 2m H05VVf insulation PVC countries D/F/B/I black		
For models:	BB150, BB150-SS, BB250, BB250-SL, BB250-SS, BB350, BB350-SL, BB350-SS, BF4, BGH2-TG, BGH3-TG, BGH4-TG, BGL2, BGL2-V, BGL2-VT, BGL3, BGL3-V, BGL3-VT, BGL4, BGL4-V, BGL4-VT, BGN2, BGN2-2G, BGN2-3G, BGN2-3SGC, BGN2-OG, BGN2-SG, BGN2-SGC, BGN2-TG, BGN2-V, BGN2-VT, BGN3, BGN3-2G, BGN3-4G, BGN3-4SGC, BGN3-OG, BGN3-SG, BGN3-SGC, BGN3-TG, BGN3-V, BGN3-VT, BGN4, BGN4-2G, BGN4-5SGC, BGN4-OG, BGN4-SG, BGN4-SGC, BGN4-TG, BGN4-V, BGN4-VT...(Other models you can see in the webshop)		

equipment-specific units

for fridges

housing and bezels

shelf rails



1

GEV No.	701389	Ref. No.	17000226 C17000226 C17000226E
description	rack L 530mm W 20mm H 14mm SS U-shape mounting pos. on both sides pair		
For models:	BGH2-TG, BGH3-TG, BGH4-TG, BGL2, BGL2-V, BGL2-VT, BGL3-V, BGL3-VT, BGL4, BGL4-V, BGL4-VT, BGN2, BGN2-2G, BGN2-3G, BGN2-3SGC, BGN2-OG, BGN2-SG, BGN2-SGC, BGN2-TG, BGN2-V, BGN2-VT, BGN3, BGN3-2G, BGN3-4SGC, BGN3-OG, BGN3-SG, BGN3-SGC, BGN3-TG, BGN4, BGN4-2G, BGN4-5SGC, BGN4-OG, BGN4-SG, BGN4-SGC, BGN4-TG, BGN4-V, BGN4-VT, CGL2A-V, CGL3A-V, CGN2A-V, CGN2-MTG, CGN2-TG, CGN3A-V, CGN3-MTG, CGN3-TG, CGN4A-V, CGN4-MTG, CGN4-TG, CSN2-MTG, CSN3-MTG...(Other models you can see in the webshop)		

doors

doors



1

GEV No.	694688	Ref. No.	B00KA250
description	door W 450mm H 790mm thickness 42mm FRENOX hinging right		
For models:	BB250, BB350		



1

GEV No.	694689	Ref. No.	01A01KA108 01A01KA112
description	door W 700mm H 1600mm thickness 47mm FRENOX hinging right/left		
For models:	BL10-V, BL10-VT, BL14, BL14-M, BL14-M-H, BL18-V, BL18-VT, BL20-V, BL20-VT, BL7, BL7-M, BL7-M-H, BL9-V, BL9-VT, BN10-V, BN10-VT, BN14, BN14-3M, BN14-M, BN14-M-H, BN18-V, BN18-VT, BN20-V, BN20-VT, BN7, BN7-M, BN7-M-H, BN9-V, BN9-VT, GRN-BN9-EV-V, VL10-V, VL10-VT, VL14, VL14-M, VL14-M-H, VL14-MP, VL14-P, VL15, VL15-M-V, VL18-V, VL18-VT, VL20-V, VL20-VT, VL7, VL7-M, VL7-M-H, VL7-P, VL8, VL8-M-V, VL8-P-V...(Other models you can see in the webshop)		



for refrigerated counters

doors



1

GEV No.	694687	Ref. No.	01A01KA100 01A01KA121
description	door hinging right/left suitable for FRENOX W 450mm H 660mm thickness 45mm FRENOX without hinge		
For models:	BGH2-TG, BGH3-TG, BGH4-TG, BGL2, BGL2-V, BGL2-VT, BGL3, BGL3-V, BGL3-VT, BGL4, BGL4-V, BGL4-VT, BGN2, BGN2-3G, BGN2-3SGC, BGN2-OG, BGN2-SG, BGN2-SGC, BGN2-TG, BGN2-V, BGN2-VT, BGN3, BGN3-4G, BGN3-4SGC, BGN3-OG, BGN3-SG, BGN3-SGC, BGN3-TG, BGN3-V, BGN3-VT, BGN4, BGN4-5SGC, BGN4-OG, BGN4-SG, BGN4-SGC, BGN4-TG, BGN4-V, BGN4-VT, BSL2, BSL2-V, BSL2-VT, BSL3, BSL3-V, BSL3-VT, BSL4, BSL4-V, BSL4-VT, BSN2, BSN2-V, BSN2-VT...(Other models you can see in the webshop)		

for freezer cabinets

housing and bezels



1

GEV No.	692614	Ref. No.	C16014032
description	front panel mounting pos. upper W 1415mm H 305mm thickness 63mm suitable for FRENOX stainless steel		
For models:	BL14, BL14-G, BL14-M, BL14-M-H, BL18-VG, BL18-VT, BL18-VTG, BL20-V, BL20-VT, BN14, BN14-M, BN14-M-H, BN18-V, BN18-VG, BN18-VT, BN18-VTG, BN20-V, BN20-VT		

for display coolers

glass panels

accessories



1

GEV No.	698903	Ref. No.	E00EV100
description	mounting set for glass plate		

locks

locking devices

producer-specific

FRENOX



1

GEV No.	692489	Ref. No.	B00KI103
description	key cylinder key lock ø 21.5mm rotation 90° cam length 12.8mm cam width 5.9mm		



1

GEV No.	692490	Ref. No.	B00KI100
description	key cylinder with slide latch ø 18.5mm thread M19x1 mounting measurements 16.5x19mm hub 12.5mm shaft ø 11mm thread L 14mm		
For models:	BB150, BB150-SS, BB250, BB250-SS, BB350, BB350-SS, BF4, BL10-V, BL10-VT, BL14, BL14-G, BL14-M, BL14-MG, BL14-M-H, BL18-V, BL18-VG, BL18-VT, BL18-VTG, BL20-V, BL20-VT, BL4, BL4-G, BL5, BL7, BL7-G, BL7-M, BL7-MG, BL7-M-H, BL9-V, BL9-VG, BL9-VT, BL9-VTG, BN10-V, BN10-VT, BN14, BN14-3M, BN14-G, BN14-M, BN14-MG, BN14-M-H, BN18-V, BN18-VG, BN18-VT, BN18-VTG, BN20-V, BN20-VT, BN4, BN4-G, BN5, BN7...(Other models you can see in the webshop)		



1

GEV No.	690028	Ref. No.	B00KI101
description	locking device H 20/12mm L 50mm W 20mm overall height 40mm		

edgemoat latches

handle latches

miscellaneous



GEV No.	694003	Ref. No.	B00K1102
description	handle latch L 137mm mounting distance 118mm lockable refrigeration units I-01 H 31.5mm W 28mm type I-01 total length 190mm handle material plastic		
For models:	SB1, VL7-RO, VL7-RO-2, VN7-RO, VN7-RO-2		
accessories for	694003		
	GEV No.	700078	Ref. No. —
	door catch L 47mm W 14mm H 29mm mounting distance 21-33mm zinc die cast adjustable		

walk-in fridge catches

CAFF/FERMOD

430/431 series



GEV No.	701502	Ref. No.	B00K1107
description	walk-in fridge catch door thickness 67-115mm lockable type 431 L 233mm W 136.5mm H 62mm with internal safety handle		

hinges

edgemoat hinges

CAFF/FERMOD



GEV No.	698901	Ref. No.	B02ME104
description	edgemoat hinge L 210mm W 35mm mounting distance 120mm hinging left/right with gradient mounting pos. upper/lower plastic grey/grey		

spring assisted hinges

producer-specific

FRENOX







GEV No.	701653	Ref. No.	P30090008
description	bracket for hinge L 180mm W 31mm lower mounting distance 58mm		
For models:	BF4, BL10-V, BL10-VT, BL14, BL14-G, BL14-M, BL14-MG, BL14-M-H, BL18-V, BL18-VG, BL18-VT, BL18-VTG, BL20-V, BL20-VT, BL4, BL4-G, BL7, BL7-G, BL7-M, BL7-MG, BL7-M-H, BL9-V, BL9-VG, BL9-VT, BL9-VTG, BN10-V, BN10-VT, BN14, BN14-3M, BN14-G, BN14-M, BN14-MG, BN14-M-H, BN18-V, BN18-VG, BN18-VT, BN18-VTG, BN20-V, BN20-VT, BN4, BN4-G, BN7, BN7-G, BN7-M, BN7-MG, BN7-M-H, BN9-V, BN9-VG, BN9-VT, BN9-VTG...(Other models you can see in the webshop)		
accessories for	701653		
	GEV No.	701416	Ref. No. B02ME100
	spring assisted hinge left/right L 114mm W 75mm mounting distance 25mm brass suitable for FRENOX		





GEV No.	701651	Ref. No.	B02ME101
description	bush for door hinge 8 ED ø 11mm 19.5 H 11.5mm Qty 5 pcs		
For models:	BF4, BL10-V, BL10-VT, BL14, BL14-G, BL14-M, BL14-MG, BL14-M-H, BL18-V, BL18-VG, BL18-VT, BL18-VTG, BL20-V, BL20-VT, BL4, BL4-G, BL5, BL7, BL7-G, BL7-M, BL7-MG, BL7-M-H, BL9-V, BL9-VG, BL9-VT, BL9-VTG, BN10-V, BN10-VT, BN14, BN14-3M, BN14-G, BN14-M, BN14-MG, BN14-M-H, BN18-V, BN18-VG, BN18-VT, BN18-VTG, BN20-V, BN20-VT, BN4, BN4-G, BN5, BN7, BN7-G, BN7-M, BN7-MG, BN7-M-H, BN9-V, BN9-VG...(Other models you can see in the webshop)		



			
1			
GEV No.	701388	Ref. No.	B02ME102
description	bush type for door hinge mounting pos. upper ED ø 31mm H 19mm plastic shaft diameter 14.3mm		
For models:	BF4, BL10-V, BL10-VT, BL14, BL14-G, BL14-M, BL14-MG, BL14-M-H, BL18-V, BL18-VG, BL18-VT, BL18-VTG, BL20-V, BL20-VT, BL4, BL4-G, BL5, BL7, BL7-G, BL7-M, BL7-MG, BL7-M-H, BL9-V, BL9-VG, BL9-VT, BL9-VTG, BN10-V, BN10-VT, BN14, BN14-3M, BN14-G, BN14-M, BN14-MG, BN14-M-H, BN18-V, BN18-VG, BN18-VT, BN18-VTG, BN20-V, BN20-VT, BN4, BN4-G, BN5, BN7, BN7-G, BN7-M, BN7-MG, BN7-M-H, BN9-V, BN9-VG...(Other models you can see in the webshop)		
accessories for	701388		
	GEV No.	701416	Ref. No. B02ME100
	spring assisted hinge left/right L 114mm W 75mm mounting distance 25mm brass suitable for FRENOX		
	GEV No.	701655	Ref. No. B02ME101-VBL
	bush upper for door hinge ID ø 10mm ED ø 14mm L 36mm for aluminium		

			
1			
GEV No.	701655	Ref. No.	B02ME101-VBL
description	bush upper for door hinge ID ø 10mm ED ø 14mm L 36mm for aluminium		
For models:	VBL-10, VBL-15, VBL-5, VBL-7		
accessories for	701655		
	GEV No.	701388	Ref. No. B02ME102
	bush type for door hinge mounting pos. upper ED ø 31mm H 19mm plastic shaft diameter 14.3mm		

			
1			
GEV No.	701377	Ref. No.	B02ME102-A B02ME105
description	spring assisted hinge kit L 114mm W 75mm mounting distance 25mm brass suitable for FRENOX		
accessories for	701377		
	GEV No.	701388	Ref. No. B02ME102
	bush type for door hinge mounting pos. upper ED ø 31mm H 19mm plastic shaft diameter 14.3mm		



			
1			
GEV No.	701416	Ref. No.	B02ME100
description	spring assisted hinge left/right L 114mm W 75mm mounting distance 25mm brass suitable for FRENOX		
For models:	BF4, BGH2-TG, BGH3-TG, BGH4-TG, BGL2, BGL2-V, BGL2-VT, BGL3, BGL3-V, BGL3-VT, BGL4, BGL4-V, BGL4-VT, BGN2, BGN2-2G, BGN2-3G, BGN2-3SGC, BGN2-OG, BGN2-SG, BGN2-SGC, BGN2-TG, BGN2-V, BGN2-VT, BGN3, BGN3-2G, BGN3-4G, BGN3-4SGC, BGN3-OG, BGN3-SG, BGN3-SGC, BGN3-TG, BGN3-V, BGN3-VT, BGN4, BGN4-2G, BGN4-5SGC, BGN4-OG, BGN4-SG, BGN4-SGC, BGN4-TG, BGN4-V, BGN4-VT, BL10-V, BL10-VT, BL14, BL14-G, BL14-M, BL14-MG, BL14-M-H, BL18-V...(Other models you can see in the webshop)		
accessories for	701416		
	GEV No.	701388	Ref. No. B02ME102
	bush type for door hinge mounting pos. upper ED ø 31mm H 19mm plastic shaft diameter 14.3mm		
	GEV No.	701653	Ref. No. P30090008
	bracket for hinge L 180mm W 31mm lower mounting distance 58mm		

door bearing

			
1			
GEV No.	701461	Ref. No.	P30037072
description	hinge L 56mm W 39mm set		
For models:	CGN2-YM, CGN3-YM, CGN4-YM, MGA2-04, MGN2, MGN3, MGN3-7G, MGN4, MGN4-9G-V, MPN2, MPN2-V, MPN3, MPN3-7G, MPN3-V, MPN4		

accessories

bushes

			
1			
GEV No.	701655	Ref. No.	B02ME101-VBL
description	bush upper for door hinge ID ø 10mm ED ø 14mm L 36mm for aluminium		
For models:	VBL-10, VBL-15, VBL-5, VBL-7		
accessories for	701655		
	GEV No.	701388	Ref. No. B02ME102
	bush type for door hinge mounting pos. upper ED ø 31mm H 19mm plastic shaft diameter 14.3mm		

pullouts

drawer slides

producer-specific



GEV No.	696701	Ref. No.	A00CK101
description	drawer slide L 450mm pull-out length 435mm Qty 1 pair mounting pos. right/left		
For models:	BSL2, BSL2-V, BSL2-VT, BSL3, BSL3-V, BSL3-VT, BSL4, BSL4-V, BSL4-VT, BSN2, BSN2-V, BSN2-VT, BSN3, BSN3-V, BSN3-VT, BSN4, BSN4-V, BSN4-VT, CSL2, CSL2-V, CSL2-VT, CSL3, CSL3-V, CSL3-VT, CSL4, CSL4-V, CSL4-VT, CSN2, CSN2-E, CSN2-G, CSN2-MTG, CSN2-R, CSN2-V, CSN2-VT, CSN3, CSN3-E, CSN3-G, CSN3-MTG, CSN3-R, CSN3-V, CSN3-VT, CSN4, CSN4-E, CSN4-G, CSN4-MTG, CSN4-R, CSN4-V, CSN4-VT, USL2, USL3... (Other models you can see in the webshop)		

GEV No.	700213 ¹	Ref. No.	B00AY102
description	swivel castor with swivel brake ø 100mm plate fixing housing zinc-plated sheet steel plate size 105x85mm hole distance 60x78mm capacity 80kg bearing slide bearing wheel body polypropylene tread TPE tyres H 128mm wheel width 32mm Qty 1 pcs		
For models:	BF4, BGH2-TG, BGH3-TG, BGH4-TG, BGL2, BGL2-V, BGL2-VT, BGL3, BGL3-V, BGL3-VT, BGL4, BGL4-V, BGL4-VT, BGN2, BGN2-2G, BGN2-3G, BGN2-3SGC, BGN2-OG, BGN2-SG, BGN2-SGC, BGN2-TG, BGN2-V, BGN2-VT, BGN3, BGN3-2G, BGN3-4G, BGN3-4SGC, BGN3-OG, BGN3-SG, BGN3-SGC, BGN3-TG, BGN3-V, BGN3-VT, BGN4, BGN4-2G, BGN4-5SGC, BGN4-OG, BGN4-SG, BGN4-SGC, BGN4-TG, BGN4-V, BGN4-VT, BL10-V, BL10-VT, BL14, BL14-G, BL14-M, BL14-MG, BL14-M-H, BL18-V... (Other models you can see in the webshop)		

¹with swivel brake

equipment feet and end caps

equipment feet

with fixing plate



GEV No.	701007	Ref. No.	B00AY100
description	equipment foot tube ø 64mm plate size 82x82mm hole distance 68x68mm H 100-150mm SS size 2 1/2" Qty 1 pcs		
For models:	BF4, BGH2-TG, BGH3-TG, BGH4-TG, BGL2, BGL2-V, BGL2-VT, BGL3, BGL3-V, BGL3-VT, BGL4, BGL4-V, BGL4-VT, BGN2, BGN2-2G, BGN2-3G, BGN2-3SGC, BGN2-OG, BGN2-SG, BGN2-SGC, BGN2-TG, BGN2-V, BGN2-VT, BGN3, BGN3-2G, BGN3-4G, BGN3-4SGC, BGN3-OG, BGN3-SG, BGN3-SGC, BGN3-TG, BGN3-V, BGN3-VT, BGN4, BGN4-2G, BGN4-5SGC, BGN4-OG, BGN4-SG, BGN4-SGC, BGN4-TG, BGN4-V, BGN4-VT, BL10-V, BL10-VT, BL14, BL14-G, BL14-M, BL14-MG, BL14-M-H, BL18-V... (Other models you can see in the webshop)		

shelves and shelf rails

grates

universal

without upstand



GEV No.	970844	Ref. No.	B01RF101
description	grate W 330mm D 430mm H 10mm plastic-coated steel wire gauge frame 6.9mm lengthwise wires gauge 3.5mm crossing wires 1 grey		
For models:	BSL2, BSL2-V, BSL2-VT, BSL3, BSL3-V, BSL3-VT, BSL4, BSL4-V, BSL4-VT, BSN2, BSN2-V, BSN2-VT, BSN3, BSN3-V, BSN3-VT, BSN4, BSN4-V, BSN4-VT, CSL2, CSL2-V, CSL2-VT, CSL3, CSL3-V, CSL3-VT, CSL4, CSL4-V, CSL4-VT, CSN2, CSN2-E, CSN2-G, CSN2-MTG, CSN2-R, CSN2-V, CSN2-VT, CSN3, CSN3-E, CSN3-G, CSN3-MTG, CSN3-R, CSN3-V, CSN3-VT, CSN4, CSN4-E, CSN4-G, CSN4-MTG, CSN4-R, CSN4-V, CSN4-VT, USL2, USL3... (Other models you can see in the webshop)		

TENTE

with fixing plate

chrome-plated steel





GEV No.	700214	Ref. No.	B00AY101
description	swivel castor ø 100mm plate fixing housing zinc-plated sheet steel plate size 105x85mm hole distance 60x78mm capacity 80kg bearing slide bearing wheel body polypropylene tread TPE tyres H 128mm wheel width 32mm		
For models:	BF4, BGH2-TG, BGH3-TG, BGH4-TG, BGL2, BGL2-V, BGL2-VT, BGL3, BGL3-V, BGL3-VT, BGL4, BGL4-V, BGL4-VT, BGN2, BGN2-2G, BGN2-3G, BGN2-3SGC, BGN2-OG, BGN2-SG, BGN2-SGC, BGN2-TG, BGN2-V, BGN2-VT, BGN3, BGN3-2G, BGN3-4G, BGN3-4SGC, BGN3-OG, BGN3-SG, BGN3-SGC, BGN3-TG, BGN3-V, BGN3-VT, BGN4, BGN4-2G, BGN4-5SGC, BGN4-OG, BGN4-SG, BGN4-SGC, BGN4-TG, BGN4-V, BGN4-VT, BL10-V, BL10-VT, BL14, BL14-G, BL14-M, BL14-MG, BL14-M-H, BL18-V... (Other models you can see in the webshop)		

GEV No.	970834	Ref. No.	B01RF100
description	grate W 330mm D 530mm H 10mm plastic-coated steel wire gauge frame 6.9mm lengthwise wires gauge 3.5mm crossing wires 1 grey		
For models:	BGH2-TG, BGH3-TG, BGH4-TG, BGL2, BGL2-V, BGL2-VT, BGL3, BGL3-V, BGL3-VT, BGL4, BGL4-V, BGL4-VT, BGN2, BGN2-3G, BGN2-3SGC, BGN2-OG, BGN2-SG, BGN2-SGC, BGN2-TG, BGN2-V, BGN2-VT, BGN3, BGN3-4G, BGN3-4SGC, BGN3-OG, BGN3-SG, BGN3-SGC, BGN3-TG, BGN3-V, BGN3-VT, BGN4, BGN4-5SGC, BGN4-OG, BGN4-SG, BGN4-SGC, BGN4-TG, BGN4-V, BGN4-VT, CGL2, CGL2A-V, CGL2-R, CGL2-R-A, CGL2-V, CGL2-VT, CGL3, CGL3A-V, CGL3-R, CGL3-R-A, CGL3-V, CGL3-VT... (Other models you can see in the webshop)		



			
GEV No.	970835	Ref. No.	B01RF115
description	grate W 600mm D 400mm H 12mm plastic-coated steel wire gauge frame 7.5mm lengthwise wires gauge 5.5mm crossing wires 1 grey		
For models:	BMN-155, BMN-210, BZT140-R, BZT155, BZT155-D, BZT160-3D, BZT186-R, BZT210, BZT210-D, BZT215-3D, PMN-155, PMN-210, PPL2, PPL2-G, PPL2-GS-V, PPL3, PPL3-G, PPN2, PPN2-G, PPN2-GS-V, PPN2-G-V, PPN3, PPN3-G, PPN3-GS-V, PPN3-G-V, PZT155, PZT155-D, PZT160-3D, PZT210, PZT210-D, PZT215-3D		

with upstand			
			
GEV No.	970471	Ref. No.	B01rf106
description	grate W 485mm D 460mm plastic-coated steel with hinge camp crossing wires 2 suitable for refrigerator for devices with Inox guide rails		
For models:	BL4, BL4-G, BN4, BN4-G		

			
GEV No.	970833	Ref. No.	B01RF102
description	grate W 530mm D 650mm GN 2/1 H 29.5mm plastic-coated steel wire gauge frame 8mm lengthwise wires gauge 3.5mm crossing wires 2 grey		
For models:	BL10-V, BL10-VT, BL14, BL14-G, BL14-M, BL14-MG, BL14-M-H, BL18-V, BL18-VG, BL18-VT, BL18-VTG, BL20-V, BL20-VT, BL7, BL7-G, BL7-M, BL7-MG, BL7-M-H, BL9-V, BL9-VG, BL9-VT, BL9-VTG, BN10-V, BN10-VT, BN14, BN14-3M, BN14-G, BN14-M, BN14-MG, BN14-M-H, BN18-V, BN18-VG, BN18-VT, BN18-VTG, BN20-V, BN20-VT, BN7, BN7-G, BN7-M, BN7-MG, BN7-M-H, BN9-V, BN9-VG, BN9-VT, BN9-VTG, GRN-BN9-EV-V, VL10-V, VL10-VT, VL10-VTG, VL14...(Other models you can see in the webshop)		

shelf rails and supports			
producer-specific			
			
GEV No.	701327	Ref. No.	17000126 C17000126
description	guide SS L 435mm W 20mm mounting pos. right/left hook width 13mm inner height 17.3mm		
For models:	BSL2, BSL2-V, BSL2-VT, BSL3, BSL3-V, BSL3-VT, BSL4, BSL4-V, BSL4-VT, BSN2, BSN2-V, BSN2-VT, BSN3, BSN3-V, BSN3-VT, BSN4, BSN4-V, BSN4-VT		

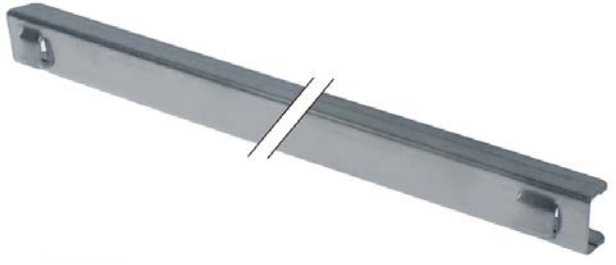
			
GEV No.	701328	Ref. No.	P11070025-A
description	guide U-shape L 580mm W 19mm mounting pos. left/right hook width 13mm inner height 15.75mm		
For models:	BL14-MG, BN14-MG, VL14-M, VL14-MG, VL14-M-H, VL15, VL15-G, VN14-M, VN14-MG, VN14-M-H, VN15, VN15-G		

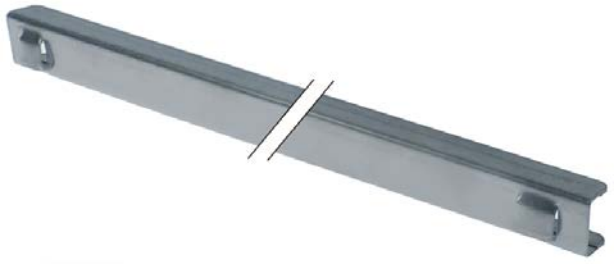
			
GEV No.	701329	Ref. No.	C11070025 P11070025
description	guide U-shape L 630mm W 19mm mounting pos. left/right hook width 13mm inner height 15mm		
For models:	BL14, BL14-G, BL14-M, BL14-MG, BL14-M-H, BL18-V, BL18-VG, BL18-VT, BL18-VTG, BL20-V, BL20-VT, BL7, BL7-G, BL7-M, BL7-MG, BL7-M-H, BN14, BN14-3M, BN14-G, BN14-M, BN14-MG, BN14-M-H, BN18-V, BN18-VG, BN18-VT, BN18-VTG, BN20-V, BN20-VT, BN7, BN7-G, BN7-M, BN7-MG, BN7-M-H, VL14, VL14-G, VL14-M, VL14-MG, VL14-M-H, VL15, VL15-G, VL15-M-V, VL18-V, VL18-VG, VL18-VT, VL18-VTG, VL20-V, VL20-VT, VL20-VTG, VL7, VL7-G...(Other models you can see in the webshop)		

			
GEV No.	701654	Ref. No.	P21000101
description	pair of setting bar L 368mm W 53mm H 40mm mounting pos. left/right Qty pair		
For models:	VBL-10, VBL-15, VBL-5, VBL-7		

			
GEV No.	701330	Ref. No.	16000825 P16000825
description	pair of setting bar L-shape L 647mm W 26mm H 18mm mounting pos. left/right		



GEV No.	890033	Ref. No.	B00DI101
description	shelf support L 29mm W 22mm H 25mm SS for shelves		
For models:	BB150, BB150-SS, BB250, BB250-SL, BB250-SS, BB350, BB350-SL, BB350-SS, BL4, BL4-G, BL5, BN4, BN4-G, BN5, BSL1, BSN1, GL13-G, GL6-G, GN13-G, GN13-SL, GN6-G, SB300, SS150, SS250, SS300, SS350, ST150, ST250, ST350, WL13-G, WL6-G, WN6-G		

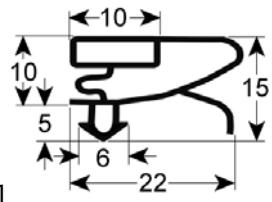

GEV No.	901734	Ref. No.	A00CO121
description	refrigeration gasket profile 9753 W 570mm L 1640mm plug size		
For models:	SB300, SS300, WA4, WN4		

gaskets

refrigeration gaskets

plug-in gaskets

profile 9753

We offer custom-made gaskets for this profile

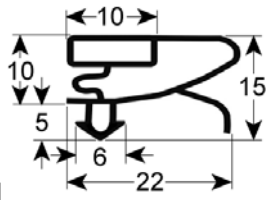

GEV No.	901728	Ref. No.	A00CO106
description	refrigeration gasket profile 9753 W 385mm L 405mm plug size		
For models:	GRN-BGL2-M		

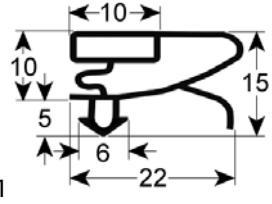

GEV No.	901733	Ref. No.	A00CO112
description	refrigeration gasket profile 9753 W 625mm L 1050mm plug size		
For models:	SB1		

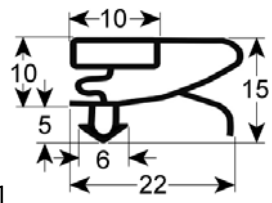

GEV No.	901729	Ref. No.	A00CO111
description	refrigeration gasket profile 9753 W 700mm L 530mm plug size		
For models:	BSL1, BSN1		

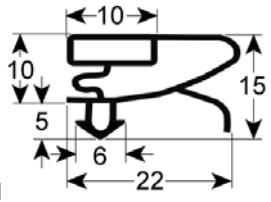

GEV No.	901725	Ref. No.	A00CO110
description	refrigeration gasket profile 9753 W 545mm L 1395mm plug size		
For models:	BF4, BL4, BL4-G, BN4, BN4-G		

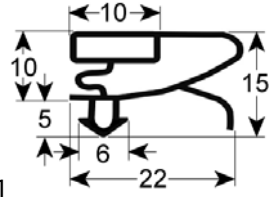

GEV No.	901738	Ref. No.	A00CO113
description	refrigeration gasket profile 9753 W 765mm L 430mm plug size		
For models:	BB150, BB250, BB350		

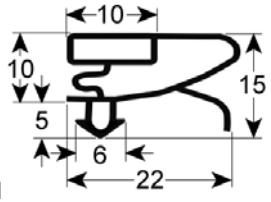

GEV No.	901739	Ref. No.	A00CO116
description	refrigeration gasket profile 9753 W 550mm L 750mm plug size		
For models:	BB150-SS, SS150, ST150		

profile 9198

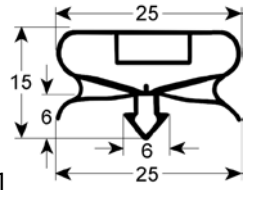

GEV No.	901732	Ref. No.	A00CO120
description	refrigeration gasket profile 9198 W 400mm L 210mm plug size		



GEV No.	901727	Ref. No.	A00CO104
description	refrigeration gasket profile 9198 W 400mm L 410mm plug size		
For models:	UGL2, UGL3, UGL4, UGN2, UGN2-SH, UGN3, UGN3-SH, UGN4, UGN4-SH, USL2, USL3, USL4, USN2, USN3, USN4		

GEV No.	901737	Ref. No.	A00CO107
description	refrigeration gasket profile 9198 W 493mm L 618mm plug size		
For models:	BMN-155, BMN-210, BZT140-R, BZT155, BZT155-D, BZT160-3D, BZT186-R, BZT210, BZT210-D, BZT215-3D, PMN-155, PMN-210, PPL2, PPL2-G, PPL2-GS-V, PPL3, PPL3-G, PPN2, PPN2-G, PPN2-GS-V, PPN2-G-V, PPN3, PPN3-G, PPN3-GS-V, PPN3-G-V, PZT155, PZT155-D, PZT160-3D, PZT210, PZT210-D, PZT215-3D		

GEV No.	901731	Ref. No.	A00CO100
description	refrigeration gasket profile 9198 W 410mm L 170mm plug size		
For models:	GRN-BGL2-M		

GEV No.	901736	Ref. No.	A00CO101
description	refrigeration gasket profile 9198 W 610mm L 405mm plug size FRENOX		
For models:	BGH2-TG, BGH3-TG, BGH4-TG, BGL2, BGL2-V, BGL2-VT, BGL3, BGL3-V, BGL3-VT, BGL4, BGL4-V, BGL4-VT, BGN2, BGN2-2G, BGN2-3G, BGN2-3SGC, BGN2-OG, BGN2-SG, BGN2-SGC, BGN2-TG, BGN2-V, BGN2-VT, BGN3, BGN3-2G, BGN3-4G, BGN3-4SGC, BGN3-OG, BGN3-SG, BGN3-SGC, BGN3-TG, BGN3-V, BGN3-VT, BGN4, BGN4-2G, BGN4-5SGC, BGN4-OG, BGN4-SG, BGN4-SGC, BGN4-TG, BGN4-V, BGN4-VT, BSL2, BSL2-V, BSL2-VT, BSL3, BSL3-V, BSL3-VT, BSL4, BSL4-V, BSL4-VT...(Other models you can see in the webshop)		

GEV No.	901730	Ref. No.	A00CO103
description	refrigeration gasket profile 9198 W 410mm L 280mm plug size		
For models:	GRN-BGL2-M		

GEV No.	901724	Ref. No.	A00CO119
description	refrigeration gasket profile 9198 W 620mm L 1540mm plug size		
For models:	BL10-V, BL10-VT, BL14, BL14-G, BL14-M, BL14-MG, BL14-M-H, BL18-V, BL18-VG, BL18-VT, BL18-VTG, BL20-V, BL20-VT, BL7, BL7-G, BL7-M, BL7-MG, BL7-M-H, BL9-V, BL9-VG, BL9-VT, BL9-VTG, BN10-V, BN10-VT, BN14, BN14-3M, BN14-G, BN14-M, BN14-MG, BN14-M-H, BN18-V, BN18-VG, BN18-VT, BN18-VTG, BN20-V, BN20-VT, BN5, BN7, BN7-G, BN7-M, BN7-MG, BN7-M-H, BN9-V, BN9-VG, BN9-VT, BN9-VTG, GRN-BN9-EV-V, VL10-V, VL10-VT, VL10-VTG...(Other models you can see in the webshop)		

GEV No.	902527	Ref. No.	A00CO142
description	refrigeration gasket profile 9198 W 432mm L 716mm plug size		
For models:	VBL-5		

GEV No.	901735	Ref. No.	A00CO118
description	refrigeration gasket profile 9198 W 620mm L 730mm plug size		
For models:	BN14-3M, VLL7, VNL14-3T, VNL7, VNL7-ST, VNL7-V, VNL7-V-T, VNL14-3T, VNN7, VNNF14-3T		

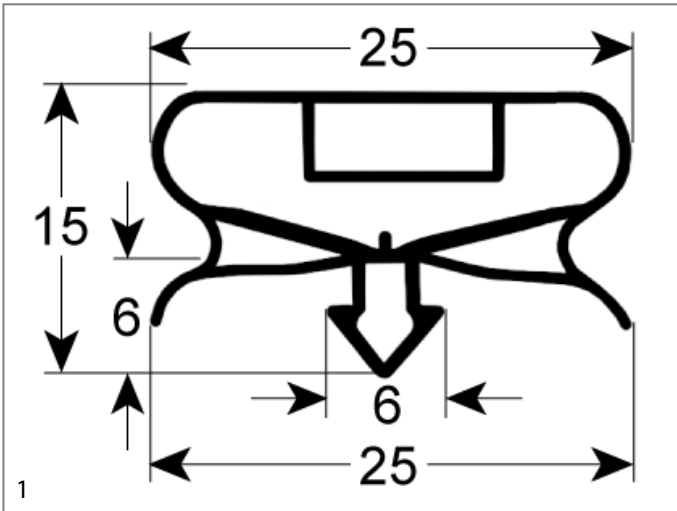

GEV No.	902526	Ref. No.	A00C0137
description	refrigeration gasket profile 9198 W 628mm L 1432mm plug size		
For models:	VBL-15		

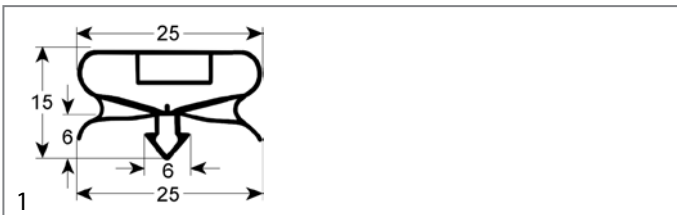

GEV No.	901726	Ref. No.	A00C0117
description	refrigeration gasket profile 9198 W 640mm L 1440mm plug size		
For models:	BL5, BN5, GL13-G, GL6-G, GN13-G, GN6-G, SL13-G, SL6-G, WL13-G, WL6-G, WN13-G, WN6-G		

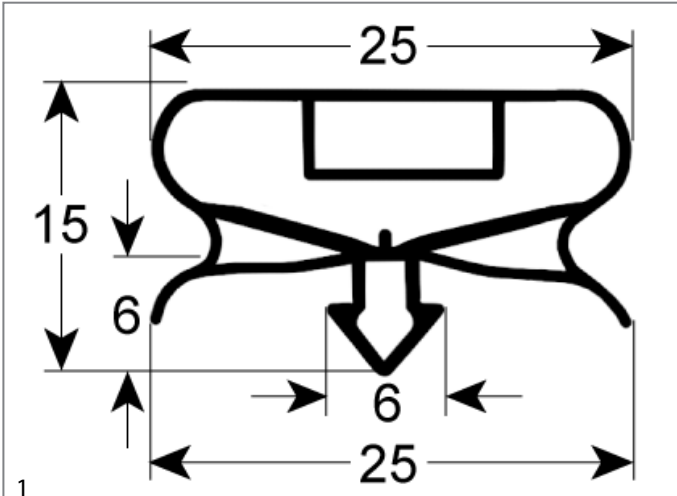

GEV No.	902528	Ref. No.	A00C0147
description	refrigeration gasket profile 9198 W 718mm L 1117mm plug size		
For models:	VBL-10, VBL-7		

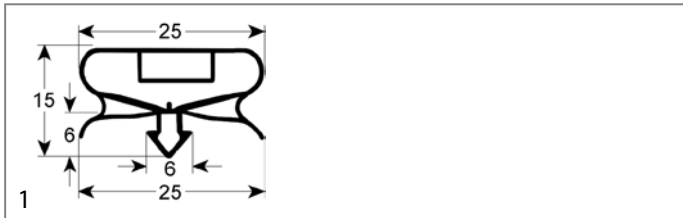

GEV No.	901740	Ref. No.	A00C0114
description	refrigeration gasket profile 9198 W 755mm L 420mm plug size		
For models:	BB250-SS, BB350-SS, SS250, SS350, ST250, ST350		

profile 9996

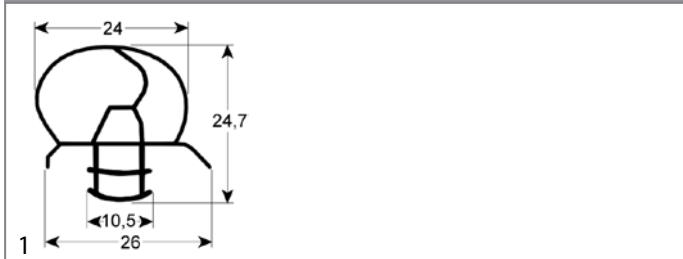

GEV No.	902148	Ref. No.	A00C0131
description	refrigeration gasket profile 9996 W 600mm L 1850mm plug size		

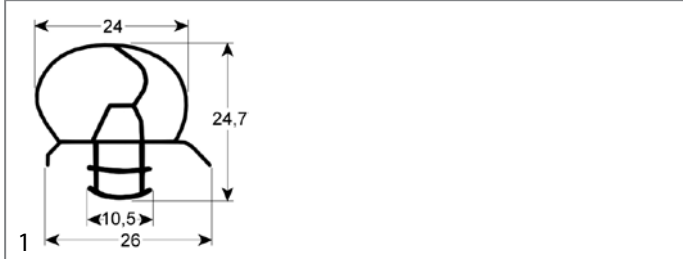

GEV No.	902293	Ref. No.	A00C0145
description	refrigeration gasket profile 9996 W 700mm L 1760mm plug size		

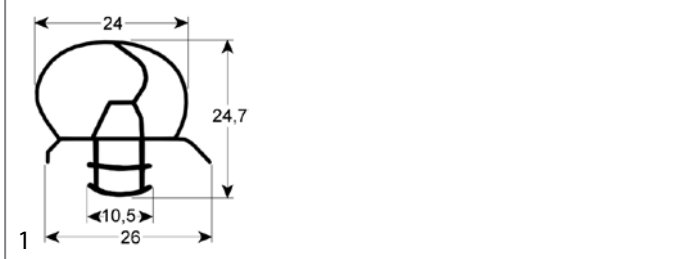

GEV No.	902149	Ref. No.	A00C0128
description	refrigeration gasket profile 9996 W 700mm L 1835mm plug size		



refrigeration cycle components

valves

expansion valves

HONEYWELL

valves



1

GEV No.	750017	Ref. No.	B00EX100+101
description	expansion valve HONEYWELL type TMV coolant R404a/R507 angled 90° thermostatically controlled inlet 5/8" UNF (3/8" SAE) outlet 3/4" UNF (1/2" SAE) p max 25bar -50 up to -27°C		

filter driers

miscellaneous



1

GEV No.	750047	Ref. No.	A00DR100
description	dryer size 30g ø 24mm L 143mm connection 6,5/6,5mm type DP20-DP70,DP140		
For models:	BB150, BB150-SS, BB250, BB250-SL, BB250-SS, BB350, BB350-SL, BB350-SS, BF4, BGH2-TG, BGH3-TG, BGH4-TG, BGL2, BGL2-V, BGL2-VT, BGL3, BGL3-V, BGL3-VT, BGL4, BGL4-V, BGL4-VT, BGN2, BGN2-2G, BGN2-3G, BGN2-3SGC, BGN2-OG, BGN2-SG, BGN2-SGC, BGN2-TG, BGN2-V, BGN2-VT, BGN3, BGN3-2G, BGN3-4G, BGN3-4SGC, BGN3-OG, BGN3-SG, BGN3-SGC, BGN3-TG, BGN3-V, BGN3-VT, BGN4, BGN4-2G, BGN4-5SGC, BGN4-OG, BGN4-SG, BGN4-SGC, BGN4-TG, BGN4-V, BGN4-VT...(Other models you can see in the webshop)		

evaporators

for blast chiller

producer-specific



1

GEV No.	750737	Ref. No.	A000EV110 A00EV110
description	evaporator L 1015mm W 520mm H 165mm suitable for FRENOX		
For models:	VBL-15		



1

GEV No.	750739	Ref. No.	A000EV117 A00EV117
description	evaporator L 470mm W 340mm H 140mm suitable for FRENOX		
For models:	VBL-5, VBL-7		



1

GEV No.	750740	Ref. No.	A000EV118 A00EV118
description	evaporator L 650mm W 470mm H 140mm suitable for FRENOX		
For models:	VBL-10		

for walk-in fridges

producer-specific

FRENOX

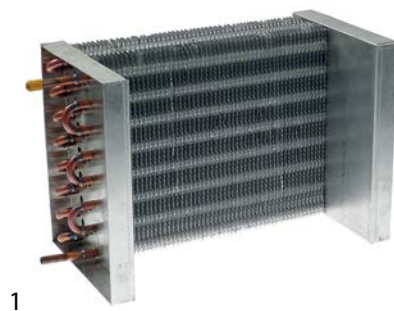

GEV No.	750643	Ref. No.	A00EV305
description	evaporator L 85mm W 320mm H 258mm total length 200mm overall width 380mm overall height 258mm		

for fridges

producer-specific



GEV No.	750403	Ref. No.	01A01EV370 for door 01A01EV370 für Tür
description	evaporator L 410mm H 450mm thickness 105mm		



GEV No.	705015	Ref. No.	01A01EV370 for drawer 01A01EV370 für Schublade
description	evaporator L 420mm H 360mm thickness 130mm for drawer		



GEV No.	750402	Ref. No.	01A01EV270
description	evaporator L 420mm H 455mm thickness 105mm FRENOX		
For models:	BGN2, BGN2-2G, BGN2-V, BGN2-VT, BSN2, BSN2-V, BSN2-VT, CGN2, CGN2-2G, CGN2-E, CGN2-G, CGN2-MTG, CGN2-R, CGN2-SH, CGN2-V, CGN2-VT, CGN2-YM, CSN2, CSN2-E, CSN2-G, CSN2-MTG, CSN2-V, CSN2-VT, MGN2, UGL3, UGN3-SH		

producer-specific



GEV No.	750405	Ref. No.	01A01EV371
description	evaporator double for deep freezing FRENOX		
For models:	BGL3, BGL3-V, BGL3-VT, BGL4, BGL4-V, BGL4-VT, BGN4, BGN4-2G, BGN4-V, BGN4-VT, BSL3, BSL3-V, BSL3-VT, BSL4, BSL4-V, BSL4-VT, BSN4, BSN4-V, CGL3, CGL3-R, CGL3-R-A, CGL3-V, CGL3-VT, CGL4, CGL4-R, CGL4-R-A, CGL4-V, CGL4-VT, CGN4, CGN4-2G, CGN4-E, CGN4-G, CGN4-MTG, CGN4-R, CGN4-SH, CGN4-V, CGN4-YM, CLL3, CSL3, CSL3-V, CSL3-VT, CSL4, CSL4-V, CSL4-VT, CSN4, CSN4-E, CSN4-G, CSN4-MTG, CSN4-R, CSN4-V...(Other models you can see in the webshop)		



GEV No.	750408	Ref. No.	01A01EV273
description	evaporator for deep freezing FRENOX		
For models:	BGH3-TG, BGH4-TG, BGN3-4G, BGN3-4SGC, BGN3-OG, BGN3-SG, BGN3-SGC, BGN3-TG, BGN4-5SGC, BGN4-OG, BGN4-SG, BGN4-SGC, BGN4-TG, CGN3-4SGC, CGN3-OG, CGN3-S, CGN3-SG, CGN3-SGC, CGN4-5SGC, CGN4-OG, CGN4-S, CGN4-SG, CGN4-SGC, UGL4, UGN4, UGN4-SH, USL3, USL4, USN4		





1

GEV No.	750655	Ref. No.	A00EV701
description	evaporator L 389mm W 100mm H 200mm total length 505mm overall width 105mm overall height 200mm		
For models:	BL14-M, BL20-V, BL20-VT, BL7-M, BL7-MG, BL7-M-H, BL9-V, BL9-VG, BL9-VT, BL9-VTG, BN10-V, BN10-VT, VL14-M, VL15, VL15-G, VL15-M-V, VL20-V, VL20-VT, VL20-VTG, VL7-M, VL7-MG, VL7-M-H, VL7-PG, VL7-RO, VL7-RO-2, VL8-M-V, VL8-P-V, VL9-V, VL9-VG, VL9-VT, VL9-VTG, VN10-V, VN10-VT, VN14, VN14-MG-V, VN14-MP-V, VN14-M-V, VN7-MG-V, VN7-MPG-V, VN7-MP-V, VN7-M-V, VN8, VN8-G, VNL14-M-V		



1

GEV No.	750401	Ref. No.	A00EV140
description	evaporator L 410mm W 100mm H 200mm total length 480mm mounting distance 1 65mm suitable for FRENOX		
For models:	BN14-3M, BN14-M, BN14-MG, BN14-M-H, BN18-V, BN18-VG, BN18-VT, BN18-VTG, VN14-M, VN14-MG, VN14-M-H, VN18-V, VN18-VG, VN18-VT, VN18-VTG		



1

GEV No.	750653	Ref. No.	A00EV150
description	evaporator L 390mm W 100mm H 195mm total length 465mm overall width 100mm overall height 200mm		
For models:	BL10-V, BL10-VT, BL14-M, BL14-MG, BL14-M-H, BL18-V, BL18-VG, BL18-VT, BL18-VTG, BN20-V, BN20-VT, VL10-V, VL10-VT, VL10-VTG, VL14-M, VL14-MG, VL14-M-H, VL14-MP, VL14-MPG, VL18-V, VL18-VG, VL18-VT, VL18-VTG, VL7-RO-2, VL8, VL8-G, VN15, VN15-G, VN20-V, VN20-VT		



1

GEV No.	750404	Ref. No.	01A01EV271
description	evaporator L 410mm W 110mm H 445mm for deep freezing FRENOX		
For models:	BGL2, BGL2-V, BGL2-VT, BGL3, BGL3-V, BGL3-VT, BGN4, BGN4-2G, BGN4-V, BGN4-VT, BMN-155, BMN-210, BSL2, BSL2-V, BSL2-VT, BSL3, BSL3-V, BSL3-VT, BSN4, BSN4-V, BZT140-R, BZT155, BZT160-3D, BZT186-R, BZT210, BZT210-D, BZT215-3D, CGL2, CGL2-R, CGL2-R-A, CGL2-V, CGL2-VT, CGL3, CGL3-R, CGL3-R-A, CGL3-V, CGL3-VT, CGN4, CGN4-2G, CGN4-E, CGN4-G, CGN4-MTG, CGN4-R, CGN4-SH, CGN4-V, CLL2, CLL3, CSL2, CSL2-V, CSL2-VT...(Other models you can see in the webshop)		



1

GEV No.	750546	Ref. No.	A00SHP009
description	evaporator L 395mm W 105mm H 367mm suitable for FRENOX complete with fan		
For models:	BL4, BL4-G, BN5, BN7, BN7-G, VLL7, VN7, VN7-G, VN7-P, VNL14, VNL14-3T, VNL7, VNL7-ST, VNL7-V, VNL7-V-T, VNL14-3T, VNN14, VNNF14-3T		



1

GEV No.	750407	Ref. No.	01A01EV272
description	evaporator L 410mm W 120mm H 350mm for refrigeration FRENOX		
For models:	BGH2-TG, BGN2-3G, BGN2-3SGC, BGN2-OG, BGN2-SG, BGN2-SGC, BGN2-TG, CGN2-3SGC, CGN2-OG, CGN2-S, CGN2-SG, CGN2-SGC, MGA2-04, UGL2, UGN2, UGN2-SH, UGN3, UGN4, USL2, USL3, USN2, USN4		

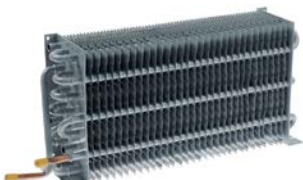

1

GEV No.	750654	Ref. No.	A00EV700
description	evaporator L 400mm W 96mm H 200mm total length 480mm overall width 103mm overall height 200mm		
For models:	BN7-M, BN7-MG, BN7-M-H, BN9-V, BN9-VG, BN9-VT, BN9-VTG, VN7-M, VN7-MG, VN7-M-H, VN7-PG, VN7-RO, VN7-RO-2, VN9-V, VN9-VG, VN9-VT, VN9-VTG		

for display coolers



GEV No.	750650	Ref. No.	A00EV100
description	evaporator L 390mm W 90mm H 150mm total length 400mm overall width 95mm overall height 430mm		
For models:	BGN2, BGN2-2G, BGN2-V, BGN2-VT, BGN3, BGN3-2G, BGN3-V, BGN3-VT, BGN4, BGN4-2G, BGN4-V, BGN4-VT, BSN2, BSN2-V, BSN2-VT, BSN3, BSN3-V, BSN3-VT, BSN4, BSN4-V, BSN4-VT, CGN2, CGN2-2G, CGN2A-V, CGN2-E, CGN2-G, CGN2-MTG, CGN2-R, CGN2-SH, CGN2-V, CGN2-VT, CGN2-YM, CGN3, CGN3-2G, CGN3A-V, CGN3-E, CGN3-G, CGN3-MTG, CGN3-R, CGN3-SH, CGN3-V, CGN3-VT, CGN3-YM, CGN4, CGN4-2G, CGN4-E, CGN4-G, CGN4-MTG, CGN4-R, CGN4-SH...(Other models you can see in the webshop)		

for saladettes



GEV No.	750652	Ref. No.	A00EV106
description	evaporator L 380mm W 85mm H 150mm total length 395mm overall width 95mm overall height 340mm		
For models:	BGH2-TG, BGH3-TG, BGH4-TG, BGN2-3G, BGN2-3SGC, BGN2-OG, BGN2-SG, BGN2-SGC, BGN2-TG, BGN3-4G, BGN3-4SGC, BGN3-OG, BGN3-SG, BGN3-SGC, BGN3-TG, BGN4-5SGC, BGN4-OG, BGN4-SG, BGN4-SGC, BGN4-TG, CGN2-3SGC, CGN2-OG, CGN2-S, CGN2-SG, CGN2-SGC, CGN2-TG, CGN3-4SGC, CGN3-OG, CGN3-S, CGN3-SG, CGN3-SGC, CGN3-TG, CGN4-5SGC, CGN4-OG, CGN4-S, CGN4-SG, CGN4-SGC, CGN4-TG, MGA2-04, UGL2, UGL3, UGL4, UGN2, UGN2-SH, UGN3, UGN3-SH, UGN4, UGN4-SH, USL2, USL3...(Other models you can see in the webshop)		



GEV No.	750406	Ref. No.	01A01EV372
description	evaporator L 415mm W 105mm H 480mm double for refrigeration FRENOX		
For models:	BGN3, BGN3-2G, BGN3-V, BGN3-VT, BGN4, BGN4-2G, BSN3, BSN3-V, BSN3-VT, BSN4, BSN4-V, BSN4-VT, CGN3, CGN3-2G, CGN3-E, CGN3-G, CGN3-MTG, CGN3-R, CGN3-SH, CGN3-V, CGN3-VT, CGN3-YM, CGN4, CGN4-2G, CGN4-E, CGN4-G, CGN4-MTG, CGN4-R, CGN4-SH, CGN4-V, CGN4-VT, CGN4-YM, CSN3, CSN3-E, CSN3-G, CSN3-MTG, CSN3-R, CSN3-V, CSN3-VT, CSN4, CSN4-E, CSN4-MTG, CSN4-V, CSN4-VT, MGN3, MGN3-7G, MGN4		

for refrigerated counters



GEV No.	750651	Ref. No.	A00EV101
description	evaporator L 390mm W 90mm H 200mm total length 400mm overall width 95mm overall height 430mm		
For models:	BGL2, BGL2-V, BGL2-VT, BGL3, BGL3-V, BGL3-VT, BGL4, BGL4-V, BGL4-VT, BGN4, BGN4-2G, BGN4-V, BMN-155, BMN-210, BSL2, BSL2-V, BSL2-VT, BSL3, BSL3-V, BSL3-VT, BSL4, BSL4-V, BSL4-VT, BSN4, BSN4-V, BZT140-R, BZT155, BZT160-3D, BZT186-R, BZT210, BZT210-D, BZT215-3D, CGL2, CGL2A-V, CGL2-R, CGL2-R-A, CGL2-V, CGL2-VT, CGL3, CGL3A-V, CGL3-R, CGL3-R-A, CGL3-V, CGL3-VT, CGL4, CGL4-R, CGL4-R-A, CGL4-V, CGL4-VT, CGN4...(Other models you can see in the webshop)		



condensers

condensers



GEV No.	750736	Ref. No.	A000KN108 A00KN108
description	condenser Capacitor L 510mm W 245mm H 140mm suitable for FRENOX		
For models:	VBL-5, VBL-7		



GEV No.	750741	Ref. No.	A000KN103 A00KN103
description	condenser Capacitor W 290mm H 150mm L 670mm suitable for FRENOX		
For models:	BL14, BL14-G, GL13-G, SL13-G, VBL-10, VL14, VL14-G, VL14-P, WL13-G		



GEV No.	750738	Ref. No.	A000KN109 A00KN109
description	condenser Capacitor W 495mm H 245mm L 530mm suitable for FRENOX		
For models:	VBL-15		

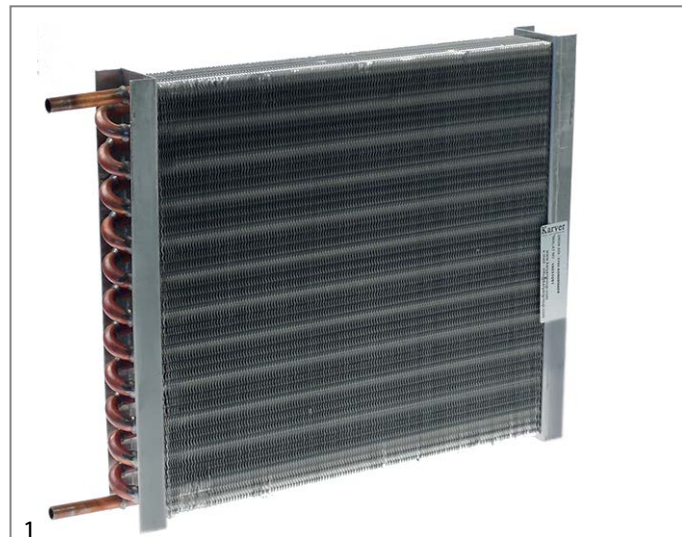

GEV No.	750656	Ref. No.	16031051 1700 Kondenser A00KN575
description	condenser W 310mm D 50mm H 425mm Qty 1 pcs suitable for FRENOX		

evaporation and condensing trays

evaporation trays



GEV No.	750524	Ref. No.	B01BH101
description	evaporation tray without heating element L 416mm W 103mm H 35mm		
For models:	BGH2-TG, BGH3-TG, BGH4-TG, BGL2, BGL2-V, BGL2-VT, BGL3, BGL3-V, BGL3-VT, BGL4, BGL4-V, BGL4-VT, BGN2, BGN2-2G, BGN2-3G, BGN2-3SGC, BGN2-OG, BGN2-SG, BGN2-SGC, BGN2-TG, BGN2-V, BGN2-VT, BGN3, BGN3-2G, BGN3-4G, BGN3-4SGC, BGN3-OG, BGN3-SG, BGN3-SGC, BGN3-TG, BGN3-V, BGN3-VT, BGN4, BGN4-2G, BGN4-5SGC, BGN4-OG, BGN4-SG, BGN4-SGC, BGN4-TG, BGN4-V, BGN4-VT, BMN-155, BMN-210, BSL2, BSL2-V, BSL2-VT, BSL3, BSL3-V, BSL3-VT, BSL4... (Other models you can see in the webshop)		

unheated condensing trays



GEV No.	750645	Ref. No.	B00BH102 B01BH102
description	evaporation tray L 298mm W 88mm H 50mm plastic		
For models:	BGH2-TG, BGH3-TG, BGH4-TG, BGL2, BGL2-V, BGL2-VT, BGL3, BGL3-V, BGL3-VT, BGL4, BGL4-V, BGL4-VT, BGN2, BGN2-2G, BGN2-3G, BGN2-3SGC, BGN2-OG, BGN2-SG, BGN2-SGC, BGN2-TG, BGN2-V, BGN2-VT, BGN3, BGN3-2G, BGN3-4G, BGN3-4SGC, BGN3-OG, BGN3-SG, BGN3-SGC, BGN3-TG, BGN3-V, BGN3-VT, BGN4, BGN4-2G, BGN4-5SGC, BGN4-OG, BGN4-SG, BGN4-SGC, BGN4-TG, BGN4-V, BGN4-VT, BMN-155, BMN-210, BSL2, BSL2-V, BSL2-VT, BSL3, BSL3-V, BSL3-VT, BSL4... (Other models you can see in the webshop)		



1

GEV No.	750644	Ref. No.	B01BH103
description	evaporation tray L 490mm W 55mm H 35mm plastic		
For models:	BB150, BB150-SS, BB250, BB250-SL, BB250-SS, BB350, BB350-SL, BB350-SS, CGN2-SH, CGN3-SH, CGN4-SH, SS150, SS250, SS350, ST150, ST250, ST350, UGN2-SH, UGN3-SH, UGN4-SH		

A			
axial fans	14		
C			
cables	17		
castors and bumper angles	22		
cold air circulating fans	17		
cold air circulating fans (complete)	16		
compressors	10		
cooling aggregates	10		
cross flow fans	17		
E			
edgemount hinges	20		
edgemount latches	20		
electric accessories	17		
electronic controllers	6		
evaporators	27		
expansion valves	27		
F			
fans	14		
filter driers	27		
fridge lamps	6		
G			
grates	22		
H			
handle latches	20		
heating cables	3		
heating cartridges	4		
heating elements	3		
heating elements for defrosting	3		
heating elements for refrigeration	3		
humidity probes	8		
I			
indicator lights	4		
indicator lights (complete)	4		
L			
lamps	4		
LED	5		
M			
microswitches	4		
P			
plug-in gaskets	24		
position switches	4		
power supply cables	17		
		pressure switches	10
		probes	8
		R	
		refrigeration cycle components	27
		refrigeration fans	15
		refrigeration gaskets	24
		refrigeration motors universal	15
		rocker/momentary rocker switches	4
		S	
		shelves and shelf rails	22
		solenoid valves	10
		spring assisted hinges	20
		switches and momentary switches	4
		T	
		temperature probes	8
		transformers	6
		U	
		universal probes	8
		W	
		walk-in fridge catches	20