



GAS COMPONENTS



ELECTRIC COMPONENTS



WATER TECHNOLOGY



MECHANICAL COMPONENTS



TOOLS

Spare parts suitable for

FRIMA

Find the complete and up-to-date range of products in our GEV Webshop



Manufacturer catalogue

The most important spare parts and accessories arranged clearly for every manufacturer

- ✓ Complete product range and all appliance data always up to date in the GEV Webshop
- ✓ Alphabetical Index at the end of the catalogue

GEV Webshop

www.gev-online.co.uk

www.gev-online.com



- 🔍 Add to Favourites
- 🔍 Sign In with email address and usual password
- 🔍 Easy-order – place several items in your basket at the same time
- 🔍 Quick Item search – no login needed



heating elements

heating elements for tilting bratt pan

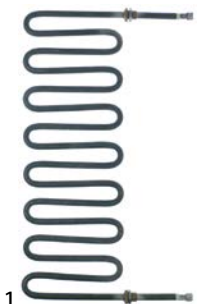

GEV No.	420211	Ref. No.	40.02.077
description	heating element 4000W 230V L 155mm W 440mm connection screw dry heating element heating circuits 1 tube ø 10mm 2 hole fixing thread 1/4" mounting distance 430mm		

thermostats

control and safety thermostats

EGO

safety thermostats

55.32_ series



GEV No.	375890	Ref. No.	4000638
description	safety thermostat switch-off temp. 650°C 3-pole starting temperature 624°C		

control thermostats with operation switch

55.34_ series



GEV No.	375570	Ref. No.	40.00.799
description	thermostat t.max. 470°C temperature range 100-470°C 1-pole 1NO 16A probe ø 3.9mm probe L 228mm capillary pipe 1110mm capillary pipe isolated 600mm gland nut shaft ø 6x4.6mm shaft L 24mm shaft position upper rotation 270° outer switch 2NO		

lamps



indicator lights

indicator lights 3-piece (housing, lens and bulb)

lamps

neon light bulbs





GEV No.	359585	Ref. No.	30240300	
description	neon light bulb socket E10 230V green ø 10mm L 28mm			
accessories for	359585			
	GEV No.	359060	Ref. No.	—
	lamp socket mounting measurements ø16.2mm socket E10 connection screw			
	GEV No.	359685	Ref. No.	—
	lamp socket mounting measurements ø16.2mm socket E10			

screw-on/push-on fit

neon light bulbs



GEV No.	359585	Ref. No.	30240300	
description	neon light bulb socket E10 230V green ø 10mm L 28mm			
accessories for	359585			
	GEV No.	359060	Ref. No.	—
	lamp socket mounting measurements ø16.2mm socket E10 connection screw			
	GEV No.	359685	Ref. No.	—
	lamp socket mounting measurements ø16.2mm socket E10			

oven lamps

universal oven lamps

mounting diameter 35.5mm



GEV No.	359723	Ref. No.	3025.0002 3025.0004	
description	oven lamp glass thr.ø 33.5mm ø 51mm borosilicate glass temp.-resist. 550°C			
accessories for	359723			
	GEV No.	359721	Ref. No.	—
	gasket silicone ED ø 48mm ID ø 39.5mm thickness 5mm Qty 1 pcs			

electronic controllers

ELIWELL

universal controllers

built-in version



GEV No.	378303	Ref. No.	40.01.360
description	electronic controller ELIWELL type IDPlus 902 mounting measurements 71x29mm 230V voltage AC NTC/Pt1000/PTC relay outputs 8A -55 up to +150°C display 3 digits + algebraic sign		
accessories for	378303		
	GEV No.	Ref. No.	—
	379052		—
	temperature probe PTC 1kOhm cable silicone probe -50 up to +150°C cable -50 up to +180°C probe ø6x40mm cable length 1.5m without screw connection 2-wire		
	GEV No.	Ref. No.	—
	379053		—
	temperature probe PTC 1kOhm cable PVC probe -50 up to +150°C cable -10 up to 100°C probe ø6x30mm cable length 3m without screw connection 2-wire		
	GEV No.	Ref. No.	—
	379064		—
	temperature probe PTC 1kOhm cable silicone probe -50 up to +150°C cable -50 up to +180°C probe ø6x40mm cable length 3m without screw connection 2-wire		
	GEV No.	Ref. No.	—
	379142		—
	temperature probe PTC 1kOhm cable PVC probe -50 up to +150°C cable -10 up to 100°C probe ø6x30mm cable length 1.5m without screw connection 2-wire		
	GEV No.	Ref. No.	—
	379160		—
	temperature probe NTC 10kOhm cable thermoplastic probe -40 up to +110°C cable -40 up to +110°C probe ø6x14mm cable length 1.5m without screw connection 2-wire		
	GEV No.	Ref. No.	—
	379161		—
	temperature probe NTC 10kOhm cable thermoplastic probe -40 up to +110°C cable -40 up to +110°C probe ø6x14mm cable length 3m without screw connection 2-wire		
	GEV No.	Ref. No.	—
	379162		—
	temperature probe NTC 10kOhm cable thermoplastic probe -40 up to +110°C cable -40 up to +110°C probe ø6x14mm cable length 6m 2-wire		
	GEV No.	Ref. No.	—
	379169		—
	temperature probe NTC 10kOhm cable thermoplastic probe -40 up to +110°C cable -40 up to +110°C probe ø6x14mm cable length 2m without screw connection 2-wire		
	GEV No.	Ref. No.	—
	379199		—
	temperature probe PTC 1kOhm cable PVC probe -50 up to +150°C cable -10 up to 100°C probe ø6x30mm cable length 5m without screw connection 2-wire		
	GEV No.	Ref. No.	—
	379343		—
	temperature probe NTC 10kOhm cable silicone probe -40 up to +110°C cable -50 up to +180°C probe ø6x40mm cable length 3m 2-wire		
	GEV No.	Ref. No.	—
	379458		—
	temperature probe NTC 10kOhm cable silicone probe -40 up to +110°C cable -50 up to +180°C probe ø6x40mm cable length 1.5m without screw connection 2-wire		
	GEV No.	Ref. No.	—
	379630		—
	temperature probe NTC 10kOhm cable thermoplastic probe -40 up to +110°C cable -40 up to +110°C probe ø6x14mm cable length 2.5m without screw connection 2-wire resistor 10kOhm		

probes

producer-specific probes

core probes



GEV No.	378646	Ref. No.	24.01.122 24.01.300 24.02.645 87.00.301 87.00.527 87.00.559
description	core temperature probe cable PTFE connection coded plug probe ø3x100mm cable length 2.7m handle ø 12mm handle length 44mm		



GEV No.	378279	Ref. No.	40.02.045
description	core temperature probe thermocouple K (NiCr-Ni) cable PTFE probe -40 up to +250°C cable -40 up to +250°C connection 2-wire probe ø3.5x100mm cable length 2.6m handle ø 10mm handle length 40mm		

flow meters and flow sensors

flow sensors



GEV No.	402256	Ref. No.	4001311
description	flow sensor inlet ø 10mm outlet ø 10mm L 110mm flow rate 1-25l/min		

fans

hot air motors

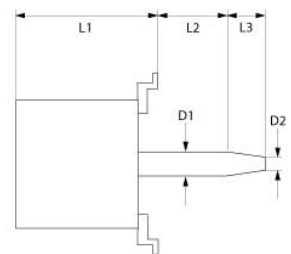

GEV No.	500169	Ref. No.	3100.1023
description	fan motor 220-240/380-415V 3 phase 50Hz 1kW 1400rpm speeds 1 L1 190mm L2 41mm L3 37mm M10R IT 4.0/2.3A power input 1250W at 50Hz 1400rpm type L9FGw4D-395 no. X1 D1 ø 17mm D2 ø 13mm		



motors

gear motors

for ovens

for flues



1

GEV No.	361999	Ref. No.	3101.1010 3101.1010S
description	gear motor CROUZET type 82841042 12V voltage DC shaft ø 4mm L 65mm W 50mm H 51mm for oven		

gas burners

bar burners



1

GEV No.	109184	Ref. No.	72.00.048
description	insulation for burner ø 97.5mm ID ø 62.5mm thickness 9.5mm		

equipment-specific units

for tilting bratt pans

motors



1

GEV No.	417769	Ref. No.	4001602
description	lifting cylinder		

gaskets

special gaskets

for combi-steamers



1

GEV No.	699803	Ref. No.	72.00.020
description	gasket L 139mm W 130mm silicone thickness 4mm		

hose reels and spray guns

spray guns



1

GEV No.	542380	Ref. No.	50.00.549 50.00.549S 5000590
description	spray gun removable L 165mm		

hose reels

appliance hose reels



1

GEV No.	542381	Ref. No.	50.00.799 50.00.799P
description	hose reel without spray gun hose length 1m		



ancillary products

clamps

double wire clamps



1

GEV No.	505351	Ref. No.	2066.0527V
description	wire clamp ø 11.6-12.2mm wire gauge ø 1.5mm zinc-coated steel Qty 100 pcs		

fastening material

fasteners

clamps

double wire clamps

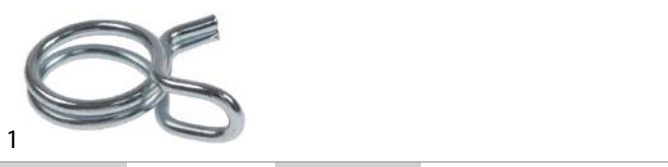

1

GEV No.	505351	Ref. No.	2066.0527V
description	wire clamp ø 11.6-12.2mm wire gauge ø 1.5mm zinc-coated steel Qty 100 pcs		

consumables

sealants and adhesives

high temperature silicone

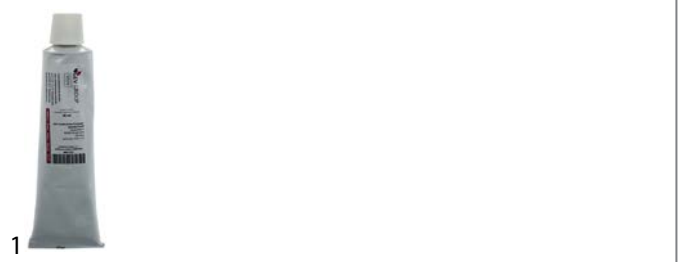

1

GEV No.	890107	Ref. No.	50060200 50060207
description	high temperature silicone TOMABOND TB76 -40 up to +250°C red/ brown tube 90ml		
description	Tomabond TB76 - tube 90ml - red brown Special elastic silicone for general bonding & sealing applications with high thermal loads. TB 76 is primarily used in building services, HVAC and mechanical engineering. Temperature-resistant to 300 °C over the short term		

A			
appliance hose reels	5	sealants and adhesives	6
B		silicone	6
bar burners	5	spray guns	5
C		T	
clamps	6, 6	thermostats	3
consumables	6		
D			
double wire clamps	6, 6		
E			
electronic controllers	4		
F			
fans	4		
fasteners	6		
fastening material	6		
flow sensors	4		
G			
gas burners	5		
H			
heating elements	3		
heating elements for tilting bratt pan	3		
high temperature silicone	6		
hose reels	5		
hot air motors	4		
I			
indicator lights	3		
L			
lamps	3		
M			
motors	5		
N			
neon light bulbs	3, 3		
O			
oven lamps	3		
P			
probes	4		
S			
safety thermostats	3		