



**GAS COMPONENTS**



**ELECTRIC COMPONENTS**



**WATER TECHNOLOGY**



**MECHANICAL COMPONENTS**



**TOOLS**

Spare parts suitable for

**GIGA**

Find the complete and up-to-date range of products in our GEV Webshop



# Manufacturer catalogue

The most important spare parts and accessories arranged clearly for every manufacturer

- ✓ Complete product range and all appliance data always up to date in the GEV Webshop
- ✓ Alphabetical Index at the end of the catalogue

## GEV Webshop

[www.gev-online.co.uk](http://www.gev-online.co.uk)

[www.gev-online.com](http://www.gev-online.com)



- 🔍 Add to Favourites
- 🔍 Sign In with email address and usual password
- 🔍 Easy-order – place several items in your basket at the same time
- 🔍 Quick Item search – no login needed



# heating elements

## heating elements for ovens

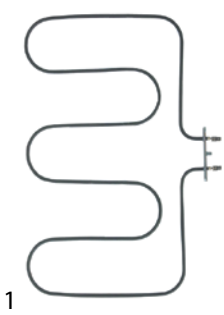

<b>GEV No.</b>	416042	<b>Ref. No.</b>	X68203
<b>description</b>	heating element 1500W 230V heating circuits 1 L 365mm W 500mm L1 45mm L2 315mm W1 240mm W2 30mm flange length 100mm flange width 22mm hole distance 86mm hole ø 5mm tube ø 6.3mm connection male faston 6.3mm mounting pos. lower rectangular flange dry heating element oven		
<b>For models:</b>	C4FFCEP, C4FFLE, C4FFLEP, C4FZCE, C4FZCEP, C4FZSFCEP, C4PFCE, C4PFLE, C4PQFCE, C4VFCE, C4VFLE, C6FFCEP, C6FFLE, C6FFLEP, C6FFLEPV, C6FFLEV, C6FZCE, C6FZCEP, C6FZSFCEP, C6FZSFCEV, C6PFCE, C6PFCEV, C6PFLE, C6PFLEV, C6PQFCE, C6PQFCEV, CC120E, CC81E, CCG120CE, CCG120E, CCG81CE, CCG81E, CCQ120E, CCQ81E, CCV81E, K2FTPFCE, K4FSFCE, K4FZCE, K4FZSFCE, K4PFCE, K4VFCE, K6FZCE, K6PFCE, K8FZCE, KTFPCE, SK4FZCEP, SK4PFCE, SK4PQFCE, SK4VFCE, SK6FZCEP... (Other models you can see in the webshop)		

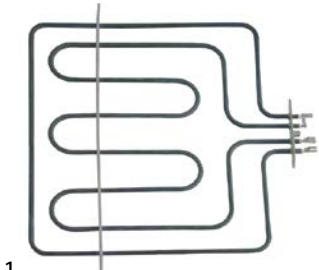





<b>GEV No.</b>	416041	<b>Ref. No.</b>	X68202
<b>description</b>	heating element 2600W 230V heating circuits 2 L 350mm W 355mm L1 36mm L2 314mm W1 147mm W2 60mm flange length 100mm flange width 22mm hole distance 80mm bridge length 480mm hole ø 5mm tube ø 6.3mm connection male faston 6.3mm mounting pos. upper rectangular flange dry heating element oven		
<b>For models:</b>	C4FFCEP, C4FFLE, C4FFLEP, C4FZCE, C4FZCEP, C4FZSFCEP, C4PFCE, C4PFLE, C4PQFCE, C4VFCE, C4VFLE, C6FFCEP, C6FFLE, C6FFLEP, C6FFLEPV, C6FFLEV, C6FZCE, C6FZCEP, C6FZSFCEP, C6FZSFCEV, C6PFCE, C6PFCEV, C6PFLE, C6PFLEV, C6PQFCE, C6PQFCEV, CC120E, CC81E, CCG120CE, CCG120E, CCG81CE, CCG81E, CCQ120E, CCQ81E, CCV81E, K2FTPFCE, K4FSFCE, K4FZCE, K4FZSFCE, K4PFCE, K4VFCE, K6FZCE, K6PFCE, K8FZCE, KTFPCE, SK4FZCEP, SK4PFCE, SK4PQFCE, SK4VFCE, SK6FZCEP... (Other models you can see in the webshop)		









<b>GEV No.</b>	416043	<b>Ref. No.</b>	0000X47000
<b>description</b>	heating element 990W 230V L 475mm W 106mm H 24mm lug length 55mm lug width 18mm hole distance 138mm hole ø 5mm tube ø 6.3mm connection M4 heating circuits 1 bracket mounting oven		
<b>For models:</b>	C2FTPFCE, C2FTPFCEP, C4FFE, C4FFEP, C4FZFE, C4FZFEP, C4FZSFEP, C4PFCE, C4PFE, C4PQFCE, C4PQFE, C4VFE, C6FFE, C6FFEP, C6FZFE, C6FZFEP, C6PFCE, C6PFCEV, C6PFE, C6PQFCE, C6PQFCEV, C6PQFE, CCTPFE8, CN10FE, K2FTPFCE, K4FFE, K4FS, K4FSFE, K4FZFE, K4FZSFE, K4PFE, K4VFE, K6FFE, K6FZFE, K6PFE, K8FFE, K8FZFE, KTFPCE, M74FMPFE, M74FPFE, M76FMPFE, M76FPFE		

## heating elements for bain maries



<b>GEV No.</b>	416244	<b>Ref. No.</b>	Y19700
<b>description</b>	heating element 1000W 230V heating circuits 1 L 258mm W 34mm connection male faston 6.3mm tube ø 6.3mm 2 hole fixing thread 1/8" immersion heater H 35mm mounting distance 26mm		
<b>For models:</b>	M6B4E, M7B4E		
<b>accessories for</b>	416244		
	<b>GEV No.</b>	361181	<b>Ref. No.</b> —
	nut thread 1/8" H 4.5mm nickel-plated brass WS 14 Qty 1 pcs		
	<b>GEV No.</b>	525780	<b>Ref. No.</b> —
	flat gasket copper ED ø 13mm ID ø 10.2mm thickness 1.5mm for thread 1/8" Qty 1 pcs		
	<b>GEV No.</b>	560192	<b>Ref. No.</b> —
	tooth lock washer ID ø 10.4mm ED ø 18mm SS DIN/ISO DIN 6798A Qty 1 pcs for thread M10		



<b>GEV No.</b>	415130	<b>Ref. No.</b>	X45800
<b>description</b>	heating element 1500W 230V heating circuits 1 L 412mm W 50mm connection M3 tube ø 8.5mm 2 hole fixing thread 3/8" immersion heater mounting distance 42mm		
<b>For models:</b>	CBE4, CBE8, SKB40E, SKB80E, TB40E, TB60E, TB80E		
<b>accessories for</b>	415130		
	<b>GEV No.</b>	361183	<b>Ref. No.</b> —
	nut thread 3/8" H 6mm nickel-plated brass WS 20 Qty 1 pcs		
	<b>GEV No.</b>	521137	<b>Ref. No.</b> —
	flat gasket fibre ED ø 20mm ID ø 18mm thickness 1.5mm for thread 3/8" Qty 1 pcs		
	<b>GEV No.</b>	527169	<b>Ref. No.</b> —
	hexagonal nut thread M3 H 2.8mm WS 5.5 brass Qty 1 pcs		
	<b>GEV No.</b>	560110	<b>Ref. No.</b> —
	plain washer ID ø 3.2mm ED ø 7mm thickness 0.5mm SS Qty 20 pcs DIN 125A for thread M3		
	<b>GEV No.</b>	560130	<b>Ref. No.</b> —
	hexagonal nut thread M3 H 2.4mm WS 5.5 SS DIN/ISO DIN 934 / ISO 4032/8673 Qty 20 pcs		









<b>GEV No.</b>	416047	<b>Ref. No.</b>	Y10600
<b>description</b>	heating element 1780W 230V L 650mm W 170mm connection length 24mm connection M4 tube ø 9mm 2 hole fixing thread M14x1 immersion heater L1 25mm L2 35mm L3 590mm H 19mm mounting distance 161mm		
<b>For models:</b>	KB4, KB8		
<b>accessories for</b>	416047		
	<b>GEV No.</b>	510417	<b>Ref. No.</b> N/A
	flat gasket fibre ED ø 20mm ID ø 14mm thickness 2mm Qty 1 pcs		

Table continues overleaf



accessories for 416047			
	GEV No.	520228	Ref. No. —
tooth lock washer ID ø 15.3mm ED ø 24mm steel Qty 1 pcs for thread M14			
	GEV No.	521133	Ref. No. —
nut thread M14x1.5 H 6mm WS 19 zinc-coated steel Qty 1 pcs			
	GEV No.	550261	Ref. No. N/A
nut thread M14x1 H 4mm WS 19 SS Qty 1 pcs			
	GEV No.	550262	Ref. No. —
flat gasket copper ED ø 20mm ID ø 14mm thickness 2mm			

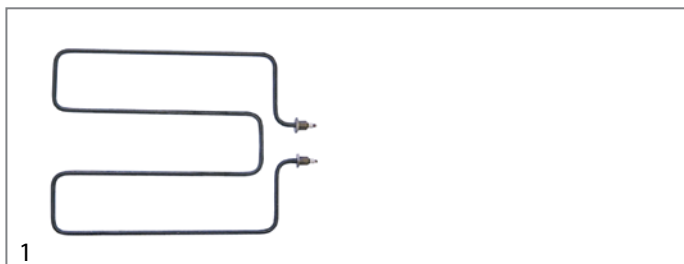

GEV No.	415844	Ref. No.	X45900
<b>description</b>	heating element 2600W 230V heating circuits 1 L 410mm W 300mm connection length 10mm connection M4 tube ø 8.5mm 2 hole fixing thread 3/8" immersion heater L1 27mm L2 383mm W1 120mm W2 60mm mounting distance 50mm		
<b>For models:</b>	CBE6, SKB60E, TB40E, TB60E, TB80E		
<b>spare parts for</b>	415844		
	GEV No.	521137	Ref. No. —
flat gasket fibre ED ø 20mm ID ø 18mm thickness 1.5mm for thread 3/8" Qty 1 pcs			
<b>accessories for</b>	415844		
	GEV No.	361183	Ref. No. —
nut thread 3/8" H 6mm nickel-plated brass WS 20 Qty 1 pcs			

## heating elements for chip scuttles

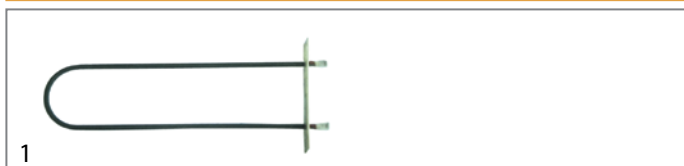





GEV No.	416082	Ref. No.	X48400
<b>description</b>	heating element 350W 230V heating circuits 8.5 L 172mm W 74mm flange length 110mm flange width 22mm hole distance 94mm connection length 20mm connection male faston 6.3mm tube ø 8.5mm rectangular flange hole ø 6mm dry heating element		
<b>For models:</b>	CSP40E, M6SP4E, MC, SKP40E, TSP40E		

## heating elements for fryers





## off-center connection

## with retaining rings

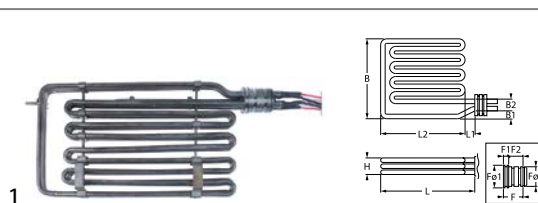

GEV No.	416408	Ref. No.	0000Y17000
<b>description</b>	heating element 12000W 230/400V heating circuits 3 mounting pos. left L 280mm W 225mm H 32mm flange length 45mm flange length 1 9.6mm flange length 2 35.4mm flange ø1 44.5mm flange ø2 39.5mm thermostat sleeves ø 7mm length thermostat sleeves 280mm number of thermostat sleeves 1 thermostat sleeve eccentric, non clinging windings 5 L1 10mm L2 270mm W1 13mm W2 31mm tube ø 8.5mm cable length 600mm rotation flange fryer connection length 50mm		
<b>For models:</b>	CFE15, CFE159, CFE15D, CFE15D9, KFE15, KFE159, KFE15D, KFE15D9, OPFE15, OPFE15D		
<b>accessories for</b>	416408		
	GEV No.	510899	Ref. No. X05400
	GEV No.	528155	Ref. No. X05300
	GEV No.	532545	Ref. No. X05000
	GEV No.	691621	Ref. No. M29600



GEV No.	416407	Ref. No.	Y14400
<b>description</b>	heating element 15000W 230/400V heating circuits 3 mounting pos. left L 355mm W 190mm H 32mm flange length 45mm flange length 1 9.6mm flange length 2 35.4mm flange ø1 44.5mm flange ø2 39.5mm thermostat sleeves ø 7mm length thermostat sleeves 280mm number of thermostat sleeves 1 thermostat sleeve eccentric, clinging windings 4 L1 15mm L2 340mm W1 13mm W2 32mm tube ø 8.5mm cable length 570mm rotation flange connection length 60mm		
<b>For models:</b>	KFE20, KFE20D, OPFE20, OPFE20D		
<b>accessories for</b>	416407		
	GEV No.	510899	Ref. No. X05400
	GEV No.	528155	Ref. No. X05300
	GEV No.	532545	Ref. No. X05000
	GEV No.	691621	Ref. No. M29600

1		
	<b>GEV No.</b>	<b>Ref. No.</b>
<b>description</b>	heating element 11000W 230V heating circuits 3 L 310mm W 125mm H 320mm rectangular flange connection M4 W2 93mm H1 280mm H2 45mm hole distance 95mm hole ø 5mm flange length 105mm flange width 35mm tube ø 8.5mm connection length 37mm	
<b>GEV No.</b>	419154	<b>Ref. No.</b> FZ211085

1		
	<b>GEV No.</b>	<b>Ref. No.</b>
<b>description</b>	heating element 6000W 230/400V heating circuits 3 L 300mm W 182mm H 252mm L1 65mm L2 235mm W1 59mm W2 134mm W3 250mm H1 220mm H2 32mm windings 12 flange ø 40mm rotation flange cable length 380mm fryer heaters mounting ø 25mm	
<b>GEV No.</b>	415257	<b>Ref. No.</b> X46200

1		
	<b>GEV No.</b>	<b>Ref. No.</b>
<b>description</b>	heating element 7500W 230/400V heating circuits 3 L 315mm W 170mm H 190mm L1 60mm L2 258mm W1 58mm W2 135mm W3 250mm H1 165mm H2 25mm windings 15 flange ø 30mm rotation flange cable length 980mm mounting ø 30mm tube ø 6.2mm connection length 21mm	
<b>For models:</b>	CF1E4, CF2E6, CF4E, CF6E, IF1E4, IF2E6, KFE1, KFE2, OPFE1, OPFE2, SKF1E, SKF2E, TF1E, TF2E, TF4E, TF6E	
<b>GEV No.</b>	416409	<b>Ref. No.</b> X57000 X57100SX







1		
	<b>GEV No.</b>	<b>Ref. No.</b>
<b>description</b>	heating element 3200W 230V	
<b>For models:</b>	CF2E4, SKF2E4, TF2E4	
<b>GEV No.</b>	418870	<b>Ref. No.</b> Y01100

<b>2 hole fixing</b>			
1			
	<b>GEV No.</b>	<b>Ref. No.</b>	<b>Ref. No.</b>
<b>description</b>	heating element 1700W 230V heating circuits 1 L 290mm W 130mm W1 27mm W2 76mm connection M4 2 hole fixing immersion heater thread 1/4" tube ø 8.5mm mounting distance 64mm		
<b>For models:</b>	M6F4E, M6F6E, M7F4E, M7F6E		
<b>accessories for</b>	418652		
	<b>GEV No.</b>	361182	<b>Ref. No.</b> —
	nut thread 1/4" H 5mm nickel-plated brass WS 17 Qty 1 pcs		
	<b>GEV No.</b>	510417	<b>Ref. No.</b> N/A
	flat gasket fibre ED ø 20mm ID ø 14mm thickness 2mm Qty 1 pcs		
	<b>GEV No.</b>	520228	<b>Ref. No.</b> —
	tooth lock washer ID ø 15.3mm ED ø 24mm steel Qty 1 pcs for thread M14		
	<b>GEV No.</b>	521103	<b>Ref. No.</b> —
	nut thread M4 H 3mm WS 7 brass Qty 20 pcs		
	<b>GEV No.</b>	521104	<b>Ref. No.</b> —
	washer ID ø 4.3mm ED ø 8mm thickness 0.5mm brass Qty 20 pcs for thread M4		
	<b>GEV No.</b>	550262	<b>Ref. No.</b> —
	flat gasket copper ED ø 20mm ID ø 14mm thickness 2mm		
	<b>GEV No.</b>	560111	<b>Ref. No.</b> —
	plain washer ID ø 4.3mm ED ø 9mm thickness 0.8mm SS Qty 20 pcs DIN 125A for thread M4		
	<b>GEV No.</b>	560131	<b>Ref. No.</b> —
	hexagonal nut thread M4 H 3.2mm WS 7 SS DIN/ISO DIN 934 / ISO 4032/8673 Qty 20 pcs		

1			
	<b>GEV No.</b>	<b>Ref. No.</b>	<b>Ref. No.</b>
<b>description</b>	heating element 2500W 230V heating circuits 1 L 290mm W 55mm H 165mm H1 135mm H2 35mm thread 1/4" tube ø 8.5mm mounting distance 30mm 2 hole fixing connection M4		
<b>For models:</b>	CF1E4, CF2E6, CF4E, CF6E, IF4E, IF6E, SKF4E, SKF6E, TF1E, TF2E, TF4E, TF6E		
<b>accessories for</b>	416411		
	<b>GEV No.</b>	361182	<b>Ref. No.</b> —
	nut thread 1/4" H 5mm nickel-plated brass WS 17 Qty 1 pcs		
	<b>GEV No.</b>	510417	<b>Ref. No.</b> N/A
	flat gasket fibre ED ø 20mm ID ø 14mm thickness 2mm Qty 1 pcs		

Table continues overleaf





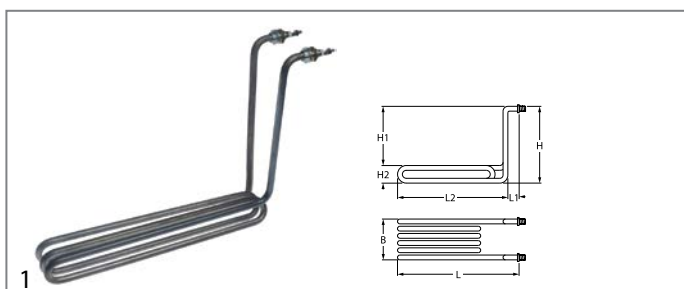

accessories for		416411	
	GEV No.	520228	Ref. No. —
tooth lock washer ID $\varnothing$ 15.3mm ED $\varnothing$ 24mm steel Qty 1 pcs for thread M14			
	GEV No.	521103	Ref. No. —
nut thread M4 H 3mm WS 7 brass Qty 20 pcs			
	GEV No.	521104	Ref. No. —
washer ID $\varnothing$ 4.3mm ED $\varnothing$ 8mm thickness 0.5mm brass Qty 20 pcs for thread M4			
	GEV No.	550262	Ref. No. —
flat gasket copper ED $\varnothing$ 20mm ID $\varnothing$ 14mm thickness 2mm			
	GEV No.	560111	Ref. No. —
plain washer ID $\varnothing$ 4.3mm ED $\varnothing$ 9mm thickness 0.8mm SS Qty 20 pcs DIN 125A for thread M4			
	GEV No.	560131	Ref. No. —
hexagonal nut thread M4 H 3.2mm WS 7 SS DIN/ISO DIN 934 / ISO 4032/8673 Qty 20 pcs			

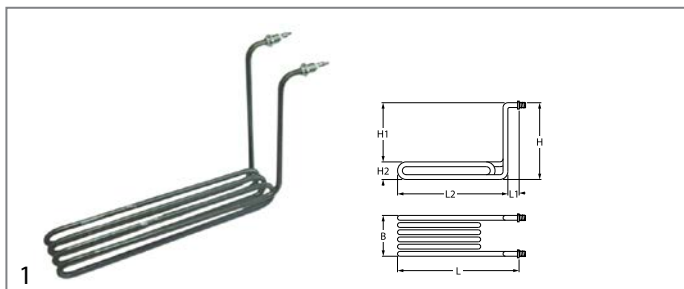





GEV No.	419020	Ref. No.	Y17100
<b>description</b>	heating element 2500W 230V heating circuits 1 L 315mm W 45mm H 230mm L1 25mm L2 290mm H1 193mm H2 37mm thread 1/4" mounting distance 37mm tube $\varnothing$ 8.4mm connection M4 windings 3 for fryer		
<b>For models:</b>	SK10DSE, SK10SE		









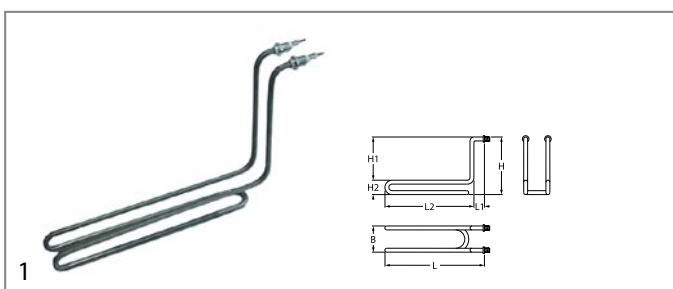

GEV No.	416055	Ref. No.	X46500
<b>description</b>	heating element 3000W 230V heating circuits 1 L 335mm W 65mm H 223mm L1 20mm L2 315mm H1 180mm H2 40mm thread 1/4" mounting distance 57mm tube $\varnothing$ 8.5mm 2 hole fixing connection M4 connection length 26mm immersion heater windings 4		
<b>For models:</b>	15DPE, 15PE, SK10DSE9, SK10SE9		

accessories for		416055	
	GEV No.	361182	Ref. No. —
nut thread 1/4" H 5mm nickel-plated brass WS 17 Qty 1 pcs			
	GEV No.	510417	Ref. No. N/A
flat gasket fibre ED $\varnothing$ 20mm ID $\varnothing$ 14mm thickness 2mm Qty 1 pcs			
	GEV No.	520228	Ref. No. —
tooth lock washer ID $\varnothing$ 15.3mm ED $\varnothing$ 24mm steel Qty 1 pcs for thread M14			
	GEV No.	521103	Ref. No. —
nut thread M4 H 3mm WS 7 brass Qty 20 pcs			

accessories for		416055	
	GEV No.	521104	Ref. No. —
washer ID $\varnothing$ 4.3mm ED $\varnothing$ 8mm thickness 0.5mm brass Qty 20 pcs for thread M4			
	GEV No.	550262	Ref. No. —
flat gasket copper ED $\varnothing$ 20mm ID $\varnothing$ 14mm thickness 2mm			
	GEV No.	560111	Ref. No. —
plain washer ID $\varnothing$ 4.3mm ED $\varnothing$ 9mm thickness 0.8mm SS Qty 20 pcs DIN 125A for thread M4			
	GEV No.	560131	Ref. No. —
hexagonal nut thread M4 H 3.2mm WS 7 SS DIN/ISO DIN 934 / ISO 4032/8673 Qty 20 pcs			



GEV No.	416053	Ref. No.	X46100
<b>description</b>	heating element 1335-1450W 230-240V heating circuits 1 L 317mm W 42mm H 190mm L1 27mm L2 290mm H1 160mm H2 31mm thread 1/4" mounting distance 33mm tube $\varnothing$ 8.5mm 2 hole fixing connection M4 connection length 25mm immersion heater windings 2		
<b>For models:</b>	7DSET, 7SET		

accessories for		416053	
	GEV No.	361182	Ref. No. —
nut thread 1/4" H 5mm nickel-plated brass WS 17 Qty 1 pcs			
	GEV No.	510417	Ref. No. N/A
flat gasket fibre ED $\varnothing$ 20mm ID $\varnothing$ 14mm thickness 2mm Qty 1 pcs			
	GEV No.	520228	Ref. No. —
tooth lock washer ID $\varnothing$ 15.3mm ED $\varnothing$ 24mm steel Qty 1 pcs for thread M14			
	GEV No.	521103	Ref. No. —
nut thread M4 H 3mm WS 7 brass Qty 20 pcs			
	GEV No.	521104	Ref. No. —
washer ID $\varnothing$ 4.3mm ED $\varnothing$ 8mm thickness 0.5mm brass Qty 20 pcs for thread M4			
	GEV No.	550262	Ref. No. —
flat gasket copper ED $\varnothing$ 20mm ID $\varnothing$ 14mm thickness 2mm			
	GEV No.	560111	Ref. No. —
plain washer ID $\varnothing$ 4.3mm ED $\varnothing$ 9mm thickness 0.8mm SS Qty 20 pcs DIN 125A for thread M4			
	GEV No.	560131	Ref. No. —
hexagonal nut thread M4 H 3.2mm WS 7 SS DIN/ISO DIN 934 / ISO 4032/8673 Qty 20 pcs			



<b>GEV No.</b>	416054	<b>Ref. No.</b>	X46600
<b>description</b>	heating element 1700W 230V heating circuits 1 L 320mm W 70mm H 215mm L1 25mm L2 295mm H1 177mm H2 38mm thread 1/4" mounting distance 62mm tube ø 8.5mm 2 hole fixing connection M4 immersion heater windings 3		
<b>For models:</b>	SK10DSE, SK10SE		
<b>accessories for</b>	416054		
	<b>GEV No.</b>	361182	<b>Ref. No.</b> —
	nut thread 1/4" H 5mm nickel-plated brass WS 17 Qty 1 pcs		
	<b>GEV No.</b>	510417	<b>Ref. No.</b> N/A
	flat gasket fibre ED ø 20mm ID ø 14mm thickness 2mm Qty 1 pcs		
	<b>GEV No.</b>	520228	<b>Ref. No.</b> —
	tooth lock washer ID ø 15.3mm ED ø 24mm steel Qty 1 pcs for thread M14		
	<b>GEV No.</b>	521103	<b>Ref. No.</b> —
	nut thread M4 H 3mm WS 7 brass Qty 20 pcs		
	<b>GEV No.</b>	521104	<b>Ref. No.</b> —
	washer ID ø 4.3mm ED ø 8mm thickness 0.5mm brass Qty 20 pcs for thread M4		
	<b>GEV No.</b>	550262	<b>Ref. No.</b> —
	flat gasket copper ED ø 20mm ID ø 14mm thickness 2mm		
	<b>GEV No.</b>	560111	<b>Ref. No.</b> —
	plain washer ID ø 4.3mm ED ø 9mm thickness 0.8mm SS Qty 20 pcs DIN 125A for thread M4		
	<b>GEV No.</b>	560131	<b>Ref. No.</b> —
	hexagonal nut thread M4 H 3.2mm WS 7 SS DIN/ISO DIN 934 / ISO 4032/8673 Qty 20 pcs		

heating elements for griddles

<b>GEV No.</b>	418650	<b>Ref. No.</b>	DER001ZR10
<b>description</b>	heating element 1200W 230V heating circuits 1 L 402mm W 75mm H 70mm tube ø 6.5mm L1 35mm connection male faston 6.3mm connection distance 68mm dry heating element		
<b>For models:</b>	M6FT4EL, M6FT4ER, M6FT6EL, M6FT6ELR, M7FT4EL, M7FT4ER, M7FT6EL, M7FT6ELR		

<b>GEV No.</b>	415651	<b>Ref. No.</b>	X45700
<b>description</b>	heating element 1500W 230V heating circuits 1 L 425mm W 72mm H 53mm tube ø 8.5mm L1 22mm connection male faston 6.3mm connection distance 52mm dry heating element		
<b>For models:</b>	CFTE1, CFTE1C, CFTE1R, CFTE2, CFTE22, CFTE2C, CFTE2C2, CFTE2LR, CFTE2R, CFTE3, CFTE3C, CFTE3LR, CFTE4, CFTE4C, CFTE4R, CFTE6, CFTE62, CFTE6C, CFTE6C2, CFTE6LR, CFTE6R, CFTE8, CFTE8C, CFTE8LR, SKT1E, SKT1EC, SKT1ER, SKT2E, SKT2E2, SKT2EC, SKT2EC2, SKT2ELR, SKT2ER, SKT2ER2, SKT3E, SKT3EC, SKT3ELR, SKT40E, SKT40EC, SKT40ER, SKT60E, SKT60E2, SKT60EC, SKT60EC2, SKT60ELR, SKT60ER, SKT60ER2, SKT80E, SKT80EC, SKT80ER...(Other models you can see in the webshop)		

<b>GEV No.</b>	420537	<b>Ref. No.</b>	Y15800
<b>description</b>	heating element 1750W 230V heating circuits 1 L 430mm W 60mm H 87mm tube ø 8.5mm		
<b>For models:</b>	CFTE1, CFTE1C, CFTE1R, CFTE2, CFTE22, CFTE2C, CFTE2C2, CFTE2LR, CFTE2R, CFTE2R2, CFTE3, CFTE3C, CFTE3LR, CFTE3R, CFTE4, CFTE4C, CFTE4R, CFTE6, CFTE62, CFTE6C, CFTE6C2, CFTE6LR, CFTE6R, CFTE6R2, CFTE8, CFTE8C, CFTE8LR, CFTE8R, CMP4, IFTE1, IFTE1C, IFTE1R, IFTE2, IFTE22, IFTE2C, IFTE2C2, IFTE2LR, IFTE2R, IFTE2R2, IFTE3, IFTE3C, IFTE3LR, IMP4, SKMP4, SKT1E, SKT1EC, SKT1ER, SKT2E, SKT2E2, SKT2EC...(Other models you can see in the webshop)		

<b>GEV No.</b>	416046	<b>Ref. No.</b>	0000Y10400
<b>description</b>	heating element 2350/2560W 220/240V heating circuits 1 L 590mm W 77mm H 80mm tube ø 8.5mm dry heating element		
<b>For models:</b>	KBRE, KBRE12, KBRE12IN, KBREIN, KBREM, KBREM12, KBREM12IN, KBREMIN, KFT4E, KFT4EC, KFT4ER, KFT8E, KFT8E23C, KFT8EC, KFT8ELR, KFT8ER, KFTE1, KFTE1C, KFTE1R, KFTE3, KFTE3C, KFTE3LR, KFTE4, KFTE4C, KFTE4R, KFTE8, KFTE8C, KFTE8LR, OPFT4E, OPFT4EC, OPFT4ER, OPFT8E, OPFT8E23C, OPFT8EC, OPFT8ELR, OPFT8ER		

heating elements for tilting bratt pan





<b>GEV No.</b>	415077	<b>Ref. No.</b>	Y00100
<b>description</b>	heating element stock pot 1300W 230V L 280mm W 150mm H 40mm connection male faston 6.3mm tilting bratt pan heating circuits 1 tube ø 8.5mm bracket mounting hole distance 142mm hole ø 5mm lug length 25mm lug width 15mm		
<b>For models:</b>	SKBR40E		

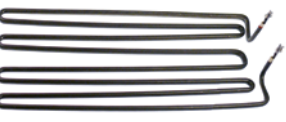













			
<b>GEV No.</b>	416045	<b>Ref. No.</b>	X48100
<b>description</b>	heating element tilting bratt pan 3400W 230V L 313mm W 195mm H 82mm connection M5 dry heating element heating circuits 1 tube ø 10mm W1 67mm W2 61mm		
<b>For models:</b>	CBRE, CBRE8, CBREIN		

			
<b>GEV No.</b>	417344	<b>Ref. No.</b>	0000Y10500
<b>description</b>	heating element tilting bratt pan 4700W 230V L 540mm W 210mm H 60mm heating circuits 1 tube ø 8.5mm W1 70mm W2 70mm		
<b>For models:</b>	KBRE, KBRE12, KBRE12IN, KBREIN, KBREM, KBREM12, KBREM12IN, KBREMIN, OPBRE, OPBRE12, OPBRE12IN, OPBRE12MIN, OPBREIN, OPBREM, OPBREM12, OPBREM12IN, OPBREMIN		

## heating elements for pasta cookers

			
<b>GEV No.</b>	416408	<b>Ref. No.</b>	0000Y17000
<b>description</b>	heating element 12000W 230/400V heating circuits 3 mounting pos. left L 280mm W 225mm H 32mm flange length 45mm flange length 1 9.6mm flange length 2 35.4mm flange ø1 44.5mm flange ø2 39.5mm thermostat sleeves ø 7mm length thermostat sleeves 280mm number of thermostat sleeves 1 thermostat sleeve eccentric, non clinging windings 5 L1 10mm L2 270mm W1 13mm W2 31mm tube ø 8.5mm cable length 600mm rotation flange fryer connection length 50mm		
<b>For models:</b>	CFE15, CFE159, CFE15D, CFE15D9, KFE15, KFE159, KFE15D, KFE15D9, OPFE15, OPFE15D		
<b>accessories for</b>	416408		
	<b>GEV No.</b>	510899	<b>Ref. No.</b> X05400
	O-ring EPDM thickness 3.53mm ID ø 37.69mm Qty 1 pcs		
	<b>GEV No.</b>	528155	<b>Ref. No.</b> X05300
	O-ring Viton thickness 3.53mm ID ø 32.93mm Qty 1 pcs		
	<b>GEV No.</b>	532545	<b>Ref. No.</b> X05000
	O-ring Viton thickness 3.53mm ID ø 49.21mm Qty 1 pcs		
	<b>GEV No.</b>	691621	<b>Ref. No.</b> M29600
	retaining ring shaft ø 40mm thickness 1.8mm steel DIN 471		





			
<b>GEV No.</b>	416407	<b>Ref. No.</b>	Y14400
<b>description</b>	heating element 15000W 230/400V heating circuits 3 mounting pos. left L 355mm W 190mm H 32mm flange length 45mm flange length 1 9.6mm flange length 2 35.4mm flange ø1 44.5mm flange ø2 39.5mm thermostat sleeves ø 7mm length thermostat sleeves 280mm number of thermostat sleeves 1 thermostat sleeve eccentric, clinging windings 4 L1 15mm L2 340mm W1 13mm W2 32mm tube ø 8.5mm cable length 570mm rotation flange connection length 60mm		
<b>For models:</b>	KFE20, KFE20D, OPFE20, OPFE20D		
<b>accessories for</b>	416407		
	<b>GEV No.</b>	510899	<b>Ref. No.</b> X05400
	O-ring EPDM thickness 3.53mm ID ø 37.69mm Qty 1 pcs		
	<b>GEV No.</b>	528155	<b>Ref. No.</b> X05300
	O-ring Viton thickness 3.53mm ID ø 32.93mm Qty 1 pcs		
	<b>GEV No.</b>	532545	<b>Ref. No.</b> X05000
	O-ring Viton thickness 3.53mm ID ø 49.21mm Qty 1 pcs		
	<b>GEV No.</b>	691621	<b>Ref. No.</b> M29600
	retaining ring shaft ø 40mm thickness 1.8mm steel DIN 471		

			
<b>GEV No.</b>	418651	<b>Ref. No.</b>	0000Y19800
<b>description</b>	heating element 1500W 230V heating circuits 1 L 300mm W 51mm 2 hole fixing connection male faston 6.3mm thread M14x1 tube ø 8.5mm mounting distance 43mm pasta cooker immersion heater		
<b>For models:</b>	CCPE4, CCPE6, ICPE4, M6CP4E, M7CP4E, SKCP40E, TCP40E, TCP60E		
<b>spare parts for</b>	418651		
	<b>GEV No.</b>	507313	<b>Ref. No.</b> —
	O-ring EPDM thickness 2.62mm ID ø 13.95mm Qty 1 pcs		
<b>accessories for</b>	418651		
	<b>GEV No.</b>	510417	<b>Ref. No.</b> N/A
	flat gasket fibre ED ø 20mm ID ø 14mm thickness 2mm Qty 1 pcs		
	<b>GEV No.</b>	520228	<b>Ref. No.</b> —
	tooth lock washer ID ø 15.3mm ED ø 24mm steel Qty 1 pcs for thread M14		
	<b>GEV No.</b>	521133	<b>Ref. No.</b> —
	nut thread M14x1.5 H 6mm WS 19 zinc-coated steel Qty 1 pcs		
	<b>GEV No.</b>	550261	<b>Ref. No.</b> N/A
	nut thread M14x1 H 4mm WS 19 SS Qty 1 pcs		
	<b>GEV No.</b>	550262	<b>Ref. No.</b> —
	flat gasket copper ED ø 20mm ID ø 14mm thickness 2mm		









1

<b>GEV No.</b>	415902	<b>Ref. No.</b>	X47100 Y19900
<b>description</b>	heating element 2510W 230V L 295mm W 115mm Hmm 2 hole fixing connection male faston 6.3mm thread M14x1 tube ø 8.5mm		
<b>For models:</b>	CCPE6, ICPE6, SKCP60E, TCP60E		
<b>accessories for</b>	415902		
	<b>GEV No.</b>	510417	<b>Ref. No.</b> N/A
	flat gasket fibre ED ø 20mm ID ø 14mm thickness 2mm Qty 1 pcs		
	<b>GEV No.</b>	520228	<b>Ref. No.</b> —
	tooth lock washer ID ø 15.3mm ED ø 24mm steel Qty 1 pcs for thread M14		
	<b>GEV No.</b>	521133	<b>Ref. No.</b> —
	nut thread M14x1.5 H 6mm WS 19 zinc-coated steel Qty 1 pcs		
	<b>GEV No.</b>	550261	<b>Ref. No.</b> N/A
	nut thread M14x1 H 4mm WS 19 SS Qty 1 pcs		
	<b>GEV No.</b>	550262	<b>Ref. No.</b> —
	flat gasket copper ED ø 20mm ID ø 14mm thickness 2mm		







1

<b>GEV No.</b>	416989	<b>Ref. No.</b>	Y00900
<b>description</b>	heating element 4500W 230/400V heating circuits 3 L 357mm W 200mm H 25mm rotation flange tube ø 6.3mm L1 45mm L2 312mm W1 30mm W2 170mm cable length 570mm connection length 40mm flange length 1 9.6mm flange length 2 35.5mm flange length 45mm flange ø1 44.5mm flange ø2 39.5mm mounting pos. left fryer		
<b>For models:</b>	CCPE4, SKCP40E, TCP40E		
<b>accessories for</b>	416989		
	<b>GEV No.</b>	510899	<b>Ref. No.</b> X05400
	O-ring EPDM thickness 3.53mm ID ø 37.69mm Qty 1 pcs		
	<b>GEV No.</b>	528155	<b>Ref. No.</b> X05300
	O-ring Viton thickness 3.53mm ID ø 32.93mm Qty 1 pcs		
	<b>GEV No.</b>	532545	<b>Ref. No.</b> X05000
	O-ring Viton thickness 3.53mm ID ø 49.21mm Qty 1 pcs		
	<b>GEV No.</b>	691621	<b>Ref. No.</b> M29600
	retaining ring shaft ø 40mm thickness 1.8mm steel DIN 471		







1

<b>GEV No.</b>	418907	<b>Ref. No.</b>	Y18400
<b>description</b>	heating element 7500W 230V heating circuits 3 L 422mm W 186mm H 25mm tube ø 6.3mm L1 32mm L2 390mm W1 170mm W2 28mm cable length 550mm flange length 1 9.6mm flange length 2 35.4mm flange length 45mm flange ø1 44.5mm flange ø2 40mm mounting pos. left		
<b>For models:</b>	KCP4E, KCP82E, OPCP4E, OPCP82E		
<b>accessories for</b>	418907		
	<b>GEV No.</b>	510899	<b>Ref. No.</b> X05400
	O-ring EPDM thickness 3.53mm ID ø 37.69mm Qty 1 pcs		
	<b>GEV No.</b>	528155	<b>Ref. No.</b> X05300
	O-ring Viton thickness 3.53mm ID ø 32.93mm Qty 1 pcs		
	<b>GEV No.</b>	532545	<b>Ref. No.</b> X05000
	O-ring Viton thickness 3.53mm ID ø 49.21mm Qty 1 pcs		
	<b>GEV No.</b>	691621	<b>Ref. No.</b> M29600
	retaining ring shaft ø 40mm thickness 1.8mm steel DIN 471		

### heating elements for chargrills



1

<b>GEV No.</b>	416000	<b>Ref. No.</b>	Y00200
<b>description</b>	heating element 1500W 230V L 438mm W 80mm H 62mm thread 1/4" mounting distance 19mm tube ø 8.5mm connection male faston 6.3mm windings 2 heating circuits 1 connection length 23mm 2 hole fixing dry heating element		
<b>For models:</b>	CRE4, CRE6, IRE4, IRE6, SKR40E, SKR60E, TR40E, TR60E		
<b>spare parts for</b>	416000		
	<b>GEV No.</b>	510417	<b>Ref. No.</b> N/A
	flat gasket fibre ED ø 20mm ID ø 14mm thickness 2mm Qty 1 pcs		
<b>accessories for</b>	416000		
	<b>GEV No.</b>	361182	<b>Ref. No.</b> —
	nut thread 1/4" H 5mm nickel-plated brass WS 17 Qty 1 pcs		
	<b>GEV No.</b>	520228	<b>Ref. No.</b> —
	tooth lock washer ID ø 15.3mm ED ø 24mm steel Qty 1 pcs for thread M14		
	<b>GEV No.</b>	550262	<b>Ref. No.</b> —
	flat gasket copper ED ø 20mm ID ø 14mm thickness 2mm		

heating elements for salamanders/toast-



<b>GEV No.</b>	416050	<b>Ref. No.</b>	0000X47800
<b>description</b>	heating element 1600W 220V heating circuits 1 L 304mm W 208mm H 50mm W1 94mm W2 30mm flange length 70mm flange width 22mm hole distance 56mm cable length 1480mm connection cable tube ø 6.3mm connection length 29mm hole ø 6mm rectangular flange dry heating element		
<b>For models:</b>	S600E, S680E		



<b>GEV No.</b>	416049	<b>Ref. No.</b>	X48900
<b>description</b>	heating element 2500W 230V L 223mm W 310mm L1 18mm L2 205mm W1 120mm W2 70mm thread 1/4" mounting distance 61mm tube ø 8.5mm connection M4 connection length 39mm dry heating element 2 hole fixing salamander grill		

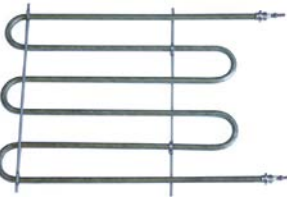

<b>GEV No.</b>	416154	<b>Ref. No.</b>	071018
<b>description</b>	heating element 2500W 230V L 368mm W 255mm thread 1/4" mounting distance 246mm connection M5 dry heating element tube ø 8.5mm heating circuits 1 connection length 36mm H 8.5mm connection distance 247mm		
<b>For models:</b>	S110E		

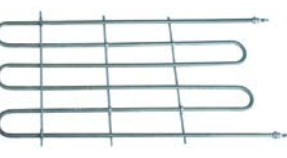

<b>GEV No.</b>	416156	<b>Ref. No.</b>	071036
<b>description</b>	heating element 3000W 230V L 600mm W 265mm flange with thread thread 1/4" mounting distance 260mm connection M5 dry heating element tube ø 8.5mm connection length 34mm		
<b>For models:</b>	S300E		



<b>GEV No.</b>	416759	<b>Ref. No.</b>	080328
<b>description</b>	heating element 650W 115V L 614mm thread M14x1.5 connection length 25mm tube ø 8.5mm connection M4 heating circuits 1 dry heating element		

ceramic heaters

245x60mm



<b>GEV No.</b>	415103	<b>Ref. No.</b>	X48000
<b>description</b>	ceramic emitter 650W 230V cable beaded cord L 245mm W 60mm H 35mm		
<b>For models:</b>	CSP40E, ISP4, SKP40E, TSP40E		
<b>spare parts for</b>	415103		
		<b>GEV No.</b>	415109
		<b>Ref. No.</b>	—
	spring clip		
<b>accessories for</b>	415103		
		<b>GEV No.</b>	415110
		<b>Ref. No.</b>	—
	reflector L 245mm W 95mm H 31mm thickness 0.75mm hole ø 15x40mm		

quartz heating elements





<b>GEV No.</b>	415301	<b>Ref. No.</b>	FZ23050001
<b>description</b>	quartz heating element 190W 230V L 450mm ø 10mm connection plug-in connection		

immersion heating elements

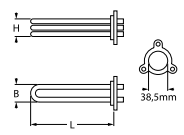
3 hole flange ø38.5mm

<b>GEV No.</b>	416263	<b>Ref. No.</b>	905493
<b>description</b>	heating element 2600W 230V mounting ø 38.5mm heating circuits 1 L 293mm W 26mm H 26mm number of thermostat sleeves 1 thermostat sleeves ø 7mm length thermostat sleeves 260mm thermostat sleeve not clinging tube ø 6.3mm hole distance 57mm hole ø 10mm 3 hole flange connection male faston 6.3mm immersion heater		
<b>For models:</b>	GLB615		
<b>spare parts for</b>	416263		
		<b>GEV No.</b>	521120
		<b>Ref. No.</b>	907981 SD907981
	O-ring EPDM thickness 5.34mm ID ø 37.47mm Qty 1 pcs		
<b>accessories for</b>	416263		
		<b>GEV No.</b>	532577
		<b>Ref. No.</b>	—
	O-ring EPDM thickness 5.34mm ID ø 40.65mm Qty 1 pcs		

1

<b>GEV No.</b>	416264	<b>Ref. No.</b>	905521
<b>description</b>	heating element 3000W 230V hole distance 57mm		
<b>For models:</b>	GLB785, GLB795		
<b>accessories for</b>	416264		
	<b>GEV No.</b>	532577	<b>Ref. No.</b> —
	O-ring EPDM thickness 5.34mm ID ø 40.65mm Qty 1 pcs		

1

<b>GEV No.</b>	416267	<b>Ref. No.</b>	905560
<b>description</b>	heating element 4500W 230V mounting ø 38.5mm heating circuits 3 L 358mm W 32mm H 58mm L1 36mm L2 72mm L3 250mm H1 28mm H2 30mm hole distance 57mm hole ø 10mm tube ø 6.3mm connection male faston 6.3mm immersion heater 3 hole flange		
<b>For models:</b>	GLS805, GLS845, GLS905, GLS925		
<b>spare parts for</b>	416267		
	<b>GEV No.</b>	521120	<b>Ref. No.</b> 907981 SD907981
	O-ring EPDM thickness 5.34mm ID ø 37.47mm Qty 1 pcs		
<b>accessories for</b>	416267		
	<b>GEV No.</b>	532577	<b>Ref. No.</b> —
	O-ring EPDM thickness 5.34mm ID ø 40.65mm Qty 1 pcs		

1

<b>GEV No.</b>	416268	<b>Ref. No.</b>	905570
<b>description</b>	heating element 6000W 230V mounting ø 38.5mm heating circuits 3 L 360mm W 34mm H 55mm L1 35mm L2 70mm L3 255mm H1 27mm H2 28mm hole distance 57mm hole ø 10mm tube ø 6.3mm connection male faston 6.3mm immersion heater 3 hole flange		
<b>For models:</b>	GLS935, GLS945, GLS945S		
<b>spare parts for</b>	416268		
	<b>GEV No.</b>	532577	<b>Ref. No.</b> —
	O-ring EPDM thickness 5.34mm ID ø 40.65mm Qty 1 pcs		

### 3 hole flange ø47.5mm



1

<b>GEV No.</b>	418136	<b>Ref. No.</b>	080328DHE
<b>description</b>	heating element 4360W 240V mounting ø 47.5mm heating circuits 3 L 310mm W 31mm H 35mm number of thermostat sleeves 1 thermostat sleeves ø 7mm length thermostat sleeves 200mm thermostat sleeve clinging tube ø 6.3mm hole distance 62mm hole ø 8mm connection M4 3 hole flange immersion heater		
<b>spare parts for</b>	418136		
	<b>GEV No.</b>	510408	<b>Ref. No.</b> E11700
	O-ring EPDM thickness 5.34mm ID ø 47mm Qty 1 pcs		
<b>accessories for</b>	418136		
	<b>GEV No.</b>	510408	<b>Ref. No.</b> E11700
	O-ring EPDM thickness 5.34mm ID ø 47mm Qty 1 pcs		
	<b>GEV No.</b>	510562	<b>Ref. No.</b> —
	O-ring silicone thickness 5.34mm ID ø 47mm Qty 1 pcs		



1

<b>GEV No.</b>	415001	<b>Ref. No.</b>	N/A
<b>description</b>	heating element 4500W 230V mounting ø 47.5mm heating circuits 3 L 316mm W 35mm H 34mm number of thermostat sleeves 1 thermostat sleeves ø 7mm length thermostat sleeves 180mm thermostat sleeve eccentric, non clinging tube ø 6.3mm hole distance 62mm hole ø 8mm connection M4 3 hole flange immersion heater		
<b>spare parts for</b>	415001		
	<b>GEV No.</b>	510408	<b>Ref. No.</b> E11700
	O-ring EPDM thickness 5.34mm ID ø 47mm Qty 1 pcs		
<b>accessories for</b>	415001		
	<b>GEV No.</b>	510562	<b>Ref. No.</b> —
	O-ring silicone thickness 5.34mm ID ø 47mm Qty 1 pcs		
	<b>GEV No.</b>	521103	<b>Ref. No.</b> —
	nut thread M4 H 3mm WS 7 brass Qty 20 pcs		
	<b>GEV No.</b>	521104	<b>Ref. No.</b> —
	washer ID ø 4.3mm ED ø 8mm thickness 0.5mm brass Qty 20 pcs for thread M4		
	<b>GEV No.</b>	560111	<b>Ref. No.</b> —
	plain washer ID ø 4.3mm ED ø 9mm thickness 0.8mm SS Qty 20 pcs DIN 125A for thread M4		
	<b>GEV No.</b>	560131	<b>Ref. No.</b> —
	hexagonal nut thread M4 H 3.2mm WS 7 SS DIN/ISO DIN 934 / ISO 4032/8673 Qty 20 pcs		





<b>GEV No.</b>	416048	<b>Ref. No.</b>	Y15300
<b>description</b>	heating element 6000W 230V mounting $\varnothing$ 47.5mm 3 hole flange immersion heater		
<b>accessories for</b>	416048		
	<b>GEV No.</b>	510408	<b>Ref. No.</b> E11700
	O-ring EPDM thickness 5.34mm ID $\varnothing$ 47mm Qty 1 pcs		
	<b>GEV No.</b>	510562	<b>Ref. No.</b> —
	O-ring silicone thickness 5.34mm ID $\varnothing$ 47mm Qty 1 pcs		





<b>GEV No.</b>	418439	<b>Ref. No.</b>	E11500
<b>description</b>	heating element 8000W 230V mounting $\varnothing$ 47.5mm heating circuits 3 L 315mm W 37mm H 35mm number of thermostat sleeves 1 thermostat sleeves $\varnothing$ 8.5mm length thermostat sleeves 215mm thermostat sleeve clinging tube $\varnothing$ 8.5mm hole distance 62mm hole $\varnothing$ 8mm connection M4 3 hole flange immersion heater		
<b>For models:</b>	KPI10E, KPI10EA, KPI20E, KPI20EA, OPPI10E, OPPI10EA		
<b>accessories for</b>	418439		
	<b>GEV No.</b>	510408	<b>Ref. No.</b> E11700
	O-ring EPDM thickness 5.34mm ID $\varnothing$ 47mm Qty 1 pcs		
	<b>GEV No.</b>	510562	<b>Ref. No.</b> —
	O-ring silicone thickness 5.34mm ID $\varnothing$ 47mm Qty 1 pcs		





<b>GEV No.</b>	416410	<b>Ref. No.</b>	E11600
<b>description</b>	heating element 9000W 230V mounting $\varnothing$ 47.5mm heating circuits 3 L 395mm W 33mm H 35mm number of thermostat sleeves 1 thermostat sleeves $\varnothing$ 7mm length thermostat sleeves 210mm thermostat sleeve eccentric, clinging tube $\varnothing$ 8.5mm hole distance 63mm hole $\varnothing$ 8mm connection M4		
<b>For models:</b>	CPEI, KPI15E, KPI15EA, KPI30E, KPI30EA, KPI50E, KPI50EA, OPPI15E, OPPI15EA		
<b>accessories for</b>	416410		
	<b>GEV No.</b>	510408	<b>Ref. No.</b> E11700
	O-ring EPDM thickness 5.34mm ID $\varnothing$ 47mm Qty 1 pcs		
	<b>GEV No.</b>	510562	<b>Ref. No.</b> —
	O-ring silicone thickness 5.34mm ID $\varnothing$ 47mm Qty 1 pcs		



<b>GEV No.</b>	416835	<b>Ref. No.</b>	40400042
<b>description</b>	heating element 9000W 230V mounting $\varnothing$ 47.5mm heating circuits 3 L 415mm W 30mm H 46mm number of thermostat sleeves 1 thermostat sleeves $\varnothing$ 7.5mm length thermostat sleeves 255mm thermostat sleeve eccentric, clinging hole distance 62mm hole $\varnothing$ 8mm connection M4 3 hole flange immersion heater		
<b>For models:</b>	KPI15ET, KPI15ETA, KPI30ET, KPI30ETA, KPI50ET, KPI50ETA		
<b>accessories for</b>	416835		
	<b>GEV No.</b>	510408	<b>Ref. No.</b> E11700
	O-ring EPDM thickness 5.34mm ID $\varnothing$ 47mm Qty 1 pcs		
	<b>GEV No.</b>	510562	<b>Ref. No.</b> —
	O-ring silicone thickness 5.34mm ID $\varnothing$ 47mm Qty 1 pcs		

group 7



<b>GEV No.</b>	418505	<b>Ref. No.</b>	40400048
<b>description</b>	heating element 8000W 230V heating circuits 3 flange $\varnothing$ 47.5mm L 497mm W 35mm H 56mm tube $\varnothing$ 8.5mm thermostat sleeves $\varnothing$ 7.5mm length thermostat sleeves 266mm number of thermostat sleeves 1 thermostat sleeve not clinging connection M4 immersion heater 3 hole flange hole distance 58mm mounting $\varnothing$ 47.5mm hole $\varnothing$ 8mm		
<b>For models:</b>	KPI10ET, KPI10ETA, KPI20ETA		
<b>accessories for</b>	418505		
	<b>GEV No.</b>	510408	<b>Ref. No.</b> E11700
	O-ring EPDM thickness 5.34mm ID $\varnothing$ 47mm Qty 1 pcs		
	<b>GEV No.</b>	510562	<b>Ref. No.</b> —
	O-ring silicone thickness 5.34mm ID $\varnothing$ 47mm Qty 1 pcs		

with compression flange 50 x 26mm





<b>GEV No.</b>	416209	<b>Ref. No.</b>	904957 905858
<b>description</b>	heating element 2000W 230V heating circuits 1 compression flange flange 50x26mm L 180mm W 90mm H 24mm L1 55mm L2 125mm W1 28mm W2 35mm connection male faston 6.3mm tube $\varnothing$ 8.5mm connection length 28mm immersion heater		
<b>For models:</b>	GLS905, GLS925		
<b>accessories for</b>	416209		
	<b>GEV No.</b>	510387	<b>Ref. No.</b> —
	gasket L 46mm W 22mm $\varnothing$ mm EPDM for heating element for flange 50x26mm		

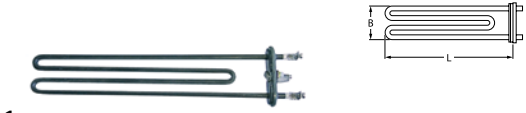

with compression flange 70 x 26mm







1

<b>GEV No.</b>	415000	<b>Ref. No.</b>	N/A
<b>description</b>	heating element 2900W 230V heating circuits 1 flange 70x26mm L 272mm W 51mm H mm tube ø 6.3mm connection M4 immersion heater compression flange		
<b>spare parts for</b>	415000		
	<b>GEV No.</b>	521128	<b>Ref. No.</b> N/A
	gasket L 66mm W 21mm ømm for heating element suitable for ELETTOBAR, WOLK		
<b>accessories for</b>	415000		
	<b>GEV No.</b>	521128	<b>Ref. No.</b> N/A
	gasket L 66mm W 21mm ømm for heating element suitable for ELETTOBAR, WOLK		





1

<b>GEV No.</b>	416244	<b>Ref. No.</b>	Y19700
<b>description</b>	heating element 1000W 230V heating circuits 1 L 258mm W 34mm connection male faston 6.3mm tube ø 6.3mm 2 hole fixing thread 1/8" immersion heater H 35mm mounting distance 26mm		
<b>For models:</b>	M6B4E, M7B4E		
<b>accessories for</b>	416244		
	<b>GEV No.</b>	361181	<b>Ref. No.</b> —
	nut thread 1/8" H 4.5mm nickel-plated brass WS 14 Qty 1 pcs		
	<b>GEV No.</b>	525780	<b>Ref. No.</b> —
	flat gasket copper ED ø 13mm ID ø 10.2mm thickness 1.5mm for thread 1/8" Qty 1 pcs		
	<b>GEV No.</b>	560192	<b>Ref. No.</b> —
	tooth lock washer ID ø 10.4mm ED ø 18mm SS DIN/ISO DIN 6798A Qty 1 pcs for thread M10		



1



<b>GEV No.</b>	416259	<b>Ref. No.</b>	905771
<b>description</b>	heating element 1600W 230V heating circuits 1 L 275mm W 38mm H 28mm thread M10x1 mounting distance 27mm tube ø 7.1mm connection male faston 6.3mm 2 hole fixing connection length 26mm immersion heater		
<b>For models:</b>	GLB615, GLB785, GLB795		
<b>accessories for</b>	416259		
	<b>GEV No.</b>	510416	<b>Ref. No.</b> —
	flat gasket fibre ED ø 19mm ID ø 10.5mm thickness 1.5mm for thread M10 Qty 1 pcs		
	<b>GEV No.</b>	510893	<b>Ref. No.</b> 904391
	O-ring EPDM thickness 2.62mm ID ø 9.92mm Qty 1 pcs		
	<b>GEV No.</b>	520231	<b>Ref. No.</b> —
	nut thread M10x1 H 6mm WS 14 zinc-coated steel Qty 1 pcs		

**accessories for** 416259

	<b>GEV No.</b>	521129	<b>Ref. No.</b>	—
	nut thread M10 H 6mm SS WS 17 Qty 1 pcs DIN/ISO DIN 439			



1

<b>GEV No.</b>	415010	<b>Ref. No.</b>	D230017
<b>description</b>	heating element 2000W 230V heating circuits 1 L 260mm W 125mm H 20mm L1 110mm L2 150mm W1 42mm W2 83mm thread M10x1 mounting distance 70mm tube ø 6.5mm connection M4 immersion heater 2 hole fixing		
<b>spare parts for</b>	415010		
	<b>GEV No.</b>	510416	<b>Ref. No.</b> —
	flat gasket fibre ED ø 19mm ID ø 10.5mm thickness 1.5mm for thread M10 Qty 1 pcs		
<b>accessories for</b>	415010		
	<b>GEV No.</b>	504306	<b>Ref. No.</b> —
	gasket fibre ED ø 16mm ID ø 10mm thickness 2mm Qty 1 pcs		
	<b>GEV No.</b>	510893	<b>Ref. No.</b> 904391
	O-ring EPDM thickness 2.62mm ID ø 9.92mm Qty 1 pcs		
	<b>GEV No.</b>	520231	<b>Ref. No.</b> —
	nut thread M10x1 H 6mm WS 14 zinc-coated steel Qty 1 pcs		
	<b>GEV No.</b>	521103	<b>Ref. No.</b> —
	nut thread M4 H 3mm WS 7 brass Qty 20 pcs		
	<b>GEV No.</b>	521104	<b>Ref. No.</b> —
	washer ID ø 4.3mm ED ø 8mm thickness 0.5mm brass Qty 20 pcs for thread M4		
	<b>GEV No.</b>	521129	<b>Ref. No.</b> —
	nut thread M10 H 6mm SS WS 17 Qty 1 pcs DIN/ISO DIN 439		
	<b>GEV No.</b>	560111	<b>Ref. No.</b> —
	plain washer ID ø 4.3mm ED ø 9mm thickness 0.8mm SS Qty 20 pcs DIN 125A for thread M4		
	<b>GEV No.</b>	560131	<b>Ref. No.</b> —
	hexagonal nut thread M4 H 3.2mm WS 7 SS DIN/ISO DIN 934 / ISO 4032/8673 Qty 20 pcs		



1







<b>GEV No.</b>	415665	<b>Ref. No.</b>	N/A
<b>description</b>	heating element 2750/3250W 220/240V heating circuits 1 L 380mm W 110mm H 30mm thread M10x1 mounting distance 75mm tube ø 6.5mm connection M4 immersion heater 2 hole fixing		
<b>spare parts for</b>	415665		
	<b>GEV No.</b>	510893	<b>Ref. No.</b> 904391
	O-ring EPDM thickness 2.62mm ID ø 9.92mm Qty 1 pcs		
<b>accessories for</b>	415665		
	<b>GEV No.</b>	510416	<b>Ref. No.</b> —
	flat gasket fibre ED ø 19mm ID ø 10.5mm thickness 1.5mm for thread M10 Qty 1 pcs		

Table continues overleaf





<b>accessories for</b>	415665		
	GEV No.	520231	Ref. No. —
	nut thread M10x1 H 6mm WS 14 zinc-coated steel Qty 1 pcs		
	GEV No.	520876	Ref. No. —
	protection cap for heating element ø 11.5mm H 32mm W 25mm plastic		
	GEV No.	521103	Ref. No. —
	nut thread M4 H 3mm WS 7 brass Qty 20 pcs		
	GEV No.	521104	Ref. No. —
	washer ID ø 4.3mm ED ø 8mm thickness 0.5mm brass Qty 20 pcs for thread M4		
	GEV No.	521129	Ref. No. —
	nut thread M10 H 6mm SS WS 17 Qty 1 pcs DIN/ISO DIN 439		
	GEV No.	560111	Ref. No. —
	plain washer ID ø 4.3mm ED ø 9mm thickness 0.8mm SS Qty 20 pcs DIN 125A for thread M4		
	GEV No.	560131	Ref. No. —
	hexagonal nut thread M4 H 3.2mm WS 7 SS DIN/ISO DIN 934 / ISO 4032/8673 Qty 20 pcs		

	1		
<b>GEV No.</b>	416261	<b>Ref. No.</b>	905748
<b>description</b>	heating element 3000W 230V heating circuits 1 L 358mm W 32mm H 34mm H2 37mm thread M10x1 mounting distance 26mm tube ø 6.5mm connection male faston 6.3mm 2 hole fixing immersion heater		
<b>For models:</b>	GLS805, GLS845, GLS935, GLS945, GLS945S		
<b>accessories for</b>	416261		
	GEV No.	510416	Ref. No. —
	flat gasket fibre ED ø 19mm ID ø 10.5mm thickness 1.5mm for thread M10 Qty 1 pcs		
	GEV No.	510893	Ref. No. 904391
	O-ring EPDM thickness 2.62mm ID ø 9.92mm Qty 1 pcs		
	GEV No.	520231	Ref. No. —
	nut thread M10x1 H 6mm WS 14 zinc-coated steel Qty 1 pcs		
	GEV No.	521129	Ref. No. —
	nut thread M10 H 6mm SS WS 17 Qty 1 pcs DIN/ISO DIN 439		

heating elements for convection

	1		
<b>GEV No.</b>	415251	<b>Ref. No.</b>	50039
<b>description</b>	heating element 2500W 230V heating circuits 1 ID ø 178mm ED ø 190mm L 242mm H 35mm L1 46mm W1 31mm H1 10mm H2 25mm flange length 70mm flange width 22mm hole distance 56mm connection male faston 6.3mm horizontal tube ø 6.3mm convection heating element hole ø 5mm rectangular flange		

	1		
<b>GEV No.</b>	416040	<b>Ref. No.</b>	X68002
<b>description</b>	heating element 2500W 230V heating circuits 1 ID ø 185mm ED ø 198mm L 212mm H 30mm L1 17mm W1 32mm H1 6mm H2 24mm flange length 70mm flange width 22mm hole distance 56mm connection male faston 6.3mm connection length 33mm tube ø 6.5mm dry heating element hole ø 5mm rectangular flange		
<b>For models:</b>	C4FFCEP, C4FFLE, C4FFLEP, C4FZFCE, C4FZFCEP, C4FZSFCEP, C4PFCE, C4PFLE, C4PQFCE, C4VFCE, C4VFLE, C6FFCEP, C6FFLE, C6FFLEP, C6FFLEPV, C6FFLEV, C6FZFCE, C6FZFCEP, C6FZFCEPV, C6FZFCEV, C6PFCE, C6PFCEV, C6PFLE, C6PFLEV, C6PQFCE, C6PQFCEV, CC120E, CC80E, CC81E, CCG120CE, CCG120E, CCG80E, CCG81CE, CCG81E, CCQ120E, CCQ80E, CCQ81E, CCV80E, CCV81E, K2FTPFCE, K4FSFCE, K4FZFCE, K4FZSFCE, K4PFCE, K4VFCE, K6FZFCE, K6PFCE, K8FZFCE, KTPFCE, M74FFXE...(Other models you can see in the webshop)		
<b>accessories for</b>	416040		
	GEV No.	510368	Ref. No. —
	gasket L 70mm W 23.5mm hole ø 5mm hole distance 56mm FIBER thickness 2mm for heating element		

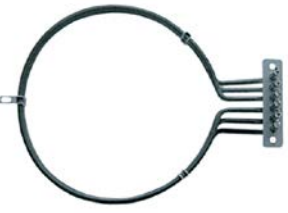
	1		
<b>GEV No.</b>	415850	<b>Ref. No.</b>	760978
<b>description</b>	heating element 5400W 230V heating circuits 3 ID ø 191mm ED ø 204mm L 268mm H 84mm L1 57mm W1 103mm H1 17mm H2 67mm flange length 140mm flange width 23mm hole distance 63/63mm connection M4 tube ø 6.5mm		

	1		
<b>GEV No.</b>	415871	<b>Ref. No.</b>	761344
<b>description</b>	heating element 6000W 230V heating circuits 3 ID ø 217mm ED ø 230mm L 267mm H 75mm L1 38mm W1 103mm H1 65mm H2 10mm flange length 140mm flange width 23mm hole distance 67mm connection M4 connection length 25mm tube ø 6.5mm convection heating element hole ø 5mm rectangular flange		



radiation heaters



1

<b>GEV No.</b>	490152	<b>Ref. No.</b>	Y17602
<b>description</b>	radiation heater octagonal 2500W 230V L 250mm W 250mm heating circuits 2 with heating coil energy regulation with temperature signalization connections 3+2 connection type cable AD		
<b>For models:</b>	C2V, C4V, C4VFCE, C4VFE, I2V, I4V, SK4VFCE, SKCV40E, SKCV80E, TCV40E, TCV80E		



1

<b>GEV No.</b>	490113	<b>Ref. No.</b>	Y12207
<b>description</b>	radiation heater ø 200mm 1800W 230V heating circuits 1 energy regulation with temperature signalization with ribbon heater connections 2+2 connection type male faston 6.3mm CERAMASPEED		
<b>For models:</b>	CCV80E, CCV81E, SKCV40E, SKCV80E		

1-circuit



1

<b>GEV No.</b>	490169	<b>Ref. No.</b>	AER009ZR10
<b>description</b>	radiation heater ø 165mm 1200W 230V heating circuits 1 H 32mm 7-position control without temperature signalization round connections 4 connection type male faston 6.3mm EGO		
<b>For models:</b>	M62V, M64V, M74V, M74VFXE		



1

<b>GEV No.</b>	490042	<b>Ref. No.</b>	Y17702
<b>description</b>	radiation heater ø 200mm 1800W 230V heating circuits 1 energy regulation with temperature signalization with ribbon heater connections 2+2 connection type male faston 6.3mm EGO		
<b>For models:</b>	C4V, C4VFCE, C4VFE, I4V, SK4VFCE, SKCV40E, SKCV80E, TCV80E		



1

<b>GEV No.</b>	490116	<b>Ref. No.</b>	Y12208
<b>description</b>	radiation heater ø 165mm 1200W 230V heating circuits 1 H 33mm 7-position control with temperature signalization with ribbon heater connections 2+2 connection type male faston 6.3mm CERAMASPEED		
<b>For models:</b>	CCV80E, CCV81E, SKCV40E, SKCV80E		



1

<b>GEV No.</b>	490171	<b>Ref. No.</b>	AER011ZR10
<b>description</b>	radiation heater ø 230mm 2100W 230V heating circuits 1 H 32mm 7-position control round		
<b>For models:</b>	M62V, M64V, M74V, M74VFXE		



1

<b>GEV No.</b>	490170	<b>Ref. No.</b>	AER010ZR10
<b>description</b>	radiation heater ø 200mm 1700W 230V heating circuits 1 7-position control without temperature signalization connections 4 connection type male faston 6.3mm EGO		
<b>For models:</b>	M64V, M74V, M74VFXE		



1

<b>GEV No.</b>	490050	<b>Ref. No.</b>	Y12408
<b>description</b>	radiation heater ø 250mm 2500W 230V heating circuits 1 with ribbon heater		
<b>For models:</b>	C2V, C4V, C4VFE, C4VFLE, TCV40E, TCV80E		

2-circuit



<b>GEV No.</b>	490114	<b>Ref. No.</b>	Y12409
<b>description</b>	radiation heater ø 230mm 2200W 230V heating circuits 2 energy regulation with temperature signalization partial power 750W with ribbon heater connections 2+2 connection type male faston 6.3mm CERAMASPEED		
<b>For models:</b>	C2V, C4V, C4VFE, C4VFLE, TCV40E, TCV80E		



<b>GEV No.</b>	490118	<b>Ref. No.</b>	Y17802
<b>description</b>	radiation heater ø 250mm 2500W heating circuits 2 partial power 1000W		
<b>For models:</b>	K2V, K4V, K4VFCE, K4VFE, OP2V, OP4V		

foil heating elements

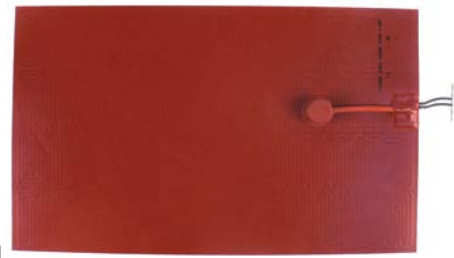

<b>GEV No.</b>	416406	<b>Ref. No.</b>	Y15900
<b>description</b>	foil heating element L 400mm W 240mm 1000W 230V t.max. 150°C with temperature limiter silicone cable length 2000mm thickness 1mm		
<b>For models:</b>	CBE4, CBE8, IBE4, IBE8, KB4, KB8, OPB4, OPB8, SKB40E, SKB80E, TB40E, TB80E		

accessories

hexagonal nuts



<b>GEV No.</b>	550261	<b>Ref. No.</b>	N/A
<b>description</b>	nut thread M14x1 H 4mm WS 19 SS Qty 1 pcs		

retaining rings



<b>GEV No.</b>	691621	<b>Ref. No.</b>	M29600
<b>description</b>	retaining ring shaft ø 40mm thickness 1.8mm steel DIN 471		
<b>For models:</b>	CCPE4, CFE15, CFE159, CFE15D, CFE15D9, KCP4E, KCP82E, KFE15, KFE159, KFE15D, KFE15D9, KFE20, KFE20D, OPCP4E, OPCP82E, OPFE15, OPFE15D, OPFE20, OPFE20D, SKCP40E, TCP40E		

sealing washers

fibre gaskets

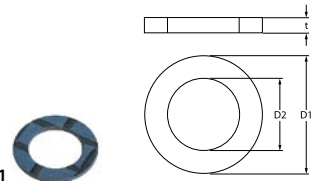

<b>GEV No.</b>	510417	<b>Ref. No.</b>	N/A
<b>description</b>	flat gasket fibre ED ø 20mm ID ø 14mm thickness 2mm Qty 1 pcs		

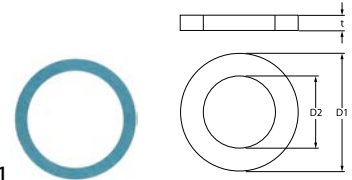

<b>GEV No.</b>	510406	<b>Ref. No.</b>	E50300
<b>description</b>	flat gasket fibre ED ø 60mm ID ø 48mm thickness 3mm for thread 1½" Qty 1 pcs		
<b>For models:</b>	KP10G, KP10GA, KP10GT, KP10GTA, KP15G, KP15GA, KP15GT, KP15GTA, KP20G, KP20GA, KP30G, KP30GA, KP50G, KP50GA, KPI10E, KPI10E9, KPI10EA, KPI10EA9, KPI10G, KPI10GA, KPI10GT, KPI10GTA, KPI15E, KPI15E9, KPI15EA, KPI15EA9, KPI15G, KPI15GA, KPI15GT, KPI15GTA, KPI20E, KPI20EA, KPI20G, KPI20GA, KPI30E, KPI30EA, KPI30G, KPI30GA, KPI50E, KPI50EA, KPI50G, KPI50GA, OPP10G, OPP10GA, OPP15G, OPP15GA, OPPI10E, OPPI10EA, OPPI10G, OPPI10GA... (Other models you can see in the webshop)		

O-rings

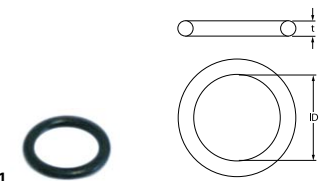

<b>GEV No.</b>	510893	<b>Ref. No.</b>	904391
<b>description</b>	O-ring EPDM thickness 2.62mm ID ø 9.92mm Qty 1 pcs		
<b>For models:</b>	GLB785, GLB795		



<b>GEV No.</b>	510072	<b>Ref. No.</b>	904350 N/A
<b>description</b>	O-ring EPDM thickness 3.53mm ID ø 32.93mm Qty 1 pcs		
<b>For models:</b>	GLB615, GLB785, GLB795		

<b>GEV No.</b>	510899	<b>Ref. No.</b>	X05400
<b>description</b>	O-ring EPDM thickness 3.53mm ID ø 37.69mm Qty 1 pcs		
<b>For models:</b>	CCPE4, CFE15, CFE159, CFE15D, CFE15D9, CMP4, KCP4E, KCP82E, KFE15, KFE159, KFE15D, KFE15D9, KFE20, KFE20D, OPCP4E, OPCP82E, OPFE15, OPFE15D, OPFE20, OPFE20D, SKCP40E, TCP40E, TMP4		

<b>GEV No.</b>	521120	<b>Ref. No.</b>	907981 SD907981
<b>description</b>	O-ring EPDM thickness 5.34mm ID ø 37.47mm Qty 1 pcs		
<b>For models:</b>	GLB785, GLB795, GLS905, GLS925, GLS935		

<b>GEV No.</b>	510408	<b>Ref. No.</b>	E11700
<b>description</b>	O-ring EPDM thickness 5.34mm ID ø 47mm Qty 1 pcs		
<b>For models:</b>	CPEI, CPEI9, KPI10E, KPI10E9, KPI10EA, KPI10EA9, KPI15E, KPI15E9, KPI15EA, KPI15EA9, KPI20E, KPI20EA, KPI30E, KPI30EA, KPI50E, KPI50EA, OPPI10E, OPPI10EA, OPPI15E, OPPI15EA		

<b>GEV No.</b>	532545	<b>Ref. No.</b>	X05000
<b>description</b>	O-ring Viton thickness 3.53mm ID ø 49.21mm Qty 1 pcs		
<b>For models:</b>	CCPE4, CFE15, CFE159, CFE15D, CFE15D9, KCP4E, KCP82E, KFE15, KFE159, KFE15D, KFE15D9, KFE20, KFE20D, OPCP4E, OPCP82E, OPFE15, OPFE15D, OPFE20, OPFE20D, SKCP40E, TCP40E		

### flange gaskets

<b>GEV No.</b>	521128	<b>Ref. No.</b>	N/A
<b>description</b>	gasket L 66mm W 21mm ømm for heating element suitable for ELETTOBAR, WOLK		

### capillary tube clips

<b>GEV No.</b>	551105	<b>Ref. No.</b>	M86800
<b>description</b>	capillary tube clip for pipe ø 6mm Qty 1 pcs		
<b>For models:</b>	CF1E4, CF2E6, CF4E, CF6E, GSP01, IF1E4, IF2E6, IF4E, IF6E, KFE1, KFE2, OPFE1, OPFE2, SKF1E, SKF2E, SKF4E, SKF6E, TF1E, TF2E, TF4E, TF6E		

<b>GEV No.</b>	550980	<b>Ref. No.</b>	M86900
<b>description</b>	capillary tube clip for pipe ø 8.5mm Qty 1 pcs		
<b>For models:</b>	15DPE, 15PE, 15PSE, 4DME, 4ME, 6+4LE, 6+4ME, 6DLE, 6DME, 6LE, 6ME, 7DSE, 7DSET, 7SE, 7SET, CF2E4, SK10DSE, SK10DSE9, SK10SE, SK10SE9, SKF2E4, TF2E4		

### spring clips

<b>GEV No.</b>	550258	<b>Ref. No.</b>	M86500
<b>description</b>	probe clip for pipe ø 8mm for probe ø 6mm		
<b>For models:</b>	15DPE, 15PE, 15PSE, 4DME, 4ME, 6+4LE, 6+4ME, 6DLE, 6DME, 6LE, 6ME, 7DSE, 7SE, CF1E4, CF2E4, CF2E6, CF4E, CF6E, IF1E4, IF2E6, IF4E, IF6E, KFE1, KFE2, KFE4, KFE8, M6F4E, M6F6E, M7F4E, M7F6E, OPFE1, OPFE2, SK10DSE9, SK10SE9, SKF1E, SKF2E, SKF2E4, SKF4E, SKF6E, TF1E, TF2E, TF2E4, TF4E, TF6E		

### protection caps

<b>GEV No.</b>	510093	<b>Ref. No.</b>	N/A
<b>description</b>	protection cap		

<b>GEV No.</b>	514202	<b>Ref. No.</b>	0900B42300
<b>description</b>	bracket for heating element mounting pos. right		



			
1			
<b>GEV No.</b>	514203	<b>Ref. No.</b>	1901B42300
<b>description</b>	bracket heating element mounting pos. left		

## hot plates

### square & rectangular

#### with radiused edge

			
1			
<b>GEV No.</b>	490066 <sup>1</sup>	<b>Ref. No.</b>	X45500
<b>description</b>	hot plate dimensions 220x220mm 2600W 230V with spill ring connection 4 screw clamps protector yes square		
<b>For models:</b>	C2PQ, C4PQ, C4PQFCE, C4PQFE, C6PQ, C6PQFCE, C6PQFCEV, C6PQFE, CCQ120E, CCQ80E, CCQ81E, I2PQ, I4PQ, M74PQ, M74PQFXE, SK4PQFCE, SK6PQFCE, SKCQ40E, SKCQ80E, TCQ120E, TCQ40E, TCQ80E		

<sup>1</sup>incl. protector

			
1			
<b>GEV No.</b>	490056 <sup>1</sup>	<b>Ref. No.</b>	Y12000
<b>description</b>	hot plate dimensions 300x300mm 3000W 230V with spill ring connection 4 screw clamps protector yes square		
<b>For models:</b>	K2P, K4P, K4PFE, K6P, K6PFE		

<sup>1</sup>incl. protector

			
1			
<b>GEV No.</b>	490071 <sup>1</sup>	<b>Ref. No.</b>	0000Y12100
<b>description</b>	hot plate dimensions 300x300mm 4000W 230V with spill ring connection 4 screw clamps protector yes square		
<b>For models:</b>	K2P, K4P, K4PFE, K4PFE, K6P, K6PFE, K6PFE, OP2P, OP4P, OP6P		

<sup>1</sup>incl. protector

### round



#### with radiused edge

#### for domestic and commercial kitchens

			
1			
<b>GEV No.</b>	490014	<b>Ref. No.</b>	AER003ZR10
<b>description</b>	hot plate ø 180mm 1500W 230V connection 4 screw clamps with 8mm spill ring		
<b>For models:</b>	M62P, M64P		

			
1			
<b>GEV No.</b>	490016	<b>Ref. No.</b>	AER002ZR10
<b>description</b>	hot plate ø 180mm 2000W 230V connection 4 screw clamps with 8mm spill ring		
<b>For models:</b>	M62P, M64P, M74P, M74PFXE, M76P, M76PFXE		

			
1			
<b>GEV No.</b>	490018	<b>Ref. No.</b>	X45400
<b>description</b>	hot plate ø 220mm 2000W 230V connection 4 screw clamps with 8mm spill ring		
<b>For models:</b>	C2P, C4P, C4PFCE, C4PFE, C6P, C6PFCE, C6PFCEV, C6PFE, CC80E, I2P, I4P, SK4PFCE, SK6PFCE, SKC40E, SKC80E, TC120E, TC40E, TC80E		

			
1			
<b>GEV No.</b>	490020	<b>Ref. No.</b>	0000X45300
<b>description</b>	hot plate ø 220mm 2600W 230V connection 4 screw clamps with 8mm spill ring		
<b>For models:</b>	C2P, C4P, C4PFCE, C4PFE, C4PFLE, C6P, C6PFCE, C6PFCEV, C6PFE, C6PFLE, C6PFLEV, CC120E, CC80E, CC81E, I2P, I4P, SK4PFCE, SK6PFCE, SKC40E, SKC80E, TC120E, TC40E, TC80E		
<b>accessories for</b>	490020		
	<b>GEV No.</b>	550796	<b>Ref. No.</b>
	 fixing plate for hot plate ø220mm		



accessories

miscellaneous



1			
<b>GEV No.</b>	490111	<b>Ref. No.</b>	X44900
<b>description</b>	cover for hot plate ø 237mm		
<b>For models:</b>	C2P, C4P, C4PFCE, C4PFCE9, C4PFE, C4PFE9, C4PFLE, C6P, C6PFCE, C6PFCEV, C6PFE, C6PFLE, C6PFLEV, CC120E, CC80E, CC81E, I2P, I4P, SK4PFCE, SK6PFCE, SKC40E, SKC80E, TC120E, TC40E, TC80E		

energy regulators

EGO

1-circuit



1			
<b>GEV No.</b>	380021	<b>Ref. No.</b>	Y12406
<b>description</b>	energy regulator		
<b>For models:</b>	C2V, C4V, C4VFE, C4VFLE, TCV40E, TCV80E		



1			
<b>GEV No.</b>	380022	<b>Ref. No.</b>	Y12407
<b>description</b>	energy regulator		



1			
<b>GEV No.</b>	380015	<b>Ref. No.</b>	073010 X44400 Y12206 Y12406 Y44400
<b>description</b>	energy regulator 230V 13A single-circuit turn direction right shaft ø 6x4.6mm shaft L 23mm mounting thread M4 power release 6-100% no. 50.57021.010		
<b>For models:</b>	C4V, C4VFCE, C4VFE, CBE4, CBE8, CCV80E, CCV81E, CRE4, CRE6, IRE4, IRE6, K2V, K4V, K4VFCE, K4VFE, OP2V, OP4V, S110E, S300E, S600E, S680E, SK4VFCE, SKB40E, SKB80E, SKCV40E, SKCV80E, SKR40E, SKR60E, TB40E, TB80E, TCV80E, TR40E, TR60E		

2-circuit



1			
<b>GEV No.</b>	381304	<b>Ref. No.</b>	Y17604
<b>description</b>	energy regulator EGO 230V 13A dual circuit turn direction right shaft ø 6x4.6mm shaft L 22mm mounting thread M4 no. 50.55071.100		
<b>For models:</b>	C2V, C4V, C4VFCE, C4VFE, I2V, I4V, K2V, K4V, K4VFCE, K4VFE, OP2V, OP4V, SK4VFCE, SKCV40E, SKCV80E, TCV40E, TCV80E		



1			
<b>GEV No.</b>	380027	<b>Ref. No.</b>	Y12407
<b>description</b>	energy regulator EGO 230V 13A dual circuit turn direction right shaft ø 6x4.6mm shaft L 23mm mounting thread M4 power release 6-70% no. 50.55021.100		
<b>For models:</b>	C2V, C4V, C4VFE, C4VFLE, TCV40E, TCV80E		

thermostats

bi-metal thermostats

safety bi-metal thermostats



1			
<b>GEV No.</b>	390233	<b>Ref. No.</b>	N/A
<b>description</b>	bi-metal safety thermostat hole distance 24mm switch-off temp. 110°C 1NC 1-pole 16A connection F6.3 2 hole fixing without holder		
<b>accessories for</b>	390233		



<b>GEV No.</b>	504736	<b>Ref. No.</b>	—
----------------	--------	-----------------	---

bracket for contact thermostat



<b>GEV No.</b>	550388	<b>Ref. No.</b>	—
----------------	--------	-----------------	---

bracket for contact thermostat mounting distance 24.5mm mounting ø 3.8

control and safety thermostats

EGO

control thermostats

55.10/19\_ series



<b>GEV No.</b>	375055	<b>Ref. No.</b>	X43100
<b>description</b>	thermostat t.max. 110°C temperature range 30-110°C 1-pole 1CO 16A probe ø 6mm probe L 130mm capillary pipe 1500mm capillary pipe isolatedmm gland nut shaft L 23mm shaft position upper rotation 318° 250V		
<b>For models:</b>	CBE4, CBE6, CBE8, SKB40E, SKB60E, SKB80E, TB40E, TB60E, TB80E		





<b>GEV No.</b>	375054	<b>Ref. No.</b>	X43100
<b>description</b>	thermostat t.max. 110°C temperature range 30-110°C 1-pole capillary pipe isolatedmm gland nut		



<b>GEV No.</b>	375363	<b>Ref. No.</b>	40100050 E10600
<b>description</b>	thermostat t.max. 161°C temperature range 73-161°C 1-pole 1NO 16A probe ø 3mm probe L 144mm capillary pipe 1600mm capillary pipe isolated 1600mm gland nut shaft ø 6x4.6mm shaft L 23mm shaft position upper rotation 270°		
<b>For models:</b>	CPEI, CPEI9, KPI10E, KPI10E9, KPI10EA, KPI10EA9, KPI10ET, KPI10ETA, KPI15E, KPI15E9, KPI15EA, KPI15EA9, KPI15ET, KPI15ETA, KPI20E, KPI20EA, KPI20ET, KPI20ETA, KPI30E, KPI30EA, KPI30ET, KPI30ETA, KPI50E, KPI50EA, KPI50ET, KPI50ETA, OPPI10E, OPPI10EA, OPPI15E, OPPI15EA		



<b>GEV No.</b>	375063	<b>Ref. No.</b>	0000X43300
<b>description</b>	thermostat t.max. 170°C temperature range 70-170°C 1-pole 1NO 16A probe ø 11mm probe L 28mm capillary pipe 900mm capillary pipe isolated 900mm gland nut shaft L 23mm shaft position upper rotation 270° screw-in probe probe thread M14x1		
<b>accessories for</b>	375063		
	<b>GEV No.</b>	510417	<b>Ref. No.</b> N/A
	flat gasket fibre ED ø 20mm ID ø 14mm thickness 2mm Qty 1 pcs		
	<b>GEV No.</b>	510420	<b>Ref. No.</b> —
	gasket copper ED ø 19.9mm ID ø 14.3mm thickness 2mm Qty 1 pcs		
	<b>GEV No.</b>	521133	<b>Ref. No.</b> —
	nut thread M14x1.5 H 6mm WS 19 zinc-coated steel Qty 1 pcs		

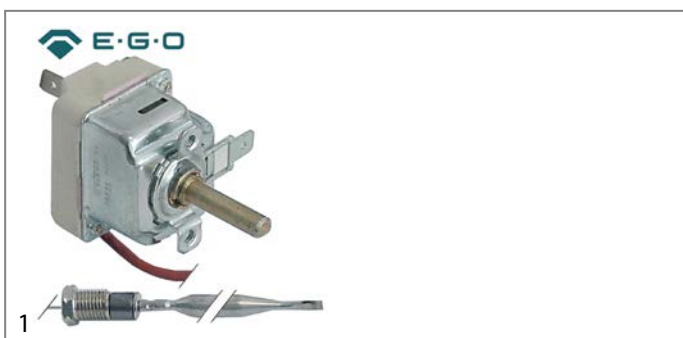

<b>GEV No.</b>	375237	<b>Ref. No.</b>	0000Y16000 X56800
<b>description</b>	thermostat t.max. 190°C temperature range 100-190°C 1-pole 1NO 16A probe ø 6mm probe L 130mm capillary pipe 1800mm capillary pipe isolated 1200mm gland nut M9x1 shaft L 23mm shaft position upper rotation 270°		
<b>For models:</b>	4DME, 4ME, 6+4LE, 6+4ME, CF15DG8, CF15G4, CF2E4, CFE15, CFE159, CFE15D, CFE15D9, KFE15, KFE159, KFE15D, KFE15D9, KFE20, KFE20D, KFE4, KFE8, KFG4, KFG8, OPFE15, OPFE15D, OPFE20, OPFE20D, SKF2E4, TF2E4		

1			
<b>GEV No.</b>	390068	<b>Ref. No.</b>	0000X43600
<b>description</b>	thermostat t.max. 269°C temperature range 55-269°C 1-pole 1CO 16A probe ø 3.1mm probe L 219mm capillary pipe 1280mm capillary pipe isolated 1270mm gland nut shaft ø 6x4.6mm shaft L 23mm shaft position upper° rotation 318°		
<b>For models:</b>	CMP4, IMP4, KBRE, KBRE12, KBRE12IN, KBREIN, KBREM, KBREM12, KBREM12IN, KBREMIN, KBRG, KBRG12, KBRG12IN, KBRGIN, KBRGM, KBRGM12, KBRGM12IN, KBRGMIN, OPBRE, OPBRE12, OPBRE12IN, OPBREIN, OPBREM, OPBREM12, OPBREM12IN, OPBREMIN, OPBRG, OPBRG12, OPBRG12IN, OPBRGIN, OPBRGM, OPBRGM12, OPBRG-12IN, OPBRGMIN, SKMP4, TMP4		

1			
<b>GEV No.</b>	375797	<b>Ref. No.</b>	Y19200
<b>description</b>	thermostat t.max. 300°C temperature range 50-300°C 1-pole 1NO 16A probe ø 6mm probe L 74mm capillary pipe 900mm capillary pipe isolatedmm gland nut shaft L 23mm shaft position upper rotation 270°		
<b>For models:</b>	CBRE, CBRE9, CBREIN, CBREIN9, CMP4, KBRE, KBRE12, KBRE12IN, KBRE9, KBREIN, KBREIN9, KBREM, KBREM12, KBREM12IN, KBREMIN, KBRG, KBRG12, KBRG12IN, KBRGIN, KBRGM, KBRGM12, KBRGM12IN, KBRGMIN, OPBRE, OPBRE12, OPBRE12IN, OPBRE12MIN, OPBREIN, OPBREM, OPBREM12, OPBREMIN, OPBRG, OPBRG12, OPBRG12IN, OPBRG12MIN, OPBRGIN, OPBRGM, OPBRGM12, OPBRGMIN, TMP4		

2			
<b>GEV No.</b>	375216	<b>Ref. No.</b>	X49600
<b>description</b>	thermostat t.max. 280°C temperature range 50-280°C 1-pole 1NO 16A probe ø 3mm probe L 228mm capillary pipe 1300mm capillary pipe isolated 1150mm gland nut shaft L 23mm shaft position upper rotation 318°		
<b>For models:</b>	CC80E, CCG80E, CCQ80E, CCV80E		

1			
<b>GEV No.</b>	375002	<b>Ref. No.</b>	X68205
<b>description</b>	thermostat t.max. 320°C temperature range 55-320°C 1-pole 1NO 16A probe ø 3.1mm probe L 226mm capillary pipe 870mm capillary pipe isolated 850mm gland nut shaft L 23mm shaft position upper rotation 270°		
<b>For models:</b>	C4FFCEP, C4FFLE, C4FFLEP, C4FZFCE, C4FZFCEP, C4FZSFCEP, C4PFCE, C4PFLE, C4PQFCE, C4VFCE, C4VFLE, C6FFCEP, C6FFLE, C6FFLEP, C6FFLEPV, C6FFLEV, C6FZFCE, C6FZFCEP, C6FZFCEPV, C6FZFCEV, C6PFCE, C6PFCEV, C6PFLE, C6PFLEV, C6PQFCE, C6PQFCEV, CC120E, CC80E, CC81E, CCG120CE, CCG120E, CCG80E, CCG81CE, CCG81E, CCQ120E, CCQ81E, CCV81E, K2FTPFCE, K4FSFCE, K4FZFCE, K4FZSFCE, K4PFCE, K4VFCE, K6FZFCE, K6PFCE, K8FZFCE, KTFPCE, M74FFXE, M74FMPFXE, M74FPFXE...(Other models you can see in the webshop)		

1			
<b>GEV No.</b>	375270	<b>Ref. No.</b>	X49800
<b>description</b>	thermostat t.max. 295°C temperature range 45-295°C 1-pole 1NO 16A probe ø 4mm probe L 100mm capillary pipe 900mm capillary pipe isolated 350mm gland nut shaft L 23mm shaft position upper rotation 270°		
<b>For models:</b>	CBRE, CBRE8, CBREIN		

55.13_series			
1			
<b>GEV No.</b>	375677	<b>Ref. No.</b>	FZ400541
<b>description</b>	thermostat t.max. 195°C temperature range 103-195°C 1-pole 1NO 16A probe ø 4mm probe L 157mm capillary pipe 2250mm capillary pipe isolated 2020mm gland nut shaft L 18mm shaft position upper rotation 270°		

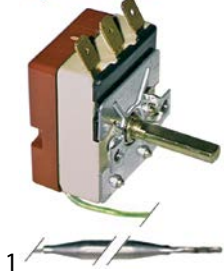

<b>GEV No.</b>	375006	<b>Ref. No.</b>	N/A
<b>description</b>	thermostat t.max. 85°C temperature range 30-85°C 1-pole 1CO 16A probe ø 6mm probe L 92mm capillary pipe 3150mm capillary pipe isolated 300mm gland nut shaft L 23mm shaft position upper rotation 270° probe material SS		



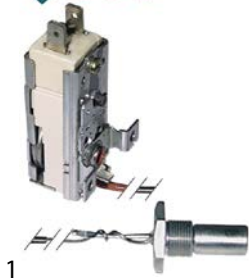

<b>GEV No.</b>	375426	<b>Ref. No.</b>	X57900
<b>description</b>	thermostat t.max. 93°C temperature range 30-93°C 1-pole 1CO 16A probe ø 6mm probe L 85mm capillary pipe 1230mm capillary pipe isolatedmm gland nut shaft position left rotation 270° probe material SS		
<b>For models:</b>	CBE4, CBE8, IBE4, IBE8, M6B4E, M7B4E, SKB40E, SKB80E, TB40E, TB80E		

55.14\_series



<b>GEV No.</b>	390001	<b>Ref. No.</b>	D236023
<b>description</b>	thermostat t.max. 58°C temperature range fixed 58°C 1-pole 1NC 16A probe ø 11mm probe L 35mm capillary pipe 580mm capillary pipe isolated 580mm gland nut shaft Lmm shaft position° shaft position screw-in probe probe thread M14x1		

**accessories for** 390001

	<b>GEV No.</b>	510417	<b>Ref. No.</b>	N/A
	flat gasket fibre ED ø 20mm ID ø 14mm thickness 2mm Qty 1 pcs			
	<b>GEV No.</b>	550261	<b>Ref. No.</b>	N/A
	nut thread M14x1 H 4mm WS 19 SS Qty 1 pcs			

55.34\_series



<b>GEV No.</b>	375022	<b>Ref. No.</b>	AEC002ZR10
<b>description</b>	thermostat t.max. 180°C temperature range 95-180°C 3-pole 3NO 16A probe ø 6mm probe L 133mm capillary pipe 1780mm capillary pipe isolated 1400mm gland nut M9x1 shaft ø ø6x4.6mm shaft L 23mm rotation 270°		
<b>For models:</b>	M6F4E, M6F6E, M7F4E, M7F6E		



<b>GEV No.</b>	375097	<b>Ref. No.</b>	0000X43800
<b>description</b>	thermostat t.max. 195°C temperature range 95-195°C 3-pole 3NO 16A probe ø 6mm probe L 117mm capillary pipe 1780mm capillary pipe isolated 1400mm gland nut M9x1 shaft ø ø6x4.6mm shaft L 23mm shaft position upper rotation 270°		
<b>For models:</b>	15DPE, 15PE, 15PSE, 6+4ME, 6DME, 6ME, 7DSET, 7SET, CF1E4, CF2E6, CF4E, CF6E, CRE4, CRE6, IF1E4, IF2E6, IF4E, IF6E, IRE4, IRE6, KFE1, KFE2, OPFE1, OPFE2, SK10DSE, SK10DSE9, SK10SE, SK10SE9, SKF1E, SKF2E, SKF4E, SKF6E, SKR40E, SKR60E, TF1E, TF2E, TF4E, TF6E, TR40E, TR60E		



<b>GEV No.</b>	375453	<b>Ref. No.</b>	0000X43200 0000X43900 Y16400
<b>description</b>	thermostat t.max. 308°C temperature range 100-300°C 3-pole 3NO 16A probe ø 6mm probe L 75mm capillary pipe 1150mm capillary pipe isolatedmm gland nut shaft ø 6x4.6mm shaft L 23mm rotation 270° probe material SS		
<b>For models:</b>	C2FTPFE, C2FTPFEF, C4FFE, C4FFPE, C4FZFE, C4FZFEP, C4FZSFEP, C4PFCE, C4PFE, C4PFE9, C4PQFCE, C4PQFCE, C4VFE, C6FFE, C6FFPE, C6FZFE, C6FZFEP, C6PFCE, C6PFCEV, C6PFE, C6PQFCE, C6PQFCEV, C6PQFE, C6PQFE8, CFTE1, CFTE1C, CFTE1R, CFTE2, CFTE22, CFTE2C, CFTE2C2, CFTE2LR, CFTE2R, CFTE2R2, CFTE3, CFTE3C, CFTE3LR, CFTE3R, CFTE4, CFTE49, CFTE4C, CFTE4C9, CFTE4R, CFTE4R9, CFTE6, CFTE62, CFTE6C, CFTE6C2, CFTE6LR, CFTE6R...(Other models you can see in the webshop)		

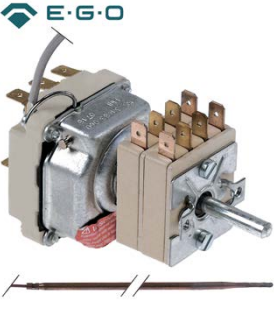

<b>GEV No.</b>	375917	<b>Ref. No.</b>	776-008-00
<b>description</b>	thermostat t.max. 550°C temperature range 85-500/85-550°C 3-pole 2NO/1NO 16A probe ø 3.9mm probe L 228mm capillary pipe 1110mm capillary pipe isolated 600mm gland nut shaft ø 6x4.6mm shaft L 23mm rotation 318° outer switch 2NO/2NO		

safety thermostats

55.10/19\_series

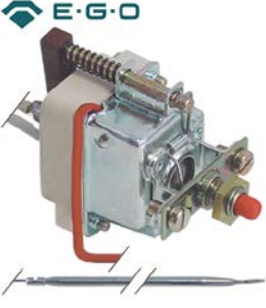

<b>GEV No.</b>	375178	<b>Ref. No.</b>	0000X56700
<b>description</b>	safety thermostat switch-off temp. 230°C 1-pole 0.5A probe ø 4mm probe L 116mm capillary pipe 1500mm capillary pipe isolatedmm gland nut probe SS		
<b>For models:</b>	CFG15, CFG15D, KFG15, KFG15D, KFG20, KFG20D, OPFG15, OPFG15D, OPFG20, OPFG20D		



<b>GEV No.</b>	375282	<b>Ref. No.</b>	0000X43400
<b>description</b>	safety thermostat switch-off temp. 230°C 1-pole 16A probe ø 11mm probe L 28mm capillary pipe 850mm capillary pipe isolated 830mm gland nut probe screw-in probe probe thread M14x1		
<b>For models:</b>	CF10DG8M, CF10G4M, KFG1, KFG2, M7F4G, M7F8G, OPFG1, OPFG2, SKF10GM, SKF20GM, TF10GM, TF20GM		
<b>accessories for</b>	375282		
	<b>GEV No.</b>	507313	<b>Ref. No.</b> —
	O-ring EPDM thickness 2.62mm ID ø 13.95mm Qty 1 pcs		
	<b>GEV No.</b>	510420	<b>Ref. No.</b> —
	gasket copper ED ø 19.9mm ID ø 14.3mm thickness 2mm Qty 1 pcs		
	<b>GEV No.</b>	521133	<b>Ref. No.</b> —
	nut thread M14x1.5 H 6mm WS 19 zinc-coated steel Qty 1 pcs		



<b>GEV No.</b>	390062	<b>Ref. No.</b>	0000X49500 0000Y16300
<b>description</b>	safety thermostat switch-off temp. 235°C 1-pole 0.5A probe ø 6mm probe L 130mm capillary pipe 1800mm capillary pipe isolated 1500mm gland nut M9x1 probe SS		
<b>For models:</b>	15DPE, 15PE, 15PSE, 4DME, 4ME, 6+4LE, 6+4ME, 6DLE, 6DME, 6LE, 6ME, 7DSE, 7DSET, 7SE, 7SET, CF15DG8, CF15G4, CF1E4, CF2E4, CF2E6, CF4E, CF6E, CFE15, CFE15D, IF1E4, IF2E6, IF4E, IF6E, KFE1, KFE15, KFE15D, KFE2, KFE20, KFE20D, KFE4, KFE8, KFG4, KFG8, OPFE1, OPFE15, OPFE15D, OPFE2, OPFE20, OPFE20D, SK10DSE, SK10DSE9, SK10SE, SK10SE9, SKF1E, SKF2E...(Other models you can see in the webshop)		
<b>accessories for</b>	390062		
	<b>GEV No.</b>	551083	<b>Ref. No.</b> —
	cap for safety thermostat thread M8x1		



<b>GEV No.</b>	375352	<b>Ref. No.</b>	0000X49500 Y16300
<b>description</b>	safety thermostat switch-off temp. 245°C 1-pole 1NC 16A probe ø 6mm probe L 130mm capillary pipe 1200mm capillary pipe isolated 1200mm gland nut probe		

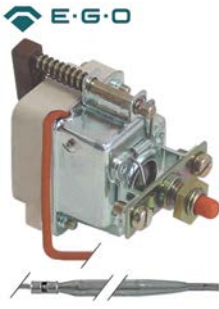

<b>GEV No.</b>	375353	<b>Ref. No.</b>	0000Y16500
<b>description</b>	safety thermostat switch-off temp. 355°C 1-pole 0.5A probe ø 4mm probe L 120mm capillary pipe 870mm capillary pipe isolated 870mm gland nut probe SS		
<b>For models:</b>	CBRE, CBRE9, CBREIN, CBREIN9, KBRE, KBRE12, KBRE12IN, KBRE9, KBREIN, KBREIN9, KBREM, KBREM12, KBREM12IN, KBREMIN, KBRG, KBRG12, KBRG12IN, KBRGIN, KBRGM, KBRGM12, KBRGM12IN, KBRG- MIN, KFT4G, KFT4GC, KFT4GR, KFT8G, KFT8G23C, KFT8GC, KFT8GLR, KFT8GR, KFTG1, KFTG1C, KFTG1R, KFTG3, KFTG3C, KFTG3LR, KFTG4, KFTG4C, KFTG4R, KFTG8, KFTG8C, KFTG8LR, KPI20GA, KPI30GA, KPI50GA, KTF4G, KTF4GC, KTF8GLR, OPBRE, OPBRE12...(Other models you can see in the webshop)		

55.32\_series

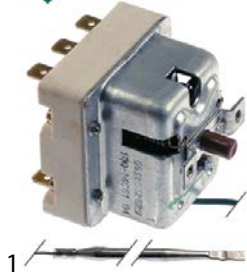

<b>GEV No.</b>	375364	<b>Ref. No.</b>	40100041 E10500
<b>description</b>	safety thermostat switch-off temp. 190°C 3-pole 20A probe ø 4mm probe L 120mm capillary pipe 3000mm capillary pipe isolated 3000mm gland nut probe		
<b>For models:</b>	CPEI, CPEI9, CPG, CPGI, KP10G, KP10GA, KP15G, KP15GA, KP110E, KP110E9, KP110EA, KP110EA9, KP110ET, KP110ETA, KP110G, KP110GA, KP110GT, KP110GTA, KP115E, KP115E9, KP115EA, KP115EA9, KP115ET, KP115ETA, KP115G, KP115GA, KP115GT, KP115GTA, KP120ET, KP120ETA, KP130ET, KP130ETA, KP150ET, KP150ETA, OPPI10E, OPPI10EA, OPPI10G, OPPI10GA, OPPI15E, OPPI15EA, OPPI15G, OPPI15GA		



<b>GEV No.</b>	375551	<b>Ref. No.</b>	AEC001ZR10
<b>description</b>	safety thermostat switch-off temp. 235°C 3-pole 20A probe ø 4mm probe L 120mm capillary pipe 1800mm capillary pipe isolated 1600mm gland nut probe SS		
<b>For models:</b>	M6F4E, M6F6E, M7F4E, M7F6E		



<b>GEV No.</b>	375252	<b>Ref. No.</b>	0000X44800
<b>description</b>	safety thermostat switch-off temp. 350°C 3-pole 20A probe ø 6mm probe L 89mm capillary pipe 3000mm capillary pipe isolated 960mm gland nut probe		
<b>For models:</b>	C4FFEP, C4ZFZE, C4ZFZEP, C4FZSFEP, C4PFCE, C4PFE, C4PFE9, C4PQFCE, C4PQFE, C4VFE, C6FFEP, C6FZFE, C6FZFEP, C6PFCE, C6PFCEV, C6PFE, C6PQFCE, C6PQFCEV, C6PQFE, CFTE1, CFTE1C, CFTE1R, CFTE2, CFTE22, CFTE2C, CFTE2C2, CFTE2LR, CFTE2R, CFTE2R2, CFTE3, CFTE3C, CFTE3LR, CFTE3R, CFTE4, CFTE49, CFTE4C, CFTE4C9, CFTE4R, CFTE4R9, CFTE6, CFTE62, CFTE6C, CFTE6C2, CFTE6LR, CFTE6R, CFTE6R2, CFTE8, CFTE89, CFTE8C, CFTE8C9...(Other models you can see in the webshop)		



<b>GEV No.</b>	375392	<b>Ref. No.</b>	Y72100
<b>description</b>	safety thermostat switch-off temp. 360°C 3-pole 1CO/2NC 20A probe ø 4mm probe L 120mm capillary pipe 1490mm capillary pipe isolated 1450mm gland nut probe SS		

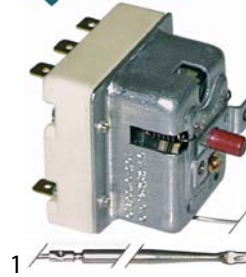

<b>GEV No.</b>	375350	<b>Ref. No.</b>	X49900 Y16600
<b>description</b>	safety thermostat switch-off temp. 360°C 3-pole 20A probe ø 4mm probe L 120mm capillary pipe 1800mm capillary pipe isolated 1800mm gland nut probe SS		

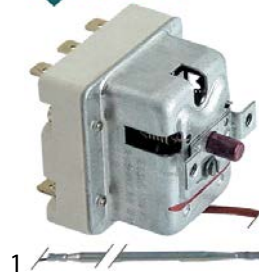

<b>GEV No.</b>	390227	<b>Ref. No.</b>	40100062 X49900
<b>description</b>	safety thermostat switch-off temp. 360°C 3-pole 20A probe ø 4mm probe L 120mm capillary pipe 1800mm capillary pipe isolated 1800mm gland nut probe SS		
<b>For models:</b>	CBRE, CBRE8, CBREIN, KPI20E, KPI20EA, KPI30E, KPI30EA, KPI50E, KPI50EA		



control thermostats with operation switch

55.10/19\_ series





<b>GEV No.</b>	390039	<b>Ref. No.</b>	X57800 X5780011
<b>description</b>	thermostat t.max. 90°C temperature range 30-90°C 1-pole 1CO 16A probe ø 6mm probe L 173mm capillary pipe 980mm capillary pipe isolated 980mm gland nut shaft ø 6x4.6mm shaft L 23mm shaft position upper rotation 270° outer switch 2NO		
<b>For models:</b>	KB4, KB8, OPB4, OPB8		
<b>accessories for</b>	390039		
	<b>GEV No.</b>	111934	<b>Ref. No.</b> —
	knob thermostat t.max. 90°C ø 50mm shaft ø 6x4.6mm shaft flat upper black temperature range 30-90°C rotation 270°		

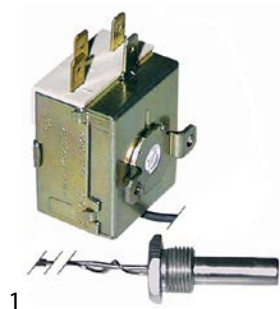

IMIT / TEMPOMATIC / ARTHERMO

control thermostats



<b>GEV No.</b>	390310	<b>Ref. No.</b>	907124
<b>description</b>	thermostat t.max. 85°C temperature range fixed 55°C 1-pole 1CO 16A probe ø 9.5mm probe L 37mm capillary pipe 600mm capillary pipe isolated 540mm gland nut shaft ømm shaft Lmm shaft position rotation° screw-in probe probe thread 3/8" probe material SS		
<b>For models:</b>	GLB615, GLB785, GLB795, GLS805, GLS845, GLS905, GLS925		
<b>accessories for</b>	390310		
	<b>GEV No.</b>	506024	<b>Ref. No.</b> 902104
	nut thread 3/8" H 6mm SS WS 22 Qty 1 pcs		
	<b>GEV No.</b>	529349	<b>Ref. No.</b> —
	flat gasket FIBER ED ø 22mm ID ø 16.5mm thickness 2mm for thread 3/8" Qty 1 pcs		



<b>GEV No.</b>	390006	<b>Ref. No.</b>	907100 907110 SD907110
<b>description</b>	thermostat t.max. 86°C temperature range 0-86°C 1-pole 1CO 16A probe ø 6.5mm probe L 95mm capillary pipe 1500mm capillary pipe isolatedmm gland nut shaft ø 6x4.6mm shaft L 19mm rotation 270°		
<b>For models:</b>	GLB785, GLB795, GLS935, GLS945, GLS945S		
<b>accessories for</b>	390006		
	<b>GEV No.</b>	110100	<b>Ref. No.</b> 903982
	knob thermostat t.max. 90°C 0-90°C ø 42mm shaft ø 6x4.6mm shaft flat -135° black		
	<b>GEV No.</b>	110105	<b>Ref. No.</b> —
	rosette knob ø 42mm ø 56mm zero mark		

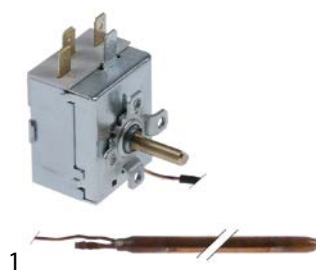

<b>GEV No.</b>	390683	<b>Ref. No.</b>	TR0440
<b>description</b>	thermostat t.max. 86°C temperature range 0-86°C 1-pole 1CO 16A probe ø 6.5mm probe L 98mm capillary pipe 1000mm capillary pipe isolated 960mm gland nut shaft ø 6x4.6mm shaft L 20mm shaft position +135° rotation 270° probe material copper		
<b>For models:</b>	GLB615, GLS805, GLS845, GLS905, GLS925		
<b>accessories for</b>	390683		
	<b>GEV No.</b>	110100	<b>Ref. No.</b> 903982
	knob thermostat t.max. 90°C 0-90°C ø 42mm shaft ø 6x4.6mm shaft flat -135° black		

safety thermostats

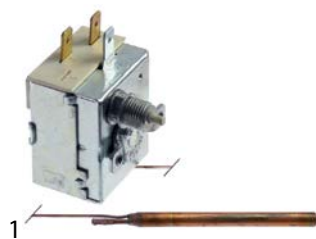

<b>GEV No.</b>	390023	<b>Ref. No.</b>	907125 SD907125
<b>description</b>	safety thermostat switch-off temp. 90-110°C 1-pole 16A probe ø 6.5mm probe L 90mm capillary pipe 1000mm capillary pipe isolatedmm gland nut probe		
<b>For models:</b>	GLB615, GLB785, GLB795, GLS805, GLS845, GLS905, GLS925, GLS935, GLS945, GLS945S		

various

control thermostats



1

<b>GEV No.</b>	390225	<b>Ref. No.</b>	X49400
<b>description</b>	thermostat		
<b>For models:</b>	4DME, 4ME, 6+4LE, 6+4ME, 6DLE, 6LE, 7DSE, 7SE		



1

<b>GEV No.</b>	375221	<b>Ref. No.</b>	X49800
<b>description</b>	thermostat gland nut		

safety thermostats



1

<b>GEV No.</b>	390676	<b>Ref. No.</b>	907120
<b>description</b>	safety thermostat switch-off temp. 60°C 1-pole 1CO 16A probe ø 7mm probe L 100mm capillary pipe 1500mm		
<b>For models:</b>	GLS935, GLS945, GLS945S		

refrigeration thermostats

RANCO

K22 series



1

<b>GEV No.</b>	390207	<b>Ref. No.</b>	I62026414
<b>description</b>	thermostat RANCO type K22L2030 probe ø 2mm probe Lmm capillary pipe 2000mm temperature range -13 up to -4°C		



1

<b>GEV No.</b>	390209	<b>Ref. No.</b>	I62020100
<b>description</b>	thermostat RANCO type K22L1020 probe ø 9mm probe L 40mm capillary pipe 2000mm temperature range -20.5 up to -1.5°C		



1

<b>GEV No.</b>	390277	<b>Ref. No.</b>	I63003800
<b>description</b>	thermostat RANCO type K22L3020 probe ø 9mm probe L 40mm capillary pipe 1600mm temperature range -26.5 up to -19.5°C		



1

<b>GEV No.</b>	390280	<b>Ref. No.</b>	I62012500
<b>description</b>	thermostat RANCO type K22L3021 probe ø 9mm probe L 35mm capillary pipe 1600mm temperature range -14 up to -9°C		



1

<b>GEV No.</b>	390279	<b>Ref. No.</b>	I62012900
<b>description</b>	thermostat RANCO type K22L3022 probe ø 9mm probe L 35mm capillary pipe 1600mm		

K50 series



1

<b>GEV No.</b>	390208	<b>Ref. No.</b>	I620209100
<b>description</b>	thermostat RANCO type K50L3006 probe ømm probe Lmm capillary pipe 2000mm temperature range +1.5 up to +4°C		

K55 series

RANCO



<b>GEV No.</b>	390210	<b>Ref. No.</b>	I62026302
<b>description</b>	thermostat RANCO type K55L1042 capillary pipe 1100mm temperature range +1.7 up to +9.5°C probe ø10x110mm		

K61 series

RANCO



<b>GEV No.</b>	390206	<b>Ref. No.</b>	I62026400
<b>description</b>	thermostat RANCO type K61L1501 probe ømm probe Lmm capillary pipe 1800mm		

accessories

probe clips

spring clips

for thermostat



<b>GEV No.</b>	550258	<b>Ref. No.</b>	M86500
<b>description</b>	probe clip for pipe ø 8mm for probe ø 6mm		
<b>For models:</b>	15DPE, 15PE, 15PSE, 4DME, 4ME, 6+4LE, 6+4ME, 6DLE, 6DME, 6LE, 6ME, 7DSE, 7SE, CF1E4, CF2E4, CF2E6, CF4E, CF6E, IF1E4, IF2E6, IF4E, IF6E, KFE1, KFE2, KFE4, KFE8, M6F4E, M6F6E, M7F4E, M7F6E, OPFE1, OPFE2, SK10DSE9, SK10SE9, SKF1E, SKF2E, SKF2E4, SKF4E, SKF6E, TF1E, TF2E, TF2E4, TF4E, TF6E		

capillary tube clips



<b>GEV No.</b>	551105	<b>Ref. No.</b>	M86800
<b>description</b>	capillary tube clip for pipe ø 6mm Qty 1 pcs		
<b>For models:</b>	CF1E4, CF2E6, CF4E, CF6E, GSP01, IF1E4, IF2E6, IF4E, IF6E, KFE1, KFE2, OPFE1, OPFE2, SKF1E, SKF2E, SKF4E, SKF6E, TF1E, TF2E, TF4E, TF6E		



<b>GEV No.</b>	550980	<b>Ref. No.</b>	M86900
<b>description</b>	capillary tube clip for pipe ø 8.5mm Qty 1 pcs		
<b>For models:</b>	15DPE, 15PE, 15PSE, 4DME, 4ME, 6+4LE, 6+4ME, 6DLE, 6DME, 6LE, 6ME, 7DSE, 7DSET, 7SE, 7SET, CF2E4, SK10DSE, SK10DSE9, SK10SE, SK10SE9, SKF2E4, TF2E4		



plunger sockets



<b>GEV No.</b>	519211	<b>Ref. No.</b>	905191
<b>description</b>	thermowell thread 1/2" L 120mm single ø 6.5mm		
<b>For models:</b>	GLS935		



<b>GEV No.</b>	510986	<b>Ref. No.</b>	TR0298
<b>description</b>	thermowell thread 1/2" L 120mm SS double ø 6.5mm		
<b>For models:</b>	GLS945, GLS945S		

<b>accessories for</b>	510986			
	<b>GEV No.</b>	361184	<b>Ref. No.</b>	—
	nut thread 1/2" H 6mm nickel-plated brass WS 24 Qty 1 pcs			
	<b>GEV No.</b>	521122	<b>Ref. No.</b>	—
	flat gasket fibre ED ø 31mm ID ø 21.5mm thickness 2mm for thread 1/2" Qty 1 pcs			

connecting bows



<b>GEV No.</b>	550060	<b>Ref. No.</b>	X44600 X457
<b>description</b>	connecting bow long for thermostat Qty 1 pcs		
<b>For models:</b>	C2FTPF, C2FTPFEP, C4FFE, C4FFEP, C4ZF, C4ZFEP, C4ZSFEP, C4PFCE, C4PFE, C4PFE9, C4PQFCE, C4PQFE, C4VFE, C6FFE, C6FFEP, C6ZF, C6ZFEP, C6PFCE, C6PFCEV, C6PFE, C6PQFCE, C6PQFCEV, C6PQFE, CBRE, CBRE8, CBREIN, CC80E, CCG80E, CCQ80E, CCTPFEP, CCV80E, CF1E4, CF2E4, CF2E6, CF4E, CF6E, CFE15, CFE159, CFE15D, CFE15D9, CFTE1, CFTE1C, CFTE1R, CFTE2, CFTE22, CFTE2C, CFTE2C2, CFTE2LR, CFTE2R, CFTE2R2...(Other models you can see in the webshop)		



# switches and momentary switches

## rocker/momentary rocker switches

30x22mm

labelled



<b>GEV No.</b>	300125	<b>Ref. No.</b>	0000X50800
----------------	--------	-----------------	------------

**description** rocker switch mounting measurements 30x22mm green 2NO 230V 16A 0-I connection male faston 6.3mm ambient temperature max. 125/55°C protection IP65 with cover cap

**For models:** CBE4, CBE6, CBE8, CC80G, CF15DG8, CF15G4, CRE4, CRE6, CSP40E, IBE4, IBE8, IRE4, IRE6, ISP4, M6B4E, M6SP4E, M7B4E, MC, SK10DSE, SK10SE, SKB40E, SKB60E, SKB80E, SKP40E, SKR40E, SKR60E, TB40E, TB60E, TB80E, TR40E, TR60E, TSP40E

**accessories for** 300125



<b>GEV No.</b>	301036	<b>Ref. No.</b>	—
----------------	--------	-----------------	---

protective cover internal size 30x22mm for rocker switch mounting measurementsmm

## push/momentary push switches

28.5x28.5mm



<b>GEV No.</b>	346866	<b>Ref. No.</b>	905324
----------------	--------	-----------------	--------

**description** momentary push switch mounting measurements 28.5x28.5mm yellow 2CO 250V 16A connection male faston 6.3mm ambient temperature max. 150/75°C protection IP40

**For models:** GLB785, GLB795



<b>GEV No.</b>	345588	<b>Ref. No.</b>	905326
----------------	--------	-----------------	--------

**description** push switch mounting measurements 28.5x28.5mm yellow 1CO 250V 16A connection male faston 6.3mm ambient temperature max. 85/125°C protection IP40

**For models:** GLB785, GLB795, GLS935

28.5x77.5mm



<b>GEV No.</b>	345590	<b>Ref. No.</b>	905327
----------------	--------	-----------------	--------

**description** switch combination latching mounting measurements 28.5x77.5mm orange/green/yellow 1NO/indicator light/indicator light 250V 16A connection male faston 6.3mm ambient temperature max. 85°C protection IP40

**For models:** GLS935

ø22mm



<b>GEV No.</b>	347425	<b>Ref. No.</b>	X56200 X69100
----------------	--------	-----------------	------------------

**description** momentary push switch mounting measurements ø22mm black 1NC/1NO 250V 5A connection screw ambient temperature max. 85°C protection IP40

**For models:** KBREM, KBREM12, KBREM12IN, KBREMIN, KBRGM, KBRGM12, KBRGM12IN, KBRGMIN, OPBRE12MIN, OPBREM, OPBREM12, OPBREM12IN, OPBREMIN, OPBRG12MIN, OPBRGM, OPBRGM12, OPBRGM12IN, OPBRGMIN



<b>GEV No.</b>	347426 <sup>1</sup>	<b>Ref. No.</b>	X56300 X69000
----------------	---------------------	-----------------	------------------

**description** momentary push switch mounting measurements ø22mm red 1NC/1NO 250V 5A connection screw ambient temperature max. 85°C protection IP40

**For models:** KBREM, KBREM12, KBREM12IN, KBREMIN, KBRGM, KBRGM12, KBRGM12IN, KBRGMIN, OPBRE12MIN, OPBREM, OPBREM12, OPBREM12IN, OPBREMIN, OPBRG12MIN, OPBRGM, OPBRGM12, OPBRGM12IN, OPBRGMIN

<sup>1</sup>incl. knob

ø25mm



<b>GEV No.</b>	345001	<b>Ref. No.</b>	D999070
----------------	--------	-----------------	---------

**description** momentary push switch mounting ø 25mm yellow 1NO/indicator light 250V 16A cover connection male faston 6.3mm ambient temperature max. 85°C protection IP65

**accessories for** 345001



<b>GEV No.</b>	345039	<b>Ref. No.</b>	—
----------------	--------	-----------------	---

protective cover round ED ø 33mm external size 23mm internal size 21mm H 12mm clear mounting ø 25mm

## microswitches

lever actuated



<b>GEV No.</b>	345773	<b>Ref. No.</b>	X52800
----------------	--------	-----------------	--------



**description** microswitch with lever 250V 16A 1CO connection male faston 6.3mm L 60mm ambient temperature max. 125°C mounting distance 22mm actuating force: 65g lever length 51mm

**For models:** 15DPE, 15PE, CF1E4, CF2E4, CF2E6, CF4E, CF6E, CFE15, CFE159, CFE15D, CFE15D9, IF1E4, IF2E6, IF4E, IF6E, KFE1, KFE15, KFE159, KFE15D, KFE15D9, KFE2, KFE20, KFE20D, OPFE1, OPFE15, OPFE15D, OPFE2, OPFE20, OPFE20D, SK10DSE, SK10SE, SKF1E, SKF2E, SKF4E, SKF6E, TF1E, TF2E, TF2E4, TF4E, TF6E



			
1			
<b>GEV No.</b>	345044	<b>Ref. No.</b>	620033
<b>description</b>	microswitch with lever 250V 16A 1CO connection male faston 6.3mm ambient temperature max. 85°C mounting distance 25mm type C99ZP3 actuating force: 25g lever length 71mm		

pin-plunger actuated

M12			
			
1			
<b>GEV No.</b>	345350	<b>Ref. No.</b>	R31600
<b>description</b>	microswitch with plunger mounting distance 22mm thread M12x0.75 thread L 16mm 250V 16A 1CO connection male faston 6.3mm stroke 4mm ambient temperature max. 125°C type EF83161.3 actuating force: 66g		
<b>For models:</b>	15DPE, 15PE, 15PSE, 4DME, 4ME, 6+4LE, 6+4ME, 6DLE, 6DME, 6LE, 6ME, 7DSE, 7SE, CRE4, CRE6, IRE4, IRE6, KFE4, KFE8, SK10DSE, SK10DSE9, SK10SE, SK10SE9, SKR40E, SKR60E, TR40E, TR60E		
<b>accessories for</b>	345350		
	<b>GEV No.</b>	345351	<b>Ref. No.</b> R3160D
	 nut thread M12x0.75 H 1.6mm WS 14 chrome-plated brass Qty 1 pcs		

			
1			
<b>GEV No.</b>	346176	<b>Ref. No.</b>	X54900
<b>description</b>	microswitch with plunger mounting distance 25mm thread M12x0.75 250V 1CO ambient temperature max. 125°C type MK V11D10		
<b>For models:</b>	CBRE, CBRE9, CBREIN, CBREIN9, KBRE, KBRE12, KBRE12IN, KBRE9, KBREIN, KBREIN9, KBREM, KBREM12, KBREM12IN, KBREMIN, KBRG, KBRG12, KBRG12IN, KBRGIN, KBRGM, KBRGM12, KBRGM12IN, KBRGMIN, OPBRE, OPBRE12, OPBRE12IN, OPBRE12MIN, OPBREIN, OPBREM, OPBREM12, OPBREM12IN, OPBREM12MIN, OPBREIN, OPBREM, OPBREM12, OPBREM12IN, OPBREM12MIN, OPBRGIN, OPBRGM, OPBRGM12, OPBRGM12IN, OPBRGMIN		

accessories

			
1			
<b>GEV No.</b>	518000	<b>Ref. No.</b>	N/A
<b>description</b>	adjusting screw for pressure pin		

			
1			
<b>GEV No.</b>	518041	<b>Ref. No.</b>	N/A
<b>description</b>	pressure pin for microswitch L 25.4mm ø 4.7mm		

system switches (ROLD)

			
1			
<b>GEV No.</b>	346498	<b>Ref. No.</b>	905307
<b>description</b>	element holder mounting measurements 28.5x28.5mm black single element holder		
<b>For models:</b>	GLB615, GLS805, GLS845, GLS905, GLS925		

			
1			
<b>GEV No.</b>	345604	<b>Ref. No.</b>	905309
<b>description</b>	element holder single mounting measurements 28.5x28.5mm black for push buttons 23x23mm		
<b>For models:</b>	GLS945, GLS945S		

			
1			
<b>GEV No.</b>	301104	<b>Ref. No.</b>	905312
<b>description</b>	momentary switch unit 1NO 250V 16A connection male faston 6.3mm		
<b>For models:</b>	GLB615, GLS805, GLS845, GLS905, GLS925		

			
1			
<b>GEV No.</b>	345606	<b>Ref. No.</b>	D226071
<b>description</b>	momentary switch unit 2CO 250V 16A connection male faston 6.3mm		



1	<b>GEV No.</b>	345650	<b>Ref. No.</b>	905313
	<b>description</b>	momentary switch unit 2CO 250V 16A connection male faston 6.3mm		
	<b>For models:</b>	GLS945		



1	<b>GEV No.</b>	346816	<b>Ref. No.</b>	N/A
	<b>description</b>	push button ø 23mm black		



1	<b>GEV No.</b>	347439	<b>Ref. No.</b>	905305
	<b>description</b>	push button ø 23mm shaft 3.7x3.7mm yellow		
	<b>For models:</b>	GLB615, GLS805, GLS845, GLS905, GLS925		



1	<b>GEV No.</b>	347100	<b>Ref. No.</b>	905317
	<b>description</b>	switch 1CO 250V 16A connection male faston 6.3mm		
	<b>For models:</b>	GLS945		



1	<b>GEV No.</b>	345651	<b>Ref. No.</b>	905314 905318
	<b>description</b>	switch 2CO 250V 16A connection male faston 6.3mm		
	<b>For models:</b>	GLB615, GLS805, GLS845, GLS905, GLS925, GLS945S		

## SWITCHES AND MOMENTARY SWITCHES GIGA

### float switches

#### floats



1	<b>GEV No.</b>	695036	<b>Ref. No.</b>	I78312700
	<b>description</b>	float for ice maker ø 75mm L 115mm H 40mm plastic		

### cam switches

#### on/off

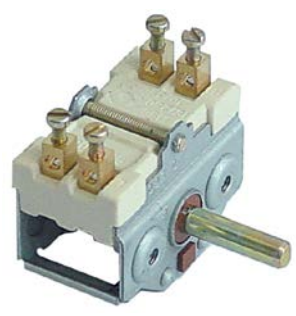

1	<b>GEV No.</b>	300151	<b>Ref. No.</b>	0000X51300
	<b>description</b>	cam switch 2 operating positions 2NO sequence 0-1 16A shaft ø 6x4.6mm shaft L 23mm connection screw ceramic		
	<b>For models:</b>	15DPE, 15PE, 15PSE, 6+4LE, 6+4ME, 6DLE, 6DME, 6LE, 6ME, 7DSET, 7SET, CMP4, IMP4, KBRE, KBRE12, KBRE12IN, KBRE9, KBREIN, KBREIN9, KBREM, KBREM12, KBREM12IN, KBREMIN, KBRG, KBRG12, KBRG12IN, KBRGIN, KBRGM, KBRGM12, KBRGM12IN, KBRGMIN, OPBRE, OPBRE12, OPBRE12IN, OPBRE12MIN, OPBREIN, OPBREM, OPBREM12, OPBREM12IN, OPBREM12MIN, OPBREIN, OPBREM, OPBREM12, OPBREM12IN, OPBREM12MIN, OPBRG, OPBRG12, OPBRG12IN, OPBRG12MIN, OPBRGIN, OPBRGM, OPBRGM12, OPBRGM12IN, OPBRGMIN, SK10DSE... (Other models you can see in the webshop)		

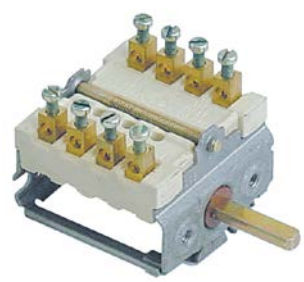

1	<b>GEV No.</b>	345665	<b>Ref. No.</b>	X40700
	<b>description</b>	cam switch 2 operating positions 4NO sequence 0-1 16A shaft ø 6x4.6mm shaft L 23mm connection screw		
	<b>For models:</b>	CRE4, KFTE1, KFTE1C, KFTE1R, KFTE3, KFTE3C, KFTE3LR, KFTE4, KFTE4C, KFTE4R, KFTE8, KFTE8C, KFTE8LR, SKR40E, TR40E		

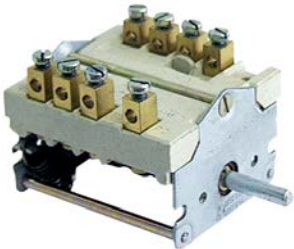
1

<b>GEV No.</b>	300095	<b>Ref. No.</b>	X40600
<b>description</b>	cam switch ON-OFF connection screw clamp		
<b>For models:</b>	CRE6, SKR60E, TR60E		

### 3 operating positions

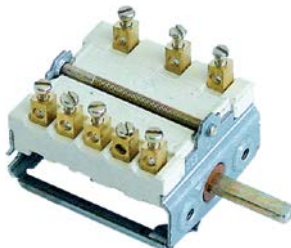

1

<b>GEV No.</b>	300167	<b>Ref. No.</b>	0000E11000 40100004
<b>description</b>	cam switch 3 operating positions 2NO/1CO sequence 0-1-2 16A shaft $\varnothing$ 6x4.6mm shaft L 23mm connection screw		
<b>For models:</b>	CPEI, CPEI9, KPI10E, KPI10E9, KPI10EA, KPI10EA9, KPI10ET, KPI10ETA, KPI15E, KPI15E9, KPI15EA, KPI15EA9, KPI15ET, KPI15ETA, KPI20E, KPI20EA, KPI20ET, KPI20ETA, KPI30E, KPI30EA, KPI30ET, KPI30ETA, KPI50E, KPI50EA, KPI50ET, KPI50ETA, M6CP4E, M7CP4E, OPPI10E, OPPI10EA, OPPI15E, OPPI15EA		

### 4-position



1

<b>GEV No.</b>	300104	<b>Ref. No.</b>	0000X44000
<b>description</b>	cam switch 4 operating positions 3NO/1CO sequence 0-1-2-3 32A shaft $\varnothing$ 6x4.6mm shaft L 23mm connection screw ceramic		
<b>For models:</b>	CCPE4, CCPE6, ICPE4, ICPE6, KCP4E, KCP82E, OPCP4E, OPCP82E, SKCP40E, SKCP60E, TCP40E, TCP60E		

### 4 operating positions

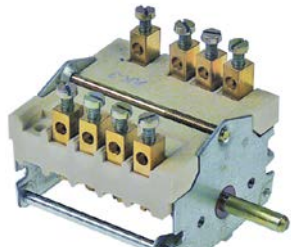

1

<b>GEV No.</b>	300076	<b>Ref. No.</b>	X40600
<b>description</b>	cam switch 4 operating positions 3NO/1CO sequence 0-1-2-3 32A shaft $\varnothing$ 6x4.6mm shaft L 23mm connection screw 4-position ceramic		

### 7-position

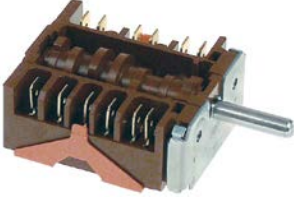

1

<b>GEV No.</b>	301250	<b>Ref. No.</b>	AEC004ZR10
<b>description</b>	cam switch 7 operating positions 1NO/2CO sequence 0-1-2-3-4-5-6 10A shaft $\varnothing$ 6x4.6mm shaft L 23mm connection male faston 6.3mm 7-position		
<b>For models:</b>	M62P, M62V, M64P, M64V, M74P, M74PFXE, M74PQ, M74PQFXE, M74V, M74VFXE, M76P, M76PFXE		

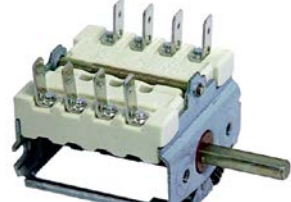

1

<b>GEV No.</b>	300184	<b>Ref. No.</b>	0000X44100
<b>description</b>	cam switch 4 operating positions sequence 0-3-2-1 shaft $\varnothing$ 6x4.6mm connection male faston 4-pole		
<b>For models:</b>	C2FTPF, C2FTPFEP, C4FFE, C4FFEP, C4FZFE, C4FZFEP, C4FZSFEP, C4PFCE, C4PFE, C4PFE9, C4PQFCE, C4PQFE, C4VFE, C6FFE, C6FFEP, C6FZFE, C6FZFEP, C6PFCE, C6PFCEV, C6PFE, C6PQFCE, C6PQFCEV, C6PQFE, CCTPFE8, CN10FE, K2FTPF, K4FFE, K4FS, K4FSFE, K4FZFE, K4FZSFE, K4PFE, K4PFE9, K4VFE, K6FFE, K6FZFE, K6PFE, K6PFE9, K8FFE, K8FZFE, KTPFE, M74FMPFE, M74FPFE, M76FMPFE, M76FPFE		



1

<b>GEV No.</b>	300004	<b>Ref. No.</b>	0000X54100
<b>description</b>	cam switch 7 operating positions 1NO/2CO sequence 0-1-2-3-4-5-6 16A shaft $\varnothing$ 6x4.6mm shaft L 23mm connection male faston 6.3mm 7-position ceramic		
<b>For models:</b>	C2P, C2PQ, C4P, C4PFCE, C4PFCE9, C4PFE, C4PFE9, C4PFLE, C4PQ, C4PQFCE, C4PQFE, C6P, C6PFCE, C6PFCEV, C6PFE, C6PFLE, C6PFLEV, C6PQ, C6PQFCE, C6PQFCEV, C6PQFE, CC120E, CC80E, CC81E, CCQ120E, CCQ80E, CCQ81E, I2P, I2PQ, I4P, I4PQ, K2P, K4P, K4PFCE, K4PFCE9, K4PFE, K4PFE9, K6P, K6PFCE, K6PFE, K6PFE9, OP2P, OP4P, OP6P, SK4PFCE, SK4PQFCE, SK6PFCE, SK6PQFCE, SKC40E, SKC80E... (Other models you can see in the webshop)		

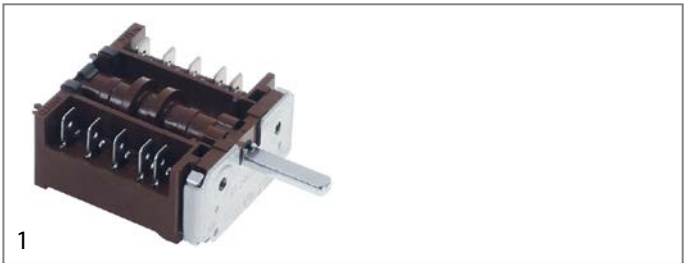

<b>GEV No.</b>	300239	<b>Ref. No.</b>	776-024-00
<b>description</b>	operation switch 4 operating positions 4NO sequence 0-1-2-3 16A shaft ø 6x4.6mm shaft L 23mm connection male faston 6.3mm plastic		

10 operating positions

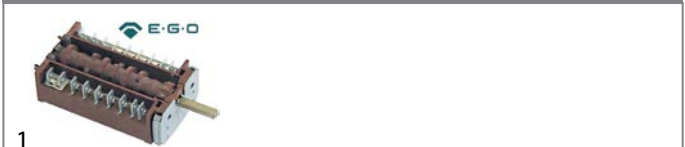

<b>GEV No.</b>	345666	<b>Ref. No.</b>	X68204
<b>description</b>	cam switch 10 operating positions 6NO/1CO sequence 0-1-2-3-4-5-6-7-8-9 8A shaft ø 6x4.6mm shaft L 23mm connection male faston 6.3mm plastic		
<b>For models:</b>	C4FFCEP, C4FFLE, C4FFLEP, C4FZFCE, C4FZFCEP, C4FZSFCEP, C4PFCE, C4PFLE, C4PQFCE, C4VFCE, C4VFLE, C6FFCEP, C6FFLE, C6FFLEP, C6FFLEPV, C6FFLEV, C6FZFCE, C6FZFCEP, C6FZFCEPV, C6FZFCEV, C6PFCE, C6PFCEV, C6PFLE, C6PFLEV, C6PQFCE, C6PQFCEV, CC120E, CC81E, CCG120CE, CCG120E, CCG81CE, CCG81E, CCQ120E, CCQ81E, CCV81E, K2FTPFCE, K4FSFCE, K4FZFCE, K4FZSFCE, K4PFCE, K4VFCE, K6FZFCE, K6PFCE, K8FZFCE, KTPFCE, SK4FZFCEP, SK4PFCE, SK4PQFCE, SK4VFCE, SK6FZFCEP...(Other models you can see in the webshop)		

operation switches



<b>GEV No.</b>	300166	<b>Ref. No.</b>	X40900
<b>description</b>	cam switch 2 operating positions 4NO 16A sequence 0-1 shaft ø 6x4.6mm shaft L 23mm connection male faston 6.3mm ceramic 4-pole ambient temperature max. 318°C		
<b>For models:</b>	CBRE, CBRE8, CBREIN, CC80E, CCG80E, CFTE1, CFTE1C, CFTE1R, CFTE2, CFTE22, CFTE2C, CFTE2C2, CFTE2LR, CFTE2R, CFTE3, CFTE3C, CFTE3LR, CFTE4, CFTE4C, CFTE4R, CFTE6, CFTE62, CFTE6C, CFTE6C2, CFTE6LR, CFTE6R, CFTE8, CFTE8C, CFTE8LR, SKBR40E, SKT1E, SKT1EC, SKT1ER, SKT2E, SKT2E2, SKT2EC, SKT2EC2, SKT2ELR, SKT2ER, SKT2ER2, SKT3E, SKT3EC, SKT3ELR, SKT40E, SKT40EC, SKT40ER, SKT60E, SKT60E2, SKT60EC, SKT60EC2...(Other models you can see in the webshop)		



<b>GEV No.</b>	300080	<b>Ref. No.</b>	0000X49700
<b>description</b>	cam switch 2 operating positions 4NO 16A sequence 0-1 shaft ø 6x4.6mm shaft L 23mm connection screw operation switch ceramic ambient temperature max. 150°C		

<b>accessories for</b>	300080			
	<b>GEV No.</b>	551456	<b>Ref. No.</b>	—
	gasket for switch ED ø 14mm ID ø 2.5mm thickness 3.5mm white			

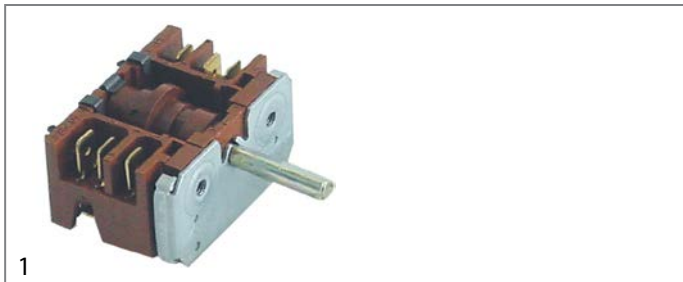

<b>GEV No.</b>	300127	<b>Ref. No.</b>	X56900
<b>description</b>	cam switch operation switch 16A connection male faston 2-pole		



<b>GEV No.</b>	345668	<b>Ref. No.</b>	X49700
<b>description</b>	operation switch		
<b>For models:</b>	C2FTPFCE, C2FTPFCEP, C4FFE, C4FFCEP, C4FZFE, C4FZFCEP, C4FZSFCEP, C4PFCE, C4PFCE, C4PFE9, C4PQFCE, C4PQFCE, C4VFE, C6FFE, C6FFCEP, C6FZFCE, C6FZFCEP, C6PFCE, C6PFCEV, C6PFE, C6PQFCE, C6PQFCEV, C6PQFE, C2TPFE8, CFE159, CFE15D9, CFTE1, CFTE1C, CFTE1R, CFTE2, CFTE22, CFTE2C, CFTE2C2, CFTE2LR, CFTE2R, CFTE2R2, CFTE3, CFTE3C, CFTE3LR, CFTE3R, CFTE4, CFTE49, CFTE4C, CFTE4C9, CFTE4R, CFTE4R9, CFTE6, CFTE62, CFTE6C, CFTE6C2...(Other models you can see in the webshop)		

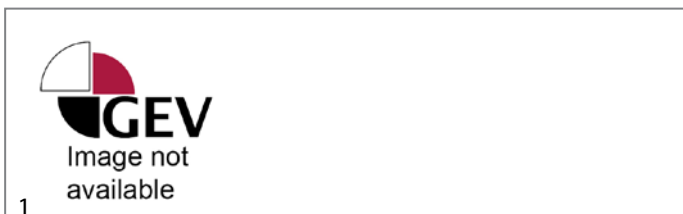

<b>GEV No.</b>	345995	<b>Ref. No.</b>	X56900
<b>description</b>	operation switch 2-pole		
<b>For models:</b>	4DME, 4ME, 6+4LE, 6+4ME		







1

<b>GEV No.</b>	300091	<b>Ref. No.</b>	0000Y16200
<b>description</b>	operation switch EGO 2 operating positions 2NO 16A sequence 0-1 shaft $\varnothing$ 6x4.6mm shaft L 23mm connection screw ceramic		
<b>For models:</b>	CBRE, CBRE9, CBREIN, CBREIN9, CF1E4, CF2E4, CF2E6, CF4E, CF6E, CFE15, CFE159, CFE15D, CFE15D9, IF1E4, IF2E6, IF4E, IF6E, KFE1, KFE15, KFE159, KFE15D, KFE15D9, KFE2, KFE20, KFE20D, KFE4, KFE8, KFG4, KFG8, M74FFXE, M74FMPFXE, M74FPFXE, M74PFXE, M74PQFXE, M74VFXE, M76FFXE, M76FMPFXE, M76FPFXE, M76PFXE, OPFE1, OPFE15, OPFE15D, OPFE2, OPFE20, OPFE20D, SKF1E, SKF2E, SKF2E4, SKF4E, SKF6E...(Other models you can see in the webshop)		

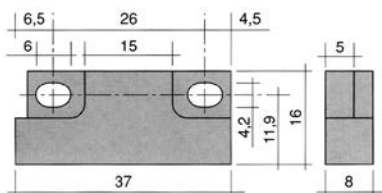
37x16mm

1

<b>GEV No.</b>	345600	<b>Ref. No.</b>	TR0666
<b>description</b>	magnetic switch L 37mm W 16mm 1NO 250V 0.2A P max. 50W connection cable cable length 960mm		
<b>For models:</b>	GLS935, GLS945, GLS945S		
<b>accessories for</b>	345600		
	<b>GEV No.</b>	519049	<b>Ref. No.</b>
			903651 908706 TR0220
	magnet $\varnothing$ mm L 63mm H 10.7mm W 18.8mm hole distance 52mm M2 hole $\varnothing$ 2mm		

touch sensitive light switches



1

<b>GEV No.</b>	402009	<b>Ref. No.</b>	I78316701
<b>description</b>	light barrier L 310mm W 35mm H 47mm		

magnetic switches

36x13mm

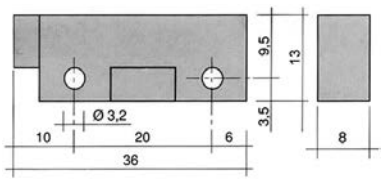



1

<b>GEV No.</b>	345118 <sup>1</sup>	<b>Ref. No.</b>	D211002
<b>description</b>	magnetic switch L 36mm W 13mm 1NO 250V 1A P max. 50W connection cable cable length 980mm		
<b>accessories for</b>	345118		
	<b>GEV No.</b>	345399	<b>Ref. No.</b>
			—
	magnet $\varnothing$ 3.3mm L 40mm H 8mm W 13mm hole distance 30mm M3		

<sup>1</sup>with coded connector

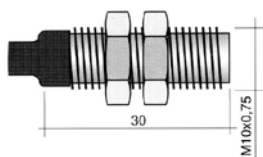
M10x0.75

1

<b>GEV No.</b>	345632	<b>Ref. No.</b>	TR0309
<b>description</b>	magnetic switch thread M10x0.75 1NO 250V 0.5A P max. 50W connection cable cable length 2000mm type 102		
<b>For models:</b>	GLB615, GLB785, GLB795, GLS805, GLS845, GLS905, GLS925		
<b>accessories for</b>	345632		
	<b>GEV No.</b>	100779	<b>Ref. No.</b>
			—
	nut thread M10x0.75 H 3mm WS 14 SS Qty 2 pcs		



## accessories

## magnets

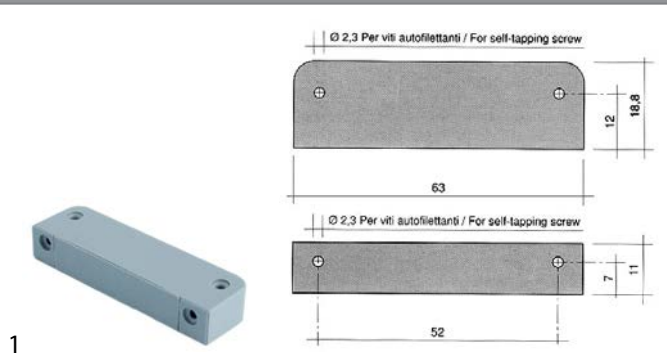

<b>GEV No.</b>	519049	<b>Ref. No.</b>	903651 908706 TR0220
<b>description</b>	magnet ømm L 63mm H 10.7mm W 18.8mm hole distance 52mm M2 hole ø 2mm		
<b>For models:</b>	GLB615, GLB785, GLB795, GLS805, GLS845, GLS905, GLS925, GLS935, GLS945, GLS945S		
<b>accessories for</b>	519049		
	<b>GEV No.</b>	560095	<b>Ref. No.</b> —
	sheet metal screws ø 2.9mm L 9.5mm SS Qty 20 pcs DIN 7981/ISO 7049 head ø 5.6mm oval head		

## control equipment

## ABB

## ø22mm

## switches (complete)



<b>GEV No.</b>	347425	<b>Ref. No.</b>	X56200 X69100
<b>description</b>	momentary push switch mounting measurements ø22mm black 1NC/1NO 250V 5A connection screw ambient temperature max. 85°C protection IP40		
<b>For models:</b>	KBREM, KBREM12, KBREM12IN, KBREMIN, KBRGM, KBRGM12, KBRGM12IN, KBRGMIN, OPBRE12MIN, OPBREM, OPBREM12, OPBREM12IN, OPBREMIN, OPBRG12MIN, OPBRGM, OPBRGM12, OPBRGM12IN, OPBRGMIN		



<b>GEV No.</b>	347426 <sup>1</sup>	<b>Ref. No.</b>	X56300 X69000
<b>description</b>	momentary push switch mounting measurements ø22mm red 1NC/1NO 250V 5A connection screw ambient temperature max. 85°C protection IP40		
<b>For models:</b>	KBREM, KBREM12, KBREM12IN, KBREMIN, KBRGM, KBRGM12, KBRGM12IN, KBRGMIN, OPBRE12MIN, OPBREM, OPBREM12, OPBREM12IN, OPBREMIN, OPBRG12MIN, OPBRGM, OPBRGM12, OPBRGM12IN, OPBRGMIN		

<sup>1</sup>incl. knob

## ERSCE



<b>GEV No.</b>	345989	<b>Ref. No.</b>	X56500
<b>description</b>	contact block ERSCE C01B 1NC max 230V 10(4)A red		
<b>For models:</b>	KBREM, KBREM12, KBREM12IN, KBREMIN, KBRGM, KBRGM12, KBRGM12IN, KBRGMIN, OPBRE12MIN, OPBREM, OPBREM12, OPBREM12IN, OPBREMIN, OPBRG12MIN, OPBRGM, OPBRGM12, OPBRGM12IN, OPBRGMIN		

## TELEMECANIQUE (EFA)

## XA2 series

## switches (complete)



<b>GEV No.</b>	345593	<b>Ref. No.</b>	TR0850
<b>description</b>	rotary selector mounting measurements ø22mm 2NO complete		
<b>For models:</b>	GLS945S		

## lamps

## indicator lights

## indicator lights 2-piece (lens and indicator lamp)

## indicator lamps for socket type SRZ / SDK / SDY / SFK



<b>GEV No.</b>	359130	<b>Ref. No.</b>	903645
<b>description</b>	indicator lamp 230V clear connection male faston 6.3mm ø 8mm		
<b>For models:</b>	GLS905, GLS925		





<b>GEV No.</b>	359133	<b>Ref. No.</b>	40200154
<b>description</b>	indicator lamp 400V green connection male faston 6.3mm		
<b>For models:</b>	KPI10ET, KPI10ETA, KPI15ET, KPI15ETA, KPI20E, KPI20EA, KPI20ET, KPI20ETA, KPI30E, KPI30EA, KPI30ET, KPI30ETA, KPI50E, KPI50EA, KPI50ET, KPI50ETA		



<b>GEV No.</b>	359132	<b>Ref. No.</b>	903633
<b>description</b>	indicator lamp green 250V connection male faston 6.3mm protection IP54 ambient temperature max. 85°C		
<b>For models:</b>	GLS905, GLS925		

indicator lights (complete)			
ø 9mm			
			
<b>GEV No.</b>	345597	<b>Ref. No.</b>	903632 903643
<b>description</b>	indicator light ø 9mm 400V green connection male faston 6.3mm temp.-resist. 85°C		
<b>For models:</b>	GLB615, GLB785, GLB795, GLS805, GLS845, GLS945, GLS945S		

			
<b>GEV No.</b>	345598	<b>Ref. No.</b>	903629 903642
<b>description</b>	indicator light ø 9mm 400V yellow connection male faston 6.3mm temp.-resist. 85°C		
<b>For models:</b>	GLB615, GLB785, GLB795, GLS805, GLS845, GLS935, GLS945, GLS945S		

ø12mm			
with screw socket			
			
<b>GEV No.</b>	359048	<b>Ref. No.</b>	076006
<b>description</b>	indicator light ø 12mm 230V yellow connection male faston 6.3mm		
<b>For models:</b>	S110E, S300E		

			
<b>GEV No.</b>	359023	<b>Ref. No.</b>	X50600
<b>description</b>	indicator light ø 12mm 24V green connection male faston 6.3mm		

			
<b>GEV No.</b>	359291	<b>Ref. No.</b>	40200152
<b>description</b>	indicator light ø 12mm 400V green connection male faston 6.3mm		
<b>For models:</b>	KPI10ET, KPI10ETA, KPI15ET, KPI15ETA, KPI20E, KPI20EA, KPI20ET, KPI20ETA, KPI30E, KPI30EA, KPI30ET, KPI30ETA, KPI50E, KPI50EA, KPI50ET, KPI50ETA		

			
<b>GEV No.</b>	359292	<b>Ref. No.</b>	40200148
<b>description</b>	indicator light ø 12mm 400V red connection male faston 6.3mm		
<b>For models:</b>	KPI10ET, KPI10ETA, KPI15ET, KPI15ETA, KPI20ET, KPI20ETA, KPI30ET, KPI30ETA, KPI50ET, KPI50ETA		

			
<b>GEV No.</b>	359290	<b>Ref. No.</b>	40200150
<b>description</b>	indicator light ø 12mm 400V yellow connection male faston 6.3mm		
<b>For models:</b>	KPI10ET, KPI10ETA, KPI15ET, KPI15ETA, KPI20E, KPI20EA, KPI20ET, KPI20ETA, KPI30E, KPI30EA, KPI30ET, KPI30ETA, KPI50E, KPI50EA, KPI50ET, KPI50ETA		

with plug-in socket			
			
<b>GEV No.</b>	359041	<b>Ref. No.</b>	0000X50900
<b>description</b>	indicator light ø 12mm green 230V connection male faston 6.3mm temp.-resist. 120°C Qty 1 pcs		
<b>For models:</b>	15DPE, 15PE, 15PSE, 4DME, 4ME, 6+4LE, 6+4ME, 6DLE, 6DME, 6LE, 6ME, 7DSE, 7DSET, 7SE, 7SET, C2FTPFE, C2FTPFEP, C2P, C2PQ, C2V, C4FFCEP, C4FFCGP, C4FFE, C4FFEP, C4FFLE, C4FFLEP, C4FZFCE, C4FZFCEP, C4FZFCG, C4FZFCGP, C4FZFE, C4FZFEP, C4FZSFCEP, C4FZSFCGP, C4FZSFEP, C4P, C4PFCE, C4PFCE9, C4PFE, C4PFE9, C4PFLE, C4PQ, C4PQFCE, C4PQFE, C4V, C4VFCE, C4VFE, C4VFLE, C6FFCEP, C6FFCGP... (Other models you can see in the webshop)		

			
<b>GEV No.</b>	359042	<b>Ref. No.</b>	0000X41200
<b>description</b>	indicator light ø 12mm yellow 230V connection male faston 6.3mm temp.-resist. 120°C Qty 1 pcs		
<b>For models:</b>	15DPE, 15PE, 15PSE, 4DME, 4ME, 6+4LE, 6+4ME, 6DLE, 6DME, 6LE, 6ME, 7DSE, 7DSET, 7SE, 7SET, C2FTPFE, C2FTPFEP, C4FFCEP, C4FFE, C4FFEP, C4FFLE, C4FFLEP, C4FZFCE, C4FZFCEP, C4FZFE, C4FZFEP, C4FZSFCEP, C4FZSFEP, C4PFCE, C4PFE, C4PFE9, C4PFLE, C4PQFCE, C4PQFE, C4VFCE, C4VFE, C4VFLE, C6FFCEP, C6FFE, C6FFEP, C6FFLE, C6FFLEP, C6FFLEPV, C6FFLEV, C6FZFCE, C6FZFCEP, C6FZFCEPV, C6FZFCEV, C6FZFE, C6FZFEP... (Other models you can see in the webshop)		

screw-on/push-on fit

light bulbs

for ovens

			
<b>GEV No.</b>	359610	<b>Ref. No.</b>	X68005
<b>description</b>	light bulb t.max. 300°C socket E14 15W 230V ø 22mm L 47mm lens L 20mm for oven lamp type Philips		
<b>For models:</b>	CC80E, CC80G, CCG80E, CCQ80E, CCV80E, GSP01		

oven lamps

universal oven lamps

mounting diameter 35.5mm



			
<b>GEV No.</b>	359718	<b>Ref. No.</b>	X68004
<b>description</b>	oven lamp mounting ø 35.5mm 230V 15W socket E14 temp.-resist. 300°C connection male faston 6.3mm hard glas		
<b>For models:</b>	CC80E, CC80G, CCG80E, CCQ80E, CCV80E, GSP01, SKC40G, SKC80G		
<b>spare parts for</b>	359718		
	<b>GEV No.</b>	<b>Ref. No.</b>	—
	 lamp socket socket E14 220-230V mounting ø 35.5mm connection male faston 6.3mm 15W		



Table continues overleaf



<b>spare parts for</b>	359718		
	<b>GEV No.</b>	359740	<b>Ref. No.</b>
			—
	light bulb t.max. 300°C socket E14 15W 230V ø 22mm L 48mm lens L 20mm for oven lamp IMPORT		

### lamps

#### light bulbs

			
			
1			
<b>GEV No.</b>	359610	<b>Ref. No.</b>	X68005
<b>description</b>	light bulb t.max. 300°C socket E14 15W 230V ø 22mm L 47mm lens L 20mm for oven lamp type Philips		
<b>For models:</b>	CC80E, CC80G, CCG80E, CCQ80E, CCV80E, GSP01		

### residual heat indicators



			
1			
<b>GEV No.</b>	359326	<b>Ref. No.</b>	Y12506
<b>description</b>	residual heat indicator 4-fold		
<b>For models:</b>	C4V, C4VFE, C4VFLE, TCV80E		



			
1			
<b>GEV No.</b>	359096	<b>Ref. No.</b>	Y12209 Y12410
<b>description</b>	residual heat indicator single		
<b>For models:</b>	C2V, CCV80E, CCV81E, SKCV40E, SKCV80E, TCV40E		



### timers

#### programme timers

			
1			
<b>GEV No.</b>	360655	<b>Ref. No.</b>	907182
<b>description</b>	timer CDC 4904DV engines 2 chambers 4 operation time 6s/180s 230V		
<b>For models:</b>	GLS805, GLS845, GLS905, GLS925, GLS935, GLS945		

			
1			
<b>GEV No.</b>	360231	<b>Ref. No.</b>	907172
<b>description</b>	timer CDC 7803 engines 1 chambers 3 operation time 120s 230V shaft ømm shaft Lmm manuf. no. 7803F1 / 360231 motor type M37RN		
<b>For models:</b>	GLB615, GLB785, GLB795		
<b>spare parts for</b>	360231		
	<b>GEV No.</b>	360119	<b>Ref. No.</b>
			—
	motor CDC pinion ø 5.4mm teeth 12 230V turn direction right motor ø 37mm motor type M37RN for timer		

			
1			
<b>GEV No.</b>	360133	<b>Ref. No.</b>	D238066
<b>description</b>	timer CDC 7804DV engines 2 chambers 4 operation time 60s / 20min 230V shaft ømm shaft Lmm manuf. no. 7804DV / 360133 motor type M37RN/M37LN		
<b>spare parts for</b>	360133		
	<b>GEV No.</b>	360119	<b>Ref. No.</b>
			—
	motor CDC pinion ø 5.4mm teeth 12 230V turn direction right motor ø 37mm motor type M37RN for timer		
	<b>GEV No.</b>	360131	<b>Ref. No.</b>
			—
	motor CDC pinion ø 5.4mm teeth 12 230V turn direction left motor ø 37mm motor type M37LN for timer		

			
1			
<b>GEV No.</b>	360215	<b>Ref. No.</b>	907183
<b>description</b>	timer CDC 7805DV engines 2 chambers 5 operation time 6s / 3min 230V shaft ømm shaft Lmm motor type M37RN/M37LN		
<b>For models:</b>	GLS945S		
<b>spare parts for</b>	360215		
	<b>GEV No.</b>	360119	<b>Ref. No.</b>
			—
	motor CDC pinion ø 5.4mm teeth 12 230V turn direction right motor ø 37mm motor type M37RN for timer		
	<b>GEV No.</b>	360131	<b>Ref. No.</b>
			—
	motor CDC pinion ø 5.4mm teeth 12 230V turn direction left motor ø 37mm motor type M37LN for timer		

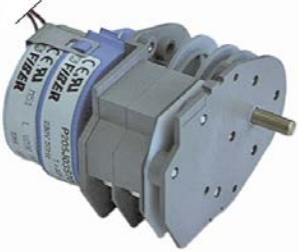



1

<b>GEV No.</b>	360160	<b>Ref. No.</b>	I62032801
<b>description</b>	timer FIBER P20 engines 1 chambers 2 operation time 32h 230V shaft $\varnothing$ 6x6x6mm shaft L 18mm manif. no. P205J03S705 motor type M51BJ0L6400		
<b>spare parts for</b>	360160		
	<b>GEV No.</b>	360674	<b>Ref. No.</b> —
	motor kit pinion $\varnothing$ 6.8mm teeth 15 230V voltage AC 50/60Hz turn direction counterclockwise motor $\varnothing$ 48mm H 18.5mm motor type UDS40NE1RNZ165 cable length 150mm with holder		





1

<b>GEV No.</b>	360052	<b>Ref. No.</b>	I62024404
<b>description</b>	timer FIBER P23 engines 1 chambers 2 operation time 15min 230V manif. no. P235JR1J707 motor type M51BJ0R6400		
<b>spare parts for</b>	360052		
	<b>GEV No.</b>	360673	<b>Ref. No.</b> —
	motor kit pinion $\varnothing$ 6.8mm teeth 15 230V voltage AC 50/60Hz turn direction clockwise motor $\varnothing$ 48mm H 18.5mm motor type UDS40NE1RNZ165 cable length 150mm with holder		





1

<b>GEV No.</b>	360163	<b>Ref. No.</b>	I62024402
<b>description</b>	timer FIBER P23 engines 1 chambers 1 operation time 15min 230V shaft L 30mm manif. no. P235JR1J706 motor type M51BJ0R6400		
<b>spare parts for</b>	360163		
	<b>GEV No.</b>	360673	<b>Ref. No.</b> —
	motor kit pinion $\varnothing$ 6.8mm teeth 15 230V voltage AC 50/60Hz turn direction clockwise motor $\varnothing$ 48mm H 18.5mm motor type UDS40NE1RNZ165 cable length 150mm with holder		



1

<b>GEV No.</b>	360233	<b>Ref. No.</b>	SD907183
<b>description</b>	timer FIBER P25 engines 2 chambers 5 operation time 6s / 3min 230V shaft $\varnothing$ 6mm shaft Lmm manif. no. P255J05JBA9 motor type M51BJ0R6400 / M51BJ0L6400		
<b>spare parts for</b>	360233		
	<b>GEV No.</b>	360673	<b>Ref. No.</b> —
	motor kit pinion $\varnothing$ 6.8mm teeth 15 230V voltage AC 50/60Hz turn direction clockwise motor $\varnothing$ 48mm H 18.5mm motor type UDS40NE1RNZ165 cable length 150mm with holder		
	<b>GEV No.</b>	360674	<b>Ref. No.</b> —
	motor kit pinion $\varnothing$ 6.8mm teeth 15 230V voltage AC 50/60Hz turn direction counterclockwise motor $\varnothing$ 48mm H 18.5mm motor type UDS40NE1RNZ165 cable length 150mm with holder		



1

<b>GEV No.</b>	360162	<b>Ref. No.</b>	62024409
<b>description</b>	timer FIBER P23 engines 1 chambers 2 operation time 12min 230V manif. no. P235JR2J501 motor type M51BJ0R6400		
<b>spare parts for</b>	360162		
	<b>GEV No.</b>	360673	<b>Ref. No.</b> —
	motor kit pinion $\varnothing$ 6.8mm teeth 15 230V voltage AC 50/60Hz turn direction clockwise motor $\varnothing$ 48mm H 18.5mm motor type UDS40NE1RNZ165 cable length 150mm with holder		

mechanical timers



1

<b>GEV No.</b>	350003	<b>Ref. No.</b>	R31700
<b>description</b>	timer M2 with bell 2-pole operation time 120min impulse mechanical 2NO at 250V 16A permanent position no shaft $\varnothing$ 6x4.6mm shaft 6x4.6mm shaft L 23mm mounting distance 28mm connection lateral		
<b>accessories for</b>	350003		
	<b>GEV No.</b>	110366	<b>Ref. No.</b> —
	knob switch zero mark t.max.°C $\varnothing$ 44mm shaft $\varnothing$ 6x4.6mm shaft flat upper black		
	<b>GEV No.</b>	111199	<b>Ref. No.</b> —
	dial plate graduation 120min permanent position no rotation 0-330° $\varnothing$ 60mm timers knob $\varnothing$ 45mm		

contactors

GENERAL ELECTRIC (AEG)

power contactors



1			
<b>GEV No.</b>	380239	<b>Ref. No.</b>	D229019
<b>description</b>	power contactor resistive load 20A 230VAC (AC3/400V) 8.4A/4kW main contacts 3NO auxiliary contacts 1NC connection screw connection type LS05 01A type AEG LS05 01A type GE MC1A 301A		



1			
<b>GEV No.</b>	380244	<b>Ref. No.</b>	0000Y10000
<b>description</b>	power contactor resistive load 25A 230VAC (AC3/400V) 9A/4kW main contacts 3NO auxiliary contacts 1NO connection screw connection type AEG LS4K 10A type GE CL00A 310		
<b>For models:</b>	15DPE, 15PE, CBRE, CBREIN, CF1E4, CF2E6, CF4E, CF6E, CFE15, CFE15D, IF1E4, IF2E6, IF4E, IF6E, KBRE, KBRE12, KBRE12IN, KBREIN, KBREM, KBREM12, KBREM12IN, KBREMIN, KFE15, KFE15D, KFE20, KFE20D, KFE4, KFE8, OPBRE, OPBRE12, OPBRE12IN, OPBREIN, OPBREM, OPBREM12, OPBREM12IN, OPBREM12MIN, OPBREIN, OPBRE12MIN, OPBRE12MIN, OPBREMIN, OPFE15, OPFE15D, OPFE20, OPFE20D, SK10DSE, SK10SE, SKF1E, SKF2E, SKF4E, SKF6E, TF1E, TF2E, TF4E, TF6E		



1			
<b>GEV No.</b>	380262	<b>Ref. No.</b>	0000Y11100
<b>description</b>	power contactor resistive load 32A 230VAC (AC3/400V) 17A/7.5kW main contacts 3NO auxiliary contacts 1NC connection screw connection type AEG LS7K01A type GE CL02A 301 H 85mm		
<b>For models:</b>	CFE15, CFE15D, CPEI, KBRE, KBRE12, KBRE12IN, KBREIN, KBREM, KBREM12, KBREM12IN, KBREMIN, KFE15, KFE15D, KFE20, KFE20D, KFE4, KFE8, OPBRE, OPBRE12, OPBRE12IN, OPBRE12MIN, OPBREIN, OPBREM, OPBREM12, OPBREM12IN, OPBREM12MIN, OPBREIN, OPBRE12MIN, OPBRE12MIN, OPBREMIN, OPFE15, OPFE15D, OPFE20, OPFE20D		



1			
<b>GEV No.</b>	380261	<b>Ref. No.</b>	X55300
<b>description</b>	power contactor resistive load 32A 230VAC (AC3/400V) 17A/7.5kW main contacts 3NO auxiliary contacts 1NO connection screw connection type AEG LS7K 10A type GE CL02A 310		
<b>For models:</b>	CBRE, CBRE8, CBREIN		

SIEMENS

power contactors



1			
<b>GEV No.</b>	380389	<b>Ref. No.</b>	907095
<b>description</b>	power contactor resistive load 22A 230VAC (AC3/400V) 9A/4kW main contacts 3NO auxiliary contacts 1NO connection screw connection type 3RT10-16-1AP01		
<b>For models:</b>	GLS805, GLS845, GLS905, GLS925, GLS945, GLS945S		

TELEMECANIQUE (Schneider Electric)

power contactors



1			
<b>GEV No.</b>	380965	<b>Ref. No.</b>	y10100
<b>description</b>	power contactor resistive load 20A 230VAC (AC3/400V) 6A/2.2kW main contacts 3NO auxiliary contacts 1NO connection screw connection type LC1K0610P7+		
<b>For models:</b>	15DPE, 15PE, 15PSE, 6+4ME, 6DME, 6ME, 7DSET, 7SET, CF1E4, CF2E4, CF2E6, CMP4, CRE4, CRE6, IMP4, IRE4, IRE6, KFE1, KFE2, OPFE1, OPFE2, SK10DSE, SK10DSE9, SK10SE, SK10SE9, SKF1E, SKF2E, SKF2E4, SKMP4, SKR40E, SKR60E, TF1E, TF2E, TF2E4, TMP4, TR40E, TR60E		



			
1			
<b>GEV No.</b>	380617	<b>Ref. No.</b>	907043
<b>description</b>	power contactor resistive load 25A 24VAC (AC3/400V) 9A/4kW main contacts 3NO auxiliary contacts 1NO/1NC connection screw connection type LC1D09B7		
<b>For models:</b>	GLS935		

			
1			
<b>GEV No.</b>	380687	<b>Ref. No.</b>	905486
<b>description</b>	power relays FINDER 230VAC 30A 2NO connection F6.3 bracket mounting manuf. no. 66.82.8.230.0300		
<b>For models:</b>	GLS905, GLS925		

## relays

### power relays

#### with bracket mounting

			
1			
<b>GEV No.</b>	380312	<b>Ref. No.</b>	N/A
<b>description</b>	power relays FINDER 230VAC 10A 3CO connection male faston 4.8mm bracket mounting dimensions 52x32.2x36.5mm manuf. no. 60.63.8.230.0000		

			
1			
<b>GEV No.</b>	380139	<b>Ref. No.</b>	905476
<b>description</b>	power relays FINDER 230VAC 16A 2CO connection F6.3 bracket mounting dimensions 68x38.2x35.8mm manuf. no. 62.82.8.230.0000		
<b>For models:</b>	GLS805, GLS845, GLS935, GLS945, GLS945S		

			
1			
<b>GEV No.</b>	380403	<b>Ref. No.</b>	905474 905475
<b>description</b>	power relays FINDER 230VAC 16A 3CO connection F6.3 bracket mounting manuf. no. 62.83.8.230.0500		
<b>For models:</b>	GLB615, GLB785, GLB795, GLS935, GLS945, GLS945S		





			
1			
<b>GEV No.</b>	380311	<b>Ref. No.</b>	N/A
<b>description</b>	power relays Italiana Relè 230VAC 20A 1NC/1NO connection F6.3 bracket mounting manuf. no. A1B-230AC-FA		

## electronic controllers

### ELIWELL

#### refrigeration controllers

##### built-in version

				
1				
<b>GEV No.</b>	379577	<b>Ref. No.</b>	F00800	
<b>description</b>	electronic controller ELIWELL type ID974 mounting measurements 71x29mm 230V voltage AC NTC/PTC relay outputs 3 relays -50 up to +150°C display 3½ digits RoomTempIN yes DEF Probe yes DEF Relay 8A fan relay 5A compressor relay 8A			
<b>accessories for</b>	379577			
	<b>GEV No.</b>	379053	<b>Ref. No.</b>	—
	temperature probe PTC 1kOhm cable PVC probe -50 up to +150°C cable -10 up to 100°C probe ø6x30mm cable length 3m without screw connection 2-wire			
	<b>GEV No.</b>	379064	<b>Ref. No.</b>	—
	temperature probe PTC 1kOhm cable silicone probe -50 up to +150°C cable -50 up to +180°C probe ø6x40mm cable length 3m without screw connection 2-wire			
	<b>GEV No.</b>	379161	<b>Ref. No.</b>	—
	temperature probe NTC 10kOhm cable thermoplastic probe -40 up to +110°C cable -40 up to +110°C probe ø6x14mm cable length 3m without screw connection 2-wire			
	<b>GEV No.</b>	379782	<b>Ref. No.</b>	—
	temperature probe PTC 1kOhm cable thermoplastic probe -50 up to +150°C cable -40 up to +110°C probe ø6x14mm cable length 3m 2-wire resistor 1kOhm			



## EVCO - EVERY CONTROL

## universal controllers

## built-in version



1

<b>GEV No.</b>	378293	<b>Ref. No.</b>	W106560253
<b>description</b>	electronic controller EVCO mounting measurements 71x29mm 230V voltage AC NTC relay outputs 1-99 up to +150°C display 4 digits 16A default setting +50 up to +70°C type EVK401N7VHXXX01		
<b>accessories for</b>	378293		
	<b>GEV No.</b>	<b>Ref. No.</b>	—
	378261		
	temperature probe NTC 10kOhm cable thermoplastic probe -40 up to +110°C cable -40 up to +110°C probe ø6x35mm cable length 3m without screw connection 2-wire		
	<b>GEV No.</b>	<b>Ref. No.</b>	—
	379057		
	temperature probe NTC 10kOhm cable PVC probe -20 up to +80°C cable -10 up to 100°C probe ø6x25mm cable length 3m 2-wire		
	<b>GEV No.</b>	<b>Ref. No.</b>	—
	379160		
	temperature probe NTC 10kOhm cable thermoplastic probe -40 up to +110°C cable -40 up to +110°C probe ø6x14mm cable length 1.5m without screw connection 2-wire		
	<b>GEV No.</b>	<b>Ref. No.</b>	—
	379161		
	temperature probe NTC 10kOhm cable thermoplastic probe -40 up to +110°C cable -40 up to +110°C probe ø6x14mm cable length 3m without screw connection 2-wire		
	<b>GEV No.</b>	<b>Ref. No.</b>	—
	379342		
	temperature probe NTC 10kOhm cable PVC probe -20 up to +80°C cable -10 up to 100°C probe ø6x25mm cable length 1.5m 2-wire protection IP67		
	<b>GEV No.</b>	<b>Ref. No.</b>	—
	379343		
	temperature probe NTC 10kOhm cable silicone probe -40 up to +110°C cable -50 up to +180°C probe ø6x40mm cable length 3m 2-wire		
	<b>GEV No.</b>	<b>Ref. No.</b>	—
	379458		
	temperature probe NTC 10kOhm cable silicone probe -40 up to +110°C cable -50 up to +180°C probe ø6x40mm cable length 1.5m without screw connection 2-wire		
	<b>GEV No.</b>	<b>Ref. No.</b>	—
	379784		
	temperature probe NTC 2kOhm cable thermoplastic probe -40 up to +110°C cable -40 up to +110°C probe ø6x35mm cable length 2m without screw connection 2-wire resistor 2kOhm		
	<b>GEV No.</b>	<b>Ref. No.</b>	—
	379860		
	temperature probe NTC 10kOhm cable PVC probe -20 up to +80°C cable -10 up to 100°C probe ø6x40mm cable length 1.5m without screw connection 2-wire		

## probes

## universal probes

## temperature probes



1

<b>GEV No.</b>	378067	<b>Ref. No.</b>	RX70401
<b>description</b>	temperature probe PTC 1kOhm cable silicone probe -50 up to +150°C cable -50 up to +180°C probe ø6x40mm cable length 2m without screw connection 2-wire		

## producer-specific probes

## probes



1

<b>GEV No.</b>	378332	<b>Ref. No.</b>	SD909025
<b>description</b>	temperature probe NTC 10kOhm cable silicone probe -40 up to +110°C cable -50 up to +180°C connection 2-wire thread probe ø6x50mm cable length 2.5m		



1

<b>GEV No.</b>	402006	<b>Ref. No.</b>	I62040406
<b>description</b>	temperature probe PTC 2kOhm cable PVC probe -50 up to +150°C cable -10 up to 100°C connection plug thread probe ø5x60mm cable length 1.5m		



1

<b>GEV No.</b>	402008	<b>Ref. No.</b>	I62040402
<b>description</b>	temperature probe PTC 2kOhm cable PVC probe -50 up to +150°C cable -10 up to 100°C connection plug thread probe ø6x50mm cable length 1.2m		



1

<b>GEV No.</b>	402191	<b>Ref. No.</b>	I62040401
<b>description</b>	temperature probe PTC 2kOhm cable TPE probe -50 up to +150°C cable -40 up to +110°C connection plug thread probe ø5x20mm cable length 1.8m		



1

<b>GEV No.</b>	378132	<b>Ref. No.</b>	RX70401
<b>description</b>	temperature probe PTC cable silicone probe -50 up to +150°C cable -50 up to +180°C connection 2-wire thread probe ø6x40mm cable length 2m		





## electronics

### PCBs

1



<b>GEV No.</b>	361366	<b>Ref. No.</b>	N/A
<b>description</b>	PCB dishwasher 11F suitable for DB2 type DB2/EV1/EKP-M		

1



<b>GEV No.</b>	403326	<b>Ref. No.</b>	SD909012
<b>description</b>	PCB dishwasher Tronic L 145mm W 116mm		

## keypads

### front foils

1



<b>GEV No.</b>	519441	<b>Ref. No.</b>	907064
<b>description</b>	front foil L 180mm W 98mm		
<b>For models:</b>	GLS9455		

## solenoïd valves

### solenoïd valves (water)

ELBI

1



<b>GEV No.</b>	370246	<b>Ref. No.</b>	N/A
<b>description</b>	solenoïd valve double straight 230VAC inlet 3/4" outlet 11.5mm t.max. 90°C ELBI plastic output B 0.5l/min flow regulating valve outlet B red		

































TP				
				
<b>GEV No.</b>	370021	<b>Ref. No.</b>	N/A	
<b>description</b>	solenoïd valve double straight 230VAC inlet 3/4" outlet 11.5mm DN10 TP flow regulating valve inlet white			
<b>spare parts for</b>	370021			
	<b>GEV No.</b>	371013	<b>Ref. No.</b>	—
<b>accessories for</b>	370021			
	<b>GEV No.</b>	371220	<b>Ref. No.</b>	—
<b>description</b>	reducer TP flow rate 3l/min red tolerance ±15%			
	<b>GEV No.</b>	371221	<b>Ref. No.</b>	—
<b>description</b>	reducer TP flow rate 5.5l/min yellow tolerance ±15%			
	<b>GEV No.</b>	371222	<b>Ref. No.</b>	—
<b>description</b>	reducer TP flow rate 6l/min grey tolerance ±15%			
	<b>GEV No.</b>	371223	<b>Ref. No.</b>	—
<b>description</b>	reducer TP flow rate 10l/min white tolerance ±15%			
	<b>GEV No.</b>	371224	<b>Ref. No.</b>	—
<b>description</b>	reducer TP flow rate 12l/min bronze tolerance ±15%			
	<b>GEV No.</b>	371225	<b>Ref. No.</b>	—
<b>description</b>	reducer TP flow rate 16l/min light brown tolerance ±15%			
	<b>GEV No.</b>	371226	<b>Ref. No.</b>	—
<b>description</b>	reducer TP flow rate 20l/min red tolerance ±15%			
	<b>GEV No.</b>	371230	<b>Ref. No.</b>	—
<b>description</b>	reducer TP flow rate 0.25l/min red tolerance ±25%			
	<b>GEV No.</b>	371231	<b>Ref. No.</b>	—
<b>description</b>	reducer TP flow rate 0.35l/min violet tolerance ±25%			
	<b>GEV No.</b>	371232	<b>Ref. No.</b>	—
<b>description</b>	reducer TP flow rate 0.5l/min orange tolerance ±25%			
	<b>GEV No.</b>	371233	<b>Ref. No.</b>	—
<b>description</b>	reducer TP flow rate 0.8l/min white tolerance ±25%			
	<b>GEV No.</b>	371234	<b>Ref. No.</b>	—
<b>description</b>	reducer TP flow rate 1l/min light blue tolerance ±25%			
	<b>GEV No.</b>	371235	<b>Ref. No.</b>	—
<b>description</b>	reducer TP flow rate 1.2l/min brown tolerance ±25%			
	<b>GEV No.</b>	371236	<b>Ref. No.</b>	—
<b>description</b>	reducer TP flow rate 1.5l/min light brown tolerance ±25%			









Table continues overleaf

1 electric components



accessories for		370021		
GEV No.	Ref. No.	Ref. No.	Ref. No.	—
	371237			
reducer TP flow rate 2.5l/min yellow tolerance ±25%				
	371238			
reducer TP flow rate 3.4l/min dark green tolerance ±25%				
	371239			
reducer TP flow rate 5l/min black tolerance ±25%				
	371240			
reducer TP flow rate 8l/min blue tolerance ±20%				

  <b>1</b>				
GEV No.	Ref. No.	Ref. No.	Ref. No.	—
370017			902390 D240011	
<b>description</b> solenoid valve single straight 230VAC inlet 3/4" outlet 11.5mm DN10 TP p max 10bar				
<b>For models:</b> GLB615, GLB785, GLB795, GLS805, GLS845, GLS905, GLS925, GLS935, GLS945, GLS945S				
spare parts for		370017		
	GEV No.	371013	Ref. No.	—
solenoid coil TP 230VAC 50/60Hz				
accessories for		370017		
	GEV No.	371220	Ref. No.	—
reducer TP flow rate 3l/min red tolerance ±15%				
	GEV No.	371221	Ref. No.	—
reducer TP flow rate 5.5l/min yellow tolerance ±15%				
	GEV No.	371222	Ref. No.	—
reducer TP flow rate 6l/min grey tolerance ±15%				
	GEV No.	371223	Ref. No.	—
reducer TP flow rate 10l/min white tolerance ±15%				
	GEV No.	371224	Ref. No.	—
reducer TP flow rate 12l/min bronze tolerance ±15%				
	GEV No.	371225	Ref. No.	—
reducer TP flow rate 16l/min light brown tolerance ±15%				
	GEV No.	371226	Ref. No.	—
reducer TP flow rate 20l/min red tolerance ±15%				
	GEV No.	371230	Ref. No.	—
reducer TP flow rate 0.25l/min red tolerance ±25%				
	GEV No.	371231	Ref. No.	—
reducer TP flow rate 0.35l/min violet tolerance ±25%				
	GEV No.	371232	Ref. No.	—
reducer TP flow rate 0.5l/min orange tolerance ±25%				

accessories for		370017		
GEV No.	Ref. No.	Ref. No.	Ref. No.	—
	371233			
reducer TP flow rate 0.8l/min white tolerance ±25%				
	371234			
reducer TP flow rate 1l/min light blue tolerance ±25%				
	371235			
reducer TP flow rate 1.2l/min brown tolerance ±25%				
	371236			
reducer TP flow rate 1.5l/min light brown tolerance ±25%				
	371237			
reducer TP flow rate 2.5l/min yellow tolerance ±25%				
	371238			
reducer TP flow rate 3.4l/min dark green tolerance ±25%				
	371239			
reducer TP flow rate 5l/min black tolerance ±25%				
	371240			
reducer TP flow rate 8l/min blue tolerance ±20%				

solenoid valves with reducers

 <b>1</b>				
GEV No.	Ref. No.	Ref. No.	Ref. No.	—
370527			65010572 I65010564	
<b>description</b> solenoid valve single straight 220-240VAC inlet 3/4" outlet 11.5mm output 0.8l/min TP plastic flow regulating valve outlet white 8VA				

pressure switches

for warewashing

ø 58mm with male faston 6.3mm

with connection horizontal

 <b>1</b>				
GEV No.	Ref. No.	Ref. No.	Ref. No.	—
541847			776-009-00	
<b>description</b> pressure control pressure range 112/70mbar connection 6mm ø 58mm				





			
1			
<b>GEV No.</b>	541781	<b>Ref. No.</b>	905288
<b>description</b>	pressure control pressure range 118/50mbar connection male faston 6.3mm ø 58mm pressure connection horizontal pressure connection ø 6mm		
<b>For models:</b>	GLS945		

			
1			
<b>GEV No.</b>	541017	<b>Ref. No.</b>	905270
<b>description</b>	pressure control with mounting strap pressure range 40/20mbar connection 6mm ø 58mm pressure connection horizontal warewashing		
<b>For models:</b>	GLB615, GLB785, GLB795, GLS805, GLS845		

			
1			
<b>GEV No.</b>	541169	<b>Ref. No.</b>	905282
<b>description</b>	pressure control pressure range 160/30mbar connection 6mm ø 58mm pressure connection horizontal warewashing		
<b>For models:</b>	GLS945S		

			
1			
<b>GEV No.</b>	541003	<b>Ref. No.</b>	N/A
<b>description</b>	pressure control pressure range 55/35mbar connection 6mm ø 58mm pressure connection horizontal warewashing pressure connection ø 6mm		

			
1			
<b>GEV No.</b>	541168	<b>Ref. No.</b>	905275
<b>description</b>	pressure control pressure range 90/35mbar connection 6mm ø 58mm pressure connection horizontal warewashing pressure connection ø 6mm		
<b>For models:</b>	GLS905, GLS925, GLS935		

			
1			
<b>GEV No.</b>	541106	<b>Ref. No.</b>	N/A
<b>description</b>	pressure control pressure range 90/56mbar connection 6mm ø 58mm pressure connection horizontal warewashing pressure connection ø 6mm		

accessories

			
1			
<b>GEV No.</b>	541109	<b>Ref. No.</b>	N/A
<b>description</b>	Y-piece plastic hose ø 8-6-8mm for pressure switch		

for refrigeration

<p>DANFOSS</p>			
			
1			
<b>GEV No.</b>	541824	<b>Ref. No.</b>	I62045100
<b>description</b>	pressure control pressure connection 6mm soldering connection type ACB-2UA426W 250V cable length 2000mm 6A -30 up to +85°C contacts 1NO		

<p>SAGI NO MIYA</p>			
			
1			
<b>GEV No.</b>	541115	<b>Ref. No.</b>	I62024800
<b>description</b>	pressure control reset manual refrigeration connection 7/16" UNF (1/4" SAE)		

<p>JOHNSON CONTROLS</p>			
			
1			
<b>GEV No.</b>	541116	<b>Ref. No.</b>	I62007500
<b>description</b>	pressure control HD switch pressure 10bar reset automatic switching diff. 1.1 bar pressure range 7-29bar p max 38bar refrigeration type P20EA-9950C connection soldering connection 6.35mm CO JOHNSON CONTROLS pressure connection soldering connection 6.35mm		



hot air fans

ebm-papst



1

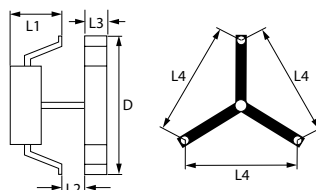

<b>GEV No.</b>	601741	<b>Ref. No.</b>	V02900
<b>description</b>	hot air fan 230V 32W 0.27A 3 hole fixing L1 60mm L2 21mm L3 20mm L4 88mm fan wheel ø 150mm type R2K150-AC01-14 ebm-papst		



1

<b>GEV No.</b>	541117	<b>Ref. No.</b>	I62023101
<b>description</b>	pressure control HD switch pressure 24bar reset manual switching diff. 4.7bar pressure range 7-29bar p max 38bar refrigeration type P20GA-9950T connection male faston 6.3mm CO JOHNSON CONTROLS pressure connection soldering connection 6.35mm		

electrodes



1

<b>GEV No.</b>	400130	<b>Ref. No.</b>	50001910
<b>description</b>	level electrode M14x1.25 total length 220mm probe L 194mm insulated probe length 26mm connection male faston 6.3mm ø 2.5mm		

fans

refrigeration fans

refrigeration motors universal

ELCO

RE series



1

<b>GEV No.</b>	601608	<b>Ref. No.</b>	FQ320590
<b>description</b>	fan motor 18W 230/240V 50/60Hz W 90mm cable length 1000mm 2600rpm ELCO R18-25/010 3 mounting options bearing slide bearing H 110mm L 90mm		
<b>spare parts for</b>	601608		
	<b>GEV No.</b>	601413	<b>Ref. No.</b> —
	fixing plate suitable for fanwheel ED ø 32mm shaft ø 7 mounting distance 26mm		

hot air motors



1

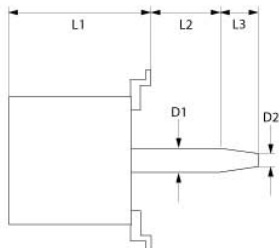

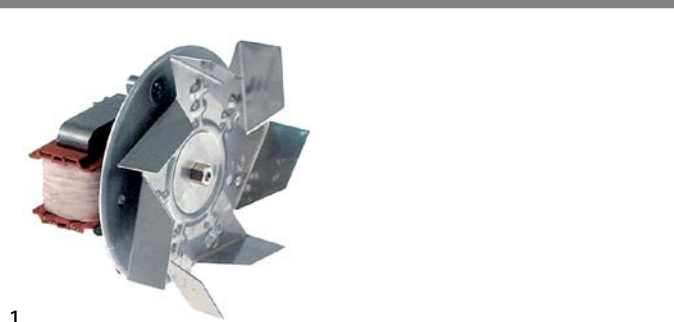

<b>GEV No.</b>	500671	<b>Ref. No.</b>	LAR65040071
<b>description</b>	fan motor 200-240V 1 phase 50/60Hz 0.11kW 2760/3320rpm speeds 1 L1 130mm L2 55mm L3 30mm D1 ø 15mm D2 ø 12mm M10L ET at 50Hz 2760rpm at 60Hz 3320rpm		

miscellaneous

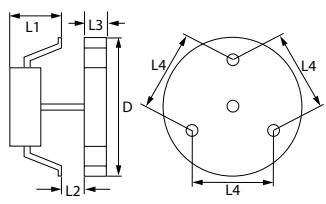

1



<b>GEV No.</b>	601054	<b>Ref. No.</b>	X68003
<b>description</b>	hot air fan 220-240V 32W 50/60Hz L1 60mm L2 10mm L3 25mm L4 87mm fan wheel ø 150mm FIME type C20X0E01/46		
<b>For models:</b>	C4FFLE, C4FFLEP, C4PFLE, C4VFLE, C6FFLE, C6FFLEP, C6FFLEPV, C6FFLEV, C6PFLE, C6PFLEV, CC120E, CC80E, CC81E, CCG120E, CCG80E, CCG81E, CCQ120E, CCQ80E, CCQ81E, CCV80E, CCV81E		
<b>spare parts for</b>	601054		
	<b>GEV No.</b>	601441	<b>Ref. No.</b> —
	fan wheel ø 150mm W 25mm shaft intake ø 6x5mm stainless steel blades 7		
<b>accessories for</b>	601054		
	<b>GEV No.</b>	550879	<b>Ref. No.</b> V05400
	insulation ø 130mm thickness 3mm hole ø 20mm for hot air fan		

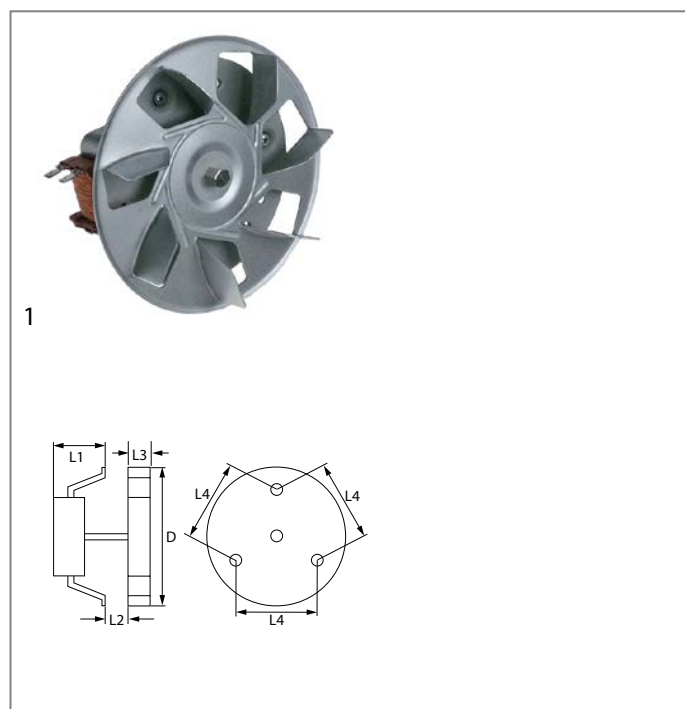

1

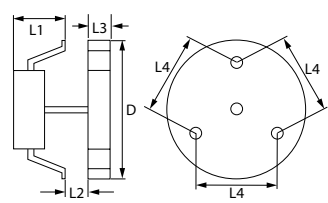

<b>GEV No.</b>	601448	<b>Ref. No.</b>	V03000
<b>description</b>	hot air fan 220-240V 32W 50/60Hz L1 60mm L2 11mm L3 25mm L4 87mm fan wheel ø 155mm FIME type C20X0E01/11		
<b>For models:</b>	C4FFCEP, C4FFCGP, C4FZFCE, C4ZFCEP, C4ZFCEG, C4ZFCEGP, C4FZSFCEP, C4FZSFCGP, C4PFCE, C4PQFCE, C4VFCE, C6FFCEP, C6FFCGP, C6FZFCE, C6FZFCEP, C6FZFCEPV, C6FZFCEV, C6FZFCEG, C6FZFCEGP, C6FZFCEGPV, C6FZFCEGV, C6PFCE, C6PFCEV, C6PQFCE, C6PQFCEV, CC120CG, CC80E, CC81CG, CCG120CE, CCG80E, CCG81CE, K2FTPFCE, K2FTPFCEG, K4FSFCE, K4FSFCEG, K4FZFCE, K4FZFCEG, K4FZSFCE, K4FZSFCEG, K4PFCE, K4VFCE, K6FZFCE, K6FZFCEG, K6PFCE, K8FZFCE, K8FZFCEG, KTPFCE, KTPFCEG, M74FFXE, M74FMPFXE...(Other models you can see in the webshop)		
<b>accessories for</b>	601448		
	<b>GEV No.</b>	550879	<b>Ref. No.</b> V05400
	insulation ø 130mm thickness 3mm hole ø 20mm for hot air fan		

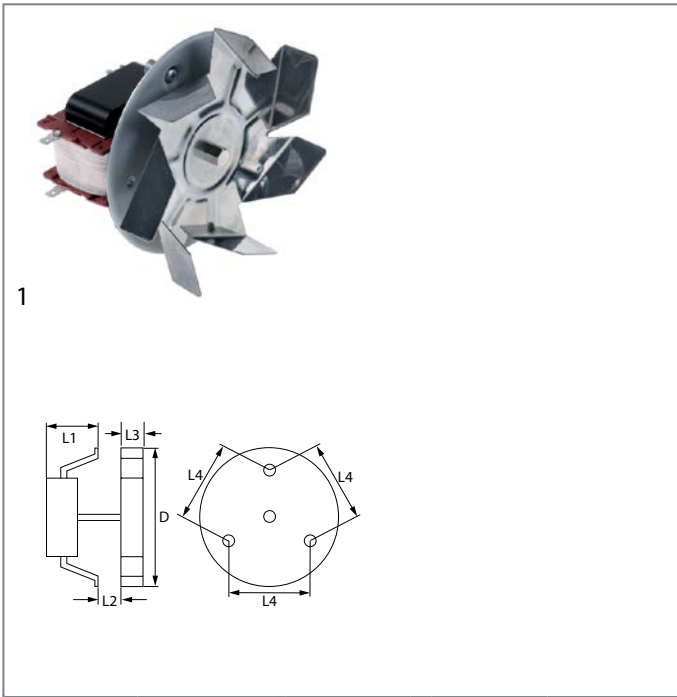

<b>GEV No.</b>	601125	<b>Ref. No.</b>	G6EX
<b>description</b>	hot air fan 220-240V 45W 50/60Hz L1 70mm L2 11mm L3 25mm L4 87mm fan wheel ø 150mm FIME type C30R0479CLF		
<b>accessories for</b>	601125		
	<b>GEV No.</b>	550879	<b>Ref. No.</b> V05400
insulation ø 130mm thickness 3mm hole ø 20mm for hot air fan			

accessories

miscellaneous







<b>GEV No.</b>	550879	<b>Ref. No.</b>	V05400
<b>description</b>	insulation ø 130mm thickness 3mm hole ø 20mm for hot air fan		
<b>For models:</b>	C4FFCEP, C4FFCGP, C4FZFCE, C4ZFCEP, C4ZFZFCG, C4FZFZFCGP, C4FZSFCEP, C4FZSFZFCGP, C4PFCE, C4PQFCE, C4VFCE, C6FFCEP, C6FFZFCGP, C6FZFCE, C6FZFCEP, C6FZFCEPV, C6FZFCEV, C6FZFZFCG, C6FZFZFCGP, C6FZFZFCGPV, C6FZFZFCGV, C6PFCE, C6PFCEV, C6PQFCE, C6PQFCEV, CC120CG, CC80E, CC81CG, CCG120CE, CCG80E, CCG81CE, K2FTPFCE, K2FTPFZFCG, K4FSFCE, K4FSFZFCG, K4FZFCE, K4FZFZFCG, K4FZSFCE, K4FZSFZFCG, K4PFCE, K4VFCE, K6FZFCE, K6FZFZFCG, K6PFCE, K8FZFCE, K8FZFZFCG, KTPFCE, KTPFZFCG, M74FFXE, M74FMPFXE...(Other models you can see in the webshop)		

pumps

wash and rinse pumps

FIR pumps



<b>GEV No.</b>	500023	<b>Ref. No.</b>	D130025
<b>description</b>	pump inlet ø 63mm outlet ø 47mm type 1225.2725 230/400V 50Hz 3 phase 1.1kW 1.5HP L 335mm rotation direction right FIR		
<b>spare parts for</b>	500023		
	<b>GEV No.</b>	510602	<b>Ref. No.</b> D124002
impellor ø 110mm H 34mm rotation direction right thread M8L shaft ø 28mm seat ø 12.2mm blades 6			
	<b>GEV No.</b>	510693	<b>Ref. No.</b> D141002
mechanical shaft seal for shaft ø 12mm slide ring ext. ø 24mm slide ring H 15.5mm slide ring int. ø 11mm counter ring mounting ø 24mm height counter ring 8mm counter ring int. ø 13.5mm			
	<b>GEV No.</b>	521513	<b>Ref. No.</b> —
pump cover FIR inlet ø 63mm outlet ø 47mm turn direction right ID ø 150mm inner height 32mm			
	<b>GEV No.</b>	524416	<b>Ref. No.</b> —
pump cover gasket thickness 4x4mm Qty 1 pcs			

LGB



1

<b>GEV No.</b>	500542	<b>Ref. No.</b>	D130097
<b>description</b>	pump inlet ø 28mm outlet ø 26mm type ZF130DX 230V 50Hz 1 phase 0.3kW 0.41HP L 190mm rotation direction left capacitor 6.3µF LGB		
<b>spare parts for</b>	500542		
	<b>GEV No.</b>	365012	<b>Ref. No.</b> —
	operating capacitor capacity 6.3µF 450V tolerance 5% 50Hz ambient temperature max. -25 to +85°C ø 30mm L 61mm M8 plastic connection male faston 6.3mm protection		
	<b>GEV No.</b>	510703	<b>Ref. No.</b> N/A
	mechanical shaft seal for shaft ø 13mm slide ring H 13mm height counter ring 5.5mm ED ø 26mm		
	<b>GEV No.</b>	521107	<b>Ref. No.</b> —
	pump cover LGB inlet ø 28mm outlet ø 26mm auxiliary pressure connection 12mm ID ø 77mm		
	<b>GEV No.</b>	521228	<b>Ref. No.</b> —
	impellor ø 72mm H 17mm rotation direction left thread M7R shaft ø 13mm shaft length 12mm blades 3		
	<b>GEV No.</b>	528800	<b>Ref. No.</b> —
	O-ring EPDM thickness 2.62mm ID ø 75.87mm Qty 1 pcs		



1

<b>GEV No.</b>	500094	<b>Ref. No.</b>	902231
<b>description</b>	pump inlet ø 28mm outlet ø 26mm type ZF131SX 230V 50Hz 1 phase 0.2kW 0.15HP L 195mm rotation direction left capacitor 6.3µF LGB		
<b>For models:</b>	GLB785, GLB795		
<b>spare parts for</b>	500094		
	<b>GEV No.</b>	365012	<b>Ref. No.</b> —
	operating capacitor capacity 6.3µF 450V tolerance 5% 50Hz ambient temperature max. -25 to +85°C ø 30mm L 61mm M8 plastic connection male faston 6.3mm protection		

<b>spare parts for</b>	500094		
	<b>GEV No.</b>	502266	<b>Ref. No.</b> —
	pump cover inlet ø 28mm outlet ø 26mm		
	<b>GEV No.</b>	510703	<b>Ref. No.</b> N/A
	mechanical shaft seal for shaft ø 13mm slide ring H 13mm height counter ring 5.5mm ED ø 26mm		
	<b>GEV No.</b>	521085	<b>Ref. No.</b> —
	impellor ø 72mm H 17mm thread M7L shaft ø 13mm shaft length 12mm blades 3		
	<b>GEV No.</b>	528800	<b>Ref. No.</b> —
	O-ring EPDM thickness 2.62mm ID ø 75.87mm Qty 1 pcs		

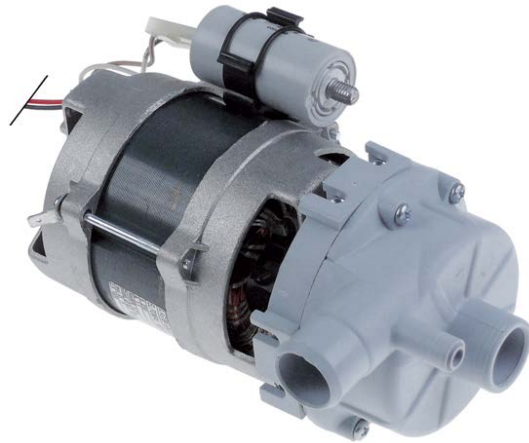





1

<b>GEV No.</b>	500567	<b>Ref. No.</b>	902238
<b>description</b>	pump inlet ø 28mm outlet ø 28mm type ZF121DX 230V 50Hz 1 phase 0.25kW L 195mm rotation direction left capacitor 6.3µF LGB		
<b>For models:</b>	GLB615		
<b>spare parts for</b>	500567		
	<b>GEV No.</b>	365012	<b>Ref. No.</b> —
	operating capacitor capacity 6.3µF 450V tolerance 5% 50Hz ambient temperature max. -25 to +85°C ø 30mm L 61mm M8 plastic connection male faston 6.3mm protection		
	<b>GEV No.</b>	510703	<b>Ref. No.</b> N/A
	mechanical shaft seal for shaft ø 13mm slide ring H 13mm height counter ring 5.5mm ED ø 26mm		
	<b>GEV No.</b>	521098	<b>Ref. No.</b> —
	pump cover LGB inlet ø 28mm outlet ø 26mm auxiliary pressure connection 12mm ID ø 77mm		
	<b>GEV No.</b>	521099	<b>Ref. No.</b> —
	impellor ø 72mm H 17mm thread M7R shaft ø 13mm shaft length 12mm		
	<b>GEV No.</b>	528800	<b>Ref. No.</b> —
	O-ring EPDM thickness 2.62mm ID ø 75.87mm Qty 1 pcs		







1

<b>GEV No.</b>	500508	<b>Ref. No.</b>	902293
<b>description</b>	pump inlet $\varnothing$ 45mm outlet $\varnothing$ 38mm type ZF320VSX 230V 50Hz 1 phase 0.75kW 1HP L 230mm rotation direction right capacitor 12.5 $\mu$ F LGB		
<b>For models:</b>	GLS945		
<b>spare parts for</b>	500508		
	GEV No.	365014	Ref. No. —
	operating capacitor capacity 12.5 $\mu$ F 450V tolerance 5%Hz ambient temperature max. -25 to +85°C $\varnothing$ 35mm L 70mm M8 plastic connection male faston 6.3mm 45S.C3DS.12.5 protection		
	GEV No.	510702	Ref. No. —
	mechanical shaft seal height counter ring 5.5mm ID $\varnothing$ 12mm		
	GEV No.	521247	Ref. No. —
	impellor $\varnothing$ 90mm H 27mm rotation direction right thread M8L blades 6		
	GEV No.	521542	Ref. No. —
	pump cover LGB inlet $\varnothing$ 45mm outlet $\varnothing$ 40mm auxiliary pressure connection 13mm supporting pressure open $\varnothing$ 150mm ID $\varnothing$ 120mm inner height 25mm		
	GEV No.	521714	Ref. No. —
	pump cover gasket thickness 4x4mm Qty 1 pcs		



1

<b>GEV No.</b>	500470	<b>Ref. No.</b>	902304
<b>description</b>	pump inlet $\varnothing$ 45mm outlet $\varnothing$ 40mm type ZF270VDX 230V 50Hz 1 phase 0.6kW 0.8HP L 225mm rotation direction left capacitor 12.5 $\mu$ F LGB		
<b>For models:</b>	GLS905, GLS925		
<b>spare parts for</b>	500470		
	GEV No.	365014	Ref. No. —
	operating capacitor capacity 12.5 $\mu$ F 450V tolerance 5%Hz ambient temperature max. -25 to +85°C $\varnothing$ 35mm L 70mm M8 plastic connection male faston 6.3mm 45S.C3DS.12.5 protection		
	GEV No.	510702	Ref. No. —
	mechanical shaft seal height counter ring 5.5mm ID $\varnothing$ 12mm		
	GEV No.	521109	Ref. No. —
	pump cover LGB inlet $\varnothing$ 45mm outlet $\varnothing$ 40mm supporting pressure 12		
	GEV No.	521111	Ref. No. —
	impellor $\varnothing$ 105mm H 29mm thread M8R shaft $\varnothing$ 20mm shaft length 5mm		
	GEV No.	521714	Ref. No. —
	pump cover gasket thickness 4x4mm Qty 1 pcs		











1

<b>GEV No.</b>	500156	<b>Ref. No.</b>	D130109
<b>description</b>	pump inlet ø 50mm outlet ø 50mm type ZF400SX 230V 50Hz 1 phase 0.6kW 0.8HP L 210mm rotation direction right capacitor 16µF LGB		
<b>spare parts for</b>	500156		
	<b>GEV No.</b>	509020	<b>Ref. No.</b> —
	impellor ø 104mm H 25mm M8L		
	<b>GEV No.</b>	510703	<b>Ref. No.</b> N/A
	mechanical shaft seal for shaft ø 13mm slide ring H 13mm height counter ring 5.5mm ED ø 26mm		
	<b>GEV No.</b>	513713	<b>Ref. No.</b> —
	pump cover bottom part		
	<b>GEV No.</b>	521548	<b>Ref. No.</b> N/A
	pump cover LGB inlet ø 50mm outlet ø 50mm		
	<b>GEV No.</b>	521562	<b>Ref. No.</b> N/A
	pump cover		
	<b>GEV No.</b>	521734	<b>Ref. No.</b> —
	pump cover bottom part		
	<b>GEV No.</b>	523509	<b>Ref. No.</b> —
	deep-groove ball bearing type 6201-2RS shaft ø 12mm ED ø 32mm W 10mm with sealing discs deep-groove ball bearing DIN 625-1		
	<b>GEV No.</b>	532623	<b>Ref. No.</b> —
	O-ring EPDM thickness 2.62mm ID ø 120.32mm Qty 1 pcs		
<b>accessories for</b>	500156		
	<b>GEV No.</b>	365021	<b>Ref. No.</b> —
	operating capacitor capacity 16µF 425V tolerance 5% 50/60Hz ambient temperature max. -25 to +85°C ø 35mm L 73mm single M8 plastic connection male faston 6.3mm 416.10.99 protection		



1





<b>GEV No.</b>	500543	<b>Ref. No.</b>	N/A
<b>description</b>	pump inlet ø 50mm outlet ø 50mm type ZF400VSX 230V 50Hz 1 phase 0.85kW 1.2HP L 245mm rotation direction right capacitor 16µF LGB		
<b>spare parts for</b>	500543		
	<b>GEV No.</b>	365021	<b>Ref. No.</b> —
	operating capacitor capacity 16µF 425V tolerance 5% 50/60Hz ambient temperature max. -25 to +85°C ø 35mm L 73mm single M8 plastic connection male faston 6.3mm 416.10.99 protection		
	<b>GEV No.</b>	509020	<b>Ref. No.</b> —
	impellor ø 104mm H 25mm M8L		
	<b>GEV No.</b>	510703	<b>Ref. No.</b> N/A
	mechanical shaft seal for shaft ø 13mm slide ring H 13mm height counter ring 5.5mm ED ø 26mm		
	<b>GEV No.</b>	521548	<b>Ref. No.</b> N/A
	pump cover LGB inlet ø 50mm outlet ø 50mm		
	<b>GEV No.</b>	521734	<b>Ref. No.</b> —
	pump cover bottom part		
	<b>GEV No.</b>	532623	<b>Ref. No.</b> —
	O-ring EPDM thickness 2.62mm ID ø 120.32mm Qty 1 pcs		



1			
<b>GEV No.</b>	500002	<b>Ref. No.</b>	D130068
<b>description</b>	pump inlet ø 60mm outlet ø 50mm type ZA400SX 230V 50Hz 1 phase 0.9kW 1.2HP L 300mm rotation direction right capacitor 20µF LGB		
<b>spare parts for</b>	500002		
	<b>GEV No.</b>	365019	<b>Ref. No.</b> —
	operating capacitor capacity 20µF 400V tolerance 5% 50/60Hz ambient temperature max. -25 to +85°C ø 39.5mm L 70mm M8 plastic connection male faston 6.3mm 16.10.25. protection		
	<b>GEV No.</b>	509020	<b>Ref. No.</b> —
	impellor ø 104mm H 25mm M8L		
	<b>GEV No.</b>	510703	<b>Ref. No.</b> N/A
	mechanical shaft seal for shaft ø 13mm slide ring H 13mm height counter ring 5.5mm ED ø 26mm		
	<b>GEV No.</b>	521547	<b>Ref. No.</b> —
	pump cover LGB inlet ø 60mm outlet ø 50mm supporting pressure M8 turn direction right ø 160mm ID ø 127mm inner height 36mm		
	<b>GEV No.</b>	532623	<b>Ref. No.</b> —
	O-ring EPDM thickness 2.62mm ID ø 120.32mm Qty 1 pcs		



1			
<b>GEV No.</b>	500469	<b>Ref. No.</b>	902322
<b>description</b>	pump inlet ø 63mm outlet ø 48mm type ZF650SX 230/400V 50Hz 3 phase 1.35kW 1.83HP L 335mm rotation direction right LGB		
<b>For models:</b>	GLS945S		
<b>spare parts for</b>	500469		
	<b>GEV No.</b>	510551	<b>Ref. No.</b> D456023
	pump cover gasket ID ø 158.3mm pump type 1214/1293/1225/2243/1226/1204/3473/1241 thickness 3.53mm EPDM Qty 1 pcs		

<b>spare parts for</b>	500469		
	<b>GEV No.</b>	510694	<b>Ref. No.</b> —
	mechanical shaft seal for shaft ø 13mm height counter ring 8mm ID ø 11.5mm H 16mm mounting ø 24/26mm int. ø 1 14mm		
	<b>GEV No.</b>	521069	<b>Ref. No.</b> —
	fanwheel cover		
	<b>GEV No.</b>	521240	<b>Ref. No.</b> —
	impellor ø 110mm H 32mm rotation direction left thread M8L shaft ø 20mm shaft length 10mm seat ø 8.2mm blades 6		
	<b>GEV No.</b>	521536	<b>Ref. No.</b> —
	pump cover ALBA / LGB inlet ø 62mm outlet ø 50mm auxiliary pressure connection 12mm supporting pressure closed turn direction right ø 180mm ID ø 150mm inner height 38mm		

booster pumps II

accessories

1			
	<b>GEV No.</b>	365015	<b>Ref. No.</b> 901730
	operating capacitor capacity 10µF 400V tolerance 5%Hz ambient temperature max. -25 to +85°C ø 35.5mm L 59mm M8 plastic connection male faston 6.3mm protection		
<b>For models:</b>	GLS805, GLS845, GLS905, GLS925		

pumps for ice machines

1			
	<b>GEV No.</b>	500047	<b>Ref. No.</b> I6204330
	pump REBO type MH30F1 30W 230V 50Hz outlet ø 12.7mm L 135mm rotation direction left		

1			
	<b>GEV No.</b>	500204	<b>Ref. No.</b> I67000206
	pump REBO type MH50F 60W 230V 50Hz inlet ø 19mm outlet ø 19mm L 125mm rotation direction right for ice-cube maker		



			
1			
<b>GEV No.</b>	500048	<b>Ref. No.</b>	179311303
<b>description</b>	pump REBO type MH50F 60W 230V 50Hz outlet ø 18mm L 137mm rotation direction right for ice maker		

			
1			
<b>GEV No.</b>	500203	<b>Ref. No.</b>	167000212
<b>description</b>	pump REBO type MH50F 60W 230V 50Hz outlet ø 21mm L 110mm rotation direction right for ice maker		

			
1			
<b>GEV No.</b>	500046	<b>Ref. No.</b>	167003606
<b>description</b>	pump REBO type NR40 40W 230V 50Hz inlet ø 12mm outlet ø 12mm L 75mm rotation direction right for ice-cube maker		

## condensators & interference suppression filters

### operating capacitors

#### plastic

			
1			
<b>GEV No.</b>	365015	<b>Ref. No.</b>	901730
<b>description</b>	operating capacitor capacity 10µF 400V tolerance 5%Hz ambient temperature max. -25 to +85°C ø 35.5mm L 59mm M8 plastic connection male faston 6.3mm protection		
<b>For models:</b>	GLS805, GLS845, GLS905, GLS925		

### filters

#### interference suppression filters

			
1			
<b>GEV No.</b>	365130	<b>Ref. No.</b>	902105
<b>description</b>	interference suppression filter capacity 0.47µF(X2)+2x0.01µF(Y2) 1M0hm		
<b>For models:</b>	GLS805, GLS845, GLS935, GLS945S		

			
1			
<b>GEV No.</b>	365168	<b>Ref. No.</b>	902107
<b>description</b>	interference suppression filter type FCP045000 250V 50/60Hz conductor 4 with E connection male faston 6.3mm L 56mm ø 38mm Hmm Wmm M8 plastic Qty 1 pcs		
<b>For models:</b>	GLS905, GLS925, GLS945		

			
1			
<b>GEV No.</b>	365048	<b>Ref. No.</b>	N/A
<b>description</b>	interference suppression filter type KPB7028 275V 50/60Hz conductor 2 with E connection male faston 6.3mm L 50mm ø 38mm Hmm Wmm M8 aluminium Qty 1 pcs		

### fuses

#### fine fuses

			
1			
<b>GEV No.</b>	358605	<b>Ref. No.</b>	40200084
<b>description</b>	fine fuse size ø5x20mm 3.15A slow-acting rated 250V Qty 10 pcs		
<b>For models:</b>	KPI10ET, KPI10ETA, KPI15ET, KPI15ETA		



## electric accessories

## cables

## accessories

## cable glands

## threaded cable glands

## screw connections



1

<b>GEV No.</b>	530431	<b>Ref. No.</b>	902687
<b>description</b>	cable gland thread PG13.5 cable $\varnothing$ 12mm mounting $\varnothing$ 21mm Qty 1 pcs plastic WS 24		
<b>For models:</b>	GLB615, GLB785, GLB795		

## terminals

## connection terminals with screw/faston connections



1

<b>GEV No.</b>	550278	<b>Ref. No.</b>	904140
<b>description</b>	power terminal block 3-pole max. 40A max 400V connection $\varnothing$ 6mm <sup>2</sup> / F6.3 temp.-resist. 150°C cross section 6mm <sup>2</sup>		
<b>For models:</b>	GLB615, GLB785, GLB795		



1

<b>GEV No.</b>	550411	<b>Ref. No.</b>	904150 X59000
<b>description</b>	power terminal block 6-pole max. 40A max 450V connection $\varnothing$ 6mm <sup>2</sup> / F6.3 temp.-resist. 150°C cross section 6mm <sup>2</sup>		
<b>For models:</b>	C1W, C2I, C2P, C2PQ, C2V, C4FFEP, C4ZFCE, C4ZFCEP, C4ZSFEP, C4I, C4P, C4PQ, C4V, C4VFCE, C4VFE, C6FFEP, C6FZFE, C6FZFEP, C6P, C6PQ, CBRE, CBRE9, CBREIN, CBREIN9, CC80E, CCPE4, CCPE6, CF1E4, CF2E4, CF2E6, CF4E, CF6E, CFTE1, CFTE1C, CFTE1R, CFTE2, CFTE22, CFTE2C, CFTE2C2, CFTE2LR, CFTE2R, CFTE2R2, CFTE3, CFTE3C, CFTE3LR, CFTE3R, CFTE4, CFTE49, CFTE4C, CFTE4C9...(Other models you can see in the webshop)		

## connection terminals with screw connection



1

<b>GEV No.</b>	550470	<b>Ref. No.</b>	X59200
<b>description</b>	power terminal block 3-pole max. 40A max 400V connection M6/M6 temp.-resist. 150°C cross section 6mm <sup>2</sup>		
<b>For models:</b>	C4FFCEP, C4FFCGP, C4ZFCE, C4ZFCEP, C4ZFCEG, C4ZFCEGP, C4ZSFCEP, C4ZSFCEGP, C4PFCE, C4PQFCE, C4VFCE, C6FFCEP, C6FFCEGP, C6FZFCE, C6FZFCEP, C6FZFCEPV, C6FZFCEV, C6FZFCEG, C6FZFCEGP, C6FZFCEGPV, C6FZFCEGV, C6PFCE, C6PFCEV, C6PQFCE, C6PQFCEV, CBE4, CBE8, CC120CG, CC80G, CC81CG, CCG120CE, CCG80E, CCG81CE, CSP40E, GSP01, IBE4, IBE8, ISP4, K2FTPFCE, K2FTPFE, K4FFE, K4FSFCE, K4FSFE, K4ZFCE, K4ZFCE, K4ZSFCE, K4ZSFE, K4PFE, K4VFE, K6FFE...(Other models you can see in the webshop)		



1

<b>GEV No.</b>	550507	<b>Ref. No.</b>	X59100
<b>description</b>	power terminal block 4-pole max. 40A max 400V connection M6/M6 temp.-resist. 150°C		
<b>For models:</b>	CF1E4, CF2E6, CF4E, CF6E, CFE15, CFE159, CFE15D, CFE15D9, CMP4, IF1E4, IF2E6, IMP4, KFE1, KFE15, KFE159, KFE15D, KFE15D9, KFE2, KFE20, KFE20D, OPFE1, OPFE15, OPFE15D, OPFE2, OPFE20, OPFE20D, SKF1E, SKF2E, SKF4E, SKF6E, SKMP4, TF1E, TF2E, TF4E, TF6E, TMP4		

## connection terminals with faston connections

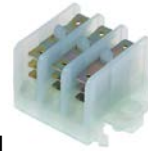

1

<b>GEV No.</b>	519304	<b>Ref. No.</b>	955068
<b>description</b>	distribution terminal block 3-pole max. 15A max 450V connection male faston 6.3mm temp.-resist. 110°C Qty 1 pcs		
<b>For models:</b>	GLS935, GLS945		

## plug-in terminal blocks



1

<b>GEV No.</b>	519360	<b>Ref. No.</b>	904170
<b>description</b>	plug-in terminal block 16-pole max. 32A max 450V connection screw connection temp.-resist. 150°C cross section 4mm <sup>2</sup> female		
<b>For models:</b>	GLS805, GLS845, GLS905, GLS925		



			
1			
<b>GEV No.</b>	519361	<b>Ref. No.</b>	904200
<b>description</b>	plug-in terminal block 16-pole max. 32A max 450V connection screw connection temp.-resist. 150°C cross section 4mm <sup>2</sup> male		
<b>For models:</b>	GLS805, GLS845, GLS905, GLS925		

**rail-mounted terminals**

**rail-mounted terminal blocks**

			
1			
<b>GEV No.</b>	550407	<b>Ref. No.</b>	0000X53900 X53400+X53700+X53800+X53900
<b>description</b>	rail-mounted terminal block 5-pole cross section 16mm <sup>2</sup> max 600V		
<b>For models:</b>	C2V, C4PFCE, C4PFE, C4PFE9, C4PQFCE, C4PQFE, C4V, C4VFCE, C4VFE, C6PFCE, C6PFCEV, C6PFE, C6PQFCE, C6PQFCEV, C6PQFE, CF1E4, CF2E6, CF4E, CF6E, CFE15, CFE159, CFE15D, CFE15D9, IF1E4, IF2E6, IF4E, K2V, K4PFE, K4PFE9, K4V, K4VFCE, K4VFE, K6PFE, K6PFE9, KBRE, KBRE12, KBRE12IN, KBRE9, KBREIN, KBREIN9, KBREM, KBREM12, KBREM12IN, KBREMIN, KFE1, KFE15, KFE159, KFE15D, KFE15D9, KFE2... (Other models you can see in the webshop)		

**WIELAND**

**rail-mounted terminals type 9700A**

			
1			
<b>GEV No.</b>	550375	<b>Ref. No.</b>	904169
<b>description</b>	rail-mounted terminal WIELAND type 9700A/10 SL2 S35 1.5-16mm <sup>2</sup> top-hat rail 35mm yellow/green W 10mm L 53mm		
<b>For models:</b>	GLS935		



**various**

			
Image not available			
1			
<b>GEV No.</b>	550408	<b>Ref. No.</b>	X52500
<b>description</b>	power terminal block		
<b>For models:</b>	CF1E4, CF2E6, CFE15, CFE15D, KFE1, KFE15, KFE15D, KFE2, KFE20, KFE20D, KFE4, KFE8, SKF1E, SKF2E, TF1E, TF2E		











**gas taps**

**PEL**

**20S series**

				
1				
<b>GEV No.</b>	101094	<b>Ref. No.</b>	0000X10100	
<b>description</b>	gas tap PEL type 20S gas inlet M16x1.5 (tube ø 10mm) bypass nozzle ø 0.35mm gas outlet M16x1.5 (tube ø 10/8mm) thermocouple connection M8x1 pilot connection shaft ø 8x6.5mm shaft L 22/15mm shaft flat lower			
<b>spare parts for</b>	101094			
	<b>GEV No.</b>	100408	<b>Ref. No.</b>	—
	bypass nozzle type PEL20/21 bore ø 0.35mm thread M5x0.5			
	<b>GEV No.</b>	101060	<b>Ref. No.</b>	—
	magnet unit standard L 39mm D1 ø 15.4mm D2 ø 11mm suitable for PEL20-21/JUNKERS/EGA			
	<b>GEV No.</b>	101205	<b>Ref. No.</b>	—
	gas tap front part shaft ø 8x6.5mm shaft L 22/15mm shaft flat upper/lower suitable for PEL20			
	<b>GEV No.</b>	101230	<b>Ref. No.</b>	—
	thermocouple nut T1: M8x1 T2: M18x1 aluminium			
<b>accessories for</b>	101094			
	<b>GEV No.</b>	101278	<b>Ref. No.</b>	—
	olive for pipe ø 10mm Qty 1 pcs			
	<b>GEV No.</b>	101300	<b>Ref. No.</b>	—
	union nut thread M16x1.5 tube ø 10mm			
	<b>GEV No.</b>	101450	<b>Ref. No.</b>	—
	olive for pipe ø 8mm L 12.7mm Qty 1 pcs ED ø 10mm			
	<b>GEV No.</b>	101451	<b>Ref. No.</b>	—
	union nut thread M16x1.5 tube ø 8mm			
	<b>GEV No.</b>	110081	<b>Ref. No.</b>	—
	knob ø 70mm shaft ø 8x6.5mm shaft flat universal			
	<b>GEV No.</b>	110083	<b>Ref. No.</b>	—
	knob dial plate gas tap without ignition flame silver			



			
1			
<b>GEV No.</b>	101491	<b>Ref. No.</b>	0000X10100 0000X10400 1000X10100 2000X10100 2000X10400 3000X10100 X08000
<b>description</b>	gas tap PEL type 20S gas inlet M16x1.5 (tube ø 10mm) bypass nozzle ø 0.35mm gas outlet M16x1.5 (tube ø 10/8mm) thermocouple connection M9x1 pilot connection shaft ø 8x6.5mm shaft L 22/15mm shaft flat lower		
<b>For models:</b>	B4F, B6F, B8F, C2F, C2FTPF, C2FTPF, C2FZ, C2TP2FGP, C4F, C4FFE, C4FFG, C4FFLE, C4FFLG, C4FZ, C4FZFC, C4FZFCG, C4FZFE, C4FZFG, C6F, C6FFE, C6FFG, C6FFGA, C6FFLE, C6FFLEV, C6FFLG, C6FFLV, C6FZ, C6FZFC, C6FZFCV, C6FZFCG, C6FZFCV, C6FZFE, C6FZFG, C6FZFGA, CC120G, CC80G, CC81G, CCG120E, CCG80E, CCG81E, K2F, K2FTPF, K4F, K4FFE, K4FFG, K6F, K6FFE, K6FFG, K8F, K8FFG...(Other models you can see in the webshop)		
<b>spare parts for</b>	101491		
	<b>GEV No.</b>	100408	<b>Ref. No.</b> —
	bypass nozzle type PEL20/21 bore ø 0.35mm thread M5x0.5		
	<b>GEV No.</b>	101060	<b>Ref. No.</b> —
	magnet unit standard L 39mm D1 ø 15.4mm D2 ø 11mm suitable for PEL20-21/JUNKERS/EGA		
	<b>GEV No.</b>	101205	<b>Ref. No.</b> —
	gas tap front part shaft ø 8x6.5mm shaft L 22/15mm shaft flat upper/lower suitable for PEL20		
<b>accessories for</b>	101491		
	<b>GEV No.</b>	101287	<b>Ref. No.</b> —
	olive for pipe ø 6mm Qty 1 pcs		
	<b>GEV No.</b>	101300	<b>Ref. No.</b> —
	union nut thread M16x1.5 tube ø 10mm		
	<b>GEV No.</b>	101450	<b>Ref. No.</b> —
	olive for pipe ø 8mm L 12.7mm Qty 1 pcs ED ø 10mm		
	<b>GEV No.</b>	101451	<b>Ref. No.</b> —
	union nut thread M16x1.5 tube ø 8mm		
	<b>GEV No.</b>	110081	<b>Ref. No.</b> —
	knob ø 70mm shaft ø 8x6.5mm shaft flat universal		
	<b>GEV No.</b>	110083	<b>Ref. No.</b> —
	knob dial plate gas tap without ignition flame silver		

## 21S series















			
1			
<b>GEV No.</b>	101397	<b>Ref. No.</b>	0000X08100 0000X10500 0000X10800 1000X10500 2000X10500 3000X10500
<b>description</b>	gas tap PEL type 21S gas inlet M16x1.5 (tube ø 10mm) bypass nozzle ø 0.35mm gas outlet M16x1.5 (tube ø 10/8mm) thermocouple connection M9x1 pilot connection M10x1 shaft ø 8x6.5mm shaft L 22/15mm shaft flat lower		
<b>For models:</b>	2FZP, B4F, B4FZ, B6F, B6FZ, B8F, B8FZ, C2FP, C2FTPF, C2FTPF, C2FZP, C2TP2FGP, C4FFCEP, C4FFCGP, C4FFEP, C4FFGP, C4FFLEP, C4FFLGP, C4FP, C4FZFC, C4FZFCG, C4FZFE, C4FZFGP, C4FZP, C4FZSFC, C4FZSFCGP, C4FZSFE, C4FZSFGP, C4FZSP, C6FFCEP, C6FFCGP, C6FFEP, C6FFGAP, C6FFGP, C6FFLEP, C6FFLEPV, C6FFLGP, C6FFLGPV, C6FP, C6FZFC, C6FZFC, C6FZFCGP, C6FZFCGPV, C6FZFE, C6FZFGAP, C6FZFGP, C6FZP, CCTP8, CCTPFG8, CFTG1...(Other models you can see in the webshop)		
<b>spare parts for</b>	101397		
	<b>GEV No.</b>	100408	<b>Ref. No.</b> —
	bypass nozzle type PEL20/21 bore ø 0.35mm thread M5x0.5		
	<b>GEV No.</b>	101060	<b>Ref. No.</b> —
	magnet unit standard L 39mm D1 ø 15.4mm D2 ø 11mm suitable for PEL20-21/JUNKERS/EGA		
	<b>GEV No.</b>	101206	<b>Ref. No.</b> —
	gas tap front part shaft ø 8x6.5mm shaft L 22/15mm shaft flat upper/lower suitable for PEL21		
	<b>GEV No.</b>	101231	<b>Ref. No.</b> —
	thermocouple nut T1: M9x1 T2: M18x1		
<b>accessories for</b>	101397		
	<b>GEV No.</b>	100908	<b>Ref. No.</b> X13200
	union screw thread M10x1 for pipe ø 4mm Qty 1 pcs		
	<b>GEV No.</b>	100909	<b>Ref. No.</b> —
	union screw thread M10x1 for pipe ø 6mm Qty 1 pcs		
	<b>GEV No.</b>	101246	<b>Ref. No.</b> —
	olive for pipe ø 4mm Qty 1 pcs		
	<b>GEV No.</b>	101278	<b>Ref. No.</b> —
	olive for pipe ø 10mm Qty 1 pcs		
	<b>GEV No.</b>	101286	<b>Ref. No.</b> —
	olive ID ø 6mm Qty 1 pcs		
	<b>GEV No.</b>	101300	<b>Ref. No.</b> —
	union nut thread M16x1.5 tube ø 10mm		
	<b>GEV No.</b>	101450	<b>Ref. No.</b> —
	olive for pipe ø 8mm L 12.7mm Qty 1 pcs ED ø 10mm		
	<b>GEV No.</b>	101451	<b>Ref. No.</b> —
	union nut thread M16x1.5 tube ø 8mm		

Table continues overleaf



<b>accessories for</b> 101397				
	GEV No.	110081	Ref. No.	—
knob ø 70mm shaft ø 8x6.5mm shaft flat universal				
	GEV No.	112206	Ref. No.	—
knob dial plate silver gas tap PEL21/22/23 t.max.°C ED ø 63mm ID ø 45.5mm				

22S/O series

 <p>1</p>				
<b>GEV No.</b>	101086	<b>Ref. No.</b>	0000Y21400 0000Y21500 0000Y21600 0000Y21700	
<b>description</b>	gas tap PEL type 22S/O gas inlet M20x1.5 (tube ø 12mm) bypass nozzle ø 0.35mm gas outlet M20x1.5 (tube ø 12/10mm) thermocouple connection M9x1 pilot connection M10x1 shaft ø 10x8mm shaft L 25/17mm shaft flat lower			
<b>For models:</b>	B4F, B6F, B8F, C2FTPFE, C2FTPFEF, C2FTPFG, C2FTPFGP, CCPG4, CCPG82, CCTP8, CCTPFG8, CPG, CPGI, K2F, K2FTPFG, K4F, K4FFE, K4FFG, K6F, K6FFE, K6FFG, K8F, K8FFE, K8FFG, KCP4, KCP82, KTP, KTPFG, OPCP4, OPCP82			
<b>spare parts for</b> 101086				
	GEV No.	100259	Ref. No.	—
bypass nozzle type PEL22 bore ø 0.35mm thread M6x0.5				
	GEV No.	101058	Ref. No.	—
magnet unit L 39mm D1 ø 15.4mm D2 ø 13.5mm suitable for PEL22/EGA24197 standard				
	GEV No.	101201	Ref. No.	—
gas tap front part shaft ø 10x8mm shaft L 25/17mm shaft flat upper/lower suitable for PEL22				
	GEV No.	101231	Ref. No.	—
thermocouple nut T1: M9x1 T2: M18x1				
	GEV No.	101240	Ref. No.	—
gas connection thread M20x1.5 tube ø 12/10mm for PEL gas taps with gasket and screws horizontal				
	GEV No.	101460	Ref. No.	—
O-ring ø 12.37mm D1 ø 2.62mm suitable for PEL22				
	GEV No.	101461	Ref. No.	—
screw kit suitable for PEL22 Qty 4 pcs				
<b>accessories for</b> 101086				
	GEV No.	100908	Ref. No.	X13200
union screw thread M10x1 for pipe ø 4mm Qty 1 pcs				
	GEV No.	100909	Ref. No.	—
union screw thread M10x1 for pipe ø 6mm Qty 1 pcs				
	GEV No.	101241	Ref. No.	—
gas connection thread M20x1.5 tube ø 12/10mm for PEL gas taps vertical				
	GEV No.	101246	Ref. No.	—
olive for pipe ø 4mm Qty 1 pcs				

<b>accessories for</b> 101086				
	GEV No.	101248	Ref. No.	—
olive for pipe ø 12mm Qty 1 pcs suitable for PEL				
	GEV No.	101249	Ref. No.	—
olive for pipe ø 10mm Qty 1 pcs				
	GEV No.	101250	Ref. No.	—
union nut thread M20x1.5 for pipe ø 10mm				
	GEV No.	101251	Ref. No.	—
union nut thread M20x1.5 for pipe ø 12mm				
	GEV No.	101286	Ref. No.	—
olive ID ø 6mm Qty 1 pcs				
	GEV No.	110080	Ref. No.	—
knob ø 70mm shaft ø 10x8mm shaft flat universal				
	GEV No.	112206	Ref. No.	—
knob dial plate silver gas tap PEL21/22/23 t.max.°C ED ø 63mm ID ø 45.5mm				

22S/V series



















 <p>1</p>				
<b>GEV No.</b>	101087	<b>Ref. No.</b>	0000Y21700 000Y21600	
<b>description</b>	gas tap PEL type 22S/V gas inlet M20x1.5 (tube ø 12mm) bypass nozzle ø 0.35mm gas outlet M20x1.5 (tube ø 12/10mm) thermocouple connection M9x1 pilot connection M10x1 shaft ø 10x8mm shaft L 25/17mm shaft flat upper			
<b>For models:</b>	B4F, B6F, B8F, CCPG8, K4F, K4FFE, K4FFG, K6F, K6FFE, K6FFG, K8F, K8FFE, K8FFG, KCP4, KCP8, KCP82, OPCP4, OPCP82			
<b>spare parts for</b> 101087				
	GEV No.	100259	Ref. No.	—
bypass nozzle type PEL22 bore ø 0.35mm thread M6x0.5				
	GEV No.	101058	Ref. No.	—
magnet unit L 39mm D1 ø 15.4mm D2 ø 13.5mm suitable for PEL22/EGA24197 standard				
	GEV No.	101201	Ref. No.	—
gas tap front part shaft ø 10x8mm shaft L 25/17mm shaft flat upper/lower suitable for PEL22				
	GEV No.	101231	Ref. No.	—
thermocouple nut T1: M9x1 T2: M18x1				
	GEV No.	101241	Ref. No.	—
gas connection thread M20x1.5 tube ø 12/10mm for PEL gas taps vertical				
	GEV No.	101460	Ref. No.	—
O-ring ø 12.37mm D1 ø 2.62mm suitable for PEL22				
	GEV No.	101461	Ref. No.	—
screw kit suitable for PEL22 Qty 4 pcs				

Table continues overleaf



















accessories for		101087		
	GEV No.	100908	Ref. No.	X13200
	union screw thread M10x1 for pipe ø 4mm Qty 1 pcs			
	GEV No.	100909	Ref. No.	—
	union screw thread M10x1 for pipe ø 6mm Qty 1 pcs			
	GEV No.	101240	Ref. No.	—
	gas connection thread M20x1.5 tube ø 12/10mm for PEL gas taps with gasket and screws horizontal			
	GEV No.	101246	Ref. No.	—
	olive for pipe ø 4mm Qty 1 pcs			
	GEV No.	101248	Ref. No.	—
	olive for pipe ø 12mm Qty 1 pcs suitable for PEL			
	GEV No.	101249	Ref. No.	—
	olive for pipe ø 10mm Qty 1 pcs			
	GEV No.	101250	Ref. No.	—
	union nut thread M20x1.5 for pipe ø 10mm			
	GEV No.	101251	Ref. No.	—
	union nut thread M20x1.5 for pipe ø 12mm			
	GEV No.	101286	Ref. No.	—
	olive ID ø 6mm Qty 1 pcs			
	GEV No.	110080	Ref. No.	—
	knob ø 70mm shaft ø 10x8mm shaft flat universal			
	GEV No.	112206	Ref. No.	—
	knob dial plate silver gas tap PEL21/22/23 t.max.°C ED ø 63mm ID ø 45.5mm			

## 23S/O series



1

GEV No.	101893	Ref. No.	30100003	
<b>description</b>	gas tap PEL type 23S/O gas inlet M28x1.5 (tube ø 20mm) bypass nozzle ø 0.35mm gas outlet M24x1.5 (tube ø 16mm) thermocouple connection M9x1 pilot connection M10x1 shaft ø 10x8mm shaft L 25/17mm shaft flat lower			
<b>For models:</b>	KP20G, KP20GA, KP20GT, KP20GTA, KP30G, KP30GA, KP30GT, KP30GTA, KP50G, KP50GA, KP50GT, KP50GTA, KPGN18G, KPGN27G, KPGN37G, KPI20G, KPI20GA, KPI20GT, KPI20GTA, KPI30G, KPI30GA, KPI30GT, KPI30GTA, KPI50G, KPI50GA, KPI50GT, KPI50GTA, KPIGN18G, KPIGN27G, KPIGN37G			
<b>spare parts for</b>	101893			
	GEV No.	101045	Ref. No.	—
	magnet unit T1: M9x1 T2: M22x1 L 46mm ø 18mm suitable for PEL23S M9x1			
	GEV No.	101204	Ref. No.	—
	gas tap front part shaft ø 10x8mm shaft L 25/17mm shaft flat upper/lower suitable for PEL23S			

spare parts for		101893		
	GEV No.	101244	Ref. No.	—
	gas connection thread M24x1.5 tube ø 12/16mm horizontal for PEL gas taps			
	GEV No.	101463	Ref. No.	—
	screw suitable for PEL23S Qty 4 pcs			
	GEV No.	528455	Ref. No.	—
	O-ring Viton thickness 2.62mm ID ø 18.72mm Qty 1 pcs			
<b>accessories for</b>	101893			
	GEV No.	100908	Ref. No.	X13200
	union screw thread M10x1 for pipe ø 4mm Qty 1 pcs			
	GEV No.	100909	Ref. No.	—
	union screw thread M10x1 for pipe ø 6mm Qty 1 pcs			
	GEV No.	101246	Ref. No.	—
	olive for pipe ø 4mm Qty 1 pcs			
	GEV No.	101252	Ref. No.	—
	union nut thread M24x1.5 for pipe ø 12mm			
	GEV No.	101253	Ref. No.	—
	union nut thread M24x1.5 PEL for pipe ø 16mm			
	GEV No.	101254	Ref. No.	—
	union nut thread M28x1.5 tube ø 20mm			
	GEV No.	101255	Ref. No.	—
	olive for pipe ø 12mm Qty 1 pcs			
	GEV No.	101256	Ref. No.	—
	olive for pipe ø 16mm Qty 1 pcs			
	GEV No.	101257	Ref. No.	—
	olive for pipe ø 20mm Qty 1 pcs			
	GEV No.	101286	Ref. No.	—
	olive ID ø 6mm Qty 1 pcs			
	GEV No.	110080	Ref. No.	—
	knob ø 70mm shaft ø 10x8mm shaft flat universal			
	GEV No.	112206	Ref. No.	—
	knob dial plate silver gas tap PEL21/22/23 t.max.°C ED ø 63mm ID ø 45.5mm			









23S/V series





<b>GEV No.</b>	101093	<b>Ref. No.</b>	0000Y21300
<b>description</b>	gas tap PEL type 23S/V gas inlet M28x1.5 (tube ø 20mm) bypass nozzle ø 0.35mm thermocouple connection M10x1 pilot connection M10x1 shaft ø 10x8mm shaft L 25/17mm shaft flat lower		
<b>For models:</b>	CPG, CPGI, KP10G, KP10GA, KP10GT, KP10GTA, KP15G, KP15GA, KP15GT, KP15GTA, KP20G, KP20GA, KP30G, KP30GA, KP50G, KP50GA, KP110G, KP110GA, KP110GT, KP110GTA, KP115G, KP115GA, KP115GT, KP115GTA, OPP10G, OPP10GA, OPP15G, OPP15GA, OPPI10G, OPPI10GA, OPPI15G, OPPI15GA		
<b>spare parts for</b>	101093		
	<b>GEV No.</b>	100455	<b>Ref. No.</b> —
	bypass nozzle type PEL23/24 bore ø 0.35mm thread M8x0.5		
	<b>GEV No.</b>	101059	<b>Ref. No.</b> —
	magnet unit T1: M10x1 T2: M22x1 L 46mm ø 18mm suitable for PEL23S M10x1		
	<b>GEV No.</b>	101204	<b>Ref. No.</b> —
	gas tap front part shaft ø 10x8mm shaft L 25/17mm shaft flat upper/lower suitable for PEL23S		
	<b>GEV No.</b>	101245	<b>Ref. No.</b> —
	gas connection thread M24x1.5 tube ø 12/16mm vertical for PEL gas taps		
	<b>GEV No.</b>	101463	<b>Ref. No.</b> —
	screw suitable for PEL23S Qty 4 pcs		
	<b>GEV No.</b>	528455	<b>Ref. No.</b> —
	O-ring Viton thickness 2.62mm ID ø 18.72mm Qty 1 pcs		
<b>accessories for</b>	101093		
	<b>GEV No.</b>	100908	<b>Ref. No.</b> X13200
	union screw thread M10x1 for pipe ø 4mm Qty 1 pcs		
	<b>GEV No.</b>	100909	<b>Ref. No.</b> —
	union screw thread M10x1 for pipe ø 6mm Qty 1 pcs		
	<b>GEV No.</b>	101246	<b>Ref. No.</b> —
	olive for pipe ø 4mm Qty 1 pcs		
	<b>GEV No.</b>	101252	<b>Ref. No.</b> —
	union nut thread M24x1.5 for pipe ø 12mm		
	<b>GEV No.</b>	101253	<b>Ref. No.</b> —
	union nut thread M24x1.5 PEL for pipe ø 16mm		
	<b>GEV No.</b>	101254	<b>Ref. No.</b> —
	union nut thread M28x1.5 tube ø 20mm		
	<b>GEV No.</b>	101255	<b>Ref. No.</b> —
	olive for pipe ø 12mm Qty 1 pcs		
	<b>GEV No.</b>	101256	<b>Ref. No.</b> —
	olive for pipe ø 16mm Qty 1 pcs		

<b>accessories for</b>	101093		
	<b>GEV No.</b>	101257	<b>Ref. No.</b> —
	olive for pipe ø 20mm Qty 1 pcs		
	<b>GEV No.</b>	101286	<b>Ref. No.</b> —
	olive ID ø 6mm Qty 1 pcs		
	<b>GEV No.</b>	110080	<b>Ref. No.</b> —
	knob ø 70mm shaft ø 10x8mm shaft flat universal		
	<b>GEV No.</b>	112206	<b>Ref. No.</b> —
	knob dial plate silver gas tap PEL21/22/23 t.max. °C ED ø 63mm ID ø 45.5mm		

miscellaneous

			
<b>1</b>			
<b>GEV No.</b>	106574	<b>Ref. No.</b>	AGC003ZR10
<b>description</b>	bracket		
<b>For models:</b>	CC120CG, CC80G, CC81CG, CCG120CE, CCG80E, CCG81CE, M62F, M64F, M74F, M74FFXE, M74FFXG, M76F, M76FFXE, M76FFXG, M7FT-4GL, M7FT4GR, M7FT6GL, M7FT6GLR, SKC40G, SKC80G		

			
<b>1</b>			
<b>GEV No.</b>	106573	<b>Ref. No.</b>	AGC005ZR10
<b>description</b>	gas tap gas inlet pipe flange ø16mm bypass nozzle ø 0.39mm gas outlet M13x1 IT pilot connection thermocouple connection plug-in connection shaft ø 6x4.6mm shaft L 32.5/20.5mm shaft flat upper		
<b>For models:</b>	CC120CG, CC80G, CC81CG, CCG120CE, CCG80E, CCG81CE, M62F, M64F, M74F, M74FFXE, M74FFXG, M76F, M76FFXE, M76FFXG, M7FT-4GL, M7FT4GR, M7FT6GL, M7FT6GLR, SKC40G, SKC80G		
<b>accessories for</b>	106573		
	<b>GEV No.</b>	106574	<b>Ref. No.</b> AGC003ZR10
	bracket		

gas thermostats

SIT

630 Eurosit series

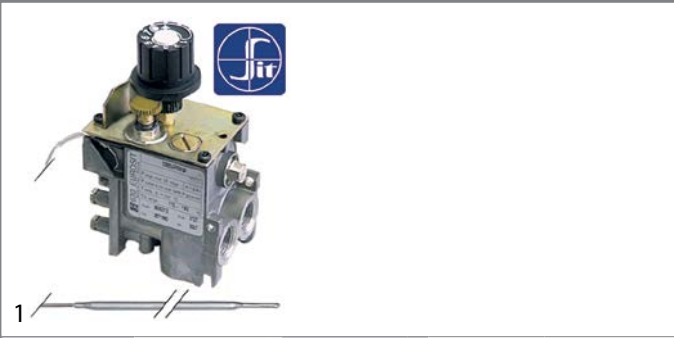

<b>GEV No.</b>	101413	<b>Ref. No.</b>	X16700
<b>description</b>	gas thermostat type 630 Eurosit series t.max. 100°C 30-100°C gas inlet 3/8" gas outlet 3/8" thermocouple connection M9x1 pilot connection M10x1 probe ø 5mm probe L 122mm capillary pipe 1050mm SIT		
<b>For models:</b>	CBG4, CBG6, CBG8, KB4G, KB8G, OPB4G, SKB40G, SKB60G, SKB80G, TB40G, TB60G, TB80G, TP40G		
<b>accessories for</b>	101413		
	GEV No.	100904	Ref. No. —
	locking screw M10x1 for pipe ø 4mm Qty 1 pcs		
	GEV No.	100905	Ref. No. —
	locking screw M10x1 for pipe ø 6mm Qty 1 pcs		
	GEV No.	101273	Ref. No. —
	olive for pipe ø 12mm L 9.5mm brass Qty 1 pcs suitable for universal		
	GEV No.	101276	Ref. No. —
	union screw thread 3/8" tube ø 12mm Qty 1 pcs		
	GEV No.	101333	Ref. No. —
	plug thread 3/8" with O-ring		

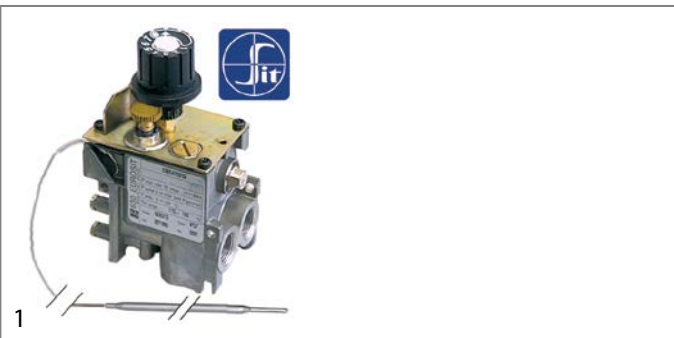

<b>GEV No.</b>	101188	<b>Ref. No.</b>	0000X12900
<b>description</b>	gas thermostat type 630 Eurosit series t.max. 190°C 110-190°C gas inlet 3/8" gas outlet 3/8" thermocouple connection M9x1 pilot connection M10x1 probe ø 4mm probe L 202mm capillary pipe 1050mm SIT		
<b>For models:</b>	CF10DG8M, CF10G4M, KFG1, KFG2, M7F4G, M7F8G, OPFG1, OPFG2, SKF10GM, SKF20GM, TF10GM, TF20GM		
<b>accessories for</b>	101188		
	GEV No.	100904	Ref. No. —
	locking screw M10x1 for pipe ø 4mm Qty 1 pcs		
	GEV No.	100905	Ref. No. —
	locking screw M10x1 for pipe ø 6mm Qty 1 pcs		



<b>accessories for</b>	101188		
	GEV No.	101273	Ref. No. —
	olive for pipe ø 12mm L 9.5mm brass Qty 1 pcs suitable for universal		
	GEV No.	101276	Ref. No. —
	union screw thread 3/8" tube ø 12mm Qty 1 pcs		
	GEV No.	101333	Ref. No. —
	plug thread 3/8" with O-ring		



<b>GEV No.</b>	101915	<b>Ref. No.</b>	0000X13400
<b>description</b>	gas thermostat type 630 Eurosit series t.max. 320°C 80-320°C gas inlet 3/8" gas outlet 3/8" thermocouple connection M9x1 pilot connection M10x1 probe ø 4mm probe L 72mm capillary pipe 1050mm SIT		
<b>For models:</b>	C2FTPFPG, C2TP2FGP, C4FFGP, C4FZFG, C4FZFGP, C4FZSFGP, C6FFGA, C6FFGAP, C6FFGP, C6FZFG, C6FZFGA, C6FZFGAP, C6FZFGP, CBRG, CBRGIN, CCTPFG8, CFTG1C, CFTG2C, CFTG2C2, CFTG3C, CFTG4C, CFTG6C, CFTG6C2, CFTG8C, CN14FGA, K2FTPPG, K4FFG, K4FSFG, K4FZFG, K4FZSFG, K6FFG, K6FFGA, K6FZFG, K6FZFGA, K8FFG, K8FZFG, KFT4G, KFT4GC, KFT4GR, KFT8G, KFT8G23C, KFT8GC, KFT8GLR, KFT8GR, KFTG1, KFTG1C, KFTG1R, KFTG3, KFTG3C, KFTG3LR...(Other models you can see in the webshop)		
<b>accessories for</b>	101915		
	GEV No.	100825	Ref. No. —
	gas tap spindle shaft ø 8x6.5mm shaft L 22/14mm suitable for EUROSIT		
	GEV No.	100904	Ref. No. —
	locking screw M10x1 for pipe ø 4mm Qty 1 pcs		
	GEV No.	100905	Ref. No. —
	locking screw M10x1 for pipe ø 6mm Qty 1 pcs		
	GEV No.	100949	Ref. No. —
	gasket suitable for 630 Eurosit series		
	GEV No.	101273	Ref. No. —
	olive for pipe ø 12mm L 9.5mm brass Qty 1 pcs suitable for universal		
	GEV No.	101276	Ref. No. —
	union screw thread 3/8" tube ø 12mm Qty 1 pcs		
	GEV No.	101333	Ref. No. —
	plug thread 3/8" with O-ring		
	GEV No.	101390	Ref. No. —
	gas tap spindle shaft ø 6x4.6mm shaft L 32/15mm gas tap with ignition flame suitable for ZANUSSI, MARENO for gas thermostat EUROSIT		
	GEV No.	101392	Ref. No. —
	adapter suitable for 630 Eurosit series		

Table continues overleaf



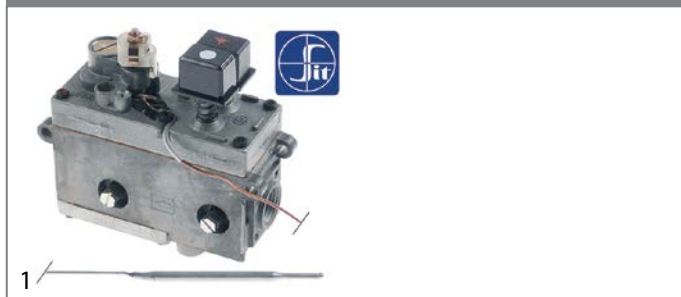

<b>accessories for</b> 101915	
	GEV No. 110357 Ref. No. — gas tap spindle shaft ø 8x6.5mm shaft L 36/12mm suitable for 630 Eurosit series
	GEV No. 110358 Ref. No. — adapter shaft ø 10x8mm shaft L 29/18mm suitable for 630 Eurosit series

710 Minisit series



<b>GEV No.</b>	101135	<b>Ref. No.</b>	Y23000
<b>description</b>	gas thermostat SIT type MINISIT 710 t.max. 190°C 110-190°C gas inlet 1/2" gas outlet 3/8" thermocouple connection M9x1 pilot connection M10x1 probe ø 6mm probe L 102mm capillary pipe 1050mm probe type type A3 pressure controller no pressure regulator mbar gland nut		
<b>For models:</b>	CFG15, CFG15D, KFG15, KFG15D, KFG20, KFG20D, OPFG15, OPFG15D, OPFG20, OPFG20D		



<b>spare parts for</b> 101135	
	GEV No. 101053 Ref. No. — magnet unit T1: M9x1 T2: M24x1 L 45mm ø 17mm suitable for Minisit
	GEV No. 102118 Ref. No. — probe 110-190°C probe ø 6mm probe L 102mm capillary pipe 1050mm t.max. 190°C fryer probe type type A3 suitable for MINISIT 710

<b>accessories for</b> 101135	
	GEV No. 100809 Ref. No. — O-ring EPDM thickness 2mm ID ø 21mm Qty 1 pcs
	GEV No. 100820 Ref. No. — gland duct ET M14x1.5 IT M10x0.75 probe ø max. 6.5mm WS 22
	GEV No. 100904 Ref. No. — locking screw M10x1 for pipe ø 4mm Qty 1 pcs
	GEV No. 100905 Ref. No. — locking screw M10x1 for pipe ø 6mm Qty 1 pcs
	GEV No. 101054 Ref. No. — magnet unit T1: M10x1 T2: M24x1 L 45mm ø 17mm suitable for Minisit
	GEV No. 101136 Ref. No. Y17400 piezoelectric igniter suitable for Minisit with cover cap ømm connection F6.3x0.8
	GEV No. 101137 Ref. No. — cover cap without piezoelectric igniter
	GEV No. 101267 Ref. No. — reducer IT 3/8" ET 1/2" L 21mm
	GEV No. 101268 Ref. No. — gas connection thread 3/8" angled with O-ring MINISIT 710

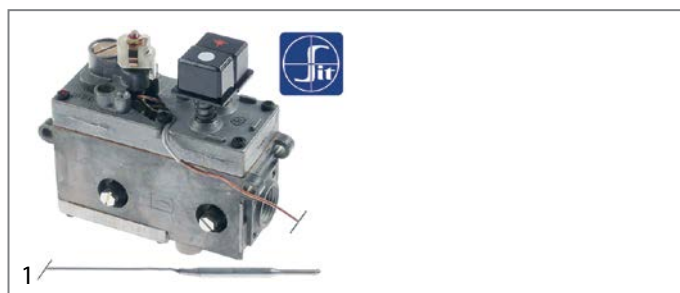
<b>accessories for</b> 101135	
	GEV No. 101269 Ref. No. — gas connection thread 1/2" angled with O-ring MINISIT 710
	GEV No. 101270 Ref. No. — screw connection IT 3/8" ET 3/8" L 28mm
	GEV No. 101272 Ref. No. — screw connection IT 1/2" ET 3/8" L 57mm
	GEV No. 101273 Ref. No. — olive for pipe ø 12mm L 9.5mm brass Qty 1 pcs suitable for universal
	GEV No. 101274 Ref. No. — olive for pipe ø 16mm Qty 1 pcs
	GEV No. 101275 Ref. No. — union screw thread 1/2" for pipe ø 16mm Qty 1 pcs
	GEV No. 101276 Ref. No. — union screw thread 3/8" tube ø 12mm Qty 1 pcs
	GEV No. 110068 Ref. No. Y17400 Y23100 knob suitable for Minisit ø 37mm



<b>GEV No.</b>	101132	<b>Ref. No.</b>	Y17400
<b>description</b>	gas thermostat SIT type MINISIT 710 t.max. 340°C 100-340°C gas inlet 1/2" gas outlet 3/8" thermocouple connection M9x1 pilot connection M10x1 probe ø 5mm probe L 68mm capillary pipe 1050mm probe type type B1 pressure controller no pressure regulator mbar gland nut ignition gas no		

<b>spare parts for</b> 101132	
	GEV No. 101053 Ref. No. — magnet unit T1: M9x1 T2: M24x1 L 45mm ø 17mm suitable for Minisit
	GEV No. 102102 Ref. No. — probe 100-340°C probe ø 5mm probe L 68mm capillary pipe 1750mm t.max. 340°C oven/grill probe type type B1 suitable for MINISIT 710

















<b>accessories for</b> 101132	
	GEV No. 100809 Ref. No. — O-ring EPDM thickness 2mm ID ø 21mm Qty 1 pcs
	GEV No. 100904 Ref. No. — locking screw M10x1 for pipe ø 4mm Qty 1 pcs
	GEV No. 100905 Ref. No. — locking screw M10x1 for pipe ø 6mm Qty 1 pcs
	GEV No. 101054 Ref. No. — magnet unit T1: M10x1 T2: M24x1 L 45mm ø 17mm suitable for Minisit

Table continues overleaf

accessories for		101132		
	GEV No.	101136	Ref. No.	Y17400
	piezoelectric igniter suitable for Minisit with cover cap omm connection F6.3x0.8			
	GEV No.	101137	Ref. No.	—
	cover cap without piezoelectric igniter			
	GEV No.	101267	Ref. No.	—
	reducer IT 3/8" ET 1/2" L 21mm			
	GEV No.	101268	Ref. No.	—
	gas connection thread 3/8" angled with O-ring MINISIT 710			
	GEV No.	101269	Ref. No.	—
	gas connection thread 1/2" angled with O-ring MINISIT 710			
	GEV No.	101270	Ref. No.	—
	screw connection IT 3/8" ET 3/8" L 28mm			
	GEV No.	101272	Ref. No.	—
	screw connection IT 1/2" ET 3/8" L 57mm			
	GEV No.	101273	Ref. No.	—
	olive for pipe ø 12mm L 9.5mm brass Qty 1 pcs suitable for universal			
	GEV No.	101274	Ref. No.	—
	olive for pipe ø 16mm Qty 1 pcs			
	GEV No.	101275	Ref. No.	—
	union screw thread 1/2" for pipe ø 16mm Qty 1 pcs			
	GEV No.	101276	Ref. No.	—
	union screw thread 3/8" tube ø 12mm Qty 1 pcs			
	GEV No.	110068	Ref. No.	Y17400 Y23100
	knob suitable for Minisit ø 37mm			

spare parts for		101076		
	GEV No.	101058	Ref. No.	—
	magnet unit L 39mm D1 ø 15.4mm D2 ø 13.5mm suitable for PEL22/EGA24197 standard			
	GEV No.	106200	Ref. No.	—
	nut thread M9x1 suitable for PEL 24/25S			
accessories for		101076		
	GEV No.	100908	Ref. No.	X13200
	union screw thread M10x1 for pipe ø 4mm Qty 1 pcs			
	GEV No.	100909	Ref. No.	—
	union screw thread M10x1 for pipe ø 6mm Qty 1 pcs			
	GEV No.	101246	Ref. No.	—
	olive for pipe ø 4mm Qty 1 pcs			
	GEV No.	101248	Ref. No.	—
	olive for pipe ø 12mm Qty 1 pcs suitable for PEL			
	GEV No.	101249	Ref. No.	—
	olive for pipe ø 10mm Qty 1 pcs			
	GEV No.	101250	Ref. No.	—
	union nut thread M20x1.5 for pipe ø 10mm			
	GEV No.	101251	Ref. No.	—
	union nut thread M20x1.5 for pipe ø 12mm			
	GEV No.	101286	Ref. No.	—
	olive ID ø 6mm Qty 1 pcs			
	GEV No.	110079	Ref. No.	—
	knob dial plate gas thermostat 1-8 silver			
	GEV No.	110080	Ref. No.	—
	knob ø 70mm shaft ø 10x8mm shaft flat universal			

PEL

24ST series



<b>GEV No.</b>	101076	<b>Ref. No.</b>	0000X11200	
<b>description</b>	gas thermostat PEL type 24ST 120-320°C gas inlet M20x1.5 (tube ø 12mm) bypass nozzle ø 0.35mm gas outlet M20x1.5 (tube ø 12/10mm) thermocouple connection M9x1 pilot connection M10x1 capillary pipe 1200mm probe ø 6mm probe L 100mm shaft ø 10x8mm shaft L 27/17mm shaft flat upper			
<b>For models:</b>	C2FTPFPG, C2FTPFPGP, C4FFG, C4FFGP, C6FFG, C6FFGP, CCTPFPG8, CFTG4C, CFTG6C, CFTG8C, K2FTPFPG, K4FFG, K6FFG, K8FFG, KFTG4, KFTG4C, KFTG4R, KFTG8, KFTG8C, KFTG8LR, KTPFG, SKT40GC, SKT60GC, SKT80GC, TT40GC, TT60GC, TT80GC			
<b>spare parts for</b>	101076			
	GEV No.	100455	Ref. No.	—
	bypass nozzle type PEL23/24 bore ø 0.35mm thread M8x0.5			



SABAF

<b>GEV No.</b>	101181	<b>Ref. No.</b>	AGC006ZR10 X68053
<b>description</b>	gas thermostat SABAF t.max. 300°C gas inlet pipe flange ø16mm bypass nozzle ø 0.46mm gas outlet M13x1 IT (tube ø 8mm) gas outlet 2 thermocouple connection M8x1 pilot connection capillary pipe 850mm probe ø 4mm probe L 150mm shaft ø 6x4.6mm shaft L 45/27mm shaft flat upper		
<b>For models:</b>	C4FFCGP, C4FFLG, C4FFLGP, C4FZFCG, C4FZFCGP, C4FZSFCGP, C6FFCGP, C6FFLG, C6FFLGP, C6FFLGPV, C6FFLGV, C6FZFCG, C6FZFCGP, C6FZFCGPV, C6FZFCGV, CC120CG, CC120G, CC80G, CC81CG, CC81G, K2FTPCG, K4FSFCG, K4FZFCG, K4FZSFCG, K6FZFCG, K8FZFCG, KTPFCG, M74FFXG, M74FMPFXG, M74FPFXG, M76FFXG, M76FMPFXG, M76FPFXG, SK4FZFCGP, SK6FZFCGP		
<b>spare parts for</b>	101181		
	<b>GEV No.</b>	101060	<b>Ref. No.</b> —
	magnet unit standard L 39mm D1 ø 15.4mm D2 ø 11mm suitable for PEL20-21/JUNKERS/EGA		
<b>accessories for</b>	101181		
	<b>GEV No.</b>	101277	<b>Ref. No.</b> —
	olive ID ø 8mm Qty 1 pcs		
	<b>GEV No.</b>	101376	<b>Ref. No.</b> X68050
	gasket ID ø 8mm ED ø 12mm H 3/5mm		
	<b>GEV No.</b>	101477	<b>Ref. No.</b> —
	union screw thread M13x1 tube ø 8mm Qty 1 pcs		
	<b>GEV No.</b>	101751	<b>Ref. No.</b> X07400 X68052
	bracket		
	<b>GEV No.</b>	110360	<b>Ref. No.</b> —
	knob without symbol ø 65mm shaft ø 6x4.6mm shaft flat upper black		
	<b>GEV No.</b>	110603	<b>Ref. No.</b> —
	knob dial plate gas thermostat t.max. 300°C 90-300°C		

gas valves and ignition boxes

gas control valves

SIT

NOVASIT



<b>GEV No.</b>	101162	<b>Ref. No.</b>	0000X11400
<b>description</b>	gas valve SIT series Novasit 820 230V 50Hz gas inlet 1/2" gas outlet 1/2" thermocouple connection M9x1 pilot connection M10x1 ignition pressure 3-5mbar pressure range 3-30mbar pressure regulator connection blind equiv. no. 0.820.010		
<b>For models:</b>	CF15DG8, CF15G4, KBRG, KBRG12, KBRG12IN, KBRGIN, KBRGM, KBRGM12, KBRGM12IN, KBRGMIN, KFG4, KFG8, OPBRG, OPBRG12, OPBRG12IN, OPBRG12MIN, OPBRGIN, OPBRGM, OPBRGM12, OPBRGM12IN, OPBRGMIN		
<b>spare parts for</b>	101162		
	<b>GEV No.</b>	101065	<b>Ref. No.</b> —
	magnet unit with cable L 44mm D1 ø 30mm D2 ø 20mm suitable for NOVASIT		
	<b>GEV No.</b>	101313	<b>Ref. No.</b> X50400
	solenoid coil 230V 50Hz		
<b>accessories for</b>	101162		
	<b>GEV No.</b>	100006	<b>Ref. No.</b> —
	piezoelectric igniter suitable for ELETTROSIT body plastic blowing connection ø2.4mm ø 14mm		
	<b>GEV No.</b>	101305	<b>Ref. No.</b> —
	gas connection straight 1/2" flange 45x45mm ELETTROSIT/V4400/4600/4605 suitable for SIT/HONEYWELL hole distance 36x36mm		
	<b>GEV No.</b>	101306	<b>Ref. No.</b> —
	gas connection angled flange 45x45mm hole distance 36x36mm 1/2" ELETTROSIT/V4400/4600/4605 screw with O-ring suitable for SIT/HONEYWELL		
	<b>GEV No.</b>	101307	<b>Ref. No.</b> —
	gas connection straight flange 45x45mm hole distance 36x36mm 3/4" ELETTROSIT/V4400/4600/4605 screw with O-ring suitable for SIT/HONEYWELL		
	<b>GEV No.</b>	101308	<b>Ref. No.</b> —
	gas connection angled flange 45x45mm hole distance 36x36mm 3/4" ELETTROSIT/V4400/4600/4605 screw with O-ring suitable for SIT/HONEYWELL		
	<b>GEV No.</b>	101312	<b>Ref. No.</b> 0000X49000 X49000
	microswitch		
	<b>GEV No.</b>	101314	<b>Ref. No.</b> X50300
	solenoid coil 24V 50Hz		
	<b>GEV No.</b>	101317	<b>Ref. No.</b> —
	plug with cable L 1000mm suitable for NOVASIT		

Table continues overleaf





<b>accessories for</b>	101162		
	GEV No.	101318	Ref. No. —
cover cap for solenoid coil suitable for NOVASIT			



<b>accessories</b>			
			
1			
<b>GEV No.</b>	101312	<b>Ref. No.</b>	0000X49000
<b>description</b>	microswitch		
<b>For models:</b>	CF15DG8, CF15G4, KBRG, KBRG12, KBRG12IN, KBRGIN, KBRGM, KBRGM12, KBRGM12IN, KBRGMIN, KFG4, KFG8, OPBRG, OPBRG12, OPBRG12IN, OPBRG12MIN, OPBRGIN, OPBRGM, OPBRGM12, OPBRGM12IN, OPBRGMIN		

			
1			
<b>GEV No.</b>	101313	<b>Ref. No.</b>	X50400
<b>description</b>	solenoid coil 230V 50Hz		
<b>For models:</b>	CF15DG8, CF15G4, KFG4, KFG8		
<b>accessories for</b>	101313		
	GEV No.	550896	Ref. No. —
gasket with screw gas valves NOVASIT			

			
1			
<b>GEV No.</b>	101314	<b>Ref. No.</b>	X50300
<b>description</b>	solenoid coil 24V 50Hz		

## safety valves

<b>SIT</b>			
<b>400 series</b>			
			
1			
<b>GEV No.</b>	101470	<b>Ref. No.</b>	0000Y21800
<b>description</b>	safety valve front fixing M12x1 pressure range 50mbar gas inlet 1/8" IT gas outlet 1/8" - M6x0.75 thermocouple connection M8x1 equiv. no. 0.400.088 suitable for SIT		
<b>For models:</b>	KBRG12, KBRG12IN, KBRGM12, KBRGM12IN, OPBRG12, OPBRG12IN, OPBRG12MIN, OPBRGM12, OPBRGM12IN		
<b>spare parts for</b>	101470		
	GEV No.	101052	Ref. No. —
magnet unit L 43.5mm D1 ø 15.3mm D2 ø 10.5mm suitable for SIT M1			

<b>accessories for</b>	101470		
	GEV No.	101299	Ref. No. —
nut thread M12x1			
	GEV No.	101499	Ref. No. —
protection cap for safety valve thread M12x0.75 ID ø 18mm L 24mm aluminium			

## ignition parts

### pilot burners

























<b>SIT</b>			
<b>100 series</b>			
			
1			
<b>GEV No.</b>	106904	<b>Ref. No.</b>	0000X19900
<b>description</b>	pilot burner SIT type 100 series 1 flame nozzle ø 0.2mm gas connection 6mm		
<b>For models:</b>	B4F, B6F, B8F, C2FP, C2FTPFG, C2FTPFGP, C2TP2FGP, C4FFCEP, C4FFCGP, C4FFEP, C4FFG, C4FFGP, C4FP, C4FZFG, C4FZFGP, C4FZSFGP, C6FFCEP, C6FFCGP, C6FFEP, C6FFG, C6FFGP, C6FP, C6FZFG, C6FZFGP, CCTPFG8, K2F, K2FTPFCE, K2FTPFCG, K2FTPFE, K2FTPFG, K4F, K4FFE, K4FFG, K4FS, K4FSFCE, K4FSFCG, K4FSFE, K4FSFG, K4FZFG, K4FZSFG, K6F, K6FFE, K6FFG, K6FZFG, K8F, K8FFE, K8FFG, K8FZFG, KTPFG, M72FTPFG...(Other models you can see in the webshop)		
<b>spare parts for</b>	106904		
	GEV No.	100245	Ref. No. X19906
pilot burner nozzle LPG code 20 bore ø 0.2mm Qty 1 pcs thread M8x0.75			
	GEV No.	100855	Ref. No. —
pilot burner bracket triple			
	GEV No.	100885	Ref. No. X19901
air mixing sleeve for pilot burner Qty 1 pcs			
	GEV No.	100916	Ref. No. —
compression spring for pilot burner Qty 1 pcs			
	GEV No.	100917	Ref. No. —
gasket for pilot burner Qty 1 pcs aluminium			
	GEV No.	100918	Ref. No. —
screw for pilot burner			
	GEV No.	107160	Ref. No. —
pilot burner cap SIT 1 flame Hmm Lmm Qty 1 pcs			
	GEV No.	107166	Ref. No. —
pilot burner head SIT 1 flame Hmm Lmm Qty 1 pcs			
	GEV No.	107701	Ref. No. X19900
pilot burner bottom part SIT 100 series nozzle ø 0.2mm			

Table continues overleaf



accessories for		106904	
	GEV No.	100246	Ref. No. 0000X19907 X19907
	pilot burner nozzle natural gas bore ø 0.35mm Qty 1 pcs thread M8x0.75		
	GEV No.	100904	Ref. No. —
	locking screw M10x1 for pipe ø 4mm Qty 1 pcs		
	GEV No.	100905	Ref. No. —
	locking screw M10x1 for pipe ø 6mm Qty 1 pcs		
	GEV No.	102110	Ref. No. —
	pilot tube copper pipe ø 4mm thickness 1mm L 3000mm		
	GEV No.	102111	Ref. No. —
	pilot tube copper pipe ø 6mm thickness 1mm L 3000mm		
	GEV No.	107171	Ref. No. —
	pilot burner nozzle SIT natural/liquid gas bore ø 0.25mm Qty 1 pcs		
	GEV No.	107700	Ref. No. —
	pilot burner bottom part SIT 100 series nozzle ø 0.25mm		
	GEV No.	107702	Ref. No. —
	pilot burner bottom part SIT 100 series nozzle ø 0.35mm		

 <p>1</p>			
<b>GEV No.</b>	106906	<b>Ref. No.</b>	0000X13500 30100005
<b>description</b>	pilot burner SIT type 100 series 3 flames nozzle ø 0.2mm gas connection 6mm		
<b>For models:</b>	C2FTPFE, C2FTPFEF, C2FTPFG, C2FTPFGP, C6FFGA, C6FFGAP, CBG4, CBG6, CBG8, CBRG, CBRGIN, CCPG4, CCPG8, CCPG82, CCTP8, CCTPFG8, CFTG22, CFTG2C2, CFTG2LR, CFTG2R2, CFTG62, CFTG6C2, CFTG6LR, CFTG6R2, CPG, CPGI, CPLG1, CPLG2, CPLG4, CPLG8, K2FTPFCF, K2FTPFCG, K2FTPFE, K2FTPFG, KB4G, KB8G, KCP4, KCP8, KCP82, KP10G, KP10GA, KP10GT, KP10GTA, KP15G, KP15GA, KP15GT, KP15GTA, KP20G, KP20GA, KP20GT...(Other models you can see in the webshop)		
<b>spare parts for</b>		106906	
	GEV No.	100245	Ref. No. X19906
	pilot burner nozzle LPG code 20 bore ø 0.2mm Qty 1 pcs thread M8x0.75		
	GEV No.	100855	Ref. No. —
	pilot burner bracket triple		
	GEV No.	100885	Ref. No. X19901
	air mixing sleeve for pilot burner Qty 1 pcs		
	GEV No.	100916	Ref. No. —
	compression spring for pilot burner Qty 1 pcs		
	GEV No.	100917	Ref. No. —
	gasket for pilot burner Qty 1 pcs aluminium		
	GEV No.	100918	Ref. No. —
	screw for pilot burner		

spare parts for		106906	
	GEV No.	107162	Ref. No. —
	pilot burner cap SIT 3 flames Hmm Lmm Qty 1 pcs		
	GEV No.	107701	Ref. No. X19900
	pilot burner bottom part SIT 100 series nozzle ø 0.2mm		
<b>accessories for</b>		106906	
	GEV No.	100245	Ref. No. X19906
	pilot burner nozzle LPG code 20 bore ø 0.2mm Qty 1 pcs thread M8x0.75		
	GEV No.	100246	Ref. No. 0000X19907 X19907
	pilot burner nozzle natural gas bore ø 0.35mm Qty 1 pcs thread M8x0.75		
	GEV No.	100904	Ref. No. —
	locking screw M10x1 for pipe ø 4mm Qty 1 pcs		
	GEV No.	100905	Ref. No. —
	locking screw M10x1 for pipe ø 6mm Qty 1 pcs		
	GEV No.	102110	Ref. No. —
	pilot tube copper pipe ø 4mm thickness 1mm L 3000mm		
	GEV No.	102111	Ref. No. —
	pilot tube copper pipe ø 6mm thickness 1mm L 3000mm		
	GEV No.	107171	Ref. No. —
	pilot burner nozzle SIT natural/liquid gas bore ø 0.25mm Qty 1 pcs		
	GEV No.	107700	Ref. No. —
	pilot burner bottom part SIT 100 series nozzle ø 0.25mm		
	GEV No.	107702	Ref. No. —
	pilot burner bottom part SIT 100 series nozzle ø 0.35mm		





accessories			
pilot burner bottom parts			
 <p>1</p>			
<b>GEV No.</b>	107701	<b>Ref. No.</b>	X19900
<b>description</b>	pilot burner bottom part SIT 100 series nozzle ø 0.2mm		
<b>For models:</b>	B4F, B6F, B8, B8F, C2FP, C2FTPFEF, C2FTPFGP, C2TP2FGP, C4FFCEP, C4FFCGP, C4FFEP, C4FFGP, C4FFLEP, C4FFLGP, C4FP, C6FFCEP, C6FFCGP, C6FFEP, C6FFGAP, C6FFGP, C6FFLEP, C6FFLGP, C6FFLGPV, C6FP, FCE, FCG, FE, K2F, K2FTPFCF, K2FTPFCG, K2FTPFE, K2FTPFG, K4F, K4FFE, K4FFG, K4FS, K4FSFG, K6F, K6FFE, K6FFG, K6FG, K8F, K8FFE, K8FFG, OP2F, OP4F, OP4FS, OP6F, OP8F...(Other models you can see in the webshop)		
<b>spare parts for</b>		107701	
	GEV No.	100245	Ref. No. X19906
	pilot burner nozzle LPG code 20 bore ø 0.2mm Qty 1 pcs thread M8x0.75		
	GEV No.	100916	Ref. No. —
	compression spring for pilot burner Qty 1 pcs		

Table continues overleaf



spare parts for		107701		
	GEV No.	100917	Ref. No.	—
gasket for pilot burner Qty 1 pcs aluminium				
	GEV No.	100918	Ref. No.	—
screw for pilot burner				
accessories for		107701		
	GEV No.	100246	Ref. No.	0000X19907 X19907
pilot burner nozzle natural gas bore $\phi$ 0.35mm Qty 1 pcs thread M8x0.75				
	GEV No.	100904	Ref. No.	—
locking screw M10x1 for pipe $\phi$ 4mm Qty 1 pcs				
	GEV No.	100905	Ref. No.	—
locking screw M10x1 for pipe $\phi$ 6mm Qty 1 pcs				
	GEV No.	102110	Ref. No.	—
pilot tube copper pipe $\phi$ 4mm thickness 1mm L 3000mm				
	GEV No.	102111	Ref. No.	—
pilot tube copper pipe $\phi$ 6mm thickness 1mm L 3000mm				
	GEV No.	102742	Ref. No.	—
pilot burner nozzle LPG code 25 bore $\phi$ 0.25mm Qty 1 pcs				

pilot burner nozzles

	1		
GEV No.	100245	Ref. No.	X19906
description pilot burner nozzle LPG code 20 bore $\phi$ 0.2mm Qty 1 pcs thread M8x0.75			
For models: B4F, B6F, B8, B8F, C2FP, C2FTPFGP, C2TP2FGP, C4FFCEP, C4FFCGP, C4FFEP, C4FFGP, C4FP, C4FZFG, C4FZFGP, C4FZSFGP, C6FFCEP, C6FFCGP, C6FFEP, C6FFGP, C6FP, C6FZFG, C6FZFGP, CBG4, CBRG, CBRGIN, CCPG4, CCPG82, CCTP8, CCTPFG8, CF10DG8M, CF10G4M, CFTG22, CFTG2C2, CFTG2LR, CFTG2R2, CFTG62, CFTG6C2, CFTG6LR, CFTG6R2, CPG, CPGI, CPLG1, CPLG2, FCE, FCG, FE, K2F, K2FTPFC, K2FTPFCG, K2FTPFE...(Other models you can see in the webshop)			

	1		
GEV No.	100246	Ref. No.	0000X19907
description pilot burner nozzle natural gas bore $\phi$ 0.35mm Qty 1 pcs thread M8x0.75			
For models: B4F, B6F, B8, B8F, C2FP, C2FTPFGP, C2TP2FGP, C4FFCEP, C4FFCGP, C4FFEP, C4FFGP, C4FP, C4FZFG, C4FZFGP, C4FZSFGP, C6FFCEP, C6FFCGP, C6FFEP, C6FFGP, C6FP, C6FZFG, C6FZFGP, CBG4, CBRG, CBRGIN, CCPG4, CCPG82, CCTP8, CCTPFG8, CF10DG8M, CF10G4M, CFTG22, CFTG2C2, CFTG2LR, CFTG2R2, CFTG62, CFTG6C2, CFTG6LR, CFTG6R2, CPG, CPGI, CPLG1, CPLG2, FCE, FCG, FE, K2F, K2FTPFC, K2FTPFCG, K2FTPFE...(Other models you can see in the webshop)			

	1		
GEV No.	102972	Ref. No.	30500003
description pilot burner nozzle natural gas code 40 bore $\phi$ 0.4mm Qty 1 pcs			
For models: KP20G, KP20GA, KP20GT, KP20GTA, KP30G, KP30GA, KP30GT, KP30GTA, KP50G, KP50GA, KP50GT, KP50GTA, KPGN18G, KPGN27G, KPGN37G, KPI20G, KPI20GA, KPI20GT, KPI20GTA, KPI30G, KPI30GA, KPI30GT, KPI30GTA, KPI50G, KPI50GA, KPI50GT, KPI50GTA, KPIGN18G, KPIGN27G, KPIGN37G			

ignition electrodes

	1		
GEV No.	100706	Ref. No.	0000X14600 30100054 719-020-00
description ignition electrode connection M4 Qty 1 pcs			
For models: C2FTPFE, C2FTPFEF, C2FTPFG, C2FTPFGP, C2TP2FGP, C4FFCGP, C4FFG, C4FFGP, C4FZFCG, C4FZFCGP, C4FZSFCGP, C6FFCGP, C6FFG, C6FFGA, C6FFGAP, C6FFGP, C6FZFCG, C6FZFCGP, C6FZFCGPV, C6FZFCGV, CBG4, CBG6, CBG8, CBRG, CBRGIN, CC120CG, CC81CG, CCPG4, CCPG8, CCPG82, CCTP8, CCTPFG8, CFG15, CFG15D, CFTG22, CFTG2C2, CFTG2LR, CFTG2R2, CFTG62, CFTG6C2, CFTG6LR, CFTG6R2, CPG, CPGI, CPLG1, CPLG2, CPLG4, CPLG8, K2FTPFC, K2FTPFCG...(Other models you can see in the webshop)			

miscellaneous

	1		
GEV No.	100885	Ref. No.	X19901
description air mixing sleeve for pilot burner Qty 1 pcs			
For models: B4F, B6F, B8, B8F, C2FP, C2FTPFEF, C2FTPFGP, C2TP2FGP, C4FFCEP, C4FFCGP, C4FFEP, C4FFGP, C4FFLEP, C4FFLGP, C4FP, C6FFCEP, C6FFCGP, C6FFEP, C6FFGP, C6FFGAP, C6FFGP, C6FFLEP, C6FFLEPV, C6FFLGP, C6FFLGPV, C6FP, FCE, FCG, FE, K2F, K2FTPFC, K2FTPFCG, K2FTPFE, K2FTPFG, K4F, K4FFE, K4FFG, K4FS, K4FSFCE, K4FSFCG, K4FSFE, K4FSFG, K6F, K6FFE, K6FFG, K6FG, K8F, K8FFE, K8FFG, M72FPTFG, M74FMPFG...(Other models you can see in the webshop)			

140 - 145 -150 series













	1			
GEV No.	102450	Ref. No.	X14400	
description pilot burner SIT type 150 series 1 flame nozzle $\phi$ mm gas connection 6mm				
For models: 2FZP, B4FZ, B6FZ, B8FZ, C2FZP, C2TP2FGP, C4FZFCPE, C4FZFCGP, C4FZFEP, C4FZFGP, C4FZP, C4FZSFCEP, C4FZSFCGP, C4FZSFEP, C4FZSFGP, C4FZSP, C6FFGAP, C6FZFCPE, C6FZFCPEPV, C6FZFCGP, C6FZFCGPV, C6FZFEP, C6FZFGA, C6FZFGAP, C6FZFGP, C6FZP, CN14FGA, I2FZP, I4FZP, I6FZP, K2FZ, K4FZ, K4FZFCE, K4FZFCEG, K4FZFE, K4FZFG, K4FZFGA, K4FZS, K4FZSFCE, K4FZSFCEG, K4FZSFE, K4FZSFG, K6FFGA, K6FZ, K6FZFCE, K6FZFCG, K6FZFE, K6FZFG, K6FZFGA, K8FZ...(Other models you can see in the webshop)				
spare parts for		102450		
	GEV No.	100204	Ref. No.	—
pilot burner nozzle SIT LPG code 14 bore $\phi$ 0.18/0.20mm Qty 1 pcs suitable for 140 series				
	GEV No.	100205	Ref. No.	0000X30000 X30000
pilot burner nozzle SIT LPG code 19 bore $\phi$ 0.23/0.26mm Qty 1 pcs suitable for SIT 150 series				









Table continues overleaf





spare parts for		102450	
	GEV No.	100206	Ref. No. 0000X30100 X30100
pilot burner nozzle SIT natural gas code 36 bore ø 0.60/0.55mm Qty 1 pcs suitable for SIT 150 series			
	GEV No.	100207	Ref. No. X30300
pilot burner nozzle SIT natural gas code 27 bore ø 0.40/0.38mm suitable for SIT 140 series			
	GEV No.	100216	Ref. No. —
pilot burner nozzle SIT natural gas code 38 bore ø 0.45mm Qty 1 pcs suitable for SIT 150 series			
	GEV No.	100765	Ref. No. —
pilot burner nozzle SIT LPG code 20 bore ø 0.35mm Qty 1 pcs suitable for 150 series			
	GEV No.	100897	Ref. No. —
olive for pipe ø 4mm Qty 1 pcs for pilot burner			
	GEV No.	100898	Ref. No. —
olive for pipe ø 6mm Qty 1 pcs for pilot burner			
	GEV No.	100906	Ref. No. X13002
screw connection thread M10x1 for ignition electrode brass Qty 1 pcs WS 10			
	GEV No.	100907	Ref. No. —
screw connection thread M10x1 Qty 1 pcs type SEF 1 ømm for thermocouple			
	GEV No.	100908	Ref. No. X13200
union screw thread M10x1 for pipe ø 4mm Qty 1 pcs			
	GEV No.	100909	Ref. No. —
union screw thread M10x1 for pipe ø 6mm Qty 1 pcs			
	GEV No.	101246	Ref. No. —
olive for pipe ø 4mm Qty 1 pcs			

			
1			
GEV No.	100170	Ref. No.	0000X13000
description pilot burner SIT type 150 series 1 flame nozzle ømm gas connectionmm			
For models: C2FTPFPG, CCTP8, CCTPFG8, CFTG1, CFTG1C, CFTG1R, CFTG2, CFTG2C, CFTG2R, CFTG3, CFTG3C, CFTG3LR, CFTG3R, CFTG4, CFTG4C, CFTG4R, CFTG6, CFTG6C, CFTG6R, CFTG8, CFTG8C, CFTG8LR, CFTG8R, K2FTPFCE, K2FTPFCEG, K2FTPFE, K2FTPFG, KBRG, KBRG12, KBRG12IN, KBRGIN, KBRGM, KBRGM12, KBRGM12IN, KBRGMIN, KFT4G, KFT4GC, KFT4GR, KFT8G, KFT8G23C, KFT8GC, KFT8GLR, KFT8GR, KFTG1, KFTG1C, KFTG1R, KFTG3, KFTG3C, KFTG3LR, KFTG4...(Other models you can see in the webshop)			
spare parts for 100170			
	GEV No.	100907	Ref. No. —
screw connection thread M10x1 Qty 1 pcs type SEF 1 ømm for thermocouple			
accessories for 100170			
	GEV No.	100204	Ref. No. —
pilot burner nozzle SIT LPG code 14 bore ø 0.18/0.20mm Qty 1 pcs suitable for 140 series			
	GEV No.	100205	Ref. No. 0000X30000 X30000
pilot burner nozzle SIT LPG code 19 bore ø 0.23/0.26mm Qty 1 pcs suitable for SIT 150 series			

accessories for		100170	
	GEV No.	100206	Ref. No. 0000X30100 X30100
pilot burner nozzle SIT natural gas code 36 bore ø 0.60/0.55mm Qty 1 pcs suitable for SIT 150 series			
	GEV No.	100207	Ref. No. X30300
pilot burner nozzle SIT natural gas code 27 bore ø 0.40/0.38mm suitable for SIT 140 series			
	GEV No.	100216	Ref. No. —
pilot burner nozzle SIT natural gas code 38 bore ø 0.45mm Qty 1 pcs suitable for SIT 150 series			
	GEV No.	100701	Ref. No. 0000X13001 X13001 X16900
ignition electrode connection M4 Qty 1 pcs			
	GEV No.	100801	Ref. No. —
gasket for pilot burner Qty 1 pcs			
	GEV No.	100897	Ref. No. —
olive for pipe ø 4mm Qty 1 pcs for pilot burner			
	GEV No.	100898	Ref. No. —
olive for pipe ø 6mm Qty 1 pcs for pilot burner			
	GEV No.	100906	Ref. No. X13002
screw connection thread M10x1 for ignition electrode brass Qty 1 pcs WS 10			
	GEV No.	100908	Ref. No. X13200
union screw thread M10x1 for pipe ø 4mm Qty 1 pcs			
	GEV No.	100909	Ref. No. —
union screw thread M10x1 for pipe ø 6mm Qty 1 pcs			

160 series

			
1			
GEV No.	100056	Ref. No.	X17000
description pilot burner SIT type 160 series 3 flames nozzle ømm gas connectionmm			
For models: CBRG, CBRG8, CBRGIN			
spare parts for 100056			
	GEV No.	100907	Ref. No. —
screw connection thread M10x1 Qty 1 pcs type SEF 1 ømm for thermocouple			
accessories for 100056			
	GEV No.	100202	Ref. No. —
pilot burner nozzle natural gas code 41 Qty 1 pcs nozzle ø 0.41mm			
	GEV No.	100203	Ref. No. —
pilot burner nozzle LPG code 25 Qty 1 pcs nozzle ø 0.25mm			
	GEV No.	100701	Ref. No. 0000X13001 X13001 X16900
ignition electrode connection M4 Qty 1 pcs			

Table continues overleaf



accessories for		100056		
GEV No.	100801	Ref. No.	—	
			gasket for pilot burner Qty 1 pcs	
GEV No.	100869	Ref. No.	—	
			pilot burner nozzle natural gas code 51 Qty 1 pcs suitable for 160 series nozzle $\varnothing$ 0.51mm	
GEV No.	100870	Ref. No.	—	
			olive for pipe $\varnothing$ 4mm Qty 1 pcs suitable for 160 series for pilot burner	
GEV No.	100906	Ref. No.	X13002	
			screw connection thread M10x1 for ignition electrode brass Qty 1 pcs WS 10	
GEV No.	100908	Ref. No.	X13200	
			union screw thread M10x1 for pipe $\varnothing$ 4mm Qty 1 pcs	
GEV No.	100909	Ref. No.	—	
			union screw thread M10x1 for pipe $\varnothing$ 6mm Qty 1 pcs	
GEV No.	101287	Ref. No.	—	
			olive for pipe $\varnothing$ 6mm Qty 1 pcs	
GEV No.	102110	Ref. No.	—	
			pilot tube copper pipe $\varnothing$ 4mm thickness 1mm L 3000mm	
GEV No.	102111	Ref. No.	—	
			pilot tube copper pipe $\varnothing$ 6mm thickness 1mm L 3000mm	
GEV No.	107650	Ref. No.	—	
			pilot burner nozzle SIT LPG code 30 Qty 1 pcs	

producer-specific pilot burners

GIGA

Counter 700 / Top 700 / Kappa 900 / Snack 600 series

1			
GEV No.	100145	Ref. No.	0000X19000
description	pilot burner SIT type 100 series 3 flames nozzle $\varnothing$ 0.2mm gas connectionmm		
For models:	CF10DG8M, CF10G4M, CFG15, CFG15D, KFG1, KFG15, KFG15D, KFG2, KFG20, KFG20D, M7F4G, M7F8G, OPFG1, OPFG2, SKF10GM, SKF20GM, TF10GM, TF20GM		
spare parts for	100145		
GEV No.	100245	Ref. No.	X19906
			pilot burner nozzle LPG code 20 bore $\varnothing$ 0.2mm Qty 1 pcs thread M8x0.75
GEV No.	100837	Ref. No.	—
			pilot burner cap 3 flames H 24mm L 48mm Qty 1 pcs
GEV No.	100855	Ref. No.	—
			pilot burner bracket triple





spare parts for		100145		
GEV No.	100881	Ref. No.	—	
			pilot burner bottom part PRO-GAS 100 series nozzle $\varnothing$ 0.2mm	
GEV No.	100885	Ref. No.	X19901	
			air mixing sleeve for pilot burner Qty 1 pcs	
GEV No.	100916	Ref. No.	—	
			compression spring for pilot burner Qty 1 pcs	
GEV No.	100917	Ref. No.	—	
			gasket for pilot burner Qty 1 pcs aluminium	
GEV No.	100918	Ref. No.	—	
			screw for pilot burner	





accessories for		100145		
GEV No.	100246	Ref. No.	0000X19907 X19907	
			pilot burner nozzle natural gas bore $\varnothing$ 0.35mm Qty 1 pcs thread M8x0.75	
GEV No.	100882	Ref. No.	—	
			pilot burner bottom part PRO-GAS 100 series nozzle $\varnothing$ 0.25mm	
GEV No.	100883	Ref. No.	—	
			pilot burner bottom part PRO-GAS 100 series nozzle $\varnothing$ 0.35mm	
GEV No.	100904	Ref. No.	—	
			locking screw M10x1 for pipe $\varnothing$ 4mm Qty 1 pcs	
GEV No.	100905	Ref. No.	—	
			locking screw M10x1 for pipe $\varnothing$ 6mm Qty 1 pcs	
GEV No.	102110	Ref. No.	—	
			pilot tube copper pipe $\varnothing$ 4mm thickness 1mm L 3000mm	
GEV No.	102111	Ref. No.	—	
			pilot tube copper pipe $\varnothing$ 6mm thickness 1mm L 3000mm	
GEV No.	102742	Ref. No.	—	
			pilot burner nozzle LPG code 25 bore $\varnothing$ 0.25mm Qty 1 pcs	



1			
GEV No.	107701	Ref. No.	X19900
description	pilot burner bottom part SIT 100 series nozzle $\varnothing$ 0.2mm		
For models:	B4F, B6F, B8, B8F, C2FP, C2FTPFEP, C2FTPFPG, C2TP2FGP, C4FFCEP, C4FFCGP, C4FFEP, C4FFGP, C4FFLEP, C4FFLGP, C4FP, C6FFCEP, C6FFCGP, C6FFEP, C6FFGAP, C6FFGP, C6FFLEP, C6FFLEPV, C6FFLGP, C6FFLGPV, C6FP, FCE, FCG, FE, K2F, K2FTPFCE, K2FTPFPG, K2FTPFE, K2FTPFG, K4F, K4FFE, K4FFG, K4FS, K4FSFG, K6F, K6FFE, K6FFG, K6FG, K8F, K8FFE, K8FFG, OP2F, OP4F, OP4FS, OP6F, OP8F...(Other models you can see in the webshop)		
spare parts for	107701		
GEV No.	100245	Ref. No.	X19906
			pilot burner nozzle LPG code 20 bore $\varnothing$ 0.2mm Qty 1 pcs thread M8x0.75

Table continues overleaf



spare parts for		107701		
	GEV No.	100916	Ref. No.	—
compression spring for pilot burner Qty 1 pcs				
	GEV No.	100917	Ref. No.	—
gasket for pilot burner Qty 1 pcs aluminium				
	GEV No.	100918	Ref. No.	—
screw for pilot burner				
accessories for		107701		
	GEV No.	100246	Ref. No.	0000X19907 X19907
pilot burner nozzle natural gas bore ø 0.35mm Qty 1 pcs thread M8x0.75				
	GEV No.	100904	Ref. No.	—
locking screw M10x1 for pipe ø 4mm Qty 1 pcs				
	GEV No.	100905	Ref. No.	—
locking screw M10x1 for pipe ø 6mm Qty 1 pcs				
	GEV No.	102110	Ref. No.	—
pilot tube copper pipe ø 4mm thickness 1mm L 3000mm				
	GEV No.	102111	Ref. No.	—
pilot tube copper pipe ø 6mm thickness 1mm L 3000mm				
	GEV No.	102742	Ref. No.	—
pilot burner nozzle LPG code 25 bore ø 0.25mm Qty 1 pcs				

	1			
<b>GEV No.</b>	100099	<b>Ref. No.</b>	Y20300	
<b>description</b>	pilot burner cap 1 flame suitable for 100 series			
<b>For models:</b>	B4F, B6F, B8, B8F, C2FP, C2FTPFEP, C2FTPFPG, C2TP2FGP, C4FFCEP, C4FFCGP, C4FFEP, C4FFGP, C4FFLEP, C4FFLGP, C4FP, C6FFCEP, C6FFCGP, C6FFEP, C6FFGAP, C6FFGP, C6FFLEP, C6FFLEPV, C6FFLGP, C6FFLGPV, C6FFLGP, C6FFLGPV, C6FP, FCE, FCG, FE, K2F, K2FTPFCE, K2FTPFCEG, K2FTPFE, K2FTPFG, K4F, K4FFE, K4FFG, K4FS, K4FSFCE, K4FSFCG, K4FSFE, K4FSFG, K6F, K6FFE, K6FFG, K6FG, K8F, K8FFE, K8FFG, OP2F, OP4F...(Other models you can see in the webshop)			
accessories for		100099		
	GEV No.	100245	Ref. No.	X19906
pilot burner nozzle LPG code 20 bore ø 0.2mm Qty 1 pcs thread M8x0.75				
	GEV No.	100246	Ref. No.	0000X19907 X19907
pilot burner nozzle natural gas bore ø 0.35mm Qty 1 pcs thread M8x0.75				
	GEV No.	100881	Ref. No.	—
pilot burner bottom part PRO-GAS 100 series nozzle ø 0.2mm				
	GEV No.	100882	Ref. No.	—
pilot burner bottom part PRO-GAS 100 series nozzle ø 0.25mm				

accessories for		100099		
	GEV No.	100883	Ref. No.	—
pilot burner bottom part PRO-GAS 100 series nozzle ø 0.35mm				
	GEV No.	100885	Ref. No.	X19901
air mixing sleeve for pilot burner Qty 1 pcs				
	GEV No.	102742	Ref. No.	—
pilot burner nozzle LPG code 25 bore ø 0.25mm Qty 1 pcs				

### accessories universal

#### covers



1

<b>GEV No.</b>	106572	<b>Ref. No.</b>	0000X23200
<b>description</b>	cover for pilot burner		
<b>For models:</b>	CF10DG8M, CF10G4M, KFG1, KFG2, KFG20, KFG20D, M7F4G, M7F8G, OPFG1, OPFG2, OPFG20, OPFG20D, SKF10GM, SKF20GM, TF10GM, TF20GM		

#### electrodes



1

<b>GEV No.</b>	102439	<b>Ref. No.</b>	AGB013ZR10
<b>description</b>	ignition electrode		
<b>For models:</b>	M7FT4GL, M7FT4GR, M7FT6GL, M7FT6GLR		



1

<b>GEV No.</b>	102440	<b>Ref. No.</b>	AGB011ZR10
<b>description</b>	ignition electrode		
<b>For models:</b>	CC120CG, CC80G, CC81CG, CCG120CE, CCG80E, CCG81CE, M62F, M64F, M74F, M74FFXE, M74FFXG, M76F, M76FFXE, M76FFXG, M7FT4GL, M7FT4GR, M7FT6GL, M7FT6GLR, SKC40G, SKC80G		

<b>GEV No.</b>	100701	<b>Ref. No.</b>	0000X13001 X16900
<b>description</b>	ignition electrode connection M4 Qty 1 pcs		
<b>For models:</b>	C2TP2FGP, C6FFGAP, C6FZFGA, C6FZFGAP, CFTG1, CFTG1C, CFTG1R, CFTG2, CFTG2C, CFTG2R, CFTG3, CFTG3C, CFTG3LR, CFTG3R, CFTG4, CFTG4C, CFTG4R, CFTG6, CFTG6C, CFTG6R, CFTG8, CFTG8C, CFTG8LR, CFTG8R, CN14FGA, K2FTPFCE, K2FTPFCEG, K2FTPFE, K2FTPFG, K6FFGA, K6FZFGA, KBRG, KBRG12, KBRG12IN, KBRGIN, KBRGM, KBRGM12, KBRGM12IN, KBRGMIN, KFT4G, KFT4GC, KFT4GR, KFT8G, KFT8G23C, KFT8GC, KFT8GLR, KFT8GR, KFTG1, KFTG1C, KFTG1R...(Other models you can see in the webshop)		
<b>accessories for</b>	100701		
		<b>GEV No.</b>	100906
		<b>Ref. No.</b>	X13002
	screw connection thread M10x1 for ignition electrode brass Qty 1 pcs WS 10		

<b>GEV No.</b>	100706	<b>Ref. No.</b>	0000X14600 30100054 719-020-00
<b>description</b>	ignition electrode connection M4 Qty 1 pcs		
<b>For models:</b>	C2FTPFE, C2FTPFEP, C2FTPFG, C2FTPFGP, C2TP2FGP, C4FFCGP, C4FFG, C4FFGP, C4FZFCG, C4FZFCGP, C4FZSFCGP, C6FFCGP, C6FFG, C6FFGA, C6FFGAP, C6FFGP, C6FZFCG, C6FZFCGP, C6FZFCGPV, C6FZFCGV, CBG4, CBG6, CBG8, CBRG, CBRGIN, CC120CG, CC81CG, CCPG4, CCPG8, CCPG82, CCTP8, CCTPFG8, CFG15, CFG15D, CFTG22, CFTG2C2, CFTG2LR, CFTG2R2, CFTG62, CFTG6C2, CFTG6LR, CFTG6R2, CPG, CPGI, CPLG1, CPLG2, CPLG4, CPLG8, K2FTPFCE, K2FTPFCEG...(Other models you can see in the webshop)		

<b>GEV No.</b>	102467	<b>Ref. No.</b>	AGB019ZR10
<b>description</b>	ignition electrode D1 ø 5.5mm D2 ø 7mm connection ø2.4mm cable length 600mm L1 1mm BL1 16mm BL2 6mm BL3 3mm BL4 8mm D3 ø 10mm D4 ø 5mm connection ø 3mm		
<b>For models:</b>	CC120CG, CC80G, CC81CG, CCG120CE, CCG80E, CCG81CE, M62F, M64F, M74F, M74FFXE, M74FFXG, M76F, M76FFXE, M76FFXG, SKC40G, SKC80G		

<b>GEV No.</b>	100733	<b>Ref. No.</b>	X14500
<b>description</b>	ignition electrode D1 ø 7mm D2 ø 8.5mm cable length 600mm BL1 28mm BL2 3mm BL3 23mm to clip connection ø 2.4mm		
<b>For models:</b>	C2F, C2FTPFE, C2FTPFG, C2FZ, C2TP2FGP, C4F, C4FFE, C4FFG, C4FFLE, C4FFLG, C4FZ, C4FZFCG, C4FZFCG, C4FZFE, C4FZFG, C6F, C6FFE, C6FFG, C6FFGA, C6FFLE, C6FFLEV, C6FFLG, C6FFLGV, C6FZ, C6FZFCG, C6FZFCG, C6FZFCGV, C6FZFE, C6FZFG, C6FZFGA, I2FZ, I4FZ, T2F, T2FZ, T4F, T4FZ, T6F, T6FZ		

<b>GEV No.</b>	100822	<b>Ref. No.</b>	0000X16800
<b>description</b>	ignition electrode D1 ø 7mm D2 ø 9mm connection M4 L1 16mm L2 25mm L3 8mm BL1 18mm BL2 3mm BL3 23mm to clip		
<b>For models:</b>	C2FTPFGP, C2TP2FGP, C4FFGP, C4FZFG, C4FZFGP, C4FZSFGP, C6FFGP, C6FZFG, C6FZFGP, CCTPFG8, CF10DG8M, CF10G4M, K2FTPFG, K4FFG, K4FFSFG, K4FZFG, K4FZSFG, K6FFG, K6FZFG, K8FFG, K8FZFG, KFG1, KFG2, KTPFG, M72FPTFG, M74FMPFG, M74FPFG, M76FMPFG, M76FPFG, M7F4G, M7F8G, OPFG1, OPFG2, SKF10GM, SKF20GM, TF10GM, TF20GM		

<b>GEV No.</b>	100818	<b>Ref. No.</b>	X68041
<b>description</b>	ignition electrode flange length 23mm flange width 15mm D1 ø 7mm L1 18mm BL1 12mm BL2 41mm connection F 2.8x0.8mm fixing dimensions ø5x4mm with flange		
<b>For models:</b>	C4FFLG, C4FFLGP, C6FFLG, C6FFLGP, C6FFLGPV, C6FFLGV, CC120G, CC80G, CC81G, M74FFXG, M74FMPFXG, M74FPFXG, M76FFXG, M76FMPFXG, M76FPFXG		

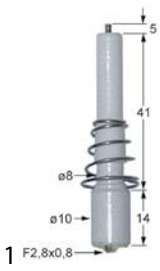
<b>GEV No.</b>	100729	<b>Ref. No.</b>	X15000
<b>description</b>	ignition electrode L1 5mm D1 ø8mm D2 ø10mm BL1 41mm BL2 14mm connection F 2.8x0.8mm to clip with spring		
<b>For models:</b>	CC120CG, CC120G, CC80G, CC81CG, CC81G, CCG120CE, CCG120E, CCG80E, CCG81CE, CCG81E, SKC40G, SKC80G		



<b>GEV No.</b>	100906	<b>Ref. No.</b>	X13002
<b>description</b>	screw connection thread M10x1 for ignition electrode brass Qty 1 pcs WS 10		



<b>GEV No.</b>	100175	<b>Ref. No.</b>	0000X40300
<b>description</b>	ignition cable cable length 1750mm connection ø2.4mm / ø4mm		
<b>For models:</b>	C2FTPFPG, C2FTPFPGP, C2TP2FPG, C4FFG, C4FFGPG, C4FZFG, C4FZFGP, C4FZSFGP, C6FFG, C6FFGA, C6FFGAP, C6FFGP, C6FZFG, C6FZFGA, C6FZFGAP, C6FZFGP, CCTPF8, CN14FGA, K2FTPFCE, K2FTPFCC, K2FTPFCE, K2FTPFPG, K4FFG, K4FSFCG, K4FSFG, K4FZFCG, K4FZFG, K4FZSFCG, K4FZSFG, K6FFG, K6FFGA, K6FZFCG, K6FZFG, K6FZFGA, K8FFG, K8FZFCG, K8FZFG, KTP, KTPFCE, KTPFCG, KTPFE, KTPFG, M72FPTFG, M74FMPFG, M74FPFG, M76FMPFG, M76FPFG, OPTP		



<b>GEV No.</b>	100177	<b>Ref. No.</b>	X40500
<b>description</b>	ignition cable cable length 600mm		



<b>GEV No.</b>	100197	<b>Ref. No.</b>	000X40500
<b>description</b>	ignition cable cable length 600mm connection F2.8mm / ø2.4mm		
<b>For models:</b>	CC120CG, CC120G, CC80G, CC81CG, CC81G, CCG120CE, CCG120E, CCG80E, CCG81CE, CCG81E, CCPG4, CCPG8, CCPG82, CF15DG8, CF15G4, KBRG, KBRG12, KBRG12IN, KBRGIN, KBRGM, KBRGM12, KBRGM12IN, KBRGMIN, KCP4, KCP82, KFG4, KFG8, M7FT4GL, M7FT4GR, M7FT6GL, M7FT6GLR, OPBRG, OPBRG12, OPBRG12IN, OPBRG12MIN, OPBRGIN, OPBRGM, OPBRGM12, OPBRGM12IN, OPBRGMIN, OPCP4, OPCP82, SKC40G, SKC80G		

ignition cables

pre-assembled cables



<b>GEV No.</b>	100176	<b>Ref. No.</b>	0000X41000 E10000
<b>description</b>	ignition cable cable length 1000mm connection ø2.4mm / ø4mm permanent temperature 200°C		
<b>For models:</b>	C2FTPFE, C2FTPFEP, C2FTPFPG, C2FTPFPGP, C2TP2FPG, CCPG4, CCPG82, CCTP8, CCTPF8, CFG15, CFG15D, CPG, CPGI, CPLG4, CPLG8, K2FTPFCE, K2FTPFCC, K2FTPFCE, K2FTPFPG, KCP4, KCP8, KCP82, KFG1, KFG15, KFG15D, KFG2, KFG20, KFG20D, KP10G, KP10GA, KP10GT, KP10GTA, KP15G, KP15GA, KP15GT, KP15GTA, KP10G, KP10GA, KP10GT, KP10GTA, KP15G, KP15GA, KP15GT, KP15GTA, KTP, KTPFCE, KTPFCG, KTPFE, KTPFG, M7CP4G...(Other models you can see in the webshop)		



<b>GEV No.</b>	100015	<b>Ref. No.</b>	X40100
<b>description</b>	ignition cable cable length 600mm connection ø2.4mm / ø2.4mm		



<b>GEV No.</b>	100178	<b>Ref. No.</b>	0000X40500
<b>description</b>	ignition cable cable length 900mm connection F2.8mm / ø2.4mm		

piezoelectric igniters

mounting diameter 18mm



<b>GEV No.</b>	100026	<b>Ref. No.</b>	X40100
<b>description</b>	ignition cable cable length 1000mm connection ø4mm / F6.3mm		
<b>For models:</b>	C2TP2FPG, CBG4, CBG6, CBG8, CBRG, CBRG8, CBRGIN, CF10DG8M, CF10G4M, CFG15, CFG15D, CFTG1, CFTG1C, CFTG1R, CFTG2, CFTG22, CFTG2C, CFTG2C2, CFTG2LR, CFTG2R, CFTG2R2, CFTG3, CFTG3C, CFTG3LR, CFTG3R, CFTG4, CFTG4C, CFTG4R, CFTG6, CFTG62, CFTG6C, CFTG6C2, CFTG6LR, CFTG6R, CFTG6R2, CFTG8, CFTG8C, CFTG8LR, CFTG8R, CPLG1, CPLG2, K2FTPFCE, K2FTPFCC, K2FTPFCE, K2FTPFPG, KB4G, KB8G, KFG1, KFG15, KFG15D...(Other models you can see in the webshop)		



<b>GEV No.</b>	100003	<b>Ref. No.</b>	0000M00500
<b>description</b>	piezoelectric igniter body metal blowing mounting ø 18mm connection F2.8x0.8		
<b>For models:</b>	C2F, C2FTPFE, C2FTPFEP, C2FTPFPG, C2FTPFPGP, C4F, C4FFE, C4FFG, C4FFGPG, C4FFLE, C4FFLG, C6F, C6FFE, C6FFG, C6FFGA, C6FFGAP, C6FFGP, C6FFLE, C6FFLEV, C6FFLG, C6FFLGV, CBG4, CBG6, CBG8, CC120G, CC80G, CC81G, CCG120E, CCG80E, CCG81E, CCPG4, CCPG8, CCPG82, CCTP8, CCTPFE8, CCTPF8, CF10DG8M, CF10G4M, CFG15, CFG15D, CFTG1, CFTG1C, CFTG1R, CFTG2, CFTG22, CFTG2C, CFTG2C2, CFTG2LR, CFTG2R, CFTG2R2...(Other models you can see in the webshop)		



<b>GEV No.</b>	100174	<b>Ref. No.</b>	X68040
<b>description</b>	ignition cable cable length 1500mm connection F2.8mm / F2.8mm		
<b>For models:</b>	C4FFLG, C4FFLGP, C6FFLG, C6FFLGP, C6FFLGPV, C6FFLGV, CC80G, M74FFXG, M74FMPFXG, M74FPFXG, M76FFXG, M76FMPFXG, M76FPFXG		





			
1			
<b>GEV No.</b>	100004	<b>Ref. No.</b>	0000M02100
<b>description</b>	piezoelectric igniter body plastic blowing mounting ø 18mm connection ø2.4mm		
<b>For models:</b>	C2FTPFGP, C2FZ, C2TP2FGP, C4FFCGP, C4FFGP, C4FZ, C4FZFCE, C4FZFCG, C4FZFCGP, C4FZFE, C4FZFG, C4FZFGP, C4FZSFCGP, C4FZSFGP, C6FFCGP, C6FFGAP, C6FFGP, C6FZ, C6FZFCE, C6FZFCEV, C6FZFCG, C6FZFCGP, C6FZFCGPV, C6FZFCGV, C6FZFE, C6FZFG, C6FZFGA, C6FZFGAP, C6FZFGP, CBG4, CBRG, CBRGIN, CC120CG, CC80G, CC81CG, CCG120CE, CCG80E, CCG81CE, CCPG4, CCPG82, CCTP8, CCTPFG8, CF10DG8M, CF10G4M, CFG15, CFG15D, CFTG1, CFTG1C, CFTG1R, CFTG2...(Other models you can see in the webshop)		

## mounting diameter 22mm

			
1			
<b>GEV No.</b>	100013	<b>Ref. No.</b>	40100130
<b>description</b>	piezoelectric igniter body plastic blowing mounting ø 22mm connection ø2.4mm cable lengthmm		
<b>For models:</b>	KP20G, KP20GA, KP20GT, KP20GTA, KP30G, KP30GA, KP30GT, KP30GTA, KP50G, KP50GA, KP50GT, KP50GTA, KPGN18G, KPGN27G, KPGN37G, KPI20G, KPI20GA, KPI20GT, KPI20GTA, KPI30G, KPI30GA, KPI30GT, KPI30GTA, KPI50G, KPI50GA, KPI50GT, KPI50GTA, KPIGN18G, KPIGN27G, KPIGN37G		
<b>accessories for</b>	100013		
	<b>GEV No.</b>	100023	<b>Ref. No.</b> —
	female bullet size 2.3mm 0.5-1.5mm <sup>2</sup> CuZn t.max. 125°C Qty 20 pcs		



## miscellaneous

			
1			
<b>GEV No.</b>	nla <sup>1</sup>	<b>Ref. No.</b>	Y17400
<b>description</b>	piezoelectric igniter suitable for Minisit with cover cap ømm connection F6.3x0.8		
<b>spare parts for</b>	101136		
	<b>GEV No.</b>	100001	<b>Ref. No.</b> —
	piezoelectric igniter suitable for Minisit connection F6.3x0.8 ømm		

<sup>1</sup>no longer available

## ignition units

			
1			
<b>GEV No.</b>	101011	<b>Ref. No.</b>	X50200
<b>description</b>	ignition unit outputs 1 24V		

			
1			
<b>GEV No.</b>	101009	<b>Ref. No.</b>	068160
<b>description</b>	ignition unit outputs 2 1.5 V/DC dimensions 88x23x34mm mounting distance 73mm inlet F6.3x0.8 outlet F2.8x0.8 mounting ø 73mm		
<b>For models:</b>	S350G		
<b>accessories for</b>	101009		
	<b>GEV No.</b>	301195	<b>Ref. No.</b> 068163
	ignition switch for battery type AA 1.5V mounting ø 22mm built-in depth 42mm connection male faston 2.8mm/6.3mm red ignitionA protection IP40 ambient temperature max. 125/55°C		

			
1			
<b>GEV No.</b>	102485	<b>Ref. No.</b>	0000X50000
<b>description</b>	ignition unit outputs 2 220-240VAC 0.6VA 50-60Hz		
<b>For models:</b>	CF15DG8, CF15G4, KBRG, KBRG12, KBRG12IN, KBRGIN, KBRGM, KBRGM12, KBRGM12IN, KBRGMIN, KFG4, KFG8, OPBRG, OPBRG12, OPBRG12IN, OPBRG12MIN, OPBRGIN, OPBRGM, OPBRGM12, OPBRGM12IN, OPBRGMIN		

## ignition switches



			
1			
<b>GEV No.</b>	301195	<b>Ref. No.</b>	068163
<b>description</b>	ignition switch for battery type AA 1.5V mounting ø 22mm built-in depth 42mm connection male faston 2.8mm/6.3mm red ignitionA protection IP40 ambient temperature max. 125/55°C		
<b>For models:</b>	S350G		
<b>accessories for</b>	301195		
	<b>GEV No.</b>	101009	<b>Ref. No.</b> 068160
	ignition unit outputs 2 1.5 V/DC dimensions 88x23x34mm mounting distance 73mm inlet F6.3x0.8 outlet F2.8x0.8 mounting ø 73mm		
	<b>GEV No.</b>	101031	<b>Ref. No.</b> —
	ignition unit outputs 4 1.5 V/DC dimensions 111x23x34mm mounting distance 100mm inlet F6.3x0.8 outlet F2.8x0.8 mounting ø 100mm		

Table continues overleaf

accessories for	301195		
GEV No.	101032	Ref. No.	—
	ignition unit outputs 6 1.5 V/DC dimensions 135x23x34mm mounting distance 123mm inlet F6.3x0.8 outlet F2.8x0.8 mounting $\varnothing$ 122mm		

## thermocouples

### plug-in thermocouples

### plug-in thermocouples standard

with barrel socket  $\varnothing$ 5mm - type Junkers with aluminised tip



GEV No.	102251	Ref. No.	719-003-00
description	thermocouple M9x1 L 750mm plug connection $\varnothing$ 5.0mm		

with barrel socket  $\varnothing$ 6mm

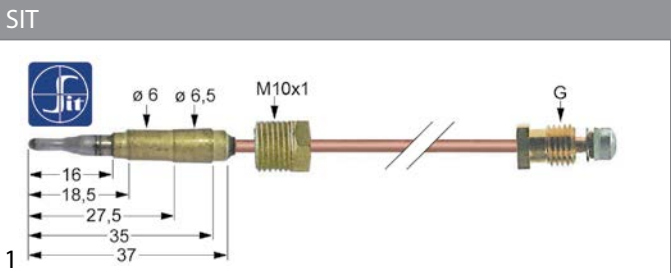

GEV No.	102438	Ref. No.	0000X13300
description	thermocouple M10x1 L 600mm plug connection $\varnothing$ 6.0mm		
For models:	2FZP, B4FZ, B6FZ, B8FZ, C2FZP, C4FZFCPE, C4FZFCGP, C4FZFEP, C4FZFPG, C4FZ, C4FZSFCEP, C4FZSFCE, C4FZSFCE, C4FZSFCE, C4FZSFCE, C4FZSFCE, C4FZSFCE, C4FZSFCE, C6FZFCPEP, C6FZFCGP, C6FZFCGPV, C6FZFEP, C6FZFGAP, C6FZFGP, C6FZ, 12FZP, 14FZP, 16FZP, K2FZ, K4FZ, K4FZFCPE, K4FZFCG, K4FZFE, K4FZFG, K4FZFGA, K4FZS, K4FZSFCE, K4FZSFCE, K4FZSFE, K4FZSFG, K6FZ, K6FZFCPE, K6FZFCG, K6FZFE, K6FZFE, K6FZFE, K6FZFE, K6FZFG, K6FZFGA, K8FZ, K8FZFCPE, K8FZFCG, K8FZFE, K8FZFG, M72FPTFG... (Other models you can see in the webshop)		

with barrel socket  $\varnothing$ 6(6.5)mm

### thermocouples SIT

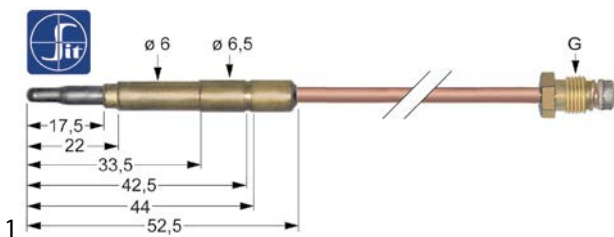

GEV No.	107612	Ref. No.	40400100 X17600
description	thermocouple SIT M9x1 L 1000mm plug connection $\varnothing$ 6.0(6.5)mm		
For models:	B4F, B6F, B8, B8F, FCE, FCG, FE, K2F, K2FTPFCE, K2FTPFCE, K2FTPFCE, K2FTPFCE, K4F, K4FFE, K4FFG, K4FS, K4FSFG, K6F, K6FFE, K6FFG, K6FG, K8F, K8FFE, K8FFG, KCP8, KP10G, KP10GA, KP15G, KP15GA, KP20G, KP20GA, KP20GT, KP20GTA, KP30G, KP30GA, KP30GT, KP30GTA, KP50G, KP50GA, KP50GT, KP50GTA, KPGN18G, KPGN27G, KPGN37G, KPI20G, KPI20GA, KPI20GT, KPI20GTA, KPI30G, KPI30GA... (Other models you can see in the webshop)		

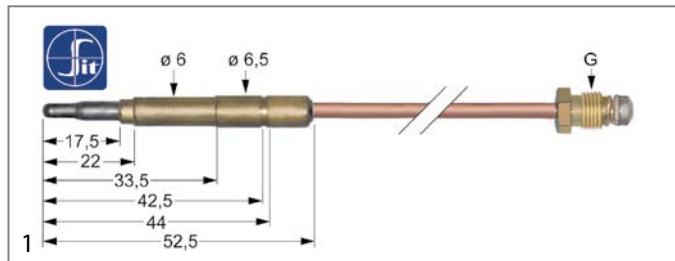

GEV No.	107614	Ref. No.	X14900
description	thermocouple SIT M9x1 L 1500mm plug connection $\varnothing$ 6.0(6.5)mm		
For models:	C2FTPF, C2FTPF, C4FFG, C4FFG, C6FFG, C6FFGA, C6FFGAP, C6FFG, C6FFG, C2FTPF, K2FTPF, K4FFG, K6FFG, K8FFG, K2FTPF, M72FPT-FG, M74FMPFG, M74FPFG, M76FMPFG, M76FPFG		

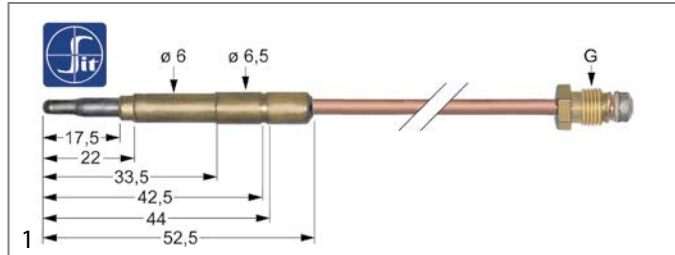

GEV No.	107608	Ref. No.	0000X13900
description	thermocouple SIT M9x1 L 500mm plug connection $\varnothing$ 6.0(6.5)mm		
For models:	C2F, C2FP, C2FTPFE, C2FTPFEP, C2FTPF, C2FTPF, C2FTPF, C2FZ, C2TP2FGP, C4F, C4FFCEP, C4FFCGP, C4FFE, C4FFEP, C4FFG, C4FFG, C4FFLE, C4FFLE, C4FFLG, C4FFLGP, C4F, C4FZ, C4FZCE, C4FZFCG, C4FZFCGP, C4FZFE, C4FZFG, C4FZFGP, C4FZSFCEP, C4FZSFCGP, C6F, C6FFCEP, C6FFCGP, C6FFE, C6FFEP, C6FFG, C6FFG, C6FFGAP, C6FFG, C6FFLE, C6FFLEP, C6FFLEP, C6FFLEV, C6FFLG, C6FFLG, C6FFLGP, C6FFLGP, C6FFLGP, C6F, C6FZ, C6FZCE, C6FZCE... (Other models you can see in the webshop)		

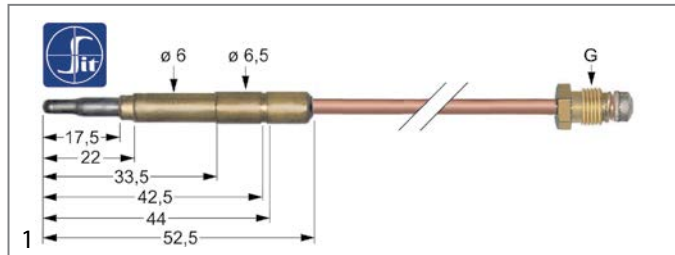

GEV No.	107609	Ref. No.	0000X14100 0000X14200
description	thermocouple SIT M9x1 L 600mm plug connection $\varnothing$ 6.0(6.5)mm		
For models:	2FZP, B4F, B4FZ, B6F, B6FZ, B8, B8F, B8FZ, C2F, C2FP, C2FTPFE, C2FTPFEP, C2FTPF, C2FTPF, C2FZ, C2FZP, C2TP2FGP, C4F, C4FFCEP, C4FFCGP, C4FFE, C4FFEP, C4FFG, C4FFG, C4FFLE, C4FFLE, C4FFLG, C4FFLGP, C4F, C4FZ, C4FZCE, C4FZFCPE, C4FZFCG, C4FZFCGP, C4FZFE, C4FZFE, C4FZFG, C4FZFGP, C4FZ, C4FZSFCEP, C4FZSFCEP, C4FZSFCEP, C4FZSFCGP, C6F, C6FFCEP, C6FFCGP, C6FFE, C6FFEP, C6FFG... (Other models you can see in the webshop)		

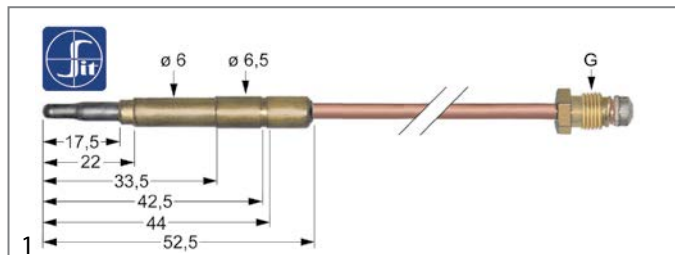

GEV No.	107611	Ref. No.	X14800
description	thermocouple SIT M9x1 L 850mm plug connection $\varnothing$ 6.0(6.5)mm		

gas components

plug-in thermocouples with cable link

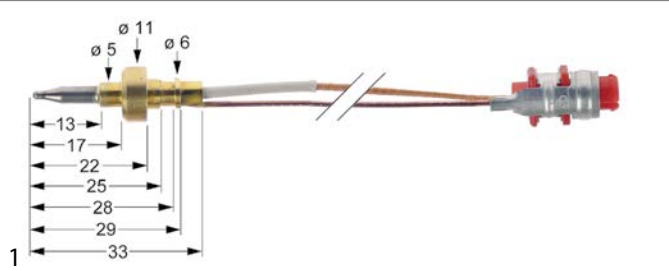

<b>GEV No.</b>	102466	<b>Ref. No.</b>	AGB017ZR10
<b>description</b>	thermocouple with coupling L 600mm bullet receptacle ø2mm plug-in connection		
<b>For models:</b>	CC120CG, CC80G, CC81CG, CCG120CE, CCG80E, CCG81CE, M62F, M64F, M74F, M74FFXE, M74FFXG, M76F, M76FFXE, M76FFXG, M7FT-4GL, M7FT4GR, M7FT6GL, M7FT6GLR, SKC40G, SKC80G		

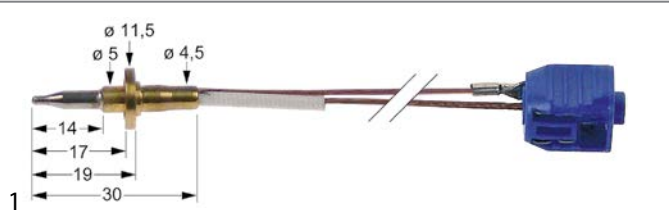

<b>GEV No.</b>	102441	<b>Ref. No.</b>	AGB009ZR10
<b>description</b>	thermocouple with two-conductors L 500mm plug-in connection bullet receptacle ø2mm plug-in connection		
<b>For models:</b>	CC120CG, CC80G, CC81CG, CCG120CE, CCG80E, CCG81CE, M62F, M64F, M74F, M74FFXE, M74FFXG, M76F, M76FFXE, M76FFXG, M7FT-4GL, M7FT4GR, M7FT6GL, M7FT6GLR, SKC40G, SKC80G		

plug-in thermocouples with interruption

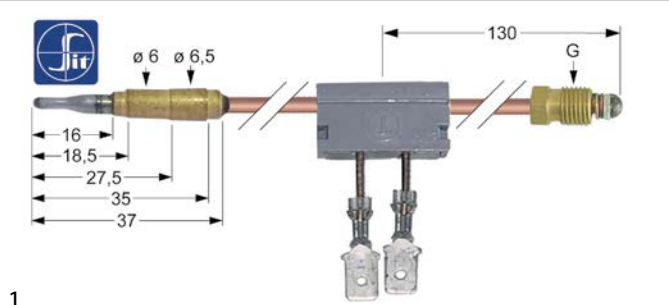

<b>GEV No.</b>	100172	<b>Ref. No.</b>	0000X14300
<b>description</b>	thermocouple SIT with interrupter ASA 11/32 L 400mm plug connection ø6.0mm F 6.3mm		
<b>For models:</b>	KBRG, KBRG12, KBRG12IN, KBRGIN, KBRGM, KBRGM12, KBRGM12IN, KBRGMIN, KFT4G, KFT4GC, KFT4GR, KFT8G, KFT8G23C, KFT8GC, KFT8GLR, KFT8GR, KFTG1, KFTG1C, KFTG1R, KFTG3, KFTG3C, KFTG3LR, KFTG4, KFTG4C, KFTG4R, KFTG8, KFTG8C, KFTG8LR, KTF4G, KTF4GC, KTF8GLR, OPBRG, OPBRG12, OPBRG12IN, OPBRG12MIN, OPBRGIN, OPBRGM, OPBRGM12, OPBRGM12IN, OPBRGMIN, OPFT4G, OPFT4GC, OPFT4GR, OPFT8G, OPFT8G23C, OPFT8GC, OPFT8GLR, OPFT8GR, OPFT4G, OPFT4GC...(Other models you can see in the webshop)		

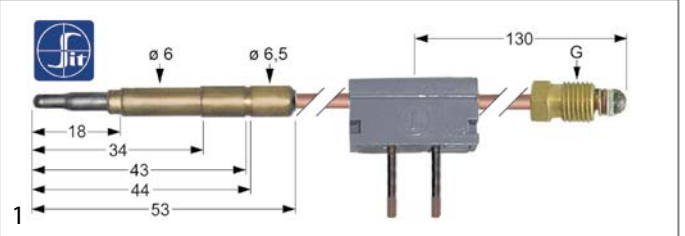

<b>GEV No.</b>	107164	<b>Ref. No.</b>	0000X14000
<b>description</b>	thermocouple SIT with interrupter M9x1 L 1000mm plug connection ø6.0(6.5)mm soldering connection		
<b>For models:</b>	CPG, CPGI, KP10G, KP10GA, KP15G, KP15GA, KPI10G, KPI10GA, KPI15G, KPI15GA, OPP10G, OPP10GA, OPP15G, OPP15GA, OPPI10G, OPPI10GA, OPPI15G, OPPI15GA		

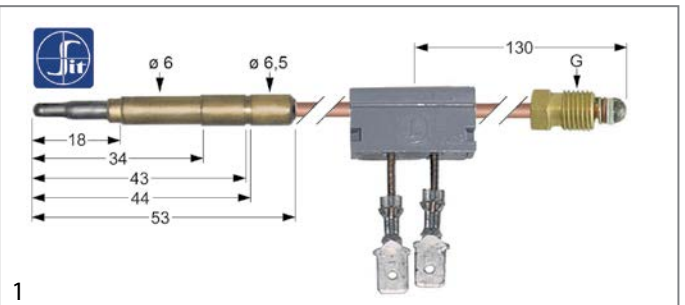

<b>GEV No.</b>	107177	<b>Ref. No.</b>	0000X19100
<b>description</b>	thermocouple SIT with interrupter M9x1 L 600mm plug connection ø6.0mm F 6.3mm		
<b>For models:</b>	CF10DG8M, CF10G4M, CF15DG8, CF15G4, CFG15, CFG15D, KFG1, KFG15, KFG15D, KFG2, KFG20, KFG20D, KFG4, KFG8, M7CP4G, M7F4G, M7F8G, OPFG1, OPFG15, OPFG15D, OPFG2, OPFG20, OPFG20D, SKF10GM, SKF20GM, TF10GM, TF20GM		

threaded thermocouples

threaded thermocouples standard

with socket with thread M8x1

SIT

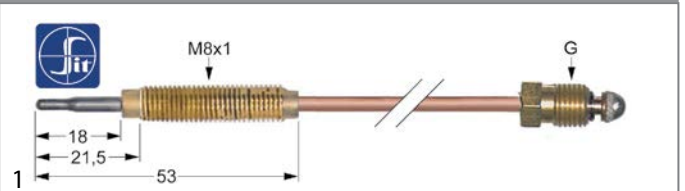

<b>GEV No.</b>	107634	<b>Ref. No.</b>	X68045
<b>description</b>	thermocouple SIT M8x1 L 1500mm M8x1		
<b>For models:</b>	C4FFLG, C4FFLGP, C6FFLG, C6FFLGP, C6FFLGPV, C6FFLGV, CC120G, CC80G, CC81G, M74FFXG, M74FMPFXG, M74FPFXG, M76FFXG, M76FMPFXG, M76FPFXG		

<b>accessories for</b>	107634		
	<b>GEV No.</b>	102067	<b>Ref. No.</b>
			X15900
	nut thread M8x1 H 3mm brass Qty 1 pcs type SEF 1		





<b>GEV No.</b>	107636	<b>Ref. No.</b>	X15700
<b>description</b>	thermocouple SIT M9x1 L 600mm M8x1		
<b>For models:</b>	C2TP2FGP, CC120CG, CC120G, CC80G, CC81CG, CC81G, CCG120CE, CCG120E, CCG80E, CCG81CE, CCG81E, SKC40G, SKC80G		
<b>accessories for</b>	107636		
		<b>GEV No.</b>	102067
		<b>Ref. No.</b>	X15900
	nut thread M8x1 H 3mm brass Qty 1 pcs type SEF 1		

### extensions

<b>GEV No.</b>	102852	<b>Ref. No.</b>	0000X19400
<b>description</b>	thermocouple extension thread M9x1 L 1500mm		
<b>For models:</b>	C2FTPFPG, C2TP2FGP, C4FFCGP, C4FFGP, C4FZFCG, C4FZFCGP, C4FZFG, C4FZFGP, C4FZSFCGP, C4FZSFGP, C6FFCGP, C6FFGAP, C6FFGP, C6FZFCG, C6FZFCGP, C6FZFCGPV, C6FZFCGV, C6FZFG, C6FZFGA, C6FZFGAP, C6FZFGP, CC120CG, CC81CG, CCTPFG8, CN14FGA, K2FTPFPG, K2FTPF, K4FFG, K4FSFCG, K4FSFG, K4FZFCG, K4FZFG, K4FZSFCG, K4FZSFG, K6FFG, K6FFGA, K6FZFCG, K6FZFG, K6FZFGA, K8FFG, K8FZFCG, K8FZFG, KTFPG, KTFPG, SK4FZFCGP, SK6FZFCGP		
<b>accessories for</b>	102852		
		<b>GEV No.</b>	101261
		<b>Ref. No.</b>	—
	thermocouple fitting thread M9x1 Qty 1 pcs		

### accessories

#### nuts

<b>GEV No.</b>	102067	<b>Ref. No.</b>	X15900
<b>description</b>	nut thread M8x1 H 3mm brass Qty 1 pcs type SEF 1		
<b>For models:</b>	CC120CG, CC120G, CC80G, CC81CG, CC81G, CCG120CE, CCG120E, CCG80E, CCG81CE, CCG81E, SKC40G, SKC80G		

#### screws

<b>GEV No.</b>	102464	<b>Ref. No.</b>	X16500
<b>description</b>	thermocouple fitting thread M10x1 brass Qty 1 pcs		
<b>For models:</b>	B4F, B6F, B8, B8F, C2FP, C2FTPFPG, C2TP2FGP, C4FFCEP, C4FFCGP, C4FFGP, C4FFGP, C4FP, C6FFCEP, C6FFCGP, C6FFGP, C6FFGP, C6FP, FCE, FCG, FE, K2F, K2FTPFCE, K2FTPF, K2FTPF, K2FTPF, K4F, K4FFE, K4FFG, K4FS, K4FSFCE, K4FSFCG, K4FSFE, K4FSFG, K6F, K6FFE, K6FFG, K6FG, K8F, K8FFE, K8FFG, OP2F, OP4F, OP4FS, OP6F, OP8F, T2FP, T4FP, T6FP		

## gas burners

### hob burners

#### universal hob burners

##### GEV





<b>GEV No.</b>	103068	<b>Ref. No.</b>	M00400
<b>description</b>	burner cap ø 100mm		
<b>For models:</b>	CC120CG, CC120G, CC80G, CC81CG, CC81G, CCG120CE, CCG120E, CCG80E, CCG81CE, CCG81E, SKC40G, SKC80G		
<b>accessories for</b>	103068		
		<b>GEV No.</b>	103067
		<b>Ref. No.</b>	M01100
	burner ring for burner cap ø 100mm		
		<b>GEV No.</b>	104102
		<b>Ref. No.</b>	M00900
	burner head for burner cap ø 100mm ext. ø 130		
		<b>GEV No.</b>	104103
		<b>Ref. No.</b>	M00700
	burner holder suitable for burner ø100mm with nozzle holder		





<b>GEV No.</b>	103066	<b>Ref. No.</b>	M00300
<b>description</b>	burner cap ø 80mm		
<b>For models:</b>	CC120CG, CC120G, CC80G, CC81CG, CC81G, CCG120CE, CCG120E, CCG80E, CCG81CE, CCG81E, SKC40G, SKC80G		
<b>accessories for</b>	103066		
		<b>GEV No.</b>	103065
		<b>Ref. No.</b>	M01000
	burner ring for burner cap ø 80mm		
		<b>GEV No.</b>	104100
		<b>Ref. No.</b>	M00800
	burner head for burner cap ø 80mm		
		<b>GEV No.</b>	104101
		<b>Ref. No.</b>	M00600
	burner holder for burner cap ø 80mm with nozzle holder with mixing sleeve		





<b>GEV No.</b>	104102	<b>Ref. No.</b>	M00900
<b>description</b>	burner head for burner cap ø 100mm ext. ø 130		
<b>For models:</b>	CC120CG, CC120G, CC80G, CC81CG, CC81G, CCG120CE, CCG120E, CCG80E, CCG81CE, CCG81E, SKC40G, SKC80G		







			
1			
<b>GEV No.</b>	104100	<b>Ref. No.</b>	M00800
<b>description</b>	burner head for burner cap ø 80mm		
<b>For models:</b>	CC120CG, CC120G, CC80G, CC81CG, CC81G, CCG120CE, CCG120E, CCG80E, CCG81CE, CCG81E, SKC40G, SKC80G		
<b>accessories for</b>	104100		
	<b>GEV No.</b>	103065	<b>Ref. No.</b> M01000
burner ring for burner cap ø 80mm			
	<b>GEV No.</b>	103066	<b>Ref. No.</b> M00300
burner cap ø 80mm			
	<b>GEV No.</b>	104103	<b>Ref. No.</b> M00700
burner holder suitable for burner ø100mm with nozzle holder			

			
1			
<b>GEV No.</b>	104101	<b>Ref. No.</b>	M00600
<b>description</b>	burner holder for burner cap ø 80mm with nozzle holder with mixing sleeve		
<b>For models:</b>	CC120CG, CC120G, CC80G, CC81CG, CC81G, CCG120CE, CCG120E, CCG80E, CCG81CE, CCG81E, SKC40G, SKC80G		
<b>accessories for</b>	104101		
	<b>GEV No.</b>	103065	<b>Ref. No.</b> M01000
burner ring for burner cap ø 80mm			
	<b>GEV No.</b>	103066	<b>Ref. No.</b> M00300
burner cap ø 80mm			
	<b>GEV No.</b>	104100	<b>Ref. No.</b> M00800
burner head for burner cap ø 80mm			

			
1			
<b>GEV No.</b>	104103	<b>Ref. No.</b>	M00700
<b>description</b>	burner holder suitable for burner ø100mm with nozzle holder		
<b>For models:</b>	CC120CG, CC120G, CC80G, CC81CG, CC81G, CCG120CE, CCG120E, CCG80E, CCG81CE, CCG81E, SKC40G, SKC80G		
<b>accessories for</b>	104103		
	<b>GEV No.</b>	103067	<b>Ref. No.</b> M01100
burner ring for burner cap ø 100mm			
	<b>GEV No.</b>	103068	<b>Ref. No.</b> M00400
burner cap ø 100mm			
	<b>GEV No.</b>	104102	<b>Ref. No.</b> M00900
burner head for burner cap ø 100mm ext. ø 130			





			
1			
<b>GEV No.</b>	103067	<b>Ref. No.</b>	M01100
<b>description</b>	burner ring for burner cap ø 100mm		
<b>For models:</b>	CC120CG, CC120G, CC80G, CC81CG, CC81G, CCG120CE, CCG120E, CCG80E, CCG81CE, CCG81E, SKC40G, SKC80G		
<b>accessories for</b>	103067		
	<b>GEV No.</b>	103068	<b>Ref. No.</b> M00400
burner cap ø 100mm			
	<b>GEV No.</b>	104102	<b>Ref. No.</b> M00900
burner head for burner cap ø 100mm ext. ø 130			
	<b>GEV No.</b>	104103	<b>Ref. No.</b> M00700
burner holder suitable for burner ø100mm with nozzle holder			

			
1			
<b>GEV No.</b>	103065	<b>Ref. No.</b>	M01000
<b>description</b>	burner ring for burner cap ø 80mm		
<b>For models:</b>	CC120CG, CC120G, CC80G, CC81CG, CC81G, CCG120CE, CCG120E, CCG80E, CCG81CE, CCG81E, SKC40G, SKC80G		
<b>accessories for</b>	103065		
	<b>GEV No.</b>	103066	<b>Ref. No.</b> M00300
burner cap ø 80mm			
	<b>GEV No.</b>	104100	<b>Ref. No.</b> M00800
burner head for burner cap ø 80mm			
	<b>GEV No.</b>	104101	<b>Ref. No.</b> M00600
burner holder for burner cap ø 80mm with nozzle holder with mixing sleeve			

## producer-specific hob burners

## GIGA

## Snack 600 series



			
1			
<b>GEV No.</b>	103068	<b>Ref. No.</b>	M00400
<b>description</b>	burner cap ø 100mm		
<b>For models:</b>	CC120CG, CC120G, CC80G, CC81CG, CC81G, CCG120CE, CCG120E, CCG80E, CCG81CE, CCG81E, SKC40G, SKC80G		
<b>accessories for</b>	103068		
	<b>GEV No.</b>	103067	<b>Ref. No.</b> M01100
burner ring for burner cap ø 100mm			
	<b>GEV No.</b>	104102	<b>Ref. No.</b> M00900
burner head for burner cap ø 100mm ext. ø 130			
	<b>GEV No.</b>	104103	<b>Ref. No.</b> M00700
burner holder suitable for burner ø100mm with nozzle holder			







 <p>1</p>			
<b>GEV No.</b>	103066	<b>Ref. No.</b>	M00300
<b>description</b>	burner cap ø 80mm		
<b>For models:</b>	CC120CG, CC120G, CC80G, CC81CG, CC81G, CCG120CE, CCG120E, CCG80E, CCG81CE, CCG81E, SKC40G, SKC80G		
<b>accessories for</b>	103066		
	<b>GEV No.</b>	103065	<b>Ref. No.</b> M01000
burner ring for burner cap ø 80mm			
	<b>GEV No.</b>	104100	<b>Ref. No.</b> M00800
burner head for burner cap ø 80mm			
	<b>GEV No.</b>	104101	<b>Ref. No.</b> M00600
burner holder for burner cap ø 80mm with nozzle holder with mixing sleeve			

 <p>1</p>			
<b>GEV No.</b>	104102	<b>Ref. No.</b>	M00900
<b>description</b>	burner head for burner cap ø 100mm ext. ø 130		
<b>For models:</b>	CC120CG, CC120G, CC80G, CC81CG, CC81G, CCG120CE, CCG120E, CCG80E, CCG81CE, CCG81E, SKC40G, SKC80G		





 <p>1</p>			
<b>GEV No.</b>	104100	<b>Ref. No.</b>	M00800
<b>description</b>	burner head for burner cap ø 80mm		
<b>For models:</b>	CC120CG, CC120G, CC80G, CC81CG, CC81G, CCG120CE, CCG120E, CCG80E, CCG81CE, CCG81E, SKC40G, SKC80G		
<b>accessories for</b>	104100		
	<b>GEV No.</b>	103065	<b>Ref. No.</b> M01000
burner ring for burner cap ø 80mm			
	<b>GEV No.</b>	103066	<b>Ref. No.</b> M00300
burner cap ø 80mm			
	<b>GEV No.</b>	104103	<b>Ref. No.</b> M00700
burner holder suitable for burner ø100mm with nozzle holder			

 <p>1</p>			
<b>GEV No.</b>	104101	<b>Ref. No.</b>	M00600
<b>description</b>	burner holder for burner cap ø 80mm with nozzle holder with mixing sleeve		
<b>For models:</b>	CC120CG, CC120G, CC80G, CC81CG, CC81G, CCG120CE, CCG120E, CCG80E, CCG81CE, CCG81E, SKC40G, SKC80G		
<b>accessories for</b>	104101		
	<b>GEV No.</b>	103065	<b>Ref. No.</b> M01000
burner ring for burner cap ø 80mm			
	<b>GEV No.</b>	103066	<b>Ref. No.</b> M00300
burner cap ø 80mm			

<b>accessories for</b>	104101		
	<b>GEV No.</b>	104100	<b>Ref. No.</b> M00800
burner head for burner cap ø 80mm			

 <p>1</p>			
<b>GEV No.</b>	104103	<b>Ref. No.</b>	M00700
<b>description</b>	burner holder suitable for burner ø100mm with nozzle holder		
<b>For models:</b>	CC120CG, CC120G, CC80G, CC81CG, CC81G, CCG120CE, CCG120E, CCG80E, CCG81CE, CCG81E, SKC40G, SKC80G		
<b>accessories for</b>	104103		
	<b>GEV No.</b>	103067	<b>Ref. No.</b> M01100
burner ring for burner cap ø 100mm			
	<b>GEV No.</b>	103068	<b>Ref. No.</b> M00400
burner cap ø 100mm			
	<b>GEV No.</b>	104102	<b>Ref. No.</b> M00900
burner head for burner cap ø 100mm ext. ø 130			

 <p>1</p>			
<b>GEV No.</b>	103067	<b>Ref. No.</b>	M01100
<b>description</b>	burner ring for burner cap ø 100mm		
<b>For models:</b>	CC120CG, CC120G, CC80G, CC81CG, CC81G, CCG120CE, CCG120E, CCG80E, CCG81CE, CCG81E, SKC40G, SKC80G		
<b>accessories for</b>	103067		
	<b>GEV No.</b>	103068	<b>Ref. No.</b> M00400
burner cap ø 100mm			
	<b>GEV No.</b>	104102	<b>Ref. No.</b> M00900
burner head for burner cap ø 100mm ext. ø 130			
	<b>GEV No.</b>	104103	<b>Ref. No.</b> M00700
burner holder suitable for burner ø100mm with nozzle holder			

 <p>1</p>			
<b>GEV No.</b>	103065	<b>Ref. No.</b>	M01000
<b>description</b>	burner ring for burner cap ø 80mm		
<b>For models:</b>	CC120CG, CC120G, CC80G, CC81CG, CC81G, CCG120CE, CCG120E, CCG80E, CCG81CE, CCG81E, SKC40G, SKC80G		
<b>accessories for</b>	103065		
	<b>GEV No.</b>	103066	<b>Ref. No.</b> M00300
burner cap ø 80mm			
	<b>GEV No.</b>	104100	<b>Ref. No.</b> M00800
burner head for burner cap ø 80mm			
	<b>GEV No.</b>	104101	<b>Ref. No.</b> M00600
burner holder for burner cap ø 80mm with nozzle holder with mixing sleeve			



Top 700, Sistema 800, Opera 900 series



<b>GEV No.</b>	108144	<b>Ref. No.</b>	V00400
<b>description</b>	burner cap ø 117mm 6/7.8kW		
<b>For models:</b>	2FZP, B4FZ, B6FZ, B8FZ, C2FZ, C2FZP, C2TP2FGP, C4FZ, C4FZFCE, C4FZFCEP, C4FZFCEG, C4FZFCEP, C4FZFCE, C4FZFEP, C4FZFG, C4FZFGP, C4FZP, C4FZSFCEP, C4FZSFCEG, C4FZSFCE, C4FZSFGP, C4FZSP, C6FZ, C6FZFCE, C6FZFCEP, C6FZFCEPV, C6FZFCEV, C6FZFCEG, C6FZFCEG, C6FZFCEGP, C6FZFCEGPV, C6FZFCEGV, C6FZFCE, C6FZFEP, C6FZFG, C6FZFGA, C6FZFGAP, C6FZFGP, C6FZP, I2FZ, I2FZP, I4FZ, I4FZP, I6FZP, K2FZ, K4FZ, K4FZFCE, K4FZFCEG, K4FZFCE, K4FZFG, K4FZFGA...(Other models you can see in the webshop)		
<b>accessories for</b>	108144		
	<b>GEV No.</b>	106422	<b>Ref. No.</b> 0000V01900 V01900
	burner lower part for burner cap ø 117/125mm 6/7.8/9.5kW		
	<b>GEV No.</b>	108143	<b>Ref. No.</b> V00200
	burner head for burner cap ø 117mm 6/7.8kW		



<b>GEV No.</b>	103018	<b>Ref. No.</b>	V02600
<b>description</b>	burner cap ø 125mm		
<b>For models:</b>	B4FZ, B6FZ, B8FZ, K2FZ, K4FZ, K4FZFCE, K4FZFCEG, K4FZFCE, K4FZFG, K4FZFGA, K4FZS, K4FZSFCE, K4FZSFCEG, K4FZSFE, K4FZSFG, K6FZ, K6FZFCE, K6FZFCEG, K6FZFCE, K6FZFG, K6FZFGA, K8FZ, K8FZFCE, K8FZFCG, K8FZFE, K8FZFG, OP2FZ, OP4FZ, OP6FZ, OP8FZ, OPFZ		



<b>GEV No.</b>	103026	<b>Ref. No.</b>	V00300
<b>description</b>	burner cap ø 87mm 4kW		
<b>For models:</b>	2FZP, B4FZ, B6FZ, B8FZ, C2FZ, C2FZP, C4FZ, C4FZFCE, C4FZFCEP, C4FZFCEG, C4FZFCEG, C4FZFCE, C4FZFEP, C4FZFG, C4FZFGP, C4FZP, C6FZ, C6FZFCE, C6FZFCEP, C6FZFCEPV, C6FZFCEV, C6FZFCEG, C6FZFCEG, C6FZFCEGP, C6FZFCEGPV, C6FZFCEGV, C6FZFCE, C6FZFEP, C6FZFG, C6FZFGA, C6FZFGAP, C6FZFGP, C6FZP, I2FZ, I2FZP, I4FZ, I4FZP, I6FZP, K2FZ, K4FZ, K4FZFCE, K4FZFCEG, K4FZFCE, K4FZFG, K4FZFGA, K4FZSFG, K6FZ, K6FZFCE, K6FZFCEG, K6FZFCE, K6FZFG...(Other models you can see in the webshop)		
<b>accessories for</b>	103026		
	<b>GEV No.</b>	103000	<b>Ref. No.</b> V01800
	burner lower part for burner cap ø 87mm 4kW		
	<b>GEV No.</b>	103025	<b>Ref. No.</b> V00100
	burner head for burner cap ø 87mm 4kW		



<b>GEV No.</b>	108143	<b>Ref. No.</b>	V00200
<b>description</b>	burner head for burner cap ø 117mm 6/7.8kW		
<b>For models:</b>	2FZP, B4FZ, B6FZ, B8FZ, C2FZ, C2FZP, C2TP2FGP, C4FZ, C4FZFCE, C4FZFCEP, C4FZFCEG, C4FZFCE, C4FZFEP, C4FZFG, C4FZFGP, C4FZP, C4FZSFCEP, C4FZSFCEG, C4FZSFCE, C4FZSFGP, C4FZSP, C6FZ, C6FZFCE, C6FZFCEP, C6FZFCEPV, C6FZFCEV, C6FZFCEG, C6FZFCEG, C6FZFCEGP, C6FZFCEGPV, C6FZFCEGV, C6FZFCE, C6FZFEP, C6FZFG, C6FZFGA, C6FZFGAP, C6FZFGP, C6FZP, I2FZ, I2FZP, I4FZ, I4FZP, I6FZP, K2FZ, K4FZ, K4FZFCE, K4FZFCEG, K4FZFCE, K4FZFG, K4FZFGA...(Other models you can see in the webshop)		
<b>accessories for</b>	108143		
	<b>GEV No.</b>	106422	<b>Ref. No.</b> 0000V01900 V01900
	burner lower part for burner cap ø 117/125mm 6/7.8/9.5kW		
	<b>GEV No.</b>	108144	<b>Ref. No.</b> V00400
	burner cap ø 117mm 6/7.8kW		





<b>GEV No.</b>	103017	<b>Ref. No.</b>	V02500
<b>description</b>	burner head for burner cap ø 125mm 9.5kW		
<b>For models:</b>	B4FZ, B6FZ, B8FZ, K2FZ, K4FZ, K4FZFCE, K4FZFCEG, K4FZFCE, K4FZFG, K4FZFGA, K4FZS, K4FZSFCE, K4FZSFCEG, K4FZSFE, K4FZSFG, K6FZ, K6FZFCE, K6FZFCEG, K6FZFCE, K6FZFG, K6FZFGA, K8FZ, K8FZFCE, K8FZFCG, K8FZFE, K8FZFG, OP2FZ, OP4FZ, OP6FZ, OP8FZ, OPFZ		





<b>GEV No.</b>	103025	<b>Ref. No.</b>	V00100
<b>description</b>	burner head for burner cap ø 87mm 4kW		
<b>For models:</b>	2FZP, B4FZ, B6FZ, B8FZ, C2FZ, C2FZP, C4FZ, C4FZFCE, C4FZFCEP, C4FZFCEG, C4FZFCEG, C4FZFCE, C4FZFEP, C4FZFG, C4FZFGP, C4FZP, C6FZ, C6FZFCE, C6FZFCEP, C6FZFCEPV, C6FZFCEV, C6FZFCEG, C6FZFCEG, C6FZFCEGP, C6FZFCEGPV, C6FZFCEGV, C6FZFCE, C6FZFEP, C6FZFG, C6FZFGA, C6FZFGAP, C6FZFGP, C6FZP, I2FZ, I2FZP, I4FZ, I4FZP, I6FZP, K2FZ, K4FZ, K4FZFCE, K4FZFCEG, K4FZFCE, K4FZFG, K4FZFGA, K4FZSFG, K6FZ, K6FZFCE, K6FZFCEG, K6FZFCE, K6FZFG...(Other models you can see in the webshop)		
<b>accessories for</b>	103025		
	<b>GEV No.</b>	103000	<b>Ref. No.</b> V01800
	burner lower part for burner cap ø 87mm 4kW		
	<b>GEV No.</b>	103026	<b>Ref. No.</b> V00300
	burner cap ø 87mm 4kW		

















			
1			
<b>GEV No.</b>	106422	<b>Ref. No.</b>	0000V01900
<b>description</b>	burner lower part for burner cap ø 117/125mm 6/7.8/9.5kW		
<b>For models:</b>	2FZP, B4FZ, B6FZ, B8FZ, C2FZP, C2TP2FGP, C4FZFCPEP, C4FZFCGP, C4FZFE, C4FZFGP, C4FZFP, C4FZSFCEP, C4FZSFCGP, C4FZSFEP, C4FZSFGP, C4FZSP, C6FZFCPEP, C6FZFCGP, C6FZFCGPV, C6FZFEP, C6FZFGAP, C6FZFGP, C6FZP, I2FZP, I4FZP, I6FZP, K2FZ, K4FZ, K4FZFCE, K4FZFCG, K4FZFE, K4FZFG, K4FZFGA, K4FZS, K4FZSFCE, K4FZSFCG, K4FZSFE, K4FZSFG, K6FZ, K6FZFCE, K6FZFCG, K6FZFE, K6FZFG, K6FZFGA, K8FZ, K8FZFCE, K8FZFCG, K8FZFE, K8FZFG...(Other models you can see in the webshop)		
<b>accessories for</b>	106422		
	GEV No.	108143	Ref. No. V00200
burner head for burner cap ø 117mm 6/7.8kW			
	GEV No.	108144	Ref. No. V00400
burner cap ø 117mm 6/7.8kW			







			
1			
<b>GEV No.</b>	103000	<b>Ref. No.</b>	V01800
<b>description</b>	burner lower part for burner cap ø 87mm 4kW		
<b>For models:</b>	2FZP, B4FZ, B6FZ, B8FZ, C2FZP, C4FZFCPEP, C4FZFCGP, C4FZFEP, C4FZFGP, C4FZFP, C6FZFCPEP, C6FZFCGP, C6FZFCGPV, C6FZFEP, C6FZFGAP, C6FZFGP, C6FZP, I2FZP, I4FZP, I6FZP, K2FZ, K4FZ, K4FZFCE, K4FZFCG, K4FZFE, K4FZFG, K4FZFGA, K4FZSFG, K6FZ, K6FZFCE, K6FZFCG, K6FZFE, K6FZFG, K8FZ, K8FZFCE, K8FZFCG, K8FZFE, K8FZFG, M74FMP, M74FMPFE, M74FMPFG, M74FMPFXE, M74FMPFXG, M76FMP, M76FMPFE, M76FMPFG, M76FMPFXE, M76FMPFXG, OP2FZ...(Other models you can see in the webshop)		
<b>accessories for</b>	103000		
	GEV No.	103025	Ref. No. V00100
burner head for burner cap ø 87mm 4kW			
	GEV No.	103026	Ref. No. V00300
burner cap ø 87mm 4kW			

Counter 700, Kappa 900 series

			
1			
<b>GEV No.</b>	105300	<b>Ref. No.</b>	X21800
<b>description</b>	burner cap ø 120mm 7kW with central hole ID ø 64mm		
<b>For models:</b>	B4F, B6F, B8F, FCE, FCG, FE, K4F, K4FFE, K4FFG, K4FS, K4FSFCE, K4SFCE, K4FSFE, K4FSFG, K6F, K6FFE, K6FFG, K6FG, K8F, K8FFE, K8FFG, OP4F, OP4FS, OP6F, OP8F		
<b>accessories for</b>	105300		
	GEV No.	100907	Ref. No. —
screw connection thread M10x1 Qty 1 pcs type SEF 1 ømm for thermocouple			
	GEV No.	101452	Ref. No. B83900
ignition electrode support for burner type C/D suitable for 900 series			

<b>accessories for</b>	105300		
	GEV No.	101453	Ref. No. B83800
bracket for thermocouple gas range for burner type C/D suitable for 900 series			
	GEV No.	101454	Ref. No. —
union screw for igniter thread M10x1 ID ø 7mm L 15mm			
	GEV No.	104108	Ref. No. 0000X16100
nozzle holder nozzle mounting M10x1 tube ø 10mm gas inlet M16x1.5 gas outlet M14x1			
	GEV No.	104294	Ref. No. —
burner head E for burner cap ø 120mm 8.3kW			
	GEV No.	105301	Ref. No. —
venturi for burner cap ø 120mm 7kW			









			
1			
<b>GEV No.</b>	103069	<b>Ref. No.</b>	X21600
<b>description</b>	burner cap ø 80mm 4.3kW with central hole		
<b>For models:</b>	B4F, B6F, B8F, C2F, C2FP, C2FTPE, C2FTPEP, C2FTPEG, C2FTPEGP, C2TP2FGP, C4F, C4FFCEP, C4FFCGP, C4FFE, C4FFEP, C4FFG, C4FFGP, C4FFLE, C4FFLEP, C4FFLG, C4FFLGP, C4FP, C6F, C6FFCEP, C6FFCGP, C6FFE, C6FFEP, C6FFG, C6FFGA, C6FFGAP, C6FFGP, C6FFLE, C6FFLEP, C6FFLEPV, C6FFLEV, C6FFLG, C6FFLGP, C6FFLGPV, C6FFLGV, C6FP, FE, K2F, K2FTPECE, K2FTPECG, K2FTPEE, K2FTPEG, K4F, K4FFE, K4FFG, K6F...(Other models you can see in the webshop)		
<b>accessories for</b>	103069		
	GEV No.	100907	Ref. No. —
screw connection thread M10x1 Qty 1 pcs type SEF 1 ømm for thermocouple			
	GEV No.	101452	Ref. No. B83900
ignition electrode support for burner type C/D suitable for 900 series			
	GEV No.	101453	Ref. No. B83800
bracket for thermocouple gas range for burner type C/D suitable for 900 series			
	GEV No.	101454	Ref. No. —
union screw for igniter thread M10x1 ID ø 7mm L 15mm			
	GEV No.	104104	Ref. No. —
burner head for burner cap ø 80mm 3.5kW code 100212			
	GEV No.	104105	Ref. No. 0900X21300
burner lower part for burner cap ø 80mm 3.5kW			
	GEV No.	104108	Ref. No. 0000X16100
nozzle holder nozzle mounting M10x1 tube ø 10mm gas inlet M16x1.5 gas outlet M14x1			
	GEV No.	105297	Ref. No. 0750X22200 0900X22200 721-030-00
burner head for burner cap ø 80mm 4.3kW for pilot burner			

			
1			
<b>GEV No.</b>	103070	<b>Ref. No.</b>	X21700
<b>description</b>	burner cap ø 95mm 6.4kW with central hole		
<b>For models:</b>	B4F, B6F, B8F, C2F, C2FP, C2FTPFE, C2FTPFG, C2FTPFGP, C2TP2FGP, C4F, C4FFCEP, C4FFCGP, C4FFE, C4FFEP, C4FFG, C4FFGP, C4FFLE, C4FFLEP, C4FFLG, C4FFLGP, C4FP, C6F, C6FFCEP, C6FFCGP, C6FFE, C6FFEP, C6FFG, C6FFGA, C6FFGAP, C6FFGP, C6FFLE, C6FFLEP, C6FFLEPV, C6FFLEV, C6FFLG, C6FFLGP, C6FFLGPV, C6FFLGV, C6FP, K2F, K2FTPFC, K2FTPFCG, K2FTPFE, K2FTPFG, K4F, K4FFE, K4FFG, K6F, K6FFE...(Other models you can see in the webshop)		
<b>accessories for</b>	103070		
	<b>GEV No.</b>	100907	<b>Ref. No.</b> —
	screw connection thread M10x1 Qty 1 pcs type SEF 1 ømm for thermocouple		
	<b>GEV No.</b>	101452	<b>Ref. No.</b> B83900
	ignition electrode support for burner type C/D suitable for 900 series		
	<b>GEV No.</b>	101453	<b>Ref. No.</b> B83800
	bracket for thermocouple gas range for burner type C/D suitable for 900 series		
	<b>GEV No.</b>	101454	<b>Ref. No.</b> —
	union screw for igniter thread M10x1 ID ø 7mm L 15mm		
	<b>GEV No.</b>	104106	<b>Ref. No.</b> —
	burner head for burner cap ø 100mm 5.5kW for igniter		
	<b>GEV No.</b>	104107	<b>Ref. No.</b> —
	burner lower part for burner cap ø 100mm 6.4kW		
	<b>GEV No.</b>	104108	<b>Ref. No.</b> 0000X16100
	nozzle holder nozzle mounting M10x1 tube ø 10mm gas inlet M16x1.5 gas outlet M14x1		









			
1			
<b>GEV No.</b>	104478	<b>Ref. No.</b>	0750X21100 0900X21100
<b>description</b>	burner head for burner cap ø 100mm for igniter		
<b>For models:</b>	C2F, C2FTPFE, C2FTPFG, C2TP2FGP, C4F, C4FFE, C4FFG, C4FFLE, C4FFLG, C6F, C6FFE, C6FFG, C6FFGA, C6FFLE, C6FFLEV, C6FFLG, C6FFLGP, T2F, T4F, T6F		

			
1			
<b>GEV No.</b>	105348	<b>Ref. No.</b>	0750X21200 0900X21200 721-026-00
<b>description</b>	burner head for burner cap ø 120mm 7kW with ignition flame		
<b>For models:</b>	B4F, B6F, B8F, FCE, FCG, FE, K4F, K4FFE, K4FFG, K4FS, K4FSFCE, K4FSFCG, K4FSFE, K4FSFG, K6F, K6FFE, K6FFG, K6FG, K8F, K8FFE, K8FFG, OP4F, OP4FS, OP6F, OP8F		

			
1			
<b>GEV No.</b>	104480	<b>Ref. No.</b>	0750X21000 0900X21000
<b>description</b>	burner head for burner cap ø 80mm 3.5kW		
<b>For models:</b>	C2F, C2FTPFE, C2FTPFG, C4F, C4FFE, C4FFG, C4FFLE, C4FFLG, C6F, C6FFE, C6FFG, C6FFGA, C6FFLE, C6FFLEV, C6FFLG, C6FFLGP, T2F, T4F, T6F		



			
1			
<b>GEV No.</b>	105297	<b>Ref. No.</b>	0750X22200 0900X22200 721-030-00
<b>description</b>	burner head for burner cap ø 80mm 4.3kW for pilot burner		
<b>For models:</b>	B4F, B6F, B8F, C2FP, C2FTPFE, C2FTPFG, C2TP2FGP, C4FFCEP, C4FFCGP, C4FFEP, C4FFGP, C4FFLE, C4FFLGP, C4FP, C6FFCEP, C6FFCGP, C6FFEP, C6FFGAP, C6FFGP, C6FFLE, C6FFLEPV, C6FFLG, C6FFLGPV, C6FP, FE, K2F, K2FTPFC, K2FTPFCG, K2FTPFE, K2FTPFG, K4F, K4FFE, K4FFG, K6F, K6FFE, K6FFG, K6FG, K8F, K8FFE, K8FFG, OP2F, OP4F, OP6F, OP8F, T2FP, T4FP, T6FP		
<b>accessories for</b>	105297		
	<b>GEV No.</b>	100907	<b>Ref. No.</b> —
	screw connection thread M10x1 Qty 1 pcs type SEF 1 ømm for thermocouple		
	<b>GEV No.</b>	101452	<b>Ref. No.</b> B83900
	ignition electrode support for burner type C/D suitable for 900 series		
	<b>GEV No.</b>	101453	<b>Ref. No.</b> B83800
	bracket for thermocouple gas range for burner type C/D suitable for 900 series		
	<b>GEV No.</b>	101454	<b>Ref. No.</b> —
	union screw for igniter thread M10x1 ID ø 7mm L 15mm		
	<b>GEV No.</b>	103069	<b>Ref. No.</b> X21600
	burner cap ø 80mm 4.3kW with central hole		
	<b>GEV No.</b>	104105	<b>Ref. No.</b> 0900X21300
	burner lower part for burner cap ø 80mm 3.5kW		
	<b>GEV No.</b>	104108	<b>Ref. No.</b> 0000X16100
	nozzle holder nozzle mounting M10x1 tube ø 10mm gas inlet M16x1.5 gas outlet M14x1		



			
1			
<b>GEV No.</b>	105298	<b>Ref. No.</b>	0750X22100 0900X22100 721-028-00
<b>description</b>	burner head for burner cap ø 95mm 6.4kW for pilot burner		
<b>For models:</b>	B4F, B6F, B8F, C2F, C2FTPFE, C2FTPFG, C2TP2FGP, C4FFCEP, C4FFCGP, C4FFEP, C4FFGP, C4FFLEP, C4FFLGP, C4FP, C6FFCEP, C6FFCGP, C6FFEP, C6FFGAP, C6FFGP, C6FFLEP, C6FFLEPV, C6FFLGP, C6FFLGPV, C6FP, K2F, K2FTPCE, K2FTPFCG, K2FTPFE, K2FTPFG, K4F, K4FFE, K4FFG, K6F, K6FFE, K6FFG, K8F, K8FFE, K8FFG, OP2F, OP4F, OP6F, OP8F, T2FP, T4FP, T6FP		
<b>accessories for</b>	105298		
	<b>GEV No.</b>	100907	<b>Ref. No.</b> —
	screw connection thread M10x1 Qty 1 pcs type SEF 1 ømm for thermocouple		
	<b>GEV No.</b>	101452	<b>Ref. No.</b> B83900
	ignition electrode support for burner type C/D suitable for 900 series		
	<b>GEV No.</b>	101453	<b>Ref. No.</b> B83800
	bracket for thermocouple gas range for burner type C/D suitable for 900 series		
	<b>GEV No.</b>	101454	<b>Ref. No.</b> —
	union screw for igniter thread M10x1 ID ø 7mm L 15mm		
	<b>GEV No.</b>	103070	<b>Ref. No.</b> X21700
	burner cap ø 95mm 6.4kW with central hole		
	<b>GEV No.</b>	104107	<b>Ref. No.</b> —
	burner lower part for burner cap ø 100mm 6.4kW		
	<b>GEV No.</b>	104108	<b>Ref. No.</b> 0000X16100
	nozzle holder nozzle mounting M10x1 tube ø 10mm gas inlet M16x1.5 gas outlet M14x1		



			
1			
<b>GEV No.</b>	104482	<b>Ref. No.</b>	0750X21300 0900X21300 721-029-00
<b>description</b>	burner lower part 3.5/4.3kW		
<b>For models:</b>	B4F, B6F, B8F, C2F, C2FP, C2FTPFE, C2FTPFG, C2FTPFGP, C2TP2FGP, C4F, C4FFCEP, C4FFCGP, C4FFE, C4FFEP, C4FFG, C4FFGP, C4FFLE, C4FFLEP, C4FFLG, C4FFLGP, C4FP, C6F, C6FFCEP, C6FFCGP, C6FFE, C6FFEP, C6FFG, C6FFGA, C6FFGAP, C6FFGP, C6FFLE, C6FFLEP, C6FFLEPV, C6FFLEV, C6FFLG, C6FFLGP, C6FFLGPV, C6FFLGV, C6FP, K2F, K2FTPCE, K2FTPFCG, K2FTPFE, K2FTPFG, K4F, K4FFE, K4FFG, K6F, K6FFE...(Other models you can see in the webshop)		



			
1			
<b>GEV No.</b>	104476	<b>Ref. No.</b>	0750X21400 0900X21400
<b>description</b>	burner lower part 5.5/6.4kW		
<b>For models:</b>	B4F, B6F, B8F, C2F, C2FP, C2FTPFE, C2FTPFE, C2FTPFG, C2FTPFGP, C2TP2FGP, C4F, C4FFCEP, C4FFCGP, C4FFE, C4FFEP, C4FFG, C4FFGP, C4FFLE, C4FFLEP, C4FFLG, C4FFLGP, C4FP, C6F, C6FFCEP, C6FFCGP, C6FFE, C6FFEP, C6FFG, C6FFGA, C6FFGAP, C6FFGP, C6FFLE, C6FFLEP, C6FFLEPV, C6FFLEV, C6FFLG, C6FFLGP, C6FFLGPV, C6FFLGV, C6FP, K2F, K2FTPCE, K2FTPFCG, K2FTPFE, K2FTPFG, K4F, K4FFE, K4FFG, K6F, K6FFE...(Other models you can see in the webshop)		

			
1			
<b>GEV No.</b>	104477	<b>Ref. No.</b>	0750X21500 0900X21500 721-025-00
<b>description</b>	burner lower part 7/8.3kW		
<b>For models:</b>	B4F, B6F, B8F, FCE, FCG, FE, K4F, K4FFE, K4FFG, K4FS, K4FSFCE, K4FSFCG, K4FSFE, K4FSFG, K6F, K6FFE, K6FFG, K6FG, K8F, K8FFE, K8FFG, OP4F, OP4FS, OP6F, OP8F		
<b>accessories for</b>	104477		
	<b>GEV No.</b>	104108	<b>Ref. No.</b> 0000X16100
	nozzle holder nozzle mounting M10x1 tube ø 10mm gas inlet M16x1.5 gas outlet M14x1		

			
1			
<b>GEV No.</b>	104105	<b>Ref. No.</b>	0900X21300
<b>description</b>	burner lower part for burner cap ø 80mm 3.5kW		
<b>accessories for</b>	104105		
	<b>GEV No.</b>	100907	<b>Ref. No.</b> —
	screw connection thread M10x1 Qty 1 pcs type SEF 1 ømm for thermocouple		
	<b>GEV No.</b>	101452	<b>Ref. No.</b> B83900
	ignition electrode support for burner type C/D suitable for 900 series		
	<b>GEV No.</b>	101453	<b>Ref. No.</b> B83800
	bracket for thermocouple gas range for burner type C/D suitable for 900 series		
	<b>GEV No.</b>	101454	<b>Ref. No.</b> —
	union screw for igniter thread M10x1 ID ø 7mm L 15mm		
	<b>GEV No.</b>	103069	<b>Ref. No.</b> X21600
	burner cap ø 80mm 4.3kW with central hole		
	<b>GEV No.</b>	104104	<b>Ref. No.</b> —
	burner head for burner cap ø 80mm 3.5kW code 100212		



Table continues overleaf



<b>accessories for</b> 104105			
	<b>GEV No.</b>	104108	<b>Ref. No.</b> 0000X16100
nozzle holder nozzle mounting M10x1 tube ø 10mm gas inlet M16x1.5 gas outlet M14x1			
	<b>GEV No.</b>	105297	<b>Ref. No.</b> 0750X22200 0900X22200 721-030-00
burner head for burner cap ø 80mm 4.3kW for pilot burner			





	<b>GEV No.</b>	104108	<b>Ref. No.</b>	0000X16100
<b>description</b> nozzle holder nozzle mounting M10x1 tube ø 10mm gas inlet M16x1.5 gas outlet M14x1				
<b>For models:</b> B4F, B6F, B8, B8F, C2F, C2FP, C2FTPFE, C2FTPFEF, C2FTPFG, C2FTPFGP, C2TP2FGP, C4F, C4FFCEP, C4FFCGP, C4FFE, C4FFEP, C4FFG, C4FFGP, C4FFLE, C4FFLEP, C4FFLG, C4FFLGP, C4FP, C4FZFG, C4FZFGP, C4FZS-FGP, C6F, C6FFCEP, C6FFCGP, C6FFE, C6FFEP, C6FFG, C6FFGA, C6FF-GAP, C6FFGP, C6FFLE, C6FFLEP, C6FFLEPV, C6FFLEV, C6FFLG, C6FFLGP, C6FFLGPV, C6FFLGV, C6FP, C6FZFG, C6FZFGP, CCTP8, CCTPFE8, CCTPFG8, CF10DG8M...(Other models you can see in the webshop)				
<b>accessories for</b> 104108				
	<b>GEV No.</b>	102382	<b>Ref. No.</b>	—
nut thread M14x1 H 3.5mm WS 18 brass Qty 1 pcs				
	<b>GEV No.</b>	104105	<b>Ref. No.</b>	0900X21300
burner lower part for burner cap ø 80mm 3.5kW				
	<b>GEV No.</b>	104107	<b>Ref. No.</b>	—
burner lower part for burner cap ø 100mm 6.4kW				

<b>solid tops</b>				
	<b>GEV No.</b>	107586	<b>Ref. No.</b>	X22800
<b>description</b> round burner ø 120mm				
<b>For models:</b> C2FTPFGP, CCTP8, CCTPFG8, K2FTPFE, K2FTPFCG, K2FTPFE, K2FTPFG, KTP, KTPFCE, KTPFCG, KTPFE, KTPFG, OPTP, TTP8				

	<b>GEV No.</b>	105104	<b>Ref. No.</b>	0903X20900
<b>description</b> round burner ø 180mm				
<b>For models:</b> C2FTPFE, C2FTPFEF, C2FTPFG, C2FTPFGP, CCTP8, CCTPFG8				

<b>miscellaneous</b>				
	<b>GEV No.</b>	108145	<b>Ref. No.</b>	AGB004ZR10
<b>description</b> burner cap ø 100mm				
<b>For models:</b> CC120CG, CC80G, CC81CG, CCG120CE, CCG80E, CCG81CE, M62F, M64F, M74F, M74FFXE, M74FFXG, M76F, M76FFXE, M76FFXG, SKC40G, SKC80G				
<b>accessories for</b> 108145				
	<b>GEV No.</b>	108146	<b>Ref. No.</b>	AGB003ZR10
burner head for burner cap ø 100mm				

	<b>GEV No.</b>	108146	<b>Ref. No.</b>	AGB003ZR10
<b>description</b> burner head for burner cap ø 100mm				
<b>For models:</b> CC120CG, CC80G, CC81CG, CCG120CE, CCG80E, CCG81CE, M62F, M64F, M74F, M74FFXE, M74FFXG, M76F, M76FFXE, M76FFXG, SKC40G, SKC80G				
<b>accessories for</b> 108146				
	<b>GEV No.</b>	108145	<b>Ref. No.</b>	AGB004ZR10
burner cap ø 100mm				
	<b>GEV No.</b>	108147	<b>Ref. No.</b>	AGB012ZR10
burner lower part for burner cap ø 100mm				

	<b>GEV No.</b>	108147	<b>Ref. No.</b>	AGB012ZR10
<b>description</b> burner lower part for burner cap ø 100mm				
<b>For models:</b> CC120CG, CC80G, CC81CG, CCG120CE, CCG80E, CCG81CE, M62F, M64F, M74F, M74FFXE, M74FFXG, M76F, M76FFXE, M76FFXG, SKC40G, SKC80G				
<b>accessories for</b> 108147				
	<b>GEV No.</b>	102440	<b>Ref. No.</b>	AGB011ZR10
ignition electrode				
	<b>GEV No.</b>	108145	<b>Ref. No.</b>	AGB004ZR10
burner cap ø 100mm				
	<b>GEV No.</b>	108146	<b>Ref. No.</b>	AGB003ZR10
burner head for burner cap ø 100mm				









bar burners

bar burners



<b>GEV No.</b>	105102	<b>Ref. No.</b>	X68046
<b>description</b>	bar burner 1-row ø 27mm Wmm Hmm L 418mm oven		
<b>For models:</b>	CBG4, CBG6, CBG8, CC80G, KB4G, KB8G, M74FFXG, M74FMPFXG, M74FPPFXG, M76FFXG, M76FMPFXG, M76FPPFXG, OPB4G, SKB40G, SKB60G, SKB80G, TB40G, TB60G, TB80G, TP40G		
<b>spare parts for</b>	105102		
	<b>GEV No.</b>	104651	<b>Ref. No.</b> X68047
	mounting flange for igniter and thermocouple		



<b>GEV No.</b>	105115	<b>Ref. No.</b>	Y22200
<b>description</b>	bar burner 1-row ø 40mm Wmm Hmm L 500mm flange width 43mm flange length 43mm tilting bratt pan		
<b>For models:</b>	KBRG, KBRG12, KBRG12IN, KBRGIN, KBRGM, KBRGM12, KBRGM12IN, KBRGMIN, OPBRG, OPBRG12, OPBRG12IN, OPBRG12MIN, OPBRGIN, OPBRGM, OPBRGM12, OPBRGM12IN, OPBRGMIN		



<b>GEV No.</b>	104217	<b>Ref. No.</b>	717-144-00 X23900
<b>description</b>	bar burner 1-row ø 60mm Wmm Hmm L 505mm flange width 67mm flange length 67mm fryer		
<b>For models:</b>	KCP4, KCP82, OPCP4, OPCP82		



<b>GEV No.</b>	105260	<b>Ref. No.</b>	X20100
<b>description</b>	bar burner 2 row L 450mm W 300mm ømm H 50mm 8.5kW griddle		
<b>For models:</b>	CFTG2, CFTG2C, CFTG2R, CFTG6, CFTG6C, CFTG6R, SKT2G, SKT2GC, SKT2GR, SKT60G, SKT60GC, SKT60GR, TT2G, TT2GC, TT2GR, TT60G, TT60GC, TT60GR		



<b>GEV No.</b>	105302	<b>Ref. No.</b>	Y22000
<b>description</b>	bar burner 3 row L 445mm W 280mm ømm H 40mm solid top		
<b>For models:</b>	K2FTPFCF, K2FTPFCG, K2FTPFE, K2FTPFG, KTP, KTPFCE, KTPFCG, KTPFE, KTPFG, OPTP		



<b>GEV No.</b>	105340	<b>Ref. No.</b>	X24100
<b>description</b>	bar burner 3 row L 480mm W 305mm ømm H 60mm mounting distance 280mm chargrill		
<b>For models:</b>	CPLG1, CPLG2, CPLG4, CPLG8, KPLG1, KPLG2, M7PL1G, M7PL2G, OPPLG1, OPPLG2, SKPL1G, SKPL2G, SKPL4G, SKPL8G, TPLG1, TPLG2		



<b>GEV No.</b>	105303	<b>Ref. No.</b>	0000Y20100
<b>description</b>	bar burner 3 row L 630mm W 265mm ømm H 60mm griddle		
<b>For models:</b>	KFT4G, KFT4GC, KFT4GR, KFT8G, KFT8G23C, KFT8GC, KFT8GLR, KFT8GR, KFTG1, KFTG1C, KFTG1R, KFTG3, KFTG3C, KFTG3LR, KFTG4, KFTG4C, KFTG4R, KFTG8, KFTG8C, KFTG8LR, KTF4G, KTF4GC, KTF8GLR, OPFT4G, OPFT4GC, OPFT4GR, OPFT8G, OPFT8G23C, OPFT8GC, OPFT8GLR, OPFT8GR, OPTF4G, OPTF4GC, OPTF8GLR		



<b>GEV No.</b>	109056	<b>Ref. No.</b>	DGB002ZR10
<b>description</b>	bar burner angled L 460mm W 183mm ømm Hmm oven		
<b>For models:</b>	M7FT4GL, M7FT4GR, M7FT6GL, M7FT6GLR		



<b>GEV No.</b>	105105	<b>Ref. No.</b>	X20400
<b>description</b>	bar burner angled L 600mm W 305mm ømm Hmm oven		
<b>For models:</b>	C2FTPFG, C2FTPFGP, C2TP2FGP, C4FFG, C4FFGP, C4FZFG, C4FZFGP, C4FZSFGP, C6FFG, C6FFGP, C6FZFG, C6FZFGP, CCTPFG8, K2FTPFG, K4FFG, K4FSFG, K4FZFG, K4FZSFG, K6FFG, K6FZFG, K8FFG, K8FZFG, KTPFG		



1

<b>GEV No.</b>	105114	<b>Ref. No.</b>	Y22100
<b>description</b>	bar burner for kettle		



1

<b>GEV No.</b>	109055	<b>Ref. No.</b>	DGB001ZR10
<b>description</b>	bar burner ø 26mm Wmm Hmm L 580mm oven		
<b>For models:</b>	M72FPTFG, M74FMPFG, M74FPFG, M76FMPFG, M76FPFG		



1

<b>GEV No.</b>	105103	<b>Ref. No.</b>	X68401
<b>description</b>	bar burner ø 27mm Wmm Hmm L 638mm oven		
<b>For models:</b>	C4FFLG, C4FFLGP, C6FFLG, C6FFLGP, C6FFLGPV, C6FFLGV, CC120G, CC81G		

<b>spare parts for</b>	105103			
	<b>GEV No.</b>	104651	<b>Ref. No.</b>	X68047
	mounting flange for igniter and thermocouple			

<b>accessories for</b>	105103			
	<b>GEV No.</b>	104651	<b>Ref. No.</b>	X68047
	mounting flange for igniter and thermocouple			

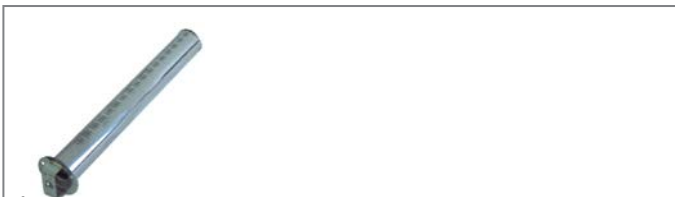

1

<b>GEV No.</b>	105110	<b>Ref. No.</b>	X20600
<b>description</b>	bar burner ø 40mm Wmm Hmm L 323mm tilting bratt pan flange ø 61mm		
<b>For models:</b>	CBRG, CBRG8, CBRGIN, CPG, CPGI		



1

<b>GEV No.</b>	105718	<b>Ref. No.</b>	E30100
<b>description</b>	bar burner ø 40mm Wmm Hmm L 395mm flange ø 61mm tilting bratt pan		
<b>For models:</b>	CPG, CPGI, KP10G, KP10GA, KP10GT, KP10GTA, KP15G, KP15GA, KP15GT, KP15GTA, KPI10G, KPI10GA, KPI10GT, KPI10GTA, KPI15G, KPI15GA, KPI15GT, KPI15GTA, OPP10G, OPP10GA, OPP15G, OPP15GA, OPPI10G, OPPI10GA, OPPI15G, OPPI15GA		



1

<b>GEV No.</b>	105257	<b>Ref. No.</b>	Y22100
<b>description</b>	bar burner ø 40mm Wmm Hmm L 397mm kettle flange ø 61mm mounting distance 45mm		



1

<b>GEV No.</b>	105108	<b>Ref. No.</b>	X23800
<b>description</b>	bar burner ø 50mm Wmm Hmm L 350mm pasta cooker		
<b>For models:</b>	CCPG4, CCPG82		

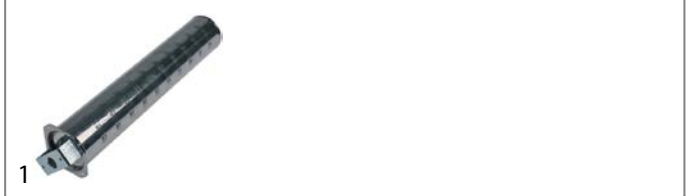

1

<b>GEV No.</b>	109057	<b>Ref. No.</b>	Y23500
<b>description</b>	bar burner ø 60mm Wmm Hmm L 335mm pasta cooker		
<b>For models:</b>	CCPG4, CCPG82, M7CP4G		







1

<b>GEV No.</b>	105255	<b>Ref. No.</b>	0000X20000
<b>description</b>	bar burner ømm W 41mm H 34mm L 490mm flange width 70mm 5.5kW griddle		







 <p>1</p>			
<b>GEV No.</b>	105256	<b>Ref. No.</b>	0000X20100
<b>description</b>	bar burner tilting bratt pan		

 <p>1</p>			
<b>GEV No.</b>	105341	<b>Ref. No.</b>	B49900
<b>description</b>	lava rock grid L 450mm W 330mm		
<b>For models:</b>	CPLG4, CPLG8		

 <p>Image not available</p> <p>1</p>			
<b>GEV No.</b>	104651	<b>Ref. No.</b>	X68047
<b>description</b>	mounting flange for igniter and thermocouple		
<b>spare parts for</b>	104651		
	<b>GEV No.</b>	105103	<b>Ref. No.</b>
			X68401
	bar burner ø 27mm Wmm Hmm L 638mm oven		
<b>accessories for</b>	104651		
	<b>GEV No.</b>	105103	<b>Ref. No.</b>
			X68401
	bar burner ø 27mm Wmm Hmm L 638mm oven		

lava rock grids

 <p>1</p>			
<b>GEV No.</b>	105341	<b>Ref. No.</b>	B49900
<b>description</b>	lava rock grid L 450mm W 330mm		
<b>For models:</b>	CPLG4, CPLG8		

 <p>Image not available</p> <p>1</p>			
<b>GEV No.</b>	104651	<b>Ref. No.</b>	X68047
<b>description</b>	mounting flange for igniter and thermocouple		
<b>spare parts for</b>	104651		
	<b>GEV No.</b>	105103	<b>Ref. No.</b>
			X68401
	bar burner ø 27mm Wmm Hmm L 638mm oven		
<b>accessories for</b>	104651		
	<b>GEV No.</b>	105103	<b>Ref. No.</b>
			X68401
	bar burner ø 27mm Wmm Hmm L 638mm oven		

tube burners





 <p>1</p>			
<b>GEV No.</b>	105107	<b>Ref. No.</b>	X23000
<b>description</b>	tubular burner L 255mm W 49mm H 65mm for fryer oval		
<b>For models:</b>	CF15DG8, CF15G4, KFG4, KFG8		



 <p>1</p>			
<b>GEV No.</b>	105261	<b>Ref. No.</b>	0900X23100
<b>description</b>	tubular burner ø 74mm L 180mm W 75mm H 60mm for fryer round		
<b>For models:</b>	CF10DG8M, CF10G4M, KFG1, KFG2, M7F4G, M7F8G, OPFG1, OPFG2, SKF10GM, SKF20GM, TF10GM, TF20GM		

accessories

nozzle holders

 <p>1</p>			
<b>GEV No.</b>	106283	<b>Ref. No.</b>	X68042
<b>description</b>	nozzle holder nozzle M6 M10x1 screw pipe fitting 1/4" tube ø 6mm		
<b>For models:</b>	CBG4, CBG6, CBG8, KB4G, KB8G, OPB4G, SKB40G, SKB60G, SKB80G, TB40G, TB60G, TB80G, TP40G		

			
1			
<b>GEV No.</b>	104108	<b>Ref. No.</b>	0000X16100
<b>description</b>	nozzle holder nozzle mounting M10x1 tube ø 10mm gas inlet M16x1.5 gas outlet M14x1		
<b>For models:</b>	B4F, B6F, B8, B8F, C2F, C2FP, C2FTPFE, C2FTPFEF, C2FTPFG, C2FTPFGP, C2TP2FGP, C4F, C4FFCEP, C4FFCGP, C4FFE, C4FFEP, C4FFG, C4FFGP, C4FFLE, C4FFLEP, C4FFLG, C4FFLGP, C4FP, C4FZFG, C4FZFGP, C4FZS-FGP, C6F, C6FFCEP, C6FFCGP, C6FFE, C6FFEP, C6FFG, C6FFGA, C6FF-GAP, C6FFGP, C6FFLE, C6FFLEP, C6FFLEPV, C6FFLEV, C6FFLG, C6FFLGP, C6FFLGPV, C6FFLV, C6FP, C6FZFG, C6FZFGP, CCTP8, CCTPFE8, CCTPFG8, CF10DG8M...(Other models you can see in the webshop)		
<b>accessories for</b>	104108		
	<b>GEV No.</b>	102382	<b>Ref. No.</b> —
	nut thread M14x1 H 3.5mm WS 18 brass Qty 1 pcs		
	<b>GEV No.</b>	104105	<b>Ref. No.</b> 0900X21300
	burner lower part for burner cap ø 80mm 3.5kW		
	<b>GEV No.</b>	104107	<b>Ref. No.</b> —
	burner lower part for burner cap ø 100mm 6.4kW		

			
1			
<b>GEV No.</b>	106520	<b>Ref. No.</b>	0600V01100
<b>description</b>	nozzle holder thread 3/8" L 53mm IT M10x1 nozzle mounting M10x1		
<b>For models:</b>	2FZP, B4FZ, B6FZ, B8FZ, C2FZ, C2FZP, C2TP2FGP, C4FZ, C4FZFCE, C4FZFCEP, C4FZFCG, C4FZFCGP, C4FZFE, C4FZFEP, C4FZFG, C4FZFGP, C4FZP, C4FZSFCEP, C4FZSFCEP, C4FZSFEP, C4FZSFGP, C4FZSP, C6FZ, C6FZFCE, C6FZFCEP, C6FZFCEPV, C6FZFCEV, C6FZFCG, C6FZFCGP, C6FZFCGPV, C6FZFCGV, C6FZFCE, C6FZFEP, C6FZFG, C6FZFGA, C6FZFGAP, C6FZFGP, C6FZP, K2FZ, K4FZ, K4FZFCE, K4FZFCG, K4FZFE, K4FZFG, K4FZFGA, K4FZS, K4FZSFCE, K4FZSFCG, K4FZSFE, K4FZSFG...(Other models you can see in the webshop)		
<b>accessories for</b>	106520		
	<b>GEV No.</b>	106521	<b>Ref. No.</b> 0600V01500 V01500
	air mixing sleeve L 30mm thread 3/8" IT		

<b>miscellaneous</b>			
			
1			
<b>GEV No.</b>	104481	<b>Ref. No.</b>	872-091-00
<b>description</b>	reducer for burner H 7mm D1 ø 24mm D2 ø 26mm hole ø 14mm		
<b>For models:</b>	B4F, B6F, B8F, C2FP, C2TP2FGP, C4FFCEP, C4FFCGP, C4FFEP, C4FFGP, C4FP, C6FFCEP, C6FFCGP, C6FFEP, C6FFGP, C6FP, K2F, K2FTPCE, K2FTPFCG, K2FTPFE, K2FTPFG, K4F, K4FFE, K4FFG, K4FS, K4FSFCE, K4FSFCG, K4FSFE, K4FSFG, K6F, K6FFE, K6FFG, K8F, K8FFE, K8FFG, OP2F, OP4F, OP4FS, OP6F, OP8F, T2FP, T4FP, T6FP		

gas nozzles

main nozzles

<b>gas nozzles M6x0.75</b>			
			
1			
<b>GEV No.</b>	106481	<b>Ref. No.</b>	DGI095N09E
<b>description</b>	gas injector thread M6x0.75 WS 7 bore ø 0.95mm		
<b>For models:</b>	CC120CG, CC80G, CC81CG, CCG120CE, CCG80E, CCG81CE, M62F, M64F, M74F, M74FFXE, M74FFXG, M74FMPFXG, M74FPFXG, M76F, M76FFXE, M76FFXG, M76FMPFXG, M76FPFXG, M77T6GL, M77T6GLR, SKC40G, SKC80G		

			
1			
<b>GEV No.</b>	106591	<b>Ref. No.</b>	X25800
<b>description</b>	gas injector thread M6x0.75 WS 7 bore ø 1.15mm		
<b>For models:</b>	CBG4, CBG6, CBG8, CC80G, KB4G, KB8G, OPB4G, SKB40G, SKB60G, SKB80G, TB40G, TB60G, TB80G, TP40G		

			
1			
<b>GEV No.</b>	106482	<b>Ref. No.</b>	DGI110N09E
<b>description</b>	gas injector thread M6x0.75 WS 7 bore ø 1.1mm		
<b>For models:</b>	M77T4GL, M77T4GR		

			
1			
<b>GEV No.</b>	106483	<b>Ref. No.</b>	DGI135N09E
<b>description</b>	gas injector thread M6x0.75 WS 7 bore ø 1.35mm		
<b>For models:</b>	M72FPTFG, M74FMPFG, M74FPFG, M76FMPFG, M76FPFG		

			
1			
<b>GEV No.</b>	106484	<b>Ref. No.</b>	DGI145N09E
<b>description</b>	gas injector thread M6x0.75 WS 7 bore ø 1.45mm		
<b>For models:</b>	M62F, M64F, M74F, M74FFXE, M74FFXG, M74FMPFXG, M74FPFXG, M76F, M76FFXE, M76FFXG, M76FMPFXG, M76FPFXG, M77T6GL, M77T6GLR		





			
1			
<b>GEV No.</b>	106485	<b>Ref. No.</b>	DGI160N09E
<b>description</b>	gas injector thread M6x0.75 WS 7 bore ø 1.6mm		
<b>For models:</b>	M7FT4GL, M7FT4GR		

			
1			
<b>GEV No.</b>	106486	<b>Ref. No.</b>	DGI198N09E
<b>description</b>	gas injector thread M6x0.75 WS 7 bore ø 1.98mm		
<b>For models:</b>	M72FPTFG, M74FMPFG, M74FPFG, M76FMPFG, M76FPFG		

gas nozzles M7x1

			
1			
<b>GEV No.</b>	100976	<b>Ref. No.</b>	X37800
<b>description</b>	gas injector thread M7x1 WS 10 bore ø 0.7mm		

			
1			
<b>GEV No.</b>	100518	<b>Ref. No.</b>	X38100
<b>description</b>	gas injector thread M7x1 WS 10 bore ø 0.85mm		

			
1			
<b>GEV No.</b>	100517	<b>Ref. No.</b>	X38000
<b>description</b>	gas injector thread M7x1 WS 10 bore ø 0.8mm		
<b>For models:</b>	CC120CG, CC120G, CC80G, CC81CG, CC81G, CCG120CE, CCG120E, CCG80E, CCG81CE, CCG81E, SKC40G, SKC80G		

			
1			
<b>GEV No.</b>	100519	<b>Ref. No.</b>	X38300
<b>description</b>	gas injector thread M7x1 WS 10 bore ø 0.95mm		
<b>For models:</b>	CC120CG, CC120G, CC80G, CC81CG, CC81G, CCG120CE, CCG120E, CCG80E, CCG81CE, CCG81E, SKC40G, SKC80G		

			
1			
<b>GEV No.</b>	100523	<b>Ref. No.</b>	X38800
<b>description</b>	gas injector thread M7x1 WS 10 bore ø 1.4mm		
<b>For models:</b>	CC120CG, CC120G, CC80G, CC81CG, CC81G, CCG120CE, CCG120E, CCG80E, CCG81CE, CCG81E, SKC40G, SKC80G		

			
1			
<b>GEV No.</b>	100524	<b>Ref. No.</b>	X39300
<b>description</b>	gas injector thread M7x1 WS 10 bore ø 1.55mm		
<b>For models:</b>	CC120CG, CC120G, CC80G, CC81CG, CC81G, CCG120CE, CCG120E, CCG80E, CCG81CE, CCG81E, SKC40G, SKC80G		

gas nozzles M10x1

			
1			
<b>GEV No.</b>	100639	<b>Ref. No.</b>	Y30500
<b>description</b>	gas injector thread M10x1 WS 11 bore ø 1.25mm inner peaked		
<b>For models:</b>	CPLG4, CPLG8, SKPL1G, SKPL2G		

			
1			
<b>GEV No.</b>	100641	<b>Ref. No.</b>	Y08600
<b>description</b>	gas injector thread M10x1 WS 11 bore ø 1.35mm inner peaked		
<b>For models:</b>	CBRG, CBRGIN, KP10G, KP10GA, KP10GT, KP10GTA, KP15G, KP15GA, KP15GT, KP15GTA, KP110G, KP110GA, KP110GT, KP110GTA, KP115G, KP115GA, KP115GT, KP115GTA, OPP10G, OPP10GA, OPP15G, OPP15GA, OPPI10G, OPPI10GA, OPPI15G, OPPI15GA		

			
1			
<b>GEV No.</b>	106306	<b>Ref. No.</b>	X29600
<b>description</b>	gas injector thread M10x1 WS 11 bore ø 1.45mm code 145		
<b>For models:</b>	CPLG1, CPLG2, KPLG1, KPLG2, M7PL1G, M7PL2G, OPPLG1, OPPLG2, SKPL1G, SKPL2G, TPLG1, TPLG2		

			
1			
<b>GEV No.</b>	106286	<b>Ref. No.</b>	Y30700
<b>description</b>	gas injector thread M10x1 WS 11 bore ø 1.55mm inner peaked		
<b>For models:</b>	C4FFCGP, C4FZFCG, C4FZFCGP, C4FZSFCGP, C6FFCGP, C6FZFCG, C6FZFCGP, C6FZFCGPV, C6FZFCGV, CC120CG, CC81CG, CFTG22, CFTG2C2, CFTG2LR, CFTG2R2, CFTG62, CFTG6C2, CFTG6LR, CFTG6R2, K2FTPFPG, K4FSFCG, K4FZFCG, K4FZSFCG, K6FZFCG, K8FZFCG, KBRG, KBRGIN, KBRGM, KBRGMIN, KTPFCG, OPBRG, OPBRGIN, OPBRGM, OPBRGMIN, SK4FZFCGP, SK6FZFCGP, SKT2G2, SKT2GC2, SKT2GLR, SKT2GR2, SKT60G2, SKT60GC2, SKT60GLR, SKT60GR2, TT2G2, TT2G2LR, TT2GC2, TT2GLR, TT2GR2, TT60G2...(Other models you can see in the webshop)		



<b>GEV No.</b>	100643	<b>Ref. No.</b>	Y08700
<b>description</b>	gas injector thread M10x1 WS 11 bore ø 1.5mm inner peaked		
<b>For models:</b>	CCPG4, CCPG82, M7CP4G		



<b>GEV No.</b>	102867	<b>Ref. No.</b>	0000Y09100
<b>description</b>	gas injector thread M10x1 WS 11 bore ø 1.65mm		
<b>For models:</b>	KFT4G, KFT4GC, KFT4GR, KFT8G, KFT8G23C, KFT8GC, KFT8GLR, KFT8GR, KFTG1, KFTG1C, KFTG1R, KFTG3, KFTG3C, KFTG3LR, KFTG4, KFTG4C, KFTG4R, KFTG8, KFTG8C, KFTG8LR, KTF4G, KTF4GC, KTF8GLR, OPFT4G, OPFT4GC, OPFT4GR, OPFT8G, OPFT8G23C, OPFT8GC, OPFT8GLR, OPFT8GR, OPTF4G, OPTF4GC, OPTF8GLR		



<b>GEV No.</b>	100644	<b>Ref. No.</b>	Y30800
<b>description</b>	gas injector thread M10x1 WS 11 bore ø 1.6mm inner peaked		
<b>For models:</b>	KBRG, KBRG12, KBRG12IN, KBRGIN, KBRGM, KBRGM12, KBRGM12IN, KBRGMIN, KCP4, KCP82, OPBRG, OPBRGIN, OPBRGM, OPBRGM12, OPBRGM12IN, OPBRGMIN, OPCP4, OPCP82, SKCP60G, TCP60G		



<b>GEV No.</b>	103328	<b>Ref. No.</b>	Y30000
<b>description</b>	gas injector thread M10x1 WS 11 bore ø 1mm		
<b>For models:</b>	C4FFCGP, C4ZFZCG, C4ZFZCGP, C4FZSFCGP, C6FFCGP, C6ZFZCG, C6ZFZCGP, C6FZFCGPV, C6FZFCGV, CC120CG, CC81CG, K2FTPFCC, K4FSFCG, K4ZFZCG, K4FZSFCG, K6FZFCG, K8FZFCG, KTFPCG, SK4FZFCGP, SK6FZFCGP		



<b>GEV No.</b>	106288	<b>Ref. No.</b>	Y31300
<b>description</b>	gas injector thread M10x1 WS 11 bore ø 2.05mm inner peaked		
<b>For models:</b>	KP10G, KP10GA, KP10GT, KP10GTA, KP15G, KP15GA, KP15GT, KP15GTA, KP110G, KP110GA, KP110GT, KP110GTA, KP115G, KP115GA, KP115GT, KP115GTA, OPP10G, OPP10GA, OPP15G, OPP15GA, OPPI10G, OPPI10GA, OPPI15G, OPPI15GA		



<b>GEV No.</b>	106287	<b>Ref. No.</b>	Y31200
<b>description</b>	gas injector thread M10x1 WS 11 bore ø 2.2mm inner peaked		
<b>For models:</b>	C6FFGA, C6FFGAP, CPLG1, CPLG2, KPLG1, KPLG2, M7PL1G, M7PL2G, OPPLG1, OPPLG2, SKPL1G, SKPL2G, TPLG1, TPLG2		



<b>GEV No.</b>	106500	<b>Ref. No.</b>	Y08800
<b>description</b>	gas injector thread M10x1 WS 11 bore ø 2.3mm inner peaked		
<b>For models:</b>	CCPG4, CCPG82, KP10G, KP10GA, KP15G, KP15GA, KP110G, KP110GA, KP115G, KP115GA, M7CP4G, OPP10G, OPP10GA, OPP15G, OPP15GA, OPPI10G, OPPI10GA, OPPI15G, OPPI15GA		



<b>GEV No.</b>	106289	<b>Ref. No.</b>	Y31500
<b>description</b>	gas injector thread M10x1 WS 11 bore ø 2.45mm inner peaked		
<b>For models:</b>	KCP4, KCP82, OPCP4, OPCP82		



<b>GEV No.</b>	100154	<b>Ref. No.</b>	Y30100
<b>description</b>	gas injector thread M10x1 bore ø 1.05mm L 30mm WS 12		
<b>For models:</b>	KBRG12, KBRG12IN, KBRGM12, KBRGM12IN, OPBRG12, OPBRG12IN, OPBRG12MIN, OPBRGM12, OPBRGM12IN		



<b>GEV No.</b>	106466	<b>Ref. No.</b>	X34000
<b>description</b>	gas injector thread M10x1 WS 12 bore ø 1.15mm		
<b>For models:</b>	B4F, B6F, B8F, C2F, C2FP, C2FTPFE, C2FTPFEP, C2FTPFG, C2FTPFGP, C4F, C4FFE, C4FFEP, C4FFG, C4FFGP, C4FFLE, C4FFLEP, C4FFLG, C4FFLGP, C4FP, C6F, C6FFE, C6FFEP, C6FFG, C6FFGA, C6FFGAP, C6FFGP, C6FFLE, C6FFLEP, C6FFLEPV, C6FFLEV, C6FFLG, C6FFLGP, C6FFLGPV, C6FFLGV, C6FP, CFTG1, CFTG1C, CFTG1R, CFTG3, CFTG3C, CFTG3LR, CFTG3R, CFTG4, CFTG4C, CFTG4R, CFTG8, CFTG8C, CFTG8LR, CFTG8R, I2FZ... (Other models you can see in the webshop)		



<b>GEV No.</b>	102705	<b>Ref. No.</b>	X33300
<b>description</b>	gas injector thread M10x1 WS 11 bore ø 0.8mm		



<b>GEV No.</b>	100420	<b>Ref. No.</b>	X33600
<b>description</b>	gas injector thread M10x1 WS 11 bore ø 0.95mm		
<b>For models:</b>	B4F, B4FZ, B6F, B6FZ, B8F, B8FZ, C2F, C2FP, C2FTPFE, C2FTPFEP, C2FTPFG, C2FTPFGP, C4F, C4FFE, C4FFEP, C4FFG, C4FFGP, C4FFLE, C4FFLEP, C4FFLG, C4FFLGP, C4FP, C6F, C6FFE, C6FFEP, C6FFG, C6FFGA, C6FFGAP, C6FFGP, C6FFLE, C6FFLEP, C6FFLEPV, C6FFLEV, C6FFLG, C6FFLGP, C6FFLGPV, C6FFLGV, C6FP, CF10DG8M, CF10G4M, K2F, K2FTPFG, K2FZ, K4F, K4FFE, K4FFG, K4FZ, K4FZFCG, K4FZFE... (Other models you can see in the webshop)		





			
1			
<b>GEV No.</b>	106285	<b>Ref. No.</b>	X34000
<b>description</b>	gas injector thread M10x1 WS 11 bore ø 1.15mm		

			
1			
<b>GEV No.</b>	106490	<b>Ref. No.</b>	X34200
<b>description</b>	gas injector thread M10x1 WS 11 bore ø 1.25mm		
<b>For models:</b>	B4FZ, B6FZ, B8FZ, C2FTPFGP, C2FZ, C2FZP, C2TP2FGP, C4FZ, C4FZFCEP, C4FZFCGP, C4FZFEP, C4FZFGP, C4FZP, C4FZSP, C6FZ, C6FZFCEP, C6FZFCEPV, C6FZFCGP, C6FZFCGPV, C6FZFEP, C6FZFGAP, C6FZFGP, C6FZP, CCTP8, CCTPFG8, CFTG1, CFTG1C, CFTG1R, CFTG3, CFTG3C, CFTG3LR, CFTG4, CFTG4C, CFTG4R, CFTG8, CFTG8C, CFTG8LR, K2FZ, K4FZ, K4FZCE, K4FZFCG, K4FZFE, K4FZFG, K4FZFGA, K4FZSFG, K6FZ, K6FZCE, K6FZFCG, K6FZFE, K6FZFG...(Other models you can see in the webshop)		

			
1			
<b>GEV No.</b>	102774	<b>Ref. No.</b>	X34600
<b>description</b>	gas injector thread M10x1 WS 11 bore ø 1.45mm		
<b>For models:</b>	2FZP, B4FZ, B6FZ, B8FZ, C2FTPFG, C2FTPFGP, C2FZ, C2FZP, C4FFG, C4FFGP, C4FZ, C4FZCE, C4FZFCEP, C4FZFCG, C4FZFCGP, C4FZFE, C4FZFEP, C4FZFG, C4FZFGP, C4FZP, C6FFG, C6FFGP, C6FZ, C6FZFCE, C6FZFCEP, C6FZFCEPV, C6FZFCEV, C6FZFCEG, C6FZFCEGP, C6FZFCEGPV, C6FZFCEGV, C6FZFE, C6FZFEP, C6FZFG, C6FZFGA, C6FZFGAP, C6FZFGP, C6FZP, CCTPFG8, CF10DG8M, CF10G4M, I2FZ, I2FZP, I4FZ, I4FZP, I6FZP, K2FTPFG, K2FZ, K4FFG, K4FSFG...(Other models you can see in the webshop)		

			
1			
<b>GEV No.</b>	101997	<b>Ref. No.</b>	X34500
<b>description</b>	gas injector thread M10x1 WS 11 bore ø 1.4mm		
<b>For models:</b>	B4F, B6F, B8F, C2FTPFGP, C2TP2FGP, C4FFGP, C4FZFG, C4FZFGP, C4FZSFGP, C6FFGP, C6FZFG, C6FZFGP, CCTPFG8, FCE, FCG, FE, K2FTPFG, K4F, K4FFE, K4FFG, K4FS, K4FSCE, K4FSFCG, K4FSFE, K4FSFG, K4FZFG, K4FZSFG, K6F, K6FFE, K6FFG, K6FG, K6FZFG, K8F, K8FFE, K8FFG, K8FZFG, KTPFG, OP4F, OP4FS, OP6F, OP8F		

			
1			
<b>GEV No.</b>	100793	<b>Ref. No.</b>	X34700
<b>description</b>	gas injector thread M10x1 WS 11 bore ø 1.5mm		
<b>For models:</b>	B4F, B4FZ, B6F, B6FZ, B8F, B8FZ, C2F, C2FP, C2FTPFE, C2FTPFGP, C2FTPFG, C2FTPFGP, C2TP2FGP, C4F, C4FFCEP, C4FFCGP, C4FFE, C4FFEP, C4FFG, C4FFGP, C4FFLE, C4FFLEP, C4FFLG, C4FFLGP, C4FP, C6F, C6FFCEP, C6FFCGP, C6FFE, C6FFEP, C6FFG, C6FFGA, C6FFGAP, C6FFGP, C6FFLE, C6FFLEP, C6FFLEPV, C6FFLEV, C6FFLG, C6FFLGP, C6FFLGPV, C6FFLGV, C6FP, CCTP8, CCTPFG8, CFTG2, CFTG2C, CFTG2R, CFTG6, CFTG6C...(Other models you can see in the webshop)		

			
1			
<b>GEV No.</b>	106440	<b>Ref. No.</b>	X35400
<b>description</b>	gas injector thread M10x1 WS 11 bore ø 1.85mm		
<b>For models:</b>	B4F, B6F, B8F, C2F, C2FP, C2FTPFE, C2FTPFG, C2FTPFGP, C2FTPFGP, C2FZ, C2FZP, C2TP2FGP, C4F, C4FFE, C4FFEP, C4FFG, C4FFGP, C4FFLE, C4FFLEP, C4FFLG, C4FFLGP, C4FP, C4FZ, C4FZFCEP, C4FZFCGP, C4FZFEP, C4FZFGP, C4FZP, C4FZSP, C6F, C6FFE, C6FFEP, C6FFG, C6FFGA, C6FFGAP, C6FFGP, C6FFLE, C6FFLEP, C6FFLEPV, C6FFLEV, C6FFLG, C6FFLGP, C6FFLGPV, C6FFLGV, C6FP, C6FZ, C6FZFCEP, C6FZFCEPV, C6FZFCGP, C6FZFCGPV...(Other models you can see in the webshop)		

			
1			
<b>GEV No.</b>	102984	<b>Ref. No.</b>	X35300
<b>description</b>	gas injector thread M10x1 WS 11 bore ø 1.8mm		
<b>For models:</b>	B4F, B6F, B8F, C2FP, C2FTPFGP, C2TP2FGP, C4FFCEP, C4FFCGP, C4FFEP, C4FFGP, C4FP, C6FFCEP, C6FFCGP, C6FFEP, C6FFGP, C6FP, K2FTPCE, K2FTPFCG, K2FTPFE, K2FTPFG, K4F, K4FFE, K4FFG, K6F, K6FFE, K6FFG, K8F, K8FFE, K8FFG, OP2F, OP4F, OP6F, OP8F, T2FP, T4FP, T6FP		

			
1			
<b>GEV No.</b>	109116	<b>Ref. No.</b>	X33700
<b>description</b>	gas injector thread M10x1 WS 11 bore ø 1mm code 100		
<b>For models:</b>	2FZP, B4F, B4FZ, B6F, B6FZ, B8F, B8FZ, C2FP, C2FTPFGP, C2FZ, C2FZP, C2TP2FGP, C4FFCEP, C4FFCGP, C4FFEP, C4FFGP, C4FP, C4FZ, C4FZFCE, C4FZFCEP, C4FZFCG, C4FZFCGP, C4FZFE, C4FZFEP, C4FZFG, C4FZFGP, C4FZP, C6FFCEP, C6FFCGP, C6FFEP, C6FFGP, C6FP, C6FZ, C6FZFCE, C6FZFCEP, C6FZFCEPV, C6FZFCEV, C6FZFCEG, C6FZFCEGP, C6FZFCEGPV, C6FZFCEGV, C6FZFE, C6FZFEP, C6FZFG, C6FZFGA, C6FZFGAP, C6FZFGP, C6FZP, I2FZ, I2FZP...(Other models you can see in the webshop)		

			
1			
<b>GEV No.</b>	106284	<b>Ref. No.</b>	X32700
<b>description</b>	gas injector thread M10x1 WS 11 bore ø 2.15mm		
<b>For models:</b>	C2FTPFGP, C2TP2FGP, C4FFGP, C4FZFG, C4FZFGP, C4FZSFGP, C6FFGP, C6FZFG, C6FZFGP, CCTPFG8, K2FTPFG, K4FFG, K4FSFG, K4FZFG, K4FZSFG, K6FFG, K6FZFG, K8FFG, K8FZFG, KTPFG		

			
1			
<b>GEV No.</b>	106491	<b>Ref. No.</b>	X35800
<b>description</b>	gas injector thread M10x1 WS 11 bore ø 2.1mm		
<b>For models:</b>	B4F, B6F, B8F, K4F, K4FFE, K4FFG, K6F, K6FFE, K6FFG, K8F, K8FFE, K8FFG		



<b>GEV No.</b>	106495	<b>Ref. No.</b>	X36000
<b>description</b>	gas injector thread M10x1 WS 11 bore ø 2.25mm		
<b>For models:</b>	B4FZ, B6FZ, B8FZ, CFTG2, CFTG2C, CFTG2R, CFTG6, CFTG6C, CFTG6R, K2FZ, K4FZ, K4FZFCE, K4FZFCG, K4FZFE, K4FZFG, K4FZFGA, K4FZS, K4FZSFCE, K4FZSFCG, K4FZSFE, K4FZSFG, K6FZ, K6FZFCE, K6FZFCG, K6FZFE, K6FZFG, K6FZFGA, K8FZ, K8FZFCE, K8FZFCG, K8FZFE, K8FZFG, OP2FZ, OP4FZ, OP6FZ, OP8FZ, OPFZ, SKT2G, SKT2GC, SKT2GR, SKT60G, SKT60GC, SKT60GR, TT2G, TT2GC, TT2GR, TT60G, TT60GC, TT60GR		



<b>GEV No.</b>	100404	<b>Ref. No.</b>	X34400
<b>description</b>	gas injector thread M10x1 WS 12 bore ø 1.35mm		
<b>For models:</b>	2FZP, B4FZ, B8FZ, C2FZ, C2FZP, C4FZ, C4FZFCE, C4FZFCEP, C4FZFCG, C4FZFCGP, C4FZFE, C4FZFEP, C4FZFG, C4FZFGP, C4FZP, C4FZSFCEP, C4FZSFCGP, C4FZSFEP, C4FZSFGP, C4FZSP, C6FZ, C6FZFCE, C6FZFCEP, C6FZFCEPV, C6FZFCEV, C6FZFCG, C6FZFCGP, C6FZFCGPV, C6FZFCGV, C6FZFE, C6FZFEP, C6FZFG, C6FZFGA, C6FZFGAP, C6FZFGP, C6FZP, I2FZP, I4FZP, I6FZP, K4FZ, K4FZFCE, K4FZFCG, K4FZFE, K4FZFG, K4FZS, K4FZSFCE, K4FZSFCG, K4FZSFE, K4FZSFG, K6FZ...(Other models you can see in the webshop)		



<b>GEV No.</b>	100067	<b>Ref. No.</b>	Y35000
<b>description</b>	gas injector thread M10x1 WS 12 bore ø 1.1mm G30 gas pressure 30mbar		
<b>For models:</b>	CFG15, CFG15D, KFG15, KFG15D, OPFG15, OPFG15D		



<b>GEV No.</b>	100401	<b>Ref. No.</b>	X34300
<b>description</b>	gas injector thread M10x1 WS 12 bore ø 1.3mm		
<b>For models:</b>	B4F, B6F, B8F, K4F, K4FFE, K4FFG, K6F, K6FFE, K6FFG, K8F, K8FFE, K8FFG		



<b>GEV No.</b>	107343	<b>Ref. No.</b>	Y35200
<b>description</b>	gas injector thread M10x1 WS 12 bore ø 1.2mm LPG gas pressure 30mbar		
<b>For models:</b>	KFG20, KFG20D, OPFG20, OPFG20D		



<b>GEV No.</b>	100629	<b>Ref. No.</b>	X35700
<b>description</b>	gas injector thread M10x1 WS 12 bore ø 2mm		
<b>For models:</b>	2FZP, B4F, B4FZ, B6F, B8F, B8FZ, C2FZ, C2FZP, C4FZ, C4FZFCE, C4FZFCEP, C4FZFCG, C4FZFCGP, C4FZFE, C4FZFEP, C4FZFG, C4FZFGP, C4FZP, C4FZSFCEP, C4FZSFCGP, C4FZSFEP, C4FZSFGP, C4FZSP, C6FZ, C6FZFCE, C6FZFCEP, C6FZFCEPV, C6FZFCEV, C6FZFCG, C6FZFCGP, C6FZFCGPV, C6FZFCGV, C6FZFE, C6FZFEP, C6FZFG, C6FZFGA, C6FZFGAP, C6FZFGP, C6FZP, FCE, FCG, FE, I2FZ, I2FZP, I4FZ, I4FZP, I6FZP, K2FZ, K4F, K4FFE...(Other models you can see in the webshop)		



<b>GEV No.</b>	106290	<b>Ref. No.</b>	Y35900
<b>description</b>	gas injector thread M10x1 WS 12 bore ø 1.85mm inner peaked		
<b>For models:</b>	KFG20, KFG20D, OPFG20, OPFG20D		



<b>GEV No.</b>	106318	<b>Ref. No.</b>	X34100
<b>description</b>	gas injector thread M10x1 WS 12 bore ø 1.2mm		
<b>For models:</b>	B4F, B6F, B8F, C2FP, C2FTPFGP, C2TP2FGP, C4FFCEP, C4FFCGP, C4FFEP, C4FFGP, C4FP, C6FFCEP, C6FFCGP, C6FFEP, C6FFGP, C6FP, K2F, K2FTPFC, K2FTPFCG, K2FTPFE, K2FTPFG, K4F, K4FFE, K4FFG, K6F, K6FFE, K6FFG, K8F, K8FFE, K8FFG, OP2F, OP4F, OP6F, OP8F, T2FP, T4FP, T6FP		

pilot burner nozzles

pilot burner nozzles SIT

100 series



<b>GEV No.</b>	100245	<b>Ref. No.</b>	X19906
<b>description</b>	pilot burner nozzle LPG code 20 bore ø 0.2mm Qty 1 pcs thread M8x0.75		
<b>For models:</b>	B4F, B6F, B8, B8F, C2FP, C2FTPFGP, C2TP2FGP, C4FFCEP, C4FFCGP, C4FFEP, C4FFGP, C4FP, C4FZFG, C4FZFGP, C4FZSFGP, C6FFCEP, C6FFCGP, C6FFEP, C6FFGP, C6FP, C6FZFG, C6FZFGP, CBG4, CBRG, CBRGIN, CCPG4, CCPG82, CCTP8, CCTPFG8, CF10DG8M, CF10G4M, CFTG22, CFTG2C2, CFTG2LR, CFTG2R2, CFTG62, CFTG6C2, CFTG6LR, CFTG6R2, CPG, CPGI, CPLG1, CPLG2, FCE, FCG, FE, K2F, K2FTPFC, K2FTPFCG, K2FTPFE...(Other models you can see in the webshop)		





1			
<b>GEV No.</b>	100246	<b>Ref. No.</b>	0000X19907
<b>description</b>	pilot burner nozzle natural gas bore $\varnothing$ 0.35mm Qty 1 pcs thread M8x0.75		
<b>For models:</b>	B4F, B6F, B8, B8F, C2FP, C2FTPPFGP, C2TP2FGP, C4FFCEP, C4FFCGP, C4FFEP, C4FFGP, C4FP, C4FZFG, C4FZFGP, C4FZSFGP, C6FFCEP, C6FFCGP, C6FFEP, C6FFGP, C6FP, C6FZFG, C6FZFGP, CBG4, CBRG, CBRGIN, CCPG4, CCPG82, CCTP8, CCTPPFG8, CF10DG8M, CF10G4M, CFTG22, CFTG2C2, CFTG2LR, CFTG2R2, CFTG62, CFTG6C2, CFTG6LR, CFTG6R2, CPG, CPGL1, CPLG2, FCE, FCG, FE, K2F, K2FTPFCE, K2FTPFCG, K2FTPFE...(Other models you can see in the webshop)		

2			
<b>GEV No.</b>	102973	<b>Ref. No.</b>	X19909
<b>description</b>	pilot burner nozzle natural gas bore $\varnothing$ 0.45mm Qty 1 pcs		
<b>For models:</b>	CFG15, CFG15D, KFG15, KFG15D, KFG20, KFG20D, OPFG15, OPFG15D, OPFG20, OPFG20D		

1			
<b>GEV No.</b>	102972	<b>Ref. No.</b>	30500003
<b>description</b>	pilot burner nozzle natural gas code 40 bore $\varnothing$ 0.4mm Qty 1 pcs		
<b>For models:</b>	KP20G, KP20GA, KP20GT, KP20GTA, KP30G, KP30GA, KP30GT, KP30GTA, KP50G, KP50GA, KP50GT, KP50GTA, KPGN18G, KPGN27G, KPGN37G, KPI20G, KPI20GA, KPI20GT, KPI20GTA, KPI30G, KPI30GA, KPI30GT, KPI30GTA, KPI50G, KPI50GA, KPI50GT, KPI50GTA, KPIGN18G, KPIGN27G, KPIGN37G		

140/150 series			
1			
<b>GEV No.</b>	100205	<b>Ref. No.</b>	0000X30000
<b>description</b>	pilot burner nozzle SIT LPG code 19 bore $\varnothing$ 0.23/0.26mm Qty 1 pcs suitable for SIT 150 series		
<b>For models:</b>	2FZP, B4FZ, B6FZ, B8FZ, C2FZP, C2TP2FGP, C4FZFCEP, C4FZFCGP, C4FZFEP, C4FZFGP, C4FZP, C4FZSFCEP, C4FZSFCGP, C4FZSFEP, C4FZSFGP, C4FZSP, C6FFGAP, C6FZFCEP, C6FZFCEPV, C6FZFCEPGP, C6FZFCEGPV, C6FZFEP, C6FZFEGA, C6FZFEGAP, C6FZFGP, C6FZP, CFTG1, CFTG1C, CFTG1R, CFTG2, CFTG2C, CFTG2R, CFTG3, CFTG3C, CFTG3LR, CFTG3R, CFTG4, CFTG4C, CFTG4R, CFTG6, CFTG6C, CFTG6R, CFTG8, CFTG8C, CFTG8LR, CFTG8R, CN14FGA, I2FZP, I4FZP, I6FZP...(Other models you can see in the webshop)		

1			
<b>GEV No.</b>	100207	<b>Ref. No.</b>	X30300
<b>description</b>	pilot burner nozzle SIT natural gas code 27 bore $\varnothing$ 0.40/0.38mm suitable for SIT 140 series		
<b>For models:</b>	2FZP, B4FZ, B6FZ, B8FZ, C2FZP, C2TP2FGP, C4FZFCEP, C4FZFCGP, C4FZFEP, C4FZFGP, C4FZP, C4FZSFCEP, C4FZSFCGP, C4FZSFEP, C4FZSFGP, C4FZSP, C6FZFCEP, C6FZFCEPV, C6FZFCEPGP, C6FZFCEGPV, C6FZFEP, C6FZFEGAP, C6FZFGP, I2FZP, I4FZP, I6FZP, K2FZ, K4FZ, K4FZFCE, K4FZFCG, K4FZFE, K4FZFG, K4FZFGA, K4FZS, K4FZSFCE, K4FZSFCG, K4FZSFE, K4FZSFG, K6FZ, K6FZFCE, K6FZFCEG, K6FZFE, K6FZFG, K6FZFGA, K8FZ, K8FZFCE, K8FZFCEG, K8FZFE, K8FZFG...(Other models you can see in the webshop)		

1			
<b>GEV No.</b>	100206	<b>Ref. No.</b>	0000X30100
<b>description</b>	pilot burner nozzle SIT natural gas code 36 bore $\varnothing$ 0.60/0.55mm Qty 1 pcs suitable for SIT 150 series		
<b>For models:</b>	C6FFGAP, C6FZFGA, C6FZFGAP, CFTG1, CFTG1C, CFTG1R, CFTG2, CFTG2C, CFTG2R, CFTG3, CFTG3C, CFTG3LR, CFTG3R, CFTG4, CFTG4C, CFTG4R, CFTG6, CFTG6C, CFTG6R, CFTG8, CFTG8C, CFTG8LR, CFTG8R, CN14FGA, K2FTPFCE, K2FTPFCG, K2FTPFE, K2FTPFG, K6FFGA, K6FZFGA, KBRG, KBRG12, KBRG12IN, KBRGIN, KBRGM, KBRGM12, KBRGM12IN, KBRGMIN, KFT4G, KFT4GC, KFT4GR, KFT8G, KFT8G23C, KFT8GC, KFT8GLR, KFT8GR, KFTG1, KFTG1C, KFTG1R, KFTG3...(Other models you can see in the webshop)		

## bypass nozzles

## bypass nozzles PEL20/21

1			
<b>GEV No.</b>	100554	<b>Ref. No.</b>	X11000
<b>description</b>	bypass nozzle type PEL20/21 bore $\varnothing$ 0.45mm thread M5x0.5		
<b>For models:</b>	2FZP, B4F, B4FZ, B6F, B6FZ, B8F, B8FZ, C2FP, C2FTPPFGP, C2FZ, C2FZP, C2TP2FGP, C4FFCEP, C4FFCGP, C4FFEP, C4FFGP, C4FP, C4FZ, C4FZFCE, C4FZFCEP, C4FZFCEG, C4FZFCEGP, C4FZFE, C4FZFEP, C4FZFG, C4FZFGP, C4FZP, C6FFCEP, C6FFCGP, C6FFEP, C6FFGP, C6FP, C6FZ, C6FZFCE, C6FZFCEP, C6FZFCEPV, C6FZFCEG, C6FZFCEGP, C6FZFCEGPV, C6FZFCEGPV, C6FZFE, C6FZFEP, C6FZFG, C6FZFGA, C6FZFGAP, C6FZFGP, C6FZP, I2FZ, I2FZP...(Other models you can see in the webshop)		

1			
<b>GEV No.</b>	100550	<b>Ref. No.</b>	X11100
<b>description</b>	bypass nozzle type PEL20/21 bore $\varnothing$ 0.55mm thread M5x0.5		
<b>For models:</b>	C2FTPPFGP, C2TP2FGP, CFTG22, CFTG2LR, CFTG2R2, CFTG62, CFTG6LR, CFTG6R2, I2FZ, I4FZ, SKT2G2, SKT2GLR, SKT2GR2, SKT60G2, SKT60GLR, SKT60GR2, TT2G2, TT2G2LR, TT2GR2, TT60G2, TT60GLR, TT60GR2		

1			
<b>GEV No.</b>	100278	<b>Ref. No.</b>	X04800
<b>description</b>	bypass nozzle type PEL20/21 bore $\varnothing$ 0.75mm thread M5x0.5		
<b>For models:</b>	2FZP, B4F, B4FZ, B6F, B6FZ, B8, B8F, B8FZ, C2FP, C2FTPPFGP, C2FZ, C2FZP, C2TP2FGP, C4FFCEP, C4FFCGP, C4FFEP, C4FFGP, C4FP, C4FZ, C4FZFCE, C4FZFCEP, C4FZFCEG, C4FZFCEGP, C4FZFE, C4FZFEP, C4FZFG, C4FZFGP, C4FZP, C4FZSFCEP, C4FZSFCGP, C4FZSFEP, C4FZSFGP, C4FZSP, C6FFCEP, C6FFCGP, C6FFEP, C6FFGP, C6FP, C6FZ, C6FZFCE, C6FZFCEP, C6FZFCEPV, C6FZFCEG, C6FZFCEGP, C6FZFCEGPV, C6FZFCEGPV, C6FZFE, C6FZFEP, C6FZFG...(Other models you can see in the webshop)		

1			
<b>GEV No.</b>	100552	<b>Ref. No.</b>	X09700
<b>description</b>	bypass nozzle type PEL20/21 bore $\varnothing$ 0.7mm thread M5x0.5		
<b>For models:</b>	CFTG1, CFTG1R, CFTG22, CFTG2LR, CFTG2R2, CFTG3, CFTG3LR, CFTG3R, CFTG4, CFTG4R, CFTG62, CFTG6LR, CFTG6R2, CFTG8, CFTG8LR, CFTG8R, SKT2G, SKT2G2, SKT2GLR, SKT2GR, SKT2GR2, SKT60G, SKT60G2, SKT60GLR, SKT60GR, SKT60GR2, TT1G, TT1GR, TT2G2, TT2GLR, TT2GR2, TT3G, TT3GLR, TT40G, TT40GR, TT60G2, TT60GLR, TT60GR2, TT80G, TT80GLR		

	<b>1</b>		
<b>GEV No.</b>	100555	<b>Ref. No.</b>	X09800
<b>description</b>	bypass nozzle type PEL20/21 bore ø 0.8mm thread M5x0.5		





	<b>1</b>		
<b>GEV No.</b>	100528	<b>Ref. No.</b>	X10600
<b>description</b>	bypass nozzle type PEL20/21 bore ø 0.9mm thread M5x0.5		
<b>For models:</b>	CFTG1, CFTG1R, CFTG2, CFTG2R, CFTG3, CFTG3LR, CFTG3R, CFTG4, CFTG4R, CFTG6, CFTG6R, CFTG8, CFTG8LR, CFTG8R, SKT1G, SKT1GR, SKT3G, SKT3GLR, SKT40G, SKT40GR, SKT80G, SKT80GLR, TT1G, TT1GR, TT2G, TT2GR, TT3G, TT3GLR, TT40G, TT40GR, TT60G, TT60GR, TT80G, TT80GLR		

## auxiliary gas parts

### screw connections

#### union screws

	<b>1</b>		
<b>GEV No.</b>	100906	<b>Ref. No.</b>	X13002
<b>description</b>	screw connection thread M10x1 for ignition electrode brass Qty 1 pcs WS 10		

	<b>1</b>			
<b>GEV No.</b>	100908	<b>Ref. No.</b>	X13200	
<b>description</b>	union screw thread M10x1 for pipe ø 4mm Qty 1 pcs			
<b>For models:</b>	2FZP, B4FZ, B6FZ, B8FZ, C2FZP, C4FZFCE, C4FZFCEP, C4FZFCEG, C4FZFCEGP, C4FZFE, C4FZFEP, C4FZFG, C4FZFGP, C4FZP, C4FZSFCEP, C4FZSFCEGP, C4FZSFEP, C4FZSFGP, C4FZSP, C6FFGAP, C6FZFCE, C6FZFCEP, C6FZFCEPV, C6FZFCEV, C6FZFCEG, C6FZFCEGP, C6FZFCEGPV, C6FZFCEGPV, C6FZFCE, C6FZFEP, C6FZFG, C6FZFGA, C6FZFGAP, C6FZFGP, C6FZP, CN14FGA, I2FZP, I4FZP, I6FZP, K2FZ, K4FZ, K4FZFCE, K4FZFCEG, K4FZFE, K4FZFG, K4FZFGA, K4FZS, K4FZSFCE, K4FZSFCEG, K4FZSFE... (Other models you can see in the webshop)			
<b>accessories for</b>	100908			
	<b>GEV No.</b>	100897	<b>Ref. No.</b>	—
	olive for pipe ø 4mm Qty 1 pcs for pilot burner			
	<b>GEV No.</b>	101246	<b>Ref. No.</b>	—
	olive for pipe ø 4mm Qty 1 pcs			
	<b>GEV No.</b>	101280	<b>Ref. No.</b>	—
	olive for pipe ø 4mm Qty 1 pcs			
	<b>GEV No.</b>	101282	<b>Ref. No.</b>	—
	olive for pipe ø 4mm L 7.4mm Qty 1 pcs			

### angle pieces

	<b>1</b>		
<b>GEV No.</b>	106283	<b>Ref. No.</b>	X68042
<b>description</b>	nozzle holder nozzle M6 M10x1 screw pipe fitting 1/4" tube ø 6mm		
<b>For models:</b>	CBG4, CBG6, CBG8, KB4G, KB8G, OPB4G, SKB40G, SKB60G, SKB80G, TB40G, TB60G, TB80G, TP40G		

### gas ball valves

#### miscellaneous

	<b>1</b>		
<b>GEV No.</b>	514215	<b>Ref. No.</b>	M75300
<b>description</b>	outlet tap angled wing handle inlet 1/2" IT outlet 3/4" IT L 53.5mm approval EN 331		
<b>For models:</b>	15PSE, 7DSE, 7DSET, 7SE, 7SET		

### consumables

#### lava rocks / ceramic briquetts

	<b>1</b>		
<b>GEV No.</b>	105342	<b>Ref. No.</b>	M30500
<b>description</b>	lava rocks content 9kg		
<b>For models:</b>	CPLG1, CPLG2, CPLG4, CPLG8, KPLG1, KPLG2, M7PL1G, M7PL2G, OPPLG1, OPPLG2, SKPL1G, SKPL2G, SKPL4G, SKPL8G, TPLG1, TPLG2		

## equipment-specific units

### for meat mincers

#### augers

#### complete

	<b>1</b>		
<b>GEV No.</b>	698037	<b>Ref. No.</b>	W12477
<b>description</b>	auger model 12 ø 53mm L 135mm stainless steel with spindle ENTERPRISE		



1

<b>GEV No.</b>	698036	<b>Ref. No.</b>	W012410085
<b>description</b>	auger model 12 ø 53mm L 150mm cast iron with spindle ENTERPRISE		

for potato peelers

abrasive side elements

grinding discs



1

<b>GEV No.</b>	696377	<b>Ref. No.</b>	PL400
<b>description</b>	grating disc ø 350mm for potato peeler device		

for dough mixers

flange bearings



1

<b>GEV No.</b>	693112	<b>Ref. No.</b>	X61500
<b>description</b>	flange bearing type UCF204 shaft ø 20mm 4 hole flange hole distance 64mm H 33mm flange length 86mm flange width 86mm hole ø 12mm flange F204 ball bearing UC204G2 FH 25.5mm		

for ice-cube maker

drain systems

overflow pipes



1

<b>GEV No.</b>	695047	<b>Ref. No.</b>	I66021901
<b>description</b>	overflow pipe L 78mm straight		

curtains

without holder



1

<b>GEV No.</b>	695076	<b>Ref. No.</b>	I78416909
<b>description</b>	curtain for ice maker W 284mm H 83mm		



1

<b>GEV No.</b>	695075	<b>Ref. No.</b>	I78416901
<b>description</b>	curtain for ice maker W 305mm H 115mm shaft length 323mm shaft ø 6mm		



1

<b>GEV No.</b>	695077	<b>Ref. No.</b>	I78425003
<b>description</b>	curtain for ice maker W 570mm H 115mm shaft length 610mm shaft ø 6mm		

accessories

holders



1

<b>GEV No.</b>	695078	<b>Ref. No.</b>	I66046900
<b>description</b>	curtain holder for ice maker		



1

<b>GEV No.</b>	695080	<b>Ref. No.</b>	I66038800
<b>description</b>	curtain holder for ice maker W 15mm H 80mm left		



1

<b>GEV No.</b>	695079	<b>Ref. No.</b>	I66038801
<b>description</b>	curtain holder for ice maker W 15mm H 80mm right		

## lamellas



1

<b>GEV No.</b>	695081	<b>Ref. No.</b>	I66062900
<b>description</b>	lamella for ice maker W 28mm H 71mm ø 6mm		

## hoses

## hose connectors

## with thread



1

<b>GEV No.</b>	695045	<b>Ref. No.</b>	I66022400
<b>description</b>	hose connector 3-way ID ø 15mm ED ø 21mm L 91mm		

## floats

## container lids



1

<b>GEV No.</b>	695038	<b>Ref. No.</b>	I66036300
<b>description</b>	lid L 150mm W 102mm for float container		

## float containers



1

<b>GEV No.</b>	695037	<b>Ref. No.</b>	I79312601
<b>description</b>	float container for ice maker plastic		

## for espresso machines

## steam/water taps

## steam/water pipes

## accessories

## gaskets



1

<b>GEV No.</b>	510893	<b>Ref. No.</b>	904391
<b>description</b>	O-ring EPDM thickness 2.62mm ID ø 9.92mm Qty 1 pcs		
<b>For models:</b>	GLB785, GLB795		

## for deep fryers

## lids



1

<b>GEV No.</b>	970369	<b>Ref. No.</b>	B65300
<b>description</b>	lid for fryer		
<b>For models:</b>	CF1E4, CF2E6, CF4E, CF6E, IF1E4, IF2E6, KFE1, KFE2, OPFE1, OPFE2, SKF1E, SKF2E, TF1E, TF2E, TF4E, TF6E		

## glass panels



1

<b>GEV No.</b>	691623	<b>Ref. No.</b>	K98111
<b>description</b>	glass panel L 28mm W 28mm thickness 3mm		
<b>For models:</b>	CFG15, CFG15D, KFG15, KFG15D, KFG20, KFG20D, OPFG15, OPFG15D, OPFG20, OPFG20D		

## miscellaneous



1

<b>GEV No.</b>	514204	<b>Ref. No.</b>	A75500
<b>description</b>	cam		

for convection ovens/combi-steamers

spare parts and accessories



1			
<b>GEV No.</b>	550734	<b>Ref. No.</b>	X53400
<b>description</b>	bracket		

for tilting bratt pans

spindles



1			
<b>GEV No.</b>	690546	<b>Ref. No.</b>	K49100
<b>description</b>	thread block thread Tr24x5 right-hand thread W 38mm bolt ø 20mm D 40mm H 40mm		
<b>For models:</b>	KBRE, KBRE12, KBRE12IN, KBRE9, KBREIN, KBREIN9, KBREM, KBREM12, KBREM12IN, KBREMIN, KBRG, KBRG12, KBRG12IN, KBRGIN, KBRGM, KBRGM12, KBRGM12IN, KBRGMIN, OPBRE, OPBRE12, OPBRE12IN, OPBRE12MIN, OPBREIN, OPBREM, OPBREM12, OPBREM12IN, OPBREM12MIN, OPBRG, OPBRG12, OPBRG12IN, OPBRG12MIN, OPBRGIN, OPBRGM, OPBRGM12, OPBRGM12IN, OPBRGMIN		



1			
<b>GEV No.</b>	690543	<b>Ref. No.</b>	X65400 X65402
<b>description</b>	threaded rod		
<b>For models:</b>	CBRE, CBRE8, CBRE9, CBREIN, CBREIN9, CBRG, CBRG8, CBRGIN		



1			
<b>GEV No.</b>	690547	<b>Ref. No.</b>	K49200
<b>description</b>	threaded rod		

miscellaneous



1			
<b>GEV No.</b>	690545	<b>Ref. No.</b>	Y42100
<b>description</b>	ball bearing		
<b>For models:</b>	KBREM, KBREM12, KBREM12IN, KBREMIN, KBRGM, KBRGM12, KBRGM12IN, KBRGMIN, OPBRE12MIN, OPBREM, OPBREM12, OPBREM12IN, OPBREM12MIN, OPBRG12MIN, OPBRGM, OPBRGM12, OPBRGM12IN, OPBRGMIN		



1			
<b>GEV No.</b>	690967	<b>Ref. No.</b>	X65403
<b>description</b>	spindle L 400mm ø 20mm for hand wheel		
<b>For models:</b>	CBRE, CBRE9, CBREIN, CBREIN9, CBRG, CBRGIN		



1			
<b>GEV No.</b>	690542	<b>Ref. No.</b>	X65500
<b>description</b>	threaded bush		
<b>For models:</b>	CBRE, CBRE8, CBRE9, CBREIN, CBREIN9, CBRG, CBRG8, CBRGIN		

for boiling pans

filters



1			
<b>GEV No.</b>	514503	<b>Ref. No.</b>	30700122
<b>description</b>	drain filter for kettle size 76x145mm		
<b>For models:</b>	KPI10ET, KPI10ETA, KPI10VT, KPI10VTA, KPI15ET, KPI15ETA, KPI15VT, KPI15VTA		

miscellaneous



1			
<b>GEV No.</b>	540639	<b>Ref. No.</b>	10400058
<b>description</b>	extension		
<b>For models:</b>	KPI10VT, KPI10VTA, KPI15VT, KPI15VTA, KPI20VT, KPI20VTA, KPI30VT, KPI30VTA, KPI50VT, KPI50VTA		

## for ovens

## glass panels



1

<b>GEV No.</b>	694363	<b>Ref. No.</b>	Y61800
<b>description</b>	glass panel L 516mm W 380mm thickness 4mm for door		

## for dishwashers

## containers

## container lids



1

<b>GEV No.</b>	510109	<b>Ref. No.</b>	N/A
<b>description</b>	lid for salt tank		



1

<b>GEV No.</b>	510110	<b>Ref. No.</b>	N/A
<b>description</b>	lid for salt tank		

## salt tanks



1

<b>GEV No.</b>	524177	<b>Ref. No.</b>	N/A	
<b>description</b>	lid ø 69mm H 20mm for salt tank ID ø 50mm			
<b>accessories for</b>	524177			
	<b>GEV No.</b>	524148	<b>Ref. No.</b>	—
	O-ring EPDM thickness 3.53mm ID ø 40.86mm Qty 1 pcs			







1

<b>GEV No.</b>	510018	<b>Ref. No.</b>	N/A
<b>description</b>	nut ø 92mm H 10.5mm for salt tank ID ø 64mm		



1

<b>GEV No.</b>	510032	<b>Ref. No.</b>	N/A	
<b>description</b>	salt tank without gasket new model			
<b>spare parts for</b>	510032			
	<b>GEV No.</b>	506015	<b>Ref. No.</b>	—
	O-ring EPDM thickness 3.53mm ID ø 39.69mm Qty 1 pcs			
	<b>GEV No.</b>	510018	<b>Ref. No.</b>	N/A
	nut ø 92mm H 10.5mm for salt tank ID ø 64mm			
	<b>GEV No.</b>	510071	<b>Ref. No.</b>	N/A
	flat gasket rubber ED ø 81mm ID ø 68mm thickness 3mm for salt tank Qty 1 pcs			
	<b>GEV No.</b>	524177	<b>Ref. No.</b>	N/A
	lid ø 69mm H 20mm for salt tank ID ø 50mm			





accessories



1

<b>GEV No.</b>	510071	<b>Ref. No.</b>	N/A
<b>description</b>	flat gasket rubber ED ø 81mm ID ø 68mm thickness 3mm for salt tank Qty 1 pcs		

boilers

boilers for dishwashers



1

<b>GEV No.</b>	518378	<b>Ref. No.</b>	N/A
<b>description</b>	boiler		



1

<b>GEV No.</b>	519028	<b>Ref. No.</b>	900486
<b>description</b>	boiler		
<b>For models:</b>	GLS905, GLS925		



1

<b>GEV No.</b>	519021	<b>Ref. No.</b>	900351
<b>description</b>	boiler ø 100mm L 340mm		
<b>For models:</b>	GLB615		



Image not available

1

<b>GEV No.</b>	519023	<b>Ref. No.</b>	900355	
<b>description</b>	boiler ø 125mm L 330mm			
<b>For models:</b>	GLB785, GLB795			
<b>accessories for</b>	519023			
	<b>GEV No.</b>	415167	<b>Ref. No.</b>	—
	heating element 3000W 230V mounting ø 38.5mm heating circuits 2 L 300mm W 21mm H 35mm number of thermostat sleeves 1 thermostat sleeves ø 6.5mm length thermostat sleeves 53mm thermostat sleeve not clinging tube ø 6.3mm hole distance 57mm hole ø 10mm 3 hole flange connection male faston 6.3mm immersion heater			
	<b>GEV No.</b>	532577	<b>Ref. No.</b>	—
	O-ring EPDM thickness 5.34mm ID ø 40.65mm Qty 1 pcs			



1

<b>GEV No.</b>	518377	<b>Ref. No.</b>	N/A
<b>description</b>	boiler ø 150mm L 360mm		



1

<b>GEV No.</b>	519022	<b>Ref. No.</b>	900353 SD900353
<b>description</b>	boiler ø 150mm L 400mm		
<b>For models:</b>	GLS805, GLS845		



1

<b>GEV No.</b>	519487	<b>Ref. No.</b>	900485	
<b>description</b>	boiler with heating element 6000W 230V ø 155mm L 400mm			
<b>For models:</b>	GLS935, GLS945, GLS945S			
<b>spare parts for</b>	519487			
	<b>GEV No.</b>	416268	<b>Ref. No.</b>	905570
	heating element 6000W 230V mounting ø 38.5mm heating circuits 3 L 360mm W 34mm H 55mm L1 35mm L2 70mm L3 255mm H1 27mm H2 28mm hole distance 57mm hole ø 10mm tube ø 6.3mm connection male faston 6.3mm immersion heater 3 hole flange			
	<b>GEV No.</b>	532577	<b>Ref. No.</b>	—
	O-ring EPDM thickness 5.34mm ID ø 40.65mm Qty 1 pcs			

accessories



1

<b>GEV No.</b>	518348	<b>Ref. No.</b>	N/A
<b>description</b>	hose connector		

housing and bezels

miscellaneous



1

<b>GEV No.</b>	697926	<b>Ref. No.</b>	901657
<b>description</b>	sticker for handle rail L 460mm		
<b>For models:</b>	GLS805, GLS845		

hood mechanics for dishwashers

bolts



1

<b>GEV No.</b>	519202	<b>Ref. No.</b>	904771
<b>description</b>	screw bolt hood mechanics		
<b>For models:</b>	GLS935		

bushes



1

<b>GEV No.</b>	519031	<b>Ref. No.</b>	900514
<b>description</b>	bush for hood rod		
<b>For models:</b>	GLS935		



1

<b>GEV No.</b>	519205	<b>Ref. No.</b>	904796
<b>description</b>	bush hood mechanics		
<b>For models:</b>	GLS935, GLS945, GLS945S		

spring holders



1

<b>GEV No.</b>	519243	<b>Ref. No.</b>	906066
<b>description</b>	bush for spring holder hood mechanics		
<b>For models:</b>	GLS935, GLS945, GLS945S		

hood handles



1

<b>GEV No.</b>	519447	<b>Ref. No.</b>	908728
<b>description</b>	hood handle		
<b>For models:</b>	GLS945, GLS945S		



1

<b>GEV No.</b>	519206	<b>Ref. No.</b>	904930
<b>description</b>	lever joint hood mechanics		
<b>For models:</b>	GLS935		

screws for spring compressor



1

<b>GEV No.</b>	519260	<b>Ref. No.</b>	907222
<b>description</b>	screw for spring compressor hood mechanics		
<b>For models:</b>	GLS935		



1

<b>GEV No.</b>	519274	<b>Ref. No.</b>	902377
<b>description</b>	screw thread M10 L 187mm for spring compressor hood mechanics		
<b>For models:</b>	GLS945, GLS945S		

basket guides

basket holders

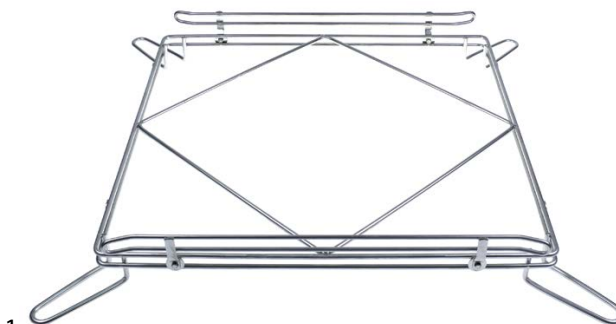

1

<b>GEV No.</b>	971057	<b>Ref. No.</b>	908708
<b>description</b>	basket support		
<b>For models:</b>	GLS945, GLS945S		

air traps

air traps

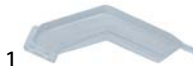

1

<b>GEV No.</b>	511450	<b>Ref. No.</b>	SD907254
<b>description</b>	air trap		
<b>accessories for</b>	511450		







<b>GEV No.</b>	511197	<b>Ref. No.</b>	903261
----------------	--------	-----------------	--------



gasket L 46mm W 33mm for air trap











 <p>1</p>			
<b>GEV No.</b>	518488	<b>Ref. No.</b>	N/A
<b>description</b>	air trap		
<b>accessories for</b>	518488		
	<b>GEV No.</b>	504618	<b>Ref. No.</b> —
	O-ring EPDM thickness 2.62mm ID ø 15.54mm Qty 1 pcs		
	<b>GEV No.</b>	510075	<b>Ref. No.</b> N/A
	flat gasket rubber ED ø 22mm ID ø 13mm thickness 1.5mm Qty 1 pcs		
	<b>GEV No.</b>	510106	<b>Ref. No.</b> N/A
	hose connector for air trap		

 <p>1</p>			
<b>GEV No.</b>	519250	<b>Ref. No.</b>	907254
<b>description</b>	air trap		
<b>For models:</b>	GLS905, GLS925, GLS945, GLS945S		

 <p>1</p>			
<b>GEV No.</b>	519263	<b>Ref. No.</b>	907252
<b>description</b>	air trap		
<b>For models:</b>	GLB785, GLB795, GLS805, GLS845		
<b>accessories for</b>	519263		
	<b>GEV No.</b>	519057	<b>Ref. No.</b> —
	nut thread 3/8" WS 25 H 6mm brass		
	<b>GEV No.</b>	519114	<b>Ref. No.</b> 903260 SD903260
	flat gasket rubber ED ø 25mm ID ø 16.5mm thickness 2mm Qty 1 pcs		

 <p>1</p>			
<b>GEV No.</b>	519319	<b>Ref. No.</b>	TR0268
<b>description</b>	air trap		
<b>For models:</b>	GLS935		
<b>accessories for</b>	519319		
	<b>GEV No.</b>	519057	<b>Ref. No.</b> —
	nut thread 3/8" WS 25 H 6mm brass		
	<b>GEV No.</b>	519114	<b>Ref. No.</b> 903260 SD903260
	flat gasket rubber ED ø 25mm ID ø 16.5mm thickness 2mm Qty 1 pcs		

 <p>1</p>			
<b>GEV No.</b>	519212	<b>Ref. No.</b>	905273
<b>description</b>	air trap L 54mm W 41mm H 45mm hose ø 6mm		
<b>For models:</b>	GLB615		
<b>accessories for</b>	519212		
	<b>GEV No.</b>	519057	<b>Ref. No.</b> —
	nut thread 3/8" WS 25 H 6mm brass		
	<b>GEV No.</b>	519114	<b>Ref. No.</b> 903260 SD903260
	flat gasket rubber ED ø 25mm ID ø 16.5mm thickness 2mm Qty 1 pcs		

 <p>1</p>			
<b>GEV No.</b>	510103	<b>Ref. No.</b>	N/A
<b>description</b>	air trap L 85mm W 20mm H 80mm hose ø 6mm plastic		
<b>spare parts for</b>	510103		
	<b>GEV No.</b>	505045	<b>Ref. No.</b> —
	O-ring EPDM thickness 1.78mm ID ø 5.28mm Qty 1 pcs		
	<b>GEV No.</b>	505094	<b>Ref. No.</b> —
	air trap		
	<b>GEV No.</b>	510016	<b>Ref. No.</b> N/A
	eye bolt for rinse aid container connection		
	<b>GEV No.</b>	510105	<b>Ref. No.</b> N/A
	hose connector for air trap		



 <p>1</p>			
<b>GEV No.</b>	518200	<b>Ref. No.</b>	N/A
<b>description</b>	air trap ø 34mm H 78mm hose ø 6mm plastic		
<b>spare parts for</b>	518200		
	<b>GEV No.</b>	504618	<b>Ref. No.</b> —
	O-ring EPDM thickness 2.62mm ID ø 15.54mm Qty 1 pcs		
	<b>GEV No.</b>	510075	<b>Ref. No.</b> N/A
	flat gasket rubber ED ø 22mm ID ø 13mm thickness 1.5mm Qty 1 pcs		
	<b>GEV No.</b>	510106	<b>Ref. No.</b> N/A
	hose connector for air trap		

air trap accessories

			
1			
<b>GEV No.</b>	511385	<b>Ref. No.</b>	907926
<b>description</b>	flange L 46mm W 32mm for air trap		
<b>For models:</b>	GLS905, GLS925, GLS945, GLS945S		

			
1			
<b>GEV No.</b>	510075	<b>Ref. No.</b>	N/A
<b>description</b>	flat gasket rubber ED ø 22mm ID ø 13mm thickness 1.5mm Qty 1 pcs		

			
1			
<b>GEV No.</b>	511197	<b>Ref. No.</b>	903261
<b>description</b>	gasket L 46mm W 33mm for air trap		
<b>For models:</b>	GLS905, GLS925, GLS945, GLS945S		

			
1			
<b>GEV No.</b>	510105	<b>Ref. No.</b>	N/A
<b>description</b>	hose connector for air trap		
<b>spare parts for</b>	510105		
	<b>GEV No.</b>	510017	<b>Ref. No.</b> N/A
	union screw		



			
1			
<b>GEV No.</b>	510106	<b>Ref. No.</b>	N/A
<b>description</b>	hose connector for air trap		

backflow preventers

backflow preventers

			
1			
<b>GEV No.</b>	518237	<b>Ref. No.</b>	N/A
<b>description</b>	backflow preventer		

			
1			
<b>GEV No.</b>	518297	<b>Ref. No.</b>	N/A
<b>description</b>	backflow preventer		

			
1			
<b>GEV No.</b>	516101	<b>Ref. No.</b>	TR2433
<b>description</b>	backflow preventer dishwasher hose ø 12mm		
<b>For models:</b>	GLB785, GLB795, GLS805, GLS845, GLS905, GLS925, GLS935, GLS945, GLS945S		
<b>spare parts for</b>	516101		
	<b>GEV No.</b>	506367	<b>Ref. No.</b> —
	flat gasket rubber ED ø 40mm ID ø 28mm thickness 1.8mm Qty 1 pcs		

miscellaneous

			
1			
<b>GEV No.</b>	519237	<b>Ref. No.</b>	906001
<b>description</b>	plain washer		
<b>For models:</b>	GLS945S		

door mechanics

linkage

			
1			
<b>GEV No.</b>	518355	<b>Ref. No.</b>	N/A
<b>description</b>	door pin stop rod		

			
1			
<b>GEV No.</b>	519261	<b>Ref. No.</b>	907240
<b>description</b>	door pin tie bar		
<b>For models:</b>	GLB785, GLS805, GLS845		



threaded shafts

			
1			
<b>GEV No.</b>	519228	<b>Ref. No.</b>	905424
<b>description</b>	threaded part end stop		
<b>For models:</b>	GLB785, GLS805, GLS845		

sliding plates

			
1			
<b>GEV No.</b>	518356	<b>Ref. No.</b>	N/A
<b>description</b>	sliding plate sliding plate		

			
1			
<b>GEV No.</b>	519208	<b>Ref. No.</b>	904952
<b>description</b>	sliding plate sliding plate		
<b>For models:</b>	GLB785, GLS805, GLS845		

hinges

			
1			
<b>GEV No.</b>	519035	<b>Ref. No.</b>	901245
<b>description</b>	door hinge bores 3 hinge		
<b>For models:</b>	GLB615, GLB785, GLB795, GLS805, GLS845		

			
1			
<b>GEV No.</b>	518547	<b>Ref. No.</b>	N/A
<b>description</b>	door hinge hinge mounting pos. left		

			
1			
<b>GEV No.</b>	518253	<b>Ref. No.</b>	N/A
<b>description</b>	door hinge hinge mounting pos. right		

			
1			
<b>GEV No.</b>	518301	<b>Ref. No.</b>	N/A
<b>description</b>	door hinge mounting pos. left/right		

			
1			
<b>GEV No.</b>	502263	<b>Ref. No.</b>	901249
<b>description</b>	hinge mounting pos. left L 94mm N45/N50		
<b>For models:</b>	GLS905, GLS925		

			
1			
<b>GEV No.</b>	502262	<b>Ref. No.</b>	901248
<b>description</b>	hinge mounting pos. right L 94mm N45/N50		
<b>For models:</b>	GLS905, GLS925		

## hinge camps



1

<b>GEV No.</b>	518257	<b>Ref. No.</b>	N/A
<b>description</b>	hinge camp mounting pos. left		

## hinge pins



1

<b>GEV No.</b>	518267	<b>Ref. No.</b>	N/A
<b>description</b>	hinge pin hinge pin		



1

<b>GEV No.</b>	519204	<b>Ref. No.</b>	904795
<b>description</b>	hinge pin hinge pin		
<b>For models:</b>	GLB615, GLB785, GLB795, GLS805, GLS845		

## door bumpers

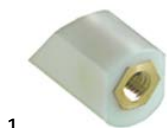

1

<b>GEV No.</b>	518066	<b>Ref. No.</b>	N/A
<b>description</b>	door bumper end stop		

## locks



1

<b>GEV No.</b>	519247	<b>Ref. No.</b>	906121 SD906121
<b>description</b>	door catch door locking catch		
<b>For models:</b>	GLB615, GLB785, GLB795, GLS805, GLS845, GLS905, GLS925		

accessories for 519247



1

<b>GEV No.</b>	519050	<b>Ref. No.</b>	902023
<b>description</b>	nut thread M12x1.75 H 4mm WS 16 SS Qty 1 pcs for snap lock		



1

<b>GEV No.</b>	513138	<b>Ref. No.</b>	N/A
<b>description</b>	door catch with nut door locking catch		



1

<b>GEV No.</b>	518245	<b>Ref. No.</b>	N/A
<b>description</b>	spigot door catch		

## miscellaneous



1

<b>GEV No.</b>	504435	<b>Ref. No.</b>	908146
<b>description</b>	flat gasket plastic ED ø 18mm ID ø 9.5mm thickness 2.5mm for door hinge Qty 1 pcs		
<b>For models:</b>	GLS905, GLS925		

## screw connections



1

<b>GEV No.</b>	519054	<b>Ref. No.</b>	902070
<b>description</b>	locknut thread 1"		
<b>For models:</b>	GLB615, GLB785, GLB795		



1

<b>GEV No.</b>	519053	<b>Ref. No.</b>	902061
<b>description</b>	locknut thread 1/2"		
<b>For models:</b>	GLS935, GLS945, GLS945S		



1

<b>GEV No.</b>	519055	<b>Ref. No.</b>	902080
<b>description</b>	locknut thread 1 1/4"		
<b>For models:</b>	GLB615, GLB785, GLB795, GLS805, GLS845, GLS935, GLS945, GLS945S		





1

<b>GEV No.</b>	519056	<b>Ref. No.</b>	902090
<b>description</b>	locknut thread 1 3/4"		
<b>For models:</b>	GLS805, GLS845		



 <p>1</p>			
<b>GEV No.</b>	519008	<b>Ref. No.</b>	900050
<b>description</b>	locknut thread 2¼" Qty 1 pcs		
<b>For models:</b>	GLS945S		

 <p>1</p>			
<b>GEV No.</b>	501351	<b>Ref. No.</b>	908124
<b>description</b>	flange mounting pos. upper ø 91mm H 11mm ID ø 45mm hole ø 5.5mm		
<b>For models:</b>	GLS905, GLS925		

 <p>1</p>			
<b>GEV No.</b>	519076	<b>Ref. No.</b>	902679
<b>description</b>	screw with nut thread M10x1.5 H 17mm WS 22		
<b>For models:</b>	GLB785, GLB795		

 <p>1</p>			
<b>GEV No.</b>	519122	<b>Ref. No.</b>	903351
<b>description</b>	flat gasket for rinse arm		
<b>For models:</b>	GLB615, GLB785, GLB795, GLS935, GLS945, GLS945S		

washing and rinsing systems

 <p>1</p>			
<b>GEV No.</b>	519088	<b>Ref. No.</b>	902891
<b>description</b>	bush for wash arm		
<b>For models:</b>	GLS945S		

 <p>1</p>			
<b>GEV No.</b>	519006	<b>Ref. No.</b>	900035
<b>description</b>	locknut		
<b>For models:</b>	GLB785, GLB795, GLS935		

 <p>1</p>			
<b>GEV No.</b>	519062	<b>Ref. No.</b>	902351
<b>description</b>	cap		
<b>For models:</b>	GLB615, GLB785, GLB795		



 <p>1</p>			
<b>GEV No.</b>	519087	<b>Ref. No.</b>	902890
<b>description</b>	locknut for wash arm		
<b>For models:</b>	GLS945S		

 <p>1</p>			
<b>GEV No.</b>	518238	<b>Ref. No.</b>	N/A
<b>description</b>	manifold ø 12mm L 98mm		

 <p>1</p>			
<b>GEV No.</b>	510016	<b>Ref. No.</b>	N/A
<b>description</b>	eye bolt for rinse aid container connection		

 <p>1</p>			
<b>GEV No.</b>	519007	<b>Ref. No.</b>	900049
<b>description</b>	opposite support mounting pos. lower for wash arm support		
<b>For models:</b>	GLS945S		

 <p>1</p>			
<b>GEV No.</b>	518461	<b>Ref. No.</b>	N/A
<b>description</b>	flange for wash arm support		

			
1			
<b>GEV No.</b>	519444	<b>Ref. No.</b>	905449
<b>description</b>	opposite support mounting pos. upper/lower for wash arm support suitable for Silanos		
<b>For models:</b>	GLS805, GLS845, GLS905, GLS925, GLS945		
<b>accessories for</b>	519444		
	<b>GEV No.</b>	519445	<b>Ref. No.</b> 908141
gasket D1 ø 80mm D2 ø 50mm thickness 3mm with 4 screw holes			

			
1			
<b>GEV No.</b>	519238	<b>Ref. No.</b>	906002
<b>description</b>	plain washer ID ø 15mm ED ø 33mm thickness 0.8mm SS Qty 1 pcs		
<b>For models:</b>	GLB785, GLB795		

			
1			
<b>GEV No.</b>	501349	<b>Ref. No.</b>	908456
<b>description</b>	reducer for rinse arm shaft		
<b>For models:</b>	GLS945		

			
1			
<b>GEV No.</b>	519201	<b>Ref. No.</b>	904765
<b>description</b>	rinse pipe		
<b>For models:</b>	GLB615, GLB785, GLB795, GLS935		

			
1			
<b>GEV No.</b>	519198	<b>Ref. No.</b>	904753
<b>description</b>	rinse pipe mounting pos. lower ø 16mm L 13.5mm		
<b>For models:</b>	GLS945S		

			
1			
<b>GEV No.</b>	518003	<b>Ref. No.</b>	N/A
<b>description</b>	screw cap		

			
1			
<b>GEV No.</b>	510011	<b>Ref. No.</b>	N/A
<b>description</b>	screw connection plastic		

			
1			
<b>GEV No.</b>	501348	<b>Ref. No.</b>	906004
<b>description</b>	shim for rinse arm shaft		
<b>For models:</b>	GLS945		

			
1			
<b>GEV No.</b>	519437	<b>Ref. No.</b>	902183
<b>description</b>	spacer piece		
<b>For models:</b>	GLS905, GLS925		

			
1			
<b>GEV No.</b>	517355	<b>Ref. No.</b>	908702
<b>description</b>	spacer piece for wash arm support ID ø 44mm ED ø 80mm thickness 18mm L 55mm plastic		
<b>For models:</b>	GLS805, GLS845		

			
1			
<b>GEV No.</b>	518337	<b>Ref. No.</b>	N/A
<b>description</b>	throttle disc		

			
1			
<b>GEV No.</b>	519085	<b>Ref. No.</b>	902880
<b>description</b>	Thumb screw ø 34mm thread M6		
<b>For models:</b>	GLB615, GLB785, GLB795, GLS805, GLS845, GLS905, GLS925, GLS935, GLS945, GLS945S		



1

<b>GEV No.</b>	510112	<b>Ref. No.</b>	N/A
<b>description</b>	Thumb screw thread M10 thread L 10mm ø 22mm H 4.5mm SS		



1

<b>GEV No.</b>	518484	<b>Ref. No.</b>	N/A
<b>description</b>	wash arm support for stationary arms mounting pos. upper		



1

<b>GEV No.</b>	519019	<b>Ref. No.</b>	900164
<b>description</b>	wash pipe mounting pos. upper		
<b>For models:</b>	GLS935		



1

<b>GEV No.</b>	519459	<b>Ref. No.</b>	908729
<b>description</b>	wash pipe mounting pos. upper edition until 11/2005		
<b>For models:</b>	GLS945, GLS945S		



1

<b>GEV No.</b>	519438	<b>Ref. No.</b>	903743
<b>description</b>	wash pipe ø 37mm L 700mm plastic suitable for Silanos		
<b>For models:</b>	GLS905, GLS925		



1

<b>GEV No.</b>	519537	<b>Ref. No.</b>	908701
<b>description</b>	wash pipe ø 37mm L 720mm plastic suitable for Silanos		
<b>For models:</b>	GLS805, GLS845		

washing and rinsing systems (sorted by producer)

GIGA

rinse arms

rotary

complete







<b>GEV No.</b>	510118	<b>Ref. No.</b>	N/A	
<b>description</b>	wash arm L 245mm nozzles 4 mounting ø 12mm mounting pos. upper			
<b>spare parts for</b>	510118			
	<b>GEV No.</b>	510011	<b>Ref. No.</b>	N/A
	screw connection plastic			
	<b>GEV No.</b>	510012	<b>Ref. No.</b>	N/A
	flat gasket PTFE ED ø 16.5mm ID ø 12.5mm thickness 1.5mm Qty 1 pcs equiv. no. 437008			
	<b>GEV No.</b>	510013	<b>Ref. No.</b>	N/A
	rinse arm shaft			
	<b>GEV No.</b>	510130	<b>Ref. No.</b>	N/A
	union nut for rinse jet			
	<b>GEV No.</b>	510139	<b>Ref. No.</b>	N/A
	rinse jet			
	<b>GEV No.</b>	518326	<b>Ref. No.</b>	N/A
	rinse arm boss			
	<b>GEV No.</b>	518328	<b>Ref. No.</b>	N/A
	rinse arm mounting pos. right L 110mm mounting ø 13mm nozzles 2			
	<b>GEV No.</b>	518329	<b>Ref. No.</b>	—
	rinse arm mounting pos. left L 110mm mounting ø 13mm nozzles 2			



wash and rinse arms combined

rotary







complete

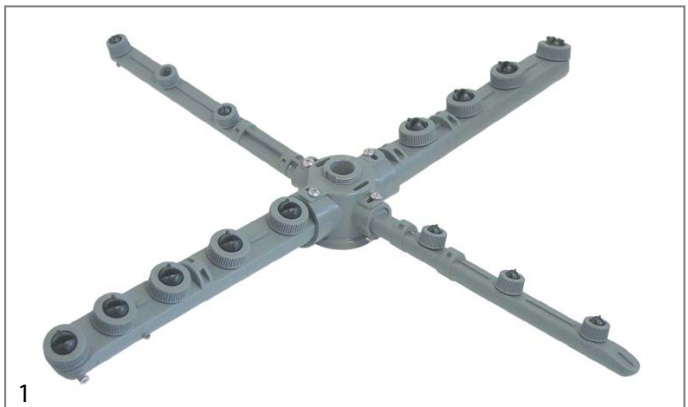

<b>GEV No.</b>	510119	<b>Ref. No.</b>	N/A
<b>description</b>	wash and rinse arm wash arm L 410mm rinse arm L 410mm w. jets 7 r. jets 5 mounting ø 16.5mm mounting pos. lower		
<b>spare parts for</b>	510119		
	<b>GEV No.</b>	510010	<b>Ref. No.</b> N/A
	wash arm boss L1 64mm L2 60mm mounting ø 16.5mm		
	<b>GEV No.</b>	510130	<b>Ref. No.</b> N/A
	union nut for rinse jet		
	<b>GEV No.</b>	510131	<b>Ref. No.</b> N/A
	union nut for wash jet		
	<b>GEV No.</b>	510138	<b>Ref. No.</b> —
	wash jet fine groove		
	<b>GEV No.</b>	510139	<b>Ref. No.</b> N/A
	rinse jet		
	<b>GEV No.</b>	518004	<b>Ref. No.</b> N/A
	wash jet		
	<b>GEV No.</b>	518382	<b>Ref. No.</b> N/A
	wash arm mounting pos. right L 175mm mounting ø 24mm nozzles 4		
	<b>GEV No.</b>	518383	<b>Ref. No.</b> —
	rinse arm mounting pos. left L 175mm mounting ø 13mm nozzles 2		
	<b>GEV No.</b>	518384	<b>Ref. No.</b> —
	rinse arm mounting pos. right L 175mm mounting ø 13mm nozzles 3		
	<b>GEV No.</b>	518631	<b>Ref. No.</b> —
	wash arm mounting pos. left L 170mm nozzles mounting ø 24mm		
<b>accessories for</b>	510119		
	<b>GEV No.</b>	510108	<b>Ref. No.</b> N/A
	rinse arm shaft		
	<b>GEV No.</b>	510112	<b>Ref. No.</b> N/A
	Thumb screw thread M10 thread L 10mm ø 22mm H 4.5mm SS		
	<b>GEV No.</b>	518003	<b>Ref. No.</b> N/A
	screw cap		

<b>accessories for</b>	510119		
	<b>GEV No.</b>	518008	<b>Ref. No.</b> —
	gasket D1 ø 43mm D2 ø 78mm thickness 2mm with 6 holes wash arm support		
	<b>GEV No.</b>	518036	<b>Ref. No.</b> N/A
	formed hose angled warewashing		



<b>GEV No.</b>	518411	<b>Ref. No.</b>	N/A
<b>description</b>	wash and rinse arm wash arm L 410mm rinse arm L 415mm w. jets 7 r. jets 5 mounting ø 17/52mm mounting pos. upper		
<b>spare parts for</b>	518411		
	<b>GEV No.</b>	510138	<b>Ref. No.</b> —
	wash jet fine groove		
	<b>GEV No.</b>	510139	<b>Ref. No.</b> N/A
	rinse jet		
	<b>GEV No.</b>	518053	<b>Ref. No.</b> N/A
	union nut for rinse jet		
	<b>GEV No.</b>	518272	<b>Ref. No.</b> N/A
	union nut for wash jet		
<b>accessories for</b>	518411		
	<b>GEV No.</b>	510112	<b>Ref. No.</b> N/A
	Thumb screw thread M10 thread L 10mm ø 22mm H 4.5mm SS		
	<b>GEV No.</b>	518003	<b>Ref. No.</b> N/A
	screw cap		

# knobs

## producer-specific knobs

### GIGA

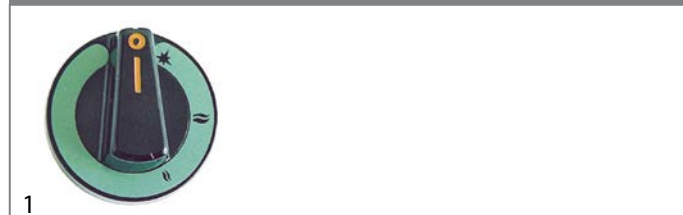

<b>GEV No.</b>	110771	<b>Ref. No.</b>	0000X00800
<b>description</b>	knob gas tap with ignition flame ø 60mm shaft ø 8x6.5mm shaft flat upper black		
<b>For models:</b>	C2FP, C2FTPFP, C2FTPFGP, C4FFE, C4FFGP, C4FFLE, C4FFLGP, C4FP, C6FFE, C6FFGAP, C6FFGP, C6FFLE, C6FFLEPV, C6FFLGP, C6FFLGPV, C6FP, CFTG1, CFTG1R, CFTG2, CFTG22, CFTG2LR, CFTG2R, CFTG2R2, CFTG3, CFTG3LR, CFTG4, CFTG4R, CFTG6, CFTG62, CFTG6LR, CFTG6R, CFTG6R2, CFTG8, CFTG8LR, CPG, CPGI, CPLG4, CPLG8, SKPL1G, SKPL2G, SKT1G, SKT1GR, SKT2G, SKT2G2, SKT2GLR, SKT2GR, SKT2GR2, SKT3G, SKT3GLR, SKT40G...(Other models you can see in the webshop)		



<b>GEV No.</b>	110049	<b>Ref. No.</b>	0000X00100
<b>description</b>	knob gas tap without ignition flame ø 60mm shaft ø 8x6.5mm shaft flat upper		
<b>For models:</b>	C2F, C2FTPFE, C2FTPFG, C4F, C4FFE, C4FFG, C4FFLE, C4FFLG, C6F, C6FFE, C6FFG, C6FFGA, C6FFLE, C6FFLEV, C6FFLG, C6FFLGV, CC120G, CC80G, CC81G, CCG120E, CCG80E, CCG81E, SKC40G, SKC80G, T2F, T4F, T6F		



<b>GEV No.</b>	110352	<b>Ref. No.</b>	0000X00900
<b>description</b>	knob gas thermostat 1-8 ø 60mm shaft ø 8x6.5mm shaft flat upper black		
<b>For models:</b>	C4FFLG, C4FFLGP, C6FFLG, C6FFLGP, C6FFLGPV, C6FFLGV, CC120G, CC80G, CC81G		



<b>GEV No.</b>	110774	<b>Ref. No.</b>	0000X03800 old version
<b>description</b>	knob oven ø 60mm shaft ø 6x4.6mm shaft flat lower black		



<b>GEV No.</b>	110775	<b>Ref. No.</b>	0000X01200
<b>description</b>	knob oven TH/BH/TH+BH ø 60mm shaft ø 6x4.6mm shaft flat upper black		
<b>For models:</b>	C2FTPFE, C2FTPFP, C4FFE, C4FFGP, C4PFE, C4PQFE, C4VFE, C6FFE, C6FFGP, C6PFE, C6PQFE, CCTPFE8		

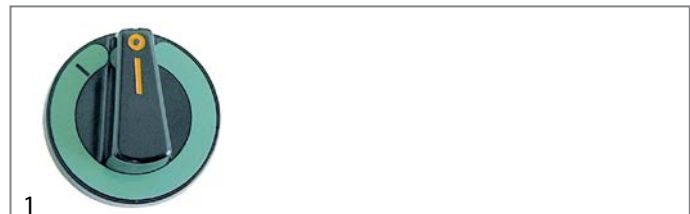

<b>GEV No.</b>	110773	<b>Ref. No.</b>	0000X00600
<b>description</b>	knob switch 0-1 ø 60mm shaft ø 6x4.6mm shaft flat upper black		
<b>For models:</b>	15DPE, 15PE, 15PSE, 6+4LE, 6+4ME, 6DLE, 6DME, 6LE, 6ME, 7DSET, 7SET, CRE4, CRE6, SK10DSE, SK10DSE9, SK10SE, SK10SE9, SKR40E, SKR60E, TR40E, TR60E		

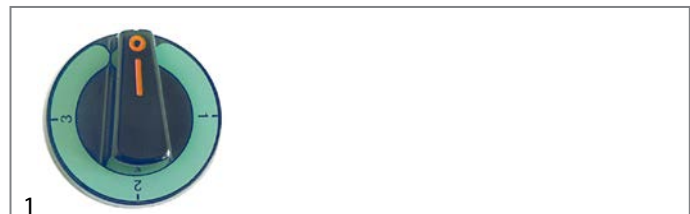

<b>GEV No.</b>	110770	<b>Ref. No.</b>	0000X01000
<b>description</b>	knob switch 4-position ø 60mm shaft ø 6x4.6mm shaft flat upper		
<b>For models:</b>	CCPE4, CCPE6, SKCP40E, SKCP60E, TCP40E, TCP60E		



<b>GEV No.</b>	110451	<b>Ref. No.</b>	0000X00500
<b>description</b>	knob switch 7-position ø 60mm shaft ø 6x4.6mm shaft flat upper black		
<b>For models:</b>	C2P, C2PQ, C4P, C4PFE, C4PFLE, C4PQ, C4PQFE, C6P, C6PFE, C6PFLE, C6PFLEV, C6PQ, C6PQFE, CC120E, CC80E, CC81E, CCQ120E, CCQ80E, CCQ81E, SKC40E, SKC80E, SKCQ40E, SKCQ80E, TC120E, TC40E, TC80E, TCQ120E, TCQ40E, TCQ80E		



<b>GEV No.</b>	110453	<b>Ref. No.</b>	0000X00400
<b>description</b>	knob thermostat t.max. 110°C 30-110°C ø 60mm shaft ø 6x4.6mm shaft flat upper black temperature range 30-110°C		
<b>For models:</b>	CBE4, CBE6, CBE8, SKB40E, SKB60E, SKB80E, TB40E, TB60E, TB80E		



1

<b>GEV No.</b>	110455	<b>Ref. No.</b>	0000X00700
<b>description</b>	knob thermostat t.max. 195°C ø 60mm shaft ø 6x4.6mm shaft flat upper temperature range 100-195°C		
<b>For models:</b>	15DPE, 15PE, 15PSE, 4DME, 4ME, 6+4LE, 6+4ME, 6DLE, 6DME, 6LE, 6ME, 7DSE, 7DSET, 7SE, 7SET, CF15DG8, CF15G4, CF1E4, CF2E4, CF2E6, SK10DSE, SK10DSE9, SK10SE, SK10SE9, SKF1E, SKF2E, SKF2E4, TF1E, TF2E		



1

<b>GEV No.</b>	110454	<b>Ref. No.</b>	0000X00300
<b>description</b>	knob thermostat t.max. 300°C 50-300°C ø 60mm shaft ø 6x4.6mm shaft flat upper		
<b>For models:</b>	C4FFLE, C4FFLEP, C4PFLE, C4VFLE, C6FFLE, C6FFLEP, C6FFLEPV, C6FFLEV, C6PFLE, C6PFLEP, CBRE8, CC120E, CC81E, CCG120E, CCG81E, CCQ120E, CCQ81E, CCV81E, CFTE1, CFTE1C, CFTE1R, CFTE2, CFTE22, CFTE2C, CFTE2C2, CFTE2LR, CFTE2R, CFTE3, CFTE3C, CFTE3LR, CFTE4, CFTE4C, CFTE4R, CFTE6, CFTE62, CFTE6C, CFTE6C2, CFTE6LR, CFTE6R, CFTE8, CFTE8C, CFTE8LR, SKBR40E, SKT1E, SKT1EC, SKT1ER, SKT2E, SKT2E2, SKT2EC, SKT2EC2...(Other models you can see in the webshop)		



1

<b>GEV No.</b>	110776	<b>Ref. No.</b>	0000X03700
<b>description</b>	knob thermostat t.max. 300°C 50-300°C ø 60mm shaft ø 6x4.6mm shaft flat upper black		
<b>For models:</b>	C2FTPF, C2FTPFEP, C4FFE, C4FFEP, C4PFE, C4PQFE, C4VFE, C6FFE, C6FFEP, C6PFE, C6PQFE, CCTPFEB		



1

<b>GEV No.</b>	110452	<b>Ref. No.</b>	0000X01400
<b>description</b>	knob thermostat t.max. 300°C ø 60mm shaft ø 6x4.6mm shaft flat upper temperature range 50-300°C		
<b>For models:</b>	CC80E, CCG80E, CCQ80E, CCV80E		



1

<b>GEV No.</b>	110779	<b>Ref. No.</b>	0000Y03800
<b>description</b>	knob gas thermostat 1-8 ø 75mm shaft ø 10x8mm shaft flat upper black		
<b>For models:</b>	K2FTPF, K4FFG, K6FFG, K8FFG, KFTG4, KFTG4C, KFTG4R, KFTG8, KFTG8C, KFTG8LR, KTPFG		



1

<b>GEV No.</b>	110781	<b>Ref. No.</b>	0000Y04700
<b>description</b>	knob oven TH/BH/TH+BH ø 75mm shaft ø 6x4.6mm shaft flat upper black		
<b>For models:</b>	K4FFE, K4PFE, K6FFE, K6PFE, K8FFE		



1

<b>GEV No.</b>	110786	<b>Ref. No.</b>	0000Y04400
<b>description</b>	knob switch 0-1 ø 75mm shaft ø 6x4.6mm shaft flat upper black		
<b>For models:</b>	KBRE, KBRE12, KBRE12IN, KBREIN, KBREM, KBREM12, KBREM12IN, KBREMIN, KBRG, KBRG12, KBRG12IN, KBRGIN, KBRGM, KBRGM12, KBRGM12IN, KBRGMIN, KFTE1, KFTE1C, KFTE1R, KFTE3, KFTE3C, KFTE3LR, KFTE4, KFTE4C, KFTE4R, KFTE8, KFTE8C, KFTE8LR		



1

<b>GEV No.</b>	110780	<b>Ref. No.</b>	0000Y04600
<b>description</b>	knob t.max. 300°C temperature range 50-300°C ø 75mm shaft ø 6x4.6mm shaft flat upper black		
<b>For models:</b>	K4FFE, K4PFE, K6FFE, K6PFE, K8FFE		

**1**

<b>GEV No.</b>	110785	<b>Ref. No.</b>	0000Y04900
<b>description</b>	knob thermostat t.max. 300°C 50-300°C ø 75mm shaft ø 6x4.6mm shaft flat upper black rotation 270°		
<b>For models:</b>	KBRE, KBRE12, KBRE12IN, KBREIN, KBREM, KBREM12, KBREM12IN, KBREMIN, KBRG, KBRG12, KBRG12IN, KBRGIN, KBRGM, KBRGM12, KBRGM12IN, KBRGMIN, KFTE1, KFTE1C, KFTE1R, KFTE3, KFTE3C, KFTE3LR, KFTE4, KFTE4C, KFTE4R, KFTE8, KFTE8C, KFTE8LR, OPBREM, OPBREM12, OPBREM12IN, OPBREM12IN		



**2**

<b>GEV No.</b>	110784	<b>Ref. No.</b>	0000Y04500
<b>description</b>	knob water ø 75mm shaft ø 10x8mm shaft flat upper		
<b>For models:</b>	KB4, KB8, KBRE, KBRE12, KBRE12IN, KBREIN, KBREM, KBREM12, KBREM12IN, KBREMIN, KBRG, KBRG12, KBRG12IN, KBRGIN, KBRGM, KBRGM12, KBRGM12IN, KBRGMIN, KCP8		



**1**

<b>GEV No.</b>	111485	<b>Ref. No.</b>	0000Y65005
<b>description</b>	knob 7-position t.max.°C ø 71mm shaft ø 6x4.6mm shaft flat upper		
<b>For models:</b>	C1W, C2I, C2P, C2PQ, C4I, C4P, C4PFCE, C4PFCE9, C4PFE, C4PFE9, C4PQ, C4PQFCE, C4PQFE, C4VFE, C6P, C6PFCE, C6PFCEV, C6PFE, C6PQ, C6PQFCE, C6PQFCEV, C6PQFE, CC80E, I1W, I2I, I2P, I2PQ, I4I, I4P, I4PQ, K1W, K2P, K4P, K4PFCE, K4PFCE9, K4PFE, K4PFE9, K6P, K6PFCE, K6PFE, K6PFE9, OP1W, OP2P, OP4P, OP6P, SK1W, SK2I, SK4I, SK4PFCE, SK4PQFCE...(Other models you can see in the webshop)		



**1**

<b>GEV No.</b>	110442	<b>Ref. No.</b>	0000Y65203
<b>description</b>	knob gas tap with ignition flame t.max.°C ø 71mm shaft ø 10x8mm shaft flat upper black		
<b>For models:</b>	CCPG4, CCPG82, CPG, CPGI, KCP4, KCP82, KP10G, KP10GA, KP10GT, KP10GTA, KP15G, KP15GA, KP15GT, KP15GTA, KP20G, KP20GA, KP30G, KP30GA, KP50G, KP50GA, KP110G, KP110GA, KP110GT, KP110GTA, KP115G, KP115GA, KP115GT, KP115GTA, KP120G, KP120GA, KP130G, KP130GA, KP150G, KP150GA, OPCP4, OPCP82, OPP10G, OPP10GA, OPP15G, OPP15GA, OPPI10G, OPPI10GA, OPPI15G, OPPI15GA		



**1**

<b>GEV No.</b>	112012	<b>Ref. No.</b>	0000Y65103
<b>description</b>	knob gas tap with ignition flame t.max.°C ø 71mm shaft ø 8x6.5mm shaft flat upper		
<b>For models:</b>	2FZP, B4F, B4FZ, B6F, B6FZ, B8, B8F, B8FZ, C2FP, C2FTPFPG, C2FZ, C2FZP, C2TP2FGP, C4FFCEP, C4FFCEGP, C4FFEP, C4FFGP, C4FP, C4FZ, C4FZ-FCEP, C4FZFCGP, C4FZFEF, C4FZFGP, C4FZP, C4FZSFCEP, C4FZSFCGP, C4FZSFEP, C4FZSFGP, C4FZSP, C6FFCEP, C6FFCEGP, C6FFEP, C6FFGP, C6FP, C6FZ, C6FZFCEP, C6FZFCEPV, C6FZFCGP, C6FZFCGPV, C6FZFEP, C6FZFGAP, C6FZFGP, C6FZP, CCTP8, CCTPF8, CFTG1, CFTG1R, CFTG2, CFTG22, CFTG2LR...(Other models you can see in the webshop)		



**1**

<b>GEV No.</b>	111829	<b>Ref. No.</b>	0000Y65101
<b>description</b>	knob gas tap without ignition flame t.max.°C ø 71mm shaft ø 8x6.5mm shaft flat upper black		
<b>For models:</b>	C2FZ, C2FZP, C4FZ, C4FZFCE, C4FZFCEGP, C4FZFE, C4FZFG, C4FZP, C4FZSP, C6FZ, C6FZFCE, C6FZFCEV, C6FZFCG, C6FZFCGV, C6FZFE, C6FZFG, C6FZFGA, C6FZP, I2FZ, I4FZ, T2FZ, T2FZP, T4FZ, T4FZP, T6FZ, T6FZP		



**1**

<b>GEV No.</b>	111496	<b>Ref. No.</b>	0000Y65010
<b>description</b>	knob ON-OFF ø 71mm shaft ø 6x4.6mm shaft flat upper black		
<b>For models:</b>	CMP4, IMP4, KBRE, KBRE12, KBRE12IN, KBRE9, KBREIN, KBREIN9, KBREM, KBREM12, KBREM12IN, KBREMIN, KBRG, KBRG12, KBRG12IN, KBRGIN, KBRGM, KBRGM12, KBRGM12IN, KBRGMIN, KFT4E, KFT4EC, KFT4ER, KFT8E, KFT8E23C, KFT8EC, KFT8ELR, KFT8ER, OPBRE, OPBRE12, OPBRE12IN, OPBRE12MIN, OPBREIN, OPBREM, OPBREM12, OPBREM12IN, OPBREM12IN, OPBRG, OPBRG12, OPBRG12IN, OPBRG-12MIN, OPBRGIN, OPBRGM, OPBRGM12, OPBRGM12IN, OPBRGMIN, OPFT4E, OPFT4EC, OPFT4ER, OPFT8E...(Other models you can see in the webshop)		



**1**

<b>GEV No.</b>	112102	<b>Ref. No.</b>	0000Y65015
<b>description</b>	knob oven t.max. 250°C 100-250°C ø 71mm shaft ø 6x4.6mm shaft flat upper black		
<b>For models:</b>	CC80E, CCG80E		



1

<b>GEV No.</b>	111470	<b>Ref. No.</b>	0000Y65007
<b>description</b>	knob oven t.max. °C ø 71mm shaft ø 6x4.6mm shaft flat upper black		
<b>For models:</b>	C4FFEP, C4ZFEP, C4ZFCE, C4ZSFEP, C4PFCE, C4PFE, C4PFE9, C4PQFCE, C4PQFE, C4VFE, C6FFEP, C6FZFE, C6FZFEP, C6PFCE, C6PFCEV, C6PFE, C6PQFCE, C6PQFCEV, C6PQFE, CN10FE, K2FTPF, K4FFE, K4FS, K4FSFE, K4ZFEP, K4ZSFE, K4PFE, K4PFE9, K4VFE, K6FFE, K6ZFEP, K6PFE, K6PFE9, K8FFE, K8ZFEP, KTFPE		



1

<b>GEV No.</b>	111493	<b>Ref. No.</b>	0000X03800 0000Y65008
<b>description</b>	knob oven t.max. °C ø 71mm shaft ø 6x4.6mm shaft flat upper black		
<b>For models:</b>	C4FFCEP, C4FFLE, C4FFLEP, C4ZFCE, C4ZFCEP, C4ZSFCEP, C4PFCE, C4PFLE, C4PQFCE, C4VFE, C4VFE, C4VFE, C6FFCEP, C6FFLE, C6FFLEP, C6FFLEPV, C6FFLEV, C6ZFCE, C6ZFCEP, C6ZFCEPV, C6ZFCEV, C6PFCE, C6PFCEV, C6PFLE, C6PFLEV, C6PQFCE, C6PQFCEV, CC120E, CC81E, CCG120CE, CCG120E, CCG81CE, CCG81E, CCQ120E, CCQ81E, CCV81E, K2FTPFCE, K4FSFCE, K4ZFCE, K4ZSFCE, K4PFCE, K4VFE, K6ZFCE, K6PFCE, K8ZFCE, KTFPE, SK4ZFCEP, SK4PFCE, SK4PQFCE, SK4VFE, SK6ZFCEP...(Other models you can see in the webshop)		



1

<b>GEV No.</b>	112136	<b>Ref. No.</b>	0000Y65011
<b>description</b>	knob switch 4-position t.max. °C ø 71mm shaft ø 6x4.6mm shaft flat upper black		
<b>For models:</b>	CCPE4, CCPE6, CPEI, CPEI9, ICPE4, ICPE6, K4PFE, K6PFE, KCP4E, KC-P82E, KP110E, KP110E9, KP110EA, KP110EA9, KP115E, KP115E9, KP115EA, KP115EA9, KP120E, KP120EA, KP130E, KP130EA, KP150E, KP150EA, OPC-P4E, OPCP82E, SKCP40E, SKCP60E, TCP40E, TCP60E		



1

<b>GEV No.</b>	112137	<b>Ref. No.</b>	0000Y65002
<b>description</b>	knob thermostat t.max. 195°C ø 71mm shaft ø 6x4.6mm shaft flat upper black temperature range 100-195°C		
<b>For models:</b>	15DPE, 15PE, CF1E4, CF2E4, CF2E6, CF4E, CF6E, CFE15, CFE159, CFE15D, CFE15D9, IF1E4, IF2E6, IF4E, IF6E, KFE1, KFE15, KFE159, KFE15D, KFE15D9, KFE2, KFE20, KFE20D, OPFE1, OPFE15, OPFE15D, OPFE2, OPFE20, OPFE20D, SK10DSE, SK10SE, SKF1E, SKF2E, SKF2E4, SKF4E, SKF6E, TF1E, TF2E, TF2E4, TF4E, TF6E		



1

<b>GEV No.</b>	112135	<b>Ref. No.</b>	0000Y65004
<b>description</b>	knob thermostat t.max. 300°C ø 71mm shaft ø 6x4.6mm shaft flat upper black temperature range 50-300°C rotation 270°		
<b>For models:</b>	C4FFCEP, C4FFEP, C4ZFCE, C4ZFCEP, C4ZFEP, C4ZSFCEP, C4ZSFCEP, C4PFE, C4PFE9, C4PQFCE, C4PQFE, C4VFE, C6FFCEP, C6FFEP, C6ZFCE, C6ZFCEP, C6ZFCEPV, C6ZFCEV, C6FZFE, C6FZFEP, C6PFCE, C6PFCEV, C6PFE, C6PQFCE, C6PQFCEV, C6PQFE, CBRE, CBRE9, CBREIN, CBREIN9, CCG120CE, CCG81CE, CFTE1, CFTE1C, CFTE1R, CFTE2, CFTE22, CFTE2C, CFTE2C2, CFTE2LR, CFTE2R, CFTE2R2, CFTE3, CFTE3C, CFTE3LR, CFTE3R, CFTE4...(Other models you can see in the webshop)		



1

<b>GEV No.</b>	110456	<b>Ref. No.</b>	Y65000
<b>description</b>	knob universal ø 71mm shaft ø 6x4.6mm shaft flat upper black		



1

<b>GEV No.</b>	110457	<b>Ref. No.</b>	Y65100
<b>description</b>	knob universal ø 71mm shaft ø 8x6.5mm shaft flat upper black		



1

<b>GEV No.</b>	110458	<b>Ref. No.</b>	Y65003
<b>description</b>	knob dial plate gas tap with ignition flame ED ø 66mm ID ø 50mm silver		



1

<b>GEV No.</b>	110465	<b>Ref. No.</b>	Y65007
<b>description</b>	knob dial plate oven BH/TH/BH+TH ED ø 66mm ID ø 50mm silver		

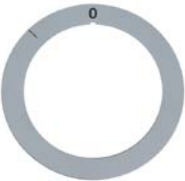

1

<b>GEV No.</b>	110479	<b>Ref. No.</b>	Y65010
<b>description</b>	knob dial plate switch 0-1 ED ø 66mm ID ø 50mm silver		

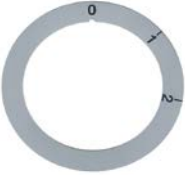

1

<b>GEV No.</b>	110690	<b>Ref. No.</b>	0000Y65012
<b>description</b>	knob dial plate switch 0-1-2 ED ø 66mm ID ø 50mm silver		
<b>For models:</b>	CPEI, CPEI9, KPI10E, KPI10E9, KPI10EA, KPI10EA9, KPI15E, KPI15E9, KPI15EA, KPI15EA9, KPI20E, KPI20EA, KPI30E, KPI30EA, KPI50E, KPI50EA, OPPI10E, OPPI10EA, OPPI15E, OPPI15EA		

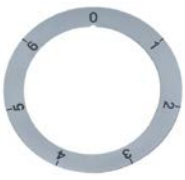

1

<b>GEV No.</b>	110464	<b>Ref. No.</b>	Y65005
<b>description</b>	knob dial plate switch 7-position ED ø 66mm ID ø 50mm silver		

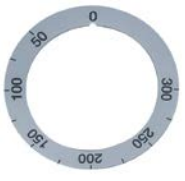

1

<b>GEV No.</b>	110462	<b>Ref. No.</b>	Y65004
<b>description</b>	knob dial plate thermostat t.max. 300°C 50-300°C rotation 270° ED ø 66mm ID ø 50mm silver		



1

<b>GEV No.</b>	110778	<b>Ref. No.</b>	Y65014
<b>description</b>	knob dial plate thermostat t.max. 90°C 30-90°C rotation 270° ED ø 66mm ID ø 50mm silver		



1

<b>GEV No.</b>	111226	<b>Ref. No.</b>	DFP032A60A DFP032A80A
<b>description</b>	knob gas tap with ignition flame t.max.°C ø 70mm shaft ø 8x6.5mm shaft flat upper		
<b>For models:</b>	M72FPTFG, M74FMP, M74FMPFE, M74FMPFG, M74FMPFXE, M74FMPFXG, M74FP, M74FPFE, M74FPFG, M74FPFXE, M74FPFXG, M76FMP, M76FMPFE, M76FMPFG, M76FMPFXE, M76FMPFXG, M76FP, M76FPFE, M76FPFG, M76FPFXE, M76FPFXG, M7CP4G, M7PL1G, M7PL2G		



1

<b>GEV No.</b>	111228	<b>Ref. No.</b>	DFP012A60A
<b>description</b>	knob gas tap without ignition flame t.max.°C ø 70mm shaft ø 6x4.6mm shaft flat upper		
<b>For models:</b>	M62F, M64F, M74F, M74FFXE, M74FFXG, M76F, M76FFXE, M76FFXG, M7FT4GL, M7FT4GR, M7FT6GL, M7FT6GLR		



1

<b>GEV No.</b>	111231	<b>Ref. No.</b>	DFP092A60A
<b>description</b>	knob gas thermostat 1-8 ø 70mm shaft ø 6x4.6mm shaft flat upper black		
<b>For models:</b>	M74FFXG, M74FMPFXG, M74FPFXG, M76FFXG, M76FMPFXG, M76FPFXG		



1

<b>GEV No.</b>	111229	<b>Ref. No.</b>	DFP072A60A
<b>description</b>	knob oven TH/BH/TH+BH ø 70mm shaft ø 6x4.6mm shaft flat upper		
<b>For models:</b>	M74FMPFE, M74FPFE, M76FMPFE, M76FPFE		



1

<b>GEV No.</b>	111227	<b>Ref. No.</b>	DFP122A60A
<b>description</b>	knob switch 0-1-2 ø 70mm shaft ø 6x4.6mm shaft flat upper		
<b>For models:</b>	M6CP4E, M7CP4E		



1

<b>GEV No.</b>	111224	<b>Ref. No.</b>	DFP052A60A
<b>description</b>	knob switch 7-position ø 70mm shaft ø 6x4.6mm shaft flat upper		
<b>For models:</b>	M62P, M62V, M64P, M64V, M74P, M74PFXE, M74PQ, M74PQFXE, M74V, M74VFXE, M76P, M76PFXE		



1

<b>GEV No.</b>	111225	<b>Ref. No.</b>	DFP022A60A
<b>description</b>	knob thermostat t.max. 195°C ø 70mm shaft ø 6x4.6mm shaft flat upper temperature range 100-195°C		
<b>For models:</b>	M6F4E, M6F6E, M7F4E, M7F6E		



1

<b>GEV No.</b>	111230	<b>Ref. No.</b>	DFP042A60A
<b>description</b>	knob thermostat t.max. 300°C ø 70mm shaft ø 6x4.6mm shaft flat upper black temperature range 50-300°C rotation 270°		
<b>For models:</b>	M6FT4EL, M6FT4ER, M6FT6EL, M6FT6ELR, M74FFXE, M74FMPFE, M74FMPFXE, M74FPFE, M74FPFXE, M74PFXE, M74PQFXE, M74VFXE, M76FFXE, M76FMPFE, M76FMPFXE, M76FPFE, M76FPFXE, M76PFXE, M7FT4EL, M7FT4ER, M7FT6EL, M7FT6ELR		



1

<b>GEV No.</b>	111232	<b>Ref. No.</b>	DFP142A60A
<b>description</b>	knob thermostat t.max. 90°C ø 70mm shaft ø 6x4.6mm shaft flat upper black temperature range 30-90°C rotation 270°		
<b>For models:</b>	M6B4E, M7B4E		



1

<b>GEV No.</b>	110824	<b>Ref. No.</b>	Y65300
<b>description</b>	knob switch zero mark ø 40mm shaft ø 6x4.6mm shaft flat upper black		
<b>For models:</b>	S600E		



1

<b>GEV No.</b>	699300	<b>Ref. No.</b>	761-005-00
<b>description</b>	knob zero mark ø 67mm shaft ø 6x4.6mm shaft flat upper black		



1

<b>GEV No.</b>	699301	<b>Ref. No.</b>	761-006-00
<b>description</b>	knob zero mark ø 67mm shaft ø 8x6mm shaft flat upper black		

accessories

button springs



1

<b>GEV No.</b>	550132	<b>Ref. No.</b>	063009
<b>description</b>	knob spring ø 6x4.6mm Qty 10 pcs		
<b>For models:</b>	S110E, S300E, S350G		

handles and hand wheels

hand wheels



1

<b>GEV No.</b>	690540	<b>Ref. No.</b>	X18500
<b>description</b>	hand wheel ø 150mm		
<b>For models:</b>	CBRE, CBRE8, CBREIN, CBRG, CBRG8, CBRGIN		





			
1			
<b>GEV No.</b>	690544	<b>Ref. No.</b>	0900X18500
<b>description</b>	hand wheel ø 150mm		

			
1			
<b>GEV No.</b>	693113	<b>Ref. No.</b>	0900X18500
<b>description</b>	hand wheel ø 150mm D1 ø 38mm bore ø 14mm thread groove width 5mm L1 38mm L2 40mm handle length 65mm with folding handle		
<b>For models:</b>	CBRE, CBRE9, CBREIN, CBREIN9, CBRG, CBRGIN		
<b>spare parts for</b>	693113		
	<b>GEV No.</b>	514255	<b>Ref. No.</b>
		folding handle ø 26mm total length 85mm seat ø 20mm shaft ømm thread M6 with pin L 85mm	
<b>accessories for</b>	693113		
	<b>GEV No.</b>	690968	<b>Ref. No.</b>
		roll pin ø 5mm L 20mm	

			
1			
<b>GEV No.</b>	692430	<b>Ref. No.</b>	0900Y41900
<b>description</b>	hand wheel ø 200mm D1 ø 50mm bore ø 20mm thread groove width 6mm groove depth 13mm mounting distance 30mm L1 47mm L2 50mm handle length 90mm with folding handle		

			
1			
<b>GEV No.</b>	692431	<b>Ref. No.</b>	0900Y41900
<b>description</b>	hand wheel ø 200mm D1 ø 50mm bore ø 20mm thread groove width 8mm groove depth 12mm mounting distance 32mm L1 40mm L2 43mm handle length 65mm with folding handle		
<b>For models:</b>	KBRE, KBRE12, KBRE12IN, KBRE9, KBREIN, KBREIN9, KBRG, KBRG12, KBRG12IN, KBRGIN, OPBRE, OPBRE12, OPBRE12IN, OPBREIN, OPBRG, OPBRG12, OPBRG12IN, OPBRGIN		

### cone handles

			
1			
<b>GEV No.</b>	693121	<b>Ref. No.</b>	065007
<b>description</b>	cone handle thread M8 ø 33mm L 82mm plastic black		
<b>For models:</b>	S110E, S300E, S350G		

			
1			
<b>GEV No.</b>	695615	<b>Ref. No.</b>	761-081-00 AVA017ZR10
<b>description</b>	cone handle thread M5x0.8 fryer cover		
<b>For models:</b>	CBE4, CBE8, CBG4, CF4E, CF6E, CRE4, CRE6, M6CP4E, M6F4E, M6F6E, M7CP4E, M7CP4G, M7F4E, M7F4G, M7F6E, M7F8G, SKB40E, SKB40G, SKB80E, SKF10GM, SKF1E, SKF20GM, SKF2E, SKF4E, SKF6E, SKR40E, SKR60E, TB40E, TB40G, TB80E, TF10GM, TF1E, TF20GM, TF2E, TF4E, TF6E, TR40E, TR60E		

### ball handles

			
1			
<b>GEV No.</b>	540323	<b>Ref. No.</b>	20200013
<b>description</b>	ball handle thread M10 ø 40mm with metal bush black		
<b>For models:</b>	KPI10ET, KPI10ETA, KPI15ET, KPI15ETA, KPI20ET, KPI20ETA, KPI20VT, KPI20VTA, KPI30ET, KPI30ETA, KPI30VT, KPI30VTA, KPI50ET, KPI50ETA, KPI50VT, KPI50VTA		

## handle rails

## handle rails



**GEV No.** 524271 **Ref. No.** 903933

**description** handle rail L 512mm W 28mm H 40mm dark blue Qty 1 pcs

**For models:** GLS805, GLS845

**accessories for** 524271

**GEV No.** 697926 **Ref. No.** 901657

sticker for handle rail L 460mm



**GEV No.** 511195 **Ref. No.** 903934

**description** handle rail L 562mm W 40mm suitable for Silanos blue hole distance 257/393/493mm

**For models:** GLS905, GLS925

## end caps

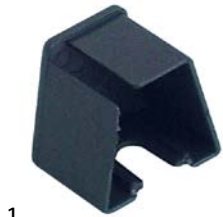

**GEV No.** 518530 **Ref. No.** N/A

**description** end cap mounting pos. left



**GEV No.** 518529 **Ref. No.** N/A

**description** end cap mounting pos. right

## bracket handles



**GEV No.** 695616 **Ref. No.** AVA013ZR10

**description** handle L 185mm bracket handle

**For models:** M7CP4G, M7F4G, M7F8G



**GEV No.** 390732 **Ref. No.** Y65700

**description** handle rod L 590mm H 60mm tube ø 30mm stainless steel

**For models:** B4F, B4FZ, B6F, B6FZ, B8FZ, C1W, C2FTPFPG, C2TP2FGP, C4FFCEP, C4FFCGP, C4FFEP, C4FFGP, C4FZFCE, C4FZFCEP, C4FZFCEG, C4FZFCGP, C4FZFCE, C4FZFEP, C4FZFG, C4FZFGP, C4FZSFCGP, C4FZSFCGP, C4FZSFEP, C4FZSFGP, C4I, C4PFCE, C4PFE, C4PFE9, C4PQFCE, C4PQFE, C4V, C4VCE, C4VFE, C6FFCEP, C6FFCGP, C6FFEP, C6FFGAP, C6FFGP, C6FZFCE, C6FZFCEP, C6FZFCEPV, C6FZFCEV, C6FZFCEG, C6FZFCEGP, C6FZFCEGPV, C6FZFCEGV, C6FZFE, C6FZFEP, C6FZFG, C6FZFGA...(Other models you can see in the webshop)



**GEV No.** 691338 **Ref. No.** AVA011ZR10  
AVA037ZR10

**description** pull handle L 485mm H 52mm mounting distance 470mm

**For models:** M72FPTFG, M74FFXE, M74FFXG, M74FMPFE, M74FMPFG, M74FMPFXE, M74FMPFXG, M74FPFE, M74FPFG, M74FPFXE, M74FPFXG, M74PFXE, M74PQFXE, M74VFXE, M76FFXE, M76FFXG, M76FMPFE, M76FMPFG, M76FMPFXE, M76FMPFXG, M76FPFE, M76FPFG, M76FPFXE, M76FPFXG, M76PFXE

## accessories

## miscellaneous



**GEV No.** 693119 **Ref. No.** 055807

**description** hand protection for griddle

**For models:** S110E, S300E, S350G





# locks

## edgemount latches

### handle latches

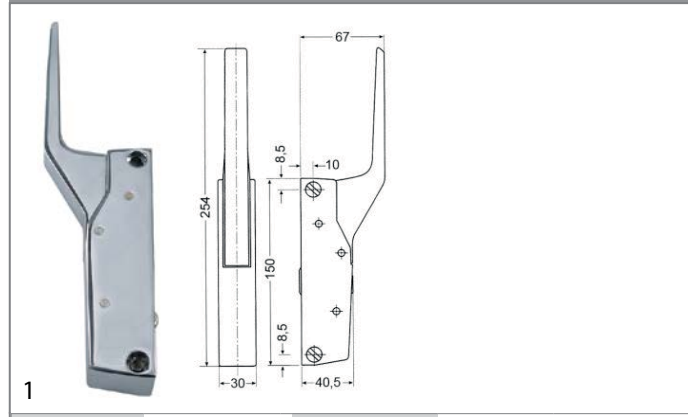
#### CAFF/FERMOD





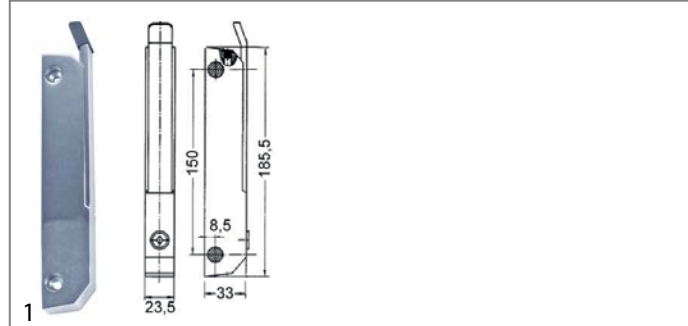

<b>GEV No.</b>	700060	<b>Ref. No.</b>	RX1496
<b>description</b>	handle latch L 150mm mounting distance 133mm non lockable heated units G 791		
<b>accessories for</b>	700060		
	<b>GEV No.</b>	700061	<b>Ref. No.</b> —
	door catch L 58mm W 20mm H 35mm mounting distance 42mm chrome-plated brass for headed units		
	<b>GEV No.</b>	700062	<b>Ref. No.</b> —
	handle protection heated units		

#### RAHRBACH

##### 6188 ERGO series



<b>GEV No.</b>	690808	<b>Ref. No.</b>	M19700
<b>description</b>	handle latch L 185mm mounting distance 150mm chrome-plated non lockable for headed units 6188 type ERGO		
<b>For models:</b>	GSP01		
<b>accessories for</b>	690808		
	<b>GEV No.</b>	690110	<b>Ref. No.</b> —
	base plate H 1mm L 38mm W 11mm mounting distance 26mm plastic		
	<b>GEV No.</b>	690111	<b>Ref. No.</b> —
	base plate H 2mm L 38mm W 11mm mounting distance 26mm plastic		
	<b>GEV No.</b>	690114	<b>Ref. No.</b> —
	base plate H 3.5mm L 185mm W 30mm mounting distance 150mm with inclination thread M5		
	<b>GEV No.</b>	700082	<b>Ref. No.</b> —
	door catch L 38mm W 18mm mounting distance 26mm		

# snap locks

## universal



<b>GEV No.</b>	690596	<b>Ref. No.</b>	R31200
<b>description</b>	snap lock L 60mm W 15mm H 36mm mounting distance 48/28mm spring thickness 1.5mm complete with door catch zamak		

# hinges

## spring assisted hinges

### producer-specific

#### DESMON



<b>GEV No.</b>	701011	<b>Ref. No.</b>	FP280847
<b>description</b>	spring assisted hinge with hinge camp L 74mm W 24mm shaft length 18mm mounting distance 25mm mounting measurements 22x22x100mm		

#### GIGA



<b>GEV No.</b>	701011	<b>Ref. No.</b>	FP280847
<b>description</b>	spring assisted hinge with hinge camp L 74mm W 24mm shaft length 18mm mounting distance 25mm mounting measurements 22x22x100mm		

oven hinges

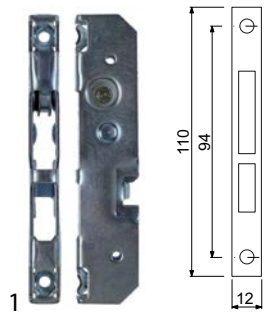

<b>GEV No.</b>	700003	<b>Ref. No.</b>	X68006
<b>description</b>	opposite support L 110mm W 12mm mounting distance 94mm		
<b>For models:</b>	C4FFLE, C4FFLEP, C4FFLG, C4FFLGP, C4PFLE, C4VFLE, C6FFLE, C6FFLEP, C6FFLEPV, C6FFLEV, C6FFLG, C6FFLGP, C6FFLGPV, C6FFLGV, C6PFLE, C6PFLEV, CC120E, CC120G, CC80E, CC80G, CC81E, CC81G, CCG120E, CCG80E, CCG81E, CCQ120E, CCQ80E, CCQ81E, CCV80E, CCV81E		

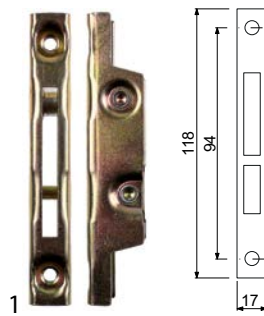

<b>GEV No.</b>	700001	<b>Ref. No.</b>	N/A
<b>description</b>	opposite support L 118mm W 17mm mounting distance 94mm		

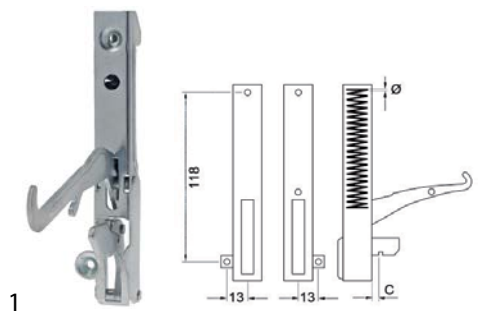

<b>GEV No.</b>	700013	<b>Ref. No.</b>	X68021
<b>description</b>	oven hinge mounting distance 118mm lug mounting 13mm lever length 119mm groove distance 13mm spring thickness 3.5mm mounting ear position left spring length 60mm L 154mm		
<b>For models:</b>	C4FFLE, C4FFLEP, C4FFLG, C4FFLGP, C4PFLE, C4VFLE, C6FFLE, C6FFLEP, C6FFLEPV, C6FFLEV, C6FFLG, C6FFLGP, C6FFLGPV, C6FFLGV, C6PFLE, C6PFLEV, CC120E, CC120G, CC80E, CC80G, CC81E, CC81G, CCG120E, CCG80E, CCG81E, CCQ120E, CCQ80E, CCQ81E, CCV80E, CCV81E		
<b>accessories for</b>	700013		
	<b>GEV No.</b>	700003	<b>Ref. No.</b> X68006
	opposite support L 110mm W 12mm mounting distance 94mm		

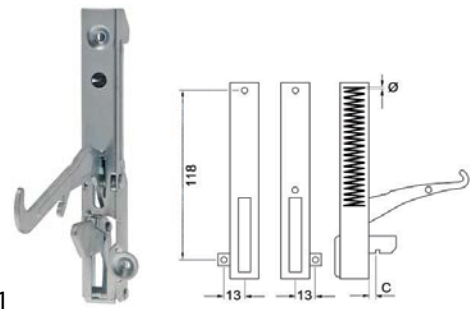

<b>GEV No.</b>	700014	<b>Ref. No.</b>	X68020
<b>description</b>	oven hinge mounting distance 118mm mounting distance 2mm lug mounting 13mm lever length 119mm groove distance 13mm spring thickness 3.5mm mounting ear position right spring length 60mm L 154mm		
<b>For models:</b>	C4FFLE, C4FFLEP, C4FFLG, C4FFLGP, C4PFLE, C4VFLE, C6FFLE, C6FFLEP, C6FFLEPV, C6FFLEV, C6FFLG, C6FFLGP, C6FFLGPV, C6FFLGV, C6PFLE, C6PFLEV, CC120E, CC120G, CC80E, CC80G, CC81E, CC81G, CCG120E, CCG80E, CCG81E, CCQ120E, CCQ80E, CCQ81E, CCV80E, CCV81E		
<b>accessories for</b>	700014		
	<b>GEV No.</b>	700003	<b>Ref. No.</b> X68006
	opposite support L 110mm W 12mm mounting distance 94mm		



<b>GEV No.</b>	700006	<b>Ref. No.</b>	0000X66000
<b>description</b>	oven hinge mounting distance 173mm mounting distance 2 105mm lug mounting 14mm lever length 120mm groove distance 11mm spring thickness 3.5mm mounting ear position left spring length 112mm W 25mm		
<b>For models:</b>	C2FTPF, C2FTPFEP, C2FTPFG, C2FTPFGP, C2TP2FGP, C4FFCEP, C4FFFCGP, C4FFE, C4FFEP, C4FFG, C4FFGP, C4ZFCE, C4ZFCEP, C4ZFZFCG, C4ZFZFCGP, C4ZFZE, C4ZFZEP, C4ZFZFG, C4ZFZFGP, C4FZSFCEP, C4FZSFCEP, C4FZSFEP, C4FZSFGP, C4PFCE, C4PFE, C4PFE9, C4PQFCE, C4PQFE, C4VFCE, C4VFE, C6FFCEP, C6FFFCGP, C6FFE, C6FFEP, C6FFG, C6FFGA, C6FFGAP, C6FFGP, C6FZFCE, C6FZFCEP, C6FZFCEPV, C6FZFCEV, C6FZFZCG, C6FZFZCGP, C6FZFZCGPV, C6FZFZCGV, C6FZFE, C6FZFEP, C6FZFG, C6FZFGA...(Other models you can see in the webshop)		
<b>accessories for</b>	700006		
	<b>GEV No.</b>	700001	<b>Ref. No.</b> N/A
	opposite support L 118mm W 17mm mounting distance 94mm		
	<b>GEV No.</b>	700007	<b>Ref. No.</b> 0000X66100 X66100
	oven hinge mounting distance 173mm mounting distance 2 105mm lug mounting 14mm lever length 120mm groove distance 11mm spring thickness 3.5mm mounting ear position right spring length 112mm W 25mm		



<b>GEV No.</b>	700007	<b>Ref. No.</b>	0000X66100
<b>description</b>	oven hinge mounting distance 173mm mounting distance 2 105mm lug mounting 14mm lever length 120mm groove distance 11mm spring thickness 3.5mm mounting ear position right spring length 112mm W 25mm		
<b>For models:</b>	C2FTPFE, C2FTPFEP, C2FTPFG, C2FTPFGP, C2TP2FGP, C4FFCEP, C4FFCGP, C4FFE, C4FFEP, C4FFG, C4FFGP, C4FZCE, C4FZCEP, C4FZFCG, C4FZFCGP, C4FZFE, C4FZFEP, C4FZFG, C4FZFGP, C4FZSFCEP, C4FZSFCGP, C4FZSFEP, C4FZSFGP, C4PFCE, C4PFE, C4PFE9, C4PQFCE, C4PQFE, C4VFCE, C4VFE, C6FFCEP, C6FFCGP, C6FFE, C6FFEP, C6FFG, C6FFGA, C6FFGAP, C6FFGP, C6FZFCE, C6FZFCEP, C6FZFCEPV, C6FZCEV, C6FZFCG, C6FZFCGP, C6FZFCGPV, C6FZFCGV, C6FZFE, C6FZFEF, C6FZFG, C6FZFGA...(Other models you can see in the webshop)		
<b>accessories for</b>	700007		
<b>GEV No.</b>	700001	<b>Ref. No.</b>	N/A
<b>description</b>	opposite support L 118mm W 17mm mounting distance 94mm		
<b>GEV No.</b>	700006	<b>Ref. No.</b>	0000X66000 X66000
<b>description</b>	oven hinge mounting distance 173mm mounting distance 2 105mm lug mounting 14mm lever length 120mm groove distance 11mm spring thickness 3.5mm mounting ear position left spring length 112mm W 25mm		

door bearing

<b>GEV No.</b>	700721	<b>Ref. No.</b>	DVA012ZR10
<b>description</b>	bolt L 15mm ø 6mm		
<b>For models:</b>	M7CP4G, M7F4G, M7F8G		
<b>GEV No.</b>	700720	<b>Ref. No.</b>	SLM563ZR10
<b>description</b>	door hinge for fryer		
<b>For models:</b>	M7CP4G, M7F4G, M7F8G		
<b>accessories for</b>	700720		
<b>GEV No.</b>	700721	<b>Ref. No.</b>	DVA012ZR10
<b>description</b>	bolt L 15mm ø 6mm		

pullouts

rollers

<b>GEV No.</b>	692465	<b>Ref. No.</b>	908704
<b>description</b>	roller rollerø 33mm B1 8mm A 33mm B 8mm C 14.5mm D M8mm E 11.5mm plastic tread plastic bearing ball bearing thread M8x1.25 thread L 20mm Qty 1 pcs		
<b>For models:</b>	GLS945, GLS945S		

fittings for catering equipment

outlet taps

producer-specific

GIGA

<b>GEV No.</b>	514325	<b>Ref. No.</b>	M75400
<b>description</b>	ball valve connection 1" IT - 1" IT DN25 total length 83mm with lever handle		
<b>For models:</b>	15DPE, 15PE, CCPE4, CCPE6, CCPG4, CCPG8, CCPG82, CF10DG8M, CF10G4M, CF15DG8, CF15G4, CFE15, CFE15D, CFG15, CFG15D, KCP4, KCP4E, KCP8, KCP82, KCP82E, KFE15, KFE15D, KFE20, KFE20D, KFE4, KFE8, KFG1, KFG15, KFG15D, KFG2, KFG20, KFG20D, KFG4, KFG8, OPCP4, OPCP4E, OPCP82, OPCP82E, OPFE15, OPFE15D, OPFE20, OPFE20D, OPFG1, OPFG15, OPFG15D, OPFG2, OPFG20, OPFG20D, TCP40E, TCP60E		
<b>GEV No.</b>	540730	<b>Ref. No.</b>	M75500
<b>description</b>	ball valve connection 3/4" IT - 3/4" IT DN20 total length 70mm with lever handle handle length 95mm		
<b>For models:</b>	CCPE4, CCPE6, KB4, KB4G, KB8, OPB4, OPB4G, OPB8, SKCP40E, SKCP60E, TCP40E, TCP60E		
<b>GEV No.</b>	514411	<b>Ref. No.</b>	M22200
<b>description</b>	handle		
<b>For models:</b>	CBE4, CBE8, CBG4, CF10DG8M, CF10G4M, CF1E4, CF2E4, CF2E6, CF4E, CF6E, CRE4, CRE6, SK10DSE, SK10SE, SKB40E, SKB40G, SKB80E, SKCP40E, SKCP60E, SKCP60G, SKF10GM, SKF1E, SKF20GM, SKF2E, SKF2E4, SKF4E, SKF6E, SKR40E, SKR60E, TB40E, TB40G, TB80E, TCP60G, TF10GM, TF1E, TF20GM, TF2E, TF2E4, TF4E, TF6E, TP40G, TR40E, TR60E		

			
<b>GEV No.</b>	514446	<b>Ref. No.</b>	M75700
<b>description</b>	handle for outlet tap		
<b>For models:</b>	15DPE, 15PE, CCPG4, CCPG8, CCPG82, KCP4, KCP4E, KCP82, KCP82E, KFG1, KFG2, OPCP4, OPCP4E, OPCP82, OPCP82E, OPFG1, OPFG2, TF10GM, TF20GM		

			
<b>GEV No.</b>	514410	<b>Ref. No.</b>	T30200
<b>description</b>	lever		
<b>For models:</b>	CBE4, CBE8, CBG4, CF10DG8M, CF10G4M, CF1E4, CF2E4, CF2E6, CF4E, CF6E, CRE4, CRE6, SK10DSE, SK10SE, SKB40E, SKB40G, SKB80E, SKCP60G, SKF10GM, SKF1E, SKF20GM, SKF2E, SKF2E4, SKF4E, SKF6E, SKR40E, SKR60E, TB40E, TB40G, TB80E, TCP60G, TF10GM, TF1E, TF20GM, TF2E, TF2E4, TF4E, TF6E, TP40G, TR40E, TR60E		

			
<b>GEV No.</b>	514215	<b>Ref. No.</b>	M75300
<b>description</b>	outlet tap angled wing handle inlet 1/2" IT outlet 3/4" IT L 53.5mm approval EN 331		
<b>For models:</b>	15PSE, 7DSE, 7DSET, 7SE, 7SET		

			
<b>GEV No.</b>	514233	<b>Ref. No.</b>	0000X15200
<b>description</b>	outlet tap DN25 connection 3/4" total length 85mm		
<b>For models:</b>	CBE4, CBE8, CBG4, CF10DG8M, CF10G4M, CF1E4, CF2E4, CF2E6, CF4E, CF6E, CRE4, CRE6, SKB40E, SKB40G, SKB80E, SKF10GM, SKF1E, SKF20GM, SKF2E, SKF4E, SKF6E, SKR40E, SKR60E, TB40E, TB40G, TB80E, TCP60G, TF10GM, TF1E, TF20GM, TF2E, TF2E4, TF4E, TF6E, TP40G, TR40E, TR60E		
<b>accessories for</b>	514233		
	<b>GEV No.</b>	514410	<b>Ref. No.</b> T30200
	<b>GEV No.</b>	514411	<b>Ref. No.</b> M22200

aerators and air bleeders



			
<b>GEV No.</b>	540827	<b>Ref. No.</b>	Y70200
<b>description</b>	aerator and air bleeder thread 3/4" ET chrome-plated L 45mm ø 36mm		
<b>For models:</b>	KPI20E, KPI20EA, KPI20G, KPI20GA, KPI30E, KPI30EA, KPI30G, KPI30GA, KPI50E, KPI50EA, KPI50G, KPI50GA		

lid hinges

type RUBINETTERIE DEL FRIULI

for circular lids

lid hinges

			
<b>GEV No.</b>	540839	<b>Ref. No.</b>	0000E50000 0000Y45200
<b>description</b>	lid hinge L 270mm mounting distance 139mm flange radius 470mm opening angle 80° spring thickness 5mm bore ø M16mm for circular lids		
<b>For models:</b>	CPEI, CPG, CPGI, KP10G, KP10GA, KP10GT, KP10GTA, KP15G, KP15GA, KP15GT, KP15GTA, KPI10E, KPI10EA, KPI10G, KPI10GA, KPI10GT, KPI10GTA, KPI15E, KPI15EA, KPI15G, KPI15GA, KPI15GT, KPI15GTA, OPP10G, OPP10GA, OPP15G, OPP15GA, OPP10E, OPP10EA, OPP10G, OPP10GA, OPP15E, OPP15EA, OPP15G, OPP15GA		
<b>spare parts for</b>	540839		
	<b>GEV No.</b>	514137	<b>Ref. No.</b> —
	spring guide for lid hinge ID ø 28mm ED ø 32mm L 225mm zinc-coated steel		
	<b>GEV No.</b>	514140	<b>Ref. No.</b> —
	lid hinge body lid radius 470mm		
	<b>GEV No.</b>	514144	<b>Ref. No.</b> —
	bracket for lid hinge		
	<b>GEV No.</b>	514145	<b>Ref. No.</b> —
	adjusting bush L 108mm ø 80/60mm		
	<b>GEV No.</b>	540854	<b>Ref. No.</b> —
	torsion spring ø 50.8mm wire gauge ø 5.1mm L1 34mm L2 104mm L3 29mm mounting pos. right		
	<b>GEV No.</b>	540855	<b>Ref. No.</b> —
	torsion spring ø 50.8mm wire gauge ø 5.1mm L1 34mm L2 104mm L3 29mm mounting pos. left		

lid hinges



1

<b>GEV No.</b>	540720	<b>Ref. No.</b>	Y45200
<b>description</b>	lid hinge for circular lids		
<b>spare parts for</b>	540720		
	<b>GEV No.</b>	514143	<b>Ref. No.</b> —
	lid hinge body lid radius 320mm		
	<b>GEV No.</b>	514146	<b>Ref. No.</b> —
	bracket for lid hinge		
	<b>GEV No.</b>	514147	<b>Ref. No.</b> —
	adjusting bush		
	<b>GEV No.</b>	540846	<b>Ref. No.</b> —
	torsion spring ø 42.5mm wire gauge ø 4.1mm L1 93mm L2 26mm L3 26mm mounting pos. left		
	<b>GEV No.</b>	540847	<b>Ref. No.</b> —
	torsion spring ø 42.5mm wire gauge ø 4.1mm L1 93mm L2 26mm L3 26mm mounting pos. right		

FIREX

lid hinges



1

<b>GEV No.</b>	514412	<b>Ref. No.</b>	20300096
<b>description</b>	lid hinge L 230mm mounting distance 1 150mm flange radius 320mm spring thickness 4mm for circular lids		
<b>For models:</b>	KPI10ET, KPI10ETA, KPI10VT, KPI10VTA, KPI15ET, KPI15ETA, KPI15VT, KPI15VTA		
<b>spare parts for</b>	514412		
	<b>GEV No.</b>	540846	<b>Ref. No.</b> —
	torsion spring ø 42.5mm wire gauge ø 4.1mm L1 93mm L2 26mm L3 26mm mounting pos. left		
	<b>GEV No.</b>	540847	<b>Ref. No.</b> —
	torsion spring ø 42.5mm wire gauge ø 4.1mm L1 93mm L2 26mm L3 26mm mounting pos. right		



1

<b>GEV No.</b>	514413	<b>Ref. No.</b>	20300086
<b>description</b>	lid hinge L 270mm mounting distance 1 139mm flange radius 395mm spring thickness 5mm bore ø M15mm for circular lids		
<b>For models:</b>	KP20G, KP20GA, KP20GT, KP20GTA, KP30G, KP30GA, KP30GT, KP30GTA, KP50G, KP50GA, KP50GT, KP50GTA, KPI20E, KPI20EA, KPI20ET, KPI20G, KPI20GA, KPI20GT, KPI20GTA, KPI20VT, KPI20VTA, KPI30E, KPI30EA, KPI30G, KPI30GA, KPI30GT, KPI30GTA, KPI50E, KPI50EA, KPI50G, KPI50GA, KPI50GT, KPI50GTA		
<b>spare parts for</b>	514413		
	<b>GEV No.</b>	540854	<b>Ref. No.</b> —
	torsion spring ø 50.8mm wire gauge ø 5.1mm L1 34mm L2 104mm L3 29mm mounting pos. right		
	<b>GEV No.</b>	540855	<b>Ref. No.</b> —
	torsion spring ø 50.8mm wire gauge ø 5.1mm L1 34mm L2 104mm L3 29mm mounting pos. left		



1

<b>GEV No.</b>	514414	<b>Ref. No.</b>	20300108
<b>description</b>	lid hinge L 270mm mounting distance 1 139mm flange radius 470mm spring thickness 6mm bore ø M15mm for circular lids		
<b>For models:</b>	KPI30ET, KPI30VT, KPI30VTA, KPI50ET, KPI50VT, KPI50VTA		
<b>spare parts for</b>	514414		
	<b>GEV No.</b>	540856	<b>Ref. No.</b> —
	torsion spring ø 52mm wire gauge ø 6.2mm L1 30mm L2 95mm L3 30mm mounting pos. right		
	<b>GEV No.</b>	540857	<b>Ref. No.</b> —
	torsion spring ø 52mm wire gauge ø 6.2mm L1 30mm L2 95mm L3 30mm mounting pos. left		

lid catches

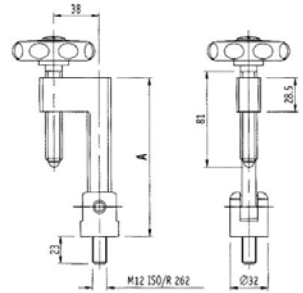
1

<b>GEV No.</b>	540850	<b>Ref. No.</b>	Y70900
<b>description</b>	lid lock handle ø 70mm L 134mm ET M12		

1

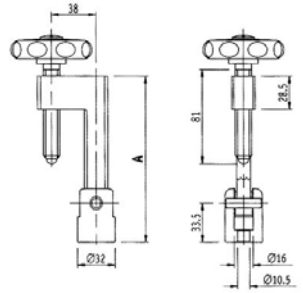
<b>GEV No.</b>	514127	<b>Ref. No.</b>	20300093
<b>description</b>	lid lock handle ø 70mm L 143mm		
<b>For models:</b>	KP20GA, KP20GTA, KP30GA, KP30GTA, KP50GA, KP50GTA, KPI10ETA, KPI10VTA, KPI15ETA, KPI15VTA, KPI20EA, KPI20ETA, KPI20GA, KPI20GTA, KPI20VT, KPI20VTA, KPI30EA, KPI30ETA, KPI30GA, KPI30GTA, KPI30VT, KPI30VTA, KPI50EA, KPI50ETA, KPI50GA, KPI50GTA, KPI50VT, KPI50VTA		

inlet taps



1

<b>GEV No.</b>	514210	<b>Ref. No.</b>	X18000
<b>description</b>	shut-off valve		

drain taps

brass  
drain taps



1

<b>GEV No.</b>	540132	<b>Ref. No.</b>	39.302.02523 Y71100
<b>description</b>	drain tap 1 1/2" IT conical seal kettle A 90mm B 137mm B1 70mm chrome-plated brass		
<b>For models:</b>	KP20G, KP20GA, KP30G, KP30GA, KP50G, KP50GA, KPI20E, KPI20EA, KPI20G, KPI20GA, KPI30E, KPI30EA, KPI30G, KPI30GA, KPI50E, KPI50EA, KPI50G, KPI50GA		
<b>spare parts for</b>	540132		
	<b>GEV No.</b>	540213	<b>Ref. No.</b> —
	handle ID ø 5mm L 117mm		
	<b>GEV No.</b>	540461	<b>Ref. No.</b> —
	shim for drain tap		
	<b>GEV No.</b>	540464	<b>Ref. No.</b> —
	nut for drain tap thread 1 1/2"		
<b>accessories for</b>	540132		
	<b>GEV No.</b>	510404	<b>Ref. No.</b> —
	flat gasket fibre ED ø 44mm ID ø 34mm thickness 2mm Qty 1 pcs		





1

<b>GEV No.</b>	540275	<b>Ref. No.</b>	30200198
<b>description</b>	drain tap 2" IT with union nut A 90mm B 151mm B1 80mm chrome-plated brass		
<b>For models:</b>	KP20G, KP20GA, KP20GT, KP20GTA, KP30G, KP30GA, KP30GT, KP30GTA, KP50G, KP50GA, KP50GT, KP50GTA, KPGN18G, KPGN27G, KPGN37G, KPI10ET, KPI10ETA, KPI10VT, KPI10VTA, KPI15ET, KPI15ETA, KPI15VT, KPI15VTA, KPI20E, KPI20EA, KPI20ET, KPI20ETA, KPI20G, KPI20GA, KPI20GT, KPI20GTA, KPI20VT, KPI20VTA, KPI30E, KPI30EA, KPI30ET, KPI30ETA, KPI30G, KPI30GA, KPI30GT, KPI30GTA, KPI30VT, KPI30VTA, KPI50E, KPI50EA, KPI50ET, KPI50ETA, KPI50G, KPI50GA, KPI50GT...(Other models you can see in the webshop)		
<b>spare parts for</b>	540275		
	<b>GEV No.</b>	540214	<b>Ref. No.</b> —
	handle ID ø 6mm L 145mm		

Table continues overleaf





accessories for		540275	
	GEV No.	529484	Ref. No. —
	flat gasket fibre ED ø 58mm ID ø 50mm thickness 2mm Qty 1 pcs		
	GEV No.	542448	Ref. No. —
	gasket silicone 60x49x2 for drain tap 2"		

			
1	GEV No.	540267	Ref. No. E50200
	description drain tap connection with union nut thread 2"		
For models:	KP10G, KP10GA, KP10GT, KP10GTA, KP15G, KP15GA, KP15GT, KP15GTA, KP110E, KP110E9, KP110EA, KP110EA9, KP110G, KP110GA, KP110GT, KP110GTA, KP115E, KP115E9, KP115EA, KP115EA9, KP115G, KP115GA, KP115GT, KP115GTA, OPP10G, OPP10GA, OPP15G, OPP15GA, OPP110E, OPP110EA, OPP110G, OPP110GA, OPP115E, OPP115EA, OPP115G, OPP115GA		
spare parts for		540267	
	GEV No.	505517	Ref. No. —
	O-ring EPDM thickness 5.34mm ID ø 53.34mm Qty 1 pcs		
	GEV No.	540214	Ref. No. —
	handle ID ø 6mm L 145mm		

accessories			
			
1	GEV No.	540959	Ref. No. 10500060
	description gasket for drain tap hose ext. ø 60mm ID ø 50mm H 2mm		
For models:	KP20G, KP20GA, KP20GT, KP20GTA, KP30G, KP30GA, KP30GT, KP30GTA, KP50G, KP50GA, KP50GT, KP50GTA, KPGN18G, KPGN27G, KPGN37G, KPI10ET, KPI10ETA, KPI10VT, KPI10VTA, KPI15ET, KPI15ETA, KPI15VT, KPI15VTA, KPI20E, KPI20EA, KPI20ET, KPI20ETA, KPI20G, KPI20GA, KPI20GT, KPI20GTA, KPI20VT, KPI20VTA, KPI30E, KPI30EA, KPI30ET, KPI30ETA, KPI30G, KPI30GA, KPI30GT, KPI30GTA, KPI30VT, KPI30VTA, KPI50E, KPI50EA, KPI50ET, KPI50ETA, KPI50G, KPI50GA, KPI50GT...(Other models you can see in the webshop)		

			
1	GEV No.	540958	Ref. No. 10200002
	description rosette for drain tap hose ext. ø 120mm ID ø 60mm H 13mm		
For models:	KP20G, KP20GA, KP20GT, KP20GTA, KP30G, KP30GA, KP30GT, KP30GTA, KP50G, KP50GA, KP50GT, KP50GTA, KPGN18G, KPGN27G, KPGN37G, KPI10ET, KPI10ETA, KPI10VT, KPI10VTA, KPI15ET, KPI15ETA, KPI15VT, KPI15VTA, KPI20E, KPI20EA, KPI20ET, KPI20ETA, KPI20G, KPI20GA, KPI20GT, KPI20GTA, KPI20VT, KPI20VTA, KPI30E, KPI30EA, KPI30ET, KPI30ETA, KPI30G, KPI30GA, KPI30GT, KPI30GTA, KPI30VT, KPI30VTA, KPI50E, KPI50EA, KPI50ET, KPI50ETA, KPI50G, KPI50GA, KPI50GT...(Other models you can see in the webshop)		

			
1	GEV No.	540957	Ref. No. 10400006
	description screw-in socket for drain tap thread 2" L 120mm		
For models:	KPI10VT, KPI10VTA, KPI15VT, KPI15VTA		

test taps

test taps

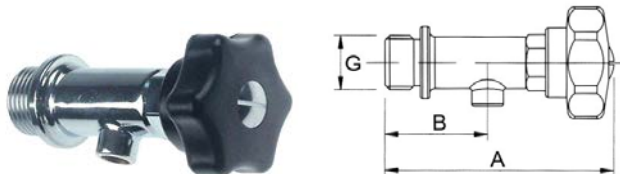
			
1	GEV No.	540818	Ref. No. E50400 Y71300
	description test tap thread 1/2" ETW 88mm W1 38mm		
For models:	CPEI, CPEI9, CPG, CPGI, KPI10E, KPI10E9, KPI10EA, KPI10EA9, KPI10G, KPI10GA, KPI10GT, KPI10GTA, KPI15E, KPI15E9, KPI15EA, KPI15EA9, KPI15G, KPI15GA, KPI15GT, KPI15GTA, KPI20E, KPI20EA, KPI20G, KPI20GA, KPI30E, KPI30EA, KPI30G, KPI30GA, KPI50E, KPI50EA, KPI50G, KPI50GA, OPP110E, OPP110EA, OPP110G, OPP110GA, OPP115E, OPP115EA, OPP115G, OPP115GA		

safety fittings

accessories



<b>GEV No.</b>	540835	<b>Ref. No.</b>	10400061
<b>description</b>	screw cap thread 3/4"		
<b>For models:</b>	KP20GT, KP20GTA, KP30GT, KP30GTA, KP50GT, KP50GTA, KPI10ET, KPI10ETA, KPI15ET, KPI15ETA, KPI20E, KPI20EA, KPI20ET, KPI20ETA, KPI20G, KPI20GA, KPI20GT, KPI20GTA, KPI30E, KPI30EA, KPI30ET, KPI30ETA, KPI30G, KPI30GA, KPI30GT, KPI30GTA, KPI50E, KPI50EA, KPI50ET, KPI50ETA, KPI50G, KPI50GA, KPI50GT, KPI50GTA, KPIGN37G		
<b>spare parts for</b>	540835		
	<b>GEV No.</b>	513016	<b>Ref. No.</b>
	O-ring EPDM thickness 3.53mm ID ø 26.58mm Qty 1 pcs		
<b>accessories for</b>	540835		
	<b>GEV No.</b>	513016	<b>Ref. No.</b>
	O-ring EPDM thickness 3.53mm ID ø 26.58mm Qty 1 pcs		

safety valves



<b>GEV No.</b>	514415	<b>Ref. No.</b>	30300018 30300024
<b>description</b>	safety valve for kettle thread M33		
<b>For models:</b>	KP20GA, KP20GTA, KP30GA, KP30GTA, KP50GA, KP50GTA, KPI10VTA, KPI15VTA, KPI20EA, KPI20GA, KPI20GTA, KPI20VT, KPI20VTA, KPI30EA, KPI30GA, KPI30GTA, KPI30VT, KPI30VTA, KPI50EA, KPI50GA, KPI50GTA, KPI50VT, KPI50VTA		



<b>GEV No.</b>	540721	<b>Ref. No.</b>	Y70300
<b>description</b>	safety valve triggering pressure 0.5bar M88 thread 1 1/4"		
<b>accessories for</b>	540721		
	<b>GEV No.</b>	541501	<b>Ref. No.</b>
	reducer for safety fitting IT 1 1/4" ET 3/4"		



<b>GEV No.</b>	540722	<b>Ref. No.</b>	30300026 Y70800
<b>description</b>	safety valve with outlet for lid		
<b>For models:</b>	KPI10ETA, KPI15ETA, KPI20ETA, KPI30ETA, KPI50ETA		

equipment feet and end caps

equipment feet

with screw mounting



<b>GEV No.</b>	701092	<b>Ref. No.</b>	713-007-00 713-028-00 AVA010ZR10
<b>description</b>	equipment foot tube ø 50mm thread M10 thread L 23mm H 113/160mm SS Qty 1 pcs		
<b>For models:</b>	M72FPTFG, M74F, M74FFXE, M74FFXG, M74FMP, M74FMPFE, M74FMPFG, M74FMPFXE, M74FMPFXG, M74FP, M74FPFE, M74FPFG, M74FPFXE, M74FPFXG, M74P, M74PFXE, M74PQ, M74PQFXE, M74V, M74VFXE, M76F, M76FFXE, M76FFXG, M76FMP, M76FMPFE, M76FMPFG, M76FMPFXE, M76FMPFXG, M76FP, M76FPFE, M76FPFG, M76FPFXE, M76FPFXG, M76P, M76PFXE, M7B4E, M7CP4E, M7CP4G, M7F4E, M7F4G, M7F6E, M7F8G, M7FT4EL, M7FT4ER, M7FT4GL, M7FT4GR, M7FT6EL, M7FT6ELR, M7FT6GL, M7FT6GLR...(Other models you can see in the webshop)		



<b>GEV No.</b>	701304	<b>Ref. No.</b>	905016
<b>description</b>	equipment foot tube ø 52mm thread M10 thread L 18mm H 130-190mm SS size 2" Qty 1 pcs WS 44		
<b>For models:</b>	GLS925		



screw-in feet

			
1			
<b>GEV No.</b>	695614	<b>Ref. No.</b>	765-049-00 M06400
<b>description</b>	equipment foot thread M10 ø 26mm H 30mm		
<b>For models:</b>	15PSE, 2FZP, C1W, C2FZ, C2FZP, C2I, C2P, C2PQ, C2V, C4FZ, C4FZP, C4FZSP, C4I, C4P, C4PQ, C4V, C4VFCE, C4VFE, C6FZ, C6FZP, C6P, C6PQ, CBE4, CBE8, CBG4, CCPE4, CCPE6, CCTP8, CF10DG8M, CF10G4M, CF1E4, CF2E4, CF2E6, CF4E, CF6E, CFTE1, CFTE1C, CFTE1R, CFTE2, CFTE22, CFTE2C, CFTE2C2, CFTE2LR, CFTE2R, CFTE2R2, CFTE3, CFTE3C, CFTE3LR, CFTE3R, CFTE4...(Other models you can see in the webshop)		

bolting feet

			
1			
<b>GEV No.</b>	693442	<b>Ref. No.</b>	064001
<b>description</b>	equipment foot ø 29mm H 15mm rubber bore ø 6mm Qty 1 pcs		
<b>For models:</b>	S300E		

baskets  
fryer baskets

			
1			
<b>GEV No.</b>	970609	<b>Ref. No.</b>	Y46900
<b>description</b>	fryer basket L1 275mm W1 130mm H1 120mm H2 240mm		
<b>For models:</b>	15DPE, 15PE, CF10DG8M, CF10G4M, CFE15, CFE159, CFE15D, CFE15D9, CFG15, CFG15D, KFE15, KFE159, KFE15D, KFE15D9, KFG1, KFG15, KFG15D, KFG2, M7F4G, M7F8G, OPFE15, OPFE15D, OPFG1, OPFG15, OPFG15D, OPFG2, SKF10GM, SKF20GM, TF10GM, TF20GM		

			
1			
<b>GEV No.</b>	970603	<b>Ref. No.</b>	Y46800
<b>description</b>	fryer basket L1 275mm W1 270mm H1 120mm L2 470mm H2 150mm H3 230mm chrome-plated steel		
<b>For models:</b>	15DPE, 15PE, CF10DG8M, CF10G4M, CFE15, CFE159, CFE15D, CFE15D9, KFE15, KFE159, KFE15D, KFE15D9, KFG1, KFG2, M7F4G, M7F8G, OPFE15, OPFE15D, OPFG1, OPFG2, SKF10GM, SKF20GM, TF10GM, TF20GM		

			
1			
<b>GEV No.</b>	970451	<b>Ref. No.</b>	Y48100
<b>description</b>	fryer basket L1 280mm W1 100mm H1 100mm chrome-plated steel		
<b>For models:</b>	CF1E4, CF2E6, CF4E, CF6E, IF1E4, IF2E6, IF4E, IF6E, KFE1, KFE2, M6F4E, M6F6E, M7F4E, M7F6E, OPFE1, OPFE2, SKF1E, SKF2E, SKF4E, SKF6E, TF1E, TF2E, TF4E, TF6E		

			
1			
<b>GEV No.</b>	970215	<b>Ref. No.</b>	Y47700 Y48000
<b>description</b>	fryer basket L1 280mm W1 200mm H1 100mm chrome-plated steel		
<b>For models:</b>	CF1E4, CF2E6, CF4E, CF6E, IF1E4, IF2E6, IF4E, IF6E, KFE1, KFE2, M6F4E, M6F6E, M7F4E, M7F6E, OPFE1, OPFE2, SK10DSE, SK10SE, SKF1E, SKF2E, SKF4E, SKF6E, TF1E, TF2E, TF4E, TF6E		

			
1			
<b>GEV No.</b>	970610	<b>Ref. No.</b>	X55600
<b>description</b>	fryer basket L1 290mm W1 215mm H1 120mm L2 230mm H2 230mm H3 230mm chrome-plated steel		
<b>For models:</b>	CFE15, CFE15D, CFG15, CFG15D, KFE15, KFE15D, KFG15, KFG15D, OPFE15, OPFE15D, OPFG15, OPFG15D		



1

<b>GEV No.</b>	970214	<b>Ref. No.</b>	Y47900
<b>description</b>	fryer basket L1 295mm W1 100mm H1 105mm		
<b>For models:</b>	CF1E4, CF2E6, CF4E, CF6E, IF1E4, IF2E6, IF4E, IF6E, KFE1, KFE2, OPFE1, OPFE2, SK10DSE, SK10SE, SKF1E, SKF2E, SKF4E, SKF6E, TF1E, TF2E, TF4E, TF6E		



1

<b>GEV No.</b>	970449	<b>Ref. No.</b>	X63100
<b>description</b>	fryer basket L1 300mm W1 110mm H1 110mm chrome-plated steel		
<b>For models:</b>	15DPE, 15PE, CF10DG8M, CF10G4M, CF2E4, KFG1, KFG2, OPFG1, OPFG2, SK10DSE, SK10DSE9, SK10SE, SK10SE9, SKF10GM, SKF20GM, SKF2E4, TF10GM, TF20GM, TF2E4		



1

<b>GEV No.</b>	970217	<b>Ref. No.</b>	X62000
<b>description</b>	fryer basket L1 300mm W1 230mm H1 105mm		
<b>For models:</b>	15DPE, 15PE, CF10DG8M, CF10G4M, KFG1, KFG2, OPFG1, OPFG2, SK10DSE, SK10DSE9, SK10SE, SK10SE9, SKF10GM, SKF20GM, TF10GM, TF20GM		



1

<b>GEV No.</b>	970262	<b>Ref. No.</b>	X63200
<b>description</b>	fryer basket L1 315mm W1 123mm H1 130mm		
<b>For models:</b>	CF15DG8, CF15G4		



1

<b>GEV No.</b>	970265	<b>Ref. No.</b>	Y45900
<b>description</b>	fryer basket L1 330mm W1 140mm H1 135mm L2 700mm H2 160mm H3 250mm chrome-plated steel		
<b>For models:</b>	KFE4, KFE8, KFG4, KFG8		



1

<b>GEV No.</b>	970266	<b>Ref. No.</b>	Y46000
<b>description</b>	fryer basket L1 330mm W1 280mm H1 140mm		
<b>For models:</b>	KFE4, KFE8, KFG4, KFG8		

pasta baskets

GIGA



1

<b>GEV No.</b>	970771	<b>Ref. No.</b>	X59600
<b>description</b>	pasta basket H1 160mm W1 135mm L1 275mm L2 470mm H2 185mm H3 270mm stainless steel		
<b>For models:</b>	CCPE4, CCPE6, ICPE4, ICPE6, SKCP40E, SKCP60E, SKCP60G, TCP40E, TCP60E, TCP60G		



1

<b>GEV No.</b>	970608	<b>Ref. No.</b>	DVC002ZR10
<b>description</b>	pasta basket L1 120mm W1 90mm H1 148mm H2 235mm stainless steel		
<b>For models:</b>	M6CP4E, M7CP4E		



1

<b>GEV No.</b>	970607	<b>Ref. No.</b>	712-049-00 X62900
<b>description</b>	pasta basket L1 140mm W1 140mm H1 205mm H2 300mm stainless steel		
<b>For models:</b>	M7CP4G		



1

<b>GEV No.</b>	970223	<b>Ref. No.</b>	X60600
<b>description</b>	pasta basket L1 160mm W1 290mm H1 200mm H3 340mm stainless steel		
<b>For models:</b>	CCPG4, CCPG82, KCP4, KCP4E, KCP82, KCP82E, OPCP4, OPCP4E, OPCP82, OPCP82E		



1

<b>GEV No.</b>	970550	<b>Ref. No.</b>	712-064-00 X59700
<b>description</b>	pasta basket L1 295mm W1 135mm H1 200mm L2 390mm H2 220mm H3 305mm stainless steel		
<b>For models:</b>	CCPG4, CCPG82, M7CP4G		



1

<b>GEV No.</b>	970206	<b>Ref. No.</b>	X62600
<b>description</b>	pasta basket L1 280mm W1 145mm H1 160mm H3 298mm stainless steel		



1

<b>GEV No.</b>	970606	<b>Ref. No.</b>	DVC001ZR10
<b>description</b>	pasta basket L1 295mm W1 95mm H1 125mm H2 240mm stainless steel		
<b>For models:</b>	M6CP4E, M7CP4E		



1

<b>GEV No.</b>	970224	<b>Ref. No.</b>	X62800
<b>description</b>	pasta basket L1 290mm W1 160mm H1 200mm H2 280mm stainless steel		
<b>For models:</b>	CCPG8, KCP8		

crumb screens

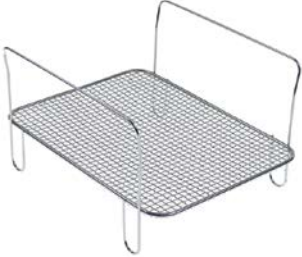

1

<b>GEV No.</b>	970280	<b>Ref. No.</b>	X62300
<b>description</b>	crumb screen L 280mm W 210mm H 150mm suitable for fryer		
<b>For models:</b>	7DSE, 7DSET, 7SE, 7SET		



1

<b>GEV No.</b>	970216	<b>Ref. No.</b>	X62600
<b>description</b>	pasta basket L1 295mm W1 135mm H1 160mm H3 290mm stainless steel		
<b>For models:</b>	CCPE4, CCPE6, SKCP40E, SKCP60E, TCP40E, TCP60E		



1

<b>GEV No.</b>	970271	<b>Ref. No.</b>	X62300
<b>description</b>	crumb screen L 280mm W 210mm suitable for fryer		



1

<b>GEV No.</b>	970222	<b>Ref. No.</b>	Y47800
<b>description</b>	crumb screen L 303mm W 212mm suitable for fryer		
<b>For models:</b>	CF1E4, CF2E6, CF4E, CF6E, IF1E4, IF2E6, IF4E, IF6E, KFE1, KFE2, OPFE1, OPFE2, SK10DSE, SK10SE, SKF1E, SKF2E, SKF4E, SKF6E, TF1E, TF2E, TF4E, TF6E		

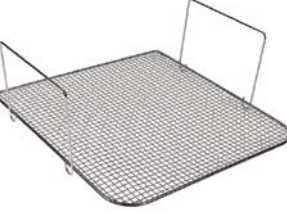

1

<b>GEV No.</b>	970605	<b>Ref. No.</b>	0000Y47000
<b>description</b>	crumb screen L 310mm W 295mm suitable for fryer		
<b>For models:</b>	15DPE, 15PE, CF10DG8M, CF10G4M, CFE15, CFE159, CFE15D, CFE15D9, KFE15, KFE159, KFE15D, KFE15D9, KFG1, KFG2, M7F4G, M7F8G, OPFE15, OPFE15D, OPFG1, OPFG2, SKF10GM, SKF20GM, TF10GM, TF20GM		



1

<b>GEV No.</b>	970219	<b>Ref. No.</b>	X62200
<b>description</b>	crumb screen L 337mm W 237mm fryer		
<b>For models:</b>	CF10DG8M, CF10G4M, KFG1, KFG2, OPFG1, OPFG2, SKF10GM, SKF20GM, TF10GM, TF20GM		



1

<b>GEV No.</b>	970261	<b>Ref. No.</b>	X64600
<b>description</b>	crumb screen L 340mm W 290mm suitable for fryer		
<b>For models:</b>	CF15DG8, CF15G4		

## shelves and shelf rails

### grates

#### producer-specific



1

<b>GEV No.</b>	693443	<b>Ref. No.</b>	055809
<b>description</b>	chargrill grid W 400mm D 345mm SS wire gauge frame 8mm lengthwise wires gauge 3mm crossing wires 1		
<b>For models:</b>	S110E		

## gaskets

### refrigeration gaskets

#### plug-in gaskets

#### profile 9010

We offer custom-made gaskets for this profile

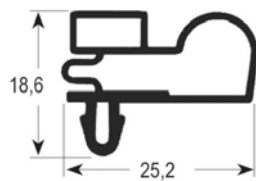

1

<b>GEV No.</b>	900600	<b>Ref. No.</b>	FH250051
<b>description</b>	refrigeration gasket profile 9010 W 660mm L 1585mm plug size		

### gaskets for heated units

#### door seals

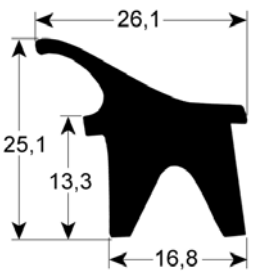

1

<b>GEV No.</b>	900683	<b>Ref. No.</b>	RX3351
<b>description</b>	door seal profile 2400 W 475mm L 645mm Qty 1		

<b>GEV No.</b>	900544	<b>Ref. No.</b>	0000X05600
<b>description</b>	door seal profile 2740 L 1350mm Qty 1		
<b>For models:</b>	C2FTPF, C2FTPFEP, C2FTPFG, C2FTPFGP, C2TP2FGP, C4FFE, C4FFEP, C4FFG, C4FFGP, C4FZFE, C4FZFEP, C4FZFG, C4FZFGP, C4FZSFEP, C4FZSFGP, C4PFCE, C4PFE, C4PFE9, C4PQFCE, C4PQFE, C4VFE, C6FFE, C6FFEP, C6FFG, C6FFGA, C6FFGAP, C6FFGP, C6FZFE, C6FZFEP, C6FZFG, C6FZFGP, C6PFCE, C6PFCEV, C6PFE, C6PQFCE, C6PQFCEV, C6PQFE, CCTPF8, CCTPFG8, CN10FE, K2FTPF, K2FTPFG, K4FFE, K4FFG, K4FS, K4FSFE, K4FSFG, K4FZFE, K4FZFG, K4FZSFE...(Other models you can see in the webshop)		

<b>GEV No.</b>	900230	<b>Ref. No.</b>	X68009
<b>description</b>	door seal profile 2920 L 1400mm Qty 1		
<b>For models:</b>	CC80E, CC80G, CCG80E, CCQ80E, CCV80E		

<b>GEV No.</b>	900229	<b>Ref. No.</b>	0000X05600
<b>description</b>	door seal profile 2930 L 1350mm Qty 1		

### door seals with fixing hook

<b>GEV No.</b>	900231 <sup>1</sup>	<b>Ref. No.</b>	X68201
<b>description</b>	door seal L 590mm W 300mm 3-sided long side open with mounting clip		
<b>For models:</b>	C4FFLE, C4FFLEP, C4FFLG, C4FFLGP, C4PFLE, C4VFLE, C6FFLE, C6FFLEP, C6FFLEPV, C6FFLEV, C6FFLG, C6FFLGP, C6FFLGPV, C6FFLGV, C6PFLE, C6PFLEV, CC120E, CC120G, CC81E, CC81G, CCG120E, CCG81E, CCQ120E, CCQ81E, CCV81E		

<sup>1</sup>3-sided, long side open

### boiling pan gaskets

<b>GEV No.</b>	900819	<b>Ref. No.</b>	10600300
<b>description</b>	boiling pan gasket profile 3010 L 1000mm		
<b>For models:</b>	KP20GA, KP20GTA, KP30GA, KP30GTA, KP50GA, KP50GTA, KPI10ETA, KPI10VTA, KPI15ETA, KPI15VTA, KPI20EA, KPI20GA, KPI20GTA, KPI30EA, KPI30GA, KPI30GTA, KPI50EA, KPI50GA, KPI50GTA		

<b>GEV No.</b>	900821	<b>Ref. No.</b>	10600300/1
<b>description</b>	boiling pan gasket profile 3010 L 2000mm		
<b>For models:</b>	KPI10ETA, KPI10VTA, KPI15ETA, KPI15VTA		

<b>GEV No.</b>	900822	<b>Ref. No.</b>	10600300/2
<b>description</b>	boiling pan gasket profile 3010 L 2400mm		
<b>For models:</b>	KPI20ETA, KPI20VTA		

<b>GEV No.</b>	900823	<b>Ref. No.</b>	10600300/3
<b>description</b>	boiling pan gasket profile 3010 L 3000mm		
<b>For models:</b>	KPI30ETA, KPI30VTA, KPI50ETA, KPI50VTA		

### O-rings

#### EPDM

<b>GEV No.</b>	529545	<b>Ref. No.</b>	904324
<b>description</b>	O-ring EPDM thickness 1.78mm ID $\phi$ 10.82mm Qty 1 pcs		
<b>For models:</b>	GLB615, GLS805, GLS845, GLS945		

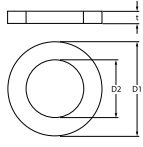
1		
	<b>GEV No.</b> 511500	<b>Ref. No.</b> N/A
<b>description</b> O-ring EPDM thickness 1.78mm ID ø 2.9mm Qty 10 pcs		

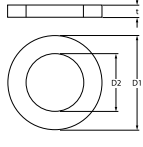
1		
	<b>GEV No.</b> 528815	<b>Ref. No.</b> X05200
<b>description</b> O-ring EPDM thickness 1.78mm ID ø 3.69mm Qty 1 pcs		
<b>For models:</b> CF10DG8M, CF10G4M, KFG1, KFG2, M7F4G, M7F8G, OPFG1, OPFG2, SKF10GM, SKF20GM, TF10GM, TF20GM		

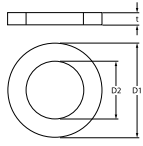
1		
	<b>GEV No.</b> 510303	<b>Ref. No.</b> 904321
<b>description</b> O-ring EPDM thickness 1.78mm ID ø 6.75mm Qty 1 pcs		
<b>For models:</b> GLB615, GLB785, GLB795, GLS805, GLS845, GLS905, GLS925, GLS935, GLS945, GLS945S		

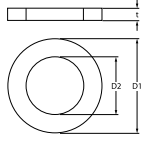
1		
	<b>GEV No.</b> 510177	<b>Ref. No.</b> N/A
<b>description</b> O-ring EPDM thickness 1.78mm ID ø 7.66mm Qty 1 pcs		

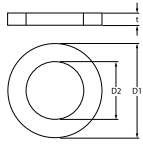
1		
	<b>GEV No.</b> 519181	<b>Ref. No.</b> 904388
<b>description</b> O-ring EPDM thickness 1mm ID ø 5mm Qty 1 pcs		
<b>For models:</b> GLB615, GLB785, GLB795, GLS805, GLS845, GLS905, GLS925, GLS935, GLS945, GLS945S		

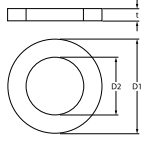
1		
	<b>GEV No.</b> 518227	<b>Ref. No.</b> N/A
<b>description</b> O-ring EPDM thickness 2.62mm ID ø 12.37mm Qty 1 pcs		

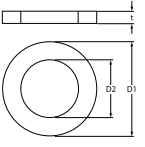
1		
	<b>GEV No.</b> 528333	<b>Ref. No.</b> 904390
<b>description</b> O-ring EPDM thickness 2.62mm ID ø 13.1mm Qty 1 pcs		
<b>For models:</b> GLS935		

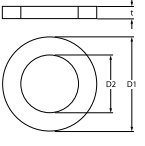
1		
	<b>GEV No.</b> 510893	<b>Ref. No.</b> 904391
<b>description</b> O-ring EPDM thickness 2.62mm ID ø 9.92mm Qty 1 pcs		
<b>For models:</b> GLB785, GLB795		

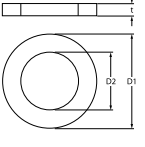
1		
	<b>GEV No.</b> 510554	<b>Ref. No.</b> N/A
<b>description</b> O-ring EPDM thickness 2mm ID ø 120mm Qty 1 pcs		

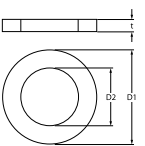
1		
	<b>GEV No.</b> 510009	<b>Ref. No.</b> N/A
<b>description</b> O-ring EPDM thickness 3.53mm ID ø 101.2mm Qty 1 pcs		

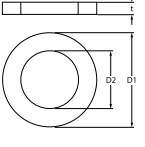
1		
	<b>GEV No.</b> 511322	<b>Ref. No.</b> 904430
<b>description</b> O-ring EPDM thickness 3.53mm ID ø 20.22mm Qty 1 pcs		
<b>For models:</b> GLB615, GLB785, GLB795, GLS805, GLS845, GLS905, GLS925, GLS945, GLS945S		

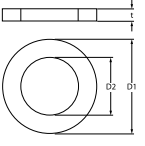
1		
	<b>GEV No.</b> 501352	<b>Ref. No.</b> 904404
<b>description</b> O-ring EPDM thickness 3.53mm ID ø 21.82mm Qty 1 pcs		
<b>For models:</b> GLS805, GLS845, GLS905, GLS925		



<b>GEV No.</b>	511937	<b>Ref. No.</b>	10500110
<b>description</b>	O-ring EPDM thickness 3.53mm ID ø 28.17mm Qty 1 pcs		
<b>For models:</b>	KP20GT, KP20GTA, KP30GT, KP30GTA, KP50GT, KP50GTA, KPI10ET, KPI10ETA, KPI15ET, KPI15ETA, KPI20E, KPI20EA, KPI20ET, KPI20ETA, KPI20G, KPI20GA, KPI20GT, KPI20GTA, KPI30E, KPI30EA, KPI30ET, KPI30ETA, KPI30G, KPI30GA, KPI30GT, KPI30GTA, KPI50E, KPI50EA, KPI50ET, KPI50ETA, KPI50G, KPI50GA, KPI50GT, KPI50GTA, KPIGN37G		

<b>GEV No.</b>	521120	<b>Ref. No.</b>	907981 SD907981
<b>description</b>	O-ring EPDM thickness 5.34mm ID ø 37.47mm Qty 1 pcs		
<b>For models:</b>	GLB785, GLB795, GLS905, GLS925, GLS935		

<b>GEV No.</b>	510072	<b>Ref. No.</b>	904350 N/A
<b>description</b>	O-ring EPDM thickness 3.53mm ID ø 32.93mm Qty 1 pcs		
<b>For models:</b>	GLB615, GLB785, GLB795		

<b>GEV No.</b>	510408	<b>Ref. No.</b>	E11700
<b>description</b>	O-ring EPDM thickness 5.34mm ID ø 47mm Qty 1 pcs		
<b>For models:</b>	CPEI, CPEI9, KPI10E, KPI10E9, KPI10EA, KPI10EA9, KPI15E, KPI15E9, KPI15EA, KPI15EA9, KPI20E, KPI20EA, KPI30E, KPI30EA, KPI50E, KPI50EA, OPPI10E, OPPI10EA, OPPI15E, OPPI15EA		

<b>GEV No.</b>	510899	<b>Ref. No.</b>	X05400
<b>description</b>	O-ring EPDM thickness 3.53mm ID ø 37.69mm Qty 1 pcs		
<b>For models:</b>	CCPE4, CFE15, CFE159, CFE15D, CFE15D9, CMP4, KCP4E, KCP82E, KFE15, KFE159, KFE15D, KFE15D9, KFE20, KFE20D, OPCP4E, OPCP82E, OPFE15, OPFE15D, OPFE20, OPFE20D, SKCP40E, TCP40E, TMP4		

<b>GEV No.</b>	532545	<b>Ref. No.</b>	X05000
<b>description</b>	O-ring Viton thickness 3.53mm ID ø 49.21mm Qty 1 pcs		
<b>For models:</b>	CCPE4, CFE15, CFE159, CFE15D, CFE15D9, KCP4E, KCP82E, KFE15, KFE159, KFE15D, KFE15D9, KFE20, KFE20D, OPCP4E, OPCP82E, OPFE15, OPFE15D, OPFE20, OPFE20D, SKCP40E, TCP40E		

<b>GEV No.</b>	519179	<b>Ref. No.</b>	904380
<b>description</b>	O-ring EPDM thickness 3.53mm ID ø 41.28mm Qty 1 pcs		
<b>For models:</b>	GLB615, GLB785, GLB795, GLS805, GLS845, GLS935, GLS945, GLS945S		

<b>GEV No.</b>	510551	<b>Ref. No.</b>	D456023
<b>description</b>	pump cover gasket ID ø 158.3mm pump type 1214/1293/1225/2243/1226/1204/3473/1241 thickness 3.53mm EPDM Qty 1 pcs		

<b>GEV No.</b>	511331	<b>Ref. No.</b>	904395
<b>description</b>	O-ring EPDM thickness 3.53mm ID ø 53.57mm Qty 1 pcs		
<b>For models:</b>	GLS935, GLS945, GLS945S		

silicone			
<b>GEV No.</b>	695064	<b>Ref. No.</b>	I64004120
<b>description</b>	O-ring silicone thickness 2mm ID ø 66.4mm Qty 1 pcs		

Viton

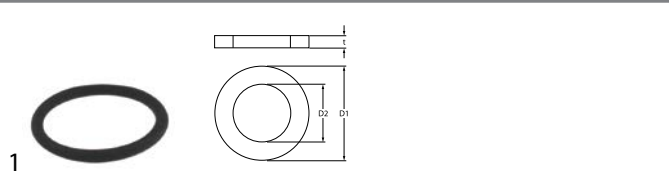

<b>GEV No.</b>	528155	<b>Ref. No.</b>	X05300
<b>description</b>	O-ring Viton thickness 3.53mm ID ø 32.93mm Qty 1 pcs		
<b>For models:</b>	CCPE4, CFE15, CFE159, CFE15D, CFE15D9, KCP4E, KCP82E, KFE15, KFE159, KFE15D, KFE15D9, KFE20, KFE20D, OPCP4E, OPCP82E, OPFE15, OPFE15D, OPFE20, OPFE20D, SKCP40E, TCP40E		

sealing washers

fibre gaskets



<b>GEV No.</b>	518541	<b>Ref. No.</b>	N/A
<b>description</b>	flat gasket FIBER ED ø 12mm ID ø 8mm thickness 1.5mm Qty 1 pcs		



<b>GEV No.</b>	518393	<b>Ref. No.</b>	N/A
<b>description</b>	flat gasket FIBER ED ø 24mm ID ø 17mm thickness 2mm Qty 1 pcs		



<b>GEV No.</b>	510417	<b>Ref. No.</b>	N/A
<b>description</b>	flat gasket fibre ED ø 20mm ID ø 14mm thickness 2mm Qty 1 pcs		



<b>GEV No.</b>	510406	<b>Ref. No.</b>	E50300
<b>description</b>	flat gasket fibre ED ø 60mm ID ø 48mm thickness 3mm for thread 1½" Qty 1 pcs		
<b>For models:</b>	KP10G, KP10GA, KP10GT, KP10GTA, KP15G, KP15GA, KP15GT, KP15GTA, KP20G, KP20GA, KP30G, KP30GA, KP50G, KP50GA, KPI10E, KPI10EA, KPI10EA9, KPI10G, KPI10GA, KPI10GT, KPI10GTA, KPI15E, KPI15EA, KPI15EA9, KPI15G, KPI15GA, KPI15GT, KPI15GTA, KPI20E, KPI20EA, KPI20G, KPI20GA, KPI30E, KPI30EA, KPI30G, KPI30GA, KPI50E, KPI50EA, KPI50G, KPI50GA, OPP10G, OPP10GA, OPP15G, OPP15GA, OPPI10E, OPPI10EA, OPPI10G, OPPI10GA... (Other models you can see in the webshop)		

rubber gaskets



<b>GEV No.</b>	510075	<b>Ref. No.</b>	N/A
<b>description</b>	flat gasket rubber ED ø 22mm ID ø 13mm thickness 1.5mm Qty 1 pcs		



<b>GEV No.</b>	511936	<b>Ref. No.</b>	904991
<b>description</b>	flat gasket rubber ED ø 25mm ID ø 16.5mm thickness 1.8mm Qty 1 pcs warewashing		
<b>For models:</b>	GLB615, GLS805, GLS845, GLS905, GLS925		



<b>GEV No.</b>	519114	<b>Ref. No.</b>	903260 SD903260
<b>description</b>	flat gasket rubber ED ø 25mm ID ø 16.5mm thickness 2mm Qty 1 pcs		
<b>For models:</b>	GLB615, GLB785, GLB795, GLS805, GLS845		



<b>GEV No.</b>	519113	<b>Ref. No.</b>	903250
<b>description</b>	flat gasket rubber ED ø 28mm ID ø 19mm thickness 3mm Qty 1 pcs		
<b>For models:</b>	GLS935, GLS945, GLS945S		



<b>GEV No.</b>	513059	<b>Ref. No.</b>	N/A
<b>description</b>	flat gasket rubber ED ø 52mm ID ø 40mm thickness 3mm Qty 1 pcs		





<b>GEV No.</b>	519117	<b>Ref. No.</b>	903301
<b>description</b>	flat gasket rubber ED ø 60mm ID ø 47mm thickness 3mm Qty 1 pcs		
<b>For models:</b>	GLB615, GLB785, GLB795		



<b>GEV No.</b>	519118	<b>Ref. No.</b>	903320
<b>description</b>	flat gasket rubber ED ø 70mm ID ø 52mm thickness 3mm Qty 1 pcs		
<b>For models:</b>	GLS805, GLS845		

 <p>1</p>			
<b>GEV No.</b>	519347	<b>Ref. No.</b>	TR2448
<b>description</b>	flat gasket rubber ED ø 80mm ID ø 60mm thickness 3mm Qty 1 pcs equiv. no. TR2448 suitable for Silanos		
<b>For models:</b>	GLS9455		

 <p>1</p>			
<b>GEV No.</b>	510071	<b>Ref. No.</b>	N/A
<b>description</b>	flat gasket rubber ED ø 81mm ID ø 68mm thickness 3mm for salt tank Qty 1 pcs		

 <p>1</p>			
<b>GEV No.</b>	518060	<b>Ref. No.</b>	D456040
<b>description</b>	gasket rubber ED ø 132mm ID ø 122mm thickness 5mm		

plastic gaskets

 <p>1</p>			
<b>GEV No.</b>	504435	<b>Ref. No.</b>	908146
<b>description</b>	flat gasket plastic ED ø 18mm ID ø 9.5mm thickness 2.5mm for door hinge Qty 1 pcs		
<b>For models:</b>	GLS905, GLS925		

copper gaskets

DIN-7603-C

 <p>1</p>			
<b>GEV No.</b>	691624	<b>Ref. No.</b>	K98800
<b>description</b>	gasket copper ED ø 17mm ID ø 12.5mm thickness 2.5mm		
<b>For models:</b>	CFG15, CFG15D, KFG15, KFG15D, KFG20, KFG20D, OPFG15, OPFG15D, OPFG20, OPFG20D		

paper gasket

 <p>1</p>			
<b>GEV No.</b>	511650	<b>Ref. No.</b>	903403
<b>description</b>	flat gasket paper ED ø 24mm ID ø 10.5mm thickness 1mm Qty 1 pcs warewashing		
<b>For models:</b>	GLB615, GLS805, GLS845		

PTFE gaskets

 <p>1</p>			
<b>GEV No.</b>	510012	<b>Ref. No.</b>	N/A
<b>description</b>	flat gasket PTFE ED ø 16.5mm ID ø 12.5mm thickness 1.5mm Qty 1 pcs equiv. no. 437008		

special gaskets

door seals for dishwashers

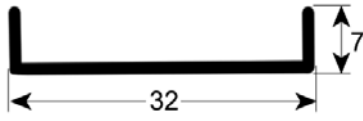
 <p>1</p>			
<b>GEV No.</b>	518536	<b>Ref. No.</b>	N/A
<b>description</b>	door seal L 590mm W 32mm dishwasher suitable for ELETTRORBAR, WOLK equiv. no. 437052		

miscellaneous

 <p>1</p>			
<b>GEV No.</b>	510066	<b>Ref. No.</b>	N/A
<b>description</b>	gasket for filter		

 <p>1</p>			
<b>GEV No.</b>	510014	<b>Ref. No.</b>	N/A
<b>description</b>	gasket suitable for HOBART equiv. no. 139321-155 L 84mm W 40mm thickness 2.5mm		

gaskets for wash arm support

 <p>1</p>			
<b>GEV No.</b>	506223	<b>Ref. No.</b>	905257
<b>description</b>	gasket D1 ø 110mm D2 ø 82mm thickness 3mm with 4 screw holes flange		
<b>For models:</b>	GLS905, GLS925		



1

<b>GEV No.</b>	518025	<b>Ref. No.</b>	N/A
<b>description</b>	gasket D1 ø 50mm D2 ø 82mm thickness 2mm with 6 holes wash arm support equiv. no. 437014 suitable for COLGED		



1

<b>GEV No.</b>	519445	<b>Ref. No.</b>	908141
<b>description</b>	gasket D1 ø 80mm D2 ø 50mm thickness 3mm with 4 screw holes		
<b>For models:</b>	GLS805, GLS845, GLS905, GLS925, GLS945		



1

<b>GEV No.</b>	518339	<b>Ref. No.</b>	N/A
<b>description</b>	gasket D2 ø 50mm thickness 2mm with 3 screw holes wash arm support equiv. no. 437064 suitable for COLGED hole ø 50mm hole distance 67mm		

## refrigeration cycle components

### cooling water regulators

#### JOHNSON CONTROLS



1

<b>GEV No.</b>	541483	<b>Ref. No.</b>	I62011100
<b>description</b>	cooling water regulator 3/8" type V46AA-9950 connection 6mm soldering connection pressure range 5-18bar water pressure max. 10bar water temperature max. 90°C capillary pipe 750mm L 160mm 0.9kg		

## transmission technology and ball bearings

### ball bearings

#### flange bearings



1

<b>GEV No.</b>	693112	<b>Ref. No.</b>	X61500
<b>description</b>	flange bearing type UCF204 shaft ø 20mm 4 hole flange hole distance 64mm H 33mm flange length 86mm flange width 86mm hole ø 12mm flange F204 ball bearing UC204G2 FH 25.5mm		

## springs

### torsion springs



1

<b>GEV No.</b>	690548	<b>Ref. No.</b>	Y71500
<b>description</b>	torsion spring ø 39mm wire gauge ø 7mm L1 281mm L2 31mm L3 24mm mounting pos. left		
<b>For models:</b>	KBRE, KBRE12, KBRE12IN, KBRE9, KBREIN, KBREIN9, KBREM, KBREM12, KBREM12IN, KBREMIN, KBRG, KBRG12, KBRG12IN, KBRGIN, KBRGM, KBRGM12, KBRGM12IN, KBRGMIN, OPBRE, OPBRE12, OPBRE12IN, OPBRE12MIN, OPBREIN, OPBREM, OPBREM12, OPBREM12IN, OPBREM12MIN, OPBRG, OPBRG12, OPBRG12IN, OPBRG12MIN, OPBRGIN, OPBRGM, OPBRGM12, OPBRGM12IN, OPBRGMIN		



1

<b>GEV No.</b>	690549	<b>Ref. No.</b>	Y71800
<b>description</b>	torsion spring ø 39mm wire gauge ø 7mm L1 31mm L2 281mm L3 24mm mounting pos. left		
<b>For models:</b>	KBRE12, KBRE12IN, KBREM, KBREM12, KBREM12IN, KBREMIN, KBRG12, KBRG12IN, KBRGM12, KBRGM12IN, OPBRE12, OPBRE12IN, OPBRE12MIN, OPBREM, OPBREM12, OPBREM12IN, OPBREM12MIN, OPBRG12, OPBRG12IN, OPBRG12MIN, OPBRGM12, OPBRGM12IN		



### compression springs

			
1			
<b>GEV No.</b>	691622	<b>Ref. No.</b>	X15800
<b>description</b>	compression spring ø 13.4/8.3mm L 15mm wire gauge ø 0.75mm conical		
<b>For models:</b>	CC120CG, CC120G, CC80G, CC81CG, CC81G, CCG120CE, CCG120E, CCG80E, CCG81CE, CCG81E, IFTE1, IFTE1C, IFTE1R, IFTE2, IFTE22, IFTE2C, IFTE2C2, IFTE2LR, IFTE2R, IFTE2R2, IFTE3, IFTE3C, IFTE3LR, SKC40G, SKC80G, SKT1E, SKT1EC, SKT1ER, SKT2E, SKT2E2, SKT2EC, SKT2EC2, SKT2ELR, SKT2ER, SKT2ER2, SKT3E, SKT3EC, SKT3ELR, SKT40E, SKT40EC, SKT40ER, SKT60E, SKT60E2, SKT60EC, SKT60EC2, SKT60ELR, SKT60ER, SKT60ER2, SKT80E, SKT80EC...(Other models you can see in the webshop)		

### tension springs

			
1			
<b>GEV No.</b>	519443	<b>Ref. No.</b>	908041
<b>description</b>	tension spring ø 11.5mm total length 220mm wire gauge ø 2mm		
<b>For models:</b>	GLS905, GLS925		

			
1			
<b>GEV No.</b>	519163	<b>Ref. No.</b>	904133 904137
<b>description</b>	tension spring ø 38.5mm total length 394mm wire gauge ø 6.5mm for hood		
<b>For models:</b>	GLS935, GLS945, GLS945S		

### manometers



			
1			
<b>GEV No.</b>	541579	<b>Ref. No.</b>	E51000
<b>description</b>	manometer ø 52mm pressure range 0 up to 1bar connection marking 0.5 thread 1/4"		
<b>For models:</b>	CPEI, CPEI9, CPG, CPGI, KP10G, KP10GA, KP15G, KP15GA, KP10E, KP10E9, KP10EA, KP10EA9, KP110G, KP110GA, KP110GT, KP110GTA, KP115E, KP115E9, KP115EA, KP115EA9, KP115G, KP115GA, KP115GT, KP115GTA, OPPI10E, OPPI10EA, OPPI10G, OPPI10GA, OPPI15E, OPPI15EA, OPPI15G, OPPI15GA		

			
1			
<b>GEV No.</b>	541062	<b>Ref. No.</b>	30300022 Y70700
<b>description</b>	manometer ø 63mm pressure range 0 up to 1bar connection marking adjustable kettle thread 1/4"		
<b>For models:</b>	KP20GT, KP20GTA, KP30GT, KP30GTA, KP50GT, KP50GTA, KP10ET, KP110ETA, KP110VT, KP110VTA, KP115ET, KP115ETA, KP115VT, KP115VTA, KP120E, KP120EA, KP120ET, KP120ETA, KP120G, KP120GA, KP120GT, KP120GTA, KP120VT, KP120VTA, KP130E, KP130EA, KP130ET, KP130ETA, KP130G, KP130GA, KP130GT, KP130GTA, KP130VT, KP130VTA, KP150E, KP150EA, KP150ET, KP150ETA, KP150G, KP150GA, KP150GT, KP150GTA, KP150VT, KP150VTA, KPIGN37G		

### dosing pumps

#### piston pumps

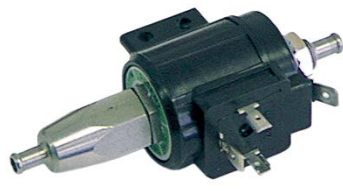
##### with solenoid coil

			
1			
<b>GEV No.</b>	361026	<b>Ref. No.</b>	D987017
<b>description</b>	dosing pump inlet 5mm outlet 5mm 230V detergent duty cycle 30% type EV1		
<b>spare parts for</b>	361026		
		<b>GEV No.</b>	361365
		<b>Ref. No.</b>	D201020
	solenoid coil 230VAC for type EV1		
		<b>GEV No.</b>	510298
		<b>Ref. No.</b>	—
	lip valve dosing pump suitable for DB2/DS5		

##### spare parts

			
1			
<b>GEV No.</b>	361113	<b>Ref. No.</b>	D201002
<b>description</b>	solenoid coil 230VAC for type DB2		

			
1			
<b>GEV No.</b>	361365	<b>Ref. No.</b>	D201020
<b>description</b>	solenoid coil 230VAC for type EV1		



1

<b>GEV No.</b>	361366	<b>Ref. No.</b>	N/A
<b>description</b>	PCB dishwasher 11F suitable for DB2 type DB2/EV1/EKP-M		









## membrane dosing pumps

### self-priming

#### LANG



1

<b>GEV No.</b>	361575	<b>Ref. No.</b>	902199
<b>description</b>	dosing pump type N6 rinse aid pressure connection $\varnothing$ straight, 4x6mm suction connection $\varnothing$ angled, 6mm LANG		
<b>For models:</b>	GLB785, GLB795, GLS935		
<b>spare parts for</b>	361575		
	<b>GEV No.</b>	361079	<b>Ref. No.</b> —
	spring for type N5/N6 for ball		
	<b>GEV No.</b>	361080	<b>Ref. No.</b> —
	O-ring EPDM thickness 2mm ID $\varnothing$ 16mm Qty 1 pcs		
	<b>GEV No.</b>	361085	<b>Ref. No.</b> —
	O-ring EPDM thickness 2mm ID $\varnothing$ 8mm Qty 1 pcs		
	<b>GEV No.</b>	361309	<b>Ref. No.</b> —
	ball for type N5/N6		
	<b>GEV No.</b>	361310	<b>Ref. No.</b> —
	bracket for type N6 ball guide		
	<b>GEV No.</b>	361311	<b>Ref. No.</b> —
	O-ring EPDM thickness 2mm ID $\varnothing$ 6mm Qty 1 pcs for type N6		
	<b>GEV No.</b>	361314	<b>Ref. No.</b> —
	valve ring for type N6 holder for O-ring		
	<b>GEV No.</b>	361317	<b>Ref. No.</b> —
	sealing disc for type N6		
	<b>GEV No.</b>	361886	<b>Ref. No.</b> —
	non-return valve inletmm outletmm outlet $\varnothing$ 12.4mm L 12.7mm		

## self-priming with supporting pressure

### GERMAC

#### type 2001



1

<b>GEV No.</b>	361545	<b>Ref. No.</b>	902018
<b>description</b>	dosing pump type 2001 rinse aid inlet 4x6mm outlet M10x1 suction connection $\varnothing$ 4x6mm supporting pressure 11mm rebound ball PTFE 1mm GERMAC CODE VNR/U3		
<b>For models:</b>	GLB615, GLS805, GLS845, GLS905, GLS925, GLS945, GLS945S		
<b>spare parts for</b>	361545		
	<b>GEV No.</b>	361551	<b>Ref. No.</b> —
	compression spring wire gauge $\varnothing$ 1mm		
	<b>GEV No.</b>	361700	<b>Ref. No.</b> —
	hose connector rotary hose $\varnothing$ 4x6mm plastic connection M10x1		
	<b>GEV No.</b>	361702	<b>Ref. No.</b> —
	hose connector brass hose $\varnothing$ 4x6mm		
	<b>GEV No.</b>	361705	<b>Ref. No.</b> —
	gasket for hose connector M12x1		
	<b>GEV No.</b>	510298	<b>Ref. No.</b> —
	lip valve dosing pump suitable for DB2/DS5		
<b>accessories for</b>	361545		
	<b>GEV No.</b>	361142	<b>Ref. No.</b> —
	mounting set detergent hose type 4x6mm hose length 2m PVC 2x hose/container filter/tank intake transparent		
	<b>GEV No.</b>	361550	<b>Ref. No.</b> —
	hose connector hose $\varnothing$ 4x6mm		
	<b>GEV No.</b>	361553	<b>Ref. No.</b> —
	membrane EPDM		
	<b>GEV No.</b>	361701	<b>Ref. No.</b> —
	hose connector thread M10x1 grommet $\varnothing$ 7.5mm		
	<b>GEV No.</b>	361703	<b>Ref. No.</b> —
	hose connector thread M10x1 brass pipe connection $\varnothing$ 4x6mmmm		
	<b>GEV No.</b>	361704	<b>Ref. No.</b> —
	hose connector brass straight thread M12x1 hose $\varnothing$ 11mm Qty 1 pcs		
	<b>GEV No.</b>	510296	<b>Ref. No.</b> —
	membrane silicone		
	<b>GEV No.</b>	520090	<b>Ref. No.</b> —
	PVC hose ID $\varnothing$ 4mm ED $\varnothing$ 6mm L 2m thickness 1mm t.max. 60°C transparent		
	<b>GEV No.</b>	520091	<b>Ref. No.</b> —
	nylon hose ID $\varnothing$ 4mm ED $\varnothing$ 6mm L 2m thickness 1mm operating p. 10bar burst p. 50bar t.max. 100°C transparent		



accessories



container filters

			
1			
<b>GEV No.</b>	361062	<b>Ref. No.</b>	902568
<b>description</b>	container filter hose ø 4mm		
<b>For models:</b>	GLS935, GLS945S		

			
1			
<b>GEV No.</b>	513043	<b>Ref. No.</b>	N/A
<b>description</b>	container filter hose ø 4mm		

T-pieces

without non-return valve

				
1				
<b>GEV No.</b>	512093	<b>Ref. No.</b>	905408	
<b>description</b>	T-piece connection 1: 12mm connection 2: 4mm			
<b>For models:</b>	GLB615, GLS805, GLS845, GLS905, GLS925, GLS945, GLS945S			
<b>accessories for</b>	512093			
	<b>GEV No.</b>	361083	<b>Ref. No.</b>	—
union nut T1: M10x1 for hose 6mm				

			
1			
<b>GEV No.</b>	519217	<b>Ref. No.</b>	905381
<b>description</b>	T-piece plastic hose ø 12-9-12mm 3-way hose ø 12-9-12mmmm		
<b>For models:</b>	GLS935		



tank inlets

			
1			
<b>GEV No.</b>	361270	<b>Ref. No.</b>	D468151 D999104
<b>description</b>	tank inlet SS M12 hose ø 4mm		

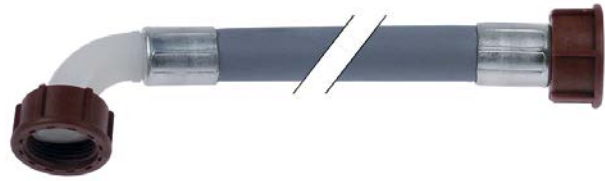

hoses

supply hoses

PVC supply hoses

				
1				
<b>GEV No.</b>	520010	<b>Ref. No.</b>	907344	
<b>description</b>	supply hose PVC straight-curved DN13 connections 3/4" L 1500mm operating p. 10bar burst p. 32bar t.max. 90°C blue approval VDE flat seal			
<b>For models:</b>	GLB615, GLB785, GLB795, GLS805, GLS845, GLS905, GLS925			
<b>accessories for</b>	520010			
	<b>GEV No.</b>	520053	<b>Ref. No.</b>	—
screen connection 3/4" D1 ø 26mm D2 ø 15mm Qty 10 pcs rubber thickness 8mm				
	<b>GEV No.</b>	520054	<b>Ref. No.</b>	—
flat gasket rubber ED ø 23.5mm ID ø 14mm thickness 2.3mm Qty 10 pcs				

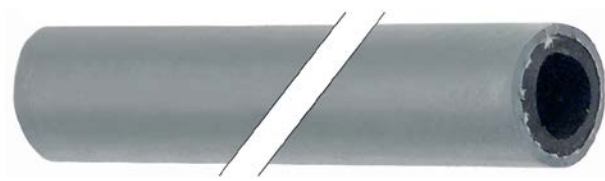
			
1			
<b>GEV No.</b>	520011	<b>Ref. No.</b>	907345
<b>description</b>	supply hose PVC straight-curved DN13 connections 3/4" L 2000mm operating p. 10bar burst p. 32bar t.max. 90°C approval VDE flat seal		
<b>For models:</b>	GLS935, GLS945, GLS945S		

				
1				
<b>GEV No.</b>	520015	<b>Ref. No.</b>	N/A	
<b>description</b>	supply hose ID ø 10mm ED ø 17mm L 5m operating p. 20bar burst p. 60bar t.max. 95°C grey Qty 5m			
<b>accessories for</b>	520015			
	<b>GEV No.</b>	504377	<b>Ref. No.</b>	—
hose connector grommet ø 23mm grommet length 25mm total length 55mm for water filling				



drain hoses

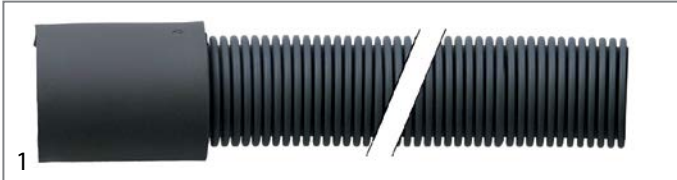

<b>GEV No.</b>	513718	<b>Ref. No.</b>	D143120
<b>description</b>	drain hose DN19 L 1500mm straight ø inside 24mm straight ext. ø 28mm outer hose ø 23mm		



<b>GEV No.</b>	518068	<b>Ref. No.</b>	D143136
<b>description</b>	drain hose DN34 L 2000mm elbow ø inside 50mm elbow ext. ø 59mm inner hose ø 35mm outer hose ø 42mm PVC		

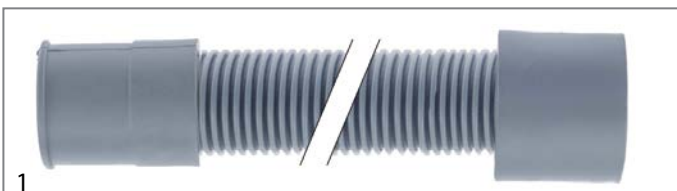

<b>GEV No.</b>	518518	<b>Ref. No.</b>	N/A
<b>description</b>	drain hose DN19 L 1500mm A int. ø 21mm A ext. ø 27mm B int. ø 29mm B ext. ø 35mm outer hose ø 25mm		

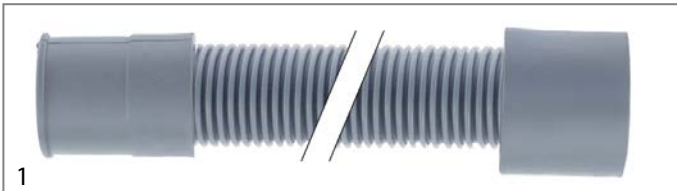

<b>GEV No.</b>	518219	<b>Ref. No.</b>	N/A
<b>description</b>	drain hose DN19 L 630mm A int. ø 20mm A ext. ø 27mm B int. ø 21mm B ext. ø 28mm outer hose ø 24mm		

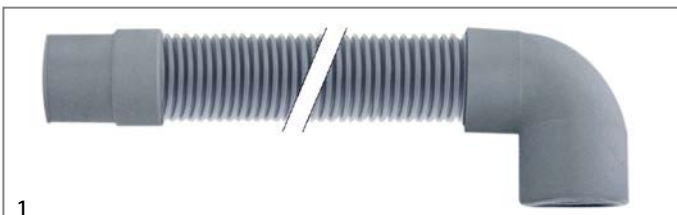

<b>GEV No.</b>	530571	<b>Ref. No.</b>	907440
<b>description</b>	drain hose DN24 L 1500mm straight ø inside 24mm straight ext. ø 29mm elbow ø inside 29mm elbow ext. ø 35mm outer hose ø 28mm		
<b>For models:</b>	GLB615, GLB785, GLB795		

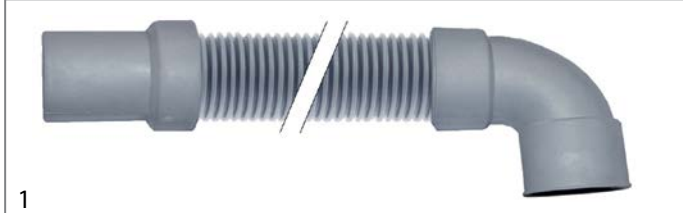

<b>GEV No.</b>	519272	<b>Ref. No.</b>	907450 907451
<b>description</b>	drain hose DN24 L 1500mm straight ø inside 32mm straight ext. ø 35mm elbow ø inside 40mm elbow ext. ø 46mm outer hose ø 38mm		
<b>For models:</b>	GLS805, GLS845, GLS935, GLS945, GLS945S		

industrial hoses

nylon hoses



<b>GEV No.</b>	520032	<b>Ref. No.</b>	907260
<b>description</b>	nylon hose ID ø 4mm ED ø 6mm L 5m thickness 1mm operating p. 10bar burst p. 50bar t.max. 100°C blue		
<b>For models:</b>	GLS805, GLS845		

pressure control hoses



<b>GEV No.</b>	530560	<b>Ref. No.</b>	N/A
<b>description</b>	pressure control hose ID ø 5mm ED ø 9mm L 5m operating p. 30bar burst p. 90bar temp.-resist. 60°C		

PVC hoses

PVC hoses without fabric



<b>GEV No.</b>	520027	<b>Ref. No.</b>	907270
<b>description</b>	PVC hose ID ø 4mm ED ø 7mm L 10m thickness 1.5mm t.max. 60°C transparent		
<b>For models:</b>	GLB615, GLB785, GLB795, GLS805, GLS845, GLS935		



**silicone hoses**  
without fabric



1

<b>GEV No.</b>	530410	<b>Ref. No.</b>	907272 907279
<b>description</b>	silicone hose ID ø 4mm ED ø 7mm L 2m thickness 1.5mm t.max. 200°C transparent		
<b>For models:</b>	GLB615, GLB785, GLB795, GLS805, GLS845, GLS905, GLS925, GLS935, GLS945, GLS945S		



1

<b>GEV No.</b>	519392	<b>Ref. No.</b>	903756
<b>description</b>	formed hose L 61mm dishwasher straight hose ext. ø 50mm hose int. ø 38mm		
<b>For models:</b>	GLS805, GLS845, GLS905, GLS925, GLS945		

**formed hoses**

**straight**



1

<b>GEV No.</b>	518070	<b>Ref. No.</b>	N/A
<b>description</b>	formed hose dishwasher straight mounting pos. upper equiv. no. 127026		



1

<b>GEV No.</b>	518381	<b>Ref. No.</b>	N/A
<b>description</b>	formed hose dishwasher straight mounting pos. upper equiv. no. 127035		



1

<b>GEV No.</b>	518380	<b>Ref. No.</b>	N/A
<b>description</b>	formed hose ext. ø 53 ID ø 43mm L 65mm dishwasher straight mounting pos. upper equiv. no. 127036		

**form L**



1

<b>GEV No.</b>	519137	<b>Ref. No.</b>	903701
<b>description</b>	formed hose D1 ø 75mm D2 ø 59mm L 220mm curved		
<b>For models:</b>	GLS935		



1

<b>GEV No.</b>	519563	<b>Ref. No.</b>	908136
<b>description</b>	formed hose end piece A ext. ø 56mm end piece A int. ø 45mm AD2 ø 56mm ø end piece B 44mm L 160mm Qty 1 L-shape		
<b>For models:</b>	GLS905, GLS925		



1

<b>GEV No.</b>	519160	<b>Ref. No.</b>	903876
<b>description</b>	formed hose L 150mm warewashing L-shape equiv. no. 903876 W 110mm hose int. ø 40mm		
<b>For models:</b>	GLS805, GLS845		



1

<b>GEV No.</b>	518216	<b>Ref. No.</b>	N/A
<b>description</b>	formed hose warewashing L-shape equiv. no. 127001 mounting pos. upper		



1

<b>GEV No.</b>	518520	<b>Ref. No.</b>	N/A
<b>description</b>	formed hose warewashing L-shape equiv. no. 127005		



1

<b>GEV No.</b>	518225	<b>Ref. No.</b>	N/A
<b>description</b>	formed hose warewashing L-shape equiv. no. 127041		



1

<b>GEV No.</b>	519128	<b>Ref. No.</b>	903665
<b>description</b>	formed hose warewashing L-shape equiv. no. 903665		
<b>For models:</b>	GLB785, GLB795		



1

<b>GEV No.</b>	519132	<b>Ref. No.</b>	903674
<b>description</b>	formed hose warewashing L-shape equiv. no. 903674		
<b>For models:</b>	GLB615, GLB785, GLB795		



1

<b>GEV No.</b>	519151	<b>Ref. No.</b>	908713
<b>description</b>	formed hose warewashing L-shape equiv. no. 903761		
<b>For models:</b>	GLS9455		



1

<b>GEV No.</b>	519159	<b>Ref. No.</b>	903875
<b>description</b>	formed hose warewashing L-shape equiv. no. 903875		
<b>For models:</b>	GLS805, GLS845		

**form S**



1

<b>GEV No.</b>	519131	<b>Ref. No.</b>	903668
<b>description</b>	formed hose S-shape warewashing equiv. no. 903668		
<b>For models:</b>	GLB615		

**form U**



1

<b>GEV No.</b>	518517	<b>Ref. No.</b>	N/A
<b>description</b>	formed hose for drain pump D1 ø 28mm D2 ø 21mm warewashing U-shape		



miscellaneous



1

<b>GEV No.</b>	518036	<b>Ref. No.</b>	N/A
<b>description</b>	formed hose angled warewashing		



1

<b>GEV No.</b>	519216	<b>Ref. No.</b>	905382
<b>description</b>	T-piece plastic hose ø 12-12-12mm 3-way		
<b>For models:</b>	GLB615, GLB785, GLB795, GLS805, GLS845, GLS905, GLS925, GLS935, GLS945S		

for dishwashers

miscellaneous



1

<b>GEV No.</b>	519448	<b>Ref. No.</b>	907295
<b>description</b>	hose D1 ø 12mm D2 ø 19.5mm		
<b>For models:</b>	GLB615, GLB785, GLB795, GLS805, GLS845, GLS905, GLS925, GLS935, GLS945, GLS945S		



1

<b>GEV No.</b>	519217	<b>Ref. No.</b>	905381
<b>description</b>	T-piece plastic hose ø 12-9-12mm 3-way hose ø 12-9-12mmmm		
<b>For models:</b>	GLS935		



1

<b>GEV No.</b>	530590	<b>Ref. No.</b>	907359
<b>description</b>	hose ED ø 15mm ID ø 8mm equiv. no. 200117 Qty supplied by meter		
<b>For models:</b>	GLS935		

fittings

angle pieces



1

<b>GEV No.</b>	520821	<b>Ref. No.</b>	908120
<b>description</b>	angle piece thread 1/4" IT - 1/4" IT nickel-plated brass		
<b>For models:</b>	GLB785, GLB795, GLS935, GLS945, GLS945S		



1

<b>GEV No.</b>	530432	<b>Ref. No.</b>	907360
<b>description</b>	pressure hose ED ø 17mm ID ø 10mm L 1000mm operating p. 10bar burst p. 25bar temp.-resist. 110°C		
<b>For models:</b>	GLB615, GLB785, GLB795		

fittings, hose and pipe connectors

hose connectors

without screw connection



1

<b>GEV No.</b>	541109	<b>Ref. No.</b>	N/A
<b>description</b>	Y-piece plastic hose ø 8-6-8mm for pressure switch		

hose connectors

brass



1

<b>GEV No.</b>	513253	<b>Ref. No.</b>	N/A
<b>description</b>	hose connector brass angled thread 1/4" hose ø 12mm Qty 1 pcs		

nickel-plated brass



1

<b>GEV No.</b>	519239	<b>Ref. No.</b>	905452 905453
<b>description</b>	hose connector nickel-plated brass thread 1/4" hose ø 11mm Qty 1 pcs		
<b>For models:</b>	GLB615, GLS945, GLS945S		

producer-specific



1			
<b>GEV No.</b>	519290	<b>Ref. No.</b>	908121
<b>description</b>	hose connector		
<b>For models:</b>	GLS935, GLS945, GLS9455		



1			
<b>GEV No.</b>	519291	<b>Ref. No.</b>	906003
<b>description</b>	hose connector		
<b>For models:</b>	GLB785, GLB795, GLS805, GLS845		



1			
<b>GEV No.</b>	512093	<b>Ref. No.</b>	905408
<b>description</b>	T-piece connection 1: 12mm connection 2: 4mm		
<b>For models:</b>	GLB615, GLS805, GLS845, GLS905, GLS925, GLS945, GLS9455		
<b>accessories for</b>	512093		



<b>GEV No.</b>	361083	<b>Ref. No.</b>	—
union nut T1: M10x1 for hose 6mm			



1			
<b>GEV No.</b>	514325	<b>Ref. No.</b>	M75400
<b>description</b>	ball valve connection 1" IT - 1" IT DN25 total length 83mm with lever handle		
<b>For models:</b>	15DPE, 15PE, CCPE4, CCPE6, CCPG4, CCPG8, CCPG82, CF10DG8M, CF10G4M, CF15DG8, CF15G4, CFE15, CFE15D, CFG15, CFG15D, KCP4, KCP4E, KCP8, KCP82, KCP82E, KFE15, KFE15D, KFE20, KFE20D, KFE4, KFE8, KFG1, KFG15, KFG15D, KFG2, KFG20, KFG20D, KFG4, KFG8, OPCP4, OPCP4E, OPCP82, OPCP82E, OPFE15, OPFE15D, OPFE20, OPFE20D, OPFG1, OPFG15, OPFG15D, OPFG2, OPFG20, OPFG20D, TCP40E, TCP60E		



1			
<b>GEV No.</b>	540730	<b>Ref. No.</b>	M75500
<b>description</b>	ball valve connection 3/4" IT - 3/4" IT DN20 total length 70mm with lever handle handle length 95mm		
<b>For models:</b>	CCPE4, CCPE6, KB4, KB4G, KB8, OPB4, OPB4G, OPB8, SKCP40E, SKCP60E, TCP40E, TCP60E		

producer-specific

GIGA



1			
<b>GEV No.</b>	514212	<b>Ref. No.</b>	0000X15300
<b>description</b>	ball valve total length 93mm handle length 95mm L 93mm inlet 3/4" ET lever handle grommet ø 22mm outlet ø22mm		
<b>For models:</b>	15DPE, 15PE, CF10DG8M, CF10G4M, CF1E4, CF2E6, CF4E, CF6E, CFE15, CFE159, CFE15D, CFE15D9, IBE4, IBE8, ICPE4, ICPE6, IF1E4, IF2E6, IF4E, IF6E, IRE4, IRE6, KFE1, KFE15, KFE159, KFE15D, KFE15D9, KFE2, KFE20, KFE20D, KFG1, KFG2, OPFE1, OPFE15, OPFE15D, OPFE2, OPFE20, OPFE20D, OPFG1, OPFG2, TF1E, TF2E, TF4E, TF6E		

accessories



1			
<b>GEV No.</b>	514217	<b>Ref. No.</b>	M75700 old
<b>description</b>	handle for outlet tap		

valves and tank inlets

ball valves

universal

ball valves with lever handle



1			
<b>GEV No.</b>	520282	<b>Ref. No.</b>	AVA015ZR10
<b>description</b>	ball valve connection 1" IT - 1" IT DN25 total length 67mm with lever handle		
<b>For models:</b>	15DPE, 15PE, CCPG4, CCPG82, CF10DG8M, CF10G4M, CFG15, CFG15D, KCP4, KCP4E, KCP82, KCP82E, KFG1, KFG15, KFG15D, KFG2, KFG20, KFG20D, M7CP4G, M7F4G, M7F8G, OPCP4, OPCP4E, OPCP82, OPCP82E, OPFG1, OPFG15, OPFG15D, OPFG2, OPFG20, OPFG20D		







shut-off valves

universal



1

<b>GEV No.</b>	514370	<b>Ref. No.</b>	0000X18000
<b>description</b>	shut-off valve connection 1/2" 1/2" hot total length 54mm shaft ø M5x0.8mm		
<b>For models:</b>	CBRE, CBRE9, CBREIN, CBREIN9, CBRG, CBRGIN, CCPE4, CCPE6, CCPG4, CCPG8, CCPG82, ICPE4, ICPE6, KB4, KB4G, KB8, KBRE, KBRE12, KBRE12IN, KBRE9, KBREIN, KBREIN9, KBREM, KBREM12, KBREM12IN, KBREMIN, KBRG, KBRG12, KBRG12IN, KBRGIN, KBRGM, KBRGM12, KBRGM12IN, KBRGMIN, KCP4, KCP4E, KCP82, KCP82E, M7CP4G, OPB4, OPB4G, OPB8, OPBRE, OPBRE12, OPBRE12IN, OPBRE12MIN, OPBREIN, OPBREM, OPBREM12, OPBREM12IN...(Other models you can see in the webshop)		
<b>spare parts for</b>	514370		
	<b>GEV No.</b>	514085	<b>Ref. No.</b> —
	rosette connection 26x19G chrome-plated total lengthmm mounting pos.		
	<b>GEV No.</b>	514086	<b>Ref. No.</b> —
	hexagonal nut connection 26x19G brass total lengthmm mounting pos. H 6mm WS 34 Qty 1 pcs		
	<b>GEV No.</b>	540414	<b>Ref. No.</b> —
	star handle connection hot total lengthmm mounting pos. shaft diameter 7x7mm ø 55mm 35 built-in depth 22mm		
	<b>GEV No.</b>	540415	<b>Ref. No.</b> —
	star handle connection cold total lengthmm mounting pos. shaft diameter 7x7mm ø 55mm 35 built-in depth 22mm		
	<b>GEV No.</b>	540672	<b>Ref. No.</b> —
	gasket suitable for tap head		





1

<b>GEV No.</b>	514208	<b>Ref. No.</b>	M75600
<b>description</b>	shut-off valve connection 1/2" 1/2" straight total length 64mm shaft ø 8x10mm		
<b>For models:</b>	KB4, KB8, KBRE, KBRE12, KBRE12IN, KBREIN, KBREM, KBREM12, KBREM12IN, KBREMIN, KBRG, KBRG12, KBRG12IN, KBRGIN, KBRGM, KBRGM12, KBRGM12IN, KBRGMIN, KCP8, OPBRG, OPBRG12, OPBRG12IN, OPBRGIN		

inlet taps



1

<b>GEV No.</b>	514214	<b>Ref. No.</b>	Y71000
<b>description</b>	inlet spout tube ø 20mm projection 90mm overall height 175mm spout height 135mm rotation 360° thread 1/2" ET		
<b>accessories for</b>	514214		
	<b>GEV No.</b>	511470	<b>Ref. No.</b> —
	nut thread 1/2" ø 40mm H 8mm WS 25 brass Qty 1 pcs		
	<b>GEV No.</b>	511474	<b>Ref. No.</b> —
	flat washer for thread 1/2"		
	<b>GEV No.</b>	511477	<b>Ref. No.</b> —
	flat gasket rubber ED ø 42mm ID ø 21mm thickness 2mm Qty 1 pcs		

ancillary products

clamps

hose clamps

DIN 3017 - W2



1

<b>GEV No.</b>	520115	<b>Ref. No.</b>	902460
<b>description</b>	hose clamp ø 25-40mm width 9mm Qty 10 pcs DIN 3017		
<b>For models:</b>	GLB615, GLB785, GLB795, GLS905, GLS925, GLS935		



1

<b>GEV No.</b>	520116	<b>Ref. No.</b>	902441
<b>description</b>	hose clamp ø 32-50mm width 9mm Qty 5 pcs DIN 3017		
<b>For models:</b>	GLB615, GLB785, GLB795, GLS805, GLS845, GLS905, GLS925, GLS945, GLS945S		



1

<b>GEV No.</b>	520117	<b>Ref. No.</b>	902480
<b>description</b>	hose clamp stainless steel ø 40-60mm width 9mm Qty 5 pcs DIN 3017		
<b>For models:</b>	GLS805, GLS845, GLS945, GLS945S		



DIN 3017 - W4



<b>GEV No.</b>	520120	<b>Ref. No.</b>	902440
<b>description</b>	hose clamp SS W4 ø 12-20mm width 9mm Qty 1 pcs DIN 3017		
<b>For models:</b>	GLB615, GLB785, GLB795, GLS805, GLS845, GLS905, GLS925, GLS935, GLS945, GLS945S		

oval head screws



<b>GEV No.</b>	560569	<b>Ref. No.</b>	907785
<b>description</b>	oval head screw thread M6 internal thread L 13mm head ø 16mm stainless steel Qty 1 pcs ø 9x13mm		
<b>For models:</b>	GLS935		

measuring equipment

thermometers

built-in thermometers



<b>GEV No.</b>	541086	<b>Ref. No.</b>	907090
<b>description</b>	thermometer mounting measurements 58x25.5mm 0 up to +120°C capillary pipe 2000mm probe ø 6mm probe L 23mm		
<b>For models:</b>	GLS935, GLS945, GLS945S		

hexagonal screws



<b>GEV No.</b>	560309	<b>Ref. No.</b>	907846
<b>description</b>	hexagonal screw thread M10 thread L 16mm SS WS 17 Qty 1 pcs DIN 933 / ISO 4017		
<b>For models:</b>	GLB615		

fastening material

screws

countersunk screws



<b>GEV No.</b>	560266	<b>Ref. No.</b>	907651
<b>description</b>	countersunk screw thread M4 L 8mm SS DIN 965/ISO 7046 Qty 1 pcs head ø 7.5mm		
<b>For models:</b>	GLB615, GLB785, GLB795, GLS805, GLS845, GLS905, GLS925, GLS935, GLS945, GLS945S		



<b>GEV No.</b>	560086	<b>Ref. No.</b>	907780
<b>description</b>	hexagonal screw thread M6 thread L 10mm SS WS 10 Qty 20 pcs DIN 933 / ISO 4017		
<b>For models:</b>	GLS945		



<b>GEV No.</b>	560464	<b>Ref. No.</b>	907820
<b>description</b>	hexagonal screw thread M8 thread L 12mm SS WS 13 Qty 1 pcs head thickness 5mm DIN 933 / ISO 4017		
<b>For models:</b>	GLB615, GLB785, GLB795, GLS805, GLS845, GLS905, GLS925, GLS935, GLS945, GLS945S		

knurled screws



<b>GEV No.</b>	560267	<b>Ref. No.</b>	907871
<b>description</b>	countersunk screw thread M5 L 25mm SS DIN 965/ISO 7046 Qty 1 pcs intake Phillips		
<b>For models:</b>	GLS805, GLS845		

<b>GEV No.</b>	510112	<b>Ref. No.</b>	N/A
<b>description</b>	Thumb screw thread M10 thread L 10mm ø 22mm H 4.5mm SS		



nuts

hexagonal nuts

DIN 934 / ISO 4032/8673

 <p>1</p>			
<b>GEV No.</b>	560197	<b>Ref. No.</b>	902022 902025
<b>description</b>	nut thread M10 H 8mm WS 17 SS DIN/ISO DIN 934 / ISO 4032/8673 Qty 1 pcs		
<b>For models:</b>	GLB615, GLS805, GLS845, GLS935		

DIN 985

 <p>1</p>			
<b>GEV No.</b>	560142	<b>Ref. No.</b>	902040
<b>description</b>	hexagonal nut thread M6 H 6mm SS WS 10 Qty 20 pcs DIN/ISO DIN 985 self-locking		
<b>For models:</b>	GLB785, GLS805, GLS845		

hexagonal nuts metric (without norm)

 <p>1</p>			
<b>GEV No.</b>	521134	<b>Ref. No.</b>	N/A
<b>description</b>	hexagonal nut thread M14x1 SS		

 <p>1</p>			
<b>GEV No.</b>	519059	<b>Ref. No.</b>	902130
<b>description</b>	locknut thread 1"		
<b>For models:</b>	GLS935		

 <p>1</p>			
<b>GEV No.</b>	519056	<b>Ref. No.</b>	902090
<b>description</b>	locknut thread 1 3/4"		
<b>For models:</b>	GLS805, GLS845		

 <p>1</p>			
<b>GEV No.</b>	345351	<b>Ref. No.</b>	R3160D
<b>description</b>	nut thread M12x0.75 H 1.6mm WS 14 chrome-plated brass Qty 1 pcs		

 <p>1</p>			
<b>GEV No.</b>	519050	<b>Ref. No.</b>	902023
<b>description</b>	nut thread M12x1.75 H 4mm WS 16 SS Qty 1 pcs for snap lock		
<b>For models:</b>	GLB615, GLB785, GLB795, GLS805, GLS845, GLS905, GLS925		

 <p>1</p>			
<b>GEV No.</b>	550261	<b>Ref. No.</b>	N/A
<b>description</b>	nut thread M14x1 H 4mm WS 19 SS Qty 1 pcs		

 <p>1</p>			
<b>GEV No.</b>	102067	<b>Ref. No.</b>	X15900
<b>description</b>	nut thread M8x1 H 3mm brass Qty 1 pcs type SEF 1		
<b>For models:</b>	CC120CG, CC120G, CC80G, CC81CG, CC81G, CCG120CE, CCG120E, CCG80E, CCG81CE, CCG81E, SKC40G, SKC80G		

hexagonal nuts inch thread

 <p>1</p>			
<b>GEV No.</b>	503042	<b>Ref. No.</b>	902100
<b>description</b>	nut thread 3/8" H 6mm brass WS 22 Qty 1 pcs		
<b>For models:</b>	GLB615, GLB785, GLB795, GLS805, GLS845		

 <p>1</p>			
<b>GEV No.</b>	506024	<b>Ref. No.</b>	902104
<b>description</b>	nut thread 3/8" H 6mm SS WS 22 Qty 1 pcs		
<b>For models:</b>	GLB615, GLS805, GLS845, GLS905, GLS925		

washers

spring rings

 <p>1</p>			
<b>GEV No.</b>	519235	<b>Ref. No.</b>	905941
<b>description</b>	lock washer		
<b>For models:</b>	GLS935, GLS945, GLS945S		



1

<b>GEV No.</b>	560124	<b>Ref. No.</b>	905940
<b>description</b>	lock washer ID $\varnothing$ 8.3mm ED $\varnothing$ 15mm SS DIN127 Qty 20 pcs for thread M8		
<b>For models:</b>	GLS935		

## washers

## DIN 125A



1

<b>GEV No.</b>	560312	<b>Ref. No.</b>	906055
<b>description</b>	plain washer ID $\varnothing$ 10.5mm ED $\varnothing$ 20mm thickness 2mm SS Qty 1 pcs DIN 125A for thread M10		
<b>For models:</b>	GLB615, GLS805, GLS845, GLS935, GLS945, GLS945S		

## miscellaneous



1

<b>GEV No.</b>	519241	<b>Ref. No.</b>	906050
<b>description</b>	plain washer for roller spring		
<b>For models:</b>	GLS935		



1

<b>GEV No.</b>	519238	<b>Ref. No.</b>	906002
<b>description</b>	plain washer ID $\varnothing$ 15mm ED $\varnothing$ 33mm thickness 0.8mm SS Qty 1 pcs		
<b>For models:</b>	GLB785, GLB795		

## fasteners

## clamps

## hose clamps

## DIN 3017 - W2



1

<b>GEV No.</b>	520115	<b>Ref. No.</b>	902460
<b>description</b>	hose clamp $\varnothing$ 25-40mm width 9mm Qty 10 pcs DIN 3017		
<b>For models:</b>	GLB615, GLB785, GLB795, GLS905, GLS925, GLS935		



1

<b>GEV No.</b>	520116	<b>Ref. No.</b>	902441
<b>description</b>	hose clamp $\varnothing$ 32-50mm width 9mm Qty 5 pcs DIN 3017		
<b>For models:</b>	GLB615, GLB785, GLB795, GLS805, GLS845, GLS905, GLS925, GLS945, GLS945S		



1

<b>GEV No.</b>	520117	<b>Ref. No.</b>	902480
<b>description</b>	hose clamp stainless steel $\varnothing$ 40-60mm width 9mm Qty 5 pcs DIN 3017		
<b>For models:</b>	GLS805, GLS845, GLS945, GLS945S		

## DIN 3017 - W4



1

<b>GEV No.</b>	520120	<b>Ref. No.</b>	902440
<b>description</b>	hose clamp SS W4 $\varnothing$ 12-20mm width 9mm Qty 1 pcs DIN 3017		
<b>For models:</b>	GLB615, GLB785, GLB795, GLS805, GLS845, GLS905, GLS925, GLS935, GLS945, GLS945S		

## retaining rings

## DIN 471



1

<b>GEV No.</b>	691621	<b>Ref. No.</b>	M29600
<b>description</b>	retaining ring shaft $\varnothing$ 40mm thickness 1.8mm steel DIN 471		
<b>For models:</b>	CCPE4, CFE15, CFE159, CFE15D, CFE15D9, KCP4E, KCP82E, KFE15, KFE159, KFE15D, KFE15D9, KFE20, KFE20D, OPCE4E, OPCE82E, OPFE15, OPFE15D, OPFE20, OPFE20D, SKCP40E, TCP40E		

## DIN 7993



1

<b>GEV No.</b>	518308	<b>Ref. No.</b>	N/A
<b>description</b>	retaining ring DIN 7993 for drain assembly thickness 3mm ED $\varnothing$ 57mm		





roll pins



1

<b>GEV No.</b>	690968	<b>Ref. No.</b>	E10300028
<b>description</b>	roll pin ø 5mm L 20mm		

consumables

lava rocks / ceramic briquetts



1

<b>GEV No.</b>	105342	<b>Ref. No.</b>	M30500
<b>description</b>	lava rocks content 9kg		
<b>For models:</b>	CPLG1, CPLG2, CPLG4, CPLG8, KPLG1, KPLG2, M7PL1G, M7PL2G, OPPLG1, OPPLG2, SKPL1G, SKPL2G, SKPL4G, SKPL8G, TPLG1, TPLG2		

fuses

fine fuses



1

<b>GEV No.</b>	358605	<b>Ref. No.</b>	40200084
<b>description</b>	fine fuse size ø5x20mm 3.15A slow-acting rated 250V Qty 10 pcs		
<b>For models:</b>	KPI10ET, KPI10ETA, KPI15ET, KPI15ETA		



**B**

ball valves	140
bar burners	83
bi-metal thermostats	19
boiling pan gaskets	127
booster pumps II	50

**C**

cable glands	52
cables	52
cam switches	30
capillary tube clips	27
ceramic heaters	10
clamps	141, 144
condensators & interference suppression filters	51
consumables	145
contactors	38
container filters	135
control equipment	34
control thermostats	20, 25
cooling water regulators	132
countersunk screws	142

**D**

door seals	126
door seals for dishwashers	131
door seals with fixing hook	127
dosing pumps	133
drain hoses	136

**E**

edgemount latches	115
electric accessories	52
electrodes	44
electronic controllers	39
energy regulators	19

**F**

fans	44
fasteners	144
fastening material	142
filters	51
fine fuses	145
fittings	139
float switches	30
foil heating elements	16
formed hoses	137
fuses	51, 145

**G**

gas ball valves	92
gas burners	73

gas control valves	61
gas nozzles	86
gas taps	53
gas thermostats	58
gaskets for heated units	126
gaskets for wash arm support	131
grates	126

**H**

handle latches	115
heating elements	3
heating elements for bain maries	3
heating elements for chargrills	9
heating elements for chip scuttles	4
heating elements for convection	14
heating elements for fryers	4
heating elements for griddles	7
heating elements for ovens	3
heating elements for pasta cookers	8
heating elements for salamanders/toasters	10
heating elements for tilting bratt pan	7
hexagonal nuts	143
hexagonal screws	142
hob burners	73
hose clamps	141, 144
hose connectors	139, 139
hoses	135
hot air fans	44
hot air motors	44
hot plates	18

**I**

ignition cables	69
ignition switches	70
ignition units	70
immersion heating elements	10
indicator lights	34
indicator lights (complete)	35
industrial hoses	136
inlet spouts	141
inlet taps	141

**K**

knurled screws	142
----------------	-----

**L**

lamps	34
lava rocks / ceramic briquetts	92, 145
light bulbs	35

**M**

magnetic switches	33
measuring equipment	142

mechanical timers	37	shut-off valves	141
microswitches	28	silicone hoses	137
<b>N</b>		snap locks	115
nuts	143	solenoid valves	41
nylon hoses	136	spring assisted hinges	115
<b>O</b>		spring clips	27
operating capacitors	51	spring rings	143
O-rings	127	supply hoses	135
oval head screws	142	switches and momentary switches	28
oven hinges	116	system switches (ROLD)	29
oven lamps	35	<b>T</b>	
<b>P</b>		tank inlets	135
piezoelectric igniters	69	temperature probes	40
pilot burners	62	terminals	52
plug-in gaskets	126	thermocouples	71
plunger sockets	27	thermostats	19
pressure control hoses	136	threaded cable glands	52
pressure switches	42	timers	36
probe clips	27	touch sensitive light switches	33
probes	40	tube burners	85
programme timers	36	<b>U</b>	
pumps	46	universal probes	40
pumps for ice machines	50	<b>V</b>	
push/momentary push switches	28	valves and tank inlets	140
PVC hoses	136	<b>W</b>	
PVC supply hoses	135	wash and rinse pumps	46
<b>Q</b>		washers	144
quartz heating elements	10		
<b>R</b>			
radiation heaters	15		
refrigeration cycle components	132		
refrigeration fans	44		
refrigeration gaskets	126		
refrigeration motors universal	44		
refrigeration thermostats	26		
relays	39		
residual heat indicators	36		
retaining rings	144		
rocker/momentary rocker switches	28		
roll pins	145		
<b>S</b>			
safety bi-metal thermostats	19		
safety thermostats	23, 25		
safety valves	62		
screws	142		
sealing washers	130		
shelves and shelf rails	126		