



GAS COMPONENTS



ELECTRIC COMPONENTS



WATER TECHNOLOGY



MECHANICAL COMPONENTS



TOOLS

Spare parts suitable for

GAMKO

Find the complete and up-to-date range of products in our GEV Webshop



Manufacturer catalogue

The most important spare parts and accessories arranged clearly for every manufacturer

- ✓ Complete product range and all appliance data always up to date in the GEV Webshop
- ✓ Alphabetical Index at the end of the catalogue

GEV Webshop

www.gev-online.co.uk

www.gev-online.com



- 🔍 Add to Favourites
- 🔍 Sign In with email address and usual password
- 🔍 Easy-order – place several items in your basket at the same time
- 🔍 Quick Item search – no login needed



switches and momentary switches

microswitches

with push button

switches with snap-fit



1

GEV No.	346772	Ref. No.	008040111
description	microswitch with push button 250V 5A 1CO connection male faston 4.8mm L 24x27mm ambient temperature max. 85°C actuating force: 160g		

timers

defrost timers

MINI T



1

GEV No.	360150	Ref. No.	008060005
description	switch clock type 3611 defrosting interval 1-48x per 24h defrosting time 15-144 minmin fan delaymin defr. funct. 1-48x per 24h		

electronic controllers

DIXELL

refrigeration controllers

built-in version



1

GEV No.	378267	Ref. No.	005050168	
description	electronic controller DIXELL XR02CX-5N0C1 mounting measurements 71x29mm built-in depth 56mm 230V voltage AC NTC relay outputs 1 NO-20A(8) NTC DI protection IP54 defrosting function/time control -40 up to +110°C display 2½ digit			
For models:	MG145-McDonalds, MG95-McDonalds			
accessories for	378267			
	GEV No.	379161	Ref. No.	—
	temperature probe NTC 10kOhm cable thermoplastic probe -40 up to +110°C cable -40 up to +110°C probe ø6x14mm cable length 3m without screw connection 2-wire			
	GEV No.	381249	Ref. No.	—
	temperature probe NTC 10kOhm cable PVC probe -40 up to +110°C cable -10 up to 100°C connection 2-wire thread probe ø6x14mm cable length 3m			

LAE

refrigeration controllers

built-in version



1

GEV No.	378184	Ref. No.	005050225	
description	electronic controller LAE type LCD32Q4E-C mounting measurements 149x30mm 230V voltage AC NTC relay outputs 4 NO-20A(6) NO-12A(4) NO-8A(3) CO-8A(3) NTC NTC DI DI front measurements 169x38mm built-in depth 78mm protection IP55 yes yes -30 up to +30°C display 3 digits			
accessories for	378184			
	GEV No.	379784	Ref. No.	—
	temperature probe NTC 2kOhm cable thermoplastic probe -40 up to +110°C cable -40 up to +110°C probe ø6x35mm cable length 2m without screw connection 2-wire resistor 2kOhm			

evaporation and condensing trays

condensing trays heated

universal

condensing trays



1

GEV No.	750431	Ref. No.	008100029	
description	condensing tray horizontal L 300mm W 140mm H 100mm with howle for heating cartridge PTC (3/8") universal capacity 2.8l			
accessories for	750431			
	GEV No.	417570	Ref. No.	—
	heating cartridge 110W 230V ø 12mm L 120mm thread 3/8" cable length 1000mm universal			
	GEV No.	417571	Ref. No.	—
	heating cartridge 230W 230V ø 12mm L 180mm thread 3/8" cable length 1000mm universal			
	GEV No.	417572	Ref. No.	—
	heating cartridge 330W 230V ø 12mm L 240mm thread 3/8" cable length 1000mm universal			
	GEV No.	417577	Ref. No.	—
	heating cartridge 190W 230V ø 12mm L 180mm thread 3/8" cable length 300mm suitable for MONDIAL			



fans

axial fans

import



1

GEV No.	601601 ¹	Ref. No.	007030229
description	axial fan L 119mm W 119mm H 38mm 230VAC 50/60Hz 22W bearing slide bearing manuf. no. DP200A2123XST.GN SUNON input current 0.14A		
For models:	MG145-McDonalds, MG95-McDonalds		

¹with slide bearings

1

GEV No.	601457 ¹	Ref. No.	007030260
description	axial fan L 127mm W 127mm H 38mm 12VDC 12.72W bearing ball bearing connection cable 300mm plastic ADDA fan wheel ø 120mm		

¹with ball bearings

refrigeration fans

refrigeration motors universal

ebm-papst

multi fit fan motors

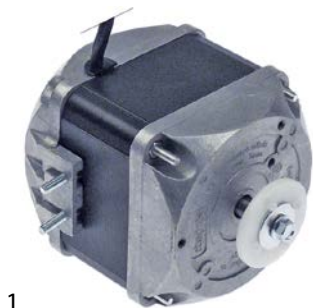

1

GEV No.	601760	Ref. No.	007030268	
description	fan motor 25W 230V 50/60Hz L1 44mm L3 103mm W 77.5mm cable length 1500mm 1300/1550rpm ebm-papst M4Q045-EA01-75 5 mounting options bearing slide bearing			
spare parts for	601760			
	GEV No.	601413	Ref. No.	—
	fixing plate suitable for fanwheel ED ø 32mm shaft ø 7 mounting distance 26mm			

ELCO

N series - multi fit







1

GEV No.	601528	Ref. No.	007030267	
description	fan motor ELCO 16W 230V 50/60Hz bearing slide bearing L1 48mm L2 64mm L3 91.5mm W 83mm connection cable 500mm 1300/1550rpm 5 mounting options VNT16-25/029			
spare parts for	601528			
	GEV No.	601413	Ref. No.	—
	fixing plate suitable for fanwheel ED ø 32mm shaft ø 7 mounting distance 26mm			



1

GEV No.	601430	Ref. No.	007030265	
description	fan motor ELCO 5W 230V 50/60Hz bearing slide bearing L1 48mm L2 52mm L3 79.5mm W 83mm connection cable 500mm 1300/1550rpm 5 mounting options VNT5-13/027			
spare parts for	601430			
	GEV No.	560140	Ref. No.	—
	hexagonal nut thread M4 H 4.8mm SS WS 7 Qty 20 pcs DIN/ISO DIN 985 self-locking			
	GEV No.	560332	Ref. No.	—
	plain washer ID ø 4.3mm ED ø 9mm thickness 0.8mm SS Qty 1 pcs			
	GEV No.	560340	Ref. No.	—
	hexagonal nut thread M4 H 3.2mm WS 7 SS DIN/ISO DIN 934 / ISO 4032/8673 Qty 1 pcs			
	GEV No.	601413	Ref. No.	—
	fixing plate suitable for fanwheel ED ø 32mm shaft ø 7 mounting distance 26mm			

FMI



1

GEV No.	601331	Ref. No.	007030203
description	fan motor 10W 230V 50Hz L1 58mm L2 51mm L3 88mm W 84mm cable length 500mm 1250rpm AA.7AL.639.X 5 mounting options bearing slide bearing		
spare parts for	601331		
	GEV No.	601413	Ref. No. —
	fixing plate suitable for fanwheel ED ϕ 32mm shaft ϕ 7 mounting distance 26mm		



1

GEV No.	601330	Ref. No.	
description	fan motor 5W 230V 50Hz L1 51mm L2 51mm L3 81mm W 84mm cable length 500mm 1250rpm AA.7AL.639.X 5 mounting options bearing slide bearing		
spare parts for	601330		
	GEV No.	601413	Ref. No. —
	fixing plate suitable for fanwheel ED ϕ 32mm shaft ϕ 7 mounting distance 26mm		

motors

gear motors

for ice-cube maker

miscellaneous



1

GEV No.	601445	Ref. No.	025010609
description	gear motor 1rpm		

for gyros grills



1

GEV No.	500605	Ref. No.	025010611
description	gear motor CROUZET type 805274 16.7W 230V 50Hz 1rpm shaft ϕ 7x8mm L 65mm W 65mm H 58mm		

gaskets

refrigeration gaskets

plug-in gaskets

profile 9197

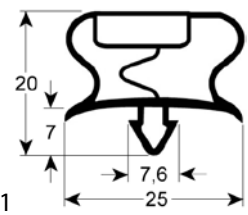

1

GEV No.	902568	Ref. No.	006110523
description	refrigeration gasket profile 9197 W 295mm L 399mm plug size		

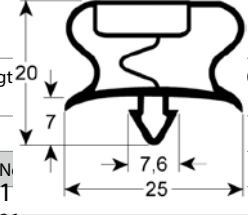

1

GEV No.	902567	Ref. No.	006110522
description	refrigeration gasket profile 9197 W 399mm L 627mm plug size		

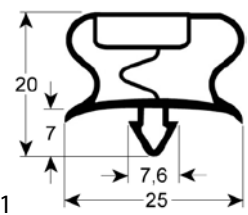

1

GEV No.	902566	Ref. No.	006110517
description	refrigeration gasket profile 9197 W 399mm L 670mm plug size		

GEV No.	902572	Ref. No.	006110565
description	refrigeration gasket profile 9197 W 485mm L 506mm plug size		

GEV No.	902565	Ref. No.	006110512
description	refrigeration gasket profile 9197 W 617mm L 1467mm plug size		

profile 9153

We offer custom-made gaskets for this profile

GEV No.	902561	Ref. No.	006110484
description	refrigeration gasket profile 9153 W 224mm L 491mm plug size		

GEV No.	902570	Ref. No.	006110537
description	refrigeration gasket profile 9153 W 287mm L 752mm plug size		

GEV No.	902563	Ref. No.	006110486
description	refrigeration gasket profile 9153 W 294mm L 491mm plug size		

GEV No.	902560	Ref. No.	006110483
description	refrigeration gasket profile 9153 W 356mm L 491mm plug size		

GEV No.	902562	Ref. No.	006110485
description	refrigeration gasket profile 9153 W 420mm L 491mm plug size		

GEV No.	902558	Ref. No.	006110417
description	refrigeration gasket profile 9153 W 483mm L 738mm plug size		

GEV No.	902559	Ref. No.	006110470
description	refrigeration gasket profile 9153 W 491mm L 752mm plug size		

GEV No.	902569	Ref. No.	006110536
description	refrigeration gasket profile 9153 W 499mm L 752mm plug size		

GEV No.	902564	Ref. No.	006110487
description	refrigeration gasket profile 9153 W 502mm L 707mm plug size		

GEV No.	902571	Ref. No.	005110555
description	refrigeration gasket profile 9153 W 527mm L 752mm plug size		



screw-in gaskets

profile 9207

We offer custom-made gaskets for this profile



GEV No.	902557	Ref. No.	006110104
description	refrigeration gasket profile 9207 W 494mm L 753mm external size		

refrigeration cycle components

valves

Schrader valves

Schrader valves (complete)



GEV No.	750101	Ref. No.	010030216
description	Schrader valve complete connection 1/4" SAE L 130mm		

refrigeration pipes

insulation



GEV No.	694746	Ref. No.	006030466
description	insulating hose 10mm (3/8") thickness 9mm Qty 50m ARMAFLEX refrigeration		



GEV No.	694747	Ref. No.	006030467
description	insulating hose 12mm (1/2") thickness 9mm Qty 45m ARMAFLEX refrigeration		



GEV No.	694748	Ref. No.	006030468
description	insulating hose 16mm (5/8") thickness 9mm Qty 40m ARMAFLEX refrigeration		

A

axial fans 4

C

condensing trays heated 3

D

defrost timers 3

E

electronic controllers 3

F

fans 4

I

insulation 7

M

microswitches 3

motors 5

P

plug-in gaskets 5

R

refrigeration cycle components 7

refrigeration fans 4

refrigeration gaskets 5

refrigeration motors universal 4

refrigeration pipes 7

S

Schrader valves 7

screw-in gaskets 7

switches and momentary switches 3

T

timers 3