



GAS COMPONENTS



ELECTRIC COMPONENTS



WATER TECHNOLOGY



MECHANICAL COMPONENTS



TOOLS

Spare parts suitable for

GARLAND

Find the complete and up-to-date range of products in our GEV Webshop



Manufacturer catalogue

The most important spare parts and accessories arranged clearly for every manufacturer

- ✓ Complete product range and all appliance data always up to date in the GEV Webshop
- ✓ Alphabetical Index at the end of the catalogue

GEV Webshop

www.gev-online.co.uk

www.gev-online.com



- 🔍 Add to Favourites
- 🔍 Sign In with email address and usual password
- 🔍 Easy-order – place several items in your basket at the same time
- 🔍 Quick Item search – no login needed



hot plates

round

ring shaped



1

GEV No.	490203	Ref. No.	2195001
description	heating element ϕ 190mmW 240V connection screw with central hole inserts H 60mm open		

energy regulators

ROBERTSHAW

INF series



1

GEV No.	380041	Ref. No.	G031185-2
description	energy regulator 240V 15A turn direction left shaft ϕ 6x4.6mm shaft L 23mm mounting thread 8"-32UNC no. INF2401165		

thermostats

control and safety thermostats

INVENSYS / ROBERTSHAW

control thermostats



1

GEV No.	376038	Ref. No.	G0893-01
description	thermostat t.max. 232°C temperature range 12-232°C 1-pole 1NO 25A probe ϕ 6.5mm probe L 173mm capillary pipe 870mm capillary pipe isolatedmm gland nut shaft ϕ 6x4.6mm shaft L 20mm shaft position right 100-450°F		

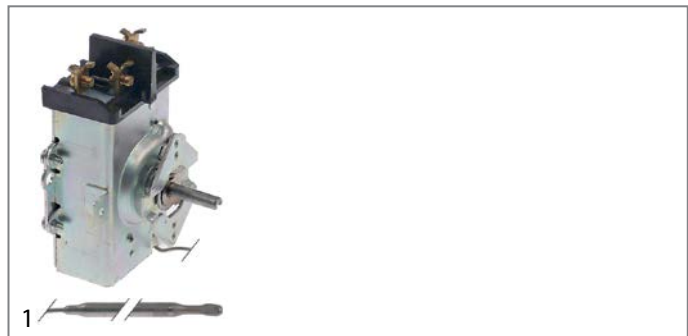

1

GEV No.	376044	Ref. No.	1102703
description	thermostat t.max. 232°C temperature range 37-232°C 2-pole 2NO 30A probe ϕ 6.5mm probe L 172mm capillary pipe 1045mm shaft ϕ 6.4x4.8mm shaft L 24mm 100-450°F		



1

GEV No.	376032	Ref. No.	1032499
description	thermostat t.max. 260°C temperature range 60-260°C 1-pole 1NO probe ϕ 5mm probe L 286mm capillary pipe 900mm capillary pipe isolatedmm gland nut shaft ϕ 6x4.6mm shaft L 20mm shaft position upper 140-500°F		



1

GEV No.	376033	Ref. No.	G02902-01
description	thermostat t.max. 260°C temperature range 64-260°C 1-pole 1NO probe ϕ 5mm probe L 285mm capillary pipe 1045mm capillary pipe isolatedmm gland nut shaft ϕ 6x4.6mm shaft L 20mm shaft position right 148-500°F		



1

GEV No.	376030	Ref. No.	1010300
description	thermostat t.max. 288°C temperature range 38-288°C 2-pole 2NO 30A probe ϕ 5mm probe L 295mm capillary pipe 1540mm capillary pipe isolatedmm gland nut shaft ϕ 6x4.6mm shaft L 20mm shaft position upper 100-550°F		



1

GEV No.	376037	Ref. No.	1032400 G0894-01
description	thermostat t.max. 288°C temperature range 65-288°C 1-pole 1NO probe ø 5mm probe L 286mm capillary pipe 1010mm capillary pipe isolated 255mm gland nut shaft ø 6x4.6mm shaft L 20mm shaft position right rotation 320° 150-550°F		



1

GEV No.	376036	Ref. No.	1611900
description	thermostat t.max. 314°C temperature range 38-314°C 1-pole 1NO probe ø 5mm probe L 285mm capillary pipe 1750mm capillary pipe isolatedmm gland nut shaft ø 6x4.6mm shaft L 20mm shaft position upper 100-598°F		



1

GEV No.	376031	Ref. No.	1010304
description	thermostat t.max. 371°C temperature range 148-371°C 2-pole 2NO 30A probe ø 5mm probe L 285mm capillary pipe 1540mm capillary pipe isolatedmm gland nut shaft ø 6x4.6mm shaft L 20mm shaft position upper probe material zinc-plated 300-700°F		

RANCO

thermostats



1

GEV No.	376040	Ref. No.	G2674-1
description	thermostat t.max. 204°C temperature range 65-204°C 1-pole 1NOA probe ø 6mm probe L 165mm capillary pipe 930mm capillary pipe isolatedmm gland nut shaft ø 6x4.6mm shaft L 24mm shaft position upper° rotation 320°		



1

GEV No.	376041	Ref. No.	2613100
description	thermostat t.max. 232°C temperature range 65-232°C 1-pole 1NOA probe ø 5mm probe L 324mm capillary pipe 1540mm capillary pipe isolatedmm gland nut shaft ø 6x4.6mm shaft L 24mm shaft position upper operating temperature range 150-450°F		



1

GEV No.	376039	Ref. No.	2613101
description	thermostat t.max. 260°C temperature range 65-260°C 1-pole 1NOA probe ø 4.8mm probe L 320mm capillary pipe 925mm capillary pipe isolatedmm gland nut shaft ø 6x4.6mm shaft L 24mm shaft position upper operating temperature range 150-500°F		



switches and momentary switches

rocker/momentary rocker switches

28x13.5mm



1

GEV No.	348099	Ref. No.	1358900
description	rocker switch mounting measurements 27.4x12.4mm black 1CO 250V 10A with neutral position connection male faston 6.3mm ambient temperature max. 85°C protection IP40		

37x21mm



1

GEV No.	348094	Ref. No.	1019205
description	momentary rocker switch mounting measurements 37x21mm black 2NO 250V 10A momentary connection male faston 6.3mm ambient temperature max. 125°C protection IP40		



1

GEV No.	348097 ¹	Ref. No.	1019204 G03055-1
description	rocker switch mounting measurements 37x21mm black 1CO 250V 10A with neutral position connection male faston 6.3mm ambient temperature max. 125/55°C protection IP55		

¹with neutral position



1

GEV No.	348095	Ref. No.	1019203 228006-2 G03054-2
description	rocker switch mounting measurements 37x21mm black 1NO 250V 20A connection male faston 6.3mm ambient temperature max. 125°C protection IP40		



1

GEV No.	348093	Ref. No.	1019209 1955402 G03054-1
description	rocker switch mounting measurements 37x21mm black 2CO 250V 10A connection male faston 6.3mm ambient temperature max. 125/55°C protection IP55		



1

GEV No.	348092 ¹	Ref. No.	1872404
description	rocker switch mounting measurements 37x21mm black 2CO 250V 10A illuminated connection male faston 6.3mm ambient temperature max. 125°C protection IP40		

¹illuminated



1

GEV No.	348096 ¹	Ref. No.	1729100 228264-1 2140 4527835
description	rocker switch mounting measurements 37x21mm black 2CO 250V 10A with neutral position connection male faston 6.3mm ambient temperature max. 125/55°C protection IP55		

¹with neutral position



1

GEV No.	348098 ¹	Ref. No.	1955401
description	rocker switch mounting measurements 37x21mm black 2CO 250V 10A with neutral position connection male faston 6.3mm ambient temperature max. 125/55°C protection IP55		

¹with neutral position

microswitches

pin-plunger actuated

M12



1

GEV No.	345138	Ref. No.	1019600
description	microswitch with plunger mounting distance 25mm thread M12x1 thread L 12mm 250V 20A 1CO connection screw stroke 7mm L1 13mm ambient temperature max. 85°C type Z15G1307 actuating force: 250g		



cam switches

4 operating positions



1

GEV No.	301313	Ref. No.	2667-1 4523164 CK114 02667-1 1010705 1010706 G02667-1
description	cam switch 4 operating positions 2CO/1NO sequence 0-1-2-3 16A shaft \varnothing 6.9x4.3mm shaft L 21.5mm connection screw ceramic		

7 operating positions



1

GEV No.	301312	Ref. No.	2146900 4523166
description	cam switch 7 operating positions 2CO/1NO sequence 0-1-2-3-4-5-6 16A shaft \varnothing 6x4.6mm shaft L 23mm connection male faston 6.3mm ceramic		

lamps

indicator lights

indicator lights (complete)

 \varnothing 13mm

with screw socket



1

GEV No.	360656	Ref. No.	G01296-2
description	indicator light \varnothing 12.5mm orange 250V connection cable 280mm Qty 1 pcs		

20x13mm



1

GEV No.	360657	Ref. No.	2138500
description	indicator light mounting measurements 20x13mm orange 250V connection cable 200mm rectangular snap-on connection		

screw-on/push-on fit

light bulbs

miscellaneous



1

GEV No.	360658	Ref. No.	1623900
description	light bulb socket E27 115V 40W \varnothing 48mm L 84mm		

contactors

HARTLAND

power contactors



1

GEV No.	580012	Ref. No.	1026101
description	contactor resistive load 50A 240VAC 40A/10HP (AC3/240V) 40A/7.46kW main contacts 4NO connection screw clamp/male faston 6.3mm type HCCY4XU04CG		



motors

gear motors

miscellaneous



1

GEV No.	602068	Ref. No.	7000240
description	gear motor MERKLE type B3715UP-095 3.45W 230V 50Hz 10rpm shaft ø 8mm L 125mm W 70mm H 75mm		

gas taps

PEL

21S series



1

GEV No.	106138	Ref. No.	2200199
description	gas tap PEL type 21S gas inlet M16x1.5 (tube ø 10mm) bypass nozzle ø 0.35mm gas outlet M10x1 IT (tube ø 6mm) thermocouple connection M8x1 pilot connection M10x1 shaft ø 8x6.5mm shaft L 37/15mm shaft flat upper		
spare parts for	106138		
	GEV No.	101060	Ref. No. —
	magnet unit standard L 39mm D1 ø 15.4mm D2 ø 11mm suitable for PEL20-21/JUNKERS/EGA		
	GEV No.	101231	Ref. No. —
	thermocouple nut T1: M9x1 T2: M18x1		
	GEV No.	106147	Ref. No. —
	gas tap front part shaft ø 8x6.5mm shaft L 37/15mm shaft flat upper/lower type PEL21		
	GEV No.	106202	Ref. No. —
	bypass nozzle type PEL20/21 bore ø 0mm thread M5x0.5		
accessories for	106138		
	GEV No.	100909	Ref. No. —
	union screw thread M10x1 for pipe ø 6mm Qty 1 pcs		
	GEV No.	101278	Ref. No. —
	olive for pipe ø 10mm Qty 1 pcs		
	GEV No.	101286	Ref. No. —
	olive ID ø 6mm Qty 1 pcs		
	GEV No.	101300	Ref. No. —
	union nut thread M16x1.5 tube ø 10mm		



1

GEV No.	107365 ¹	Ref. No.	CK2200196
description	gas tap PEL type 21S gas inlet M16x1.5 (tube ø 10mm) bypass nozzle ø 0mm gas outlet 2x ED 11mm G24 (tube ø 6mm) thermocouple connection M9x1 pilot connection M10x1 shaft ø 8x6.5mm shaft L 37/15mm shaft flat upper pipe outlet ø 6.5mm		

¹incl. union nuts and olives

22S/O series



1

GEV No.	107364	Ref. No.	2187099
description	gas tap PEL type 22S/O gas inlet M20x1.5 (tube ø 7/16") bypass nozzle ø 0mm gas outlet M20x1.5 (tube ø 7/16") thermocouple connection M9x1 pilot connection M10x1 shaft ø 10x8mm shaft L 25/17mm shaft flat upper pipe outlet ø 11.3mm		



1

GEV No.	107690	Ref. No.	CK179
description	gas tap PEL type 22S/O gas inlet M20x1.5 (tube ø 7/16") bypass nozzle ømm gas outlet M20x1.5 (tube ø 12/10mm) thermocouple connection M9x1 pilot connection M10x1 shaft ø 8x10mm shaft L 25/17mm shaft flat upper incl. accessories shaft length knob 17mm pipe outlet ø 11.3mm		



1

GEV No.	107363 ¹	Ref. No.	2513399 4601583
description	gas tap PEL type 22S/O gas inlet M20x1.5 (tube ø 7/16") bypass nozzle ømm gas outlet M20x1.5 (tube ø 12/10mm) thermocouple connection M9x1 pilot connection M10x1 shaft ø 8x10mm shaft L 25/17mm shaft flat upper shaft length knob 17mm pipe outlet ø 11.3mm		

¹incl. union nuts and olives

→ electric components





miscellaneous

			
1			
GEV No.	103258	Ref. No.	4530966
description	gas tap GARLAND type MV3514 gas inlet 1/4" bypass nozzle ømm gas outlet 1/4" pilot connection thermocouple connection shaft ø 4CR-1-650mm shaft L 45mm brass		





GEV No.	101430	Ref. No.	1587700
description	gas valve gas inlet 3/4" gas outlet 3/4" thermocouple connection 11/32" pilot connection 1/4" pipe US type 7000BGOR-S7B pressure controller natural gas 3.5" W.C. suitable for ROBERTSHAW		

spare parts for 101430

	GEV No.	101047	Ref. No.	—
	magnet unit T1: ASA 11/32 T2: M24x1 L 59mm ø 4mm suitable for ROBERTSHAW			
	GEV No.	101389	Ref. No.	—
	pressure controller natural gas suitable for ROBERTSHAW			
	GEV No.	101481	Ref. No.	—
	olive for pipe ø 1/4" CCT Qty 1 pcs			
	GEV No.	106109	Ref. No.	—
	locking screw thread 7/16"-24 UNS for pipe ø 1/4" L 16mm brass Qty 1 pcs WS 7/16" (11.113mm) hole ø 6.4mm			
	GEV No.	580033	Ref. No.	1292703 2516-1 F810-0109 G02518-1 UK22
	knob suitable for ROBERTSHAW			

accessories for 101430

	GEV No.	102122	Ref. No.	—
	thermocouple ROBERTSHAW ASA 11/32 L 18" - 455mm 7/16"			
	GEV No.	102277	Ref. No.	812284
	thermocouple ROBERTSHAW ASA 11/32 L 36" - 915mm 7/16"			



GEV No.	580043	Ref. No.	1092700
description	gas valve supply Operator gas inlet 1/4" CCT outlet 1/4" CCT gas inlet 3/4" NPT gas outlet 3/4" NPT thermocouple connection 3/8" NEF pilot connection 1/4" CCT type 7000BMSGOR pressure controller natural gas 3.5" W.C. suitable for ROBERTSHAW		

spare parts for 580043



	GEV No.	101042	Ref. No.	—
	magnet unit T1: 3/8" NEF suitable for ROBERTSHAW for gas operator			

Table continues overleaf

gas thermostats

ROBERTSHAW

			
1			
GEV No.	580180	Ref. No.	10170193 G01920-01
description	gas thermostat type FDO-1-04-48 65-287°C 150-550°F gas inlet 1/2" NPT gas outlet 1/2" NPT capillary pipe 48" - 1220mm probe ø 3/16" - 4.7mm probe L 14 3/4" - 375mmmm gland nut shaft ø 11.2x 7.5mm shaft L 21/21mm shaft flat lower ROBERTSHAW		

gas valves and ignition boxes





gas control valves

ROBERTSHAW





gas controlled valves

			
1			
GEV No.	106923	Ref. No.	1467000 1467001
description	gas valve 60Hz type 7000BDER-S7A supply 24VAC		



spare parts for 580043				
	GEV No.	101481	Ref. No.	—
olive for pipe ø 1/4" CCT Qty 1 pcs				
	GEV No.	106109	Ref. No.	—
locking screw thread 7/16"-24 UNS for pipe ø 1/4" L 16mm brass Qty 1 pcs WS 7/16" (11.113mm) hole ø 6.4mm				
	GEV No.	580033	Ref. No.	1292703 2516-1 F810-0109 G02518-1 UK22
knob suitable for ROBERTSHAW				
accessories for 580043				
	GEV No.	580035	Ref. No.	1093418 1577001 F810-0162
thermopile L 36" - 915mm probe ø 9mm probe L 38mm 250-750mV screw connection 7/16" connection 3/8" NEF				

millivolt controlled valves

				
1				
GEV No.	580031	Ref. No.	1292799 2511 F807-2427	
description	gas valve supply Operator millivolt gas inlet 3/4" NPT gas outlet 3/4" NPT thermocouple connection pilot connection 1/4" CCT type 7000BMVR pressure controller natural gas 3.5" W.C. suitable for ROBERTSHAW			
spare parts for 580031				
	GEV No.	101422	Ref. No.	—
operator natural gas supply Operator millivolt				
	GEV No.	106109	Ref. No.	—
locking screw thread 7/16"-24 UNS for pipe ø 1/4" L 16mm brass Qty 1 pcs WS 7/16" (11.113mm) hole ø 6.4mm				
	GEV No.	106121	Ref. No.	—
pressure controller natural gas 3.5" W.C.				
	GEV No.	580033	Ref. No.	1292703 2516-1 F810-0109 G02518-1 UK22
knob suitable for ROBERTSHAW				

ignition parts





pilot burners

SIT			
140 - 145 -150 series			
			
1			
GEV No.	107215	Ref. No.	2200701
description	pilot burner SIT type 145 series 2 flames nozzle ømm gas connectionmm without nozzles burner bearing left		

ROBERTSHAW

pilot burners

universal series - type 2			
			
1			
GEV No.	107367	Ref. No.	G0526-1
description	pilot burner ROBERTSHAW type 2C-2 1 flame natural gas code 18 for pipe ø 1/4" CCT		

				
1				
GEV No.	106078	Ref. No.	1415300 G0635-1	
description	pilot burner ROBERTSHAW type 2C-2 1 flame natural gas code 18 for pipe ø 3/16" - 1/4" CCT			
spare parts for 106078				
	GEV No.	100276	Ref. No.	1028202 1293000 F810-0126
pilot burner nozzle natural gas code 18 suitable for ROBERTSHAW				
	GEV No.	101481	Ref. No.	—
olive for pipe ø 1/4" CCT Qty 1 pcs				
	GEV No.	101483	Ref. No.	—
union nut thread 1/4" CCT short				





1

GEV No.	107403	Ref. No.	1091899
description	pilot burner ROBERTSHAW type 2C-2 1 flame natural gas code 18 for pipe ø 3/16" CCT		



1

GEV No.	107405	Ref. No.	1028200
description	pilot burner ROBERTSHAW type 2CH-6 1 flame natural/liquid gas code 18/10 for pipe ø 1/4" CCT 1/4"		
spare parts for	107405		
	GEV No.	100275	Ref. No.
			1028203 1028207 1293001
	pilot burner nozzle LPG code 10 bore ø 0.1mm suitable for ROBERTSHAW		
	GEV No.	100276	Ref. No.
			1028202 1293000 F810-0126
	pilot burner nozzle natural gas code 18 suitable for ROBERTSHAW		





1

GEV No.	107407	Ref. No.	1028298 1028299
description	pilot burner ROBERTSHAW type 2CH-10 1 flame natural gas code 21 for pipe ø 3/16" CCT 3/16"		

universal series - type 3



1

GEV No.	107399	Ref. No.	1028288 1028289
description	pilot burner ROBERTSHAW type 3CH-4 2 flames natural/liquid gas code 18/10 for pipe ø 1/4" CCT		
spare parts for	107399		
	GEV No.	100275	Ref. No.
			1028203 1028207 1293001
	pilot burner nozzle LPG code 10 bore ø 0.1mm suitable for ROBERTSHAW		
	GEV No.	100276	Ref. No.
			1028202 1293000 F810-0126
	pilot burner nozzle natural gas code 18 suitable for ROBERTSHAW		



1

GEV No.	580034	Ref. No.	8100154
description	pilot burner ROBERTSHAW type 3CH-6 2 flames natural gas code 18 for pipe ø 1/4" CCT		

universal series - type 6

Width of caps:
 6CH10 = 1" (25,4mm)
 6CH14 = 1½" (38,1mm)
 6CH24 = 2½" (63,5mm)
 6CH30 = 3" (76,2mm)





1

GEV No.	106117	Ref. No.	2706400
description	pilot burner ROBERTSHAW type 6CH24-1 3 flames natural gas code 26 for pipe ø 1/4" CCT gas connection 1/4" CCTmm nozzle ømm		





Mini Pilot series			
			
1			
GEV No.	107414	Ref. No.	1191300
description	pilot burner ROBERTSHAW type 2 2 flames natural/liquid gas code for pipe ø 3/16" - 1/4" CCT with thermocouple		

HONEYWELL			
pilot burners			
			
1			
GEV No.	107410	Ref. No.	1814901 1935802 CK1935802
description	pilot burner HONEYWELL type Q3451B1301 1315 1 flame natural gas nozzle BCR20 1/4"		

BASO			
pilot burners			
			
1			
GEV No.	107368	Ref. No.	G01267-5
description	pilot burner type J990MDA-2 2 flames natural/liquid gas		

accessories universal			
pilot burner brackets			
			
1			
GEV No.	692611	Ref. No.	2554500
description	pilot burner bracket zinc-plated suitable for GARLAND		

ignition electrode holders			
			
1			
GEV No.	107753	Ref. No.	2525800
description	spacer zinc-plated for piezoelectric igniter suitable for GARLAND		

electrodes			
			
1			
GEV No.	109198	Ref. No.	1466100
description	monitoring electrode connection ø male faston 6.3mm D1 ø 8mm D2 ø 5mm L1 20mm BL1 32mm BL2 13mm		

			
1			
GEV No.	100906	Ref. No.	2200704
description	screw connection thread M10x1 for ignition electrode brass Qty 1 pcs WS 10		

piezoelectric igniters				
mounting diameter 18mm				
				
1				
GEV No.	100009	Ref. No.	1309201	
description	piezoelectric igniter body plastic blowing mounting ø 18mm connection ø2.4mm front measurements 26mm M18x1.5			
accessories for	100009			
	GEV No.	101339	Ref. No.	—
cover cap for piezoelectric igniter				
	GEV No.	106869	Ref. No.	—
cover cap for piezoelectric igniter ID ø 22mm ED ø 35mm H 25mm				
	GEV No.	107931	Ref. No.	—
cover cap for piezoelectric igniter ID ø 21mm ED ø 36mm				

ignition units



GEV No.	103257	Ref. No.	4515818
description	ignition unit outputs 4 230VAC dimensions 111x28x34mm mounting distance 98mm inlet F6.3x0.8 outlet F2.8x0.8 type FZ4 set 6-piece 0.3VA 50-60Hz		
accessories for	103257		
GEV No.	101023	Ref. No.	—
description	ignition unit outputs 4 230VAC dimensions 111x28x34mm mounting distance 98mm inlet F6.3x0.8 outlet F2.8x0.8 type ZAG4 0.3VA 50-60Hz		

thermocouples

thermocouple sets universal



GEV No.	102280	Ref. No.	1019418 1029410 1415000 227183 G01575-1
description	thermocouple set ROBERTSHAW 5-piece L 18" - 455mm		



GEV No.	102283	Ref. No.	1920401
description	thermocouple set ROBERTSHAW 5-piece L 72" - 1825mm		

plug-in thermocouples

plug-in thermocouples standard

ROBERTSHAW

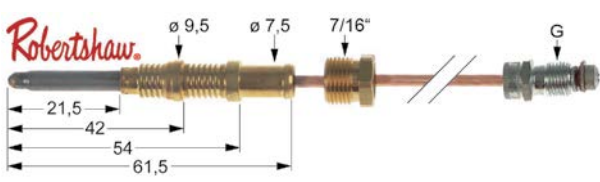

GEV No.	102277	Ref. No.	812284
description	thermocouple ROBERTSHAW ASA 11/32 L 36" - 915mm 7/16"		

with barrel socket ø6mm

SIT

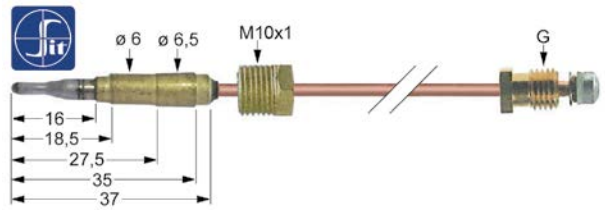

GEV No.	102944	Ref. No.	2200601 4523506
description	thermocouple M9x1 L 1500mm M10x1		

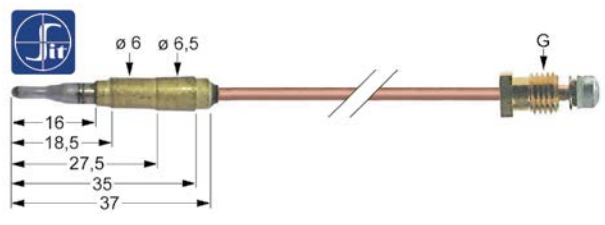

GEV No.	102246	Ref. No.	2200600 2200602
description	thermocouple M9x1 L 600mm plug connection ø6.0mm		

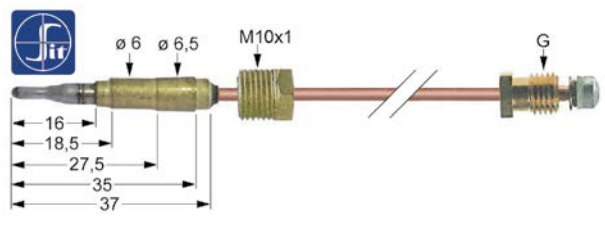

GEV No.	113041	Ref. No.	2321902
description	thermocouple SIT ASA 11/32 L 600mm plug connection ø6.0mm		

threaded thermocouples

threaded thermocouples standard

with socket with thread M8x1

SIT

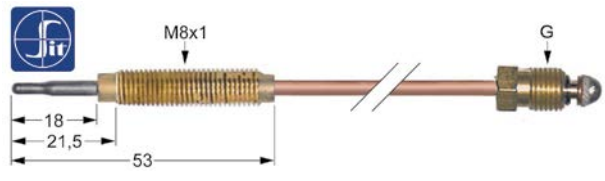

GEV No.	107644	Ref. No.	2155201
description	thermocouple SIT M10x1 L 750mm M8x1		
accessories for	107644		
GEV No.	102067	Ref. No.	—
description	nut thread M8x1 H 3mm brass Qty 1 pcs type SEF 1		



thermopiles

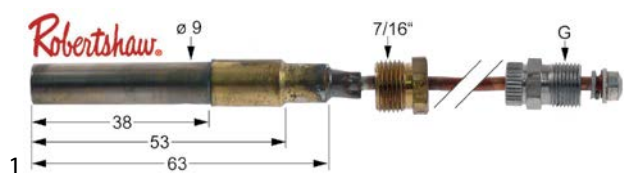

GEV No.	580035	Ref. No.	1093418 1577001 F810-0162
description	thermopile L 36" - 915mm probe \varnothing 9mm probe L 38mm 250-750mV screw connection 7/16" connection 3/8" NEF		

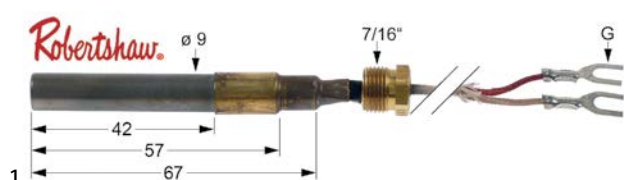

GEV No.	102116	Ref. No.	UK33
description	thermopile ROBERTSHAW L 900mm probe \varnothing 9mm probe L 57mm 250-750mV screw connection 7/16"		



GEV No.	103362	Ref. No.	810-06171 8101873
description	thermopile WHITE RODGERS L 900mm probe \varnothing 11.5mm probe L 46mm screw connection connection male faston 6.3mm		

accessories

interrupters



GEV No.	580046	Ref. No.	1092702
description	extension for interruptor L 18" - 455mm		

gas burners

hob burners

producer-specific hob burners

GARLAND



GEV No.	104667	Ref. No.	2217300
description	burner range \varnothing 180mmkW nozzle mounting 11.8 H 78mm star-shaped suitable for GARLAND mounting pos. front		

accessories

pan supports



GEV No.	210055	Ref. No.	G6214
description	pan support W 275mm L 275mm H 35mm mounting pos. burner suitable for GARLAND		



GEV No.	210056	Ref. No.	G0594-1
description	pan support W 275mm L 275mm H 35mm mounting pos. burner suitable for GARLAND		



GEV No.	210054	Ref. No.	1769101
description	pan support W 300mm L 325mm H 75mm mounting pos. range suitable for GARLAND		

bar burners

bar burners



GEV No.	104668	Ref. No.	1090500 1090599
description	burner cast iron W 58mm H 80mm L 533mm mounting pos. OVEN		

accessories

air slides



GEV No.	104666	Ref. No.	1028002
description	air slide ø 58mm thickness 0.8mm hole ø 11.8mm plate		



GEV No.	104665	Ref. No.	2519200
description	air slide ø 60mm thickness 0.8mm hole ø 11.5mm plate		

gas nozzles

main nozzles

gas nozzles (other)



GEV No.	107371	Ref. No.	G02486-52F
description	gas injector code 52 bore ø 1.6mm natural/liquid gas for grill		



GEV No.	107747	Ref. No.	2104563
description	gas injector thread 3/8" code 63 WS 13 bore ø 0.53mm L 35mm natural/liquid gas		



GEV No.	107743	Ref. No.	G02486-46
description	gas injector thread 7/16" code 46 WS 1/2" bore ø 1.5mm L 44mm natural/liquid gas		



GEV No.	107745	Ref. No.	G02486-51F
description	gas injector thread code 51 WS 13 bore ø 1.28mm L 45mm natural/liquid gas		



GEV No.	107744	Ref. No.	M8-50
description	gas injector thread M8 code 50 WS 13 bore ø 1.6mm L 18mm natural/liquid gas		



GEV No.	107746	Ref. No.	M8-55
description	gas injector thread M8 code 55 WS 13 bore ø 1.24mm L 18.5mm natural/liquid gas		

pilot burner nozzles

pilot burner nozzles ROBERTSHAW



GEV No.	100275	Ref. No.	1028203 1028207 1293001
description	pilot burner nozzle LPG code 10 bore ø 0.1mm suitable for ROBERTSHAW		



GEV No.	100276	Ref. No.	1028202 1293000 F810-0126
description	pilot burner nozzle natural gas code 18 suitable for ROBERTSHAW		

pilot burner nozzles (other)

GARLAND





GEV No.	107369	Ref. No.	G01267-3
description	pilot burner nozzle LPG code 012 Qty 1 pcs		



			
1			
GEV No.	107751	Ref. No.	2520802
description	pilot burner nozzle LPG code 30 gas pressurebar bore ø 0.5mm thread mounting distancemm Qty 1 pcs metal		

			
1			
GEV No.	107370	Ref. No.	G01267-2
description	pilot burner nozzle natural gas code 020 Qty 1 pcs		

			
1			
GEV No.	107749	Ref. No.	2200702
description	pilot burner nozzle natural gas code 32 gas pressurebar bore ø 0.2mm thread mounting distancemm Qty 1 pcs metal		

			
1			
GEV No.	107750	Ref. No.	2520801
description	pilot burner nozzle natural/liquid gas code 51 gas pressurebar bore ø 1mm thread mounting distancemm Qty 1 pcs metal		

			
1			
GEV No.	107748	Ref. No.	2200703 220703
description	pilot burner nozzle natural/liquid gas code gas pressurebar bore ø 1.3mm thread mounting distancemm Qty 1 pcs metal		

chokes

AB			
			
1			
GEV No.	107801	Ref. No.	1086597
description	restrictor AB type AP5-1 gas inlet 1/8"x27 NPT (tube ø 5mm) gas outlet 3/8"x24 UNF (tube ø 3/16" CC)		

auxiliary gas parts

screw connections

olives

			
1			
GEV No.	107752	Ref. No.	2520804
description	olive for pipe ø 3/16" L 10mm brass Qty 1 pcs suitable for SIT		

union nuts

			
1			
GEV No.	103254	Ref. No.	M245
description	union nut thread 3/8" tube ø 3/16"mm gas WS 11 L 10mm brass Qty 1 pcs		

union screws

			
1			
GEV No.	100906	Ref. No.	2200704
description	screw connection thread M10x1 for ignition electrode brass Qty 1 pcs WS 10		

			
1			
GEV No.	100907	Ref. No.	2200706
description	screw connection thread M10x1 Qty 1 pcs type SEF 1 ømm for thermocouple		

gas lines

pilot tubes

producer-specific

			
1			
GEV No.	107741	Ref. No.	CK2324001
description	pilot tube tube ø 4.6mm L 273mm W 4.6mm H 55mm metal connection screw		

1

GEV No.	107740	Ref. No.	2229000
description	pilot tube tube ø 4.6mm L 4300mm W 50mm H 100mm metal connection screw		

universal



1

GEV No.	106357	Ref. No.	GM308
description	pilot tube aluminium pipe ø 1/4" CCT L 300mm		

miscellaneous



1









GEV No.	694825	Ref. No.	G01275-1 GARG01275-1
description	support for solid top high temperature resistant L 75mm W 75mm H 65mm ceramic fibre		

for ovens

miscellaneous



1

GEV No.	696672	Ref. No.	1011203
description	bush brass for door bolt L 29mm W 29mm H 16mm		
accessories for	696672		
	GEV No.	696671	Ref. No. 1082700
	ring chrome-plated spacer L 35mm W 35mm H 4.5mm		
	GEV No.	696673	Ref. No. 1082199
	lever joint metal for oven L 100mm W 70mm H 30mm mounting pos. right		
	GEV No.	696674	Ref. No. 1082198
	lever joint metal for oven L 100mm W 70mm H 30mm mounting pos. left		
	GEV No.	696675	Ref. No. 1082802
	connector metal for oven L 110mm W 18.5mm H 18.5mm mounting pos. right		
	GEV No.	696676	Ref. No. 1082803
	connector metal for oven L 110mm W 18.5mm H 18.5mm mounting pos. left		
	GEV No.	696677	Ref. No. 1005800
	door spring metal for oven L 165mm W 26.5mm H 26.5mm		
	GEV No.	696678	Ref. No. 1083001
	holding plate metal for oven L 98mm W 32mm H 6mm		
	GEV No.	696679	Ref. No. 9004701
	hook metal for door spring L 79mm W 22mm H 5.4mm		

equipment-specific units

for grills

housing and bezels



1









GEV No.	696680	Ref. No.	03866-1-5
description	bar metal for grill L 535mm ø 16mm suitable for GARLAND		











1









GEV No.	696681	Ref. No.	03866-2-5
description	bar metal for grill L 795mm ø 16mm suitable for GARLAND		



 <p>1</p>			
GEV No.	696676	Ref. No.	1082803
description	connector metal for oven L 110mm W 18.5mm H 18.5mm mounting pos. left		
accessories for	696676		
	GEV No.	696671	Ref. No. 1082700
ring chrome-plated spacer L 35mm W 35mm H 4.5mm			
	GEV No.	696672	Ref. No. 1011203
bush brass for door bolt L 29mm W 29mm H 16mm			
	GEV No.	696673	Ref. No. 1082199
lever joint metal for oven L 100mm W 70mm H 30mm mounting pos. right			
	GEV No.	696674	Ref. No. 1082198
lever joint metal for oven L 100mm W 70mm H 30mm mounting pos. left			
	GEV No.	696675	Ref. No. 1082802
connector metal for oven L 110mm W 18.5mm H 18.5mm mounting pos. right			
	GEV No.	696677	Ref. No. 1005800
door spring metal for oven L 165mm W 26.5mm H 26.5mm			
	GEV No.	696678	Ref. No. 1083001
holding plate metal for oven L 98mm W 32mm H 6mm			
	GEV No.	696679	Ref. No. 9004701
hook metal for door spring L 79mm W 22mm H 5.4mm			



 <p>1</p>			
GEV No.	696675	Ref. No.	1082802
description	connector metal for oven L 110mm W 18.5mm H 18.5mm mounting pos. right		
accessories for	696675		
	GEV No.	696671	Ref. No. 1082700
ring chrome-plated spacer L 35mm W 35mm H 4.5mm			
	GEV No.	696672	Ref. No. 1011203
bush brass for door bolt L 29mm W 29mm H 16mm			
	GEV No.	696673	Ref. No. 1082199
lever joint metal for oven L 100mm W 70mm H 30mm mounting pos. right			
	GEV No.	696674	Ref. No. 1082198
lever joint metal for oven L 100mm W 70mm H 30mm mounting pos. left			
	GEV No.	696676	Ref. No. 1082803
connector metal for oven L 110mm W 18.5mm H 18.5mm mounting pos. left			
	GEV No.	696677	Ref. No. 1005800
door spring metal for oven L 165mm W 26.5mm H 26.5mm			
	GEV No.	696678	Ref. No. 1083001
holding plate metal for oven L 98mm W 32mm H 6mm			









accessories for	696675		
	GEV No.	696679	Ref. No. 9004701
hook metal for door spring L 79mm W 22mm H 5.4mm			

 <p>1</p>			
GEV No.	696677	Ref. No.	1005800
description	door spring metal for oven L 165mm W 26.5mm H 26.5mm		
accessories for	696677		
	GEV No.	696671	Ref. No. 1082700
ring chrome-plated spacer L 35mm W 35mm H 4.5mm			
	GEV No.	696672	Ref. No. 1011203
bush brass for door bolt L 29mm W 29mm H 16mm			
	GEV No.	696673	Ref. No. 1082199
lever joint metal for oven L 100mm W 70mm H 30mm mounting pos. right			
	GEV No.	696674	Ref. No. 1082198
lever joint metal for oven L 100mm W 70mm H 30mm mounting pos. left			
	GEV No.	696675	Ref. No. 1082802
connector metal for oven L 110mm W 18.5mm H 18.5mm mounting pos. right			
	GEV No.	696676	Ref. No. 1082803
connector metal for oven L 110mm W 18.5mm H 18.5mm mounting pos. left			
	GEV No.	696678	Ref. No. 1083001
holding plate metal for oven L 98mm W 32mm H 6mm			
	GEV No.	696679	Ref. No. 9004701
hook metal for door spring L 79mm W 22mm H 5.4mm			





 <p>1</p>			
GEV No.	696678	Ref. No.	1083001
description	holding plate metal for oven L 98mm W 32mm H 6mm		
accessories for	696678		
	GEV No.	696671	Ref. No. 1082700
ring chrome-plated spacer L 35mm W 35mm H 4.5mm			
	GEV No.	696672	Ref. No. 1011203
bush brass for door bolt L 29mm W 29mm H 16mm			
	GEV No.	696673	Ref. No. 1082199
lever joint metal for oven L 100mm W 70mm H 30mm mounting pos. right			
	GEV No.	696674	Ref. No. 1082198
lever joint metal for oven L 100mm W 70mm H 30mm mounting pos. left			
	GEV No.	696675	Ref. No. 1082802
connector metal for oven L 110mm W 18.5mm H 18.5mm mounting pos. right			









Table continues overleaf

accessories for		696678		
GEV No.		696676	Ref. No.	1082803
	connector metal for oven L 110mm W 18.5mm H 18.5mm mounting pos. left			
	door spring metal for oven L 165mm W 26.5mm H 26.5mm			
	hook metal for door spring L 79mm W 22mm H 5.4mm			

accessories for		696679		
GEV No.		696679	Ref. No.	9004701
	hook metal for door spring L 79mm W 22mm H 5.4mm			
	ring chrome-plated spacer L 35mm W 35mm H 4.5mm			
	bush brass for door bolt L 29mm W 29mm H 16mm			
	lever joint metal for oven L 100mm W 70mm H 30mm mounting pos. right			
	lever joint metal for oven L 100mm W 70mm H 30mm mounting pos. left			
	connector metal for oven L 110mm W 18.5mm H 18.5mm mounting pos. right			
	connector metal for oven L 110mm W 18.5mm H 18.5mm mounting pos. left			
	door spring metal for oven L 165mm W 26.5mm H 26.5mm			
	holding plate metal for oven L 98mm W 32mm H 6mm			

accessories for		696674		
GEV No.		696674	Ref. No.	1082198
	lever joint metal for oven L 100mm W 70mm H 30mm mounting pos. left			
	ring chrome-plated spacer L 35mm W 35mm H 4.5mm			
	bush brass for door bolt L 29mm W 29mm H 16mm			
	lever joint metal for oven L 100mm W 70mm H 30mm mounting pos. right			

accessories for		696674		
GEV No.		696675	Ref. No.	1082802
	connector metal for oven L 110mm W 18.5mm H 18.5mm mounting pos. right			
	connector metal for oven L 110mm W 18.5mm H 18.5mm mounting pos. left			
	door spring metal for oven L 165mm W 26.5mm H 26.5mm			
	holding plate metal for oven L 98mm W 32mm H 6mm			
	hook metal for door spring L 79mm W 22mm H 5.4mm			

accessories for		696673		
GEV No.		696673	Ref. No.	1082199
	lever joint metal for oven L 100mm W 70mm H 30mm mounting pos. right			
	ring chrome-plated spacer L 35mm W 35mm H 4.5mm			
	bush brass for door bolt L 29mm W 29mm H 16mm			
	lever joint metal for oven L 100mm W 70mm H 30mm mounting pos. left			
	connector metal for oven L 110mm W 18.5mm H 18.5mm mounting pos. right			
	connector metal for oven L 110mm W 18.5mm H 18.5mm mounting pos. left			
	door spring metal for oven L 165mm W 26.5mm H 26.5mm			
	holding plate metal for oven L 98mm W 32mm H 6mm			
	hook metal for door spring L 79mm W 22mm H 5.4mm			



accessories for		696671		
GEV No.		696671	Ref. No.	1082700
	ring chrome-plated spacer L 35mm W 35mm H 4.5mm			
	bush brass for door bolt L 29mm W 29mm H 16mm			

Table continues overleaf



accessories for 696671	
	GEV No. 696673 Ref. No. 1082199
	GEV No. 696674 Ref. No. 1082198
	GEV No. 696675 Ref. No. 1082802
	GEV No. 696676 Ref. No. 1082803
	GEV No. 696677 Ref. No. 1005800
	GEV No. 696678 Ref. No. 1083001
	GEV No. 696679 Ref. No. 9004701

for pizza ovens

firebricks



1	GEV No. 850124 Ref. No. 4523903
description ceramic briquetts L 54.5mm W 42.5mm H 27mm Qty 126 pcs	

knobs

producer-specific knobs

GARLAND



1	GEV No. 112759 Ref. No. 4512139
description knob gas tap with ignition flame T.max. temp. ø 54x24mm shaft ø 8.9x6.4mm shaft flat horizontal/vertical black range	



1	GEV No. 112749 Ref. No. 4512140
description knob gas tap with ignition flame T.max. temp. ø 62mm shaft ø 8.9x6.4mm shaft flat horizontal/vertical black/silver for stove top	

1	GEV No. 112753 Ref. No. 4512120
description knob gas tap with ignition flame T.max. temp. ø 62mm shaft ø 8.9x6.4mm shaft flat horizontal/vertical black/silver for stove top	

1	GEV No. 112750 Ref. No. 4512150
description knob gas valve with ignition flame T.max. temp. ø 62mm shaft ø 10 8.9x6.4mm shaft flat horizontal/vertical black/silver for oven	



1	GEV No. 112757 Ref. No. 1089101
description knob OVEN T.max. temp. ø 54x24mm shaft ø 8.7x6.2mm shaft flat lower black gas oven	
accessories for 112757	
	GEV No. 112749 Ref. No. 4512140
knob gas tap with ignition flame T.max. temp. ø 62mm shaft ø 8.9x6.4mm shaft flat horizontal/vertical black/silver for stove top	
	GEV No. 112750 Ref. No. 4512150
knob gas valve with ignition flame T.max. temp. ø 62mm shaft ø 10 8.9x6.4mm shaft flat horizontal/vertical black/silver for oven	
	GEV No. 112751 Ref. No. 4512141
knob thermostat T.max. 500°F temp. 150-500°F ø 62mm shaft ø 10 8.9x6.4mm shaft flat horizontal/vertical black/silver for oven	
	GEV No. 112752 Ref. No. G02716-1
knob T.max. temp. ø 63mm shaft ø 6.4x4.8mm shaft flat horizontal/vertical black	
	GEV No. 112753 Ref. No. 4512120
knob gas tap with ignition flame T.max. temp. ø 62mm shaft ø 8.9x6.4mm shaft flat horizontal/vertical black/silver for stove top	
	GEV No. 112754 Ref. No. 4512142
knob thermostat T.max. 260°C temp. 70-260°C ø 62mm shaft ø 10mm shaft flat upper black/silver for oven	

Table continues overleaf

accessories for	112757		
	GEV No.	112755	Ref. No. G02716-3
	knob T.max. temp. ø 63mm shaft ø 11x7.9mm shaft flat horizontal/vertical black		
	GEV No.	112758	Ref. No. G02725-16
	knob dial plate thermostat T.max. 500°F temp. 150-500°F ø 59mm shaft ømm shaft flat silver oven		

	1		
GEV No.	112742	Ref. No.	4527470 CK4527470
description	knob range kit ignition/large/small ø 66mm shaft ø 8x6.5mm black/silver shaft 8 H 40mm Qty 1 pcs		



	1		
GEV No.	112756	Ref. No.	1089100
description	knob T.max. temp. ø 54x24mm shaft ø 8.5mm shaft flat upper black gas oven		

	1		
GEV No.	112755	Ref. No.	G02716-3
description	knob T.max. temp. ø 63mm shaft ø 11x7.9mm shaft flat horizontal/vertical black		
accessories for	112755		
	GEV No.	112758	Ref. No. G02725-16
	knob dial plate thermostat T.max. 500°F temp. 150-500°F ø 59mm shaft ømm shaft flat silver oven		

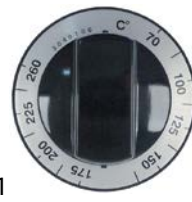
	1		
GEV No.	112752	Ref. No.	G02716-1
description	knob T.max. temp. ø 63mm shaft ø 6.4x4.8mm shaft flat horizontal/vertical black		
accessories for	112752		
	GEV No.	112758	Ref. No. G02725-16
	knob dial plate thermostat T.max. 500°F temp. 150-500°F ø 59mm shaft ømm shaft flat silver oven		

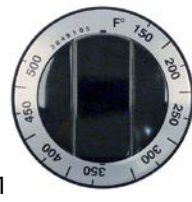
	1		
GEV No.	112754	Ref. No.	4512142
description	knob thermostat T.max. 260°C temp. 70-260°C ø 62mm shaft ø 10mm shaft flat upper black/silver for oven		

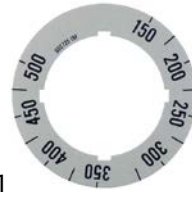
	1		
GEV No.	112751	Ref. No.	4512141
description	knob thermostat T.max. 500°F temp. 150-500°F ø 62mm shaft ø 10 8.9x6.4mm shaft flat horizontal/vertical black/silver for oven		

	1		
GEV No.	112758	Ref. No.	G02725-16
description	knob dial plate thermostat T.max. 500°F temp. 150-500°F ø 59mm shaft ømm shaft flat silver oven		
accessories for	112758		
	GEV No.	112752	Ref. No. G02716-1
	knob T.max. temp. ø 63mm shaft ø 6.4x4.8mm shaft flat horizontal/vertical black		
	GEV No.	112755	Ref. No. G02716-3
	knob T.max. temp. ø 63mm shaft ø 11x7.9mm shaft flat horizontal/vertical black		

baskets

fryer baskets

US producers

	1		
GEV No.	970184	Ref. No.	1035303
description	fryer basket L1 330mm W1 315mm H1 135mm		

B

bar burners 14

C

cam switches 6

contactors 6

E

energy regulators 3

G

gas burners 13

gas control valves 8

gas lines 15

gas nozzles 14

gas taps 7

gas thermostats 8

H

hob burners 13

hot plates 3

I

ignition units 12

indicator lights 6

indicator lights (complete) 6

L

lamps 6

light bulbs 6

M

microswitches 5

motors 7

P

piezoelectric igniters 11

pilot burners 9

R

rocker/momentary rocker switches 5

S

switches and momentary switches 5

T

thermocouples 12

thermostats 3