



GAS COMPONENTS



ELECTRIC COMPONENTS



WATER TECHNOLOGY



MECHANICAL COMPONENTS



TOOLS

Spare parts suitable for

GICO

Find the complete and up-to-date range of products in our GEV Webshop



Manufacturer catalogue

The most important spare parts and accessories arranged clearly for every manufacturer

- ✓ Complete product range and all appliance data always up to date in the GEV Webshop
- ✓ Alphabetical Index at the end of the catalogue

GEV Webshop

www.gev-online.co.uk

www.gev-online.com



- 🔍 Add to Favourites
- 🔍 Sign In with email address and usual password
- 🔍 Easy-order – place several items in your basket at the same time
- 🔍 Quick Item search – no login needed



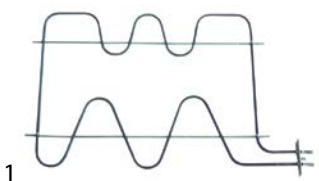

heating elements

heating elements for ovens



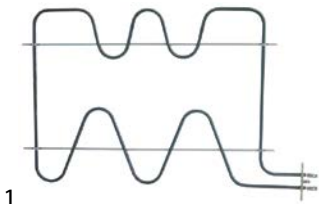

GEV No.	416090	Ref. No.	260200070
description	heating element 2000W 230V L 500mm W 325mm L1 73mm L2 427mm W1 295mm W2 30mm flange length 70mm flange width 22mm hole distance 56mm hole ø M4mm tube ø 6.3mm connection length 22mm heating circuits 1 rectangular flange dry heating element oven		
For models:	64-040FE, 64-050FE-FEV, 64-057T, 64-222FE		



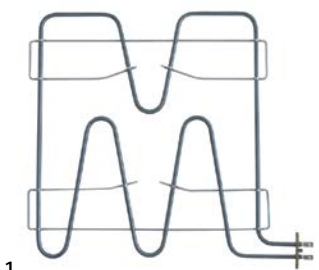



GEV No.	416089	Ref. No.	260203130
description	heating element 2000W 400V L 500mm W 325mm L1 73mm L2 427mm W1 295mm W2 30mm flange length 70mm flange width 22mm hole distance 55mm hole ø M4mm tube ø 6.5mm connection length 22mm connection M4 heating circuits 1 rectangular flange dry heating element oven		
For models:	500-050FE		
accessories for	416089		
	GEV No.	510368	Ref. No. —
	gasket L 70mm W 23.5mm hole ø 5mm hole distance 56mm FIBER thickness 2mm for heating element		



GEV No.	416091	Ref. No.	270200402
description	heating element 2740W 230V L 500mm W 485mm L1 68mm L2 430mm W1 450mm W2 32mm flange length 70mm flange width 22mm hole distance 56mm hole ø M4mm tube ø 8.5mm connection M4 heating circuits 1 rectangular flange dry heating element oven		
spare parts for	416091		
	GEV No.	510368	Ref. No. —
	gasket L 70mm W 23.5mm hole ø 5mm hole distance 56mm FIBER thickness 2mm for heating element		



GEV No.	416092	Ref. No.	270203360
description	heating element 2740W 400V L 500mm W 485mm L1 68mm L2 430mm W1 450mm W2 32mm flange length 70mm flange width 22mm hole distance 56mm hole ø M4mm tube ø 8.5mm connection M4 heating circuits 1 mounting thread M3 rectangular flange dry heating element oven		
For models:	700-040FEB, 700-050FEB, 700-052FEB, 700-054FEB, 700-055FEB, 700-057FEB, 700-138FEBA, 700-162FEBA, 700-200FEB, 700-222FEB, 700-224FEBA, 700-411B		
accessories for	416092		
	GEV No.	510368	Ref. No. —
	gasket L 70mm W 23.5mm hole ø 5mm hole distance 56mm FIBER thickness 2mm for heating element		
	GEV No.	527169	Ref. No. —
	hexagonal nut thread M3 H 2.8mm WS 5.5 brass Qty 1 pcs		
	GEV No.	560110	Ref. No. —
	plain washer ID ø 3.2mm ED ø 7mm thickness 0.5mm SS Qty 20 pcs DIN 125A for thread M3		
	GEV No.	560130	Ref. No. —
	hexagonal nut thread M3 H 2.4mm WS 5.5 SS DIN/ISO DIN 934 / ISO 4032/8673 Qty 20 pcs		

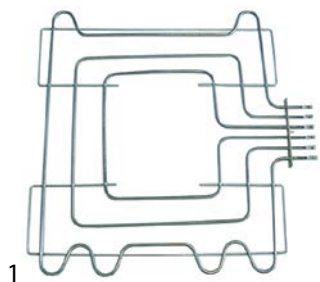

GEV No.	416093	Ref. No.	241200922
description	heating element 3275W 230/400V heating circuits 3 L 538mm W 615mm L1 38mm L2 500mm W1 248mm W2 127mm flange length 160mm flange width 22mm hole distance 144mm hole ø M5mm tube ø 6.5mm connection M4 connection length 60mm rectangular flange dry heating element		

heating elements for bain maries

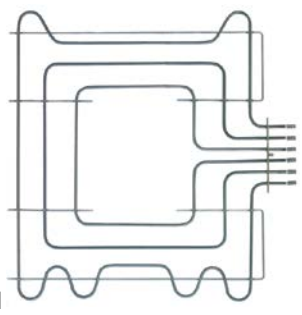

1

GEV No.	416087	Ref. No.	290203720
description	heating element 3275W 400V heating circuits 3 L 538mm W 615mm L1 38mm L2 500mm W1 248mm W2 127mm flange length 160mm flange width 22mm hole distance 144mm hole ø 5mm tube ø 6.5mm connection M4 connection length 60mm rectangular flange dry heating element		
For models:	900-040FE, 900-050FE, 900-052FE, 900-054FE, 900-057FE, 900-138FEA, 900-162FEA, 900-172FEA, 900-182FE, 900-200FE, 900-411-413, 920-050FE, 920-052FE, 920-057FE, 920-122FELC, 920-122FEL-FELR-FER, 920-122FELR, 920-122FER, 920-172FEA, 920-200FE, 920-322FEL-FELC-FELR-FER		

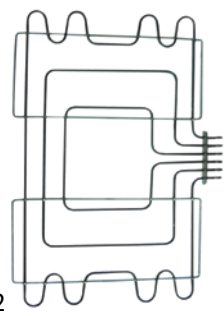

2

GEV No.	416094	Ref. No.	211200020
description	heating element 4300W 230/400V heating circuits 3 L 530mm W 843mm L1 32mm L2 498mm W1 359mm W2 127mm flange length 161mm flange width 23mm bridge length 550mm hole distance 143mm hole ø M5mm tube ø 6.6mm connection M4 connection length 54mm rectangular flange dry heating element oven		

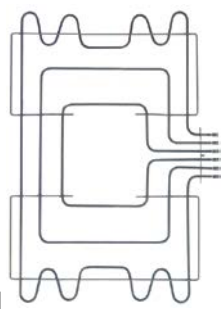

1

GEV No.	416088	Ref. No.	211200240
description	heating element 4300W 400V heating circuits 3 L 530mm W 843mm L1 32mm L2 498mm W1 359mm W2 127mm flange length 161mm flange width 23mm bridge length 550mm hole distance 143mm thread M5 tube ø 7.1mm connection M4 connection length 52mm rectangular flange dry heating element		
For models:	110-050FE, 110-052FE, 110-057FE, 110-122FELC, 110-122FEL-FELR, 110-200FE, 110-322FEL-FELC-FELR		

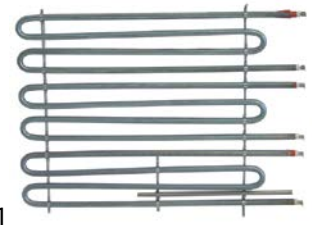

1

GEV No.	416136	Ref. No.	270204530
description	heating element 1500W 230V heating circuits 3 L 384mm W 274mm connection male faston 6.3mm tube ø 8.5mm connection distance 71mm dry heating element		
For models:	700-500A-C-T, 700-542A-C-T		



1

GEV No.	416106	Ref. No.	290204050 292200160
description	heating element 2700W 240V heating circuits 3 L 490mm W 274mm connection male faston 6.3mm tube ø 8.5mm connection distance 15mm dry heating element thermostat sleeves ø 5.4mm length thermostat sleeves 222mm bain marie		
For models:	110-500A-T, 900-500A-C-T, 900-542A-C-T, 920-500A-T, 920-542A-T		



1

GEV No.	416079	Ref. No.	292200160
description	heating element 2700W 240V heating circuits 3 L 503mm W 274mm connection male faston 6.3mm tube ø 8.5mm dry heating element thermostat sleeves ø 5mm length thermostat sleeves 222mm number of thermostat sleeves 1		



1

GEV No.	416105	Ref. No.	290200091
description	heating element 800W 240V L 440mm W 72mm H 12mm connection male faston		

heating elements for frying pans

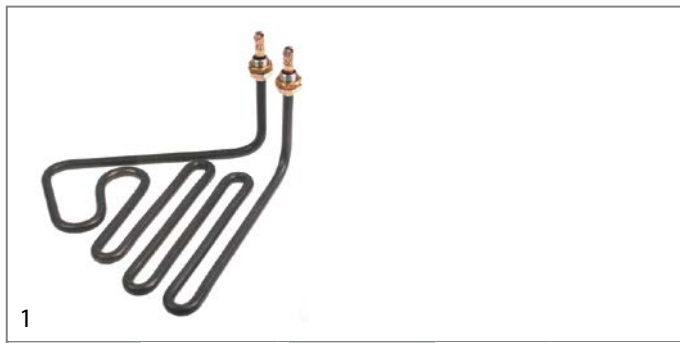

GEV No.	416111	Ref. No.	A00089
description	heating element 2000W 240V L 200mm W 213mm tube ø 6mm 2 hole fixing thread M14x1.5 dry heating element kettle W1 178mm W2 35mm H 85mm mounting distance 34mm		
For models:	900-521-522		
accessories for	416111		
	GEV No.	510417	Ref. No. —
	flat gasket fibre ED ø 20mm ID ø 14mm thickness 2mm Qty 1 pcs		
	GEV No.	520228	Ref. No. —
	tooth lock washer ID ø 15.3mm ED ø 24mm steel Qty 1 pcs for thread M14		
	GEV No.	520230	Ref. No. —
	nut thread M14x1.5 H 5mm WS 19 zinc-coated steel Qty 1 pcs		
	GEV No.	521101	Ref. No. —
	nut thread M14x1.5 H 5mm WS 19 SS Qty 1 pcs		
	GEV No.	550262	Ref. No. —
	flat gasket copper ED ø 20mm ID ø 14mm thickness 2mm		

heating elements for chip scuttles



GEV No.	416080	Ref. No.	284203390
description	heating element 1000W 240V heating circuits 1 L 315mm W 75mm flange length 110mm flange width 22mm hole distance 94mm connection length 27mm connection M4 tube ø 8.5mm rectangular flange hole ø 6mm dry heating element		
For models:	64-519T, 64-520T, 700-519A-C-T, 700-520T		

heating elements for fryers

2 hole fixing

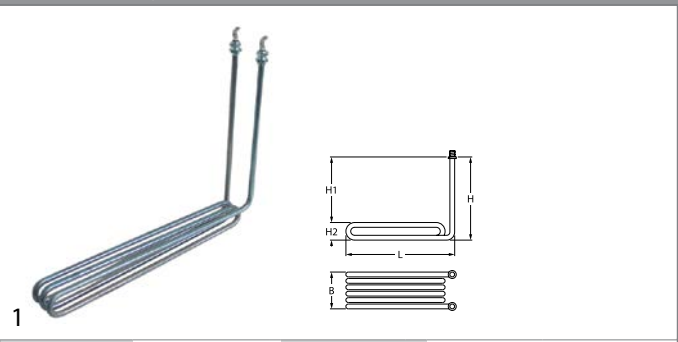

GEV No.	416084	Ref. No.	290203710
description	heating element 3000W 240V heating circuits 1 L 370mm W 45mm H 270mm H1 270mm H2 42mm thread M12x1 tube ø 8.5mm mounting distance 37mm windings 3 2 hole fixing connection M4 connection length 20mm fryer		
For models:	900-706A-S		
spare parts for	416084		
	GEV No.	521110	Ref. No. —
	flat gasket fibre ED ø 20mm ID ø 13mm thickness 2mm Qty 1 pcs		
accessories for	416084		
	GEV No.	520229	Ref. No. —
	nut thread M12x1 H 4mm WS 16 zinc-coated steel Qty 1 pcs		
	GEV No.	521103	Ref. No. —
	nut thread M4 H 3mm WS 7 brass Qty 20 pcs		
	GEV No.	521104	Ref. No. —
	washer ID ø 4.3mm ED ø 8mm thickness 0.5mm brass Qty 20 pcs for thread M4		
	GEV No.	521131	Ref. No. —
	nut thread M12x1 H 3.5mm WS 17 SS Qty 1 pcs		
	GEV No.	528110	Ref. No. —
	O-ring EPDM thickness 2.62mm ID ø 12.37mm Qty 1 pcs		
	GEV No.	560111	Ref. No. —
	plain washer ID ø 4.3mm ED ø 9mm thickness 0.8mm SS Qty 20 pcs DIN 125A for thread M4		
	GEV No.	560131	Ref. No. —
	hexagonal nut thread M4 H 3.2mm WS 7 SS DIN/ISO DIN 934 / ISO 4032/8673 Qty 20 pcs		

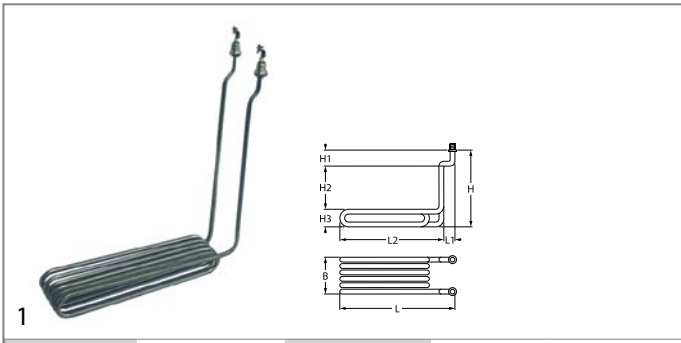

GEV No.	416101	Ref. No.	260200360
description	heating element 2100W 240V heating circuits 1 L 260mm W 70mm H 270mm L1 12mm L2 248mm H1 15mm H2 220mm H3 35mm mounting distance 64mm thread M12x1 tube ø 6.3mm connection length 25mm connection M4 2 hole fixing fryer		

accessories for	416101			
	GEV No.	520229	Ref. No.	—
	nut thread M12x1 H 4mm WS 16 zinc-coated steel Qty 1 pcs			
	GEV No.	521103	Ref. No.	—
	nut thread M4 H 3mm WS 7 brass Qty 20 pcs			
	GEV No.	521104	Ref. No.	—
	washer ID ø 4.3mm ED ø 8mm thickness 0.5mm brass Qty 20 pcs for thread M4			
	GEV No.	521110	Ref. No.	—
	flat gasket fibre ED ø 20mm ID ø 13mm thickness 2mm Qty 1 pcs			
	GEV No.	521131	Ref. No.	—
	nut thread M12x1 H 3.5mm WS 17 SS Qty 1 pcs			
	GEV No.	528110	Ref. No.	—
	O-ring EPDM thickness 2.62mm ID ø 12.37mm Qty 1 pcs			
	GEV No.	560111	Ref. No.	—
	plain washer ID ø 4.3mm ED ø 9mm thickness 0.8mm SS Qty 20 pcs DIN 125A for thread M4			
	GEV No.	560131	Ref. No.	—
	hexagonal nut thread M4 H 3.2mm WS 7 SS DIN/ISO DIN 934 / ISO 4032/8673 Qty 20 pcs			

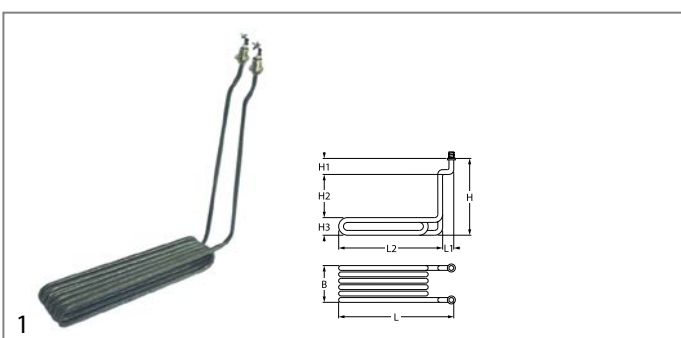

GEV No.	416102	Ref. No.	270203150
description	heating element 3000W 240V heating circuits 1 L 249mm W 45mm H 265mm L1 17mm L2 232mm H1 50mm H2 180mm H3 35mm thread M12x1 tube ø 6.3mm connection M4 2 hole fixing fryer		

accessories for	416102			
	GEV No.	520229	Ref. No.	—
	nut thread M12x1 H 4mm WS 16 zinc-coated steel Qty 1 pcs			
	GEV No.	521103	Ref. No.	—
	nut thread M4 H 3mm WS 7 brass Qty 20 pcs			

accessories for	416102			
	GEV No.	521104	Ref. No.	—
	washer ID ø 4.3mm ED ø 8mm thickness 0.5mm brass Qty 20 pcs for thread M4			
	GEV No.	521110	Ref. No.	—
	flat gasket fibre ED ø 20mm ID ø 13mm thickness 2mm Qty 1 pcs			
	GEV No.	521131	Ref. No.	—
	nut thread M12x1 H 3.5mm WS 17 SS Qty 1 pcs			
	GEV No.	528110	Ref. No.	—
	O-ring EPDM thickness 2.62mm ID ø 12.37mm Qty 1 pcs			
	GEV No.	560111	Ref. No.	—
	plain washer ID ø 4.3mm ED ø 9mm thickness 0.8mm SS Qty 20 pcs DIN 125A for thread M4			
	GEV No.	560131	Ref. No.	—
	hexagonal nut thread M4 H 3.2mm WS 7 SS DIN/ISO DIN 934 / ISO 4032/8673 Qty 20 pcs			

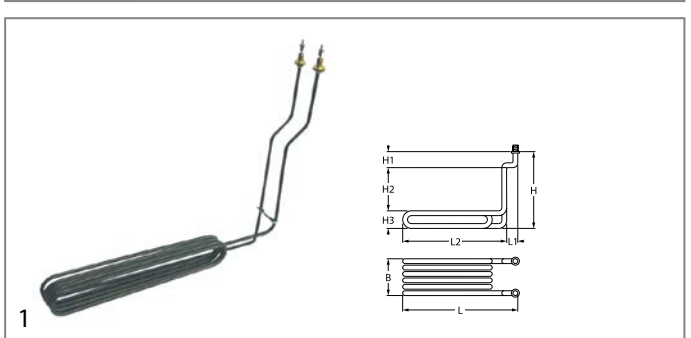

GEV No.	416103	Ref. No.	290200280
description	heating element 3000W 240V heating circuits 1 L 415mm W 43mm H 335mm L1 35mm L2 380mm H1 140mm H2 150mm H3 45mm thread M10 tube ø 6.3mm connection M4 2 hole fixing fryer		

accessories for	416103			
	GEV No.	510416	Ref. No.	—
	flat gasket fibre ED ø 19mm ID ø 10.5mm thickness 1.5mm for thread M10 Qty 1 pcs			
	GEV No.	510893	Ref. No.	—
	O-ring EPDM thickness 2.62mm ID ø 9.92mm Qty 1 pcs			
	GEV No.	520231	Ref. No.	—
	nut thread M10x1 H 6mm WS 14 zinc-coated steel Qty 1 pcs			
	GEV No.	521129	Ref. No.	—
	nut thread M10 H 6mm SS WS 17 Qty 1 pcs DIN/ISO DIN 439			



GEV No.	416086	Ref. No.	270203790
description	heating element 3000W 230V heating circuits 1 L 210mm W 50mm H 230mm H1 162mm H2 68mm thread M12x1 tube ø 8.5mm windings 6 2 hole fixing connection M4 fryer		
accessories for	416086		
	GEV No.	521103	Ref. No. —
	nut thread M4 H 3mm WS 7 brass Qty 20 pcs		
	GEV No.	521104	Ref. No. —
	washer ID ø 4.3mm ED ø 8mm thickness 0.5mm brass Qty 20 pcs for thread M4		
	GEV No.	560111	Ref. No. —
	plain washer ID ø 4.3mm ED ø 9mm thickness 0.8mm SS Qty 20 pcs DIN 125A for thread M4		
	GEV No.	560131	Ref. No. —
	hexagonal nut thread M4 H 3.2mm WS 7 SS DIN/ISO DIN 934 / ISO 4032/8673 Qty 20 pcs		

GEV No.	416085	Ref. No.	270204600
description	heating element 3000W 240V heating circuits 1 L 228mm W 50mm H 246mm H1 180mm H2 66mm thread 1/4" tube ø 8.5mm windings 5 2 hole fixing mounting distance 42mm connection M5 immersion heater		
For models:	500-701A, 700-701A-S, 700-702A-S, 900-701A-S, 900-702A-S		
accessories for	416085		
	GEV No.	361182	Ref. No. —
	nut thread 1/4" H 5mm nickel-plated brass WS 17 Qty 1 pcs		
	GEV No.	510417	Ref. No. —
	flat gasket fibre ED ø 20mm ID ø 14mm thickness 2mm Qty 1 pcs		
	GEV No.	520228	Ref. No. —
	tooth lock washer ID ø 15.3mm ED ø 24mm steel Qty 1 pcs for thread M14		
	GEV No.	550262	Ref. No. —
	flat gasket copper ED ø 20mm ID ø 14mm thickness 2mm		
	GEV No.	560112	Ref. No. —
	plain washer ID ø 5.3mm ED ø 10mm thickness 1mm SS Qty 20 pcs DIN 125A for thread M5		
	GEV No.	560132	Ref. No. —
	hexagonal nut thread M5 H 4mm WS 8 SS DIN/ISO DIN 934 / ISO 4032/8673 Qty 20 pcs		

GEV No.	416083	Ref. No.	290203840
description	heating element 4500W 230V heating circuits 1 L 325mm W 50mm H 235mm H1 180mm H2 55mm thread M12x1 tube ø 8.5mm windings 6 2 hole fixing mounting distance 42mm connection M4 fryer		
accessories for	416083		
	GEV No.	520229	Ref. No. —
	nut thread M12x1 H 4mm WS 16 zinc-coated steel Qty 1 pcs		
	GEV No.	521103	Ref. No. —
	nut thread M4 H 3mm WS 7 brass Qty 20 pcs		
	GEV No.	521104	Ref. No. —
	washer ID ø 4.3mm ED ø 8mm thickness 0.5mm brass Qty 20 pcs for thread M4		
	GEV No.	521110	Ref. No. —
	flat gasket fibre ED ø 20mm ID ø 13mm thickness 2mm Qty 1 pcs		
	GEV No.	521131	Ref. No. —
	nut thread M12x1 H 3.5mm WS 17 SS Qty 1 pcs		
	GEV No.	528110	Ref. No. —
	O-ring EPDM thickness 2.62mm ID ø 12.37mm Qty 1 pcs		
	GEV No.	560111	Ref. No. —
	plain washer ID ø 4.3mm ED ø 9mm thickness 0.8mm SS Qty 20 pcs DIN 125A for thread M4		
	GEV No.	560131	Ref. No. —
	hexagonal nut thread M4 H 3.2mm WS 7 SS DIN/ISO DIN 934 / ISO 4032/8673 Qty 20 pcs		

GEV No.	416117	Ref. No.	284203501 293202090
description	heating element 1700W 230V heating circuits 1 L 305mm W 45mm H 205mm L1 30mm L2 275mm H1 180mm H2 25mm thread M10x1 tube ø 6.5mm 2 hole fixing connection M4 immersion heater windings 3 fryer		
spare parts for	416117		
	GEV No.	510416	Ref. No. —
	flat gasket fibre ED ø 19mm ID ø 10.5mm thickness 1.5mm for thread M10 Qty 1 pcs		

Table continues overleaf



accessories for		416117	
	GEV No.	510893	Ref. No. —
	O-ring EPDM thickness 2.62mm ID ø 9.92mm Qty 1 pcs		
	GEV No.	520231	Ref. No. —
	nut thread M10x1 H 6mm WS 14 zinc-coated steel Qty 1 pcs		
	GEV No.	521103	Ref. No. —
	nut thread M4 H 3mm WS 7 brass Qty 20 pcs		
	GEV No.	521104	Ref. No. —
	washer ID ø 4.3mm ED ø 8mm thickness 0.5mm brass Qty 20 pcs for thread M4		
	GEV No.	521129	Ref. No. —
	nut thread M10 H 6mm SS WS 17 Qty 1 pcs DIN/ISO DIN 439		
	GEV No.	560111	Ref. No. —
	plain washer ID ø 4.3mm ED ø 9mm thickness 0.8mm SS Qty 20 pcs DIN 125A for thread M4		
	GEV No.	560131	Ref. No. —
	hexagonal nut thread M4 H 3.2mm WS 7 SS DIN/ISO DIN 934 / ISO 4032/8673 Qty 20 pcs		

heating elements for griddles

	1		
GEV No.	416095	Ref. No.	260200020
description	heating element 1100W 240V heating circuits 1 L 360mm W 82mm H 50mm tube ø 6.3mm L1 7mm W1 8mm W2 57mm connection M4 connection distance 76mm dry heating element		
For models:	64-320TL-TLC-TR, 64-322TL-TLC-TLR-TR		

	1		
GEV No.	416096	Ref. No.	270200662
description	heating element 1370W 240V heating circuits 1 L 430mm W 100mm H 60mm tube ø 6.3mm L1 10mm L2 420mm W1 10mm W2 80mm connection M4 connection length 26mm griddle dry heating element		

	1		
GEV No.	416100	Ref. No.	290200112
description	heating element 2020W 240V heating circuits 1 L 550mm W 100mm H 60mm tube ø 6.3mm L1 10mm L2 540mm W1 10mm W2 80mm connection M4 connection length 26mm griddle dry heating element		

heating elements for large hobs

	1		
GEV No.	416099	Ref. No.	211200550
description	heating element 370W 57.5V heating circuits 1 L 340mm H 73mm tube ø 8.5mm connection distance 328mm connection male faston 6.3mm dry heating element		

	1		
GEV No.	416097	Ref. No.	270204500
description	heating element 450W 57.5V heating circuits 1 L 438mm H 72mm tube ø 8.5mm connection distance 428mm connection male faston 6.3mm dry heating element		

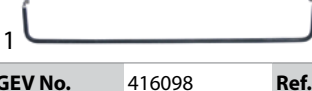
	1		
GEV No.	416098	Ref. No.	290204040
description	heating element 600W 230V heating circuits 1 L 580mm H 72mm tube ø 8.5mm connection distance 571mm connection male faston 6.3mm dry heating element		

heating elements for tilting bratt pan

	1		
GEV No.	416140	Ref. No.	290202450
description	heating element 2300W 230V heating circuits 1 L 510mm W 90mm H 45mm connection distance 62mm tube ø 6.3mm dry heating element connection M4		

	1		
GEV No.	416115	Ref. No.	241201401
description	heating element 2400W 240V L 660mm W 120mm H 12mm connection male faston dry heating element heating circuits 1 tube ø 11mm		

	1		
GEV No.	416114	Ref. No.	270200812
description	heating element tilting bratt pan 2600W 230V L 375mm W 152mm H 58mm connection M4 dry heating element heating circuits 1 tube ø 8.5mm L1 25mm W2 100mm connection distance 88mm		
For models:	64-930T, 700-632, 700-930		



heating elements for pasta cookers

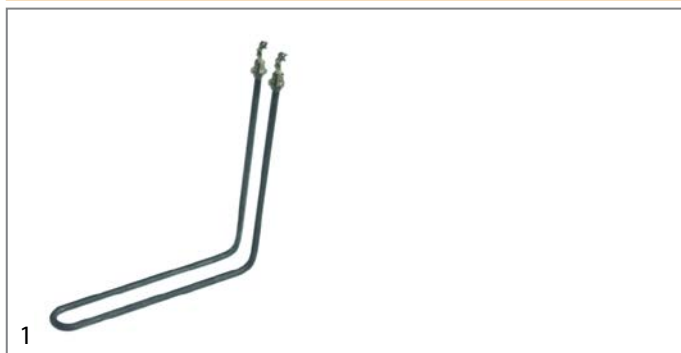

GEV No.	416108	Ref. No.	260203010
description	heating element 1500W 240V L 245mm W 38mm H 237mm 2 hole fixing connection M4 thread M12x1 mounting distance 23mm pasta cooker		
accessories for	416108		
	GEV No.	521103	Ref. No. —
	nut thread M4 H 3mm WS 7 brass Qty 20 pcs		
	GEV No.	521104	Ref. No. —
	washer ID ø 4.3mm ED ø 8mm thickness 0.5mm brass Qty 20 pcs for thread M4		
	GEV No.	560111	Ref. No. —
	plain washer ID ø 4.3mm ED ø 9mm thickness 0.8mm SS Qty 20 pcs DIN 125A for thread M4		
	GEV No.	560131	Ref. No. —
	hexagonal nut thread M4 H 3.2mm WS 7 SS DIN/ISO DIN 934 / ISO 4032/8673 Qty 20 pcs		

GEV No.	420219	Ref. No.	270205870
description	heating element 1700W 230V heating circuits 1 L 310mm thread M16x1.5 tube ø 10mm mounting distance 40mm pasta cooker immersion heater		

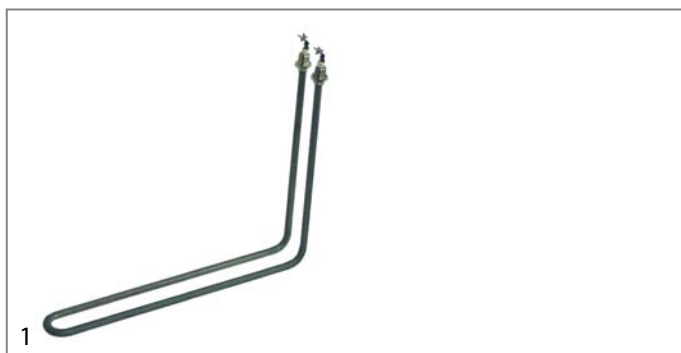

GEV No.	416110	Ref. No.	270203090
description	heating element 1900W 230V L 300mm W 37mm H 220mm 2 hole fixing connection M4 thread M12x1 mounting distance 25mm pasta cooker		
accessories for	416110		
	GEV No.	521103	Ref. No. —
	nut thread M4 H 3mm WS 7 brass Qty 20 pcs		
	GEV No.	521104	Ref. No. —
	washer ID ø 4.3mm ED ø 8mm thickness 0.5mm brass Qty 20 pcs for thread M4		
	GEV No.	560111	Ref. No. —
	plain washer ID ø 4.3mm ED ø 9mm thickness 0.8mm SS Qty 20 pcs DIN 125A for thread M4		

accessories for	416110		
	GEV No.	560131	Ref. No. —
	hexagonal nut thread M4 H 3.2mm WS 7 SS DIN/ISO DIN 934 / ISO 4032/8673 Qty 20 pcs		

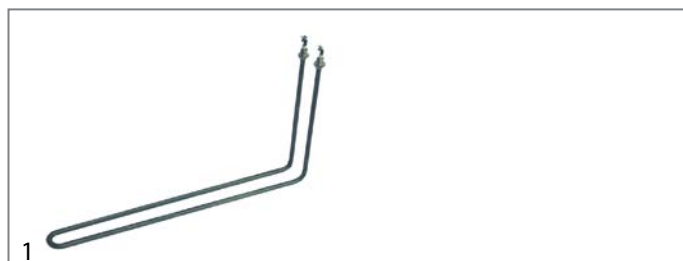



GEV No.	416109	Ref. No.	290203600
description	heating element 2600W 230V L 445mm W 50mm H 225mm 2 hole fixing connection M4 thread M12x1 mounting distance 42mm pasta cooker		
accessories for	416109		
	GEV No.	521103	Ref. No. —
	nut thread M4 H 3mm WS 7 brass Qty 20 pcs		
	GEV No.	521104	Ref. No. —
	washer ID ø 4.3mm ED ø 8mm thickness 0.5mm brass Qty 20 pcs for thread M4		
	GEV No.	560111	Ref. No. —
	plain washer ID ø 4.3mm ED ø 9mm thickness 0.8mm SS Qty 20 pcs DIN 125A for thread M4		
	GEV No.	560131	Ref. No. —
	hexagonal nut thread M4 H 3.2mm WS 7 SS DIN/ISO DIN 934 / ISO 4032/8673 Qty 20 pcs		

GEV No.	416137	Ref. No.	270204220
description	heating element 2700W 230V heating circuits 1 L 300mm W 67mm H mm 2 hole fixing connection M4 thread M16x1.5 tube ø 8.5mm mounting distance 60mm pasta cooker immersion heater		

accessories for	416137		
	GEV No.	521103	Ref. No. —
	nut thread M4 H 3mm WS 7 brass Qty 20 pcs		
	GEV No.	521104	Ref. No. —
	washer ID ø 4.3mm ED ø 8mm thickness 0.5mm brass Qty 20 pcs for thread M4		
	GEV No.	560111	Ref. No. —
	plain washer ID ø 4.3mm ED ø 9mm thickness 0.8mm SS Qty 20 pcs DIN 125A for thread M4		
	GEV No.	560131	Ref. No. —
	hexagonal nut thread M4 H 3.2mm WS 7 SS DIN/ISO DIN 934 / ISO 4032/8673 Qty 20 pcs		

GEV No.	416138	Ref. No.	290203880
description	heating element 4000W 230V heating circuits 1 L 485mm W 64mm 2 hole fixing connection M4 thread 3/8" tube ø 8.5mm mounting distance 56mm pasta cooker		
accessories for	416138		
	GEV No.	521103	Ref. No. —
	nut thread M4 H 3mm WS 7 brass Qty 20 pcs		

Table continues overleaf

accessories for		416138	
	GEV No.	521104	Ref. No. —
washer ID ø 4.3mm ED ø 8mm thickness 0.5mm brass Qty 20 pcs for thread M4			
	GEV No.	560111	Ref. No. —
plain washer ID ø 4.3mm ED ø 9mm thickness 0.8mm SS Qty 20 pcs DIN 125A for thread M4			
	GEV No.	560131	Ref. No. —
hexagonal nut thread M4 H 3.2mm WS 7 SS DIN/ISO DIN 934 / ISO 4032/8673 Qty 20 pcs			

heating elements for plate warmers



			
GEV No.	416107	Ref. No.	241200562 A00084
description	heating element 1300W 240V 2 hole fixing thread M10x1 L 380mm W 100mm heating circuits 1 connection male faston 6.3mm L1 70mm L3 300mm dry heating element tube ø 6.5mm W1 29mm W2 42mm mounting distance 36mm heated cabinet		
For models:	ES-424NC, ES-828NC, ES-861NC, ES-891NC		
accessories for		416107	
	GEV No.	510416	Ref. No. —
flat gasket fibre ED ø 19mm ID ø 10.5mm thickness 1.5mm for thread M10 Qty 1 pcs			
	GEV No.	510893	Ref. No. —
O-ring EPDM thickness 2.62mm ID ø 9.92mm Qty 1 pcs			
	GEV No.	520231	Ref. No. —
nut thread M10x1 H 6mm WS 14 zinc-coated steel Qty 1 pcs			
	GEV No.	521129	Ref. No. —
nut thread M10 H 6mm SS WS 17 Qty 1 pcs DIN/ISO DIN 439			

heating cables

drain heating cables

			
GEV No.	416338	Ref. No.	296201910
description	drain heating cable 55W 230V ø 6mm L 2500mm L1 (unheated) 500mm L2 (heated) 2000mm silicone connection terminal		



pilot heating elements

			
GEV No.	416113	Ref. No.	290202790
description	heating element 300W 240V heating circuits 1 mounting ø 47.5mm L 265mm W 31mm H 14mm round flange connection male faston 6.3mm immersion heater tube ø 6.3mm connection length 20mm thermostat sleeves ø 7.2mm length thermostat sleeves 246mm number of thermostat sleeves 1 thermostat sleeve clinging		
For models:	700-528, 900-523, 900-526, 920-523, 920-526		
accessories for		416113	
	GEV No.	510408	Ref. No. —
O-ring EPDM thickness 5.34mm ID ø 47mm Qty 1 pcs			



accessories for		416113	
	GEV No.	510562	Ref. No. —
O-ring silicone thickness 5.34mm ID ø 47mm Qty 1 pcs			
	GEV No.	520235	Ref. No. —
3 hole flange hole distance 70.5mm perforation ø 6.5mm ID ø 53.5mm			
	GEV No.	520236	Ref. No. —
flange for heating element ID ø 50mm ED ø 90mm hole ø 6.5mm 3 holes			
	GEV No.	550002	Ref. No. —
tension strap H 10mm L 21mm W 10mm hole ø 6.5mm for heating element			
	GEV No.	550362	Ref. No. —
blind flange ø 64mm mounting ø 47.5mm			

immersion heating elements

3 hole flange ø47.5mm

			
GEV No.	416139	Ref. No.	270203330
description	heating element 3000W 230V mounting ø 47.5mm heating circuits 3 L 362mm W 29mm H 35mm hole distance 62mm hole ø 8mm connection M4 3 hole flange immersion heater		
For models:	700-528		
spare parts for		416139	
	GEV No.	510408	Ref. No. —
O-ring EPDM thickness 5.34mm ID ø 47mm Qty 1 pcs			
accessories for		416139	
	GEV No.	510562	Ref. No. —
O-ring silicone thickness 5.34mm ID ø 47mm Qty 1 pcs			





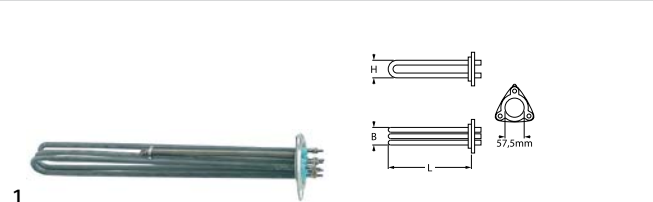

3 hole flange ø57.5mm

			
GEV No.	416126	Ref. No.	293200360
description	heating element 10500W 230V mounting ø 57.5mm heating circuits 3 L 590mm W 30mm H 40mm number of thermostat sleeves 1 thermostat sleeves ø 7mm length thermostat sleeves 480mm thermostat sleeve upper tube ø 8.5mm hole distance 73mm hole ø 10mm connection M4 3 hole flange immersion heater		
spare parts for		416126	
	GEV No.	510409	Ref. No. —
O-ring EPDM thickness 5.34mm ID ø 56.52mm Qty 1 pcs			

			
GEV No.	416125	Ref. No.	293200760
description	heating element 7500W 230V mounting ϕ 57.5mm heating circuits 3 L 398mm W 36mm H 41mm number of thermostat sleeves 1 thermostat sleeves ϕ 7mm length thermostat sleeves 212mm thermostat sleeve not clinging tube ϕ 8.5mm hole distance 72mm hole ϕ 8mm connection M4 3 hole flange immersion heater		

with expansion flange 70 x 18mm			
			
GEV No.	417629	Ref. No.	260203110
description	heating element 1200W 230V heating circuits 1 flange 70x18mm L 320mm W 65mm tube ϕ 8.5mm thermostat sleeves ϕ 8mm length thermostat sleeves 180mm thermostat sleeve outer number of thermostat sleeves 1 TD ϕ 7mm		
For models:	64-500T, 64-542T		

with round flange ϕ 60.0mm			
			
GEV No.	417573	Ref. No.	434008100 A00270
description	heating element 3990W 230V heating circuits 3 mounting ϕ 60mm L 320mm W 120mm H 40mm connection male faston 6.3mm tube ϕ 8.5mm		

1½"			
			
GEV No.	416112	Ref. No.	A00149
description	heating element 4500W 230V heating circuits 3 thread 1 1/2" L 420mm W 25mm H 38mm tube ϕ 6.5mm connection M4 immersion heater flange with thread		
For models:	900-523, 920-523		
spare parts for	416112		
	GEV No.	510406	Ref. No. —
	flat gasket fibre ED ϕ 60mm ID ϕ 48mm thickness 3mm for thread 1½" Qty 1 pcs		
accessories for	416112		
	GEV No.	510424	Ref. No. —
	gasket copper ED ϕ 55mm ID ϕ 48mm thickness 2.2mm Centellen for thread 1½"		
	GEV No.	520211	Ref. No. —
	reducer thread 2" ET - 1½" IT brass		
	GEV No.	520212	Ref. No. —
	hexagonal nut thread 1½" brass WS 60 H 8mm		
	GEV No.	550361	Ref. No. —
	blind flange ϕ 58mm thread 1½"		

heating elements for convection

			
GEV No.	416122	Ref. No.	293201430
description	heating element 10500W 230V heating circuits 3 ID ϕ 373mm ED ϕ 390mm L 124mm H 124mm L1 38mm W1 105mm H1 36mm H2 88mm flange length 142mm flange width 25mm hole distance 62mm connection M4 tube ϕ 8.5mm convection heating element hole ϕ 6mm rectangular flange		
For models:	EMD.E081MA, EMD.E081MN, EMD.E081MW		

			
GEV No.	416123	Ref. No.	293200340
description	heating element 15000W 230V heating circuits 1 ID ϕ 428mm ED ϕ 443mm L 482mm H 158mm L1 27mm H1 32mm H2 123mm flange length 142mm flange width 25mm hole distance 63mm connection M6 connection length 71mm tube ϕ 8.5mm convection heating element hole ϕ 6mm rectangular flange		
For models:	EMD.E101MA, EMD.E101MN, EMD.E101MW		

			
GEV No.	416118	Ref. No.	284203511 296201860
description	heating element 2000W 230V heating circuits 1 ID ϕ 180mm ED ϕ 192mm L 245mm H 34mm L1 45mm W1 32mm H1 10mm H2 24mm flange length 70mm flange width 22mm hole distance 56mm connection male faston 6.3mm connection length 60mm tube ϕ 6.3mm convection heating element mounting thread M5 rectangular flange with thread bolt		
For models:	9ES-122N, 9ES-152N, 9ES-182N, ES-121NVC, ES-151NVC, ES-181NVC		





1

GEV No.	416119	Ref. No.	238200212
description	heating element 2000W 240V heating circuits 1 ID ø 182mm ED ø 195mm L 245mm H 34mm L1 43mm W1 30mm H1 10mm H2 24mm flange length 70mm flange width 22mm hole distance 56mm connection male faston 6.3mm connection length 56mm tube ø 6.3mm convection heating element mounting thread M5 rectangular flange with thread bolt		
accessories for	416119		
	GEV No.	510368	Ref. No. —
	gasket L 70mm W 23.5mm hole ø 5mm hole distance 56mm FIBER thickness 2mm for heating element		







1

GEV No.	416120	Ref. No.	284201560
description	heating element 2800W 240V heating circuits 1 ID ø 185mm ED ø 198mm L 245mm H 34mm L1 42mm W1 30mm H1 12mm H2 22mm flange length 70mm flange width 22mm hole distance 56mm connection male faston 6.3mm tube ø 6.3mm convection heating element mounting thread M5 rectangular flange with thread bolt		
For models:	64-040FCE, 64-050FCE, 64-222FCE		
accessories for	416120		
	GEV No.	510368	Ref. No. —
	gasket L 70mm W 23.5mm hole ø 5mm hole distance 56mm FIBER thickness 2mm for heating element		



1

GEV No.	416124	Ref. No.	293201010
description	heating element 4000W 230V heating circuits 1 ID ø 465mm ED ø 482mm L 655mm L1 160mm H 17mm thread M14x1.5 connection M4 2 hole fixing tube ø 8.5mm convection heating element		
For models:	EMD.E102MA, EMD.E102MN		
accessories for	416124		
	GEV No.	510417	Ref. No. —
	flat gasket fibre ED ø 20mm ID ø 14mm thickness 2mm Qty 1 pcs		
	GEV No.	520228	Ref. No. —
	tooth lock washer ID ø 15.3mm ED ø 24mm steel Qty 1 pcs for thread M14		
	GEV No.	520230	Ref. No. —
	nut thread M14x1.5 H 5mm WS 19 zinc-coated steel Qty 1 pcs		
	GEV No.	521101	Ref. No. —
	nut thread M14x1.5 H 5mm WS 19 SS Qty 1 pcs		

accessories for 416124

	GEV No.	550262	Ref. No.	—
	flat gasket copper ED ø 20mm ID ø 14mm thickness 2mm			



1

GEV No.	416121	Ref. No.	293200380
description	heating element 7500W 230V heating circuits 3 ID ø 315mm ED ø 332mm L 370mm H 101mm L1 25mm W1 105mm H1 14mm H2 87mm flange length 143mm flange width 26mm hole distance 63mm connection M4 tube ø 8.5mm convection heating element hole ø 6mm rectangular flange		
For models:	EMD.E061MA, EMD.E061MN, EMD.E061MW		

radiation heaters



1

GEV No.	490153	Ref. No.	292200520
description	radiation heater octagonal 3400W 230V L 300mm W 300mm heating circuits 2 H 30mm with heating coil energy regulation with temperature signalization connections 4+2 connection type cable cable length 900mm AD		

square





1

GEV No.	490159	Ref. No.	511062335
description	radiation heater L 300mm W 300mm 3500W 230V connections 3 square without pan detection EGO		
For models:	110-037A-T, 110-057A-T, 110-057FE, 920-037A-T, 920-057A-T, 920-057FE		
spare parts for	490159		
	GEV No.	499157	Ref. No. —
	protection pipe for temperature probe ceramic L 297mm ED ø 7mm ID ø 5mm		

			
1			
GEV No.	419079	Ref. No.	270204020
description	radiation heater L 330mm W 330mm 2100W 230V heating circuits 1 H 35mm square without pan detection IRCA		

square (others)

			
1			
GEV No.	490192	Ref. No.	270205010 770124250
description	radiation heater L 335mm W 310mm 6000W 400V H 45mm		
For models:	500-755A, 700-755A-S, 700-855A-S		

			
1			
GEV No.	419074	Ref. No.	290204520
description	radiation heater rectangular 5000W 400V L 605mm W 240mm heating circuits 3		
For models:	900-320AL-ALC, 900-320AR, 900-320CL-CLC-CR, 900-320TL-TLC-TR, 920-032A-T, 920-320AL-ALC-AR, 920-320TL-TLC-TR		

1-circuit

			
1			
GEV No.	490025	Ref. No.	511062317
description	radiation heater ø 200mm 1700W 230V heating circuits 1 energy regulation with temperature signalization with heating coil connections 2+2 connection type male faston 6.3mm EGO		
For models:	64-037T, 64-057FE, 64-057T, 700-037A-T, 700-057A-T, 700-057FEB		

			
1			
GEV No.	490113	Ref. No.	260203260
description	radiation heater ø 200mm 1800W 230V heating circuits 1 energy regulation with temperature signalization with ribbon heater connections 2+2 connection type male faston 6.3mm CERAMASPEED		

			
1			
GEV No.	490150	Ref. No.	270120320 511062325
description	radiation heater ø 250mm 2500W 230V heating circuits 1 energy regulation with temperature signalization with heating coil connections 2+2 connection type male faston 6.3mm EGO		
For models:	700-037A-T, 700-057A-T, 700-057FEB, 900-037A-T, 900-057A-T, 900-057FE		

2-circuit

			
1			
GEV No.	490114	Ref. No.	270204030
description	radiation heater ø 230mm 2200W 230V heating circuits 2 energy regulation with temperature signalization partial power 750W with ribbon heater connections 2+2 connection type male faston 6.3mm CERAMASPEED		

hot plates

square & rectangular

with radiused edge

			
1			
GEV No.	490073	Ref. No.	5110003
description	hot plate dimensions 300x300mm 3000W 400V with spill ring connection 4 screw clamps protector no square		
For models:	110-030A-T, 110-050A-T, 110-050FE, 500-050A-T, 500-050FE, 900-030A-C-T, 900-050A-C-T, 900-050FE, 900-172A-C-T, 900-172FEA, 920-030A-T, 920-050A-T, 920-050FE, 920-172A-T, 920-172FEA		

energy regulators

EGO

1-circuit



GEV No.	380015	Ref. No.	539209
description	energy regulator 230V 13A single-circuit turn direction right shaft ø 6x4.6mm shaft L 23mm mounting thread M4 power release 6-100% no. 50.57021.010		



GEV No.	380019	Ref. No.	539205
description	energy regulator 240V 13A single-circuit turn direction right shaft ø 6x4.6mm shaft L 23mm mounting thread M4 power release 6-100% no. 50.57071.010		
For models:	70-820, 70-840, ES-702N, ES-IR090C-I, ES-IR120C-I, ES-IR150C-I, ES-IR180C-I		

2-circuit



GEV No.	380027	Ref. No.	539206 539207 539208
description	energy regulator EGO 230V 13A dual circuit turn direction right shaft ø 6x4.6mm shaft L 23mm mounting thread M4 power release 6-70% no. 50.55021.100		
For models:	AB-370080A, AB-370080W, AB-370801A, AB-370801W, AB-96080A, AB-96080W, AB-96801A, AB-96801W, AB-96802A, AB-96802W, AB-AB03A, AB-AB03FA, AB-AB03PA, AB-AB03W, AB-AB05A, AB-AB05PA, AB-AB05W, AB-AB10A, AB-AB10PA, AB-AB10PW, AB-AB10W, AB-AB14A, AB-AB14PA, AB-AB14PW, AB-AB14W		



GEV No.	490071 ¹	Ref. No.	511012440
description	hot plate dimensions 300x300mm 4000W 230V with spill ring connection 4 screw clamps protector yes square		

¹incl. protector

round

with radiused edge

for domestic and commercial kitchens



GEV No.	490010	Ref. No.	611062410
description	hot plate ø 145mm 1000W 230V connection 4 screw clamps with 8mm spill ring		
For models:	64-030T, 64-050FCE, 64-050FE-FEV, 64-050T		



GEV No.	490014	Ref. No.	611062415
description	hot plate ø 180mm 1500W 230V connection 4 screw clamps with 8mm spill ring		
For models:	64-030T, 64-050FCE, 64-050FE-FEV, 64-050T		



GEV No.	490020	Ref. No.	511022426
description	hot plate ø 220mm 2600W 230V connection 4 screw clamps with 8mm spill ring		
accessories for	490020		
	GEV No.	Ref. No.	—
	fixing plate for hot plate ø220mm		



thermostats

control and safety thermostats

EGO

control thermostats

55.10/19_series



GEV No.	375238	Ref. No.	53401030110
description	thermostat t.max. 110°C temperature range 33-110°C 1-pole 1CO 16A probe ø 6mm probe L 138mm capillary pipe 880mm capillary pipe isolated 870mm gland nut shaft ø 6x4.6mm shaft L 23mm shaft position upper rotation 270°		

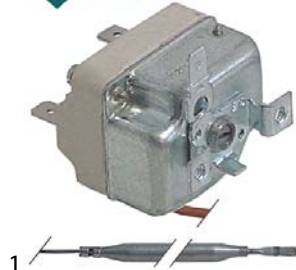

GEV No.	375229	Ref. No.	53400112150
description	thermostat t.max. 150°C temperature range fixed 150°C 1-pole 1CO 16A probe ø 6mm probe L 133mm capillary pipe 900mm capillary pipe isolated 700mm gland nut shaft Lmm shaft position		
For models:	700-528, 900-523, 900-526, 920-523, 920-526		

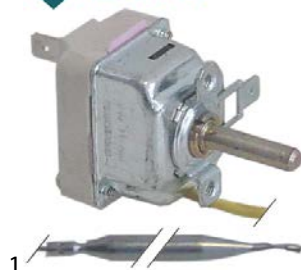

GEV No.	375367	Ref. No.	5340101
description	thermostat t.max. 182°C temperature range 93-180°C 1-pole 1NO 16A probe ø 6mm probe L 133mm capillary pipe 2020mm capillary pipe isolated 1800mm gland nut shaft ø 6x4.6mm shaft L 23mm shaft position upper rotation 270°		
For models:	500-701A, 64-700T, 64-703T, 700-609A, 700-701A-S, 700-702A-S, 700-704A-S, 700-705A-S, 700-708A-S, 900-609A, 900-701A-S, 900-702A-S, 900-704A-S, 900-705A-S, 900-706A-S, 920-609A, 920-704A-S		



GEV No.	375216	Ref. No.	53401005270
description	thermostat t.max. 280°C temperature range 50-280°C 1-pole 1NO 16A probe ø 3mm probe L 228mm capillary pipe 1300mm capillary pipe isolated 1150mm gland nut shaft L 23mm shaft position upper rotation 318°		
For models:	500-050FE, 64-040FCE, 64-040FE, 64-050FE-FEV, 64-050T, 64-057FE, 64-222FCE, 64-222FE, 700-040FEB, 700-050FEB, 700-052FEB, 700-054FEB, 700-055FEB, 700-057FEB, 700-138FEBA, 700-162FEBA, 700-200FEB, 700-222FEB, 700-224FEBA, 700-411B, 900-652, 900-950, 920-652, 920-950, EMD.E061MA, EMD.E061MN, EMD.E061MW, EMD.E081MA, EMD.E081MN, EMD.E081MW, EMD.E101MA, EMD.E101MN, EMD.E101MW, EMD.E102MA, EMD.E102MN		

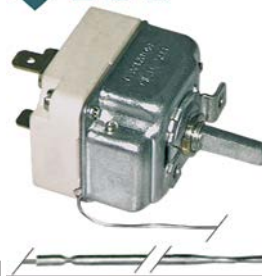

GEV No.	375232	Ref. No.	53401005320
description	thermostat t.max. 320°C temperature range 55-320°C 1-pole capillary pipe isolatedmm gland nut		
For models:	110-500A-T, 64-930T, 700-500A-C-T, 700-542A-C-T, 700-622, 700-632, 700-900, 700-930, 900-500A-C-T, 900-542A-C-T, 900-622, 900-632, 900-642, 900-900, 900-930, 900-940, 920-500A-T, 920-542A-T, 920-622, 920-632, 920-642, 920-900, 920-930, 920-940		



GEV No.	375360	Ref. No.	6340000005503
description	thermostat t.max. 55°C temperature range fixed 55°C 1CO 16A probe ø 6mm probe L 130mm capillary pipe 900mm capillary pipe isolated 900mm gland nut		

electric components



55.34_series



GEV No.	375303	Ref. No.	53401031820
description	thermostat t.max. 185°C temperature range 95-185°C 3-pole 3NO 156A probe ø 6mm probe L 131mm capillary pipe 1470mm capillary pipe isolated 1100mm gland nut		

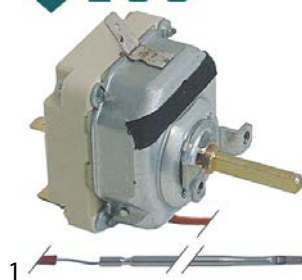

GEV No.	375230	Ref. No.	53403050390
description	thermostat t.max. 270°C temperature range 55-270°C 3-pole 3NO 16A probe ø 3mm probe L 219mm capillary pipe 900mm capillary pipe isolated 900mm gland nut shaft ø 6x4.6mm shaft L 23mm shaft position upper rotation 270°		
For models:	110-050FE, 110-052FE, 110-057FE, 110-122FELC, 110-122FEL-FELR, 110-200FE, 500-320AL-ALC-AR, 500-320TL-TLC-TR, 500-322AL-ALC-ALR-AR, 500-322TL-TLC-TLR-TR, 700-320AL-ALC-AR, 700-320CL-CLC-CR, 700-320TL-TLC-TR, 700-322AL-ALC-ALR-AR, 700-322CL-CLC-CLR-CR, 700-322TL-TLC-TLR-TR, 700-960A-D, 700-962A, 900-040FE, 900-050FE, 900-052FE, 900-054FE, 900-057FE, 900-138FEA, 900-162FEA, 900-172FEA, 900-182FE, 900-200FE, 900-320AL-ALC, 900-320CL-CLC-CR, 900-320TL-TLC-TR, 900-411-413, 900-960A, 900-962A, 920-050FE, 920-052FE, 920-057FE, 920-122FELC, 920-122FEL-FELR-FER, 920-122FELR, 920-122FER, 920-172FEA, 920-200FE		



GEV No.	375192	Ref. No.	00402 53402705320
description	thermostat t.max. 300°C temperature range 50-300°C 3-pole 3NO 16A probe ø 3mm probe L 219mm capillary pipe 900mm capillary pipe isolatedmm gland nut shaft ø 6x4.6mm shaft L 23mm shaft position upper rotation 270°		



GEV No.	375412	Ref. No.	53403050300
description	thermostat t.max. 320°C temperature range 50-320°C 3-pole 3NO 16A probe ø 3.1mm probe L 226mm capillary pipe 1480mm capillary pipe isolated 1400mm gland nut shaft ø 6x4.6mm shaft L 23mm shaft position upper rotation 318°		
For models:	64-320TL-TLC-TR, 64-322TL-TLC-TLR-TR, 9ES-122N, 9ES-122NG, 9ES-152N, 9ES-152NG, 9ES-182N, 9ES-182NG		

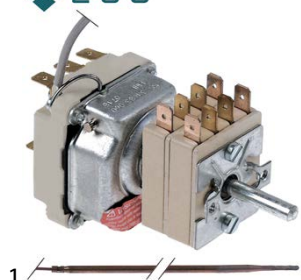

GEV No.	375917	Ref. No.	53403085550
description	thermostat t.max. 550°C temperature range 85-500/85-550°C 3-pole 2NO/1NO 16A probe ø 3.9mm probe L 228mm capillary pipe 1110mm capillary pipe isolated 600mm gland nut shaft ø 6x4.6mm shaft L 23mm rotation 318° outer switch 2NO/2NO		

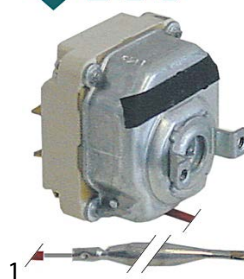

GEV No.	375361	Ref. No.	6340007509002
description	thermostat t.max. 90°C temperature range fixed 75/90°C 2-pole 2CO 16A probe ø 6mm probe L 130mm capillary pipe 900mm capillary pipe isolated 900mm gland nut		



GEV No.	375411	Ref. No.	53403003090
description	thermostat t.max. 93°C temperature range 30-93°C 3-pole 3NO 16A probe ø 6mm probe L 129mm capillary pipe 1480mm capillary pipe isolated 1100mm gland nut M10x1 shaft ø 6x4.6mm shaft L 23mm shaft position upper rotation 270°		
For models:	9ES-122N, 9ES-122NG, 9ES-152N, 9ES-152NG, 9ES-182N, 9ES-182NG		



GEV No.	375371	Ref. No.	53400112220
description	safety thermostat switch-off temp. 225°C 1-pole 1NC probe ø 6mm probe L 86mm capillary pipe 2020mm capillary pipe isolated 1770mm gland nut probe SS		
For models:	500-701A, 64-700T, 64-703T, 700-701A-S, 700-702A-S, 700-704A-S, 700-705A-S, 700-708A-S, 900-701A-S, 900-702A-S, 900-704A-S, 900-705A-S, 900-706A-S, 920-704A-S, 9ES-122N, 9ES-152N, 9ES-182N, ES-121NVC, ES-151NVC, ES-181NVC		



safety thermostats

55.10/19_series



GEV No.	375373	Ref. No.	63401053230
description	safety thermostat capillary pipe 900mm probe ø 11mm 1-pole probe L 26mm 0.5A capillary pipe isolated 700mm gland nut switch-off temp. 230°C probe screw-in probe probe thread M14x1		



GEV No.	375166	Ref. No.	5340101230
description	safety thermostat switch-off temp. 230°C 1-pole 0.5A probe ø 11mm probe L 16.5mm capillary pipe 850mm capillary pipe isolated 850mm gland nut probe screw-in probe probe thread M14x1		
accessories for	375166		
	GEV No.	521133	Ref. No. —
	nut thread M14x1.5 H 6mm WS 19 zinc-coated steel Qty 1 pcs		
	GEV No.	532520	Ref. No. —
	O-ring silicone thickness 2.62mm ID ø 15.08mm Qty 1 pcs		
	GEV No.	550261	Ref. No. —
	nut thread M14x1 H 4mm WS 19 SS Qty 1 pcs		



GEV No.	375218	Ref. No.	6340004014500
description	safety thermostat switch-off temp. 145°C 1-pole 16A probe ø 6mm probe L 130mm capillary pipe 900mm capillary pipe isolated 900mm gland nut probe SS		



GEV No.	375227	Ref. No.	5340011200
description	safety thermostat switch-off temp. 238°C 1-pole 0.5A probe ø 4mm probe L 116mm capillary pipe 900mm capillary pipe isolated 700mm gland nut M9x1 probe SS		
For models:	500-601A, 64-600T-603T, 64-755T, 700-508, 700-601A-S, 700-602A-S, 700-603A, 700-604A-605A, 700-609A, 900-503, 900-506, 900-601A-S, 900-602A-S, 900-604A-S, 900-605A-S, 900-609A, 920-503, 920-506, 920-604A-S, 920-609A		

55.32_ series

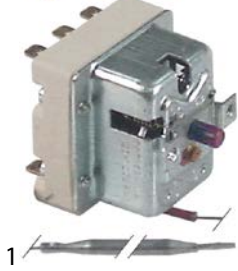

GEV No.	375369	Ref. No.	53403000120
description	safety thermostat switch-off temp. 120°C 3-pole 0.5A probe ø 6mm probe L 94mm capillary pipe 890mm capillary pipe isolatedmm gland nut probe SS		
For models:	64-500T, 64-542T		

56_ series



GEV No.	375987	Ref. No.	63400040320 6340004032001
description	safety thermostat switch-off temp. 335°C 1-pole 20A probe ø 3.03mm probe L 160mm capillary pipe 900mm capillary pipe isolated 750mm gland nut probe SS		
For models:	64-040FCE, 64-050FCE, 64-222FCE		

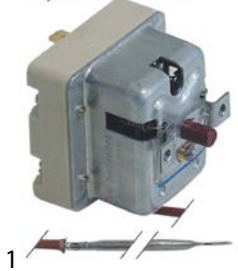

GEV No.	375226	Ref. No.	53403000340
description	safety thermostat switch-off temp. 340°C 1-pole 0.5A probe ø 3mm probe L 190mm capillary pipe 900mm capillary pipe isolated 900mm gland nut probe SS		
For models:	110-122ALC, 110-122FELC, 110-122FLC, 500-120ALC, 500-120TLC, 500-122ALC, 500-122TLC, 64-120TLC, 64-122TLC, 700-120ALC-CLC, 700-120TLC, 700-122ALC, 700-122CLC, 700-122TLC, 900-120ALC, 900-120CLC-TLC, 900-122ALC-CLC-TLC, 920-120ALC, 920-120TLC, 920-122ALC, 920-122FELC, 920-122FLC, 920-122TLC		

control thermostats with operation switch

55.34_ series

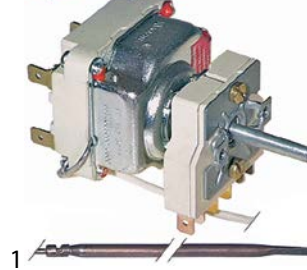

GEV No.	375246	Ref. No.	53401100615
description	thermostat t.max. 645°C temperature range 100-615/645°C 2-pole 2NO 16A probe ø 4mm probe L 230mm capillary pipe 1100mm capillary pipe isolated 600mm gland nut shaft ø 6x4.6mm shaft L 25mm shaft position lower rotation 270° outer switch 2NO probe material copper		



GEV No.	375228	Ref. No.	53403000350
description	safety thermostat switch-off temp. 350°C 3-pole 20A probe ø 3mm probe L 188mm capillary pipe 900mm capillary pipe isolated 900mm gland nut probe SS		
For models:	110-050FE, 110-052FE, 110-057FE, 110-122FELC, 110-122FEL-FELR, 110-200FE, 500-050FE, 500-320AL-ALC-AR, 500-320TL-TLC-TR, 500-322AL-ALC-ALR-AR, 500-322TL-TLC-TLR-TR, 64-320TL-TLC-TR, 64-322TL-TLC-TLR-TR, 64-930T, 700-040FEB, 700-050FEB, 700-052FEB, 700-054FEB, 700-055FEB, 700-057FEB, 700-138FEBA, 700-162FEBA, 700-200FEB, 700-222FEB, 700-224FEBA, 700-320AL-ALC-AR, 700-320CL-CLC-CR, 700-320TL-TLC-TR, 700-322AL-ALC-ALR-AR, 700-322CL-CLC-CLR-CR, 700-322TL-TLC-TLR-TR, 700-411B, 700-622, 700-632, 700-900, 700-930, 700-960A-D, 700-962A, 900-040FE, 900-050FE, 900-052FE, 900-054FE, 900-057FE, 900-138FEA, 900-162FEA, 900-172FEA, 900-182FE, 900-200FE, 900-320AL-ALC, 900-320CL-CLC-CR...(Other models you can see in the webshop)		

accessories

plunger sockets



GEV No.	550469	Ref. No.	A00431
description	thermowell thread 3/4" ID ø 4mm L 230mm SS/brass double		
For models:	500-601A, 64-600T-603T, 700-601A-S, 700-602A-S, 700-603A, 700-604A-605A, 900-601A-S, 900-602A-S, 900-604A-S, 900-605A-S, 920-604A-S		
accessories for	550469		



GEV No.	510403	Ref. No.	—
description	flat gasket fibre ED ø 36.5mm ID ø 27mm thickness 2mm Qty 1 pcs		



GEV No.	510421	Ref. No.	—
description	gasket copper ED ø 31.8mm ID ø 26.4mm thickness 2.2mm for thread 3/4"		





GEV No.	520234	Ref. No.	—
description	nut thread 3/4" H 5mm brass WS 30 Qty 1 pcs		



connecting bows

			
1			
GEV No.	550060	Ref. No.	5200995
description	connecting bow long for thermostat Qty 1 pcs		
For models:	110-032A-T, 110-050FE, 110-052A, 110-052FE, 110-052T, 110-057FE, 110-122FELC, 110-122FEL-FELR, 110-200FE, 110-320AL-ALR, 110-320TL-TLR, 110-322AL-ALC-ALR, 110-322FEL-FELC-FELR, 110-322TL-TLC-TLR, 500-320AL-ALC-AR, 500-320TL-TLC-TR, 500-322AL-ALC-ALR-AR, 500-322TL-TLC-TLR-TR, 64-320TL-TLC-TR, 64-322TL-TLC-TLR-TR, 700-052A-C-T, 700-052FEB, 700-054A, 700-054C, 700-054FEB, 700-054T, 700-320AL-ALC-AR, 700-320CL-CLC-CR, 700-320TL-TLC-TR, 700-322AL-ALC-ALR-AR, 700-322CL-CLC-CLR-CR, 700-322TL-TLC-TLR-TR, 700-960A-D, 700-962A, 900-040FE, 900-050FE, 900-052A-C-T, 900-052FE, 900-054A-C-T, 900-054FE, 900-057FE, 900-138FEA, 900-162FEA, 900-172FEA, 900-182FE, 900-200FE, 900-320AL-ALC, 900-320AR, 900-320CL-CLC-CR, 900-320TL-TLC-TR...(Other models you can see in the webshop)		

			
1			
GEV No.	345643	Ref. No.	A00413
description	push switch mounting ø 25mm clear 1NO/indicator light 250V 16A reset connection male faston 6.3mm ambient temperature max. 85°C protection IP40		

			
1			
GEV No.	345392	Ref. No.	A00285
description	push switch mounting ø 25mm orange 2NO 250V 16A illuminated core temperature connection male faston 6.3mm ambient temperature max. 85°C protection IP40		

switches and momentary switches

push/momentary push switches



ø25mm			
			
1			
GEV No.	300155	Ref. No.	A00252 A00252neu
description	momentary push switch mounting ø 25mm black 2NO 250V 16A light connection male faston 6.3mm ambient temperature max. 85°C protection IP40		

			
1			
GEV No.	300154	Ref. No.	A00255 A00256
description	push switch mounting ø 25mm orange 2NO/indicator light 250V 16A illuminated fan connection male faston 6.3mm ambient temperature max. 85°C protection IP40		

			
1			
GEV No.	300156	Ref. No.	A00253
description	push switch mounting ø 25mm red 250V 16A voltage connection male faston 6.3mm ambient temperature max. 85°C protection IP40		

			
1			
GEV No.	345642	Ref. No.	A00292
description	push switch mounting ø 25mm red 1NO/indicator light 250V 16A water connection male faston 6.3mm ambient temperature max. 85°C protection IP40		
For models:	700-622, 700-632, 700-900, 700-930, 900-622, 900-632, 900-642, 900-652, 900-900, 900-930, 900-940, 900-950, 920-622, 920-632, 920-642, 920-652, 920-900, 920-930, 920-940, 920-950		

			
1			
GEV No.	300169	Ref. No.	52280116380
description	push switch mounting ø 25mm clear 1NO 250V 16A connection male faston 6.3mm ambient temperature max. 85°C protection IP40		

			
1			
GEV No.	345039	Ref. No.	55463001
description	protective cover round ED ø 33mm external size 23mm internal size 21mm H 12mm clear mounting ø 25mm		
For models:	500-701A, 64-519T, 64-520T, 700-519A-C-T, 700-520T, 700-622, 700-632, 700-900, 700-930, 900-622, 900-632, 900-642, 900-652, 900-900, 900-930, 900-940, 900-950, 920-622, 920-632, 920-642, 920-652, 920-900, 920-930, 920-940, 920-950		
accessories for	345039		
	GEV No.	345001	Ref. No.
			—
	 momentary push switch mounting ø 25mm yellow 1NO/indicator light 250V 16A cover connection male faston 6.3mm ambient temperature max. 85°C protection IP65		

			
1			
GEV No.	300161 ¹	Ref. No.	5209201 6209201
description	push switch mounting ø 25mm white 2NO/indicator light 250V 16A illuminated connection male faston 6.3mm ambient temperature max. 85°C protection IP40		
For models:	110-500A-T, 500-500A, 500-701A, 64-500T, 64-519T, 64-520T, 64-542T, 700-520T		

¹illuminated



microswitches

lever actuated



GEV No.	345773	Ref. No.	63952511
description	microswitch with lever 250V 16A 1CO connection male faston 6.3mm L 60mm ambient temperature max. 125°C mounting distance 22mm actuating force: 65g lever length 51mm		
For models:	AF6-1202B, AF6-1202M, AF6-1203B, AF6-1203M, AF6-1204B, AF6-1204M, AF6-1402B, AF6-1402M, AF6-1402MB, AF6-1402MM, AF6-1403B, AF6-1403M, AF6-1403MB, AF6-1404B, AF6-1404M, AF6-1404MM, AF6-601B-701B, AF6-601M, AF6-601MV, AF6-602B-702B, AF6-602M, AF6-701M, AF6-701MV, AF6-701P, AF6-702M, AF6-702MB, AF6-702MM, AF7-1402B, AF7-1402M, AF7-1402MB, AF7-1402MM, AF7-1403B, AF7-1403M, AF7-1403MB, AF7-1404B, AF7-1404M, AF7-1404MM, AF7-701B, AF7-701M, AF7-701P, AF7-702B, AF7-702M, AF7-702MB, AF7-702MM		



GEV No.	300152	Ref. No.	784106510
description	microswitch with lever CO connection male faston		



GEV No.	300158	Ref. No.	539504neu 790107730
description	microswitch with lever 250V 8A 1CO connection cable L 31mm L1 76mm ambient temperature max. 85°C mounting distance 22mm type 831690 actuating force: 300g protection IP67		

pin-plunger actuated

M10



GEV No.	345032	Ref. No.	522583131
description	microswitch with plunger thread M10x1 thread L 12mm 250V 16A 1CO connection male faston 6.3mm stroke 7mm mounting distance 22mm L 28mm ambient temperature max. 125°C type SP9603 actuating force: 180g		

cam switches

on/off



GEV No.	300102	Ref. No.	539502
description	cam switch 4 operating positions 4NO sequence 0-1-0-1 32A shaft ø 6x4.6mm shaft L 23mm connection screw ceramic		
For models:	500-701A, 64-700T, 64-703T, 64-930T, 700-701A-S, 700-702A-S, 700-704A-S, 700-705A-S, 700-708A-S, 900-701A-S, 900-702A-S, 900-704A-S, 900-705A-S, 900-706A-S, 920-704A-S		

4-position



GEV No.	300103	Ref. No.	00410 52002432
description	cam switch 4 operating positions 1NO/2CO sequence 0-1-2-3 32A shaft ø 6x4.6mm shaft L 23mm connection screw ceramic		
For models:	110-030A-T, 110-050A-T, 110-050FE, 500-030A-T, 500-050A-T, 500-050FE, 700-035A-C-T, 700-055A-C-T, 700-055FEB, 900-030A-C-T, 900-050A-C-T, 900-050FE, 900-172A-C-T, 900-172FEA, 900-521-522, 90-821, 920-030A-T, 920-050A-T, 920-050FE, 920-172A-T, 920-172FEA		

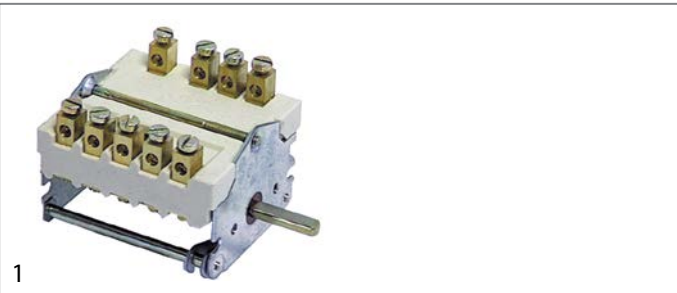



GEV No.	300104	Ref. No.	52003432
description	cam switch 4 operating positions 3NO/1CO sequence 0-1-2-3 32A shaft ø 6x4.6mm shaft L 23mm connection screw ceramic		
For models:	64-755T, 700-528, 900-523, 900-526, 920-523, 920-526		



7-position



1

GEV No.	300025	Ref. No.	52002715
description	cam switch 7 operating positions 1NO/2CO sequence 0-1-2-3-4-5-6 16A shaft \varnothing 6x4.6mm shaft L 23mm connection screw 7-position ceramic		
For models:	64-030T, 64-050FCE, 64-050FE-FEV, 64-050T, 700-030A-C-T		
accessories for	300025		
	GEV No.	112172	Ref. No. —
	knob universal \varnothing 70mm black without adaptor/dial plate		
	GEV No.	112213	Ref. No. —
	knob dial plate silver switch 7-position t.max.°C ED \varnothing 63mm ID \varnothing 45.5mm		
	GEV No.	112311	Ref. No. —
	knob adapter shaft \varnothing 6x4.6mm L 0mm with spring		

4 operating positions

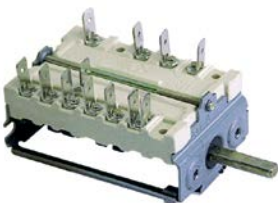

1

GEV No.	300010	Ref. No.	620044924
description	cam switch 4 operating positions 2NO/2CO sequence 0-1-2-3 16A shaft \varnothing 6x4.6mm shaft L 23mm connection male faston 6.3mm ceramic		

5 operating positions

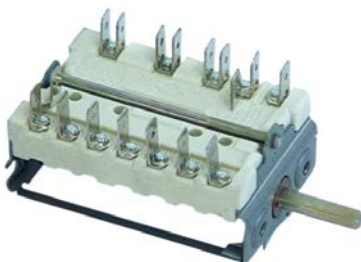

1

GEV No.	300162	Ref. No.	62051824
description	cam switch 5 operating positions shaft \varnothing 6x4.6mm connection male faston 7-pole		
For models:	EMD.E061MN, EMD.E081MN, EMD.E101MN, EMD.E102MN		

operation switches



1

GEV No.	300080	Ref. No.	00423 52004115
description	cam switch 2 operating positions 4NO 16A sequence 0-1 shaft \varnothing 6x4.6mm shaft L 23mm connection screw operation switch ceramic ambient temperature max. 150°C		
For models:	110-032A-T, 110-050FE, 110-052A, 110-052FE, 110-052T, 110-057FE, 110-122FELC, 110-122FEL-FELR, 110-200FE, 110-320AL-ALR, 110-320TL-TLR, 110-322AL-ALC-ALR, 110-322FEL-FELC-FELR, 110-322TL-TLC-TLR, 500-320AL-ALC-AR, 500-320TL-TLC-TR, 500-322AL-ALC-ALR-AR, 500-322TL-TLC-TLR-TR, 64-320TL-TLC-TR, 64-322TL-TLC-TLR-TR, 700-052A-C-T, 700-052FEB, 700-054A, 700-054C, 700-054FEB, 700-054T, 700-320AL-ALC-AR, 700-320CL-CLC-CR, 700-320TL-TLC-TR, 700-322AL-ALC-ALR-AR, 700-322CL-CLC-CLR-CR, 700-322TL-TLC-TLR-TR, 700-960A-D, 700-962A, 900-040FE, 900-050FE, 900-052A-C-T, 900-052FE, 900-054A-C-T, 900-054FE, 900-057FE, 900-138FEA, 900-162FEA, 900-172FEA, 900-182FE, 900-200FE, 900-320AL-ALC, 900-320AR, 900-320CL-CLC-CR, 900-320TL-TLC-TR...(Other models you can see in the webshop)		
accessories for	300080		
	GEV No.	551456	Ref. No. —
	gasket for switch ED \varnothing 14mm ID \varnothing 2.5mm thickness 3.5mm white		

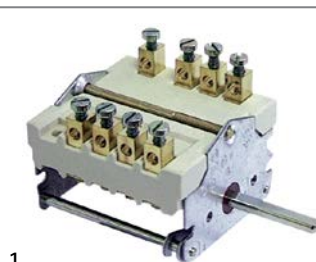

1

GEV No.	300107	Ref. No.	52004132
description	cam switch 2 operating positions operation switch 32A sequence 0-1 shaft \varnothing 6x4.6mm shaft L 23mm connection screw ceramic		



1	GEV No.	300200	Ref. No.	52002115
description	operation switch 2 operating positions 2NO 16A sequence 0-1 shaft \varnothing 6x4.6mm shaft L 23mm connection male faston 6.3mm operation switch ceramic			
For models:	500-050FE, 500-755A, 64-519T, 64-520T, 64-700T, 64-703T, 64-930T, 700-040FEB, 700-050FEB, 700-052FEB, 700-054FEB, 700-055FEB, 700-057FEB, 700-138FEBA, 700-162FEBA, 700-200FEB, 700-222FEB, 700-224FEBA, 700-411B, 700-519A-C-T, 700-520T, 700-701A-S, 700-702A-S, 700-704A-S, 700-705A-S, 700-708A-S, 700-755A-S, 700-855A-S, 900-701A-S, 900-702A-S, 900-704A-S, 900-705A-S, 900-706A-S, 900-755A-S, 900-855A-S, 920-704A-S, 920-755A-S, EMD.E061MA, EMD.E061MW, EMD.E081MA, EMD.E081MW, EMD.E101MA, EMD.E101MW, EMD.E102MA, ES-023N, ES-121NVC, ES-151NVC, ES-181NVC			

magnetic switches

40x13mm



1	GEV No.	300150	Ref. No.	695001
description	magnetic switch L 40mm W 13mm 250V 0.04A connection cable			
For models:	AB-370080A, AB-370080W, AB-370801A, AB-370801W, AB-96080A, AB-96080W, AB-96801A, AB-96801W, AB-96802A, AB-96802W, AB-AB03A, AB-AB03FA, AB-AB03PA, AB-AB03W, AB-AB05A, AB-AB-05PA, AB-AB05W, AB-AB10A, AB-AB10PA, AB-AB10PW, AB-AB10W, AB-AB14A, AB-AB14PA, AB-AB14PW, AB-AB14W, EMD.E061MA, EMD.E061MN, EMD.E061MW, EMD.E081MA, EMD.E081MN, EMD.E081MW, EMD.E101MA, EMD.E101MN, EMD.E101MW, EMD.E102MA, EMD.E102MN			

control equipment

GENERAL ELECTRIC (AEG)

push buttons



1	GEV No.	300168	Ref. No.	52210001
description	push button mounting measurements \varnothing 22mm black			

switches (complete)



1	GEV No.	345644	Ref. No.	A00411
description	momentary push switch mounting measurements \varnothing 22mm 1NC/1NO			
For models:	700-622, 700-632, 900-622, 900-632, 900-642, 900-652, 920-622, 920-632, 920-642, 920-652			



1	GEV No.	300165	Ref. No.	A00128
description	mushroom switch mounting measurements \varnothing 22mm complete			



1	GEV No.	300163	Ref. No.	A00126
description	push switch mounting measurements \varnothing 22mm complete			

lamps

indicator lights

indicator lights 2-piece (lens and indicator lamp)

indicator light lenses



\varnothing 10mm (type SRZ-3)





1	GEV No.	359123	Ref. No.	6229044
description	indicator light housings mounting measurements \varnothing 10mm green round Qty 1 pcs			
accessories for	359123			
	GEV No.	359132	Ref. No.	6229046
	indicator lamp green 250V connection male faston 6.3mm protection IP54 ambient temperature max. 85°C			







1	GEV No.	359125	Ref. No.	6229047
description	indicator light housings mounting measurements \varnothing 10mm red round Qty 1 pcs			



			
1			
GEV No.	359124	Ref. No.	6229043
description	indicator light housings mounting measurements ø10mm yellow round Qty 1 pcs		
For models:	64-755T		
accessories for	359124		
	GEV No.	359132	Ref. No. 6229046
	indicator lamp green 250V connection male faston 6.3mm protection IP54 ambient temperature max. 85°C		

indicator lamps for socket type SRZ / SDK / SDY / SFK			
			
1			
GEV No.	359132	Ref. No.	6229046
description	indicator lamp green 250V connection male faston 6.3mm protection IP54 ambient temperature max. 85°C		
For models:	64-755T		

indicator lights (complete)			
ø10mm			
with plug-in socket			
			
1			
GEV No.	359139	Ref. No.	A00409
description	indicator light ø 10mm green 230V connection male faston 6.3mm Qty 1 pcs		
For models:	110-030A-T, 110-032A-T, 110-037A-T, 110-050A-T, 110-050FE, 110-052A, 110-052FE, 110-052T, 110-057A-T, 110-057FE, 110-122FELC, 110-122FEL-FELR, 110-200FE, 110-320AL-ALR, 110-320TL-TLR, 110-322AL-ALC-ALR, 110-322FEL-FELC-FELR, 110-322TL-TLC-TLR, 110-500A-T, 500-030A-T, 500-050A-T, 500-050FE, 500-320AL-ALC-AR, 500-320TL-TLC-TR, 500-322AL-ALC-ALR-AR, 500-322TL-TLC-TLR-TR, 500-701A, 500-755A, 64-030T, 64-037T, 64-040FCE, 64-050FCE, 64-050FE-FEV, 64-050T, 64-057FE, 64-057T, 64-222FCE, 64-320TL-TLC-TR, 64-322TL-TLC-TLR-TR, 64-519T, 64-520T, 64-700T, 64-703T, 64-930T, 700-030A-C-T, 700-035A-C-T, 700-037A-T, 700-040FEB, 700-050FEB, 700-052A-C-T...(Other models you can see in the webshop)		

			
1			
GEV No.	359140	Ref. No.	A00410
description	indicator light ø 10mm yellow 230V connection male faston 6.3mm Qty 1 pcs		
For models:	110-032A-T, 110-050FE, 110-052A, 110-052FE, 110-052T, 110-057FE, 110-122FELC, 110-122FEL-FELR, 110-200FE, 110-320AL-ALR, 110-320TL-TLR, 110-322AL-ALC-ALR, 110-322FEL-FELC-FELR, 110-322TL-TLC-TLR, 110-500A-T, 500-050FE, 500-320AL-ALC-AR, 500-320TL-TLC-TR, 500-322AL-ALC-ALR-AR, 500-322TL-TLC-TLR-TR, 500-500A, 500-755A, 64-040FCE, 64-040FE, 64-050FCE, 64-050FE-FEV, 64-057FE, 64-222FCE, 64-222FE, 64-320TL-TLC-TR, 64-322TL-TLC-TLR-TR, 64-500T, 64-519T, 64-520T, 64-542T, 64-700T, 64-703T, 64-930T, 700-040FEB, 700-050FEB, 700-052A-C-T, 700-052FEB, 700-054A, 700-054C, 700-054FEB, 700-054T, 700-055FEB, 700-057FEB, 700-138FEBA, 700-162FEBA...(Other models you can see in the webshop)		

ø13mm			
with screw socket			
			
1			
GEV No.	359049	Ref. No.	5229054
description	indicator light ø 13mm 400V green		
For models:	70-820, 70-840, 9ES-122N, 9ES-122NG, 9ES-152N, 9ES-152NG, 9ES-182N, 9ES-182NG, ES-023N, ES-121NVC, ES-121NVCG, ES-151NVC, ES-151NVCG, ES-181NVC, ES-181NVCG, ES-702N, ES-IR090C-I, ES-IR120C-I, ES-IR150C-I, ES-IR180C-I		
accessories for	359049		
	GEV No.	510302	Ref. No. —
	O-ring EPDM ID ø 12.42mm thickness 1.78mm Qty 1 pcs		
	GEV No.	511505	Ref. No. —
	O-ring EPDM thickness 1.78mm ID ø 12.42mm Qty 10 pcs		

			
1			
GEV No.	359050	Ref. No.	5229052
description	indicator light ø 13mm 400V yellow		
For models:	9ES-122N, 9ES-122NG, 9ES-152N, 9ES-152NG, 9ES-182N, 9ES-182NG, ES-023N, ES-121NVC, ES-121NVCG, ES-151NVC, ES-151NVCG, ES-181NVC, ES-181NVCG, ES-424NC, ES-702N, ES-828NC, ES-861NC, ES-891NC		
accessories for	359050		
	GEV No.	510302	Ref. No. —
	O-ring EPDM ID ø 12.42mm thickness 1.78mm Qty 1 pcs		
	GEV No.	511505	Ref. No. —
	O-ring EPDM thickness 1.78mm ID ø 12.42mm Qty 10 pcs		

screw-on/push-on fit			
halogen lamp			
for socket G4 / G6.35 / G9			
			
1			
GEV No.	357193	Ref. No.	6242122001
description	halogen lamp socket G4 12V 20W temp.-resist. 300°C OSRAM HALOSTAR OVEN		

			
1			
GEV No.	359599	Ref. No.	6242122001
description	halogen lamp socket G4 12V 20W temp.-resist. 500°C		

linear lamps

infrared lamps

with base type R7s



GEV No.	359628	Ref. No.	5190001
description	infrared lamp socket R7s L 117.6mm 240V 300W IMPORT unjacketed		



oven lamps

universal oven lamps

mounting diameter 35.5mm



GEV No.	359718	Ref. No.	6230001
description	oven lamp mounting ø 35.5mm 230V 15W socket E14 temp.-resist. 300°C connection male faston 6.3mm hard glas		

spare parts for	359718			
	GEV No.	359701	Ref. No.	—
	lamp socket socket E14 220-230V mounting ø 35.5mm connection male faston 6.3mm 15W			
	GEV No.	359740	Ref. No.	—
	light bulb t.max. 300°C socket E14 15W 230V ø 22mm L 48mm lens L 20mm for oven lamp IMPORT			

lamps

halogen lamps

for socket G4 / G6.35 / G9



GEV No.	357193	Ref. No.	6242122001
description	halogen lamp socket G4 12V 20W temp.-resist. 300°C OSRAM HALOSTAR OVEN		



GEV No.	359599	Ref. No.	6242122001
description	halogen lamp socket G4 12V 20W temp.-resist. 500°C		

residual heat indicators



GEV No.	359095	Ref. No.	260204050
description	residual heat indicator 4-fold		



GEV No.	359096	Ref. No.	260203270
description	residual heat indicator single		

timers

programme timers



GEV No.	360332	Ref. No.	6352000
description	timer FIBER P25 engines 1 chambers 1 operation time 60s 230V shaft ømm shaft Lmm manuf. no. P255J01H191 motor type M51BJ0R6400		

spare parts for	360332			
	GEV No.	360673	Ref. No.	—
	motor kit pinion ø 6.8mm teeth 15 230V voltage AC 50/60Hz turn direction clockwise motor ø 48mm H 18.5mm motor type UDS-40NE1RNZ165 cable length 150mm with holder			

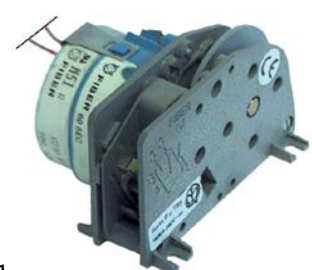

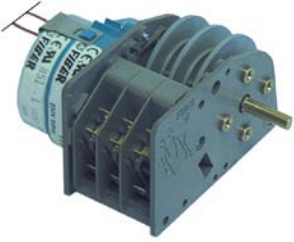

GEV No.	350046	Ref. No.	6352000
description	timer FIBER P25 engines 1 chambers 1 operation time 60s shaft ømm shaft Lmm		

spare parts for	350046			
	GEV No.	360673	Ref. No.	—
	motor kit pinion ø 6.8mm teeth 15 230V voltage AC 50/60Hz turn direction clockwise motor ø 48mm H 18.5mm motor type UDS-40NE1RNZ165 cable length 150mm with holder			

1

GEV No.	350045	Ref. No.	6352001
description	timer FIBER P25 engines 1 chambers 3 operation time 1h 230V shaft ø 6x4.6mm shaft L 20mm manuf. no. P255J03W195 motor type M51BJ0L6400		
spare parts for	350045		
	GEV No.	360674	Ref. No. —
	motor kit pinion ø 6.8mm teeth 15 230V voltage AC 50/60Hz turn direction counterclockwise motor ø 48mm H 18.5mm motor type UDS40NE1RNZ165 cable length 150mm with holder		



1

GEV No.	350008	Ref. No.	6351120
description	timer M2 with bell 2-pole operation time 120min impulse mechanical 2NO at 250V 16A permanent position yes shaft ø 6x4.6mm shaft 6x4.6mm shaft L 24mm mounting distance 28mm connection lateral		
For models:	64-040FCE, 64-050FCE, 64-222FCE		

electric timers

with time spread



1

GEV No.	350074	Ref. No.	293202310
description	timer MS65 operation time 120min time spread 30min 1CO/2NO/1NC at 250V 16A permanent position yes impulse electric shaft ø 6x4.6mm shaft L 22mm mounting distance 28mm connection lateral Invensys 4-pole shaft position lower°		

mechanical timers



1

GEV No.	350003	Ref. No.	63510120
description	timer M2 with bell 2-pole operation time 120min impulse mechanical 2NO at 250V 16A permanent position no shaft ø 6x4.6mm shaft 6x4.6mm shaft L 23mm mounting distance 28mm connection lateral		
accessories for	350003		
	GEV No.	110366	Ref. No. —
	knob switch zero mark t.max.°C ø 44mm shaft ø 6x4.6mm shaft flat upper black		
	GEV No.	111199	Ref. No. —
	dial plate graduation 120min permanent position no rotation 0-330° ø 60mm timers knob ø 45mm		

alarm devices

alarm units



1

GEV No.	350056	Ref. No.	623002
description	alarm device 220-240VAC ømm H 25mm wall-mounted version mounting distancemm 83dB protection IPx0		
For models:	EMD.E061MA, EMD.E081MA, EMD.E101MA, EMD.E102MA		

contactors

LOVATO

power contactors



1

GEV No.	380084	Ref. No.	5300016
description	power contactor 230VAC		
For models:	700-528, 700-632, 700-930, 70-820, 900-523, 900-526, 900-632, 900-652, 900-930, 900-950, 920-523, 920-526, 920-632, 920-652, 920-930, 920-950		



1

GEV No.	380086	Ref. No.	63002406
description	power contactor resistive load 16A 230VAC (AC3/400V) 5A/2.2kW main contacts 3NO auxiliary contacts 1NC connection screw connection type 11BG0601A230 manuf. no. 11BG0601A230		
For models:	EMD.E061MA, EMD.E061MN, EMD.E061MW, EMD.E081MA, EMD.E081MN, EMD.E081MW, EMD.E101MA, EMD.E101MN, EMD.E101MW, EMD.E102MA, EMD.E102MN		

			
1			
GEV No.	380087	Ref. No.	6300240600
description	power contactor resistive load 16A 230VAC (AC3/400V) 5A/2.2kW main contacts 3NO auxiliary contacts 1NO connection screw connection type 11BG0610A230		

			
1			
GEV No.	380082	Ref. No.	53002420904
description	power contactor resistive load 20A 240VAC (AC3/400V) 9A/4kW main contacts 4NO		
For models:	110-500A-T, 500-701A, 64-700T, 64-703T, 64-755T, 64-930T, 700-325A-326A, 700-500A-C-T, 700-542A-C-T, 700-708A-S, 70-840, 900-325A-326A, 900-500A-C-T, 900-542A-C-T, 900-706A-S, 920-500A-T, 920-542A-T		

			
1			
GEV No.	380083	Ref. No.	530024501
description	power contactor resistive load 25A 230VAC (AC3/400V) 9A/4.2kW main contacts 3NO auxiliary contacts 1NC connection screw connection type BF0901A230		
For models:	500-755A, 700-701A-S, 700-702A-S, 700-704A-S, 700-705A-S, 700-755A-S, 700-855A-S, 900-701A-S, 900-702A-S, 900-704A-S, 900-705A-S, 900-755A-S, 900-855A-S, 920-704A-S, 920-755A-S, AB-370080A, AB-370080W, AB-370801A, AB-370801W, AB-96080A, AB-96080W, AB-96801A, AB-96801W, AB-96802A, AB-96802W, AB-AB03A, AB-AB-03FA, AB-AB03PA, AB-AB03W, AB-AB05A, AB-AB05PA, AB-AB05W, AB-AB10A, AB-AB10PA, AB-AB10PW, AB-AB10W, AB-AB14A, AB-AB14PA, AB-AB14PW, AB-AB14W, EMD.E061MA, EMD.E061MN, EMD.E061MW, EMD.E081MA, EMD.E081MN, EMD.E081MW, EMD.E101MA, EMD.E101MN, EMD.E101MW, EMD.E102MA...(Other models you can see in the webshop)		

miscellaneous

power contactors

			
1			
GEV No.	380085	Ref. No.	5300240600
description	power contactor		
For models:	700-622, 700-632, 900-622, 900-632, 900-642, 900-652, 920-622, 920-632, 920-642, 920-652, EMD.E061MA, EMD.E061MN, EMD.E061MW, EMD.E081MA, EMD.E081MN, EMD.E081MW, EMD.E101MA, EMD.E101MN, EMD.E101MW, EMD.E102MA, EMD.E102MN, TR-G2341BN, TR-G234BN, TR-N2341BN, TR-N2342BN, TR-N234BN		

relays

level relays

			
1			
GEV No.	400018	Ref. No.	639624051
description	level relay 230V voltage AC connection F6.3 type RL30/3ES/F/G		

time relays

time relays

			
1			
GEV No.	380075	Ref. No.	53601030 6320000
description	time relay LOVATO TM P time range 0.1s-240h 24-240VAC/24-48VDC 8A 1CO connection screw clamp		
For models:	EMD.E061MA, EMD.E061MW, EMD.E081MA, EMD.E081MW, EMD.E101MA, EMD.E101MW, EMD.E102MA		



transformers

toroidal core transformers

			
1			
GEV No.	401618	Ref. No.	293203880
description	transformer primary 230V secondary 12V 50VA		
For models:	EMD.E061MA, EMD.E061MN, EMD.E061MW, EMD.E081MA, EMD.E081MW, EMD.E101MA, EMD.E101MW, EMD.E102MA		

encapsulated transformers

PMA			
			
1			
GEV No.	379054	Ref. No.	639603
description	transformer primary 230VAC secondary 12VAC 3VA secondary 0.25A H 40mm L 45mm W 50mm connection screw 50/60Hz type 153/M		

for lighting

			
1			
GEV No.	400095	Ref. No.	639602
description	electrical ballast primary 230V secondary 11.5V 45VA		

			
1			
GEV No.	400668	Ref. No.	639601
description	transformer primary 230V secondary 12V 20VA		

electronic controllers

EVCO - EVERY CONTROL

universal controllers

built-in version

			
1			
GEV No.	378131	Ref. No.	629601
description	electronic controller EVERY CONTROL EVK411M mounting measurements 71x29mm 12V voltage AC/DC NTC/PTC/Pt100/Pt1000 relay outputs 1 CO-16A(8) NTC/PTC/Pt100/Pt1000/TC(J,K)/mV/mA yes protection IP65 dependent on probe°C display 3½ digits		
accessories for	378131		
	GEV No.	379050	Ref. No. —
		temperature probe Pt100 cable Vetrotex probe -200 up to +600°C cable -50 up to +350°C probe ø6x100mm cable length 2.7m without screw connection 3-wire	
	GEV No.	379160	Ref. No. —
		temperature probe NTC 10kOhm cable thermoplastic probe -40 up to +110°C cable -40 up to +110°C probe ø6x14mm cable length 1.5m without screw connection 2-wire	
	GEV No.	379781	Ref. No. —
		temperature probe PTC 1kOhm cable thermoplastic probe -50 up to +150°C cable -40 up to +110°C probe ø6x14mm cable length 1.5m without screw connection 2-wire	
	GEV No.	379944	Ref. No. —
		temperature probe Pt1000 cable Vetrotex probe -70 up to +500°C cable -50 up to +350°C connection 2-wire thread probe ø6x180mm cable length 1.7m	

SHANGFANG

accessories

			
1			
GEV No.	379054	Ref. No.	639603
description	transformer primary 230VAC secondary 12VAC 3VA secondary 0.25A H 40mm L 45mm W 50mm connection screw 50/60Hz type 153/M		



probes

producer-specific probes

probes



GEV No.	400261	Ref. No.	62771000 A00317
description	temperature probe Pt100 cable Vetrotex probe -100 up to 450°C cable -50 up to +350°C connection 3-wire thread probe ø6x80mm cable length 1m		



GEV No.	400719	Ref. No.	540201
description	temperature probe thread probe ø4x50mm		

core probes



GEV No.	400263	Ref. No.	6277041000
description	core temperature probe Pt100 cable PTFE probe -40 up to +250°C cable -40 up to +250°C connection 2-wire probe ø4x100mm thread cable length 2m handle ø 10mm handle length 90mm		

electronics

PCBs



GEV No.	400200	Ref. No.	292200640
description	PCB		



GEV No.	401451	Ref. No.	292200620
description	PCB pyroceram range 110/920 series		



GEV No.	401397	Ref. No.	A00301
description	PCB replace set		



GEV No.	400281	Ref. No.	66210001
description	programming PCB		



GEV No.	400282	Ref. No.	66210002
description	relay PCB		

keypads

front foils



GEV No.	400272	Ref. No.	293200920
description	front foil		

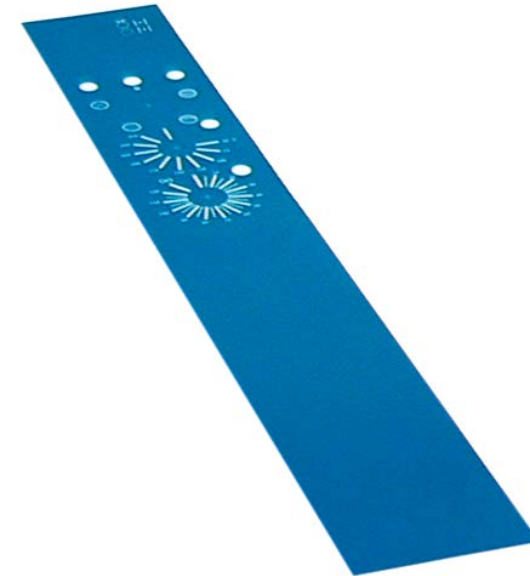

GEV No.	400273	Ref. No.	293201850
description	front foil		

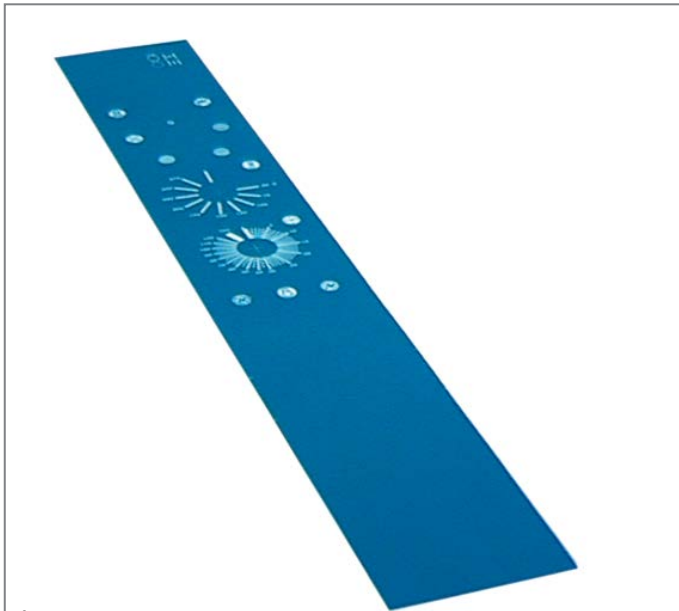

1

GEV No.	400274	Ref. No.	293200220
description	front foil		

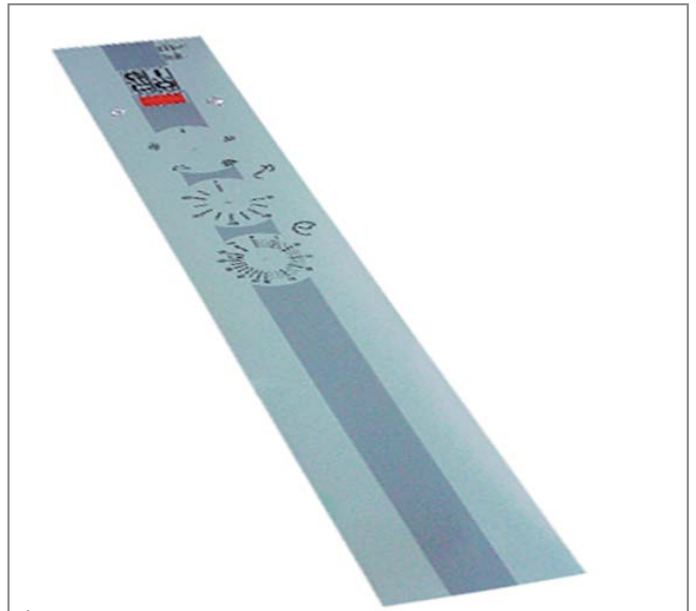

1

GEV No.	400277	Ref. No.	293201490 293202430
description	front foil		



1

GEV No.	400276	Ref. No.	293200900
description	front foil		

membrane keypads



1

GEV No.	400278	Ref. No.	66201001
description	membrane keypad		



1

GEV No.	400279	Ref. No.	66200001
description	membrane keypad		



1

GEV No.	400280	Ref. No.	66202001
description	membrane keypad		

TP



1















GEV No.	370021	Ref. No.	425311034
description	solenoid valve double straight 230VAC inlet 3/4" outlet 11.5mm DN10 TP flow regulating valve inlet white		
spare parts for	370021		
	GEV No.	371013	Ref. No. —
	solenoid coil TP 230VAC 50/60Hz		
accessories for	370021		
	GEV No.	371220	Ref. No. —
	reducer TP flow rate 3l/min red tolerance ±15%		
	GEV No.	371221	Ref. No. —
	reducer TP flow rate 5.5l/min yellow tolerance ±15%		
	GEV No.	371222	Ref. No. —
	reducer TP flow rate 6l/min grey tolerance ±15%		
	GEV No.	371223	Ref. No. —
	reducer TP flow rate 10l/min white tolerance ±15%		
	GEV No.	371224	Ref. No. —
	reducer TP flow rate 12l/min bronze tolerance ±15%		
	GEV No.	371225	Ref. No. —
	reducer TP flow rate 16l/min light brown tolerance ±15%		
	GEV No.	371226	Ref. No. —
	reducer TP flow rate 20l/min red tolerance ±15%		
	GEV No.	371230	Ref. No. —
	reducer TP flow rate 0.25l/min red tolerance ±25%		
	GEV No.	371231	Ref. No. —
	reducer TP flow rate 0.35l/min violet tolerance ±25%		
	GEV No.	371232	Ref. No. —
	reducer TP flow rate 0.5l/min orange tolerance ±25%		
	GEV No.	371233	Ref. No. —
	reducer TP flow rate 0.8l/min white tolerance ±25%		
	GEV No.	371234	Ref. No. —
	reducer TP flow rate 1l/min light blue tolerance ±25%		
	GEV No.	371235	Ref. No. —
	reducer TP flow rate 1.2l/min brown tolerance ±25%		
	GEV No.	371236	Ref. No. —
	reducer TP flow rate 1.5l/min light brown tolerance ±25%		

Table continues overleaf

solenoid valves

solenoid valves (water)

RPE





JOHN GUEST























1

GEV No.	374064	Ref. No.	539434110
description	solenoid valve single straight 230VAC inlet 3/4" outlet JG 10 input/ min output/min DN10 t.max. 25/60/90°C duty cycle 100% RPE 160001230V plastic		



accessories for		370021		
GEV No.	Ref. No.	Ref. No.	Ref. No.	—
	371237			
reducer TP flow rate 2.5l/min yellow tolerance ±25%				
	371238			
reducer TP flow rate 3.4l/min dark green tolerance ±25%				
	371239			
reducer TP flow rate 5l/min black tolerance ±25%				
	371240			
reducer TP flow rate 8l/min blue tolerance ±20%				

 <p>1</p>				
GEV No.	Ref. No.	Ref. No.	Ref. No.	53943410240 A00287
description				
solenoid valve single straight 230VAC inlet 3/4" outlet 11.5mm DN10 TP p max 10bar				
For models:				
110-500A-T, 700-622, 700-632, 700-900, 700-930, 900-622, 900-632, 900-642, 900-652, 900-900, 900-930, 900-940, 900-950, 920-622, 920-632, 920-642, 920-652, 920-900, 920-930, 920-940, 920-950, 9ES-122N, 9ES-122NG, 9ES-152N, 9ES-152NG, 9ES-182N, 9ES-182NG				
spare parts for		370017		
	371013			
solenoid coil TP 230VAC 50/60Hz				
accessories for		370017		
	371220			
reducer TP flow rate 3l/min red tolerance ±15%				
	371221			
reducer TP flow rate 5.5l/min yellow tolerance ±15%				
	371222			
reducer TP flow rate 6l/min grey tolerance ±15%				
	371223			
reducer TP flow rate 10l/min white tolerance ±15%				
	371224			
reducer TP flow rate 12l/min bronze tolerance ±15%				
	371225			
reducer TP flow rate 16l/min light brown tolerance ±15%				
	371226			
reducer TP flow rate 20l/min red tolerance ±15%				
	371230			
reducer TP flow rate 0.25l/min red tolerance ±25%				
	371231			
reducer TP flow rate 0.35l/min violet tolerance ±25%				

accessories for		370017		
GEV No.	Ref. No.	Ref. No.	Ref. No.	—
	371232			
reducer TP flow rate 0.5l/min orange tolerance ±25%				
	371233			
reducer TP flow rate 0.8l/min white tolerance ±25%				
	371234			
reducer TP flow rate 1l/min light blue tolerance ±25%				
	371235			
reducer TP flow rate 1.2l/min brown tolerance ±25%				
	371236			
reducer TP flow rate 1.5l/min light brown tolerance ±25%				
	371237			
reducer TP flow rate 2.5l/min yellow tolerance ±25%				
	371238			
reducer TP flow rate 3.4l/min dark green tolerance ±25%				
	371239			
reducer TP flow rate 5l/min black tolerance ±25%				
	371240			
reducer TP flow rate 8l/min blue tolerance ±20%				



pressure switches for gas equipment

 <p>1</p>			
GEV No.	Ref. No.	Ref. No.	6440001
description			
pressure control ø 45mm pressure range adjustable 5-20mbar pressure connection vertical gas technology connection 1/4" pressure connection ø 1/4"mm			

electrodes

 <p>1</p>			
GEV No.	Ref. No.	Ref. No.	793103640
description			
level electrode 1/4" total length 111.5mm probe L 86.5mm insulated probe length 84mm connection male faston 6.3mm stainless steel ø 2.5mm			
For models:			
500-755A, 700-755A-S, 700-855A-S, 900-755A-S, 900-855A-S, 920-755A-S			



			
1			
GEV No.	400260	Ref. No.	639314125
description	level electrode 1/4" total length 220mm probe L 195mm insulated probe length 185mm PTFE insulated connection male faston 6.3mm stainless steel ø 2.5mm		
accessories for	400260		
	GEV No.	521003	Ref. No. —
	nut thread 1/4" H 6.3mm chrome-plated brass WS 20 Qty 1 pcs		

hot air motors

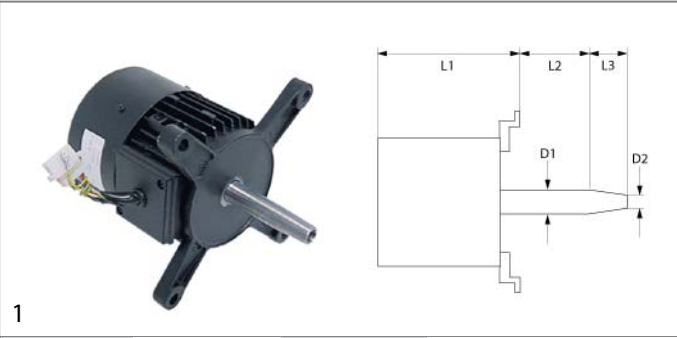

1			
GEV No.	601091	Ref. No.	293200190
description	fan motor 200-240/415V 3 phase 50/60Hz 1HP 1400/1700rpm speeds 1 L1 210mm L2 45mm L3 47mm D1 ø 24mm D2 ø 20mm M8L IT 3.6/2.1A at 50Hz 200-240/415V at 60Hz 200-240/480V at 50Hz 1400rpm at 60Hz 1700rpm type 1040A4450		

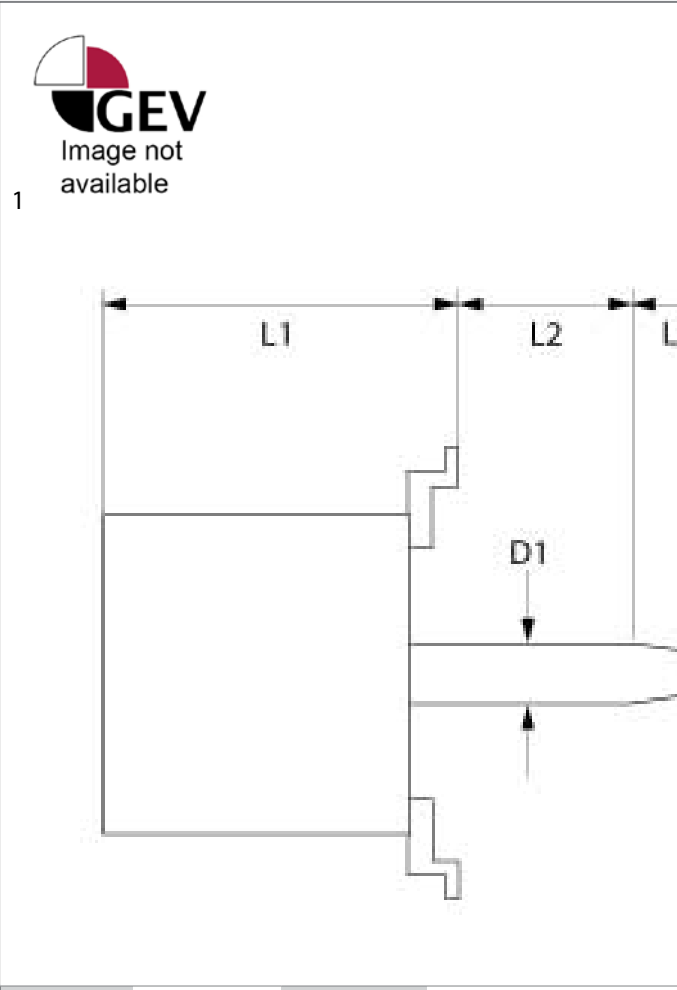



1			
GEV No.	601848	Ref. No.	A00381
description	fan motor 200-240/415V 3 phase 50/60Hz 1HP 1400rpm speeds 1 L1 210mm L2 45mm L3 47mm D1 ø 24mm D2 ø 20mm M8L IT 3.6/2.1A at 50Hz 200-240/415V at 60Hz 200-240/480V at 50Hz 1400rpm at 60Hz 1700rpm		

fans

axial fans

ebm-papst



1			
GEV No.	601030 ¹	Ref. No.	607008
description	axial fan L 119mm W 119mm H 38mm 230VAC 50Hz 18W bearing ball bearing manuf. no. 4656Z metal connection male faston 2.8mm ebm-papst fan wheel ø 110mm temp.-resist. 75°C		
For models:	700-050FEB, 700-052FEB, 700-054FEB, 700-055FEB, 900-050FE, 900-052FE, 900-054FE, 900-172FEA, AB-370080W, AB-370801W, AB-96080W, AB-96801W, AB-96802W, AB-AB03W, BF70120, BF70160, EMD.E061MA, EMD.E061MN, EMD.E061MW, EMD.E081MA, EMD.E081MN, EMD.E081MW, EMD.E101MA, EMD.E101MN, EMD.E101MW, EMD.E102MA, EMD.E102MN, TF-G110-G1101, TF-G138-G1381, TF-G158-G1581, TF-G2060-G2061, TF-N110-N1101-N1102, TF-N138-N1381-N1382, TF-N158, TF-N1581-N1582, TF-N2060-N2061-N2062, TR-G110-G1101, TR-G138-G1381, TR-G158-G1581, TR-G1860-G1861, TR-G2060BN, TR-G2060-G2061, TR-G2061BN, TR-G2341BN, TR-G234BN, TR-G234-G2341, TR-N110-N1101-N1102, TR-N138-N1381-N1382, TR-N158-N1581-N1582, TR-N1860-N1861-N1862... (Other models you can see in the webshop)		
accessories for	601030		
	GEV No.	550898	Ref. No. —
	connecting cable cable length 2000mm connection F 2.8 connection distance 7.9mm for axial flow fan		
	GEV No.	692497	Ref. No. —
	guard ø 105mm mounting distance 150mm for axial fan ebm-papst-mm		

¹with ball bearings

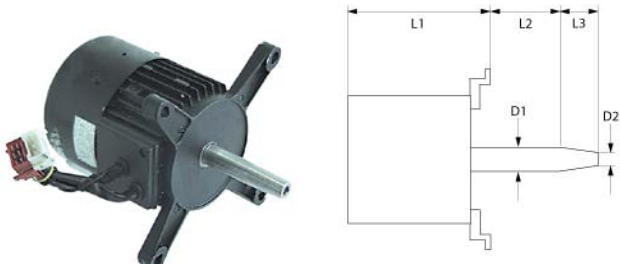

1

GEV No.	601093	Ref. No.	293201150
description	fan motor 200-240/415V 3 phase 50Hz 0.3/1HP 900/1400rpm speeds 2 L1 210mm L2 50mm L3 45mm D1 ø 24mm D2 ø 20mm M8L IT 3.6/2.1-1.5/0.9A at 50Hz 200-240/415V at 60Hz 200-240/480V at 50Hz 900/1400rpm at 60Hz 1100/1700rpm type 1041A4450		



1

GEV No.	601096	Ref. No.	293200240
description	fan wheel D1 ø 285mm H1 140mm blades 24 D2 ø 19.5mm D3 ø 23.5mm H2 45mm		
For models:	EMD.E081MA, EMD.E081MN, EMD.E081MW, EMD.E101MA, EMD.E101MN, EMD.E101MW		

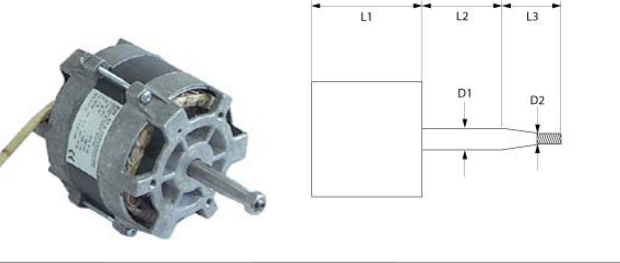

1

GEV No.	601090	Ref. No.	293200840
description	fan motor 200-240V 1 phase 50/60Hz 0.18kW 0.25HP 1400rpm speeds 1 L1 123mm L2 41mm L3 30mm D1 ø 15mm D2 ø 10mm M10L ET 1.6A suitable capacitor 5µF/450V at 50Hz 1400rpm at 60Hz 1700rpm type 1071		



1

GEV No.	601097	Ref. No.	293201100
description	fan wheel D1 ø 310mm H1 160mm blades 24 D2 ø 19.5mm D3 ø 23mm H2 46mm		
For models:	EMD.E102MA, EMD.E102MN		

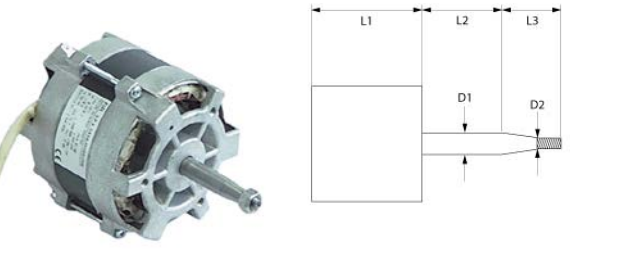

1

GEV No.	601092	Ref. No.	293200420
description	fan motor 200-240V 1 phase 50Hz 0.1/0.25HP 900/1400rpm speeds 2 L1 123mm L2 41mm L3 30mm D1 ø 15mm D2 ø 10mm M10L ET 1/0.6A suitable capacitor 5µF/450V at 50Hz 900/1400rpm at 60Hz 1100/1700rpm type 1071		



1

GEV No.	601095	Ref. No.	293200680
description	fan wheel D1 ø 210mm H1 100mm blades 20 D2 ø 11mm D3 ø 16mm H2 30mm		
For models:	EMD.E061MA, EMD.E061MN, EMD.E061MW		



hot air fans

miscellaneous



1

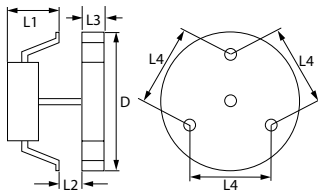

GEV No.	601094	Ref. No.	507005 507007 507009
description	fan motor 240V 36W 50Hz L1 85mm L2 15mm L3 20mm L4 87mm fan wheel ø 150mm Emmevi type 260305X		
For models:	9ES-122N, 9ES-152N, 9ES-182N, ES-121NVC, ES-151NVC, ES-181NVC		

pumps

booster pumps II

accessories



1

GEV No.	365017	Ref. No.	6410005
description	operating capacitor capacity 5µF 450V tolerance 5% 50/60Hz ambient temperature max. -25 to +85°C ø 28mm L 54mm M8 plastic connection male faston 6.3mm 16.10.08 protection		
For models:	EMD.E061MA, EMD.E061MN, EMD.E061MW		

condensators & interference suppression filters

operating capacitors

plastic



1

GEV No.	365017	Ref. No.	6410005
description	operating capacitor capacity 5µF 450V tolerance 5% 50/60Hz ambient temperature max. -25 to +85°C ø 28mm L 54mm M8 plastic connection male faston 6.3mm 16.10.08 protection		
For models:	EMD.E061MA, EMD.E061MN, EMD.E061MW		

electric accessories

terminals

connection terminals with screw/faston connections



1

GEV No.	550411	Ref. No.	652502
description	power terminal block 6-pole max. 40A max 450V connection ø6mm ² / F6.3 temp.-resist. 150°C cross section 6mm ²		
For models:	110-500A-T, 500-039A, 500-701A, 500-755A, 64-050FCE, 64-050FE-FEV, 64-050T, 64-057FE, 64-057T, 64-700T, 64-703T, 64-755T, 700-037A-T, 700-039A, 700-050FEB, 700-055A-C-T, 700-055FEB, 700-057A-T, 700-057FEB, 700-500A-C-T, 700-542A-C-T, 700-622, 700-701A-S, 700-702A-S, 700-704A-S, 700-705A-S, 700-708A-S, 700-755A-S, 700-855A-S, 700-900, 900-037A-T, 900-038A-058A, 900-038AM-058AM, 900-039A, 900-050A-C-T, 900-050FE, 900-057A-T, 900-057FE, 900-172A-C-T, 900-172FEA, 900-500A-C-T, 900-542A-C-T, 900-622, 900-642, 900-701A-S, 900-702A-S, 900-704A-S, 900-705A-S, 900-706A-S, 900-755A-S...(Other models you can see in the webshop)		



gas taps

PEL

20N series













1

GEV No.	101398	Ref. No.	435213
description	gas tap PEL type 20N gas inlet M16x1.5 (tube ø 10mm) bypass nozzle ø 0.35mm gas outlet M16x1.5 (tube ø 10/8mm) thermocouple connection pilot connection M10x1 shaft ø 8x6.5mm shaft L 22/15mm shaft flat upper		
spare parts for	101398		
	GEV No.	100408	Ref. No. —
	bypass nozzle type PEL20/21 bore ø 0.35mm thread M5x0.5		
	GEV No.	101205	Ref. No. —
	gas tap front part shaft ø 8x6.5mm shaft L 22/15mm shaft flat upper/lower suitable for PEL20		
accessories for	101398		
	GEV No.	101278	Ref. No. —
	olive for pipe ø 10mm Qty 1 pcs		
	GEV No.	101300	Ref. No. —
	union nut thread M16x1.5 tube ø 10mm		
	GEV No.	101450	Ref. No. —
	olive for pipe ø 8mm L 12.7mm Qty 1 pcs ED ø 10mm		
	GEV No.	101451	Ref. No. —
	union nut thread M16x1.5 tube ø 8mm		
	GEV No.	110081	Ref. No. —
	knob ø 70mm shaft ø 8x6.5mm shaft flat universal		
	GEV No.	110083	Ref. No. —
	knob dial plate gas tap without ignition flame silver		

20S series



1

GEV No.	101094	Ref. No.	435212
description	gas tap PEL type 20S gas inlet M16x1.5 (tube ø 10mm) bypass nozzle ø 0.35mm gas outlet M16x1.5 (tube ø 10/8mm) thermocouple connection M8x1 pilot connection shaft ø 8x6.5mm shaft L 22/15mm shaft flat lower		
For models:	64-020T-64-040T, 64-040FCE, 64-040FE, 64-040F-FV, 64-222F, 64-222FCE, 64-222FE, 64-222T		
spare parts for	101094		
	GEV No.	100408	Ref. No. —
	bypass nozzle type PEL20/21 bore ø 0.35mm thread M5x0.5		
	GEV No.	101060	Ref. No. —
	magnet unit standard L 39mm D1 ø 15.4mm D2 ø 11mm suitable for PEL20-21/JUNKERS/EGA		
	GEV No.	101205	Ref. No. —
	gas tap front part shaft ø 8x6.5mm shaft L 22/15mm shaft flat upper/lower suitable for PEL20		
	GEV No.	101230	Ref. No. —
	thermocouple nut T1: M8x1 T2: M18x1 aluminium		
accessories for	101094		
	GEV No.	101278	Ref. No. —
	olive for pipe ø 10mm Qty 1 pcs		
	GEV No.	101300	Ref. No. —
	union nut thread M16x1.5 tube ø 10mm		
	GEV No.	101450	Ref. No. —
	olive for pipe ø 8mm L 12.7mm Qty 1 pcs ED ø 10mm		
	GEV No.	101451	Ref. No. —
	union nut thread M16x1.5 tube ø 8mm		
	GEV No.	110081	Ref. No. —
	knob ø 70mm shaft ø 8x6.5mm shaft flat universal		
	GEV No.	110083	Ref. No. —
	knob dial plate gas tap without ignition flame silver		



21S series



1

GEV No.	101095	Ref. No.	435210
description	gas tap PEL type 21S gas inlet M16x1.5 (tube ø 10mm) bypass nozzle ø 0.35mm gas outlet M16x1.5 (tube ø 10/8mm) thermocouple connection M8x1 pilot connection M10x1 shaft ø 8x6.5mm shaft L 22/15mm shaft flat lower		
For models:	64-125T-126T, 64-130TL-TR, 64-132TL-TLR-TR, 64-222F, 64-222FCE, 64-222FE, 64-222T, 64-900T, 700-020A-C-T, 700-040A-C-T, 700-040FB, 700-040FEB, 700-125T, 700-126T, 700-127T, 700-130AL-AR, 700-130CL-CR, 700-130TL-TR, 700-132AL-AR, 700-132ALR, 700-132CL-CR, 700-132CLR, 700-132TLR, 700-132TL-TR, 700-138A-C-T, 700-138FBA, 700-138FEBA, 700-162A-C-T, 700-162FBA, 700-162FEBA, 700-162FG, 700-222A-C, 700-222FB, 700-222FEB, 700-222T, 700-224A-C, 700-224FBA, 700-224FEBA, 700-224FG, 700-224T, 900-020A-C-T, 900-040A-C-T, 900-040F, 900-040FE, 900-125T, 900-126T, 900-127T, 900-130AL-AR, 900-130CL-CR, 900-130TL-TR...(Other models you can see in the webshop)		
spare parts for	101095		
	GEV No.	100408	Ref. No. —
	bypass nozzle type PEL20/21 bore ø 0.35mm thread M5x0.5		
	GEV No.	101060	Ref. No. —
	magnet unit standard L 39mm D1 ø 15.4mm D2 ø 11mm suitable for PEL20-21/JUNKERS/EGA		
	GEV No.	101206	Ref. No. —
	gas tap front part shaft ø 8x6.5mm shaft L 22/15mm shaft flat upper/lower suitable for PEL21		
accessories for	101095		
	GEV No.	100908	Ref. No. —
	union screw thread M10x1 for pipe ø 4mm Qty 1 pcs		
	GEV No.	100909	Ref. No. —
	union screw thread M10x1 for pipe ø 6mm Qty 1 pcs		
	GEV No.	101246	Ref. No. —
	olive for pipe ø 4mm Qty 1 pcs		
	GEV No.	101278	Ref. No. —
	olive for pipe ø 10mm Qty 1 pcs		
	GEV No.	101286	Ref. No. —
	olive ID ø 6mm Qty 1 pcs		
	GEV No.	101300	Ref. No. —
	union nut thread M16x1.5 tube ø 10mm		
	GEV No.	101450	Ref. No. —
	olive for pipe ø 8mm L 12.7mm Qty 1 pcs ED ø 10mm		
	GEV No.	101451	Ref. No. —
	union nut thread M16x1.5 tube ø 8mm		
	GEV No.	110081	Ref. No. —
	knob ø 70mm shaft ø 8x6.5mm shaft flat universal		

accessories for 101095



GEV No.	112206	Ref. No.	—
knob dial plate silver gas tap PEL21/22/23 t.max.°C ED ø 63mm ID ø 45.5mm			

22S/O series



1

GEV No.	101089	Ref. No.	435221
description	gas tap PEL type 22S/O gas inlet M20x1.5 (tube ø 12mm) bypass nozzle ø 0.35mm gas outlet M20x1.5 (tube ø 12/10mm) thermocouple connection M8x1 pilot connection M10x1 shaft ø 10x8mm shaft L 25/17mm shaft flat upper		
For models:	110-200A-T, 110-200F, 110-200FE, 500-125A-126A, 500-750A, 500-800A, 700-125A-C, 700-126A-C, 700-127A-C, 700-138A-C-T, 700-138FBA, 700-138FEBA, 700-200A-C-T, 700-200FB, 700-200FEB, 700-750A-S, 700-800A-S, 900-125A-C, 900-126A-C, 900-127A-C, 900-138A-C-T, 900-138FA, 900-138FEA, 900-200A-C-T, 900-200F, 900-200FE, 900-750A-S, 900-800A-S, 90-301, 920-200A-T, 920-200F, 920-200FE, 920-750A-S		
spare parts for	101089		
	GEV No.	100259	Ref. No. —
	bypass nozzle type PEL22 bore ø 0.35mm thread M6x0.5		
	GEV No.	101058	Ref. No. —
	magnet unit L 39mm D1 ø 15.4mm D2 ø 13.5mm suitable for PEL22/EGA24197 standard		
	GEV No.	101201	Ref. No. —
	gas tap front part shaft ø 10x8mm shaft L 25/17mm shaft flat upper/lower suitable for PEL22		
	GEV No.	101230	Ref. No. —
	thermocouple nut T1: M8x1 T2: M18x1 aluminium		
	GEV No.	101240	Ref. No. —
	gas connection thread M20x1.5 tube ø 12/10mm for PEL gas taps with gasket and screws horizontal		
	GEV No.	101460	Ref. No. —
	O-ring ø 12.37mm D1 ø 2.62mm suitable for PEL22		
	GEV No.	101461	Ref. No. —
	screw kit suitable for PEL22 Qty 4 pcs		
accessories for	101089		
	GEV No.	100908	Ref. No. —
	union screw thread M10x1 for pipe ø 4mm Qty 1 pcs		
	GEV No.	100909	Ref. No. —
	union screw thread M10x1 for pipe ø 6mm Qty 1 pcs		
	GEV No.	101241	Ref. No. —
	gas connection thread M20x1.5 tube ø 12/10mm for PEL gas taps vertical		
	GEV No.	101246	Ref. No. —
	olive for pipe ø 4mm Qty 1 pcs		

Table continues overleaf



accessories for		101089		
GEV No.	Ref. No.	GEV No.	Ref. No.	—
	101248	Ref. No.	—	—
olive for pipe ø 12mm Qty 1 pcs suitable for PEL				
	101249	Ref. No.	270201580	—
olive for pipe ø 10mm Qty 1 pcs				
	101250	Ref. No.	270201680	—
union nut thread M20x1.5 for pipe ø 10mm				
	101251	Ref. No.	—	—
union nut thread M20x1.5 for pipe ø 12mm				
	101286	Ref. No.	—	—
olive ID ø 6mm Qty 1 pcs				
	110080	Ref. No.	—	—
knob ø 70mm shaft ø 10x8mm shaft flat universal				
	112206	Ref. No.	—	—
knob dial plate silver gas tap PEL21/22/23 t.max.°C ED ø 63mm ID ø 45.5mm				

accessories for		101092		
GEV No.	Ref. No.	GEV No.	Ref. No.	—
	100909	Ref. No.	—	—
union screw thread M10x1 for pipe ø 6mm Qty 1 pcs				
	101246	Ref. No.	—	—
olive for pipe ø 4mm Qty 1 pcs				
	101252	Ref. No.	—	—
union nut thread M24x1.5 for pipe ø 12mm				
	101253	Ref. No.	—	—
union nut thread M24x1.5 PEL for pipe ø 16mm				
	101254	Ref. No.	—	—
union nut thread M28x1.5 tube ø 20mm				
	101255	Ref. No.	—	—
olive for pipe ø 12mm Qty 1 pcs				
	101256	Ref. No.	—	—
olive for pipe ø 16mm Qty 1 pcs				
	101257	Ref. No.	—	—
olive for pipe ø 20mm Qty 1 pcs				
	101286	Ref. No.	—	—
olive ID ø 6mm Qty 1 pcs				
	110080	Ref. No.	—	—
knob ø 70mm shaft ø 10x8mm shaft flat universal				
	112206	Ref. No.	—	—
knob dial plate silver gas tap PEL21/22/23 t.max.°C ED ø 63mm ID ø 45.5mm				

23S/O series

				
1				
GEV No.	101092	Ref. No.	435280	
description	gas tap PEL type 23S/O gas inlet M28x1.5 (tube ø 20mm) bypass nozzle ø 0.35mm gas outlet M24x1.5 (tube ø 16mm) thermocouple connection M10x1 pilot connection M10x1 shaft ø 10x8mm shaft L 25/17mm shaft flat upper			
For models:	700-508, 900-503, 900-506, 920-503, 920-506			
spare parts for	101092			
	GEV No.	100455	Ref. No.	—
bypass nozzle type PEL23/24 bore ø 0.35mm thread M8x0.5				
	GEV No.	101059	Ref. No.	—
magnet unit T1: M10x1 T2: M22x1 L 46mm ø 18mm suitable for PEL23S M10x1				
	GEV No.	101204	Ref. No.	—
gas tap front part shaft ø 10x8mm shaft L 25/17mm shaft flat upper/lower suitable for PEL23S				
	GEV No.	101244	Ref. No.	—
gas connection thread M24x1.5 tube ø 12/16mm horizontal for PEL gas taps				
	GEV No.	101463	Ref. No.	—
screw suitable for PEL23S Qty 4 pcs				
	GEV No.	528455	Ref. No.	—
O-ring Viton thickness 2.62mm ID ø 18.72mm Qty 1 pcs				
accessories for	101092			
	GEV No.	100908	Ref. No.	—
union screw thread M10x1 for pipe ø 4mm Qty 1 pcs				





gas thermostats







SIT



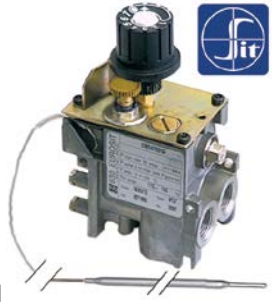









630 Eurosit series

				
1				
GEV No.	101413	Ref. No.	A00414	
description	gas thermostat type 630 Eurosit series t.max. 100°C 30-100°C gas inlet 3/8" gas outlet 3/8" thermocouple connection M9x1 pilot connection M10x1 probe ø 5mm probe L 122mm capillary pipe 1050mm SIT			
For models:	700-400A-C-T, 700-402A-C-T, 900-400A-C-T, 900-402A-C-T, 920-400A-T, 920-402A-T			
accessories for	101413			
	GEV No.	100904	Ref. No.	4392050
locking screw M10x1 for pipe ø 4mm Qty 1 pcs				

Table continues overleaf

accessories for 101413			
	GEV No.	100905	Ref. No. —
locking screw M10x1 for pipe ø 6mm Qty 1 pcs			
	GEV No.	101273	Ref. No. —
olive for pipe ø 12mm L 9.5mm brass Qty 1 pcs suitable for universal			
	GEV No.	101276	Ref. No. —
union screw thread 3/8" tube ø 12mm Qty 1 pcs			
	GEV No.	101333	Ref. No. —
plug thread 3/8" with O-ring			

			
GEV No.	101188	Ref. No.	A00405
description	gas thermostat type 630 Eurosit series t.max. 190°C 110-190°C gas inlet 3/8" gas outlet 3/8" thermocouple connection M9x1 pilot connection M10x1 probe ø 4mm probe L 202mm capillary pipe 1050mm SIT		
For models:	500-601A, 700-601A-S, 700-602A-S, 700-603A, 700-604A-605A, 900-601A-S, 900-602A-S, 900-604A-S, 900-605A-S, 920-604A-S		
accessories for 101188			
	GEV No.	100904	Ref. No. 4392050
locking screw M10x1 for pipe ø 4mm Qty 1 pcs			
	GEV No.	100905	Ref. No. —
locking screw M10x1 for pipe ø 6mm Qty 1 pcs			
	GEV No.	101273	Ref. No. —
olive for pipe ø 12mm L 9.5mm brass Qty 1 pcs suitable for universal			
	GEV No.	101276	Ref. No. —
union screw thread 3/8" tube ø 12mm Qty 1 pcs			
	GEV No.	101333	Ref. No. —
plug thread 3/8" with O-ring			

			
GEV No.	101125	Ref. No.	A00406
description	gas thermostat type 630 Eurosit series t.max. 340°C 100-340°C gas inlet 3/8" gas outlet 3/8" thermocouple connection M9x1 pilot connection M10x1 probe ø 4mm probe L 72mm capillary pipe 1050mm SIT		
For models:	110-120AL-ALR, 110-120TL-TLR, 110-122AL-ALR, 110-122ALC, 110-122FELC, 110-122FEL-FELR, 110-122FLC, 110-122FL-FLR, 110-122TL, 110-122TL-TLR, 110-200F, 500-120AL-AR, 500-120ALC, 500-120TLC, 500-120TL-TR, 500-122AL-ALR-AR, 500-122ALC, 500-122TLC, 500-122TL-TLR-TR, 64-040F-FV, 64-120TLC, 64-120TL-TR, 64-122TL, 64-122TLC, 64-122TLR-TR, 64-222F, 700-040FB, 700-120AL-AR-CL, 700-120ALC-CLC, 700-120CR-TL, 700-120TLC, 700-120TR, 700-122AL, 700-122ALC, 700-122ALR-AR-CL, 700-122CLC, 700-122CLR-CR-TL, 700-122TLC, 700-122TLR-TR, 700-138FBA, 700-162FG, 700-200FB, 700-222FB, 700-224FBA, 700-224FG, 700-401B, 900-040F, 900-120AL-AR, 900-120ALC, 900-120CL-CR...(Other models you can see in the webshop)		
accessories for 101125			
	GEV No.	100825	Ref. No. —
gas tap spindle shaft ø 8x6.5mm shaft L 22/14mm suitable for EUROSIT			
	GEV No.	100904	Ref. No. 4392050
locking screw M10x1 for pipe ø 4mm Qty 1 pcs			
	GEV No.	100905	Ref. No. —
locking screw M10x1 for pipe ø 6mm Qty 1 pcs			
	GEV No.	100949	Ref. No. —
gasket suitable for 630 Eurosit series			
	GEV No.	101273	Ref. No. —
olive for pipe ø 12mm L 9.5mm brass Qty 1 pcs suitable for universal			
	GEV No.	101276	Ref. No. —
union screw thread 3/8" tube ø 12mm Qty 1 pcs			
	GEV No.	101333	Ref. No. —
plug thread 3/8" with O-ring			
	GEV No.	101390	Ref. No. —
gas tap spindle shaft ø 6x4.6mm shaft L 32/15mm gas tap with ignition flame suitable for ZANUSSI, MARENO for gas thermostat EUROSIT			
	GEV No.	101392	Ref. No. —
adapter suitable for 630 Eurosit series			
	GEV No.	110357	Ref. No. —
gas tap spindle shaft ø 8x6.5mm shaft L 36/12mm suitable for 630 Eurosit series			
	GEV No.	110358	Ref. No. —
adapter shaft ø 10x8mm shaft L 29/18mm suitable for 630 Eurosit series			



710 Minisit series

GEV No.	101132	Ref. No.	433011 770203180
description	gas thermostat SIT type MINISIT 710 t.max. 340°C 100-340°C gas inlet 1/2" gas outlet 3/8" thermocouple connection M9x1 pilot connection M10x1 probe ø 5mm probe L 68mm capillary pipe 1050mm probe type type B1 pressure controller no pressure regulator mbar gland nut ignition gas no		
spare parts for	101132		
	GEV No.	101053	Ref. No. —
	magnet unit T1: M9x1 T2: M24x1 L 45mm ø 17mm suitable for Minisit		
	GEV No.	102102	Ref. No. —
	probe 100-340°C probe ø 5mm probe L 68mm capillary pipe 1750mm t.max. 340°C oven/grill probe type type B1 suitable for MINISIT 710		
accessories for	101132		
	GEV No.	100809	Ref. No. —
	O-ring EPDM thickness 2mm ID ø 21mm Qty 1 pcs		
	GEV No.	100904	Ref. No. 4392050
	locking screw M10x1 for pipe ø 4mm Qty 1 pcs		
	GEV No.	100905	Ref. No. —
	locking screw M10x1 for pipe ø 6mm Qty 1 pcs		
	GEV No.	101054	Ref. No. —
	magnet unit T1: M10x1 T2: M24x1 L 45mm ø 17mm suitable for Minisit		
	GEV No.	101136	Ref. No. —
	piezoelectric igniter suitable for Minisit with cover cap ømm connection F6.3x0.8		
	GEV No.	101137	Ref. No. —
	cover cap without piezoelectric igniter		
	GEV No.	101267	Ref. No. —
	reducer IT 3/8" ET 1/2" L 21mm		
	GEV No.	101268	Ref. No. —
	gas connection thread 3/8" angled with O-ring MINISIT 710		
	GEV No.	101269	Ref. No. —
	gas connection thread 1/2" angled with O-ring MINISIT 710		
	GEV No.	101270	Ref. No. —
	screw connection IT 3/8" ET 3/8" L 28mm		
	GEV No.	101272	Ref. No. —
	screw connection IT 1/2" ET 3/8" L 57mm		
	GEV No.	101273	Ref. No. —
	olive for pipe ø 12mm L 9.5mm brass Qty 1 pcs suitable for universal		

accessories for	101132		
	GEV No.	101274	Ref. No. —
	olive for pipe ø 16mm Qty 1 pcs		
	GEV No.	101275	Ref. No. —
	union screw thread 1/2" for pipe ø 16mm Qty 1 pcs		
	GEV No.	101276	Ref. No. —
	union screw thread 3/8" tube ø 12mm Qty 1 pcs		
	GEV No.	110068	Ref. No. —
	knob suitable for Minisit ø 37mm		

GEV No.	101114 ¹	Ref. No.	433208 A00044
description	gas thermostat with pressure controller SIT type MINISIT 710 t.max. 190°C 110-190°C gas inlet 1/2" gas outlet 3/8" thermocouple connection M9x1 pilot connection M10x1 probe ø 10.5mm probe L 26mm capillary pipe 1050mm probe type type F3 pressure controller yes pressure regulator 3-18mbar gland nut		
spare parts for	101114		
	GEV No.	101053	Ref. No. —
	magnet unit T1: M9x1 T2: M24x1 L 45mm ø 17mm suitable for Minisit		
	GEV No.	102104	Ref. No. 439621019
	probe 110-190°C probe ø 11mm probe thread 1/4" probe L 26mm capillary pipe 1050mm t.max. 190°C fryer probe type type F3 suitable for MINISIT 710		
accessories for	101114		
	GEV No.	100809	Ref. No. —
	O-ring EPDM thickness 2mm ID ø 21mm Qty 1 pcs		
	GEV No.	100820	Ref. No. —
	gland duct ET M14x1.5 IT M10x0.75 probe ø max. 6.5mm WS 22		
	GEV No.	100904	Ref. No. 4392050
	locking screw M10x1 for pipe ø 4mm Qty 1 pcs		
	GEV No.	100905	Ref. No. —
	locking screw M10x1 for pipe ø 6mm Qty 1 pcs		
	GEV No.	101054	Ref. No. —
	magnet unit T1: M10x1 T2: M24x1 L 45mm ø 17mm suitable for Minisit		
	GEV No.	101136	Ref. No. —
	piezoelectric igniter suitable for Minisit with cover cap ømm connection F6.3x0.8		
	GEV No.	101137	Ref. No. —
	cover cap without piezoelectric igniter		

¹probe thread 1/4"
Table continues overleaf

1 gas components





accessories for	101114		
	GEV No.	101267	Ref. No. —
	reducer IT 3/8" ET 1/2" L 21mm		
	GEV No.	101268	Ref. No. —
	gas connection thread 3/8" angled with O-ring MINISIT 710		
	GEV No.	101269	Ref. No. —
	gas connection thread 1/2" angled with O-ring MINISIT 710		
	GEV No.	101270	Ref. No. —
	screw connection IT 3/8" ET 3/8" L 28mm		
	GEV No.	101272	Ref. No. —
	screw connection IT 1/2" ET 3/8" L 57mm		
	GEV No.	101273	Ref. No. —
	olive for pipe ø 12mm L 9.5mm brass Qty 1 pcs suitable for universal		
	GEV No.	101274	Ref. No. —
	olive for pipe ø 16mm Qty 1 pcs		
	GEV No.	101275	Ref. No. —
	union screw thread 1/2" for pipe ø 16mm Qty 1 pcs		
	GEV No.	101276	Ref. No. —
	union screw thread 3/8" tube ø 12mm Qty 1 pcs		
	GEV No.	110068	Ref. No. —
	knob suitable for Minisit ø 37mm		
	GEV No.	361182	Ref. No. —
	nut thread 1/4" H 5mm nickel-plated brass WS 17 Qty 1 pcs		
	GEV No.	532520	Ref. No. —
	O-ring silicone thickness 2.62mm ID ø 15.08mm Qty 1 pcs		

accessories

probes



GEV No.	102101	Ref. No.	439631034
description	probe 100-340°C probe ø 5mm probe L 70mm capillary pipe 1000mm t.max. 340°C suitable for MINISIT 710		

	GEV No.	102104 ¹	Ref. No.	439621019
description	probe 110-190°C probe ø 11mm probe thread 1/4" probe L 26mm capillary pipe 1050mm t.max. 190°C fryer probe type type F3 suitable for MINISIT 710			
accessories for	102104			
	GEV No.	361182	Ref. No.	—
	nut thread 1/4" H 5mm nickel-plated brass WS 17 Qty 1 pcs			
	GEV No.	510420	Ref. No.	—
	gasket copper ED ø 19.9mm ID ø 14.3mm thickness 2mm Qty 1 pcs			
	GEV No.	529251	Ref. No.	—
	O-ring EPDM thickness 2.62mm ID ø 15.08mm Qty 1 pcs			



¹probe thread 1/4"

PEL

24ST series



GEV No.	101078	Ref. No.	435218
description	gas thermostat PEL type 24ST 55-110°C gas inlet M20x1.5 (tube ø 12mm) bypass nozzle ø 0.35mm gas outlet M20x1.5 (tube ø 12/10mm) thermocouple connection M9x1 pilot connection M10x1 capillary pipe 1200mm probe ø 6mm probe L 160mm shaft ø 10x8mm shaft L 27/17mm shaft flat upper		

spare parts for	101078		
	GEV No.	100455	Ref. No. —
	bypass nozzle type PEL23/24 bore ø 0.35mm thread M8x0.5		
	GEV No.	101058	Ref. No. —
	magnet unit L 39mm D1 ø 15.4mm D2 ø 13.5mm suitable for PEL22/EGA24197 standard		
	GEV No.	106200	Ref. No. —
	nut thread M9x1 suitable for PEL 24/25S		













accessories for	101078		
	GEV No.	100908	Ref. No. —
	union screw thread M10x1 for pipe ø 4mm Qty 1 pcs		
	GEV No.	100909	Ref. No. —
	union screw thread M10x1 for pipe ø 6mm Qty 1 pcs		
	GEV No.	101246	Ref. No. —
	olive for pipe ø 4mm Qty 1 pcs		
	GEV No.	101248	Ref. No. —
	olive for pipe ø 12mm Qty 1 pcs suitable for PEL		
	GEV No.	101249	Ref. No. 270201580
	olive for pipe ø 10mm Qty 1 pcs		

Table continues overleaf



accessories for		101078		
	GEV No.	101250	Ref. No.	270201680
	union nut thread M20x1.5 for pipe ø 10mm			
	GEV No.	101251	Ref. No.	—
	union nut thread M20x1.5 for pipe ø 12mm			
	GEV No.	101286	Ref. No.	—
	olive ID ø 6mm Qty 1 pcs			
	GEV No.	110079	Ref. No.	—
	knob dial plate gas thermostat 1-8 silver			
	GEV No.	110080	Ref. No.	—
	knob ø 70mm shaft ø 10x8mm shaft flat universal			

accessories for		101172		
	GEV No.	110079	Ref. No.	—
	knob dial plate gas thermostat 1-8 silver			
	GEV No.	110081	Ref. No.	—
	knob ø 70mm shaft ø 8x6.5mm shaft flat universal			

25ST series





1	GEV No.	101172	Ref. No.	435219
	description	gas thermostat PEL type 25ST 100-300°C gas inlet M16x1.5 (tube ø 10mm) bypass nozzle ø 0.35mm gas outlet M16x1.5 (tube ø 10/8mm) thermocouple connection M9x1 pilot connection M10x1 capillary pipe 1200mm probe ø 6mm probe L 100mm shaft ø 8x6.5mm shaft L 21/15mm shaft flat upper		
	spare parts for	101172		
	GEV No.	100259	Ref. No.	—
	bypass nozzle type PEL22 bore ø 0.35mm thread M6x0.5			
	GEV No.	101060	Ref. No.	—
	magnet unit standard L 39mm D1 ø 15.4mm D2 ø 11mm suitable for PEL20-21/JUNKERS/EGA			
	GEV No.	106200	Ref. No.	—
	nut thread M9x1 suitable for PEL 24/25S			
	accessories for	101172		
	GEV No.	100908	Ref. No.	—
	union screw thread M10x1 for pipe ø 4mm Qty 1 pcs			
	GEV No.	100909	Ref. No.	—
	union screw thread M10x1 for pipe ø 6mm Qty 1 pcs			
	GEV No.	101246	Ref. No.	—
	olive for pipe ø 4mm Qty 1 pcs			
	GEV No.	101278	Ref. No.	—
	olive for pipe ø 10mm Qty 1 pcs			
	GEV No.	101286	Ref. No.	—
	olive ID ø 6mm Qty 1 pcs			
	GEV No.	101300	Ref. No.	—
	union nut thread M16x1.5 tube ø 10mm			
	GEV No.	101450	Ref. No.	—
	olive for pipe ø 8mm L 12.7mm Qty 1 pcs ED ø 10mm			
	GEV No.	101451	Ref. No.	—
	union nut thread M16x1.5 tube ø 8mm			

gas valves and ignition boxes
gas control valves

HONEYWELL



1	GEV No.	101395	Ref. No.	43330001
	description	gas valve type VR4605P 230V 50Hz gas inlet 1/2" gas outlet 1/2" thermocouple connection pilot connection pressure range 8-50mbar operator type 230V (V404A 1071) pressure controller type 220/240V (V404A 1071 4) HONEYWELL coil type 220/240V (V4336A 2220) flange 45x45mm		
	accessories for	101395		
	GEV No.	101320	Ref. No.	—
	cover suitable for gas valves HONEYWELL			
	GEV No.	102845	Ref. No.	—
	gas connection angled 1/2" flange 32x32mm hole distance 24x24mm Tandem			
	GEV No.	102846	Ref. No.	—
	gas connection straight 1/2" flange 32x32mm hole distance 24x24mm suitable for Tandem			

SIT

ELETTROSIT











1	GEV No.	101127	Ref. No.	43300012
	description	gas valve SIT type ELETTROSIT 230V gas inlet 3/4" gas outlet 3/4" thermocouple connection M9x1 pilot connection M10x1 lateral equiv. no. 0.810.175		
	spare parts for	101127		
	GEV No.	101312	Ref. No.	—
	microswitch			



Table continues overleaf

spare parts for 101127				
	GEV No.	101352	Ref. No.	—
solenoid coil 230V 50Hz suitable for ELETTROSIT				
accessories for 101127				
	GEV No.	100006	Ref. No.	—
piezoelectric igniter suitable for ELETTROSIT body plastic blowing connection ø2.4mm ø 14mm				
	GEV No.	100904	Ref. No.	4392050
locking screw M10x1 for pipe ø 4mm Qty 1 pcs				
	GEV No.	100905	Ref. No.	—
locking screw M10x1 for pipe ø 6mm Qty 1 pcs				
	GEV No.	101301	Ref. No.	—
gas connection thread 1/2" straight ELETTROSIT screw with O-ring				
	GEV No.	101303	Ref. No.	—
gas connection straight thread 3/4" ELETTROSIT				
	GEV No.	101309	Ref. No.	—
extension				

TANDEM

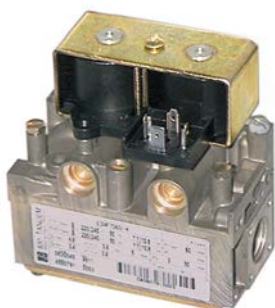

1				
GEV No.	101189	Ref. No.	433012	
description	gas valve 230V 50Hz gas inlet 1/2" gas outlet 1/2" pilot connection M10x1 level slow ignition ignition times pressure range 3-50mbar power supply for modulator equiv. no. 0.830.040 suitable for Tandem			
For models:	700-622, 700-900, 900-622, 900-642, 900-900, 900-940, 920-622, 920-642, 920-900, 920-940			
spare parts for 101189				
	GEV No.	101379	Ref. No.	—
solenoid coil 230V 50Hz suitable for Tandem				
accessories for 101189				
	GEV No.	100904	Ref. No.	4392050
locking screw M10x1 for pipe ø 4mm Qty 1 pcs				
	GEV No.	100905	Ref. No.	—
locking screw M10x1 for pipe ø 6mm Qty 1 pcs				
	GEV No.	101274	Ref. No.	—
olive for pipe ø 16mm Qty 1 pcs				
	GEV No.	101275	Ref. No.	—
union screw thread 1/2" for pipe ø 16mm Qty 1 pcs				
	GEV No.	101925	Ref. No.	—
plug with O-ring thread M10x1 for pilot burner suitable for NOVASIT				

accessories for 101189				
	GEV No.	102845	Ref. No.	—
gas connection angled 1/2" flange 32x32mm hole distance 24x24mm Tandem				
	GEV No.	102846	Ref. No.	—
gas connection straight 1/2" flange 32x32mm hole distance 24x24mm suitable for Tandem				
	GEV No.	102847	Ref. No.	—
O-ring				

ignition boxes

HONEYWELL



1				
GEV No.	101165	Ref. No.	43331001	
description	ignition box HONEYWELL type S4560A 1008 equiv. no. S4560A 1008 electrodes 1 waiting time 0s safety time 10s 220-240V 10VA 50Hz			
For models:	700-622, 700-900, 900-622, 900-642, 900-900, 900-940, 920-622, 920-642, 920-900, 920-940			
spare parts for 101165				
	GEV No.	358696	Ref. No.	—
fine fuse size ø5x20mm 4A medium lag rated 250V Qty 10 pcs				



1				
GEV No.	102367	Ref. No.	293203200	
description	ignition box HONEYWELL type S4565A 2092 1 electrodes 3 waiting times safety time 10s 220-240V 4VA 50/60Hz			



1				
GEV No.	106949	Ref. No.	43331002	
description	ignition box HONEYWELL type S4960A 1008 electrodes 1 waiting time 2s safety time 10s 220-240V 10VA 50Hz			



ignition parts









pilot burners



SIT





100 series



GEV No.	106906	Ref. No.	A00132 A00280
description	pilot burner SIT type 100 series 3 flames nozzle \varnothing 0.2mm gas connection 6mm		
For models:	110-120AL-ALR, 110-120TL-TLR, 110-122AL-ALR, 110-122ALC, 110-122FELC, 110-122FEL-FELR, 110-122FLC, 110-122FL-FLR, 110-122TL, 110-122TL-TLR, 500-120AL-AR, 500-120ALC, 500-120TLC, 500-120TL-TR, 500-122AL-ALR-AR, 500-122ALC, 500-122TLC, 500-122TL-TLR-TR, 64-120TLC, 64-120TL-TR, 64-122TL, 64-122TLC, 64-122TLR-TR, 64-130TL-TR, 64-132TL-TLR-TR, 64-600T-603T, 700-120AL-AR-CL, 700-120ALC-CLC, 700-120CR-TL, 700-120TLC, 700-120TR, 700-122AL, 700-122ALC, 700-122ALR-AR-CL, 700-122CLC, 700-122CLR-CR-TL, 700-122TLC, 700-122TLR-TR, 700-130AL-AR, 700-130CL-CR, 700-130TL-TR, 700-132AL-AR, 700-132ALR, 700-132CL-CR, 700-132CLR, 700-132TLR, 700-132TL-TR, 700-138A-C-T, 700-138FBA, 700-138FEBA...(Other models you can see in the webshop)		

spare parts for	106906		
	GEV No.	100245	Ref. No. 4370001
	pilot burner nozzle LPG code 20 bore \varnothing 0.2mm Qty 1 pcs thread M8x0.75		
	GEV No.	100855	Ref. No. —
	pilot burner bracket triple		
	GEV No.	100885	Ref. No. —
	air mixing sleeve for pilot burner Qty 1 pcs		
	GEV No.	100916	Ref. No. —
	compression spring for pilot burner Qty 1 pcs		
	GEV No.	100917	Ref. No. —
	gasket for pilot burner Qty 1 pcs aluminium		
	GEV No.	100918	Ref. No. —
	screw for pilot burner		
	GEV No.	107162	Ref. No. —
	pilot burner cap SIT 3 flames Hmm Lmm Qty 1 pcs		
	GEV No.	107701	Ref. No. —
	pilot burner bottom part SIT 100 series nozzle \varnothing 0.2mm		

accessories for	106906		
	GEV No.	100245	Ref. No. 4370001
	pilot burner nozzle LPG code 20 bore \varnothing 0.2mm Qty 1 pcs thread M8x0.75		
	GEV No.	100246	Ref. No. —
	pilot burner nozzle natural gas bore \varnothing 0.35mm Qty 1 pcs thread M8x0.75		
	GEV No.	100904	Ref. No. 4392050
	locking screw M10x1 for pipe \varnothing 4mm Qty 1 pcs		

accessories for	106906		
	GEV No.	100905	Ref. No. —
	locking screw M10x1 for pipe \varnothing 6mm Qty 1 pcs		
	GEV No.	102110	Ref. No. —
	pilot tube copper pipe \varnothing 4mm thickness 1mm L 3000mm		
	GEV No.	102111	Ref. No. —
	pilot tube copper pipe \varnothing 6mm thickness 1mm L 3000mm		
	GEV No.	107171	Ref. No. —
	pilot burner nozzle SIT natural/liquid gas bore \varnothing 0.25mm Qty 1 pcs		
	GEV No.	107700	Ref. No. —
	pilot burner bottom part SIT 100 series nozzle \varnothing 0.25mm		
	GEV No.	107702	Ref. No. —
	pilot burner bottom part SIT 100 series nozzle \varnothing 0.35mm		

accessories

pilot burner nozzles



GEV No.	100245	Ref. No.	4370001
description	pilot burner nozzle LPG code 20 bore \varnothing 0.2mm Qty 1 pcs thread M8x0.75		

ignition electrodes



GEV No.	100706	Ref. No.	4398070
description	ignition electrode connection M4 Qty 1 pcs		
For models:	110-120AL-ALR, 110-120TL-TLR, 110-122AL-ALR, 110-122ALC, 110-122FELC, 110-122FEL-FELR, 110-122FLC, 110-122FL-FLR, 110-122TL, 110-122TL-TLR, 500-120AL-AR, 500-120ALC, 500-120TLC, 500-120TL-TR, 500-122AL-ALR-AR, 500-122ALC, 500-122TLC, 500-122TL-TLR-TR, 64-120TLC, 64-120TL-TR, 64-122TL, 64-122TLC, 64-122TLR-TR, 64-130TL-TR, 64-132TL-TLR-TR, 64-600T-603T, 700-120AL-AR-CL, 700-120ALC-CLC, 700-120CR-TL, 700-120TLC, 700-120TR, 700-122AL, 700-122ALC, 700-122ALR-AR-CL, 700-122CLC, 700-122CLR-CR-TL, 700-122TLC, 700-122TLR-TR, 700-130AL-AR, 700-130CL-CR, 700-130TL-TR, 700-132AL-AR, 700-132ALR, 700-132CL-CR, 700-132CLR, 700-132TLR, 700-132TL-TR, 700-138A-C-T, 700-138FBA, 700-138FEBA...(Other models you can see in the webshop)		





140 - 145 -150 series



























GEV No.	100159	Ref. No.	790200900
description	pilot burner SIT type 150 series 2 flames nozzle 19 nozzle ø 0.23/0.26mm gas connection 4mm		
spare parts for	100159		
	GEV No.	100205	Ref. No. 43702019
	pilot burner nozzle SIT LPG code 19 bore ø 0.23/0.26mm Qty 1 pcs suitable for SIT 150 series		
	GEV No.	100701	Ref. No. 270200700
	ignition electrode connection M4 Qty 1 pcs		
	GEV No.	100897	Ref. No. —
	olive for pipe ø 4mm Qty 1 pcs for pilot burner		
	GEV No.	100906	Ref. No. —
	screw connection thread M10x1 for ignition electrode brass Qty 1 pcs WS 10		
	GEV No.	100907	Ref. No. —
	screw connection thread M10x1 Qty 1 pcs type SEF 1 ømm for thermocouple		
	GEV No.	100908	Ref. No. —
	union screw thread M10x1 for pipe ø 4mm Qty 1 pcs		
	GEV No.	107888	Ref. No. —
	pilot burner SIT type 150 series 2 flames		
accessories for	100159		
	GEV No.	100204	Ref. No. —
	pilot burner nozzle SIT LPG code 14 bore ø 0.18/0.20mm Qty 1 pcs suitable for 140 series		
	GEV No.	100206	Ref. No. 43702036
	pilot burner nozzle SIT natural gas code 36 bore ø 0.60/0.55mm Qty 1 pcs suitable for SIT 150 series		
	GEV No.	100207	Ref. No. —
	pilot burner nozzle SIT natural gas code 27 bore ø 0.40/0.38mm suitable for SIT 140 series		
	GEV No.	100216	Ref. No. —
	pilot burner nozzle SIT natural gas code 38 bore ø 0.45mm Qty 1 pcs suitable for SIT 150 series		
	GEV No.	100898	Ref. No. —
	olive for pipe ø 6mm Qty 1 pcs for pilot burner		
	GEV No.	100909	Ref. No. —
	union screw thread M10x1 for pipe ø 6mm Qty 1 pcs		



GEV No.	106942	Ref. No.	A00407
description	pilot burner type 150 series 1 flame nozzle ømm gas connectionmm		
For models:	700-020A-C-T, 700-040A-C-T, 700-040FB, 700-040FEB, 700-138A-C-T, 700-138FBA, 700-138FEBA, 700-162A-C-T, 700-162FBA, 700-162FEBA, 700-162FG, 900-020A-C-T, 900-040A-C-T, 900-040F, 900-040FE, 900-138A-C-T, 900-138FA, 900-138FEA, 900-162A-C-T, 900-162FA, 900-162FEA, 900-162FG, 900-182F, 900-182FE, 900-302		
spare parts for	106942		
	GEV No.	100907	Ref. No. —
	screw connection thread M10x1 Qty 1 pcs type SEF 1 ømm for thermocouple		
accessories for	106942		
	GEV No.	100204	Ref. No. —
	pilot burner nozzle SIT LPG code 14 bore ø 0.18/0.20mm Qty 1 pcs suitable for 140 series		
	GEV No.	100205	Ref. No. 43702019
	pilot burner nozzle SIT LPG code 19 bore ø 0.23/0.26mm Qty 1 pcs suitable for SIT 150 series		
	GEV No.	100206	Ref. No. 43702036
	pilot burner nozzle SIT natural gas code 36 bore ø 0.60/0.55mm Qty 1 pcs suitable for SIT 150 series		
	GEV No.	100207	Ref. No. —
	pilot burner nozzle SIT natural gas code 27 bore ø 0.40/0.38mm suitable for SIT 140 series		
	GEV No.	100216	Ref. No. —
	pilot burner nozzle SIT natural gas code 38 bore ø 0.45mm Qty 1 pcs suitable for SIT 150 series		
	GEV No.	100701	Ref. No. 270200700
	ignition electrode connection M4 Qty 1 pcs		
	GEV No.	100897	Ref. No. —
	olive for pipe ø 4mm Qty 1 pcs for pilot burner		
	GEV No.	100898	Ref. No. —
	olive for pipe ø 6mm Qty 1 pcs for pilot burner		
	GEV No.	100906	Ref. No. —
	screw connection thread M10x1 for ignition electrode brass Qty 1 pcs WS 10		
	GEV No.	100908	Ref. No. —
	union screw thread M10x1 for pipe ø 4mm Qty 1 pcs		
	GEV No.	100909	Ref. No. —
	union screw thread M10x1 for pipe ø 6mm Qty 1 pcs		



160 series			
			
GEV No.	100054	Ref. No.	A00281
description	pilot burner SIT type 160 series 2 flames nozzle ømm gas connecti- onmm		
For models:	110-200A-T, 110-200F, 110-200FE		
spare parts for	100054		
	GEV No.	100907	Ref. No. —
	screw connection thread M10x1 Qty 1 pcs type SEF 1 ømm for thermocouple		
accessories for	100054		
	GEV No.	100202	Ref. No. —
	pilot burner nozzle natural gas code 41 Qty 1 pcs nozzle ø 0.41mm		
	GEV No.	100203	Ref. No. —
	pilot burner nozzle LPG code 25 Qty 1 pcs nozzle ø 0.25mm		
	GEV No.	100701	Ref. No. 270200700
	ignition electrode connection M4 Qty 1 pcs		
	GEV No.	100801	Ref. No. —
	gasket for pilot burner Qty 1 pcs		
	GEV No.	100869	Ref. No. —
	pilot burner nozzle natural gas code 51 Qty 1 pcs suitable for 160 series nozzle ø 0.51mm		
	GEV No.	100906	Ref. No. —
	screw connection thread M10x1 for ignition electrode brass Qty 1 pcs WS 10		
	GEV No.	100908	Ref. No. —
	union screw thread M10x1 for pipe ø 4mm Qty 1 pcs		
	GEV No.	100909	Ref. No. —
	union screw thread M10x1 for pipe ø 6mm Qty 1 pcs		
	GEV No.	101282	Ref. No. —
	olive for pipe ø 4mm L 7.4mm Qty 1 pcs		
	GEV No.	101287	Ref. No. —
	olive for pipe ø 6mm Qty 1 pcs		
	GEV No.	102110	Ref. No. —
	pilot tube copper pipe ø 4mm thickness 1mm L 3000mm		
	GEV No.	102111	Ref. No. —
	pilot tube copper pipe ø 6mm thickness 1mm L 3000mm		
	GEV No.	107650	Ref. No. 43703030
	pilot burner nozzle SIT LPG code 30 Qty 1 pcs		

			
GEV No.	100056	Ref. No.	A00282
description	pilot burner SIT type 160 series 3 flames nozzle ømm gas connecti- onmm		
spare parts for	100056		
	GEV No.	100907	Ref. No. —
	screw connection thread M10x1 Qty 1 pcs type SEF 1 ømm for thermocouple		
accessories for	100056		
	GEV No.	100202	Ref. No. —
	pilot burner nozzle natural gas code 41 Qty 1 pcs nozzle ø 0.41mm		
	GEV No.	100203	Ref. No. —
	pilot burner nozzle LPG code 25 Qty 1 pcs nozzle ø 0.25mm		
	GEV No.	100701	Ref. No. 270200700
	ignition electrode connection M4 Qty 1 pcs		
	GEV No.	100801	Ref. No. —
	gasket for pilot burner Qty 1 pcs		
	GEV No.	100869	Ref. No. —
	pilot burner nozzle natural gas code 51 Qty 1 pcs suitable for 160 series nozzle ø 0.51mm		
	GEV No.	100870	Ref. No. —
	olive for pipe ø 4mm Qty 1 pcs suitable for 160 series for pilot burner		
	GEV No.	100906	Ref. No. —
	screw connection thread M10x1 for ignition electrode brass Qty 1 pcs WS 10		
	GEV No.	100908	Ref. No. —
	union screw thread M10x1 for pipe ø 4mm Qty 1 pcs		
	GEV No.	100909	Ref. No. —
	union screw thread M10x1 for pipe ø 6mm Qty 1 pcs		
	GEV No.	101287	Ref. No. —
	olive for pipe ø 6mm Qty 1 pcs		
	GEV No.	102110	Ref. No. —
	pilot tube copper pipe ø 4mm thickness 1mm L 3000mm		
	GEV No.	102111	Ref. No. —
	pilot tube copper pipe ø 6mm thickness 1mm L 3000mm		
	GEV No.	107650	Ref. No. 43703030
	pilot burner nozzle SIT LPG code 30 Qty 1 pcs		



POLIDORO

pilot burners





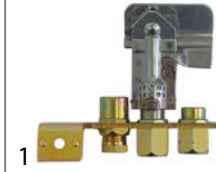

GEV No.	102295	Ref. No.	436201 526FSUF4
description	pilot burner POLIDORO 3 flames code gas connection 4mm		
spare parts for	102295		
	GEV No.	100907	Ref. No. —
	screw connection thread M10x1 Qty 1 pcs type SEF 1 ømm for thermocouple		
accessories for	102295		
	GEV No.	100208	Ref. No. 4372022
	pilot burner nozzle POLIDORO LPG code 20 bore ø 0.2mm Qty 1 pcs		
	GEV No.	100209	Ref. No. —
	pilot burner nozzle POLIDORO natural gas code 40 bore ø 0.4mm Qty 1 pcs		
	GEV No.	100701	Ref. No. 270200700
	ignition electrode connection M4 Qty 1 pcs		
	GEV No.	100906	Ref. No. —
	screw connection thread M10x1 for ignition electrode brass Qty 1 pcs WS 10		
	GEV No.	100908	Ref. No. —
	union screw thread M10x1 for pipe ø 4mm Qty 1 pcs		
	GEV No.	100909	Ref. No. —
	union screw thread M10x1 for pipe ø 6mm Qty 1 pcs		
	GEV No.	101280	Ref. No. —
	olive for pipe ø 4mm Qty 1 pcs		
	GEV No.	101287	Ref. No. —
	olive for pipe ø 6mm Qty 1 pcs		
	GEV No.	102110	Ref. No. —
	pilot tube copper pipe ø 4mm thickness 1mm L 3000mm		
	GEV No.	102111	Ref. No. —
	pilot tube copper pipe ø 6mm thickness 1mm L 3000mm		





GEV No.	100076	Ref. No.	A00283
description	pilot burner POLIDORO 3 flames natural gas code 29.2 gas connection 6mm		
For models:	110-122FLC, 110-122FL-FLR, 500-125A-126A, 500-750A, 500-800A, 64-040FCE, 64-040F-FV, 64-125T-126T, 64-222F, 64-900T, 700-040FB, 700-125A-C, 700-125T, 700-126A-C, 700-126T, 700-127A-C, 700-127T, 700-138FBA, 700-162FBA, 700-162FG, 700-200FB, 700-222FB, 700-224FBA, 700-224FG, 700-508, 700-750A-S, 700-800A-S, 900-040F, 900-125A-C, 900-125T, 900-126A-C, 900-126T, 900-127A-C, 900-127T, 900-138FA, 900-162FA, 900-162FG, 900-200F, 900-503, 900-506, 900-750A-S, 900-800A-S, 920-122FLC, 920-122FL-FLR-FR, 920-200F, 920-503, 920-506, 920-750A-S		
accessories for	100076		
	GEV No.	100000	Ref. No. —
	pilot burner nozzle POLIDORO LPG code 22 bore ø 0.22mm Qty 1 pcs		
	GEV No.	100208	Ref. No. 4372022
	pilot burner nozzle POLIDORO LPG code 20 bore ø 0.2mm Qty 1 pcs		
	GEV No.	100209	Ref. No. —
	pilot burner nozzle POLIDORO natural gas code 40 bore ø 0.4mm Qty 1 pcs		
	GEV No.	100701	Ref. No. 270200700
	ignition electrode connection M4 Qty 1 pcs		
	GEV No.	100906	Ref. No. —
	screw connection thread M10x1 for ignition electrode brass Qty 1 pcs WS 10		
	GEV No.	100907	Ref. No. —
	screw connection thread M10x1 Qty 1 pcs type SEF 1 ømm for thermocouple		
	GEV No.	100908	Ref. No. —
	union screw thread M10x1 for pipe ø 4mm Qty 1 pcs		
	GEV No.	100909	Ref. No. —
	union screw thread M10x1 for pipe ø 6mm Qty 1 pcs		
	GEV No.	102110	Ref. No. —
	pilot tube copper pipe ø 4mm thickness 1mm L 3000mm		
	GEV No.	102111	Ref. No. —
	pilot tube copper pipe ø 6mm thickness 1mm L 3000mm		
	GEV No.	102508	Ref. No. —
	union screw thread M10x1 for pipe ø 4mm Qty 5 pcs		
	GEV No.	102509	Ref. No. —
	union screw thread M10x1 for pipe ø 6mm Qty 5 pcs		
	GEV No.	102699	Ref. No. —
	pilot burner nozzle POLIDORO natural gas code 25.2 bore ø 2x0.25mm Qty 1 pcs 2 bores		
	GEV No.	102795	Ref. No. —
	olive for pipe ø 4mm Qty 1 pcs		
	GEV No.	102797	Ref. No. —
	olive for pipe ø 6mm Qty 1 pcs		

Table continues overleaf



accessories for		100076	
	GEV No.	106703	Ref. No. —
pilot burner nozzle POLIDORO natural gas code 27.2 bore ø 2x0.27mm Qty 1 pcs			
	GEV No.	106704	Ref. No. —
pilot burner nozzle POLIDORO LPG code 16.2 bore ø 2x0.16mm Qty 1 pcs			
	GEV No.	106763	Ref. No. 4372027
pilot burner nozzle POLIDORO natural gas code 27.2A bore ø 2x 0.27mm Qty 1 pcs			
	GEV No.	106859	Ref. No. —
pilot burner nozzle POLIDORO LPG code 24 bore ø 0.24mm Qty 1 pcs			

accessories for		100165	
	GEV No.	101282	Ref. No. —
olive for pipe ø 4mm L 7.4mm Qty 1 pcs			
	GEV No.	101287	Ref. No. —
olive for pipe ø 6mm Qty 1 pcs			
	GEV No.	107650	Ref. No. 43703030
pilot burner nozzle SIT LPG code 30 Qty 1 pcs			

PRO-GAS

140 - 145 -150 series

pilot burners



1

GEV No.	102804	Ref. No.	A00424
description pilot burner type 150 series 1 flame			
For models: 500-601A, 64-222F, 64-222FCE, 64-222FE, 64-222T, 700-222A-C, 700-222FB, 700-222FEB, 700-222T, 700-224A-C, 700-224FBA, 700-224FEBA, 700-224FG, 700-224T, 700-601A-S, 700-602A-S, 700-603A, 700-604A-605A, 900-601A-S, 900-602A-S, 900-604A-S, 900-605A-S, 920-604A-S			





producer-specific pilot burners

GICO

50 / 60 / 62 / 70 / 90 / 92 / 110 series (version 1)



1

GEV No.	100165	Ref. No.	270200020
description pilot burner			
accessories for 100165			
	GEV No.	100202	Ref. No. —
pilot burner nozzle natural gas code 41 Qty 1 pcs nozzle ø 0.41mm			
	GEV No.	100203	Ref. No. —
pilot burner nozzle LPG code 25 Qty 1 pcs nozzle ø 0.25mm			
	GEV No.	100908	Ref. No. —
union screw thread M10x1 for pipe ø 4mm Qty 1 pcs			
	GEV No.	100909	Ref. No. —
union screw thread M10x1 for pipe ø 6mm Qty 1 pcs			



1

GEV No.	100068	Ref. No.	270200020 A00001
description pilot burner 2 flames gas connection 6mm			
accessories for 100068			
	GEV No.	100202	Ref. No. —
pilot burner nozzle natural gas code 41 Qty 1 pcs nozzle ø 0.41mm			
	GEV No.	100203	Ref. No. —
pilot burner nozzle LPG code 25 Qty 1 pcs nozzle ø 0.25mm			
	GEV No.	100908	Ref. No. —
union screw thread M10x1 for pipe ø 4mm Qty 1 pcs			
	GEV No.	100909	Ref. No. —
union screw thread M10x1 for pipe ø 6mm Qty 1 pcs			
	GEV No.	101282	Ref. No. —
olive for pipe ø 4mm L 7.4mm Qty 1 pcs			
	GEV No.	101287	Ref. No. —
olive for pipe ø 6mm Qty 1 pcs			
	GEV No.	107649	Ref. No. —
pilot burner nozzle SIT LPG code 20 Qty 1 pcs			
	GEV No.	107650	Ref. No. 43703030
pilot burner nozzle SIT LPG code 30 Qty 1 pcs			



ignition cables

pre-assembled cables



GEV No.	100036	Ref. No.	5509060
description	ignition cable cable length 500mm connection F2.8mm / F2.8mm		
For models:	64-020T-64-040T, 64-040FCE, 64-040FE, 64-040F-FV, 64-222F, 64-222FCE, 64-222FE, 64-222T		



GEV No.	100018	Ref. No.	5509040
description	ignition cable cable length 600mm connection ø2.4mm / ø4mm permanent temperature 200°C		
For models:	110-120AL-ALR, 110-120TL-TLR, 110-122AL-ALR, 110-122ALC, 110-122FELC, 110-122FEL-FELR, 110-122FLC, 110-122FL-FLR, 110-122TL, 110-122TL-TLR, 500-120AL-AR, 500-120ALC, 500-120TLC, 500-120TL-TR, 500-122AL-ALR-AR, 500-122ALC, 500-122TLC, 500-122TL-TLR-TR, 64-120TLC, 64-120TL-TR, 64-122TL, 64-122TLC, 64-122TLR-TR, 64-130TL-TR, 64-132TL-TLR-TR, 64-600T-603T, 64-900T, 700-120AL-AR-CL, 700-120ALC-CLC, 700-120CR-TL, 700-120TLC, 700-120TR, 700-122AL, 700-122ALC, 700-122ALR-AR-CL, 700-122CLC, 700-122CLR-CR-TL, 700-122TLC, 700-122TLR-TR, 700-130AL-AR, 700-130CL-CR, 700-130TL-TR, 700-132AL-AR, 700-132ALR, 700-132CL-CR, 700-132CLR, 700-132TLR, 700-132TL-TR, 700-400A-C-T, 700-402A-C-T... (Other models you can see in the webshop)		



GEV No.	100146	Ref. No.	270112320
description	ignition cable cable length 900mm connection ø2.4mm / lug M4		
For models:	110-122FLC, 110-122FL-FLR, 110-200A-T, 110-200F, 110-200FE, 64-040F-FV, 64-222F, 700-138A-C-T, 700-138FBA, 700-138FEBA, 700-162FBA, 700-162FG, 700-200A-C-T, 700-200FB, 700-200FEB, 700-222FB, 700-224FBA, 700-224FG, 700-401B, 700-508, 900-040F, 900-138A-C-T, 900-138FA, 900-138FEA, 900-162FA, 900-162FG, 900-200A-C-T, 900-200F, 900-200FE, 900-401, 900-503, 900-506, 920-122FLC, 920-122FL-FLR-FR, 920-200A-T, 920-200F, 920-200FE, 920-503, 920-506		



GEV No.	100019	Ref. No.	45509080
description	ignition cable cable length 900mm connection ø2.4mm / ø4mm		
For models:	500-601A, 500-750A, 500-800A, 64-040F-FV, 64-125T-126T, 64-222F, 700-222A-C, 700-222FB, 700-222FEB, 700-222T, 700-224A-C, 700-224FBA, 700-224FEBA, 700-224FG, 700-224T, 700-601A-S, 700-602A-S, 700-603A, 700-604A-605A, 700-609A, 700-750A-S, 700-800A-S, 900-182F, 900-402A-C-T, 900-601A-S, 900-602A-S, 900-604A-S, 900-605A-S, 900-609A, 900-750A-S, 900-800A-S, 920-402A-T, 920-604A-S, 920-609A, 920-750A-S		

piezoelectric igniters

mounting diameter 22mm



GEV No.	100013	Ref. No.	4398050
description	piezoelectric igniter body plastic blowing mounting ø 22mm connection ø2.4mm cable lengthmm		
For models:	64-020T-64-040T, 64-040FCE, 64-040FE, 64-040F-FV, 64-120TLC, 64-120TL-TR, 64-122TL, 64-122TLC, 64-122TLR-TR, 64-125T-126T, 64-130TL-TR, 64-132TL-TLR-TR, 64-222F, 64-222FCE, 64-222FE, 64-222T, 64-600T-603T, 64-900T		

accessories for	100013		
		GEV No.	100023
		Ref. No.	—
	female bullet size 2.3mm 0.5-1.5mm ² CuZn t.max. 125°C Qty 20 pcs		



GEV No.	102977	Ref. No.	A00477
description	piezoelectric igniter body plastic blowing mounting ø 22mm connection ø2.4mm cable lengthmm with cover cap		
For models:	110-120AL-ALR, 110-120TL-TLR, 110-122AL-ALR, 110-122ALC, 110-122FELC, 110-122FEL-FELR, 110-122FLC, 110-122FL-FLR, 110-122TL, 110-122TL-TLR, 110-200A-T, 110-200F, 110-200FE, 500-120AL-AR, 500-120ALC, 500-120TLC, 500-120TL-TR, 500-122AL-ALR-AR, 500-122ALC, 500-122TLC, 500-122TL-TLR-TR, 500-125A-126A, 500-601A, 500-750A, 500-800A, 700-040FB, 700-120AL-AR-CL, 700-120ALC-CLC, 700-120CR-TL, 700-120TLC, 700-120TR, 700-122AL, 700-122ALC, 700-122ALR-AR-CL, 700-122CLC, 700-122CLR-CR-TL, 700-122TLC, 700-122TLR-TR, 700-125A-C, 700-125T, 700-126A-C, 700-126T, 700-127A-C, 700-127T, 700-130AL-AR, 700-130CL-CR, 700-130TL-TR, 700-132AL-AR, 700-132ALR, 700-132CL-CR...(Other models you can see in the webshop)		

miscellaneous



GEV No.	nla ¹	Ref. No.	00073
description	piezoelectric igniter body metal connection F6.3x0.8 2 hole fixing ø 22mm		

¹no longer available



accessories



GEV No.	101339	Ref. No.	290204470
description	cover cap for piezoelectric igniter		

ignition units



GEV No.	101002	Ref. No.	539613240
description	ignition unit outputs 2 230VAC dimensions 88x23x34mm mounting distance 73mm inlet F6.3x0.8 outlet F2.8x0.8 0.6VA 50/60Hz		

thermocouples

plug-in thermocouples

plug-in thermocouples standard

with barrel socket $\phi 6\text{mm}$

SIT

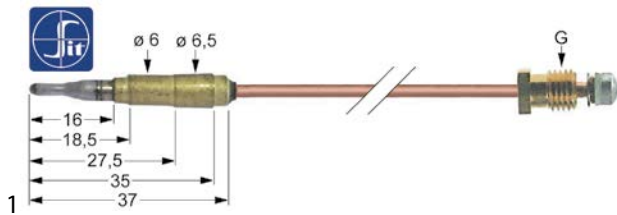

GEV No.	102267	Ref. No.	434008085
description	thermocouple M8x1 L 850mm plug connection $\phi 6.0\text{mm}$		

with barrel socket $\phi 6(6.5)\text{mm}$

thermocouples SIT

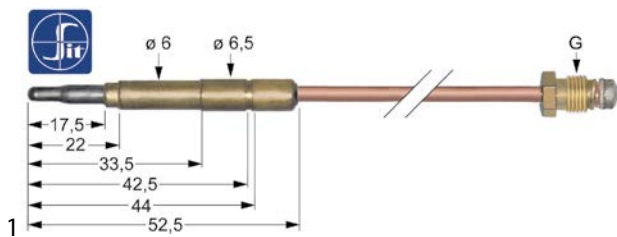

GEV No.	107603	Ref. No.	A00426
description	thermocouple SIT M8x1 L 1000mm plug connection $\phi 6.0(6.5)\text{mm}$		
For models:	700-020A-C-T, 700-040A-C-T, 700-040FB, 700-040FEB, 700-138A-C-T, 700-138FBA, 700-138FEBA, 700-162A-C-T, 700-162FBA, 700-162FEBA, 700-162FG, 700-222A-C, 700-222FB, 700-222FEB, 700-222T, 700-224A-C, 700-224FBA, 700-224FEBA, 700-224FG, 700-224T, 900-020A-C-T, 900-040A-C-T, 900-040F, 900-040FE, 900-138A-C-T, 900-138FA, 900-138FEA, 900-162A-C-T, 900-162FA, 900-162FEA, 900-162FG, 900-182F, 900-182FE		

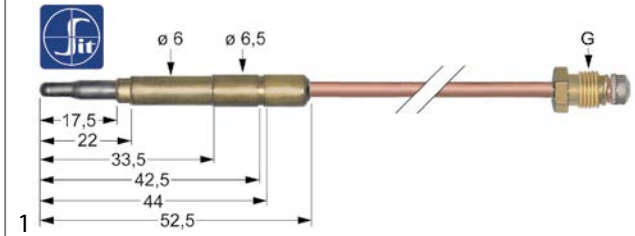

GEV No.	107605	Ref. No.	A00201
description	thermocouple SIT M8x1 L 1500mm plug connection $\phi 6.0(6.5)\text{mm}$		

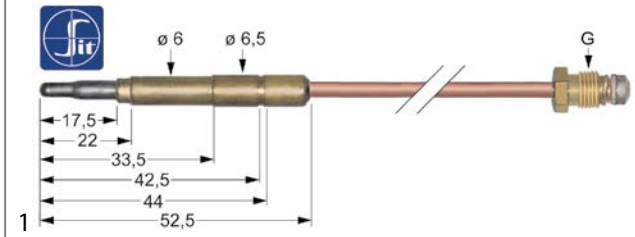

GEV No.	107601	Ref. No.	434008050
description	thermocouple SIT M8x1 L 600mm plug connection $\phi 6.0(6.5)\text{mm}$		

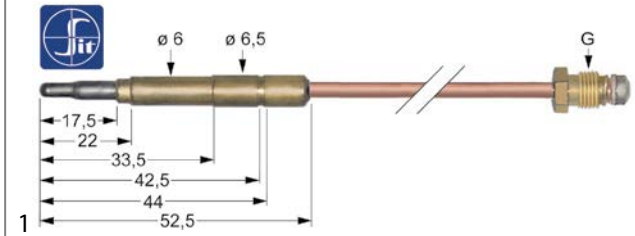

GEV No.	107612	Ref. No.	434009110
description	thermocouple SIT M9x1 L 1000mm plug connection $\phi 6.0(6.5)\text{mm}$		

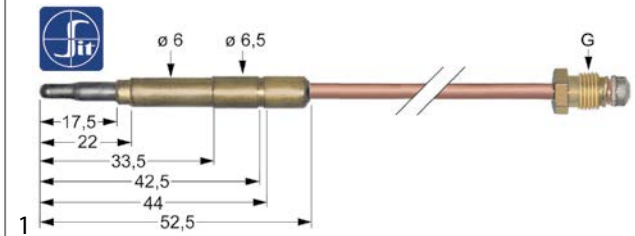

GEV No.	107611	Ref. No.	434009175
description	thermocouple SIT M9x1 L 850mm plug connection $\phi 6.0(6.5)\text{mm}$		

For models:	110-120AL-ALR, 110-120TL-TLR, 110-122AL-ALR, 110-122ALC, 110-122FELC, 110-122FEL-FELR, 110-122FLC, 110-122FL-FLR, 110-122TL, 110-122TL-TLR, 110-200A-T, 110-200F, 110-200FE, 500-120AL-AR, 500-120ALC, 500-120TLC, 500-120TL-TR, 500-122AL-ALR-AR, 500-122ALC, 500-122TLC, 500-122TL-TLR-TR, 64-040F-FV, 64-125T-126T, 64-222F, 700-040FB, 700-040FEB, 700-120AL-AR-CL, 700-120ALC-CLC, 700-120CR-TL, 700-120TLC, 700-120TR, 700-122AL, 700-122ALC, 700-122ALR-AR-CL, 700-122CLC, 700-122CLR-CR-TL, 700-122TLC, 700-122TLR-TR, 700-138FBA, 700-162FBA, 700-200FB, 700-222FB, 700-224FBA, 700-400A-C-T, 700-401B, 700-402A-C-T, 900-040F, 900-120AL-AR, 900-120ALC, 900-120CL-CR...(Other models you can see in the webshop)		
--------------------	---	--	--



thermocouples with aluminised tip

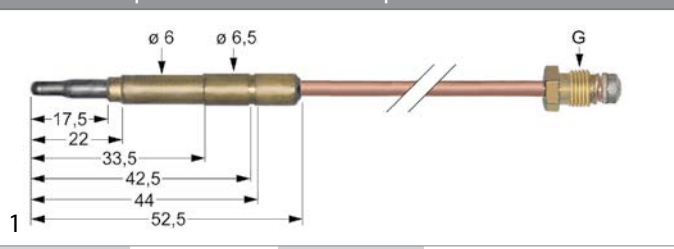

GEV No.	102043	Ref. No.	434009000
description	thermocouple M9x1 L 1000mm plug connection ø6.0(6.5)mm		

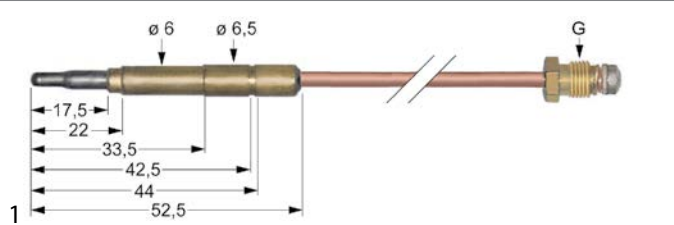

GEV No.	102039	Ref. No.	434010100
description	thermocouple M9x1 L 320mm plug connection ø6.0(6.5)mm		

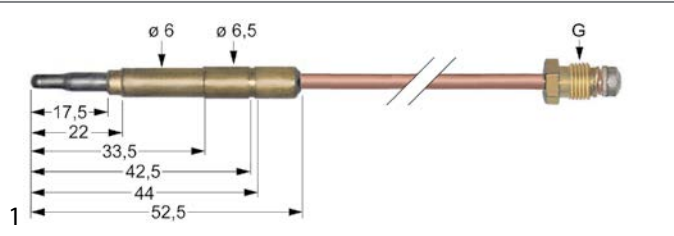

GEV No.	102041	Ref. No.	434209075
description	thermocouple M9x1 L 600mm plug connection ø6.0(6.5)mm		

plug-in thermocouples with aluminised tip



GEV No.	103058	Ref. No.	434008060
description	thermocouple aluminized tip M8x1 L 600mm plug connection ø6.0(6.5)mm		
For models:	700-020A-C-T, 700-040A-C-T, 700-040FB, 700-040FEB, 700-162A-C-T, 700-162FBA, 700-162FEBA, 700-162FG, 700-222A-C, 700-222FB, 700-222FEB, 700-222T, 700-224A-C, 700-224FBA, 700-224FEBA, 700-224FG, 700-224T, 900-020A-C-T, 900-040A-C-T, 900-040F, 900-040FE, 900-162A-C-T, 900-162FA, 900-162FEA, 900-162FG, 900-182F, 900-182FE		

plug-in thermocouples with interruption

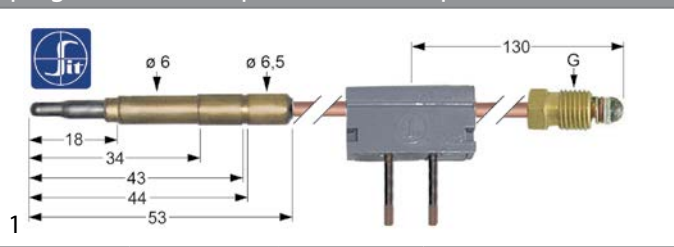

GEV No.	107164	Ref. No.	434009100 4343103
description	thermocouple SIT with interrupter M9x1 L 1000mm plug connection ø6.0(6.5)mm soldering connection		
For models:	64-600T-603T, 700-508, 900-503, 900-506, 920-503, 920-506		

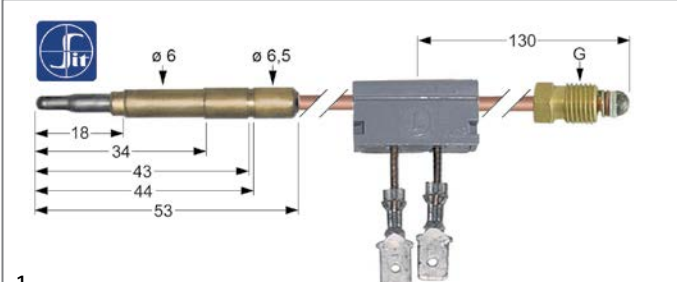

GEV No.	107177	Ref. No.	434099045 4343106 A00425
description	thermocouple SIT with interrupter M9x1 L 600mm plug connection ø6.0mm F 6.3mm		
For models:	500-601A, 64-600T-603T, 700-601A-S, 700-602A-S, 700-603A, 700-604A-605A, 700-609A, 900-601A-S, 900-602A-S, 900-604A-S, 900-605A-S, 900-609A, 920-604A-S, 920-609A		

threaded thermocouples

threaded thermocouples standard

with socket with thread M8x1

SIT

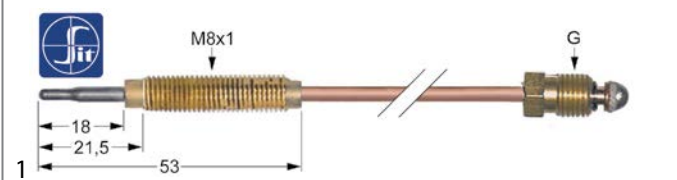

GEV No.	107632	Ref. No.	A00270
description	thermocouple SIT M8x1 L 1000mm M8x1		
accessories for	107632		
	GEV No.	102067	Ref. No. —
	nut thread M8x1 H 3mm brass Qty 1 pcs type SEF 1		

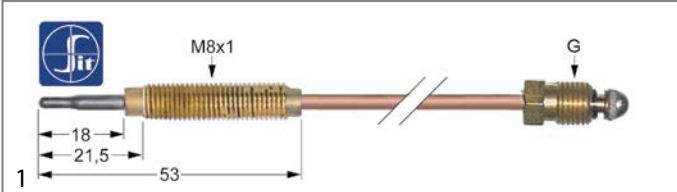

GEV No.	107631	Ref. No.	A00017
description	thermocouple SIT M8x1 L 850mm M8x1		
accessories for	107631		
	GEV No.	102067	Ref. No. —
	nut thread M8x1 H 3mm brass Qty 1 pcs type SEF 1		

gas burners

hob burners

producer-specific hob burners

GICO

50, 60, 62, 70, 90, 92, 110 (old series)



GEV No.	105068	Ref. No.	741312350
description	air mixing sleeve		
For models:	64-020T-64-040T, 64-040FCE, 64-040FE, 64-040F-FV, 64-222F, 64-222FCE, 64-222FE, 64-222T, 700-020A-C-T, 700-040A-C-T, 700-040FB, 700-040FEB, 700-138A-C-T, 700-138FBA, 700-138FEBA, 700-162A-C-T, 700-162FBA, 700-162FEBA, 700-162FG, 700-222A-C, 700-222FB, 700-222FEB, 700-222T, 700-224A-C, 700-224FBA, 700-224FEBA, 700-224FG, 700-224T, 900-020A-C-T, 900-040A-C-T, 900-040F, 900-040FE, 900-138A-C-T, 900-138FA, 900-138FEA, 900-162A-C-T, 900-162FA, 900-162FEA, 900-162FG, 900-182F, 900-182FE, 900-302		
accessories for	105068		
	GEV No.	104091	Ref. No. 790300799
	burner head D ø 124mm for burner cap ø 80mm suitable for 50, 90, 92, 110 series (old)		
	GEV No.	104093	Ref. No. 270200170 770324790
	venturi C/D		
	GEV No.	104096	Ref. No. 241202412
	burner holder with nozzle holder connection M20x1.5		
	GEV No.	105060	Ref. No. 760305080 764305190
	burner head C for burner cap ø 60mm suitable for 60, 62 series		
	GEV No.	105062	Ref. No. 760311640
	venturi C		
	GEV No.	105076	Ref. No. 790300789
	burner head C for burner cap ø 60mm suitable for 70, 90, 92 series (old)		
	GEV No.	105079	Ref. No. 770336760
	burner head D ø 100mm		
	GEV No.	105091	Ref. No. 770339300
	burner head C for burner cap ø 60mm		
	GEV No.	105098	Ref. No. 770336750
	burner head D for burner cap ø 80mm		
	GEV No.	105099	Ref. No. A00419
	burner head A for burner cap ø 110mm		
	GEV No.	105100	Ref. No. A00418
	burner head A for burner cap ø 110mm		
	GEV No.	105119	Ref. No. A00420
	burner head B for burner cap ø 90mm		
	GEV No.	105707	Ref. No. —
	burner cap ø 95mm		

Table continues overleaf

GEV No.	107637	Ref. No.	A00022
description	thermocouple SIT M9x1 L 850mm M8x1		
accessories for	107637		
	GEV No.	102067	Ref. No. —
	nut thread M8x1 H 3mm brass Qty 1 pcs type SEF 1		



threaded thermocouples (miscellaneous)

GEV No.	102055	Ref. No.	A00016
description	thermocouple M8x1 L 450mm M8x1		
For models:	64-020T-64-040T, 64-040FCE, 64-040FE, 64-040F-FV, 64-222F, 64-222FCE, 64-222FE, 64-222T		
accessories for	102055		
	GEV No.	102067	Ref. No. —
	nut thread M8x1 H 3mm brass Qty 1 pcs type SEF 1		

thermopiles

GEV No.	102116	Ref. No.	434010580
description	thermopile ROBERTSHAW L 900mm probe ø 9mm probe L 57mm 250-750mV screw connection 7/16"		



accessories for	105068		
	GEV No.	105708	Ref. No. —
	burner head for burner cap ø 95mm		
	GEV No.	105709	Ref. No. —
	venturi		
	GEV No.	105710	Ref. No. —
	burner holder with nozzle holder		

	1		
GEV No.	105078	Ref. No.	290200450
description	burner cap C ø 60mm		
accessories for	105078		
	GEV No.	104093	Ref. No. 270200170 770324790
	venturi C/D		
	GEV No.	104096	Ref. No. 241202412
	burner holder with nozzle holder connection M20x1.5		
	GEV No.	105068	Ref. No. 741312350
	air mixing sleeve		
	GEV No.	105076	Ref. No. 790300789
	burner head C for burner cap ø 60mm suitable for 70, 90, 92 series (old)		
	GEV No.	105077	Ref. No. 270204230 290200460
	burner ring C for burner cap ø 60mm		
	GEV No.	105091	Ref. No. 770339300
	burner head C for burner cap ø 60mm		

	1		
GEV No.	105081	Ref. No.	290200480 A00004
description	burner cap D ø 80mm		
accessories for	105081		
	GEV No.	104091	Ref. No. 790300799
	burner head D ø 124mm for burner cap ø 80mm suitable for 50, 90, 92, 110 series (old)		
	GEV No.	104093	Ref. No. 270200170 770324790
	venturi C/D		
	GEV No.	104096	Ref. No. 241202412
	burner holder with nozzle holder connection M20x1.5		
	GEV No.	105068	Ref. No. 741312350
	air mixing sleeve		
	GEV No.	105080	Ref. No. 270204240
	burner ring D for burner cap ø 80mm		
	GEV No.	105098	Ref. No. 770336750
	burner head D for burner cap ø 80mm		

	1		
GEV No.	105060	Ref. No.	760305080 764305190
description	burner head C for burner cap ø 60mm suitable for 60, 62 series		
For models:	64-020T-64-040T, 64-040FCE, 64-040FE, 64-040F-FV, 64-222F, 64-222FCE, 64-222FE, 64-222T		
accessories for	105060		
	GEV No.	103060	Ref. No. 770319550
	burner cap C ø 70mm		
	GEV No.	104096	Ref. No. 241202412
	burner holder with nozzle holder connection M20x1.5		
	GEV No.	105062	Ref. No. 760311640
	venturi C		
	GEV No.	105068	Ref. No. 741312350
	air mixing sleeve		

	1		
GEV No.	105076	Ref. No.	790300789
description	burner head C for burner cap ø 60mm suitable for 70, 90, 92 series (old)		
accessories for	105076		
	GEV No.	104093	Ref. No. 270200170 770324790
	venturi C/D		
	GEV No.	104096	Ref. No. 241202412
	burner holder with nozzle holder connection M20x1.5		
	GEV No.	105068	Ref. No. 741312350
	air mixing sleeve		
	GEV No.	105077	Ref. No. 270204230 290200460
	burner ring C for burner cap ø 60mm		
	GEV No.	105078	Ref. No. 290200450
	burner cap C ø 60mm		







	1		
GEV No.	104091	Ref. No.	790300799
description	burner head D ø 124mm for burner cap ø 80mm suitable for 50, 90, 92, 110 series (old)		
accessories for	104091		
	GEV No.	104093	Ref. No. 270200170 770324790
	venturi C/D		





Table continues overleaf



accessories for		104091		
	GEV No.	105068	Ref. No.	741312350
	air mixing sleeve			
	GEV No.	105080	Ref. No.	270204240
	burner ring D for burner cap ø 80mm			
	GEV No.	105081	Ref. No.	290200480 A00004
	burner cap D ø 80mm			

	1			
GEV No.	104096	Ref. No.	241202412	
description	burner holder with nozzle holder connection M20x1.5			
For models:	64-020T-64-040T, 64-040FCE, 64-040FE, 64-040F-FV, 64-222F, 64-222FCE, 64-222FE, 64-222T, 700-020A-C-T, 700-040A-C-T, 700-040FB, 700-040FEB, 700-138A-C-T, 700-138FBA, 700-138FEBA, 700-162A-C-T, 700-162FBA, 700-162FEBA, 700-162FG, 700-222A-C, 700-222FB, 700-222FEB, 700-222T, 700-224A-C, 700-224FBA, 700-224FEBA, 700-224FG, 700-224T, 900-020A-C-T, 900-040A-C-T, 900-040F, 900-040FE, 900-138A-C-T, 900-138FA, 900-138FEA, 900-162A-C-T, 900-162FA, 900-162FEA, 900-162FG, 900-182F, 900-182FE, 900-302			
accessories for		104096		
	GEV No.	101250	Ref. No.	270201680
	union nut thread M20x1.5 for pipe ø 10mm			
	GEV No.	101278	Ref. No.	—
	olive for pipe ø 10mm Qty 1 pcs			
	GEV No.	104091	Ref. No.	790300799
	burner head D ø 124mm for burner cap ø 80mm suitable for 50, 90, 92, 110 series (old)			
	GEV No.	104093	Ref. No.	270200170 770324790
	venturi C/D			
	GEV No.	105060	Ref. No.	760305080 764305190
	burner head C for burner cap ø 60mm suitable for 60, 62 series			
	GEV No.	105062	Ref. No.	760311640
	venturi C			
	GEV No.	105068	Ref. No.	741312350
	air mixing sleeve			
	GEV No.	105076	Ref. No.	790300789
	burner head C for burner cap ø 60mm suitable for 70, 90, 92 series (old)			
	GEV No.	105079	Ref. No.	770336760
	burner head D ø 100mm			
	GEV No.	105091	Ref. No.	770339300
	burner head C for burner cap ø 60mm			
	GEV No.	105098	Ref. No.	770336750
	burner head D for burner cap ø 80mm			
	GEV No.	105099	Ref. No.	A00419
	burner head A for burner cap ø 110mm			

accessories for		104096		
	GEV No.	105100	Ref. No.	A00418
	burner head A for burner cap ø 110mm			
	GEV No.	105119	Ref. No.	A00420
	burner head B for burner cap ø 90mm			

	1			
GEV No.	105077	Ref. No.	270204230 290200460	
description	burner ring C for burner cap ø 60mm			
accessories for		105077		
	GEV No.	104093	Ref. No.	270200170 770324790
	venturi C/D			
	GEV No.	104096	Ref. No.	241202412
	burner holder with nozzle holder connection M20x1.5			
	GEV No.	105068	Ref. No.	741312350
	air mixing sleeve			
	GEV No.	105076	Ref. No.	790300789
	burner head C for burner cap ø 60mm suitable for 70, 90, 92 series (old)			
	GEV No.	105078	Ref. No.	290200450
	burner cap C ø 60mm			
	GEV No.	105091	Ref. No.	770339300
	burner head C for burner cap ø 60mm			

	1			
Image not available				
GEV No.	105082	Ref. No.	A00003	
description	burner ring C with burner cap ø 60mm			
For models:	64-020T-64-040T, 64-040FCE, 64-040FE, 64-040F-FV, 64-222F, 64-222FCE, 64-222FE, 64-222T, 700-020A-C-T, 700-040A-C-T, 700-040FB, 700-040FEB, 700-138A-C-T, 700-138FBA, 700-138FEBA, 700-162A-C-T, 700-162FBA, 700-162FEBA, 700-162FG, 700-222A-C, 700-222FB, 700-222FEB, 700-222T, 700-224A-C, 700-224FBA, 700-224FEBA, 700-224FG, 700-224T, 900-302			









	1			
GEV No.	105080	Ref. No.	270204240	
description	burner ring D for burner cap ø 80mm			
accessories for		105080		
	GEV No.	104091	Ref. No.	790300799
	burner head D ø 124mm for burner cap ø 80mm suitable for 50, 90, 92, 110 series (old)			
	GEV No.	104093	Ref. No.	270200170 770324790
	venturi C/D			

Table continues overleaf



accessories for 105080					
	<table border="1"> <tr> <th>GEV No.</th> <td>104096</td> <th>Ref. No.</th> <td>241202412</td> </tr> </table> <p>burner holder with nozzle holder connection M20x1.5</p>	GEV No.	104096	Ref. No.	241202412
GEV No.	104096	Ref. No.	241202412		
	<table border="1"> <tr> <th>GEV No.</th> <td>105068</td> <th>Ref. No.</th> <td>741312350</td> </tr> </table> <p>air mixing sleeve</p>	GEV No.	105068	Ref. No.	741312350
GEV No.	105068	Ref. No.	741312350		
	<table border="1"> <tr> <th>GEV No.</th> <td>105081</td> <th>Ref. No.</th> <td>290200480 A00004</td> </tr> </table> <p>burner cap D ø 80mm</p>	GEV No.	105081	Ref. No.	290200480 A00004
GEV No.	105081	Ref. No.	290200480 A00004		
	<table border="1"> <tr> <th>GEV No.</th> <td>105098</td> <th>Ref. No.</th> <td>770336750</td> </tr> </table> <p>burner head D for burner cap ø 80mm</p>	GEV No.	105098	Ref. No.	770336750
GEV No.	105098	Ref. No.	770336750		

 Image not available 1			
GEV No.	105083	Ref. No.	A00004
description	burner ring D with burner cap ø85mm		
For models:	900-020A-C-T, 900-040A-C-T, 900-040F, 900-040FE, 900-138A-C-T, 900-138FA, 900-138FEA, 900-162A-C-T, 900-162FA, 900-162FEA, 900-162FG, 900-182F, 900-182FE, 900-302		

 1					
GEV No.	105062	Ref. No.	760311640		
description	venturi C				
For models:	64-020T-64-040T, 64-040FCE, 64-040FE, 64-040F-FV, 64-222F, 64-222FCE, 64-222FE, 64-222T				
accessories for 105062					
	<table border="1"> <tr> <th>GEV No.</th> <td>103060</td> <th>Ref. No.</th> <td>770319550</td> </tr> </table> <p>burner cap C ø 70mm</p>	GEV No.	103060	Ref. No.	770319550
GEV No.	103060	Ref. No.	770319550		
	<table border="1"> <tr> <th>GEV No.</th> <td>104096</td> <th>Ref. No.</th> <td>241202412</td> </tr> </table> <p>burner holder with nozzle holder connection M20x1.5</p>	GEV No.	104096	Ref. No.	241202412
GEV No.	104096	Ref. No.	241202412		
	<table border="1"> <tr> <th>GEV No.</th> <td>105060</td> <th>Ref. No.</th> <td>760305080 764305190</td> </tr> </table> <p>burner head C for burner cap ø 60mm suitable for 60, 62 series</p>	GEV No.	105060	Ref. No.	760305080 764305190
GEV No.	105060	Ref. No.	760305080 764305190		
	<table border="1"> <tr> <th>GEV No.</th> <td>105068</td> <th>Ref. No.</th> <td>741312350</td> </tr> </table> <p>air mixing sleeve</p>	GEV No.	105068	Ref. No.	741312350
GEV No.	105068	Ref. No.	741312350		

 1					
GEV No.	104093	Ref. No.	270200170 770324790		
description	venturi C/D				
For models:	64-222F, 64-222FCE, 64-222FE, 64-222T, 700-020A-C-T, 700-040A-C-T, 700-040FB, 700-040FEB, 700-138A-C-T, 700-138FBA, 700-138FEBA, 700-162A-C-T, 700-162FBA, 700-162FEBA, 700-162FG, 700-222A-C, 700-222FB, 700-222FEB, 700-222T, 700-224A-C, 700-224FBA, 700-224FEBA, 700-224FG, 700-224T, 900-020A-C-T, 900-040A-C-T, 900-040F, 900-040FE, 900-138A-C-T, 900-138FA, 900-138FEA, 900-162A-C-T, 900-162FA, 900-162FEA, 900-162FG, 900-182F, 900-182FE				
accessories for 104093					
	<table border="1"> <tr> <th>GEV No.</th> <td>104091</td> <th>Ref. No.</th> <td>790300799</td> </tr> </table> <p>burner head D ø 124mm for burner cap ø 80mm suitable for 50, 90, 92, 110 series (old)</p>	GEV No.	104091	Ref. No.	790300799
GEV No.	104091	Ref. No.	790300799		
	<table border="1"> <tr> <th>GEV No.</th> <td>104096</td> <th>Ref. No.</th> <td>241202412</td> </tr> </table> <p>burner holder with nozzle holder connection M20x1.5</p>	GEV No.	104096	Ref. No.	241202412
GEV No.	104096	Ref. No.	241202412		
	<table border="1"> <tr> <th>GEV No.</th> <td>105068</td> <th>Ref. No.</th> <td>741312350</td> </tr> </table> <p>air mixing sleeve</p>	GEV No.	105068	Ref. No.	741312350
GEV No.	105068	Ref. No.	741312350		
	<table border="1"> <tr> <th>GEV No.</th> <td>105076</td> <th>Ref. No.</th> <td>790300789</td> </tr> </table> <p>burner head C for burner cap ø 60mm suitable for 70, 90, 92 series (old)</p>	GEV No.	105076	Ref. No.	790300789
GEV No.	105076	Ref. No.	790300789		
	<table border="1"> <tr> <th>GEV No.</th> <td>105079</td> <th>Ref. No.</th> <td>770336760</td> </tr> </table> <p>burner head D ø 100mm</p>	GEV No.	105079	Ref. No.	770336760
GEV No.	105079	Ref. No.	770336760		
	<table border="1"> <tr> <th>GEV No.</th> <td>105091</td> <th>Ref. No.</th> <td>770339300</td> </tr> </table> <p>burner head C for burner cap ø 60mm</p>	GEV No.	105091	Ref. No.	770339300
GEV No.	105091	Ref. No.	770339300		
	<table border="1"> <tr> <th>GEV No.</th> <td>105098</td> <th>Ref. No.</th> <td>770336750</td> </tr> </table> <p>burner head D for burner cap ø 80mm</p>	GEV No.	105098	Ref. No.	770336750
GEV No.	105098	Ref. No.	770336750		
	<table border="1"> <tr> <th>GEV No.</th> <td>105099</td> <th>Ref. No.</th> <td>A00419</td> </tr> </table> <p>burner head A for burner cap ø 110mm</p>	GEV No.	105099	Ref. No.	A00419
GEV No.	105099	Ref. No.	A00419		
	<table border="1"> <tr> <th>GEV No.</th> <td>105100</td> <th>Ref. No.</th> <td>A00418</td> </tr> </table> <p>burner head A for burner cap ø 110mm</p>	GEV No.	105100	Ref. No.	A00418
GEV No.	105100	Ref. No.	A00418		
	<table border="1"> <tr> <th>GEV No.</th> <td>105119</td> <th>Ref. No.</th> <td>A00420</td> </tr> </table> <p>burner head B for burner cap ø 90mm</p>	GEV No.	105119	Ref. No.	A00420
GEV No.	105119	Ref. No.	A00420		



700/900 (old series)



1

GEV No.	105068	Ref. No.	741312350
description	air mixing sleeve		
For models:	64-020T-64-040T, 64-040FCE, 64-040FE, 64-040F-FV, 64-222F, 64-222FCE, 64-222FE, 64-222T, 700-020A-C-T, 700-040A-C-T, 700-040FB, 700-040FEB, 700-138A-C-T, 700-138FBA, 700-138FEBA, 700-162A-C-T, 700-162FBA, 700-162FEBA, 700-162FG, 700-222A-C, 700-222FB, 700-222FEB, 700-222T, 700-224A-C, 700-224FBA, 700-224FEBA, 700-224FG, 700-224T, 900-020A-C-T, 900-040A-C-T, 900-040F, 900-040FE, 900-138A-C-T, 900-138FA, 900-138FEA, 900-162A-C-T, 900-162FA, 900-162FEA, 900-162FG, 900-182F, 900-182FE, 900-302		
accessories for	105068		
	GEV No.	104091	Ref. No. 790300799
	burner head D ø 124mm for burner cap ø 80mm suitable for 50, 90, 92, 110 series (old)		
	GEV No.	104093	Ref. No. 270200170 770324790
	venturi C/D		
	GEV No.	104096	Ref. No. 241202412
	burner holder with nozzle holder connection M20x1.5		
	GEV No.	105060	Ref. No. 760305080 764305190
	burner head C for burner cap ø 60mm suitable for 60, 62 series		
	GEV No.	105062	Ref. No. 760311640
	venturi C		
	GEV No.	105076	Ref. No. 790300789
	burner head C for burner cap ø 60mm suitable for 70, 90, 92 series (old)		
	GEV No.	105079	Ref. No. 770336760
	burner head D ø 100mm		
	GEV No.	105091	Ref. No. 770339300
	burner head C for burner cap ø 60mm		
	GEV No.	105098	Ref. No. 770336750
	burner head D for burner cap ø 80mm		
	GEV No.	105099	Ref. No. A00419
	burner head A for burner cap ø 110mm		
	GEV No.	105100	Ref. No. A00418
	burner head A for burner cap ø 110mm		
	GEV No.	105119	Ref. No. A00420
	burner head B for burner cap ø 90mm		
	GEV No.	105707	Ref. No. —
	burner cap ø 95mm		
	GEV No.	105708	Ref. No. —
	burner head for burner cap ø 95mm		
	GEV No.	105709	Ref. No. —
	venturi		

accessories for	105068		
	GEV No.	105710	Ref. No. —
	burner holder with nozzle holder		

	1		
GEV No.	103060	Ref. No.	770319550
description	burner cap C ø 70mm		
For models:	64-222F, 64-222FCE, 64-222FE, 64-222T		
accessories for	103060		
	GEV No.	104096	Ref. No. 241202412
	burner holder with nozzle holder connection M20x1.5		
	GEV No.	105060	Ref. No. 760305080 764305190
	burner head C for burner cap ø 60mm suitable for 60, 62 series		
	GEV No.	105062	Ref. No. 760311640
	venturi C		
	GEV No.	105068	Ref. No. 741312350
	air mixing sleeve		

	1		
GEV No.	103061	Ref. No.	770319560
description	burner cap D ø 100mm		
For models:	700-222A-C, 700-222FB, 700-222FEB, 700-222T, 700-224A-C, 700-224FBA, 700-224FEBA, 700-224FG, 700-224T		
accessories for	103061		
	GEV No.	104091	Ref. No. 790300799
	burner head D ø 124mm for burner cap ø 80mm suitable for 50, 90, 92, 110 series (old)		
	GEV No.	104093	Ref. No. 270200170 770324790
	venturi C/D		
	GEV No.	104096	Ref. No. 241202412
	burner holder with nozzle holder connection M20x1.5		
	GEV No.	105068	Ref. No. 741312350
	air mixing sleeve		
	GEV No.	105079	Ref. No. 770336760
	burner head D ø 100mm		

	1		
GEV No.	103062	Ref. No.	241200430
description	burner cap E ø 135mm		



			
1			
GEV No.	104091	Ref. No.	790300799
description	burner head D ø 124mm for burner cap ø 80mm suitable for 50, 90, 92, 110 series (old)		
accessories for	104091		
	GEV No.	104093	Ref. No. 270200170 770324790
	venturi C/D		
	GEV No.	105068	Ref. No. 741312350
	air mixing sleeve		
	GEV No.	105080	Ref. No. 270204240
	burner ring D for burner cap ø 80mm		
	GEV No.	105081	Ref. No. 290200480 A00004
	burner cap D ø 80mm		

			
1			
GEV No.	104096	Ref. No.	241202412
description	burner holder with nozzle holder connection M20x1.5		
For models:	64-020T-64-040T, 64-040FCE, 64-040FE, 64-040F-FV, 64-222F, 64-222FCE, 64-222FE, 64-222T, 700-020A-C-T, 700-040A-C-T, 700-040FB, 700-040FEB, 700-138A-C-T, 700-138FBA, 700-138FEBA, 700-162A-C-T, 700-162FBA, 700-162FEBA, 700-162FG, 700-222A-C, 700-222FB, 700-222FEB, 700-222T, 700-224A-C, 700-224FBA, 700-224FEBA, 700-224FG, 700-224T, 900-020A-C-T, 900-040A-C-T, 900-040F, 900-040FE, 900-138A-C-T, 900-138FA, 900-138FEA, 900-162A-C-T, 900-162FA, 900-162FEA, 900-162FG, 900-182F, 900-182FE, 900-302		
accessories for	104096		
	GEV No.	101250	Ref. No. 270201680
	union nut thread M20x1.5 for pipe ø 10mm		
	GEV No.	101278	Ref. No. —
	olive for pipe ø 10mm Qty 1 pcs		
	GEV No.	104091	Ref. No. 790300799
	burner head D ø 124mm for burner cap ø 80mm suitable for 50, 90, 92, 110 series (old)		
	GEV No.	104093	Ref. No. 270200170 770324790
	venturi C/D		
	GEV No.	105060	Ref. No. 760305080 764305190
	burner head C for burner cap ø 60mm suitable for 60, 62 series		
	GEV No.	105062	Ref. No. 760311640
	venturi C		
	GEV No.	105068	Ref. No. 741312350
	air mixing sleeve		
	GEV No.	105076	Ref. No. 790300789
	burner head C for burner cap ø 60mm suitable for 70, 90, 92 series (old)		

accessories for	104096		
	GEV No.	105079	Ref. No. 770336760
	burner head D ø 100mm		
	GEV No.	105091	Ref. No. 770339300
	burner head C for burner cap ø 60mm		
	GEV No.	105098	Ref. No. 770336750
	burner head D for burner cap ø 80mm		
	GEV No.	105099	Ref. No. A00419
	burner head A for burner cap ø 110mm		
	GEV No.	105100	Ref. No. A00418
	burner head A for burner cap ø 110mm		
	GEV No.	105119	Ref. No. A00420
	burner head B for burner cap ø 90mm		











			
1			
GEV No.	104093	Ref. No.	270200170 770324790
description	venturi C/D		
For models:	64-222F, 64-222FCE, 64-222FE, 64-222T, 700-020A-C-T, 700-040A-C-T, 700-040FB, 700-040FEB, 700-138A-C-T, 700-138FBA, 700-138FEBA, 700-162A-C-T, 700-162FBA, 700-162FEBA, 700-162FG, 700-222A-C, 700-222FB, 700-222FEB, 700-222T, 700-224A-C, 700-224FBA, 700-224FEBA, 700-224FG, 700-224T, 900-020A-C-T, 900-040A-C-T, 900-040F, 900-040FE, 900-138A-C-T, 900-138FA, 900-138FEA, 900-162A-C-T, 900-162FA, 900-162FEA, 900-162FG, 900-182F, 900-182FE		
accessories for	104093		
	GEV No.	104091	Ref. No. 790300799
	burner head D ø 124mm for burner cap ø 80mm suitable for 50, 90, 92, 110 series (old)		
	GEV No.	104096	Ref. No. 241202412
	burner holder with nozzle holder connection M20x1.5		
	GEV No.	105068	Ref. No. 741312350
	air mixing sleeve		
	GEV No.	105076	Ref. No. 790300789
	burner head C for burner cap ø 60mm suitable for 70, 90, 92 series (old)		
	GEV No.	105079	Ref. No. 770336760
	burner head D ø 100mm		
	GEV No.	105091	Ref. No. 770339300
	burner head C for burner cap ø 60mm		
	GEV No.	105098	Ref. No. 770336750
	burner head D for burner cap ø 80mm		
	GEV No.	105099	Ref. No. A00419
	burner head A for burner cap ø 110mm		

Table continues overleaf





accessories for 104093				
	GEV No.	105100	Ref. No.	A00418
	burner head A for burner cap ø 110mm			
	GEV No.	105119	Ref. No.	A00420
	burner head B for burner cap ø 90mm			

500, 700new, 900, 920, 110 (new series)



GEV No.	105068	Ref. No.	741312350
description	air mixing sleeve		
For models:	64-020T-64-040T, 64-040FCE, 64-040FE, 64-040F-FV, 64-222F, 64-222FCE, 64-222FE, 64-222T, 700-020A-C-T, 700-040A-C-T, 700-040FB, 700-040FEB, 700-138A-C-T, 700-138FBA, 700-138FEBA, 700-162A-C-T, 700-162FBA, 700-162FEBA, 700-162FG, 700-222A-C, 700-222FB, 700-222FEB, 700-222T, 700-224A-C, 700-224FBA, 700-224FEBA, 700-224FG, 700-224T, 900-020A-C-T, 900-040A-C-T, 900-040F, 900-040FE, 900-138A-C-T, 900-138FA, 900-138FEA, 900-162A-C-T, 900-162FA, 900-162FEA, 900-162FG, 900-182F, 900-182FE, 900-302		





accessories for 105068				
	GEV No.	104091	Ref. No.	790300799
	burner head D ø 124mm for burner cap ø 80mm suitable for 50, 90, 92, 110 series (old)			
	GEV No.	104093	Ref. No.	270200170 770324790
	venturi C/D			
	GEV No.	104096	Ref. No.	241202412
	burner holder with nozzle holder connection M20x1.5			
	GEV No.	105060	Ref. No.	760305080 764305190
	burner head C for burner cap ø 60mm suitable for 60, 62 series			
	GEV No.	105062	Ref. No.	760311640
	venturi C			
	GEV No.	105076	Ref. No.	790300789
	burner head C for burner cap ø 60mm suitable for 70, 90, 92 series (old)			
	GEV No.	105079	Ref. No.	770336760
	burner head D ø 100mm			
	GEV No.	105091	Ref. No.	770339300
	burner head C for burner cap ø 60mm			
	GEV No.	105098	Ref. No.	770336750
	burner head D for burner cap ø 80mm			
	GEV No.	105099	Ref. No.	A00419
	burner head A for burner cap ø 110mm			
	GEV No.	105100	Ref. No.	A00418
	burner head A for burner cap ø 110mm			
	GEV No.	105119	Ref. No.	A00420
	burner head B for burner cap ø 90mm			
	GEV No.	105707	Ref. No.	—
	burner cap ø 95mm			

accessories for 105068				
	GEV No.	105708	Ref. No.	—
	burner head for burner cap ø 95mm			
	GEV No.	105709	Ref. No.	—
	venturi			
	GEV No.	105710	Ref. No.	—
	burner holder with nozzle holder			



GEV No.	105088	Ref. No.	270203540	
description	burner cap A ø 110mm with central hole			
For models:	900-020A-C-T, 900-040A-C-T, 900-040F, 900-040FE, 900-138A-C-T, 900-138FA, 900-138FEA, 900-162A-C-T, 900-162FA, 900-162FEA, 900-162FG, 900-182F, 900-182FE			
accessories for 105088				
	GEV No.	104093	Ref. No.	270200170 770324790
	venturi C/D			
	GEV No.	104096	Ref. No.	241202412
	burner holder with nozzle holder connection M20x1.5			
	GEV No.	105068	Ref. No.	741312350
	air mixing sleeve			
	GEV No.	105099	Ref. No.	A00419
	burner head A for burner cap ø 110mm			
	GEV No.	105100	Ref. No.	A00418
	burner head A for burner cap ø 110mm			



GEV No.	105084	Ref. No.	270203550	
description	burner cap B ø 90mm with central hole			
For models:	700-020A-C-T, 700-040A-C-T, 700-040FB, 700-040FEB, 700-138A-C-T, 700-138FBA, 700-138FEBA, 700-162A-C-T, 700-162FBA, 700-162FEBA, 700-162FG, 700-222A-C, 700-222FB, 700-222FEB, 700-222T, 700-224A-C, 700-224FBA, 700-224FEBA, 700-224FG, 700-224T			
accessories for 105084				
	GEV No.	104093	Ref. No.	270200170 770324790
	venturi C/D			
	GEV No.	104096	Ref. No.	241202412
	burner holder with nozzle holder connection M20x1.5			
	GEV No.	105068	Ref. No.	741312350
	air mixing sleeve			
	GEV No.	105119	Ref. No.	A00420
	burner head B for burner cap ø 90mm			



			
1			
GEV No.	105078	Ref. No.	290200450
description	burner cap C ø 60mm		
accessories for	105078		
	GEV No.	104093	Ref. No. 270200170 770324790
	venturi C/D		
	GEV No.	104096	Ref. No. 241202412
	burner holder with nozzle holder connection M20x1.5		
	GEV No.	105068	Ref. No. 741312350
	air mixing sleeve		
	GEV No.	105076	Ref. No. 790300789
	burner head C for burner cap ø 60mm suitable for 70, 90, 92 series (old)		
	GEV No.	105077	Ref. No. 270204230 290200460
	burner ring C for burner cap ø 60mm		
	GEV No.	105091	Ref. No. 770339300
	burner head C for burner cap ø 60mm		

			
1			
GEV No.	105081	Ref. No.	290200480 A00004
description	burner cap D ø 80mm		
accessories for	105081		
	GEV No.	104091	Ref. No. 790300799
	burner head D ø 124mm for burner cap ø 80mm suitable for 50, 90, 92, 110 series (old)		
	GEV No.	104093	Ref. No. 270200170 770324790
	venturi C/D		
	GEV No.	104096	Ref. No. 241202412
	burner holder with nozzle holder connection M20x1.5		
	GEV No.	105068	Ref. No. 741312350
	air mixing sleeve		
	GEV No.	105080	Ref. No. 270204240
	burner ring D for burner cap ø 80mm		
	GEV No.	105098	Ref. No. 770336750
	burner head D for burner cap ø 80mm		

			
1			
GEV No.	107018	Ref. No.	A00471
description	burner cap ø 175mm		

			
1			
GEV No.	105099	Ref. No.	A00419
description	burner head A for burner cap ø 110mm		
accessories for	105099		
	GEV No.	104093	Ref. No. 270200170 770324790
	venturi C/D		
	GEV No.	104096	Ref. No. 241202412
	burner holder with nozzle holder connection M20x1.5		
	GEV No.	105068	Ref. No. 741312350
	air mixing sleeve		
	GEV No.	105088	Ref. No. 270203540
	burner cap A ø 110mm with central hole		

			
1			
GEV No.	105100	Ref. No.	A00418
description	burner head A for burner cap ø 110mm		
For models:	900-020A-C-T, 900-040A-C-T, 900-040F, 900-040FE, 900-138A-C-T, 900-138FA, 900-138FEA, 900-162A-C-T, 900-162FA, 900-162FEA, 900-162FG, 900-182F, 900-182FE		
accessories for	105100		
	GEV No.	104093	Ref. No. 270200170 770324790
	venturi C/D		
	GEV No.	104096	Ref. No. 241202412
	burner holder with nozzle holder connection M20x1.5		
	GEV No.	105068	Ref. No. 741312350
	air mixing sleeve		
	GEV No.	105088	Ref. No. 270203540
	burner cap A ø 110mm with central hole		

			
1			
GEV No.	105119	Ref. No.	A00420
description	burner head B for burner cap ø 90mm		
For models:	700-020A-C-T, 700-040A-C-T, 700-040FB, 700-040FEB, 700-138A-C-T, 700-138FBA, 700-138FEBA, 700-162A-C-T, 700-162FBA, 700-162FEBA, 700-162FG, 700-222A-C, 700-222FB, 700-222FEB, 700-222T, 700-224A-C, 700-224FBA, 700-224FEBA, 700-224FG, 700-224T		
accessories for	105119		
	GEV No.	104093	Ref. No. 270200170 770324790
	venturi C/D		
	GEV No.	104096	Ref. No. 241202412
	burner holder with nozzle holder connection M20x1.5		
	GEV No.	105068	Ref. No. 741312350
	air mixing sleeve		
	GEV No.	105084	Ref. No. 270203550
	burner cap B ø 90mm with central hole		

			
1			
GEV No.	105091	Ref. No.	770339300
description	burner head C for burner cap ø 60mm		
For models:	700-020A-C-T, 700-040A-C-T, 700-040FB, 700-040FEB, 700-138A-C-T, 700-138FBA, 700-138FEBA, 700-162A-C-T, 700-162FBA, 700-162FEBA, 700-162FG, 700-222A-C, 700-222FB, 700-222FEB, 700-222T, 700-224A-C, 700-224FBA, 700-224FEBA, 700-224FG, 700-224T, 900-302		
accessories for	105091		
	GEV No.	104093	Ref. No. 270200170 770324790
	venturi C/D		
	GEV No.	104096	Ref. No. 241202412
	burner holder with nozzle holder connection M20x1.5		
	GEV No.	105068	Ref. No. 741312350
	air mixing sleeve		
	GEV No.	105077	Ref. No. 270204230 290200460
	burner ring C for burner cap ø 60mm		
	GEV No.	105078	Ref. No. 290200450
	burner cap C ø 60mm		

			
1			
GEV No.	105098	Ref. No.	770336750
description	burner head D for burner cap ø 80mm		
For models:	900-020A-C-T, 900-040A-C-T, 900-040F, 900-040FE, 900-138A-C-T, 900-138FA, 900-138FEA, 900-162A-C-T, 900-162FA, 900-162FEA, 900-162FG, 900-182F, 900-182FE, 900-302		
accessories for	105098		
	GEV No.	104093	Ref. No. 270200170 770324790
	venturi C/D		
	GEV No.	104096	Ref. No. 241202412
	burner holder with nozzle holder connection M20x1.5		
	GEV No.	105068	Ref. No. 741312350
	air mixing sleeve		
	GEV No.	105080	Ref. No. 270204240
	burner ring D for burner cap ø 80mm		
	GEV No.	105081	Ref. No. 290200480 A00004
	burner cap D ø 80mm		

			
1			
GEV No.	107025	Ref. No.	A00472
description	burner head ø 185mm for burner cap ø 185mm		









			
1			
GEV No.	104096	Ref. No.	241202412
description	burner holder with nozzle holder connection M20x1.5		
For models:	64-020T-64-040T, 64-040FCE, 64-040FE, 64-040F-FV, 64-222F, 64-222FCE, 64-222FE, 64-222T, 700-020A-C-T, 700-040A-C-T, 700-040FB, 700-040FEB, 700-138A-C-T, 700-138FBA, 700-138FEBA, 700-162A-C-T, 700-162FBA, 700-162FEBA, 700-162FG, 700-222A-C, 700-222FB, 700-222FEB, 700-222T, 700-224A-C, 700-224FBA, 700-224FEBA, 700-224FG, 700-224T, 900-020A-C-T, 900-040A-C-T, 900-040F, 900-040FE, 900-138A-C-T, 900-138FA, 900-138FEA, 900-162A-C-T, 900-162FA, 900-162FEA, 900-162FG, 900-182F, 900-182FE, 900-302		
accessories for	104096		
	GEV No.	101250	Ref. No. 270201680
	union nut thread M20x1.5 for pipe ø 10mm		
	GEV No.	101278	Ref. No. —
	olive for pipe ø 10mm Qty 1 pcs		
	GEV No.	104091	Ref. No. 790300799
	burner head D ø 124mm for burner cap ø 80mm suitable for 50, 90, 92, 110 series (old)		



Table continues overleaf











accessories for		104096		
	GEV No.	104093	Ref. No.	270200170 770324790
venturi C/D				
	GEV No.	105060	Ref. No.	760305080 764305190
burner head C for burner cap ø 60mm suitable for 60, 62 series				
	GEV No.	105062	Ref. No.	760311640
venturi C				
	GEV No.	105068	Ref. No.	741312350
air mixing sleeve				
	GEV No.	105076	Ref. No.	790300789
burner head C for burner cap ø 60mm suitable for 70, 90, 92 series (old)				
	GEV No.	105079	Ref. No.	770336760
burner head D ø 100mm				
	GEV No.	105091	Ref. No.	770339300
burner head C for burner cap ø 60mm				
	GEV No.	105098	Ref. No.	770336750
burner head D for burner cap ø 80mm				
	GEV No.	105099	Ref. No.	A00419
burner head A for burner cap ø 110mm				
	GEV No.	105100	Ref. No.	A00418
burner head A for burner cap ø 110mm				
	GEV No.	105119	Ref. No.	A00420
burner head B for burner cap ø 90mm				

	1			
GEV No.	107017	Ref. No.	292305990	
description	burner pipe ø 28mm L 110mm			
For models:	90-301			

	1			
GEV No.	105077	Ref. No.	270204230 290200460	
description	burner ring C for burner cap ø 60mm			
accessories for	105077			
	GEV No.	104093	Ref. No.	270200170 770324790
venturi C/D				
	GEV No.	104096	Ref. No.	241202412
burner holder with nozzle holder connection M20x1.5				
	GEV No.	105068	Ref. No.	741312350
air mixing sleeve				

accessories for		105077		
	GEV No.	105076	Ref. No.	790300789
burner head C for burner cap ø 60mm suitable for 70, 90, 92 series (old)				
	GEV No.	105078	Ref. No.	290200450
burner cap C ø 60mm				
	GEV No.	105091	Ref. No.	770339300
burner head C for burner cap ø 60mm				

 Image not available 1				
GEV No.	105082	Ref. No.	A00003	
description	burner ring C with burner cap ø60mm			
For models:	64-020T-64-040T, 64-040FCE, 64-040FE, 64-040F-FV, 64-222F, 64-222FCE, 64-222FE, 64-222T, 700-020A-C-T, 700-040A-C-T, 700-040FB, 700-040FEB, 700-138A-C-T, 700-138FBA, 700-138FEBA, 700-162A-C-T, 700-162FBA, 700-162FEBA, 700-162FG, 700-222A-C, 700-222FB, 700-222FEB, 700-222T, 700-224A-C, 700-224FBA, 700-224FEBA, 700-224FG, 700-224T, 900-302			

	1			
GEV No.	105080	Ref. No.	270204240	
description	burner ring D for burner cap ø 80mm			
accessories for	105080			
	GEV No.	104091	Ref. No.	790300799
burner head D ø 124mm for burner cap ø 80mm suitable for 50, 90, 92, 110 series (old)				
	GEV No.	104093	Ref. No.	270200170 770324790
venturi C/D				
	GEV No.	104096	Ref. No.	241202412
burner holder with nozzle holder connection M20x1.5				
	GEV No.	105068	Ref. No.	741312350
air mixing sleeve				
	GEV No.	105081	Ref. No.	290200480 A00004
burner cap D ø 80mm				
	GEV No.	105098	Ref. No.	770336750
burner head D for burner cap ø 80mm				



			
1			
GEV No.	107012	Ref. No.	711107640
description	cover plate ø 83mm		

			
1			
GEV No.	104093	Ref. No.	270200170 770324790
description	venturi C/D		
For models:	64-222F, 64-222FCE, 64-222FE, 64-222T, 700-020A-C-T, 700-040A-C-T, 700-040FB, 700-040FEB, 700-138A-C-T, 700-138FBA, 700-138FEBA, 700-162A-C-T, 700-162FBA, 700-162FEBA, 700-162FG, 700-222A-C, 700-222FB, 700-222FEB, 700-222T, 700-224A-C, 700-224FBA, 700-224FEBA, 700-224FG, 700-224T, 900-020A-C-T, 900-040A-C-T, 900-040F, 900-040FE, 900-138A-C-T, 900-138FA, 900-138FEA, 900-162A-C-T, 900-162FA, 900-162FEA, 900-162FG, 900-182F, 900-182FE		
accessories for	104093		
	GEV No.	104091	Ref. No. 790300799
	burner head D ø 124mm for burner cap ø 80mm suitable for 50, 90, 92, 110 series (old)		
	GEV No.	104096	Ref. No. 241202412
	burner holder with nozzle holder connection M20x1.5		
	GEV No.	105068	Ref. No. 741312350
	air mixing sleeve		
	GEV No.	105076	Ref. No. 790300789
	burner head C for burner cap ø 60mm suitable for 70, 90, 92 series (old)		
	GEV No.	105079	Ref. No. 770336760
	burner head D ø 100mm		
	GEV No.	105091	Ref. No. 770339300
	burner head C for burner cap ø 60mm		
	GEV No.	105098	Ref. No. 770336750
	burner head D for burner cap ø 80mm		
	GEV No.	105099	Ref. No. A00419
	burner head A for burner cap ø 110mm		
	GEV No.	105100	Ref. No. A00418
	burner head A for burner cap ø 110mm		
	GEV No.	105119	Ref. No. A00420
	burner head B for burner cap ø 90mm		

solid tops series 60, 62





			
1			
GEV No.	105068	Ref. No.	741312350
description	air mixing sleeve		
For models:	64-020T-64-040T, 64-040FCE, 64-040FE, 64-040F-FV, 64-222F, 64-222FCE, 64-222FE, 64-222T, 700-020A-C-T, 700-040A-C-T, 700-040FB, 700-040FEB, 700-138A-C-T, 700-138FBA, 700-138FEBA, 700-162A-C-T, 700-162FBA, 700-162FEBA, 700-162FG, 700-222A-C, 700-222FB, 700-222FEB, 700-222T, 700-224A-C, 700-224FBA, 700-224FEBA, 700-224FG, 700-224T, 900-020A-C-T, 900-040A-C-T, 900-040F, 900-040FE, 900-138A-C-T, 900-138FA, 900-138FEA, 900-162A-C-T, 900-162FA, 900-162FEA, 900-162FG, 900-182F, 900-182FE, 900-302		
accessories for	105068		
	GEV No.	104091	Ref. No. 790300799
	burner head D ø 124mm for burner cap ø 80mm suitable for 50, 90, 92, 110 series (old)		
	GEV No.	104093	Ref. No. 270200170 770324790
	venturi C/D		
	GEV No.	104096	Ref. No. 241202412
	burner holder with nozzle holder connection M20x1.5		
	GEV No.	105060	Ref. No. 760305080 764305190
	burner head C for burner cap ø 60mm suitable for 60, 62 series		
	GEV No.	105062	Ref. No. 760311640
	venturi C		
	GEV No.	105076	Ref. No. 790300789
	burner head C for burner cap ø 60mm suitable for 70, 90, 92 series (old)		
	GEV No.	105079	Ref. No. 770336760
	burner head D ø 100mm		
	GEV No.	105091	Ref. No. 770339300
	burner head C for burner cap ø 60mm		
	GEV No.	105098	Ref. No. 770336750
	burner head D for burner cap ø 80mm		
	GEV No.	105099	Ref. No. A00419
	burner head A for burner cap ø 110mm		
	GEV No.	105100	Ref. No. A00418
	burner head A for burner cap ø 110mm		
	GEV No.	105119	Ref. No. A00420
	burner head B for burner cap ø 90mm		
	GEV No.	105707	Ref. No. —
	burner cap ø 95mm		
	GEV No.	105708	Ref. No. —
	burner head for burner cap ø 95mm		
	GEV No.	105709	Ref. No. —
	venturi		



Table continues overleaf







accessories for	105068		
	GEV No.	105710	Ref. No. —
	burner holder with nozzle holder		

1			
GEV No.	105078	Ref. No.	290200450
description	burner cap C ø 60mm		
accessories for	105078		
	GEV No.	104093	Ref. No. 270200170 770324790
	venturi C/D		
	GEV No.	104096	Ref. No. 241202412
	burner holder with nozzle holder connection M20x1.5		
	GEV No.	105068	Ref. No. 741312350
	air mixing sleeve		
	GEV No.	105076	Ref. No. 790300789
	burner head C for burner cap ø 60mm suitable for 70, 90, 92 series (old)		
	GEV No.	105077	Ref. No. 270204230 290200460
	burner ring C for burner cap ø 60mm		
	GEV No.	105091	Ref. No. 770339300
	burner head C for burner cap ø 60mm		

1			
GEV No.	103060	Ref. No.	770319550
description	burner cap C ø 70mm		
For models:	64-222F, 64-222FCE, 64-222FE, 64-222T		
accessories for	103060		
	GEV No.	104096	Ref. No. 241202412
	burner holder with nozzle holder connection M20x1.5		
	GEV No.	105060	Ref. No. 760305080 764305190
	burner head C for burner cap ø 60mm suitable for 60, 62 series		
	GEV No.	105062	Ref. No. 760311640
	venturi C		
	GEV No.	105068	Ref. No. 741312350
	air mixing sleeve		

1			
GEV No.	103061	Ref. No.	770319560
description	burner cap D ø 100mm		
For models:	700-222A-C, 700-222FB, 700-222FEB, 700-222T, 700-224A-C, 700-224FBA, 700-224FEBA, 700-224FG, 700-224T		
accessories for	103061		
	GEV No.	104091	Ref. No. 790300799
	burner head D ø 124mm for burner cap ø 80mm suitable for 50, 90, 92, 110 series (old)		

accessories for	103061		
	GEV No.	104093	Ref. No. 270200170 770324790
	venturi C/D		
	GEV No.	104096	Ref. No. 241202412
	burner holder with nozzle holder connection M20x1.5		
	GEV No.	105068	Ref. No. 741312350
	air mixing sleeve		
	GEV No.	105079	Ref. No. 770336760
	burner head D ø 100mm		

1			
GEV No.	105060	Ref. No.	760305080 764305190
description	burner head C for burner cap ø 60mm suitable for 60, 62 series		
For models:	64-020T-64-040T, 64-040FCE, 64-040FE, 64-040F-FV, 64-222F, 64-222FCE, 64-222FE, 64-222T		
accessories for	105060		
	GEV No.	103060	Ref. No. 770319550
	burner cap C ø 70mm		
	GEV No.	104096	Ref. No. 241202412
	burner holder with nozzle holder connection M20x1.5		
	GEV No.	105062	Ref. No. 760311640
	venturi C		
	GEV No.	105068	Ref. No. 741312350
	air mixing sleeve		

1			
GEV No.	105143	Ref. No.	760305630
description	burner head C for burner cap ø 70mm		













1			
GEV No.	105146	Ref. No.	760302390
description	burner head D for burner cap ø 100mm		
accessories for	105146		
	GEV No.	103061	Ref. No. 770319560
	burner cap D ø 100mm		
	GEV No.	104093	Ref. No. 270200170 770324790
	venturi C/D		







Table continues overleaf



accessories for	105146		
	GEV No.	104096	Ref. No. 241202412
	burner holder with nozzle holder connection M20x1.5		
	GEV No.	105068	Ref. No. 741312350
	air mixing sleeve		

	1		
GEV No.	104096	Ref. No.	241202412
description	burner holder with nozzle holder connection M20x1.5		
For models:	64-020T-64-040T, 64-040FCE, 64-040FE, 64-040F-FV, 64-222F, 64-222FCE, 64-222FE, 64-222T, 700-020A-C-T, 700-040A-C-T, 700-040FB, 700-040FEB, 700-138A-C-T, 700-138FBA, 700-138FEBA, 700-162A-C-T, 700-162FBA, 700-162FEBA, 700-162FG, 700-222A-C, 700-222FB, 700-222FEB, 700-222T, 700-224A-C, 700-224FBA, 700-224FEBA, 700-224FG, 700-224T, 900-020A-C-T, 900-040A-C-T, 900-040F, 900-040FE, 900-138A-C-T, 900-138FA, 900-138FEA, 900-162A-C-T, 900-162FA, 900-162FEA, 900-162FG, 900-182F, 900-182FE, 900-302		
accessories for	104096		
	GEV No.	101250	Ref. No. 270201680
	union nut thread M20x1.5 for pipe ø 10mm		
	GEV No.	101278	Ref. No. —
	olive for pipe ø 10mm Qty 1 pcs		
	GEV No.	104091	Ref. No. 790300799
	burner head D ø 124mm for burner cap ø 80mm suitable for 50, 90, 92, 110 series (old)		
	GEV No.	104093	Ref. No. 270200170 770324790
	venturi C/D		
	GEV No.	105060	Ref. No. 760305080 764305190
	burner head C for burner cap ø 60mm suitable for 60, 62 series		
	GEV No.	105062	Ref. No. 760311640
	venturi C		
	GEV No.	105068	Ref. No. 741312350
	air mixing sleeve		
	GEV No.	105076	Ref. No. 790300789
	burner head C for burner cap ø 60mm suitable for 70, 90, 92 series (old)		
	GEV No.	105079	Ref. No. 770336760
	burner head D ø 100mm		
	GEV No.	105091	Ref. No. 770339300
	burner head C for burner cap ø 60mm		
	GEV No.	105098	Ref. No. 770336750
	burner head D for burner cap ø 80mm		
	GEV No.	105099	Ref. No. A00419
	burner head A for burner cap ø 110mm		
	GEV No.	105100	Ref. No. A00418
	burner head A for burner cap ø 110mm		

accessories for	104096		
	GEV No.	105119	Ref. No. A00420
	burner head B for burner cap ø 90mm		

	1		
GEV No.	105077	Ref. No.	270204230 290200460
description	burner ring C for burner cap ø 60mm		
accessories for	105077		
	GEV No.	104093	Ref. No. 270200170 770324790
	venturi C/D		
	GEV No.	104096	Ref. No. 241202412
	burner holder with nozzle holder connection M20x1.5		
	GEV No.	105068	Ref. No. 741312350
	air mixing sleeve		
	GEV No.	105076	Ref. No. 790300789
	burner head C for burner cap ø 60mm suitable for 70, 90, 92 series (old)		
	GEV No.	105078	Ref. No. 290200450
	burner cap C ø 60mm		
	GEV No.	105091	Ref. No. 770339300
	burner head C for burner cap ø 60mm		



	1		
GEV No.	105082	Ref. No.	A00003
description	burner ring C with burner cap ø60mm		
For models:	64-020T-64-040T, 64-040FCE, 64-040FE, 64-040F-FV, 64-222F, 64-222FCE, 64-222FE, 64-222T, 700-020A-C-T, 700-040A-C-T, 700-040FB, 700-040FEB, 700-138A-C-T, 700-138FBA, 700-138FEBA, 700-162A-C-T, 700-162FBA, 700-162FEBA, 700-162FG, 700-222A-C, 700-222FB, 700-222FEB, 700-222T, 700-224A-C, 700-224FBA, 700-224FEBA, 700-224FG, 700-224T, 900-302		



















	1		
GEV No.	105062	Ref. No.	760311640
description	venturi C		
For models:	64-020T-64-040T, 64-040FCE, 64-040FE, 64-040F-FV, 64-222F, 64-222FCE, 64-222FE, 64-222T		
accessories for	105062		
	GEV No.	103060	Ref. No. 770319550
	burner cap C ø 70mm		





Table continues overleaf









accessories for		105062		
	GEV No.	104096	Ref. No.	241202412
burner holder with nozzle holder connection M20x1.5				
	GEV No.	105060	Ref. No.	760305080 764305190
burner head C for burner cap ø 60mm suitable for 60, 62 series				
	GEV No.	105068	Ref. No.	741312350
air mixing sleeve				

solid tops series 70, 90, 92, 110 (old), 700, 900, 920, 110 (new)

	1			
GEV No.	105068	Ref. No.	741312350	
description	air mixing sleeve			
For models:	64-020T-64-040T, 64-040FCE, 64-040FE, 64-040F-FV, 64-222F, 64-222FCE, 64-222FE, 64-222T, 700-020A-C-T, 700-040A-C-T, 700-040FB, 700-040FEB, 700-138A-C-T, 700-138FBA, 700-138FEBA, 700-162A-C-T, 700-162FBA, 700-162FEBA, 700-162FG, 700-222A-C, 700-222FB, 700-222FEB, 700-222T, 700-224A-C, 700-224FBA, 700-224FEBA, 700-224FG, 700-224T, 900-020A-C-T, 900-040A-C-T, 900-040F, 900-040FE, 900-138A-C-T, 900-138FA, 900-138FEA, 900-162A-C-T, 900-162FA, 900-162FEA, 900-162FG, 900-182F, 900-182FE, 900-302			
accessories for	105068			
	GEV No.	104091	Ref. No.	790300799
burner head D ø 124mm for burner cap ø 80mm suitable for 50, 90, 92, 110 series (old)				
	GEV No.	104093	Ref. No.	270200170 770324790
venturi C/D				
	GEV No.	104096	Ref. No.	241202412
burner holder with nozzle holder connection M20x1.5				
	GEV No.	105060	Ref. No.	760305080 764305190
burner head C for burner cap ø 60mm suitable for 60, 62 series				
	GEV No.	105062	Ref. No.	760311640
venturi C				
	GEV No.	105076	Ref. No.	790300789
burner head C for burner cap ø 60mm suitable for 70, 90, 92 series (old)				
	GEV No.	105079	Ref. No.	770336760
burner head D ø 100mm				
	GEV No.	105091	Ref. No.	770339300
burner head C for burner cap ø 60mm				
	GEV No.	105098	Ref. No.	770336750
burner head D for burner cap ø 80mm				
	GEV No.	105099	Ref. No.	A00419
burner head A for burner cap ø 110mm				
	GEV No.	105100	Ref. No.	A00418
burner head A for burner cap ø 110mm				
	GEV No.	105119	Ref. No.	A00420
burner head B for burner cap ø 90mm				

accessories for		105068		
	GEV No.	105707	Ref. No.	—
burner cap ø 95mm				
	GEV No.	105708	Ref. No.	—
burner head for burner cap ø 95mm				
	GEV No.	105709	Ref. No.	—
venturi				
	GEV No.	105710	Ref. No.	—
burner holder with nozzle holder				

	1			
GEV No.	105078	Ref. No.	290200450	
description	burner cap C ø 60mm			
accessories for	105078			
	GEV No.	104093	Ref. No.	270200170 770324790
venturi C/D				
	GEV No.	104096	Ref. No.	241202412
burner holder with nozzle holder connection M20x1.5				
	GEV No.	105068	Ref. No.	741312350
air mixing sleeve				
	GEV No.	105076	Ref. No.	790300789
burner head C for burner cap ø 60mm suitable for 70, 90, 92 series (old)				
	GEV No.	105077	Ref. No.	270204230 290200460
burner ring C for burner cap ø 60mm				
	GEV No.	105091	Ref. No.	770339300
burner head C for burner cap ø 60mm				

	1			
GEV No.	103061	Ref. No.	770319560	
description	burner cap D ø 100mm			
For models:	700-222A-C, 700-222FB, 700-222FEB, 700-222T, 700-224A-C, 700-224FBA, 700-224FEBA, 700-224FG, 700-224T			
accessories for	103061			
	GEV No.	104091	Ref. No.	790300799
burner head D ø 124mm for burner cap ø 80mm suitable for 50, 90, 92, 110 series (old)				
	GEV No.	104093	Ref. No.	270200170 770324790
venturi C/D				
	GEV No.	104096	Ref. No.	241202412
burner holder with nozzle holder connection M20x1.5				
	GEV No.	105068	Ref. No.	741312350
air mixing sleeve				

Table continues overleaf



accessories for	103061		
	GEV No.	105079	Ref. No. 770336760
	burner head D ø 100mm		

	1		
GEV No.	105076	Ref. No.	790300789
description	burner head C for burner cap ø 60mm suitable for 70, 90, 92 series (old)		
accessories for	105076		
	GEV No.	104093	Ref. No. 270200170 770324790
	venturi C/D		
	GEV No.	104096	Ref. No. 241202412
	burner holder with nozzle holder connection M20x1.5		
	GEV No.	105068	Ref. No. 741312350
	air mixing sleeve		
	GEV No.	105077	Ref. No. 270204230 290200460
	burner ring C for burner cap ø 60mm		
	GEV No.	105078	Ref. No. 290200450
	burner cap C ø 60mm		



	1		
GEV No.	105079	Ref. No.	770336760
description	burner head D ø 100mm		
For models:	700-222A-C, 700-222FB, 700-222FEB, 700-222T, 700-224A-C, 700-224FBA, 700-224FEBA, 700-224FG, 700-224T		
accessories for	105079		
	GEV No.	103061	Ref. No. 770319560
	burner cap D ø 100mm		
	GEV No.	104093	Ref. No. 270200170 770324790
	venturi C/D		
	GEV No.	104096	Ref. No. 241202412
	burner holder with nozzle holder connection M20x1.5		
	GEV No.	105068	Ref. No. 741312350
	air mixing sleeve		

	1		
GEV No.	105144	Ref. No.	290202870
description	burner head for burner cap ø 100mm		

	1		
GEV No.	104096	Ref. No.	241202412
description	burner holder with nozzle holder connection M20x1.5		
For models:	64-020T-64-040T, 64-040FCE, 64-040FE, 64-040F-FV, 64-222F, 64-222FCE, 64-222FE, 64-222T, 700-020A-C-T, 700-040A-C-T, 700-040FB, 700-040FEB, 700-138A-C-T, 700-138FBA, 700-138FEBA, 700-162A-C-T, 700-162FBA, 700-162FEBA, 700-162FG, 700-222A-C, 700-222FB, 700-222FEB, 700-222T, 700-224A-C, 700-224FBA, 700-224FEBA, 700-224FG, 700-224T, 900-020A-C-T, 900-040A-C-T, 900-040F, 900-040FE, 900-138A-C-T, 900-138FA, 900-138FEA, 900-162A-C-T, 900-162FA, 900-162FEA, 900-162FG, 900-182F, 900-182FE, 900-302		
accessories for	104096		
	GEV No.	101250	Ref. No. 270201680
	union nut thread M20x1.5 for pipe ø 10mm		
	GEV No.	101278	Ref. No. —
	olive for pipe ø 10mm Qty 1 pcs		
	GEV No.	104091	Ref. No. 790300799
	burner head D ø 124mm for burner cap ø 80mm suitable for 50, 90, 92, 110 series (old)		
	GEV No.	104093	Ref. No. 270200170 770324790
	venturi C/D		
	GEV No.	105060	Ref. No. 760305080 764305190
	burner head C for burner cap ø 60mm suitable for 60, 62 series		
	GEV No.	105062	Ref. No. 760311640
	venturi C		
	GEV No.	105068	Ref. No. 741312350
	air mixing sleeve		
	GEV No.	105076	Ref. No. 790300789
	burner head C for burner cap ø 60mm suitable for 70, 90, 92 series (old)		
	GEV No.	105079	Ref. No. 770336760
	burner head D ø 100mm		
	GEV No.	105091	Ref. No. 770339300
	burner head C for burner cap ø 60mm		
	GEV No.	105098	Ref. No. 770336750
	burner head D for burner cap ø 80mm		
	GEV No.	105099	Ref. No. A00419
	burner head A for burner cap ø 110mm		

Table continues overleaf



accessories for	104096		
	GEV No.	105100	Ref. No. A00418
	burner head A for burner cap ø 110mm		
	GEV No.	105119	Ref. No. A00420
	burner head B for burner cap ø 90mm		

	1		
GEV No.	105077	Ref. No.	270204230 290200460
description	burner ring C for burner cap ø 60mm		
accessories for	105077		
	GEV No.	104093	Ref. No. 270200170 770324790
	venturi C/D		
	GEV No.	104096	Ref. No. 241202412
	burner holder with nozzle holder connection M20x1.5		
	GEV No.	105068	Ref. No. 741312350
	air mixing sleeve		
	GEV No.	105076	Ref. No. 790300789
	burner head C for burner cap ø 60mm suitable for 70, 90, 92 series (old)		
	GEV No.	105078	Ref. No. 290200450
	burner cap C ø 60mm		
	GEV No.	105091	Ref. No. 770339300
	burner head C for burner cap ø 60mm		

	1		
GEV No.	105082	Ref. No.	A00003
description	burner ring C with burner cap ø60mm		
For models:	64-020T-64-040T, 64-040FCE, 64-040FE, 64-040F-FV, 64-222F, 64-222FCE, 64-222FE, 64-222T, 700-020A-C-T, 700-040A-C-T, 700-040FB, 700-040FEB, 700-138A-C-T, 700-138FBA, 700-138FEBA, 700-162A-C-T, 700-162FBA, 700-162FEBA, 700-162FG, 700-222A-C, 700-222FB, 700-222FEB, 700-222T, 700-224A-C, 700-224FBA, 700-224FEBA, 700-224FG, 700-224T, 900-302		

	1		
GEV No.	105147	Ref. No.	A00024
description	nozzle holder L 61mm M10x1 gas inlet 1/2" gas outlet M14x1		
For models:	110-120AL-ALR, 110-120TL-TLR, 110-122AL-ALR, 110-122ALC, 110-122FELC, 110-122FEL-FELR, 110-122FLC, 110-122FL-FLR, 110-122TL, 110-122TL-TLR, 110-200A-T, 110-200F, 110-200FE, 500-120AL-AR, 500-120ALC, 500-120TLC, 500-120TL-TR, 500-122AL-ALR-AR, 500-122ALC, 500-122TLC, 500-122TL-TLR-TR, 500-125A-126A, 500-601A, 500-750A, 500-800A, 64-040F-FV, 64-120TLC, 64-120TL-TR, 64-122TL, 64-122TLC, 64-122TLR-TR, 64-125T-126T, 64-130TL-TR, 64-132TL-TLR-TR, 64-222F, 64-600T-603T, 700-040FB, 700-120AL-AR-CL, 700-120ALC-CLC, 700-120CR-TL, 700-120TLC, 700-120TR, 700-122AL, 700-122ALC, 700-122ALR-AR-CL, 700-122CLC, 700-122CLR-CR-TL, 700-122TLC, 700-122TLR-TR, 700-125A-C...(Other models you can see in the webshop)		

	1		
GEV No.	105364	Ref. No.	A00176
description	round burner ø 190mm		
For models:	110-200A-T, 110-200F, 110-200FE, 700-138A-C-T, 700-138FBA, 700-138FEBA, 700-200A-C-T, 700-200FB, 700-200FEB, 900-138A-C-T, 900-138FA, 900-138FEA, 900-200A-C-T, 900-200F, 900-200FE, 920-200A-T, 920-200F, 920-200FE		

	1		
GEV No.	104093	Ref. No.	270200170 770324790
description	venturi C/D		
For models:	64-222F, 64-222FCE, 64-222FE, 64-222T, 700-020A-C-T, 700-040A-C-T, 700-040FB, 700-040FEB, 700-138A-C-T, 700-138FBA, 700-138FEBA, 700-162A-C-T, 700-162FBA, 700-162FEBA, 700-162FG, 700-222A-C, 700-222FB, 700-222FEB, 700-222T, 700-224A-C, 700-224FBA, 700-224FEBA, 700-224FG, 700-224T, 900-020A-C-T, 900-040A-C-T, 900-040F, 900-040FE, 900-138A-C-T, 900-138FA, 900-138FEA, 900-162A-C-T, 900-162FA, 900-162FEA, 900-162FG, 900-182F, 900-182FE		
accessories for	104093		
	GEV No.	104091	Ref. No. 790300799
	burner head D ø 124mm for burner cap ø 80mm suitable for 50, 90, 92, 110 series (old)		
	GEV No.	104096	Ref. No. 241202412
	burner holder with nozzle holder connection M20x1.5		
	GEV No.	105068	Ref. No. 741312350
	air mixing sleeve		
	GEV No.	105076	Ref. No. 790300789
	burner head C for burner cap ø 60mm suitable for 70, 90, 92 series (old)		
	GEV No.	105079	Ref. No. 770336760
	burner head D ø 100mm		
	GEV No.	105091	Ref. No. 770339300
	burner head C for burner cap ø 60mm		
	GEV No.	105098	Ref. No. 770336750
	burner head D for burner cap ø 80mm		
	GEV No.	105099	Ref. No. A00419
	burner head A for burner cap ø 110mm		
	GEV No.	105100	Ref. No. A00418
	burner head A for burner cap ø 110mm		
	GEV No.	105119	Ref. No. A00420
	burner head B for burner cap ø 90mm		



pan supports



1	
GEV No. 210028	Ref. No. 270203609
description	pan support W 287mm L 387mm H 46mm suitable for GICO

reducers for pan supports



1	
GEV No. 210001	Ref. No. 241200480
description	reducer for pan support L 265mm W 265mm SS suitable for universal

accessories

reducers for pan supports



1	
GEV No. 210001	Ref. No. 241200480
description	reducer for pan support L 265mm W 265mm SS suitable for universal

bar burners

bar burners



1	
GEV No. 105353	Ref. No. A00271
description	bar burner 2 row L 370mm W 178mm ømm H 145mm griddle



1	
GEV No. 105148	Ref. No. A00422
description	bar burner 2 row L 380mm W 245mm ømm H 150mm fryer
For models:	700-601A-S, 700-602A-S, 900-601A-S, 900-602A-S



1	
GEV No. 105354	Ref. No. A00272
description	bar burner 2 row L 400mm W 205mm ømm H 150mm griddle



1	
GEV No. 107147	Ref. No. A00226
description	bar burner 2 row L 440mm W 250mm ømm H 50mm



1	
GEV No. 105363	Ref. No. 260202640 A00273
description	bar burner 2 row L 445mm W 200mm ømm H 50mm chargrill



1	
GEV No. 105149	Ref. No. A00423
description	bar burner 2 row L 470mm W 245mm ømm H 150mm fryer
For models:	700-604A-605A, 900-604A-S, 900-605A-S, 920-604A-S





1	
GEV No. 104342	Ref. No. A00274
description	bar burner 2 row L 510mm W 200mm ømm H 45mm chargrill





1	
GEV No. 105351	Ref. No. A00162
description	bar burner 2 row L 510mm W 250mm ømm H 45mm gas range
For models:	700-040FB, 700-138FBA, 700-162FBA, 700-162FG, 700-200FB, 700-222FB, 700-224FBA, 700-224FG, 700-401B





			
1			
GEV No.	105355	Ref. No.	A00110 A00193
description	bar burner 2 row L 530mm W 250mm ømm H 35mm griddle		
For models:	920-120AL-AR, 920-120ALC, 920-120TLC, 920-120TL-TR, 920-122AL-ALR-AR, 920-122ALC, 920-122FELC, 920-122FEL-FELR-FER, 920-122FELR, 920-122FER, 920-122FLC, 920-122FL-FLR-FR, 920-122TLC, 920-122TL-TLR-TR		

			
1			
GEV No.	105145	Ref. No.	790117780
description	bar burner ø 40mm Wmm Hmm L 510mm with retainer for nozzle rod flange width 50mm flange length 70mm griddle		

			
1			
GEV No.	105352	Ref. No.	A00161
description	bar burner 2 row L 650mm W 235mm ømm H 40mm gas range		
For models:	900-040F, 900-138FA, 900-162FA, 900-162FG, 900-182F, 900-200F, 900-401, 920-122FLC, 920-122FL-FLR-FR, 920-200F		

			
1			
GEV No.	105361	Ref. No.	4323117
description	bar burner ø 50mm L 463mm flange width 71mm pasta cooker flange ø 75mm		

			
1			
GEV No.	105152	Ref. No.	770118950
description	bar burner ø 40mm Wmm Hmm L 309mm flange width 50mm gas range flange ø 61mm		
For models:	64-040F-FV, 64-222F, 64-900T, 700-400A-C-T, 700-402A-C-T		

			
1			
GEV No.	105156	Ref. No.	270203350
description	bar burner ø 50mm Wmm Hmm L 185mm flange width 71mm kettle flange ø 75mm		
For models:	700-508		

			
1			
GEV No.	105142	Ref. No.	770118960
description	bar burner ø 40mm Wmm Hmm L 409mm flange width 50mm griddle flange ø 61mm		
For models:	900-400A-C-T, 900-402A-C-T, 920-400A-T, 920-402A-T		

			
1			
GEV No.	105366	Ref. No.	293200290
description	bar burner ø 50mm Wmm Hmm L 298mm flange width 65mm flange length 71mm		

			
1			
GEV No.	104155	Ref. No.	4323105
description	bar burner ø 40mm Wmm Hmm L 460mm 5.8kW frying pan		
For models:	900-622, 900-900		

			
1			
GEV No.	105154	Ref. No.	770120430
description	bar burner ø 50mm Wmm Hmm L 308mm flange width 71mm pasta cooker flange ø 75mm		
For models:	500-750A, 700-750A-S, 700-800A-S		





			
1			
GEV No.	105359	Ref. No.	4323115
description	bar burner ø 50mm Wmm Hmm L 325mm flange width 71mm frying pan flange ø 75mm		
For models:	900-503, 920-503		

			
1			
GEV No.	105155	Ref. No.	790118660
description	bar burner ø 50mm Wmm Hmm L 465mm with retainer for nozzle rod with flange flange width 70mm flange length 75mm pasta cooker		
For models:	900-750A-S, 900-800A-S, 920-750A-S		

			
1			
GEV No.	105365	Ref. No.	293200270
description	bar burner ø 50mm Wmm Hmm L 615mm flange width 65mm flange length 71mm		

			
1			
GEV No.	105358	Ref. No.	250200190
description	bar burner ø 50mm Wmm Hmm L 715mm with bolt M5x12 flange with bolt M4 flange width 65mm flange length 71mm pasta cooker		
For models:	500-800A		

			
1			
GEV No.	105157	Ref. No.	293201090
description	bar burner ø 50mm Wmm Hmm L 775mm flange with bolt M4 flange width 65mm flange length 71mm		

			
1			
GEV No.	105151	Ref. No.	A00169
description	bar burner ømm W 40mm H 35mm L 490mm		

			
1			
GEV No.	105150	Ref. No.	A00290
description	bar burner ømm W 42mm H 38mm L 375mm bain marie		

tube burners

			
1			
GEV No.	105357	Ref. No.	A00174
description	tubular burner L 225mm W 55mm H 54mm mounting pos. left for fryer oval		

			
1			
GEV No.	105356	Ref. No.	A00173
description	tubular burner L 225mm W 55mm H 54mm mounting pos. right for fryer oval		



accessories

nozzle holders



1	GEV No.	105147	Ref. No.	A00024
	description	nozzle holder L 61mm M10x1 gas inlet 1/2" gas outlet M14x1		
For models:	110-120AL-ALR, 110-120TL-TLR, 110-122AL-ALR, 110-122ALC, 110-122FELC, 110-122FEL-FELR, 110-122FLC, 110-122FL-FLR, 110-122TL, 110-122TL-TLR, 110-200A-T, 110-200F, 110-200FE, 500-120AL-AR, 500-120ALC, 500-120TLC, 500-120TL-TR, 500-122AL-ALR-AR, 500-122ALC, 500-122TLC, 500-122TL-TLR-TR, 500-125A-126A, 500-601A, 500-750A, 500-800A, 64-040F-FV, 64-120TLC, 64-120TL-TR, 64-122TL, 64-122TLC, 64-122TLR-TR, 64-125T-126T, 64-130TL-TR, 64-132TL-TLR-TR, 64-222F, 64-600T-603T, 700-040FB, 700-120AL-AR-CL, 700-120ALC-CLC, 700-120CR-TL, 700-120TLC, 700-120TR, 700-122AL, 700-122ALC, 700-122ALR-AR-CL, 700-122CLC, 700-122CLR-CR-TL, 700-122TLC, 700-122TLR-TR, 700-125A-C...(Other models you can see in the webshop)			

gas nozzles

main nozzles

gas nozzles M10x1



1	GEV No.	100973	Ref. No.	290201330
	description	gas injector thread M10x1 bore ø 0.8mm L 30mm WS 12		



1	GEV No.	106400	Ref. No.	270200461
	description	gas injector thread M10x1 bore ø 1.1mm L 30mm WS 12		



1	GEV No.	100671	Ref. No.	290201400
	description	gas injector thread M10x1 bore ø 1.25mm L 30mm WS 12		



1	GEV No.	106762	Ref. No.	290201530
	description	gas injector thread M10x1 bore ø 2.1mm L 30mm WS 12		



1	GEV No.	106469	Ref. No.	241204941
	description	gas injector thread M10x1 WS 12 bore ø 2.5mm		



1	GEV No.	106491	Ref. No.	241203471
	description	gas injector thread M10x1 WS 11 bore ø 2.1mm		



1	GEV No.	107341	Ref. No.	290201890
	description	gas injector thread M10x1 WS 12 bore ø 0.75mm		



1	GEV No.	100380	Ref. No.	241204851
	description	gas injector thread M10x1 WS 12 bore ø 0.7mm		





1	GEV No.	100535	Ref. No.	241204861
	description	gas injector thread M10x1 WS 12 bore ø 0.8mm		





1	GEV No.	102126	Ref. No.	270202260
	description	gas injector thread M10x1 WS 12 bore ø 0.9mm		





			
1			
GEV No.	100382	Ref. No.	270202170
description	gas injector thread M10x1 WS 12 bore ø 1.05mm		

			
1			
GEV No.	100540	Ref. No.	241202341
description	gas injector thread M10x1 WS 12 bore ø 1.2mm		

			
1			
GEV No.	107544	Ref. No.	241204891
description	gas injector thread M10x1 WS 12 bore ø 1.35mm		

			
1			
GEV No.	100387	Ref. No.	241204901
description	gas injector thread M10x1 WS 12 bore ø 1.45mm		

			
1			
GEV No.	102151	Ref. No.	270200140
description	gas injector thread M10x1 WS 12 bore ø 1.4mm		

			
1			
GEV No.	100661	Ref. No.	290201850
description	gas injector thread M10x1 WS 12 bore ø 1.65mm		

			
1			
GEV No.	100537	Ref. No.	270200910
description	gas injector thread M10x1 WS 12 bore ø 1mm		

pilot burner nozzles

pilot burner nozzles POLIDORO

			
1			
GEV No.	100208	Ref. No.	4372022
description	pilot burner nozzle POLIDORO LPG code 20 bore ø 0.2mm Qty 1 pcs		

			
1			
GEV No.	106763	Ref. No.	4372027
description	pilot burner nozzle POLIDORO natural gas code 27.2A bore ø 2x 0.27mm Qty 1 pcs		

pilot burner nozzles SIT

100 series

			
1			
GEV No.	100245	Ref. No.	4370001
description	pilot burner nozzle LPG code 20 bore ø 0.2mm Qty 1 pcs thread M8x0.75		

			
1			
GEV No.	107170	Ref. No.	4370002
description	pilot burner nozzle SIT natural gas bore ø 0.35mm Qty 1 pcs		

140/150 series

			
1			
GEV No.	100205	Ref. No.	43702019
description	pilot burner nozzle SIT LPG code 19 bore ø 0.23/0.26mm Qty 1 pcs suitable for SIT 150 series		

			
1			
GEV No.	100206	Ref. No.	43702036
description	pilot burner nozzle SIT natural gas code 36 bore ø 0.60/0.55mm Qty 1 pcs suitable for SIT 150 series		





			
1			
GEV No.	106761	Ref. No.	43701037
description	pilot burner nozzle SIT natural gas code 37 bore ø 0.55mm Qty 1 pcs		

160 series

			
1			
GEV No.	107172	Ref. No.	43701025
description	pilot burner nozzle SIT LPG code 25 Qty 1 pcs		

			
1			
GEV No.	107650	Ref. No.	43703030
description	pilot burner nozzle SIT LPG code 30 Qty 1 pcs		

			
1			
GEV No.	107173	Ref. No.	43701035
description	pilot burner nozzle SIT natural gas code 35 Qty 1 pcs suitable for 160 series nozzle ø 0.35mm		

			
1			
GEV No.	107174	Ref. No.	43701041
description	pilot burner nozzle SIT natural gas code 41 Qty 1 pcs		

			
1			
GEV No.	107175	Ref. No.	43703051
description	pilot burner nozzle SIT natural gas code 51 Qty 1 pcs suitable for 160 series		

bypass nozzles

bypass nozzles PEL20/21

			
1			
GEV No.	100550	Ref. No.	4399206
description	bypass nozzle type PEL20/21 bore ø 0.55mm thread M5x0.5		

			
1			
GEV No.	100526	Ref. No.	4399209
description	bypass nozzle type PEL20/21 bore ø 0.5mm thread M5x0.5		

			
1			
GEV No.	100548	Ref. No.	4399208
description	bypass nozzle type PEL20/21 bore ø 0.65mm thread M5x0.5		

			
1			
GEV No.	100551	Ref. No.	4399260
description	bypass nozzle type PEL20/21 bore ø 0.6mm thread M5x0.5		

			
1			
GEV No.	100278	Ref. No.	4399237
description	bypass nozzle type PEL20/21 bore ø 0.75mm thread M5x0.5		

			
1			
GEV No.	100552	Ref. No.	4399251
description	bypass nozzle type PEL20/21 bore ø 0.7mm thread M5x0.5		

			
1			
GEV No.	100527	Ref. No.	4399239
description	bypass nozzle type PEL20/21 bore ø 0.85mm thread M5x0.5		

			
1			
GEV No.	100394	Ref. No.	4399247
description	bypass nozzle type PEL20/21 bore ø 1.25mm thread M5x0.5		

			
1			
GEV No.	100534	Ref. No.	4399238
description	bypass nozzle type PEL20/21 bore ø 1.4mm thread M5x0.5		



1			
GEV No.	100529	Ref. No.	4399250
description	bypass nozzle type PEL20/21 bore ø 1mm thread M5x0.5		

bypass nozzles PEL23/24



1			
GEV No.	106760	Ref. No.	4399235
description	bypass nozzle type PEL23/24 bore ø 2.8mm thread M8x0.5		

pressure switches



1			
GEV No.	541073	Ref. No.	6440001
description	pressure control ø 45mm pressure range adjustable 5-20mbar pressure connection vertical gas technology connection 1/4" pressure connection ø 1/4"mm		

equipment-specific units for pasta cookers



1			
GEV No.	520505	Ref. No.	A00465
description	ball valve ET 3/8" for pasta cooker shaft ø 10x8mm		
For models:	700-750A-S, 700-755A-S, 700-800A-S, 700-855A-S, 900-750A-S, 900-755A-S, 900-800A-S, 900-855A-S, 920-750A-S, 920-755A-S		



1			
GEV No.	694345	Ref. No.	750309770
description	coupling for water valve int. ø 1 10mm int. ø 2 22mm ED ø 20/28mm L 34mm WS 24 thread M5		

for dishwashers

drain and intake components

miscellaneous

overflow pipes





1			
GEV No.	540268	Ref. No.	711106890
description	overflow pipe		

auxiliary gas parts

screw connections

olives



1			
GEV No.	101249	Ref. No.	270201580
description	olive for pipe ø 10mm Qty 1 pcs		
accessories for	101249		
	GEV No.	101250	Ref. No. 270201680
	union nut thread M20x1.5 for pipe ø 10mm		

union nuts

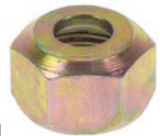

1			
GEV No.	101250	Ref. No.	270201680
description	union nut thread M20x1.5 for pipe ø 10mm		
accessories for	101250		
	GEV No.	101249	Ref. No. 270201580
	olive for pipe ø 10mm Qty 1 pcs		

union screws



1			
GEV No.	100904	Ref. No.	4392050
description	locking screw M10x1 for pipe ø 4mm Qty 1 pcs		

knobs

producer-specific knobs

GICO



1

GEV No.	110875	Ref. No.	293202250 A00250
description	knob switch zero mark ø 54mm shaft ø 6x4.6mm shaft flat upper black		
For models:	64-040FCE, 64-050FCE, 64-222FCE		



1

GEV No.	110833	Ref. No.	790106630
description	knob		



1

GEV No.	110039	Ref. No.	790106610
description	knob gas tap with ignition flame ø 60mm shaft ø 10x8mm shaft flat left		



1

GEV No.	110834	Ref. No.	790106620
description	knob gas tap with ignition flame ø 60mm shaft ø 8x6.5mm shaft flat upper		



1

GEV No.	110857	Ref. No.	790106980
description	knob gas thermostat 1-8 ø 60mm shaft ø 8x6.5mm shaft flat upper black		



1

GEV No.	110846	Ref. No.	790106900
description	knob switch 0-1-0-1 ø 60mm shaft ø 6x4.6mm shaft flat upper		



1

GEV No.	110837	Ref. No.	790106910
description	knob switch 4-position ø 60mm shaft ø 6x4.6mm shaft flat upper black		



1

GEV No.	110838	Ref. No.	790106920
description	knob switch 7-position ø 60mm shaft ø 6x4.6mm shaft flat upper		



1

GEV No.	110850	Ref. No.	790106930
description	knob thermostat t.max. 110°C ø 60mm shaft ø 6x4.6mm shaft flat upper black temperature range 30-110°C		



1

GEV No.	110842	Ref. No.	790106940
description	knob thermostat t.max. 180°C ø 60mm shaft ø 6x4.6mm shaft flat lower black temperature range 100-180°C		



1

GEV No.	110853	Ref. No.	790107000
description	knob thermostat t.max. 300°C ø 60mm shaft ø 6x4.6mm shaft flat upper black temperature range 50-300°C		



1

GEV No.	110854	Ref. No.	790109210
description	knob thermostat t.max. 300°C ø 60mm shaft ø 6x4.6mm shaft flat upper black temperature range 50-300°C thermostat		



1

GEV No.	110841	Ref. No.	790106950
description	knob thermostat t.max. 300°C ø 60mm shaft ø 6x4.6mm shaft flat upper temperature range 50-300°C rotation 270° thermostat		



1

GEV No.	110845	Ref. No.	790106970
description	knob thermostat t.max. 90°C ø 60mm shaft ø 6x4.6mm shaft flat upper black temperature range 30-90°C		



1

GEV No.	110849	Ref. No.	760106080
description	knob water ø 60mm shaft ø 6x4.6mm shaft flat upper		



1

GEV No.	110011	Ref. No.	790119450
description	knob gas tap with ignition flame ø 60mm shaft ø 10x8mm shaft flat left black		
For models:	110-200A-T, 110-200F, 110-200FE, 500-125A-126A, 500-750A, 500-800A, 700-125A-C, 700-126A-C, 700-127A-C, 700-138A-C-T, 700-138FBA, 700-138FEBA, 700-200A-C-T, 700-200FB, 700-200FEB, 700-224FG, 700-508, 700-750A-S, 700-800A-S, 900-125A-C, 900-126A-C, 900-127A-C, 900-138A-C-T, 900-138FA, 900-138FEA, 900-200A-C-T, 900-200F, 900-200FE, 900-503, 900-506, 900-750A-S, 900-800A-S, 90-301, 920-200A-T, 920-200F, 920-200FE, 920-503, 920-506, 920-750A-S		



1

GEV No.	112909	Ref. No.	790119460
description	knob gas tap with ignition flame ø 60mm shaft ø 8x6.5mm shaft flat upper		
For models:	64-125T-126T, 64-130TL-TR, 64-132TL-TLR-TR, 64-222F, 64-222FCE, 64-222FE, 64-222T, 700-020A-C-T, 700-040A-C-T, 700-040FB, 700-040FEB, 700-125T, 700-126T, 700-127T, 700-130AL-AR, 700-130CL-CR, 700-130TL-TR, 700-132AL-AR, 700-132ALR, 700-132CL-CR, 700-132CLR, 700-132TLR, 700-132TL-TR, 700-138A-C-T, 700-138FBA, 700-138FEBA, 700-162A-C-T, 700-162FBA, 700-162FEBA, 700-162FG, 700-222A-C, 700-222FB, 700-222FEB, 700-222T, 700-224A-C, 700-224FBA, 700-224FEBA, 700-224FG, 700-224T, 900-020A-C-T, 900-040A-C-T, 900-040F, 900-040FE, 900-125T, 900-126T, 900-127T, 900-130AL-AR, 900-130CL-CR, 900-130TL-TR, 900-132AL-ALR-AR...(Other models you can see in the webshop)		





1

GEV No.	112103	Ref. No.	790119470
description	knob gas tap without ignition flame ø 60mm shaft ø 8x6.5mm shaft flat upper black		
For models:	64-020T-64-040T, 64-040FCE, 64-040FE, 64-040F-FV, 64-222F, 64-222FCE, 64-222FE, 64-222T		

			
1			
GEV No.	110863	Ref. No.	790106960 790119530
description	knob graduated \varnothing 60mm shaft \varnothing 6x4.6mm shaft flat upper black		
For models:	110-032A-T, 110-038A, 110-052A, 110-052FE, 110-052T, 110-058A, 500-038A, 500-039A, 700-038A-058A, 700-039A, 700-052A-C-T, 700-052FEB, 700-054A, 700-054C, 700-054FEB, 700-054T, 700-325A-326A, 70-820, 70-840, 900-038A-058A, 900-038AM-058AM, 900-039A, 900-052A-C-T, 900-052FE, 900-054A-C-T, 900-054FE, 900-325A-326A, 920-032A-T, 920-038A, 920-052A-T, 920-052FE, 920-058A, ES-023N, ES-121NVC, ES-121NVCG, ES-151NVC, ES-151NVCG, ES-181NVC, ES-181NVCG, ES-702N, ES-IR090C-I, ES-IR120C-I, ES-IR150C-I, ES-IR180C-I		

			
2			
GEV No.	110871	Ref. No.	790119500 A00428
description	knob switch 1-0-1 \varnothing 60mm shaft \varnothing 6x4.6mm shaft flat left black		

			
1			
GEV No.	110868	Ref. No.	790119490
description	knob switch 1-0-1 \varnothing 60mm shaft \varnothing 6x4.6mm shaft flat upper black		
For models:	110-500A-T, 700-500A-C-T, 700-542A-C-T, 900-500A-C-T, 900-542A-C-T, 920-500A-T, 920-542A-T, 9ES-122N, 9ES-122NG, 9ES-152N, 9ES-152NG, 9ES-182N, 9ES-182NG		

			
1			
GEV No.	111749	Ref. No.	790119510
description	knob switch 4-position \varnothing 60mm shaft \varnothing 6x4.6mm shaft flat upper black		
For models:	110-030A-T, 110-050A-T, 110-050FE, 500-030A-T, 500-050A-T, 500-050FE, 64-755T, 700-035A-C-T, 700-055A-C-T, 700-055FEB, 700-528, 900-030A-C-T, 900-050A-C-T, 900-050FE, 900-172A-C-T, 900-172FEA, 900-521-522, 900-523, 900-526, 90-821, 920-030A-T, 920-050A-T, 920-050FE, 920-172A-T, 920-172FEA, 920-523, 920-526		

			
1			
GEV No.	112199	Ref. No.	790106910
description	knob switch 4-position \varnothing 60mm shaft \varnothing 6x4.6mm shaft flat upper black		

			
1			
GEV No.	112163	Ref. No.	790119520
description	knob switch 7-position \varnothing 60mm shaft \varnothing 6x4.6mm shaft flat upper black		
For models:	64-030T, 64-050FCE, 64-050FE-FEV, 64-050T, 700-030A-C-T, 700-050A-C-T, 700-050FEB		



			
1			
GEV No.	110852	Ref. No.	790109390 790119590
description	knob thermostat t.max. 110°C \varnothing 60mm shaft \varnothing 6x4.6mm shaft flat upper black temperature range 30-110°C		

			
1			
GEV No.	111750	Ref. No.	790119560
description	knob thermostat t.max. 180°C 100-180°C \varnothing 60mm shaft \varnothing 6x4.6mm shaft flat upper black		
For models:	500-701A, 64-700T, 64-703T, 700-701A-S, 700-702A-S, 700-704A-S, 700-705A-S, 700-708A-S, 900-701A-S, 900-702A-S, 900-704A-S, 900-705A-S, 900-706A-S, 920-704A-S		

			
1			
GEV No.	111714	Ref. No.	790119570
description	knob thermostat t.max. 300°C 50-300°C ø 60mm shaft ø 6x4.6mm shaft flat upper black		
For models:	110-050FE, 110-052FE, 110-057FE, 110-122FELC, 110-122FEL-FELR, 110-200FE, 110-320AL-ALR, 110-320TL-TLR, 110-322AL-ALC-ALR, 110-322FEL-FELC-FELR, 110-322TL-TLC-TLR, 500-320AL-ALC-AR, 500-320TL-TLC-TR, 500-322AL-ALC-ALR-AR, 500-322TL-TLC-TLR-TR, 64-320TL-TLC-TR, 64-322TL-TLC-TLR-TR, 700-320AL-ALC-AR, 700-320CL-CLC-CR, 700-320TL-TLC-TR, 700-322AL-ALC-ALR-AR, 700-322CL-CLC-CLR-CR, 700-322TL-TLC-TLR-TR, 700-960A-D, 700-962A, 900-040FE, 900-050FE, 900-052FE, 900-054FE, 900-057FE, 900-138FEA, 900-162FEA, 900-172FEA, 900-182FE, 900-200FE, 900-320AL-ALC, 900-320AR, 900-320CL-CLC-CR, 900-320TL-TLC-TR, 900-322AL-ALC, 900-322ALR-AR, 900-322CL-CLC, 900-322CLR-CR, 900-322TLR-TR, 900-322TL-TLC, 900-411-413, 900-960A, 900-962A, 920-050FE, 920-052FE...(Other models you can see in the webshop)		

			
1			
GEV No.	112251	Ref. No.	790119550
description	knob thermostat t.max. 90°C ø 60mm shaft ø 6x4.6mm shaft flat upper black temperature range 30-90°C rotation 270°		
For models:	110-500A-T, 500-500A, 64-500T, 64-519T, 64-520T, 64-542T, 700-500A-C-T, 700-519A-C-T, 700-520T, 700-542A-C-T, 900-500A-C-T, 900-542A-C-T, 920-500A-T, 920-542A-T, 9ES-122N, 9ES-122NG, 9ES-152N, 9ES-152NG, 9ES-182N, 9ES-182NG, ES-121NVC, ES-121NVCG, ES-151NVC, ES-151NVCG, ES-181NVC, ES-181NVCG, ES-424NC, ES-828NC, ES-861NC, ES-891NC		

 <p>Image not available</p>			
1			
GEV No.	110836	Ref. No.	790109350
description	knob		

			
1			
GEV No.	110835	Ref. No.	790109350
description	knob gas tap with ignition flame ø 60mm shaft ø 10x8mm shaft flat left		
accessories for	110835		
		GEV No.	110832
		Ref. No.	290202430
	knob spring		

			
1			
GEV No.	110859	Ref. No.	790109340
description	knob gas tap with ignition flame ø 60mm shaft ø 8x6.5mm shaft flat upper		

			
2			
GEV No.	110873	Ref. No.	790119580 A00427
description	knob thermostat t.max. 300°C ø 60mm shaft ø 6x4.6mm shaft flat left black temperature range 50-300°C		
For models:	64-930T, 700-622, 700-632, 700-900, 700-930, 900-622, 900-632, 900-642, 900-652, 900-900, 900-930, 900-940, 900-950, 920-622, 920-632, 920-642, 920-652, 920-900, 920-930, 920-940, 920-950		

			
1			
GEV No.	110866	Ref. No.	790115900
description	knob thermostat t.max. 300°C ø 60mm shaft ø 6x4.6mm shaft flat upper black temperature range 50-300°C		

			
1			
GEV No.	110867	Ref. No.	790115910 790119600
description	knob thermostat t.max. 300°C ø 60mm shaft ø 6x4.6mm shaft flat upper black temperature range 50-300°C		
For models:	500-050FE, 700-040FEB, 700-050FEB, 700-054A, 700-054FEB, 700-055FEB, 700-057FEB, 700-138FEBA, 700-162FEBA, 700-200FEB, 700-222FEB, 700-224FEBA, 700-411B		



1

GEV No.	110864	Ref. No.	790109420
description	knob graduated \varnothing 60mm shaft \varnothing 6x4.6mm shaft flat upper		



1

GEV No.	110844	Ref. No.	790109410
description	knob thermostat t.max. 180°C \varnothing 60mm shaft \varnothing 6x4.6mm shaft flat upper black		



1

GEV No.	110872	Ref. No.	A00430
description	knob switch 0-1-0-1 \varnothing 60mm shaft \varnothing 6x4.6mm shaft flat lower		



1

GEV No.	110843	Ref. No.	790109400
description	knob thermostat t.max. 300°C \varnothing 60mm shaft \varnothing 6x4.6mm shaft flat upper		



1

GEV No.	110848	Ref. No.	790109360 A00430
description	knob switch 0-1-0-1 \varnothing 60mm shaft \varnothing 6x4.6mm shaft flat lower black		



1

GEV No.	110874	Ref. No.	A00429
description	knob thermostat t.max. 300°C \varnothing 60mm shaft \varnothing 6x4.6mm shaft flat upper black temperature range 45-295°C		



1

GEV No.	110839	Ref. No.	790109370
description	knob switch 4-position \varnothing 60mm shaft \varnothing 6x4.6mm shaft flat upper black		



1

GEV No.	110847	Ref. No.	790109480
description	knob thermostat t.max. 90°C \varnothing 60mm shaft \varnothing 6x4.6mm shaft flat upper black temperature range 30-90°C		
For models:	9ES-122N, 9ES-122NG, 9ES-152N, 9ES-152NG, 9ES-182N, 9ES-182NG		



1

GEV No.	110840	Ref. No.	790109380
description	knob switch 7-position \varnothing 60mm shaft \varnothing 6x4.6mm shaft flat upper		





1

GEV No.	110851	Ref. No.	760105400
description	knob water \varnothing 60mm shaft \varnothing 6x4.6mm shaft flat upper black		





1

GEV No.	112681	Ref. No.	766100000
description	knob gas tap with ignition flame t.max.°C°C ø 60mm shaft ø 10x8mm shaft flat left grey		
accessories for	112681		
	GEV No.	110832	Ref. No. 290202430
	knob spring		



1

GEV No.	112676	Ref. No.	766100010
description	knob gas tap with ignition flame t.max.°C°C ø 60mm shaft ø 8x6.5mm shaft flat upper grey		
accessories for	112676		
	GEV No.	110830	Ref. No. 290202350
	rosette for knob red ID ø 60mm		
	GEV No.	110832	Ref. No. 290202430
	knob spring		



1

GEV No.	112675	Ref. No.	766100020
description	knob gas tap without ignition flame t.max.°C°C ø 60mm shaft ø 8x6.5mm shaft flat upper grey		



1

GEV No.	112883	Ref. No.	766100100
description	knob switch 1-0-1 ø 60mm shaft ø 6x4.6mm shaft flat left grey		



1

GEV No.	111794	Ref. No.	766100040
description	knob switch 1-0-1 t.max.°C°C ø 60mm shaft ø 6x4.6mm shaft flat upper grey		



1

GEV No.	111478	Ref. No.	766100050
description	knob switch 4-position t.max.°C°C ø 60mm shaft ø 6x4.6mm shaft flat upper grey		



1

GEV No.	112679	Ref. No.	766100070
description	knob switch 7-position t.max.°C°C ø 60mm shaft ø 6x4.6mm shaft flat upper grey		



1

GEV No.	112872	Ref. No.	766100160
description	knob thermostat t.max. 110°C ø 60mm shaft ø 6x4.6mm shaft flat upper grey		





1

GEV No.	112683	Ref. No.	766100120
description	knob thermostat t.max. 180°C 100-180°C ø 60mm shaft ø 6x4.6mm shaft flat upper grey		

			
1			
GEV No.	112685	Ref. No.	766100130
description	knob thermostat t.max. 300°C 50-300°C ø 60mm shaft ø 6x4.6mm shaft flat upper grey		

			
1			
GEV No.	112776	Ref. No.	766100140
description	knob thermostat t.max. 300°C 50-300°C ø 60mm shaft ø 6x4.6mm shaft flat upper grey		

			
1			
GEV No.	112680	Ref. No.	766100110
description	knob thermostat t.max. 90°C 30-90°C ø 60mm shaft ø 6x4.6mm shaft flat upper grey temperature range 30-90°C rotation 270°		

			
1			
GEV No.	112873	Ref. No.	770124670
description	knob gas tap with ignition flame ø 70mm shaft ø 8x6mm shaft flat upper grey		

			
1			
GEV No.	112779	Ref. No.	770124790
description	knob thermostat t.max. 110°C 30-110°C ø 70mm shaft ø 6x4.6mm shaft flat upper		

			
1			
GEV No.	110832	Ref. No.	290202430
description	knob spring		
For models:	110-030A-T, 110-032A-T, 110-037A-T, 110-038A, 110-050A-T, 110-050FE, 110-052A, 110-052FE, 110-052T, 110-057A-T, 110-057FE, 110-058A, 110-122FELC, 110-122FEL-FELR, 110-200A-T, 110-200F, 110-200FE, 110-320AL-ALR, 110-320TL-TLR, 110-322AL-ALC-ALR, 110-322FEL-FELC-FELR, 110-322TL-TLC-TLR, 500-030A-T, 500-038A, 500-039A, 500-050A-T, 500-050FE, 500-125A-126A, 500-320AL-ALC-AR, 500-320TL-TLC-TR, 500-322AL-ALC-ALR-AR, 500-322TL-TLC-TLR-TR, 64-020T-64-040T, 64-030T, 64-037T, 64-040FCE, 64-040FE, 64-040F-FV, 64-050FCE, 64-050FE-FEV, 64-050T, 64-057FE, 64-057T, 64-125T-126T, 64-132TL-TLR-TR, 64-222F, 64-222FCE, 64-222FE, 64-222T, 64-320TL-TLC-TR...(Other models you can see in the webshop)		

			
1			
GEV No.	110830	Ref. No.	290202350
description	rosette for knob red ID ø 60mm		
For models:	110-030A-T, 110-032A-T, 110-037A-T, 110-038A, 110-050A-T, 110-050FE, 110-052A, 110-052FE, 110-052T, 110-057A-T, 110-057FE, 110-058A, 110-122FELC, 110-122FEL-FELR, 110-200A-T, 110-200F, 110-200FE, 110-320AL-ALR, 110-320TL-TLR, 110-322AL-ALC-ALR, 110-322FEL-FELC-FELR, 110-322TL-TLC-TLR, 110-500A-T, 500-030A-T, 500-038A, 500-039A, 500-050A-T, 500-050FE, 500-125A-126A, 500-320AL-ALC-AR, 500-320TL-TLC-TR, 500-322AL-ALC-ALR-AR, 500-322TL-TLC-TLR-TR, 500-500A, 500-701A, 700-020A-C-T, 700-030A-C-T, 700-035A-C-T, 700-037A-T, 700-038A-058A, 700-039A, 700-040A-C-T, 700-040FB, 700-040FEB, 700-050A-C-T, 700-050FEB, 700-052A-C-T, 700-052FEB, 700-054A, 700-054C...(Other models you can see in the webshop)		

steam/water taps

steam/water taps

			
1			
GEV No.	110851	Ref. No.	760105400
description	knob water ø 60mm shaft ø 6x4.6mm shaft flat upper black		

handles and hand wheels

hand wheels

hand wheels



1

GEV No.	691815	Ref. No.	770307460
description	hand wheel ø 180mm D1 ø 40mm bore ø 14mm depth of bore 26mm hole ø 4mm hole distance 5mm L2 156mm with folding handle		
spare parts for	691815		
	GEV No.	690856	Ref. No. —
	folding handle ø 28mm total length 105mm seat ø 21mm shaft ø 8mm thread M6 with shaft and pin L 105mm		



1

GEV No.	540742	Ref. No.	790325450
description	hand wheel ø 180mm D1 ø 40mm bore ø 17mm depth of bore 26mm hole ø 5mm hole distance 10mm L2 156mm with folding handle		
For models:	700-900, 700-930, 900-900, 900-930, 900-940, 900-950, 920-900, 920-930, 920-940, 920-950		
spare parts for	540742		
	GEV No.	690856	Ref. No. —
	folding handle ø 28mm total length 105mm seat ø 21mm shaft ø 8mm thread M6 with shaft and pin L 105mm		

star handles



1

GEV No.	540738	Ref. No.	760308790 790305070
description	star handle thread bore ø 10mm ø 58mm L 38mm black		

hand cranks



1

GEV No.	540741	Ref. No.	770307460
description	hand crank bore ø 14mm L 80mm with folding handle		



1

GEV No.	540743	Ref. No.	790107790
description	hand crank for frying pan		
For models:	700-622, 700-632, 900-622, 900-632, 900-642, 900-652, 920-622, 920-632, 920-642, 920-652		

locks

edgemount latches



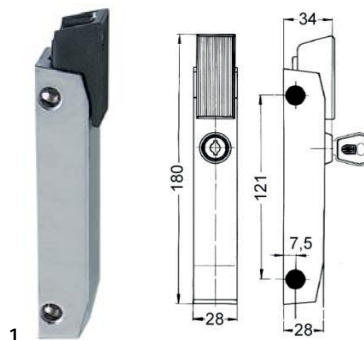

push button latches

RAHRBACH

6186 PRESTO series







1

GEV No.	700045	Ref. No.	419506186
description	push button latch L 180mm mounting distance 121mm non lockable refrigeration units 6186 H 34mm W 28mm type PRESTO		
spare parts for	700045		
	GEV No.	700046	Ref. No. —
	handle H 26.5mm L 55mm W 23.5mm plastic with spring spring length 14mm mounting thread M4 spring thickness 0.5mm		
accessories for	700045		
	GEV No.	690108	Ref. No. —
	base plate H 5mm L 47.5mm W 21mm for swinging strike hole distance 31mm type PRESTO no. 6186		
	GEV No.	690109	Ref. No. —
	base plate H 1mm L 47.5mm W 21mm plastic hole distance 31mm type PRESTO no. 6186		
	GEV No.	700050	Ref. No. —
	door catch H 5mm L 47mm W 21mm hole distance 31mm with spigot refrigeration units type PRESTO no. 6186		
	GEV No.	700051	Ref. No. —
	door catch H 5mm L 48mm W 21mm adjustable hole distance 31mm with spigot type PRESTO no. 6186		



handle latches





GEV No.	700045	Ref. No.	419506186
description	push button latch L 180mm mounting distance 121mm non lockable refrigeration units 6186 H 34mm W 28mm type PRESTO		
spare parts for	700045		
	GEV No.	700046	Ref. No. —
	handle H 26.5mm L 55mm W 23.5mm plastic with spring spring length 14mm mounting thread M4 spring thickness 0.5mm		
accessories for	700045		
	GEV No.	690108	Ref. No. —
	base plate H 5mm L 47.5mm W 21mm for swinging strike hole distance 31mm type PRESTO no. 6186		
	GEV No.	690109	Ref. No. —
	base plate H 1mm L 47.5mm W 21mm plastic hole distance 31mm type PRESTO no. 6186		
	GEV No.	700050	Ref. No. —
	door catch H 5mm L 47mm W 21mm hole distance 31mm with spigot refrigeration units type PRESTO no. 6186		
	GEV No.	700051	Ref. No. —
	door catch H 5mm L 48mm W 21mm adjustable hole distance 31mm with spigot type PRESTO no. 6186		

hinges

oven hinges

	Image not available		
GEV No.	690565	Ref. No.	741105831
description	oven hinge left		

	Image not available		
GEV No.	690564	Ref. No.	741105741
description	oven hinge right		

	1		
GEV No.	690560	Ref. No.	A00006
description	oven hinge right/left		
For models:	110-050FE, 110-052FE, 110-057FE, 110-122FELC, 110-122FEL-FELR, 110-122FLC, 110-122FL-FLR, 110-200F, 110-200FE, 110-322FEL-FELC-FELR, 500-050FE, 64-050FE-FEV, 64-057FE, 64-222FE, 700-040FB, 700-040FEB, 700-050FEB, 700-052FEB, 700-054FEB, 700-055FEB, 700-057FEB, 700-138FBA, 700-138FEBA, 700-162FBA, 700-162FEBA, 700-162FG, 700-200FB, 700-200FEB, 700-222FB, 700-222FEB, 700-224FBA, 700-224FEBA, 700-224FG, 700-411B, 900-040F, 900-040FE, 900-050FE, 900-052FE, 900-054FE, 900-057FE, 900-138FA, 900-138FEA, 900-162FA, 900-162FEA, 900-162FG, 900-172FEA, 900-200F, 900-200FE, 900-411-413, 920-050FE...(Other models you can see in the webshop)		

	1		
GEV No.	700995	Ref. No.	241201850
description	spring L 170mm ø 18mm wire gauge ø 3.5mm for oven hinge		

fittings for catering equipment

outlet taps

producer-specific

GICO

	1		
GEV No.	540746	Ref. No.	760103840
description	adapter for outlet		
For models:	64-600T-603T		

	1		
GEV No.	514130	Ref. No.	333302006
description	ball handle thread M6 IT		
For models:	64-500T, 64-542T, 700-400A-C-T, 700-402A-C-T, 700-500A-C-T, 700-542A-C-T		



			
1			
GEV No.	540730	Ref. No.	433207
description	ball valve connection 3/4" IT - 3/4" IT DN20 total length 70mm with lever handle length 95mm		
For models:	500-750A, 500-755A, 500-800A, 700-750A-S, 700-755A-S, 700-800A-S, 700-855A-S, 900-750A-S, 900-755A-S, 900-800A-S, 900-855A-S, 920-750A-S, 920-755A-S		

			
1			
GEV No.	540734	Ref. No.	760302430
description	drain pipe thread		
For models:	64-600T-603T, 64-700T, 64-703T, 700-400A-C-T, 700-402A-C-T		

			
1			
GEV No.	540735	Ref. No.	760103020
description	lever for outlet tap		

			
1			
GEV No.	520506	Ref. No.	A00450
description	outlet tap connection 1" IT complete with shaft and lever handle length 70mm H 89mm L 115mm W 47mm shaft L 170mm for fryer IT 1" lever handle spout ø 26mm		
For models:	700-601A-S, 700-602A-S, 700-604A-605A, 700-609A, 700-701A-S, 700-702A-S, 900-601A-S, 900-602A-S, 900-604A-S, 900-605A-S, 900-701A-S, 900-702A-S, 920-604A-S		

aerators and air bleeders

			
1			
GEV No.	540824	Ref. No.	42233014
description	pressure compensation valve thread 1/4" ET WS 19 chrome-plated L 18mm		
For models:	900-503, 900-506, 900-523, 900-526, 920-503, 920-506, 920-523, 920-526		

lid hinges

miscellaneous

lid hinges

			
1			
GEV No.	700034	Ref. No.	A00421
description	lid hinge flange radius 220mm type 700 series for circular lids		
For models:	700-508, 700-528		

			
1			
GEV No.	700035	Ref. No.	A00415
description	lid hinge flange radius 320mm type 900,920 series for circular lids		
For models:	900-503, 900-506, 900-521-522, 900-523, 900-526, 920-503, 920-506, 920-523, 920-526		

drain taps

brass

drain taps

			
1			
GEV No.	548001	Ref. No.	422116
description	drain tap 1 1/2" IT O-ring seal kettle connection with union nut A 80mm B1 68mm B2 132mm		
For models:	700-508, 700-528		
spare parts for	548001		
	GEV No.	505092	Ref. No. —
	O-ring EPDM thickness 5.34mm ID ø 43.82mm Qty 1 pcs		
	GEV No.	540213	Ref. No. —
	handle ID ø 5mm L 117mm		



safety fittings

accessories



GEV No.	540860	Ref. No.	4227034
description	fitting support thread 3/4" ET suitable for manometer		
For models:	700-508, 700-528		

safety valves



GEV No.	540721	Ref. No.	42230020
description	safety valve triggering pressure 0.5bar M88 thread 1 1/4"		
For models:	900-503, 900-506, 900-523, 900-526, 920-503, 920-506, 920-523, 920-526		

accessories for 540721



GEV No.	541501	Ref. No.	—
description	reducer for safety fitting IT 1 1/4" ET 3/4"		

baskets

fryer baskets

GICO



GEV No.	970641	Ref. No.	270202130
description	fryer basket L1 300mm W1 103mm H1 100mm L2 515mm H2 210mm H3 245mm		



GEV No.	970604	Ref. No.	270203840
description	fryer basket L1 365mm W1 115mm H1 100mm L2 575mm H2 150mm H3 200mm chrome-plated steel		



GEV No.	970731	Ref. No.	290201220
description	fryer basket W1 128mm L1 400mm H1 102mm		



GEV No.	970732	Ref. No.	270202100 270204830
description	fryer basket W1 210mm L1 310mm H1 120mm L2 520mm H2 190mm H3 260mm chrome-plated steel		



GEV No.	970730	Ref. No.	270203850
description	fryer basket W1 230mm L1 365mm H1 102mm		

pasta baskets

GICO



GEV No.	970000	Ref. No.	264200240
description	pasta basket L1 150mm W1 110mm H1 176mm H2 285mm SS		



1

GEV No.	970003	Ref. No.	264200230
description	pasta basket L1 300mm W1 112mm H1 176mm H3 270mm SS		

accessories for 970123

GEV No.	694701	Ref. No.	—
----------------	--------	-----------------	---



shelf support L 31/28mm W 22mm H 17mm SS with hook Qty 12 pcs

gaskets

refrigeration gaskets

plug-in gaskets

profile 9048

We offer custom-made gaskets for this profile

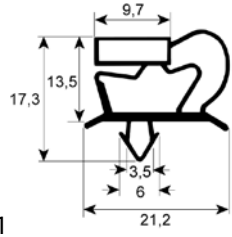

1

GEV No.	901412	Ref. No.	239201360
description	refrigeration gasket profile 9048 W 375mm L 375mm plug size		
For models:	BF70120, BF70160, ES123N, ES124N, ES153N, ES154N, ES183N, ES184N		

gaskets for heated units

window seals

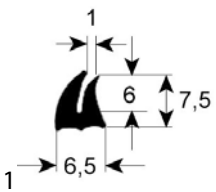

1

GEV No.	900172	Ref. No.	293200610
description	window gasket profile 1540 Qty supplied by meter		

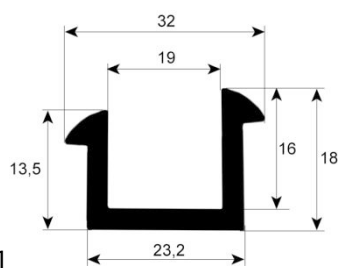

1

GEV No.	900173	Ref. No.	293200620 293203080
description	window gasket profile 1900 L 2400mm Qty 1		

shelves and shelf rails

grates

universal

without upstand



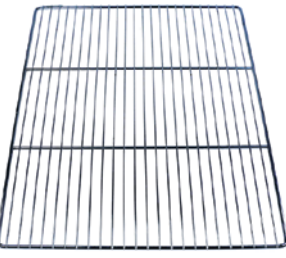

1

GEV No.	970120	Ref. No.	793108350	
description	grate W 325mm D 530mm GN 1/1 chrome-plated steel wire gauge frame 7mm lengthwise wires gauge 4mm crossing wires 1			
accessories for	970120			
	GEV No.	690330	Ref. No.	—
	rack L 1000mm W 22mm H 4mm aperture 3x8mm hole distance 12.5mm stainless steel			
	GEV No.	694700	Ref. No.	—
	shelf support L 31/28mm W 22mm H 18mm SS Qty 12 pcs			
	GEV No.	694701	Ref. No.	—
	shelf support L 31/28mm W 22mm H 17mm SS with hook Qty 12 pcs			



1

GEV No.	970123	Ref. No.	241200292	
description	grate W 650mm D 530mm GN 2/1 stainless steel wire gauge frame 7.8mm lengthwise wires gauge 3.8mm crossing wires 2 suitable for refrigerator			
accessories for	970123			
	GEV No.	690330	Ref. No.	—
	rack L 1000mm W 22mm H 4mm aperture 3x8mm hole distance 12.5mm stainless steel			
	GEV No.	694700	Ref. No.	—
	shelf support L 31/28mm W 22mm H 18mm SS Qty 12 pcs			

door seals

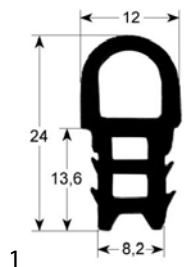

GEV No.	900171	Ref. No.	284204130
description	door seal profile 2050 external size Qty supplied by meter		

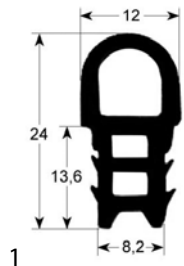

GEV No.	901428	Ref. No.	293201230
description	door seal profile 2050 L 1850mm		

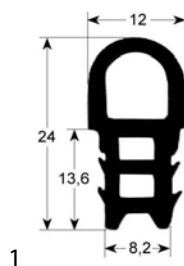

GEV No.	901316	Ref. No.	284201430 284201490 293200500 293201400 684201490
description	door seal profile 2050 L 3010mm Qty 1 suitable for GICO		

sealing cords

square



GEV No.	601098	Ref. No.	793303880
description	sealing cord square size 6x6mm braided L 0.2m Qty 1		

springs

torsion springs



GEV No.	700066	Ref. No.	270203340
description	torsion spring \varnothing 31.1mm L2 140mm wire gauge \varnothing 3.6mm L1 27mm		
For models:	700-508, 700-528		



GEV No.	700068	Ref. No.	241200840
description	torsion spring \varnothing 33.2mm L2 135mm wire gauge \varnothing 5.2mm L1 31mm		
For models:	900-503, 900-506, 900-521-522, 900-523, 900-526, 920-503, 920-506, 920-523, 920-526		

compression springs



GEV No.	540736	Ref. No.	260201950
description	compression spring \varnothing 20mm L 23mm wire gauge \varnothing 1.3mm		



GEV No.	100767	Ref. No.	270200710
description	compression spring \varnothing 9mm L 18mm		



GEV No.	700995	Ref. No.	241201850
description	spring L 170mm \varnothing 18mm wire gauge \varnothing 3.5mm for oven hinge		

tension springs



GEV No.	700169	Ref. No.	290203700
description	tension spring \varnothing 35mm total length 360mm wire gauge \varnothing 5.3mm		
For models:	900-622, 900-642, 900-900, 900-940, 920-622, 920-642, 920-900, 920-940		



GEV No.	700168	Ref. No.	290202420
description	tension spring \varnothing 35mm total length 555mm wire gauge \varnothing 5.1mm		



valves and tank inlets

ball valves

universal

ball valves with lever handle



1

GEV No.	514325	Ref. No.	4332010
description	ball valve connection 1" IT - 1" IT DN25 total length 83mm with lever handle		
For models:	700-603A, 700-609A, 900-609A, 920-609A		



1

GEV No.	520280	Ref. No.	422312012
description	ball valve connection 1/2" IT - 1/2" IT DN15 total length 50mm with lever handle handle length 85mm		



1

GEV No.	540730	Ref. No.	433207
description	ball valve connection 3/4" IT - 3/4" IT DN20 total length 70mm with lever handle handle length 95mm		
For models:	500-750A, 500-755A, 500-800A, 700-750A-S, 700-755A-S, 700-800A-S, 700-855A-S, 900-750A-S, 900-755A-S, 900-800A-S, 900-855A-S, 920-750A-S, 920-755A-S		

producer-specific

GICO



1

GEV No.	520505	Ref. No.	A00465
description	ball valve ET 3/8" for pasta cooker shaft ø 10x8mm		
For models:	700-750A-S, 700-755A-S, 700-800A-S, 700-855A-S, 900-750A-S, 900-755A-S, 900-800A-S, 900-855A-S, 920-750A-S, 920-755A-S		



1

GEV No.	540733	Ref. No.	433206
description	ball valve inlet 1/2" ET outlet 1/2" ET L 74mm without handle shaft ø 10x7mm for pipe ø 14mm		
For models:	500-125A-126A, 500-750A, 500-755A, 500-800A, 64-500T, 64-542T, 64-600T-603T, 64-700T, 64-703T, 64-755T, 700-125A-C, 700-125T, 700-126A-C, 700-126T, 700-127A-C, 700-127T, 700-325A-326A, 700-400A-C-T, 700-402A-C-T, 700-500A-C-T, 700-542A-C-T, 900-125A-C, 900-125T, 900-126A-C, 900-126T, 900-127A-C, 900-127T, 900-325A-326A		



1

GEV No.	520506	Ref. No.	A00450
description	outlet tap connection 1" IT complete with shaft and lever handle length 70mm H 89mm L 115mm W 47mm shaft L 170mm for fryer IT 1" lever handle spout ø 26mm		
For models:	700-601A-S, 700-602A-S, 700-604A-605A, 700-609A, 700-701A-S, 700-702A-S, 900-601A-S, 900-602A-S, 900-604A-S, 900-605A-S, 900-701A-S, 900-702A-S, 920-604A-S		

ball valves electric



1

GEV No.	403026 ¹	Ref. No.	6441001 6441002
description	ball valve inlet 1/2" IT outlet 1/2" IT 230V L 90mm 50/60Hz off-current open mode of operation electric W 60mm H 100mm connection cable 450mm IT 1/2"		

¹off-current open





shut-off valves

producer-specific

GICO



1

GEV No.	540737	Ref. No.	790304640
description	shut-off valve connection 1/2" 1/2" straight total length 52mm mounting pos. rosette thread G2 26x19G shaft ø M5x0.8mm		
accessories for	540737		
	GEV No.	514085	Ref. No. —
	rosette connection 26x19G chrome-plated total lengthmm mounting pos.		
	GEV No.	514086	Ref. No. —
	hexagonal nut connection 26x19G brass total lengthmm mounting pos. H 6mm WS 34 Qty 1 pcs		
	GEV No.	540738	Ref. No. 760308790 790305070
	star handle thread bore ø 10mm ø 58mm L 38mm black		



1

GEV No.	540738	Ref. No.	760308790 790305070
description	star handle thread bore ø 10mm ø 58mm L 38mm black		



inlet taps

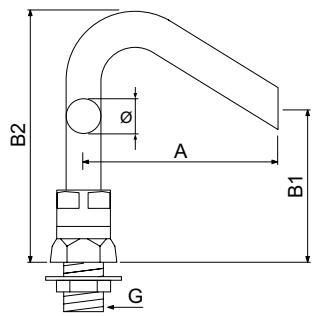

1



GEV No.	542005	Ref. No.	A00086
description	inlet spout connection 1/2" ET tube ø 18mm projection 105mm overall height 130mm spout height 70mm rotation 360°		
For models:	500-750A, 500-755A, 500-800A, 700-508, 700-528, 700-750A-S, 700-755A-S, 700-800A-S, 700-855A-S, 900-503, 900-506, 900-521-522, 900-523, 900-526, 900-750A-S, 900-755A-S, 900-800A-S, 900-855A-S, 920-503, 920-506, 920-523, 920-526, 920-750A-S, 920-755A-S		
accessories for	542005		
	GEV No.	511470	Ref. No. —
	nut thread 1/2" ø 40mm H 8mm WS 25 brass Qty 1 pcs		

accessories for	542005		
	GEV No.	511474	Ref. No. —
	flat washer for thread 1/2"		
	GEV No.	511477	Ref. No. —
	flat gasket rubber ED ø 42mm ID ø 21mm thickness 2mm Qty 1 pcs		



1

GEV No.	540740	Ref. No.	760105750
description	inlet spout		

accessories

miscellaneous



1

GEV No.	694345	Ref. No.	750309770
description	coupling for water valve int. ø 1 10mm int. ø 2 22mm ED ø 20/28mm L 34mm WS 24 thread M5		

drain systems and wash basins

drain fittings

producer-specific



1

GEV No.	515117	Ref. No.	423301 739308000
description	drain fitting thread 3/4" ID ø 20mm ED ø 32mm		



standpipes

producer-specific

GICO



1

GEV No.	515116	Ref. No.	270122320
description	drain fitting thread M36x2 H 20mm ID ø 30mm complete with overflow pipe ED ø 45mm WS 41		

accessories



1

GEV No.	697894	Ref. No.	790330660
description	drain pipe thread 3/4 L 100mm ø 26.6mm		

measuring equipment

thermometers

built-in thermometers

ø52mm



1

GEV No.	541077	Ref. No.	4251103552
description	thermometer mounting ø 52mm t.max. 350°C +50 up to +350°C probe ø 6mm probe L 30mm capillary pipe 1000mm built-in depth 28mm		

A			
alarm devices	25	heating elements for griddles	8
axial fans	32	heating elements for large hobs	8
B		heating elements for ovens	3
ball valves	88	heating elements for pasta cookers	9
ball valves electric	88	heating elements for plate warmers	10
bar burners	68	heating elements for tilting bratt pan	8
booster pumps II	34	hob burners	52
C		hot air fans	34
cam switches	20	hot air motors	32
condensators & interference suppression filters	34	hot plates	13
contactors	25	I	
control equipment	22	ignition boxes	42
control thermostats	15	ignition cables	49
D		ignition units	50
door seals	87	immersion heating elements	10
drain fittings	89	indicator lights	22
drain systems and wash basins	89	indicator lights (complete)	23
E		infrared lamps	24
edgemount latches	82	inlet spouts	89
electric accessories	34	inlet taps	89
electric timers	25	L	
electrodes	31	lamps	22
electronic controllers	27	linear lamps	24
energy regulators	14	M	
F		magnetic switches	22
fans	32	measuring equipment	90
G		mechanical timers	25
gas burners	52	microswitches	20
gas control valves	41	O	
gas nozzles	71	operating capacitors	34
gas taps	35	oven hinges	83
gas thermostats	37	oven lamps	24
gaskets for heated units	86	P	
grates	86	piezoelectric igniters	49
H		pilot burners	43
halogen lamp	23	pilot heating elements	10
handle latches	83	plug-in gaskets	86
heating cables	10	plunger sockets	18
heating elements	3	pressure switches	31, 74
heating elements for bain maries	4	probes	28
heating elements for chip scuttles	5	programme timers	24
heating elements for convection	11	pumps	34
heating elements for fryers	5	push button latches	82
heating elements for frying pans	5	push/momentary push switches	19
		R	
		radiation heaters	12
		refrigeration gaskets	86

relays	26
residual heat indicators	24

S

safety thermostats	17
sealing cords	87
shelves and shelf rails	86
shut-off valves	89
solenoid valves	30
standpipes	90
switches and momentary switches	19

T

terminals	34
thermocouples	50
thermostats	15
time relays	26
timers	24
transformers	27
tube burners	70

V

valves and tank inlets	88
------------------------	----

W

window seals	86
--------------	----