



GAS COMPONENTS



ELECTRIC COMPONENTS



WATER TECHNOLOGY



MECHANICAL COMPONENTS



TOOLS

Spare parts suitable for

GIERRE

Find the complete and up-to-date range of products in our GEV Webshop



Manufacturer catalogue

The most important spare parts and accessories arranged clearly for every manufacturer

- ✓ Complete product range and all appliance data always up to date in the GEV Webshop
- ✓ Alphabetical Index at the end of the catalogue

GEV Webshop

www.gev-online.co.uk

www.gev-online.com



- 🔍 Add to Favourites
- 🔍 Sign In with email address and usual password
- 🔍 Easy-order – place several items in your basket at the same time
- 🔍 Quick Item search – no login needed



heating elements

heating elements for ovens

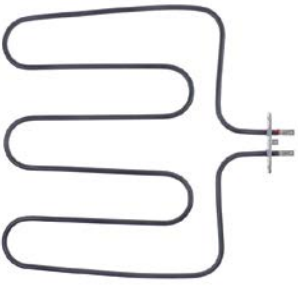

1

GEV No.	418792	Ref. No.	RES155
description	heating element 1400W 230V heating circuits 1 L 315mm W 320mm L1 55mm L2 260mm W1 150mm W2 30mm flange length 70mm flange width 22mm hole distance 56mm hole ø 4.2mm tube ø 6.3mm connection male faston 6.3mm rectangular flange		

heating cables

connection on both sides

with wire end ferrules



1

GEV No.	419147	Ref. No.	R016781
description	heating cable 7W 230V L 3250mm L1 (unheated) 1150mm L2 (heated) 1050mm silicone ø 3mm		

immersion heating elements



1

GEV No.	416149	Ref. No.	PRO065/5
description	heating element 7500W 220V heating circuits 6 L 310mm W 145mm H 130mm thermostat sleeves ø 6mm length thermostat sleeves 125mm number of thermostat sleeves 1 connection male faston 6.3mm special fixing		



1

GEV No.	418111	Ref. No.	PRO065/5
description	heating element 7500W 220V heating circuits 6 L 310mm W 145mm H 130mm thermostat sleeves ø 6x4mm length thermostat sleeves 137/125mm number of thermostat sleeves 2 thermostat sleeve clinging / not clinging connection male faston 6.3mm immersion heater special fixing		
accessories for	418111		
	GEV No.	Ref. No.	—
		gasket silicone thickness 7mm ID ø 193.7mm Qty 1 pcs for heating element suitable for BARON equiv. no. A037485	

heating elements for convection



1

GEV No.	418998	Ref. No.	KITRES230
description	heating element 3000W 230V heating circuits 1 ID ø 182mm ED ø 195mm L 245mm H 52mm L1 45mm W1 30mm H1 25mm H2 27mm flange length 70mm flange width 22mm hole distance 56mm connection male faston 6.3mm connection length 44mm tube ø 6.2mm convection heating element hole ø 5mm		



1

GEV No.	418503	Ref. No.	RES101
description	heating element 7500W 230V heating circuits 3 ID ø 299mm ED ø 316mm L 350mm H 106mm L1 27mm W1 105mm H1 16mm H2 90mm flange length 142mm flange width 25mm hole distance 63mm connection M4 connection length 72mm tube ø 8.5mm convection heating element hole ø 6.3mm rectangular flange		



energy regulators

EGO

1-circuit



GEV No.	380015	Ref. No.	SIM123
description	energy regulator 230V 13A single-circuit turn direction right shaft ø 6x4.6mm shaft L 23mm mounting thread M4 power release 6-100% no. 50.57021.010		

thermostats

bi-metal thermostats

bi-metal thermostats



GEV No.	390148	Ref. No.	PRO065/8
description	bi-metal thermostat hole distance 23.5mm switch-off temp. 90°C 1NC 1-pole 16A connection F6.3 with flange		

control and safety thermostats

EGO

control thermostats

55.10/19_ series



GEV No.	375983	Ref. No.	TER110
description	thermostat t.max. 262°C temperature range 50-255°C 1-pole 1NO 16A probe ø 3mm probe L 230mm capillary pipe 900mm capillary pipe isolated 350mm gland nut M10x1 shaft ø 6x4.6mm shaft L 23mm shaft position upper rotation 270° probe material SS		

E·G·O

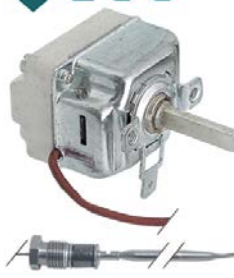

GEV No.	375652	Ref. No.	TER114
description	thermostat t.max. 266°C temperature range 50-255°C 1-pole 1NO 16A probe ø 3mm probe L 219mm capillary pipe 900mm capillary pipe isolated 350mm gland nut M10x1 shaft ø 6x4.6mm shaft L 23mm shaft position upper rotation 270°		

E·G·O

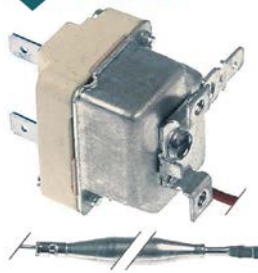

GEV No.	375806	Ref. No.	TER145
description	thermostat t.max. 85°C temperature range fixed 85°C 1-pole 1CO 16A probe ø 6mm probe L 75mm capillary pipe 900mm capillary pipe isolated 700mm gland nut		

safety thermostats

55.10/19_ series

E·G·O



GEV No.	375807	Ref. No.	TER116
description	safety thermostat switch-off temp. 320°C 1-pole 16A probe ø 6mm probe L 77mm capillary pipe 870mm capillary pipe isolated 660mm gland nut M10x1 probe		



CAEM

safety thermostats



GEV No.	375000	Ref. No.	PRO065/4
description	safety thermostat switch-off temp. 135°C 1-pole 16A/250VA probe ø 6mm probe L 80mm capillary pipe 540mm capillary pipe isolatedmm gland nut copper		

PRODIGY / FIRT

control thermostats with operation switch

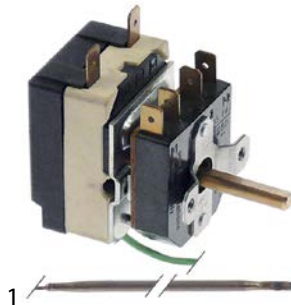

GEV No.	420445	Ref. No.	TER123
description	thermostat t.max. 300°C temperature range 50-300°C 1-pole 1NO 16A probe ø 3mm probe L 190mm capillary pipe 1015mm capillary pipe isolated 795mm gland nut shaft ø 6x4.6mm shaft L 24mm shaft position° shaft position upper rotation 270° outer switch 2NO		

switches and momentary switches

microswitches

lever actuated



GEV No.	345044	Ref. No.	MIC500
description	microswitch with lever 250V 16A 1CO connection male faston 6.3mm ambient temperature max. 85°C mounting distance 25mm type C99ZP3 actuating force: 25g lever length 71mm		

cam switches

on/off



GEV No.	300129	Ref. No.	COM123
description	cam switch 2 operating positions 2NO sequence 0-1 16A shaft ø 6x4.6mm shaft L 23mm connection male faston 6.3mm ceramic		

3 operating positions

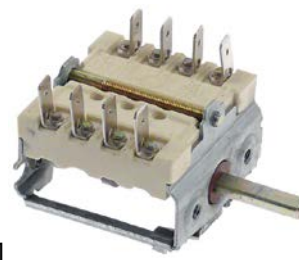

GEV No.	301315	Ref. No.	COM140
description	cam switch 3 operating positions 4NO sequence 1-0-2 16A shaft ø 6x4.6mm shaft L 23mm connection male faston 6.3mm 49.44915.712 ceramic		

rotary switches

BREMAS

A1200 series



GEV No.	346600	Ref. No.	COM160
description	rotary switch sets of contacts 8 4 0-1-2-3 type CS012461B 400V 12A shaft ø 4x5mm shaft L 25mm shaft square connection male faston 6.3mm		



control equipment

SIEMENS

3SB series ø22mm new



1

GEV No.	346602	Ref. No.	SEL560/2
description	contact block SIEMENS 3SB3400-0D 2NO max 400V 10A black		



1

GEV No.	346603	Ref. No.	SEL560/3
description	contact block SIEMENS 3SB3400-0E 2NC max 400V 10A black		

rotary switches



1

GEV No.	346601	Ref. No.	SEL560
description	rotary selector mounting measurements ø22mm black latching sequence 0-1		

accessories for 346601



GEV No.	346602	Ref. No.	SEL560/2
description	contact block SIEMENS 3SB3400-0D 2NO max 400V 10A black		



GEV No.	346603	Ref. No.	SEL560/3
description	contact block SIEMENS 3SB3400-0E 2NC max 400V 10A black		



GEV No.	346630	Ref. No.	—
description	contact block SIEMENS 3SB3400-0B 1NO max 400V 10A black		



GEV No.	346631	Ref. No.	—
description	contact block SIEMENS 3SB3400-0C 1NC max 400V 10A black		



GEV No.	346632	Ref. No.	—
description	contact block SIEMENS 3SB3400-0D 1NC/1NO max 400V 10A black		

lamps

indicator lights

indicator lights (complete)

ø10mm

with plug-in socket



1

GEV No.	359019	Ref. No.	SEG311
description	indicator light ø 10mm green 400V connection male faston 6.3mm Qty 1 pcs		



1

GEV No.	359034	Ref. No.	SEG312
description	indicator light ø 10mm yellow 400V connection male faston 6.3mm Qty 1 pcs		

screw-on/push-on fit

halogen lamp

for socket G4 / G6.35 / G9



1

GEV No.	359599	Ref. No.	LAM125
description	halogen lamp socket G4 12V 20W temp.-resist. 500°C		

oven lamps

lamps

halogen lamps

for socket G4 / G6.35 / G9



1

GEV No.	359599	Ref. No.	LAM125
description	halogen lamp socket G4 12V 20W temp.-resist. 500°C		

sockets

G4 / G5,3 / G6,35



1

GEV No.	359369	Ref. No.	POR150/3
description	lamp socket socket G4/G5.3/G6.35 24V ø 17mm H 10mm connection cable 120mm mounting distance 11.5mm for halogen lamp cable length 730mm		





timers

programme timers



1

GEV No.	360334	Ref. No.	TEM105
description	timer FIBER P04 engines 1 chambers 2 operation time 120min 230V shaft \varnothing 6x4.6mm shaft L 20mm manuf. no. P045J02W401 motor type M51BJ0R6400 impulse electric		
spare parts for	360334		
	GEV No.	360673	Ref. No. —
	motor kit pinion \varnothing 6.8mm teeth 15 230V voltage AC 50/60Hz turn direction clockwise motor \varnothing 48mm H 18.5mm motor type UDS-40NE1RNZ165 cable length 150mm with holder		



1

GEV No.	360627	Ref. No.	TEM115
description	timer FIBER P255J03H9U3c engines 1 chambers 3 operation time 6min 230V 50/60Hz shaft \varnothing mm shaft Lmm motor type M51BJ0R00AA		

alarm devices

buzzer boards



1

GEV No.	401062	Ref. No.	TEM105/1
description	buzzer board 230VAC L 48mm W 45mm connection Faston 6.3mm		

contactors

LOVATO

power contactors



1

GEV No.	380083	Ref. No.	TEL144
description	power contactor resistive load 25A 230VAC (AC3/400V) 9A/4.2kW main contacts 3NO auxiliary contacts 1NC connection screw connection type BF0901A230		



1

GEV No.	380714	Ref. No.	TEL145
description	power contactor resistive load 25A 230VAC (AC3/400V) 9A/4.2kW main contacts 3NO auxiliary contacts 1NO connection screw connection type BF0910A230		

overload switches



1

GEV No.	380752	Ref. No.	TER213
description	overload switch setting range 1.6-2.5A for contactors BF (09-38) series connection screw		

relays

level relays

GICAR



1

GEV No.	401224	Ref. No.	PRO065/1
description	level relay 230V connection F6.3 type RL30/3ES/F/G		

transformers

for lighting



1

GEV No.	401570	Ref. No.	POR150/5
description	transformer primary 230V secondary 12V 105W		

electronic controllers

DIXELL

universal controllers



1

GEV No.	378008	Ref. No.	TER130
description	electronic controller DIXELL type XT110C-0C0KU- mounting measurements 71x29mm 12V voltage AC/DC NTC/PTC/Pt100/TC(J,K) relay outputs 1 CO-8A(3) NTC/PTC/Pt100/Pt1000/TC(J,K) DI defr. funct. dependent on probe°C display 3½ digits		



1

GEV No.	378007	Ref. No.	TER129
description	electronic controller DIXELL type XT111C-0C0TU mounting measurements 71x29mm 12V voltage AC/DC NTC/PTC/Pt100/TC(J,K) relay outputs 2 CO-8A(3) NO-5A(3) NTC/PTC/Pt100/TC(J,K) DI yes defr. funct. no dependent on probe°C display 3½ digits		

probes

producer-specific probes

probes



1

GEV No.	378009	Ref. No.	TER137
description	temperature probe thermocouple K (NiCr-Ni) cable silicone probe -50 up to 1150°C cable -50 up to +180°C connection 2-wire thread 1/8" probe ø3x200mm cable length 1m		

solenoid valves

solenoid valves (water)

RPE



1

GEV No.	370379	Ref. No.	VAL110
description	solenoid valve double straight 230VAC inlet 3/4" outlet 1/4" DN10 RPE plastic inlet 3/4"mm		

ball valves electric



1

GEV No.	400460	Ref. No.	VAL555
description	ball valve inlet 3/4" IT outlet 3/4" IT 230V L 68mm 50/60Hz mode of operation electric		

electrodes





1

GEV No.	400377	Ref. No.	PRO065/3
description	level electrode 1/4" total length 183mm probe L 158mm insulated probe length 114mm PTFE insulated connection male faston 6.3mm stainless steel ø 2.5mm		



1





GEV No.	400260	Ref. No.	PRO065/2
description	level electrode 1/4" total length 220mm probe L 195mm insulated probe length 185mm PTFE insulated connection male faston 6.3mm stainless steel ø 2.5mm		
accessories for	400260		
	GEV No.	521003	Ref. No. —
	nut thread 1/4" H 6.3mm chrome-plated brass WS 20 Qty 1 pcs		

fans

hot air motors

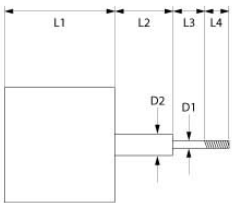
1

GEV No.	601648	Ref. No.	MOT300
description	fan motor 220-240V 1 phase 50/60Hz 0.12kW 2800/3400rpm speeds 1 L1 95mm L2 32mm L3 23mm L4 12mm D1 ø 6x8mm D2 ø 10mm M6R ET 0.9A power input 0.12W at 50Hz 2800rpm at 60Hz 3400rpm suitable capacitor 6.3µF/450V		
accessories for	601648		
	GEV No.	365012	Ref. No. —
	operating capacitor capacity 6.3µF 450V tolerance 5% 50Hz ambient temperature max. -25 to +85°C ø 30mm L 61 mm M8 plastic connection male faston 6.3mm protection		

1

GEV No.	601356	Ref. No.	MOT103
description	fan motor 220-240V 1 phase 50Hz 0.37kW 1400rpm speeds 1 L1 168mm L2 45mm L3 47mm D1 ø 24mm D2 ø 20mm M8L IT 2A suitable capacitor 12.5µF/400V at 50Hz 1400rpm type 1021S2250		

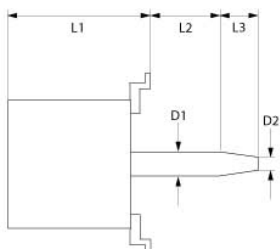
1

GEV No.	601544	Ref. No.	MOT101
description	fan motor 230/400V 3 phase 50Hz 0.5HP 1350rpm speeds 1 L1 168mm L2 45mm L3 27mm D1 ø 24mm D2 ø 20mm M8L IT 1.8/1A at 50Hz 1350rpm type FIR 1021		

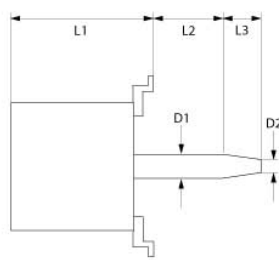
1



GEV No.	601355	Ref. No.	VEN127
description	fan wheel D1 ø 270mm H1 100mm blades 12 D2 ø 19.5mm D3 ø 23mm H2 45mm		

1



GEV No.	602023	Ref. No.	VEL100
description	fan wheel D1 ø 270mm H1 120mm blades 12 D2 ø 19.5mm D3 ø 23mm H2 46mm		



hot air fans

miscellaneous

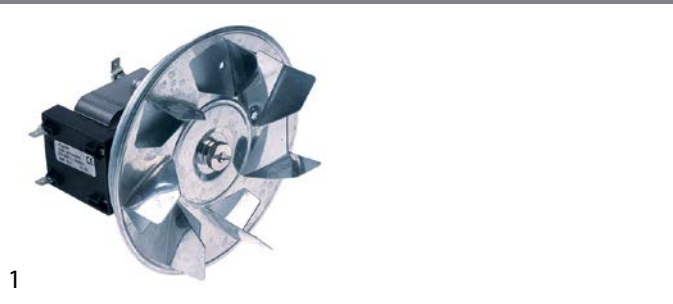

1

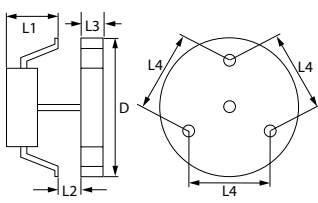

GEV No.	601509	Ref. No.	KITMOT204.01001 ZMOT214
description	hot air fan 220-240V 40W 50-60Hz L1 70mm L2 12mm L3 30mm L4 87mm fan wheel ø 155mm PLASET 57981		

accessories

miscellaneous



1

GEV No.	550879	Ref. No.	ZMOT214/1
description	insulation ø 130mm thickness 3mm hole ø 20mm for hot air fan		

gas valves and ignition boxes

ignition boxes

SIT



1

GEV No.	102303	Ref. No.	ELE300/1
description	ignition box SIT type 501EFD electrodes 2 waiting time 1.5s safety time 5s 250V 10VA 50-60Hz		

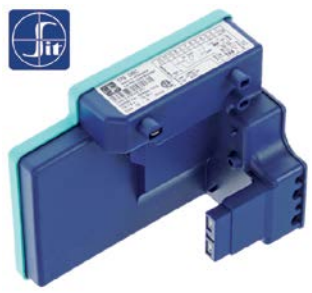

1

GEV No.	107850	Ref. No.	ELE500/1
description	ignition box SIT type 579DBC electrodes 2 waiting time 1.5s safety time 6s 220/240V 12VA 50/60Hz		

knobs

producer-specific knobs

GIERRE

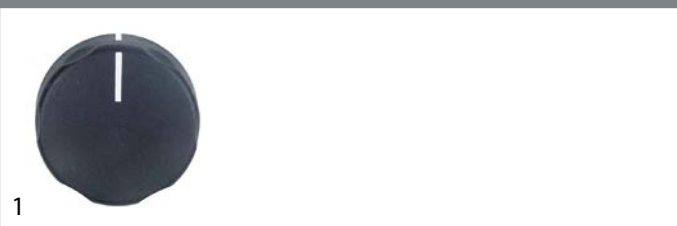

1

GEV No.	110000	Ref. No.	MAN122 MAN125
description	knob switch zero mark ø 50mm shaft ø 6x4.6mm shaft flat upper black		

locks

handle latches

universal

inside fixing

locks



1







GEV No.	694054	Ref. No.	MAN710	
description	door handle for headed units L 145mm W 40mm H 62mm spring length 33mm inner black			
spare parts for	694054			
	GEV No.	514390	Ref. No.	—
	spring for door handle ø 6mm L 54mm W 27.5mm			
	GEV No.	694675	Ref. No.	—
	door catch L 88mm W 40mm H 37mm spring length 33mm mounting distance 60mm			
	GEV No.	694734	Ref. No.	—
	door handle L 165mm W 40mm H 25mm black			

Table continues overleaf



spare parts for	694054		
	GEV No.	694735	Ref. No. —
	cap ø 32mm black		
accessories for	694054		
	GEV No.	691123	Ref. No. —
	duct for door opener		
	GEV No.	694055	Ref. No. —
	door catch L 25mm W 14mm total length 54mm thread M8 thread L 29mm		
	GEV No.	694066	Ref. No. —
	door catch with spigot 2-stage L 28mm W 14mm H 15mm H1 16mm total length 51mm thread M8 thread L 23mm stainless steel		
	GEV No.	694067	Ref. No. MAN710/1
	door catch with spigot 1-stage L 26mm total length 51mm thread M8		

accessories for	694054		
	GEV No.	691123	Ref. No. —
	duct for door opener		
	GEV No.	694055	Ref. No. —
	door catch L 25mm W 14mm total length 54mm thread M8 thread L 29mm		
	GEV No.	694066	Ref. No. —
	door catch with spigot 2-stage L 28mm W 14mm H 15mm H1 16mm total length 51mm thread M8 thread L 23mm stainless steel		
	GEV No.	694067	Ref. No. MAN710/1
	door catch with spigot 1-stage L 26mm total length 51mm thread M8		

producer-specific

GIERRE



1

GEV No.	693840	Ref. No.	PIA530
description	base plate L 75mm W 35mm H 4mm for door handle mounting distance 60mm		







1

GEV No.	694067	Ref. No.	MAN710/1
description	door catch with spigot 1-stage L 26mm total length 51mm thread M8		



1

GEV No.	694054	Ref. No.	MAN710
description	door handle for headed units L 145mm W 40mm H 62mm spring length 33mm inner black		
spare parts for	694054		
	GEV No.	514390	Ref. No. —
	spring for door handle ø 6mm L 54mm W 27.5mm		
	GEV No.	694675	Ref. No. —
	door catch L 88mm W 40mm H 37mm spring length 33mm mounting distance 60mm		
	GEV No.	694734	Ref. No. —
	door handle L 165mm W 40mm H 25mm black		
	GEV No.	694735	Ref. No. —
	cap ø 32mm black		

hinges

oven hinges



1

GEV No.	694354	Ref. No.	CER145
description	oven hinge mounting distance 118mm lug mounting 13mm lever length 119mm groove distance 12mm spring thickness 4mm mounting ear position left spring length 53mm L 154mm W 22mm		



1

GEV No.	694353	Ref. No.	CER146
description	oven hinge mounting distance 118mm lug mounting 13mm lever length 119mm groove distance 12mm spring thickness 4mm mounting ear position right spring length 53mm L 154mm W 22mm Qty 1 pcs		

gaskets

gaskets for heated units

window seals

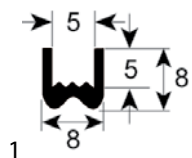

GEV No.	900868	Ref. No.	GUA540
description	window gasket profile 1575 L 2020mm Qty 1		

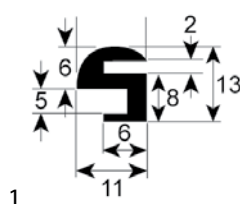

GEV No.	900869	Ref. No.	GUA520
description	window gasket profile 1873 L 1850mm Qty 1		

door seals

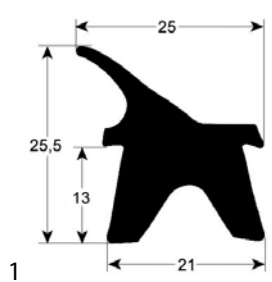

GEV No.	901690	Ref. No.	GUA065 GUA124
description	door seal profile 2402 W 640mm L 890mm external size 4-piece		

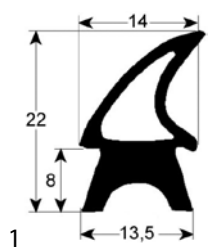

GEV No.	901688	Ref. No.	GUA400
description	door seal profile 2455 W 465mm L 745mm external size		

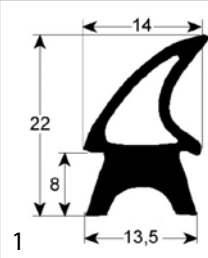

GEV No.	900770	Ref. No.	GUA500
description	door seal profile 2455 W 475mm L 650mm external size Qty 1		

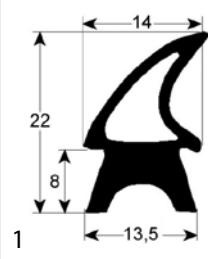

GEV No.	901689	Ref. No.	GUA090 GUA600
description	door seal profile 2455 W 635mm L 1700mm external size		

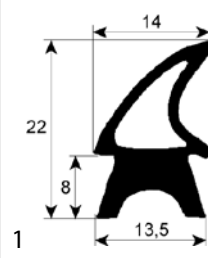

GEV No.	900771	Ref. No.	GUA510
description	door seal profile 2455 W 650mm L 870mm external size Qty 1		

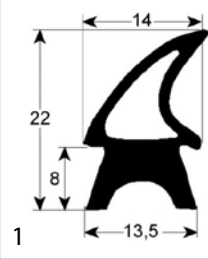

GEV No.	901687	Ref. No.	GUA410
description	door seal profile 2455 W 745mm L 865mm external size		

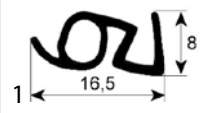

GEV No.	900772	Ref. No.	GUA320
description	door seal profile 2926 L 1500mm Qty 1		



door seals with fixing hook



1

GEV No.	900774	Ref. No.	GUA315
description	oven gasket L 660mm W 350mm with 6 mounting clips external size		

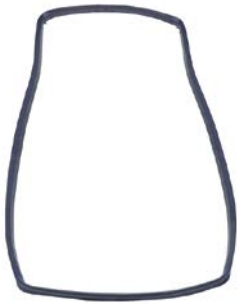

1

GEV No.	900773	Ref. No.	GUA312
description	oven gasket L 670mm W 280mm with 6 mounting clips external size		

O-rings

silicone



1

GEV No.	532488	Ref. No.	PRO065/7
description	O-ring silicone thickness 6.99mm ID ø 196.22mm Qty 1 pcs		

foam rubber gaskets



1

GEV No.	900867	Ref. No.	GUA310
description	foam rubber gasket W 10mm thickness 3mm self-adhesive Qty supplied by meter		

valves and tank inlets

ball valves

ball valves electric



1

GEV No.	400460	Ref. No.	VAL555
description	ball valve inlet 3/4" IT outlet 3/4" IT 230V L 68mm 50/60Hz mode of operation electric		

water cycle components

pressure reduction valves

pressure reduction valves

producer-specific



1

GEV No.	541185	Ref. No.	MIC510
description	pressure controller Metal Work series Bit MRA connection 1/4" default setting bar setting range 0-8bar p max 13bar t.max. 50°C plastic thread 1/4"		

accessories

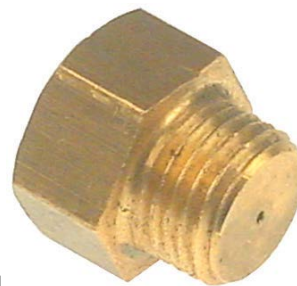

1

GEV No.	693841	Ref. No.	UGE655
description	nozzle for safety valve		



fastening material

fasteners

roll pins



1

GEV No.	691637	Ref. No.	SPI102
description	roll pin ø 3mm L 20mm		

A			
alarm devices		7	
B			
ball valves		13	
ball valves electric		8, 13	
bi-metal thermostats		4, 4	
C			
cam switches		5	
contactors		7	
control equipment		6	
control thermostats		4	
D			
door seals		12	
door seals with fixing hook		13	
E			
electrodes		8	
electronic controllers		8	
energy regulators		4	
F			
fans		9	
fasteners		14	
fastening material		14	
foam rubber gaskets		13	
G			
gaskets for heated units		12	
H			
halogen lamp		6	
heating cables		3	
heating elements		3	
heating elements for convection		3	
heating elements for ovens		3	
hot air fans		10	
hot air motors		9	
I			
ignition boxes		10	
immersion heating elements		3	
indicator lights		6	
indicator lights (complete)		6	
L			
lamps		6	
M			
microswitches		5	
O			
O-rings		13	
oven hinges		11	
oven lamps		6	
P			
pressure reduction valves		13, 13	
probes		8	
programme timers		7	
R			
relays		8	
roll pins		14	
rotary switches		5	
S			
safety thermostats		4	
solenoid valves		8	
switches and momentary switches		5	
T			
thermostats		4	
timers		7	
transformers		8	
V			
valves and tank inlets		13	
W			
water cycle components		13	
window seals		12	